

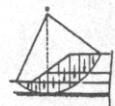

U.S. Department  
of Transportation  
**Federal Highway  
Administration**

# **DRILLED SHAFTS: CONSTRUCTION PROCEDURES AND DESIGN METHODS**

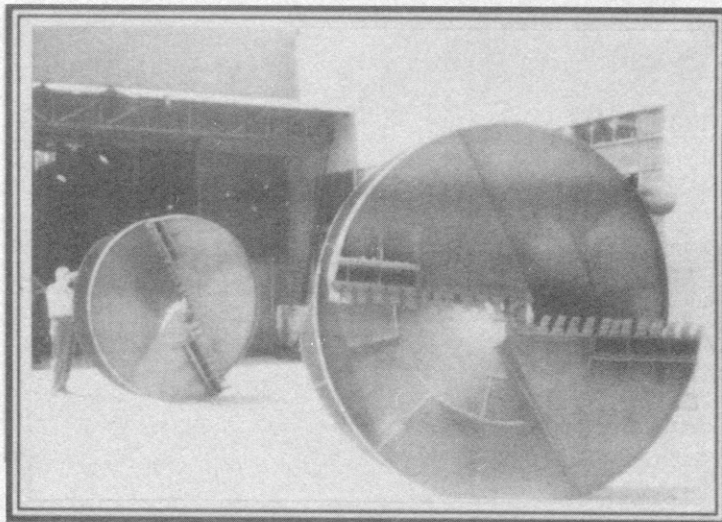
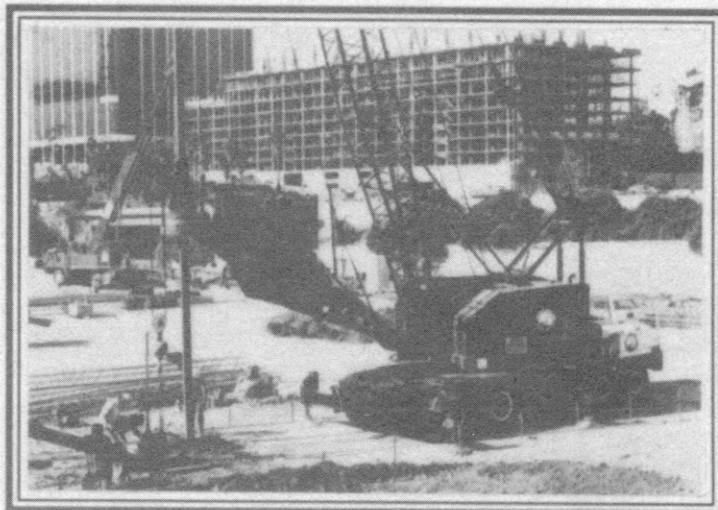

## **NOTICE**

**The contents of this report reflect the views of the authors, who are responsible for the facts and the accuracy of the data presented herein. The contents do not necessarily reflect the policy of the Department of Transportation. This report does not constitute a standard, specifications, or regulation. The United States Government does not endorse products or manufacturers. Trade or manufacturer's names appear herein only because they are considered essential to the objective of this document.**

1. Report No. FHWA-IF-99-025		2. Government Accession No.		3. Recipient's Catalog No.	
4. Title and Subtitle Drilled Shafts: Construction Procedures and Design Methods				4. Report Date August 1999	
				6. Performing Organization Code:	
7. Author(s) Michael W. O'Neil and Lymon C. Reese				8. Performing Organization Report No.	
9. Performing Organization Name and Address All American Soils 17921 Sky Park Circle, Suite J Irvine, CA 92614				10. Work Unit No.(TRAIS)	
				11. Contract or Grant No. DTFH61-96-Z-00051	
12. Sponsoring Agency Name and Address Federal Highway Administration Office of Infrastructure/Office of Bridge Technology HIBT, Room 3203 400 7 <sup>th</sup> Street S.W. Washington D.C. 20590				13. Type of Report and Period Covered Technical Manual	
				14. Sponsoring Agency Code	
15. Supplementary Notes COTR: Mr. Chien-Tan Chang Technical Assistance: Mr. Richard S. Cheney, P.E. Technical Review and Revision: Mr. Sumant Singla					
16. Abstract: This manual is FHWA's primary reference of recommended construction procedures and design methods for drilled shafts.  This document was written as a resource for participants in a short course covering the topic of construction and design of drilled shaft foundations for bridges and other structures. It is the second edition of an FHWA workbook on construction and design of drilled shafts. The first edition was written in 1988 ( FHWA Publication No. FHWA-SA-HI-88-042). While introductory material from the 1988 edition was retained, the emphasis in this document is on providing relatively comprehensive information for engineers who already have some experience with drilled shaft construction and/or design. The initial chapters cover an overview of the characteristics of drilled shafts, site investigations for drilled shafts (to collect information for both construction and design), and details of drilled shaft construction. These chapters are followed by several chapters on the design of drilled shafts in soil and rock for both axial and lateral loading, with examples. Both allowable stress design and load and resistance factor design principles are addressed. Details of design calculations procedures are provided in the appendices. Procedures for performing load tests, an important component of design, are then reviewed, following which model construction specifications are presented and discussed. The latter chapters of the document deal with construction inspection, structural integrity testing, repair of defective drilled shafts and cost estimation. The chapter on inspection includes acceptance criteria and is intended to complement other short courses and documents on drilled shaft construction inspection.					
17. Key Words Foundations, Drilled Shafts, Construction, Design, Soil, Rock, Computations, Specifications			18. Distribution Statement No restrictions. This document is available to the public from the National Technical Information Service, Springfield, Virginia 22161		
19. Security Classif. (of this report) Unclassified		20. Security Classification (of this page) Unclassified		21. No. of Pages 758	22. Price



## PREFACE

The Federal Highway Administration has produced two educational publications (in 1977 and 1988) on the construction and design of drilled shaft foundations. The second publication, *Publication No. FHWA-HI-88-042*, July 1988, has been used as the textbook to teach over 50 three-day short courses on drilled shafts in over 30 states between 1989 and 1998. However, drilled shaft technology has advanced rapidly since 1988, and it became necessary to revise and update this publication. This present publication is a new, expanded, edition of the 1988 publication, which it is intended to replace. New material contained in the present publication includes operations with polymer drilling slurries, admixtures for drilled shaft concrete, new drilling equipment, specifications for performing non-destructive evaluations, design in intermediate geomaterials and in rock, additional material on structural design, LRFD procedures, and methods for analyzing groups of drilled shafts.

The main text addresses most common design and construction conditions. The appendices contain supporting material that may need to be used in certain circumstances and that gives foundation engineers detailed information not available in the text. It is intended that this publication serve as a living reference document that will be updated continually as further advances in the construction and design of drilled shafts take place.

The authors express gratitude to Axiom Engineering and Science company, which compiled the text for this publication. They are also grateful to ADSC: The International Association of Foundation Drilling, its Executive Director, Mr. Scot Litke, and its technical review committee, chaired by Mr. Ed Nolan; Dr. Alaa Ata and Mr. Jose Arrellaga, who each reviewed all or parts of the document and provided considerable valuable input. The senior author also thanks his colleagues at the University of Houston, Dr. Cumaraswamy Vipulanadan and Dr. Sami Tabsh for their helpful comments about behavior of cementitious materials and structural design of drilled shafts, respectively, and to many colleagues, too numerous to name here, who provided photographs.

Michael W. O'Neill  
Lymon C. Reese

## ENGLISH TO METRIC (SI) CONVERSION FACTORS

The primary metric (SI) units used in civil and structural engineering are:

length	-	meter (m)
mass	-	kilogram (kg)
time	-	second (s)
force	-	newton (N) or kilonewton (kN)
pressure	-	pascal (Pa = N/m <sup>2</sup> ) or kilopascal (kPa = kN/m <sup>2</sup> )

The following are the conversion factors for units presented in this manual:

Quantity	From English Units	To Metric (SI) Units	Multiply by	For aid to Quick Mental Calculations
Mass	lb	kg	0.453 592	1 lb(mass) = 0.5kg
Force	lb	N	4.448 22	1 lb(force) = 4.5N
	kip	kN	4.448 22	1 kip(force) = 4.5kN
Force/unit length	plf	N/m	14.593 9	1 plf = 14.5N/m
	klf	kN/m	14.593 9	1 klf = 14.5kN/m
Pressure, stress, modulus of elasticity	psf	Pa	47.880 3	1 psf = 48 Pa
	ksf	kPa	47.880 3	1 ksf = 48 kPa
	psi	kPa	6.894 76	1 psi = 6.9 kPa
	ksi	Mpa	6.894 76	1 ksi = 6.9 Mpa
Length	inch	mm	25.4	1 in = 25 mm
	foot	m	0.3048	1 ft = 0.3 m
		mm	304.8	1 ft = 300 mm
Area	square inch	mm <sup>2</sup>	645.16	1 sq in = 650 mm <sup>2</sup>
	square foot	m <sup>2</sup>	0.09290304	1 sq ft = 0.09 m <sup>2</sup>
	square yard	m <sup>2</sup>	0.83612736	1 sq yd = 0.84 m <sup>2</sup>
Volume	cubic inch	mm <sup>3</sup>	16386.064	1 cu in = 16,400 mm <sup>3</sup>
	cubic foot	m <sup>3</sup>	0.0283168	1 cu ft = 0.03 m <sup>3</sup>
	cubic yard	m <sup>3</sup>	0.764555	1 cu yd = 0.76 m <sup>3</sup>

### A few points to remember:

1. In a “soft” conversion, an English measurement is mathematically converted to its exact metric equivalent.
2. In a “hard” conversion, a new rounded, metric number is created that is convenient to work with and remember.
3. Use only the meter and millimeter for length (avoid centimeter).
4. The pascal (Pa) is the unit for pressure and stress (Pa = N/m<sup>2</sup>).
5. Structural calculations should be shown in MPa or kPa.
6. A few basic comparisons worth remembering to help visualize metric dimensions are:
  - One mm is about 1/25 inch or slightly less than the thickness of a dime.
  - One m is the length of a yardstick plus about 3 inches.
  - One inch is just a fraction (1/64 inch) longer than 25 mm (1 inch = 25.4 mm).
  - Four inches are about 1/16 inch longer than 100 mm (4 inches = 101.6 mm).
  - One foot is about 3/16 inch longer than 300 mm (12 inches = 304.8 mm).

## TABLE OF CONTENTS

CHAPTER 1: INTRODUCTION .....	1
TYPES OF DEEP FOUNDATIONS.....	1
DESCRIPTION OF DRILLED SHAFTS .....	1
BRIEF HISTORY OF DRILLED SHAFT FOUNDATIONS.....	4
MOTIVATION FOR USING DRILLED SHAFTS .....	6
REVIEW OF CURRENT PRACTICE.....	10
Construction.....	10
Design for Axial Load .....	12
Design for Lateral Load.....	14
APPLICATIONS OF DRILLED SHAFTS .....	14
ADVANTAGES AND DISADVANTAGES OF DRILLED SHAFTS.....	15
Advantages .....	15
Disadvantages .....	19
TRAINING RESOURCE .....	20
REFERENCES.....	20
CHAPTER 2: SITE CHARACTERIZATION .....	22
PURPOSE OF SITE CHARACTERIZATION .....	22
SITE INVESTIGATIONS .....	23
General.....	23
Surface Features.....	24
Subsurface Pipelines, Cables, and Other Obstructions.....	25
Preliminary Subsurface Mapping .....	25
Detailed Site Investigations .....	27
TECHNIQUES FOR SUBSURFACE INVESTIGATIONS.....	28
Information Required for Design.....	28
Information Required for Construction .....	33
Comments .....	34
Full-Sized Test Excavations .....	35
UNCERTAINTY IN SOIL OR ROCK PROPERTIES AT A SITE.....	36
EFFECTS OF PILES AND DRILLED SHAFTS ON SOIL AND ROCK PROPERTIES .....	37
Installation in Clays .....	37
Installation in Sands.....	38
Installation in Rock.....	39
SOIL AND ROCK MECHANICS RELATED TO DRILLED SHAFT DESIGN .....	40
REFERENCES .....	46
CHAPTER 3: GENERAL CONSTRUCTION METHODS .....	49
INTRODUCTION .....	49
UNDERREAMS (BELLS).....	50
VERTICAL ALIGNMENT .....	53
DRY METHOD OF CONSTRUCTION.....	53
CASING METHOD OF CONSTRUCTION.....	56
WET METHOD OF CONSTRUCTION.....	63

The Static Process .....	64
The Circulation Process .....	68
RELATIONSHIP OF CONSTRUCTION METHOD TO DESIGN PHILOSOPHY .....	69
REFERENCES .....	71
 CHAPTER 4: METHODS OF EXCAVATION.....	72
EXCAVATION BY ROTARY METHODS .....	72
Truck-Mounted Drilling Machines .....	73
Crane-Mounted Drilling Machines .....	73
Special Mounts For Drilling Machines.....	76
Low Headroom Drilling Machines .....	77
Summary of Rotary Drilling Machine Characteristics .....	77
Tools for Rotary Drilling .....	79
Drilling Bucket.....	79
Flight Augers (Open Helix) .....	80
Rock Auger .....	83
Core Barrel.....	85
Shot Barrel .....	85
Full-Faced Excavators .....	87
Underreamers or Belling Buckets.....	87
Special Tools.....	87
EXCAVATION BY PERCUSSION METHODS .....	87
Lifting Machines .....	88
Clamshell or Grab Bucket.....	88
Rock Breakers .....	88
Hammergrabs .....	92
OTHER METHODS OF EXCAVATION.....	92
Rodless Drill .....	92
Air-Operated Hammers.....	94
Use of Drilling Fluid.....	95
Grouting .....	95
Mining Techniques .....	95
REFERENCES .....	96
 CHAPTER 5: CASINGS AND LINERS .....	97
TEMPORARY CASING .....	97
PERMANENT CASING .....	98
INFLUENCE OF CASING ON LOAD TRANSFER.....	99
TYPES AND DIMENSIONS .....	101
PROBLEMS OF PLACEMENT AND RECOVERY .....	103
DESIGN CONSIDERATIONS .....	105
REFERENCES .....	105



CHAPTER 6: DRILLING SLURRY.....	106
INTRODUCTION .....	106
PRINCIPLES OF SLURRY OPERATION.....	108
Mineral Slurries .....	108
Polymers .....	111
Blended Slurries.....	114
APPLICATIONS .....	115
MATERIALS.....	117
Bentonite .....	117
Polymers .....	122
MIXING AND HANDLING.....	124
Mineral Slurry .....	124
Polymer Slurry .....	127
Blended Slurry .....	128
SAMPLING AND TESTING.....	128
Sampling .....	128
Testing.....	129
Density .....	129
Viscosity .....	130
pH Value .....	134
Sand Content.....	135
Hardness.....	136
Free Water and Cake Thickness .....	136
Shear Strength.....	137
Comments on Field Testing of Drilling Slurries.....	137
MEASURING THE VOLUME OF THE EXCAVATION UNDER DRILLING SLURRY .....	139
EXCESSIVE EXPOSURE OF SOIL OR ROCK TO DRILLING SLURRY.....	142
DESIRABLE PROPERTIES OF DRILLING SLURRY .....	143
INFLUENCE OF SLURRY ON AXIAL CAPACITY OF DRILLED SHAFTS .....	147
Soil and Rock Resistance.....	147
Bond with Reinforcing Steel.....	151
EXAMPLES OF PROBLEMS WITH SLURRY CONSTRUCTION .....	152
TRAINING RESOURCE .....	159
REFERENCES .....	159
 CHAPTER 7: REBAR CAGES.....	 162
INTRODUCTION .....	162
PROPERTIES OF STEEL.....	163
LONGITUDINAL REINFORCING .....	163
TRANSVERSE REINFORCING.....	167
SPLICES.....	168
SIZING HOOPS .....	169
CENTERING DEVICES .....	170
STRENGTHENING THE CAGE TO RESIST LIFTING FORCES .....	173
ARRANGEMENTS FOR LIFTING CAGE .....	174

FABRICATION AND STORAGE.....	177
CONSIDERATIONS RELATED TO METHOD OF CONSTRUCTION .....	177
REFERENCES .....	179
<b>CHAPTER 8: DESIGN AND PLACEMENT OF CONCRETE.....</b>	<b>180</b>
<b>BASIC CHARACTERISTICS OF DRILLED SHAFT CONCRETE .....</b>	<b>180</b>
<b>MIX DESIGN .....</b>	<b>182</b>
Cementitious Materials .....	182
Cement .....	182
Pozzolanic Additives .....	182
Expansive Additives .....	183
Chemical Admixtures .....	184
Air-entraining agents .....	184
Retarders .....	185
Water Reducers .....	185
Accelerators .....	186
Other Admixtures.....	186
Aggregate and Water .....	186
Workability .....	187
Mix Proportions .....	187
Strength.....	194
<b>CONCRETE TESTS.....</b>	<b>194</b>
Tests at the Batch Plant.....	194
Tests at the Jobsite .....	195
Addition of Water at Job Site.....	196
<b>PLACEMENT OF CONCRETE .....</b>	<b>197</b>
Placement by Free Fall .....	197
Placement of Concrete by Tremie .....	200
Placement by Gravity-Fed Tremie.....	201
Placement by Pump.....	208
<b>DRILLING NEAR A RECENTLY CONCRETED SHAFT .....</b>	<b>215</b>
<b>CONCRETING CURVES .....</b>	<b>216</b>
<b>CONTAMINATED CONCRETE AT SHAFT HEAD .....</b>	<b>219</b>
<b>POST-GROUTING.....</b>	<b>220</b>
<b>REFERENCES.....</b>	<b>220</b>
<b>CHAPTER 9: CASE STUDIES OF DRILLED SHAFT CONSTRUCTION UNDER VARIOUS</b>	
<b>CONDITIONS.....</b>	<b>224</b>
<b>INTRODUCTION .....</b>	<b>224</b>
<b>CHAPTER 10: DESIGN CONCEPTS FOR DRILLED SHAFTS .....</b>	<b>225</b>
<b>INTRODUCTION .....</b>	<b>225</b>
The Design Process.....	225
Importance of subsurface Investigation.....	226
Influence of Construction on Geomaterial Properties .....	231
Cohesive Soil .....	232

Granular soil and Granular IGM's.....	233
Rock and Cohesive IGM's.....	234
Principal Design Considerations.....	235
GENERAL APPROACHED TO DESIGN .....	238
Allowable Stress Design.....	239
Load and Resistance Factor Design.....	240
Comparison of ASD and LRFD.....	241
COMPUTATION OF A NOMINAL ULTIMATE AXIAL RESISTANCE, $R_{TN}$ .....	243
Nominal Base Resistance, $R_{BN}$ .....	247
Cohesive Soil.....	247
Granular Soil and Cohesionless Intermediate Geomaterials .....	248
Rock and Cohesive Intermediate Geomaterials.....	250
Nominal Side Resistance, $R_{SN}$ .....	250
Cohesive Soil .....	250
Granular Soil and Cohesionless Intermediate Geomaterials .....	251
Rock and Cohesive Intermediate geomaterials.....	252
COMPUTAION OF DEFORMATIONS .....	253
GROUPS OF DRILLED SHAFTS.....	254
TOLERABLE MOVEMENTS.....	257
STRUCTURAL DESIGN.....	258
REFERENCES.....	259
CHAPTER 11: GEOTECHNICAL DESIGN FOR AXIAL LOADING .....	262
INTRODUCTION .....	262
DIRECTION OF SIDE AND BASE RESISTANCE.....	262
DESIGN OF DRILLED SHAFTS UNDER AXIAL LOADING .....	264
STEP-BY-STEP DESIGN PROCEDURES FOR AXIAL LOAD DESIGN.....	266
REFERENCES.....	296
CHAPTER 12: DESIGN FOR VERTICAL MOVEMNET OF THE GROUND SURFACE.....	297
INTRODUCTION .....	297
DOWNDRAG.....	297
Occurrence .....	297
Estimating the Neutral Point Location and Distribution of Load and Resistance .....	301
Design Solutions .....	303
UPLIFT.....	307
Occurrence and Identification of Expansive Soils.....	307
Estimating the Depth of the Zone of Seasonal Moisture Change.....	309
Design Solutions .....	310
RESOURCE.....	316
REFERENCES.....	316
CHAPTER 13: DESIGN FOR LATERAL LOADING AND STRUCTURAL DESIGN.....	319
INTRODUCTION .....	319
EXAMPLES OF LATERAL LOADING.....	319

Single-Column Support for a Bridge .....	319
Foundation for an Overhead-Sign Structure .....	321
Drilled-Shaft-Supported Bridge Over Water .....	321
Foundation for a Bridge Abutment .....	322
Foundation for an Arch Bridge .....	322
Stabilization of a Moving Slope and Earth Retaining Structures .....	324
COMPUTING PENETRATION, DEFORMATIONS, MOMENTS AND SHEARS .....	327
Characteristic Load Method .....	327
p-y Method .....	337
Simulation of Nonlinear Bending in Drilled Shafts Using the p-y Method .....	342
Simulation of Group Action Using the p-y Method .....	347
Other Methods of Analysis of Laterally Loaded Drilled Shafts and Drilled Shaft Groups .....	350
STRUCTURAL DESIGN .....	351
Cases with Axial Load Only .....	352
Cases with Axial Load and Bending Moment .....	353
General Concepts .....	353
Structural Design Procedure: Longitudinal Reinforcement .....	354
Structural Design Procedure: Minimum Longitudinal Reinforcement .....	362
Design of Transverse Reinforcement .....	363
Spiral Column Design .....	363
Tied Column Design .....	366
Design for Transverse Shear Forces .....	367
Depth of Code-Controlled Transverse Reinforcement .....	370
Splices, Connections and Cutoffs .....	370
Analysis to Obtain Distribution of Moment and Shear with Depth: Step-by-Step Procedure for Design (p-y method) .....	371
STRUCTURAL ANALYSIS OF PLAIN-CONCRETE UNDERREAMS .....	378
RESOURCES .....	381
REFERENCES .....	381
CHAPTER 14: FIELD LOADING TESTS .....	386
PURPOSE OF LOADING TESTS .....	386
AXIAL LOADING TESTS .....	387
Considerations in Sizing, Locating and Constructing the Test Shaft .....	387
Methods of Applying Compressive Loads .....	391
Conventional Loading Test Arrangements .....	391
Osterberg Cell Testing Arrangement .....	393
Statnamic <sup>R</sup> Testing Arrangement .....	399
Conventional Uplift Testing .....	402
Instrumentation .....	403
Proof Test .....	403
Load Transfer Test .....	405

Testing Procedures.....	412
Data and Analysis .....	413
LATERAL LOADING TESTS .....	415
Conventional Test .....	416
Osterberg Cell Test .....	418
Statnamic <sup>R</sup> Test.....	419
<del>TYPES OF PROJECTS TO WHICH LOADING TESTS ARE APPLICABLE .....</del>	<del>419</del>
<del>INFORMATION ON COST .....</del>	<del>419</del>
<del>REFERENCES .....</del>	<del>420</del>
CHAPTER 15: GUIDE DRILLED SHAFT CONSTRUCTION SPECIFICATIONS .....	423
INTRODUCTION .....	423
Construction Method .....	424
Drilling Slurry .....	424
Payment for Shaft Excavation .....	425
Qualification of Drilled Shaft Contractors for Bidding .....	426
Special Bidding Requirement .....	426
GUIDE DRILLED SHAFT CONSTRUCTION SPECIFICATIONS.....	426
ITEM xxx. DRILLED SHAFTS.....	428
xxx.10 DESCRIPTION.....	428
xxx.11 QUALIFICATIONS OF DRILLED SHAFT CONTRACTOR: .....	428
xxx.12 SUBMITTALS: .....	428
xxx.13 TRIAL SHAFT INSTALLATION:.....	430
xxx.20 MATERIALS:.....	431
xxx.30 CONSTRUCTION METHODS AND EQUIPMENT: .....	433
xxx.30.1 PROTECTION OF EXISTING STRUCTURES: .....	433
xxx.30.2 CONSTRUCTION SEQUENCE:.....	434
xxx.30.3 GENERAL METHODS AND EQUIPMENT:.....	434
xxx.31 DRY CONSTRUCTION METHOD: .....	435
xxx.32 WET CONSTRUCTION METHOD:.....	436
xxx.33 CASING CONSTRUCTION METHOD: .....	436
xxx.34 EXCAVATION AND DRILLING EQUIPMENT:.....	437
xxx.35 EXCAVATIONS:.....	437
xxx.35.1 UNCLASSIFIED EXCAVATION:.....	438
xxx.35.2 CLASSIFIED EXCAVATION:.....	438
xxx.35.21 STANDARD EXCAVATION: .....	438
xxx.35.22 SPECIAL EXCAVATION:.....	439
xxx.35.3 OBSTRUCTIONS: .....	439
xxx.35.4 LOST TOOLS:.....	439
xxx.35.5 EXPLORATION (SHAFT EXCAVATION):.....	439
xxx.36 CASINGS: .....	441
xxx.36.1 TEMPORARY CASING:.....	441
xxx.36.2 PERMANENT CASING: .....	443
xxx.38 SLURRY:.....	443
xxx.40 EXCAVATION INSPECTION:.....	447
xxx.41 CONSTRUCTION TOLERANCES:.....	448

xxx.50 REINFORCING STEEL CAGE CONSTRUCTION AND PLACEMENT: .....	451
xxx.60 CONCRETE PLACEMENT: .....	452
xxx.61 TREMIES: .....	453
xxx.62 PUMPED CONCRETE: .....	453
xxx.63 DROP CHUTES: .....	454
xxx.64 NONDESTRUCTIVE EVALUATION: .....	455
xxx.64.1 TESTS IN ACCESS TUBES:.....	455
xxx.64.2 SONIC ECHO TESTS:.....	456
xxx.70 DRILLED SHAFT LOAD TESTS:.....	458
xxx.71 METHOD OF MEASUREMENT: .....	460
xxx.71.1 FURNISHING DRILLED SHAFT DRILLING EQUIPMENT: .....	460
xxx.71.2 DRILLED SHAFTS: .....	460
xxx.71.3 STANDARD EXCAVATION: .....	460
xxx.71.4 SPECIAL EXCAVATION:.....	460
xxx.71.5 UNCLASSIFIED SHAFT EXCAVATION: .....	460
xxx.71.6 UNCLASSIFIED EXTRA DEPTH EXCAVATION:.....	461
xxx.71.7 OBSTRUCTIONS: .....	461
xxx.71.8 TRIAL SHAFT:.....	461
xxx.71.9 EXPLORATION (SHAFT EXCAVATION):.....	461
xxx.71.10 LOAD TESTS:.....	461
xxx.71.11 PERMANENT CASING: .....	461
xxx.71.12 INSTRUMENTATION AND DATA COLLECTION: .....	462
xxx.71.13 PROTECTION OF EXISTING STRUCTURES: .....	462
xxx.71.14 ACCESS TUBES:.....	462
xxx.71.15 NON-DESTRUCTIVE EVALUATION TESTS: .....	462
xxx.72 BASIS OF PAYMENT:.....	462
xxx.72.1 FURNISHING DRILLED SHAFT DRILLING EQUIPMENT: .....	462
xxx.72.2 DRILLED SHAFTS: .....	462
xxx.72.3 STANDARD EXCAVATION: .....	463
xxx.72.4 SPECIAL EXCAVATION:.....	463
xxx.72.5 UNCLASSIFIED SHAFT EXCAVATION: .....	463
xxx.72.6 UNCLASSIFIED EXTRA DEPTH EXCAVATION:.....	463
xxx.72.7 OBSTRUCTIONS: .....	464
xxx.72.8 TRIAL SHAFT HOLES: .....	465
xxx.72.9 EXPLORATION (SHAFT EXCAVATION):.....	465
xxx.72.10 LOAD TESTS:.....	465
xxx.72.11 PERMANENT CASING: .....	465
xxx.72.12 INSTRUMENTATION AND DATA COLLECTION: .....	465
xxx.72.13 PROTECTION OF EXISTING STRUCTURES: .....	465
xxx.72.14 ACCESS TUBES:.....	465
xxx.72.15 NON-DESTRUCTIVE EVALUATION TESTS: .....	466
xxx.72.16 ITEMS OF PAYMENT:.....	466
ADDENDUM - SHAFT EXCAVATION IN ROCK BY BLASTING: .....	466
Construction Requirements.....	466
Payment .....	468

CHAPTER 16: INSPECTION AND RECORDS.....	469
RESPONSIBILITIES .....	469
CONSTRUCTION CONFERENCES .....	470
UNANTICIPATED CONDITIONS .....	470
SITE CONDITIONS.....	471
CONSTRUCTION OPERATIONS.....	471
Excavation.....	472
Reinforcing Steel .....	472
Drilling Slurry .....	472
Concrete Quality and Placement.....	472
Completed Drilled Shaft .....	477
COMMON PROBLEMS .....	477
INSPECTION FORMS.....	477
ACCEPTANCE CRITERIA.....	478
RESOURCES .....	480
REFERENCES .....	480
 CHAPTER 17: TESTS FOR COMPLETED DRILLED SHAFTS.....	 481
INTRODUCTION .....	481
SUMMARY DESCRIPTIONS OF INTEGRITY TESTS .....	483
Sonic Echo Test .....	483
Impulse-Response Test.....	487
Impedance Log.....	489
Parallel Seismic Test.....	490
Internal Stress Wave Test .....	491
Drilling and Coring .....	494
Crosshole Acoustic (Sonic and Ultrasonic) Tests.....	495
Gamma-Gamma Testing.....	499
Concreteoscopy.....	501
Other Procedures.....	504
EXPECTED DEFECT RATE FOR DRILLED SHAFTS.....	504
DESIGN OF AN INTEGRITY TESTING PROGRAM AND ACCEPTANCE	
CRITERIA BASED ON INTEGRITY TESTING .....	505
EVALUATING DEFECTS .....	511
REFERENCES .....	512
 CHAPTER 18: REPAIR OF DEFECTIVE DRILLED SHAFTS .....	 515
TYPES OF DEFECTS.....	515
Defects at the Base of the Drilled Shaft.....	515
Poor Concrete Along the Length of the Shaft.....	516
Inadequate Contact Along Sides of Shaft .....	516
Incorrect Dimensions and/or Location.....	517
METHODS OF REPAIR.....	517
Grouting .....	517
Hand Repairs.....	519

Underpinning with Microshafts .....	519
Removal and Replacement .....	522
Straddle Shafts .....	522
REFERENCES.....	524
 CHAPTER 19: COST ESTIMATION.....	 525
GENERAL .....	525
FACTORS INFLUENCING COST .....	525
COMMENTARY ABOUT COST.....	527
COST SURVEY... ..	527
ON-LINE DATA BASES.....	533
CONTRACTORS' COST COMPUTATION .....	536
EXAMPLES.....	536
Texas .....	536
Florida .....	537



## LIST OF APPENDICES

APPENDIX A: ELEMENTS OF LRFD FOR DRILLED SHAFTS.....	A-1
QUANTIFICATION OF UNCERTAINTY OF SOIL PROPERTIES .....	A-1
Suggested Approximate Statistical Test for Site Variability .....	A-3
Further Reading .....	A-10
BASIC CONCEPT OF RELIABILITY.....	A-11
AASHTO LIMIT STATES.....	A-17
RESISTANCE FACTORS FOR DRILLED SHAFTS .....	A-21
MODIFYING RESISTANCE FACTORS FOR DRILLED SHAFTS.....	A-23
FORMAL STEP-BY-STEP PROCEDURE FOR APPLYING LRFD TO THE DESIGN OF DRILLED SHAFTS.....	A-24
EXAMPLE PROBLEM.....	A-26
REFERENCES .....	A-29
APPENDIX B: COMMENTARY ON METHODS OF COMPUTING THE NOMINAL AXIAL RESISTANCE OF DRILLED SHAFTS.....	B-1
INTRODUCTION .....	B-1
BASIC DESIGN EQUATIONS FOR GEOTECHNICAL AXIAL RESISTANCE.....	B-1
Compression Loading .....	B-1
Uplift Loading.....	B-3
Downdrag.....	B-3
IDEALIZATION OF GEOMATERIALS .....	B-4
BASE RESISTANCE, $R_B$ .....	B-7
Bearing Capacity Equation .....	B-7
Drained and Undrained Loading.....	B-8
Undrained Loading .....	B-9
Evaluating the Shear Strength.....	B-9
Drained Loading .....	B-19
Drained Loading in Soil.....	B-19
Drained Loading in Preferentially Sloping, Jointed Rock.....	B-22
SIDE RESISTANCE, $R_S$ .....	B-26
Undrained Loading .....	B-26
Cohesive Soils.....	B-26
Cohesive Intermediate Geomaterials - Compression Loading .....	B-28
Cohesive Intermediate Geomaterials - Uplift Loading.....	B-37
Rock - Compression Loading .....	B-38
Rock - Uplift Loading.....	B-42
Rock - Adding Base and Shaft Resistance .....	B-42
Drained Loading .....	B-43
Cohesive Soils - Compression Loading.....	B-43
Cohesive Soils - Uplift Loading .....	B-45
Granular Soils - Compression Loading.....	B-45
Granular Soils - Uplift .....	B-49
Cohesionless Intermediate Geomaterials - Compression .....	B-51
Cohesionless Intermediate Geomaterials - Uplift Loading.....	B-52

Intermediate Geomaterials -- Considerations for Desert Regions .....	B-52
Rock.....	B-53
Cyclic Axial Loading.....	B-53
Combined Axial and Lateral Loading.....	B-55
AXIAL GROUP EFFECTS.....	B-56
RELIABILITY OF DESIGN EQUATIONS FOR AXIAL RESISTANCE.....	B-61
ALTERNATIVE METHODS FOR ESTIMATING AXIAL RESISTANCE OF DRILLED SHAFTS.....	B-62
OTHER SOURCES OF INFORMATION .....	B-64
RESOURCES .....	B-64
REFERENCES .....	B-65
APPENDIX C: ESTIMATION OF AXIAL MOVEMENT OF DRILLED SHAFTS .....	C-1
INTRODUCTION .....	C-1
SOILS - SIMPLE FORMULAS.....	C-2
Single Drilled Shafts in Soil .....	C-2
Groups of Drilled Shafts in Soil.....	C-4
SOILS - NORMALIZED LOAD-TRANSFER METHODS (COMPRESSION).....	C-5
SOILS AND IGM'S - COMPUTER SIMULATION METHODS.....	C-12
IGM's - SIMPLIFIED EQUATIONS BASED ON ANALYTICAL SOLUTIONS .....	C-19
Cohesive IGM's.....	C-19
Granular (Cohesionless) IGM's.....	C-21
ROCK.....	C-27
GROUPS OF DRILLED SHAFTS IN SOIL AND ROCK.....	C-32
Equivalent Raft Method.....	C-32
Equivalent Pier Method .....	C-36
CYCLIC LOADING IN THE SERVICE LOAD RANGE .....	C-45
RESOURCES .....	C-46
REFERENCES .....	C-46
APPENDIX D: EXAMPLE DESIGN PROBLEMS .....	D-1
EXAMPLE D-1: LRFD of a Drilled Shaft in Layered Cohesive Soil and Cohesive Intermediate Geomaterial. ....	D-1
Work Table for Example D-1, Step 15 .....	D-5
EXAMPLE D-2: Drilled Shaft to Rock by LRFD.....	D-8
EXAMPLE D-3: Design of a Drilled Shaft in Mixed Cohesionless Geomaterial by ASD.....	D-15
Work Table for Example D-3, Step 14 .....	D-18
EXAMPLE D-4: Design of a Drilled Shaft in Cohesive Intermediate Geomaterial by LRFD .....	D-21
APPENDIX E: EXAMPLE SOLUTIONS FOR A DOWNDRAG PROBLEM.....	E-1
Example E1a: Hand Solution with total stress parameters. ....	E-1
Example E1b: Hand Solution Using Effective Stress Parameters. ....	E-4
Example E2: Computer solution using elastic-plastic side load transfer relations.....	E-7
APPENDIX F: INSPECTION, REPORTING AND BIDDING FORMS.....	F-1

APPENDIX G: CONSTRUCTION CASE HISTORIES .....	G-1
CASE 1: STIFF CLAY, WATER TABLE SLIGHTLY BELOW BASE OF SHAFT .....	G-1
CASE 2: HARD CLAY AND SHALE WITH LAYER OF WATER-BEARING SAND .....	G-3
CASE 3: SOFT CLAY ABOVE JOINTED AND SLICKENSIDED CLAY .....	G-5
CASE 4: DRY SAND .....	G-6
CASE 5: GRANULAR SOIL BELOW THE WATER TABLE .....	G-8
CASE 6: CAVING SOIL ABOVE SOUND ROCK .....	G-10
CASE 7: CAVING SOIL ABOVE FRACTURED ROCK .....	G-12
CASE 8: BOULDER FIELDS.....	G-14
CASE 9: IRREGULARLY WEATHERED ROCK .....	G-16
CASE 10: KARSTIC AND OLD MINING REGIONS .....	G-20
CASE 11: CONSTRUCTION IN OPEN WATER .....	G-22
CASE 12: CONSTRUCTION IN AN ENVIRONMENTALLY SENSITIVE AREA .....	G-23
REFERENCES .....	G-26

## LIST OF FIGURES

<u>No.</u>	<u>Title</u>	<u>Page No.</u>
1.1.	Schematic of a typical drilled shaft.....	2
1.2.	A typical construction job in progress (Photograph courtesy of Watson, Inc.).....	3
1.3.	Photograph of Queets River Bridge at time of completion (Note old bridge in background and flood debris against the columns).....	8
1.4.	Construction of drilled shafts from barge in the Great Pee Dee River .....	10
1.5.	Cases for use of drilled shafts: (a) bearing in hard clay, (b) skin friction design, (c) socket into rock, (d) installation into expansive clay (continued) .....	16
1.5	(continued). Cases for use of drilled shafts: (e) stabilizing a slope, (f) foundation for overhead sign, (g) foundation near existing structure, (h) closely-spaced drilled shafts to serve as a cantilever or tied-back wall (drilled shafts installed prior to excavation).....	17
1.5	(continued). Cases for use of drilled shafts: (i) foundation at a marine site, and (j) pier protection or navigation aid.....	18
2.1.	Subsurface characterization related to design and construction .....	22
2.2.	Low-frequency continuous seismic reflection profile for the Connecticut River at the Glastonbury-Wethersfield Bridge (Haeni, 1988).....	26
2.3.	Kriging surfaces for three layers at overconsolidated clay site (Yoon and O'Neill, 1996).....	27
2.4.	Schematic elevation showing definition of vertical and horizontal effective stresses in the ground.....	32
2.5.	Wet rotary-type soil boring rig .....	35
2.6.	Illustration of the concept of dilation at the interface of concrete and rock (O'Neill et al., 1996) .....	41
2.7.	Effect of borehole smear on load-settlement behavior of a drilled shaft in rock (Hassan and O'Neill, 1997).....	41
2.8.	Possible sliding surface when a drilled shaft is pushed downward .....	42
2.9.	Friction angles for sand at or near the wall of a drilled shaft .....	44
2.10.	Failure relationship for saturated clay at or near the wall of a drilled shaft .....	44
3.1.	Shapes of typical underreams (a) cut with "standard" conical reamer; (b) cut with "bucket," or hemispherical, reamer.....	51
3.2.	Dry method of construction: (a) initiating drilling (b) starting concrete pour, (c) placing rebar cage, (d) completed shaft .....	55
3.3.	Casing method of construction: (a) initiating drilling, (b) drilling with slurry; (c) introducing casing, (d) casing is sealed and slurry is being removed from interior of casing (continued) .....	61
3.3	(continued). Casing method of construction: (e) drilling below casing, (f) underreaming, (g) removing casing, and (h) completed shaft .....	62
3.4.	Alternate method of construction with casing: (a) installation of casing, (b) drilling ahead of casing, (c) removing casing with vibratory driver.....	63
3.5.	Case-and-drill (full-depth-casing) rigs: (a) track-mounted rig with auger .....	65
3.5	(continued) (b) skid-mounted rig with hammergrab.....	65

3.6	Slurry method of construction (a) drilling to full depth with slurry; (b) placing rebar cage; (c) placing concrete; (d) completed shaft.....	67
3.7.	Effect of time lapse between drilling and concreting on CPT resistance of sand adjacent to drilled shafts constructed by the wet method: (a) Two hours between completion of drilling and concreting, (b) Two weeks between completion of drilling and concreting (De Beer, 1988) .....	70
4.1.	A typical truck-mounted drilling machine.....	74
4.2.	A typical crane-mounted drilling machine (Photograph courtesy of Farmer Foundation Company, Inc.) .....	75
4.3.	A typical crawler-mounted drilling machine (Courtesy of Case Pacific Company) .....	76
4.4.	Low-headroom drilling machine (crawler-mounted)(Photograph courtesy of A. H. Beck Foundation Company) .....	77
4.5.	A typical drilling bucket .....	80
4.6.	A typical "muck bucket" or "clean-out bucket" .....	81
4.7.	A single-flight auger .....	82
4.8.	A typical double-flight auger.....	82
4.9.	A typical rock auger.....	84
4.10.	Tapered rock auger for loosening fragmented rock (Photograph courtesy of John Turner) .....	84
4.11.	A typical single-walled core barrel.....	86
4.12.	A double-wall core barrel (Photograph courtesy of W. F. J. Drilling Tools, Inc.).....	86
4.13.	Full-faced tool with roller bit (Photograph courtesy of Caissons, Inc.).....	89
4.14.	A typical closed bellings tool inserted into a borehole.....	89
4.15.	A typical bellings bucket in drilling position .....	90
4.16.	A Glover rock-grab (Drawing courtesy of Steven M. Hain) .....	90
4.17.	A typical grab bucket (Photograph courtesy of John Turner).....	91
4.18.	An example of a churn drill (Photograph courtesy of John Turner).....	91
4.19.	An example of a hammergrab (from LCPC, 1986) .....	93
4.20.	An example of a rodless soil drill (Photograph courtesy of Tone Boring Corp., Ltd.).....	93
4.21.	Mach drill (Photograph courtesy of Tone Boring Corp., Ltd.).....	94
5.1.	A typical view of stored temporary casing .....	98
5.2.	Examples of use of permanent casing.....	99
5.3.	J slots in top of casing for use with casing twister (Photograph courtesy of Herzog Foundation Drilling, Inc.) .....	104
5.4.	Teeth for use in sealing casing into rock (Photograph courtesy of Herzog Foundation Drilling, Inc.) .....	104
6.1.	Formation of mudcake and positive effective pressure in a mineral slurry in sand formation.....	110
6.2.	Mineral slurry plates in pores of open-pored formation (modified after Fleming and Sliwinski, 1977) .....	111
6.3.	Stabilization of borehole by the use of polymer drilling slurries.....	113
6.4.	Relation of viscosity of mineral slurries to dosage (after Leyendecker, 1978) .....	120
6.5.	Schematic diagram of unit for mixing and treating mineral slurry .....	126
6.6.	Sampler for slurry (from Fleming and Sliwinski, 1977).....	130
6.7.	Schematic of viscometer .....	132

6.8.	Interpretation of data from a viscometer (Ata and O'Neill, 1997).....	134
6.9.	Photograph of sand content test (backwashing sand into burette).....	135
6.10.	Photograph of titration test for hardness.....	136
6.11.	Photograph of complete set of field testing equipment for drilling slurries .....	138
6.12.	Commercial borehole caliper (Western Atlas, Inc.) .....	141
	(a) Sensors in retracted position.....	141
	(b) Sensors extended.....	141
6.13.	Caliper log (Foundations for US 231 Crossing of Ohio River).....	142
6.14.	The buildup of bentonite filter cake in a model apparatus in response to different pressure heads (after Wates and Knight, 1975) .....	149
6.15.	Placing concrete through heavily-contaminated slurry.....	153
6.16.	Factors causing weakened resistance at base of a drilled shaft .....	154
6.17.	Placing casing into mineral slurry with excessive solids content.....	156
6.18.	Pulling casing with insufficient head of concrete .....	157
6.19.	Placing concrete where casing was improperly sealed .....	158
7.1.	View of a rebar cage being assembled, showing longitudinal steel .....	166
7.2.	View of bundles of No. 18 rebar in a drilled shaft cage .....	166
7.3.	Transverse ties and spiral steel, showing hook anchors and spiral laps .....	168
7.4.	Possible distortion of poorly assembled cage due to pickup forces or hydraulic forces from fresh concrete .....	168
7.5.	Sizing hoop assembly (from LCPC, 1986).....	170
7.6.	Centering with plain, epoxy-coated rebar skids (from LCPC, 1986) .....	171
7.7.	Concrete rollers.....	172
7.8.	Installation of rollers: (a) correct, (b) incorrect (from LCPC, 1986).....	173
7.9.	Transverse stiffeners for temporary strengthening of the rebar cage (after LCPC, 1986) .....	174
7.10.	Longitudinal stiffeners for temporary or permanent strengthening of a rebar cage (from LCPC, 1986).....	175
7.11.	Photograph of bands used for strengthening lower part of a rebar cage.....	175
7.12.	Photograph of rebar cage being lifted improperly (Photo courtesy of Barry Berkovitz, FHWA).....	176
7.13.	Photograph of rebar cage being lifted properly .....	176
7.14.	Inward-turned hooks in a rebar cage for a drilled shaft at an abutment (photograph courtesy of Barry Berkovitz, FHWA).....	179
8.1.	Slump loss relationship from a trial mix design .....	189
8.2.	Concrete with insufficient workability for use in drilled shafts .....	193
8.3.	Concrete with high workability but with improper mix design for tremie placement.....	193
8.4.	Concrete with high workability and with good mix design for tremie placement Strength.....	194
8.5.	Placing concrete directly from the ready-mix truck without a dropchute .....	198
8.6.	Steel dropchute with multiple windows.....	199
8.7.	Hinged closure (from LCPC, 1986).....	202
8.8.	"Hat" closure (from LCPC, 1986) .....	202
8.9.	Loose-plate closure .....	202
8.10.	Photograph of simple plywood loose plate closure on a gravity-fed tremie.....	203

8.11.	Photograph of gravity-fed tremie partially extracted.....	204
8.12.	Capped tremie pipe with breather tube (from LCPC, 1986).....	205
8.13.	Polystyrene plug (from LCPC, 1986).....	206
8.14.	Plug of cement paste.....	206
8.15.	Notching of lower portion of tremie tube (from LCPC, 1986).....	207
8.16.	Potential distribution of leached concrete resulting from excessive initial lifting of gravity-fed tremie (from LCPC, 1986).....	208
8.17a.	Pumping operation with a portable, "tremieless" pump unit that does not require a crane to hold the pump line.....	210
8.17b.	Pump unit from Figure 8.17 a operating beneath a bridge (Photograph courtesy of A. H. Beck, Inc.).....	210
8.17c.	Typical tremie for placement of concrete by pump.....	211
8.17d.	Large-scale concrete pumping operation for drilled shafts in a river.....	211
8.18.	Technique of starting the placement of concrete with a pump (from LCPC, 1986).....	213
8.19 a.	Defect in a drilled shaft caused by interruption in concrete supply during pumping (Photograph courtesy of Caltrans).....	214
8.19 b.	Drilled shaft of excellent quality after exhumation.....	214
8.20.	Comparison of actual amount of concrete required to fill excavation incrementally with theoretical volume of the excavation; Example 1 (LCPC, 1986).....	217
8.21.	Comparison of actual amount of concrete required to fill excavation incrementally with theoretical volume of the excavation; Example 2 (LCPC, 1986).....	217
8.22.	Comparison of actual amount of concrete required to fill excavation incrementally with theoretical volume of the excavation; Example 3 (ADSC/DFI, 1989).....	218
10.1.	Schematic of the overall design process for drilled shaft foundations.....	227
10.2.	Total cost vs. intensity of exploration (after Kulhawy et al., 1983).....	229
10.3.	Hypothetical load-settlement relations for drilled shafts, indicating factors that influence shaft behavior under axial load.....	237
10.4.	Idealized geomaterial layering for computation of compression resistance.....	244
10.5.	Idealized geomaterial layering for computation of uplift resistance.....	245
10.6.	Potential effect of loading slightly above unfactored load on lateral deflection of a drilled shaft.....	254
10.7.	Concept of group behavior in drilled shafts.....	256
11.1.	Condition in which $R_S + R_B$ is not equal to actual ultimate resistance.....	263
11.2.	Idealized geomaterial layering for computation of compression resistance.....	267
11.3.	Idealized geomaterial layering for computation of uplift resistance.....	267
11.4.	Exclusion zones for computation of side resistance for drilled shafts in cohesive soils.....	275
11.5.	Factor $\alpha$ for cohesive IGM's.....	283
11.6.	Definition of geometric terms in Equation (11.25).....	285
11.7.	Definition of area $A_u$ .....	287
11.8.	Normalized side load transfer for drilled shaft in cohesive soil.....	291
11.9.	Normalized base load transfer for drilled shaft in cohesive soil.....	291
11.10.	Normalized side load transfer for drilled shaft in cohesionless soil.....	292
11.11.	Normalized base load transfer for drilled shaft in cohesionless soil.....	292
12.1.	Examples of cases where downdrag could occur.....	299
12.2.	Possible downdrag loading of drilled shafts supporting a bridge abutment.....	300

12.3.	Potential geotechnical strength limit states for drilled shafts .....	300
12.4.	The equivalent pier concept applied to downdrag in groups of drilled shafts .....	302
12.5.	Elementary mechanics of downdrag: (a) example problem; (b) load transfer curves; (c) relative movement of drilled shaft with respect to geomaterial (neutral point assumed at bottom of settling stratum); (d) distribution of load along drilled shaft; (e) revised estimate of relative movement of drilled shaft with respect to geomaterial; (f) revised estimate of distribution of load along drilled shaft.....	305
12.6.	Definition of $c'$ and $f'$ where curved failure envelope exists.....	306
12.7.	Example soil profile with expansive geomaterial .....	312
12.8.	Use of a permanent surface casing for design in expansive soil.....	315
12.9.	Raba method of design in expansive soil.....	315
12.10.	Use of rebar cage for design in expansive geomaterial .....	317
13.1.	Single-column supports .....	320
13.2.	Loadings on single-column support for a bridge .....	320
13.3.	Overhead sign .....	321
13.4.	Elevation view of an overhead sign structure (a) two-shaft foundation and (b) single-shaft foundation (from FHWA-IP-84-11) .....	322
13.5.	Bridge abutment.....	323
13.6.	Sketch of foundation for a bridge abutment (FHWA-IP-84-11) .....	323
13.7.	Arch bridge (photograph courtesy of Ronald C. O'Neill) .....	324
13.8.	Reaction block for arch bridge (photograph courtesy of Ronald C. O'Neill) .....	325
13.9.	Drilled shaft foundation for an arch bridge (from FHWA-IP-84-11).....	325
13.10.	Drilled shafts for stabilizing a slide (Reese et al., 1987) .....	326
13.11.	Drilled shaft retaining structure for depressed section of highway .....	326
13.12.	Groundline shear – deflection curves for (a) clay and (b) sand (Duncan et al., 1994) .....	330
13.13.	Groundline moment – deflection curves for (a) clay and (b) sand (Duncan et al., 1994) .....	330
13.14.	Groundline shear – maximum moment curves for (a) clay and (b) sand (Duncan et al., 1994) .....	332
13.15.	Parameters $A_m$ and $B_m$ (Matlock and Reese, 1961).....	332
13.16.	Model of a deep foundation under lateral loading showing concept of soil response curves .....	339
13.17.	Definition of terms in Equations (13.12) and (13.13).....	344
13.18.	Variation of EI of a drilled shaft cross section with bending moment and axial load.....	345
13.19.	Assumed stress-strain relation for concrete .....	346
13.20.	Assumed stress-strain curve for steel reinforcement .....	347
13.21.	The p-multiplier (Brown and Shie, 1991).....	349
13.22.	Modification of p-y curve for group action using the p-multiplier.....	349
13.23.	Interaction diagram for a reinforced concrete column .....	355
13.24.	Interaction diagram for factored resistance for combined axial load and flexure .....	364
13.25.	Deflection, moment and shear as a function of depth for Example 13.5.....	375
13.26.	Results from computer solutions for Example 13.6 (after FHWA-IP-84-11) .....	377
13.27.	Typical underream (after Farr, 1974).....	379
13.28.	Tensile stress contours for flat-bottom bell (after Farr, 1974).....	380



14.1.	Caliper log for deep drilled shaft in rock.....	390
14.2.	Arrangement for testing a drilled shaft conventionally under axial compressive loading.....	393
14.3.	Osterberg cell loading system .....	396
	(a) Schematic of Osterberg cell test.....	396
	(b) Photograph of Osterberg cell.....	396
14.4.	Side and base load-movement results from an Osterberg cell test on a rock socket in granite (Osterberg, 1994).....	397
14.5.	Comparison of mobilized side shear stress along a drilled shaft in Florida limestone for both Osterberg cell (OC) and conventional surface loading at the load corresponding to side shear failure in the OC test from finite element analysis (from O'Neill et al., 1997, after McVay et al., 1994).....	398
14.6.	Multiple-level arrangement for Osterberg cells (O'Neill et al., 1997).....	399
14.7.	Schematic of Statnamic <sup>R</sup> test.....	400
14.8.	Photograph of Statnamic <sup>R</sup> test arrangement, showing masses being accelerated inside gravel-filled sheath.....	401
14.9.	Arrangement for testing a drilled shaft under uplift loading .....	403
14.10.	Photograph of head of test shaft showing hydraulic jack and electronic load cell.....	404
14.11.	Photograph of a telltale system.....	406
14.12.	Photograph of a vibrating wire sister bar.....	407
14.13.	The Mustran cell .....	409
14.14.	View of a test shaft with contact pressure cells at its base .....	410
14.15.	Typical set of load distribution curves obtained from use of Mustran cells.....	411
14.16.	Method of analysis of data from axial loading test.....	414
14.17.	Arrangement for a conventional full-scale field lateral loading test using a pushing procedure.....	418
14.18.	Osterberg Cell arranged for 26.7 MN (3000 ton) lateral loading test in a 1.22m (4ft.) diameter rock socket .....	420
16.1.	Concrete curve showing normal amount of overbreak.....	475
16.2.	Concrete curve showing an excessive amount of overbreak .....	476
16.3.	Decision tree for acceptance of drilled shafts (Baker et al., 1993).....	479
17.1.	Sonic echo method (after Sliwinski and Fleming, 1983).....	484
17.2.	A severe defect that can likely be detected by sonic echo testing .....	487
17.3.	Ideal response curve for the impulse-response or vibration test (after Weltman, 1977) .....	488
17.4.	Examples of impedance logs (Davis and Hertlein, 1991).....	489
17.5.	The parallel seismic test (Davis, 1995).....	490
17.6.	Compression wave propagation method with internal receivers (Hearne et al., 1981) .....	492
17.7.	Typical results from internal stress wave test (from Harrell and Stokoe, 1984) .....	492
17.8.	Concrete cores from non-defective and defective drilled shafts.....	493
	(a) Shaft with no defect.....	493
	(b) Shaft with defect caused when concrete began to set while removing the casing .....	493
17.9.	Reinforcing cage to which PVC access tubes have been attached .....	496
17.10.	Diagram of crosshole acoustic logging system (Weltman, 1977) .....	498

17.11.	Crosshole sonic log for a shaft with a known defect (Baker et al., 1993) .....	498
17.12.	Gamma-gamma testing system (after Preiss et al., 1978).....	501
17.13.	Results from gamma-gamma logging of a drilled shaft with four access tubes .....	502
17.14.	Photograph of defect similar to the defect that produced the logs in Figure 17.12 .....	503
17.15.	Photograph of a small transverse crack in a concrete pile from a concreteoscope test .....	503
18.1.	Visual inspection of the base of a defective drilled shaft .....	520
18.2.	Circular pattern of microshafts to underpin defective drilled shaft .....	521
18.3.	Schemes for underpinning a defective drilled shaft with microshafts .....	522
18.4.	Use of "straddle" shafts .....	523
19.1.	Pricing scenario 1 for 1997 ADSC survey.....	528
19.2.	Pricing scenario 2 for 1997 ADSC survey.....	529
19.3.	Pricing scenario 3 for 1997 ADSC survey.....	530
A.1.	Plan view of characterization domain.....	A-7
A.2.	Elevation of borings and values of $s_u$ in characterization domain.....	A-8
A.3.	Undrained shear strength ( $s_u$ ) vs. elevation in upper stratum .....	A-8
A.4.	Undrained shear strength ( $s_u$ ) vs. elevation in lower stratum .....	A-9
A.5.	Idealized probability distributions of load and resistance on a drilled shaft.....	A-12
A.6.	Definition of the reliability index .....	A-14
B.1.	Illustration of deflection-softening behavior of drilled shafts under compression loading .....	B-2
B.2.	Idealized geomaterial layering for computation of compression resistance .....	B-5
B.3.	Idealized geomaterial layering for computation of uplift resistance .....	B-5
B.4.	Relation between $s_u$ from CIUC tests and UU tests (Chen and Kulhawy, 1994) .....	B-10
B.5.	Relation between $s_u$ from UC tests and UU tests (Chen and Kulhawy, 1994) .....	B-11
B.6.	Fracturing (punching) of a foundation in massive rock or IGM.....	B-13
B.7.	Bearing capacity factors (Chen and Kulhawy, 1994) .....	B-20
B.8.	Bearing capacity factor $N_{cs}$ as a function of joint slope and relative shear strength of joints and intact rock (Carter and Kulhawy, 1988) .....	B-24
B.9.	Correlation between $\alpha$ and $s_u/p_a$ .....	B-28
B.10.	Factor $\alpha$ for IGM's (O'Neill et al., 1996).....	B-30
B.11.	Factor $M$ vs. concrete slump (O'Neill et al., 1996).....	B-31
B.12.	Parameter $n$ for smooth cohesive IGM sockets (O'Neill et al., 1996) .....	B-34
B.13.	Roughness pattern assumed in the development of design equations (O'Neill et al., 1996) .....	B-34
B.14.	Simplified representation of Poisson's effect (exaggerated) .....	B-38
B.15.	Unit shaft resistance versus shear displacement for drilled shaft socket in rock of moderate roughness with $q_u = 3.0$ MPa (Baycan, 1996).....	B-39
B.16.	Definition of terms in Equation (B.48).....	B-41
B.17.	Variations of $\beta$ with depth (O'Neill and Hassan, 1994).....	B-48
B.18.	$\eta$ vs. center-to-center spacing, $s$ , normalized by shaft diameter, $B_{shaft}$ , for underreamed drilled shafts in compression in moist silty sand (Modified after Garg, 1979) .....	B-57
B.19.	Relative unit side and base resistances for single shaft and typical shaft in a nine- shaft groups (Liu et al., 1985).....	B-58

B.20.	Block failure model for drilled shaft group in cohesive soil with cap in contact with the ground .....	B-60
B.21.	Computed axial resistance ( $R_c$ ) vs. measured axial resistance ( $R_m$ ) (Isenhower and Long, 1997).....	B-62
C.1.	Normalized load transfer relations for side resistance in cohesive soil .....	C-6
C.2.	Normalized load transfer relation for base resistance in cohesive soil .....	C-7
C.3.	Normalized load transfer relations for side resistance in cohesionless soil.....	C-7
C.4.	Normalized load transfer relations for base resistance in cohesionless soil .....	C-8
C.5.	Mechanistic model of axially loaded drilled shaft .....	C-14
C.6.	Element from an axially loaded shaft .....	C-14
C.7.	Illustration of the definition of $\psi$ .....	C-16
C.8.	Segment of a load-distribution curve along an axially loaded drilled shaft .....	C-18
C.9.	Idealized soil modulus profile for computing settlement in granular IGM's.....	C-22
C.10.	Load-settlement relation for method for granular IGM's.....	C-22
C.11.	Vertical strain influence factors below center of rectangular area (Poulos, 1993).....	C-35
C.12.	Embedment correction factor (after Poulos, 1993).....	C-36
C.13.	Influence factor $I_s$ for drilled shaft groups for $E_e/E'_s = 88$ and $n_{soil} = 0.3$ (Poulos, 1994) .....	C-38
C.14.	Weighting factors for equivalent pier method (Poulos, 1994).....	C-39
C.15.	Ratio of load transferred to base to applied load for the equivalent pier method (Poulos, 1994).....	C-40
G.1.	Case 1: Construction in stiff clay with water table slightly below base of shaft.....	G-2
G.2.	Case 2: Construction in hard clay and shale with layer of waterbearing sand .....	G-4
G.3.	Case 3: Construction in soft and heavily-jointed clays .....	G-6
G.4.	Case 4: Construction in dry sand .....	G-7
G.5.	Case 5: Construction in granular soil below the water table .....	G-9
G.6.	Case 6: Construction through caving soil into sound rock .....	G-11
G.7.	Case 7: Construction through caving soil into fractured rock .....	G-13
G.8.	Case 8: Construction through boulders.....	G-16
G.9a.	Case 9 a: Blocky weathered rock profile (Sowers, 1994).....	G-18
G.9b.	Case 9 b: Construction where the founding rock is vertically slotted .....	G-19
G.10.	Case 10: Construction in karstic regions.....	G-21
G.11.	Case 11: Construction in open water .....	G-23
G.12.	Case 12: Construction through potentially contaminated surface water.....	G-25

## LIST OF TABLES

<u>Table No.</u>	<u>Title</u>	<u>Page No.</u>
2.1.	Recommended frequency of borings for drilled shaft foundations for bridges when unclassified excavation is specified (FHWA, 1991).....	28
2.2.	Geotechnical parameters from borings or soundings to be evaluated numerically if design procedures in this manual are used.....	30
4.1.	Brief listing of characteristics of some drilling machines .....	78
6.1.	Mineral slurry specifications for drilled shaft construction in fine sands (modified after Florida Department of Transportation, 1987).....	144
6.2.	Slurry specifications for a rock-socketed drilled shaft (after Holden, 1984).....	145
6.3.	Ranges of properties of various fresh-water slurries at time of concreting consistent with maintenance of angle of wall friction in sand of $0.67 \phi$ in laboratory tests (after Majano et al., 1994).....	146
7.1.	Properties of reinforcing steel for concrete reinforcement .....	164
7.2.	Weights and dimensions of deformed bars (Customary).....	164
7.3.	Weights and dimensions of deformed bars (Metric).....	165
8.1.	Typical mix proportions for workable drilled shaft concrete (after Sliwinski, 1980).....	189
8.2.	Concentrations of typical aggressive soil and groundwater contaminants (after Bartholomew, 1980) .....	190
8.3.	Typical proportions of pozzolanic additives.....	191
8.4.	Typical proportions of some prequalified chemical admixtures (extracted from TXDOT, 1996).....	192
10.1.	Resistance factors, $\phi$ , for selected values of global safety factor, F .....	242
11.1.	Values of $I_r = E_s$ (Young's Modulus of soil)/ $3s_u$ and $N_c^*$ .....	276
11.2.	Descriptions of Rock Types for Use in Table 11.3.....	277
11.3.	Values of $s$ and $m$ (Dimensionless) for Equation (11.7) based on Classification in Table 11.2 .....	278
11.4.	Factors $\phi$ for cohesive IGM's .....	283
12.1.	WES Method of Identifying Potentially Expansive Soils.....	309
13.1.	Minimum Drilled Shaft Penetrations Based on Lateral Loading from the Characteristic Load Method.....	333
13.2.	Values of Maximum Net Bearing Stresses for Unreinforced Concrete Underreams .....	380
17.1.	Summary of Common NDE Methods for Evaluating Structural Integrity of Drilled shafts.....	482
17.2.	Classification of Defects Found in 5000 Drilled Shafts Constructed by Cementation Ltd. in the United Kingdom in 1982 (Sliwinski and Fleming, 1983) .....	505
17.3.	Possible Acceptance Criteria for Drilled Shafts Constructed Using the Wet Method Where Primary Loading is Axial (Modified After Baker et al., 1993) .....	507
17.4.	Rating Guideline for Supporting Decisions for Implementation of Integrity Testing (Modified After Baker et al., 1993) .....	509
19.1.	ADSC Pricing Survey; Summer, 1997 .....	532
19.2.	Low-Bid Table for Drilled Shafts, Texas DOT, Statewide .....	534
19.3.	Low-Bid Table for Drilled Shafts, Texas DOT, District 12 Only. ....	535

A.1.	Typical Values of $COV_w$ 's of Geomaterial Parameters for Drilled Shaft Design (Modified after Phoon et al., 1995).....	A-6
A.2.	Load Combinations and Load Factors from AASHTO (1994) .....	A-18
A.3.	Load factors ( $\gamma$ ) for Permanent Loads.....	A-19
A.4.	Notation for Load Components .....	A-20
A.5.	Resistance Factors for Geotechnical Strength Limit State for Axially Loaded Drilled Shafts .....	A-22
B.1.	$E_s/3s_u$ for Cohesive Soil in UU Triaxial Compression and Values of $N^*_c$ .....	B-13
B.2.	Values of $s$ and $m$ Based on Rock Classification (Carter and Kulhawy, 1988) .....	B-16
B.3.	Descriptions of Rock Types for Use in Table B.2 (Hoek, 1983).....	B-17
B.4.	Correction Coefficients for Bearing Capacity Factors (Chen and Kulhawy, 1994) .....	B-22
B.5.	Estimation of $E_m/E_i$ Based on RQD (Modified after Carter and Kulhawy, 1988).....	B-32
B.6.	$f_{aa}/f_a$ Based on $E_m/E_i$ (O'Neill et al., 1996).....	B-32
C.1.	Values of $C_p$ is Various Soils (Vesic, 1977).....	C-3



## CHAPTER 1: INTRODUCTION

### TYPES OF DEEP FOUNDATIONS

The usual role of a deep foundation is to transfer vertical load through weak, near-surface soils to rock or strong soil at depth. Shallow foundations, on the other hand, are frequently used when the surface soils are capable of supporting load without excessive settlement.

There are many types of deep foundations, and classification can be done in various ways. Several of the factors that can be used in classifying deep foundations are given below.

- **Materials:** steel; concrete--plain, reinforced, or pre-stressed; timber; or some combination of these materials.
- **Methods of transferring load to the soil or rock:** principally in end-bearing, principally in skin friction, or in some combination of the two methods.
- **Influence of installation on soil or rock:** displacement piles, such as a closed-ended steel pipe, that displace a large volume of soil as the piles are driven; or nondisplacement piles, such as an H-pile or open-ended steel pipe, that displace a relatively small volume of soil during driving (until the pipe becomes plugged), or drilled shafts, which result in essentially no displacement of the soil or rock.
- **Method of installation:** impact hammers--hydraulic-, air-, or steam-powered, or diesel-; vibratory hammers; drilling an open hole; or by use of some special method.

Thus, an example of a type of deep foundation is a structural-steel shape (essentially nondisplacement), driven by a diesel hammer to rock, that carries its load in end-bearing.

The drilled shaft is normally used as a deep foundation, but it can also be used as a shallow foundation.

### DESCRIPTION OF DRILLED SHAFTS

A drilled shaft is a deep foundation that is constructed by placing fluid concrete in a drilled hole. Reinforcing steel can be installed in the excavation, if desired, prior to placing the concrete. A schematic example of a typical drilled shaft is shown in Figure 1.1. The arrows indicate that drilled shafts can carry both axial and lateral loads.

In the United States, the drilled shaft is most commonly constructed by employing rotary drilling equipment to bore a cylindrical hole. The borehole may remain unsupported in soils with cohesion or in rock, or it may be kept open by using drilling slurry or casing in granular or bouldery soils, occasionally in highly jointed cohesive soil or rock or in very soft cohesive soil.

The casing is usually temporary. It can be placed in a number of ways. After the cylindrical hole is excavated and the casing placed, if necessary, an underreaming tool can be used, if desired, to enlarge the base of a drilled shaft in cohesive soil. A rebar cage can be placed, if needed from a design perspective, and the excavation is filled with fresh concrete. The temporary casing is recovered.

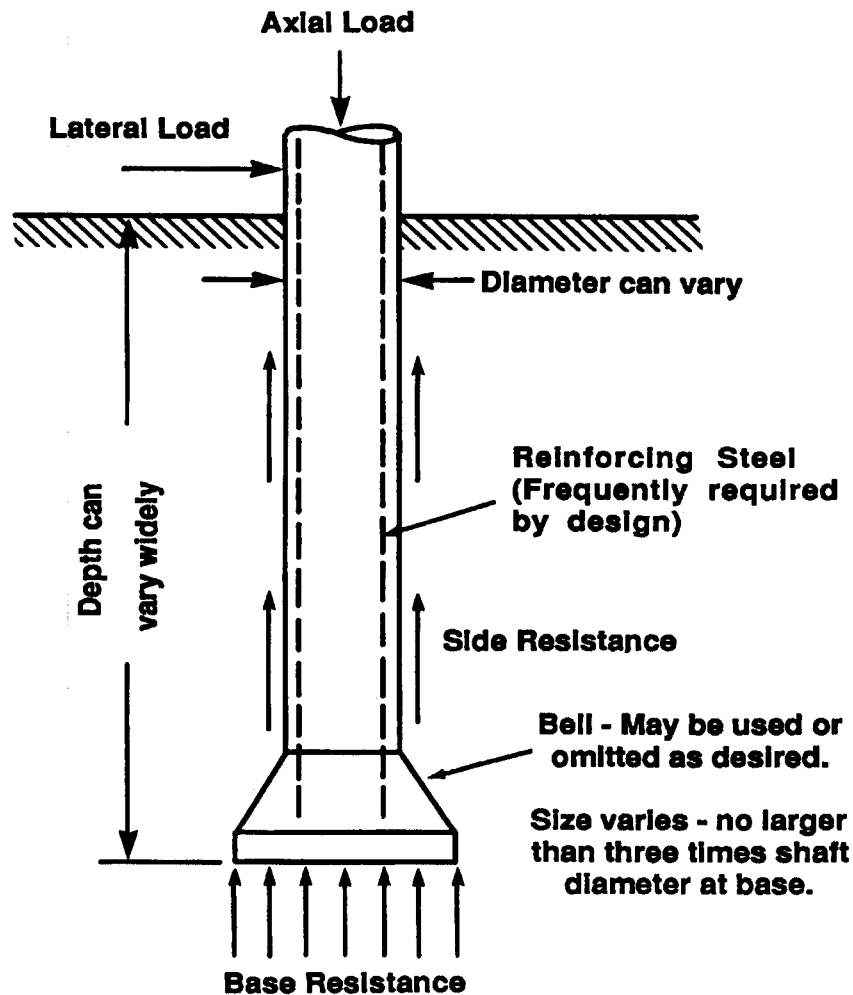

Figure 1.1. Schematic of a typical drilled shaft

Drilled shafts may also be constructed by the percussion method of excavation. In this case, surface casing is set, and the soil or rock is excavated by a grab bucket, or clamshell. In hard soil or rock, a rock breaker or similar tool can be employed to break the rock before excavation. A rock breaker consists of a heavy bar with a chisel-like tip or a heavy implement shaped like a star



that is dropped repeatedly to fracture the hard soil or rock. An alternate method is to use a hammergrab, a heavy bucket with sharp point that when dropped will penetrate the geomaterial and can then be used to excavate it without removing the tool and changing to a clamshell.

The borehole for the drilled shaft can be excavated by percussion to make excavations with noncircular cross sections. A surface casing, or guide, in the form of a cross or a rectangle can be placed. The transverse dimensions of the guide will conform to the size of the grab bucket. A drilled shaft of this type is called a "barrette." Barrettes have had little use in the United States during the recent past, except that slurry walls have been excavated with the identical method used to excavate the barrette.

Figure 1.2 shows a typical drilled-shaft construction project in progress. The crane-mounted machines are making the excavations, and a service crane, which will be used to place the reinforcing cage and to assist in placing the concrete, is shown in the background.

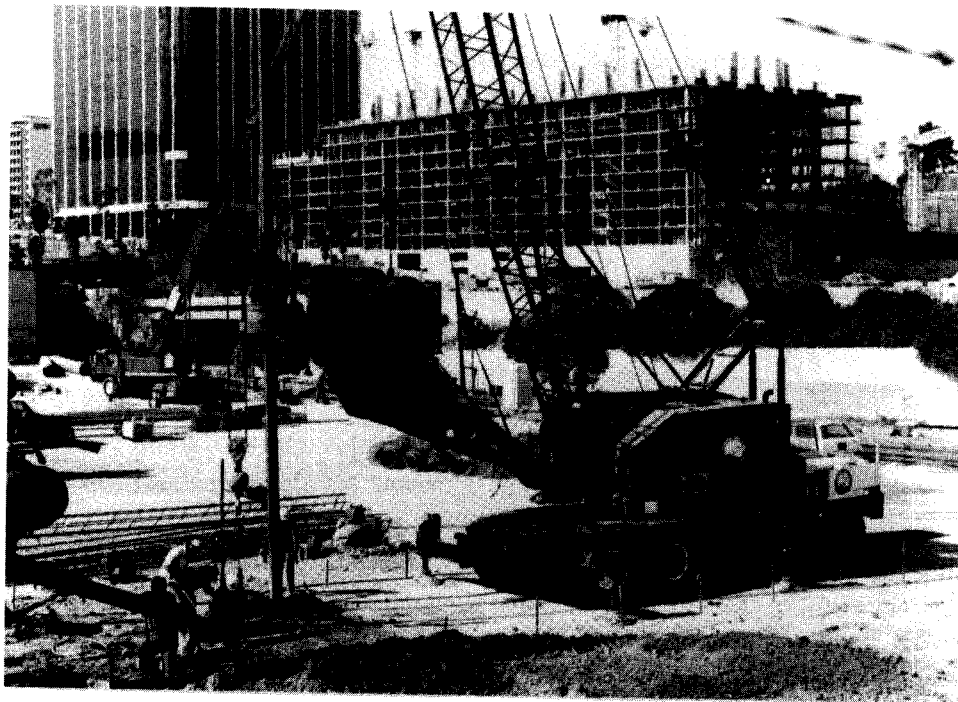

Figure 1.2. A typical construction job in progress (Photograph courtesy of Watson, Inc.)  
Some deep foundations that are not classified as drilled shafts also involve the placing of concrete in a preformed hole. For example,

- The pressure-injected footing is constructed, normally in granular soils, by placing a casing and excavating the interior soil, by placing a quantity of dry-mix concrete in the bottom of the casing, and dropping a weight on the concrete. The impact causes the granular soil to be compacted and, as more dry-mix concrete is added, a bulb is formed. The process is continued as the casing is gradually retrieved. The completed foundation consists of a nearly cylindrical shaft with an enlarged base.
- The step-taper pile and similar types of cast-in-place piles are constructed by driving a thin, steel shell into place by the use of a mandrel. The mandrel is withdrawn and the shell is filled with concrete.
- The auger-placed-grout pile is constructed by rotating a continuous-flight auger into place. The auger has a hollow stem through which grout is forced under pressure. The auger is gradually withdrawn, and the grout, or special concrete, fills the space formerly occupied by the auger.

It is important to recognize that these and similar types of foundations, while having some characteristics of drilled shafts, are not drilled shafts and should not be designed using the principles and procedures described in this manual. It is also important to recognize that drilled shafts have different effects on soils and rocks than do driven piles and that design methods for driven piles are therefore not usually appropriate for drilled shafts.

## **BRIEF HISTORY OF DRILLED SHAFT FOUNDATIONS**

The construction of higher and heavier buildings in cities such as Chicago, Cleveland, Detroit, and London, where the subsurface conditions consisted of a relatively thick layers of medium to soft clays overlying deep glacial till or bedrock, led to the development of the earliest versions of the drilled shaft foundation. For example, in the late nineteenth century, hand-dug "Chicago" and "Gow" caissons were excavated to a hardpan layer to act as a type of deep footing. These foundations were constructed by making the excavation and by placing sections of permanent liners to retain the soil (wood lagging or meal sheets) by hand. Early designs specified bearing pressures for the hardpan that were usually very conservative, around 380 kPa (8,000 psf) (Baker and Khan, 1971).

Machine excavation soon superseded the hand-dug caissons. An early power-driven auger, built around 1908, capable of boring a 0.3 m (12-in) hole to a depth of 6 to 12 m (20 to 40 ft) is described by Osterberg (1968). Records of horse-driven rotary machines used to auger boreholes for drilled shafts in San Antonio, Texas, around 1920 for shafts 7.6 m (25 ft) or more in depth are described by Greer (1969). Early development of drilled shafts in the San Antonio area was motivated by very different subsurface conditions than in the cities described above. There, the surface soils are generally strong, but highly expansive, and drilled shafts were used to carry loads below the expansive surficial soils.

In 1931, Hugh B. Williams of Dallas, Texas, started to build small machines for excavating shallow holes and later manufactured truck-mounted machines. His machine became popular in the drilled-shaft industry, and versions are still used today.

Prior to World War II, the development of large scale, mobile, auger-type and bucket-type, earth-drilling equipment allowed more economical and faster construction of the drilled-shaft foundation. In the late 1940's and early 1950's, drilling contractors continued to introduce techniques for larger underreams and for cutting in rock. Large-diameter, straight shafts founded entirely in clay and deriving most of their support from side resistance came into common usage in Britain. Many contractors found that by introducing casing and drilling mud into boreholes, a process long established by the oil industry, boreholes could be cut through permeable soils below the water table and in caving soils economically.

Stabilization of the borehole also has been accomplished by injection of grouts (Glossop and Greeves, 1946), by dewatering, and by freezing of the soil. These techniques can be expensive, and are not usually required.

The first planned use of drilled shafts on a state department of transportation project is believed to have been a bridge project in the San Angelo District of Texas in 1950 (McClelland, 1996). By the early 1970's drilled shafts became the foundation of choice in coastal locations in Texas.

The development of drilled shafts, more or less independently, in various parts of the world led to different terminologies. "Drilled shaft" is the term first used in Texas, while "drilled caisson" or "drilled pier" is more common in the midwestern United States. "Cast-in-drilled-hole pile" is a term used in California by Caltrans, and "bored pile" is common outside of the United States. These terms all describe essentially the same type of foundation. Many contractors prefer not to refer to drilled shafts as "caissons," since that term is considered descriptive of foundations excavated by hand in pneumatic chambers, which are not drilled shafts.

While the construction technology advanced rapidly after World War II, the developments of theories for design and analytical techniques lagged behind. In the late 1950's and early 1960's, computers, analytical methods, and full-scale load-testing programs began to produce a better understanding of drilled-shaft behavior. Marked differences between the behavior of driven piles and drilled shafts were noted, and the importance of proper quality control and inspection was realized. Extensive research was carried on through the 1960's and into the 1980's (Whitaker and Cooke, 1966; Reese, 1978; Kulhawy, 1989), and improved design methods and construction procedures were developed such that drilled shafts became regarded as a reliable foundation system for highway structures by numerous state DOT's. In the 1980's and 1990's intensive research has continued, much of it sponsored by state DOT's, the FHWA and the Electric Power Research Institute. Much of this research has focused on collection and analysis of large data bases of full-scale tests, development of expedient methods for performing loading tests, improvements in methods for characterizing uncertainty in the prediction of resistance and settlement, adaptations of principles of rock mechanics to drilled shaft design, and improvement

of procedures for evaluating the structural integrity of drilled shafts.

In 1977 a set of design manuals for drilled shafts was first produced by the FHWA, based on experience at the time. A new design manual was published by the FHWA in 1988, which dealt heavily with construction procedures and proposed simple, conservative design methods. This manual is the second edition of the 1988 manual. Its purpose is to update both design procedures and descriptions of construction technology, and it should be considered to supersede all previous FHWA manuals on the subject.

## **MOTIVATION FOR USING DRILLED SHAFTS**

Since properly designed and constructed drilled shafts have proved to be reliable foundations for bridges and other highway structures, the principal motivation for using drilled shafts relative to other alternatives (primarily driven piles) is the issue of economics. The economic advantage of drilled shafts often occurs as a result of the fact that very large drilled shafts can be installed to replace groups of driven piles, which in turn obviates the need for a pile cap. This advantage is illustrated in the following two examples:

---

### **Example 1. Foundations for the Interior Bents of the Queens River Bridge, Olympic Peninsula, State of Washington**

This example resulted from the development of alternate designs by the design agency before the project was bid. The construction schedule for the foundations for this bridge was severely constrained by the imposition of a short construction season due to the migration of salmon in the stream that the bridge was to span. One alternate foundation called for the construction of one spread footing and two capped groups of steel H-piles for the three interior bents that were required to be placed in the river. Both the spread footing and driven piles (with pile caps) were to be constructed within cofferdams because of the need to construct footings/caps. The drilled shaft alternate called for the replacement of the spread footing and driven pile groups by three large-diameter drilled shafts. The drilled shafts could be drilled during low water using a crane-mounted drill rig positioned on timber mats within the river and pouring the concrete for the shafts to an elevation above the water level, eliminating the need for cofferdams. Other general data are as follows:

- *Bridge:* Two-lane bridge that was a replacement for an existing bridge.
- *Number of Spans:* 4, with each of the three interior bents consisting of a single column. The abutments were supported on driven piles with either alternate.
- *Span Length:* 76 m (250 ft) for the two spans between the interior bents. Shorter spans to the abutments.
- *Year of Construction:* 1986

- ***Drilled Shaft Contractor:*** DBM Contractors, Inc.
- ***Subsurface Conditions:*** Siltstone near the surface at one end dipping to a depth of about 6.1 m (20 ft) near the other end of the bridge. Mixed fine sediments above the siltstone.
- ***Pile Alternate:*** 25 capped H-piles driven into the soft siltstone for each of two interior bents and a spread-footing at the other interior bent. All pile driving, cap construction and spread footing construction were within cofferdams. A single-bent column was formed on the top of the spread footing or pile cap prior to removal of the cofferdams. The need to construct cofferdams prior to installing the foundations required first the construction of a work trestle. Because of the length of time required to construct the trestle and cofferdams, construction of pile groups, caps and footing could not proceed until the following working season, since operations in the river had to be suspended during the salmon runs.
- ***Drilled Shaft Alternate:*** 3, 3.20-m- (10.5-ft-) diameter drilled shafts socketed about 10 m (30 ft) into the siltstone, with casing extending from the top of the siltstone to high water level. The casing was used as a form, and the drilled shaft concrete was poured directly up to the top of the casing. The single columns for the bents were formed on top of the extended sections of drilled shafts, without the requirement to construct cofferdams.
- ***Drilled Shaft Construction:*** The casings were installed, the shaft excavations drilled and the reinforcing steel and concrete were placed during the low-water season by operating off timber mats placed on the floor of the river, which was less than 1.5 m (5 ft) deep during low water. All of the construction in the river took place within the low water season, during which salmon did not migrate in the river. The elimination of the need to operate in the river over two seasons greatly enhanced the cost-effectiveness of the drilled shaft alternate.
- ***Estimated Foundation Cost of the Pile-Footing Alternate:*** \$842,000
- ***Actual Foundation Cost of the Drilled Shaft Alternate:*** \$420,000
- ***Cost Savings Realized by Using Drilled Shafts:*** \$422,000 (50.1%)

A photo of the completed Queets River Bridge is shown in Figure 1.3.

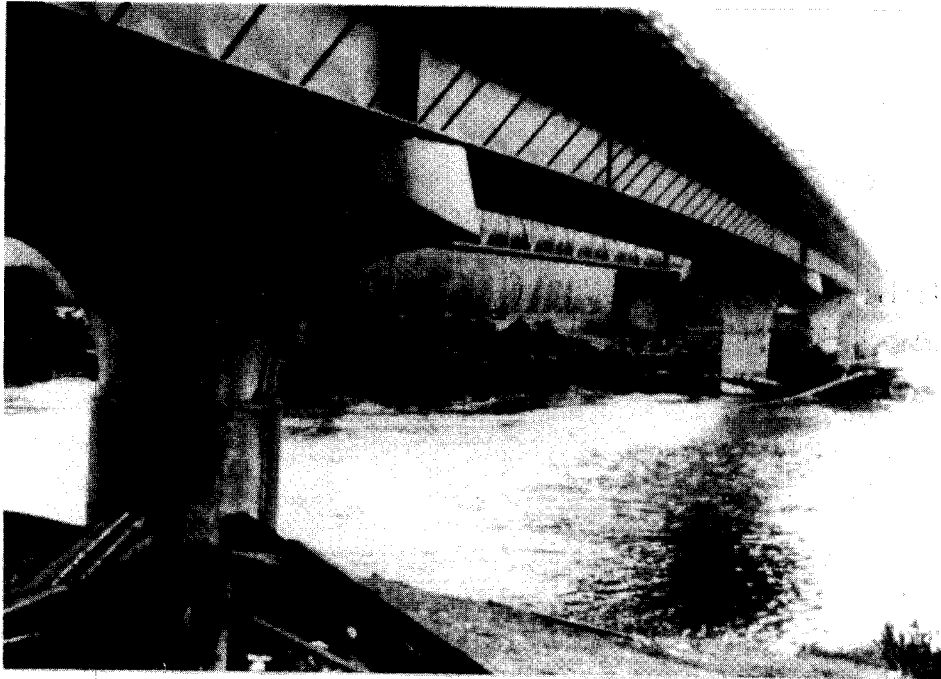

Figure 1.3. Photograph of Queets River Bridge at time of completion  
(Note old bridge in background and flood debris against the columns)

---

**Example 2.** *Foundations for Central Spans for State Route 34 over the Great Pee Dee River, South Carolina*

This example resulted from a value-engineering proposal to replace groups of capped driven steel H-piles, as originally designed, with single drilled shafts. The approach spans and abutments were founded on driven, prestressed concrete piles. The issue for the value engineering proposal was the interior bents. Two of the six interior bents on this bridge were in the river, which was 3 - 6 m (10 - 20 ft) deep; the remaining four were on land. The pile foundations originally designed for the bents in the river were to be installed within sheet-piled cofferdams. The drilled shafts within the river were installed off barges. Other general data are as follows:

- *Bridge:* Two-lane bridge that was a replacement for an existing bridge
- *Number of Spans:* 5 (excluding approach spans)
- *Span Length:* 58 - 73 m (190 - 240 ft)
- *Year of Construction:* 1994

- *Drilled Shaft Contractor:* Long Foundation Drilling Company
- *Subsurface Conditions:* Soft to stiff clays interbedded with layers of generally dense, waterbearing sand and silt. No rock formation. No boulders.
- *Pile Design:* 234 steel HP 14 X 73 piles driven in six capped groups, 33 to 44 piles per group, with multiple bent columns formed on top of each pile cap. Approximate minimum penetration of the piles below cofferdam seal elevation = 12.2 m (40 ft). Cofferdam seal elevation was about 6.1 m (20 ft) below the soil surface within the river. The seal elevations were approximately at the predicted scour depth.
- *Drilled Shaft Design:* 14 drilled shafts (one per bent column) with diameters of 1.53 m to 1.83 m (5 to 6 ft), with one bent column formed on the top of each drilled shaft. Approximate penetration of drilled shafts below soil surface = 21.3 m (70 ft).
- *Drilled Shaft Construction:* Permanent steel casing was set from the scour line elevation to the water level within the river for the river bents or to finished ground level for land bents. The scour elevation was estimated to be approximately 4.5 - 6.1 m (15 to 20 ft) below the soil surface at all bents. Polymer drilling slurry was used to maintain borehole stability. [Note: Permanent steel casing is expensive. Temporary casing or removable forms should be used where possible.]
- *Cost of Driven Pile Foundation as Bid (including cofferdams and caps):*  
\$1,709,400.00
- *Actual Cost of Drilled Shaft Foundation Option:* \$1,567,500.00
- *Cost Savings Realized by Using Drilled Shafts:* \$141,900 (8.3% of cost of piles)
- *General Note:* An axial loading test was conducted on a full-sized drilled shaft to evaluate drilled shaft performance prior to implementation of the drilled shaft proposal. The cost of this test (\$175,000) was included in the cost of drilled shaft option.

A photo of the construction operations for the Great Pee Dee River project, in which the drilled shaft contractor is placing casings off a barge within the river, is shown in Figure 1.4.

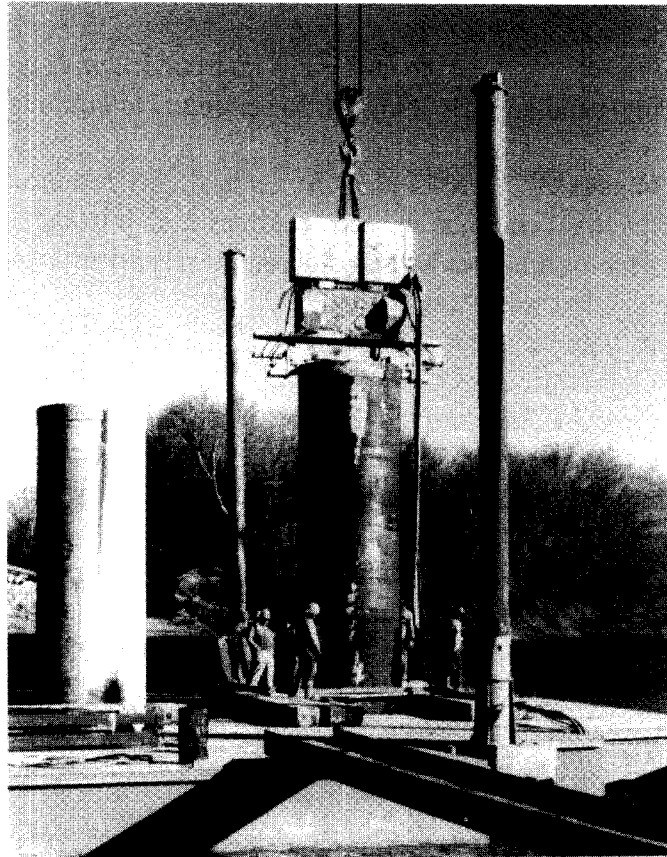

Figure 1.4. Construction of drilled shafts from barge in the Great Pee Dee River

There may also be situations in which drilled shafts are not economically suited to a particular project. For example, where soft clays and/or loose, waterbearing sands to large depths are encountered, the resistance advantage and relative ease of construction afforded by driven piles or other alternates may sometimes make them more economical than drilled shafts. For small, single-span, bridges in which the designer requires batter piles in the abutments, driven piles are often more economical than drilled shafts. However, in most other instances drilled shafts are cost-competitive with driven piles when both systems are designed appropriately. It is advisable that, where feasible, alternate designs, one including drilled shafts, be made and bids solicited on each alternate. Some guidance on the estimation of costs of drilled shafts is provided in Chapter 19.

## **REVIEW OF CURRENT PRACTICE**

### **Construction**

The attention to detail in the construction of drilled shafts is critical to ensure successful foundations. Several of the following chapters of this manual will deal with a number of those details. If proper and well-established procedures are employed, drilled shafts can be installed



successfully in a wide variety of subsurface conditions with differing geometries and for a number of applications. The applications are dealt with in the next section.

Certain limitations exist with regard to the geometry of a drilled shaft. Diameters of 300 - 360 mm (12 to 14 in.) can be used if the length of the shaft is no more than perhaps 10 m (30 ft). The concrete may be placed by free fall in small diameter shafts (as well as in shafts of larger diameter) if the mix is carefully designed to ensure that the excavation is filled and segregation is minimized. Such small foundations are commonly used to support sign structures and traffic barriers.

As the depth of the excavation becomes greater, the diameter normally must increase. Several factors that influence the ratio of depth to diameter are: the nature of the soil profile, the position of the water table, whether or not a rebar cage is required, the design of the concrete mix, and the need to support lateral loading. A concrete mix with a high workability (slump) is frequently required, as noted in Chapter 8. Ordinarily, the aspect ratio of a drilled shaft, or its length divided by its diameter, should not exceed about 30.

Heavy, rotary-drilling equipment is available for large drilled-shaft excavations. Cylindrical holes can be drilled with diameters of up to 6 m (20 ft), to depths of up to 80 m (244 ft), and with underreams up to 10 m (33 ft) in diameter, although such sizes are unusual. Percussion equipment can make excavations of almost depth with diameters up to 1.53 m (5 ft).

The versatility of drilled shafts is evident when the constructability is considered in various subsurface conditions. Situations that can be dealt with using readily available methods of construction are:

- Sockets into soft or hard rock.
- Boulders above glacial till or rock (if the boulders cannot be broken or removed, the diameter of the shaft excavation should be sized larger than the boulders).
- Residual soils where weathering is highly irregular.
- Karstic formations (solution cavities).
- Caving soils below the water table.
- Very soft soils (permanent casing may sometimes be required).
- Marine sites.

The detailed methods of construction that can be used in a variety of subsurface and surface conditions are presented later in this manual.

## Design for Axial Load

Drilled shafts were originally designed to resist load only in end bearing. Thus, the design involved the use of the equations of bearing capacity, such as those of Terzaghi (1943). Numerous loading tests conducted on instrumented drilled shafts over many years showed, however, that drilled shafts can often produce a substantial amount of resistance in side shear or "skin friction." Concurrently, design methods have been developed to predict the skin-friction resistance. The following general equation is now widely accepted by the engineering profession for the computation of the ultimate resistance of drilled shafts:

$$R_T = R_B + R_S \quad (1.1)$$

where

- $R_T$  = ultimate axial resistance of the drilled shaft,
- $R_B$  = net ultimate resistance in end bearing, and
- $R_S$  = ultimate resistance in side resistance or skin friction.

In the design methods presented here,  $R_B$  is considered to be a net bearing resistance, which is the gross, total resistance minus the weight of the shaft, so the shaft weight need not be considered as a load. For computing uplift resistance, however, the weight of the drilled shaft should be added to the right-hand side of the equation. That weight should include the effects of buoyancy if all or part of the drilled shaft is below the water table (piezometric surface).

While the magnitude of  $R_B$  could be determined theoretically from available equations of bearing capacity, research has revealed that these equations frequently need to be modified for drilled shafts to account for effects of construction. The magnitude of  $R_S$  depends on soil conditions, properties of the concrete, and method of construction. Prediction of values for  $R_S$  and  $R_B$  constitute a major focus of this manual. Considerable attention is given to evaluating  $R_S$  and  $R_B$  from soil or rock properties in Chapters 10 and 11. Once  $R_S$  and  $R_B$  are computed, the value of  $R_T$  can be found by use of Equation (1.1).

It is essential for the reader to understand that the factors suggested later in this manual for the determination of  $R_S$  and  $R_B$  are based primarily on experience in soils and rocks that can be described as "normal." For example, considerable information is available in data bases about the behavior of drilled shafts in uncemented sands deposited recently in geologic time and preconsolidated by the lowering and raising of the water table, for uncemented, overconsolidated clays and for uniform, soft rock. However, relatively little is known about the general behavior of drilled shafts in "structured" soils (soils that are cemented, highly sensitive or retain the structure of the parent rock) and in many types of rock, particularly heterogeneous and highly fractured rock. When these types of geomaterials are encountered, the acquisition of site-specific information on side and base resistance and resultant movements through load testing is strongly recommended.

Construction practices and controls have a significant effect on the performance of drilled shafts. The design factors that will be suggested in this manual should be coupled to the level of quality control and quality assurance that is expected by the designer to exist during construction. It is for this primary reason that it is essential for designers of drilled shafts to understand basic construction methods.

Design for axial loading can proceed in one of two ways. The traditional working stress design (WSD) method, sometimes referred to as the allowable stress design (ASD) design method, can be used in which a global factor of safety is selected and applied by using Equation (1.2):

$$R_A = \frac{R_A}{F} \geq Q \quad (1.2)$$

where

$R_A$  = allowable working load, and  
 $F$  = global factor of safety.

The value of  $R_A$  must equal or exceed the maximum unfactored, or "nominal," load applied to the drilled shaft.

More recently, AASHTO (1994) has produced a design code recommending the use of load and resistance factor design (LRFD) for drilled shafts and other structural components. The LRFD method in highway substructure design is described in detail in other FHWA publications (FHWA, 1996). With this method, various factors, with values of 1 or above, are applied to the individual components of load. Other factors, with values of 1 or less, are applied to the total resistance, or individual components of resistance, in such a way as to assure a margin of safety consistent with historical practice using global factors of safety. The LRFD approach to foundation design has the advantages that (a) foundations are easier to design if the superstructure is designed using LRFD (multiple sets of loads do not have to be carried along in the calculations) and (b) it offers a means to incorporate reliability into the design process in a rational manner. The basic design equation for axially loaded drilled shafts in the LRFD context, which is equivalent to Equation (1.2), can be written as:

$$\eta \sum \gamma_i Q_i \leq \sum \phi_i R_i \quad (1.3)$$

where

$\eta$  = a factor varying from 0.95 to 1.05 to reflect ductility, redundancy and operational importance of the structure.

- $\gamma_i$  = load factor for load type  $i$  (for example, dead load),
- $Q_i$  = nominal value of load type  $i$ ,
- $\phi_i$  = resistance (or "performance") factor for resistance component  $i$   
(for example, skin friction), and
- $R_i$  = value of estimated (nominal) ultimate resistance component  $i$   
(for example,  $R_s$ ).

Equation (1.3) is evaluated at the ultimate limit state, or state at which the foundation is viewed to collapse. Several different loading conditions, such as those for normal strength requirements and those for extreme-event-loading requirements, can be considered in this evaluation. Analysis of both geomaterial and structural resistance is required. Equation (1.3) is also evaluated for the service limit state, or state at which the structure becomes unserviceable, although it may not actually collapse. Different values of the load and resistance factors are often specified for the service limit state than for the ultimate limit state. That particular application of Equation (1.3) leading to the largest foundation is the most critical application for a given design, and the resulting drilled shaft configuration is incorporated in the final plans.

[The symbols for the load factors ( $\gamma$ ) and resistance factors ( $\phi$ ) are not to be confused with similar symbols used in another context with soil properties, in which  $\gamma$  represents unit weight and  $\phi$  represents angle of internal friction. These symbols are used both for LRFD factors and for soil properties in this manual; however, the specific use of each symbol should be clear in every instance.]

Equations (1.1) - (1.3) can be used to design drilled shafts in a variety of soils, rocks and geomaterials whose behavior is intermediate between soil and rock (so-called intermediate geomaterials). The details of such designs are discussed in later chapters.

### **Design for Lateral Load**

Drilled shafts can be used to sustain lateral loads (loads perpendicular to the axis of the drilled shaft) of large magnitude if a sufficient amount of reinforcing steel is employed and if the shaft is sized properly. The FHWA has sponsored various development projects that produced design procedures that are generally accepted and widely used in the engineering community. The procedures for design for lateral load will be discussed in Chapter 13, although lateral-load design is covered more completely in other FHWA references.

## **APPLICATIONS OF DRILLED SHAFTS**

The drilled shaft foundation is employed most frequently either to support heavy loads and minimize settlement, to support uplift loads, or to support lateral loads. Because of the versatility of the methods of construction that are described in subsequent chapters, drilled shafts can be constructed properly in a wide variety of soils. Casing or drilling slurry may be used to

allow effective construction in soils that are soft or have a tendency to cave or collapse.

The method of construction can be adapted to reduce noise pollution and damage to adjacent structures produced by loss of ground or by soil stress waves that are produced by driving piling. Specialized equipment is capable of excavating under severely restricted headroom.

The high load capacity of drilled shafts may allow the use of a single, large-diameter drilled shaft instead of a group of driven piles, as demonstrated by the examples summarized earlier in this chapter. Such foundations can also accommodate tight construction areas, such as freeway medians. The size and reinforcing of the drilled shaft is determined by the soil conditions, the loading, and the performance requirements. If lateral forces and/or moments have to be resisted, modifications to the structural properties are made to resist the bending stresses. Tensile loads are normally resisted by side friction of the drilled shaft. Reinforcement can be extended directly from the foundation into the structure to mobilize these tensile resistances. Drilled-shaft retaining walls can be used to resist lateral earth pressure as, for example, at a bridge abutment.

Drilled shafts can also be used to assist in stabilizing slopes (Wilson, 1964). In such a case a detailed study must be made of the slope, and a stability analysis made to investigate the effectiveness of the solution. The procedures on design for lateral loading will prove helpful in making such designs.

Other applications of drilled shafts are anchorages for tied-back walls, foundations for waterfront structures, breasting and mooring dolphins, and pier-protection systems. Figure 1.5 illustrates cases where drilled shafts with a variety of geometries have been placed in a variety of stratigraphies, and also illustrates various applications. Later sections of this manual provide guidance in selecting the geometry of the drilled shaft for a particular situation.

The final decision as to whether drilled shafts are a better solution for a particular problem than another type of foundation must be based on performance requirements, economic considerations, and equipment availability.

## **ADVANTAGES AND DISADVANTAGES OF DRILLED SHAFTS**

### **Advantages**

- Construction equipment is normally mobile and construction can proceed rapidly.
- The excavated material and the drilled hole can usually be examined to ascertain whether the soil conditions at a site agree with the expected soil profile. For end-bearing designs, the soil beneath the base can be probed for cavities or weak soil if desirable.

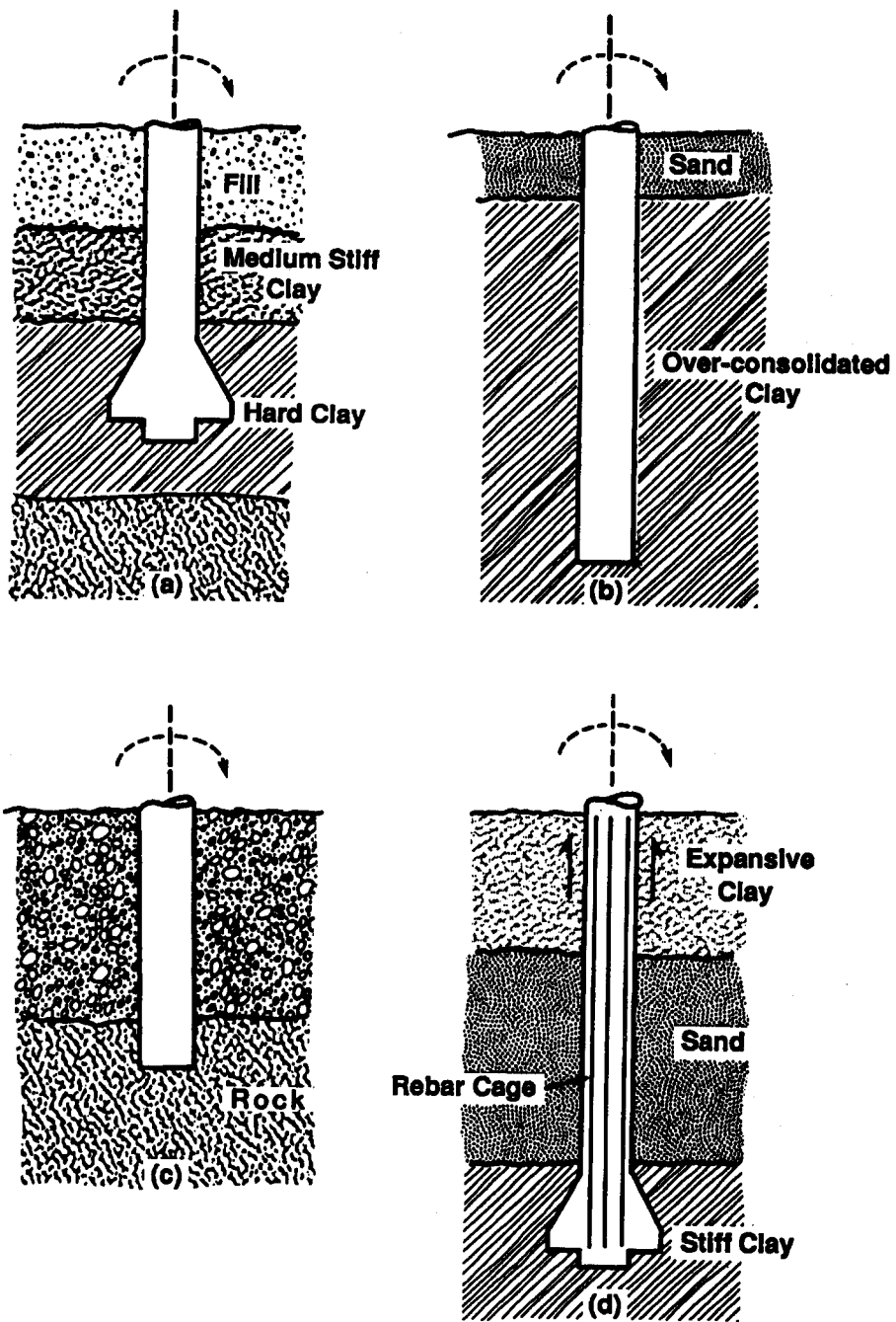

Figure 1.5. Cases for use of drilled shafts: (a) bearing in hard clay, (b) skin friction design, (c) socket into rock, (d) installation into expansive clay (continued)

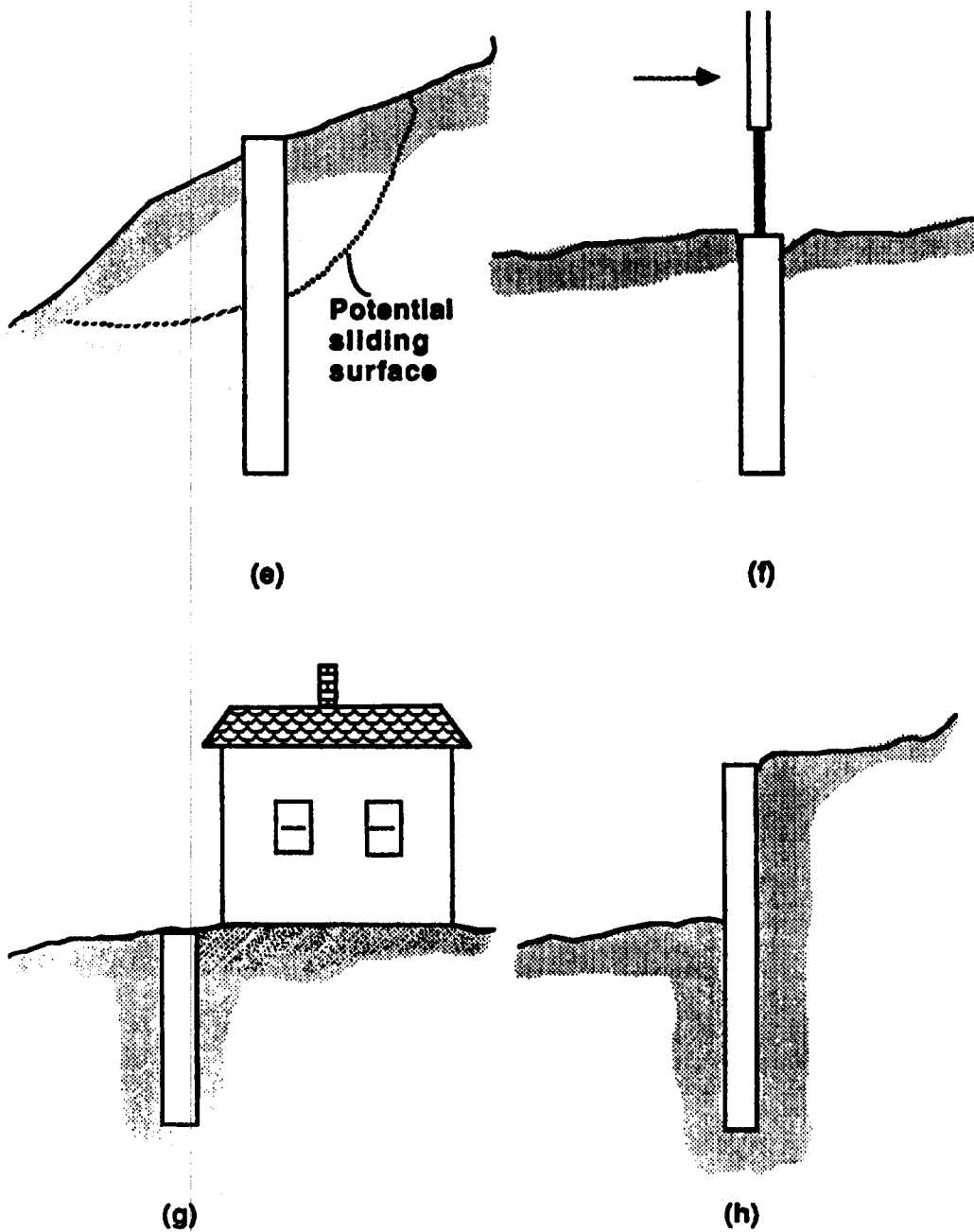

Figure 1.5 (continued). Cases for use of drilled shafts: (e) stabilizing a slope, (f) foundation for overhead sign, (g) foundation near existing structure, (h) closely-spaced drilled shafts to serve as a cantilever or tied-back wall (drilled shafts installed prior to excavation)

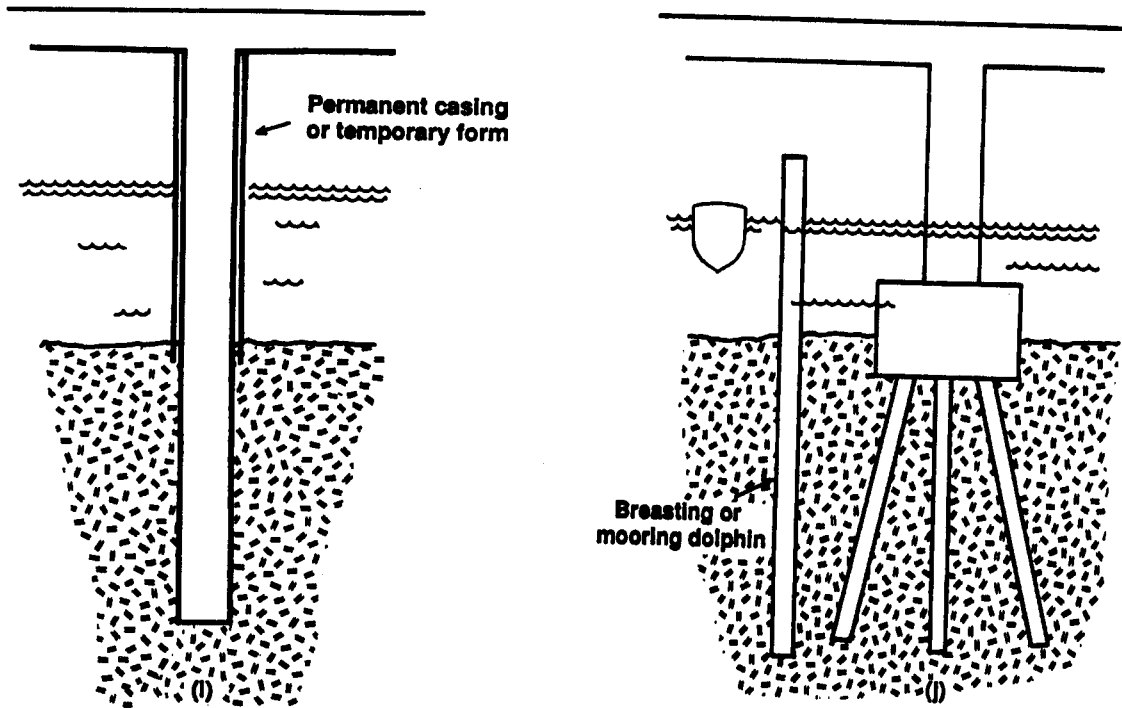

Figure 1.5 (continued). Cases for use of drilled shafts: (i) foundation at a marine site, and (j) pier protection or navigation aid

- Changes in geometry of the drilled shaft can be readily made during the progress of a job if the subsurface conditions so dictate. These changes include adjustment in diameter and in penetration and the addition or exclusion of underreams.
- The heave and settlement at the ground surface will normally be very small if proper construction practices are followed.
- The personnel, equipment, and materials for construction are usually readily available anywhere in the United States.
- The noise level of the equipment is less than for some other methods of construction, making drilled shafts appropriate for urban construction.
- The drilled shaft is applicable to a wide variety of soil conditions. For example, it is possible to drill through a layer of cobbles and for many feet into sound rock. It is also possible to drill through frozen ground.
- Minimal disturbance is caused to the surrounding soils by the drilling operation; thus, any consolidation settlement due to remolding of the soil is limited and reduction of shear strength of clay soils on a slope due to the installation of drilled shafts is typically smaller



than with driven piles, because large pore water pressures are not generated by drilled shaft construction.

- Very large loads can be carried by a single drilled shaft so that a cap is often not needed, as illustrated previously.
- Design procedures for axial loading, presented in Chapter 11, are available that allow designs of drilled shafts to be made considering load transfer both in end bearing and side resistance.
- Special instrumentation and high-capacity loading systems have been developed to allow load tests to be performed to obtain detailed information on the manner in which load is transferred from the drilled shaft to the supporting soil. These are described in Chapter 14.
- Special techniques are available to allow the non-destructive evaluation of drilled shafts for purposes of quality control and quality assurance.
- The circular shape of the drilled shaft makes it more resistant to the development of local scour around foundations in rivers, streams and estuaries than the non-circular shapes of many other foundations. Elimination of the pile cap, which can commonly be accomplished with drilled shaft foundations, also improves scour resistance. [Further information on scour computations, which is an important issue in bridge foundation design may be found in Richardson and Davis (1995).]

### **Disadvantages**

- The quality and performance of drilled shafts are sensitive to construction procedures, so that both experienced construction personnel and careful inspection are required.
- Drilled shafts are not normally used in situations where the shaft must penetrate an aquifer that is under artesian head (phreatic surface above ground surface).
- The construction of drilled shafts through contaminated soils is problematical because of the expenses incurred in disposing of the spoil.
- General knowledge of construction and design methods is lacking in some engineering organizations. Therefore, construction techniques may sometimes be specified that are unsuitable for the stratigraphy at the construction site.
- Since a single drilled shaft is frequently designed to replace a number of driven piles, the redundancy present in the group of driven piles is absent, which again requires diligence and expertise in construction and inspection.

While the quality of inspection that is required is not a disadvantage of drilled shafts, an uninformed inspector can create a number of problems during construction. Knowledgeable inspectors and a sufficient inspection staff are of critical importance when difficult drilling or unanticipated soil conditions are encountered. Precise, well-written construction specifications are also extremely important to assure that drilled shafts are constructed in accordance with the assumptions made by the designer and to minimize claims by the contractor.

## TRAINING RESOURCE

A video, approximately 20 minutes in length, introducing the viewer to drilled shafts is available from ADSC, The International Association of Foundation Drilling, P. O. Box 280379, Dallas, TX 75228; (214) 343-2091.

## REFERENCES

AASHTO (1994). *LRFD Bridge Design Specifications*, American Association of State Highway and Transportation Officials, Washington, D. C., First Edition.

Baker, C. N., Jr., and Khan, F. (1971). "Caisson Construction Problems and Correction in Chicago," *Journal of the Soil Mechanics and Foundations Division*, ASCE, Vol. 97, No. SM2, pp. 417-440.

FHWA (1996). *Load and Resistance Factor Design (LRFD) for Highway Substructures*, Manual for NHI Course, Federal Highway Administration, Washington, D. C.

Glossop, R., and Greeves, I. S. (1946). "A New Form of Bored Pile," *Concrete and Constructional Engineering*, London, Dec.

Greer, D. M. (1969). "Drilled Piers - State of the Art," *WCA Geotechnical Bulletin*, Vol. III, No. 2, Woodward-Clyde and Associates, New York.

Kulhawy, F. H. (1989). "Drilled Shaft Foundations," in *Foundation Engineering Handbook, Second Edition*, Ed. by H. Winterkorn and H.-Y. Fang, Van Nostrand Reinhold and Company, New York.

McClelland, M. (1996). "History of Drilled Shaft Construction in Texas," Paper presented before the 75th Annual Meeting of the Transportation Research Board, Washington, D. C., Jan.

Osterberg, J. O. (1968). "Drilled Caissons - Design, Installation, Application," *Proceedings, Soil Mechanics Lecture Series, Foundation Engineering*, Department of Civil Engineering, Northwestern University, Evanston, IL, pp. 151 - 208.

Reese, L. C. (1978). "Design and Construction of Drilled Shafts," *Journal of the Geotechnical Engineering Division*, ASCE, Vol. 104, No. GT1, pp. 91 - 116.

Richardson, E. V., and Davis, S. R. (1995). "Evaluating Scour at Bridges, Third Edition," *FHWA Publication No. FHWA-IP-90-017*, Hydraulic Engineering Circular No. 18, Federal Highway Administration, Washington, D. C.

Terzaghi, K. (1943). *Theoretical Soil Mechanics*, John Wiley and Sons, New York.

Whitaker, T., and Cooke, R. W., (1966). "An Investigation of the Shaft and Base Resistance of Large Bored Piles in London Clay," *Proceedings*, Symposium on Large Bored Piles, Institution of Civil Engineers, London, pp. 7 - 49.

Wilson, N. E. (1964), "Drilled-In Caissons Used to Stabilize a Moving Foundation," *Proceedings*, Congreso Sobre Cimientos Profundos, Sociedad Mexicana de Mecanica de Suelos, Mexico City, pp. 311 - 326.

## CHAPTER 2. SITE CHARACTERIZATION

### PURPOSE OF SITE CHARACTERIZATION

A key activity in the design and construction of drilled shafts, as for other foundations, is characterizing the site on which the drilled shaft foundation will be constructed. As illustrated in Figure 2.1, accurate subsurface characterization is required to aid in the design of the foundation, the selection of a construction method by the contractor, and to give both state DOT and contracting personnel guidance during construction operations. The site is characterized through surveys of existing historical, geologic and hydrologic data; surface reconnaissance; general site surveys by geophysical and/or remote sensing methods; and acquisition of detailed values of soil and rock parameters in order to forecast potential construction methods and potential difficulties and to perform the design. Certain details are required for any given design method. The engineer managing the site characterization effort should be aware of the details required for all potential design methods that may be used and should arrange for the collection of data accordingly. In this chapter the data required for the design methods outlined later in this manual will be clearly pointed out.

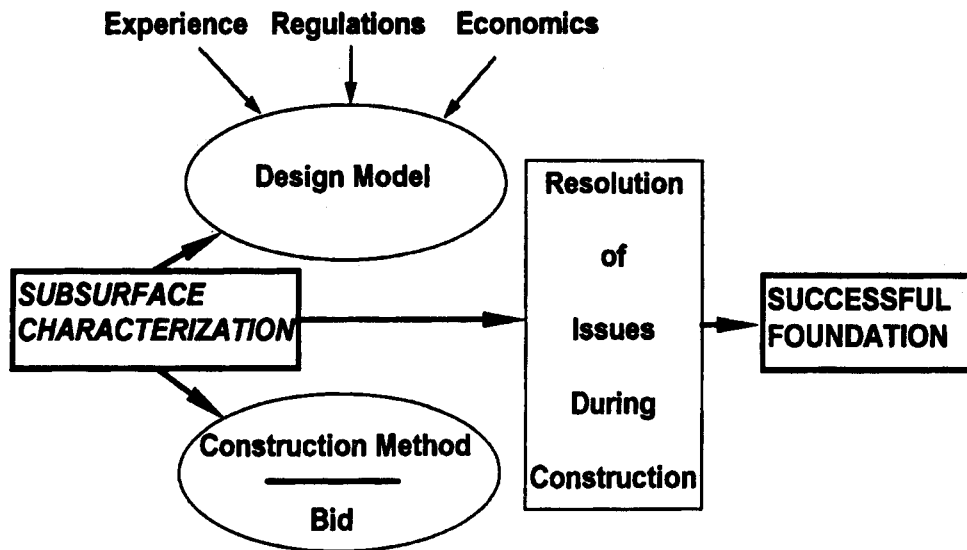

Figure 2.1. Subsurface characterization related to design and construction

Often, the best way to attack the problem of site characterization for drilled shaft foundations is through a phased exploration program, in which a general picture of the site conditions is drawn from a knowledge of the geologic setting of the site, existing subsurface data, surface reconnaissance and aerial surveys, perhaps augmented by widely spaced soil borings, probes

and/or geophysical studies to evaluate the general stratigraphy and any special features that may exist. An understanding of the three-dimensional structure of the site gained from this general picture is then used to assign locations for other borings and/or *in-situ* tests that will provide numerical values for the relevant geomaterial properties without excessive effort and will allow appropriate profiles and maps of subsurface features to be constructed by geotechnical personnel. A constant concern of geotechnical engineering personnel performing the site characterization is the variability of the site conditions and the reliability with which the strata can be located and principal properties of the geomaterials determined.

The choice of resistance factors (LRFD) or factors of safety (ASD) should depend directly on the level of confidence that the geotechnical personnel have in the values assigned to the various soil and rock properties and locations of strata. This means that the level of effort that goes into the characterization of a site and the level of expertise employed in interpreting geomaterial data will be directly reflected in the economics of the completed foundation. Appropriate investment in site characterization efforts will pay off in lower initial bids and reduced claims by the drilled shaft contractor.

It is not within the scope of this manual to describe detailed procedures for obtaining soil and rock properties. For the reader who is not familiar with sampling, laboratory testing, *in-situ* testing of soils, and soil mapping, the FHWA Soils and Foundations Manual (Cheney and Chassie, 1993), a detailed report on exploration and sampling by the Corps of Engineers (Hvorslev, 1962), ASTM Guide D5434-93 (ASTM, 1996), and the FHWA manual on Design and Construction of Pile Foundations, Vol. I (Hannigan et al., 1996a) should be consulted.

## **SITE INVESTIGATIONS**

### **General**

A site investigation for drilled shafts must not only provide the properties and spatial pattern of the major strata, but it should also provide details of the stratigraphy at the site. For example, the presence of a stratum of soft, compressible clay below a dense sand deposit may preclude the use of an end-bearing foundation in the sand. Furthermore, the importance of recording and reporting apparently minor details in a site investigation cannot be overstated, because such details may have major effects on the construction and performance of drilled shafts. For instance, the failure to identify a relatively thin stratum of submerged sand within a stratum of cohesive soil or rock could mean that the use of an inexpensive dry method of construction would be impossible. Caving soil, such as the submerged sand, would require the contractor to mobilize additional equipment, to use more materials, to take more time to do the work than he/she had envisioned in preparing the bid, and almost certainly to file a claim of "changed" (or more correctly, "unforeseen") conditions against the DOT.

Perhaps the most common problem of this type is the failure to identify the presence or extent of boulders in the subsurface exploration documents provided to the bidders. If a contractor has not

foreseen the need to drill through boulders or has underestimated the time necessary to do so based on the site investigation report, delays and claims are likely.

Accurate and detailed documentation of the subsurface conditions at a site also forms the basis by which the subsurface conditions that are actually encountered during construction can be confirmed to be equivalent to those used by the designer in making the design. Drilled shaft designers, therefore, should specify that logs be made of the character of the excavated soil or rock during drilled shaft construction and compare them in a timely manner with the stratigraphy assumed in making the design from the program of subsurface exploration. If there are significant differences, appropriate and timely changes can be made in the depth and/or diameter of the drilled shafts.

Philosophically, many foundation designers consider the driving resistance of a driven pile to afford a measure of the pile's capacity, particularly if the resistance is measured on a pile that is restruck, if the energy delivered by the hammer is monitored in some fashion, and if a computation is made with wave-equation methods (e. g., Hannigan et al., 1996b). Capacities of drilled shafts cannot be verified so easily during construction, so the designer must assure that subsurface information on the site stratigraphy and soil properties are documented thoroughly prior to designing and constructing the drilled shafts.

### **Surface Features**

The preliminary investigation should be approached so as to uncover all pertinent surface features at the site that will affect construction operations. Among the factors to be dealt with are the following:

- Restrictions on points of entry for drilling equipment, and restrictions on positioning of construction equipment, such as overhead power lines, existing bridges, and restricted work areas (e. g., medians).
- Existence of utilities and limitations concerning removal, relocation, or protection.
- Locations of existing structures on the site and on adjacent sites. Descriptions of the as-built foundations of those structures must be obtained if it can be reasonably expected that subsurface soil movements could occur at the locations of those foundations due to drilled shaft construction.
- Locations of trees and other major surface vegetation and limitations concerning removal or damage.
- Possibility of the existence of contaminated soils, such as may occur near the locations of abandoned underground petroleum tanks at service station locations or at the location of old landfills.

- Presence of surface water.
- Presence of fault escarpments, boulders, hummocky ground and other surface features that may suggest subsurface conditions.
- Initial and final surface contours of the site.
- Any information on the condition of the ground surface that might be reasonably expected at time of construction as related to the trafficability of construction equipment.
- Restrictions on noise and/or other environmental considerations.

### **Subsurface Pipelines, Cables, and Other Obstructions**

The site investigation must include, at an early stage, a careful survey of the subsurface facilities, both active and inactive. As-built locations of utilities that are currently in service must be carefully defined and clearly marked to prevent damage by construction equipment. Active utilities can often be located by reference to plans on file with local governmental agencies. The employment of a company that specializes in the location of subsurface facilities may sometimes be desirable, even if plans are available, as plans often do not show the as-built locations of utilities.

In urban areas, old foundations, storage tanks, abandoned utilities or old landfills are also frequently buried beneath the existing ground surface. Not only do encounters with such obstructions cause expensive delays, but hazardous gases trapped in landfills or hazardous liquids in abandoned tanks or pipes may pose a safety hazard to construction personnel and to the public. Such obstructions should be identified and marked at the job site.

### **Preliminary Subsurface Mapping**

On large projects it is advisable to map the subsurface using relatively inexpensive survey techniques, existing geologic data and existing subsurface exploration data prior to making detailed subsurface investigations. At soil sites, cone penetrometer test (CPT) probes can often be used for this purpose. Geophysical techniques such as spectral analysis of surface waves (SASW) are useful in delineating major strata and defining the continuity of subsurface structure, including the identification of soil/rock interfaces at sites where a clear demarcation between soil and rock exists. A specific technique that can be useful in bodies of water is the continuous seismic reflection profiling technique. This technique is illustrated for a crossing of the Connecticut River near Hartford in Figure 2.2. An excellent summary of geophysical site investigation techniques is provided in ISSMFE TC 10 (1994).

Geostatistical techniques, unavailable a few years ago, can be used to produce best-estimate, three-dimensional maps of selected key soil parameters from the results of a relatively small

number of probes. The techniques use the correlation between soil or rock parameters as a function of distances between sampling points on the site to derive interpolation or weighting functions to make a best estimate of the values of a particular parameter at points where it was not measured. One technique to accomplish such mapping is called "Kriging." Kriging theory is explained by Journel and Huijbregts (1978), and software to produce Kriging maps is documented by Englund and Sparks (1991). An example of a three-dimensional Kriging map for CPT tip resistance,  $q_c$ , for a small, overconsolidated clay site is shown in Figure 2.3. Anomalous conditions are evident where "spikes" appear on the Kriging diagrams, for example, near (X = 30, Y = 95) in Layer 2 in Figure 2.3. More intensive investigations may need to be made near such locations in the detailed site investigation that follows. Tomographic methods for the display of three-dimensional data based on probes, borehole geophysics and surface geophysics are being developed rapidly and should be a great help to designers of drilled shaft foundations in the future. It is still necessary, however, to obtain samples of the geomaterials from each of the strata identified in such a preliminary study for classification purposes and for laboratory testing.

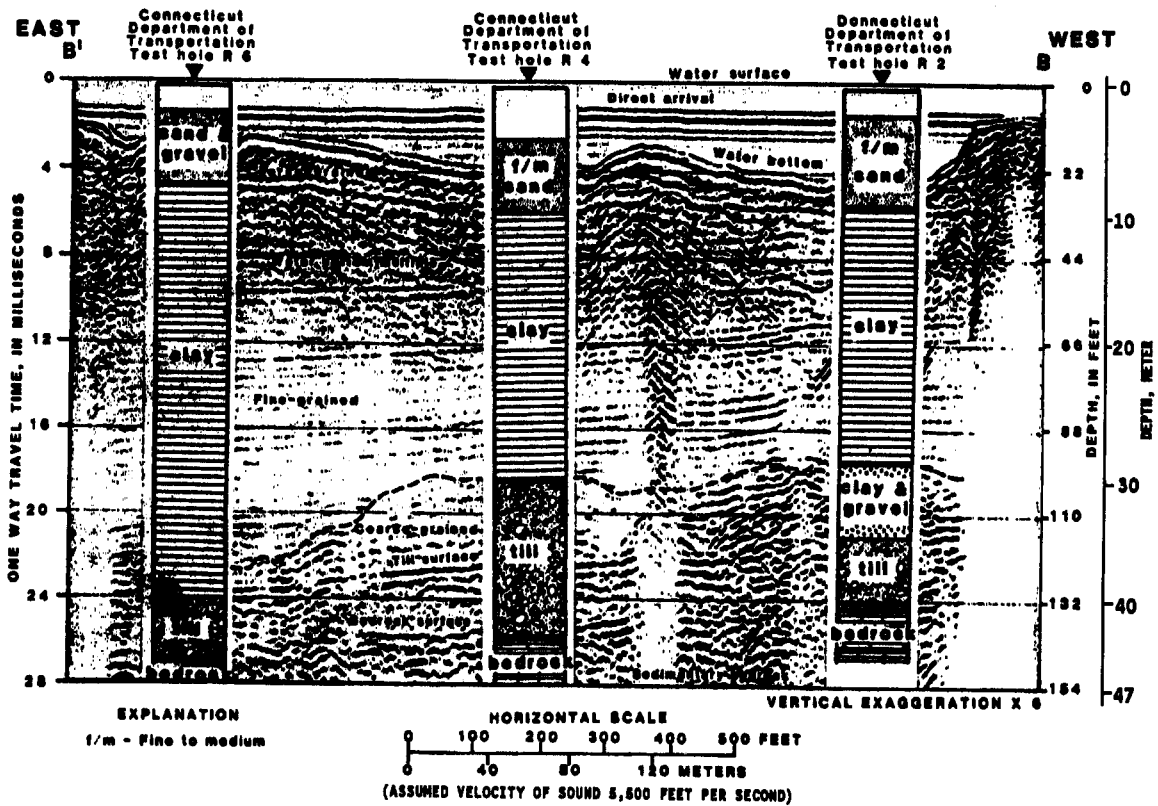

Figure 2.2. Low-frequency continuous seismic reflection profile for the Connecticut River at the Glastonbury-Wethersfield Bridge (Haeni, 1988)



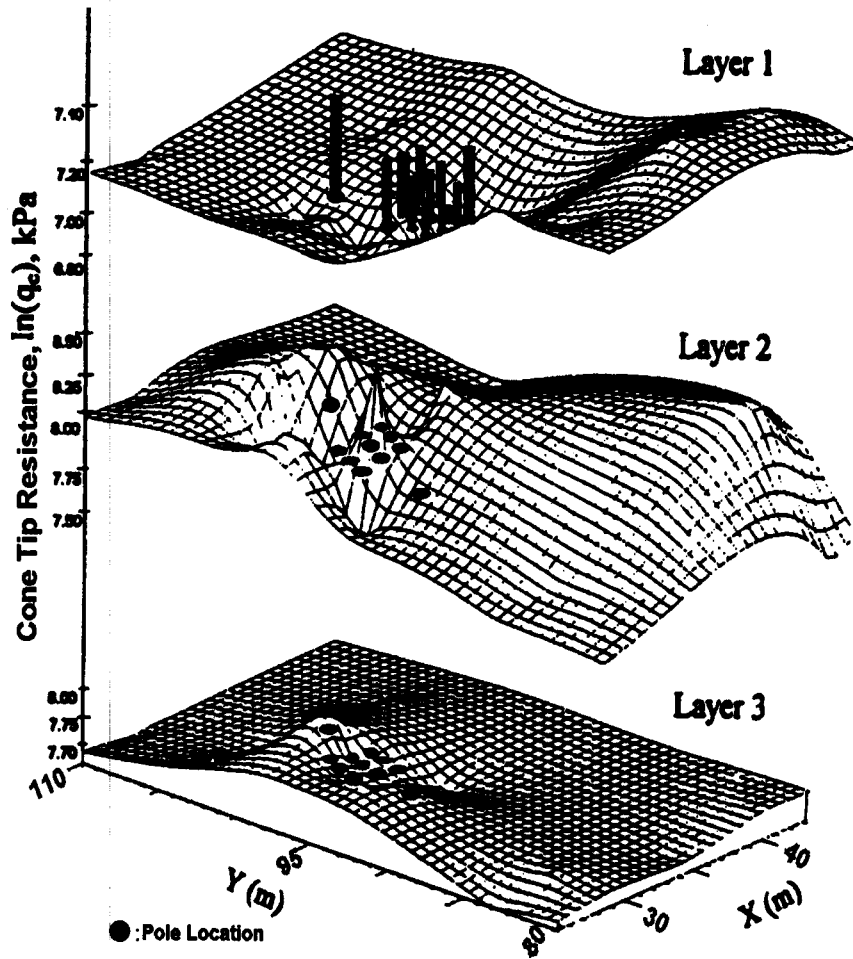

Figure 2.3. Kriging surfaces for three layers at overconsolidated clay site (Yoon and O'Neill, 1996)

### Detailed Site Investigations

The detailed site investigation that follows the preliminary investigation usually consists of making borings at close intervals to obtain relatively undisturbed samples of cohesive soil or rock and samples plus *in-situ* test values of some sort for granular soils. The locations of the borings are chosen carefully with respect to the planned locations of the drilled shafts. Because of the need for accurate subsurface information to perform the design and to forecast construction procedures, the frequency of borings shown in Table 2.1 is suggested for drilled shaft foundations for bridges [FHWA (1991)]. Of course, geologic details, observed variability of the subsurface conditions and practical considerations of site access may dictate other boring patterns. Boring depths should extend to at least 125% of the expected depths of the drilled shaft bases plus two base diameters in soil or in rock when the RQD is less than about 50 percent. Often, the design criterion is for bases to bear on sound rock, so, if RQD values in rock are

greater than about 50 per cent at the planned base elevation, the borings will normally only need to be taken to 100% of the expected depths plus two base diameters as long as the RQD remains above 50 per cent, since it is not very likely that the shafts will need to be deepened once the actual strata are exposed. Local geologic conditions may dictate other criteria for boring depths. The preceding is only a general suggestion. If, in the course of design or construction, it becomes necessary to deepen the shafts, supplementary borings should be taken.

The eventual method of payment for construction of drilled shaft foundations should be tied to the extent of the boring program. The program indicated in Table 2.1 is generally appropriate for "unclassified" payment, in which the drilled shaft contractor is paid by the meter or foot of completed drilled shaft regardless of the type of geomaterial encountered during the excavation process. It is not advisable to use less detailed boring programs when unclassified payment is specified.

Table 2.1. Recommended frequency of borings for drilled shaft foundations for bridges when unclassified excavation is specified (FHWA, 1991)

Redundancy Condition	Shaft Diameter (m)	Guideline
Single-Column, Single Shaft Foundations	All	One Boring Per Shaft
Redundant, Multiple-Shaft Foundations	≥ 1.83 m (6 ft)	One Boring Per Shaft
Redundant, Multiple-Shaft Foundations	1.22 - 1.82 m (4 ft - 6 ft)	One Boring Per Two Shafts
Redundant, Multiple-Shaft Foundations	< 1.22 m (4 ft)	One Boring Per Four Shafts

## TECHNIQUES FOR SUBSURFACE INVESTIGATIONS

### Information Required for Design

Prior to finalizing a program of subsurface investigation, it is helpful to know which soil parameters will be needed for the design calculations. Obviously, the subsurface investigation program should be planned so as to recover samples and/or acquire *in-situ* data that enable the designer to evaluate these parameters. Table 2.2 provides a brief list of the geomaterial parameters that must be evaluated in order to design axially loaded drilled shafts according to procedures given later in this manual.

The symbols used in Table 2.2 are as follows.

- $s_u$  = undrained shear strength, sometimes denoted  $c_u$ , often taken as one-half of the compressive strength (units of  $F/L^2$ ),
- $q_c$  = tip resistance from quasi-static cone penetration test (CPT) (corrected for pore pressure if data are from a piezocone) (units of  $F/L^2$ ),
- $f_s$  = sleeve resistance from quasi-static cone penetration test (CPT) (units of  $F/L^2$ ),
- $N_{60}$  = standard penetration test (SPT) blow count when 60% of the hammer energy is transferred to the drill string (Blows/0.3 m). Values will be uncorrected for depth or submergence unless otherwise noted,
- $q_u$  = unconfined compression strength (units of  $F/L^2$ ),
- RQD = "rock quality designation" =  $[\Sigma (\text{lengths of all pieces of recovered core} > 100 \text{ mm long})] / [\text{distance cored}]$  (dimensionless, sometimes expressed as a percent),
- $\phi_{RC}$  = effective angle of friction between the rock or IGM (defined below) and the concrete comprising the wall of the drilled shaft, not including any geometrically induced dilation (can be estimated crudely if not measured) (degrees),
- $E_{\text{core}}$  = Young's modulus of the rock or IGM core (can be estimated approximately from  $q_u$  if not measured) (units of  $F/L^2$ ), and
- IGM = "intermediate geomaterial," which is defined here as a cohesive earth material with  $0.5 \text{ MPa} < q_u < 5.0 \text{ MPa}$  or a cohesionless material containing minimal gravel sizes with  $50 < N_{60} < 100$ . These materials are transitional between soil and rock. Physically, they can be residual soils such as saprolites, glacial tills, or soft argillaceous (clay-based) rocks such as clay-shale and mudstone.

Table 2.2. Geotechnical parameters from borings or soundings to be evaluated numerically if design procedures in this manual are used

Geomaterial Type	Required Parameters
Cohesive soil (clay or cohesive silt) (Design for Undrained Conditions)	Classification (Unified or other system). Unit weight. $s_u$ (UU triaxial test) <u>or</u> $q_c$ , $f_s$ (CPT).
Cohesionless soil (sand, gravel or cohesionless silt, cohesionless IGM) (Design for Drained Conditions)	Classification (Unified or other system). Unit weight. $N_{60}$ (SPT), <u>or</u> ; $q_c$ , $f_s$ (CPT). Elevation of piezometric surface.
Rock or Cohesive IGM	Geologic description. Type of rock (Sandstone, Limestone, etc.) $q_u$ (Unconfined compression test)* RQD. Fracture/seam pattern; seam thickness. $f_{RC}$ , $E_{core}$ .

\* Point load tests may be performed if core lengths are too short for compression testing

In the event that drilled shafts in cohesive soils will be checked for loading under drained pore pressure conditions (long-term stability), the fundamental effective stress parameters  $c'$  and  $\phi'$  will need to be measured in the laboratory, and the coefficient of earth pressure at rest  $K_0$  will need to be evaluated in the laboratory or from *in-situ* tests, such as the pressuremeter test or the flat-plate dilatometer test. Ordinarily, however, drained loading does not represent a critical condition for design in cohesive soils.

It may also be beneficial to evaluate  $K_0$  for design for drained loading in cohesionless soils by similar testing methods. However, an approximate process to evaluate  $K_0$  from the SPT will be given for design in cohesionless IGM's, so that measurement of  $K_0$  at the site, while desirable, is not mandatory.

Additional data may be acquired where desirable to provide a clear understanding of geotechnical properties. For example, consolidation tests may be performed to evaluate the stress history of the soil in order to verify that the values of  $s_u$  that are obtained are reasonable, in order to compute long-term settlements beneath drilled shafts, or to estimate settlement of soil around drilled shafts due to imposed loads from embankments and similar sources; stress-strain data may be acquired from triaxial specimens if the engineer wants to predict lateral load-deformation behavior of drilled shafts or if procedures based on principles of elasticity are used to predict settlement; and one-dimensional swell tests may be conducted for evaluating the

performance of drilled shafts in expansive soils.

An important concept in the construction and design of drilled shafts is the concept of "effective stress" in the ground. This concept is illustrated in Figure 2.4, in which a layer of permeable, waterbearing geomaterial is encountered, in this case beneath a surface layer of relatively impermeable geomaterial. The position of the piezometric surface (or surfaces -- there may be separate piezometric surfaces in each layer) must be established in the subsurface investigation by employing piezometers or observation wells. If possible, the piezometric data from the site should be correlated to historical groundwater records to determine the expected range of water level to be encountered. The highest level historically should generally be used in design calculations.

To find the effective vertical normal stress,  $s'_v$ , at any depth  $z$  in the water bearing stratum, the simple equation at the bottom of the figure is applied if there is no free water above the ground surface. In that equation  $g$  is the total unit weight of the soil. If the site is under water (not shown in Figure 2.4),  $z$  is measured from the surface of the water, and  $\gamma$  is a depth-weighted average of the total unit weight of the soil and the overlying water.

The effective stress is the pressure applied by the weight of the overlying soil, including the water in the pores and free water above the ground surface, if any, minus the water pressure in the soil pores, as defined by the location of the piezometric surface. An important distinction is that the pore water pressure is not defined based on the level at which groundwater is first encountered in a drilling operation, but rather by the level to which it eventually rises (the piezometric surface). This level is shown below the level of the ground surface in Figure 2.4, but under certain geologic conditions, the piezometric surface could be above the ground surface (so-called artesian conditions). It is extremely important to identify such cases during the subsurface investigation. The location of the piezometric surface has important implications in assessing means by which a borehole can be stabilized during construction of a drilled shaft.

The piezometric surface is also used in estimating side shear resistance in drilled shafts, because the side shear resistance is related to the horizontal effective stress  $\sigma'_h$  in the ground, which is in turn related to  $\sigma'_v$  through the coefficient of earth pressure at rest  $K_0$ . It is possible, using pressuremeter tests, dilatometer tests, quasi-static cone penetrometer tests and standard penetration tests to estimate  $\sigma'_h$  directly, although such tests will normally not be conducted routinely.

When rock strata are encountered, they should be sampled, if possible, by coring. The most effective sampling tool is a triple-walled core barrel. Care should be taken to match the cutting bit to the type of rock encountered, information for which is provided in the sampling tool manufacturer's literature. It is important to measure the unconfined compression strength of rock cores ( $q_u$ ) where possible. Where the RQD of the recovered rock cores is too low to permit acquisition of samples, suitable for compression testing, the point load test may be conducted to provide an approximation of  $q_u$  (Rock Testing Handbook, 1990). Much additional useful information on characterizing rock formations is available in ASCE (1996).

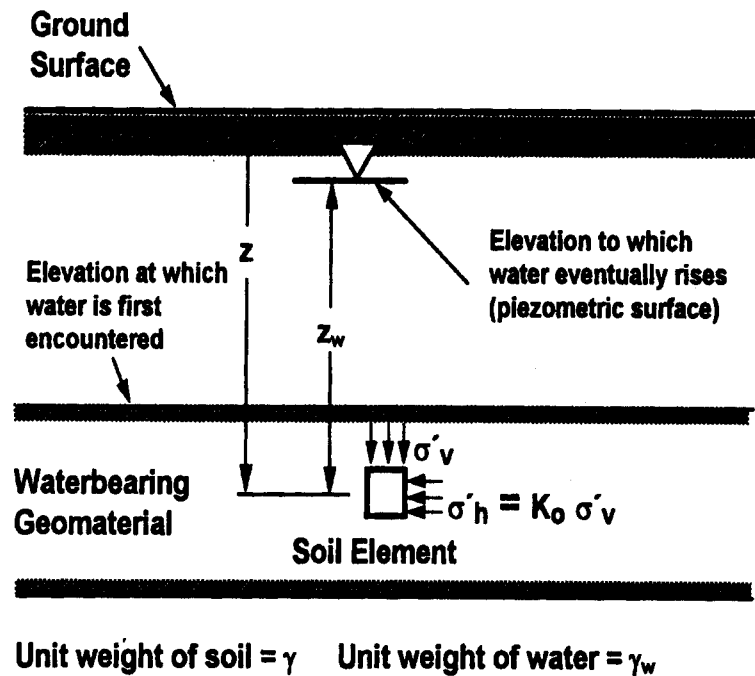

$$\sigma'_v = \gamma Z - \gamma_w Z_w$$

Figure 2.4. Schematic elevation showing definition of vertical and horizontal effective stresses in the ground

Contractors will be interested in knowing the difficulties that will be encountered in drilling the rock. Therefore, the numerical values of compressive strength and not just descriptive values of rock consistency, such as "hard rock" or "competent rock," should be reported to potential bidders. Joints, cracks, and other types of secondary structure will be of considerable interest to contractors, and such information is important to the designer, as well. It is important to retain rock cores for examination by prospective bidders on a construction project. Insisting that bidders examine rock cores may preclude excavation problems and claims during construction.

Intermediate geomaterials (IGM's) are earth materials that are transitional from soil to rock. The design rules for IGM's are different from those for soil or rock. Generally, however, the subsurface investigation is conducted much as for rock. When possible, the IGM is cored and classified, and cores are returned to the laboratory for unconfined compression or point load testing. An attempt should be made to define the joint pattern, as for rock. If the IGM is granular, then SPT tests are conducted to obtain N values and samples for classification and grain-size distribution. As with soils, it is important to determine the locations of water inflow, the piezometric surface and, where possible, unit weight.

## **Information Required for Construction**

As much information as possible should also be acquired to guide the construction of the drilled shafts. An adequate program for investigating the conditions of the subsurface soils and rocks is important for the selection of the proper construction procedure in addition to obtaining information for design. For example, if the site investigation so indicates, the contractor will come to the jobsite with equipment for making an excavation in rapid order without the use of casing or slurry. However, if a stratum of soil is encountered that is unstable, it may be necessary to stop the job, bring additional equipment to the job, and start negotiations about extra payment. Thus, the importance of a careful investigation that will reveal all the necessary details about construction procedures cannot be over-emphasized. The subsurface investigation must be accomplished in a manner that the appropriate equipment can be assembled at the job site. Specific data acquired from the subsurface investigation can be useful in making decisions about construction details later. Examples of such data are

- Grain-size distribution of granular soils (including sizes of cobbles and boulders) and hardness of boulders.
- Presence of cohesionless soils below the water table that may cause hole stability problems.
- Location of water seeps and rate of inflow of groundwater (if any) into the borehole, as well as location of piezometric (long-term) water level.
- Hardness, pH and chlorides content of the groundwater (if slurry construction is anticipated).
- Remains of old foundations, construction rubble, pipes or other buried obstructions (for which special provisions may need to be developed if obstruction removal is not considered in the standard construction specifications).
- Rate of advancement of the sample borehole.
- Torque and crowd (downward drilling force applied to the drill string) of the drilling machine used.
- Drilling tools and sampling tools used, and
- Shear strength, compression strength, joint patterns, SPT values, and other similar data supplied to the designer.
- Methods for borehole stabilization (casing, drilling mud, other).

Typical rotary wash-boring equipment for use in making a detailed subsurface investigation is shown in Figure 2.5.

Where it is possible that the geomaterial on a site may have been contaminated in the past, or where landfills are encountered, appropriate tests should be conducted on the soil, fill material and/or groundwater to identify the contaminants and their concentrations. The presence of toxic gases should be noted, as they can have a potentially deadly effect on persons entering boreholes during construction. There may be other reasons that gas could exist at a construction site. The subsurface investigation should deal with the possible existence of gas and whether or not there could be a risk to workers.

The design of many drilled shafts requires that they be socketed into "sound rock." Sound rock may be defined based on its RQD (for example, 50% or higher). The plans and construction documents should indicate the depth of exploration drilling at the borehole locations, particularly the penetration of rock cores. Either the contractor and engineer should agree on drilling depths at locations other than boring locations based on this information, or provisions should be made to core the rock at the base of every drilled shaft to confirm the rock quality. It is important that rock cores penetrate deeply enough into the rock formation to define the location of the sound rock zone and to confirm that rock that is not sound does not exist below the intended base elevations of the drilled shafts. If rock layers above the layer of sound rock that is decided upon for bearing will have to be penetrated by the drilling contractor, rock cores should be taken and tested in those layers and the information so obtained provided to the bidders for the project. When rock is to be used as a bearing material, an engineer who is familiar with the geology at the site should direct the subsurface investigation. Pinnacled rock presents special problems with regard to establishing bearing surface depths and construction procedures (Brown, 1990). It is imperative that such rock be identified and mapped as accurately as possible. Detailed construction documents must be available to allow correct decisions to be made as construction progresses.

Items other than  $q_u$  and the RQD of the rock that are useful in assessing the drillability of the rock are: drill water gain or loss; rock type with lithological description; characteristics of weathering; and the presence, attitude and thickness of bedding planes, foliation, joints, faults, stress cracks, cavities, shear planes, or other discontinuities. If available, experience in construction at adjacent sites in the same lithology should be documented.

The data enumerated in this section should be made a part of the boring logs and made available to bidders in order to provide them information for making informed decisions. They are also of use to the engineer, who must, in addition to making the design, forecast potential construction methods and construction problems in order to develop specifications for the project, make cost estimates and perform risk analyses.

### **Comments**

Some comments are in order. First, the successful completion of the design and construction of a drilled shaft foundation is highly dependent on the acquisition of accurate information about the subsurface materials. There is, of course, for each job an optimum expenditure that should be



made in obtaining data on subsurface conditions. In the opinion of the writers, actual expenditures are frequently less than the optimum.

The most frequent failures of drilled shaft foundations have almost always been related to improper construction procedures; therefore, careful attention should be given to the acquisition of all pertinent information about the subsurface conditions relating to the selection of construction methods.

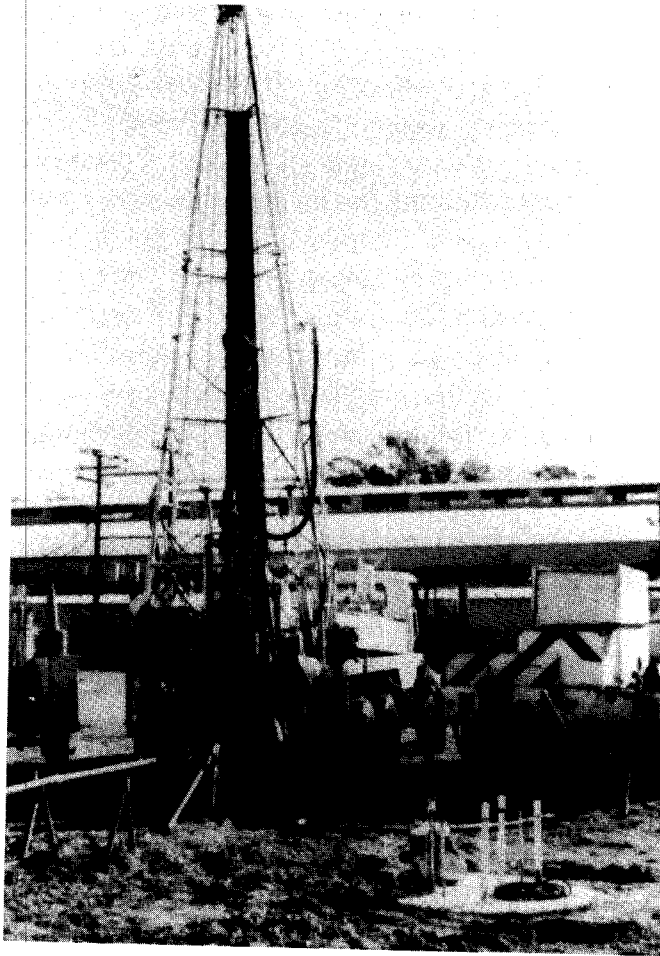

Figure 2.5. Wet rotary-type soil boring rig

### **Full-Sized Test Excavations**

With regard to construction and procedures, questions frequently arise that cannot be answered by use of data from small-sized boreholes. An example of such a question is the amount of water that will be found when the full-sized hole is drilled. Thus, the drilling of one or more full-sized excavations at representative locations with equipment similar to that to be used in the construction of the drilled shafts is desirable. Such activity should be carried out during the

subsurface investigation stage of the project. The drilling of a hole large enough to discover problems likely to be encountered by a contractor is imperative. The following difficulties are minimized if such a hole is drilled: (a) failure to discover caving or squeezing soil, especially if the wash-boring technique is employed in the site investigation; (b) failure to discover the presence of cobbles or boulders; a small diameter drill hole could pass by a cobble or boulder that would be easily found if the large-diameter hole was cut, or it could cut through a boulder that might be misidentified as a rock ledge; and (c) incorrect determination of the elevations at which water will flow into the excavation, and failure to learn the rate at which water will flow into an open borehole.

Full-sized test excavations are also useful in establishing the degree of roughness and general quality of the drilled surfaces of boreholes in rock and IGM's, and they also reveal fracture patterns in rock masses. Such information is needed for design purposes. Full-sized test excavations can also be used for performing *in-situ* plate load tests against rock masses to ascertain mass moduli of elasticity considering the effects of jointing in the rock. Establishment of fracture patterns can be accomplished by having personnel enter the test excavation within a protective casing in which observation windows have been cut or photographing the borehole with a down-hole camera. Such observations might then be correlated with observations in nearby cuts or natural slopes to assist the designer to obtain an overall picture of discontinuity patterns, specifically the orientation of the discontinuities, their spacing and whether they are closed, open and voided or open and filled with softer material.

## **UNCERTAINTY IN SOIL OR ROCK PROPERTIES AT A SITE**

One of the major tasks that the drilled shaft designer must execute is the choice of a factor of safety or a resistance factor. Often, choices are made based on values that have been used in the past in a given location, tempered with the judgment of the geotechnical engineer. The value used for the factor of safety or resistance factor depends to be degree on the level of uncertainty that exists in the quantification of the design parameters, which depends directly on the uncertainty in the numerical values for the soil parameters obtained in the subsurface exploration. When a site is extremely variable and/or when few geomaterial samples are tested, uncertainty is high, and a high factor of safety or low resistance factor should be used, unless the engineer selects very conservative values for the soil parameters based on available data. In ASD, factors of safety for axially loaded drilled shafts typically range from about 2.0 to 3.5, depending on the designer's judgment. This uncertainty can be reduced considerably by making a boring at the location of every drilled shaft on the project. This also reduces the probability of contractor claims. If such a boring program is not executed, the designer must develop design parameters for a grouping of drilled shafts from a grouping of nearby borings. Statistical methods for handling such data are addressed in Appendix A.

Statistical methods are slowly coming into use through a process known as "reliability-based design," where formal mathematical calculations are made regarding the uncertainty of the soil and rock parameters used for design, and factors of safety or resistance factors are related to the

computed level of uncertainty. A simple process for making statistical estimates of geomaterial variability and evaluation of uncertainty in geomaterial properties is described in Appendix A. It is not necessary to apply this process in design, but doing so provides a measure of support to the application of the designer's judgment.

## **EFFECTS OF PILES AND DRILLED SHAFTS ON SOIL AND ROCK PROPERTIES**

In addition to discussing the soil and rock properties that are needed in assessing constructability and in performing designs, it is useful to describe how soil and rock properties are affected by installation of both driven piles and drilled shafts. Driven piles are included in the discussion in order to emphasize the differences in the effects of installation caused by the two types of foundations and consequently the need to apply different design procedures for estimating resistances of piles and drilled shafts.

### **Installation in Clays**

When a pile is driven into clay, the clay undergoes only a minor decrease in volume and is forced away from the pile as it penetrates. The movement of the clay may cause some heave of the ground surface, depending on the volume-change characteristics of the soil that is displaced and the type of pile.

The disturbance of the clay caused by driving the pile will produce an initial reduction in the shear strength of the clay, but simultaneously lateral stresses are generated as the soil is displaced. The lateral stresses will cause a time-related decrease in the water content of the soil at the pile wall and an increase in the shear strength. Thus, there will be an increase in the "skin friction" with time; a phenomenon that accounts for the "set-up" that is often observed for driven piles in clay and other fine-grained material.

The effects of installing a drilled shaft into clay are, of course, entirely different from those of installing a pile. If the clay is homogeneous so that the excavation will remain open and dry, there will be a creep of the clay toward the axis of the excavation and subsidence of the ground surface. The creep and subsidence will be substantial if the clay is weak but minimal for stronger overconsolidated clays where drilled shafts are often employed. Drilled shafts can often be constructed without supporting the excavation in homogeneous clay until the depth exceeds about  $5 s_v/\gamma$ , where  $\gamma$  is the total unit weight of the soil, beyond which rapid squeezing or collapse of the borehole will occur. The disturbance and stress relief due to drilling will cause some loss of shear strength at the surface of the borehole, which must be dealt with in design..

If the clay is jointed and cracked, it is possible that water will seep into the excavation. The joints could open and blocks of clay could fall into the excavation, possibly during concrete placement, where such a condition could require reconstruction of the drilled shaft. Thus, it may be necessary to fill the excavation with water or with bentonitic or polymeric slurry to maintain hole stability. The fluid in the excavation may possibly have some additional effect on the shear

strength of the clay along the surface of the borehole.

The placement of the fluid concrete in the excavation will impose a lateral stress on the sides of the excavation, the magnitude of which is dependent on the fluidity and rate of placement of the concrete. If the excavation is drilled dry, moisture from the fluid concrete can migrate into the clay and cause some additional softening. This problem can be important in concrete that is mixed with a high water-cement ratio, in which much more water than is needed to hydrate the cement is used in batching. Whether the excavation in the clay is wet or dry, there is evidence to show that there is an interaction between the clay and particles of cement and/or products of cement hydration, with a consequent strengthening of the bond between the concrete and the clay. The interaction results in a larger strength at the interface than the softened strength that exists just after concrete placement.

After a driven pile or a drilled shaft is subjected to a compressive load from the superstructure, there will be an increase in the stresses in the soil surrounding the pile. These stress increases can cause decreases in the water content around the foundation and a consequent increase in the shear strength. A time-related increase in load capacity and settlement will accompany the increase in shear strength, which is the reason that drained pore pressure conditions normally do not control the strength design. Occasionally, however, in highly overconsolidated clays and clay-shales, the geomaterial along the sides of the shaft may dilate and draw moisture from the surrounding material, resulting in long-term strength loss.

The above discussion is a much simplified account of the effects on properties and behavior of clay soils when a pile or a drilled shaft is placed; however, the account serves to emphasize the point that the character of the soil around a deep foundation is not the same as that of the *in-situ* soil. Nevertheless, the intent of the subsurface investigation must be to determine, as well as possible, the properties of the *in-situ* soil. Beyond establishment of *in-situ* soil properties, the most common additional concerns become the sensitivity of the clay (loss of strength due to disturbance) and its propensity to absorb water from either slurry or fluid concrete.

### **Installation in Sands**

The ground surface often settles when a pile is driven into a stratum of loose to medium dense sand. The vibration of the pile due to the impact of the pile driver can cause the sand grains to move downward and outward as the pile penetrates, resulting in a densification of the sand around the pile and a consequent settlement of the ground surface.

If the pile toe encounters a layer of dense sand, the grains cannot move about and densify further. The energy at the tip of the pile must be sufficient to crush the grains and to move a large mass of soil beneath the pile if the pile is to penetrate. If the energy is insufficient, the penetration of the pile will cease.

The lateral effective stress  $\sigma'_h$  against the walls of a straight-sided pile in granular soil is usually

somewhat greater than the at-rest earth pressure ( $K_o \sigma'_v$ ). The lateral stress is related to the movement of the particles of sand during pile-driving, the lateral vibration of a driven pile, the strength and stiffness of the sand stratum, and the phenomenon of arching. The sand beneath the toe of the pile will be densified, and it might be expected that the ability of the sand to support load in end bearing would be improved over that for the *in-situ* condition.

If the sand in a drilled-shaft excavation is prevented from collapsing by driving a casing into place, the behavior of the sand around the perimeter of the casing will be similar to that of a driven pile. On the other hand, drilling under bentonitic or polymeric slurry (Chapter 6) may loosen the sand to some extent. The sand may tend to creep laterally toward the axis of the slurry-supported excavation because the unit weight of the slurry is less than the unit weight of the sand that was excavated. In either case the sand will heave at the base of the excavation, resulting in lower unit end bearing than for a driven pile. The end-bearing load-deformation behavior may be adversely affected by construction practices that fail to remove cuttings that have been suspended in drilling slurries during borehole excavation.

The placing of concrete with high workability (cohesive mixes with high slump) will impose stresses against the sides and base of the excavation that are larger than those from the slurry, and the fluid concrete could then cause a slight densification of the sand adjacent to the wall and base of the drilled shaft. Concrete with a low slump will bulk and not collapse under its own weight. In addition to producing potential defects such as "honeycomb" or voids in the concrete, this effect causes the lateral stress against the sides of the excavation to be less than would occur had the concrete been fluid. The resistance along the sides are to some extent dependent on this concrete pressure, so that low-slump concrete can also have a negative effect on geomaterial resistance.

As with clay, the properties of sand around a drilled shaft can be very different from the *in-situ* properties. The subsurface investigation should be designed to reveal as well as possible the *in-situ* characteristics of the sand, especially its density and grain-size distribution. The parameters selected for the design of a drilled shaft in sand will then be adjusted by the design method according to the best estimate of the properties of the sand that exist around the drilled shaft as built.

### **Installation in Rock**

Piles are not often driven into rock. The requirement to bear on or penetrate rock strata often dictates the use of drilled shaft foundations. One of the important considerations of rock-socketed drilled shafts is the condition of the side of the borehole. High values of side shearing resistance can develop because of dilation that occurs between a rough surface at the boundary of the concrete and the mating surface in the rock, as illustrated by Figure 2.6. Upward or downward movement ( $w$ ) of the concrete shaft caused by applying axial loads produces lateral compression of the rock ( $\Delta v$ ) and, as a result, higher lateral stresses along the concrete-rock interface than existed after the concrete was placed. The increased lateral stresses can in turn

increase the strength of the rock if pore pressures dissipate rapidly.  $\Delta v$  depends to a large extent on the angle  $\gamma$  of the asperities along the interface. Either the rock or concrete finally fails by some manner of shearing through the respective asperities, at a high value of resistance, which will be described further below.

Construction practices that cause the concrete-rock interface to be smooth, rather than rough, can have a profoundly negative effect on the side shearing resistance that develops in rock sockets. For example, in argillaceous (clay-based) rock, such as shale, mudstone and slate, the presence of free water in the borehole during drilling (for example, due to minor inflow of water from a small perched aquifer near the surface or due to intentional introduction of water by the contractor to aid in excavating cuttings) can cause the surface of the rock to become fully softened, or "smeared," so that any effect of borehole roughness is almost completely masked. Figure 2.7 shows an analysis of the smearing condition for a drilled shaft of 0.61 m in diameter penetrating 6.1 m into a soft shale. The side load-settlement curve on the right considers a rough interface in a rock. The curve on the left indicates the effect of a rough interface in a geomaterial with the properties of the degraded (smeared) rock; the next curve shows a smooth interface in the original rock; and the third curve from the left shows a rough interface in the original rock in which a smear zone of approximately 12 mm (0.5 in.) in thickness was produced during drilling and which exists between the concrete and soil during compression loading. The rough interface with degraded (smeared) rock behaves very similarly to the smooth interface, and the behavior of drilled shaft with a smeared interface is closer to the behavior of a drilled shaft in a mass of soil with the properties of the degraded rock than one with a rough interface in the original rock. The appearance of borehole surfaces can be examined during the drilling of full-sized test excavations at a given site, providing valuable guidance in the design process.

## SOIL AND ROCK MECHANICS RELATED TO DRILLED SHAFT DESIGN

The subsurface investigation and subsequent laboratory testing performed for the design of drilled shafts should be carried out in consideration of the soil and rock properties to be used. A brief discussion of elementary design concepts is presented here, first for a granular soil, second for a cohesive soil and finally for a rock.

Figure 2.8 shows two sections from a drilled shaft that has been pushed downward by loading. An element, shown in Figure 2.8a, is taken along the length of the drilled shaft at the depth  $z$  below the ground surface. It has a height  $dz$ . The dashed line in Figure 2.8a is intended to depict a sliding failure surface that develops as the drilled shaft is pushed downward. The sliding surface is drawn at some distance from the shaft wall but, depending on the circumstances, the sliding surface could be at the interface between the concrete and the soil.

The normal effective stress in the radial direction  $\sigma'_h$  on the failure surface is shown in Figure 2.8a, along with the resulting shearing resistance  $f$ . The load that can be carried in side shear by the drilled shaft can be found by integrating the stresses at failure, termed  $f_{max}$  over the surface of the shaft.

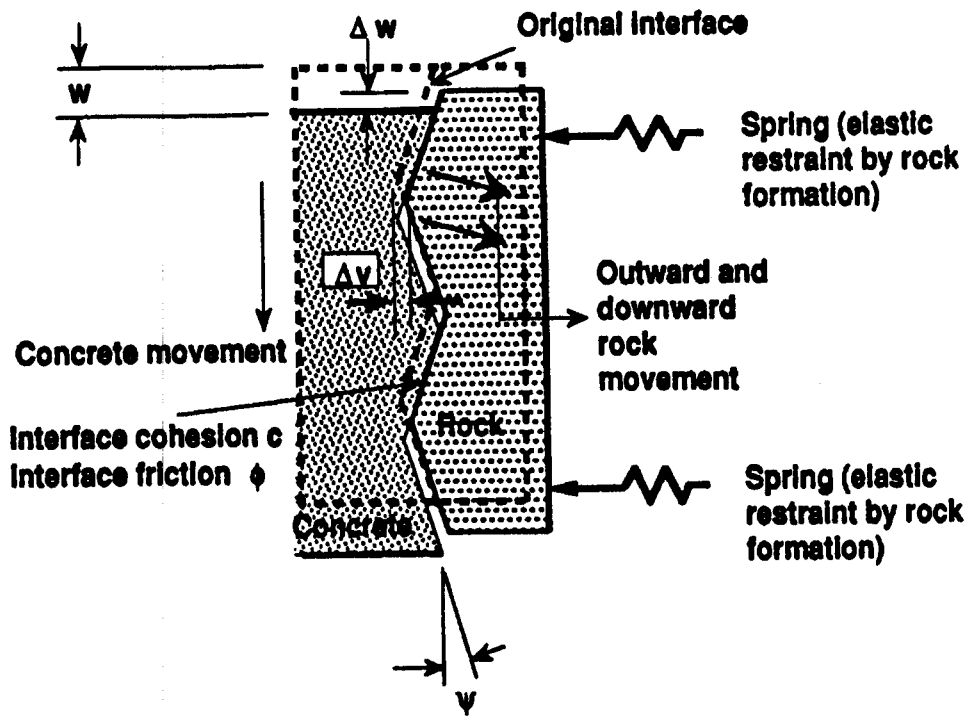

Figure 2.6. Illustration of the concept of dilation at the interface of concrete and rock (O'Neill et al., 1996)

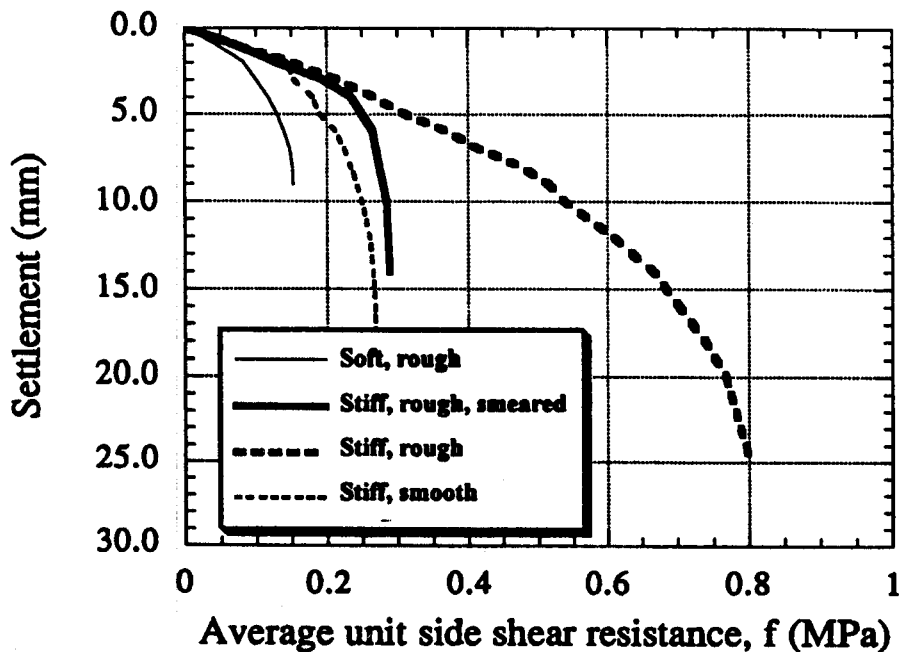

Figure 2.7. Effect of borehole smear on load-settlement behavior of a drilled shaft in rock (Hassan and O'Neill, 1997)

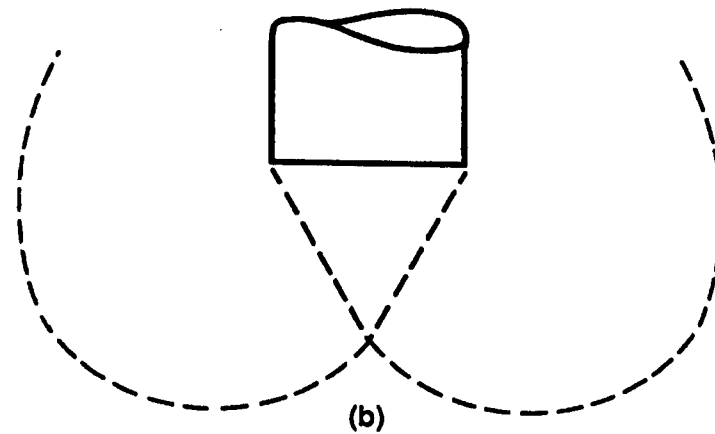
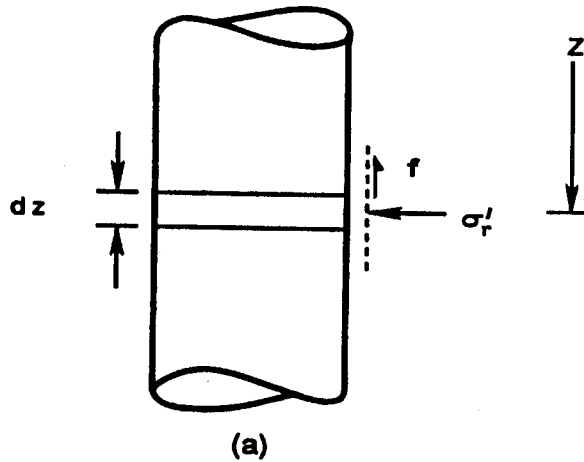

Figure 2.8. Possible sliding surface when a drilled shaft is pushed downward

Figure 2.8b shows the base of a drilled shaft, with the dashed lines indicating possible sliding surfaces that will develop as the base of the shaft is pushed downward and undergoes bearing failure. Bearing-capacity factors correlated with the friction angle of the sand can be used to obtain the ultimate load that may be carried in end bearing. However, the sand mass is relatively looser beneath the base of a drilled shaft than it is *in situ* because of the stress release that occurred during construction, so considerable displacement may be required to develop the computed bearing capacity. Therefore, empirical methods calibrated to loading tests, rather than methods that use theoretical values, will be proposed in Chapter 11 to compute base resistance.



The relationship between the normal stress  $\sigma'_r$  and the maximum shear stress  $f_{\max}$  will be discussed briefly. Terzaghi (1936) stated that  $\sigma'_r$  should be the effective stress (the intergranular stress between the grains of the soil) and not the total stress, which would include the water pressure in the soil pores. For sands, gravels and sandy silts, it can be assumed that drainage of water will occur rapidly into or out of the soil pores, as necessary for the pore water pressures to be in equilibrium with the surrounding formation, and that the normal effective stress  $\sigma'_r$  will also reach equilibrium soon after installation of the drilled shaft. Figure 2.9 shows the relationship for sand between  $f_{\max}$  and  $\sigma'_r$ . Three lines are shown that give the friction angles: one of the lines shows the friction angle for the grain-to-grain behavior *in situ*, and the two bounding lines show the possible range of friction angles for concrete-to-soil behavior after the drilled shaft has been constructed. The range shown is an example of the uncertainty that arises from the construction process. It is caused by possible densification or loosening of the soil at the borehole wall by the drilling process and by other factors such as penetration of drilling slurry into the soil pores. As may be seen, the shear stress (and side resistance of the drilled shaft) increases with an increase in normal effective stress  $\sigma'_r$ . It is also important to note that the construction process may result in values of  $\sigma'_r$  that are different from (often less than) the values that exist *in situ*, so that measuring either  $K_0$  or  $\sigma'_r$  *in situ* during the site investigation may not be sufficient to make estimates of side shear resistance for design without adjustment.

If the drilled shaft is constructed at a site where there is saturated clay, a very different approach is taken to the computation of the shaft resistance. The permeability of a homogeneous clay is extremely low, so that drainage will occur at a slow rate if the porewater is stressed during either construction or loading. Theory and experimental observations show that, when an increment of stress is imposed on a soil mass, the stress is taken initially by the pore water. If the soil is a homogeneous clay, there will be no initial increase in the effective stress (the intergranular stress). Because the decrease in the pore water stress will occur slowly, the design of a foundation on clay is usually based on the concept that the strength of a saturated clay is independent of the applied stress. Thus, the undrained strength of the clay is used in the analyses. [Analyses using effective stresses may occasionally be performed to ensure that the resistance of the drilled shaft after all excess pore water pressures have dissipated exceeds the resistance before they have dissipated, particularly in very heavily overconsolidated clays, in which negative pore water pressures can develop during construction and loading.]

Figure 2.10 illustrates the undrained strength concept that is used for the design of drilled shafts in clay soils. The undrained strength,  $c_u = s_u$  of the clay, is illustrated by the horizontal, solid line. The line indicates that the undrained strength  $c_u$  is independent of the normal stress  $\sigma_r$ . [The effective stress remains constant as the total stress is increased, so the total stress,  $\sigma_r = \sigma'_r +$  pore water pressure, is shown here.] The solid line shows the shear strength of the clay in the vicinity of the shaft wall as modified by the installation of the drilled shaft, as discussed in the previous section.

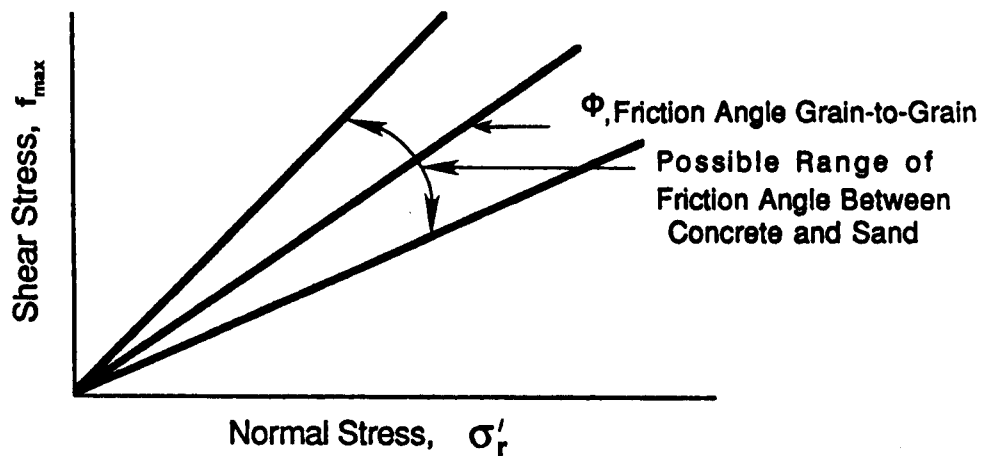

Figure 2.9. Friction angles for sand at or near the wall of a drilled shaft

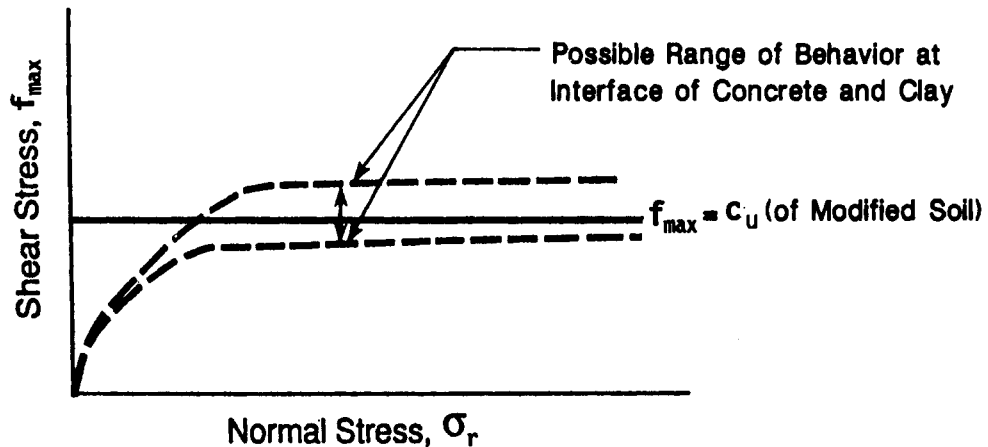

Figure 2.10. Failure relationship for saturated clay at or near the wall of a drilled shaft

The two dashed lines in the figure show the possible range of behavior of the clay at the interface of the concrete and clay, again illustrating a level of uncertainty. If the normal stress is zero at the interface, no shearing resistance will be mobilized. This is consistent with the case where the concrete has a low slump and will not exert pressure against the sides of the excavation. As the normal stress at the interface is increased, the shearing resistance will increase until a limiting value is reached. The clay at or near the interface, depending on the interaction between the

fresh concrete and the clay, may gain or lose strength. If the interaction has achieved a stronger shearing resistance than the shear strength of the modified soil  $c_u$  as indicated by the upper dashed line, Figure 2.10, the failure that occurs when the drilled shaft is pushed down will develop in the soil near the interface. If on the other hand the interface resistance is given by the lower dashed line in Figure 2.10, the failure will occur at the interface and not in the soil. Base bearing capacity can be assessed sufficiently accurately from bearing capacity theory using the *in-situ* undrained shear strength of the soil.

The brief discussion that is presented on the behavior of clay around a drilled shaft indicates that design methods, presented in Chapter 11, must take into account the modification of the undrained strength by the numerous factors associated with the installation of the drilled shaft.

When drilled shafts are socketed into rock, a concern of the designer is whether the ultimate side and base resistances can be added together to obtain the total ultimate resistance of the drilled shaft. Some rocks [generally having unconfined compression strengths over about 5 MPa (700 psi)] lose much of their shearing resistance after having been sheared to failure and then subjected to greater displacement. One can consider this phenomenon to be equivalent to destroying the cohesive component of shear strength of the rock, while leaving the frictional component intact.

It usually takes much more displacement to mobilize base resistance than side resistance, so, to develop the ultimate capacity of the drilled shaft, one must add together the base resistance and the side resistance that are achieved at a displacement of perhaps 5 per cent of the socket diameter. By this time, if the rock is brittle, its side resistance will be less, perhaps much less, than will be suggested by the design methods in Chapter 11. A conservative approach will therefore need to be taken.

The designer should first find out whether the rock exhibits brittle shear behavior. This can be done by conducting direct shear tests on samples of the rock using constant normal stresses, or by conducting load tests on segments of rock sockets in the field by methods described in Chapter 14. If, in one or more of these tests, the rock is found to lose most of its shear strength (which will be the cohesive component) after developing its peak shearing resistance, the designer can choose to ignore side resistance in design, which is probably much too conservative for sockets with appreciable penetration of rock. Alternatively, he or she can add the full, peak side resistance to the base resistance that is developed at the settlement that produces side shear failure (less than the full, ultimate base resistance). If such a design approach will be taken, it is important for the designer to know the Young's modulus of the rock through *in-situ* or laboratory testing in order to compute settlements. He or she could also add the full, ultimate base resistance to only the frictional component of side resistance. The ultimate unit side resistance in such as case in a rough, smear-free socket can be estimated as  $\sigma'_v K_o \tan \phi_{\text{rock}}$ . This would require measurement or estimation of  $K_o$  at the site and the value of  $\phi$  for the rock at large displacements.

If the rock is found not to exhibit brittle behavior (that is, does not lose strength when shear

displacement is increased beyond the displacement that first produces failure), then it is appropriate to compute both peak (maximum) side and base resistances and add them together to obtain the total (unfactored) resistance.

An additional consideration in rock is the important effect that discontinuities and seams have on the behavior of the rock mass into which the drilled shaft is placed. Shaft resistance can be reduced substantially if open horizontal discontinuities or soil-filled seams exist along the side of the shaft, since the harder layers will tend to break in flexure as shear loads are applied due to lack of vertical support. Soft seams also restrict normal stresses produced by dilation and also have important effects on base resistance and on drilled shaft settlement. They should be documented in the subsurface investigation from examination of rock cores, in full-sized test excavations and by observing cuts and natural slopes in the area of the construction site. Recently, borehole scanning systems have been developed that provide 360-degree rapid color panoramic views of borehole surfaces. These instruments may be useful in the future. A staff geologist is an indispensable person in this activity.

## REFERENCES

- AASHTO (1994). LRFD Bridge Design Specifications, American Association of State Highway and Transportation Officials, Washington, D. C., First Edition.
- ASCE (1996). *Rock Foundations*, Technical Engineering and Design Guide, As Adapted from the U. S. Army Corps of Engineers, No. 16, ASCE Press, New York.
- ASTM (1996). "Guide D 5434-93, Standard Guide for Field Logging of Subsurface Explorations of Soil and Rock," *Annual Book of Standards, Vol. 4.09*, American Society for Testing and Materials, West Conshohocken, PA, pp. 273 - 275.
- Brown, D. A. (1990). "Construction of Drilled Shafts in Hard Pinnacle Limestones," Transportation Research Record 1277, Transportation Research Board, Washington, D. C., pp. 148 - 152.
- Cheney, R. S., and Chassie, R. G. (1993). "Soils and Foundations, Workshop Manual - Second Edition," *Publication No. FHWA HI-88-009*, Federal Highway Administration, Washington, D. C., July.
- Englund, E., and Sparks, A. (1991). *Geostatistical Environmental Assessment Software, User's Guide*, U. S. EPA Environmental Monitoring Systems Laboratory, Las Vegas, NV.
- FHWA (1991). "Guide Drilled Shaft Specification," Geotechnical Guideline No. 14, *Geotechnical Engineering Notebook*, U. S. DOT, Federal Highway Administration, Washington, DC.

Haeni, F. P. (1988). "Evaluation of the Continuous Seismic Refraction Method for Determining the Thickness and Lithology of Stratified Drift in the Glaciated Northeast," in *Regional Aquifer Systems of the United States -- The Northeast Glacial Aquifers*, American Water Resources Association Monograph No. 11, Randall, A. D. and Johnson, A. I., Eds., pp. 63-82.

Hannigan, P. J., Goble, G. G., Thendean, G., Likins, G. E., and Rausche, F. (1996a). "Design and Construction of Driven Pile Foundations," Vol. I, (Working Draft) Federal Highway Administration, Washington, D. C.

Hannigan, P. J., Goble, G. G., Thendean, G., Likins, G. E., and Rausche, F. (1996b). "Design and Construction of Driven Pile Foundations," Vol. II, (Working Draft) Federal Highway Administration, Washington, D. C.

Hassan, K. M., and O'Neill, M. W. (1997). "Side Load Transfer Mechanisms in Drilled Shafts in Soft, Argillaceous Rock," *Journal of Geotechnical and Geoenvironmental Engineering*, ASCE, Vol. 123, No. 2, February.

Hvorslev, M. J. (1962). *Subsurface Exploration and Sampling of Soils for Civil Engineering Purposes*, U. S. A. E. Waterways Experiment Station, Vicksburg, MS, and the Engineering Foundation, New York.

ISSMFE TC 10 (1994). *Geophysical Characterization of Sites*, Ed. by R. W. Woods, International Society for Soil Mechanics and Foundation Engineering, Oxford and IBH Publishing Co. Pvt. Ltd., New Delhi.

Journel, A. G., and Huijbregts, C. J. (1978). *Mining Geostatistics*, Academic Press, New York.

O'Neill, M. W., Townsend, F. C., Hassan, K. H., Buller, A., and Chan, P. S. (1996). "Load Transfer for Drilled Shafts in Intermediate Geomaterials," *Report No. FHWA-RD-95-172*, Federal Highway Administration, Washington, D. C., January.

Phoon, K. K., Kulhawy, F. H., and Grigoriu, M. D. (1995). "Reliability-Based Design of Foundations for Transmission Line Structures," *Report No. TR-105000*, Electric Power Research Institute, Palo Alto, CA, 380 pp.

*Rock Testing Handbook*. (1990). Technical Information Center, U. S. Army Engineer Waterways Experiment Station, Vicksburg, MS.

Terzaghi, K. (1936). "The Shearing Resistance of Saturated Soils," *Proceedings, First International Conference on Soil Mechanics*, Cambridge, MA, Vol. I, pp. 54-56.

Yoon, G. L., and O'Neill, M. W. (1996). "Design Model Bias Factors for Driven Piles at NGES-UH," *Geotechnical Special Publication No. 58, Uncertainty in the Geologic Environment - From*

*Theory to Practice*, Ed. by C. D. Shackelford, P. P. Nelson and M. J. S. Roth, ASCE, Vol. 2, pp. 759 - 773.

## **CHAPTER 3: GENERAL CONSTRUCTION METHODS**

### **INTRODUCTION**

The principal features of the usual construction methods are described in this chapter, but the details of the methods can vary widely. As a matter of fact, each contractor and possibly each construction crew will do their work a little differently. However, the information presented here and in the other chapters that deal with construction should provide the basis for an understanding of the particular method that is being employed.

The general or overall construction methods are discussed herein. Later chapters are concerned with various details such as excavation, casing, drilling slurry, rebar cages, concrete, and other construction methods. Many important details with regard to construction methods have also been given by Greer and Gardner (1986).

The methods described here are those most common in the United States, where rotary drilling is principally used. Some special machines and special techniques used in Europe and elsewhere are not described, except where they are beginning to be used in the United States. In some parts of the world it is common practice to excavate by hand, although such methods will not be covered here. Regardless of the method that is employed for construction, there are features that constitute good practice. The intent is that those features be amply presented here and in the following chapters.

The methods of drilled shaft construction, all involving rotary drilling, can be classified in three broad categories. These are: (1) the dry method, (2) the casing method, and (3) the wet method. The method of construction that is selected depends on the subsurface conditions. Because elements of the drilled shaft design can depend on the method of construction, consideration of the construction method is a part of the design process.

While drilled shaft performance is dependent to some extent on the method of construction, it is normally the contractor's responsibility to choose the most appropriate method for installing drilled shafts at a given site. Selection of the specific construction method by the designer prior to bidding a project will likely add to the cost of construction and is not recommended except in special cases. Nevertheless, the designer should be familiar with construction methods for several reasons:

- To write appropriate construction specifications that encompass the methods likely to be used by the contractor on a specific project.
- To make accurate preliminary cost estimates, as the cost of construction is dependent upon the construction method (Chapter 19).
- To be in a position to evaluate alternative construction procedures in the event that the contractor's primary procedure proves to be ineffective.
- To be prepared to specify specific procedures when warranted, for example, when

uncased-hole construction could be detrimental to the performance of nearby structures or when certain construction practices have been assumed in making the design, such as the roughening of sockets in rock.

It is of interest to mention at this point some recent advances in the United States in construction methods. The wet (slurry) method of construction has been available for some time, but recent developments have allowed the method to be applied more widely. The methods for control of slurry quality, including desanding and effective base clean-out procedures, have led to confidence in the use of mineral slurry (slurries made from processed bentonite and other processed clay minerals) at sites where the soils might have a tendency to cave or collapse. More recently, considerable progress has been made in the understanding of the use of synthetic polymer slurries, which can often be used less expensively than mineral slurries because less cleaning equipment is needed, and which are considered less environmentally offensive.

The use of the vibratory driver for the placing and extraction of casing has increased dramatically in recent years. At some sites where cohesionless soil predominates, the vibratory driver can lead to significant improvements in construction time.

There have also been recent improvements in the construction of drilled shafts in water. In Florida alone, many thousands of meters of drilled shafts have been constructed for bridges where the water depth was shallow. The drilled-shaft industry is active and innovative, and better construction methods can be expected as time goes on.

### **UNDERREAMS (BELLS)**

Because the underream is common in more than one method of construction, some information is given here prior to proceeding with the description of the three major construction methods. With the rotary method of making an excavation, an underream (or bell) is sometimes excavated to achieve greater bearing resistance than would be available with a cylindrical shaft. However, underreams must be founded in materials that will stand open. Occasional difficulties are also reported in cleaning the bases of underream.

The underream normally has the general conical shape shown in Figure 3.1 a, with the maximum diameter of the underream being not more than three times the diameter of the shaft. The toe height and the underream angle shown in the figure are variables. The shaft extension ("reamer seat") in Figure 3.1 a is to ensure that the underream is centered and does not wobble during drilling, and to assist in the removal of cuttings. The length of the extension depends on the equipment employed. The notch angle will normally be 90 degrees, but the angle will probably be rounded off in drilling in most soils. The stress concentrations in the vicinity of this extension in the finished bell can limit the bearing load that is placed on an underream.



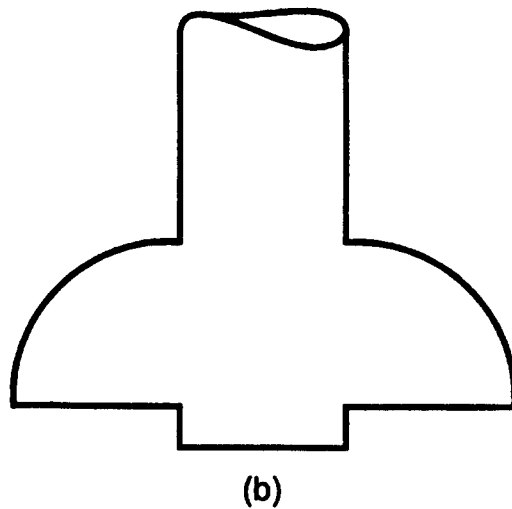
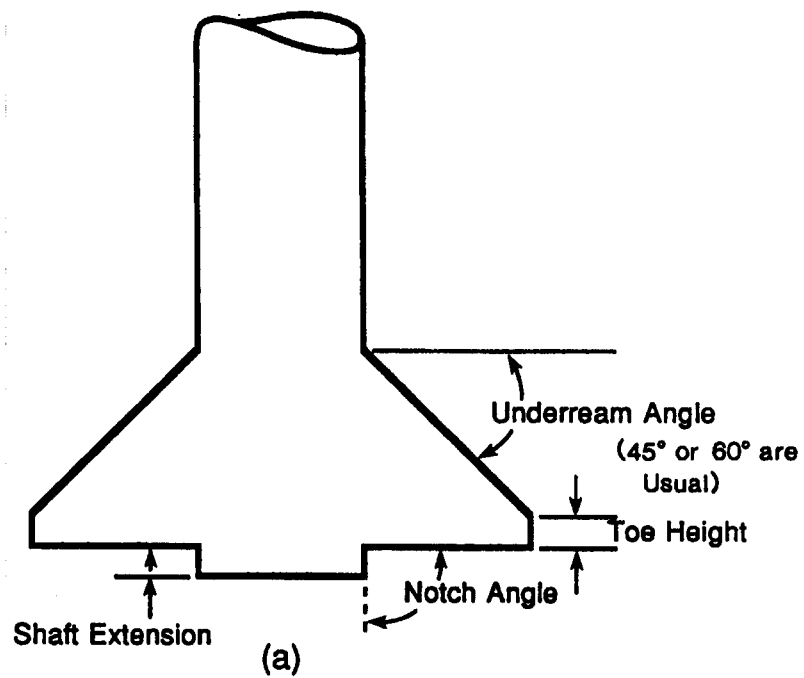

Figure 3.1. Shapes of typical underreams (a) cut with "standard" conical reamer; (b) cut with "bucket," or hemispherical, reamer

Conical belling tools (described in more detail in Chapter 4) have hinged arms that are pushed outward by a downward force on the kelly (drill rod) so that rotation of the tool in the borehole will cause soil to be cut away. The loose soil will be swept to the center of the tool, the base of which contains a bucket for capturing the cuttings. When an upward force is put on the kelly, the cutter arms are retracted and the underreaming tool is lifted out of the borehole. The spoil is removed from the bucket by unhinging the bottom of the tool. The excavation of a bell can be a time-consuming process compared to cutting a straight shaft because only a limited amount of soil can be removed at one pass.

Underreams can also be cut with the hemispherical shape shown in Figure 3.1 b. The reamer that is used to obtain this shape is called a "bucket" reamer. As may be seen, for the same diameter, more concrete is required for the shape shown in Figure 3.1 b than for that shown in Figure 3.1 a. Furthermore, the mechanics of the tool that forms hemispherical bells makes it more difficult to sweep cuttings from the bottom of the hole than with the tool for the conical bell.

Other underreaming tools have been designed to be guided by the bottom of a casing so that a shaft extension is not required.

A rebar cage, if used, will extend through the center of the shaft and the bell; therefore, the portion of the bell outside of the central shaft normally is not reinforced.

The bell angle and bell shape will have an influence on the tensile stresses in the bell around the reamer-seat notch when a compressive load is applied, and these stresses in turn limit the permissible bearing pressure. Some research has been conducted to determine how to dimension the bell in consideration of the bearing stress at the base of the underream (Farr and Reese, 1980; Sheikh et al., 1983; Sheikh and O'Neill, 1988). The principal reason for the research relates to the allowable bearing stress that can be sustained by 45-degree and 60-degree underreams. Plainly, the 60-degree underream will perform more favorably. However, there are disadvantages to the 60-degree underreaming tool. More concrete is required, and the tool is too tall to fit under the rotary table of most mobile truck rigs if the bell diameter exceeds about 2.3 m (90 in.), unless the rig is ramped up. It is therefore advantageous to use 45-degree belling tools where possible, because they are much shorter and can fit more easily under the turntable of a truck-mounted drill rig. The alternative is to use a crane-mounted drill rig (Chapter 4), which can be equipped with a high turntable, but the cost of using such a rig on a small project may make drilled shafts very expensive. Analysis and experience indicates that 45-degree underreams are adequate for most designs if end-bearing stresses are controlled. A discussion is presented in Chapter 13 on the bearing stresses that can be permitted for unreinforced bells with bell angles of both 60 and 45 degrees.

In the construction process there is some danger of collapse of the bell; the classification and strength of the soil, the presence of joints in the soil, and the possible inflow of groundwater are important considerations. There have been instances where inexperienced designers have specified bells in deposits of collapsible gravel, sand or silt. While it is possible to install bells in

such soils using special techniques, bells are not recommended to be installed in non-cohesive soils. It is specifically advised that bells should not be excavated under drilling slurry unless expert advice is obtained from reputable engineers specializing in such construction. While bells can sometimes be made under slurry, there is a significant possibility that the cuttings will not be picked up in the tool and will instead remain on the bottom of the borehole beneath the tool, becoming a "mush" on which the bell would be required to bear.

A field trial is advisable if numerous bells are to be excavated at a site. Another possibility would be to prepare an alternate design so that either 45-degree underreams or straight shafts can be employed if the soil is unable to support standard 60-degree bells. [45-degree bells of a given diameter, despite their more severe overhang, are sometimes more stable prior to concreting than 60-degree bells because 45-degree bells can be constructed more quickly.]

Close attention should be given to the belling operation. Not only is there a danger of collapse of the excavation but there is the possibility that loose soil will collect beneath the underreaming tool causing the tool to "ride up," even if the bell is excavated in the dry. The observation of a reference mark on the kelly, relative to a surface datum, as underreaming progresses will indicate whether loose soil is collecting below the belling tool. Account should be taken of the downward movement of the kelly as the arms move outward.

Prior to placing concrete in the belled shaft, the bottom must be free of drilling spoils and certified as a competent bearing surface. The inspection of the base of the excavation can be done visually from the ground surface in many instances, but the inspector may sometimes need to enter the excavation, using appropriate safety precautions. This action is generally recommended only where high bearing stresses are employed. If there is concern about the character of the soil or rock below the excavation, a probe hole can be drilled.

## **VERTICAL ALIGNMENT**

Drilled shafts are nearly always installed vertically, but battered shafts can be constructed where absolutely necessary. However, drilling at an angle with the vertical is difficult to control, and the difficulty increases significantly if an underream is required. Temporary casing is also often difficult to extract without causing damage to reinforcing cages or in-place concrete when drilled shafts are placed on a batter.

## **DRY METHOD OF CONSTRUCTION**

The dry method is applicable to soil and rock that are above the water table and that will not cave or slump when the hole is drilled to its full depth. A geomaterial that meets this requirement is a homogeneous, stiff clay. The dry method can be employed in some instances with sands above the water table if the sands contain some cohesive material, or if they will stand for a period of time because of apparent cohesion. This behavior generally cannot be predicted unless there is

prior experience with the specific formation being excavated or full-sized test excavations have been made during site characterization. If the soil at the ground surface is weak or if there is a thin stratum of caving soil near the surface, a short piece of casing, called a "surface" casing, is employed, especially if the rig will be bearing on the soil close to the hole. The surface casing may be temporary or permanent. Surface casings are good practice, in fact, in all soils, particularly if they are left protruding some distance above the ground surface, because they act as drilling tool guides, as safety barriers for personnel and as means of preventing deleterious material from falling into the borehole after it has been cleaned.

The dry method can sometimes be used for soils below the water table if the soils are low in permeability and the shaft is excavated and concreted quickly, so that only a small amount of water will seep into the hole during the time the excavation is open.

The first steps in making the excavation are to position the equipment at the proper location, to select an appropriate drilling tool, and to begin the excavation, as shown in Figure 3.2 a. The excavation is carried to its full depth with the spoil from the hole being deposited nearby. The spoil will normally be hauled away at a convenient time.

The length of time necessary to complete the excavation will depend on the soil conditions, the presence of obstructions, and the geometry of the hole. Where homogeneous stiff clays exist, a hole that is 0.915 m (3 ft) in diameter can probably be drilled to a depth of 18 m (60 ft) in less than 1 hour. A longer period of time will be required, of course, if obstructions are encountered or if unforeseen caving occurs that requires conversion to one of the other construction methods. On the other end of the spectrum, it may be possible to excavate hard rocks at rates of only a small fraction of a meter per hour.

After the excavation has been carried to its full depth, an underreaming tool can be employed and the base of the drilled shaft can be enlarged. After completion of drilling of the cylindrical borehole if no bell is employed, or after excavating the bell, the base of the excavation is cleaned of loose material. The clean-out operation is especially critical in the case where the borehole is not drilled and concreted in a continuous manner, in which considerable loose material may have had an opportunity to collect in the bottom of the excavation. In the case of a straight-sided borehole, cleaning is usually accomplished with a special clean-out bucket. In bells, cleaning is ordinarily done using the arms of the underreaming tool as sweepers to push cuttings into the tool's bucket. Hand cleaning is possible, but it should not be used unless absolutely necessary because of safety considerations. The belling and cleaning operations are not shown in Figure 3.2.

Figure 3.2 b shows the next step in the process, which is to place concrete in the cylindrical hole. The dry method allows for a rebar cage to be placed only in the upper portion of the drilled shaft if desired, in which case concrete would be poured to the elevation of the bottom of the rebar cage; the rebar cage would be placed, as shown in Figure 3.2 c; and the concreting would be

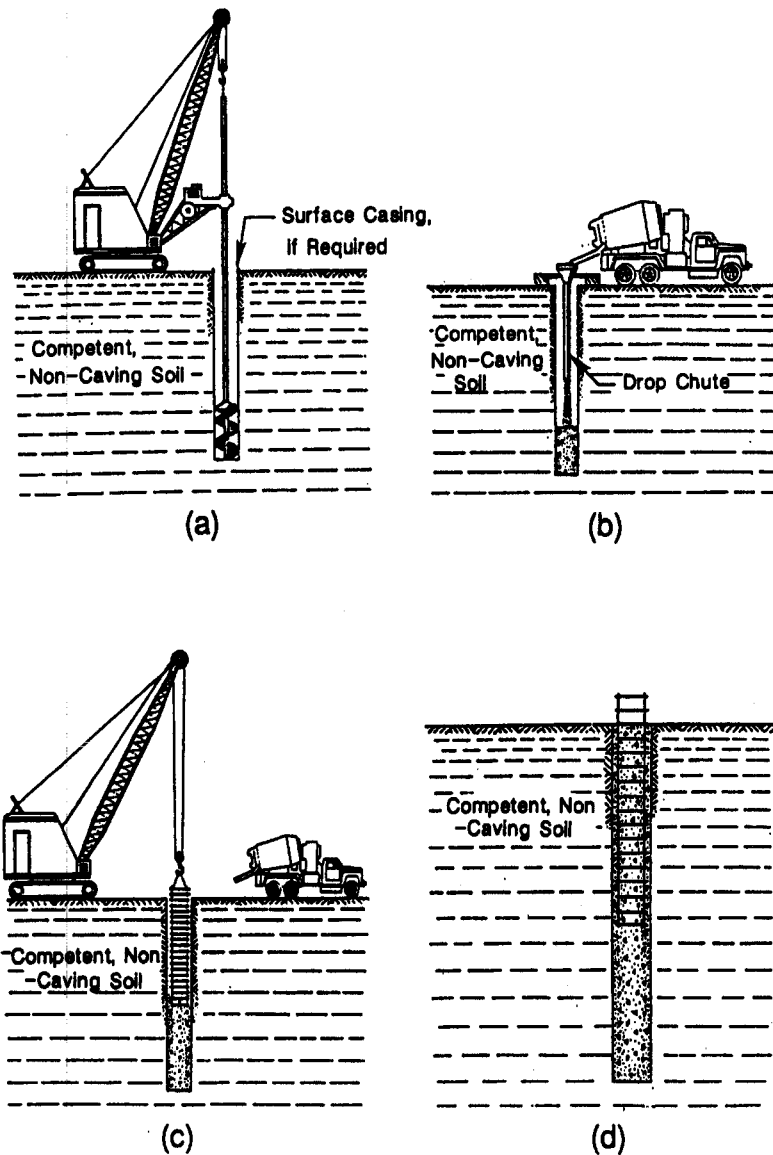

Figure 3.2. Dry method of construction: (a) initiating drilling, (b) starting concrete pour, (c) placing rebar cage, (d) completed shaft

completed, leaving the completed drilled shaft shown in Figure 3.2 d. The partial-depth cage would be supported off surface skids as the concrete hardens. A full-depth cage is also possible. As shown in Figure 3.2 b, the concrete was allowed to fall freely without striking the sides of the hole. A drop chute or equivalent means of directing the flow would be needed for this purpose in most cases. After the rebar is placed the drop chute prevents the concrete from contacting the cage and segregating. Concrete and its placement will be discussed in more detail in Chapter 8.

The percentage of reinforcing steel to be employed and the length of the shaft that is reinforced are to be determined from the loading conditions. In some instances the reinforcing steel may be omitted entirely, although such is not recommended for highway structures. In other instances a full-length rebar cage may be used.

In the completed foundation shown in Figure 3.2 d, the excavation is fully filled with concrete and the rebar cage extends some distance above the ground surface where it will be mated with the cage for the column using lap splices. In some cases designers may prefer not to splice to the column cage to the drilled shaft cage at the ground surface, so that the drilled shaft cage may have a continuous extension to a higher elevation in the structure (e. g., the bent cap). When the cage is allowed to project above the top of the drilled shaft the difficulty in placing concrete and pulling casing increases. If it has been properly designed and constructed, the foundation will be compatible with the superstructure in size and location, and the load-carrying capacity of the foundation will be sufficient to sustain the applied load with an appropriate margin of safety. Furthermore, it is assumed that the settlement of the foundation under load will not exceed the allowable value.

## **CASING METHOD OF CONSTRUCTION**

The casing method is applicable to sites where soil conditions are such that caving or excessive soil or rock deformation can occur when a borehole is excavated. The most common scenario for the use of casing is construction in generally dry soils or rocks that are stable when they are cut but which will slough soon afterwards. In such a case the borehole is drilled, and casing (a simple steel pipe) is quickly set to prevent sloughing. Another notable example of a scenario in which casing could be used is a clean sand below the water table underlain by a layer of impermeable limestone into which the drilled shaft will penetrate. In this case, since the overlying sand is water bearing, it is necessary to seal the bottom of the casing into the limestone to prevent flow of water into the borehole. Most casing is made of steel and is recovered as the concrete is being placed. Instances requiring the use of permanent casing are discussed in Chapter 5, as are other characteristics of temporary and permanent casings.

Another common situation for casing construction is shown in Figure 3.3. If it is assumed that dry soil of sufficient strength to prevent caving exists near the ground surface, as shown in Figure 3.3 a, the construction procedure can be initiated as with the dry method. However, if it is anticipated that casing is to be used, the excavation through the zone to be cased proceeds with a drilling tool having a diameter greater than the outside diameter of the casing. When the caving soil is encountered, slurry may be introduced into the borehole, and the excavation proceeds as shown in Figure 3.3 b. The slurry is usually manufactured on the job, using potable water and dry bentonite (or other approved mineral such as attapulgite or sepiolite) or, if permitted by the State, a synthetic polymer. The manufacture and control of drilling slurry are discussed in Chapter 6.

The slurry column should extend and be continuously maintained well above the level of the

piezometric surface so that any fluid flow is from the excavation outward into the formation and not *vice-versa*. During excavation, the drilling tool should be designed to lift the soil up through the slurry, rather than mixing it with the slurry, regardless of the type of slurry used or the soil encountered. In granular soils, even with this technique, some granular soil will unavoidably be left in suspension in the slurry. The strategy in the casing method should be to leave only as much soil in suspension in the slurry as the slurry can hold for a long period of time, because some of the slurry will eventually become trapped behind the casing, when it is placed, where excess soil can settle out of suspension and become the source of a defect in the completed drilled shaft.

Drilling is continued until the stratum of caving soil is penetrated and a stratum of impermeable soil or rock is encountered. At this point, before setting the casing, it is good practice to check the sand concentration in the slurry near the bottom of the borehole. This process for doing this is discussed in Chapter 6. If there is excessive sand in the slurry and the casing is set, some of this sand will settle out in small annular spaces between the casing and the borehole wall and potentially produce a defect in the completed drilled shaft when the casing is removed. In order to rid the slurry of excessive sand, the contractor can simply pause for a few minutes to allow the sand to settle out of suspension (a process more effective with polymer slurries than with mineral slurries) and then remove the settled material from the base of the borehole with a special clean-out device. He or she can also exchange the soil-contaminated slurry with clean slurry before setting the casing, as described in Chapter 6. If there is no excess suspended material in the slurry at this point, construction can proceed directly.

As shown in Figure 3.3 c, a casing is introduced at this point, a "twister" or "spinner" is placed on the kelly of the drill rig, and the casing is dropped, tapped, rotated, and/or pushed into the impermeable soil or rock a distance sufficient to effect a seal. A length of casing of the appropriate height will have to be selected in order to extend a small distance above the ground surface but not so far as to reach the base of the rotary table on the drilling rig, since there is a limited distance between the ground surface and the rotary table. If necessary, the casing could also be driven by impact or vibration to produce a seal in soil or rock. It is sometimes necessary to place teeth on the bottom of the casing in order to twist or core the casing a sufficient depth into the impermeable formation, especially rock, to produce a seal. The precise pattern and geometry of cutting teeth may need to be modified for different formations.

Figure 3.3 d indicates that a bailing bucket is placed on the kelly and the slurry is bailed from the casing. This process can also be accomplished by using a submersible pump. A smaller drill is introduced into the hole, one that will just pass through the casing, and the excavation is carried to the projected depth, as shown in Figure 3.3 e. A belling tool can be placed on the kelly, as shown in Figure 3.3 f, and the base of the drilled shaft can be enlarged. When belling cased shafts, the top of the bell must be far enough below the casing to prevent breaking of the casing seal.

During this operation, slurry is trapped in the annular space between the outside of the casing and

the inside of the upper drilled hole. Therefore, it is important that the casing be sealed in the impermeable formation so as to prevent the slurry from flowing beneath the casing. Since this slurry will have to be flushed out later by the fluid concrete, it must meet all of the requirements for slurry used in the wet method described subsequently. These requirements are given in Chapter 6.

Many controversies have arisen between engineers and contractors where soil borings have failed to reflect properly whether or not a formation of low permeability exists at a reasonable depth into which the base of the drilled shaft can be placed. If one does not exist, it may be impossible to remove all of the slurry and ground water from the excavation. However, if the casing serves to prevent collapse of the soil, the concrete can be poured underwater with a tremie<sup>1</sup> if necessary, with simultaneous extraction of the casing as described in the next section.

If reinforcing steel is to be used with drilled shafts constructed by the casing method, the rebar cage will usually need to extend to the full depth of the excavation because it is difficult to keep a partial-length cage in position by a hoist line around which the casing is pulled. The cage will usually be designed to meet two requirements: (1) the structural requirements for bending, shear, torsion and column action imposed by loads from the superstructure, and (2) constructability requirements of the rebar cage, including (a) stability during pickup and placing of the cage, during the placing of concrete, and during withdrawal of the casing, and (b) sufficient space between bars to permit the free flow of concrete during concrete placement. The former aspect is covered in Chapter 13, while the latter is covered in Chapter 7.

After any reinforcing steel has been placed, the hole should be completely filled with fresh concrete having good flow characteristics, as shown in Figure 3.3 g. Under no circumstances should the seal at the bottom of the casing be broken until the concrete produces a hydrostatic pressure greater than that of the fluid external to the casing (trapped slurry or ground water). The casing may be pulled and the seal broken when there is sufficient hydrostatic pressure in the column of concrete to lift the slurry that has been trapped behind the casing from the hole (Figure 3.3 g). The concrete will then flow down around the base of the casing to displace the trapped slurry and fill the annular space. The casing should be pulled slowly in order to keep the forces from the downward-moving concrete on the rebar cage at a tolerable level.

The most crucial operation in the casing method is indicated in Figure 3.3 g. If the workability of the concrete (slump) is too low, arching of the concrete will occur and the concrete will move up with the casing, creating a gap into which slurry can flow. The rebar cage will also move up, of course. The same kind of problem will occur if the design of the concrete mix and time of placement are such that a premature set of the concrete inside the casing will occur. As the casing is pulled, it is usually necessary to add additional fresh concrete by bucket or pump so that

---

<sup>1</sup>The word "tremie" is used here to indicate the pipe that is used to place concrete underwater by gravity feed or by pumping. It is also used elsewhere to describe the same kind of pipe used to place concrete in the bottom of a dry hole when free-fall placement is not allowed.



the height of the completed pour is somewhat above the cut-off elevation of the shaft in order to flush all of the trapped slurry from behind the casing. Some of the upper concrete will be contaminated and must be discarded.

An examination of Figure 3.3 g shows that the upper portion of the column of concrete must move downward with respect to the rebar cage when the casing is pulled. This downward movement of the column of concrete will cause a downward force on the rebar cage; the magnitude of the downward force will depend on the shearing resistance of the fresh concrete at the velocity of flow that exists and on the area of the elements of the rebar cage. The rebar cage can fail at this point by torsional buckling, by slipping at joints, and possibly by single-bar buckling (Reese and O'Neill, 1995).

The completed shaft is shown in Figure 3.3 h. It can be a very effective foundation if appropriate care is taken in the construction procedure. However, even with good construction, some engineers believe that skin friction is reduced along the portion of the shaft that was behind the casing during construction as compared to that of the dry method or the wet method. This is not considered in the design methods presented herein.

As can be noted in exaggerated scale in Figure 3.3 h, the method of construction dictates that the diameter of the portion of the drilled shaft below the casing will be about equal to or smaller than the inside diameter of the casing. In connection with casing diameter, most of the casing that is available is dimensioned by its outside diameter and comes in 152 mm (6 in.) nominal increments of diameter. A contractor would ordinarily use a casing with the increment of outside diameter that is the smallest value in excess of the specified diameter of the borehole below the casing. If it is specified that the inside diameter of the casing is to be only slightly larger than the diameter of the drilled shaft below the casing, and the shaft diameter is a nominal one [e. g., a 0.965 m (38 in.) ID casing for a 0.915 m (36 in.) OD shaft], special pipe may have to be purchased by the contractor, and the cost of the job will be significantly greater. These facts will need to be considered by the designer.

There are other instances in which the soil profile at a site is such that only a thin stratum of soil that will not remain stable long enough to permit drilling through it before collapsing is present. In such a case, it is possible to eliminate the use of slurry and introduce the casing when the caving formation is encountered. The casing is pushed and twisted through the thin stratum into impermeable soil below. Excavation can then proceed inside the casing, along with the other steps in the construction process, as described above. However, it is not considered appropriate to attempt to loosen the thin caving stratum by churning, or "processing," it with the drilling tool in advance of thrusting the casing through it, unless it is expressly allowed by the engineer, who has considered the effect of processing on the performance of the foundation.

There are sites where the caving formation is a cohesionless soil beneath the water table, with a stiff clay or rock below that stratum. An acceptable construction procedure that eliminates the need for slurry in such a case could be the driving of the casing with vibratory equipment, or

with other pile-driving equipment, through the cohesionless soil into the impermeable geomaterial below. A procedure that could be used is shown in Figures 3.4 a through 3.4 c. This procedure is likely to produce settlement of the ground surface due to the densification of the soil; therefore, it might not be acceptable in the close vicinity of other structures. Another concern is that the resistance of the soil on the outside of the casing and of the fluid concrete on the inside of the casing are so great that the casing cannot be lifted, even with the aid of a vibratory driver. This method has some of the advantages of driven piling, in that lateral earth pressures are maintained or even increased, which can result in larger values of skin friction in overlying sands or gravels. However, skin friction will be reduced, perhaps significantly, if the casing cannot be withdrawn.

A modification of the procedure shown in Figure 3.4 is the use of special drilling rigs, sometimes termed "full-depth casing" rigs, that simultaneously excavate and rotate / push heavy-walled casing into place, keeping the base of the casing at or below the elevation of the excavating tool at all times. The casing on such rigs, which may be equipped with cutting teeth, actually helps make the excavation. These types of rigs have proved very successful in excavating soils with small boulders on occasion. They can also often be used where otherwise a wet drilling process would be required. [See the following section.] However, full-depth casing rigs have the potential disadvantage that they can produce smooth boreholes in clay and rock, which can have an adverse effect on skin friction, unless special roughening studs are placed on the outside of the casing. Such rigs can be either semi-stationary, skid-mounted rigs, or they can be mounted on trucks. Truck-mounted rigs normally have augers that remove the cuttings from inside the casing as the casing is being inserted. Skid-mounted rigs can be equipped with clamshells or hammergrabs to help break up and remove rock fragments, boulders or soil from within the casing. Photographs of these devices are shown in Figure 3.5.

Casing often needs to be inserted into very deep boreholes and/or into very strong geomaterials, which may make it difficult to remove the casings. In such instances, contractors may choose to "telescope" the casing. That is, the first several meters will be excavated and a large-diameter casing sealed into the geomaterial at the bottom of the hole. A smaller-diameter borehole will then be advanced below the bottom of the casing, and a second casing, of smaller diameter than the first casing, will be sealed into the geomaterial at the bottom of the second-stage borehole. The process can be repeated several times to greater and greater depths until the plan base elevation is reached. The last casing should be sealed into the underlying stratum as with the single casing method outlined in Figure 3.3. With each step, the borehole diameter is reduced, usually by about 152 mm (6 in.), so that the contractor will need to know how many steps he or she will need to make and approximately how deep each step will be before excavating the first borehole. This procedure is often used where the geomaterial to be retained contains boulders.

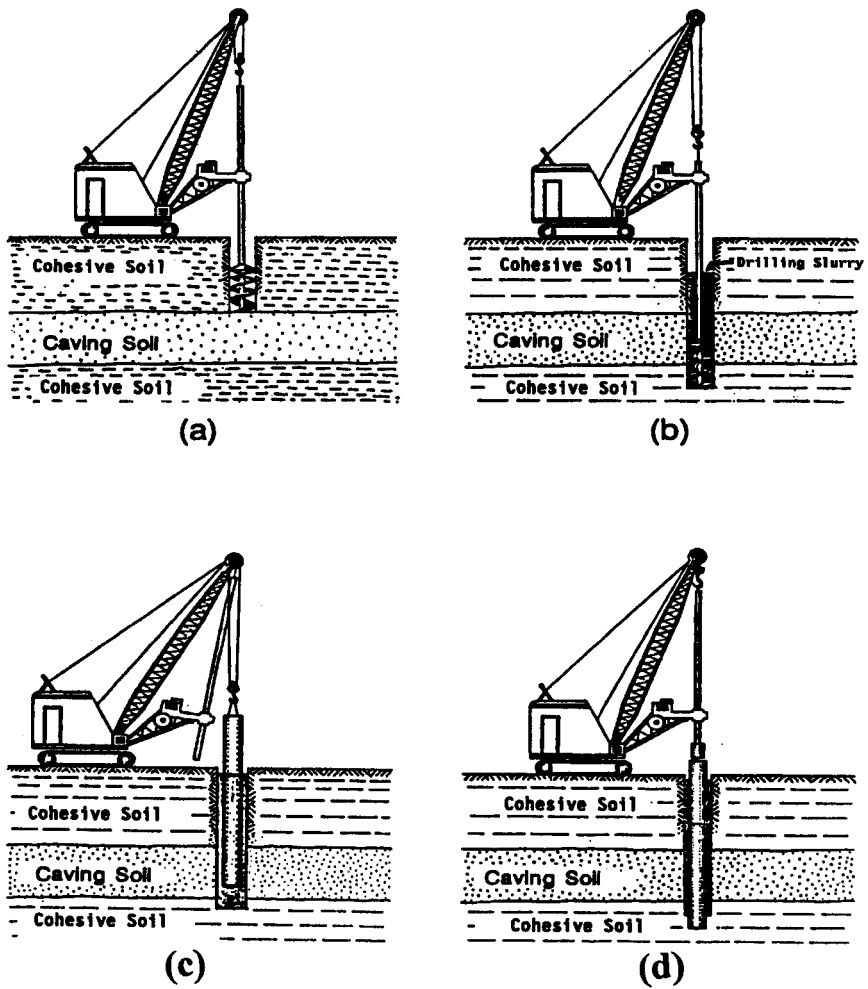

Figure 3.3. Casing method of construction: (a) initiating drilling, (b) drilling with slurry; (c) introducing casing, (d) casing is sealed and slurry is being removed from interior of casing (continued)

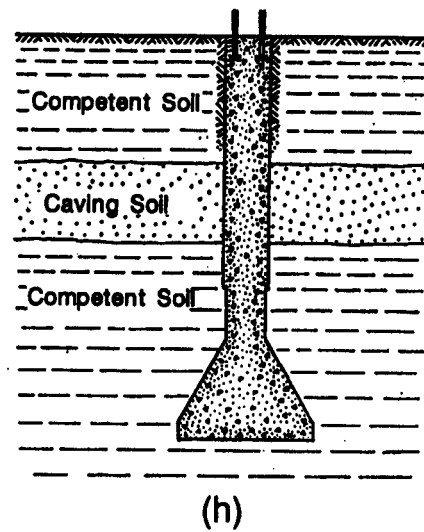
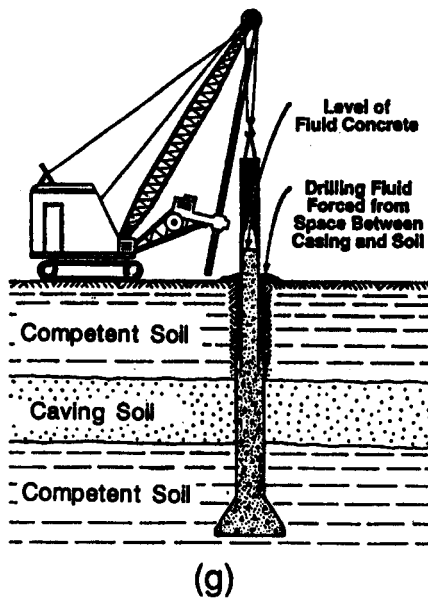
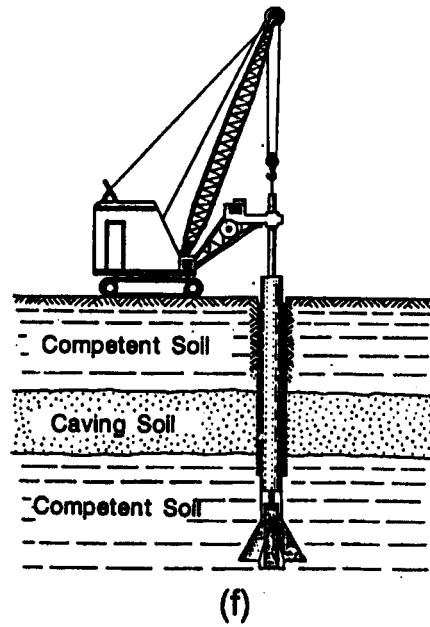
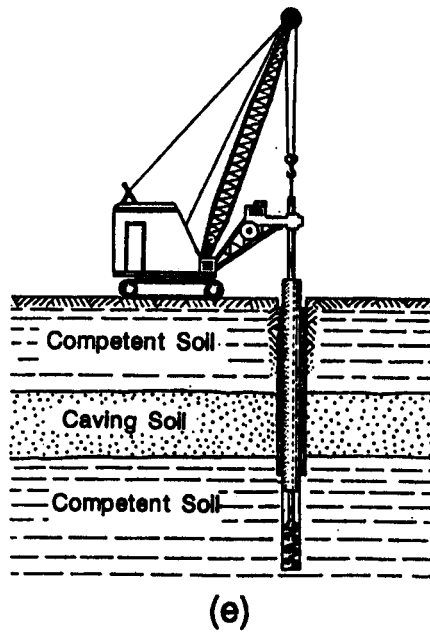

Figure 3.3 (continued). Casing method of construction: (e) drilling below casing, (f) underreaming, (g) removing casing, and (h) completed shaft

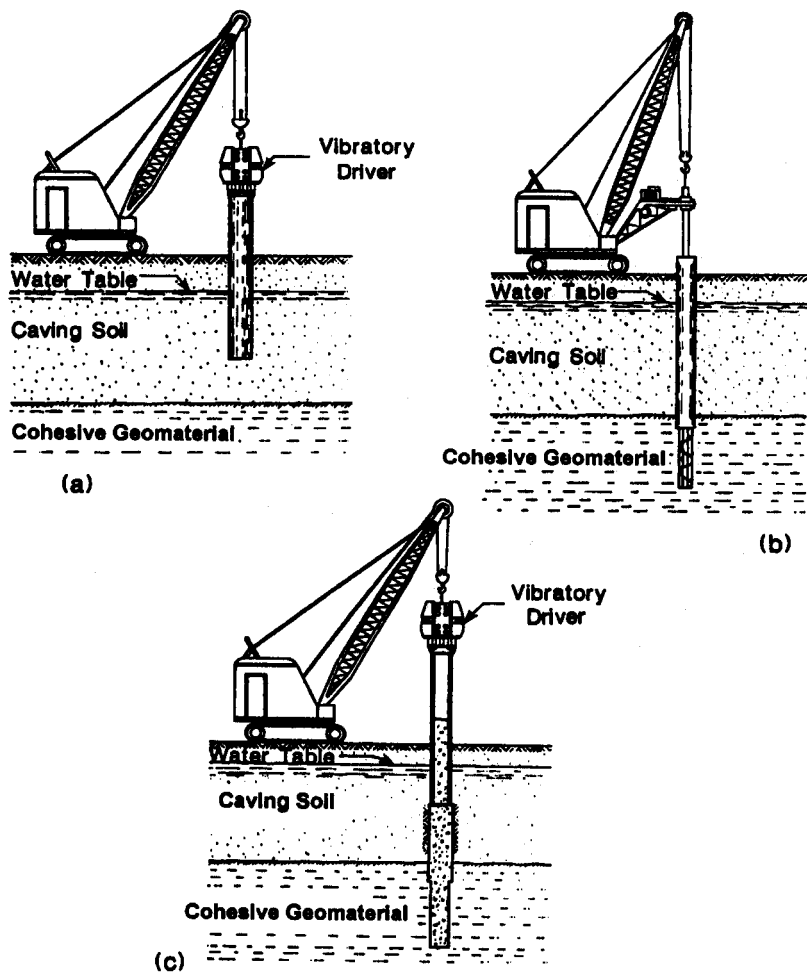

Figure 3.4. Alternate method of construction with casing: (a) installation of casing, (b) drilling ahead of casing, (c) removing casing with vibratory driver

All telescoped casings can be set so that their tops are at the same elevation as the largest casing that is set nearest the surface. This facilitates withdrawing the casings successively from deepest to shallowest as concrete is being placed without the concrete overflowing a casing and trapping groundwater, slurry or sloughed soil behind the next casing to be removed. Alternatively, if the tops of the interior casings are set below the top of the top casing, the contractor must be diligent to assure that such overflows do not occur.

### WET METHOD OF CONSTRUCTION

The "wet" method of construction, sometimes called the slurry-displacement method, usually involves the use of a prepared slurry to keep the borehole stable for the entire depth of the excavation. The soil conditions for which the slurry-displacement method is applicable could be

any of the conditions described for the casing method. The slurry-displacement method is a viable option at any site where there is caving soil, and it could be the only feasible option in a permeable, waterbearing soil if it is impossible to seal casing into a stratum of soil or rock with low permeability. It can also be used in very deep holes where casing might otherwise be used because of the difficulty of handling very long casing.

There are two general processes for accomplishing wet-method construction. The first process is termed here the "static" process. It is by far the most common process in the United States. The second process is termed the "circulation" process. The primary difference in the two processes is that the cuttings are lifted by the drilling tool in the static method, but they are transported to the surface in the slurry in the circulation method. Circulation drilling has the advantage that the cuttings can be pumped in the slurry to a remote point before being removed from the slurry and spoiled. Some experts also contend that reverse circulation drilling, the most common form of circulation drilling, produces a cleaner borehole base than ordinary static drilling.

The wet method can be readily adapted for the construction of drilled shafts in a lake, ocean, or river. The construction equipment can be placed on a barge, a template set to locate the excavation and hold formwork, and a casing (form for the section of drilled shaft within the water) can be installed through the template. The casing should be set deep enough into the soil at the bottom of the body of water so that there is a seal to contain the concrete when it is poured to the top of the casing. In some cases the casing is left in place permanently or is cut off below the low water line by divers. In others it is possible to use temporary split casing that can be removed after the concrete has set, possibly with the assistance of divers, or to use other special procedures such as two concentric casing forms separated by granular soil. In this way the inner casing form is pulled out when the concrete is placed, leaving the granular soil between the unset concrete and the outer casing form to keep the concrete from bonding to the outer casing form. The outer casing form is pulled out after the concrete has set, leaving the concrete with a stippled appearance. At least two problems have arisen with the "double-casing" method: (1) Sometimes the sand goes "quick" when the inner casing is removed with a vibratory driver, with undesirable consequences. (2) Sometimes the outside of the inner casing will have a layer of sand cling to it. Which may lift or groove the layer of sand.

### **The Static Process**

The first step in the static construction process is to position the drilling equipment and to drill using the dry method until the piezometric surface is reached, the elevation of which has been determined during the subsurface investigation. At this point, slurry is introduced into the hole, as for the casing method, and drilling is continued. The excavation is carried to the full depth of the hole, with the slurry in place. During excavation, the top of the slurry column is always kept at an elevation above the piezometric surface. If the piezometric surface is at or above the ground surface (artesian or near-artesian conditions), a surface casing that protrudes above the ground surface to serve as a standpipe is necessary to keep the slurry head at its proper position. Maintaining head position in the slurry column is particularly important with polymer slurries,



(a)

Figure 3.5. Case-and-drill (full-depth-casing) rigs: (a) track-mounted rig with auger

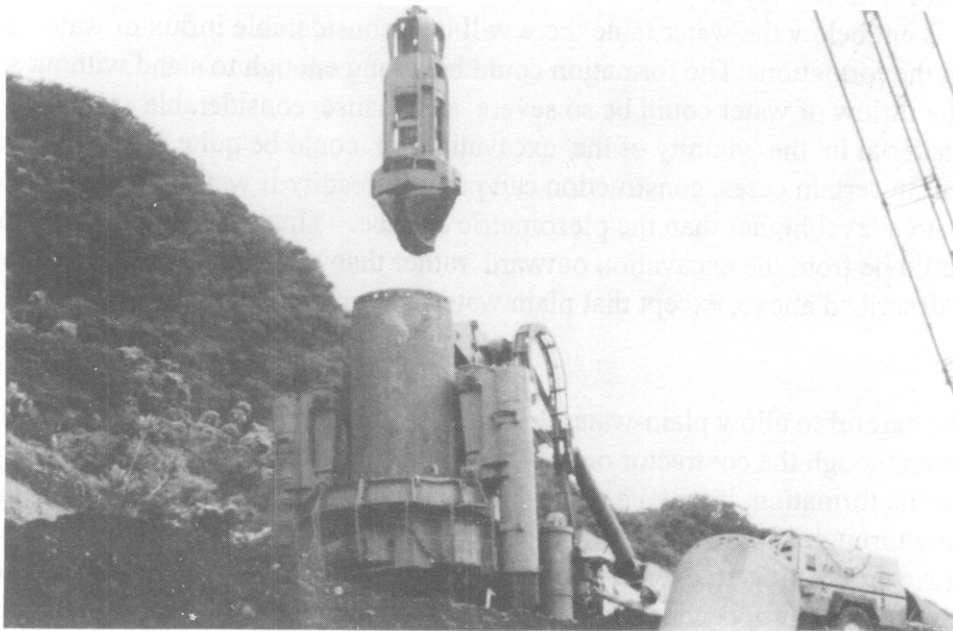

(b)

Figure 3.5 (continued). Case-and-drill (full-depth-casing) rigs: (b) skid-mounted rig with hammergrab

whose unit weights are approximately equal to the unit weight of water.

Some contractors choose to wait until a caving stratum of soil is reached before introducing the slurry; however, if such a stratum is beneath the piezometric surface, considerable caving could occur before enough slurry can be added to balance the ground water pressure. Furthermore, it may not be possible to arrest the caving once it starts, even if the groundwater pressures are balanced and inflow of groundwater is stopped, because an overhang will have been developed. Such a practice is therefore not recommended.

Either mineral slurry (such as bentonite-based slurry) or polymer slurry can be employed in the static process. Mineral slurry is mixed such that some of the particles of granular soil being excavated are put and kept in suspension and are brought out of the hole when the slurry is flushed from the hole by placing the fluid concrete. Much of the soil being excavated, however, is lifted out with the drilling tool. Polymer slurries, on the other hand, have insufficient gel strength to hold sands in suspension (although silts may be held in suspension for a considerable time) so that all of the cuttings down to the size of fine sand must be lifted out with the drilling tool. Further details on drilling slurries are given in Chapter 6.

If the excavation is to be carried through a stratum of clay, the excavated clay-cuttings will be lifted out mechanically through the slurry and brought to the ground surface in either type of slurry. A drilling tool should be employed that allows the column of slurry to flow through the tool in order to prevent the development of a vacuum beneath the drilling tool that would possibly collapse the hole. Figure 3.6 a indicates the situation as the excavation is advanced to full depth.

Some rock formations may be jointed or cracked or may contain fissures such that when an excavation is cut below the water table there will be a considerable influx of water through the openings in the formation. The formation could be strong enough to stand without support; however, the inflow of water could be so severe as to cause considerable erosion or sloughing of the geomaterial in the vicinity of the excavation. It could be quite difficult to dewater such a formation. In certain cases, construction can proceed readily if water is introduced into the drilled hole to a level higher than the piezometric surface. Thus, any fluid flow in the vicinity of the hole would be from the excavation outward, rather than the reverse. Construction would proceed as described above, except that plain water is introduced into the hole rather than a slurry.

One must be careful to allow plain-water drilling only in formations that are not erodible. For example, even though the contractor only needs to balance ground water pressure to prevent inflow from the formation, it may be advisable to use a polymer slurry rather than plain water while drilling through a jointed shale or a mudstone, since such geomaterials can be eroded with the drilling water, creating an oversized borehole and possibly creating an unstable condition. The drilling water, in turn, becomes contaminated with the eroded geomaterial, and its properties become difficult to control.



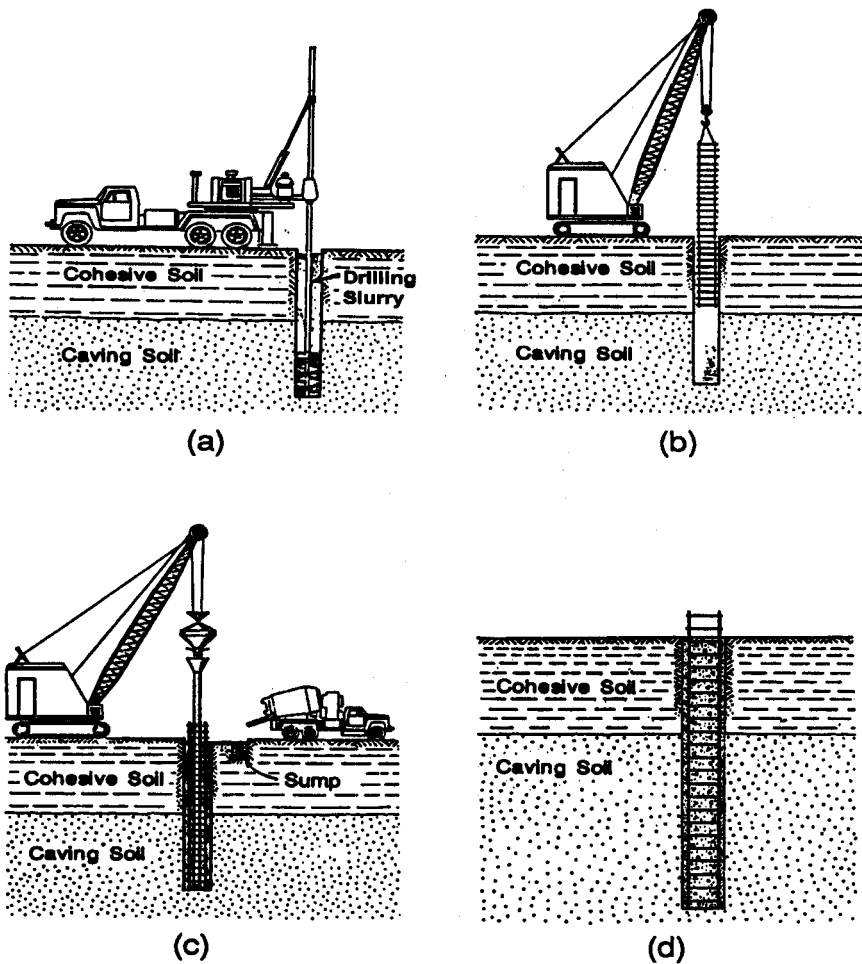

Figure 3.6. Slurry method of construction (a) drilling to full depth with slurry; (b) placing rebar cage; (c) placing concrete; (d) completed shaft

After the excavation has been drilled to its full depth, steps must be taken to see that the slurry meets appropriate specifications (Chapter 6). If there is too much sediment in suspension, particles can settle to the bottom of the excavation before concrete is poured, resulting in a "soft" base, or as the concrete is being placed, resulting in structural defects in the completed drilled shaft. At this point the bottom of the borehole is cleaned of cuttings and sediments using a mechanical clean-out bucket or a vacuum device such as an air lift.

If reinforcing steel is to be used, the rebar cage is placed in the slurry as shown in Figure 3.6 b. After the rebar cage has been placed, the concrete is placed with a tremie either by gravity feed or by pumping. If a gravity feed is used, the bottom end of the tremie pipe should be closed with an appropriate closure plate (Chapter 8) until the base of the tremie reaches the bottom of the borehole, in order to prevent contamination of the concrete by the slurry.

Filling of the tremie with concrete, followed by subsequent slight lifting of the tremie will then open the plate, and concreting proceeds. Steps must be taken to ensure that the bottom of the tremie remains at the bottom of the excavation until at least 1.5 m (5 ft) of concrete has been placed and thereafter remains at least 1.5 m (5 ft) below the top of the column of fluid concrete. As shown in Figure 3.6 c, the column of concrete will rise in the hole and displace the column of slurry that is of lower density. The completed foundation is depicted in Figure 3.6 d.

Placement of the concrete by pump is accomplished in a similar manner. The tremie for pumped concrete can be considerably smaller than a gravity-feed tremie because the concrete is being pumped into the borehole under pressure. An alternate method of preventing the contamination of the concrete by the slurry is usually used in placement by pump. A sliding plug (or "pig") is inserted in the top of the tremie line before the concrete is poured. The plug will slide down the tremie under the weight of the concrete and normally can be recovered when it floats upward to the ground surface. A small volume of grout, which is forced to the surface of the fluid concrete column by the concrete that follows it, is sometimes used in lieu of a plug.

Gravity-feed placement, using a closure plate at the bottom, is considered by some contractors to be preferable to placement by pump because the tremie needs to be lifted only slightly to start the flow of the concrete, and larger initial surges of concrete can be obtained than with a pump. Such surges are desirable in order for the concrete to "get under" the slurry and raise it to the top of the borehole. If the bottom of the line is too far above the bottom of the excavation when concrete flow is commenced, cement can be washed from the concrete and deterioration will occur. With a pump, the tremie orifice must be raised far enough off the bottom to allow the plug to pass before the first concrete is expelled, which can result in some washing of the cement at the base of the borehole. If the orifice is raised only a small amount, any washed concrete should be lifted out by the concrete that follows.

### **The Circulation Process**

The circulation process is similar to the static process, except that only bentonite slurries are used, since other minerals and polymers are not capable of transporting solid cuttings effectively. The most common of the circulation processes, the "reverse circulation" process, is summarized here. It is also possible to drill using the "direct circulation process." The general differences in the two will be pointed out.

In reverse circulation drilling the drill rod shown in Figure 3.6 a is a hollow pipe. The top of the pipe is connected to a flexible hose that is mated to a vacuum pump located on the ground surface. As the borehole is drilled, the cuttings at the bottom of the hole, directly under the drilling tool, are pushed to the center of the borehole by the special design of the drill and then sucked, along with the slurry, into an orifice at the bottom of the drill pipe and transported to the surface by the vacuum pump. After going through the pump the slurry/cuttings are

pumped through another line to a cleaning plant, where the sand, silt and larger particles are removed through a process explained in Chapter 6. The clean slurry is then pumped back to the top of the borehole to be reused, resulting in a "closed loop" process. The slurry level is always maintained at the ground surface to allow the vacuum pump to lift the slurry and cuttings efficiently. A proprietary version of this process, known as the "Tone" method, developed by the Tone Corporation in Japan, uses a downhole hydraulic motor to power the drilling tool (using skids held against the side of the borehole as a torque reaction and directional guide) and a flexible line to transport the slurry and cuttings to the surface. Therefore, it does not require a string of drill pipe and can be operated by using a very small crane with low headroom (6 m or less). Once the borehole is completed and the quality of the slurry and the bottom of the borehole are checked, any required reinforcing steel can be placed and the hole concreted as with the static process.

In direct circulation drilling, slurry is pumped down the drill pipe to the base of the drilling tool and floats the cuttings up the borehole outside of the pipe to the surface. From there the slurry and cuttings are pumped to the cleaning plant, and the cleaned slurry is pumped back down the hole. This method is less effective in obtaining a clean borehole than reverse circulation drilling.

Circulation drilling is usually ineffective in clays, which clog the lines and pumps, but can be very effective in granular soils and in rocks that can be pulverized by drilling tools prior to lifting the slurry and cuttings. Circulation drilling generally becomes economical relative to static drilling when borehole depths exceed about 30 m (100 ft) because of the time that is saved in not sending the drilling tool into and out of the hole to extract cuttings in the static method.

## **RELATIONSHIP OF CONSTRUCTION METHOD TO DESIGN PHILOSOPHY**

The sections of this manual that deal with design will indicate that the details of the construction procedures are critical with regard to the performance of the drilled shafts. Therefore, construction methods must be carefully controlled in order for the design to be correct. For example, if the casing method is being employed and if a thick sand-contaminated slurry is trapped behind the casing, the side resistance in the interval of soil behind the casing could well be lost. In another example, the failure of a contractor to complete the construction of a drilled shaft in rapid order could have a profound effect on the settlement and resistance of a drilled shaft. Figure 3.7 shows the results of cone penetration tests performed adjacent to two drilled shafts constructed in sand under a bentonite slurry. One of the drilled shafts (Figure 3.7 a) was concreted within two hours after the borehole was drilled. The other (Figure 3.7 b) was not concreted for two weeks. The loss in cone resistance ( $q_c$ ) relative to the cone resistance that existed before construction is dramatic in the second shaft. This loss of resistance will be reflected negatively in the performance of the second drilled shaft. However, no loss of resistance is indicated in the first shaft that was constructed in rapid order.

The design methods that are given in this manual do not distinguish among construction methods. That is, since it is assumed that the contractor will usually make the final choice of the construction method, it is not possible for the designer to know the exact details of the construction method prior to construction unless he or she chooses to specify a particular method. While there may be occasions when it is necessary for the designer to specify a particular construction method, for example, use of full-depth casing to protect adjacent structures, doing so will almost always add significantly to the cost of the job. If the method of construction in the general case is unspecified, there is a possibility that an ingenious and innovative contractor can devise procedures that are rapid and inexpensive so that the job cost is significantly reduced.

The key to ensuring that the design methods are appropriate is to assure that, whatever method of construction is chosen, the construction is done properly for that method. This requires well-crafted construction specifications that result in high-quality construction but that allow the contractor as much freedom as possible. If proper construction techniques are described

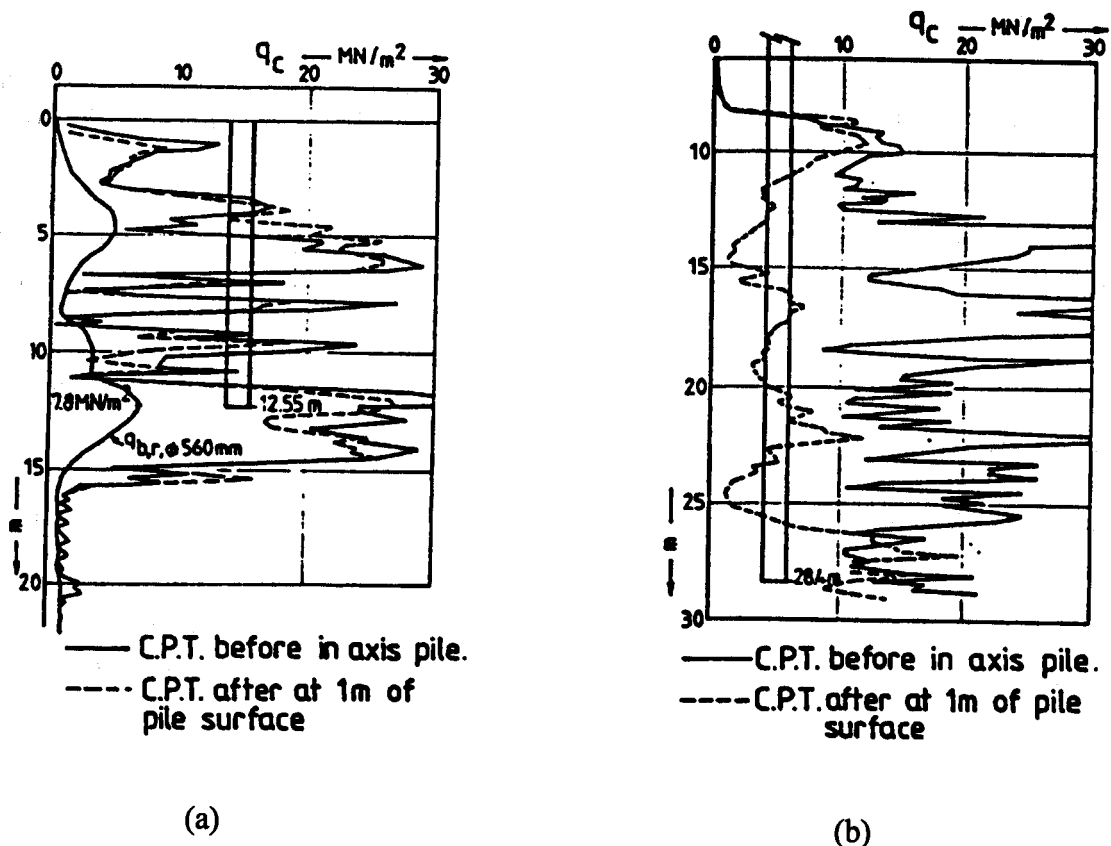

Figure 3.7. Effect of time lapse between drilling and concreting on CPT resistance of sand adjacent to drilled shafts constructed by the wet method: (a) Two hours between completion of drilling and concreting, (b) Two weeks between completion of drilling and concreting (De Beer, 1988)

clearly in the specifications for any method that the contractor chooses to use, and such specifications are followed, the design methods in this manual for estimation of capacity and settlement should be appropriate regardless of the construction method used.

To assist inspectors, engineers and contractors in the assessment of construction methods, expert systems for drilled shaft construction have recently begun to be developed (for example, Fisher et al., 1995). These are computer programs that ask the user questions about the project scenario and suggest optimum construction methods and solutions to problems that may be occurring during construction. While this technology is in its infancy at present (1997), it holds promise, particularly as a teaching resource for engineers and inspectors. Their purpose is not to replace experience and judgment but to provide an interactive and rapid way of training individuals to recognize and solve routine construction problems.

## REFERENCES

- De Beer, E. (1988). "Different Behavior of Bored and Driven Piles," in *Deep Foundations on Bored and Auger Piles*, W. Van Impe, Ed., Balkema, Rotterdam, pp. 47 - 82.
- Farr, S. J., and Reese, L. C. (1980). "Plain Concrete Underreams for Drilled Shafts," *Journal of the Structural Engineering Division*, American Society of Civil Engineers, Vol. 106, No. ST6, June.
- Fisher, D. J., O'Neill, M. W., Contreras, J. C. (1995). "DS<sup>2</sup>: Drilled Shaft Decision Support System," *Journal of Construction Engineering and Management*, American Society of Civil Engineers, Vol. 121, No. 1, March, pp. 86 - 94.
- Greer, D. M., and Gardner, W. S. (1986). *Construction of Drilled Pier Foundations*, John Wiley and Sons, New York.
- Reese, L. C., and O'Neill, M. W. (1995). "A Note on the Torsional Buckling of Rebar Cages," *Foundation Drilling*, ADSC, Dallas, Texas, June/July, pp. 16-17.
- Sheikh, S. A., O'Neill, M. W., and Venkatesan, N. (1983). "Behavior of 45-Degree Underreamed Footings," *Research Report No. 83-18*, University of Houston, Houston, Texas, November, 126 pp.
- Sheikh, S. A., and O'Neill, M. W. (1988). "Structural Behavior of 45-Degree Underreamed Footings," *Transportation Research Record 1119*, Transportation Research Board, Washington, D. C., pp. 83 - 91.

## **CHAPTER 4: METHODS OF EXCAVATION**

The types of drilling rigs and drilling tools that are to be used to make excavations for drilled shafts on a specific project are almost always chosen by the contractor. These choices are made based upon subsurface conditions that the contractor expects to find from his or her own experience and from the subsurface investigation data provided by the State and upon equipment available to the contractor. The choice of rigs and tools is critical to the success of a project. With only minor changes in a drilling tool, for example, the rate of excavation can change dramatically. Because of the importance of selecting proper tools, it is critical for both engineers and inspectors to understand the general types of rigs and tools available in the United States.

### **EXCAVATION BY ROTARY METHODS**

Almost all excavations for drilled shafts in the United States are made by some sort of rotary-drilling machine. The machines vary greatly in size and in design; however, the characteristic that principally differentiates the machines is the manner in which the drilling unit, or "rig," is mounted. Drilling units are mounted on trucks, cranes, or crawler-tractors. A few are mounted on skids. The characteristics of these mountings will be described in the following paragraphs.

The capacity of a drilling rig is expressed in terms of several parameters. Two of these parameters are the maximum torque that can be delivered to the drilling tools and the "crowd" or downward force that can be applied. Torque and crowd are transmitted from the drilling rig to the drilling tool by means of a drive shaft of steel, known as the kelly bar, or simply the "kelly." The drilling tool is mounted on the bottom of the kelly. Many kellys are square in cross section, but other shapes are used as well. The kelly can be a single piece to drill to depths of 15 to 18 m (50 to 60 ft), or it can be telescoped either to drill to greater depths or to allow drilling with low headroom. The kelly passes through a rotary table that is turned by the power unit to provide the torque. In some rigs the weight of the kelly and the tool provides the crowd. In others, hydraulic or mechanical devices are positioned to add additional downward force during drilling.

With regard to the efficiency in the making of an excavation, the drilling tool that is used is as important, or perhaps more important, than the drilling machine itself. Some specifications have been written, perhaps with reason on occasion, that require that the drilling machine for a project will have more than a minimum value of torque and crowd but without requirements regarding tools. Experts in drilling have pointed out that a dull tool or a poorly-selected one can frustrate a powerful machine but that a proper tool can result in good progress even with a machine that might appear to be under-powered. However, there is no doubt that the downward force on the drilling tool and the torque are important factors concerning the drilling rate.

The sections that follow the description of drilling machines and mounts will describe some of the tools that are in common use in rotary drilling, but the descriptions will be abbreviated to be consistent with the aims of this manual. Many details that are important to the drilling contractor in the preparation and maintaining of tools must obviously be omitted.

## **Truck-Mounted Drilling Machines**

Mobility is the greatest advantage of truck-mounted drilling machines. If the site is accessible to rubber-tired vehicles, excavation can proceed quickly. The derrick can be stored in a horizontal position, and the unit can move readily along a roadway. Special trucks that cannot travel under their own power on public roadways but which are mobile on construction sites, are termed "carriers." The truck or carrier can move to location, erect the derrick, activate hydraulic rams to level the rotary table, and begin drilling within a few minutes of reaching the borehole location. After a load of soil has been collected by the drilling tool, the kelly can be lifted, the tool swung to one side, and the soil can be discharged.

Truck-mounted machines are normally designed so that crowd can be applied to the drilling tool by mechanical means. Thus, the force at the point of drilling is larger than that provided by the weight of the kelly and drilling tool alone. Larger truck-mounted and carrier-mounted machines are therefore very effective in drilling rock.

A typical truck-mounted drilling machine is shown in Figure 4.1. The mobility of the machine is easy to visualize. It is of interest to point out that the space between the rotary table and the ground surface is necessarily limited. Thus, the truck-mounted rig is not very effective in drilling and subsequently working casing deeper and deeper into the ground, which may be desirable in some formations, such as bouldery, alluvial soils. Such a process requires a yoke or twister bar to be mounted on the kelly and for the casing to protrude a considerable distance, perhaps higher than the elevation of the rotary table, during initial excavation. Truck-mounted rigs can also have difficulty handling tall drilling tools, such as large-diameter, 60-degree beveling tools. The space below the rotary table can be increased by placing the rig on a ramped platform, but this procedure is obviously slow and expensive and would be used only in unusual circumstances. The alternative in such situations would be a crane-mounted drilling machine.

While the truck-mounted unit has a secondary line with some lifting capacity, that capability is necessarily small because of the limited size of the derrick. The drilling tools can be lifted for attachment to and detachment from the kelly, but, if a rebar cage, tremie or casing must be handled, a service crane may be necessary. Some truck rigs can handle rebar cages and tremies of limited length.

## **Crane-Mounted Drilling Machines**

A power unit, rotary table, and kelly can be obtained separately and mounted on a crane of the contractor's choice. A crane-mounted drilling machine is shown in Figure 4.2. Several features and definitions of components of the machine are evident.

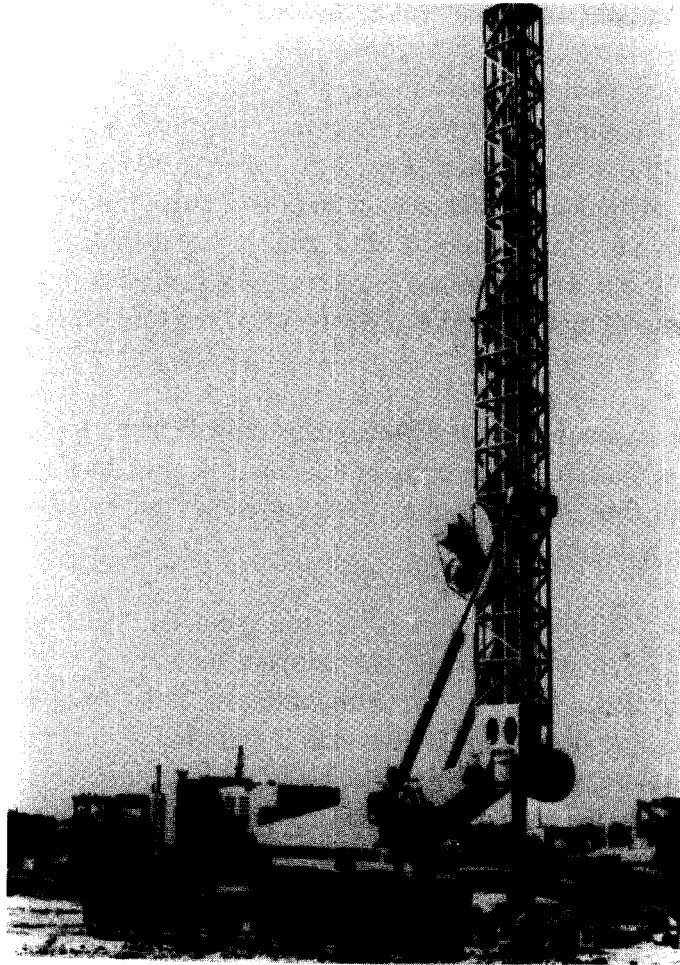

Figure 4.1. A typical truck-mounted drilling machine

The crane-mounted machine is obviously less mobile than the truck unit. When moving the machine from job to job, or location to location on the same job, the derrick, or "boom" is laid down or even disassembled; therefore, some rigging must be done before and after the move. This makes the crane-mounted rig less desirable than the truck-mounted rig in cases where only a few drilled shafts are to be installed at a given location unless the design requires the specific attributes of the crane mount, such as very large-diameter shafts.

Power units of various sizes can be obtained to supply torque up to 540 kN-m (400,000 ft-lb) at slow rotational speeds to the drilling tool. Usually, the downward force on the tool is due to the dead weight of the drill string, but the dead weight can be increased by use of heavy drill pipe (drill collars), "doughnuts," or a heavy cylinder. Special rigging is available for crane machines that will apply a crowd for drilling in hard rock. The cross-sectional area of the kelly can be increased to accommodate high crowds.



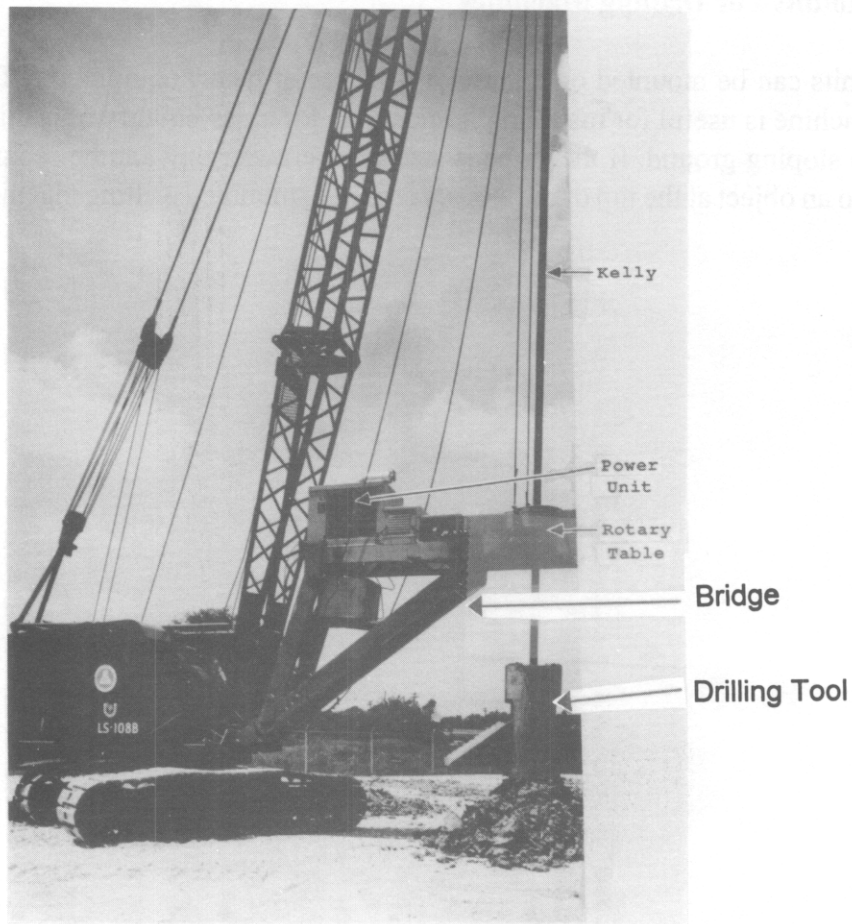

Figure 4.2. A typical crane-mounted drilling machine  
(Photograph courtesy of Farmer Foundation Company, Inc.)

The framework or "bridge" that is used to support the power unit and rotary table can vary widely. The rotary table may be positioned 23 m (75 ft) or more from the base of the boom of a 890-kN (100-ton) crane by using an extended mount (Reese and Farmer, 1977). The bridge for the drilling unit can also be constructed in such a way that a tool of almost any height can fit beneath the rotary table. Therefore, crane-mounted units with high bridges can be used to work casing into the ground while drilling or for accommodating tall drilling tools.

A service crane or the drilling crane itself is used on the construction site for handling rebar cages, tremies, concrete buckets and casings. The secondary lift line on the drilling crane can be used for common lifting by tilting the derrick forward and away from the rotary table.

Thus, the crane-mounted drilling unit is highly versatile.

### Special Mounts For Drilling Machines

Drilling units can be mounted on a variety of pieces of heavy equipment. The crawler-mounted drilling machine is useful for installing foundations for cross-country transmission lines and when drilling on sloping ground. If the slope is steep, the crawler unit can be secured by a cable that is anchored to an object at the top of the slope. A crawler-mounted drilling machine is shown in Figure 4.3.

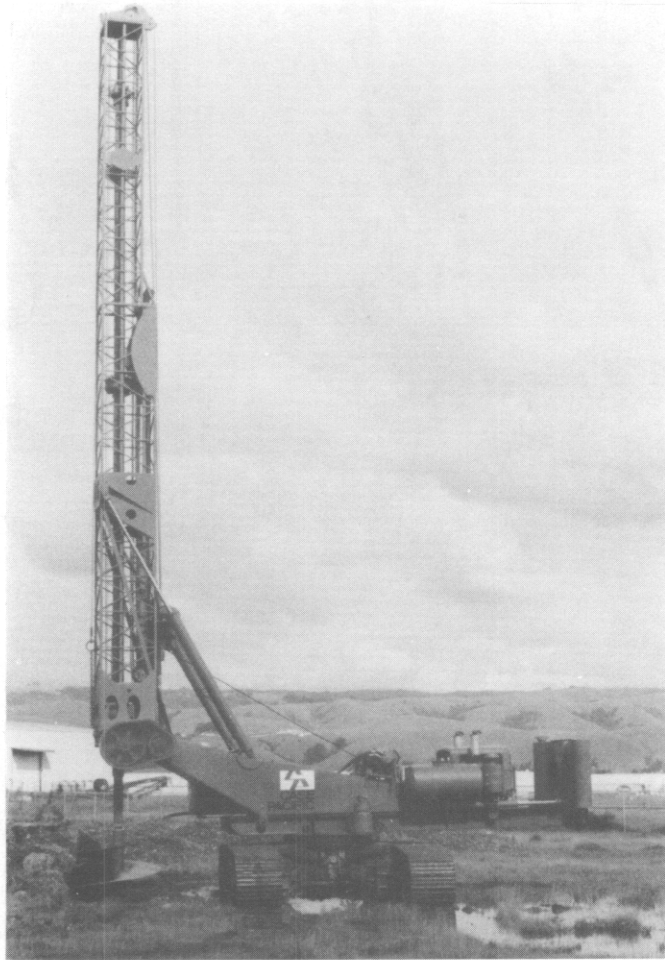

Figure 4.3. A typical crawler-mounted drilling machine  
(Courtesy of Case Pacific Company)

Full-depth casing rigs are occasionally mounted on skids. For example, the rig shown in Figure 3.5 b is mounted on skids and must be moved from location to location by picking it up with a crane. In this case, the skids help provide the torque reaction for the rig. Other versions of the full-depth casing rig have free-standing oscillators that twist and push casing into the ground using a device that sits atop the casing.

## Low Headroom Drilling Machines

With the recent interest in bridge rehabilitation, low-headroom drilling machines have become popular. These rigs are normally mounted on trucks or crawlers and are highly mobile. The most common version consists of a hydraulic rotary table mounted atop a string of telescoping Kellys with short steps. Such rigs can easily work within about 4.6 m (15 ft) of head space and excavate boreholes up to 1.83 m (6 ft) in diameter up to about 27.5 m (90 ft) deep. A photograph of such a machine is shown in Figure 4.4. Other drilling machines are capable of working in less head space but are more limited in the diameter and depth of excavations.



Figure 4.4. Low-headroom drilling machine (crawler-mounted)  
(Photograph courtesy of A. H. Beck Foundation Company)

## Summary of Rotary Drilling Machine Characteristics

Table 4.1 presents a summary of some of the general characteristics of drilling machines that are in common use in the United States. Omitted from the table are data on machines that are manufactured in Europe, Japan and elsewhere. Manufacturers should be consulted for any detailed information to be included in construction specifications.

Table 4.1. Brief listing of characteristics of some drilling machines

Model	Mount	Max. torque (kN-m)	Crowd (kN)*	Approx. max. hole diam. (m)	Approx. max. hole depth (m)	Kelly size (mm on side)**
<b>Watson</b> 5000CA EDT-7	Crane Crawler (low h'roon)	135 68	Variable*** 89	3.05 1.37	43 28.7	203 Varies
3100	Truck or Crawler	136	223	2.75	36.5	203
2500	Truck or Crawler	110	169	2.44	27	152
1500	Truck or Crawler	76	107	1.93	27	152
<b>Hain</b> 8V71/754 4-71/3531-3	Crane Crane	509 (stall) 227 (stall)	Variable*** Variable***	3.66 3.05	45 36.5	343 279
<b>Atlantic</b> Hughes LDH Hughes LLDH	Truck Truck	68 136	164 267	2.44 3.05	30.5 36.6	152 275
<b>Calweld</b> 155 ADL	Crane Truck	204 87	160 178	2.44 1.83	61 20	Round kelly 152
<b>Texoma</b> 700 II TAURUS	Truck or Crawler Truck	73 114	100 228	1.83 2.44	18 30.5	140 178

\* Crowd is limited by rig weight.

\*\* Outside dimension of outer kelly. Inner sections will have smaller diameters.

\*\*\* Crowd depends on weight of kelly plus drilling tool used.

Note 1: The values given in this table represent approximate limiting economic capabilities and not continuous operating capacities. Deeper and larger diameter boreholes can often be drilled by using special tools and longer kelly bars.

Note 2: 1 kN-m = 737 ft-lb; 1 kN = 224.7 lb; 1 m = 3.28 ft; 1 mm = 0.0394 in.

## **Tools for Rotary Drilling**

The tool selected for rotary drilling may be any one of several types, depending on the type of soil or rock to be excavated. The exact characteristics of the tool must be defined.

For example, it is necessary that the lower portion of the tool cut a hole slightly larger than the upper part of the tool to prevent binding and excessive friction. It would not be unusual for one driller to reach refusal with a particular tool while another driller could start making good progress with only a slight adjustment to the same tool.

The following paragraphs give brief descriptions of some of the common tools used in rotary drilling, but many important details must necessarily be omitted. Different contractors and drillers will select different tools for a particular task and in many instances will have their own particular way of setting up and operating the tool. Thus, it is not possible to describe all "standard" tools that are in use in the industry.

The tools for rotary drilling are available in sizes that vary in 152-mm (6-in.) increments up to approximately 3.05 m (10 ft) in diameter. Larger sizes are available for special cases.

### **Drilling Bucket**

A typical drilling bucket is shown in Figure 4.5. Drilling buckets are used mainly in soil formations, as they are not effective in excavating rock. Soil is forced by the rotary digging action to enter the bucket through the two openings (slots) in the bottom; flaps inside the bucket prevent the soil from falling out through the slots. After obtaining a load of soil, the tool is withdrawn from the hole, and the hinged bottom of the bucket is opened to empty the spoil. Drilling buckets are particularly efficient in granular soils, where an open-helix auger cannot bring the soils out.

They are also effective in excavating soils under drilling slurries, where soils tend to "slide off" of open helix augers. When used to excavate soil under slurry, the drilling bucket should have channels through which the slurry can freely pass without building up excess positive or negative pressures in the slurry column below the tool. It is much easier to provide such pressure relief on drilling buckets than on open-helix augers.

The cutting teeth on the bucket in Figure 4.5 are flat-nosed. These teeth effectively "gouge" the soil out of the formation. If layers of cemented soil or rock are known to exist within the soil matrix, conical, or "ripping," teeth might be substituted for one of the rows of flat-nosed teeth to facilitate drilling through alternating layers of soil and rock without changing drilling tools.

Some drilling buckets are designed to be used for bailing water out of the hole. Still other buckets are designed to clean the base when there is water or drilling slurry in the hole (Figure 4.6). These are known as "muck buckets" or "clean-out buckets." Clean-out buckets have cutting blades, and drilling buckets are generally not appropriate for cleaning the bases of

boreholes. The operation of the closure flaps on the clean-out bucket, or steel plates that serve the same purpose as flaps, are critical for proper operation of the clean-out bucket. If such flaps or plates do not close tightly and allow soil to fall out of the bucket, the base cleaning operation will not be successful. As with drilling buckets, clean-out buckets should be equipped with channels for pressure relief if they are used to clean boreholes under slurry.

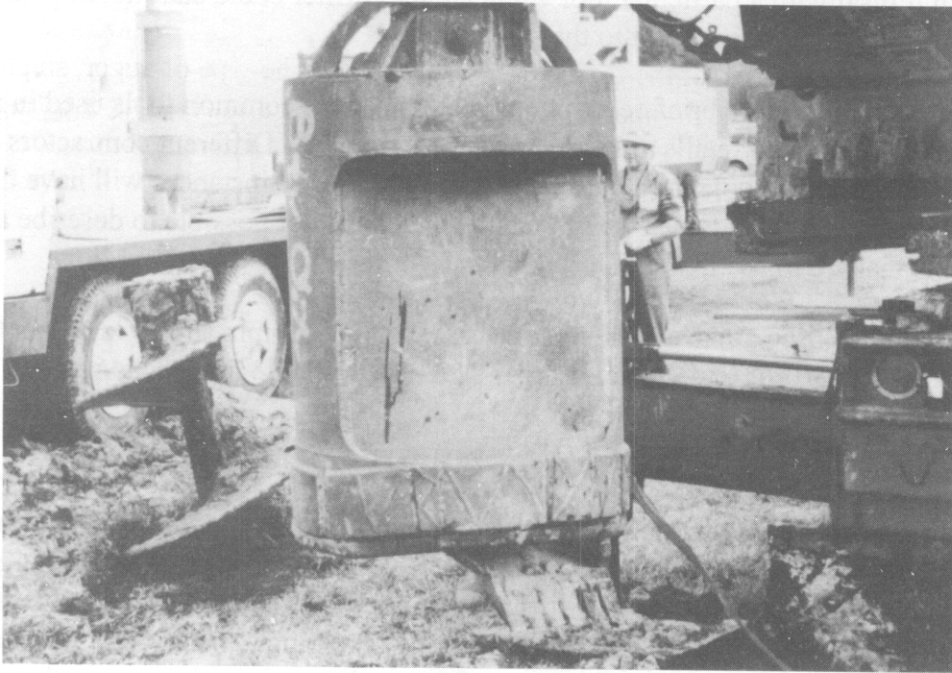

Figure 4.5. A typical drilling bucket

### **Flight Augers (Open Helix)**

This type of drilling tool can be used to drill a hole in a variety of soil and rock types and conditions. It is most effective in soils or rocks that have some degree of cohesion. The auger is equipped with a cutting edge that during rotation breaks the soil or rips the rock, after which the cuttings travel up the flights. The auger is then withdrawn from the hole, bringing the cuttings with it, and emptied by spinning. Problems can arise when drilling in cohesionless sands where soil slides off the auger flights or in some cohesive soils where the tool can become clogged. Care must be exercised in inserting and extracting augers from columns of drilling slurry, as the slurry is prone to development of positive (insertion) and negative (extraction) pressures that can destabilize the borehole.

Augers may be of the single- or double-flight type, and many have a central point or "stinger" that prevents the auger from wobbling. Double-flight augers are usually used for excavating stronger geomaterials than are excavated with single-flight augers. The stinger for a single-flight

auger (Figure 4.7) must be more substantial than for a double-flight auger (Figure 4.8) because the single-flight auger must sustain an unbalanced moment while the geomaterial is being cut, whereas the double-flight auger does not. Some contractors have found that double-flight augers without stingers can be used efficiently.

The flighting for augers must be carefully designed so that the material that is cut can move up the auger without undue resistance. Some contractors have found that augers with a slight cup shape are more effective at holding soils when drilling under slurry than standard non-cupped augers. The number and pitch of the flights can vary widely. The type of auger, single-flight or double-flight, cupping, and the number and pitch of flights will be selected after taking into account the nature of the soil to be excavated. Continuous-flight augers, up to a certain length, may be advantageous in some situations.

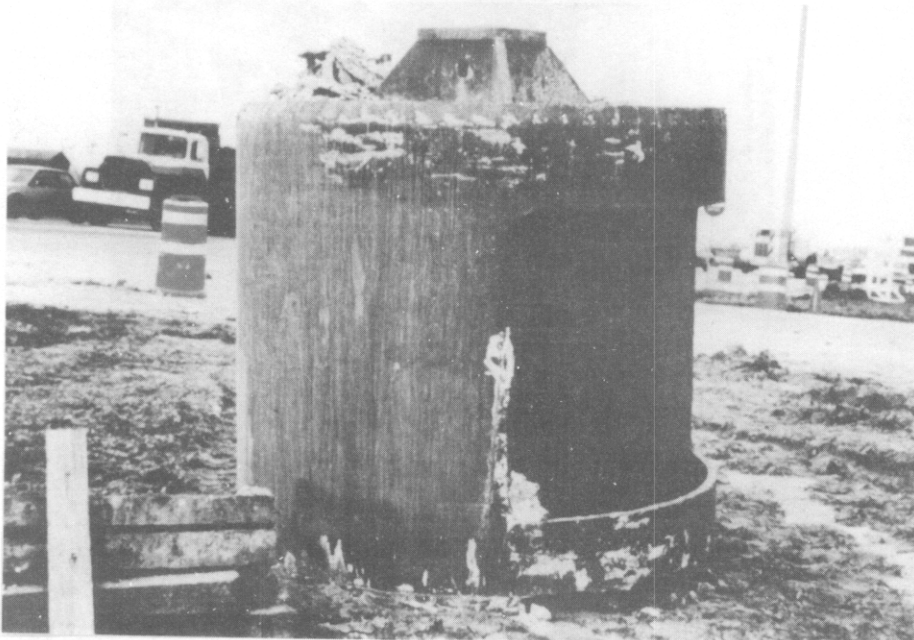

Figure 4.6. A typical "muck bucket" or "clean-out bucket"

The cutting face on most augers is such that a flat base in the borehole results (that is, the cutting face is perpendicular to the axis of the tool). The teeth in Figures 4.7 and 4.8 are flat-nosed for excavating soil. The teeth could also be conical ripping teeth to excavate rock, as described under "Rock Augers," and the shape and pitch of flat-nosed teeth can be varied. Modifying the pitch on auger teeth by a few degrees can make a significant difference in the rate at which soil or rock can be excavated, and the contractor may have to experiment with the pitch and type of teeth on a project before reaching optimum drilling conditions.

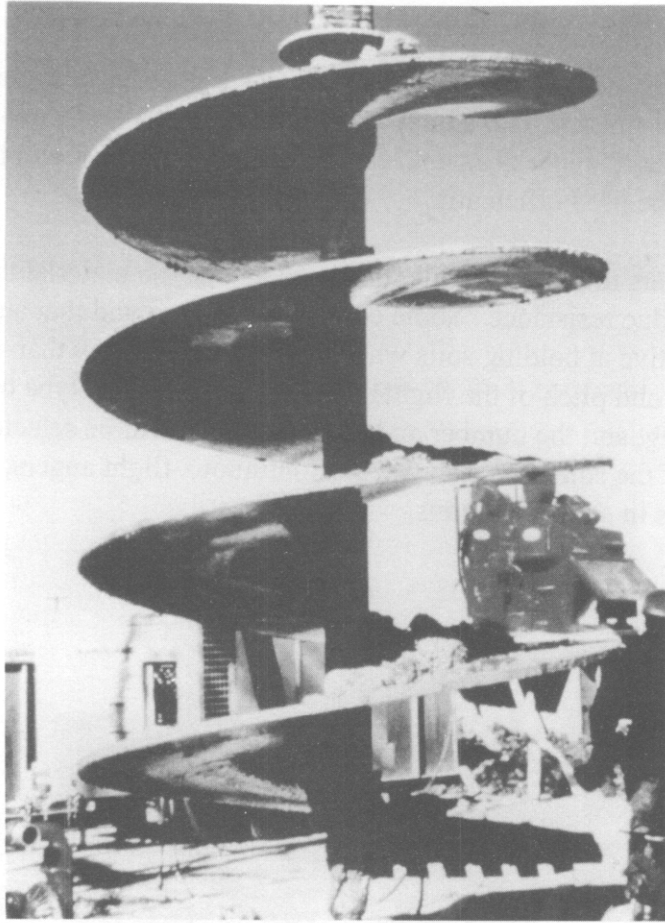

Figure 4.7. A single-flight auger

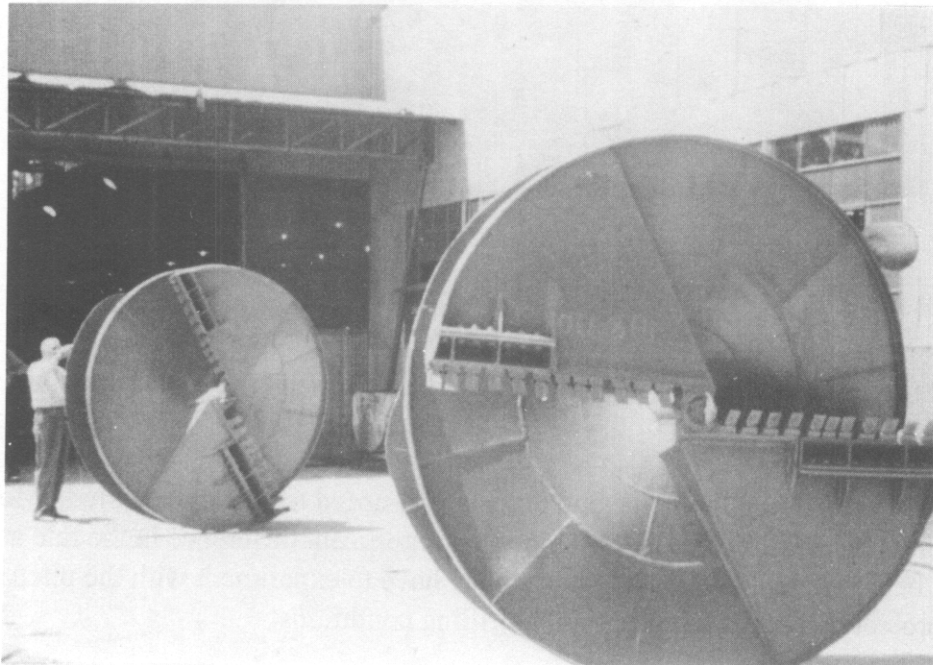

Figure 4.8. A typical double-flight auger



An important detail, particularly in soils or rocks containing or derived from clay, is that softened soil or degraded rock is often smeared on the sides of otherwise dry boreholes by augers as the cuttings are being brought to the surface in the flights of the auger. This smeared material is most troublesome when some free water exists in the borehole, either through seeps from the formation being drilled or from water that is introduced by the contractor to make the cuttings sticky and thus facilitate lifting. Soil smear can significantly reduce the side resistance of drilled shafts, particularly in rock sockets. A simple way to remove such smear is to reposition the outermost teeth on the auger so that they face to the outside, instead of downward, and to insert the auger and rotate it to scrape the smeared material off the side of the borehole prior to final cleanout and concreting.

Careful exploration and planning must be done if the excavation must penetrate a layer of cobbles or boulders. The preferred method of excavating cobbles or boulders is with an auger. Cobbles or small boulders can sometimes be excavated by augers. Modified single-helix augers, designed with a taper and with a calyx bucket mounted on the top of the auger, called "boulder rooters," can sometimes be more successful at extracting small boulders than standard digging augers. The extraction of a large boulder or rock fragment can cause considerable difficulty, however. If a boulder is solidly embedded, it can be cored. Many boulders, however, are loosely embedded in soil, and coring is ineffective. The removal of such boulders may require that the boulders be broken by impact or by blasting (if permitted). A boulder can sometimes be lifted from the excavation after a rock bolt has been attached.

### **Rock Auger**

The flight auger can also be used to drill relatively soft rock (hard shale, sandstone, soft limestone, decomposed rock).

Hard-surfaced, conical teeth, usually made of tungsten carbide, are used with the rock auger. Rock augers are usually of the double-helix type. A rock auger is shown in Figure 4.9. As may be seen in the figure, the thickness of the metal used in making the flights is more substantial than that used in making augers for excavating soil. As with soil augers, the geometry and pitch of the teeth are important details in the success of the excavation process.

Rock augers can also be tapered, as shown in Figure 4.10. Some contractors may choose to make pilot holes in rock with a tapered auger of a diameter smaller than (perhaps one-half of) that of the borehole. Then, the hole is excavated to its final, nominal diameter with a larger-diameter, flat-bottom rock auger or with a core barrel. The stress relief afforded by pilot-hole drilling often makes the final excavation proceed much more easily than it would had the pilot hole not been made. It should be observed, however, that tapered rock augers will not produce a flat-bottomed borehole, so that it is important that a flat base be produced by the nominal-diameter tool. Failure to produce a flat base in the borehole will make it very difficult to clean the base and produce a sound bearing surface.

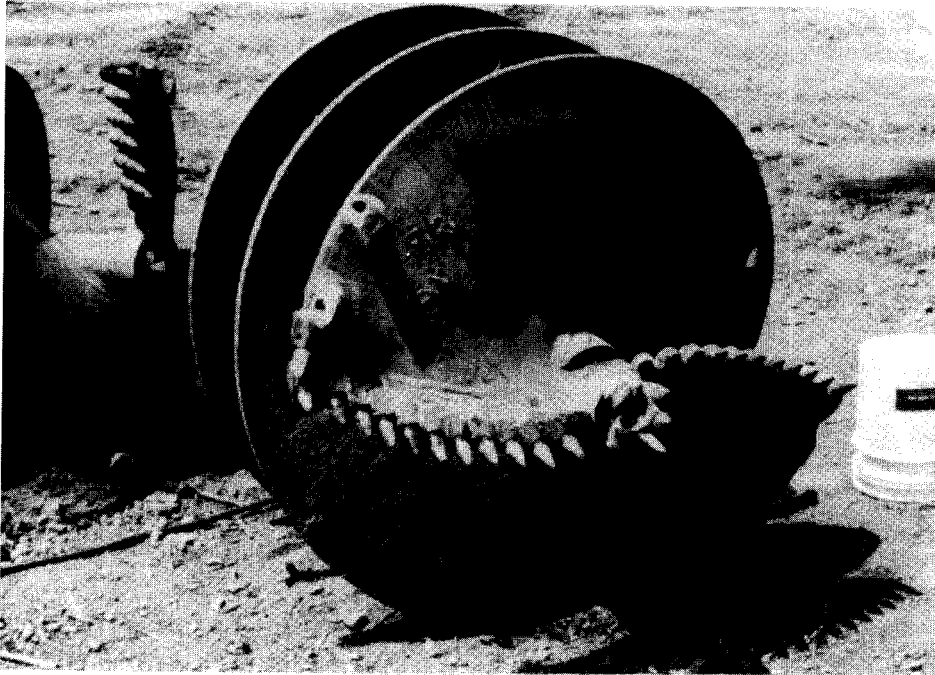

Figure 4.9. A typical rock auger

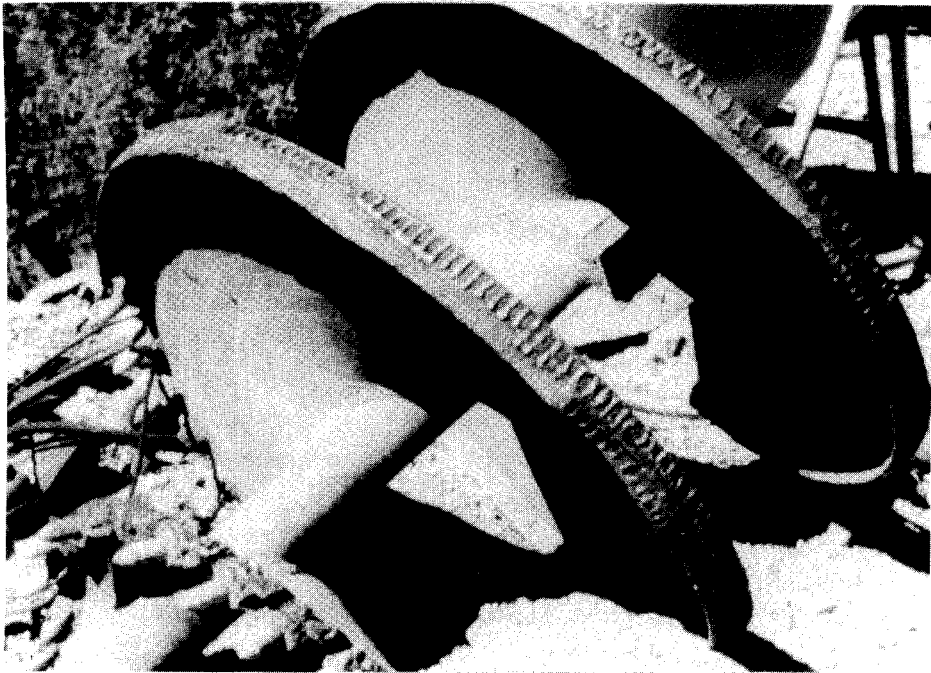

Figure 4.10. Tapered rock auger for loosening fragmented rock  
(Photograph courtesy of John Turner)

## **Core Barrel**

If augers are ineffective in excavating rock (for example, the rock is too hard), most contractors would next attempt to excavate the rock with a core barrel. The simplest form of core barrel is a single, cylindrical steel tube with hard metal teeth at the bottom edge to cut into the rock. The tube cores into the rock until a discontinuity is reached and the core breaks off. The section of rock contained in the tube, or "core," is held in place by friction from the cuttings and is brought to the surface by simply lifting the core barrel. The core is then deposited on the surface by shaking or hammering the core barrel or occasionally by using a chisel to split the core within the core barrel to allow it to drop out. A core barrel is shown in Figure 4.11. Excavation by core barrel is a slow process, but it may be necessary in some geologic formations.

Core barrels are also available with double walls. The inner wall is a cylinder of steel that contacts the core, while the outer wall, which contains conical roller bits at the cutting edge, rotates and cuts the rock away. Both barrels ordinarily rotate. A double-walled core barrel is shown in Figure 4.12. The cuttings are removed by circulation of air if a dry hole is being excavated or by circulation of water in a wet hole. The hardness of the teeth of the conical bits can be altered for drilling in different kinds of rock. Normally, medium chisel-type, button cones are used, but there are long button cones that are used in soft materials, and short round button cones that are used in harder materials.

Double-walled core barrels are generally capable of extracting longer cores than single-walled core barrels, which constantly twist and fracture the rock. However, double-walled barrels are more expensive and difficult to maintain than single-walled barrels.

One of the problems with the use of the core barrel is to loosen and recover the core after the core barrel has penetrated an appropriate distance (one to two meters). Various techniques can be used for such a purpose. For instance, if the core breaks at a horizontal seam in the rock, drillers may be able to lift the core directly or by a rapid turning of the tool. When the core does not come up with the barrel, a chisel (wedge-shaped tool) can be lowered and driven into the annular space cut by the core barrel either to break the core off or to break it into smaller pieces for removal with another piece of equipment. If the hole is dry and not too deep, a worker protected by a casing can be lowered to attach a line to the core for removal by a crane. A hammergrab or clamshell can be used to lift loose or broken cores, if necessary.

## **Shot Barrel**

Only a slight penetration of rock is often required to provide ample bearing resistance for a drilled shaft in some rock formations, but such rocks are occasionally so hard that a rock auger or core barrel is ineffective in providing even minor penetration. In such a case an alternate technique is to employ a barrel similar to the core barrel but with a plain bottom. Hard steel shot are fed below the base of the rotating core barrel so as to grind away even the hardest rock. The resulting short core is lifted out, exposing the bearing surface.

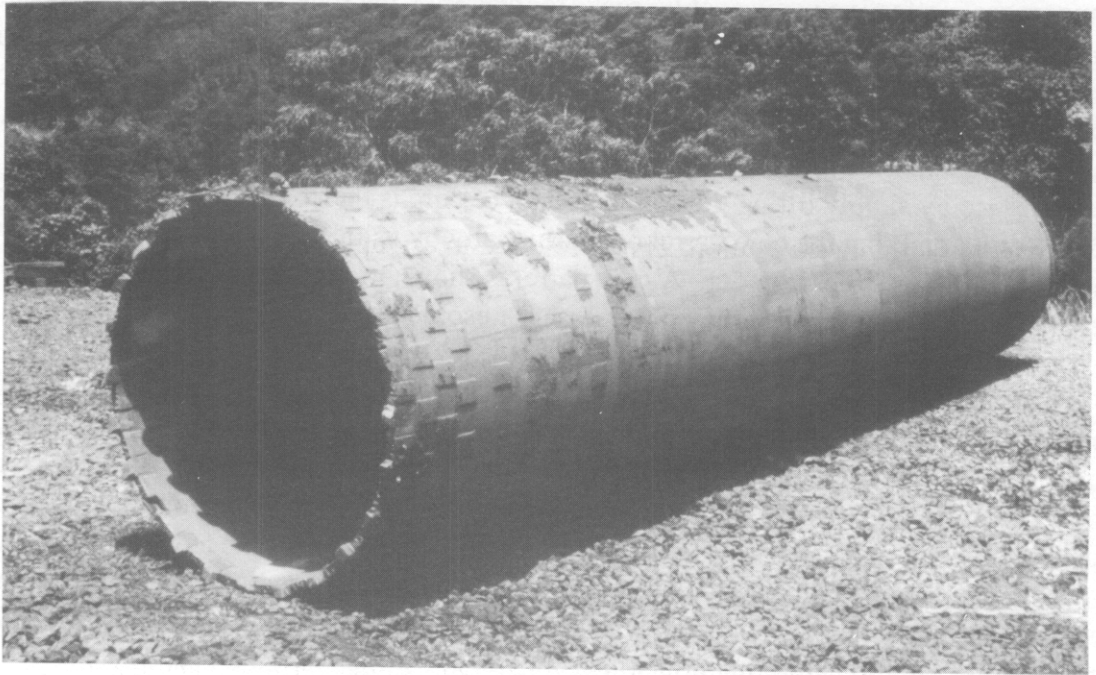

Figure 4.11. A typical single-walled core barrel

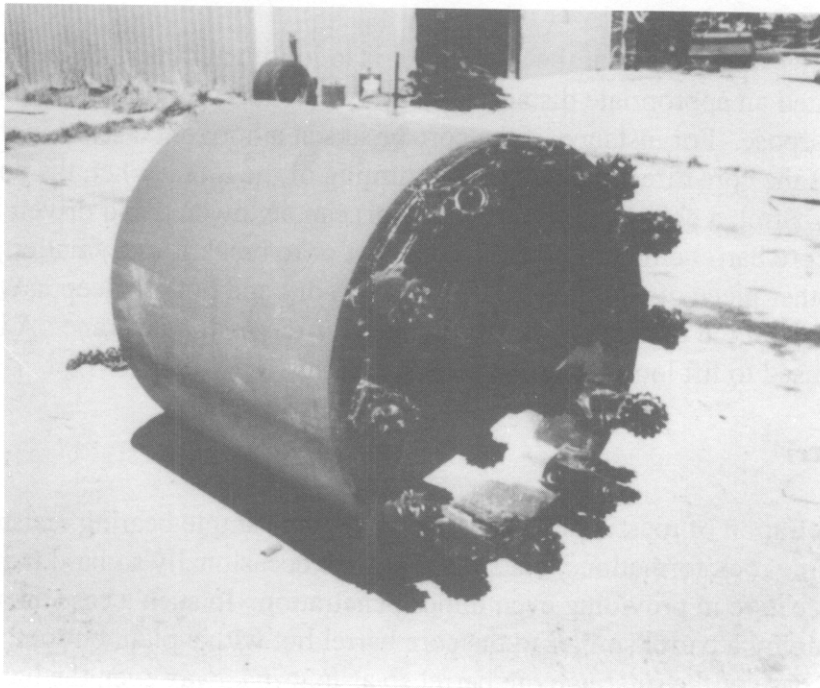

Figure 4.12. A double-wall core barrel (Photograph courtesy of W. F. J. Drilling Tools, Inc.)

## **Full-Faced Excavators**

Oil-field techniques are sometimes used for drilling rock, particularly at a large depth. Figure 4.13 shows a tool that makes use of roller bits that are attached across the entire face of the body of a 0.61-m- (24-in.-) diameter tool. The roller bits grind the rock, which is transported to the surface by flushing drilling fluid down the hole in the "direct circulation" process that was described in Chapter 3, or blowing cuttings out with compressed air. In very hard rock, a small cutter can be placed in the center of the face to cut ahead of the main cutters and relieve stresses in the rock to facilitate excavation. This is referred to as duplex excavation.

## **Underreamers or Belling Buckets**

A special tool has been designed to increase the bearing area and the load capacity of a shaft by forming an enlarged base, or a "bell," as described in Chapter 3. This tool, called a belling bucket or underreamer (Figure 4.14), is designed to be lowered into the hole on the kelly with its arms closed. The reamer, with arms extended as it would appear in the drilling position, is shown in Figure 4.15. Upon reaching the bottom of the shaft, the downward force applied by the drilling machine forces the arms to open and the soil is dug while the tool is rotated. The cuttings are collected inside the tool and brought to the ground surface for spoiling. This continues until the arms reach a stop, resulting in a fully-formed bell with a predetermined angle and bell dimensions. Commercially available drilling buckets cut 60-degree underreams (sides of the bell make an angle of 60 degrees with the horizontal) and 45-degree underreams, or the tools can be adjusted by the contractor to cut other angles. The bell diameter does not exceed three times the shaft diameter.

## **Special Tools**

Innovative equipment suppliers and contractors have developed a large number of special tools for unusual problems that are encountered. For example, some tools cut grooves in the walls of the borehole in order to facilitate development of the shearing strength of the soil or rock along the sides of the drilled shaft. Core barrels have been outfitted with steel rods on the outside of the barrel to scrape cuttings or loose rock from the surface of rock sockets. Such devices are known regionally as "backscratchers." Other tools are used for assistance in excavation. For example, Figure 4.16 shows a drawing of a tool (the "Glover Rock-Grab") that can core and subsequently grab rock to lift it to the surface. This tool is sometimes effective in excavating boulders or fragmented rock where augers or ordinary core barrels are of little help. Scores of other such tools could be mentioned.

## **EXCAVATION BY PERCUSSION METHODS**

In contrast to rotary drilling, percussion drilling involves the breaking up of rock, or occasionally soil, if necessary, by impact, and lifting the broken rock with a clamshell-type bucket. The method may appear to be cumbersome and uneconomical; however, as will be explained, the method has certain advantages.

The first oil wells in the United States were drilled by percussion methods using "cable tools." The cable-tool procedures were soon replaced by rotary drilling, but cable tools are still used in some instances in the United States for drilling water wells.

Percussion drilling is initiated by the setting of a guide for the tools, a procedure that corresponds to the setting of a surface casing when rotary methods are being used. The guide may be circular or rectangular and is designed to conform to the excavating tool. The cross sections of such excavations can have a variety of shapes and can be quite large.

### **Lifting Machines**

Two types of lifting machines may be used to handle the digging tools that are needed for percussion excavation. The simplest procedure is to raise and lower the tools with a cable such as provided by a crane (hence, the term "cable tool"). The jaws of the digging bucket can be opened and closed by a mechanical arrangement that is actuated by a second cable or by a hydraulic system.

The other type of lifting machine uses a solid rod for moving the excavating tools up and down. The rod, which may be called a kelly, is substantial enough to allow the easy positioning of the tool. The kelly in this case does not rotate but merely moves up and down in appropriate guides. As before, a mechanism must be provided for opening and closing the jaws of the bucket.

### **Clamshell or Grab Bucket**

A digging bucket can be used to excavate broken rock, cobbles and soils that are loose and that can be readily picked up by the bucket. If hard, massive rock or boulders are encountered, a tool such as a rock breaker may be used. The broken rock is then lifted using a clamshell or a grab bucket. A typical clamshell, with a circular section for use in drilled shafts, is shown in Figure 4.17. Clamshells and grab buckets are available in various diameters up to about 1.83 m (6 ft). Clamshells or grab buckets can also be used with the percussion method to make excavations with noncircular cross sections. The transverse dimension of the tool must conform to the shape of the guides that are used.

### **Rock Breakers**

Several types of tools are made to be dropped by a crane to impact bedrock, strong soils, or boulders in order to break up the geomaterial and permit it to be lifted by a clamshell or a grab bucket. An example of a rock breaker is shown in Figure 4.18. This particular rock breaker is termed a "churn drill" or a "star drill." As can be seen, the bottom of the tool has a wedge shape so that high stresses will occur in the rock that is being impacted by the tool. While such tools can be a significant aid in excavating some materials (for example, in making a "purchase," or initial cut, in severely sloping rock that cannot be drilled with an auger or core barrel), their use should be avoided if possible because the rate of excavation will be severely reduced if it is necessary to change tools, and even machines, as the hole is advanced.



Figure 4.13. Full-faced tool with roller bit (Photograph courtesy of Caissons, Inc.)

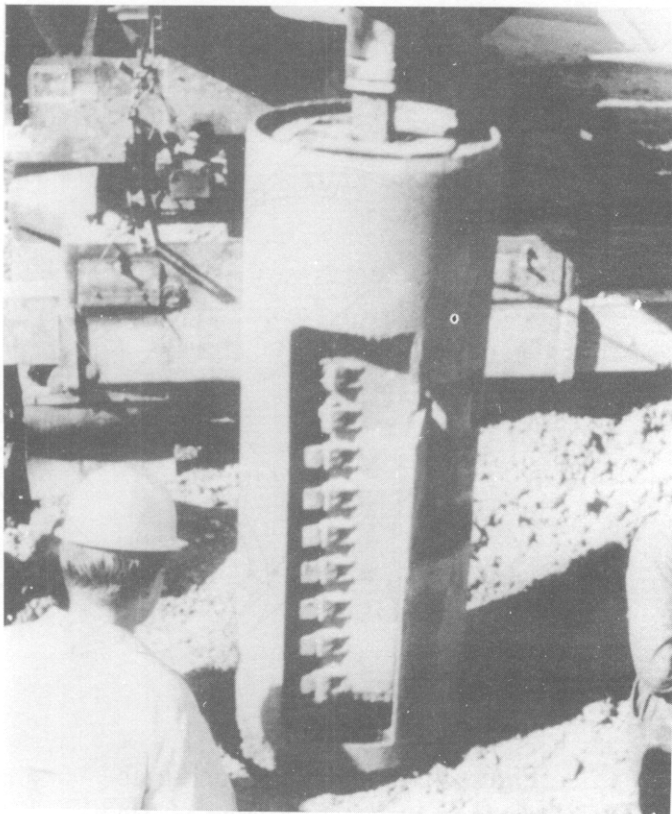

Figure 4.14. A typical closed boring tool inserted into a borehole

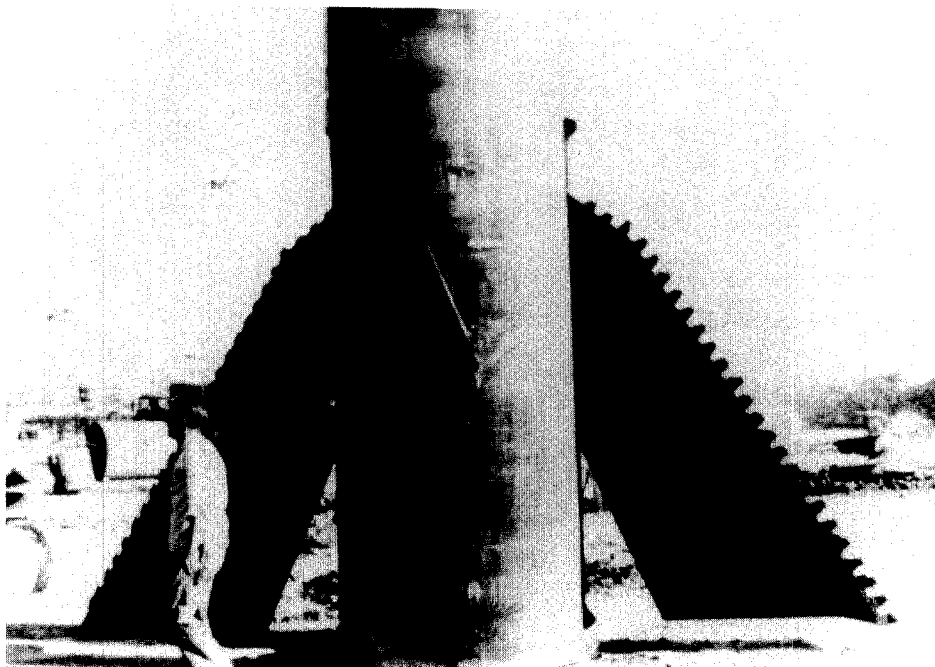

Figure 4.15. A typical belling bucket in drilling position

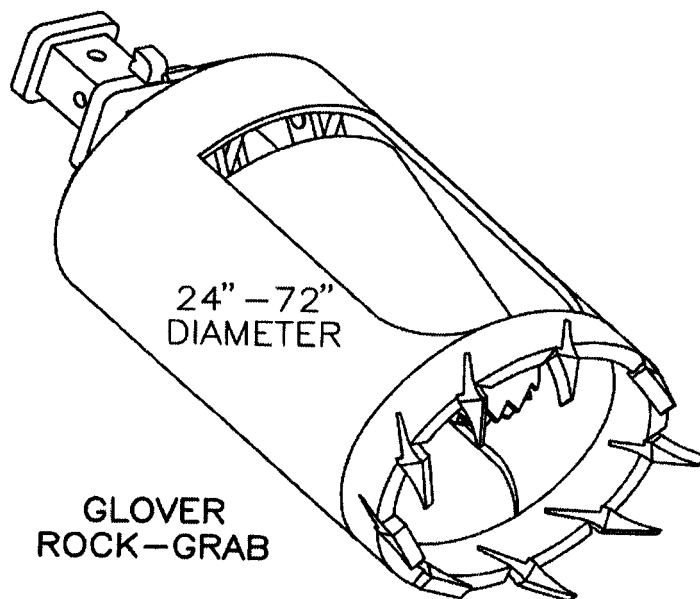

Figure 4.16. A Glover rock-grab  
(Drawing courtesy of Steven M. Hain)  
(Note: 1 in. = 25.4 mm)





Figure 4.17. A typical grab bucket (Photograph courtesy of John Turner)



Figure 4.18. An example of a churn drill (Photograph courtesy of John Turner)

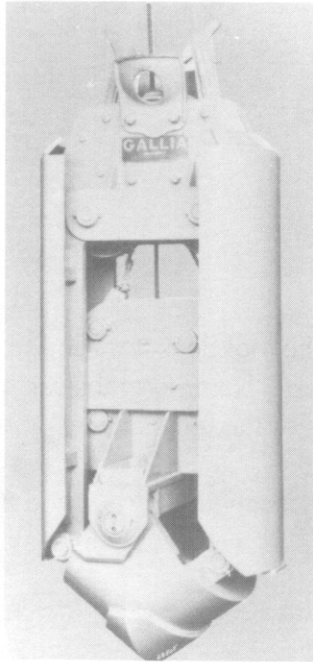

Figure 4.19. An example of a hammergrab (from LCPC, 1986)

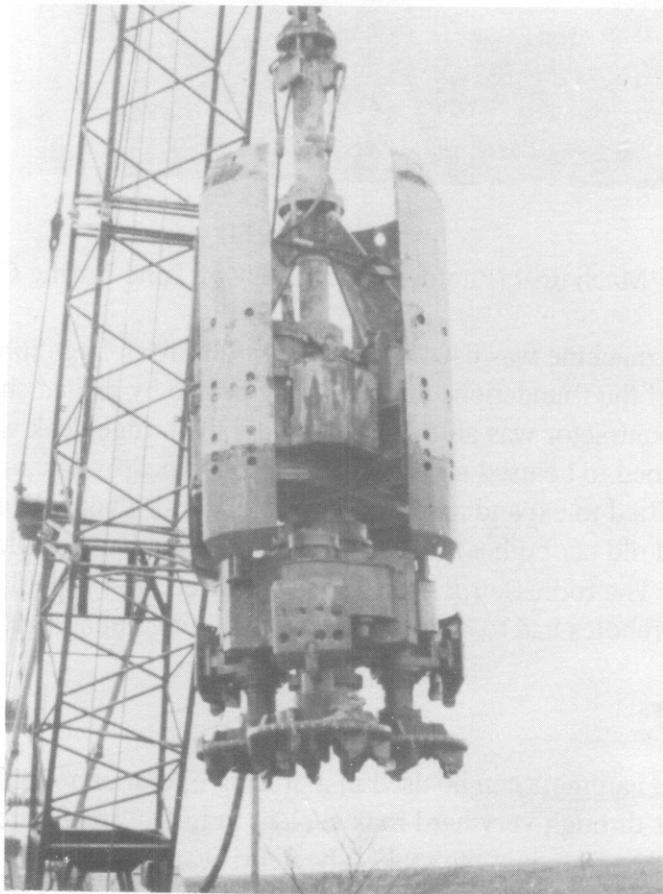

Figure 4.20. An example of a rodless soil drill (Photograph courtesy of Tone Boring Corp., Ltd.)

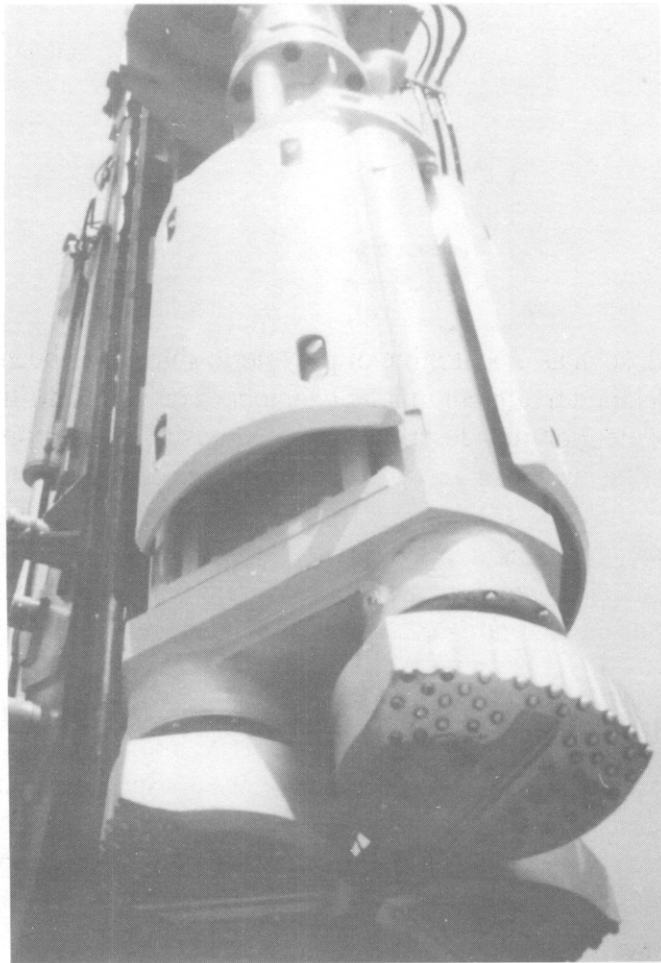

Figure 4.21. Mach drill (Photograph courtesy of Tone Boring Corp., Ltd.)

The rodless soil drilling machine was used quite successfully for a large job on the Gulf coast involving replacement of the foundations of an existing bridge by drilled shafts. The headroom was restricted, and the contractor was able to work below the bridge deck with a rodless drill. The same drill was planned to be used on another project at a nearby location where very deep drilled shafts were specified to expand an existing bridge across a lake. Dumped fill (construction rubble and old car bodies) was encountered at relatively shallow depths at some drilled shafts locations. The rodless drill was rendered ineffective by the presence of the hard obstructions, and the boreholes had to be excavated with conventional kelly-bar tools

### **Air-Operated Hammers**

A cluster of air-operated hammers can be used in a drilling operation to make an excavation up to 1.53 m (5 ft) in diameter through very hard rock such as granite. The cluster of air-operated hammers can be lowered to fragment the rock. The debris can be raised by the use of air (i. e., debris is blown out of the borehole) if the hole is dry. The excavation of rock in such a manner is obviously extremely expensive and normally is to be avoided, especially in urban environments

## **Hammergrabs**

Hammergrabs are percussion tools that both break and lift rock. An example of a hammergrab is shown in Figure 4.19, and a hammergrab in use is shown in Figure 3.5 b. Hammergrabs are made heavy by the use of dead weight. The jaws at the bottom of the tool are closed when the tool dropped, and the wedge formed by the closed jaws breaks the rock. The jaws have strong, hardened teeth and they can open to the full size of the tool to pick up the broken rock. Hammergrabs are heavy and relatively expensive devices; however, they have the advantage over rock breakers and clamshells that the tool does not need to be changed to lift out the broken rock, which speeds the excavation process. Hammergrabs can also be used to construct non-circular barrettes by changing the length of the long side.

The hammergrab is an effective tool for excavating strong soil and relatively soft rock, if it is properly selected and maintained. Boulders or rock fragments of a considerable size can be broken up or lifted intact by the hammergrab. Hammergrabs are available in various diameters up to 1.83 m (6 ft).

## **OTHER METHODS OF EXCAVATION**

### **Rodless Drill**

Several versions of rodless drilling machines have been developed in Japan that can be used in certain cases to solve difficult problems. The version of the machine that is effective in excavating soil is shown in Figure 4.20. It consists of down-the-hole motors that drive excavating cutters that rotate in a column of bentonite drilling slurry. The cutters are designed to gouge the soil from the bottom of the excavation and push it to the center of the excavation, where it is then sucked into a flexible return line with the slurry and transported to the surface. As may be seen, the machine is handled with a cable; therefore, it is not necessary to have a high derrick. Along with the drilling machine, a system for mixing and conditioning the drilling slurry must be used as described under the reverse-circulation drilling process in Chapter 3. The rodless drill comes in a variety of diameters ranging from 1 to 3 m (39 to 118 in.), and the manufacturer indicates that the maximum drilling depth is 79 m (259 ft). Contractors who use it state that it is competitive economically with other excavation methods for drilled shafts exceeding a depth of about 30 m (100 ft).

Another version of the rodless drill, termed the "Mach Drill" by the manufacturer, can excavate through the hardest rock. Instead of the drag bits used for gouging soil shown in Figure 4.20, the Mach Drill has a series of hydraulically-operated hammers with button teeth that pulverize the rock and rotate to push the pulverized rock to the center of the excavation, where the rock fragments are removed by the reverse circulation process. A photograph of the Mach drill is shown in Figure 4.21. The manufacturer states that the Mach Drill is capable of excavating sound rock with a maximum uniaxial compressive strength of approximately 193 MPa (28,000 psi) at rates of up to 2 m per hour during continuous operation of a 0.76-m- (30-in.-) diameter machine.

where rock dust can create a hazard to humans not involved in the construction process. If the design is made on the basis of compressive load alone, penetration of more than a fraction of a meter into hard rock may be unnecessary if the rock is free of voids and discontinuities. If the design is made on the basis of lateral load, the properties of the overburden soils may be more important in the design than the penetration of the rock.

### **Use of Drilling Fluid**

The use of a drilling fluid, such as a bentonitic or polymeric slurry, has been mentioned earlier and will be given more detailed treatment in later chapters. The use of drilling fluid is so important that it deserves mention in a description of methods of excavation. For example, it is used to lift the cuttings to the surface in the circulation process.

Drilling fluid when properly mixed and utilized will allow excavations to be made in subsurface conditions that were considered to be impossible to excavate until a few years ago. Therefore, this technique has expanded considerably the application of the drilled shaft to foundation construction.

Chapter 6 will present a detailed discussion of drilling slurry, and Chapter 9 will present some examples of situations where it is essential that slurry be used. Specifications will be discussed in Chapter 15, and some consideration of drilling slurry will be given in Chapter 16, which deals with inspection and records. Drilling slurry as an aid to excavation has an important role, as indicated by the attention given to the material in this document. It is very important, however, that drilling slurry be mixed and used exactly as specified, because poorly designed drilling slurry may not only be ineffective in assuring borehole stability but may actually be detrimental to the structural integrity of the completed drilled shaft.

### **Grouting**

Baker et al (1982) report that grouting in advance of excavation can sometimes be used to reduce water inflow effectively and even to permit construction of underreams in granular soil. Examples were given where the technique was used successfully in Chicago.

### **Mining Techniques**

The various mechanical methods that are described above can be used to make excavations into strong rock; however, hand labor may be cheaper and faster. If bells are to be cut into shale with limestone stringers, for example, it may be desirable for workers to excavate the bell by hand with the use of air hammers. Hand excavation is also sometimes employed when it is necessary to penetrate steeply sloping rock, as in a formation of pinnacled limestone, where ordinary drilling tools cannot make a purchase in the rock surface. Safety precautions must be strictly enforced when hand mining is employed. The overburden soil must be restrained against collapse, the water table must be lowered if necessary, and fresh air must be circulated to the

bottom of the hole. Explosives may be considered on rare occasions, where they are absolutely necessary, to aid in hand excavation of rock near the surface. Explosives must be handled by experts and should be used only with the permission of the regulating authorities. Highly expansive cements have on occasion been used as alternates to explosives by placing cement paste in small holes drilled using air tracks into rock to split the rock and permit it to be excavated easily.

## REFERENCES

Baker, C. N., Jr., Echevarria, F. A., and Gnaedinger, J. P. (1982). "Use of Grouting in Caisson Construction," in *Proceedings*, Specialty Conference on Grouting in Geotechnical Engineering, New Orleans, LA, American Society of Civil Engineers, February.

LCPC (Laboratoire Central des Ponts et Chaussées) (1986). "Bored Piles", English Translation of "Le Pieux Fore" (available as FHWA Publication No. Ts-86-206).

Reese, L. C., and Farmer, G. (1977). "Drilled Shafts for Waterfront Structures," in *Proceedings*, Ports '77 Conference, Long Beach, CA, American Society of Civil Engineers, March.

## CHAPTER 5: CASINGS AND LINERS

Casings and liners play an important role in the construction of drilled shafts, and special attention must be given to their selection and use. Except for surface casing or guides, the casings and liners that are described in this chapter are for rotary drilling where cylindrical holes are being excavated.

Casings are tubes that are relatively strong, usually made of steel, and joined, if necessary, by welding. Therefore, steel tubes that have special joints, such as those that are used with full-depth casing machines, are excluded from discussion in this chapter.

Liners, on the other hand, are light in weight and become a permanent part of the foundation. Liners may be made of sheet metal, plastic, or pressed fibers (e.g., Sonotube™). While their use is much less frequent than that of casings, liners can become important in some situations.

### TEMPORARY CASING

Contractors like to emphasize the fact that the casing that is used temporarily in the drilling operation is essentially a tool, so it is sometimes termed "temporary tool casing."

As noted earlier, it is necessary in some construction procedures to seat a temporary casing into an impervious formation such as massive rock. This temporary casing is used to retain the sides of the borehole only long enough for the fluid concrete to be placed. The temporary casing remains in place until the concrete has been poured to a level sufficient to withstand ground and groundwater pressures. The casing is removed after the concrete is placed. Additional concrete is placed as the casing is being pulled to maintain the pressure balance. Thereafter, the fluid pressure of the concrete is assumed to provide borehole stability. The use of temporary casing has been described briefly in Chapter 3.

Temporary casing must be cleaned thoroughly after each use to have very low shearing resistance to the movement of fluid concrete. Casing with bonded concrete should not be allowed, because the bonded concrete will increase the shearing resistance between the casing and the column of fluid concrete placed inside the casing, and as the casing is lifted, it is possible that the column of concrete will be picked up, creating a neck or a void in the concrete, usually at the bottom of the casing, that will manifest itself as a defect in the completed drilled shaft. In addition, concrete bonded to the outside of the casing may be of poor quality and may be released in the borehole to become a permanent part of the drilled shaft. Obviously, the casing should be free of soil, lubricants and other deleterious material.

Most drilling contractors will maintain a large supply of temporary casing in their construction yards. A typical view of stored temporary casing is shown in Figure 5.1. Casing from the stockpile will be welded or cut to match the requirements of a particular project.



Figure 5.1. A typical view of stored temporary casing

## **PERMANENT CASING**

The use of permanent casing is implied by its name; the casing remains and becomes a permanent part of the foundation. An example of the use of permanent casing is when a drilled shaft is to be installed through water and the protruding portion of the casing is used as a form. A possible technique that has been used successfully is to set a template for positioning the drilled shaft, to set a permanent casing through the template with its top above the water and with its base set an appropriate distance below the mudline, to make the excavation with the use of drilling slurry, and to place the concrete through a tremie to the top of the casing. One possible objection to the use of such a technique is that the steel may corrode at the water level and become unsightly.

Several examples of the use of permanent casing are given in Figure 5.2. Whether or not rigid, semi-rigid, or flexible material is used for the permanent casing is a matter to be determined for the particular case in question. One of the principal factors will be the lateral stress to which the permanent casing will be subjected prior to the placement of the concrete.

One consideration for using permanent casing is the time that will be required to place the concrete for a deep, large-diameter, high-capacity drilled shaft founded in sound rock. Control of the concrete supply may be such that several hours could pass between placing the first concrete and extracting temporary casing. In that case, the concrete may already be taking its initial set when the seal is broken by raising the casing, making it difficult to extract the temporary casing without damaging the concrete in the shaft. In such as case, permanent casing may be specified.



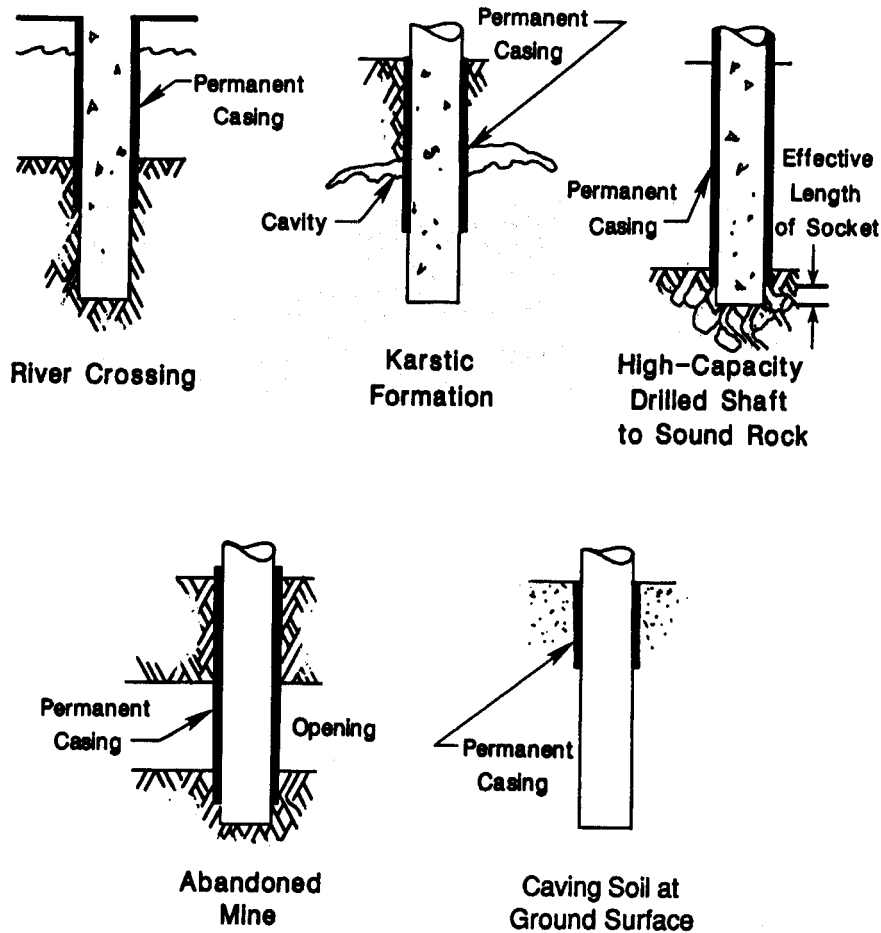

Figure 5.2. Examples of use of permanent casing

Another common situation for using permanent casing is when the drilled shaft must pass through a cavity, as in a karst formation. The permanent casing becomes a form that prevents the concrete from flowing into the cavity. In addition to causing the cost of the drilled shaft to increase, the flow of concrete into large cavities can flush loose geomaterial out of the cavity and into the body of the drilled shaft in some cases, producing a defect.

### INFLUENCE OF CASING ON LOAD TRANSFER

There are occasions when it is desirable to use a permanent casing in the construction of a drilled shaft, such as when very soft soil exists at the ground surface. On other occasions temporary casings cannot be recovered and therefore become permanent. Care must be taken in the

installation of temporary casing to ensure that it can be recovered after the concrete is placed. Not only is the casing expensive, but the skin friction along the sides of the drilled shaft could be seriously reduced.

The responsible engineer needs to apply judgment to the evaluation of the loss (or gain) of axial capacity of a drilled shaft that results from unintentionally leaving temporary casing in the borehole or intentionally using permanent casing. Expedient load-testing methods, such as those described in Chapter 14, may be helpful in evaluating side resistance around casings that are left permanently in place. Although it is impossible to make general statements that apply to all cases, some studies have been conducted that show that the load transfer from the casing to the supporting soil can be significantly less than if concrete had been in contact with the soil. Owens and Reese (1982) describe three drilled shafts in sand, one of which was constructed in the normal manner by the casing method and two of which were constructed in an oversized holes with casings left in place. The two drilled shafts that were constructed with the permanent casings had virtually no load transfer in skin friction in the region of the oversized excavation, as might have been expected. The annular space between the casing and the parent soil was subsequently filled with grout. A small-diameter pipe was used to convey the grout into the space. The grouting led to a significant increase in load capacity. The skin friction for the grouted piles was in the order of that for the normally-constructed pile, but the volume of grout that was used was much larger than the volume of the annular space around the casings. While grouting is plainly an effective method of increasing the load capacity of drilled shafts for those cases where casings are left in place by mistake, it is not possible to make recommendations about detailed grouting techniques and about the amount of the increase in load transfer when grouting is employed.

Owens and Reese (1982) reported on another study in which a casing was inserted into sand by use of a vibratory driver. After the concrete was poured, it was impossible to pull the casing with the vibratory driver, even as supplemented by other lifting machines that were on the job. A second drilled shaft was constructed by use of the same procedure, but in the second case the contractor used care before the concrete was placed to make sure that the casing could be lifted. Both of the drilled shafts were load-tested, and the one with the permanent casing was able to carry much less load than the one constructed in the usual manner. For this particular case, the load transfer in skin friction was significantly less for the outside of a steel pipe that was placed by a vibratory driver than for the concrete that was cast against the sand.

It is impossible, from the small amount of available data, to generalize about the influence of casing that is unavoidably left in place. However, it must be assumed that the skin friction can be significantly reduced. If the construction is carried out properly, the load transfer in end bearing should be equivalent for the drilled shaft with the permanent casing and the one constructed in the usual manner.

## TYPES AND DIMENSIONS

Casings and liners can be classified in three categories: rigid, semi-rigid, or flexible. Temporary casing is always rigid and invariably consists of round steel pipe. The practice in the United States is to employ used pipe for temporary casing. An important consideration is that the pipe is dimensioned according to its outside diameter.

ADSC: The International Association of Foundation Drilling, has adopted the outside diameter of casing as a standard and uses traditional units [e.g. 36-in. (0.915 m) O.D.] because used pipe in O.D. sizes is available at much lower cost than specially rolled pipe with specified I.D. (ADSC, 1995). However, some contractors have a supply of I.D. casing, and if special sizes need to be rolled, it is possible to do so. The size and availability of casing in a particular area should be ascertained before design drawings are prepared if it is the intent of the designer to specify casing sizes. Ordinarily, O.D. sizes are available in 152-mm (6-in.) increments [457 mm (18 in.), 610 mm (24 in.), 762 mm (30 in.), and so on up to 3048 mm (120 in.)].

If temporary casing size is not specified, most contractors will usually employ a casing that has an O.D. that is 152 mm (6 in.) larger than the specified drilled shaft diameter below the casing to allow for the passage of a drilling tool of proper diameter during final excavation of the borehole. A drilling tool with a diameter equal to the specified shaft diameter below the casing will usually be used. That tool will almost always excavate a hole that is somewhat larger in diameter [typically by 13 to 100 mm (0.5 to 4 in.)] than the nominal diameter of the tool, although with the passage of time boreholes in medium stiff to stiff clays at significant depths may constrict back to the diameter of the tool. If there is a boulder field or if the contractor otherwise decides to use telescoping casing, the first casing that is set may have an O.D. that is more than 152 mm (6 in.) larger than the specified shaft diameter. If an excavation of such size is not tolerable to the designer, he or she should specify the maximum diameter of the cased hole. Doing so will almost always unavoidably add to the cost of construction.

As described in Chapter 3, some contractors sometimes prefer to make deep excavations using more than one piece of casing with the "telescoping casing" process. This process has the economic advantage that smaller cranes and ancillary equipment can be used to install and remove telescoping casing than would be required with a single piece of casing. To review, a borehole with a diameter considerably larger than that specified is made at the surface, and a section of casing is inserted. A second borehole is excavated below that section of casing, which is then supported with another section of casing of smaller diameter. This process may proceed through three or more progressively smaller casings, with the I.D. (O.D. if excavating does not proceed below casing) of the lowest casing being equal to or greater than the specified O.D. of the drilled shaft. The O.D. of a lower section of such "telescoping casing" should be at least 152 mm (6 in.) smaller than the O.D. of the section above it, although larger differential diameters are permissible when necessary. While this procedure is most often used for drilled shafts that are bearing on or socketed into rock and where no skin friction is considered in the soils or rock that is cased, care must be taken by the contractor that the process of removing the smaller section(s)

of casing does not disturb the larger section(s) of casing still in place, or deposit water, slurry or debris behind casings still in place, thereby contaminating the fluid concrete. The most positive way to prevent trapping contaminants is to bring the tops of all casings to the surface. The casings are concreted and pulled progressively from the inside out.

The thicknesses of used pipe that is available for rigid casings will vary. The contractor is usually responsible to select a casing with sufficient strength to resist the pressures imposed by the soil or rock and internal and external fluids. Most steel casing has a wall thickness of at least 9.6 mm (0.325in.), and casings larger than 1.22 m (48 in.) O.D. tend to have larger wall thicknesses. Experienced contractors usually rely on past experience to size casing. However, if the contractor's workers or State inspectors are required to enter an excavation, the temporary or permanent casing should be designed to have an appropriate factor of safety against collapse.

The computation of the allowable lateral pressure that can be sustained by a given casing is a complex problem, and methods for such computations are beyond the scope of this publication. The problem is generally one of assuring that buckling of the casing does not occur due to the external soil and water pressures. Factors to be considered are: diameter, wall thickness, out-of-roundness, corrosion, minor defects, combined stresses, microseismic events, instability of soil on slopes and other sources of nonuniform lateral pressure, and lateral pressure that increases with depth. In view of the unavoidable uncertainties that are involved in such an analysis, inspection and other work should be performed from the ground surface, if at all possible.

Semi-rigid liners can be used for permanent casing. They can consist of corrugated sheet metal, plain sheet metal, or pressed fiber. Plastic tubes or tubes of other material can also be used. These liners are most often used for surface casing where it is desirable to restrain unstable surface soil that could collapse into the fluid concrete, creating structural defects. For example, corrugated sheet metal is often used for this purpose when the concrete cutoff elevation is below working grade. Occasionally, rigid liners, such as sections of precast concrete pipe, are also used effectively for this purpose.

A semi-rigid liner can be may also be used to minimize the skin friction that results from downdrag or from expansive soils. Coatings that have a low skin friction (such as bitumen) have also been used. Liners made of two concentric pressed-fiber tubes separated by a thin coating of asphalt have been found to be effective in reducing skin friction in drilled shafts constructed in expansive soils by as much as 90 per cent compared to using no liner.

Flexible liners are used infrequently in the United States, but can have an important role in certain situations. Flexible liners can consist of plastic sheets, rubber-coated membranes, or a mesh. The rebar cage can be encased in the flexible liner before being placed in a dry or dewatered hole; then, the concrete is placed with a tremie inside the liner. The procedure is designed to prevent the loss of concrete into a cavity in the side of the excavation or perhaps to prevent caving soil from falling around the rebar cage during the placement of the concrete. Flexible liners are applicable only to those cases where the drilled shaft is designed to take load

only in end bearing, or in skin friction below the level of the liner, because skin friction in the region of the liner can not be computed with any accuracy.

## **PROBLEMS OF PLACEMENT AND RECOVERY**

Semirigid casing will be placed at locations where the forces necessary to place the casing are relatively minor so that the casing can be merely lifted and dropped into place. The placement of a flexible liner is a special problem, as noted earlier.

The placement of a rigid permanent casing and the placement and recovery of a temporary casing may be done in several ways. A permanent casing may be placed with the use of a vibratory or impact driver in some instances, but the usual procedure is to place a permanent casing in a drilled hole either by dropping it or by twisting it into place with the kelly bar of the rotary drilling rig. The top of a rigid casing that is put into place by use of a rotary drill must be prepared as shown by the photograph in Figure 5.3. A tool ("twister" or "yoke") is placed on the bottom of the kelly that engages the "J" slots in the casing, and the casing is pushed and twisted into place until a seal is achieved.

If the rigid casing is to be sealed into rock, the bottom of the casing must be specially prepared. One of the procedures is to weld hardened teeth to the bottom, as shown in Figure 5.4. The positioning of the teeth is critical because the opening that is cut in the rock must neither be too large nor too small. If the rotation of the casing causes an opening to be cut that is too large, a seal cannot be achieved, and ground water or drilling fluid remaining outside the casing can flow into any excavation that is cut below the casing. If the opening is too small, the casing may not be able to penetrate the rock. The setting of the teeth at the base of a casing can be varied for different kinds of rock. While procedures that define the various setting may possibly be formulated, these settings are decided by the driller on the basis of experience and may well require trial and error on any given jobsite.

The difficulties in the recovery of a temporary casing have already been mentioned. The experience of the driller is important, because the recovery depends on the equipment that is available and on the methods of installation that are employed. While shearing resistance can develop between the casing and the geomaterial outside of the casing and the concrete that the casing contains, making it difficult to extract the casing with lifting lines on hand at a site, contractors should be cautioned about "lubricating" casing to facilitate lifting. One method of lubrication of the casing is to add uncontrolled bentonite slurry to a borehole before setting the casing, perhaps by dumping bentonite from bags directly into water in the borehole. While the resulting slurry may be an effective lubricant, it can produce a serious loss of frictional resistance in the region of the casing and can potentially result in structural defects in the completed drilled shaft if unhydrated lumps of bentonite trapped outside the casing fail to be flushed to the surface when the concrete is placed and the casing lifted.



Figure 5.3. J slots in top of casing for use with casing twister  
(Photograph courtesy of Herzog Foundation Drilling, Inc.)



Figure 5.4. Teeth for use in sealing casing into rock  
(Photograph courtesy of Herzog Foundation Drilling, Inc.)

When temporary casing is removed, it is best to do so slowly and with as little rotation as possible to minimize the forces that will be transferred to the rebar cage through the fluid concrete during the casing extraction process, because the rebar cage is usually low in torsional resistance and could buckle if the extraction forces are excessive.

## **DESIGN CONSIDERATIONS**

Procedures for the design of drilled shafts under lateral loading and under axial loading will be presented later. The capacity of drilled shafts under axial loads depends on both skin friction and end bearing. If casings are left in place for drilled shafts that are designed to resist some or all of the applied load in side resistance, skin friction may be negatively affected, often significantly, and the constructed shaft should be considered defective unless proved otherwise. The design procedures that are given later are applicable to cases where temporary casing is used and is recovered.

With regard to design for lateral loading, a short presentation is made in Chapter 13 with references to other documents that have been published by the FHWA. The response of a drilled shaft (or pile) to lateral loading is largely determined by the nature of the soil near the ground surface. Therefore, surface casing should be used in such a way that the near-surface soils are disturbed no more than necessary and that there is as good a contact as possible between the drilled shaft and the supporting soil.

A further issue in the use of temporary casing is that casing can sometimes cause considerable problems during extraction if the drilled shaft is installed on a batter (an angle with the horizontal other than 90 degrees). Often, casing drags on reinforcing cages in battered shafts and damages or displaces them. It is also difficult to make an axial pull on battered casings. Therefore, the designer should consider options other than battered drilled shafts when the subsurface conditions are such that it appears that temporary casing will probably be used by the contractor. For example, larger-diameter vertical drilled shafts that can take large transverse loads might be substituted for smaller battered drilled shafts that carry horizontal loads in axial resistance. Such a consideration is an example of "designing for constructability," which should be a continuous consideration of the designer.

## **REFERENCES**

ADSC (1995). *Standards and Specifications for the Drilled Shaft Industry*, ADSC: The International Association of Foundation Drilling, Dallas, TX.

Owens, M. J., and Reese, L. C. (1982). "The Influence of a Steel Casing on the Axial Capacity of a Drilled Shaft," *Research Report 255-1F*, Report to the Texas State Department of Highways and Public Transportation Center for Transportation Research, Bureau of Engineering Research, The University of Texas at Austin, Austin, TX, July, 204 pp.

## CHAPTER 6: DRILLING SLURRY

### INTRODUCTION

Drilling slurry is employed as a construction aid in two of the three general methods of drilled shaft construction that were described in Chapter 3 (the casing method and the wet method), and there can be no doubt that slurry plays an important role in the construction of drilled shafts. When an excavation encounters soil that potentially may cave, filling of the excavation with drilling slurry, with the proper characteristics and at the proper time, will allow the excavation to be completed to full depth with little difficulty. As described in Chapter 3, two procedures are possible at this point: a casing can be installed in the excavation and sealed into impermeable soil or rock, the slurry can be bailed or pumped from the casing, the excavation can be completed, and the concrete can be placed; or the slurry can be left in the excavation, and the concrete can be placed with the use of a tremie. In either of these procedures the slurry must have the proper characteristics during the drilling operations and at the time the concrete is placed. The required characteristics of the slurry and correct procedures for handling the slurry are discussed in this chapter.

Water alone is sometimes an ideal drilling fluid and may be used successfully in areas where the formations being penetrated are permeable but, at the same time, do not slough when ground water pressures are balanced by the drilling water and are not eroded by water (for example, permeable sandstone, cemented sand). The level of the water in the excavation should be kept above the piezometric surface in the natural formation so that any flow from the excavation into the formation is prevented in order that sloughing of the sides of the borehole is not precipitated by inflow of ground water.

During the 1950's and 1960's it was common practice for drilled shaft contractors to make slurry by mixing water with on-site clay materials, primarily for use in the casing method. The resulting slurry has properties that are difficult to control and suffers from the fact that it is unstable -- that soil particles are continuously falling out of suspension -- which makes cleaning of the borehole difficult and which can lead to soil settling from the slurry column into the fluid concrete during concrete placement if the wet method of construction is used. For this reason the use of slurries made from on-site materials is not normally recommended for drilled shaft construction.

More suitable materials can be added to water to make a controllable slurry for use in drilling boreholes. Bentonite, a type of processed, powdered clay, has been the most common material used for this purpose, historically. Cross and Harth (1929) obtained patents on the use of bentonite as an agent that could gel and suspend cuttings. The technology of the use of drilling fluids has been developed extensively by the petroleum industry, and many references on bentonite slurries are available; for example, Chilingarian and Vorabutr (1981) and Gray et al. (1980). A balance is presented in this chapter between the detailed information given in oil-industry publications on drilling slurries and the "rough-and-ready" methods of some foundation-



drilling contractors. In an early civil engineering application, Veder (1953) described the construction of an impermeable diaphragm wall using bentonitic slurry. A line of contiguous, unlined boreholes, 0.61 m (24 in.) in diameter, were drilled while being kept full of slurry. Reinforcing steel was placed in the slurry and the concrete was placed with a tremie.

Bentonite slurries have been used commonly in drilled shaft construction in the United States since the 1960's. Other processed, powdered clay minerals, notably attapulgite and sepiolite, have been used on occasion in place of bentonite, usually in saline ground water conditions. Any slurry that is made from one of these clay minerals will hereafter be termed a "mineral" slurry.

Recently, some environmental agencies have expressed concern that slurries containing bentonite and other clay minerals are hazardous materials. Slurries made with minerals contain solid particles that can suffocate aquatic life, and some oil-field bentonite products contain additives that could conceivably produce additional problems in the environment. Bentonite that is used in drilled shaft construction rarely has these additives. Nonetheless, mineral slurries must be handled carefully, not allowed to flow into bodies of water or sewers, and disposed of in an approved facility at the end of a project. These requirements generally force the contractor to handle mineral slurries in a closed loop process -- that is, to condition slurry continuously and reuse it from borehole to borehole in order to eliminate the need to spoil the slurry on the site and to minimize the amount of slurry that has to be disposed of at the end of the project. Such careful handling obviously adds to the cost of excavating with mineral slurry.

Slurries made from potable water mixed with polymers, particularly synthetic polymers, have recently found favor with drilled shaft contractors, because such slurries are not subject to the environmental controls that are as stringent as those required for mineral slurries. Polymer slurries also have the characteristic that they do not generally suspend particulate matter such as sand. Therefore, no special treatment is needed prior to reuse except to allow the slurry to remain still in a tank for several hours to allow all particulate matter to settle out before pumping the clean supernatant liquid, perhaps with fresh slurry added, into a new borehole.

While drilling slurries have proved effective in advancing boreholes through many types of unstable soil and rock, the use of drilling slurry of any type should be avoided for economic reasons unless it is necessary for the completion of a borehole. The additional cost on a job could be considerable for materials, handling, mixing, placing, recovering, cleaning of mineral slurry, and testing of slurry at several times during the excavation of a borehole. Finally, the cost of disposing of mineral slurry is relatively high. Costs may increase dramatically if construction is being done in an area that is environmentally sensitive. For example, in some coastal locations a tightly woven, fabric screen must be placed in the water to encompass completely the drilling operations.

## **PRINCIPLES OF SLURRY OPERATION**

### **Mineral Slurries**

Bentonite and other clay minerals, when mixed with water in a proper manner, form suspensions of microscopic, plate-like solids within the water. This suspension, in essence, is the drilling slurry. If the fluid pressures within the slurry column in the borehole exceed the fluid ground water pressures in a permeable formation (e. g., a sand stratum), the slurry penetrates the formation and deposits the suspended clay plates on the surface of the borehole, in effect forming a membrane, or "mudcake" that assists in keeping the borehole stable.

In order for bentonite particles to break down into these separate plates, the mixing water must first hydrate the bentonite. The electrostatically bound water surrounding bentonite plates promotes repulsion of the bentonite particles and keeps the bentonite in suspension almost indefinitely. Not until this process is completed will bentonite slurry be effective. The process requires both mixing effort (shearing) and time -- generally several hours. One of the cardinal rules of drilling with bentonite slurry is that all newly mixed bentonite must be allowed to be hydrated for several hours before final mixing and introduction into a borehole. Bentonite slurry should be added to the borehole only after its viscosity (resistance to flow, discussed later) stabilizes, which is an indication that the bentonite has become fully hydrated.

Slurry made with bentonite, and to some extent other minerals, serves to put soil particles through which the excavation is progressing in suspension. Below a certain concentration of the soil particles, which depends on the size of the soil particles, the mineral "dosage" (proportion of dry mineral to water), type of mineral being used to make the slurry and other factors, the soil particles will stay in suspension long enough for the slurry to be pumped out of the borehole upon setting casing and/or for the borehole to be completed and the slurry (with suspended cuttings) remaining in the borehole to be flushed out when the fluid concrete is placed in the wet method of construction.

Longer periods of suspension stability are obtained with bentonite than with attapulgite or sepiolite, which is desirable. However, bentonite tends to flocculate in saline ground water, and solids will fall from suspension under such a condition more quickly in bentonite slurries than in attapulgite or sepiolite slurries unless special procedures are used.

Properly prepared slurry, in addition to keeping the borehole stable, also provides a kind of lubricant and reduces the soil resistance when a casing is installed. The wear of drilling tools is reduced when slurry is employed. Proper preparation of slurry will be discussed later in this chapter.

Unlike bentonite, attapulgite and sepiolite are not hydrated by water and therefore do not tend to flocculate in saline environments. These minerals do not tend to stay in suspension as long as bentonite and require very vigorous mixing and continual remixing to place and keep the clay in

suspension. However, since they are not hydrated by water, their slurries can be added to the borehole as soon as mixing is complete. They do not form solid mudcakes, as does bentonite, but they do tend to form relatively soft, thick zones of clay on the borehole wall, which are generally effective at controlling filtration and which appear to be relatively easy to scour off the sides of the borehole with the rising column of concrete. These minerals are used almost exclusively for drilling in permeable soils in saline environments at sites near the sources of the minerals (e. g., Georgia, Florida and Nevada), where transportation costs are relatively low. While it is acknowledged that these minerals are used occasionally, and are preferred by some contractors, the discussion of mineral slurries in this chapter will be limited primarily to bentonite.

After mixing, all mineral slurries have unit weights that are slightly higher than the unit weight of the mixing water. Their specific gravities, with proper dosages of solids, are typically about 1.03 - 1.05 after initial mixing. As drilling progresses and the slurry picks up more soil (clay, sand and silt), the unit weights, and often the viscosities, of mineral slurries will increase. This is not harmful up to a point; however, excessive unit weight and viscosity will eventually have to be corrected by the contractor if mineral slurry is reused.

As stated earlier, when the slurry column is introduced into the borehole in a permeable formation, bentonite slurry stabilizes the borehole by depositing some of the mineral plates on the sides of the borehole as the slurry flows into the soil or rock formation. This action, which is termed "filtration," can occur only if the piezometric head in the slurry column exceeds the piezometric head in the formation being drilled at all times. This process is illustrated in Figure 6.1. Once the "mudcake" of plate-like solids has been deposited, filtration gradually stops. (A similar process develops with other mineral slurries, but the mudcake is replaced with a zone of soft clay, sometimes called a "wallcake.") There will then be a greater fluid pressure inside the borehole (on the inside surface of the mudcake) than in the pores of the soil in the formation. This differential pressure will be manifested as an "effective stress" that holds the soil particles along the borehole wall in place. Unless the contractor continuously maintains this positive head difference, however, the borehole could collapse, because backflushing of the mudcake can occur if the head in the slurry column becomes less than the head in the formation, even for a short period of time.

When the pore sizes in the formation being excavated are large (as in gravelly soils or poorly graded coarse sands), the mudcake may be replaced by a deep zone of clay plate deposition within the pores that may or may not be effective in producing a stable borehole. This effect is illustrated in Figure 6.2. Nash (1974) notes that a bentonite slurry penetrating into a gravel quickly seals the gravel if there are no enormous voids. He notes that the main factors that are involved in the ability of the slurry to seal the voids in gravel are: (1) the differential hydrostatic pressures between the slurry and the ground water, (2) the grain-size distribution of the gravel, and (3) the shearing strength of the slurry. It is obvious that a slurry will penetrate a greater distance into an "open" gravel than into one with smaller voids. As the velocity of flow of the slurry into the soil voids is reduced due to drag from the surfaces of the particles of soil, a

thixotropic gelling of the slurry will take place in the void spaces, which may afford some measure of stability. If the bentonitic slurry proves ineffective, special techniques (for example, use of driven or crowded casings, other types of drilling slurry or grouting of the formation) may have to be used to stabilize the borehole.

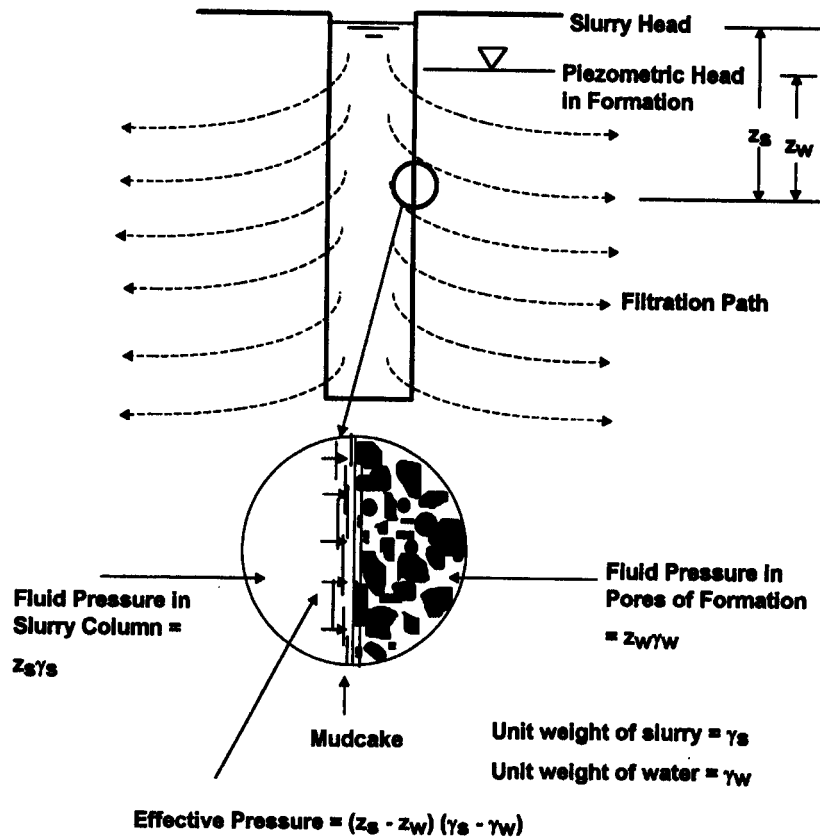

Figure 6.1. Formation of mudcake and positive effective pressure in a mineral slurry in sand formation

Bentonite should not be used in certain situations. For example, bentonite use should be restricted when constructing a drilled shaft rock socket in smooth-drilling rock (e. g., generally uniform sandstone) in which bond between the concrete and the rock is achieved by penetration of cement paste into the pores of the rock (Pells et al., 1978). The bentonite will usually inhibit such a bond from forming and will produce values of side resistance that will be lower than would be predicted by the design methods suggested in this manual.

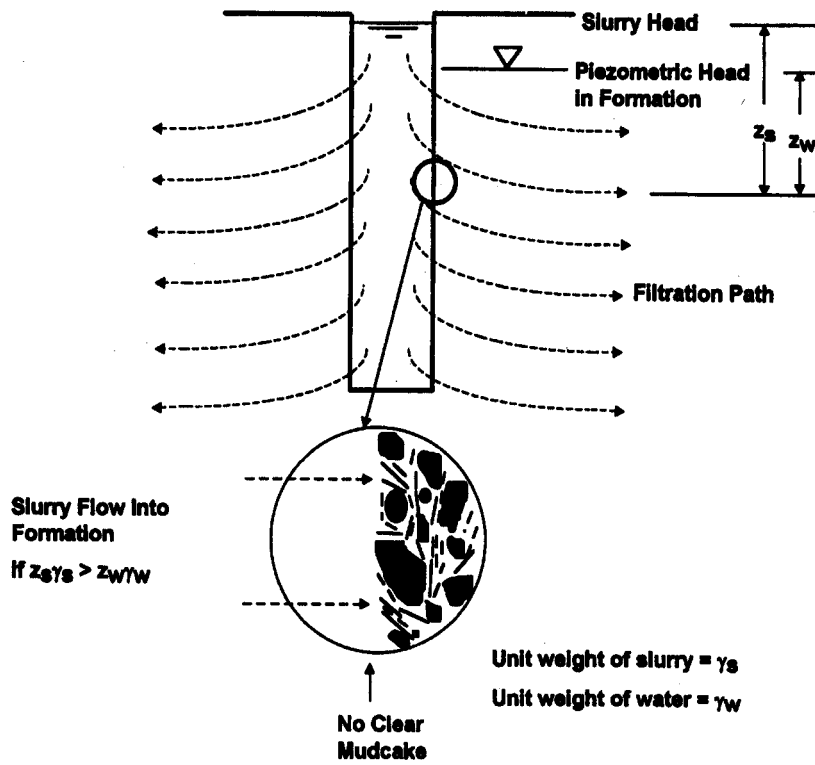

Figure 6.2. Mineral slurry plates in pores of open-pored formation (modified after Fleming and Sliwinski, 1977)

Bentonite can sometimes be used for limited periods of time in saline water by first mixing it with fresh water and then mixing the resulting fluid with additives such as potassium acetate to impede the migration of salt into the hydrated zone around the clay plates, sometimes referred to as the "diffuse double layer." With time, however, the salts in salt water will slowly attack the bentonite and cause it to begin to flocculate and settle out of suspension. Therefore, in this application, careful observation of the slurry for signs of flocculation (attraction of many bentonite particles into mushy masses) should be made continuously, and the contractor should be prepared to exchange the used slurry for conditioned slurry as necessary.

## Polymers

Drilling slurries can also be made of mixtures of chemicals called polymers and potable water. Polymers have been used in preference to bentonite in well drilling for some time in soil profiles that contain considerable clay or argillaceous (clay-based) rock, because bentonite slurries have a tendency to erode clayey rocks and to produce enlargements and subsequent instabilities in the boreholes. Polymer slurries have become popular in drilled shaft construction in all types of soil

profiles because they require less conditioning before reuse than bentonite slurries and because they can be disposed of more inexpensively than bentonite slurries.

Polymers that are used in drilling slurries consist of very long, chain-like hydrocarbon molecules, which act somewhat like clay mineral molecules in their interactions with each other and in the way in which they stabilize boreholes. Like bentonite plates, the polymer chains are intended to remain separate from one another in the slurry through electrical repulsion, and therefore remain in suspension in the makeup water by virtue of a negative electrical charge around the edges of the backbones of the chains. The polymer slurry, like bentonite slurry, permeates into permeable formations (sand, silt, and permeable rock) if the head in the slurry column exceeds the piezometric head in the formation being drilled, and the polymer molecules become lodged in the pores of the soil around the edge of the borehole. This process is illustrated in Figure 6.3. Since the polymer molecules are hair-shaped strands and not plate-shaped, they do not form mudcakes, and borehole stability is produced through continual filtration of the slurry through the zone containing the polymer strands, where the drag forces and cohesion formed due to binding of the soil particles in the formation by the polymer strands tend to keep the soil particles in place. Eventually, if enough polymer strands become deposited, filtration may cease due to viscous drag effects in the soil near the borehole. This drag can produce an effective seal, much like the mudcake in a hole drilled with bentonite slurry.

Since slurry is continuously being lost to the formation, the contractor must be diligent in maintaining a positive head in the slurry column with respect to the piezometric surface in the formation at all times so that filtration and hole stability continue. This often means continually adding slurry stock to the column of slurry in the borehole that is continuing to permeate the formation. Bentonitic slurries have unit weights that range from about three to twenty percent higher than that of water, once soil from the formation has been picked up by the slurry, so that allowing the slurry level in the borehole to drop down to the piezometric level occasionally may not cause problems (although it is not good practice). However, the unit weights of polymer slurries are essentially equal to that of water, so that allowing the head in a polymer slurry column to drop to the piezometric level in the formation, even momentarily, may initiate hole sloughing or raveling. A good rule of thumb is to keep the level of polymer slurry at least 2 m (6.5 ft) above the piezometric surface at all times. An equally good rule is to place the slurry in the borehole before the piezometric level is reached so that sloughing or raveling does not have a chance to start.

Long-chain polymer molecules tend to wrap around clay and silt particles that are mixed into the slurry during the drilling process. They attach first to the more active clays from the slaked cuttings in the slurry mix, producing small agglomerated structures that tend to clay particles, such as illites and kaolinites and then finally to silts. The resulting agglomerated structure tends to begin to settle out of suspension slowly and accumulate as mushy sediments on or near the bottom of the borehole. Some of the agglomerated particles also tend to float on the surface of polymer slurry stay in suspension, at least temporarily. The polymer molecules then proceed to attach themselves to larger and larger s and appear as a bulky material that some observers have

termed "oatmeal." This process appears to be accelerated by the presence of excessive hardness in the slurry water, which tends to reduce the repulsive forces between the polymer chains and the soil particles. The degree of water hardness that can be tolerated by various polymer products depends upon the specific design of the product; therefore, the manufacturer should be consulted regarding how water hardness should be controlled. Control of makeup water hardness is discussed briefly later.

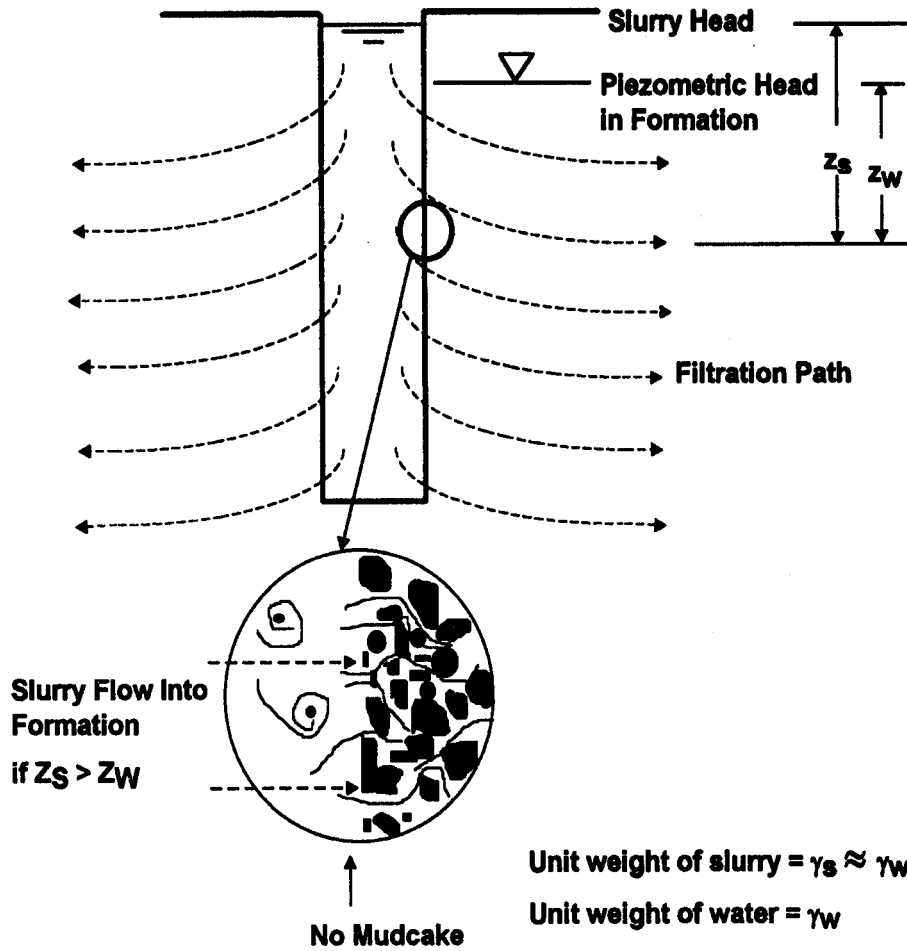

Figure 6.3. Stabilization of borehole by the use of polymer drilling slurries

The use of polymer slurries with very low polymer concentrations (low viscosity) can sometimes promote agglomeration. Some commercial polymers are specially formulated to minimize agglomeration. The problem of agglomeration of polymer slurries is not experienced with sands, which tend to fall out of suspension, unless special products are used to keep the sand in suspension.

Agglomeration makes it necessary to exercise caution in borehole cleanup in soils that contain large percentages of silts and dispersive (easily eroded) clays. That is, the slurry properties, discussed later, should come to a steady state in the bottom 2 m (6.5 ft) of the borehole before final clean-out and placement of the rebar cage and concrete. Agglomeration also reduces the number of polymer strands available to fill the voids in the soil at the borehole wall, which can result in destabilization of the borehole. Since polymer chains can agglomerate, attach themselves to particles of soil within the formation and filter into the formation, polymer slurries cannot be reused indefinitely. For this reason, the consistency and physical appearance of the drilling fluid should be inspected prior to each use and, if necessary, freshly mixed slurry added to restore the desired properties.

Some construction polymers are often formulated to give a very slick and heavy texture when fully polymerized. These polymer slurries are intended for lubrication of pipe used in trenchless technology applications, where the final shearing resistance between the pipe and the soil is of little concern. They should not be used in drilled shaft construction.

While the use of synthetic drilled shaft polymers is not regulated, it is advisable to depolymerize the slurry before it is discharged into the environment. The most common types of polymer formulated for use in drilled shaft slurries, partially hydrolyzed polyacrylamides, or "PHPA's," and their vinyl extensions, can usually be treated with a dilute solution of sodium hypochlorite [about four liters (one gallon) of a 5 per-cent solution of common household chlorine bleach to 0.4 cubic m. (100 gallons) of slurry] to completely depolymerize the slurry prior to discharging it onto the ground or into streams or storm sewers, as permitted.

When depolymerization must be done in closed spaces, a 3 per-cent solution of hydrogen peroxide should be substituted for sodium hypochlorite to avoid personnel exposure to toxic gases.

If local regulations prohibit the use of sodium hypochlorite or hydrogen peroxide to break down polymers prior to disposal, cationic coagulants can be used to react with the polymer chains, which are anionic (negatively charged on the edges), to produce a non-reactive solid mass that can be disposed of after adjustment of its pH.

### **Blended Slurries**

Mineral slurries tend to require considerable effort to mix, treat and dispose of, and they can destabilize (erode away) boreholes in argillaceous (clay-based) geomaterials on occasion. By contrast, they are excellent stabilizers of boreholes in completely cohesionless soils. Polymer slurries, on the other hand, tend to be much easier to mix, treat and dispose of, and they are excellent stabilizers of boreholes in which considerable argillaceous soil or rock appears in the profile. Nature often presents the contractor with the challenge of geomaterial profiles that contain both thick strata of cohesionless soil and thick strata of argillaceous soil or rock. In such a case a blend of bentonite and polymer might be used. The proportions of each component can



be varied from job to job and hole to hole, as necessary. Since the bentonite component is usually higher than the polymer component, the quality control factors described later for bentonite can be used for the control of such blended slurries. Experts are available to assist contractors in selecting slurry materials to be blended.

Blended bentonite and polymer slurries are also available as packaged products that are marketed as "extended" bentonites. The polymer additive helps less bentonite produce a given amount of slurry, which is an economic consideration, since high-quality bentonite is becoming harder and harder to find.

## **APPLICATIONS**

As indicated in Figures 6.1 through 6.3, the slurry will penetrate into permeable formations, the distance of penetration depending on the sizes and connectivity of the pores of the material being drilled, the differential head, the type of slurry material and other factors. There is concern that the drilling of a very open formation, such as karstic limestone or basalt with lava tubes, will result in the loss of large quantities of slurry into cavities. The program of subsurface exploration should reveal whether such geologic conditions exist, and the appropriate construction planning should be done in the event the chance for encountering such features is high.

Mistakes can be made in the application of mineral, polymer or blended slurries, as with any method of construction of deep foundations, and the next-to-last section in this chapter will discuss some of the common mistakes and methods of avoiding them. However, there are numerous examples of circumstances where drilling slurry has been used with outstanding success. A few are given here.

1. A site was encountered where the soil consisted of a very silty clay, which was not sufficiently stable to permit the construction of drilled shafts by the dry method. Bentonitic slurry was used, and shafts up to 1.22 m (4 ft) in diameter and 27.5 m (90 ft) long were installed successfully despite the fact that claystone boulders were encountered near the bottoms of the shaft excavations.
2. A mineral drilling slurry was used to penetrate a soil profile that consisted of interbedded silts, sands and clays to a depth of about 32 m (105 ft), where soft rock was encountered. Drilled shafts with diameters of 1.22 m (4 ft) were successfully installed down to the soft rock. A loading test was performed, and the test shaft sustained a load of over 8.9 MN (1000 tons), with little permanent settlement.
3. Three test shafts were constructed with bentonitic drilling slurry in a soil profile containing alternating layers of stiff clay, clayey silt and fine sand below the water table. These test shafts were all instrumented to measure side and base resistance during the loading tests, which were found to be comparable to the resistances that would have been achieved had the dry method of construction been used. The shafts were later exhumed,

and it was found that the geometry of the constructed shafts was excellent. The information obtained in this test program was then used to design foundations for a large freeway interchange.

4. Two instrumented test shafts, 0.76 m (30 in.) in diameter, were installed with PHPA polymer slurry in a mixed profile of stiff, silty clay, clayey silt, lignite and dense sand to depths of up to 15.6 m (51 ft) at a freeway interchange site. The contractor allowed the sand in the slurry columns to settle out of suspension for 30 minutes after completing the excavations before cleaning the bases with a clean-out bucket and concreting. The shafts were tested to failure, and the measured side and base resistances were comparable to the values that would have been anticipated in this soil profile with bentonitic drilling slurry.

These are only four examples of the use of drilling slurry in the construction of drilled shafts. To date, tens of thousands of large-diameter drilled shafts have been constructed worldwide with drilling slurry and are performing successfully.

While much is known about the properties of drilling slurries and their effects, success in maintaining borehole stability with a given slurry depends on many factors that are understood qualitatively but not all of which are readily quantified. Some of these are:

- Density of the granular soil being retained. [Denser soils are retained more easily than looser soils.]
- Grain-size distribution of the granular soil being retained. [Well-graded soils are retained more easily than poorly graded soils.]
- Fines content of the granular soil being retained. [Silt or clay within the matrix of sand or gravel assists in maintaining stability, especially with polymer slurries, but fines can become mixed with the slurry, causing its properties to deteriorate.]
- Maintenance of excess fluid pressure in the slurry column at all times (Figure 6.1). [This factor is especially important with polymer slurries, which have unit weights that are lower than those of mineral slurries and thus produce smaller effective stresses against borehole walls for a given differential head.]
- Diameter of the borehole. [Stability is more difficult to maintain in large-diameter boreholes than in small-diameter boreholes because of a reduction in arching action in the soil and because more passes of the drilling tool often must be made to excavate a given depth of soil or rock compared with excavation of a smaller-diameter borehole. Such excess tool activity tends to promote instability.]
- Depth of the borehole. [For various reasons, the deeper the borehole, the more difficult it is to assure stability, especially with polymer slurries. Anecdotal evidence suggests that

difficulties have occurred using polymer slurries at some sites where granular soil is encountered at depths greater than about 25 m (80 ft).]

- Time the borehole remains open. [On some occasions, boreholes in granular soil have been kept open and stable for weeks with bentonite slurry and for days with polymer slurry. However, in general, stability decreases with time, and ground stresses, which affect axial resistance in the completed drilled shaft, decrease, regardless of whether the borehole remains stable.]

## **MATERIALS**

### **Bentonite**

As noted earlier, water alone may occasionally constitute the drilling fluid. Polymers and polymer-bentonite blends are also being used more frequently. However, the normal and most widely-used procedure has been to mix potable water and high-quality sodium smectite ("Wyoming bentonite") to form a slurry that will both produce a membrane (mudcake) against the sides of the borehole and suspend some of the solid soil particles that have been excavated.

Specifications can be prepared on the materials that are used to produce the drilling slurry initially, but the slurry will change character as drilling begins because of mixing with the soils and ground water being penetrated. If granular soil is drilled, some of the grains will be put in suspension and, similarly, if clay soils or silts are being drilled, some of the particles will be mixed with the slurry and become a part of the slurry. This natural process will require treatment of the slurry to restore its properties if it is to be reused.

If the soil being excavated is organic, acidic or saline, the bentonitic slurry may be "killed" (flocculate). The addition of deflocculants or other measures will be required to maintain proper consistency. Therefore, the critical factor in regard to the materials is that specifications be written to control the slurry as it is manufactured and as it is being used during excavation. Suggestions will be given later in this chapter on the preparation of specifications for mineral slurry.

While the testing of water and bentonite powder will not be discussed in detail, there are a number of other general factors about materials that will prove to be useful.

- The materials to be selected for a particular job will depend on the requirements of the drilling operation. Different types of drilling fluids are required to drill through different types of formations. Some of the factors that influence the selection of drilling fluid are economics, contamination, available make-up water, pressure, temperature, hole depth and the material being drilled, especially pore sizes and the chemistry of the soil or rock and the ground water.

- An economic consideration for the contractor is the "yield" of the mineral used to make the slurry. The yield is the number of barrels (42 gallons) of liquid slurry that can be made per ton of the dry mineral added to achieve a slurry with a viscosity of 15 cP (described later).
- The best yield comes from sodium smectite ("Wyoming bentonite"). Natural clays give very low yield and, for other reasons discussed previously, should not be used in drilled shaft construction. Calcium smectite ("sub-bentonite") yields a lesser amount of slurry per unit of weight than Wyoming bentonite because it is hydrated by only about one-fourth as much water as Wyoming bentonite.
- The yield of Wyoming bentonite has been dropping due to the depletion of high-quality deposits in the areas where it is mined. The yield of some pure bentonite products is now as low as 0.9 cubic meters per kilo-Newton (50 barrels of slurry per ton of dry bentonite). High-quality Wyoming bentonite that will produce a yield of 1.8 cubic m./kN (100 bbl./ton) is still available, but at a premium price. As mentioned earlier, suppliers have been recently producing Wyoming bentonite mixed with dry polymer "extenders" to increase the yield. The main agents used to extend, or "stretch," the Wyoming bentonite are dry polymers, so that some bentonite products available today are actually mixes of bentonite and synthetic polymer. Some suppliers are also chemically modifying calcium smectite to give it essentially the same properties as Wyoming bentonite, but the resulting products are relatively expensive.
- The quality of the water that is used to make drilling slurry is important. For bentonitic slurries potable water should be used. Saline water can be used for slurry if attapulgite or sepiolite clay is used instead of bentonite. These clays derive their viscosity from being vigorously sheared by specialized mixing equipment designed to accelerate the suspension of such clays. As described previously, bentonite, with proper preparation, can be used for limited periods of time while drilling in salt water if the makeup water is fresh and if additives are applied to inhibit migration of salt. The key is that makeup water should be uncontaminated.

The detailed design of the bentonite slurry (particle size, additives, mixing water, mixing technique and time) and the interaction of the slurry with the chemicals in the drilling slurry water, as modified by the conditions in the ground through which the shaft is drilled, affect the thickness and hardness of the mudcake that is built up, as well as the gel strength of the fluid slurry. It is good practice for the contractor to conduct tests on trial mixes of the mineral slurry that he/she proposes to use with the makeup water from the proposed source to determine cake thickness and filtration loss using an API filter press. With this device a small amount of slurry is forced through a standard piece of filter paper under a differential pressure of 689 kPa (100 psi) for a fixed period of time (typically, 30 minutes). It is advisable that the resulting mudcake be no more than about 2 mm (0.1 in.) thick and that the filtration loss (amount of slurry passing through the filter paper) be less than about 10 mL. Higher values of cake thickness from this

standard test may indicate that a substantial thickness of mudcake will remain on the sides of the borehole, and will perhaps attach to the rebar, after the concrete has been placed. This condition is undesirable, as it will reduce the load transfer between the drilled shaft and the soil formation to a magnitude below that which will be calculated using the procedures in Chapter 11. Of course, the structural integrity of the drilled shaft can be compromised if the concrete-rebar bond is reduced. Filtration loss is a measure of the effectiveness of the mineral slurry in controlling loss of fluid to the formation, which is an economic factor for the contractor, but in and of itself is not critical to the drilled shaft as long as the borehole remains stable.

The gel strength of mineral slurry should also be measured and adjusted as necessary as the trial mix is being prepared. The gel strength is the shear strength of the unagitated slurry after hydration with water, if any, has taken place. As a standard, the gel strength is measured 10 minutes after vigorous mixing is completed. A high gel strength is necessary if it is desired that the slurry be used to transport solids, as in direct or reverse circulation drilling, in which the cuttings are transported to the surface by suspending them in the slurry and pumping the slurry to the surface, where the cuttings are removed. However, high gel strengths can be problematical when concrete is being used to displace the slurry. A lower gel strength should be used if the purpose of the drilling slurry is only to maintain borehole stability and to maintain a minimal volume of cuttings in suspension, which is the usual objective of mineral slurries for drilled shaft construction, since the cuttings are usually lifted mechanically. Ordinarily, for this purpose, 10-minute gel strength should be between about 2 Pa (0.2 psf) and 10 Pa (0.9 psf).

The gel strength, cake thickness and filtration loss are not usually measured during construction operations, after the mix design has been established, unless the slurry begins to perform poorly. Instead, they are monitored indirectly by measuring the viscosity of the slurry by means of a rheometer or "viscometer" (preferable) or a Marsh funnel, whose results relate crudely to these properties.

The relation of viscosity to dosage, or weight of mineral solids per unit of water volume, is shown in Figure 6.4 for the three types of clay minerals that are most commonly used to make mineral slurry and for native clay that might be found on a typical site. Assume that a desirable slurry viscosity for drilled shaft construction is on the order of 10 to 30 centipoise. Then, the unit weight of a slurry made from high-quality Wyoming bentonite upon mixing should be between about 9.95 and 10.15 kN/cubic m. (64 and 66 lb./cubic ft). Since the unit weight of fresh water is 9.81 kN/cubic m. (62.4 lb./cubic ft), about 0.14 to 0.34 kN of bentonite needs to be added to every cubic meter (1.6 to 3.6 lb./ cubic ft, or about 0.2 to 0.4 lb. per gallon) of makeup water to produce a slurry of proper consistency. Use of less mineral solids in the initial mix will likely make the slurry ineffective at maintaining borehole stability, and use of more mineral solids will produce too much gel strength (excessive viscosity) for the slurry to be flushed effectively by the fluid concrete. It can be inferred from Figure 6.4 that the dosage of attapulgite in the slurry mix should be about the same as for bentonite but that the dosage of sub-bentonite needs to be about four times as high as for Wyoming bentonite and that the dosage for native clay must be over 10 times as high as for Wyoming bentonite. The figure also shows the

changes of unit weight of the slurry, commonly referred to as "density," and viscosity of the slurry with changes in the type of mineral used and the weight of solids per unit volume ("dosage"). Viscosity is obviously sensitive to the mineral dosage.

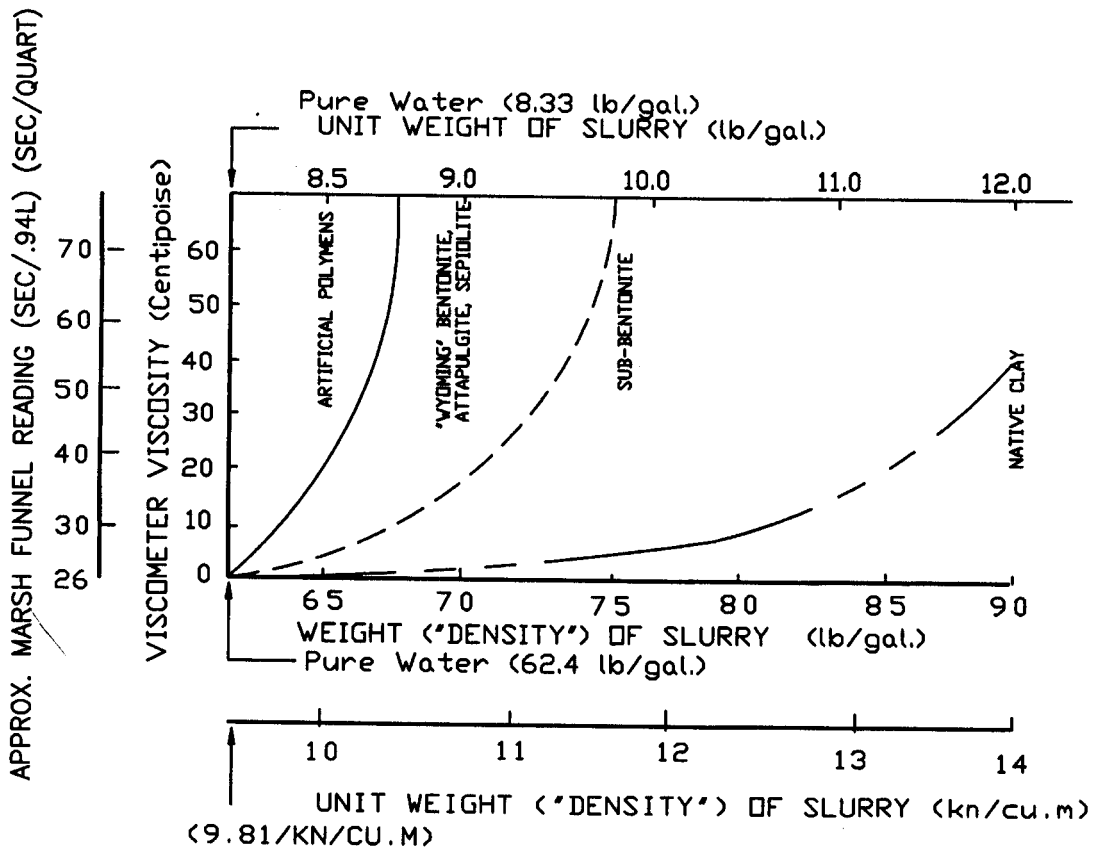

Figure 6.4. Relation of viscosity of mineral slurries to dosage (after Leyendecker, 1978)\*

\* Viscosity is defined as the shear stress in the slurry liquid divided by the shearing rate. The unit of viscosity in the metric system is the poise, defined as stress in dynes per square centimeter required to produce a difference in velocity of one centimeter per second between two layers one centimeter apart. The centipoise is one-one hundredth of a poise.

Drilling slurry can be improved in some instances by the addition of chemicals. On these occasions a specialist should be consulted; the supplier of the bentonite or other mineral product can usually be helpful in regard to the use of chemical additives. In fact, a technical representative of the slurry product supplier should be present at the beginning of any important project that will involve the use of drilling slurry to ensure that the properties of the slurry are appropriate for the excavation of soils and rocks at the specific site involved, even if special additives are not contemplated by the contractor.

A comprehensive report, *Bored Piles*, compiled by the Laboratoire Central des Ponts et Chaussées in France (LCPC, 1986), points out that the following additives are available.

- **Cake thinners.** Organic colloids [soda alginate, extract of marine algae, carboxymethylcellulose (CMC), starch], which reduce the free-water content (thus thinning the cake and enhancing its resistance to contamination) and increasing the viscosity of the slurry somewhat. These additives also act as filtrate reducers (below).
- **Filtrate reducers.** Additives, such as tanins (especially quebracho), polyphosphates (pyro, tetra, and hexametaphosphates) which diminish slurry viscosity, and also lignosulfonates, which act as filtrate reducers and thus reduce loss of slurry to the formation.
- **Anti-hydrating agents.** Additives such as potassium lignosulfonate are effective in inhibiting the erosion of dispersive clays and clay-based rocks into the slurry and the expansion of expansive clays.
- **pH reducers.** Pyrophosphate acid can be added to lower the pH of the slurry. This additive is of special interest when excavating certain expansive marls in which hydration, which occurs when the drilling slurry is highly basic ( $\text{pH} > 11$ ), can be limited by maintaining the pH value between 7.5 and 8. Maintaining pH below 11 is also necessary to maintain good characteristics of bentonite slurries.
- **Weighting agents.** Barite (barium sulfate), hematite, pyrite, siderite, or galenite may be added to the slurry when it is necessary to resist the intrusion of water under pressure or flowing subsurface water. The specific gravity of the slurry, which is normally around 1.03 to 1.05 upon mixing, may be increased to 2.0 or even greater with these agents, without appreciably affecting the other properties of the slurry (for example, its gel strength and viscosity).

These additives affect the yield of the slurry, to varying degrees. Again, the assistance of a technical representative of the supplier of the slurry solids and additives is important to ensure that the desired properties are achieved, at least in the initial mixing of the slurry.

Bentonite slurry is strongly affected by the presence of excessive concentrations of positive ions, as are found in very hard water and acidic groundwater, by excessive chlorides concentrations, as are found in sea water, and by organics. Acidic conditions are indicated by pH values that are lower than 7. Some commercial bentonites are packaged with additives that raise the pH of the bentonite-water mixture to 8 to 9 to counteract the effects of minor acid contamination, but excessive acid contamination can lower the pH to a point where the bentonite will become acid and subsequently flocculate. Bentonite can be used sparingly in an acid pH for short periods of time (pH down to about 5). One function of the manufacturer's technical representative would be to measure the hardness, acidity, chlorides content and organics content of the mixing water and the ground water, if necessary, and to recommend conditioners in the event the water is not

suited to mixing with the bentonite without modification.

## **Polymers**

There are two general types of polymers for drilling slurries: Natural (or semi-synthetic) and synthetic. Polymers in the first category consist of starches, guar/xanthan gum, welan gums, scleroglucan and cellulose. They are biodegradable and are capable of remaining stable in highly acid environments for short periods, which is a characteristic not shared by most other types of drilling slurries. Cellulose polymers are sometimes blended with bentonite to reduce the filtration rate of bentonitic slurry (fluid loss into the formation) and inhibit swelling (softening) and consequent erosion of clays and shales. Blends of natural or semi-synthetic polymers and bentonite can produce effective drilling slurries for specific drilling projects. However, these polymers are expensive and generally non-reusable. Therefore, most polymer slurries used for foundation drilling today are made with purely synthetic polymers.

Polymers in the second category, synthetic polymers, consist of various forms of the hydrocarbon-derived family of chemicals called polyacrylamides. Polyacrylamide slurries consist of large groups of long-chain, hair-like molecules that have been designed to charge sites along their backbones negatively to promote molecular repulsion, restrict agglomeration (attraction of many molecules into large masses) and keep the molecules in suspension once mixed with and suspended in water. Different suppliers of polyacrylamides adjust the density of the negative electrical charges along the polyacrylamide chains by adding groups of atoms ( $\text{OH}^-$  groups) with locally negative charges on their exteriors through a process called hydrolyzation. Polymers used for drilled shaft excavation do not have all of the possible positions for negative charges filled because the surfaces of the polymer chains would be so negatively charged as to be repelled by the soil they are intended to penetrate. Hence, the polyacrylamide is said to be "partially hydrolyzed," and the drilling polymer is termed a partially hydrolyzed polyacrylamide, or "PHPA."

All synthetic polymer slurry materials commonly available today (1997) are various formulations of PHPA's. Some polymer slurry manufacturers have performed alterations of the PHPA chemistry. In at least one product the PHPA molecule has been extended to form a vinyl, which consists of a pair of parallel PHPA chains connected by complex molecules, and in at least one product the single PHPA chain has been retained but made very heavy and has been designed so that the negative charge density along its backbone is high. These polymers will exhibit somewhat different properties when used in different soil and ground water conditions. The vinyl polymer usually performs optimally if it is used at a higher viscosity than the viscosity that is optimum for the heavy PHPA. For further details of polymer chemistry for any drilling product, the reader should contact the manufacturer's technical representatives and/or literature. In the following, all synthetic polymers will be referred to as PHPA's.

The commercial products vary in physical form (dry powder, granules or liquid emulsions) and in the details of the chemistry of the hydrocarbon molecules [molecular weight (typically 14 to



17 million, but some as low as 100,000), molecule length, surface charge density (typically, 30 to 45% of the possible negative charge sites are filled), etc.]. Therefore, Formulation A may be more successful than Formulation B at one site, while Formulation B may be more successful than Formulation A at another in maintaining hole stability. No one formulation is likely to be superior in all cases. For example, PHPA formulations containing surfactants (anti-surface-tension agents) have a history of successful applications in silty sands below the water table, but on occasion they may accelerate borehole instability in moist sands above the water table that are held in a quasi-stable state by surface tension forces in the soil pores

Many polymer slurry suppliers market several formulations that can be customized for a given site. For this reason, as with mineral slurry drilling, the drilling contractor should employ a technical representative of the polymer supplier to advise on the specific formulation that is best suited for the job at hand. That representative should be present for the drilling of trial shafts and/or the first few production shafts to make sure that the slurry is working as intended and, if not, to make such modifications to the slurry mix and procedures as necessary.

Most of the additives that are effective in modifying the performance of bentonite, such as weighting agents, have not been proved effective with polymer slurries. However, potassium chloride can sometimes be used to weight PHPA slurries up to a specific gravity of about 1.25.

PHPA's are especially sensitive to the presence of free calcium and magnesium in the mixing water or ground water. Excess calcium and magnesium produce what is commonly called "hard water." The total hardness of the slurry mixing water should be reduced to a value in the range of 50 parts per million or less (varies with the specific product used) unless the polymer has been modified chemically to remain stable in high-hardness conditions. If the hardness is too high, polymer chains lose their repulsion and can begin to attract one another and agglomerate, causing the polymer to be ineffective.

Total hardness of the slurry can be checked easily by a titration process, in which one or two chemicals are added to a known volume of slurry to change its color and another chemical is titrated into the colored slurry. When the color of the slurry again changes (typically from purple to blue), the volume of the final chemical added to the slurry is read, and the hardness is obtained from a simple calibration chart. Some simpler, though more approximate, methods can also be used for field control of hardness.

Excessive hardness is reduced by thoroughly mixing sodium carbonate ("soda ash") with the slurry until the hardness is within the desired range. Manufacturers of vinyl-extension PHPA polymers supply other softening agents for use with their slurries. Hardness is not usually monitored routinely during construction due to the effort involved; however, pH, which can be measured quickly and easily, should be monitored. The agent that is used to lower hardness also raises pH, so that a check on pH is an indirect check on hardness.

Chlorides also have a negative effect on PHPA's. PHPA's tend not to be effective in water whose

chloride content is greater than about 1500 parts per million. Therefore, they are not usually effective in sea water. Sometimes, suppliers' technical representatives can find additives or devise mixing procedures to allow the use of polymer slurry in brackish water.

## **MIXING AND HANDLING**

### **Mineral Slurry**

The procedures employed for the mixing and handling of mineral slurry can vary widely. The principal concern is that the slurry have appropriate characteristics during the excavation of the borehole. Certain procedures should not be permitted, for example, dumping dry bentonite into a water-filled excavation and stirring the mixture with the auger. This procedure produces an ineffective slurry that contains clods of dry, sticky bentonite that fail to stabilize the borehole because the individual bentonite plates are not available to form the mudcake. Furthermore, the clods can become lodged in the rebar or against the borehole wall and produce a defective drilled shaft.

A schematic diagram of a complete, appropriate system for mixing and handling bentonite slurry for drilled shafts is shown in Figure 6.5. Two acceptable types of mixers are shown in Figure 6.5 b. The mixer identified by  $b_1$  consists of a funnel into which dry bentonite is fed into a jet of water directed at right angles to the flow of the bentonite (a "venturi"). The mixture is then pumped to a holding tank. The mixer identified by  $b_2$  consists of an electric motor, with or without speed controls, that drives a vertical shaft. The shaft has blades attached that operate at a circumferential speed of up to about 80 m/s (260 ft/s), and excellent mixing of bentonite with water is obtained.

Freshly-mixed slurry should be held in storage for a period of time to allow complete hydration. The stored slurry can be re-mixed, if necessary, by pumps, mechanical agitation, or compressed air. The mixed slurry should not be used in drilling until the viscosity has completely stabilized, which usually requires several hours following initial mixing. Less time, but more vigorous mixing, is required for attapulgite or sepiolite slurries.

Figure 6.5 d depicts the common "static" (non-circulation) mineral slurry drilling process. The slurry stored in the storage tank (Figure 6.5 c) is carried to the borehole by pump or by gravity with the slurry level in the borehole kept continuously above the level of the piezometric surface in the formation during drilling. When soils with significant amounts of granular material (sand or silt) are being excavated, the slurry may quickly thicken as the particulate matter is placed in suspension. This is not desirable, because (a) the slurry becomes incapable of suspending additional particulate matter, the consequence of which is that the additional particulate matter may slowly settle out of suspension after the borehole is cleaned and as the concrete is being placed, and (b) the slurry may become too viscous to be displaced by rising fluid concrete. This condition can be identified by measuring the sand content, density and viscosity of the slurry at the bottom of the borehole before concreting. Slurry with excessive sand or viscosity must be

pumped from the bottom of the borehole to a treatment unit located on the surface for removal of the particulate matter. Simultaneously, fresh slurry meeting all of the sand content, density and viscosity requirements is pumped from a holding tank on the surface and introduced at the top of the borehole, keeping the level of slurry in the borehole constant.

A procedure for removing the slurry from the bottom of the borehole is to use an airlift. A jet of air at low pressure and high volume is introduced near the bottom of an open pipe, which is placed near the bottom of the borehole. As the air flows upward, the reduced pressure in the pipe causes slurry to enter, and a mixture of air and slurry will be blown up the pipe to the surface by the air lift. Air lifting is also effective in cleaning loose sediments and agglomerated slurry from the bottom of the borehole if a diffuser plate is placed on the bottom of the pipe to distribute the suction equally around the bottom of the borehole.) A submersible pump can also be used for this purpose. With either method, the rate of the fluid flow should lift all sediments in the slurry from the borehole.

When the hole is advanced through primarily cohesive soil, the slurry may not thicken appreciably during drilling, unless the clay erodes. In such a case, exchange of the slurry in the borehole may not be necessary. However, agitation of the slurry (as with the auger) is still desirable to ensure that particulate matter stays in suspension. This action is especially important with attapulgite or sepiolite, which do not suspend solids as readily as bentonite. In this case, the slurry needs to be recovered from the hole only once (as the concrete is placed) and directed to the treatment unit before reuse or discarded.

The contaminated mineral slurry is moved to a treatment unit, Figure 6.5 e, that consists of screens and hydrocyclones. The slurry first passes through the screens (usually No. 4 size), where the large-sized sediments are removed, and then is pumped through the cyclone unit where the small-sized material is removed by vigorously spinning the slurry. Most hydrocyclones are capable of removing virtually all sand-sized particles. Some units are equipped with smaller hydrocyclones that also remove silt, although several passes through the hydrocyclones may be necessary. Silt removal can be just as important as sand removal for reused mineral or blended slurries, because suspended silt can cause the viscosity, density and filtration rate to increase, rendering the slurry ineffective.

The cleaned ("desanded") slurry is pumped back to a holding tank where it should be tested. Since slurry drilling ordinarily involves some loss of slurry to the formation, some amount of fresh slurry is usually mixed with the desanded slurry at this point. If the used slurry is to be discarded without treatment, it is essential that approved methods be used for disposing of the slurry.

For a small job where it is uneconomical to bring in a full treatment unit to the jobsite, the contractor may wish to fabricate a screen system that can be cleaned by hand and to obtain a small cyclone unit to do the final cleaning. As stated earlier, another procedure that can be employed on some jobs where relatively little sand is present in the formation being drilled is to

employ the static drilling process, without any treatment of the slurry, as long as sand and silt content in the slurry do not become excessive. A clean-out bucket can be lowered to the bottom of the borehole and rotated to pick up sediments that have settled out of the slurry. This kind of cleaning operation, although time-consuming, is necessary to prevent significant amounts of sediment from either being trapped beneath the concrete as it is introduced into the borehole or from collecting at the top of the concrete column during concrete placement. The slurry that is flushed out by the placement of the fluid concrete can sometimes be reused several times if the specified ranges for density, viscosity, sand content and pH can be maintained.

Attapulgite and sepiolite slurries are treated much like bentonite slurries, except that very vigorous mixing for a long period of time is required. Once the mineral is thoroughly mixed with the makeup water, the slurry can be introduced directly into the borehole, as these minerals do not hydrate with water and so do not need to be held for several hours for hydration, like bentonite, before introducing them into the borehole.

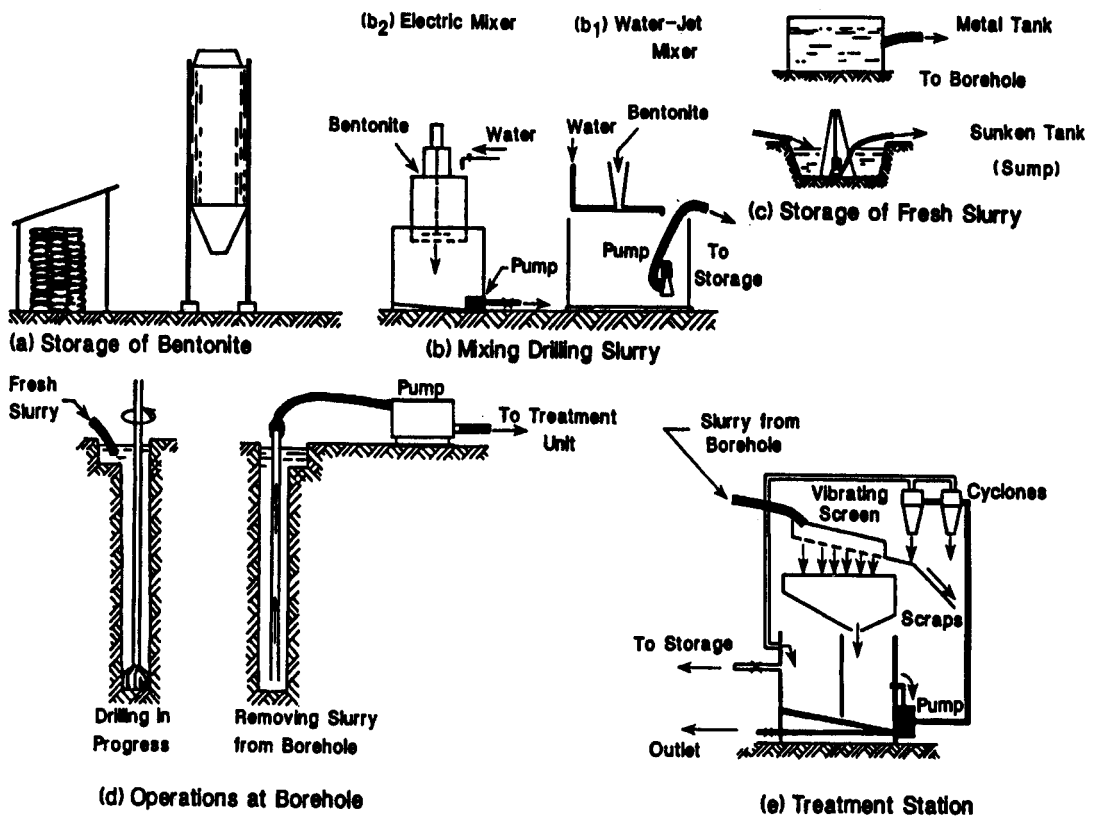

Figure 6.5. Schematic diagram of unit for mixing and treating mineral slurry (after LCPC, 1986)

## **Polymer Slurry**

Polymer slurries can be mixed in a number of ways. The supplier of the particular polymer being used should be contacted for recommendations. Emulsified PHPA's can be mixed by pumping them from one tank to another and back again to the first tank, perhaps repeating the process several times. Dry PHPA's can be mixed with a venturi mixer. Vigorous mixing of polymers supplied in the dry form should be avoided, however, since polymer chains can be broken down and the polymer slurry rendered ineffective. It is not generally recommended that polymer slurry be mixed in the borehole; however, some dry polymer products are specifically marketed to be mixed with uncontaminated ground water in the borehole with the drilling tool. Success with the resulting slurry varies with soil or rock type. It is strongly recommended that a trial or technique shaft be constructed to test the effectiveness of such slurry prior to constructing production shafts.

Whatever the mixing method, soda ash or another hardness reducer is almost always added to the makeup water during mixing to control the hardness of the water, which simultaneously adjusts the pH of the polymer slurry to a high value. Note that soda ash should not be used with vinyl extensions of PHPA.

Polymer slurries cannot be cleaned effectively in the manner shown in Figure 6.5. The polymer strands are broken down by vigorous mixing in hydrocyclones and in addition tend to "gum up" the components of the treatment plant. Fortunately, polymers do not suspend most solids for a long period of time. The sand content at the bottom of the borehole will stabilize at a small value (usually less than 1 per cent by volume) after the slurry column is allowed to stand without agitation for a period of time [for example, about 30 minutes to 2 hours in boreholes less than 20 m (66 ft) deep]. The particulate matter can then be removed from the bottom of the borehole with a clean-out bucket or possibly an air lift. The slurry that is flushed out of the borehole by the rising column of fluid concrete is then essentially clean, although good practice is to store it for a few hours in a tank on the surface to permit small amounts of solids still in suspension to settle out. The supernatant polymer can then be reused in drilling subsequent boreholes after checking its properties and adding fresh slurry, if necessary.

Full circulation drilling, referred to as either direct or reverse circulation drilling, in which the cuttings are transported by pumping the slurry from the cutting face of the drilling tool continuously to the surface, is possible with mineral slurry. It is not very effective with polymer slurries without special additives since the current generation of polymer slurries do not effectively suspend particulates (cuttings).

Diaphragm-type pumps are generally best for moving polymer slurries from tank to borehole and back. Diaphragm pumps do not damage the polymer chains as severely as centrifugal or piston-type pumps. Any form of mechanical agitation, however, damages the polymer chains to some extent, such that a given batch of polymer slurry cannot be reused indefinitely. This includes air lifting, since the highly turbulent flow of the lifting mechanism can shear the polymer chains

excessively. For this reason, air lifting of polymer slurries should be used only for limited durations if the slurry is to be reused.

The mixing of either polymer or bentonite slurry with portland cement at any time in the construction process can be very detrimental to the slurry because the hydration of portland cement releases calcium ions in such concentration that the hardness of the slurry may become very high. For this reason the contractor must be very diligent to keep cement out of the slurry. He or she should also minimize the time that the slurry is in contact with the rising column of concrete in the wet method of construction by charging the borehole with concrete at a steady rate. The contractor should use pump lines for polymer or mineral slurry that have either never been used for pumping concrete or have been thoroughly cleaned since doing so.

### **Blended Slurry**

Blended slurries are generally handled like bentonite slurries. However, many combinations of bentonites and polymers are possible, so that the supplier should always be consulted for proper mixing and handling procedures.

## **SAMPLING AND TESTING**

As will be discussed in a subsequent section, mineral and polymer slurries will have certain desirable characteristics when being used to facilitate excavation. Therefore, certain key properties must be measured to ensure that these characteristics are operative. Testing will be desirable just before the slurry is introduced into the borehole, perhaps on occasion as drilling progresses, and always before concrete is placed.

The following paragraphs describe briefly several tests that can be performed for the control of mineral, polymer or blended slurry. For blended slurry, the tests and criteria are the same as for mineral slurry. Some of the tests would normally be used only for designing slurry mixes or for troubleshooting during construction. For most jobs, the mud balance for density, the Marsh funnel or rheometer (preferred) for viscosity, and a pocket pH meter or pH paper are adequate to monitor the properties of the slurry during routine construction operations, once the slurry mix has been designed for the site in question.

### **Sampling**

Careful attention must be given to the sampling procedure, which would appear superficially to be quite simple. It is easy to sample slurry improperly, however, which leads to false information regarding the slurry's characteristics.

If the slurry has been freshly mixed and is being agitated, satisfactory samples may be taken almost anywhere in the storage tank. The important point is to obtain a sample that is representative of the mixture.

The sampling of the slurry during the drilling operation or just prior to concreting (after cleaning the base) is another matter. Sediment should neither settle from the slurry prior to starting the concreting nor should a layer of sediment form on top of the column of fresh concrete during placement. Therefore, the sample of the slurry must be taken at the bottom of the slurry column where the sand concentration is usually the highest. A special tool is needed in order to obtain a sample from any point in the slurry column; the tool shown in Figure 6.6, sometimes referred to by drilling contractors as a "thief," is suitable in most cases. A steel or lead sinker is lowered to the bottom of the borehole (or the level at which the sample is to be taken) on a piece of airplane cable. This sinker can be used to sound the bottom of the hole to discover evidence of sediment and to judge the effectiveness of the clean-out procedure. Experienced inspectors can learn to feel whether a borehole is solid or soft (indicating sediment) with this sinker, although a heavier sounding device, such as a short piece of No. 18 rebar, may be more sensitive for the purpose of probing the bottom.

A metal casing, or tube, is then dropped down over the airplane cable and seals against the sinker, capturing a sample of slurry at the desired depth in the borehole. A steel or lead cover is then dropped to seal the top of the tube and the sample is winched out of the hole. While limits on certain slurry properties will be recommended, it is always good practice to take multiple samples at different times after the cessation of drilling to assure that the properties of the slurry have stabilized. Only then should concreting proceed. When the "thief" is brought to the surface, its contents are usually poured into a plastic slurry cup to await testing.

## **Testing**

This section describes several items of testing equipment, which can be obtained from any of several oil-field service companies.

### **Density**

A mud balance (lever-arm scale) is typically used to measure the density, or unit weight, of the slurry. A metal cup that will hold a small quantity of slurry is carefully filled out of the slurry cup and cleaned of excess slurry on its exterior. It is then balanced by moving a sliding weight on a balance beam. The density of the slurry is read directly from a scale on the beam in several forms [unit weight (lb/cubic foot, lb/gallon), specific gravity]. The scale should be properly calibrated with water in the cup before making slurry density readings.

This device is accurate, and readings can be taken rapidly. The only problem is to obtain a representative sample because the quantity of the slurry that is tested is small in relation to the quantity in a borehole. Therefore, multiple tests are recommended where feasible.

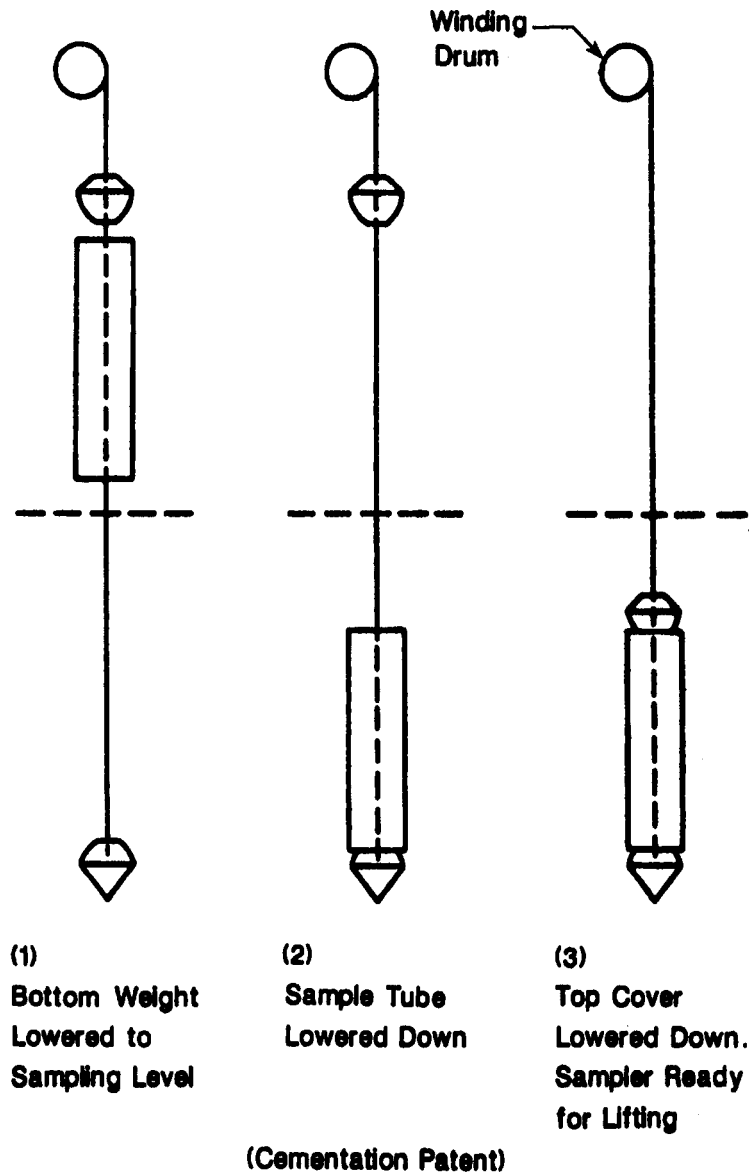

Figure 6.6. Sampler for slurry  
(from Fleming and Sliwinski, 1977)

## Viscosity

Several measures of viscosity are used in specifications. The simplest (but most indirect) measurement is with the Marsh funnel, a simple funnel with a small orifice at its bottom end. The Marsh funnel, while simple and expedient, does not truly measure viscosity and can be misleading when monitoring the viscosity of some polymer slurries. The test is performed by placing a finger over the tip of the small orifice at the bottom of the funnel (after making sure



that the orifice is clean) and filling the funnel with slurry to a line at the base of a screen located near the top of the funnel. When filling the funnel, the slurry should be poured through the screen to filter out large solid fragments. The slurry then is allowed to flow out of the funnel through the orifice back into an empty slurry cup, which has a mark denoting one quart (0.94 L), and the number of seconds required for one quart of the slurry to drain from the funnel into the cup is recorded. (It should be noted that not all of the slurry will have flowed out of the Marsh funnel at the time one quart has accumulated in the slurry cup.) This measure of time, in seconds, is the "Marsh funnel viscosity." Many specifications for drilling slurry rely on the Marsh funnel, and the device allows adequate control of slurry for many jobs.

Other jobs require more stringent controls, and some specifications are based on the use of instruments that truly measure viscosity. An instrument, generically called a "rheometer" or a "viscometer," that can be used to measure viscosity of drilling slurries is shown schematically in Figure 6.7. As may be seen in the figure, the cup, or "rotating cylinder," can be rotated at a known speed. This will cause a shearing stress to be transmitted to the suspended cylinder, which in turn will cause a twist of the torsional spring. The scale can measure the twist, and thus the shearing stress. Some commercial versions of this device, for example, the Fann viscometer, are arranged to be direct reading. Use of this device is almost as simple as using a Marsh funnel.

The information that can be obtained from a viscometer test is illustrated in Figure 6.8, which presents results from tests on a dry PHPA polymer slurry (without soil contamination) that was mixed at a dosage of 1 g / L (1 lb/100 gal.). The shear rate is read directly in RPM but can be converted to shear strain rate in 1/seconds on a standard Fann viscometer by multiplying the number of RPM's by 1.703. That is the shear strain rate that is shown in the figure. The shear stress is read in lb/100 sq. ft. This value can be converted to dynes/sq. cm by multiplying the shear stress reading in lb/100 sq. ft by 4.79. The shear strain rate was changed from a very low value of  $5.11 \text{ sec}^{-1}$ , which corresponds to a rotational speed reading of 3 RPM on the viscometer, to progressively higher rates, including  $511 \text{ sec}^{-1}$ , (300 RPM) and  $1022 \text{ sec}^{-1}$  (600 RPM), which are the standard rates for testing bentonitic slurries. Note that rates lower than 3 RPM are obtained by turning the cup by hand.

As the shear strain rate is increased by increasing the RPM of the container, the shear stress increases. The resulting relationship between shear strain rate and shear stress, shown by the solid line in Figure 6.8, is usually nonlinear from the lowest rotational speed to the highest. A simple power function equation for this relationship for the example that is given, which can be obtained by simple curve fitting methods, is shown in the figure. In that relationship  $y$  is the shear stress in lb/100 sq. ft, and  $x$  is the shear strain rate in  $\text{sec}^{-1}$ .

The power function relationship is termed a "rheological" relationship. It is usually more highly nonlinear for polymer slurries than for bentonitic slurries. The exponent, in this case 0.46, is referred to as the "n" value for the slurry. The n value has been proposed for use in some polymer slurry specifications.

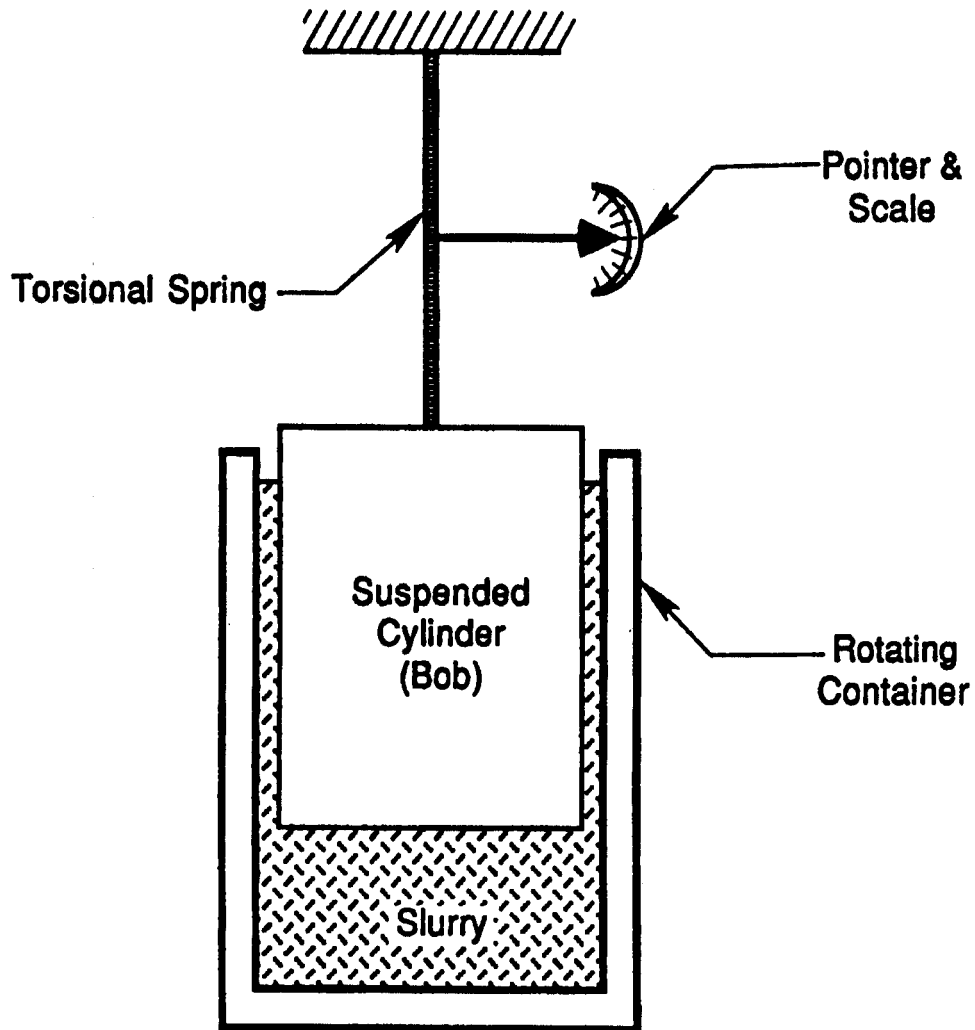

Figure 6.7. Schematic of viscometer

Several characteristics from the measured rheological relationship can be used to describe the slurry for purposes of writing specifications. First, a straight line (dashed line in Figure 6.8) can be drawn between the points relating shear stress in the slurry to shear strain rate in the slurry at rotational speeds of 300 and 600 RPM. This straight line presumes that the slurry obeys a "Bingham plastic model" law, which is approximately correct for mineral slurries. The "yield point" (YP) is the ordinate of the intercept of the straight line approximation in the Bingham plastic model at zero shear strain rate (apparent shear stress at zero RPM) and is obtained by testing slurry that has been recently agitated. The YP in Pa, or N/sq. m, is the YP in lb/100 sq. ft times 0.479. The "plastic viscosity" (PV) of the slurry is defined as the slope of this line. PV is expressed in units of centipoise (cP) or 1/100's of a poise, where a poise is the shear stress in

dynes/sq. cm per sec<sup>-1</sup> of shear strain rate. Equation 6.1 can be used to obtain the PV in cP.

$$PV (cP) = \frac{\{(t \text{ at } 600 \text{ RPM} - t \text{ at } 300 \text{ RPM}) \times (4.79)\} / [511 \text{ sec}^{-1}]}{100} \quad (6.1)$$

$$\approx t \text{ at } 600 \text{ RPM} - t \text{ at } 300 \text{ RPM}$$

in which t is the shear stress reading in lb/100 sq. ft.

The "apparent viscosity" (AV) is given by the slope of a line drawn through the origin of the curve to a specific point on the measured curve relating shear stress to shear strain rate (at 300 RPM, as shown here, or more commonly at 600 RPM, on a direct-reading viscometer). The AV is also expressed in cP. AV can be obtained from Equation 6.2.

$$AV (cP) = \frac{\{(t \text{ at desired strain rate}) \times 4.79\} / (\text{strain rate in sec}^{-1})}{100} \quad (6.2)$$

The "gel strength" is the shear stress generated at a rotational speed of 3 RPM by testing the slurry after it has been allowed to stand unagitated for a given period of time, usually ten minutes. In some mineral slurries the 10-minute gel strength can be near the yield point, but the 10-minute gel strength is always considerably less than the yield point in synthetic polymer slurries.

Each of these quantities, YP, PV, AV and gel strength, is used in some slurry specifications. Traditionally, when viscometers have been used to monitor the rheological properties of mineral slurries for drilled shaft construction, the slurry properties that are controlled are the 10-minute gel strength and/or the YP, and occasionally the PV. Representative specifications described later in this chapter use these parameters.

Beresford et al. (1989) suggest that polymer slurries should be controlled by monitoring n and the AV's at 3 RPM (corresponding to the gel strength) and 600 RPM. The value of n for polymer slurries should be relatively low, which indicates that the slurry tends to thin rapidly on the application of increased shear strain rates. The value of n for the slurry depicted in Figure 6.8 is 0.46. Beresford et al. also suggest that the AV of the slurry at the shear rate of 5.11 sec<sup>-1</sup> (3 RPM) be as high as 250 cP in order to maintain hole stability with the polymer slurry in a static condition in the borehole. However, they do not present evidence that such high values of AV in the drilling slurry result in acceptable magnitudes of unit side shear in completed drilled shafts. Using Equation 6.2, the slurry shown in Figure 6.8 exhibits an AV of  $\frac{\{(1.03 \text{ lb./100 sq. ft}) \times 4.79\} / 5.11 \text{ sec}^{-1}}{100} = 97 \text{ cP}$  at 3 RPM. Beresford et al. also suggest that the AV at 600 RPM be no greater than about 12 cP so that the slurry will flow readily to the top of the borehole when displaced by the fluid concrete. The slurry shown in Figure 6.8 exhibits an AV of  $\frac{\{(10.0 \text{ lb./100 sq. ft}) \times 4.79\} / 1022 \text{ sec}^{-1}}{100} = 4.7 \text{ cP}$  at 600 RPM.

The polymer slurry whose rheological properties are shown in Figure 6.8, also exhibited a Marsh funnel viscosity of 44 sec/quart (44 sec/0.94 L). It was successful in excavating 21.4-m- (70-ft-)

deep, 0.915-m- (3-ft-) diameter boreholes and producing values of unit side shearing resistance that equal or exceed the predicted values obtained from the design methods in Chapter 11 in overconsolidated stiff clay / stiff very silty clay and in medium dense silty sand with water table depths of about 3 m (10 ft) (Ata and O'Neill, 1997).

As the silt and sand contents of any mineral or polymer slurry increase,  $n$  will tend to decrease, and the gel strength, YP and AV values will tend to increase. Therefore, the values described above should be applied to the condition of the slurry in the borehole before concreting.

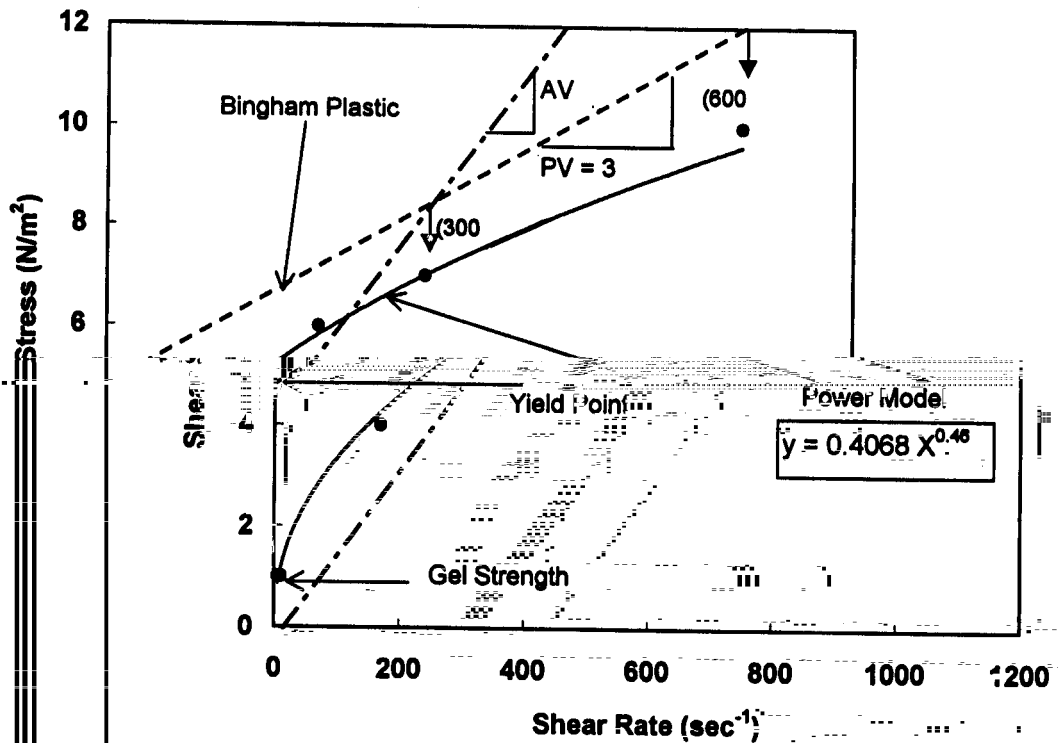

Figure 6.8. Interpretation of data from a viscometer. (Ata and O'Neill, 1997)

### pH Value

The pH of the slurry is an indicator of the degree of acidity or alkalinity of the slurry. Maintenance of a proper range of pH is important to the proper functioning of the slurry and indicator of the effectiveness of anti-hardness additives. For example, neutral-to-acid pH (7. lower) can reflect conditions in a borehole that is being drilled through an acidic fill and that bentonite-based slurry may be in danger of flocculating, or it could indicate that a polymer slurry is mixing with acid ground water and is in danger of agglomerating. Values for the allowable range of pH are given in the next section. The pH can be determined readily by the use of pH paper or by a pocket pH meter. The pocket pH meter, which is the size of a large pencil, is more accurate and is easy to use, but it must be calibrated often against a standard buffer solution.

## Sand Content

The material retained on a No. 200 screen (74 microns) is defined as sand. An increase in the amount of sand in the slurry is cause for concern that additional sand may not be held in stable suspension. It is important that the sand being held in suspension in a slurry not exceed the amount that can be held there for a period of time long enough to allow the slurry to be displaced by the fluid concrete. The sand content is measured using a standard API (American Petroleum Institute) sand content kit by taking a slurry sample of 100 mL. The sample is usually taken from the slurry cup after stirring vigorously to make sure all of the sand in the original sample in the cup is uniformly distributed in the suspension from which the 100 mL sample is taken. The slurry sample is diluted with water and then passed through a No. 200 screen. The sand from the slurry is retained on the screen. That sand is then backwashed from the screen into a burette with a graduated, conical base, and the sand content in percent by volume is obtained by reading the scale on the burette.

When testing polymer or blended bentonite-polymer slurries for sand content, particularly if the soil being drilled contains dispersive clay or silt that can be put in suspension temporarily during drilling and become entangled with the polymer strands, it is important that the slurry be washed over the No. 200 screen with a mixture of household bleach containing sodium hypochlorite and water (perhaps 50/50 by volume), several times if necessary, to detach the polymer strands from the soil. Otherwise, the clay/silt/polymer assemblages will be registered as sand. In any event, it is important that the final wash water in the burette be clear. Otherwise, the washing process should be repeated until the wash water becomes clear before making the sand content reading. A photograph of an API sand content test in progress is shown in Figure 6.9.



Figure 6.9. Photograph of sand content test (backwashing sand into burette)

## Hardness

Hardness of mixing water or ground water is measured by a titration process using a standard API kit that can be obtained for this purpose. A small sample of the water is put into an evaporating dish, and chemicals are added to change its color, usually to purple. An amount of another chemical sufficient to turn the color of the water to a target color, usually blue, is then released from a graduated burette (titrated) into the water, and the volume required for the color change measured. The hardness is then determined from a table provided with the kit from the measured volume of the titrated chemical. A photograph of a hardness test is shown in Figure 6.10. A simpler, but less accurate, field kit for hardness is also available. This kit requires that only one chemical be added to the water in order to estimate hardness.

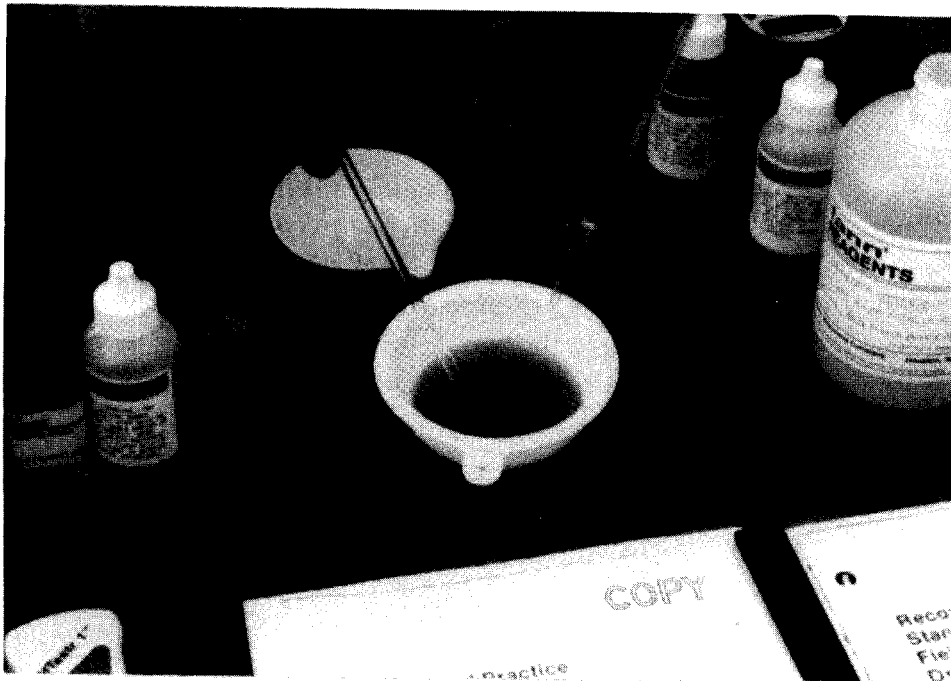

Figure 6.10. Photograph of titration test for hardness

## Free Water and Cake Thickness

A device called a filter-press is commonly used for this test. The device consists of a small slurry reservoir that is installed in a frame, a filtration device, a system for collecting and measuring a quantity of free water, and a pressure source. The test is performed by forcing slurry through a piece of filter paper under a pressure of 689 kPa (100 psi) for a period of 30 minutes. The free water that is recovered is measured in cubic centimeters, and the thickness of the cake that is formed is measured to the nearest millimeter. Before measuring the cake thickness, the superficial gel is washed away.

## **Shear Strength**

The shear strength of mineral slurry is influenced by the percentage of mineral that is present, by the thoroughness of mixing, and by the amount of time since agitation. The shear strength at a given time can be measured by use of a device called a shearometer. A determination by the shearometer merely involves the rate in which a thin-walled cylinder will settle in a beaker of slurry. While the shearometer is easy to use, Holden (1984) reports that it is difficult to obtain repeatable readings. The shear strength test is not commonly performed for drilled shaft slurries but can be of aid in diagnosing problems on occasion.

## **Comments on Field Testing of Drilling Slurries**

The purposes of field tests on drilling slurries are to assure that the drilling slurry has the necessary properties to

- maintain hole stability,
- minimize relaxation of ground stresses, and
- leave the sides and base of the borehole in a condition of minimum contamination.

Overall, the field testing of drilling slurries is not difficult. The tests and the skills can easily be mastered by most State DOT inspectors, or the tests can be performed by the contractor's personnel with oversight by a State inspector. All of the equipment necessary to perform the tests described above, except for the filter press and shearometer, are shown laid out on a small table in the field in Figure 6.11.

Not all of the tests described above need to be performed on every drilled shaft on every project. Some of the tests for the slurry are time-consuming and in some cases could actually result in poorer work because of the inevitable delays that would result as testing is being done. In an ideal situation, all, or most, of the tests described above would be conducted on trial batches of slurry made from the makeup water available on a given site, using the particular type and brand of slurry material being considered for the drilling operation, and perhaps adding site soils to the slurry mix to determine if mixing the site soils with the slurry affects the slurry's properties. Then, considering the job-specific requirements (drilling in large-grained, open-pored soils; drilling in rock; drilling in clean, loose sand; equipment available, etc.), job-specific specifications are developed. In most situations, however, standard specifications that work in most cases are followed, and the tests required by those specifications are conducted to monitor the slurry. The user of standard slurry specifications should be aware that occasionally soil and/or water conditions could exist at any site or slight changes in formulation of the drilling slurry product being used may occur that may render such specifications, and the test values required by the specifications, invalid. The user of the slurry, ordinarily the drilled shaft contractor, should then be prepared to design the slurry to accommodate the soil and water

conditions at the jobsite and to arrive at job-specific specifications, perhaps through modification of the standard specifications, that will need to be approved by the State.

Once acceptable slurry mixes and job-specific specifications have been developed for a particular project, testing is ordinarily performed during production drilling to assure that slurry properties, once established, do not change, and these tests are generally minimal.

Tests performed for monitoring production drilling are generally the density test, the viscosity test, the pH test, and the sand content test. Many authorities believe that in mineral slurries the sand content can be correlated to the density of the slurry provided the proper mineral dosage has been applied when the slurry was mixed (Stebbins and Williams, 1986). That is, once mixed, the only factor that changes the unit weight of the slurry is the amount of sand held in suspension. Therefore, the sand content test does not need to be performed independently of the density test. It only needs to be conducted on slurry that has been through a cleaning process to test the effectiveness of that cleaning process. Other authorities recommend that both sand content and density be measured. This is good advice when significant silt and clay are present in the soil profile.

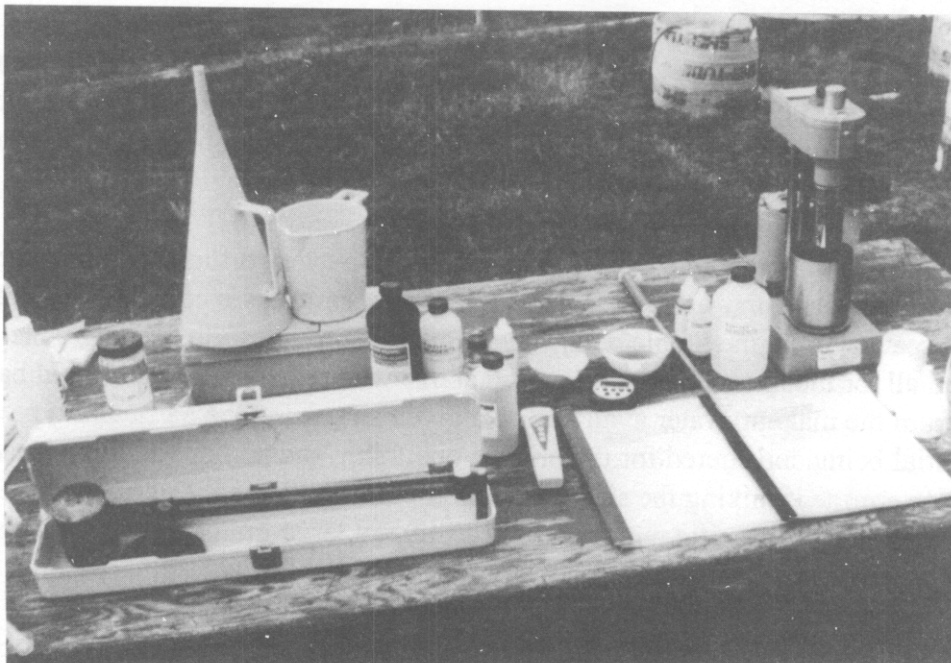

Figure 6.11. Photograph of complete set of field testing equipment for drilling slurries



## **MEASURING THE VOLUME OF THE EXCAVATION UNDER DRILLING SLURRY**

If the dry method of construction is used, some knowledge can be gained of the shape of the completed excavation by visual observation. But if slurry is used, some other means such as the techniques described in this section may need to be employed.

The preparation of a plot showing the actual volume of concrete that is placed versus anticipated volume for small increments of depth (development of a "concreting curve") is an excellent practice. Details of constructing such a plot will be described in Chapter 8. This plot will allow the engineer to make a judgment about the possible loss of concrete in an undiscovered cavity, about the possible collapse of the excavation during concreting and the general roughness of the borehole, which is of interest in evaluating the shaft capacity. Such a plot is useful regardless of the method of construction, but the technique is mentioned here because of its particular importance with regard to the slurry methods, in which neither the finished borehole nor the placement of concrete can be observed visually. A description of how the actual volume of an excavation under slurry can be obtained is provided below.

Figure 6.12 shows a commercial borehole caliper that can be used to obtain data on the average hole diameter as a function of depth, which can be used in lieu of assuming that the borehole is cylindrical. Figure 6.12 a shows the arms of the caliper in the collapsed position for lowering into the borehole, and Fig. 6.12 b shows the arms fully extended. The four arms of the caliper will swing out to contact the sides of the excavation when the springs that actuate the arms are released. An electronic angle-measuring transducer is placed so that the angle between each diagonally opposite pair of arms can be obtained as the device is pulled from the excavation. Calibrations of the transducers are easily made with the device at the ground surface.

The arms are pulled against the axis of the caliper and held with a keeper as the caliper is lowered into the slurry-filled hole, the keeper is released by command from the ground surface when the caliper reaches the desired depth, and the caliper is slowly pulled to the ground surface with readings of the transducers being taken at regular, closely-spaced intervals. Simultaneously, readings of depth are made electronically by means of an electrical transducer on the winch line used to pull the caliper. Companies that perform caliper services generally acquire the electronic data on a computer, can print profiles immediately and can provide digital records for further analysis. A caliper log requires about 5 to 10 minutes to acquire in holes up to 30 m (100 ft) deep after the caliper device has been attached to a hoisting line, which is often a line from a drilling rig or service crane.

Borehole caliper services can be obtained from most oil-well service companies and from other specialists for boreholes up to about 2 m (78 in.) in diameter. Names of such companies can be obtained by calling the ADSC at (214) 343-2091. These services can be rather expensive, however, so that electronic caliper services would ordinarily be used only on test shafts, technique (trial) shafts, the first few production shafts on major structures and in geomaterials that have problematical stability. Some enterprising contractors have built simple mechanical or electronic

calipers to be used to check grooving operations, in which the borehole is artificially roughened to enhance shaft capacity, and very precise calipers based on the use of lasers to profile the borehole are under development.

Figure 6.13 shows a caliper log (hole diameters in two perpendicular directions in excess of 1780 mm) in a borehole socket drilled with a polymer slurry in a profile of shale overlying sandstone within the Ohio River. The bottom of a casing used to retain overburden soils can readily be seen at a depth (below river surface level) of about 30 m (99 ft). The inside diameter of the casing is measured at 1.888 m (74.3 in.). The actual inside diameter of the casing was 1.880 m (74 in.), which indicates that the accuracy of this instrument is on the order of 0.5 per cent. The socket extends to a depth of 34.5 m (113 ft), at which depth an Osterberg cell was placed in order to load test the socket. (Osterberg cell testing will be discussed in Chapter 14.) The socket is seen to have been slightly larger in the shale than in the sandstone, possibly due to slight erosion of the shale. Otherwise, it is seen to be well-formed. These data are quite useful for the interpretation of load test data, in addition to constructing concreting curves.

The diameter of the borehole shown in Figure 6.13 is near the upper limit for commercial calipers. Some innovative contractors have built calipers for specific projects that have been effective in large-diameter boreholes, in which the per-hole cost is much less than the cost of renting a commercial device and a crew to operate it.

Sonic loggers are used routinely to obtain continuous borehole profiles rapidly in slurry-filled boreholes in Japan and elsewhere in Asia at a fraction of the cost of mechanical/electrical calipers of the type shown in Figure 6.12. Their accuracy is equivalent to that of electrical/mechanical calipers (0.5 per cent or less). Descriptions of sonic loggers are given in the manufacturer's technical literature (e.g., Koden, 1996). These calipers operate on the principle of sonar, in which sound waves are "bounced" off the sides of the borehole by a sonde that is lowered down the center of the hole. The continuous profile is plotted electronically. The initial cost of the equipment is relatively high, but, if used for many shafts, the cost per shaft can be low.

If casing is to be installed, the borehole should be calipered prior to setting the casing, if possible, so that any large overbreak zones behind the casing can be detected. When the slurry-displacement method of construction is being used, a measurement of the diameter of a slurry-filled hole along its depth should be made just prior to the placement of concrete.

In addition to measuring the diameter of the borehole, the depth of the borehole should be measured immediately after the base is cleaned and compared to the depth attained by the cleaning tools to determine if sloughing has occurred from the borehole walls. Another depth sounding should be made immediately prior to placing concrete, after the cage is placed in the borehole, to ascertain whether soil that has been in suspension has settled to the bottom of the borehole. If such is the case, it would be necessary to remove the cage and re-clean the base of the borehole.

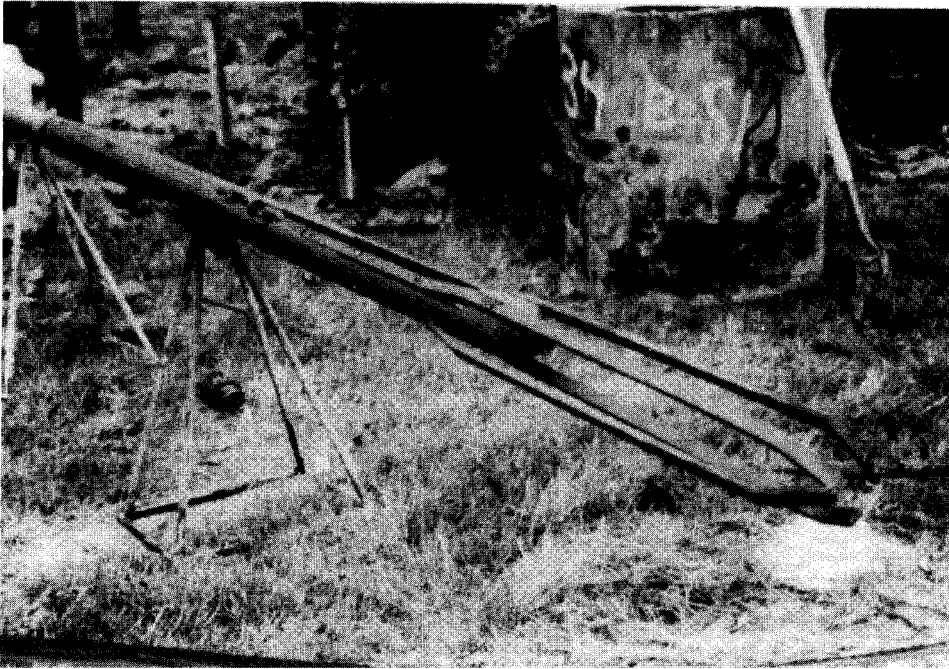

(a) Senors in retracted position

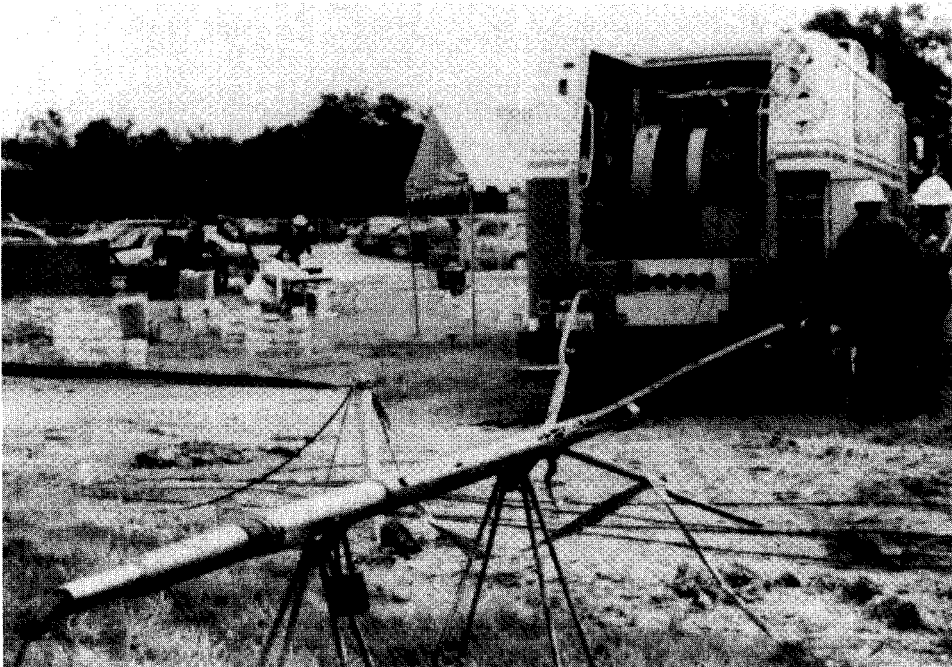

(b) Senors extended

Figure 6.12. Commercial borehole caliper (Western Atlas, Inc.)

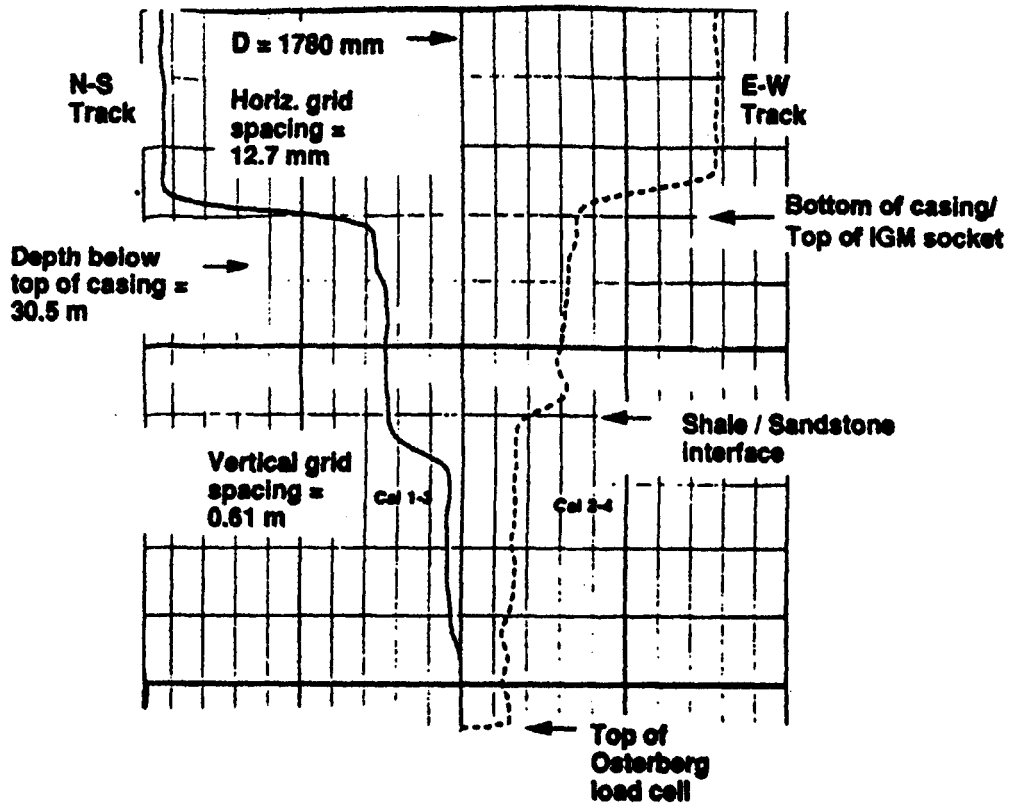

Figure 6.13. Caliper log (Foundations for US 231 Crossing of Ohio River)

A subsequent plot of the actual volume of concrete placed per increment of depth versus the expected volume computed from the caliper logs in each increment of depth (Chapter 8) should show excellent agreement. Such information can be of great value to the engineer if questions arise later about the quality of a particular drilled shaft.

### EXCESSIVE EXPOSURE OF SOIL OR ROCK TO DRILLING SLURRY

When drilling slurry is used, the drilling and concreting processes should proceed in a continuous fashion and the geomaterial not be exposed to the slurry, especially bentonitic slurry, for an excessive period of time. In general, if bentonitic slurry remains in a borehole unagitated for more than about four hours, its gel or shear strength becomes too high to permit full flushing by the concrete. Furthermore, the mudcake that builds up on the borehole walls can become hard, and a thickness of very viscous gel can accumulate on top of the mudcake, possibly reducing the side resistance that can be developed in the completed drilled shaft. Good practice, therefore, includes specifying that the contractor agitate mineral slurry that will be held in the borehole for more than about four hours between the completion of drilling and the commencement of concreting. The thickness of the mudcake and gel on the sides of the borehole can be checked by lowering a sidewall sampler into the hole to confirm that the mudcake is not thicker than about

2.5 mm (0.1 in.). Otherwise, the contractor should re-cut the sides of the borehole, possibly using a side cutter affixed to an auger or drilling bucket, to a diameter of about 50 mm (2 in.) larger than the diameter of the original borehole and then re-clean the base before concreting. Considering this potential problem, contractors should not be permitted to place the rebar cage in the slurry until just prior to concreting.

## **DESIRABLE PROPERTIES OF DRILLING SLURRY**

A number of agencies and writers have made recommendations about the desirable properties for bentonitic slurries for drilled shafts. Much less information is available on polymer slurry properties, however. Good references on the subject of bentonitic slurries are available, including those developed by engineers with Cementation, Ltd., in the United Kingdom (Fleming and Sliwinski, 1977) and a detailed set of recommendations given by the Federation of Piling Specialists (1975), also in the United Kingdom. The FPS specifications have been adopted by a number of owners as being adequate for most jobs involving the use of drilling slurry. Other detailed sets of bentonite slurry specifications are given by Hutchinson et al. (1975) and by Hodgeson (1979).

There is no perfect set of slurry specifications that can be used on every job, but specifications should be tailored to fit the requirements of a particular job at a particular location, where possible. One simple, although not always sufficient, axiom to follow is that the most important characteristic of a mineral slurry is its density and that the slurry should be only dense enough to maintain a stable borehole.

A synoptic table of recommendations for mineral slurry properties to be maintained during the construction process, based generally on the requirements of the Florida Department of Transportation (1987), is provided in Table 6.1. These recommendations have been adopted as standard specifications by the Federal Highway Administration for construction monitoring and are included in the drilled shaft construction specifications described in Chapter 15. These specifications apply to either sodium smectite (bentonite) or attapulgite slurries. Attention is called to the fact that these specifications may need to be modified for job-specific requirements.

An example of more detailed specifications developed by the Road Construction Authority of Victoria, Australia (VicRoads) for highway bridge foundation construction in mudstone (Holden, 1984) is shown in Table 6.2. These specifications are an example of job-specific specifications aimed at providing assurance that the load transfer in rock-socketed drilled shafts will be adequate for cases where construction could be delayed while bentonitic slurry is in the borehole and a considerable amount of mudcake could collect on the sides of the boreholes. Fresh water is assumed. Holden emphasizes that the slurry specifications for a particular job should be modified to suit the equipment, methods, and conditions of the project.

Table 6.1. Mineral slurry specifications for drilled shaft construction in fine sands  
(modified after Florida Department of Transportation, 1987)

Property (units)	Range of values at time of introduction of slurry to borehole*	Range of values at time of concreting*	Test method
Density (kN/m <sup>3</sup> ) (lb/ft <sup>3</sup> )	410 - 440** 64.3 - 69.1**	410 - 478** 64.3 - 75.0**	Density balance
Viscosity (seconds/quart) (seconds/0.945 L)	28 - 45 28 - 45	28 - 45 28 - 45	Marsh funnel
pH	8 - 11	8 - 11	pH meter (more accurate) or pH paper (less accurate)

\*\*Upper limit assumes that the slurry is being reused after having been treated. Initial mixing of mineral powder and fresh water should be at no higher than 417 kN/sq. m (65.5 pcf) unless additional density is obtained with weighting agents. Increase by 12.5 kN/sq. m (2 pcf) in salt water.

- NOTES:
- A. Values may be modified if bottom-hole conditions do not need to be controlled or if tests demonstrate that other criteria are appropriate.
  - B. If desanding is required, sand content shall not exceed 4 per cent (by volume) at any point in the borehole after treated slurry is introduced.

Table 6.2. Slurry specifications for a rock-socketed drilled shaft (after Holden, 1984)

<b>Bentonite property</b>	<b>Drilling slurry supplied to borehole</b>	<b>Drilling slurry properties in socket during interruptions in drilling</b>	<b>Drilling slurry properties during concreting</b>
Bentonite type	sodium smectite		
Bentonite dosage: Weight / weight of water, in per cent	4		
Specific gravity (Density in g/cc)	1.03 min 1.08 max	1.03 min 1.08 max	1.03 min 1.20 max
Sand content (per cent by volume by API method)	0 min 2 max	0 min 2 max	0 min 10 max
Cake thickness (mm) (filter press test)	1 max	1 max	
pH (field check)	8 min 11 max	8 min 11 max	
Plastic viscosity (PV) from viscometer (centipoise)	4 min 10 max	4 min 10 max	4 min 20 max
Yield point (YP) from viscometer (Pa)	14 max	7.5 min 14 max	20 max
10-min gel strength from viscometer (Pa)	2 min 10 max		
Marsh funnel (field check) (sec/quart or sec/0.945 L)	30 min 40 max	30 min 40 max	
Fluid loss (mL / 30min.) (filter press test)	10 max	10 max	
Head of bentonite slurry	1.0 m above piezometric surface	1.0 m above piezometric surface - min 1.5 m above piezometric surface - max	1.0 m above piezometric surface - min

Majano et al. (1994) recommended trial specifications for slurry made from fresh water and bentonite (sodium smectite without additives), attapulgite (without additives), emulsified PHPA polymer and dry PHPA ("vinyl") polymer slurries based primarily on a series of laboratory tests conducted on model drilled shafts in submerged, clean, poorly graded medium to fine sand.

Slurries with properties within the ranges shown in Table 6.3 were found to produce angles of wall friction between the simulated concrete (mortar) in the model drilled shafts and the sand exceeding  $0.67 \phi$ , where  $\phi$  is the effective angle of internal friction of the sand from drained triaxial compression tests. Many of the sand samples used in the laboratory study were purposely contaminated with hydrocarbons, alkaline water, chlorides and silt, which did not affect the final load transfer as long as the slurry properties in Table 6.3 were obtained from the slurry just before concreting. The value of wall friction obtained is consistent with the minimum conditions assumed for the design methods considered in Chapter 11. It should be emphasized that Table 6.3 does not constitute a standard, nor has it been adopted as a specification. It has been used by the senior author of this manual successfully on several projects when polymer slurries were used. Currently, no standard specifications for polymer drilling slurries have been approved by the drilled shaft industry.

The data in Table 6.3 are consistent with AV values of up to 150 cP at a 3 RPM shear rate and less than 7 cP at a 600 RPM shear strain rate. If specifications based on the use of the viscometer are used, control of these AV values may be more appropriate than controlling the Marsh funnel reading, YP or PV. Further field research may show that higher values of these AV's are acceptable under certain conditions. While the dry PHPA polymer slurry in Table 6.3 performed acceptably when the Marsh funnel viscosity was as high as 120 sec/quart (sec/0.94 L), the upper limit for the yield point was about the same as for the other slurries tested. These data suggest that the Marsh funnel may give unrepresentative values of viscosity for some polymer slurries, and that the viscometer is the best device to monitor viscosities of polymer slurries in the field.

Table 6.3. Ranges of properties of various fresh-water slurries at time of concreting consistent with maintenance of angle of wall friction in sand of  $0.67 \phi$  in laboratory tests (after Majano et al., 1994)

Property	Bentonite	Attapulgit	Emulsified PHPA	Dry PHPA ("Vinyl")
Specific gravity (Density in g/cc)	1.06 min 1.18 max	1.04 min 1.25 max	0.995 min 1.01 max	0.995 min 1.01 max
Marsh funnel viscosity (sec/quart or sec/0.945 L)	32 - 50	28 - 40	33-45	50 - 120
Yield point (Pa) (lb/100 ft <sup>2</sup> )	0.5 to 3.8 1 to 8	1.4 to 6.2 3 to 13	1.4 to 5.7 3 to 12	1.4 to 5.7 3 to 12
pH	8 - 10	8 - 11	8 - 11.6	8 - 11.7
Sand content, API method (per cent by volume)	0 to 8	0 to 14	0 to 1	0 to 1



## INFLUENCE OF SLURRY ON AXIAL CAPACITY OF DRILLED SHAFTS

### Soil and Rock Resistance

One of the main concerns of engineers who specify the slurry method of construction is the possible loss of side resistance because of the development of a thick membrane of weak material at the sides of the borehole. Earlier in this chapter, it was pointed out that many drilled shafts have been successfully installed with slurry, as evidenced by the results of numerous load tests. Also noted was that drilled shafts that were installed with bentonitic slurry have been recovered and the interface between the concrete and the parent soil examined. No evidence was found of a thick, weak layer of bentonite. Furthermore, no evidence was found in the drilled shafts described of any loss of bond between the rebar and the concrete. Similar statements can be made about shafts installed with polymer slurries. With polymer slurries, the interface is actually roughened somewhat by some slurry products, which may account for some of their excellent load transfer characteristics. Nevertheless, in shafts drilled with mineral slurry, particularly bentonite slurry, some attention must be given to the possibility that a thick membrane of bentonite could develop that will remain in the borehole after concreting.

A thickness of mudcake at the borehole wall, shown in Figure 6.1, will reduce the roughness of the contact surface between the concrete and the soil or rock and will also reduce the angle of sliding friction between the two materials. Generally, the thickness of the mudcake, sometimes called the "filter cake," will depend on time of exposure of the slurry to the borehole wall, the properties of the slurry, the properties of the filter cake, and the excess hydrostatic pressure in the slurry column. Nash (1974) formulated an equation for computing the thickness of the filter cake,  $h$ . The equation is given below, without units, just to illustrate the magnitude of the effect of each of the major parameters. This equation would not normally be used in designing slurry mixes.

$$h = \{ [2k_c (1 - n_c) (\gamma_s z_s - \gamma_w z_w)] / [(n_s - n_c) \gamma_w] \}^{0.5} (t)^{0.5} \quad (6.3)$$

where

- $k_c$  = coefficient of permeability of filter cake,
- $n_c$  and  $n_s$  = porosity of filter cake and slurry, respectively,
- $\gamma_s$  and  $\gamma_w$  = unit weight of slurry and water, respectively,
- $z_s$  and  $z_w$  = depths of slurry and ground water head levels (Figure 6.1), and
- $t$  = time.

Laboratory tests for a given slurry would be necessary to obtain  $k_c$ ,  $n_c$  and  $n_s$ . In connection with the development of the filter cake, the permeability of the parent soil does not enter into the process if its permeability is greater than that of the filter cake, which is the normal case.

Nash pointed out that Equation 6.3 leads to a thickness of about 5 mm (0.2 in.) in 24 hours for typical slurry and filter cake at a depth of 20 m (65 ft). This would probably be unacceptable, as it is generally desired to keep the filter cake thickness less than 2.5 mm (0.1 in.). This empirical value is used because experience indicates that thinner mudcakes are not especially harmful to the development of skin friction, even though they may not be completely scoured away by the rising concrete, whereas thicker mudcakes can have a profoundly negative effect on skin friction.

Wates and Knight (1975) investigated the thickness of bentonitic mudcake between the concrete and sand for both diaphragm walls and drilled shafts. Laboratory tests were performed in which the membrane thickness was found to vary with time and with the hydrostatic head of the slurry column, as shown in Figure 6.14. The curve for the final thickness was obtained for the time at which flow through the membrane had virtually ceased. Small-sized piles were cast against the slurry in the laboratory, and their tensile capacities were compared to those of a pile that was cast dry and one that was cast with direct displacement of the slurry by the concrete. The authors concluded that a membrane of a significant thickness will develop in 24 hours and that the membrane, unless removed, will reduce the skin friction to a value that is significantly less than if the concrete is cast directly against the natural soil. Assuming the unbalanced head for a particular project to be about one meter, Figure 6.14 shows that the slurry should be left in place much less than 24 hours in order to prevent a build-up of filter cake that would reduce side resistance. For this reason, a maximum four-hour holding time for mineral slurry in a borehole is recommended. Otherwise, overcutting the hole, as discussed earlier, should be performed before concreting.

Holden (1984) has reported on a project in Australia where the slurry remained in place for a month before the concrete was placed. It was learned subsequently that a thick filter cake had built up and that the side resistance was significantly reduced. O'Neill and Hassan (1994) reported on two drilled shafts, 0.915 m (36 in.) in diameter, that were constructed side by side to a depth of about 10.7 m (35 ft) in a medium dense, saturated, silty sand under bentonite drilling slurry. In one drilled shaft the Marsh funnel viscosity was 155 sec./quart (sec./0.94 L), the yield point was 30 Pa, the time of exposure of the slurry to the borehole without slurry agitation prior to concreting was 72 hours, and the resulting measured mudcake thickness before concreting was 10 mm (0.4 in.). In the other drilled shaft, the Marsh funnel viscosity was 40 sec./quart (sec./0.94 L), the yield point was 9.6 Pa, the time of exposure was 2 hours, and the mudcake thickness was less than 1 mm. The first drilled shaft developed an ultimate side resistance of 200 kN (22.5 tons), or about 6.5 kPa (136 psf) on the average, while the second drilled shaft developed an ultimate side resistance of about 2700 kN (303 tons), or about 86 kPa (1800 psf) on the average.

This demonstration dramatically shows that bentonitic drilling slurry can either produce a devastating loss of skin friction or a completely satisfactory value of skin friction, depending on how the slurry is mixed and controlled, and the importance of good slurry specifications and inspection of the slurry drilling process. In fact, Sliwinski (1977) and Fleming and Sliwinski (1977) argue strongly that the influence of filter cake should be minimal, which was the case in

the second shaft (properly controlled slurry) reported by O'Neill and Hassan. This opinion is confirmed by the results of a number of load tests of instrumented drilled shafts, constructed with the use of controlled bentonitic slurry, that have been analyzed by the writers and their associates. Sliwinski (1977) reports that the displacement of the slurry and cake complex from the sides of the borehole does not constitute a major problem. The rising column of concrete will displace the slurry and much of the cake because of the considerable difference in unit weight and shear strength of the fluid concrete and bentonite. Although the portion of the slurry that penetrates the soil cannot be displaced, Sliwinski states that field and laboratory tests seem to indicate that the influence of some bentonite in the parent soil has an insignificant influence on load transfer. The conclusion is based on the assumptions that the properties of the slurry are within reasonable limits and that the concreting is done within a reasonably short time after the excavation is completed.

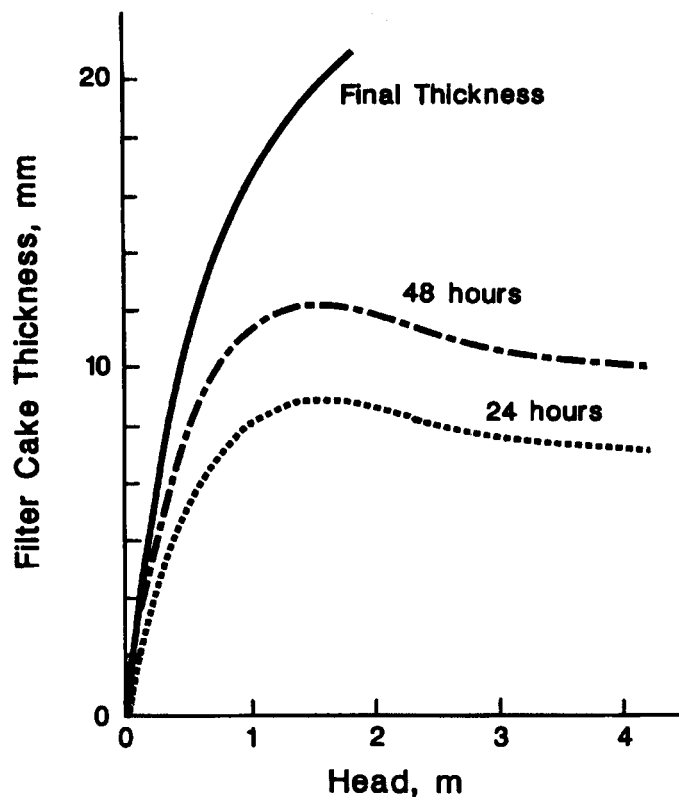

Figure 6.14. The buildup of bentonite filter cake in a model apparatus in response to different pressure heads (after Wates and Knight, 1975)

Fleming and Sliwinski (1977) reported on 49 field tests from several different countries. They report that the test results suggest that the development of shaft friction had not been "impaired or inhibited" by the presence of bentonite. They point out that the drilled shafts that were tested and analyzed had "in all probability been constructed and tested without any inordinately long

delay between boring and concrete placing."

The solution to the problem of reduced skin friction due to excessive filter cake is therefore to maintain the properties of the slurry within tolerable limits and to place the concrete within a maximum of a few hours after the excavation is completed. A value of four hours is recommended in this manual. If for some reason it is impossible to place the concrete without undue delay, the drilling machine must re-occupy the excavation and recut the borehole, as described previously. If the slurry remains for a period of time without agitation, both it and the filter cake can become very thick. As an example of the change of conditions of slurry with time, a recent research project involved an unexpected shutdown of two to three weeks because of weather conditions. On returning to the site, bentonitic slurry was so thick that the slurry-sampling tool could not be lowered. The slurry quickly reverted to its former condition after agitation.

The preceding discussion relates to the production of mudcake in permeable soils and rocks. Since filtration into the formation being drilled is the principal mechanism of mudcake buildup in bentonitic slurries, mudcake tends not to develop in impermeable geomaterials such as clays, and concern about loss of skin friction due to filter cake buildup is lessened.

O'Neill and Hassan (1994) also report on load tests performed by Caltrans on five drilled shafts in sandy silt to silty sand in the Los Angeles area. These shafts were all 0.61 m (2 ft) in diameter and about 10 m (33 ft) deep. Four of the drilled shafts were constructed under PHPA polymer slurry -- two with emulsified PHPA and two with dry vinyl-extended PHPA. They were loaded in compression. In all four cases the ratio of average maximum unit side resistance to average effective vertical stress in the ground appeared to be 1.0 or greater. This value is consistent with the values that are used with the design methods in Chapter 11. While no mudcake builds up with polymer slurry, the slurry itself has a "slimy" texture, and it may appear that such slurry could lubricate the interface between the concrete and soil. However, the polymer breaks down at values of pH greater than about 11.7 when exposed to lime in the concrete, with the resulting chemical products being water and carbon dioxide. Since fluid concrete generally has a pH greater than 12, the exposure of concrete to polymer slurry destroys the polymer and appears to leave the concrete in contact with the soil at the surface of the borehole. The small amount of residual water and carbon dioxide remaining near the interface do not appear to cause any problems, although long-term test data are not available. Some polymer strands remain deeper in the pores of the soil, however, which may have some minimal effect on side resistance. A fifth drilled shaft, constructed at the Los Angeles site with only water as a drilling fluid, developed even higher unit side resistance than the shafts constructed with polymer drilling slurries, so the slurry itself appeared to affect some reduction in side resistance from the value that would have been achieved had slurry not been used. Majano et al. (1994) note that side resistance increases slightly with time of exposure of polymer slurry to the soil prior to concreting in model drilled shafts constructed with the two polymer slurries denoted in Table 6.3, whereas it tends to decrease with time of exposure when mineral slurries are used. These properties are accounted for in the design equations presented later.

Other evidence of the viability of synthetic polymer slurries was provided by Meyers (1996). Two drilled shafts 0.76 m (2.5 ft) in diameter and 13.7 m (45 ft) deep were constructed and tested in saturated sand/gravel/cobble alluvium to develop design criteria for a foundation for a bridge project in New Mexico. One shaft was constructed with controlled bentonite slurry, and one was constructed with a high-molecular-weight dry PHPA. Both boreholes were calipered to verify that they had equivalent diameters. While both drilled shafts developed higher side resistances than would be predicted by the methods given in Chapter 11, the drilled shaft constructed with the polymer slurry developed higher side resistance than the shaft constructed with bentonite slurry. Ata and O'Neill (1997) report values of unit side shear resistance in excess of those that are predicted with the design equations in Chapter 11 for drilled shafts constructed with high-molecular-weight PHPA slurry in stiff clay, stiff very silty clay and medium dense sand.

While development of side resistance does not appear to be a problem with polymer drilling slurries, there is anecdotal evidence that difficulties have been experienced on some highway projects with polymer slurries that have not maintained borehole stability, particularly for deep, large-diameter boreholes in sand and gravel. Whether these problems are caused by the inherent low densities of polymer slurries and/or the inability of polymer slurries to develop a mudcake, or whether they are caused by inadequate contractor practices, is unclear. It is clear that the slurry should be mixed and conditioned properly and its viscosity and hardness closely controlled throughout the drilling process (for hardness, indirectly by continually monitoring pH).

It is also clear that contractors must be diligent in introducing the slurry at the time the piezometric surface is reached, not at the time caving problems are experienced. Once caving starts at any level, it is very difficult for a drilling slurry, especially a low-density polymer slurry, to keep the borehole from continuing to ravel or slough, even if ideal practices are followed for the remainder of borehole excavation. The contractor must also be careful to maintain the slurry head well above the piezometric level at all times and use vented drilling tools operated at a relatively slow rate. If sloughing starts under a head of slurry, the contractor may be forced to recut the hole back to a cylindrical shape to arrest the sloughing.

The condition of the base of the drilled shaft is also of concern. If excessive sloughed geomaterial, cuttings or flocculated or agglomerated slurry accumulate on the base of a drilled shaft constructed by the wet method, some of this loose material may be pushed to the side by the introduction of concrete, rather than being lifted up by the concrete. This action will result in a "bullet-shaped" base that is bearing against the soil or rock only over part of the cross-section of the drilled shaft, resulting in reduced base resistance. Cleaning of the base of the drilled shaft just prior to placing the cage and concreting, and verification that the base is clean just before concreting, are therefore very important parts of the construction and inspection processes.

### **Bond with Reinforcing Steel**

It is of interest here to comment about the possible influence of slurry on the bond between

concrete and the reinforcing steel. Fleming and Sliwinski (1977) report that the general opinion is that there is no significant reduction of bond in bentonitic slurry. They report that the Federation of Piling Specialists (1975) recommends the use of the maximum allowable bond stress values for round, nondeformed bars in bentonitic slurry. For deformed bars the FPS recommend an increase in bond of not more than 10 per cent of the value specified for plain bars. Butler (1973) exhumed full-sized drilled shafts constructed under light bentonitic drilling slurry and conducted pullout tests on the rebar. He concluded that the bond between the concrete and No. 8 deformed longitudinal rebars was not degraded.

Most information on bond between concrete and rebar when the drilled shaft is concreted under a polymer slurry has been developed by research commissioned by the polymer suppliers, and documentation can be obtained from them. One laboratory study was made of the simulated placement of a standard mix of concrete [Type II Portland cement and maximum coarse aggregate size of 12.7 mm (1/2 in.)] around No. 5 deformed bars under a slurry made from an anionic, high-molecular-weight PHPA mixed to the manufacturer's specifications. Test results suggested that the bond strength develops more slowly than when drilled shafts are concreted under light bentonite slurry. At 28 days, however, the bond strength obtained when the rebar had been exposed to the polymer slurry at a dosage of 2.5 g (solid powder) / L (mixing water) was slightly greater than the bond strength obtained by similar simulated concreting under a light bentonite slurry [50 g (solid powder / L (mixing water))] (Maxim Technologies, Inc., 1996).

## EXAMPLES OF PROBLEMS WITH SLURRY CONSTRUCTION

Several scenarios are discussed in this section in which problems can develop with slurry construction. They demonstrate that, when installing a drilled shaft with drilling slurry, both the contractor and the inspector need to be continually trying to visualize what is happening in the ground.

- **Problem:** Figure 6.15 illustrates one of the most common cases where difficulties arise when the slurry method is being used to construct a drilled shaft. The slurry can be either a mineral slurry or a polymer slurry. An excavation is made through overburden soil into disintegrated rock using slurry. Figure 6.15 a shows the completed excavation with the slurry in place. The slurry is carrying more sand than it can hold in suspension. However, it is not sampled properly and consequently is not cleaned prior to starting the concrete placement with a tremie. A quantity of granular material settles to the top of the concrete column as the pour progresses, as shown in Fig. 6.15 b. The frictional resistance between the borehole wall and granular material is such that the flowing concrete breaks through and folds the layer of granular material into the concrete, creating a defect, as shown in Fig. 6.15 c. This type of defect often occurs at the water table elevation where the bed of granular material first loses its buoyancy. A cubic meter or more of granular material can settle to the top of the concrete column in a large-sized drilled shaft if the slurry is poorly cleaned.

**Solution:** Measure the depth of the excavation two or more times after drilling ceases to see that sediment is not settling out and that the hole is as deep as indicated by the penetration of the drilling tools. Furthermore, the slurry should be sampled carefully from the bottom of the hole and tested to ensure that specifications are met. A comparison of the actual volume of concrete that is placed with the expected volume, as pre-determined from the use of calipers, can readily reveal if a considerable amount of sediment has been left in the concrete, and the plotting of a concreting curve (Chapter 8) can reveal the general location of the trapped sediment.

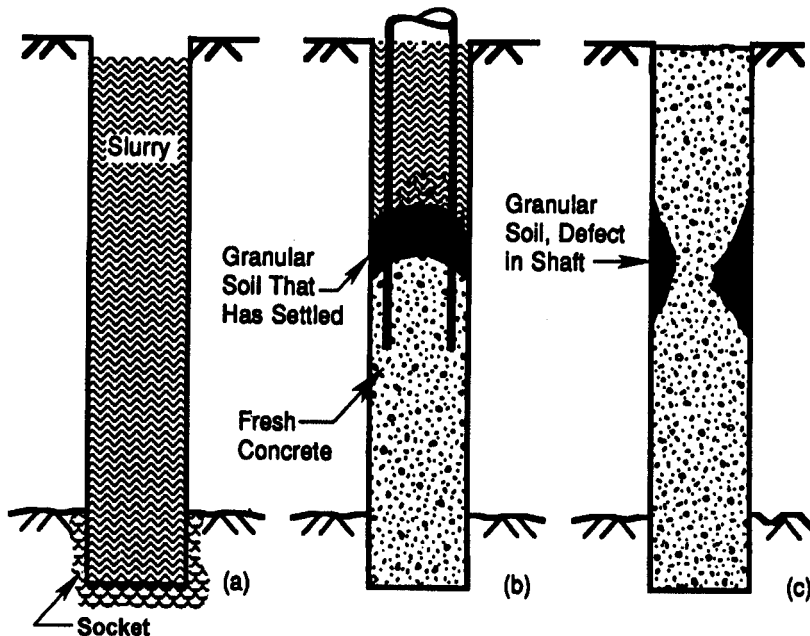

Figure 6.15. Placing concrete through heavily-contaminated slurry

- **Problem:** A "tremie defect," can arise if the bottom of the tremie is lifted above the top of the column of fresh concrete during the placement of concrete, allowing the concrete to fall through the slurry and become leached.

**Solution:** The engineer should monitor the elevation of the top of the concrete column and the location of the bottom of the tremie simultaneously and continuously during the pour. This can be done using a weighted tape to monitor the top of the concrete and marking the tremie to monitor the depth of its bottom (discharge orifice). Procedures to follow if the tremie is pulled out of the concrete column are discussed in Chapter 8. Even if the tremie is not pulled out of the concrete, interruptions in feeding concrete into the borehole can produce a situation in which the concrete already in the hole begins to lose fluidity. When the new concrete arrives, it may break through the concrete of lower fluidity at the top of the concrete column, leaving it, and any sediment that has accumulated on top of it, or mixed in it, in the borehole.

- **Problem:** Plugged tremie, restricting or stopping concrete flow, which may require withdrawal of the tremie during the concrete pour, potentially producing a tremie defect.

**Solution:** Proper design of the concrete mix, a matter that will be discussed in Chapter 8, and proper tremie cleaning procedures by the contractor.

Figure 6.16 illustrates other problems that can develop at the base of the drilled shaft when the wet method is employed. It is assumed here that the foundation is to be carried into sound rock so that a high value of end bearing can be achieved, but the concepts that are illustrated in the figure apply equally well to any other kind of geomaterial where the full value of end bearing is required.

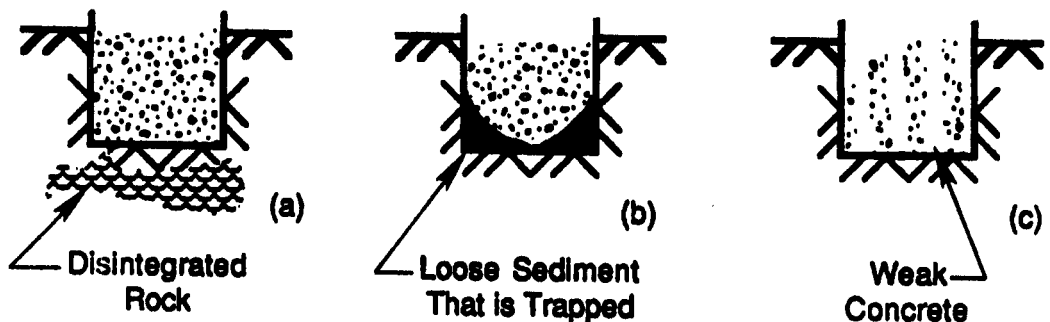

Figure 6.16. Factors causing weakened resistance at base of a drilled shaft

- **Problem:** Figure 6.16 a illustrates the case where the excavation is stopped in disintegrated rock, which has lower bearing capacity than was assumed by the designer. This problem is more likely to occur with the wet method than with the dry or casing methods because inspection below the slurry column is more difficult.

**Solution:** Conduct the site investigation with sufficient detail so that the depth of sound rock is known with assurance at the locations of drilled shafts. Another procedure is to examine the cores that are obtained if a core barrel is being used to excavate the rock. If no rock cores are being removed from the excavation, a useful procedure is to use a small core barrel and to core below the bottom of the excavation for a distance equal to at least the diameter of the base of the drilled shaft and to examine such cores for signs of low rock quality prior to concreting. The small test corehole is also useful in karstic formations if there is a danger that a cavity could exist below the excavation. Sometimes, a down-hole television camera can be used to good advantage to examine the base of a drilled shaft constructed under slurry, although it is often difficult to discern the quality of the bearing material by such means.



- **Problem:** Figure 6.16 b illustrates a case where loose sediment has settled to the bottom of the excavation after cleaning and is subsequently encased by the concrete.

**Solution:** Do an adequate job of sampling and testing the slurry (and modifying it by exchanging and cleaning it and re-cleaning the base of the borehole, if necessary) before starting the concrete pour.

- **Problem:** Figure 6.16 c illustrates a case where weak concrete exists at the bottom of the drilled shaft. The problem was caused by lifting the tremie too far above the bottom of the borehole so that the fresh concrete fell through the slurry, washing the cement from the concrete and/or causing the concrete to mix with the slurry.

**Solution:** Ascertain the location of the bottom of the tremie at the start of concreting to be sure that the bottom of the tremie is just far enough above the bottom of the excavation that the concrete can start flowing. By this technique any contaminated concrete (there will be some minor mixing of the concrete and slurry) will rise to the top of the concrete column and can be spoiled.

This problem appears to be more common when concrete is pumped to the bottom of the borehole rather than fed by gravity because the pump line has to be raised far enough to allow the plug to pass out of the discharge orifice before concrete starts flowing. Most pumps also do not produce as high an initial rate of concrete flow out of the tremie as when concrete is fed by gravity. The high rate of flow is desirable for the concrete to "get under" the slurry on the bottom of the borehole. When the concrete is fed by gravity in a large-diameter tremie with a closure plate on the bottom, only slight lifting is required to start a rapid surge of concrete.

- **Problem:** Cut-off level is well below the ground surface.

**Solution:** The concrete should continue to be placed until good quality concrete is above the cut-off level. The excess concrete must then be chipped away when the shaft head is exposed.

- **Problem:** Figure 6.17 a shows that an excavation has been made to a certain depth by use of mineral slurry and that a casing has been placed in the slurry with its bottom being sealed in an impermeable formation. The slurry has been pumped from the casing, and the excavation has been carried to its full depth. Some slurry is left in the overbreak (void) zone between the casing and the side of the borehole. Figure 6.17 b shows that the concrete has been placed and that a layer of liquid slurry has been left at the interface of the concrete and the natural soil. The slurry is so thick that a considerable mound of thickened slurry and solids has piled up on the ground surface where it was displaced by the concrete, which in turn has impeded the complete flushing of all of the liquid slurry

that was initially in the overbreak zone. The problem was caused because the slurry was not sampled and tested before the casing was placed. The mineral slurry was much too thick (too viscous), contained inclusions of clay and granular material (had too high a density value), and it could not be displaced completely by the concrete.

**Solution:** Be sure that the slurry meets the proper specifications before the casing is placed, and complete the concrete pour within a reasonable time after the casing is placed.

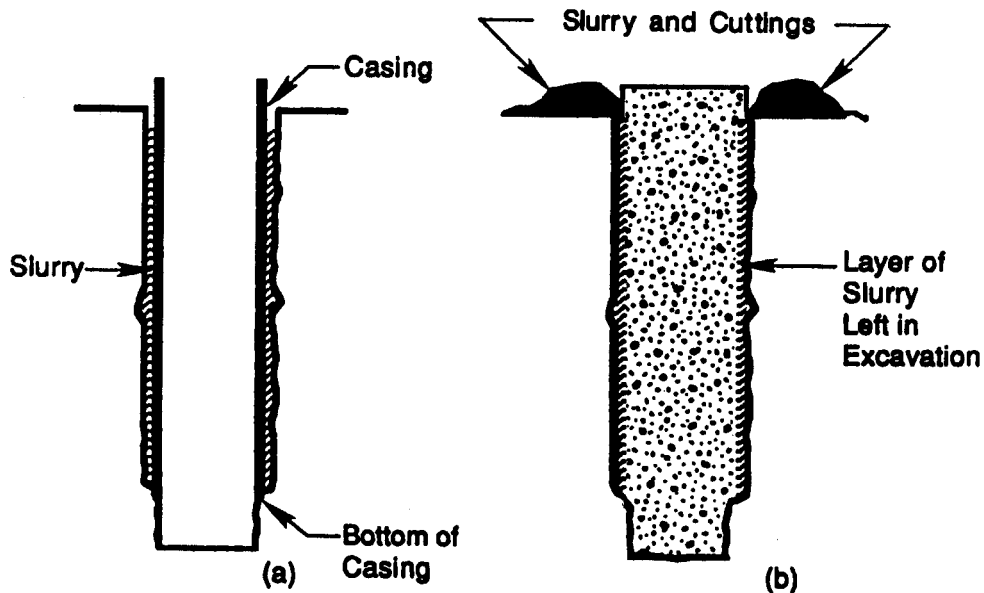

Figure 6.17. Placing casing into mineral slurry with excessive solids content

- **Problem:** Figure 6.18 a shows the case where the construction has been carried out properly with the casing method, with the casing being sealed at its base in an impermeable formation. Figure 6.18 b shows that the casing has been pulled with an insufficient amount of concrete in the casing so that the hydrostatic pressure in the slurry was greater than that in the concrete, with the result that the slurry invaded the concrete and produced a "neck" in the drilled shaft.

**Solution:** Pull the casing only after it is filled with concrete with good flow characteristics. Then, the hydrostatic pressure in the concrete will always be greater than that in the slurry in the overbreak zone because the unit weight of the concrete is greater than that of the slurry.

- **Problem:** If the concrete in the casing is too stiff and has considerable frictional resistance against the casing, a plug of concrete can be pulled up with the casing. In this case, there will be a horizontal gap or opening in the concrete that will be filled with

slurry -- another "neck," like the one shown in Figure 6.18.

**Solution:** Use concrete with the proper flow characteristics (Chapter 8), make sure that the placement of concrete and removal of the casing proceed in a timely and coordinated manner, make sure that the casing does not have excessive concrete caked on the inside surface, and measure the volume of concrete that is placed to be sure that the excavation is fully filled.

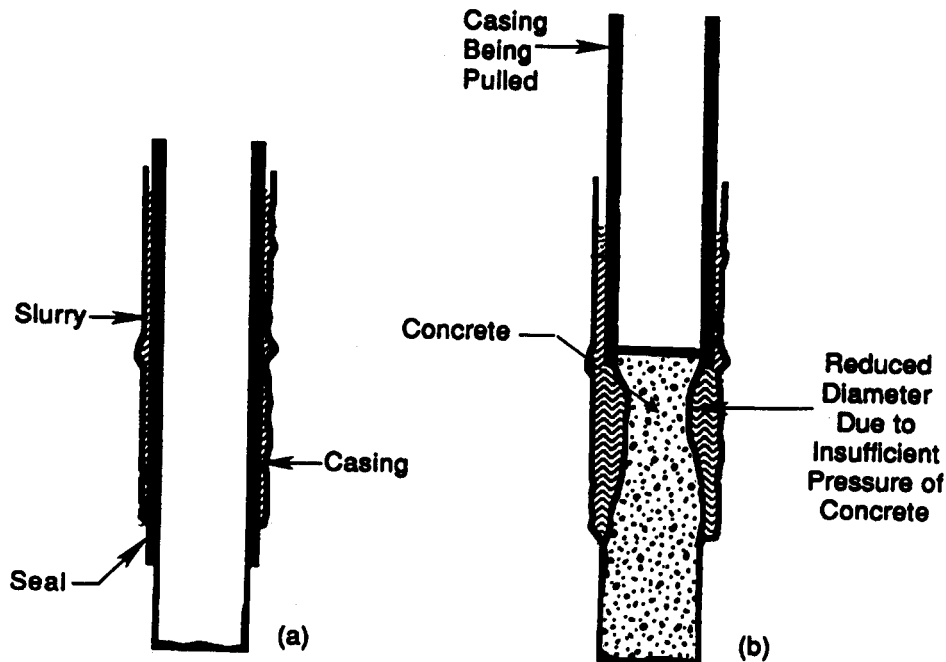

Figure 6.18. Pulling casing with insufficient head of concrete

- **Problem:** Figure 6.19 illustrates a casing that is driven by a vibratory driver into a sand stratum, and it is intended that the casing penetrate through the stratum of caving soil into an impermeable material. However, the casing is stopped short of the impermeable material into which it could seal. Slurry drilling is used to extend the borehole below the casing. As the drilling progresses, the sand collapses behind the casing for a considerable distance, as shown in Fig. 6.19 a. When the concrete is placed, even though the casing is filled with concrete with good flow characteristics, some of the slurry outside and above the bottom of the casing becomes trapped and is not ejected. The result is shown in Fig. 6.19 b; some of the slurry has fallen into the concrete, and a weak zone is created in the completed drilled shaft.

**Solution:** Be sure that the casing penetrates the caving layer fully, if at all possible. The fluid pressure in the slurry column in any case should be kept at an appropriate value so

that no caving occurs. It is of utmost importance that the level of the slurry column be kept well above that of the natural water table (piezometric level) in order to prevent any inward flow and a consequent loosening of the supporting soil. Finally, the hole below the casing should be calipered and, if the enlarged excavation is discovered, appropriate measures taken.

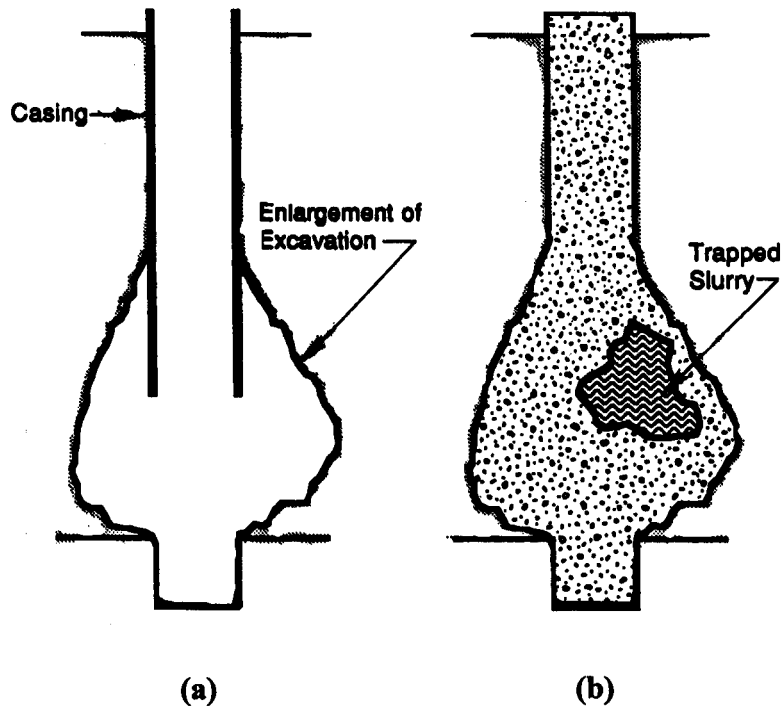

Figure 6.19. Placing concrete where casing was improperly sealed

- Problem:** A large-diameter drilled shaft is being advanced into a stratum of sand and gravel under a polymer slurry and, despite using an effective tool and bringing up considerable cuttings on each pass, the borehole is not being deepened. This condition is likely being caused by sloughing from the walls of the borehole, indicating that the slurry is not acting effectively in maintaining stability.
- Solution:** Verify that the slurry properties, particularly the viscosity and the pH, are as specified. If not, modify the properties of the polymer slurry before proceeding. In any event, make sure that the head of slurry is kept above the piezometric surface at all times and is not even momentarily allowed to drop below that level. This may require placing a surface casing to use as a standpipe to bring the slurry surface above ground level if the piezometric surface is near the ground surface. It may be necessary to enlarge the diameter of the borehole to the full depth of the present excavation to arrest the sloughing process even though the slurry properties and construction procedures are now correct.

Once overhang zones start to appear due to borehole sloughing, sloughing may continue, even with correct techniques, until the hole is made cylindrical once again.

The account given in this chapter of a number of things that can go wrong with slurry itself and to the quality of drilled shafts that are constructed with the use of drilling slurry may give the impression that many failures are to be expected. It is true that there have been occasional difficulties in the past; however, earlier in this chapter it was reported that many load tests have been performed on slurry-constructed shafts and their performance has generally been excellent. A number of drilled shafts constructed with drilling slurry have been removed or exposed for inspection, or have been examined using nondestructive evaluation, mostly with good results. For those shafts that are not satisfactory, steps in the construction process can almost always be identified that were not in accordance with good practice, either due to contractor errors or to factors that were beyond the contractor's immediate control, such as a suspension of delivery of concrete from a ready mix plant while a slurry pour was underway. If care is taken in the construction process, carefully considering the material in this chapter, and that given by the references that are cited, a finished product of high quality should be produced.

## TRAINING RESOURCE

A video entitled "Construction and Inspection of Drilled Shafts Using the Slurry Method" is available through ADSC: The International Association of Foundation Drilling, P.O. Box 280379, Dallas, TX 75228; (214) 343-2091. This video runs for 23.5 minutes. A set of six color overhead transparencies intended for use in introducing and discussing this video with inspectors, a commentary on the transparencies, and potential questions for the viewers, is available through the Federal Highway Administration, P. O. Box 902003, 819 Taylor Street, Room 8A00, Fort Worth, TX 76102-9003; (817) 978-4382.

## REFERENCES

Ata, A. and O'Neill, M. W. (1997). *Characterization of the Effect of Polybore™ Polymer on the Construction and Performance of Drilled Shaft Foundations*, Report to Baroid Drilling Fluids, Inc., University of Houston, Houston, Texas, May, 1997.

Beresford, J. J., Cashman, P. M., and Hollamby, R. G. (1989). "The Merits of Polymeric Fluids as Support Slurries," in *Proceedings*, International Conference on Piling and Deep Foundations, London, Vol. 1, Ed. by J. B. Burland and J. M. Mitchell, Balkema, Rotterdam.

Butler, H. D. (1973). *A Study of Drilled Shafts Constructed by the Slurry Displacement Method*, Bridge Division, Texas Highway Department, Austin, Texas, February.

Chilingarian, G. V., and Vorabutr, P. (1981). *Drilling and Drilling Fluids*, Elsevier, Amsterdam.

- Cross, R., and Harth, P. E. (1929). U. S. Patents Nos. 1,991,584 and 1,991,637, respectively, Relating to the Use of Bentonitic Clays with and without Magnesium Oxide as Suspending and Gelling Agents, U. S. Patent Office (Reported by Nash, 1974).
- Federation of Piling Specialists (1975). "Specifications for Cast-in-Place Piles Formed under Bentonite Suspension," *Ground Engineering*, Vol. 8, No. 2, London, March.
- Fleming, W. K., and Sliwinski, Z. J. (1977). "The Use and Influence of Bentonite in Bored Pile Construction," *Report No. PG3*, Construction Industry Research and Industry Association, London, September.
- Florida Department of Transportation (1987). Item 455, "Drilled Shaft Foundations," Standard Specifications, November.
- Gray, G. R., Darley, H. C. H., and Rogers, W. F. (1980). *Composition and Properties of Oil Well Drilling Fluid*, Fourth Edition, Gulf Publishing Company, Houston.
- Hodgeson, P. T. (1979). "Design and Control of Bentonite/Clay Suspensions and Concrete Diaphragm Wall Construction," *Review of Diaphragm Walls*.
- Holden, J. C. (1984). "Construction of Bored Piles in Weathered Rock, Part 4: Bentonite Construction Procedures," *Technical Report No. 6*, Road Construction Authority of Victoria, Australia.
- Holland, G. R. (1976). "Bentonite Piling in Southampton," *Ground Engineering*, London, September, pp. 40 - 42.
- Hutchinson, M. T., Daw, G. P., Shotton, P. G., and James, A. N. (1975). "The Properties of Bentonite Slurries Used in Diaphragm Walling and Their Control," *Diaphragm Walls and Construction*, ICE, London, pp. 33 © 39.
- Koden (1996). *Drilling Monitor DM-682/684*. Technical Brochure. Koden Electronics Co., Ltd., Tokyo, Japan.
- LCPC (Laboratoire Central des Ponts et Chaussées) (1986). "Bored Piles," English translation of *Les Pieux Fores*, March (available as *FHWA Publication No. TS-86-206*).
- Leyendecker, E. A. (1978). "Drilling Fluid as Used with Drilled Shaft Construction," Paper presented to the State Department of Highways and Public Transportation (Texas), Joe C. Thompson Conference Center, The University of Texas at Austin.
- Majano, R. E., O'Neill, M. W., and Hassan, K. M. (1994). "Perimeter Load Transfer in Model Drilled Shafts Formed Under Slurry," *Journal of Geotechnical Engineering*,

ASCE, Vol. 120, No. 12, pp. 2136 - 2154.

Maxim Technologies, Inc. (1996). "Baroid Division of Dresser Industries, Testing Program," *Report No. 620272A*, Fort Worth, Texas, August.

Meyers, B. (1996). "A Comparison of Two Shafts: Between Polymer and Bentonite Slurry Construction and Between Conventional and Osterberg Cell Load Testing," Paper Presented at the Southwest Regional FHWA Geotechnical Conference, Little Rock, Arkansas, April.

O'Neill, M. W., and Hassan, K. H. (1994). "Drilled Shafts: Effects of Construction on Performance and Design Criteria," in *Proceedings*, International Conference on Design and Construction of Deep Foundations, U. S. Federal Highway Administration, Vol. 1, pp. 137 - 187.

Nash, K. L. (1974). "Stability of Trenches Filled with Fluids," *Journal of the Construction Engineering Division*, American Society of Civil Engineers, Vol. 100, No. CO4, December, pp. 533 - 542.

Pells, P. J. N., Douglas, D. J., Rodway, B., Thorne, C., and McMahon, B. K. (1978). "Design Loadings for Foundations in Shale and Sandstone in the Sydney Region," *Australian Geomechanics Journal*, Vol. 2, pp. 31 - 38.

Sliwinski, Z. J. (1977). "The Effect of the Bentonite Displacement Method of Construction on the Bearing Capacity of Piles and Diaphragm Wall Elements," Unpublished Notes for the Meeting of the Concrete Society, Croyden, UK, October 12.

Stebbins, E. E., and Williams, R. C. (1986). "Wet-Hole Drilled Shaft Construction," in *Participant Notes*, Drilled Shaft Foundation Seminar, Atlanta, GA, Auburn University, February, unnumbered.

Veder, C. (1953). "Procédé Construction de Diaphragmes Imperméables à Grande Profondeur au Moyen de Boues Thixotropiques," in *Proceedings*, Third International Conference on Soil Mechanics and Foundation Engineering, Vol. II, Zurich, ISSMFE, pp. 91 - 94.

Wates, J. A., and Knight, K. (1975). "The Effect of Bentonite on the Skin Friction in Cast-in-Place Piles and Diaphragm Walls," in *Proceedings*, Sixth Regional Conference for Africa on Soil Mechanics and Foundation Engineering, Durban, South Africa, September, pp. 183 - 188.

## CHAPTER 7: REBAR CAGES

### INTRODUCTION

The design of the reinforcing, or "rebar," cage for a drilled shaft is a necessary step in the engineering process. Rebar cages will be considered from two perspectives in this manual: (1) geometry of the steel necessary to resist stresses that develop because of loads applied to the drilled shaft, which is addressed in Chapter 13, and (2) the characteristics of the cage from the perspective of constructability, which is addressed in this chapter.

A rebar cage for a drilled shaft is made up of longitudinal bars that are distributed with (usually) equal spacing around the outside of a cylinder. Transverse reinforcing is placed around and attached to the longitudinal bars, with the longitudinal and transverse steel being held together with ties, clamps, or, in special cases, with welds. Other components of a rebar cage that may be used are hoops for sizing, guides for centering the cage in the borehole and the tremie inside the cage, and stiffeners and pickup devices to aid in lifting the cage. For long cages and cages with large diameters, temporary or permanent strengthening elements should be provided to prevent permanent distortion of the cage as a result of stresses due to lifting and placing.

Where structural requirements result in shaft cage diameters that must be different from column cage diameters, cages with sufficient lap distance can be used to transfer the load. This is not normally done when large groundline shears are expected.

The required amount of reinforcing steel to be placed in a drilled shaft must be computed carefully from structural requirements and not selected by rule of thumb. The axial load, lateral load, and moment (taking into account the eccentricities due to accidental batter and tolerance in location) can be applied to the shaft head and the combined stresses can be computed. The placement of reinforcing steel is made in consideration of the stresses that will exist, using appropriate load factors in the computations. The buckling load for those cases where the soil is very weak or where the drilled shaft projects some distance above the groundline may also need to be considered. Buckling of a drilled shaft is not ordinarily a problem because the lateral support of the surrounding soil, even relatively weak soil, is such that the effective length of the shaft for computation of buckling is usually quite small. These issues are addressed in Chapter 13. However, when considering how the steel cage resulting from the structural computations is to be assembled and handled during construction, a number of important empirical rules discussed in this chapter should be followed.

The assumption is made that the rebar cage is always placed in the excavation, and the concrete is then placed, during which it flows around the cage. Short rebar cages may be pushed or vibrated into fresh concrete, but such a procedure is unusual.



## **PROPERTIES OF STEEL**

The American Society for Testing and Materials (ASTM) provides specifications for several steels that can be used for reinforcing drilled shafts. These specifications are presented in the Annual Book of ASTM Standards and are conveniently collected in Publication SP-71 of the American Concrete Institute (ACI, 1996). Most of the ASTM steels also have a designation from the American Association of State Highway and Transportation Officials (AASHTO).

The properties of steel that may be employed for building rebar cages for drilled shafts are shown in Table 7.1. The steel that is usually available is AASHTO M 31 (ASTM A 615) in either Grade 40 [40 ksi (276 MPa) yield strength] or Grade 60 [60 ksi (413 MPa) yield strength]. The specifications in the table do not address the welding of the M 31 or M 42 steels because these bars are not to be welded in normal practice. Where the welding of the rebar cage is desirable, a weldable steel, ASTM A 706, can be specified, but availability is often limited. Galvanized or epoxy-coated steel is also available for longitudinal and transverse reinforcement for those cases where there is danger of corrosion. Epoxy-coated steel is often specified for drilled shaft rebar cages in marine environments, where the chlorides content of the ground and/or surface water is high. Alternatively, the rebar may be used without epoxy, and a dense concrete of low permeability may be specified, as discussed in Chapter 8.

The designations of deformed bars, their weights per unit length, cross-sectional areas, and perimeters are given in Tables 7.2 and 7.3. The values shown in the tables are equivalent to those of a plain bar with the same weight per unit length as the deformed bar. Table 7.1 shows the maximum size of bar that is available for the designations of steel that are shown. Very rarely are plain bars used for the fabrication of rebar cages, and they should never be used if the cage is to be placed in a drilling slurry.

The modulus of elasticity of steel is usually taken as 199.8 GPa (29,000,000 psi). For design purposes the stress-strain curve for steel is usually assumed to be elastic-plastic, with the knee at the yield strength (Ferguson, 1981).

## **LONGITUDINAL REINFORCING**

The principal role of the longitudinal reinforcing steel is to resist stresses due to bending and tension. If the computed bending and tensile stresses are negligible, there may seem to be no need at all for longitudinal steel except as required by specifications. However, construction tolerances will allow nominally concentric axial loads to be applied with some amount of eccentricity, unanticipated lateral loads may occur (such as those caused by long-term lateral translation of soil), and the top portion of any drilled shaft will need to act as a short column if there is any axial load. Therefore, it is good practice to provide at least some amount of longitudinal steel reinforcing in all drilled shafts for bridge foundations.

In virtually all designs, the steel requirements will be maximum near the groundline and will

diminish rapidly with depth. Therefore, the maximum number of longitudinal bars will be required at the top of a drilled shaft. Some of the bars can be eliminated, or "cut off," as depth increases. In some of the methods of construction, as noted in the last section of this chapter, a short rebar cage can be sometimes be used near the top of the drilled shaft, leaving the bottom unreinforced. In the casing method of construction, however, the cage should be able to stand alone on the bottom of the borehole during the placement of the concrete; thus, some of the longitudinal bars must extend over the full length of the shaft.

Table 7.1. Properties of reinforcing steel for concrete reinforcement

ASTM Designation	AASHTO No.	Description	Yield Strength, MPa (ksi)	Weldable?	Max. Bar Size
A 615	M 31	Deformed and plain billet-steel bars	276 (40) 413 (60)	No	55 M (No. 18)
A 616	M 42	Deformed and plain rail-steel bars	345 (50) 413 (60)	No	35 M (No. 11)
A 706	-	Deformed low-alloy steel bars	413 (60)	Yes	55 M (No. 18)

Table 7.2. Weights and dimensions of deformed bars (Customary)

Bar No.	Weight, N/m (lb/ft)	Diameter, mm (in.)	Cross-Sectional Area, mm <sup>2</sup> (in. <sup>2</sup> )	Perimeter, mm (in.)
3	5.49 (0.376)	9.53 (0.375)	71.3 (0.11)	29.9 (1.178)
4	9.75 (0.668)	12.7 (0.500)	126.7 (0.20)	39.9 (1.571)
5	15.22 (1.043)	15.9 (0.625)	198.6 (0.31)	49.9 (1.963)
6	21.92 (1.502)	19.1 (0.750)	286.5 (0.44)	59.8 (2.356)
7	29.83 (2.044)	22.2 (0.875)	387.1 (0.60)	69.8 (2.749)
8	38.97 (2.670)	25.4 (1.000)	506.7 (0.79)	79.8 (3.142)
9	49.63 (3.400)	28.7 (1.128)	646.9 (1.00)	90.0 (3.544)
10	62.91 (4.303)	32.3 (1.270)	819.4 (1.27)	101 (3.990)
11	77.55 (5.313)	35.8 (1.410)	1006 (1.56)	113 (4.430)
14	111.7 (7.650)	43.0 (1.693)	1452 (2.25)	135 (5.320)
18	198.5 (13.60)	57.3 (2.257)	2579 (4.00)	180 (7.090)

Table 7.3. Weights and dimensions of deformed bars (Metric)

Bar No.	Weight, kg/m (lb/ft)	Diameter, mm (in.)	Cross- Sectional Area, mm <sup>2</sup> (in. <sup>2</sup> )	Corresponding Customary Bar Designation (Approximate)
10M	0.784 (0.526)	11.3 (0.455)	100 (0.155)	No. 3 - No. 4
15M	1.568 (1.052)	16.0 (0.630)	200 (0.310)	No. 5
20M	2.352 (1.578)	19.5 (0.768)	300 (0.466)	No. 6
25M	3.920 (2.629)	25.2 (0.992)	500 (0.777)	No. 8
30M	5.488 (3.681)	29.9 (1.177)	700 (1.088)	No. 9 - No. 10
35M	7.840 (5.259)	35.7 (1.406)	1000 (1.554)	No. 11
45M	11.76 (7.888)	43.7 (1.720)	1500 (2.332)	No. 14
55M	19.60 (13.15)	56.4 (2.220)	2500 (3.886)	No. 18

Deformed bars are invariably selected for the reinforcement even though there could be some loss of bond in the slurry method of construction. As the concrete rises to displace the slurry around the rebar steel, there is a possibility that some of the bentonite or polymer will be trapped under the deformations. As discussed in Chapter 6, there is no evidence at present to indicate that any loss of bond that may occur because of such action presents a problem if the slurry meets appropriate specifications at the time the concrete is poured.

It is conceptually possible to vary the spacing of the longitudinal bars and to orient the cage in a specific direction in the case where the main forces causing bending have a preferential direction. However, the savings that would be gained by such a procedure might be more than offset by the delays that would be inevitable in the inspection and construction. Therefore, the longitudinal bars are recommended to be spaced equally around the cage, except in cases where there are compelling reasons for nonsymmetrical spacing. The minimum number of bars in a symmetrical cage should be five or six so that the bending resistance be virtually equal in any direction. A view of the longitudinal steel in a rebar cage that is being assembled on a job site is shown in Figure 7.1.

The No. 8 bar is usually the minimum size of the longitudinal steel in a drilled shaft. The minimum spacing between longitudinal bars (and between transverse bars or spiral loops, as well) must be sufficient to allow free passage of the concrete through the cage and into the space between the cage and the borehole wall without resorting to vibrating the concrete. Various authorities recommend that the minimum clear space between bars range from three to five times the size of the largest of the coarse aggregate in the concrete mix. Although this spacing is somewhat dependent upon other characteristics of the fluid concrete mix, a good rule to follow is to use a minimum spacing of five times the size of the largest coarse aggregate in the mix or 76 mm (3 in.), whichever is larger. The bar size that is selected for the longitudinal steel must be such that the proper clear spacing between bars is maintained. If a very large amount of reinforcing steel is required, two rebar cages, one inside the other, may be required.

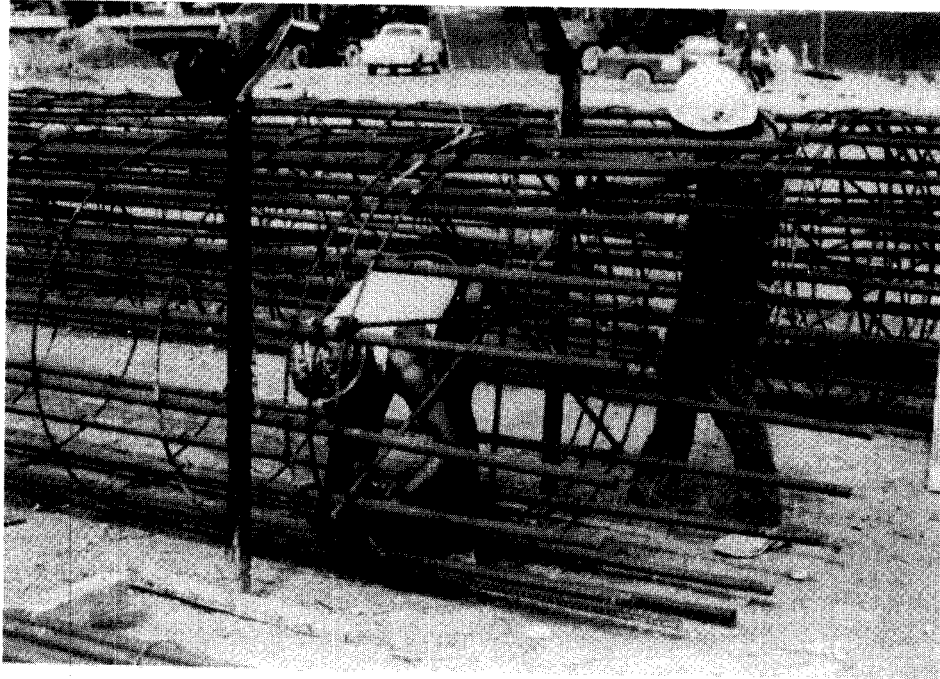

Figure 7.1. View of a rebar cage being assembled, showing longitudinal steel

In some instances, two or three bars can be clustered, or "bundled," together in order to increase the steel percentage while maintaining a cage with appropriate rebar spacing. Bundling of bars does not degrade the bond between the steel and the concrete by trapping bleed water or slurry, as long as the bars are vertical. A photograph of a cage with bundles of two No. 18 bars is shown in Figure 7.2.

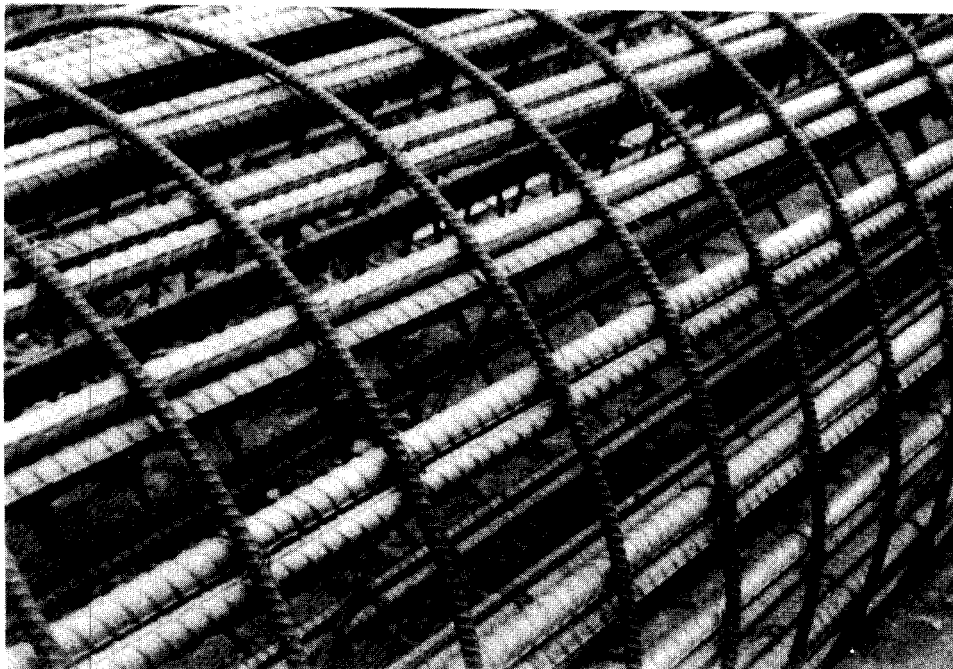

Figure 7.2. View of bundles of No. 18 rebar in a drilled shaft cage

## TRANSVERSE REINFORCING

The transverse reinforcing steel has the function of resisting the shearing forces that act on a drilled shaft, holding the longitudinal steel in place during construction so that the loaded drilled shaft has sufficient resistance against compressive or flexural stresses, and confining the concrete in the core of the cage to give the drilled shaft post-yield ductility. The transverse reinforcing steel is provided in the form of ties, hoops or spirals.

When either a transverse tie or spiral is used, it is essential that the end of the steel be anchored in the concrete for a distance sufficient to assure that the full bar capacity is achieved at the point of connection of the two ends of the tie or the end of one spiral section and the beginning of the next. Figure 7.3 shows two scenarios for providing such anchorage. On the left is a schematic of a series of transverse ties. It shows the anchorage of the transverse ties being developed by the use of hooks. The hooks shown in the figure will complicate the assembly of the steel, and the protrusion of the bars into the interior of the cage could interfere with the introduction of a tremie or the placing of the concrete by free fall. The best practice is to anchor the transverse steel by the use of a sufficient amount of lapping. The use of sections of spiral anchored with a lap is illustrated on the right side of Figure 7.3. An extension of the steel beyond the point where its resistance is needed ("development length"), computed according to the relevant concrete design code, is recommended for the steel on each side of the connection point for all lap joints. ACI (1995) recommends in general a development length in inches (25.4 mm) of  $0.04A_b f_y / [f'_c]^{0.5}$  for bars of No. 11 size or smaller that take tension, such as transverse steel, where  $A_b$  is the cross sectional area of the bar in square inches,  $f_y$  is the yield strength of the steel in psi and  $f'_c$  is the cylinder compression strength of the concrete, also in psi. Some agencies specify that spiral steel be lapped for one full turn.

The craftspeople who assemble the reinforcing steel should be skilled in the tying of the rebar so that the bars will maintain their relative positions as the concrete is poured. The cage should be assembled to resist the forces caused by the concrete as it flows from the inside of the cage. An undesirable displacement of the transverse steel is sketched in Figure 7.4. A frequent cause of that kind of deformation is that the steel in the transverse ties is too small. On some cages, No. 3 or No. 4 bars may satisfy structural requirements, where No. 6 bars may be needed to prevent permanent distortion of the cage during handling and placement of concrete. The stability of rebar cages for drilled shafts during handling and concreting can be improved by tying, clamping or welding every crossing between the longitudinal and transverse steel, rather than tying, clamping or welding only some of the crossings, as is common practice in some localities (for example, Figure 7.2).

It is possible, of course, to assemble the reinforcing steel by welding if the proper steel is at hand. But, as noted earlier, weldable steel is not normally used for rebar cages.

The geometry of the transverse steel to resist shear loads and provide column action is covered by codes on reinforced concrete. This issue will be addressed in Chapter 13.

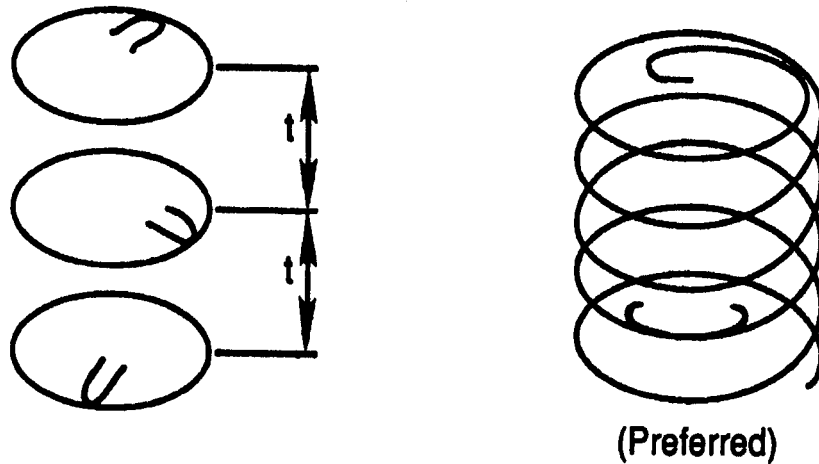

Figure 7.3. Transverse ties and spiral steel, showing hook anchors and spiral laps

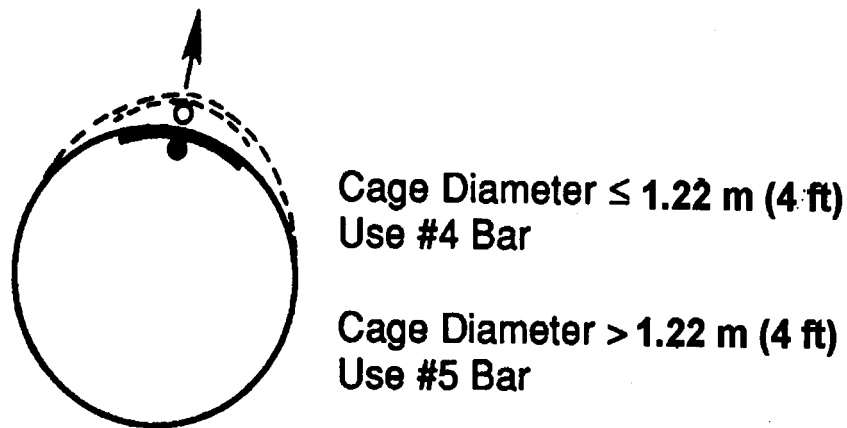

Figure 7.4. Possible distortion of poorly assembled cage due to pickup forces or hydraulic forces from fresh concrete

## SPLICES

The depth of an excavation frequently may be less than the length of the longitudinal steel that can be delivered, which is normally supplied in lengths of 18.3 m (60 ft) or less; thus, the length of the cage can be made equal to the full length of the shaft with no need for splicing the longitudinal bars. For cages longer than about 18.3 m (60 ft), however, splices are required.

Splices in the longitudinal steel can be made by lapping the bars so that the bond in the rebar is

sufficient to develop the full capacity of the bar in tension or compression in each bar at the point of the splice. Again, an appropriate development length, as indicated in the governing code (e.g., ACI, 1995; AASHTO, 1994) is necessary in both bars on either side of the splice. The tie wire or clamps that are used to connect the bars must have sufficient strength to allow the cage to be lifted and placed in the borehole without permanent distortion of the cage. The steel can also be spliced by welding if a weldable steel is available for the job.

Splices in the longitudinal steel can be made also by the use of special connectors if necessary, although their use will increase costs. One such connector encloses the butt joint of two rebars and the ignition of the patented material inside the connector results in a joint with considerable strength. Weldable steel is not required because the temperature necessary to install the connectors is moderate.

Splices in the longitudinal steel, if required, should be staggered so all splices do not occur in the same horizontal plane along the rebar cage. Not more than 50 per cent of the splices should be at any one level. Many structural designers prefer not to place any splices in zones near the location of maximum flexural stresses in the drilled shaft-column system when large lateral loads are applied (as when the design includes seismic considerations). When the foundation is a single drilled shaft supporting a single bridge column and the drilled shaft has a larger diameter than the column, these stresses occur at the junction between the column and the drilled shaft (top of the drilled shaft). In this case, an option open to the designer is to design the cage so that splices are located deep within the drilled shaft well below the connection, and well below the depth of maximum bending moment in the shaft, and the upper part of the drilled shaft cage extends up into the column to become the reinforcement for the column as well. This usually results in a very long cage that requires special handling by the contractor. Such a cage must be supported externally as the concrete is being placed and as it cures.

There are cases where the cage is so long that it cannot be lifted conveniently in one piece. In such a case, the cage can be spliced in the borehole. The lower portion of the cage is lifted, placed in the excavation, and held with its top at a convenient working level while the upper portion is lifted and positioned so that the two portions of the cage can be spliced together. Wire ties or clamps are usually employed to make the splices, with the ties or clamps in the longitudinal steel being staggered. The entire cage is then lowered to the correct position.

Since concrete should be placed in the completed excavation as soon as possible after completion of drilling, time-consuming splicing in the hole should be minimized, or avoided if possible.

Some agencies disallow splices in zones where the probability of steel corrosion is the highest, such as splash zones in a marine environment.

## **SIZING HOOPS**

Sizing hoops of the proper diameter are often constructed to aid in the fabrication of the rebar

cage and to ensure that the finished cage diameter is correct. The hoops simply provide guides for the fabrication of the cage and can be made of plain rebar or thin rolled-plate stock. The sizing hoop, sometimes called a "gauge hoop," can be made with a lapped splice as illustrated on the left side of Figure 7.5, but the ends of the hoop can also be butt-welded, as illustrated on the right side of that figure. Marks on the sizing hoops will facilitate the placing of the longitudinal steel. Although sizing hoops give the finished cage some additional dimensional stability, they serve no structural purpose. Therefore, butt welding on non-weldable steel should not be prohibited.

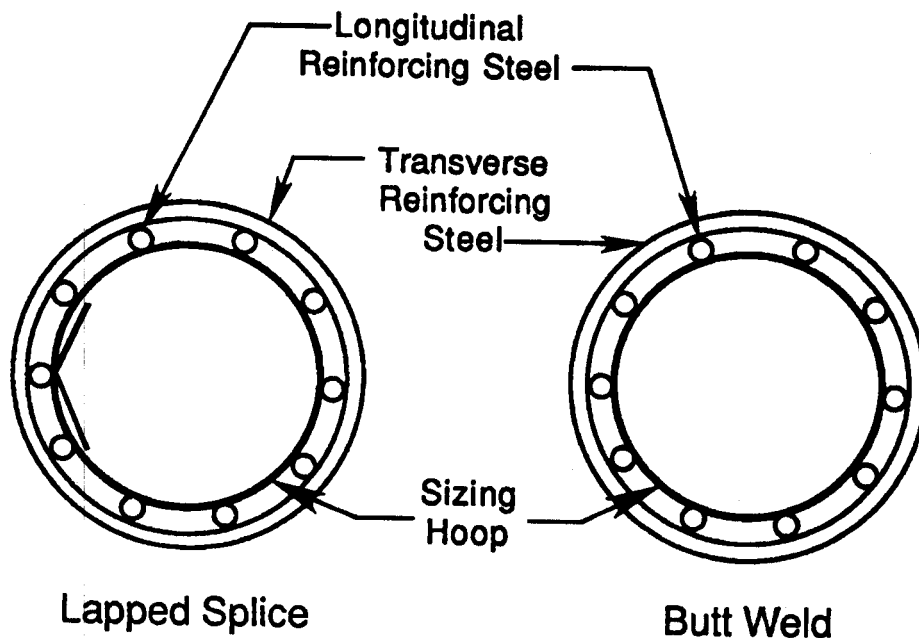

Figure 7.5. Sizing hoop assembly (from LCPC, 1986)

## CENTERING DEVICES

The completed rebar cage must be sized to provide ample room for the fresh concrete to flow up the annular space between the cage and the sides of the excavation, as well as to provide adequate cover for the rebar. The necessary minimum annular space is usually about 76 mm (3 in.) or five times the largest size of coarse aggregate in the concrete mix, whichever is greater. Although in the dry and casing methods of construction it is possible to place the cage by eye, it is far more effective to assure that the cage is held an appropriate distance away from the walls of the borehole or casing during the concrete pour by means of centering devices. Such devices also serve to center the cage in the excavation so as to maintain the correct location of the center of the cage relative to the center of the column to be placed at the head of the drilled shaft. Figure 7.6 shows how plain rebar skids may be used to center the rebar cage. Fastening the



centering skids with tie wires must be done carefully to provide the lateral stability that is needed. Stability of the centering skids can also be provided by bending them to a shape such that the base of a skid will be tied to two of the vertical bars. The centering skids should not be welded to the structural rebar, not even tack welded, unless the rebar is weldable.

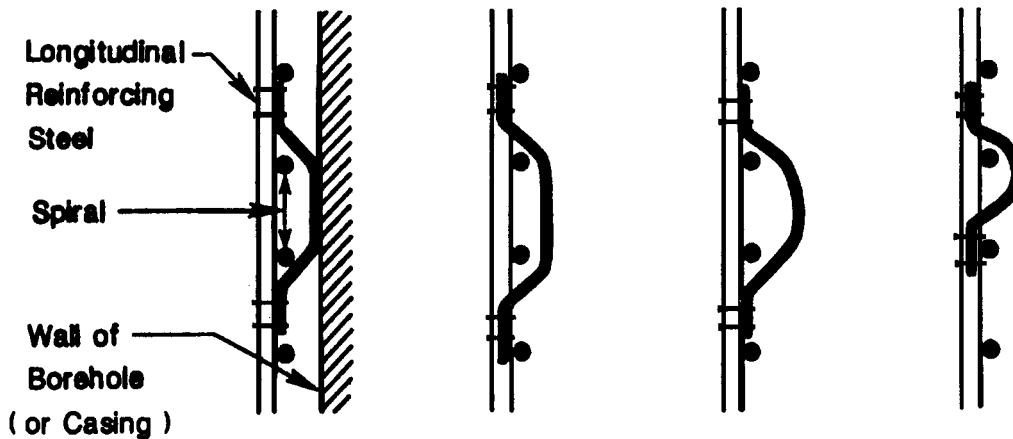

Figure 7.6. Centering with plain, epoxy-coated rebar skids (from LCPC, 1986)

The use of steel skids is problematical. Rebars that are used as centering skids should be epoxy-coated in order to impede corrosion of the rebar cage. Corrosion can be initiated where the bars touch the soil, and the deterioration could progress inward rapidly such that the strength of the drilled shaft could be compromised. Such corrosion is most severe above the water table, where oxygen is available, but corrosion can also occur below the water table due to galvanic action.

Centering skids can also be placed on the inside of the cage to act as a guide for the tremie, if a tremie is to be used to place the concrete. In this manner the tremie will be kept clear of the rebar cage, which will reduce the danger of the tremie damaging the cage when it is being inserted and perhaps initiating raveling of the cage. Tremie centering skids do not have to be epoxy coated.

A better solution to the problem of centering a rebar cage, or centering the tremie within the cage, is shown in the photograph in Figure 7.7. The contractor has cast concrete rollers, or "wheels," which are tied to the rebar cage with short pieces of steel rod. The concrete roller must have a lateral dimension to fit between the longitudinal bars. (The white tube in the photograph is used for cross-hole ultrasonic testing of the completed drilled shaft, which will be discussed in Chapter 17.) The rollers can be cast with different diameters; for any particular job the rollers will provide an appropriate space between the rebar and the sides of the borehole. Concrete and plastic devices such as this are also available commercially.



Figure 7.7. Concrete rollers

Figure 7.8 a shows the proper way to install centering rollers. An improper use is shown in Figure 7.8 b. If the soil or rock has a tendency to cave, the horizontal roller orientation could loosen chunks of soil or rock as it bumps against the side of the borehole while the cage is being lowered. Such loose soil or rock will fall to the bottom of the excavation and would adversely influence the capacity of the drilled shaft in end bearing.

Three or four centering devices should be placed at equal spacings around the cage at each level where they are installed, and levels of centering devices should be no farther apart longitudinally than about 10 cage diameters. Whatever type of centering devices are used by the contractor, they must be substantial enough so that they do not collapse as the cage bumps against the side of the excavation, and the contractor must be diligent to ensure that they are not damaged when the cage is being lifted.

Some specifications also call for the base of the drilled shaft cage to be suspended off the soil or rock at the bottom of the borehole in order to impede rebar corrosion. Small concrete, mortar or plastic "chairs" can be made or purchased for this purpose.

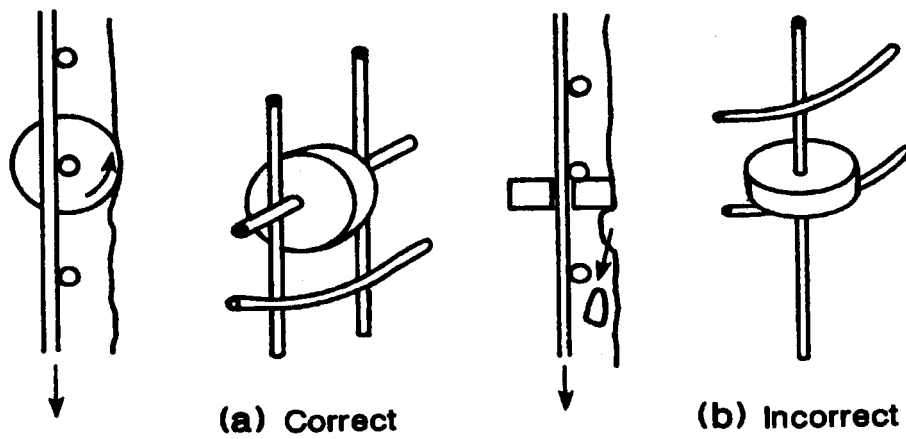

Figure 7.8. Installation of rollers: (a) correct, (b) incorrect (from LCPC, 1986)

## STRENGTHENING THE CAGE TO RESIST LIFTING FORCES

A critical stage in the construction of a drilled shaft is when the cage is lifted from a horizontal position on the ground (its orientation when fabricated), rotated to the vertical, and lowered into the borehole. To strengthen the cage against distortion during lifting operations, temporary or permanent stiffening may be necessary. Figure 7.9 is a sketch of transverse stiffeners that can be tied to the sizing hoops or to the longitudinal bars; these stiffeners will need to be removed as the cage is lowered so that the tremie or pump line can be lowered into the excavation.

Two other types of stiffeners are shown in Figure 7.10. These stiffeners assist in increasing cage stiffness in both bending and torsion. The stiffeners shown in Figure 7.10 a can remain in place when the cage is lowered, but those shown in Figure 7.10 b must be removed to allow space for the passage of the tremie or pump line. The types of stiffeners shown in Figures 7.9 and 7.10 should be tied, not welded, to the rebar cage unless they are attached to the sizing hoops or the steel used to make the cage is weldable steel. Since contractors often lift the cage to the vertical from lifting points near the top and pivot it about its bottom, it is good practice to stiffen the bottom of the cage. These stiffeners need to be removed after the cage is upright because they can interfere with the placement of concrete.

Many contractors prefer to brace rebar cages externally so there is no need to remove bracing as cage is placed. One way of doing this is to use a "strongback" or section of pipe or wide flange section tied to the cage while it is being lifted.

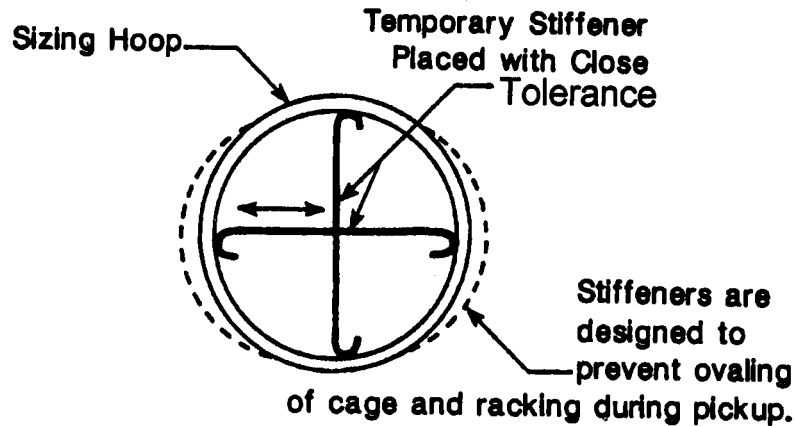

Figure 7.9. Transverse stiffeners for temporary strengthening of the rebar cage (after LCPC, 1986)

Near the bottom of the drilled shaft cage, where the only purpose served by the longitudinal steel is to support the portion of the cage near the top of the shaft that is designed to carry structural stresses, the transverse reinforcement can consist only of steel bands (Texas DOT, 1993). A photograph of such bands is shown in Figure 7.11. The bands are securely tied or welded into place and provide permanent stiffening of the rebar cage. (Welding is permitted here, even on "nonweldable" steel, because the bottom of the rebar cage serves no structural purpose.) The bands are spaced perhaps two cage diameters apart vertically. The strengthening of the lower portion of a rebar cage with tied or welded bands will significantly reduce, or perhaps eliminate entirely, the strengthening that is otherwise needed for the upper portion of the cage.

### ARRANGEMENTS FOR LIFTING CAGE

The rebar cage can be lifted from its horizontal position to the vertical, prior to placing the cage in the borehole, with the use of slings or temporary attachments that are provided by the personnel on the job or by lifting hoops tied to the cage. Lifting from several longitudinal rebars, rather than just one bar, at each pickup point is desirable. Careless lifting of a cage may result in permanent distortion of the rebar. For example, the cage being lifted in Figure 7.12 was permanently distorted and had to be disqualified for use in a drilled shaft because an insufficient number of pickup points were used. A more appropriate procedure is shown in Figure 7.13. Two cranes were used to lift a 21.4-m- (70-ft-) long cage using four support points: the top of the cage using one crane line, two points near the center using another crane line and a spreader bar, and the ground at the bottom of the cage. Although some distortion is visible in Figure 7.13, it is all elastic, so when the cage is in its vertical position it is free of any permanent distortion.

Elastic deformation of a cage during lifting is of no great concern; however, if plastic (permanent) deformation occurs or slippage of the ties or spiral is evident after the cage is brought to the vertical, the cage must be repaired before placing it in the borehole.

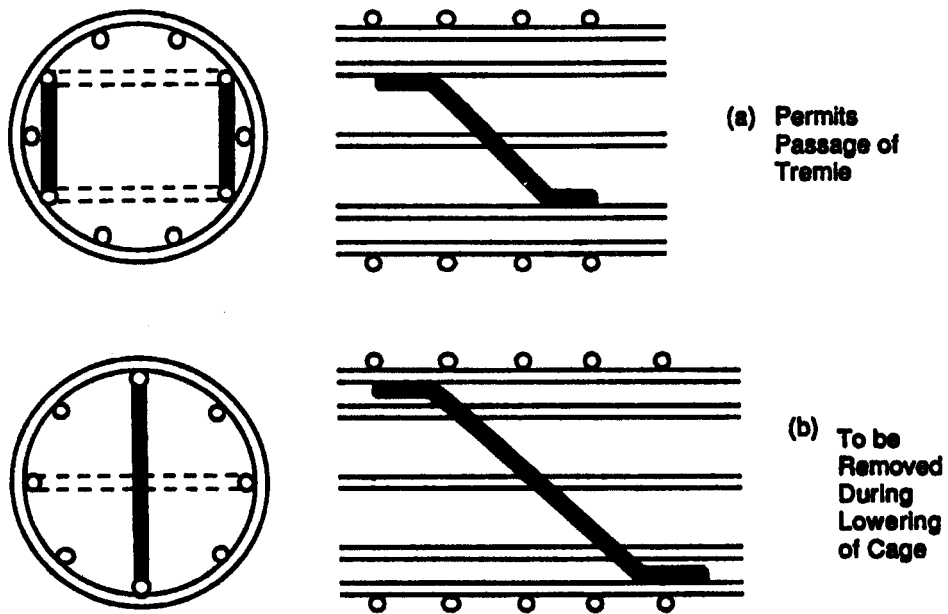

Figure 7.10. Longitudinal stiffeners for temporary or permanent strengthening of a rebar cage (from LCPC, 1986)

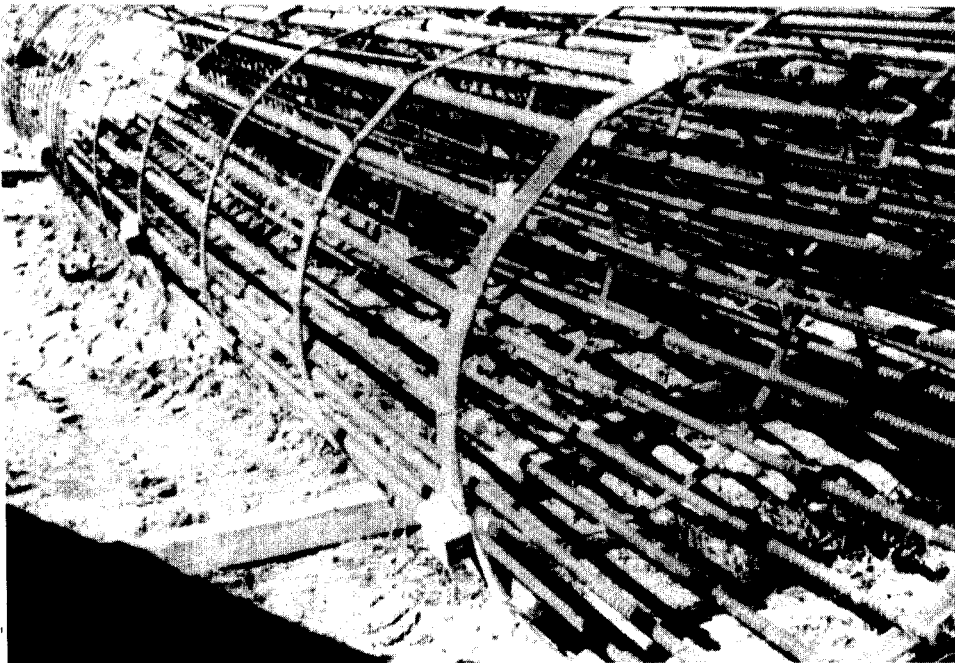

Figure 7.11. Photograph of bands used for strengthening lower part of a rebar cage

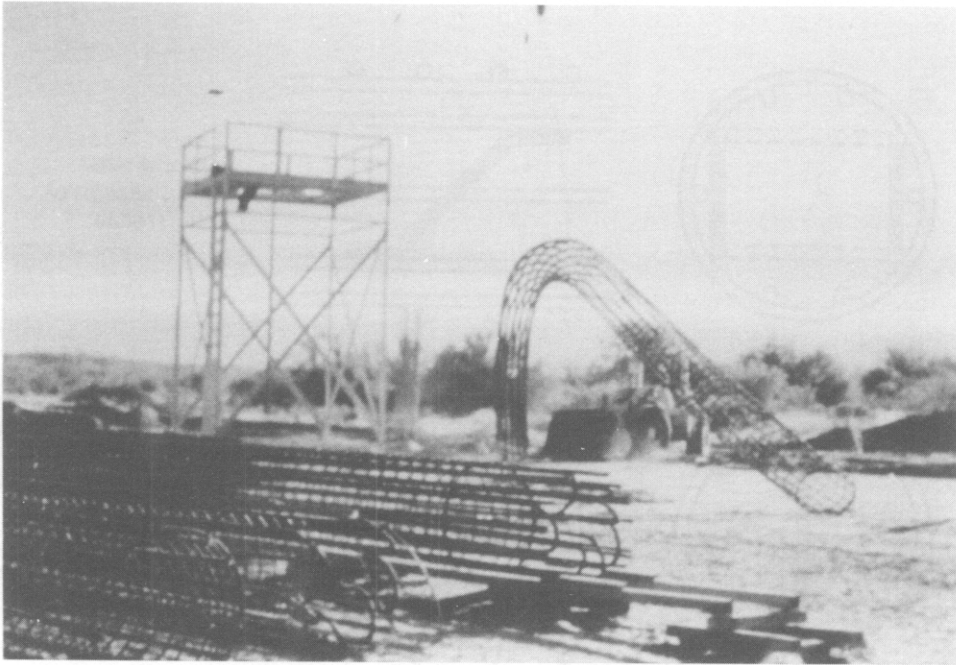

Figure 7.12. Photograph of rebar cage being lifted improperly  
(Photo courtesy of Barry Berkovitz, FHWA)



Figure 7.13. Photograph of rebar cage being lifted properly

## **FABRICATION AND STORAGE**

The fabrication of rebar cages can be done most conveniently in a fabrication yard; however, there is a problem of transporting the cages to the job site. Not only are there restrictions about the moving of over-length loads on roads and streets, but the additional handling that is necessary can cause distortion in the cages. Except possibly for short cages, the usual procedure is to transport the rebar to the job site and to assemble the cage reasonably close to where the cage is to be installed. Cage transportation is eliminated, and handling of the completed cage is reduced to a minimum -- usually only to picking up the cage with a crane or cranes and placing it in the borehole. The photograph in Figure 7.1 shows workers who are fabricating a rebar cage at a job site. The frame that is shown for the temporary support of the cage is one of several that are used. They are essential to the fabrication process.

The usual procedure is that a number of cages are fabricated prior to drilling the boreholes and stored at the job site until a particular cage is needed. Proper arrangements should be made to keep the stored cages free from contamination with mud or other deleterious materials.

## **CONSIDERATIONS RELATED TO METHOD OF CONSTRUCTION**

As was indicated earlier in this chapter, the bending moment due to lateral loading is frequently negligible over the lower portion of a drilled shaft, and reinforcing steel may be needed for structural purposes only over the upper portion of the shaft. Short rebar cages can be used with the dry method or the wet method of construction. The concrete can be placed in the lower portion of the excavation, the rebar cage can then be placed and held in position, and the concreting can be completed. If the uplift forces become too large as the concrete flows past the rebar cage, it may become necessary to slow the rate of placement of the concrete or to lift the tremie some distance if the wet method is used. The bottom of the tremie must be kept in the column of fresh concrete, however. The suspended casing can sometimes be restrained from upward movement while concreting by means of surface hold-downs, such as chains tied to screw anchors.

The situation is quite different with the casing method. The casing is filled completely with fresh concrete before the casing is pulled. Alternately, the casing is filled with fresh concrete to the point where the internal pressure in the fluid concrete is greater than the external pressure of any slurry or groundwater, if present, in the overbreak zone behind the casing. As the casing is lifted, additional concrete is added to fill the annular space behind the casing. The direction of flow of the concrete within the casing is downward, so that a partial-length rebar cage being held in position by a crane line will be pulled downward as the casing is being extracted. This action can produce very high forces that can permanently distort the cage at the level where it is being held or even break the connection with the holding line, so that the cage is pulled uncontrollably into the shaft. Even if the cage remains in proper position, it is difficult to bring the casing up over the line holding the cage in place and to secure the cage once the casing is removed. Therefore, the rebar cage for the casing method should be designed to stand on the bottom of the

excavation and to retain its position and geometry as the concrete placement is accomplished regardless of whether a full-length cage is required structurally. Partial length cages have been used for very long drilled shafts, but only with difficulty.

The downward forces imparted to the cage by the fluid concrete inside the casing as it is being extracted can be minimized if the casing is lifted slowly and if the concrete is very fluid. Nonetheless, some movement of the cage is normal. Most of the specifications for the construction of drilled shafts will give some tolerance with respect to the final position of the top of the rebar cage. However, there have been instances where a rebar cage has buckled torsionally or where a splice in the cage has displaced during placement of concrete, particularly with the casing method. These problems are magnified when the drilled shaft is installed on a batter. There is currently no analytical solution to the problem of determining the forces from the concrete; therefore, a field solution must be obtained to the problem of maintaining the proper position of the rebar cages during concrete placement when the casing method of construction is being used. Careful observation of the permanent movement of a rebar cage during concrete placement should be made by the inspector to make sure that torsional buckling or slipping of splices has not occurred, or that the cage does not rise up due to excessive shear forces that are transferred from the interior surface of the casing to the cage when the casing is being removed.

The longitudinal bars at the top of a rebar cage will need to extend far enough above the top of the drilled shaft so that enough extended length is provided for development of the full capacity of the bars once they are cast into the substructure element. If a column is placed directly on the head of a drilled shaft, the straight bars of the column cage can be spliced to the rebar cage for the drilled shaft just above the shaft head. However, if the drilled shaft frames into a cap (for example, at an abutment) insufficient vertical distance may be available between the head of the shaft and the top of the cap to allow the extended bars to remain straight. In such a case, the bars may have to be hooked to achieve adequate development. If the casing method is used by the contractor, the temporary casing cannot be extracted if the hooks are turned outward over the top of the casing. If the designer judges, based on the site investigation data, that the contractor may use the casing method, or if the casing method is specified, the longitudinal steel should not be bent outward at the top of the shaft. Instead, the hooks should be turned inward, as shown in Figure 7.14, or some alternate way of developing the steel should be found. Note that if the hooks are turned inward, room should be left for inserting a tremie or dropchute in the center of the cage in order to place the concrete.



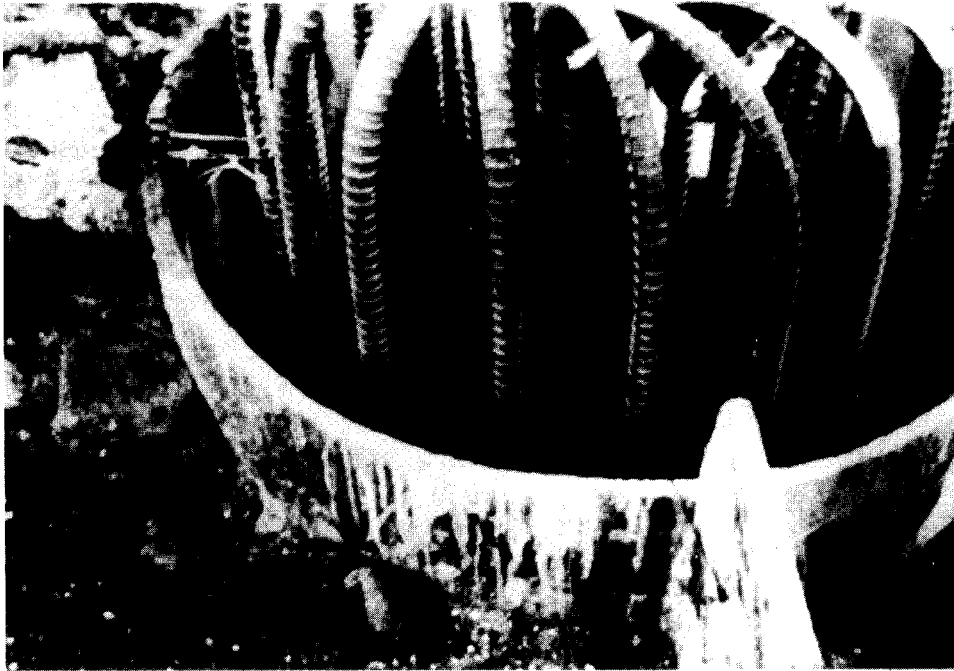

Figure 7.14. Inward-turned hooks in a rebar cage for a drilled shaft at an abutment  
(photograph courtesy of Barry Berkovitz, FHWA)

## REFERENCES

- ACI (1995). *Building Code Requirements for Reinforced Concrete (ACI 318-95) and Notes on ACI 318-95, Building Code Requirements for Structural Concrete*, American Concrete Institute, Detroit, MI.
- ACI (1996). *ASTM Standards in ACI 301, 318, and 349, Publication SP-71*, American Concrete Institute, Detroit, MI.
- AASHTO (1994). *AASHTO LRFD Bridge Design Specifications*. American Association of State Highway and Transportation Officials, Washington, D. C.
- Ferguson, P. M. (1981). *Reinforced Concrete Fundamentals*, Fourth Edition, John Wiley and Sons, Inc., New York.
- LCPC (Laboratoire Central des Ponts et Chaussées) (1986). "Bored Piles," English translation of *Les Pieux Forés*, March (available as *FHWA Publication No. TS-86-206*).
- Texas DOT (1993). *Standard Specifications for Construction of Highways, Streets and Bridges*, Item 416, Texas Department of Transportation, Austin, TX, March.

## CHAPTER 8: DESIGN AND PLACEMENT OF CONCRETE

### BASIC CHARACTERISTICS OF DRILLED SHAFT CONCRETE

Concrete for drilled shafts must be designed and placed in a manner that is unique to drilled shafts. Most drilled shafts have length-to-diameter ratios of 10 to 30 and have reinforcing steel cages. Many are constructed using either temporary casing or drilling slurry. Concrete for drilled shafts must therefore be designed and placed in such a manner that it can be pumped, be dropped or flow through a tremie by gravity to the bottom of the excavation; flow easily through the rebar cage without vibration (so that the concrete is not inadvertently mixed with drilling fluid, ground water or soil); displace drilling slurry or water while rising in a narrow borehole and in the annular space between the cage and the borehole wall; and will not segregate or become leached of cement paste in the process. Simultaneously, it must have the appropriate strength, stiffness and durability after it has cured.

Drilled shaft concrete and aspects of construction of drilled shafts related to concreting are discussed in ACI 336.1 (ACI, 1994), which is recommended as parallel reading for this chapter. The publication *Design and Control of Concrete Mixtures* (PCA, 1988) is appropriate background reading for the reader who is not familiar with concrete mixes in general or with terminology related to concrete.

In the context of design and placement of concrete for drilled shafts, it is important to distinguish between *drilled shafts* and *drilled footings*, which are sometimes called drilled shafts. For example, to concrete a drilled footing in a dry, stable borehole 3 m (10 ft) in diameter and only 3 m (10 ft) deep, a ready-mix truck can be positioned near the excavation, and low-slump concrete can be placed directly in the excavation through a dropchute. If necessary, the concrete can be compacted by vibration since there is no danger of the vibrated concrete becoming mixed with drilling fluids or soil. Therefore, almost any concrete mix that is acceptable for structures will be satisfactory. For most drilled shafts, however, this is not the case. This chapter will address some of the key issues in concrete design and placement that are unique to drilled shafts.

When it is necessary to place the concrete under a drilling fluid (wet method, Chapter 3) or when placement by free fall may tend to destabilize the borehole (for example, in lightly cemented sands or sand deposits that are stable during drilling because of capillary moisture and that can collapse from the stress waves produced by the falling concrete), concrete for drilled shafts must be placed using a gravity-fed tremie or by pumping. The tremie is a conduit (usually a steel pipe) that is used to place concrete in a fluid-filled excavation or in a dry excavation in cases such as the one described above. It has a funnel-shaped top when used for gravity placement or is connected to a pump line when used for placement by pump. Special considerations are required in the mix design for tremie placement.

The basic characteristics of concrete for drilled shafts can be expressed as follows:

- ***Excellent workability:*** It is essential that the concrete have the ability to flow readily through the tremie, to flow laterally through the rebar cage, and to impose a high lateral stress against the sides of the borehole. From a geotechnical perspective, the objective of placing concrete is to reestablish the lateral stresses in the ground around the drilled shaft that existed before the borehole was excavated. This objective can best be met by using concrete that is highly fluid.
- ***Self-weight compaction:*** Vibration of concrete in a borehole is impractical, except very near the surface, and in some cases it will lead to defects in the completed shaft by causing ground water, drilling fluid or soil to mix with the concrete.
- ***Resistance to segregation:*** The concrete mix should have a high degree of cohesion and should be free of large-sized coarse aggregate; otherwise, it may segregate during placement, particularly if free fall is allowed, resulting in inferior concrete.
- ***Resistance to leaching:*** In some instances flowing ground water could cause a weakening of the concrete after it is placed, and a properly designed mix should be resistant to such flow. (However, if the rate of flow is substantial, a permanent casing or liner will be necessary.) Furthermore, when concrete is placed under a drilling fluid (slurry or water), there is inevitable contact between the concrete and the fluid, which is a condition that also requires the mix to be resistant to leaching.
- ***Controlled setting:*** Drilled shaft concrete should retain its fluidity throughout the depth of the borehole during the full time required for complete placement of the concrete in the borehole in order to maximize the ground pressures that are imposed by the fluid concrete. Slow setting is also required to allow for inevitable delays that may occur during concreting (interrupted concrete supply, difficulties in extracting casing, etc.). At the same time, it should attain an appropriate strength within a reasonable time after placement.
- ***Good durability:*** If the subsurface environment is aggressive or can become aggressive during the life of the foundation, the concrete should be designed to have high density and low permeability so that the concrete is able to resist the negative effects of the environment.
- ***Appropriate strength and stiffness:*** The size of most drilled shafts will be controlled by the peripheral area and base area that are needed to develop the required axial resistance. Therefore, high-performance concrete is not needed. The mechanical properties of the hardened concrete can be satisfied in such instances without difficulty. However, provision of appropriate tensile strength for the concrete in unreinforced bells and appropriate compressive strength where high levels of combined bending and axial stress occur must be dealt with in some cases.

- *Low heat of hydration for large volumes of concrete:* Careful attention must be given to the design of concrete for bells (Gerwick, 1965) and for large-diameter drilled shafts so that excessive heat does not produce thermal tensile cracking.

## **MIX DESIGN**

### **Cementitious Materials**

#### **Cement**

Ordinary Type I or Type I/II portland cement is normally used for the design of concrete for drilled shafts. Type III, high-early-strength, cement should usually be avoided, especially when underreams (bells) are used and in shafts with diameters greater than 1.53 m (5 ft). The cement should meet the requirements of the American Society for Testing and Materials in Specification C 150 (ASTM C 150, 1995). Special sulfate-resisting cements should be considered in environments where the sulfate content of the geomaterial or ground water is extremely high.

#### **Pozzolan Additives**

The addition of pozzolanic minerals to ordinary portland cement may improve the durability and the strength of drilled shaft concrete. Pozzolans, of themselves, possess very little strength when hydrated by water, but in the presence of portland cement, particularly the free calcium hydroxide (lime) that exists in portland cement, they form cementitious materials. Fly ash (ASTM C 618-94, 1995), silica fume and ground blast furnace slag (ASTM C 989-94, 1995) are pozzolans that are supplied such that the particle sizes of the minerals are considerably smaller than those of ordinary portland cement. (Although finely ground slag is classified as a pozzolan here, it does have some attributes of a cement, in that it will form a solid paste with some strength when hydrated.)

The advantage of adding these pozzolanic materials to portland cement is that a better distribution of the sizes of the hydrated cementitious material particles in the cement paste is achieved, which results in lower void volumes, which, in turn, results in lower permeability of the hardened concrete, as well as in other desirable properties that will be described later. Fly ash derived from the burning of anthracite and hard bituminous coal ("Type F" - low calcium - fly ash) is preferable to fly ash derived from the burning of soft bituminous coal or lignite ("Type C" - high calcium - fly ash). However, Type C fly ash is permitted in some states, especially in non-marine environments. Silica fume, which is rich in silicon dioxide, combines with the excess lime in the portland cement and produces a cement paste that is usually stronger than that produced by using either portland cement alone or by using other pozzolanic additives; however, silica fume is relatively expensive compared to fly ash or slag. Fly ash and silica fume generally reduce the amount of bleeding experienced by the concrete, which can be bothersome if bleed water escapes through channels in the concrete or at the interfaces between concrete and rebar. Fly ash, silica fume and slag will have an effect on the rate of strength and stiffness development

in drilled shaft concrete. The rate of strength development will often be slower when fly ash or slag are added than with concretes made with portland cement alone. Silica fume, however, may act to increase the rate of strength gain in the first month after setting.

The mineral additives considered here produce other desirable effects in drilled shaft concrete. Fly ash tends to reduce the heat of hydration, so that its use is recommended in large-diameter shafts and underreams. Pozzolanic additives tend to retard the set of the cement paste, thereby increasing the time that the concrete remains workable. However, concrete with fly ash may be slightly "stickier" than normal portland cement concrete. There have been anecdotal reports that this characteristic may make it slightly more difficult to extract temporary casing than when concrete with only portland cement is used. This effect may be due to the fact that fly ash reduces the water demand of the minerals in the cement paste somewhat for a given slump, which allows the use of less water in the concrete mix for that particular slump, but which also provides less water for lubrication of the casing as it slides against the concrete. This effect should not be considered cause to disallow the use of fly ash, but both contractors and inspectors should be aware of the potential for the development of defects from "poorly lubricated" casings, particularly if the casing is not clean or is not extracted in a timely manner.

Typical ranges of pozzolanic additives are described in the section on mix proportions.

### **Expansive Additives**

Expansive cement would seem to have some advantages in the construction of drilled shafts. Certain minerals form ettringite crystals as they are hydrated, which causes the concrete to expand, rather than to shrink, as may occur in some subsurface environments in ordinary portland cement concrete. Normally, expansion would cause the concrete to crack uncontrollably and lose most of its strength. However, in drilled shafts installed in strong soil or in rock, the expansion is resisted by the geomaterial and the transverse reinforcement, which reduces the cracking in the concrete, and therefore the strength loss, and simultaneously increases the normal stresses at the interface between the concrete and the geomaterial. The increase in normal stress at the concrete-geomaterial interface will, in turn, increase the side resistance of the foundation.

Research has been performed to ascertain the benefits of expansive cement in the construction of drilled shafts (Sheikh and O'Neill, 1986; Sheikh et al., 1985; Hassan et al., 1993, van Bijsterveld, 1993; Sheikh et al., 1994; Baycan, 1996). Hassan et al. (1993) found that the use of expansive concrete produced a 30 per cent increase in side resistance for a drilled shaft with a diameter of 0.76 m (30 in.) in a soft clay-shale compared with a similar shaft constructed with concrete having Type I portland cement. However, they also found that the expansive concrete set quickly after mixing when field operations were carried out at high ambient temperatures (above 27 deg. C), so that precise scheduling of field operations to enable concrete placement before setting occurred was a paramount issue. Baycan (1996) found that side resistance was increased by about the same amount when expansive concrete was employed for drilled shafts in mudstone

when shaft diameters were 0.30 m (12 in.), but that almost no advantage existed when the shaft diameters were increased to 0.60 m (24 in.). Hassan et al. used a complex mix of additives to the portland cement to produce their expansive cement concrete and found that the concrete set completely within about 20 minutes of mixing when the ambient air temperature was 35 deg. C. To produce the maximum practical increase in side resistance, Baycan used a commercially available additive for portland cement, Denka (brand) CSA (calcium sulfo aluminates), in the amount of about 300 kg / m<sup>3</sup> (505 lb / yd<sup>3</sup>), while (a) reducing the concentration of portland cement by an amount required to keep the volume of cementitious material (portland cement and CSA additive) at the value that would ordinarily be used if no CSA additive had been used and (b) keeping the water/cementitious material ratio at 0.45, the value ordinarily used for the case of zero CSA additive. This mix resulted in about ten times the concentration of CSA that is required to produce shrinkage-compensating cement paste. Baycan found that at this concentration the concrete developed a slump loss of 60 per cent within 30 minutes at laboratory temperature (around 22 deg. C), which was the approximate useful life of the fluid concrete once it was mixed. Smaller concentrations of CSA additive produced less slump loss but also produced a smaller increase in side load transfer. Van Bijsterveld also recommended the use of the CSA additive to produce expansive concrete for drilled shafts.

The body of the research reviewed briefly here suggests that CSA-based expansive cement concrete can be used effectively for small-diameter drilled shafts [less than about 0.48 m (18 in.) in diameter] in soft to hard rock, provided the time between mixing of the additive and completion of placement is less than about 20 minutes and provided concreting is not done at ambient air temperatures higher than about 27 deg. C (80 deg. F).

## **Chemical Admixtures**

The use of chemical admixtures for drilled shaft concrete is discussed in this section. Typical ranges of concrete admixtures (except for accelerators, which are not ordinarily used in drilled shafts) are described in the following section on mix proportions. Admixtures are covered by various ACI and ASTM specifications, some of which are described individually below.

### **Air-entraining agents**

Air-entraining agents (ASTM C 260-94, 1995) can be used in drilled shaft concrete when deterioration of the concrete by freeze-thaw action is possible (e. g., where the top of the shaft is above the depth of frost penetration). Entrained air will also improve workability and pumpability and reduce bleeding; however, it can produce a slightly more permeable concrete and will also produce a concrete mix that is more susceptible to segregation during free-fall placement than a mix without entrained air. Therefore, the decision to use air-entraining agents (AEA) in the concrete mix will be a trade-off between the need to resist freeze-thaw deterioration and bleeding (AEA desirable), produce easy pumping (AEA desirable) resist deterioration due to chemical attack (e. g., chlorides) (AEA undesirable) and the cost advantages of free-fall placement (AEA undesirable). When air is added, about 5% is needed to improve pumpability.

Most of this air will be lost by diffusion by the time the concrete begins to set.

### **Retarders**

Retarding admixtures may be needed in the concrete mix when the concrete is to be placed during periods of high temperatures (> 20 deg. C) in order to reduce the slump loss in the period during which the concrete is being placed in the drilled shaft. This is primarily to provide the contractor with an adequate period of time to work with temporary casing and tremie-placed concrete. A general rule is that this period should be about four hours to allow for unforeseen delays. While it is important to retard the set of concrete in many field settings, the use of excessive retarders can keep the concrete fluid for too long and can affect its long-term strength. Retarders (ASTM C 494-92, 1995) consist of lignin, borax, tartaric acid and similar compounds.

### **Water Reducers**

Water reducers reduce the friction between the hydrating cement particles in the cement paste before the concrete begins to take its set, thereby increasing the workability (slump) of the fluid concrete without the need for excessive water. In order to achieve the high values of slump that are desirable for drilled shaft construction without water reducers, water/cementitious material ratios (W/CM) need to be in the range of 0.5 - 0.6 (by weight). [In this context, "cementitious materials," CM, are considered to be the portland cement and pozzolans that are made part of the cement paste.] More than half of the water in such a mix is present only for lubrication of the cement paste during concrete placement and is not needed for cement hydration. The excess water produces a hydrated cement paste that contains many pores, which results in a permeable, weak concrete. With water reducers, W/CM can be reduced conveniently to 0.45 or lower, which helps produce a denser and less permeable paste while at the same time providing excellent fluidity. Both low-range and high-range water reducers have been used in drilled shaft concrete. With high-range water reducers (HRWR, also known as "superplasticizers"), W/CM can be reduced to 0.3 or less while maintaining a high slump. HRWR's can consist of lignosulfonates and similar compounds (ASTM C 1017-92, 1995). Low-range water reducers (LRWR) can be used to obtain W/CM in the range of 0.40 to 0.45. LRWR's can consist of lignosulfonates, hydroxylated carboxylic acids, and similar ASTM Type A compounds (ASTM C 494-92, 1995).

Although the lower W/CM obtainable with the HRWR will result in a more durable and stronger concrete, HRWR's can, on occasion, cause flash sets, which can be very detrimental to the drilled shaft construction process, since the contractor needs to have some warning that the concrete is beginning to set if unexpected delays are occurring. Highly fluid concrete with slow-rate slump loss properties is preferred to highly fluid concrete that has a very low value of W/CM but that also has the potential for undergoing a flash set, even though the final product may not be quite as strong or durable. HRWR's should not necessarily be disallowed, but if their use is contemplated on a job, the slump loss characteristics of the concrete mix that is to be used on the job, and that is made with the exact high-range product that is to be used on the job, should be

measured at the ambient temperature at which the concrete is to be placed in order to verify that the additive does not produce undesirable slump loss effects. A plan for management of HRWR concrete should also be required of the contractor as part of the construction specifications (e. g., TxDOT, 1994)

### **Accelerators**

Accelerators have a place in some instances in substructure and superstructure construction, but they should not be used in drilled shaft construction except in extraordinary situations [e. g., possibly when a segment of a drilled shaft is being placed in a stratum of granular soil having rapidly flowing groundwater, when a casing cannot be used to seal off the stratum, in order to minimize leaching of the cement]. Concrete specialists should be consulted whenever the use of accelerators is contemplated, and the contractor will need to be very attentive to cleaning casings, pumps, pump lines and tremies quickly, before setting occurs.

### **Other Admixtures**

Other types of admixtures are available for special cases. Examples of these are anti-bacterial and anti-fungal agents, alkali-reactivity reducers, bonding admixtures, corrosion inhibitors and pumping aids. Except for pumping aids, which are normally polymer products added to the concrete prior to pumping to aid in lubricating the pump lines, these are rarely used in drilled shaft construction. The reader should be aware of their existence.

### **Aggregate and Water**

The materials to be used in the concrete, in addition to the cement, pozzolanic additives, and chemical admixtures, consist of the aggregates and mixing water. Natural materials are normally used as aggregates for drilled shaft concrete. Lightweight aggregates are not ordinarily recommended. It is recognized that natural aggregates (natural gravel, sand and crushed stone) that are used for drilled shaft concrete in the United States are typically stronger and less permeable than the hydrated cement paste in the hardened concrete. For this reason, conventional wisdom states that the largest aggregate must be as large as possible [up to 5 mm (2 in.)] and that the aggregate should be well-graded, in order to minimize the amount of paste in the mix. However, for economical construction, the concrete should be designed so that it can fall freely through some distance if it is to be placed in the dry (dry or casing methods, Chapter 3) and should be able to flow freely through the rebar in the cage. For these reasons, relatively smaller aggregate on the coarse end of the spectrum should be used. A maximum size of 19 mm (3/4 in.) is recommended. Good gradation down to smaller sizes is an important characteristic.

All aggregate should be checked to see that the appropriate specifications are met. Some of the relevant specifications of the American Society for Testing and Materials for concrete aggregate are ASTM C 33-93 (1995), Specification for Concrete Aggregate; ASTM C 87-90 (1995), Test for Effect of Organic Impurities in Fine Aggregate on Strength of Mortar; and ASTM C 227-90



(1995), ASTM C 289-94 (1995), ASTM C 295-90 (1995), and ASTM C 586-92 (1995), all of which address tests that measure the alkali susceptibility of aggregates. As an example of the importance of testing the aggregates that are used in concrete, there are aggregates in existence that can expand when exposed to portland cement, which has a very high pH value (above 12) and is therefore very alkaline. Such action will have a negative effect on concrete strength, stiffness and durability. Water used for mixing the concrete should be potable (free of organic contamination and deleterious materials) and should have low chlorides and sulfates contents.

## **Workability**

One of the most important characteristics of concrete to be placed by tremie or by pumping is high workability; this characteristic is essential because, as noted previously, the concrete must compact and flow through the rebar cage without the use of vibration. A number of methods are available for measuring the workability of concrete, but the slump test is used almost exclusively in practice. Concrete for drilled shafts should have a slump of 150 mm (6 in.) or higher when the dry method is used and about 200 mm (8 in.) when the wet or casing methods are used. Some authorities, such as Sliwinski (1980), describe the appearance of good drilled shaft concrete as "collapse" concrete, a mix that will simply fall freely when the slump cone is removed. The slump test is not very good for measuring the workability of a mix of collapse concrete; however, no other test is generally accepted for field use. The long-term performance of collapse concrete with slumps exceeding about 200 mm (8 in.) has not been established. Since slumps higher than this are not ordinarily needed in drilled shaft construction, specifications should limit slumps to no higher than about 200 mm (8 in.).

High workability is best achieved with rounded natural aggregate and natural sand. However, crushed stone is being used more and more as rounded natural aggregate supplies are being depleted. If crushed stone is used as the aggregate, care must be taken to wash away all of the dust, because the dust can use up water that is ordinarily available for lubrication and hydration of the concrete mix.

## **Mix Proportions**

The proportions of water, cement, additives and aggregate required to achieve a given set of target concrete properties (slump, loss, strength, permeability) should be determined on a job-by-job basis using the trial mix method (e. g., PCA, 1988). The trial mix testing and evaluation of that testing should be carried out by a qualified concrete laboratory. Care should be taken to verify that the conditions that existed in the trial mix tests continue to exist during construction. If conditions change (aggregate source, cement source, ambient temperature, etc.), new trial mix studies should be conducted to ensure that the target properties will continue to be achieved.

A trial mix study for drilled shaft concrete should include the construction of a graph of slump loss versus time after batching. Such a graph is shown in Figure 8.1. A desirable slump loss relationship is depicted, in which slump reduces slowly and still exceeds 100 mm (4 in.) four

hours after batching. Four hours was selected because ordinarily this is the maximum time required for concrete placement. Other times could be selected as required. An undesirable slump loss relationship is also shown, in which the initial slump is quite appropriate but in which slump loss occurs rapidly about 90 minutes after batching, which is a potential problem when superplasticizers are used. Care should be taken to perform slump loss tests at the approximate temperature at which the concrete will exist in the field. An increase in temperature of about 10 deg. C (18 deg. F) will increase the rate of slump loss by a factor of approximately 2, which means that a slump loss graph made in the laboratory at 22 deg. C (72 deg. F) will be very misleading for concrete being placed in the field at 32 deg. C (90 deg. F).

Table 8.1 shows typical mix proportions for drilled shaft concrete that are suggested by Sliwinski (1980). The proportions shown in Table 8.1 will produce a cohesive concrete mix with a slump of about 175 mm (7 in.). The water-cementitious material ratio is 0.55. Note that the coarsest aggregate is small, no larger than 19 mm (3/4 in.), to allow for good flow through the rebar cage without vibration and to resist segregation in the event that free-fall-placement is used. Note also that the mix proportions will change from location to location, depending on the quality of the portland cement and aggregates available locally; however, Table 8.1 can be considered fairly typical and can be used to visualize the approximate proportions of the various components that are needed in drilled shaft concrete. No pozzolanic or chemical additives are shown in this particular mix.

The mix in Table 8.1 should produce a height of bleed water that is less than 1 per cent of the depth of the pour, which is acceptable according to Sliwinski, as long as bleeding does not occur through channels. Fly ash in the concentration shown in Table 8.2, or air-entraining agents in the concentrations shown in Table 8.3, will reduce bleeding if channelized bleeding becomes a problem, and fly ash should also be considered if the drilled shaft has a diameter exceeding 1.53 m (5 ft) or contains a bell, in order to reduce the heat of hydration.

If the site conditions are aggressive, consideration should be given to producing a concrete of reduced permeability by adding one of the pozzolans to the mix. An aggressive subsurface environment can be considered to exist when the soil, rock or ground water has free oxygen and/or carbon dioxide (e. g., partially saturated soils), has high concentrations of sulfates or chlorides, or is substantially acidic. Some industrial contaminants (usually organic wastes, alkalis and salts) can also be aggressive. Expert assistance should be solicited when industrial contaminants are encountered on a site. Table 8.2, based on recommendations contained in Bartholomew (1980), suggest upper limits of concentrations for some typical ground water and soil contaminants. If concentrations at the jobsite exceed these values, preventive action should be taken. If levels of contaminants exceed the "negligible" levels shown in Table 8.2, the use of sulfate-resisting cement and/or of pozzolans in the concrete mix are indicated. If they are at "high" levels, a concrete specialist should be contacted. Preventive action in such cases could require major redesigns of the concrete mix or use of permanent casing through the highly aggressive zone.

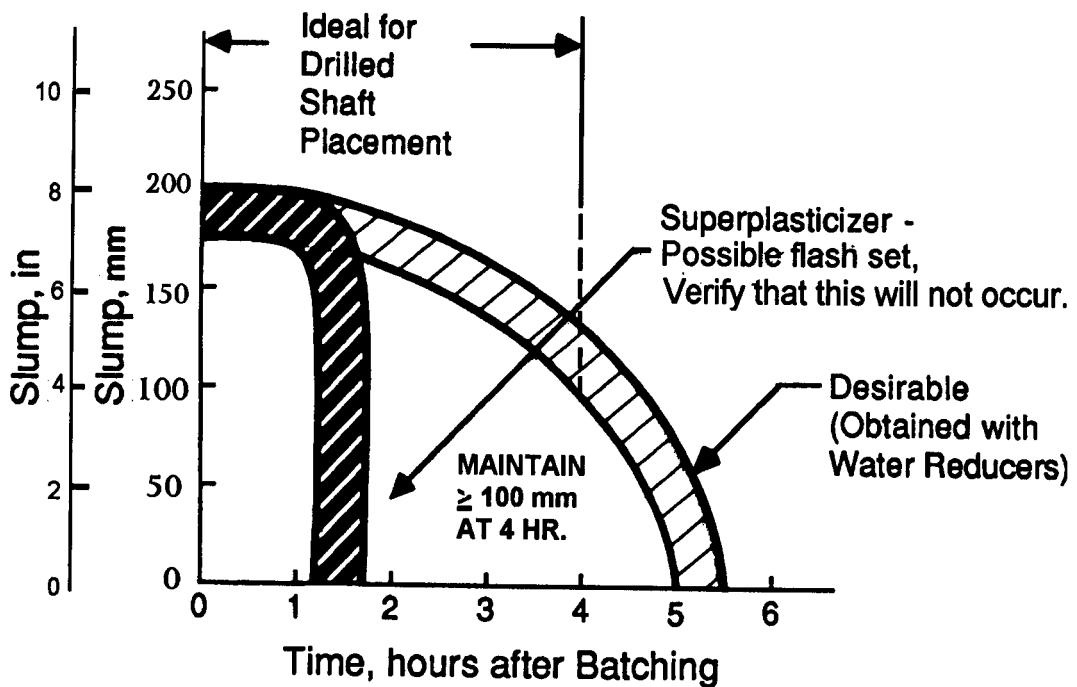

Figure 8.1. Slump loss relationship from a trial mix design

Table 8.1. Typical mix proportions for workable drilled shaft concrete (after Sliwinski, 1980).

Material	Weight, kg/m <sup>3</sup> (lb/yd <sup>3</sup> )	
Portland cement	400 (674)	
Aggregate	Passing 25.4 mm (1.00 in.) Passing 19 mm (0.75 in.) Passing 9.5 mm (0.375 in.) Passing 4.8 mm (0.188 in.) Passing 2.3 mm (0.09 in.) (#7 Sieve) Passing 1.3 mm (0.05 in.) (#14 Sieve) Passing 0.5 mm (0.02 in.) (#25 Sieve) Passing 0.02 mm (0.01 in.) # (52 Sieve) Passing 0.15 mm (0.006 in.) (#100 Sieve)	1754 (2950) 1754 (2950) 1070 (1800) 613 (1033) 544 (915) 491 (826) 403 (679) 140 (236) 0 (0)
Water (including water in aggregate at time of batching)	220 (371)	

Table 8.2. Concentrations of typical aggressive soil and ground water contaminants (after Bartholomew, 1980)

Contaminant	Negligible Level	High Level
Sulfates	150 parts per million	500 parts per million
Chlorides	2000 parts per million	10,000 parts per million
Acids	pH > 6.5	pH < 5.5

Each of the contaminants in Table 8.2 has the potential for causing deterioration in the strength of the concrete, particularly at the interface between the concrete and the geomaterial, where the transfer of load from the foundation to the geomaterial is taking place. Sulfates react with the tricalcium aluminates ( $C_3A$ ) in portland cement to produce ettringite. Sulfate-resistant cement is low in  $C_3A$  and so reduces the formation of ettringite. Chlorides can attack the rebar, causing corrosion of the steel and subsequent cracking of the concrete produced by the expanding corrosive material. In a high-chloride environment, epoxy coated rebar can be used as an alternate to, or in addition to, low-permeability concrete; however, some state DOT's prefer to use only low-permeability concrete produced with the addition of pozzolans.

Returning to the example mix shown in Table 8.1, it is also desirable to add a low-range water reducer to the mix and to reduce the weight of water by about 20 per cent to reduce the water/cementitious material ratio to 0.45 or less [and also to raise the slump of the mix to about 200 mm (8 in.)] if (a) the pour can occur under a drilling slurry, if drilling slurry can be used in the casing method or if there is a possibility that ground water will be trapped behind casing, or (b) if the concrete might be placed in an aggressive environment. Retarders are essential additives if construction is to take place under high ambient temperatures [ $> 27$  deg. C. (80 deg. F)], or if the design of the drilled shaft is such that the time required to place the concrete can be such that the slump in the first concrete placed within the drilled shaft excavation will be less than 100 mm (4 in.) by the time the last concrete is placed. Certain additives can act as both water reducer and retarder.

The use of air-entraining agents should be considered if the depth of the frost penetration zone is below the cutoff level of the shaft or if the pour will extend into the substructure.

Table 8.3 shows approximate amounts of some pozzolanic additives that should be considered for drilled shaft concrete. These amounts vary from location to location since the quality of both the cement and pozzolanic additives vary. Therefore, Table 8.2 should be considered only a general guide. Local concrete specifications should be consulted before arriving at a final mix design.

Table 8.3. Typical proportions of pozzolanic additives.

Type of Additive	Amount of Additive
Fly ash (Type F)	Replace 15 per cent of the portland cement in the mix by weight with an equivalent weight of fly ash
Silica fume	Replace 7.5 per cent of the portland cement in the mix by weight with an equivalent weight of silica fume
Slag	Generally, about the same as fly ash. Varies -- consult local experts

Table 8.4 lists some chemical admixtures and approximate dosages that are permitted by the Texas Department of Transportation (TxDOT, 1996), which requires that all chemical admixtures for concrete be prequalified. Please note that the list in Table 8.4 is not complete and that other admixtures are perfectly acceptable according to TxDOT. The products shown are merely provided as examples. Permissible admixtures may vary from state to state.

Figures 8.2 - 8.4 are photographs of potential concrete mixes for drilled shafts. The photograph in Figure 8.2 shows the results of a slump test where the concrete has a slump of 50 mm (2 in.). The workability of the mix is insufficient for the placement by a tremie, by pump, or even by free fall through a dropchute, because the concrete will not flow readily through the tremie, will not compact under its own weight, and will not flow through the rebar cage without vibration (which is undesirable in drilled shafts). Serious placement problems can arise if such a concrete is used. It is possible that the addition of a high-range water reducer will bring this mix to an acceptable level of workability, but care must be taken that a flash set will not occur as the concrete is being placed.

Figure 8.3 shows a concrete mix that has a high slump, but the mix design is poor. The mix is deficient in cement and fine aggregate, and the coarse aggregate is too large. There will doubtless be segregation and bleeding during placement of this concrete, and it is very likely that the concrete, despite the high slump, will not flow through the rebar cage properly. Slump alone, therefore, is not a complete measure of workability.

The concrete shown in Figure 8.4 is an appropriate "collapse" mix for drilled shafts when the concrete is to be placed by a gravity-fed or pump-fed tremie. The workability is high, placement will be easy, and compaction will be achieved under its own weight. The maximum size of the coarse aggregate is 12.7 - 19 mm (1/2 in. to 3/4 in.), and the sand content and cement content are relatively high compared to the coarse-aggregate content. The mix is homogeneous and cohesive, and placement can be made without segregation or bleeding. The high slump has been

achieved with a W/CM ratio of 0.45 through the use of a low-range water reducer. The smaller size of the coarse aggregate will allow the concrete to flow through the rebar much better than the mixes shown in Figures 8.2 and 8.3.

Table 8.4. Typical proportions of some prequalified chemical admixtures  
(extracted from TxDOT, 1996).

Type	Product	Producer	Permissible Dosage: mL / 100 kg. of cement (fl. oz. / 100 lb. of cement)
Water Reducers (Low Range)	Daracem 65	W. R. Grace	223 - 446 (3 - 6)
	Eucon WR 75	Euclid Chem. Corp.	149 - 223 (2 - 3)
	MasterPave	Master Builders	297 - 446 (4 - 6)
	Pozzolith 300N	Master Builders	223 - 372 (3 - 5)
	Monex LW	Monex Resources	223 - 446 (3 - 6)
	Plastiment NS	Sika Corp.	149 - 297 (2 - 4)
Water-Reducing Retarders	Daratard-HC	W. R. Grace	149 - 446 (2 - 6)
	Eucon Retarder	Euclid Chem. Corp.	595 (8)
	Delvo Stabilizer	Master Builders	223 - 372 (3 - 5)
	Pozzolith 300R	Master Builders	223 - 372 (3 - 5)
	Monex NR	Monex Resources	297 - 595 (4 - 8)
Plastiment	Sika Corp.	149 - 297 (2 - 4)	
Air-Entraining Agents	Daravair 1000	W. R. Grace	56 - 223 (3/4 - 3)
	Air-In XT	Hunt - Southern	37 (1/2)
	Air-Mix 200	Euclid Chem. Corp.	37 - 74 (1/2 - 1)
	MB-VR	Master Builders	19 - 297 (1/4 - 4)
	Monex Air 30	Monex Resources	37 - 297 (1/2 - 4)
Sika AEA-15	Sika Corp.	37 - 112 (1/2 - 1 1/2)	
Water Reducers (High Range) <i>[Use only in special circumstances]</i>	Daracem ML500	W. R. Grace	446 - 1340 (6 - 18)
	Eucon 37	Euclid Chem. Corp.	744 - 1190 (10 - 16)
	Mighty 150	Boremco Specialty	744 - 1487 (10 - 20)
	Pozzolith 400N	Master Builders	744 - 1487 (10 - 20)
	Monex SP	Monex Resources	446 - 1487 (6 - 20)
	Sikament 300	Sika Corp.	446 - 1340 (6 - 18)

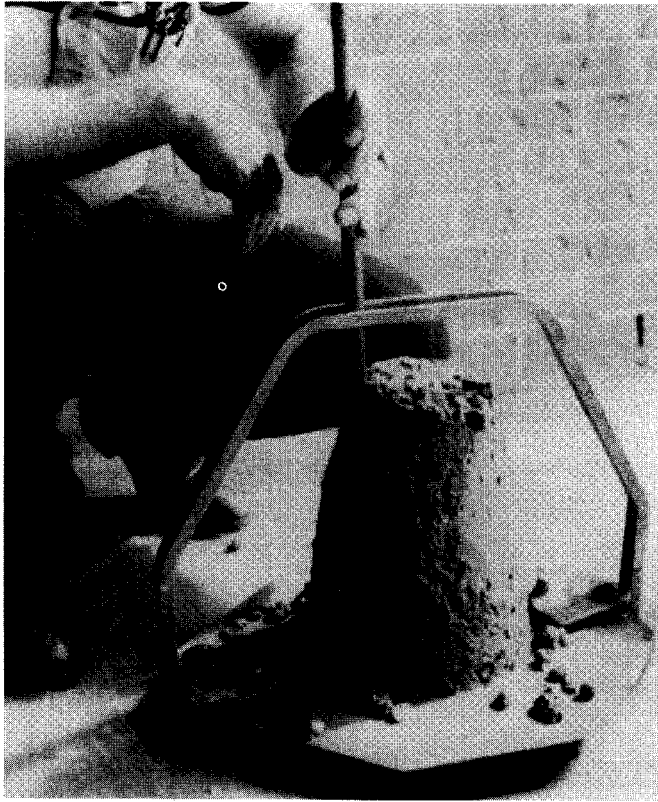

**Figure 8.2. Concrete with insufficient workability for use in drilled shafts**

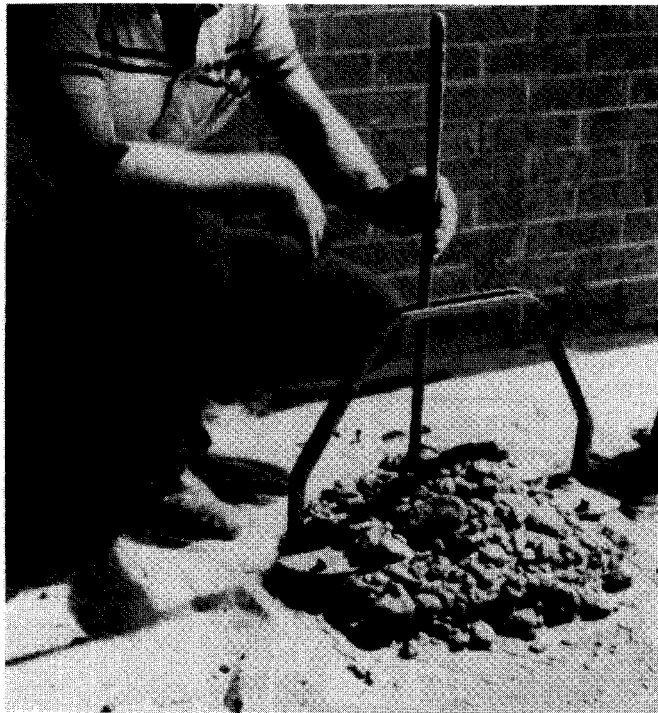

**Figure 8.3. Concrete with high workability but with improper mix design for tremie placement**



Figure 8.4. Concrete with high workability and with good mix design for tremie placement

## **Strength**

The strength of drilled shaft concrete is normally specified by its 28-day compressive strength in 152-mm- (6-in.-) diameter by 305-mm- (12-in.-) deep cylinders. Most mixes for drilled shafts will be adequate if they produce 28-day compressive cylinder strengths in the range of 24.1 to 27.6 MPa (3500 - 4000 psi). However, higher strength concrete can be useful under conditions in which the designer wishes to make use of very strong bearing strata and reduce the cross-sectional area of the drilled shaft, which will produce high compressive stresses in the concrete, or for cases in which high combined bending and axial stresses will be applied to the drilled shaft.

## **CONCRETE TESTS**

### **Tests at the Batch Plant**

Most concrete for drilled shafts is supplied by ready-mix plants, but in some cases the job is large enough to justify a batch plant at the jobsite. Some suppliers also can bring batched dry ingredients to a job site and blend and mix them with water only when the contractor is ready to make the pour. This has obvious advantages. In any case tests at the concrete batch plant site are advisable. Items that can be checked are the nature and quantities of the components of the mix, the aggregates, cement, water, and admixtures. There have been occasions when errors have been made at the plant in the mix proportions, with the error not being found until cylinders are broken at some later date. The consequences of such errors can cause great difficulty and construction delays.



It would not be unusual for the aggregates to change as a job progresses, such that a new mix design would be required. Depending on how the aggregates are stored, the water content may experience rapid changes with time so that the amount of water to be added to the mix would need to be adjusted daily or even more frequently.

An important factor in the making of concrete is the temperature of the components of the mix. For example, hot aggregates and mixing water could produce a flash set in the concrete during placement. An inspector at the mix plant should check the temperature of the components and of the completed mix for conformance with the specifications.

### **Tests at the Jobsite**

The organization of the job must be such that the time required to perform tests at the job site is kept to a minimum. There are two reasons: first, the excavation should remain open for as short a period of time as possible to reduce the chance of creep and caving in the geomaterial and, second, the concrete should be placed as rapidly as possible so that the workability of the concrete will remain high during the entire pour. Because of the first requirement, batch-plant inspection and the timely ordering and delivery of concrete should be emphasized. Jobsite inspection and possible rejection of concrete is not desirable because a delay in placement of concrete may result in caving of the borehole, collection of sediment on the top of the concrete already placed in an excavation during a slurry pour, or a slump loss that is so large that casing cannot be extracted as planned. While it is not strictly a test of the concrete, care must be taken to ensure that sufficient concrete is at the jobsite or in transit to the jobsite so that the entire pour can be made without delay. Thus, it is essential for the contractor to make an estimate of the as-drilled size of the excavation and to order enough concrete to fill the as-drilled excavation, allowing for some inevitable losses.

Jobsite concrete testing should be viewed as a process of verification and not as a process of control. The recommended minimum jobsite testing is to measure temperature, which can be done rapidly, and slump, and to recover cylinder samples for later strength testing. An experienced worker can measure the slump by the use of a slump cone. Different state DOT's have different rules for frequency of sampling. It is recommended that at least three cylinder samples be made for each drilled shaft and that a minimum of one cylinder be made from each ready-mix truck. Cylinder samples can be made from small stockpiles that are recovered from each truck in a few seconds, freeing the truck to deposit concrete in the borehole immediately. If the concrete is to be pumped, slump loss can occur in the pump line so that good practice is to take samples for slump testing at the discharge point. Cylinders should be cured and tested in accordance with state DOT specifications.

There are instances when excessive jobsite testing can lead to harmful effects. For example, on one project the air content of the concrete was being measured for each of the trucks that came to the job. The volume of the concrete to be placed was large, and several trucks were standing by while the concrete was being tested. There was difficulty with the collapse of the rebar cages

during placement of the concrete, possibly because the concrete was losing workability during the delay that was incurred in performing the air content tests.

Because many jobs require placement by gravity tremie or pump, the concrete that arrives first at the top of the shaft is normally that which was placed first. Therefore, the first concrete that reaches the top of the shaft should be examined, and possibly be subjected to slump testing, to see that its workability has remained good throughout the pour, and some overpour should be made to confirm that good-quality, uncontaminated concrete continues to flow from the borehole.

Where concrete is placed with a dropchute (e. g., in the dry or casing methods), the first concrete placed will remain on the bottom of the borehole. It is still desirable that this concrete remain workable until the last concrete is placed at the top of the drilled shaft to ensure that ground pressures are reestablished. Workability of the first concrete placed can be verified by setting aside a small stockpile of concrete from the trucks from which the first concrete was obtained and conducting slump tests on that concrete after all concrete has been placed. Care should be taken, however, to keep the concrete stockpile at the same ambient temperature that exists deep in the ground at the construction site [often between 13 and 19 deg. C (55 and 66 deg. F) in the contiguous 48 states]; otherwise, the slump values will not be representative of the condition of the in-place concrete.

### **Addition of Water at Job Site**

One of the reasons for rejecting a batch of concrete is that the slump is too low. The question always arises as to the advisability of adding water to the concrete in a ready-mix truck. The added water will increase the workability, but it will have the detrimental effect of reducing the strength and durability of the concrete. The result of adding water at the jobsite could be a significant change in the characteristics of the mix and increase the possibility of segregation as the pour is made.

In some cases only part of the mixing water is added at the batch plant, and the remainder is intended to be added at the jobsite. Furthermore, some mixes will be tolerant of some extra water. In either of these cases, the amount of water permitted to be added at the jobsite should be stated on the mix design sheet carried by the ready-mix truck driver. Additional water can then be added without harm. If the slump is then adequate, the pour can begin.

If travel times from the batch plant to the jobsite are unpredictable, the process mentioned previously, bring dry ingredients to the jobsite, and mixing them with water just prior to the pour, should be considered.

If, after all water permitted by the mix design has been added, the slump is still not high enough, the inspector must note the deficiency and inform the contractor. The contractor is then faced with the decision of adding water sufficient to bring the slump up to the minimum value or

ordering new concrete. The decision is a difficult one. Waiting for new concrete to arrive will allow time for deterioration of the borehole, possibly even sloughing or collapse of the borehole or similar negative events. On the other hand, adding water beyond that which is permitted may preserve the borehole but produce substandard structural concrete. Where it is necessary to produce durable concrete of low permeability (aggressive environments), the addition of excess water should be absolutely disallowed. Where this is not a concern, at the Engineer's discretion, the contractor might be allowed to proceed at his or her own risk. If the cylinder strengths measured at a later date are not adequate, however, the contractor should be required to repair or replace the questionable shaft or shafts at his or her expense. Repair and replacement techniques are discussed in Chapter 18.

## **PLACEMENT OF CONCRETE**

### **Placement by Free Fall**

It is possible to place concrete by free fall if the method of construction is the dry method or the casing method. Most specifications allow the concrete to fall freely for a short distance. The problem with the concrete falling freely to position is that there may be segregation. Segregation is more likely to occur if the concrete is allowed to strike an obstruction as it falls. Therefore, the concrete should not fall through the rebar cage or strike the sides of the excavation. Figure 8.5 shows concrete being placed directly out of the chute of a ready-mix truck, without a dropchute to direct the concrete, which is not advisable for this reason.

The flow of the concrete in free fall should be directed to the center of the borehole and cage by a dropchute or other acceptable device to keep the stream of falling concrete centered in the hole. A flexible hose that can be cut off as the pour proceeds that is attached to a hopper that receives the concrete from the ready-mix truck ("elephant trunk") provides an adequate dropchute. Figure 8.6 shows a different type of dropchute. A rigid steel pipe is attached below the hopper in which holes have been cut every 1.53 m (5 ft) of depth. The state in which this dropchute is used allowed a maximum free fall distance of only 1.53 m (5 ft). With this dropchute, it is possible to discharge directly from the ready-mix truck (either into the hopper on top or into one of the side holes as the level of concrete in the hole rises), while ensuring that the 1.53-m (5-ft) free fall distance is not exceeded. In either case, the length and position of the bottom orifice of the drop chute must be controlled so that the concrete does not strike an obstruction as it falls.

Several detailed studies have been conducted to investigate the effects of free fall on drilled shaft concrete. Baker and Gnaedinger (1960) report a study on the influence of free fall on the quality of concrete. The concrete was placed in an excavation that was 0.914 m (36 in.) in diameter and 24.4 m (80 ft) deep. The concrete was guided at the top of the excavation and allowed to fall freely without striking the sides of the excavation. The design of the concrete called for a strength of 34.5 MPa (5000 psi) at 28 days. After the concrete had set for approximately two weeks, the drilled shaft was cored, and cores with a diameter of approximately 54 mm (2 1/8 in.) were obtained. These cores were examined visually. An excavation was made to a depth of 15.3

m (50 ft) along the side of the shaft, and the strength of the concrete was tested by use of a Schmidt hammer. Free fall was found not to result in any observable segregation of the mix, and the compressive strength of the concrete was not reduced.

Bru et al. (1991) describe studies made at the Laboratoires des Ponts et Chaussées in France in which cohesive concrete was allowed to fall freely for 9 m (30 ft) without striking rebar or the side of the borehole. No evidence of strength loss in the concrete in the bottom 0.56 m (1.8 ft) was observed based on wave velocity measurements.

Kiefer and Baker (1994) conducted a detailed parametric field study of the effects of free fall, in which the slump and coarse aggregate size of the concrete were varied, superplasticizers were used in some mixes and some drops were made through the reinforcing steel. The slump varied from 100 to 200 mm (4 to 8 in.), the coarse aggregate size varied from 16 to 32 mm (5/8 to 1 1/4 in.); a retarder was used in the mix; and the W/CM ratio was held constant at 0.53. The diameter of the cage was 0.914 m (36 in.) and maximum drop height was 18.3 m (60 ft). There were 5 - 5 1/3 sacks of portland cement and a weight of fly ash equivalent to about 1 sack of portland cement per cubic yard (0.765 cubic meter), together with enough fine aggregate to make a cohesive concrete mix. Core samples were recovered and Schmidt hammer tests were made,



Figure 8.5. Placing concrete directly from the ready-mix truck without a dropchute

as above, and access shafts were made to permit observation of the concrete in the constructed shafts. No loss in compressive strength or segregation in the concrete was observed when the concrete was dropped centrally inside the cages with any of the mix variations indicated above. In fact, there was a slight positive correlation between drop height, density of the cores and compressive strength, suggesting that the impact of the free-fallen concrete drove out air, produced denser concrete, and thereby produced stronger concrete. Similar results were obtained when the W/CM ratio was reduced and high-range water reducers were added. Dropping the concrete in such a manner that it fell through the rebar cage did not, in most cases, result in reduced strength or increased segregation, although this action did result in moving the cage off position and some contamination of the concrete as it traveled down the soil sides of the borehole.

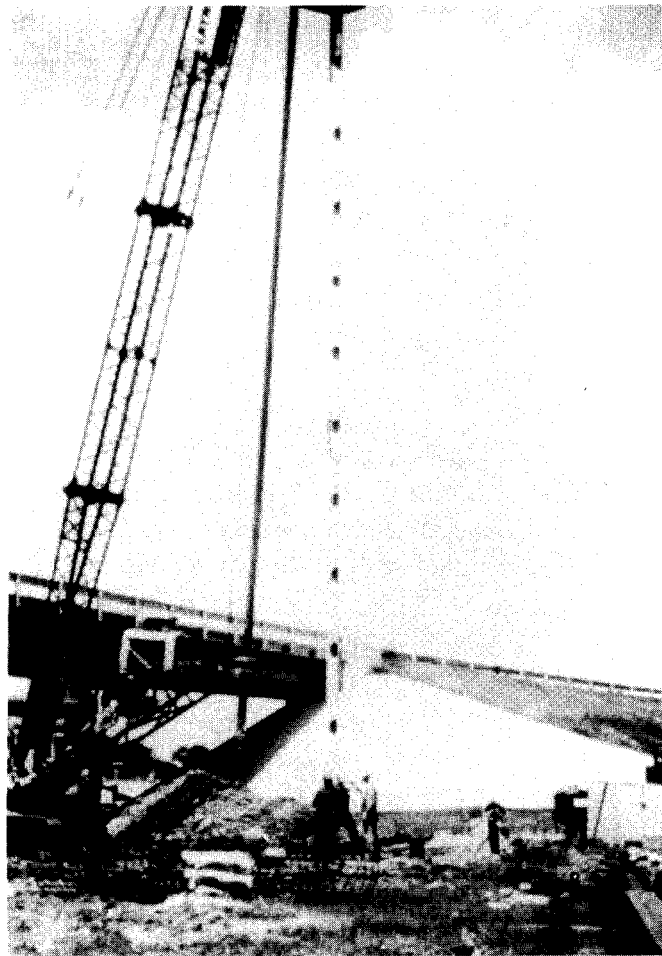

Figure 8.6. Steel dropchute with multiple windows

The authors of this manual have conducted studies of free fall of drilled shaft concrete with a slump of 125 mm (5 in.) and a maximum coarse aggregate size of 38 mm (1.5 in.) for a distance of 9.2 m (30 ft) and have confirmed the above results.

It appears, therefore, that concrete can be dropped freely for distances up to about 24.4 m (80 ft) without problem as long as the concrete does not strike the cage or the borehole wall. Kiefer and Baker (1994) report that keeping the concrete stream away from the rebar cage was not a problem for a depth-to-cage-diameter ratio of 24 or less, and they suggest that free fall could be used to a depth of 36.6 m (120 ft) in a 1.53 m- (5-ft-) diameter cage based on these tests and construction experiences with large-diameter, deep drilled shafts in the Chicago area.

The conclusions given above are not yet reflected in most specifications for the construction of drilled shafts. Some of the possible reasons are that the data on free-fall placement, while convincing, are somewhat limited and that in many instances it would be impossible for the concrete to fall freely without striking the sides of the excavation or the rebar cage (e. g, if the cage is small or if it is battered). A possibility with regard to the placement of concrete by free fall for designers concerned about segregation is to design a concrete mix that can fall against or through obstructions without segregation. Such a mix could be designed with an aggregate with a maximum size of 6.4 to 9.5 mm (1/4 to 3/8 in.). Despite the reluctance of specification writers to allow unlimited free fall, there is a trend toward allowing greater free-fall distances. For example, in 1993 the Texas DOT increased its allowable free fall distance from 1.53 m (5 ft) to 4.58 m (15 ft), which has had a positive effect on the speed with which contractors can install drilled shafts, on the construction equipment needed for some jobs, and, consequently, on costs.

### **Placement of Concrete by Tremie**

The placement of concrete must be made by use of a tremie (steel tube) or flexible hose if the free fall placement is not permitted. Examples of this situation would be if the excavation is partially filled with a fluid (e.g., water), if the drilled shaft is installed on a batter, or if the geomaterial potentially can collapse when shock waves are generated by falling concrete. The tremie or pump line must be used to guide the concrete to an appropriate discharge point in the borehole, usually the center of the bottom of the hole.

Occasionally, a quantity of water will seep into an excavation that was designed for a dry pour. The specific amount of water to be permitted in the hole during concrete placement depends on design considerations. If the drilled shaft is to be founded on rock and to carry load with high allowable bearing pressures [ $>3.5$  MPa (500 psi)] in end-bearing, no water should be allowed, and the water should be removed or the concrete should be placed by tremie or pump line. On the other hand, if the drilled shaft is designed to support load substantially in skin friction or if low end-bearing pressures are used [ $3.5 \leq$  MPa (500 psi)] the usual practice is to allow about 75 mm (3 in.) of water, into which the concrete can be poured by free fall. If water is collecting in the excavation at a relatively rapid rate, such that the above recommendations cannot be met at the time the pour is made, concrete placement by tremie or pump should be required.

## **Placement by Gravity-Fed Tremie**

A gravity-fed tremie is a steel tube, usually with a hopper on the top, that is fed from a pump or by discharging from a bucket. Aluminum should never be used because of reactions with the concrete, and plastic pipe such as PVC should be discouraged because it is not robust enough. The diameter of a tremie tube for gravity placement of concrete depends on the diameter and depth of the excavation; tremies with an inside diameter of 250 - 305 mm (10 to 12 in.) are in frequent use. Some experts suggest that a tremie must have an inside diameter that is at least six times that of the size of the largest coarse aggregate in order to maintain free flow (LCPC, 1986).

Tremies may be assembled from sections with waterproof joints that are about 3 m (10 ft) long that can be connected by threads such that the inside surface is smooth. Such tremies can be disassembled as they are being extracted from the excavation, which minimizes the height that concrete must be pumped or lifted by bucket to charge the tremie. However, most gravity tremies that are in use in the United States are constructed by welding together sections of pipe to form a single tube. The inside surface of the tremie should be smooth to minimize drag on the concrete. The outside surface of the tremie should also be smooth so that there is no danger of a projection becoming hooked on the rebar cage as the tremie is removed during concreting. The wall thickness of the tremie must be sufficient to provide the necessary strength and stiffness.

If concrete is being placed where there is water or slurry in the excavation, the tremie must be deployed so that there is a minimum of contamination of the concrete. Two general procedures are in use: (a) The bottom of the tremie may be sealed with some kind of plate before the tremie is placed in the wet excavation, or (b) a plug of some description may be inserted at the top of the tremie after the tremie is placed in the wet excavation but before the tremie is charged with concrete. Neither of these methods can be used without care, as will be explained in the following paragraphs.

A seal at the bottom of the tremie may be accomplished in several ways. Three possibilities are shown in Figures 8.7 through 8.9. The hinged closure in Fig. 8.7 is designed to remain closed when the tremie pipe is empty, to remain closed as the tremie is being filled with fluid concrete as it is resting on the bottom of the cleaned borehole, and to open when the tremie is lifted. The hinge and latch that extend beyond the outside diameter can cause difficulties by hanging on the rebar cage as the tremie is extracted. The pan-type or "hat" device shown in Figure 8.8 and the steel (or plywood) plate shown in Figure 8.9 are designed to come off when the tremie is filled with concrete and lifted.

The closure devices shown in Figures 8.8 and 8.9 will ordinarily remain in the concrete at the bottom of the borehole and should not produce a defect. A photograph of the closure plate shown schematically in Figure 8.9 is shown in Figure 8.10, and a photograph of a partially extracted gravity tremie near the end of a tremie pour is shown in Figure 8.11. During proper operations, the gravity tremie will produce a surge of concrete when the tremie is first pulled upwards a small distance (about one tremie diameter). This "rush" of concrete occurs without the concrete dropping through the fluid in the borehole and provides enough inertia so that the

concrete forces its way under the fluid at the base of the borehole in order for further flow to lift it out. Note that this action may not be totally effective when the drilled shaft is on a batter, which is further reason to avoid batter shafts if possible.

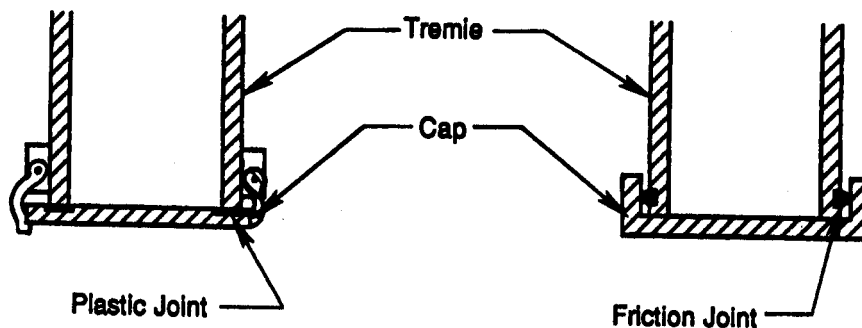

Figure 8.7. Hinged closure  
(from LCPC, 1986)

Figure 8.8. "Hat" closure  
(from LCPC, 1986)

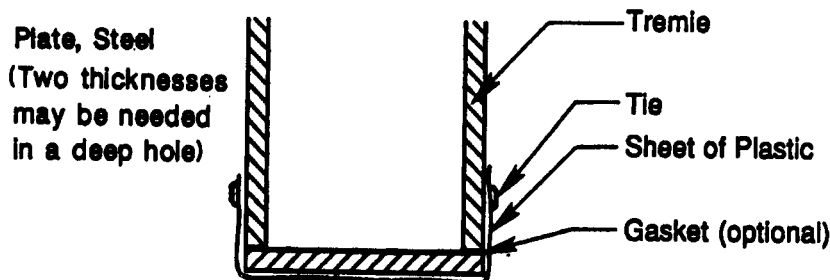

Figure 8.9. Loose-plate closure

Whether concrete placement is by gravity-fed tremie, with a pump or by free-fall placement, if the bottom of the borehole contains loose debris (e. g., settled solids from a drilling slurry), some of this debris will be pushed to the perimeter of the base by the initial concrete surge, reducing the effective base bearing area, and some will be lifted and mixed with the concrete, usually most strongly along the sides of the shaft (Bru et al., 1991). This effect could produce very unfavorable results in rock sockets, in which this concrete is subjected to high shear stresses in the loaded drilled shaft. Construction specifications should therefore address the issue of cleanliness of the base of the drilled shaft at the time it is concreted. The absolute absence of loose debris is seldom needed, but a minimum level of cleanliness should be assured. Unfortunately, no definitive research has been done to establish this level, but experience shows



that if debris is present over about one-half of the area of the base or less to a depth of 12.7 mm (1/2 in.) or less, excessive concrete contamination should not occur, and the completed drilled shaft should be able to carry its design load without problem if the bottom of the drilled shaft is not a rock socket. In rock sockets, more severe restrictions on base cleanliness may be required.

Occasionally, the closure device at the bottom of a gravity-fed tremie will fail to open. This problem can be caused by an insufficient difference in the hydrostatic pressure in the slurry and in the concrete at the bottom of the tremie. The slurry may not have been cleaned prior to starting the pour, so there may be insufficient differences in the unit weights of slurry and concrete. Other factors that relate to a failure of the concrete to flow are as follows.

- The tremie is too small for the workability of the concrete. If the tremie has a diameter less than 250 mm (10 in.), the concrete should have a slump of about 200 to 225 mm (8 to 9 in.) in order to flow, and the maximum size of the coarse aggregate should be 12.7 mm (1/2 in.) or less.
- The tremie is improperly prepared for use. The inside of the tremie must be cleaned after each use and it must be cooled if stored in the sun. The combination of an ill-prepared tremie and concrete with poor workability can defeat a tremie pour.



Figure 8.10. Photograph of simple plywood loose plate closure on a gravity-fed tremie

- The concrete has large inclusions that plug the tremie. There are occasions when a chunk of unmixed cement or a block of concrete is in the concrete truck by mistake. The plugging of the tremie by such an inclusion can cause great difficulty. It can even cause a pour to be lost. The placing of a grillage of steel bars at the top of the hopper on the tremie to retain such inclusions is good practice.

There are also two potential problems that are associated with the initial charging of the tremie with concrete: (a) the concrete can segregate during placement, and (b) air in the tremie will prevent the complete filling of the tremie. The problem of segregation may be lessened or eliminated if the maximum size of the coarse aggregate is 19 mm (3/4 in.) or smaller. A scheme for removal of the air from the pipe is to place a temporary breather tube on the bottom before the concrete is placed, as shown in Figure 8.12. Most observers indicate, however, that segregation seems not to be a problem with the initial charging of a tremie and that air is not a problem if the tremie is filled slowly.



Figure 8.11. Photograph of gravity-fed tremie partially extracted

Several types of plugs or "pigs" may be inserted at the top of the tremie to prevent the contamination of the concrete by slurry or water if the contractor chooses not to use a bottom closure device with a gravity-fed tremie. The plug serves the same purpose as the closure plate, or cap, namely to prevent mixing of the concrete with the fluid in the borehole. It is a device that is placed in the top of the tremie and pushed through the tremie and out the discharge orifice at the bottom by the weight of the fluid concrete, always keeping the water or slurry below the plug separated from the fluid concrete above. Preferably, the plug should float up to the surface of the concrete during the pour, but it should be of such a consistency that it will not cause a defect if it remains in the shaft. Two types of plugs are shown in Figures 8.13 and 8.14. The polystyrene plug shown in Figure 8.13 is precut to split into four pieces upon reaching the bottom of the tremie. The plug is dimensioned to be slightly larger than the inside of the tremie. The plug shown in Figure 8.14 is made of cement paste. This plug is designed to remain in the concrete after exiting the tremie. Although used by many contractors, a soccer ball or a similar sports ball is not as effective as the types of plugs discussed here. Such a ball may collapse under the pressure of the concrete column before reaching the bottom of the tremie and, thus, fail to accomplish the desired separation of concrete and slurry.

When a plug is used, the slurry or water (and some air) that are in the tremie tube will be displaced as the plug moves down. The bottom of the tremie may be notched as shown in Figure 8.15 so that fluids can be expelled with the bottom of the tremie resting on the bottom of the excavation.

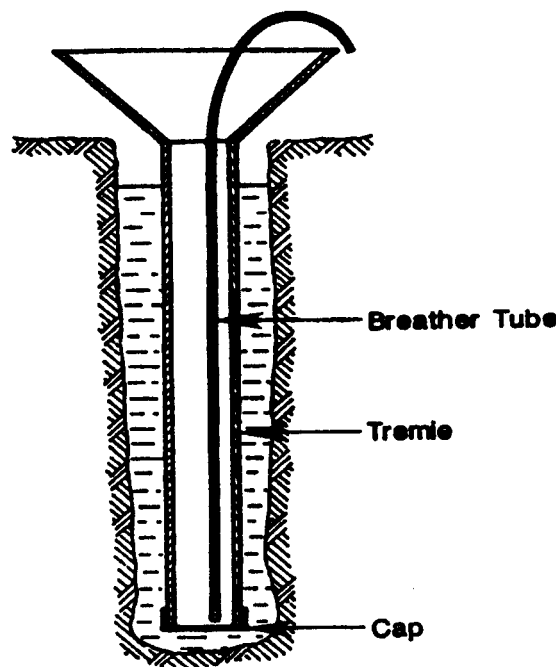

Figure 8.12. Capped tremie pipe with breather tube (from LCPC, 1986)

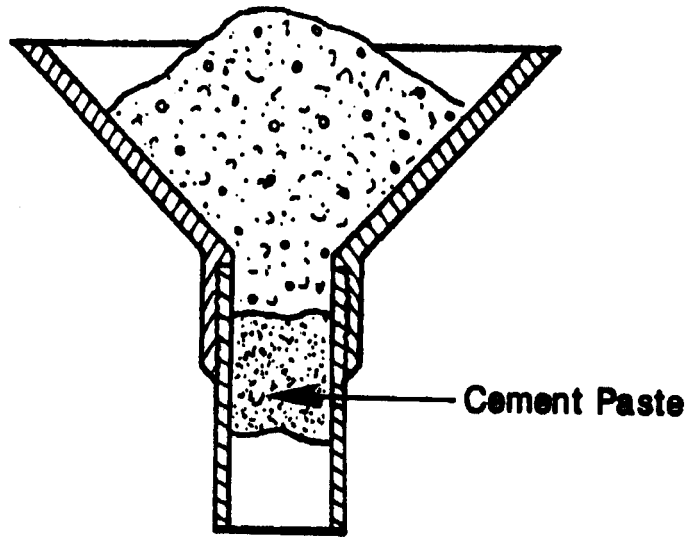

Figure 8.13. Polystyrene plug (from LCPC, 1986)

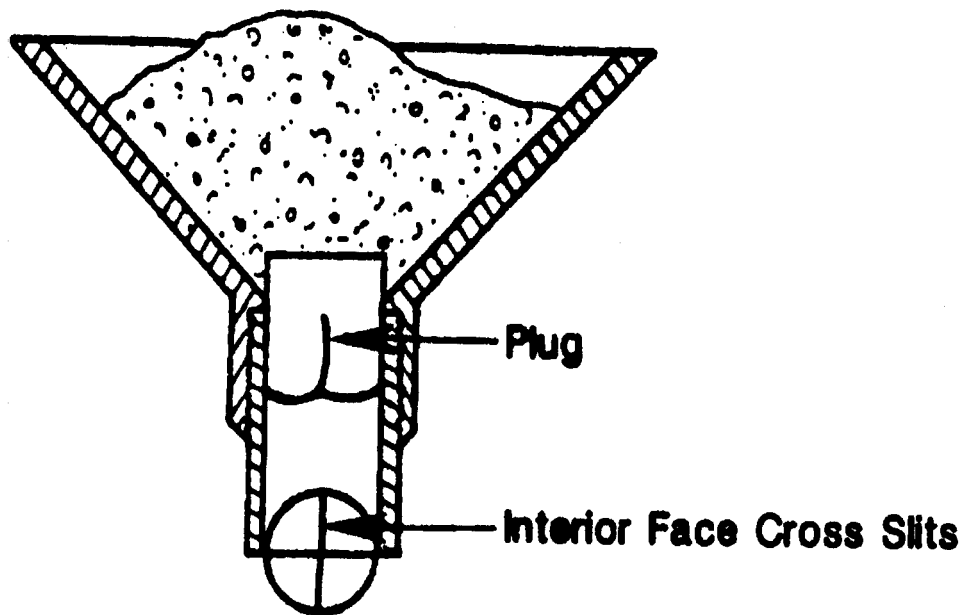

Figure 8.14. Plug of cement paste

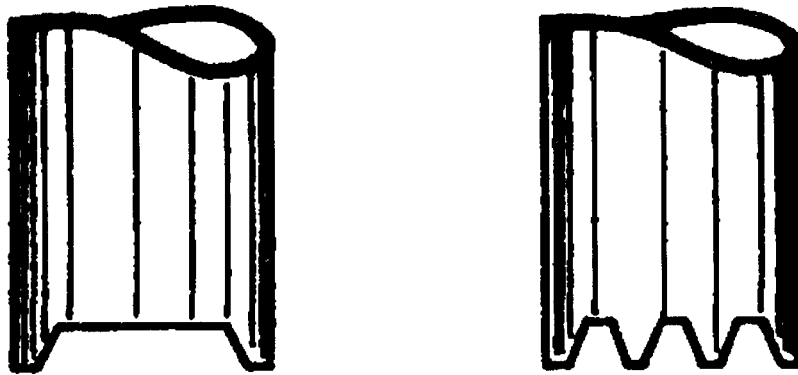

Figure 8.15. Notching of lower portion of tremie tube (from LCPC, 1986)

If a plug is used, the tremie will have to be raised some distance to allow the plug to pass out of the tremie. This results in some minor leaching of the first small amount of concrete that is placed. Although there is no evidence that this effect has ever been problematic, some contractors avoid the use of plugs and only use closure plates. Plugs designed to separate fluids that are used in the petroleum industry have sometimes been used in the construction of drilled shafts. Some of these plugs are quite long, and the tremie will have to be raised a considerable distance to discharge the plug. Then, the concrete will have to fall a considerable distance through the slurry or water, and significant leaching can occur. Furthermore, this weakened concrete may not be flushed to the surface where it can be discarded. A possible distribution of the leached concrete in such a case is shown in Figure 8.16. For this reason, plugs should be as short as possible.

When the concreting is initiated with the tremie, there is usually a large difference in the hydrostatic pressure between the concrete at the bottom of the tremie and the water or slurry in the borehole. Therefore, the initial flow surge of the concrete will be relatively large. As the column of concrete rises in the borehole, the difference in the hydrostatic pressures will decrease, and the rate of flow of the concrete will decrease. Depending on the length of the tremie that extends above the borehole, the fluidity of the concrete, and the cleanliness of the interior surface of the tremie, the flow of concrete may cease, and it will be necessary to raise the tremie to start the concrete flowing again. Careful attention must be given at this stage of the operation to see that the bottom of the tremie stays well below the top of the column of fresh concrete. A minimum penetration of 1.53 m (5 ft) is recommended. Furthermore, the tremie should not be lifted and lowered rapidly ("yo-yoed") to start or restart the flow of concrete. The rapid raising and lowering of the tremie can cause serious contamination of the concrete.

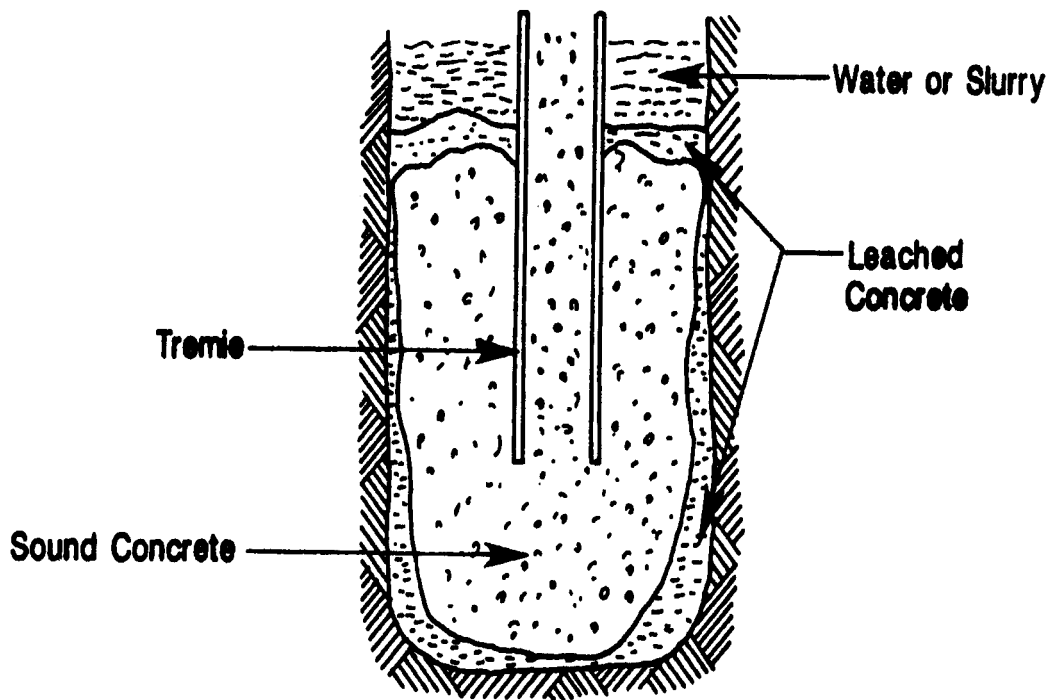

Figure 8.16. Potential distribution of leached concrete resulting from excessive initial lifting of gravity-fed tremie (from LCPC, 1986)

In excavations of large diameter, 2.1 m (7 ft) or more, two tremies may be used in order to minimize the time of placement. Care must be taken to see that the two tremies are fed about equally. An alternative is to use one larger tremie and to charge the single tremie from two ready mix trucks simultaneously. Slurry-filled drilled shafts 3.66 m (12 ft) in nominal diameter and 42.7 m (140 ft) deep were successfully concreted within 4 hours using a double-truck feed into a 380-mm-(15-in.-) ID gravity tremie at a major highway interchange in Texas. In any case, the concrete should be placed at a steady rate.

### Placement by Pump

A concrete pump is used frequently to transport the concrete from a convenient discharge location for the ready-mix trucks to the gravity-fed tremie. Another frequent use of the concrete pump is to transport the concrete directly into the borehole. A pump line, 100 to 150 mm (4 to 6 in.) in inside diameter, can be run from the pump directly into the borehole. It is preferable that the portion of the line that is in the borehole be a rigid steel tremie. The line running from the pump to the tremie is usually flexible. However, complete flexible-line systems have been used successfully as long as they have been designed so that they stay straight within the borehole (e. g., with the use of a weight on the bottom of the flexible line). In general, concrete can be placed

much more rapidly with the pump than by gravity feed, and less or lighter construction equipment is usually needed when a pump operation is used.

Several photographs of pumping operations are shown in Figure 8.17. A ready-mix truck is shown in Figure 8.17 placing concrete into the hopper of a pump truck that is equipped with a

flexible hose that is unrolled into the borehole and rolled back onto a spool on the truck when the concrete is placed. This is a very expeditious method for placing concrete by pump because it does not require the use of a crane for holding the pump line (which is flexible in this case). The operation of the pump truck is evident in Figure 8.17 b, in which the concrete is being placed into the hopper of the pump truck in a confined room. Figure 8.17 c shows a conventional rigid steel pump line with a hopper on the pump truck attached at its top. In order to place concrete, it is held in place by a crane with an eye at the crook near the connection with the flexible tube. Finally, Figure 8.17 d shows a complex pumping operation in a river (New Acosta Bridge, St. Johns River in Jacksonville, Florida). Two ready-mix trucks are brought out on a barge to the site of a shaft in which a very large group of large-diameter drilled shafts is being installed. The trucks are used to pump concrete from the trucks, which remain on the barge, over a considerable distance to the shaft. The concrete is placed above the drilled shaft being concreted. As additional concrete is needed, it is brought out on a second barge, and the barge containing the empty trucks is moved to the shaft. That interruptions in the pour are very short. An inner casing that serves to guide the concrete to the mudline is extracted after it is filled, and the concrete flows against the casing. Later, a concrete cap with its base near the water line will be cast on top of the shafts, above which the substructure will be built. Note that it would be necessary to place a joint in the splash zone if the water is sea water or otherwise has a high chloride content.

Concrete placed by pumps can develop relatively high momentary pressures, 10 MPa (1500 psi) or more. Concrete with a lower fluidity than for concrete placed with gravity-fed methods may be required for pumping low fluidity concrete in small-diameter [125 - 150 mm (5 - 6 in.)] shafts. This is also undesirable in some respects. Concrete with higher workability characteristics is necessary for pumping (i. e., concrete with the workability characteristics described in this chapter) will flow through the rebar cage more easily, will exert higher pressures against the sides of the excavation and will be more effective in scouring away filter cake in a borehole excavated under bentonite slurry, which are all beneficial attributes of drilled shafts. Therefore, workability requirements for pumped concrete for drilled shafts should be based on the minimum workability required for pumping.

flexible hose that is unrolled into the borehole and rolled back onto a spool on the truck when the concrete is placed. This is a very expeditious method for placing concrete by pump because it does not require the use of a crane for holding the pump line (which is flexible in this case). The operation of the pump truck is evident in Figure 8.17 b, in which the concrete is being placed into the hopper of the pump truck in a confined room. Figure 8.17 c shows a conventional rigid steel pump line with a hopper on the pump truck attached at its top. In order to place concrete, it is held in place by a crane with an eye at the crook near the connection with the flexible tube. Finally, Figure 8.17 d shows a complex pumping operation in a river (New Acosta Bridge, St. Johns River in Jacksonville, Florida). Two ready-mix trucks are brought out on a barge to the site of a shaft in which a very large group of large-diameter drilled shafts is being installed. The trucks are used to pump concrete from the trucks, which remain on the barge, over a considerable distance to the shaft. The concrete is placed above the drilled shaft being concreted. As additional concrete is needed, it is brought out on a second barge, and the barge containing the empty trucks is moved to the shaft. That interruptions in the pour are very short. An inner casing that serves to guide the concrete to the mudline is extracted after it is filled, and the concrete flows against the casing. Later, a concrete cap with its base near the water line will be cast on top of the shafts, above which the substructure will be built. Note that it would be necessary to place a joint in the splash zone if the water is sea water or otherwise has a high chloride content.

Because concrete placed by pumps can develop relatively high momentary pressures, 10 MPa (1500 psi) or more, concrete with a lower fluidity than for concrete placed with gravity-fed methods may be required for pumping low fluidity concrete in small-diameter [125 - 150 mm (5 - 6 in.)] shafts. This is also undesirable in some respects. Concrete with higher workability characteristics is necessary for pumping (i. e., concrete with the workability characteristics described in this chapter) will flow through the rebar cage more easily, will exert higher pressures against the sides of the excavation and will be more effective in scouring away filter cake in a borehole excavated under bentonite slurry, which are all beneficial attributes of drilled shafts. Therefore, workability requirements for pumped concrete for drilled shafts should be based on the minimum workability required for pumping.



Figure 8.17 a. Pumping operation with a portable, "tremieless" pump unit that does not require a crane to hold the pump line



Figure 8.17 b. Pump unit from Figure 8.17 a operating beneath a bridge (Photograph courtesy of A. H. Beck, Inc.)



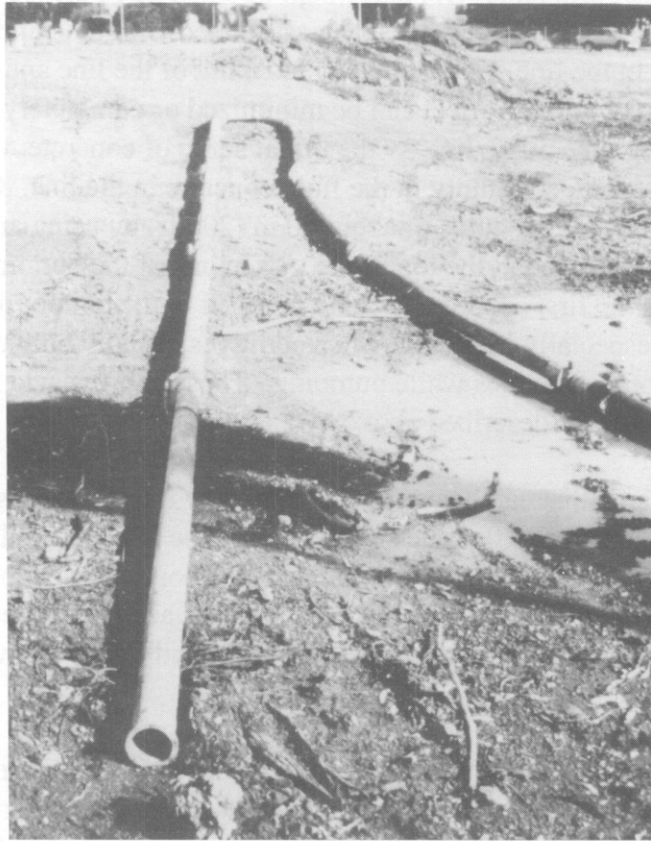

Figure 8.17 c. Typical tremie for placement of concrete by pump

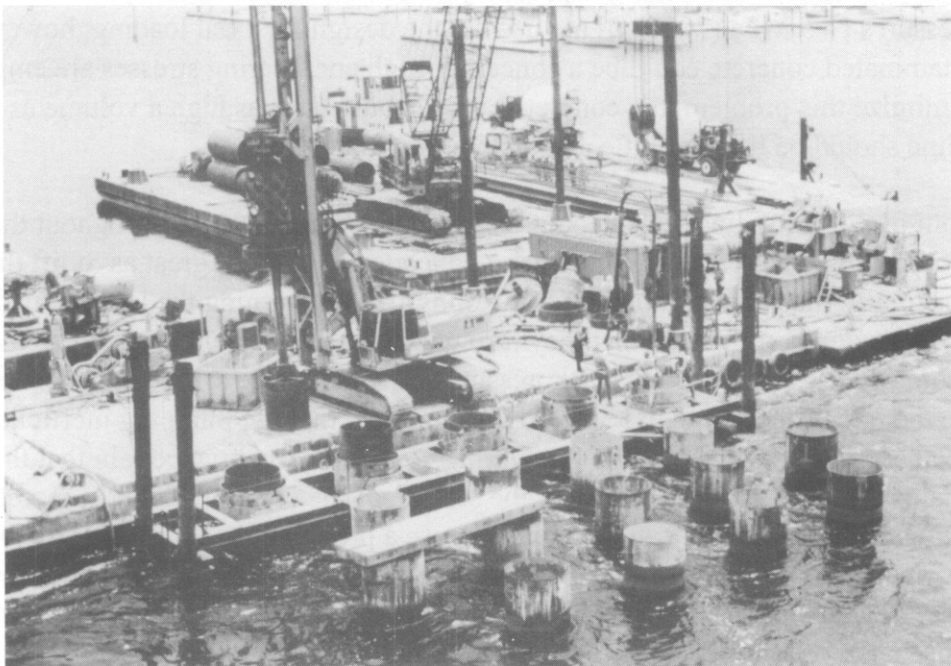

Figure 8.17 d. Large-scale concrete pumping operation for drilled shafts in a river

There can also be potential problems with placement of concrete in drilled shafts by pumping directly into the borehole. These problems can be associated with the concrete flowing ahead of itself, leaving a vacuum in the line, which leads to blocking of the line and possibly segregation of the concrete (Gerwick, 1987). This effect can be minimized or completely eliminated by using a plug that is pushed through the pump line by the initial surge of concrete, which helps keep a positive pressure and maintain continuity in the fluid concrete in the line. Contractors report successfully pumping concrete to depths of about 60 m (200 ft) by using an effective plug. The plug, however, needs to be placed at the top of the tremie, not at the bottom, so that it offers resistance to pumping as the first concrete is being pumped to the bottom of the borehole. Use of a plug in this manner is especially important when additives, usually polymers, are placed in the concrete to reduce friction in the lines while pumping. These additives do not harm the concrete but can exaggerate the problem described above by Gerwick.

Figure 8.18 shows a scheme that can be used for introducing the plug and starting the concrete flow at the connection between the flexible surface pump line and the rigid downhole line (tremie). The left-hand sketch shows the plug in place, the concrete flowing from the pump, and the air vent open to prevent buildup of air pressure in the surface line. The middle figure shows the arrival of the concrete at the connection, and the right-hand figure shows the air vent closed and the concrete flowing under pressure into the borehole.

A second issue associated with pumping concrete is that concrete pumps are piston-type pumps that do not have sufficient volume or speed of operation to reproduce the initial surge of concrete that can be obtained using a gravity-fed tremie. This problem is compounded by the fact that use of a plug requires lifting the bottom of the tremie to allow the plug to pass. The result is that some mixing of drilling slurry or water in the borehole and the pumped concrete can occur at the bottom of the borehole. This mixing is probably of no concern if relatively low ultimate end bearing pressures [ $< 5$  MPa (700 psi)] are used in the design for axial loading; however, the slurry-contaminated concrete could be a concern if high end-bearing stresses are employed. In order to minimize this problem, the concrete pump should have as high a volume as possible and the pump line should be lifted at little as possible to initiate flow.

If the bottom of the pump line were kept at the bottom of the borehole throughout the entire pour, the force against the rebar cage from the rising concrete could be so great as to lift the cage (although lifting of the cage can sometimes be minimized by turning the longitudinal steel bars 90 degrees and extending them so that they turn under the fluid concrete and keep the cage anchored somewhat). Likewise, the backpressure at the discharge orifice may become so large as to decrease the rate of discharge to a very low magnitude, making pumping inefficient. It may therefore be necessary to lift the pump line during concreting, making certain that the discharge orifice remains at least 1.53 m (5 ft) below the surface of the column of fluid concrete at all times. Lifting of the pump line can potentially cause a problem, however. Unless the pump is momentarily stopped or the pumping pressure reduced during the repositioning of the pump line, the line pressure that was in equilibrium with the fluid concrete pressure at the discharge orifice when the discharge orifice was at the bottom of the hole will produce an upward reaction force

on the pump line as the line is lifted and the backpressure from the column of fluid concrete is thereby reduced. This action can cause the pump line to jump out of the column of fresh concrete, and a defect could result.

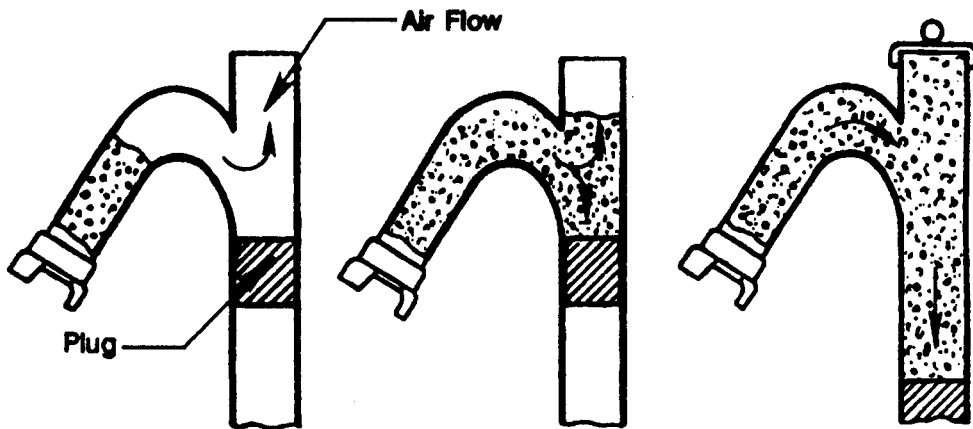

Figure 8.18. Technique of starting the placement of concrete with a pump  
(from LCPC, 1986)

Most specifications allow concrete to be placed by tremie or by pump. But whatever the placement method, precautions must be observed to be certain that good quality construction is obtained. To emphasize this statement, Figure 8.19 shows the results of both bad and good construction. In Figure 8.19 a an interruption in the supply of concrete allowed for either suspended solids or sloughed soil to accumulate on the top of the column of concrete while the borehole was partially concreted. When concreting resumed, the fresh concrete, although it was introduced beneath the surface of the concrete that had been standing in the borehole broke through the older concrete and apparently pushed the laitance to the side of the borehole, where it became trapped in the rebar cage. This defect was later detected by means of downhole nondestructive integrity tests (Chapter 17) and repaired (Chapter 18). On the other hand, Figure 8.19 b shows a 24.4-m- (80-ft-) long drilled shaft that has been properly concreted and exhumed for examination. There are no defects, and the soil is well bonded to the concrete despite the fact that bentonite slurry was used as a construction aid. Drilled shafts of this quality should be the norm as long as good construction practices are followed.

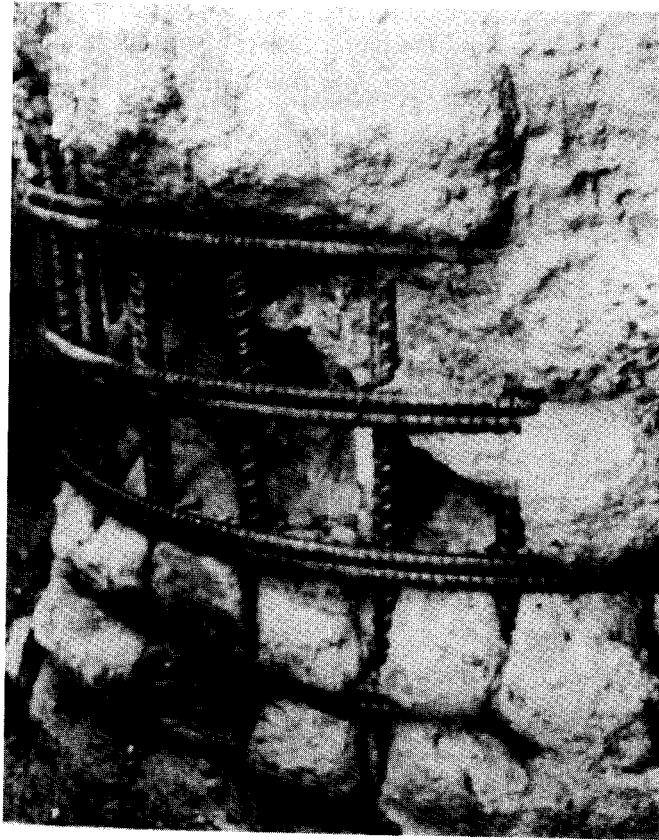

Figure 8.19 a. Defect in a drilled shaft caused by interruption in concrete supply during pumping  
(Photograph courtesy of Caltrans)



Figure 8.19 b. Drilled shaft of excellent quality after exhumation

## **DRILLING NEAR A RECENTLY CONCRETED SHAFT**

Some specifications for the construction of drilled shafts include a requirement that the concrete in a recently concreted shaft must achieve an initial set before drilling can be done in the vicinity. The definition of "vicinity" varies widely. Such a specification has an important place in construction procedures if there is a possibility of communication between the nearby excavations. For example, if the construction is being carried out in a karstic region, the recently placed concrete may have filled a cavity. If a new, nearby excavation pierces that cavity, the fresh concrete will flow into the new excavation with serious consequences. Perhaps the best solution to this problem from the engineer's perspective is to make it the contractor's responsibility to see that damage does not occur to an existing shaft due to cross-communication of concrete or some other similar circumstance while the concrete is still unset and to notify the engineer if cross-communication is observed. Any required reconstruction that follows is almost sure to produce a claim from the contractor. Such a claim may be justified if the site characterization failed to reveal the presence of karst features, lava tubes or similar subsurface conditions.

Studies reported by Bastian (1970) indicate that nearby construction, such as drilling or pile installation, either by a vibratory driver or an impact hammer, do not normally damage a recently-placed drilled shaft while the concrete is still unset. He reports on a case where pile driving was being done 5.5 m (18 ft) away from a shell-pile that had just been filled with fresh concrete. Three days after pouring the concrete, cores were taken. Subsequent testing showed that the compressive strength of the cores was slightly higher than that of concrete cylinders that were taken at the time of the casting of the concrete.

Bastian reports on five other investigations by various agencies and groups. In each of the cases the results showed that the properties of fresh concrete were not adversely affected by vibration. Bastian reached the following conclusion: "There is ample evidence that the vibration of concrete during its initial setting period is not detrimental..... It can be concluded, therefore, that vibrations due to the driving of piles immediately adjacent to freshly placed concrete in steel pile shells is not harmful to the concrete and no minimum concreting radius should be established for this reason." There is no reason to believe that vibrations due to nearby pile driving would influence the concrete in drilled shafts any differently than that in steel shells. Apparently, restrictions on driving piles near freshly poured concrete should be based on factors other than vibration.

On the other hand, little is known about the effects of construction immediately adjacent to drilled shafts with freshly set ("green") concrete. Driving, vibration and extraction of casing, particularly in rock, or unbalanced ground pressures due to the opening of a nearby excavation, could cause cracking in the green concrete, which would conceivably affect its durability and future performance. Until more is known about this effect, it is prudent to disallow driving of piles or casing, or opening of boreholes for new drilled shafts, closer than about two shaft diameters clear spacing to the shaft with newly set concrete. If the concrete mix follows the recommendations in this chapter, it will not begin its set until four hours after batching and

should achieve sufficient strength within 24 hours after batching, so it is within this time window that adjacent construction should be disallowed. The 24-hour limit can possibly be shortened by using silica fume as an additive. Use of high-early-strength cement in the concrete mix is not recommended if shaft diameters exceed 1.53 m (5 ft) because of the high heat of hydration and attendant cracking problems. Staggering of the construction sequence of closely-spaced drilled shafts to avoid this problem is not ordinarily a problem provided the contractor is informed clearly of this requirement in the construction specifications.

## CONCRETING CURVES

An earlier mention was made of the desirability of constructing a curve to show the actual amount of concrete that was required to fill an excavation *incrementally* compared to the theoretical incremental volume of the excavation. Three examples of such concreting curves are shown in Figures 8.20 through 8.22 (LCPC, 1986; ADSC/DFI, 1989).

The first example, Figure 8.20, shows a drilled shaft that was 18 m (60 ft) deep and had a theoretical volume of concrete of about  $16 \text{ m}^3$  ( $21 \text{ yd}^3$ ). The volume of concrete that was actually required was about  $20 \text{ m}^3$  ( $27 \text{ yd}^3$ ). A comparison of the theoretical incremental curve with the actual curve shows a gradual deviation, which probably indicates the squeezing back of the silt as postulated by the sketch. This should not be a problem, so that the pouring of 5 extra cubic meters (7 cubic yards) of concrete should have no effect on the integrity of the completed drilled shaft.

The second example, Figure 8.21, shows a drilled shaft that was 25.9 m (85 ft) deep and had a theoretical volume of concrete of about  $20 \text{ m}^3$  ( $26 \text{ yd}^3$ ). The volume of the concrete that was actually required was about  $35 \text{ m}^3$  ( $45 \text{ yd}^3$ ). The figure indicates two types of overrun of the concrete. Curve (a) indicates that the cavity in the karstic region was filled as the concrete filled the hole. Curve (b) indicates that there was a sudden breaking through of the concrete when the depth of concrete in the excavation reached within about 5.5 m (18 ft) of the top of the shaft. Curve (a) suggests that there is probably no integrity problem with the drilled shaft. However, Curve (b) could result in excessive downward forces on the rebar cage, causing it to ravel, and could indicate that the concrete at the level of the karstic zone may have surged into the cavity and displaced debris or groundwater back into the drilled shaft, causing a defect. Therefore, Curve (b) would probably be cause for further investigation, perhaps using some of the techniques discussed in Chapter 17.

The third example, in Figure 8.22, shows a concreting curve in which the actual volume of concrete placed is less than the theoretical volume for a portion of the depth of pour. This behavior indicates that a block of soil or rock may have fallen into the concrete at the point at the first (lowest) point where the measured curve crosses the theoretical curve and that it may have broken loose from the depth at which the measured curve crosses back to the other side of the theoretical curve higher up the shaft. This, of course, is cause for further investigation.

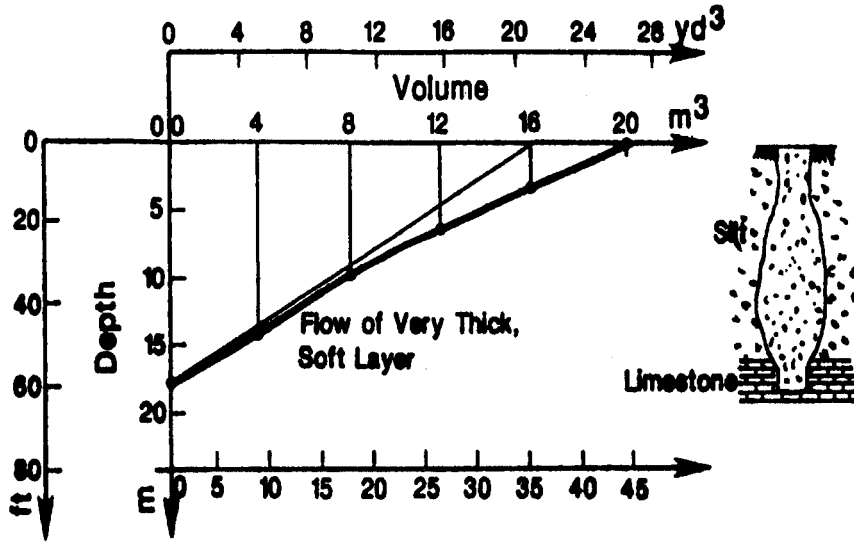

Figure 8.20. Comparison of actual amount of concrete required to fill excavation incrementally with theoretical volume of the excavation; Example 1 (LCPC, 1986)

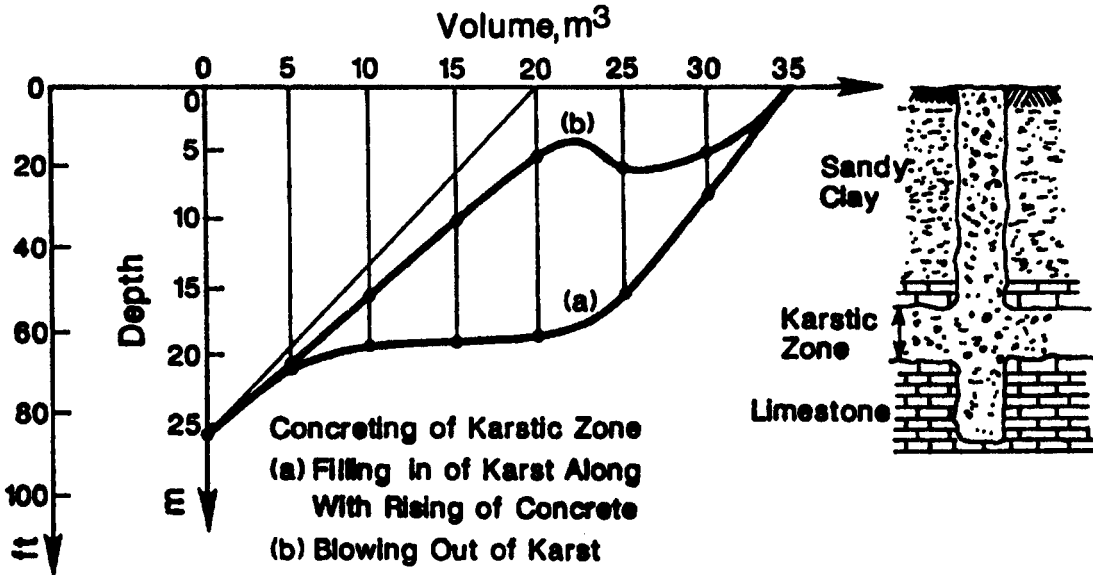

Figure 8.21. Comparison of actual amount of concrete required to fill excavation incrementally with theoretical volume of the excavation; Example 2 (LCPC, 1986)

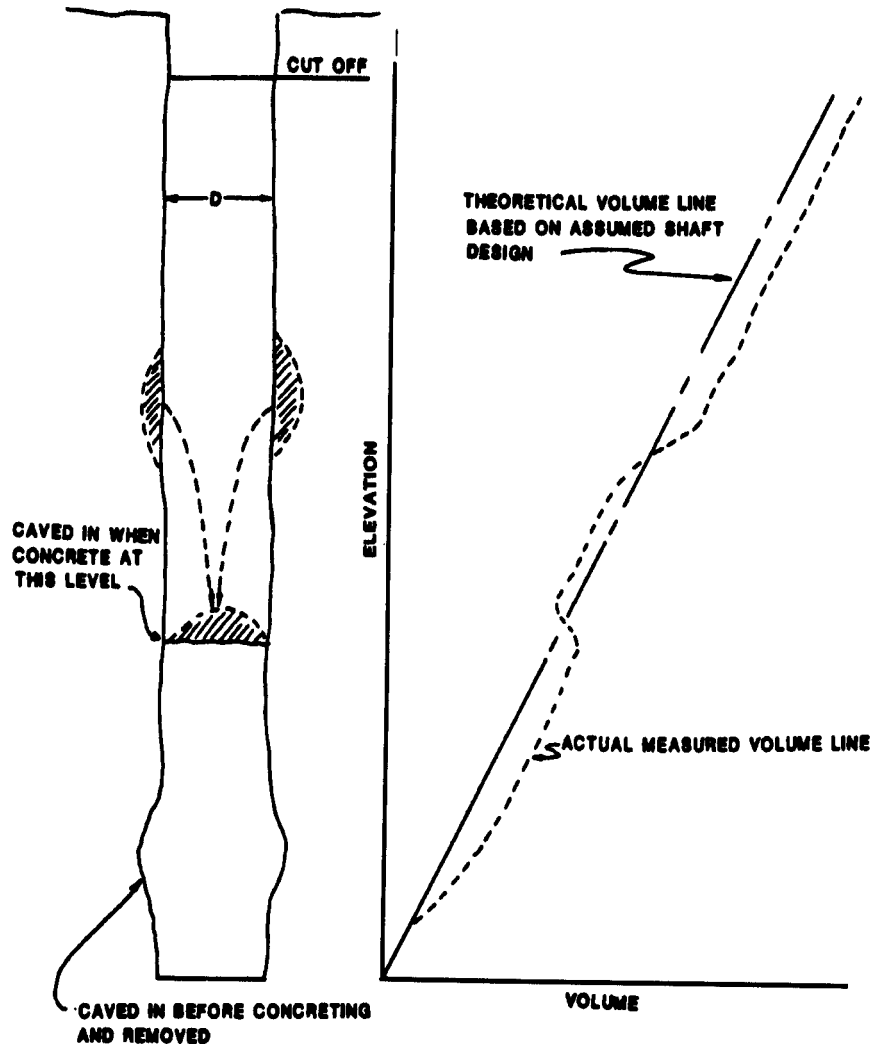

Figure 8.22. Comparison of actual amount of concrete required to fill excavation incrementally with theoretical volume of the excavation; Example 3 (ADSC/DFI, 1989)

Development of the concreting curve requires that an estimate be made of the diameter of the shaft with respect to depth. Accurate plots of the theoretical curves can be made using borehole diameter data from mechanical or laser calipers or sonic borehole loggers referenced in Chapter 6, or the actual diameter can be estimated by experience based on the nominal diameter. In either case the theoretical concrete volume in each depth increment is  $0.7854 \text{ times (average borehole diameter over the depth increment)}^2 \text{ times (depth increment)}$ . The actual volume of concrete placed as a function of depth can be determined by counting the number of pump strokes in a piston pump (knowing the volume of the pump) for each selected increment of concrete surface depth [usually about 1 m (3 ft)], which can be measured by means of a weighted tape, even if the concrete is under a slurry, or by measuring concrete volume with a magnetic flow meter. If



concrete is placed into the tremie hopper using a bucket, the volume of the bucket will have to be known accurately, and the number of meters or feet of concrete rise in the borehole is measured for each bucket placed. While some time on the part of the inspector will be required for obtaining concreting curves, these examples illustrate the value of collecting data during the filling of an excavation with concrete.

## **CONTAMINATED CONCRETE AT SHAFT HEAD**

Assuming that the design of the concrete mix has been done properly, there should be no undue bleeding of any pour. If a pour is being made in a dry hole, any contamination at the shaft head should consist only of a minor amount of laitance. Therefore, the preparation of the top of the shaft for a cap or a column should require only a small amount of effort.

The situation is quite different if a wet pour is being made. Even with the best technique of capping a tremie or providing a plug for a tremie or a pump line, there will be some mixing of the fluid being lifted from the excavation and the concrete. If a poor technique has been used of separating the concrete from the slurry or water, the contamination of the first concrete that appears at the top of the shaft could be severe.

There is an additional aspect of the problem of contamination as reported by Gerwick (1987). "During the pouring of concrete into an excavation filled with bentonite slurry, the cement may cause the bentonite to gel. Only a small amount of such contamination will occur when concrete is placed correctly by the tremie methods, but if the concrete is allowed to drop freely through bentonite or the two fluids are mixed by agitation, then contamination will occur." A similar effect can occur with polymer drilling slurries.

In any case, the workers at the job should make a careful examination of the fresh concrete as it appears at the top of the shaft. There should be sufficient concrete on the job to continue the pour until any visually contaminated concrete has been flushed away. Careful visual observation should be adequate for detecting contaminated concrete at the shaft head.

Also with regard to a wet pour, the situation is quite different if the cutoff elevation of the shaft is some distance below the ground line. As a matter of fact, the requirement to stop the pour of the concrete more than perhaps half a meter (1.5 ft) below the working ground surface should be avoided if at all possible. The only reasonable solution for eliminating concrete that is potentially contaminated in the case when cutoff is well below grade is to pour one or two extra meters (several extra feet) of shaft, being as sure as possible that the concrete is sound below the cutoff, and plan to chip away the extra concrete after the excavation is made. If cutoff is only a small distance below grade wet concrete can be removed after bringing the pour to working grade and the surface of the shaft at cutoff elevation inspected before the set begins.

## POST-GROUTING

Because the excavation of a drilled shaft borehole tends to loosen granular soils, especially beneath the base, making the load-settlement response of the base "soft" compared to that of driven piles, some engineers, particularly in Europe, specify post-grouting to stiffen the base response and to increase the bearing capacity of the shaft. While this process is not recommended for routine practice because of its cost, it may be considered in circumstances where limitation of settlement is a critical concern to the engineer. Post-grouting can also be used as a remedial measure when problems are suspected to have occurred during construction (e.g., excess laitance at the base, casing left in the borehole accidentally). Applications in this area will be discussed briefly in Chapter 18.

Bustamante and Gouvenot (1983) and Stocker (1983) report large increases in both side shear and base resistance in drilled shafts constructed in gravel and marl by grouting the soil around the drilled shaft through tubes that are placed either internally within the shaft or external to the shaft. The grout is normally a neat water-cement mixture. It may be introduced into the soil at the base of the shaft either through internal or external tubes, where gauge pressures of 20 - 30 atmospheres are used. With base grouting, increases in base resistance of 25 per cent and increases in side resistance of over 200 per cent were reported in gravelly soils by Bustamante and Gouvenot where bentonite slurry was used to excavate the borehole. The large increase in side resistance is surprising, but apparently the grout flowed up around the sides of the shaft for a considerable distance in porous gravels. The grout may also be introduced through internal tubes cast within the concrete and placed outside the rebar cage, with valves at various elevations. The grout is pumped into the tubes when the concrete is green. Use of grout pressures in the range of 50 atmospheres causes the green concrete to fracture and exert very high lateral pressures on the interface. Stocker reported increases in side resistance of 200 - 300 per cent in both cohesive and granular soils with this system.

It is emphasized that post-grouting requires considerable expertise on the part of the contractor, and it may not be successful in all cases. The construction and load testing of post-grouted test shafts are therefore recommended for projects where it is planned to be used.

## REFERENCES

ACI (1994). *ACI 336.1, Standard Specification for the Construction of Drilled Piers*, American Concrete Institute, Detroit, Michigan.

ADSC/DFI (1989). *Drilled Shaft Inspector's Manual*, Joint Caisson - Drilled Shaft Committee of the ADSC: The International Association of Foundation Drilling and DFI: The Deep Foundations Institute, Dallas, Texas.

ASTM C 33-93 (1995). "Standard Specifications for Concrete Aggregates," *Annual Book of*

*ASTM Standards*, Vol. 4.02, American Society for Testing and Materials, West Conshohocken, Pennsylvania.

ASTM C 87-90 (1995). "Standard Test Method for Effect of Organic Impurities in Fine Aggregate on Strength of Mortar," *Annual Book of ASTM Standards*, Vol. 4.02, American Society for Testing and Materials, West Conshohocken, Pennsylvania.

ASTM C 150 (1995). "Specifications for Portland Cement," *Annual Book of ASTM Standards*, Part 14, American Society for Testing and Materials, West Conshohocken, Pennsylvania.

ASTM C 227-90 (1995). "Standard Test Method for Potential Alkali Reactivity of Cement-Aggregate Combinations," *Annual Book of ASTM Standards*, Vol. 4.02, American Society for Testing and Materials, West Conshohocken, Pennsylvania.

ASTM C 260-94 (1995). "Standard Specification for Air-Entraining Admixtures for Concrete," *Annual Book of ASTM Standards*, Vol. 4.02, American Society for Testing and Materials, West Conshohocken, Pennsylvania.

ASTM C 289-94 (1995). "Standard Test Method for Potential Alkali-Silica Reactivity of Aggregates (Chemical Method)," *Annual Book of ASTM Standards*, Vol. 4.02, American Society for Testing and Materials, West Conshohocken, Pennsylvania.

ASTM C 295-90 (1995). "Standard Guide for Petrographic Examination of Aggregate for Concrete," *Annual Book of ASTM Standards*, Vol. 4.02, American Society for Testing and Materials, West Conshohocken, Pennsylvania.

ASTM C 494-92 (1995). "Standard Test Method for Chemical Admixtures for Concrete," *Annual Book of ASTM Standards*, Vol. 4.02, American Society for Testing and Materials, West Conshohocken, Pennsylvania.

ASTM C 586-92 (1995). "Standard Test Method for Potential Alkali Reactivity of Carbonate Rocks for Concrete Aggregates (Rock Cylinder Method)," *Annual Book of ASTM Standards*, Vol. 4.02, American Society for Testing and Materials, West Conshohocken, Pennsylvania.

ASTM C 618-94 (1995). "Standard Specification for Coal Fly Ash and Raw or Calcinated Natural Pozzolan for Use as a Mineral Admixture in Portland Cement," *Annual Book of ASTM Standards*, Vol. 4.02, American Society for Testing and Materials, West Conshohocken, Pennsylvania.

ASTM C 989-94 (1995). "Standard Specification for Ground Granulated Blast-Furnace Slag for Use in Concrete and Mortars," *Annual Book of ASTM Standards*, Vol. 4.02, American Society

for Testing and Materials, West Conshohocken, Pennsylvania.

ASTM C 1017-92 (1996). "Standard Specification for Chemical Admixtures for Use in Producing Flowing Concrete," *Annual Book of ASTM Standards*, Vol. 4.02, American Society for Testing and Materials, West Conshohocken, Pennsylvania.

Baker, C. N., Jr., and Gnaedinger, J. P. (1960). *Investigation of the Concrete Free Fall Method of Placing High Strength Concrete in Deep Caisson Foundation*, Soil Testing Services, Inc., Chicago, 1960, 11 pp. (Report available from ADSC, Dallas, Texas.)

Bartholomew, R. F. (1980). "The Protection of Concrete Piles in Aggressive Ground Conditions: An International Appreciation," in *Proceedings*, Conference on Recent Developments in the Design and Construction of Piles, ICE, London, pp. 131 - 141.

Bastian, C. E. (1970). "Effect of Vibration on Freshly Poured Concrete," *Foundation Facts*, Raymond International, Inc., Vol. VI, No. 1, pp. 14 - 17.

Baycan, S. (1996). *Field Performance of Expansive Anchors and Piles in Rock*, Thesis Submitted for the Degree of Doctor of Philosophy in the Department of Civil Engineering, Monash University, Clayton, Victoria, Australia.

Bru, J-P, Delude, P., and Laperne, P. (1991). *Études Expérimentales sur le Bétonnage des Pieux Forés, Série Géotechnique GT 45*, des Laboratoires des Ponts et Chaussées, Paris (in French), 62 pp.

Bustamante, M., and Gouvenot, D. (1983), "Grouting: A Method Improving the Bearing Capacity of Deep Foundation," in *Proceedings*, Eighth European Conference on Soil Mechanics and Foundation Engineering, Helsinki, Vol. 1, pp. 131 - 134.

Gerwick, B. C. (1965). "Bell-Pier Construction, Recent Developments and Trends," *Journal of the American Concrete Institute*, Vol. 62, October, pp. 128 - 129.

Gerwick, B. C. (1987). Personal Communication.

Hassan, K. H., O'Neill, M. W., and Sheikh, S. A. (1993). "Bored Piles in Clay-Shale Using Expansive Concrete," in *Proceedings*, Second International Geotechnical Seminar on Deep Foundations on Bored and Auger Piles, W. F. Van Impe, Ed., Balkema, Rotterdam, pp. 289 - 294.

Kiefer, T. A., and Baker, C. N., Jr. (1994). *The Effects of Free Fall Concrete in Drilled Shafts*, ADSC, Dallas, Texas.

LCPC (1986). *Bored Piles*, English Translation of *Les Pieux Fores*, Le Laboratoire Central des Ponts et Chaussées, March. (Also published as *Report No. FHWA TS-86-206*.)

PCA (1988). *Design and Control of Concrete Mixtures*, Thirteenth Edition, Portland Cement Association, Skokie, Illinois, 205 pp.

Sheikh, S. A., and O'Neill, M. W. (1986), "Long-Term Performance of Expansive Concrete Drilled Shafts," *Canadian Journal of Civil Engineering*, NRC, Vol. 13., No. 2, April, pp. 213 - 217.

Sheikh, S. A., O'Neill, M. W., and Mehrazarin, M. A. (1985). "Expansive Concrete Drilled Shafts," *Canadian Journal of Civil Engineering*, NRC, Vol. 12., No. 2, May, pp. 382-395.

Sheikh S. A., Fu, Y., and O'Neill, M. W. (1994). "Expansive Cement Concrete for Drilled Shafts," *American Concrete Institute Materials Journal*, Vol. 91, No. 3, May-June, pp. 237 - 245.

Sliwinski, Z. J. (1980). Personal Communication.

Stocker, M. (1983). "The Influence of Post-Grouting on the Load-Bearing Capacity of Bored Piles," in *Proceedings*, Eighth European Conference on Soil Mechanics in Foundation Engineering, Helsinki, Vol. 1, pp. 167 - 170.

TxDOT (1994). *Construction Bulletin C-11*, Texas Department of Transportation, Austin, Texas.

TxDOT (1996). *Prequalified Concrete Admixtures*, Texas Department of Transportation, Materials and Tests Division, Austin, Texas.

van Bijsterveld, J. J. (1993). "A New Promising Concept for Bored Piles and Tension Piles," in *Proceedings*, Second International Geotechnical Seminar on Deep Foundations on Bored and Auger Piles, W. F. Van Impe, Ed., Balkema, Rotterdam, pp. 317 - 322.

## **CHAPTER 9: CASE STUDIES OF DRILLED SHAFT CONSTRUCTION UNDER VARIOUS CONDITIONS**

### **INTRODUCTION**

A number of examples are given in the final appendix of this manual, Appendix G, of diverse soil and rock profiles and the techniques that may be used to construct a drilled shaft in each of those profiles. The procedures that are suggested are not meant to be prescriptive. In fact, qualified contractors, faced with any one of the given cases, might choose to employ other methods successfully. Nevertheless, the ideas that are presented may be useful to the engineer who is planning the construction of a transportation facility. The procedures that are suggested are known to be effective and indicate the versatility of construction methods. Innovations in construction techniques are coming about regularly, and an innovative technique, applied to one of the cases given here or to some other case, might well mean significant savings in materials and labor.

All of the examples that are given are for drilled shafts that are installed vertically. While drilled shafts can certainly be installed on a batter, problems can occur due to the bending of the kelly that will result in a curvature in the shaft, among other things. Battered shafts are obviously more effective in resisting lateral loads than vertical shafts; however, technology that has been developed in recent years, and which is presented briefly in Chapter 13, shows that vertical shafts can also resist a significant amount of lateral load. For example, a heavily reinforced drilled shaft in stiff clay, 0.76 m (30 in.) in diameter and about 9 m (30 ft) long, was loaded with a groundline shear of 0.45 MN (50 tons) and sustained a groundline deflection of about 25 mm (1 in.) (Welch and Reese, 1972). A reinforced drilled shaft 1.83 m (6 ft) in diameter and 11.3 m (37 ft) long was loaded in a similar soil with a groundline shear of 1.7 MN (190 tons) with a groundline deflection of only 50 mm (2 in.) (Dunnivant and O'Neill, 1989). References to these citations are given in Chapter 13.

## CHAPTER 10: DESIGN CONCEPTS FOR DRILLED SHAFTS

### INTRODUCTION

#### The Design Process

The overall process of designing drilled shaft foundations, or any other foundation system, involves many individual, coordinated activities, including characterizing the subsurface and following the initial design into the field. The entire process is illustrated in simplified form in Figure 10.1. Drilled shaft foundations are initially sized, usually based on geotechnical conditions, and then designed structurally in the office by considering the factors listed under "Design the drilled shafts" in Figure 10.1. The initial design sometimes needs to be modified if warranted by conditions encountered in the field, and the designer should be prepared to respond to such requirements.

This chapter deals with the general concepts of designing drilled shafts to support axial loads. It is intended to stand alone, without the need for the reader to refer to other chapters or references. This chapter may be skipped by designers who are experienced in the design of drilled shafts and who only wish to obtain "nuts and bolts" information on values of side and base resistance and information on analyzing laterally loaded drilled shafts. For those who care to pursue further details, issues dealing with safety are covered in Appendix A, and details concerning assignment of unit side and base resistance is covered in Appendix B.

A step-by-step procedure for making the "nuts and bolts" design calculations is outlined in Chapter 11, which also summarizes specific methods for assigning unit values of ultimate side and base resistance in various geomaterials. Methods for estimating nominal movements (settlement and uplift) of axially loaded drilled shafts and drilled shaft groups are contained in Appendix C. Structural design is covered in Chapter 13, with further details provided in Reese (1984). Use of loading tests to assist the designer is covered in Chapter 14. Numerical examples that use the design concepts advanced here are provided in Appendix D. The emphasis throughout is on a seismic design; however, many of the procedures and principles are adaptable to seismic design, as well.

For each drilled shaft in the foundation, the designer must first estimate the diameter and penetration of the shaft, based on an examination of the groupings of borings that have been developed at the site of the structure and the expected loads. This is normally an exercise that is based in large measure on the designer's experience. The trial geometries are then assigned values of nominal ultimate resistance,  $R_{TN}$ , which are then used in an ASD or LRFD format to assess whether the selected geometries are adequate geotechnically. During the execution of this task, the designer should realize that it is usually most economical to select shaft diameters that are multiples of 150 mm (6 in.), since these are the commonly available drilling tool diameters, and that specification of drilled shafts with lengths greater than about 30 times their diameters can cause difficulties in construction.

In some subsurface profiles the contractor may choose to use telescoping casing or to use some other method to make the upper part of the borehole larger than the designer has specified (for example, to excavate boulders). In such a case the drilled shaft should be designed as if its entire diameter will be equal to the diameter of the lowest section (section with the smallest diameter) unless downdrag or expansion from soils surrounding the shaft are expected (Chapter 12). In such a case, the actual as-constructed diameter must be estimated during the design process (conservatively, if necessary) and controlled during construction, since downdrag or expansion forces constitute loads on the drilled shaft. Conferences with drilled shaft contractors about such issues can be very helpful to designers at this point in the design process.

From an economics viewpoint, the designer should select as few different diameters and cage designs as is feasible for a given project. While it may be theoretically possible to specify many different diameters in order to minimize the sizes of the drilling tools and the volume of concrete that will need to be placed on a job, the risk of achieving an incorrect diameter and the cost of constantly changing tools, especially for drilled shafts in rock, increases with an increasing number of shaft diameters.

While resistances and deformations of drilled shafts can be estimated using the procedures given in Chapters 11 - 13, factors related to the details of local geology and construction processes have a major influence on the performance of drilled shafts under load (Williams et al., 1980; Crapps, 1986; O'Neill and Hassan, 1994). In order to keep the design methods straightforward, many of these factors are not included explicitly in the design equations. For that reason, it is highly recommended that the various design factors that are given in this manual be verified or modified based on local geologic conditions and construction practices. This can only be accomplished through a program of field load testing. Loading tests should be conducted during the "Design the drilled shafts" phase of the overall design sequence (Figure 10.1) whenever feasible in order to obtain information relevant to the design parameters. For that reason, loading tests should also be conducted to a state of geotechnical failure if at all possible and upon test shafts that are as close to full-scale as possible.

### **Importance of Subsurface Investigation**

It is important for the designer to follow the recommendations given in Chapter 2 and Appendix A regarding the establishment of uncertainty levels for the design parameters for the geomaterials into which the drilled shafts will be placed. If the designer is to use the resistance factors recommended in Table A.4 (AASHTO), then trend lines and coefficients of variation should be established for every zone of the site and every stratum as indicated in Appendix A. It is particularly important that the coefficient of variation  $COV_w$  of the values of shear strength indicators  $s_u$ ,  $q_u$ , and  $q_c$  not exceed about 0.35 and that  $N$  have values of  $COV_w$  with respect to the trend line of 0.45 or less (Table A.1).

$COV_w$  can often be reduced by acquiring additional data points (taking additional borings and conducting additional *in-situ* or laboratory tests). Since each grouping of borings, or "design



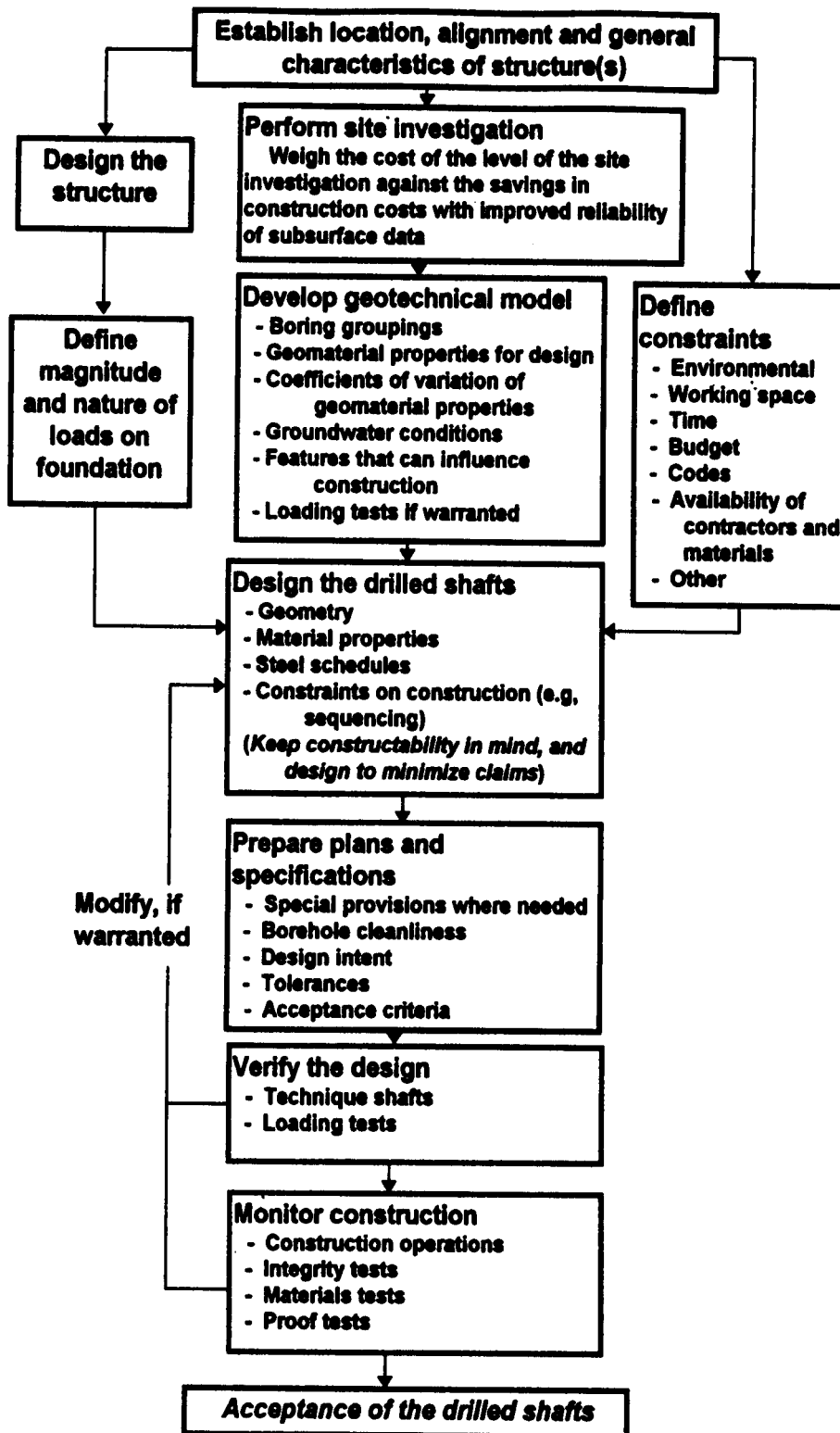

Figure 10.1. Schematic of the overall design process for drilled shaft foundations

zone," will have its own unique set of geotechnical design values, sometimes  $COV_w$  can be reduced simply by regrouping the available borings into different zones (which will of course change the mean or trend design values for the zones involved). Of course, drilled shafts can also be designed using intuitive factors of safety based upon experience without going through a formed process of evaluating coefficient of variation if the designer chooses to do so.

The issue often arises whether to acquire more borings and perform more tests on the soil or rock, and perhaps whether to conduct one or more field loading tests on full-sized drilled shafts during the design phase of a project, or to design the drilled shafts more conservatively (with lower resistance factors or higher factors of safety than are suggested in Appendix A). The issue of the level of intensity of the site investigation, including performance of drilled shaft loading tests, is illustrated conceptually from a cost perspective in Figure 10.2. The cost of the site investigation increases as more borings, geophysical studies, full-scale excavations and loading tests are performed. That cost is related to the efficiency of the subsurface investigation methods, for example, the use of geophysical methods to replace some borings at river crossings. The cost of foundation construction decreases as the amount of information about subsurface conditions increases, since minimal subsurface investigations may result in very high coefficients of variation for the geotechnical design parameters and, consequently, higher resistance factors and factors of safety (larger drilled shafts). On the other hand, the cost of drilled shaft construction increases as the desired level of reliability increases at a constant level of level of information about subsurface conditions. For example, one may not need the same level of reliability in an "off-system" structure on a secondary or tertiary road as in a primary highway bridge across a major river. In the former case it might be reasonable to use resistance factors that are slightly higher than those in Table A.4, reflecting a lower level of reliability. The concept illustrated in Figure 10.2 may be difficult to quantify on a real project; however, it is helpful in considering the tradeoffs involved in arriving at a final design.

A more easily quantifiable approach can be taken to judging whether the level of subsurface investigation is not intense enough, too intense or optimum. Suppose on a major interchange project a State-standard subsurface investigation is performed. [In one state, this intensity of investigation is one boring every 46 m (150 ft) along the alignment of every separate structure.] The borings are grouped into zones for design calculations, the trend (nominal) values of the soil parameters are determined and the values of  $COV_w$  of the soil parameters within each layer of each zone are calculated (Appendix A). Suppose that the designer uses the trend values for a particular zone that will be called Zone "E" and determines, using the design equations presented in this manual, that 2000 m of 1.22-m-diameter drilled shafts will be needed for Zone E. [A drilled shaft of a single diameter will be used in this scenario for simplicity. Ordinarily, because of differing loadings, more than one diameter will ordinarily be used on a major bridge project.] However, in this zone it is found that  $COV_w$  significantly exceeds the values given in Table A.1, and no field load tests have been performed, which has required the designer to use judgment to reduce the resistance factors to values that are 20 per cent lower than the values given in Table A.4. Using information presented in Chapter 19 or other similar information available locally and by forecasting the most likely method of construction (through study of Chapters 3 - 9 and/or

by conversations with drilled shaft contractors) the designer estimates a cost of \$400 per m for the 1.22-m-diameter shafts in Zone E. This results in a foundation cost of  $(2000) (\$400) = \$800,000$  for Zone E.

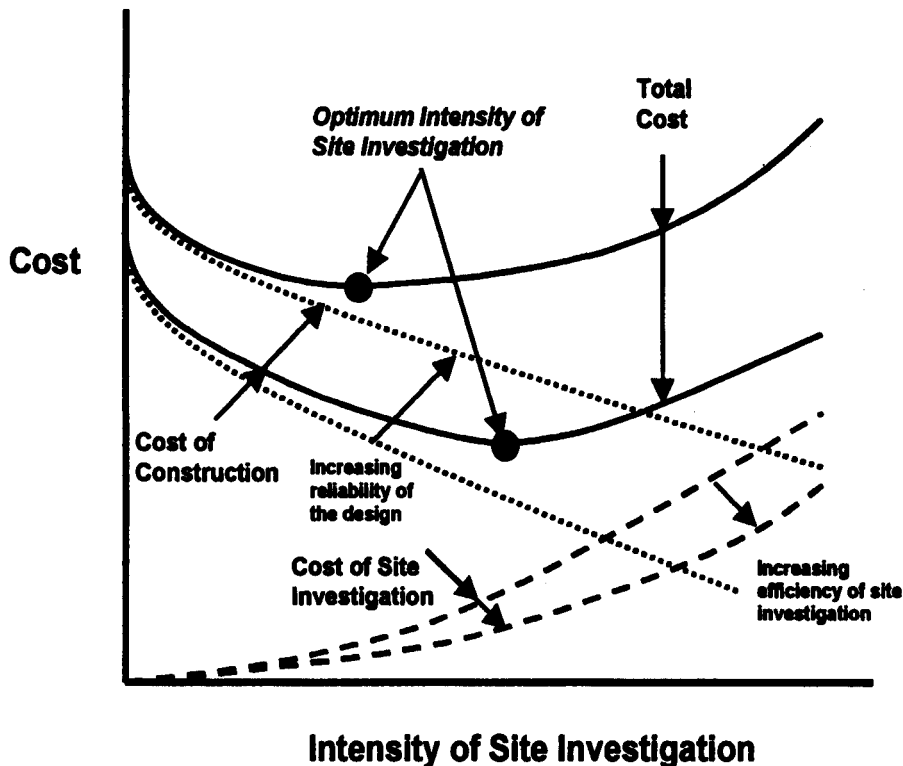

Figure 10.2. Total cost vs. intensity of exploration (after Kulhawy et al., 1983)

The acquisition of additional subsurface and drilled shaft performance data in a second phase of exploration within Zone E can possibly result in increased reliability and thus in increased resistance factors (reduced factors of safety), which will lead to economy in construction. Whether this would be cost effective needs to be determined. To investigate this issue, the designer resizes the drilled shafts based on

(a) resistance factors = 0.8, which assumes that once new borings have been taken and new geomaterial strength tests conducted, the values of  $COV_w$  are within the limits prescribed in Table 2.3, and that a load test has been conducted within Zone E that indicates that the unit side resistance and unit base resistance are 10 per cent higher than assumed. This assumption results in the outcome that only 1300 m of drilled shafts of 1.22-m-diameter are required in Zone E.

(b) resistance factors as given in Table A.4, predicated on conducting a loading test that shows that the unit side and base resistances are 10 per cent higher than originally assumed but that additional soil borings fail to confirm that  $COV_w$  is less than the limits shown in Table 2.3.

The selection of these resistance factors is basically a matter of judgment on the part of the designer. This assumption results in 1700 m of drilled shafts.

(c) no change in the resistance factors. The additional subsurface exploration effort fails to indicate lower  $COV_w$  values than are now available, and the loading test reveals values of unit resistances that are virtually the same as were used in the original calculations. With this assumption 2000 m of drilled shafts are still needed.

(d) resistance factors that are 5 per cent lower than were originally assumed. Additional borings reveal that  $COV_w$  is actually higher than existed with the original limited set of subsurface data and the full-scale field load test gives values of unit resistance that are lower than were assumed in the original computations. With this assumption 2200 m of drilled shafts are needed.

An "expected value criterion analysis" is then carried out (Kulhawy et al., 1983). In this simple probability analysis, a probability value is assigned to each outcome resulting from obtaining additional site and drilled shaft performance data. Normally, this is done through a judgment process (anything from a formal delphi analysis involving a number of experts to simple estimates by the designer himself or herself, depending on the cost of the project). Suppose that the above outcomes are assigned the probabilities, P, as follows:

Outcome (a)	P = 0.3	(30 per cent)
Outcome (b)	P = 0.4	(40 per cent)
Outcome (c)	P = 0.2	(20 per cent)
Outcome (d)	P = 0.1	(10 per cent)

The corresponding construction costs multiplied by their respective probability values are:

Outcome (a)	0.3 (1300 m) (\$400/m)	= \$156,000
Outcome (b)	0.4 (1700 m) (\$400/m)	= \$272,000
Outcome (c)	0.2 (2000 m) (\$400/m)	= \$160,000
Outcome (d)	0.1 (2200 m) (\$400/m)	= \$ 88,000
Total		\$676,000

The total value (sum) is the probable cost of the foundation if additional borings and geomaterial tests are made and if a loading test is conducted. This is \$124,000 less than the estimate if no further field investigation is done, which suggests that it may be reasonable to consider spending up to about \$124,000 on additional borings and loading tests. Of course, additional outcomes can be conceived (e. g., an outcome that includes only additional soil borings and laboratory tests, with no field loading tests), and it may be possible that the unit costs would vary as the number of meters of drilled shaft construction changes. These factors can be included in the analysis if desired. This simple method can provide guidance to the management of the design

team whether to invest in additional site investigation operations.

A simple cost-benefit analysis of this type, of course, is not the only basis for deciding to perform a more intense level of foundation exploration than would otherwise be done. There is a need to define the extent of anomalies in the subsurface that are encountered in the initial phase of site exploration (e. g., waterbearing sand layers within masses of cohesive soil, zone of fragmented rock or boulder fields, and slots within limestone) so as to avoid construction delays and claims. These factors can be considered in a cost-benefit analysis as well, but such an analysis should include the costs of settling claims, delays in completion of the structure and similar factors. There is also a need to define the stress-strain properties of the geomaterial, rather than just its strength, in order to conduct settlement, uplift or lateral deformation analyses if the structure is sensitive to movement. Obtaining stress-strain data obviously adds to the cost of the subsurface investigation in terms of requirements to obtain higher-quality samples than are needed for strength testing and/or performance of *in-situ* tests that reveal stress-strain properties.

A special program of subsurface exploration is frequently necessary in order to obtain the *in-situ* (mass) properties of rock. Not only is it important to obtain the compressive strength and stiffness of the sound, intact rock, but it is necessary to obtain detailed information on the nature and spacing of joints and cracks so that the stiffness of the rock mass can be obtained. The properties of the rock mass will normally determine the amount of load that can be imposed on a rock-socketed drilled shaft and the amount of settlement or uplift that will occur when the shaft is loaded. Joint patterns can be studied by constructing full-sized test excavations and either entering those excavations to view the joint patterns or surveying the borehole with a TV camera. The pressuremeter and borehole jacks have been used to investigate the deformability of the *in-situ* rock masses.

Field load testing is particularly useful in rock. In fact, a substantial expenditure of funds for the development of design methods from loading tests, followed by analytical studies, could be warranted for a specific site if there is to be a significant amount of construction at the site. Williams, et al. (1980) stated, "A satisfactory design cannot be arrived at without consideration of pile load tests, field and laboratory parameter determinations and theoretical analyses; initially elastic, but later hopefully also elasto-plastic. With the present state of the art, and the major influence of field factors, particularly failure mechanisms and rock defects, a design method must be based primarily on the assessment of field tests."

Other literature concerning drilled shafts in rock confirms the above statements about a design method; therefore, the methods that are presented in Appendices B and C for assessing resistance and deformation of rock and IGM sockets must be considered to be approximate. Detailed studies, including field tests, are needed in many instances to develop or confirm a design.

### **Influence of Construction on Geomaterial Properties**

Several of the previous chapters have dealt with the details of the various construction methods,

and the influence of some of the procedures on geomaterial properties have been indicated. Because of the importance of construction on the performance of drilled shafts, it is desirable to deal with the topic prior to a presentation of details concerning design calculations. It is quite important that these issues be kept in mind by the designer as the design evolves. Attention here will be given only to those factors that affect the geomaterial properties.

### **Cohesive Soil**

The dry method of construction can frequently be used in cohesive soil. The relief of stress produced by excavation allows the soil to deform inward with a resulting loss of shear strength. If the clay is jointed or cracked, care should be employed so that chunks of the soil do not loosen and fall into the excavation, which if not removed can have significant negative effects on base resistance.

If the casing method or the slurry method of construction is employed, a fluid may be introduced into the excavation at least over part of the depth of the excavation. Some stress relief and soil deformation will still occur, but these effects will be reduced because the fluid pressure will re-impose some of the soil stress. If the clay is saturated, there will possibly be some slight elevation in the water content of the clay at the wall of the excavation, especially if the soil is heavily overconsolidated. If the clay is partially saturated, the situation with respect to water migration is quite different. Water will move from the slurry into the soil and there will be a reduction in shear strength as the clay swells. The amount of the reduction will depend on the degree of saturation of the clay and, at present, there is no simple method to predict such strength loss.

In both saturated and partially saturated clays, destructuring of the soil may occur at the borehole wall due to the action of the drilling tools. Such destructuring (remolding) also promotes strength loss, especially in highly overconsolidated and/or cemented clays. If the maximum unit side resistance is termed  $f_{\max}$ , it is reasonable to use values of  $f_{\max}/s_u$  (termed  $\alpha$ ) that decrease with increasing  $s_u$ , since a high value of  $s_u$  in clays at the depths to which drilled shafts are normally installed result from high degrees of overconsolidation or from cementation.

The placing of the concrete will re-impose a stress in the clay surrounding the drilled shaft that can be greater than the *in-situ* stress and possibly reestablish some of the shear strength lost by remolding and swelling. The magnitude of the concrete stress is dependent on the fluidity of the concrete, and high-slump concrete is strongly recommended for this reason in most cases.

Laboratory experiments with partially saturated clays have been performed by the authors by placing a layer of mortar (simulated concrete) over a layer of clay. The surface of the clay was prepared to simulate construction (e.g., remolded or grooved). The testing of the resulting specimens in a direct-shear machine showed that some of the water from the concrete, not needed for hydration of the cementitious material, moves into the clay. Also, there is apparently some chemical bonding between the particles of clay and the cement in the concrete. The nature

and degree of such bonding is not well-understood, but the laboratory tests have shown that the shear strength at the interface between the clay and the mortar is somewhat greater than that in the clay itself and that shear failure actually occurs in the soil a short distance (perhaps 1 mm) from the interface.

The transformation of the clay from its *in-situ* character to the geomaterial near the interface with the concrete, which provides the side shearing resistance for the drilled shaft, is seen to be a complex process. It is clear, however, that since most of the factors that affect the clay lead to a reduction in its shear strength, it is not prudent to use the full cohesive shear strength of the soil when computing unit side resistance  $f_{\max}$ .

### **Granular Soil and Granular IGM's**

In constructing drilled shafts in uncemented non-plastic silt, sand, or gravel it is necessary that the soil be prevented from loosening excessively or collapsing as the excavation is advanced, and mineral or polymer slurry can be used to good advantage. Another procedure, discussed briefly in Chapter 3, with advantages in certain instances is to install a casing through the granular soil with a vibratory or impact driver. In either case, there are influences on the characteristics of the soil that are of interest to the designer.

When slurry is employed, there will be stress relief, a flow of at least some of the slurry into the soil formation (termed "filtration"), the creation of a membrane at the wall of the borehole ("mudcake") when mineral slurry is used, and a time-dependent thickening of the membrane with decreasing filtration. If polymer slurry is used, a membrane is not formed, but a mass of polymer strands becomes attached to the grains in the soil in the vicinity of the borehole wall, which also decreases filtration with time. If it is assumed that the concrete is cast within a few hours after the excavation is completed and that fluid, cohesive concrete is used, the result will probably be a good bond between the concrete and the sand. In the case of mineral slurry, most of it is scoured off by the rising column of concrete, leaving a paper-thin film of mudcake attached to the borehole wall. Shearing failure does not ordinarily occur through this weak residual mudcake film because the borehole is always slightly rough, which forces the majority of the shearing surface into the soil. In the case of polymer slurry, exposure to the concrete, which is very alkaline (high pH), causes the polymer strands to undergo a chemical change, which converts the polymer primarily to carbon dioxide and water, although some of the polymer strands located at some distance from the interface apparently remain permanently lodged in the soil pores. The result is that the residual polymer has very little effect on the shearing resistance of the soil. If the hole is left open for too long a period of time before concreting, excessive mudcake can build up in a mineral slurry, and the mudcake may harden, resulting in a thicker film of residual mudcake than if concreting occurs rapidly after drilling.

The fluid pressure of the concrete will restore some of the stress relief that resulted from the drilling and has an important influence on the frictional shearing resistance that develops at the borehole wall when the drilled shaft is loaded.

If a casing is installed by an impact or vibratory driver, the sand around the casing may be densified. If the casing is filled completely with fluid (high-slump) concrete, with the pulling of the casing, the concrete will flow outward and upward to fill the space vacated by the wall of the casing. The result should be to produce high lateral effective stresses between the concrete and soil whose properties may have been improved somewhat by vibration.

The excavation of a drilled shaft in granular soil also causes a reduction in stress on the base of the borehole. When this happens, the base heaves upward, although less so when drilling slurry is used. This heave reduces the density of the cohesionless soil beneath the base of the drilled shaft, which in turn reduces the bearing capacity and stiffness of the soil at the base in a way that is difficult to predict. For this reason it is suggested that design for base resistance in granular soil should be predicated on the use of empirical relations deduced from loading tests on full-sized drilled shafts loaded to failure in compression.

### **Rock and Cohesive IGM's**

Drilled shafts in rock and cohesive intermediate geomaterials will normally be able to derive their compressive resistance, in base resistance and/or in side resistance, from a relatively short length of socket. Because of the relatively small area of the rock exposed to the concrete in the socket and the relatively high load transfer values that must be achieved, the construction procedures should assure complete contact between the rock and the concrete of the shaft. The degree of roughness between the sides of the borehole and the drilled shaft concrete is very important. The roughening of the sides of the excavation is necessary when the drilling leaves a smooth, slick surface in the rock. For example, if water is placed in an excavation to facilitate drilling through shale, soft, highly remolded cuttings can be left at the sides of the excavation. The roughening of the sides of the excavation by grooving or rifling in such a case is imperative. The design method for cohesive IGM's and the method proposed for computing axial movement involve a conscious decision on the part of the designer to determine whether the borehole will be smooth or rough. If it is assumed to be rough, appropriate items should be placed in the construction specifications to assure that the desired roughness is achieved.

The amount of cleaning of the bottom of the excavation is dependent on design assumptions. If the design is based only on side resistance, rigorous cleaning of the bottom of the excavation is not as important as if the design is based on base resistance. [However, it is still important to clean the bottom. If not, some of the cuttings will become mixed with the concrete and compromise the structural integrity of the drilled shaft.]

Another matter of concern with regard to construction in rock is whether or not the rock will react to the presence of water or drilling fluids. Some shales will lose strength rapidly in the presence of water.

If the rock is jointed and cracked below the water table and if the water table is lowered in the excavation, there will be a flow of water into the open borehole. There could be a significant



amount of lateral or vertical deformation of blocks of the rock with a consequent loss of integrity of the rock mass. If the rock is porous and a mineral drilling slurry is used in the excavation, a considerable thickness of mudcake can collect on the sides of the borehole if the slurry is left in place for some time. In fact, it is best to avoid using mineral drilling slurry in rock formations whenever possible. Plain water can often be used to balance the water head in the rock formation, and freezing of the formation has been used in some instances to cut off water flow and stabilize the rock.

### **Principal Design Considerations**

The design of drilled shafts to resist applied loads involves a number of considerations. However, three principal considerations are the estimation of the

- (1) nominal *ultimate resistance*, both in terms of
  - (a) the structural resistance of the drilled shaft, and
  - (b) the resistance of the soil or rock in which the drilled shaft is constructed (geotechnical resistance),
- (2) the *deformation* of the foundation under working or service limit load, and
- (3) the *reliability* of the constructed foundation.

Factors that impact these principal considerations can be listed as follows:

- Magnitude and nature of loads (including uplift and lateral loading, torsional loading, and the potential for cyclic loading).
- Determination of the most critical combination of loads that can be applied with reasonable probability.
- Subsurface stratigraphy and soil/rock properties, and the level of uncertainty in defining values for the subsurface geometry and geomaterial properties at the construction site.
- Method used to compute the value of nominal soil/rock resistance,
- Targeted level of reliability of the foundation, as expressed through either a global factor of safety or load and resistance factors that in some manner incorporate the degree of uncertainty involved in characterizing the loads, the properties of the soil and/or rock and the effects of construction.
- Computed value of nominal structural resistance considering uncertainties in concrete strength, the position of the steel and the possibility of unavoidable minor defects within

the drilled shaft.

- Tolerable total and differential movements of the structure.
- Long-term response of the foundation (including potential for the deterioration of the materials of construction, creep and consolidation in the geomaterial).
- Constructability of the foundation that is designed.
- Availability of equipment for constructing the drilled shafts as designed, performing field loading tests, construction monitoring and post-construction structural integrity tests.
- Restrictions on vibration of the foundation or superstructure.
- Aesthetic considerations.

Some of the above considerations are illustrated graphically in Figure 10.3. Two idealized load vs. settlement curves for a drilled shaft are shown in the figure, one that gives axial load versus settlement for cohesive soil and one for a dense granular soil or rock. The two curves are distinguished from one another by the fact that the load-settlement curve for the cohesive soil exhibits "plunging" behavior, while that for the granular soil and rock does not. Both curves are almost linear for loads of small magnitude, and the early portions of the curves show very small settlement. Rebound curves are not plotted in order to retain clarity; however, almost no permanent settlement would occur if the loads were released from the early portions of the curves. The permanent settlement increases with increasing magnitude of load.

The load-settlement curve for the drilled shaft in cohesive soil exhibits failure in plunging, which is typical for drilled shafts in saturated clay soils, and the curve for sand and rock shows that failure occurs gradually with a progressive increase in settlement. Numerous methods have been employed to define the ultimate load from load-settlement curves. One of the most theoretically sound methods, which is applicable specifically to drilled shafts in compression, was proposed by Hirany and Kulhawy (1988), from which it can be concluded that failure in drained base resistance (granular geomaterials) occurs at a settlement of approximately four per cent of the diameter of the base of the drilled shaft. The procedure used in this manual to define the ultimate resistance of a drilled shaft is to establish the ultimate resistance as (1) the plunging load for cohesive soils in compression, (2) the load corresponding to an arbitrary settlements of five per cent of the base diameter for granular soil and intermediate geomaterials (defined later) in compression, (3) 25 mm (1 in.) for rock and cohesive intermediate geomaterials (defined later) in compression, and (4) as the pullout loads for drilled shafts in any geomaterial in uplift. All of the design factors for geotechnical resistance for axial loading in this manual have been developed to yield resistances corresponding to these definitions of failure.

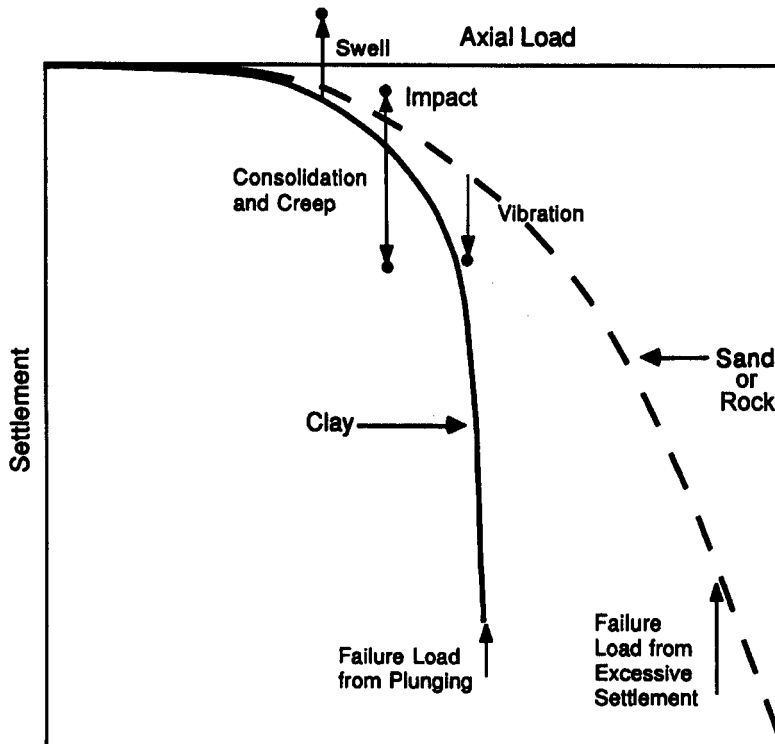

Figure 10.3. Hypothetical load-settlement relations for drilled shafts, indicating factors that influence shaft behavior under axial load

In addition to assuring safety against ultimate resistance, it is important to check the axial deformation of both individual drilled shafts and groups of drilled shafts against the serviceability requirements of the structure. This practice is somewhat different from the practice followed when analyzing driven piles, in which settlement of individual piles is rarely a concern. Individual drilled shafts are more susceptible to settlement than individual piles because they are typically of larger diameter and carry higher loads, and the short-term settlement of a driven pile or drilled shaft is generally proportional to its diameter for a given ratio of applied load to ultimate resistance.

Shown in Figure 10.3 are aspects of behavior that may require special consideration on the part of the designer, beyond the straightforward estimation of resistance and short-term movement, which are emphasized in this and the following chapters. These include the possibility of swell, consolidation, and creep of clays or soft rocks and the possibility of settlement due to vibration or liquefaction of sands.

The definition of ultimate resistance for drilled shafts under lateral loading is more complex. Ordinarily, drilled shafts for highway structures are embedded deeply enough such that structural failure in the drilled shaft occurs before complete geotechnical failure occurs in the geomaterial in which the drilled shaft is embedded (in which the geomaterial will resist no additional load,

allowing the drilled shaft to translate or rotate without bound). Therefore, the emphasis in lateral load design is to limit the loads from a structural perspective and to assure that deformations of the drilled shaft are such that serviceability of the structure is not impaired. Only for relatively short, rigid drilled shafts is it necessary to design against complete geotechnical failure. The primary emphasis in Chapter 13 is the design of relatively long, flexible drilled shafts to resist lateral loads, in combination with axial loads.

The design examples in this manual focus primarily on single, isolated drilled shafts for non-seismic axial loading because that is the condition that is most often of primary interest to designers of transportation structures. However, basic design principles for drilled shaft groups are considered in Appendices A through C and in Chapter 13. Many of these principles can be also used for seismic design, with modification.

Important concepts about the overall behavior of drilled shafts, including their response to load, are addressed in the remainder of this chapter.

## **GENERAL APPROACHES TO DESIGN**

Many state DOT's design drilled shafts geotechnically using allowable stress design (ASD) methods, sometimes referred to as working stress design (WSD) methods. However, there have been serious efforts in recent years to incorporate the factors mentioned in the introduction, and all other factors to be considered in design, into a formal procedure that is generally referred to as limit-states design (LSD). The intent of LSD is to present techniques to ensure that a structure (or foundation) is adequately constructed to resist collapse and will have appropriate serviceability throughout its life, an aim that is in agreement with the objectives of all good designers. The design factors in LSD do not guarantee the absence of failure, only that the probability of failure is tolerably small, or, put in a more positive way, that the reliability of the structure and its foundation are high enough to meet the demands of the travelling public.

In order to assure a selected, quantitative level of reliability for the foundation and the structure, the development of design techniques and parameters in LSD should have involved extensive use of probability theory and statistics. While the probabilistic basis of such techniques may not be apparent to the designer, the application of design parameters arrived at by their use is referred to as reliability-based design (RBD). RBD is not necessarily restricted only to LSD. It can also be applied to ASD, but as presently practiced ASD is not reliability based, except perhaps conceptually in the minds of some practitioners.

Limit-states design, as currently conceived by AASHTO (1994), is called load and resistance factor design, or LRFD. LRFD evolved from the concept of a partial safety factors, which began in Europe in the 1950's. In partial factor of safety methods consideration was given to the nature of the structure, the nature of the loading, the expected control of construction, the quality of the data concerning soil parameters, and the degree of confidence in the analytical procedures (Hansen, 1970; Meyerhof, 1970; Wright, 1977). A factor of safety is applied to each separate

component of both the load and the resistance, since it was perceived by the developers of this approach to design that the level of uncertainty associated with each component can usually be established more accurately than that for the entire structure or foundation system globally. The partial safety factors for the load multiply each component of load (e. g., dead load, live load, wind load on the structure), and the partial safety factors for the resistance divide each component of resistance (e. g., side resistance, base resistance in the foundation). The global factor of safety,  $F$ , which divides the total computed, or "nominal," resistance is equivalent to multiplying together all of the partial factors of safety for the individual load and resistance components.

### **Allowable Stress Design**

For axial load design of a drilled shaft using ASD, Equation (1.2) from Chapter 1 is used to compute the allowable load,  $R_A$ , from a geotechnical perspective, in which  $R_T = R_B + R_S$  (+ effective weight of the shaft in uplift in some design methods) is the computed or "nominal" ultimate resistance of the drilled shaft, which can be obtained from procedures described in Chapter 11 and Appendix B.

$$R_A = \frac{R_T}{F} \geq Q \quad (1.2)$$

$R_A$  must then be equal to or greater than the critical, nominal (unfactored) load  $Q$ . If  $R_A$  and  $Q$  (the nominal applied load) do not match closely, the geometry (depth or diameter) of the drilled shaft should be changed until a close match is achieved. This should be done intelligently, making sure that the constructability of the drilled shaft is not compromised.

Wright (1977) recommended values of the global factor of safety  $F$  for axially loaded drilled shafts for monumental structures (i e., major bridges) ranging from 3.5 where "poor" control is exercised over the construction to 2.3 where "normal" control is exercised over construction. For temporary structures,  $F$  is recommended to be 2.3 where "good" control is exercised over the construction and 1.7 where normal control is exercised. Intermediate values are recommended for structures intermediate between temporary and monumental. The differences in the values of  $F$  are justified by the need to target a higher level of reliability in monumental structures than in temporary ones. Most designers select values of  $F$  based on experience, upon a sense of the accuracy of their soil and rock parameters and upon the perceived accuracy of the method that they are using to compute resistance.

Once the shaft is sized based on geomaterial loading safety, the strength of the concrete and the strength and geometry of the reinforcing steel are selected, and the adequacy of the structural design is checked. This can be accomplished using LRFD techniques, even though the drilled shaft has been sized for geomaterial safety using ASD. Methods for structural analysis are given in Chapter 13.

Finally, the movement (settlement, uplift, lateral deformation) of the drilled shaft under the nominal load  $Q$  is checked using the methods discussed in Appendix C and Chapter 13 or by another suitable method. The estimated axial movement may need to be modified if consolidation beneath the base of the shaft or creep is possible, or if the soil can settle around the drilled shaft due to consolidation or compaction (as when the drilled shaft is constructed through a settling fill, Chapter 12). The estimated movements, as modified if necessary, are then compared with the tolerable movement of the structure, information for which is summarized later in this chapter for bridges.

### Load and Resistance Factor Design

ASD is familiar to most foundation designers. However, it suffers from the shortcoming that all uncertainty is lumped into one global factor of safety that is difficult to evaluate rationally in terms of the functional numerical reliability of the foundation, which is generally desired to be in the range of 0.999 - 0.9999, depending upon the consequences of failure of the foundation. [This value is the ratio of successful foundations to the total population of all foundations installed.] Functional reliability of the foundation involves the variability of the soil and rock properties and pattern and quality of soil and rock sampling, as well as the accuracy of the design model and quality of construction, which all affect the uncertainty in the computed (nominal) resistances and movements; the uncertainty in the estimation of the loads; and the consequences of a failure of the foundation. While it is difficult to arrive at a global factor of safety that addresses all of these effects, each of the component uncertainties can be analyzed individually and incorporated into a load and resistance design method, which considers the load and resistance components separately.

The step-by-step process of applying LRFD for drilled shaft foundations is illustrated in Appendix A and is elaborated upon below.

In the AASHTO (1994) version of the LRFD method a global factor of safety is not computed. Instead, the drilled shaft is sized based upon satisfaction of Inequality (1.3) from Chapter 1 for several different "strength" cases, which involve different logical components and combinations of loads, and possibly different load factors.

$$\eta \sum \gamma_i Q_i \leq \sum \phi_i R_i \quad (1.3)$$

where

$\eta$  = structure significance/ductility/redundancy factor ranging from 0.95 to 1.05,

$\gamma_i$  = load factor for load type  $i$  (for example, dead load of structural components, live load, wind load on the structure, load due to braking forces, load due to centrifugal forces, etc.),

$Q_i$  = nominal value of load type  $i$  on the drilled shaft (obtained from an analysis of the

structure) ,

$\phi_i$  = resistance factor, sometimes referred to as a performance factor, for resistance component  $i$  (for example, side resistance, base resistance or combined resistance), and

$R_i$  = nominal value of estimated or computed resistance component  $i$  (e. g.,  $R_T$ ,  $R_B$  or  $R_S$ , Chapter 11).

The foundation geometry may also need to be checked for "extreme event" limit state loading in cases where earthquake loads, ice loads, ship impact loads and similar loads can occur. In some cases, the geometry of the drilled shaft for geomechanical resistance purposes is controlled by extreme event state loading. Extreme event loading involves different combinations of load components and different load factors than in ordinary loading ("strength" state loading). In strength state loading the values of the load and resistance factors are prescribed to give very low probabilities of occurrence of the respective load and resistance components. Relatively little is known at present about extreme event state loading and a greater risk is often accepted in extreme event states than in strength states, which involve more common events; therefore, the load and resistance factors: for extreme events tend to be near 1.0. That is, the foundation is designed for near-nominal loads and resistance.

The load components that must be considered for each strength and extreme event state are prescribed by AASHTO (1994). They are summarized in Appendix A.

Inequality (1.3) is next satisfied for structural behavior, after selecting concrete and steel properties and reinforcing patterns. Chapter 13 addresses this step in the design.

Finally, Inequality (1.3) is satisfied for one or more "service" states to ensure that settlement or uplift movement, or lateral movement, is not excessive. Load and resistance factors for the service states are generally taken to be equal to or near 1.0. This reflects the philosophy that a lower level of reliability can be accepted when the factor being checked is serviceability (excessive deformation) as opposed to strength (collapse).

An excellent detailed resource covering LRFD for highway substructures is FHWA (1996).

### **Comparison of ASD and LRFD**

FHWA (1996) shows that there is a mathematical relationship between an overall resistance factor  $\phi$  (applied to the sum of all components of resistance) and the global factor of safety  $F$  for a strength or extreme event case [the only  $R$  term in Inequality (1.3) being the sum of the ultimate side and base resistances], for the simple case where the only two load components are dead load and live load. That relationship, which assumes that factor  $\eta = 1$ , is given in Equation (10.1).

$$\phi = \frac{\gamma_D \left( \frac{Q_D}{Q_L} \right) + \gamma_L}{F \left( \frac{Q_D}{Q_L} + 1 \right)} \quad (10.1)$$

where,

$\gamma_D$  = load factor for dead load,

$\gamma_L$  = load factor for live load,

$Q_D$  = nominal (computed) value of dead load, and

$Q_L$  = nominal (computed) value of live load.

One can obtain a sense of the relative values of resistance factors and factors of safety from Equation (10.1), which can be of assistance to designers who are making the transition from ASD to LRFD. For example, Table 10.1 gives values of  $\phi$  corresponding to the tabulated values of F for the ratios of  $Q_D$  to  $Q_L$  that are shown, assuming  $\gamma_D = 1.25$ ,  $\gamma_L = 1.75$  and  $\eta = 1$ , which are typical factors prescribed by AASHTO (1994).

Table 10.1. Resistance factors,  $\phi$ , for selected values of global safety factor, F

F	$Q_D/Q_L = 1$	$Q_D/Q_L = 2$	$Q_D/Q_L = 3$	$Q_D/Q_L = 4$
1.5	1.00	0.94	0.92	0.90
2.0	0.75	0.71	0.69	0.68
2.5	0.60	0.57	0.55	0.54
3.0	0.50	0.47	0.46	0.45
3.5	0.53	0.40	0.39	0.39
4.0	0.38	0.35	0.34	0.34

Note that global factors of safety, F, in the usual range of 2 to 3 correspond to resistance factors in the range of 0.46 to 0.71 for structures with dead to live load ratios of 2 to 3. Simple equations such as Equation (10.1) can be used to "calibrate" resistance factors for use in an LRFD method using familiar factors of safety. In fact, this method was used as a guideline in arriving at resistance factors prescribed by AASHTO (1994); however, it was augmented by detailed statistical studies. The approximate range of resistance factors,  $\phi$ , that are prescribed for axially loaded drilled shafts is 0.46 to 0.71; however, the  $\phi$  factors prescribed by AASHTO are tied to a



particular method of resistance computation, which is elaborated upon in Appendix A, in which suggested values for  $\phi$  corresponding to those methods are tabulated. The methods for computing resistance against which the AASHTO resistance factors have been calibrated, and that are referred to in Appendix A, are described in Appendix B. In addition to these "calibrated" methods, other "uncalibrated" methods are also given in Appendix B. The user of an uncalibrated resistance computation method must carefully select an appropriate resistance factor himself or herself, for example, by referring  $\phi$  to a global factor of safety (F) that the designer feels is appropriate through the use of Equation (10.1). It is important to understand that in LRFD methods that have an RBD basis, such as the AASHTO method, the tabulated values for the resistance factors ( $\phi$ ) should be used only with the geotechnical and structural resistance computation procedures for which they have been calibrated.

### COMPUTATION OF NOMINAL ULTIMATE AXIAL RESISTANCE, $R_{TN}$

This section relates to the use of equations from soil and rock mechanics to predict the ultimate axial resistance of a drilled shaft. The section following this section provides a brief discussion of procedures for estimating axial deformation (settlement or uplift).

For purposes of estimating nominal axial resistance in either compression or uplift, the following general process is followed:

- The subsurface profile is divided into layers within each boring grouping determined during the site investigation (Chapter 2), based on the judgment and experience of the geotechnical engineer.
- Each layer is assigned one of four classifications:
  - ▶ *Cohesive soil* [clays and plastic silts with undrained shear strength  $s_u \leq 0.25$  MPa (2.5 tsf)]
  - ▶ *Granular soil* [cohesionless geomaterial, such as sand, gravel or nonplastic silt, with uncorrected SPT N values of 50 blows / 0.3 m or less]
  - ▶ *Intermediate geomaterial* [cohesive geomaterial with undrained shear strength  $s_u$  between 0.25 MPa and 2.5 MPa (2.5 and 25 tsf) (equivalent to unconfined compression strength  $q_u$  between 0.5 and 5.0 MPa (5 and 50 tsf)); or cohesionless geomaterials with SPT N values > 50 blows / 0.3 m]
  - ▶ *Rock* [highly cemented geomaterial with unconfined compression strength > 5.0 MPa (50 tsf)].
- The unit side resistance  $f_{max}$  is computed in each layer through which the drilled shaft

passes, and the unit base resistance  $q_{max}$  is computed for the layer on or in which the base of the drilled shaft is founded.

- The nominal ultimate resistance  $R_{TN}$  of the drilled shaft in compression is computed from the geometric properties of the drilled shaft and the estimated values of  $f_{max}$  and  $q_{max}$  from Equation (10.2).

$$R_{TN} = \pi B \sum_{i=1}^n \Delta z_i f_{max i} + \frac{\pi B^2}{4} q_{max} = \sum_{i=1}^n R_{SN i} + R_{BN} \quad (10.2)$$

The use of this equation is illustrated in Figure 10.4.

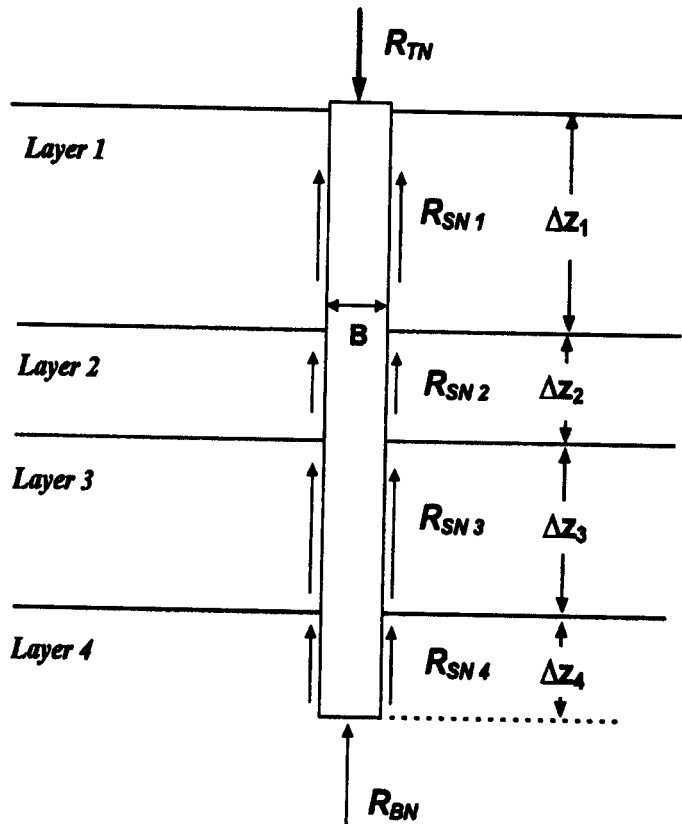

Figure 10.4 Idealized geomaterial layering for computation of compression resistance

- If a cylindrical drilled shaft will be located in uplift, Equation (10.3) is used. Base resistance is neglected but shaft weight (buoyant below the water table),  $W'$ , is included.

$$R_{TN} = \pi B \sum_{i=1}^n \Delta z_i f_{\max i} + W' = \sum_{i=1}^n R_{SN i} + W' \quad (10.3)$$

The use of this equation is illustrated in Figure 10.5. Methods for estimating  $f_{\max}$  and  $q_{\max}$  will be deferred to Chapter 11.

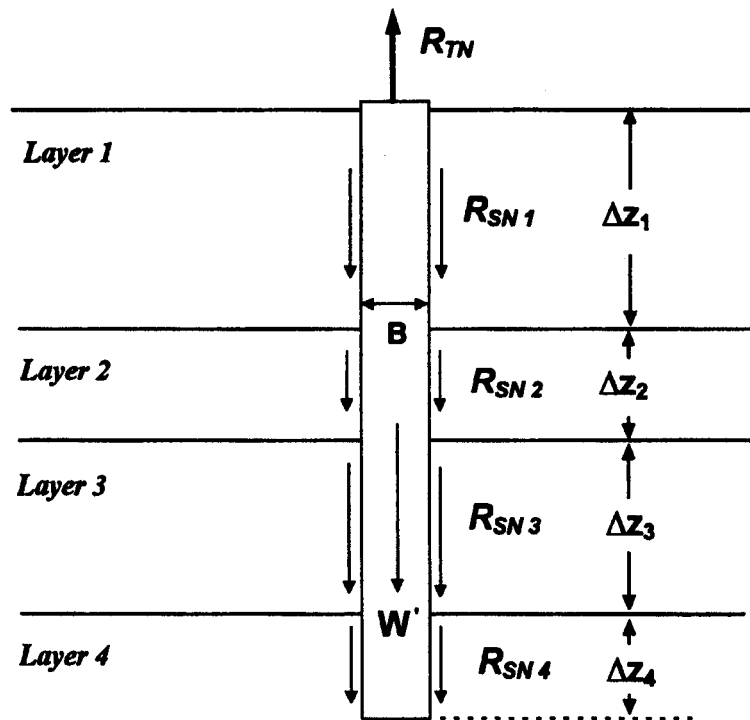

Figure 10.5 Idealized geomaterial layering for computation of uplift resistance

In Equations (10.2) and (10.3),  $i$  represents the geomaterial layer number,  $n$  is the total number of layers,  $B$  is the shaft diameter,  $\Delta z_i$  is the thickness of Layer  $i$ ,  $f_{\max i}$  is the unit side resistance in Layer  $i$ , and  $q_{\max}$  is the unit bearing resistance of the geomaterial upon which the base of the drilled shaft bears. For uplift loading the term involving  $q_{\max}$  is set equal to zero, and the effective weight of the drilled shaft is added to the right-hand side of the equation. Values for  $f_{\max i}$ , for each layer  $i$ , and  $q_{\max}$  are assigned so that they each correspond to a value of deformation that represents failure of the drilled shaft, described earlier.

This manual introduces a category of geomaterials termed "intermediate geomaterials," or "IGM's," which are harder and denser than ordinary soils but which are not cemented to the extent found in rock. Physically, IGM's can be saprolites (geomaterials derived from rock that has been weathered in place, which often are found in transition zones between surface soils and sound rock), very soft sedimentary rock (clay-shale, mudstone, limestone or sandstone) or very heavily overconsolidated soils, such as glacial tills. They can be either cohesive or granular.

Drilled shafts installed in IGM's can exhibit load-settlement behavior similar to either of the curves shown in Figure 10.3. IGM's are sometimes appropriate strata for founding the bases of drilled shafts, thus reducing the cost of drilled shaft construction by eliminating the cost of establishing a bearing surface on sound rock or socketing into rock.

Values of  $f_{\max}$  and  $q_{\max}$  are known to depend on the details of construction. It is presumed in this manual that the designer either cannot or does not wish to dictate to the contractor the specific construction processes that are to be followed. (In fact, dictating specific construction practices to bidders will likely result in very high initial costs and an increased number of claims, so it is a practice to be avoided unless it is absolutely necessary.) It is also assumed, however, that whatever construction method is followed, good practice, as summarized in Chapters 3 - 8, will be followed. The methods for evaluating  $f_{\max}$  and  $q_{\max}$  described in Chapter 11 are therefore appropriate for any method of construction (wet, dry or casing), perhaps more conservative for some than for others, except where the method is specifically excluded.

Appendix B provides a detailed overview of methods for computing both the unit compression and uplift resistances of drilled shafts in all four of the major classifications of geomaterials listed above. These are summarized in Chapter 11 for ease of reference. Some special methods are included for those cases in which the engineer chooses to specify certain construction practices (e. g., artificial roughening of boreholes in rock).

The simplified methods for estimating resistance that are given in Chapter 11 focus primarily on undrained loading of the geomaterials in cohesive soils, cohesive IGM's and rocks, and drained loading in granular soils and granular IGM's. However, Appendix B covers methods for assessing axial resistance for both drained and undrained loading in most of the major geomaterial classes. Simply put, undrained loading considers that any pore water pressures that are generated in the soil due to loading the drilled shaft remain undissipated during the loading event. This is a common assumption in saturated clay soils, for example. If the clay is saturated, loading of the soil by the drilled shaft produces an increase in pore water pressure that is considered to be identical to the increase in total stress applied by the drilled shaft, so that the effective stress within the soil framework does not change. Consequently, the strength of the clay does not change. The undrained shear strength of the clay soil, denoted  $s_u$ , is therefore used in the design. Under long-term axial loading in most instances the positive pore water pressures that are generated in the soil will slowly dissipate so that there will be an increase in the shear strength of the clay with time; hence, the level of safety will increase as time passes. This means that the undrained condition at the instant of loading is the most critical condition. Even if undrained conditions are assumed for computation of resistance, there will be some settlement with time, as the pore water pressures dissipate, that may need to be taken into account.

However, consideration may need to be given to the prediction of drilled shaft resistance under drained loading in cohesive soils, which can be the critical pore water pressure condition if the cohesive soil is very heavily overconsolidated. This is due to the observation that in heavily overconsolidated clays or soft clay-based rock there is a possibility that negative pore water

pressures (suction) can develop in the soil pores along the sides of drilled shafts when shearing loads are applied and that the geomaterial would soften in time as the suction pressures dissipate, with a corresponding reduction in side resistance. Some of the lost resistance will be transferred as load to the base where positive pore water pressures are to be expected to be generated and then slowly dissipate. The computational methods presented in this manual for drilled shafts in cohesive soils (that are based on undrained shear strength that is modified to account for construction and loading effects based on results of short-term load tests) could be unconservative for heavily overconsolidated clays or clay-based IGM's under sustained loading, which would suggest that an analysis for resistance under fully drained conditions should be made. Such an analysis requires the estimation of the drained, or effective stress, shear strength parameters  $c$  and  $\phi$ , as well as the earth pressures in the geomaterial mass. This type of analysis is not performed in Chapter 11 or in the example problems presented in Appendix D, but the basic procedures are given in Appendix B.

Alternatively, the concern over soil softening in heavily overconsolidated clay-based geomaterial can be addressed by the method used to evaluate undrained shear strength,  $s_u$ . In hard clays and clay shales, for example, samples can be permitted to imbibe water while being appropriately confined (for example, at an isotropic pressure equal to the effective overburden pressure) prior to undrained shearing in a triaxial cell. The test to assess shear strength thus becomes a "consolidated, undrained" (CU) test. This step will reduce the negative pore pressures in the specimen so that the shear strength obtained will approximate the long-term, softened shear strength. The estimation of side resistance can then proceed using the methods for undrained loading, which are illustrated in Chapter 11 and in Appendices B and D.

### **Nominal Base Resistance, $R_{BN}$**

Base resistance is ordinarily assigned in compression loading but not in uplift loading, unless the base is underreamed. Base resistance normally depends upon the shear strength properties of the soil in the vicinity of the base, most strongly within two shaft base diameters below the base.

#### **Cohesive Soil**

For drilled shafts in cohesive soils, the unit base resistance may be computed from a general bearing capacity equation. Typically, the angle of internal friction is taken as zero for undrained loading. For this condition, if the load is axial and the ground surface is horizontal, the general bearing capacity equation given in Appendix B reduces to the following:

$$q_{max} = s_u N_c^* \tag{10.4}$$

where

$q_{max}$  = net ultimate unit base resistance,

$s_u$  = average undrained shear strength of the soil between the base and 2 base

diameters beneath the base, and

$N_c^*$  = a bearing capacity factor, which can be taken to be 9 for most drilled shafts whose base is situated at least 2.5 base diameters beneath the surface of the soil and in which the clay has an undrained shear strength of 96 kPa (1 tsf) or higher. For other conditions, Appendix B should be consulted.

$q_{max}$  should also be limited for cohesive soil for drilled shafts of very large diameter in order to restrict settlement if settlement is not explicitly computed.

### **Granular Soil and Cohesionless Intermediate Geomaterials**

Theoretical methods exist for evaluating  $q_{max}$  in granular soils and cohesionless IGM's. They are reviewed in Appendix B. In the theoretical analyses, drained pore water pressure conditions are most often assumed; however for many field cases some critical loadings are likely to produce pore water pressure conditions that are between drained and undrained, particularly for cohesionless IGM's with considerable fines.

The construction of a drilled shaft affects the properties of these geomaterials by unloading them when the borehole is excavated, with a resulting change in their density and state of stress. The placement of concrete may or may not return them to their original density and state of stress. For this reason, Chapter 11 recommends empirical methods for computing  $q_{max}$  that have been correlated to N values from the SPT at loading test sites at which  $q_{max}$  has been measured rather than using the theoretical methods. As with any empirical correlation, those given here should be used with caution. For example, there are no data supporting the empirical correlations for drilled shafts deeper than about 30 m (100 ft) and for drilled shafts whose bases contain residual cuttings that have fallen out of suspension in a drilling slurry, and the SPT correlations have been performed in a limited number of geological formations.

The theoretical methods can be used as long as the designer can predict the effect of stress relief and disturbance on the properties of the soil upon which the base of the drilled shaft bears. Whether they are used or not, they give the designer insights into the effect of depth of the base, soil stiffness and soil compressibility on the unit base resistance, and they should be studied and understood. They especially provide a means for evaluating  $q_{max}$  in very deep drilled shafts, in which  $q_{max}$  does not increase in linear proportion with depth.

Vesic (1970) pointed out the following: "Beyond a depth of approximately twenty pile diameters both point (base) and skin (side) resistances reach nearly constant final values. These findings depart from the established concepts of linear increase of bearing capacity of deep foundations with depth."

For cohesionless geomaterials the theoretical methods take the form

$$q_{max} = \zeta^* (N_q - 1) \sigma'_{vb} \quad (10.5)$$

where

$\zeta^*$  = depth, shape, load inclination and rigidity index factor,

$N_q$  = basic bearing capacity factor based on  $\phi$ , the angle of internal friction of the geomaterial, and

$\sigma'_{vb}$  = vertical effective stress in the soil at the elevation of the base of the drilled shaft (Chapter 2).

Vesic (1972) provided a basis for the rational explanation of the phenomenon of decreasing rate of increase of  $q_{max}$  with depth in granular soil based on the concept of the "rigidity index" of the soil, or the ratio of the shear stiffness of the soil to its shear strength, considering also the effect of soil compressibility. Values for  $\zeta^*(N_q)$ , termed  $F_q$ , are given in that reference. If bearing failure is viewed as emanating from the production of a plastic sphere beneath the base of a deep foundation that is confined by surrounding elastic soil, then  $\zeta^*N_q$  depends upon the rigidity index of the soil near the base of the drilled shaft. In a uniform granular soil deposit the shear strength of the soil depends directly upon the vertical effective stress, which increases linearly with depth, while the shear stiffness increases only approximately with the square root of the vertical effective stress and therefore increases approximately with the square root of depth. Therefore, as depth increases the rigidity of the soil (stiffness/strength) decreases, and consequently  $\zeta^*N_q$  decreases. The angle of internal friction  $f$  may also decrease as confining pressures increase with depth.

Meyerhof (1976) proposed to deal with this phenomenon in another way, involving the estimation of a "critical depth" beyond which  $q_{max}$  does not increase with further penetration of the drilled shaft. He stated that for a circular bearing area "the factor  $N_q$  [ $\zeta^*N_q$  in the case of Equation (10.5)] increases roughly linearly with the ratio of depth to width and reaches its maximum value at a depth ratio of roughly one-half of the critical depth ratio." A curve for the critical depth ratio was given as a function of the angle of internal friction. The following approximate values for critical depth ratios were given: 6 for  $\phi$  of 28 degrees, 7 for  $\phi$  of 30 degrees, 8 for  $\phi$  of 32 degrees, 11 for  $\phi$  of 35 degrees, and 16 for  $\phi$  of 40 degrees. Using the Meyerhof recommendations,  $q_{max}$  for a drilled shaft will reach a limiting value. For example, a drilled shaft with a diameter of 0.915 m (3 ft) installed in sand with  $\phi = 32$  degrees would reach a limiting value of  $q_{max}$  if the ratio of depth to width were one-half of 8 (the critical depth ratio for  $\phi = 32$  degrees). Thus, the limiting value of  $q_{max}$  would occur at a depth of 4 times 0.915 m (3 ft) or 3.66 m (12 ft).

The design method given in Chapter 11, based on the SPT, presumes that SPT N values are

limited by the same factors as  $q_{\max}$ , so  $q_{\max}$  can be related directly to  $N$  below critical depth (3 to 8 shaft diameters).

As with cohesive soil,  $q_{\max}$  is limited in Chapter 11 for large-diameter drilled shafts in cohesionless soil in order to restrict settlement if settlement is not explicitly computed.

### Rock and Cohesive Intermediate Geomaterials

The estimation of  $q_{\max}$  in cohesive IGM's and, especially, in rock is dependent upon the joint pattern in the geomaterial. Semi-empirical and simplified theoretical methods are given for the estimation of  $q_{\max}$  in Appendix B for (1) massive (unjointed) material, (2) materials that are primarily horizontally jointed, (3) materials that have preferentially sloping joints and (4) random jointing. Very significant differences in  $q_{\max}$  appear when the various joint patterns are considered. If the joint pattern is not known or cannot be predicted, it is prudent to use the most conservative estimate or to base the assignment of  $q_{\max}$  on loading tests.

Since joint patterns and even voids can occur in some rock formations spuriously, it is important either to verify the quality and joint pattern in the rock at the location of each drilled shaft on a project by coring into the rock below the base level to a depth of 1.5 to 2 base diameters below the base elevation (either prior to commencing excavation or at the time that excavation reaches the elevation of the base) or to disregard base resistance altogether. If coring is accomplished after the drilled shaft has been drilled to final elevation, the core hole can be inspected from the base of the drilled shaft either by means of "feeler rods" or by visual means (for example, fiberoptics cameras), so that the joint pattern assumed in design can be verified. Disregarding base resistance may be too extreme in most rocks, but it might be a reasonable assumption in karstic regions (limestone formations known to have solution cavities).

### Nominal Side Resistance, $R_{SN}$

#### Cohesive Soil

The undrained loading condition usually controls the design of drilled shafts in geomaterials of this category. For the design of drilled shafts in cohesive soil and cohesive intermediate geomaterials under undrained loading, where time-dependent changes in *in-situ* strength are not significant or critical, the ultimate value of  $f_{\max z}$  at any depth  $z$  is computed as follows.

$$f_{\max z} = \alpha s_{uz} \quad (10.6)$$

where

$\alpha$  = a shear strength reduction factor, based primarily on experimental results from full-sized load tests, which depends upon  $s_{uz}$  and



$s_{uz}$  = undrained shear strength of the soil at depth  $z$ .

$\alpha$  represents the effects of construction and loading that tend to reduce the shear strength indicated by unconsolidated, undrained (UU) triaxial compression tests to the operational value along the side of the drilled shaft. Its value, which is dependent on shear strength, has been obtained by analysis of various data bases, as described in Appendix B. In general,  $f_{max z}$  can be taken to be identical in compression and uplift.

### Granular Soil and Cohesionless Intermediate Geomaterials

The drained loading condition is most often assumed for the design for geomaterials in this category. For the design of drilled shafts in granular (cohesionless) soil (well-draining sands and gravels) or intermediate geomaterials under drained loading, the cohesion is assumed to be equal to zero, and the ultimate value of the unit side resistance,  $f_{max z}$ , at depth  $z$  is computed as follows:

$$f_{max z} = K_z \sigma'_{vz} \tan \delta_z = \beta_z \sigma'_{vz} \quad (10.7)$$

where

- $K_z$  = coefficient of lateral pressure at depth  $z$ ,
- $\sigma'_{vz}$  = vertical effective stress in the geomaterial at depth  $z$ ,
- $z$  = depth below the ground surface,
- $\delta_z$  = friction angle between concrete and soil at depth  $z$ , and
- $\beta_z$  =  $K_z \tan \delta_z$ .

$K_z \sigma'_{vz}$  defines the normal (horizontal) effective stress against the interface between the concrete and the soil. Ordinarily, the granular soil or cohesionless IGM is assumed to be freedraining, and  $\sigma'_{vz}$  is taken to be the geostatic value at the construction site, explained in Chapter 2. If a drilled shaft is installed in sands, gravels or IGM's with considerable fines, the engineer should investigate the possibility of excess pore water pressure at the time of the loading event for which the drilled shaft is being designed and make any necessary adjustments in the effective stress,  $\sigma'_{vz}$ .

Several versions of Equation (10.7) are described in Appendix B. A conservative approach is the use the expression on the right side of the second equal sign in Equation (10.7), along with lower-limit values for  $\beta_z$  that are proposed for both sand and gravel in Appendix B [Figure B.17 and Equations (B.54 through B.56)]. Those values were obtained from the analysis of compression loading tests on full-scale drilled shafts constructed under drilling slurries (mineral and polymer), with casing and in the dry, so the construction method does not have to be predicted in order to use the lower-limit values of  $\beta_z$  in Appendix B. However, if the at-rest earth pressure coefficients for the soil are known through on-site measurements, and if  $\delta_z$  can be

estimated based on an assurance that a known method of construction will be followed, a version of Equation (10.7) in Appendix B that uses such known values can certainly be employed to compute  $f_{\max z}$ .

In this manual  $\sigma'_{vz}$  is taken to be the ambient vertical effective stress in the soil, unmodified by the presence of the drilled shaft; however, there has been some suggestion from research (Bernal and Reese, 1983; Milititsky, 1983) that  $K_z \sigma'_{vz}$  might be taken as the horizontal pressure in the fluid column of concrete, rather than the pressure in the soil. In point of fact, the horizontal effective pressure at the interface between the concrete and the soil (or more properly the pressure one or two millimeters into the soil from the interface, where shearing failure takes place),  $K_z \sigma'_{vz}$ , which controls the side shearing resistance, is probably between the ambient horizontal effective stress in the soil, unmodified by the presence of the drilled shaft and the effective stress produced by the fluid concrete. Certainly, the pressure of the fluid concrete has some effect on the value of  $K_z \sigma'_{vz}$  and it should be maintained as high as possible by using high-slump, fluid concrete placed continuously in the borehole. The effect of the accommodation between soil and concrete pressures is taken into account empirically in Appendix B through the use of the factor  $\beta_z$ , which was back-calculated from full-scale field loading tests in which high-slump concrete was used to construct the drilled shafts.

It is recommended in Appendix B that  $f_{\max z}$  be reduced slightly for uplift loading in some circumstances relative to its value for compression loading.

### **Rock and Cohesive Intermediate Geomaterials**

In many geologic environments drilled shafts are completely supported in cohesive and cohesionless soils. However, where rock or intermediate geomaterial is found within an economical depth (say, 30 m or less for foundations of major structures), it may be more cost effective to carry the drilled shafts down to the rock or intermediate geomaterial in order to take advantage of the higher unit side and/or base resistance values afforded by such geomaterial.

Side resistance in rock and cohesive IGM's depend upon factors other than the strength of the geomaterial. These include the roughness of the socket (portion of the drilled shaft drilled into the rock or IGM), the presence of soft seams within the geomaterial, and the angle of friction between the concrete and geomaterial. The methods for estimating  $f_{\max}$  in these geomaterials is therefore somewhat more complex than for estimating  $f_{\max}$  in cohesive soils and in granular soils and intermediate geomaterials. Details are given in Appendix B, and step-by-step methods for applying the methods are given in Chapter 11. Behavior is generally considered to be drained along joints in the rock and at the shaft-rock interface but undrained within the intact pieces of rock within the rock mass.

An important issue for drilled shafts socketed into rock is whether the side resistance behavior is deflection softening. If so, either the resistance  $R_T$  should be taken to be the full side resistance

plus the incomplete base resistance at a deflection that corresponds to shear failure along the sides, or a residual value of side resistance should be assumed before adding side resistance to the full base resistance to compute  $R_T$  for compression loading. This issue is considered in Appendix B and in Chapter 11.

In some instances side resistance in rock should be reduced due to uplift loading, as described in Appendix B.

## COMPUTATION OF DEFORMATIONS

Figure 10.3 presents typical idealized load-settlement curves and indicates the influence on settlement of factors other than load. The curve drawn with a solid line and the one with the dashed lined indicate the typical response to short-term loading of a drilled shaft in cohesive soil/IGM and in granular soil/IGM and rock, respectively. The arrows in the figure indicate time-related movements. The time-related effects (consolidation, swell, creep, for example) are difficult to generalize and must be treated in a site-specific manner. The settlement due to short-term loading, however, is important and can be analyzed by theoretical or empirical procedures.

Appendix C presents several approaches to estimating settlement of drilled shafts and drilled shaft groups in soil, IGM and rock. The simplest method, a "back of the envelope" approach, may suffice in certain situations such as preliminary design. In other cases, the use of normalized load-deformation relations or solutions based on the theory of elasticity can be used with sufficient accuracy for routine design. More complicated numerical simulations are described involving the mechanics of load transfer as a nonlinear function of deformation, leading to the computation of the short-term settlement. Such simulations may be needed in more complex cases (layered geomaterial systems, rough boreholes in rocks or IGM's, for example).

The methods discussed in Chapter 13 provide means for simulating the lateral deformation and rotation of drilled shafts. They require that local soil resistance-local deformation relations be determined for the soil or rock and that the bending stiffness of the drilled shaft, which is dependent upon the bending moment, be modeled.

The numerical simulations documented in Appendix C and in Chapter 13, as well as the simpler methods for estimating axial deformation in Appendix C, should be considered to be methods under development, despite the fact that considerable theoretical development and experimental calibration has been performed for all of these methods. Data from axial and lateral field loading tests of drilled shafts that are fully instrumented in soil and rock formations that have been carefully studied are still needed to bring these methods to the point where they can be used in general design in specific geologic formations.

Deformations of drilled shafts are estimated for the working load in ASD and for the unfactored nominal load, or for a fraction of the unfactored nominal load for some components, in LRFD (Appendix A). Ordinarily, computed deformations are not factored before comparing them with

tolerable deformations. However, drilled shafts can behave in a highly nonlinear manner during lateral loading, because the concrete section can suddenly crack or the soil near the top of the shaft can yield in a plastic manner. In Chapter 13, therefore, it will be recommended that the lateral deformations be checked using factored loads in order to assure that the deformations computed with unfactored loads do not represent a quasi-stable condition, as illustrated in Figure 10.6.

## GROUPS OF DRILLED SHAFTS

One of the important characteristics of drilled shafts is that they can have large diameters and can extend to great depths. Therefore, a single drilled shaft can be designed and constructed to support large axial and lateral loads, so that it is not often necessary to use drilled shafts in groups that are closely spaced. If for some reason it is necessary to put drilled shafts in closely-spaced groups, as for example for column foundations for very large bridges, the interaction among the shafts, and perhaps the interaction between the drilled shaft cap (column or abutment footing) and the shafts, which will be referred to as "shaft-soil-shaft interaction," or SSSI, must be considered.

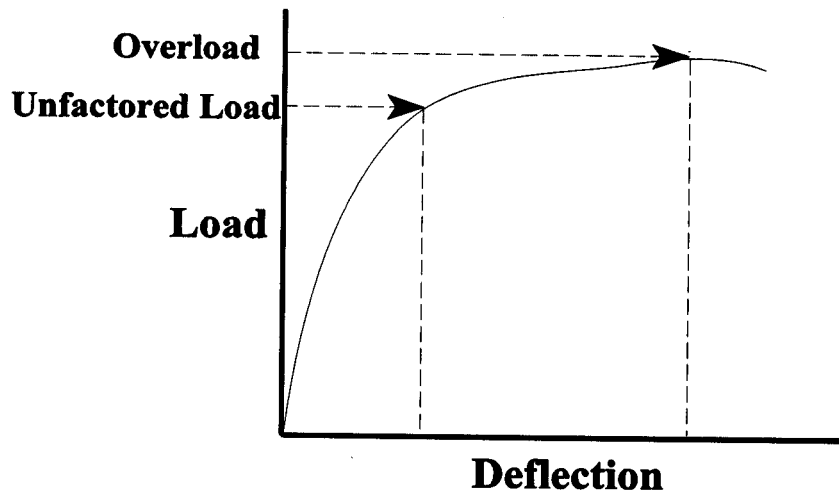

Figure 10.6. Potential effect of loading slightly above unfactored load on lateral deflection of a drilled shaft

SSSI takes two forms. First, the resistance of a drilled shaft within a group can be reduced by the stress changes in the soil produced by the construction and loading of neighboring drilled shafts. This effect can occur both for axial and lateral loading. The ratio of the resistance of the drilled shaft as it participates in a group divided by its resistance as a single, isolated drilled shaft is termed "efficiency." Second, the loading of neighboring drilled shafts will increase the flexibility of each drilled shaft in the group such that the deformation of each drilled shaft under

a given load will be greater than its deformation under the same load had the drilled shaft been isolated from the group. The increased deformations are accompanied by increased bending moments in the case of laterally loaded drilled shafts.

The concept of group behavior is presented simplistically in Figure 10.7. Figure 10.7a shows a single drilled shaft undergoing compression loading and the possible downward movement of an imaginary surface at some distance below the groundline. As may be seen, that surface moves downward more at the wall of the drilled shaft than elsewhere, but movements occur at distances well away from the wall of the drilled shaft.

Figure 10.7b shows a group of three closely spaced drilled shafts undergoing compression loading. The zones of influence from the individual shafts will overlap so that the imaginary surface moves downward more for the group than for the single drilled shaft. The stresses in the soil around the center drilled shaft are different than for the single shaft because of the superposition of the zones of influence from the adjacent shafts and because of construction effects, which may also affect the resistance of the center drilled shaft.

The problem of group action in both driven piles and drilled shafts has been discussed in general by O'Neill (1983). Excellent recent papers on the settlement of drilled shaft groups have been presented by Poulos (1993), Randolph and Clancy (1993) and Randolph (1994). The approach proposed by Poulos, the so-called equivalent pier approach, is described in Appendix C.

The two latter papers also describe methods for estimating the sharing of load between cap and shafts. Ordinarily, the cap (footing) is assumed not to carry any load for design purposes; however, if the subgrade is carefully prepared and possesses a stiffness of the same order as the geomaterial surrounding the drilled shafts, some economy may be possible by including the soil resistance against the cap in the design. Van Impe and de Clerq (1995) have described a case history on sharing of load between group caps and groups of drilled shafts for a highway bridge in France. Twenty-seven per cent of the working load was found to be carried by the cap for the particular situation that is described. The authors also propose a method for analyzing this type of foundation, termed a "piled raft," in which the cap and drilled shafts are designed to share in the load resistance. This concept will not be covered in this manual, as it is not commonly applied in the United States, but the concept is certainly worthy of future consideration.

A major difference between groups of drilled shafts and groups of driven piles is that the driving of piles increases effective stresses in the soil against piles that have already been installed, which causes the ultimate capacities of the individual piles within the group to be at least as large as if the piles were isolated from the group unless the piles are so close to each other as to fail as a block. In drilled shafts, however, the opening of a borehole for construction of a drilled shaft near a drilled shaft that has already been installed reduces the effective stresses against both the sides and bases of those shafts already in place. Therefore, capacities of individual drilled shafts within a group tend to be equal to or lower than corresponding capacities of isolated shafts. This observation leads to the conclusion that methods for estimating the efficiency of groups of driven

piles should not necessarily be used for estimating the efficiency of a group of drilled shafts. While considerable research has been performed on the efficiency of groups of driven piles, relatively little has been performed on the efficiency of drilled shaft groups. Available information on the efficiency of drilled shaft groups is given in Appendix B, and it is suggested that such information be used in estimating the efficiency of axially loaded drilled shaft groups for design. Corresponding information for groups of laterally loaded drilled shafts is given in Chapter 13.

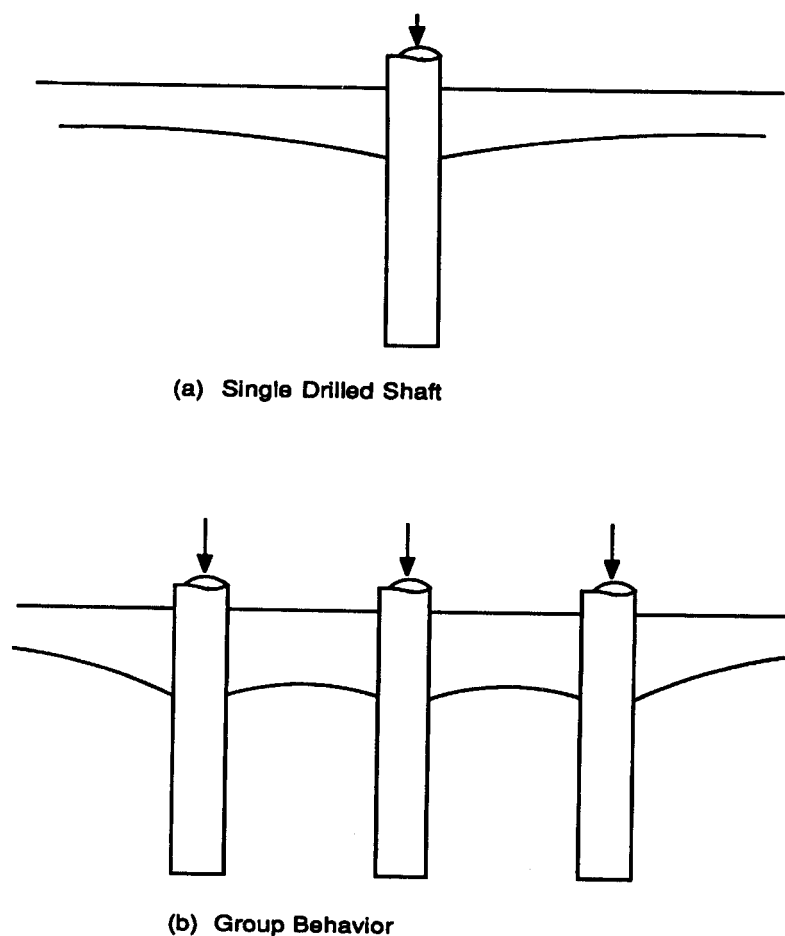

Figure 10.7. Concept of group behavior in drilled shafts

The minimum spacing in a group of drilled shafts is controlled primarily by construction conditions. For example, extraction or driving of casing during construction of a shaft can cause shear stresses to develop on the perimeter of shafts in the same group that were installed earlier, possibly damaging those shafts when the concrete is green. For this reason, it is recommended that drilled shafts used for the bearing support of bridges or walls not be spaced more closely

than computed by the simple procedure given in Appendix B, which is based on common construction tolerances. If significant lateral loads will be applied to the group, it is further recommended that center-to-center spacings of drilled shafts not be less than 2.5 shaft diameters in order to allow the individual shafts to develop predictable resistances. If rapid construction is called for (i. e., construction of a shaft within three days of concreting of a shaft within 2.5 diameters center-to-center spacing of another shaft in the group), the designer should specify a sequence of shaft installation within a group that will assure maximum spacing between shafts being installed and those recently concreted while simultaneously minimizing the number of moves that the contractor needs to make.

## TOLERABLE MOVEMENTS

Vertical and horizontal movements of foundations should be checked against the serviceability requirements of the structure. Serviceability can be checked by performing distortional analyses of the entire structure and its components. However, Moulton (1983) provides guidelines for tolerable movements based on extensive field observations and analytical modeling of bridges. Moulton established serviceability limits for the following parameters.

- Differential settlement:
  - ▶ *Angular distortion:* Differential settlement ( $\Delta$ ) along a span of length  $L$  divided by the span length ( $L$ ),  $\Delta/L = 0.004$  is tolerable in continuous steel bridges;  $\Delta/L = 0.005$  is tolerable for simply supported steel bridges.
  - ▶ *Deck cracking:* Deck cracking due to differential settlement is ordinarily a problem only in continuous span bridges and depends upon the maximum negative (tensile) stress produced over a support due to differential settlements between the support and adjacent bents or abutments plus the negative stress produced by the design loads. Moulton gives simple graphs by which differential settlements can be used along with span length, number of spans in a continuous structure and deck thickness to predict the tensile stresses due to differential settlement. These are added to the negative stresses due to the loads, factored for service conditions, and the resulting tensile stress is compared with AASHTO maximums. If they do not exceed the AASHTO maximums, the structure should remain serviceable.
- Horizontal movement of abutments: Horizontal movements were found to be more damaging than differential vertical movements. Horizontal movements of abutments of less than 38 mm (1.5 in.) are tolerable from a serviceability perspective.
- Bridge vibrations: Uncomfortable ride conditions develop when the forcing frequency of the traffic or other loads approaches one of the natural frequencies of the bridge. Natural frequencies, particularly under horizontal loading, can be influenced significantly by the stiffness and mass of the foundations, which may need to be adjusted for this effect.

Further information on tolerable movements of bridges is provided by Barker et al. (1991).

## STRUCTURAL DESIGN

Well-constructed drilled shafts are not normally stressed to the point where the structural stress controls the design. Instead, the geometric properties of the drilled shaft are usually governed by the requirements to construct the shaft with a length, perimeter area and cross-sectional area large enough to develop the necessary geotechnical resistance. Exceptions to this statement are drilled shafts with sockets in hard rock, where it is possible that concrete stress, rather than failure in the socket, may limit the load that the drilled shaft can carry; drilled shafts with significant lateral loads, where reinforcing steel must be designed to take flexural stresses and diagonal tension; drilled shafts in expansive soils, where uplift stresses can cause tensile failure of a shaft that is not properly reinforced; and drilled shafts with unreinforced bells, in which fracturing around stress concentrations may limit bearing stresses. The analysis of drilled shafts to ensure that there will not be a structural failure is an important concept that should not be neglected.

Chapter 13 presents a brief discussion of the main aspects of structural design. If LRFD methods are used to design the drilled shaft structurally, the load factors and limit states outlined in Appendix A are employed.

The structural adequacy of an axially loaded drilled shaft in compression is checked by determining the factored axial load acting on the drilled shaft and comparing it with the factored axial resistance of the drilled shaft acting as a short column,  $\phi_a (0.85 f_c A_c + f_y A_s)$ , where  $\phi_a$  is the resistance factor for axial loading,  $f_c$  is the 28-day cylinder strength of the concrete,  $A_c$  is the cross-sectional area of the concrete in the drilled shaft section,  $f_y$  is the yield strength of the rebar and  $A_s$  is the cross-sectional area of the steel in the drilled shaft section. At present AASHTO (1994) specifies  $\phi_a$  to be 0.75 regardless of whether horizontal ties or spiral is used as transverse reinforcement. Recent editions of the structural code of the American Concrete Institute (ACI) specify  $\phi_a = 0.75$  when spiral reinforcement is used and 0.70 when horizontal ties are used.  $\phi_a$  is a factor that accounts for errors and uncertainties. ACI also recommends that  $\phi_a$  be further reduced to consider any effects of eccentricities in loading. Considering the rather large tolerances that are ordinarily allowed in the horizontal position and the verticality of drilled shafts because of constructability considerations, it is recommended that an eccentricity factor also be applied to drilled shafts for bridge foundations. The ACI eccentricity factor, termed  $\beta_a$ , is 0.85 for spirally reinforced columns and 0.80 for tied columns, so that the final factored axial resistance becomes  $\beta_a \phi_a (0.85 f_c A_c + f_y A_s)$ .

The structural adequacy of a drilled shaft undergoing lateral loading is checked by determining the maximum bending moment induced in the drilled shaft by the factored loads acting upon the drilled shaft and comparing it with  $\phi_m M_{nc}$ , where  $M_{nc}$  is the nominal moment capacity of the drilled shaft cross-section and  $\phi_m$  is a structural resistance factor that accounts for errors and



uncertainties. At present  $\phi_m$  is recommended to be 0.9 for bending where the axial loads is small (Barker et al., 1991), although future research may indicate that different factors should be used to account for minor defects in drilled shafts that occur during construction that cannot be detected by standard integrity testing methods (Chapter 17). Both the maximum bending moment and  $M_{nc}$  are influenced by the axial load and by group action, which are discussed briefly in Chapter 13. Finally, shear should be checked to determine whether the transverse reinforcement must act as shear reinforcement to carry diagonal tension ("shear") in the drilled shafts. This issue is also reviewed in Chapter 13.

## REFERENCES

AASHTO (1994). *LRFD Bridge Design Specifications*, First Ed., American Association of State Highway and Transportation Officials, Washington, D. C.

Barker, R. M., Duncan, J. M., Rojiani, K. B., Ooi, P. S. K., Tan, C. K., and Kim, S. G. (1991). "Manuals for the Design of Bridge Foundations," *NCHRP Report No. 343*, Transportation Research Board, Washington, D. C., 308 pp.

Bernal, J. B., and Reese, L. C. (1983). "Study of the Lateral Pressure of Fresh Concrete as Related to the Design of Drilled Shafts," *Research Report 308-1F*, Center for Transportation Research, The University of Texas at Austin, Austin, Texas.

Crapps, D. K. (1986). "Design, Construction and Inspection of Drilled Shafts in Limerock and Limestone," Preprint, 35th Annual Geotechnical Conference, ASCE/AEG, University of Kansas, Lawrence, Kansas, March, 38 pp.

FHWA (1996). "Load and Resistance Factor Design (LRFD) for Highway Substructures," NHI Training Course Draft Document, Federal Highway Administration, Washington, D. C., August.

Kulhawy, F. H., Trantmann, C. H., Beech, J. F., O'Rourke, T. D., and McGuire, W. (1983), "Transmission Line Structure Foundations for Uplift-Compression Loading." *Final Report*, Project 1493-1, EPRI EL-2870, Geotechnical Engineering Group, Cornell University, Ithaca, NY, February.

Hansen, J. B. (1970). "A Revised and Extended Formula for Bearing Capacity," *Danish Geotechnical Institute Bulletin 28*, Copenhagen, 21 pp.

Hirany, A., and Kulhawy, F. H. (1988). "Conduct and Interpretation of Load Tests on Drilled Shaft Foundations, Volume 1: Detailed Guidelines," *Report No. EL-5915, Vol. 1*, Cornell University, Geotechnical Engineering Group, Ithaca, New York, July.

Meyerhof, G. G. (1970). "Safety Factors in Soil Mechanics," *Canadian Geotechnical Journal*, Vol. 7, No. 4, pp. 349 - 355.

- Meyerhof, G. G. (1976). "Bearing Capacity and Settlement of Pile Foundations," *Journal of the Geotechnical Engineering Division*, ASCE, Vol. 102, No. GT3, March, pp. 197 - 228.
- Milititsky, J. (1983). *Installation of Bored Piles in Stiff Clays: An Experimental Study of Local Changes in Soil Conditions*, thesis submitted to the University of Surrey for the Degree of Doctor of Philosophy, Surrey, UK, February.
- Moulton, L. K. (1983). "Tolerable Movement Criteria for Highway Bridges," *Final Report*, Federal Highway Administration, Office of Research and Development, Washington, D. C., December.
- O'Neill, M. W. (1983). "Group Action in Offshore Piles," in *Proceedings*, Conference on Geotechnical Practice in Offshore Engineering, ASCE, Austin, Texas, April, pp. 25 - 64.
- O'Neill, M. W., and Hassan, K. M. (1994). "Drilled Shafts: Effects of Construction and Performance and Design Criteria," in *Proceedings*, International Conference on Deep Foundations, Orlando, Florida, Federal Highway Administration, December, pp. 137 - 187.
- Poulos, H. G. (1993). "Settlement Prediction for Bored Pile Groups," in *Proceedings*, Second International Geotechnical Seminar on Deep Foundations on Bored and Auger Piles, Van Impe, ed., Balkema, Rotterdam, pp. 103 - 117.
- Randolph, M. F., and Clancy, P. (1993). "Efficient Design of Piled Rafts," in *Proceedings*, Second International Geotechnical Seminar on Deep Foundations on Bored and Auger Piles, Van Impe, ed., Balkema, Rotterdam, pp. 119 - 130.
- Randolph, M. F. (1994). "Design Methods for Pile Groups and Piled Rafts," in *Proceedings*, XIII International Conference on Soil Mechanics and Foundation Engineering, Oxford and IBM, Ltd., New Delhi, pp. 61 - 82.
- Reese, L. C. (1984). "Handbook on Design of Piles and Drilled Shafts Under Lateral Load," *Report No. FHWA IP-84-11*, Federal Highway Administration, Washington, D. C., July.
- Van Impe, W. F., and de Clerq, Y. (1995). "A Piled Raft Interaction Model," *Geotechnica*, Vol. 73, pp. 1 - 23.
- Vesic, A. S. (1970). "Tests on Instrumented Piles, Ogeechee River Site," *Journal of the Soil Mechanics and Foundation Engineering Division*, ASCE, Vol. 96, No. SM2, pp. 561 - 584.
- Vesic, A. S. (1972). "Expansion of Cavities in Infinite Soil Mass," *Journal of the Soil Mechanics and Foundation Engineering Division*, ASCE, Vol. 98, No. SM3, pp. 265 - 290.
- Williams, A. F., Johnston, I. W., and Donald, I. B. (1980). "The Design of Socketed Piles in

Weak Rock," in *Proceedings*, International Conference on Structural Foundations on Rock, Balkema, Rotterdam, pp. 327 - 347.

Wright, S. J. (1977). *Limit-State Design of Drilled Shafts*, thesis submitted to The University of Texas at Austin for the degree of Master of Science in Civil Engineering, Austin, Texas, August.

## CHAPTER 11: GEOTECHNICAL DESIGN FOR AXIAL LOADING

### INTRODUCTION

A number of concepts that relate to design for axial loading were presented in Chapters 1, 2 and 10, and details and documentation of computational procedures are given in Appendices A - C. This chapter deals primarily with the estimation of the nominal ultimate resistance and the settlement or uplift at the working or service load, through the application of these concepts and procedures. This part of the design process will be termed "geotechnical design." Structural design will be addressed in Chapter 13. Simple design examples related to the step-by-step design procedure outlined in this chapter are provided in Appendix D.

The results of a number of loading tests of full-sized drilled shafts under compressive loads are presented and/or documented by Reese and O'Neill (1988) and by Chen and Kulhawy (1994). Analytical methods for the computation of the resistance and movements of drilled shafts (Appendices B and C) are important, but a review of the results of full-scale loading tests is of great benefit in providing guidance in making the design.

In some cases new rigs and/or drilling tools can reduce construction costs, but they can also have an effect upon drilled shaft resistance. This effect can be positive or negative. For example, it has been pointed out that the case-ahead rig can leave a smooth borehole in cohesive geomaterial. Some degree of borehole roughness is required to develop the values of unit side resistance that are predicted by the design equations. Therefore, either the values of  $f_{\max}$  will need to be reduced by the designer, or the contractor should use fixtures that will develop a degree of borehole roughness that would be consistent with auger drilling. The choice is up to the designer. The magnitude of an effect such as this will be site specific, so that it will be prudent to conduct loading tests of drilled shafts at the construction site during the design phase to assess the effects of any construction procedure with which the designer is not familiar.

Field testing should be considered to be a part of the design process. Chapter 14 will deal with the performance of field loading tests. While the analytical methods described in the appendices have considerable usefulness, the performance of well-designed tests of full-sized drilled shafts at the site of a construction project is normally cost effective and desirable. Construction procedures can be established, and the designer can proceed with greater confidence. If loading tests are performed, factors of safety can perhaps be lowered or resistance factors raised (Appendix A).

### DIRECTION OF SIDE AND BASE RESISTANCE

From extensive field testing throughout the world it has been well established that drilled shafts can carry a substantial portion of the applied load in side resistance. Much of the data from field tests of instrumented drilled shafts show that the initial load increments in compression are often sustained almost completely by developed side resistance. As loading continues, some load is

transferred to the base of the drilled shaft. At a relatively small downward movement [usually less than about 12 mm (1/2 inch)], the full side resistance is mobilized, and the remaining increments of applied compressive load are carried in base resistance. At the ultimate compressive load,  $Q_T$ , a sizeable portion of the total resistance,  $R_T$ , may be in end bearing, but, by that time, a significant amount of downward movement of the drilled shaft will have occurred.

In some soils and rocks, there is a reduction in side resistance as the downward (or upward) movement continues beyond the point at which initial side shear failure occurs, the so-called "slip" point, due to a reduction in shear strength of the geomaterial along the sides of the shaft at large displacements. This problem is illustrated in Figure 11.1. For compressive loading, the designer should take into account the amount of downward movement that is likely to occur when ultimate failure is reached and the resulting influence on load transfer when both base and side resistance are being counted on. This is particularly important in rock and brittle intermediate geomaterials that can lose considerable strength once side shear failure has occurred. It is often difficult to forecast whether a given geomaterial will undergo such deflection softening without performing a load test.

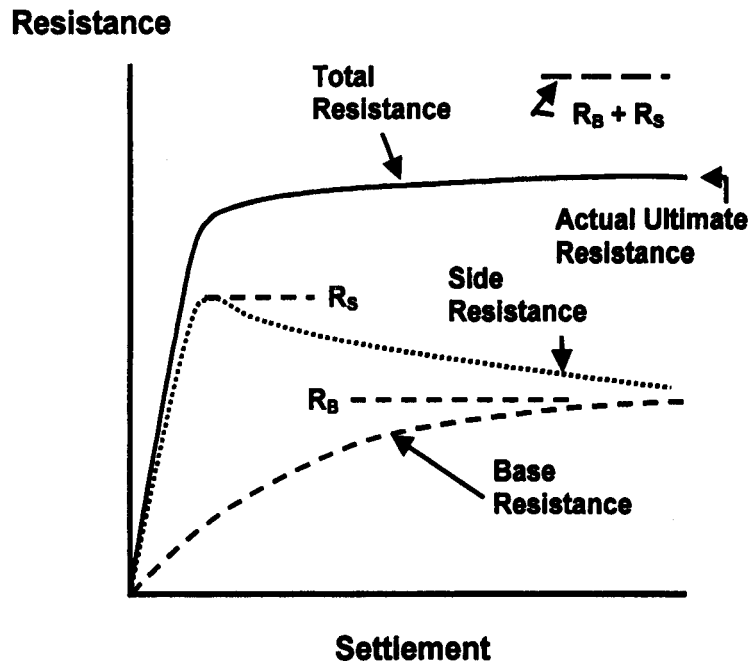

Figure 11.1. Condition in which  $R_s + R_b$  is not equal to actual ultimate resistance

If deflection-softening is severe and if the drilled shaft is relatively long and slender, side shear failure could occur progressively along the sides of the drilled shaft so that the side resistance  $R_s$  will not equal the integrated peak unit side resistance all along the drilled shaft but will need to

include reduced values at some locations (locations at which slip first occurred). This effect can be modeled analytically using codes such as *TZPILE*, referenced as a resource at the end of Appendix C, provided the side shear resistance-movement relations are known (either through load testing or independent mathematical modeling, such as by using *ROCKET 95*, also referenced as a resource at the end of Appendix C). It is important for the designer to understand that the methods referenced here for evaluating  $f_{max}$  in all give values that are near the peak value, prior to any reduction that may occur due to deflection softening.

## DESIGN OF DRILLED SHAFTS UNDER AXIAL LOADING

This chapter is intended to be used as a ready reference for estimating the geotechnical axial resistance and settlement/uplift of individual drilled shafts for common conditions. Since drilled shafts for bridge foundation are often very large, it is advisable to check the settlement or uplift of the shaft in addition to its safety against axial failure. The drilled shaft designer should be familiar with the detailed procedures that are presented in Appendices A - C and with the design examples given in Appendix D. The designer should also constantly keep in mind the need to design drilled shafts for constructability, which requires a familiarity with Chapters 3 - 9 and Appendix G.

Concerning the pore water pressure conditions in the geomaterial, it will be assumed that drilled shafts in cohesive (fine-grained) geomaterials will be designed using undrained shear strength properties such as  $s_u$ , the undrained shear strength. In cohesionless (coarse-grained) geomaterials, methods are given that assume the material will be fully drained. These are generally the pore water pressure conditions that should be considered in design. However, there will occasionally be cases where drained conditions need to be considered for drilled shafts in cohesive soils. Drilled shafts in which a substantial portion of the shaft penetrates very heavily overconsolidated clay ( $OCR > 8 - 10$ ), where negative (tensile) pore water pressures can develop during loading, need to be designed assuming both drained and undrained conditions and the larger resulting drilled shaft specified for actual construction. Drained behavior is covered in Appendices B and C.

The general equations for the geotechnical resistance design of axially loaded drilled shafts were presented as Equations (1.1), (1.2) and (1.3).

$$R_T = R_B + R_S \quad (1.1)$$

$$R_A = \frac{R_T}{F} \quad (\text{ASD}), \quad \text{and} \quad (1.2)$$

$$\eta \sum \gamma_i Q_i \leq \sum \phi_i R_i \quad (\text{LRFD}) \quad (1.3)$$

In the above equations,

$R_T$  = total calculated or nominal ultimate axial resistance of the drilled shaft (add the weight of the drilled shaft, buoyant if under the water table, to  $R_B + R_S$  in the case of uplift),

$R_B$  = nominal ultimate base resistance,

$R_S$  = nominal ultimate side resistance,

$R_A$  = allowable resistance (ASD),

$F$  = global factor of safety (ASD),

$\eta$  = ductility/redundancy/operational importance factor (0.95 to 1.05) (LRFD),

$\gamma_i$  = load factor for load component i (LRFD),

$Q_i$  = nominal load value for load component i,

$\phi_i$  = resistance factor for resistance component i, and

$R_i$  = nominal value of resistance component i.

The problem of assuring safe geotechnical resistance becomes one of assessing values for  $R_B$  and  $R_S$  and selecting appropriate resistance factors or factors of safety. Appendix A deals with the selection of global factors of safety, load factors and resistance factors, as well as the various load combinations that need to be considered under LRFD. A conservative factor of safety or resistance factors lower than those recommended in Appendix A can be used at a location where only a few drilled shafts are to be installed and where it is not economical to perform a detailed subsurface investigation or to conduct loading tests. On the other hand, as suggested in Appendix A, factors of safety can be lowered and resistance factors increased when loading test data are available and the site is sufficiently well characterized.

The companion problem of assessing deformations can be shown mathematically as

$$w_T = f(R_T / F) \leq w_{T \text{ tolerable}} \quad \text{or} \quad (11.1)$$

$$w_T = f(\eta \sum \gamma_i \text{ service } Q_i) \leq w_{T \text{ tolerable}} \quad (11.2)$$

where

$w_T$  = deformation (settlement or uplift) at the head of the drilled shaft.

$w_{T \text{ tolerable}}$  = tolerable movement of the structure (Chapter 10).

$f()$  = "function of," determined for the load argument by one of the detailed methods shown in Appendix C.

$\gamma_i \text{ service}$  = load factor for service limit state (usually equal to 1) for load component i.

If lateral loads are to be applied to the drilled shaft, it is prudent in making computations to consider the possible loss of side resistance in the geomaterial near the ground surface where there may be a significant amount of lateral deflection.

## STEP-BY-STEP DESIGN PROCEDURES FOR AXIAL LOAD DESIGN

The following step-by-step design procedure is suggested. This procedure is as general as possible; however, there may be exceptions on a particular project that may require deviations from this procedure. The term "geomaterial" is used here to describe any kind of soil, rock or transitional earth material ("intermediate geomaterial") found in the subsurface.

1. **Analyze the borings from the site and group them into zones for foundation design according to similarities in the geomaterial profile, geomaterial properties and piezometric surface location.**

Common soil parameters and geomaterial layering profiles will be applied in each zone.

2. **Within each design zone develop an idealized geomaterial layering profile, such as the one shown in Figure 10.4 (Figure 11.2) and Figure 10.5 (Figure 11.3), which are reproduced here.**

In fact, more than one profile may need to be drawn within each design zone if the strata or piezometric surface (Chapter 2) are not horizontal, so that sub-zones can be created. In an extreme case, every drilled shaft could have its own design sub-zone.

Based on index tests and other preliminary classification tests, classify the geomaterial within each layer as

- (a) Cohesive soil (clay or plastic silt with  $s_u \leq 0.25$  MPa, or roughly 2.5 tsf);
- (b) Granular soil [sand, gravel or non-plastic silt with  $N$  (average within layer)]  $\leq 50$  B / 0.3 m (50 blows / foot);
- (c) Intermediate Geomaterial
  - Cohesive: e. g., clay shales or mudstones with  $0.25$  MPa (2.5 tsf)  $< s_u < 2.5$  Mpa (25 tsf);
  - Cohesionless: e. g., granular tills, granular residual soils with  $N > 50$  B / 0.3 m (50 blows / foot);
- (d) Rock [cohesive, cemented geomaterial with  $s_u \geq 2.5$  MPa (25 tsf) or  $q_u \geq 5.0$  MPa (50 tsf)].

If further testing (Step 3) indicates that the wrong classification was made at this point, modify the classification following Step 3.

In establishing the geomaterial profiles for performing the design, remember to exclude any



material that may be scoured away during the design scour event or to be excavated during current or future construction and to reduce  $\sigma'_v$ , accordingly in any remaining layers.

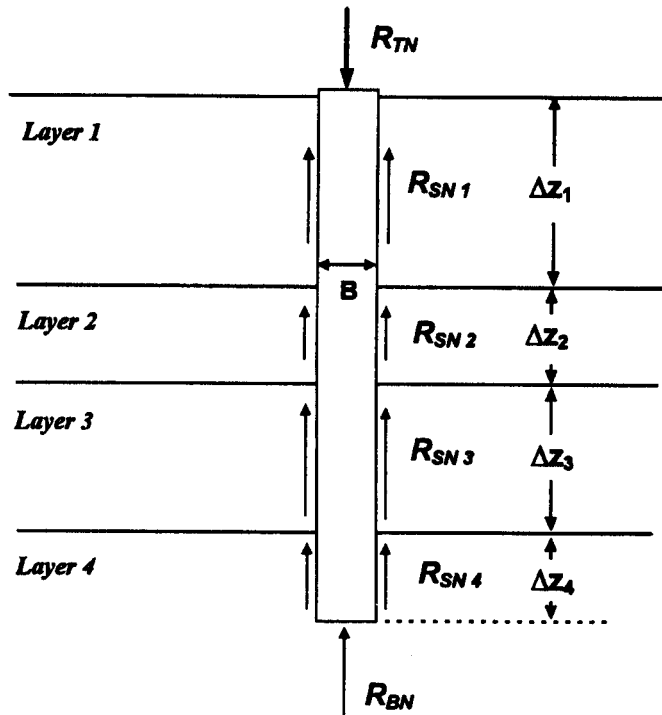

Figure 11.2. Idealized geomaterial layering for computation of compression resistance

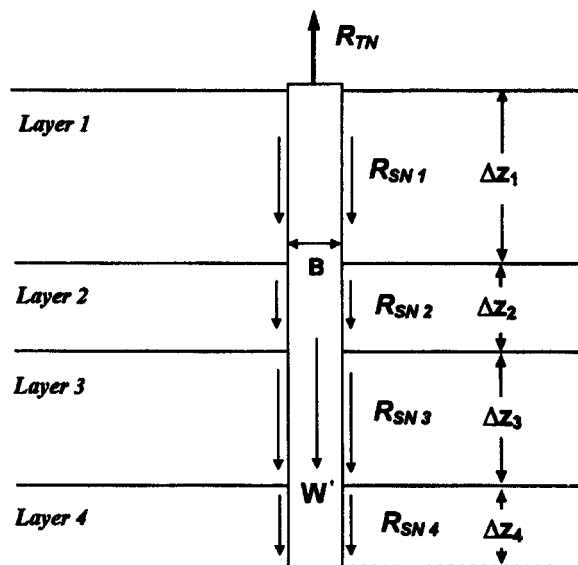

Figure 11.3. Idealized geomaterial layering for computation of uplift resistance

**3. Evaluate accurately the geomaterial properties within each stratum of each design zone.**

Note that a sufficient number of tests should be conducted so that the coefficients of variation of the properties can be estimated for each layer if feasible economically. This can be approached formally, as in Appendix A, or intuitively.

**For cohesive soil layers**, conduct UU triaxial compression tests on Shelby tube samples from the borings and obtain the undrained shear strength  $s_u$ , or measure  $s_u$  in some other way. For example, the clay layers could also be characterized by using  $q_c$  from the CPT. Transform the measurements, if made by other than UU triaxial compression tests, into equivalent UU triaxial compression test values. These transformations are best made from local experience, but suggestions are given in Appendix B. If PMT test data are used, limit pressure values ( $p_L$ ) from the pressuremeter divided by a theoretical cavity-expansion factor (of about 6) will normally lead to excessively high values of  $s_u$  and, ultimately, to unconservative design. Instead,  $p_L$  should be factored by a correlation factor that has been developed between  $s_u$  from UU triaxial tests and  $p_L$  for the soil formation under consideration.  $q_c$  values from the CPT can be used directly if the method of Alsamman, documented at the end of Appendix B, is used. Design examples are not provided for that method.

**For cohesive intermediate geomaterial layers** UC test values ( $q_u$  values) of intact cores are satisfactory.

It is also necessary to know the frequency, size and thickness of soft seams embedded within the IGM, if any. Full-sized observation shafts are advisable for this purpose; however, if no other information is available, their effect can be estimated using the RQD of the cohesive IGM as suggested in Appendix B. Young's modulus ( $E$ ) of the intact cores should be measured. The most reliable design parameters will be values of  $f_{max}$ ,  $q_{max}$  and  $E$  of the geomaterial deduced from loading tests within the layer if they are available.

**For layers of granular soils or cohesionless intermediate geomaterials** perform SPT tests and obtain the  $N$  values. Preferably, these should be  $N_{60}$  values. The CPT can also be used to characterize finer-grained cohesionless soils (sands and silts); however, the design examples in this manual are geared to the use of the SPT. The SPT  $N$  values should not be corrected for fines or for depth, as is done in some methods. A method for direct correlation of drilled shaft resistance with the CPT in granular soils is given in Appendix B. In addition, SPT  $N$  values and CPT  $q_c$  values can be converted to values of  $\phi$ , and the theoretical bearing capacity equations in Appendix B can be used with considerable judgment, considering that the construction process is likely to modify  $\phi$ . No design example is presented for that approach.

**For rock layers**, obtain the same parameters as for cohesive intermediate geomaterials and determine the direction of dip of the joints and character of the material within the joints ("gouge") where feasible.

**Note:** For any geomaterial make sure that the characteristics of the soil or rock are similar to those for which load test data are available (e. g., from which the design parameters in this manual have been developed). For example, there are no data for clays with sensitivities greater than about 4 in the data base. More sensitive clays might exhibit lower  $\alpha$  factors than the clays of lower sensitivities in the data base. Highly organic clays are also excluded. The sands in the data base are all largely uncemented, primarily siliceous and relatively lightly overconsolidated. Calcareous sands, highly cemented sands and highly overconsolidated sands might behave differently than predicted here. For rock, the preponderance of data are from loading tests in sedimentary rock. Therefore, consideration should always be given to acquiring side and base resistance data from loading tests at the construction site during the design phase.

**4. Within each layer of each design zone, do one of the following in order to arrive at the geotechnical design parameters.**

- (a) *If a formal analysis of the reliability of the data will be carried out, as discussed in Appendix A, draw a linear trend line for the data to be used to quantify the strength of the layer ( $s_u$ ,  $q_u$ , or  $N$ ). Ordinarily, this should be a best-fit line (drawn neither conservatively nor unconservatively). The average value (value at the middle of the layer) should be taken as the value to be used in design. Check to make sure that  $COV_w$  of the strength variable, as defined in Appendix A, is less than the value in the last column of Table A-1. If so, the values of the resistance factor  $\phi$  given in Table A-5 can be used. If not, consider regrouping the borings and/or acquiring additional subsurface data in order to reduce  $COV_w$ , or reduce the resistance factors according to judgment.*
- (B) If no formal reliability analysis is to be carried out, select the design value of the primary geomaterial design parameter ( $s_u$ ,  $q_u$ , or  $N$ ) based on judgment and experience. This value would ordinarily be near the average value for the layer. Extreme conservatism should be avoided.

**5. Make a decision whether to perform long-term (drained) resistance and settlement analyses.**

Drained resistance (strength) analyses should be considered for drilled shafts in which substantial penetrations are in very heavily overconsolidated cohesive clays ( $OCR > 10$ ), and drained settlement analyses should be considered for individual drilled shafts or groups of drilled shafts with granular soils below the bases of the shafts or for groups of drilled shafts where normally to moderately overconsolidated clays exist below the bases of the shafts. If drained (long-term) resistance analyses are contemplated for drilled shafts in cohesive soils or IGM's, it will be necessary to evaluate the effective angle of internal friction of the soil,  $\phi'$ , from CD triaxial compression tests or similar tests. It can be assumed conservatively that  $c' = 0$ ; however,

$c'$  can also be measured if desired and used in a formal analysis. It is also recommended that an attempt be made to evaluate  $K_0$  values at the site. For long-term settlement analyses of groups of drilled shafts in cohesive soil, the Young's modulus ( $E'$ ) and the Poisson's ratio ( $\nu_s'$ ) of the soil framework are needed. It is suggested that values be obtained from the correlations given in Appendix C with undrained geomaterial properties for designing groups of shafts in cohesive soil. For estimating the modulus of the soil beneath the bases of drilled shafts, standard one-dimensional consolidation tests can also be used, as documented in Appendix C. In granular soils, the necessary modulus correlations for analysis of group settlement can be obtained from the  $N$  values, as indicated in Appendix C.

For most routine designs of drilled shafts not fitting into the categories just enumerated, formal drained analyses are not necessary, so that the simple equations and graphs given later in this chapter, which are based on analysis of relatively short-term loading tests, will be sufficient.

**6. Review available construction specifications and inspection procedures** from the perspective of the geomaterials encountered at the site to ensure that high quality construction will be done. If proper construction practices, described in Chapters 3 - 8, are specified and ensured through good inspection, the dependence of drilled shaft performance on construction details is minimized.

**7. Make it clear whether the design will be made according to ASD or LRFD.** Some of the details of the design process will change depending upon which design approach is taken.

**8. Obtain the nominal loadings, both axial and lateral, for the each of the drilled shafts in the system to be designed.**

Take any possible downdrag or uplift due to expansive soils (Chapter 12) into account. For ASD, the components of nominal load are simply added together to obtain the design load on the drilled shaft. Several cases may need to be considered (e. g., case producing maximum instantaneous compressive load; case producing maximum uplift load, if any; case producing maximum sustained compressive load) to obtain the most critical design condition. For LRFD (Appendix A), make certain that the states for which the drilled shafts are to be designed and  $\eta$  are clearly defined for the project at hand. The nominal loads for each limit state for which the drilled shafts are to be designed are multiplied by their respective load factors (Appendix A) and added to give the factored load for that state (strength, service, extreme event). The most critical load case(s) is selected for the purpose of sizing the drilled shafts. (A geometric design may have to be developed for more than one load case for each state. The most obvious example is the situation in which one or more load components can act either in uplift or in compression. It may not be immediately clear which direction of loading controls the geometry, so shaft geometries would have to be developed for more than one loading case and compared.)

Normally, in ASD, capacity will control the design. In LRFD, one of the strength states

normally controls the design, so size the drilled shafts for capacity (the critical design load or the critical strength-state load). Occasionally, a service state (settlement or uplift) will control. Experience will dictate when drilled shafts should be sized for the critical service-state loading. However, if the service state (settlement/uplift) is verified after the shafts are sized for the critical strength state, any undersizing made during the strength state design will become obvious and can be corrected. In some situations the extreme event state will control.

**9. Select either a global factor of safety (ASD) or resistance factors (LRFD) for the drilled shafts under axial loading in each design zone, taking into account all of the pertinent information about the project.**

With high-quality and consistent geomaterial data within the design zone the overall (global) factor of safety for ASD commonly ranges from 2 to 3. This would occur when  $COV_w$  values are within the limits shown in the last column in Table A-1. Otherwise, values of the factor of safety in the range of 3.5 might be selected. When  $COV_w$  values are within the limits shown in Table A-1 the values of the resistance factors given in Table A-5 can be used for axial-load design. For layers of intermediate geomaterial the resistance factor  $\phi_i$  will have to be chosen using judgment, since values have not yet been established. It is suggested that cohesive intermediate geomaterials be treated as "rock" and that cohesionless intermediate geomaterials be treated as "sand" for this purpose until better information becomes available. In LRFD, if the values of  $COV_w$  are higher than the tabulated limits within a significant part of the geomaterial profile, judgment must be applied in selecting resistance factors. This might be done by selecting a global factor of safety based on the judgment of several experienced members of the design team or of outside consultants and converting that factor of safety into an overall resistance factor using a simple method suggested in FHWA (1996). General guidance on converting judgment-based factors of safety to overall resistance factors (factors to be applied to the sum of  $R_B$  and  $R_S$ ) for drilled shafts is provided in Table 10.1.

**10. Estimate whether the geometry of the drilled shaft will be controlled by lateral loading or by axial loading.**

This estimate can only be made through experience. It need be made only for convenience in order to avoid making two separate geometric designs. If the most critical loading mode (axial or lateral) is chosen correctly, the geometry of the drilled shaft need only be verified as being safe in the other mode. If the wrong mode is estimated to be critical, and the other mode is not safe, a second design will of course have to be made. The remaining part of this section proceeds under the assumption that the axial loading mode is critical. Information for lateral load design is contained in Chapter 13.

**11. If clay exists at the ground surface:**

- (a) **Estimate the depth of the zone of seasonal moisture change.**

**(b) Assume for design purposes that zero side resistance exists in the top 1.5 m (5 feet) of the drilled shaft, or within the zone of seasonal moisture change, if deeper.**

This assumption is based on the reasoning that the low fluid concrete pressures in that depth range do not restore the high lateral effective stresses that almost always exist in natural or compacted clay near the ground surface and that with time the soil will therefore soften. It is also based on the assumption that if the ground surface is not protected by an impermeable seal the clay can dry out and shrink away from the sides of the drilled shaft during periods of dry weather. If the depth of the zone of seasonal moisture change is greater than 1.5 m (5 feet), consider eliminating side resistance to a depth equal to the depth of seasonal moisture change [greater than 1.5 m (5 feet)]. Side resistance need not be eliminated at the top of a drilled shaft in clay that is part of a group with a buried cap if soil resistance against the cap is not used in the foundation design.

**(c) If the lateral loads are present, the drilled shaft will have to be sized and assigned a steel schedule to resist the lateral loads as described in Chapter 13. When that is done, compute the lateral groundline deflection of the drilled shaft under the loading case that produces the highest lateral groundline deflection. If the computed groundline deflection is more than 0.01 B (which will likely result in separation between the soil and the drilled shaft), consider eliminating side resistance in the clay down to the point at which lateral deflection becomes less than 0.01 B.**

**12. Select the trial length and diameter of the drilled shaft to support each column, abutment or wall within the design zone or sub-zone.**

Both of these geometric parameters are dependent on the geomaterial conditions at the site and the availability of construction equipment in the area. A good rule of thumb is that the ratio of length (L) to diameter (B) of a drilled shaft should be 30 or less. If  $L/B < 3$ , the foundation unit is technically not a drilled shaft. Ordinarily, in soils or intermediate geomaterials, drilled shafts can be installed to a depth of 30 m (100 feet) and to a diameter of 2.44 m (8 feet) with relatively little difficulty. Rock sockets can be installed to depths of 30 m (100 feet), but commonly diameters are limited to around 1.53 m (5 feet) or less. When well-equipped specialty contractors are available in the area, depths of 53.4 m (175 feet) are possible, and diameters of 3.66 m (12 feet) in soil and intermediate geomaterial and about 2.44 m (8 feet) in rock can be obtained. Deeper and larger-diameter shafts can be installed in all geomaterials, but such sizes are out of the ordinary and the cost may be at a premium.

Constructability should be kept in mind when selecting trial values of depth and diameter. If possible, the bases of the shafts should be kept at an elevation where the shafts can be installed using the dry method. This will reduce the cost of construction (Chapter 19) and the effort of inspection. Where boulders or highly fragmented rock have been shown by the subsurface investigation to be present, the largest feasible diameters should be used, since such materials will normally be easier to remove than when smaller diameters are specified. The size of any

column that will mate with the drilled shaft should also be taken into account when selecting the drilled shaft diameter. It is desirable that the drilled shaft rebar cage and the rebar cage for the column have the same diameter so that splices can be made easily at the foot of the column. In cases in which structural designers prefer not to splice the column cage to the drilled shaft cage at the groundline, the drilled shaft and column cages will need to be made continuous at the groundline. Otherwise, insert cages must be designed and constructed to transfer loads in the steel rebar for the column to that in the drilled shaft. The shaft diameter should be greater than the outside diameter of its cage by at least 10 times the width of the largest coarse aggregate in the concrete mix. A minimum of 76 mm (3 in.) of actual cover is needed. Allowing for a 76 mm (3 in.) tolerance in locating the center of the borehole, it is prudent to specify shaft diameters that are 305 mm (12 in.) larger than cage diameters to allow for precise centering of cages while maintaining the minimum 76 mm (3 in.) cover.

If rock exists within the practical depth of excavation, a decision must be made whether to place the base of the drilled shaft on top of the rock formation, to socket the drilled shaft in the rock formation or “float” the drilled shaft above the rock formation. Where adequate resistance can be developed to satisfy the critical strength or extreme event loading case, where scour is not an issue and where movements are tolerably small for the critical service state case, drilled shafts should usually be allowed to float, as considerable cost savings can be realized. An exception to this statement would be cases in which the drilled shafts would not develop adequate resistance even with very large diameters [say, up to 3.66 m (12 feet)] and rock is relatively close to the ground surface.

If the decision is made to carry the drilled shafts to rock, it must be decided whether to bear on the rock or to socket the drilled shafts into the rock. Ordinarily, this decision is based on the perceived quality of the rock near its interface with the overburden material, whether the rock is sloping severely and whether adequate resistance can be developed without a socket. If the rock is highly weathered, karstic, or sloping severely, or if the overburden can be scoured away down to the top of the rock, a socket is usually used. Otherwise, restricting excavation into the rock can result in cost savings relative to using a socket. If the rock is hard [for example,  $q_u > 35$  MPa (5000 psi)] and massive, socket excavation will likely proceed very slowly, and construction costs will be high. In such a case, it may be reasonable to specify a drilled shaft of relatively large diameter and position its base on the surface of the rock, or perhaps 150 - 300 mm into the rock to allow for making a seal with a casing, rather than designing for a smaller-diameter socket.

When designing drilled shafts that bear on or are socketed into rock, alternate designs may be generated for the purpose of making rapid field changes in the event the rock encountered during construction is found to have characteristics that are different from those assumed in the design of the primary foundation system. For example, even though a drilled shaft is designed to develop all of its resistance in base resistance on the surface of a rock formation, when the rock is exposed at a specific drilling site, evidence of extreme local weathering might be found that would require conversion of the drilled shaft to a rock socket. If a socket design has already been

produced, making the necessary field change can be accomplished in short order.

The process of selecting the drilled shaft diameter is an iterative one. If a selected length and diameter do not provide the required performance, other sets of lengths and diameters need to be tried until the resistance and deformation requirements are met.

If one drilled shaft cannot carry the required load (as determined from computation of the ultimate resistance, below), a group of drilled shafts can be used.

**13. If cohesive soil is present at the base of any drilled shaft (and only if cohesive soil is present), establish a side resistance exclusion zone at the base of the drilled shaft equal to the height of the bell (if any) plus one shaft diameter (B) for compression loading.**

If there is no bell, the exclusion zone extends for a distance B (one shaft diameter) above the base. Side resistance should conservatively be assumed to be zero in this zone for evaluating resistance to compression loading because the downward movement of the base will produce tensile stresses in the soil for some distance above the base (much more prominently in underreamed drilled shafts). With time, these tensile stresses will be relieved because the soil will crack and/or pore water suction will be reduced by the inward flow of water into the soil, both of which will reduce the shear strength of the soil. If the drilled shaft is loaded in uplift, the exclusion zone at the bottom of the drilled shaft should not be used, since this effect does not occur under uplift loading. The exclusion, or "non-contributing," zones for drilled shafts in compression in cohesive soils are shown in Figure 11.2. Note that these zones do not apply if the base is not situated in a cohesive soil, or, in the case of the top of the drilled shaft, if the soil at the ground surface is not a cohesive soil. Exclusion zones for uplift loading are discussed in the next section.

**14. Estimate the nominal ultimate base and side resistances,  $R_{BN}$  and  $R_{SN}$ , respectively.**

Recall from Chapter 10 that

$$R_{TN} = \pi B \sum_{i=1}^n \Delta z_i f_{max i} + \frac{\pi B^2}{4} q_{max} = R_{SN} + R_{BN} \quad (10.2)$$

B and  $\Delta z_i$  are defined in Figure 10.4 (Figure 11.2) and Figure 10.5 (Figure 11.3), which are reproduced in this chapter. The index n in those figures is 4 (4 geomaterial layers). This is only an example. "n" can be any number, but practically not larger than 10.



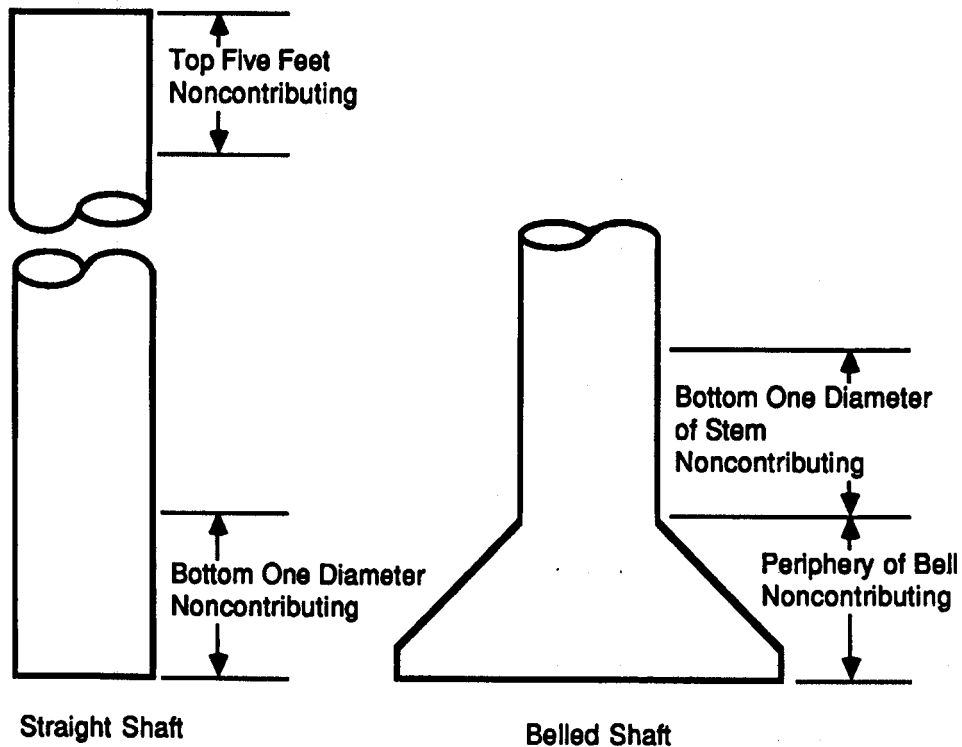

Figure 11.4. Exclusion zones for computation of side resistance for drilled shafts in cohesive soils

The maximum unit side resistance,  $f_{\max i}$  (in which  $i$  pertains to the index number assigned to each layer through which the shaft passes) and base resistance  $q_{\max}$  (in which the properties of the layer in or on which the base is founded are used) remain to be computed. These can be estimated by formula, given below, or from site-specific measurements from loading tests. Where they are feasible, intelligently conducted loading tests are the preferred source of design information.

Ordinarily,  $q_{\max}$  is taken to be zero for uplift loading unless the shaft has a bell, in which case some uplift resistance at the base can be assumed.  $f_{\max}$  for uplift loading is taken as indicated toward the end of this step.

Base Resistance for Compression Loading,  $q_{\max i}$ :

Base in cohesive soil (e. g., Layer 4 in Figure 10.4):

If  $s_u$  (design value)  $\geq 96$  kPa (1 tsf): and depth of base  $\geq 3 B$  (of the base):

$$q_{\max} = 9 s_u \tag{11.1}$$

If  $s_u$  (design value) < 96 kPa (1 tsf) and depth of base  $\geq 3 B$  (of the base):

$$q_{max} = (4/3) [\ln (I_r + 1)] s_u = N^*_c s_u \quad (11.2)$$

where  $I_r$  is a "rigidity" index which varies directly with soil stiffness and inversely with shear strength. Values for  $N^*_c$  are given in Table 11.1. Linear interpolation should be used for values between those tabulated.  $s_u$  is the operational (usually average) value between the base and a depth of  $2B$  (of base) beneath the base.

Table 11.1. Values of  $I_r = E_s / 3s_u$  (Young's modulus of soil)/ $3s_u$  and  $N^*_c$

$s_u$	$E_s/3s_u$	$N^*_c$
24 kPa (500 lb / ft <sup>2</sup> )	50	6.5
48 kPa (1000 lb / ft <sup>2</sup> )	150	8.0
$\geq 96$ ka (2000 lb / ft <sup>2</sup> )	250 - 300	9.0

If depth of base ( $D$ ) <  $3B$  (of the base):

$$q_{max} = (2/3) [1 + (1/6)(D/B)] N^*_c s_u \quad (11.3)$$

Base in cohesionless soil ( $N_{SPT} \leq 50 B/0.3$  m (B/ft))

$$q_{max} \text{ (kPa)} = 57.5 N_{SPT} \leq 2.9 \text{ MPa} \quad (11.4 \text{ a})$$

$$q_{max} \text{ (tsf)} = 0.60 N_{SPT} \leq 30 \text{ tsf} \quad (11.4 \text{ b})$$

Equations (11.6) are based on observations from compression loading tests on drilled shafts with clean bases at settlements of five per cent of the base diameter. The upper limits represent the largest values measured in geomaterial classified as cohesionless soil. When  $N$  exceeds  $50 B/0.3$  m (B/ft),  $q_{max}$  should be evaluated according to procedures for cohesionless IGM's.  $N_{SPT}$  is the operational value in the zone described above for cohesive soil.

Base in cohesive IGM or rock:

If the cohesive IGM or rock is massive (RQD = 100 per cent) and the depth of the socket,  $D_s$ , in the IGM or rock  $\geq 1.50 B$ :

$$q_{max} = 2.5 q_u \text{ (at and below the base)} \quad (11.5)$$

If the cohesive IGM or rock has an RQD between 70 and 100 per cent, all joints are closed (not containing voids or soft material in the seams), the closed joints are

approximately horizontal, and  $q_u > 0.5$  MPa (5.2 tsf):

$$q_{max} \text{ (MPa)} = 4.83 [q_u \text{ (MPa)}]^{0.51} \quad (11.6)$$

If the rock or cohesive IGM is jointed, the joints have random orientation, and the condition of the joints can be evaluated from cuts in the area or from test excavations:

$$q_{max} = [s^{0.5} + (ms^{0.5} + s)^{0.5}] q_u \quad (11.7)$$

$q_u$  is measured on intact cores from within 2B (base) below the base of the drilled shaft.  $q_{max}$  has the units of  $q_u$ .  $s$  and  $m$  are properties of the rock or IGM mass that can be estimated from Tables 11.2 and 11.3.

Table 11.2. Descriptions of Rock Types for Use in Table 11.3

Rock Type	Description
A	Carbonate rocks with well-developed crystal cleavage (e.g., dolostone, limestone, marble)
B	Lithified argillaceous rocks (mudstone, siltstone, shale, slate)
C	Arenaceous rocks (sandstone, quartzite)
D	Fine-grained igneous rocks (andesite, dolerite, diabase, rhyolite)
E	Coarse-grained igneous and metamorphic rocks (amphibole, gabbro, gneiss, granite, norite, quartz-diorite)

A well-proven method for rocks or IGM's in Category B, Table 11.2, in which the layering in the geomaterial is essentially horizontal is the Canadian Foundation Manual method, documented in Appendix B. That method requires a numerical estimate of the thickness and vertical spacing of joints. Net unit base resistance is prescribed by

$$q_{max} = 3 K_{sp} \Theta q_u \quad (11.8)$$

in which

$K_{sp}$  = dimensionless bearing capacity factor based on geomaterial jointing characteristics, given by

$$K_{sp} = \frac{3 + \frac{s_v}{B}}{10 \sqrt{1 + 300 \frac{t_d}{s_v}}} \quad \text{and} \quad (11.9)$$

$\Theta$  = dimensionless factor related to the depth of penetration of the socket into the rock or IGM layer ( $D_s$ ) (not the depth below the ground surface) to the socket diameter ( $B$ ), given by

$$\Theta = 1 + 0.4 \left( \frac{D_s}{B} \right) \leq 3.4 \quad (11.10)$$

Table 11.3. Values of  $s$  and  $m$  (Dimensionless) for Equation (11.7) based on Classification in Table 11.2

Quality of Rock Mass	Joint Description and Spacing	$s$	Value of $m$ as Function of Rock Type (A - E) from				
			A	B	C	D	E
Excellent	Intact (closed); spacing > 3 m (10 ft)	1	7	10	15	17	25
Very good	Interlocking; Spacing of 1 to 3 m (3 to 10 ft)	0.1	3.5	5	7.5	8.5	12.5
Good	Slightly weathered; Spacing of 1 to 3 m (3 to 10 ft)	$4 \times 10^{-2}$	0.7	1	1.5	1.7	2.5
Fair	Moderately weathered; Spacing of 0.3 to 1 m (1 to 3 ft)	$10^{-4}$	0.14	0.2	0.3	0.34	0.5
Poor	Weathered with Gouge (soft material); Spacing of 30 to 300 mm (1 in. to 1 ft)	$10^{-5}$	0.04	0.05	0.08	0.09	0.13
Very poor	Heavily weathered; spacing of less than 50 mm (2 in.)	0	0.007	0.01	0.015	0.017	0.025

In Equation (11.9)

$s_v$  = average vertical spacing between joints in the rock on which the base bears, and  
 $t_d$  = average thickness or "aperture" of those joints (open or filled with debris).

The ranges of validity for Equation (11.8) are:  $B > 0.3$  m (12 in.) and  $0.05 < s_v/B < 2.0$ , and  $0 < t_d/s_v < 0.02$ .

Other methods are given in Appendix B for rock that has vertical joints or where the joints slope (dip) at preferential angles.

Base in cohesionless IGM:

Cohesionless IGM's are characterized by SPT blow counts that exceed 50 B/0.3 m (B/ft). In such a case, the following equation is suggested.  $q_{max}$  is in the units of  $\sigma'_{vb}$ .

$$q_{max} = 0.59 [N_{60} (p_a / \sigma'_{vb})]^{0.8} \sigma'_{vb} , \quad (11.11)$$

where

$N_{60}$  = average SPT blow count in blows per 0.3 m or blows per foot in the IGM between the base of the drilled shaft and an elevation 2B below the base for the condition in which approximately 60 per cent of the potential energy of the hammer is transferred to the top of the drive string. The value of  $N_{60}$  should be limited to 100 if higher values are measured.

$p_a$  = atmospheric pressure in the units used for  $\sigma'_{vb}$  (e. g., 101 kPa in the SI system), and

$\sigma'_{vb}$  = vertical effective stress (Chapter 2) at the elevation of the base of the drilled shaft.

Reduced base resistance when explicit settlement analysis is not performed:

If settlement estimates are not to be performed, it is prudent to limit the base resistance in large-diameter drilled shafts in cohesive and cohesionless soils and intermediate geomaterials. This suggestion is made because the service loads that will be calculated from the equations in this chapter and the resistance factors or factors of safety normally used in drilled shaft design may result in excessive settlements for large-diameter drilled shafts. If settlement estimates will be performed, reducing  $q_{max}$  at this stage of the design is not necessary, since the settlement analysis (Step 17) will uncover any problems. Recommended values of reduced, net unit base resistance,  $q_{max,r}$ , in terms of the computed value for  $q_{max}$ , are:

Reduced base resistance in cohesive soils or IGM's,  $B_b > 1.90$  m:

$$q_{max,r} \text{ (in units of } q_{max}\text{)} = \{ 2.5 / [a B_b (m) + 2.5 b] \} q_{max} \leq q_{max} \quad (11.12)$$

where

$$a = 0.28 B_b(m) + 0.083 (L/B_b) , \text{ and} \quad (11.13)$$

$$b = 0.065 [s_{ub} \text{ (kPa)}]^{0.5} \quad (11.14)$$

In Equations (11.13) and (11.14),

$L$  = length of the drilled shaft = depth of base below the ground surface (or top of bearing layer if bearing layer is substantially stronger than the overburden soils),

$B_b$  = diameter of the base of the drilled shaft, and

$s_{ub}$  = average undrained shear strength of the soil or rock between the elevation of the base and  $2 B_b$  below the base. In rock,  $s_u$  can be taken to be  $q_u/2$ .

Reduced base resistance in cohesionless soils or IGM's,  $B_b \geq 1.27$  m:

$$q_{max r} = [1.27 / B_b \text{ (m)}] q_{max} \quad (11.15)$$

Equation (11.12) need only be applied when  $B_b > 1.90$  m (75 inches) (in cohesive geomaterial), and Equation (11.15) need only be applied when  $B_b > 1.27$  m (50 inches) (in cohesionless geomaterial).

Side Resistance for Compression Loading in Layer i,  $f_{max i}$ :

Sides in layer of cohesive soil (e. g., Layers 1 - 4 in Figure 10.4):

$$f_{max i} = \alpha s_u \quad (11.16)$$

where

$\alpha$  = a dimensionless correlation coefficient defined as follows:

$\alpha = 0$  between the ground surface and a depth of 1.5 m (5 ft) or to the depth of seasonal moisture change, whichever is deeper;

$\alpha = 0$  for a distance of  $B_b$  (the diameter of the base) above the base or, in the case of a belled shaft, the top of the bell, and the peripheral surface of the bell itself; and

$\alpha = 0.55$  elsewhere for  $s_u / p_a \leq 1.5$  and varying linearly between 0.55 and 0.45 for  $s_u / p_a$  between 1.5 and 2.5. This relation is shown graphically in Figure B-9.

In the last expression for  $\alpha$ , above,  $p_a$  is the atmospheric pressure in the units

being used (e. g., 101 kPa in the SI system). The exclusion zones are shown in Figure 11.2.

$s_u$  = design value for undrained shear strength for the layer being considered (Layer i) (typically taken as the average value unless the average value is judged to be unrepresentative by the geotechnical specialist).

Sides in layer of cohesionless soil:

$$f_{max\ i} = \beta_i \sigma'_{vi} \quad (11.17)$$

where,

in sands,

$$\beta_i = 1.5 - 0.245 [z_i(m)]^{0.5} \text{ for SPT } N_{60} \text{ (uncorrected)} \geq 15 \text{ B/0.3 m (B/ft), or} \quad (11.18)$$

$$\beta_i = [N_{60}/15] \{1.5 - 0.245 [z_i(m)]^{0.5}\} \text{ for SPT } N_{60} \text{ (uncorrected)} < 15 \text{ B/0.3 m (B/ft);} \quad (11.19)$$

in gravelly sands or gravels when SPT  $N_{60} \geq 15 \text{ B/0.3 m (B/ft)}$ .

$$\beta_i = 2.0 - 0.15 [z_i(m)]^{0.75} \quad (11.20)$$

In gravelly sands or gravels, use the method for sands if  $N_{60} < 15 \text{ B/0.3 m (B/ft)}$ .

In Equations (11.17) through (11.20),

$\beta_i$  = dimensionless correlation factor between vertical effective stress  $\sigma'_{vi}$  (Chapter 2) and  $f_{max}$  for Layer i, limited to a maximum value of 1.20 in sands and 1.80 in gravelly sands and gravel and to a minimum value of 0.25 in both types of soil.  $f_{max}$  should be limited to 200 kPa (2.1 tsf).

$\sigma'_{vi}$  = vertical effective stress at the middle of Layer i. See Chapter 2.

$N_{60}$  = design value for SPT blow count, uncorrected for depth, saturation or fines, representative of Layer i (typically taken as the average value within the layer), not to exceed 50 B/0.3 m (B/ ft) (otherwise treat as cohesionless IGM), and

$z_i$  = vertical distance from the ground surface, in meters, to the middle of Layer i.

Since Equation (11.17) is nonlinear,  $\Delta z_i$  should be limited to about 9 m (30 ft).

Alternatively, if information on earth pressures at the construction site is available,  $f_{\max i}$  can be estimated using friction theory, as explained in Appendix B for side resistance under drained conditions.

Sides in layer of cohesive IGM:

The designer must first decide whether the socket in an IGM layer will be *smooth* or *rough*, since roughness of the borehole wall has a large effect on side resistance. It is currently recommended that unless the sides of the borehole will be artificially roughened during construction that the socket be considered *smooth*. A "smooth" socket should have some degree of natural roughness if the specifications call for the contractor to avoid or remove any smeared material on the sides of the borehole. For design purposes, a "smooth" socket is not "gun-barrel" smooth but rather cut naturally with the drilling tool without leaving smeared material on the sides of the borehole wall. If artificial roughening of the borehole wall is specified, the socket can be considered *rough* if keys at least 76 mm (3 in.) in height are cut to a depth of at least 51 mm (2 in.) into the borehole wall every 0.46 m (1.5 ft) of depth for shafts with diameters equal to or larger than 0.61 m (24 in.) in diameter. The method for estimating  $f_{\max}$  in *smooth* sockets will be given here. The method for *rough* sockets in cohesive IGM's involves concurrent calculation of resistance and settlement and requires a spreadsheet. It is covered in Appendix B. For a smooth socket,

$$f_{\max i} = \alpha \varphi q_{u i} \quad (11.21)$$

$\alpha$  (not equal to the value of  $\alpha$  for cohesive soils) is obtained from Figure 11.3 for the range of conditions shown on the figure.  $E_m$  is the Young's modulus of the IGM mass and  $q_u$  is the unconfined strength of the intact IGM.  $w_i$  is the settlement of the socket at which  $\alpha$  is developed.  $E_m$  can be estimated from measured Young's moduli on intact cores,  $E_i$ , using Table B-5. Figure 11.13 is based upon the assumption that the angle of interface friction  $\varphi_{rc}$  is 30°. If evidence exists that  $\varphi_{rc}$  is significantly different than 30°, then  $\alpha$  should be modified according to Equation (11.22).

$$\alpha = [\alpha \text{ (Figure 11.5)}] \cdot [\tan \varphi_{rc} \text{ (for the layer in question)} / \tan 30^\circ] \quad (11.22)$$

In order to estimate  $\alpha$  from Figure 11.5, the designer must first estimate the pressure imparted by the fluid concrete at the middle of Layer  $i$ ,  $\sigma_n$ .  $p_a$  is the atmospheric pressure in the units in which  $\sigma_n$  is computed. If the slump of concrete with unit weight  $\gamma_c$  is kept at or above 175 mm (7 in.) as it is placed and the concrete is placed in the borehole at the rate of 12 m (40 ft) per hour or faster, then  $\sigma_n$  at a depth of  $z_i^*$  below cutoff elevation of up to 12 m (40 ft) can be estimated from Equation (11.23).  $\sigma_n$  at greater depths should be taken to be equal to the value at  $z_i^* = 12$  m. Further information is given in Appendix B.



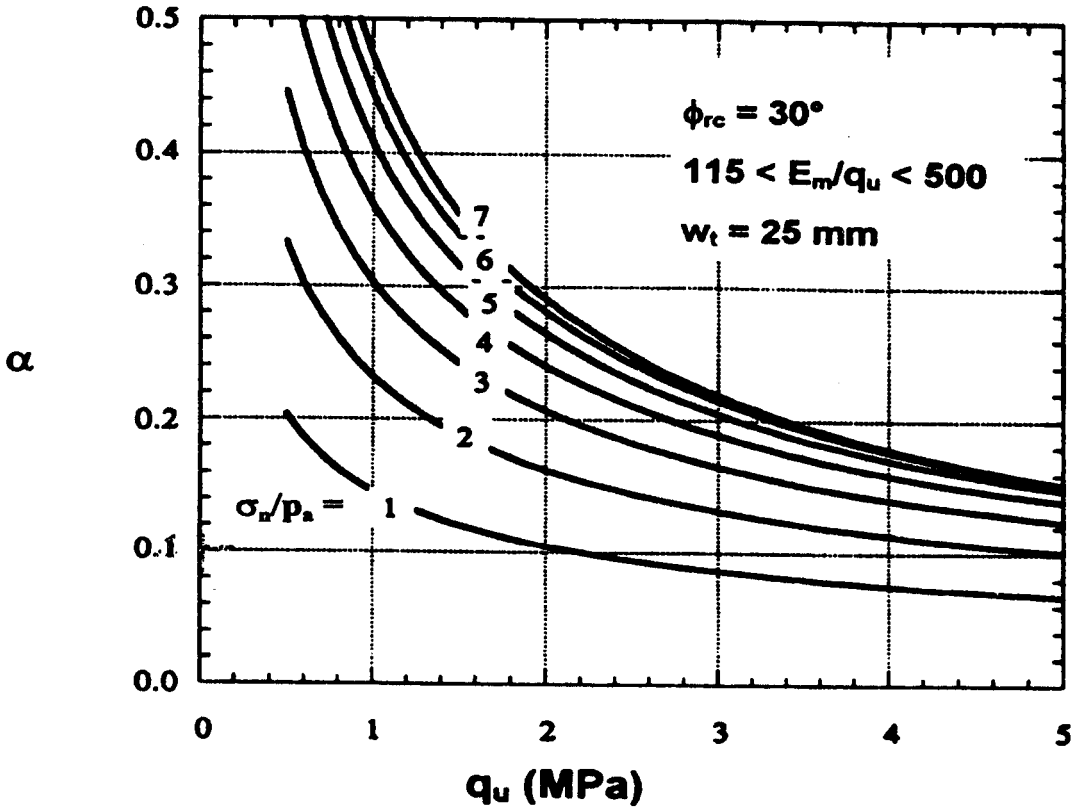

Figure 11.5. Factor  $\alpha$  for cohesive IGM's

$$\sigma_n = 0.65 \gamma z_i^* \quad (11.23)$$

$\varphi$  is a joint-effect factor that accounts for the presence of open joints that either are voided or contain soft gouge.  $\varphi$  can be estimated from Table 11.4. Values cannot be recommended for IGM's with RQD's less than about 20 per cent. The existence of such a condition should be cause for arranging for loading tests to establish  $f_{max}$ .

Table 11.4. Factors  $\varphi$  for cohesive IGM's

RQD (per cent)	$\varphi$	
	Closed joints	Open or gouge-filled joints
100	1.00	0.85
70	0.85	0.55
50	0.60	0.55
30	0.50	0.50
20	0.45	0.45

$q_{ui}$  is the design value for  $q_u$  in Layer  $i$ . This is often taken to be the mean value from tests on intact cores of 50 mm (2 in.) diameter or larger. The existence of weaker material between the intact geomaterial that could be sampled is considered through factor  $\phi$ .

Note that Equation (11.21) does not apply to boreholes that are smeared with cuttings.

Sides in layer of rock:

If the layer is a rock layer, the side of the borehole should be classified as *smooth* or *rough*, as for cohesive IGM's. That is, a *rough* condition should be applied only where the borehole is specified to be artificially roughened by grooving, as described for cohesive IGM's. Otherwise, the socket should be considered *smooth*.

For a smooth rock socket:

$$f_{max\ i} = 0.65 p_a [q_{ui}/p_a]^{0.5} \leq 0.65 p_a [f'_c/p_a]^{0.5} \quad (11.24)$$

where

$f'_c$  = 28-day compressive cylinder strength of the drilled-shaft concrete.

The other symbols in Equation (11.24) are as defined previously for cohesive IGM's. The second expression in Equation (11.24) applies when the rock is stronger than the concrete.

For a rough rock socket:

$$f_{max\ i} = 0.8 \left[ \frac{\Delta r}{r} \left( \frac{L'}{L} \right) \right]^{0.45} q_{ui} \quad (11.25)$$

$q_{ui}$  is as defined for cohesive IGM's, but it should not exceed  $0.75f'_c$ . The remaining terms refer to the geometry of the socket and are defined in Figure 11.6.

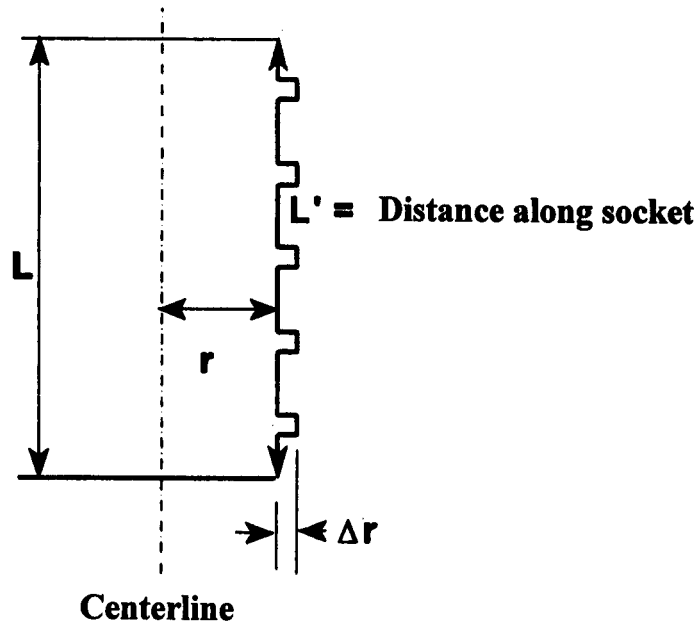

Figure 11.6. Definition of geometric terms in Equation (11.25)

Other details and alternate methods for estimating side resistance of drilled shafts in rock are given in Appendix B.

Some authorities suggest setting  $f_{\max}$  in a layer of harder rock overlying a layer of softer rock equal to the value computed for the softer rock for compression loading. While this is probably unnecessary in most instances, if the softer rock is much more compressible than the overlying harder rock (i. e., contains considerable voids), consideration should be given to reducing  $f_{\max}$  in the harder layer by at least some amount, perhaps to a value that is the average of the computed values in the two layers, especially if the harder layer is brittle. Very little research is available to support any definite recommendations, so the designer should proceed conservatively.

$f_{\max}$  also appears to depend on shaft diameter in some rocks, especially hard rocks. Physical information (e. g., Carrubba, 1997) indicates that large-diameter shafts (e. g.,  $B > 1$  m) in specific sedimentary rocks developed lower values of  $f_{\max}$  than smaller-diameter shafts, for which the design equations presented here are intended to be used. This issue is related to the dilation that occurs at the rock-concrete interface and is addressed in Appendix B. Computer program *ROCKET*, referenced in the "Resources" section at the end of Appendix B, can be used to investigate the effect of diameter on  $f_{\max}$  from a theoretical perspective. Load testing of rock sockets at full-scale during the design process can be very helpful to confirm or modify the design equations if large-diameter rock sockets ( $B > 1$  m) are planned.

Sides in layer of cohesionless IGM:

Friction theory can be used to estimate  $f_{\max}$  in cohesionless IGM's, as follows.

$$f_{\max i} = \sigma'_{vi} K_{oi} \tan \phi'_i, \quad (11.26)$$

where

$\sigma'_{vi}$  = vertical effective stress at the middle of Layer i,

$K_{oi}$  = design value of earth pressure coefficient at rest in Layer i, and

$\phi_i$  = design value for angle of internal friction in Layer i.

The latter two parameters can be evaluated through direct field and/or laboratory testing, or they can be estimated from the SPT, as described below, where  $p_a$  and  $N_{60}$  are as defined previously.

$$\phi'_i = \tan^{-1} \left\{ \left[ \frac{N_{60} (\text{Layer } i)}{12.3 + 20.3 \left( \frac{\sigma'_{vi}}{p_a} \right)} \right]^{0.34} \right\}, \quad (11.27)$$

$$K_{oi} = (1 - \sin \phi'_i) \left[ \frac{0.2 p_a N_{60} (\text{Layer } i)}{\sigma'_{vi}} \right]^{\sin \phi'_i} \quad (11.28)$$

When applying Equations (11.26) through (11.28),  $N_{60}$  should be limited to 100 B/0.3 m (100 B/ft), regardless of its actual value.  $\Delta z_i$  should be limited to about 9m (30 ft).

Base Resistance for Uplift Loading,  $q_{\max}$ :

$q_{\max}$  should be taken as zero for uplift loading unless experience or load testing at the construction site can show that suction between the bottom of the drilled shaft and the soil can be predicted reliably (as may be the case for rapid, pulse-type loading) or the drilled shaft has a bell.

Base in cohesive soil or IGM:

For a belled drilled shaft in cohesive soil or cohesive IGM,

$$q_{max} (\text{uplift}) = s_u N_u \quad (11.29)$$

where

$N_u$  = bearing capacity factor for uplift =  $3.5 D_b / B_b \leq 9$  (for clay that is not fissured), or  
 $= 0.7 D_b / B_b \leq 9$  (for clay that is fissured), and

$s_u$  = average undrained shear strength of the cohesive soil between the base of the bell and  $2 B_b$  above the base.

In the definitions given above,  $D_b$  is the depth of the base of the bell below the top of the layer in which the bell is constructed, and  $B_b$  is the diameter of the bell. Any soil within the depth of seasonal moisture change should not be counted when determining  $D_b$  for bells in surface layers. If the loading is cyclic, some consideration should be given to reducing the value of  $q_{max}$ .

When computing the uplift resistance force,  $q_{max}$  should be applied over the projected area  $A_u$ , depicted in Figure 11.5, and  $W'$  [Equation (10.3)] should include the weight of the bell.

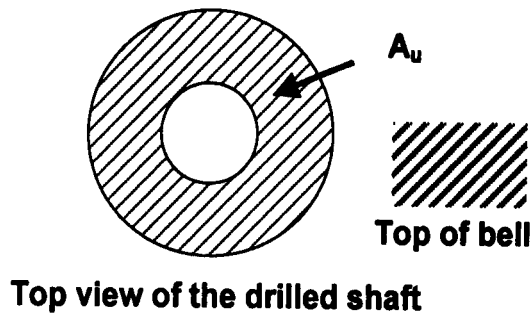

Figure 11.7. Definition of area  $A_u$

Base in cohesionless soil or IGM:

Belled drilled shafts should not ordinarily be used for situations in which the bell would be situated in cohesionless soil or IGM because of construction difficulties; therefore, no recommendations are given for  $q_{max}$  for this situation.

Base in rock:

Ordinarily, it is difficult to construct bells in rock, and they should be avoided if at all

possible. If the rock is massive, Equation (11.29) can be used, in which  $N_u = 3.5 D_b / B_b \leq 9$ , and  $s_u = 0.5 q_u$ . However, if the rock is jointed,  $q_{max}$  should be determined by load testing. The resistance force should be determined from  $q_{max}$  as for belled drilled shafts in cohesive soil.

Side Resistance for Uplift Loading,  $f_{max}$ :

When the axial load is applied in uplift, there is no need to have an exclusion zone at the base of the drilled shaft in any kind of soil or rock, except as indicated below, since base-side interaction does not occur, except in belled shafts.  $f_{max}$  should be computed as follows:

$$f_{max} (\text{uplift}) = \Psi f_{max} (\text{compression}) \quad (11.30)$$

In Equation (11.30) the factor  $\Psi$  can be taken as follows:

Cohesive soil, cohesive IGM and rock:

$\Psi = 1.0$  if the drilled shaft is in cohesive soil or is rigid compared to harder geomaterial (IGM or rock). A rigid drilled shaft is one in which  $[E_c/E_s] [B/D]^2 \geq 4$ .  $E_c$  is the composite Young's modulus of the drilled shaft (concrete and steel),  $E_s$  is the estimated mass Young's modulus of the geomaterial,  $B$  is the shaft diameter (shaft assumed cylindrical) and  $D$  is the depth of the base or length of the shaft. Otherwise, take  $\Psi = 0.7$  in IGM or rock unless proven otherwise by loading test.

If the drilled shaft is belled, and the uplift resistance of the bell is used,  $f_{max}$  should be taken to be zero between the base of the bell and a distance equal to  $2.0 B_b$  above the top of the bell.

Cohesionless soil and cohesionless IGM:

$\Psi = 0.75$ , conservatively.  $\Psi$  can often be taken to be higher than 0.75, however. See Appendix B for further information.

Documentation of the methods summarized above, further commentary on those methods, procedures for using the cone penetration test for drilled shaft design, effects of cyclic loading and design for group action are presented in Appendix B. Appendix B also describes methods for dealing with long-term (drained) resistance of drilled shafts in cohesive soil.

**15. If employing LRFD, compute the factored resistances  $\phi_{base}R_B$  and  $\phi_{side}R_S$  and add to obtain the factored total resistance,  $\phi R_T$ .** Recall that  $W'$  should be added to the computed resistance for uplift loading and that  $R_B$  is ordinarily taken to be zero for that condition. Alternatively, add  $R_B$  and  $R_S$  and multiply the sum by an overall resistance factor  $\phi$ .

The designer might follow this option if the LRFD method is specified but the designer chooses to use an overall factor of safety based on his or her experience. In that case the overall factor of safety is first converted to an overall resistance factor  $\phi$ , as discussed earlier.

Care should be exercised in adding  $\phi_{\text{base}}R_B$  and  $\phi_{\text{sides}}R_S$  or  $R_B$  and  $R_S$  in rock sockets. Doing so is reasonable if it can be demonstrated by load testing that the rock along the sides of the rock socket behaves in a ductile manner (does not exhibit deflection-softening behavior after initial shear failure). If the rock is known to behave in a non-ductile (brittle) manner, or if the degree of ductility has not been investigated, it is conservative to take  $R_T$  equal to  $R_S$  or  $R_B$ , whichever is greater. A more accurate estimate of  $R_T$  in such a case (brittle rock) can be obtained from Equation (C.35), in Appendix C.  $R_T$  is set equal to  $Q_T$  from Equation (C.35) for a user-specified settlement,  $w_T$  (e. g., 25 mm). Equation (C.35) considers brittle failure of the sides of the socket and elastic behavior of the base. Once  $Q_T$  is determined from Equation (C.35)  $R_B$  (developed) corresponding to  $Q_T$  should be computed using Equation (C.49) and compared with  $R_B$  (ultimate). If  $R_B$  (developed)  $>$   $R_B$  (ultimate), the shaft geometry should be changed (diameter, length or both) and the analysis repeated.  $R_T$  for the final geometry is then factored to obtain the factored resistance.

The overall factored resistances in compression and uplift should then be compared with the respective factored loads,  $\eta\Sigma\gamma_i Q_i$ , from the most critical design case (strength or extreme event, Appendix A) to verify that the design is satisfactory to resist the applied axial load. If  $\phi R_T \gg \eta\Sigma\gamma_i Q_i$ , the design is too conservative. Return to Step 12, specify a less conservative geometric design and repeat up to this step. If  $\eta\Sigma\gamma_i Q_i > \phi R_T$ , the design is not safe. Return to Step 12 and specify a more conservative geometric design and repeat up to this step. Continue until an optimum geometric design has been achieved.

**16. If employing ASD, compute the allowable load,  $R_A = (R_B + R_S)/F$ , or in the case of a rock socket in compression, where the rock is deflection softening,  $R_A = R_T/F$ , where  $R_T$  is evaluated as explained above. Compare  $R_A$  with the critical design load,  $Q$ . If  $R_A > Q$ , the design is safe against the applied load. If not, or if  $R_A \gg Q$ , return to Step 12 and specify a more appropriate geometry and repeat up to this step. Continue until an optimum geometric design has been achieved.**

**Note:** If the design calls for a group of drilled shafts, the axial resistance for each shaft in the group may have to be reduced by a group efficiency factor  $\eta_{\text{group}}$ . This is done by determining  $\eta_{\text{group}}$  for the group of drilled shafts, as described in Appendix B. That is  $R_T(\text{group}) = \eta_{\text{group}} \Sigma R_T(\text{individual drilled shafts in the group})$ . Several methods for assessing  $\eta_{\text{group}}$  in soils are addressed in Appendix B in the section "Axial Group Effects."

Each of these group efficiency methods will give somewhat different results, since they are based upon different sets of experiments, so judgment will be involved in selecting a value of the efficiency factor for design. It is recommended that  $\eta_{\text{group}}$  not be taken to be greater than 1 for design purposes in groups of drilled shafts. Design of the group will also involve the selection of

a layout of the drilled shafts, in particular, the spacing of the shafts. Commentary is provided on this issue at the end of the section on "Axial Group Effects" in Appendix B.

**17. Determine the vertical movement of the drilled shaft or group of drilled shafts** (settlement or uplift) under the factored axial load for the critical service state for LRFD or for the critical design load for ASD. Suggested methods are indicated below.

**Compression Loading:**

**Single Shafts in Soil:** Use the normalized load transfer curves given in Figures 11.8 through 11.11 if a hand solution is being made. Use *TZPILE* or *SHAFT* otherwise. For a hand solution, use Figures 11.8 and 11.9 for cohesive soil and Figures 11.10 and 11.11 for granular soil. Use of these curves will result in short-term settlements, which are probably sufficient except in cases in which normally consolidated clay or moderately overconsolidated clay exists below the base. In order to use these curves, follow the process outlined below.

a. Estimate a trial value of  $w_T$  (deflection of the head of the shaft) corresponding to  $\phi(\text{service})Q_T$  (LRFD) or  $R_T/F$  (ASD), where  $Q_T$  is the unfactored or nominal applied load and  $R_T$  is the ultimate resistance of the drilled shaft.

b. Compute the approximate elastic compression  $\delta_s$  of the drilled shaft under this load using

$$\delta_s = kQ_{Td}L / AE_c \quad (11.31)$$

In which  $Q_{Td}$  = design load (unfactored load for critical loading case for ASD and factored load for critical loading case for LRFD -- current load factors for serviceability in LRFD are 1);  $L$  = shaft length;  $A$  = cross-sectional area of the shaft; and  $E_c$  = composite Young's modulus of the drilled shaft.  $k$  is a factor that is selected based on the judgment of the designer regarding how much of the applied design load will reach the base. If all will reach the base (end-bearing shaft),  $k = 1$ . If the entire load is transferred to the ground through side resistance, then  $k = 0.5$ .  $k$  can often be taken to be 0.67 in relatively uniform geomaterial with little error.

c. Compute the average deflection along the sides of the drilled shaft,  $w_s = w_T - \delta_s/2$ .

d. For each layer  $i$ , tabulate the nominal ultimate side resistance  $R_{Si}$ . These have already been computed when the nominal resistance of the drilled shaft was obtained.

e. For each layer  $i$ , compute  $w_s/B$ , and enter Figure 11.8 if Layer  $i$  is a cohesive soil or Figure 11.10 if the layer is a cohesionless soil.  $w_s/B$  (where  $B$  = shaft diameter) is entered on the horizontal axis and the ratio of the developed side resistance to the ultimate side resistance ( $R_{Si}$ ) is obtained from the vertical axis. Define this ratio as  $\alpha_i$ . The designer will need to apply some



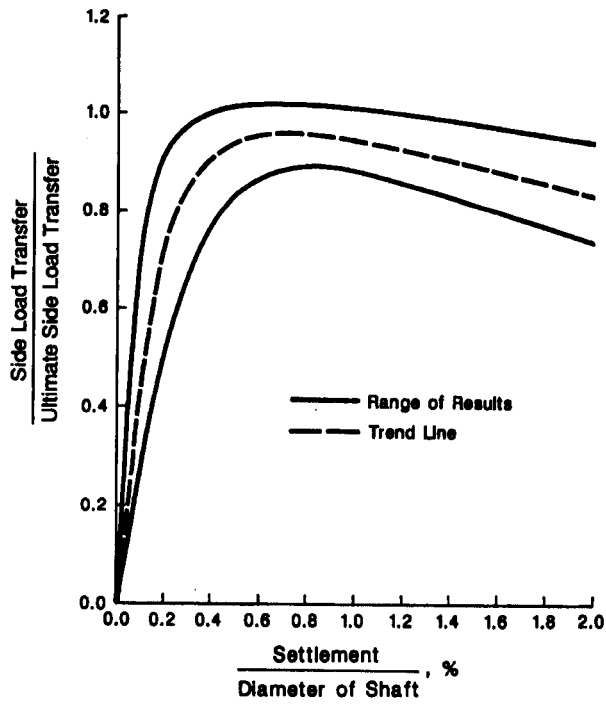

Figure 11.8. Normalized side load transfer for drilled shaft in cohesive soil.

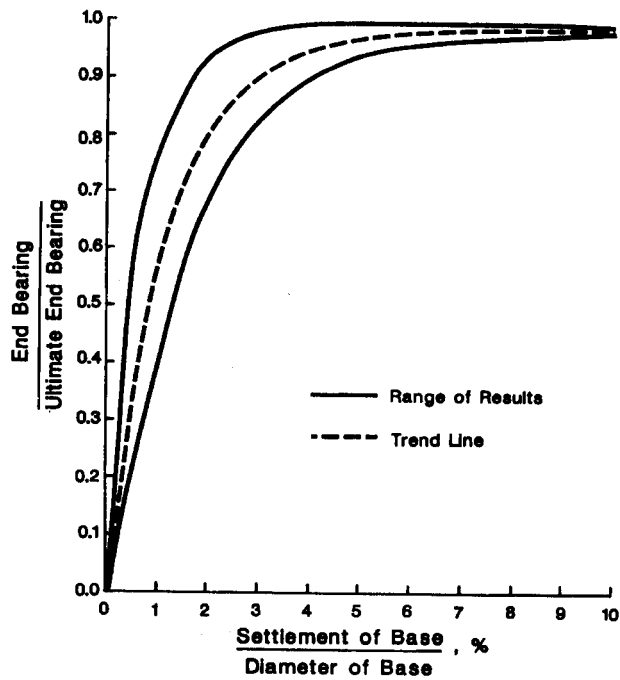

Figure 11.9. Normalized base load transfer for drilled shaft in cohesive soil.

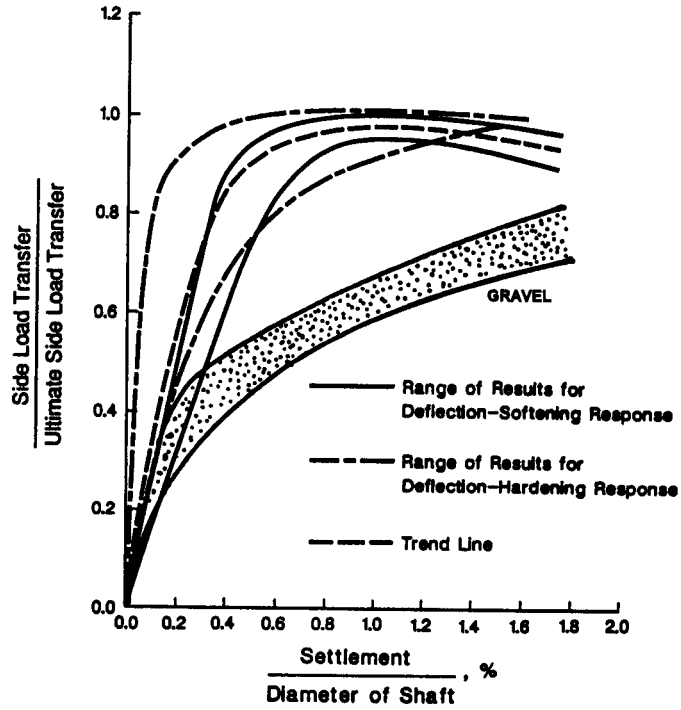

Figure 11.10. Normalized side load transfer for drilled shaft in cohesionless soil

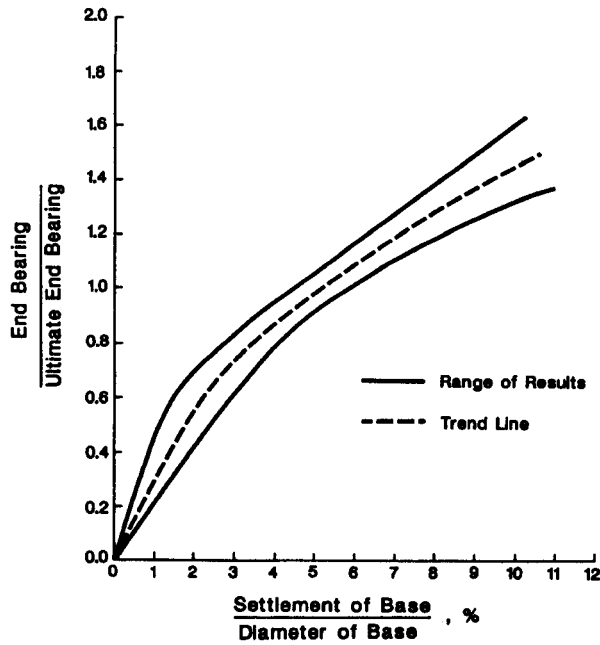

Figure 11.11. Normalized base load transfer for drilled shaft in cohesionless soil.

judgment relative to whether the trend line, one of the limits, or some relation in between should be used. Then  $R_{Si}$  (developed) =  $\omega_i R_{Si}$  for each  $i$ th layer. Finally,  $R_s$  (developed) is the sum of the  $R_{Si}$  values for all of the layers.

f. Compute the deflection at the base of the drilled shaft,  $w_b = w_T - \delta_s$ .

g. Tabulate the ultimate base resistance  $R_B$ . This has already been computed when the nominal resistance of the drilled shaft was obtained.

h. Compute  $w_b/B_b$  (where  $B_b$  = base diameter), and enter Figure 11.9 if the base is situated in cohesive soil or Figure 11.11 if the base is in a granular soil.  $w_b/B_b$  is entered on the horizontal axis and the ratio of the developed base resistance to the ultimate base resistance ( $R_B$ ) is obtained from the vertical axis. Define this ratio as  $\omega_B$ . The designer will need to apply judgment relative to whether the trend line (expected value), one of the limits, or some relation in between should be used. Then,  $R_B$  (developed) =  $\omega_B R_B$ .

i.  $Q_T$  (applied) =  $R_B$ (developed) +  $R_s$  (developed) should be compared to  $\phi$ (service)  $Q_T$  or  $R_T/F$ . If the computed and assumed values are identical, then the value of  $w_T$  that was assumed is correct. If not, assume another value of  $w_T$  and repeat the calculations. Note, if the shaft is "rigid" (Appendix C),  $w_s$  and  $w_b$  can be assumed equal to  $w_T$ .

**Note:** If the designer is concerned that significant long-term settlement might occur, the equivalent pier method described in Appendix C for groups of drilled shafts can be used in conjunction with values for  $E'$  and  $\nu_s'$  that are suggested for that method for drilled shaft groups. In this case,  $E_c = E_c$  and the diameter of the equivalent pier is the same as the diameter of the actual drilled shaft.  $E_{st}$  becomes irrelevant.

**Single-Shaft Sockets in Intermediate Geomaterial:** Assume that the settlement of the drilled shaft above the socket is due only to elastic compression of the drilled shaft material and is negligible. It is also assumed that the load transferred in the overburden above the IGM is minimal. That is, all of the load is transferred in the socket. This assumption will ordinarily result in overpredicted settlements, since some load is invariably transferred in the overburden.

The methods for estimating settlements in IGM's are somewhat more involved than the methods for soil. Therefore, the details are given in Appendix C. The methods can generally be executed easily on spreadsheets.

In cohesive IGM, use Equations (C.25) and (C.26) by selecting several values of  $w_T$  (settlement at the top of the socket) and computing a load-settlement relation. Determine the value of  $w_T$  corresponding to the working load (ASD) or the factored service load (LRFD) from this relation.

In cohesionless (granular) IGM, use Equations (C.28) through (C.32) to arrive at a load-

settlement relation. Determine the value of  $w_T$  corresponding to the working load (ASD) or the factored service load (LRFD) from this relation.

**Single-Shaft Sockets in Rock:** As with intermediate geomaterials, assume that the settlement of the drilled shaft above the rock socket is due only to elastic compression of the drilled shaft material and is negligible. It is also assumed that the load transferred in the overburden above the IGM is minimal. That is, all of the load is transferred in the socket. This assumption will ordinarily result in overpredicted settlements, since some load is invariably transferred in the overburden. It is also assumed that the geomaterial within and beneath the rock socket is uniform (not layered).

The methods for estimating settlements in rock are also somewhat more involved than the methods for soil. Therefore, as with IGM's, the details are given in Appendix C.

Use Equations (C.30) and (C.35) to construct a three-branched load-settlement relation. Use of these equations assumes that reduced values of side resistance occur after slip. Determine the value of  $w_T$  corresponding to the working load (ASD) or the factored service load (LRFD) from this relation.

If there is concern about long-term settlement of a drilled shaft in rock, consider using Equation (C.58) to evaluate the magnitude of creep with the understanding that the applicability of this equation to all rocks has not been proven.

**Groups of Drilled Shafts:** The factored service load or the working load to be used in the analysis is the load applied to the entire group. The elastic moduli,  $E_b$ ,  $E_s$  and  $E_{st}$  and the Poisson's ratio of the soil,  $\nu_s$ , are evaluated as discussed in Appendix C, "Equivalent Pier Method." Alternatively, the equivalent raft method can be used, which is also documented in Appendix C. However, the equivalent pier method is normally more accurate when layers of rock are encountered at or near the shaft bases, and that method is recommended here. The various moduli correspond to appropriate secant moduli at the various levels of strain expected in the soil or rock beneath the base of the group ( $E_b$ ), the soil or rock laterally surrounding the group ( $E_s$ ), and the soil or rock between the shafts within the group ( $E_{st}$ ). Equation (C.64) is then used to estimate the settlement of the group. Note that if drained values are used for the soil moduli ( $E'$  and  $\nu'$ ) the settlement computed will be the long-term settlement. If undrained moduli are used the settlement computed will be the short-term, or elastic, settlement.

### **Uplift Loading :**

**Single Shafts in Soil:** After determining either the critical factored load for the service state (LRFD) or the working load (ASD), determine  $R_s$  for uplift loading and the amount of elastic extension for the drilled shaft, following the procedure for compression loading but noting that  $f_{max}$  may be different for uplift loading than for compression loading. The elastic extension is computed using Equation (11.31) using  $k = 0.5$  and realizing that the deformation computed is

extensional. Estimate load-movement behavior using the normalized load-transfer relations for side resistance, Figures 11.8 and 11.10. Base resistance should normally be ignored.

**Single-Shaft Sockets in Intermediate Geomaterial:** For cohesive IGM's follow the same procedure as for compression loading, but set base resistance = 0 in Equations (C.25) and (C.26), since there will be no base resistance. Recognize that the movement computed will be an uplift movement. For cohesionless IGM's compute  $R_s$  using Equation (B.62). First, however, correct  $f_{max}$  by using Equation (B.57) or the small, unnumbered table following that equation. Then, set  $Q_{T1} = R_s$  and compute  $w_{T1}$  from Equation (C.30), recognizing that  $w_{T1}$  is an uplift movement. Note that  $I$  from Equation (C.29) will be used in Equation (C.30). Where zero base resistance is assumed, set the parameter  $E_b = 0$ , which will make  $\xi$  become infinite, and those terms involving  $\xi$  (which is in the denominator) will go to zero. The uplift movement will be a linear function of uplift load until  $Q_{T1}$  is reached. It will then increase without limit (shaft will ideally pull out).

**Single Shafts in Rock:** Compute  $R_s$  for the rock socket. Set  $Q_{T1} = R_s$  unless tensile resistance can be proven to exist at the base of the socket and use Equation (C.30) to compute  $w_{T1}$ . Note that  $I$  is computed from Equation (C.29) and  $\xi$  can be taken to be 2.5. The uplift movement will be a linear function of uplift load until  $Q_{T1}$  is reached. It will then increase without limit (shaft will ideally pull out).

**Groups of Drilled Shafts:** Uplift loading of a group of drilled shafts can be estimated at the service load limit state or under the working load by first computing the uplift movement of a single drilled shaft within the group,  $-w_{ss}$ , under the load  $-Q_{Tgroup}$  (applied) / Number of shafts in the group. The procedure most appropriate for the subsurface conditions found in the design zone, outlined above, is used. The uplift movement of the group,  $-w_{Tgroup}$ , is then computed using Equation (C.66). This procedure assumes that the base resistance during uplift loading will be zero.

**18. Compare computed settlement or uplift with tolerable movement (Chapter 10).** If the settlement or uplift under service load or working load exceeds the tolerable movement, revise the drilled shaft geometry and repeat the entire analysis for strength and service limit states (LRFD) or for critical design loads (ASD).

**19. Finally, after the geometry has been selected to satisfy axial loading, employ the procedures presented in Chapter 13 to select the concrete strength and steel schedule for the rebar cage based on structural considerations and/or for lateral loading.** During this process the acceptability of the diameter and length of the drilled shaft determined for axial loading will either be confirmed for lateral loading, or it will be found necessary to increase the diameter or length, or both, to ensure adequate performance under lateral loading.

The reader is encouraged to consult Appendix D for several examples of the application of this

step-by-step design procedure. Examples of individual steps and equations are given in Appendices B and C.

## REFERENCES

- Carrubba, P. (1997). "Skin Friction of Large-Diameter Piles Socketed into Rock," *Canadian Geotechnical Journal*, Vol. 34, No. 2, April, pp. 230 - 240.
- Chen, Y.-J., and Kulhawy, F. H. (1994). "Case History Evaluation of the Behavior of Drilled Shafts Under Axial and Lateral Loading," *Final Report*, Project 1493-04, EPRI TR-104601, Geotechnical Group, Cornell University, Ithaca, NY, December.
- FHWA (1996). *Load and Resistance Factor Design (LRFD) for Highway Substructures*, Manual for NHI Course, Federal Highway Administration, Washington, D. C.
- Reese, L. C., and O'Neill, M. W. (1988). "Field Load Tests of Drilled Shafts," in *Proceedings, International Seminar on Deep Foundations on Bored and Auger Piles*, Van Impe (ed.), Balkema, Rotterdam, June, pp. 145 - 192.

## CHAPTER 12: DESIGN FOR VERTICAL MOVEMENT OF THE GROUND SURFACE

### INTRODUCTION

Two classes of problems are encountered when surface soils undergo vertical movement relative to drilled shaft foundations:

- The problem of downdrag ("negative skin friction") from settling soil, and
- The problem of uplift from expansive soil.

The problems are similar, even though the forces on a drilled shaft from the soil act in opposite directions in the two cases. Peck, et al. (1974, p. 285) indicate the importance of dealing with this class of problems when they state that "Several examples of unexpected settlement of large magnitude have been attributed to neglect of negative skin friction." Failures have also occurred where structures on drilled shafts have been founded on expansive clay. This chapter will describe general methods for dealing with the two problems.

Tomlinson (1980) makes a statement about downdrag that applies equally well to the uplift problem: "The calculation of the total negative skin friction or drag-down force on a pile is a matter of great complexity, and the time factor is of importance." In order for these moving-ground problems to be solved properly, it is necessary that the load transfer from point to point along the drilled shaft be known as a function of the relative movement between the drilled shaft and the soil and as a function of time. Such information is generally unavailable. However, the problems must be recognized and dealt with, and the approximate solutions shown herein, while perhaps conservative, should lead to useful designs. One recent practical reference that readers may find especially useful is an NCHRP report by Briaud and Tucker (1997).

A rational way of dealing with the moving-ground problem is to employ the technique demonstrated in Appendix E and discussed later in this chapter. If downdrag and/or uplift are economically important problems in a particular area, field data on that subject for that local area should be acquired. Such data should allow the development of additional analytical techniques, along the lines of Appendix E, that should prove beneficial.

### DOWNDRAG

#### Occurrence

Drilled shafts will be subjected to downdrag when the soils in contact with the upper portion of the foundation move downward relative to the drilled shaft and literally drag the shaft down. The resulting downward force from the near-surface soils will add to the load applied to the drilled shaft by the structure and can lead to excessive settlement of the foundation.

The potential for downdrag exists when the surface soils can settle and where the drilled shaft passes through those settling soils into a stratum of relatively rigid geomaterial, such as hard/dense soil, IGM or rock. It is of interest to note that, even if the surface soils settle, downdrag will not develop if the drilled shaft moves downward under the applied dead and live loads more than does the settling soil. Thus, the relative movements of the soil and drilled shaft are fundamental in regard to the occurrence of downdrag.

Any relative downward movement of the soil with respect to the drilled shaft will result in some downdrag; however, the full load transfer from the soil to the drilled shaft will occur at relative movements of from about 2.5 mm (0.1 inches) to about 13 mm (0.5 inches). It is prudent in making designs to consider that full downdrag will occur if any relative downward movement of the soil is anticipated. The condition that is thus assumed is termed the "fully plastic" condition.

Some examples of cases where downdrag can occur are shown in Figure 12.1. In the three examples that are shown, all of the drilled shafts are founded in a stratum of strong soil or rock and in all cases there is some surface loading, which might not be present in all instances. The loose sand in Figure 12.1a will settle in time, especially if the stratum is subjected to cyclic loading, as might result from a seismic event or major fluctuations in the ground water level; the presence of some sort of surface loading would also contribute to the settlement.

With regard to the near-surface layer of soft clay shown in Figure 12.1b, the tendency for settlement may be minimal if there is no surface loading; however, the addition of a fill such as an approach embankment could induce considerable consolidation settlement that may continue long after the drilled shafts have been installed. Figure 12.1c illustrates a drilled shaft that is constructed through a recently-placed fill. Evidence is available to show that virtually any fill will settle to some extent with time under its own weight, particularly if it is not well compacted.

As is evident, the determination of the relative amount of settlement between the upper soil layers and the drilled shaft is necessary in order to obtain a rational solution to the problem. For the cases where the surface soils are moving downward more than the drilled shaft, a conservative solution can be obtained if the assumption is made that the downdrag (downward-directed side shear load) will develop along the drilled shaft all the way from the ground surface to the top of the founding stratum. However, a less conservative solution will be described in this chapter.

Figure 12.2 illustrates a situation encountered frequently in highway design where downdrag can occur. The drilled shafts are installed, the abutment is constructed, and the fill is placed. The settlement of the soil along the length of the drilled shafts may be difficult to prevent. Downdrag can be exceptionally problematical if the drilled shafts are placed on a batter, as shown in the figure, because both axial drag and lateral loading will be produced in the battered drilled shafts by the settling soil. The process of consolidation of the weak soil can even induce lateral loading on vertical drilled shafts because the soil not only settles, but it also has a tendency to squeeze laterally toward the right in the figure. Therefore, downdrag is a common problem with the type of construction that is shown, which needs to be dealt with in design. There is also a tendency for



lateral movement of the abutment itself, but such movement can be minimized by the use of a properly designed system of drilled shafts.

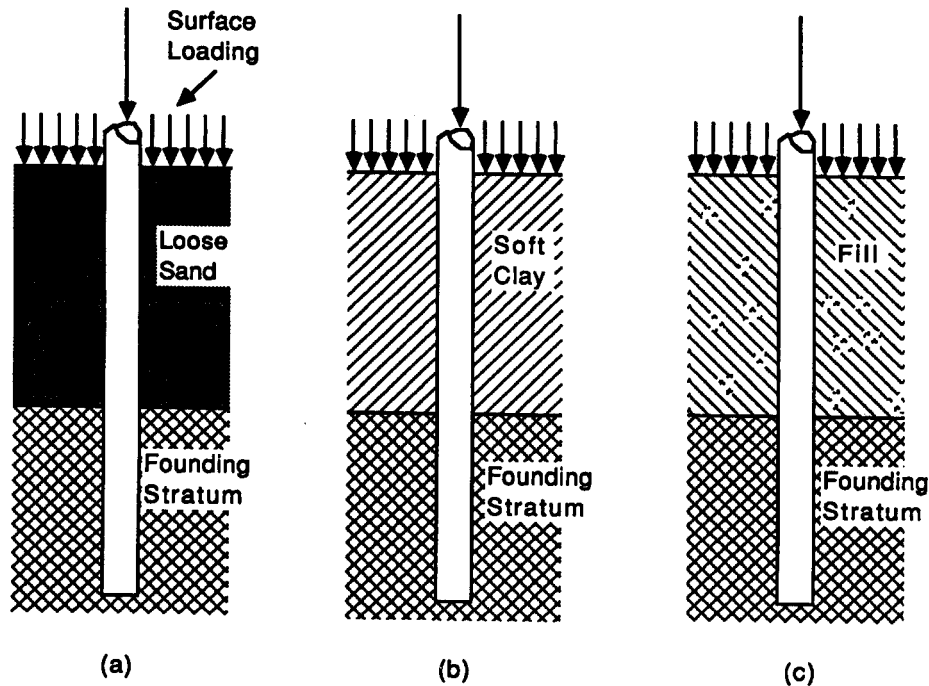

Figure 12.1. Examples of cases where downdrag could occur

Figure 12.3 shows schematically the forces that develop against vertical drilled shafts when downdrag is occurring due to settling soil. Line A-A represents the plane above which the soil settles more than the drilled shaft and below which the drilled shaft settles more than the soil or rock in the so-called founding stratum. This plane is referred to as the "neutral plane."

Two very different strength limit states for drilled shafts loaded by downdrag need to be understood. The limit state illustrated on the left occurs when the combination of applied head load and drag load in the settling stratum produces both side shear and base resistance failure in the founding stratum. At that point there is an associated applied load, settlement and maximum load in the drilled shaft (which occurs at the depth of Plane A-A), and no further resistance can be developed in the founding stratum. This can be assumed to represent a strength limit state.

The limit state illustrated on the right occurs when compressive load greater than that associated with the state on the left is applied. The lower portion of the shaft can be assumed to settle without developing any further resistance. However, as the additional settlement occurs, the drilled shaft eventually settles more than the soft stratum of surface soil, and the negative side resistance is reversed and becomes positive side resistance. Downdrag no longer exists. In this state the resistance of the drilled shaft to load is higher than that in the state on the left.

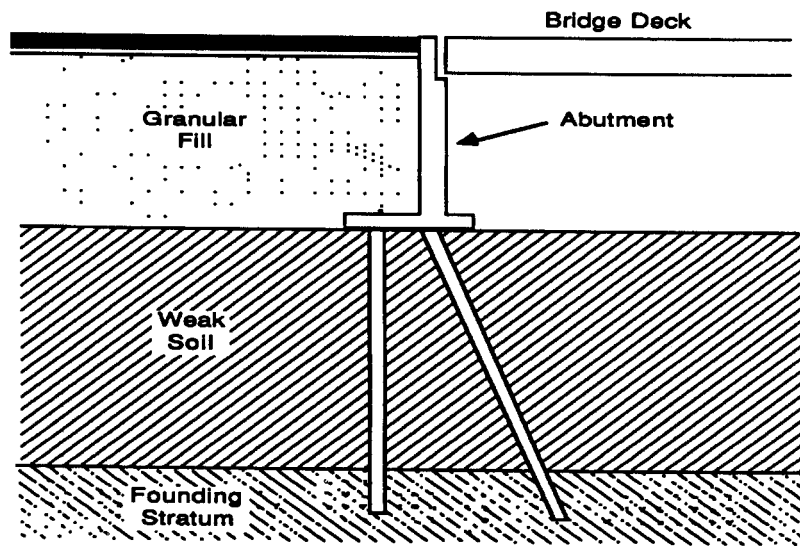

Figure 12.2. Possible downdrag loading of drilled shafts supporting a bridge abutment

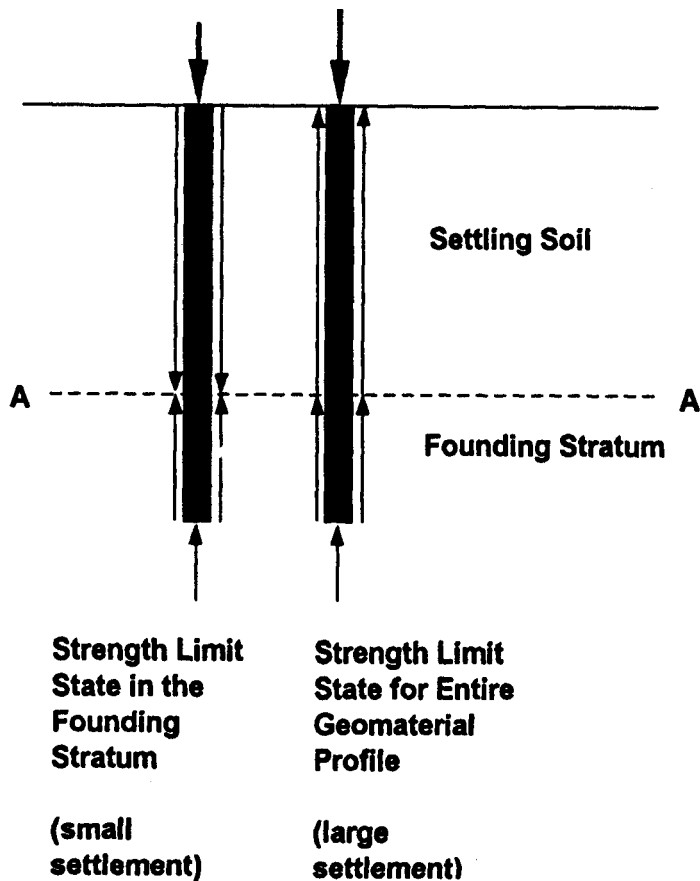

Figure 12.3. Potential geotechnical strength limit states for drilled shafts undergoing downdrag loading

An issue in design is whether to define ultimate resistance as that which occurs in the state on the left or the state on the right in Figure 12.3. In fact, the state on the right represents the true ultimate geotechnical limit state for strength. However, since that state can only exist when the settlement of the drilled shaft exceeds the settlement of the ground surface, which may be hundreds of millimeters (several inches to several feet), the state on the left is customarily the one that is considered in design as the geotechnical strength limit state. In the 1994 AASHTO LRFD method the drag forces (downward-directed shear forces along the upper part of the drilled shaft) become factored loads with a load factor  $\gamma$  of 1.80 (Table A-3). The usual load factors are used with the loads applied at the head of the drilled shaft. The upward-directed shearing resistance and base resistance in the founding stratum then become factored resistance values, using the usual resistance factors, and the basic LRFD equation [Equation (1.3)] is applied. If uplift loading from the structure occurs, the side shear forces at the limit state are all always resistances.

It is of interest to note that the occurrence of downdrag causes a reduction in the overburden stress at the top of the founding stratum, since the soil is "hanging" partially on the drilled shaft instead of bearing completely against the soil or rock beneath it and thereby confining it. Therefore, there could be some reduction in the bearing capacity of the drilled shaft at its base, particularly when drained loading is being considered.

Downdrag can also occur when groups of drilled shafts are constructed. The topic of downdrag in groups of piles is summarized by Briaud and Tucker (1997), and much research remains to be done on the long-term effects of downdrag in groups of both driven piles and drilled shafts. However, it is usually sufficient for design purposes to assume that the drilled shaft group is an equivalent pier with a depth equal to the depth of the drilled shafts in the group and a perimeter area equal to the perimeter area of the group. The location of the neutral plane is determined as if the group were one large drilled shaft with the length and perimeter area of the equivalent pier and an equivalent elastic modulus as determined for the equivalent pier method in Appendix C [Equation (C-63)]. The computations proceed as indicated below for individual drilled shafts. That is, the drag loads occur only around the perimeter of the group and do not develop against interior shafts, as indicated in Figure 12.4. The resistance of that portion of the group below the neutral plane can be evaluated as if the neutral plane were the bottom of the structural drilled shaft cap (in consideration of block action and similar effects addressed in Appendix B).

### **Estimating the Neutral Point Location and Distribution of Load and Resistance**

The neutral point is defined as the point along the drilled shaft where the neutral plane (Plane A-A in Figure 12.3) intersects the drilled shaft; that is, the depth along the shaft at which relative movement between the shaft and the soil is zero. Above the neutral point, the settling soil will add load to the shaft, and the load will be transferred into the geomaterial below the neutral point.

If the near-surface stratum is weak and subjected to surface loading, and if the drilled shaft is founded in a stratum of strong geomaterial, such as one of the cases in Figure 12.1, it may be satisfactory to assume the neutral point to be at the surface of the strong layer. The downdrag load

can be computed by integrating the maximum load transfer, based on the shear strength of the soil obtained from either total or effective stress calculations, from depth to depth along the portion of the drilled shaft in the settling soil. The maximum load along the shaft would occur at the top of the founding layer and would be the sum of the downdrag load and the load applied at the top of the drilled shaft. Structurally, the shaft would need to be designed for that load.

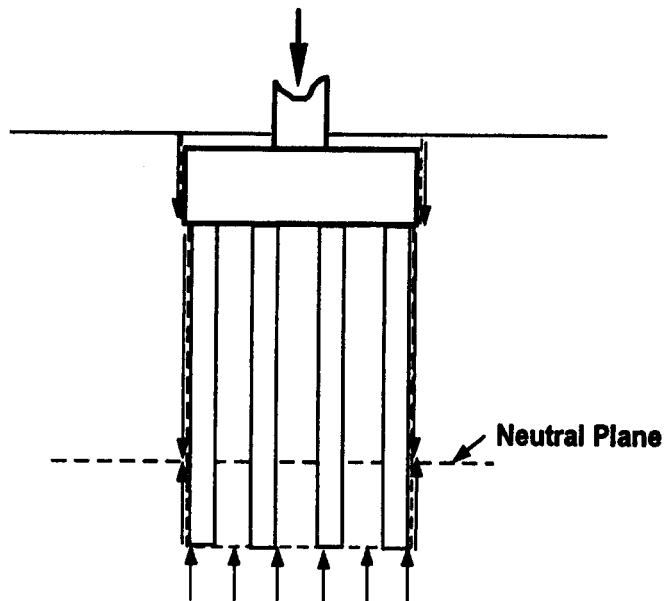

Figure 12.4. The equivalent pier concept applied to downdrag in groups of drilled shafts

A somewhat more rational, and less conservative, analysis is illustrated in Figure 12.5. Figure 12.5a shows the example problem: a cylindrical drilled shaft that penetrates a weak, settling soil and is founded in a strong, relatively unyielding stratum. The unit load-transfer curves for the soil (unit side or base resistance vs. relative movement between the shaft and geomaterial) are shown in Figure 12.5b. In this case they are fully plastic. A solution could be obtained if the curves were elastic-plastic, or even generally nonlinear, but the computations would be somewhat more tedious. Not shown in the sketch is that the load in end bearing is assumed to be a linear function of the downward movement of the base of the drilled shaft.

The relative movement of the drilled shaft with respect to the soil is first assumed to be as shown in Figure 12.5c, with the neutral point selected at the contact between the weak and strong strata. The negative sign shows that the soil is moving downward with respect to the drilled shaft (or that downdrag is occurring), and the positive sign shows that the drilled shaft is moving downward with respect to the geomaterial (or that load is being transferred into the geomaterial). With these assumptions, the pattern of the distribution of load along the drilled shaft is as shown in Figure 12.5d. It follows from these assumptions that the maximum load in the drilled shaft occurs at the contact between the weak and strong strata (the assumed neutral point).

It is evident, however, that the patterns of movement and loading shown in Figures 12.5c and d

cannot occur. The base of the drilled shaft must move down for the base resistance load  $R_{Bd}$  to develop. Furthermore, the portion of the drilled shaft in the strong stratum must deform elastically. Therefore, the neutral point cannot occur at the interface between the layers but must move upward, as shown in Figure 12.5e. A revised distribution of load along the drilled shaft is shown in Figure 12.5f. If  $R_{Bd}$  remains constant, both  $Q_T$  (the applied load) and  $Q_{max}$  (the maximum load in the drilled shaft) will increase relative to the values in Figure 12.5d, as indicated in Figure 12.5f. If  $Q_T$  remains constant,  $Q_{max}$  and  $R_{Bd}$  in Figure 12.5f will be less than the respective values shown in Figure 12.5d. Convergence can be achieved after only a few trials if the shaft is elastic and if the load transfer functions are simple, as assumed in the demonstration.

If  $Q_T$  at the top of the shaft is increased by an increment,  $Q_{max}$  is not increased by a like amount because the neutral point must move up. If the shaft moves down a sufficient amount, which may not be tolerable, the downdrag will disappear completely, as illustrated in Figure 12.3.

## Design Solutions

Example calculations for downdrag in drilled shafts are given in Appendix E.

Based on the mechanics described in the previous section, a procedure for obtaining an approximate solution to the downdrag problem can be stated as follows.

1. From the geomaterial profile, estimate as accurately as possible the magnitude of the downward movement of the settling soil. The downward movement is needed as a function of depth through the stratum. The downward movement is undoubtedly time-related, and a decision must be made for which period of time in the life of the structure the analysis will be made. Often, it is satisfactory for design purposes to assume that the appropriate time is the time at which all settlement stops and that the variation of settlement with depth is a linear function varying from a maximum value at the ground surface to zero at the interface with the underlying strong stratum of geomaterial.
2. Select the geometry of the drilled shaft and its axial stiffness (AE).
3. Select load transfer curves for all of the layers the drilled shaft will penetrate. If a linear curve is selected for load transfer in base resistance and fully plastic curves are selected for load transfer in side resistance, a hand solution can be made without difficulty.
4. Select a value of base settlement and iterate to find the neutral point and the distribution of load along the drilled shaft, taking into account the downward movement of the base and the elastic shortening of the drilled shaft. The hand computations for this step are illustrated in Appendix E.

If the numerical modeling (computer) procedure described in Appendix C is adopted, Steps 1 and 2 are the same. Curves are selected in Step 3 that give load transfer in side resistance and in end bearing as a function of the downward movement of the drilled shaft. In the general case, the curves

are nonlinear. The iteration corresponding to Step 4 is done by the computer. Suitable software for performing the computations is referenced in the "Resource" section at the end of this chapter. An outline of a numerical solution of this type is also given in Appendix E.

A review of the mechanics of the downdrag problem leads to the following points:

- The assumptions that are implicit in Figures 12.5 a, b, and c lead to a solution that is conservative.
- The elementary solution suggested by Figures 12.5 e and f, and detailed in Steps 1 through 4 (above), may be worthwhile in some instances.
- The procedure described in Appendix E can be adapted to yield a more exact solution to the problem, but the accuracy of the solution is subject to question. It is not at all clear that the settlement of the weak stratum can be computed with accuracy and that accurate nonlinear load transfer curves can be obtained. However, if the computer solution is implemented, parametric studies can be performed, and the designer can develop an improved understanding of the important elements of the downdrag problem. Furthermore, guidance can be obtained from field observations that may be useful in performing updated estimates of settlement and drag loading for a particular foundation.

An important element in the downdrag analysis is the selection of the maximum value of the unit side resistance imposed by the settling soil,  $f_{\max}$ . Consolidation of soil (sand or clay) under an imposed surcharge produces time-dependent increases in the shear strength of the settling soil as well as settlement. This means that  $f_{\max}$  near the end of the consolidation (ground settlement) process will be larger than it will be near the beginning of the process. Therefore, shear strength near the end of the consolidation process must be predicted. Since consolidation involves drainage of the soil,  $f_{\max}$  in the settling zone will be related to the drained shear strength, rather than the undrained shear strength, of the soil. Equation (B.50) can be applied to the prediction of long-term drained shearing strength along the drilled shaft.

Time and depth dependence are implied in Equation (B.50) because  $\sigma'_v$  is a time- and depth-dependent effective stress. For making calculations for design purposes,  $\sigma'_v$  would normally be taken (conservatively) as the value corresponding to full dissipation of excess porewater pressure produced by whatever mechanism is causing consolidation (e.g., fill placed above normally consolidated or slightly overconsolidated clay). Where rapid drilled shaft construction with workable concrete takes place, and the drilled shaft borehole is slightly rough,  $K/K_0$ , the ratio of the lateral earth pressure coefficient to the at-rest earth pressure coefficient of the soil against the face of the drilled shaft, and  $\delta/\phi'$ , the ratio of the interface friction angle to the effective angle of internal friction of the soil, can both be taken as 1.0 for downdrag design conditions. Equation (B.50) therefore reduces to

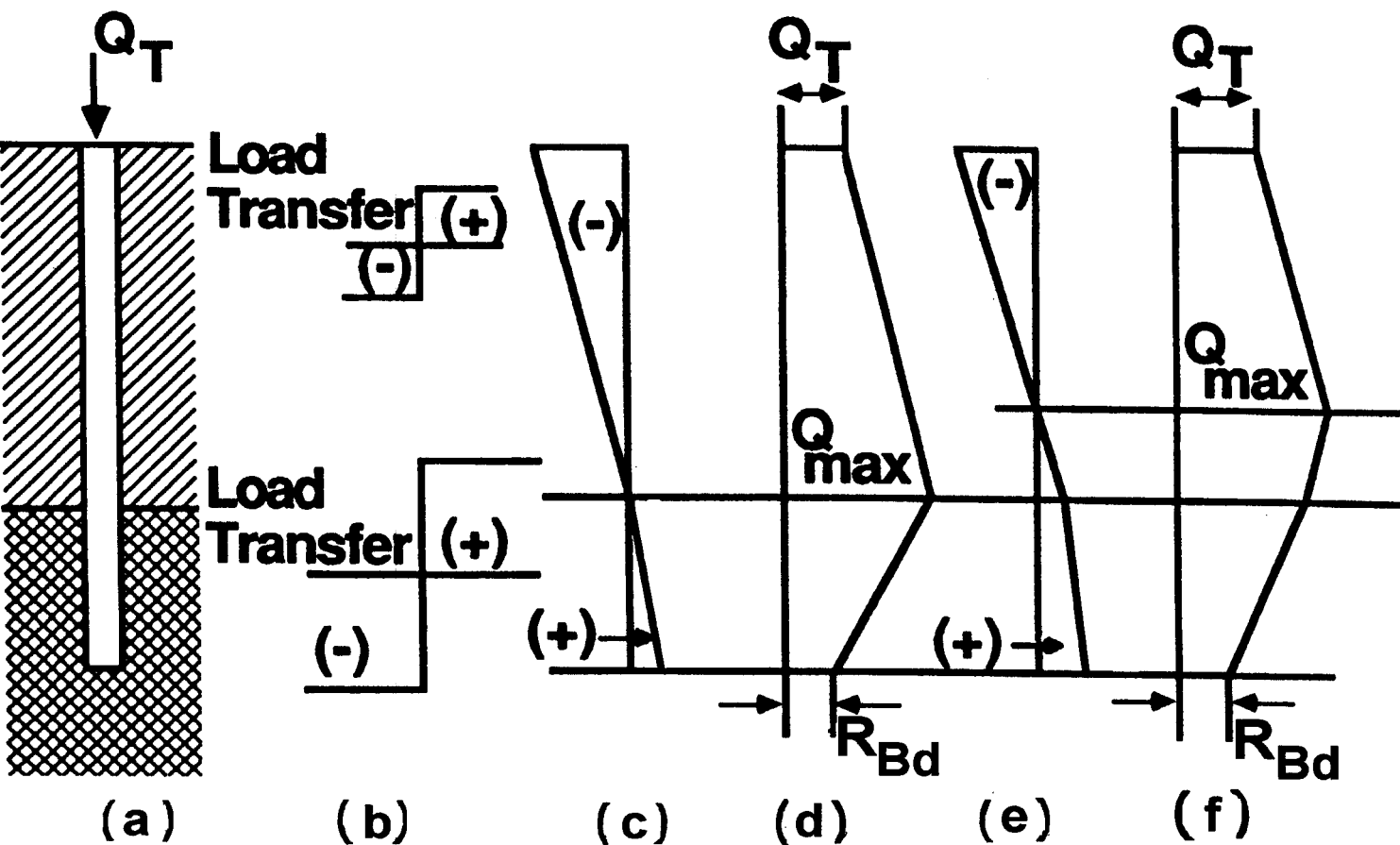

Figure 12.5. Elementary mechanics of downdrag: (a) example problem; (b) load transfer curves; (c) relative movement of drilled shaft with respect to geomaterial (neutral point assumed at bottom of settling stratum); (d) distribution of load along drilled shaft; (e) revised estimate of relative movement of drilled shaft with respect to geomaterial; (f) revised estimate of distribution of load along drilled shaft

$$f_{max} = a' + K_o \sigma'_v \tan \phi' \quad (12.1)$$

The parameters  $a'$  and  $\phi'$  can be assumed to be equal to the effective stress parameters  $c'$  and  $\phi'$  for the soil measured in drained shear tests, either triaxial compression, direct shear or direct simple shear. Stas and Kulhawy (1984) point out that some soils, particularly those that are overconsolidated, can have curved Mohr-Coulomb failure envelopes, so that  $a'$  and  $\phi'$  should be defined at a particular depth corresponding to a given value of  $K_o \sigma'_v$ , according to Figure 12.6.

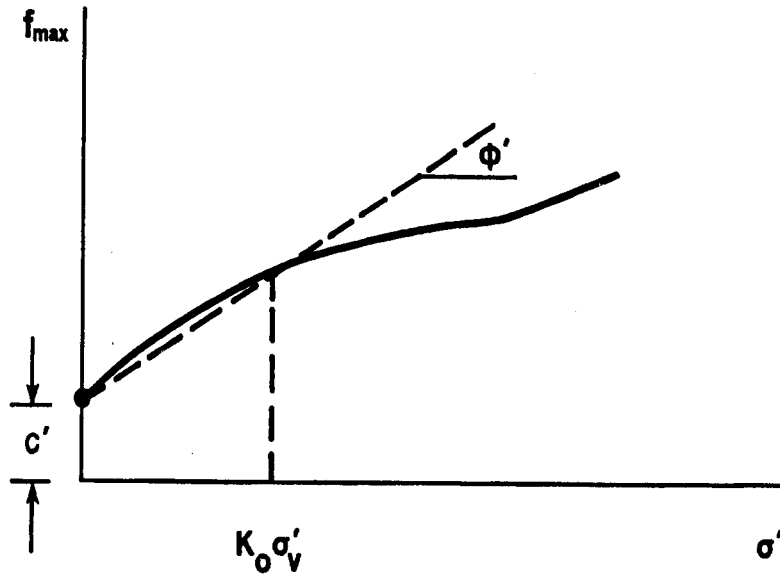

Figure 12.6. Definition of  $c'$  and  $\phi'$  where curved failure envelope exists

The coefficient of earth pressure at rest  $K_o$  is evaluated approximately from Equation (12.2).

$$K_o = (1 - \sin \phi') OCR \sin \phi' \quad (12.2)$$

where

$$OCR = \sigma'_{v \max} / \sigma'_{v o} \quad (12.3)$$

in which

$\sigma'_{v \max}$  = the maximum vertical effective stress on the soil during its past history, and

$\sigma'_{v o}$  = the vertical effective stress on the soil at the time at which the shear strength is to be estimated.



OCR refers to the overconsolidation ratio of the soil (at the time the downdrag calculations are made), which is often near 1 in downdrag problems.

While it may not always be feasible to employ effective stress methods in practice, it is important to understand the effective stress concepts described here when choosing design parameters for downdrag calculations. For example, these principles can be used to provide estimates of the undrained shear strength of the soil after consolidation as a function of the undrained shear strength of the soil at the time of sampling. It can then be assumed that  $f_{\max}$  for estimating downdrag is equal to the undrained shear strength of the soil after consolidation, with  $\alpha$  [Equation (11.16)] = 1, since the effects of remolding during drilling and water migration from the concrete into the soil, which cause  $\alpha$  to be less than 1, will have been largely erased by the long-term consolidation of the soil caused by the imposition of surface loads.

## **UPLIFT**

This section addresses uplift of drilled shafts caused by the swelling of expansive soils. Expansive soils are ordinarily overconsolidated clays that have moisture contents below the plastic limit. Such soils expand primarily because their mineralogies permit the formation of thick diffuse double layers around the clay particles, which in effect jacks the clay particles apart. The water required to satisfy the formation of these double layers is usually absent in soils near the surface during the dry season of the year, and if the drilled shaft is constructed at such time, the clay can later swell and pull the drilled shaft upwards. Sometimes, soft rocks such as clay-shale and mudstone can be expansive, as can rocks that form crystalline hydrates, such as gypsum.

A related problem that will not be treated explicitly here, ice jacking, can be important in cold climates. Ice jacking can occur when an ice sheet covering a body of water is adfrozen to a drilled shaft and the ice rises because of, for example, an increase in the volume of water beneath the ice. Frost heave (heaving of frozen soil near the surface) is another manifestation of ice jacking. Once the strength of the adfrozen ice, or the frozen soil in the case of frost action, is determined, the procedure for design is similar to that for design of drilled shafts in expansive clays.

## **Occurrence and Identification of Expansive Soils**

Swelling soils exist in many places in the United States. Peck, et al. (1974) report that swelling soils are "especially prevalent in a belt extending from Texas northward through Oklahoma, into the upper Missouri valley, and on through the western prairie provinces of Canada. In many parts of this belt, considerations of swelling dominate the design of foundations of structures." There are probably about twenty States in the United States where expansive clays present a problem, at least to some degree (Gromko, 1974). The design of drilled shafts in expansive soils requires some special care to ensure that there are no undesirable movements of the foundation.

The first step in the design of a drilled shaft in expansive soil is to determine whether the soil in the design zone is expansive. There are a number of techniques for identifying geomaterials that have

the potential for swelling. Among these methods are:

- observation of existing structures near the site,
- identification of the clay minerals in the geomaterial (smectites, particularly those containing sodium are especially prone to swelling),
- performance of pressure/ volume-change tests using undisturbed specimens recovered from the site, and
- use of published correlations with index properties of the soil. A brief presentation of this latter method is given in the following.

Snethen et al. (1977) made a comprehensive study of 17 different methods for the use of index properties in the identification of potentially expansive soils. The study included field sampling and laboratory testing. The authors contacted 11 state highway agencies and did field sampling at 20 sites. The soil at each site was "representative of an overly extensive deposit of expansive soil which poses problems as defined by the state highway agency."

The laboratory tests involved the determination of specific gravity, grain-size distribution, liquid limit, plastic limit, activity, liquidity index, shrinkage limit, shrinkage ratio, shrinkage index (liquid limit minus shrinkage limit), and bar linear shrinkage. The natural suction of the undisturbed soil ( $\tau_{nat}$ ) was also measured at given moisture contents. Swell tests were performed in the odometer under a stress equal to the overburden stress. Void ratios, water contents, degrees of saturation, and unit weights were measured, along with the percent of swell, at the beginning and end of each swell test. Thus, the authors had a large amount of data for analysis.

Snethen and his colleagues required a definition of the potential swell in order to develop a correlation, and they considered the various factors that were involved. The definition that arose from their research is as follows:

"Potential swell is the equilibrium vertical volume change or deformation from an odometer-type test (i.e., total lateral confinement), expressed as a percent of original height, of an undisturbed specimen from its natural water content and density to a state of saturation under an applied load equivalent to the *in-situ* overburden pressure."

Extensive statistical analyses were performed to develop an indirect method that would yield the best prediction of potential swell. The method that ensued was termed the "WES (Waterways Experiment Station) Classification Method." That classification method is shown in Table 12.1. The value of  $\tau_{nat}$  shown in Table 12.1 can be determined expeditiously from a soil suction test, which can be performed easily by wrapping clods of soil for prescribed periods of time in initially dry filter paper, with certain specifications, leaving the soil in close contact with the filter paper in a confined space and measuring the moisture content of the filter paper (ASTM, 1996). The authors noted that the

correlation shown in Table 12.1 gave an accurate prediction for 12 of the sites, was conservative for 6 of the sites, and was not conservative for 2 of the sites.

Table 12.1. WES Method of Identifying Potentially Expansive Soils

Liquid Limit (%)	Plasticity Index (%)	$\tau_{nat}$ (kPa)	Potential Swell (%)	Potential Swell Classification
> 60	> 35	> 383 (4 tsf)	> 1.5	High
50 - 60	25 - 35	144 - 383 (1.5 - 4 tsf)	0.5 - 1.5	Marginal
< 50	< 25	< 144 (1.5 tsf)	< 0.5	Low

At sites in which the geomaterials near the surface are classified as having a "high" swell potential according to this method, drilled shafts should be designed explicitly considering the forces exerted on the drilled shaft by the expansive geomaterials. At sites in which the geomaterials have a "low" swell potential, explicit consideration of the effects of the expansive soil is not usually necessary because the design requirements for reinforcing and for shaft penetration derived from compression or uplift loading from the structure are usually sufficient to overcome any effects of expansive soils. In "marginal" geomaterials, the designer should rely on local history of the performance of bridges and buildings in order to decide whether to consider effects of expansive geomaterials explicitly.

### Estimating the Depth of the Zone of Seasonal Moisture Change

It is usually assumed that swelling only occurs down to the depth at which seasonal moisture change occurs, although there can be exceptions to that situation. Therefore, a critical step in the analysis of a drilled shaft subjected to uplift from expansive geomaterial is the determination of the thickness of the stratum that will swell or, in other terms, the depth below which there is no change in moisture content with the change of seasons. Stroman (1986) spoke of personal experience in finding the depth of the zone of seasonal moisture change: A useful procedure is to examine the cores from a soil boring and to determine the depth to which the soil is jointed, perhaps slickensided, and blocky in structure. There may also be a change in color that is evident at the bottom of the zone of seasonal moisture change. The soil has probably been dried and subsequently wetted in that zone. Stroman further said that useful information on the penetration of wetting and drying could be obtained by making extremely careful determinations of moisture content and by plotting these values as a function of depth. The water contents will frequently reflect a more erratic nature in the zone of seasonal moisture-content change.

O'Neill and Poormoayed (1980) also describe a method wherein liquidity indexes obtained from samples recovered over two or more seasons are plotted versus depth. The liquidity index will be

rather scattered in the zone of seasonal moisture change but will approach a constant value within the zone of stable moisture.

Normally, a drilled shaft would be designed and constructed so that it penetrates through the zone of seasonal moisture change well into moisture-stable soils, which provide anchorage against uplift movement produced by soils swelling against the sides of the shaft within the zone of seasonal moisture change.

In some locations the surface zone of seasonal moisture change may overlie a stable but moisture-deficient clay or clay-shale. The stable but moisture-deficient zone is simply too deep to be influenced by seasonal rains, high temperatures and similar effects. In such a case the placement of the drilled shaft into the lower moisture-deficient geomaterial may provide a conduit for moisture from the surface directly into the moisture-deficient geomaterial, which may then swell. Drilled shafts that have poor contact between the sides and the surrounding geomaterial (e. g., shafts constructed with temporary casing and low-slump concrete) are especially vulnerable to this process. Johnson and Stroman (1984) describe a case where long-term swelling in a situation such as this apparently severed a reinforced drilled shaft in tension more than 9 m (30 feet) below the ground surface.

According to Lytton (1979), a moisture-deficient soil above a general water table (but hydraulically isolated from any overlying perched water table), will possess a value of  $\tau_{nat}$  greater than about 240 kPa (2.5 tsf) in moist climates and higher values [perhaps as high as 960 kPa (10 tsf)] in moderately arid climates. If it is economically infeasible to carry drilled shafts below such soils, permanent design loads should be as high as possible, consistent with maintenance of an adequate factor of safety in compression, in order to resist upward movement of the shaft and to minimize the tendency for tensile cracking (Stroman, 1986).

## Design Solutions

The design of drilled shafts for a site where the soil is expansive is not a straightforward process. However, there are several definite steps that must be taken in order to achieve an acceptable solution. Because of the present inability to make an accurate prediction of the amount that a given stratum of expansive soil will swell, the use of a conservative approach is strongly advised. This approach is similar to the approach used in designing drilled shafts under downdrag loading except that the shearing loads on the sides of the drilled shaft above the depth of seasonal moisture change (or the depth to which swelling is judged to occur) are directed upward and, if those shearing loads exceed the applied compressive load, the shearing resistances in the stratum below the expansive soil are directed downwards. The neutral point is assumed to be at the bottom of the expansive layer.

The following general steps are necessary in making a design of a drilled shaft in expansive soil:

1. *Identify the expansive geomaterial.* The techniques that were described earlier in this chapter can be used (e. g., Table 12.1). It is possible that a relatively accurate identification

can be made from a field reconnaissance and from the values of the liquid limit and the plasticity index. However, because construction is to be done at the site, a more definitive soil investigation is undoubtedly being done. If there is any doubt about the potential swell of the soils at the site, it will be advisable to perform soil suction tests and swell tests in the odometer. It is important to perform such tests under the driest moisture conditions that are expected during the construction season since  $\tau_{nat}$  can change considerably from season to season, and  $\tau_{nat}$  largely determines how much swell will occur.

2. *Estimate the depth of the expansive stratum.* The thickness of the expansive zone near the surface can be found to an approximation by use of the techniques given earlier. The soil profile may be such that the depth of the expansive zone is evident and that the founding stratum below that zone is non-expansive. Such a case exists, for example, when some limestones have weathered into clay. The clay above the limestone is of limited thickness in many instances and is judged to be expansive. The limestone is not.

However, the profile shown in Figure 12.7 presents a problem. There is a stratum of expansive soil below the zone of seasonal moisture change that is judged to be deficient in moisture. The drilling of the excavation and the placing of concrete can provide moisture to this zone of soil, if the concrete is not highly fluid when it is placed, especially if a temporary casing is used. Stiff concrete with large coarse aggregate tends to leave small "honeycomb" channels in the outer portion of a drilled shaft, against the borehole wall against which the concrete was cast. These small channels provide a direct path for movement of free water from the surface into the moisture-deficient stratum. A prudent design for the profile shown in Figure 12.7 would be based on the assumption that all of the soil above the founding stratum could expand.

3. *Estimate the amount of swell.* A number of procedures have been proposed for estimating the amount of swell for a specific soil profile. Because of the large number of factors that affect the prediction and because of the complex nature of the problem, the opinion of most designers is that the amount of swell can be predicted only within broad limits. Therefore, the prudent course is to assume a significant amount of swell (swell in excess of any upward movement of the drilled shaft) and to design accordingly if the site is classified as having a "high" swell potential. Methods for predicting magnitudes of swell in expansive geomaterials in a rational manner are described by Fredlund and Rahardjo (1993) and elsewhere.

4. *Estimate the uplift loads.* When the expansive soil absorbs moisture, it will swell laterally and vertically. The lateral stress against the sides of a drilled shaft can be large. A reasonable procedure might be to assume that the full undrained shear strength of the expansive soil at equilibrium moisture content will act to lift the drilled shaft. The equilibrium moisture content of the soil is the water content it will have after it imbibes all the water possible under the overburden pressure corresponding to the depth of the soil below finished grade.

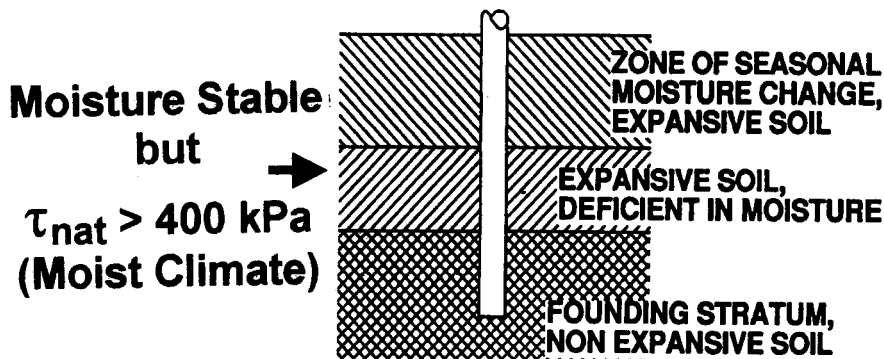

Figure 12.7. Example soil profile with expansive geomaterial

Effective stress methods can be used in problems of this type to good advantage. It can be argued that the maximum lateral effective stress developed against the shaft is approximately equal to the zero swell pressure of horizontally trimmed specimens with initial water content or suction equivalent to that which are expected to exist at the time of drilled shaft construction. It can also be argued that effective cohesion is destroyed and that in very heavily overconsolidated clays a residual shear strength condition is achieved in the soil at the interface with the drilled shaft because of remolding during the drilling process and the large relative movement that develops between the soil and the drilled shaft as the soil swells. This leads to the application of Equation (12.4) to compute the value of  $f_{max}$  in the zone of expansion.

$$f_{max} = \varphi \sigma'_{ho} \tan \delta_r \quad (12.4)$$

where

$\varphi$  = a correlation coefficient,

$\sigma'_{ho}$  = the horizontal zero swell pressure in the soil at the depth at which  $f_{max}$  is computed, relative to the predicted moisture state at the time of drilled shaft construction, which can be measured in an odometer, and

$\delta_r$  = the effective residual angle of interface friction between the soil and the concrete.

Use of Equation (12.4) presumes that the process of expansion occurs slowly enough that excess positive or negative pore water pressures are not developed. O'Neill and Poormoayed

(1980) suggest a value of  $\phi = 1.3$  for the particular site in Texas at which Johnson and Stroman (1984) conducted their study. This factor corresponds to factors being used for design of drilled shafts in expansive soils in Colorado (Chen, 1987); however, its universal application has not been established. Therefore, correlation coefficients for Equation (12.4) should be developed for purposes of design for each particular geologic formation in which drilled shafts are installed if possible. O'Neill and Poormoayed (1980) also determined that  $\delta_r$  was about 9 degrees in the clay-shale formation in which the tests of Johnson and Stroman (1984) were performed. Consolidated-drained direct shear tests on samples of geomaterial from the site, conducted to large displacements, can be used to establish  $\delta_r$  in the laboratory, which can conservatively be taken as the residual drained angle of internal friction of the expansive geomaterial.

5. *Execute the design.* Three possible procedures that can be employed are presented below for the design of a drilled shaft in expansive soil. Regardless of which procedure is selected, any wall beams or caps that are placed above the drilled shafts should be placed well above the ground surface to allow the ground surface to swell without imposing loads on the wall beams or caps. A generous estimate of the amount of swell should be made for determining the necessary size of the gap between the beams or cap and soil.

It is assumed here that drilled shafts that are subjected to uplift loads from expansive soils are individual shafts and are not shafts in closely-spaced groups. Very little is known about the performance of closely-spaced groups of drilled shafts in highly expansive soils, so that if it is necessary to design groups of drilled shafts in expansive geomaterials, they should be designed conservatively. For example, any group action, such as was considered for downdrag loading, could be neglected, and each drilled shaft within the group could be designed for expansive geomaterial loading as if it were an isolated shaft.

- **Procedure A.** A procedure that has been used with success is to isolate the drilled shaft from the expansive geomaterial by the use of a permanent casing. An oversized hole is excavated to the top of the founding stratum (to a point below the expansive soil), a permanent casing is placed, and then the drilled shaft is installed up to the level of the bottom of this casing. A second casing of smaller diameter is then set inside of the outer casing and the remainder of the shaft is concreted inside the inner casing. The inner casing, which serves as a form, can be made of a lightweight material such as a corrugated steel tube. Sometimes it is removed after the concrete has set. Ordinarily, this procedure works best where the outside casing can be placed down into inert soil (such as sand) or rock so that any water that enters the annular space between the inner and outer casings is not exposed to potentially expansive geomaterials (such as clay). Figure 12.8 shows the concept for this method. The permanent casing extends to Point A. No calculations are necessary except to compute the resistance and movement of the drilled shaft below the outside casing in relation to the load applied from the structure and insuring that the penetration and diameter are safe, per the examples in Appendix D.

Kim and O'Neill (1996) describe long-term field experiments in which two concentric lengths of pressed-fiber-tube casing separated by layers of asphalts of varying consistencies were used to isolate surficial expansive soil from drilled shafts. This process can be used where clay exists below the permanent casing because the concentric casing can be placed to a close tolerance against the expansive soil, or backfill can be placed outside of the outside tube if necessary, and its use obviates the need for temporary casing. Although the expansive soil contacts the outside of the casing and the concrete is formed against the inside, the method was found to reduce uplift forces by up to 90 per cent when compared to the forces generated against a shaft that was not protected from the expansive clays in this way. This behavior was a result of the low shear strength of the asphalt inserts when sheared relatively slowly.

- **Procedure B.** Raba (1977) and his associates in San Antonio, Texas, have successfully used the procedure shown in Figure 12.9. The excavation is made to the full depth into rock or into any other stable bearing stratum. The concrete is poured to the top of the bearing stratum, Point A in the figure. A structural shape, such as a steel H-pile, is embedded into the fresh concrete so that the top of the steel section extends above the ground surface. This becomes the point of attachment of the drilled shaft to the superstructure. The space around the steel member within the expansive zone is filled with weak concrete to complete the foundation. The portion of the steel member that traverses the expansive zone can be coated with an asphaltic layer, if desired, to ensure that no uplift forces are transmitted through the weak concrete. The weak concrete cracks when uplift shear forces are applied and does not transfer significant shearing loads to the steel section if asphaltic layers are applied. The process of applying asphaltic layers that are effective can be tricky, especially in hot weather, so the design of the asphalts and handling methods should be done by experts.
- **Procedure C.** The method of design that is most frequently used for drilled shafts in expansive geomaterial that is illustrated in Figure 12.10, which shows the forces that must be dealt with. The excavation is carried out in the usual manner, a properly designed rebar cage is placed, and the concrete is placed in the usual manner. The rebar cage is sized so that it is capable of sustaining a tensile force at Point A (the assumed neutral point, which is located at the base of the zone of swelling geomaterial) that is equal to the factored uplift load  $Q_U$  applied by the expansive soil, less the axial force  $Q_T$  that acts at the top of the drilled shaft. The factored uplift load  $Q_U$  is equal to the nominal load side shear load produced by the swelling geomaterial times the load factor that is ordinarily used in downdrag (Table A-5). The force  $Q_T$  should be taken as the least downward force that can reasonably exist during the period in which it is possible that uplift loading from the surrounding geomaterial can develop. There is no appropriate strength loading state for this condition in the AASHTO design code, so that the applied compressive load for this situation must be assumed by the designer. A decision must be made about the possibility that the expansive soil could swell during the construction operations, perhaps due to the availability of water during that period. In that case  $Q_T$  could be as low as the nominal dead load of the substructure if the construction of the substructure is carried out promptly after the



foundation is constructed. If substructure / superstructure construction is delayed,  $Q_T$  may be as low as zero at the time swelling occurs. Kim and O'Neill (1996) demonstrated that full uplift loading from cracked, swelling clays can be exerted on drilled shafts within a few days of heavy rains following a prolonged period of dry weather.

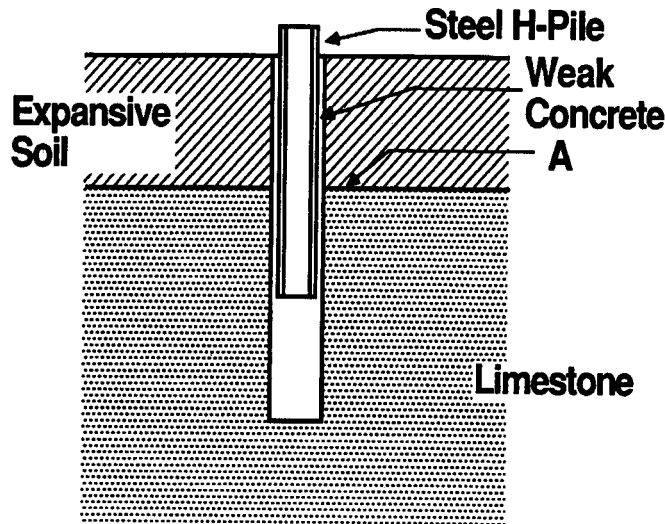

Figure 12.8. Use of a permanent surface casing for design in expansive soil

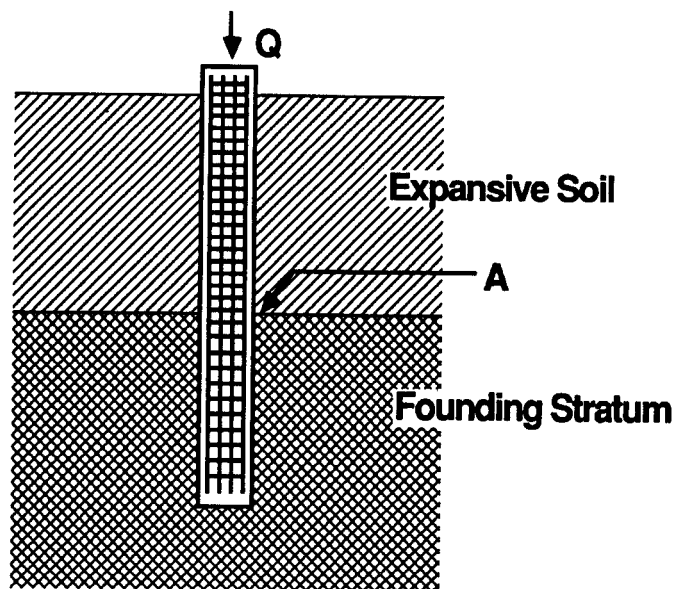

Figure 12.9. Raba method of design in expansive soil

The founding stratum must be able to sustain the tension loads that will exist at Point A. Only side resistance should be used in the analysis for the case shown in Figure 12.10 (cylindrical shaft), as tension resistance at the base will be unreliable. The portion of the drilled shaft that is anchored in the founding stratum can be designed as a shaft loaded in uplift using an appropriate procedure from among those given in Chapter 11 and Appendix B, based on the type of geomaterial in the stable zone. If the shaft has a bell, side resistance can be discounted above the bell, and the bell can be designed as an anchor using Equation (11.29) (Vesic 1971). In that case  $D_b$  is the depth of the bell below Point A or below the ground surface, whichever is less.

If the soil above the base of the bell is heavily jointed,  $N_u$  should be reduced according to the designer's perception of how significantly the joint structure reduces the mass shear strength below that of intact samples.

## RESOURCE

A computer program for performing the downdrag calculations, called PILENEG, is available from the NCHRP and can be downloaded from the internet at <http://civilgrads.tamu.edu/briaud>. This software is coordinated with Briaud and Tucker (1997).

## REFERENCES

- ASTM (1996). "D 5298-94, Standard Test Method for Measurement of Soil Potential (Suction) Using Filter Paper," *Annual Book of Standards*, American Society for Testing and Materials, Vol. 4.09, West Conshohocken, PA, pp. 154 - 159.
- Briaud, J-L, and Tucker, L. M. (1997). "Design and Construction Guidelines for Downdrag on Uncoated and Bitumen-Coated Piles," *NCHRP Report No. 393*, Transportation Research Board, Washington, DC, 198 pp.
- Chen, F. H. (1987). Personal Communication.
- Fredlund, D. G, and Rahardjo, H. (1993). *Soil Mechanics for Unsaturated Soils*, Wiley Interscience, New York, 517 pp.
- Gromko, G. J. (1974). "Review of Expansive Soils," *Journal of the Geotechnical Engineering Division*, ASCE, Vol. 100, No. GT6, June, pp. 667 - 687.
- Johnson, L. D., and Stroman, W. R. (1984). "Vertical Behavior of Two 16-Year-Old Drilled Shafts in Expansive Soil," in *Analysis and Design of Pile Foundations*, Ed. by J. R. Meyer, ASCE, October, 1984, pp. 154 - 173.

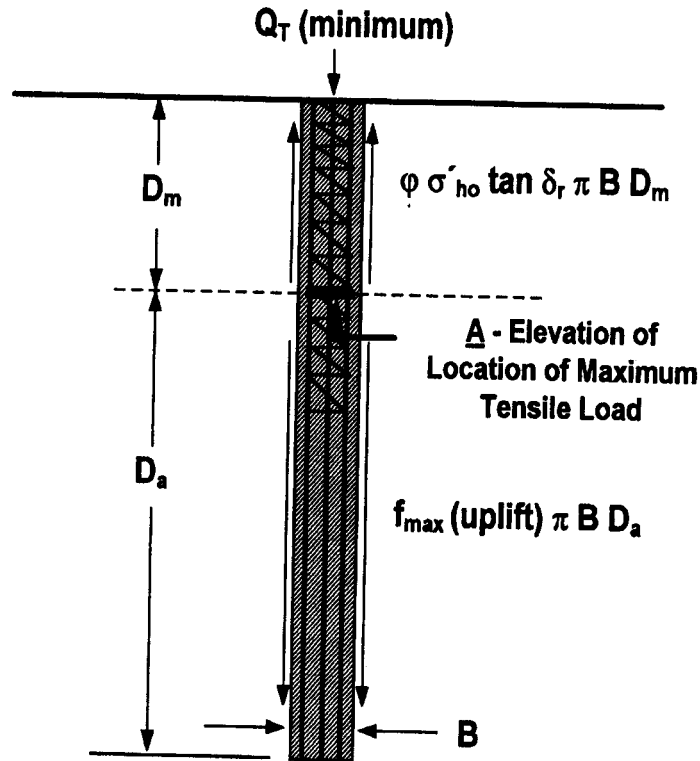

**LRFD inequality for geotechnical stability:**

$$Q_U = \eta \{ \sum \gamma_i Q_i (\text{minimum}) + \gamma_{\text{soil}} [\phi \sigma'_{ho} \tan \delta_r \pi B D_m] \} <$$

$$\phi \{ f_{\text{max}} (\text{uplift}) \pi B D_a + W' \}$$

where  $W'$  is the weight of drilled shaft (buoyant below piezometric surface).

$\gamma_{\text{soil}}$  is the load factor for the soil (drag).

**LRFD inequality for structural stability:**

$$Q_U = \eta \{ \sum \gamma_i Q_i (\text{minimum}) + \gamma_{\text{soil}} [\phi \sigma'_{ho} \tan \delta_r \pi B D_m] \} <$$

$$\phi f_y A_s,$$

where  $f_y$  = nominal yield strength of the longitudinal steel rebar; and

$A_s$  = cross-sectional area of all of the longitudinal rebar.

Figure 12.10. Use of rebar cage for design in expansive geomaterial

Kim, M. H., and O'Neill, M. W. (1996). *Effect of an Expansive Clay on the Behavior of Drilled Shafts*, a report to the National Science Foundation and University of Washington, Department of Civil and Environmental Engineering, University of Houston, December, 1996, 222 pp.

Lytton, R. L. (1979). *Design and Construction of Post-Tensioned Slabs-on-Ground*, Post-Tensioning Institute, Phoenix, Arizona.

O'Neill, M. W., and Poormoayed, N. (1980). "Methodology for Foundations on Expansive Clays," *Journal of the Geotechnical Engineering Division*, ASCE, Vol. 106, No. GT12, December, 1980, pp. 1345-1367.

Peck, R. B., Hanson, W. E., and Thornburn, T. H. (1974). *Foundation Engineering*, Second Edition, John Wiley and Sons, New York.

Raba, C. (1977). Informal lecture on foundations for expansive soils, Texas Section, American Society of Civil Engineers, Austin, Texas, October.

Snethen, D. R., Johnson, L. D., and Patrick, D. M. (1977). "An Evaluation of Expedient Methodology for Identification of Potentially Expansive Soils," *Report No. FHWA-RD-77-94*, Office of Research, Federal Highway Administration, Department of Transportation, Washington, D. C., June.

Stas, C. V., and Kulhawy, F. H. (1984). "Critical Evaluation of Design Methods for Foundations Under Axial and Compressional Loading," *Report No. EL-3771*, Cornell University, Ithaca, New York, November.

Stroman, W. R. (1986). Personal Communication.

Tomlinson, M. J. (1980). *Foundation Design and Construction*, Fourth Edition, Pitman Press, Bath-London, England, United Kingdom, p. 406.

Vesic, A. S. (1971). "Breakout Resistance of Objects Embedded in Ocean Bottom," *Journal of the Soil Mechanics and Foundations Division*, ASCE, Vol. 97, No. SM9, September, pp. 1183 - 1205.

## CHAPTER 13: DESIGN FOR LATERAL LOADING AND STRUCTURAL DESIGN

### INTRODUCTION

The topics of lateral loading and structural design deserve major attention by the engineer; however, the treatment here is merely to give some example of applications in highway structures and to present briefly some significant concepts. A much more comprehensive coverage can be found in the FHWA publication "Handbook on Design of Piles and Drilled Shafts Under Lateral Load," *FHWA-IP-84-11*, July, 1984.

This manual does not explicitly address the design of drilled shaft foundations for seismic loading; however, many of the principles described in this chapter can be used for the determination of linear or nonlinear constraints (spring constants) for the bases of structural columns for the purpose performing dynamic analysis of the structure. The reader who is concerned with the seismic design of drilled shafts is referred to ABAM (1996), Geospectra (1997) and Lam and Chaudhuri (1997) for further information.

### EXAMPLES OF LATERAL LOADING

The principal use of drilled shafts in highway structures is for supporting bridge piers and abutments, but they can also be used in the construction of retaining walls, overhead signs, sound walls and for slope retention.

The lateral loads that are exerted on drilled shafts for highway structures are derived from earth pressures, centrifugal forces from moving vehicles, braking forces, wind loads, current forces from flowing water, wave forces in some unusual instances, ice and vessel impact and earthquakes. The latter sources of loads are often referred to as "extreme events." Even if none of the above sources of lateral loading are present, an analysis of a drilled shaft may be necessary to investigate the deformations and stresses that result within a drilled shaft from the intentional or unintentional eccentric application of axial load and from accidental batter.

Examples of some cases in highway construction where drilled shafts are subjected to lateral loading are given in the following paragraphs. Analytical techniques are then described, along with examples of their use.

#### Single-Column Support for a Bridge

For aesthetic reasons, it is becoming more popular to use single columns instead of rows of columns in bents. In some structures, the use of single columns is dictated by the geometry of the structure or the site access conditions for retrofitting and rehabilitation work. Figure 13.1 is a photograph that illustrates the use of single-column bents. Figure 13.2 is a schematic that shows the loadings on the column and column cap. The foundation in this case is a drilled shaft that is

continuous with the column. The equations of statics can be employed to compute an axial load, a lateral shear load, and a moment at the groundline. Analytical methods can be employed to compute the deflection and rotation of the drilled shaft at the groundline and the bending moment and shearing force within the drilled shaft as a function of depth. Such information is necessary in order to assess deformations in the superstructure and to design the drilled shaft structurally.

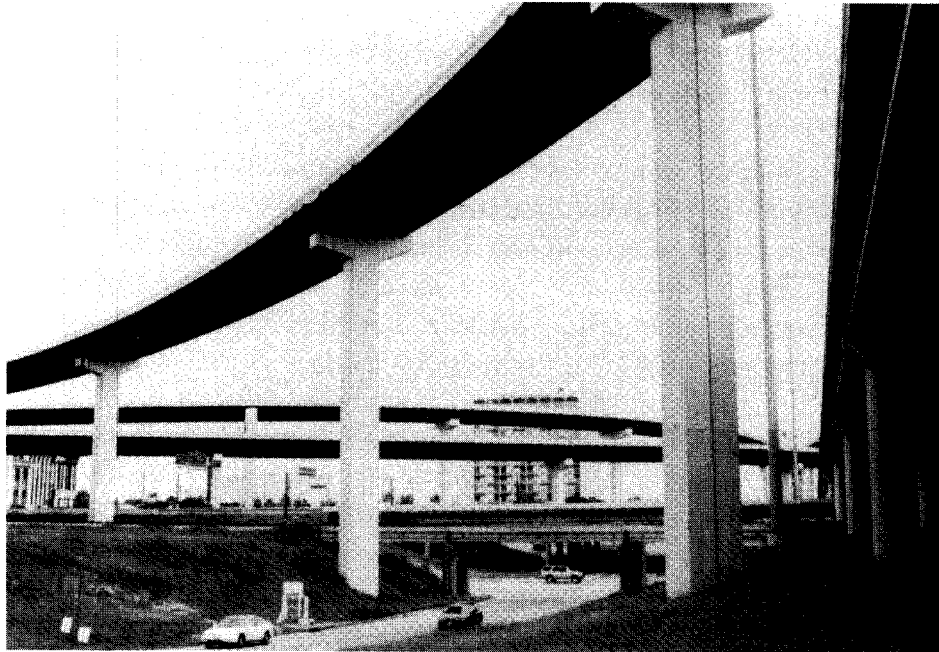

Figure 13.1. Single-column supports

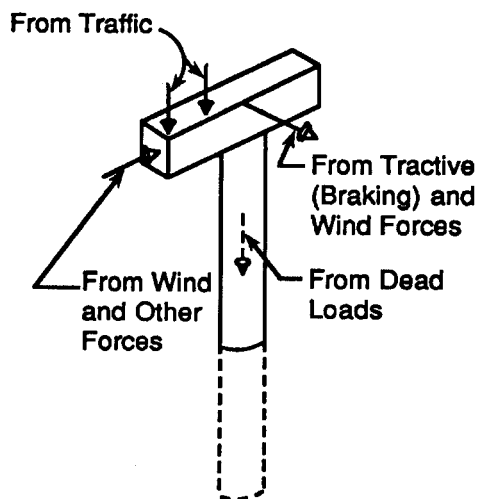

Figure 13.2. Loadings on single-column support for a bridge

## Foundation for an Overhead-Sign Structure

A photograph of an overhead-sign structure is shown in Figure 13.3. The principal loading is from wind that acts against the projected area of the structure. The winds are usually gusty, and a cyclic lateral load is imposed on the foundation. A similar situation exists for sound walls, which in addition to wind loading must be designed for vehicle impact.

Figure 13.4 shows views of two types of foundations used for sign structures. Figure 13.4a shows a two-shaft foundation, and Figure 13.4b shows a single-shaft support. The two-shaft system resists the wind moment largely by added tension and compression (a "push-pull" couple) in the shafts, although some bending is required to resist the wind shear, while the single-shaft foundation resists both the moment and shear produced by the wind load through bending.

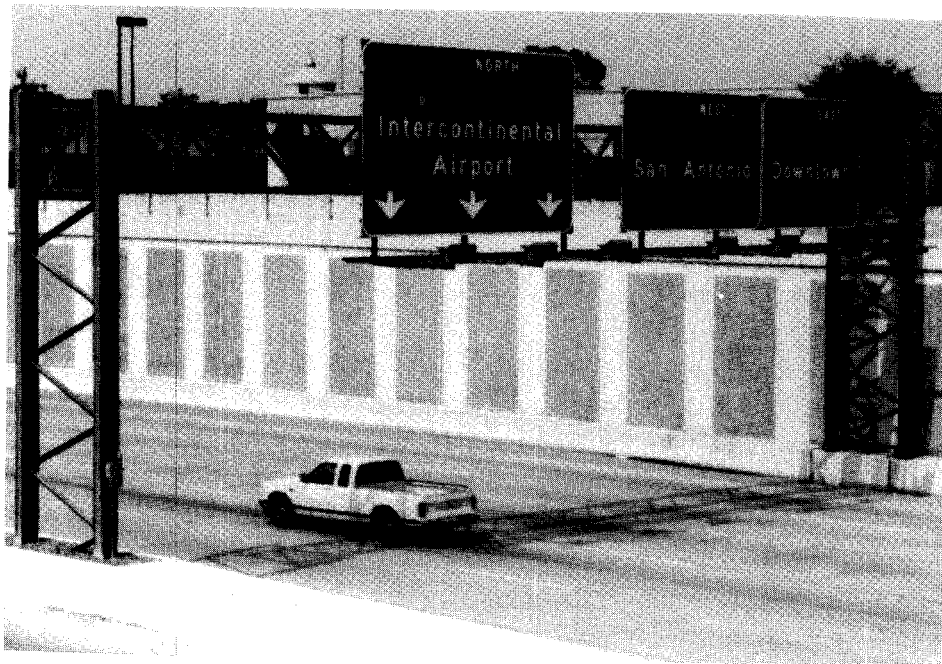

Figure 13.3. Overhead sign

## Drilled-Shaft-Supported Bridge Over Water

A bridge over open water is subjected to lateral forces that include wind loads, current and wave forces, ship or barge impact, possibly seismic loads, and centrifugal forces and braking forces resulting from traffic. Braking forces could be sizeable, especially if heavily-loaded trucks are suddenly brought to a stop on a downward-sloping span. It is also possible that the soil surface around the foundations could be lowered due to scour of soils in floods.

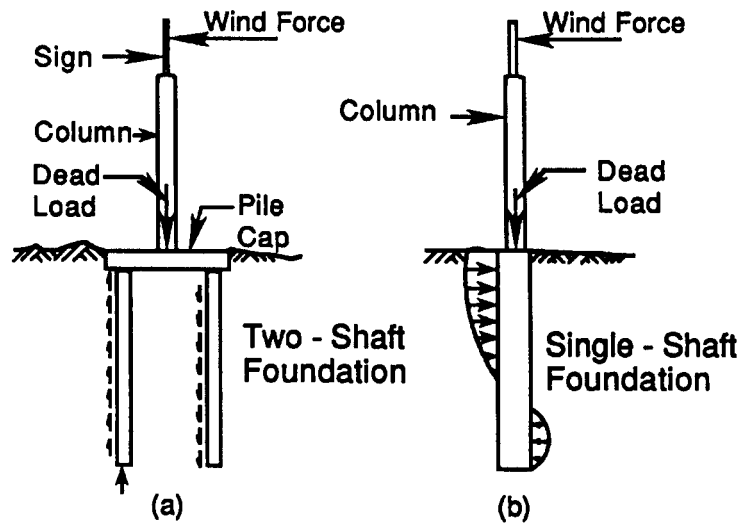

Figure 13.4. Elevation view of an overhead sign structure  
 (a) two-shaft foundation and (b) single-shaft foundation  
 (from *FHWA-IP-84-11*)

### Foundation for a Bridge Abutment

Figure 13.5 is a photograph of a bridge abutment. The slope was graded, and the drilled shafts supporting the abutment were then installed. The abutment was poured and backfilled, and the slope was then covered with concrete facing. The lateral loadings that will be imposed on the drilled shafts will result from settlement and outward creep of the slope, soil pressures from the backfill acting on the abutment, braking forces that are transmitted through the deck system and possibly other sources. Drilled shafts can carry large lateral loads because they can be installed with large diameters, which often allows them to carry the loads from abutments without battering. A sketch of an abutment is shown in Figure 13.6.

### Foundation for an Arch Bridge

A photograph of an arch bridge is shown in Figure 13.7, and a close-up view of one of the foundation reaction blocks is shown in Figure 13.8. The foundation is composed of drilled shafts with large diameters, some installed on a batter to resist the large thrust loads from the arch, as illustrated in Figure 13.9. The problem of the design of the foundation involves the solution of numerous structural details, including estimation of distribution of the thrust, shear and moment loads among the shafts in the foundation. Computer codes such as FLPIER (Florida Department of Transportation, 1997) and GROUP (Ensoft, Inc., 1997) are useful in estimating the distribution of loads to the shafts within a complex arrangement such as this. While these codes are not covered in this manual, the methods of analysis presented in this chapter are essential in making the necessary computations for stresses and deformations within the individual shafts.



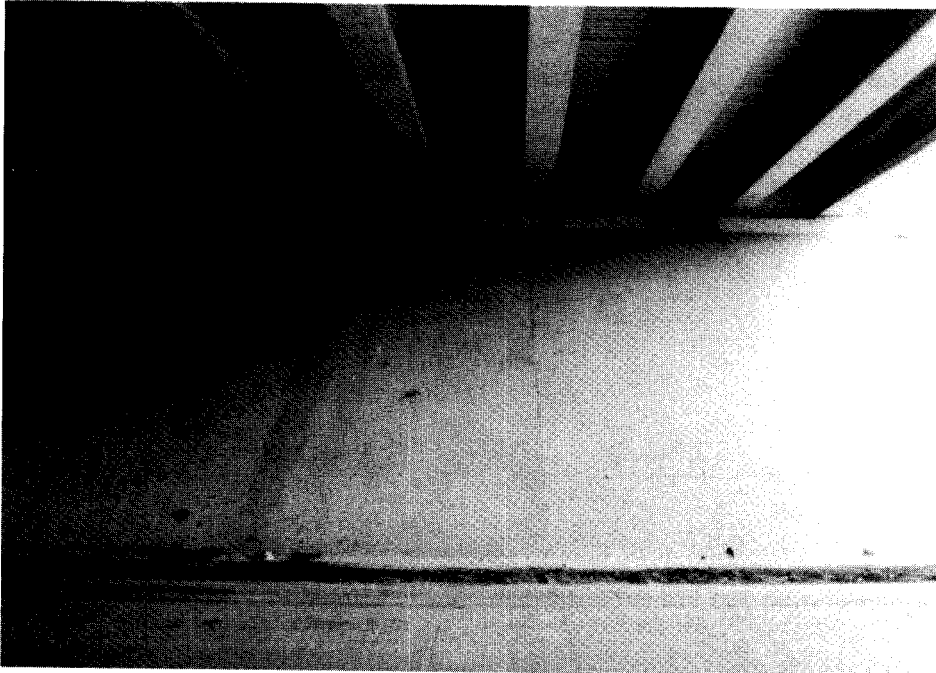

Figure 13.5. Bridge abutment

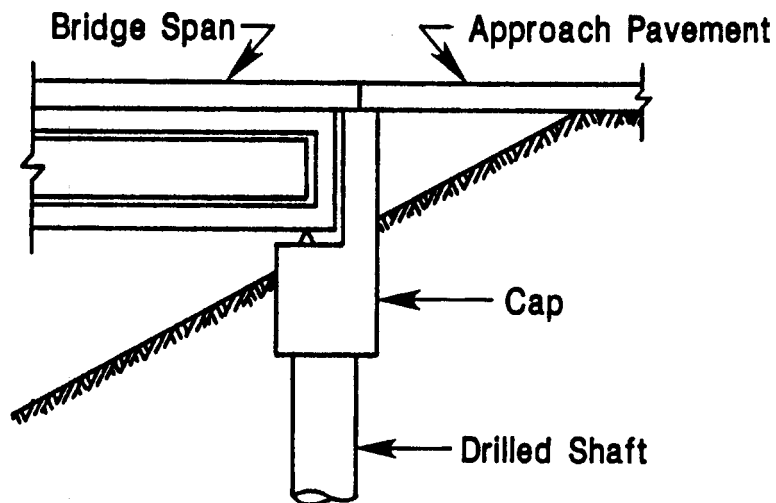

Figure 13.6. Sketch of foundation for a bridge abutment  
(from *FHWA-IP-84-11*)

## Stabilization of a Moving Slope and Earth Retaining Structures

One of the ways an unstable slope can be stabilized is shown in Figure 13.10. Some of the forces from the moving soil mass are transferred to the upper portions of the drilled shafts, which serves to increase the resisting forces in the soil, with a resulting increase in the factor of safety. An excellent theoretical discussion of the analysis of piles and drilled shafts under this condition is provided by Chen and Poulos (1997).

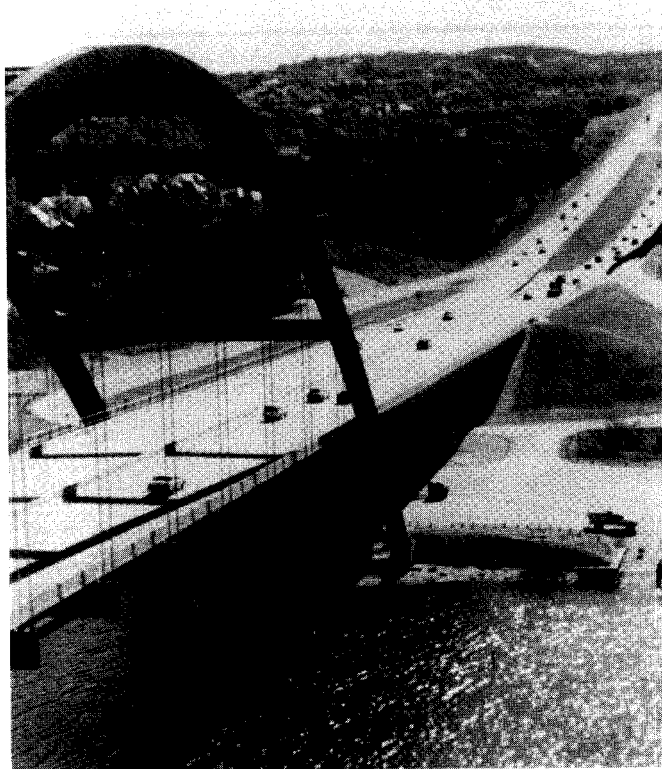

Figure 13.7. Arch bridge (photograph courtesy of Ronald C. O'Neill)

The portion of a drilled shaft below the sliding surface must be designed to resist the applied forces without excessive deflection or bending moment. Technology has been developed to allow a rational solution for the design of the drilled shafts (Reese et al., 1987; Chen and Poulos, 1997).

Drilled shafts have some advantages in stabilizing a slope. The drilling of an excavation and the placing of concrete will cause less soil disturbance than driving a pile. Also, a crane-mounted drilling machine can be rigged so that the machine can sit above the slope, or below it, and reach 25 m (82 feet) or more to make the excavation.

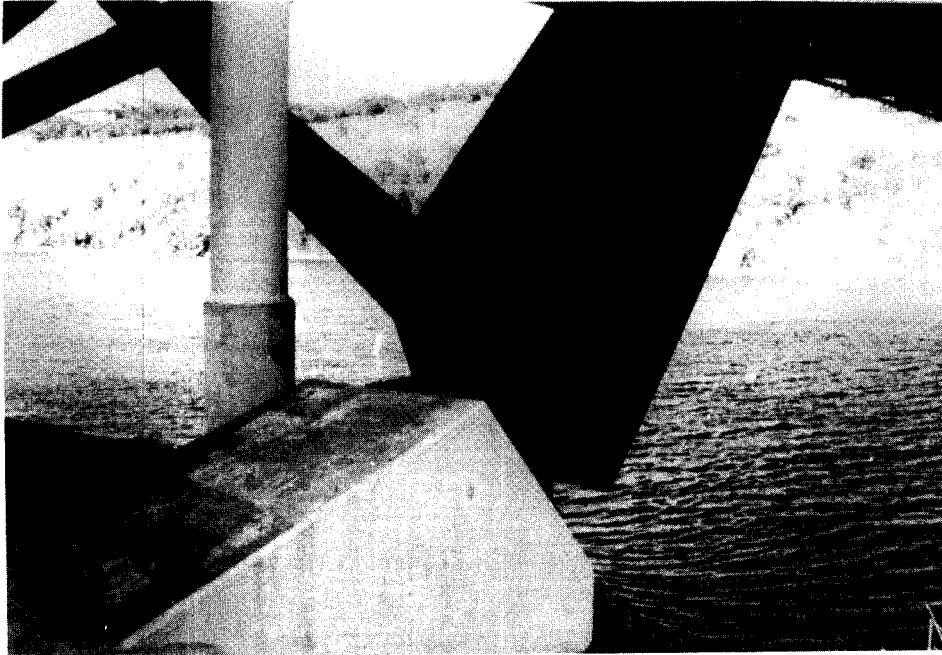

Figure 13.8. Reaction block for arch bridge (photograph courtesy of Ronald C. O'Neill)

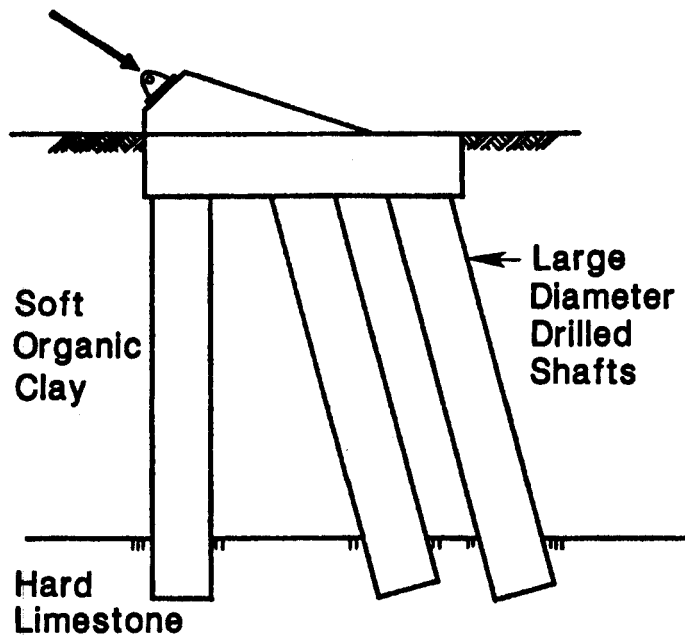

Figure 13.9. Drilled shaft foundation for an arch bridge (from *FHWA-IP-84-11*)

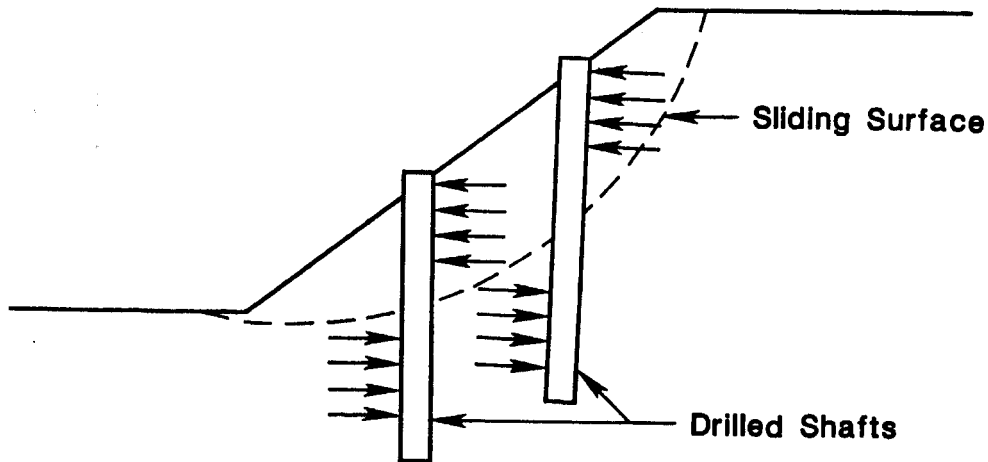

Figure 13.10. Drilled shafts for stabilizing a slide (Reese et al., 1987)

Drilled shafts are also routinely used to construct earth retaining structures for highways. Large-diameter drilled shafts are drilled vertically either tangent to one another or at some finite spacing. If the depth of excavation in front of the wall of drilled shafts is too large for the shafts to carry the lateral loads as cantilevers, they can be tied back with grouted anchors. Figure 13.11 shows a depressed section of highway in which the excavation has been retained by widely-spaced drilled-shaft soldiers with panels between the soldiers and with flat facing on the exterior of the wall.

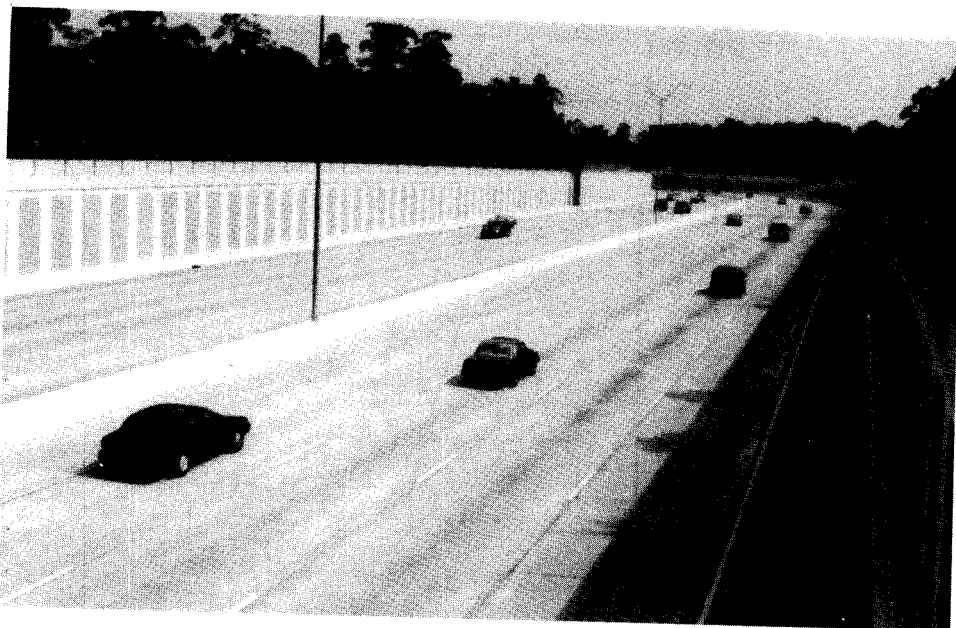

Figure 13.11. Drilled shaft retaining structure for depressed section of highway

## COMPUTING PENETRATION, DEFORMATIONS, MOMENTS AND SHEARS

With regard to lateral loading, the design can be controlled by a maximum deformation (service limit state) criterion, but the more likely limiting condition is the restriction on bending moment, or sometimes on transverse shear (structural strength limit state). In order to design a drilled shaft under lateral loading, the engineer should have the capability to compute the bending moment for a reinforced-concrete section at which a plastic hinge will develop, termed the ultimate bending moment. The ultimate bending moment depends on the magnitude of the axial force acting upon the drilled shaft. Simultaneously, the engineer should also have the capability to compute deflection and rotation at the head of the drilled shaft and the maximum bending moment and shear force in the embedded drilled shaft. All of these factors depend to a large degree on the reaction provided by the soil or rock as the drilled shaft translates laterally beneath the ground and the relationship between bending moment and rotation of the drilled shaft cross section. Both of these effects are inherently nonlinear and are addressed in this section.

The objectives of a design for lateral loading are to:

- a. determine the necessary penetration of the drilled shaft to carry the computed loads at the shaft head without undergoing excessive movement.
- b. determine the necessary diameter, steel schedule and mechanical properties of the concrete to resist the bending moment, shear and axial thrust that will be imposed on the drilled shaft by the lateral loads in combination with axial loads, and
- c. determine the deformations and/or stiffnesses of the drilled shaft in lateral translation and rotation in order to model the effects of foundation deformation on the performance of the structure.

Two relatively simple methods that can be used to analyze laterally loaded drilled shafts approximately are the "Equivalent Cantilever Method" (Davisson, 1970) and "Broms' Method" (Broms, 1964a, 1964b, 1965). The Equivalent Cantilever Method is well-suited for estimating the buckling load for freestanding drilled shaft - column systems. Broms' Method, which can be used to estimate ultimate strength-state resistances, is covered in some detail in *FHWA IP-84-11*. Two other methods, the "Characteristic Load Method," and the "p-y Method," which can deal better with the nonlinear aspects of the problem, are described in the following.

### Characteristic Load Method

An approximate method of laterally loaded drilled shaft analysis, which is based on a parametric analysis of numerous p-y method solutions, is the "characteristic load method" (Duncan et al., 1994). The method has the advantage over the equivalent cantilever method because it includes soil nonlinearity. The method can be used to compute (1) groundline deflections due to groundline shears for fixed-head shaft conditions (i. e., shaft framed solidly into a rigid footing), free-head shaft conditions, or "flagpole" conditions (partial penetration); (2) groundline deflections due to moments applied at the groundline; (3) maximum bending moments within the

shaft for fixed-head, free-head and flagpole head constraint conditions; and (4) the position of the maximum moment.

The characteristic load method is not as general as the p-y method, which will be covered later. For example, the effect of axial load on the moments and shears produced in the drilled shaft (the "p- $\delta$ " effect) is not considered, as in the p-y method, and certain outputs available from the p-y method (such as shear distribution within the drilled shaft) are not directly obtained. Therefore, it is recommended that the p-y method be used for critical foundations.

The characteristic load method proceeds by defining a characteristic, or normalizing, shear load ( $P_c$ ) and a characteristic, or normalizing, bending moment ( $M$ ), according to Equations (13. 1) through (13.4).

For clay:

$$P_c = 7.34 B^2 (E_p R_I) \left( \frac{s_u}{E_p R_I} \right)^{0.68} \quad \text{and} \quad (13.1)$$

$$M_c = 3.86 B^3 (E_p R_I) \left( \frac{s_u}{E_p R_I} \right)^{0.46} \quad (13.2)$$

For sand:

$$P_c = 1.57 B^2 (E_p R_I) \left( \frac{\gamma' B \phi' \text{ and } K_p}{E_p R_I} \right)^{0.57} \quad (13.3)$$

$$M_c = 1.33 B^3 (E_p R_I) \left( \frac{\gamma' B \phi' K_p}{E_p R_I} \right)^{0.40} \quad (13.4)$$

In the preceding equations

$B$  =shaft diameter,

$E_p$  = Young's modulus of the shaft material (modulus of concrete adjusted slightly upward for the presence of steel in the cross section),

$R_I$  =ratio of moment of inertia of drilled shaft to moment of inertia of solid section (= 1 for a normal, uncracked drilled shaft without central voids),

$s_u$  =average value of undrained shear strength of the clay in the top 8 B below the ground surface,

$\gamma'$  =average effective unit weight of the sand (total unit weight above the water table, buoyant unit weight below the water table) in the top 8 B below the ground surface,

$\phi'$  =average effective stress friction angle for the sand in the top 8 B below the ground surface, and

$K_p$  =Rankine's passive earth pressure coefficient =  $\tan^2 (45 + \phi'/2)$ .

In the design method, the moments and shears are resolved into groundline values,  $P_t$  and  $M_t$ , and then divided by the appropriate characteristic load value [Equations (13.1) through (13.4)]. It was found through parametric studies using the more definitive p-y method that essentially unique relations exist between  $P_t / P_c$  and  $y_t$  (due to shear load) / B and between  $M_t / M_c$  and  $y_t$  (due to moment) / B for either piles or drilled shafts with a specified minimum penetration, described later in this section. The lateral deflections at the shaft head,  $y_t$ , are determined from Figures 13.12 and 13.13, considering the condition of pile-head fixity.

If only a groundline shear or only a groundline moment exists, the solution from Figure 13.12 or 13.13 can be used directly. Often, however, both shear and moment are applied, and a superimposed solution, described below, should be used.

1. Use Figures 13.12 and 13.13 to compute the groundline deflections  $y_t$  due to the groundline shear applied alone ( $y_{tp}$ ) and due to the groundline moment applied alone ( $y_{tm}$ ).
2. Determine a value of groundline shear,  $P_m$ , that will produce the same deflection as is produced by the actual groundline moment,  $y_{tm}$ , and a value of groundline moment,  $M_p$ , that will produce the same deflection that is produced by the actual groundline shear,  $y_{tp}$ .
3. Determine the groundline deflection,  $y_{tpm}$ , caused by  $P_t + P_m$ , and determine the groundline deflection,  $y_{tmp}$ , caused by  $M_t + M_p$ .
4. Lastly, compute  $y_{t \text{ combined}} = 0.5 (y_{tpm} + y_{tmp})$ .

The value of the maximum moment in a free- or fixed-headed drilled shaft can be determined through the use of Figure 13.14 if the only load that is applied is a groundline shear. If both a moment and a shear are applied, one must compute  $y_{t \text{ combined}}$ , as described above, and then solve Equation (13.5) for the "characteristic length" T.

$$y_{t \text{ combined}} = \frac{2.43P_t}{E_p I_p} T^3 + \frac{1.62M_t}{E_p I_p} T^2 \quad (13.5)$$

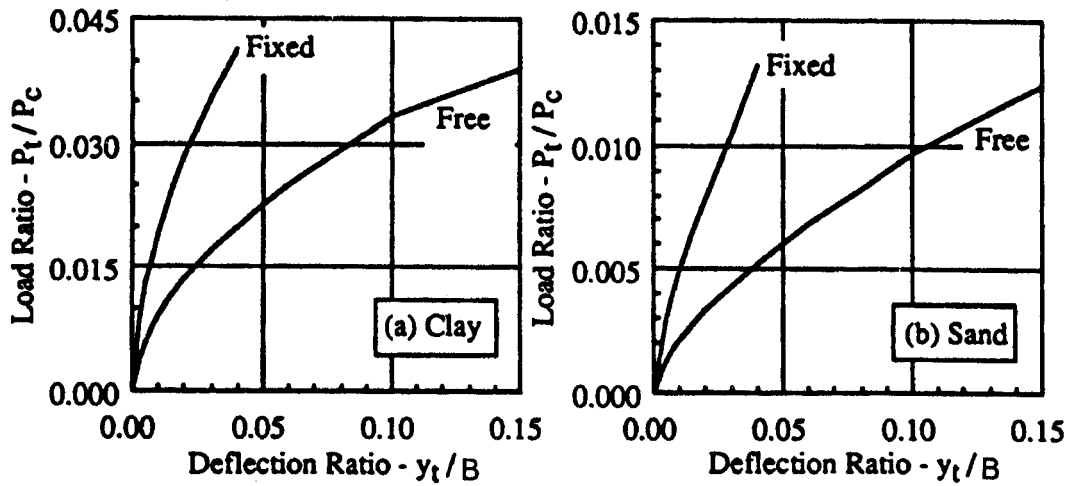

Figure 13.12. Groundline shear - deflection curves for (a) clay and (b) sand (Duncan et al., 1994)

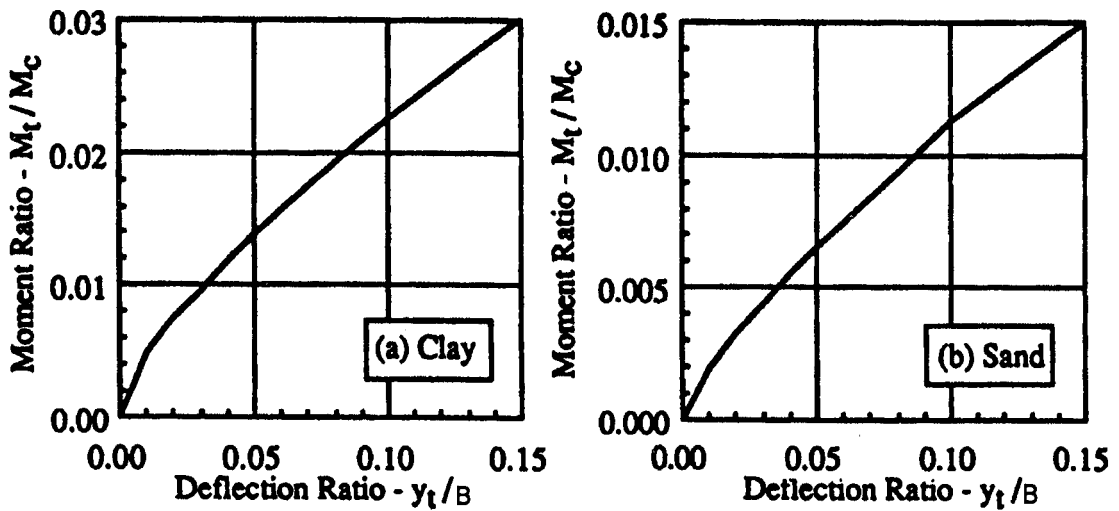

Figure 13.13. Groundline moment - deflection curves for (a) clay and (b) sand (Duncan et al., 1994)



In Equation (13.5) the only undefined term is  $I_p$ , which is the moment of inertia of the cross-section of the drilled shaft (which can be approximated by  $\pi B^4/64$ ). Once  $T$  has been determined, the relation of bending moment to depth  $x$  is given by Equation (13.6), in which the parameters  $A_m$  and  $B_m$  are given in Figure 13.15 in terms of normalized values of depth  $x$ . Thus, the moment diagram can be constructed for the portion of the shaft for which moment is likely to be critical. The maximum moment due to the shear load can be seen to occur at a depth of  $1.3 T$  (maximum value of  $A_m$ ), and the maximum moment due to the moment load occurs where  $B_m$  is maximum, which is at the ground surface ( $T = 0$ ). At what depth the actual maximum moment occurs depends upon the ratio of shear to moment at the shaft head.

$$M_x = P_t T A_m + B_m M_t \quad (13.6)$$

In a drilled shaft it is advisable to check the maximum moment that is computed against the cracking moment for the section that has been designed, which will be discussed in greater detail later. If the maximum moment within the shaft exceeds the cracking moment, it is advisable to repeat the computations for deflection by reducing the moment of inertia to about 50 per cent of that of the uncracked section. This can be done computationally by taking  $R_1 = 0.5$  in Equations (13.1) to (13.4) for an otherwise solid cross section. The presence of a cracked section has relatively little effect on the value of maximum moment.

According to the characteristic load method, the minimum penetrations of drilled shafts shown in Table 13.1 are required. These penetrations are based on the principle that the base of the drilled shaft should not deflect when the head is loaded. This condition should be applied to most drilled shafts supporting bridges, although sign and wall foundations do not always need such stringent requirements. Minimum penetration is affected by cyclic loading and by the presence of free water. When such conditions exist, analysis of the drilled shaft by the  $p$ - $y$  method will allow for more accurate computations.

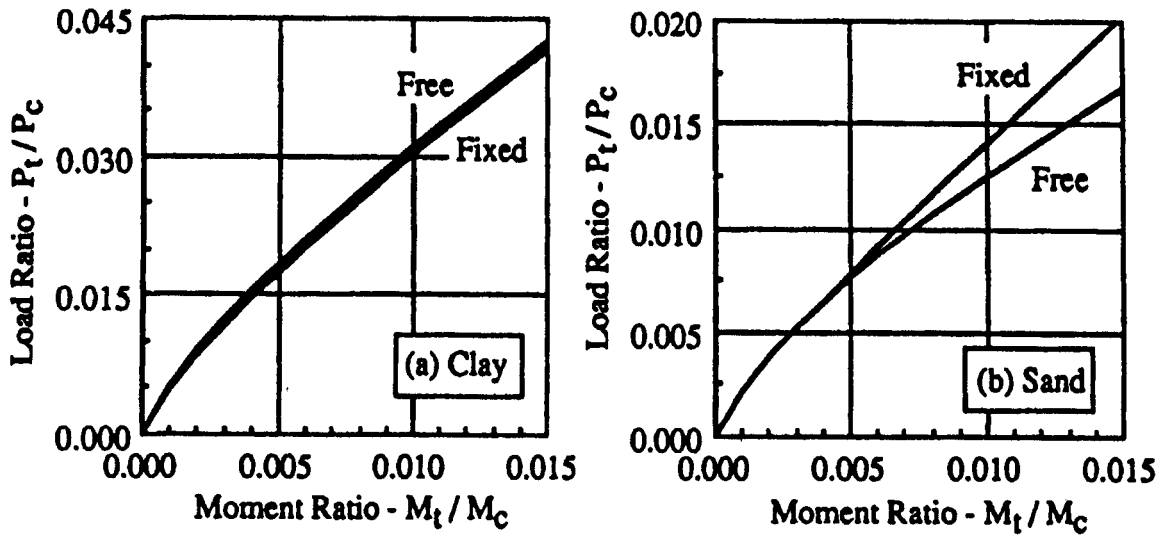

Figure 13.14. Groundline shear - maximum moment curves: (a) clay; (b) sand (Duncan et al., 1994)

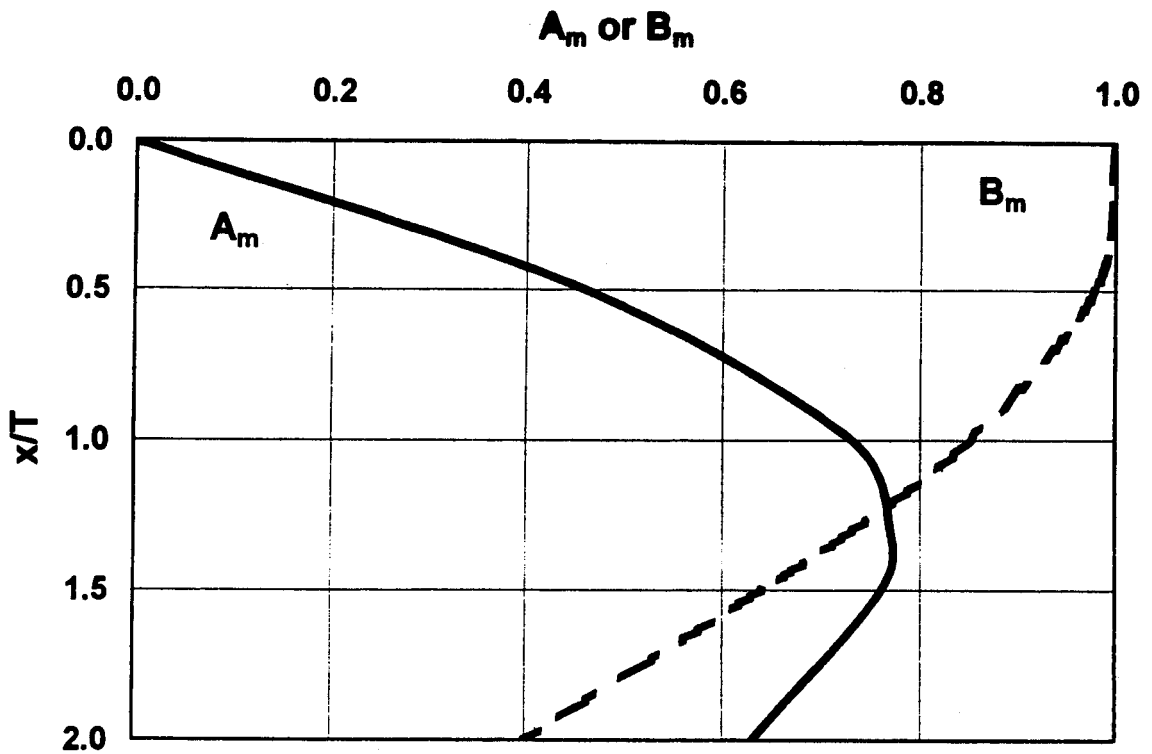

Figure 13.15. Parameters  $A_m$  and  $B_m$  (Matlock and Reese, 1961)

Table 13.1. Minimum Drilled Shaft Penetrations Based on Lateral Loading from the Characteristic Load Method.

Type of soil	$E_p R_l / s_u E_p$	$R_l / g' B \phi' K_p$	Minimum penetration
Clay	$1 \times 10^5$		6 B
Clay	$3 \times 10^5$		10 B
Clay	$1 \times 10^6$		14 B
Clay	$3 \times 10^6$		18 B
Sand		$1 \times 10^4$	8 B
Sand		$4 \times 10^4$	11 B
Sand		$2 \times 10^5$	14 B

If the drilled shaft being analyzed is shorter than indicated in Table 13.1, the groundline deflection will be underestimated and the maximum moment will be overestimated by the characteristic load method.

The characteristic load method has some clear limitations.

- (1) It is based on generally uniform soil conditions in the top 8 B. If strong layering occurs within that depth range, a direct p-y method analysis should be performed.
- (2) The method has not been verified for rock sockets.
- (3) The method does not consider the effect of axial loads on bending moments (the so-called "p- $\delta$ " effect).
- (4) The method does not consider nonlinear bending in the drilled shaft (change in flexural rigidity EI with change in bending moment, as, for example, caused by cracking). This effect results in an underestimation of groundline deflection in the drilled shaft after it develops its first tension cracks at the depth of maximum moment. However, the effect is usually minor with regard to computation of maximum bending moment along the shaft after cracking occurs.
- (5) The method does not permit the direct computation of shears, although they can be deduced from the moment diagrams.
- (6) While the method may be generally satisfactory for cyclic loading, appropriate inputs remain to be determined. The direct p-y method, described later, is readily adaptable to cyclic geomaterial degradation and should be used for cases where the loss of strength of the soil or

rock due to cyclic lateral loading of the drilled shaft is expected.

Because of its limitations the method is most appropriate for preliminary calculations and perhaps for final design for secondary structures. When analyzing for seismic loading, it is often important to know deflections and rotations at the head of the shaft as functions of head shears and moments (foundation stiffnesses) as accurately as possible. For this reason, the p-y method, discussed subsequently, should be used for cases involving seismic loading.

---

**Example 13.1.** *Analysis of a Laterally Loaded Drilled Shaft Using the Characteristic Load Method*

**Given:** Consider the drilled shaft shown in the following sketch. It is a single drilled shaft that is an extension of a column and can therefore be considered to be free-headed. Analysis of the structure indicates that the unfactored groundline shear and moment are as indicated on the figure. The drilled shaft is to be embedded in a uniform clay soil whose mean undrained shear strength is 60 kPa. The cylinder strength of the concrete specified for use in the shaft is 27.6 MPa (4000 psi), and Young's modulus of the concrete is estimated at 25,000 MPa ( $3.6 \times 10^6$  psi). The steel in the section has a Young's modulus of 200,000 MPa ( $29 \times 10^6$  psi). In this illustrative example, the amount of steel in the cross section is only about 0.8 per cent of the area of the cross section, which is relatively small.

- Required:**
- (1) Determine the groundline deflection caused by the indicated loads, which are taken as their unfactored values for purposes of computing deflections for the service limit state in this particular example.
  - (2) Determine the maximum bending moment within the drilled shaft for the same loads.
  - (3) Determine the minimum penetration of the shaft for the same loads.

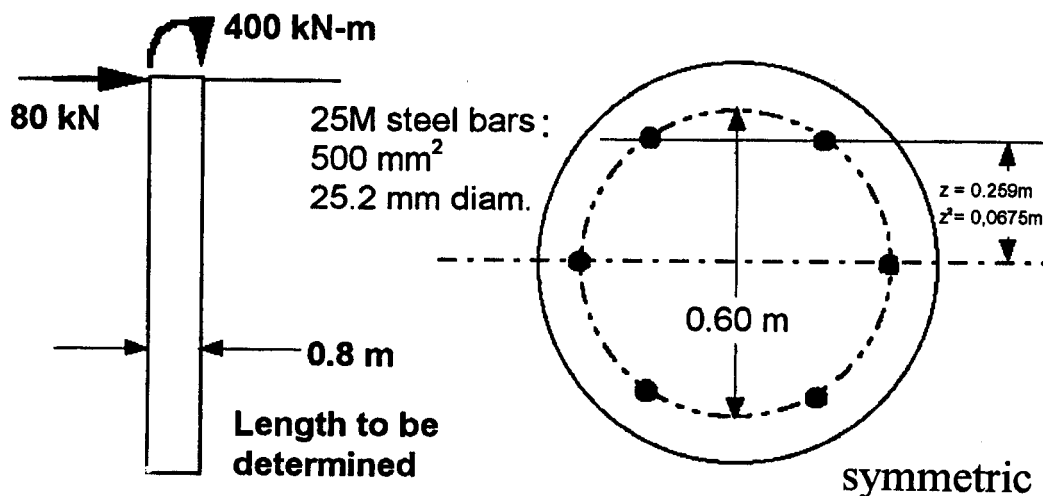

$$B_{\text{shaft}} = 0.80 \text{ m}$$

$$B_{\text{cage}} = 0.60 \text{ m (6, 25M bars equally spaced; ASTM D615M).}$$

$$I_{\text{steel}} \approx 4 [500 \times 10^{-6} \text{ m}^2 \times 0.0675 \text{ m}^2] = 135 \times 10^{-6} \text{ m}^4.$$

$$(EI)_{\text{steel}} = 200 \times 135 \times 10^{-6} = 0.027 \text{ GN-m}^2 = 27 \text{ MN-m}^2.$$

$$I_{\text{concrete}} = [\pi (0.8)^4 / 64] - 135 \times 10^{-6} = 0.01997 \text{ m}^4.$$

$$(EI)_{\text{concrete}} = (25,000) (0.01997) = 499 \text{ MN-m}^2.$$

$$(EI)_{\text{uncracked}} = 27 + 499 = 526 \text{ MN-m}^2.$$

$$R_1 = 1 \text{ (solid section, uncracked).}$$

Note that in this particular example, most of the bending stiffness for the cross section comes from the concrete.

$$s_u = 60 \text{ kPa} = 0.060 \text{ MN/m}^2.$$

$$P_c = 7.34 (0.80)^2 [(25,000)(1)][0.060/25,000]^{0.68} = 17.72 \text{ MN.}$$

$$M_c = 3.86 (0.8)^3 [(25,000) (1)][0.060/25,000]^{0.46} = 128.5 \text{ m-MN.}$$

To determine the head deflection under the unfactored shear load at the shaft head,

$$P_v/P_c = 0.080 / 17.72 = 0.00451.$$

$$M_v/M_c = 0.4 / 128.5 = 0.0031.$$

Following the step-by-step procedure to compute deflection when both shear and moment are applied:

#### Step 1:

$$\text{From Figure 13.12, } y_{tp} \approx 0.003 B = 0.003 (0.80) = 0.0024 \text{ m} = 2.4 \text{ mm.}$$

$$\text{From Figure 13.13, } y_{mp} \approx 0.006 B = 0.006 (0.80) = 4.8 \text{ mm.}$$

#### Step 2:

$$y_{mp}/B = 0.006, \text{ from which } P_m/P_c = 0.0055 \quad (\text{Figure 13.12a}).$$

$$y_{tp}/B = 0.003, \text{ from which } M_t/M_c = 0.0015 \quad (\text{Figure 13.13a}).$$

Step 3:

$$y_{tmp} \text{ is } y_t \text{ due to } P_m/P_c + P_t/P_c = 0.0055 + 0.0045 = 0.01. \text{ From Figure 13.12a, } y_{tmp} \approx 0.013B = 0.013 (0.80) = 0.0104 \text{ m} = 10.4 \text{ mm}.$$

$$y_{tmp} \text{ is } y_t \text{ due to } M_m/M_c + M_t/M_c = 0.0015 + 0.0031 = 0.0046. \text{ From Figure 13.13a, } y_{tmp} \approx 0.011B = 0.11 (0.80) = 0.0088 \text{ m} = 8.8 \text{ mm}.$$

Step 4:

$$y_{t \text{ combined}} = 0.5 [10.4 + 8.8] = 9.6 \text{ mm} (0.38 \text{ in.}).$$

This value would need to be checked against the permissible lateral deflection for the drilled shaft. Before this can be done, however, it is important to check the maximum moment in the drilled shaft to determine whether the shaft will crack under the applied load. If cracking occurs, the computed deflection will be too small.

In order to obtain  $M_{\max}$  for the system of head loads that were given, Equation (13.5) is solved for T.

$$0.0096 \text{ m} = 2.43 [(0.080 \text{ MN}) / 526 \text{ MN-m}^2] T^3 + 1.62 [(0.40 \text{ MN-m}) / 526 \text{ MN-m}^2] T^2,$$

$$\text{from which } T = 2.17 \text{ m}.$$

Next,  $M_{\max}$  is determined by a numerical solution of Equation (13.6).

$$M_x (\text{kN-m}) = 80 \text{ kN} (2.17 \text{ m}) A_m + 400 \text{ kN-m} B_m = 173.6 A_m + 400 B_m.$$

Using Figure 13.15 to determine the values of  $A_m$  and  $B_m$ :

$x/T$	$M_x (\text{m-kN})$
0	$173.6 (0) + 400 (1) = 400$
0.4	$173.6(0.360) + 400(0.980) = 454$
0.5	$173.6(0.460) + 400(0.975) = 469.9$
0.6	$173.6(0.520) + 400(0.950) = 470.5$ ( <b>maximum</b> )
0.7	$173.6(0.590) + 400(0.920) = 470.4$
0.8	$173.6(0.630) + 400(0.900) = 469$

The maximum bending moment occurs at  $x/T = 0.6$ , or  $x = 0.6 (2.17) = 1.3 \text{ m} (4.27 \text{ ft})$ . This value should in no way be generalized to other conditions. It depends significantly on the

diameter of the drilled shaft, the strength and stiffness of the soil, the magnitude of the loads and the distribution of applied load between shear and moment. Note that the effects of any axial load that is present is not considered in computing the maximum moment in this method.

The maximum tensile stress in the concrete created by the bending moment in the section is approximated as

$$[M_{\max} (B/2)] / I = 470.5 (0.40) / [\pi 0.8^4 / 64] = 9360 \text{ kPa (1357 psi)}.$$

For most concrete mixes, this stress will be higher than the tensile strength of the concrete. Unless a compressive axial load is applied that superimposes compressive stress upon the critical section (at a depth of 1.3 m) that brings the net tensile stress to a value less than the tensile strength of the concrete, the problem should be reanalyzed considering a cracked section. That is, the calculations should be repeated with  $R = 0.5$  instead of 1.0. This exercise will result in a larger groundline deflection and is left to the reader as an exercise.

Finally, the minimum penetration of the drilled shaft is obtained from Table 13.1. Since the soil in the upper 8 B is a clay that is loaded undrained, the minimum penetration is computed from the following equation. Note that  $R_f$  is taken as 1 even though the section may crack in order to control the deflections of the shaft at loads smaller than the cracking loads. If a cracked section is assumed,  $R_f$  should be taken as 0.5, and the required penetration will be reduced.

$$E_p R_f / s_u = 25,000 (1) / 0.06 = 417,000,$$

from which by interpolation in Table 13.1, the length of the shaft should be at least  $11 B = 11 (0.80) = 8.8 \text{ m (29 ft)}$ .

Note that this example has only considered the service limit state. Additional analyses are required for the strength limit state, in which the critical loads are factored. This will lead to higher maximum moments than were obtained in this example, which should be compared to the limiting moment capacity of the section factored by an appropriate structural resistance factor. Further commentary on this condition will be given when the p-y method of analysis is summarized in the following section.

---

---

## p-y Method

The p-y method is a general method for analyzing laterally loaded piles and drilled shafts with combined axial and lateral loads, including distributed loads along the pile or shaft caused by flowing water or creeping soil, nonlinear bending characteristics, including cracked sections, layered soils and/or rock and nonlinear soil response. This method is the most general of the two methods covered in this manual and is recommended for use in most critical foundations. It requires the use of a desktop computer, but available software is user-friendly and straightforward to apply. The essence of the method is presented here, and the reader is referred

to two FHWA documents that will give further information for making designs: *FHWA-IP-84-11*, July 1984, and *FHWA/RD-85/106*, March 1986.

The method that is presented in the referenced FHWA documents, and which has been widely accepted by practitioners, is termed the "p-y" method because the soil resistance relations that develop against the side of the pile or drilled shaft are termed p-y relations or simply p-y curves.

The application of a lateral load to a drilled shaft must result in some lateral deflection. The lateral deflection will, in turn, cause a soil reaction that acts in a direction opposite to the deflection. The magnitude of the soil reaction is a nonlinear function of the deflection, and the deflection is dependent on the soil reaction. Thus, determining the behavior of the drilled shaft under lateral loading involves the solution of a soil-structure interaction problem. Two conditions must be satisfied: the equations of equilibrium of the drilled shaft and compatibility between deflection and soil reaction. A solution would have been quite difficult in the past but the desktop computer, user-friendly software and the availability of results of full-scale experiments on which to base p-y criteria now permit answers to be obtained routinely.

A physical model for the laterally-loaded deep foundation is shown in Figure 13.16. A deep foundation, drilled shaft or pile, is shown in the figure with loadings at its head. The soil has been replaced with a series of mechanisms that show the soil response in concept. At each depth  $x$  the soil reaction  $p$  (resisting force per unit length along the drilled shaft) is a nonlinear function of lateral deflection  $y$  and is defined by a curve that reflects the shear strength of the soil, its Young's modulus, the position of the piezometric surface, the drilled shaft diameter, depth and whether the loading is static (monotonic) or cyclic. Bilinear curves are shown in this figure, but actual p-y curves are usually more complex.

The methods of representing the p-y curves for a variety of soils are cited after presenting the governing equations.

The drilled shaft itself is treated as a beam-column with lateral soil support. The general behavior of the drilled shaft under a combination of lateral and axial loading can be obtained by solving the following differential equation (Hetenyi, 1946),

$$EI \frac{d^4 y}{dx^4} + P_x \frac{d^2 y}{dx^2} - p - w = 0 \quad (13.7)$$

where

$P_x$  =axial load on the shaft,

$y$  =lateral deflection of the shaft at a point  $x$  along the length of the shaft,



- $p$  =lateral soil reaction per unit length,
- $EI$  =flexural rigidity of the drilled shaft, and
- $w$  =distributed load along the length of the shaft (soil or water), if any.

The software that is used to solve Equation (13.7) also includes the various boundary conditions that occur at the top and bottom of the shaft. For example, the applied moment and shear at the shaft head can be specified, and the moment and shear at the base of the drilled shaft can be taken to be zero if the shaft is long. For shorter shafts, a base boundary condition can be specified that allows for the imposition of a shear reaction on the base as a function of lateral base deflection. Full or partial head restraint can also be specified. If an objective of the analysis is the computation of deflection,  $EI$  can be assumed to be the value for the uncracked section only as long as the drilled shaft section has not cracked. If deflections are of no particular concern, the value of  $EI$  for the uncracked section can be used even if the section cracks, because  $EI$  has relatively little effect on the computed bending moment diagram. Procedures are available in current software (e.g., use "Resources" sections at the end of the chapter) that allow for the computation of reduced  $EI$  along those portions of the drilled shaft in which cracking occurs. These reduced values of  $EI$  are then used at appropriate locations along the shaft in the numerical solution of Equation (13.7).

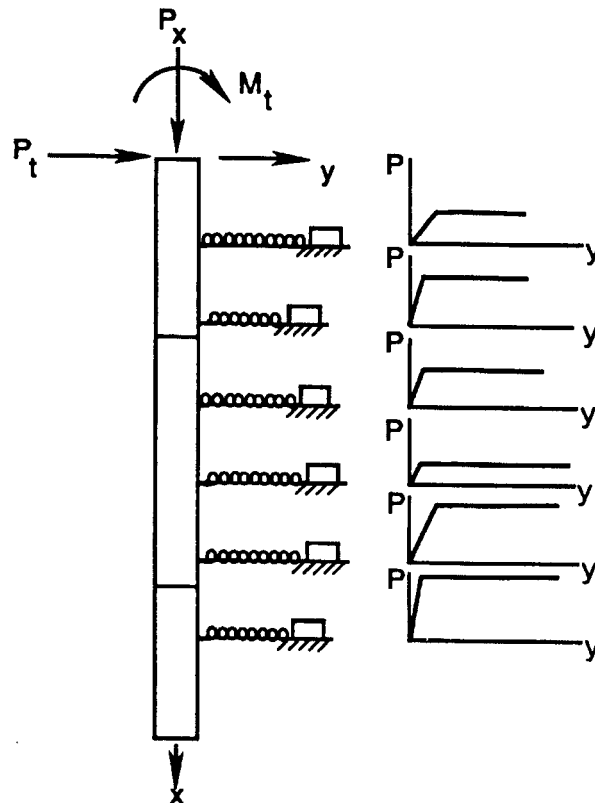

Figure 13.16. Model of a deep foundation under lateral loading showing concept of soil response curves

Other beam formulae necessary in the analysis are:

$$EI \frac{d^3 y}{dx^3} = V \quad (13.8)$$

$$EI \frac{d^2 y}{dx^2} = M \quad \text{and} \quad (13.9)$$

$$\frac{dy}{dx} = S \quad (13.10)$$

In the preceding equations

- $V$  =transverse shear in the drilled shaft,
- $M$  =bending moment in the drilled shaft, and
- $S$  =slope of the deflection diagram,

The derivation of these equations is discussed in Chapter 2 of *FHWA-RD-85-106*.

The axial load,  $P_x$ , is included in the differential equation because of its influence on bending moments and lateral deflections, so Equation (13.7) is a beam-column equation that can be used to investigate buckling as well as bending.

The analysis is described in general terms below.

The slope of a secant to any p-y curve is defined as follows:

$$E_s = p/y \quad (13.11)$$

where

$E_s$  = soil modulus (a function of y and x with units of F/L).

Equation (13.11) is substituted into Equation (13.7), and the resulting equation is formulated in finite difference terms, at each of a number of points, or nodes, along the drilled shaft. The value of p at each node i is expressed as  $E_{si} y_i$ , so that the unknowns in the problem become the y values at all of the nodes. A computer solution, which involves the simultaneous solution of the difference equations numerous times, proceeds as follows:

1. A deflected shape of the drilled shaft is assumed by the computer.
2. The p-y curves are entered with the deflections, and a set of  $E_s$  values is obtained.
3. With the  $E_{si}$  and  $Y_{si}$  values the difference equations are solved for a new set of deflections.
4. Steps 2 and 3 are repeated until the deflections computed at all nodes are within a specified tolerance of the values from the previous set of computations (iteration).
5. Bending moment, shear, and other aspects of the behavior of the drilled shaft are then computed from finite difference forms of Equations (13.8) through (13.10), and both tabular and graphical outputs of the shear, moment, slope and soil resistance diagrams can be displayed. The soil reaction along the shaft can also be obtained and output if the user desires such information.

The computer solution is efficient and computer time is minimal. A Windows-based program, COM624P Version 2.0, is available through the FHWA to perform the calculations. A similar program, LPILE<sup>PLUS</sup>, can be purchased privately as indicated in the "Resources" section at the end of this chapter. A separate computer program using this method, LTBASE, has been developed for short shafts with both shear and moment resistance at their bases (Borden and Gabr, 1987).

The procedure described above is dependent on being able to represent the response of the soil by an appropriate family of p-y curves. Full-scale experiments and theory have been used and recommendations have been presented for obtaining p-y curves, both for static and for cyclic loading, for the following situations, among others:

- Soft clay below the water table (Matlock, 1970).
- Stiff clay below the water table (Reese et al., 1975).
- Stiff clay above the water table (Welch and Reese, 1972).
- Sand (Cox et al., 1974).

Detailed descriptions of these p-y models are provided in *FHWA-RD-85-106*. These models have been programmed as subroutines to the computer programs (COM624P and LPILE<sup>PLUS</sup>), and the user merely needs to input the loadings, the section geometry of the drilled shaft and its stiffness, and the soil, steel and concrete properties. Other p-y methods can also be specified (e.g., Murchison and O'Neill, 1984, the API method for sands; Reese, 1997, an updated method for rock based on analysis of loading tests), and site-specific p-y relations measured from loading tests by the user can also be input. Highly layered soil profiles can be accommodated, as well. Application of the cyclic p-y criteria are important for situations in which the loading is cyclic, such as wave loading, wind loading and loading from seismic events, since the geomaterial will weaken compared to cases in which the loading is constant.

The computer programs provide an opportunity for investigating the influence of a large number of parameters with a minimum of difficulty. Some of these factors are the loading; the geometry, stiffness, and penetration of the drilled shaft; soil properties; and the interaction between the drilled shaft and the superstructure. In addition, if an unsupported portion of the drilled shaft extends above the groundline, buckling can be easily studied.

One of the most appropriate uses of the programs is to investigate the effects of drilled shaft penetration on performance. For a given system of loads the penetration of the shaft can be varied and the lateral deflection of the head can be determined as a function of penetration. For "short" and "intermediate" length shafts, the lateral deflection will vary considerably with small changes in penetration, but as the shaft becomes "long," penetration will have essentially no effect on lateral displacement. For major structures, this is a reasonable criterion for determining the minimum penetration of a drilled shaft to resist lateral load. It must also be recalled that the penetration necessary to resist axial load must be satisfied simultaneously.

While most p-y method programs do not explicitly allow for the input of resistance to lateral loads through tiebacks or struts attached to the drilled shaft, the presence of a tieback or strut can easily be simulated by means of a very stiff p-y curve, representing the axial stiffness of the support, at the location of the support. That curve is merely input along with the p-y curves for the soil.

### **Simulation of Nonlinear Bending in Drilled Shafts Using the p-y Method**

**General.** For design of drilled shafts under lateral loading the engineer must recognize that the shaft is essentially a reinforced concrete beam-column and that its bending behavior cannot always be appropriately represented by linear conditions, that is, by a single EI value. If the purpose of the analysis is to determine moments and shears within the shaft in order to design the steel schedule and to obtain the appropriate diameter, a linear analysis will almost always be sufficient. But, if the purpose of the analysis is to estimate deflections and rotations of the head of the shaft, nonlinear bending should be considered. The procedures for accomplishing a nonlinear bending analysis are included in COM624P (Version 2.0 and higher) and LPILE<sup>PLUS</sup>

With regard to structural design of the shaft, the amount and placement of the reinforcing steel is critical to a successful foundation. Errors in detail cannot be tolerated. However, in the experience of the authors, the most frequent error made by designers is the use of an excessive amount of reinforcing steel. For example, heavy steel cages are sometimes designed to extend to the full length of the drilled shaft well beyond the depth at which bending moment becomes insignificant. Some bending moments are caused by the unavoidable eccentricity of axial loads; however, such moments are dissipated within the top few diameters of the drilled shaft, even when the surface soils are relatively weak. When designing reinforcing cages, therefore, it is recommended that a method be used that will produce the moment and shear diagrams under the critical combination of factored loads, including axial loads applied at the bounds of the eccentricity permitted by the construction specifications. The reinforcing steel cage can then be

designed rationally. The p-y method is well-suited for this type of analysis.

**Ultimate Bending Moment and Bending Stiffness.** Equations for the behavior of a slice from a beam-column under a combination of bending and axial loading are formulated. As the bending moment on any reinforced concrete section increases to the point at which it produces tensile stresses on one side of the shaft that exceed the tensile strength of the concrete, the section will crack, and a dramatic reduction in the EI of the section at that point will occur. Since the concentric axial component of load (if compressive) produces uniform compressive stresses across the section that superimpose upon the bending stresses, the moment at which cracking occurs is a function of the magnitude of axial load on the drilled shaft. The assumption normally made is that cracks will be closely spaced along segments of the shaft in which the net tensile stress exceeds the tensile strength of the concrete. Nonlinear stress-strain curves are used for both steel and concrete. It is assumed that compressive collapse occurs in the concrete when the ultimate value of normal strain  $\epsilon_c$  of approximately 0.003; for steel, the ultimate value of strain in both tension and compression is taken as 0.0020. The tensile strength of the concrete  $f_r$  is taken as  $19.7 (f'_c)^{0.5}$ , where  $f'_c$  and  $f_r$  are both in units of kPa, and the stress-strain behavior of the concrete in tension is assumed to be linear up to that stress.

The derivation of the relation between bending moment, axial load and EI proceeds by assuming that plane sections in a beam-column remain plane after loading (Reese et al., 1998). Thus, when an axial load and a bending moment are applied, the neutral axis will be displaced from the center of gravity of a symmetrical section. The equilibrium equations for such a condition can be expressed as follows, where  $\sigma$  is a stress normal to the section..

$$b \int_{-h_2}^{h_1} \sigma dy = P_x \quad \text{and} \quad (13.12)$$

$$b \int_{-h_2}^{h_1} \sigma y dy = M \quad (13.13)$$

The terms used in the above equations are defined in Figure 13.17.

The numerical procedure for determining the relation between axial load, bending moment and EI of the section, considering the nonlinear stress-strain properties of the concrete and steel, is as follows for compressive axial loading and applied bending moment.

- A position of the neutral axis is estimated and a strain gradient  $\phi_e$  across the section about the neutral axis is selected.  $\phi_e$  is defined such that the product of  $\phi_e$  and distance from the neutral axis gives the strain at a specific distance from the neutral axis.  $\phi_e$ , which has units of strain / length, is assumed to be constant, whether the section is in an elastic or an inelastic state.

This defines the strain at every point in the section.

- Knowing the strain distribution across the section and the stress-strain relations for the steel and concrete, the distribution of stresses ( $\sigma$ ) across the cross-section are computed numerically.

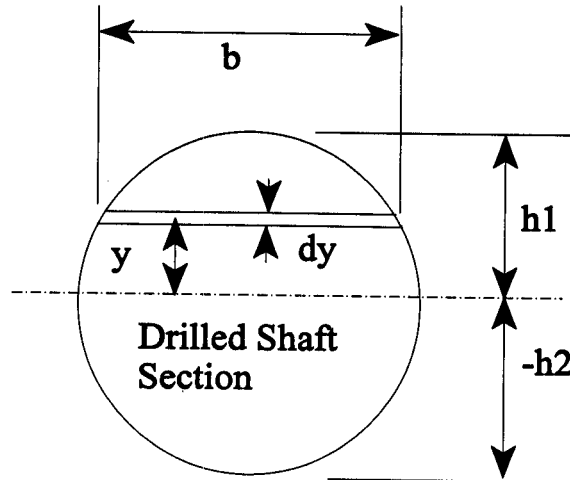

Figure 13.17. Definition of terms in Equations (13.12) and (13.13)

- The axial load acting upon the section is the integral of all of the compressive and tensile normal stresses acting on the section over the area of the section, Equation (13.12). If the value of computed axial load does not equal the applied axial load ( $P_x$ ), the position of the neutral axis is moved and the computations are repeated. This process is continued until the computed value of  $P_x$  is equal to the applied value of  $P_x$ .
- The bending moment associated with this condition is then computed by summing moments from the normal stresses in the cross-section about a convenient point in the section [(e.g., the centroidal axis) or the neutral axis, Equation (13.13)].
- The EI value for this particular stress state in the cross section, which is associated with particular values of axial load  $P_x$  and bending moment  $M$  then remains to be determined.
- It can be shown from beam mechanics theory that  $EI = M / \phi_e$ . Therefore, a unique relationship between  $P_x$ ,  $M$  and  $EI$  is found for any particular section considering the number and placement of steel bars, the compressive strength of the concrete (and therefore its tensile strength) and the yield strength of the steel. The process is repeated for different values of  $\phi_e$ , so that a complete relationship between  $M$  and  $EI$  can be obtained for a given value of  $P_x$ . An example of such a relationship for two different values of  $P_x$  is given in Figure 13.18.

Note, in Figure 13.18, the effect of the axial load  $P_x$  on the bending moment - EI relationship. The presence of a compressive axial load stiffens the section by retarding the onset of cracking. In this particular example the EI at the plastic-hinge (ultimate) moment is also higher when the compressive axial load is applied.

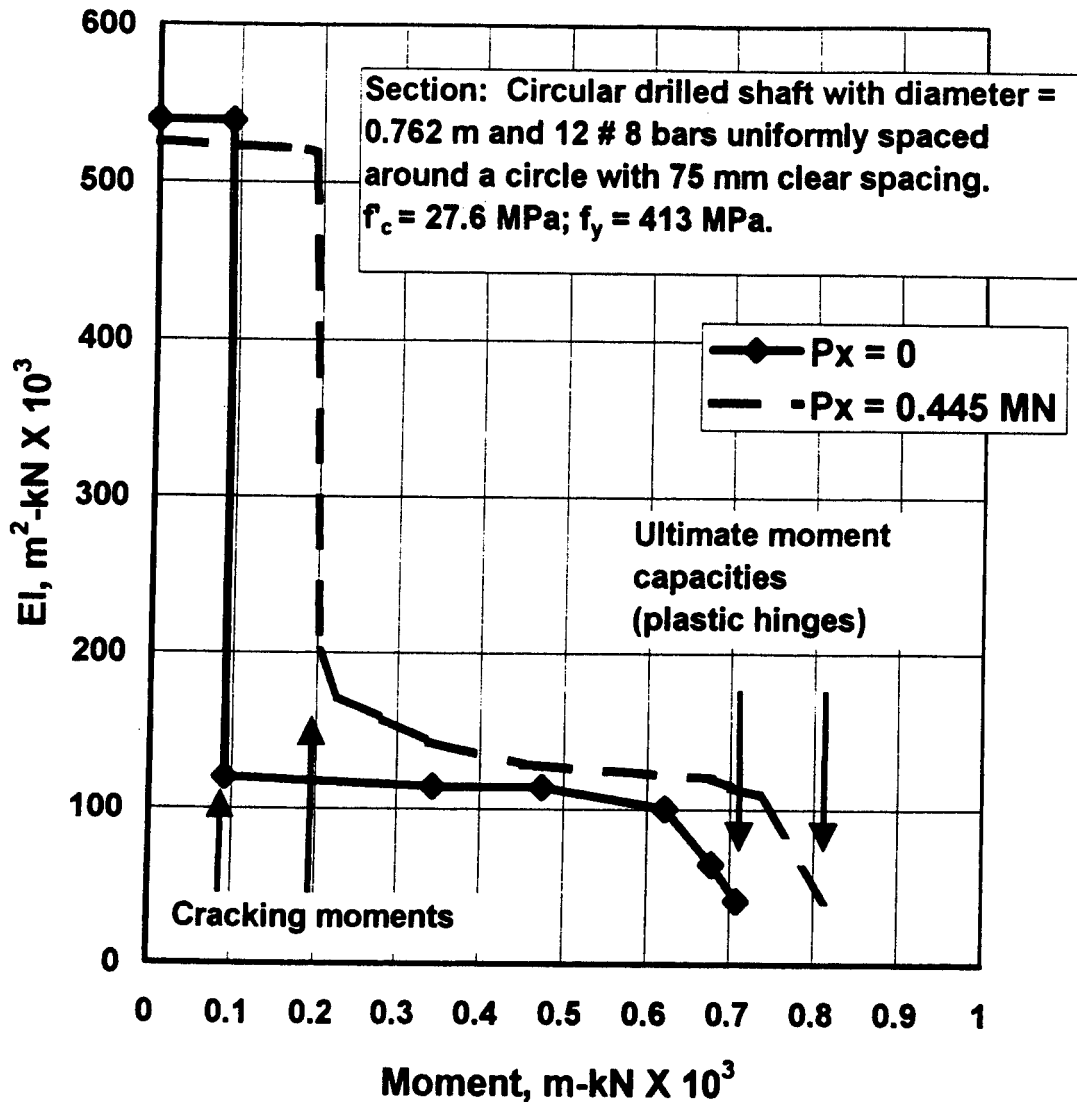

Figure 13.18. Variation of EI of a drilled shaft cross section with bending moment and axial load

The stress-strain curves that are used by COM624P (Version 2.0) and LPILE<sup>PLUS</sup> are shown in Figures 13.19 and 13.20 for concrete and steel, respectively.

Referring to Figure 13.19,

$$f'_c = 0.85 f'_c \quad (13.14)$$

$$E_c \text{ (initial slope of the stress-strain curve)} = 151,000 (f'_c)^{0.5} \quad (13.15)$$

$$f_c = f'_c [ 2(\epsilon/\epsilon_o) - (\epsilon/\epsilon_o)^2 ] \quad (\epsilon < \epsilon_o) , \quad (13.16)$$

$$\epsilon_o = 1.7 f'_c / E_c \quad (13.17)$$

$$f_r = 19.7 (f_c')^{0.5} \quad (13.18)$$

In these equations, the units of  $E_c$ ,  $f_c$  (28-day cylinder strength),  $f_c'$  and  $f_r$  are in kPa.

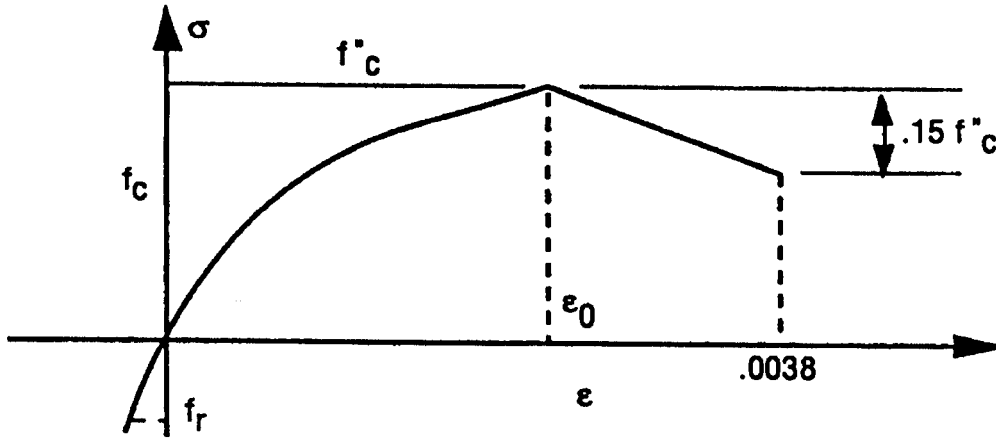

Figure 13.19. Assumed stress-strain relation for concrete

In Figure 13.20,

$$\varepsilon_y = f_y/E \quad \text{and} \quad (13.19)$$

$$E = 200,000 \text{ MPa} \quad (13.20)$$

Most reinforcing steel used in drilled shafts currently is Grade 60, which has a nominal value of  $f_y$ , the yield stress, = 413 MPa.

Software used to compute moments, shears and deformations in the drilled shaft using the p-y method contain subroutines that automatically perform these computations and adjust the EI value along the drilled shaft during the computation of results according to a relationship similar to the ones shown in Figure 13.18. The user need only input the strength properties of the concrete and steel and the geometric properties of the cross section and longitudinal rebar. The deflected shape, shears and moments that are computed for the drilled shaft with a prescribed system of loads then reflect the effects of nonlinear bending, including cracking.

When laterally loaded drilled shafts are used in closely-spaced groups, a given shaft will deflect further under a given system of loads than if loaded when the neighboring shafts are not present, and bending stresses will increase beyond those that occur when neighboring shafts are not present. It is therefore important to consider group effects due to loading when shaft spacing is less than about six diameters in any direction.



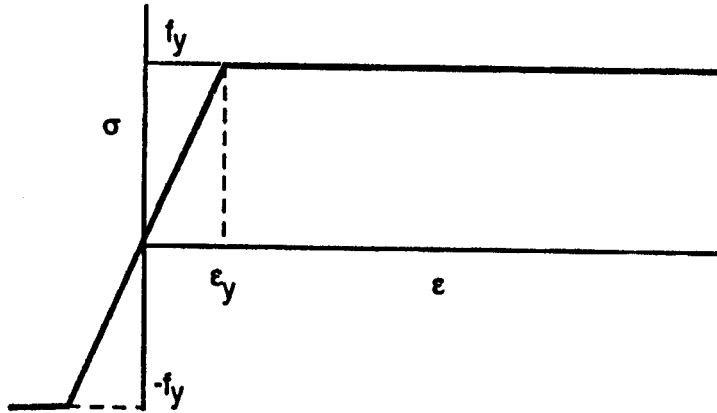

Figure 13.20. Assumed stress-strain curve for steel reinforcement

### Simulation of Group Action Using the p-y Method

Both the equivalent cantilever method and the characteristic load method can be used to investigate the effects of group action on the behavior of laterally loaded drilled shafts (Davisson, 1970; Ooi and Duncan, 1994). In the interest of brevity, these methods will not be described here. However, a brief description will be given of a straightforward method for estimating group action using the p-y method. Brown et al. (1987) showed that the behavior of a pile within a 3 X 3 group of free-headed laterally loaded piles with a 3-diameter spacing could be modelled with the same software that is used to analyze a single laterally loaded pile or drilled shaft, provided the p-y curves were scaled with a "p- multiplier," which will be given the symbol  $\rho$ . That is, all of the values of soil resistance p are multiplied by a factor that is less than 1, the p-multiplier, depending upon the location of the shaft within the group and the spacing of the shafts within the group. That is, all along the p-y curve.

$$P_{group\ shaft} = \rho P_{single\ shaft} \quad (13.21)$$

This factor reflects a dominant physical situation that develops within a laterally loaded group of drilled shafts or piles: The piles in the leading row push into the soil in front of the group. The soil reacting against any drilled shaft in this "front row" is relatively unaffected by the presence of the other drilled shafts in the group and only a minor adjustment needs to be made to the p-y curves. However, the shafts in the rows that "trail" the front row are obtaining resistance from soil that is being pushed by the shafts into the voids left by the forward movement of the piles in front of them. This phenomenon causes the value of soil resistance p on a p-y curve to be reduced at any given value of lateral deflection y relative to the value that would exist if the drilled shafts in the forward row were not there. In addition, the presence of all of the shafts in

the group produces a mass movement of the soil surrounding the shafts in the group, which reduces the  $p$ -value for a given displacement  $y$  to varying degrees for all drilled shafts in the group.

Brown and Shie (1991) suggested values for the  $p$ -multiplier. These values were developed from loading tests on pile groups in clay and sand and from nonlinear, three-dimensional finite element modelling of laterally loaded pile groups in both simulated clay and sand.

Figure 13.21 presents the recommended values of the  $p$ -multiplier ( $\rho$ ) proposed by Brown and Shie, based on the position of the shaft by row. Only two positions are identified, front and back. A "back" row for purposes of the use of this figure is any row of drilled shafts behind the front row. Pinto et al. (1997) confirmed from centrifuge tests on in-line pile groups in sand that the second through the seventh rows of in-line piles in sand behave essentially identically, so that Brown and Shie's recommendation concerning the uniformity of the  $p$ -factor for rows other than the leading row appears to be valid. It is also assumed that the  $p$ -multipliers recommended by Brown and Shie apply to cyclic loading as well as static loading.

The procedure for modifying  $p$ - $y$  curves using the  $p$ -multiplier ( $\rho$ ) is illustrated in Figure 13.22. All values of  $p$  along any  $p$ - $y$  curve and all of the  $p$ - $y$  curves for the drilled shafts in any row within the group are modified by the same value of  $\rho$ .

The software that uses  $p$ - $y$  curves to analyze laterally loaded drilled shafts allows the user to input values of the  $p$ -multiplier,  $\rho$ , based on the recommendations of Brown and Shie or based on other information, such as site-specific loading tests.

The issue should be raised here that the  $p$ -multipliers have been developed primarily for laterally loaded driven piles. That is, no consideration is given to stress relief around existing drilled shafts when new drilled shafts are installed adjacent to the existing drilled shafts. Whether such a phenomenon occurs depends on the details of the construction method and the details of the soil composition. Therefore, it is desirable, when feasible, to conduct lateral loading tests on groups of two or more drilled shafts for major projects in order to confirm the  $p$ -multipliers of Brown and Shie or to derive new, site-specific values.

A single-shaft computer code can be used conveniently to analyze a group of identical, vertical, laterally loaded drilled shafts subjected to a shear load at the elevation of the shaft heads and a concentric axial load. In such a case, it is advisable to use the lateral displacement as a head boundary condition, rather than lateral load (applied shear at the shaft head). The head restraint condition (free, fixed or intermediate restraint) is used as the other head boundary condition, depending upon how the shaft is connected to the cap. A typical front row shaft is analyzed using  $\rho$  for the front row. This analysis gives the head shear, moment and rotation, as well as the deflected shape of the shaft and the shear and moment diagrams along the shaft for the shafts in the front row. This analysis is repeated for a typical drilled shaft on a trailing (back) row applying the same value of head deflection and using the value of  $\rho$  for shafts on back rows to

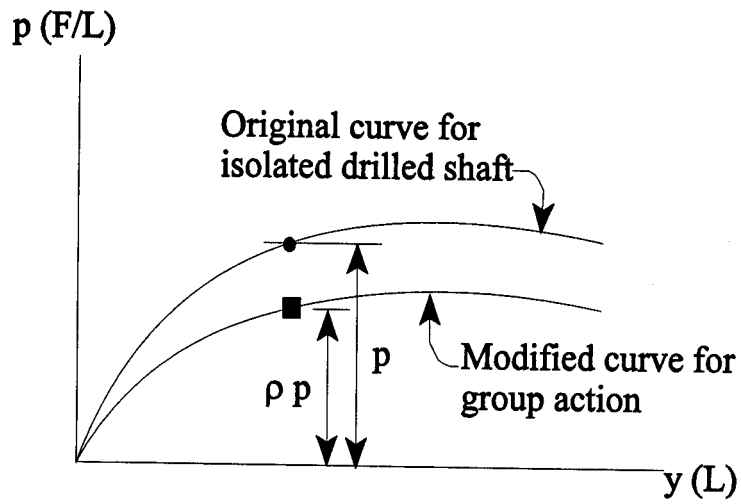

Figure 13.21. The p-multiplier (Brown and Shie, 1991)

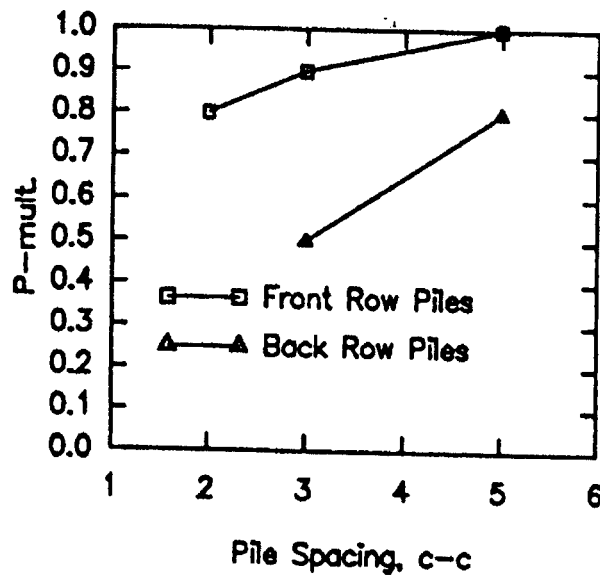

Figure 13.22. Modification of p-y curve for group action using the p-multiplier

modify the p-y curves. Similar output is obtained. The shear load that must have been applied to the group to produce the assumed lateral head deflection is then equal to the head shear on a front row shaft times the number of shafts on the front row plus the head shear on a back row shaft times the number of shafts in the group that are not on the front row. If this shear is not equal to the applied shear, a different head displacement is selected and the process is repeated until the computed head shears among all of the shafts sum to the applied group shear. The moment and shear diagrams for the shafts in the front row will be different from those for the shafts not on the front row; therefore, different steel schedules will often be appropriate among the shafts in the various rows within the group

If the shaft heads are restrained in any way, moments will develop at the shaft heads that will cause the cap to rotate and to induce compressive and tensile loads in the shafts, such that the sum of the shaft-head moments is resisted by the sum of the push-pull couples in the shafts within the group and possibly partly by soil resistance against the cap. The cap rotation will also serve to relieve somewhat the moments applied to the shaft heads. The engineer can ignore this effect and design using the solutions from the single-shaft computer code, or he or she can use a computer code that considers all of the interactions among the shafts in the group, including this effect. Hoit et al. (1997) describe FPLIER, a computer code that is capable of considering this coupled effect in addition to much more complex three-dimensional group configurations, as well as three-dimensional loading conditions, caps with flexibility, the soil resistance against the cap and similar features. Ensoft, Inc. (1997) describes a similar code, called GROUP, that performs the calculations in two dimensions. Both codes have the capability of allowing for the consideration of lateral group action within the group through the use of p-multipliers and both run in a user-friendly Windows environment. Space does not permit the description of these computer codes here; however, the reader is encouraged to obtain and review the literature cited above in preparation for the analysis of complex drilled shaft groups with lateral loads.

### **Other Methods of Analysis of Laterally Loaded Drilled Shafts and Drilled Shaft Groups**

The technical literature contains numerous other references to methods for analyzing laterally loaded piles and pile groups that presumably can be applied to drilled shafts. Most predominant are simplified methods that are based on solutions by the boundary element method (e. g., Poulos and Davis, 1980; Randolph and Poulos, 1982). For the analysis of pile groups, these methods use interaction factors that are derived assuming that the soil is an elastic mass, similar in concept to the p-multiplier but applied to the pile-head stiffness, rather than to the p-y relations. Computer codes such as PALLAS (Chen, 1994) and PIGLET (Randolph and Poulos, 1982), can be used to execute the calculations for relatively complex groups geometrically. Ochoa and O'Neill (1989) describe a similar pile-head interaction factor method with interaction factors for sand determined from full-scale experiments.

Although codes such as COM624P, LPILE<sup>PLUS</sup>, FLPIER and GROUP, which are based on the p-y method, are more popular in the United States, the various boundary element codes, which were developed abroad, have been well calibrated against full-scale and centrifuge loading tests

on single piles and groups. Care must be taken, however, to understand how such codes deal with nonlinear bending.

A useful and simple approach to the analysis of short, rigid, laterally loaded drilled shafts in clay using a simplified form of the boundary element method is given by Mayne and Kulhawy (1991). A useful and simple approach for analysis of laterally loaded deep foundations using the results of pressuremeter tests is provided by Briaud (1997).

Hybrid methods for analyzing groups of piles, in which the p-y method is used to represent the behavior of soil near each pile and the elastic boundary element method is used to adjust the y values for group action were first developed by Focht and Koch (1973) and O'Neill et al. (1977) and are incorporated as an option in FLPIER.

Finally, software now exists that will permit the nonlinear analysis of drilled shafts or groups of drilled shafts using the finite element method (FEM) with relative ease on a high-end PC or a workstation, for example ABAQUS (Hibbett et al., 1996). FEM analysis is justified when the soil or rock conditions, foundation geometry or loading of the group is unusual. An example of a case in which a comprehensive FEM analysis might be conducted is for designing a group of drilled shafts that are to be socketed into sloping rock on a steep mountainside, in which it is necessary to use permanent tiebacks to secure the drilled shaft group to stable rock.

## **STRUCTURAL DESIGN**

The section that follows is intended to give a brief description of the structural design of drilled shafts. They will be treated as reinforced-concrete beam-columns. Textbooks (Ferguson, 1988; Wang and Salmon, 1985) are available that present detailed information on design of reinforced concrete beam-columns.

Because the soil around a deep foundation provides bracing, a drilled shaft can be designed as a short column below the point where the soil comes in contact with the shaft. A short column is one where the unsupported length is small. The design of a beam-column in which there is a large unsupported length of the beam-column is beyond the scope of this manual.

The following points are important with regard to the material that follows.

1. The procedure generally follows the ACI (American Concrete Institute) methods for reinforced columns, although it is compatible with AASHTO (1994).
2. ACI indicates that there are cases where the reinforced-column treatment is unnecessary for drilled shafts; however, many experienced designers would not use a drilled shaft without minimum reinforcement because of the potential for unforeseen loading (tension due to wind loads, uplift due to expansive clay, and similar loadings). That position is taken in this manual.

3. ACI 318(95) (ACI, 1995), the structural design code for reinforced concrete buildings, Item 1.1.5, specifically exempts drilled piers (drilled shafts) from reinforced-column treatment and references instead ACI 336.3R(93) (ACI, 1993).
4. The method is based on the load and resistance factor design (LRFD) procedure that was first described in Chapter 1.
5. Only compression loading conditions are considered here. The ACI and AASHTO design codes should be consulted for cases in which the applied load is tensile.

### Cases with Axial Load Only

There are some cases where no moment or shear is transmitted to the head of the drilled shaft, so that the design needs only to deal with axial load. Any eccentricity of the axial load is ignored explicitly (although included implicitly) in this computation.

The following equation can be utilized in LRFD for calculating the factored nominal structural resistance of a section in a short, reinforced concrete column subjected only to compressive axial load.

$$\phi P_n = \beta \phi [ 0.85 f'_c (A_g - A_s) + A_s f_y ] \quad (13.22)$$

where

$\phi P_n$  = factored structural resistance of an axially loaded short column (drilled shaft), in which  $P_n$  is the nominal (computed) resistance given by the expression in the brackets on the right side of the above equation.

$\phi$  = capacity reduction ("resistance") factor = 0.75 for spiral columns and 0.70 for horizontally tied columns, according to the ACI Code, Section 9.3.

$\beta$  = reduction factor to account for the possibility of small eccentricities of the axial load = 0.85 for spiral columns and 0.80 for tied columns.

$f'_c$  = specified compressive cylinder strength of the concrete.

$A_g$  = gross cross-sectional area of the concrete section.

$A_s$  = cross-sectional area of the longitudinal reinforcing steel.

$f_y$  = yield strength of the longitudinal reinforcing steel.

In AASHTO (1994),  $\beta$  is identical to that in ACI, but  $\phi = 0.75$  for columns with both horizontal tie and spiral transverse reinforcement, except for cases of extreme event seismic loading in seismic zones 3 and 4. There,  $\phi$  is reduced to 0.50 if the factored load for the extreme event exceeds  $0.2 f'_c A_g$  and increases linearly, in proportion to the decrease in the factored extreme event load, to 1 for a factored extreme event load equal to zero. The ACI method thus gives slightly smaller factored resistances for the same amount of longitudinal steel than AASHTO for

ried columns under aseismic loading conditions. This would appear more appropriate for drilled shafts, which are constructed with less control on position of the borehole and rebar than structural columns, for which the AASHTO factors for aseismic loading apply; however, further research is needed.

In executing a preliminary design to obtain the approximate cross-sectional area and longitudinal steel schedule, a reasonable percentage of steel of from 1 to 4 percent of the gross column section area,  $A_g$ , can be assumed. If the drilled shaft will be loaded with an axial load having an eccentricity larger than is permitted in the construction specifications for horizontal position of the drilled shaft (Chapter 15), or if shears or bending moments will be applied to the drilled shaft, a lateral load analysis should be carried out. (An eccentric axial load will produce a moment at the shaft head that is regarded as a lateral load.) Depending on the level of load eccentricity and the magnitudes of the lateral loads, the calculated structural capacity for axial loading should be well in excess of the factored, applied axial load so that the section will also be found to be safe against moments.

## Cases with Axial Load and Bending Moment

### General Concepts

When a cross-section of an axially loaded drilled shaft is subjected to a bending moment from any source, there is a decrease in its axial structural resistance. The decrease can be explained by referring to Figure 13.23. The curve in Figure 13.23a shows the combinations of maximum axial load and maximum bending moment that the cross section of the drilled shaft can carry at failure (ultimate collapse). Points inside the curve, called an "interaction diagram," give combinations of loads that can be sustained; points on the curve, or outside of it, give the failure condition. Curves such as those in Figure 13.23a can be obtained by using computer codes such as COM624P (Version 2.0 or higher) and LPILE<sup>PLUS</sup>.

Figure 13.23b shows a schematic of a drilled shaft cross section that is being analyzed to obtain the interaction diagram. Figures 13.23c to 13.23h illustrate the distribution of strain in the cross section when it is subjected to different combinations of axial load and bending moment, represented by the points on the interaction curve A, B, C, D, E and F, respectively. When failure occurs due to axial load  $P_o$  only as at A, a uniform compressive strain  $\epsilon_{cu}$  exists on the entire cross section as shown in Figure 13.23c.  $\epsilon_{cu}$  is the compressive strain that causes crushing in the concrete (0.003). When failure occurs with a lesser axial load combined with a small amount of bending moment, as at B, the strain distribution on the cross section is no longer uniform. The top-fiber strain reaches the value of  $\epsilon_{cu}$ , whereas the bottom-fiber strain is reduced, but may still be compressive as in Figure 13.23d, if the moment is not large.

For a condition where bending moment is increased further and axial load decreased further, as represented by C, part of the cross section is subjected to tension, which is taken by steel

reinforcement if, for simplicity, it is assumed that the concrete is a material that cannot resist tension. This is a stage when sufficient tension is not developed to cause yielding of the steel, and the failure is still by crushing in the concrete. Proceeding to the state represented by D, the failure combination of axial load and bending moment is such that the ultimate strain  $\epsilon_{cu}$  in the concrete and tensile yield strain  $\epsilon_y$  in the steel are simultaneously reached. This stage is known as the balanced condition, and  $M_b$  and  $P_b$  are the moment and axial load capacity of the section at the balanced condition. At any failure combination between A and D on the curve, failure is caused by crushing in the concrete before the steel yields.

Tensile yielding in the steel can occur with a lesser bending moment than that at the balanced condition if the compression is removed by decreasing the axial load. This stage is represented by the lower portion, DF, of the curve. Since the axial load is less, the steel yields before the ultimate concrete strain,  $\epsilon_{cu}$ , is reached. With further bending the concrete compressive strain reaches  $\epsilon_{cu}$ , and failure occurs. At F the section is subjected to bending moment only ( $M_o$ ), and failure occurs well after the steel yields.

Because the capacity of a cross section with given properties of steel and concrete depends upon the percentage of reinforcement and the position of the steel with respect to the centroidal axis, a set of interaction diagrams needs to be drawn for each drilled shaft cross section that is analyzed. As stated, this can be done automatically using COM624P V2.0 or LPILE<sup>PLUS</sup>. These diagrams are also available in tabulated form in Volume Two of the Design Handbook, American Concrete Institute Publication SP-17A(85) (ACI, 1985) and can be conveniently used for drilled-shaft design. Interaction diagrams for some specific drilled shaft sections are also given by Barker et al. (1991).

### **Structural Design Procedure: Longitudinal Reinforcement**

Using the general information presented above, the structural design of a drilled shaft is executed following the step-by-step procedure outlined below, which deals only with compressive axial loading and aseismic conditions.

- 1. Calculate the factored axial, moment, and shear loads that are acting on the concrete section.** In some cases the critical section will be at the head of the drilled shaft (for example, for an eccentrically applied axial load, with no head shear or moment). Even if shear and moment loads are present at the shaft head, the designer may choose to size the section based on these loads and to verify the appropriateness of the section properties later using a comprehensive p-y analysis. Otherwise, a preliminary analysis of the drilled shaft can be conducted using one of the lateral load analysis procedures described earlier in this chapter. Factored applied loads are used to obtain moment and shear diagrams along the shaft as a function of depth in order to estimate the highest values of shear and moment that occur along the shaft, so that the critical-section loads can be established with higher accuracy when the section is designed initially. It is customary to assume that the axial load  $P_x$  acting on any



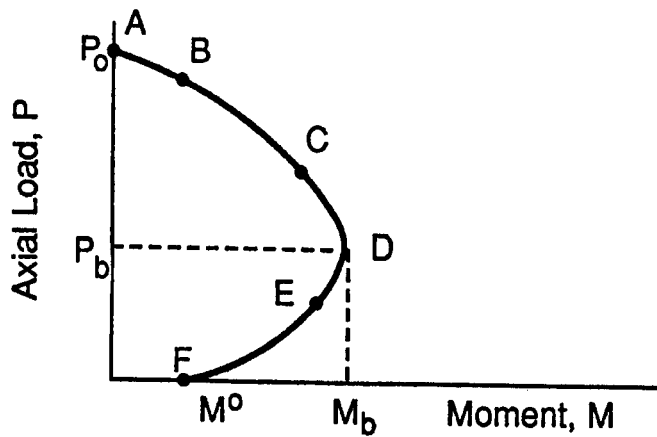

(a)

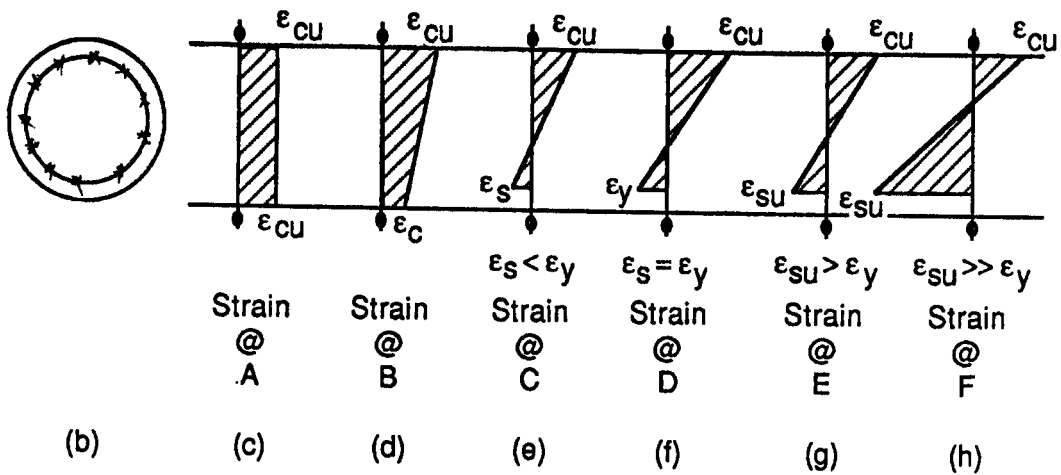

$\epsilon_{cu}$  = ultimate concrete strain in compression

$\epsilon_c$  = concrete strain in compression

$\epsilon_s$  = steel strain in tension

$\epsilon_y$  = yield strain of steel

$\epsilon_{su}$  = steel strain when concrete strain reaches  $\epsilon_{cu}$

Figure 13.23. Interaction diagram for a reinforced concrete column

such section is equal to the axial load applied to the head. The results of the preliminary lateral drilled shaft analysis using factored applied loads can be considered to be the factored loads (shear, moment and axial thrust) that act on the section under consideration.

2. **Check whether the factored axial load is well within the factored nominal axial load capacity  $\phi(P_n)$  of the shaft using Equation (13.22).** If not, increase the section appropriately. Some judgment is involved in determining how safe the design needs to be against axial load alone. If the estimate at this point is unsafe or overly conservative, it will be shown to be so later, and the designer will need to return to this step.

3. **Check to see whether the concrete section has adequate shear capacity without special shear reinforcement.** The nominal shear capacity of a section without properly designed shear reinforcement is calculated as:

$$\phi V_n = \phi v_c A_v \quad (13.23)$$

where

$V_n$  =nominal (computed, unfactored) shear resistance of the section,

$\phi$  =capacity reduction (resistance) factor for shear = 0.85, and

$v_c$  =the limiting concrete shear stress, which is evaluated from:

$$v_c = 2.63 (f'_c)^{0.5}, \text{ if } P_x = 0, \text{ or} \quad (13.24)$$

$$2.63 \left( 1 + \frac{\phi P_x}{13,780 A_g} \right) (f'_c)^{0.5}, \quad \text{if } P_x > 0, \quad (13.25)$$

where both  $f'_c$ , the compressive cylinder strength, and  $v_c$ , the shear strength of the concrete, are expressed in kPa, and the ratio  $P_x/A_g$  is in kPa, and

$A_v$  = the area of the column cross section that is effective in resisting shear, which can be taken as  $B[(B/2) + 0.5756 r_{is}]$  for a circular drilled shaft, where

$r_{is}$  =the radius of the ring formed by the centroids of the longitudinal rebars, which can be taken as  $(B/2 - d_c - d_b/2)$ , in which  $d_c$  = depth of concrete cover and  $d_b$  = diameter of rebars.

In most cases  $A_v$  can be taken to be 0.95  $A_g$  for round drilled shafts with little loss of accuracy.

If the factored shear load applied to the section is greater than the factored resistance, determined above, two options are available. The first and simplest solution is to increase the column size

(diameter of the drilled shaft) to increase  $A_g$  and  $A_v$  and thus increase the shear capacity. The second alternative is to provide properly designed shear reinforcement, in the form of closed transverse ties or spiral, to resist the shear forces that are in excess of the concrete's shear capacity. This shear reinforcement should be designed in accordance with Section 11.5, "Shear Strength Provided by Shear Reinforcement," of the ACI Building Code 318(95) (ACI, 1995) or Section 11.7, "Transverse Reinforcement for Flexural Members," of the AASHTO code (AASHTO, 1994). This is discussed further later.

4. **Compute the apparent eccentricity**  $e = \Sigma\gamma M / \Sigma\gamma P_x$  where  $\Sigma\gamma M$  is the factored moment at the section and  $\Sigma\gamma P_x$  is the factored axial load at the section. Take  $e$  as the actual computed value, or use an overriding value given in the specifications, if given.
5. **Compute the eccentricity ratio**  $e/h$  and  $\Sigma\gamma P_x / A_g$ , and assume a value of concrete cover,  $\gamma_{cov}$ .  $h$  is equal to the diameter of the shaft.  $\gamma_{cov}$  = cage diameter/shaft diameter.
6. **Enter the appropriate table in the ACI Design Handbook** (ACI, 1985) and select  $\rho = A_s / A_g$  by interpolation.  $A_s$  is the cross-sectional area of the longitudinal steel.
7. **For reinforced concrete columns, the ACI code limits the value of  $\rho$  to a minimum of 1 per cent and maximum of 8 per cent.** A column with 8 per cent reinforcement generally results in crowding of steel with little possibility of splicing (dowels for example). Better practice is to limit the maximum reinforcement to between 4 and 6 per cent depending on the requirement for continuity with the supported structure. In some cases, described later,  $\rho$  can be as small as 0.5 per cent.
8. **Select the actual steel reinforcement**, i.e., size and number of bars, and bar spacing. Keep in mind the requirement for designing for constructability (e. g., maintain adequate bar spacing by bundling bars if necessary).
9. **Calculate  $\gamma_{cov}$  for the designed section and check it against the assumed value.** If the two values are significantly different, repeat Steps 5 through 7 until the assumed  $\gamma_{cov}$  and calculated  $\gamma_{cov}$  are reasonably close to each other.
10. **Select appropriate ties or spirals** according to the requirements of ACI or AASHTO specifications.

The following example illustrates this procedure.

---

**Example 13.2. Selection of Longitudinal Reinforcing Steel Schedule for a Drilled Shaft**

Consider a cross section with the following properties.

Diameter of drilled shaft = 762 mm (30 inches)  
 $f_c = 27,560$  kPa (4,000 psi)  
 $f_y = 413,400$  kPa (60,000 psi)  
 Clear cover to longitudinal steel = 75 mm (3 inches)  
 Transverse reinforcement will be spiral.

Step 1. *Determine the loads.* The loads acting on the section are as follows:

Axial load,  $P_x$

Nominal dead load =  $P_{x\text{dn}} = 4,895$  kN (1,100,000 lb)

Nominal live load =  $P_{x\text{ln}} = 890$  kN (200,000 lb)

(Other load components may be acting in a typical design problem, but for sake of clarity, consider only these two components in this example.)

$\eta = 1$  (ordinary structure).

Using AASHTO load factors for dead and live load,

$\eta \Sigma \gamma P_{x\text{n}} = 1.25 P_{x\text{dn}} + 1.75 P_{x\text{ln}} = 7,676$  kN (1,725,000 lb).

Shear force,  $V$

Nominal dead load =  $V_{\text{dn}} = 26.7$  kN (6,000 lb)

Nominal live load =  $V_{\text{ln}} = 4.45$  kN (1,000 lb)

$\eta \Sigma \gamma V_{\text{n}} = 1.25 V_{\text{dn}} + 1.75 V_{\text{ln}} = 41.2$  kN (9,250 lb)

Bending Moment,  $M$

Nominal dead load =  $M_{\text{dn}} = 508.5$  kN-m (4,500,000 lb-in)

Nominal live load =  $M_{\text{ln}} = 113$  kN-m (1,000,000 lb-in)

$\eta \Sigma \gamma M_{\text{n}} = 1.25 M_{\text{dn}} + 1.75 M_{\text{ln}} = 833.4$  kN-m (7,375,000 lb-in)

*Note:* If a head shear is present, the bending moment at the shaft head may not be the highest bending moment along the shaft. A higher value may exist at some greater depth. In such a case the design values of  $\eta \Sigma \gamma V_{\text{n}}$  and  $\eta \Sigma \gamma M_{\text{n}}$  can be determined by applying simultaneously all of the factored head loads to the head of the shaft and using one of the analysis methods to determine the resulting maximum shear and moment along the shaft. The resulting maximum shear and moment values would then be assigned as  $\eta \Sigma \gamma V_{\text{n}}$  and  $\eta \Sigma \gamma M_{\text{n}}$ , and the design would continue as indicated below. If the head loads are only an axial load with a known eccentricity, in which case the critical section is at the head of the shaft, the appropriate design values for  $\eta \Sigma \gamma M_{\text{n}}$  and  $P_x$  are the head loads.

To conduct the preliminary analysis for moment and shear distribution, a reinforcing schedule would first have to be assumed in order to estimate EI. The correct distribution of moment and shear are not highly sensitive to the assumed steel schedule, so if the initial assumption concerning the size and locations of the rebars is reasonably close to the final solution, an iteration will seldom be necessary later.

Alternatively, the designer can merely assume that the factored loads acting on the critical section are the loads acting at the shaft head and design the preliminary section for those loads. This does not require a preliminary lateral load analysis for moment and shear distribution, but it can sometimes lead to errors sufficient to require redesign when the "loop is closed" at the end of the process by performing a complete p-y analysis. (Whether a preliminary lateral load analysis is performed to determine maximum moment and shear or the head loads are used, the design will be always be checked by making a final p-y method analysis, in which case any section design problems can be corrected.)

For this example it will be assumed that the given loads are loads at the shaft head, and the design of the drilled shaft section will be checked in subsequent examples.

Step 2. *Compare the factored ultimate axial load,  $\eta \Sigma \gamma P_{xn}$ , with the factored axial resistance,  $\phi P_n$ , as determined using Equation (13.22). Assume a reasonable steel ratio ( $A_s/A_g$ ) of approximately 2 per cent and calculate the limiting axial load resistance. For preliminary sizing, the column capacity should be considerably more than the applied ultimate axial load to account for the lateral loads.*

$$A_g = \pi (0.762^2/4) = 0.456 \text{ m}^2 (707 \text{ in}^2)$$

$$A_s = 0.02 (0.456) = 0.00912 \text{ m}^2 = 9120 \text{ mm}^2 (14.14 \text{ in}^2)$$

For a spirally reinforced column, using the ACI resistance factors, from Equation (13.22)

$$\begin{aligned} \phi P_n &= (0.85) (0.75) [0.85 (27,560) (0.456 - 0.00912) + (413,400) (0.00912)] \\ &= 9,077 \text{ kN} > 7676 \text{ kN (say OK)} \end{aligned}$$

Step 3. *Check the shear capacity of the concrete section.*

$$\phi V_n = \phi v_c A_v$$

$$\begin{aligned} v_c &= 2.63 \{1 + 7676 / [13,780 (0.456)]\} (27,560)^{0.5} \text{ (since } P_x > 0) \\ &= 970 \text{ kPa (141 psi)} \end{aligned}$$

$$\phi V_n = 0.85 (970) (0.95) (0.456) = 357 \text{ kN (80,220 lb)} > 41.2 \text{ kN (OK)}$$

Step 4. *Determine the value of the apparent eccentricity.*

$$e = 833.4 \text{ kN-m} / 7,676 \text{ kN} = 0.109 \text{ m (4.29 inches)}$$

Step 5. Compute  $\Sigma\gamma P_x/A_g$ ,  $e/h$ , and assume a value for  $\gamma_{cov}$ .

In ACI SP-17A,  $\Sigma\gamma P_x/A_g$  has the units of kips/in<sup>2</sup> (= 0.0001451  $\Sigma\gamma P_x/A_g$  in kPa)

$$\Sigma\gamma P_x/A_g = 1,725,000 / [(707)(1000)] = 2.44 \text{ ksi}$$

$$e/h = 0.109 / 0.762 = 0.143$$

Assume temporarily rebars with diameters of 25 mm (#8 or 25M); the clear cover will be 75 mm, and the distance from the center of the rebar ring to the outside of the drilled shaft will be  $75 + 0.5(25) = 87.5$  mm.:

$$\gamma_{cov} = [762 - 2(87.5)] / 762 = 0.77$$

Step 6. Determine  $\rho$  based on ACI SP-17A (ACI, 1985):

For most large-diameter drilled shafts,  $\gamma_{cov}$  will fall between 0.75 and 0.90, unless more than 75 mm of cover is specified. The ACI design tables for  $\gamma_{cov} = 0.75$  and 0.90 are therefore partially reproduced here. The solution will be obtained by linear interpolation, first between  $\gamma_{cov}$  values.

For  $\gamma_{cov} = 0.75$ :

$e/h$	$\Sigma\gamma P_x/A_g$ (ksi)	$\rho$
0.1	2.40	0.014
	2.60	0.021
	2.44	0.015
0.2	2.40	0.042
	2.60	0.051
	2.44	0.044
0.143	2.44	0.027

For  $\gamma_{cov} = 0.90$ :

e/h	$\Sigma\gamma P_x/A_g$ (ksi)	$\rho$
0.1	2.40	0.013
	2.60	0.020
	2.44	0.014
0.2	2.40	0.036
	2.60	0.043
	2.44	0.037
0.143	2.44	0.024

Finally, interpolating between 0.027 and 0.024,

$$\rho = 0.027 - [(0.77 - 0.75) / (0.90 - 0.75)] (0.027 - 0.024) = 0.027 \text{ (2.7 per cent).}$$

Step 7. *Verify that the reinforcement is between 1 and 4 per cent.*

$$1 < 2.7 < 4 \quad (\text{OK})$$

Step 8. *Select the actual longitudinal steel reinforcement schedule.*

Try 25M bars ( $A_s = 500 \text{ mm}^2$  per bar). Required area =  $0.027 (456,000) = 12,312 \text{ mm}^2 / 500 \text{ mm}^2 = 24.6$ , say 25 bars.

C to C spacing between bars =  $\pi [762 - 2 (87.5)] / 25 = 73.76 \text{ mm}$ . Clear spacing =  $73.76 - 25 = 48.76 \text{ mm}$ . The minimum clear spacing should be about 5 times the maximum coarse aggregate size so that the concrete can flow smoothly through the rebar cage. If the concrete mix is to contain coarse aggregate with a maximum size of 19 mm, the required minimum clear spacing is therefore 90 mm. So the choice of rebar is not appropriate for good constructability.

Try 35M bars ( $A_s = 1000 \text{ mm}^2$ ).  $12,312 / 1000 = 12.3$ , say 13, bars are required.

C to C spacing =  $\pi [762 - 2 (87.5)] / 13 = 142 \text{ mm}$ . Clear spacing =  $142 \text{ mm} - 35 \text{ mm} = 107 \text{ mm} > 90 \text{ mm}$ , OK. Use 13, 35M bars in a circular pattern, evenly spaced, with a 75 mm clear spacing between the outside of the rebar and the edge of the drilled shaft, and use a concrete mix with a maximum coarse aggregate size of 19 mm. See Chapter 6 for construction requirements for the rebar and Chapter

8 for construction requirements for the concrete. Note that 35M bars are essentially identical to #11 bars.

Step 9. *Compute the value for  $\gamma_{cov}$  for the section as designed.*

$\gamma_{cov} = [762 - 2(75 + 35/2)] / 762 = 0.757 \approx 0.77$ , OK. Section does not have to be redesigned.

Step 10. *Design the transverse reinforcement.* This aspect of structural design will be considered in the next section.

This design should be considered preliminary. In order to verify the design, an analysis, such as a p-y analysis, should be performed to obtain the factored moments, shears and axial thrusts at the section under consideration. This analysis will be described subsequently. These forces and moments will likely be very close to the values obtained at the beginning of the preliminary analysis if the final steel ratio is near the value assumed. In this example,  $\rho$  was assumed to be 2.0 per cent and computed to be 2.7 per cent. This usually produces only a minor difference with respect to the computed shear and moment for drilled shafts in most geomaterials.

Concurrent with the final p-y analysis, the interaction diagram(s) (Figure 13.23) should be developed for the section. The combination of the factored moment and axial load acting on the section should lie on or inside the dashed line in Figure 13.24. That is, a resistance factor of 0.75 is applied to both the nominal ultimate axial resistance and nominal ultimate moment that are given by the interaction diagram simultaneously, except below load  $P'$ , where a linear interpolation is performed between the point defined in this way and a point equal to 0.9 times the nominal ultimate moment at the point where the axial load is equal to zero.  $P'$  is defined on Figure 13.24. See AASHTO (1994), Section 5.5.4.2.1 for additional information. If designing under ACI, the factor in Figure 13.24 that multiplies axial capacity should be 0.70 if transverse ties, rather than spiral, are used.

The above factors are resistance factors for combined loading; however, their values are very tenuous and depend strongly on the contractor's ability to avoid producing defects in the concrete during construction and the engineer's ability to detect defects. It may be useful to conduct the final p-y analysis by assuming a reduced cross section at the location of the section of interest to reflect the presence of voids of the largest size that the engineer judges will go undetected by the inspection and integrity testing processes (Chapters 16 and 17). This can be accomplished by reducing the shaft diameter at the location of the section being analyzed in a p-y analysis.

---

### **Structural Design Procedure: Minimum Longitudinal Reinforcement**

In the case in which there are no moments or shears the minimum steel percentage can be less



than the normal structural minimum of 1 per cent. Section 10.9.1 of the ACI Code states that the area of longitudinal reinforcement for concrete columns must be not less than 1 per cent of the gross concrete area  $A_g$ . If, however, the cross-section is larger than required by considerations of structural resistance, then Section 10.8.4 allows a reduced effective area  $A'_g$ , not less than one half the total area, to be used to determine the minimum reinforcement and design strength. This means that if the column has sufficient axial strength using only half the gross concrete area,  $A_g/2$ , then the longitudinal reinforcement ratio can be reduced to 0.5 per cent of the gross concrete area,  $A_g$ . That is,  $\rho_{\min} (\%) = A'_g / A_g \geq 0.5$ , when  $A'_g / A_g < 1$ , where  $\rho$  refers to percentage of steel. In fact, in many cases in which drilled shafts are designed with large diameters in order to develop enough side and base area to produce adequate geotechnical resistance in soils and in some soft rocks, this criterion can be used.

## Design of Transverse Reinforcement

### Spiral Column Design

The transverse reinforcement (spiral or ties) plays a critical role in the structural design of drilled shafts by confining the concrete within the core of shaft as the ultimate axial resistance is approached and by bracing the longitudinal steel against buckling. For round columns such as drilled shafts, the usual practice has been to use spiral for this purpose. Section 7.10 of the ACI code outlines the requirements for spirals used as transverse reinforcement in compression members. The ACI specifications gives the volumetric ratio of spiral reinforcement required,  $\rho_s$ , in the following equation.

$$\rho_s = 0.45 \left( \frac{A_g}{A_c} - 1 \right) \frac{f'_c}{f_y} \quad (13.26)$$

where

$A_c$  = cross-sectional area of the concrete inside the spiral steel, and the remaining terms are as defined previously.

Example 13.2 is continued in Example 13.3 with the selection of the spiral steel.

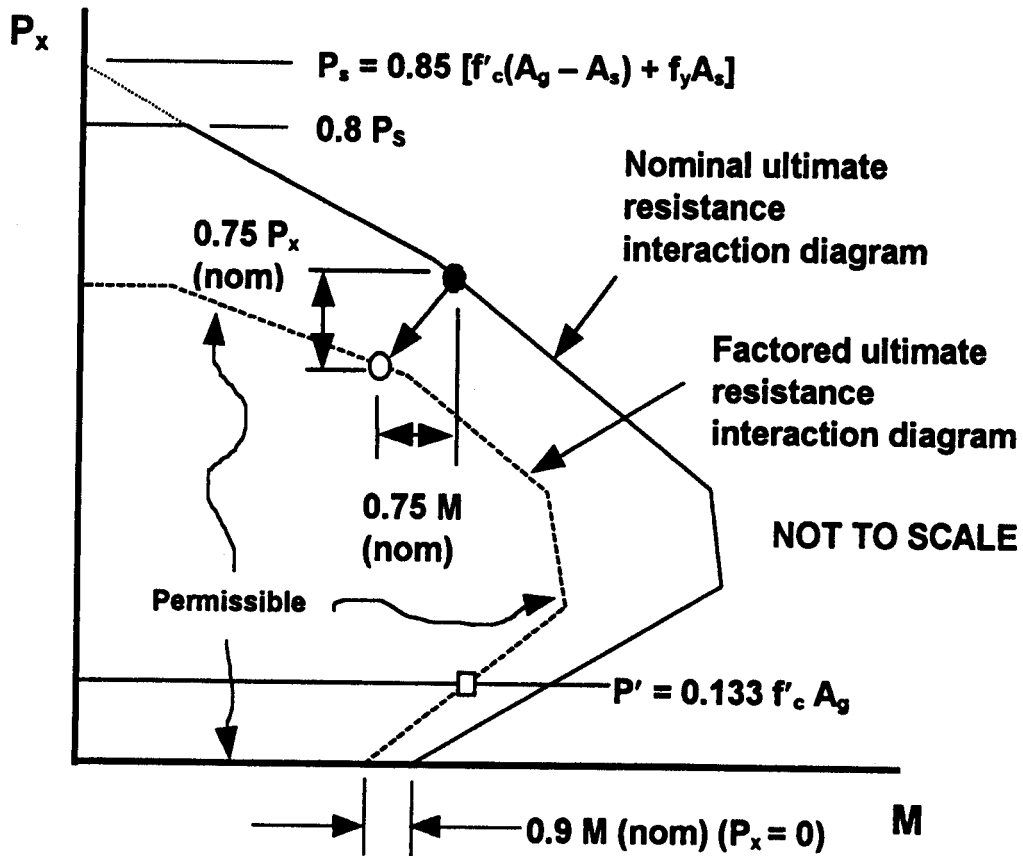

Figure 13.24. Interaction diagram for factored resistances for combined axial load and flexure

---

**Example 13.3.** *Selection of Transverse Reinforcing Steel Schedule for Example 13.2*

Note that the various parameters for the section and the materials are given in Example 13.2.

Step 10a. *Compute  $A_c$ .* Recall that the shaft diameter is 762 mm and that 75 mm of cover is specified over the longitudinal rebar.

$$A_c = (\pi/4) [762 - 2(75)]^2 = 294,200 \text{ mm}^2 = 0.2942 \text{ m}^2.$$

$$A_g = 0.456 \text{ m}^2 \text{ (from Example 13.2)}$$

$$f'_c = 27,560 \text{ kPa (4,000 psi)}$$

$$f_y = 413,400 \text{ kPa (60,000 psi)}$$

Step 10b. *Compute  $\rho_s$  from Equation (13.26).*

$$\rho_s = 0.45 [ (0.456 / 0.2942) - 1 ] (27,560 / 413,400) = 0.0165$$

Step 10c. *Choose a pitch for the spiral.*

The pitch should normally be between 75 and 150 mm. A value near the upper end of this range is desirable from the point of view of concrete flow. However, when shear loads (which are considered separately) are high, it may be necessary to use a pitch near the lower bound. When that is done, consideration should be given to reducing the maximum size of the coarse aggregate in the concrete mix so that the clear spacing between spiral turns is approximately 5 times the maximum size of the coarse aggregate.

Choose a 150-mm pitch.

Step 10d. *Determine the area of the spiral*

$$\text{Length of the spiral in one turn} = \{ \pi [762 - 2(75)]^2 + 150^2 \}^{0.5} = 1928 \text{ mm.}$$

$$\text{Volume of core per turn} = 150 \{ (\pi/4) [762 - 2(75)]^2 \} = 44,125,000 \text{ mm}^3.$$

$$\rho_s = 0.0165 = \text{Volume of spiral per turn} / \text{Volume of core per turn}$$

$$= A_{\text{spiral}} (1928 \text{ mm}) / 44,125,000 \text{ mm}^3, \text{ from which}$$

$$A_{\text{spiral}} = [0.0165 (44,125,000)] / 1928 = 377.6 \text{ mm}^2$$

Step 10f. *Select the size of the spiral.*

The smallest size spiral that will give this area is 25M

The final section design becomes 13, 35M Grade 60 longitudinal bars equally spaced around the circumference of a circle with 75 mm clear spacing between the cage and borehole wall with 25M Grade 60 spiral at a 150 mm pitch. If a liberal tolerance is given in the specifications for the horizontal position of the drilled shaft borehole [e. g., 75 mm (3 in.) from planned position], consideration can be given at this point to increasing the diameter of the drilled shaft (but not the cage) by 150 mm (6 in.). In this way, if the cage must be offset by 75 mm (3 in.) within the borehole to match the position of the rebar for the column, doing so will not cause structural problems in the shaft, and a 75 mm (3 in.) cover will be ensured all around the cage when the shaft is constructed.

The method described here, which is based on the ACI code, requires a significant amount of

transverse steel because it was developed for above-ground columns. The same requirements are undoubtedly conservative for drilled shafts, which are confined by soil, and especially conservative for drilled shafts embedded in rock. The large amount of transverse steel is required in consideration of the need to maintain ductility in the column once a plastic hinge develops, since ductility is provided largely by properly confined concrete in the core of the column. This is especially important for earthquake resistant design. Although more research is needed, it is likely that the stringent requirements of Equation (13.24) could be relaxed somewhat in drilled shafts at locations away from any plastic hinges, which can be identified by a p-y analysis, and that the requirements of Equation (13.24) could be enforced only in the vicinity of locations where plastic hinges will develop. This would aid in the constructability of the shaft.

In addition to the structural requirements enumerated here, the drilled-shaft designer should check to make sure that the size of the transverse reinforcement is not less than that recommended in Chapter 7 for good handling of the rebar cage during construction. The designer may wish to consider the option of circular ties, discussed below, instead of spiral ties, if there is no specific requirement to use spiral. Ties become attractive when the diameter of the transverse reinforcement becomes large, as it is in this example, and spiral becomes difficult to handle during cage fabrication.

---

### **Tied Column Design**

The interaction diagrams in the ACI design handbook or in Barker et al. (1991) can also be used for designing tied-concrete columns. Page 205 of the ACI design handbook (ACI, 1985) gives a description of the theoretical background used in developing the interaction charts. If the design is to be done under the provisions of ACI, there are two modifications that must be made to use the design diagrams for tied columns. (Corresponding modifications do not have to be done if one is designing under the provisions of AASHTO.) Firstly, for tied columns the capacity reduction factor is 0.70 instead of 0.75 for spiral columns. A value of 0.75 is incorporated in the column tables in the design handbook. In view of this, to design a tied column, the values of  $P_x$  and  $M_{ult}$  should be increased by a factor of  $(0.75/0.70)$  before entering the column tables. Secondly, for tied columns, the value of  $\beta$  in Equation (13.22) is equal to 0.80 (instead of 0.85 for spiral columns.) This limit on maximum axial strength should be calculated for tied columns and be used as an upper limit on strength in the interaction charts.

Section 7.10.5 of the ACI Code (ACI, 1995) outlines the requirements for ties used as lateral reinforcement in compression members. Modifications are noted in Section 8.18.2.3 of AASHTO (1994). Other additional restrictions are applicable for seismic areas.

For longitudinal bars smaller than #11 (35M) bars, #3 ties may be used. For columns using #11 bars or larger, ties must be at least #4 bars. These sizes do not correlate well with metric sizes, so that the number designation should be used in the foreseeable future for economy.

The vertical spacing of ties shall not exceed the lesser of:

1. 16 longitudinal bar diameters =  $(16)(35) = 560$  mm (22 inches)  
if the ties are the same size as the spiral in Example 13.3.
2. 48 tie diameters =  $(48) \times (25) = 1200$  mm (47 inches)  
if the ties are the same size as the spiral in Example 13.3.
3. least column dimension = 762 mm (30 inches).
4. 12 inches (305 mm), which is a provision of AASHTO (1994).

For the section in Examples 13.2 and 13.3, the above requirements merely require ties of #4 bar size at a spacing of no greater than 305 mm (12 inches). This is significantly less transverse steel than is required if spiral is used. (Note that this is not adequate for seismic loading.)

Consideration should therefore be given to the economics of designing drilled shafts as spirally-reinforced columns. Although the base strength of a spiral column is approximately 15 per cent higher than for a similar tied column according to ACI, the lateral reinforcement required for the spiral column is significantly increased with respect to that for a tied column. For Example 13.3, to develop the additional 15 per cent strength of the spirally reinforced column, almost eight times the transverse reinforcement was required (25M @ 150 mm pitch as compared to #4 @ 305 mm spacing). Therefore, an economic evaluation should be conducted to determine the net difference between the decreased longitudinal steel and the increased transverse steel of a spirally reinforced column before a final decision is made regarding the type of transverse reinforcement to specify.

With either spiral or ties adequate continuity in the transverse reinforcement must be ensured. This is usually done by lapping the transverse steel on itself according to the requirements given below. One lap must be provided for each tie, but a section of spiral requires a lap only every several turns, which somewhat offsets the added cost of the spiral. Laps are preferred to turning the steel into the interior of the cross section to obtain its development because of constructability considerations.

### **Design for Transverse Shear Forces**

Example 13.2 demonstrated how to evaluate the capacity of the concrete in the drilled shaft cross section to resist shear forces at any point along the drilled shaft using Equation (13.23). Often, when seismic loading is not to be considered, the factored resistance computed by Equation (13.23) will be sufficient, and no further design considerations are necessary to ensure that the drilled shaft can resist transverse shear forces. However, if the factored shear force in the drilled shaft at any depth along the shaft, as obtained using the p-y method or any other appropriate method, exceeds the factored resistance given by Equation (13.23), the designer must consider

several options.

- Increase the concrete strength. For instance, increasing  $f'_c$  from 27,560 kPa (4,000 psi) to 31,000 kPa (4,500 psi) would automatically increase the shear capacity of the drilled shaft by six per cent. This is ordinarily not exceptionally expensive unless the shafts have a very large volume of concrete (shafts with very large diameters and/or great length).
- Increase the diameter of the drilled shaft, and therefore  $A_v$ . This can be expensive, but it may help to reduce the congestion of rebars within the section and the deflection of the drilled shaft under lateral loads and can be a viable option when it can also serve to help constructability and serviceability of the drilled shaft.
- Let the spiral or ties within the section carry part of the shear load. In fact, the spiral or ties that have been used in the structural design for axial loading may already provide sufficient additional shear resistance. In most cases, this is the most economical alternative and is considered in the following.

To design the transverse reinforcement to carry shear forces, it must first be recalled that  $\phi V_n \geq \eta \Sigma \gamma V$ .  $V_n$  is the nominal shear resistance (in this case carried by both the concrete and the transverse reinforcing steel),  $\phi V_n$  is the factored resistance, and  $\eta \Sigma \gamma V$  is the factored maximum transverse shear force that must be resisted, which is obtained from a p-y analysis by applying factored shear, moment and axial thrust at the head of the shaft and using otherwise nominal factors (e. g., p-y curves) in the analysis.

It can be assumed that  $\phi V_n = \phi (V_{\text{concrete}} + V_{\text{steel}})$ , so that  $\phi V_{\text{steel}} = \eta \Sigma \gamma V - \phi V_{\text{concrete}}$ .

Equation (13.27) is used to compute the required area of transverse steel,  $A_{vs}$ .

$$\frac{A_{vs}}{s} = \frac{V_{\text{steel}}}{f_y \left[ \frac{B}{2} + 0.5756 r_{ls} \right]} \quad (13.27)$$

where

- $V_{\text{steel}}$  = nominal value of shear resistance not provided by the concrete,
- $s$  = longitudinal spacing of the ties or pitch of the spiral,
- $B$  = shaft diameter,
- $f_y$  = yield strength of the steel, and
- $r_{ls}$  = radius of ring formed by the centroids of the longitudinal rebars, defined in more detail following Equation (13.25).

The application of Equation (13.27) is illustrated in Example 13.4.

---

**Example 13.4. Selection of transverse steel to resist shear**

Continuing with Example 13.2, assume that calculations using the p-y method indicate that the maximum factored value of transverse shear, instead of occurring at the shaft head, actually occurs at a depth of 4.9 m (16 ft) and assumes a value of 429 kN (96.4 kips).

$\phi V_c = 357$  kN was computed in Example 13.2 assuming  $A_v = 0.95 A_g$ . The concrete in the section was shown to carry the applied shear at the shaft head easily. Here, however, the factored transverse shear force is much higher, and a more accurate calculation of  $\phi V_c$  is called for.

*Step 1.* Compute  $A_v$  [from the definition following Equation (13.25)].

$$B = 0.762 \text{ m (30 in.)};$$

Recalling that the diameter of the longitudinal bars is 35 mm and that 75 mm of clear cover over the longitudinal bars is specified,

$$[B/2 + 0.5756 r_{ls}] = 0.762/2 + 0.5756 (0.762/2 - 0.075 - 0.035) = 0.547 \text{ m (21.54 in.)};$$

$$A_v = 0.762 (0.547) = 0.4168 \text{ m}^2.$$

$A_v$  in this case is actually about  $0.914 A_g$ , rather than  $0.95 A_g$ , as assumed in Example 13.2.

*Step 2.* Compute  $v_c$  from Equation (13.25).

Note that Equation (13.25) is used in preference to Equation (13.24) since an axial load was specified in Example 13.2.

$$v_c = 2.63 \{ [1 + 7676] / [(13,780) (0.456)] \} (27,560)^{0.5} = 970 \text{ kPa} = 141 \text{ psi}.$$

*Step 3.* Compute  $\phi V_{\text{concrete}}$ .

$$\phi V_{\text{concrete}} = \phi v_c A_v = 0.85 (970) (0.4168) = 343.7 \text{ kN} < \eta \Sigma \gamma V = 429 \text{ kN}.$$

The concrete alone is not able to carry the factored maximum transverse shear load.

*Step 4.* Check the capacity of the transverse steel that was specified for axial load design to see if it is sufficient to carry the shear load that is not carried by the concrete.

$$\phi V_{\text{steel}} = 429 \text{ kN} - 343.7 \text{ kN} = 85.3 \text{ kN} (19.2 \text{ kips})$$

$$\text{Since } \phi = 0.85, V_{\text{steel}} = 85.3 / 0.85 = 100.4 \text{ kN} (22.56 \text{ kips})$$

From Equation (13.27),

$$\begin{aligned} A_{vs}/s &= V_{\text{steel}} / \{ f_y [(0.762/2 + 0.5756(0.762/2 - 0.075 - 0.035/2)) \} \\ &= 100.4 / [(413,400)(0.5471)] = 0.000444 \text{ m} = 0.444 \text{ mm} (0.01748 \text{ in.}). \end{aligned}$$

For the spiral design developed in Example 13.3,  $s = 150 \text{ mm}$  (6 in.), and the spiral consists of 25M steel. Therefore,

$$A_{vs} (\text{required}) = 150 (0.444) = 66.6 \text{ mm}^2 < A_{vs} (\text{provided}) = 2 (500) = 1,000 \text{ mm}^2. \text{ The shear resistance is ok.}$$

For the corresponding circular tie design, #4 bars at 305 mm spacing,

$$\begin{aligned} A_{vs} (\text{required}) &= (305) (0.444) = 135.4 \text{ mm}^2 (0.210 \text{ in.}^2) < A_{vs} (\text{provided}) = 2 (129 \text{ mm}^2) \\ &= 258 \text{ mm}^2 (0.400 \text{ in.}^2). \text{ The shear resistance is also ok for the circular tie design.} \end{aligned}$$

No additional ties are necessary to carry the transverse shear force for this example. If the existing transverse steel reinforcement had not been sufficient, larger bars and/or a closer longitudinal spacing would have been required.

### **Depth of Code-Controlled Transverse Reinforcement**

One issue in the structural design of axially loaded drilled shafts that has not been resolved with solid research is the depth below the ground surface to which the spiral or ties need to continue as if the drilled shaft were a structural column. At present this choice can only be made based on practice. Many agencies require spiral or ties, as determined from code requirements, down to a depth of 10 to 12 shaft diameters below the ground surface when the soil is stiff or dense, or down to the top of a solid rock socket, whichever is less. It is certainly conservative to extend the spiral to the full length of the drilled shaft, but doing so may be unnecessarily costly for long shafts.

### **Splices, Connections and Cutoffs**

If a joint is provided at the head of the drilled shaft, the transverse reinforcement should extend one-half of the column or drilled shaft diameter, whichever is larger, into the column, or 380 mm, according to AASHTO (1994), Section 5.10. For lap joints at the interface with the column or cap or for lap joints within the drilled shaft, longitudinal rebar should lap the longitudinal bar



from the column or cap, or the bar in the adjoining section of cage, by an amount equal to 1.25 times the full development length in LRFD, according to AASHTO (1994), Section 5.10, in which the full development length,  $l_{db}$ , in mm, for bars in tension is as follows. In no case should  $l_{db}$  be less than 300 mm. Similar rules apply to rebar cutoff and to lapping of transverse steel.

For 35M bar and smaller:

$$l_{db} = 0.02 A_b f_y / (f'_c)^{0.5}, \text{ but not less than } 0.06 d_b f_y . \quad (13.28)$$

For 45M bar:

$$l_{db} = 25 f_y / (f'_c)^{0.5} \quad (13.29)$$

For 55M bar:

$$l_{db} = 34 f_y / (f'_c)^{0.5} \quad (13.30)$$

For bars in compression the full development length,  $l_{db}$ , in mm, is given by the following. In no case should  $l_{db}$  be less than 200 mm.

$$l_{db} = [0.24 d_b f_y] / (f'_c)^{0.5} \text{ or } 0.044 d_b f_y \text{ (whichever is greatest)} \quad (13.31)$$

In the above equations,  $f'_c$  is the cylinder strength of the concrete at 28 days in MPa,  $f_y$  is the nominal yield strength of the steel in MPa,  $d_b$  is the diameter of the bar in mm, and  $A_b$  is the cross-sectional area of the bar in mm<sup>2</sup>. In some cases modification factors need to be applied. The reader should consult AASHTO (1994), Section 5.11.2, for such factors.

### **Analysis to Obtain Distribution of Moment and Shear with Depth: Step-by-Step Procedure for Design (p-y method)**

The final values for axial load, shear and moment at any section along the drilled shaft should be determined using an analytical, soil-structure interaction (p-y) model. The p-y model is easy to use and readily provides the required moment and shear diagrams. The step-by-step procedure for performing such an analysis on the drilled shaft with the concrete and steel details that were determined in the preceding sections, using a computer code such as COM624P V2.0, is as follows. The computer code is easy and efficient to use on a desktop computer. It is designed so that parameters can be varied easily, which will allow the designer to get a "feel" for the effects of his or her assumptions and such factors as soil properties, shaft diameter, shaft penetration, rebar schedule and similar factors. Steps 1 through 4 are performed prior to employing the computer program, although Step 4 can be performed with the program without assuming nonlinear bending.

- Step 1. Make use of all available information on subsurface conditions and *prepare a soil profile that will give all pertinent information*. The items of data that are needed are: soil classification, position of water table (piezometric surface), unit weight of the geomaterial, undrained shear strength and modulus of clay or rock, and angle of internal friction or  $N_{SPT}$  for sand. Some information on the stress-strain behavior of the geomaterial is also helpful, but it is not mandatory. Recommendations given in Chapter 2 and Appendix A should be followed concerning breaking the site into zones for analysis. Note, however, that the soil resistance values that go into the development of the p-y curves are not factored in present-day LRFD practice, since neither AASHTO nor ACI provides any guidance as to the values that such p-y resistance factors should assume, so that values of undrained shear strength, angle of internal friction and  $N_{SPT}$  should be selected carefully within each zone.
- Step 2. *Tabulate the axial load, shear, and moment* at the shaft head and apply load factors to the most critical combination of head loads or head loads plus distributed loads (stream or soil loads along the upper part of the drilled shaft) to obtain the system of applied loads to be analyzed. It may not always be obvious which case is the most critical (e. g., a high head moment with a low head shear versus a high head shear versus a low head moment), in which case analyses should be performed for all loading cases that potentially can be critical. The nature of the loading should be noted: short-term, sustained, or repeated. Consider the manner in which the shaft head is connected to the superstructure and select a restraint condition (fixed, free, intermediate). Consider whether a scour condition may exist. If so, the analysis should be made for the most extreme position of the soil surface, not the current position of the soil surface.
- Step 3. *Select the shaft diameter, size and placement of the longitudinal reinforcing steel, and strength of concrete*. These are usually based on the preliminary structural analysis (Examples 13.2 and 13.3), and usually using head loads to size the section and establish the rebar schedule. But these parameters can vary along the shaft, for example, if the designer elects to cut off part of the reinforcing steel in the lower part of the cage.
- Step 4. Average the soil properties over the top several (5 to 6) shaft diameters and *use the appropriate equations from the characteristic load method or other approximate method to verify, approximately, the section and steel schedule selected in Step 3*. This step can be skipped of course if such methods were used to estimate the maximum moments and shears in Step 3. If the maximum moment is considerably different from the value used to design the section initially (Step 3), use the procedures given earlier in this chapter (e. g., Example 13.2) to check the steel ratio  $\rho$  and the details of the longitudinal steel, and check and the necessary area and spacing of transverse reinforcement (Examples 13.3

and 13.4). If necessary, revise the section design and repeat until an approximately suitable cross-section has been obtained. This cross-section will be verified in the following steps.

- Step 5. *Enter the data into the program, and instruct the program that it is to compute bending stiffness as a function of bending moment* (Figure 13.18) and to use that relationship in making the calculations. (Otherwise, the program will assume that the EI is constant and use only the initial value that is input.) Also, request that the program produce interaction diagrams for the cross-sections of interest (Figure 13.23) for later checks of the suitability of the design.
- Step 6. *Execute the computer program* (per instructions in the user's guide and/or help screens) to determine the moment and shear diagrams under the factored loads, to find the required penetration (if the penetration is not controlled by axial loading) and to compute the head deflection (and possibly head rotation, if needed for the substructure and superstructure analysis) of the drilled shaft. These outputs might be obtained in two runs, since the load factors for the service limit state are different from those for the strength limit states. However, since the load-movement behavior of a laterally loaded drilled shaft is often highly nonlinear due to soil nonlinearities and section cracking, it may be more appropriate for assessment of the service limit state to use the load factors for the strength limit state and then, if deemed necessary, reduce the computed head deformations by the ratio of the service limit state loads to the strength limit state loads, as a conservative approximation.
- Generally, unit side resistance should be discounted or severely reduced anywhere along the length of the drilled shaft at which the lateral deflection at the strength limit state exceeds about 5 mm (0.2 inches). Since lateral deflection information is obtained only at this step in the design process, it may be necessary to reconsider the penetration and/or diameter of the drilled shaft at this time based on axial resistance criteria (Chapter 11) if large lateral deflections are computed.
- Step 7. *Verify that the steel schedule is satisfactory.* This can be done by comparing the moment and axial load computed on the section for the critical strength limit state against the factored interaction diagram for the section (Figure 13.24). At the same time a check must be made to make sure that the section is safe in shear [Example (13.4)]. For seismic loading it may be necessary to add transverse reinforcement to carry high shear loads. AASHTO (1994), Section 5, should be consulted in such a case.
- Step 8. *Revise the data for the cross section that is being investigated and/or the length*

*of the shaft, if necessary, and repeat Steps 6 and 7.*

- Step 9. *If desired, use the program to perform parametric studies to investigate the influence of the variables, and to learn the amount of rebar that is needed as a function of depth. As a part of this final step, an economic study might be performed to determine if one or more full-scale field loading tests are justified.*

A p-y analysis is illustrated in Example 13.5.

---

**Example 13.5. p-y Method Analysis of a Drilled Shaft**

---

This example continues with the cross section described in Examples 13.2 and 13.3 and arrives at moment, shear and deflection diagrams for a drilled shaft in a specific soil profile with that section all along the length of the shaft.

Example 13.2 showed that the longitudinal steel should consist of 13 35M bars, based on use of the factored loads at the head of the drilled shaft, and that there should be 75 mm (3 inches) of concrete cover over the 35M bars. With the geometry of the section and the material properties [  $f_c = 27,560$  kPa (4,000 psi);  $f_y = 413,400$  kPa (60,000 psi) ], the moment and shear with respect to depth can be computed using p-y method software. Assume that an axial geotechnical strength analysis had determined that the drilled shaft should have a length of 15.25 m (50 feet). The critical set of head loads for the strength limit state will be as indicated in Example 13.2, and the critical loading event will produce 100 cycles of the lateral loading. The soil properties to be used in the analysis are as shown in Figure 13.25.

The procedures presented earlier in this chapter for a p-y analysis can be used to obtain the necessary moment and shear relations, from which the preliminary design of the rebar schedule for the section can be verified or revised.

The results of the p-y method computations using COM624P Version 2.0 are given in Figure 13.25, which uses traditional units, not SI units, with SI conversions given as footnotes. The software is capable of using SI units directly, however. The results show that the groundline deflection was 0.84 inches (21.3 mm), the maximum bending moment was 7965 in-k (900 m-kN) at a depth of 4 feet (1.22 m), and the maximum shear was 60.3 kips (268 kN) at a depth of 13 feet (3.97 m). The bending moment and shear become virtually zero below about 35 feet (10.7 m). The axial load will probably be nearly constant over the zone where the bending moment is relatively large. The lateral deflection is large near the surface because the shaft has cracked above a depth of about 11 feet (3.4 m).

Some considerations are necessary regarding the lateral deflections. First, since the lateral deflection exceeds 5 mm (0.2 inches) above a depth of about 8 feet (2.44 m), side resistance should be neglected to that depth for axial load resistance calculations, instead of to the depth of 5 feet (1.53 m), as would normally be the case for drilled shafts in clay. This may require a

slight increase in penetration of the shaft to attain the necessary axial resistance. Second, since the shaft is cracked near its head, consideration should be given to the long-term durability of the shaft, particularly the reinforcing steel. If the cracked shaft remains for a prolonged period in an aggressive environment, it may be advisable to use epoxy-coated reinforcing steel to resist corrosion if State Specifications permit or to increase the size of the drilled shaft so that cracking does not occur under the critical factored load.

The interaction diagram from COM624P yielded a nominal ultimate moment for the section of 13,100 inch-kips (1480 m-kN) for an axial load of 1725 kips (7676 kN). Plotting both the factored axial load, 7,676 kN (1,725,000 lb), and factored moment, 7965 inch-kips (900 m-kN), acting on the section will give a point inside the dashed line in Figure 13.24, so the preliminary section is acceptable. Had weaker soil been used in the analysis, the moment in the shaft would have been closer to the ultimate moment for this section. The factored shear resistance was found to be 80.22 kips (357 kN) in Example 13.2, so the section does not need any additional shear reinforcement.

The designer can use the curves shown in Figure 13.25 to modify the design of the rebar cage if necessary and desirable. It seems evident that a considerable portion of the longitudinal steel can be reduced below a depth of 20 feet (6.1 m).

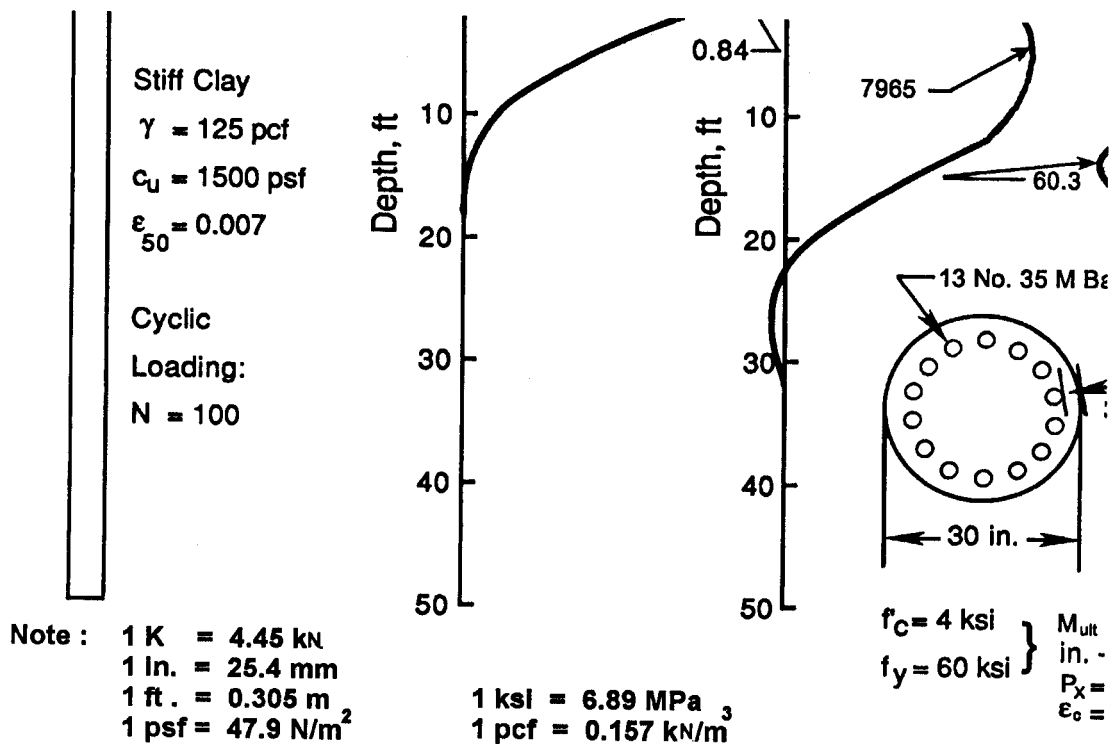

Figure 13.25. Deflection, moment, and shear as a function of depth for Example 13.5

For purposes of additional illustration, another example of the p-y method of analysis is presented. Again, the solution will be executed in customary units, with SI equivalents given in parentheses.

---

---

**Example 13.6. Drilled Shaft Supporting a Bridge Abutment**

The example that is selected is a vertical drilled shaft that will support a bridge abutment. The loading will be derived from earth pressures. It is required to check the moment and lateral deflections in a trial drilled shaft.

*Step 1. Determine Soil Profile to be Analyzed*

The soil at the site is an overconsolidated clay that is relatively homogeneous. The water table is at a depth of 12 feet (3.7 m), but the entire profile is saturated by capillarity. The undrained shear strength of the clay averages 2020 psf (96.8 kPa), and the total unit weight is 119 pcf (18.7 kN/m<sup>3</sup>). The average strain in the soil at one-half of the failure stress in the undrained triaxial compression test is 0.007.

*Step 2. Develop Loading and Shaft-Head Conditions*

The sustained, factored lateral load was determined to be 35 kips (156 kN), the sustained factored axial load is 50 kips (223 kN), and no eccentricity is assumed. The shaft-head is assumed to be free to rotate at the cap.

*Step 3. Select Trial Section and Shaft Penetration for Analysis*

The diameter of the drilled shaft is selected as 30 inches (0.762 m). Estimate a section consisting of 12 No. 8 rebars, and the center of the bars, which are equally spaced, is placed on a 24-inch- (0.61-m-) diameter circle. The yield strength of the steel is 60 ksi (413 MPa), and the compressive strength of the concrete is 4 ksi (27.6 MPa). Try a penetration of 50 feet (15.25 m).

*Step 4. Compute EI Value of the Gross Section*

The EI value of the gross section is computed to be  $1.43 \times 10^{11}$  lb-in<sup>2</sup> ( $4.105 \times 10^5$  kN-m<sup>2</sup>).

*Step 5. Perform Computer Solution*

The gross-section EI value is input into COM624PV2.0 or LPILE<sup>PLUS</sup>, along with the other section, soil and loading parameters in the locations prompted by the program on-screen, and the program is instructed to produce an M-EI relation and interaction diagrams. The ultimate bending moment is computed by the program to be 6,780 inch-kips (766 m-kN) for the value of the applied load specific to this problem, 50 kips (223 kN).

The results of the computer solution are shown in Figure 13.26. As can be seen in Figure 13.26a, a head shear load of 116 kips (516 kN) produced the ultimate moment. At the value of factored lateral and axial loads at the shaft head, the maximum moment along the drilled shaft, which occurs below the shaft head, is about 1,600 inch-kips (180 m-kN). The resistance factor for bending is thus  $1,600 / 6,780 = 0.24$ , which is much less than the value that is required for structural performance, approximately 0.9 (from Figure 13.24). The axial load similarly does not approach the value on the interaction diagram for an applied moment of 1,600 inch-kips (180 m-kN).

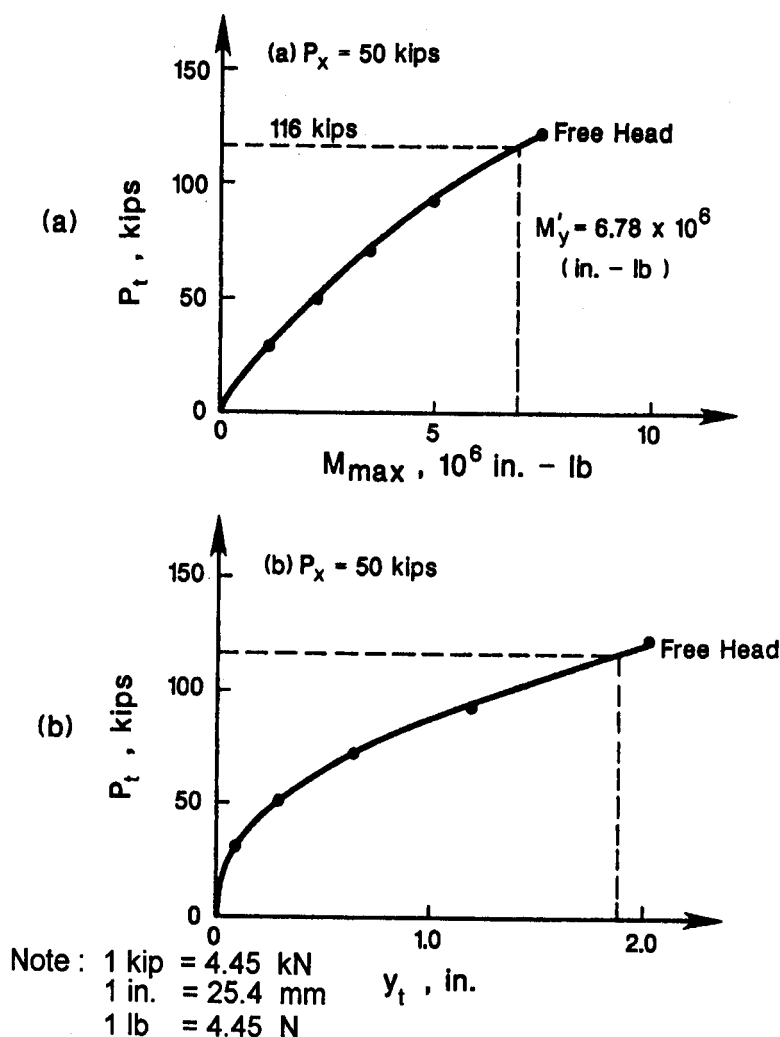

Figure 13.26. Results from computer solutions for Example 13. 6 (after *FHWA IP-84-11*)

Referring to Figure 13.26b, the lateral pile-head deflection at the load of 35 kips (156 kN) was about 0.2 inches (5 mm), a value that should be satisfactory for most bridge abutments. Furthermore, the axial resistance will not have to be reduced. Had the deflection been much larger, axial resistance would have had to be reduced, so the section that was selected is confirmed on the basis of deflection. Had a larger deflection been permitted, a section containing less steel could have been used, since  $\rho$  for the section was 1.33 per cent.

Note that a penetration of 50 feet (15.25 m) was selected for the analysis. The computer program should also be used to investigate the influence of the length of the drilled shaft on the groundline deflection, to study the sensitivity of the solution to the values of the various soil parameters, and to make computations to determine the required amount of steel as a function of depth. Guidance for computations such as these can be found in *FHWA-IP-84-11*.

The use of AASHTO or ACI procedures to check the longitudinal steel and to design the transverse steel is not presented here, but steel checks would follow the procedure described in Examples 13.2 - 13.5.

---

## STRUCTURAL ANALYSIS OF PLAIN-CONCRETE UNDERREAMS

The underreamed drilled shaft has become somewhat less popular in recent years due to research that has shown the effectiveness of straight-sided shafts in carrying axial loads. Also, the construction of an underream, or "bell," is difficult in some soils, and the settlement that is necessary for the underream to mobilize a reasonable value of soil resistance may sometimes be more than can be tolerated by the superstructure. However, there are occasions, such as when a homogeneous stiff clay, hardpan or soft cohesive rock exists at a shallow depth, that the underream can be easily constructed and is the least expensive type of foundation. The shape of a typical underream is shown in Figure 13.27. The construction of such an underream was described in Chapter 3. As noted in that chapter, other shapes are possible depending on the type of tool that is employed. As can be seen by an examination of Figure 13.27, the portion of the bell that extends beyond the shaft will behave somewhat like a short, wedge-shaped cantilever beam. The soil reaction at the base of the cantilever will generate tensile stresses within the underream, with the maximum stress concentrated at the notch angle shown in Figure 13.27. If the underream has a flat bottom, the tensile stresses will have a pattern such as shown in Figure 13.28.

The possibility of the development and propagation of tensile cracks in unreinforced underreams has concerned structural engineers in the past, and these concerns have resulted in generally low allowable contact stresses, even in strong geomaterial.

To provide a rational basis for the establishment of base contact stresses from a structural perspective, Farr (1974) conducted a study of the possible tensile failure of unreinforced underreams by performing model tests in the laboratory and by making computations with the



finite element method, developing relationships for guidance in design. The factors that were considered by Farr were the strength of the concrete, the toe height, the shape of the bottom of the underream, the distribution of bearing stress at the base of the underream, and the underream angle (45 degrees or 60 degrees). Farr stated that the guidelines for design were probably conservative and pointed out that actual field data should be used, if such data were available. With regard to field data, however, it is of interest to note that it may be difficult in a full-scale drilled shaft to control very accurately the critical parameters that are noted above. The notch angle, for example, will almost inevitably be rounded, but there could be an occasional case in strong soil where that angle is almost square.

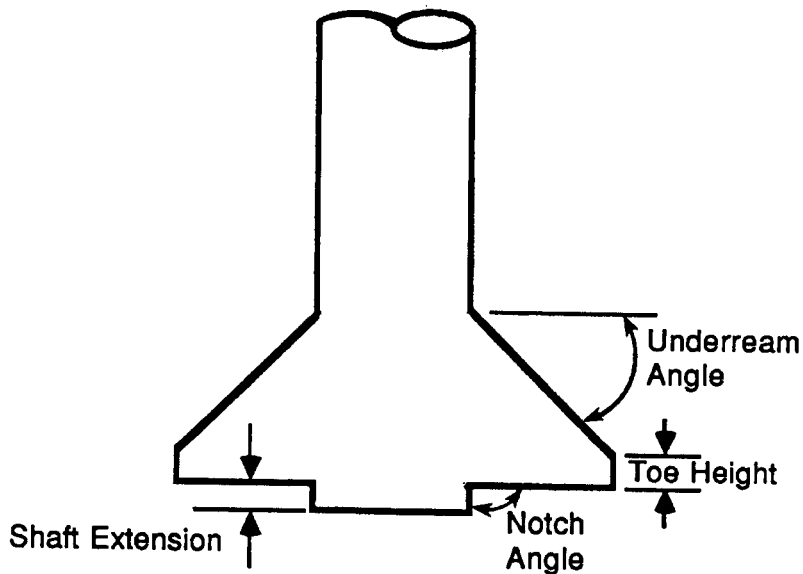

Figure 13.27. Typical underream (after Farr, 1974)

The problem of computing the tensile stresses at the intersection (notch) between the seat for the underreaming tool and the base of the underream, due to stress-concentration effects, is not amenable to simple analysis. The experimental and analytical studies by Farr (1974) were for the most conservative case, underreams without lateral confinement by soil or soft rock. Those studies suggest that as long as the minimum thickness of the perimeter of the bell (toe height) is at least 75 mm (3 inches) and as long as  $f'_c$  is at least 20,670 kPa (3.0 ksi), lower limits of net ultimate bearing pressures will be in the range of 383 kPa (8 ksf) for 45-degree bells and 766 kPa (16 ksf) for 60-degree bells where minor amounts of water are present in the base of the underream at the time of concrete placement.

However, higher bearing resistances appear to be possible if the underream is embedded within a stiff clay or a soft rock. Based upon full-scale field tests on underreams, cut within stiff clay and bearing upon stiff clay or clay-shale, whose diameters were three times the shaft diameters, the maximum average net base bearing pressures given in Table 13.2 were obtained by Sheikh and O'Neill (1988). These values, which are based on the pressures at the onset of cracking, appear to be conservative and appropriate for design.

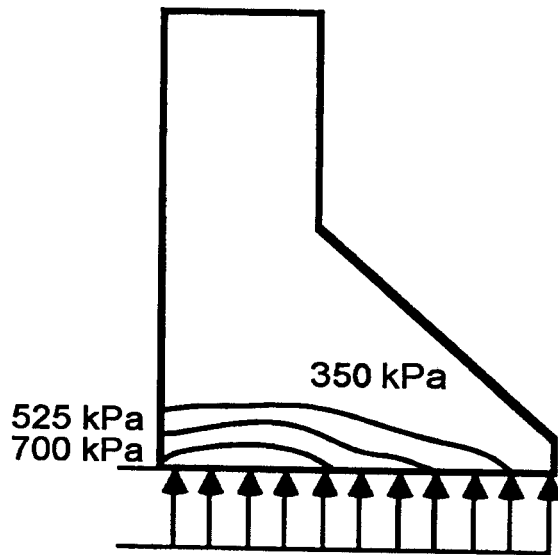

Figure 13.28. Tensile stress contours for flat-bottom bell (after Farr, 1974)

Table 13.2. Values of Maximum Net Bearing Stresses for Unreinforced Concrete Underreams

Conditions:

Concentric axial loading against clay soil or soft clay-based rock

Underream diameter / Shaft diameter = 3

Maximum net bearing stress correlates to the onset of cracking in the notch area

Underream Angle (degrees)	Toe Height (mm)	$f'_c$ (28 days) (kPa)	Net Bearing Pressure at Onset of Cracking (kPa)
45	75	27,560 (4.0 ksi)	719 (15 ksf)
45	75	31,690 (4.6 ksi)	1054 (22 ksf)
60	75	27,560 (4.0 ksi)	1188 (25 ksf)
60	75	31,690 (4.6 ksi)	1250 <sup>e</sup> (26 ksf)

e estimated value based on extrapolation of test data with finite element model

In the experimental studies of Sheikh and O'Neill the concrete was placed without segregation, the notch had a radius of curvature of about 25 mm (1 inch), bell diameters were 2.29 m (7.5 feet), the bearing surfaces were clean, and no water was present in the excavations at the time of concrete placement. Sheikh and O'Neill also measured distributions of stress in axially loaded

underreams in stiff clay and clay-shale that were essentially uniform across the bearing surface at the point in the test at which the pressures in Table 13.2 developed.

Under similar construction conditions, it appears at the present time that no penalty should be assessed for using bells whose shoulders make an angle with the horizontal of 45 degrees, but smaller angles should not be permitted. Where the above conditions are not met, ultimate base pressures should be reduced according to local experience. In some instances, particularly where load testing is performed, it may be possible to increase the maximum net bearing pressures locally because of the particular nature of the local concrete, the underream geometry, and/or the frictional restraint at the bearing surface and lateral support around the underream available in a specific soil or soft rock formation. For example a loading test conducted by the Chicago Committee on High-Rise Buildings (1986) indicated that 60-degree underreams with diameters in the range of 2.38 times the shaft diameter were capable of sustaining average contact pressures exceeding 1675 kPa (35 ksf) in Chicago hardpan before experiencing initial cracking.

It is also possible that the values that are presented in Table 13.2 can be increased through further research into the behavior of underreams following initial crack development. In the meantime, if very high underream bearing pressures are required, hand-placed horizontal reinforcement can be installed at the base of the underream, extending into the outer shoulders, or special concrete mixes can be designed to develop high tensile strength. Hand construction in underreams, however, is costly because of the need to provide proper safety for workers.

The values given in Table 13.2 can be considered nominal ultimate values for structural resistance; however, no corresponding resistance factors or factors of safety have yet been developed for the structural design of underreams. The designer must therefore prudently choose a value for the reduction factor in the LRFD method or a factor of safety in the ASD method.

## RESOURCES

*LPILEPlus 3.0 for Windows* and *GROUP for Windows* can be obtained from Ensoft, Inc., P. O. Box 180348, Austin, Texas 78718; Fax: (512) 467-1384; e-mail [ensoft@bga.com](mailto:ensoft@bga.com).

*FLPIER* can be obtained directly from the Florida Department of Transportation in Tallahassee, Florida, or it can be downloaded into a PC through the world wide web from the following address: [www.dot.state.fl.us/business/structur/proglib.htm](http://www.dot.state.fl.us/business/structur/proglib.htm).

## REFERENCES

AASHTO (1994). *AASHTO LRFD Bridge Design Specifications, SI Units, First Edition*, American Association of State Highway and Transportation Officials, Washington, D. C.

ABAM (I 996). *Seismic Bridge Design Applications*, Manual for Course No. 13063, National Highway Institute, Federal Highway Administration, Arlington, VA.

ACI (1985). "Design Handbook (in accordance with the strength design method of ACI 318)," *ACI Publication No. SP-17*, American Concrete Institute, Detroit, MI.

ACI (1993). *Design and Construction of Drilled Piers*, (ACI 336.3R-93), American Concrete Institute, Detroit, MI.

ACI (1995). *Building Code Requirements for Structural Concrete (ACI 318-95) and Commentary (ACI 318R-95)*, American Concrete Institute, Farmington Hills, MI.

Barker, R. M., Duncan, J. M., Rojiani, K. B., Ooi, P. S. K., Tan, C. K., and Kim, S. G. (1991). "Manuals for the Design of Bridge Foundations," *NCHRP Report 343*, Transportation Research Board, Washington, D. C.

Borden, R. M., and Gabr, M. A. (1987). "Analysis of Compact Pole-Type Footings, LTBASE: Computer Program for Laterally Loaded Pier Analysis," *Report No. FHWA/NC/87-001*, Department of Civil Engineering, North Carolina State University, Raleigh, NC.

Briaud, J.-L. (1997). "SALLOP: Simple Approach for Lateral Loads on Piles," *Journal of Geotechnical and Geoenvironmental Engineering*, Vol. 123, No. 10, October, pp. 956-964.

Broms, B. B. (1964a). "Lateral Resistance of Piles in Cohesive Soils," *Journal of the Soil Mechanics and Foundations Division*, ASCE, Vol. 90, No. SM2, March, pp. 27 - 63.

Broms, B. B. (1964b). "Lateral Resistance of Piles in Cohesionless Soils," *Journal of the Soil Mechanics and Foundations Division*, ASCE, Vol. 90, No. SM3, May, pp. 123 - 156.

Broms, B. B. (1965). Design of Laterally Loaded Piles," *Journal of the Soil Mechanics and Foundations Division*, ASCE., Vol. 91, No. SM3, May, pp. 79 - 99.

Brown, D. A., and Shie, C-F (1991). "Modification of p-y Curves to Account for Group Effects on Laterally Loaded Piles," *Geotechnical Special Publication No. 27*, Ed. by F. G. McLean, D. A. Campbell, and D. W. Harris, ASCE, Vol. 1, pp. 479 - 490.

Brown, D. A., Reese, L. C., and O'Neill, M. W. (1987). Behavior of Large-Scale Pile Group Subjected to Cyclic Lateral Loading, *Journal of Geotechnical Engineering*, Vol. 113, No. 11, November, pp. 1326 - 1343.

Chen, L. T. (1994). *Effect of Lateral Soil Movements on Pile Foundations*, Ph.D. thesis, Department of Civil Engineering, University of Sydney, Sydney, Australia.

Chen, L. T., and Poulos, H. G. (1997). "Piles Subjected to Lateral Soil Movements," *Journal of Geotechnical and Geoenvironmental Engineering*, ASCE, Vol. 123, No. 9, pp. 802 - 811.

- Chicago Committee on High-Rise Buildings (1986). "Full-Scale Load Test on Caisson Foundation," *Report No. 10*, October, Chicago Committee on High-Rise Buildings, Chicago, IL.
- Cox, W. R., Reese, L. C., and Grubbs, B. R. (1974). "Field Testing of Laterally Loaded Piles in Sand," in *Proceedings*, Sixth Offshore Technology Conference, Dallas, Texas, Paper No. 2079.
- Davisson, M. T. (1970). "Lateral Load Capacity of Piles," *Highway Research Record No. 333*, Highway Research Board, Washington, D. C., pp. 104 - 112.
- Duncan, J. M., Evans, L. T., Jr., and Ooi, P. S. K. (1994). "Lateral Load Analysis of Single Piles and Drilled Shafts," *Journal of Geotechnical Engineering*, ASCE, Vol. 120, No. 6, June, pp. 1018 - 1033.
- Ensoft, Inc. (1997). *GROUP for Windows*, Ensoft, Inc., Austin, Texas.
- Farr, J. S. (1974). "Study of the Load Capacity of Plain Concrete Underreams for Drilled Shafts," Master's Thesis, Department of Civil Engineering, The University of Texas at Austin, Austin, Texas, May.
- Ferguson, P. M. (1988). *Reinforced Concrete Fundamentals*, Fourth Edition, John Wiley and Sons, New York.
- Florida Department of Transportation (1997). *User's Manual for Florida-Pier Program, Version 7.0*, Florida Department of Transportation, Tallahassee, Florida.
- Focht, J. A., Jr., and Koch, K. J. (1973). "Rational Analysis of the Lateral Performance of Offshore Pile Groups," in *Proceedings*, Fifth Offshore Technology Conference, Vol. 2, Dallas, Texas, pp. 701 - 708.
- Geospectra (1997). *Design Manual. Foundation Stiffness Under Seismic Loading*, Washington State Department of Transportation, Olympia, WA, June.
- Hetenyi, M. (1946). *Beams on Elastic Foundations*, University of Michigan Press, Ann Arbor.
- Hibbett, Karlsson and Sorensen, Inc. (1996). *ABAQUS Theory Manual*, HKS, Pawtucket, RI.
- Hoit, M., Hays, C., and McVay, M. (1997). "The Florida Pier Analysis Program: Methods and Models for Pier Analysis and Design," *Transportation Research Record No. 1569*, Transportation Research Board, Washington, D. C., pp. 1 - 7.
- Kulhawy, F. H., and Chen, Y.-J. (1995). "A Thirty Year Perspective of Broms' Lateral Loading Models, as Applied to Drilled Shafts," in *Proceedings*, Bengt B. Broms Symposium on

Geotechnical Engineering, Nanyang Technological University, Singapore, December.

Lam, I. P., and Chaudhuri, D. (1997). "Modeling of Drilled Shafts for Seismic Design," NCEER Report for Task No. II 2-D-3.5, National Center for Earthquake Engineering Research, State University of New York - Buffalo, December.

Matlock, H. (1970). "Correlation for Design of Laterally Loaded Piles in Soft Clay," in *Proceedings*, Second Offshore Technology Conference, Dallas, Texas, pp. 577 - 594.

Matlock, H., and Reese, L. C. (1961). "Foundation Analysis of Offshore Pile-Supported Structures," in *Proceedings*, Fifth International Conference on Soil Mechanics and Foundation Engineering, Vol. 2, Dunod, Paris, pp. 91-97.

Mayne, P. W., and Kulhawy, F. H. (1991). "Load-Displacement Behavior of Laterally Loaded Rigid Drilled Shafts in Clay," in *Proceedings*, 4th International DFI Conference, Balkema, Rotterdam, pp. 409 - 413.

Murchison, J. M., and O'Neill, M. W. (1984). "Evaluation of p-y Relationships in Cohesionless Soils," in *Analysis and Design of Pile Foundations*, Ed. by J. R. Meyer, ASCE, pp. 174 - 191.

O'Neill, M. W., Ghazzaly, O. I., and Ha, H.-B. (1977). "Analysis of Three-Dimensional Pile Groups with Non-Linear Soil Response and Pile-Soil-Pile Interaction," in *Proceedings*, Ninth Offshore Technology Conference, Vol. 1, Dallas, Texas, pp. 245 - 256.

Ochoa, M., and O'Neill, M. W. (1989). "Lateral Pile Interaction Factors in Submerged Sand," *Journal of Geotechnical Engineering*, ASCE, Vol. 115, No. 3, March, pp. 359 - 378.

Ooi, P. K. S., and Duncan, J. M. (1994). "Lateral Load Analysis of Groups of Piles and Drilled Shafts," *Journal of Geotechnical Engineering*, ASCE, Vol. 120, No. 6, June, pp. 1034 - 1050.

Pinto, P., McVay, M., Hoit, M., and Lai, P. (1997). "Centrifuge Testing of Plumb and Battered Pile Groups in Sand," *Transportation Research Record No. 1569*, Transportation Research Board, Washington, D. C., pp. 8 - 16.

Poulos, H. G., and Davis, E. H. (1980). *Pile Foundation Analysis and Design*, John Wiley and Sons, New York.

Randolph, M. F., and Poulos, H. G. (1982). "Estimating the Flexibility of Offshore Pile Groups," in *Proceedings*, Second International Conference on Numerical Methods in Offshore Piling, ICE and University of Texas, Austin, Texas, pp. 313 - 328.

Reese, L. C., Wright, S. G., Wang, S. T., Walsh, M. A., and Mims, J. O., Herbig, R. R., and Franke, R. M. (1987). "Analysis of Drilled Shafts in a Deep Fill," Unpublished Report,

Department of Civil Engineering, The University of Texas at Austin, Austin, Texas.

Reese, L. C., Cox, W. R., and Koop, F. D. (1975). "Field Testing and Analysis of Laterally Loaded Piles in Stiff Clay," in *Proceedings, Seventh Offshore Technology Conference*, Vol. 2, Dallas, Texas, pp. 672-690.

Reese, L. C. (1997). "Analysis of Laterally-Loaded Piles in Weak Rock," *Journal of Geotechnical and Geoenvironmental Engineering*, ASCE, Vol. 123, No. 11, November.

Reese, L. C., Isenhower, W. M., and Wang, S-T (1998). "Development in the Analysis of Horizontal Capacity of Bored Piles," in *Proceedings, Third International Geotechnical Seminar on Deep Foundations on Bored and Auger Piles*, Ed. By W. F. Van Impe, Balkema, Rotterdam, pp. 23 - 24.

Sheikh, S. A., and O'Neill, M. W. (1988). "Structural Behavior of 45-Degree Underreamed Footings," *Transportation Research Record No. 1119*, Transportation Research Board, Washington, D. C., pp. 83 - 91.

Wang, C., and Salmon, C. G. (1985). *Reinforced Concrete Design*, Fourth Edition, Harper and Row, New York.

Welch, R. C. and Reese, L. C. (1972). "Lateral Load Behavior of Drilled Shafts," *Research Report No. 89-10*, Center for Highway Research, The University of Texas at Austin, Austin, Texas.

## CHAPTER 14: FIELD LOADING TESTS

### PURPOSE OF LOADING TESTS

The load-movement behavior of drilled shafts is highly dependent upon the details of local geology and upon the construction procedure followed by the drilled shaft contractor. This makes it difficult to predict both ultimate resistance and load-deformation behavior accurately from standardized design methods such as those given in this manual. Loading tests of drilled shafts are therefore very desirable when it is feasible to perform them. Note that the AASHTO LRFD method for axial design allows the use of a larger resistance factor when loading tests are performed at the project site.

Loading tests are performed for two general reasons:

- to prove that the test shaft is capable of sustaining an axial load (or, sometimes, a lateral load) of a given magnitude ("proof test"), and
- to gain detailed information on load transfer in side and base resistance, or lateral performance, to allow for an improved design ("load transfer test").

In the first instance the drilled shaft is constructed in the same manner as the production shafts, usually under the construction contract. The test shaft must sustain a load that is customarily at least twice the working load without excessive settlement. In an LRFD context the maximum combination of nominal applied loads can be considered equivalent to the working load. If the loading test produces satisfactory results, the production shafts can then be constructed as designed. If not, new test shafts are installed and load-tested to prove the design load.

Ordinarily, the new test shaft or shafts would be of the same diameter as, but deeper than, the test shaft(s) that did not pass the test. This is to preserve the design of the steel and, if some cages have already been assembled, to preclude the need for refabrication. Normally, the lengthened cage can be made by splicing to the bottom of the cage that is already assembled. If the second test is satisfactory, the final design can be fixed. However, the ultimate resistance of the test shaft would remain unknown, along with any knowledge of the level of safety of the production shafts.

A load transfer test involves the instrumentation of the test shaft by one of the means described below and usually involves loading the drilled shaft to failure by an appropriate definition. The instrumentation allows the internal load in the test shaft to be ascertained so that the distribution of the axial load with depth can be determined with reasonable accuracy. Such data will allow analyses to be made to obtain the load transfer in side resistance and in base resistance as functions of the relative movement of the shaft with respect to the supporting soil or rock. Such data can then be used to design the production shafts with more confidence than would otherwise be possible and thereby allow for a reduced safety factor or an increased resistance factor. This feature of course makes it desirable that load transfer tests be conducted during the design phase of the project, usually under a special contract. An additional advantage of the load transfer test



is that the data acquired can be fed back into the procedure being used to design drilled shafts locally so that the procedure can be continuously improved in applications for future designs.

Similarly, when the drilled shaft is to be subjected to lateral load testing, measurement of either the deflected shape of the drilled shaft or the distribution of bending moment with depth will provide important information on the soil or rock resistance as well as the structural performance of the drilled shaft itself. This type of test can be also considered a load transfer test.

It is highly recommended that load transfer tests be conducted whenever possible.

## **AXIAL LOADING TESTS**

### **Considerations in Sizing, Locating and Constructing the Test Shaft**

**General.** It is critical that the test shaft(s) be founded in the same formation(s) as the production shafts for the project and that the construction procedures that are expected to be used with the production shafts also be used with the test shafts.

A consideration in conducting a loading test of a drilled shaft is to apply enough load to satisfy the requirement of the proof test or to cause the shaft to fail, as is desired in a load transfer test of an instrumented drilled shaft. Drilled shafts are often designed to replace groups of other types of deep foundations, and the capacity of a single drilled shaft consequently is usually large compared to that of driven or augered-cast-in-place piles. Loading tests, therefore, are usually required to be performed at high magnitudes of loads relative to the loads that are applied in testing other foundation elements.

**Definition of Failure.** Failure of a drilled shaft during a loading test is defined here as either

- "plunging" of the drilled shaft [steady increase in movement, either downward or upward, depending upon whether the test is a compression test or an uplift test, under extremely small increments of load, e.g., 8.9 kN (1 ton)], or
- a gross settlement, uplift or lateral deflection (for a lateral loading test) of five per cent of the diameter of the drilled shaft if plunging cannot be achieved in an axial loading test.

If the drilled shaft is underreamed, axial loading should proceed until the settlement or uplift is at least five per cent of the diameter of the base if plunging is not observed. The designer of the field loading test program needs to select the dimensions of the test shafts and the details of the loading system to satisfy the above requirements. If local experience is not available, the procedures given in this manual may be used to size the test shafts.

**Testing of Shafts Smaller in Diameter than Production Shafts.** The engineer may be tempted to determine values of unit shaft and base resistance from tests on small-diameter drilled

shafts (microshafts or micropiles) to reduce the cost of loading tests. A formal method for doing this is described by Lizzi (1983). There is good evidence, however, that the unit ultimate resistances developed by a micropile are much higher than those developed by a full-sized drilled shaft (O'Neill et al. 1996), particularly in rock, so that values of unit shaft and base resistance determined from tests on shafts with diameters that are much smaller than those of the production shafts can be unconservative. Recent practice in the United States has been to size test shafts in rock so that they will have approximately the same diameter and depth and be constructed in a manner similar to the proposed production shafts. In soil, scaling of the diameter has a smaller effect, but test shafts should not have diameters less than one-half that of prototypes nor should they be less than 0.76 m (30 in.) in diameter unless the prototype diameters are less than 0.76 m (30 in.).

**Determining the Shape of the Test Shaft.** It is also desirable to obtain a log of the shape of the drilled shaft to be load tested, especially for shafts that are socketed into rock and for shafts constructed under drilling slurry, where the conditions of the shaft excavation cannot be observed visually. Large projections on the side of the shaft or very rough or very smooth interfaces should be noted and used to interpret the loading test results with respect to the expected behavior of prototype shafts. For example, a loading test of a drilled shaft in rock with several large projections could yield higher side resistances than the designer would expect in the average production shaft, which may not have as many such projections, and the resistance measured in the test shaft would probably need to be reduced before comparing it with the expected resistance in production shafts. There might also be situations in which the contractor is required to "groove" or "rifle" the sides of the drilled shaft, and a log of this type provides the only feasible way to verify the construction process when the wet method is used.

Logs of the shapes of test shafts can be obtained by contracting with specialty companies who routinely perform such services with electronic calipers (usually, oil field service companies) or by constructing simple down-hole calipers for the purpose. Names of companies that perform borehole caliper services can be obtained by consulting ADSC: The International Association of Foundation Drilling, 9696 Skillman St., Suite 280, Dallas, Texas 75243, (214) 343-2091.

An example of an electronic caliper log between a depth of 50 feet (15.3 m) (bottom of cased overburden) to a depth of 175 feet (53.4 m) (bottom of borehole) in mixed dolostone and sandstone in Minnesota is shown in Figure 14.1. [Only a small socket at the bottom of the borehole is to be tested in this case, by use of an Osterberg cell, described later.] This log shows that the borehole is very rough for the first 30 feet (10 m) below the casing but that it is generally smooth in the region where the test socket will be poured. A log such as this will confirm that the test socket should produce results that are likely typical of those of production shafts in this depth region that do not have protrusions.

Obtaining caliper logs is less important for test shafts in soil, where protrusions have less effect on load transfer, but they can nonetheless be helpful in determining the relation of average diameter with depth, which helps to make the reduction of load distribution data to unit side and

base resistances more accurate.

**Order of Construction of Anchor, Technique and Test Shafts.** The test shaft should not be the first shaft constructed at the site by the contractor. If a conventional reaction frame - reaction shaft loading system will be used, the contractor should install the reaction shafts first to gain experience in constructing drilled shafts at the site and to demonstrate to the engineer that he or she has the proper equipment and personnel available. If a test not requiring reaction anchors, such as an Osterberg or Statnamic<sup>®</sup> test, is to be conducted, it is recommended that the contractor construct a separate "technique" shaft for the same purpose prior to constructing the test shaft. The technique shaft would not normally be load-tested.

**Maintaining Overburden Stresses.** There are also occasionally situations in which loading tests, particularly load transfer tests that are scheduled to be performed in the design phase of a project, are to be conducted at a site where considerable soil or rock will be excavated before the drilled shaft goes into service or where considerable scour may occur before the design condition is reached. In these situations, engineers will sometimes load test the drilled shaft in such a way that it is cased inside a large sleeve placed through the geomaterial that will be removed to prevent contact between the upper part of the drilled shaft and the overlying soil or rock that is of no interest for design purposes. The remaining part of the shaft, below the sleeve, duplicates the prototype shaft. In interpreting such tests the engineer must realize that the effective stresses in the soil or rock being tested (surrounding the drilled shaft below the sleeve) will be greater with the sleeve arrangement than they will be during the design condition, in which the overburden soil is absent. As a result, the soil or rock will also be stronger during the loading test than it will be when the drilled shaft is in service. The differences in ground stress conditions might be factored into the interpreted results analytically through a scaling process (e. g., O'Neill and Person, 1998), or the engineer might choose either to move the test to a nearby site in the same formation, where the overburden can be excavated prior to testing the drilled shaft, or to conduct the test at the location on the alignment of the project after the excavation has been made. In the latter case the design would be completed only after the construction contract is let.

**Borings at the Immediate Testing Site.** Whether the loading test is conducted directly along the alignment of the project or at a nearby special site, it is important that soil/rock borings be taken within a few meters [less than 3 m (10 feet), if possible] of the test shaft, so that the characteristics of the soil at the test site can be compared with similar characteristics (e. g., SPT N values or undrained shear strength values) at the prototype shaft locations within the project boundaries in the same geologic formation. It is advisable to perform more than one loading test on a project, if possible, in order to obtain a sense of consistency in the behavior of the drilled shafts. Consistency of resistance and settlement should have an impact on the choice of the final resistance factor or factor of safety. If multiple geologic formations exist on the site, careful consideration should be given to conducting loading tests within each formation.

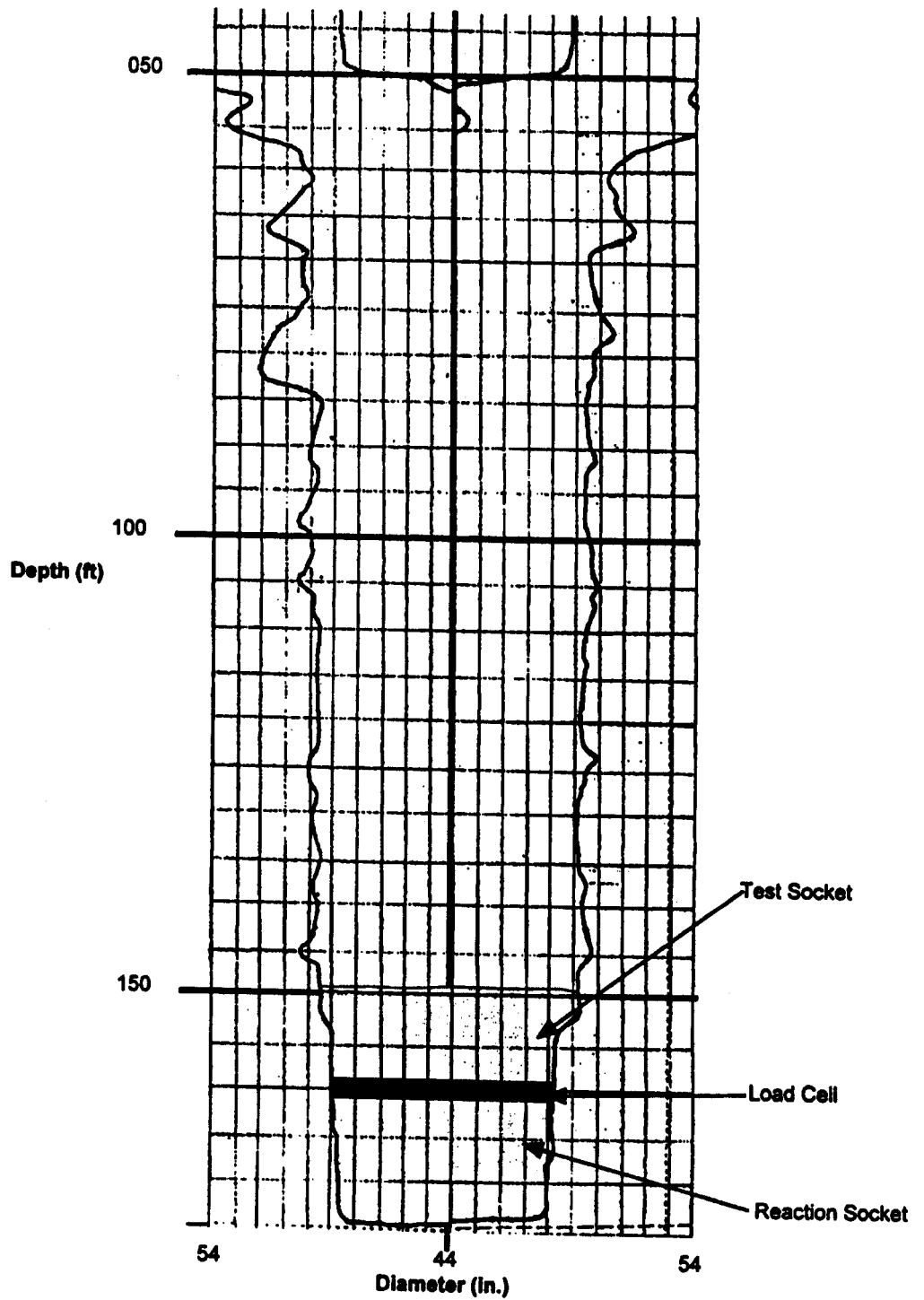

Note: 1 in. = 25.4 mm  
 1 ft = 0.305 m

Figure 14.1. Caliper log for deep drilled shaft in rock

**Considerations for Groups of Production Shafts.** Finally, if the production shafts are to be installed in groups, it should be recognized that their behavior will be different from that of the test shaft, if the test shaft is tested as an isolated, single shaft. Corrections to the measured behavior of a single test shaft should be made following the principles covered in Appendices B and C for axial loading and Chapter 13 for lateral loading. Occasionally, tests on groups of drilled shafts are justified. Testing of drilled shaft and pile groups is covered by the specifications of the American Society for Testing and Materials [ASTM D-1143 (axial loading) and ASTM D-3966 (lateral loading)] (ASTM, 1995).

### **Methods of Applying Compressive Loads**

Until recently, the only feasible way of conducting a compressive loading test on a drilled shaft was the conventional method, in which a jack (ram) was placed on the head of the shaft and thrust the test shaft into the ground by pushing against a reaction frame secured to the ground by some type of reaction anchors. The reaction frame and reaction anchors are ordinarily quite significant structures. Recently, two attractive alternative methods for conducting drilled shaft loading tests have emerged that do not require expensive reaction systems. These are the Osterberg cell testing method and the Statnamic® testing method. All three methods are described briefly in the following.

#### **Conventional Loading Test Arrangements**

Because full-scale drilled shafts often have very high capacities, a test load of high magnitude will be required. At the present time, many drilled shaft contractors have access to portable reaction frames and jacking systems capable of imposing loads on a test shaft of 11.1 MN (1,250 tons) or more. Conventional loading tests of drilled shafts are being conducted regularly upon shafts with capacities up to this value.

**Reaction Shafts.** The arrangement used most frequently for the conventional loading of a test shaft is shown in Figure 14.2. The load is applied by a hydraulic ram that reacts against a pair of reaction beams (sometimes two or four rams in parallel are used if the capacity of a single available ram is insufficient). The beams transfer the load to reaction shafts that are designed to sustain uplift loading. Load beams with substantial capacity are usually required. Two reaction shafts, as shown in the figure, are installed in most cases, but two sets of load beams, perpendicular to each other, can be used, in which case four reaction shafts are needed. Other arrangements are also possible.

A favorable situation sometimes exists so that the reaction shafts, and possibly the test shaft itself, can be used as part of the foundation for the bridge or other structure that will be designed. In such a case, the behavior of the reaction shafts under the uplift loading is carefully monitored.

**Deep Reaction Shafts or Load Platform.** Stresses are transferred from reaction shafts through the soil, and such stresses can influence the behavior of a test shaft or test pile (e. g., Latotzke et al., 1997). Therefore, the reaction shafts must be located well away from the test shaft to minimize this effect. The specifications of the American Society for Testing and Materials for piling, ASTM D-1143, require that a clear distance of at least five times the maximum of the diameters of the anchor or test pile must exist between a test pile and each reaction anchor (ASTM, 1995). The authors experience is that 3.5 diameters center-to-center spacing between each reaction shaft and the test shaft is adequate to minimize anchor shaft / test shaft interaction for loading tests of drilled shafts of large diameter in cohesive soils or rocks (e. g., O'Neill and Reese, 1970). In any event, the reaction beams must be long and strong.

An alternative would be to construct reaction shafts that develop their uplift capacity in a stratum far below the base of the test shaft and to destroy bond between the anchor shafts and the soil to a depth well below the level of the base of the test shaft. In such a case, reaction shafts can be as close to the test shaft as is feasible, keeping in mind that construction disturbance of the soil around the test shaft should be avoided.

The problem of the reaction beams and the construction of reaction shafts can be eliminated by the building of a platform over the test shaft and the placing of enough dead weight on the platform to carry the desired reaction from the loading ram. However, a load platform is seldom used because of the expense and difficulty of providing and placing enough dead weight. The load platform could be feasible if high density material, such as steel or lead ingots, is readily available, and the capacity of the test shaft is not high.

**High-Strength Anchors.** Another method of providing the reaction for the load against a test shaft is to install high-strength anchors on a batter. The angle and length of the anchors should be such that the load-transfer zone of the anchors is well away from the test shaft (usually in a rock formation below the base of a test shaft that terminates above the rock). The heads of the anchor rods or cables should come together above the test shaft and engage a loading head.

If anchors are used, computations must be made to estimate the stretch of the anchor rods or cables to ensure that the hydraulic ram has sufficient travel.

While high-strength anchors are used infrequently for providing the reaction for a load test, there may be occasions when the system is preferable to any other.

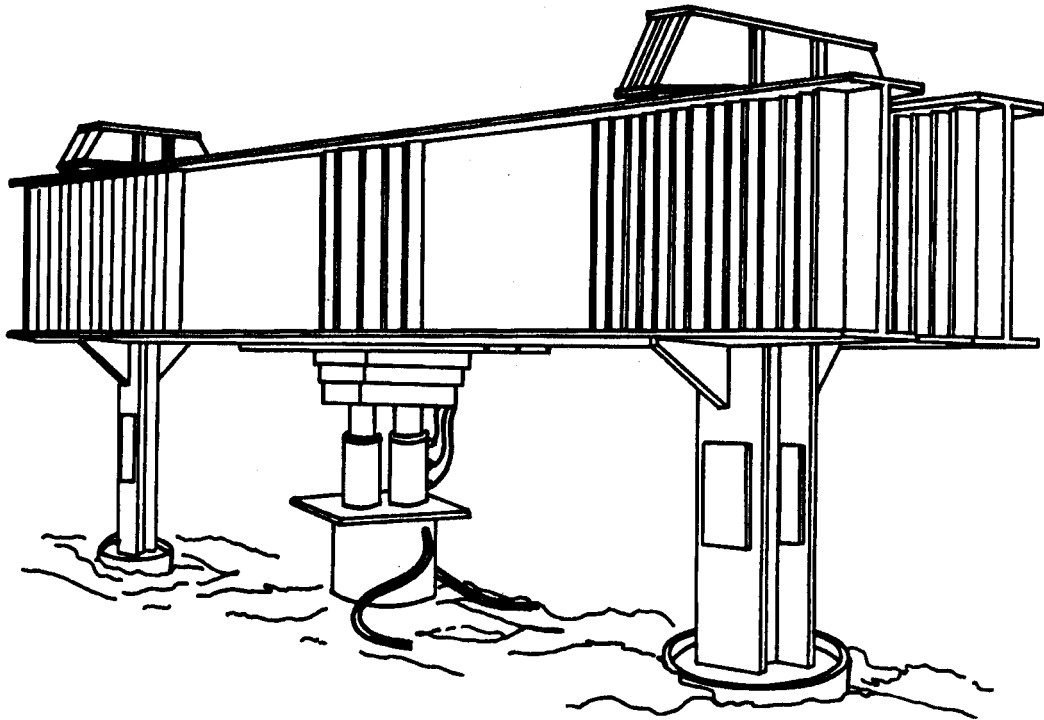

Figure 14.2. Arrangement for testing a drilled shaft conventionally under axial compressive loading

### **Osterberg Cell Testing Arrangement**

Instead of using a conventional jack, reaction frame and reaction anchor system, the axial loading test can be performed by applying the load with an expendable jack and load cell cast within the test shaft. This jack - load cell is called an Osterberg cell after its inventor, Jorj Osterberg. A schematic and a photograph of an Osterberg cell loading system are shown in Figure 14.3.

The principle of operation is very simple. The Osterberg cell consists essentially of two plates (pistons) of a prescribed diameter between which there is an expandable chamber that can hold pressurized fluid (usually oil or water). The upper and lower plates on the cell can in turn be field welded to steel plates of larger diameter, usually at least 50 mm (2 inches) thick, whose diameters are approximately equal to that of the test shaft. The chamber is pressurized by pumping from a reservoir on the ground surface. The unique feature of this device is that the pistons being pressurized have standard diameters that are approximately the full diameter of the cell, which may be up to 0.81 m (32 inches). Therefore, the pressurized fluid is acting on a very large area, unlike a conventional ram, in which the area of the piston is usually small. This

characteristic allows the Osterberg cell to apply very large loads with relatively low hydraulic pressures. Standard models with a diameter of 0.81 m (32 inches) are capable of applying loads of up to 26.7 MN (3000 tons). Smaller sizes (and consequently smaller capacities) are also available from the supplier.

The load being applied to the drilled shaft is usually monitored by measuring the pressure in the fluid being applied by the pump. The Osterberg cell will therefore need to be calibrated in a testing machine prior to installation to obtain a relation between the measured pressure and the load applied by the cell. Ordinarily, a calibration is provided by the supplier. Note that in practice the hydraulic pressure will usually be measured at the ground surface, but the cell is situated at some distance below the ground surface [about 48.8 m (160 feet) in Figure 14.1]. Therefore, the actual pressure at the level of the cell is the pressure that is measured plus the vertical distance from the pressure gauge to the middle of the cell times the unit weight of the fluid. This correction needs to be made before plotting load versus movement. Movement can be measured at the top of the cell through telltales (sleeved, unstrained rods attached to the top of the cell) that are monitored by movement sensors (e. g., dial gauges) suspended from stable reference beams on the ground surface. Similarly, movement can be measured at the top of the test shaft by means of movement sensors suspended from stable reference beams, and movement of the bottom plate can be measured by measuring the movement of the top of the Osterberg cell with telltales and then measuring the relative movement between the upper and lower ends of the cell by means of sacrificial electronic movement sensors attached between the top and bottom plates.

In Figure 14.3 the Osterberg cell is placed on the bottom of the drilled shaft excavation, so that when it is activated it applies load equally to the drilled shaft above the cell (in an upward direction) and to the geomaterial at the base of the borehole (in a downward direction). Therefore, the side resistance and the base resistance are equal. With such an arrangement it is possible to obtain relations of side resistance versus side movement and base resistance versus base movement until either the base or sides fail, as illustrated in Figure 14.4. That figure illustrates a proof-type loading test on a rock socket in granite.

It is rare that both the ultimate side and base resistances can be obtained with this arrangement. If it is desired only to measure the ultimate side resistance, the arrangement in Figure 14.1 can be used. Here, the cell is not placed on the bottom of the excavation, but is placed at the top of a socket (in this case about 4.6 m (15 feet) long). The socket below the cell serves to increase the available reaction below the cell and ensures, if designed properly, that failure will occur in the test socket above the cell in side resistance rather than in combined base and side resistance in the "reaction" socket below the cell. In the case in Figure 14.1 the test socket extended above the Osterberg cell only about 3 m (10 feet), because the intent of the test was to ascertain a design value for unit shaft resistance in a specific unit of the geologic formation. Often, however, the portion of the test shaft above the Osterberg cell will extend all the way to the ground surface.

Numerous other configurations are possible. One, shown in Figure 14.5, allows for testing the



drilled shaft in a manner such that the full side resistance and base resistance are both measured. This requires that two cells be placed, one at each of two different levels. Note that up to 80 MN (9000 tons) of combined side and base resistance can be mobilized with the arrangement shown in Figure 14.5 [26.7 MN (3000 tons) on each segment of the shaft in side resistance plus 26.7 MN (3000 tons) of base resistance]. This is obviously far more capacity than can be tested with a conventional system with any degree of economy. In fact, use of clusters of smaller Osterberg cells at multiple levels have made it possible to mobilize up to 134 MN (15,000 tons) of combined base and shaft resistance.

One important consideration in applying the results of loading tests that use Osterberg cells is that the load is being applied to the shaft in compression by pushing the shaft upwards (except for the lower segment in Figure 14.5). This is clearly a different mode of loading than is applied in service, and several physical effects, most importantly the Poisson's effect in rock sockets, will be different in the test from those in the production shafts. McVay et al. (1994) have shown through analytical modeling that the unit ultimate side load transfer in rock (specifically, typical Florida limestone) is higher just above the Osterberg cell than would occur if conventional surface compressive loading had been applied. This effect is illustrated in Figure 14.6. It appears that, if the value of unit load transfer that is obtained within about 0.5 times the diameter of the test shaft is disregarded and the average value for the remainder of the test shaft is retained, the side resistance will be approximately the same as for a test shaft loaded conventionally in compression from the surface. This observation strongly suggests that it is important to instrument the test shaft for axial load distribution when using an Osterberg cell to apply the test load.

Further descriptions of the Osterberg cell can be obtained from Osterberg (1992). The cost of a single Osterberg cell test, including the Osterberg cell itself, instrumentation and shaft construction, is often in the range of 50 to 60 per cent of the cost of performing a conventional loading test for situations in which conventional loading tests can be used (shafts of small capacity), although the percentage varies considerably from site to site.

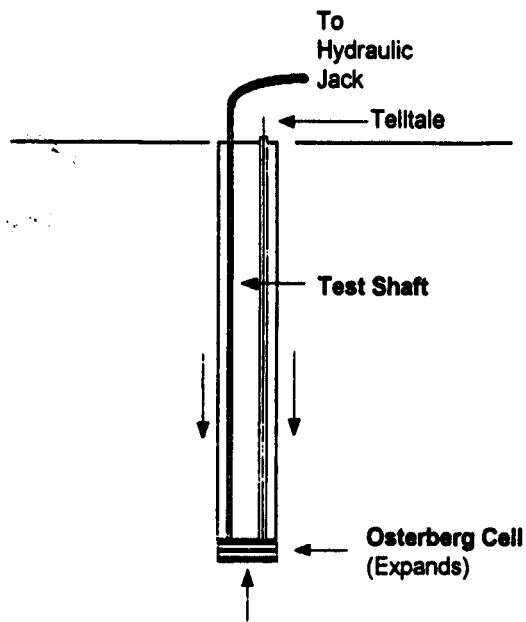

(a) Schematic of Osterberg cell test

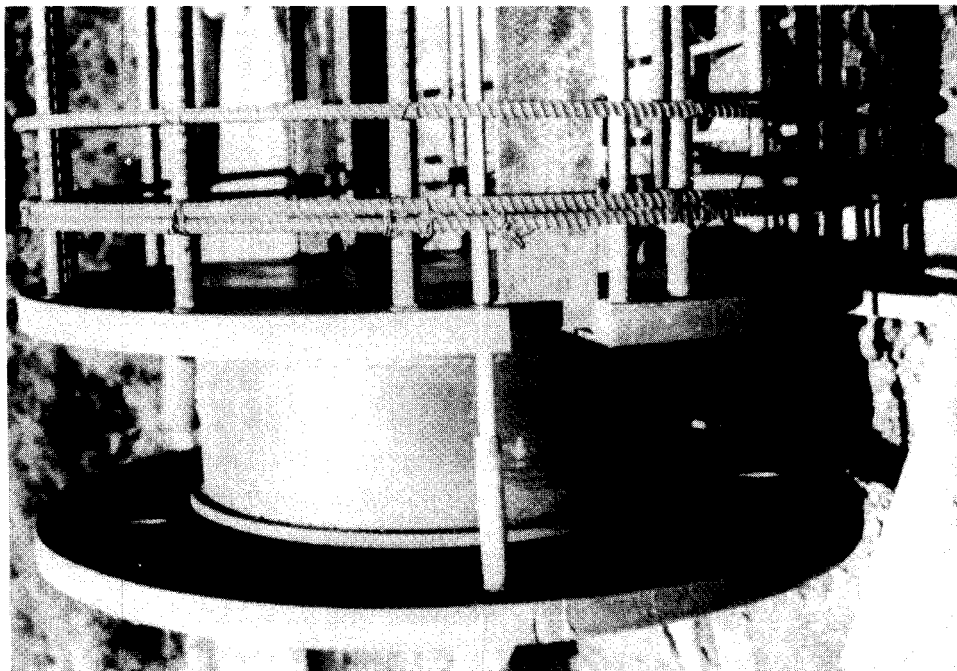

(b) Photograph of Osterberg cell

Figure 14.3. Osterberg cell loading system

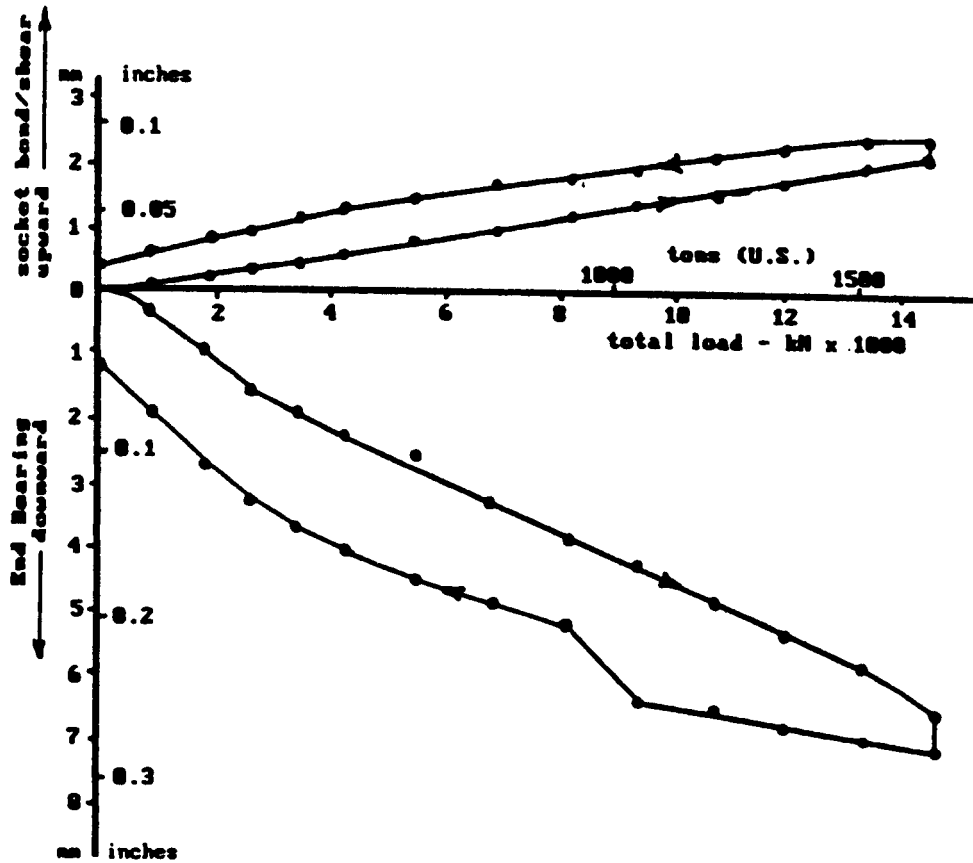

Figure 14.4. Side and base load-movement results from an Osterberg cell test on a rock socket in granite (Osterberg, 1994)

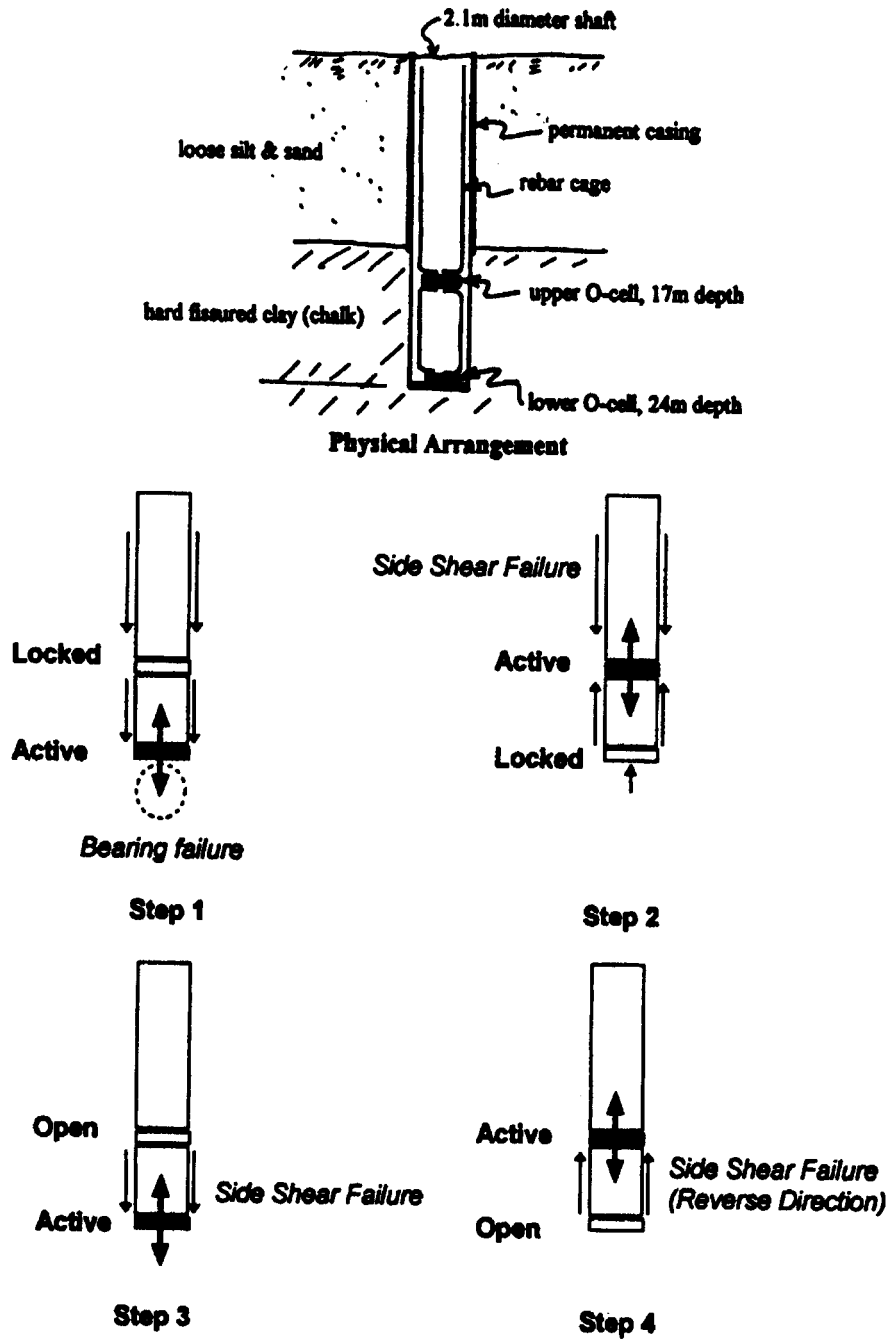

Figure 14.5. Comparison of mobilized side shear stress along a drilled shaft in Florida limestone for both Osterberg cell (OC) and conventional surface loading at the load corresponding to side shear failure in the OC test from finite element analysis (from O'Neill et al., 1997, after McVay et al., 1994)

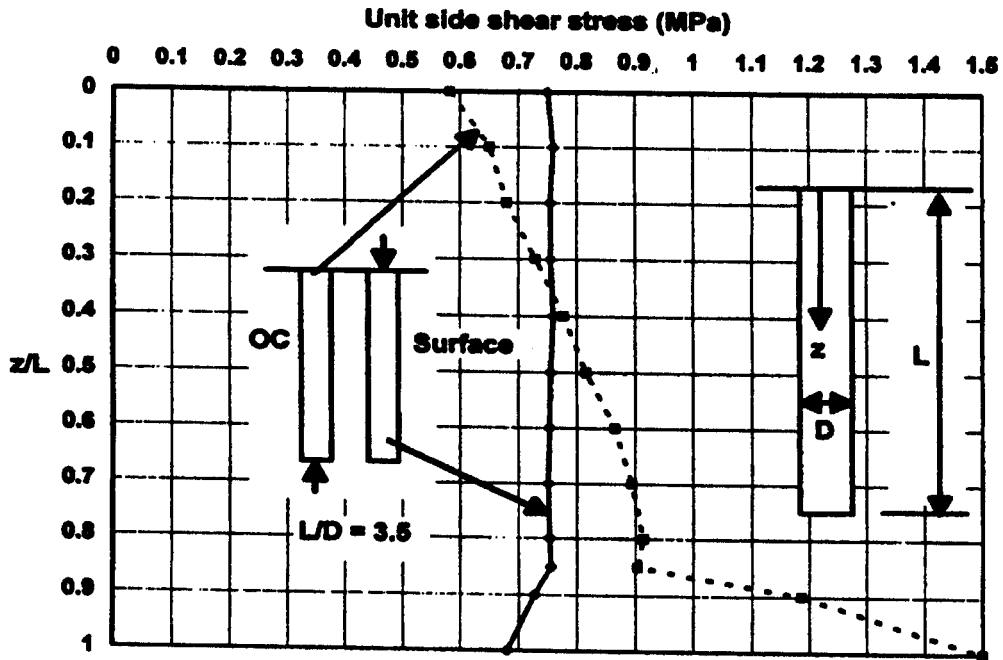

Figure 14.6. Multiple-level arrangement for Osterberg cells (O'Neill et al., 1997)

### Statnamic® Testing Arrangement

A Statnamic® loading test also can be performed without the need for an expensive reaction system. An advantage of this type of test relative to the Osterberg cell test is that it does not require the loading device to be cast into the shaft. That is, the Statnamic® loading test can be performed on a drilled shaft for which a loading test was not originally planned.

The principle of the Statnamic® test is shown in Figure 14.7. Like the Osterberg cell test, the principle is very simple. Dead weights (reaction masses) are placed upon the surface of the test shaft. Beneath the dead weights is a small volume of propellant (fuel) and a load cell. The propellant is ignited and accelerates the masses upward. As this occurs a reaction force equal to the mass of the reaction masses times their acceleration is produced against the head of the shaft, as indicated in Figure 14.7. This force, which increases with time up to one to two hundred milliseconds, causes the shaft to settle. As the ignition of the propellant stops, the reaction force rapidly decreases and the shaft rebounds. The settlement of the shaft head is measured by means of a laser beam from a source some distance away from the test shaft that is targeted on the shaft head. The load can be graphed against both time and settlement instantaneously.

For reasons of safety the reaction masses are contained within a metal sheath that is also filled with an energy absorber, such as dry gravel, that will cushion the impact of the masses as they fall back upon the head of the drilled shaft. A photograph of a Statnamic® test arrangement,

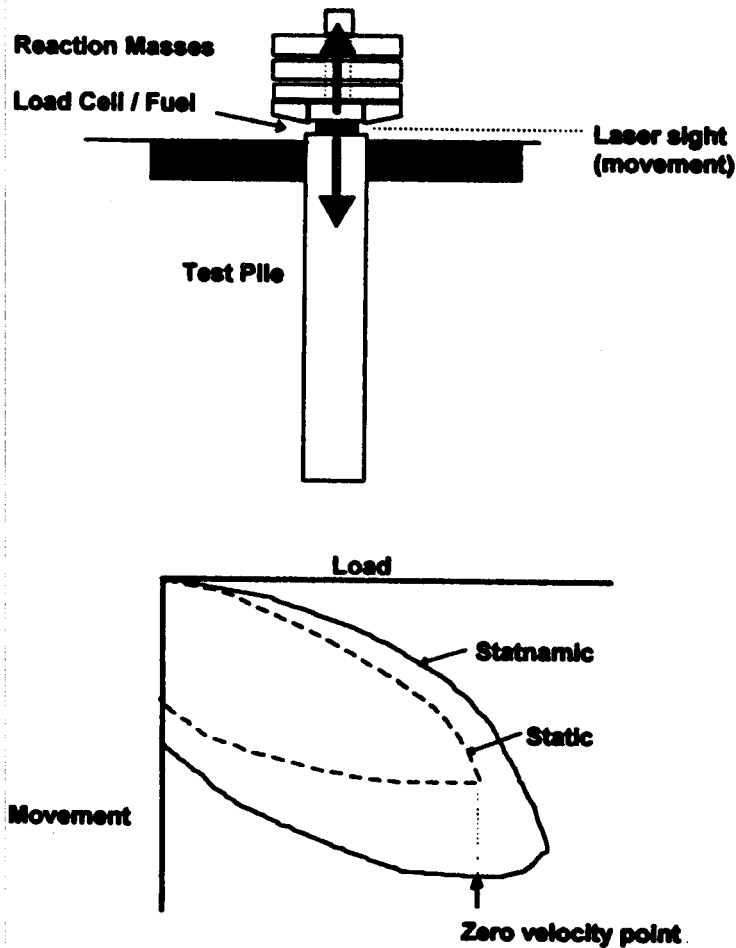

Figure 14.7. Schematic of Statnamic® test

with the gravel-filled sheath surrounding the reaction masses just after igniting the propellant, is shown in Figure 14.8.

Since there are some dynamic components to the resistance of the drilled shaft, some interpretation of the data is necessary, as illustrated in the lower part of Figure 14.7. Since the load produced at the head of the shaft by burning the propellant is applied much more slowly than is applied by the blow of a pile-driving hammer, it can usually be assumed that the stress wave that is imparted to the drilled shaft is much longer than the length of the shaft itself and that the shaft is therefore penetrating into the soil or rock as a rigid body. It may not be possible to make this simplifying assumption if the test shaft is extremely long. However, if rigid body motion is assumed, the load acting on the head of the shaft can be reasoned to be the sum of (1) the total static soil resistance (base and sides), (2) damping forces produced by the relative velocity between the shaft and the soil/rock, and (3) the mass of the drilled shaft itself times its acceleration. If the load corresponding to a zero slope on the load-settlement relation measured in the Statnamic® test (near the beginning of rebound, illustrated in Figure 14.7) is selected,

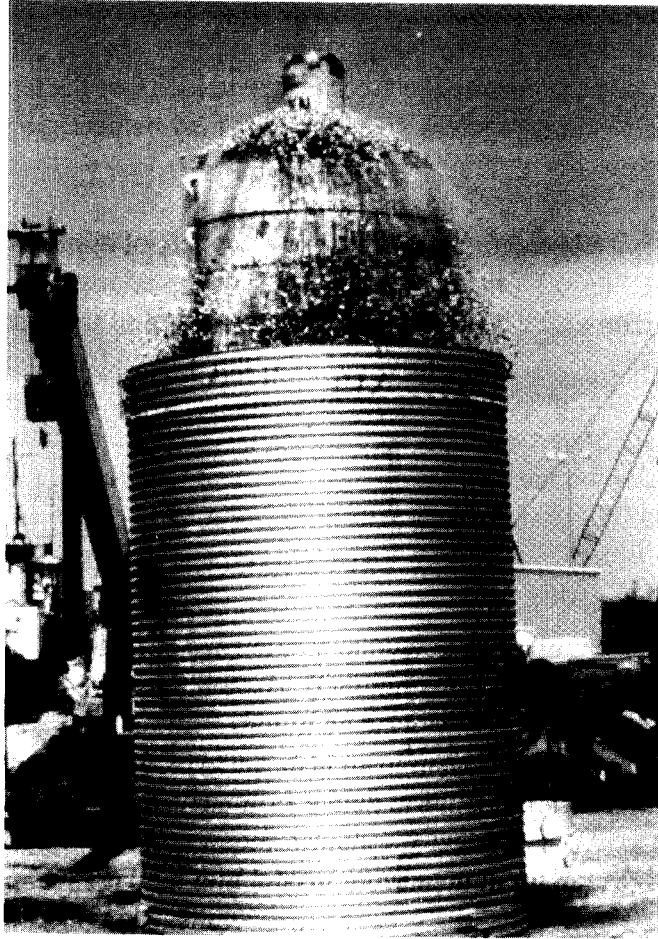

Figure 14.8. Photograph of Statnamic® test arrangement, showing masses being accelerated inside gravel-filled sheath

component (2), above, will be zero, since the velocity of the shaft will be zero, and the total static resistance of the drilled shaft,  $R_T$ , can be approximated by

$$R_T = F_{S0} - W_s (a_s / g) \quad (14.1)$$

where

$F_{S0}$  = the force measured by the load cell at the point at which the slope of the rebound curve is zero identified, by the arrow in Figure 14.7 (which also means that the velocity of the shaft is zero),

$W_s$  = total weight of the drilled shaft,

$a_s$  = acceleration of the drilled shaft corresponding to  $F_{S0}$  (which can be measured with an accelerometer at the head of the shaft), and

$g$  = acceleration of gravity.

Note that  $a_s$  will not be zero despite the fact that the velocity of the test shaft is momentarily zero at  $F_{50}$ . If the test shaft is long, a stress wave analysis may be necessary to obtain an accurate estimate of resistance.

Statnamic® devices have been constructed that are capable of applying head loads of up to approximately 32 MN (3600 tons). The cost of a Statnamic® test will usually be very approximately the same as the cost of an Osterberg cell test of the same magnitude.

Further technical information on the Statnamic® test method can be found in the *Proceedings of the First International Statnamic Seminar*, Vancouver, British Columbia, 1995. Copies can be obtained from Berminghammer Foundation Equipment Company, Wellington Street Marine Terminal, Hamilton, Ontario L8L 4Z9, Canada.

### Conventional Uplift Testing

If production shafts are to be subjected to substantial uplift loading during their design lives (e.g., because of overturning moments applied to the structure through seismic events or extreme winds, foundations at the anchorage end of permanent cantilevers), it is appropriate to perform uplift tests. An arrangement for the performance of a conventional uplift test of a drilled shaft is shown in Figure 14.9 (Sacre, 1977). The key feature of the arrangement is that some of the longitudinal rebars, that are embedded full length in the test shaft, extend upward to a point well above the head of the test shaft. It is helpful if these extended rebars are made of high-strength steel. The reaction beams, which are supported on surface mats, can sometimes be positioned so that the extended rebars pass between the beams, so that no holes need be cut. A thick plate can be connected to span between the extended rebars at some point above the reaction beams, and the loading ram can be placed between a cross beam set on top of the reaction beams and the plate. For cases where the load to be applied is greater than the capacity of a single ram, a center-hole hydraulic ram can be placed over two or more rebars to apply the load. These rams should have calibration curves that are nearly equal, especially if the rams are to be pressurized through a common manifold. However, it is desirable that load cells be used for each ram to measure the applied load.

If the rebars through which the load is applied are embedded in the concrete, the elasticity of the drilled shaft will cause the head of the shaft to move upward more than the base. If the rebars are enclosed in tubes and are attached to load plates at the base of the test shaft, the base of the shaft will move upward more than will the head. The latter situation is similar to the situation that exists with the Osterberg cell test. These two methods of applying load to the shaft may produce differences in load transfer, even though the test shaft is moving upwards, so the engineer should be careful to try to reproduce the method of loading that is expected in the production shafts.

Other types of uplift tests are possible (e.g., Johnston et al., 1980); however, most uplift tests in the United States today are of the type described above.



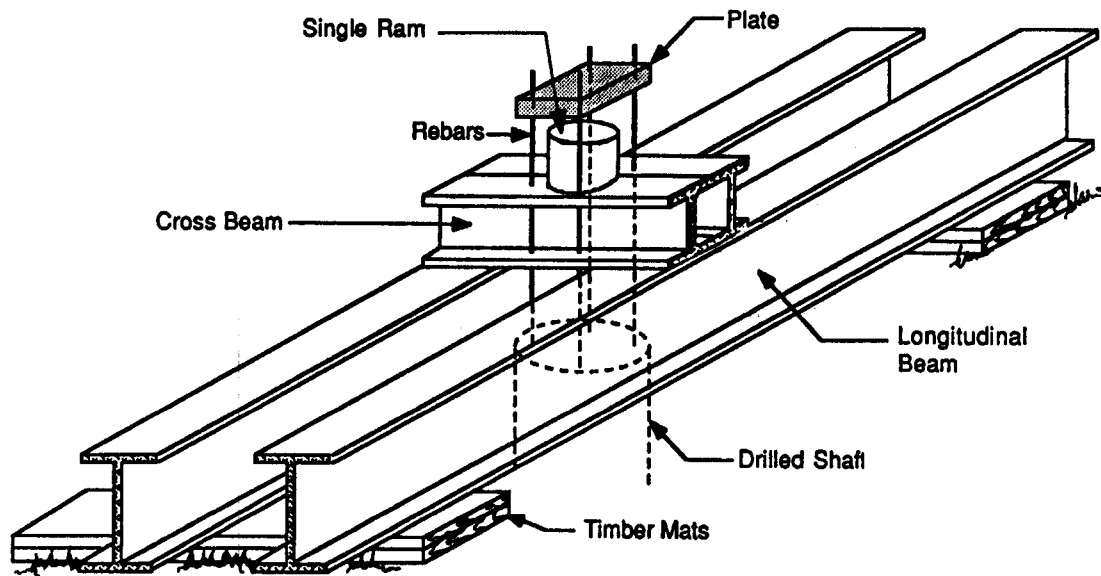

Figure 14.9. Arrangement for testing a drilled shaft under uplift loading

## Instrumentation

### Proof Test

For a conventional axial proof test of a drilled shaft, the minimum required measurements are the load and the deflection at the head of the shaft. Measurement of load and deflection in the Osterberg cell and Statnamic® tests have already been described as an integral part of the description of those tests. In a conventional test the load is sometimes determined by measuring the hydraulic pressure in the loading ram by use of a calibrated pressure gauge, in which the hydraulic ram has been calibrated in a testing machine to indicate the load as a function of the applied pressure, as for an Osterberg cell. However, the use of an electronic load cell is preferable. Where only jack pressures are monitored, a swivel-head mechanism should be placed atop the ram to minimize ram friction. A photograph of a ram-load cell system is shown in Figure 14.10. The lighter object on the bottom is the load cell. Both the ram and load cell in this photograph have capacities of (11.3 MN) 1250 tons. Both the load cell and the pressure gauge attached to the ram are read simultaneously during the loading test as a cross-check on the load measurements.

The pair of hydraulic rams shown in Figure 14.2 indicates that a single ram with sufficient capacity is sometimes unavailable. The method of measuring the load that is implied by the figure is that the pressure in the hydraulic fluid was measured. There are hydraulic rams that are designed with low friction and especially for the performance of load tests of drilled shafts. Laboratory tests have been performed with this testing arrangement designed to allow the ram to travel several inches (100 to 200 mm). Other tests have been performed where the ram was tilted

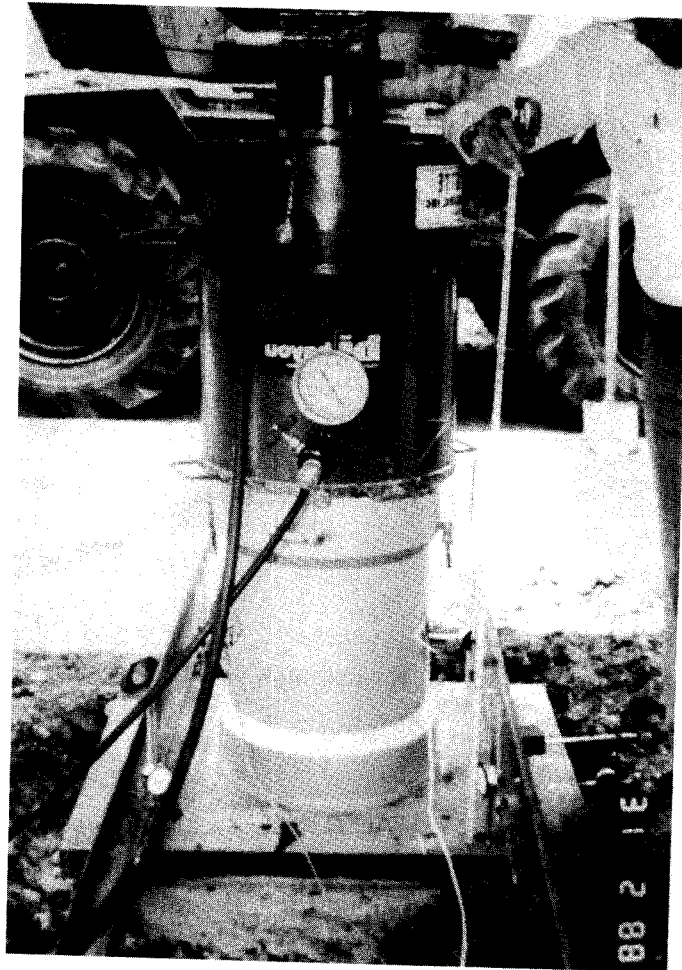

Figure 14.10. Photograph of head of test shaft showing hydraulic jack and electronic load cell

slightly in a testing machine. Such tests have led to the conclusion that the accuracy of the load-measuring system is within five per cent (Barker and Reese, 1970; O'Neill and Reese, 1970). However, as stated above, the use of an accurate electronic load cell in the system is preferred.

The deflection of the head of the drilled shaft is usually measured by the use of dial gauges or electronic deflection transducers such as LVDT's (linear variable differential transformers) that are held by stable reference beams. The reference beams are long enough that they can be supported at points well away from the test shaft and reaction shafts, such that the support points do not move substantially when the loading test is conducted. Because of the possibility that the reference beams could be disturbed, a backup system of measurement of the deflection of the shaft head is desirable. Either a stretched wire that is independently supported and passes across a scale that is attached to the drilled shaft or optical surveying instruments can be used as a backup system. It is always considered to be good practice to conduct loading tests such that all

electronic readout systems, microcomputers, lead wires, reference beams, load cells and displacement transducers are protected from direct sunlight or significant changes in temperature during the performance of the test.

### **Load Transfer Test**

It is necessary to employ the same instrumentation at the head of the drilled shaft when a load transfer test is being performed as when a proof test is being performed. However, in addition, internal instrumentation should be installed in a test shaft when tests are run to obtain information on load transfer in side and base resistance. Some of the common types of instrumentation will be described briefly below.

**Telltales.** Telltales can sometimes be used to measure the distribution of load along the test shaft (Snow, 1965). Telltales are unstrained (or spring-loaded, i. e., constantly strained) metal rods that are inserted into one or more tubes that prevent them from bonding to the concrete in the shaft. The telltales extend to a series of depths along the length of the shaft. A good practice is to install the telltales in pairs (two to each depth, with one of each pair on either side of the drilled shaft to allow for cancellation of any unintended bending that may occur during loading), and with one pair extending to near the base of the shaft. The shortening of the test shaft over a particular distance can be found by using sensitive displacement transducers to measure the difference in the movement of the shaft head and the top of the unstrained rod. Such measurements must be made for each of the telltales and for each of the applied loads. A telltale system for a conventional compression test, in which simple 0.0001-in. (0.00254-mm) dial gauges are used to measure the movements of the telltale rods relative to the head of the drilled shaft, is shown in Figure 14.11.

A curve can be plotted for a particular applied load that shows the compression of the drilled shaft (average deformation of each telltale depth relative to the head of the shaft) as a function of distance along the shaft. Differentiation of this deformation vs. depth curve with respect to depth (or simply measuring its slope) will yield the unit strain in the shaft as a function of depth. The internal load in the shaft can be obtained at as many depths as desired by multiplying the axial stiffness of the test shaft (cross-sectional area at the selected depth times composite Young's modulus of the shaft) by the strain obtained at the depth of interest in this way. The Young's modulus of the concrete is usually estimated from compression tests on concrete cylinders taken from the batch used to cast the test shaft that are tested on the same day as the loading test. The values of  $f'_c$  obtained from those tests are converted to Young's modulus  $E_c$  using  $E_c = 57,000 (f'_c)^{0.5}$ , where both  $E_c$  and  $f'_c$  are in psi (6.89 kPa). The sensitivity of the determination of load depends on the axial stiffness of the drilled shaft and the load; in some instances the sensitivity is adequate, but it is poor for short, stiff drilled shafts under light loads. An advantage of the use of telltales is that the settlement of the drilled shaft from point to point along its length can be found almost directly. Care must be taken in the installation of telltales and telltale tubes. The tubes must be rather straight so that the rods do not bind against them as the load is applied. Ordinarily,

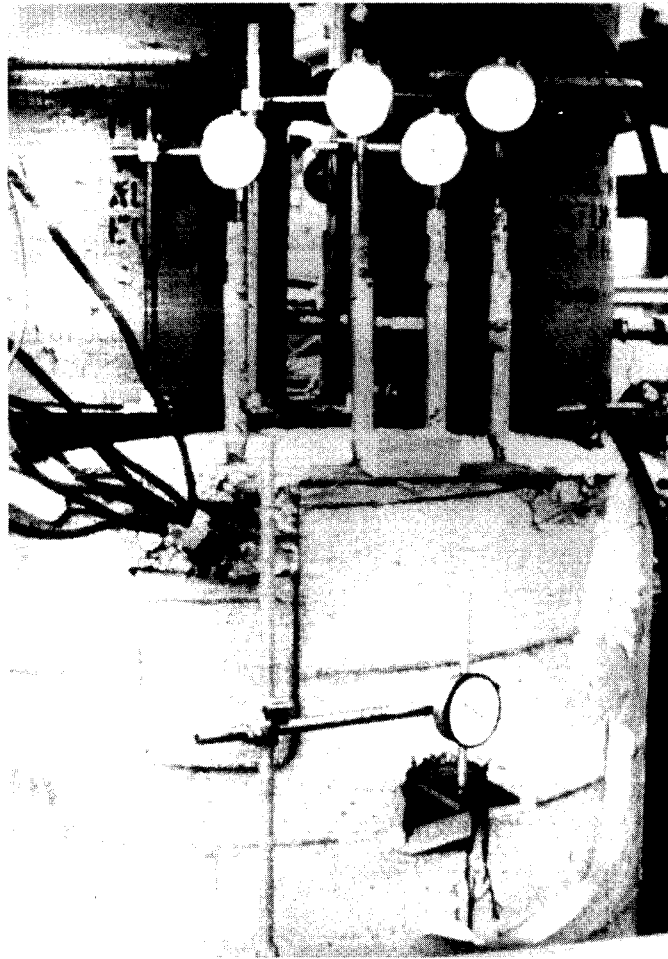

Figure 14.11. Photograph of a telltale system

the tubes are tied to the rebar cage when the test shaft is constructed. Excessive flexing of the cage or rough handling of the cage by the contractor can produce bent tubes. Later, when the telltale rods are inserted, it may not be possible to pass them all the way to their intended depths or to do so only by forcing them, which can result in binding and therefore in inaccurate readings.

**Sister bars.** The load along a drilled shaft as a function of depth can also be obtained using "sister bars." A photograph of a sister bar is shown in Figure 14.12. A sister bar is a section of reinforcing steel [e. g., a 1.2-m- (4 foot-) long section of No. 4 deformed rebar] at the middle of which is placed a strain transducer. The sister bar is easily tied onto the rebar cage and its leadwires routed to the surface. The strain transducer in the middle of the sister bar in Figure 14.12 is a vibrating wire transducer. Similar bars can be made using electrical foil resistance strain gauges that are bonded to the steel in the rebar and sealed with a waterproofing agent at the location of the vibrating wire transducer in the figure. Vibrating wire transducers have the advantage that they tend to be stable over longer periods of time than transducers based on the electrical resistance principle because the latter are quite sensitive to the invasion of moisture.

More details on the operation of vibrating wire gauging systems can be found in Osgerby and Taylor (1968). On the other hand, electronic resistance gauges are more adaptable to data acquisition systems that scan channels for voltages. A large set of gauges can be read almost instantaneously using a small personal computer, which makes electrical resistance gauges more suitable for use with Statnamic<sup>®</sup> tests. Vibrating wire gauges can be read by a microcomputer conveniently through a multiplexing unit, but it takes longer to read the entire set of gauges.

Sister bars of both types are currently the most popular instruments for measuring load distribution in drilled shafts. Their output can be interpreted in one of two ways: (1) The electrical output can be converted to strain in the steel rebar through an appropriate calibration factor, which can in turn be assumed to be equal to the strain in the concrete section. The data reduction then proceeds as with telltales. (2) A set of gauges can be placed near the point of load application (head of the shaft in a conventional loading test) so that the output from the gauges can be plotted as a function of applied load to obtain a direct calibration factor from gauge output to load "in-shaft" that can be applied to the remaining levels of gauges. If this method is followed it is important to make sure that the applied load is distributed uniformly across the cross section at the level of the gauges. This might be done in a conventional loading test by using a heavy steel loading plate bonded to the head of the shaft.

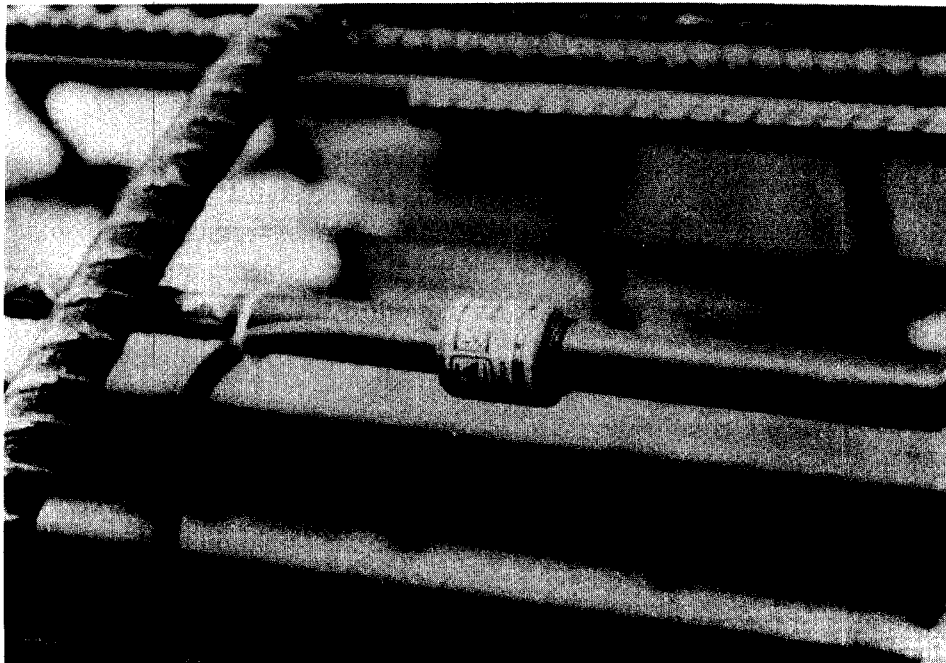

Figure 14.12. Photograph of a vibrating wire sister bar

As with telltales, it is good practice to place sister bars, and/or Mustran cells, described below, at opposite ends of diagonals at any level so that the averaged readings cancel any bending effects that may occur. Two or four sensors at each level at which load is to be measured is recommended. Three sensors per level, equally spaced around the circumference of the cage, will likewise provide for averaging of bending, but if one gauge malfunctions, such averaging will not be possible.

**Mustran Cells.** A type of cell for the internal instrumentation of drilled shafts that has performed well, termed the Mustran cell (acronym for "multiplying strain transducer"), is shown in Figure 14.13 (Barker and Reese, 1969). Several hundred Mustran cells have been built and used in drilled shaft loading tests. The Mustran cell is mounted on the rebar cage before inserting it into the borehole, in a manner similar to that for sister bars. Because of its electronic circuitry, the Mustran cell indicates strains that are larger than, but proportional to, the actual strains in the concrete. This feature is advantageous for testing large-diameter shafts subjected to relatively light loads. The Mustran cell was also designed so that the compressive stiffness of the cell is equal to the compressive stiffness of the concrete that it replaces when it is embedded in the shaft, which in theory makes it more accurate than sister bars. This is accomplished by machining the steel post in the center of the cell in Figure 14.13, which is 12.7 mm (0.5 inches) square and 152 mm (6 inches) long, so that the compression of the post is equal to the compression of the concrete displaced by the cell when a compressive axial load is applied. The post is instrumented with a full Wheatstone bridge of bonded foil electronic resistance strain gauges. Those gauges are protected from moisture by circulating dry nitrogen through the cell. Data from Mustran cells are collected and reduced in a manner very similar to the corresponding operations for sister bars.

The ends of the instrumented bar are threaded into end caps that embed in the concrete. This anchorage system works well when the drilled shaft is loaded so that the concrete is in compression but is not designed for loading in tension. The instrumentation cable extends through the top end cap and is long enough to connect to a data-acquisition system on the surface. Not shown in Figure 14.13 are brackets that allow the Mustran cells to be attached to the rebar cage.

**Contact Pressure Cells.** If the main use of the instrumentation is to delineate base from side resistance, a method that has been used successfully is to cast contact pressure cells into a mold at the bottom of the cage, as shown in Figure 14.14 and then to seat the cage in a thin layer of concrete at the bottom of the borehole prior to placing the remaining concrete in the drilled shaft. Such cells are accurate, especially since they do not require the assumption of a value for the Young's modulus of the concrete, and are inexpensive to purchase and to read. The cells shown in Figure 14.14 operate on a pneumatic principle, in which the air pressure needed to open a differential pressure valve communicating with fluid in the pressure-sensing chamber is recorded. The average pressure from the cells times the contact area of the base of the shaft can be considered to be the base resistance, since stresses across drilled shaft bases are generally uniform (Sheikh and O'Neill, 1987).

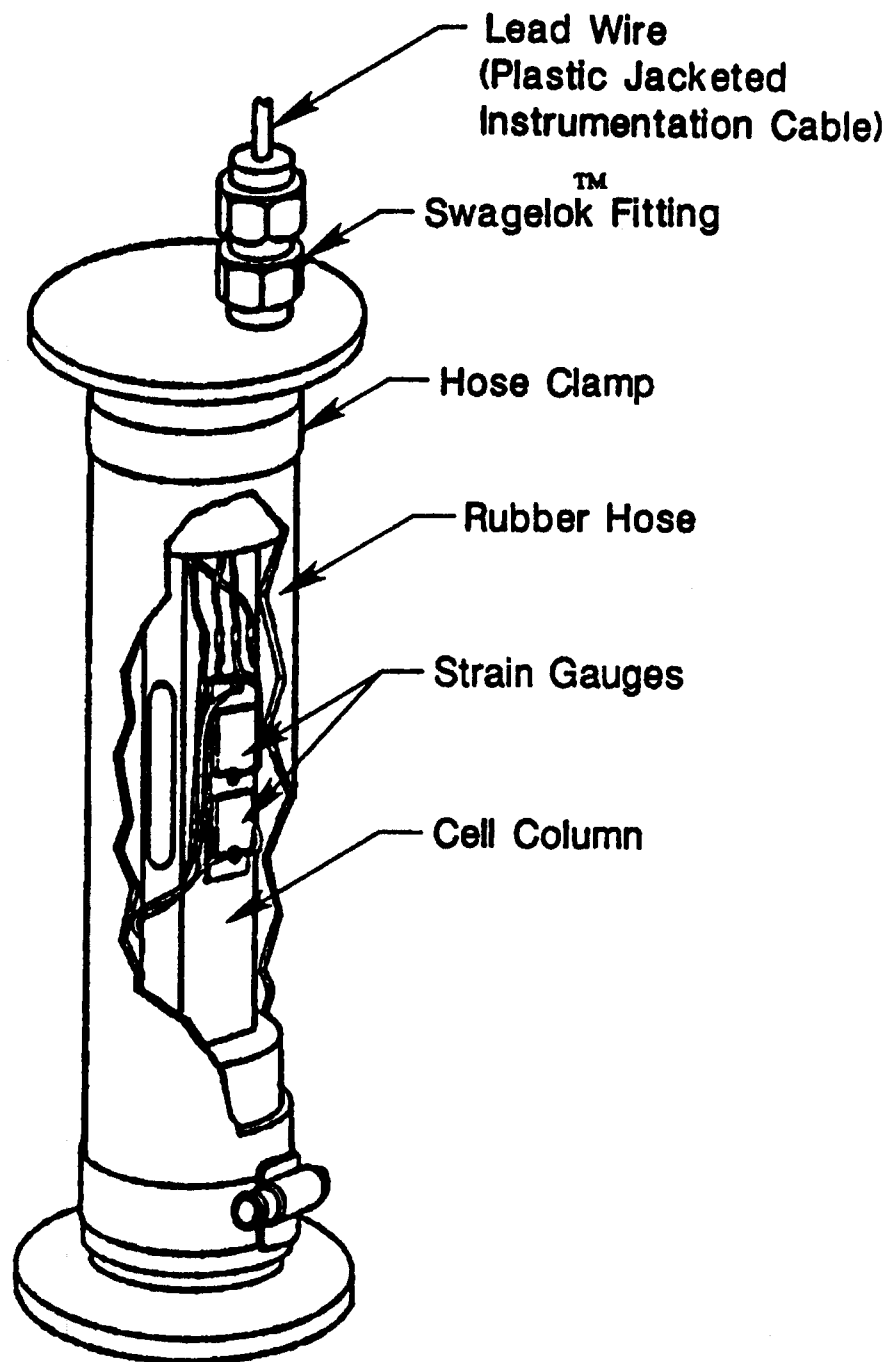

Figure 14.13. The Mustran cell



Figure 14.14. View of a test shaft with contact pressure cells at its base

Theory of elasticity predicts high contact stresses at the edge and low contact stresses at the center of the base. To avoid this effect at low loads, the contact pressure cells should not be placed at the edge of the base. However, as contact pressures build up, the soil or rock near the edge of the bearing surface begins to deform nonlinearly and redistribute load to the middle of the bearing surface, which produces the near-constant stress distribution.

**Fiber-Optic Strain Sensors.** Fiber-optic tubes have been successfully embedded in bridge decks and other concrete structures to measure the distribution of strain. For example, gratings can be inscribed at various points on a fiber-optic tube that reflect coherent laser light at varying wave lengths, depending on the strain at the location of the grating. Other physical principles can also be used. Although fiber-optic strain sensors are in their infancy, they appear to be suited to the measurement of strain (and therefore load) distributions in drilled shafts during loading tests, particularly tests conducted over long durations, since they can be made to be very stable. They are adaptable to multiplexing of data to the data acquisition unit, and many sensing locations can be established within the shaft at a fraction of the cost of other types of strain sensors. The disadvantages are that expert interpretation is still required and that the data acquisition equipment, although reusable, is initially expensive. Fiber-optic sensing should be



considered for long-term monitoring of load transfer patterns in drilled shafts that are in service. For the reader interested in pursuing this type of instrumentation, an excellent overview of fiber-optic sensors for concrete structures is given by Merzbacher et al. (1996).

**Load Distribution Data.** Once the load distribution data in a load transfer test have been acquired, they are plotted in a manner similar to that shown in Figure 14.15. This figure shows a set of load distribution curves from a compression loading test, where Mustran cells were used. Similar curves could have been obtained with sister bars, telltales or perhaps fiber-optic sensors. The value of the load for the increment for which each curve is plotted is the value of the load at depth equal to zero. Even without performing the detailed analysis that is described later in this chapter, the value of data from internal instrumentation is immediately evident. The final curve for the data set, for example, indicates that about 1.1 MN (250 kips) were sustained in base resistance, and over 6.7 MN (1500 kips) were transferred to the soil in side resistance.

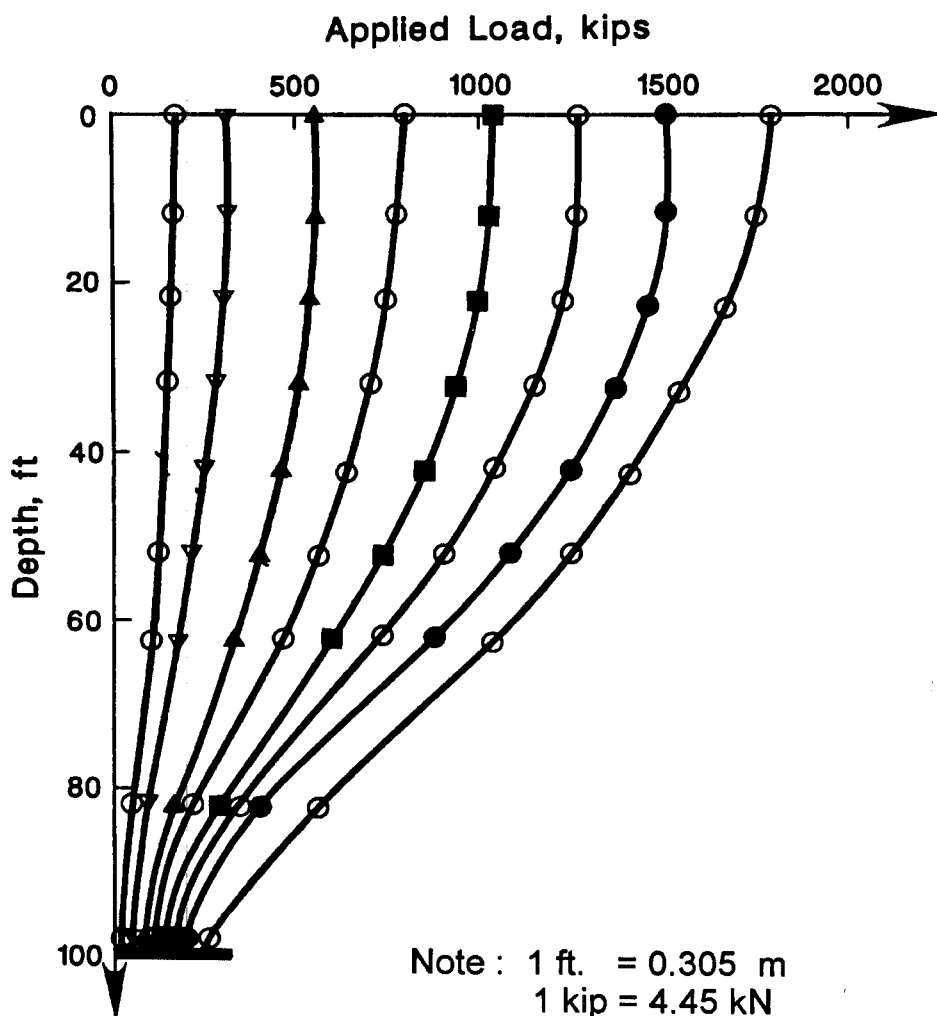

Figure 14.15. Typical set of load distribution curves obtained from use of Mustran cells

## Testing Procedures

Hydraulic pressures in excess of 7,500 psi (52 MP<sub>a</sub>) are not unusual with either conventional or Osterberg loading systems; therefore, the exercise of caution in regard to hydraulic lines and fittings is in order. If reaction beams or grouted anchors are used, the amount of energy that is stored in the system at high loads can be enormous. If the Statnamic® system is used to load the test shaft, care must be taken to ensure that personnel are warned about the loading event and are kept away from the immediate testing area. A safety meeting with the test personnel at the job site is recommended. Provisions should be made for visitors who may come to the test site.

The procedures for performing conventional testing are those that are given by ASTM 1143 (ASTM, 1995). With regard to the method of loading, ASTM lists the following. The most appropriate from among these loading methods is then selected by the engineer who designs the loading test. With minor modifications, these methods can all be used for Osterberg cell testing, as well.

- **Standard loading procedure.** This procedure will normally require a few days to complete. In this method the load is applied in increments and held constant by stroking the pump that activates the ram, if necessary, until the movement of the head of the shaft is less than 0.25 mm (0.01 in.) per hour, but load increments are not held longer than two hours. Once 200 per cent of the nominal (design) load is reached, that load remains on the shaft for 24 hours and is then removed in decrements. The load can then be reapplied in increments until failure (plunging or movement equal to five per cent of the shaft diameter, according to this manual) occurs.
- **Cyclic standard loading procedure.** The standard procedure can be used, but instead of applying the loads monotonically (in an increasing sequence), the load can be removed at the end of each increment.
- **Constant time interval (CTI) procedure.** The method is similar to the standard loading procedure except that load increments are 20 per cent of the nominal (design) load and are held for one hour regardless of the magnitude of the rate of settlement during the loading increment.
- **Constant rate of penetration (CRP) procedure.** The load is continually increased so that the head of the shaft is penetrating between 0.01 and 0.05 inches per minute (0.25 and 1.25 mm per minute) if the shaft is located in a cohesive soil. The rate can be increased to about twice this rate in a soil or rock that drains during loading (e. g., sand or gravel).
- **Quick (Q) load test method.** Increments of load equal to 10 to 15 per cent of the design load are added every 2.5 minutes until failure occurs. The maximum load is held for 15 minutes and then removed in decrements. **Constant settlement increment (CSI) loading method.** Increments of load are applied to produce specified increments of head settlement. ASTM suggests that the value of settlement increment for a pile should be around one per cent of the diameter of the pile; however, it seems for a drilled shaft that smaller settlement increments should be used, perhaps in the range of 2.5 mm (0.1

inches). Once the specified settlement is reached, the load is varied as necessary to maintain the specified value of settlement for the present increment. The final load value at the end of the increment is plotted versus the settlement to obtain the load-settlement relation, which presumably includes the effects of long-term creep in an appropriate way.

Fuller and Hoy (1970) presented the results of a thorough field study that indicates that the quick load test (Q) method is just as reliable in establishing the axial resistance of a pile in most soils as is the standard method. The settlements in the Q method will not include consolidation or creep effects in the soil, but the argument can be made that these effects will appear only after many weeks or months, so that the standard test also will not reflect creep and consolidation in the soil. Therefore, the FHWA recommends that the Q test be conducted under normal circumstances, because the test can be performed in a short period of time. However, where the strata in which the drilled shaft is founded may be subject to creep, such as is characteristic of some clay-shales, the CTI method may be preferred over the Q method because load may be shed from the sides to the base without changes in applied load, which causes shaft-head movement to increase without an increase in load, even in an uplift test. In such a case failure is interpreted as the load at which the rate of movement due to creep (settlement or uplift in the last half of the time interval) increases suddenly (O'Neill and Hawkins, 1982). It can also be argued that the load-movement curve obtained from the CSI test will be more appropriate than that from the Q test when the soil or rock is prone to creep.

The cyclic standard loading procedure may be preferable if the primary component of loading for the production shafts will be cyclic (e. g., seismic). It may be possible to reduce the time periods for which loads are held below those recommended by ASTM for the cyclic loading procedure if the design loading event occurs rapidly (seismic or impact loading). Regarding cyclic loading tests, a decision must be made whether to apply cyclic loads one-way, for example, repeated cycles of compression loading followed by full or partial unloading, or two-way, for example, cycling from compression to uplift. If two-way cyclic loading can occur in service, then it is desirable that the loading test be conducted under two-way cyclic loading because two-way cyclic loading causes more severe losses in resistance and greater deformations than one-way cyclic loading. A special two-way actuator is normally required for performing two-way cyclic loading tests.

## **Data and Analysis**

The analysis of data from the compressional loading of a test shaft that has internal instrumentation, such as Mustran cells, is illustrated in Figure 14.16. A curve showing load versus settlement is given in Figure 14.16a, and a family of curves showing the distribution of load with depth is given in Figure 14.16b. [Note that curves of this type can also be derived from uplift tests or from Osterberg cell tests, and even from Statnamic® tests. The principles of data reduction described below apply equally to compression and uplift tests.]

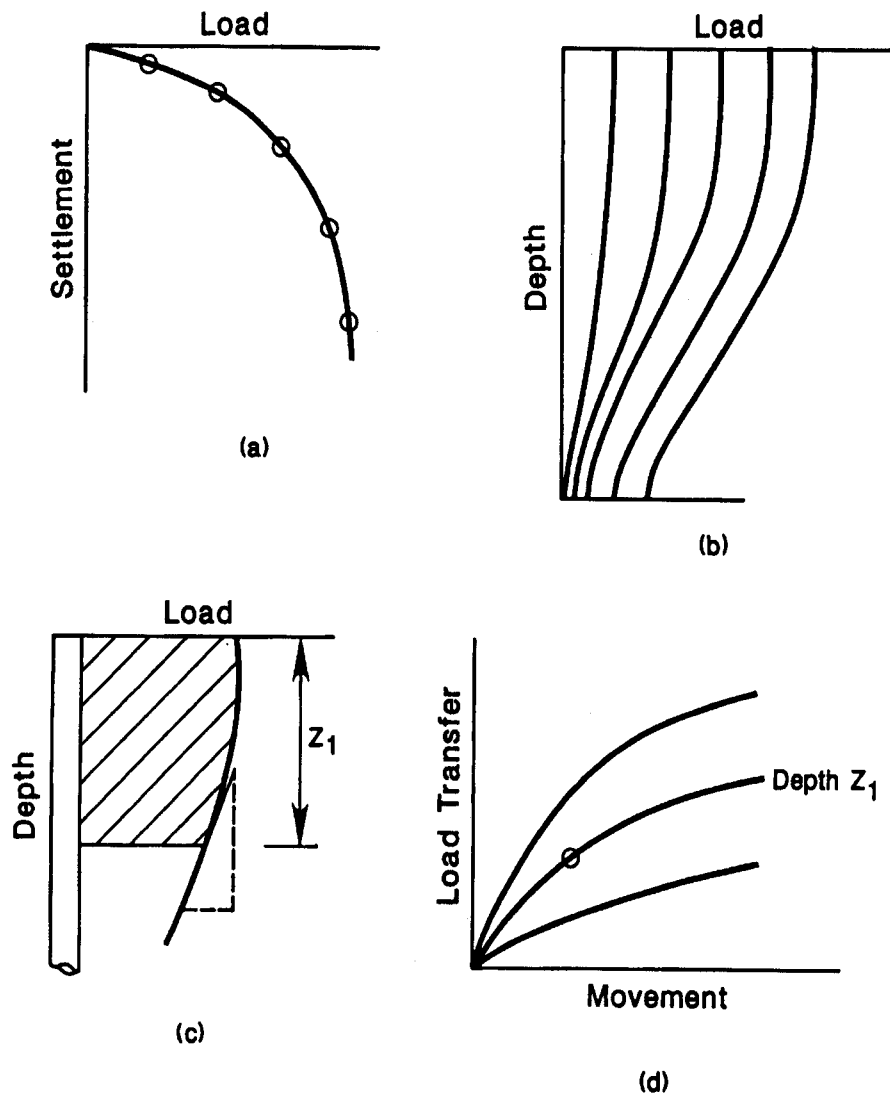

Figure 14.16. Method of analysis of data from axial loading test

The upper portion of one of the curves from Figure 14.16b, to a depth of  $z_1$  from the top of the drilled shaft, is enlarged and shown in Figure 14.16c. In an Osterberg cell test the distance  $z_1$  would be measured from the Osterberg cell. The area that is cross-hatched is found and divided by the axial stiffness of the drilled shaft [product of the cross-sectional area and the composite Young's modulus of the steel and concrete, which can be computed from  $A_s E_s + (A_g - A_s) E_c$ ] to yield the shortening of the drilled shaft over the distance  $z_1$  for the particular load that was applied when the drilled shaft is in compression. The subtraction of the shaft shortening from the measured settlement at the top of the drilled shaft (from Figure 14.16a) yields the local downward movement of the drilled shaft, with respect to the soil, at depth  $z_1$ . In the case of an uplift test, the elastic movement within the shaft will be extensional and is subtracted from the

amount of uplift measured movement at the head of the shaft to give the local movement. For uplift tests, the axial stiffness of the shaft should be taken to be  $A_s E_s$ , at any level after a stress sufficient to cause tensile failure in the concrete develops.

The slope of the load distribution curve at depth  $z_1$  is indicated in Figure 14.16c. That slope, divided by the length of the perimeter of the drilled shaft at depth  $z_1$ , yields the unit value of load transfer in side resistance at that depth (units of  $F/L^2$ ). These two steps in the analysis will allow a point to be plotted in Figure 14.16d. In a similar manner, the other load-distribution curves at depth  $z_1$  are analyzed, and the entire curve for unit load transfer versus movement for that depth ( $f$  vs.  $w$ ) can be plotted. Other depths can also be selected, and a family of load transfer curves can be obtained.

A  $q$ - $w$  curve, not shown in the figure, can be obtained for the base of the drilled shaft that shows the unit base resistance versus the downward movement of the base. The shortening of the test shaft under a particular head load can be found by obtaining the full area under the load-distribution curve for that load and dividing that value by the axial stiffness of the shaft. That value of shortening, subtracted from the observed settlement at the top of the drilled shaft, will yield the downward movement of the base. The corresponding base load is taken directly from the load distribution curve.

Downward (or upward) movement of the base, or at any other depth  $z_1$ , relative to the head of the drilled shaft, can also be measured directly with telltales, as in an Osterberg cell test.

The data obtained directly and the data derived from analysis [load-settlement, load-distribution, load transfer in side resistance ( $f$ - $w$  relations), and load transfer in base resistance ( $q$ - $w$  relation)] give the designer detailed information that is valuable in designing the production shafts. For example, these relations can be input directly into a computer program such as SHAFT (Appendix B), and the designer can investigate the effects of small changes in diameter and depth of the drilled shaft on the expected performance of production shafts.

## LATERAL LOADING TESTS

Drilled shafts are capable of sustaining very large lateral loads because of their high moments of inertia. However, their behavior under lateral loading of the type described in Chapter 13 is highly dependent upon the soil or rock in which they are embedded and upon the condition of shaft-head fixity. Prescriptions for  $p$ - $y$  curves based on elementary geomaterial properties, cited in Chapter 13, are satisfactory for designing drilled shafts in many cases, but they may not represent accurately the behavior of the ground in others. This is especially true for highly organic soils, silts, collapsible soils, highly fractured rock and similar geomaterials that have characteristics different from those for which the prescriptive criteria are available.

It can be cost-effective to perform lateral loading tests on drilled shafts when the designer wishes to take advantage of the attribute of drilled shafts, particularly those with large diameters, to

carry large permanent or cyclic lateral loads. The performance of the shaft in the geomaterial at the construction site can be evaluated, including the derivation or validation of p-y curves, and this understanding can be used to design the production shafts more accurately than would be possible without the loading tests. Lateral loading tests can be conducted conventionally, with Osterberg cells or by using the Statnamic® device, although the procedures are somewhat different than when axial loading tests are conducted. Whichever loading method is used, the test shaft should be as nearly full-sized as possible.

Since the primary focus of this manual is upon axial loading, only a brief description of lateral loading tests will be given here. For more information the reader is referred to *FHWA IP-84-11* and ASTM D-3966 (ASTM, 1995).

### **Conventional Test**

A conventional lateral loading test is commonly conducted by either pushing the test shaft away from one or more vertical or battered reaction shafts or piles or pulling it toward the reaction. Ordinarily, the load is applied either by a jack that pushes on the test shaft at ground level away from a reaction system or by a jack connected to the side of the reaction system opposite to the test shaft (or *vice versa*) and attached to a cable or tie that allows the test shaft to be pulled toward the reaction. The load is measured by a load cell that is positioned adjacent to the jack in a manner similar to that for axial loading tests.

A photograph of a typical arrangement for a lateral loading test of a drilled shaft is shown in Figure 14.17. In this case the test shaft is a vertical, 0.76-m- (30-inch-) diameter shaft that is being jacked away horizontally from a steel reaction beam that spans between two other reaction shafts of the same size. In this particular test, in stiff clay, the drilled shaft was pushed approximately 75 mm (3 inches) by a groundline shear load of about 450 kN (50 tons).

Several important points should be made.

- The amount of overburden acting on the primary layer of soil or rock that is being tested by the lateral loading test significantly affects the way that layer reacts to the loading applied by the drilled shaft. It is essential, therefore, that the ground surface during the loading test be at the same elevation as the ground surface for the production shaft. If that is not possible, for example if it is desired to test a stratum that is deep below the ground surface at an onshore test location but that will be near the soil or rock surface for the production shafts within a river or estuary, a correction will need to be made for the differences in effects that the presence of additional overburden at the test location will produce. These corrections can be performed only by understanding the background of the derivation of the p-y curves, for which the reader should consult *FHWA IP 84-11*.
- The nature of loading employed in the loading test should duplicate the loading in service as closely as possible. For example, if the primary design loading is static, the lateral loads can be applied in a slow, increasing sequence. If the primary loading is wind

loading, one-way cyclic loading (pushing or pulling the shaft and repeatedly releasing the load) may be appropriate. If the primary loading is wave or seismic loading, two-way cyclic loading (repeatedly pushing and pulling the shaft through its initial position) may be the most appropriate method of testing.

- If the surface of the geomaterial will be covered with water in service, a similar condition should be considered for the loading test, especially if cyclic loading is applied. The draining of surface or ground water into the small gap that is created between the shaft and geomaterial during cyclic loading and later pumping of that water out of the gap by moving the shaft back to its initial position creates internal erosion in the soil adjacent to the shaft, widens the gap and degrades the resistance of the geomaterial.
- A lateral loading test almost never duplicates the combination of shaft-head shear, moment, axial loading and shaft-head fixity that occur in a strength or service design state. The lateral loading test is normally performed by applying only a groundline shear to a free-headed shaft, while the production shaft may be loaded by a combination of shear and moment, or shear with full or partial head restraint, while the shaft is sustaining an axial load at the same time. As a result, the lateral loading test cannot reproduce the behavior of the production shafts. Instead, it should be viewed as a means of measuring the p-y curves for the geomaterial at the site. Once the p-y curves are measured by the loading test, they can be inserted into a computer code such as COM624 or LPILE (Chapter 13), and the behavior of the production shafts under whatever system of loads is to be applied can be synthesized. Such behavior might involve verification that the combination of factored axial load and lateral loads applied to the shaft head do not produce a condition on or outside the inner envelope in Figure 13.24 and/or that head deflections and rotations are not excessive for the structure that is being supported. This step in the analysis of the test data should not be overlooked.

In consideration of the last point, it is desirable to measure, as a minimum, the ground line shear load, the lateral ground line deflection and the rotation of the head of the shaft during a loading test. The ground line deflection is measured by means of displacement sensors suspended from reference beams, similar to the way settlement or uplift is measured in axial loading tests. A surveying instrument can be used for backup readings. Rotation is conveniently measured by using a tiltmeter or an inclinometer or by measuring the lateral deflection at a second point 1.5 to 2.5 m (5 to 8 feet) above the elevation of the point at which ground line deflection is measured. The differences in the horizontal deflections at these two points divided by the vertical distance between them is the approximate angle of rotation (in radians) of the shaft head.

Both the ground line deflection and the ground line rotation are plotted against the ground line shear, and the computer program is executed by varying the form of the p-y curves all along the shaft until a match is achieved in both deflection and rotation under all of the various loads that were applied. It should be realized that the concrete in the drilled shaft will likely crack during the loading test, so the computer program used to verify p-y curves or to derive new, site-specific p-y curves should be capable of modeling cracked sections when they occur.

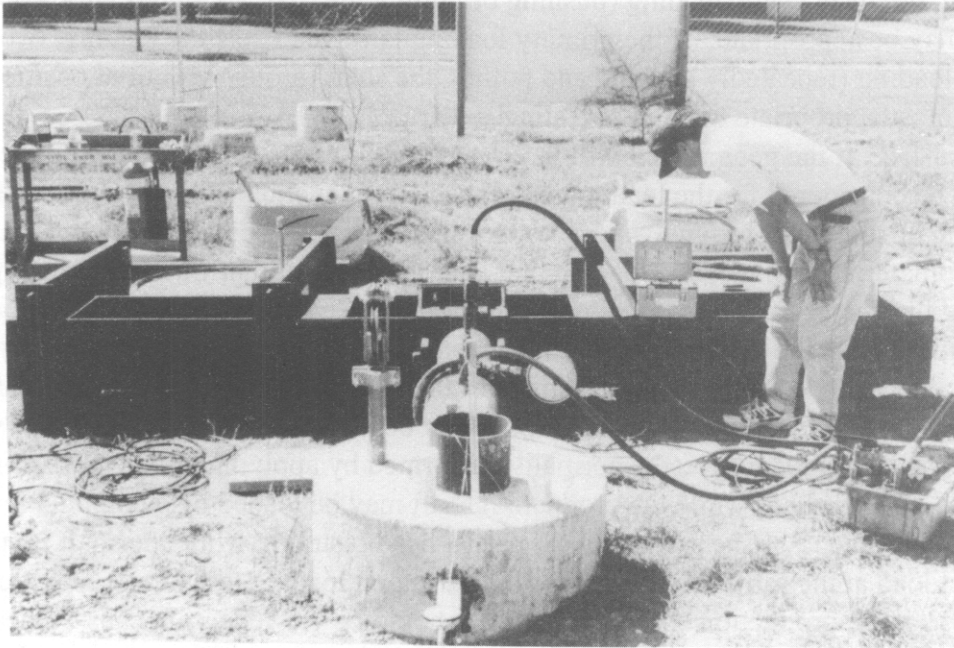

Figure 14.17. Arrangement for a conventional full-scale field lateral loading test using a pushing procedure

More accurate definition of the  $p$ - $y$  curves can be achieved if the deflected shape of the shaft is measured all along the shaft under each load, rather than just measuring rotation and deflection and the shaft head, because doing so provides for more accurate adjustment of  $p$ - $y$  curves with depth. Measurement of the deflected shape of the drilled shaft can be accomplished by means of electronic inclinometers running up and down tracks in inclinometer tubing that has been cast into the drilled shaft, preferably along the centroidal axis perpendicular to the direction of loading in the loading test.

Finally, it is possible to derive  $p$ - $y$  curves directly from loading tests if the bending moment is measured as a function of depth and lateral load (Welch and Reese, 1972; Dunnivant and O'Neill, 1989). This can be accomplished by casting steel tubes instrumented at close spacing with strain sensors into the drilled shaft along its longitudinal axis. This is the most elaborate and expensive, but most accurate, type of instrumentation for laterally loaded drilled shafts and is used mostly for applied research.

### **Osterberg Cell Test**

Rock sockets have been tested occasionally by inserting an Osterberg cell vertically into the socket, casting concrete around the cell and using the cell to jack the two halves of the socket apart, thereby somewhat duplicating the behavior of a laterally loaded drilled shaft (O'Neill et al., 1997). The lateral load applied to the geomaterial per unit of socket length is easily computed by dividing the load in the cell by the length of the test socket, which is approximately the length of heavy steel plates that are attached to each side of the cell. An arrangement for such a test is



shown in Figure 14.18. Lateral displacement is measured by using sacrificial LVDT's that connect between the plates. Care must be taken in interpreting the results of such a test, since the stresses and strains in the geomaterial are not the same in a "split socket" test, in which the halves of the socket are jacked apart, as in a drilled shaft that translates laterally within the geomaterial without splitting.

### **Statnamic® Test**

Drilled shafts and piles have also been tested recently by mounting Statnamic® devices on skids horizontally adjacent to the shaft or pile and loading with a pulse of ground line shear (O'Neill et al., 1997; Rollins et al., 1997). This type of test can be more economical than the conventional test when reactions are not available. It may also be more appropriate than the conventional test when the type of design loading being considered is impact loading (such as vessel or ice impact). However, it is necessary to process the data such that the effects of shaft and soil inertia and rate of loading effects are considered if the results are to be converted to p-y curves. Methods for accomplishing this data reduction process are currently being developed.

## **TYPES OF PROJECTS TO WHICH LOADING TESTS ARE APPLICABLE**

Loading tests should be run for those projects where the soil or rock profile is dissimilar to that for which design information is available. Loading tests are also desirable where a large number of drilled shafts are to be required. An economic study may indicate that the savings in materials and labor that result from the performance of loading tests will likely exceed the cost of the tests.

Where such an expectation is absent, as on very small projects in geomaterials with which the designer is familiar, a more conservative design may be less expensive than performing loading tests. However, it must always be kept in mind that a significant part of the value of loading tests, especially load transfer tests in which failure by some definition is achieved, is the updating of local design methods, so loading tests have economic impact on future projects in addition to the project at hand. This consideration can sometimes lead to the conclusion that loading tests should be performed even for very small projects.

## **INFORMATION ON COST**

If it is assumed that the owner has a set of reaction beams, a hydraulic jack, a pump, a calibrated load cell, and displacement gauges, the direct cost of a conventional loading test is principally the cost to the contractor for installing the test shaft and the reaction shafts. The cost of the internal instrumentation, if used, could range from a few hundred to a few thousand dollars. A number of conventional loading systems are available in the United States and many larger drilled shaft contractors can supply the equipment needed at a nominal cost to the owner if the owner does not have the testing system.

As has already been stated, Osterberg and Statnamic® tests are ordinarily less expensive than conventional tests because there is no need to construct a reaction system.

It is not possible here to assign generalized dollar figures to the costs of the various types of loading tests, since the same economic factors that affect contractors' bids for production work (Chapter 19) also affect bids for loading tests. However, there have been no examples of loading tests that were performed for obtaining design information, in the experience of the writers, where the savings as a result of the tests did not exceed the cost of the tests.

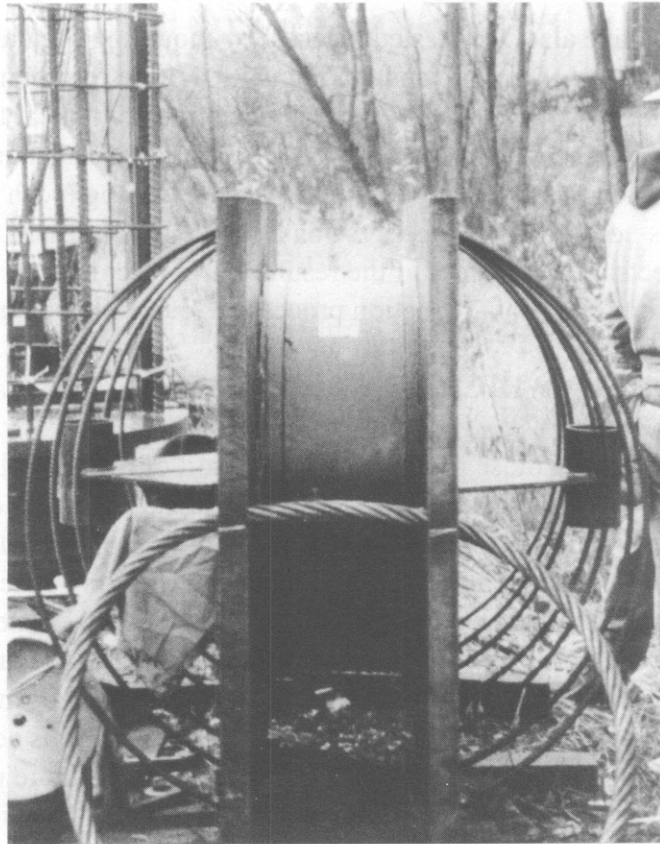

Figure 14.18. Osterberg cell arrayed for 26.7 MN (3000 ton) lateral loading test in a 1.22-m- (4-foot-) diameter rock socket

## REFERENCES

ASTM (1995). *Annual Book of ASTM Standards*, Vol. 4.08, Soil and Rock, American Society for Testing and Materials, Philadelphia, Pennsylvania.

Barker, W. R., and Reese, L. C. (1969). "Instrumentation for Axial Load in Drilled Shafts," *Research Report No. 89-6*, Center for Highway Research, The University of Texas at Austin, November, 102 pp.

Barker, W. R., and Reese, L. C. (1970). "Load-Carrying Characteristics of Drilled Shafts Constructed with the Aid of Drilling Fluids," *Research Report No. 89-9*, Center for Highway Research, The University of Texas at Austin, August, 326 pp.

Dunnivant, T. W., and O'Neill, M. W. (1989). "Experimental p-y Model for Submerged, Stiff Clay," *Journal of Geotechnical Engineering*, ASCE, Vol. 115, No. 1, January, pp. 95 - 114.

Fuller, F. M., and Hoy, H. E. (1970). "Pile Load Tests Including Quick Load Test Method, Conventional Methods and Interpretations," *Highway Research Record 333*, Highway Research Board, Washington, DC, pp. 74-86.

Johnston, I. W., Donald, I. B., Bennet, A. G., and Edwards, J. W. (1980). "The Testing of Large Diameter Pile Rock Sockets with a Retrievable Test Rig," in *Proceedings*, Third Australia / New Zealand Conference on Geomechanics, Wellington, Vol. 1, Australian Geomechanics Society, pp. 1-105 - 1-108.

Latotzke, J., König, D., and Jesseberger, H. L., 1997. "Effects of Reaction Piles in Axial Pile Tests," in *Proceedings of the Fourteenth International Conference on Soil Mechanics and Foundation Engineering*, Vol. 2, Balkema, Rotterdam, pp. 1097 - 1101.

Lizzi, F. (1983). "Ultimate Bearing Capacity of Friction Piles Calculated from Load Tests on Pilot Piles," *Ground Engineering*, July, 1983.

McVay, M., Huang, S., and Casper, R. (1994). *Numerical Simulation of Drilled Shafts for Osterberg, Pullout, and Axial Compression Loading in Florida Limestone*. Final Report. Department of Civil Engineering, University of Florida, Gainesville, Florida.

Merzbacher, C. I., Kersey, A. D., and Friebele, E. J. (1996). "Fiber Optic Sensors in Concrete Structures: A Review," *Smart Materials and Structures*, Vol. 5, IOP Publishing Company, pp. 196-208.

O'Neill, M. W., and Reese, L. C. (1970). "Behavior of Axially Loaded Drilled Shafts in Beaumont Clay," *Report No. 89-8*, Center for Highway Research, The University of Texas at Austin, December.

O'Neill, M. W., and Hawkins, R. A. (1982). "Pile-Head Behavior of Rigidly Capped Pile Group," *Transportation Research Record 884*, Transportation Research Board, Washington, DC, pp. 1 - 7.

O'Neill, M. J., and Person, G. J. (1998). "Innovative Method for Evaluating Drilled Shaft Foundations for St. Croix River Bridge," paper presented at the Annual Meeting of the Transportation Research Board, Washington, DC.

- O'Neill, M. W., Brown, D. A., Townsend, F. C., and Abar, N. (1997). "Innovative Load Testing of Deep Foundations," *Transportation Research Record 1569*, Transportation Research Board, Washington, DC, pp. 17 - 25.
- O'Neill, M. W., Townsend, F. C., Hassan, K. H., Buller, A., and Chan, P. S. (1996). "Load Transfer for Drilled Shafts in Intermediate Geomaterials," *Publication No. FHWA-RD-95-171*, Federal Highway Administration, Office of Engineering and Highway Operations R & D, McLean, VA, November, 184 pp.
- Osgerby, C., and Taylor, P. T. (1968). Vibrating-wire Load Cell for Long-Term Pile Tests, *Experimental Mechanics*, Vol. 8, No. 9, September, pp. 429-430.
- Osterberg, J. O. (1994). *Recent Advances in Load Testing Driven Piles and Drilled Shafts Using the Osterberg Load Cell Method*, Geotechnical Division, Illinois Section, ASCE, 79 pp.
- Osterberg, J. O. (1992). *The Osterberg Load Cell for Testing Drilled Shafts and Driven Piles*, report to the Federal Highway Administration, Washington, DC.
- Rollins, K. M., Weaver, T. J., and Peterson, K. T. (1997). "Statnamic Lateral Load Testing of a Full-Scale Fixed-Head Pile Group," in *Proceedings of the National Seismic Conference on Bridges and Highways*, Sacramento, California, Federal Highway Administration and California Department of Transportation, July, pp. 267 - 282.
- Sacre, A. (1977). "A Study of the Pullout Resistance of Drilled Shafts," unpublished Master's thesis, Department of Civil Engineering, The University of Texas at Austin, August, 165 pp.
- Sheikh, S. A., and O'Neill, M. W. (1987). "Structural Behavior of 45-Degree Underreamed Footings," *Transportation Research Record 1119*, Transportation Research Board, Washington, DC, pp. 83 - 91.
- Snow, R. (1965). "Telltale," *Foundation Facts*, Raymond International, Fall, 1965, pp. 12 - 13.
- Welch, R. C., and Reese, L. C. (1972). "Laterally Loaded Behavior of Drilled Shafts," *Research Report No. 89-10*, Center for Highway Research, The University of Texas at Austin, May.

## CHAPTER 15: GUIDE DRILLED SHAFT CONSTRUCTION SPECIFICATIONS

### INTRODUCTION

The guide construction specifications that are given in this chapter are modified from those that were developed and distributed by the Federal Highway Administration in 1991 to provide information that includes practical construction monitoring and quality assurance practices (*FHWA Geotechnical Notebook No. 14, 1991*). Emphasis is placed on relating construction control to design factors, i.e., construction requirements for shafts that develop most of their resistance in side shear can differ from those that develop most of their resistance in bearing at the base.

The contents of the guide specifications are the result of input from state and federal engineers, drilled shaft contractors, ADSC: The International Association of Foundation Drilling, consultants specializing in drilled shaft work, and NCHRP consultants who developed revisions to the AASHTO Division I and Division II Bridge Specifications. They also draw heavily on the descriptions of construction practices described in the preceding edition of this manual and which are carried over into this edition.

Similar to other guide specifications, these specifications may not be completely suitable for specific conditions on all projects. Because drilled shaft project requirements vary widely, engineers should develop their own specifications using the guide specifications in this chapter only as a guide. When using this guide to develop specifications or special provisions, appropriate items in standard specifications may be included by reference in lieu of including those items explicitly in the drilled shaft specifications. Other references that can be consulted when developing drilled shaft construction specifications are:

- ACI document entitled *Standard Specification for the Construction of Drilled Piers*, ACI 336.1-94 (to be revised in 1998), which can be obtained from the American Concrete Institute in Detroit, Michigan.
- ADSC document entitled *Standards and Specifications for the Foundation Drilling Industry*, 1995, which incorporates much of the information from the ACI specifications. A copy can be obtained from the ADSC, Dallas, Texas.
- Standard specifications from states with a history of drilled shaft use, such as Texas, Washington, Arizona, California, Louisiana and Florida. Much of the format and content of the FHWA guide specifications contained here is based on the Florida Department of Transportation drilled shaft specification.

Several sections include commentaries that provide further guidance to assist engineers in developing modifications based on specific project conditions. In addition, several key and potentially controversial topics are discussed further below to provide a brief background on the position advocated in these guide specifications.

## **Construction Method**

The construction methods to be permitted on a specific project (Chapter 3) are directly related to the method of load transfer assumed in the project design. The type of drilling method, presence of permanent casing, and cleanout procedure are among the factors that affect the drilled shaft load transfer behavior in side and base resistance, as well as the lateral load behavior of the drilled shaft. For instance, the permanent casing method cannot be permitted in subsurface deposits that are designated for full mobilization of side resistance in the geomaterial.

Fortunately, numerous combinations of equipment and procedures are commonly available to permit successful installation of drilled shafts for any stated design criterion. Specifications should not needlessly restrain contractors in their choice of tools, equipment or construction methods. The key to cost-effective projects is permitting flexibility in contractor operations to achieve the design intent; particularly at sites where variable subsurface conditions are expected.

Quality of the end product is monitored and controlled by including explicit definitions and controls in the following areas: installation plan, tolerances, acceptance and rejection criteria, and project documentation. Further information on acceptance criteria is provided in Chapter 17. The success of these specifications rely heavily on responsible and knowledgeable inspection and experienced drilled shaft contractors. Even the most conservative design can result in problems if: the specified construction procedure is inappropriate for the project conditions, the inspection is not effective, or the contractor is poorly equipped or is inexperienced in drilled shaft construction.

## **Drilling Slurry**

Drilling slurry is an effective means of stabilizing drilled shaft excavations until either a casing has been installed or concrete has been placed, as explained in Chapter 6. The properties of drilling slurry should be both monitored and controlled prior to and during drilling, and prior to concrete placement. Primary concerns in slurry use are: (1) the shape of the borehole should be maintained during excavation and concrete placement; (2) the slurry does not weaken the bond between the concrete and either the natural geomaterial or the rebar; (3) all of the slurry is displaced from the borehole by the rising column of fresh concrete; and (4) any sediment carried by the slurry is not deposited in the borehole.

The engineer's concerns regarding the behavior and effectiveness of slurry projects can be satisfied by appropriate specification requirements. These requirements include: (1) specifying a suitable range of slurry properties both prior to and during excavation and prior to concreting; (2) performing slurry inspection tests; and (3) construction of preproduction trial (technique) shafts by the slurry method.

## **Payment for Shaft Excavation**

The ability of a contractor to excavate a particular stratum of geomaterial depends on the type, size, and condition of the contractor's equipment, as well as the skill of the equipment operators. Two alternate methods of payment for shaft excavation are shown in the guide specifications, unclassified payment and classified payment. Both methods should require separate compensation for obstruction removal. As will be seen in Chapter 19, the construction costs in many rock formations are considerably higher than those in most soils, so the payment for excavation on the basis of the type of geomaterial being excavated, or more properly on the basis of the difficulty of excavation (classified excavation), is almost always more economical than payment for excavation on the basis of the number of meters or feet of drilled shaft installed regardless of the geomaterial encountered (unclassified excavation). However, there are geologic situations in which the transition from geomaterials that can be drilled with standard techniques at a rapid rate to geomaterials that are difficult to excavate is hard to define, or ambiguous, and in such situations unclassified excavation may be the most fair and practical means of payment. The engineer's rightful concern regarding high contingency bids when using unclassified payment can be satisfied by performing an adequate site investigations and making this information available to the bidders.

Unclassified payment is appropriate at sites where a comprehensive exploration program has been completed specifically for a drilled shaft foundation system, as outlined in Chapter 2. Such a program should include a full-size inspection shaft in representative subsurface zones and test borings to beyond the maximum anticipated shaft depths at approximately the following intervals, which can be adjusted based on the specifics of the geologic conditions at the site and structure layout by the geotechnical engineer:

**NON- REDUNDANT (SINGLE) SHAFT FOUNDATIONS:**                    1 boring per shaft

**REDUNDANT (MULTIPLE) SHAFT FOUNDATIONS:**

Shaft diameters of 1.83 m (72 inches) or greater:	1 boring per shaft
Shaft diameters of 1.22 m to 1.83 m (48 to 72 inches):	1 boring per 2 shafts
Shaft diameters of less than 1.22 m (48 inches):	1 boring per 4 shafts

The boring logs and inspection shaft logs should contain specific information about equipment used (drilling rigs, tools, and drilling aids such as slurry or casing), crowd, and rate of penetration, in addition to soil and rock conditions, obstructions (for example, cobbles, boulders, buried facilities) and water conditions. All the aforementioned information should be made available to bidders as part of the contract documents.

Separate items for classified payment should be used for all other projects and defined in terms of standard excavation and special excavation. Standard excavation includes hole advancement

with conventional augers, drilling buckets, and/or underreaming tools. Special excavation is paid when the hole cannot be advanced with conventional tools. Hole advancement under special excavation requires special rock augers, core barrels, air tools, blasting or other methods of hand excavation. All earth seams, rock fragments or voids that are encountered after special drilling commences are paid as special excavation.

Obstructions, which require unconventional excavation techniques, are not considered special excavation for payment but are paid under a separate item. Some agencies pay for obstruction removal at a factor of 2 or 3 times the rate that was bid per unit of depth based on soil drilling, some pay based on a report of the contractor's time and materials, and some use other methods.

### **Qualification of Drilled Shaft Contractors for Bidding**

Drilled shafts are critical, frequently non-redundant, elements used for structural support. To insure reliable performance, such elements require the high degree of workmanship which can be provided only by experienced drilled shaft specialty contractors. Minimum drilled shaft contractor qualifications should be required by highway agencies based on either prior contractor experience and/or a preconstruction demonstration of drilled shaft construction capabilities. The degree of risk and complexity of a particular project should be used to establish qualifications for specific projects. The guide specifications contain suggested qualification requirements for a typical primary highway project founded on drilled shafts.

It should also be considered unacceptable practice for a contractor to hire a drilled shaft specialist only to excavate the drilled shaft boreholes so that placement of steel and concrete can be performed by a different organization. The inevitable lack of coordination and increase in time that a borehole remains open prior to concreting following such a practice can severely negatively impact the performance of drilled shafts. Construction of a drilled shaft includes excavating, placing steel and placing concrete. These are all critical operations that should be performed in a continuous manner by a single, qualified contractor.

### **Special Bidding Requirement**

Drilled shaft costs are controlled largely by the character of the subsurface materials encountered during excavation. No drilled shaft contractor should be permitted either to bid drilled shaft work or act as a subcontractor to a bidder unless he or she has: visited the site, inspected soil and rock samples (if made available in the contract documents by the agency -- a practice that is highly recommended) and received the subsurface information made available in the contract documents.

## **GUIDE DRILLED SHAFT CONSTRUCTION SPECIFICATIONS**

The outline of the guide specifications are given in the following, after which the specifications and commentary are shown.



<b>Item</b>	<b>Contents</b>
xxx .10	Description
xxx .11	Qualifications of Drilled Shaft Contractor
xxx .12	Submittals
xxx .13	Trial Shaft Installation
xxx .20	Materials
xxx .30	Construction Methods and Equipment
xxx .30.1	Protection of Existing Structures
xxx .30.2	Construction Sequence
xxx .30.3	General Methods and Equipment
xxx .31	Dry Construction Method .
xxx .32	Wet Construction Method
xxx .33	Casing Construction Method
xxx .34	Excavation and Drilling Equipment
xxx .35	Excavations
xxx .35.1	Unclassified Excavation .
xxx .35.2	Classified Excavation
xxx .35.21	Standard Excavation
xxx .35.22	Special Excavation
xxx .35.3	Obstructions
xxx .35.4	Lost Tools
xxx .35.5	Exploration (Shaft Excavation)
xxx .36	Casings
xxx .36.1	Temporary Casing
xxx .36.2	Permanent Casing
xxx .37	Slurry
xxx .40	Excavation Inspection
xxx .41	Construction Tolerances
xxx .50	Reinforcing Steel Cage Construction and Placement
xxx .60	Concrete Placement
xxx .61	Tremies
xxx .62	Pumped Concrete
xxx .63	Drop Chutes
xxx .64	Non-Destructive Evaluation
xxx .64.1	Tests in Access Tubes
xxx .64.1	Socic Echo Tests

xxx .70	Drilled Shaft Loading Tests
xxx .80	Method of Measurement
xxx .90	Basis of Payment

### ITEM xxx. DRILLED SHAFTS

#### xxx.10 DESCRIPTION

This work shall consist of all labor, materials, equipment and services necessary to perform all operations to complete the drilled shaft installation in accordance with this specification, the special provisions and with the details and dimensions shown on the plans. Drilled shafts shall consist of reinforced or unreinforced concrete with or without concrete bell footings.

#### xxx.11 QUALIFICATIONS OF DRILLED SHAFT CONTRACTOR:

The Contractor performing the work described in this specification shall have installed drilled shafts of both diameter and length similar to those shown on the plans for a minimum of three (3) years prior to the bid date for this project.

#### COMMENTARY

*Drilled shafts are critical, frequently non-redundant, elements used for structural support. To insure reliable performance, such elements require the high degree of workmanship which can be provided only by experienced drilled shaft specialty contractors. Minimum drilled shaft contractor qualifications should be required by highway agencies based on either prior contractor experience and/or a preconstruction demonstration of drilled shaft construction capabilities. The degree of risk and complexity of a particular project should be used to establish qualifications for specific projects. The guide specification contains suggested qualification requirements for a typical primary highway project founded on drilled shafts.*

#### xxx.12 SUBMITTALS:

At the time of bid, the Contractor shall submit both a list containing at least three (3) projects completed in the last three (3) years on which the Contractor has installed drilled shafts of a diameter and length similar to those shown on the plans, and a signed statement that the Contractor has inspected both the project site and all the subsurface information made available in the contract documents, including any soil or rock samples referenced in the contract documents. The list of projects shall contain names and phone numbers of owner's representatives who can verify the Contractors' participation on those projects.

No later than one month prior to constructing drilled shafts, the Contractor shall submit an

installation plan for review by the Engineer. This plan shall provide information on the following:

- (a) Name and experience record of the drilled shaft superintendent who will be in charge of drilled shaft operations for this project.
- (b) List of proposed equipment to be used, including cranes, drills, augers, bailing buckets, final cleaning equipment, desanding equipment, slurry pumps, core sampling equipment, tremies or concrete pumps, casing. etc.
- (c) Details of overall construction operation sequence and the sequence of shaft construction in bents or groups.
- (d) Details of shaft excavation methods.
- (e) When the use of slurry is anticipated, details of the mix design and its suitability for the subsurface conditions at the construction site, mixing and storage methods, maintenance methods, and disposal procedures.
- (f) Details of methods to clean the shaft excavation.
- (g) Details of reinforcement placement, including support and centralization methods.
- (h) Details of concrete placement, including proposed operational procedures for free fall, tremie or pumping methods.
- (i) Details of casing installation and removal methods.

The Engineer will evaluate the drilled shaft installation plan for conformance with the plans, specifications and special provisions. Within 14 days after receipt of the installation plan, the Engineer will notify the Contractor of any additional information required and/or changes necessary to meet the contract requirements. All procedural approvals given by the Engineer shall be subject to trial in the field and shall not relieve the Contractor of the responsibility to satisfactorily complete the work as detailed in the plans and specifications.

#### *COMMENTARY*

*The sequence of drilled shaft installation and the tools used to install drilled shafts and to install and remove casing can be critical when closely spaced drilled shafts are to be constructed. It is important that the Contractor's installation plan be specific to the job at hand and not merely be a standard listing of general steps in the construction of drilled shafts.*

### **xxx.13 TRIAL SHAFT INSTALLATION:**

The Contractor shall demonstrate the adequacy of his methods, techniques and equipment by successfully constructing an unreinforced concrete, trial shaft in accordance with this specification's requirements. This trial shaft shall be positioned away from production shafts in the location shown on the plans or as directed by the Engineer. The trial shaft shall be drilled to the maximum depth of any production shaft shown in the plans. When shown on the plans, the reaming of bells at specified trial shaft holes will be required to establish the feasibility of belling in a specific soil stratum. Failure by the Contractor to demonstrate to the Engineer the adequacy of methods and equipment shall be reason for the Engineer to require alterations in equipment and/or method by the Contractor to eliminate unsatisfactory results. Any additional trial holes required to demonstrate the adequacy of altered methods or construction equipment shall be at the Contractor's expense. Once approval has been given to construct production shafts, no changes will be permitted in the methods or equipment used to construct the satisfactory trial shaft without written approval of the Engineer.

Unless otherwise shown in the contract documents, the trial shaft holes will be filled with unreinforced concrete in the same manner that production shafts will be constructed. The concreted trial shafts shall be cut off 0.6 m (2 feet) below finished grade and left in place. The disturbed areas at the sites of the trial shaft holes shall be restored as nearly as practical to their original condition.

#### *COMMENTARY*

*The purpose of specifying a trial (technique) shaft or multiple trial shafts on large projects with variable subsurface conditions is twofold: first, to insure that the Contractor has the necessary expertise to complete the work successfully and, second, to determine if the proposed equipment and drilling procedures are adequate for the site conditions. Trial shafts are not necessary for every project; however, trial shafts should be considered mandatory in any of the following situations:*

- (a) Prequalification of bidders is not included in the specifications,*
- (b) A drilled shaft installation plan is not required,*
- (c) Site conditions are difficult or unusual for drilled shaft installation,*
- (d) The production drilled shafts are non-redundant foundation elements, i.e., a single shaft supports a pier,*
- (e) Classified excavation items are used, or*
- (f) The dry method of construction is expected to be used.*

*Site-specific reasons to construct trial shafts include determining if the Contractor can: control dimensions and alignment of excavations within tolerance; seal the casing into impervious materials; control the size of the excavation under caving conditions by the use of a mineral or polymer slurry or by other means; properly clean the completed shaft excavation; construct*

*excavations in open water areas; or satisfactorily execute any other necessary construction operation.*

*Trial shaft holes should be located either at least three shaft diameters or one bell diameter, whichever is greater, from a permanent shaft location. The diameter and depth of the trial shaft hole or holes should be the same as the diameter and depth of the production drilled shafts. The trial shaft holes will generally be filled with unreinforced concrete in the same manner that production shafts will be constructed. In some cases, the trial shaft holes may be backfilled with suitable soil when concreting problems are not anticipated for production shafts.*

**xxx. 20 MATERIALS:**

Materials shall meet the requirements specified in the following subsections of Section xxx - Materials

Portland Cement Concrete: xxx.xx

Reinforcing Steel: xxx.xx

**COMMENTARY**

*The appropriate sections of each agency's standard specifications should be included under the xxx.20 Materials section. A generic materials section cannot be provided herein considering the vast combinations of materials and control methods used by individual transportation departments. The above list contains the common material components. Additions or deletions may be required based on the content of individual agency standard specifications. Some general guidance on concrete and reinforcing steel is provided in this commentary.*

**CONCRETE:** *Each state agency will likely have local mix designs that are preferred for drilled shafts, based on the performance of local cements and aggregates. Concrete mix design for drilled shafts should be given special attention. Desirable properties are fluidity, compaction under self weight, resistance to segregation and controlled set time. Specific guidance on slump and aggregate gradation are provided below.*

*Slump requirements are based on providing the necessary quality of workability for uniform and proper placement throughout the duration of shaft construction. The following table provides suggested slump values:*

<i>Slump Range</i>	<i>Typical Condition</i>
<i>175 mm ± 25 mm 7 inches ± 1 inch</i>	<i>All conditions except placement under a drilling fluid</i>

200 mm ± 25 mm      Placement under a drilling fluid  
8 inches ± 1 inch

High workability is achieved with proper aggregate gradations, water-cement ratios and appropriate admixtures, such as water reducing and air entraining agents. Angular crushed aggregates are harder to work than similar sized rounded aggregates. Sand content (by the Unified Soil Classification System) of the concrete mix should vary from 35 to 45 per cent of the total aggregate weight. An example aggregate gradation is shown below.

Sieve Size	Passing by Weight (percent)
3/4 inch (19 mm)	100
3/8 inch (9.5 mm)	60
No. 4	35
No. 8	30
No. 16	25
No. 30	20
No. 50	10
No. 100	0

To insure against segregation, the maximum aggregate top size should be in the 19 mm (3/4 inch) range and the sand-cement content should be high compared to the coarse aggregate content. If unlimited free fall placement is permitted, the Engineer may wish to reduce the maximum aggregate size to 9.5 mm (3/8 inch) to prevent segregation if the falling concrete incidentally contacts the rebar cage. Otherwise, if free falling concrete can be prevented from hitting the cage, the 19 mm (3/4 inch) size should be satisfactory to prevent segregation provided the mix has a relatively high sand-cement content in order to maintain good cohesion while it is fluid. In general, relatively high cement content is used in the drilled shaft concrete mix, i.e. typically 3.43 to 3.93 kN/m<sup>3</sup> (590 to 675 pounds per cubic yard). Fly ash can be used to replace some of the portland cement in many situations, as discussed in Chapter 8.

**REINFORCING STEEL:** The clear spacing between bars of the rebar cage should be at least five times the size of the maximum coarse aggregate. Hooks at the top of the rebar cage should not be bent outward if there is any chance that temporary casing will be used. Similarly, interior hooks must be designed to permit adequate clearance for a concrete tremie pipe, i.e., 0.305 m (12 inches) minimum. Where clearance is a problem, hooks may be placed on dowels which may be rotated after concrete placement or casing removal and repositioned after the tremie is removed. The concrete must remain fluid during dowel repositioning.

Shafts that require a large amount of reinforcing steel should use bundled longitudinal bars to maintain the minimum clear spacing requirement.

The outside diameter of the assembled rebar cage must be at least 152 mm (six inches) smaller

*than the drilled hole diameter. This clear space is necessary both to permit free flow of concrete up the annular space between the cage and the hole perimeter and to provide adequate concrete cover over the reinforcing cage.*

### **xxx.30 CONSTRUCTION METHODS AND EQUIPMENT:**

#### **xxx.30.1 PROTECTION OF EXISTING STRUCTURES:**

The Contractor shall control his operations to prevent damage to existing structures and utilities. Preventive measures shall include, but are not limited to, selecting construction methods and procedures that will prevent caving of the shaft excavation, and monitoring and controlling the vibrations from construction activities such as the driving of casing or sheeting, drilling of the shaft, or from blasting, if permitted.

#### *COMMENTARY*

*The specific monitoring requirements for structures impacted by drilled shaft construction should be assessed on a project-by-project basis. If monitoring is determined to be necessary, a preconstruction survey of existing facilities should be performed to establish baseline data, including ambient vibration levels and existing structural defects. In general, monumented survey points should be established on structures which are located within a distance of either ten shaft diameters or the estimated shaft depth, whichever is greater. These points should be monitored by the Contractor for vertical and lateral movement in an approved manner to the accuracy determined by the highway agency.*

*When deformations exceed the predetermined amount included in the plans by the agency, the Contractor shall immediately stop work and, if directed by the Engineer, backfill the excavated hole. The Contractor shall be responsible for selecting and using equipment and procedures that keep deformations of existing structures within specified levels.*

*When vibrations are to be monitored, the Contractor should be directed to engage the services of a professional vibrations consultant to monitor and record vibration levels during drilled shaft construction. In general, vibration monitoring equipment should be capable of detecting velocities of 2.5 mm per second (0.1 inch per second) or less. When vibration levels exceed established tolerable levels the Contractor should immediately stop work and take whatever measures are necessary to reduce vibration levels below tolerable levels. For typical projects, vibration velocity levels less than 50 mm per second (2.0 inches per second) are generally tolerable for modern structures. Vibrations at this level, and much below this level, can be annoying to humans, however, and human occupancy should be taken into account.*

*Periodic check elevations and vibrations measurements should be taken by the highway agency. In general, check readings should be taken before construction begins, during the driving of any required casings, and before and after blasting.*

### **xxx.30.2 CONSTRUCTION SEQUENCE:**

Excavation to footing elevation shall be completed before shaft construction begins unless otherwise noted in the contract documents or approved by the Engineer. Any disturbance to the footing area caused by shaft installation shall be repaired by the Contractor prior to the footing pour.

When drilled shafts are to be installed in conjunction with embankment placement, the Contractor shall construct drilled shafts after the placement of fills unless shown otherwise in the contract documents or approved by the Engineer.

Drilled shafts, constructed prior to the completion of the fills, shall not be capped until the fills have been placed as near to final grade as possible, leaving only the necessary work room for construction of the caps.

#### *COMMENTARY*

*When pouring concrete in a hole filled with drilling fluid, the interface between the drilling fluid and the uncontaminated concrete may not be distinct. Common practice is to continue the concrete pour after the concrete has "topped out" to insure all contaminated concrete is flushed out. When a cutoff elevation is specified some distance below ground level the only safe solution is to continue the concrete pour until uncontaminated concrete is visible above ground. Then, after the concrete sets and the excavation to grade is complete, the extra concrete must be chipped to cutoff level, taking care to expose the reinforcement connection to the footing reinforcement. For this reason, cutoff elevations below ground should be avoided where possible.*

### **xxx.30.3 GENERAL METHODS AND EQUIPMENT:**

The Contractor shall perform the excavations required for shafts, and bell footings if shown on the plans, through whatever materials are encountered, to the dimensions and elevations shown in the plans or otherwise required by the specifications and special provisions. The Contractor's methods and equipment shall be suitable for the intended purpose and materials encountered. The permanent casing method shall be used only at locations shown on the plans or when authorized by the Engineer. Blasting shall only be permitted if specifically stated on the plans or authorized in writing by the Engineer.

#### *COMMENTARY*

*Blasting should be discouraged during the construction of drilled shafts and should be used only if drilling techniques fail. Then, only controlled perimeter blasting techniques should be permitted in drilled shaft construction to insure the integrity of a load-bearing socket formed in rock. Uncontrolled blasting may cause deep structural damage to the rock formation and result*



*in undesirable structure settlements or bearing failure when load is applied. A typical special provision for rock excavation in shafts by blasting is given at the end of this guide specification.*

### **xxx.31 DRY CONSTRUCTION METHOD:**

The dry construction method shall be used only at sites where the ground water level and soil and rock conditions are suitable to permit construction of the shaft in a relatively dry excavation, and where the sides and bottom of the shaft may be visually inspected by the Engineer prior to placing the concrete. The dry method consists of drilling the shaft excavation, removing accumulated water and loose material from the excavation, placing the reinforcing cage, and concreting the shaft in a relatively dry excavation.

#### **COMMENTARY**

*The dry method (described in Chapter 3) is by far the least expensive method for drilled shaft construction. Given the choice of drilling methods, Contractors will try the dry method even in soil or rock of dubious quality. In fact, one reason for constructing a trial shaft is to determine whether dry construction will be possible or whether more expensive methods (casing and/or wet methods) may be required. During the construction of trial shafts, the Engineer should insure that the sides and bottom of the drilled hole do not degrade prior to completion of concreting, and the drilled shaft inspector must continue to observe the same conditions during the construction of production shafts. For that reason a trial shaft installation is recommended before the Contractor is permitted to use the dry method on production shafts. Approval of the dry method should be based on the following criteria:*

*The dry construction method shall only be approved by the Engineer when the trial shaft excavation demonstrates that: less than 0.305 m (12 inches) of water accumulates above the base over a one hour period when no pumping is permitted; the sides and bottom of the hole remain stable without detrimental caving, sloughing or swelling over a four-hour period immediately following completion of excavation; and any loose material and water can be satisfactorily removed prior to inspection and prior to concrete placement. The Contractor shall use the wet construction method or the casing construction method for shafts that do not meet the above requirements for the dry construction method.*

*It is also important to establish during pre-construction meetings with the Contractor how much water and loose geomaterial on the bottom of the borehole will actually be permitted at the time the concrete is poured. Ordinarily, 75 mm (3 inches) of water is tolerable if cohesive concrete mixes are used, and loose sediment up to 12.7 mm (1/2 inch) thick over one-half of the area of the base is acceptable. However, there may be situations in which these criteria are not strict enough (e. g., when high base resistance is required), so that the base cleanliness conditions for each job must be discussed and clearly understood prior to the start of construction.*

### **xxx.32 WET CONSTRUCTION METHOD:**

The wet construction method may be used at sites where a dry excavation can not be maintained for placement of the shaft concrete. This method consists of using water or slurry (mineral or polymer) to maintain stability of the borehole perimeter while advancing the excavation to final depth, placing the reinforcing cage, and concreting the shaft. Where drilled shafts are located in open water areas, exterior casings shall be extended from above the water elevation into the ground to protect the shaft concrete from water action during placement and curing of the concrete. The exterior casing shall be installed in a manner that will produce a positive seal at the bottom of the casing so that no piping of water or other materials occurs into or from the shaft excavation.

#### *COMMENTARY*

*The wet construction method (described in Chapter 3) may be used in combination with the dry method and temporary or permanent casing methods. Sections of this specification dealing with the wet method should not be deleted on projects where the dry method or casing method are specified in the event the wet method must be used. In fact, the Engineer should be open to changing to the wet method if and when other methods fail to produce stable boreholes during construction of the production shafts. The insistence on dry or casing method construction, when wet method construction will be effective, can result in defective drilled shafts. The wet method may involve desanding and cleaning the slurry (for mineral slurries); final cleaning of the excavation by means of a bailing bucket, air lift, submersible pump or other approved devices; and placing the shaft concrete with a tremie or concrete pump beginning at the shaft bottom. Temporary surface casings should be provided to aid shaft alignment and position, and to prevent sloughing of the top of the shaft excavation, unless the Contractor demonstrates to the satisfaction of the Engineer that the surface casing is not required. The Contractor must be informed that the waste slurry should be disposed of in an approved manner.*

### **xxx.33 CASING CONSTRUCTION METHOD:**

The casing method may be used either when shown on the plans or at sites where the dry or wet construction methods are inadequate to prevent hole caving or excessive deformation of the hole. In this method the casing may be either placed in a predrilled hole or advanced through the ground by twisting, driving or vibration before being cleaned out.

#### *COMMENTARY*

*When the casing is placed in a predrilled borehole, the temporary stability of the hole may need to be assured by using drilling slurry. The slurry that is trapped in the annular space behind the casing must later be forced out of that space by the rising column of fluid concrete as the casing is being pulled. For this to happen without producing defects in the drilled shaft, the slurry in the annular space must not have deposited granular soil or have gelled to the point where it will*

*not be displaced. For this reason the slurry used to stabilize a borehole temporarily prior to the placement of casing must satisfy all of the criteria of drilling slurry for the wet method of construction.*

### **xxx.34 EXCAVATION AND DRILLING EQUIPMENT:**

The excavation and drilling equipment shall have adequate capacity, including power, torque and down thrust to excavate a hole of both the maximum diameter and to a depth of 20 percent beyond the depths shown on the plans.

The excavation and overreaming tools shall be of adequate design, size and strength to perform the work shown in the plans or described herein. When the material encountered cannot be drilled using conventional earth augers with soil or rock teeth, drill buckets, grooving tools, and/or underreaming tools, the Contractor shall provide special drilling equipment, including but not limited to: rock core barrels, rock tools, air tools, blasting materials, and other equipment as necessary to construct the shaft excavation to the size and depth required. Approval of the Engineer is required before excavation by blasting is permitted.

Sidewall overreaming shall be required when the sidewall of the hole is determined by the Engineer to have either softened due to excavation methods, swelled due to delays in concreting, or degraded because of slurry cake buildup. Overreaming thickness shall be a minimum of 12.7 mm (1/2 inch) and a maximum of 75 mm (3 inches). Overreaming may be accomplished with a grooving tool, overreaming bucket or other approved equipment. The thickness and elevation of sidewall overreaming shall be as directed by the Engineer. The Contractor shall bear all costs associated with both sidewall underreaming and additional shaft concrete placement.

### **xxx.35 EXCAVATIONS:**

Shaft excavations shall be made at locations and to the top of shaft elevations, estimated bottom of shaft elevations, shaft geometry and dimensions shown in the contract documents. The Contractor shall extend drilled shaft tip (base) elevations when the Engineer determines that the material encountered during excavation is unsuitable and/or differs from that anticipated in the design of the drilled shaft.

The Contractor shall maintain a construction method log during shaft excavation. The log shall contain information such as: the description and approximate top and bottom elevation of each soil or rock material encountered, seepage or ground water, and remarks, including a description of the tools and drill rigs used and any changes necessitated by changing ground conditions.

Excavated materials that are removed from shaft excavations shall be disposed of by the Contractor in accordance with the applicable specifications for disposal of excavated materials.

When shown in the plans, bells shall be excavated to form the height and bearing area of the size

and shape shown. The bell shall be excavated by mechanical methods. Any drilled shaft concrete over the theoretical amount required to fill any excavations for the bells and shafts dimensioned on the plans shall be furnished at the Contractor's expense.

On projects with cofferdams, the Contractor shall provide a qualified diver to inspect the cofferdam conditions when a seal is required for construction. Prior to concrete seal placement the diver shall inspect the cofferdam interior periphery including each sheeting indentation and around each drilled shaft to insure no layers of mud or undesirable material remain above the planned bottom elevation of seal.

The Contractor shall not permit workers to enter the shaft excavation for any reason unless: both a suitable casing has been installed and the water level has been lowered and stabilized below the level to be occupied, and adequate safety equipment and procedures have been provided to workers entering the excavation.

#### COMMENTARY

*It is very important that any restrictions on excavating drilled shafts, including the driving, vibrating or removal of casing to assist in making the excavation, be stated explicitly. For example, if the Engineer wishes to avoid construction of drilled shafts within a specified distance of a recently installed drilled shaft for a fixed period of time, this restriction should be stated clearly at this point in the specifications to avoid any misunderstandings between the Engineer and the Contractor.*

#### **xxx.35.1 UNCLASSIFIED EXCAVATION:**

When drilled shaft excavation is designated as unclassified in the contract documents the Contractor shall provide the necessary equipment to remove and dispose of any materials encountered in forming the drilled shaft excavation to the dimensions shown on the plans or as directed by the Engineer. No separate payment will be made for either excavation of materials of different densities and character or employment of special tools and procedures necessary to accomplish the excavation in an acceptable fashion. Obstruction removal shall be paid separately.

#### **xxx.35.2 CLASSIFIED EXCAVATION:**

When designated in the contract documents, the Contractor shall perform classified excavation under standard and special excavation items. Obstruction removal shall be paid separately.

#### **xxx.35.21 STANDARD EXCAVATION:**

Standard excavation is excavation accomplished with conventional tools such as augers, drilling buckets, and overreaming (belling) buckets attached to drilling equipment of the size, power,

torque, and down thrust (crowd) approved for use by the Engineer after successful construction of a trial drilled shaft

**xxx.35.22 SPECIAL EXCAVATION:**

Special excavation is excavation that requires special tools and/or procedures to accomplish hole advancement. Special excavation is paid for excavation, except obstructions, below the depth where conventional tools and the approved drilling equipment, operating at maximum power, torque and down thrust, cannot advance the hole. All excavation, except obstructions, performed below the depth where special excavation is authorized shall be considered special excavation regardless of the density or character of materials encountered

**xxx.35.3 OBSTRUCTIONS:**

Surface and subsurface obstructions at drilled shaft locations shall be removed by the Contractor. Such obstructions may include man-made materials such as old concrete foundations and natural materials such as boulders. Special procedures and/or tools shall be employed by the Contractor after the hole cannot be advanced using conventional augers, drilling buckets and/or underreaming tools. Such special procedures/tools may include but are not limited to: chisels, boulder breakers, core barrels, air tools, hand excavation, temporary casing, and increasing the hole diameter. Blasting shall not be permitted unless specifically approved in writing by the Engineer.

**xxx.35.4 LOST TOOLS:**

Drilling tools that are lost in the excavation shall not be considered obstructions and shall be promptly removed by the Contractor without compensation. All costs due to lost tool removal shall be borne by the Contractor including, but not limited to, costs associated with the repair of hole degradation due to removal operations or an excessive time that the hole remains open.

**xxx.35.5 EXPLORATION (SHAFT EXCAVATION):**

The Contractor shall take soil samples or rock cores where shown on the plans or as directed by the Engineer to determine the character of the material directly below the completed shaft excavation. The soil samples shall be extracted with a split spoon sampler or undisturbed sample tube. The rock cores shall be cut with an approved double or triple tube core barrel to a minimum of 3 m (10 feet) below the bottom of the drilled shaft excavation either before the excavation is made or at the time the shaft excavation is approximately complete. The Engineer may require the depth of coring to be extended up to a total depth of 6 m (20 feet). Rock core and standard penetration test samples shall be measured, visually identified and described on the Contractor's log. The samples shall be placed in suitable containers, identified by shaft location, elevation, project number and delivered with the Contractor's field log to the Engineer. *If the samples are acquired when the excavation has reached the planned elevation of the shaft base, the field log*

*and samples shall be delivered to the Engineer immediately upon completion, and the Engineer shall inspect the materials and render a decision on the suitability of the bearing stratum without delay. If the samples are acquired prior to making the excavation, the samples and field log shall be delivered to the Engineer within 24 hours after the exploration is complete. The Engineer will then inspect the samples/cores and determine the final depth of required excavation based on his evaluation of the material's suitability. Two copies of the Contractor's final typed log shall be furnished to the Engineer at the time the shaft excavation is completed and accepted.*

#### COMMENTARY

*Unclassified payment should not be used unless a comprehensive exploration program has been completed specifically for a drilled shaft foundation system, as outlined in Chapter 2. Such a program should include a full-size inspection shaft in representative subsurface zones and test borings to beyond the maximum anticipated shaft depths at approximately the following intervals, which can be adjusted based on the specifics of the geologic conditions at the site by the geotechnical Engineer:*

*NON- REDUNDANT (SINGLE) SHAFT FOUNDATIONS: 1 boring per shaft*

*REDUNDANT (MULTIPLE) SHAFT FOUNDATIONS:*

<i>Shaft diameters of 1.83 m (72 inches) or greater:</i>	<i>1 boring per shaft</i>
<i>Shaft diameters of 1.22 m to 1.83 m (48 to 72 inches):</i>	<i>1 boring per 2 shafts</i>
<i>Shaft diameters of less than 1.22 m (48 inches):</i>	<i>1 boring per 4 shafts</i>

*The inspection shaft logs should contain specific information about the drilling equipment and tools used and rate of hole advancement, as well as, descriptions of soil, rock, obstructions, and water encountered.*

*Classified excavation items should not be used unless a trial (technique) drilled shaft(s) has been included in the contract. The construction of a trial drilled shaft is the only procedure which can be used to assure that the Contractor's tools and equipment are adequate to perform standard excavation to reasonably expected depths at the project site. Guidance on proper equipment size is provided in Chapter 4. Without a trial drilled shaft, disputes often arise regarding the degree of difficulty of excavation with the Contractor's equipment and tools. In no case should classified excavation be separated into soil and rock payment, as material character alone is not an accurate measure of excavation difficulty. For example, some thinly, horizontally bedded rocks are quite easy to excavate with augers, while softer, but more massive, rock may require special tools. Highway agencies are encouraged to develop practical criteria to determine when special excavation payment should begin rather than requiring that the Contractor continue drilling an indefinite amount of time with conventional tools until the hole cannot be advanced. Such criteria should define special excavation to begin when a specified rate of hole advancement is reached. Practical refusal with appropriately selected conventional tools in good working order*

*is commonly considered to be achieved when the rate of hole advancement is less than 0.3 m (one foot) after fifteen minutes of continuous drilling at full power.*

*In general, adequate subsurface exploration should be performed to define excavation conditions and bottom-of-shaft elevations prior to project advertisement. Every effort should be made during the design phase to determine if obstructions will be encountered during shaft excavation. Special notes should be included in the plans to alert both the Contractor and Engineer of the type, approximate size and location of obstructions.*

*While the quality of the soil or rock at the base of the drilled shaft can be checked during the construction phase after the excavation has been made to its planned base elevation, it is usually preferable to make exploratory boring before the shaft is excavated. Doing so will save time and reduce uncertainty.*

### **xxx.36 CASINGS:**

Casings shall be steel, smooth, clean, watertight, and of ample strength to withstand both handling and driving stresses and the pressure of both concrete and the surrounding earth materials. The outside diameter of casing shall not be less than the specified diameter of shaft, and the outside diameter of any excavation made below the casing shall not be less than the specified diameter of the shaft. No extra compensation will be allowed for concrete required to fill an oversized casing or oversized excavation. All casings, except permanent casings, shall be removed from shaft excavations. Any length of permanent casing installed below the shaft cutoff elevation, shall remain in place.

When the shaft extends above ground or through a body of water, the portion exposed above ground or through a body of water may be formed with removable casing except when the permanent casing is specified. Removable casing shall be stripped from the shaft in a manner that will not damage the concrete. Casings can be removed when the concrete has attained sufficient strength provided: curing of the concrete is continued for a 72-hour period; the shaft concrete is not exposed to salt water or moving water for 7 days; and the concrete reaches a compressive strength of at least 17.2 MPa (2500 psi), as determined from concrete cylinder breaks.

### **COMMENTARY**

*If it is necessary to designate casing size in the plans or specifications, it should be designated by outside diameter unless local practice is to specify it according to inside diameter. Casing in the United States is commonly available in 6-inch (152-mm) increments of outside diameter, although inside-diameter casing can be rolled if necessary.*

### **xxx.36.1 TEMPORARY CASING:**

All subsurface casing shall be considered temporary unless specifically shown as permanent

casing in the contract documents. The Contractor shall be required to remove temporary casing before completion of concreting the drilled shaft. Telescoping, predrilling with slurry, and/or overreaming to beyond the outside diameter of the casing may be required to install casing.

If the Contractor elects to remove a casing and substitute a longer or larger-diameter casing through caving soils, the excavation shall be either stabilized with slurry or backfilled before the new casing is installed. Other methods, as approved by the Engineer, may be used to control the stability of the excavation and protect the integrity of the foundation materials.

Before the casing is withdrawn, the level of fresh concrete in the casing shall be a minimum of 1.5 m (five feet) above either the hydrostatic water level in the formation or the level of drilling fluid in the annular space behind the casing, whichever is higher. As the casing is withdrawn, care shall be exercised to maintain an adequate level of concrete within the casing so that fluid trapped behind the casing is displaced upward and discharged at the ground surface without contaminating or displacing the shaft concrete.

Temporary casings which become bound or fouled during shaft construction and cannot be practically removed shall constitute a defect in the drilled shaft. The Contractor shall be responsible to improve such defective shafts to the satisfaction of the Engineer. Such improvement may consist of, but is not limited to, removing the shaft concrete and extending the shaft deeper to compensate for loss of frictional capacity in the cased zone, providing straddle shafts to compensate for capacity loss, or providing a replacement shaft. All corrective measures including redesign of footings caused by defective shafts shall be done to the satisfaction of the Engineer by the Contractor without either compensation or an extension of the completion date of the project. In addition, no compensation will be paid for casing remaining in place.

#### COMMENTARY

*Temporary casing is commonly installed through an unstable deposit in an overreamed hole by the wet method and sealed in an underlying impervious layer. This procedure traps drilling fluid between the casing and the borehole wall. This trapped drilling fluid must be displaced upward along the outside of the casing during casing extraction if the load support capacity of this deposit is to be mobilized and the structural integrity of the shaft is to be ensured.*

*Positive upward displacement of drilling fluid can only be achieved if an adequate head of fluid concrete fills the casing when the seal is broken during casing extraction. In general, the head of concrete should be kept at or above hydrostatic ground water level during casing extraction. This requires adding concrete during extraction, as the volume to fill the overreamed hole is greater than the casing volume. Casing should never be pulled after the concrete begins to set due to probable entrapment of drilling fluid in the shaft concrete and probable separation of the concrete within the shaft.*



### **xxx.36.2 PERMANENT CASING:**

Permanent casing shall be used when shown in the contract documents. The casing shall be continuous between top and bottom elevations prescribed in the plans. After installation is complete, the permanent casing shall be cut off at the prescribed elevation and the shaft completed by installing necessary reinforcing steel and concrete in the casing.

In cases where special temporary casings are shown on the plans or authorized in writing by the Engineer to be used in conjunction with permanent casing, the Contractor shall maintain both alignment of the temporary casing with the permanent casing and a positive, watertight seal between the two casings during excavation and concreting operations.

#### *COMMENTARY*

*The installation procedures to be permitted for permanent casing depend on the design assumptions; particularly for allowable deflection under lateral load. To minimize lateral deflection the casing should be maintained in intimate contact with the surrounding earth after installation. This requirement would preclude placement of permanent casing in an oversized hole or temporary casing outside the permanent casing beneath the ground surface unless post grouting of the exterior annular space is required to create intimate contact between the casing and the surrounding ground.*

### **xxx.38 SLURRY:**

Mineral or polymer slurries shall be employed when slurry is used in the drilling process unless other drilling fluids are approved in writing by the Engineer. Mineral slurry shall have both a mineral grain size that will remain in suspension and sufficient viscosity and gel characteristics to transport excavated material to a suitable screening system. The percentage and specific gravity of the material used to make the mineral suspension shall be sufficient to maintain the stability of the excavation and to allow proper concrete placement.

During construction, the level of the slurry shall be maintained at a height sufficient to prevent caving of the hole. In the event of a sudden significant loss of slurry to the hole, the construction of that foundation shall be stopped until either a method to stop slurry loss or an alternate construction procedure has been approved by the Engineer.

Mineral slurry shall be premixed thoroughly with clean fresh water and adequate time (as prescribed by the mineral manufacturer) allotted for hydration prior to introduction into the shaft excavation. Slurry tanks of adequate capacity will be required for slurry circulation, storage, and treatment. No excavated slurry pits will be allowed in lieu of slurry tanks without the written permission of the Engineer. Desanding equipment shall be provided by the Contractor as necessary to control slurry sand content to less than 4 percent by volume at any point in the borehole at the time the slurry is introduced, including situations in which temporary casing will

be used. Desanding will not be required for sign post or lighting mast foundations unless shown in the plans or special provisions. The Contractor shall take all steps necessary to prevent the slurry from "setting up" in the shaft. Such methods may include but are not limited to: agitation, circulation and/or adjusting the properties of the slurry. Disposal of all slurry shall be done off site in suitable areas by the Contractor

Control tests using suitable apparatus shall be carried out on the mineral slurry by the Contractor to determine density, viscosity and pH. An acceptable range of values for those physical properties is shown in the table given in this section:

**MINERAL SLURRY**  
(Sodium Bentonite or Attapulgite in Fresh Water)

Acceptable Range of Values

Property (Units)	At Time of Slurry Introduction	In Hole at Time of Concreting	Test Method
Density (kN/m <sup>3</sup> )	10.1* - 10.8*	10.1* - 11.8*	Density Balance
Density (pcf)	64.3* - 69.1*	64.3* - 75.0*	
Viscosity (sec. /quart**)	28 - 45	28 - 45	Marsh Funnel
pH	8 - 11	8 - 11	pH paper, pH meter

\* Increase by 0.31 kN/m<sup>3</sup> (2 pcf) in salt water

\*\* Standard measurements are in seconds per quart, not seconds per liter. One sec. / quart = 1.06 sec. / liter, but 1 quart, not 1 liter, of slurry should be used in the test.

Notes: a. Tests should be performed when the slurry temperature is above 4.5 degrees Celsius (40 degrees Fahrenheit).

b. If desanding is required; sand content shall not exceed 4 per cent (by volume) at any point in the borehole as determined by the American Petroleum Institute sand content test when the slurry is introduced.

Tests to determine density, viscosity and pH value shall be performed during the shaft excavation to establish a consistent working pattern. A minimum of four sets of tests shall be made during the first 8 hours of slurry use. When the results show consistent behavior the testing frequency may be decreased to one set every four hours of slurry use.

If the Contractor proposes to use a polymer slurry, either natural or synthetic, it must be a

product approved for use by the State. See Circular xxx (or other appropriate qualified products document published by the State, naming approved polymer slurry products and their manufacturers). Slurry properties at the time of mixing and at the time of concreting must be in conformance with the written recommendations of the manufacturer. However, whatever product is used, the sand content at the base of the drilled shaft excavation shall not exceed 1 per cent when measured by Method API 13B-1, Section 5, immediately prior to concreting.

If the Contractor proposes to use a blended mineral-polymer slurry, the Contractor shall submit a detailed report specific to the project prepared and signed by a qualified slurry consultant describing the slurry materials, the mix proportions, mixing methods and quality control methods.

If polymer slurry, or blended mineral-polymer slurry, is proposed, the Contractor's slurry management plan shall include detailed provisions for controlling the quality of the slurry, including tests to be performed, the frequency of those tests, the test methods, and the maximum and/or minimum property requirements that must be met to ensure that the slurry meets its intended functions in the subsurface conditions at the construction site and with the construction methods that are to be used. The slurry management plan shall include a set of the slurry manufacturer's written recommendations and shall include the following tests, as a minimum: Density test (API 13B-1, Section 1), viscosity test (Marsh funnel and cup, API 13B-1, Section 2.2, or approved viscometer), pH test (pH meter, pH paper), and sand content test (API sand content kit, API 13B-1, Section 5).

If approved by the Engineer, the Contractor may use only water as a drilling fluid. In that case, all of the provisions in the table shown in this section for mineral slurries shall be met, except that the maximum density shall not exceed  $11.0 \text{ kN/m}^3$  (70 pcf).

The Contractor shall insure that a heavily contaminated slurry suspension, which could impair the free flow of concrete, has not accumulated in the bottom of the shaft. Prior to placing concrete in any shaft excavation, the Contractor shall take slurry samples using a sampling tool approved by the Engineer. Slurry samples shall be extracted from the base of the shaft and at intervals not exceeding 3 m (10 feet) up the slurry column in the shaft, until two consecutive samples produce acceptable values for density, viscosity, and pH.

When any slurry samples are found to be unacceptable, the Contractor shall take whatever action is necessary to bring the slurry within specification requirements. Concrete shall not be poured until the slurry in the hole is re-sampled and test results produce acceptable values.

Reports of all tests required above signed by an authorized representative of the Contractor, shall be furnished to the Engineer on completion of each drilled shaft.

During construction, the level of mineral or blended mineral-polymer slurry in the shaft excavation shall be maintained at a level not less than 1.2 m (4 feet) above the highest expected

piezometric pressure head along the depth of the shaft, and the level of polymer slurry shall be maintained at a level not less than 1.8 m (6 feet) above the highest expected piezometric pressure head along the shaft. If at any time the slurry construction method fails, in the opinion of the Engineer, to produce the desired final results, then the Contractor shall both discontinue this method and propose an alternate method for approval of the Engineer.

#### COMMENTARY

*Water has limited usefulness as a drilling fluid unless stabilization of hydrostatic pressure is the only concern (as in jointed non-argillaceous rock). When water is permitted, the amount of turbulence created in the hole by the introduction and extraction of drilling tools, particularly augers, must be carefully controlled to prevent localized hole caving and sidewall softening, since water tends to erode the sides of the borehole more readily than either mineral or polymer slurry. Likewise, mixtures of water and on-site soils should be discouraged for use as drilling slurry, since particulate matter falls out of suspension easily and can potentially contaminate the concrete.*

*Drilling tools should contain vents to stabilize hydrostatic pressure above and below the tool during insertion and extraction. The rate of tool extraction should not cause any noticeable turbulence in the slurry column in the borehole.*

*Many recommendations for drilled shaft slurry specifications are contained in the literature. A detailed study of such recommendations may be appropriate for some projects. For example, where saline or chemically contaminated ground water occurs, mineral slurry may be made with attapulgite or sepiolite instead of bentonite, and/or additives may be needed. In jointed rock or other situations where subsurface voids are encountered, water may be preferred drilling fluid.*

*Tests other than those shown in the preceding table are useful in the design of slurry mixes, although they are not usually necessary for routine control. For bentonitic slurries, for example, fluid loss and cake thickness tests, described in Chapter 6, should be conducted to make sure that the slurry mix performs correctly by building a mud cake and restricting loss of drilling fluid to the formation. Another slurry test that is useful in the design of mineral slurry mixes and which could be included in the specifications is the measurement of shear strength by the Fann Viscometer device. The 10-minute gel strength for acceptable bentonitic slurry varies between 1.9 and 40.2 N/m<sup>2</sup> (0.04 and 0.84 psf) in typical Fann Viscometer specifications.*

*The testing requirements in the table in this section do not include measurement of sand content in a mineral slurry column in the borehole before concreting. It is assumed if the density (unit weight) of the slurry at the time of introduction of slurry into the borehole is not above 11.8 kN/m<sup>3</sup> (75 pcf) at any point in the slurry column just prior to concreting that the sand (and silt) content will not be excessive. Some agencies require an explicit measurement of sand content in the slurry column just prior to concreting in addition to measurement of density, viscosity and pH. In such cases, sand content is usually not allowed to exceed 8 to 10 per cent, by volume, if*

*the slurry is a mineral slurry.*

*This guide specification does not include a table of acceptable values for density, viscosity and pH for polymer or blended mineral-polymer slurries. This is because the proper operating ranges for those properties vary considerably with specific polymers. For example, vinyl polymers (Chapter 6) are designed to perform at higher viscosities than other PHPA polymers, and natural polymers (Chapter 6) have a much-extended range of operating pH values than synthetic polymers. Therefore, the project specifications should be established based on the manufacturer's specifications for the product to be used rather than on generic specifications for control values. Since this approach is necessary, it is advisable that the State qualify all polymer products prior to their use. The qualification process should include verification that the product will not degrade the side or base resistance of the drilled shaft, produce defective concrete or reduce the bond between the rebar and the concrete.*

*The Engineer may also choose to issue a special provision requiring that the Contractor retain the slurry manufacturer's technical representative to be present at the site during project startup, or throughout the entire project if continual difficulty is expected, to ensure that the slurry is mixed and managed properly. This option might be called for when there has been a history of construction problems in the area of the project when polymer or blended slurries have been used or in an area or subsurface environment where these slurries will likely be used for the first time.*

*When checking the Contractor's slurry management plan for polymer or blended slurries, the Engineer should note how the Contractor expects to measure and control the hardness of the mixing water. This is an important issue when polymers are used (Chapter 6). Control procedures vary from product to product, but the total calcium hardness of the mixing water ordinarily should not exceed about 100 mg / L.*

*Finally, whether mineral or polymer slurry is used, it is essential that the provision that the slurry head remain above the piezometric head in the formation be strictly enforced. This especially includes initial drilling of the borehole down to the piezometric level. Slurry should be introduced when the depth of the borehole is still above the piezometric level, not after the inflow of water can be detected and/or sloughing has begun. This requirement points out the need for acquisition of good piezometric head information in the subsurface exploration program and, where variations in piezometric elevation may be expected over time, the need for a provision in the specification that the Contractor make such observations as are necessary during the installation of the drilled shafts to have continuous knowledge of the current elevation of the piezometric surface.*

#### **xxx.40 EXCAVATION INSPECTION:**

The Contractor shall provide equipment for checking the dimensions and alignment of each shaft excavation. The dimensions and alignment shall be determined by the Contractor under the

direction of the Engineer. Final shaft depths shall be measured with a suitable weighted tape or other approved methods after final cleaning. Unless otherwise stated in the plans, a minimum of 50 per cent of the base of each shaft will have less than 12.7 mm (1/2 inch) of sediment at the time of placement of the concrete. The maximum depth of sediment or any debris at any place on the base of the shaft shall not exceed 38 mm (1-1/2 inches). Shaft cleanliness will be determined by the Engineer, by visual inspection for dry shafts or other methods deemed appropriate by the Engineer for wet shafts. In addition, for dry excavations, the maximum depth of water shall not exceed 75 mm (3 inches) prior to concrete pour.

For dry shafts, the sidewalls shall be visually free of cuttings that may have been smeared on the walls during the removal and insertion of drilling tools.

#### COMMENTARY

*It is noted that the specific values given above for allowable sediment and allowable depth of water in a dry hole are taken from the Florida DOT specifications for drilled shaft construction. These values are appropriate for many cases but may not be appropriate for others, as for example when very high base resistances are to be used because the bearing stratum at the base of the shaft is very strong. The values given in any specification should be specific to the design for the project. Absolute cleanliness and dryness of the excavation are seldom necessary, however.*

#### **xxx.41 CONSTRUCTION TOLERANCES:**

The following construction tolerances apply to drilled shafts unless otherwise stated in the contract documents:

- (a) The center of the drilled shaft shall be within 76 mm (3 inches) of plan position in the horizontal plane at the plan elevation for the top of the shaft.
- (b) The vertical alignment of a vertical shaft excavation shall not vary from the plan alignment by more than 20 mm per meter (1/4 inch per foot) of depth. The alignment of a battered shaft excavation shall not vary by more than 40 mm per meter (1/2 inch per foot) of the distance along the axis of the shaft from the prescribed batter.
- (c) After all the concrete is placed, the top of the reinforcing steel cage shall be no more than 152 mm (6 inches) above and no more than 76 mm (3 inches) below plan position.
- (d) All casing diameters shown on the plans refer to O.D. (outside diameter) dimensions. The dimensions of casings are subject to American Pipe Institute tolerances applicable to regular steel pipe. When approved, the Contractor may elect to provide a casing larger in diameter than shown in the plans.

- (e) Bells shall be excavated to the plan bearing area and height shown on the plans as a minimum. The actual diameter of the bells shall not exceed 3 times the specified shaft diameter. All other plan dimensions shown for the bells may be varied, when approved by the Engineer, to accommodate the Contractor's equipment.
- (f) The top elevation of the shaft shall have a tolerance of plus 25 mm (1 inch) or minus 76 mm (3 inches) from the plan top-of-shaft elevation.
- (g) Excavation equipment and methods shall be designed so that the completed shaft excavation will have a planar bottom. The cutting edges of excavation equipment shall be normal to the vertical axis of the equipment within a tolerance of  $\pm 30$  mm per meter (3/8 inch per foot) of diameter.

Drilled shaft excavations and completed shafts not constructed within the required tolerances are unacceptable. The Contractor shall be responsible for correcting all unacceptable shaft excavations and completed shafts to the satisfaction of the Engineer. Materials and work necessary, including engineering analysis and redesign, to complete corrections for out-of-tolerance drilled shaft excavations shall be furnished without either cost to the State or an extension of the completion date of the project.

#### COMMENTARY

*Generally, the excavation or shaft alignment and dimensions may be checked by any of the following methods as necessary:*

- (a) *Install reference stakes offset from the shaft excavation to determine the as-drilled center of the shaft.*
- (b) *Suspend a plumb bob over the as-drilled hole centroid and determine any deviation in verticality.*
- (c) *Insert a casing in shaft excavations temporarily for alignment and dimension checks.*
- (d) *Insert a rigid rod assembly with several 90 degree offsets equal to the shaft diameter into the shaft excavation for alignment and dimension checks.*

*The depth of the shaft during drilling is usually referenced to appropriate marks on the kelly bar or other suitable methods.*

*Inspection of a shaft excavation can be accomplished by many different methods including the use of video equipment. Visual inspection by personnel in the hole requires safety measures that include:*

- (a) *Consulting the local occupational safety officials to insure that all safety requirements are adhered to.*
- (b) *Inserting a casing in the borehole before personnel enter. If necessary, the casing may be slotted so the personnel can view the sides of the borehole. When hand-cleaning bases of belled excavations, the Contractor's personnel should always stay within the protective casing.*
- (c) *Using air sampling devices to check for volatile or poisonous gases as well as oxygen content.*
- (d) *Providing proper ventilation to the excavation.*

*The required degree of bottom cleanliness depends on design factors such as the percentage of load carried in base resistance and allowable settlement. In general the procedures for checking the bottom conditions of wet holes are crude, i.e., line devices or visual observation via video. Insistence by the engineer on the use of the proper cleaning tools for the site conditions is the best method to insure a clean bottom. Invariably, better cleanout can be achieved with air lifts and submersible pumps than with cleanout buckets.*

*The inspector should not unnecessarily prolong or delay inspection of the completed shaft hole. The length of time the hole remains open can adversely affect load transfer as well as hole stability.*

*The construction tolerances shown in this specification are for typical drilled shaft construction. The tolerance that influences the Contractor's bid most is the deviation from plan location. The 76 mm (3 inch) limit in this specification represents a practical bound for average constructability. Lower values may require special techniques and will result in higher costs. In general, shafts should be designed to accommodate a 76 mm (3 inch) deviation. It is especially important that drilled shafts with diameters smaller than about 0.91 m (36 inches) be at least 76 mm (three inches) larger than the diameter required for geotechnical or structural purposes if this provision is specified. If larger deviations are allowable in design, this 76 mm (3 inch) value should be adjusted upward in the specification.*

*When a shaft excavation is completed with unacceptable tolerances, the Contractor should be required to propose, develop, and, after approval, implement corrective treatment. The Engineer should not direct the work. Typical corrective treatments include:*

- (a) *Overdrill the shaft excavation to a larger diameter to permit accurate placement of the reinforcing steel cage with the required minimum concrete cover.*
- (b) *Increase the number and/or size of the steel reinforcement bars.*



- (c) *Enlarge the bearing area of the bell excavation within tolerance allowed.*
- (d) *Drill out the green concrete and reform the hole.*

*The approval of correction procedures is dependent on analysis of the effect of the degree of misalignment and improper positioning. Redesign drawings and computations submitted by the Contractor shall be signed by a licensed professional Engineer.*

### **xxx.50 REINFORCING STEEL CAGE CONSTRUCTION AND PLACEMENT:**

The reinforcing steel cage, consisting of longitudinal bars, ties, cage stiffener bars, spacers, centralizers, and other necessary appurtenances, shall be completely assembled and placed as a unit immediately after the shaft excavation is inspected and accepted, and prior to concrete placement. Internal stiffeners shall be removed as the cage is placed in the borehole so as not to interfere with the placement of concrete.

The reinforcing steel in the shaft shall be tied and supported so that the reinforcing steel will remain within allowable tolerances given in Section xxx.41 of this specification. Concrete spacers or other approved noncorrosive spacing devices shall be used at sufficient intervals [near the bottom and at intervals not exceeding 3 m (10 feet) up the shaft] to ensure concentric spacing for the entire cage length. Spacers shall be constructed of approved material equal in quality and durability to the concrete specified for the shaft. The spacers shall be of adequate dimension to insure a minimum 76 mm (3 inch) annular space between the outside of the reinforcing cage and the side of the excavated hole. Approved cylindrical concrete feet (bottom supports) shall be provided to insure that the bottom of the cage is maintained the proper distance above the base.

The elevation of the top of the steel cage shall be checked before and after the concrete is placed. If the upward displacement of the rebar cage exceeds 51 mm (2 inches) or if the downward displacement exceeds 152 mm (6 inches) per 6.1 m (20 feet) of shaft length, the drilled shaft will be considered defective. Corrections shall be made by the Contractor to the satisfaction of the Engineer. No additional shafts shall be constructed until the Contractor has modified his rebar cage support in a manner satisfactory to the Engineer.

### **COMMENTARY**

*Occasionally the Contractor may excavate beyond the specified bottom of hole elevation either due to excessive cleaning or errors in measurement during drilling. The question of whether or not to require the Contractor to extend the reinforcing cage should be made by the designer on a project-by-project basis. If a full-length cage is required for structural reasons the following could be included in the specification:*

*"If the bottom of the constructed shaft elevation is lower than the bottom of the shaft elevation in the plans, a minimum of one half of the longitudinal bars required in the upper portion of the*

*shaft shall be extended the additional length by adding longitudinal reinforcing bars at the bottom of the cage. Tie or spiral bars shall be continued for the extra depth and the stiffener bars shall be extended to the final depth. All longitudinal and transverse bars must be lap spliced or spliced with mechanical splices. Welding to the reinforcing steel will not be permitted unless specifically shown in either the plans or special provisions."*

*Reinforcing steel can corrode by rusting in the zone above the zone of full soil or rock saturation. Below the zone of full saturation, galvanic corrosion can occur. Therefore, it is important that no steel rebar be allowed to come in contact with the soil or rock, not even incidentally. Steel skids or chairs, or skids or chairs constructed from any other electrical conductor, should never be permitted.*

### **xxx.60 CONCRETE PLACEMENT:**

Concrete placement shall be performed in accordance with the applicable portions of the general specifications on concrete materials in Section xxx.20 of this specification and with the requirements herein.

Concrete shall be placed as soon as possible after reinforcing steel placement. Concrete placement shall be continuous from the bottom to the top elevation of the shaft. Concrete placement shall continue after the shaft excavation is filled until good quality concrete is evident at the top of shaft. Concrete shall be placed either by free fall or through a tremie or concrete pump. The free fall placement shall only be permitted in dry holes. Concrete placed by free fall shall fall directly to the base without contacting either the rebar cage or hole sidewall. Drop chutes may be used to direct concrete to the base during free fall placement.

The elapsed time from the beginning of concrete placement in the shaft to the completion of the placement shall not exceed 2-hours. Admixtures such as water reducers, plasticizers, and retarders shall not be used in the concrete mix unless permitted in the contract documents. All admixtures, when approved for use, shall be adjusted for the conditions encountered on the job so the concrete remains in a workable plastic state throughout the 2-hour placement limit. Prior to concrete placement the Contractor shall provide test results of both a trial mix and a slump loss test conducted by an approved testing laboratory using approved methods to demonstrate that the concrete meets this 2- hour requirement. The Contractor may request a longer placement time provided he or she supplies a concrete mix that will maintain a slump of 102 mm (4 inches) or greater over the longer placement time as demonstrated by trial mix and slump loss tests. The trial mix and slump loss tests shall be conducted using concrete and ambient temperatures appropriate for site conditions.

### **COMMENTARY**

*A desirable slump-time relationship for a typical drilled shaft concrete mix is to have a minimum slump of 102 mm (4 inches) existing everywhere within the concrete column after placement of*

*all concrete has been completed. The 102-mm (4-inch) slump value is the minimum at which adequate fluid pressures can be assumed to develop against the sides of the hole.*

*Research has demonstrated that virtually unlimited free fall is acceptable if the concrete mix is cohesive and contains relatively small maximum-sized coarse aggregate. From a practical perspective, a limit such as 7.6 m (25 feet) may be set from the perspective of making certain that the concrete does not drop through the reinforcing steel cage. For very large-diameter shafts with large-diameter cages, where the danger of striking the cage is reduced, it may be permissible to permit free-fall to the base of the excavation.*

### **xxx.61 TREMIES:**

Tremies may be used for concrete placement in either wet or dry holes. Tremies used to place concrete shall consist of a tube of sufficient length, weight, and diameter to discharge concrete at the shaft base elevation. The tremie shall not contain aluminum parts that will have contact with the concrete. The tremie inside diameter shall be at least 6 times the maximum size of aggregate used in the concrete mix but shall not be less than 0.25 m (10 inches). The inside and outside surfaces of the tremie shall be clean and smooth to permit both flow of concrete and unimpeded withdrawal during concreting. The wall thickness of the tremie shall be adequate to prevent crimping or sharp bends, which restrict concrete placement.

The tremie used for wet excavation concrete placement shall be watertight. Underwater or under-slurry placement shall not begin until the tremie is placed to the shaft base elevation, and the concrete shall be kept completely separated from the water or slurry prior to the time it is discharged. Valves, bottom plates or plugs may be used for this purpose only if concrete discharge can begin within one tremie diameter of the base of the drilled shaft. Plugs shall either be removed from the excavation or be of a material, approved by the Engineer, which will not cause a defect in the shaft if not removed. The discharge end of the tremie shall be constructed to permit the free radial flow of concrete during placement operations. The tremie discharge end shall be immersed at least 1.5 m (5 feet) in concrete at all times after starting the flow of concrete. The flow of the concrete shall be continuous. The level of the concrete in the tremie shall be maintained above the level of slurry or water in the borehole at all times to prevent water or slurry intrusion into the shaft concrete.

If at any time during the concrete pour, the tremie line orifice is removed from the fluid concrete column and discharges concrete above the rising concrete level, the shaft shall be considered defective. In such case, the Contractor shall remove the reinforcing cage and concrete, complete any necessary sidewall removal directed by the Engineer and repour the shaft. All costs of replacement of defective shafts shall be the responsibility of the Contractor.

### **xxx.62 PUMPED CONCRETE:**

Concrete pumps and lines may be used for concrete placement in either wet or dry excavations.

All pump lines shall have a minimum 102 mm (4 inch) diameter and be constructed with watertight joints. Concrete placement shall not begin until the pump line discharge orifice is at the shaft base elevation.

For wet excavations, a plug or similar device shall be used to separate the concrete from the fluid in the hole until pumping begins. The plug shall either be removed from the excavation or be of a material, approved by the Engineer, that will not cause a defect in the shaft if not removed.

The discharge orifice shall remain at least 1.5 m (5 feet) below the surface of the fluid concrete. When lifting the pump line during concreting, the Contractor shall temporarily reduce the line pressure until the orifice has been repositioned at a higher level in the excavation.

If at any time during the concrete pour the pump line orifice is removed from the fluid concrete column and discharges concrete above the rising concrete level, the shaft shall be considered defective. In such case, the Contractor shall remove the reinforcing cage and concrete, complete any necessary sidewall removal directed by the Engineer, and repour the shaft. All costs of replacement of defective shafts shall be the responsibility of the Contractor.

### **xxx.63 DROP CHUTES:**

Drop chutes may be used to direct placement of free-fall concrete in excavations where the maximum depth of water does not exceed 76 mm (3 inches). Free fall placement is not permitted in wet excavations. Drop chutes shall consist of a smooth tube of either one piece construction or sections that can be added and removed. A drop chute can also be a hopper with a short tube to direct the flow of concrete. Concrete may be placed through either the hopper at the top of the tube or side openings as the drop chute is retrieved during concrete placement. If concrete placement causes the shaft excavation to cave or slough, or if the concrete strikes the rebar cage or sidewall, the Contractor shall reduce the height of free fall and/or reduce the rate of concrete flow into the excavation. If caving or sloughing of the borehole walls occurs during free-fall placement of concrete, the shaft shall be considered defective. In such case, the Contractor shall remove the reinforcing cage and concrete, complete any necessary sidewall removal directed by the Engineer and repour the shaft. All costs of replacement of defective shafts shall be the responsibility of the Contractor. If concrete placement cannot be satisfactorily accomplished by free fall in the opinion of the Engineer, the Contractor shall use either tremie or pumping techniques to accomplish the pour.

### **COMMENTARY**

*In many areas the most common cause of structural defects in drilled shafts is the delayed or interrupted placement of concrete, usually caused by clogged pump lines or gravity tremies or by delays in delivery of concrete to the construction site by the concrete supplier. Proper equipment and procedures are necessary for the satisfactory placement of concrete in drilled shafts. In situations where critical non-redundant shafts are specified, the highway agency should require*

*trial shafts to insure effective concreting can be accomplished at the site by the Contractor.*

**xxx.64 NONDESTRUCTIVE EVALUATION:**

When called for in the contract documents, specific completed drilled shafts, the number and/or location of which are specified in the contract documents, shall be subjected to nondestructive tests to evaluate their structural integrity. Such tests may include (a) downhole tests conducted in access tubes, including crosshole acoustic tests and backscatter gamma ray (gamma-gamma) tests, or (b) sonic echo tests. The type of test to be used, if any, is specified in the contract documents. The Contractor shall be responsible for performing and submitting reports of such tests to the Engineer in a timely manner. All testing shall be conducted after the concrete has cured for at least 24 hours. The Contractor shall employ a registered professional engineer who has been qualified by the State to perform, evaluate and report the tests. The report on the tests on any given shaft must be submitted to the Engineer within 3 working days of the performance of the tests on that shaft. The Engineer will evaluate and analyze the results and provide to the Contractor a response regarding the acceptability of the shaft that was tested within 3 working days of receipt of the test report.

The Contractor may continue to construct drilled shafts before the receipt of notice of acceptance of the tested shaft or shafts by the Engineer; however, if the Engineer finds the tested shaft(s) to be unacceptable, the Contractor shall be required to repair, at the Contractor's expense, the unacceptable shaft to the satisfaction of the Engineer and (a) prove to the satisfaction of the Engineer, at no expense to the State, the acceptability of all shafts constructed since the unacceptable shaft was constructed and the acceptability of the procedure to be used in constructing future shafts, or (b) cease all drilled shaft construction until a new construction procedure acceptable to the Engineer has been proposed by the Contractor and accepted by the Engineer. In the latter case, those drilled shafts constructed after the unacceptable shaft shall be repaired to the satisfaction of the Engineer at the Contractor's expense. If any repair procedures or revisions to the Contractor's installation procedure are proposed by the Contractor, the contractor shall submit a written plan to the Engineer to repair defects and revise construction procedures. If these plans involve changes to the structural design of the shafts or shaft caps, or to the geometry of the shafts, any redesign proposed in the Contractor's plan to the Engineer shall be performed at the Contractor's expense by a registered professional engineer.

The Engineer may require that additional shafts be tested. If the testing of the additional shaft(s) indicates the presence of a defect in any additional shaft, the testing cost for that shaft will be borne by the Contractor and the Contractor shall repair the shaft at the Contractor's expense, as above. Otherwise, the cost will be borne by the State, and a time extension equal to the delay time created by testing of the shaft(s) found to be non-defective will be granted.

**xxx.64.1 TESTS IN ACCESS TUBES:**

Access tubes for crosshole acoustic or gamma-gamma logging shall be placed on each

reinforcing cage designated in the contract documents in the position and at the frequency shown on the plans. The access tubes for crosshole acoustic logging shall consist of Schedule 40 steel pipe conforming to ASTM A 53, Grade A or B, Type E, F, or S. The inside diameter shall be at least 38 mm (1.50 inches). Access tubes for gamma-gamma tests shall consist of Schedule 40 polyvinyl chloride (PVC) pipe with an inside diameter of at least 52 mm (2.0 inches).

All access tubes shall have a round, regular inside surface free of defects and obstructions, including all pipe joints, in order to permit the free, unobstructed passage of probes to the bottoms of the tubes. The access tubes shall be watertight, free from corrosion and free of deleterious material on the outside that can prevent bonding with the concrete. All access tubes shall be fitted with watertight caps on the bottom and top.

Prior to the beginning of downhole logging, the Contractor shall assure that the test probes can pass through every tube to the bottom. If a tube is obstructed, the Contractor shall, at the Contractor's expense, core a hole within the drilled shaft near the obstructed tube to the depth of the obstructed tube that is large enough to accommodate the probe for the full length of the hole. The coring equipment, coring procedure and location of the core hole shall be approved by the Engineer prior to beginning the coring process. The coring method shall provide for complete core recovery and shall minimize abrasion and erosion of the core. The core hole shall be placed at a position in the shaft that will not produce damage to the reinforcing steel in the shaft. The core hole shall be logged, voids or defects indicated on the log and the log submitted to the Engineer. Cores shall be preserved and made available for inspection by the Engineer. The core hole will be treated as an access tube and downhole testing shall then commence. If a defect is observed, the Contractor shall pay for all coring costs and shall repair the shaft at his/her expense, as above. If a defect is not observed, the State will pay for all coring costs, and compensation for the delay will be granted by an appropriate time extension.

Upon completion of all tests involving access tubes, the access tubes and core holes shall be filled with grout having strength properties equivalent to or better than those of the drilled shaft concrete.

#### **xxx.64.2 SONIC ECHO TESTS:**

Sonic echo (pulse-echo) tests shall be permitted in lieu of downhole tests involving access tubes at the discretion of the Engineer. Equipment and procedures to be used for sonic echo tests shall be capable of detecting defects that occupy no more than 30 per cent of the cross-sectional area of the drilled shaft and are no greater than 152 mm (6 inches) thick, and this resolution shall be indicated in the report of the Contractor's consultant. No access tubes are required to be installed prior to construction of the drilled shaft. If a defect is observed in a sonic echo test, the Contractor shall pay for all testing costs and shall repair the shaft at his/her expense, as described in Section xxx.64. If a defect is not observed, the State will pay for all coring costs, and compensation for the delay will be granted by an appropriate time extension.

## COMMENTARY

*Nondestructive integrity tests require evaluation by experts, so only those engineers and firms prequalified by the State should be permitted to perform NDE on drilled shafts. Often, proper interpretation of NDE records is enhanced significantly by correlation of anomalies on those records with events that occurred during the construction operation, so that a review of a carefully prepared inspector's report is of great value in interpreting the results of NDE.*

*Regarding placement of access tubes, it is customary to place one tube per foot (0.305 m) of drilled shaft diameter, spaced equally around the cage, although other arrays can be used. Access tubes must be firmly secured to the cage and can be placed either inside the cage (usual position) or outside the cage. If they are placed outside the cage, the Engineer should ensure that a 76 mm (3 in.) clearance will exist between the outside of the tubes and the borehole wall to allow for adequate flow of concrete. Normally, the tubes should extend from 150 mm (6 inches) above the bottom of the shaft to at least 0.92 m (3 feet) above the top of the shaft, or 0.61 m (2 feet) above the ground surface if the shaft is cut off below the ground surface. If crosshole acoustic tests are to be performed, the access tubes should be filled with clean water no later than 4 hours after placement of the concrete and the tubes capped during concrete placement to keep out concrete and debris. In all cases the access tubes should be as nearly parallel as possible and should be placed as far from the longitudinal steel bars as possible.*

*Crosshole acoustic tests should be performed with equipment capable of detecting any void that appears in the path of the sonic pulse (Chapter 17). Equipment with adjustable power and frequency is most appropriate. The operator can often find the most appropriate power level and frequency for the concrete that was used in the shaft being tested by performing preliminary calibrations at a shallow depth within the shaft being tested. Once underway, the test should proceed from the bottom of a pair of access tubes to the top, in depth increments of about 52 mm (2 inches). The source and receiver should be lifted together and careful depth measurements made before taking a set of readings. The record that should be provided to the Engineer should include a graph of acoustic pulse arrival time versus depth and power of the arriving signal (or energy vs. time) versus depth in each pair of tubes within the shaft. Any zone with long arrival times and low power relative to other zones should be considered anomalous. The Engineer then has to evaluate the importance of the anomaly relative to its apparent size and position in the shaft and relative to the location of high stresses and decide whether to declare the shaft unacceptable. The presence of an anomaly in an NDE record is not necessarily cause for rejection of a drilled shaft. In some cases anomalies can be caused by factors not associated with a defect in the shaft, such as a zone in which the access tube is not bonded to the concrete in a crosshole acoustic test. Even if the shaft has a minor defect, it may be perfectly serviceable if the defect is not large and is not in a critical location.*

*Gamma-gamma tests should be performed with equipment that has been calibrated immediately prior to testing in concrete similar to that used in the subject drilled shaft. It should be capable of resolving concrete densities to the nearest 0.08 kN/m<sup>3</sup> (0.5 pcf) within 102 mm (4 inches) of*

*the center of the access tube. Tests should be performed from the bottom of each tube in the shaft to the top in depth increments of 152 mm (6 inches). The record that should be provided to the Engineer is a graph of concrete density vs. depth in each tube. A procedure for evaluating whether a reading is anomalous is given in Chapter 17.*

*Sonic echo tests are only capable of detecting defects that are relatively large and in shafts that are relatively short [20 m (66 feet) or less]. If the Engineer deems that small defects, undetectable by sonic echo methods, will be of no concern to the performance of the drilled shaft, sonic echo tests may be appropriate, because they can be performed quickly and at a relatively low cost. They may also be appropriate when the Engineer judges it necessary to conduct NDE tests upon shafts that were not outfitted with access tubes.*

*If the NDE program is inconclusive, the Engineer may require additional testing, such as coring the shaft. Coring would be performed in the manner described in this section for the production of new access holes when access tubes become clogged. High-strain integrity testing procedures involving impact the head of the shaft with a large mass (Chapter 17), or even static load testing of the drilled shaft, can also be used if the types of NDE tests covered in this Section are not conclusive.*

*There is no clear consensus on how many drilled shafts on a given project should be subjected to NDE procedures. For a project on which only a relatively small number of large-diameter drilled shafts will be used and construction will take place under slurry, perhaps all shafts should be outfitted with access tubes, if that NDE method is called for, but only those shafts tested in which there were unusual occurrences during construction. See Chapter 17 for more information.*

*If access tubes are used, it is important to grout the tubes when the testing has been completed, or if a shaft is not tested, so as not to impair the structural integrity of the drilled shaft by the presence of the access tubes.*

### **xxx.70 DRILLED SHAFT LOAD TESTS:**

When the contract documents include static load testing of shafts, all load tests shall be completed before construction of any production drilled shafts. The Contractor shall allow 5 working days after the last load test for the analysis of the load test data and final determination of base elevations by the Engineer before receiving authorization to proceed with the construction of production shafts. The number and locations of load tests shall be as shown on the plans or as designated by the Engineer. Unless specified otherwise, the load test shafts shall be loaded to a maximum test load corresponding to failure. Failure is defined as a deflection of the shaft head equal to 5 per cent of the shaft diameter.

Static load testing shall not begin until the concrete has attained a compressive strength of 23.4 MPa (3400 psi) as determined from cylinder breaks. Drilled shafts shall be load tested in the



order directed by the Engineer. Static load tests shall be completed as described in ASTM D1143-81 (compression test quick test method) and ASTM D3966-90 (lateral test) or as modified herein. The Contractor shall supply all equipment necessary to conduct the static test, including equipment to make the measurements of loads and deflections, shown on the plans. The loading frame apparatus shall be designed to safely accommodate the maximum load to be applied.

If NDE tests are shown in the plans, the provisions of Sections xxx.64, xxx.64.1 and xxx.64.2 shall be followed.

The Contractor shall notify the Engineer within 10 calendar days of contract award of the load testing schedule. The schedule shall allow at least 1 working day for the Engineer's analysis of the NDE records prior to load testing.

Load cells will be required to measure applied load during the drilled shaft load tests. Load cells shall be of adequate size to measure the maximum load applied to the shaft and shall be equipped with an adequate readout device. Before load testing begins, the Contractor shall furnish a certificate of calibration for the load cell from an approved testing laboratory. The calibration shall have been completed for all ranges of proposed loading within the two months preceding the load tests. The certified accuracy of the load cell shall be within 1 percent of the true load.

After testing is completed, the test shafts (and any reaction shafts) shall be cut off at an elevation 0.6 m (2 feet) below the finished ground surface. The portion of the shafts cut off and removed shall remain the property of the Contractor.

#### COMMENTARY

*Frequently, static load tests are specifically located in a particular soil or rock deposit that is representative of conditions at several piers. The Engineer may permit production shafts to be installed at those pier locations after the shaft base elevations are determined from the representative load test even though load tests in other areas remain to be completed.*

*In situations where the highway agency chooses not to provide personnel either to record or interpret load test data, the Contractor should be directed to hire a consultant by including in the contract specifications the following:*

*"The Contractor shall obtain the services of a licensed professional engineer, with satisfactory load test experience, to conduct the test in compliance with these specifications, record all data and furnish reports of the test results to the Engineer."*

*Load test shafts and reaction shafts may be incorporated as production shafts if undamaged by compressive/tensile loads and if shaft length and cross section are adequate.*

*Although ASTM D1143 and D 3966 do not explicitly consider Osterberg cell testing or Statnamic® testing, loading with these devices can be permitted. If such is done, the writer should include in this item in the specifications any modifications or special provisions that are deemed necessary to accommodate the test. Simple specifications for Osterberg cell testing can be found in Report FHWA-HI-97-014 (1996), "Design and Construction of Driven Pile Foundations," Vol. II.*

**xxx.71 METHOD OF MEASUREMENT:**

**xxx.71.1 FURNISHING DRILLED SHAFT DRILLING EQUIPMENT:**

There will be no measurement of the work performed under this item.

**xxx.71.2 DRILLED SHAFTS:**

The quantities to be paid for shall be the length in meters or in feet of the completed concrete drilled shaft, including bells, of the diameter and containing the reinforcement shown on the plans. The length shall be determined as the difference between the plan top of shaft elevation and the final bottom of shaft elevation.

*COMMENTARY*

*Some agencies consider bells (underreams) as separate items of measurement.*

**xxx.71.3 STANDARD EXCAVATION:**

The quantities to be paid shall be the length in meters or feet of completed standard excavation of the diameter shown on the plans measured in linear feet along the centerline of the shaft to the top of the bell or to the bottom of the shaft if a bell is not shown on the plans.

**xxx.71.4 SPECIAL EXCAVATION:**

The quantity to be paid shall be the length in meters or feet of completed special excavation of the diameter shown on the plans measured in linear meters or feet along the centerline of the shaft to the top of the bell or to the bottom of the shaft if a bell is not shown in the plans. If a bell is shown on the plans, the bell will be paid for as a separate lump sum item.

**xxx.71.5 UNCLASSIFIED SHAFT EXCAVATION:**

The quantities to be paid shall be the length in meters or feet of completed unclassified shaft excavation of the diameter shown on the plans measured in linear meters or feet along the centerline of the shaft to the top of the bell or to the bottom of the shaft if a bell is not shown in the plans. The pay length shall be computed as the difference between the plan top-of-shaft

elevation and the plan estimated base elevation or top of bell. If a bell is shown on the plans, the bell will be paid for as a separate lump sum item.

**xxx.71.6 UNCLASSIFIED EXTRA DEPTH EXCAVATION:**

The quantities to be paid shall be the length in meters or feet of completed unclassified shaft excavation of the diameter shown on the plans measured in linear meters or feet from the estimated base elevation of the shaft shown on the plans to the final authorized and accepted bottom of shaft elevation.

**xxx.71.7 OBSTRUCTIONS:**

The quantities to be paid shall be the number of hours of work, or fraction thereof per obstruction, after designation as an obstruction by the Engineer, required to remove the obstruction and resume excavation.

**xxx.71.8 TRIAL SHAFT:**

The quantity to be paid shall be the authorized linear meters or feet of trial shaft holes, including bells, drilled to the diameter shown on the plans, completed (including backfill when required) and accepted. The linear meters or feet of trial shaft holes shall be determined as the difference between the existing ground surface elevation at the center of the trial shaft hole prior to drilling and the authorized bottom elevation of the hole, including bell.

**xxx.71.9 EXPLORATION (SHAFT EXCAVATION):**

The quantity to be paid shall be the length in linear meters or feet, measured from the bottom of shaft elevation to the bottom of the exploration hole, for each authorized exploration drilled below the shaft excavation.

**xxx.71.10 LOAD TESTS:**

The quantity to be paid shall be the number of load tests conducted according to the specified loading procedures and to the designated maximum load shown in the plans.

**xxx.71.11 PERMANENT CASING:**

The quantity to be paid shall be the linear meters or feet of each size casing used. The length to be paid for shall be measured along the casing from the top of the shaft elevation or the top of casing, whichever is lower, to the bottom of the casing at each shaft location where permanent casing is used.

**xxx.71.12 INSTRUMENTATION AND DATA COLLECTION:**

The quantity to be paid shall be lump sum for payment of all specified instrumentation, all cost associated with collection of data, all required analyses and any required reports.

**xxx.71.13 PROTECTION OF EXISTING STRUCTURES:**

The quantity to be paid shall be lump sum. When the plans do not include an item for protection of existing structures and the Engineer orders work to be performed for protection of existing structures, this work shall be paid for as extra work.

**xxx.71.14 ACCESS TUBES:**

The quantity to be paid will be per meter or foot of access tube, installed in the drilled shafts, to the depths shown on the plans.

**xxx.71.15 NON-DESTRUCTIVE EVALUATION TESTS:**

All non-destructive evaluation (NDE) tests will be paid for on a lump sum basis per shaft tested. Payment will include costs for mobilization, testing, analysis and reporting of NDE tests.

**xxx.72 BASIS OF PAYMENT:**

**xxx.72.1 FURNISHING DRILLED SHAFT DRILLING EQUIPMENT:**

Payment for this item when made at the contract lump sum amount will be full and complete payment for furnishing and moving the drilling equipment to the project site, setting the equipment up at the locations and removing the equipment from the project site. Payment of 60 per cent of the amount bid for this item will be made when all drilling equipment is on the job site, assembled and ready to drill foundation shafts. Payment for the remaining 40 per cent of the bid amount will be made when all shafts have been drilled and all shaft concrete has been placed up to the top of the shafts.

**xxx.72.2 DRILLED SHAFTS:**

Drilled shafts shall be paid for at the contract unit price per linear meter or foot for drilled shaft of the diameter specified.

Bells that are installed at the depth and to the dimensions shown on the plans shall be paid for at the contract unit price per bell. Bells that are not completed to the depth and dimensions shown on the plans shall not be paid for, and the Contractor shall be required to install the bell at a deeper elevation, as directed by the Engineer.

Such payment shall include the cost of concrete, and reinforcing steel, all labor, materials, equipment, temporary casings, slurry, blasting and incidentals necessary to complete the drilled shaft or bell.

**xxx.72.3 STANDARD EXCAVATION:**

Standard excavation shall be paid at the contract unit price per linear meter or foot for drilled shafts of the diameter specified. Such payment shall be full compensation for all labor, materials and equipment necessary to complete the work in an acceptable manner.

**xxx.72.4 SPECIAL EXCAVATION:**

Special excavation shall be paid at the contract unit price per linear meter or foot for drilled shafts of the diameter specified from the top of the shaft to the top of the bell, if a bell is shown on the plans. Bells shall be paid at the contract unit price per bell. Such payment shall be full compensation for all labor, materials, and equipment necessary to complete the work in an acceptable fashion.

Additional depth of excavation required to reach the depth of any bell after an attempt has been made to form the bell at the elevation shown on the plans and such attempt fails, despite the best efforts of the Contractor, shall be paid for at the contract unit price per linear meter or foot of depth.

**xxx.72.5 UNCLASSIFIED SHAFT EXCAVATION:**

Unclassified shaft excavation shall be paid for at the contract unit price per linear meter or foot for drilled shafts of the diameter specified from the top of the shaft to the top of the bell, if a bell is shown on the plans. Bells shall be paid at the contract unit price per bell. Such payment shall be full compensation for the shaft excavation including temporary casing, removal from the site and disposal of excavated materials, using slurry as necessary, using drilling equipment, blasting procedures, special tools and drilling equipment to excavate the shaft to the depth indicated and bell to the size indicated on the plans, and furnishing all other labor, materials and equipment necessary to complete the work.

**xxx.72.6 UNCLASSIFIED EXTRA DEPTH EXCAVATION:**

Unclassified extra depth excavation (UCEDE) shall be paid for at 150 per cent of the contract unit price per meter or linear foot for the Unclassified Shaft Excavation item of the diameter specified. Such payment shall be full compensation for all costs of excavating below the bottom of shaft elevations shown on the plans, except for the additional costs included under the associated pay items for permanent casing. Work under this item is the same as that described under unclassified shaft excavation together with any additional work as a result of excavating below the plan bottom of shaft elevation.

Additional depth of excavation required to reach the depth of any bell after an attempt has been made to form the bell at the elevation shown on the plans and such attempt fails, despite the best efforts of the Contractor, shall be paid for at 150 per cent of the contract unit price per linear meter or foot of depth.

Compensation under this item shall be paid only when the extra depth excavation is authorized by the Engineer.

#### COMMENTARY

*Some agencies also pay a surcharge, generally from 115 to 150 per cent of the contract unit price per meter or foot, for classified excavation (standard or special excavation, depending upon the character of the soil or rock at the base plan elevation) if the Contractor is required by the Engineer to deepen boreholes when classified excavation is specified. For cases where extreme deepening of boreholes may possibly be required by the Engineer, requiring the Contractor to bring new drilling equipment to the site to complete the excavations, the specifications should contain a provision for renegotiation of unit prices for extra depths of drilled shafts.*

#### **xxx.72.7 OBSTRUCTIONS:**

Removal of obstructions shall be paid at the contract unit price per hour for obstructions. Such payment shall be full compensation for all labor, materials, and equipment necessary to complete the work.

#### COMMENTARY

*This is an item that should be included in all bids where the possibility of encountering obstructions exists. Obstruction removal incidents are the leading cause of claims by drilled shaft contractors. Payment for removal of obstructions is a difficult issue. This specification stipulates payment based on a unit contract price per hour required by the Contractor to remove the obstruction. This method of payment assumes that the Contractor is competent to remove obstructions of the type encountered and will do so in a timely manner. Some state departments of transportation limit recovery to some factor (3 to 20) times the unit contract price per linear meter or foot. While this limitation can serve to prevent contractors from abusing the payment rates for removing obstructions, it can be unfair to the contractor who despite competent efforts has difficulty in removing the obstruction. The best approach is to make sure the contractor is qualified to do the work that is bid and has a good record of experience on similar projects and that the inspector can properly judge whether the contractor is making a good faith effort to remove the obstruction.*

**xxx.72.8 TRIAL SHAFT HOLES:**

Trial shaft holes of the specified diameter will be paid for at the contract unit price per linear foot for trial shaft holes. Such payment shall be full compensation for excavating the trial shaft hole through whatever materials are encountered to the bottom of shaft elevation shown on the plans or as authorized by the Engineer (using slurry approved by the Engineer as necessary), providing inspection facilities, backfilling the hole, restoring the site as required and all other expenses to complete the work. The contract unit price shall include the cost of belling, if belling is specified on the plans.

**xxx.72.9 EXPLORATION (SHAFT EXCAVATION):**

Soil samples and/or rock cores of the diameter and length required and authorized by the Engineer will be paid for at the contract unit price per linear meter or foot for either soil sample or rock core. Such payment shall be full compensation for drilling, extracting, packaging and classifying samples or cores, delivering them to the Department, furnishing concrete or grout to fill the core hole and all other expenses necessary to complete the work.

**xxx.72.10 LOAD TESTS:**

Load tests shall be paid for at the contract unit price, each, for load tests, completed and accepted. Such payment shall include all cost related to the performance of the load test and for providing a report documenting the procedures and results.

**xxx.72.11 PERMANENT CASING:**

Permanent casings shall be paid for at the contract price per linear meter or foot. Such price and payment shall be full compensation for furnishing and placing the permanent casing in the shaft excavation.

**xxx.72.12 INSTRUMENTATION AND DATA COLLECTION:**

The lump sum bid price shall include all labor, equipment and materials incidental to instrumentation and, when required, data collection and the load test report.

**xxx.72.13 PROTECTION OF EXISTING STRUCTURES:**

This item shall be paid for at the contract unit price, lump sum, for protection of existing structures.

**xxx.72.14 ACCESS TUBES:**

This item will be paid for at the unit contract price per meter or foot of access tube, installed in

the drilled shafts, to the depths shown on the plans.

**xxx.72.15 NON-DESTRUCTIVE EVALUATION TESTS:**

This item will be paid for at the unit contract price, on a lump sum basis per shaft tested. Payment will include costs for mobilization, testing, analysis and reporting of NDE tests.

**xxx.72.16 ITEMS OF PAYMENT:**

Payment shall be made under:

1. Furnishing Drilled Shaft Drilling Equipment - lump sum.
2. Drilled Shaft - per linear meter or foot.
3. Standard Excavation - per linear meter or foot.
4. Special Excavation - per linear meter or foot.
5. Unclassified Shaft Excavation - per linear meter or foot.
6. Unclassified Extra Depth Excavation - per linear meter or foot.
7. Obstructions - per hour.
8. Trial Shaft Holes - per linear meter or foot.
9. Exploration (Shaft Excavation) - per linear meter or foot.
10. Load Test - each.
11. Permanent Casing - per linear meter or foot.
12. Instrumentation and Data Collection - lump sum.
13. Protection of Existing Structures - lump sum.
14. Access Tubes - per linear meter of foot
15. Non-Destructive Evaluation Tests - per drilled shaft.

**ADDENDUM - SHAFT EXCAVATION IN ROCK BY BLASTING:**

When blasting is used to excavate the rock for shafts as shown in the plans, the Contractor shall use controlled perimeter blasting techniques to maintain the integrity of the final shaft wall. It is the intent of these specifications that the Contractor's rock excavation methods be such as to produce a sound rock surface with a very minimum of overbreak and fracturing of the rock outside the neat line of the excavation. All necessary precautions shall be taken to achieve this result.

**Construction Requirements**

Not less than two weeks prior to commencing drilling and blasting operations or at any time the Contractor proposes to change the drilling and blasting method, the Contractor shall submit a blasting plan to the Engineer for review. The blasting plan shall contain the full details of the drilling and blasting patterns and the controls the Contractor proposes to use for both the controlled perimeter and production blasting. The blasting plan shall contain the following



minimum information:

1. Plan and section views of the proposed shaft excavation showing the proposed drill pattern in the rock, burden from perimeter hole to adjacent production holes, production blast hole configuration with dimensions, blast hole diameter lift height, and any other pertinent information that details the Contractor's plan.
2. Loading diagram showing the types and amounts of explosives, primers, initiators, and other blasting components proposed for the excavations.
3. Initiation sequence of blast holes, including delay times and delay systems.
4. Manufacturer's data sheets for all explosives, primers, and initiators to be used on the project.

Review of the blast plan by the Engineer shall not relieve the Contractor of the responsibility for the accuracy and adequacy of the plan when implemented in the field.

When using controlled perimeter blasting the Contractor shall do the following:

1. Prior to commencing full-scale blasting operations, the Contractor shall demonstrate the adequacy of the proposed plan by drilling, blasting, and excavating a short test shaft approximately 1.2 m (4 feet) in depth. If the test shaft utilizing the Contractor's proposed blast plan does not produce the intended results to the satisfaction of the Engineer, the Contractor shall make modifications to the plan until the intended results are obtained.
2. The perimeter holes along the periphery of the shaft shall be spaced at 0.46 m (18 inches) center to center. Depending on the actual results obtained in the test shaft, the spacing may be increased or decreased as required to obtain the intended results.
3. The burden distance from the perimeter holes to the adjacent production holes shall be no less than 18 inches. In the event that the perimeter hole spacing is modified from the initial 0.46 m (18 inches), the ratio between the perimeter hole spacing and the burden distance to the adjacent production holes shall be no less than 1:1.
4. The diameter of the perimeter blast holes shall be no less than 32 mm (1-1/4 inches) and no greater than 76 mm (3 inches).
5. The height for each excavation lift within the shaft shall not exceed one-half the diameter of the shaft and under no circumstances be greater than 1.2 m (4 feet) in height.
6. The Contractor shall control the drilling of the perimeter holes by use of proper equipment and techniques to ensure that the deviation of each perimeter hole from the

neat line of the shaft is no greater than 76 mm (3 inches).

7. The delay sequence of the production holes shall be from the center of the shaft outward towards the perimeter.
8. The detonation of the perimeter holes shall be last, after all other blasting has been completed in each excavation lift. The Contractor may detonate these perimeter holes on a delay basis during the production blasting or as a separate shot after the production blasting.
9. Before placing explosive charges in the drill holes the Contractor shall ensure that each drill hole is free of obstructions for its entire length. All necessary precautions shall be exercised so that the placing of the charges will not cause caving of material from the walls of the drill holes
10. The maximum diameter of the explosives used in the perimeter holes shall be no greater than one-half the diameter of the perimeter hole. The explosives used for the perimeter blasting shall be small diameter, continuous column explosives (such as Hercosplit, Kleenkut, or their equivalents) especially manufactured for this type of controlled blasting. The use of bulk anfo (ammonium nitrate fuel oil) or fractional portions of standard explosive cartridges affixed to detonating cord (string load) are prohibited in the perimeter blast holes.
11. The work shall be in accordance with (xxx - call out other appropriate items in the standard specification). All blasting for any excavation shall be completed before placing any concrete for that drilled shaft.

### **Payment**

All costs associated with this work shall be included in the unit contract price per linear meter or foot for "Drilled Shaft," "Special Excavation," or "Unclassified Excavation." No payment will be made for additional rock excavation or placement of additional shaft concrete resulting from blasting overbreak.

## **CHAPTER 16: INSPECTION AND RECORDS**

Inspection of drilled shafts and the making of records concerning construction are important and deserve careful attention. The work should be done by engineers and/or technicians who are knowledgeable concerning construction methods, material properties, and design concepts.

The methods that will be used for inspection should be set forth in the construction documents in order to provide as many details as possible to the contractor. It is important that the inspection process be designed in such a way that construction delays are minimized.

The inspection of drilled shafts should always be carried out under the direction of the engineer and performed by personnel working directly for the engineer. The use of an independent firm that reports to the engineer is desirable if State personnel are unavailable or insufficiently experienced. The owner should not permit the contractor to furnish the inspection, even though the cost of the inspection can then become a part of the construction contract.

The role of the inspector is to monitor the construction process so that proper records can be made and to provide timely information to the engineer and/or the owner concerning deviations from the plans or from standard construction practice. The inspector does not direct the construction process, as that responsibility belongs strictly to the contractor.

In this chapter a brief summary will be given of the actions of a drilled shaft inspector. A document that provides much more detail and that is intended to be used by inspection personnel in the field is cited in the "Resources" section of this chapter. An excellent training video is also cited in that section.

A decision tree will also be presented detailing the logical steps that should be followed in deciding to accept or reject a constructed drilled shaft based on quality controls observed by the inspector and any non-destructive evaluation that may be conducted.

### **RESPONSIBILITIES**

The engineer has the responsibility of making a design that can be built without special difficulties and that will serve its intended purposes, and for producing plans and specifications that will give clear direction to the contractor. The contractor has the responsibility of constructing the foundations according to plans and specifications. Furthermore, there is an ethical responsibility on the parts of both contractor and engineer to call attention to possible errors in the plans and specifications so that sound work can be performed.

The inspector has the responsibility to become familiar with the plans and specifications, to make appropriate records, to check the work of the contractor, and to call attention to any errors or omissions. The inspector has the further responsibility to carry out the work in such a way that the construction is delayed as little as possible. While it is essential that the activities of the

inspector be carried out properly, delays of the construction will increase costs and can actually lead to a poorer-quality product.

## **CONSTRUCTION CONFERENCES**

Prebid and preconstruction conferences are very desirable. At such conferences, the design intent should be clearly spelled out (shafts mainly designed for base resistance, for side resistance, for lateral resistance, etc.) so that all involved in the field clearly understand the designer's concerns; procedures to be used for inspection should be explained in detail; the contractor's procedures and tools should be discussed. The contractor(s) can then know to what extent the construction work will be influenced by the inspection, and the inspector(s) will know what procedures and equipment to expect when observing the construction. Clear definitions of what the State will and will not accept in terms of cleanliness and water content in the borehole, slurry handling procedures, sequences of drilled shaft construction and similar issues can be agreed upon, which significantly reduces chances of claims later during the execution of construction.

## **UNANTICIPATED CONDITIONS**

A troublesome occurrence on some projects where drilled shafts are being installed is a perceived "change of conditions" by the contractor, with a claim that the subsurface conditions are not properly reflected in the contract documents. Such occurrences are hardly surprising in view of the manner in which natural geomaterials are created and because the normal subsurface investigation can reflect the characteristics of only a small fraction of the soil and/or rock at the site.

An example of a change of conditions (more properly termed "unanticipated conditions") is that boulders were encountered on a part of the site during excavation. The boulders had not been revealed by the subsurface borings. The contractor should be directed to work on another part of the site and negotiations should be immediately undertaken about completing the excavations through the zone of the boulders. The contract documents should contain guidance for the negotiations and the manner of computing the extra reimbursement to the contractor. For example, the guide specification in Chapter 15 treats boulders as obstructions and suggests that obstructions be a separate measurement and pay item in the contractor's bid. If the engineer and contractor agree that boulders were indeed encountered, the contractor is paid at the obstruction rate and the work continues without delay with the State having a clear understanding of the cost of excavating through the zone of boulders and the contractor receiving reasonable compensation.

The claim for extra compensation by the contractor can be settled by direct negotiation, by mediation-arbitration if covered by the contract, or by legal action. It is important, in view of the possibility that such instances can occur, that the inspector gather and document any relevant information on the subsurface conditions that are encountered and on the revisions in operations

made by the contractor to deal with unanticipated conditions, if any.

Controversies at construction sites should be avoided if possible. For example, it was noted in Chapter 2 that the drilling of full-sized boreholes at the construction site during the design phase is frequently a highly desirable procedure. Furthermore, the installation of technique, or trial, shafts preceding the construction of production shafts can serve to resolve problems before they begin to influence the construction of the production shafts.

## **SITE CONDITIONS**

Prior to the start of the construction of drilled shafts, the inspector should visit the job site to verify that the site conditions with regard to entrance, trafficability, overhead lines, subsurface features, clearing and grubbing, and any relevant permits are as stipulated in the contract documents. The appropriate information can then be transmitted to the contractor so that construction of the foundations can begin.

## **CONSTRUCTION OPERATIONS**

One of the key roles of the inspector in the construction of drilled shafts is to observe that the steps in the construction operations are in accordance with the plans and specifications. The inspector should maintain a diary in which the progress of the construction is recorded and compared daily with the diary of the contractor in order to minimize conflict. The inspector's diary should include the following general information on each of the drilled shafts:

1. Name of contractor.
2. Date.
3. Date when approval was given to construct the shaft.
4. Identification number of drilled shaft.
5. Location on job site.
6. Method of construction.
7. Machines and tools that are employed.
8. Plan and as-built shaft diameter.
9. Plan and as-built underream (bell) diameter and angle (if bell was built).
10. Ground elevation.
11. Plan and as-built elevation of top of shaft.
12. Plan and as-built elevation of the bottom of the shaft.
13. Weather conditions.
14. Major soil strata encountered, and their elevations.
15. Time and date of beginning and ending of excavation.
16. Elevation at which ground water encountered, if any.
17. Time and date of beginning and ending of concreting.
18. Concrete slump.
19. Identification of concrete samples.

20. Slurry data, including elevation of bottom of hole when introduced.
21. Unusual occurrences.

Some of the information noted above can best be put into inspection forms to be filled out by the inspector. Some examples of forms for recording information on construction operations are given in Appendix F and are discussed later in this chapter. Other forms are given in the inspector's guide cited in the Resources section.

It is very important that the inspector promptly notify the engineer when problems with excavation, casing, steel placement, concrete placement, or any other problem associated with the construction of drilled shafts is encountered, and it is essential that the engineer promptly resolve the problem in consultation with the contractor.

### **Excavation**

The contractor has the responsibility to make an excavation at the proper place and with the proper dimensions. The inspector should log the progress of the drilling and should indicate the types of soils or rocks being excavated and note any drilling difficulties. The inspector will be required to certify that the completed excavation is satisfactory and that the further construction operations can begin.

The factors of most concern to the inspector are that load transfer in side resistance and in end bearing are consistent with the assumptions made in the design. To this end, the inspector should be familiar with the design assumptions and with the properties of the soil and rock on which the design was made. In particular, the inspector should be familiar with the character of the bearing stratum in which the base of the drilled shaft is to be placed, as determined in the subsurface investigation for the site, and be qualified to identify the bearing stratum from the contractor's cuttings or by other means.

With regard to load transfer in side resistance, most of the drilling techniques will result in an exposed surface of the excavation that should result in a good bond with the concrete. Special care may need to be taken when drilling into rock; some drilling techniques can leave the sides of the excavation "gun-barrel slick", and it would be necessary to use special techniques to roughen the sides of the borehole.

With regard to load transfer in base resistance, the specifications should be explicit with regard to the required condition of the bottom of the excavation. Some designs call for extremely high stresses in end bearing and for a minimum of settlement. In such instances, it is usually necessary that the sides of the excavation be protected against collapse of the soil and/or rock or of inflow of water, that precautions be taken against gas, and that the inspector enter the excavation to inspect the condition of the base. The specifications may also require that a probe hole be drilled below the founding level in some rock formations and that the inspector use a feeler rod or similar device to determine from examination of the probe hole whether voids exist below the

bearing surface. In other designs less stringent requirements exist, and the inspection of the base of the drilled shaft can be made from the surface. It is recommended that inspection personnel not enter the drilled shaft unless it is absolutely necessary and then only if all prudent safety precautions are taken. These precautions are described in the field inspector's manual and video cited in the Resources section.

If the dry method or the casing method of construction are used, the inspector must ascertain that the amount of water in the bottom of the excavation is within the limits given in the specifications.

### **Reinforcing Steel**

There may be occasions when the stresses in the reinforcing steel are high, and the inspector may wish to have tensile tests performed on specimens from the reinforcing steel being used. In addition, hardness tests can be performed in the field.

In virtually every instance, the reinforcing steel is delivered to the job and fabrication of rebar cages is done at the job site. Coupons can be cut for tension testing at the time the cages are assembled. The unassembled bars and the completed cages should be stored properly so that the bars do not become covered with soil or otherwise contaminated.

The inspector should check the rebar cages after they are fabricated to see that the cages are in agreement with the plans and specifications in terms of the sizes and spacing of bars and are equipped with proper centering devices.

The inspector should witness the lifting of the rebar cages to see whether there is any permanent distortion due to lifting stresses. Many cages are tied rather than welded, and the cages can distort considerably during lifting without damage. If the cages have to be spliced, the inspector will check to see that the plans and specifications are followed in regard to the details of the splicing. The inspector should also confirm that the contractor has removed internal stiffeners from the cage as it is being lowered into the hole.

There is some concern that the lowering of a rebar cage can cause chunks of soil or rock to be loosened, with a detrimental effect on load transfer in base resistance. The cage should be lowered carefully in order to minimize disturbance. Roller-type centering devices are useful in this respect.

### **Drilling Slurry**

The specifications for the slurry should indicate the manner in which the slurry is to be mixed, the properties of the slurry as it is introduced into the borehole, the properties of the slurry at the time of concreting, and the kind of tests that are run to obtain the slurry properties. The inspector should see that the appropriate tests are performed.

It is also critical that the inspector understand how drilling slurries work to maintain stable boreholes. This process, which is often misunderstood, is explained succinctly and scientifically in Chapter 6. It is especially important that slurry be introduced before any sloughing occurs in the borehole.

The importance of good specifications and the proper control of the drilling slurry in the field cannot be overemphasized.

If it is necessary to use slurry when drilling into soft rock, the control of the properties of the slurry and of the entire construction process is especially important. Holden (1984) has made a special study of the use of bentonitic slurry when constructing drilled shafts in soft rock and applied some sophisticated inspection techniques in Australia. The Florida Department of Transportation has made use of bottom-hole inspection devices with sidewall samplers (socket inspection devices, or "SID's"), similar to the device Holden employed in Australia, with good success (Crapps, 1986). The key component of the FLDOT SID is a color television camera that is encased in a watertight bell. A source of light is provided to view the bottom. Air lines and a water jet can be used to improve the camera's vision and to move any sediment to obtain clear pictures of the location in the shaft at which the camera is pointed (e.g., the base). Scales visible in the picture give the viewer a good perspective of the size of sediment particles or slough. Permanent records can be made of the SID inspection by recording the camera images on videotape.

### **Concrete Quality and Placement**

Careful and detailed specifications should be written for the manufacture of the concrete, its mixing and transportation, its testing, and its placement. It is important that the inspector ensure that the specifications are followed carefully. An assistant can help to facilitate the checking of the concrete mix at the batch plant. The proportioning of the concrete and additives, if any, can be checked.

Concrete cylinder and concrete beam samples can be taken at the job site, and the slump can be measured. Air-entrainment can also be checked at the job site, if air entrainment is specified for drilled shaft concrete.

The construction specifications should cover the placement of the concrete, as suggested in Chapter 15, and the inspector should observe this aspect of construction carefully. The inspector should be familiar with Chapter 8 of this manual and with the section on concreting in the *Drilled Shaft Inspector's Manual* cited in the Resources section of this chapter.

One way of assuring that the concrete was placed properly, especially when the concrete placement cannot be observed, as in the wet method, is to plot a curve that shows the volume of concrete actually placed as compared to the theoretical volume in increments of depth. This concept was introduced in Chapter 8. Such curves are shown in Figures 16.1 and 16.2



(Koutsoftas, 1987). These so-called "concreting curves" give an excellent presentation of the stages of the concrete placement and can be instructive in determining whether defects might exist in the drilled shaft. The drilled shafts in these examples were not placed under slurry but were deep, so a tremie was used to place the concrete.

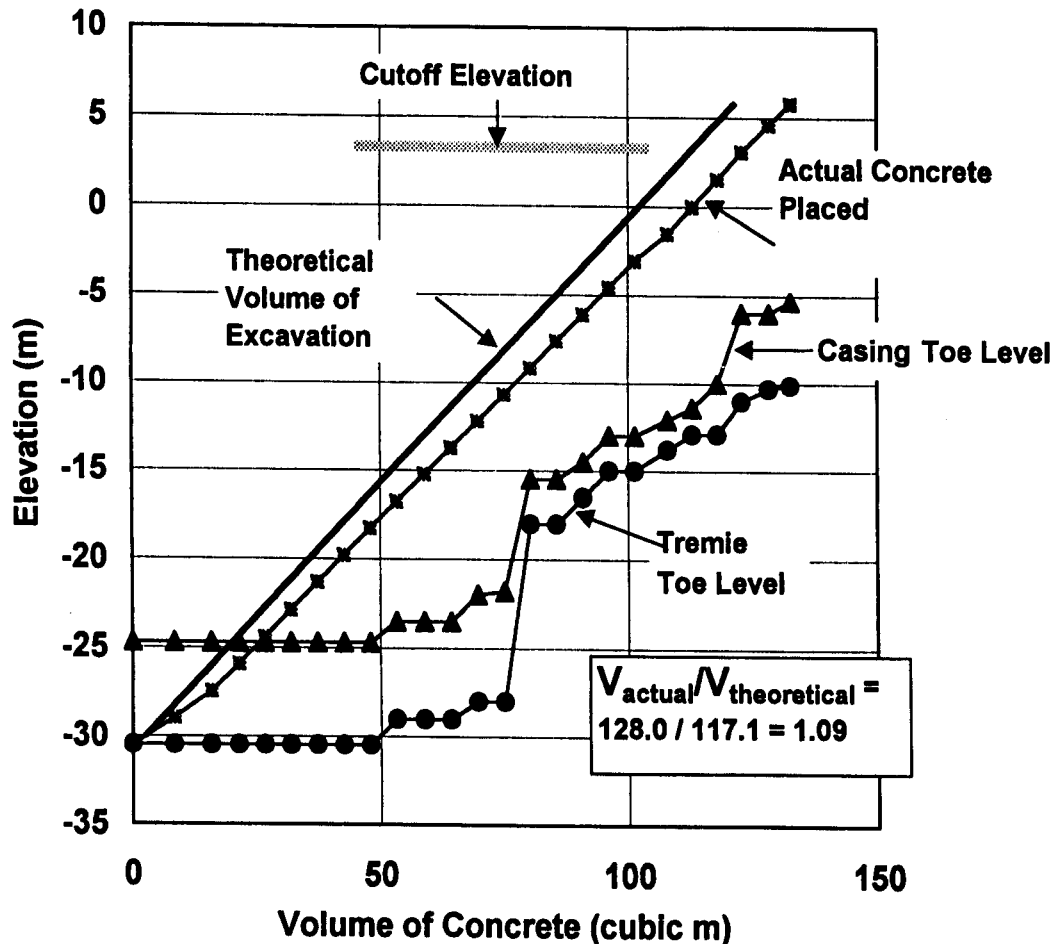

Figure 16.1. Concrete curve showing normal amount of overbreak

Figure 16.1 illustrates a case where the actual volume of concrete, divided by the theoretical volume, is 1.09 (or the "overbreak" was 9 per cent). The drilling technique normally results in an excavation that is slightly larger in diameter than the theoretical one, so a 9 per cent overbreak is not a cause of concern.

The positions of the toes of the tremie and of the casing are shown in Figure 16.1. Such information is useful in tracking the steps in the placement of the concrete. For example, the figure shows that the toe of the tremie was kept just above the bottom of the excavation until the fresh concrete had reached elevation - 18m (-59 ft), or when the column of fresh concrete was about 12.5 m (41 ft) high. The figure also shows that the casing was lifted in stages.

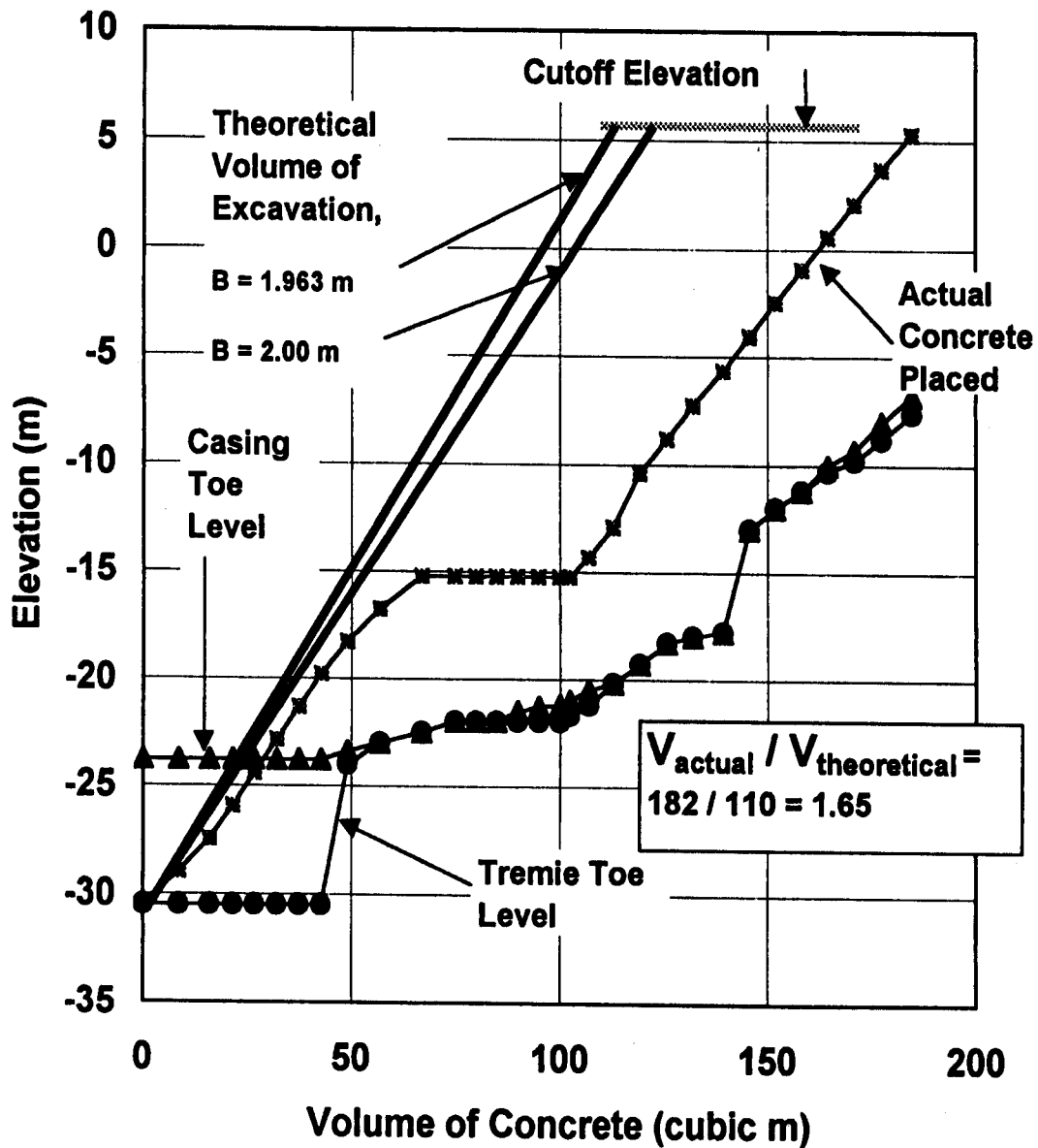

Figure 16.2. Concrete curve showing an excessive amount of overbreak

Figure 16.2 shows a concreting curve where the overbreak is excessive (65 per cent). The sketch shows that the concrete "take" started to become excessive when the level of concrete in the excavation was at about elevation -15.5m (-51 ft). About 35 m<sup>3</sup> (42 yd<sup>3</sup>) of concrete were placed before the level of the concrete reached elevation -15.0 m (-49 ft) which is excessive. The excessive overbreak is important, not only because of the extra concrete, but also because of the possibility of a defective shaft. The circumstances surrounding the construction of this particular shaft would need to be examined in detail, and there could be a need to investigate the integrity of that shaft by one of the methods described in Chapter 17.

The *Drilled Shaft Inspector's Manual* gives examples of other concreting curves.

### **Completed Drilled Shaft**

The inspector should be present as the concrete reaches the cutoff level to observe the disposal of any contaminated concrete and to observe the preparation of the top of the shaft. This includes a final check on the horizontal position of the center of the shaft, which is usually taken at this point to be coincident with the center of the rebar cage, and elevation. The location of the center of the shaft at this time or at any other time during the construction operation can be determined using offset stakes that are usually set by the contractor before the excavation of the borehole begins.

Records should be made of the elevation of the completed shaft and its horizontal position relative to its plan location.

### **COMMON PROBLEMS**

The vast majority of drilled shafts are constructed and completed without any problems. When problems occur, they are likely to fall in one of the categories listed below, taken partially from Baker et al. (1993) and O'Neill (1991). The inspector should be attentive to construction operations that can produce these problems.

- Shaft off location or out of plumb (wrong location or poor alignment while drilling)
- Base of shaft not in proper founding stratum (founding stratum misidentified or length not properly measured)
- Crack in the shaft (shaft hit by construction equipment early in curing process)
- Bulge or neck in the shaft (soft ground zones that were not cased)
- Cave-in of the shaft walls (improper use of casing or slurry; failure to use weighting agents in bentonite in running ground water)
- Excessive mudcake buildup (failure to agitate slurry or to place concrete in a timely manner)
- Temporary casing that cannot be removed (cranes for handling casing ineffective in squeezing ground)
- Horizontal separation or severe neck (pulling temporary casing with concrete adhering to it)
- Horizontal sand lens in concrete (tremie or pump line pulled out of concrete when concreting under slurry or water)
- Quarter-moon-shaped soil intrusion on the side of the shaft (interruption in flow of concrete being pumped or tremied into slurried hole for more than a few minutes; use of telescoping casing where concrete from inner casing spills into the overbreak zone behind outer casing)
- Soft shaft bottom (incomplete bottom cleaning, side sloughing or sedimentation of cuttings from slurry column)

- Voids outside of cage (low concrete slump or reinforcing bars too close together)
- Honeycombing, washout of fines or water channels in the concrete (concrete placed directly into water; excessive ground water head)
- Folded-in debris (insufficient cleaning of the drilled shaft, excessive sand being carried by the slurry)

## INSPECTION FORMS

The use of inspection forms is recommended. Several forms shown in Appendix F are quite comprehensive. The topics that are addressed by the forms are: drilling procedures and results, drilling slurry, casing or liners, installation of access tubes, concreting, weather, information on completed drilled shaft, tests of completed drilled shaft, and repairs by grouting. Other appropriate forms are given in the *Drilled Shaft Inspector's Manual*. A decision must be made by each agency about the amount of information that should be collected and the type of forms to be used by inspectors. Some guidelines are evident: the collection of useless information should be avoided, but all important data should be recorded; the collection and recording of data should not interfere with the inspector's observing important aspects of the construction operations; and the cost of the inspection should be reasonable.

## ACCEPTANCE CRITERIA

As with any other type of structure, the completed drilled shaft must be either accepted or rejected by the owner. Baker et al. (1993) provide a decision tree that should be followed in the acceptance process and in deciding whether repairs can or should be made if the shaft is not acceptable as-is. This decision tree, which is reproduced as Figure 16.3, can be modified for specific cases (for example, there are effective repair methods other than the one described here), but the thought process that is illustrated is very useful. The decision tree bases the decisions at various points on the level of "Q. C." (quality control by the contractor, and by implication, quality assurance by the inspector); the use of "N. D. T." (non-destructive testing, or "integrity testing," covered in Chapter 17); the level of stress in the shaft and the risk associated with failure of the shaft. Definitions of the last two items are left to the engineer.

In this decision support system, the N. D. T. method is assumed to be adequate to detect significant defects, regardless of what type of method is used. "Dynamic testing" refers to the use of a heavy hammer to drive the completed drilled shaft so as to be able to infer its capacity from wave propagation modeling or the implementation of a Statnamic® test. However, static loading tests, either of the conventional type or the Osterberg cell type (if integrity testing is planned for before construction), can be used in lieu of dynamic testing in some cases where systematic errors in construction have occurred (conventional) or can occur (Osterberg cell).

Baker et al. (1993) also provide a rating system to support decisions during the design phase for implementing integrity testing during and after the construction of drilled shafts. If integrity

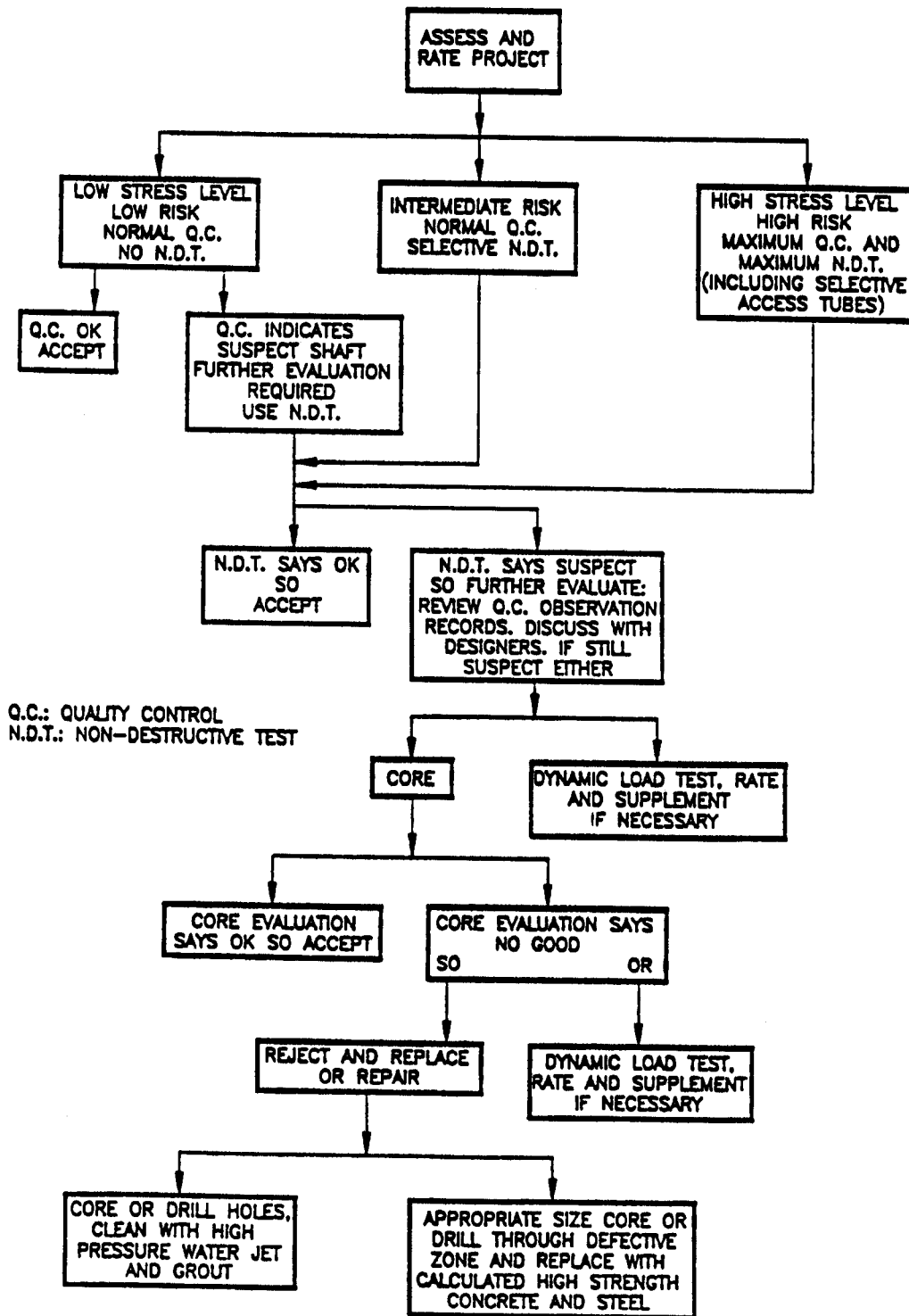

Figure 16.3. Decision tree for acceptance of drilled shafts (Baker et al., 1993)

testing is performed, it is likely to be more effective if it is planned for prior to construction than if the shaft is not prepared for integrity testing when it is installed.

## RESOURCES

The publication entitled *Drilled Shaft Inspector's Manual*, First Edition, prepared by ADSC: The International Association of Foundation Drilling and DFI: The Deep Foundations Institute, and endorsed by ASFE, The Association of Engineering Firms Practicing in the Geosciences, is an excellent detailed guideline for drilled shaft inspectors. It is available through ADSC, P. O. Box 280379, Dallas, Texas 75228.

A video is also available that is intended to be used in conjunction with the *Drilled Shaft Inspector's Manual*. That video, entitled *The Drilled Shaft Inspector*, and which runs for 32 minutes, is also available from ADSC, and is recommended viewing for DOT drilled shaft inspection personnel.

The ADSC also conducts a one-day, on-site training course for drilled shaft inspectors, covering the guidelines given in the *Drilled Shaft Inspector's Manual*. Many state DOT's have found this course useful.

## REFERENCES

Baker, C. N., Jr., Parikh, G., Briaud, J-L, Drumright, E. E., and Mensah, F. (1993). "Drilled Shafts for Bridge Foundations," *Report No. FHWA-RD-92-004*, Federal Highway Administration, Office of Engineering and Highway Operations, R & D, McLean, VA.

Crapps, D. K. (1986). "Design, Construction and Inspection of Drilled Shafts in Limerock and Limestone," Preprint for 35th Annual Geotechnical Conference, ASCE/AEG, University of Kansas, Lawrence, Kansas, March.

Holden, J. C. (1984). "Construction of Bored Piles in Weathered Rock, Part 4: Bentonite Construction Procedures," *Technical Report No. 6*, Road Construction Authority of Victoria, Melbourne, Australia.

Koutsoftas, D. C. (1987). Dames and Moore, Inc., San Francisco, CA, personal communication.

O'Neill, M. W. (1991). "Construction Practices and Defects in Drilled Shafts," *Transportation Research Record 1331*, Transportation Research Board, Washington, DC, pp. 6 - 14.

## CHAPTER 17: TESTS FOR COMPLETED DRILLED SHAFTS

### INTRODUCTION

The vast majority of drilled shafts are constructed routinely, without difficulty, and are sound structural elements. From time to time, however, defects in the completed drilled shaft can be introduced during the construction process through errors in handling of slurry, concrete, casings, cages and other factors. Therefore, tests to evaluate the structural soundness, or "integrity," of completed drilled shafts are an important part of drilled shaft inspection, especially where non-redundant shafts are installed or where construction procedures are employed in which visual inspection of the concreting process is not possible, such as underwater or under-slurry concrete placement.

From a management perspective, two general types of integrity tests can be employed on completed drilled shafts in order to ascertain whether defects might be present in the shafts. These are:

- **Planned tests** that are included as a part of the quality assurance procedure, and
- **Unplanned tests** that are performed in response to observations made by the inspector or the contractor that suggest that a defect might exist within a shaft.

Planned tests are performed on drilled shafts that are uninstrumented, excess for access tubes for drop-in instruments, or contain inexpensive transducers cast within the shaft. These tests are not normally costly, and thousands of them have been performed in recent years in the United States and abroad. The use of a cast-in-place Osterberg cell to proof load a production shaft, although more expensive, can be considered to be a planned integrity test.

Unplanned tests that are performed on drilled shafts with a suspected defect, on the other hand, will normally be time-consuming, and usually more expensive, and the results of such tests will often be more ambiguous than those of planned tests performed properly, except for those methods that employ driving or load testing of the shaft.

Some of the more common NDE tests that have been used to assess the structural integrity of drilled shafts are summarized in Table 17.1. Considerably more detail for some of these tests can be found in Olson et al. (1995), a summary of which is accessible on the World Wide Web at [www.fhwa.dot.gov/bridge](http://www.fhwa.dot.gov/bridge), under "Geotechnical", "Geotechnical Notebook Issuances" and "GT-16".

Other tests, although less common and not necessarily non-destructive, include forced vibration of the shaft (Preiss et al., 1978) and coring the shaft. Numerous techniques are available for experts to process and interpret the data. A few are summarized in the following section.

Table 17.1. Summary of Common NDE Methods for Evaluating Structural Integrity of Drilled Shafts

Test Parameter	Sonic Echo / Impulse Response (ASTM D 5882) (ASTM, 1997)	Bending Wave	Parallel Seismic	Cross-hole Acoustic	Gamma - Gamma	Concrete Scope	High-Strain Impact (ASTM D 4945) (ASTM, 1997)	Static Load Test (See Chapter 14)
Access Required	Head of Shaft	Side of Shaft	Head or Side of Shaft	Head of Shaft	Head of Shaft	Head of Shaft	Head of Shaft	Head of Shaft
Tubes in Shaft?	No	No	No	Yes	Yes	Yes	No	No
Effect of Soil on Response	Low-Medium	Medium-High	Medium	Low	Low	Low	Medium-High	Medium-High
Limitations	Effective Depth Limited by Stiff Soil or Rock. Difficulty Locating Small or Thin Defects.	Effective Depth Very Limited by Stiff Soil or Rock. Response Complicated by Bridge Superstructure. Limited Track Record.	Difficult to Interpret Regarding Defects. Less Difficult Regarding Shaft Length. Requires Drilling Boring.	Difficulty Locating Defects Outside of Line of Site Between Tubes.	Difficulty Locating Defects > 100 mm from Tubes. Readings Complicated by Rebar Nearby.	Capable of Viewing Only Concrete Adjacent to Tubes.	Expensive but Generally Definitive Regarding Shaft Capacity.	Expensive but Generally Definitive Regarding Shaft Capacity.
Advantages	Low Cost. Rapid Data Acquisition	Low Cost. Does not Require Access to Shaft Head	Moderate Cost. Useful in Estimating Shaft Length.	Relatively Accurate and Relatively Low Cost	Relatively Accurate and Relatively Low Cost	Low Cost. Visual Observation of Internal Concrete	Accurate.	Accurate and Shows Structural Effects of Defects.
Operational Costs**	\$1,000 - \$1,500	\$1,000 - \$1,500	\$1,000 - \$1,500	\$1,000 - \$1,500	\$1,000 - \$1,500	\$1,000 - \$1,500	\$3,000 - \$5,000	\$3,000 - \$5,000
Expertise Required	FDA: T* I: E	FDA: T I: E	FDA: T, E I: E	FDA: T I: E	FDA: T I: E	FDA: T I: T, E	FDA: E I: E	FDA: E I: E

\* FDA – Field Data Acquisition

I – Interpretation

T – Technician

E – Engineer

\*\* Does not include cost of drilling boreholes, placing access tubes, installing instruments, or assistance from State DOT personnel to acquire data. Does not include costs of set-up for drop-weight operations for high-strain tests or for static load tests. Operational costs include consultant's cost for acquiring and interpreting data, with local mobilization.



It is very important to point that each of the integrity tests described here requires expert knowledge to set up and execute the test and to interpret the information obtained from the test. For example, the preparation of the surface of the shaft head and the choice of a hammer with appropriate hardness, the use of proper signal conditioning for the electronic instruments, and the use of seismic techniques such as stacking of records are critical when using the sonic echo, impulse-response and impedance log methods. Obviously, the proper software must be available for processing the data for many of the methods. When a state DOT employs one or more of these tests, it should either make sure that it does so with its own employees who have been fully trained in the performance and interpretation of the test or that it employs a well-qualified outside firm to perform and interpret the test. There are several well-qualified specialty firms in the United States that are capable of carrying out the tests mentioned above.

## **SUMMARY DESCRIPTIONS OF INTEGRITY TESTS**

In this section, several of the more common of the tests from the preceding section will be summarized. There are several excellent references that describe these methods in more detail and, in addition, describe new and promising integrity testing methods for drilled shafts that are not covered here. These references include: Sliwinski and Fleming (1983), Baker et al. (1993), Rausche et al. (1994), Samman (1997), Olson et al. (1995), Reese and Stokoe (1987), Davis (1995), Jalinoos et al. (1995), Jalinoos et al. (1996), Hertlein and Baker (1996), Davis and Hertlein (1991), Rausche et al. (1991), Baker et al. (1991), and Heritier et al (1991).

### **Sonic Echo Test**

The sonic echo test procedure was developed by the TNO Dynamics Laboratory in Delft, The Netherlands, and is illustrated in Figure 17.1. The advantage of the method is that a test can be performed rapidly and inexpensively and without any internal intervention in the shaft. Recent evidence (Finno, 1995) indicates that the method can be useful even if a cap has already been cast over the head of a pile or drilled shaft.

In theory the method is simple. The head of the drilled shaft (or the top of the cap directly above the head of the shaft) is struck with a hand-held hammer. A sonic (compression) wave is generated that travels down the drilled shaft, is reflected from the base (bottom) of the shaft (or from a defect within the shaft), and is picked up by an accelerometer or other appropriate transducer at the head of the shaft. In operation, however, the method is far from simple. The signal must be processed to eliminate unwanted wave forms (noise), such as waves reflecting from the sides of the shaft, and the resulting signal must be displayed rapidly for convenient analysis. An example of an idealized result from a test is shown in Figure 17.1. The time for the wave to travel down the shaft either to the uppermost defect or to the base of the shaft and back again to the surface can be read from the signal as it is displayed on the screen of an oscilloscope or computer that displays accelerometer output versus time. With knowledge of the velocity of the compression wave  $C$  in concrete, the constructed length of the drilled shaft (or the distance from the top of the shaft to a defect) can be found from the simple equivalence that is shown in the figure.

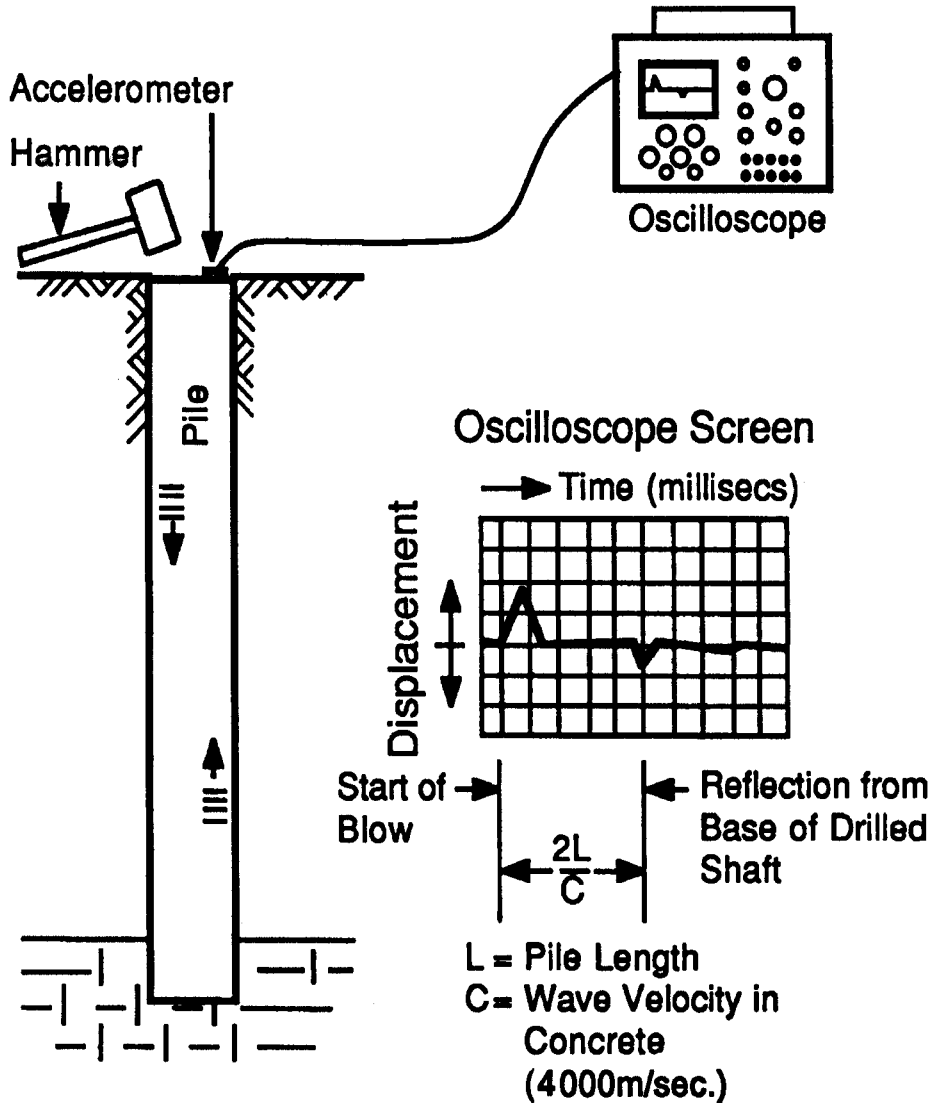

Figure 17.1 Sonic echo method (after Sliwinski and Fleming, 1983)

If there is a defect in the shaft, the value of  $L$  obtained from the first reflection will be less than the constructed length of the shaft and will in fact be the depth to the defect. A computer can be programmed easily to plot instrument signal versus depth by just multiplying the recorded values of time by  $C/2$ . Most experts now use this way of displaying the data. The operators of the test use experimental evidence that correlates the shape of the curve that is found with various kinds of defects.

It is important to understand that most sonic echo signals are not so simple as the one shown in

Figure 17.1, which shows the reflection of a wave off the base of a sound drilled shaft embedded in hard rock. The location of the base of the drilled shaft is clearly detected in this figure. But sonic waves can be reflected from any number of locations along the shaft at which the resistance to wave propagation, or "impedance," changes. Some of the recorded reflections in a sonic echo test indicate defects and some are unimportant, as explained briefly below.

- ▶ Impedance changes occur at levels in the shaft where there is a change in cross-section (e. g., at the base of the drilled shaft in Figure 17.1). Increases in cross section (bulge in a shaft, which would ordinarily be of no concern unless downdrag can occur) can be distinguished from decreases in cross section (either a defect or an inconsequential reduction in cross-section, as often occurs at the elevation of the bottom of a temporary casing) by observing the polarity of the reflected signal. A return pulse of opposite polarity to the incident pulse produced by the hammer, for example, is an indication of increased impedance, such as may be caused by a bulge in the shaft or by a base embedded in rock that is stiffer than the concrete, which is the condition illustrated in Figure 17.1.
- ▶ Impedance changes occur when there is a change in concrete modulus or density, and such a condition will often be recorded as an apparent defect. Such a situation can be caused, for example, by mixing of drilling slurry with the concrete or honeycombing in the concrete, but it can also result from changing ready mix trucks during a concrete pour in which the modulus and/or density change, although detectable, does not constitute a structural defect.
- ▶ Impedance changes also occur due to changes in geomaterial energy transmission conditions along the shaft, which has no relation to the structural integrity of the shaft. For this reason the interpreters of pulse echo and similar data (impulse-response, impedance logs) need to have access to the boring data at the construction site.

Because there are many sources of recorded wave reflections, operators of sonic echo equipment are not likely to report "defects" in the drilled shaft. Rather, they are normally in a position to report only "anomalies," or variations in the signal that could, but do not necessarily, indicate a defect. The final decision on whether to treat a shaft as defective is left to the engineer. Sometimes, the size, location and nature of the defect can be simulated using a one-dimensional wave equation program by varying the size, position and stiffness of the defect in the computer code and matching the computed velocity time history at the head of the shaft with that measured by the test. This is an important feature of the original TNO method and sometimes allows for a better understanding of the possible properties of the defect. In some cases the results of such a "curve matching" procedure may not be unique, however.

The sonic echo method has some important limitations:

First, the farther the wave travels along the shaft the more energy it loses, so that deep defects or

deep bases are not likely to be detected. An upper limit to the depth to which such tests with modern equipment are useful is about 20 m (66 ft). Some experts relate the upper depth limit to length-to-diameter ratio and stiffness of the surrounding soil, with a maximum depth-to-diameter ratio of about 30.

Second, wave energy is not likely to be reflected from defects unless the defect is either relatively thick or extends nearly across the entire cross-section of the drilled shaft. Schellingerhout and Muller (1996) show that a dramatic reduction in reflected energy occurs once the thickness of a defect drops below about one-quarter of the wave length of the propagating compression wave. For an average hammer impact, the wave length might be around 1.6 m (4.6 feet), suggesting that it will be difficult to detect defects thinner than about 0.4 m (15 inches). Many types of potential defects can be thinner than this. Samman and O'Neill (1997a) reported an experimental study in which defects that were about 25 mm (1 inch) thick could not be reliably detected experimentally by this method. Baker et al. (1993) concluded from an extensive experimental study that sonic echo methods were not reliable in identifying thick defects that covered less than about 50 per cent of the cross-sectional area of the shaft. Beyond this observation that the defect must be of significant size to be detected reliably by this method, there is no way to tell with present sonic echo technology how large the defect actually is.

Third, defects or shaft bases that are located below the topmost defect appear not to produce detectable reflections in most instances. For example, if there is a defect at a depth of one-half of the length of the shaft, the wave that reflects off the defect will return to the top of the shaft, reflect off the top of the shaft, return to the defect, reflect off of the defect and return to the top of the shaft a second time just as the reflected wave is returning from the base of the shaft, making it impossible to verify the length of the shaft using this method.

Fourth, Samman and O'Neill (1997a) concluded from a study performed by many consultants that false positives were frequently reported from sonic echo tests on short drilled shafts. See also a discussion of those tests by the testing organizations (Anonymous, 1997).

Fifth, with the sonic echo test, it is not possible with present technology to determine in what direction relative to the centerline of the shaft, the defect is located, only the depth at which the defect is to be found. A small defect on the compression side of a laterally loaded drilled shaft will be more detrimental than one on the tension side.

In summary, the sonic echo test should be considered to be only a very crude screening method that is capable of locating only major defects such as major soil inclusions or bases of shafts that were drilled to the wrong depth. The kind of internal defect that the sonic echo test is likely to be able to detect with a high degree of certainty is shown in Figure 17.2. In this shaft, the contractor worked under a specification that did not allow the use of slurry, and severe sloughing of the sides of the borehole evidently occurred while the concrete was being placed.

Baker et al. (1993) suggest that the sonic echo method and the impulse-response method, which

suffers from the same limitations in general, not be used as the primary integrity testing method for axially loaded drilled shafts in which the design loads exceed about 40 per cent of the structural capacity of the drilled shaft in an ASD context.

A variation in the sonic echo test called the bender wave test has been developed to attempt to discover defects by impacting the side of the shaft or the substructure above the head of the shaft, rather than the head, when the top is not accessible (Olson et al., 1995). This method is still under development and as indicated in Table 17.1 has a limited track record.



Figure 17.2. A severe defect that can likely be detected by sonic echo testing

### **Impulse-Response Test**

Weltman (1977) described the impulse-response method for integrity testing, which is similar to sonic echo testing, but which uses a more sophisticated means of processing the data. In addition to recording the motion at the head of the shaft versus time, the force applied by the hammer is also recorded versus time. The two signals are processed in the computer using software that employs Fourier transform methods, and the output that is produced almost instantly is a plot of head velocity ( $V_o$ ) / head force ( $F_o$ ) versus frequency ( $f$ ). An idealized output is shown in Figure 17.3, which also indicates how the output can be interpreted. In this figure  $v_c$  is equivalent to  $C$

in Figure 17.1.

First, the initial slope of the curve is related to the axial stiffness of the shaft. If the value of that slope is low compared to those of other shafts of the same size that are known to be sound, a defect may be present.

Second, the increment in frequency between peaks on the waveforms of the output is proportional to the distance from the top of the shaft to the elevation at which the energy is being reflected (major defect or base of shaft).

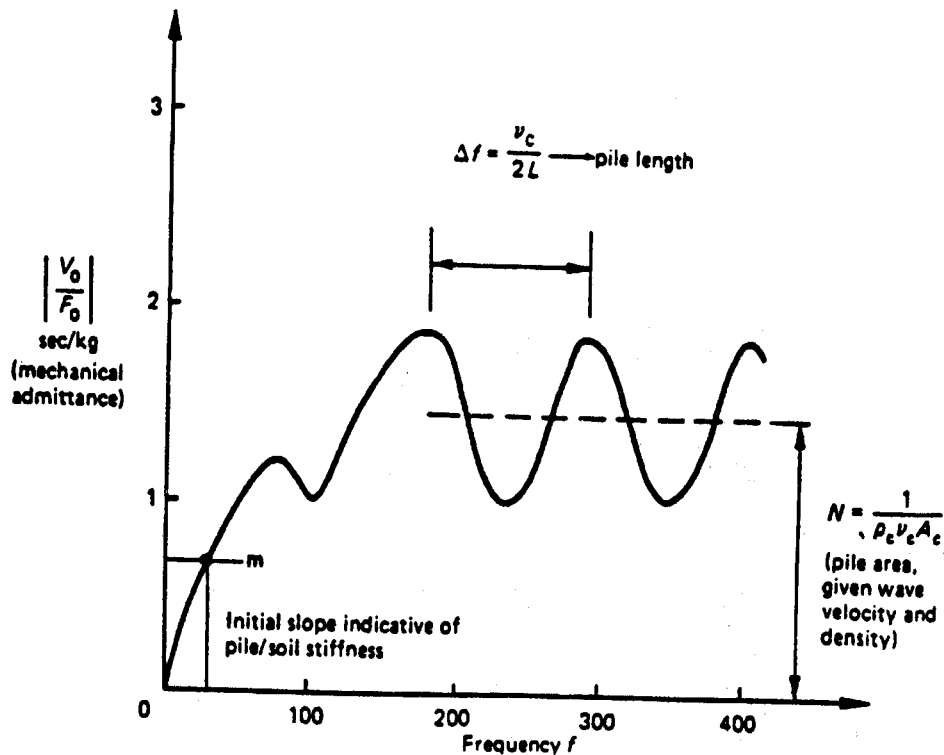

Figure 17.3. Ideal response curve for the impulse-response or vibration test (after Weltman, 1977)

Third, the mean admittance value (dashed line) of the output curve ("mobility" plot) can be related to the average cross-sectional area of the shaft if it is assumed that the modulus and density of the concrete do not change along the shaft.

While the same general limitations that apply to the sonic echo method also apply to the impulse-response method, the waveform of the mobility plot of Figure 17.3 is usually easier to interpret than the waveform produced in sonic echo plots.

## Impedance Log

Further computer processing of the information shown in both Figures 17.1 and 17.3 can be performed to make a graph of the cross-sectional area of the shaft as a function of depth, assuming that the density and wave velocity of the concrete remain constant. The result of this processing is an impedance log, which can be displayed as a graph of a vertical section of the shaft, giving a clear indication of average shaft diameter versus depth. Examples of impedance logs are shown in Figure 17.4. These logs show indications of defects (reduced diameters) in Shafts 3, 4 and 5, and a slight reduction in diameter near the top of Shaft 2, which might warrant further investigation. Although the images in Figure 17.4 appear to be cross-sections of the shafts, they are not. Calculated cross-sectional areas are plotted as diameters, so cross-section changes are always shown symmetrically. The diameters near the base are in error because of the way the data have to be processed, causing the logs to exhibit round bases incorrectly. The plots are provided in this way for convenience in interpretation.

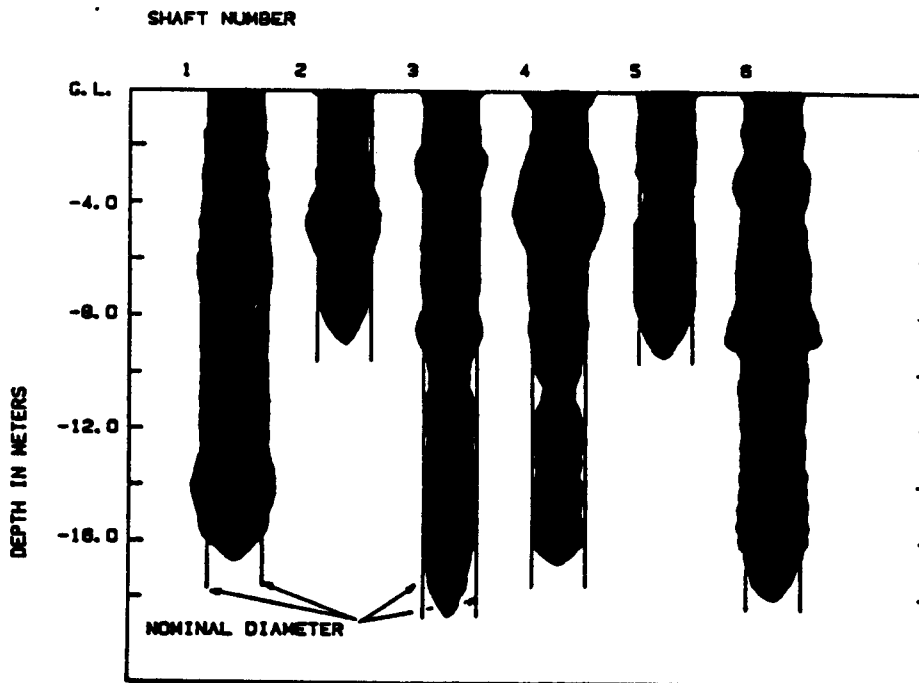

Figure 17.4. Examples of impedance logs (Davis and Hertlein, 1991)

Impedance logging has the same general limitations as the sonic echo method but may not be prone to as many false positives. Impedance logging cannot detect the direction of the location of the defect relative to the centerline of the shaft, nor can it distinguish between actual cross-section changes and modulus or density changes in the concrete.

## Parallel Seismic Test

The principle of the parallel seismic test is illustrated in Figure 17.5. This test is useful in cases where the top of the shaft, or the top of the cap just above the shaft, are not accessible. In this case, a point on the substructure above the shaft (or "pile" in Figure 17.5) is impacted, and the propagated wave travels down the shaft. Part of the wave energy in the shaft is transmitted into the soil or rock near the shaft, and the time of the arrival of the wave energy in the soil is sensed by hydrophones (piezo-electric receivers) positioned at various depths in the tube. A change in

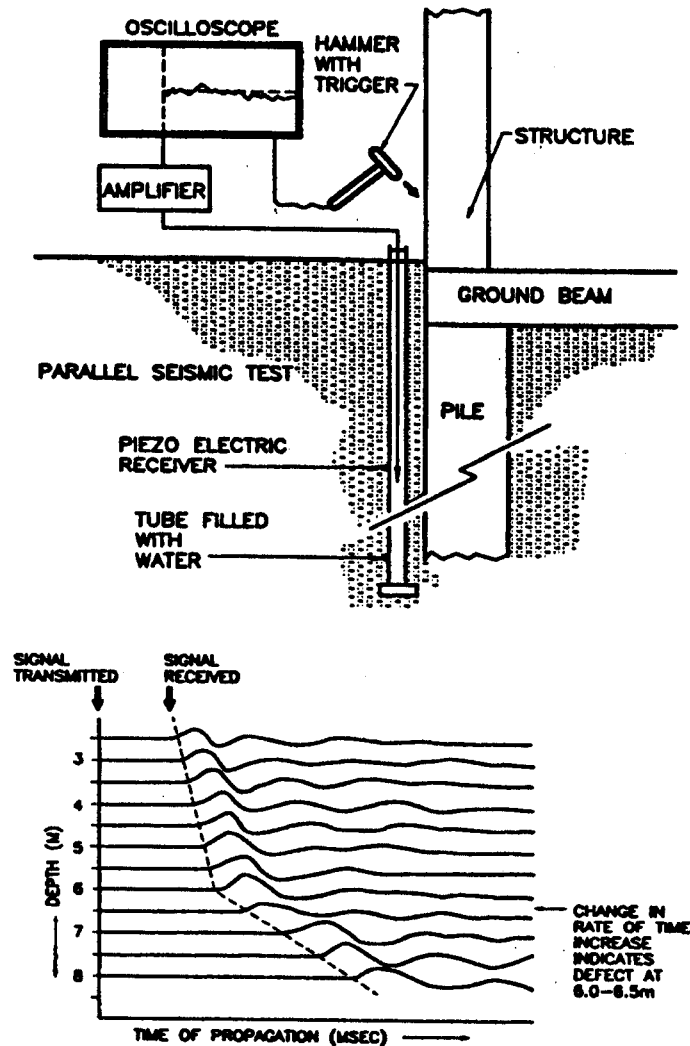

Figure 17.5. The parallel seismic test (Davis, 1995)



the arrival rate, illustrated in Figure 17.5, indicates the presence of a major defect. The depth of the base of the drilled shaft can also be found in this manner. Spurious waves called tube waves (waves that travel from the pile to the tube at higher elevations than that of the sensing point and then travel down the tube to reach a sensing point before the compression wave travelling down the shaft can reach the same sensing point) normally have larger amplitudes than the waves of interest, so the interpreter must be skilled in separating the effects of tube waves from the effects of the shaft waves shown in Figure 17.5, which are the only waves of interest. As with the preceding small-strain methods, small defects are not likely to be detected with parallel seismic tests.

### **Internal Stress Wave Test**

Hearne et al. (1981) reported a method that uses the same concept as is employed in the sonic echo test, except that the receivers are embedded at different depths within the drilled shaft. Figure 17.6 illustrates the test arrangement. Note that the embedded receivers are inexpensive vertically mounted, encapsulated geophones, and they are isolated from the steel rebar. The lead wires are routed to the surface along the rebar and extend for 3 or 4 meters (about 10 feet) beyond the top of the shaft, where they are connected to the data acquisition equipment. These instruments are very easy to install. The intent of the test is to track the compression waves in concrete. In addition to the embedded receivers, an accelerometer can be used at the top of the drilled shaft to provide further data.

The two receivers that are shown in the figure, plus an accelerometer, yield a significant amount of data and allow a confirmation of any possible irregularities in the signals. For example, Figure 17.7 shows the amplitudes of the geophone signals plotted against a common time scale. The passage of the incident compression wave, as well as the compression wave reflected off the bottom of the shaft can be seen at the location of each geophone. The horizontal axis is time. Lines joining the points on the curves (plotted to scale in depth) intersect at the depth from which the wave is reflecting, which hopefully is the planned elevation of the base of the drilled shaft, as shown in this figure. If the reflection comes from a higher level, or if the signals are interrupted at one or more levels before the base reflection occurs, the shaft possibly has a defect.

The embedded receivers are advantageous in that the noise level is much reduced compared to that which exists in sonic echo testing (which reduces the need for signal processing and which may lead to fewer false positives), and any number of receivers can be installed. It is possible, of course, to install a receiver at the bottom of a drilled shaft. The disadvantages are the same as for those listed for sonic echo testing and, in addition, there is a somewhat greater cost for this test, and the decision to use this test must be made before construction.

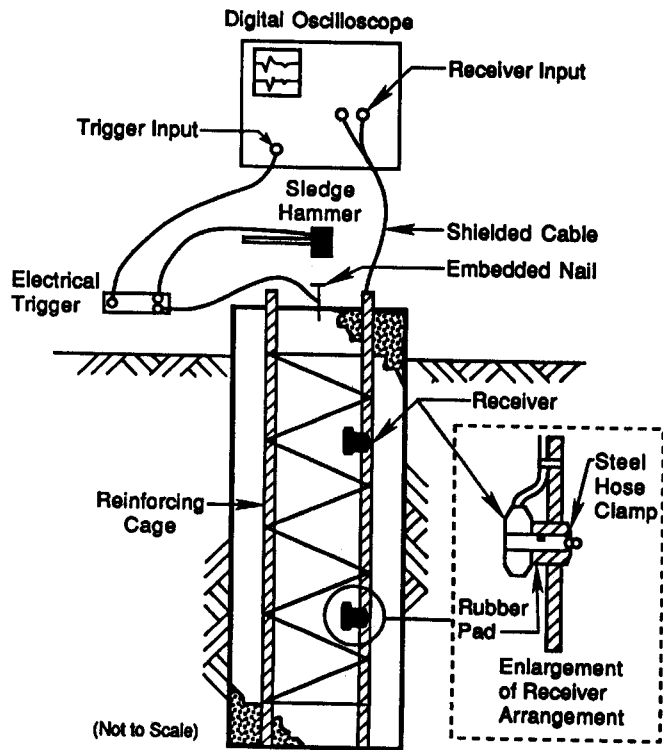

Figure 17.6. Compression wave propagation method with internal receivers (Hearne et al., 1981)

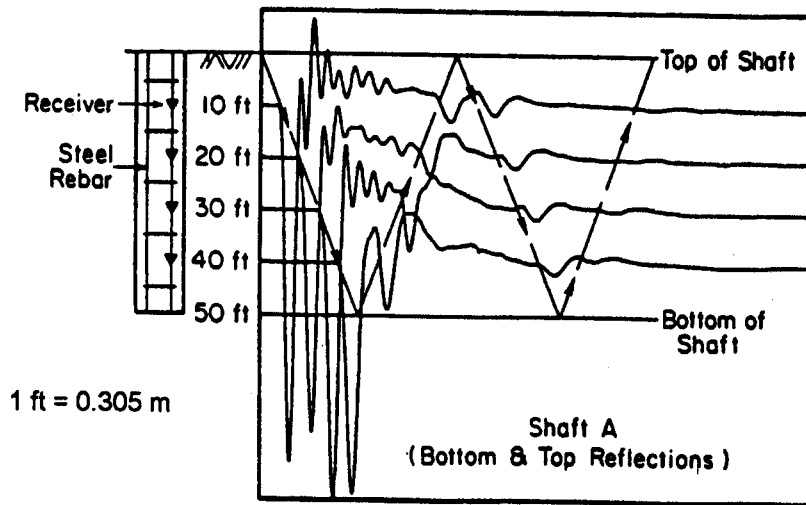
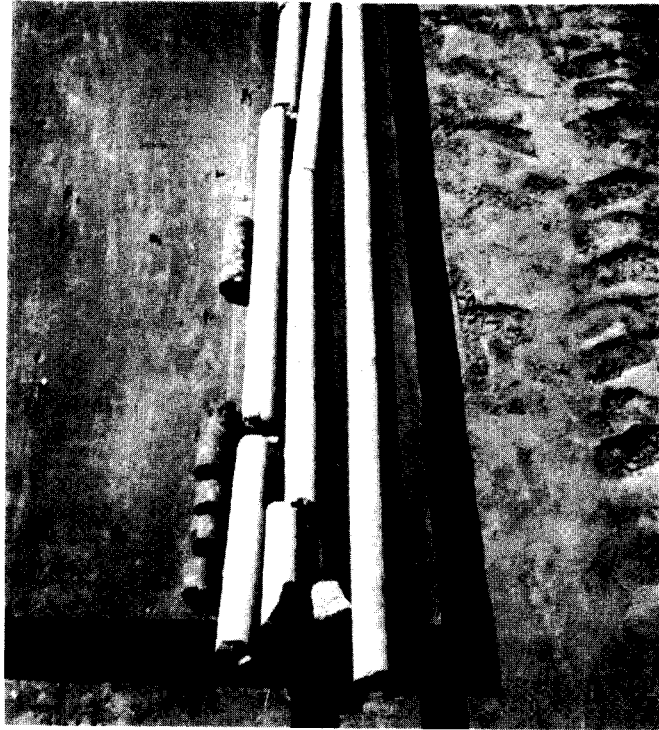
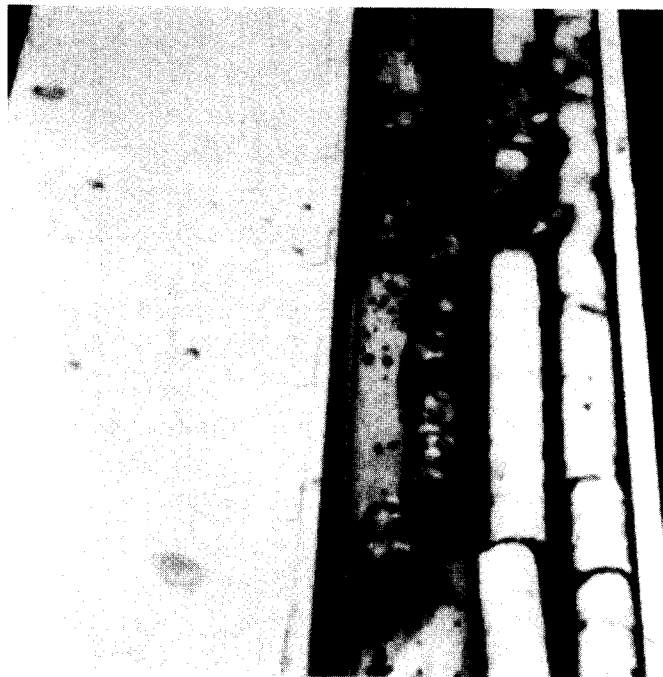

Figure 17.7. Typical results from internal stress wave test (from Harrell and Stokoe, 1984)



(a) Shaft with no defect



(b) Shaft with defect caused when concrete began to set while removing the casing

Figure 17.8. Concrete cores from non-defective and defective drilled shafts

## **Drilling and Coring**

A frequent response to concern about the integrity of a particular drilled shaft, usually as a result of some problem that arose in the placement of the concrete and identified by the inspector or as a result of the identification of anomalies in small-strain integrity tests (e.g., sonic echo, impulse-response, impedance log, parallel seismic), is to institute a program of drilling and/or coring. Such techniques give a relatively positive indication about the character of the concrete in a relatively small volume of the shaft, but drilling and coring are time-consuming and expensive, and sometimes they too can be misleading.

An ever-present problem with drilling or coring is the control of the direction of the drilling. The hole sometimes runs out the side of the drilled shaft or encounters one or more bars of the reinforcing steel. Experienced personnel are required, along with appropriate equipment, to ensure that the drilling is done correctly in the direction intended.

Drilling is much faster than coring, but less information is often gained. The quality of the concrete that is being penetrated can sometimes be inferred from the drilling rate. Some positive evidence of a defect is uncovered if a soil-filled cavity is encountered and the drill drops a significant distance. After the drilling is completed, a caliper can be employed to investigate the diameter, and the drilled hole can be inspected visually by means of a down-hole television camera.

Coring is much slower than drilling, but often more instructive. The percentage of recovery can be logged, the cores can be examined for inclusions of soil or drilling slurry, compression tests can be performed on the cores if desired, and the contact between the concrete at the base of the drilled shaft and the supporting soil can be investigated. Core holes, like drilled holes, can also be inspected by means of a miniature downhole television cameras (e. g., Weltman, 1977). Coring is perhaps the most positive integrity testing method short of high-strain integrity testing load testing for identifying soft bottoms in drilled shafts, particularly in rock sockets.

Photographs of two sets of cores are shown in Figure 17.8. In Figure 17.8a, the shaft was cored because samples of concrete that had been taken from the first ready-mix truck that began discharging concrete into the borehole had exhibited a slump of less than 100 mm (4 inches) when the last amount of concrete had been placed. Since the concrete was placed underwater by means of a tremie, it was thought that the concrete first placed may have "stuck" within the cage and newer, more fluid concrete may have broken through the low-slump concrete and returned to the surface. With such a scenario, the concrete below the top of the shaft may have been severely honeycombed or diluted with ground water. The cores shown in the figure are clearly sound and indicated that this action did not occur. [In fact, the temperatures in the ground were low enough to maintain the slump of the concrete in the borehole above 100 mm (4 inches) even though the samples that had been taken from the first truck and held on the surface for later slump testing, where the ambient temperatures were high, indicated that the concrete had lost most of its fluidity.]

The cores in Figure 17.8b were taken after constructing a drilled shaft on a batter. Temporary casing was used to retain the borehole, and when the contractor tried to withdraw the casing it hung on the cage. While the contractor was trying to work the casing free of the cage the concrete began to set up. By the time the casing could be recovered, considerable movement of both the cage and the concrete had occurred, which prompted the coring. The core that was recovered clearly showed defective concrete in the upper 4 - 5 m (about 15 feet), and the contractor was required to repair the top portion of the shaft down to the depth indicated by the core to which the concrete had been shown to be defective, including replacement of the concrete and repair of the rebar cage.

Another procedure that can be employed if a hole has been cored or drilled into the shaft is to pack off a portion of the hole and to perform a fluid pressure test. Again, the procedure is expensive but sometimes instructive.

The drilling or the coring of a hole in a drilled shaft is an excellent method to find a defect of large size. If the excavation has collapsed during the concrete placement and if the concrete is absent in a section of the shaft (Figure 17.2, for example), the defect is almost always sure to be detected. However, defects can be missed, such as if the sides of a socket in rock are smeared with remolded and weak material. The reverse can also be true; that is, coring may reveal a defect that is thought to be severe but in fact is insignificant. For example, coring can reveal weak concrete or sand at the base of a rock socket but sound rock and a good contact could exist across the rest of the socket.

Core or drill holes should be filled with grout or concrete upon completion of sampling if the shaft will be used in a structure.

### **Crosshole Acoustic (Sonic and Ultrasonic) Tests**

Metal (usually Schedule 40 steel) or plastic (usually Schedule 40 PVC) access tubes can be cast longitudinally into a drilled shaft by attaching the tubes to the reinforcing cage if it is planned to test a particular shaft. It is advisable to place several tubes in the shaft but not to place so many as to impede the flow of concrete. A rule of thumb employed by several agencies is to place the access tubes uniformly around the cage, fastened to the inside of the cage, using one longitudinal access tube for each foot (0.3 m) of shaft diameter. At least two tubes are installed. Although it is possible to perform single-tube tests to evaluate the quality of concrete around one tube, this method will not be covered here. Other patterns may also be acceptable.

The tubes have a diameter sufficient to admit the probes that are to be used (in the range of 25 to 52 mm (1 to 2 inches), depending upon the size of the probes), will normally extend to the full length of the drilled shaft, and are plugged on their lower ends to keep out concrete. Steel tubes are usually preferred over PVC tubes because the concrete tends to debond more quickly from the PVC. If PVC tubes are used, acoustic tests should be performed within a few days of casting the shaft. PVC access tubes can be used to accommodate both ultrasonic and sonic crosshole

tests and gamma-gamma tests. A longer lapse time can usually be used when steel access tubes are employed; however, they are inappropriate for gamma-gamma testing. The tubes must be filled with water before acoustic testing so that energy can be transmitted from the wall of the tube into the probes and vice versa. Water also helps to stabilize the temperature of the tube to keep it from debonding from the concrete. A photograph of a reinforcing cage on which are mounted PVC access tubes for integrity testing is shown in Figure 17.9.

The use of access tubes has the added advantage that the tubes can be used as conduits for coring the base of the drilled shaft relatively quickly to check the quality of the base contact, and they can also be used for post-grouting of the soils at the base if such an action becomes necessary. Crosshole acoustic tests, or other tests that use access tubes, are inexpensive and can be performed rapidly.

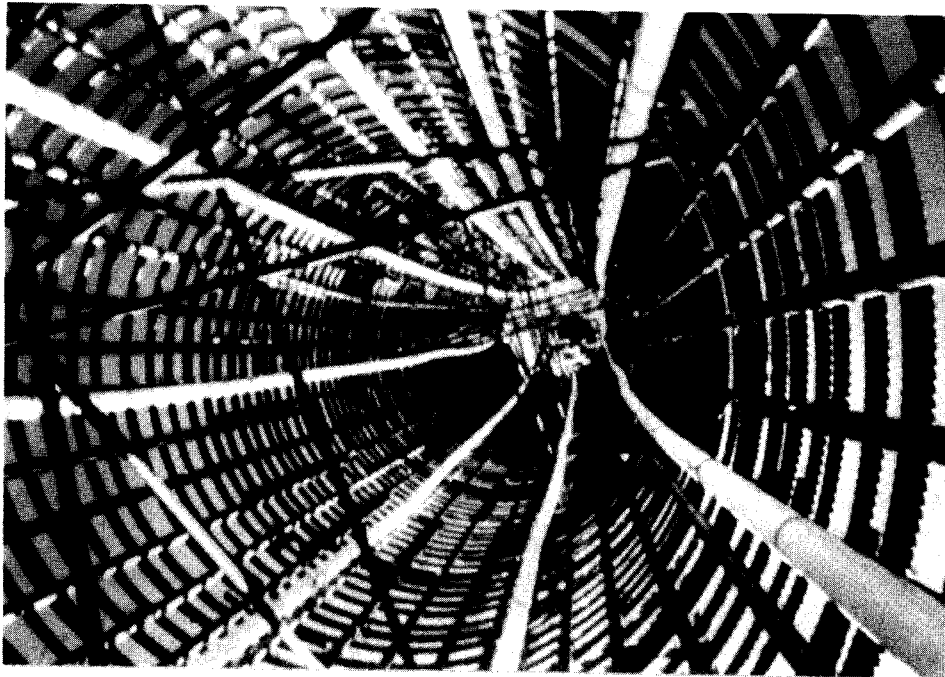

Figure 17.9. Reinforcing cage to which PVC access tubes have been attached

To perform a crosshole sonic or ultrasonic test, an acoustic transmitter is lowered into one of the fluid-filled access tubes, and a receiver is lowered to the same depth in another fluid-filled tube. The transmitter emits an acoustic signal at an assigned frequency, and that signal is picked up by the receiver. The test is repeated at many depths. A schematic of the method is shown in Figure 17.10.

The receiver signal can be examined to determine the travel time of the acoustic pulse from one tube to another. If there is a defect between the two tubes, the travel time increases for the depth at which the defect exists compared to other depths. It is not necessary for the defect to be directly between the source tube and the receiver tube, but the farther the defect is from the "line of sight," the more difficult it is to detect. It is also possible to examine the ratio of the energy that is received to that transmitted. Strong anomalies in either travel time or energy transmission are interpreted as potential defects.

The higher the frequency that is used, the smaller the defect that can be detected. As with sonic echo tests, the smallest defect that can be reasonably "seen" is about one-fourth of the wave length of the transmitted acoustic signal. For greatest accuracy, it is best that the acoustic device operate in the ultrasonic range, perhaps 40 to 60 KHz. At 60 KHz, the smallest defect that can possibly be detected ideally in normal concrete is less than 19 mm (3/4 inch) across  $[(1/4) (4000) (1000) / (60,000)]$ , where the wave velocity in concrete is taken to be 4000 m / sec (13,100 feet / sec)]. This is around the size of the largest coarse aggregate in fluid concrete recommended for under-slurry placement (Chapter 8). If the frequency is higher than about 60 Hz, the sizes of the individual grains of coarse aggregate begin to affect the results, so there is a reasonable upper limit to the frequency that should be used. Higher frequency signals also tend to dissipate faster than lower frequency signals in the concrete and so may be received very weakly by the receiver, if at all. If the tubes are far apart or the concrete for some reason is a poor acoustic transmitter, or if the coarse aggregate is very large, the operator may need to use sonic signals (frequencies less than 20 KHz), rather than ultrasonic signals. The operator must be aware of the limitations on frequency and power levels of the instruments.

Typical results for a crosshole acoustic test are shown in Figure 17.11. At a depth of 40 feet (12.2 m) there is a both a delay in the arrival time of the acoustic pulses, which in this case are sonic, not ultrasonic, and a sharp reduction in the energy transmitted. This is a clear indication of a defect in the concrete between the two tubes. It can also be determined that the defect is about 1.5 to 2 feet (0.5 to 0.6 m) thick.

Referring to Figure 17.10, note is made of the fact that if more than two access tubes are used, the source and receiver can effectively pin down the location of the defect in terms of its direction from the centerline of the shaft by taking acoustic profiles between each pair of tubes, and analysis of the multiple acoustic profiles can provide some idea of the size of the defect. This is a significant advantage over the kind of information that can normally be obtained from surface sonic echo testing.

There is some controversy over whether crosshole sonic and ultrasonic methods can detect defects that are outside of the rebar cage, since such defects will always lie outside of the line of sight between tubes mounted inside the cage. There is evidence that if the defect is large (although completely outside the cage) and there is a major velocity contrast between the sound concrete and the material in the defect (e. g., the defect is a complete void), this method can sometimes detect it. However, it is the authors' experience that such defects go largely undetected with this method.

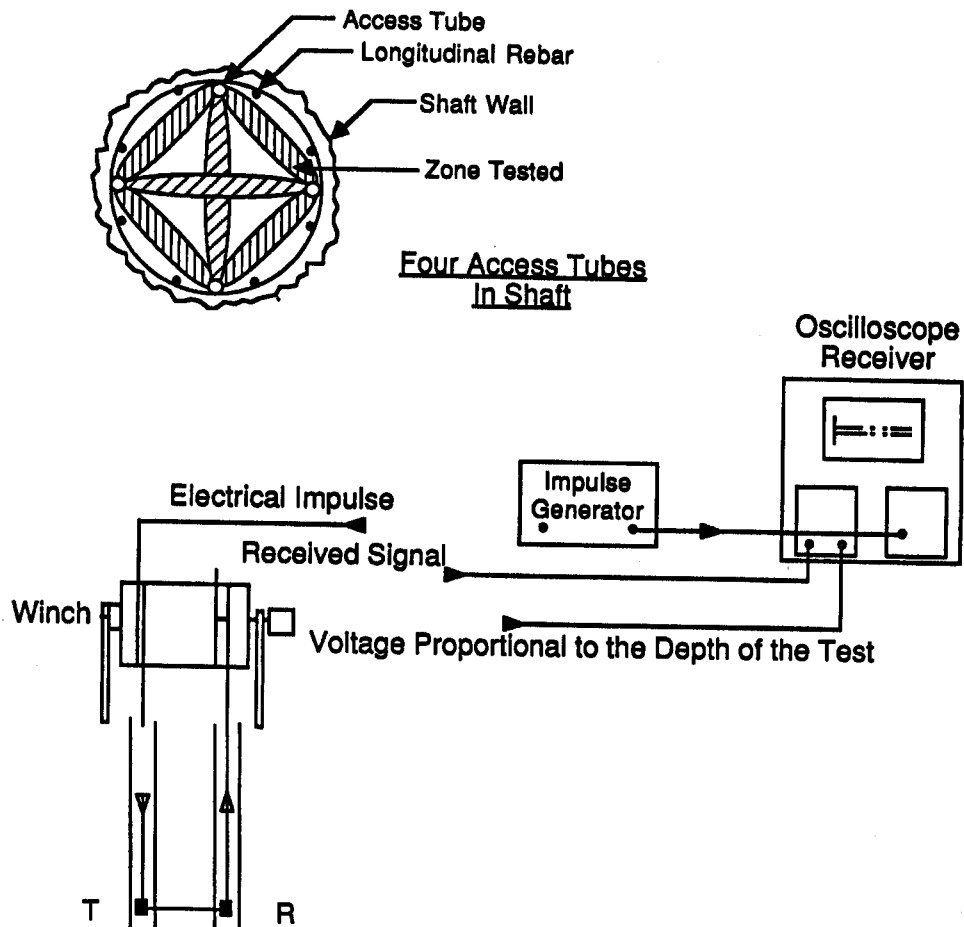

Figure 17.10. Diagram of crosshole acoustic logging system (Weltman, 1977)

The crosshole acoustic method can also be employed with the source and receiver at many depths, each different from one another. The data can be processed so that a three-dimensional "picture" of any defects can be produced. This method has not been used to any extent in practice to date in the United States but offers considerable promise for visualization of defects in the future as the method is refined. This technique has come to be known as tomography and is not unlike some of the modern imaging techniques used by medical personnel.



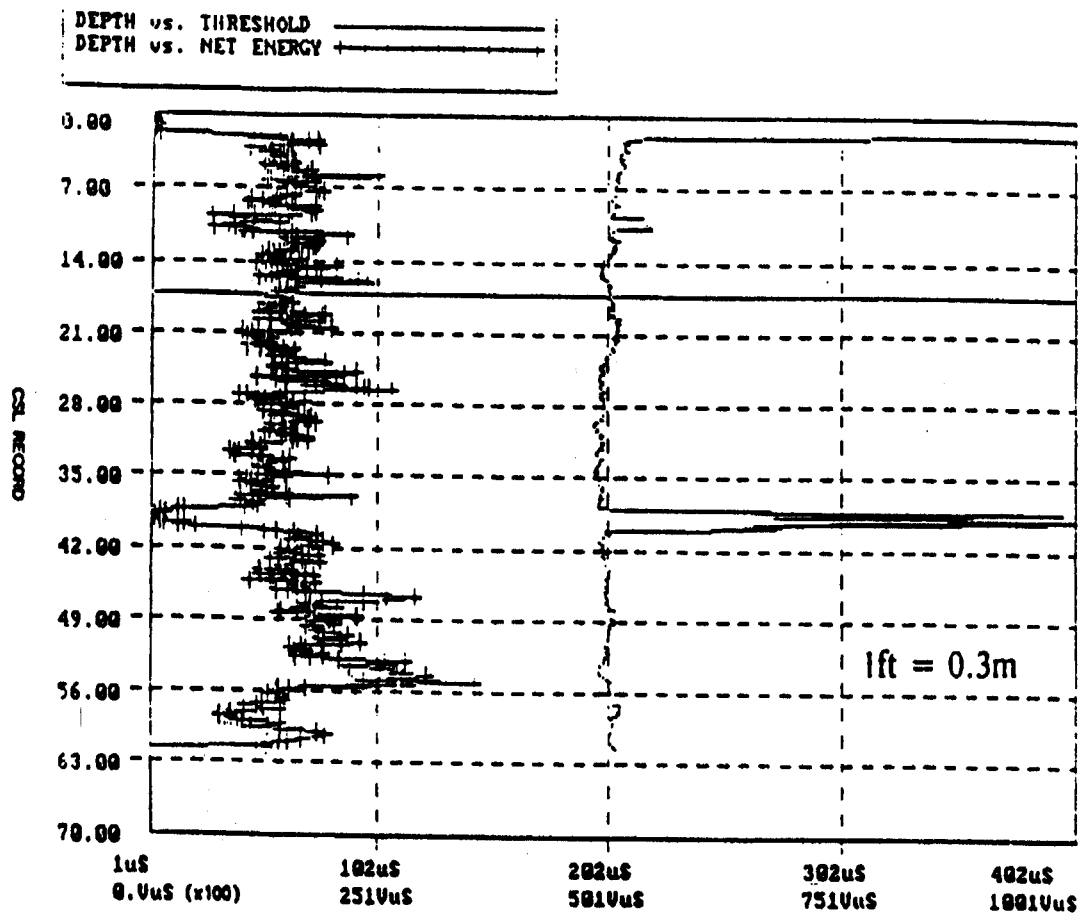

Figure 17.11. Crosshole sonic log for a shaft with a known defect (Baker et al., 1993)

### Gamma-Gamma Testing

In the method of gamma-ray backscatter testing, better known as "gamma-gamma" testing, a source of ionizing radiation is lowered down an access tube. This tube should not be made of steel, which would prevent the gamma photons from penetrating into the concrete. The instrument containing the radioactive source also contains a gamma-ray detector. The device is depicted in Figure 17.12. The number of gamma-ray photons per unit of time that are reflected from the nuclei of the molecules that make up the material surrounding the tube and return at a given energy level to the detector is related to the density of the material surrounding the tube. The photon count per unit of time can be calibrated to the concrete density. If the density reduces significantly below the normal density for locally produced concrete over a certain depth range, a void or imperfection in the concrete is indicated.

The volume of concrete surrounding the tube that can be investigated is relatively small. Generally, the device will not detect the density of the concrete for a distance more than about

100 mm (4 inches) from the edge of the access tube. Since the tubes can not be practically placed 200 mm (8 inches) on centers within the shaft (and should not be even if the shaft is small enough to permit such placement), the engineer must be content with having intermittent sampling of the concrete density around the perimeter of the cage, to which the access tubes are fastened.

While gamma-gamma tests do not permit as thorough a coverage of the cross-section as is possible with crosshole acoustic testing, the gamma-gamma test does afford the opportunity to "look outside of" the rebar cage into the zone between the cage and the borehole wall more effectively. Some agencies believe that this advantage outweighs its disadvantages relative to crosshole acoustic tests. For the gamma-gamma test to be accurate the access tubes need to be placed away from the longitudinal rebar and to remain a constant distance from the nearest bar, as the presence of the steel affects the readings.

Crosshole direct transmission tests using radiographic techniques can also be performed, but they are not common in the United States at the present time.

Figure 17.13 shows typical results from gamma-gamma testing on a drilled shaft with four access tubes [cage diameter is four feet (1.22 m)]. This shaft was installed under a drilling slurry. It can be seen that low densities occur near the base of the shaft, possibly because of some mixing of slurry or sediment with the concrete. For this particular shaft, the possible contamination of concrete near the base was not judged to be severe enough to warrant consideration. However, there is a zone higher up the shaft, clearly around two of the four tubes, where a marked reduction in concrete density occurs. This zone represents a defect, which if uncovered, would appear much like the defect shown in Figure 17.14. In fact, in Figure 17.14, a white PVC gamma-gamma access tube can be seen clearly.

Not all defects present themselves this clearly in gamma-gamma logs. There is normally some variation in the density of normal concrete from point to point as detected by gamma-gamma probes. When such variation represents a defect is problematical. Caltrans has proposed a procedure to define defects from gamma-gamma logs. Since each point on the log is a bit of digital information (a specific value of density at a specific depth), the mean density ( $m$ ) from all data points within a shaft is computed. Then, the standard deviation ( $\sigma$ ) of the individual values of density is calculated. If a measured value of density in any of the tubes is less than  $(m - 3\sigma)$ , the shaft is defined to be defective at that point.

As with core holes, all access tubes for crosshole acoustic or gamma-gamma tests should be filled with grout or concrete before the shaft is placed in service.

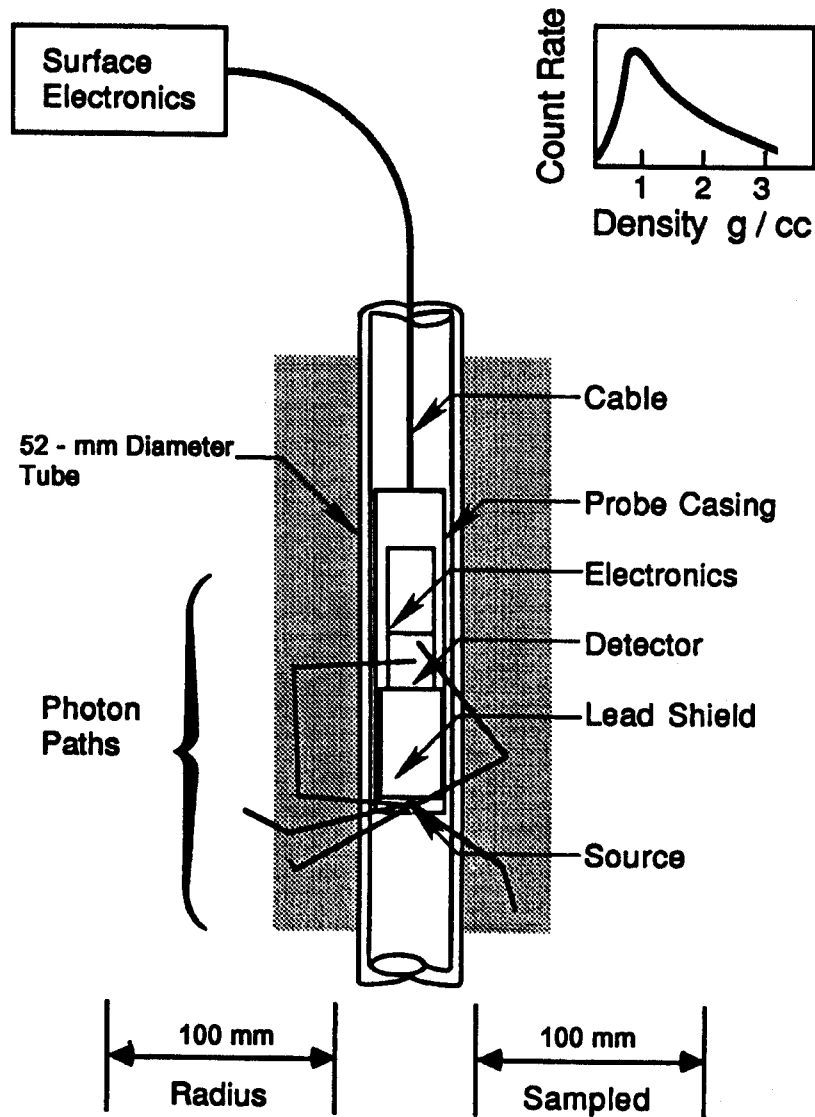

Figure 17.12. Gamma-gamma testing system (after Preiss et al., 1978)

### Concreteoscopy

A relatively new method for observing the quality of the concrete in a drilled shaft *in situ* is to attach small-diameter [12.7 mm (1/2 inch)] clear plastic tubes to the rebar cage at intervals around the cage and to use a microminiature television camera on a fiber-optic cable to view the concrete from within the tubes, in a manner similar to the way in which a physician views interior parts of the human body. This test is similar in operation to the gamma-gamma test except that visual acuity, rather than density monitoring, is used to evaluate the quality of the concrete. Of course, no indication of the quality of the concrete between the tubes is available;

however, cracks and honeycombing can be clearly seen. The method requires expensive photographic and recording equipment, but the test itself is rapid and inexpensive. While the record of experience with this device is short, it appears that it may be very effective when used in combination with other downhole methods such as the gamma-gamma or crosshole acoustic test.

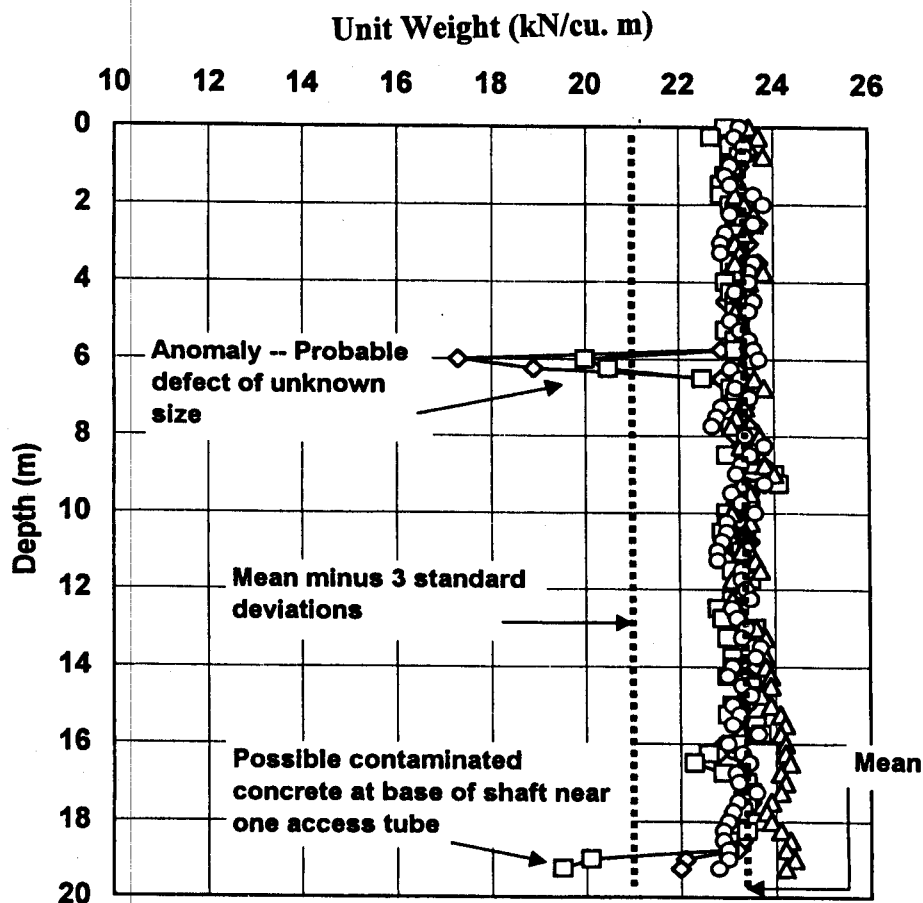

Figure 17.13. Results from gamma-gamma logging of a drilled shaft with four access tubes (Courtesy of Caltrans)

A photograph from a VCR recording of a concreteoscope test is shown in Figure 17.15. The crack that is shown is less than 1 mm (0.04 inch) thick. Further information can be obtained from Samman and O'Neill (1997b).

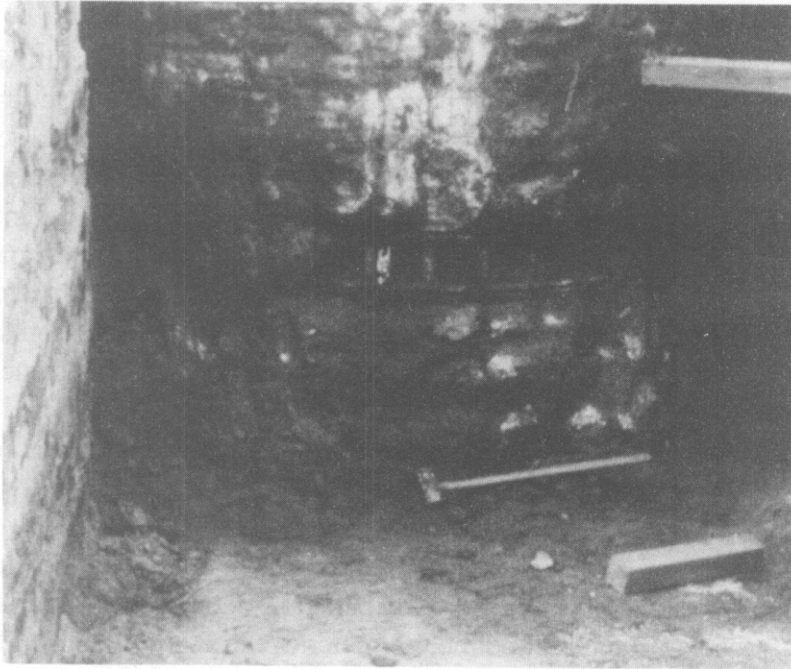

Figure 17.14. Photograph of defect similar to the defect that produced the logs in Figure 17.12 (Courtesy of Caltrans)

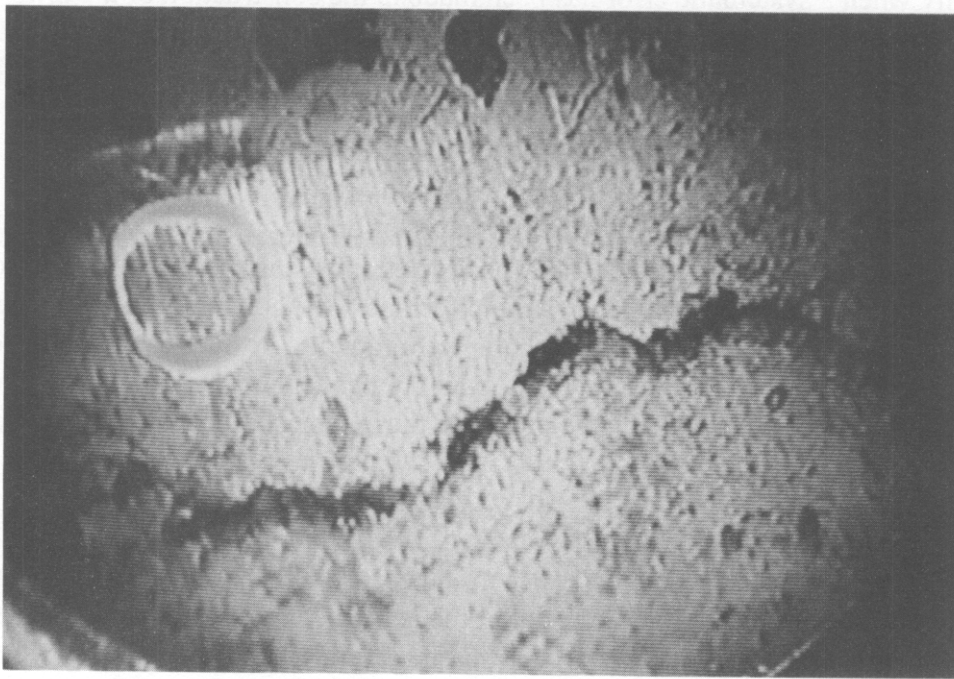

Figure 17.15. Photograph of a small transverse crack in a concrete pile from a concreteoscope test

## **Other Procedures**

The most definitive means of checking the structural integrity, and at the same time the geotechnical capacity, of a drilled shaft is to perform a dynamic or static loading test. A dynamic test can be performed by employing the Statnamic® procedure (Chapter 14). It can also be performed by dropping a large weight (about 1/4 of the weight of the shaft) onto the head of the drilled shaft (outfitted with an appropriate driving cushion), measuring simultaneously the force and velocity time histories at the shaft head and interpreting the shaft's performance by performing a "CAPWAP" analysis or similar analysis normally used with driven piles. A CAPWAP analysis is particularly useful to uncover the presence of soft bottoms, which are very difficult to detect with other testing procedures. The test must be performed such that the drilled shaft assumes a permanent set after having been subjected to the rapidly applied load in order to investigate its structural capacity. Dynamic tests of this type are often referred to as "high-strain" integrity tests.

There is no accepted method for performing small-strain acoustic or gamma-gamma NDE tests on underreams (bells). The size of the constructed bell can sometimes be ascertained approximately by invasive probing around the perimeter of the shaft with a soil boring rig. If errors in bell construction are suspected, high-strain integrity tests, such as Statnamic® tests, can be performed to assess the capacity of the bell.

The shaft can also be subjected to a full-scale static test, to prove its capacity, which is ordinarily more costly than a test of the type described above. Full-scale static load tests are ordinarily indicated only when a systematic error has been made in the construction of the drilled shafts for a project, where a definitive test on one shaft would either confirm the acceptance of all of the shafts or show that the systematic error has affected the performance of all of the shafts.

## **EXPECTED DEFECT RATE FOR DRILLED SHAFTS**

Sliwinski and Fleming (1983) provide some revealing information on the rate at which defective drilled shafts are normally constructed. They conducted inexpensive, cost-effective sonic echo tests on 5000 drilled shafts constructed by a major drilled shaft contractor in the United Kingdom at numerous sites in 1982. Only 73 of the shafts were found to be questionable. The defects that were found are classified in Table 17.2. Only about 0.6 per cent of the shafts (31 out of 5000) were determined to have defects that were produced during the shaft construction process, although, considering the potential

errors in the sonic echo test described previously, it is possible that other shafts had small defects. The remaining defects apparently occurred because of lack of attention to traffic control on the construction sites and similar factors after the concrete had been poured. This study indicates that, while defects do occur in drilled shafts, careful operations by a knowledgeable contractor should make the occurrence of a defective shaft the exception rather than the rule.

Table 17.2. Classification of Defects Found in 5000 Drilled Shafts Constructed by Cementation Ltd. in the United Kingdom in 1982 (Sliwinski and Fleming, 1983)

Type of Defect Interpreted	Number of Drilled Shafts (out of 5000)
Soil contamination in top 2 m (6.5 feet)	18
Soil contamination or necking in the zone from 2 to 5 m deep (6.5 to 16.4 feet deep)	7
Poor quality concrete (slower than normal return times for reflected waves)	4
Voids adjacent to shafts with loss of concrete	2
Faults due to damage from trimming the top of the shaft or due to traffic at the site	42
Total	73

### DESIGN OF AN INTEGRITY TESTING PROGRAM AND ACCEPTANCE CRITERIA BASED ON INTEGRITY TESTING

The point has been made that surface acoustics tests such as sonic echo tests and impulse response tests are not reliable in locating small defects. Tests that involve downhole logging within access tubes, such as the cross-hole acoustic (sonic or ultrasonic) test and the gamma-gamma test, can resolve smaller defects. Baker et al. (1993), based on experimental research on shafts with known defects, concluded that the size of the smallest defect that could be "seen" with surface acoustics tests is about one-half the cross-sectional area of the shaft. The defect may also need to be upwards of 0.4 m (15 inches) thick to be seen, as pointed out previously. Defects deeper than about 30 shaft diameters cannot usually be detected with surface acoustics. On the other hand, crosshole acoustics and other methods that use access tubes were found by Baker et al. to detect defects that were as small as 12 to 15 per cent of the cross-sectional area of the shaft and thinner than 0.4 m (15 inches).

Based on these observations, Baker et al. (1993) proposed an acceptance criterion for integrity tests for the special case of axial loading and wet-method construction. The criterion is based on the need for the concrete remaining in the cross section of the shaft outside of the defect to carry all of the design load with an average compressive stress of no more than about 0.25 - 0.30  $f_c$ , the maximum allowable stress in ASD. The presumption is made that if a defect is not detected by surface acoustics, there may in fact be a defect (or defects) within the shaft as large as 50 per cent of the cross-sectional area of the shaft. Allowing for stress concentration effects around the defect, the assumption is then made that if the ratio of the maximum axial stress in the shaft divided by the maximum allowable stress (the "stress ratio") is less than 0.4, the presence of an

undetected defect will not produce failure and surface acoustic methods are acceptable integrity tests. In an LRFD context, the recommendations can be interpreted as follows: If the maximum factored axial load applied to the drilled shaft is less than 0.4 times the factored structural resistance of the cross section given by Equation (13.22), surface acoustics methods are acceptable. Otherwise, tests involving the use of access tubes should be used. If the stress ratio reaches 0.8 or higher, even the test methods involving access tubes will not be reliable, and the shaft should either be designed by including an additional multiplicative resistance factor, in addition to  $\phi$  and  $\beta$ , equal to 0.8, in Equation (13.22) or the shaft should be constructed without that factor but to continuous inspection by an experienced inspector should be provided, and all integrity tests interpreted conservatively.

The acceptance criterion of Baker et al. for the conditions described above is given in slightly simplified form in Table 17.3. In its original form the authors distinguish in a few cases between side-resisting ("friction") shafts and base-resisting ("base") shafts; however, that distinction is not made here. Table 17.3 is included in this manual as a guide. It does not apply to all construction methods, and it does not apply to shafts that sustain primarily lateral loads. However, it provides a good basis for exercising engineering judgment and is provided in that light.

In Table 17.3, shafts are classified into three categories, according to the risk that exists if the shaft contains a defect.

- Category A: Single, non-redundant shaft in a foundation or shaft in a two-shaft bent (low tolerance for defects)
- Category B: Multiple-shaft group or bent (intermediate tolerance for defects)
- Category C: Multiple-shaft abutment (higher tolerance for defects)

Table 17.3 is used to determine whether a given shaft is acceptable. If it is not acceptable according to this table, the engineer should turn to Figure 16.3 to continue the evaluation process. For example, if the shaft is not acceptable according to Table 17.3, this condition would be considered as "NDT says suspect" in Figure 16.3, and further evaluation would be needed. The suspect shaft could be drilled or cored and/or a high-strain integrity test or Statnamic® loading test could be carried out before a final decision is made either to repair the shaft or to replace it. The latter options would ordinarily be used only on Category A shafts.

The engineer needs to decide at the beginning of a project whether to plan to conduct integrity tests and include integrity tests ("NDT") in the quality assurance program. This is a subjective matter, but an objective guideline is given by Baker et al. (1993), which is reproduced in slightly simplified form in Table 17.4. Numerical risk factors are assigned to eleven items that affect the risk of a foundation failure, and these risk factors are combined according to the process described below.



Table 17.3. Possible Acceptance Criteria for Drilled Shafts Constructed Using the Wet Method Where Primary Loading is Axial (Modified After Baker et al., 1993)

	Activities That Are Required in All Cases		Activities That May Be Required Based on Rating System (Table 17.4) or Engineering Judgment			
	Observational Quality Controls / Inspection During Construction		Surface NDE (NDT) employed (Pulse Echo, Impulse-Response, Impedance Log Tests)			Downhole Logging in Access Tubes <sup>5</sup>
Shaft Type (Based on Risk Level)	Clean Base Confirmed	Concrete Curve Showed Satisfactory Concrete Cross Sections <sup>1</sup>	Clear Toe Reflection <sup>2</sup>	No Observable Cross-Section Reductions	Adequate Stiffness <sup>3</sup>	Defect Either Clearly Not Indicated -- or Defect Observed, Location and Size Determined, and Effect Evaluated
<i>Axial Stress Ratio ≤ 0.4</i>						
A	X	X	XX	XX	XX	XX
B	X	X	X	X	X	X
C	X	--	X	X	X	X
<i>0.4 &lt; Axial Stress Ratio &lt; 0.8<sup>4</sup></i>						
A	X	X	XX	XX	XX	XX
B	X	X	X	X	X	X
C	X	X	X	X	X	X

1 Proper tremie or pump line control required on all shafts.

2 Up to depths ≤ 30 shaft diameters.

3 Ratio of axial stiffness of suspect shaft from impulse-response test to average value of stiffness for known good shafts of the same diameter and length ≥ 0.85.

4 Axial stress ratios ≥ 0.8 are not normally acceptable for slurry construction.

5 Crosshole Acoustic or Gamma-Gamma Tests.

Note: Where lateral load and bending are the primary modes of resistance for the shaft and the role of rebar in developing the moment capacity of the shaft is essential, defects that expose the rebar, such as necks, cracks and cave-ins, are not normally acceptable regardless of category unless adequate provision is made for corrosion protection of the rebar.

X - Information from this observation or test is required and must show that shaft is satisfactory

XX - Information from this observation or test is required and, when interpreted conservatively, must show that the shaft is satisfactory.

Shaded areas are ordinarily not applicable but may be employed at the discretion of the engineer.

The following procedure is used in applying Table 17.4. A numerical risk factor (1, 2 or 3) is assigned for each of Items 1 - 9. For each item, that risk factor is multiplied by its respective weighting factor. The resulting nine numbers are then added and multiplied by the numerical risk factor from Item 10. The number from this multiplication is then multiplied by the numerical risk factor from Item 11 to give a numerical factor,  $Z$ , for the project.

The following suggestions are made by Baker et al. (1993) for using  $Z$  in planning for an integrity testing program:

- If  $Z < 42$ , post-construction integrity testing is probably not necessary. Use good quality control and inspection during construction.
- If  $Z = 42 - 60$ , use good quality control and inspection during construction, but employ some integrity testing (NDT) after construction. If stress ratios are less than 0.4 and lateral loading is small, surface acoustic methods may suffice.
- If  $Z > 60$ , use good quality control and inspection during construction, and use extensive integrity testing (NDT), including acquisition of data from access tubes, after construction. This requires a planned integrity testing program.

Table 17.4. Rating Guideline for Supporting Decisions for Implementation of Integrity Testing  
(Modified After Baker et al., 1993)

Item	Description	Numerical Risk Factor			Weighting Factor
		1	2	3	
1	Magnitude of Foundation Contract (\$US) <sup>1</sup>	≤300,000	300,000 - 1,000,000	≥ 1,000,000	1.0
2	Experience and Equipment of the Drilled Shaft Contractor	Excellent	Adequate	Marginal	1.5
3	Thoroughness of Subsurface Investigation and Geotechnical Experience Level of the Inspector	High	Medium	Low	1.5
4	Anticipated Construction Difficulties	Low	Medium	High	1.5
5	Uniformity (predictability) of Subsurface Conditions	High	Medium	Low	1.5
6	Load Resistance Mechanism Assumed in Design	Side Resistance	Combined	Base Resistance	1.0
7	Anticipated Construction Method	Dry	Permanent Casing Temporary Casing	Wet with Temporary Casing Wet without Temporary Casing	1.0 0.5 1.5 2.5 3.0
8	Type of Loading	Axial	Axial Battered	Lateral	1.0
9	Load Duration	Mainly Static, Short-Term Live Loads	Impact or Seismic	Mainly Static, Long-Term Dead Loads	1.0 2.0
10	Stress Ratio	≤ 0.4	> 0.4 but < 0.8	≥ 0.8	N/A
11	Risk Level for Loss of Human Life or Economic Catastrophe	Low	Medium	High	N/A

<sup>1</sup> 1997 dollars

An example of the use of Table 17.4 is given in Example 17.1. The reader is encouraged to consult the report of Baker et al. (1993) for more detailed explanations.

---

**Example 17.1. *Development of Rating for Planning for Use of Integrity Tests***

A simple example of the use of Table 17.4 is to determine whether to employ integrity testing at all, to employ only surface acoustics methods, or whether to attach access tubes to the cages and employ crosshole acoustic or gamma-gamma tests for a project which has the following attributes:

◆	The foundation contract value is \$700,000	(2 X 1.0 = 2.0)
◆	Adequate contractors	(2 X 1.5 = 3.0)
◆	High level subsurface data and inspection	(1 X 1.5 = 1.5)
◆	Difficult construction expected	(3 X 1.5 = 4.5)
◆	Very nonuniform subsurface conditions	(3 X 1.5 = 4.5)
◆	Shafts designed for combined side and base resistance	(2 X 1.0 = 2.0)
◆	Wet method construction without any casing anticipated	(3 X 3.0 = 9.0)
◆	Strictly axial loading	(1 X 1.0 = 1.0)
◆	Loads are mostly static dead loads	(3 X 1.0 = 3.0)
	<b>Total</b>	<b>30.5</b>
◆	Design stress level (< 40 per cent)	1.0
◆	Risk level for loss of life / economic catastrophe is medium	2.0
	<b>Final Rating = 30.5 X 1.0 X 2.0 =</b>	<b>61.0</b>

**Conclusion:** Access tubes and either crosshole acoustic or gamma-gamma tests should be strongly considered as the integrity test (NDT) method.

---

The question of how many shafts to monitor with integrity testing methods in a planned testing program is addressed by Hertlein and Baker (1996), who rely heavily upon earlier recommendations by Williams and Stain (1987). A general guideline, which can be freely modified by the engineer based on local experience, can be stated as follows:

- If a percentage of defective shafts can be tolerated (i. e., shafts are not in Category A), and if there are 30 shafts or less on the project, plan to test all shafts. If there are more than 30 shafts on the project, test the first 30 shafts to determine that the construction procedures are adequate or to provide guidance for the contractor to modify construction procedures. Then, test only a percentage (sampling) of the remaining shafts, not less than 30 per cent. If defects are found in the shafts in the sample, increase the rate of testing to 100 per cent until it can be shown that further defects are being prevented through proper

construction procedures. [Alternately, access tubes could be placed in all production shafts and only those shafts that experienced problems in construction subjected to actual NDE tests. This approach requires careful inspection]

- If defects cannot be tolerated in any of the shafts on the project, test all shafts on the project.
- If a defects cannot be tolerated in a subset of shafts on the project (e. g., all Category A shafts), test all of those shafts and consider the remaining shafts to fall under the first bullet.

## EVALUATING DEFECTS

If a defect is found, or if a test anomaly is strongly suspected of being a defect, it may or may not be cause for rejecting the drilled shaft. For example, the potential defect detected by gamma-gamma logging near the bottom of the drilled shaft in Figure 17.13 was not considered to be cause for rejection of the shaft because the shaft was designed primarily for lateral loading, and the moments and shears at the base of the shaft were found to be nearly zero by analysis with COM624 (Chapter 13). Had that shaft been designed primarily to carry axial load, however, and especially if the major part of the resistance had been at the base, the potential defect would have been cause for further investigation and perhaps rejection.

Detailed analyses can be made with COM624 and other software to evaluate the possible effects of other defects, even defects or potential defects that might be in zones of high load transfer, to determine whether the defect is cause for concern. Anwar (1996) provides an excellent description of a case history in which it was shown that small defects that might have been produced by interruptions in concrete placement in a drilled shaft in a highway bridge foundation could be tolerated with the particular combination of axial and lateral loads and percentages of longitudinal steel that were employed.

When substantial lateral loads are applied to the shaft in question, consideration should be given to the amount of corrosion that can occur in any rebar that is exposed to the soil during the life of the foundation. Corrosion can occur because of oxidation (rusting) of the rebar if the defect is in a zone of partial saturation in the soil or rock (above the water table) and the rebar is exposed to the geomaterial, which is very likely if a defect in fact exists. See Figures 17.2 and 17.14. However, another form of corrosion, galvanic corrosion (the "battery effect"), can occur in the rebar even if the defect is below the water table and the rebar is never exposed to oxygen. Therefore, if the defect is above the water table, below the water table in an electrically aggressive geomaterial (e.. g., acidic) that can support galvanic corrosion, or if the corrosion conditions are not known, it is prudent in the defect evaluation process to (1) assume that all rebars within the defect can be exposed to the soil and will be completely corroded away or (2) institute a positive corrosion resistance program for the rebar in question (e. g., cathodic protection), in which case the rebars can be assumed to be effective. In either case, the defective

cross section, with the concrete and/or steel missing, must still be able to carry the factored moment, shear and axial load at the level of the defect with the resistance factors described in Chapter 13 for combined loading. Otherwise, the shaft will need to be rejected, and it would have to be repaired or replaced by the contractor.

Obviously, the best information for sizing and locating the defect within the cross section, so that the effect of the defect can be analyzed, will come from tests with multiple access tubes. For purposes of analysis, it is prudent to increase the size of the defect that is inferred from crosshole acoustic testing by about 5 to 7 per cent of the cross-sectional area of the drilled shaft to take into account errors in the test. Even larger allowances should be made for gamma-gamma tests.

Analyses such as these can also be made to investigate the effects of errors made in positioning the drilled shaft -- for example, eccentric loads caused by placing the center of the shaft out of tolerance.

It is important to understand that NDE testing is almost always subject to interpretation. False positives can sometimes occur, and defects can sometimes go undetected. The best method to minimize the uncertainty in NDE testing is to make sure that the tests are performed by qualified individuals who have had extensive training with the testing process and the equipment being used and are interpreted by civil engineers who are familiar with the function and performance of drilled shafts. In interpreting the results of NDE tests, uncertainty can be further reduced if the interpreter has access to inspection records that document unusual occurrences during installation of every drilled shaft and the exact point in the construction process at which such occurrences took place.

## REFERENCES

- Anonymous (1997). "Nondestructive Evaluation Test Day "Discussions," *Foundation Drilling*, ADSC, Dallas, TX, February, pp. 11 - 15.
- Anwar, N. (1996). "Strength Evaluation of a Defective Reinforced Concrete Bored Pile (Drilled Shaft)," *Foundation Drilling*, ADSC, Dallas, TX, June/July, pp. 13 - 18.
- ASTM (1997). *Annual Book of ASTM Standards*, Section 4, Volume 4.09, American Society for Testing and Materials, West Conshohocken, PA.
- Baker, C. N., Jr., Drumright, E. E., Mensah, F. D., Parikh, G., and Ealy, C. D. (1991). Use of Nondestructive Testing to Evaluate Defects in Drilled Shafts: Results of FHWA Research," *Transportation Research Record 1331*, Transportation Research Board, Washington, DC, pp. 28 - 35.
- Baker, C. N., Jr., Parikh, G., Briaud, J-L, Drumright, E. E., and Mensah, F. (1993). "Drilled Shafts for Bridge Foundations," *Report No. FHWA-RD-92-004*, Federal Highway

Administration, McLean, VA, August.

Davis, A. G. (1995). "Nondestructive Evaluation of Existing Deep Foundations," *Journal of the Performance of Constructed Facilities*, ASCE, Vol. 9, No. 1, February, pp. 57 - 74.

Davis, A. G., and Hertlein, B. H. (1991). "Development of Nondestructive Small-Strain Methods for Deep Foundations: A Review," *Transportation Research Record 1331*, Transportation Research Board, Washington, DC, pp. 15 - 20.

Finno, R. (1995). Personal Communication.

Harrell, S., and Stokoe, K. H., II (1984). "Integrity Testing of Drilled Piers by Stress Waves," *Research Report 257-1F*, Center for Transportation Research, The University of Texas at Austin, January.

Hearne, T. M., Jr., Stokoe, K. H., II, and Reese, L. C. (1981). "Drilled Shaft Integrity by Wave Propagation," *Journal of the Geotechnical Engineering Division*, ASCE, Vol. 107, No. GT10, October, pp. 1327 - 1344.

Heritier, B., Paquet, J., and Stain, R. T. (1991). "Accuracy and Limitations of Full-Scale Dynamic Shaft Testing," *Transportation Research Record 1331*, Transportation Research Board, Washington, DC, pp. 50 - 55.

Hertlein, B. H., and Baker, C. N., Jr. (1996). "Practical Experience with Non-Destructive Testing of Deep Foundations: A Drilled Shaft Inspector's Guide to Detecting Anomalies and Assessing the Significance of 'Defects,'" *Foundation Drilling*, ADSC, Dallas, TX, March/April 1996, pp. 19 - 26.

Jalinoos, F., Aouad, M. F., and Olson, L. D. (1996). "Three Stress-Wave Methods for the Determination of Unknown Pile Depths," in *Proceedings, Fifth International Conference on the Application of Stress-Wave Theory to Piles*, Ed. by F. C. Townsend, M. H. Hussein, and M. C. McVay, University of Florida, Gainesville, pp. 673 - 687.

Jalinoos, F., Olson, L. D., and Aouad, M. F., (1995). "Ultrasonic Crosshole and Crossmedium Tomography for the Detection of Defects in Structural Concrete," in *Proceedings, Symposium on the Applications of Geophysics to Engineering and Environmental Problems (SAGEEP)*, Orlando, FL, 8 pp.

Olson, L. D., Jalinoos, F., and Aouad, M. F. (1995). "Determination of Unknown Subsurface Bridge Foundations," *Final Report, Project No. 21-5*, National Cooperative Highway Research Program, Transportation Research Board, Washington, DC, August.

Preiss, K., Weber, H., and Caiserman, A. (1978). "Integrity Testing of Bored Piles and

Diaphragm Walls," *Transactions*, South African Institution of Civil Engineers, Vol. 20, No. 8, August, pp. 191 - 196.

Rausche, F., Ren-Kung, S., and Likins, G. E., Jr. (1991). "Comparison of Pulse Echo and Transient Response Pile Integrity Test Methods," *Transportation Research Record 1331*, Transportation Research Board, Washington, DC, pp. 21 - 27.

Rausche, F., Likins, G., and Hussein, M. (1994). "A Formalized Procedure for Quality Assessment of Cast-in-Place Shafts Using Sonic Pulse Echo Methods," Preprint for Paper No. 940401, Transportation Research Board, Washington, DC, January.

Reese, L. C., and Stokoe, K. H., II (1987). "Instrumentation for Tests of Piles Subjected to Axial Loading," Preprint for Paper No. CJ041, Transportation Research Board, Washington, DC, January.

Samman, M. M. (1997). "Non-Destructive Testing of Drilled Shafts Using Pattern Recognition," *Final Report, Contract DTRS-57-93-C-00170*, Federal Highway Administration, Washington, DC, April.

Samman, M. M., and O'Neill, M. W. (1997a). "The Reliability of Sonic Testing of Drilled Shafts," *Concrete International*, ACI, Farmington, Hills, MI, January, pp. 49 - 54.

Samman, M. M., and O'Neill, M. W. (1997b). "Fiber-Optic Inspection of Drilled Shafts," *Concrete International*, ACI, Farmington, Hills, MI, October, pp. 63 - 66.

Schellingerhout, A. J. G., and Muller, T. K. (1996). "Detection Limits of Integrity Testing," in *Proceedings*, Fifth International Conference on the Application of Stress-Wave Theory to Piles, Ed. by F. C. Townsend, M. H. Hussein, and M. C. McVay, University of Florida, Gainesville, pp. 960 - 964.

Sliwinski, Z. J., and Fleming, W. G. K. (1983). "The Integrity and Performance of Bored Piles," in *Piling and Ground Treatment for Foundations*, Thomas Telford, London, pp. 153 - 165.

Weltman, A. J. (1977). "Integrity Testing of Piles: A Review," *Report PG4*, Construction Industry Research and Information Association, London, September.

Williams, H., and Stain, R. T. (1987). "Pile Integrity Testing -- Horses for Courses," in *Proceedings*, International Conference on Foundations and Tunnels," Engineering Technics Press, Edinburgh, Scotland, Vol. 1, pp. 184 - 191.



## CHAPTER 18: REPAIR OF DEFECTIVE DRILLED SHAFTS

Barring accidents or mistakes, drilled shafts can be built without defects by experienced contractors with the proper equipment. Methods and equipment have developed to the point that drilled shafts of good quality can be built in virtually any soil or rock profile. Furthermore, construction of high quality can be reasonably assured if appropriate procedures are employed by a knowledgeable, experienced inspector. Inspection can sometimes include the application of integrity testing methods, as discussed in Chapter 17.

Sometimes during construction, however, there is reason to believe that a particular drilled shaft is defective. For example, the casing method of construction may have been used, and the contractor and the inspector both observed the concrete column and the cage being pulled up a significant distance when the temporary casing was extracted. Likely, a neck or a void was formed at the location of the bottom of the temporary casing. Two options are available. The first is to wait for the concrete to set, conduct appropriate integrity tests, and then repair the shaft if the defect is detected. The second, and usually the most cost effective, is to drill out the concrete before it takes a set, removing the steel cage at the same time, and to reconstruct the shaft with a slightly larger diameter and to a slightly greater depth (to avoid disturbed geomaterials along the sides and at the base) at the exact position of the original shaft. Concrete and reinforcing steel will be wasted and drilling time will be lost; however, the overall cost of obtaining a drilled shaft with suitable capacity will usually be less than if repair is delayed until after the concrete has hardened. Thus, the management of the project must be such that competent personnel are at the site with the authority to make a rapid decision.

The construction documents should address procedures to be employed when a drilled shaft with questionable integrity is installed. The documents should state clearly under what conditions the owner or the contractor will pay for the necessary investigation (e. g., integrity tests) and for repairs, if necessary.

### TYPES OF DEFECTS

This section addresses some of the most common defects that occur in drilled shaft construction. Also see O'Neill (1991).

#### Defects at the Base of the Drilled Shaft

There are three principal defects that can occur at the base of a drilled shaft (LCPC, 1986). These are:

- Weak soil or rock at the base because the drilling was not carried to the appropriate depth or because the founding stratum was not present at the particular location.
- Loose sand or other sediment at the base because the excavation was not cleaned properly

or because sediment was deposited from slurry.

- Weak concrete at the base because the concrete was allowed to fall through water or drilling slurry. In the supposedly dry construction method, excessive water could have collected before the concrete was placed; in the wet method of construction, a tremie could have been lifted too far above the bottom of the excavation when the first concrete was placed.

Soft bases can sometimes be repaired by grouting, described briefly later, or they can be spanned by the use of microshafts or straddle shafts, also described later.

### **Poor Concrete Along the Length of the Shaft**

There are a number of reasons why there can be discontinuities or defects along the length of a drilled shaft. Some of the reasons are:

- ◆ Excessive bulging of the shaft because weak soil along the shaft had insufficient strength to withstand the pressures from the fluid concrete. The bulging may or may not cause a reduction in the load-carrying ability of the shaft. Bulging is usually a concern only if it occurs in a soft soil zone that can produce downdrag (Chapter 12).
- ◆ Reduction in the diameter of the shaft because of squeezing by the soil due to the horizontal stresses in the soil, perhaps combined with low fluid pressures in the concrete.
- ◆ Inclusions of soil, perhaps across the entire area of the shaft, due to sloughing of the soil from the borehole wall during concrete placement or poor concrete placement practice.
- ◆ "Cold" joints in the concrete as a result of interruptions in the placement of the concrete. These can be particularly serious when the concrete is being placed under drilling slurry or water.
- ◆ Leaching of the concrete due to rapid, horizontal flow of water through joints or pores in the subsurface formation.

In general, serious defects along the length of a drilled shaft will mean that the shaft cannot be used and some kind of replacement must be installed. However, grouting may sometimes be attempted.

### **Inadequate Contact Along Sides of Shaft**

There are three occasions when the contact between the sides of the drilled shaft and the soil or rock is inadequate:

- ◆ when a temporary casing is used and can not be retrieved (or when permanent casing is used intentionally),
- ◆ when low-slump concrete is used or the rebar cage restricts the outward flow of concrete, and
- ◆ when the sides of the excavation are smeared with a layer of weak soil, or have an excessively thick mudcake, because of errors in the drilling operations.

With regard to the failure to recover temporary casing, a study was made that showed, as would be expected, a significant loss of axial resistance with the casing in place (Owens and Reese, 1982). Much of the axial resistance was recovered in the particular cases being investigated by grouting the annular space behind the temporary casing. However, it was not possible to suggest procedures for use in evaluating the efficiency of the grouting, except by performing a static or dynamic load test.

Good design, good construction, and knowledgeable inspection should prevent the other difficulties that are mentioned above. In case there are mistakes that result in inadequate contact between the concrete and the sides of the excavation, the only solutions that are currently available are replacement or underpinning, as discussed below.

### **Incorrect Dimensions and/or Location**

In case a drilled shaft is installed that is too small or improperly located, analyses can be performed to ascertain the magnitude of load, either axial or lateral, that can be supported by the drilled shaft as built. It may be possible to install one or more auxiliary shafts near the as-built shaft that will combine to provide the necessary load capacity.

If there is excessive accidental batter and/or if the top of the drilled shaft exceeds the position tolerance, the procedures outlined in Chapter 13 for analysis under lateral load can be implemented. The additional bending moment due to eccentricity and accidental batter can be computed and the drilled shaft may be found to be adequate if some corrective action, such as grouting extra rebars into the upper portion of the shaft, is taken.

Obviously, every effort should be made in the construction and inspection procedures to prevent errors in dimensions and location.

## **METHODS OF REPAIR**

### **Grouting**

A defective base, described above, can sometimes be treated by grouting the base of the drilled shaft. There are specialty firms in the United States that can do such work. The grouting of the

base of a drilled shaft will usually involve the following steps:

- ◆ The placing of at least two holes along the full length of the shaft so that fluid can be circulated to and through the soft zone at the base of the drilled shaft. These conduits are normally available as access tubes if access tubes have been installed for integrity testing or as drill or core holes that were placed in an investigation of the quality of the base.
- ◆ The washing or flushing of the defective zone by pumping an air - water mixture down one tube and returning it with suspended debris through the other.
- ◆ The injection of the grout into one hole with the others packed off.
- ◆ The inspection of the grouting operation in order to analyze its efficiency.

With at least two holes through the drilled shaft and into the weak base material, the weak material at the base can be washed away by forcing fluid down one of the holes and having it return through the other. An air-water mixture under high pressure can be an effective technique except when the drilled shaft is founded in cohesionless material. In that case, no air and low pressures must be used so as not to undermine nearby drilled shafts. The solids in the returning fluid should be monitored all during the process as a means of evaluating the efficiency of the washing operation. As the cleaning of the base of the drilled shaft progresses, probing and possibly a television camera or concreteoscope can be used to evaluate the effectiveness of the operation.

When the cleaning of the weak material from the base has been completed, one of the holes through the shaft can be used for injecting the grout while the other hole or holes are packed off. The composition of the grout and the injection technique, including the grout pressure, must be carefully controlled. Too much grout pressure can cause the fracturing of the formation beneath the base of the shaft.

Following the injection of the grout, one of the techniques described in Chapter 17, particularly a surface acoustics test or a parallel seismic test, can be employed to judge whether or not the cleaning and the grouting were successful. With a good grouting job, the base reflections from a surface acoustics test theoretically will be stronger than with a soft base, and the base elevation will be more easily detected with a parallel seismic test. As was noted in Chapter 17, however, methods of this type are somewhat uncertain, so more involved methods, such as Statnamic® testing or driving of the drilled shaft, may be required to prove conclusively the resistance of the shaft.

Grouting can also sometimes be used to repair defects along the length of a drilled shaft. Baker and Khan (1971) report that, although grouting is sometimes used in such cases, in practice, grouting has failed more times than it has succeeded.

## **Hand Repairs**

If there is a defect along the length of the drilled shaft, is exposed on at least one side of the shaft and is relatively close to the ground surface, an economically feasible procedure may be to install a braced excavation around the shaft so that workers can be lowered to the elevation of the defect. The defective concrete can be removed by hand and repair made by packing the defect zone with fresh concrete or non-shrink grout and perhaps additional reinforcing steel, and placing a form around the fresh concrete or grout (a process sometimes referred to as "dental work"). This operation is taking place in Figure 17.2. The designer should be consulted to determine the necessary quality of the backfill to be placed around the top of the shaft once the repairs to the shaft itself are completed in consideration of the resistance, both axial and lateral, that the geomaterial in that area is required to provide.

## **Underpinning with Microshafts**

There may be occasions when a drilled shaft is installed with a deficiency that is undetected until the load from the superstructure is applied. An example occurred when a general contractor engaged a drilled shaft contractor to drill boreholes for drilled shaft foundations for a building but not to set the steel or place the concrete. Several days lapsed before the concrete and steel were placed by one of the general contractor's own crews, who unfortunately did not inspect or clean the bases before casting the shafts. Sloughings from the uncased boreholes had evidently accumulated in the bases of the boreholes, and very soft bases were produced. To compound the problem, the geotechnical engineer had designed the drilled shafts as mostly base-resisting shafts. After several floors of the building had been constructed, the contractor, who was monitoring settlements carefully, observed a sudden settlement of about 75 mm (3 inches) in two columns, evidently occurring when the side resistance had fully developed and an increment of applied load (construction of a floor slab) could not be resisted efficiently by the bases.

In this case an unusual, but highly effective, integrity testing method was used. Construction was stopped and the floor beams above the basement level were supported with temporary shoring to take load off the problematic shafts. A low-headroom drilled shaft rig was then brought in to drill a cased, open shaft adjacent to the drilled shafts supporting the two columns that had settled excessively. Windows were cut into the sides of the casing, and an engineer was lowered into the cased observation shaft. He removed the geomaterial by hand from around the suspect shafts and observed their condition. This operation is shown in Figure 18.1. The shafts were in excellent condition, except at their bases. At the base of each shaft 200 - 300 mm (8 to 12 inches) of very soft soil was observed. The soil did not have the consistency or color of the soft rock in which the shafts were supposed to bear, which indicated the sloughing scenario described above.

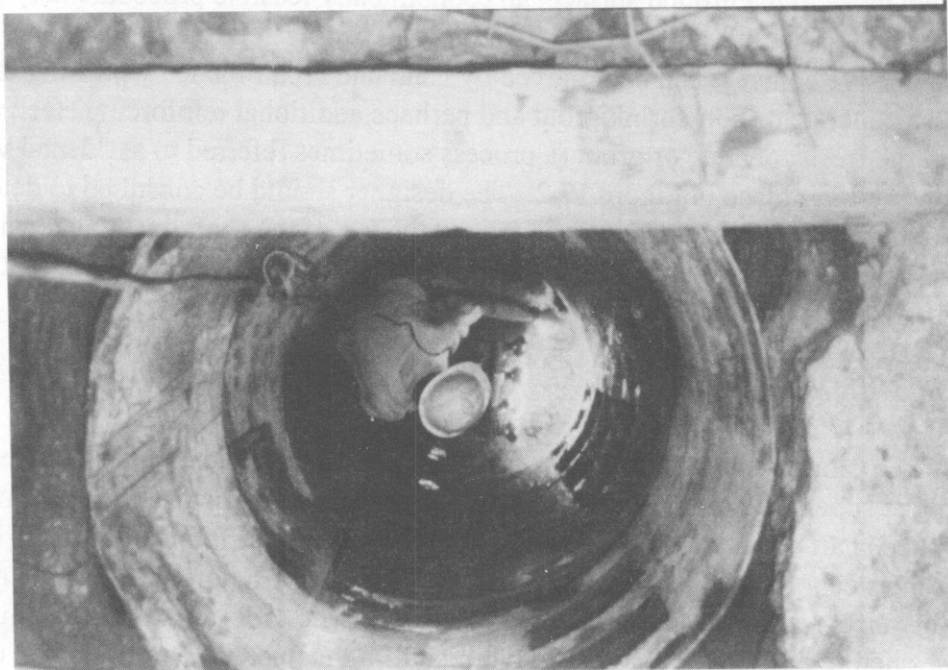

Figure 18.1. Visual inspection of the base of a defective drilled shaft

Since the heads of the shafts were not accessible, repairs were made, after backfilling the observation shaft with soil-cement, by constructing a series of microshafts with a low-headroom drilling rig in a circular pattern around the defective shafts, as shown in Figure 18.2. These microshafts were 200 mm (8 inches) in diameter, were constructed with sand-cement-water grout and were reinforced with one internal rebar each. They were carried to a depth well below the depths of the defective shafts [to about 20 m (65 feet) in this case].

The concrete on the outside surfaces of the upper parts of the defective shafts was then removed down to the depth of the rebar cage, and a reinforced concrete cap was constructed that provided a shear connection between the top of each defective shaft and the surrounding microshafts. After repairs were made to spandrel beams in the superstructure that had been damaged slightly by the sudden excessive settlement, construction resumed and the structure was completed without further incident.

One valuable lesson to be learned from this case is that drilled shaft contractors should be employed to construct the drilled shafts, not merely to drill the boreholes.

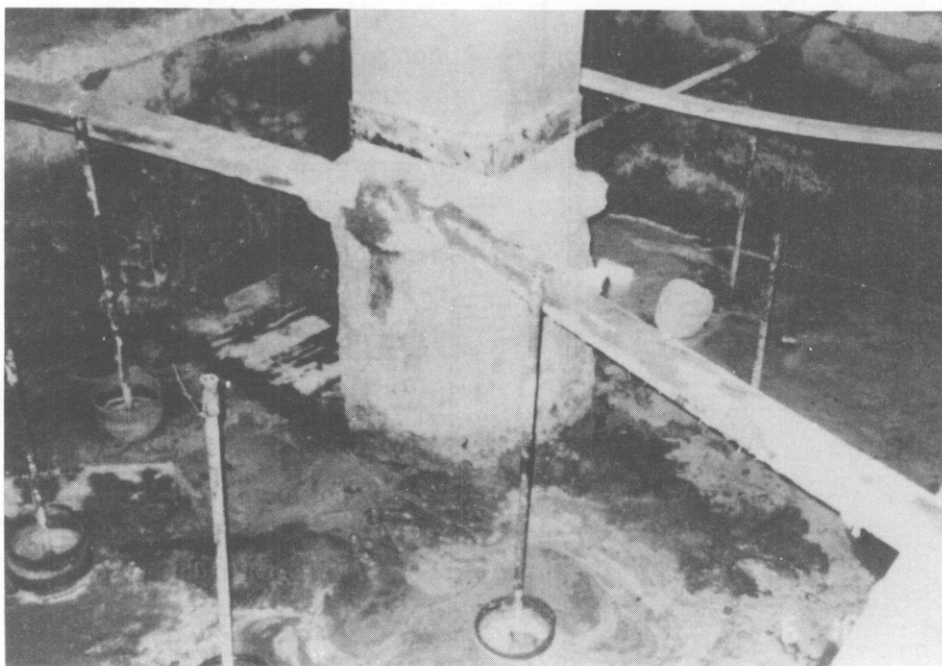

Figure 18.2. Circular pattern of microshafts to underpin defective drilled shaft

Two other schemes for underpinning a defective drilled shaft with microshafts are shown in Figure 18.3. A series of microshafts, perhaps 200 to 400 mm (8 to 16 inches) in diameter, can be drilled around the defective shaft, but unlike those shown in Figure 18.2, they are drilled immediately along side the shaft, as shown. Reinforcing steel is installed into the drilled hole and grouted into place. The axial load can then be transferred from the drilled shaft to the microshafts by use of a strong strap or by individual ties instead of by constructing a reinforced concrete footing. This process requires access to the area immediately adjacent to the defective shaft.

An alternate procedure is also shown in Figure 18.3. Holes are drilled directly through the head of the drilled shaft, assuming that the head is accessible, and into the founding stratum. A pipe, large rebar or structural shape is then grouted into place. A sufficient number of such elements would have to be installed to sustain the axial load.

The axial capacities of corrective microshafts ordinarily need to be established on a site-specific basis using compression or pullout tests. The design methods given in this manual do not apply to microshafts.

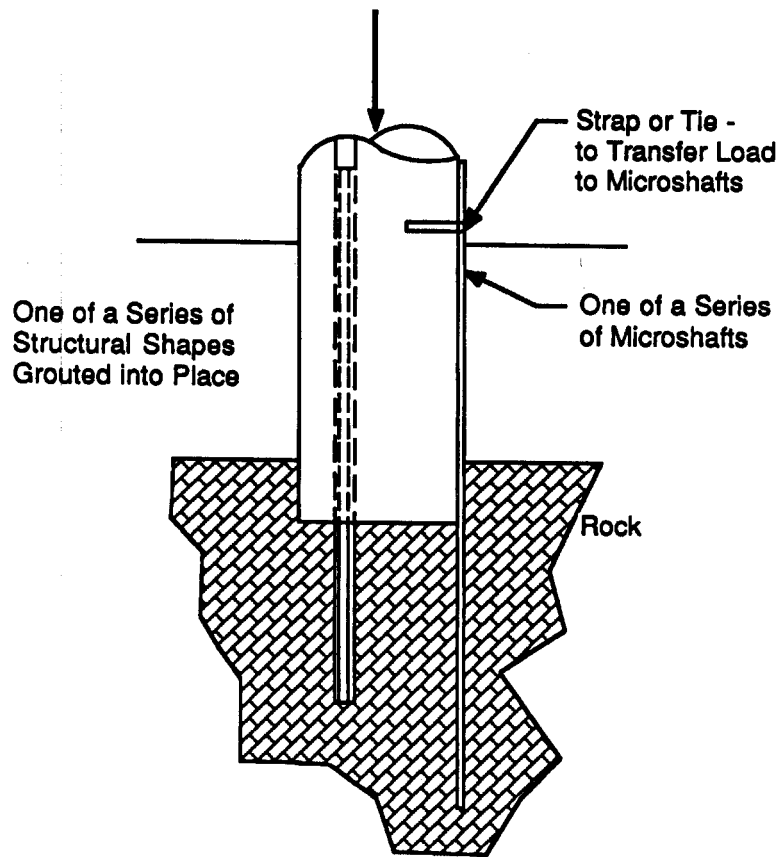

Figure 18.3. Schemes for underpinning a defective drilled shaft with microshafts

### Removal and Replacement

As noted earlier, if a substantial defect is discovered in a drilled shaft during the construction operation, the most economical procedure is usually to remove the concrete and rebar cage before the concrete sets up and to reconstruct the shaft on location. Sometimes, this operation can be performed even after the concrete has taken its initial set but has not hardened appreciably.

After the concrete has hardened, the removal of a drilled shaft becomes very expensive and is to be avoided, although for short shafts it is possible to drill around the shaft and loosen it as much as possible and then to use a cable-operated extractor. The ground around the test shaft will be highly disturbed and a replacement shaft would be quite large in diameter.

### Straddle Shafts

Figure 18.4 illustrates the use of "straddle" shafts. It is assumed that a defective shaft was



discovered following construction. A drilled shaft of appropriate dimensions is installed on each side of the defective shaft, the top part of the defective shaft is chipped away, and a reinforced-concrete beam of appropriate dimensions is constructed across the two new drilled shafts to sustain the load from the column.

The installation of such straddle shafts is expensive and time-consuming, and the construction and inspection operations should be carried out so that such a remedy is not necessary. The use of straddle shafts is a corrective procedure that can be used in most circumstances, and in some instances the defective shaft can be used to support part of the load if the load-carrying ability of the defective shaft can be estimated.

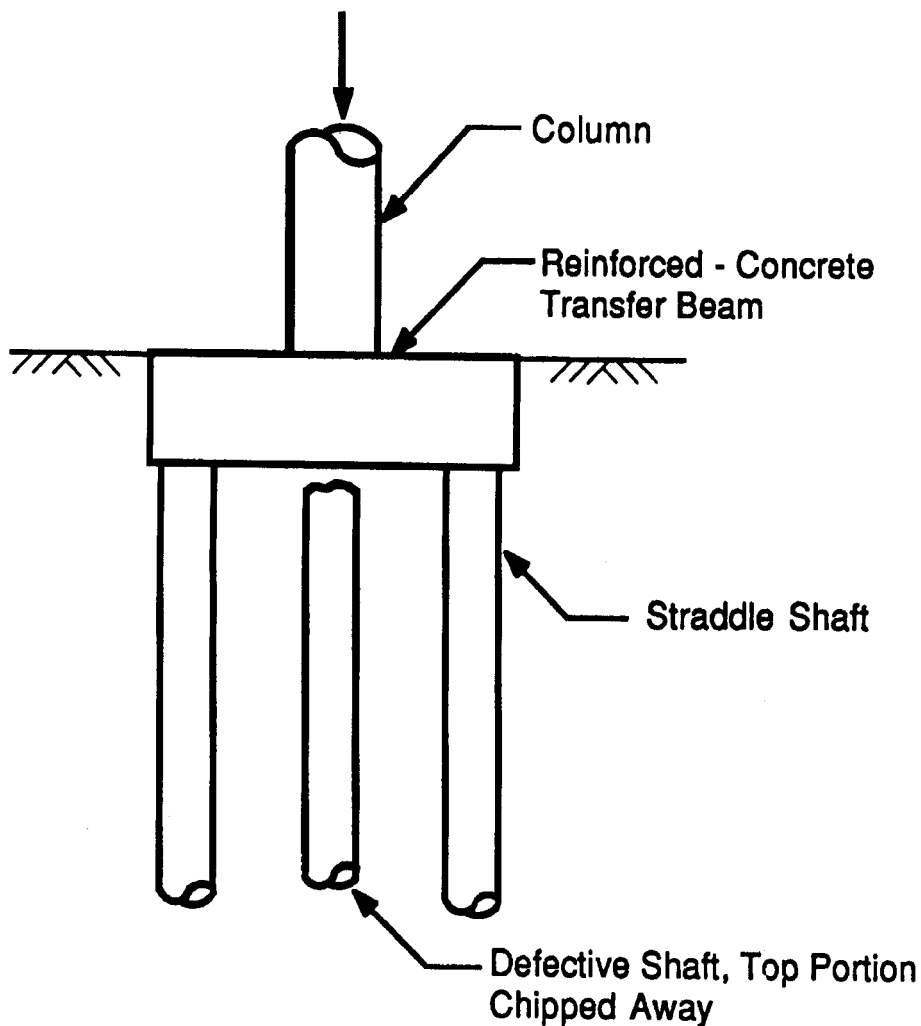

Figure 18.4. Use of "straddle" shafts

## REFERENCES

- Baker, C. N., Jr., and Khan, F. (1971). "Caisson Construction Problems and Correction in Chicago," *Journal of the Soil Mechanics and Foundations Division*, ASCE, Vol. 97, No. SM2, February, pp. 417 - 440.
- LCPC (1986). "Bored Piles [English Translation of French Publication *Les Pieux Fores* by Le Laboratoire Central des Ponts et Chaussées]," *Report No. FHWA-TS-86-206*, Federal Highway Administration, Office of Implementation, McLean, VA, March.
- O'Neill, M. W. (1991). "Construction Practices and Defects in Drilled Shafts," *Transportation Research Record 1331*, Transportation Research Board, Washington, DC, pp. 6 - 14.
- Owens, M. J., and Reese, L. C. (1982). "The Influence of Steel Casing on the Axial Capacity of a Drilled Shaft," *Research Report 255-1F*, Center for Transportation Research, The University of Texas at Austin, July.

## CHAPTER 19: COST ESTIMATION

### GENERAL

The best way to determine the overall cost of a foundation for a highway construction project is to design competing foundation systems and to request bids on each of the systems. The extra engineering time is generally more than offset by the savings in cost that will result. For large projects (\$30,000,000 or larger) the FHWA often requires that alternate designs be made and, normally, the design alternate with the lowest bid price accepted. Cost estimation is therefore done in the open marketplace. However, the engineer must still make cost estimates for initial feasibility studies, and for designing foundations for smaller projects, then he or she often must choose the foundation system from among those that are technically acceptable based on preliminary estimates of the cost of the constructed foundation. This chapter briefly addresses the factors that impact costs of drilled shaft foundations and gives some general guidance on estimating costs.

### FACTORS INFLUENCING COST

The cost of the construction of drilled shafts will vary widely with geographic location and with the passage of time. The cost will also be affected by the quality and detail of the subsurface data available to the bidders and by the assumptions that the contractor makes regarding the construction method that he or she expects to employ. These and other factors are listed and discussed briefly in the following paragraphs:

- **Subsurface and site conditions.** This factor probably has the largest influence on the cost of construction. The difficulty of drilling will vary widely; for example, rock will be relatively soft in some locations and extremely hard at other places. The site conditions will also have a big influence on cost. Factors affecting the cost that are associated with the site are: trafficability, nearby structures, traffic control, underground lines, overhead lines, overhead bridge decks, trees, contours, and cut-off elevation of drilled shafts in relation to the ground surface.
- **Geometry of drilled shaft.** The cost per unit volume or length of drilling at a shallow depth will be less than that for a greater depth. In drilling soil, the unit cost of drilling per unit volume is less as the diameter of the hole increases until the hole becomes so large that readily available equipment cannot do the drilling. In drilling rock, it is difficult to state the influence of diameter; however, holes with a large diameter become difficult to drill in hard rock.
- **Specifications, including inspection procedures.** Some specifications are written in such a manner as to make a large impact on cost; for example, permanent casing can be required in some instances where the job could be constructed as well or better without the use of the permanent casing. There are occasions when it is known that a "tough"

(interpreted as "unreasonable") inspector will be on the job. Some contractors raise their prices to adjust to such a situation. Whether excavation is considered to be classified or unclassified can impact bid costs.

- **Expected weather conditions.** The weather is an important factor regarding cost of construction.
- **Location of work as related to travel and living costs of crew.** The cost of some projects is significantly greater than others because of location. Travel time and living costs can vary widely from place to place.
- **Time allowed for the construction and penalty clauses.** Some jobs are laid out on a very tight construction schedule and with a significant penalty if the work is not done on time. Drilled shafts can usually be constructed relatively rapidly, but the time for construction must be reasonable in order to restrict the cost.
- **Work rules.** The number of workers that are required for constructing a drilled shaft can vary from place to place. For example, in only some places is an oiler required. Also, the restrictions on what a particular worker can do will vary. In some locations a certified welder is required for any welding that is needed, but in other locations the general workers on the job can do tack welding.
- **Governmental regulations.** The influence of governmental regulations on the cost of construction has been increasing in recent years as the sensitivity to environmental effects has increased. Restrictions concerning the pollution of the air and water have become more severe, and more attention is being placed on noise pollution. Also, the regulations concerning job safety have become more stringent. Governmental regulations can vary from place to place in the United States.
- **Availability of optimum equipment.** There will normally be a number of pieces of equipment that will best fit the construction to be done. The availability of a wide variety of drilling equipment will vary with location.
- **Experience and ingenuity of contractor.** Many experienced contractors have developed techniques that significantly reduce the cost of construction. Inexperienced contractors, on the other hand, may submit a low bid because of misjudgment of the difficulty of a particular job.
- **Economic conditions and amount of construction activity.** The cost of construction will vary depending on the availability of work. The principle of supply-and-demand works strongly in the drilled shaft industry.
- **Insurance and bonding.** The cost of these items appears to be having a larger and larger

impact on the cost of construction.

- **Cost of money and terms for payment.** Interest rates have an impact on construction costs, and the schedule of payment to the contractor is an important factor.
- **Terms of the contract.** The cost of the construction will increase if the contractor is required to assume all risks, including the possibility that the actual site conditions are not the same as shown in the contract documents.
- **General contractor's fees.** Drilled shaft contractors are usually subcontractors to general contractors, who actually submit the bids for the project, so bid costs include the general contractor's fee for management, which can vary considerably among general contractors.

## COMMENTARY ABOUT COST

The cost of the foundation in many instances is a relatively small cost of the entire project. Therefore, the prudent action is to select a contractor who has the necessary equipment, experienced personnel and record of high-quality construction so that the foundation can be built in rapid order and with good quality. In order to ensure this situation, some agencies have a requirement that the drilled shaft contractor be prequalified, which should aid in obtaining work of excellent quality.

## COST SURVEY

In order to give highway engineers some feel for drilled shaft costs, a survey was made through ADSC: The International Association of Foundation Drilling in the summer of 1997 to ascertain typical costs for common construction scenarios. Twenty-three member contractors of ADSC participated in the survey. The summer of 1997 was a period in which the business climate in the drilled shaft industry was generally good. That is, prices would not be expected to be unusually low because contractors were "hungry."

The only information that was provided to the survey participants is shown in Figures 19.1 through 19.3. These three figures list three separate scenarios in terms of subsurface conditions. In the first scenario it might be expected that the contractor would plan to use the casing method and some sort of rock drilling technique, possibly a core barrel, to complete the socket. In the second it might be expected that the contractor would use the wet method. In the third the contractor might expect difficulty excavating through the boulder field and may have to work casing through the boulders to keep the borehole open and to allow the excavation of the hard clay to proceed in the dry. In all cases the drilled shafts have relatively large diameters.

**Scenario 1:**

**Drilled shaft through caving, granular overburden soil, socketed into relatively hard rock:**

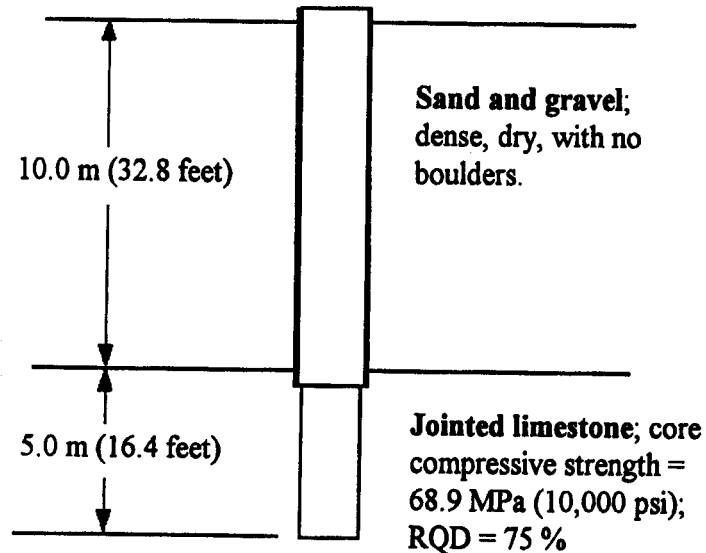

Socket diameter = 1.22 m (48 inches)

Number of identical shafts to be drilled = 50

Surface restrictions (overhead, restricted work area): None

Permanent casing in overburden: Not allowed

Cage: 12 No. 11 bars; No. 5 spiral with 150-mm (6-inch) pitch. No splicing allowed.  
(Steel to be purchased, tied and placed by drilled shaft contractor)

Bid price per meter (3.28 feet) (overburden - soil): \$ \_\_\_\_\_

Bid price per meter (3.28 feet) (socket - rock): \$ \_\_\_\_\_

Figure 19.1. Pricing scenario 1 for 1997 ADSC survey

**Scenario 2:**

**Drilled shaft through alternating thin layers of clay and waterbearing sand, with no socket in rock. Since the sand and clay layers are thin, assume that you will have to terminate the drilled shaft in a waterbearing sand layer and will need to do a wet-hole pour. The slurry will probably have to be first introduced very high up in the hole since the water table is at the ground surface.**

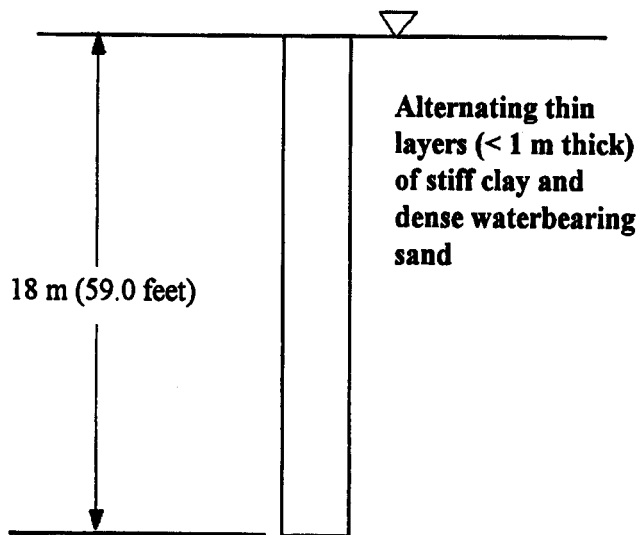

Shaft diameter = 1.52 m (60 inches)

Number of identical shafts to be drilled = 50

Surface restrictions (overhead, restricted work area): None

Permanent casing: Not allowed

Cage: 18 No. 11 bars; No. 5 spiral with 150-mm (6-inch) pitch. No splicing allowed.  
(Steel to be purchased, tied and placed by drilled shaft contractor)

Bid price per meter (3.28 feet) (any and all soils): \$ \_\_\_\_\_

Figure 19.2. Pricing scenario 2 for 1997 ADSC survey

**Scenario 3:**

**Drilled shaft through bouldery alluvium into hard clay.**

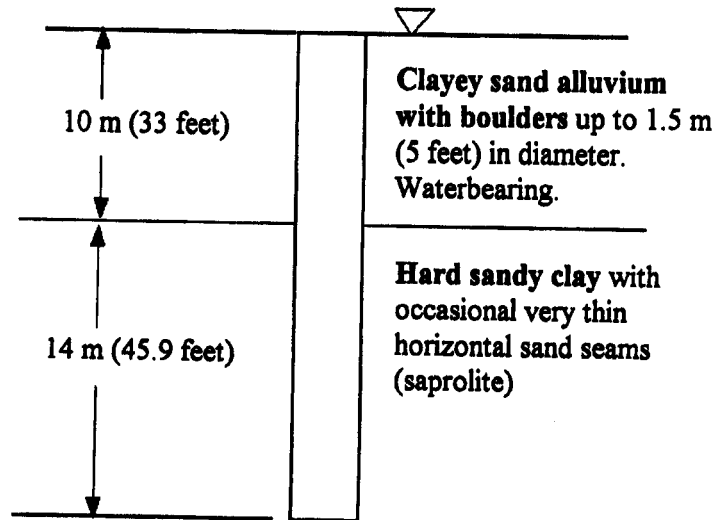

Shaft diameter = 1.52 m (60 inches)

Number of identical shafts to be drilled = 50

Surface restrictions (overhead, restricted work area): None

Permanent casing: Not allowed

Cage: 18 No. 11 bars; No. 5 spiral with 150-mm (6-inch) pitch. No splicing allowed.  
(Steel to be purchased, tied and placed by drilled shaft contractor)

Bid price per meter (3.28 feet) (bouldery alluvium): \$ \_\_\_\_\_

Bid price per meter (3.28 feet) (soil -- hard clay): \$ \_\_\_\_\_

Figure 19.3. Pricing scenario 3 for 1997 ADSC survey



The participants were asked to submit a bid price per linear meter of drilled shaft to construct 50 drilled shafts in each scenario. The excavation was classified, in which a separate price was requested for soil and rock in Scenario 1 and bouldery overburden and uniform hard soil in Scenario 3. "Construction" of a drilled shaft is construed to mean drilling, tying and placing the steel, and placing the concrete. The participating contractors were left to estimate the construction methods for themselves and to include whatever pricing considerations they might need to include in the area of the country in which they practice. It was anticipated therefore that the bid prices would vary considerably among the participating contractors because of the variations in the factors listed above. The point is made that the prices that the participants supplied were the prices that they would supply to the general contractor, who would then be expected to add a percentage (usually 10 to 15 per cent) to that price in his or her bid to the owner.

The results of the survey are shown in Table 19.1. The first column in Table 19.1 identifies the contractor by number, and the next column shows the general location of the contractor's office. The geographic coverage of the survey was nationwide. The next five columns give the cost of constructing a linear meter of drilled shaft using whatever method the contractor deemed necessary. The last two lines in the table give the averages for each of the scenarios and the coefficient of variation in the individual bids, which is a general measure of the effect of the various factors listed above on bid prices for each of the given scenarios.

Table 19.1 should be used only for general guidance and to observe the relative costs of construction under various subsurface conditions. The costs clearly vary widely from contractor to contractor. This variation reflects the particular conditions listed above in the contractor's geographic area of practice, including typical local subsurface conditions, and his or her type of practice (private development, industrial, transportation, etc.). The conditions given in the survey to the "bidder" were also ideal. Participants in the survey had no opportunity to see individual boring logs, view soil and rock samples, visit the site to determine accessibility and obtain other similar input normally available to bidders. Therefore, the individual bid prices should not be assumed by the reader to be equivalent to published costs in soils and rocks of the types depicted. Some may be much higher and some much lower than would be received in an actual bid in the part of the country represented by a specific survey participant. However, the average value across the United States for each scenario is probably meaningful with respect to the average value for the other scenarios. The designer of a particular job may gain a considerable amount of insight into the relative cost of construction from an examination of Table 19.1.

Table 19.1 ADSC Pricing Survey; Summer, 1997

Contractor Number	Location	Bid Price Per Linear Meter (US Dollars, August, 1997)				
		Scenario 1		Scenario 2	Scenario 3	
		Overburden	Socket		Alluvium	Hard Clay
1	Missouri	710	1400	950	1360	825
2	Missouri	500	1500	750	1200	400
3	Iowa	470	970	695	895	695
4	Illinois	407	1811	776		
5	New York	950	2840	945	1095	1095
6	Washington	590	984	590	1212	690
7	Alabama	547	1261	345	260	260
8	Michigan	930	1500	675	580	580
9	Texas	200	400	677	800	857
10	Texas			490		
11	Missouri	61	984	120	246	85
12	Florida			750		
13	Virginia	580	4300	940	1760	740
14	Washington	750	920	840	1125	745
15	New Mexico	623	964	797	1990	797
16	Minnesota	350	885	810	840	840
17	Utah	386	520	736	764	562
18	California	1000	1600	760	1200	450
19	Ohio	530	1650	935		
20	California	504	1395	1115	1595	1025
21	Washington	550	4135	945	1472	695
22	Washington	275	915	510	2150	430
23	Oklahoma	840	1330	900	1400	870
<b>Average</b>	<b>United States</b>	\$560	\$1,536	\$741	\$1,155	\$665
<b>Coefficient of Variation</b>		0.44	0.67	0.30	0.45	0.38

Note: The following notations were provided by the indicated contractors:

- 7 - cost of steel not included -- could get better price if rock unit for Scenario 1 is stated
- 9 - prices are given for low headroom (< 2.14 m (7 ft)) work only
- 13 - also charges \$36,000 lump sum for mobilization
- 14 - discounted boulder removal somewhat in Scenario 3 since State pays for by force account
- 15 - needs more information on the cohesiveness of the soils to estimate overbreak. Concrete costs vary in working area from \$48/CY to \$90/CY. Prices are very approximate.
- 22 - does not include mobilization beyond 50 miles from headquarters. Obstructions are extra.

Blank entry means that the contractor provided no response because he/she does not ordinarily do work under that scenario.

For example, it can be seen in Scenario 1 that construction of the hard rock socket is about three times as expensive, on the average, as constructing the shaft through the dry overburden. However, when the overburden is alluvium that is wet and filled with boulders and the socket is in a soft geomaterial, as is the case in Scenario 3, the overburden construction is about twice as expensive per unit of length as construction of the soft socket. Scenario 2, which would require drilling slurry or full-length casing, is about one-third more expensive than constructing through the dry overburden in Scenario 1. Scenario 2 also exhibited the least scatter among the scenarios (lowest coefficient of variation), which suggests that the engineer might be able to make more accurate cost estimates when the wet or full-depth casing method of construction might be anticipated through a heterogeneous but generally predictable geomaterial profile. The most uncertain cost is the cost of excavating the hard rock (Scenario 1). The large coefficient of variation for that situation likely reflected the different experiences of the participating contractors with excavating the specific geologic formations in their respective work areas. This interpretation makes it clear that the engineer needs to know enough about drilled shaft construction to anticipate the most likely method that the contractor will use.

## **ON-LINE DATA BASES**

Cost information may also be available from on-line data bases maintained by agencies, including state DOT's, that design and construct a considerable number of drilled shafts. Table 19.2 is an extract of a low-bid summary for drilled shafts from the Texas Department of Transportation. Texas is a state with an abundance of good drilled shaft contractors, the market is competitive and TxDOT uses many drilled shafts. Therefore, bid prices are expected to be below the national average. The geology across Texas varies considerably. The subsurface conditions among jobs represented in this table undoubtedly also varied considerably, and the lengths of drilled shafts, which are not tabulated, also undoubtedly varied from job to job. [Prices for drilled shafts bid in metric dimensions, with diameters specified in millimeters ("MM"), per linear meter ("M") are given along with those that were bid in traditional dimensions.] Again, therefore, this table cannot be used to pinpoint costs for any particular job. The table does give a general picture of costs relative to the diameter of the drilled shaft and, by comparing the latest bids with the 12-month moving average, a general idea of the pricing trends in Texas.

The prices are clearly not linearly dependent upon shaft diameter. For example, the 12-month moving average price for "Drilled Shaft (36 IN)" [drilled shafts with a 36-inch (914-mm) diameter] is about \$80 per "LF" (linear foot). The corresponding bid price for "Drilled Shaft (48 IN)" [1220-mm diameter] is about \$127 per LF.

In the Texas DOT database, it is possible to extract only those low-bid prices for a particular administrative district. Table 19.3 shows the low-bid prices for District 12, which is a coastal district in the vicinity of the city of Houston. There, the geomaterials are all soils (no rock), and there are numerous water bearing sand and silt layers, which in almost all cases require the use of the wet method of construction. Therefore, the 12-month moving average bids are a fair

Table 19.2 Low-Bid Table for Drilled Shafts, Texas DOT, Statewide.

[ [http://www.dot.state.tx.us/insdtdot/orgchart/cmd/cserve/bidprice/s\\_16.ht](http://www.dot.state.tx.us/insdtdot/orgchart/cmd/cserve/bidprice/s_16.ht): ]  
 Latest Update: June 27, 1997

Item No.	Description	Units	6/30/1997		12-Month Moving	
			Quantity	Avg. Bid	Quantity	Avg. Bid
*** ****	Drilled Shaft (18 IN)	LF	2,714	\$36.54	9,074	\$36.40
*** ****	Drilled Shaft (24 IN)	LF	2,290	\$104.75	14,138	\$71.44
*** ****	Drilled Shaft (30 IN)	LF	7,264	\$69.00	80,259	\$73.56
*** ****	Drilled Shaft (36 IN)	LF	44,246	\$83.49	96,146	\$79.36
*** ****	Drilled Shaft (42 IN)	LF	1,920	\$105.00	8,022	\$102.17
*** ****	Drilled Shaft (48 IN)	LF	12,768	\$132.98	17,243	\$127.23
*** ****	Drilled Shaft (54 IN)	LF	4,712	\$165.00	8,721	\$156.22
*** ****	Drilled Shaft (54 IN) Alt. Bid	LF	2,432	\$165.00	2,432	\$165.00
*** ****	Drilled Shaft (60 IN)	LF	996	\$190.00	1021	\$195.14
*** ****	Drilled Shaft (66 IN)	LF	528	\$210.00	1566	\$256.40
*** ****	Drilled Shaft (72 IN)	LF	0	\$0.00	4,398	\$256.37
*** ****	Drilled Shaft (78 IN)	LF	0	\$0.00	592	\$293.28
*** ****	Drilled Shaft (84 IN)	LF	1,682	\$518.79	1,682	\$518.79
*** ****	Drilled Shaft (96 IN)	LF	0	\$0.00	326	\$490.00
*** ****	Drilled Shaft (450 MM)	M	0	\$0.00	367	\$126.17
*** ****	Drilled Shaft (600 MM)	M	0	\$0.00	1,279	\$252.11
*** ****	Drilled Shaft (750 MM)	M	0	\$0.00	4,092	\$319.88
*** ****	Drilled Shaft (900 MM)	M	0	\$0.00	6,540	\$221.22
*** ****	Drilled Shaft (1200 MM)	M	4,529	\$370.00	5,301	\$371.05
*** ****	Drilled Shaft (1500 MM)	M	480	\$570.00	480	\$570.00
*** ****	Drilled Shaft (1650 MM)	M	0	\$0.00	360	\$640.00
*** ****	Drilled Shaft (1800 MM)	M	0	\$0.00	192	\$740.00
*** ****	Drilled Shaft (66 IN) High Mast Pole	LF	366	\$275.00	396	\$284.47
*** ****	Drilled Shaft (1500 MM) High Mast Pole	M	21	\$975.00	73	\$858.78
*** ****	Drilled Shaft (12 IN) Sign Mounts	LF	0	\$0.00	17	\$53.35
*** ****	Drilled Shaft (24 IN) Sign Mounts	LF	120	\$85.00	250	\$73.99
*** ****	Drilled Shaft (30 IN) Sign Mounts	LF	160	\$120.00	464	\$109.85
*** ****	Drilled Shaft (36 IN) Sign Mounts	LF	304	\$129.74	944	\$133.65
*** ****	Drilled Shaft (42 IN) Sign Mounts	LF	978	178.43	1,374	\$173.56
*** ****	Drilled Shaft (48 IN) Sign Mounts	LF	646	193.4	1,066	\$204.14
*** ****	Drilled Shaft (54 IN) Sign Mounts	LF	1,352	244.54	3,101	\$266.90
*** ****	Drilled Shaft (750 MM) Sign Mounts	M	0	0	68	\$394.72
*** ****	Drilled Shaft (900 MM) Sign Mounts	M	0	0	205	\$482.37
*** ****	Drilled Shaft (1050 MM) Sign Mounts	M	0	0	42	\$508.93
*** ****	Drilled Shaft (1200 MM) Sign Mounts	M	57	650	175	\$664.84
*** ****	Drilled Shaft (1350 MM) Sign Mounts	M	43	800	77	\$747.24
*** ****	Drilled Shaft (1500 MM) Sign Mounts	M	21	975	73	\$857.78

Table 19.3. Low-Bid Table for Drilled Shafts, Texas DOT; District 12 Only.

[ [http://www.dot.state.tx.us/insdotdot/orgchart/cmd/cserve/bidprice/s\\_4.ht](http://www.dot.state.tx.us/insdotdot/orgchart/cmd/cserve/bidprice/s_4.ht): ]

Latest Update: July 24, 1997

Item No.	Description	Units	6/30/1997		12-Month Moving	
			Quantity	Avg. Bid	Quantity	Avg. Bid
*** **	Drilled Shaft (18 IN)	LF	0	\$0.00	1,697	\$31.88
*** **	Drilled Shaft (24 IN)	LF	0	\$0.00	86	\$75.00
*** **	Drilled Shaft (30 IN)	LF	0	\$0.00	11,846	\$53.17
*** **	Drilled Shaft (36 IN)	LF	1,480	\$70.00	14,224	\$67.90
*** **	Drilled Shaft (42 IN)	LF	0	\$0.00	1	\$137.39
*** **	Drilled Shaft (48 IN)	LF	35	\$110.00	4,307	\$104.99
*** **	Drilled Shaft (54 IN)	LF	1,600	\$140.00	5,244	\$139.34
*** **	Drilled Shaft (60 IN)	LF	0	\$0.00	0	\$0.00
*** **	Drilled Shaft (66 IN)	LF	0	\$0.00	1,038	\$280.00
*** **	Drilled Shaft (72 IN)	LF	216	\$220.00	4,616	\$254.67
*** **	Drilled Shaft (78 IN)	LF	1,185	\$270.00	1,777	\$277.76
*** **	Drilled Shaft (84 IN)	LF	0	\$0.00	0	\$0.00
*** **	Drilled Shaft (96 IN)	LF	968	\$400.00	1,294	\$422.67
*** **	Drilled Shaft (108 IN)	LF	118	\$400.00	118	\$400.00
*** **	Drilled Shaft (450 MM)	M	0	\$0.00	72	\$80.00
*** **	Drilled Shaft (600 MM)	M	12	\$235.00	12	\$235.00
*** **	Drilled Shaft (750 MM)	M	0	\$0.00	368	\$150.00
*** **	Drilled Shaft (900 MM)	M	64	\$208.00	256	\$226.96
*** **	Drilled Shaft (1200 MM)	M	21	\$783.00	296	\$405.60
*** **	Drilled Shaft (1500 MM)	M	0	\$0.00	0	\$0.00
*** **	Drilled Shaft (1650 MM)	M	560	\$915.00	560	\$915.00
*** **	Drilled Shaft (1800 MM)	M	0	\$0.00	0	\$0.00
*** **	Drilled Shaft (1500 MM) Alt. Bid	M	936	\$600.00	936	\$600.00
*** **	Drilled Shaft (60 IN) High Mast Pole	LF	102	\$250.00	1,527	\$306.31
*** **	Drilled Shaft (66 IN) High Mast Pole	LF	731	\$275.00	731	\$275.00
*** **	Drilled Shaft (30 IN) Sign Mounts	LF	0	\$0.00	30	\$95.00
*** **	Drilled Shaft (36 IN) Sign Mounts	LF	0	\$0.00	16	\$180.00
*** **	Drilled Shaft (42 IN) Sign Mounts	LF	208	\$185.00	372	\$182.58
*** **	Drilled Shaft (48 IN) Sign Mounts	LF	0	\$0.00	172	\$210.97
*** **	Drilled Shaft (54 IN) Sign Mounts	LF	35	\$260.00	71	\$260.00
*** **	Drilled Shaft (1350 MM) Sign Mounts	M	0	\$0.00	11	\$800.00

representation of the relative costs of wet-method construction completely in soil in southeast Texas in 1996 and 1997 based on shaft diameter. Much of the work during that time involved the upgrading of existing roads and freeways, so some costs associated with site access undoubtedly are included. Up to a diameter of about 54 inches (1370 mm) the bid prices are quite consistent between the most recent bids and the 12-month moving average, suggesting that the 12-month average could be used as a reasonable basis for estimating future costs for drilled shaft construction projects in that geographic area. Gaining access to information such as this, for projects in a given locality, is by far the best way to estimate costs.

## **CONTRACTORS' COST COMPUTATION**

Many contractors compute the cost of a job by first estimating the number of rig-hours or rig-days to complete the work. Then, the unit costs of equipment and labor are used to obtain cost components. Amounts for lump-sum costs, along with the profit, are added to obtain the total cost. An example of the forms used by one contractor to arrive at bid prices is shown in Appendix F.

## **EXAMPLES**

Two examples of prices bid for specific projects are given in this section. Both projects involved state DOT work in states where many good drilled shaft contractors practice. The first project, in Texas, involved relatively small-diameter shafts and numerous moves. The second project, in Florida, involved relatively large-diameter shafts, few moves and involved a much larger magnitude of work than the Texas project. The costs per unit of volume were lower in the Florida project.

### **Texas**

A contract was awarded in the mid-1980's in central Texas for drilled-shaft foundations for thirteen bridges for interchanges, and crossings of railroad tracks and small creeks. The drilled shafts were either 30 inches (762 mm) or 36 inches (914 mm) in diameter and averaged 16.8 feet (5.12 m) in length, ranging from 6.5 feet (1.98) to 29 feet (8.85 m). The cutoffs were at or near the ground line. The neat-line excavation for the 352 drilled shafts in this project totaled about 1,300 yd<sup>1</sup> (990 m<sup>1</sup>), about 1,000 yd<sup>3</sup> (760 m<sup>3</sup>) of soil and about 300 yd<sup>3</sup> (230 m<sup>3</sup>) of limestone. Excavation, however, for bid purposes was unclassified. The limestone was quite hard in some places. The reinforcing-steel cages were full length; the longitudinal steel ranged from 8 No. 9 to 10 No. 9 rebars. The steel was furnished by the general contractor, but the tying was done by the drilled-shaft contractor. The concrete was supplied by the drilled-shaft contractor. The contract was for slightly less than \$400,000, or about \$300 per cubic yard (\$390 per cubic meter) of theoretical volume of concrete [or about \$66 per linear foot (\$216 per linear meter)]. The cost was influenced greatly by the number of moves of the equipment.

## Florida

A job was completed in the mid-1980's in Florida in which drilled shafts were installed for a viaduct along an interstate highway. There were 275 drilled shafts that were 60 inches (1520 mm) in diameter and ranged in length from 60 to 85 feet (18.3 to 25.9 m). In addition, there was one test hole that was 60 inches (1520 mm) in diameter by 70 feet (21.4 m) deep, and 10 holes for loading and technique tests that were 36 inches (914 mm) in diameter by 60 to 70 feet (18.3 to 21.4 m) deep. (The actual loading tests were priced separately.) Overlying the primary resisting layer of limestone was 15 to 20 feet (4.6 to 6.1 m) of fill and 20 to 35 feet (6.1 to 10.7 m) of cemented and uncemented sand. The limestone was hard and contained seams filled with sand or clay. The reinforcing steel was furnished and tied by the general contractor, and the concrete was furnished by the drilled shaft contractor. The amount of the contract was \$2,646,000, or \$198 per cubic yard (\$259 per cubic meter) of theoretical volume of concrete [or about \$144 per linear foot (\$471 per linear meter)].

**(Intentionally Left Blank)**



## **APPENDIX A: ELEMENTS OF LRFD FOR DRILLED SHAFTS**

### **QUANTIFICATION OF UNCERTAINTY OF SOIL PROPERTIES**

The choice of a factor of safety or a resistance factor for designing drilled shafts for any specific project should be made with the understanding that there is always a degree of uncertainty in assigning values for design parameters associated with the geomaterial (soil and rock) conditions at the site. The level of uncertainty with which soil or rock properties employed in design equations are expressed can be estimated qualitatively by experience and judgment through comparison of the general nature of the geomaterials and the variability of the properties of the geomaterials at the current site with those at other sites with which the design team is familiar. This process is essential and is always recommended, and it may be sufficient for small projects. For example, if the geomaterial properties are highly variable, properties near the lower bounds of the measurements might be used. For large projects, somewhat more formal procedures, such as the one explained below, are advisable.

The reliability with which drilled shaft resistance and movements can be predicted depends upon the uncertainties involved in assigning the geomaterial parameters in the design process, as well as upon effects produced by variations in construction practices. It has also been found that the uncertainty in the ultimate axial resistance of a drilled shaft decreases with its length (Kulhawy and Grigoriu, 1987) because the shaft tends to average out any random variations in soil or rock properties that it encounters along its length. The resistance factors for ultimate axial resistance recommended by AASHTO (1994) and given later in this manual were calibrated using formal reliability analyses to maintain a targeted level of reliability consistent with current levels of reliability of foundations. That calibration method used simple correlations between drilled shaft length and variance in drilled shaft resistance based originally on statistical inferences for piles and drilled shafts at "normal" test sites. It is therefore incumbent upon the geotechnical engineer to ensure that the construction site has been characterized in such a way that the uncertainty of soil or rock properties is no greater than that at "normal" sites -- that is, that the construction site is not so variable that the site investigation program and the manner in which the site data have been interpreted represent a higher level of uncertainty in soil or rock properties than is inferred from the calibration procedure for the safety and resistance factors.

It is reasonable to define limits to site variability within which the recommended factors can be expected to apply and beyond which caution should be exercised by the designer. For example, within these limits, it might be sufficient to assign design values for appropriate soil parameters, such as undrained shear strength of cohesive soils and standard penetration test (SPT N) values of granular soils from soil borings. These limits can be established by a straightforward, formal process:

- Group borings or other data sets such as CPT probes at the site according to common attributes of location on the site, geology, stress history, proximity to one another, visual classification and index properties. Such a spatial grouping of borings can be called a

"characterization domain." One way of developing a strategy for making these groupings is the use of three-dimensional subsurface maps that are made for the site from preliminary geophysical surveys or probes.

- Establish the stratigraphy (layering pattern) for the characterization domain based on the above attributes.
- Plot the parameter of interest (for example, undrained shear strength,  $s_u$ , in cohesive soil) versus elevation within each stratum in the domain. Discard obvious "outliers" that may represent highly disturbed samples or minor inclusions of stronger material.
- Define a linear trend line for the property of interest for each stratum in the domain. A trend line could, for example, be a linear, least-squares fit of the data within each stratum of the characterization domain. At this point it should also be determined that the trends that occur in each boring for the stratum are similar -- that is, that there are no strong horizontal or vertical variations in the patterns of parameters from boring location to boring location. Otherwise, the borings should be regrouped.
- Apply a test to the data for each stratum in the characterization domain to determine whether the variance of the *in-situ* soil properties within the characterization domain are generally consistent with those for "normal" site conditions for which the prescribed resistance factors or factors of safety that will be used in the design are ordinarily applied. There are several ways to accomplish this task; however, a simple method, using the coefficient of variation (COV, defined later) of the parameter used for design, adapted from Phoon et al. (1995), is suggested below.

The above process is illustrated later by a numerical example. If the results of this process show that the variance of the *in-situ* or "inherent" soil or rock properties in the characterization domain are consistent with those generally assumed in the calibration process for the safety or resistance factors, the factors recommended by AASHTO can be used. If not, several options are open to the designer:

- First, the domains and/or strata can be regrouped, generally into smaller sets of borings, and the process repeated. This simple reanalysis may result in acceptable COV's of parameters within each stratum of each domain. The result will be a more detailed set of design calculations, with more sets of design parameters for the entire array of drilled shafts at the site, than would have been the case for the initial trial groupings. However, the reliability of the design estimates would be higher.
- Second, more borings can be taken, and additional geomaterial parameter values can be obtained. The characterization domains and strata within the domains can be grouped again using the new data, if desired, and the process repeated.

- Third, the trend lines for the design parameters can be taken so as to give lower values of the design parameters than are given by least-squares (mean-value) fits. As a limit, lower bounds can be taken. This option, while it should result in a safe foundation, will also often result in a more expensive foundation than would otherwise be necessary if the appropriate investment had been made in site characterization.

### **Suggested Approximate Statistical Test for Site Variability**

The uncertainty in any measured geomaterial parameter comes from three sources:

- Inherent soil variability or natural geologic variability of the soil *in situ*, which is the variability of interest in characterizing a site for the purpose described here.
- Measurement error (statistical uncertainty owing to too few samples and/or procedural errors in conducting the tests).
- Transformation errors (errors in converting an *in-situ* measurement, for example a tip resistance from a CPT, into a design value, for example  $s_u$ ).

An additional uncertainty, model uncertainty, exists when computing drilled shaft resistance or settlement for the soil or rock parameters. For example, the methods for computing resistance and movement recommended in this manual may systematically overpredict or underpredict the shaft's resistance or movement. However, these models have been calibrated against relatively large load test data bases, so that, when used with properly-selected soil or rock parameters, as described here, they can usually be used with the resistance factors recommended by AASHTO.

Where *in-situ* measurements are used in design, the approach used in this manual will usually be to use design correlations directly between the *in-situ* measurements and the drilled shaft design parameters, rather than converting the measurements into conventional soil parameters such as cohesion and angle of internal friction. This practice eliminates property transformation as a source of error, provided the soil parameters are determined using the soil or rock test method for which the design methods have been calibrated. For example, for undrained loading in cohesive soils, the primary design method given in Chapter 11 assumes that the undrained shear strength,  $s_u$ , has been obtained from laboratory unconsolidated, undrained (UU) triaxial compression tests. For drained loading in cohesionless soils, it is assumed in the primary design method that the soil is characterized by the uncorrected value of the SPT resistance,  $N$ . If other test methods have been used, the values need to be transformed to  $s_u$  for the UU triaxial test or to  $N$  from the SPT, in which case a transformation formula must be used, which carries with it some uncertainty.

The data available to the geotechnical engineer contain at least the first two effects in the bulleted list above, and possibly the third, if data transformations have been carried out. However, it is desirable to reduce the uncertainty in the measured data only to the uncertainty in "inherent" or *in-situ* soil properties. Once this is accomplished within the characterization domain, the result is

compared with upper bounds for inherent variability of the property of interest at "normal" sites.

An index for the inherent variability of the soil property of interest in any stratum in the characterization domain is the coefficient of variation of the inherent soil property referenced to the linear trend line, denoted  $COV_w$ . It is presumed that this trend line, or its mean value will be used for design of the drilled shaft within that stratum of the characterization domain. If the horizontal separation of the borings or soundings from which the measured data are acquired is greater than the horizontal correlation distance (the distance below which the sample data are not independent), the data are "uncorrelated" in the horizontal direction and can be treated as random. Horizontal correlation distances rarely exceed about 15 m (50 ft) in most geologic formations, so that borings spaced farther apart than 15 m can usually be treated as uncorrelated horizontally. This assumption will be made in the following numerical example. If there is no horizontal correlation among values of the measured parameter, the coefficient of variation of the value for the *measured* parameter for the stratum,  $COV_z$ , not to be confused with  $COV_w$ , can be expressed as:

$$(COV_z)^2 = \Gamma^2(COV_w)^2 + (COV_e)^2 \quad (A.1)$$

where

$COV_w$  = the coefficient of variation of the difference  $\Delta_{wi}$  of the *i*th value of the parameter *in situ* from the trend line for that stratum at a given elevation, which is a measure of the inherent variability of the parameter,

$COV_e$  = the coefficient of variation of the measurement error for the parameter of interest, and

$\Gamma^2$  = an adjustment factor to be applied to  $COV_w$  if the samples are vertically correlated (not entirely independent of one another in the vertical direction). The correlation distance in the vertical direction for soil properties is usually considerably smaller than that for properties in the horizontal direction. A simple way to estimate this parameter is given in the following.

$COV_e$  is typically 0.05 to 0.15 for  $s_u$  from UU triaxial compression tests on cohesive soils. The value to be used in Equation (A.1) is selected based on the perceived quality controls in handling and testing specimens in the specific laboratory in which the samples for the project are being tested.  $COV_e$  for N for the SPT has not been established in general, but it is well-known that considerable errors exist in the performance of the SPT. Each agency should attempt to establish a value for  $COV_e$  for its SPT operation separately considering the field practices used by the organization. A value of 0.15 might be appropriate in cases where field practices are well controlled.

$COV_{\xi}$  may be estimated by first establishing a linear trend line for the measured data within each stratum of the characterization domain and then computing its value using Equation (A.2). Use of a linear trend line is a very important concept, because the data within a stratum typically are not completely random and have some trend with change in elevation. It is reasonable, therefore, to "detrend" the data before making statistical calculations. This is accomplished by computing the value for  $COV_{\xi}$  based on the deviation of data values from the trend line rather than on the absolute values of the data, as is done in Equation (A.2).

$$COV_{\xi} = \frac{\text{standard deviation of } \Delta_{mi}}{\text{mean value of } \xi_{mi}} \quad (A.2)$$

$$= \frac{\sqrt{\frac{1}{n-1} \sum_{i=1}^n \Delta_{mi}^2}}{\frac{1}{n} \sum_{i=1}^n \xi_{mi}}$$

In Equation (A.2),  $\Delta_{mi}$  is the difference between the value on the trend line and the  $i$ th measured value at the elevation of that measured value.  $\xi_{mi}$  is the  $i$ th measured value of the soil parameter in the domain, and  $n$  is the number of measured soil parameter values in the stratum under consideration.

An appropriate value for  $COV_e$  is estimated, and Equation (A.1) is then solved to give:  $\Gamma^2 COV_w^2 = COV_{\xi}^2 - COV_e^2$ .  $\Gamma^2$  is estimated assuming measured values apply to some vertical averaging distance. For example, all data from a depth of 7.2 m to 7.5 m can be averaged and assumed to apply to a depth of 7.35 m, in which case the averaging distance,  $L_a$ , will be  $7.5 - 7.2 = 0.3$  m. Alternatively, one can reasonably assume that  $L_a$  is the vertical sampling interval if the stratum is quasi-homogeneous vertically. If the vertical correlation distance  $\delta_v \geq L_a$ ,  $\Gamma^2 = 1$ . If  $\delta_v < L_a$ ,  $\Gamma^2 = 0.8 [\delta_v/L_a]$ , approximately. A simple approximate method for estimating  $\delta_v$  will be shown in the numerical example at the end of this section. Finally,  $COV_w$  is computed from Equation A.1.

The computed value of  $COV_w$  is then compared with values given in Table A.1, which reports typical ranges of  $COV_w$  for  $s_u$  for clay (UU triaxial compression for 38 sites) and  $N$  for sand (SPT for 22 sites) for all types of site conditions, including conditions that would not be considered the authors to be "normal." The last column contains upper limits for  $COV_w$  that are recommended by the authors of this manual for the application of the AASHTO safety and resistance factors. If  $COV_w$  for any stratum of a characterization domain exceeds this limit, one of the options described previously for dealing with excessive uncertainty in the geotechnical parameter should be exercised.

COV<sub>w</sub> values for "normal" rock sites have not been determined. However, experience indicates that COV<sub>w</sub> values for unconfined compression strength from unconfined compression tests on rock cores, the test recommended in this manual, tend to be higher than COV<sub>w</sub> for s<sub>u</sub> from UU triaxial compression tests for clay because of the profound effect that inclusions, seams and cracks have on rock strength. COV<sub>e</sub> values for unconfined compression tests also tend to be higher than COV<sub>e</sub> for UU triaxial compression tests, so that one would expect to find greater variability in measured data in "normal" rock strata than in "normal" clay strata.

Table A.1. Typical Values of COV<sub>w</sub>'s of Geomaterial Parameters for Drilled Shaft Design (Modified after Phoon et al., 1995)

Property	COV <sub>w</sub> -- lower limit, all sites	COV <sub>w</sub> -- upper limit, all sites	COV <sub>w</sub> -- recommended in this manual as upper limit for "normal" site
s <sub>u</sub> (UU triaxial)	0.11	0.49	0.35
N (blows/0.3 m) (uncorrected) in sand	0.19	0.62	0.45

**Example A-1. Approximate Statistical Test for Characterization Domain**

A simple numerical example is illustrated in Figures A.1 - A.4 for the formal evaluation of COV<sub>w</sub> for a site characterization domain consisting of layers of overconsolidated clay and saprolite. The domain shown in Figure A.1 consists of two bents and three soil borings, although in practice characterization domains can sometimes be much larger. The soil parameter of interest for designing the drilled shafts is s<sub>u</sub>. The individual measured values of s<sub>u</sub> (in kPa) obtained from samples recovered from the site and upon which UU triaxial compression tests have been performed are shown in Figure A.2 adjacent to the depths at which the samples were taken, represented by the small bold rectangles. For each of the two strata a linear trend line has been drawn for the measured data by using a least-squares regression analysis available with most spreadsheet programs, as illustrated in Figures A.3 and A.4. These lines could also have been estimated carefully by "eye." Outlier points, denoted by parentheses, have not been included in the plots from which the trend lines have been developed. [Before drawing this trend line, the data from the individual borings should be observed to ensure that all borings within the characterization domain exhibit similar trends. Otherwise, they should be placed in separate characterization domains.] The deviations of the individual ith values, Δ<sub>mi</sub>, from the trend line are illustrated in Figures A.3 and A.4.

$COV_{su} = COV_{\xi}$  defined by Equation (A.1) from the measured data set for the upper stratum, is 0.20.  $COV_e$  is assumed to be 0.10 for the organization taking the samples and performing the tests. Consequently,  $\Gamma^2 [COV_w]^2 = 0.20^2 - 0.10^2 = 0.03$ . The vertical correlation distance is then estimated by plotting the average value within each vertical sampling interval (1 m in the upper stratum) versus elevation, which is shown by the dotted line in Figure A.3.

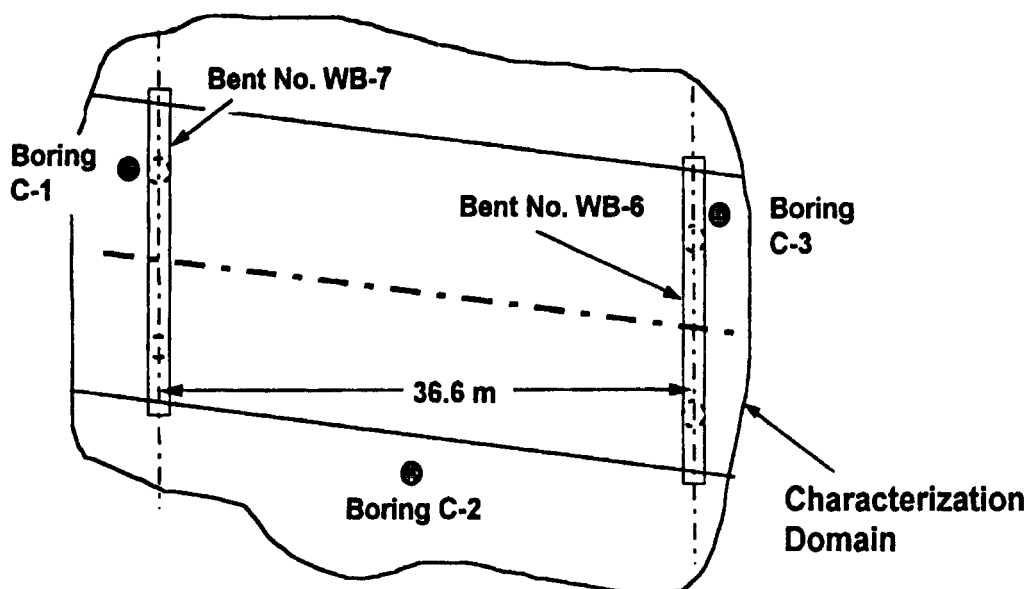
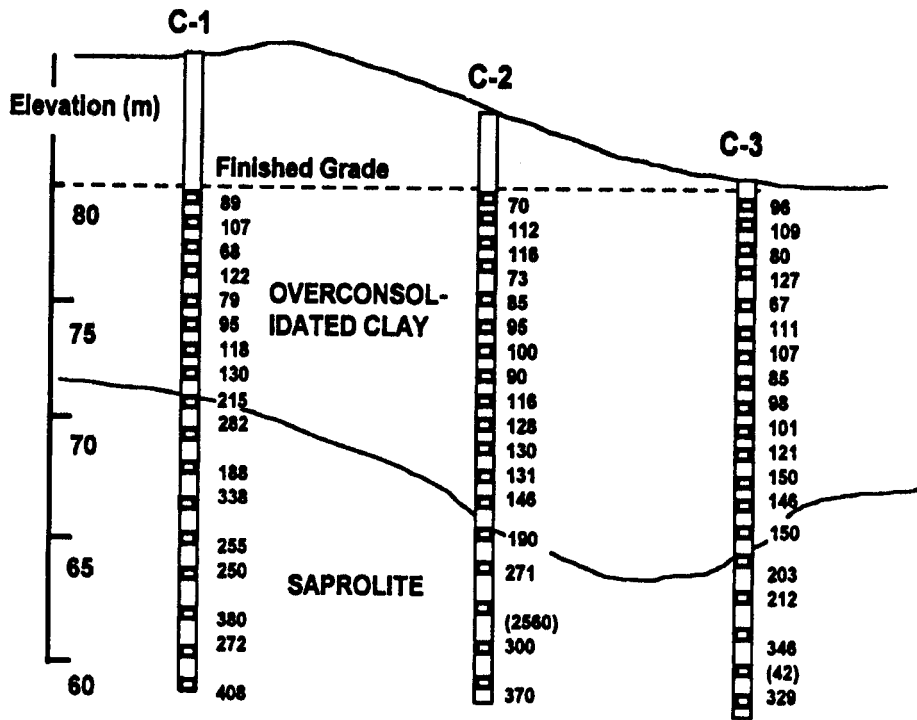

Figure A.1. Plan view of characterization domain



Upper Stratum - Overconsolidated Clay: Vertical sampling interval = 1 m  
 Lower Stratum - Saprolite: Vertical sampling interval = 1.5 m

Horizontal spacing of borings > assumed horizontal correlation distance of 10 m.

Numerical values are values of laboratory undrained shear strength in kPa.

Figure A.2 Elevation of borings and values of  $s_u$  in characterization domain

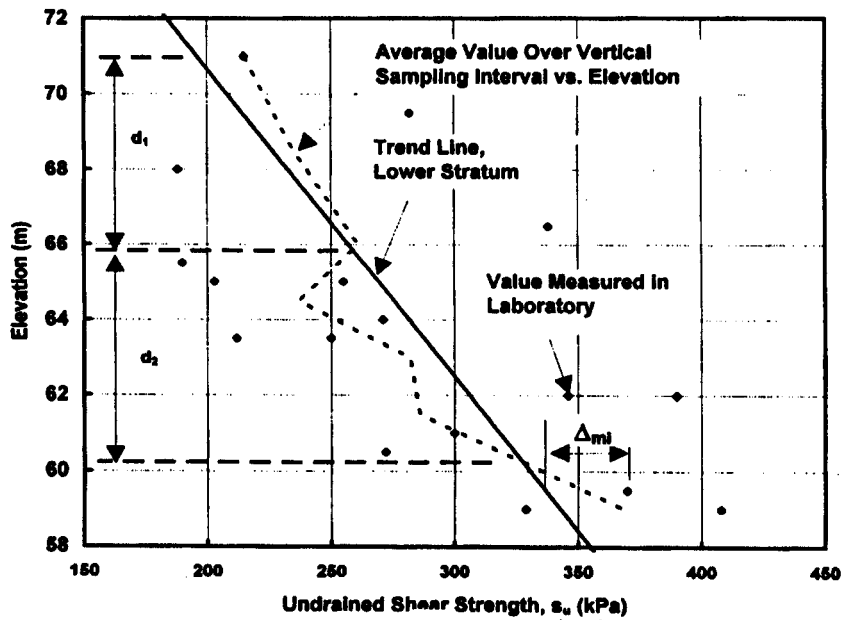

Figure A.3. Undrained shear strength ( $s_u$ ) vs. elevation in upper stratum



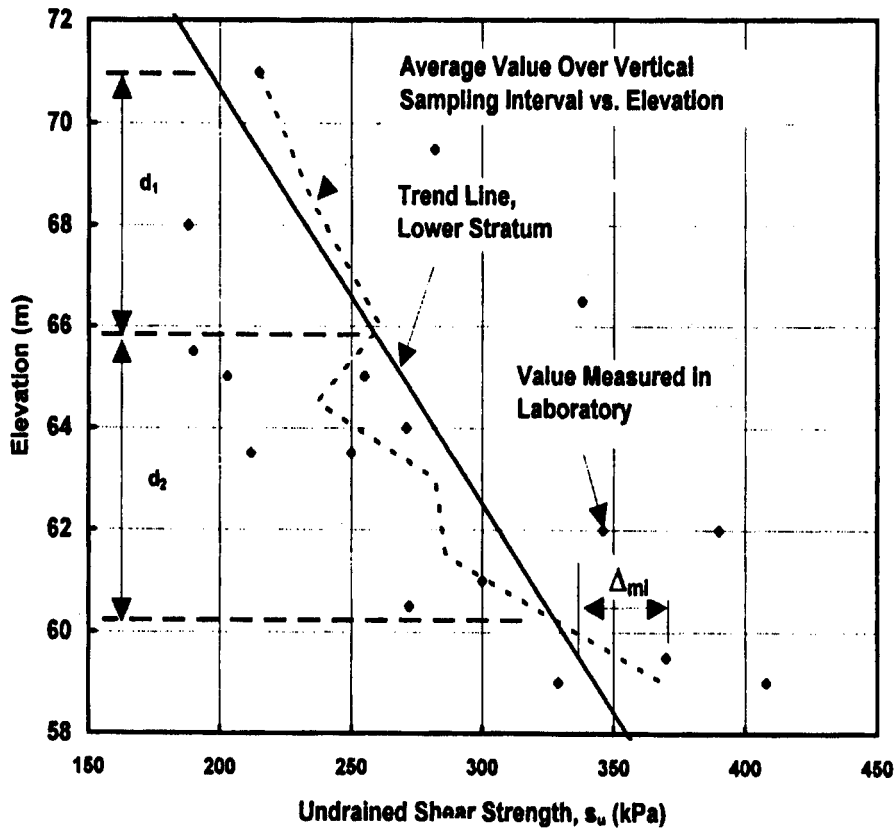

Figure A.4. Undrained shear strength ( $s_u$ ) vs. elevation in lower stratum

The elevations at which this line intersects the trend line are noted, and the vertical distances,  $d_1$ ,  $d_2$ , etc., between these intersections are determined. The average value of  $d$  ( $d_{avg}$ ) is computed, and the value of vertical correlation distance is estimated using Equations (A.3) and (A.4):

$$d_{avg} = \frac{1}{5} \sum_{i=1}^5 d_i = \frac{1}{5} (1.90 + 0.50 + 0.95 + 2.68 + 3.85) = 1.98 \text{ m} \quad (\text{A.3})$$

$$\delta_v = 0.8 d_{avg} = 0.8(1.98) = 1.58 \text{ m} \quad (\text{A.4})$$

$\delta_v$  is seen to be  $>$  the vertical sampling interval of 1 m, which is assumed to be equal to  $L_a$ , so that  $\Gamma^2 = 1$  for the upper stratum.

Finally, then,  $COV_w = [0.03]^{0.5} = 0.17$ . The upper limit for a normal stratum from Table A.1 for  $COV_w$  for  $s_u$  from UU triaxial compression tests is 0.35, so the upper stratum can be considered a

"normal" stratum.

$COV_{su}$  from the measured data set for the lower stratum, is 0.17.  $COV(e)$  is again assumed to be 0.10 for the organization taking the samples and performing the tests. Consequently,  $\Gamma^2 COV_w^2 = 0.17^2 - 0.10^2 = 0.019$ .  $d_{avg} > 5$  m, by inspection, which is  $>$  the vertical sampling interval of 1.5 m =  $L_a$  for the lower stratum. Again, therefore,  $\Gamma^2 = 1$ , so that  $COV_w = [0.019]^{0.5} = 0.14$ , which also qualifies the lower stratum as a "normal" stratum.

Since both strata in this characterization domain are "normal," the AASHTO safety and resistance factors can be used in the design calculations, in which values defined by the trend lines are used represent the design parameters.

---

In applying the above method, it is important to verify that enough data are available for each stratum to define the trend line with reasonable accuracy. Otherwise, the trend line may contain a significant systematic error in the geomaterial property of interest, which may result in a significantly lowered level of reliability for the completed drilled shaft. A simple rule of thumb to ensure that there are enough data to define the trend line properly is:

$$\frac{COV_w}{\sqrt{n}} \leq 0.13 \quad (A.5)$$

If not enough data can be acquired to meet this criterion, either conservative values of the design parameters should be chosen or the resistance factor reduced / factor of safety increased. In the example given above, this criterion is easily met. Systematic errors can also exist in the measurement error. It is essential that such errors be minimized.

The existence of a level of uncertainty that is beyond that with which the engineer is comfortable should be grounds for specifying field loading tests of drilled shafts. Loading tests at the future construction site are best performed during the site investigation phase. Such tests, especially if more than one test is conducted in order to give the engineer a sense of variability of drilled shaft resistance around the site, reduce the level of uncertainty and can justify the use of smaller factors of safety or higher resistance factors than would be justified using only the information from the subsurface investigation for design.

### Further Reading

The current section on uncertainty in soil or rock properties at a site provides only an elementary and approximate treatment of the subject. For the geotechnical engineer who wishes to obtain more information on the topic, several practical papers that can be applied to foundations are recommended: Christian et al. (1994), Lacasse and Nadim (1996), Yuhr et al. (1996), Benson et al. (1996), Phoon and Kulhawy (1996), and Liao et al. (1996).

## BASIC CONCEPT OF RELIABILITY

The remainder of this appendix describes and illustrates the use of load and resistance factor design (LRFD) for the design of drilled shafts using the load and resistance factors recommended in AASHTO (1994). Prior to describing the use of LRFD, however, an introduction to the concept of reliability in design is presented.

LRFD has as its objective the assurance of a specified level of safety, or a "target level of reliability," for the structure and its components, including its foundations. There is uncertainty in estimating both the loads ("demand") on the foundation and resistance ("capacity") of the foundation. For example, uncertainties in resistance of drilled shafts in soil or rock come from (a) uncertainty in the designer's representation of the soil and rock properties and their spatial distributions, (b) uncertainty in the accuracy of the method used to estimate resistance and (c) uncertainty in the effects of construction details.

Conceptually, the uncertainties in load and resistance can both be represented by normalized probability distributions, as shown schematically in Figure A.5. The term "normalized" means that the probabilities for each occurrence of the value of load or resistance plotted have been scaled so that the area under each curve is 1. These probability distributions may be normal (Gaussian), lognormal or some other distribution, but most loads and resistances on bridges are assumed to be lognormally distributed, which means that the logarithm of the load or resistance is normally distributed, according to a "bell curve." This kind of probability distribution can be used to compute load and resistance factors mathematically. To the extent possible, this approach has been taken to derive the AASHTO load and resistance factors. It is emphasized that rigorous mathematical analyses of probability distributions are not necessary in order to design drilled shafts, but some understanding of the underlying theory is helpful, and the principles are summarized briefly below.

The mean value for each parameter in Figure A.5, load or resistance (denoted with the subscript  $m$ ), is the most probable value of load or resistance that occurs with the highest frequency. If the methods for computing loads, soil and rock properties, and ultimate resistance (including construction effects) are accurate, then the values of load and resistance computed from the design method using the parameters input into the design method (e. g., soil and rock properties) will give  $Q_m$  and  $R_m$ , and the actual factor of safety,  $F$ , will be  $R_m/Q_m$ . Obviously, it is desirable that  $R_m$  be greater than  $Q_m$  and that  $F$  be greater than 1. One question that is posed by reliability considerations is "how large should  $F$  be?" Traditionally, the answer to this question has come from precedent and experience, not from rational analysis.

The problem of taking a rational approach based on statistical principles is complicated by the consideration that the process used to characterize the properties of the soil or rock at the site and the properties of the materials of construction, the formulae used to compute loads on the structure, the analytical methods for computing loads on the foundation (reactions from the structure), and the analytical methods used for computing the resistance of the foundation are

usually "biased," which means that they do not give values of  $Q$  or  $R$  that are equal to the actual mean values,  $Q_m$  or  $R_m$ . Instead, the values of load and resistance that the designer computes from standard methods are termed "nominal values" and denoted  $Q_n$  and  $R_n$ . The calculated factor of safety,  $F_n$ , which is equal to  $R_n/Q_n$ , may be different from the actual factor of safety,  $F$ , which is equal to  $R_m/Q_m$ . However, if the biases in the load and resistance estimation methods are known,  $F_n$  can be related to  $F$ , which will allow the nominal methods for estimating loads and resistances to be associated with a known level of reliability. Research has developed methods of relating  $Q_n$  to  $Q_m$  and  $R_n$  to  $R_m$  according to the bias in the method used to make the estimates of nominal load and resistance. In a similar manner, the load and resistance factors,  $\gamma$  and  $\phi$ , can be evaluated considering these biases as they relate to a target level of reliability.

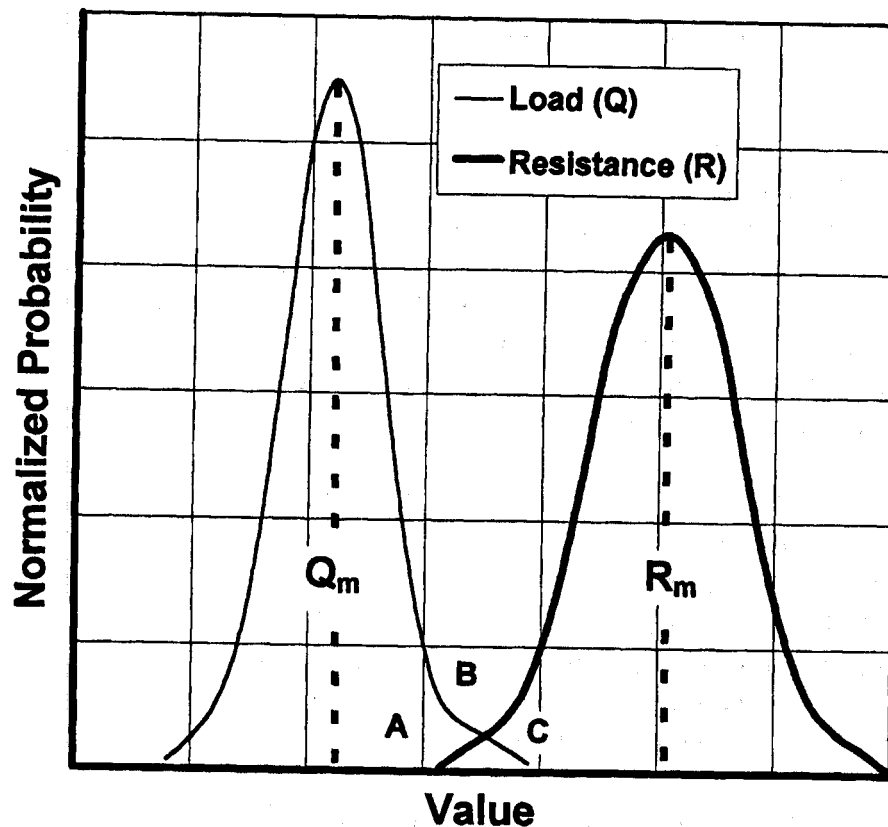

Figure A.5. Idealized probability distributions of load and resistance on a drilled shaft

The widths of the probability distribution curves in Figure A.5, which represent the degree of dispersion in the sets of data, can be represented by their standard deviations, denoted by the symbol  $\sigma$ . Mathematically,

$$\sigma = \sqrt{\frac{\sum_i (x_i - x_{\#})^2}{n-1}} \quad (\text{A-6})$$

where  $i$  is a data point,  $x_i$  is the value of the load or resistance for data point  $i$ ,  $x_{\#}$  is the mean value of load or resistance, and  $n$  is the number of data points in the set.

While the derivation of load and resistance factors requires that the biases and standard deviations in the various components of load and resistance be measured or estimated, the application of LRFD to the design of drilled shafts does not require the actual computation of standard deviations or biases, so the formulae will not be repeated here. However, the concept is useful, as will be illustrated below.

The greater the degree of uncertainty, the larger will be the value of  $\sigma$  and the wider will be the probability distribution curve. There will always be an area of overlap of the curves for load and resistance, marked as ABC on Figure A.5, in which the load is greater than the resistance. Consequently, ABC represents combinations of values of load and resistance for which failure of the foundation will occur. Obviously, the possibility of these combinations occurring should be kept low, but it cannot be eliminated entirely. Approximately, the ratio of area ABC to the total area under both curves in Figure A.5 ( $1 + 1 = 2$ ), is the probability that failure will occur,  $p_f$ . The "reliability" of the foundation is  $1 - p_f$ .

It is very important that the designer be concerned with maintaining a target level of reliability in the drilled shaft foundation and not with assuring a certain safety factor. This is easily illustrated by observing Figure A.5. As the value of  $\sigma$  in either the load or resistance increases, the area ABC will increase if  $Q_m$  and  $R_m$  do not change. Therefore,  $p_f$  will increase and the reliability will decrease without any change in the factor of safety. The converse is true if  $\sigma$  decreases. The safety factor in ASD or load and resistance factors in LRFD should only be a means to assure a target level of reliability.

Once a design community decides on a prudent value of reliability, it is possible to compute factors of safety (ASD) or load and resistance factors (LRFD) from rational procedures. For example, Figure A.5 can be transformed into Figure A-6, in which the probability distribution of resistance (R) minus load (Q) has been plotted. In this single curve,  $p_f$  is expressed by the area under the curve in the region where  $R-Q$  is negative divided by the entire area under the curve. The level of safety of the structural component (for example, a drilled shaft foundation), can then be expressed quantitatively by the number of standard deviations between the mean value of  $R - Q$ , which is equal to  $Q_m (F - 1)$  in an ASD context, and  $R - Q = 0$ . That number is the "reliability index," or "safety index" for the structural component and is denoted here by the symbol  $\beta_T$ .  $\beta_T$ ,

which is illustrated on Figure A.6, can be used to express the level of reliability ( $1 - p_f$ ) of any structural component (for example, a drilled shaft). For example, if one chooses that the reliability of a particular drilled shaft be 0.9999, then  $\beta_T$  theoretically needs to be 3.63 for a normal distribution of  $R - Q$ . Meyerhof (1995) suggests that foundations historically have a level of reliability on the order of 0.9999.

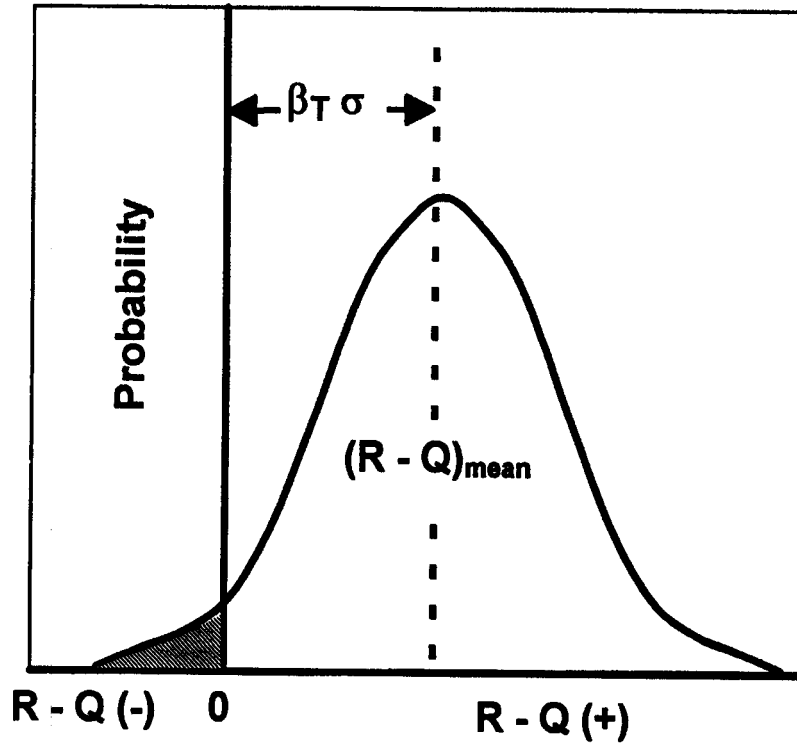

Figure A.6. Definition of the reliability index

If one targets a specific value for  $\beta_T$  and can estimate the probability distributions of  $R$  and  $Q$  and the biases involved in computing  $R$  and  $Q$ , values of  $F$  can be estimated for the ASD method that will produce the targeted value of reliability. Similarly, values of load and resistance factors can be computed for the LRFD method. For example, in deriving resistance factors for drilled shafts, known loads, load factors and biases in computed resistances can be used in Equation A.7 by research personnel to compute an overall resistance factor.

$$\phi = \frac{\lambda_R (\sum \gamma_i Q_i) \sqrt{(1 - V_Q^2)(1 - V_R^2)}}{Q_m \exp\left\{ \beta_T \sqrt{\ln[(1 - V_R^2)(1 - V_Q^2)]} \right\}} \quad (\text{A-7})$$

where,

$\phi$  = resistance factor for the sum of all components of resistance,

$\lambda_R$  = bias factor for resistance, or nominal computed value/actual mean value (estimated by comparing computed resistance with resistance measured in loading tests),

$\gamma_i$  = load factor for load component i,

$Q_i$  = value of nominal load component i (live, dead, etc.),

$V_Q$  = coefficient of variation (COV) of load =  $\sigma_{load}/Q_m$ ,

$V_R$  = coefficient of variation (COV) of resistance =  $\sigma_{resistance}/R_m$ ,

$Q_m$  = actual mean value of load (all components),

$R_m$  = actual mean value of resistance, and

$\beta_T$  = target reliability index.

Note that if the components of load and the components of resistance are completely independent of one another,

$$Q = \sqrt{\sum V_{Qi}^2} \quad \text{and} \quad (A.8)$$

$$R = \sqrt{\sum V_{Ri}^2} \quad (A.9)$$

where  $V_{Qi}$  and  $V_{Ri}$  are the coefficients of variation (COV) in the individual *i*th components of load and resistance. For further information, the reader is encouraged to consult Barker et al. (1991), Phoon et al. (1994), and FHWA (1996).

At present, the selection of  $\beta_T$  for the design of deep foundations in the office, and consequently of resistance factors, is somewhat unsettled for several reasons.

- Field loading tests can increase the confidence of the designer in the design model and the parameters that were selected and therefore can be used to justify the use of lower values of  $\beta_T$ , which will result in the use of higher resistance factors in the LRFD method. Such tests can be performed statically, or they can be performed using high-strain

dynamic methods. Berger and Goble (1994), for example, argue that, if high-strain dynamic loading tests are performed on a high percentage of deep foundations, the value of  $\beta_T$  associated with the design method used in the design office can be as low as 2.5, since most of the uncertainties can be eliminated during construction in the field. Reducing  $\beta_T$  from 3.63 to 2.5 can have a significant effect on resistance factors (Yoon and O'Neill, 1997).  $\beta_T$  should therefore be selected based on whether field loading tests will be performed for the project. The current set of resistance factors for the AASHTO (1994) LRFD method allows for increasing the resistance factor for drilled shafts if static loading tests are performed in the field, but not if high-strain dynamic tests are performed.

- The prequalification of drilled shaft contractors, the competency and extent of inspection during construction, and human factors such as the contractor or inspector calling the designer's attention to subsurface conditions encountered during excavation that were not shown on the boring logs impact the reliability of the finished foundation. Therefore, the choice of  $\beta_T$  and consequently of the resistance factors are impacted. If competent contractors and field personnel are used and if the inspection program is vigorous and is carried out by knowledgeable individuals in the field, lower values of  $\beta_T$  and higher values of resistance factors can be used than if the opposite is true. No account of these factors is directly taken in the AASHTO (1994) LRFD code.
- The consequences of failure of a single foundation component have widely different effects on structures. LRFD as currently envisioned for drilled shaft foundations is a component design method. That is, it is assumed that if a drilled shaft fails the structure will be in a failure state. In fact, the failure of a single drilled shaft or pile in a large group may have very little effect on the performance of the structure as a whole, whereas the failure of a single, isolated drilled shaft supporting a bent in a simply-supported bridge span may in fact result in structural failure. The effect of foundation failure on the structural performance and on the safety of the public impacts on the choice of  $\beta_T$ . Phoon et al. (1994) suggest that  $\beta_T$  can be taken as about 3.2 for drilled shafts for transmission tower foundations. They also show that the use of this reliability index will result in different values of resistance factors for transmission tower foundations depending on the variability of the strength parameters for the soil. While their relations cannot be applied directly to highway structures, the concept clearly can. This is the reason that a formalized procedure for evaluating soil parameters in such a way as to limit the coefficient of variation was suggested in the previous section.

No account of the effect of failure of a specific structural component is taken in the AASHTO (1994) LRFD code in terms of resistance factors; however, the factor  $\eta$  in Equation (1.3) allows for the consideration of structures with a high degree of redundancy and operational significance. For highly redundant drilled shaft groups, it is possible that  $\eta$  could be taken as 0.95 for purposes of designing the drilled shafts. For single drilled shafts,  $\eta$  should be chosen



based on the ductility, redundancy and operational significance of the superstructure and should usually be in the range of 1.00 - 1.05.

As these and other issues become better understood, it is expected that load and resistance factors for highway structure foundations will be modified somewhat. However, in the remainder of this appendix, the factors and procedures prescribed in AASHTO (1994) will be followed. Those factors have been developed through a rational, reliability approach, such as suggested in Equation (A.7), with certain simplifying assumptions, and have also been calibrated to historical global factors of safety.

## **AASHTO LIMIT STATES**

AASHTO (1994) prescribes eleven loading cases, or limit states, for LRFD. Some of these relate to ultimate capacity ("strength" and "extreme event" states) and some relate to serviceability ("service" states). One, which does not apply to foundations, applies to fatigue. The AASHTO code also prescribes methods for computing both the loads and the resistances. Most of the methods for computing nominal axial resistances of drilled shafts are covered in detail in Chapter 11 of this manual.

Not all of the load combinations comprising the eleven limit states need to be considered for every structure. However, all that are relevant for the structure being designed must be considered. For each limit state, the load components that need to be considered and the corresponding load factors are given in Tables A.2 through A.4. Values for resistance factors for drilled shafts are also recommended by AASHTO. They are described in the next section.

Details and commentary on the computation of loads and on the application of LRFD for foundations, including drilled shaft foundations, are given in FHWA (1996). It is not appropriate to repeat the details here. However, a brief summary is given.

The AASHTO limit states are shown in Tables A.2 and A.3. The limit states in Table A.2 can be summarized as follows. The load components are defined in Table A.4.

- **Strength I:** The combination of loads that is related to the operation of a bridge under normal vehicular use without wind loading on the bridge.
- **Strength II:** The combination of loads related to the use of the bridge by special vehicles permitted by the owner without wind loading on the bridge.
- **Strength III:** The combination of loads related to the safety of the bridge without live loads exposed to winds exceeding 90 km/hr (55 miles/hr).
- **Strength IV:** The combination of loads related to the safety of bridges with very high ratios of dead load to live loads (about 7 or higher, for spans of 75 m or greater).

- Strength V: The combination of loads related to the safety of bridges with normal vehicular use exposed to winds of 90 km/hr (55 miles/hr).
- Extreme Event I: The combination of loads that can occur during earthquakes.
- Extreme Event II: The combination of loads that relate to collision with the structure of vehicles, vessels or ice.
- Service I: The combination of loads relating to normal operational use of the bridge with 90 km/hr (55 miles/hr) winds on the structure.

Table A.2. Load Combinations and Load Factors from AASHTO (1994)

LOAD COMBINATIONS	DC DD DW EH EV ES	LL IM CE BR PL LS	WA	WS	WL	FR	TU CR SH	TG	SE	Use One of These at a Time			
										EQ	IC	CT	CV
LIMIT STATE													
STRENGTH-I	$\gamma_P$	1.75	1.00	-	-	1.00	0.50/1.20	$\gamma_{TG}$	$\gamma_{SE}$	-	-	-	-
STRENGTH-II	$\gamma_P$	1.35	1.00	-	-	1.00	0.50/1.20	$\gamma_{TG}$	$\gamma_{SE}$	-	-	-	-
STRENGTH - III	$\gamma_P$	-	1.00	1.40	-	1.00	0.50/1.20	$\gamma_{TG}$	$\gamma_{SE}$	-	-	-	-
STRENGTH - V				-	-								
STRENGTH-V EH,EV,ES,DW. DC ONLY	$\gamma_P$ 1.5	1.35	1.00	0.40	0.40	1.00	0.50/1.20	$\gamma_{TG}$	$\gamma_{SE}$	-	-	-	-
EXTREME EVENT-I	$\gamma_P$	$\gamma_{ES}$	1.00	-	-	1.00	-	-	-	1.00	-	-	-
EXTREME EVENT -II	$\gamma_P$	0.5	1.00	-	-	1.00	-	-	-	-	1.00	1.00	1.00
SERVICE - I	1.00	1.0	1.00	0.30	0.30	1.00	1.00/1.20	$\gamma_{TG}$	$\gamma_{SE}$	-	-	-	-
SERVICE - II	1.00	1.30	1.00	-	-	1.00	1.00/1.20	-	-	-	-	-	-
SERVICE -III	1.00	0.80	1.00	-	-	1.00	1.00/1.20	$\gamma_{TG}$	$\gamma_{SE}$	-	-	-	-
FATIGUE-LL IM & CE ONLY	-	0.75	-	-	-	-	-	-	-	-	-	-	-

Table A.3. Load Factors ( $\gamma$ ) for Permanent Loads

TYPE OF LOAD	LOAD FACTOR	
	MAXIMUM	MINIMUM
DC: Component and Attachments	1.25	0.90
DD: Downdrag	1.80	0.45
DW: Wearing Surfaces and Utilities	1.50	0.65
EH: Horizontal Earth Pressure		
● Active	1.50	0.90
● At-Rest	1.35	0.90
EV: Vertical Earth Pressure		
● Overall Stability	1.35	N/A
● Retaining Structure	1.35	1.00
● Rigid Buried Structure	1.30	9.90
● Rigid Frames	1.35	0.90
● Flexible Buried Structures Other than Metal Box Culverts	1.95	0.90
● Flexible Metal Box Culverts	1.50	0.90
ES: Earth Surcharge	1.50	0.75

Table A.4. Notation for Load Components

Symbol	Definition
<i>Permanent Loads</i>	
DD	Dead load due to downdrag on piles or drilled shafts
DC	Dead load due to structural and nonstructural components
DW	Dead load due to wearing surfaces and utilities on structure
EH	Loads produced by horizontal earth pressures
ES	Loads produced by earth surcharges
EV	Loads produced by vertical pressures from dead load of fill
<i>Transient Loads</i>	
BR	Loads produced by vehicular braking
CE	Loads produced by vehicular centrifugal forces
CR	Loads produced by creep in the structural material
CV	Loads produced by collision of a vehicle with the structure
EQ	Loads produced by earthquakes
FR	Loads produced by friction
IC	Loads produced by ice acting against the structure
IM	Dynamic load allowance for vehicles
LL	Vehicular live load
LS	Surcharge on the vehicular live load
PL	Load produced by pedestrians
SE	Loads produced by settlement of the foundations
SH	Loads produced by shrinkage in superstructure components
TG	Loads produced by temperature gradients in superstructure
TU	Loads produced by uniform temperatures in superstructure
WA	Loads produced by water and stream forces
WL	Loads produced by wind on live load
WS	Loads produced by wind on the structure

- **Service II:** The combination of loads that are intended to control yield of steel structures and slip of slip-critical connections due to vehicular live load.
- **Service III:** The combination of loads relating only to tension in prestressed concrete structures with the objective of crack control.
- **Fatigue:** The combination of loads relating to repetitive gravitational vehicular live loads and dynamic responses under the action of a single design vehicle.

A few comments are in order.

The various load factors reflect the uncertainties in each of the load components for each condition represented by the limit state. For example, the live load (LL) factor is higher for Strength I (normal operational use) than for Strength II (use of the bridge by special permitted vehicles) because the variability of load is probably greater for the former condition.

The load factors are lower for the Service I state than for the strength limit states because the consequences of a serviceability failure are much less severe than those of a structural failure or failure of the soil or rock supporting the foundation.

The load factors for most of the permanent loads (Table A.3) have both maximum and minimum values. The need for this can be illustrated by the following scenario. AASHTO considers downdrag loads on piles and drilled shafts to be loads that must be resisted by the portion of the foundation below the zone of downdrag. When a drilled shaft is subjected to downdrag forces by consolidating or compacting soils (Chapter 12) and the drilled shaft is used to resist compressional loading from the structure, the downdrag load (which is estimated with a low level of reliability) adds to the structural load, so the value of  $\gamma_{p \max}$  (1.80) should be used to multiply the nominal downdrag load to achieve the critical condition for analysis. On the other hand, when the drilled shaft is subjected to uplift loading from the structure, the value of  $\gamma_{p \min}$  (0.45) should be used in the calculations because the uncertain downdrag load reduces (is subtracted from) the tension load applied to the drilled shaft by the structure.

## **RESISTANCE FACTORS FOR DRILLED SHAFTS**

AASHTO (1994) gives specific values for resistance factors ( $\phi$ ) for drilled shafts under axial loading. Each of the factors is associated with a specific method of resistance estimation. These are specific methods that were evaluated by the research team that developed the  $\phi$  factors. Other methods may also be appropriate, possibly more appropriate, for computing the resistance of drilled shafts; however, resistance factors for those methods would need to be evaluated by the designer. Most of the methods for evaluating resistance are described in Chapter 11.

Recommended values of  $\phi$  for the geotechnical strength limit states are summarized in Table A.5.

Table A.5. Resistance factors for geotechnical strength limit state for axially loaded drilled Shafts

Type of Loading	Component of Resistance / Geomaterial	Resistance Evaluation Method	Resistance Factor $\phi$
Compression for Single Drilled Shafts	Side / Clay	$\alpha$ method of Chapter 11 (See Note 1)	0.65
"	Base / Clay	Undrained Bearing Capacity Formula of Chapter 11	0.55
"	Side / Sand	See Note 2	See Note 2
"	Base / Sand	See Note 2	See Note 2
"	Side / Rock	Carter and Kulhawy (Chapter 11) Horvath and Kenny (Chapter 11)	0.55 0.65
"	Base / Rock	Canadian Geotechnical Society (Chapter 11) Pressuremeter Method (Not covered in this Manual)	0.50 0.50
"	Combined Side and Base Resistance	Load Test	0.80
Compression on a Drilled Shaft Group	Clay	Block Failure (Chapter 10)	0.65
Uplift for Single Drilled Shafts	Clay	$\alpha$ Method of Chapter 11 for Straight Shafts (See Note 1) Undrained Strength Method in Chapter 11- Belled Shafts	0.55 0.50
"	Sand	See Note 3	See Note 3
"	Rock	Carter and Kulhawy (Chapter 11) Horvath and Kenney (Chapter 11)	0.45 0.55
"	Combined Side and Base Resistance	Load Test	0.80
Uplift on Drilled Shaft Group	Sand or Clay	Not specified	0.55

**Note 1:** The  $\alpha$  method described in Chapter 11 is modified slightly from the version used in deriving  $\phi$ . However, the modified procedure gives slightly more conservative values of resistance than the method used in deriving  $\phi$ , so that the use of the specified resistance factor will not impact safety.

**Note 2:** It was found when deriving  $\phi$  that not enough data were available for drilled shafts in sand to arrive at a value for  $\phi$ . The  $\beta$  method described in Chapter 11 is designed to be conservative and to produce no larger proportion of predictions of ultimate side resistance that are more than 25 per cent unconservative than the  $\alpha$  method for clay. Application of the  $\beta$  method to loading tests on drilled shafts in sand subsequent to the derivation of the  $\phi$  factors in Table A-5 have proved conservative. Therefore, the authors of this manual suggest that if the  $\beta$  method is used the resistance factors for strength limit states for drilled shafts in sand (or gravel) be taken to be equal to those for drilled shafts in clay pending a rederivation of  $\phi$  by appropriate research groups.

Concerning base resistance in sand, the authors have observed large variations, which depend to a large degree on the care taken in the construction of the drilled shaft. If close controls are kept on the properties of drilling slurry and the base cleanout procedures, and the time that the base is exposed to stress relief is minimized, it is reasonable to use a resistance factor of about 0.50 for this case. However, if close construction controls will not be exercised, a lower  $\phi$  factor will have to be selected based on the judgment of the designer.

**Note 3:** This manual (Chapter 11) suggests a small reduction in side resistance for uplift loading in sand relative to compression loading, based on recent research. Therefore, it appears that the conditions of Note 2 for side resistance also apply to uplift loading.

The LRFD method is applied both to the geomaterial limit state (Table A.5) and to the structural limit state. The resistance factors for structural limit states for axially and laterally loaded drilled shafts are considered in Chapter 13, which deals with structural design for axial loading and loading other than axial.

Resistance factors for the service limit states are taken to be 1 for all loading conditions.

## **MODIFYING RESISTANCE FACTORS FOR DRILLED SHAFTS**

The factors that are recommended by AASHTO may be modified for specific projects if it is judged by the design team that such modification is warranted based on historical precedent or for other reasons. FHWA (1996) describes methods for converting the resistance factors that are tabulated in Table A.5 to other values corresponding to selected factors of safety for those cases where the designer decides to use a conventional safety factor in an LRFD design.

## FORMAL STEP-BY-STEP PROCEDURE FOR APPLYING LRFD TO THE DESIGN OF DRILLED SHAFTS

The following step-by-step procedure can be followed to design a drilled shaft according to the LRFD method. This procedure follows the assumption that the geotechnical strength limit states will normally control the geometry of the foundation. As a result, that limit state is satisfied first to simplify the computations. However, there may be cases in which structural or service limit states appear to be more critical. In those cases it is more efficient to satisfy those limit states first and then check the geotechnical strength states last.

- 1. Select the limit states for which the foundation is to be designed.**
- 2. Determine the nominal values of each of the components of load  $Q_i$  acting on the foundation.** This step ordinarily requires that the structure be analyzed and the foundation loads be treated as structural reactions. These loads should be resolved into loads applied axially and laterally in two perpendicular directions at the location of the head of each drilled shaft to be installed in the foundation. Computation of downdrag loads and loads from expansive soils are covered in Chapter 12. These loads should also be considered. Otherwise, the reader is referred to AASHTO (1994) and FHWA (1996) for methods for load calculation.
- 3. Multiply each of the components of load determined in Step 2 by its respective load factor  $\gamma_i$  (Tables A.2 and A.3) for each of the strength and extreme event limit states to be analyzed and sum the resulting factored loads according to the combinations prescribed for each limit state considered.** Multiply each resultant sum by  $\eta$  (0.95 - 1.05) to obtain  $\eta \Sigma \gamma_i Q_i$  for each limit state. Often, it will be possible to determine a critical limit state (that which produces the highest loads) at this point. When the design involves combined axial and lateral loading, the most critical limit state may not be readily apparent at this point.
- 4. Select the soil and rock (geomaterial) parameters to be used in design by grouping borings and probes in such a manner that the coefficients of variation of the relevant geomaterial parameters are within the limits described in this appendix.** Specific descriptions of the relevant parameters for design are covered in Chapter 11. Decide on the method to be used in estimating axial resistance (for example, the  $\alpha$  factor in clays or the method of Carter and Kulhawy in rock for side resistance). Select the corresponding resistance factors for axial loading from Table A.5. [Note, this presumes that axial loading will control, which is a common design assumption.]
- 5. Select a trial geometry for the drilled shaft or group of drilled shafts at each structural support point.** This will include depths and diameters of the drilled shafts, as well as underream sizes, if any. The trial geometry depends on subsurface conditions.



- 6. Compute the nominal geotechnical resistance of each drilled shaft to axial loading,  $R_n = \Sigma \phi_i R_i$ . This value should be equal to or slightly greater than the axial component of factored load  $\eta \Sigma \gamma_i Q_i$  for the most critical limit state for which the design is made. If it is not, the geometry of the drilled shaft should be selected again and Steps 4 through 6 repeated until this condition is met. Methods for making resistance computations are covered in Chapter 11 and in Appendix B.**
- 7. Specify a trial reinforcing steel schedule and concrete strength for each drilled shaft with the drilled shaft geometry obtained in Step 6.**
- 8. Assure that the factored structural resistance of each drilled shaft exceeds the factored load using one of two approaches: (1) If only axial load is applied, use the simple column formula given in Chapter 13, which includes structural resistance factors, to compute factored structural resistance. This resistance must exceed the critical factored structural load. (2) If the load is lateral or if combined axial and lateral loading is applied, model the drilled shaft using the method for considering lateral and combined axial and lateral loading in Chapter 13. In this method, the set of critical factored loads is applied and maximum factored moments, thrusts and shears are computed along the drilled shaft. These loads should be the *resultant* loads from the components in the two perpendicular directions for which they have been tabulated in the structural design. The factored moment and shear resistances for the drilled shaft cross section with the trial steel schedule and concrete strength are also calculated as described in Chapter 13. If the factored moment and shear resistances of the section exceed the maximum factored moment and shear loads at every point along the drilled shaft, the section is safe. If not, return to Step 7 and select a new trial reinforcing steel schedule and concrete strength, or select a new (larger) diameter or depth, if necessary. Rechecking the geotechnical strength limit states will not normally be necessary if the depths and/or diameters of the drilled shafts are not decreased, unless downdrag or expansive soil loading is involved. In that case, or if the section is excessively oversized, return to Step 5 and additionally compute new downdrag and uplift loads imposed by the soil. Continue until a satisfactory section is achieved.**
- 9. Verify that the service limit states have been satisfied. This requires multiplying the unfactored loads from Step 2 by the service load factors from Table A.2. If the drilled shaft is part of a group, the service-factored axial load for the entire group is applied to the group to estimate its settlement. The settlement of a drilled shaft group is then computed using a method from Appendix C or by some other appropriate method. If the drilled shaft is an isolated foundation not part of a group, the settlement is computed using the method described in Chapter 11 or by some other appropriate method. The computed settlement is compared with a value of tolerable settlement. Finally, lateral deflections and rotations are computed from the factored service limit loads using procedures from Chapter 13 or from some other appropriate method, and they are compared with tolerable lateral deflections and rotations. If at this point the settlements, lateral deflections and rotations of the head of a drilled shaft are not acceptable, the geometry must be reevaluated and the process begun again at Step 5 and continued until a satisfactory design is achieved.**

## EXAMPLE PROBLEM

The following is a simple example of the determination of factored loads for the design of drilled shafts.

---

### Example A-2. *Determination of Factored Loads for a Typical Drilled Shaft.*

Consider a single drilled shaft supporting column F-1 in the bent shown in the sketch below. Analysis of the subsurface conditions indicates that the soil will not produce either downdrag or uplift loads on the drilled shaft supporting this column. The structure will not be designed for extreme events. The structure is assigned a value of  $\eta = 1.0$  (not operationally important). Maximum design wind velocity is 164 km / hr (100 miles / hr).

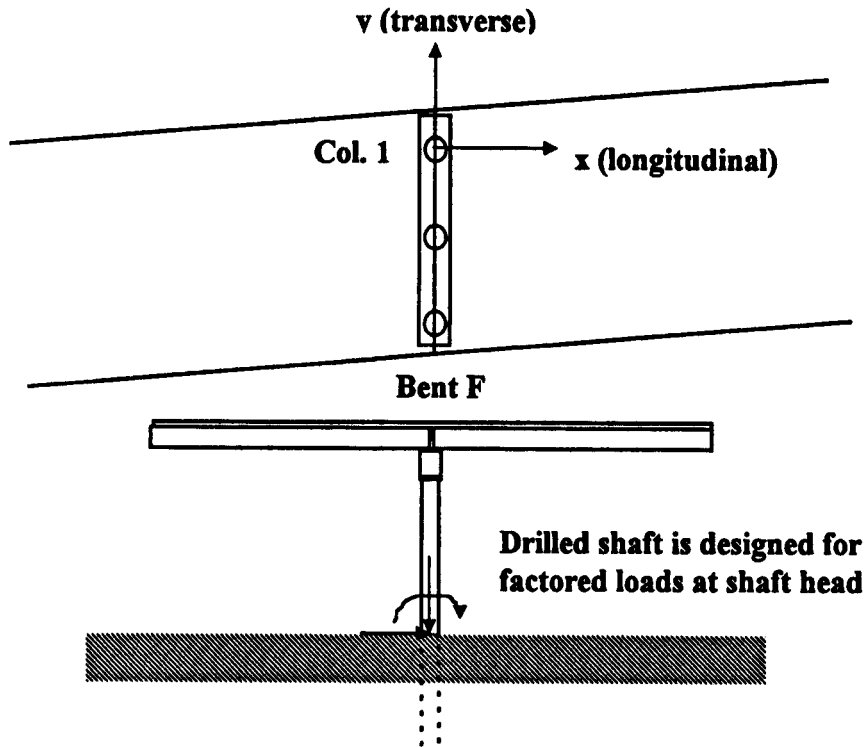

Superstructure analysis produces the nominal loads at the heads of the drilled shafts shown in the following table. (All other loads are assumed to be zero):

Component	Axial (kN)	Lateral Transverse		Lateral Shear (kN)	Longitudinal Moment (kN- m)
		Shear (kN)	Moment (kN-m)		
DC	916 (206 k)	0	0	0	0
DW	18 ( 4 k)	0	0	0	0
LL	690 (155 k)	0	0	0	0
WS (164 km/hr)	307 ( 69 k)	223 (50 k)	-1115 (-822 ft-k)	37 (8 k)	-185 (-136 ft-k)
WL (164 km/hr)	100 ( 22 k)	66 (15 k)	-342 (252 ft-k)	5 (1 k)	-40 ( 29 ft-k)
WS (90 km/hr)	93 ( 21 k)	70 (16 k)	-335 (-247 ft-k)	11 (2 k)	-56 (-41 ft-k)
WL (90 km/hr)	30 ( 7 k)	20 ( 5 k)	-103 ( 96 ft-k)	2 (0 k)	-12 ( -9 ft-k)

Positive loads are compressive axial loads, shears in the x and y directions and moments about the x and y axes following the right-hand rule.

Two sets of wind loads are computed. The first set is for the maximum wind speed of 164 km/hr (100 mph). The second set is for the standard value of 90 km / hr (55 mph). Note that live load is not used in combination with the former wind loads, but it is used with the latter set. In fact, WL for 164 km / hr is not needed.

The following limit states will be satisfied for this design:

*Strength I, Strength III, Strength V and Service I.*

The combinations of factored loads for these limit states are as follows:

**Strength I:**  $\eta \sum \gamma_i Q_i = 1.00 [1.25 DC + 1.50 DW + 1.75 LL]$  (Tables A.2 and A.3)

Factored axial load =  $1.00 [1.25 (916) + 1.50 (18) + 1.75 (690)] = \underline{2380N (535k)}$

Factored transverse shear =  $1.00 [0] = \underline{0}$ .

Factored transverse moment =  $1.00 [0] = \underline{0}$ .

Factored longitudinal shear =  $1.00 [0] = \underline{0}$ .

Factored longitudinal moment =  $1.00 [0] = \underline{0}$ .

**Strength III:**  $\eta \sum \gamma_i Q_i = 1.00[1.25 DC + 1.50 DW + 1.40 WS]$  (Tables A.2 and A.3)

Factored axial load =  $1.00 [1.25 (916) + 1.50 (18) + 1.40 (307)] = \underline{1602 \text{ kN (360 k)}}$

Factored transverse shear =  $1.00 [1.40 (223)] = \underline{312 \text{ kN (70 k)}}$

Factored transverse moment =  $1.00 [1.40 (-1115)] = \underline{-1561 \text{ kN-m (-1151 ft-k)}}$

Factored longitudinal shear =  $1.00 [1.40 (37)] = \underline{52 \text{ kN (12 k)}}$

$$\text{Factored longitudinal moment} = 1.00 [1.40 (-185)] = \underline{-259 \text{ kN-m } (-191 \text{ ft-k})}$$

$$\text{Strength V: } \eta \sum \gamma_i Q_i = 1.00 [1.25 \text{ DC} + 1.5 \text{ DW} + 1.35 \text{ LL} + 0.40 \text{ WS} + 0.40 \text{ WL}]$$

(Tables A.2 and A.3)

$$\text{Factored axial load} = 1.00 [1.25 (916) + 1.50 (18) + 1.35(690) + 0.40 (93) + 0.40 (30)] = \underline{2154 \text{ kN} = 484 \text{ k}}$$

$$\text{Factored transverse shear} = 1.00 [0.40 (70) + 0.40 (20)] = \underline{36 \text{ kN } (8 \text{ k})}$$

$$\text{Factored transverse moment} = 1.00 [0.40 (-335) + 0.40 (-103)] = \underline{-175 \text{ kN-m } (-129 \text{ ft-K})}$$

$$\text{Factored longitudinal shear} = 1.00 [0.40 (11) + 0.40 (2)] = \underline{5 \text{ kN } (1 \text{ k})}$$

$$\text{Factored longitudinal moment} = 1.00 [0.40 (-56) + 0.40 (-12)] = \underline{-27 \text{ kN-m } (-20 \text{ ft-k})}$$

By examination of the factored loads, Strength I is obviously critical for axial loading, so that the drilled shaft depth and diameter must be chosen such that:

$$\phi_{\text{side resistance}} R_s + \phi_{\text{base resistance}} R_b > 2380 \text{ kN } (535 \text{ k}),$$

where

$R_s$  = nominal ultimate side resistance,

$R_b$  = nominal ultimate base resistance, and

the  $\phi$  factors are chosen from Table A.5 based on the type of geomaterial(s) in which the drilled shaft is installed and upon the methods selected to make the estimates of side and base resistance.

However, Strength III is the critical case for lateral loading. The factored axial load, and factored resultant shaft-head shears and resultant moments should be input into a model to compute maximum shears and moments along the drilled shaft. The values of those maximum moments and shears should then be compared with the factored moment and shear resistances of the cross-section of the drilled shaft, after selecting a rebar schedule and concrete properties.

$$\text{Service I: } \eta \sum \gamma_i Q_i = 1.00 [1.00 \text{ DC} + 1.00 \text{ LL} + 1.00 \text{ DW} + 0.30 \text{ WS} + 0.30 \text{ WL}] \quad (\text{Table A.2})$$

$$\text{Factored axial load} = 1.00 [1.00 (916) + 1.00(690) + 1.00 (18) + 0.30 (93) + 0.30 (30)] = \underline{1661 \text{ kN } (373 \text{ k})}$$

$$\text{Factored transverse shear} = 1.00 [0.30 (70) + 0.30 (20)] = \underline{27 \text{ kN } (6 \text{ k})}$$

$$\text{Factored transverse moment} = 1.00 [0.30 (-335) + 0.30 (-103)] = \underline{-131 \text{ kN-m } (-96 \text{ ft-K})}$$

$$\text{Factored longitudinal shear} = 1.00 [0.30 (11) + 0.30 (2)] = \underline{4 \text{ kN } (1 \text{ k})}$$

$$\text{Factored longitudinal moment} = 1.00 [0.30 (-56) + 0.30 (-12)] = \underline{-20 \text{ kN-m } (-15 \text{ ft-k})}$$

Settlement of the drilled shaft should be checked against the tolerable settlement using the method in Chapter 11 or another appropriate method under the axial load of 1661 kN

(373 k). Deflection and rotation of the head of the drilled shaft should be checked against the tolerable lateral movements for the structure using the method in Chapter 13 or another appropriate method using a shaft-head shear load of  $[27^2 + 4^2]^{0.5} = 27.3$  kN (6.1 k) simultaneously applied with a shaft-head moment of  $[(-131)^2 + (-20)^2]^{0.5} = 133$  kN-m = 97.4 ft-k and the axial load of 1661 kN (373 k). The latter load is included because of the "P- $\delta$ " effect (increase in lateral deflection due to the presence of compressive axial load).

---

## REFERENCES

- AASHTO (1994). *LRFD Bridge Design Specifications*, American Association of State Highway and Transportation Officials, Washington, D. C., First Edition.
- Barker, R. M., Duncan, J. M., Rojiani, K. B., Ooi, P. S. K., Tan, C. K., and Kim, S. G., "Manuals for the Design of Bridge Foundations," *National Cooperative Highway Research Program Report 343*, Transportation Research Board, Washington, D. C., December, 308 p.
- Benson, R. C., Yuhr, L., and Sharma, D. (1996). "Uncertainty in the Geologic Setting and Its Impact on Site Characterization," *Geotechnical Special Publication No. 58, Uncertainty in the Geologic Environment - From Theory to Practice*, Ed. by C. D. Shackelford, P. P. Nelson and M. J. S. Roth, ASCE, Vol. 1, pp. 91 - 103.
- Berger, J., and Goble, G. G. (1994). "Soil Resistance Factors for LRFD of Driven Piles," *Proceedings*, International Conference on Design and Construction of Deep Foundations, Vol. II, Federal Highway Administration, Washington, D. C., pp. 427 - 438.
- Christian, J. T., Ladd, C. C., and Baecher, G. (1994). "Reliability Applied to Slope Stability," *Journal of Geotechnical Engineering*, Vol. 120, No. 12, ASCE, pp. 2180-2207.
- FHWA (1996). *Load and Resistance Factor Design (LRFD) for Highway Substructures*, Federal Highway Administration, Washington, D. C. (Draft Manual).
- Kulhawy, F. H., and Grigoriu, M. D. (1987). "Some Uncertainties in Deep Foundation Design," *Proceedings*, Fifth International Conference on Applications of Statistics and Probability in Soil and Structural Engineering, Vol. 2, Vancouver, pp. 710-717.
- Lacasse, S., and Nadim, F. (1996). "Uncertainties in Characterizing Soil Properties," *Geotechnical Special Publication No. 58, Uncertainty in the Geologic Environment - From Theory to Practice*, Ed. by C. D. Shackelford, P. P. Nelson and M. J. S. Roth, ASCE, Vol. 1, pp. 49 - 75.
- Liao, S. S. C., Druss, D. L., Neff, T. L., and Brenner, B. R. (1996). "Just One More Boring and We'll Know For Sure!," *Geotechnical Special Publication No. 58, Uncertainty in the Geologic*

*Environment - From Theory to Practice*, Ed. by C. D. Shackelford, P. P. Nelson and M. J. S. Roth, ASCE, Vol. 1, pp. 119 - 133.

Meyerhof, G. G. (1995). "Evolution of Safety Factors and Geotechnical Limit State Design," *Canadian Geotechnical Journal*, Vol. 32, No. 1, pp. 128 - 136.

Phoon, K. K., Kulhawy, F. H., and Grigoriu, M. D. (1994). "Reliability-Based Design of Foundations for Transmission Tower Structures," *Report No. TR-105000*, Project 1493-04, EPRI, Palo Alto, CA.

Phoon, K. K., and Kulhawy, F. H. (1996). "On Quantifying Inherent Soil Variability," *Geotechnical Special Publication No. 58, Uncertainty in the Geologic Environment - From Theory to Practice*, Ed. by C. D. Shackelford, P. P. Nelson and M. J. S. Roth, ASCE, Vol. 1, pp. 326 - 340.

Yoon, G. L., and O'Neill, M. W. (1997). "Resistance Factors for Single Driven Piles from Experiments," Paper presented to the Annual Meeting of the Transportation Research Board, January, Paper No. 970088.

Yuhr, L., Benson, R. C., and Sharma, D. (1996). "Achieving a Reasonable Level of Accuracy in Site Characterization in the Presence of Geologic Uncertainty," *Geotechnical Special Publication No. 58, Uncertainty in the Geologic Environment - From Theory to Practice*, Ed. by C. D. Shackelford, P. P. Nelson and M. J. S. Roth, ASCE, Vol. 1, pp. 195 - 209.

## APPENDIX B: COMMENTARY ON METHODS OF COMPUTING THE NOMINAL AXIAL RESISTANCE OF DRILLED SHAFTS

### INTRODUCTION

Appendix B elaborates on the methods described in Chapters 10 and 11 for estimating the axial resistance of drilled shafts, documents the sources of the information (for further reading, if desired), provides additional commentary on the design methods and describes alternate methods for design.

### BASIC DESIGN EQUATIONS FOR GEOTECHNICAL AXIAL RESISTANCE

#### Compression Loading

The ultimate geotechnical resistance of a drilled shaft to compressive axial load can be expressed as follows:

$$R_{TN} = R_{BN} + R_{SN} \quad (\text{B.1})$$

in which

$R_{TN}$  = nominal total ultimate resistance in compression,

$R_{BN}$  = nominal net ultimate base resistance in compression, and

$R_{SN}$  = nominal ultimate side resistance in compression.

In the above definitions, the word "nominal" means that the value of resistance is that value that is determined by employing the geotechnical engineer's estimates of the soil/rock properties using one of the computational methods described in this manual. Henceforth, the subscript "N" will be dropped. It is emphasized that the nominal resistance is unlikely to be the actual resistance, as discussed in Appendix A. For this reason, resistance factors or factors of safety are applied to the computed values of nominal resistance in the design process. It is also emphasized that the nominal resistances for drilled shafts are different from those for driven piles because of the different effects on the geomaterial produced by installation.

The weight of the drilled shaft is not considered as a part of the load; however, the base resistance is a *net* resistance, which means that the effect of the weight of the drilled shaft is already considered by assuming that the effective pressure produced by the weight of the concrete against the base is equal to the vertical effective pressure produced by the soil at the elevation of the base.

It is important that  $R_B$  and  $R_S$  be evaluated at a common value of axial displacement, since the maximum values of base and side resistance are not generally mobilized at the same value of displacement. In some soils, and especially in some brittle rocks, the side shear may develop fully at a small value of displacement and then decrease with further displacement while the base resistance is still being mobilized. Such geomaterials are termed "displacement softening" materials. This phenomenon is illustrated in Figure B.1. If the value of side resistance at Point A is added to the value of base resistance at Point B, the total resistance will be overpredicted. Instead, if the designer wants to take advantage primarily of base resistance, the side resistance at Point C should be added to the base resistance at Point B to evaluate  $R_T$ . Otherwise, the designer may wish to design for the side resistance at Point A and to disregard base resistance entirely. In many geomaterials, the side resistance relation will not result in reduced resistance beyond Point A, so that the issue of whether to add maximum base resistance to maximum side resistance becomes unimportant. It is important, however, that the geotechnical specialist identify those soils and rocks that shear in a brittle fashion and exhibit deflection-softening behavior.

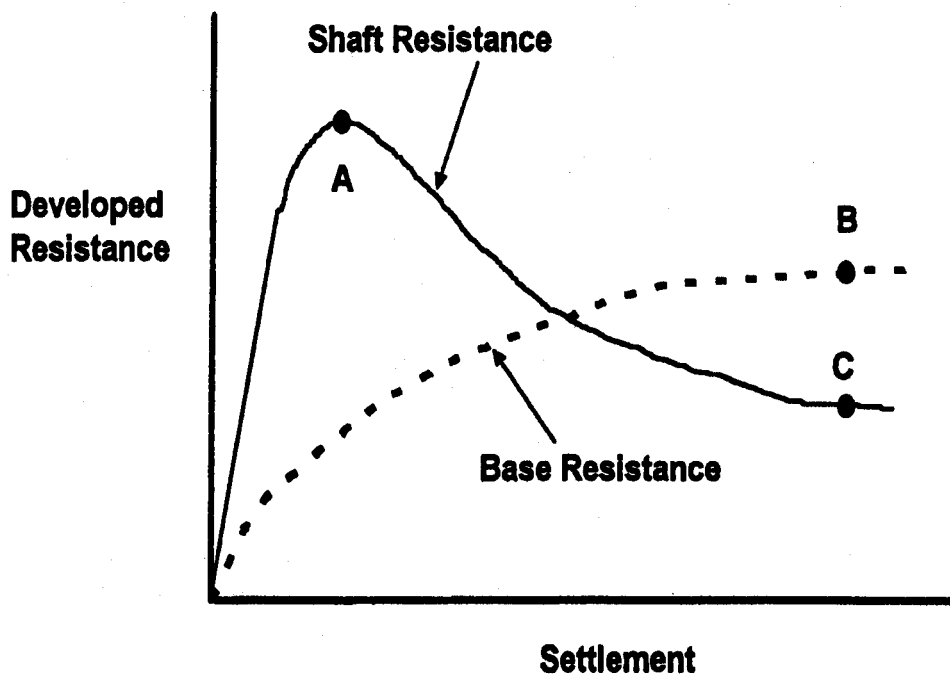

Figure B.1. Illustration of deflection-softening behavior of drilled shafts under compression loading



## Uplift Loading

Drilled shafts are most often used in bridge foundations to resist compression loads. However, some structural loading events, particularly those that produce large overturning moments on the structure, can produce uplift loads on drilled shafts. The design equation for uplift is similar to that for compression:

$$R_T = R_B + R_S + W' \quad (\text{B.2})$$

in which

$R_T$  = nominal total ultimate resistance in uplift,

$R_B$  = nominal net ultimate base resistance in uplift,

$R_S$  = nominal ultimate side resistance in uplift, and

$W'$  = weight of the drilled shaft, corrected for buoyancy, if any.

The base resistance in uplift  $R_B$  is almost always taken to be zero for design purposes. This assumption is commonly made because drilled shafts used for highway construction are ordinarily straight-sided (constructed without underreams) and because it is usually assumed that the soil or rock at the interface between the base of the drilled shaft and the geomaterial beneath the base has no tensile strength. If the drilled shaft is constructed with an underream, some reliable bearing resistance against the roof of the bell can be counted upon to produce base resistance. Consult, for example, Yazdanbod et al. (1987) for methods to compute uplift resistance against roofs of bells in cohesive geomaterials. For very short-term loading (wind gusts, seismic loading), suction between the base of the drilled shaft and the soil or rock of up to almost one atmosphere may develop temporarily, but that suction is quickly lost and should not be counted upon in design except for unusual situations, in which a design expert should be consulted.

$W'$  is estimated by computing the total weight of that part of the drilled shaft above the piezometric surface and adding that weight to the buoyant weight of that part of the drilled shaft below the piezometric surface. Note in Equation (B.2) that the weight of the drilled shaft is taken to be a component of the resistance rather than a (negative) component of the load.

## Downdrag

When the drilled shaft is installed with its base in a stable soil or rock layer that will not settle without the imposition of load from the drilled shaft and when the overburden soil can settle due to natural processes such as soil liquefaction produced by seismic events or the construction of fills, independent of loading by the drilled shaft, downdrag, or downward-directed shearing forces on the drilled shaft, can be produced by the settling soil. These forces can be considered as applied load, or they can be treated by assuming that the drilled shaft can settle ultimately

more than the settling soils, in which case downdrag will cease to exist and will in fact ultimately become a positive resistance. This consideration should not be overlooked by designers. An approach to designing for this special case is covered in Chapter 12.

## IDEALIZATION OF GEOMATERIALS

Whenever Equations (B.1) and (B.2) are applied in designing a drilled shaft, it is first necessary to idealize the soil and/or rock for each grouping of borings (Chapter 2). For purposes of using the design methods described in this manual, this idealization is accomplished by establishing depths and thicknesses of layers of soil or rock based on analysis of the boring logs and other geotechnical/geological evidence and assigning soil or rock properties to each of those layers from the elevation of finished grade to several shaft diameters below the expected base elevations of the shafts. In case it is found to be necessary in the field to deepen the drilled shaft, it is suggested that the geomaterial idealization continue to a depth below the proposed base elevation of at least 125 per cent of the planned embedded length of the drilled shaft plus  $2B$  in soil and in rock with  $RQD \leq 50\%$ . Extend to  $2B$  below planned length in soil and rock with  $RQD \geq 50\%$ . The design equations will be different for each layer, depending upon the type of geomaterial in the layer, so it is important to classify the geomaterial in each layer into one of the following four categories:

- **Cohesive soil** [clay or plastic silt with  $s_u \leq 0.25$  MPa (5,200 lb/ft<sup>2</sup>) ],
- **Granular soil** [sand, non-plastic silt or gravel, with  $N_{SPT} \leq 50$  blows/0.3 m],
- **Intermediate geomaterial** [earth materials that are transitional from soil to rock in residual profiles, glacial tills, very soft argillaceous or arenaceous rock;  $0.25$  MPa (5,200 lb/ft<sup>2</sup>)  $\leq s_u \leq 2.5$  MPa (52,000 lb/ft<sup>2</sup>) or  $N_{SPT} \geq 50$  blows/0.3 m. Intermediate geomaterials can be either cohesive or granular.],
- **Rock** [strongly cemented earth materials that exhibit  $s_u > 2.5$  MPa (52,000 lb/ft<sup>2</sup>)].

Note that a new layer should be established when the classification of the geomaterial changes. However, separate layers may be established within a geomaterial of the same classification if the properties (e. g.,  $s_u$ ) change significantly within the layer.

The appropriate design factors are then selected for each layer, as called for in Chapter 11, the side resistance is computed for each layer, and the base resistance is computed for the layer in which the base is placed. This step is illustrated in Figure B.2 for a drilled shaft loaded in compression and in Figure B.3 for a drilled shaft loaded in uplift. In both of these figures four layers are shown, and the base is placed in Layer 4. However, any number of layers can be specified. Since the side resistance will be a nonlinear function of depth in granular soil, the layer thickness in granular (cohesionless) soil or IGM should not exceed 9 m (30 ft) regardless of the consistency of the soil properties. (This condition is applied to ensure accuracy of the computations and not for any physical reason.)

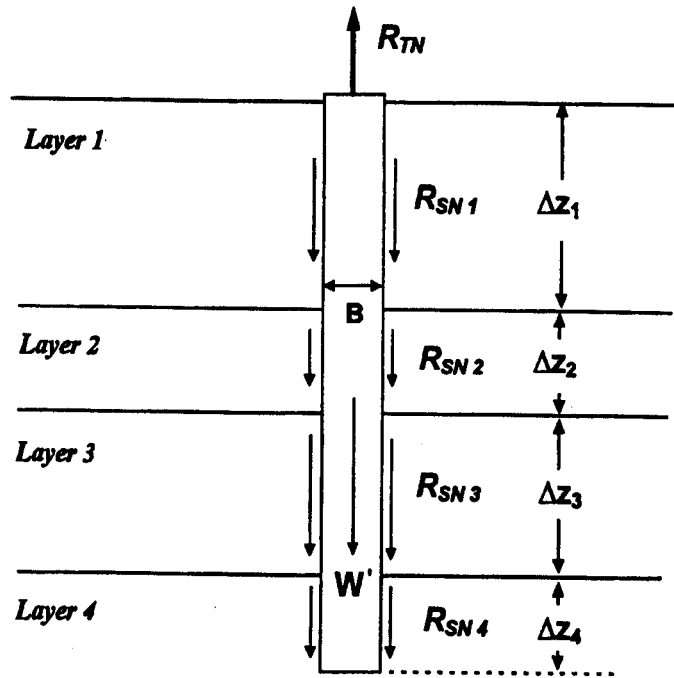

Figure B.2. Idealized geomaterial layering for computation of compression resistance

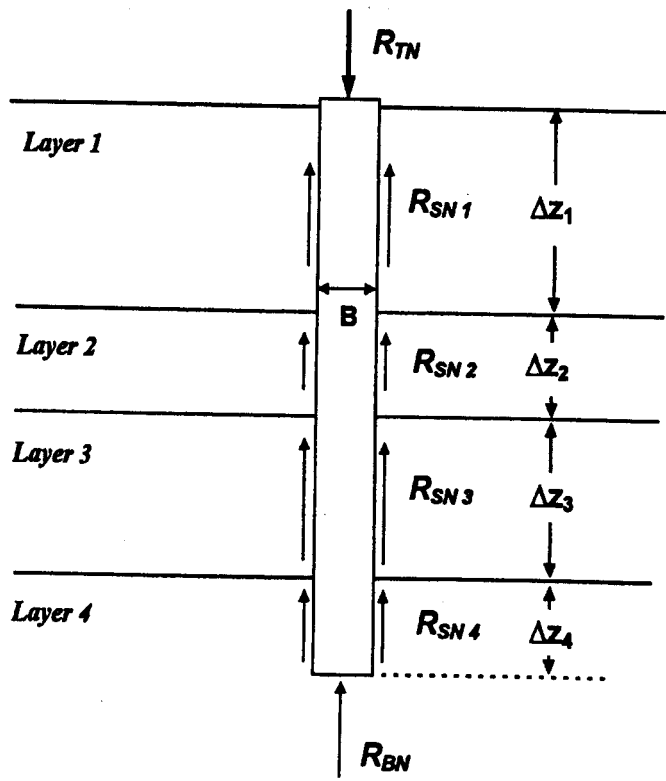

Figure B.3. Idealized geomaterial layering for computation of uplift resistance

Equation (B.1) can be written for the case shown in Figure B.2 as:

$$R_T = \sum_{i=1}^4 R_{S i} + R_B \quad (B.3)$$

If the shaft is cylindrical, Equation (B.3) can be written more specifically as:

$$R_T = \sum_{i=1}^4 (f_{max i}) \pi B \Delta z_i + (q_{max}) \left( \pi \frac{B^2}{4} \right) \quad (B.4)$$

in which

$f_{max i}$  = unit side shearing resistance in Layer  $i$ , which depends on the geomaterial type, the properties of that geomaterial and, for some geomaterials, depth of the center of the layer, the vertical effective stress in the soil at that depth, the concrete pressure at that depth and the roughness of the borehole. That is,  $R_{S i} = f_{max i} \pi B \Delta z_i$ , in which  $\pi B \Delta z_i$  is the peripheral area of the side of the drilled shaft, within Layer  $i$ , over which  $f_{max i}$  acts.

$q_{max}$  = net unit base resistance, which depends on the geomaterial type, the properties of that geomaterial in the layer in which the base is placed, and for some geomaterials, the vertical effective stress in the geomaterial at the depth of the base. That is,  $R_B = q_{max} \pi (B^2/4)$ , in which  $\pi (B^2/4)$  is the bearing area for the base of the drilled shaft.

$\Delta z_i$  = thickness of Layer  $i$ .

The word "resistance" in the context of the above equations refers to ultimate, unfactored (nominal) resistance, not a resistance developed at some small value of deflection, allowable resistance or factored resistance.

The remaining material in this appendix will address the issue of determining specific values for  $f_{max}$  and  $q_{max}$  for the four categories of geomaterials outlined above.

Equation (B.2) can be written for the case shown in Figure B.3 as Equation (B.5), assuming no base resistance in uplift.

$$R_T = \sum_{i=1}^4 R_{S i} + W' \quad (B.5)$$

If the shaft is cylindrical, and it is furthermore assumed that the piezometric surface is below the base of the shaft, Equation (B.5) can be written more specifically as:

$$R_T = \sum_{i=1}^4 (f_{max i}) \pi B \Delta z_i + \gamma_c \pi \frac{B^2}{4} L \quad (B.6)$$

in which

$f_{max i}$  = unit side shearing resistance in Layer  $i$ , which may be different from the value assigned for compression loading in the same layer,

$L$  = total embedded length of the drilled shaft, and

$\gamma_c$  = unit weight of reinforced concrete [typically, 23.5 kN/m<sup>3</sup> (150 lb/ft<sup>3</sup>)].

Note that the expression  $\gamma_c \pi (B^2/4) L$  is the product of the unit weight of the shaft material and the volume of the drilled shaft. If the piezometric surface is located at a depth  $z_w$  below the ground surface, that part of the drilled shaft below depth  $z_w$  would be buoyed up by the pressure in the pore water of the soil or rock. In that case Equation (B.6) becomes:

$$R_T = \sum_{i=1}^4 (f_{max i}) \pi B \Delta z_i + \gamma_c \pi \frac{B^2}{4} z_w + (\gamma_c - \gamma_w) \pi \frac{B^2}{4} (L - z_w) \quad (B.7)$$

in which  $\gamma_w$  is the unit weight of water [9.81 kN/m<sup>3</sup> (62.4 lb/ft<sup>3</sup>) for fresh water; 10.05 kN/m<sup>3</sup> (64.0 lb/ft<sup>3</sup>) for sea water] and  $z_w$  is the depth to the piezometric surface.

## BASE RESISTANCE, $R_B$

### Bearing Capacity Equation

The complete theoretical bearing capacity equation for a bearing surface (base of a drilled shaft) on or beneath the surface of the ground can be expressed by Equation (B.8), which gives the net unit ultimate bearing resistance  $q_{max}$ . It is assumed in this equation that the geomaterial is homogeneous, isotropic, and non-strain softening, so it is not appropriate for jointed rock, rock with karst features or brittle rock without significant modification. It also requires modification for drilled shafts in granular geomaterials in which the stress relief due to excavation can change the values of the parameters used to evaluate the terms in Equation (B.8).

$$q_{max} = \zeta_{sc} \zeta_{dc} \zeta_{ic} N_c c + \zeta_{sq} \zeta_{dq} \zeta_{iq} (N_q - 1) \sigma'_{vb} + 0.5 B \zeta_{sy} \zeta_{dy} \zeta_{iy} N_y \gamma'_b \quad (B.8)$$

in which,

$N_c, N_q, N_\gamma$  = bearing capacity factors for infinitely long footings at the ground surface, which depend upon the angle of internal friction and the rigidity of the soil,

$\zeta_{jk}$  = correction coefficients to account for shape ( $j = s$ ), depth ( $j = d$ ) and inclination of load ( $j = i$ ), for the respective bearing capacity factors,  $N_c$  ( $k = c$ ),  $N_q$  ( $k = q$ ) and  $N_\gamma$  ( $k = \gamma$ ),

$\sigma'_{vb}$  = ambient vertical effective stress in the soil mass (total vertical stress minus pore water pressure in the soil, if any), discounting any stresses induced due to installing or loading the drilled shaft, at the elevation of the base (bottom) of the drilled shaft,

$\gamma'_b$  = effective unit weight of the soil below the base (bottom) of the drilled shaft, (total unit weight if the soil to a depth of  $1.5 B$  below the base is above the piezometric surface and buoyant unit weight if that soil is below the piezometric surface), and

$c$  = average cohesion of the soil in the vicinity of the base elevation. [ $c$  is taken as the undrained shear strength  $s_u$  if undrained loading is assumed or the cohesion intercept on a Mohr-Coulomb diagram from drained shear strength tests if drained loading is assumed.]

If soil substantially softer than the soil surrounding the base is present below the base, the possibility of punching failure, described near the end of this appendix, should be checked.

For most drilled shafts, which are deep foundations, the value of the expression involving  $N_\gamma$  is small compared to the values of the expressions involving  $N_c$  and  $N_q$ , so that the expression involving  $N_\gamma$  is normally ignored in design.

### **Drained and Undrained Loading**

The geotechnical engineer should determine whether loading the drilled shaft will produce undrained or consolidated, drained ("drained") pore water pressure conditions in the geomaterial beneath the base of the drilled shaft for each condition for which the foundation is to be designed (e. g., for each limit state in LRFD). Which condition is selected is a function of the permeability and compressibility of the geomaterial and the duration of the critical design loads. Ordinarily, undrained conditions (no dissipation of pore water pressure produced by constructing or loading the drilled shaft) are assumed when the base of the drilled shaft is placed in a cohesive soil. Undrained loading is sometimes assumed for rock that is saturated and even for cohesionless intermediate geomaterials. Drained conditions are ordinarily assumed for free-draining granular soils for loading cases other than impact or seismic loading.

During undrained loading, the shear strength of the geomaterial does not change while the drilled shaft is being loaded to a geotechnical failure condition. During drained loading, the loads that

are applied are transferred as normal stresses (as well as shear stresses) to the soil framework because the pore water pressures generated by loading the geomaterial dissipate immediately. Since soils and rocks are frictional materials, the increased normal stresses produced by loading usually increase the strength of the soil or rock, so that drained conditions are usually not critical unless undrained behavior can be ruled out (e. g., in freedraining sands and gravels subjected to non-dynamic loads). In some geomaterials, however, notably heavily overconsolidated cohesive geomaterials, the shearing component of applied load can cause part of the geomaterial surrounding the base to expand or "dilate" as the load is applied. During undrained loading dilation is resisted by the generation of negative pore water pressures (suction), which keeps the geomaterial from losing strength. During drained loading, the suction pressures in the pore water dissipate, which can result in a reduction in shear strength and consequently in bearing resistance. Such behavior is likely only in very heavily overconsolidated cohesive geomaterials.

If very heavily overconsolidated cohesive geomaterials are to be used to support the base of a drilled shaft, it is prudent to assess  $q_{\max}$  for both undrained and drained loading conditions. It is advisable, in fact, to evaluate  $q_{\max}$  assuming that any geomaterial is both undrained and drained if there is any doubt about which condition will exist for a given limit state. With such an approach, the drainage condition that results in the lowest value of  $q_{\max}$  should be assumed for design.

## **Undrained Loading**

### **Evaluating the Shear Strength**

For undrained loading, the shear strength of the soil is characterized by the parameter  $s_u$ . This parameter is usually assumed to be the indicated cohesion of the soil that is extracted from the ground during the subsurface investigation and tested either in unconsolidated, undrained (UU) triaxial compression or in consolidated, undrained (CU) triaxial compression.  $s_u$  is taken to be  $0.5 (\sigma_1 - \sigma_3)_{\text{failure}}$  when the pressure in the triaxial cell ( $\sigma_3$ ) is equal to the estimated total vertical pressure in the ground at the depth of the sample when UU testing is performed or the estimated effective vertical pressure in the ground at the depth of the sample when CU testing is performed.  $\sigma_1$  is the axial stress that is applied to the sample, which exceeds  $\sigma_3$ . The cell pressure  $\sigma_3$  is applied isotropically in the UU compression test, and it is ordinarily applied isotropically in the CU compression test unless the geotechnical engineer has reason to believe that the test results will be more accurate if the soil samples are tested after they are consolidated anisotropically.

CU triaxial testing is preferred when the soil is soft or when there is to be considerable filling or excavation (including scour) at the site of the drilled shaft. In the event that filling or excavation will occur, the cell pressure is taken to be the estimated vertical effective stress in the ground after filling or excavation has occurred in order to simulate the effects of filling or excavation on the final strength of the soil. In most stiff to hard clays, there is relatively little difference in the value of  $s_u$  obtained by UU and CU triaxial testing, except for the filling/excavation condition.

A special case of the UU triaxial test is the unconfined compression test (UC) test. The absence of confinement will almost always result in a value of  $s_u$  that is below the *in-situ* value. In soils, therefore, it is recommended that the UU triaxial test, and not the unconfined compression test, be used to evaluate  $s_u$ .

The design equations in Chapter 11 are predicated on the assumption that the UU triaxial test has been used to evaluate the undrained shear strength of cohesive soils. If only CU or UC test results are available, the geotechnical engineer should develop a local correlation between  $s_u$  determined under CU or UC conditions and  $s_u$  determined under UU conditions before proceeding to evaluate the geotechnical resistance of the drilled shaft. Some guidance on this point is provided by Chen and Kulhawy, 1994. Figures B.4 and B.5, from that reference, provide approximate correlations from a data base of moderate size between  $s_u$  values determined from CIUC tests (CU triaxial compression tests with isotropic soil consolidation), UC tests and UU tests. In those figures the correlation is seen to be dependent on the degree of overconsolidation in the soil. The notations that are used to describe degree of overconsolidation are NC (normally consolidated,  $1 \leq OCR \leq 1.3$ ); LOC (lightly overconsolidated,  $1.3 \leq OCR \leq 3.0$ ); MOC (moderately overconsolidated,  $3.0 \leq OCR \leq 10$ ); and HOC (heavily overconsolidated,  $OCR > 10$ ). OCR (overconsolidation ratio) is defined as  $\sigma'_{vm} / \sigma'_{vo}$ , in which  $\sigma'_{vm}$  is the maximum

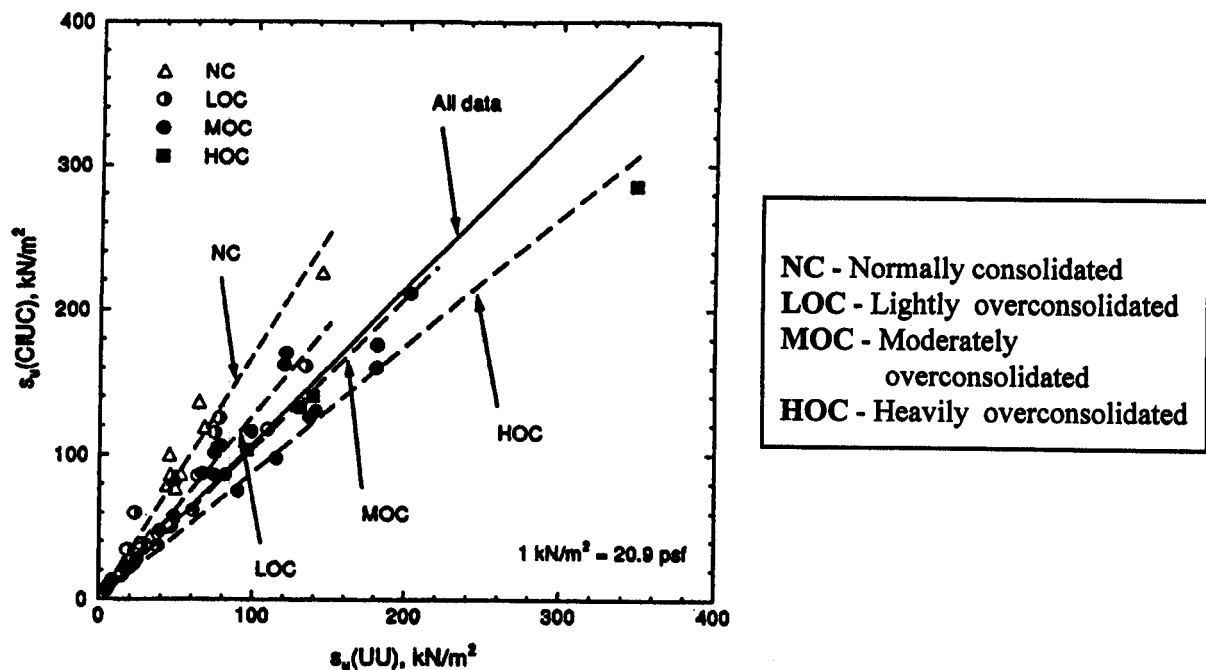

Figure B.4. Relation between  $s_u$  from CIUC tests and UU tests (Chen and Kulhawy, 1994)



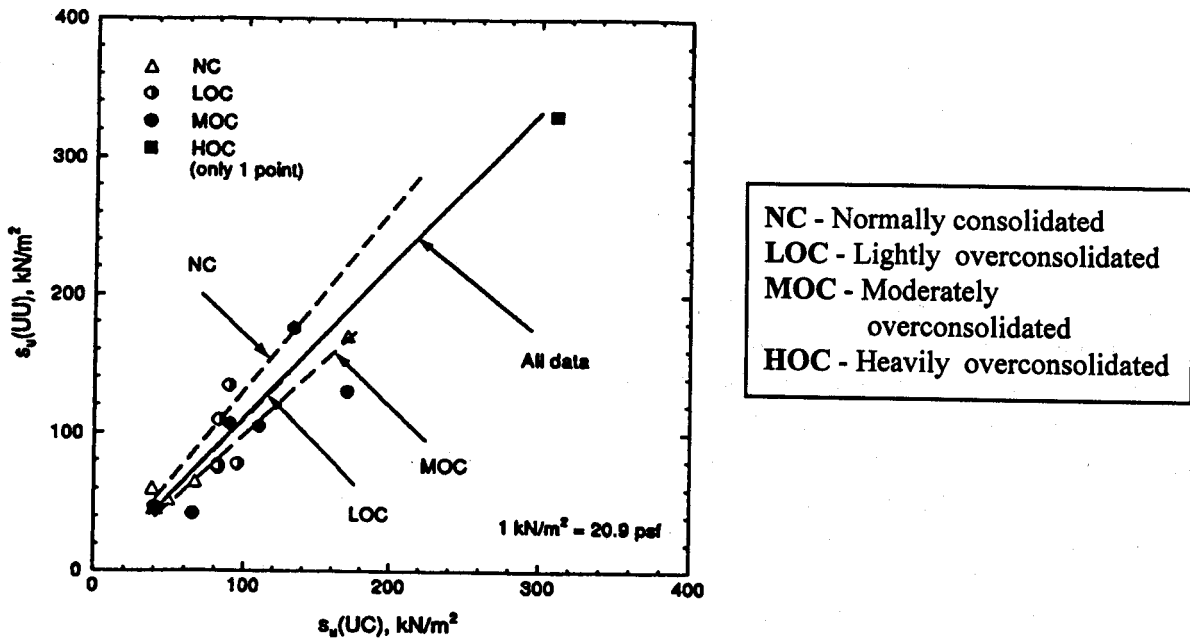

Figure B.5. Relation between  $s_u$  from UC tests and UU tests (Chen and Kulhawy, 1994)

vertical effective stress that has ever existed in the soil throughout its geologic history, and  $\sigma'_{vo}$  is the current vertical effective stress in the ground. Both pressures are determined at the elevation from which the sample was recovered. OCR is determined by a combination of laboratory consolidation tests and geologic evidence. It is pointed out that it is important to know the unit weight of the soil and the elevation of the piezometric surface in order to compute the current vertical effective stress through standard principles of soil mechanics. See Cheney and Chassie, 1993.

In rock, it is cumbersome and expensive to conduct triaxial compression tests, so that  $s_u$  is ordinarily determined from UC tests on rock cores. Furthermore, in rock, as well in cohesive intermediate geomaterials, it is customary to report the unconfined strength of the rock or intermediate geomaterial,  $q_u$ , rather than  $s_u$  ( $=q_u/2$ ). For example, a cohesive intermediate geomaterial is defined for purposes of this manual as a geomaterial in which  $0.5 \text{ MPa} \leq q_u \leq 5.0 \text{ MPa}$ , and rock is defined for purposes of this manual as a cemented geomaterial with  $q_u > 5 \text{ MPa}$ . The value of  $q_u$  obtained from such tests in most rocks and intermediate geomaterials is dependent on the size of the test core. The lower the RQD of the rock or intermediate geomaterial (Chapter 2) the larger should be the diameter of the core. Rocks and intermediate geomaterials with high RQD's (e. g., 70 per cent or higher) can be tested adequately with 50-mm- (2-in.-) diameter cores. However, those with RQD's below 50 per cent should be tested with 75- to 100-mm- (3- to 4-in.-) diameter cores.

It is also possible to evaluate  $s_u$  from results of the pressuremeter test (PMT) and cone penetrometer test (CPT) in cohesive soils, and the PMT in cohesive intermediate geomaterials

and rocks. In fact, the use of *in-situ* tests such as these is advisable when good-quality samples of such geomaterials cannot be obtained for testing in the laboratory. Descriptions of the interpretation of those tests to obtain soil parameters such as  $s_u$  is beyond the scope of this manual. However, a method to evaluate drilled shaft resistance based directly upon CPT records is covered briefly at the end of this appendix.

**Simplified Bearing Capacity Equation - Cohesive Soil**  
 **$[s_u \leq 0.25 \text{ MPa (5,200 lb / ft}^2\text{)]}$**

For undrained analysis, the angle of internal friction of the soil,  $\phi$ , is taken to be zero since no change in shear strength occurs during loading. With that assumption,  $N_q = 1$  ( $N_q - 1 = 0$ ) and  $N_\gamma = 0$ . If it is assumed that the inclination of the soil reaction on the base of the drilled shaft is zero (soil base reaction parallel to the axis of the shaft) and the depth of the base  $L \geq 3B$ , where  $B$  is the diameter of the shaft at the base,  $\zeta_{sc} \zeta_{dc} \zeta_{ic} N_c = N_c^*$  can be determined by assuming that base failure occurs in the soil by the expansion of a spherical cavity against the surrounding elastic soil mass (e. g., Vesic, 1972). In such a case, Equation (B.8) simplifies to:

$$q_{max} = N_c^* s_u \tag{B.9}$$

in which

$$N_c^* = 1.33 (\ln I_r + 1) \tag{B.10}$$

In Equation (B.10)  $I_r$  is the "rigidity index" of the soil, which for a  $\phi = 0$  (undrained) geomaterial can be expressed by Equation (B.11):

$$I_r = \frac{E_s}{3s_u} \tag{B.11}$$

in which  $E_s$  is the Young's modulus of the soil in undrained loading.  $E_s$  should be measured in order to apply Equations (B.9) through (B.11). This can be accomplished through triaxial or *in-situ* testing, such as pressuremeter testing. If  $E_s$  is not measured, it can be assumed with less accuracy to be a function of  $s_u$  for design purposes by using Table B.1.

Table B.1.  $E_s/3s_u$  for Cohesive Soil in UU Triaxial Compression and Values of  $N^*_c$ .

$s_u$	$E_s/3s_u$	$N^*_c$
24 kPa (500 lb / ft <sup>2</sup> )	50	6.5
48 kPa (1000 lb / ft <sup>2</sup> )	150	8.0
96 kPa (2000 lb / ft <sup>2</sup> )	250	8.7
192 kPa (4000 lb / ft <sup>2</sup> )	300	8.9

If the cohesive soil in which the base bears has a value of  $s_u \geq 96$  kPa (2000 lb / ft<sup>2</sup>), then

$$q_{max} = 9 s_u \quad (B.12)$$

can be used with sufficient accuracy.

If  $L < 3B$ ,  $q_{max}$  should be reduced to take account of the effect of the presence of the soil surface. This may be done by taking

$$q_{max} = 0.667[1 + 0.1667(L/B)] N^* s_u \quad (B.13)$$

in which  $L/B \leq 3$ .

**Modified Bearing Capacity Equation - Intermediate Geomaterials and Rock**  
 **$[s_u > 0.25$  MPa (5,200 lb / ft<sup>2</sup>)]**

**Massive Rock and Cohesive Intermediate Geomaterial.** Rock and cohesive intermediate geomaterials (IGM's) are characterized by very low framework compressibility and, therefore, according to the theory of consolidation, they tend to drain when loaded much more rapidly than cohesive soils, which have high framework compressibility. The assumption of undrained loading for rock and IGM's is therefore probably never correct, but it is usually conservative. Furthermore, since it is difficult to evaluate the shear strength properties for rock and IGM's under drained conditions, undrained shear strength parameters are often used in design.

When the base of a drilled shaft bears on rock or an IGM, its bearing capacity  $q_{max}$  is highly dependent upon the joint structure of the geomaterial. In fact, the effect of the joint structure, which can weaken the rock or IGM mass considerably relative to the strength of the intact geomaterial between the joints and which is the geomaterial that is normally tested, is the distinguishing difference between analyzing bearing capacity in rock/IGM and in soil. The reader is referred to appropriate references on rock mechanics and foundations in rock for

background information (e. g., Carter and Kulhawy, 1988; Goodman, 1989; and ASCE, 1996).

If the rock or IGM is massive (there are an insignificant number of joints) the base resistance of a drilled shaft can be assumed to be limited to the average stress that produces fracturing in the rock or IGM. Such fractures develop around the edges of the base and generally propagate downward and outward, as indicated in Figure B.6, and result in punching failure of the base of the shaft.

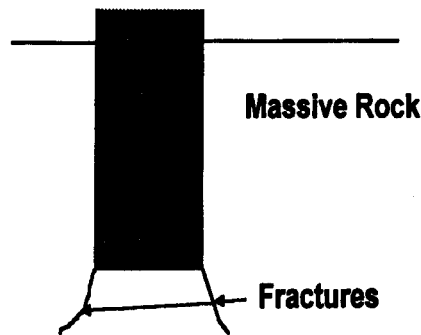

Figure B.6. Fracturing (punching) of a foundation in massive rock or IGM

According to Rowe and Armitage (1987), fracturing can be expected to occur when  $q_{max} \approx 2.5 q_u$ . Hence, in massive rock or IGM, the following expression may be used for design purposes:

$$q_{max} = 2.5 q_u \quad (D_s > 1.5 B) \quad (B.14)$$

This value is appropriate for a drilled shaft socketed into rock or IGM by a distance ( $D_s$ ) below the rock surface equal to about  $1.5 B$ . If the base of the drilled shaft is bearing on the surface of the massive rock or IGM, and that geomaterial is overlain by a softer overburden geomaterial, it is prudent to limit  $q_{max}$  to a maximum value of  $2 q_u$ . Williams et al. (1980) suggest limiting  $q$  (the developed base resistance) to  $0.5 q_u (< q_{max})$  in mudstone in order to limit the settlement of the drilled shaft to less than  $0.01 B$ . However, this does not represent a limit state in terms of bearing capacity.

Zhang and Einstein (1998) have analyzed a data base of full-scale drilled shaft tests in which the shaft bases were cast on or in generally soft rock with some degree of jointing (lower mass strength than massive rock or IGM) and have recommended the following best-fit expression for the data.

$$q_{max} (MPa) = 4.83 [q_u (MPa)]^{0.51} \quad (B.14a)$$

The bases of drilled shafts founded on the surface of rock ( $D_s = 0$ ) should be placed on unweathered rock if feasible. From a construction perspective, this usually requires that the drilled shaft excavation pass through a zone of weathered rock. Since the elevation of the surface

of unweathered rock is often difficult to define, the definition of  $D_b$  is somewhat dependent upon judgment, which requires skilled inspectors. When the bedrock is karstic, the designer may wish to disregard base resistance altogether unless the presence of unweathered rock below the base is verified before or during construction.

If the base of the drilled shaft is to be placed in rock, it is also important to determine the structural resistance of the drilled shaft, which may control. See Chapter 13. Checking structural resistance is especially important if side resistance is to be used in the design in addition to base resistance.

**Cohesionless Intermediate Geomaterials.** Cohesionless intermediate geomaterials are residual or transported granular earth materials that exhibit  $N > 50$ . It is customary and conservative to treat such materials as behaving in an undrained manner in base bearing. Often, such materials contain considerable fines, which limit base drainage. Following the correlative method of Mayne and Harris (1993),  $q_{max}$  for such materials is approximately  $(0.59)[N_{60} (p_a / \sigma'_{vb})]^{0.8} \sigma'_{vb}$ , where  $N_{60}$  is the SPT blow count in blows/0.3 m immediately below the base of the shaft, based on experimental studies in Piedmont residuum.  $q_{max}$  has the units of  $\sigma'_{vb}$ .

**Jointed Rock and Cohesive Intermediate Geomaterial.** There are several procedures to estimate undrained bearing capacity (base resistance) of drilled shafts in jointed rock. Two will be given here. It can be assumed that they also apply to cohesive IGM's.

**Method 1.** Carter and Kulhawy (1988), based partially on the work of Hoek (1983); suggest a lower bound solution for bearing capacity for a drilled shaft bearing on randomly jointed rock. The same solution can be applied whether the base of the drilled shaft is situated at the surface of the rock or is embedded (socketed) into the rock. In this method the rock has mass properties  $s$  and  $m$ , which are crudely equivalent to  $c'$  (cohesion) and  $\phi'$  (internal frictional) for a soil. The assumption is made that the joints are drained but the rock between the joints is undrained and the shearing stresses in the rock mass are nonlinearly dependent upon the normal stresses at failure. The joints are not necessarily oriented preferentially. The joints may be closed or open and even filled with weathered geomaterial ("gouge"). The net ultimate bearing capacity of the base is given by Equation (B.15):

$$q_{max} = [s^{0.5} + (m s^{0.5} + s)^{0.5}] q_u \quad (B.15)$$

in which the expression in the brackets assumes mathematically the function of  $N^*$ , for clay soils. Values of the parameters  $s$  and  $m$  of the jointed rock mass are evaluated from Tables B.2 and B.3.

An example of the use of this method is given below. Note that this method is not explicitly covered in AASHTO (1994), so that factors of safety or resistance factors must be estimated by the designer.

Table B.2. Values of  $s$  and  $m$  Based on Rock Classification (Carter and Kulhawy, 1988)

Quality of Rock Mass	Joint Description and Spacing	$s$	Value of $m$ as Function of Rock Type (A - E) from Table B.3				
			A	B	C	D	E
Excellent	Intact (closed); Spacing > 3 m (10 ft)	1	7	10	15	17	25
Very good	Interlocking; Spacing of 1 to 3 m (3 to 10 ft)	0.1	3.5	5	7.5	8.5	12.5
Good	Slightly Weathered; Spacing of 1 to 3 m (3 to 10 ft)	$4 \times 10^{-2}$	0.7	1	1.5	1.7	2.5
Fair	Moderately Weathered; Spacing of 0.3 to 1 m (1 to 3 ft)	$10^{-4}$	0.14	0.2	0.3	0.34	0.5
Poor	Weathered with Gouge (soft material); Spacing of 30 to 300 mm (1 in. to 1 ft)	$10^{-5}$	0.04	0.05	0.08	0.09	0.13
Very poor	Heavily Weathered; Spacing of less than 50 mm (2 in.)	0	0.007	0.01	0.015	0.017	0.025

Table B.3. Descriptions of Rock Types for Use in Table B.2 (Hoek, 1983)

Rock Type	Description
A	Carbonate rocks with well-developed crystal cleavage (dolostone, limestone, marble)
B	Lithified argillaceous rocks (mudstone, siltstone, shale, slate)
C	Arenaceous rocks (sandstone, quartzite)
D	Fine-grained igneous rocks (andesite, dolerite, diabase, rhyolite)
E	Coarse-grained igneous and metamorphic crystalline rocks (amphibolite, gabbro, gneiss, granite, norite, quartzdiorite)

An example of this method is given below.

---

**Example B-1.** *Computation of  $q_{max}$  in a jointed rock - Method 1.*

A drilled shaft is to be installed with its base in a shale formation. During the subsurface exploration phase, an observation shaft is excavated, and it is observed that the shale is heavily jointed. The average joint spacing near the planned elevation of the base of the shaft is 0.3 m (1 ft), and the joints appear to the observer to be moderately weathered. Unconfined compression tests on the intact rock cores recovered with a triple walled core barrel reveal an average  $q_u$  of 6.0 MPa (870 lb/in<sup>2</sup>) within the grouping of borings assumed for the design. The following calculations are made.

- From Table B.3, the rock is classified as "Type B."
- From Table B.2, the rock quality is classified as "fair" and the values of  $s$  and  $m$  are  $10^{-4}$  and 0.2, respectively.
- From Equation (B.15),

$$\begin{aligned}
 q_{max} &= \{0.0001^{0.5} + [0.2 (0.0001^{0.5}) + 0.0001]^{0.5}\} 6 \text{ MPa} \\
 &= \{0.01 + 0.00201^{0.5}\} 6 \text{ MPa} \\
 &= \{0.056\} 6 \text{ MPa} = 0.335 \text{ MPa} = 3.50 \text{ tons/ft}^2 = 48.6 \text{ lb/in}^2.
 \end{aligned}$$

Note that  $q_{max}$  is only 0.056  $q_u$  in this case, which illustrates the severity of the effect of jointing on the bearing capacity. Note also that this is a lower bound solution and that load testing may prove the actual bearing capacity (base resistance) to be higher.

---

**Method 2.** The Canadian Foundation Engineering Manual (CFEM) (Canadian Geotechnical Society, 1985) recommends the use of Equation (B.16) for  $q_{max}$  for cases where the rock (or IGM) is sedimentary jointed and where the joints are primarily horizontal. This method is based on the work of Ladanyi et al. (1974) and involves both theoretical and empirical components. It is the method for estimating base resistance of drilled shafts in rock for which resistance factors are recommended in AASHTO (1994).

$$q_{max} = 3 K_{sp} \Theta q_u \quad (B.16)$$

in which

$K_{sp}$  = bearing capacity factor based on vertical joint spacing and quality, and

$\Theta$  = depth factor =  $1 + 0.4 (D_s/B) \leq 3.4$ , where  $D_s$  is the depth of the drilled shaft socket measured from the top of the rock surface (not from the ground surface).

$K_{sp}$  is evaluated from the spacing and quality of the joints and generally falls between 0.4 for very wide joint spacing [ $> 3$  m (10 ft)] and 0.1 for moderately close joint spacing [0.3 to 1 m (1 to 3 ft)]. An analytical expression recommended in the CFEM for  $K_{sp}$  is:

$$K_{sp} = \frac{3 + \frac{s_v}{B}}{10 \sqrt{1 + 300 \frac{t_d}{s_v}}} \quad (B.17)$$

in which

$s_v$  = vertical spacing between joints,

$t_d$  = thickness, or "aperture," of joints (open joints or joints filled with debris), and

$B$  = diameter of the base of the drilled shaft.

The ranges of validity for Equation (B.17) are for  $B > 0.3$  m (12 in.),  $0.05 < s_v/B < 2.0$ , and  $0 < t_d/s_v < 0.02$ .

A numerical example of the use of this method is given below.

---

**Example B-2. Computation of  $q_{max}$  in a jointed rock - Method 2.**

Suppose an observation shaft in a sedimentary rock reveals  $s_v = 0.3$  m,  $t_d = 2$  mm (debris filled), and tests on rock cores reveal an average value of  $q_u = 6$  MPa (870 lb/in<sup>2</sup>) at the elevation at



which the base of a drilled shaft will be installed. The coefficient of variation of  $q_u$  within the grouping of borings selected to represent the rock at the site of this shaft is 0.25, which permits the resistance factors in AASHTO (1994) (Table A-4 of this manual) to be used. It is proposed to design the drilled shaft with a diameter  $B = 1$  m (3 ft., 4 in.), and the shaft will be embedded (socketed) 0.5 m (1 ft, 7 in.) into the rock. What value of  $q_{\max}$  is appropriate according to Equation (B.16)?

- First, evaluate  $\Theta$ :  $B = 1$  m,  $D_s = 0.5$  m, so  $\Theta = 1 + 0.4 (0.5/1) = 1.2$
- Second, evaluate  $K_{sp}$  from Equation (B.17):

$$s_v/B = 0.3 / 1 = 0.3 \text{ (within limits)}$$

$$t_d/s_v = 0.002/0.3 = 0.0067 \text{ (within limits)}$$

$$K_{sp} = \{3 + 0.3\} / \{10 [1 + 300 (0.0067)]^{0.5}\} = 3.3 / 17.35 = 0.19$$

- Finally, compute  $q_{\max}$  from Equation (B.16):

$$q_{\max} = 1.2 (0.19) 6.0 = (0.228) 6 = 1.37 \text{ MPa} = 14.3 \text{ tons/ft}^2 = 199 \text{ lb/in.}^2$$

Notice, as with Example B-1, the ultimate bearing capacity (base resistance) is reduced to a value of less than 25 per cent of  $q_u$  because of the effect of the joints.

## Drained Loading

### Drained Loading in Soil

Equation (B.8) can be applied theoretically to drained loading conditions (fully dissipated excess pore pressure) in either cohesive or cohesionless soil. It is important that the designer understand that  $\sigma'_{vb}$  and  $\gamma'$  are defined in terms of *effective* and not total stresses and unit weights. Except for very shallow drilled shafts, the expression involving  $N_\gamma$  can be ignored. Even in very shallow drilled shafts, ignoring  $N_\gamma$  will result in only a slightly conservative design. Therefore, Equation (B.8) reduces to

$$q_{\max} = \zeta_{sc} \zeta_{dc} \zeta_{ic} N_c c + \zeta_{sq} \zeta_{dq} \zeta_{iq} (N_q - 1) \sigma'_{vb} \quad (\text{B.18})$$

Values of  $N_c$  and  $N_q$  for strip footings on the surface of rigid soils are plotted in Figure B.7. During bearing failure a plastic failure zone develops beneath a circular loaded area that is accompanied by elastic deformation in the surrounding elastic soil mass. The confinement of the elastic soil surrounding the failing (plastic) soil has an effect on  $q_{\max}$ . For that reason,  $N_c$  and  $N_q$  are dependent not only on  $\phi$ , the drained angle of internal friction of the soil, but also on  $I_r$ , the rigidity index of the soil. They must be corrected for soil rigidity as indicated below. The

corrected values are used in Equation (B.18).

$$N_c \text{ (corrected)} = N_{c \text{ (from Figure B.7)}} \zeta_{rc} \quad (\text{B.19})$$

$$N_q \text{ (corrected)} = N_{q \text{ (from Figure B.7)}} \zeta_{rq} \quad (\text{B.20})$$

in which, according to Chen and Kulhawy (1994),

$$\zeta_{rc} = \zeta_{rq} - [(1 - \zeta_{rq}) / (N_{c \text{ (from Figure B.7)}} \tan \phi)] \quad \text{and} \quad (\text{B.21})$$

$$\zeta_{rq} = \exp \{[-3.8 \tan \phi] + [(3.07 \sin \phi)(\log_{10} 2I_{rv}) / (1 + \sin \phi)]\} \quad (\text{B.22})$$

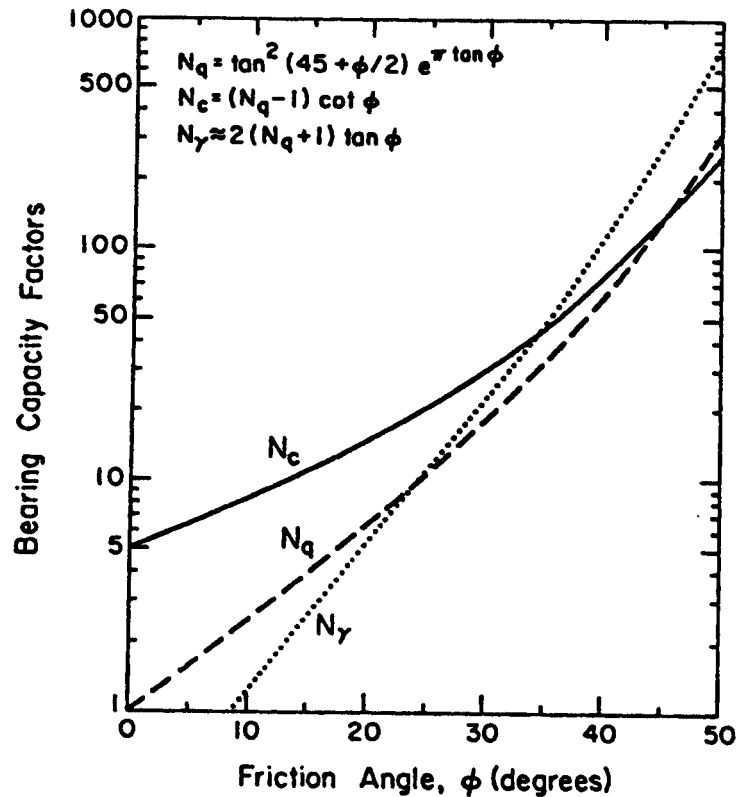

Figure B.7. Bearing capacity factors (Chen and Kulhawy, 1994)

$\phi$  is an effective stress angle of internal friction. It can be estimated for granular soils from standard penetration tests, cone penetrometer tests or from similar procedures [e. g., Chen and Kulhawy, 1994; Hannigan et al., 1996].  $\phi$  typically ranges from 25° to 40° in cohesionless soils.  $\phi$  is determined for cohesive soils from consolidated drained (CD) triaxial compression and/or

direct shear tests performed in the laboratory on recovered samples.  $\phi$  typically ranges from 10° to 25° in clay.

$I_{rr}$  is the "reduced rigidity index," which relates shear modulus to shear strength and volume change during drained loading. It can be evaluated approximately by using Equation (B.23).

$$I_{rr} = I_r / [1 + I_r \Delta] \quad (\text{B.23})$$

in which

$\Delta$  = volumetric strain within the plastic zone during the loading process, and  
 $I_r$  = soil rigidity index =  $E_d / [2(1 + \nu_d) \sigma'_{vb} \tan \phi]$ , ignoring cohesion.

In the expressions above,  $E_d$  is the drained Young's modulus of the soil around the base of the drilled shaft and  $\nu_d$  is the drained Poisson's ratio of the soil. Chen and Kulhawy suggest that, for granular soils,  $E_d = 100 p_a$  to  $200 p_a$  for loose soils,  $200 p_a$  to  $500 p_a$  for medium dense soils and  $500 p_a$  to  $1000 p_a$  for dense soils, in which  $p_a$  = atmospheric pressure (e.g. 101 kPa). In order to evaluate  $\nu_d$  and  $\Delta$  for uncemented granular soils, they also suggest that a relative friction angle factor  $\phi_{rel}$  be defined, from which  $\nu_d$  and  $\Delta$  can be estimated, as follows.

$$\phi_{rel} = [\phi^\circ - 25^\circ] / [45^\circ - 25^\circ] \quad 25^\circ \leq \phi \leq 45^\circ \quad (\text{B.24})$$

$$\nu_d = 0.1 + 0.3 \phi_{rel} \quad (\text{B.25})$$

$$\Delta = 0.005 (1 - \phi_{rel}) (\sigma'_{vb} / p_a) \quad (\text{B.26})$$

In cohesive soils,  $\phi$ ,  $E_d$ ,  $\nu_d$  and  $\Delta$  need to be evaluated or estimated on a site-specific basis, since no simplified procedure is available. Measurements can be made by conducting consolidated drained (CD) triaxial compression tests on several samples of soil confined at effective pressures near the estimated vertical effective stress  $\sigma'_{vb}$ . It is often conservative to assume that  $I_{rr} = 10$ .

More rigorous, but also more complex, methods for evaluating  $I_{rr}$  are described by Vesic (1972).

These equations indicate that soils that are compressible and are confined beneath the base of a drilled shaft by flexible (soft) elastic soil exhibit lower bearing capacities than soils with the same  $\phi$  that are less compressible and are confined by stiff soils. Thus, an overconsolidated soil with a given value of  $\phi$  will have a higher bearing capacity than a normally consolidated soil with the same value of  $\phi$ .

These equations also reflect the fact that the rigidity index is the ratio of shear stiffness to shear

strength and that the shear stiffness of the soil increases at a slower rate with increasing effective confining pressure (depth) than does the shear strength. Consequently, the deeper the base of the drilled shaft the smaller the value of  $I_{rr}$ , which means that in a soil of constant unit weight, compressibility and  $\phi$ ,  $q_{\max}$  increases with depth at a decreasing rate. This concept is broadly equivalent to limiting  $q_{\max}$  to a constant value regardless of  $\sigma'_{vb}$  below some "critical depth," which is used in other design methods.

The reductions implied in Equations (B.19) and (B.20) need be applied only if  $I_{rr}$  is less than the critical rigidity index  $I_{rc}$ , which is given by Equation (B.27). Otherwise, the factors  $\zeta_{ic}$  and  $\zeta_{iq}$  are assumed to be equal to unity.

$$I_{rc} = 0.5 \exp [2.85 \cot (45^\circ - \phi / 2)] \quad (\text{B.27})$$

The  $\zeta$  coefficients for Equation (B.18) are evaluated as indicated in Table B.4.

Table B.4. Correction Coefficients for Bearing Capacity Factors (Chen and Kulhawy, 1994)

Coefficient	Value
$\zeta_{sc}$	$1 + (N_q/N_c)$ (from Figure B.7)
$\zeta_{dc}$	$\zeta_{dq} - [(1 - \zeta_{dq}) / (N_c \text{ (from Figure B.7)} \tan \phi)]$
$\zeta_{sq}$	$1 + \tan \phi$
$\zeta_{dq}$	$1 + 2 (\tan \phi) (1 - \sin \phi)^2 \{[\pi/180^\circ] \tan^{-1} [L/B \text{ (in radians)}]\}$

In point of fact, the theoretical method outlined above is problematical to apply in practice because the stress relief that is produced upon excavating drilled shafts in granular soils, particularly at large depths, also has an effect on  $q_{\max}$ . The effect is difficult to quantify analytically, although in the future it may be possible to modify Equation (B.26) or to introduce a new expression to account for stress relief. In Chapter 11, therefore, a simple, direct empirical correlation between the average SPT N value from the standard penetration test (i.e.  $q_{\max} \text{ (kPa)} = 57.5 N_{\text{SPT}}$ ) is used to evaluate  $q_{\max}$  under drained loading conditions in granular soils.

### Drained Loading in Preferentially Sloping, Jointed Rock

Methods 1 and 2 for bearing capacity of undrained, jointed rock will usually suffice for making conservative estimates of base resistance for drilled shafts in rock for design purposes when loading test data are not available. However, when the drilled shaft is founded on sloping or horizontally bedded rock with parallel or near-parallel rock joints, as illustrated in Figure B.8, the value of  $q_{\max}$  can be estimated for drained loading using a method proposed by Davis as reported by Carter and Kulhawy (1988). In this method, both the rock and the joints are considered

drained and the bearing capacity is strongly related to the slope (dip) of the joints (discontinuities). This method requires that the spatial orientation of the joints be estimated. The analytical solution was developed for a strip footing on the surface of the rock, but it is applicable, with some additional conservatism, to a circular drilled shaft founded on or socketed into sloping or horizontally bedded rock. In this method,  $q_{max}$  is evaluated using Equation (B.28):

$$q_{max} = N_{cs} (c_r + q \tan \phi_r) \quad (B.28)$$

in which

$c_r$  = the drained cohesion of the intact rock,

$\phi_r$  = the drained angle of internal friction of the intact rock, and

$q$  = the effective surcharge from the overburden and overlying rock (if any) at the level of the base of the drilled shaft (= ambient vertical effective stress  $\sigma'_{vb}$  at the elevation of the base of the drilled shaft, after any excavation or filling in the vicinity of the shaft), and

$N_{cs}$  = a bearing capacity factor given by Figure B.8.

Note that in Figure B.8 it is assumed that  $\phi_r = 35$  degrees.  $\phi_j$ , the angle of friction along the joint, or "discontinuity," is also assumed to be 35 degrees. The solution to Equation (B.28) is sensitive to both  $\phi_r$  and  $\phi_j$ , but it is given only for one set of values of  $\phi$  ( $\phi_r = \phi_j = 35$  degrees). The true value of 35 degrees, therefore, represents a conservative design value for both  $\phi_r$  and  $\phi_j$  for most rocks, except for rocks that have open joints that are filled with soft gouge. In that case, either Methods 1 and 2, described in the preceding section, should be used (conservatively) in design, or loading tests should be performed to evaluate  $q_{max}$ .

Figure B.8 evaluates  $N_{cs}$  for the condition in which  $q = 0$  (footing on the surface); however, the values are appropriate for use in Equation (B.28). Values are given as functions of discontinuity orientation (joint slope)  $\omega$ , and  $c_j/c_r$ . The latter ratio is a measure of the shear strength of the joints relative to the shear strength of the intact rock. Whenever there is no surcharge,  $c_j/c_r =$  drained cohesion along the rock joint / drained cohesion of the intact rock = 0. When the base of the drilled shaft is beneath the ground surface (usual case), a surcharge,  $q$ , exists, and  $c_j/c_r$  may be evaluated from Equation (B.29)

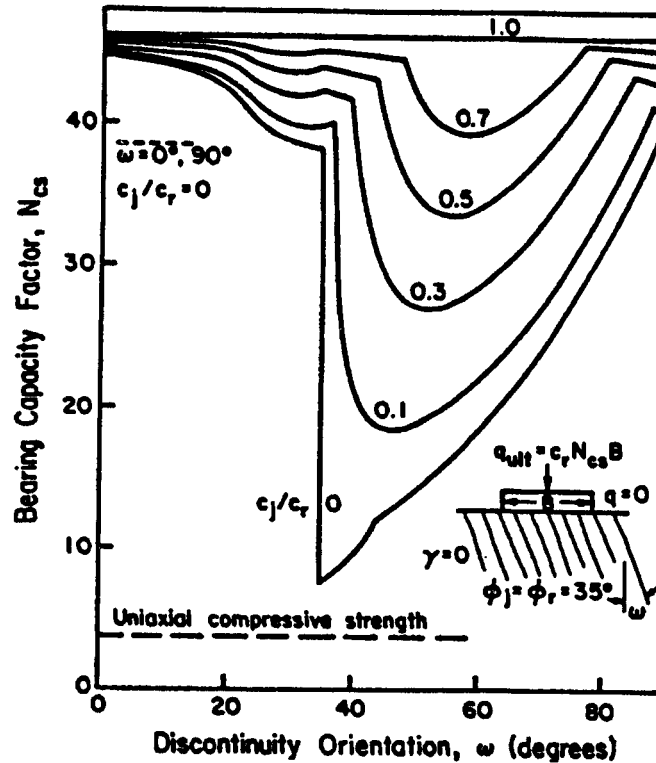

Figure B.8. Bearing capacity factor  $N_{cs}$  as a function of joint slope and relative shear strength of joints and intact rock (Carter and Kulhawy, 1988)

$$c_j/c_r (q > 0) = (c_j + q \tan \phi_j) / (c_r + q \tan \phi_r) \quad (\text{B.29})$$

For the particular situation given in Figure B.8,  $\phi_r = \phi_j = 35$  degrees, so  $\tan \phi_r$  and  $\tan \phi_j$  can be replaced by 0.70, in which case

$$c_j/c_r (q > 0) = (c_j + 0.7 q) / (c_r + 0.7 q) \quad (\text{B.30})$$

The value of  $c_r$  can be obtained from CD triaxial or direct shear tests on the rock cores. Since  $c_r$  is a value for drained pore pressure conditions, it is not equal to  $q_u/2$ . Alternatively,  $c_r$  can be estimated by conducting unconfined compression tests and splitting tension or direct tension tests on the rock cores, which give the unconfined compression strength  $q_u$  and the tensile strength  $q_t$ , respectively. McVay et al. (1992) show that  $c_r \approx 0.5 [q_u]^{0.5} [q_t]^{0.5}$ .  $c_j$  is rarely measured, but it can be estimated conservatively or assumed to be equal to zero when estimates cannot be made. If  $c_j$  is assumed to be zero,

$$c_j/c_r (q > 0) = (0.7 q) / (c_r + 0.7 q) \quad (\text{B.31})$$

Note that this method can be used where the joints are horizontal ( $\omega = 0$ ), or nearly horizontal, so that it is appropriate for analyzing virtually any case where drained base resistance is to be computed in rock with parallel primary joints. The computed bearing capacity is not highly sensitive to  $c_j/c_r$  when  $\omega$  is near zero but is quite sensitive to  $c_j/c_r$  when  $\omega$  is near the value of  $\phi_r$  ( $35^\circ$ ), as can be seen in Figure B.8.

An example of the use of this procedure is given below.

---

**Example B-3.** *Computation of  $q_{max}$  in a jointed, sloping rock under drained pore pressure conditions.*

Observations of cuts in the area, of rock cores and of findings made in an observation shaft indicate that the stratum in which the base of a drilled shaft is contemplated to be placed consists of rock with parallel joints sloping at an angle  $\omega = 45$  degrees. The average value of  $q_u$  (from cores) = 9.0 MPa (1300 lb/in<sup>2</sup>), and the average value of  $c_j$  (from the cores) is 0.50 MPa (73 lb/in<sup>2</sup>). The base of the drilled shaft will be placed at a depth of 15 m (49 ft). The average moist unit weight of the geomaterial above the base of the drilled shaft is estimated to be 20.4 kN/m<sup>3</sup> (130 lb/ft<sup>3</sup>). The piezometric surface is below the planned base elevation of the drilled shaft. The drained cohesion along the joints is assumed to be equal to zero.

$$q = \sigma'_{vb} \text{ (at depth of 15 m)} = 20.4 (15) = 306 \text{ kPa.}$$

$$c_r = 0.5 (9.0)^{0.5} (0.50)^{0.5} = 1.06 \text{ MPa} = 1060 \text{ kPa} = 11.07 \text{ tons/ft}^2 = 154 \text{ lb/in}^2.$$

$$\text{From Equation (B.31), } c_j/c_r (q > 0) = [(0.7) (306)] / [1060 + 0.7 (306)] = 0.168.$$

$$\text{From Figure B.7, for } c_j/c_r = 0.168 \text{ and } \omega = 45 \text{ degrees, } N_{cs} = 22.$$

$$\text{Finally, from Equation (B.18), } q_{max} = N_{cs} (c_r + q \tan \phi_r), \text{ or}$$

$$q_{max} = 22 [1.06 + 0.306 (0.7)] = 22 [1.274] = 28.0 \text{ MPa} = 3.1 q_u.$$

In this particular case, the ultimate unit bearing resistance  $q_{max}$  is quite high relative to the cases in which jointed rock was loaded under undrained conditions (Examples B-1 and B-2), because of internal drainage in the rock and the resulting effect of the overburden (surcharge) pressure. In fact  $q_{max} = 3.1 q_u$  exceeds  $2.5 q_u$ , the maximum value established for undrained loading in massive rock. Therefore, undrained loading conditions would control in this particular problem. That is,  $q_{max}$  should be limited to  $2.5 q_u$  for design purposes.

This conclusion is not universal, however. If  $\omega$  had been 40 degrees and the depth of the base had been 3 m (10 ft), all other factors remaining the same,

$$q = 3 (20.4) = 61.2 \text{ kPa};$$

$$c_f/c_r (q > 0) = [(0.7) (61.2)] / [1060 + 0.7 (61.2)] = 0.039;$$

$$N_{cs} = 13;$$

$$q_{\max} = 13 [1.06 + 0.7 (0.061)] = 14.3 \text{ MPa} = 1.6 q_u < 2.5 q_u \text{ (controls)}.$$

---

## **SIDE RESISTANCE, $R_s$**

Relatively few thorough analytical studies have been made of side shearing resistance along drilled shafts. Most of the information available, including much of the information presented in this manual, was developed empirically by relating side resistance measured in loading tests to basic soil and rock properties and stress states, if known. Side resistance can develop under undrained conditions or drained conditions, in a manner similar to base resistance.

### **Undrained Loading**

Undrained side resistance normally develops only in cohesive soils. Rarely does it develop in cohesionless soils, and that condition will not be considered. In rock and cohesive IGM's undrained behavior may exist within the intact blocks of geomaterial, but along the joints and at the interface between the drilled shaft and the geomaterial, behavior is probably almost always drained, except under extremely rapid loading conditions. The situation under which drained joint and interface behavior can occur in conjunction with partial drainage or undrained behavior in the intact geomaterial will be treated under this topic.

### **Cohesive Soils**

The process of drilling a borehole for a drilled shaft in a cohesive soil remolds the soil at the face of the borehole, which reduces its strength from its *in-situ* value. Stress relief during the time the borehole is open also permits the exposed soil to swell and lose strength further. This effect is proportional to the time the borehole is allowed to remain open prior to concreting. When the borehole is concreted, the fluid pressure from the unset concrete, and later the lateral pressure from the set concrete, may reconsolidate the soil at the face of the borehole to some extent; however, the process of placing the fluid concrete against the cohesive soil allows for migration of water not needed for hydration of the concrete from the concrete into the soil, which may serve to reduce the undrained shear strength of the soil at the borehole wall even further (O'Neill and Reese, 1970; Milititsky, 1983). Because of these related effects, which are difficult to quantify, it is very difficult to determine analytically the undrained shear strength of the soil at the borehole wall (the soil that will fail in shear when the drilled shaft is loaded to failure) at the time the drilled shaft goes into service.



As a result, it is customary to estimate  $f_{max}$  in cohesive soils by relating it to some measurable soil strength parameter or stress state. The factor most frequently used is  $s_u$ , although  $f_{max}$  has been related reasonably successfully to effective stress in the soil and other factors. The relationship shown in Equation (B.32) is used to predict the value of  $f_{max}$  from  $s_u$ .

$$f_{max} = \alpha s_u \quad (B.32)$$

Obviously,  $\alpha$  reflects the effects of disturbance, water migration from the concrete and similar factors. For most cohesive soils and for most construction processes,  $\alpha$  appears to correlate to  $s_u$ . Correlations are developed by carefully measuring  $s_u$  in UU triaxial compression tests, or in CU or UC tests and converting the values to UU values, and then conducting loading tests on drilled shafts in which the unit side resistance  $f_{max}$  is measured along the shaft. Many case histories are available from which to make these correlations. These case histories are collected in data bases. Three data bases that have been consulted for purposes of developing values of  $\alpha$  (and similar factors for other soil types) for this design manual are described by Chen and Kulhawy, 1994; Davidson et al., 1994; and Reese and O'Neill, 1988a. Only selected tests from these data bases have been extracted and used for the determination of  $\alpha$ . These tests involve drilled shafts that can be considered typical of drilled shafts in clay soils for highway foundations. For example, only drilled shafts with  $0.7 \text{ m (2.3 ft)} \leq B \leq 1.83 \text{ m (6.0 ft)}$  and  $L \geq 7 \text{ m (23 ft)}$  are included, and only tests conducted in soil with  $s_u \geq 50 \text{ kPa (0.5 tsf)}$  are included. The resulting correlation for  $\alpha$  from the suite of compression loading tests from the Chen and Kulhawy data base is shown in Figure B.9, in which  $p_a$  = atmospheric pressure. In developing the trend line that is shown in Figure B.9, it was assumed that  $f_{max} = 0$  over the top 1.5 m (5 ft) of the drilled shaft and over the bottom 1 B, since those are the conditions assumed for design under the method suggested in Chapter 11. This correlation is almost identical to the correlation achieved in analyzing the other data bases. It is recommended that the trend line shown in Figure B.9 be used in designing drilled shafts for undrained loading in cohesive soil unless site-specific loading test data are available. As is seen in Figure B.9, the use of the trend line is by no means certain. Undoubtedly, better estimates can be made at each construction site by conducting loading tests on drilled shafts that are constructed according to the techniques that are planned to be used on the prototype shafts. The suggested relationship of  $\alpha$  to  $s_u$  can be written as follows:

$$\alpha = 0.55 \quad \text{for } s_u/p_a \leq 1.5, \quad \text{and} \quad (B.33a)$$

$$\alpha = 0.55 - 0.1 (s_u/p_a - 1.5) \quad \text{for } 1.5 \leq s_u/p_a \leq 2.5 \quad (B.33b)$$

Equation (B.33) can be used for either uplift or compression loading.

It is significant to note that Chen and Kulhawy recommend a different relation than is shown in Figure B.9, because their design method does not exclude any zones along the drilled shaft, they include the weight of the drilled shaft as a load in compression, they use the CU strength test as a

standard and they include drilled shafts outside of the geometric range quoted above and tests in soft clay soils, which are excluded from Figure B.9. This set of conditions is appropriate for the types of foundations for which they have developed design rules (electrical power transmission towers). Chen and Kulhawy propose correlations for  $\alpha$  as follows.

$$\alpha = 0.29 + 0.19 s_u/p_a \quad \text{for compression loading} \quad (\text{B.34})$$

$$\alpha = 0.31 + 0.17 s_u/p_a \quad \text{for uplift loading} \quad (\text{B.35})$$

These values are reasonably close to those in the trend line in Figure B.9, except for  $s_u/p_a < 0.5$ , and they indicate that there is very little difference in  $\alpha$  in compression and in uplift.

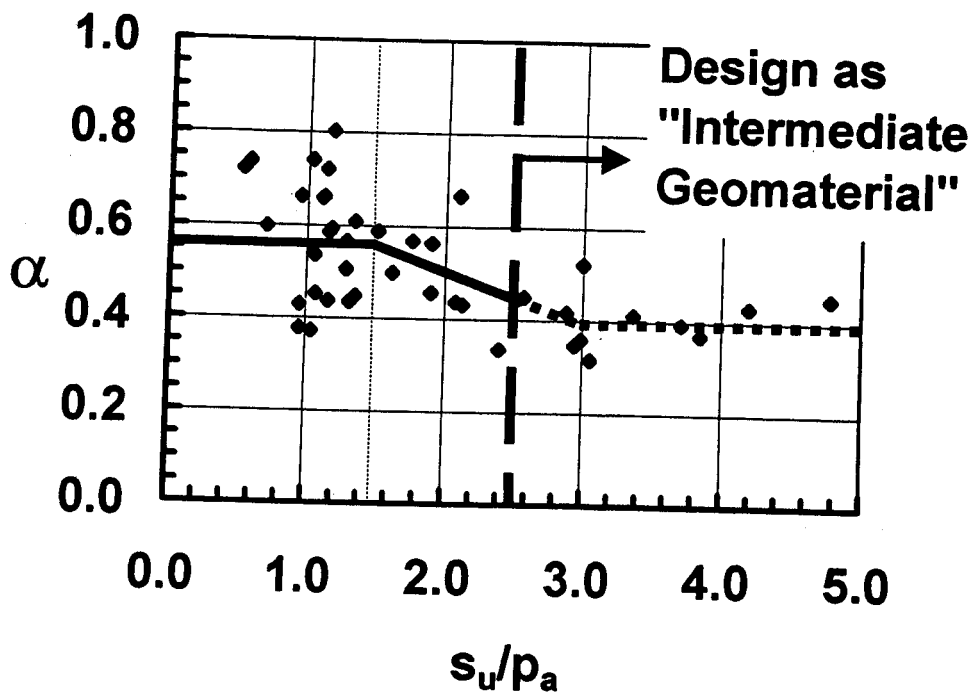

Figure B.9. Correlation between  $\alpha$  and  $s_u/p_a$

### Cohesive Intermediate Geomaterials - Compression Loading

Cohesive intermediate geomaterials (IGM's) are very hard clay-like materials, which can also be considered as very soft rock. In general, cohesive IGM's are ductile. Consequently, the failure state in the design method is based on an assumed axial deflection of 25 mm (1 in.) and not on an absolute plastic condition, so the computation of ultimate side resistance can involve the computation of axial deformation.

IGM's also behave very differently if the borehole is smooth after drilling than if it is rough (Kulhawy and Phoon, 1993; O'Neill et al., 1996). If the borehole is rough, its behavior depends upon whether the sides of the borehole have any highly degraded cuttings, or "smear," remaining on the borehole wall. If the designer wishes to assure "rough" conditions, he or she should (1) ensure that an item is placed in the construction specifications that requires the contractor to cut circular grooves approximately 76 mm (3 in.) high into the sides of the borehole that will penetrate at least 51 mm (2 in.) into the borehole wall over the full 360 degrees around the hole at spacings no greater than 0.46 m (1.5 ft) vertically, or (2) convince himself or herself that the drilling process will produce a roughness pattern generally equivalent to (1), above, without leaving soft soil-like material on the borehole wall. Otherwise, the borehole should be assumed to be smooth for design purposes. If the borehole can potentially be drilled under a drilling slurry, unless grooves are cut into the rock and those grooves are verified by calipering, a smooth borehole condition should be assumed.

The apparent, ultimate unit side resistance (that which occurs at infinite displacement), termed  $f_a$ , is assigned a value within the IGM layer according to Equation (B.36).

$$f_a = \alpha q_u \quad (\text{smooth socket}) \quad (\text{B.36a})$$

$$f_a = q_u / 2 \quad (\text{rough socket}) \quad (\text{B.36b})$$

If  $q_u$  varies widely within a layer use the median rather than the average, value for design.

In Equation (B.36a)  $\alpha$  has the same meaning as it has for the computation of  $f_{\max}$  in a cohesive soil, except that by convention it multiplies  $q_u$ , not  $s_u$ . Therefore, the values for  $\alpha$  from the right-hand side of the graph in Figure B.9 are not appropriate for use in Equation (B.36a). Instead,  $\alpha$  for an IGM is evaluated from Figure B.10. The range of validity for this  $\alpha$  value is shown on the figure, in which  $\phi_{rc}$  = the effective angle of friction between the concrete and the IGM (assuming that the interface is drained).  $w_t$  denotes the movement at the top of the socket up to which the value is valid.  $\phi_{rc} = 30$  degrees has been used in the determination of  $\alpha$  in this figure. That value is representative of interface friction angles in clay-shales in Texas (Hassan et al., 1997). *If laboratory interface shear tests are performed that indicate that  $\phi_{rc} \neq 30$  degrees, then  $\alpha$  from Figure B.10 should be modified as shown in Equation (B.37).*

$$\alpha = \alpha_{\text{Figure B.10}} [\tan \phi_{rc} / \tan 30^\circ] = 1.73 (\alpha_{\text{Figure B.10}}) \tan \phi_{rc} \quad (\text{B.37})$$

Figure B.10 was derived through finite element modeling and verified against full-scale loading tests (Hassan et al., 1997). It involves the use of  $\sigma_n / p_a$ .  $\sigma_n$  is the normal effective pressure against the side of the borehole when the loading event for which the drilled shaft is designed occurs.  $p_a$  is the atmospheric pressure. Notice that  $\alpha$  increases as  $\sigma_n / p_a$  increases, which is a direct result of higher effective normal stresses on the interface when loading is initiated.  $\sigma_n$  is further increased during

compression loading by the Poisson's effect in the concrete, which in turn affects the normal stresses at the interface according to the lateral stiffness of the IGM formation.

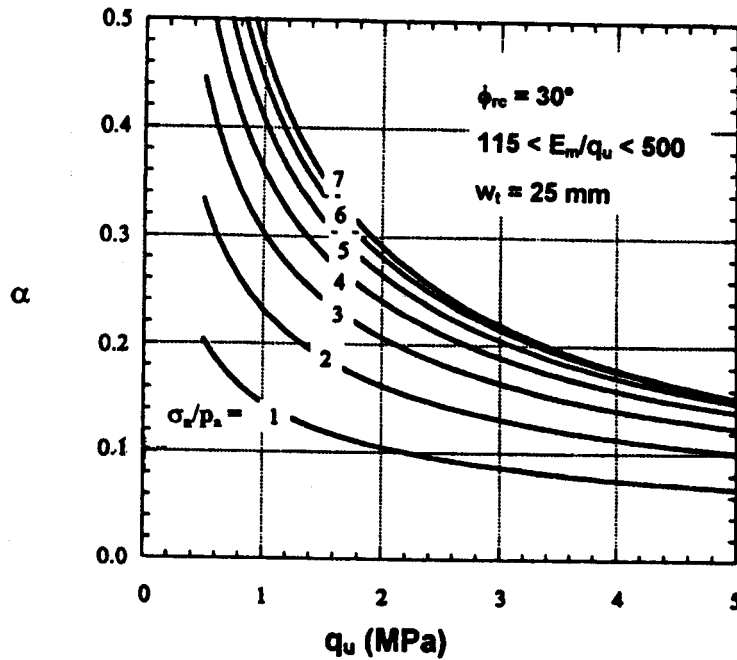

Figure B.10. Factor  $\alpha$  for IGM's (O'Neill et al., 1996)

Unless other information is available,  $\sigma_n$  can be estimated to be equal to the fluid pressure exerted by the concrete on the side of the borehole at the time of completion of the concrete pour. O'Neill et al. (1996) recommend obtaining  $\sigma_n$  from experiments performed by Bernal and Reese (1983) on fluid concrete pressures against borehole walls. From that study, if the rate of concrete placement is 12 m / hr (40 ft / hr) or greater,

$$\sigma_n = M \gamma_c z_c \tag{B.38}$$

in which

$\gamma_c$  is the unit weight of the fluid concrete,

$z_c$  is the depth to the point at which  $\sigma_n$  is to be computed, and

$M$  is an empirical factor, which depends upon the fluidity of the concrete as indexed by the concrete slump, from Figure B.11.

The mass modulus of elasticity of the IGM mass ( $E_m$ ) should be determined before proceeding in order to verify that the IGM is within the limits of Figure B.10 and to produce information for the remaining computations. The average Young's modulus of intact IGM cores ( $E_i$ ) is found through measurements in the laboratory. [Since  $E_i$  can vary considerably from sample to sample in many

formations, and since some samples may exhibit very high or very low values, the use of a median value, rather than an average value, should be considered.]

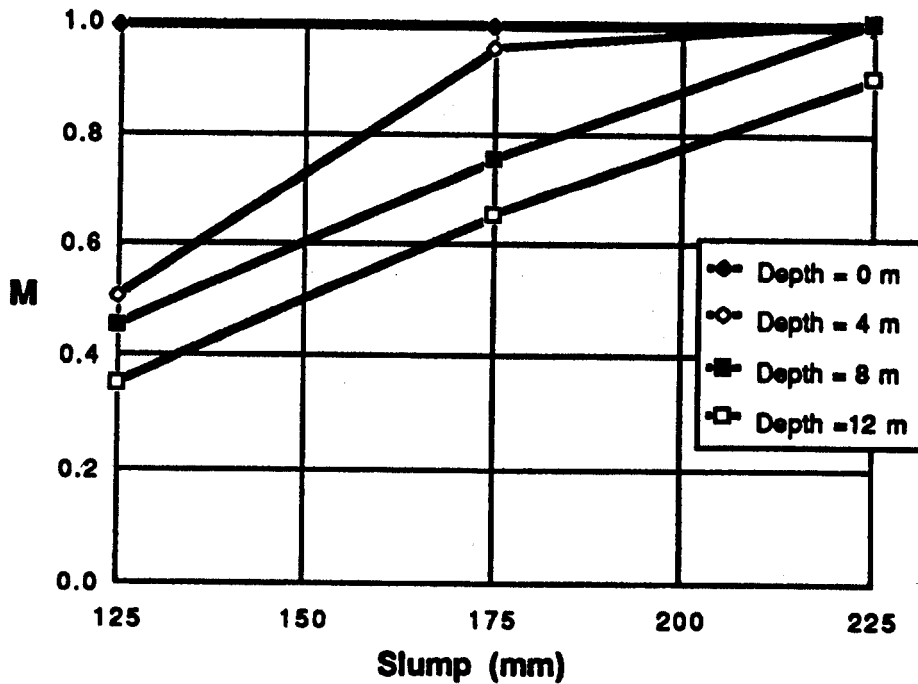

Figure B.11. Factor M vs. concrete slump (O'Neill et al., 1996)

Then,  $E_m$  can be estimated from the ratios of  $E_m/E_i$  in Table B.5 based on the RQD of the IGM cores. In cases in which the RQD of the IGM cores is less than 50 per cent, it is advisable to make direct measurements of  $E_m$  *in situ* through plate loading tests, borehole jack tests, large-scale pressuremeter tests or by back-calculating  $E_m$  from drilled shaft loading tests, since the correlations in Table B.5 become less accurate with decreasing RQD.

Values of  $E_m/E_i$  less than 1 indicate that soft seams and/or joints likely exist within the IGM. These discontinuities will reduce  $f_a$  to a value that is smaller than the value calculated by Equations (B.36a) and (B.36b).  $f_a$  should therefore be adjusted to  $f_{aa}$  (adjusted apparent value) using Table B.6, which is based on the experimental work of Williams et al. (1980) and Pabon and Nelson (1993).

In summary, therefore,

$$f_{aa} = f_a \text{ (Equation B.36a or B.36b) } (f_{aa}/f_a) \text{ (Table B.6)} \quad (\text{B.39})$$

Table B.5. Estimation of  $E_m/E_i$  Based on RQD (Modified after Carter and Kulhawy, 1988)

RQD (per cent)	$E_m/E_i$	
	Closed joints	Open joints
100	1.00	0.60
70	0.70	0.10
50	0.15	0.10
20	0.05	0.05

Note: Values intermediate between tabulated values may be obtained by linear interpolation.

Table B.6.  $f_{aa}/f_a$  Based on  $E_m/E_i$  (O'Neill et al., 1996)

$E_m/E_i$	$f_{aa}/f_a$
1.0	1.0
0.5	0.8
0.3	0.7
0.1	0.55
0.05	0.45

If the socket is classified as "smooth," it is sufficiently accurate for design purposes to set  $f_{max} = f_{aa}$ . However, if the socket is classified as "rough," it is necessary to proceed to compute  $f_{max}$  based on an assumed settlement corresponding to geotechnical failure, which is recommended to be 25 mm (1 in.). Otherwise,  $f_{aa}$  would not be achieved until the displacement is very large and the computed value would be unconservatively large. In that case, based on O'Neill et al. (1996),

$$f_{max} = K_f f_{aa} \leq f_{aa} \quad (B.40)$$

where

$$K_f = n + \frac{(H_f - n)(1 - n)}{H_f - 2n + 1} \quad , \quad (B.41)$$

and

$$H_f = \frac{E_m \Omega}{\pi L \Gamma f_{aa}} w \quad , \quad (B.42)$$

$$\Omega = 1.14 \left( \frac{D}{B} \right)^{0.5} - 0.05 \left[ \left( \frac{D}{B} \right)^{0.5} - 1 \right] \log_{10} \left( \frac{E_c}{E_m} \right) - 0.44 \quad , \quad (B.43)$$

$$\Gamma = 0.37 \left( \frac{D}{B} \right)^{0.5} - 0.15 \left[ \left( \frac{D}{B} \right)^{0.5} - 1 \right] \log_{10} \left( \frac{E_c}{E_m} \right) + 0.13 \quad . \quad (B.44)$$

In the above equations,  $D$  = the length of the entire socket within the IGM (if different from the embedded depth of the drilled shaft),  $B$  = socket diameter,  $E_c$  = estimated composite Young's modulus of the cross section,  $E_m$  is the average Young's modulus of the rock mass surrounding the entire socket (not just the mass Young's modulus of the geomaterial layer for which  $f_{max}$  is being computed if the socket consists of layers of various geomaterials), and  $w$  is the displacement defined as the failure displacement (ordinarily 25 mm). For many cohesive IGM's  $E_i$  is between 100 and 200  $q_u$ . All values must be in a consistent set of units.  $n$  is a factor related to the value of  $f$  at which plastic slip begins to occur. It can be estimated from Equation (B.45) for rough sockets. [For smooth sockets,  $n$  is needed to estimate settlement, for which purpose  $n$  is obtained from Figure B.12. That figure will be referred to in Appendix C and is presented here for completeness.]

$$n = \sigma_n / q_u \quad (\text{for rough cohesive IGM socket}). \quad (B.45)$$

While Equations (B.40) through (B.45) may seem intimidating, they are quite easy to apply, as illustrated in the next design example. They were developed through finite element modeling assuming the entire socket was embedded in one uniform IGM for  $D/B$  between 2 and 20,  $B$  between 0.5 m and 1.53 m (20 in. and 60 in.), and  $E_c/E_m$  between 10 and 500. The roughness pattern assumed in developing the equations is depicted in Figure B.13. This pattern is a gently undulating, regular pattern that has been observed in auger-cut clay-shales.

When the IGM layer is juxtaposed vertically against rock layers or other IGM layers,  $D$  should be taken to be the total length of the socket, not just the length within the layer under consideration.

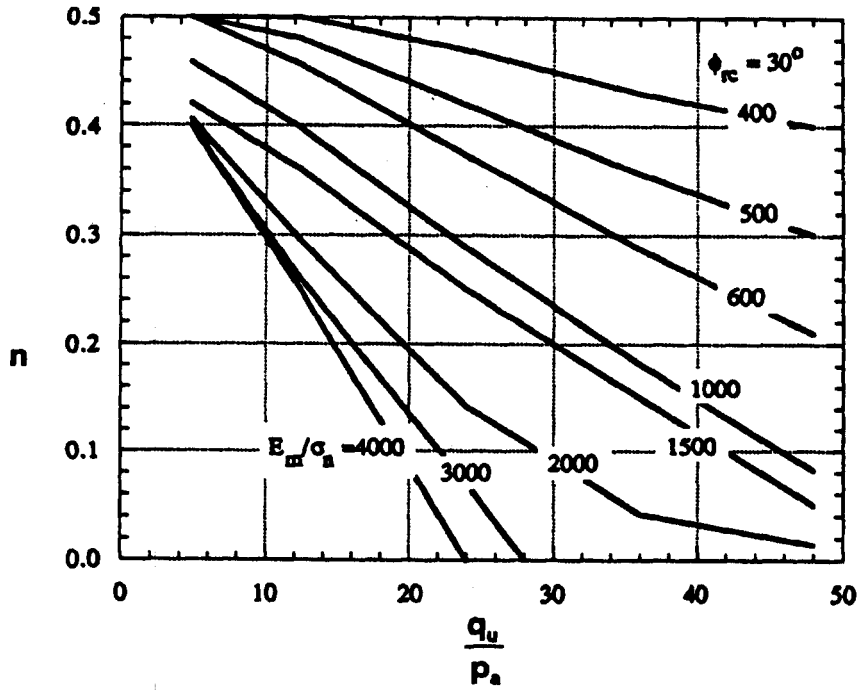

Figure B.12. Parameter  $n$  for smooth cohesive IGM sockets (O'Neill et al., 1996)

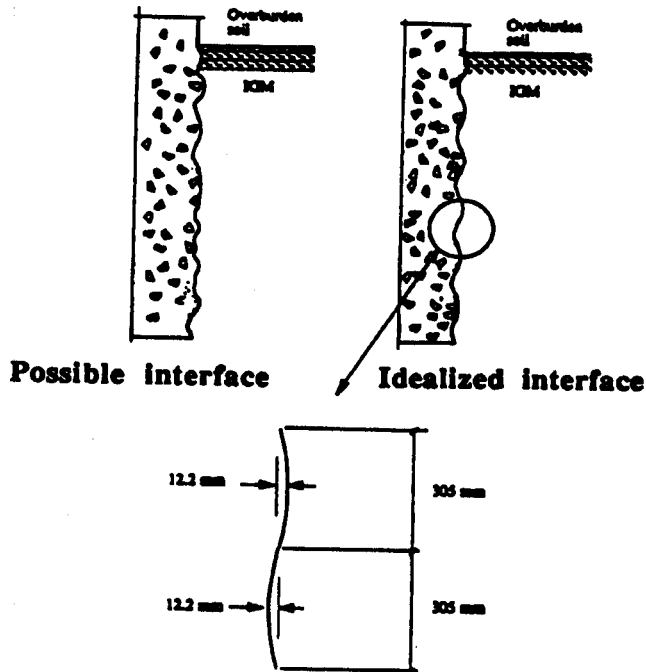

Figure B.13. Roughness pattern assumed in the development of design equations (O'Neill et al., 1996)



---

**Example B-4. Evaluation of  $f_{max}$  in cohesive IGM.**

Suppose a socket is to be designed as indicated in the sketch below. The socket is to be 1 m (39.4 in.) in diameter and will penetrate for a distance of 5 m (16.4 ft) into the clay-shale, which is classified as an IGM. The piezometric surface is at a great depth (several meters below the base of the shaft), although a small amount of perched water is present in the overburden.  $f_{max}$  for the socket is computed as the value that will occur at the middle of the socket (depth of 4.5 m).

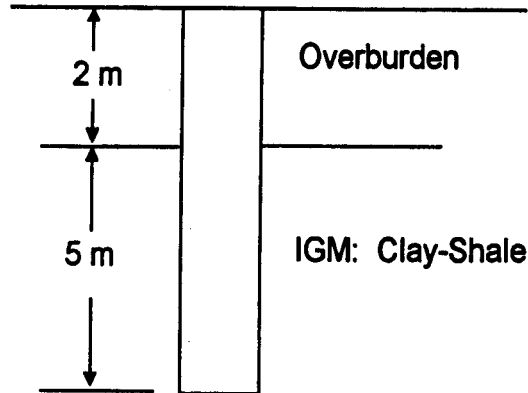

The following data are available:

Examination of cores indicates an RQD of 50 per cent. Joints are assumed to be filled with soft material and therefore are open.

$q_u$  (median value) = 2.5 MPa

$E_i$  (median value) from lab tests on cores = 500 MPa

Concrete slump = 175 mm (7 in.) minimum

Rate of concrete placement = 12 m (40 ft) / hour minimum

Unit weight of concrete = 23.55 kN/m<sup>3</sup>

$E_c$  (modulus of composite cross-section considering nominal steel) = 30 GPa

1. Assume that some of the perched water will enter the borehole during drilling, softening the face of the borehole and creating a "smear" condition. In this case, it does not matter whether the borehole is rough, because the smear will make it appear to behave as if it is smooth. Therefore, compute  $f_{max}$  for a smooth borehole condition.

a. Determine  $\alpha$ :

$M$  (Figure B.11) = 0.95 for depth = 4.5 m and slump = 175 mm.

$$\sigma_n = 0.95 (4.5) (23.55) = 100.7 \text{ kPa}$$

$$p_a = 101 \text{ kPa}; \sigma_n / p_a = 1.0$$

From Figure B.10, for  $\sigma_n / p_a = 1.0$  and  $q_u = 2.5 \text{ MPa}$ ,  $\alpha = 0.09$ .

b. Determine  $f_a$ :

$$f_a = 0.09 (2.5) = 0.225 \text{ MPa.}$$

c. Determine  $f_{aa}$  ( $= f_{max}$ ):

For RQD = 50 per cent,  $E_m/E_i = 0.10$  from Table B.5, and  $f_{aa}/f_a = 0.55$  from Table B.6.

$$\text{Therefore, } f_{max} = f_{aa} = 0.55 (0.225) = 0.124 \text{ MPa} = 124 \text{ kPa} = 1.29 \text{ tons/ft}^2.$$

2. Now, assume that the borehole will be drilled in such a manner that the roughness pattern in Figure B.13 will be approximated and that the construction specifications will require that the contractor assure that no softened geomaterial remains on the surface of the borehole at the time of concreting. The socket can be designed as a rough socket.

a. Compute  $f_a$ :

$$f_a = 2.5/2 = 1.25 \text{ MPa}$$

b. Compute  $f_{aa}$ :

As above, the reduction factor is 0.55, so  $f_{aa} = 0.55 (1.25) = 0.688 \text{ MPa}$ .

c. Compute  $n$ ,  $H_f$ ,  $\Omega$ ,  $\Gamma$  and  $K_f$ :

$$\sigma_n = 100.7 \text{ kPa} = 0.10 \text{ MPa (see above).}$$

$$n = 0.10 / 2.5 = 0.04.$$

$$E_m = 0.10 E_i \text{ (from RQD, using Table B.5)} = 0.1 (500) = 50 \text{ MPa.}$$

$$D/B = 5/1 = 5.$$

$$\Gamma = 0.37 (5)^{0.5} - 0.15[(5)^{0.5} - 1] \log_{10} [30000/50] + 0.13 = 0.442$$

$$\Omega = 1.14 (5)^{0.5} - 0.05[(5)^{0.5} - 1] \log_{10} [30000/50] - 0.44 = 1.937$$

Let  $w$  (corresponding to failure) = 25 mm = 0.025 m.

$$H_f = [(50) (1.937) (0.025)] / [\pi (5) (0.442) (0.688)] = 0.507$$

(Note that pressure units are all in expressed in MPa, and all length units are expressed in m, so the units are consistent, leading to a value for  $H_f$  that is nondimensional.)

$$K_f = 0.04 + [(0.507 - 0.04) (1 - 0.04)] / [0.507 - 2 (0.04) + 1] = 0.354.$$

d. Compute  $f_{\max}$  from Equation (B.40):

$$f_{\max} = 0.354 (0.688) = 0.243 \text{ MPa} = 2.53 \text{ tons/ft}^2.$$

Note that this value is about twice the value for the smooth interface. A cost analysis should be performed, perhaps by discussing the issue with drilled shaft contractors, relating to the increased costs incurred in cutting off infiltration of the perched water and roughening and cleaning the sides of the borehole before concreting plus careful inspection versus the benefit achieved in increasing the side resistance (reduced size of the drilled shaft).

### Cohesive Intermediate Geomaterials - Uplift Loading

Cohesive IGM's that are loaded in uplift will develop values of  $f_{\max}$  that are essentially identical to those developed in compression, provided the shaft borehole is classified as "rough." When the borehole is "smooth" the Poisson's effect influences shaft resistance. The shaft expands laterally when it is loaded in compression, increasing the lateral effective stresses against the interface and consequently the shearing resistance of the IGM at the interface, since the interface is drained and frictional. However, when the drilled shaft is loaded in uplift, the shaft contracts laterally, reducing the lateral effective stresses against the interface and the shearing resistance of the IGM at the interface. This effect is illustrated in exaggerated form in Figure B.14. For this reason values of  $f_{\max}$  for uplift loading should be reduced slightly below the values shown above for compression loading if the shaft is long and flexible. It is recommended that

$$f_{\max} (\text{uplift}) = \Psi f_{\max} (\text{compression}) \tag{B.46}$$

in which  $\Psi$  is taken to be 1.0 if  $(E_c/E_m) (B/D)^2 \geq 4$ , or 0.7 if  $(E_c/E_m) (B/D)^2 < 4$ , unless loading tests in uplift are performed.  $E_c$  and  $E_m$  are the composite Young's modulus of the shaft's cross section and IGM mass, respectively,  $B$  is the socket diameter and  $D$  is the socket length. This recommendation is based upon a study by Carter and Kulhawy (1988) for sockets in rock.

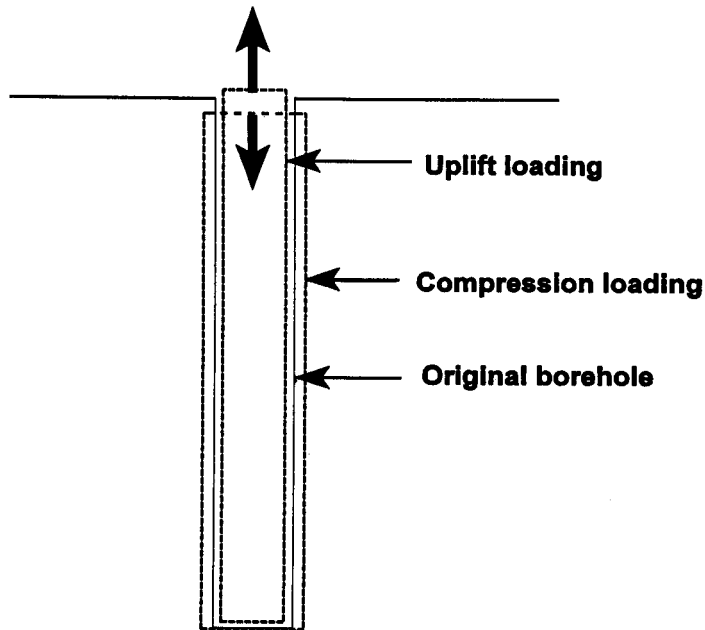

Figure B.14. Simplified representation of Poisson's effect (exaggerated)

### **Rock - Compression Loading**

Rock is defined for purposes of this manual as a cohesive geomaterial with  $q_u > 5$  MPa (52 tsf or 725 psi). This is a somewhat arbitrary definition. It appears for geomaterials with compressive strengths around 5 MPa and above that dilation of the concrete-rock interface becomes an important issue in determining shearing resistance. The dilation process was illustrated in Chapter 2 (Figure 2.6).

If geomaterials with compressive strengths in this range are easily degraded when subjected to slaking tests or are easily broken by hand in the laboratory, it might be reasonable to classify them as IGM's, even though  $q_u > 5$  MPa. In such a case the drilling process may soften the rock near the interface, and dilation effects may not be so significant as in a cleanly cut rock. For design purposes "rock" is perceived to be relatively resistant to degradation during drilling and concreting.

An excellent advanced model for simulating the load-movement behavior and ultimate shaft resistance of drilled shafts socketed into rock, in which behavior is dominated by dilation at the interface, is described by Seidel and Haberfield (1994). While that model is too complex to be reproduced in this manual, its basic feature is that it models the interface roughness pattern in a

random manner, similar to that which might be produced by normal drilling in many rock formations, in which the user first chooses the general characteristics of the pattern. The strength and normal stiffness of the rock is modeled, as are the frictional characteristics of the interface. Software (*ROCKET 95*) for executing the calculations is referenced at the end of this appendix.

Baycan (1996) used *ROCKET 95* to model the behavior of a rough rock socket and showed that initial normal pressure, degree of roughness and shaft diameter each had a major effect on the unit side resistance - movement behavior of a drilled shaft. Of importance to the designer is the effect of shaft diameter. For a given roughness pattern, radial strains, and therefore radial stresses, in the rock surrounding the shaft were found to decrease with increasing shaft diameter.

Figure B.15 shows the results of Baycan's analysis of a socket in very soft rock ( $q_u = 3.0$  MPa, with a moderately rough interface and with an initial normal stress  $\sigma_n$  of 100 kPa), in which the diameter was varied. It is of interest to note that most loading tests from which the simple design models described below were developed were performed on sockets with diameters in the range of 500 to 900 mm. Therefore, when very large-diameter sockets are designed, it may be prudent to reduce the value of  $f_{max}$  because of the dilatancy effect. For example, in Figure B.15, a 600-mm-diameter shaft in the geomaterial studied developed a maximum value of unit side resistance of 0.42 MPa, while a 2000-mm-diameter shaft in the same geomaterial is seen to have developed a maximum value of unit side resistance of 0.30 MPa, or about 0.7 times the value for the smaller socket.

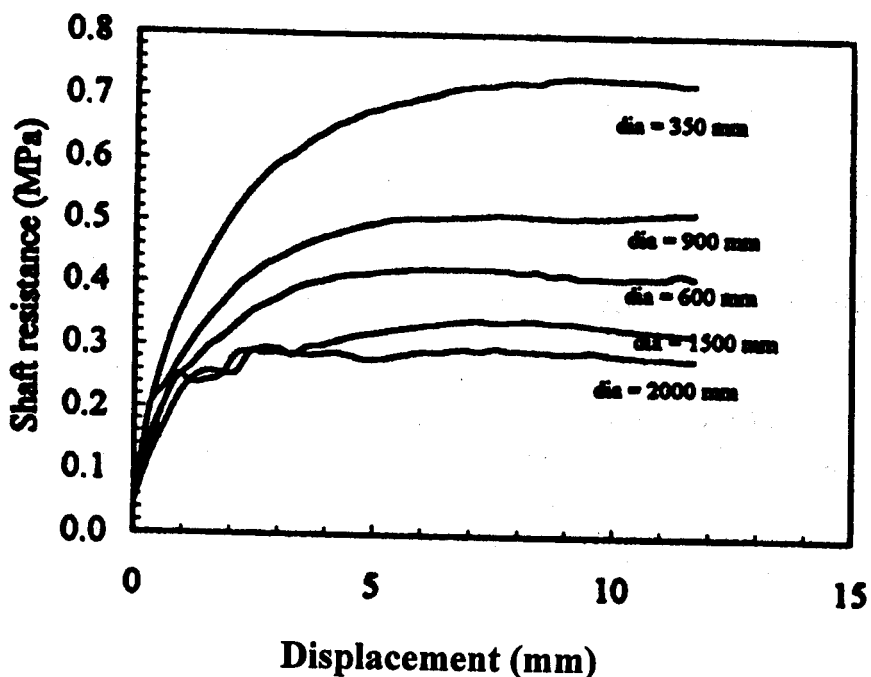

Figure B.15. Unit shaft resistance versus shear displacement for drilled shaft socket in rock of moderate roughness with  $q_u = 3.0$  MPa (Baycan, 1996)

When the effect of excavation on the lateral stiffness and quality of the geomaterial at the wall of the borehole is considered, the diameter effect may not be so strong. However, the designer should be cautious about using the values for  $f_{max}$  given by the equations that follow for very-large-diameter drilled shafts in rock without loading test results on full-sized drilled shafts (Chapter 14).

Two simple design methods are reviewed for computation of  $f_{max}$ :

**Method 1.** Horvath and Kenney (1979), based largely on a study of loading tests on drilled shaft sockets in shales in southern Ontario, suggested that the following equation be used to estimate  $f_{max}$  for drilled shafts that are excavated without artificial roughening of the borehole wall, based on  $q_u$  of the rock.

$$f_{max} = 0.65 p_a [q_u/p_a]^{0.5} \leq 0.65 p_a [f'_c/p_a]^{0.5} \quad (B.47)$$

In Equation (B.47) the term  $p_a$  is atmospheric pressure in the units being used (e. g., 101 kPa or 14.7 psi), and  $f'_c$  is the compressive cylinder strength of the concrete that is placed in the drilled shaft (e.g., at 28 days). It is reasoned that if the concrete is stronger than the rock, failure will take place through asperities within the rock, while if the rock is stronger than the concrete failure will occur through asperities in the concrete.

If the borehole is artificially roughened, Horvath et al. (1983) recommend the use of Equation (B.48), derived from the results of load tests on drilled shafts in roughened sockets.

$$f_{max} = 0.8 \left[ \frac{\Delta r}{r} \left( \frac{L'}{L} \right) \right]^{0.45} q_u \quad (B.48)$$

The coefficient of  $q_u$  replaces factor  $\alpha$  in Equation (B.36a). The various terms in Equation (B.48) are defined in Figure B.16. Note that Equation (B.48) indicates the effect of socket radius or diameter.

**Method 2.** Rowe and Armitage (1984) analyzed a data base of about 25 drilled shaft socket tests in a wide variety of soft rock formations, including sandstone, diabase, limestone, mudstone, shale and chalk. Carter and Kulhawy (1988) suggested the following design equation based on the work of Rowe and Armitage:

$$f_{max} = \mu p_a [q_u/p_a]^{0.5} \quad (B.49)$$

As before,  $p_a$  is atmospheric pressure (101 kPa, 14.7 psi, etc.). The factor  $\mu = 1.42$  on the

average. However, Rowe and Armitage cite cases in which  $\mu$  is as low as 0.63 (very near the value recommended by Horvath and Kenney), possibly in rock that drills very smooth. Presumably,  $\mu = 0.63$  also applies to cases where the rock is drilled under a drilling slurry.

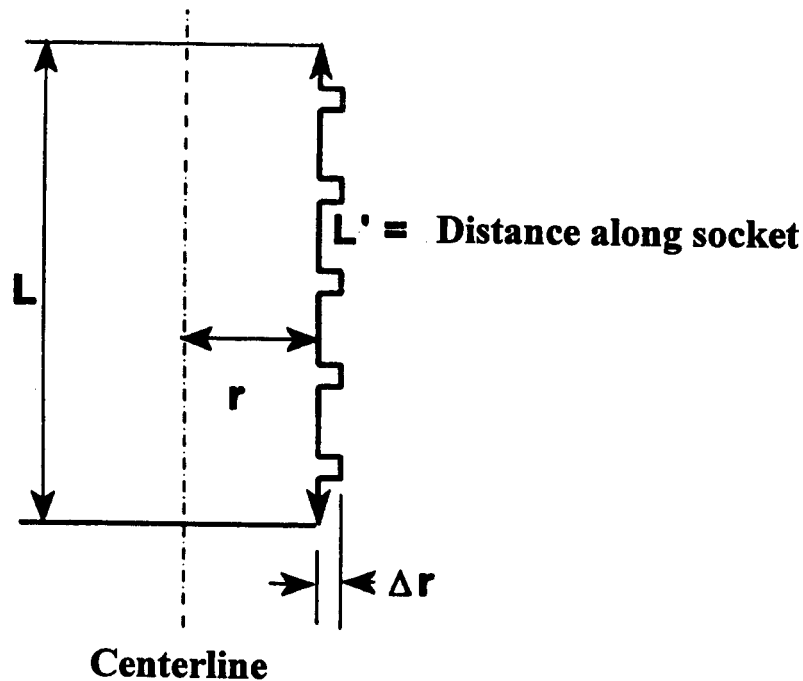

Figure B.16. Definition of terms in Equation (B.48)

In the event that the socket is rough, either through normal drilling or drilling with the use of artificial grooving,  $\mu = 1.9$ . Rowe and Armitage define a rough socket as one in which the grooves or undulations are deeper than 10 mm (0.4 in.), 10 mm (0.4 in.) wide or wider, and are situated at center-to-center spacings of 50 mm (2 in.) to 200 mm (8 in.).

The ratio  $1.9 / 0.63 \approx 3$  again points out the importance of borehole roughness in drilled shaft boreholes in hard geomaterials (IGM's and rock). Values for factor  $\mu$  may also reflect the effect of shaft diameter to some degree, as the tests from which these factors were derived were not delineated by shaft diameter.

For drilled shaft sockets in which the concrete is weaker than the rock ( $f'_c < q_w$ ), Carter and Kulhawy (1988) recommend that  $f_{max}$  be taken to be  $0.05 f'_c$  when Method 2 is used.

Equations (B.47) through (B.49) are intended for use only in intact rock. When the rock is

highly jointed, it is prudent to use Tables B.5 and B.6 to develop a reduction factor (" $f_{aa}/f_a$ ", termed " $\alpha_E$ " by Carter and Kulhawy and  $\phi$  in Chapter 11) to multiply the value  $f_{max}$  given by Equations (B.47) through (B.49) to arrive at a final value of  $f_{max}$  for design.

### Rock - Uplift Loading

As with cohesive intermediate geomaterials, the Poisson's effect can reduce  $f_{max}$  under uplift loading. Carter and Kulhawy (1988) show that  $f_{max}$  is not reduced to any important degree if the drilled shaft is "rigid" relative to the rock. Effective rigidity is defined as  $(E_c/E_m) (B/D)^2$ , in which  $E_c$  and  $E_m$  are the composite Young's modulus of the drilled shaft cross section and rock mass, respectively,  $B$  is the socket diameter and  $D$  is the length of the rock socket. A socket is rigid when  $(E_c/E_m) (B/D)^2 \geq 4$ . In this case no reduction in  $f_{max}$  is needed. Whenever  $(E_c/E_m) (B/D)^2 < 4$ , it is prudent to reduce  $f_{max}$  to about 0.7 times the value given by the design equations for compression loading unless  $f_{max}$  is proven otherwise by loading test.

### Rock - Adding Base and Shaft Resistance

If a hard, sound rock stratum exists at the base of the drilled shaft, and if only compression loads are applied, it may only be necessary to penetrate the rock a distance large enough to expose the sound rock, in which case  $R_s$  can be ignored in the rock socket. In cases where significant penetration of the socket will be made, the issue of whether  $R_s$  should be added directly to  $R_B$  to obtain an ultimate value of  $R_T$  for compression loading is a matter of engineering judgment. As indicated in Figure B.1, when the rock is brittle in shear, much side resistance will be lost as the settlement increases to the value required to develop the full value of  $q_{max}$ . If the rock is ductile in shear (deflection softening does not occur), there is no question that the two values can be added directly. However, if the rock is brittle, adding them will be unconservative, perhaps extremely so. Therefore, unless it is proven by load testing or laboratory shear strength testing that the rock is ductile in shear, in which case the two components of resistance can be added directly, the following approach can be used.

- For computing  $R_T$  (ultimate value, which occurs at large deflections), determine  $R_B = q_{max} A_b$ .  $A_b$  = bearing area of base. Then determine  $R_s$  by first computing  $f_r$ , where  $f_r$  is a fully reduced frictional shearing resistance at the interface.  $f_r$  does not include the strength gain in the rock produced by dilation at the interface between the rock and the concrete or cohesion in the rock, both of which can be assumed conservatively to be reduced to zero at large displacements. In other words,  $f_r$  becomes the residual shear strength of the rock =  $\sigma'_h \tan \phi_{rc}$ , where  $\sigma'_h$  = horizontal effective stress normal to the interface and  $\phi_{rc}$  = residual angle of interface friction between the rock and concrete.  $\phi_{rc}$  can be taken to be about 25 degrees for most rock, if measurements are not made, and  $\sigma'_h$  can be taken to be  $\sigma'_v$  at depth  $z$  (Figure 2.4), which implies that  $K_0 = 1$ .
- Alternatively, if  $R_B$  is small (for example, if it is ignored because of the presence of



karstic or highly fragmented rock below the base, or if inspection of base clean-out procedures will not be specified), the socket can be sized assuming  $R_B = 0$  and assuming  $R_S = \pi B \int_0^D f_{max} dz$  if the socket is relatively rigid  $[(E_c/E_m) (B/D_s)^2 \geq 4]$ . If the socket is not rigid, progressive side shear failure could occur, so  $R_s$  should be reduced according to the judgment of the geotechnical engineer.

For computing settlement of rock sockets at working loads, both side and base resistance components can be included, since the peak values of side resistance will not have developed at working load if values of computed settlement are less than about 7 mm (0.275 in.).

## Drained Loading

### Cohesive Soils - Compression Loading

Ordinarily, drained conditions do not control the shaft resistance design for drilled shafts in cohesive soils. It is prudent, however, to evaluate the drained side resistance of drilled shafts in heavily overconsolidated clays. These soils can experience reduced side resistance with time because negative pore water pressures developed by the shear loading, which initially provide added strength to the clay, eventually dissipate. Furthermore, drained side resistance behavior should be evaluated in cohesive soils for conditions in which construction operations will produce changes in effective stresses over a period of time, for example, when the site will be filled, causing the cohesive soil to consolidate and gain strength, or when the site will be excavated, causing the soil to swell and lose strength. Evaluation of side resistance through consideration of drained conditions will also be discussed in Chapter 12 with respect to uplift loading from expansive soils and downdrag.

Very little experimental information is available on drained side resistance for drilled shafts in cohesive soils. Therefore, a semi-theoretical approach is considered. The expression in Equation (B.50), proposed by Stas and Kulhawy (1984), forms the basis of the method, which is based on the principle of effective stress outlined in Chapter 2.

$$f_{max} = a' + \sigma'_v (K/K_0) K_0 \tan [(\delta/\phi') \phi'] \quad (B.50)$$

In Equation (B.50),

$a'$  = adhesion of the soil at the interface with the drilled shaft, defined in terms of effective stresses. If effective stress cohesion  $c'$  is measured,  $a'$  can be assumed to be equal to  $c'$ .

$\sigma'_v$  = vertical effective stress in the soil at the depth at which  $f_{max}$  is calculated (Chapter 2).

$K/K_o$  = ratio of the earth pressure coefficient at the interface between the drilled shaft and the soil to the coefficient of earth pressure at rest, which depends on the effects of construction.

$K_o$  = coefficient of earth pressure at rest in the soil surrounding the drilled shaft (after any filling or excavation has occurred).

$\delta/\phi'$  = ratio of fully drained angle of friction between the drilled shaft and soil to the fully drained angle of internal friction of the soil.

$\phi'$  = the fully drained angle of internal friction of the soil surrounding the drilled shaft, typically 25° to 40°.

In cohesive soils,  $a'$  can be taken equal to zero if measurements have not been made, unless the problem involves loading through the soil, such as when the soil produces a negative shaft load as it settles with respect to the drilled shaft (downdrag). In such a case it is important to measure or otherwise estimate  $c'$ .

In a fully drained condition, all excess pore water pressures caused by loading will have dissipated, so, when estimating  $\sigma'_v$ , the pore water pressure can be computed from the geostatic position of the piezometric surface. The increase in effective stress due to filling or the decrease in effective stress due to excavation should be considered when estimating  $\sigma'_v$ .

$K/K_o$  depends in the short term on the method of construction. However, for long-term conditions, for which drained loading is ordinarily considered, it can be assumed that  $K_o$  is unaffected by the construction process, so  $K/K_o$  can be taken to be 1.

$K_o$  can be measured using *in-situ* testing tools, such as the pressuremeter, or it can be estimated from a simple equation proposed by Mayne and Kulhawy (1982) for the case in which the soil is either normally consolidated or is experiencing its first unloading cycle geologically:

$$K_o = (1 - \sin \phi') OCR^{\sin \phi'} \quad (\text{B.51})$$

in which  $OCR$  is the overconsolidation ratio of the soil, defined earlier. This equation tends to give values of  $K_o$  that are slightly too high if the soil is undergoing reloading or unloading after its first unloading cycle; however, it can generally be considered sufficiently accurate for design purposes. Note that  $OCR$  generally decreases with increasing depth, so that  $K_o$  generally decreases with increasing depth in overconsolidated soil, while  $\sigma'_v$  increases with depth. The net effect is that  $f_{\max}$  increases with depth but at a decreasing rate in a homogeneous, overconsolidated soil.

For expansive clays,  $\sigma'_v (K/K_0) K_0 = \sigma'_h$  (Figure 2.4) can be evaluated directly by conducting one-dimensional swelling tests on horizontally trimmed samples of the cohesive soil from the moisture condition expected at the time of construction (usually high soil suction such as may occur near the end of the dry season, which will need to be evaluated locally) to the equilibrium moisture content under conditions of zero axial strain. For further information on evaluation of the shear strength of expansive soils, the reader is referred to Fredlund and Rahardjo (1993).

$\delta/\phi'$  is a function of the roughness of the interface and whether a slurry has been used in the construction process. Although there are no test data from which values of  $\delta/\phi'$  for cohesive soils can be inferred, if drilling slurry has been used it may be prudent to set this value equal to 0.67. Otherwise, it can be set equal to 1.

$\phi'$  should be measured in the geotechnical laboratory if drained analyses are to be performed. An approximation for  $\phi'$  for large deflections (critical void ratio) is obtained from Mitchell (1993):

$$\phi' = \sin^{-1} \{0.8 - 0.094 \ln [\text{Plasticity Index in per cent}]\}. \quad (\text{B.52})$$

This approximation can be used for preliminary analyses or to verify laboratory test results.

### **Cohesive Soils - Uplift Loading**

In uplift  $f_{\max}$  should be reduced slightly from the value given by Equation (B.50) using the evaluated parameters discussed above because of the reversal of the Poisson's effect and the reduction in vertical effective stresses in the soil adjacent to the drilled shaft produced by the stretching of the drilled shaft. It is suggested that the method described below for uplift loading in granular soils also be used for cohesive soils under drained conditions.

### **Granular Soils - Compression Loading**

Equation (B.50) can be considered as an ideal equation for granular soils. If the soil is uncemented, which is the usual assumption in granular soils,  $a' = 0$ . The other parameters can be evaluated as for cohesive soils, except as follows, where concepts for assigning values are given.

$K/K_0$  is dependent on the type of construction. In a soil layer in which slurry has been used to penetrate the granular soil, Chen and Kulhawy (1994) suggest  $K/K_0 = 0.67$ ; when casing has been used (without slurry) to advance the drilled shaft through the soil layer, they suggest  $K/K_0 = 0.83$ ; and when the excavation is made in the dry (using apparent cohesion of moist sand or very slight cementation in the granular soil to maintain hole stability) they suggest  $K/K_0 = 1$ .

$K_0$  should be measured *in-situ* using pressuremeter tests, dilatometer tests or other suitable means. Equation (B.51) can be used if the OCR of the granular soil is known. Chen and Kulhawy (1994), among other sources, provide several correlations for obtaining  $K_0$  in sands.

$\phi'$  can be estimated using correlations with CPT and SPT results. [See for example Equation (B.61) or Robertson and Campanella, 1983.]  $\delta/\phi'$  is a function of the effects of disturbance of the soil on the side of the borehole during excavation, borehole roughness and the existence of residual mudcake. One can argue that, since the sand is sheared to very large strains during the drilling process,  $(\delta/\phi') \phi' = \phi'$  at the critical void ratio, which for most sands is about 31 - 33 degrees. Chen and Kulhawy (1994) recommend using  $\delta/\phi' = 1$  for design purposes if the values of  $K/K_0$  reported above are used in Equation (B.50).

Both  $K/K_0$  and  $\delta/\phi'$  are very difficult to evaluate for any particular drilled shaft, since they depend significantly on the details of construction, such as whether the contractor is excavating the soil efficiently with a drilling tool that is properly matched to the soil encountered or is excessively rotating the tool in the hole, the length of time the borehole remains open, whether drilling slurry is used and when during the drilling process the slurry is introduced into the borehole, the length of time drilling slurry (especially mineral slurry) remains unagitated in the borehole, the diameter of the borehole, the grain-size distribution of the soil (as it relates to arching of stresses in the soil) and many similar factors. The effects of such factors have not yet been quantified. It is therefore highly recommended that full-scale loading tests be considered in granular soils at the construction site using the equipment and techniques that the contractor expects to use in constructing the production shafts. Data from these tests, if they are conducted to failure, can be used to derive site- and construction-technique-specific values of  $K/K_0$  and  $\delta/\phi'$ . While loading tests are also beneficial in rock, IGM's and cohesive soils, they are especially important when the primary source of support is granular soil. If such tests cannot be justified economically, then it is recommended that the simplified " $\beta$  method," described below, be considered.

Assuming  $a' = 0$ , Equation (B.50) can be rewritten as:

$$f_{max} = a' + \sigma'_v (K/K_0) K_0 \tan [(\delta/\phi') \phi'] = K [\tan \delta] [\sigma'_v] = \beta \sigma'_v \quad (B.53)$$

If a loading test is conducted  $f_{max}$  can be measured (Chapter 14), so that, empirically,

$$\beta = \sigma'_v / f_{max} \text{ (measured)} \quad (B.53a)$$

Since both  $\sigma'_v$  and  $f_{max}$  will vary with  $K$  and  $\delta$ , and since  $\sigma'_v$  varies with depth,  $\beta$ , as defined here, is a "local" factor, applying to one particular depth (e. g., the middle of Layer i, Figure B.2), and not an average value for the entire drilled shaft. While  $\beta$  is empirical, it is based on the principles expressed in Equation (B.50).

If definitive information on  $K$  and  $\delta$  is not available to the designer, it is reasonable to use a function for  $\beta$  that is near the lower bound of the values obtained from a data base of compression loading tests. Such an analysis was presented by O'Neill and Hassan (1994). A

similar analysis, but using a different data base, was made by Chen and Kulhawy (1994). The reader is encouraged to consult both references.

A summary of the results of O'Neill and Hassan is shown in Figure B.17. Several possible variations of  $\beta$  with depth are shown.  $\beta$  in this figure does not depend on a measure of strength, such as SPT N value or CPT  $q_c$  value, since it represents an approximate lower bound to all data except for cases in which the SPT N value is very low. The points marked with a filled box represent loading tests on uninstrumented drilled shafts in which the applied load at a settlement of 2.5 mm (0.1 in.) was reported as the average value of side resistance, and it appears that failure in some of those tests was incomplete. It is also apparent from Figure B.17 that  $\beta$  for gravel and gravelly sand is greater than  $\beta$  for sand in the data base that was considered. Based on these and other data the following expressions for  $\beta$  are suggested for granular soils classified as sands:

$$b = 1.5 - 0.245 [z (m)]^{0.5} \quad 0.25 \leq b \leq 1.20; \quad \text{(B.54)}$$

SPT N (uncorrected)  $\geq$  15 blows/0.3 m;

$$b = [N/15] \{1.5 - 0.245 [z (m)]^{0.5}\} \quad 0.25 \leq b \leq 1.20, \quad \text{(B.55)}$$

SPT N (uncorrected)  $<$  15 blows/0.3 m.

In very gravelly sands or gravels, from limited information:

$$b = 2.0 - 0.15 [z (m)]^{0.75} \quad 0.25 \leq b \leq 1.8; \quad \text{(B.56)}$$

SPT N (uncorrected)  $\geq$  15 blows/0.3 m.

When using traditional units,  $z$  should first be converted to meters, where 1 ft = 0.305 m.  $f_{\max}$  should be limited to 200 kPa (2.1 tsf) unless a higher value can be confirmed by load testing.

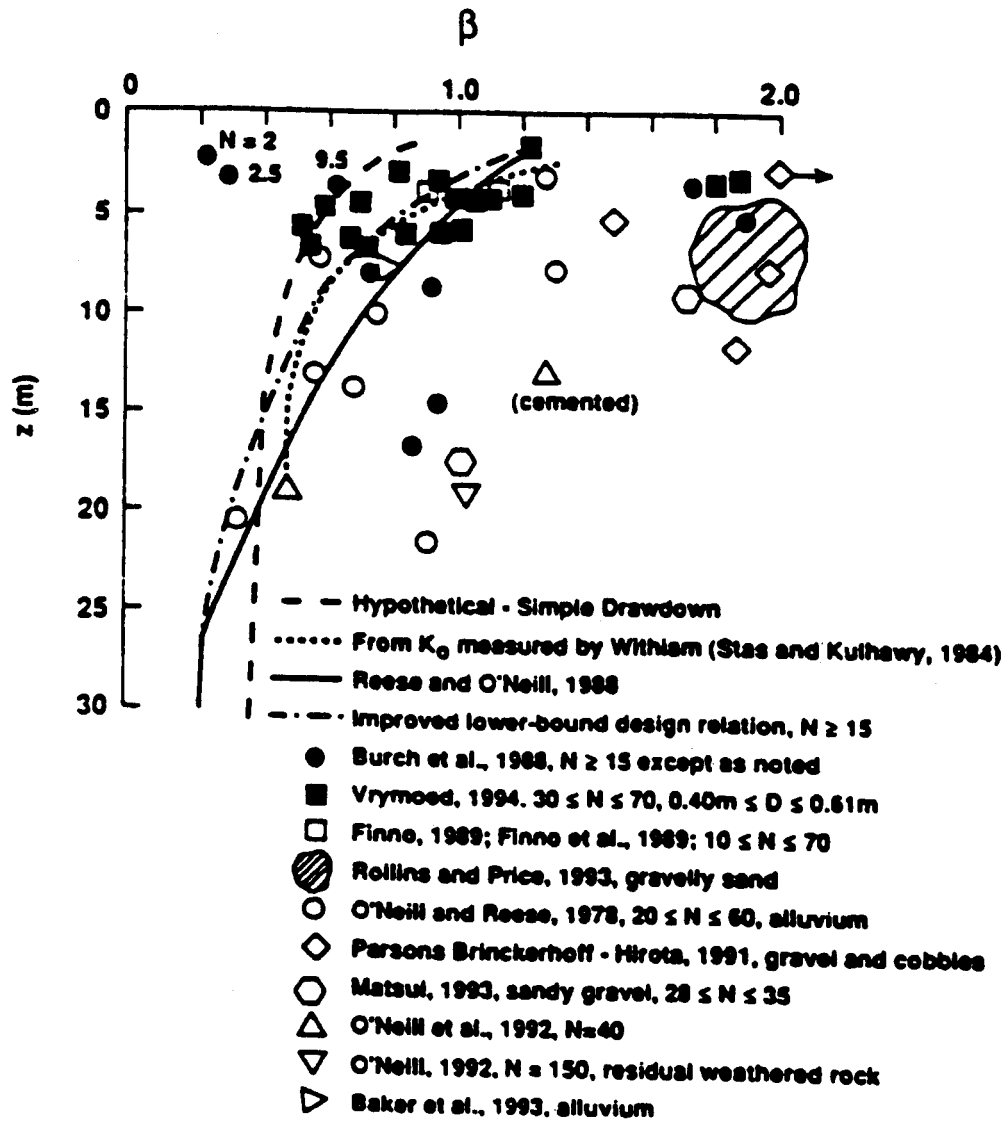
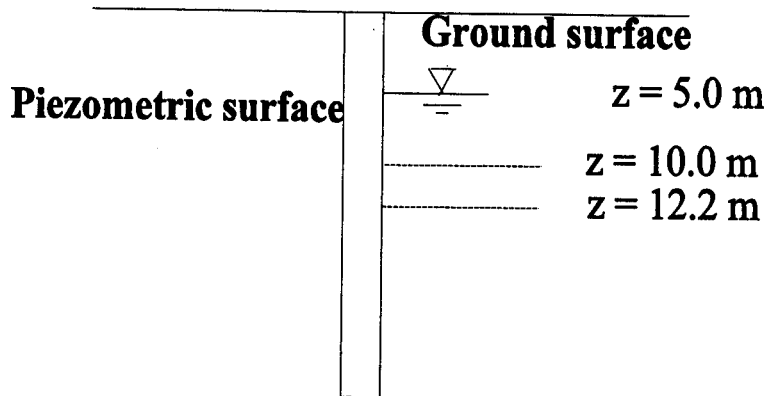

Figure B.17. Variations of  $\beta$  with depth (O'Neill and Hassan, 1994)

---

**Example B-5: Estimation  $f_{max}$  of a layer of sand using the  $\beta$  method**

Suppose we have a subsurface profile as shown in the sketch below. The total unit weight of the soil is estimated to be  $18.85 \text{ kN/m}^3$  ( $120 \text{ lb / ft}^3$ ). Estimate the average value of  $f_{max}$  for the layer of fine sand between depths,  $z$ , of 10.0 and 12.2 m (33 and 40 ft) using the  $\beta$  method. The average value of  $N$  (uncorrected) within that layer is 27 blows/0.3 m.



Both  $\sigma'_v$  and  $\beta$  are computed at the middle of the layer [depth =  $z = (10.0 + 12.2)/2 \text{ m} = 11.1 \text{ m}$ ].

$$\sigma'_v = 18.85 [(10.0 + 12.2) / 2] - 9.81 \{ [(10.0 - 5.0) + (12.2 - 5.0)] / 2 \} = 149 \text{ kPa} = 1.56 \text{ tsf} = 21.6 \text{ lb / in.}^2$$

$$\beta = 1.2 - 0.245 [(10.0 + 12.2)/2]^{0.5} = 0.684$$

$$f_{max} = 0.684 (149) = 101.9 \text{ kPa} = 1.06 \text{ tsf} = 14.8 \text{ lb / in.}^2$$

---

**Granular Soils - Uplift**

There is some controversy over whether uplift loading of deep foundations in granular soils under drained pore water pressure conditions produces lower values of  $f_{max}$  than those that are produced under compression loading. Because of the Poisson's effect in the shaft and the effect of stretching the drilled shaft when it is loaded in uplift, it appears reasonable to assume that some reduction in side resistance occurs. Based on analytical modeling and centrifuge studies by de Nicola (1996), Equation (B.46) appears to apply, in which  $\Psi$  is given by:

$$\Psi = \left[ 1 - 0.2 \log_{10} \left( \frac{100}{\left( \frac{L}{B} \right)} \right) \right] (1 - 8\eta + 25\eta^2) \quad (\text{B.57})$$

In Equation (B.57), the parameter  $\eta$  is a relative stiffness term, defined by

$$\eta = \nu_p \tan \delta (L/B) (G_{avg}/E_p) \quad (\text{B.58})$$

for a solid cylindrical foundation free of residual installation stresses, such as a drilled shaft.

$\nu_p$  is the Poisson's ratio of the pile material and  $G_{avg}$  is the average shear modulus of the soil along the length of the drilled shaft. In sand in a drained condition,  $G_{avg}$  can be assumed to be  $E_{avg} / 2.6$ , where  $E_{avg}$  is the average Young's modulus of the soil along the length of the shaft. The other parameters have been defined previously. In a medium dense sand with  $G_{avg} = 20.7$  MPa (3000 psi),  $\delta = 25$  degrees,  $L/B = 20$ ,  $E_p = 20.7$  GPa (3,000,000 psi), and  $\nu_p = 0.15$  [typical values for a concrete drilled shaft 1 m (3.3 ft) in diameter and 20 m (66 ft) long in a medium-dense sand profile],  $\eta = 0.15 (0.466) (20) (0.0207/20.7) = 0.00140$ . Then  $\Psi$  is given by  $[1 - 0.2 \log_{10} (100/20)][1 - 8(0.00140) + 25 (0.000020)] = 0.85$ . Similarly, for varying values of  $D/B$ , with the same parameters otherwise:

<u>L/B</u>	<u><math>\Psi</math></u>
5	0.74
10	0.80
15	0.83
20	0.85
30	0.88.

$\Psi$  is slightly too large for  $D/B < 20$  if  $B$  remains constant because  $G_{avg}$  will generally reduce with a reduction in depth.  $\Psi$  can therefore be taken to be 0.75 conservatively for a drilled shaft with  $D/B \geq 5$  in a uniform deposit of medium dense sand. Smaller penetrations should be avoided if possible. If the sand exhibits a value of  $G_{avg}$  higher than 20.7 MPa (dense to very dense sand), the relative shaft-soil stiffness will become smaller and  $\Psi$  will need to be decreased according to Equation (B.57).

If  $f_{max}$  is to be estimated in a layer of sand of finite thickness interbedded with other geomaterial layers, it is recommended that  $\Psi$  be computed for that layer based on the value of  $G$  for that layer ( $G_{avg} = G_{layer}$ ) but with  $L$  equal to the full penetration depth of the complete drilled shaft.



Little specific experimental information is available on side resistance in uplift for drilled shafts in gravel. Until such information becomes available,  $f_{\max}$  can be estimated in a gravel layer in the same manner as it is estimated in a sand layer.

While the above method is theoretically correct and is accurate for simulated deep foundations in a geotechnical centrifuge, it has not been tested against full-scale drilled shaft foundations. Therefore, site-specific loading tests should be conducted where they are warranted economically.

### Cohesionless Intermediate Geomaterials - Compression

A cohesionless intermediate geomaterial is a sand-like or gravel-like material (transported or residual) that exhibits  $N > 50$  blows/0.3 m.  $f_{\max}$  can be estimated in such soils using Equation (B.50). O'Neill et al. (1996) recommend the following procedure using the SPT  $N$  value, based on the original work of Mayne and Harris (1993). This method has been used and verified by load testing of full-scale drilled shafts in residual micaceous sands in the Piedmont province of the United States and has been verified for granular glacial till in the northeastern United States (O'Neill et al., 1996).

Within any one layer, the preconsolidation pressure of the IGM,  $\sigma'_p$ , is estimated from the correlation given in Equation (B.59). Then, after estimating the vertical effective stress at the middle of the layer,  $\sigma'_v$  (Figure 2.4), the overconsolidation ratio, OCR, is then estimated from Equation (B.60).

$$\sigma'_p = 0.2 N_{60} p_a \quad (\text{B.59})$$

$$\text{OCR} = \sigma'_p / \sigma'_v \quad (\text{B.60})$$

$N_{60}$  is the uncorrected SPT blow count in blows/0.3 m for the condition in which 60 per cent of the potential energy of the SPT hammer is transferred into the drive string, and  $p_a$  is atmospheric pressure in the units being used in the calculations.  $\phi'$  is then computed from:

$$\phi' = \tan^{-1} \left\{ \left[ \frac{N_{60}}{12.2 + 20.3 \left( \frac{\sigma'_v}{p_a} \right)} \right]^{0.34} \right\} \quad (\text{B.61})$$

Then,

$$K_o = (1 - \sin \phi') OCR^{\sin \phi'} \quad \text{and} \quad (B.51)$$

$$f_{max} = \sigma'_v K_o \tan \phi' \quad (B.62)$$

The method assumes that  $K = K_o$  and that  $\delta = \phi'$  in granular IGM's. Obviously, if the contractor were to leave the borehole open for an extended period of time or otherwise deviate from good practice,  $f_{max}$  would be overestimated with this procedure.

It is recommended by O'Neill et al. (1996) that  $N_{60}$  not be taken to be  $> 100$  with this method, regardless of the actual value of  $N_{60}$  measured. Otherwise, the method will overpredict  $f_{max}$ . While the method is sound, the various coefficients and exponents are based empirically on residual soils in the Piedmont province. Local correlations are therefore recommended.

### **Cohesionless Intermediate Geomaterials - Uplift Loading**

It can reasonably be assumed that Equations (B.46), (B.57) and (B.58) apply both to granular soils and cohesionless IGM's.

### **Intermediate Geomaterials -- Considerations for Desert Regions**

Some "cohesionless" IGM's exhibit cementation due to the presence of carbonates and other weak cementing agents. Such geomaterials are often found in desert regions. While more research is needed in this subject area, various empirical means have been suggested to estimate unit side resistance values. For example, Ismael et al. (1994) found from uplift loading tests on 0.3-m-diameter drilled shafts in dry cemented sand with  $N$  from 60 to 90 that  $\beta$  was 1.47 in the depth range of 3 to 5 m (10 to 16 ft). From uplift tests on 0.5-m-diameter drilled shafts in calcareous sands below the water table in the depth range of 5 to 15 m (16 to 49 ft), Ismael and Al-Sanad (1986) proposed  $f_{max}$  (kPa) = 0.96  $N$  (blows/0.3 m), or  $f_{max}$  (tsf) = 0.01  $N$  (blows/ft). These relations correspond to  $\beta \approx 1$  in that depth range, suggesting relatively high values of  $f_{max}$ . The authors caution, however, that they were careful to prevent the intrusion of groundwater into the boreholes by casing off sources of water at shallow depths.

On the other hand, Walsh et al. (1995) reported uplift tests on three small-scale drilled shafts ( $102 \text{ mm} \leq B \leq 254 \text{ mm}$ ;  $0.915 \text{ m} \leq L \leq 1.53 \text{ m}$ ) in cemented, fine-grained geomaterials above the water table having carbonate contents ranging from 4 per cent to 50 per cent. These geomaterials exhibited  $s_u$  between 250 and 670 kPa (2.6 and 7.0 tsf) based on UU triaxial compression tests with cell pressures equal to the total overburden pressures at the depths from which the samples were recovered. From these tests, and treating the geomaterial as if it were a cohesive soil [Equation (B.32)], it was found that  $\alpha = 0.45$  (average over the entire length of the small test shaft). This value is higher than would be expected if the geomaterial is classified as a

cohesive soil for the range in  $s_u$  encountered.

It is not prudent to generalize design values from these limited studies, but the results point out that  $f_{\max}$  appears to have a tendency to be higher in cemented soils than in non-cemented soils of similar strength, for which the design equations in Chapter 11 were developed. When such geomaterials are encountered, loading tests to establish local correlations for  $f_{\max}$  therefore appear to be warranted, at least on major projects.

## Rock

As stated previously, side resistance in rock is generally analyzed as if the interface is drained but the rock itself is undrained. Some procedures allow for the analysis of drained side resistance behavior in the rock mass itself (e. g., Carter and Kulhawy, 1988; Seidel and Haberfield, 1994); however, no general design rules are offered for that condition in this manual.

## Cyclic Axial Loading

All of the previous discussion in this appendix has focused on monotonic (non-cyclic) loading. In some instances, however, the designer will be faced with evaluating the axial resistance of drilled shafts subject to cyclic loading, for example, wave and wind loadings on the structure that produce overturning moments, seismic loadings, and similar effects. The approach to evaluating axial resistance in the case of cyclic loading involves the same equations as evaluating axial resistance for monotonic loading, except that the unit resistances may need to be reduced, perhaps significantly. Most of the research to date for drilled shafts has focused on the effect of cyclic loading on  $f_{\max}$ . Two-way cyclic loading, in which the drilled shaft load cycles from compression to uplift (and the magnitude of shear strain in the soil around the drilled shaft undergoes a reversal of sign), results in more severe degradation of side resistance than one-way cyclic loading. Little data are available on the effect of cyclic loading on  $q_{\max}$  for drilled shafts in soils, and little information is available for either  $f_{\max}$  or  $q_{\max}$  in intermediate geomaterials and rock.

Turner and Kulhawy (1990), based on large-scale model studies of drilled shafts under drained axial loading in sand, proposed a critical level of repeated loading (CLRL), below which cyclic degradation of the soil along the sides of the drilled shaft will not produce axial failure of the drilled shaft after 100 cycles of loading. CLRL is defined as the maximum value of  $(Q - W)_{\text{repeated}} / (Q_T - W)_{\text{static}} \times 100\%$  for which failure does not occur, where  $Q - W =$  amplitude of the developed side shear resistance in uplift that is produced by an applied two-way axial load.  $Q$  is the amplitude of the applied cyclic load where there is no biased compression load on the drilled shaft at the time the cyclic load is applied. However, for application to bridge foundations, which ordinarily support significant compression loads, upon which the cyclic load is superimposed, the authors of this manual interpret  $Q$  to be  $Q_{\text{compression}} - Q_{\text{cyclic}}$ , in which  $Q_{\text{compression}}$  is the load acting in compression on the drilled shaft (non-cyclic, unfactored compression load, or "biased" load) at the time the cyclic load having a single amplitude of  $Q_{\text{cyclic}}$  is applied. Unless

$Q_{\text{cyclic}}$  exceeds  $Q_{\text{compression}}$ , two-way loading does not occur.  $Q_T$  = unfactored static axial side resistance in uplift, and  $W$  = weight of the drilled shaft. For conditions of two-way cyclic loading and  $L/B = 8$ , CLRL was found to be 24 to 47 per cent for loose sand, 15 to 26 per cent for medium dense sand and 8 to 14 per cent for dense sand. Somewhat higher values were obtained for  $L/B = 4$ . Values for  $L/B > 8$  were not investigated. The values of CLRL, particularly in dense sand, suggest that drilled shafts in granular soils are very susceptible to loss of side resistance due to two-way cyclic loading. For design purposes it is important that the component of cyclic load not be allowed to produce a net uplift load on drilled shafts that are loaded in biased compression, in order to avoid failure of the drilled shaft. If it is necessary to design the foundation such that  $Q_{\text{cyclic}} > Q_{\text{compression}}$  on a drilled shaft in sand under drained pore water pressure conditions and  $(Q_{\text{compression}} - Q_{\text{cyclic}} - W) / (Q_T - W)$  exceeds the CLRL, data provided by Turner and Kulhawy suggest that  $f_{\text{max}}$  should be reduced for design purposes to about  $0.30 f_{\text{max}}$  (monotonic),  $0.25 f_{\text{max}}$  (monotonic),  $0.20 f_{\text{max}}$  (monotonic) for relative densities of the sand of 50, 70 and 90 per cent, respectively, to assure that pullout failure does not occur.

Furthermore, if seismic loading occurs, the values of  $f_{\text{max}}$  should be reduced further by the amount of excess pore water pressure estimated to be produced by the seismic event in the soil around the drilled shaft, regardless of whether a reduction due to two-way cyclic loading is considered. Descriptions of this effect are beyond the scope of this manual. The reader is encouraged to consult Kramer (1996) or other appropriate references on the effects of seismic loading on pore water pressure conditions in soils.

In clay (undrained), data reported by Poulos (1981) from two-way cyclic loading tests on model piles suggest that  $f_{\text{max}}$  is not reduced if the amplitude of cyclic displacement of the pile does not exceed about 40 per cent of the displacement that produces failure in side resistance when the drilled shaft is loaded monotonically (Appendix C). It can also be concluded that  $q_{\text{max}}$  is not reduced if the amplitude of displacement at the base of the drilled shaft does not exceed 40 per cent of the displacement that produces failure in base resistance when the drilled shaft is loaded monotonically. Information on the reduction in  $f_{\text{max}}$  for larger cyclic loads in clay soils varies considerably. Poulos (1981) provides an upper bound to that reduction as  $0.90 f_{\text{max}}$  (monotonic),  $0.50 f_{\text{max}}$  (monotonic), and  $0.30 f_{\text{max}}$  (monotonic) when the ratio of cyclic displacement to displacement that produces failure in side resistance during monotonic loading is 0.5, 0.75, and 1.5, respectively.

Both Poulos (1981) and Turner and Kulhawy (1990) discuss the estimation of displacement during cyclic loading. That issue will not be covered here.

Poulos (1982) discusses the effect of cyclic loading in groups of axially loaded piles in clay. This effect will not be covered in this manual.

The ratios of  $f_{\text{max}}$  for cyclic loading to  $f_{\text{max}}$  for monotonic loading (compression or uplift) in cohesive soils can be expressed as follows:

$$f_{max (cyclic)} = \Lambda_c \Lambda_p f_{max} (monotonic) \quad (B.63)$$

where,

$\Lambda_c$  = reduction factor for cyclic loading (for example 0.50 for clay when the displacement due to the cyclic load is 0.75 times the displacement required to produce side resistance failure under monotonic loading), and

$$\Lambda_r = \text{loading rate factor} = 1 - F_r \log_{10} (r_r / r) \quad (B.64)$$

In Equation (B.64) (Poulos, 1981),  $F_r$  is a rate factor, which ranges from 0.05 to 0.3,  $r_r$  is the reference rate of loading, and  $r$  is the rate of loading for the loading event being considered in design.  $r_r$  can be taken to be the average rate of loading for most field loading tests (e. g., about 0.005 mm / sec), and  $r$  is the estimated average displacement of the head of the shaft produced by  $Q_{cyclic}$  per quarter-cycle of loading. For example if  $r$  is 5 mm / sec,  $r_r$  is 0.005 mm / sec, and  $F_r = 0.1$ ,  $\Lambda_r = 1.3$ , which indicates that the reduction in  $f_{max}$  during the cyclic loading event will be less than that due only to the cyclic resistance degradation. For example, if  $\Lambda_c$  had been 0.5, then  $f_{max}$  during cyclic loading could have been taken as  $0.5 (1.3) f_{max} (monotonic) = 0.65 f_{max} (monotonic)$ , discounting any pore water pressure buildup effects.

Although reduction of axial resistance likely occurs due to cyclic loading in IGM's and rocks, little is known about this effect in those geomaterials. Whenever this effect is a concern in design, it is recommended that full-scale cyclic field loading tests be performed.

### Combined Axial and Lateral Loading

The application of shears and moments to the head of a drilled shaft will cause the drilled shaft to deflect laterally. That deflection, particularly if it is cyclic, can also reduce the magnitude of  $f_{max}$  along all or part of the drilled shaft because it will either produce a permanent gap between the drilled shaft and soil surrounding the drilled shaft or degrade the shear strength of the soil that is in contact with the sides of the drilled shaft, or both. This issue is discussed in detail by Cho and Kulhawy (1995). An approximate approach to the problem is to compute the lateral deflected shape of the drilled shaft under the combined axial and lateral system of loads, whether monotonic or cyclic. See Chapter 13. While no code prescriptions have yet been developed, it is reasonable that these loads be factored loads, since the condition under consideration is a geotechnical limit state. Dunnavant and O'Neill (1989) found that stiff clay soil around piles and drilled shafts behaved elastically as long as the lateral deflection of the deep foundation did not exceed 0.001 B. That is, the soil did not mold away from the sides of the shaft, nor did its strength degrade. In a granular soil, some plastic lateral movement of the soil can occur, but it will be minimal. Therefore, below those depths along the drilled shaft at which the lateral movement  $y \leq 0.001 B$  when the factored loads are applied to the head of the shaft, no reduction

needs to be made to  $f_{\max}$ . For example, in a 1220-mm- (48-in.-) diameter shaft, no reduction would be made in  $f_{\max}$  below the elevation at which  $y = 1.22$  mm (0.05 in.). Above the depth at which  $y = 0.001B$ ,  $f_{\max}$  can conservatively be taken to be 0.

Consideration of combined loads can lead to major reductions of  $f_{\max}$  in both compression and uplift in short, rigid drilled shafts. In long, flexible drilled shafts, the effect is usually relatively minor.

## AXIAL GROUP EFFECTS

When drilled shafts are installed in groups, the effect of excavating and concreting boreholes adjacent to drilled shafts that are already in place may be to reduce the effective stresses and thereby unit resistance in the soil along those drilled shafts. This is generally of greater concern in granular soils and cohesionless IGM's than in cohesive soils, IGM's or rocks. Group effects in axial loading are accounted for by multiplying the estimated resistance of a single drilled shaft by a group efficiency factor  $\eta$ :

$$R_T \text{ (one drilled shaft in a group)} \\ = \eta R_T \text{ (isolated drilled shaft of corresponding size)} \quad (\text{B.65})$$

Meyerhof (1976) suggested that  $\eta$  be taken to be 0.67 for a group of cylindrical drilled shafts in sand spaced  $3B$  on centers if the cap (column footing) is in contact with the soil, based on small-scale laboratory tests in clean sand.

Small-scale field tests from diverse locations around the world tend to indicate that 0.67 may be a lower bound for  $\eta$  for groups of drilled shafts in granular soil. Garg (1979) determined  $\eta$  from compression loading tests on small, full-scale groups of underreamed drilled shafts (2 x 1 and 2 X 2 arrays) in moist, poorly graded silty sand and associated single shafts in India. The shaft spacing was varied, as was the condition of contact between the cap and the ground. All of the drilled shafts tested had base (underream) diameters of 380 mm (15 in.) and shaft diameters of 152 mm (6 in.), and the bases were situated 3 m (10 ft) below the soil surface. The natural sand in which the tests were conducted had an SPT N value of between 5 and 15.  $\eta$  was somewhat higher for two-shaft and four-shaft groups than 0.67, as illustrated in Figure B.18, in which  $s$  is the center-to-center spacing of the drilled shafts in the group. Garg found that  $\eta$  increased when the cap was in contact with the ground compared to the case in which the cap did not contact the ground, possibly because the cap carried some of the applied load. Garg did not report the percentage of the load carried by the cap. It is clear, however, that  $\eta$  for the four-shaft group and cap system at  $s/B_{\text{shaft}} = 3.75$ , the closest spacing tested, was approximately 1.0 when the cap was in contact with the ground.

Liu et al. (1985) reported the results of a very large experimental study of group behavior in axially loaded drilled shafts in a moist alluvial silty sand (above the water table) in China. Some

pertinent results for groups of 9 (3 X 3) drilled shafts are summarized in Figure B.19 for cylindrical shafts with  $s/B$  in the range of 2 to 6. The test shafts were 125 mm to 330 mm (5 in. to 13 in.) in diameter ( $B$ ) and had lengths ( $L$ ) ranging from 8 to 23  $B$ . The loading tests were performed in compression. Measures of soil density were not reported.

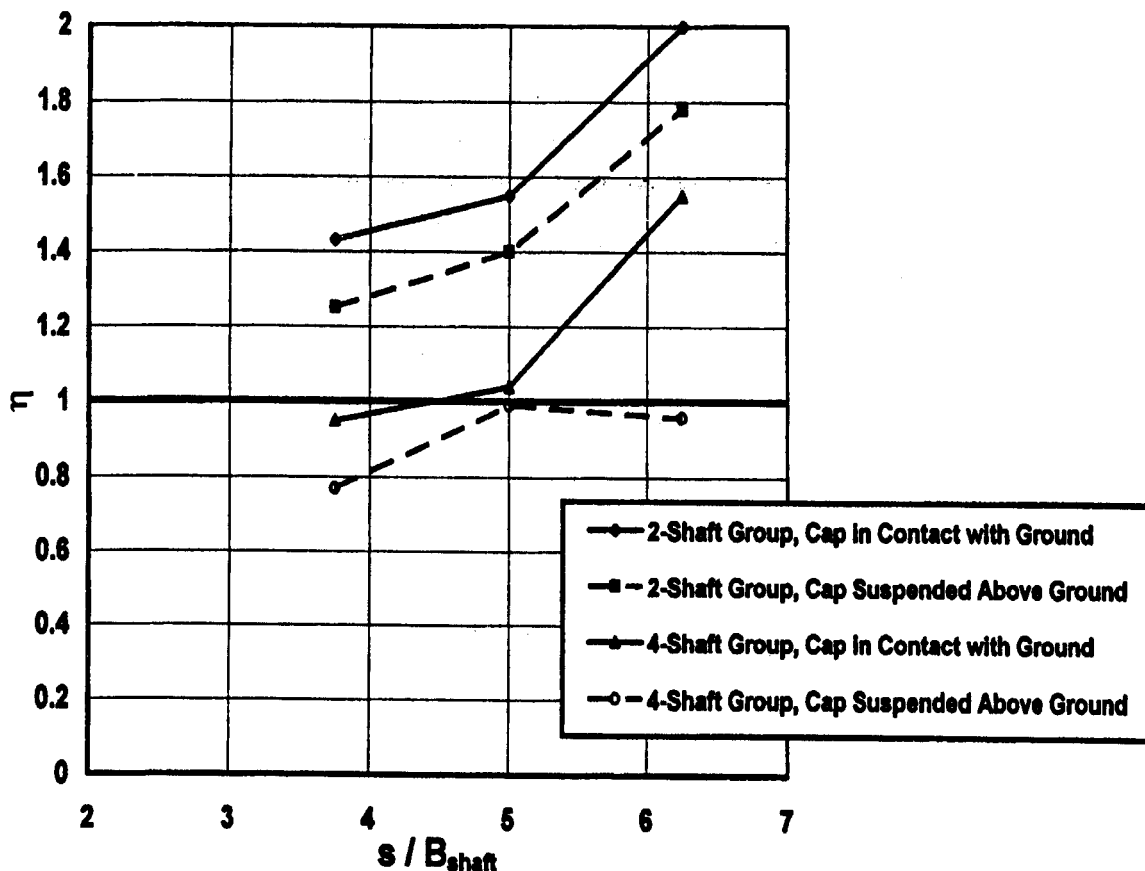

Figure B.18.  $\eta$  vs. center-to-center spacing,  $s$ , normalized by shaft diameter,  $B_{shaft}$ , for underreamed drilled shafts in compression in moist silty sand (Modified after Garg, 1979)

As with the study of Garg, the contact condition of the cap was varied. Liu et al. measured the loads at the shaft heads and bases and were therefore able to determine the actual efficiencies of the piles exclusive of the load carried by the cap. In fact, both side resistance efficiency [ $R_s(\text{group pile}) = \eta (\text{sides}) R_s(\text{single pile})$ ] and base resistance efficiency [ $R_b(\text{group pile}) = \eta (\text{base}) R_b(\text{single pile})$ ] were measured and reported. The presence of the cap in contact with the ground tended to reduce side resistance efficiency and increase base resistance efficiency. Whether the group had an overall efficiency of greater or less than 1 depended upon the center-to-center spacing  $s$ , the condition of cap contact with the ground and the ratio  $R_s/R_b$ . For  $s = 3B$ , which is a common design condition, and for the cap in contact with the ground, the group efficiency of the piles was clearly greater than 1, excluding any additional load that might have been carried by the cap.

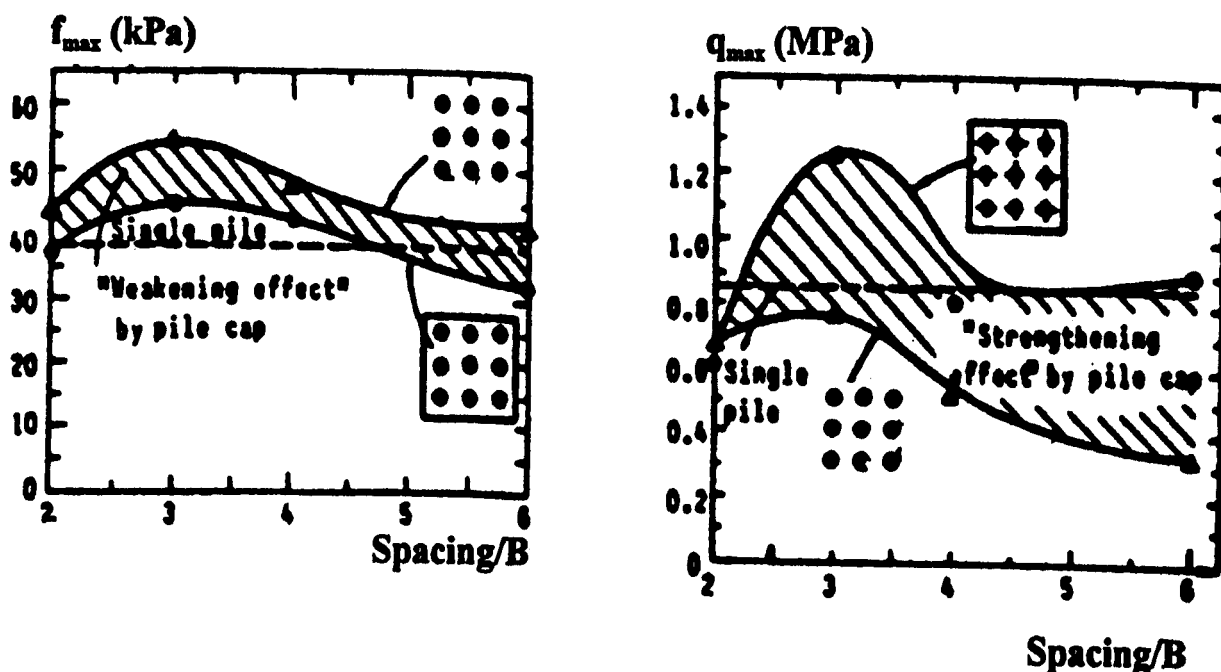

Figure B.19. Relative unit side and base resistances for single shaft and typical shaft in a nine-shaft group (Liu et al., 1985)

Senna et al. (1993) report a series of compression loading tests on single drilled shafts and groups of 2, 3 and 4 drilled shafts with caps in contact with the ground in Brazil. The test shafts had values of  $B = 250$  mm (10 in.) and  $L = 6$  m (19.7 ft). The water table was well below the 6-m depth. The center-to-center spacing  $s$  was  $3B$  in all cases. The four-shaft group was in a  $2 \times 2$  array. Two, three-shaft groups were tested; one was a row of three piles, while the other consisted of three piles in a triangular configuration. The soil was a lateritic clayey sand with  $N$  (SPT) varying from about 4 near the surface to as high as 18 blows/0.3 m at the bases of the drilled shafts.  $\eta$  (overall) was 1.1 for the 2-shaft group, 1.04 for the triangular group of 3 shafts, 1.1 for the row of 3 shafts, and 1.0 for the  $2 \times 2$  array. These values include the effects of the load carried by bearing of the cap on the soft surface soils.

For design purposes, it is suggested that the designer consider the conditions reported above that are closest to those at his or her bridge site and select values of  $\eta$  accordingly.  $\eta$  should not be taken to be greater than 1. It is pointed out that all of the studies reported here were performed either in dry sand or sand with fines above the water table. The efficiency of drilled shaft groups in clean sand below the water table may be lower than for the studies that are reported, and  $\eta$  has not been defined for that soil condition from field studies to the knowledge of the authors of this manual. In such a case, the designer should proceed conservatively. The designer should also proceed conservatively if very large groups of drilled shafts are required to be installed with their bases in granular soils or cohesionless IGM's, since little experimental information is available



concerning group efficiency in very large groups (more than nine drilled shafts) in cohesionless earth materials.

In cohesive soils and IGM's it is recommended that the designer determine  $\eta$  from the simple block failure model when the cap is in contact with the ground. This is based on the hypothesis that when drilled shafts become too closely spaced they will fail as a "block" or as one large equivalent drilled shaft having the shape of the outside boundary of the group. Consider Figure B.20. The ultimate resistance of the block of soil and drilled shafts outlined by the dotted line is given by

$$R_{TBlock} = f_{max} D [ 2(B_g + L_g) ] + q_{max} (B_g L_g) \quad (B.66)$$

$f_{max}$  is computed as if the peripheral surface of the block (dotted line) is a drilled shaft, and  $q_{max}$  is a net value computed from Equation (B.9) or from an appropriate procedure for cohesive IGM's. The value of  $f_{max}$  computed in this way will be conservative because some of the shearing around the perimeter of the block will occur in relatively undisturbed soil between the points of tangency of the bounding surface and the drilled shafts. Then,

$$\eta = R_{Block} / (n R_{T Single shaft}) \leq 1 \quad (B.67)$$

in which  $n$  is the number of drilled shafts in the group.

No specific guidance is given here concerning group efficiency in rock. Historically, the efficiency of groups of drilled shafts in rock has not been a concern, although settlement of groups of drilled shafts in rock may be a concern. That issue is covered in Appendix C.

One final practical issue regarding group efficiency is the effect of construction tolerances. It is essential that excavations for drilled shafts under construction not allow for the movement of concrete from drilled shafts that are currently in place but in which the concrete has not hardened to flow toward or into the new excavation. To avoid this condition, it is advisable that center-to-center spacings never be allowed to be less than  $2B + 0.04D + 0.15$  m [ $2B + 0.04D + 6$  in.] in a bearing shaft group. (Closer spacings can be tolerated for tangent or broached pile retaining walls.) This spacing allows for adjacent piles to be 75 mm (3 in.) out of position in the horizontal plane and to be up to 2 per cent out of plumb, which are common construction tolerances, and to allow for a 1-B clear spacing between drilled shafts at the base of the drilled shaft group.

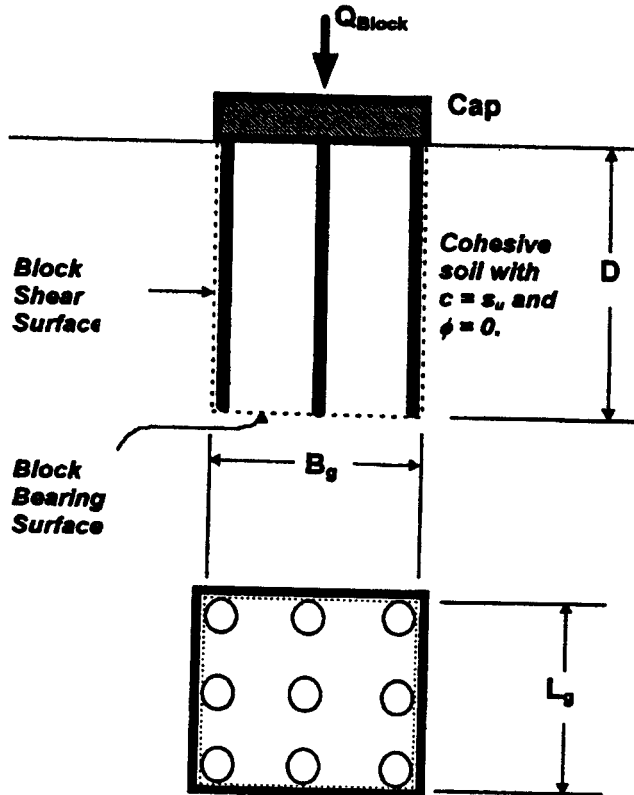

Figure B.20. Block failure model for drilled shaft group in cohesive soil with cap in contact with the ground

Another issue regarding groups of drilled shafts is that punching failure of the group can occur if a soft layer of substantial thickness underlies the layer of soil or rock on which the bases of the drilled shafts bear. A simple approach to assuring safety under such conditions is to limit the nominal base resistance of the block of drilled shafts,  $\Sigma R_B / B_g L_g$ , as follows:

$$\begin{aligned} \Sigma R_B / B_g L_g &\leq q_{max\ group\ lower} + H/10B_g [q_{max\ group\ upper} - q_{max\ group\ lower}] \\ &\leq q_{max\ group\ upper} \end{aligned} \quad (B.68a)$$

In Equation (B.68a),

$B_g$  and  $L_g$  are the horizontal dimensions of the group of piles, which is assumed to be rectangular in Equation (B.68a), in which  $B_g$  is the minimum horizontal dimension,

$q_{max\ group\ lower}$  is the ultimate bearing resistance of a bearing area of dimensions  $B_g \times L_g$  at the depth of the top of the lower layer, using the shear strength parameters of the lower layer,

$q_{max\ group\ upper}$  is the ultimate bearing resistance of a bearing area of dimensions  $B_g \times L_g$  at the actual depth of the bases of the drilled shafts, using the shear strength parameters of the layer in which the drilled shafts are placed, and

$H$  is the distance from the elevation of the bases of the drilled shafts to the elevation of the top of the soft lower layer.

If punching failure of the base is a concern  $\Sigma R_B$  should be limited to the value obtained from Equation (B.68a).

Equation (B.68a) can also be used in modified form to limit base resistance in individual, isolated drilled shafts where there is a possibility of punching failure from a hard stratum into a soft stratum. The modified form of Equation (B.68a) that is appropriate for single drilled shafts is Equation (B.68b).

$$R_B/A_b \leq q_{max\ lower} + H/10B [q_{max} - q_{max\ lower}] \leq q_{max} \quad (B.68b)$$

$A_b$  is the bearing area of the base of the drilled shaft,  $q_{max\ lower}$  is the base resistance of the drilled shaft using the shear strength parameters for the lower layer (that is, assuming that the base is located at the top of the soft, underlying stratum),  $q_{max}$  is the base resistance of the drilled shaft in the stronger layer in which it is actually situated, and  $B$  is the diameter of the base of the drilled shaft.

## RELIABILITY OF DESIGN EQUATIONS FOR AXIAL RESISTANCE

Isenhower and Long (1997) present a comparison of the measured and computed ultimate axial resistances of full-sized drilled shafts in cohesive soils, cohesionless soils and mixed soil profiles. Computations of ultimate resistance were made using earlier versions of the design equations presented in this appendix, which are recommended by AASHTO (1994) and which are documented by Reese and O'Neill (1988b). The design equations described in this appendix are slightly more conservative than those used by Isenhower and Long; however, the work of Isenhower and Long represents an excellent, approximate, independent test of the validity of the current design equations. The study was conducted for 30 loading tests catalogued in a data base maintained at the University of Illinois. Many of the tests were outside of the data base of loading tests from which the design coefficients reported in this appendix, such as  $\alpha$  and  $\beta$ , were determined empirically.

The results of the study are summarized in Figure B.21. The ratio  $R_c/R_m$  was found to be lognormally distributed, in which  $R_c$  is the computed resistance and  $R_m$  is the measured resistance. The mean value of  $R_c/R_m$  from Figure B.21 is 0.995, while the lognormal standard deviation is 0.146; hence, the global coefficient of variation is about 15 per cent. Isenhower and Long attributed the variance in the results to errors in geometry and soil characterization and to

differences in shaft geometry, load testing procedures and effects of construction among the loading tests that are not accounted for in the design equations.

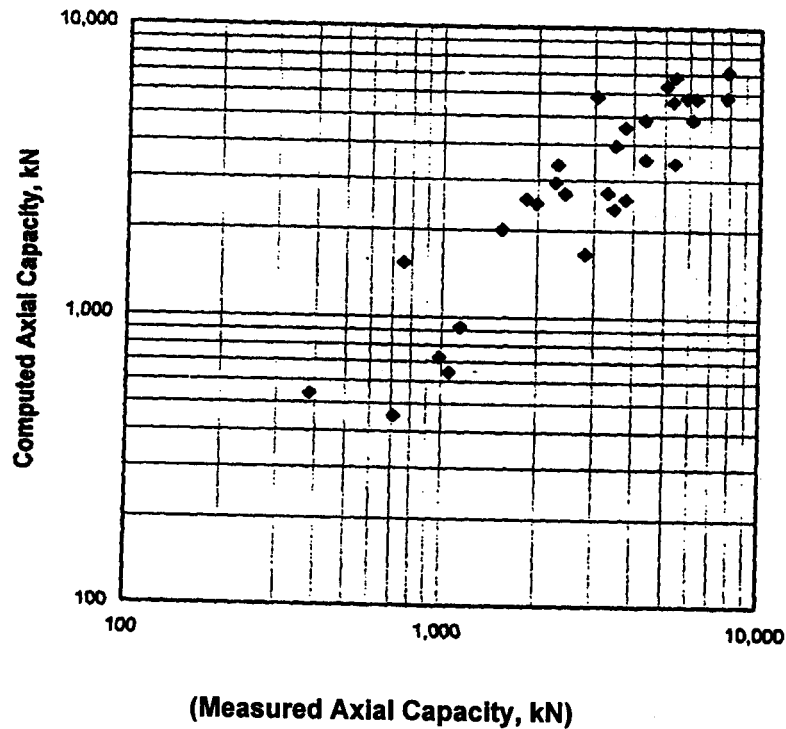

Figure B.21. Computed axial resistance ( $R_c$ ) vs. measured axial resistance ( $R_m$ ) (Isenhower and Long, 1997)

### ALTERNATIVE METHODS FOR ESTIMATING AXIAL RESISTANCE OF DRILLED SHAFTS

Numerous methods not covered in this appendix have been used successfully to estimate the axial resistance of drilled shafts. For example, Alsamman (1995) describes a procedure for the estimation of side and base resistance for drilled shafts in soils directly using results of the cone penetrometer test (CPT) based on back-analyses of full-scale loading tests. If the reader plans to use this method, he or she is advised to read the reference; however, in summary, the following design correlations are proposed.

For cohesive soils:

$$R_B = 0.27 (q_{cb} - \sigma_{vb}) A_b \quad \text{and} \quad \text{(B.69)}$$

$$R_S = \sum \pi B f_{max i} \Delta z_i, \quad \text{(B.70)}$$

in which

$$\begin{aligned}
 f_{max\ i} &= 0.0225 q_{ci} & q_{ci} \leq 37.8 p_a, \text{ and} \\
 &= 0.85 p_a & q_{ci} > 37.8 p_a.
 \end{aligned}
 \tag{B.71}$$

For granular soils:

$$\begin{aligned}
 R_B &= (0.15 q_{cb}) A_b & q_{cb} \leq 94.5 p_a \\
 &= \{14.2 p_a + 0.075[q_{cb}(atms) - 94.5 p_a]\} A_b, & 94.5 p_a \leq q_c \leq 283.4 p_a \\
 &= (28.3 p_a) A_b & q_{cb} \geq 283.4 p_a, \text{ and}
 \end{aligned}
 \tag{B.72}$$

$$R_S = \sum \pi B f_{max\ i} \Delta z_i \tag{B.73}$$

in which, for sands and silty sands,

$$\begin{aligned}
 f_{max\ i} &= 0.015 q_{ci} & q_{ci} \leq 47.2 p_a \\
 &= 0.71 p_a + 0.00167[q_{ci}(atms) - 47.2 p_a] & 47.2 p_a \leq q_{ci} \leq 189 p_a \\
 &= 0.945 p_a & q_{ci} > 189 p_a
 \end{aligned}
 \tag{B.74}$$

and for gravelly sands and gravels,

$$\begin{aligned}
 f_{max\ i} &= 0.02 q_{ci} & q_{ci} \leq 47.2 p_a \\
 &= 0.945 p_a + 0.0025[q_{ci}(atms) - 47.2 p_a] & 47.2 p_a \leq q_{ci} \leq 189 p_a \\
 &= 1.30 p_a & q_{ci} > 189 p_a
 \end{aligned}
 \tag{B.75}$$

In the above equations, the following notation is used:

$q_{cb}$  = average mechanical cone tip resistance between the base of the drilled shaft and a distance of one base diameter below the base of the drilled shaft.

$q_{ci}$  = average mechanical cone tip resistance in Layer *i*. The abbreviations "atms" indicates that the pressure is expressed in atmospheres. For example, 14.7 psi = 101 kPa = 1 atm.

$A_b$  = bearing area of the base of the drilled shaft.

$\Delta z_i$  = thickness of Layer i.

$p_a$  = atmospheric pressure in the units being used in the design.

If an electronic cone is used, a transformation expression must be used in order to apply the above equations. Alsamman suggests the use of the correlation between  $q_c$  (electronic cone) =  $q_{ce}$ , and  $q_c$  (mechanical cone) =  $q_{cm}$ , of Kulhawy and Mayne (1990), which can be expressed as

$$q_{cm} = 2.12 q_{ce}^{0.84} \quad (\text{B.76})$$

The units for both  $q_{cm}$  and  $q_{ce}$  in the above equation are kips/ft<sup>2</sup>, in which 1 kip/ft<sup>2</sup> = 47.9 kPa.

## OTHER SOURCES OF INFORMATION

Numerous other sources of information can be consulted to obtain additional methods for estimating resistances of drilled shafts under axial loading and commentary on the methods described here. Among these sources are

- ASCE (1996) (drilled shafts in rock),
- Babbie Group, Ltd. (1995) (drilled shafts in soft rock),
- Baker (1993) (drilled shafts in mixed geomaterial -- PMT rules),
- Barker et al. (1991) (drilled shafts in soil and rock),
- Bustamante and Gianselli (1982) (drilled shafts in soil -- CPT rules),
- Canadian Geotechnical Society (1985) (drilled shafts in soil and rock),
- Carter and Kulhawy (1988) (drilled shafts in soft to hard rock),
- Chen and Kulhawy (1994) (drilled shafts in soil),
- GEO (1996) (drilled shafts in soil and rock),
- Johnson (1984) (drilled shafts in cohesive soil),
- McVay et al. (1992) (drilled shafts in limestone),
- Meyerhof (1976) (drilled shafts in soil -- SPT and CPT rules),
- O'Neill et al. (1996) (drilled shafts in IGM's),
- Rowe and Armitage (1987) (drilled shafts in weak rock).

## RESOURCES

Computer code **SHAFT 3.0 for Windows** is a PC Windows program that synthesizes the axial resistance of drilled shafts in soil and rock, as well as load-movement relations, based on straightforward input by the user. SHAFT 3.0 can be obtained for a nominal fee from Ensoft, Inc., P. O. Box 180348, Austin, Texas 78718, USA.

Computer code **ROCKET 95 for Windows** is a PC Windows program that synthesizes the side

shear resistance and side shear stress-movement behavior of drilled shaft sockets in rock considering roughness and dilatancy. Inputs include initial normal stress and normal stiffness on the interface, rock modulus and strength, geometric factors and roughness pattern characteristics. It can be obtained for a nominal fee from the Department of Civil Engineering, Monash University, Wellington Road, Clayton, Victoria 3168, Australia.

## REFERENCES

AASHTO (1994). *LRFD Bridge Design Specifications*, American Association of State Highway and Transportation Officials, Washington, D. C., First Edition.

Alsamman, O. M. (1995). *The Use of CPT for Calculating Axial Capacity of Drilled Shafts*, dissertation submitted for the degree of Doctor of Philosophy, Department of Civil Engineering, University of Illinois at Urbana-Champaign, 300 pp.

ASCE (1996). *Rock Foundations* (adapted from the U. S. Army Corps of Engineers No. 16), ASCE Press, New York, 129 pp.

Babtie Group, Ltd. (1995). *Piled Foundations in Weak Rocks*, Babtie Group, Ltd., Paper RP509/94/5, London, UK, August.

Baker, C. N., Jr., (1993). "Use of Pressuremeter in Mixed Highrise Foundation Design," *Design and Performance of Deep Foundations: Piles and Piers in Soil and Soft Rock*, GSP No. 38 (Nelson, Smith, and Clukey, eds.), Dallas, October, pp. 1 - 13.

Barker, R. M., Duncan, J. M., Rojiani, K. B., Ooi, P. S. K., Tan, C. K., and Kim, S. G. (1991). "Manuals for the Design of Bridge Foundations," *NCHRP Report No. 343*, Transportation Research Board, National Research Council, Washington, D. C., December, 308 pp.

Baycan, S. (1996). *Field Performance of Expansive Anchors and Piles in Rock*, dissertation submitted for the degree of Doctor of Philosophy, Department of Civil Engineering, Monash University, Clayton, Victoria, Australia, October.

Bernal, J., and Reese, L. C. (1983). "Study of the Lateral Pressure of Fresh Concrete as Related to the Design of Drilled Shafts," *Research Report No. 308-1F*, Center for Transportation Research, The University of Texas at Austin, November.

Bustamante, M., and Gianceselli, L. (1982). "Pile Bearing Capacity Prediction by Means of Static Penetrometer CPT," in *Proceedings*, Second European Symposium on Penetration Testing, Balkema, Rotterdam.

Canadian Geotechnical Society (1985). *Canadian Foundation Engineering Manual*, 2nd Edition, Canadian Geotechnical Society Technical Committee on Foundations, Ottawa, 456 pp.

- Carter, J. P., and Kulhawy, F. H. (1988). "Analysis and Design of Drilled Shaft Foundations Socketed Into Rock," *Final Report*, Project 1493-4, EPRI EL-5918, Geotechnical Group, Cornell University, Ithaca, NY, August.
- Chen, Y.-J., and Kulhawy, F. H. (1994). "Case History Evaluation of the Behavior of Drilled Shafts Under Axial and Lateral Loading," *Final Report*, Project 1493-04, EPRI TR-104601, Geotechnical Group, Cornell University, Ithaca, NY, December.
- Cheney, R. S., and Chassie, R. G. (1993). *Soils and Foundations Workshop Manual - Second Edition*, NHI Course No. 13212, Federal Highway Administration, Washington, D. C., July, 395 pp.
- Cho, N. J., and Kulhawy, F. H. (1995). "Experimental Study of Undrained Behavior of Drilled Shafts During Static and Cyclic Inclined Loading," *Final Report*, Project 1493-04, EPRI TR-104999, Geotechnical Group, Cornell University, Ithaca, NY, July.
- Davidson, J. L., Spears, L. D., and Lai, P. W. (1994). "Drilled Shaft Load Test Data Base and an Evaluation of Program SHAFTUF," in *Proceedings*, International Conference on Deep Foundations, Vol. II, Federal Highway Administration, Orlando, December, pp. 541 - 555.
- De Nicola, A. (1996). *The Performance of Pipe Piles in Sand*, dissertation submitted for the degree of Doctor of Philosophy, Department of Civil Engineering, The University of Western Australia, Nedlands, Western Australia, March.
- Dunnivant, T. W., and O'Neill, M. W. (1989). "Experimental p-y Model for Submerged, Stiff Clay," *Journal of Geotechnical Engineering*, ASCE, Vol. 115, No. 1, January, pp. 95 - 114.
- Fredlund, D. G., and Rahardjo, H. (1993). *Soil Mechanics for Unsaturated Soils*, Wiley Interscience, New York, 517 pp.
- Garg, K. G. (1979). "Bored Pile Groups Under Vertical Load in Sand," *Journal of the Geotechnical Engineering Division*, ASCE, Vol. 105, No. GT8, pp. 939 - 956.
- GEO (1996). *Pile Design and Construction*, Geotechnical Engineering Office, Civil Engineering Department, Hong Kong, June, 348 pp.
- Goodman, R. E. (1989). *Introduction to Rock Mechanics*, Second Edition, Wiley, New York, 562 pp.
- Hannigan, P. J., Goble, G. G., Thendean, G., Likins, G. E., and Rausche, F. (1996). "Design and Construction of Driven Pile Foundations," Vols. I and II, (Working Draft) Federal Highway Administration, Washington, D. C.



- Hassan, K. H., O'Neill, M. W., Sheikh, S. A., and Ealy C. D. (1997). "Design Method for Drilled Shafts in Soft Argillaceous Rock," *Journal of Geotechnical and Geoenvironmental Engineering*, ASCE, Vol. 123, No. 3, March, pp. 272 - 280.
- Hoek, E. (1983). "Strength of Jointed Rock Masses," *Geotechnique*, Vol. 33, No. 3, September, pp. 187 - 223.
- Horvath, R. G., and Kenney, T. C. (1979). "Shaft Resistance of Rock-Socketed Drilled Piers," in *Proceedings, Symposium on Deep Foundations* (Fuller, ed.), ASCE, Atlanta, October, pp. 182 - 214.
- Horvath, R. G., Kenney, T. C., and Kozicki, P. (1983). "Methods of Improving the Performance of Drilled Piers in Weak Rock," *Canadian Geotechnical Journal*, Vol. 20, pp. 758 - 772.
- Isenhower, W. M., and Long, J. H. (1997). "Reliability Evaluation of AASHTO Design Equations for Drilled Shafts," Paper No. 970630 presented to the 1997 annual meeting of the Transportation Research Board, Washington, D. C., January, 28 pp.
- Ismael, N. F., and Al-Sanad, H. A. (1986). "Uplift Capacity of Bored Piles in Calcareous Soils," *Journal of Geotechnical Engineering*, ASCE, Vol. 112, No. 10, October, pp. 928 - 940.
- Ismael, N. F., Al-Sanad, H. A., and Al-Otaibi, F. (1994). "Tension Tests on Bored Piles in Cemented Desert Sands," *Canadian Geotechnical Journal*, Vol. 31, pp. 597 - 603.
- Johnson, L. D. (1984), "Methodology for Design and Construction of Drilled Shafts in Cohesive Soils," *Technical Report GL-84-5*, U. S. Army Engineer Waterways Experiment Station, Vicksburg, Mississippi, March, 414 pp.
- Kramer, S. (1996). *Geotechnical Earthquake Engineering*, Prentice-Hall, Upper Saddle River, NJ, 653 pp.
- Kulhawy, F. H., and Mayne, P. W. (1990). "Manual on Estimating Soil Properties for Foundation Design," *Report No. EL-6800*, EPRI, Palo Alto, California, August, 306 pp.
- Kulhawy, F. H., and Phoon, K-K. (1993). "Drilled Shaft Side Resistance in Clay Soil to Rock," *Design and Performance of Deep Foundations: Piles and Piers in Soil and Soft Rock*, GSP No. 38 (Nelson, Smith, and Clukey, eds.), Dallas, October, pp. 172 - 183.
- Ladanyi, B., DuFour, R., LaRocque, G. S., Samson, L., and Scott, J. S. (1974). *Report of the Subcommittee on Foundations and Near-Surface Structures*, Canadian Advisory Committee on Rock Mechanics, Canadian Geotechnical Society, 55 pp.
- Liu, J. L., Yuan, Z. L., and Zhang, K. P. (1985). "Cap-Pile-Soil Interaction of Bored Pile

Groups," in *Proceedings*, XI Int. Conf. on Soil Mechanics and Foundation Engineering, Vol. 3, Balkema, Rotterdam, August, pp. 1433 - 1436.

Mayne, P. W., and Kulhawy, F. H. (1982). "K<sub>o</sub> - OCR Relationships in Soil," *Journal of the Geotechnical Engineering Division*, ASCE, Vol. 108, No. GT6, June, pp. 851 - 872.

Mayne, P.W., and Harris, D.E. (1993). "Axial Load-Displacement Behavior of Drilled Shaft Foundations in Piedmont Residuum," *FHWA Reference No. 41-30-2175*, Georgia Tech Research Corporation, Geotechnical Engineering Division, Georgia Institute of Technology, School of Civil Engineering, Atlanta, February.

McVay, M. C., Townsend, F. T., and Williams, R. C. (1992). "Design of Socketed Drilled Shafts in Limestone," *Journal of Geotechnical Engineering*, ASCE Vol. 118, No. 10, ASCE, October, pp. 1626 - 1637.

Meyerhof, G. G. (1976). "Bearing Capacity and Settlement of Pile Foundations," *Journal of the Geotechnical Engineering Division*, ASCE, Vol. 102, No. GT3, March, pp. 197 - 228.

Milititsky, J. (1983). *Installation of Bored Piles in Stiff Clays: An Experimental Study of Local Changes in Soil Conditions*, dissertation submitted for the degree of Doctor of Philosophy, Department of Civil Engineering, University of Surrey, U. K., February.

Mitchell, J. K. (1993), *Fundamentals of Soil Behavior*, Second Edition, Wiley Interscience, New York, 437 pp.

O'Neill, M. W., Townsend, F. C., Hassan, K. H., Buller, A., and Chan, P. S. (1996). "Load Transfer for Drilled Shafts in Intermediate Geomaterials," *Publication No. FHWA-RD-95-171*, Federal Highway Administration, Office of Engineering and Highway Operations R & D, McLean, VA, November, 184 pp.

O'Neill, M. W., and Reese, L. C. (1970). "Behavior of Axially Loaded Drilled Shafts in Beaumont Clay," *Research Report No. 89-8*, Center for Highway Research, The University of Texas at Austin, December.

O'Neill, M. W., and Hassan, K. H. (1994). "Drilled Shafts: Effects of Construction on Performance and Design Criteria," in *Proceedings*, International Conference on Deep Foundations, FHWA, Vol. 1, Orlando, December, pp. 137 - 187.

Pabon, G., and Nelson, P. P. (1993). "Behavior of Instrumented Model Piers in Manufactured Rock with a Soft Layer," *Design and Performance of Deep Foundations: Piles and Piers in Soil and Soft Rock*, GSP No. 38 (Nelson, Smith, and Clukey, eds.), Dallas, October, pp. 260 - 276.

Poulos, H. G. (1981), "Cyclic Axial Response of Single Pile," *Journal of the Geotechnical*

- Engineering Division*, ASCE, Vol. 107, No. GT1, January, pp. 41 - 58.
- Poulos, H. G. (1982). "Influence of Cyclic Loading on Axial Pile Response," in *Proceedings*, Second Int. Conf. on Numerical Meth. in Offshore Piling, (Roesset, ed.) The University of Texas at Austin, pp. 419 - 440.
- Reese, L. C., and O'Neill, M. W. (1988a). "Field Load Tests of Drilled Shafts," in *Proceedings*, International Seminar on Deep Foundations on Bored and Auger Piles, Van Impe (ed.), Balkema, Rotterdam, June, pp. 145 - 192.
- Reese, L. C., and O'Neill, M. W. (1988b). *Drilled Shafts Student Workbook*, NHI Course No. 13214, Federal Highway Administration, August, 564 pp.
- Robertson, P. K., and Campanella, R. G. (1983). "Interpretation of Cone Penetration Tests, Part I: Sand," *Canadian Geotechnical Journal*, Vol. 20, pp. 718 - 733.
- Rowe, P. K., and Armitage, H. H. (1987). "A Design Method for Drilled Piers in Weak Rock," *Canadian Geotechnical Journal*, Vol. 24, pp. 114 - 125.
- Rowe, P. K., and Armitage, H. H. (1984). "The Design of Piles Socketed Into Weak Rock," *Report No. GEOT-11-84*, University of Western Ontario, London, Ontario, 366 pp.
- Seidel, J. P., and Haberfield, C. M. (1994). "A New Approach to the Prediction of Drilled Pier Performance in Rock," in *Proceedings*, International Conference on Deep Foundations, Vol. II, Federal Highway Administration, Orlando, December, pp. 556 - 570.
- Senna, R. S., Jr., Cintra, J. C. A., Rezebde, M. E. B., and Carvalho, D. (1993). In *Proceedings*, International Seminar on Bored and Auger Piles, Van Impe (ed.), Balkema, Rotterdam, pp. 151 - 154.
- Stas, C. V., and Kulhawy, F. H. (1984). "Critical Evaluation of Design Methods for Foundations Under Axial Uplift and Compression Loading," *Final Report*, Project 1493-1, EPRI EL-3771, Geotechnical Group, Cornell University, Ithaca, NY, November.
- Turner, J. P., and Kulhawy, F. H. (1990), "Drained Uplift Capacity of Drilled Shafts under Repeated Axial Loading," *Journal of Geotechnical Engineering*, Vol. 116, No. 3, March, pp. 470 - 491.
- Vesic, A. S. (1972). "Expansion of Cavities in Infinite Soil Mass," *Journal of the Soil Mechanics and Foundations Division*, ASCE, Vol. 98, No. SM3, March, pp. 265 - 290.
- Walsh, K. D., Houston, S. L., and Houston, W. N. (1995). "Development of t-z Curves for Cemented Fine-Grained Soil Deposits," *Journal of Geotechnical Engineering*, ASCE, Vol. 121,

No. 12, December, pp. 886 - 895.

Williams, A. F., Johnston, I. W., and Donald, I. B. (1980). "The Design of Socketed Piles in Weak Rock," in *Proceedings, International Conference on Structural Foundations in Rock*, Balkema, Sydney, May, pp. 327 - 347.

Yazdanbod, A., Sheikh, S. A., and O'Neill, M. W. (1987). "Uplift of Shallow Underreams in Jointed Clay," in *Foundations for Transmission Line Towers*, GSP No. 8, (Briaud, ed.), ASCE, April, pp. 110 - 127.

Zhang, L., and Einstein, H.H. (1998). "End Bearing Capacity of Drilled Shafts in Rock," *Journal of Geotechnical and Geoenvironmental Engineering*, ASCE, Vol. 124, No. 7, July, pp 574 - 584.

## APPENDIX C: ESTIMATION OF AXIAL MOVEMENT OF DRILLED SHAFTS

### INTRODUCTION

Axial movement can be defined as the settlement or uplift that occurs when a foundation is loaded along its axis. Axial movements are dependent on the magnitude, direction and repetitive character of the applied loads, foundation diameter, construction details, and the presence of other nearby drilled shafts (group action). They are also dependent upon the stiffness of the drilled shaft considered as a column and upon the elastic and plastic properties of the geomaterial in which the drilled shaft is embedded. It is observed in Figure 10.3 that axial deformations are nonlinear functions of load, more particularly so at high values of applied load relative to the drilled shaft's resistance.

Deformations due to the effects listed above are relatively short term. That is, they occur within minutes or hours of the application of the load. Long-term settlements can be produced by consolidation of clay soils beneath the bases of drilled shafts, by consolidation of natural soils or fills around the sides of drilled shafts (downdrag), and by creep in both the geomaterial and the structural material from which the drilled shaft is constructed.

Settlements, whether short-term or long-term, are most severe when drilled shafts are constructed in groups.

This appendix describes several methods by which axial deformations of drilled shafts and groups of drilled shafts can be predicted. These include

- *Simple formulas* for making first order settlement estimates for isolated drilled shafts in soil and drilled shaft groups at and below working loads,
- *Normalized load-transfer methods* for making estimates of the settlement of isolated drilled shafts in soil by hand at any level of load, up to and including failure,
- *Numerical methods* based on load transfer functions, and
- *Approximate numerical solutions* based on approximations of plane-strain elastic methods, finite element solutions and boundary element solutions for drilled shafts in intermediate geomaterials and in rock and for groups of drilled shafts.

It will be assumed that the soil and drilled shaft material parameters that are needed in the calculations have been obtained in a reliable manner.

The first two methods can be used for drilled shafts in cohesive or granular soil in a preliminary design or to determine that settlements will not likely be critical to the performance of the

structure. The third method is appropriate for use in designing drilled shafts in layered soil and rock profiles, for designing loading tests, and in cases where settlement or uplift can potentially control the design; and the fourth method is generally appropriate for drilled shafts whose bases are placed in or just above hard geomaterials (IGM's and rock) and for drilled shaft groups.

The general level of reliability of the deformation estimates is indicated in the figures that are used with the second method, which show the ranges of deformation expected.

## SOILS - SIMPLE FORMULAS

### Single Drilled Shafts in Soil

Vesic (1977) proposed the use of the following equations to estimate settlement of cylindrical drilled shafts in the working load range in soils based on a general description of the soil and rudimentary structural properties of the drilled shaft.

$$w_T = w_c + w_{bb} + w_{bs} \quad , \quad (C.1)$$

in which

$w_T$  = settlement of the head of the drilled shaft.

$w_c$  = elastic compression of the drilled shaft, which can be approximated as  $[L/(AE)_{\text{drilled shaft}}] [Q_h - 0.5 Q_{ms}]$ , in which  $L$  = length of the drilled shaft,  $A$  = cross sectional area of the drilled shaft,  $E$  = effective (composite) Young's modulus of the drilled shaft,  $Q_h$  = load applied to the head of the drilled shaft [=  $Q_T$  (applied)] and  $Q_{ms}$  = estimated load mobilized in side resistance when the load  $Q_h$  is applied [=  $R_S$  (mobilized)]. Note that  $Q_{ms}/Q_h \geq R_S / (R_S + R_B)$ . It is conservative to assume that  $Q_{ms} = 0$ . The effective Young's modulus of the drilled shaft,  $E = E_c (A_c + nA_s)$ , where  $E_c$  is the Young's modulus of the concrete,  $A_c$  is the area of the concrete in the cross section,  $A_s$  is the area of the longitudinal steel in the cross-section, and  $n = E_s / E_c$ , where  $E_s$  is the Young's modulus of the steel rebar.

$w_{bb}$  = settlement of the base due to the load transferred to the base,  $Q_{mb}$  [=  $R_B$  (mobilized)], which must be estimated. Note that  $Q_{mb}/Q_h \leq R_B / (R_S + R_B)$ .

$w_{bs}$  = settlement of the base due to the load transferred into the soil along the sides,  $Q_{ms}$ , which is equal to  $Q_h - Q_{mb}$ .

Vesic recommended the following expressions for  $w_{bb}$  and  $w_{bs}$ .

$$w_{bb} = C_p \left( \frac{Q_{mb}}{B q_{max}} \right) \quad \text{and} \quad (C.2)$$

$$w_{bs} = \left( 0.93 + 0.16 \sqrt{\frac{L}{B}} \right) C_p \left( \frac{Q_{ms}}{L q_{max}} \right) \quad (C.3)$$

In Equations (C.2) and (C.3), B is the shaft diameter, L is the length of the fully embedded shaft, and  $q_{max}$  is the net ultimate resistance (bearing capacity) of the base, described in Appendix B.  $C_p$  is a soil factor obtained from Table C.1. Consistent units are used.

Table C.1. Values of  $C_p$  is Various Soils (Vesic, 1977)

Soil	$C_p$
Sand (dense)	0.09
Sand (loose)	0.18
Clay (stiff)	0.03
Clay (soft)	0.06
Silt (dense)	0.09
Silt (loose)	0.12

Although methods described later can be used to estimate  $Q_{mb}/Q_h$  and  $Q_{ms}/Q_h$ , they are capable of estimating  $w_T$  directly. This method would only be used in a preliminary analysis before the elastic stiffness of the soil has been estimated or as an approximate check on other solutions.

---

**Example C-1. Settlement of cylindrical drilled shaft in soil.**

Suppose that we expect to construct drilled shafts in a generally uniform dense sand formation. The drilled shafts are proposed to be 14 m (46 ft) long and 1.22 m (48 in.) in diameter. The nominal load to be applied to each drilled shaft in the critical load case is estimated to be 2.23 MN (250 tons). It is estimated that 20 per cent of the applied load will reach the base.

The drilled shaft will be constructed with concrete having a 28-day compressive strength of 27.56 MPa (4,000 psi), so that  $E_c = 57,000 (4,000)^{0.5} = 3,605,000 \text{ psi} = 24.8 \text{ GPa}$ . The steel schedule will include 12, #35 M bars (cross-sectional area = 1000 mm<sup>2</sup>) in a circle with a value of  $E_s = 200 \text{ GPa}$  (1 per cent steel). Analysis of the borings indicates that  $q_{max}$  should be taken to be 2.30 MPa (24 tsf).

$$A_s = 12 (1000) = 12000 \text{ mm}^2 = 0.0120 \text{ m}^2.$$

$$A_c = (\pi/4) 1220^2 - 12000 = 1,156,987 \text{ mm}^2 = 1.157 \text{ m}^2$$

$$n \text{ (modular ratio)} = E_s/E_c = 200/24.8 = 8.06.$$

$$E = E_c (A_c + nA_s) = 24.8 [1.157 + 8.06 (0.0120)] = 31.09 \text{ GPa}$$

$$A = A_c + A_s = 1.157 + 0.0120 = 1.169 \text{ m}^2; AE = 36.34 \text{ GN} = 36.34 \times 10^3 \text{ MN}$$

$$Q_h = 2.23 \text{ MN}; Q_{ms} = 0.8 (2.23) = 1.784 \text{ MN}; Q_{mb} = 0.2 (2.23) = 0.446 \text{ MN}.$$

From Table C.1,  $C_p = 0.09$ .

$$w_c = [L/(AE)_{\text{shaft}}] [Q_h - 0.5 Q_{ms}] = [14/(36.34 \times 10^3)][2.23 - 0.5 (1.784)] \\ = 0.00052 \text{ m} = 0.52 \text{ mm}.$$

$$w_{bb} = 0.09 \{0.446/[1.22(2.30)]\} = 0.0143 \text{ m} = 14.3 \text{ mm}.$$

$$w_{bs} = [0.93 + 0.16 (14/1.22)^{0.5}] [0.09] \{1.784/[14(2.30)]\} = 0.00734 \text{ m} = 7.3 \text{ mm}.$$

$$w_T = 0.52 + 14.3 + 7.3 = 22.1 \text{ mm} = 0.87 \text{ in}.$$

If this magnitude of settlement is judged excessive for working load conditions, then the drilled shaft should be deepened or the diameter increased before proceeding with more elaborate analyses.

Note that relatively little of the settlement originates in compression of the drilled shaft (only 0.52 mm of the 22.1 mm total settlement).

### Groups of Drilled Shafts in Soil

Vesic (1969) also suggested the following simple equation for estimating the settlement of a group of piles at and below working load. The formula is based on observations of groups of driven and jacked piles in sand, but it can be presumed that the method also applies to drilled shafts, at least approximately.

$$w_{Tgroup} = w_{Ts} \sqrt{\frac{B_g}{B_s}} \tag{C.4}$$

where

$w_{Tgroup}$  = settlement of the group of piles,



$w_{Ts}$  = settlement of the head of a single isolated drilled shaft with a load equal to the load on the group divided by the number of drilled shafts in the group,

$B_g$  = minimum width of the drilled shaft group in plan view, and

$B_s$  = diameter of the typical drilled shaft within the group.

For preliminary estimates,  $w_{Ts}$  might be estimated as  $w_T$  from Equation (C.1).

---

**Example C-2. Settlement of drilled shaft group.**

Estimate the settlement of a group of nine drilled shafts of the design described in Example C-1 if the group is arrayed in a 3 X 3 matrix pattern with a center-to-center drilled shaft spacing of 3.66 m. The load on the group of nine drilled shafts is  $9(2.23 \text{ MN}) = 20.07 \text{ MN}$ . Use Equation (C.4).

$$B_g = 1.22 \text{ m} + 2(3.66 \text{ m}) = 8.54 \text{ m}; B_g / B_s = 8.54 / 1.22 = 7; (7)^{0.5} = 2.65$$

$$w_{T \text{ group}} = 22.1(2.65) = 58.6 \text{ mm} = 2.31 \text{ in.}$$

The value 22.1 mm comes from the computations in Example C-1.

This settlement value might be considered excessive in some circumstances, necessitating the redesign of the geometry of the individual drilled shafts or increasing the number of drilled shafts in the group to carry the working load of 20.07 MN. Considering the relatively large deflection of the single shaft in Example C-1, redesign of the geometry of the individual drilled shafts by deepening or widening the shafts would probably be the most cost effective solution unless subsurface conditions are such that construction of drilled shafts with greater penetrations or larger diameters would be unduly expensive.

---

## SOILS - NORMALIZED LOAD-TRANSFER METHODS (COMPRESSION)

Analysis of a data base of compression loading tests on single, full-sized drilled shafts in soil (Reese and O'Neill, 1989) indicated that the normalized relations shown in Figures C.1 and C.2 could be applied to the prediction of settlements of drilled shafts in cohesive (fine-grained) soils under undrained (short-term) loading. The relationships in Figures C.3 and C.4 are from a somewhat larger database that includes loading tests in gravel (O'Neill and Hassan, 1994) and can be used in cohesionless (coarse-grained) soils under drained loading.

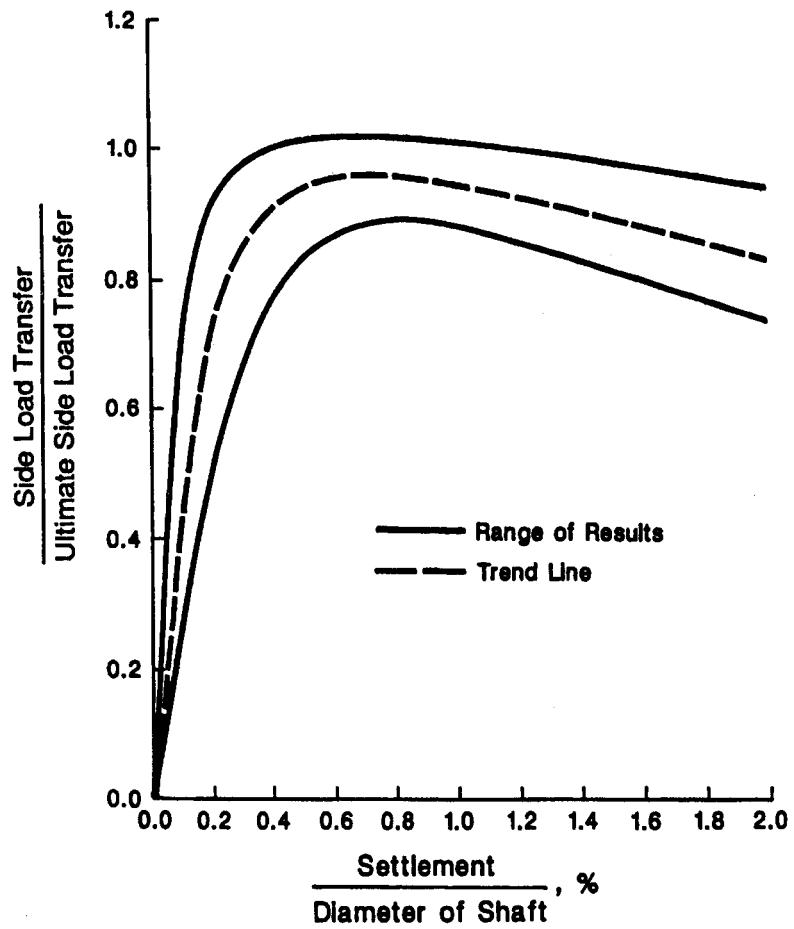

Figure C.1. Normalized load transfer relations for side resistance in cohesive soil

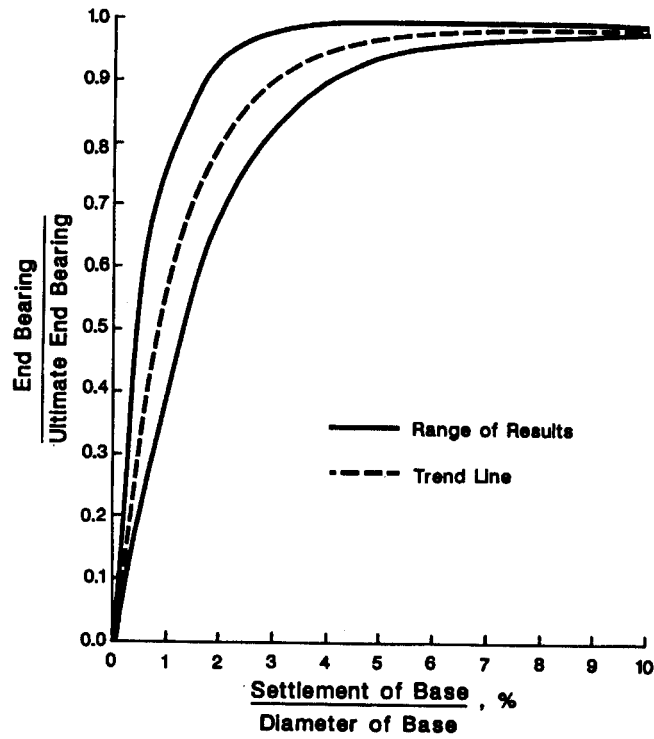

Figure C.2. Normalized load transfer relation for base resistance in cohesive soil

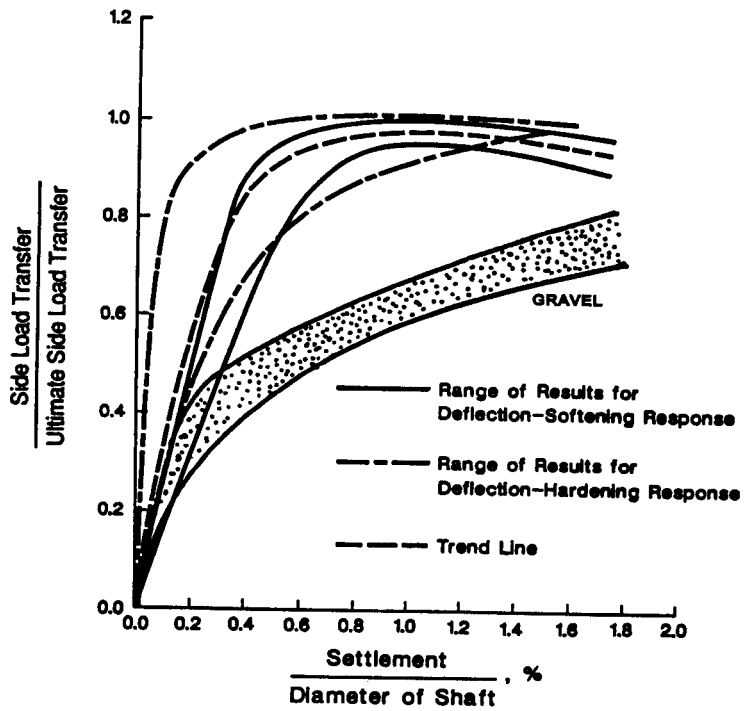

Figure C.3. Normalized load transfer relations for side resistance in cohesionless soil

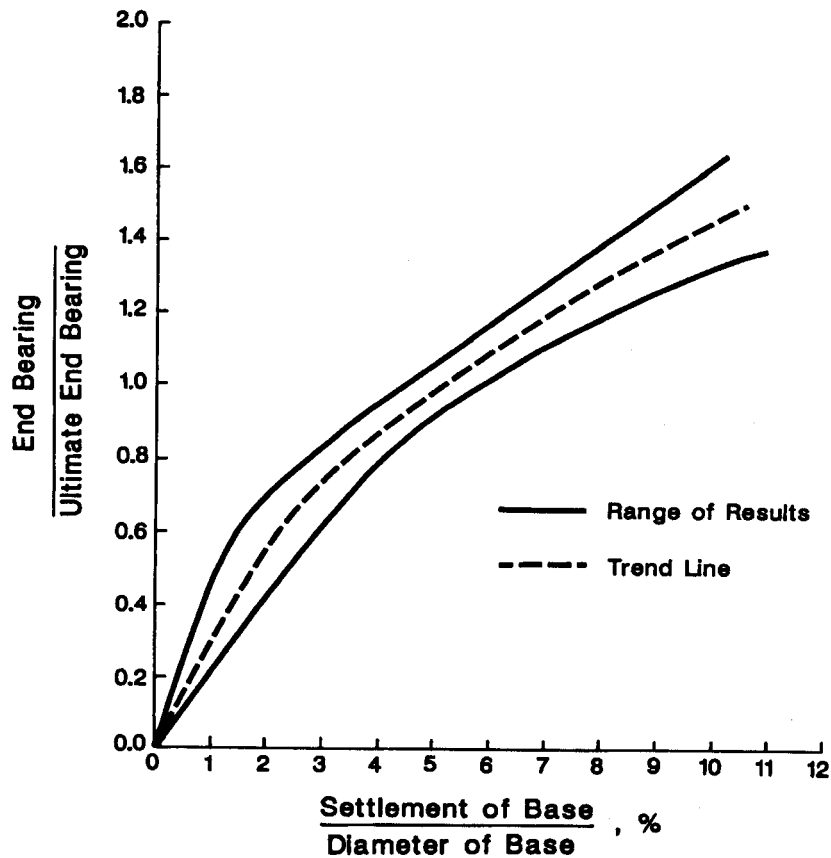

Figure C.4. Normalized load transfer relations for base resistance in cohesionless soil

The bounds of the relation in Figure C.3 that are indicated for gravel are approximately appropriate for cemented fine-grained desert IGM's according to data presented by Walsh et al. (1995).

It is noted that the normalizing factor for the dimensionless load-settlement curves given in Figures C.1 and C.3 is the shaft diameter (B). The range of validity for these curves is for B between 0.46 m (18 in.) and 1.53 m (60 in.). The normalizing factor for Figures C.2 and C.4 is the base diameter [B(base)]. The range of validity for these curves is for B(base) between 0.76 m (30 in.) and 3.36 m (132 in.). Applications of this method to drilled shafts with sizes outside of this range should be verified by loading tests.

Figures C.1 through C.4 show ranges of data (upper and lower bounds) and also show trend lines (most probable relations). The procedure for using these figures is iterative, but the procedure can be used to predict nonlinear load versus settlement behavior. The procedure is applied as follows:

- First, compute the ultimate side resistance,  $R_s$ , and the ultimate base resistance,  $R_B$ , using, for

example, one of the methods described in Appendix B.

- Assume a value of applied load  $Q_{Td}$  and corresponding head displacement,  $w_T$ . These will not necessarily be compatible at this point in the process because the settlement is an assumption.
- Assume that the drilled shaft is either "rigid" or "flexible."

Flexibility in this context is a function of relative soil/shaft stiffness,  $S_R = (L/B) \times (E_{soil}/E_{shaft})$ , in which  $L$  = shaft length,  $B$  = shaft diameter,  $E_{soil}$  = average Young's modulus of the soil along the shaft,  $E_{shaft}$  = composite Young's modulus of the shaft cross section. If  $S_R \leq 0.010$ , the shaft can be assumed to be rigid (incompressible), which means that the base and sides can be assumed to settle equally.

If  $S_R > 0.010$ , the compression within the drilled shaft due to column action  $\delta_s$  should be estimated for the applied load for which the value of settlement is being computed.

$$\delta_s = k Q_{Td} L / AE \quad (C.5)$$

in which  $Q_{Td}$  = applied load [for serviceability analysis,  $Q_{Td}$  is usually taken as a combination of nominal load components, i. e., load factors = 1, in an LRFD analysis],  $L$  = shaft length,  $A$  = cross-sectional area of the shaft, and  $E$  = composite Young's modulus of the cross-section (taking account of the differences in the moduli of the concrete and the steel).  $k$  is a factor that is selected based on the amount of load that is judged to be reaching the base. If there is no load transfer along the sides, all of the load will reach the base, and  $k = 1$ . If all of the load is transferred in side resistance, and no load reaches the base,  $k = 0.5$ .  $k$  can often be taken to be 0.67 with little error for drilled shafts in soil.

- If the shaft is classified as rigid, the factor "settlement/diameter of shaft" in Figures C.1 and C.3 will be  $w_T/B$ . When the shaft is cylindrical, such will also be true for "settlement of base/diameter of base" in Figures C.2 and C.4. When the shaft is belled, "settlement of base/diameter of base" =  $w_T/B(\text{base})$ , where  $B(\text{base})$  = diameter of the bell, in Figures C.2 and C.4. Note that these parameters are expressed as percentages.
- If the shaft is classified as flexible, the settlement of the shaft and the settlement of the base will be different from  $w_T$  and different from each other because the shaft is compressing under load. The settlement of the shaft  $w_s$  can be approximated by  $w_s = w_T - 0.5 \delta_s$ . This will be the downward movement at the center (mid-depth) of the shaft, assuming that the rate of side load transfer to the soil is uniform with depth. The corresponding settlement of the base  $w_B$  is given by  $w_B = w_T - \delta_s$ . "Settlement/diameter of shaft" in Figures C.1 and C.3 is then  $w_s/B$  (%), and "settlement of base/diameter of base" in Figures C.2 and C.4 is  $w_B/B(\text{base})$  (%).

- From Figure C.1 (shaft in cohesive soil) or C.3 (shaft in cohesionless soil), read "side load transfer/ultimate side load transfer" ( $R_{sd}/R_s$ ), using the trend line, lower bound or upper bound, based on judgment.  $R_{sd}$  is the "developed" shaft resistance under the condition being analyzed, which is less than or equal to the ultimate resistance. Note that there are two sets of bounds in Figure C.3 for sand, based on whether the sand is deflection-softening or deflection-hardening. Loose sands will often exhibit deflection-hardening behavior. If in doubt, use the trend line. A third set of bounds is shown for gravel. No trend line is shown for gravel, because the data are sparse, but reasonably accurate predictions should be possible using values equidistant between the two bounds. If the soil is layered, these figures can be used on a layer-by-layer basis.
- From Figure C.2 (base in cohesive soil) or C.4 (base in cohesionless soil), read "end bearing/ultimate end bearing" ( $R_{bd}/R_B$ ), using the appropriate line, selected as above.
- Calculate  $R_{sd} = (R_{sd}/R_s) (R_s)$  for the entire shaft or on a layer-by-layer basis.
- Calculate  $R_{bd} = (R_{bd}/R_B) (R_B)$ .
- The computed resistance that corresponds to  $w_T$  is  $R_{Td} = R_{sd} + R_{bd}$ . If the value of  $w_T$  was selected correctly,  $R_{Td}$  from this expression will be equal to the applied load,  $Q_{Td}$ . If not, the settlement that was estimated is not correct. Select a new value of  $w_T$ , and repeat until the applied load and computed resistance are approximately equal.
- If desired, repeat the process with different values of applied load to define the entire load-settlement relation.

Repeating the analysis using the upper and lower bounds to the relations in Figures C.1 through C.4 can provide some guidance relative to the range of settlements that might occur due to variations in construction procedures.

---

**Example C-3.** *Settlement of a drilled shaft using normalized load transfer relations.*

Consider the drilled shaft shown in the following sketch. Determine the settlement of the drilled shaft under a load of 2.00 MN. Assume behavior according to the trend lines in the normalized load transfer method figures.

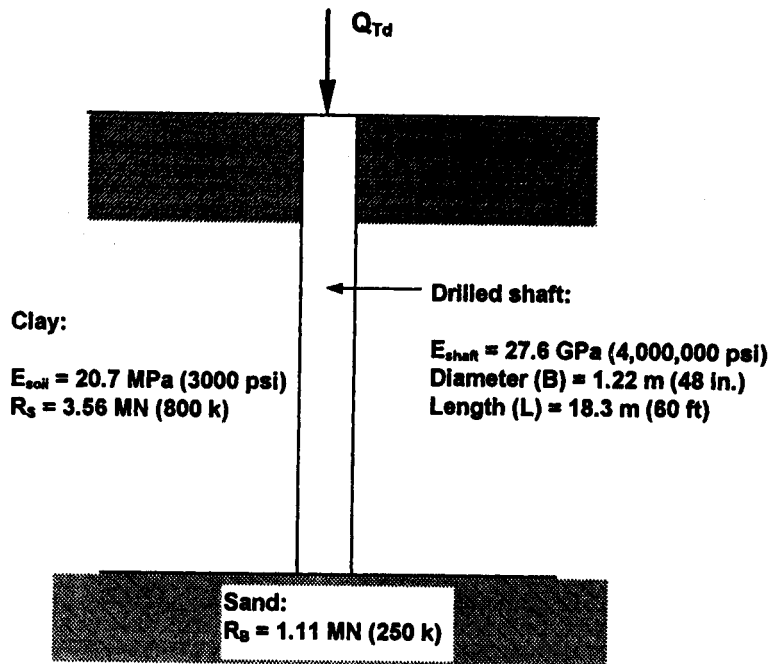

The values of  $R_s$  and  $R_B$  (ultimate side and base resistances, respectively) have already been computed by one of the methods in Appendix B / Chapter 11.

- Estimate the settlement  $w_T$  to be 2.50 mm. This is an educated guess at this point.
- Check flexibility:  
 $S_R = (18.3/1.22) (20.7/27600) = 0.01125$ , so consider the shaft to be flexible.
- $\delta_s = 0.67 (2.00)(18.3)/[(\pi 1.22^2 / 4)(27,600)] = 0.000760 \text{ m} = 0.76 \text{ mm}$ .
- $w_s/B = [2.50 - 0.76/2] / 1220 = 0.00174 = 0.174 \%$ .
- From Figure C.1 (since the side of the shaft is completely in clay),  $R_{sd}/R_s = 0.70$ .
- $R_{sd} = 3.56 (0.70) = 2.492 \text{ MN}$ .
- $w_B/B = [2.50 - 0.76] / 1220 = 0.00143 = 0.143 \%$ .
- From Figure C.4 (since the base of the shaft is bearing on sand),  $R_{Bd}/R_B = 0.05$ .
- $R_{Bd} = 1.11 (0.05) = 0.056 \text{ MN}$ .

- $R_{Td} = 2.492 + 0.056 = 2.548 \text{ MN} > 2.00 \text{ MN}$ .  
Assumed settlement is too large. Continue the calculations.
- Estimate  $w_T = 1.90 \text{ mm}$ .
- $w_s/B = [1.90 - 0.76/2] / 1220 = 0.00125 = 0.125 \%$ .
- From Figure C.1 (since the side of the shaft is completely in clay),  $R_{sd}/R_s = 0.54$ .
- $R_{sd} = 3.56 (0.54) = 1.92 \text{ kN}$ .
- $w_b/B = [1.90 - 0.76] / 1220 = 0.00093 = 0.093 \%$ .
- From Figure C.4 (since the base of the shaft is bearing on sand),  $R_{bd}/R_b = 0.035$ .
- $R_{bd} = 1.11 (0.035) = 0.039 \text{ MN}$ .
- $R_{Td} = 1.92 + 0.039 = 1.96 \text{ MN} \approx 2.00 \text{ MN}$ , say OK.  
Assumed settlement is correct.

When a load of 2.00 MN is applied, the settlement of the drilled shaft will most probably be 1.9 mm (0.075 in.). Instead of using the trend line, the upper and lower bound lines could be used to infer differential settlement due to construction differences from shaft to shaft.

---

## SOILS AND IGM'S - COMPUTER SIMULATION METHODS

For cases in which layering is present within the geomaterial profile and/or where many potential loading cases and trial designs need to be analyzed, computer simulation of load vs. settlement behavior is a practical alternative. This can be accomplished by means of finite element analysis, boundary element analysis or finite difference analysis. Computer codes exist for all three approaches. The finite difference approach, which is easily adapted to the microcomputer, is briefly described here.

Consideration of the relationships between the soil and shaft deformations and load transfer for a drilled shaft can be modeled in a straightforward way. A free body of a drilled shaft is shown in Figure C.5a. The drilled shaft and the supporting soil are idealized as a system of linear (drilled shaft) and nonlinear (geomaterial) springs in Figure C.5b. The physical drilled shaft is replaced by a spring to indicate that there will be compression (shortening) of the drilled shaft due to applied compressive load (or stretching if the load is applied in uplift). The spring is shown to have a constant stiffness with depth, but the stiffness may vary in any arbitrary manner without causing any analytical difficulty. The geomaterial (soil, IGM, or rock) has been replaced with a series of mechanisms (nonlinear springs) to represent its mechanical behavior along the sides and



at the base of the drilled shaft. The mechanisms for the geomaterial consist of a cantilever spring and a friction block. These mechanisms are merely intended to show that the transfer of load from the drilled shaft to the geomaterial is a nonlinear function of the relative movement between the shaft and the geomaterial.

Analytical functions are associated with each of the geomaterial mechanisms. Two sets of these functions are shown in Figure C.5c. The upper five curves represent relations of developed unit side shear ( $f_z$ ) to local movement (downward or upward) of the drilled shaft ( $w_z$ ) at depth  $z$  along the drilled shaft. [The use of five such curves is merely an arbitrary demonstration.] These relations can vary with depth in any arbitrary manner computationally. They can be estimated from off-line analysis, such as finite element studies or elastic-plastic analysis, from measurements made in loading tests, or by using the normalized relations shown in Figures C.1 and C.3 on a layer by layer basis.

The lower relation in Figure C.5c shows the developed unit base resistance,  $q$ , versus the settlement,  $w_B$ , at the base of the drilled shaft. This relation can be determined off line, as with those for side resistance, or it can be developed using one of the the normalized relations in Figures C.2 and C.4, as appropriate for the geomaterial on which the shaft bears.

Considering the model that is shown in Figure C.5, a differential equation can be written that ensures equilibrium and compatibility in the load and movement at any point along the drilled shaft. Solution of that differential equation numerically in the computer leads directly to a simulated load vs. settlement (or uplift) prediction. The derivation of the governing differential equation is initiated by considering an element from an axially loaded drilled shaft, Figure C.6.

The axial strain,  $\epsilon_z$ , in the drilled shaft is

$$\epsilon_z = \frac{dw_z}{dz} = \frac{Q_z}{(EA)_{\text{drilled shaft}}} \quad (\text{C.6})$$

where

$E$  = composite Young's modulus of elasticity of the shaft material (considering contributions of both concrete and steel),

$A$  = cross-sectional area of the shaft,

$Q_z$  = total load in the shaft at depth  $z$ , and,

$w_z$  = movement of the shaft at depth  $z$ .

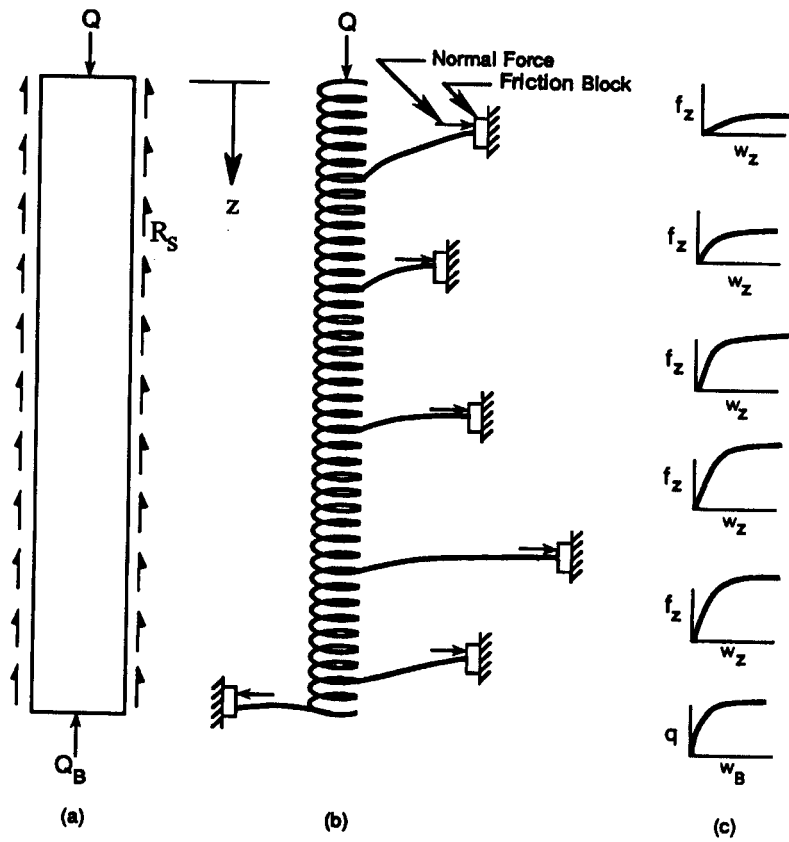

Figure C.5. Mechanistic model of axially loaded drilled shaft

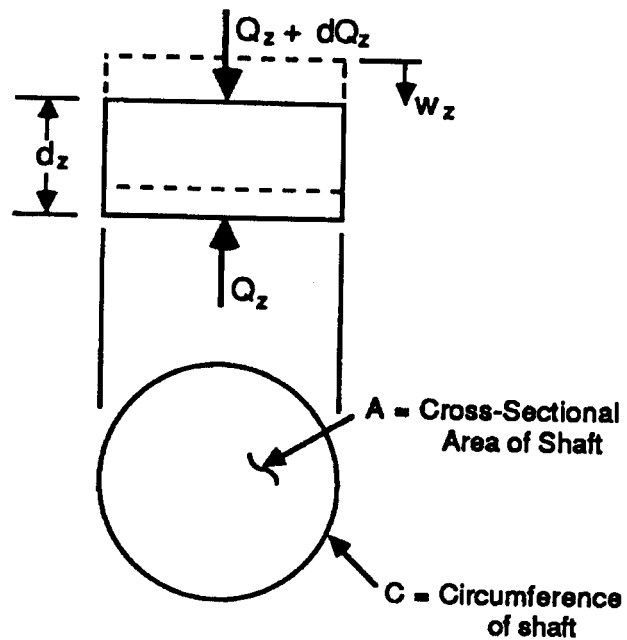

Figure C.6. Element from an axially loaded shaft

E can be computed from

$$E = \frac{E_s A_s + E_c (A_g - A_s)}{A_g} \quad (C.7)$$

where

$E_s$  = Young's modulus of steel (200 GPa or 29,000,000 psi),

$E_c$  = Young's modulus of concrete  $\{0.1496 [f'_c(\text{kPa})]^{0.5}$  in GPa or  $57,000[f'_c(\text{psi})]^{0.5}$  in psi},

$A_s$  = cross-sectional area of the steel rebar in the total cross-section, and

$A_g$  = gross cross-sectional area of the drilled shaft cross-section, including the steel and concrete.

From Equation (C.6),

$$Q_z = EA \frac{dw_z}{dz} \quad (C.8)$$

Differentiating Equation (C.8) with respect to z,

$$\frac{dQ_z}{dz} = EA \frac{d^2 w_z}{dz^2} \quad (C.9)$$

If the load transfer from the shaft to the soil at depth z, in force per unit of area, is defined as  $f_z$ , then

$$dQ_z = f_z \pi B dz \quad (C.10)$$

where

$B$  = diameter of the shaft (at depth z), and

$$\frac{dQ_z}{dz} = f_z \pi B \quad (C.11)$$

Solving Equations (C.9) and (C.11) simultaneously,

$$EA \frac{d^2 w_z}{dz^2} = \pi B f_z \quad (C.12)$$

If a value of deflection  $w_z$  is assumed at every depth  $z$  along the shaft, the load transfer can be expressed as a function of the shaft movement  $w_z$  if the  $f_z$ - $w_z$  and  $q$ - $w_B$  relations have been defined for every geomaterial layer.

$$f_z = \psi_S(w, z) w_z \quad \text{and} \quad (C.13a)$$

$$q = \psi_B(w) w_B \quad (C.13b)$$

In Equations (C.13a) and (C.13b),  $\psi_S$  and  $\psi_B$  are secant moduli to the  $f$ - $w$  and  $q$ - $w_B$  relations at the value of assumed deflection, as illustrated in Figure C.7.

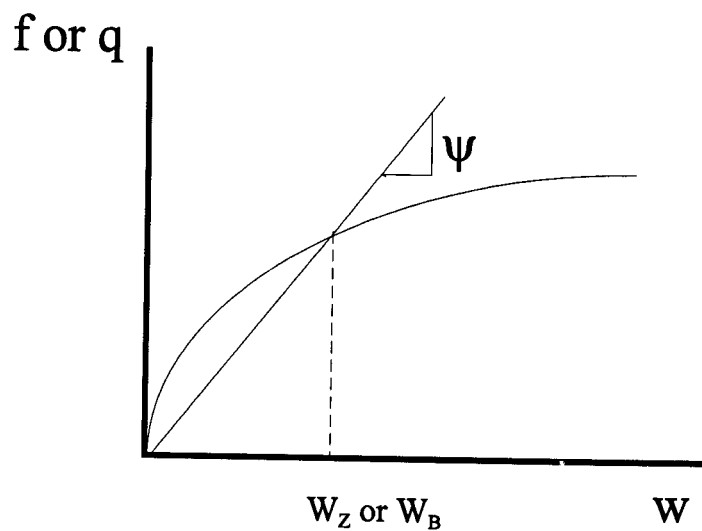

Figure C.7. Illustration of the definition of  $\psi$

If  $\psi$  is assumed to be an analytic function of depth and displacement, Equation (C.13) can be substituted into Equation (C.12) to obtain the desired differential equation:

$$\frac{d^2 w_z}{dz^2} - C \psi(w, z) w_z = 0 \quad (C.14)$$

where

$$C = \pi B / EA \quad (C.15)$$

If  $C$  and  $\psi$  are constants, a closed-form solution can be obtained for Equation (C.14). However,

$\psi$  is not normally a constant when this method is used, since one purpose for using the method is to model the nonlinear load-movement behavior in a layered geomaterial. The closed-form solution will not be presented here.

However, referring to Figure C.8, a convenient numerical solution to the differential equation, Equation (C.14), is obtained by writing the equation in central finite-difference form at each of a specified number of nodes equally spaced along the axis of the shaft. The solution requires that Equation (C.14) be linearized, which is equivalent to assuming discrete f-w and q-w relations for the nodes along the shaft at which the calculations are made ( $m-1$ ,  $m$ ,  $m+1$ , etc.) and further assuming initial values of  $w$  at each node, which fixes the values of  $\psi$ . These values (both  $w$  and  $\psi$ ) may be incorrect, but that will be determined by the following solution. If the assumed initial values are incorrect (not essentially identical to the calculated values), they are corrected, and the solution is repeated until closure is reached. Closure in this sense means that the values of  $w$  that were assumed at the beginning of a linear solution (iteration) are essentially identical to those that are computed by the linear solution.

Equation (C.14) becomes:

$$\frac{\left(\frac{\Delta w_z}{\Delta z}\right)_{m+1/2} - \left(\frac{\Delta w_z}{\Delta z}\right)_{m-1/2}}{h} = C\psi_m w_m \quad (C.16)$$

where

$\psi_m$  = temporary constant (secant to f-w or q-w curve at assumed value of  $w$ ), and  
 $h$  = increment length.

Equation (C.16) can also be further modified in central finite-difference form using

$$\left(\frac{\Delta w_z}{\Delta z}\right)_{m+1/2} = \frac{(w_z)_{m+1} - (w_z)_m}{h} \quad \text{and} \quad (C.17)$$

$$\left(\frac{\Delta w_z}{\Delta z}\right)_{m-1/2} = \frac{(w_z)_m - (w_z)_{m-1}}{h} \quad (C.18)$$

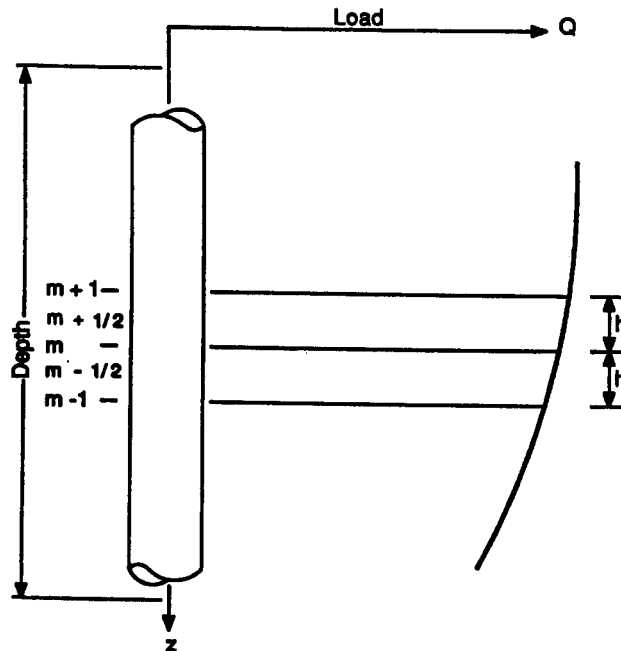

Figure C.8. Segment of a load-distribution curve along an axially loaded drilled shaft

Substituting Equations (C.17) and (C.18) into Equation (C.16), the following algebraic equation is obtained:

$$(w_z)_{m-1} - 2(w_z)_m + (w_z)_{m+1} = h^2 C \psi_m w_m \quad (C.19)$$

Equation (C.19) is written at every node  $m$  along the shaft, and special equations are written to define the boundary conditions (for example, applied load at the top). This set of equations is solved simultaneously for values of  $w_m$  at each node. If  $w_m$  at any node is inconsistent with the value assumed in estimating  $\psi_m$ ,  $\psi_m$  is revised and the solution repeated until the computed and estimated movements  $w_m$  are equal (to a specified tolerance) at all nodes.

By varying the load and repeating the solution one can obtain a curve showing the load versus the settlement at the top of the drilled shaft. At the same time, a family of curves can be obtained that shows load in the drilled shaft as a function of depth for any of the loads that act at the top of the drilled shaft. These loads are obtained from the deflection computed from Equation (C.19) by employing a finite-difference form of Equation (C.8).

Windows-based computer programs have been written to do the computations. Sources of those programs are documented in the "Resources" section at the end of this appendix. It is emphasized that research has not yet advanced to the point that the load transfer curves ( $f$ - $w$  and  $q$ - $w$  curves) can be predicted for all conditions with confidence. Construction practices and the particular response of a given formation to drilling and concreting are known to have an effect on the load transfer curves. For major projects, therefore, it is advisable to measure the load transfer

curves using full-scale loading tests performed in the design stage of the project. Chapter 14 shows how the results from a load test of an instrumented drilled shaft can be used to obtain experimental load transfer curves that are specific to a particular site and construction technique.

## IGM's - SIMPLIFIED EQUATIONS BASED ON ANALYTICAL SOLUTIONS

### Cohesive IGM's

The method for predicting load-settlement behavior of drilled shafts in sockets in cohesive intermediate geomaterials is based upon O'Neill et al. (1996), in which equations that approximate the behavior of IGM sockets modeled with nonlinear finite element techniques and verified by full-scale field load tests are used. The method applies only to the socket and does not address the resistance in the overburden, which can often be disregarded for design purposes.

Reference is made to Appendix B for the determination of  $f_{ab}$ , the adjusted apparent value of  $f_{max}$  in an IGM socket [Equations (B.36), (B.37) and (B.39)]. It is also necessary to select a value of the parameter  $n$ , based on whether the socket is smooth or rough. If the socket is classified as smooth,  $n$  can be obtained from Figure B.12. If the socket is classified as rough,  $n = \sigma_h/q_u$ , where  $\sigma_h$  is the average horizontal concrete pressure in the socket and  $q_u$  is the median unconfined compression strength of the IGM cores. A procedure is described in Appendix B for estimating  $\sigma_h$ . Limitations of the method are briefly discussed in Appendix B and are discussed in more detail by O'Neill et al. (1996). One primary limitation is that the IGM is ductile (does not exhibit deformation softening behavior following shear failure). The socket is assumed to consist of uniform geomaterial along the sides and beneath the base. Computations are best executed using a spreadsheet, examples of which are given in the reference cited above. The procedure is as follows:

- Select a trial geometry for the socket [ $D$ , penetration of the drilled shaft into the IGM socket as opposed to the full length of the drilled shaft,  $L$  and  $B$ , socket diameter]. Determine the modulus of the rock mass,  $E_m$ , as discussed in Appendix B, and estimate the Young's modulus of the concrete socket,  $E_c$ .  $E_c$  should be a composite modulus ( $E$  in the preceding section).
- Compute the geometric characteristic terms  $\Omega$  and  $\Gamma$ :

$$\Omega = 1.14 \left( \frac{D}{B} \right)^{0.5} - 0.05 \left[ \left( \frac{D}{B} \right)^{0.5} - 1 \right] \log_{10} \left( \frac{E_c}{E_m} \right) - 0.44 \quad ; \quad (C.20)$$

$$\Gamma = 0.37 \left( \frac{D}{B} \right)^{0.5} - 0.15 \left[ \left( \frac{D}{B} \right)^{0.5} - 1 \right] \log_{10} \left( \frac{E_c}{E_m} \right) + 0.13 \quad (C.21)$$

- Select a series of values of socket-head displacement  $w_T$ . For each selected value of  $w_T$ , a resistance (load at the head of the socket) corresponding to that displacement is computed in the following steps.
- Compute the elastic-range settlement term:

$$H_f = \frac{E_m \Omega}{\pi D \Gamma f_{aa}} w_T \quad (\text{C.22})$$

- Compute the inelastic-range settlement term:

$$K_f = n + \frac{(H_f - n)(1 - n)}{H_f - 2n + 1} \leq 1, \quad (\text{C.23})$$

- Compute the net unit bearing stress reaching the base,  $q_B$ :

$$q_B = 0.0134 E_m \left( \frac{D}{B+1} \right) \left[ \frac{200 w_T \left[ \left( \frac{D}{B} \right)^{0.5} - \Omega \right] \left[ 1 + \frac{D}{B} \right]^{0.67}}{\pi D \Gamma} \right] \quad (\text{C.24})$$

- Compute  $Q_T$  (applied load at the top of the socket) corresponding to  $w_T$ :

- If  $H_f \leq n$  (within the linear elastic range of settlement):

$$Q_T = \pi B L H_f f_{aa} + \frac{\pi B^2}{4} q_B \quad (\text{C.25})$$

- If  $H_f > n$  (within the inelastic range of settlement):

$$Q_T = \pi B L K_f f_{aa} + \frac{\pi B^2}{4} q_B \quad (\text{C.26})$$



The method outlined here will give accurate predictions up to about 50 mm of settlement and for B up to about 2.0 m. As a part of the design process the value of  $q_B$  that is computed should be compared to the ultimate value (strength or extreme event design) or working value (serviceability design or working load design) of base resistance. For a service condition analysis, if the IGM is massive (RQD = 100 per cent),  $q_B$  should not exceed  $q_u$ . Further information on base resistance in IGM's is given in Appendix B and in O'Neill et al. (1996).

### Granular (Cohesionless) IGM's

The method for predicting load-settlement behavior of granular (cohesionless) IGM's is based on Mayne and Harris (1993), which is in turn based on a simplified closed-form elastic analysis of the settlement of cylindrical piles by Randolph and Wroth (1978).

In this method,  $f_{max}$  and  $q_{max}$  are computed for the trial design as indicated for granular IGM's in Appendix B. Next, the profile of elastic moduli for the soil is estimated. Mayne and Harris recommend the following equation for the sands of the Piedmont residuum:

$$E_s = 22 p_a N_{60}^{0.82} \quad (C.27)$$

$N_{60}$ , the SPT blow count for an arrangement in which 60 per cent of the potential energy of the SPT hammer is delivered to the drill string, should not exceed 100 blows / 0.3 m.  $p_a$  is atmospheric pressure in the units used. The modulus profile is then idealized as shown in Figure C.9.

In Figure C.9 the symbol L is used to designate the length of the drilled shaft. If the IGM is a socket beneath a layer of overburden, L becomes D, the length of the IGM socket.

Note that in the excavation of a drilled shaft borehole, stress relief appears to reduce the effective modulus of the geomaterial beneath the base, therefore  $E_b$ , illustrated in Figure C.9, is not equal to  $E_{sL}$ , the value of E in the undisturbed soil at the bottom of the drilled shaft. Rather, it is taken to be  $0.4 E_{sL}$ , or  $E_{sL}/E_b = \xi = 2.5$ .

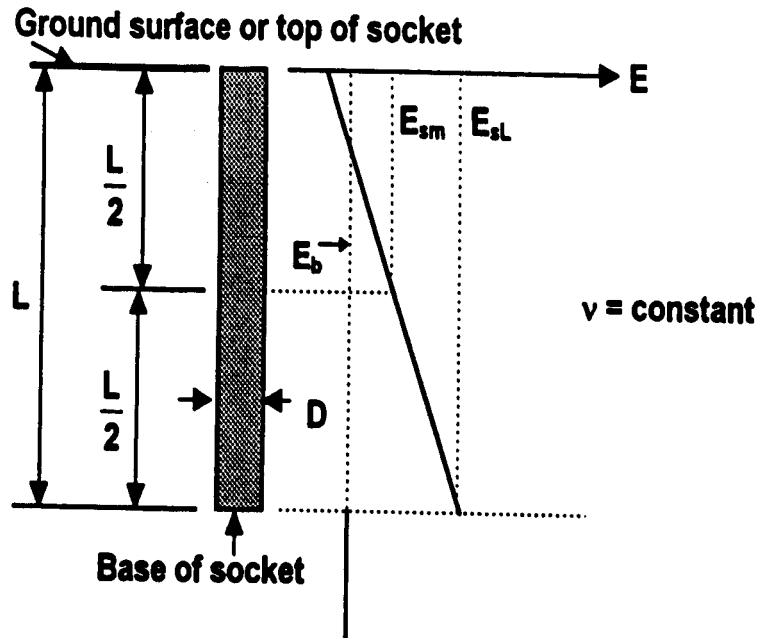

Figure C.9. Idealized soil modulus profile for computing settlement in granular IGM's

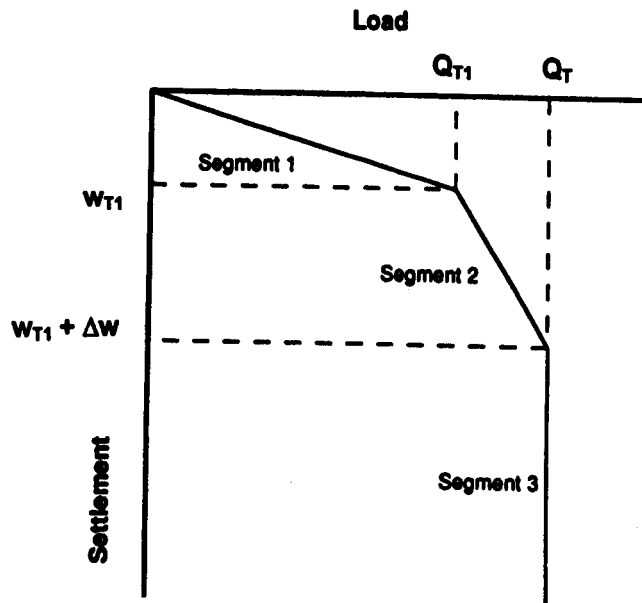

Figure C.10. Load-settlement relation for method for granular IGM's

The load-settlement relation is computed as three linear segments, as depicted in Figure C.10. The computations proceed as follows.

- The load  $Q_{T1}$  is computed.  $Q_{T1}$  is the load at the end of Segment 1, which is the total load on the head of the drilled shaft at the point at which complete side shear failure develops. Some base resistance will also have developed at this point, so that  $Q_{T1}$  cannot simply be established as  $R_s$ , unless the shaft has a very soft base (as for example when a loading test is conducted on a drilled shaft with a soft insert at the base of the shaft to eliminate base resistance).

$$Q_{T1} = \frac{f_{max} \pi B L}{1 - \left\{ \frac{I}{[\xi \cosh(\mu L)] (1 - \nu^2)} \right\}} \quad (C.28)$$

where

$$I = 4(1 + \nu) \frac{1 + \frac{8 \tanh(\mu L) L}{\pi \lambda (1 - \nu) \xi (\mu L) B}}{\frac{4}{(1 - \nu) \xi} + \frac{4 \pi \frac{E_{sm}}{E_{sL}} \tanh(\mu L) L}{\zeta (\mu L) B}} \quad (C.29)$$

Several terms appear in Equations (C.28) and (C.29) that require definition:

- $\nu$  =Poisson's ratio of the geomaterial, which can be approximated as 0.3 to 0.4 for drained loading unless specific values are available for the site.
- $\mu L$  =Lateral extent of the zone of influence of the strains produced by loading the drilled shaft =  $2 (2/\zeta \lambda)^{0.5} (L/B)$ , where
- $\zeta$  =  $\ln \{ [0.25 + (2.5(E_{sm}/E_{sL})(1-\nu)-0.25)\xi] (2L/B) \}$ ,
- $\lambda$  =  $2 (1+\nu) E_c/E_{sL}$ ,
- $\xi$  =  $E_{sL}/E_b = 2.5$ , and
- $E_c$  =Composite Young's modulus of the drilled shaft cross-section.
- $E_{sm}$  = Young's modulus of the IGM at the mid-depth of the IGM socket.
- $E_{sL}$  =Young's modulus of the IGM at the elevation of the base of the drilled shaft.
- $E_b$  =Effective Young's modulus for the IGM beneath the base of the drilled shaft.
- $I$  =Elastic settlement influence factor.

The functions "cosh" and "tanh" are hyperbolic functions that derive from the closed-form solutions for the shaft-soil system. They can be evaluated from tables in any mathematical handbook and are available in most spreadsheet programs.

- The corresponding settlement,  $w_{T1}$  is given by

$$w_{T1} = \frac{Q_{T1}I}{E_s L B} \quad (C.30)$$

- $Q_T$ , the load at the end of Segment 2 in Figure C.10, is simply the ultimate resistance of the drilled shaft, given (for a single-layer system) by

$$Q_T = R_T = f_{max} (\pi B L) + q_{max} (\pi B^2 / 4) \quad (C.31)$$

- The additional settlement that occurs between the end of Segment 1 and the end of Segment 2 is denoted  $\Delta w$ . This settlement is produced by the increment of applied load following  $Q_{T1}$  being taken completely by the base and is given by

$$\Delta w = (Q_T - Q_{T1}) \frac{(1 - \nu^2)}{E_b B} \quad (C.32)$$

This method has been shown to give reasonable results for B up to 1.53 m.

---

**Example C-4. Settlement of a drilled shaft in granular IGM.**

Consider the drilled shaft shown in the following sketch. Calculations to obtain the unit side resistances in each stratum are based on the method presented in Appendix B. They proceed as indicated in the work table for this example.

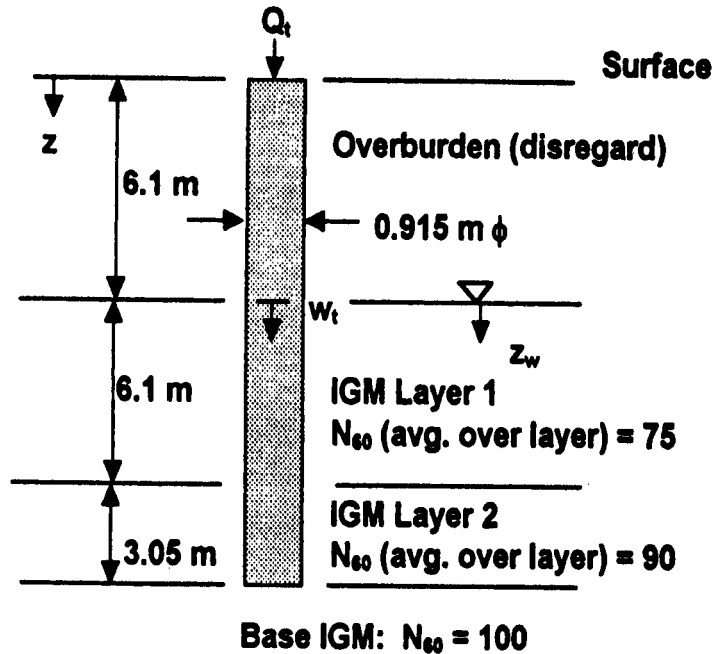

$E_c = 27.6 \text{ GPa}$     $\gamma = 21.0 \text{ kN/m}^3$     $\gamma_w = 9.81 \text{ kN/m}^3$     $\nu(\text{IGM}) = 0.4$  (estimated)

**Anticipate drilling with slurry with good construction controls.**

Conditions for Example C-4.

Work Table for Example C-4

Layer	$N_{60}$ (B per 0.3 m)	$\sigma'_p$ (kPa) (B.59)	$\sigma'_v$ (middle of layer) (kPa)	OCR (B.60)	$\sigma'_v/p_a$	$\phi'$ (deg.) (B.61)	$K_o$ (B.51)	$f_{max}$ (kPa) (B.62)
1	75	1515	162	9.35	1.60	50.0	1.30	162
2	90	1818	213	8.54	2.11	49.8	1.21	197
Base	100	2020	230	8.78	-	-	-	-

Note:  $f_{max}$  was computed using  $0.75 \phi'$  as the angle of wall friction in Equation (B.62) because slurry is likely to be used in the construction.

$q_{lmax} = 0.59 (230) [100 (101/230)]^{0.80} = 2800 \text{ kPa}$  (page B-15)

Soil moduli are assessed as follows:

$$\begin{aligned}
 E_{\text{soil}} (\text{layer 1}) &= 22 (101) 75^{0.82} = 76\,600 \text{ kPa} \\
 E_{\text{soil}} (\text{layer 2}) &= E_{\text{st}} = 22 (101) 90^{0.82} = 89\,000 \text{ kPa.} \\
 E_{\text{sm}} (\text{average along socket}) &= [6.1 (76\,600) + 3.05 (89\,000)]/9.15 = 80\,700 \text{ kPa.} \\
 E_b &= (1/2.5) (89\,000) = 35\,600 \text{ kPa (per procedure, } \xi = 2.5).
 \end{aligned}
 \tag{Equation (C.27)}$$

Parameters for computation of elastic settlement influence factor I:

$$\begin{aligned}
 L/B &= 9.15 / 0.915 = 10 \\
 l &= 2 (1+0.4) [27\,600\,000/89\,000] = 868 \\
 z &= \ln \{ [0.25 + (2.5(80\,700/89\,000)(1-0.4) - 0.25)2.5]2(10) \} = 4.10 \\
 mL &= 2[2/(4.10)(868)]^{0.5} (10) = 0.474.
 \end{aligned}$$

Compute the elastic influence factor I from (C.29):

$$I = 4(1+0.4) \frac{1 + \frac{8 \tanh(0.474) 10}{\pi (868) (1-0.4)(2.5)(0.474)}}{\frac{4}{(1-0.4)(2.5)} + \frac{4\pi \frac{80,700}{89,000} \tanh(0.474) 10}{4.10(0.474)}} = 0.20$$

Since the system is layered,  $Q_{T1}$  is computed as follows:

$$Q_{T1} = \frac{\pi (0.915) [6.1(162) + 3.05(197)]}{1 - \frac{0.20}{2.5 \cosh(0.474) [1 - 0.4^2]}} = 4995 \text{ kN} \quad \text{and} \tag{C.28}$$

$$w_{T1} = \frac{4995(0.20)}{[89,000(0.915)]} = 0.0123 \text{ m} = 12.3 \text{ mm} \tag{C.30}$$

Continuing,

$$Q_T = \pi(0.915)[6.1(162) + 3.05(197)] + (\pi/4)(0.915)^2 (2800) = 6409 \text{ kN.}$$

$$\Delta w = (6409-4995)[1-0.4^2]/[(35,600)(0.915)] = 0.0365 \text{ m} = 36.5 \text{ mm.}$$

$$w_{T2} = w_{T1} + \Delta w = 12.3 + 36.5 = 48.8 \text{ mm.}$$

The estimated load-settlement relation is shown in graphical form below.

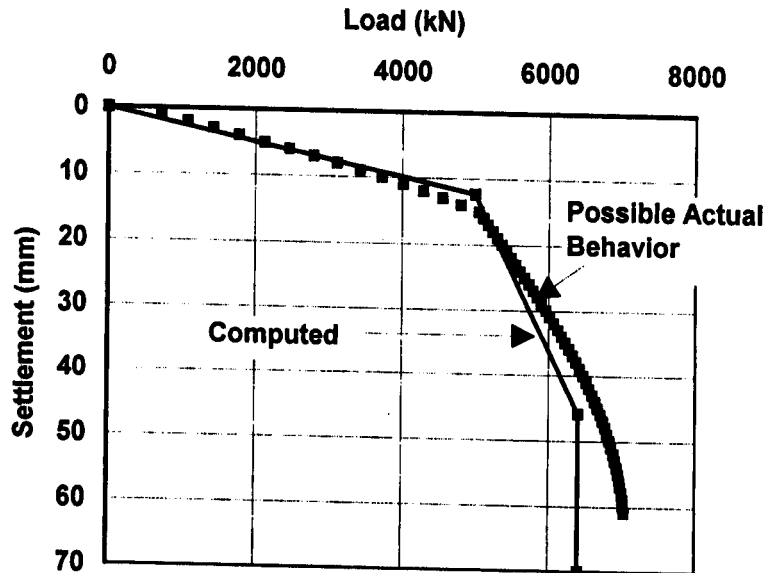

Load-settlement curve for Example C-4.

While the computations are not tedious, this method, as the method for cohesive IGM's, lends itself readily to spreadsheet computation. Note that Segment 3 is merely a vertical line, indicating complete plastic failure of the geomaterial.

## ROCK

The method described here for estimating the load-settlement behavior of drilled shaft rock sockets was proposed by Kulhawy and Carter (1992). This method is similar to the method for drilled shafts in granular intermediate geomaterials. It presumes that behavior is elastic until side shear failure occurs. In that range of loads (Segment 1, Figure C.10), the load-deformation behavior can be estimated using the elastic procedure of Randolph and Wroth (1978) [Equation (C.30)].  $E_{sL} = E_{sm} = E_b = E_m$  = average Young's modulus in the rock mass. Side shear failure is assumed to be instantaneous all along the length of the socket. In reality, it is progressive; however the error made by assuming that failure is instantaneous is not large for relatively short sockets. During the period between the development of side shear failure and complete failure of the base, it is assumed that the base behavior is elastic and that the unit side shear resistance reduces to  $c + \sigma'_h \tan \phi \tan \psi$ , where  $c$  is the residual cohesion in the rock at the rock-concrete interface after shear failure,  $\sigma'_h$  is the horizontal effective stress in the rock at the rock-concrete

interface,  $\phi$  is the material-to-material angle of interface shear between the rock and concrete, and  $\psi$  is the angle of dilation of the rock at the interface. This is assumed to be the residual strength of the rock at the interface after shear failure (slippage) has occurred between the rock and the concrete.

Empirically,

$$c = 0.1 p_a (q_u/p_a)^{0.67} \quad \text{and} \quad (C.33)$$

$$\tan \phi \tan \psi = 0.001 (q_u/p_a)^{0.67} \quad (C.34)$$

$\psi$  can be taken to be a small value (say 5 degrees) for drilling in ordinary rock unless specific information exists defining the angle of interface dilation. If the rock can be left smeared by the drilling process or is known to drill very smooth,  $\psi$  should be taken to be zero.

The computations then proceed as follows. At first glance the equations appear daunting, but the solution is easily executed using a spreadsheet program.

- $Q_{T1}$  (Figure C.10) can be computed from Equation (C.28), using the influence factor  $I$  from Equation (C.29). The length of the socket shaft  $L$  is identical to the socket penetration  $D$ .  $f_{max}$  is an appropriate value from Appendix B for rock. In this case, instead of using  $E_{sm}$  and  $E_{sL}$ , (s referring to soil), both are set equal to the average value for the rock mass,  $E_m$ , along the socket. Although not explicitly recommended by Kulhawy and Carter, it is reasonable to take  $\xi = 1$ .  $\nu$  is in the range of 0.25 to 0.35 for most rock.
- The corresponding elastic settlement of the socket is given by Equation (C.30), where  $E_{sL}$  becomes the mass modulus of the rock in the socket  $E_m$ .
- In Segment 2, Figure C.10, the settlement  $w_T$  is given by:

$$w_T = w_{T1} + \Delta w \quad \text{where} \quad (C.35)$$

$$w_{T1} + \Delta w = F_3 (Q_T / \pi E_m B) - F_4 B \quad \text{where} \quad (C.36)$$

$$F_3 = a_1 (\lambda_1 B C_3 - \lambda_2 B C_4) - 4 a_3, \quad \text{and} \quad (C.37)$$

$$F_4 = \left[ 1 - a_1 \left( \frac{\lambda_1 - \lambda_2}{D_4 - D_3} \right) B \right] a_2 \left( \frac{c}{E_m} \right) \quad (C.38)$$



The various parameters are defined as follows.

$$a_1 = (1 + \nu_{\text{concrete}}) \ln [5 (1 - \nu) (D/B)] + a_2 \quad (\text{C.39})$$

$$a_2 = [(1 - \nu_{\text{concrete}})(E_m/E_d) + (1 + \nu)]/[1/(2 \tan \phi \tan \psi)] \quad (\text{C.40})$$

$$\lambda_1 = [-\beta + (\beta^2 + 4\alpha)^{0.5}] / 2\alpha \quad (\text{C.41})$$

$$\lambda_2 = [-\beta - (\beta^2 + 4\alpha)^{0.5}] / 2\alpha \quad (\text{C.42})$$

$$\beta = a_3 [E_c/E_m] B \quad (\text{C.43})$$

$$a_3 = [\nu_{\text{concrete}} / 2 \tan \psi] (E_m/E_d) \quad (\text{C.44})$$

$$\alpha = a_1 (E_c/E_m) (B^2/4) \quad (\text{C.45})$$

$$C_3 = D_3 / (D_4 - D_3) \quad (\text{C.46})$$

$$C_4 = D_4 / (D_4 - D_3) \quad (\text{C.47})$$

$$D_3 = [\pi(1 - \nu^2) (E_m/E_b) + 4a_3 + a_1 \lambda_2 B] \exp(\lambda_2 D) \quad (\text{C.48})$$

$$D_4 = [\pi(1 - \nu^2) (E_m/E_b) + 4a_3 + a_1 \lambda_1 B] \exp(\lambda_1 D) \quad (\text{C.49})$$

- Finally, when the load that reaches the base,  $R_B$  (developed), equals  $(\pi B^2/4) q_{\text{max}}$ , where  $q_{\text{max}}$  is defined appropriately from Appendix B, complete plunging of the drilled shaft (Segment 3) occurs. For example, if the rock is massive  $q_{\text{max}}$  will be equal to about 2.5  $q_u$ . For this purpose the proportion of the load reaching the base during Segment 2 (slip along the sides) is given by

$$R_B \text{ (developed)} / Q_T \text{ (applied)} = P_3 + P_4 [\pi B^2 c / Q_T \text{ (applied)}] \quad (\text{C.50})$$

In Equation (C.50)  $P_3$  and  $P_4$  are defined by

$$P_3 = a_1 (\lambda_1 - \lambda_2) B \exp [(\lambda_1 + \lambda_2)D] / (D_4 - D_3) \text{ and} \quad (\text{C.51})$$

$$P_4 = a_2 (\exp [\lambda_2 D] - \exp [\lambda_1 D]) / (D_4 - D_3) \quad (\text{C.52})$$

In previous equations,  $B$  is the shaft diameter,  $D$  is the socket length (not necessarily equal to the drilled shaft length),  $E_c$  is the composite modulus of the drilled shaft cross section,  $E_m$  is the average mass modulus of the rock around the sides of the socket and  $E_b$  is the mass modulus of the rock at the base (both from modulus tests on cores corrected for RQD value, Table B-5),  $\nu$  is

the Poisson's ratio of the rock, and  $\nu_{\text{concrete}}$  is the Poisson's ratio of the concrete (approximately 0.15). It is critical that mass moduli be used for the rock, not the moduli values for intact cores, since the deformation behavior of the rock mass is governed largely by the jointing in the rock mass.

Note that  $Q_T$  at the end of Segment 2 (beginning of Segment 3) will in general be less than  $R_B + R_S$  because side shear failure (slip) occurs before base failure and because  $R_S$  in hard rock reduces to the residual value,  $c + \sigma'_h \tan \phi \tan \psi$ , after side shear failure (slip) occurs.  $\sigma'_h$  is controlled by the stiffness of the rock, the total load on the socket, the socket diameter and other factors reflected in the above equations.

In the above method, it is assumed that the rock is uniform from top to bottom of the socket and that the rock below the base of the socket is of the same stiffness as or stiffer than the rock along the sides.

behavior of the rock mass is governed largely by the jointing in the rock mass.

A relative stiffness term,  $I_R$ , is defined.  $I_R = (E_c/E_m) (B/2D)^2$ . If  $I_R > 1$ , the socket can be considered to be rigid, and the computations can proceed using a simplified version of the above equations, as described by Kulhawy and Carter (1992). This method will not be repeated here, as the use of the equations given in this section will be suitable whether the socket is rigid or not.

If the rock socket is loaded in uplift, it is possible to estimate the uplift movement using Equation (C.53). In this case the base contributes no resistance, so the load-movement relation is a straight line until  $R_S$  is reached, after which the drilled shaft socket pulls out of the rock. At the failure load  $Q_T = R_S$ :

$$w_T = F_5 [Q_T / \pi E_m B] + F_6 B \quad (\text{C.53})$$

in which

$$F_5 = 4a_3 - a_1(\lambda_1 B C_5 - \lambda_2 B C_6) \quad (\text{C.54})$$

$$F_6 = a_2(c/E_m) \quad (\text{C.55})$$

$$C_5 = \exp[-\lambda_2 D] / \{\exp[-\lambda_1 D] - \exp[-\lambda_2 D]\} \quad \text{and} \quad (\text{C.56})$$

$$C_6 = \exp[-\lambda_1 D] / \{\exp[-\lambda_1 D] - \exp[-\lambda_2 D]\} \quad (\text{C.57})$$

Note that  $Q_T$  is tensile and should be input as a negative value. The computed value of  $w_T$  will be negative, which means that the displacement is upward (uplift).

Kulhawy and Carter point out that this equation models the radial contraction that occurs in the socket when a tensile load is applied at the top of the socket and that such radial contraction results in reduced values of radial stress at the interface ( $\sigma'_h$ ), which could eventually lead to radial tensile stresses. Consequently, if these radial tensile stresses are not offset by increased compressive values of  $\sigma'_h$  at the interface due to dilation, Equation (C.53) could give erroneous results. The solution would therefore be expected to give good results in a socket with a rough interface (high value of  $\psi$ ) but would perhaps be less accurate where the interface is smooth.

An example of the application of the method of Kulhawy and Carter will be provided in Appendix D.

Additional, and equally useful, design methods are presented by Seidel and Haberfield (1994) for side shear-displacement behavior in soft to hard rock, Rowe and Armitage (1987) for complete socket behavior in soft rock and Williams et al. (1980) for complete socket behavior in mudstone.

While most axial deformation for drilled shafts in rock at and below working load can be attributed to elastic deformation, some creep movement may also occur. Relatively little is known about creep deformations in drilled shaft rock sockets; however, some guidance is provided by Horvath and Chae (1989). Based on field studies with compression loadings in side-shear sockets, they proposed the following equation to predict creep (deflection under sustained loading in addition to elastic displacement),  $\Delta w$ , in soft shale:

$$\Delta w = [2Q_T(\text{applied})/E_m B] \{c_{nrp} \log_{10} [t_p (\text{days})] + c_{nrs} \log_{10} [t(\text{days}) - t_p(\text{days})]\} \quad (\text{C.58})$$

In Equation (C.58)  $Q_T$  (applied) is the sustained compressive load on the rock socket,  $E_m$  is the average mass Young's modulus of the rock,  $B$  is the socket diameter,  $t$  is time since applying the sustained load,  $t_p$  is the time required to achieve "primary creep," which was found to be about 100 days by Horvath and Chae,  $c_{nrp}$  is a primary creep coefficient (dimensionless) that depends on the roughness of the interface (= 0.10 for a smooth interface and 0.06 for a rough interface from the authors' experiments), and  $c_{nrs}$  is a secondary creep coefficient (also dimensionless) that also depends on the roughness of the interface (= 0.03 for a smooth interface and 0.01 for a rough interface). If  $t < t_p$ , the second term (with the coefficient  $c_{nrs}$ ) is set equal to zero. Rough is distinguished from smooth by using the "roughness factor" (RF):

$$RF = [\Delta r/r] [L'/L] \quad (\text{C.59})$$

in which  $r$  is the socket radius,  $\Delta r$  is the average height of the concrete asperities,  $L$  is the nominal length of the socket, and  $L'$  is the distance from the top of the socket to the bottom measured along the face of the socket, including the effects of asperities or grooves cut in the rock during drilling. See Figure B.16.

If  $RF$  is less than or equal to 0.025, the interface can be assumed to be smooth. If  $RF$  is equal to or greater than 0.08, the interface can be assumed to be rough. For intermediate values, judgment must be applied. In such a case it would be prudent either to conduct creep-type load tests to obtain site-specific creep coefficients or to use the more conservative values, which apply to smooth interfaces.

## **GROUPS OF DRILLED SHAFTS IN SOIL AND ROCK**

Settlement or uplift is more often problematical in groups of drilled shafts than in single drilled shafts because of the overlapping stresses produced in the soil or rock by the loads being transferred from all of the drilled shafts in the group into the geomaterial. Therefore, settlement should always be checked for drilled shaft groups. Both short-term and long-term settlement should be considered. Short-term settlement is associated with elastic deformations in the soil or rock and possibly rapid compression of drained geomaterials. Ordinarily, long-term settlement is associated with either creep in rock (considered above) or consolidation of soft sediments below the bases of the drilled shafts. It is good design practice to place the bases of drilled shafts below the level of potentially consolidating soils, although this may not always be feasible in some formations, such as saprolites, in which variable weathering produces geomaterial layers with highly variable preconsolidation properties.

A simple formula for the settlement of a drilled shaft group in granular soil has already been given [Equation (C.4)]. More generally, other practical methods suggested by Poulos (1993, 1994) can be used for approximate estimates of group settlement. They are based on extensive numerical analyses using the boundary element method, and they will be described here. More complex design methods involving cap-geomaterial-shaft interaction have been described by Randolph (1994) and Van Impe and de Clerq (1995). Those references should be consulted for more advanced design methods involving cap reactions and cap flexibility. In the methods presented here, neither the reaction of soil against the drilled shaft group cap nor the deformation of the cap is considered explicitly.

### **Equivalent Raft Method**

This method is the simplest general method for estimating group settlement and is applicable both to short-term and long-term settlement problems (Poulos, 1993). The method assumes that the drilled shaft group is equivalent to a raft or large footing buried in the ground at some distance  $D$  below the ground surface.  $D$  is selected based upon whether the drilled shafts resist load primarily in side shear ( $D = 0.67 L_{\text{drilled shaft}}$ ) or in base resistance ( $D = L_{\text{drilled shaft}}$ ). Most drilled shafts in relatively uniform soils resist load through a combination of the two resistance components, so a value between these two limits is usually appropriate ( $D = 0.7 - 0.8 L_{\text{drilled shaft}}$ ).

The group is considered to be rigidly capped, so that all shaft heads settle the same amount. Under this condition

$$w_{T\text{ group}} = w_{er} + \Delta s \quad (\text{C.60})$$

in which  $w_{T\text{ group}}$  is the settlement of the group cap (uniform settlement of the shafts),  $w_{er}$  is the settlement of the embedded equivalent raft and  $\Delta s$  is the compression of the piles above the level of the equivalent raft assuming that the drilled shafts are freestanding columns. The settlement of the equivalent raft is computed by first dividing the geomaterial beneath the elevation of the equivalent raft into several layers. The settlement of the equivalent raft is given by

$$w_{er} = F_D \sum_{i=1}^N \varepsilon_{zi} h_i \quad (\text{C.61})$$

in which  $F_D$  is a factor that corrects for the depth of the equivalent raft,  $\varepsilon_{zi}$  is the average vertical strain in geomaterial layer  $i$ ,  $h_i$  is the thickness of layer  $i$  and  $n$  is the number of layers down to the bottom of the zone of influence.

If the drilled shaft group can be categorized as rectangular, and the horizontal dimensions of the group of drilled shafts are  $b'$  by  $l'$ , the dimensions of the equivalent raft are  $(b' + D/2)$  by  $(l' + D/2)$  if the geomaterial is relatively uniform with depth. These raft dimensions are predicated on an assumed 1 in 4 load spread gradient. They will be referred to as  $b$  and  $l$ , respectively.

If the drilled shafts are socketed into an intermediate geomaterial or rock,  $D$  should be taken to be  $0.67L$ , measured from the top of the rock, where  $L$  is the length of the socket measured from the top of the rock or IGM, and the equivalent raft will have the dimensions of  $(b' + L/3)$  by  $(l' + L/3)$ . Note that if the bases of the drilled shafts are placed on the surface of a layer of rock,  $L$  (measured from the rock surface) is zero, so that  $b = b'$  and  $l = l'$ .  $l$  is the largest dimension.

As stated, the geomaterial below the level of the equivalent raft is divided into several horizontal layers based on the deformational characteristics of each layer. If the geomaterial is uniform below the equivalent raft, for best accuracy, it should still be broken up into layers with thickness  $h_i$  not exceeding about  $0.5(bl)^{0.5}$  because the geomaterial strain  $\varepsilon_{zi}$  varies with distance  $z$  below the equivalent raft in a nonlinear manner.

Once these preliminary tasks have been performed, the calculations proceed as follows:

- Compute the net pressure on the equivalent raft,  $p$ .  $p = [Q_{T\text{ group}} (\text{applied})] / [b l]$ .  $Q_{T\text{ group}} (\text{applied})$  is the combination of loads for which settlement is to be estimated. In an LRFD approach these loads would ordinarily be the factored loads

for the service limit states that are considered.

- At the center of each *i*th geomaterial layer, compute  $\epsilon_{zi}$  according to:

$$\epsilon_{zi} = p I_{si} / E_{bi} \quad (C.62)$$

where  $E_{bi}$  is the Young's modulus of the geomaterial in Layer *i* and  $I_{si}$  is an influence factor obtained from Figure C.11. In that figure *z* is the vertical distance from the equivalent raft to the center of Layer *i*.

- Continue to compute values for  $\epsilon_{zi}$  down to the depth of strain influence, which is about  $3(b_l)^{0.5}$  below the drilled shaft bases.
- Determine  $F_D$  (depth factor) from Figure C.12 .
- Apply Equation (C.60), in which  $\Delta s = [Q_{T\text{group}}(\text{applied}) (D_{\text{raft}})] / [A_{ds} E_c]$ , where  $D_{\text{raft}}$  is the distance from the heads of the drilled shafts to the elevation of the equivalent raft,  $A_{ds}$  is the sum of the cross-sectional areas of all of the drilled shafts in the group and  $E_c$  is the Young's modulus of the concrete in the drilled shafts (corrected for steel area if higher accuracy is desired).

If short-term settlements are being computed, it is customary to use undrained moduli for clay soils and drained moduli for sands. If long-term settlements are being computed, drained moduli ( $E_{bi} = E'_{bi}$ ) should be used for all soils. If consolidation test results are available for clay soils,  $E'_{bi}$  can be estimated to be  $\{\Delta p / [\Delta e / (1 + e_o)]\} \{(1 + \nu')(1 - 2\nu') / (1 - \nu')\}$ , where  $\Delta p$  is the increment of stress applied in the consolidation test beginning from a value of initial effective stress equal to the in-situ vertical effective stress in Layer *i* and which is approximately equal to the increment of vertical stress induced by loading the equivalent raft.  $\Delta e$  is the corresponding change in void ratio, and  $e_o$  is the initial void ratio of the soil at the time of loading.  $\nu'$  is the Poisson's ratio of the soil skeleton (0.3 to 0.4 for most soils). According to Poulos (1993), if CPT results are available,  $E'_{bi}$  can be taken to be about 7.5  $q_c$  for clay and 3  $q_c$  for silica sand. [In overconsolidated clay, this value corresponds to approximately 100  $s_u$ .] If SPT results are available,  $E'_{bi} = 7 (N_{60})^{0.5}$  in MPa in silica sand. Undrained moduli ( $E_{bi}$ ) are approximately equal to  $1.5 E'_{bi} / (1 + \nu')$ . For layers of rock  $E_{bi}$  should be taken to be  $E_m$ , values of which are determined based on the moduli measured from rock cores as modified by the RQD, discussed in Appendix B.

Note is made that the largest source of error in the calculations will usually be inaccurately determined values for the geomaterial moduli, so if a settlement analysis is to be performed for a drilled shaft group, care should be taken to secure high-quality test data in sufficient quantity to assess the likely variability of the moduli.

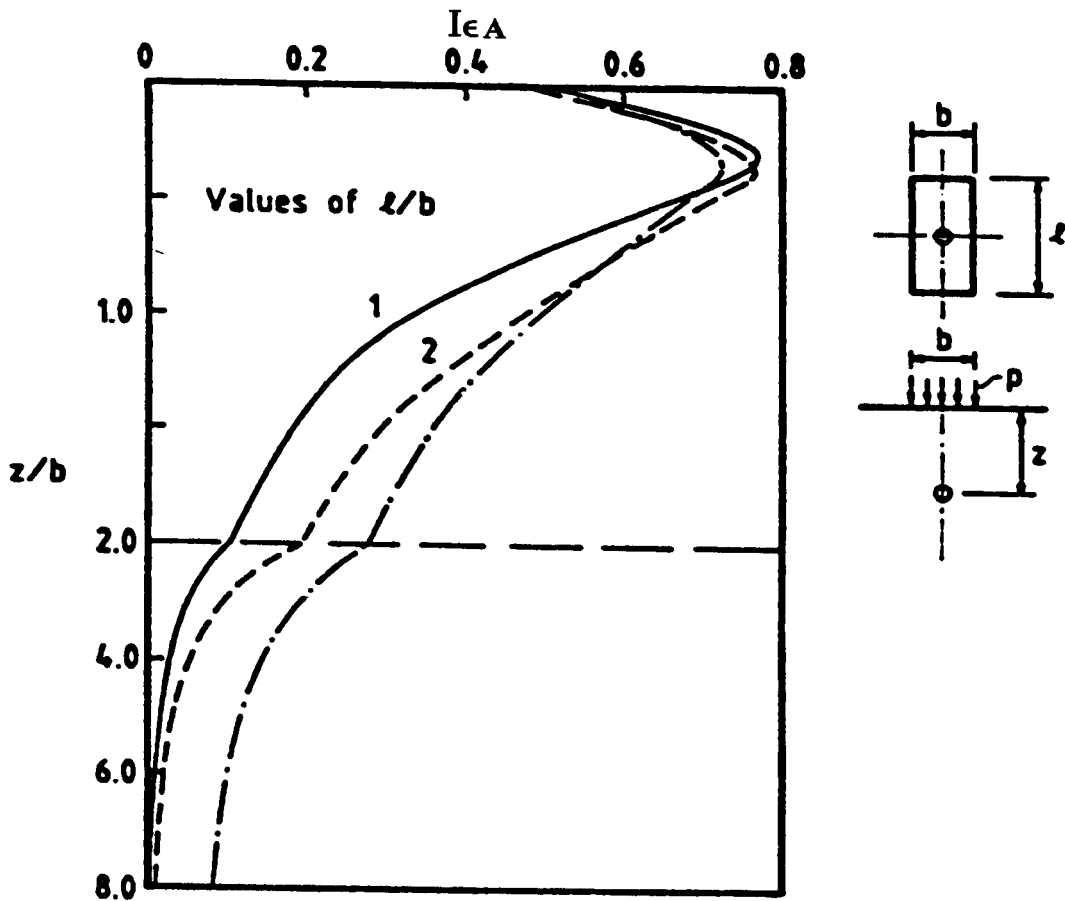

Figure C.11. Vertical strain influence factors below center of rectangular area (Poulos, 1993)

Poulos (1993) suggests that the equivalent raft method is expected to be reasonably accurate for large groups (16 piles or larger) and for relatively uniform soils; however, the equivalent pier method, described below, tends to be more accurate for smaller groups in layered geomaterials.

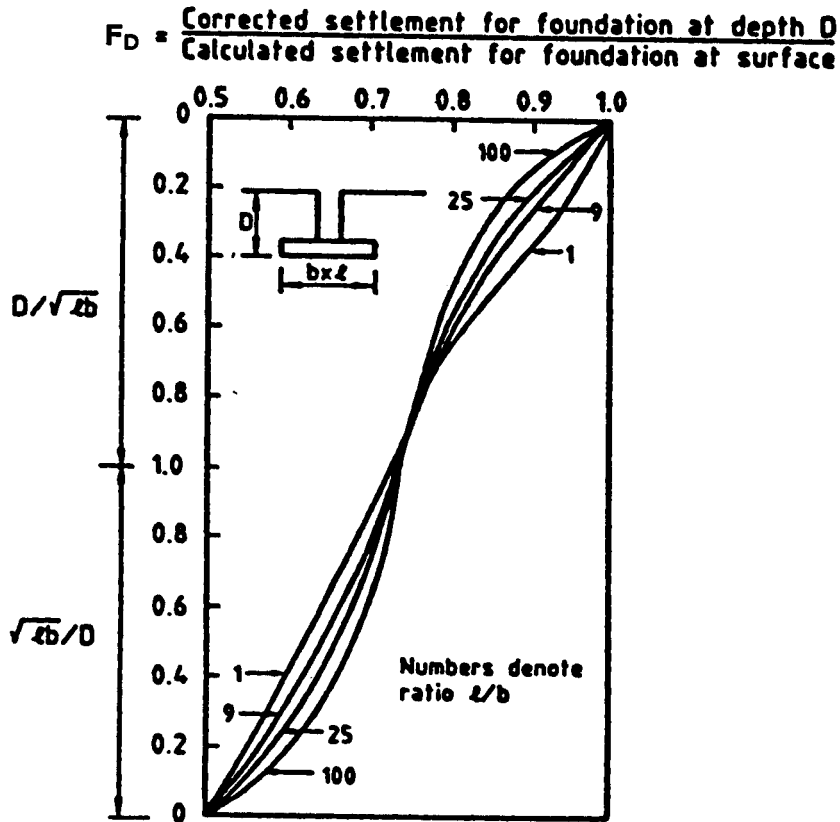

Figure C.12. Embedment correction factor (after Poulos, 1993)

### Equivalent Pier Method

In this method the drilled shaft group is considered to be a single, equivalent, large-diameter drilled shaft (or "pier"), rather than a raft. The diameter of the equivalent pier,  $d_e$ , is taken to be  $1.27 (A_{group})^{0.5}$  for shafts that resist load predominantly in side resistance and  $1.13 (A_{group})^{0.5}$  for shafts that resist load predominantly in base resistance.  $A_{group}$  is the total cross-sectional area of the drilled shaft group, including the geomaterial between the drilled shafts but not including the overhang of the cap. The Young's modulus of the equivalent pier,  $E_e$ , is the weighted average of the moduli of the drilled shafts themselves and the soil between the shafts, which is generally in a state of low strain. Mathematically,

$$E_e = E_c \frac{A_{ds}}{A_{group}} + E_{st} \left( 1 - \frac{A_{ds}}{A_{group}} \right) \quad (C.63)$$



where

$E_c$  = Young's modulus of the concrete in the drilled shafts,

$E_{st}$  = Young's modulus of the geomaterial between the shafts, and

$A_{ds}$  = Sum of cross-sectional areas of all of the drilled shafts in the group.

In Equation (C.63)  $E_{st}$  must reflect the small strains that occur in the soil between the drilled shafts. Poulos (1994) suggests that for drained (long-term) settlement analysis of driven piles  $E_{st}$  be taken as  $1500 s_u$  in clay. In sand  $E_{st} = 16.9 (N_{60})^{0.9}$  in MPa from SPT data and  $E_{st} = 53q_c^{0.61}$  ( $E_{st}$  and  $q_c$  in MPa) from CPT data. However,  $E_{st}$  can be influenced by construction details. The values suggested here reflect rapid excavation and concreting. Judgment must be exercised in cases where excessive time is taken in the construction process, which will promote lower values of  $E_{st}$  (as well as lower values for the other forms of modulus that are required, discussed below). For drilled shafts constructed rapidly with proper borehole cleanout the values of  $E_{st}$  can be expected to be approximately the same as for driven piles.

The settlement of the group is then computed using

$$w_{T\text{ group}} = [Q_{T\text{ group}}(\text{applied}) I_s] / [d_e E'_s] \quad (\text{C.64})$$

$E'_s$  in Equation (C.64) is the value of the drained soil modulus laterally adjacent to the drilled shafts. Note that  $E'_s$  is not equivalent to  $E'_{st}$ , since the soil adjacent to the drilled shafts experiences higher levels of strain than the soil confined between the drilled shafts. Poulos (1993) suggests for drilled shafts that  $E'_s = 150 - 400 s_u$  or  $10 q_c$  in clays [use  $150 s_u$  if additional information is not available],  $2.5$  to  $3.5 q_c$  (CPT) in silica sand, and  $3 N_{60}$  (SPT) in MPa in residual soils. Values of  $E_s$  for undrained loading (which would be used in place of  $E'_s$  for computation of short-term settlement) can be computed from  $E_s = 1.5 E'_s / (1 + \nu')$ . It is usually sufficiently accurate to take  $E'_s$  or  $E_s$  as the average value along the length of the drilled shafts.

$I_s$  is a settlement influence factor. It is obtained from Figure C.13 from the ratio of shaft length ( $L$ ) to equivalent pier diameter ( $d_e$ ) and ratio of  $E_b/E_s$ , where  $E_s$  is taken as  $E'_s$  (described above) for long-term settlement analyses or  $E_s$  for short-term (undrained) analyses.  $E_b$  is the weighted Young's modulus of the geomaterial below the base of the drilled shaft (drained or undrained, depending upon whether a long-term or short-term settlement analysis is to be performed). If the soil, IGM or rock below the base of the drilled shafts is uniform, then  $E_b$  is the mass Young's modulus of that geomaterial.  $E_b$  or  $E'_b$  can be evaluated for geomaterials below the bases of the drilled shafts using the recommendations for evaluating  $E_b$  and  $E'_b$  for the equivalent raft method, described in the section on the equivalent raft method.

If the geomaterial below the bases of the drilled shafts is layered, a weighted average of  $E_b$  or  $E'_b$  must be obtained. Poulos notes that these values can be influenced considerably by the details of the installation process. Rapid construction and good base cleanout will lead to relatively larger

modulus values than will occur under conditions in which slow construction gives the base time to heave and/or swell and where inadequate base cleanout produces an effective modulus that is lower than that in the undisturbed soil. All of the values considered here should be applied for well-controlled construction conditions.

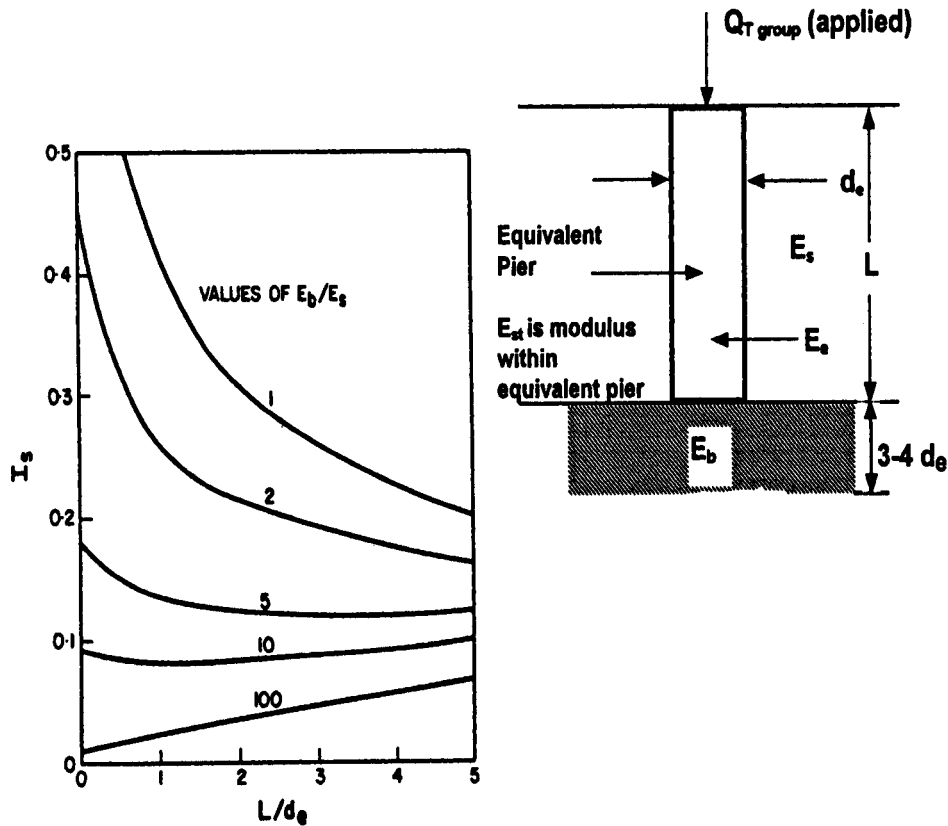

Figure C.13. Influence factor  $I_s$  for drilled shaft groups for  $E_e/E'_s = 88$  and  $\nu_{\text{soil}} = 0.3$  (Poulos, 1994)

The procedure for obtaining the weighted average for  $E_b$  or  $E'_b$  is as follows.

- Divide the geomaterial below the elevation of the bases of the drilled shafts into  $N$  layers as suggested by the classifications of the geomaterials from the boring logs. Layers should be considered down to the bottom of the depth of influence, which is  $3 - 4 d_e$  below the bases of the drilled shafts.
- Determine the vertical distance  $z_i$  from the base of the drilled shafts to the center of each  $i$ th layer.
- From Figure C.14, which provides weighting factors for settlement under a disk of diameter  $d$  (assumed equal to  $d_e$ ), determine a weighting factor  $W_i$  for each  $i$ th layer (of

thickness  $h_i$ ) using  $z_i/d$ . It is reasonable to use  $\nu_{\text{soil}} = 0.3$  for drained analysis (long-term) and  $= 0.5$  for undrained analysis (short-term).

- Finally, determine a weighted average value of  $E_b$  (or  $E'_b$ ) from Equation (C.65).

$$E_b(\text{weighted average}) = \frac{\sum_{i=1}^N W_i h_i}{\sum_{i=1}^N \frac{W_i h_i}{E_{bi}}} \quad (\text{C.65})$$

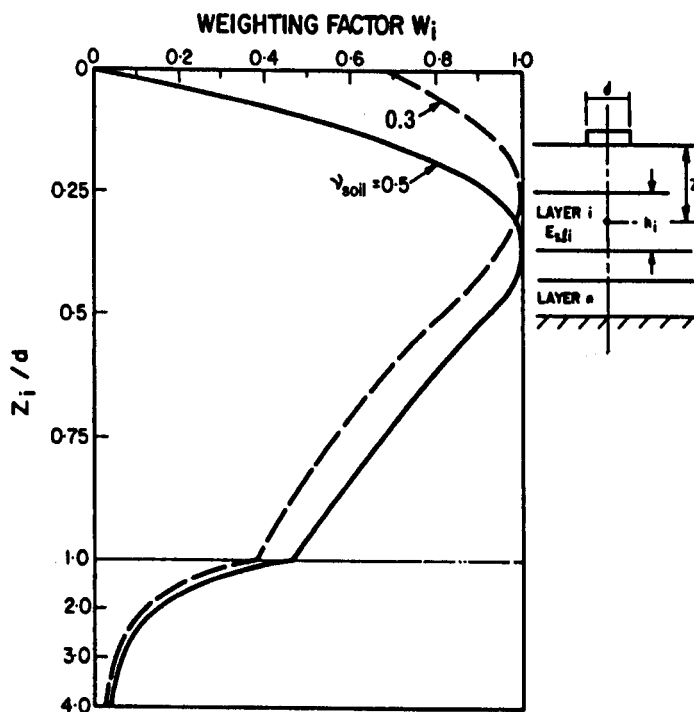

Figure C.14. Weighting factors for equivalent pier method (Poulos, 1994)

While not explicitly recommended by Poulos, it is reasonable for drilled shafts socketed into rock to take all values of  $E$  ( $E_{st}$ ,  $E_s$ ,  $E_b$ ) equal to the values determined for  $E_m$  (Appendix B) at the appropriate elevation.  $E_{st} = E_s$  in this case, but  $E_b$  may be different from  $E_s$ .  $L$  (Figure C.13) becomes the penetration into rock, or length of the rock socket, and  $w_{T \text{ group}}$  in Equation (C.64) is the settlement of the drilled shaft group at the top of the socket. Unless the extension of the shafts through the overburden is large, this should be a sufficiently accurate estimate of the

settlement at the ground surface.

Poulos (1994) also provides an approximate solution for the ratio of load transferred to the bases of the drilled shafts to the total load applied to the group (termed " $P_b/P$ ") for  $E_c/E'_s = 88$  and  $\nu_{soil} = 0.3$ . That solution is shown graphically in Figure C.15.

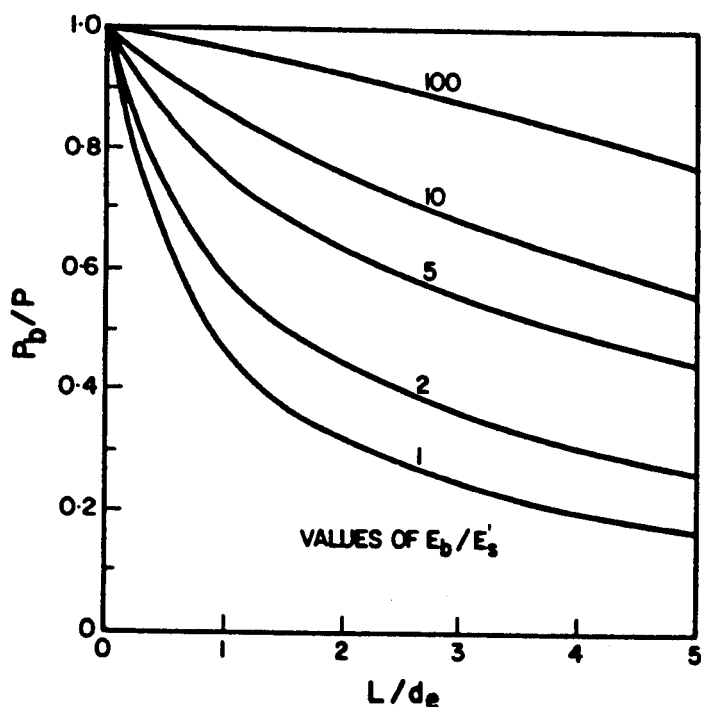

Figure C.15. Ratio of load transferred to base to applied load for the equivalent pier method (Poulos, 1994)

---

**Example C-5. Settlement of a Drilled Shaft Group by the Equivalent Pier Method**

One option for the construction of a bridge foundation in the geomaterial profile shown in the attached sketch is to socket a single, large-diameter drilled shaft into the fractured sandstone formation to support each column. However, since the sandstone is fractured, it may communicate hydraulically with a deeper deposit of sandstone that is an aquifer, and there is concern among environmental authorities about constructing the socket, which may possibly result in the introduction of foreign materials into the groundwater (slurries, potentially contaminated seep water from near the surface, etc.). The loads on the foundation are large, so that constructing a group of drilled shafts with their bases in the cohesive overburden rather than in the sandstone becomes a viable option. Keeping the drilled shafts within the overburden, which is easily drilled, may help offset the cost of installing the additional smaller drilled shafts and the group cap.

A trial design, shown in the attached sketch, is developed based on strength limit states. The concern then becomes whether this group will settle excessively under service loads. Structural designers have concluded that the limiting settlement for the structure under service loading is 25 mm (1 inch). The factored service load, which is considered to be a sustained load, is 8.00 MN (900 tons). Using this factored load, the long-term settlement of the group of drilled shafts is estimated using the equivalent pier method. The average undrained shear strength of the stiff silty clay overburden is determined by recovering and testing tube samples in UU triaxial compression, and the modulus of the sandstone is determined by recovering NX cores using triple-walled core barrels, performing compression tests on intact cores 100 mm long (during which stress-strain measurements are made in order to establish the modulus of the cores), and correcting the modulus of the intact cores based on the RQD of the samples (Appendix B). The modulus of the cores and the RQD of the sandstone are relatively uniform, so the sandstone is considered to be a single, uniform layer for design purposes.

The calculations are as follows:

- $A_g = (6.12)(6.12) = 37.45 \text{ m}^2$ .
- $d_e = 1.20 (A_g)^{0.5} = 1.20 (37.45)^{0.5} = 7.34 \text{ m}$ . [It is assumed that the drilled shafts resist load about equally between side and base resistance, so 1.20 is taken as the coefficient since it is the average of 1.13 and 1.27.]
- $E_c = 27.5 \text{ GPa} = 27,500 \text{ MPa}$ .
- $E'_{st} = 1500 (100) / 1000 = 150 \text{ MPa}$ .
- $A_{ds} = 4 [(\pi/4)(1.53)^2] = 7.35 \text{ m}^2$ .
- $E_c = 27,500 [7.35/37.45] + 150 [1 - (7.35)/37.45] = 5518 \text{ MPa}$
- $E'_s = 150 (100) / 1000 = 15 \text{ MPa}$ .
- Designate Layer 1 as the soil between the bases of the drilled shafts and the top of the sandstone layer. Then,
  - ▶  $E'_{b1} = 100 (100) / 1000 = 10 \text{ MPa}$
  - ▶  $h_1 = 5.00 \text{ m}$
  - ▶  $z_1 = 2.50 \text{ m}$
  - ▶  $z_1 / d_e = 2.50 / 7.34 = 0.34$ .
- Designate Layer 2 as the rock (sandstone) below the rock-soil interface. The depth of the zone of influence is estimated to be  $4 d_e = 4 (7.34) = 29.36 \text{ m}$  below the bases of the drilled shafts, or  $29.36 - 5.00 = 24.36 \text{ m}$  below the surface of the sandstone.
  - ▶  $E'_{b2} = 550 \text{ MPa}$
  - ▶  $h_2 = 24.36 \text{ m}$
  - ▶  $z_2 = 5 + 24.36/2 = 17.18 \text{ m}$
  - ▶  $z_2 / d_e = 17.18 / 7.34 = 2.34$ .

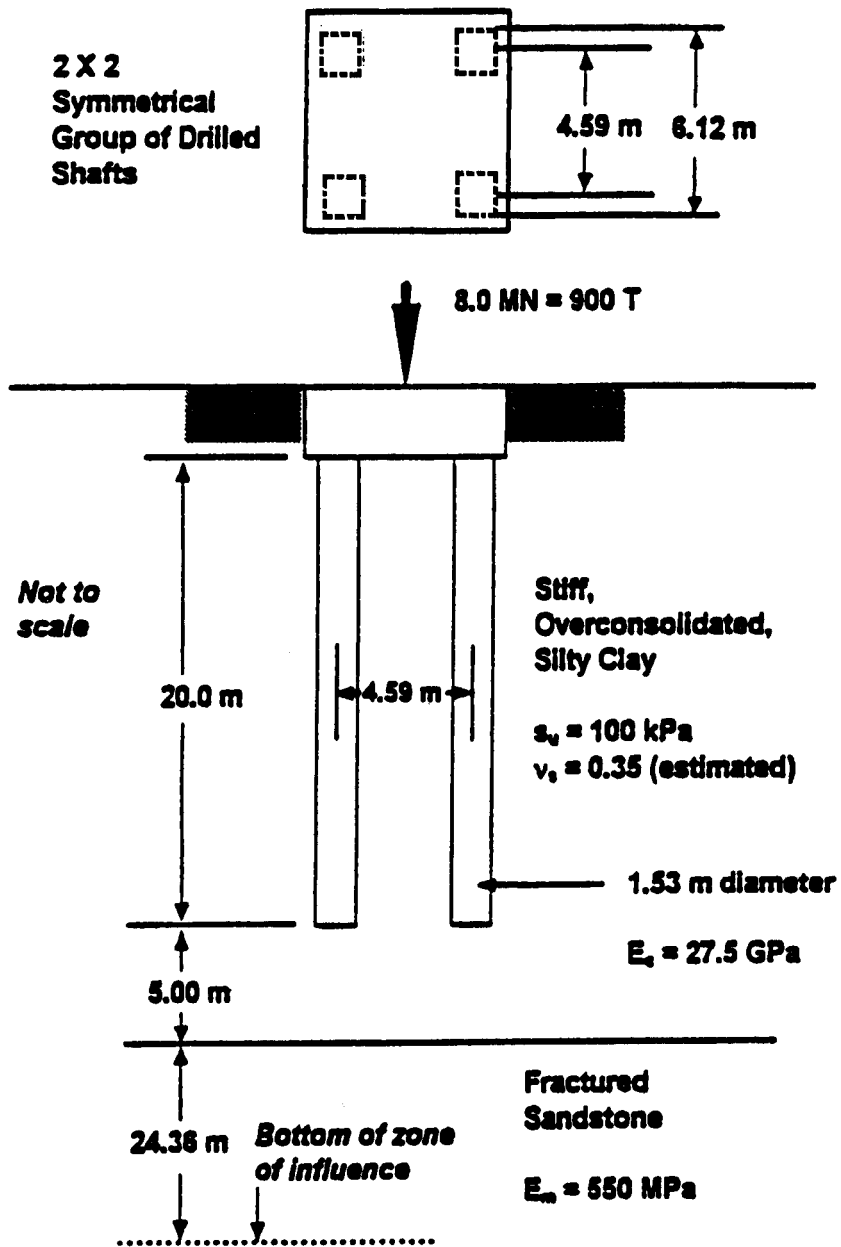

Sketch of the group layout and geomaterial conditions for Example C-5

- Using  $\nu_s = 0.3$  (drained or long-term conditions), from Figure C.14,  $W_1 = 0.97$ .
- Using  $\nu_s = 0.3$  (drained or long-term conditions), from Figure C.14,  $W_2 = 0.09$ .
- $E'_b = [0.97 (5.00) + 0.09 (24.36)] / \{[0.97 (5.0)/10] + [0.09 (24.36)/550]\} = 14.40 \text{ MPa}$ .
- Check  $E_c/E'_s = 5518/15 = 368 > 88$ , which means that the settlement may be slightly underestimated using Figure C.13. However,  $E'_s$  has been computed using the most conservative correlation with  $s_u$ , so that severe underestimation of settlement is not likely unless the geomaterial parameters have been estimated unconservatively.
- $E'_b / E'_s = 14.4 / 15 \approx 1$ .
- $L/d_c = 20/7.34 = 2.72$ .
- From Figure C.13  $I_s = 0.28$ .
- From Equation (C.64)  $w_{T\text{group}} = [8.00 (0.28)] / [7.34 (15)] = 0.0203 \text{ m (20.3 mm, 0.80 in)}$

Finally, from Figure C.15, it can be observed that approximately 28 per cent of the applied load reaches the bases of the drilled shafts. That is reasonably consistent with the assumption that  $d_c$  is determined assuming that the drilled shafts are partially end bearing.

Note that the short-term settlement could also be checked by recomputing  $w_{T\text{group}}$ , taking the values of  $E$  for the geomaterial ( $E_s$ ,  $E_{st}$ , and  $E_{bi}$ ) =  $1.5 (E')/(1+\nu')$ , where  $E'$  is  $E'_s$ ,  $E'_{st}$  or  $E'_{bi}$ , as appropriate.

The estimated long-term settlement of the drilled shaft group is 20.3 mm, which is less than the 25 mm service limit set by the structural engineer. However, it has been pointed out that since  $E_c/E'_s$  exceeds 88 the computations are slightly unconservative. The magnitude of settlement is also such that some nonlinearity may exist in the side load-settlement response. The analysis just completed assumes strictly linear elastic behavior. Therefore, if the 25 mm settlement limit is critical, more sophisticated settlement analyses might be considered. Such analyses are beyond the scope of this manual but are referenced in the following text.

The equivalent raft and equivalent pier methods are simplified approximate linear methods. Nonlinear solutions (including "slip" between the shafts and geomaterial and plastic deformation of the geomaterial at the base) can be performed, as described by Poulos (1994). For example, the three-branched load-settlement relation described for drilled shafts in granular intermediate geomaterials can be used considering the drilled shaft in that model to be the equivalent pier. More sophisticated solutions involving pile-soil-pile interaction computations, cap-soil-pile interaction, semi-flexible cap behavior and other refinements can be performed using a computer. Some of the programs that can be used are referenced in Poulos (1993, 1994). A program available from the Florida DOT, named FLPIER, can also perform nonlinear group load-settlement computations, as well as consider lateral loading, uplift loading and other effects. That program can be obtained over the internet, as documented in the "Resources" section of this appendix.

Although the equivalent pier method can be used to estimate the settlement of drilled shaft groups in rock sockets, another convenient and accurate method has been proposed by Chow et al. (1990). The reader is referred to that reference for further information on groups of rock-socketed drilled shafts.

Occasionally, it is necessary to estimate the uplift movement of a group of N drilled shafts. An approximate method for making estimates for uplift movements in the elastic range is to employ simplified interaction factors for side resistance (Randolph and Poulos, 1982). First, the load for which the uplift movement is required,  $-Q_{T \text{ group}}$  (applied), is obtained (negative sign indicating uplift). The average load per shaft is  $-Q_{T \text{ group}} / N$ . The uplift movement of an individual, isolated drilled shaft is then computed under this load by one of the methods for computing uplift movement of a drilled shaft given in this appendix. For example, the normalized load transfer method (neglecting base resistance) can be used in soils, or the method of Kulhawy and Carter [Equation (C.53)] can be used in rock. The deflection obtained is termed  $-w_{ss}$ . A "typical shaft" within the group is then selected based on its geometric position. If the group is laid out in a square matrix, the "typical shaft" would be a shaft on an outside row at or near the center of that row. For the preceding example problem, any shaft could be considered a typical shaft, since all shafts have identical relative positions.

The uplift movement of the group,  $-w_{T \text{ group}}$ , is then given for uniform soil by Equation (C.66).

$$-w_{T \text{ group}} = -w_{ss} \left[ 1 + 0.5 \sum_{m=2}^N \frac{\ln\left(\frac{L}{S}\right)}{\ln\left(\frac{L}{B}\right)} \right] \quad (\text{for } S \leq L) \quad (\text{C.66})$$

In Equation (C.66)  $m$  is the shaft designator ( $m = 1$  is the typical shaft),  $L$  is the shaft length (= socket penetration for rock sockets) (all shafts assumed to have equal lengths),  $S$  is the distance from the center of the typical shaft ( $m = 1$ ) to the center of shaft  $m$  ( $m = 2$  to  $N$ ), and  $B$  is the diameter of the individual shafts in the group (all assumed to be equal).

The second term within the brackets in Equation (C.66) (0.5 times the summation) is termed  $\alpha_\sigma$  (the side resistance interaction factor). If  $\alpha_\sigma$  exceeds 0.333, Randolph and Poulos recommend replacing it with a new value equal to  $[1 - 2/(27\alpha_\sigma)^{0.5}]$  to improve accuracy. The contribution of any  $m$ th shaft to that term may be set equal to zero in very large groups (uncommon in bridge design) in which  $S_m > 20 B$ .



## CYCLIC LOADING IN THE SERVICE LOAD RANGE

If a cyclic load amplitude,  $\pm Q_{TC}$  (applied), is superimposed on a static biased load,  $Q_T$  (applied), which may be either compressive or tensile, acting either on a single shaft or a group, the corresponding cyclic displacement amplitude  $\pm w_{ssc}$  (amplitude of displacement in uplift and settlement superimposed on the biased displacement due to the static bias load) can be computed by one of the methods recommended in this appendix for non-cyclic loading of single shafts. The load amplitude that is used to compute  $\pm w_{ssc}$  is  $Q_{TC}$  (applied) for a single shaft or  $Q_{TC \text{ group}}$  (applied) /  $N$  for a typical shaft within a group of shafts. If the biased load is applied in uplift, then  $w_{ssc}$  should be computed using one of the methods for computing uplift movement of a single drilled shaft. If the biased load is applied in compression, then  $w_{ssc}$  should be computed using one of the methods for computing compressive movement of a single drilled shaft. Very approximately, the computed displacement increment on a single shaft due to the superimposed cyclic load can then be corrected for cyclic loading by multiplying it by  $M^t$ , where  $M$  is the number of load cycles applied and  $t$  is a modulus degradation factor approximately equal to  $(1 \pm 0.4)|w_{ss}|/B$ , where  $B$  is the diameter of a single shaft (or of a typical shaft in a group) (valid for  $|w_{ss}|/B < 0.012$ ) (Poulos, 1982). The exponent  $t$  appears to be highly dependent, however, on the stress history, degree of cementation, structure and mineralogy of the geomaterial, so that it is recommended that it be measured on samples from the site by an appropriate testing method, for example, CU cyclic triaxial compression tests.

$M^t$  is a geomaterial modulus degradation term that is meant to apply strictly only to side resistance and therefore should only be applied for the uplift branch of the cyclic loading function. However, it is commonly assumed that the value of  $M^t$  computed from the above formula is conservative for base degradation, so it is used for both the compression and uplift branches of the loading cycle.

For service loads on drilled shaft groups, the assumption can be made that all of the additional displacement caused by cyclic loading occurs because of degradation in the geomaterial immediately around the individual shafts, and is not caused by group action, Equation (C.66) can therefore be used to estimate approximately the amplitude of static deformation in the group during the uplift part of the load cycle,  $w_{Tgroup}$ . The sum of the static plus cyclic deformation then becomes  $-w_{Tgroup} - w_{ssc}$ . The cyclic deformation during the compression part of the load cycle may be somewhat lower than that which occurs during the uplift part of the load cycle because of the involvement of base resistance, but the larger value that occurs in uplift will normally control the design.

Note that this method is unproven for estimation of deformations of drilled shafts and drilled shaft groups due to extreme event loads, such as earthquakes, and it may be completely invalid where cyclic mobility or complete liquefaction of the soil occurs.

## RESOURCES

Programs **TZPILE for Windows** and **SHAFT for Windows** perform the calculations shown in the section entitled "Computer Simulation Methods." The former program is predicated on user-input f-w and q-w relations, while the latter program uses the normalized relations shown in Figures C.1 through C.4 of this appendix. Both programs can be obtained for a fee from Ensoft, Inc., P. O. Box 180348, Austin, Texas 78718, phone (512) 458-1128.

**ROCKET 95** and **ROCKET 97** are Windows-based PC programs that can be used to estimate the axial load-deformation relationships for rock-socketed drilled shafts. These programs can be obtained for a fee from the Department of Civil Engineering, Monash University, Wellington Road, Clayton, Victoria 3168, Australia. It is also available thru Goble, Rausche, and Likins Associates Inc (GRL), 4535 Renaissance Parkway, Cleveland, OH 44128-57900. Contact Dr. Frank Rausche.

**FLPIER** is a program that can be used to compute load-movement relations for drilled shaft groups with regular and irregular geometries using standard geotechnical inputs to describe the soil (CPT logs, SPT logs, etc.). FLPIER is in the public domain and can be obtained by downloading it from the following address on the world wide web:  
[www.dot.state.fl.us/business/structur/proglib.htm](http://www.dot.state.fl.us/business/structur/proglib.htm).

## REFERENCES

- Chow, Y. K., Chin, J. T., Kog, Y. C., and Lee, S. L. (1990). "Settlement Analysis of Socketed Pile Groups," *Journal of Geotechnical Engineering*, ASCE, Vol. 116, No. 8, August, pp. 1171 - 1184.
- Horvath, R. G., and Chae, K-J (1989). "Long-Term Settlement of Rock-Socketed Piers," *Canadian Geotechnical Journal*, Vol. 26, No. 3, August, pp. 348 - 358.
- Kulhawy, F. H., and Carter, J. P. (1992). "Socketed Foundations in Rock Masses," in *Engineering in Rock Masses* (Chapter 25), Ed. by F. G. Bell, Butterworth-Heinemann, Oxford, pp. 509 -529.
- Mayne, P. W., and Harris, D. E. (1993). "Axial Load-Displacement Behavior of Drilled Shaft Foundations in Piedmont Residuum," *FHWA Reference No. 41-30-3175*, Georgia Tech Research Corporation, Geotechnical Engineering Division, Georgia Institute of Technology, School of Civil Engineering, Atlanta, GA, February.
- O'Neill, M. W., and Hassan, K. M. (1994). "Drilled Shafts: Effects of Construction on Performance and Design Criteria," in *Proceedings*, International Conference on Design and Construction of Deep Foundations, Vol. I, U. S. Federal Highway Administration, Orlando, FL, December, pp. 137 - 187.

O'Neill, M. W., Townsend, F. C., Hassan, K. M., Buller, A., and Chan, P. S. (1996). "Load Transfer for Drilled Shafts in Intermediate Geomaterials," *Report No. FHWA-RD-95-172*, Federal Highway Administration, McLean, VA, November.

Poulos, H. G. (1982). "Influence of Cyclic Loading on Axial Pile Response," in *Proceedings, Second International Conference on Numerical Methods in Offshore Piling*, Univ. of Texas and ICE, Austin, TX, April, pp. 419 - 440.

Poulos, H. G. (1993). "Settlement Prediction for Bored Pile Groups," in *Proceedings, Second International Geotechnical Seminar on Deep Foundations on Bored and Auger Piles*, Ed. by W. F. Van Impe, Balkema, Rotterdam, pp. 103 - 117.

Poulos, H. G. (1994). "Settlement Prediction for Driven Piles and Pile Groups," *Vertical and Horizontal Deformations of Foundations and Embankments, GSP No. 40*, Vol. 2, ASCE, June, pp. 1629 - 1649.

Randolph, M. F. (1994). "Design Methods for Pile Groups and Piled Rafts," in *Proceedings, XIII International Conference on Soil Mechanics and Foundation Engineering*, Vol. 4, January, Oxford and IBH Publishing Co. Pvt., Ltd, New Delhi, pp. 61 - 82.

Randolph, M. F., and Wroth, C. P. (1978). "Analysis of Deformation of Vertically Loaded Piles," *Journal of the Geotechnical Engineering Division*, ASCE, Vol. 104, No. 12, December, pp. 1465 - 1488.

Randolph, M. F., and Poulos, H. G. (1982). "Estimating the Flexibility of Offshore Pile Groups," in *Proceedings, Second International Conference on Numerical Methods in Offshore Piling*, Univ. of Texas and ICE, Austin, TX, April, pp. 313 - 328.

Reese, L. C., and O'Neill, M. W. (1989). "New Design Method for Drilled Shafts from Common Soil and Rock Tests," in *Foundation Engineering: Current Principles and Practices*, Ed. by F. H. Kulhawy, ASCE, Vol. 2, pp. 1026 - 1039.

Rowe, P. K., and Armitage, H. H. (1987). "A Design Method for Drilled Piers in Weak Rock," *Canadian Geotechnical Journal*, Vol. 24, No. 1, February, pp. 141 - 125.

Seidel, J. P., and Haberfield, C. M. (1994). "A New Approach to the Prediction of Drilled Pier Performance in Rock," in *Proceedings, International Conference on Deep Foundations*, Vol. II, Federal Highway Administration, Orlando, December, pp. 556 - 570.

Van Impe, W. F., and de Clerq, Y. (1995). "A Piled Raft Interaction Model," *Geotechnica*, No. 73, pp. 1 - 23.

Vesic, A. S. (1969). "Experiments with Instrumented Pile Groups in Sand," *Performance of*

*Deep Foundations, ASTM STP 444*, American Society for Testing and Materials, March, pp. 177 - 222.

Vesic, A. S. (1977). "Design of Pile Foundations," *NCHRP Synthesis of Highway Practice No. 42*, Transportation Research Board, National Research Council, Washington, D. C.

Walsh, K. D., Houston, S. L., and Houston, W. N. (1995). "Development of t-z Curves for Cemented Fine-Grained Soil Deposits," *Journal of Geotechnical Engineering*, ASCE, Vol. 121, No. 12, December, pp. 886 - 895.

Williams, A. F., Johnston, I. W., and Donald, I. B. (1980). "The Design of Socketed Piles in Weak Rock," in *Proceedings*, International Conference on Structural Foundations on Rock, Balkema, Sydney, pp. 327 - 347.

## APPENDIX D: EXAMPLE DESIGN PROBLEMS

This appendix provides four detailed computational examples of the application of the step-by-step design procedure outlined in Chapter 11 and also suggests possible scenarios for the application of engineering judgment and the consideration of likely construction practices, which are critical in the design process. The numbered steps are identical to those in the generic step-by-step guideline in Chapter 11. Where steps are omitted, a notation is made.

### EXAMPLE D-1: LRFD of a Drilled Shaft in Layered Cohesive Soil and Cohesive Intermediate Geomaterial.

Design the drilled shaft for the loading in Example A-2 (Appendix A) and for geotechnical conditions depicted in Example A-1 (Appendix A). The drilled shaft will be in Bent WB-6 (Figure A-1). The loadings on this bent are identical to those on "Bent F" in Example A-2. There are no field loading test data for the geological formations at the site, but the DOT has performed loading tests in geologically similar formations in the past.

1. Borings have been grouped as indicated in Example A-1 (3 borings within the zone to be considered). The piezometric surface is below the depths of the borings.
2. The geomaterial profile for design purposes is selected as follows:

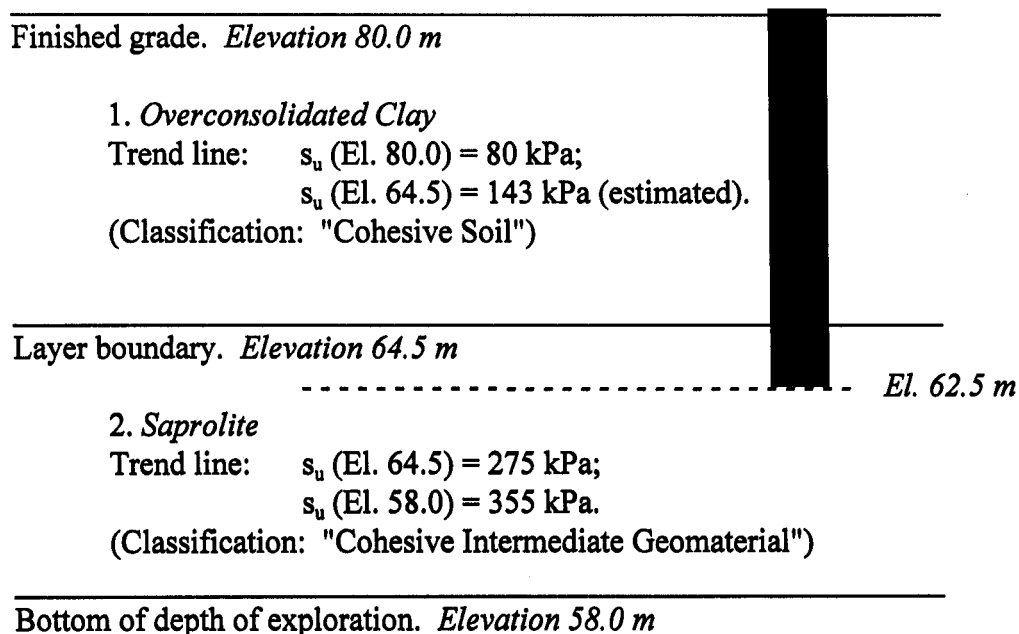

3. The values of  $s_u$  are shown in Figure A-2 and are plotted in Figures A-3 and A-4. From those plots the trend lines are drawn. The values at the tops and bottoms of the idealized layers are indicated in the above design profile.

The lower layer was classified as a cohesive IGM based on its visual description as a saprolite. Furthermore, strength testing indicates that its average  $s_u$  value is 315 kPa = 0.315 MPa, which lies between 0.25 MPa and 2.5 MPa, which indeed qualifies it as a cohesive IGM. In the design process cohesive IGM's are analyzed using  $q_u$  values rather than  $s_u$  values. The  $q_u$  values are established to be equal to  $2 \times s_u = 0.55$  MPa at the top of the layer (Elevation 64.5 m), varying linearly to 0.71 MPa at the bottom (Elevation 58 m). 1.5-m-long cores were made in the saprolite (Layer 2). The RQD values were generally consistent, with an average value of 75 per cent. Stress-strain relations were measured on both the overconsolidated clay and saprolite samples during triaxial compression testing. The average Young's modulus for the overconsolidated clay samples was 25 MPa, and the average Young's modulus for the intact saprolite cores was 90 MPa.

An observation shaft was drilled through both strata. The saprolite was generally horizontally bedded, with some colored striations, but all joints were observed to be closed. No soft seams could be observed.

4. In Example A-1, it was shown that the values of  $COV_w$  for both strata are 0.17. Comparing these with the limiting values in Table A.1 (0.35 for cohesive soils, assumed here also to apply to cohesive IGM), the design zone can be treated as "normal."

5. It is probable that the drilled shafts will be placed on or in the saprolite, which should result in low settlement at service limit load. It is also evident to the geotechnical laboratory that the overconsolidated clay in Layer 1, while stiff, does not have overconsolidation ratios exceeding 10. For these reasons, only short-term resistance and settlement analyses will be made.

6. The boring logs do not report the presence of layers of cohesionless soil within the depth of exploration, nor do they show the presence of ground water. Unless there are seasonal weather features at the site that would suggest that ground water might be present during the construction season, it is reasonable to assume that the contractor would probably install the drilled shafts using the dry method, possibly using short, temporary surface casings to prevent soil sloughing from the surface and to ensure safety around the borehole. The visual variation in the saprolite suggests that there is a small possibility that the saprolite might slough. The strength of the geomaterial is also such that it can be expected that the contractor can drill, clean, place steel in and concrete each drilled shaft down to a depth near the depth of exploration within one working shift. This stipulation is placed in the special provisions of the construction specifications for this project, and it is further specified that the contractor shall have temporary casing of sufficient length at the site to place into the saprolite to arrest sloughing if such becomes necessary. It will also be specified that concrete with a slump of 175 mm (7 inches) be used and that the concrete be placed at a rate of at least 12 m / hour. The state-DOT-standard minimum 28-day value of  $f'_c = 27\ 560$  kPa (4000 psi) will be used. No other requirements are placed on the contractor other than that he or she follow normal good practice prescribed in the standard construction specifications (Chapter 15).

7. This design is to be accomplished under the LRFD format.

8. The nominal loadings that are critical for design come from the "Strength I" limit state, as indicated in Example A-2. The factored axial load (compressive) for the most heavily loaded column in Bent WB-6 (WB-6-1) is 2380 kN (535 k). There is no uplift loading. The design will proceed for the foundation supporting this column. There are no lateral loads for this limit state. The factored axial load for the service limit state that is considered (Service I) is 1661 kN (373 k). There is no need to consider downdrag loading in this bent, since the soil is stiff and there will be no filling. Evaluation of the suction and Atterberg limits of the soil near the surface indicates that there is very little potential for the clay to expand (Chapter 12). Therefore, uplift loads from swelling soils will not be considered in the design.

9. Since the  $COV_w$  values are normal, use the resistance factors in Table A.5. That is, for the strength limit state, for geotechnical analysis, use  $\phi_{\text{overconsolidated clay}}$  and  $\phi_{\text{saprolite}} = 0.65$  for side resistance and 0.55 for base resistance. Use a resistance (or performance) factor of 1 for the service limit state. That is, assume that the nominal displacements are not factored.

10. Assume that the geometry will be controlled by axial loading. Clearly, Strength III is critical for lateral loading, and the design of the drilled shaft will need to be checked for that condition later, at which time the steel schedule and concrete strength will need to be determined. However, assume, until that analysis can be made, that axial loading controls the diameter and length.

11. The factored load is not large, and experience indicates that the load can be carried by a single drilled shaft (i. e., a group of shafts is not required for this loading). The ground surface will not be protected by a group cap or by any other membrane. Since the soil at the surface is clay, neglect the top 1.5 m (5 feet) when computing side resistance,  $R_s$ . [No evidence was found in the subsurface investigation that the zone of seasonal moisture variation was deeper than 1.5 m (5 feet).]

12. Select first the length of the drilled shaft. Observing the boring closest to Bent WB-6, Boring C-3 in Figure 2.7, the saprolite is encountered at an elevation of 64.5 m. Design the drilled shaft so that the base is keyed slightly into the saprolite to take advantage of the higher base resistance that is available there. Select a trial base elevation of 62.5 m. This will require a drilled shaft of length 17.5 m (57.4 feet) below finished grade. Unless the diameter turns out to be excessive, most contractors who would bid on the job should be able to excavate boreholes in this profile to this depth with little difficulty. While the formal procedure suggests that the diameter also be selected at this point, some conservation of computational effort can be realized if the selection of trial diameter is delayed until Step 15.

13. Since the base will be placed in a cohesive IGM, do not discount side resistance in the bottom B of the drilled shaft. If the drilled shaft had been terminated above Elevation 64.5 m, this condition would have been applied, since the base of the drilled shaft would have been in

a geomaterial classified as a cohesive soil.

14. The average value of  $s_u$  in Layer 1 (cohesive soil) = 111.5 kPa. Since  $p_a = 101$  kPa,  $s_u$  (average) /  $p_a = 1.10$ . Referring to Equation (11.16),  $\alpha$  (Layer 1) = 0.55. Note that  $s_u/p_a$  does not exceed 1.5 anywhere within the overconsolidated clay layer. Had it done so,  $\alpha$  in that region would need to have been taken to be less than 0.55 in that depth range as explained following Equation (11.16).

It is assumed that the shaft-borehole interface in Layer 2 (cohesive IGM) will be "smooth" but clean (not smeared with cuttings), since no evidence exists from earlier construction projects that boreholes are rough after drilling. Furthermore, it is decided not to require artificial roughening, since the drilled shaft does not penetrate the saprolite for a large distance, and setting up to roughen the IGM "socket" would not be cost effective. Therefore, side resistance is characterized using Equation (11.21) and Figure 11.3.

In order to use Figure 11.3,  $q_u$ ,  $E_m$ ,  $\sigma_n$  and  $\phi_{rc}$  need to be evaluated or estimated.  $q_u$  is taken as the  $2 \times s_u$  (average from El. 64.5 to El. 62.5) =  $2 \times (275 + 300)/2 = 575$  kPa. The values 275 kPa and 300 kPa correspond to trend line values at Elevations 64.5 m and 62.5 m, respectively, from Figure A.4.  $E_i$  (average for the layer) was 90 MPa (13 060 psi). From Table B-5,  $E_m/E_i$  is estimated by linear interpolation between RQD = 100 and RQD = 70, since RQD = 75. Since the joints were observed to be closed in the observation shaft,  $E_m/E_i$  for RQD = 75 is 0.75. Therefore,  $E_m = 0.75 (90) = 67.5$  MPa (9,800 psi). Atterberg limit tests indicate that the saprolite is a clay of low plasticity, so  $\phi_{rc}$  is estimated to be 30 degrees. (Had it exhibited a high liquid limit, direct interface shear tests would have been indicated to verify this assumption for  $\phi_{rc}$ ).

$\sigma_n$  is the normal (horizontal) stress at the interface between the concrete and the borehole prior to shearing, which is customarily assumed to be the fluid pressure in the concrete at the elevation of the middle of the layer of geomaterial of interest at the time the drilled shaft is cast. Equation (11.23) can be used to make an estimate of this pressure. The elevation of the middle of the saprolite layer is 63.5 m  $[(64.5 + 62.5)/2]$ , so that the depth to the middle of that layer is 16.5 m from the finished grade, which will be the surface elevation at the time of construction and which will be the elevation to which concrete will be poured.  $\sigma_n$  is therefore  $0.65 (12 \text{ m}) (23.55 \text{ kN/m}^3) = 184$  kPa for the specified slump (175 mm), assuming that the unit weight of concrete is  $23.55 \text{ kN/m}^3$ . 12 m is the maximum depth used in Equation (11.23). It is likely that  $\sigma_n$  will be larger than 184 kPa since the actual depth is greater than 12 m; however, since information is not available in Figure B.11 for a depth of greater than 12 m, no credit will be given for the additional depth in computing  $\sigma_n$ .

In summary, for Layer 2,

$$\begin{aligned} q_u &= 575 \text{ kPa (83.5 psi),} \\ E_m &= 67.5 \text{ MPa (9,800 psi),} \end{aligned}$$



$\phi_{rc} = 30$  degrees, and  
 $\sigma_n = 184$  kPa (26.7 psi)

and  $\sigma_n / p_a = 184 / 101 = 1.82$ ,  
 $E_m / q_u = 67\,500 / 575 = 117$  (essentially at the lower limit of applicability of Figure 11.5, but OK).

From Figure 11.5,  $\alpha = 0.30$ . Note that this factor multiplies  $q_u$ , not  $s_u$ .

All of the necessary factors for evaluating unit side resistance in both layers have been evaluated. Actual values are computed in Step 15 at the same time the factored resistances are computed.

Since the joints are closed within the saprolite, and no evidence exists that there are soft seams embedded within it, the saprolite at the base of the drilled shaft will be classified as massive, so that

$q_{max} = 2.5 q_u$  [Equation (11.5)] =  $2.5 q_u$  at Elevation 62.5m ( $2 \times 300$  kPa) (which is conservative since the trend for  $q_u$  is to increase with depth). Therefore,

$q_{max} = 2.5 (2) (300) = 1500$  kPa.

15. Before selecting a trial value for diameter, compute the values of factored side resistance per m of shaft diameter.

Work Table for Example D-1, Step 15

Layer	$\phi$ (resistance factor)	$\alpha s_u$ (kPa)	$\alpha q_u$ (kPa)	$\Delta z$ (m) (layer thickness)	$R_s$ / m of diameter (kN / m)
1	0.65	0.55 (111.5) = 61.3	-	15.5 - 1.5 = 14.0	14.0 (61.3) = 858
2	0.65	-	0.30 (575) = 172.5	2.0	2.0 (172.5) = 345

Sum =  $R_s$  (nominal) = 1203 kN/m

$\phi R_s = 0.65 (1203) B = 782 B$  kN / m .

Next, compute the factored base resistance.

$$\phi R_B = \phi_{\text{base}} (q_{\text{max}}) \pi B^2/4 = 0.55 (1500) \pi B^2/4 = \underline{0.55 [1178 B^2]} = 648 [B\{m\}]^2 \text{ kN}$$

2380 kN is required to be carried (critical factored strength state load). Therefore,

$$782 B(m) + 648 [B(m)^2] = 2380, \text{ from which } \underline{B = 1.41 \text{ m} = 55.5 \text{ inches.}}$$

Note that the base is  $2/1.41 = 1.42 B$  below the top of the IGM which is marginally less than the  $1.50 B$  required by Equation (11.5). Say OK since overlying clay is very stiff.

If metric drilling tools are available in the geographical area, specify  $B = 1.50 \text{ m}$ . If not, specify  $B = 60 \text{ inches}$ . Both of these are the standard sizes closest to the required value of  $B$  not smaller than the required value. Observe that if the contractor is compelled to use casing by the nature of the geomaterial behavior once the borehole is opened, the cased portion of the borehole will have to be larger than the specified borehole diameter (i. e.,  $1.50 \text{ m}$ ) in order to use tools that are of the same diameter as that specified for the borehole below the casing, or the engineer will need to be prepared to allow the contractor to use tools that are slightly smaller than the ID of the casing. This potential eventuality should be considered at this time and addressed in the project specifications if they are not addressed in the state's standard construction specifications.

16. Step 16 is bypassed since the design is not according to ASD.

17. At this point the settlement is to be computed under the factored critical service load, which from Step 8 is  $1161 \text{ kN}$  ( $373 \text{ k}$ ). Judgment needs to be exercised in selecting a method for performing the calculations. The base of the drilled shaft is in a cohesive intermediate geomaterial, while the sides develop their resistance primarily in a cohesive soil. Since the method given in Appendix C for evaluating settlement in cohesive intermediate geomaterials considers both the sides and base to develop resistance in the intermediate geomaterial, that method is not well-suited to this problem. Instead, use the normalized load transfer method, and treat the geomaterials as "cohesive soils," for settlement purposes, which should be reasonably accurate for cohesive IGM's. Use Figures 11.8 and 11.9.

Assume that the shaft is flexible, and compute the elastic compression of the drilled shaft. Assume that the ratio of developed base resistance to developed side resistance at the service load limit is  $R_s$  (nominal) /  $R_b$  (nominal) ( i.e., unfactored) =  $1203 (1.41) / 1178 (1.41)^2 = 0.72$ . This is not quite true, but it is accurate enough. Then,  $R_{Bd} / R_{Td} = 1178(1.41)^2 / [1178(1.41)^2 + 1203 (1.41)] = 0.58$ . That is, 58 per cent of the applied load reaches that base, from which

$$k = (1 + 0.58)/2 = 0.79.$$

The modulus of the cross section can be assumed with sufficient accuracy to be equal to the modulus of the concrete =  $E_c = 57,000 (4,000)^{0.5} = 3.6 \times 10^6 \text{ psi} = 24.8 \text{ GPa}$ .

From Equation (C.5),  $\delta_s = [0.79 (1661) (17.5)] / [(24,800,000) (\pi/4) (1.41)^2] = 5.93 \times 10^{-4} \text{ m} =$

0.593 mm (0.023 inches).

[Note that the assumption has been made for purposes of computing the elastic compression of the drilled shaft that the rate of load transfer into the geomaterial is uniform with depth, even though it has also been assumed that the top 1.5 m of the drilled shaft is not in contact with the soil. This results in very little error.]

Assume a settlement of the head of the drilled shaft  $w_T = 3.5 \text{ mm} = 0.138 \text{ in.}$

The settlement at the mid-depth of the drilled shaft will be  $3.5 - 0.593/2 = 3.20 \text{ mm.}$

$$w_s/B = [3.20 \text{ mm} / 1410 \text{ mm}] (100 \%) = 0.227 \%\text{.}$$

From the trend line in Figure 11.8,  $R_s \text{ (developed)} / R_s = R_{sd} / R_s = 0.80$ , or

$$R_{sd} = 1203 (1.41) (0.8) = 1357 \text{ kN}$$

The settlement at the base of the drilled shaft will be  $3.5 - 0.593 = 2.91 \text{ mm.}$

$$w_b/B = [2.91 \text{ mm} / 1410 \text{ mm}] (100\%) = 0.206 \%\text{.}$$

From the trend line in Figure 11.9,  $R_b \text{ (developed)} / R_b = R_{bd} / R_b = 0.13$ , or

$$R_{bd} = 1178 (1.41)^2 (0.13) = 304 \text{ kN}$$

$$R_{sd} + R_{bd} = 1357 + 304 = 1661 \text{ kN,}$$

which is equal to the service limit load of 1661 kN. Therefore, the assumed settlement of 3.5 mm (0.138 in.) is correct.

(Had the developed load not agreed reasonably with the service limit load, a new value of head settlement would have been chosen and the process repeated until the developed load and service limit load agreed closely.)

**18.** The most probable settlement of this drilled shaft will be 3.5 mm (0.138 inch) at the factored service limit load of 1661 kN. Upper and lower bounds of settlement for isolated shafts, not influenced by the loading on neighboring shafts, can be evaluated by repeating this process using the lower and upper bounds, respectively, in Figures 11.8 and 11.9. In this case the upper bound would be about 7 mm (0.276 inches). A check with the superstructure designers indicates that the tolerable total settlement of the particular superstructure for which the drilled shafts in the design zone are being considered is 25 mm, assuming that the differential settlement between any two drilled shafts at service load will not exceed 12.7 mm. For this case, the settlement under load is tolerable, so the design for axial loading is acceptable.

19. This design finally needs to be checked for structural safety and safety under lateral loading (Chapter 13).

### EXAMPLE D-2: Drilled Shaft to Rock by LRFD

In this example it will be assumed that the factored loads (strength and service) have already been determined. The drilled shaft is to be designed for the following conditions.

1. Borings have been grouped and design zones selected. The piezometric surface is below the depths of the borings.

2. The geomaterial profile for design purposes is selected as follows:

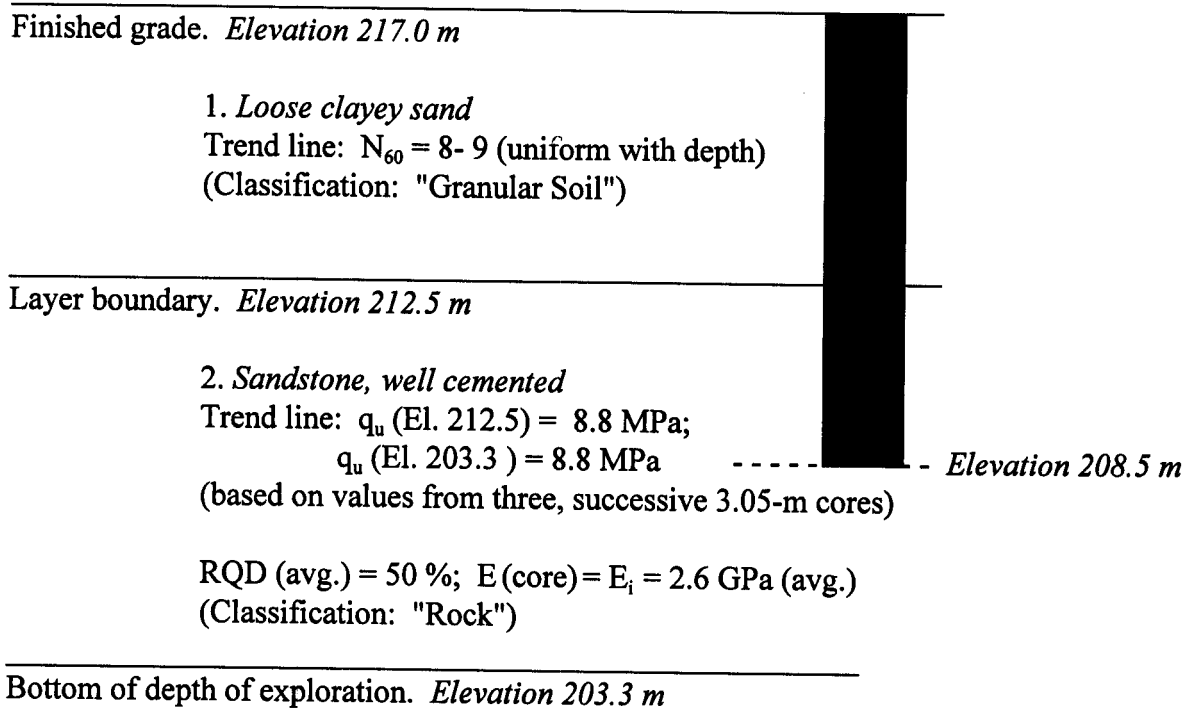

3. The average values of  $q_u$  and RQD for the rock and  $N$  for the overlying sand are indicated in the above design profile. The rock is horizontally stratified. An observation shaft and observations of exposures of the sandstone in the vicinity of the site indicate that the joints are spaced about 0.61 m (2 feet) vertically and that they are about 2.5 mm (0.1 inches) thick and filled with gouge of undetermined strength and stiffness. A few direct shear tests are conducted on the rock cores. These tests indicated that a sharp drop in shearing resistance occurred once the rock had failed in shear. This is the only evidence that exists about the ductility of the rock, so it must be assumed that the sandstone is brittle.

4. The values for the soil and rock properties are all sufficiently consistent with depth that

the constant values shown above can be assigned for design, and the coefficients of variation  $COW_w$  of both  $N$  and  $q_u$  are less than 0.35.

5. Long-term analyses will not be performed.

6. The likely method of construction will be the casing method. The sand overburden is not submerged and is clayey, so that it is likely that the contractor can drill to the top of rock in the dry, set casing to keep the sand from sloughing into the borehole and then drill either a bearing pad on the top of the sandstone or a socket into the sandstone inside the casing. The casing may be left permanently in the hole or it may be removed during placement of the concrete. The latter method is more economical, although the risk of producing a defect in the drilled shaft is slightly higher when the casing is removed. Since the surface sand layer is not thick, the contractor should not have any difficulty setting and extracting casing at this site, which minimizes the risk of damaging the shaft as the casing is being retrieved. Therefore, temporary casing is specified. The construction specifications are reviewed to make sure that sufficient attention is paid to the casing method of construction. It is established in the special provisions for this project that the contractor is not allowed to use mineral drilling slurry in the sandstone, which may clog the pores and result in a reduced bond between the concrete and the rock. The standard specification is checked to make sure that the contractor is to produce a socket that is free of smeared cuttings along the sides of the socket. The state standard specification for  $f'_c$  for drilled shaft concrete at 28 days is 24.8 MPa (3,600 psi). This is considered adequate for this application.

7. The design office performs all of its designs according to the LRFD method.

8. Analysis of the loading cases indicates a critical factored strength state load of 7.50 MN (843 tons) applied in compression for the drilled shaft in the design zone under consideration. Extreme event loading is not to be considered for this particular structure. The critical factored service load is 4.50 MN (506 tons) in compression for the drilled shaft being designed.

9. No loading tests are planned. The method of "Horvath and Kinney" [Equation (11.24)] will be used to compute the ultimate unit side resistance  $f_{max}$  after first modifying the design value of  $f_{max}$  to account for the jointing in the rock. This is a conservative method that assumes minimal roughness of the socket. Since the coefficient of variation of the  $q_u$  values in the rock in the design zone is less than 0.35, it is reasonable to assume that the values in Table A.5 are valid. Therefore, take  $\phi = 0.65$  for side resistance. Since the base will be in a horizontally stratified sedimentary rock, and since the spacing, thickness and condition of the joints can be estimated, use the Canadian Geotechnical Society method [Equation (11.8)] for computing  $q_{max}$ . Therefore, take  $\phi = 0.50$  for base resistance, as recommended in Table A.4.

10. Assume temporarily that axial loading will govern the design.

11. No clay exists at the ground surface.

12. A large-diameter drilled shaft can be set on the sandstone, or a smaller-diameter socket can be drilled into the sandstone. [At this point the designer should perhaps do a little personal research about the drillability of the sandstone. Its average unconfined compression strength is 8.8 MPa (about 1275 psi), although the laboratory tests reveal that some values are higher than this, and it is jointed with fairly widely spaced joints. It can likely be drilled with a rock auger or a drilling bucket with ripping teeth, but it may very well require the use of core barrels to advance the borehole. This will make the cost of excavation in the rock high relative to drilling through the soil. The designer observes that there will be some lateral loading on the foundation and that the overburden material is both thin and loose, which will make it desirable to socket the drilled shaft into the rock from the perspective of resisting lateral load. A rock socket is selected when a contractor who has had experience excavating drilled shafts in similar formations indicates that such excavation is likely to be straightforward.] A rock socket is selected. Assume a socket diameter of 1.0 m (39.4 inches) and a base elevation of 208.5 m [socket penetration of 4.0 m (13.1 feet)].

13. There is no clay at the base of the drilled shaft.

14. Disregard side resistance in the overburden, as it will obviously be small relative to the side and base resistance in the rock socket.

Base resistance [(Equation (11.8))]:

$$K_{sp} = \{3 + (0.61/1)\} / \{10 [1 + 300 (2.5/610)]^{0.5}\} \quad \text{[Equation (B.17)]}$$
$$= 0.24.$$

$$\Theta = 1 + 0.4 (D_s / B) = 1 + 0.4 (4/1) = 2.60$$

$$q_{max} = 3 (0.24) (2.6) 8.8 = 16.47 \text{ MPa.}$$

$$R_B = 16.47 (\pi/4) (1.0)^2 = 12.94 \text{ MN (1454 tons).}$$

$$\phi R_B = 0.50 (12.94) = \underline{6.47 \text{ MN (727 tons).}}$$

Side resistance:

From Table 11.4, (open joints, RQD = 50%)  $\phi = 0.55$ .

$$f_{max} = (0.55) 0.65 (101) [8800/101]^{0.5} = 337 \text{ kPa} = 3.52 \text{ tsf.} \quad \text{[Equation (11.24)]}$$

$$R_s = 0.337 (\pi) (1) (4) = 4.235 \text{ MN (476 tons).}$$

$$\phi R_s = 0.65 (4.23) = \underline{2.75 \text{ MN (309 tons)}}$$

**Note:** At this point the thought could be entertained that, since  $\phi R_B$  is near the factored strength state load, the drilled shaft could be set on the surface of the rock or placed in a socket of only nominal penetration (to put the bearing surface below any weathering or fragmentation that might be revealed during construction) if a way could be found to eliminate or reduce the lateral loads on the foundation. It is assumed for purposes of this exercise that such is not feasible in this case and that the socket will be needed.

15. Since the sandstone has been identified as being brittle, the ultimate base and side resistances should not be added together directly. The socket could be designed as a side resistance socket; however, with a 4.0-m socket penetration,  $\phi R_s$  (2.75 MN) is less than the factored strength state load (7.50 MN). It is possible that the base resistance that is developed at the time side shear failure occurs, added to the ultimate side resistance, will exceed 7.50 MN. If it does not, there are two options. The penetration can be deepened until the ultimate side resistance plus the developed base resistance at this point exceeds 3.31 MN, or the residual side resistance that develops after side shear failure can be added to the ultimate base resistance. It is not clear at this point which way to proceed; therefore, it is advisable to synthesize the load-settlement relation for the 4-m-deep socket, using the method given in Equations (C.33) through (C.52). At this point  $(\tan \phi \tan \psi)$  is evaluated [Equation (C.34)] as  $0.001 (8800/101)^{0.67} = 0.02$ .  $\psi$  is assumed to be 5 degrees, so that  $\tan \psi = 0.087$ .  $c$  can be taken as  $0.1 (101) (8800/101)^{0.67} = 201 \text{ kPa (29.2 psi)}$  [Equation (C.33)]. Proceed to Step 17 before completing this step.

16. ASD is not being used.

17. Compute the load-settlement diagram, assuming that brittle behavior occurs in side resistance. Begin with the elastic portion.

Compute  $Q_{T1}$ :

$$Q_{T1} = [(337) \pi (1) (4)] / \{1 - [I / (\xi \cosh (\mu L))(1 - \nu^2)]\}, \quad \text{[Equation (C.28)]}$$

where

$$\mu L = 2(2/\zeta\lambda)^{0.5} (4/1),$$

$$\zeta = \ln \{[0.25 + (2.5 (E_m/E_{sL})(1-\nu) - 0.25)\xi](2) (4/1),$$

$$\lambda = 2 (1+\nu) E_c/E_{sL}, \text{ and}$$

$E_{sL} = E_m$  (uniform mass properties of the rock in and below the socket) =  $0.1 (2.6) = 0.26 \text{ GPa} = 260 \text{ MPa} = 37,700 \text{ psi}$ . The factor 0.1 comes from Table B.5 (RQD = 50% and open

joints).

Since the geomaterial is rock and not cohesionless IGM, and since the rock is uniform, let  $\xi = 1$ .

$$E_c = 57,000 (3600)^{0.5} = 3.42 \times 10^6 \text{ psi} = 23.6 \text{ Gpa}$$

Assume  $\nu = 0.2$  for sandstone, which will drain as it is loaded, so that

$$\lambda = 2 (1.2) (23.6/0.26) = 2.4 (90.8) = 218,$$

$$\zeta = \ln \{ [0.25 + (2.5(1)(0.8) - 0.25) 1] (8) \} = 2.77,$$

$$\mu L = 2 [2 / (2.77)(218)]^{0.5} (4) = 0.460, \text{ and}$$

$$Q_{T1} = [(337) \pi (1) (4)] / \{1 - [I / (1 \cosh (0.46))(1 - 0.2^2)]\}.$$

Since  $\cosh 0.46 = 1.108$ ,

$$\begin{aligned} Q_{T1} &= [(337) \pi (1) (4)] / \{1 - [I / (1.108)(1 - 0.2^2)]\} \text{ kN} \\ &= [4235] / \{1 - [I / 1.064]\} \text{ kN}. \end{aligned}$$

From Equation (C.29),

$$\begin{aligned} I &= 4(1+0.2) \{ [1 + (8 \tanh (0.46) 4 / \pi 218 (1-0.2) (1) 0.46 (1))] / \\ &\quad [4 / ((1 - 0.2) (1)) + (4 \pi (1) (\tanh 0.46) 4) / (2.77 (0.46) (1))] \}. \end{aligned}$$

Since  $\tanh 0.46 = 0.430$ ,

$$I = 4.8 \{ [1 + (13.76 / 252.0)] / [5 + (16.96)] \} = 4.8 \{ 1.055/21.96 \} = 0.231.$$

Finally,

$$Q_{T1} = 4235 / \{1 - [0.231 / 1.064]\} = 4235 / 0.783 = \underline{5409 \text{ kN}}.$$

From Equation (C.30)

$$w_{T1} = [5409 (0.231)] / [260\,000 (1)] = 0.00481 \text{ m} = \underline{4.81 \text{ mm}}.$$

**Note:** The unfactored side resistance is 4235 kN, so that the load reaching the base is 5409 - 4235 = 1174 kN at the time side shear failure occurs  $\ll R_B$ . For LRFD, this load can be



considered to be the available resistance at the time of side failure and can be factored to give  $\phi R_B$  (at side shear failure) = 0.50 (1174) = 587 kN = 0.587 MN (66.9 tons). The total factored resistance can then be taken to be  $\phi R_S + 0.587 \text{ MN} = 2.75 + 0.59 = 3.34 \text{ MN}$ . This factored resistance can be considered a "minimum" factored resistance. In this case 3.34 MN is less than the factored load of 7.50 MN, so it is necessary to investigate post-side-slip conditions.

Compute  $w_T$  for post-side-slip conditions from Equations (C-36) through (C-49). For simplicity assume  $v_{\text{concrete}} = 0.15$ .

$$a_2 \text{ [Equation (C.40)]} = [(1-0.15) (0.26/23.6) + (1+0.2)] [1 / (2 (0.02))] = 30.2,$$

$$a_1 \text{ [Equation (C.39)]} = (1+0.15) \ln [5 (1-0.2) (4)] + 30.2 = 33.4,$$

$$a_3 \text{ [Equation (C.44)]} = [0.15 / 2 (0.087)] (0.26 / 23.6) = 0.0095,$$

$$\alpha \text{ [Equation (C.45)]} = 33.4 (23.6 / 0.26) (1^2/4) = 758 \text{ m}^2,$$

$$\beta \text{ [Equation (C.43)]} = 0.0095 (23.6 / 0.26) 1 = 0.862 \text{ m},$$

$$\lambda_1 \text{ [Equation (C.41)]} = [-0.862 + (0.862^2 + 4 (758))^{0.5}] / 2 (758) = 0.0358 \text{ m}^{-1},$$

$$\lambda_2 \text{ [Equation (C.42)]} = [-0.862 - (0.862^2 + 4 (760))^{0.5}] / 2 (758) = -0.0369 \text{ m}^{-1},$$

$$D_3 \text{ [Equation (C.48)]} = [\pi(1-0.2^2) (1) + 4 (0.0095) + 33.4 (-0.0369) (1)] \exp [-0.0369 (4)] = 1.57,$$

$$D_4 \text{ [Equation (C.49)]} = [\pi(1-0.2^2) + 4 (0.0095) + 33.4 (0.0358) (1)] \exp [0.0358 (4)] = 4.90,$$

$$C_3 \text{ [Equation (C.46)]} = 1.57 / (4.90 - 1.57) = 0.471,$$

$$C_4 \text{ [Equation (C.47)]} = 4.90 / (4.90 - 1.57) = 1.471,$$

$$F_3 \text{ [Equation (C.37)]} = 33.4 [(0.0358)(1)(0.471) - (-0.0369)(1)(1.471)] - 4 (0.0095) = 2.338, \text{ and}$$

$$F_4 \text{ [Equation (C.38)]} = \{1 - 33.4[(0.0358+0.0369)/(4.90-1.57)](1)\}[(30.2)(0.201/260)] = 0.00632.$$

Assume an applied load  $Q_T = 7500 \text{ kN} = \text{factored critical strength} - \text{static load}$ . For this load  $w_T = 2.338 \{7500 / [\pi (260 \text{ 000}) (1)]\} - 0.00632 (1) = 0.0151 \text{ m} = 15 \text{ mm}$ .

To verify that this value of applied load is less than the nominal plunging failure load, Equation (C.50) is applied. First,  $P_3$  [Equation (C.51)] and  $P_4$  [Equation (C.52)] are evaluated.

$$P_3 = 33.4 (0.0358 + 0.0369) (1) \exp [(0.0358-0.0369)(4)] / (4.90 - 1.57) = 0.726.$$

$$P_4 = 30.2 \{ \exp [(-0.0369) (4)] - \exp [(0.0358) (4)] \} / (4.90 - 1.57) = -2.64.$$

$$R_{Bd} / 6761 = 0.726 - 2.64 [\pi (1)^2 (201) / 7500] = 0.504, \text{ [Equation (C.50)], or}$$

$$\underline{R_B \text{ (developed)}} = 7500 (0.504) = 3778 \text{ kN} = \underline{3.78 \text{ MN}} < 6.47 \text{ MN}.$$

**Note:** At this point, the developed nominal side resistance is  $7500 - 3778 = 3722 \text{ kN} = 3.72 \text{ MN} < 4.235 \text{ MN}$ , which was the nominal peak side resistance computed earlier. Although reduced from its peak value, the side resistance is still considerable at the settlement of 15 mm. The full factored base resistance of 6.47 MN has not yet developed, so the load of 7500 kN (MN) is sustainable. In fact, since the interface was specified to be dilatant ( $\Psi = 5$  degrees), there would be no further loss of side resistance with increased settlement. Therefore, at the critical factored strength state load of 7.5 MN, the new nominal side resistance,  $R_s$ , can be established conservatively as 3.72 MN, instead of 4.235 MN, and  $\phi R_s = 0.65 (3.72) = 2.42 \text{ MN}$ . Finally,  $\phi R_t = 6.47 + 2.42 = 8.89 \text{ MN}$ , which would correspond to a complete collapse of the supporting rock and which exceeds the factored load of 7.50 MN. The design, therefore, is safe. The socket penetration could in fact be reduced somewhat if such reduced penetration can be tolerated from a lateral loading perspective.

It is assumed that the structure can tolerate a settlement of 15 mm, so an explicit calculation for settlement under the factored service state load (4.50 MN), which will be less than 15 mm, will not be made. However, settlement under the service limit load can be estimated from the calculations already made and shown in the following sketch.

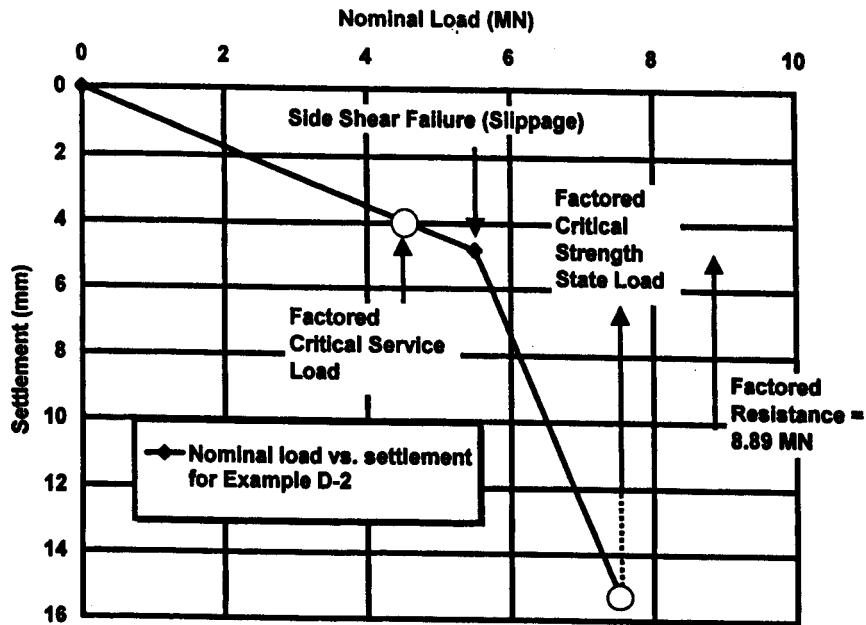

18. The expected settlement under the factored service load from the preceding figure is about 4 mm based on the calculations in Step 17. This value should be compared to the tolerable settlement of the structure. In most cases, this settlement can be tolerated easily. If settlement is critical, creep settlement can be estimated at this point [Equation (C.58)] and added to the settlement computed from the preceding procedure.

19. The final design (1-m-diameter by 8.5-m-long drilled shaft) should be checked structurally and for its ability to carry lateral loads (Chapter 13).

**EXAMPLE D-3: Design of a Drilled Shaft in Mixed Cohesionless Geomaterial by ASD.**

Design the drilled shaft for the subsurface conditions summarized below. The geomaterials grade from a granular soil ( $N_{60} \leq 50$ ) near the surface to an intermediate cohesionless geomaterial ( $N_{60} > 50$ ) at depth. Geologic evidence indicates that the site consists of a recent outwash deposit (granular soil) over a till that has been heavily overconsolidated by glacial action (cohesionless IGM). The site is adjacent to a large river, and the piezometric surface fluctuates seasonally. Furthermore, there is a strong possibility that scour will occur during flood stages. Coordination with the hydraulics section of the DOT reveals that the drilled shafts in the design zone should be designed for 4 m (13.1 feet) of scour.

1. Borings have been grouped to define design zones. For design purposes the highest seasonal position of the piezometric surface in the design zone of interest here, which is at or above the ground surface, will be taken. Note that when the piezometric surface is above the ground surface and the free water surface is at the same location, the design can proceed as if the

piezometric surface is coincident with the ground surface. That will be done here.

2. The geomaterial profile for design purposes is as follows:

<p>Scour elevation. <i>Elevation 27.2 m</i>          Piezometric surface elevation. <i>Elevation 27.2 m</i>          1. <i>Medium-dense silty sand, little gravel</i>          (Classification: "Granular Soil")</p>	<ul style="list-style-type: none"> <li>• N = 17</li> <li>• 24</li> <li>• 71</li> <li>• 30</li> <li>• 30</li> <li>• 36</li> <li>• 40</li> <li>• 38</li> </ul>	
<p>Layer boundary. <i>Elevation 12.9 m</i>          2. <i>Granular glacial till</i>          (Classification: "Cohesionless Intermediate Geomaterial")</p>	<ul style="list-style-type: none"> <li>• 62</li> <li>• 63</li> <li>• 107-----El. +4.2 m</li> <li>• 80</li> <li>• 105</li> <li>• 77</li> </ul>	
<p>Bottom of depth of exploration. <i>Elevation -4.5 m</i></p>		

3. The average value of N in Layer 1 is 31, disregarding the "outlier" value of 71, which is interpreted to have been produced by the split spoon hitting a large gravel particle. In Layer 2, the average value of N is 82.

It is necessary to estimate the unit weights of the sand and IGM, since the unit weight is a part of the design equations. This can be done in the geotechnical laboratory by estimating the relative density of the geomaterial layers based on their average N values, conducting minimum and maximum density tests on samples recovered in the split spoon samplers used in the SPT's, forming the recovered samples dry at their estimated relative densities, saturating the samples, and measuring the saturated (total) unit weights corresponding to the estimated relative density. Assume, for the site under consideration, that these unit weight values for the upper and lower strata are 18.8 kN/m<sup>3</sup> (120 pcf) and 21.2 kN/m<sup>3</sup> (135 pcf), respectively.

4. For purposes of estimating settlement, it is reasonable to represent the variation of N with depth as ranging in a linear manner from 15 at El. 27.2 to 85 at El. -4.5.

5. Since the soils are granular, it will be assumed that the geomaterial behavior is drained, so that the resistance calculations represent long-term resistance to slowly applied loads. The settlement analyses will consider only short-term settlement with geomaterial drainage. It is recognized, however, that even granular soils can experience some creep settlement, so that the comparison of the estimated settlement to the allowable settlement will be made conservatively.

6. The boring logs indicate that the soils at the site do not have a clay or rock layer into

which casing can be sealed, and they are waterbearing. It is therefore forecast that the wet (slurry displacement) method of construction will need to be employed. The project construction specifications should be carefully checked to ensure that the slurry properties are monitored properly (Chapter 6) and that the base of the borehole is inspected under slurry by sounding or by a downhole television camera prior to concreting. It will also be specified that concrete with a slump of 200 mm (8 inches) be used and that the concrete be placed at a rate of at least 12 m / hour. The state-standard minimum 28-day value of  $f'_c = 27\,560$  kPa (4000 psi) will be used. A design equation will be used in Step 14 that presumes that the drilled shaft will be drilled and concreted quickly (earth pressure coefficient =  $K_o$ ), so that this issue should be addressed in the specifications. No other requirements are placed on the contractor other than that he or she follow normal good practice prescribed in the standard construction specifications (Chapter 15).

7. This design is to be accomplished under the ASD format.

8. The critical compressive axial design load is 4.09 MN (460 tons). However, a loading case exists in which an uplift load of 1.82 MN (205 tons) will be applied. Nominal lateral loads also exist, which will need to be checked later.

9. The geomaterial test results are consistent; however, the behavior of drilled shafts is unfamiliar to the designer in the formations in which these shafts are to be installed (no load tests or performance records), so a global factor of safety of 2.5 is selected.

10. Assume, until a lateral load analysis can be made, that axial loading controls the diameter and length.

11. There is no clay at the ground surface, so there is no exclusion of side resistance near the surface.

12. The glacial till is present at a fairly shallow depth. The boring logs do not show that the till contains boulders, which would impede construction. Therefore, a drilled shaft penetrating through the sand and into the till to an elevation of +4.2 m is selected. The drilled shaft for this trial design therefore penetrates 23.0 m (75.4 feet) below the scour depth, or 27.0 m (88.6 feet) below the working grade. Only that part below the scour depth will be considered to provide resistance, and the elevation of the ground surface will be assumed to be at the elevation of the scour depth for computational purposes. Select a trial diameter of 1.00 m (39.4 inches).

13. Since there are no cohesive soils, there are no exclusion zones.

14. The nominal ultimate base and side resistances are computed as follows:

Base (in cohesionless IGM):

$$\sigma'_{vb} = (27.2 - 12.9)(18.8 - 9.81) + (12.9 - 4.2)(21.2 - 9.81) = 228 \text{ kPa}$$

$$\begin{aligned}
 q_{\max} &= (0.59) (\sigma'_{vb}) [N_{60} (p_a/\sigma'_{vb})]^{0.8} && \text{[Equation (11.11)]} \\
 &= (0.59)(228) \{[(100* + 80)/2] (101/228)\}^{0.8} \\
 &= 2,566 \text{ kPa} = 2.57 \text{ MPa}
 \end{aligned}$$

$$R_B = 2.57 (\pi/4)(1^2) = \underline{2.02 \text{ MPa}}$$

(\*Note that N = 100 was substituted for the actual value of 107, since N = 100 is taken as the upper limit for calculations for cohesionless IGM's.)

Sides (in both layers):

For accurate calculations using Equation (11.18), a granular soil layer should not be more than 9 m thick, since  $\beta$  is a nonlinear function of depth. Therefore, the upper sand layer will be subdivided. The zone near the surface in which  $\beta > 1.2$  when  $f_{\max}$  is computed using Equation (11.18) is small. In this problem, neglecting the upper limit on  $\beta$  will result in very minor errors, so the depth to which  $\beta = 1.2$  will not be considered as a separate zone. Subdivide Layer 1 into Sublayer 1.1 (Elevations 27.2 to 20.05 m) and Sublayer 1.2 (Elevations 20.05 to 12.9 m). Each of these sublayers is thinner than 9 m. Had the piezometric surface been below the ground surface, the elevation of the piezometric surface would have been a logical place to make a sublayer break. Furthermore, had there been a consistent zone of sand with  $N < 15$ , such soil should be a separate sublayer, since, according to Equation (11.19), the expression for  $f_{\max}$  will be different from that which is used when N is equal to or greater than 15.

Work Table for Example D-3, Step 14

(1) Layer (El. interval in m)	(2) Depth z to middle (m)	(3) $\sigma'_v$ (middle) kPa	(4) $\beta$ Equation (11.18)	(5) $f_{\max}$ (kPa) (See notes)	(6) $\pi B \Delta z$ (m <sup>2</sup> )	(7) $\Delta R_s$ (kN) [(5) X (6)]
1.1 (27.2-20.05)	3.58	32.2	1.06	34.1	22.46	766
1.2 (20.05-12.9)	10.73	96.6	0.70	67.6	22.46	1518
2 (12.9-4.2)	18.65	178.3	-	252	27.33	6887

Sum = 9171 kN

$R_s = 9171 \text{ kN} = \underline{9.17 \text{ MN}}$  (compression)

**Note:** For the granular soil layers (1.1 and 1.2),  $f_{\max}$  is computed from Equation (11.17). For the cohesionless IGM layer (2),  $f_{\max}$  is computed from Equations (11.26) through (11.28), as illustrated below:

The average  $N_{60}$  from the top of Layer 2 to the base of the drilled shaft (Layer 2) is  $(62 + 63 + 100)/3 = 75$ . Note again that  $N = 100$  is the upper limit to be used in evaluating resistance and settlement in cohesionless IGM's.

$$\phi' = \tan^{-1} \{75/[12.2 + 20.3(178.3/101)]\}^{0.34} = 49 \text{ deg.} \quad [\text{Equation (11.27)}]$$

$$K_o = (1 - \sin 49) [0.2 (101) (75) / 178.3]^{\sin 49} = 0.245 (8.5)^{0.755} = 1.23 \quad [\text{Equation (11.28)}]$$

$$f_{\max} = 178.3 (1.23) \tan 49 = 252 \text{ kPa (compression)}. \quad [\text{Equation (11.26)}]$$

**Note:** Since  $K_o$  is high ( $> 1.0$ ) and since drilling slurry is likely to be used in construction, consideration should be given either to reducing  $K_o$  to 1.0 to account for stress relief during excavation or to conducting a loading test to verify the high values of  $f_{\max}$  that have been computed. In this example no reductions will be made, but a further check of the construction specifications will be made to ensure that excavating and concreting proceed continuously and without delay, since delays will allow excess stress relief, which will reduce  $K_o$  and therefore will result in a reduction in  $f_{\max}$  and in the overall resistance of the drilled shaft.

15. Step 15 is bypassed since the design is not according to LRFD.

16.  $R_A$  (compression)  $(2.02 + 9.17)/2.5 = 4.48 \text{ MN} = 503 \text{ tons (compression)} < 4.09 \text{ MN}$  (460 tons) (working load), so the shaft is acceptable against compressive loading.

$R_A$  also needs to be checked in uplift by setting  $R_B = 0$  and taking  $R_S = \Psi R_S$  (compression), ignoring the weight of the shaft unless it is necessary to account for the buoyant weight to prove the shaft's resistance. For this trial drilled shaft design  $L/B = 23.0/1.00 = 23$ . In the unnumbered table following Equation (B.58), for  $L/B = 23$ ,  $\Psi = 0.86$ . That is,  $R_S$  (uplift)  $= 0.86 [R_S$  (compression)]  $= 0.86 (9.17) = 7.89 \text{ MN}$  and  $R_A = 7.89/2.5 = 3.15 \text{ MN}$ , which exceeds the design uplift load of 1.82 MN. The shaft is safe in uplift. In this example, compression loading clearly controls the geometry.

17. The settlement under the design load will be computed using the method outlined for cohesionless IGM's [Equations (C-27) through (C-32)] since most of the resistance is provided by the IGM. This is acceptable, because the procedure is also valid for sands ( $N < 50$ ). However, Figures C-3 and C-4 could also be used with relatively little error.

A linear trend line for  $N$  vs. depth was estimated in Step 4.  $N$  ( $N_{60}$ ) varies from 15 at Elevation 27.2 m to 85 at Elevation -4.5 m. At the base of the drilled shaft (Elevation +4.2 m), the value of

N from the linear trend line, from interpolation, is 66. Assume that  $\nu$  (geomaterial) = 0.3. From Equation (C.27) and Figure C.9:

$$E_{sL} = 22 (101) 66^{0.82} = 69\,000 \text{ kPa.}$$

$$E_{sm} = 22 (101) [(15 + 66)/2]^{0.82} = 46\,200 \text{ kPa.}$$

In preparation for the evaluation of I in Equation (C.29),

$$\zeta = \ln \{ [0.25 + (2.5(46\,200/69\,000)(1-0.3) - 0.25)2.5](2) (23) \} = 4.77,$$

$$E_c = 57,000 (4,000)^{0.5} = 3,600,000 \text{ psi} = 24.8 \text{ GPa (assuming no correction for rebar),}$$

$$\lambda = 2 (1+\nu) E_c/E_{sL} = 2 (1.3) (24\,800 / 69) = 934, \text{ and}$$

$$\mu L = 2 (2/\zeta\lambda)^{0.5} (L/B) = 2 [2/(4.77)(934)]^{0.5} (23) = 0.975.$$

From Equation (C.29):

$$I = 4(1.3) \{ 1 + [8 \tanh (0.975) 23 / \pi 934 (0.7) 2.5 (0.975) 1] / [4/(0.7) (2.5) + 4 \pi (46\,200/69\,000) \tanh (0.975) 23 / 4.77 (0.975) 1] \}$$

$$= (5.2) \{ 1 + [8 (0.751) 23 / 5006] / [2.29 + 31.2] \} = 0.160.$$

$$f_{\max} (\pi B L) = 9171 \text{ kN} = R_s, \text{ so}$$

$$Q_{TI} = 9171 / \{ 1 - [0.160 / (2.5 \cosh (0.975) (1 - 0.09))] \} \quad \text{[Equation (C.28)]}$$

$$= 9171 / \{ 1 - [0.160 / (2.5 (1.51) (0.91))] \} = 9619 \text{ kN} = 9.62 \text{ MN}$$

$$w_{TI} = [9619 (0.160)] / [69\,000 (1)] = 0.022 \text{ m} = 22 \text{ mm} \quad \text{[Equation (C.30)]}$$

Since the critical compressive design load is 4.09 MN, the settlement can be determined by simple linear interpolation:

$$w_T (\text{design load}) = (4.09/9.62) 22 = \underline{9.4 \text{ mm.}}$$

The uplift movement can also be checked as suggested in Chapter 11; however, the uplift load produces a very high factor of safety for this particular problem, so that it will be assumed that if  $w_T$  under the compressive working load is less than the tolerable movement of the structure,  $w_T$  under the uplift working load will likewise be less than the tolerable movement.



In addition, the entire load-movement curve could be generated, but since the objective here is to estimate settlement at working load, those calculations will not be made.

18. If the tolerable movement of the structure is in the usual range of 25 mm, the settlement at working load is only about one-third of that value, and the design should be safe. If the structure is highly sensitive to settlement, a different foundation design should be considered.

19. The diameter and depth of the drilled shaft will need to be checked for structural and lateral loading conditions.

**EXAMPLE D-4: Design of a Drilled Shaft in Cohesive Intermediate Geomaterial by LRFD.**

Design the drilled shaft for the subsurface conditions summarized below by LRFD. The subsurface materials consist of hard clays to very soft argillaceous (clay-based) rock.

1. Borings have been grouped to define design zones. No indication of a piezometric surface is observed within the potential depth of the drilled shafts.

2. The geomaterial profile for design purposes is idealized as follows in the design zone of interest:

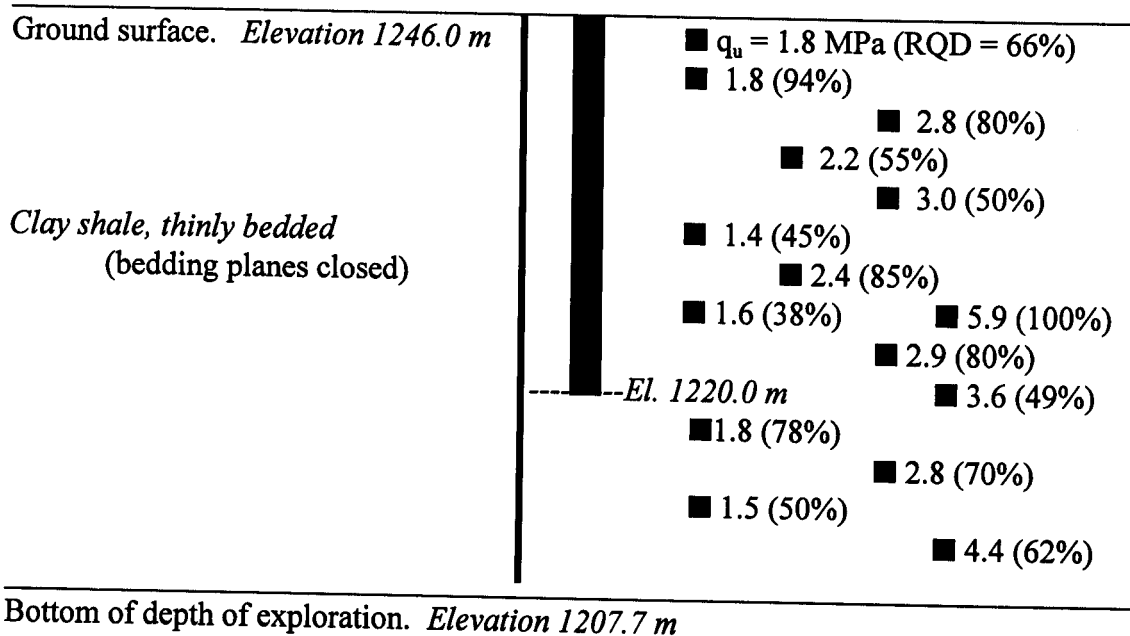

Stress-strain testing of the IGM cores was not authorized.

The site is in an arid area in which long periods of hot and dry weather are followed by intense

periods of rain. The cohesive IGM has a plasticity index of 60 near the surface. The surface of the geomaterial around the drilled shafts is to be unprotected from the atmosphere. The depth of the zone of seasonal moisture change is known to be about 5 m in the general area.

3. The pattern of  $q_u$  vs. depth suggests a trend toward a constant value, with a few outlier points. Discounting the "outlier" values of 5.9 and 4.4, which may be due to thin ledges of rock within the IGM, the average value of  $q_u$  is 2.28 MPa. This value will be assumed to apply to the entire stratum. The average value of RQD (for all 15 cores) is 67 per cent. Assuming that  $E_i = 200 q_u$ ,  $E_i$  can be assigned a value of 456 MPa.

4. Both  $q_u$  and  $E_i$  will be assumed to be constant throughout the layer. Likewise, the RQD will be assumed to be constant. Since a few values fall well below the mean, a value smaller than the mean value of 67 per cent might be considered, which would lead to a more conservative solution than is given here; however, in this solution it is assumed that the low values are caused by washout of competent clays and clay-shale during wet coring, so that a value lower than the average will not be used.

The coefficient of variation of  $q_u$  needs to be determined with respect to the trend line, in this case a uniform value with depth. See Appendix A. Assuming that all of the values of  $q_u$  are uncorrelated,  $COW_w = [\Sigma (q_u - q_{u,avg})^2 / (\text{number of data points} - 1)]^{0.5} / 2.28$ , discounting the outliers, or  $COW_w = 0.30 < 0.35$ , so proceed to use the same resistance factors that would be used for design in clay (Table A.5).

Concerning the estimation of base resistance, the IGM will be treated as massive (base resistance not reduced due to the presence of soft seams or joints) because the laminations (thin bedding planes) are completely closed.

5. Long-term, drained analyses will not be performed.

6. The boring logs indicate that the boreholes will be dry and that the geomaterial is quite strong. Dry-method construction is therefore anticipated, although it might be possible that the geomaterial could fall into the hole in blocks if vertical fissures are present. The specifications are reviewed to ensure that the dry method is adequately covered and that provisions can be made for casing in the event that it is needed. Specific statements concerning the cleanliness of the borehole and amount of water that can be present in the bottom at the time of the concrete placement should be clearly written into the specifications.

The sides of the borehole will be roughened, as discussed later. Therefore, provisions for making and checking the dimensions of "collars" are placed in the specifications. Since the collars will be relatively small, a concrete with a maximum coarse aggregate size of 19 mm (3/4 inch) is selected. The concrete is required to have a minimum 28-day compressive strength of 27.6 MPa (4000 psi) as well as a Young's modulus of 24.8 GPa (3,600,000 psi). A slump of 200 mm (8 inches) will be called for.

7. This design is to be accomplished under the LRFD format.
8. The critical factored compressive axial load for the strength state is 27.307 MN (3067 tons). The highest factored load for the service limit state is 17.9 MN (2010 tons). There is no loading case in which uplift will be applied to the drilled shaft. There are no lateral loads.
9. Because  $COV_w$  is relatively small,  $\phi$  (side resistance) = 0.65 and  $\phi$  (base resistance) = 0.50.
10. The axial loading will control because there are no lateral loads.
11. There is no "clay" at the ground surface, but the cohesive IGM is very prone to swelling and shrinking because of its environment and because it has a very high plasticity index. Therefore, prudently discount unit side resistance down to the depth of seasonal moisture change (5 m).
12. Select a trial base elevation of 1220 m (shaft length = 26 m = 85.3 feet). Select a trial shaft diameter of 1.5 m (59.1 inches).
13. There are no exclusion zones at the base since the base is in a cohesive IGM and not a clay ("cohesive soil").
14. The nominal ultimate base and side resistances are computed as follows:

Base (in cohesive IGM):

$$q_{\max} = 2.5 q_u \text{ (base).} \quad \text{[Equation (11.5)]}$$

The value of  $q_u$  varies considerably in the vicinity of the base. Although it might be justifiable to take an average of 2.9 and 3.6 MPa, the two values immediately underneath the base, unless it can be shown that these values are meaningful (not just an artifact of the way the IGM was sampled and tested) and consistent across the design zone, it will be more prudent to use the value selected for the entire layer, 2.28 MPa. The use of Equation (11.5) is permissible since the socket penetrates the IGM layer by more than 1.5 B. Therefore,

$$q_{\max} = 2.5 (2.28) = 5.7 \text{ MPa.}$$

$$R_B = 5.7 (\pi/4)(1.5^2) = \underline{10.07 \text{ MPa.}}$$

Sides (in cohesive IGM):

Because it is necessary to develop a drilled shaft of high capacity, and because the construction will be carried out in the dry, it is decided to roughen the sides of the borehole. Collars will be

cut every 0.6 m of depth to a distance of 50 mm into the sides of the borehole. The collars will be 75 mm in height. The borehole will therefore be classified as "rough" for design purposes.

Side resistance in a cohesive IGM, especially if roughened, is displacement-dependent. The defined settlement at failure will be taken to be 25 mm (1 inch), and the side resistance  $R_s$  will be computed for that value of settlement using Equations (B.36 b) through (B.45).

$$f_a = q_u/2 \text{ (roughened shaft)} = 2.28 / 2 = 1.14 \text{ MPa} \quad \text{[Equation (B.36b)]}$$

$$E_m/E_i = 0.62, \text{ from Table B.5 for RQD} = 67 \text{ per cent and closed joints.}$$

$$f_{aa}/f_a = 0.85 \text{ from Table B.6 for } E_m/E_i = 0.62.$$

$$f_{aa} = 0.85 (1.14) = 0.969 \text{ MPa} = 969 \text{ kPa.}$$

Compute D/B. Exclude the top 5 m, since at times the shaft material may not make contact with the geomaterial.

$$D/B = (26 - 5) / 1.5 = 14.$$

$$E_c/E_m = 24\,800 / [(0.62)(456)] = 88.$$

$$\Gamma = 0.37 (14)^{0.5} - 0.15[(14)^{0.5} - 1] \log_{10} (88) + 0.13 = 0.715. \quad \text{[Equation (B.44)]}$$

$$\Omega = 1.14 (14)^{0.5} - 0.05 [(14)^{0.5} - 1] \log_{10} (88) - 0.44 = 3.56. \quad \text{[Equation (B.43)]}$$

$$H_f = [0.62 (456) 3.56] / [\pi (21) (0.715) (0.969)] \text{ w (m)}. \quad \text{[Equation (B.42)]}$$

$$= 22.02 \text{ w (m)} = 22.02 (0.025 \text{ m}) = 0.550$$

The mid-depth of that part of the drilled shaft that is below the exclusion zone is 15.5 m below the surface. That is, there will be an average of 15.5 m of head of fluid concrete in the depth range in the shaft in which it is assumed that side load transfer takes place for design purposes (from a depth of 5 m to the base of the drilled shaft) Figure B-11 indicates that at a depth of 12 m (closest value to the actual value of 15.5 m available),  $M = 0.77$  for the specified slump of 200 mm. The minimum value of  $\sigma_n$  is therefore  $0.77 (12.0 \text{ m}) (23.55 \text{ kN/m}^3) = 218 \text{ kPa}$  from Equation (B.38), assuming that the unit weight of concrete is  $23.55 \text{ kN/m}^3$ .  $\sigma_n$  could also be approximated using Equation (11.23). It is likely that  $\sigma_n$  will be larger than this value near the base of the shaft and somewhat less than this value near the surface. However, this value (218 kPa) will be used to represent  $\sigma_n$  along the entire shaft below a depth of 5 m.

Continuing,

$$n = \sigma_n / q_u = 218 \text{ kPa} / 2280 \text{ kPa} = 0.096. \quad [\text{Equation (B.45)}]$$

Finally,

$$K_f = 0.096 + [(0.550 - 0.096)(1 - 0.096)] / [0.550 - 2(0.096) + 1] \\ = 0.398 (< 1), \text{ and} \quad [\text{Equation (B.41)}]$$

$$f_{\max} = 0.398 (0.969) = 0.386 \text{ MPa}. \quad [\text{Equation (B.40)}]$$

This is an average value along the socket, so that

$$R_s = (26 - 5) \pi (1.5) 0.386 = \underline{38.2 \text{ MN}} (4292 \text{ tons})$$

15. The factored total resistance is  $0.65 (38.2) + 0.50 (10.07) = 29.9 \text{ MN} = 3356 \text{ tons}$ . The factored critical strength state load is  $27.3 \text{ MN}$ , which is less than the available factored resistance of  $29.9 \text{ MN}$ , so the design is safe. The shaft could conceivably be shortened or the diameter decreased slightly to make the design more efficient.

16. ASD is not being used, so this step will be bypassed.

17. The settlement under the service limit load is evaluated using the procedure discussed in Appendix C for cohesive IGM's. Some of the preliminary calculations have already been made since the computations for  $f_{\max}$  require the evaluation of  $f_{\max}$  at a particular value of settlement. The procedure calls for the selection of values of settlement and the computation of resistances that correspond to the assumed settlements. From Step 14:

$$\Omega = 3.56,$$

$$\Gamma = 0.715,$$

$$H_f = 22.02 w_T \text{ (m)},$$

$$D/B = 14$$

$$n = 0.096$$

$$E_m = (0.62) (456) = 283 \text{ MPa}$$

$$f_{aa} = 0.969 \text{ MPa}$$

The service limit load is  $17.9 \text{ MN}$  (defined in Step 8).

Select  $w_T = 8.0 \text{ mm}$  (0.315 inches).

$$H_f = 22.02 (0.008) = 0.176 > n$$

$$K_f = 0.096 + [0.176 - 0.096][0.904] / [0.176 - 0.192 + 1] = 0.169$$

$$q_B = 0.0134 (283) \{(14)/(15)\} \{200 [0.008][(14)^{0.5} - 3.56][15] / [\pi (21) (0.715)]\}^{0.67} = 0.72 \text{ MPa} < q_u. \quad \text{[Equation (C.24)]}$$

$Q_T(\text{developed}) = \pi (1.5) 21 (0.169) (0.969) + [(\pi/4) (1.5)^2] (0.72) = 17.5 \text{ MN}$ , which is approximately equal to the factored critical service limit load (17.9 MN).

**18.** The value of settlement corresponding to the service limit load, 8.0 mm, technically corresponds to the settlement at the bottom of the exclusion zone, since the geomaterial below the exclusion zone has been treated as a "socket" for design purposes. It is assumed here that the compression of the drilled shaft in the 5-m-long exclusion zone at the top of the drilled shaft can be ignored. However, it can easily be calculated and added to the value of 8 mm at the bottom of the exclusion zone if such accuracy is desired. If the tolerable movement of the structure is greater than 8 mm (or 8 mm plus the elastic compression in the top 5 m), the design will be acceptable for the service limit state.

**19.** Lateral loading does not need to be checked since there are no lateral loads in this example. Note, however, that the drilled shaft is rather heavily loaded -- 27.3 MN in the critical strength state over a 1.5-m-diameter shaft. The axial structural resistance of the shaft should definitely be checked.

## APPENDIX E: EXAMPLE SOLUTIONS FOR A DOWNDRAG PROBLEM

The following examples address the downdrag problem from several perspectives.

### **Example E1a: Hand Solution with total stress parameters.**

Consider the drilled shaft in the sketch on the right.

Assume that the geotechnical unit has estimated that the average undrained shear strength of the soil in the fill after it consolidates around the shaft and settles will be 47.9 kPa (1 ksf) and that a ground surface settlement of 122 mm (4.8 in.) under the mechanism causing settlement will occur.

#### **Drilled Shaft:**

Length = 15.25 m (50 feet)  
 Diameter = 0.763 m (2.5 feet)  
 $AE = 12.6 \text{ kN/m}^2 \times 10^6 \times \text{m}^2$   
 $[2.83 \times 10^6 \text{ (ksi)} \times \text{in}^2]$

#### **Fill:**

Depth = 12.2 m (40 feet)  
 Settlement at surface = 122 mm (0.4 ft)  
 (Settlement is assumed to vary linearly with depth to zero at base of fill)  
 Average load transfer = 47.9 kPa (1 ksf) (nominal value)  
 Side load transfer: fully plastic

#### **Founding Stratum:**

Average unit side resistance = 479 kPa (10.0 ksf) (nominal value determined from subsurface investigation and calculations in Chapter 11.)  
 Load transfer: fully plastic  
 Unit base resistance = 4311 kPa (90 ksf) (nominal value determined from subsurface investigation and calculations from Chapter 11.)  
 Base load transfer: elastic-plastic (estimated from a bilinear approximation of Figure C.2, using a knee at settlement of 0.0167 B)

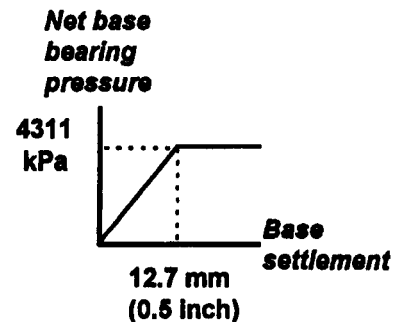
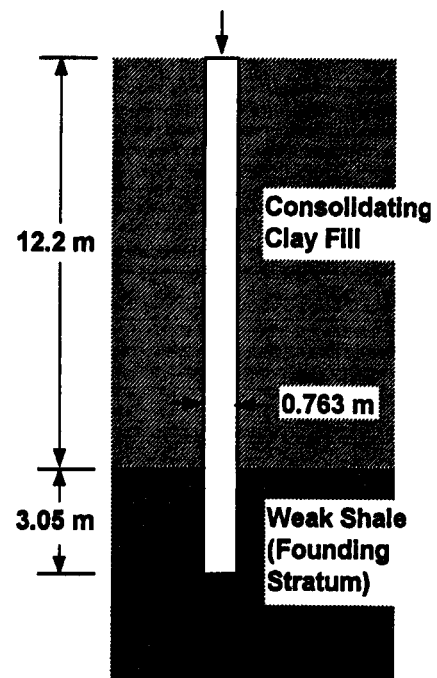

**Trial 1:** Assume that the neutral point is located at the top of the founding stratum (clay-shale).

Assume 12.7 mm (0.5 inch) of downward movement of the base ( $w_{\text{base}}$ ). According to the resistance-settlement relation for the base, this represents the point of plunging, i. e., the point at which ultimate resistance of the geomaterial under the base is reached. The corresponding unit base resistance is  $q_{\text{max}}$ . Proceed to locate the neutral point using nominal loads and resistances.

$$R_B = (\text{Area of base}) q_{\text{max}} = (\pi 0.763^2 / 4) 4311 = 1971 \text{ kN (443 kips)},$$

$$R_S = f_{\text{max}} L \pi B = 479 (3.05) \pi (0.763) = 3502 \text{ kN (787 kips) (founding stratum)},$$

$$Q_D \text{ (downdrag load)} = (47.9)(12.2) \pi (0.763) = 1401 \text{ kN (315 kips)}.$$

From static equilibrium, assuming the drilled shaft to be weightless,

$$Q_T = 1971 + 3502 - 1401 = 4072 \text{ kN (915 kips)},$$

$$Q_{\text{max}} \text{ (maximum load along the shaft)} = 4072 + 1401 = 5473 \text{ kN (1230 kips) at depth of 12.2 m (40 feet)}.$$

$$\begin{aligned} w_n &= \text{settlement of the drilled shaft at top of founding stratum (assumed neutral point)} \\ &= w_{\text{base}} + \{ [Q_{\text{max}} + R_B] [\text{Length of socket}] / \{2 AE\} \} \\ &= 12.7 + \{ [(5473 + 1971)(3.05)] / [(2)(12.6 \times 10^6)] \} (1000) \\ &= 13.6 \text{ mm (0.535 inches)} \end{aligned}$$

The distance to the new neutral point above the founding stratum  $z_n$  is given by the following simple expression if the settlement is assumed to vary linearly with depth.

$$\begin{aligned} z_n &= w_n \text{ (depth of fill)} / \text{(ground surface settlement)} \\ &= [(13.6)(12.2)] / 122 = 1.36 \text{ m (4.46 feet)}. \end{aligned}$$

**Trial 2:** Move the neutral point up by 1.36 m (4.46 feet) to 10.84 m (35.54 feet) below the original ground surface.  $R_B$  and  $w_{\text{base}}$  are unchanged.

$$R_S = 3502 + (47.9)(1.36) \pi (0.763) = 3658 \text{ kN (822 kips)},$$

$$Q_D = (47.9)(10.84) \pi (0.763) = 1245 \text{ kN (280 kips)},$$

$$Q_T = 1971 + 3658 - 1245 = 4384 \text{ kN (985 kips) [increase of 312 kN (70 kips)],}$$

$$Q_{\text{max}} = 4384 + 1245 = 5629 \text{ kN (1265 kips) at depth of 10.84 m (35.56 feet)}.$$

$$\begin{aligned} w_n &= 13.60 + \{ [(5629 + 5473)(1.36)] / [(2)(12.6 \times 10^6)] \} (1000) \\ &= 14.2 \text{ mm (0.559 inches) (new value of settlement at the neutral point)}. \end{aligned}$$

$$z_n = [(14.2)(12.2)] / 122 = 1.42 \text{ m (4.66 feet)}.$$



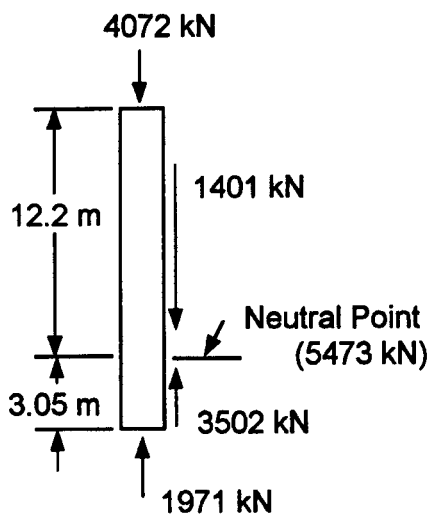

**Unfactored Forces on Drilled Shaft; Trial 1**

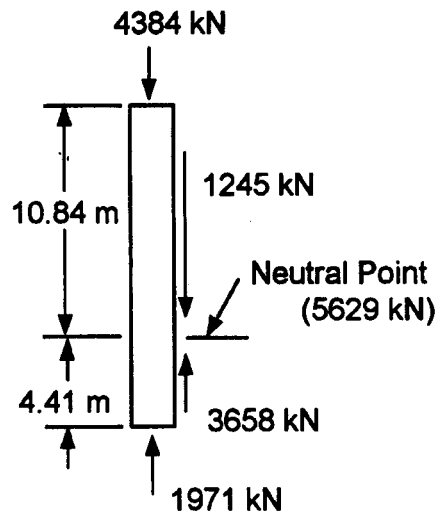

**Unfactored Forces on Drilled Shaft; Trial 2**

The improved solution from Trial 2 shows an increase in the maximum shaft load corresponding to the development of the geotechnical strength limit state for the founding stratum plus the lower part of the consolidating stratum from 5473 kN to 5629 kN. The head load also increased, however. Since the neutral point moves upward by only 0.06 m (0.2 feet) (from 1.36 to 1.42 m above the top of the founding stratum) after Trial 2, another iteration would probably not be warranted.

In LRFD, the maximum factored load that can be applied to the drilled shaft at the geotechnical strength limit state determined in Trial 2 is given by

$$\eta \sum \gamma_i Q_i + 1.8 (1245) = \phi_{\text{base}} (1971 \text{ kN}) + \phi_{\text{sides}} (3658 \text{ kN}).$$

Note that the side resistance (3658 kN) includes the resistance developed in the lower part of the consolidating stratum, in which the drilled shaft settles more than the soil. The downdrag force is treated as a load with a load factor of 1.8. Assuming that  $\phi_{\text{base}} = 0.5$  and  $\phi_{\text{sides}} = 0.65$ , the maximum factored load,  $\eta \sum \gamma_i Q_i$  is 1122 kN (252 kips). Depending upon the classification of the geomaterial in the founding stratum and its variability, the  $\phi$  factors may be different from the values given here. The factored value for  $Q_{\text{max}}$  will be  $1122 + 1.8 (1245) = 3363 \text{ kN}$  (756 kips). The structural resistance of the drilled shaft should be checked for this value in the structural strength limit state.

**Example E1b: Hand Solution Using Effective Stress Parameters.**

Consider the same geomaterial and drilled shaft profile as in Example E-1a. However, let the consolidating geomaterial be a natural soft, normally consolidated clay, and characterize that soil using effective stress parameters. Further, assume that the soil is consolidating under an imposed surface load of 95.8 kPa (2 ksf)

**Drilled Shaft:** As per Example E-1a.

**Soft Clay:**

Depth = 12.2 m (40 feet)

Piezometric surface is at ground surface

Settlement at surface = 122 mm (0.4 ft)

(Settlement is assumed to vary linearly with depth to zero at base of soft clay)

Side load transfer: fully plastic

Effective stress parameters:

$c' = 4.79 \text{ kPa (100 psf)}$ ,  $\phi' = 17 \text{ degrees}$

Average OCR (after consolidation under surcharge) = 1.

$\gamma'$  (effective unit weight) =  
8.64 kN / m<sup>3</sup> (55 pcf)

**Founding Stratum:** As per Example E-1a.

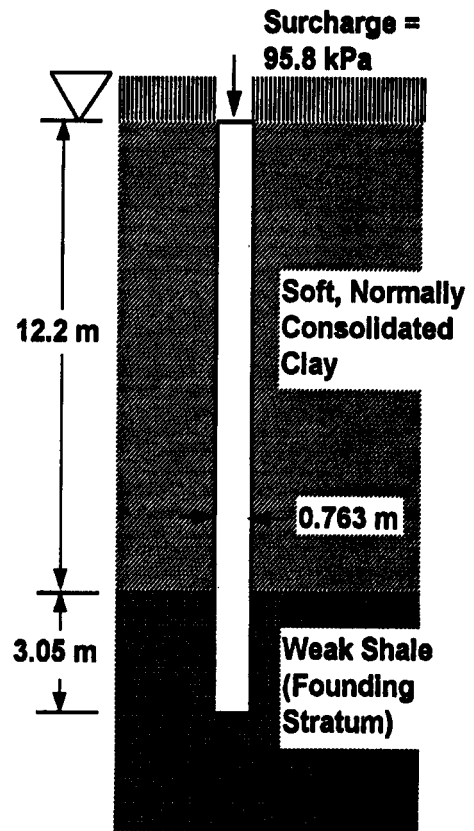

**Solution:**

**Profile of drained shear strength in the soft clay:**

$$f_{\max} = c' + [95.8 + \gamma'z] K_o \tan \phi', \text{ letting } a' = c', \quad \text{[Equation (12.1)]}$$

$$K_o = (1 - \sin 17) 1^{\sin 17} = 0.71. \quad \text{[Equation (12.2)]}$$

$$\begin{aligned} f_{\max} \text{ (kPa)} &= 4.79 + (95.8 + 8.64 z(\text{m}))(0.71) (0.306) \\ &= 25.6 + 1.88 z(\text{m}) \\ &= 25.6 \text{ kPa (0.53 ksf) at top of clay} \\ &= 25.6 + 1.88 (12.2) = 48.5 \text{ kPa (1.01 ksf) at base of clay.} \end{aligned}$$

**Trial 1:** Assume that the neutral point is located at the top of the founding stratum (clay-shale).

Assume 12.7 mm (0.5 inch) of downward movement of the base ( $w_{\text{base}}$ ). According to the resistance-settlement relation for the base, this represents the point of plunging, i. e., the point at which ultimate resistance of the geomaterial under the base is reached. The corresponding unit base resistance is  $q_{\text{max}}$ . Proceed to locate the neutral point using nominal loads and resistances. The values for  $R_B$  and  $R_S$  will be unchanged from Example E-1a.

$$R_B = A_B q_{\text{max}} = (\pi 0.763^2 / 4) 4311 = 1971 \text{ kN (443 kips)},$$

$$R_S = f_{\text{max}} L \pi B = 479 (3.05) \pi (0.763) = 3502 \text{ kN (787 kips) (founding stratum)},$$

$$Q_D \text{ (downdrag load)} = [(25.6 + 48.5)/2] (12.2) \pi (0.763) = 1083 \text{ kN (243 kips)}.$$

From static equilibrium, assuming the drilled shaft to be weightless,

$$Q_T = 1971 + 3502 - 1083 = 4390 \text{ kN (987 kips)},$$

$$Q_{\text{max}} \text{ (maximum load along the shaft)} = 4390 + 1083 = 5473 \text{ kN (1230 kips) at the depth of 12.2 m (40 feet)}.$$

$$\begin{aligned} w_n &= \text{settlement of the drilled shaft at top of founding stratum (assumed neutral point)} \\ &= w_{\text{base}} + \{ [Q_{\text{max}} + R_B] [\text{Length of socket}] \} / \{ 2 AE \} \\ &= 12.7 + \{ [(5473 + 1971)(3.05)] / [(2)(12.6 \times 10^6)] \} (1000) \\ &= 13.6 \text{ mm (0.535 inches)} \end{aligned}$$

The distance to the new neutral point above the founding stratum  $z_n$  is given by the following simple expression if the settlement is assumed to vary linearly with depth.

$$\begin{aligned} z_n &= w_n \text{ (depth of fill)} / \text{(ground surface settlement)} \\ &= [(13.6)(12.2)] / 122 = 1.36 \text{ m (4.46 feet)}. \end{aligned}$$

Note that  $Q_{\text{max}}$  and  $R_B$  are controlled by the resistance that develops in the founding stratum, so that they do not change from Example E-1a. For this reason,  $z_n$  does not change.

**Trial 2:** Move the neutral point up by 1.36 m (4.46 feet) to 10.84 m (35.54 feet) below the original ground surface.  $R_B$  and  $w_{\text{base}}$  are unchanged.

$f_{\text{max}}$  at the new neutral point is given by

$$f_{\text{max}} = 25.6 + 1.88 (10.84) = 46.0 \text{ kPa (0.96 ksf)}.$$

$$R_S = 3502 + [(48.5 + 46.0)/2](1.36) \pi (0.763) = 3656 \text{ kN (822 kips)},$$

$$Q_D = [(25.6 + 46.0)/2] (10.84) \pi (0.763) = 930 \text{ kN (209 kips)},$$

$$Q_T = 1971 + 3656 - 930 = 4697 \text{ kN (1056 kips) [increase of 307 kN (69 kips)]},$$

$$Q_{\max} = 4697 + 930 = 5627 \text{ kN (1264 kips) at depth of 10.84 m (35.56 feet).}$$

$$w_n = 13.60 + \{[(5627 + 5473)(1.36)] / [(2)(12.6 \times 10^6)]\} / 1000$$

$$= 14.2 \text{ mm (0.559 inches) (new value of settlement at the neutral point).}$$

$$z_n = [(14.2)(12.2)] / 122 = 1.42 \text{ m (4.66 feet).}$$

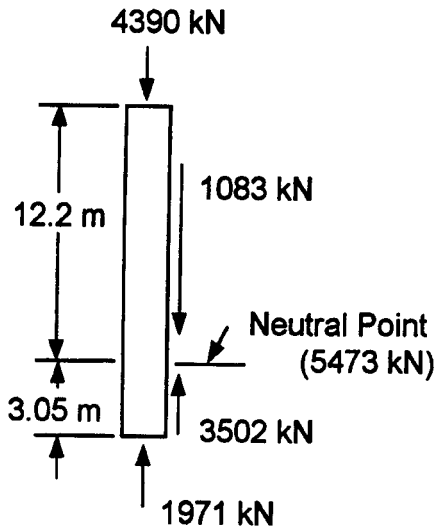

**Unfactored Forces on Drilled Shaft; Trial 1**

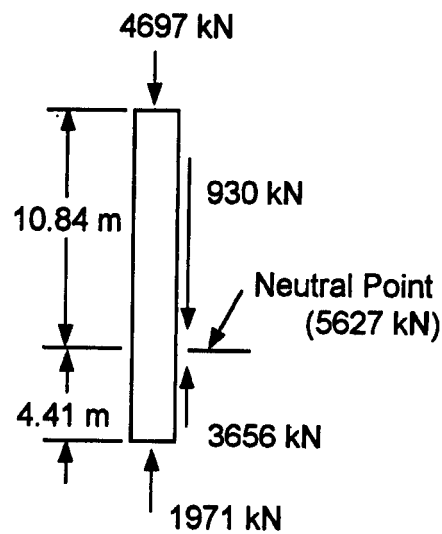

**Unfactored Forces on Drilled Shaft; Trial 2**

The improved solution from Trial 2, as in Example E-1a, shows an increase in the top load corresponding to the development of the geotechnical strength limit state for the founding stratum plus the lower part of the consolidating stratum. The downdrag load and the resistance in the founding stratum again changed between trials. As in Example E-1a, since the neutral point moves upward by only 0.06 m (0.2 feet) (from 1.36 to 1.42 m above the top of the founding stratum) after Trial 2, another iteration would probably not be warranted.

The downdrag load was slightly less for this example than for Example E-1a. It should not be taken as a general conclusion that the direct use of effective stress parameters will always lead to this result, since the assumed undrained shear strength value taken in Example E-1a and the drained shear strength parameters used in Example E-1b do not necessarily represent the same soil.

In an LRFD design, the maximum factored load that can be applied to the drilled shaft at the geotechnical strength limit state determined in Trial 2 is given by

$$\eta \sum \gamma_i Q_i + 1.8 (930 \text{ kN}) = \phi_{\text{base}} (1971 \text{ kN}) + \phi_{\text{sides}} (3656 \text{ kN}).$$

Note that the side resistance (3656 kN) includes the resistance developed in the lower part of the consolidating stratum, in which the drilled shaft settles more than the soil. The downdrag force is treated as a load with a load factor of 1.8, although an argument could be made for using a smaller load factor, because the use of effective stress parameters in a problem of this nature should lead to a lower degree of uncertainty in  $f_{\max}$  in the consolidating zone. Assuming that  $\phi_{\text{base}} = 0.5$  and  $\phi_{\text{sides}} = 0.65$ , the maximum factored load,  $\eta \sum \gamma_i Q_i$  is 1688 kN (379 kips). Depending upon the classification of the geomaterial in the founding stratum and its variability, the  $\phi$  factors may be different from the values given here. The factored value for  $Q_{\max}$  will be  $1688 + 1.8(930) = 3362$  kN (756 kips), which is unchanged from Example E-1a, indicating that  $Q_{\max}$  is controlled by the resistance that can be developed below the neutral point. The structural resistance of the drilled shaft should be checked for this value in the structural strength limit state.

**Example E2: Computer solution using elastic-plastic side load transfer relations.** This example is identical to Example E-1a, except that the side load transfer curves in both the fill and the founding stratum are elastic-perfectly-plastic, as indicated adjacent to this text. This condition requires the use of a computer.

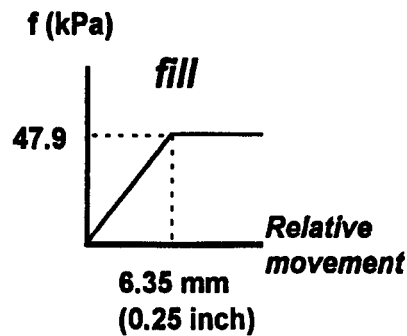

**Solution:** The neutral point was found by computer to be 10.86 m (35.8 feet) below the ground surface, compared to 10.84 m in Example E-1a (the hand solution). The resulting unfactored loads and resistances for the drilled shaft are:

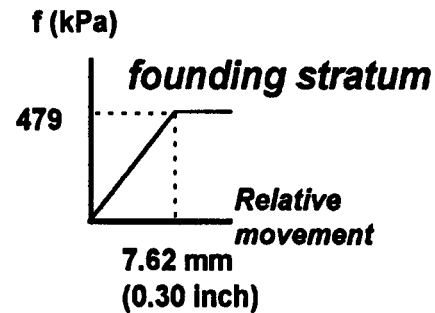

- $R_B = 1971$  kN (443 k)
- $R_S = 3582$  kN (805 k)
- $Q_D = 1205$  kN (271 k)
- $Q_T = 4348$  kN (977 k)
- $Q_{\max} = 5553$  kN (1248 k)

The comparison of the results from Examples E-1a and E-2 that follows indicates that the differences are essentially negligible and that the hand solution was satisfactory for this problem. The differences could be more substantial if other load transfer functions had been selected; however, considering the uncertainties in the various factors, a hand solution of the type given in Example E-1a or E-1b is probably satisfactory in the majority of cases.

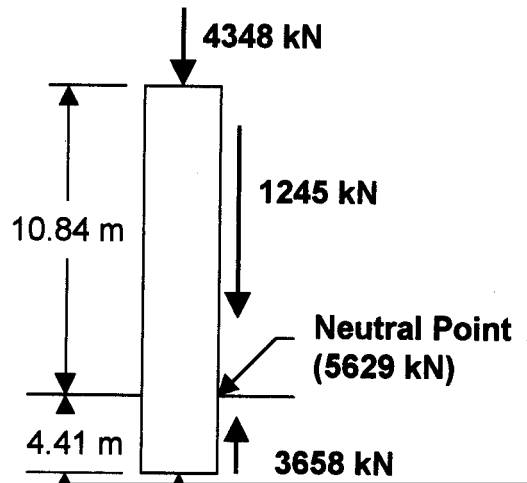
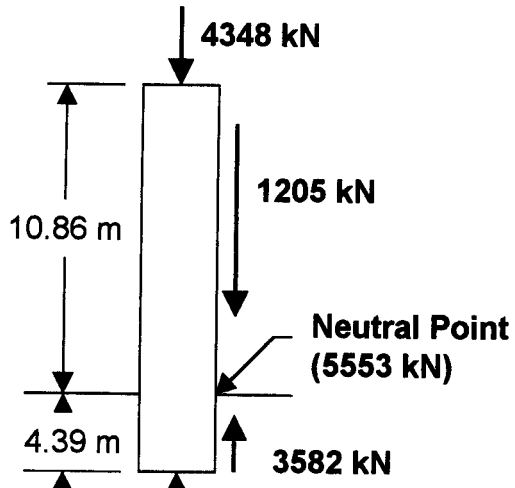

## **APPENDIX F: INSPECTION, REPORTING AND BIDDING FORMS**

This appendix contains the following forms, which have been adapted from *Report No. FHWA-TS-86-206*, March, 1986. They are generic and will often need to be modified to meet the requirements of a particular project. However, they offer a good checklist of issues that need to be considered during the inspection of the installation of drilled shaft foundations. It is strongly recommended that state inspectors be provided with inspection and reporting forms in order to ensure that all necessary steps in the construction process are monitored and reported.

- Drilling Procedures and Results
- Drilling Slurry
- Casing or Liner
- Installation of Access Tubes for Integrity Tests
- Concreting
- Tests of Completed Drilled Shaft
- Weather
- Information on Completed Drilled Shaft
- Repairs by Grouting

Examples of forms used by the contractor in making bids are also given.

Contractor : \_\_\_\_\_  
 Construction Supervisor : \_\_\_\_\_  
 District : \_\_\_\_\_  
 Subdivision : \_\_\_\_\_  
 Project : \_\_\_\_\_  
 Structure : \_\_\_\_\_  
 Foundation Element : \_\_\_\_\_  
 Drilled Shaft No. : \_\_\_\_\_

Contract No. : \_\_\_\_\_  
 General Contractor : \_\_\_\_\_  
 Project Superintendent : \_\_\_\_\_  
 Inspector : \_\_\_\_\_  
 Geotechnical Office : \_\_\_\_\_  
 Engineering Office : \_\_\_\_\_  
 Date(s) : \_\_\_\_\_

## DRILLING PROCEDURES AND RESULTS

FOUNDATION PLAN NO \_\_\_\_\_

THEORETICAL DIAMETER: \_\_\_\_\_

THEORETICAL INCLINATION: \_\_\_\_\_

Begun \_\_\_\_\_ at \_\_\_\_\_ a.m. Completed \_\_\_\_\_ at \_\_\_\_\_ a.m.  
 p.m. p.m.

Ground elevation at time of drilling		_____ ft	Site Datum	Type and main characteristics of drilling and lifting machines Access conditions		
Drilling elevation		_____ ft	SD			
Level of bottom of borehole	anticipated	_____ ft	SD			
	actual	_____ ft	SD			
Total length of borehole		_____ ft				
Upper level of casing or collar		_____ ft	SD			
Lower level of casing or collar		_____ ft	SD			
Length of casing or collar		_____ ft				
Date	Time	Depth	Soil Description	Tool Type	Details	OBSERVATIONS (setbacks, caveins, cavities, waterflow, slurry loss, recycling of slurry, etc.)



# DRILLING SLURRY

Composition	Brand	Type	Proportion	Bentonite storage { in sacks <input type="checkbox"/> in silos <input type="checkbox"/>
Bentonite				Mixing { "Mud Hopper" pulverizer <input type="checkbox"/> agitator deflocculator <input type="checkbox"/> centrifugal pump <input type="checkbox"/>
Additives				
Water source				Slurry troughs { type _____ number _____ unit _____ capacity _____

## TREATMENT OF RECYCLING UNIT

Vibrating screen Model: _____ Mesh: _____	Cyclones Type: _____ Number: _____	Circulation pump Type: _____ Output: _____
---	--	--

## PROPERTY TESTS

Date and time of sampling		at _____ a.m. _____ p.m.	at _____ a.m. _____ p.m.	at _____ a.m. _____ p.m.	at _____ a.m. _____ p.m.	at _____ a.m. _____ p.m.	at _____ a.m. _____ p.m.	at _____ a.m. _____ p.m.
Measure	Initial	at mixing	During construction at various levels at _____ ft   at _____ ft   at _____ ft   at _____ ft				At bottom of borehole before recycling   before concreting	
Density								
Viscosity								
Sand content								
Cake/filtrate								
pH								

# CONCRETING

Begun \_\_\_\_\_ at \_\_\_\_\_ a.m. Completed \_\_\_\_\_ at \_\_\_\_\_ a.m.  
p.m. p.m.

Source of design of mix	Concrete components	Category	Class	Origin	Proportion
Standard design <input type="checkbox"/> Special design <input type="checkbox"/> Job-site design <input type="checkbox"/> Other <input type="checkbox"/> - : _____ - : _____ - : _____	Cement				
	Aggregates				
Supplying by concrete mixers  1st _____ cu yd 2nd _____ cu yd 3rd _____ cu yd 4th _____ cu yd 5th _____ cu yd 6th _____ cu yd 7th _____ cu yd <span style="font-size: 2em; vertical-align: middle;">}</span> $V_t =$ _____ cu yd	Water				
	Additives				
Placement techniques				Type of priming plug	
Tremie without couplings <input type="checkbox"/> { O.D.: _____ in upper level (tremie base) : _____ ft SD base level : _____ ft SD distance under tremie : _____ ft with couplings <input type="checkbox"/>				- concreting directly from mixer <input type="checkbox"/> - concreting using bucket _____ cu yd <input type="checkbox"/> - concreting by pump with piston <input type="checkbox"/> - Other <input type="checkbox"/>	
Bucket		Model: _____ Capacity _____ cu yd		Output _____ cu yd/hr	

## CONCRETING (con'd)

Placement control : _____ Maximum concreting level: _____ ft SD Height of fresh, purged concrete: _____ ft Upper shaft level before trimming: _____ ft SD Shaft length before trimming: _____ ft Corresponding theor. vol.: $V_t = \text{_____ cu yd/ft}$ $\times \text{_____ ft} = \text{_____ cu yd}$ Volume of excess in last truck: $V_e = \text{_____ cu yd}$ Volume used in overflow and purging: $V_p = \text{_____ cu yd}$ Actual, total consumption ( $V_p$ included): $V = V_1 - V_e$ $= \text{_____ cu yd}$ Actual pile volume before trimming: $V_r = V - V_p = \text{_____ cu yd}$ Overpour $V_s = V_r - V_t = \text{_____ cu yd}$ $\frac{V_r - V_t}{V_t} \times 100 = \text{_____ \%}$	<table border="1" style="width: 100%; border-collapse: collapse;"> <thead> <tr> <th colspan="4" style="text-align: center;">Concrete quality tests</th> </tr> <tr> <th style="width: 15%;">Concrete mixer or truck</th> <th style="width: 15%;">Addition of water gal/cu yd</th> <th style="width: 15%;">Slump, in</th> <th style="width: 55%;">Number of tests</th> </tr> <tr> <td></td> <td></td> <td></td> <td style="text-align: center;">comp.    bending</td> </tr> </thead> <tbody> <tr> <td style="height: 100px;"></td> <td></td> <td></td> <td></td> </tr> </tbody> </table>	Concrete quality tests				Concrete mixer or truck	Addition of water gal/cu yd	Slump, in	Number of tests				comp.    bending				
Concrete quality tests																	
Concrete mixer or truck	Addition of water gal/cu yd	Slump, in	Number of tests														
			comp.    bending														
<p style="text-align: center;">CONCRETING CURVE</p> <div style="display: flex; align-items: center;"> <div style="flex: 1;"> </div> <div style="flex: 1; padding-left: 10px;"> <p>OBSERVATIONS: Operation of central mixing plant, supply irregularities (concrete delays), possible setbacks (loss of priming in the tremie, rising or lowering of reinforcing, difficulties with extraction of temporary casing, caving, etc.)</p> </div> </div> <p>Trimmed elevation _____ ft SD - Planned elevation _____ ft SD</p>																	

## TESTS OF COMPLETED DRILLED SHAFT

Method of acoustic investigation	Date	Operator	Report No	Coring	Date	Operator	Report No		
Wave transmission using reflection method									
Lateral transmission of waves									
Radioactive transmission of waves				Corer:            { Brand : _____ Type : _____ Coring tool    { Type : _____ Length : _____ { O.D. : _____ I.D. : _____ Crown type : _____					
Other				Depth	Level	# Core	Force lbs	Speed rpm	Adv. rate in
Defects Observed				<div style="display: flex; align-items: center;"> <div style="width: 10px; height: 100%; border-left: 1px dashed black; margin-right: 5px;"></div> <div style="width: 100%; border-left: 1px dashed black; border-right: 1px dashed black;"></div> </div>	<div style="display: flex; align-items: center;"> <div style="width: 10px; height: 100%; border-left: 1px dashed black; margin-right: 5px;"></div> <div style="width: 100%; border-left: 1px dashed black; border-right: 1px dashed black;"></div> </div>	<div style="display: flex; align-items: center;"> <div style="width: 10px; height: 100%; border-left: 1px dashed black; margin-right: 5px;"></div> <div style="width: 100%; border-left: 1px dashed black; border-right: 1px dashed black;"></div> </div>	<div style="display: flex; align-items: center;"> <div style="width: 10px; height: 100%; border-left: 1px dashed black; margin-right: 5px;"></div> <div style="width: 100%; border-left: 1px dashed black; border-right: 1px dashed black;"></div> </div>	<div style="display: flex; align-items: center;"> <div style="width: 10px; height: 100%; border-left: 1px dashed black; margin-right: 5px;"></div> <div style="width: 100%; border-left: 1px dashed black; border-right: 1px dashed black;"></div> </div>	<div style="display: flex; align-items: center;"> <div style="width: 10px; height: 100%; border-left: 1px dashed black; margin-right: 5px;"></div> <div style="width: 100%; border-left: 1px dashed black; border-right: 1px dashed black;"></div> </div>
Position	Assumed Nature								
View with T.V. camera	Date	Operator	Report No						

# WEATHER

Date: \_\_\_\_\_

Hours	Temperature	Humidity	Precipitation		Atmospheric conditions	Wind velocity	Sky Conditions	Sunshine	Observations
			Type	Rate and/or duration					

## INFORMATION ON COMPLETED DRILLED SHAFT

<p>Diagram of location of completed drilled shaft in relation to theoretical location</p> <p>(report and mark position of access tubes)</p>   	Finished length: _____ ft
	Height above ground: _____ ft
	Inspector
<p>Note: For all operations, taking of photographs is recommended, especially when there are setbacks or difficulties.</p>	

# REPAIRS BY GROUTING

Preliminary test for water flow					Pressure: _____ psi Output: _____ gal/mn		Cleaning { with pressurized water <input type="checkbox"/> { with airlift <input type="checkbox"/>						
Number and type of conduits	Access tubes	Test boreholes	Specific boreholes	Seals		TESTS	1st phase		2nd phase				
				Type	Levels		Type	stable <input type="checkbox"/> unstable <input type="checkbox"/>	stable <input type="checkbox"/> unstable <input type="checkbox"/>				
Grout						Grout	Composition	Type	Proportion	Type	Proportion		
Saturation (blowholes)							Cement						
							Sand						
							Clay						
							Water						
							Additives						
Mixer Type : _____ Volume : _____ Speed : _____					Pump Type : _____ Output : _____ Max. pres.: _____					Viscosity			
										OBSERVATIONS - DIFFICULTIES ENCOUNTERED  		Injection	Maximum pressure
		Volume	_____ gal	_____ gal									
		Duration	_____ mn	_____ mn									

**EXAMPLE BID FORMS FOR USE BY CONTRACTOR**

Bid Estimate Sheet "A"

Project:

Estimate No. \_\_\_\_\_  
 Bid Date \_\_\_\_\_  
 Engineer \_\_\_\_\_

Architect:

Boring \_\_\_\_\_  
 Concrete \_\_\_\_\_  
 Re-Steel \_\_\_\_\_

Engineer:

Total No. of Days to Install Caissons = \_\_\_\_\_ days @ \_\_\_\_\_ hours per day

**A. EQUIPMENT**

Corporation  
 Equipment per day = \_\_\_\_\_ per day @ days = \_\_\_\_\_  
 Rented equipment  
 per day = \_\_\_\_\_ per day @ days = \_\_\_\_\_

**B. LABOR**

Bare labor cost = \_\_\_\_\_ per day @ days = \_\_\_\_\_  
 Subsistence & travel = \_\_\_\_\_

Total = \_\_\_\_\_

**C. MATERIAL**

Total cost of materials = \_\_\_\_\_

**D. SUBTRADES & SERVICES**

Total cost of subtrades & services = \_\_\_\_\_

**E. MOBILIZATION & DEMOBILIZATION On-Off = \_\_\_\_\_**

Total Bare Cost = \_\_\_\_\_  
 Overhead = \_\_\_\_\_  
 Job cost including overhead = \_\_\_\_\_  
 Bond Premium = \_\_\_\_\_

**MINIMUM BID = \_\_\_\_\_**

**Bid Estimate Sheet "B"**

Project: \_\_\_\_\_

Estimate No. \_\_\_\_\_  
Bid Date \_\_\_\_\_  
Engineer \_\_\_\_\_

**A. EQUIPMENT**

<u>Corporation</u>		<u>Daily Fuel (in Gals)</u>
1. _____	@ _____ /Day	_____
2. _____	@ _____ /Day	_____
3. _____	@ _____ /Day	_____
4. _____	@ _____ /Day	_____
5. _____	@ _____ /Day	_____
6. _____	@ _____ /Day	_____
7. _____	@ _____ /Day	_____
8. _____	@ _____ /Day	_____
9. _____	@ _____ /Day	_____
	Per Day _____	_____

**Rented**

1. _____	@ _____ /Day	_____
2. _____	@ _____ /Day	_____
3. _____	@ _____ /Day	_____
4. _____	@ _____ /Day	_____
5. _____	@ _____ /Day	_____
6. _____	@ _____ /Day	_____
7. _____	@ _____ /Day	_____
8. _____	@ _____ /Day	_____
9. _____	@ _____ /Day	_____
	Per Day _____	_____



Bid Estimate Sheet "C"

Project: \_\_\_\_\_

Estimate No. \_\_\_\_\_  
 Bid Date \_\_\_\_\_  
 Engineer \_\_\_\_\_

**B. LABOR**

		<u>HRS</u>					
		<u>PER DAY</u>	8	9	10	11	12
_____	Operators @ _____	=	_____	_____	_____	_____	_____
_____	Operators @ _____	=	_____	_____	_____	_____	_____
_____	Oilers @ _____	=	_____	_____	_____	_____	_____
_____	Labor Foreman @ _____	=	_____	_____	_____	_____	_____
_____	Laborers @ _____	=	_____	_____	_____	_____	_____
_____	Miners @ _____	=	_____	_____	_____	_____	_____
_____	Swampers @ _____	=	_____	_____	_____	_____	_____
_____	Carpenters @ _____	=	_____	_____	_____	_____	_____
_____	Iron Worker F. @ _____	=	_____	_____	_____	_____	_____
_____	Iron Workers @ _____	=	_____	_____	_____	_____	_____
_____	Pile Driver F. @ _____	=	_____	_____	_____	_____	_____
_____	Pile Driver @ _____	=	_____	_____	_____	_____	_____
_____	@ _____	=	_____	_____	_____	_____	_____
_____	Supt. @ _____	=	_____	_____	_____	_____	_____

per day

**SUBSISTENCE AND TRAVEL**

_____	Persons @ _____	Day =	_____ x _____	Days =	_____
_____	Persons @ _____	Day =	_____ x _____	Days =	_____
_____	Persons @ _____	Day =	_____ x _____	Days =	_____
_____	Air Fares @ _____	=	_____ x _____	Trips =	_____
_____	Air Fares @ _____	=	_____ x _____	Trips =	_____

Bid Estimate Sheet "D"

Project:

Estimate No. \_\_\_\_\_

Bid Date \_\_\_\_\_

Engineer \_\_\_\_\_

C. MATERIALS

\_\_\_\_\_ C.Y. Concrete @ \_\_\_\_\_ = \_\_\_\_\_

\_\_\_\_\_ Lbs, Re-Steel @ \_\_\_\_\_ = \_\_\_\_\_

\_\_\_\_\_ Lbs, Casing @ \_\_\_\_\_ = \_\_\_\_\_

\_\_\_\_\_ Gals, Fuel  
Perishable @ \_\_\_\_\_ = \_\_\_\_\_

\_\_\_\_\_ Tool Allowance @ \_\_\_\_\_ = \_\_\_\_\_

\_\_\_\_\_ General  
Conditions @ \_\_\_\_\_ = \_\_\_\_\_

\_\_\_\_\_ @ \_\_\_\_\_ = \_\_\_\_\_

\_\_\_\_\_ @ \_\_\_\_\_ = \_\_\_\_\_

Taxes @ \_\_\_\_\_ % = \_\_\_\_\_

TOTAL \_\_\_\_\_

D. SERVICES & SUBCONTRACTORS

\_\_\_\_\_ @ \_\_\_\_\_ = \_\_\_\_\_

\_\_\_\_\_ @ \_\_\_\_\_ = \_\_\_\_\_

\_\_\_\_\_ @ \_\_\_\_\_ = \_\_\_\_\_

TOTAL \_\_\_\_\_

E. MOBILIZATION & DEMOBILIZATION

\_\_\_\_\_ Truckloads @ \_\_\_\_\_ = \_\_\_\_\_

\_\_\_\_\_ Equipment  
Rental @ \_\_\_\_\_ = \_\_\_\_\_

\_\_\_\_\_ Manhours @ \_\_\_\_\_ = \_\_\_\_\_

TOTAL \_\_\_\_\_

## **APPENDIX G: CONSTRUCTION CASE HISTORIES**

Several idealized case histories of drilled shaft construction are presented in this appendix. These case histories describe how the various construction techniques outlined in Chapters 1 - 8 of this manual can be used in various subsurface conditions. The solutions offered are not the only ones that could be successfully used. Innovative contractors frequently devise new, effective construction procedures for dealing with differing subsurface conditions, and those solutions should certainly be accepted when they are appropriate.

### **CASE 1: STIFF CLAY, WATER TABLE SLIGHTLY BELOW BASE OF SHAFT**

This case is illustrated by the soil profile shown in Figure G.1. The depth in meters is shown on the left of the profile, and a brief description of each layer of soil is shown on the right side of the profile. Since the soil is a stiff clay, it has been characterized by conducting UU triaxial compression tests on tube samples and tabulating values of undrained cohesion ( $c_u$ ), which can be defined as one-half of the compression strength of the soil, on the right side of the profile. The depth to the water table is indicated by the symbol "W.T." In this case the water table is at a depth of about 14 m (46 ft). "Water table" in the sense used here means piezometric-head location, rather than the location at which water was encountered during exploration.

For the case shown, the engineer decided to found the base of the drilled shaft at a depth of about 12.5 m (41 ft) in the top of the hard clay stratum. It was further decided that the shaft would be underreamed in order to increase bearing capacity.

As shown by the sketch on the right side of the figure, it is presumed that the excavation can be made without the use of a casing or of drilling fluid of any sort. It is further presumed that an underream can be cut without collapsing.

A factor in the soil description that gives some concern is the term, "sand inclusions," to describe the stratum where the base of the bell will be located. The engineer may well be concerned about the sand from two standpoints: a stable bell may not be able to be formed if there is a considerable amount of sand (slickensides can cause a similar concern), or the sand may be water-bearing at the time of construction, and the excavation will not be dry after all. There are several approaches to the problem.

The best procedure would be to make arrangements for a drilled shaft contractor to take a rig to the job and drill a full-sized hole and attempt to cut a bell prior to letting the construction contract for the foundation. The results of that experiment would provide the necessary information for reaching a final decision on the design.

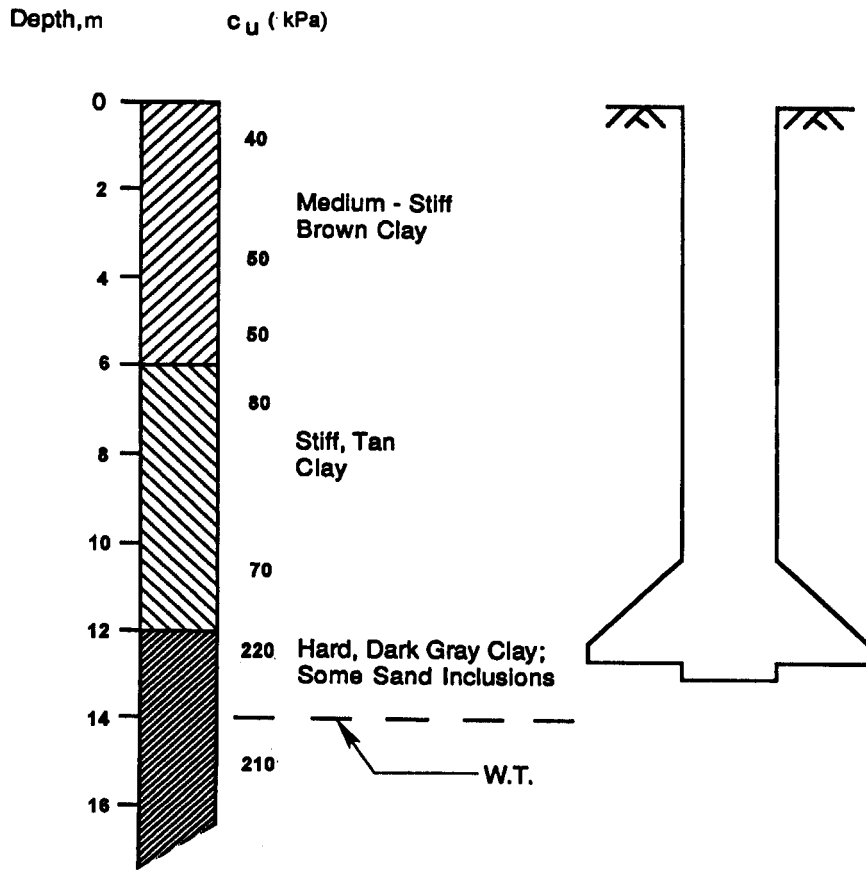

Figure G.1. Case 1: Construction in stiff clay with water table slightly below base of shaft

Another possibility would be to provide an alternate design. In this case a straight shaft could be designed several meters longer than the underreamed design. The straight shaft would extend below the water table, and water would possibly collect in the excavation. The clay could be so impermeable that little water would seep into the excavation. But the fact that at least some sand is indicated on the soil profile would lead to concern that there could be a considerable inflow of water. Therefore, the specifications should allow the contractor to use the casing or wet methods of construction for the alternate design.

The settlement under working load of an underreamed shaft and a straight (cylindrical) shaft can be quite different. That fact would have to be taken into account in the design computations. Other design approaches can be worked out for the site, depending on detailed information on loads and soil not shown here.

## **CASE 2: HARD CLAY AND SHALE WITH LAYER OF WATER-BEARING SAND**

This example indicates that even though the soil profile appears to be relatively simple, small details can have a significant effect on the construction method that can be employed.

The soil profile in Figure G.2 shows a fairly soft clay at the ground surface that is underlain by a thin, waterbearing sand layer, with is in turn underlain by hard clay and shale. The value of  $N$  shown in the figure is the field (uncorrected) standard penetration resistance in blows per 0.3 m (foot).

First, since the surface clay is quite soft, a short piece of surface casing may be necessary to contain the weak soil and to provide a guide for the drilling tools. It should be also be realized that trafficability on the site may be a problem in such soft soil.

Drilling can be carried through the clay to the top of the waterbearing sand in rapid fashion, with the excavation made somewhat oversized. The sand below the water table between the depths of 8 and 10 m (26 and 33 ft) will almost certainly cave and must be contained. The  $N$  value of 8 indicates that the sand is loose, so that it is possible that a piece of casing can be lowered and pushed and twisted to penetrate through the relatively loose sand stratum. If there is a problem of getting the casing through the sand, water can be introduced into the casing, and a drilling bucket can be used to remove some of the sand so that the resistance to penetration of the casing is reduced. The intent is to work the casing through the loose sand and to seal it into the hard clay below 10 m (33 ft).

An alternate procedure would be to introduce bentonite or polymer drilling slurry into the hole when the sand is reached at a depth of 8 m (26 ft). The sand could be penetrated by drilling the sand under slurry, the casing could be set, the slurry bailed or pumped from the excavation, and drilling could continue. The use of slurry could be more costly, but some contractors have established efficient methods for slurry construction, such that the additional costs might be slight if any.

Another possible alternate would be to dewater the site. Dewatering is frequently time-consuming and expensive. But, if the permeability of the soil is relatively low and storage of water in the soil is not great, a stratum of soil can be dewatered without difficulty. The apparent cohesion of the resulting partially saturated sand may allow the sand to be drilled without support if the hole is not left open very long.

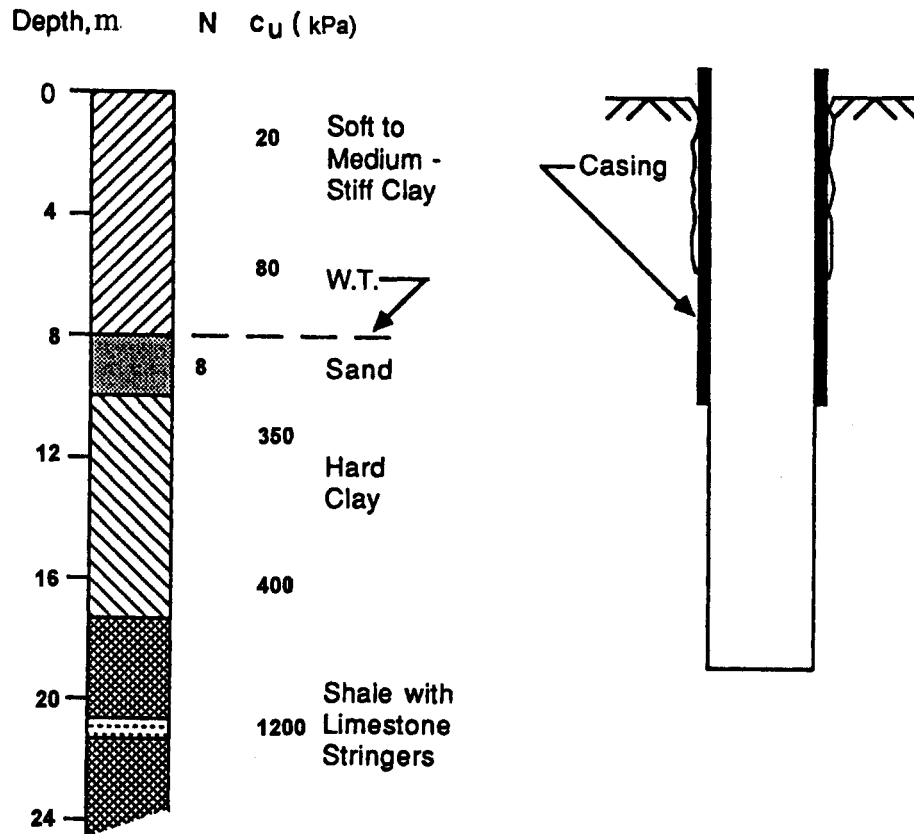

Figure G.2. Case 2: Construction in hard clay and shale with layer of waterbearing sand

The soil profile in Figure G.2 shows no permeable soil below the bottom of the sand layer, indicating that the excavation will remain relatively dry below that depth. Drilling augers can be used to carry the excavation from the bottom of the sand layer to a depth of below 20 m (66 ft) into the shale with limestone stringers. A drilling tool can be readily selected by the contractor to penetrate the shale with limestone stringers. Perhaps this would be a rock auger, or perhaps a soil auger can be used. The one strength value shown below 16 m (52 ft) does not suggest that this material is very hard. However, it is probably too hard for a bell to be excavated in the shale with the limestone stringers. If such a bell were called for on the plans, the contractor might need to seal a second casing into the shale and to lower workers to cut the bell by hand. The hand labor is obviously very expensive and should be avoided if possible. A logical decision, therefore, would be to use a straight-sided shaft, as shown on the right side of Figure G.2.

Assuming that the excavation is made as shown in Figure. 9.2, the reinforcing steel could be

placed and concreting could proceed once the desired depth is reached and the base cleaned. As noted earlier, the rebar cage should be designed as a free-standing structure because its weight can not be supported easily externally as the casing is being pulled. Concrete with good workability should be placed to the top of the casing (or to a level where the pressure from the fluid concrete in the hole is significantly greater than the fluid pressure of any drilling fluid trapped behind the casing or of the fluid in the formation) before the casing is pulled and the seal in the hard clay is broken. The high elevation of concrete in the excavation would ensure that slurry, water or sand would not move into the hole or mix with the concrete.

As the casing is gradually pulled from the hole, additional concrete should be placed inside the casing to force the fluid concrete to flow under the casing and to fill the annular space between the outside of the casing and the natural soil.

The procedure that is indicated would lead to an excellent foundation that would sustain axial load in end bearing and side resistance.

### **CASE 3: SOFT CLAY ABOVE JOINTED AND SLICKENSIDED CLAY**

The soil profile shown in Figure G.3 will obviously present problems in moving construction equipment about the site. The water table is at the ground surface, and the surface clays are extremely soft. Mud mats or some other aid to trafficability would be needed. This condition would almost surely be reflected in the contractor's bid for the job.

It will undoubtedly be necessary to set a surface casing to prevent lateral creep of the soft clay into the excavation. The surface casing can possibly be set with the drilling machine after rapidly drilling through the soft clay.

With a surface casing in place, the excavation can be drilled into the medium to stiff clay below a depth of about 5 m (16 ft). Because the clay is heavily jointed and slickensided, it is unlikely that its overall permeability will be low enough to prevent the inflow of a significant amount of water once the excavation is made. Also, the pressure of water in the joints will accentuate the possibility of the collapse of the excavation if an attempt is made to drill a dry borehole.

One solution that has been used with good success in profiles such as this is to drill the excavation with water as the drilling fluid. The casing should extend at least 1 m (3 ft) above the groundline and the head of water kept at the top of the casing so that any flow of water will be from the borehole into the formation and not *vice versa*. The possibility that there would be some weakening of the stiff clay by an increase in its moisture content should be taken into account. This effect can be minimized if either mineral or polymer slurries are used instead of plain water, since they will have a greater affinity for the water in the borehole than will the soil.

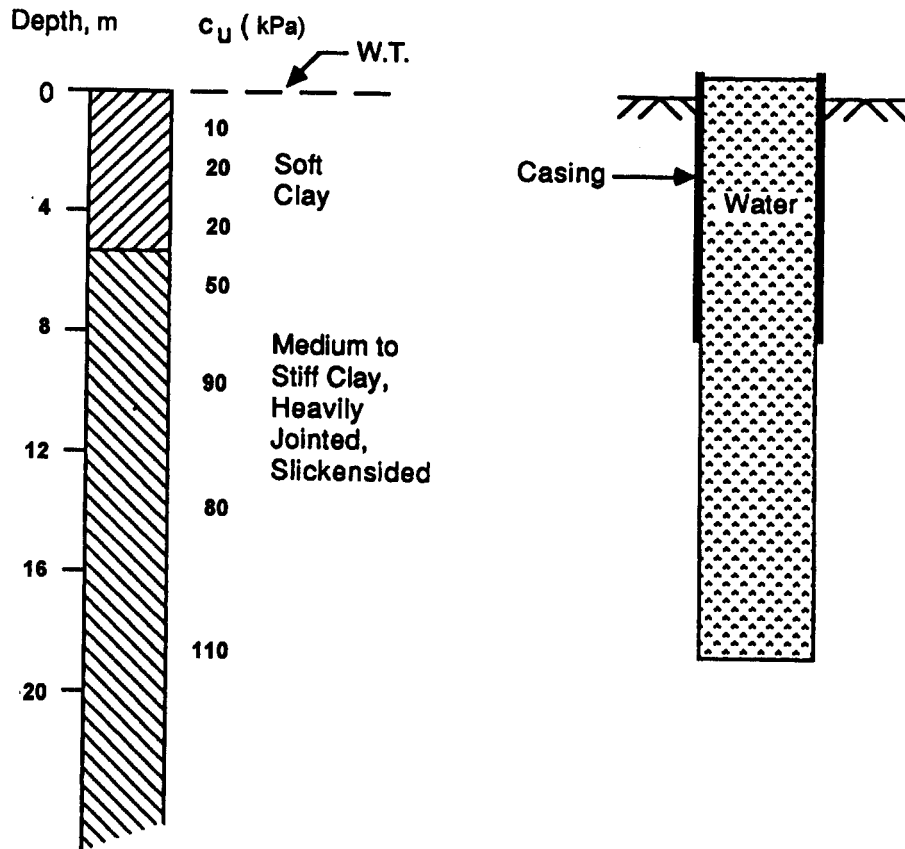

Figure G.3. Case 3: Construction in soft and heavily-jointed clays

The excavation can then be drilled to the projected depth, the rebar cage can be placed, and the concrete can be placed with a gravity tremie or pump line. The load that would be taken by skin friction in the soil in the top 5 m (16 ft) would be relatively small and could be ignored. There is a possibility that the soft clays will settle if there is any surface loading (such as fill above the ground) in the final design; in such a case, the additional load on the drilled shafts due to downdrag should be taken into account. Downdrag is discussed in Chapter 12.

#### CASE 4: DRY SAND

Excavation of sand that is dense and cemented can often proceed without any particular difficulty if the sand is above the water table. It may even be possible to construct underreams in such sand. On the other hand, loose to medium dense, uncemented sands or permeable sands below the water table present special problems that require the borehole to be stabilized by casing or slurry. If uncemented sand is completely dry or completely saturated, the excavation will likely collapse.



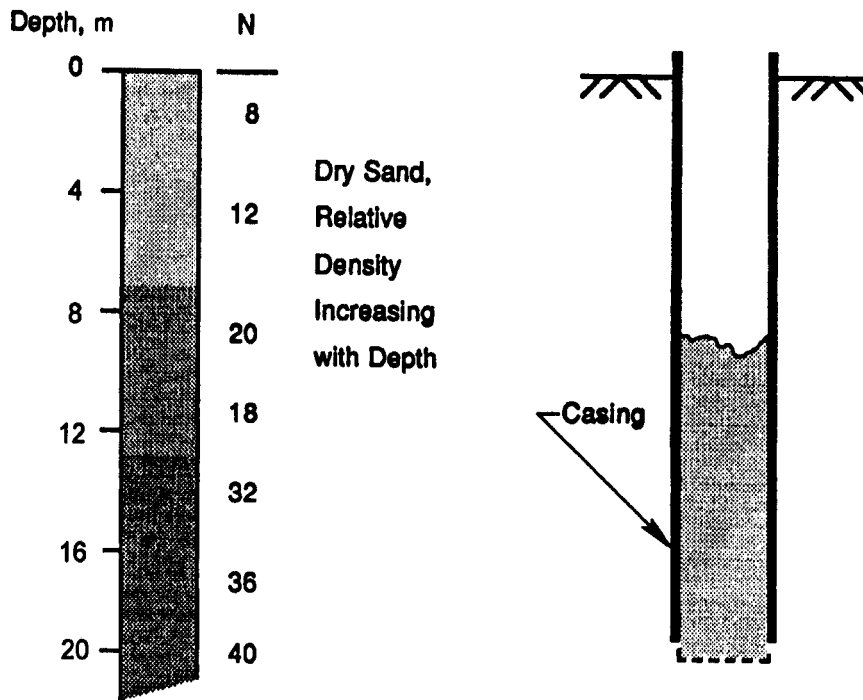

Figure G.4. Case 4: Construction in dry sand

A soil profile that shows dry sand over the full depth of investigation is given in Figure G.4. Preliminary calculations indicate that the depth of cylindrical drilled shafts should be about 20 m (66 ft). There is no evidence on the boring logs that the sand is cemented. As may be seen, the water table is not present in the depth that was investigated. The standard penetration resistance (N) of the sand increases with depth.

As is well known, sand that is partially saturated possesses apparent cohesion. Therefore, one approach to making the excavation could be to pool water on the ground surface and allow it to percolate downwards, creating partial saturation in the sand, and to continue the process as the excavation is increased in depth. Such a procedure perhaps could be used for drilling the first one or two meters of sand but would likely be unsuccessful for the profile that is shown. The chance of developing and maintaining partial saturation in a reasonable amount of time in the sand for the full depth of the profile of almost 20 m (66 ft), thereby avoiding hole collapse, would be small.

Another procedure would be to introduce mineral slurry or a synthetic polymer slurry that is not emulsified in a surfactant suspension into the excavation to achieve stability. (Surfactants should be avoided because they break down whatever surface tension may exist in the soil and could inadvertently promote collapse if some moisture is present in the dry sand.) The slurry, if mixed properly, should permit successful excavation of the borehole, but there will be slurry loss into

the formation until a filter cake of a proper thickness is built up with a bentonitic slurry. The possibility of the filter cake reducing the side resistance would have to be taken into account if concrete were not placed promptly. If a polymer is used, continuous filtration of the slurry into the formation may occur at a decreasing rate, and the contractor must be ready to deal with this issue by continually adding new slurry to the borehole.

A procedure that has worked well in profiles such as this is to drive a casing into the soil with the use of a vibratory driver. It should be a relatively simple and speedy process to drive the casing to the depth of 20 m (66 ft), since no cemented zones or boulders are shown on the profile. The sand could then be removed from the casing by the use of a drilling bucket, the steel and concrete placed, and the casing could be removed by the vibratory driver. Some additional concrete would have to be added as the casing is removed so that the space occupied by the wall of the casing becomes filled with concrete.

The use of the vibratory driver has several advantages. The sand is densified and its strength is improved by the vibrations that are imposed. There is no slurry to deal with so costs should be reduced. No filter cake is present on the borehole wall, so there will be no need for concern about the buildup of filter cake causing problems with skin friction.

Casing extraction with a vibratory driver should be carried out with caution, however. If the hammer is left on too long when extracting, most of the coarse aggregate in the concrete can end up at the bottom of the shaft, leaving mostly mortar in the upper portion of the shaft. It is best to use the vibrator to start the casing moving and then to shut it off and lift the vibrator and casing with a line the remainder of the way.

The use of vibratory drivers for the installation of casing is becoming more and more popular. The rental costs for the driver are more than offset by the advantages that are gained.

A further alternate would be to use a case-and-drill rig of the type shown in Figure 3.5. Use of this rig offers the same advantages as the use of vibrated casing, except that the soil is not densified. However, there is less risk to the concrete when the casing is removed.

#### **CASE 5: GRANULAR SOIL BELOW THE WATER TABLE**

The soil profile for this case is shown in Figure G.5. It is similar to the soil profile shown in Figure G.4, except that most of the sand is submerged. About two meters of clay are located above a sand stratum, which in turn overlies dense gravel. The water table is in the sand at about 3 m (10 ft) below the ground surface. The design calls for the drilled shaft to be founded in the dense gravel at a depth of about 12 m (39 ft).

One possibility in carrying out the construction would be to drive a casing with a vibratory driver or to insert it with a case-and-drill machine, as was suggested for Case 4. If a vibrator is used, the clay near the ground surface should be predrilled so that vibratory driving would

commence in the sand. A potential problem with a vibratory driver would be the driving of the casing into the dense gravel far enough to reach the proposed base of the shaft, which is to be situated about 1.5 m (5 ft) into the gravel. Some contractors might elect to drive the casing only to the top of the gravel so as to make sure that the casing could be retrieved without difficulty. Then, water or drilling slurry could be put inside the casing and the excavation completed. No such problem would likely occur if the case-and-drill rig were used, since the gravel could be excavated as the casing is pushed into place.

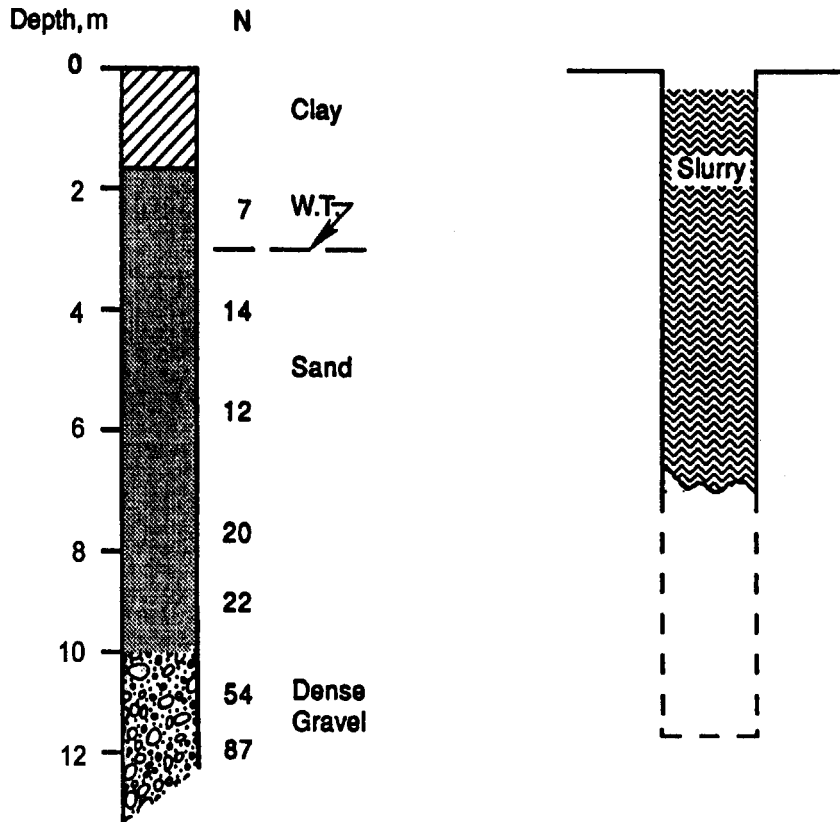

Figure G.5. Case 5: Construction in granular soil below the water table

A construction scheme that has proved reliable in situations such as this is shown in the sketch in Figure G.5. As soon as the water table is reached, mineral or polymer slurry is introduced into the hole, and the excavation proceeds. The level of the slurry should be kept in the surface clay so that the hydrostatic pressure in the borehole is always greater than that in the formation. Drilling of the sand could be accomplished by the use of a drilling bucket; the bucket should be vented so that it can be withdrawn from the excavation without causing a reduced pressure in the slurry below the bucket.

The gravel could also be removed by the use of a drilling bucket, but some adjustment in the configuration of the base of the bucket might be necessary. Care should be exercised in the last meter of drilling in order not to loosen the gravel any more than is necessary. The slurry in the borehole should be sampled and checked. If mineral slurry does not meet specifications, it should be circulated and replaced by cleaned slurry so that no loose sediment will collect on the bottom of the excavation or on the rising column of concrete. The base should then be cleaned prior to placement of the cage and concrete. Polymer slurry should be allowed to remain in the excavation without agitation until sufficient sedimentation occurs to reduce its solids content to an acceptable level, and the base of the borehole should be cleaned prior to proceeding with cage and concrete placement.

Before concrete placement it may well be worth calipering the borehole or otherwise measuring its dimensions with a downhole sonic logger to permit the construction of concreting curves (Chapter 8).

The concrete would be placed by use of a gravity tremie or a pump line. The drilled shaft would sustain axial load by combination of side and base resistance.

There have been situations similar to those shown in Figure G.5 in which the groundwater was flowing and, despite the use of well-designed slurry, the borehole collapsed. In this case it may be necessary to use only a bentonite slurry so that a weighting agent can be added. Weighting agents such as barium sulfate ("barite") can improve the stability of boreholes considerably in moving groundwater environments without unduly increasing the viscosity of the slurry.

#### **CASE 6: CAVING SOIL ABOVE SOUND ROCK**

The soil profile for this case is shown in Figure G.6. The water table is high, and there is a surface layer of clay overlying relatively loose sand. The founding stratum for a drilled shaft at the site is the limestone layer at a depth of 8 m (26 ft), into which a short socket will be drilled. The limestone was later cored and found to be sound, and the boring logs containing the results of the rock cores show that it contains no open joints.

A construction procedure that would be effective at the site is to use slurry to drill to the top of the limestone, to insert a temporary casing, and to rotate the casing and seal its bottom into the limestone. In order for the casing to penetrate the limestone, the bottom of the casing should be fitted with teeth, as shown in the sketch in Figure G.6. The teeth must be arranged so that the slot that is cut for the casing is slightly enlarged on the inside and tight against the outside of the casing. The selection of the proper kind of teeth to use and their proper positioning on the bottom of the temporary casing are matters that relate to the experience of the drilled shaft contractor.

After the casing is sealed, the slurry can be pumped or bailed from the borehole, and a slightly smaller drilling tool than was used initially can be employed to drill into the limestone. It is

possible that a rock auger can be used for this purpose, but some other technique, such as the use of a core barrel, may be required. Finding the right tool (and drilling rig) to make the cut in the rock is often a matter of experience and/or trial and error on the part of the drilled shaft contractor.

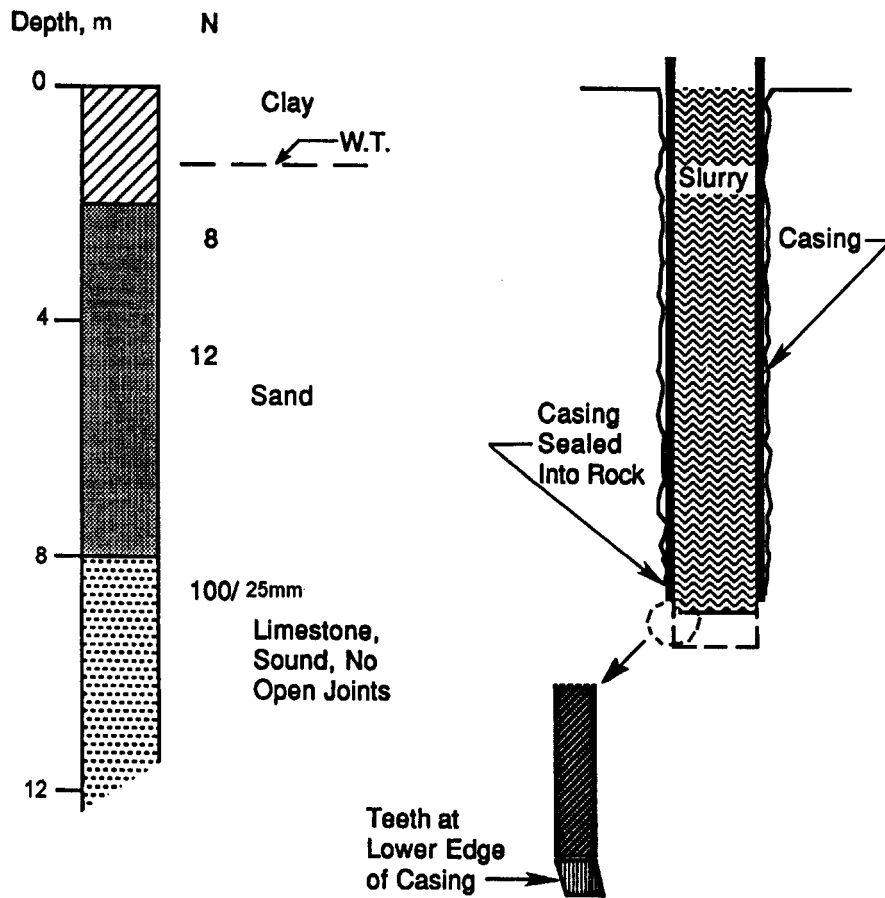

Figure G.6. Case 6: Construction through caving soil into sound rock

After the base is cleaned, reinforcing steel would be placed in the excavation. Again, the rebar cage must be designed as a free-standing unit so that it can withstand the vertical forces from the downward-moving concrete when the temporary casing is removed.

The excavation should be filled with concrete with good workability to a level such that there can be no inward movement of slurry, soil or water when the seal is broken at the bottom of the temporary casing. Extra concrete must be added as the casing is being pulled so that the annular space behind the casing is filled from the bottom up. It is preferable to add a little more concrete to the casing than to skimp; if the top of the concrete is some distance below the cutoff elevation

when the casing is completely extracted, an undesirable situation will result. Trapped slurry and perhaps collapsed soil will fall to the top of the concrete and workers will have to try to clean away the contamination by working some distance below the ground surface. After the contamination has been removed, additional concrete will have to be added to bring the top of the shaft to the proper level.

The drilled shaft will derive almost all of its support from end bearing and shaft resistance in the limestone. The side resistance offered by the clay and sand in the top 8 m (26 ft) can be ignored with little error if the designer desires. Since the sand is relatively loose ( $N$  from 8 to 12), there is a possibility that some downdrag could build up at the site if there is vibration or surface loading in the future that could cause the sand to densify and settle.

Concerning drilling in the rock, as the rock becomes harder, the progression of tools that can be used for drilling might be: rock augers, core barrels, shot barrels (core barrels that grind the rock using metal shot placed in the hole below the cutting surface of the barrel), air-operated hammers, full-faced excavators, and drilling and blasting.

Excavating in rock, even hard rock, has become relatively common in the United States for drilled shafts with diameters up to about 2.44 m (8 ft.). Equipment and experience are not as readily available for excavating drilled shafts of larger diameter in rock; therefore, when the design requires shafts of larger diameter, it is suggested that the designer consult with local drilled shaft contractors on the practicality of the design before finalizing plans and specifications. A group of drilled shafts can be substituted for a single, very large diameter shaft if necessary.

With regard to the rock depicted in Figure G.6 and rock of other character, a question arises as to how far into the rock the excavation should be drilled. The design of drilled shafts in rock is covered in Chapter 11. Soft rock, including clay-shales, have failed in bearing during load tests. However, the authors know of no instance where sound, hard rock has been made to fail (Except by fracturing using large Osterberg Cell). The penetration of a socket in hard, massive rock such as unweathered granite should be minimal.

#### **CASE 7: CAVING SOIL ABOVE FRACTURED ROCK**

The soil profile for this case is shown in Figure G.7. The profile is similar to that shown for Case 6, except that the rock was identified in the site investigation as being fractured. This causes two problems regarding construction: (1) the joints in the rock will likely allow water to drain into the excavation, (2) and the jointed rock may be more difficult to excavate than rock of similar strength that is not jointed. In the discussion of the construction procedure for the construction for Case 6, the excavation was dry when the concrete was placed against the rock in the socket. Because of the fractures shown in the profile in Figure G.7, it is logical to assume that water would flow through the fractures and that it would be impossible to achieve a dry hole except by pregrouting, freezing, or dewatering the site. Injection of cement-water grout into the

rock fractures may not always work to arrest the flow of water, although multiple-stage grouting will usually be more successful than single-stage grouting.

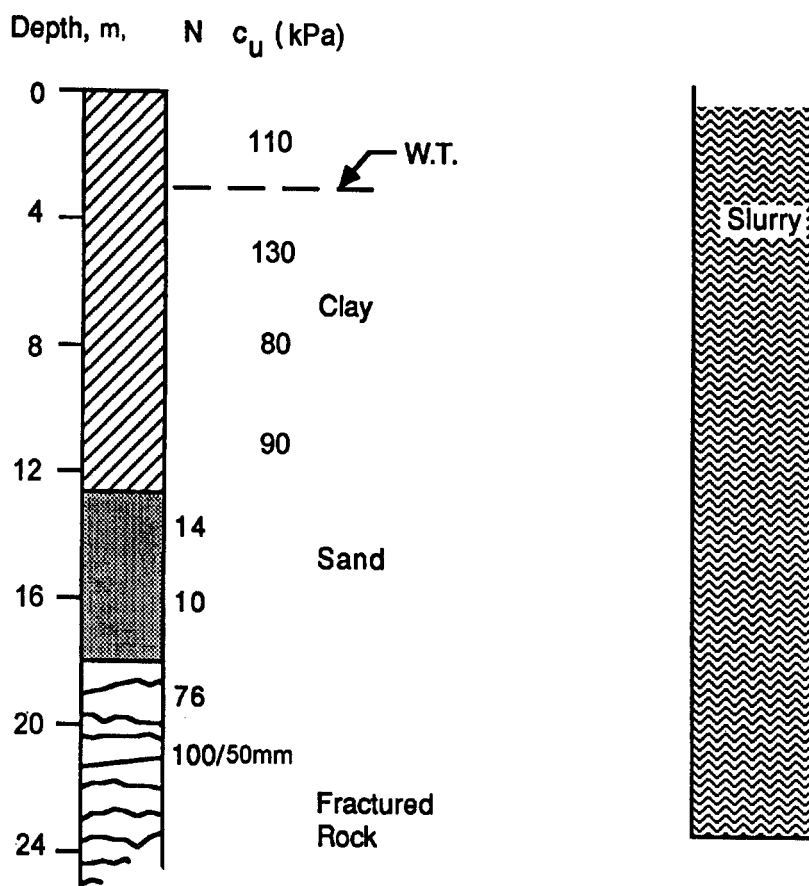

Figure G.7. Case 7: Construction through caving soil into fractured rock

The wet method of construction is indicated in the sketch in Figure G.7. Slurry might be required for drilling through the sand layer, and the slurry could continue to be used as the rock drilling was done. It should be determined, however, whether the intact rock is permeable. If it is, slurry may clog the pores and significantly reduce unit side shear resistance, particularly if the rock drills smooth. In that case, the alternate method described below should be used or the sides of the rock socket should be roughened. A slight "rifling" of the rock using a side cutter mounted on a rock auger or a special grooving tool attached directly to the kelly can provide adequate roughening and assure good shear bonding between the rock and concrete when slurry is used. The excavation can then be completed, the slurry cleaned (if necessary), the based cleaned, the rebar cage placed, and the concrete could be placed by gravity tremie or pump line.

An alternate procedure would be to drill through the sand layer with water as the drilling fluid, seal a casing into the rock, and drill the rock with water only. That procedure could possibly lead

to a better interface between the concrete and the founding rock than if drilling slurry is used, although there is an increased risk that the hole will collapse while penetrating the sand. In that case, a mineral or polymer drilling slurry could be used to penetrate the sand. After the casing is placed, the slurry could be pumped out and replaced with water before drilling the rock. This is a clear case where a full-sized test excavation during the design phase would be beneficial.

An important feature with regard to Case 7 is that it was recognized in the site investigation that the rock was fractured and therefore that it would likely be impossible to dry up the excavation. Some specifications are written on occasion by mistake that would require a dry hole for the situation shown in Figure G.7, with the result that the job has to be shut down until an alternate procedure is selected. The designer should always be open to the possibility of wet-method construction in cases such as this.

The issue of difficulty of excavating the rock because of the presence of fractures also needs to be considered. If the rock is not hard, rock augers can probably be used to remove the fractured rock. However, if the rock is hard, core barrels, which might normally be used to excavate intact hard rock, may be ineffective in the fractured rock. Because of the fracturing because the blocky rock tends to move around as it is being acted upon by the core barrel. As a result, the contractor may have to revert to percussion techniques (churn drills, hammergrabs, etc.) to break up the rock and possibly to use clams to remove the broken rock.

Such a technique is slow and expensive, and the contractor will certainly expect compensation for using such techniques if the nature of the rock was not revealed in the subsurface investigation documents that were provided for bidding purposes. It is important in a case such as this to take rock cores during the site characterization phase of the project to an elevation deeper than the base elevation expected for drilled shafts, to perform compression tests on the intact rock cores and to report geologic setting, petrographic descriptions, recovery ratios, RQD values, and compression strengths of intact cores to potential bidders.

## **CASE 8: BOULDER FIELDS**

The profile shown in Figure G.8 is almost identical to that shown in Figure G.6 except that boulders appear in Figure G.8. The presence of the boulders can cause minor to considerable difficulty in excavation, as is easy to understand. The program of subsurface exploration must be carried out in such a manner that as much information as possible is obtained about the size, extent and character of boulders. By far, the best way to identify the presence of boulders in a subsurface investigation is to make large-sized test excavations. A good procedure, perhaps an essential one, would be to pay an experienced contractor to drill some full-scale trial holes through the field of boulders at various locations on the site and to invite potential bidders to witness the trials. With such information, a reasonable bid can be obtained for the work, and future claims will undoubtedly be minimized.

If the subsurface investigation has identified the presence of cobbles, particles that range in size



from 150 to 300 mm (6 to 12 in.), the excavation will probably present little difficulty if the hole diameter is 0.76 m (30 in.) or more. But boulders can range in size from 300 mm (12 in.) up to several meters across, and the penetration of a field of boulders with an excavation can be a very expensive procedure.

Several techniques can be employed to excavate through boulders. Boulders that are not much more than 300 mm (12 in.) across may be lifted in the flights of a large auger or worked out by a boulder roter (tapered auger with a calyx bucket at its top). Some larger boulders can possibly be extracted intact with tools such as the Glover rock-grab shown in Figure 4.16. If the rock is hard and if the excavation is dry, workers protected by casing have on occasion entered the excavation and fastened rock bolts to boulders to permit lifting them out by a crane. Some boulders cannot be removed intact, however. In some cases they can be thrust aside so that the borehole can bypass them. In most cases, however, boulders that cannot be removed intact must be broken up and removed in pieces. Boulders of medium hardness may be broken by dropping a heavy, sharp tool, such as a churn drill, in the excavation and the remnants removed with a clamshell. Another possibility is that a heavy hammergrab can be used to break the boulders and bring the remnants to the ground surface. Although they are sometimes tried, core barrels are not usually successful in removing boulders because, like highly fractured rock, boulders tend to move as the driller attempts to core them, making it very difficult to make a complete cut through the boulder. Many contractors have developed their own ingenious methods to affect boulder removal in local geologic environments.

The usual procedure is to drill the excavation with a sufficient diameter that there is ample room to allow the boulders to be loosened, perhaps by using a boulder roter, so that they can be removed by one or more of the methods mentioned above. This may involve the use of telescoping casings, with the outside diameter of the bottommost casing being equal to or slightly greater than the required drilled shaft diameter.

A severe situation is indicated in Figure G.8. The stratum occupied by the boulders is several meters thick and is below the water table. The solution that is shown on the right hand side of the figure is that a temporary casing is worked through the stratum of boulders and sealed into the limestone. The casing would be worked downward in stages as the boulders are removed one by one. As suggested above, some contractors find the use of telescoping casing to be easier than the use of a single casing, depicted here (although the final borehole has more volume and thus requires more concrete). In either case, the construction can be completed as with the temporary-casing method.

The use of shallow foundations in lieu of drilled shafts should not be overlooked in this case. It may be possible to avoid the problem of excavating boreholes through boulders by founding the structure on shallow foundations at a depth of about 4 m (12 ft) if adequate information can be developed about the bearing capacity and settlement characteristics of the boulder-soil matrix and if scour is not a concern. It may even be possible to use driven piles through the boulders by drilling small-diameter holes through the boulders to the planned toe elevation of the piles and

setting off explosives in the holes to shatter the boulders, making it possible to insert and drive steel piles. This technique was used by the Colorado Department of Highways in the construction of some bridge foundations on I-70 in Glenwood Canyon. However, drilled shafts are usually the foundation of choice in situations such as shown in Figure G.8

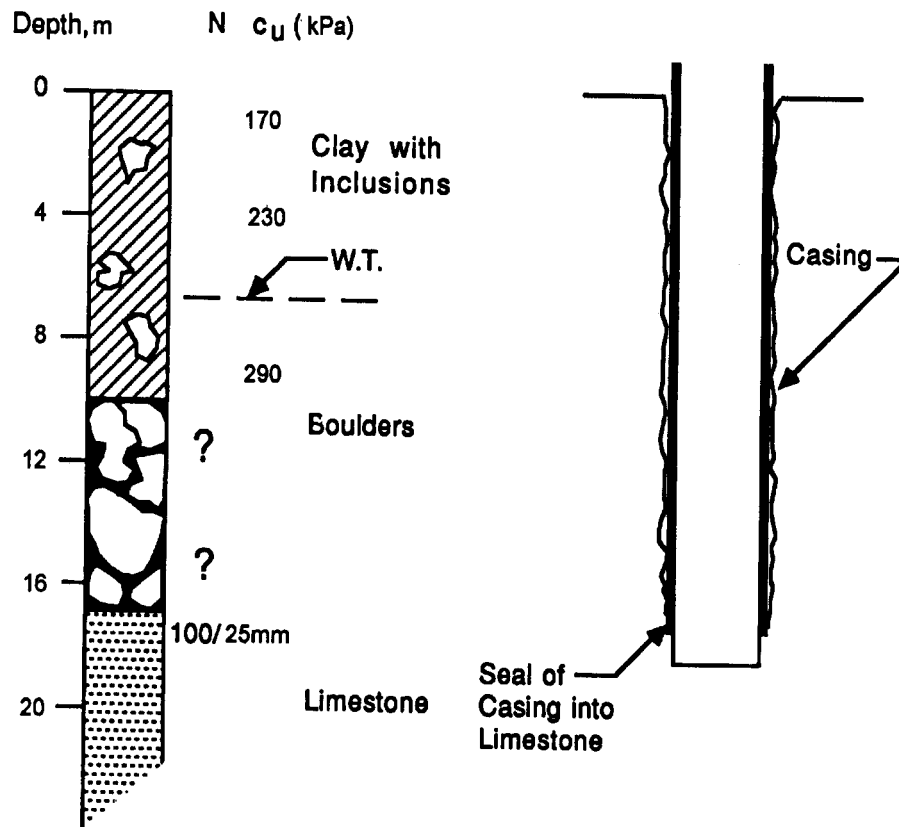

Figure G.8. Case 8: Construction through boulders

### CASE 9: IRREGULARLY WEATHERED ROCK

In locations where the soil is residual (weathered in place) and where the bedrock is basalt, schist, gneiss and similar rock, the transition from soil to rock may be gradual. A zone of intermediate geomaterial (neither soil nor rock), called saprolite, may exist between the surface of the rock and the overlying near-surface soil that may have the structural appearance of the bedrock. Saprolites normally do not cause serious construction problems except that it is important that they be identified as saprolites and not bedrock so that drilled shafts designed to be founded on or in rock are not mistakenly placed in saprolite. In some igneous and metamorphic rock formations, and sometimes in sandstone, the rock below the saprolite is weathered into disjointed blocks separated by soft seams, at various orientations. These rock

blocks may effectively have to be treated as boulders during the excavation process if drilled shafts are to be carried through these zones. In such profiles, drilled shafts have been designed both as (1) low-resistance skin friction units terminating in the saprolite in order to avoid construction problems associated with drilling through rock blocks into sound rock and (2) socket units in unweathered or slightly weathered rock below the blocks, which requires that attention be paid to the character of the disjointed blocks. An excellent summary of the character of transition zones between bedrock and residual soil is given by Sowers (1994). A schematic of a rock-block condition is shown in Figure G.9 a.

When the bedrock is limestone, a more abrupt transition can occur, depending on the impurities that were present in the limestone before it was weathered. The rock surface may weather in a very irregular way, however, depending on the fracture pattern and bedding planes that were present in the original rock and the extent to which the rock has been subjected to faulting or folding. One way in which limestone can weather is by forming slots, which may either be vertical or inclined at some angle to the vertical. Figure G.9 b indicates the way the geomaterial profile in such a region might vary across a construction site. The depth to sound limestone at sites where drilled shafts might be contemplated might range from perhaps 7 m (23 ft) to over 30 m (100 ft). The slots are normally filled with soft soil.

The first problem to be solved at a site with blocky or slotted rock is to develop as good a three-dimensional picture as possible of the subsurface conditions. Obviously, such a picture could not be obtained by a small number of standard borings. However, geophysical methods for the investigation of subsurface conditions relative to construction are rapidly being developed. Surface-wave techniques and reflection/refraction surveys could well be used to advantage. Profiling the rock surface by using air tracks (perhaps hundreds of probes at a bridge site on land) has proven successful.

Even by the use of the best techniques that are currently available for subsurface investigation, however, there would remain a number of uncertainties about the necessary lengths of drilled shafts across the site; therefore, an experienced geotechnical engineer would need to be present as the construction of the foundations is underway at sites such as those depicted in Figures G.9 a and G.9 b. Improvements can be made continually in the picture that has been developed of the subsurface geometry as the job progresses, and decisions can be made about the final lengths of the shafts in the field.

It would probably be unwise to found a drilled shaft on a "spire" as shown at the points labeled A in Figure G.9 b, and decisions would have to be made about the drilling into sloping surfaces of the rock as indicated by the points labeled B in that figure.

In some cases it may be possible to drill into a rock that has a sloping surface by the use of special tooling. The auger or coring tool could be held in position by a cylindrical guide for the kelly that occupies the part of the hole that was drilled above the rock slope, but that procedure could be ineffective in some instances. If the drilling tool is not displaced too far, it could be

desirable to simply allow a considerable deviation of the drilled hole from the vertical. The additional bending stresses that are introduced into the shaft could be computed by the procedures outlined in Chapter 13.

In some instances it is possible to drill through clays such as are shown in Figure G.9 b and to place a casing down to the level of the rock to allow workers to enter the borehole. Down-hole pumps can remove and discharge seepage water that collects if the flow rate is not too high, and the rock can be exposed so that workers can enter the excavation with safety. Appropriate drills can be lowered, the rock can be drilled by hand so that a substantial horizontal ledge is cut to allow drills attached to the kelly to make a "purchase" in the rock and continue the excavation. Alternatively, explosives can be placed, and the rock can be loosened and a purchase obtained by blasting. The procedure is expensive but does allow deep foundations of high quality to be constructed.

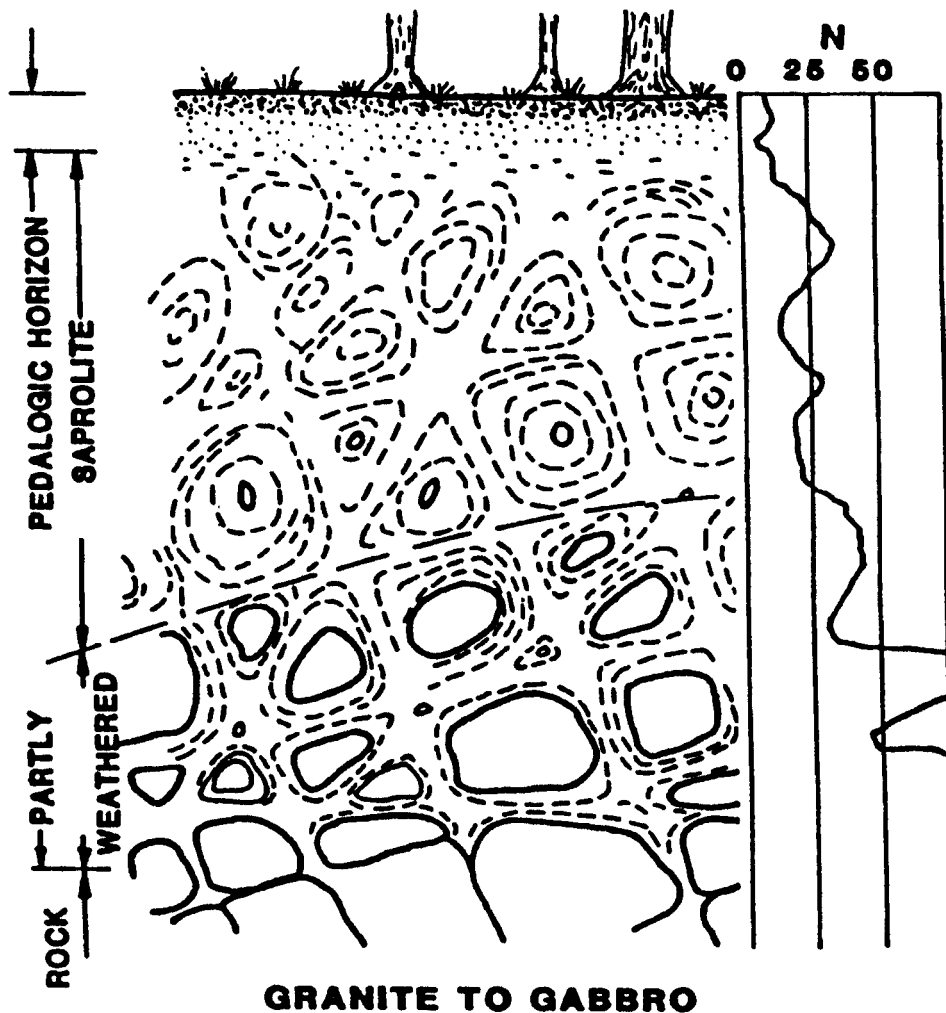

Figure G.9 a. Case 9 a: Blocky weathered rock profile (Sowers, 1994)

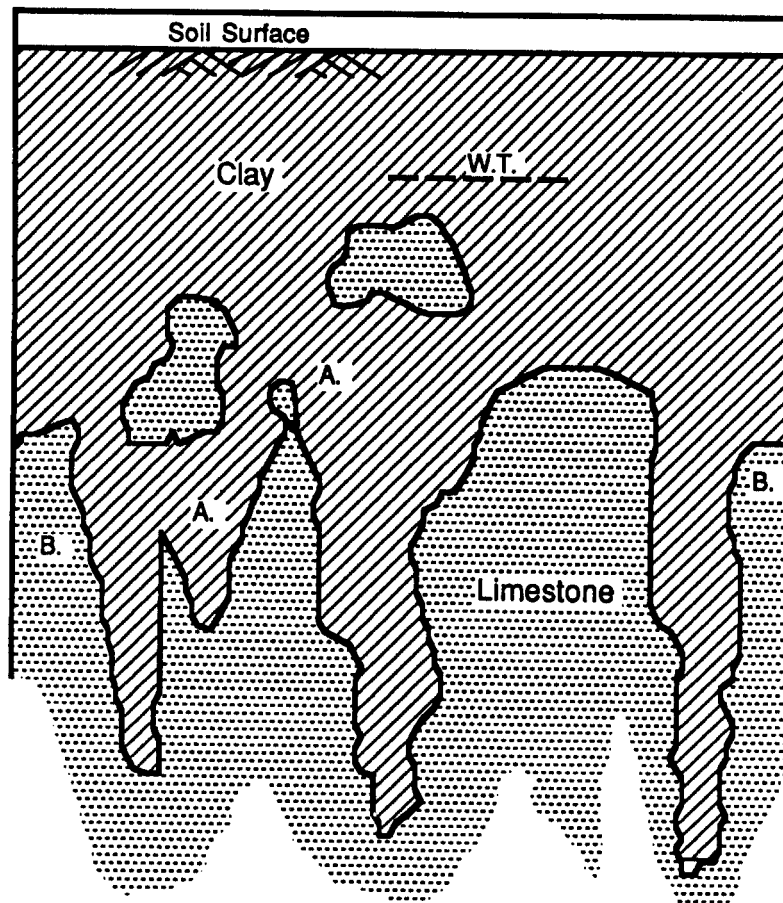

Figure G.9 b. Case 9 b: Construction where the founding rock is vertically slotted

In the case described above, in which a drilled shaft is socketed into the steep side of a limestone slot, the fact that rock support may not exist on one side of the base of the shaft must be considered when judging the bearing capacity of the rock, as well as any skin friction that might be assigned.

A similar situation arises when the rock in which the base of the drilled shaft is to be placed is potentially blocky (Figure G.9 a). In cases where geologic conditions suggest that the rock in which the drilled shafts are to be founded may have weathered into blocks, workers may be lowered into the cased borehole to probe with air drills below and to the sides of the base to confirm that any soft seams that develop between rock blocks are not present within about two shaft diameters from the base of the shaft. If soft seams (or voids) are found within a small distance below the base of the drilled shaft, which may occur both in blocky rock and in slotted rock if the slots are inclined, it may be prudent to continue to excavate the borehole until such soft seams cease to appear below the base of the shaft (say, within two base diameters) if the drilled shaft has been designed for high base resistance.

If soil seams or voids are found laterally near the shaft, or if the base of the shaft is known to be adjacent to a soil-filled slot, rock bolts may be considered as a means of tying the zone of rock immediately below the base of the drilled shaft to sound rock on one side of the base in order to improve the resistance of that zone to shearing off and moving into the slot or joint prematurely. This will require that workers enter the borehole, drill small-diameter coreholes into the rock, usually at an angle to the vertical, place the rock bolts and grout them into place. Descriptions of this process, and of drilled shaft construction in irregular rock in general, are provided in papers by Darnell et al. (1986) and Brown (1990).

Regarding the excavation of drilled shafts through blocky rock (Figure G.9 a) or through rock with inclined, soil-filled slots, the question has sometimes arisen whether to classify those sections of drilled shafts that pass through the soil-filled zones as having been drilled in soil or in rock for pay purposes. Because the contractor will have about equal difficulty excavating through the soft joints or inclined slots as excavating through sound rock (perhaps more difficulty in some cases), it is reasonable to treat all excavation as rock excavation below the depth at which rock is first encountered in cases such as this.

#### **CASE 10: KARSTIC AND OLD MINING REGIONS**

There are many regions in the United States where limestone has been weathered, usually by flowing underground water, to form internal cavities of various sizes. A formation that exhibits this kind of structure is called karst. For example, on one occasion, an excavation was being made in limestone for a bridge on a highway north of Austin, Texas, when the drilling tool broke through into a cavity. Investigation revealed a cavern of significant proportions, and that cavern is now a tourist attraction.

Old mining regions pose a similar problem. Often, the exact positions of abandoned mines are not known, and such mines must be dealt with in the construction process.

Several possibilities exist when a rock cavity or abandoned mine is encountered. One possibility is to employ a permanent casing or liner to pass through the cavity, as shown on the right hand side of Figure G.10. The drilled shaft is extended into the floor of the cavity, where it derives all of its support. Another option that has been used successfully on occasion is to pump grout into the cavity, wait for the grout to harden, and then proceed to drill through the grout into the floor of the cavity, again developing all of the resistance of the drilled shaft in the natural rock below the floor of the cavity.

In a karstic or mining region, many designers require that one or more probe holes be drilled a certain distance below the base of a drilled shaft for the purpose of locating possible cavities under the foundation in a manner similar to that discussed for Case 9, except that lateral probes are not used. There could be a cavity that is slightly to one side of the probe hole that would remain undetected that might cause a subsequent failure. However, the authors know of no failures that have resulted from undetected lateral cavities in karstic zones.

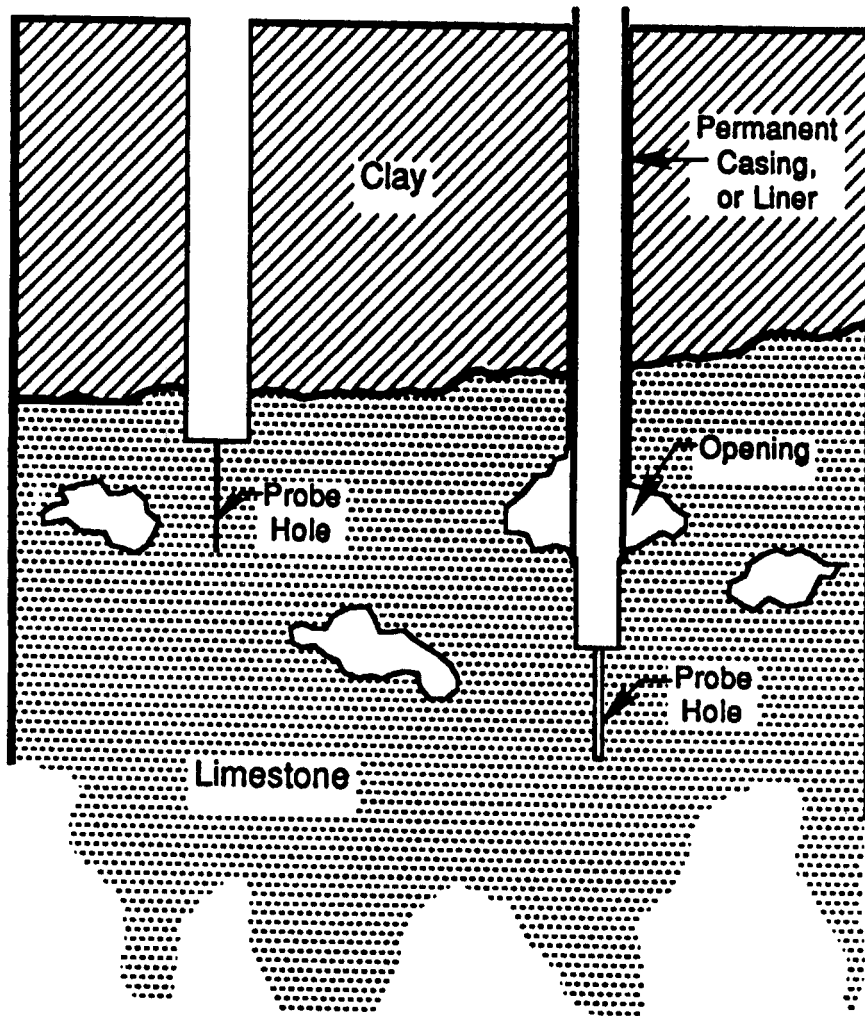

Figure G.10. Case 10: Construction in karstic regions

One perspective on this issue is that drilling probe holes to locate unseen cavities is time consuming and costly and that, therefore, drilled shafts should not be designed in karstic regions or mining zones with any assumed end bearing. The savings afforded by reduced construction time would more than make up for the higher costs of the shafts that result from excluding end bearing. Others insist that it is essential that all cavities, especially old mines, be identified, whether or not end bearing is used, because such cavities can be so large that the entire shaft can collapse into the cavity even if end bearing is not used. The use of probe holes is suggested here for major structures or where the cavities are potentially large. In order to save time, such probe holes can be drilled with coring machines from the surface at the exact location of each drilled shaft before the shaft itself is excavated.

As mentioned earlier in this chapter, geophysical methods are rapidly being developed that can

be applied to producing better information on subsurface conditions. The further development and use of such methods in regions where rock cavities can exist is to be encouraged.

## **CASE 11: CONSTRUCTION IN OPEN WATER**

There are many instances when it is desirable to construct drilled shafts in open water for the support of a bridge or some other facility. Figure G.11 is a simplified illustration of the conditions that were encountered in constructing the foundations of bridges in the Florida Keys by the Florida Department of Transportation. In many instances the water was relatively shallow, with vuggy limestone (limestone with small holes) occurring at the mudline.

A comprehensive program of load testing was carried out during the design phase of the project, and it was learned that sufficient capacity of a drilled shaft could be obtained with a penetration of about 4.6 m (15 ft) into the limestone.

A template system was designed that provided a guide for the drilling of the excavation. With barge-supported construction equipment, a short piece of permanent casing was set at the mudline after the excavation was made. The surface casing extended a short distance above the mudline and a short distance below. The surface casing was sealed well enough into the formation that concrete would not escape.

A cylindrical split column form was set around the surface casing, again with a seal that would prevent the escape of the concrete.

The concrete was poured to a distance above the surface of the ocean such that the resulting cold joint would be above the splash zone to avoid possible future corrosion of the rebar, the concrete was allowed to set, and the split column form was removed. The sketch in the right hand side of Figure G.11 shows the elements of the method. The system worked extremely well.

The FDOT specifications allowed the contractor an alternative. A permanent casing could be set to an elevation above the water surface, but it required that the contractor cut away the portion of the casing in the splash zone because of the unsightly appearance that would occur in time because of corrosion.

Another method has been used on occasion. A large casing is set at the location of a drilled shaft, using a template system to position the casing correctly. An inner casing of the proper size for the drilled shaft is then set inside the large casing, and the drilling is completed. The annular space between the two casings is filled with saturated sand. After the concrete is poured to grade, above the water surface, the inner casing is pulled. The sand provides the form for the concrete. After the concrete has set, the sand is removed by a water jet and the outer casing is removed.



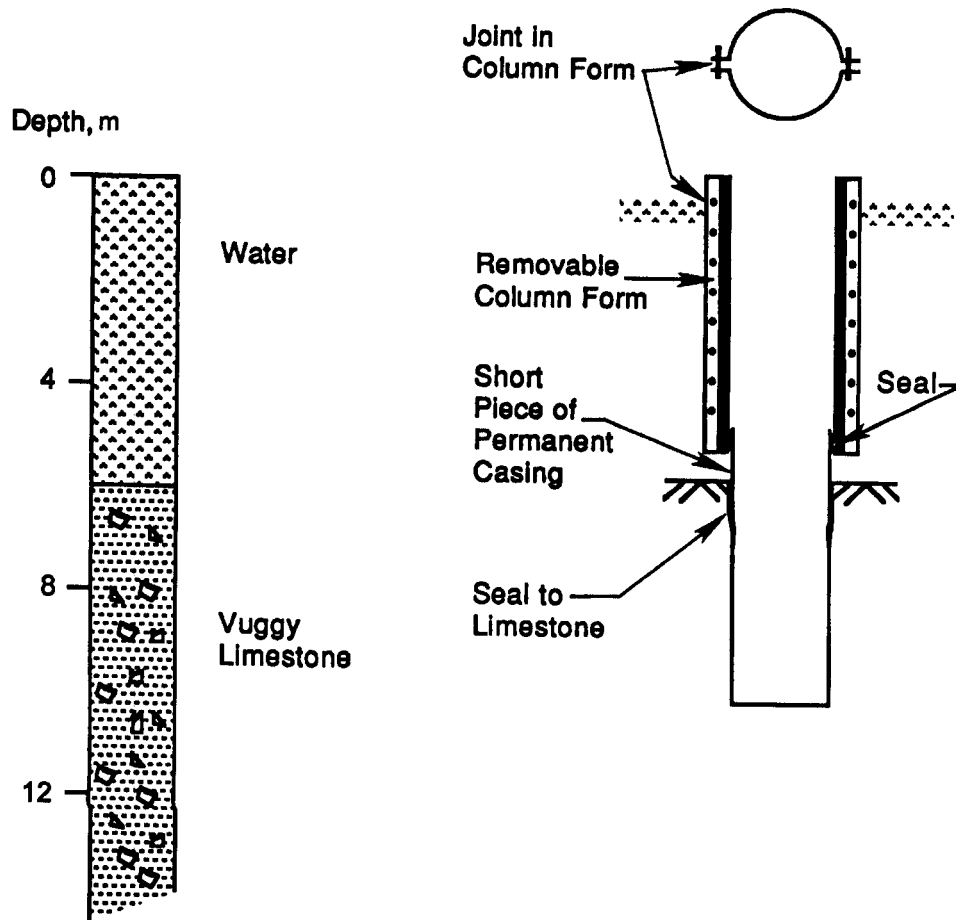

Figure G.11. Case 11: Construction in open water

This "double-casing" method is simple in concept, but its implementation requires a high degree of skill on the part of the contractor. It is understood that a patent exists on this particular method.

There has been a considerable amount of success to date in the construction of drilled shafts through open water. It is likely that the methods indicated here will find increased use in the future because a foundation that will not corrode can be constructed in subsurface conditions that might prove difficult for other types of deep foundations.

#### **CASE 12: CONSTRUCTION IN AN ENVIRONMENTALLY SENSITIVE AREA**

Often, drilled shafts must be installed under conditions in which environmental concerns are as important as providing a structurally sufficient foundation. The following is an example of one such instance.

An approach to a major bridge was to be installed through a body of shallow surface water that contained runoff from an industrial area. The soil profile is shown in Figure G.12. Consequently, it was conceivable that at times the surface water may have contained contaminants in small concentrations (in this case, hydrocarbons). The design for the entire bridge included alternatives for driven piles and for drilled shafts. For various reasons the contractor chose to drive piles. However, the state DOT was concerned that the driving of groups of piles required to support the large loads from the bridge would compact the thick layer of very loose sand that existed beneath a thin layer of plastic clay directly beneath the surface water. It was reasoned that this compaction, with resultant differential settlement, would cause the thin layer of surface clay to crack. If any contaminants were present in the surface water, cracking of the surface clay would allow the contaminants to migrate into the underlying sand. This layer of sand communicated with adjoining sand formations that were pumped from shallow wells for irrigation and for the watering of livestock.

In order to avoid the problem, drilled shafts were required in the approach spans that traversed the lagoon that contained the surficial runoff water. It was reasoned that drilled shafts could be installed without compacting the sand to any significant degree. The construction procedure was specified so as to prevent any communication between the surface water and the underlying layer of sand. This was accomplished as indicated on the right side of Figure G.12. First, samples of pore fluid in the sand layer were secured from sampling wells in the sand to provide an accurate baseline reading of the concentration of hydrocarbons in the ground water. Then, a clay berm was constructed at the location of each bent in the lagoon. This provided a work platform for the drilling rigs and also displaced the potentially contaminated free surface water from around the top of each drilled shaft. A heavy surface casing ("protective casing" in Figure G.12) was thrust downward through the berm and the thin layer of plastic surficial clay. This casing had an outside diameter 0.305 m larger than the design diameter of the drilled shaft. It provided a seal with the plastic clay whose purpose was to prevent minute quantities of contaminated water that might have been trapped below the berm from penetrating the sand. The cohesive material was then excavated from inside this protective casing and spoiled in an approved fill for hazardous waste.

A second casing was then inserted inside the protective casing through the very loose sand and sealed into the underlying stiff clay by using a combination of dead weight and vibration. The vibratory driver was turned on only when the casing stopped penetrating under its dead weight and that of the hammer. Once the seal was achieved, the sand inside the casing was removed with an auger, and the casing was filled completely and simultaneously with drilling fluid (bentonite slurry in this case).

The slurry was needed because the stiff clay below the loose sand was submerged and contained sand seams and layers that would collapse without support. Once the borehole was clean and filled with slurry, excavation proceeded carefully using soil augers until the base elevation was reached [approximately 30 m (100 ft) below the elevation of the surface water].

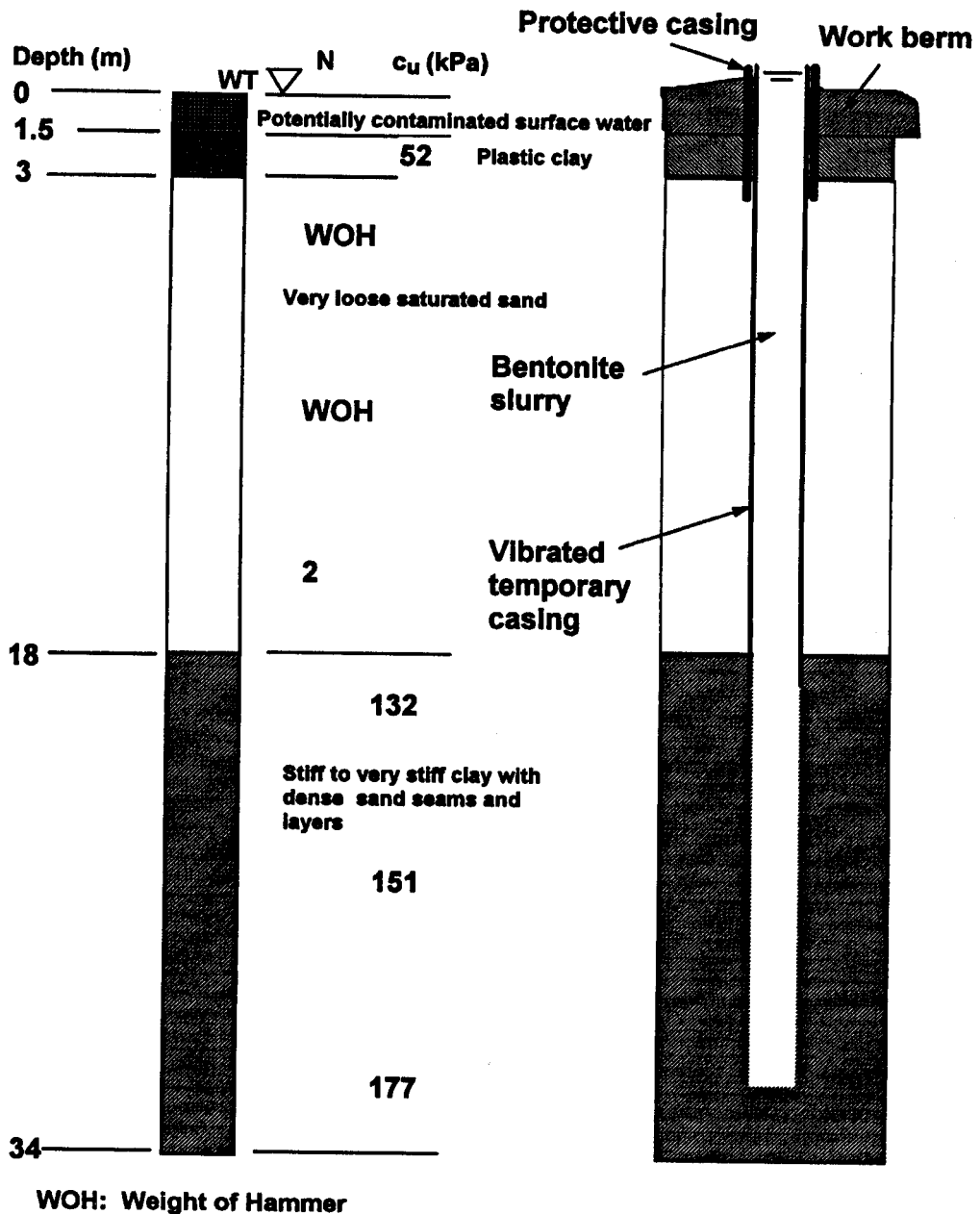

Figure G.12. Case 12: Construction through potentially contaminated surface water

In this case, the contractor was permitted to use partial-depth rebar cages despite the fact that casing of significant length had to be employed, because a large number of long drilled shafts were to be constructed and the savings in steel would be substantial. The contractor chose to hold the cage in place with a very large crane with a long line while a second large crane was used to hold the vibrator and casing. After cleaning the hole, and when necessary exchanging the slurry, the contractor suspended the cage and then placed concrete using a gravity tremie to the level of the bottom of the casing, which was approximately the depth of the bottom of the partial-depth cage. The rate of concrete placement was then slowed to avoid "floating" the cage. Once the level of concrete reached the elevation of the berm, the contractor exposed the uncontaminated concrete in the temporary casing by draining away all slurry and visually contaminated concrete and began to extract the casing by first turning on the vibrator to break the seal in the clay and then turning it off once the casing was moving up freely. The casing was then brought completely out of the hole while the second crane was still holding the cage. Additional concrete was placed into the top of the casing as it was being pulled to account for the head loss that was incurred as the concrete flowed downward to occupy the space previously occupied by the walls of the casing. The cage was then secured to fixtures at the ground surface, and the line holding the cage was released. The temporary casing was set down, the line on the other crane was reattached to the cage to hold it in position, and the protective casing was withdrawn while the concrete was still very fluid.

Samples of pore fluid were recovered from sampling wells in the sand periodically. No evidence of contamination was observed.

The construction operation was successful partially because the state had required that a trial shaft be installed prior to the construction of the first production shaft. That is, the contractor had to demonstrate to the state that the procedure described above could be carried out successfully before the state would allow the contractor to proceed. Two problems in the construction process were uncovered during this activity: (1) the contractor had underestimated the force that the downward-moving concrete exerted on the cage as the temporary casing was being extracted, which caused the rigging holding the cage to fail, and (2) the contractor found that the segmented tremie that was being used was not watertight. These problems were both corrected in a straightforward manner, and all of the production shafts were installed without incident.

## **REFERENCES**

Brown, D. A. (1990). "Construction of Drilled Shafts in Hard Pinnacle Limestones," *Transportation Research Record 1277*, Transportation Research Board, Washington, D. C., pp. 148 - 152.

Darnell, K. E., Benson, L. I., and Wilson, L. E. (1986). "Drilled Pier Foundations in Hard Carbonate Rock," in *Proceedings*, Deep Foundations Conference, Beijing, Deep Foundations Institute, Sparta, NJ.

Sowers, G. F. (1994). "Residual Soil Settlement Related to the Weathering Profile," *Geotechnical Special Publication No. 40, Vertical and Horizontal Deformations of Foundations and Embankments*, Ed. by A. T. Yeung and G. Y. Felio, ASCE, Vol. 2, pp. 1689 - 1702.

