

# CVISN System Design Description

## 3 - System Design Overview

---

1 Introduction

2 System Requirements

3 System Design Overview

General

State Systems

CVISN Core Infrastructure Systems

Carrier Systems

4 Putting It All Together

5 References

6 Change Requests

# The CVISN architecture and model system design provide a technical framework for all stakeholders to develop interoperable systems.

*This view of the CVISN System Design groups systems according to major stakeholder groups, functions, and operators. It illustrates how many subsystems owned by different stakeholders can be viewed as parts of one large system, i.e., CVISN. Each subsystem must be designed with a view toward how it fits into the whole system if interoperability is to be attained. This view of the CVISN System Design shows individual systems in the stakeholder categories. The actual system names for each stakeholder will differ, but functions are fairly common with the names shown here.*

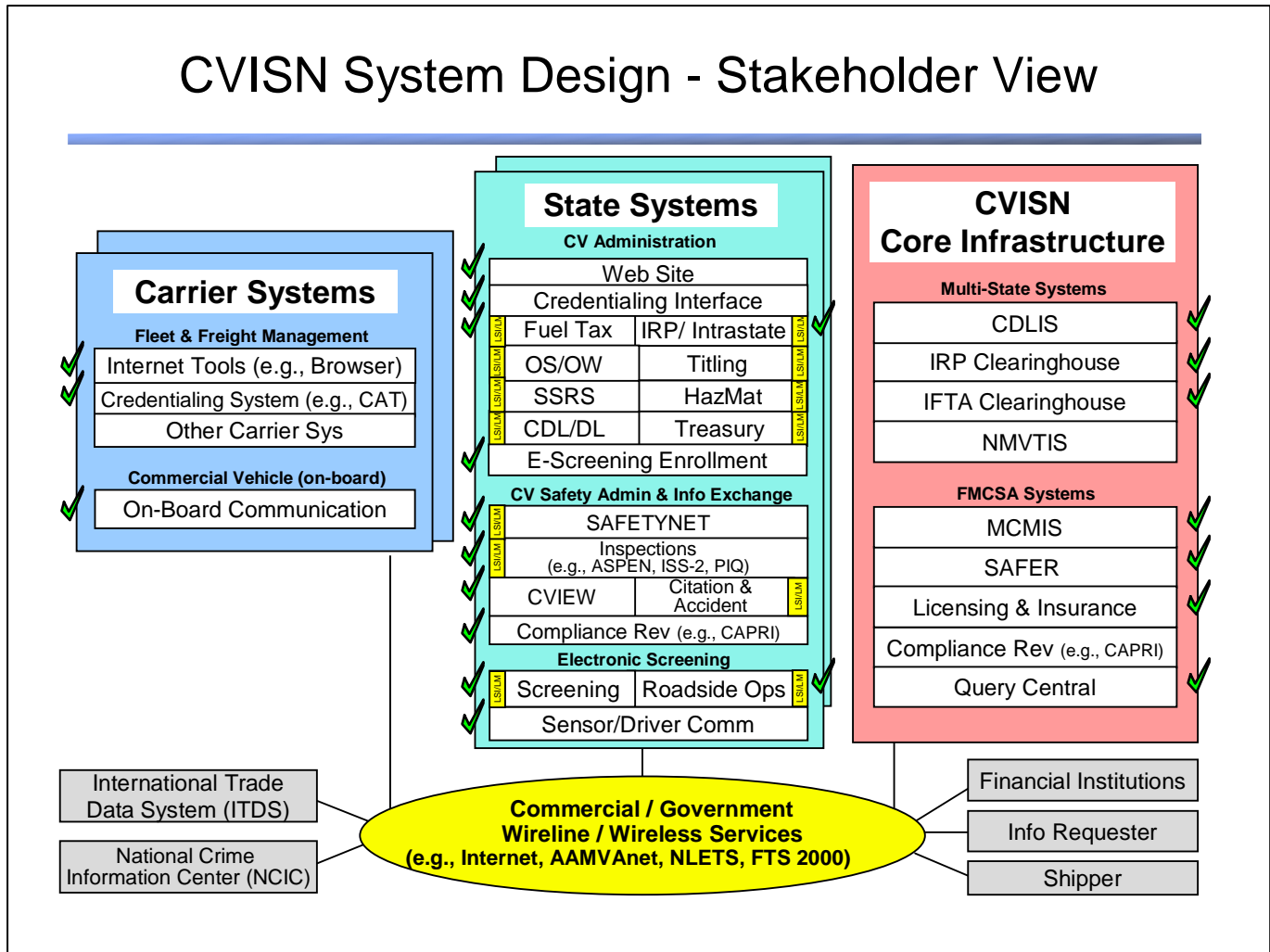

✓ Support CVISN Level 1

# CVISN System Design - Stakeholder View Components

## Carrier Systems

Credentialing System. Apply for and receive responses about credentials; file fuel tax returns. One such system is the CAT (Carrier Automated Transactions).

Internet tools. Via Internet browser, access governmental or private Web sites to apply for and receive responses about credentials, file fuel tax returns, and perform other CV-related functions.

Other Carrier Systems. Other elements of fleet and freight management.

On-Board Communication. Communicate via DSRC, voice, etc. Record trip events.

## State Systems

Web site. State WWW site support, especially for electronic credentialing

Credentialing Interface. Single interface for carrier interactions related to credentialing; handles EDI.

Fuel Tax = International Fuel Tax Agreement (IFTA) systems. Register for fuel tax credential and process fuel tax returns.

IRP/Intrastate = International Registration Plan and intrastate registration systems. Register commercial vehicles.

## State Systems (continued)

OS/OW. Issue Oversize/Overweight permits.

Titling = Title new and used vehicles

CDL/DL = Commercial Driver's License/ Driver's License.

Treasury System. Process electronic payments.

SSRS = Single State Registration System.

Carrier registration.

HazMat = Hazardous Material. Register to carry HazMat and issue HazMat permits.

E-Screening Enrollment. Collect and evaluate requests from carriers to participate in electronic screening.

SAFETYNET. Collect safety inspections and report to FMCSA.

Inspections (e.g, ASPEN, ISS-2, PIQ). Record & report safety inspections.

CVIEW= Commercial Vehicle Information Exchange Window. Collect snapshot segments for interstate and intrastate carriers, vehicles, and drivers. Interface with SAFER for interstate snapshot exchange. Provide snapshots to other state systems.

Citation & Accident. Record citation and accident data.

Compliance Review (e.g., CAPRI). Support compliance reviews.

Screening. Make pass/pull-in decision.

Roadside Ops = Roadside Operations. Process snapshots and control site traffic.

Sensor/Driver Comm = Sensor/Driver Communications. Process vehicle measures and communicate via DSRC with driver.

## CVISN Core Infrastructure Systems

CDLIS = Commercial Vehicle Driver Information System. Pointer to past performance records for commercial drivers.

IRP Clearinghouse = International Registration Plan Clearinghouse. Administration of IRP base state agreement.

IFTA Clearinghouse = International Fuel Tax Agreement. Administration of IFTA base state agreement.

NMVTIS = National Motor Vehicle Titling Information System. Pointer to title information for all vehicles.

MCMIS = Motor Carrier Management Information System. Store safety data.

SAFER = Safety and Fitness Electronic Record. Collect snapshots and safety reports, primarily for interstate carriers, vehicles, and drivers. Provide to user systems.

Licensing & Insurance. Register financial responsibility for interstate carriers.

Compliance Review (e.g., CAPRI). Support compliance reviews conducted by federal personnel.

Query Central. Provide motor carrier safety information for state and federal law enforcement personnel in response to queries.

# Key CVISN Design Features

---

- **Standard Identifiers for carriers, vehicles, transponders, drivers, international trips, & shipments**
- **World Wide Web sites for access to public services and information**
- **Open standards (e.g., DSRC, XML, EDI) for automated information exchange**
- **Snapshots for carrier and vehicle safety and credentials information exchange**
- **State Systems equivalent to**
  - **Credentialing Interface (CI) - common interface between carriers and legacy credentialing systems for computer-to-computer electronic credential applications and responses**
  - **CV Information Exchange Window (CVIEW) - manage snapshots within the state and interface with the national SAFER system**
  - **Electronic Screening Enrollment - to collect information about carriers and vehicles that want to participate in e-screening**
  - **Legacy system modifications (LMs) to handle new functionality and standardized interfaces**
  - **New legacy system interfaces (LSIs) where adoption of standardized interfaces is not practical**
  - **ASPEN to record and report inspections**
- **Carrier Systems equivalent to**
  - **Internet Tools or Carrier Automated Transaction (CAT) - apply for and receive credentials electronically**
- **SAFER (CVISN Core Infrastructure system) to manage interstate snapshots and facilitate the exchange of safety reports**

**Standard identifiers** are intended to facilitate the process of exchanging information about carriers, vehicles, drivers, shipments, and international trips.



Entity	Identifier Name	Identifier Segments	Number of Characters
Motor Carrier	Primary Carrier ID		
	For <i>interstate</i> carrier:	Carrier-Specific Identifier (alphanumeric); must be USDOT number +	12 (max)
	e.g.,	Carrier Terminal ID designated by carrier (alphanumeric) (optional) +	4 (max)
	12345 A001 (note that '12345' must be the carrier's USDOT # ; the terminal ID 'A001' is optional)		
		CVO Company Type	TBD
	For <i>intrastate</i> carrier:	Country Code (alphanumeric); the allowable codes will be defined in the FHWA Code Directory +	2
e.g.,	Jurisdiction (state or province) Code (alphanumeric); the allowable codes will be defined in the FHWA Code Directory +	2	
US CA 123A45689 1234 (note that the terminal ID '1234' is optional)			
	Carrier-Specific Identifier; if carrier is intrastate and has a USDOT number, must be USDOT number; for state-specific IDs, the Carrier-Specific Identifier may include a prefix to clarify the agency/source of the identifier) +	12 (max)	
	Carrier Terminal ID designated by carrier (alphanumeric) (optional)	4 (max)	
	CVO Company Type	TBD	

**Support CVISN Level 1**

**Standard identifiers** are intended to facilitate the process of exchanging information about carriers, vehicles, drivers, shipments, and international trips.

✓ **Support CVISN Level 1**

Entity	Identifier Name	Identifier Segments	Number of Characters
✓ Vehicle	Vehicle Identification Number e.g., 1FDKE30F8SHB33184 and Vehicle Plate ID e.g., US CA 12345664820M	VIN assigned by manufacturer (alphanumeric)  Country code (alphanumeric); the allowable codes will be defined in the FHWA Code Directory +  Jurisdiction (state or province) code (alphanumeric); the allowable codes will be defined in the FHWA Code Directory +  License plate ID (alphanumeric)	30 (max)  2  2  12 (max)
✓ Transponder	Transponder ID  e.g., 0 123456789  or 1 9999 232323	segments shown below  Transponder ID Definition Flag (0=current; 1=IEEE 1455-1999) +  <i>If Transponder ID Definition Flag = current</i> , then the other segment is: Transponder Serial Number assigned by manufacturer  <i>If Transponder ID Definition Flag = IEEE 1455-1999</i> , then the other segments are: Manufacturer Identifier +  Transponder Serial Number assigned by manufacturer	10 (max)  1 (1 bit)  8 (32-bit hexadecimal value)  4 (16 bits hexadecimal value)  5 (20 bits hexadecimal value)

**Standard identifiers** are intended to facilitate the process of exchanging information about carriers, vehicles, drivers, shipments, and international trips.



Entity	Identifier Name	Identifier Segments	Number of Characters
Driver	Driver Unique ID e.g., US MD B99999999999A	Country code (alphanumeric); the allowable country codes will be defined in the FHWA Code Directory +	2
		Jurisdiction (state or province) code (alphanumeric); the allowable subdivision codes will be defined in the FHWA Code Directory +	2
		Driver specific identifier (driver license number) assigned by jurisdiction (alphanumeric)	16 (max)
Shipment	Shipment Unique ID e.g., 776655443322	Bill of Lading number assigned by the carrier (numeric)	12 (max)
Trip	Trip/Load Number e.g., 123456789761231	Carrier DUNS number as assigned by Dun and Bradstreet (numeric) +	9
		Trip unique number as assigned by carrier (numeric)	6



**Support CVISN Level 1**

# Emerging Dedicated Short-Range Communications (DSRC) standards support near- and long-term goals.

---

In the near-term, FHWA has issued this policy guidance:

*For the immediate future, all CVO and Border Crossing projects will continue to utilize the current DSRC configuration, which is an ASTM version 6 active tag.*

FHWA issued a Notice of Proposed Rulemaking (Federal Register 30 December 1999) that would require:

*All CVO and Border Crossing projects to use an active configuration that is backward compatible with the current configuration and yet consists of the following “sandwich” protocol:*

- *ASTM PS-111-98 defines the frequency (physical) layer,*
- *ASTM v6 defines the data link layer,*
- *IEEE Std 1455-1999 defines the application layer.*

Future tags are expected to support all message sets defined in IEEE Std 1455-1999.



# Standard EDI transaction sets support computer-to-computer exchange without the need to negotiate unique interface agreements.

TS (ANSI X12)	TS Name	Purpose
149	Notice of Tax Adjustment or Assessment	Report recalculated "tax due" to filer
150	Tax Rate Notification	Request and transmit IFTA tax tables.
151	Electronic Filing of Tax Return Data Acknowledgement	✓ Acknowledge receipt of 813.
284*	Commercial Vehicle Safety Reports	Submit or request safety report. (Inspections)
285	Commercial Vehicle Safety & Credentials Information Exchange	✓ Request snapshots. ✓ Send snapshot view or snapshot segment update.
286	Commercial Vehicle (CV) Credentials	✓ Submit electronic application for credentials. ✓ Return credential data to applicants. ✓ Exchange credential data among authorized users.
813	Electronic Filing of Tax Return Data	✓ File quarterly IFTA tax return.
820	Payment Order/Remittance Advice	Initiate electronic payment process.
824	Application Advice	✓ Report results of processing received 284* or 285.
826	Tax Information Exchange	✓ Share transmittal and netting data among jurisdictions for IFTA. Report tax credit.
997	Functional Acknowledgement	✓ Acknowledge receipt of any EDI message.
many		Cargo Shipping & Routing functions.
UN/ EDIFACT	CUSDEC, CUSCAR, CUSREP, CUSRES	Entry papers for transport, cargo declaration, response/duty invoices, response/duty invoices. Customs inspection reports.

\* The TS 284 (for EDI inspection reports) is not supported by SAFER, CVIEW, or federal safety systems such as ASPEN and SAFETYNET.

✓ CVISN Level 1

# Snapshots: Fundamental Principles

---

- Three flavors: carrier, vehicle and (future) driver
- SAFER manages interstate snapshots
- State CVIEWs (or equivalent) manage intrastate and interstate snapshots of interest to the state
- Snapshots were primarily designed to support roadside electronic screening; many other uses have emerged
- Snapshots are routinely distributed according to subscription criteria
- Snapshots are also available for near-immediate response to a query
- Authoritative sources contribute specific segments of data proactively to snapshots, sometimes via indirect source systems
- Snapshots contain summary safety data, plus the equivalent of decals and paper documents carried on commercial vehicles today
- Snapshot data are stored in SAFER and CVIEW
- SAFER and CVIEW do not store copies of data readily available to SAFER/CVIEW users from other on-line systems.



# This Generic CVISN Configuration shows how new functions might be implemented, building on existing systems.

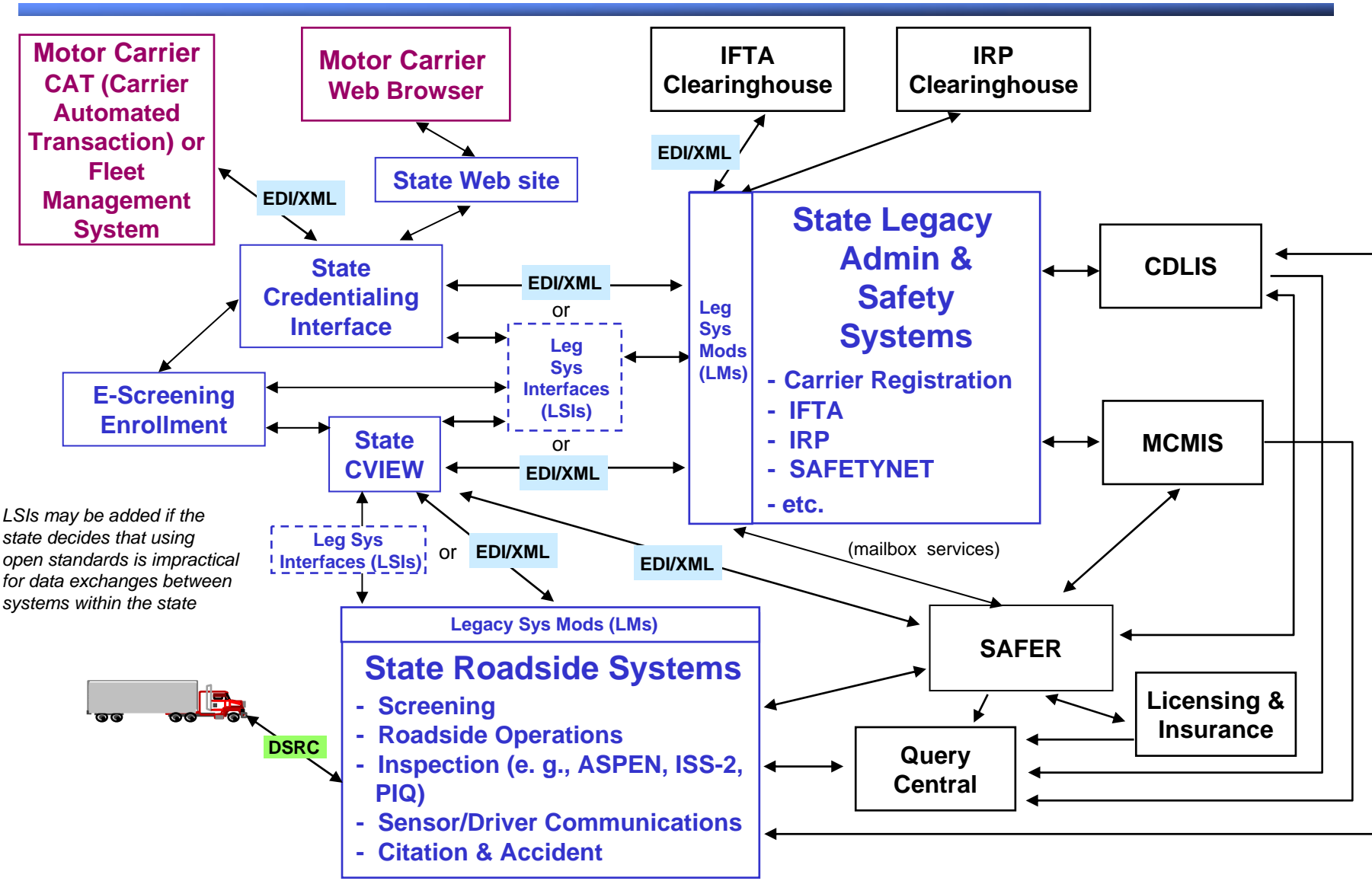

# Generic CVISN Configuration

## • Motor Carrier Systems

- **CAT (Carrier Automated Transaction) or Fleet Management System** - to transmit applications for credentials and fuel tax returns. CAT was an early option (before Web was pervasive) that is still in use.
- **Web Browser** - to transmit applications for credentials and fuel tax returns via the World Wide Web to a state-sanctioned Web site

## • State Systems

- **State Web site** - to support e-credentialing
- **Credentialing Interface (CI)** - to be the focal point for credential and tax interaction with the carrier
- **Legacy administrative and safety deskside systems (Carrier Registration, IFTA, IRP, OS/OW, Intrastate Vehicle Registration, SAFETYNET/ AVALANCHE, Titling, CDL/DL, HazMat, CAPRI); Legacy Modifications (LMs)**
- **Legacy System Interfaces (LSIs)** - to make translations into and from legacy interface definitions when adherence to EDI standards between the CI or CVIEW and legacy systems is impractical
- **E-Screening Enrollment** - to collect information about carriers and vehicles that want to participate in e-screening

## • State Systems, continued

- **CV Information Exchange Window (CVIEW)** - to generate intrastate snapshots, to handle interstate snapshot data exchange, and to distribute snapshots within the state
- **Roadside Systems (Screening, Roadside Operations, Inspection, Sensor/Driver Communications, Citation & Accident)**

## • CVISN Core Infrastructure Systems

- **IFTA Clearinghouse** - to support the IFTA base state agreement
- **IRP Clearinghouse** - to support the IRP base state agreement
- **SAFER** - to generate interstate snapshots and distribute
- **Legacy CVISN Core Infrastructure Systems (CDLIS, MCMIS, CAPRI, Licensing & Insurance)**
- **Query Central** - to provide motor carrier safety information for state and federal law enforcement personnel in response to queries.

Note for State and Core Infrastructure Systems: Many systems are already Web-enabled or planning to add Web interfaces to facilitate user interaction with the system via the World Wide Web.

# Legacy Systems in the state will be leveraged to improve commercial vehicle operations and adapt to CVISN principles.

**Administrative systems will be updated to support**

- ① **Electronic credentialing and automation of safety assurance functions;**
- ② **Legacy System Modifications (LMs) to support enhanced information exchange, electronic credentialing, improved safety programs, etc.**

**New systems may be added to support key CVISN concepts**

- ③ **Credentialing Interface for electronic transaction routing & processing;**
- ④ **CV Information Exchange Window for creation of intrastate snapshots and to provide a single source within the state for all snapshots and report queries;**
- ⑤ **Legacy System Interfaces (LSIs) may be added when adherence to EDI standards between the CI or CVIEW and legacy systems is impractical**

**Roadside systems will be updated to support use of**

- ⑥ **safety & credentials data for electronic screening, to report inspections, and to report citations and accidents.**

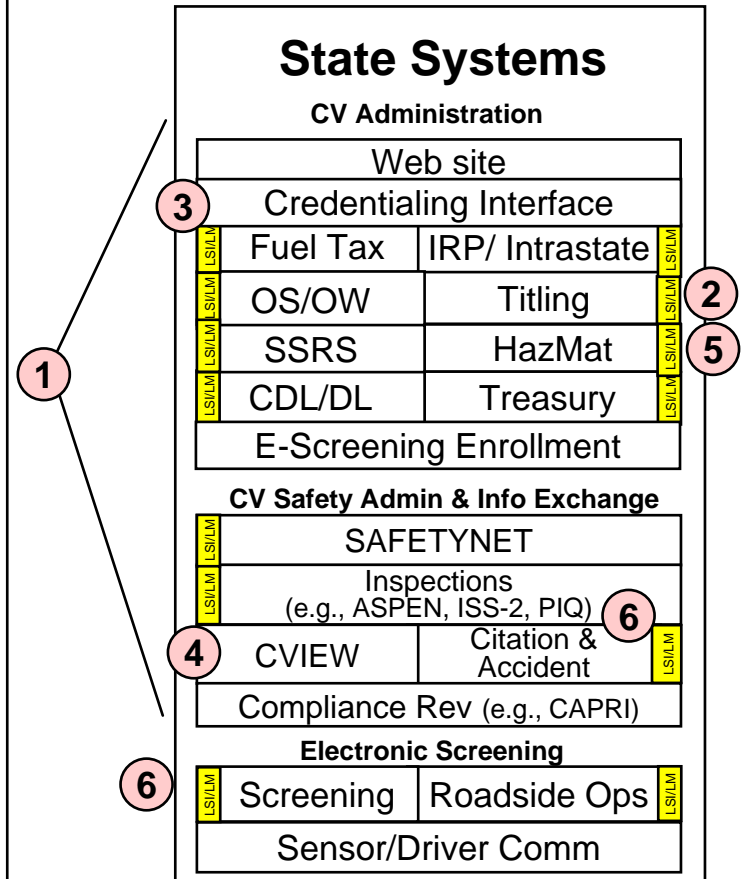

# Modifications enhance legacy systems to make better use of available information and to improve operations.

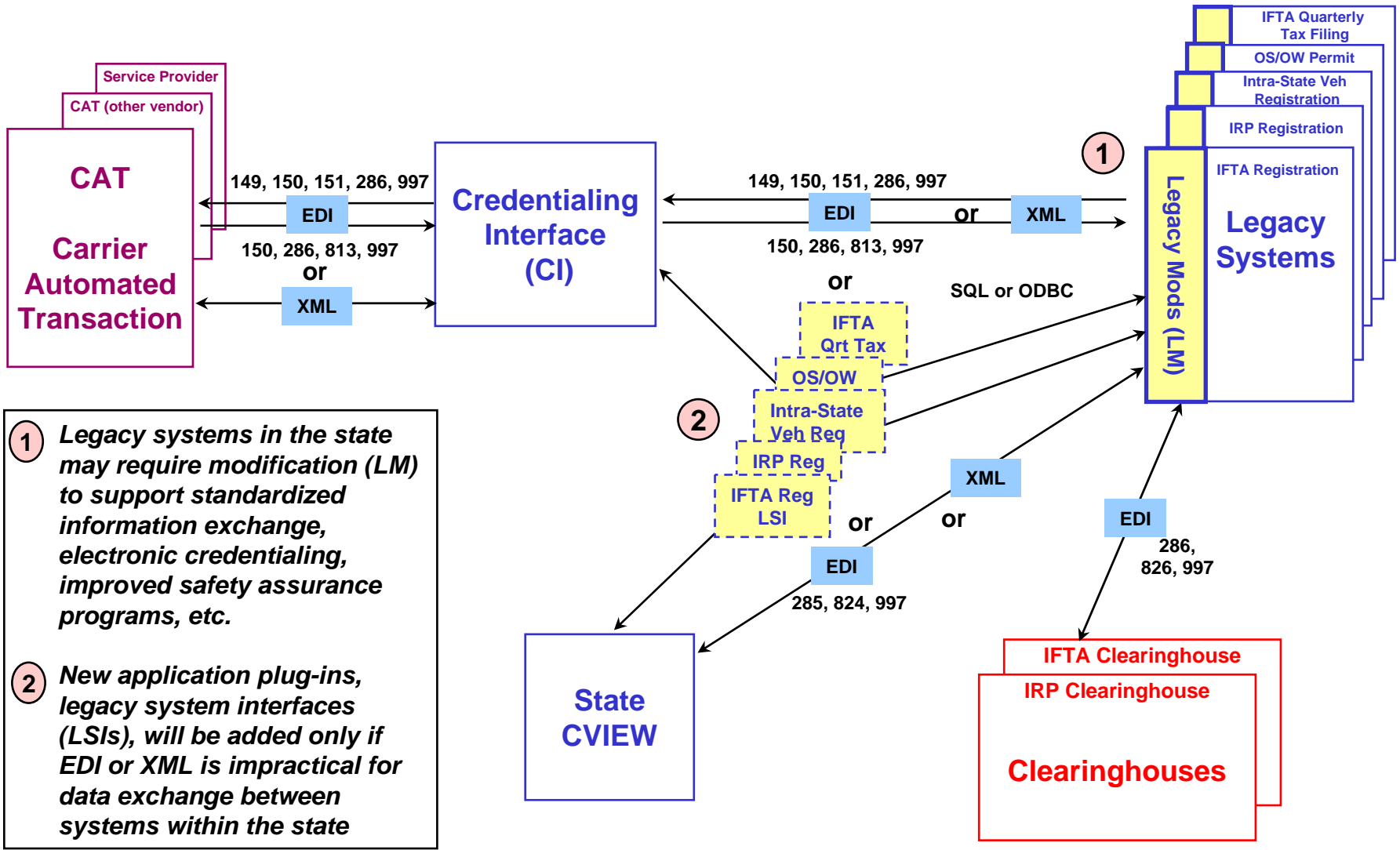

- 1** Legacy systems in the state may require modification (LM) to support standardized information exchange, electronic credentialing, improved safety assurance programs, etc.
- 2** New application plug-ins, legacy system interfaces (LSIs), will be added only if EDI or XML is impractical for data exchange between systems within the state

# The Credentialing Interface provides a convenient interface within the state to accept electronic credentialing application inputs from carriers, and to provide responses from state systems to carriers.

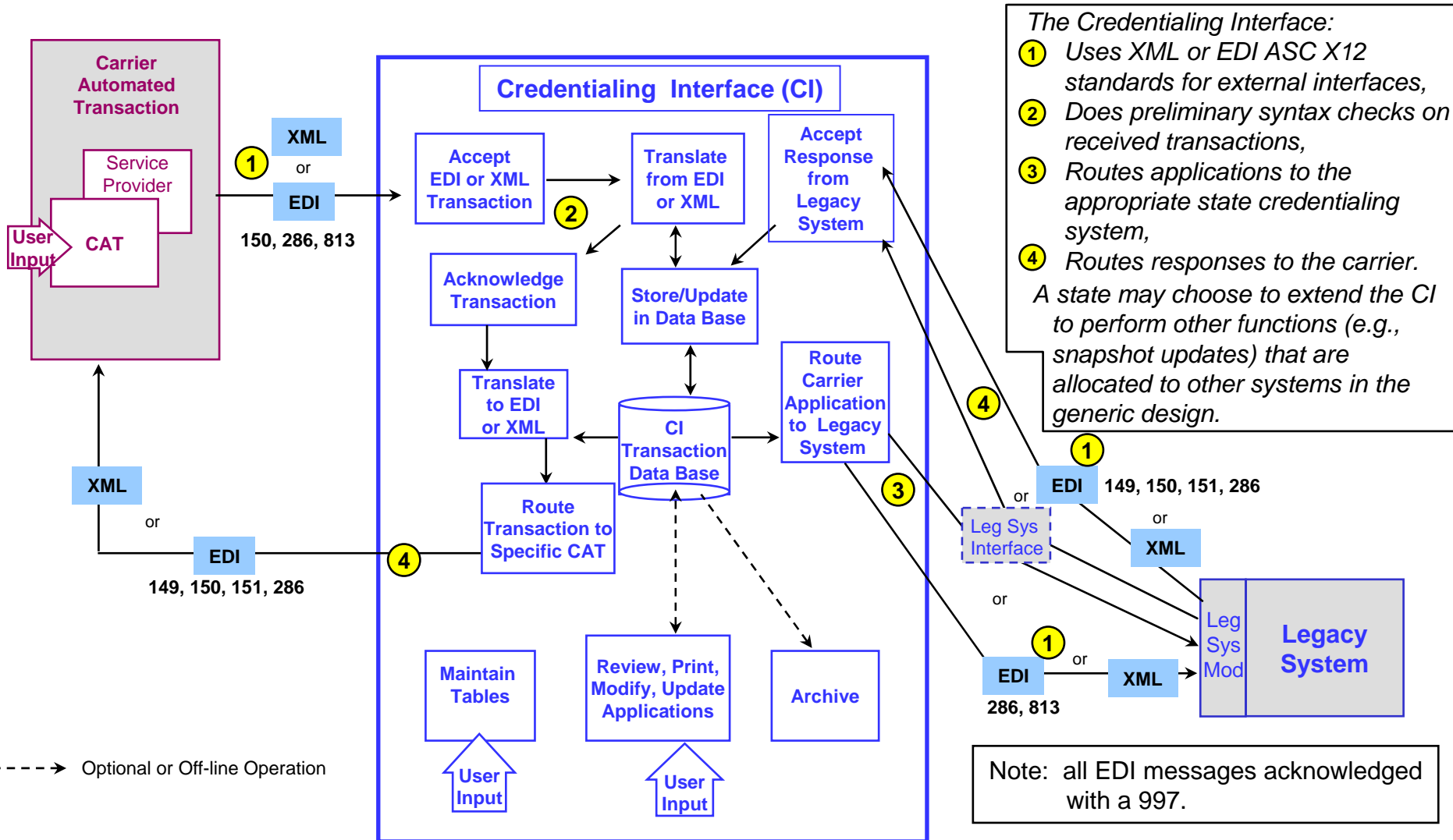

-----> Optional or Off-line Operation



As the state “Web-enables” its credentialing processes, it can re-use the core credentialing interface and legacy systems.

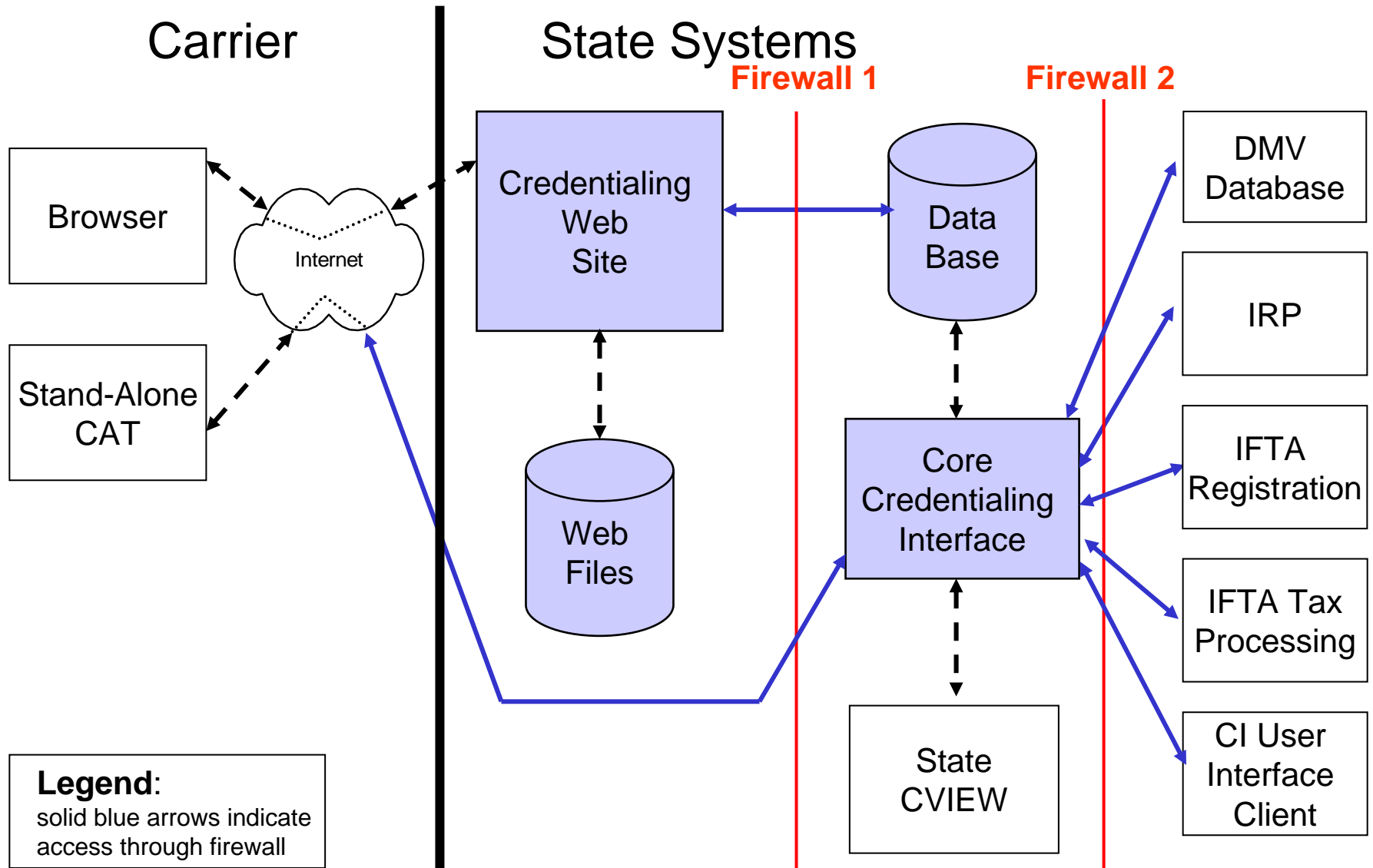

The State CVIEW handles the exchange of safety and credentials information within the state, and with other jurisdictions via SAFER.

## CVIEW

- 1 Assembles and maintains *intrastate* snapshots. Manages state's copies of interstate snapshots.
- 2 Provides interstate snapshot segment updates for credentials data to SAFER, and is pass-through for CV safety reports.
- 3 Distributes interstate and intrastate snapshots or reports to roadside sites and other state systems.
- 4 Responds to queries for snapshots and reports from state data users.

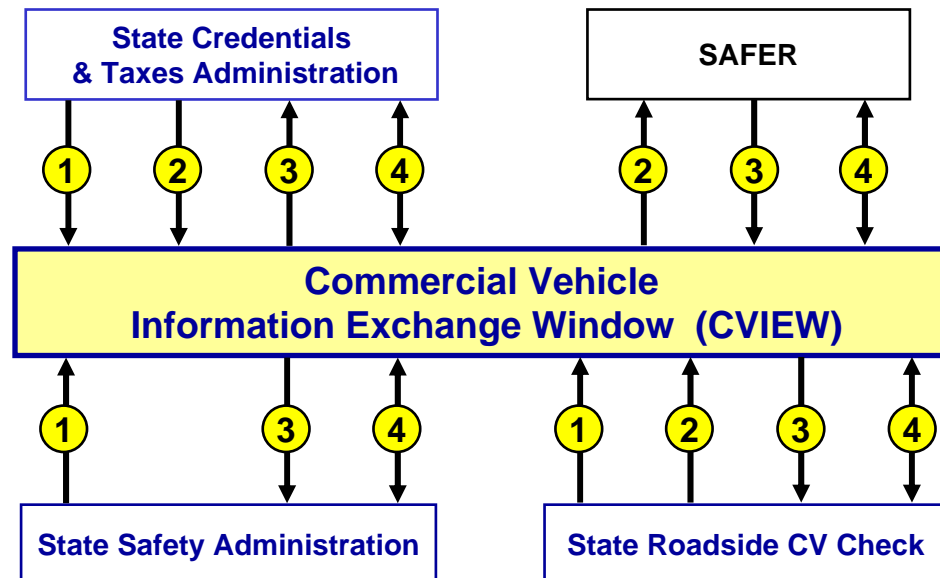

# The State CVIEW handles the exchange of safety and credentials information via SAFER.

CVIEW is a state system that collects information from the commercial vehicle (CV) credentialing and tax systems to formulate segments of the interstate carrier, vehicle, and (future) driver snapshots and reports for exchange within the state (e.g., to roadside sites) and with the SAFER system. Each state is responsible for maintaining the credential segments of the snapshots for interstate carriers for vehicles based within the state. For CVISN Level 1, there is a requirement to implement CVIEW (or a CVIEW equivalent) system for exchange of intrastate and interstate data within the state. The FMCSA-developed CVIEW is a distributed version of the FMCSA-developed SAFER system. It is owned by, located in, and usually customized by a state. The state can choose to implement the FMCSA-developed CVIEW or an equivalent system that performs the same functions. Throughout this chapter the term CVIEW is used to refer to the FMCSA-developed CVIEW or any equivalent system that a state may deploy.

The functions that CVIEW, or its equivalent, will perform are listed below:

- Provide for the electronic exchange of:
  - interstate carrier and vehicle credential data between state source systems and users
  - intrastate carrier and vehicle safety and credential data between state source systems and users
- Serve as the repository for a state-selected subset of:
  - interstate carrier and vehicle credential data between state source systems, users, and SAFER
  - intrastate carrier and vehicle safety and credential data between state source systems and users
- Support safety inspection data reporting and retrieval by roadside enforcement personnel
- Provide inter- and intrastate carrier and vehicle safety and credential data to the roadside to support electronic screening and other roadside operations
- Perform electronic exchange using one or more of the following standards:
  - EDI standards
  - non-EDI standards, the selection of which is system-dependent
  - new open standard methods of information exchange (e.g., XML) as they become available and are requested by users
- Allow the general public to access data without the security risk of providing a direct connection to sensitive legacy systems.

# Access to CVIEW: Online Queries

**(3) Data Request for data not in CVIEW;  
Carrier Snapshot or Inspection  
Report returned**

**SAFER System**



Report returned



**CVIEW System**

**Retrieve Mail Message; (2)  
Extract Requested Data**

**(4) Send Mail Message with  
Requested Data**

**CVIEW's Input  
Mailbox**

**User's  
Mailbox**

**User  
Mailboxes**

**MCSAP Inspector**

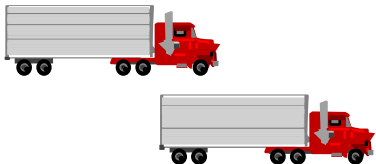

**(1)  
Send Data  
Request**

**CVIEW Data Mailbox System**

**(5)  
Retrieve Requested Data  
(Inspection Reports; Carrier  
Snapshots)**

**Inspection  
Site w/  
ISS/PIQ**

# Access to CVIEW: Online Queries

- Online queries are based on the use of standard e-mail data exchange [Simple Mail Transfer Protocol (SMTP) for sending e-mail; Post Office Protocol (POP3) for retrieving e-mail].
- Each CVIEW user is provided a personal mailbox account for on-line queries and for receipt of subscription data.
- Via a client application, users send requests for data to CVIEW, i.e., make online queries, via CVIEW's input mailbox **(1)**.
- CVIEW retrieves and processes the request **(2)**. If the data request is for an inspection report or for a carrier snapshot that is missing from CVIEW's database, CVIEW issues a request for the data to SAFER, which is returned to CVIEW via an RPC link **(3)**.
- CVIEW returns the requested data to the user via the user's personal mailbox **(4)** which is read by the client application **(5)**.
- Currently, online queries for carrier snapshots are supported; support for vehicle inspection reports to be available in Version 3.

Note: The query approach shown here is what will be available with SAFER/CVIEW Version 3. The APL version of CVIEW will not be updated beyond Version 3. However, in the future, the SAFER snapshot interface is expected to be Web-based, using XML and HTTP; new developers should concentrate on that approach.

# Access to CVIEW: Subscription Processing

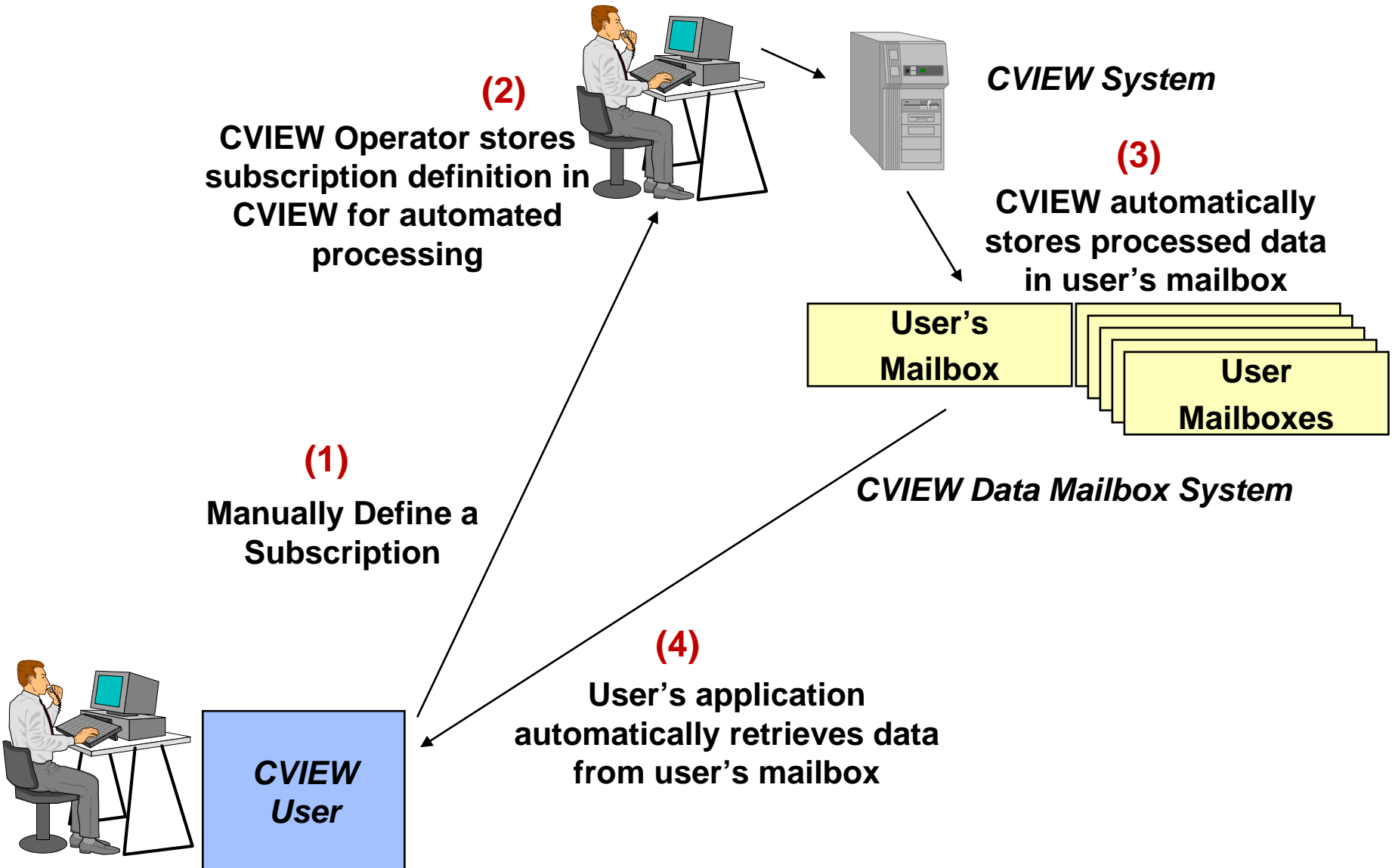

# Access to CVIEW: Subscription Processing

---

- A subscription is a manually generated request for CVIEW to provide one or more users a specific set of data using a specified format and delivery rate.
- A user defines a subscription via the CVIEW System Operator **(1)**, who stores the definition in CVIEW for subsequent automated processing **(2)**.
- CVIEW automatically processes the subscription data for each user and stores it in their individual mailboxes **(3)**.
- A user with a client application, such as the Roadside Operations Computer, automatically retrieves data from their mailbox based on the data format and delivery rate specified in the subscription **(4)**.
- Currently, subscriptions for inspection reports and for carrier and vehicle snapshots are supported.

# Electronic Screening Enrollment collects & shares data about carriers & vehicles that want to participate in electronic screening.

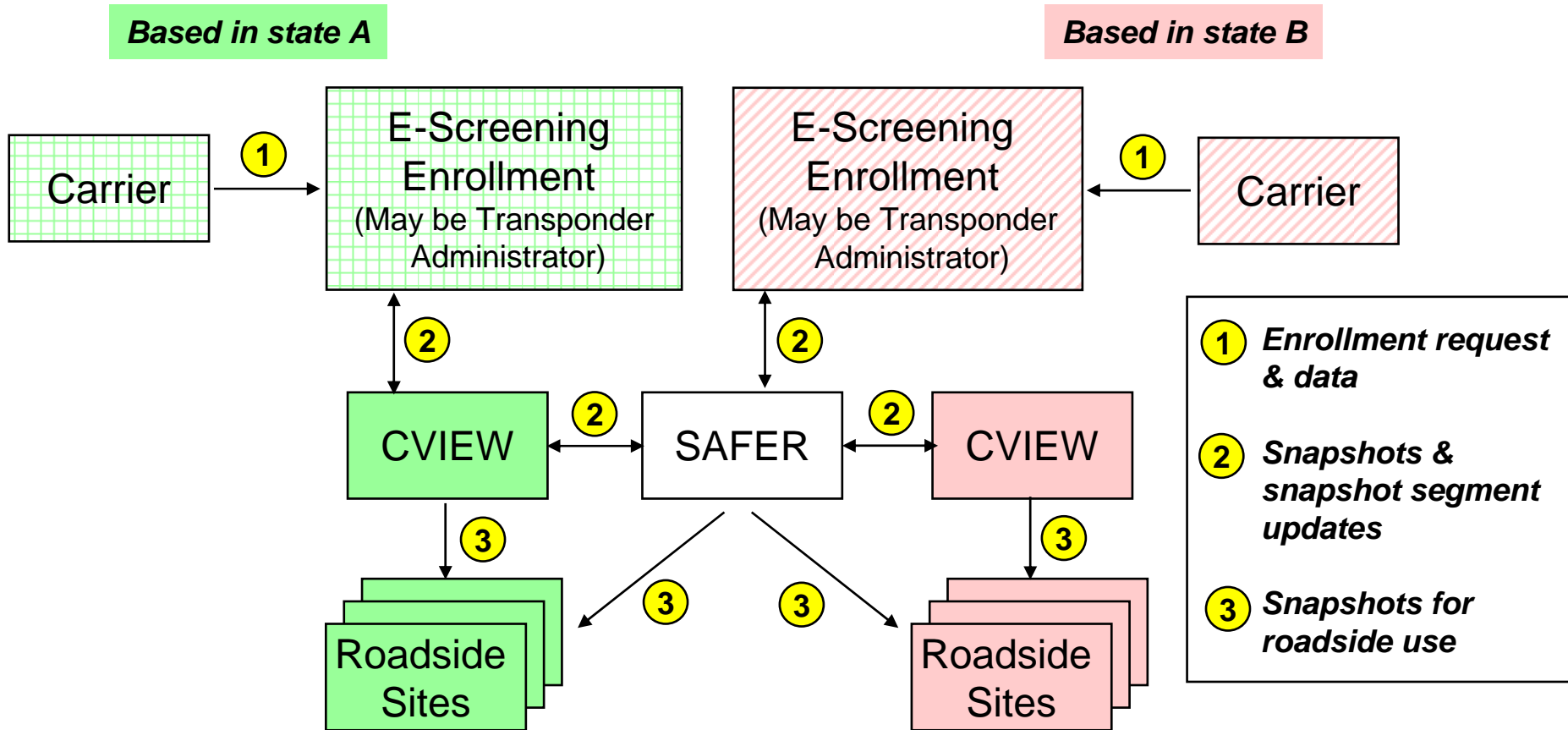

**Enrollment data are shared across jurisdictions and screening programs through snapshots**



# Roadside Systems use technology to support automated electronic screening and inspections.

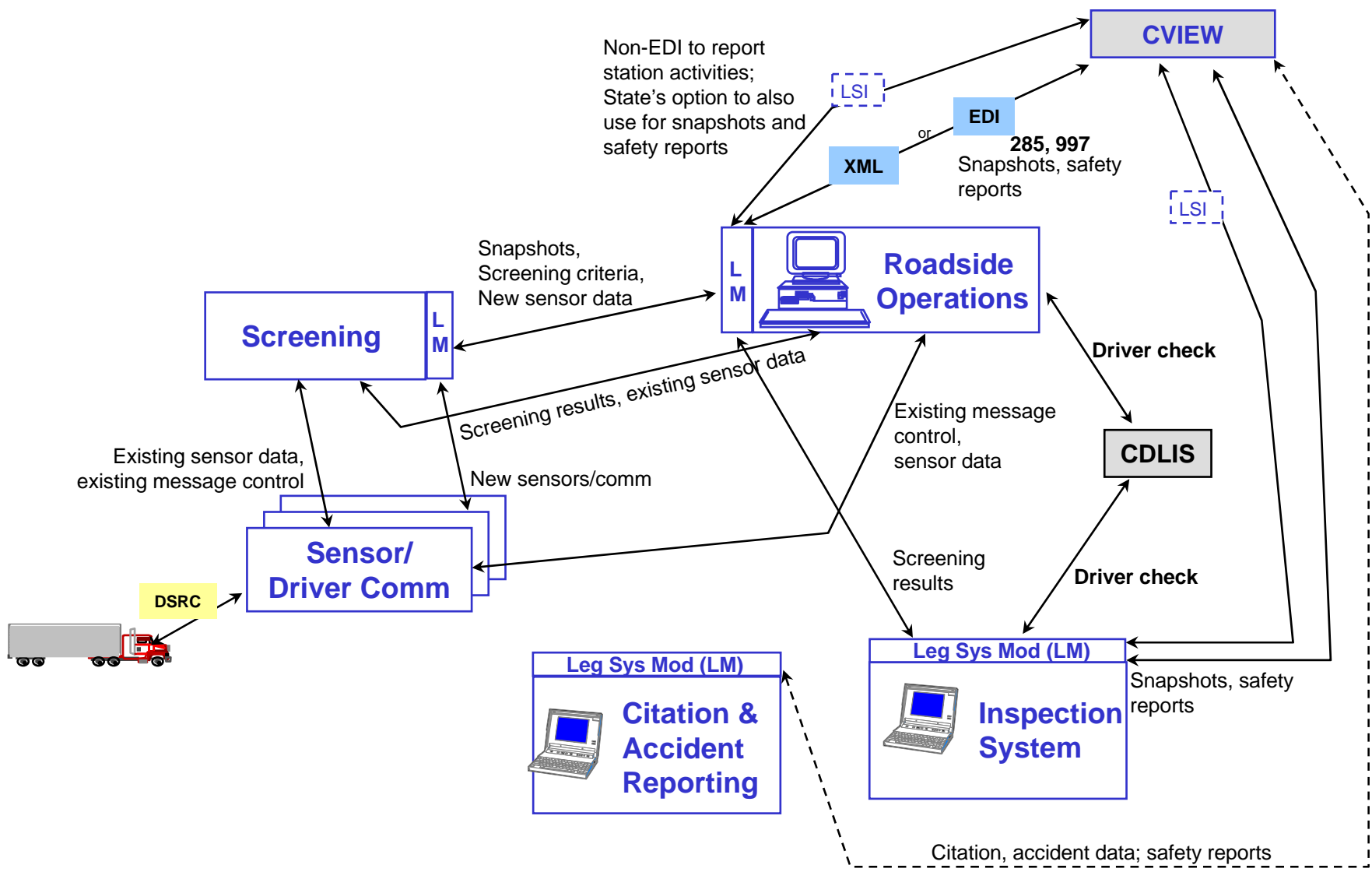

# CVISN Core Infrastructure Systems support information exchange.

- ① Existing systems may be updated to support enhanced information exchange.
- ② New systems have been developed to support primary CVISN capabilities:
  - IRP Clearinghouse to support administration of IRP base state agreement
  - IFTA Clearinghouse to support administration of IFTA base state agreement
  - SAFER for creation of interstate carrier, vehicle, and driver snapshots and to provide a consolidated source within the core infrastructure for all interstate snapshots
  - Query Central to handle queries
- ③ Other systems are being considered for development or are underway to support secondary CVISN capabilities:
  - NMVTIS development is underway to improve access to titling information for all types of vehicles

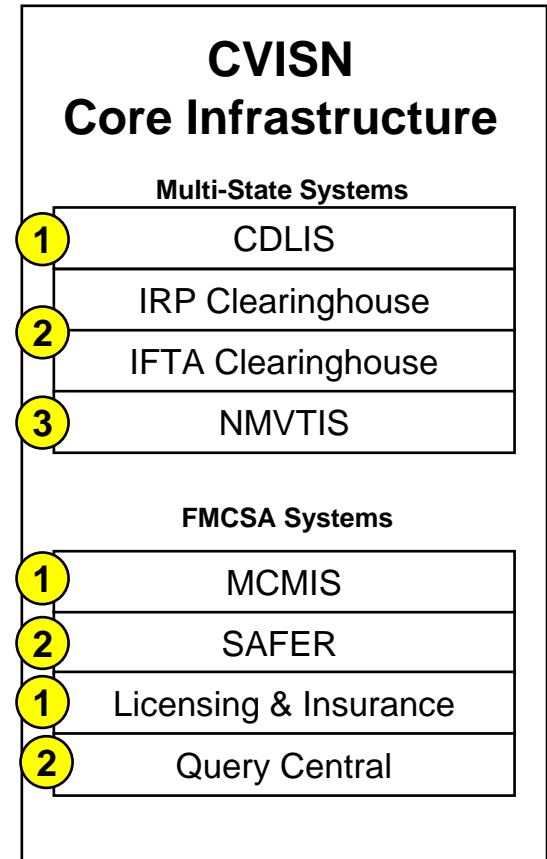

The IRP Clearinghouse processes information received electronically from states to compute fees due/owed each jurisdiction, and facilitates periodic funds transfers.

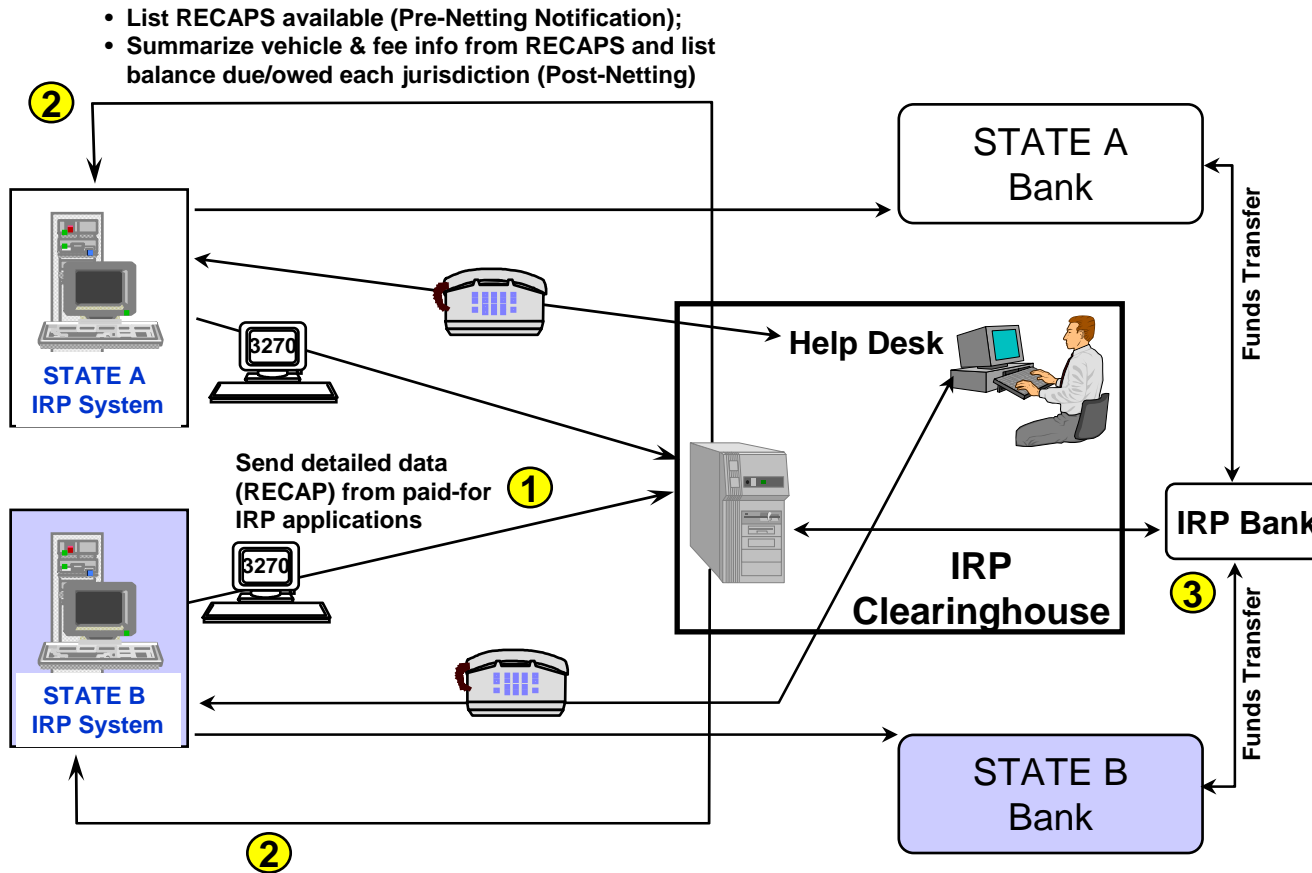

**The IRP Clearinghouse performs these major functions:**

- ① **Accepts RECAPS input from jurisdictions,**
- ② **Computes balance due/owed to/from each jurisdiction,**
- ③ **Facilitates monthly funds transfer, supporting EFT**

based on information provided by IRP, Inc.

# The IFTA Clearinghouse Central Repository provides access to confidential tax information for IFTA, Inc., clients.

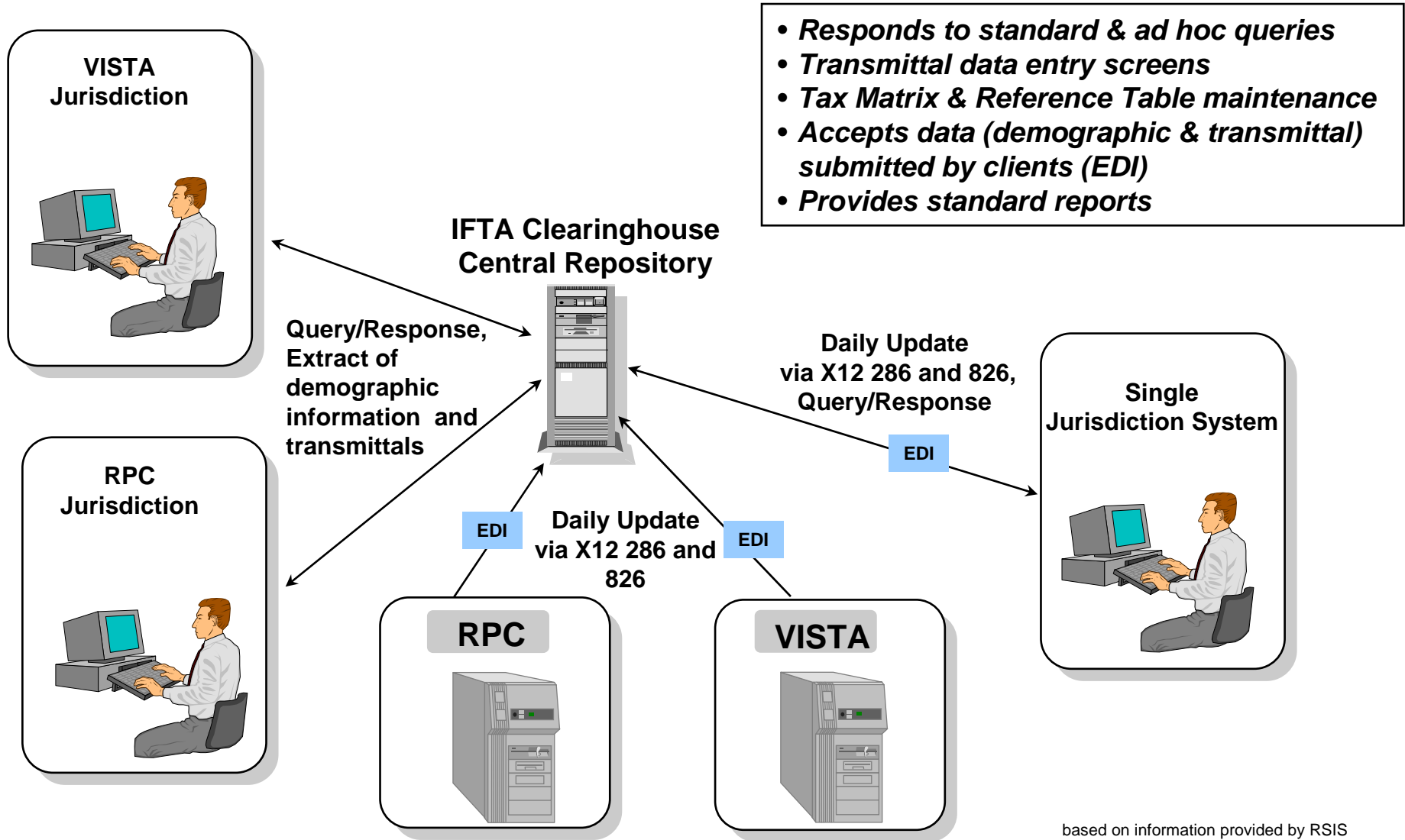

# The IFTA Clearinghouse Web site will provide public access to non-confidential tax information.

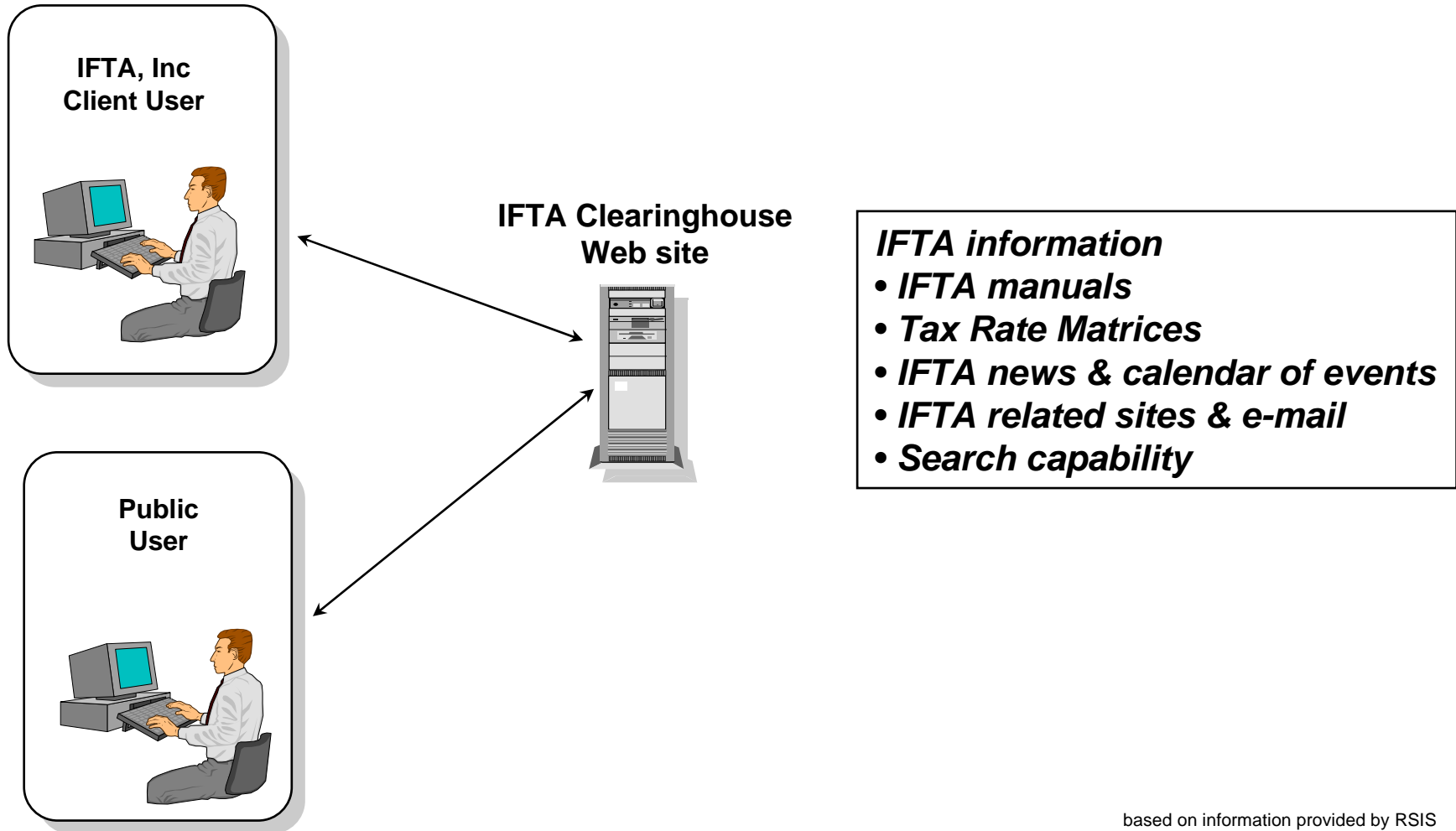

based on information provided by RSIS

SAFER assembles interstate snapshots from authoritative & indirect sources, and responds to queries for snapshots & safety reports.  
 SAFER stores and makes available inspection reports.

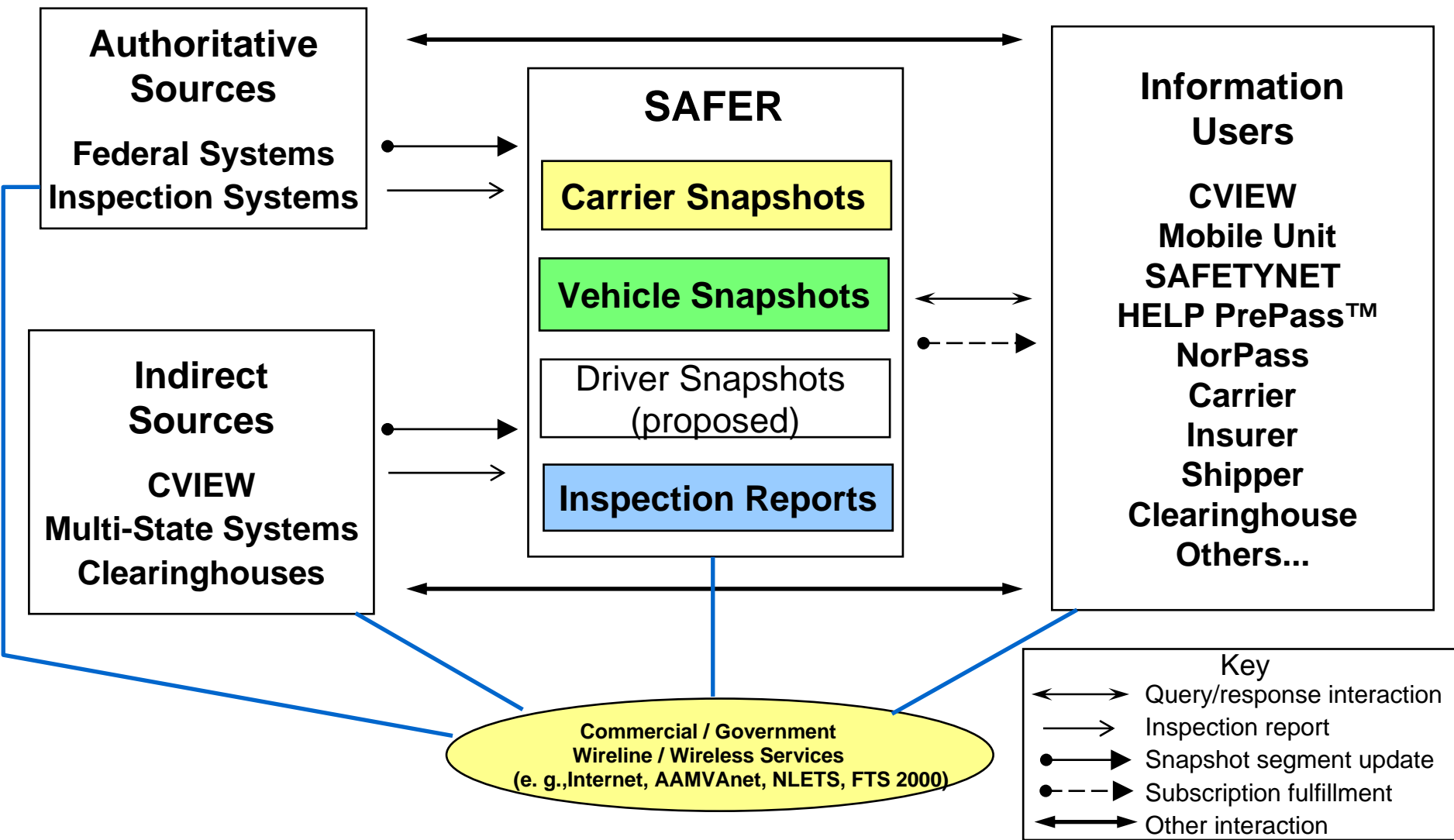

The SAFER Data Mailbox facilitates the electronic exchange of information just as manual delivery services do for the exchange of paper documents today.

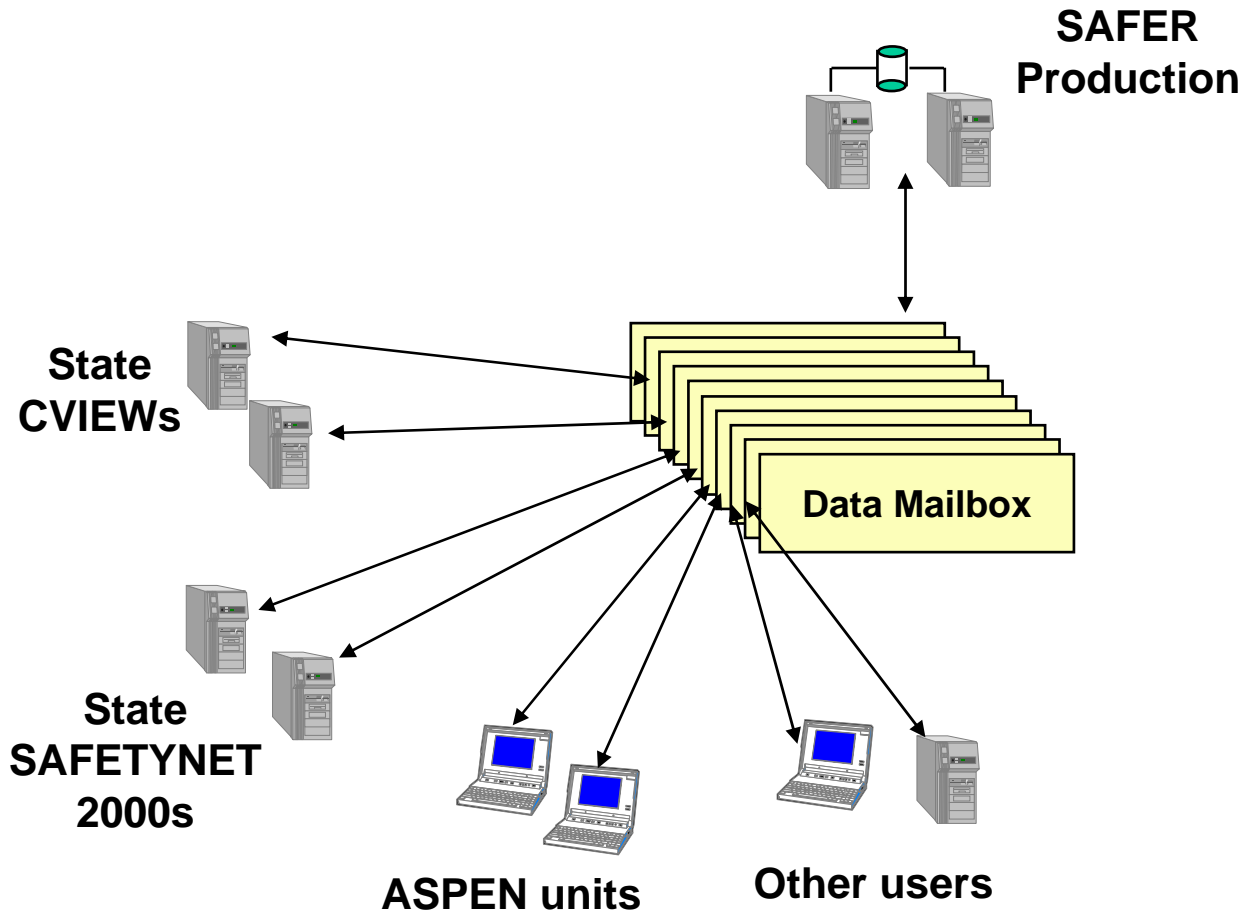

*The SAFER Data Mailbox is one component of the SAFER system. It supports the exchange of:*

- *Snapshots,*
- *Snapshot segment updates,*
- *Inspection reports,*
- *Compliance reviews,*
- *Crash data,*
- *Enforcement data,*
- *Facsimiles,*
- *F-reports.*

*The SAFER Data Mailbox is an SMTP/POP3 E-mail system.*

# The states may support different credentialing options for different carriers.

---

- Some states are planning to provide a World Wide Web site for electronic credentialing. Carriers could use their standard Internet browsers to connect to the state's Web site and submit and retrieve credential applications and responses. This option was illustrated earlier.
- Some states are sponsoring the development of a stand-alone PC-based program called the Carrier Automated Transaction (CAT). This option is further explained on the next page.
- Carriers may also choose to modify/upgrade their fleet management software systems to support electronic credentialing processes. The fleet management software would perform the same functions as the CAT, with one advantage: the processes would be integrated with other existing capabilities. (This option is not illustrated.)



# The Carrier Automated Transaction (CAT) system allows carriers to apply for and obtain credentials electronically.

## **The Carrier Automated Transaction performs these functions:**

- Data entry screens for credential applications & fuel tax filing
- Validate application
- Specify payment method
- Compute fees (some, not all)
- Print applications
- Initiate payments through banks (future)
- Translate to/from EDI/XML/Custom transactions
- Send transactions
- Receive transactions
- Acknowledge transactions
- Print credentials, if authorized
- Archive transactions

**Some carriers may choose to use a service provider to handle electronic credentialing.**

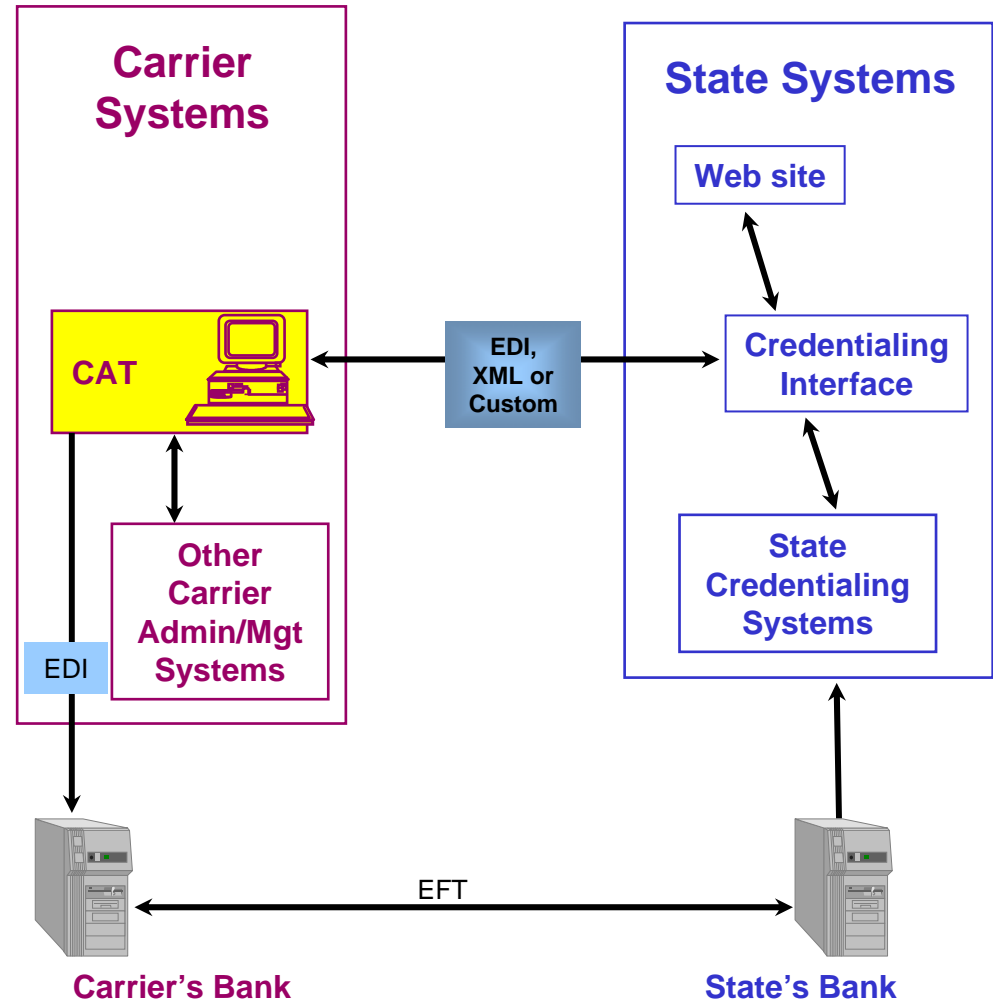

This Page Intentionally Blank

# CVISN System Design Description

## 4 - Putting It All Together

---

1 Introduction

2 System Requirements

3 System Design Overview

4 Putting It All Together

5 References

6 Change Requests

# The CVISN scope is expressed in four top-level interface drawings.

---

- **Carrier-related interfaces**
- **Interfaces within the state**
- **Interfaces between the state and the CVISN core infrastructure**
- **Interfaces among CVISN core infrastructure systems**

*The drawings are based on the standardized interfaces specified in the COACH Part 4, Interface Specification Checklists. The drawings use the “generic state design template”, overlaying lines to show connectivity among systems. If a state chooses not to implement the open standard specified for within-state exchanges, it will apply a unique legacy system interface (LSI) to accomplish the information exchange between two of its own systems. These drawings show only the CVISN Level 1 interface capabilities.*

# Generic State Design Template

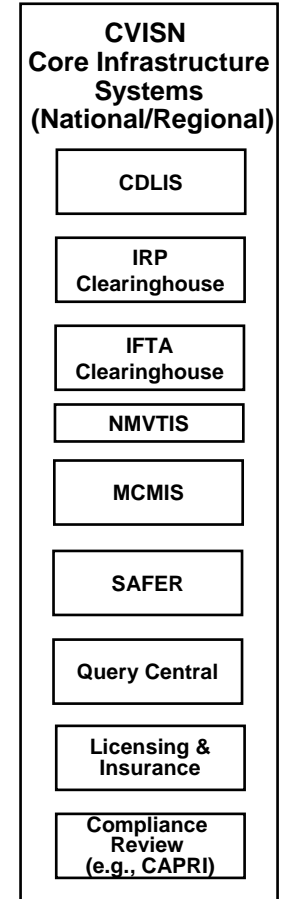
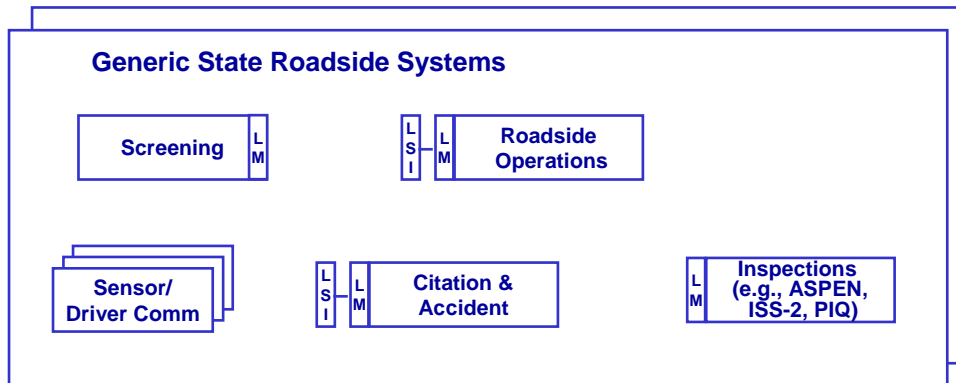
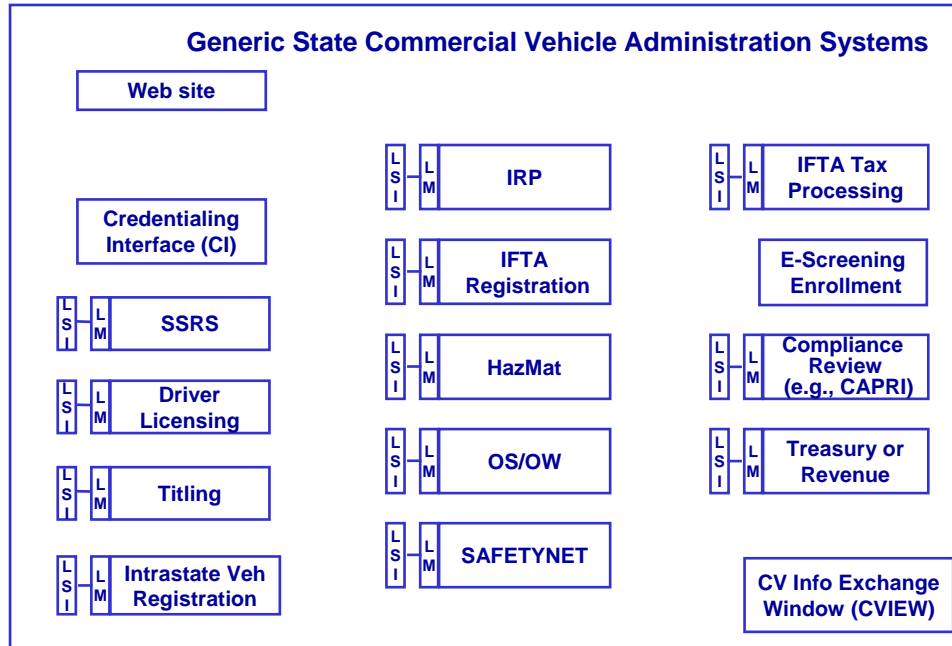
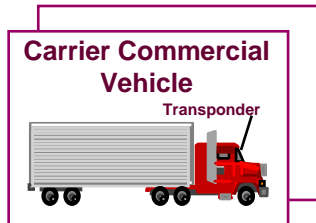
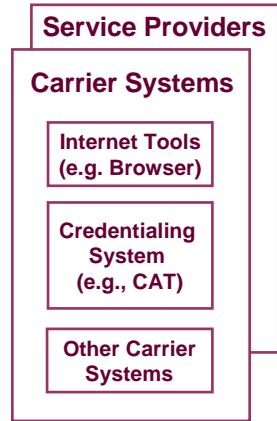

# CVISN Level 1: Carrier-Related Interfaces

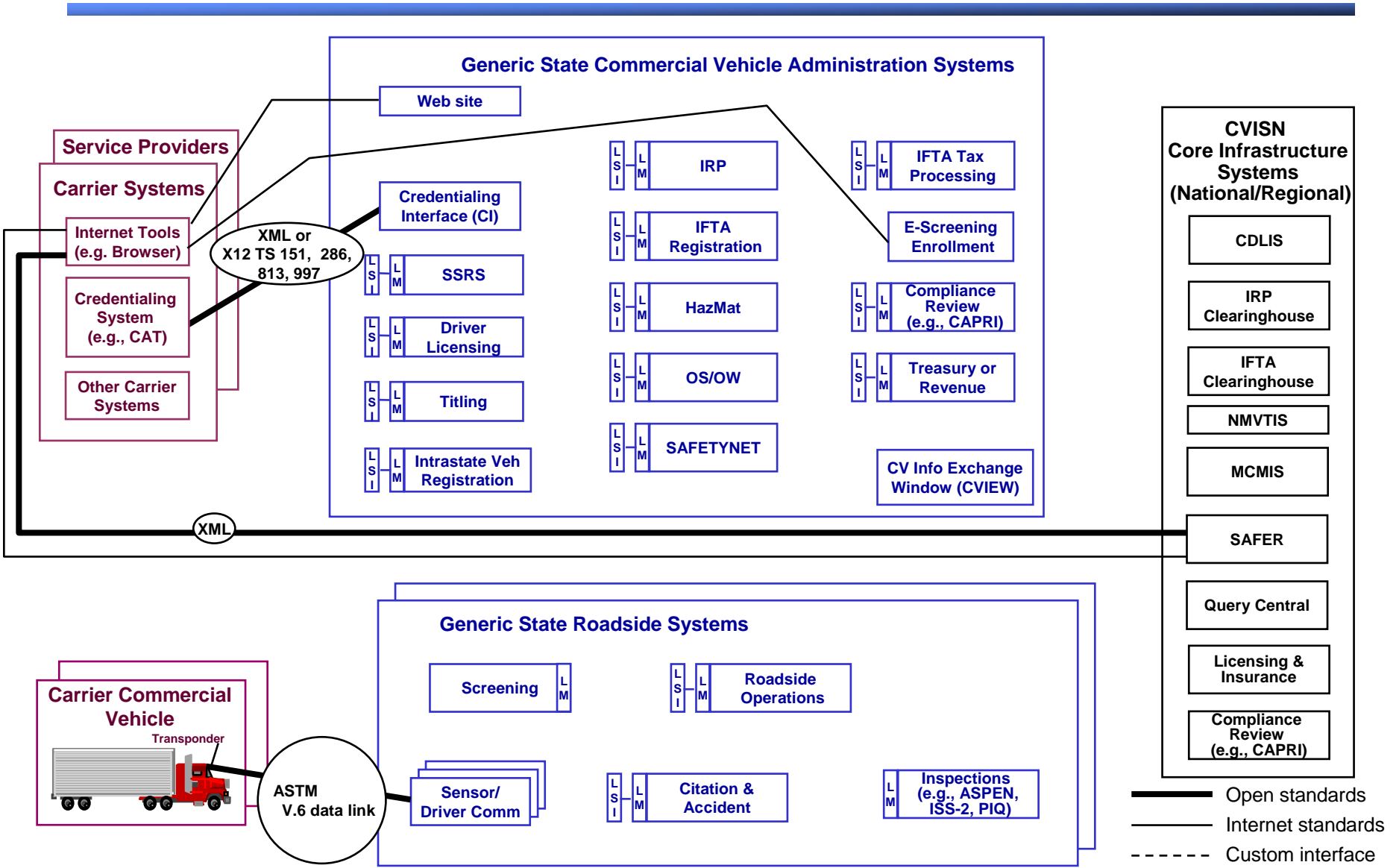

# CVISN Level 1: Interfaces Within the State

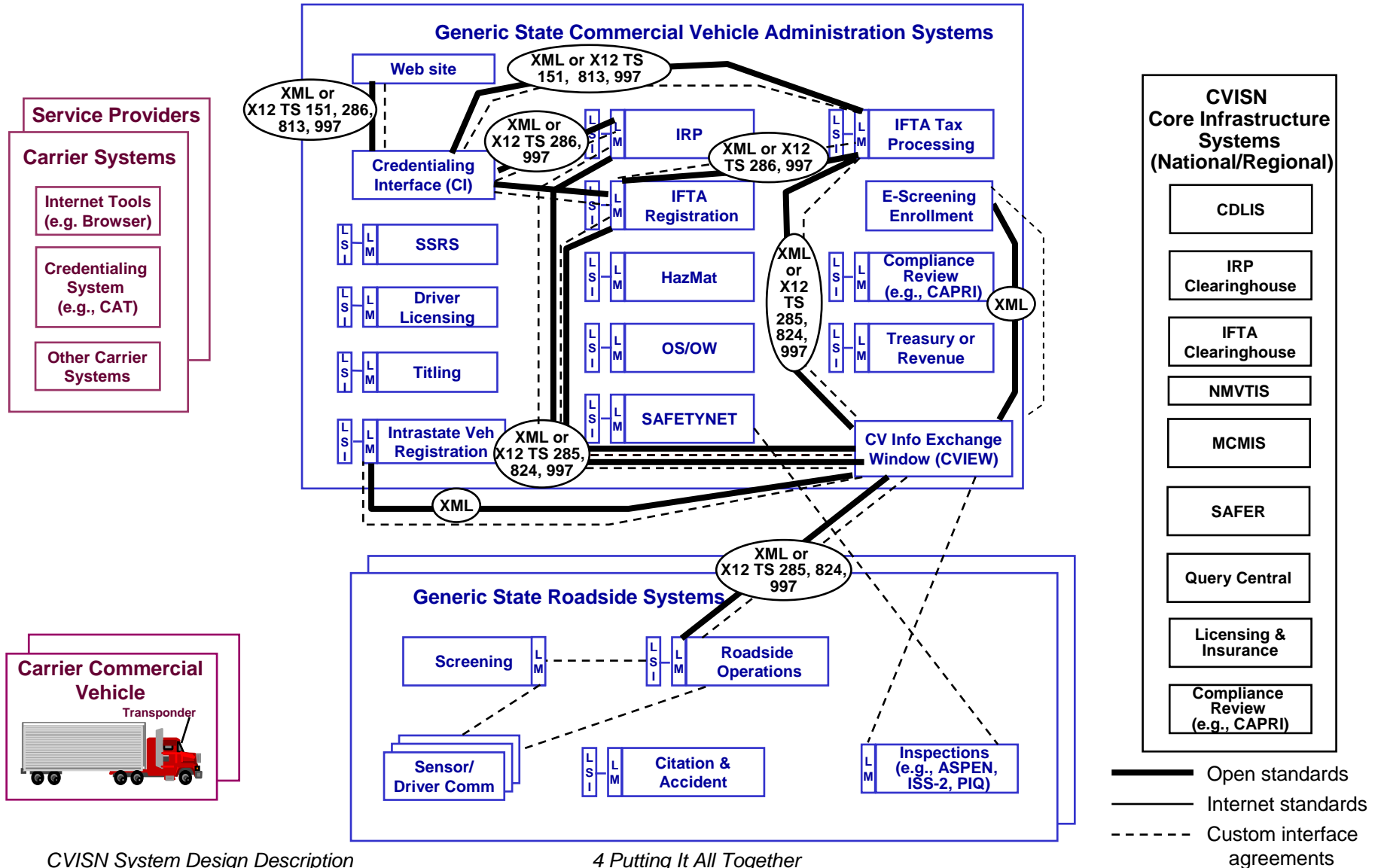

# CVISN Level 1: Interfaces Between the State and the CVISN Core Infrastructure

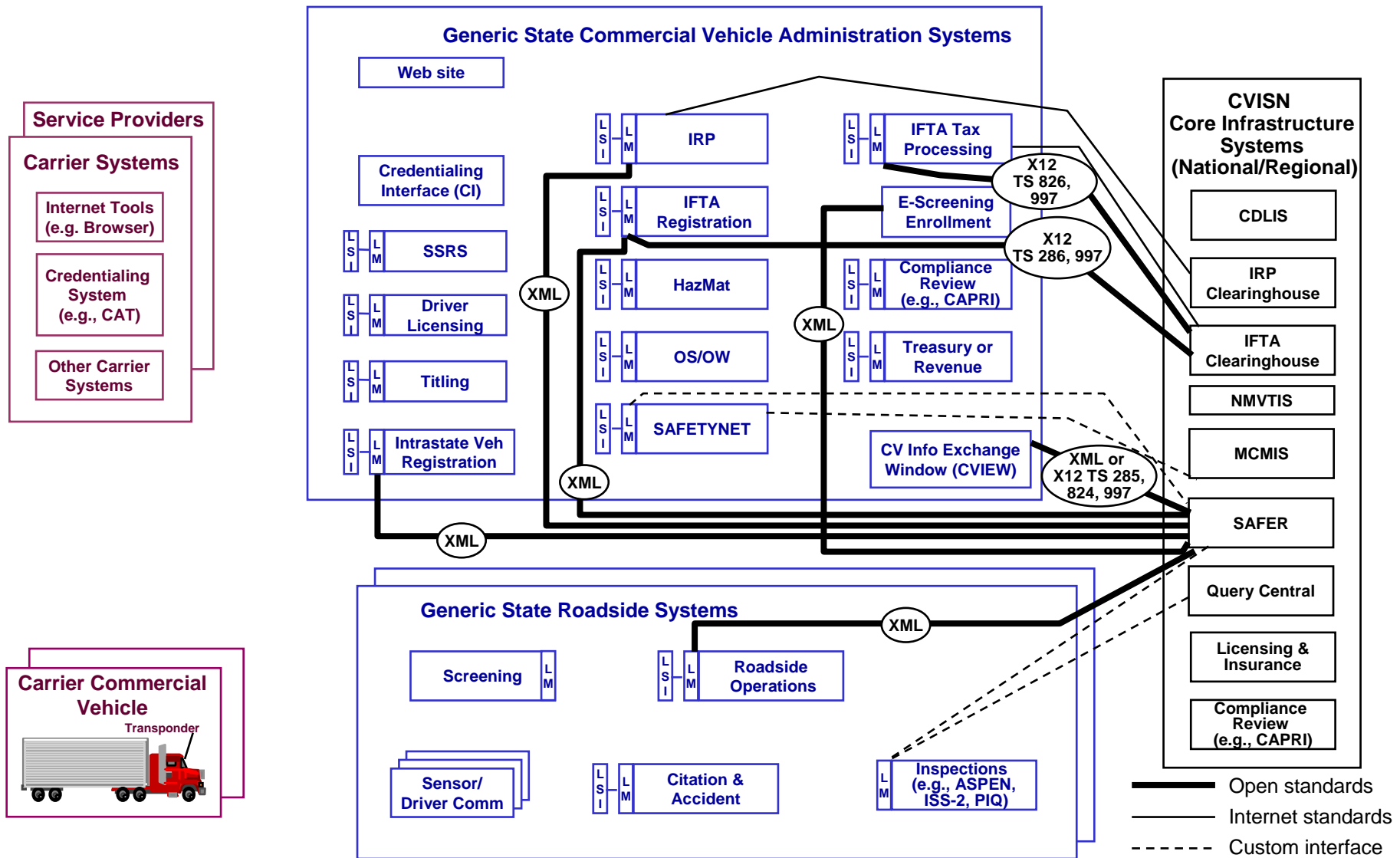



# CVISN Level 1: Interfaces Among CVISN Core Infrastructure Systems

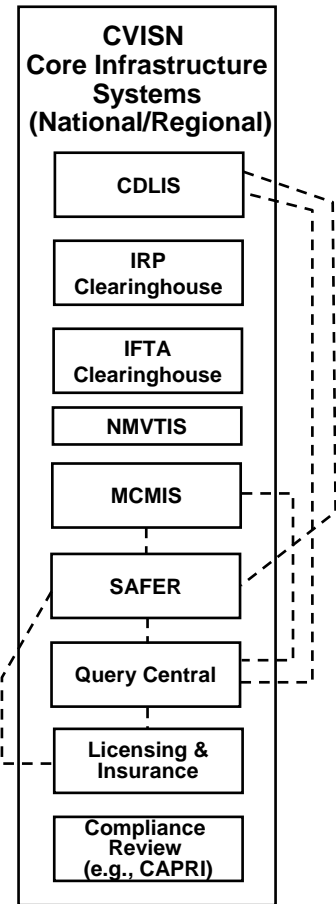
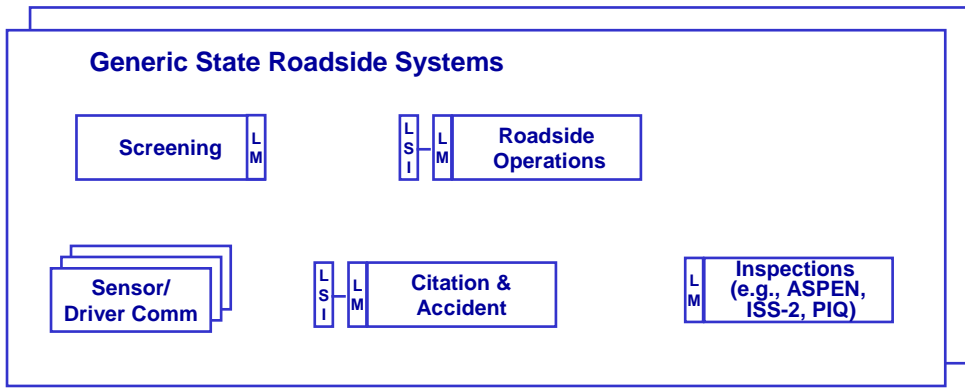
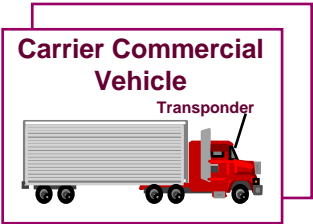
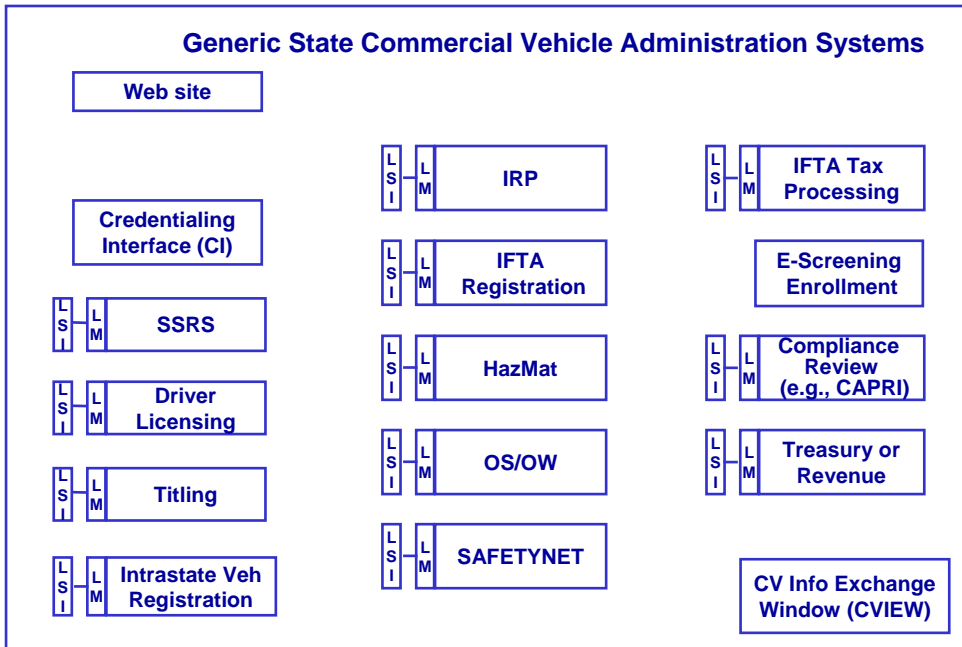
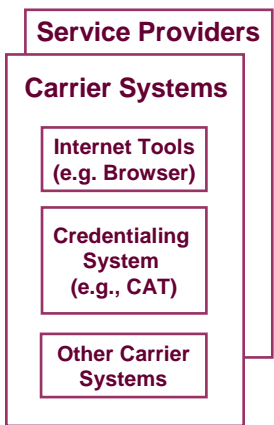

- Open standards
- Internet standards
- - - Custom interface agreements

States also use a computer and network template to express the scope of the changes required to implement CVISN.  
 This is an example of the resulting diagram.

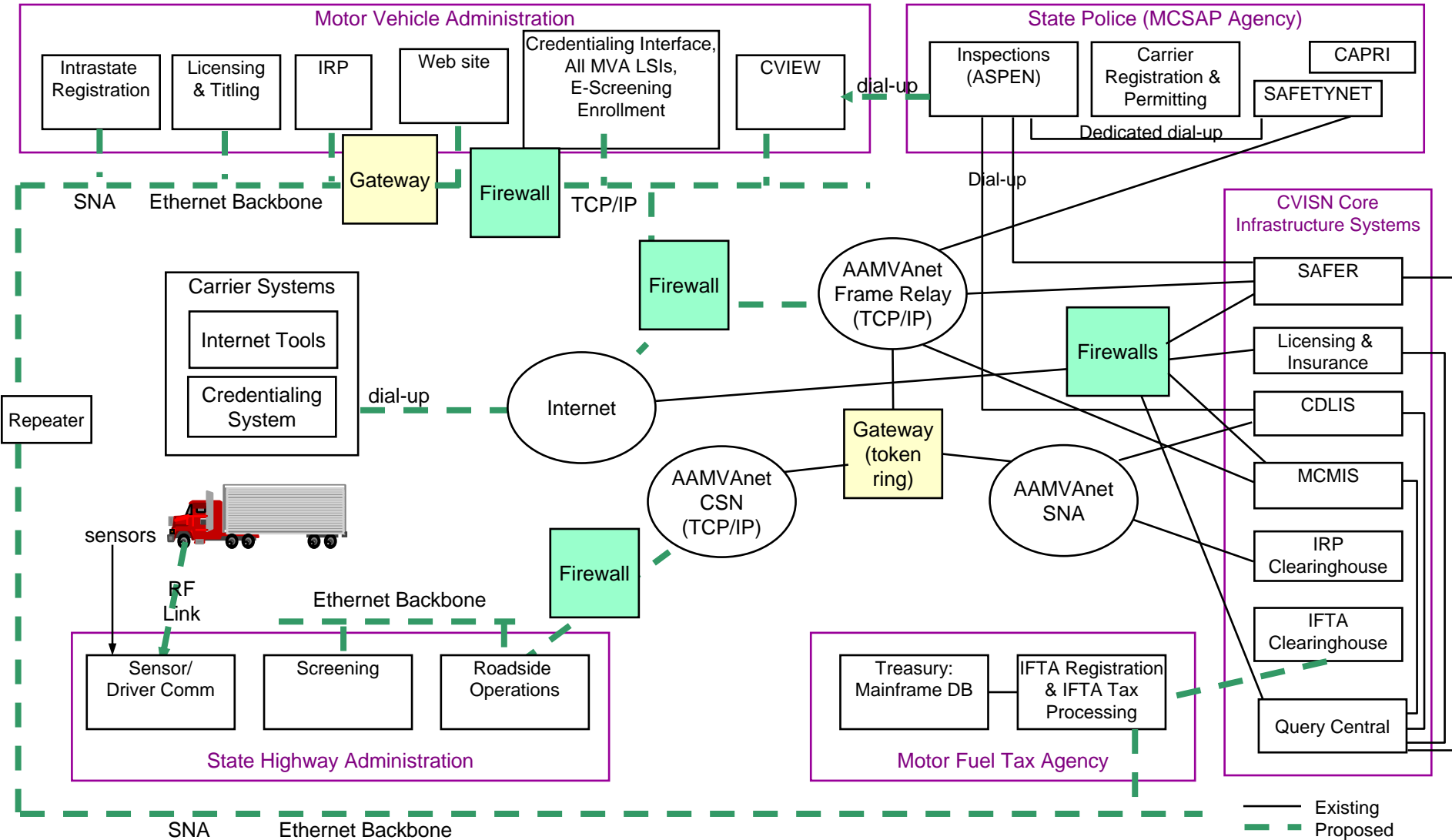

— Existing  
 - - - Proposed

# CVISN System Design Description

## 5 - References

---

1 Introduction

2 System Requirements

3 System Design Overview

4 Putting It All Together

5 References

6 Change Request

# References

---

- JHU/APL, *ITS/CVO Commercial Vehicle Information Systems and Networks (CVISN) Glossary*, POR-96-6997 V2.0, December 2000. (Delivered via SSD-PL-00-0751, 16 February 2001.) The latest version will be available on the JHU/APL CVISN Web site <http://www.jhuapl.edu/cvisn/> [Documents-CVISN Architecture and Standards].
- JHU/APL, *CVISN Operational and Architectural Compatibility Handbook (COACH), Part 1 – Operational Concept and Top-Level Design Checklists*, POR-97-7067 V3.0, to be published. The latest version will be available on the JHU/APL CVISN Web site <http://www.jhuapl.edu/cvisn/> [Documents-CVISN Architecture and Standards].
- JHU/APL, *CVISN Operational and Architectural Compatibility Handbook (COACH), Part 2 – Project Management Checklists*, POR-97-7067 P2.0, September 1999. The latest version will be available on the JHU/APL CVISN Web site <http://www.jhuapl.edu/cvisn/> [Documents-CVISN Architecture and Standards].
- JHU/APL, *CVISN Operational and Architectural Compatibility Handbook (COACH), Part 3 – Detailed System Checklists*, POR-97-7067 V1.0, October 2000. (Delivered via SSD-PL-00-0618, 1 December 2000.) [Note: This document is scheduled for update in 2003.] The latest version will be available on the JHU/APL CVISN Web site <http://www.jhuapl.edu/cvisn/> [Documents-CVISN Architecture and Standards].
- JHU/APL, *CVISN Operational and Architectural Compatibility Handbook (COACH), Part 4 – Interface Specification Checklists*, POR-97-7067 P2.0, October 2000. (Delivered via SSD-PL-00-0633, 1 December 2000.) [Note: This document is scheduled for update in 2003.] The latest version will be available on the JHU/APL CVISN Web site <http://www.jhuapl.edu/cvisn/> [Documents-CVISN Architecture and Standards].
- JHU/APL, *CVISN Operational and Architectural Compatibility Handbook (COACH), Part 5 – Interoperability Test Criteria*, POR-98-7126 V1.0, July 2001. (Delivered via SSD-PL-01-0444, 21 September 2001.) The latest version will be available on the JHU/APL CVISN Web site <http://www.jhuapl.edu/cvisn/> [Documents-CVISN Architecture and Standards].

# References

---

- ANSI ASC X12, *Electronic Data Interchange X12 Standards*, Draft Version 4 Release 4 (a.k.a. Release 4040), December 2000.
- JHU/APL, *Commercial Vehicle Information Systems and Networks (CVISN) Recommendations for Primary Identifiers*, V1.0, October 2002. (Delivered via SSD-PL-02-0471, 14 November 2002.) The latest version will be available on the JHU/APL CVISN Web site <http://www.jhuapl.edu/cvisn/> [Documents-White Papers].
- JHU/APL, *Electronic Data Interchange (EDI) Implementation Guide for Commercial Vehicle Credentials (Transaction Set 286), Volume I, International Registration Plan (IRP) Credential Transactions, ANSI ASC X12 Version 4 Release 4*, POR-96-6993 V1.0, March 2001. (Delivered via SSD-PL-01-0141, 12 April 2001.) The latest version will be available on the JHU/APL CVISN Web site <http://www.jhuapl.edu/cvisn/> [Documents-EDI and XML].
- JHU/APL, *Electronic Data Interchange (EDI) Implementation Guide for Commercial Vehicle Credentials (Transaction Set 286), Volume III, International Fuel Tax Agreement (IFTA) Credential Transactions, ANSI ASC X12 Version 4 Release 4*, POR-97-6996 V1.0, March 2001. (Delivered via SSD-PL-01-0147, 19 April 2001.) The latest version will be available on the JHU/APL CVISN Web site <http://www.jhuapl.edu/cvisn/> [Documents-EDI and XML].
- JHU/APL, *Electronic Data Interchange (EDI) Implementation Guide for Commercial Vehicle Credentials (Transaction Set 286), Volume IV, Oversize / Overweight (OS/OW) Credential Transactions, ANSI ASC X12 Version 4 Release 4*, POR-97-7068 V1.0, March 2001. (Delivered via SSD-PL-01-0151, 19 April 2001.) The latest version will be available on the JHU/APL CVISN Web site <http://www.jhuapl.edu/cvisn/> [Documents-EDI and XML].
- JHU/APL, *Electronic Data Interchange (EDI) Implementation Guide for Commercial Vehicle Safety and Credentials Information Exchange (Transaction Set 285), ANSI ASC X12 Version 4 Release 4*, POR-96-6995 V1.0, March 2001. (Delivered via SSD-PL-01-0052, 12 April 2001.) The latest version will be available on the JHU/APL CVISN Web site <http://www.jhuapl.edu/cvisn/> [Documents-EDI and XML].
- JHU/APL, *Federal Motor Carrier Safety Administration (FMCSA) Code Directory*, POR-98-7127 V1.0, March 2001. (Delivered via SSD-PL-01-0054, 12 April 2001.) The latest version will be available on the JHU/APL CVISN Web site <http://www.jhuapl.edu/cvisn/> [Documents-EDI and XML].

# References

---

- JHU/APL, *Commercial Vehicle Information Systems and Networks (CVISN) System Design Description*, POR-97-6998 V2.0, August 2000. (Delivered via SSD-PL-00-0553, 13 September 2000.) [Note: This document is scheduled for update in 2003.] The latest version will be available on the JHU/APL CVISN Web site <http://www.jhuapl.edu/cvisn/> [Documents-CVISN Architecture and Standards].
- JHU/APL, *CVISN Guide to Top-Level Design*, POR-99-7187 V1.0, February 2001. (Delivered via SSD-PL-01-0070, 26 February 2001.) The latest version will be available on the JHU/APL CVISN Web site <http://www.jhuapl.edu/cvisn/> [Documents-CVISN Guides].
- JHU/APL, *CVISN Guide to Safety Information Exchange*, POR-99-7191 V 1.0, February 2002. (Delivered via SSD-PL-02-0088, 13 June 2002.) The latest version will be available on the JHU/APL CVISN Web site <http://www.jhuapl.edu/cvisn/> [Documents-CVISN Guides].
- JHU/APL, *CVISN Guide to Credentials Administration*, POR-99-7192 P.2, August 2000. (Delivered via SSD/PL-00-0015, 10 March 2000.) The latest version will be available on the JHU/APL CVISN Web site <http://www.jhuapl.edu/cvisn/> [Documents-CVISN Guides].
- JHU/APL, *CVISN Guide to Electronic Screening*, POR-99-7193 V1.0, March 2002. (Delivered via SSD-PL-02-0224, 28 May 2002.) The latest version will be available on the JHU/APL CVISN Web site <http://www.jhuapl.edu/cvisn/> [Documents-CVISN Guides].
- JHU/APL, *Introductory Guide to CVISN*, POR-99-7186 P.2, February 2000. (Delivered via SSD/PL-00-0010, 21 January 2000.) The latest version will be available on the JHU/APL CVISN Web site <http://www.jhuapl.edu/cvisn/> [Documents-CVISN Guides].
- ASTM Standard E2158-01, *Standard Specification for Dedicated Short Range Communication (DSRC) Physical Layer Using Microwave in the 902 to 928 MHz Band*, September 2002. For a summary of the standard, see <http://www.its-standards.net/Documents/ASTM-PS111-98.PDF>.
- ASTM, *ASTM Draft Standard for Dedicated, Short Range, Two-Way Vehicle to Roadside Communications Equipment*, Draft 6, 23 February 1996.

# References

---

- IEEE, Standard 1455-99, *Standard for Message Sets for Vehicle/Roadside Communications*, September 1999. For a summary of the standard, see <http://www.its-standards.net/>.
- The U. S. Department of Transportation, Federal Highway Administration, *Proposed Rule: Dedicated Short Range Communications In Intelligent Transportation Systems (ITS) Commercial Vehicle Operations*, 23 CFR Part 945, [FHWA Docket No. FHWA 99-5844] RIN 2125-AE63, *Federal Register*, Vol. 64, No. 250, 30 December 1999. p. 73674-73742. Available from the Federal Register Online via GPO Access, [http://www.access.gpo.gov/su\\_docs/aces/aces140.html](http://www.access.gpo.gov/su_docs/aces/aces140.html) [DOCID:fr30de99-43].
- JHU/APL, *Electronic Data Interchange (EDI) Implementation Guide for Commercial Vehicle Safety Reports (Transaction Set 284), Volume I, Inspection Report Transactions, ANSI ASC X12 Version 4 Release 4*, POR-99-7202 V1.0, March 2001. (Delivered via SSD-PL-01-0132, 19 April 2001.) The latest version will be available on the JHU/APL CVISN Web site <http://www.jhuapl.edu/cvisn/> [Documents-EDI and XML].
- JHU/APL, *Commercial Vehicle Operations (CVO) Information Systems Requirements Specification*, PDI-94-195 (Working Draft), 30 November 1994.
- JHU/APL, *Commercial Vehicle Information Systems and Networks (CVISN) Architecture Specification*, POR-96-6985 (Preliminary), February 1996. (Delivered via SSD/PL-96-0147, 29 March 1996.)
- JHU/APL, *Commercial Vehicle Information Systems and Networks (CVISN) Operational Concept Document*, POR-96-6989 P.2, June 1996. (Delivered via SSD/PL-96-0330.)
- JHU/APL, *Safety and Fitness Electronic Records System (SAFER) and Commercial Vehicle Information Exchange Window (CVIEW) Carrier, Vehicle, and Driver Snapshots*, V1.0, August 2001. (Delivered via SSD-PL-01-0258, dated 6 August 2001.) The latest version will be available on the JHU/APL CVISN Web site <http://www.jhuapl.edu/cvisn/> [Documents-White Papers].

# References

---

- JHU/APL, *Draft Specification for Dedicated Short Range Communications (DSRC) for Commercial Vehicles*, V0.0.1, November 1999. (Delivered via SSD-PL-99-0784, 30 December 1999.) The latest version will be available on the JHU/APL CVISN Web site <http://www.jhuapl.edu/cvisn/> [Documents-DSRC].  
    “Active Sandwich” Protocol specification.
- JHU/APL, *Electronic Credentialing Preference Survey Results*, 29 June 2000. (Delivered via SSD-PL-00-0408, 10 July 2000.) The latest version will be available on the JHU/APL CVISN Web site <http://www.jhuapl.edu/cvisn/> [Documents-Credentials Administration].
- The US DOT Joint Program Office, *The National ITS Architecture: a Framework for Integrated Transportation into the 21<sup>st</sup> Century*, maintained by Iteris. Available in CD format or on the WWW at <http://www.iteris.com/itsarch/>.
- JHU/APL, *Commercial Vehicle Information Systems and Networks (CVISN) Architecture*, SSD-POR-02-7364 V1.0, May 2002. (Delivered via SSD-PL-02-0307, 22 August 2002.) The latest version will be available on the JHU/APL CVISN Web site <http://www.jhuapl.edu/cvisn/> [Documents-CVISN Architecture and Standards].



# CVISN System Design Description

## 6 – Change Requests

---

- 1 Introduction
- 2 System Requirements
- 3 System Design Overview
- 4 Putting It All Together
- 5 References
- 6 Change Requests
  - Incorporated into Previous Versions
  - Incorporated into Current Version

# Change Requests Incorporated into Previous Versions

---

## **Change Summary V1.0:**

Version V1.0 of the document incorporated revisions related to these change requests:

- 970116 (stakeholder view, system names, flows associated with inspection reporting)
- 970303 (capability names)
- 970307 (add intrastate vehicle registration where missing)
- 970312 - A baseline update of design drawings to incorporate comments received from stakeholders and the CVISN technical team. Additional top-level design information has also been added.
- 970710 - Change groupings on Stakeholder View; add Treasury
- CR 220 - Change inspection reporting/retrieval paths & methods
- CR 285 - Add WebCAT, remove Safety Information System; change CAT to Credentialing System (e.g., CAT)
- CR 311 - Clarify ITS/CVO versus CVISN Architecture
- CR 356 - Modifies the way intrastate inspections are reported
- CR 529 - Add Electronic Screening Enrollment to the design
- CR 530 - Add Licensing & Insurance, RSPA HazMat, SSRS; remove UCR
- CR 548 - Primary Carrier ID
- CR 549 - Transponder ID
- CR 552 - Restructure CVISN System Design Description
- CR 560 - Lengthen VIN
- CR 570 - Add jurisdiction & plate as vehicle IDs

# Change Requests Incorporated into Previous Versions

---

## **Change Summary V2.0:**

References to the CRs listed below appeared in the document so that the reader knew where each CR affected Version V2.0 of the document. Version V2.0 of the document incorporated revisions related to these change requests:

- CR 313 – Disapproved (EDI interface for IRP CH)
- CR 630 – Split country and subdivision in Driver Unique ID
- CR 631 – Clarify description of Trip/Load Number to match IEEE P1455 standard
- CR 788 – SAFER/CVIEW Data Vulnerability
- CR 827 – Snapshot update views & control, especially how SAFER & CVIEW should handle data from multiple sources
- CR 1047 – Update CVISN to include Archived Data User Service
- CR 1048 – Update CVISN for Web sites and XML for Credentialing
- CR 1084 – Update Design Template and Stakeholder View
- CR 1099 – Add Web to Generic CVISN Configuration
- CR 1159 – Update DSRC references
- CR 1164 – Clarify interface options (EDI, XML, Web, other) for Safety
- CR 1171 – Use Snapshots for E-Screening in Automated Process
- CR 1172 – Clarify & complete concepts and requirements for E-Screening Enrollment
- CR 1202 – Update Network Template

Note: to see how these change requests were applied, see V2.0 of this document.

# Change Requests Incorporated into the Current Version

---

*In January, 2002, APL transitioned to a new tool for Configuration Management. The change request numbering was reinitialized; hence CR numbers have wrapped around.*

The following Change Requests (CR) were incorporated into the current version of this document.

- CR 1084 – Update Design Template and Stakeholder View
  - ISS-2 and PIQ added to Roadside block (oversight in Version 2.0)
- CR 58 – Transponder ID
  - Transponder ID is now represented as a hexadecimal number vice decimal.
- CR 69 – IFTA tax scenario changes
  - Added TS 149 and clarified use of TS 150, 151, and 813 in accordance with IFTA Tax Group advice.
- CR 72 – No EDI queries from APL developed CVIEW to SAFER; SAFER accepts EDI and RPC
  - Clarified current implementation for queries in SAFER and CVIEW
- CR 82 – Align CVISN and National ITS Architecture flows
  - JHU/APL, *Alignment of the CVISN and National ITS Architectures*, SSD/PL-01-0358, with enclosure *CVISN and National ITS Architecture Alignment*, June 2001, dated August 2001. (pages 16 and 17)
  - Aggregated VS with the CVS and included relevant VS equipment packages to show those ITS services that are common to all vehicles, not exclusive to Commercial Vehicles. (pages 14, 15, 18)
  - Changed the legend on the line types to align with the National ITS Architecture to show connections between subsystems. (page 14)
  - Updated the National ITS Architecture sausage diagram
  - Updated the CVISN Architecture equipment packages diagram
- CR 90 – Clarify Level 1 summary slide
  - The summary definition of CVISN Level 1 deployment was included in the text
- CR 95 – Update DSRC “sandwich” spec guidance
  - Updated carrier-state interfaces to reflect currently-recommended standards.
- CR 98 – Update the Interfaces Within the State diagram in the CVISN System Design Description
  - Added dashed lines to indicate custom interface agreements as alternatives to EDI interfaces
- CR 100 – IBC/CVISN/National ITS Architecture alignment
  - Updated the CVISN Architecture flow diagram
  - Updated the CVISN Architecture equipment packages diagram
  - Removed IBC as an independent architecture

# Change Requests Incorporated into the Current Version

---

- CR 101 – Update documents regarding TS 284 not supported in Fed systems
  - Added note saying that the TS 284 is not supported
- CR 103 – Align with National ITS Arch Maintenance & Construction Ops
  - Updated the CVISN Architecture Flow Diagram
  - Updated the National ITS Architecture sausage diagram
  - Updated the CVISN Architecture equipment packages diagram
- CR 358 – Update documentation reflecting V4 of Nat'l ITS Architecture
  - Updated the CVISN Architecture Flow Diagram
  - Updated the National ITS Architecture sausage diagram
  - Updated the CVISN Architecture equipment packages diagram
- CR 604 – Disapproved (EDI interface for IRP and IFTA CH)
  - Lines connecting SAFER to the IRP and IFTA CHs were removed.
- CR 607 – Remove WWW, EDI, DSRC interfaces diagram; improve CVIEW description
  - Removed “The CVISN architecture connects subsystems via a combination of WWW, EDI and DSRC interface standards.” slide.
  - Added slide “The State CVIEW handles the exchange of safety and credentials information via SAFER.”
- \* {
  - CR 681 – Changes to IFTA transactions in SAFER 4.2
  - CR 682 – Changes to IRP transactions in SAFER 4.2
  - CR 683 – Changes to E-Screening transactions in SAFER 4.2
  - CR 684 – Changes to SAFER to State trans. for MCMIS and L&I in SAFER 4.2
  - CR 685 – Changes to SAFER to State trans. for IFTA in SAFER 4.2
  - CR 686 – Changes to SAFER to State trans. for IRP in SAFER 4.2
  - CR 687 – Changes to SAFER to State trans. for E-Screening in SAFER 4.2
  - CR 688 – Changes to EDI State-SAFER interface in SAFER 4.2
  - CR 785 – Changes to SAFER to State trans. for Veh.Inspection in SAFER 4.2
    - Added the SAFER Option to safety information exchange slides
    - Added XML interfaces between SAFER and: IRP, IFTA registration, e-screening, roadside, and intrastate vehicle registration
  - CR 704 - Recommendations for Primary Identifiers White Paper
    - Replaced Standard Identifiers table in Section 3

# Change Requests Incorporated into the Current Version

---

- CR 861 – System Design Description document “clean-up”
  - Acronyms were expanded at first use
  - Organized to increase clarity
  - Section 6 (Change Requests) created for change management tracking
  - Modified some slide titles for consistency
  - Updated References format and versions
  - Section headings added to page footer
  - XML was added as an option for many transactions that used to be solely EDI
  - Double arrows between SAFER and MCMIS were replaced by a single arrow from New MCMIS to SAFER
  - Information was updated to bring it into line with the most recent CVISN guides and SAFER ICD
  - CAPRI functionality updated to be L1
- Note: For the most part, these changes are not identified with the CR number.*
- CR 877 – New MCMIS replaces MCMIS
  - Diagrams updated to reflect that the SAFER-MCMIS gateway removed
- CR 895 – Query Central needs to be added to the list of CVISN Core Infrastructure systems.
  - Query Central was added to the list of CVISN Core Infrastructure systems in both text and diagrams.
  - Diagrams were updated to show Query Central interfaces

\* These CRs are lumped together and called “SAFER XML” within the document.