

September 2007

Environmental Technology Verification Report

SKC, INC.
SIOUTAS PERSONAL CASCADE
IMPACTOR SAMPLER WITH
LELAND LEGACY[®] PUMP

Prepared by
Battelle

Battelle
The Business of Innovation

Under a cooperative agreement with

U.S. Environmental Protection Agency

ETV ✓ ETV ✓ ETV ✓

September 2007

Environmental Technology Verification Report

ETV Advanced Monitoring Systems Center

SKC, Inc.
Sioutas Personal Cascade
Impactor Sampler
with
Leland Legacy[®] Pump

by
Marielle Brinkman
Kenneth Cowen
Amy Dindal
Zachary Willenberg

Battelle
Columbus, Ohio 43201

Notice

The U.S. Environmental Protection Agency (EPA), through its Office of Research and Development, has financially supported and collaborated in the extramural program described here. This document has been peer reviewed by the Agency. Mention of trade names or commercial products does not constitute endorsement or recommendation by the EPA for use.

Foreword

The U.S. Environmental Protection Agency (EPA) is charged by Congress with protecting the nation's air, water, and land resources. Under a mandate of national environmental laws, the Agency strives to formulate and implement actions leading to a compatible balance between human activities and the ability of natural systems to support and nurture life. To meet this mandate, the EPA's Office of Research and Development provides data and science support that can be used to solve environmental problems and to build the scientific knowledge base needed to manage our ecological resources wisely, to understand how pollutants affect our health, and to prevent or reduce environmental risks.

The Environmental Technology Verification (ETV) Program has been established by the EPA to verify the performance characteristics of innovative environmental technology across all media and to report this objective information to permittees, buyers, and users of the technology, thus substantially accelerating the entrance of new environmental technologies into the marketplace. Verification organizations oversee and report verification activities based on testing and quality assurance protocols developed with input from major stakeholders and customer groups associated with the technology area. ETV consists of six environmental technology centers. Information about each of these centers can be found on the Internet at <http://www.epa.gov/etv/>.

Effective verifications of monitoring technologies are needed to assess environmental quality and to supply cost and performance data to select the most appropriate technology for that assessment. Under a cooperative agreement, Battelle has received EPA funding to plan, coordinate, and conduct such verification tests for "Advanced Monitoring Systems for Air, Water, and Soil" and report the results to the community at large. Information concerning this specific environmental technology area can be found on the Internet at <http://www.epa.gov/etv/centers/center1.html>.

Acknowledgments

The authors wish to acknowledge the support of all those who helped plan and conduct the verification test, analyze the data, and prepare this report. We would like to thank the Mickey Leland National Urban Air Toxics Research Center for providing co-funding to perform the verification testing. We also appreciate SKC's cooperation and prompt assistance in obtaining not only the test equipment but the Personal Environmental Monitor reference equipment as well. We would also like to thank the peer reviewers for their assistance in planning this verification test and carefully reviewing the test/QA plan and verification report. Specifically, we would like to acknowledge Jeff Cook of the California Air Resources Board, Ron Williams of the EPA (NERL), and Will Ollison of the American Petroleum Institute.

Contents

	<u>Page</u>
Notice.....	ii
Foreword.....	iii
Acknowledgments.....	iv
List of Abbreviations	x
Chapter 1 Background	1
Chapter 2 Technology Description	2
Chapter 3 Test Design.....	4
3.1 Pump Testing	8
3.1.1 Moderate Temperature and Humidity (25°C, 30%).....	8
3.1.2 Sampling Performance at Different Pressure Loads.....	9
3.1.3 High Temperature and Moderate/High Humidity (40°C, 60/90%).....	10
3.2 Sampling Efficiency Comparison	11
3.2.1 Nozzle Selection	13
3.2.2 Sampler Placement.....	14
3.3 Sampling Metals in Ambient Air.....	16
3.4 Sampler Ease of Use, Reliability, and Subject Acceptance/Compliance	17
Chapter 4 Quality Assurance/Quality Control.....	20
4.1 Flow Rate Checks	20
4.2 Pressure Drop Checks.....	20
4.3 Field Replicates.....	24
4.4 Field Blanks	24
4.5 Checks of Metal/Element Analysis Accuracy	28
4.6 Gravimetric Measurement Checks.....	30
4.7 Audits.....	31
4.7.1 Performance Evaluation Audit	31
4.7.2 Technical Systems Audit.....	33
4.7.3 Audit of Data Quality	33
4.8 QA/QC Reporting.....	33
4.9 Data Review.....	33
4.10 Deviation from the Test/QA Plan	35
Chapter 5 Statistical Methods and Reported Parameters.....	36
5.1 Comparability of Sampling Efficiency	36
5.2 Variability	36
5.3 Metal/Element Detection	37
5.4 Ease of Use, Reliability and Subject Acceptance/Compliance.....	37
Chapter 6 Test Results	38

6.1 Pump Testing	38
6.1.1 Moderate Temperature and Humidity (25°C, 30%)	38
6.1.2 Sampling Performance at Different Pressure Loads	41
6.1.3 High Temperature and Moderate/High Humidity (40°C, 60/90%)	46
6.2 Sampling Efficiency Comparison	46
6.2.1 PCIS:DCI-6 and PCIS:PEM TPM Comparisons	48
6.2.2 PCIS:DCI-6 0.5 – 1.0 µm and ≤0.5 µm Comparisons	50
6.2.3 PCIS:FRM PM _{2.5} Comparison	50
6.3 Sampling Metals in Ambient Air	52
6.4 Sampler Ease of Use, Reliability and Subject Acceptance/Compliance	56
6.4.1 Ease of Use and Subject Acceptability	56
6.4.2 Reliability and Subject Compliance	60
Chapter 7 Performance Summary	63
7.1 Pump Testing	63
7.2 Sampling Efficiency Comparison	64
7.3 Sampling Metals in Ambient Air	65
7.4 Ease of Use, Reliability, and Subject Acceptance/Compliance	65
Chapter 8 References	67

Figures

Figure 2-1. Components of SKC Sioutas PCIS	2
Figure 2-2. Sioutas PCIS and Leland Legacy [®] Pump	2
Figure 3-1. Leland Legacy [®] Pumps (4) Inside the Constant Temperature and Humidity Chamber	8
Figure 3-2. Leland Legacy [®] Pumps (4) Inside the Constant Temperature and Humidity Chamber (top) Connected to Electronic Flow Meters External to the Chamber (bottom)	9
Figure 3-3. Leland Legacy [®] Pumps (4) Connected to Flow Cells Equipped with Hot Wire Anemometers in a Constant Temperature and Humidity Chamber (top) For the Extreme Temperature (40°C) and Moderate/High Humidity (60/90%) Tests. Data Logging Velocity Meters Used to Monitor the Pumps' Flow Performance Were Located Outside the Chamber (bottom)	10
Figure 3-4. Exploded Diagram of the PEM	12
Figure 3-5. Schematic of the DCI-6	12
Figure 3-6. Schematic Diagram Showing the Location of Test and Reference Particle Samplers in the Large Environmental Chamber for the Sampling Efficiency Testing	14
Figure 3-7. Test and Reference Particle Samplers Inside the Battelle Environmental Chamber Just Prior to Aerosol Generation for the Sampling Efficiency Testing	15

Figure 3-8. The Leland Legacy [®] Pumps Were Placed Outside the Large Environmental Chamber (left), and Were Connected via Feedthroughs to the Sioutas PCIS (Test) and PEM (Reference) Samplers Inside the Chamber (right)	16
Figure 6-1. Battery Operation Duration for Original and Retrofitted Pumps in 25°C, 30% Relative Humidity Environment (n = 4 pumps per test).....	41
Figure 6-2. Battery Operation Duration for Original (top) and Retrofitted (bottom) Pumps Sampling Under Different Pressure Drops (n = 4 pumps per test).....	42
Figure 6-3. Average Flow (L/min) for Original and Retrofitted (bottom) Pumps Sampling Under Different Pressure Drops (n = 4 pumps per test)	43
Figure 6-4. Flow Rate (L/min) for Original Pump Test #2 at 19 inch H ₂ O pressure drop	44
Figure 6-5. Sound Level (dB) for Original (top) and Retrofitted (bottom) Pumps Sampling Under Different Pressure Drops (n = 4 pumps per test)	45
Figure 6-6. Comparison of TPM Collected Using Test (Sioutas PCIS) and Reference (DCI-6 and PEM 10 µm cutpoint) Sampler Gravimetric Results for TPM	49
Figure 6-7. Comparison of PM _{2.5} Collected Using Test (Sioutas PCIS) and Reference (FRM PM _{2.5} and DCI-6 ≤2.0 µm cutpoint) Samplers	51
Figure 6-8. Detectable Metals/Elements Found in Ambient Air PM _{2.5} Collected Over a 48-hour Period using Test (Sioutas PCIS) and Reference (PEM) Samplers for Test 1.....	52
Figure 6-9. Detectable Metals/Elements Found in Ambient Air PM _{2.5} Collected Over a 48-hour Period using Test (Sioutas PCIS) and Reference (PEM) Samplers for Test 2.....	53
Figure 6-10. Detectable Metals/Elements Found in Ambient Air PM _{2.5} Collected Over a 48-hour Period using Test (Sioutas PCIS) and Reference (PEM) Samplers for Test 3.....	53
Figure 6-11. Metal/Element Levels Detected in 48-hour Ambient Air PM _{2.5} Samples Collected Using Test (Sioutas PCIS) and Reference (PEM) Samplers	54
Figure 6-12. Particle Distribution of Detectable Metals/Elements Measured in 48-hr Ambient Air (Columbus, OH) PM _{2.5} Samples Collected Using Sioutas PCIS Samplers.....	55
Figure 6-13. Comparison of the Pump Movement Data Logged by the Accelerometers with The Time/Activity Diary Data (Show in Red, 5 = High Activity) for Three Subjects Who Appeared to Follow the Sampling Protocol for the 48-hour Period	61
Figure 6-14. Comparison of the Pump Movement Data Logged by the Accelerometers with The Time/Activity Diary Data (Show in Red, 5 = High Activity) for Three Subjects Who Appeared to Stop Following the Sampling Protocol for the 48-hour Period.....	62

Tables

Table 3-1. Manufacturer’s Operating Specifications for the Leland Legacy [®] Pump and Sioutas PCIS	5
Table 3-2. Verification Test Activities	6

Table 3-3. Experimental Matrix for Sioutas PCIS Sampling Efficiency Comparison	11
Table 3-4. Mass Mean Diameter, Geometric Standard Deviation, Number Mean Diameter, and Aerosol Generation Rate for Evaluated Nozzles.....	13
Table 3-5. Instrument and Method Detection Limits (MDLs) for Metal/Element Analyses Using XRF	18
Table 4-1. Summary of Section 3.1 Pump Testing Flow Rate and Pressure Drop Data	21
Table 4-2. Summary of Sections 3.2-3.4 Sioutas PCIS Testing Flow Rate and Pressure Drop Data	22
Table 4-3. Field Replicates for the Sampling Efficiency Comparison Test	24
Table 4-4. PEMs Field Blank (PTFE, 37 mm) Summary of Detectable Metals/Elements	25
Table 4-5. Sioutas PCIS After-Filter Field Blank (PTFE, 37 mm) Summary of Detectable Metals/Elements.....	26
Table 4-6. Sioutas PCIS Field Blank (PTFE, 25 mm) Summary of Detectable Metals/Elements.....	27
Table 4-7. Summary of Quality Assurance Standards (QS), NIST-Certified Standard Reference Materials (SRMs), and Blind Performance Evaluation (PE) Samples Analyzed Using XRF	29
Table 4-8. Summary of the Gravimetric Precision Data Collected During the Sampling Efficiency Comparison Testing	30
Table 4-9. Summary of the Substrate Stability Data Collected During the Sampling Efficiency Comparison Testing	31
Table 4-10. Summary of Performance Evaluation Flow Audits.....	32
Table 4-11. Performance Evaluation Audit of the Analytical Balance	32
Table 4-12. Summary of the Data Recording Process.....	34
Table 6-1. Flow Rate Variability (L/min) and Duration of Battery-Powered <i>Original</i> Pump Operation (Hours) at 25°C and 30% Relative Humidity After a 15-hour Battery Charge	39
Table 6-2. Flow Rate Variability (L/min) and Duration of Battery-Powered <i>Retrofitted</i> Pump Operation (Hours) at 25°C and 30% Relative Humidity After a 15-hour Battery Charge	40
Table 6-3. Test and Reference Sampler Gravimetric Comparisons	47
Table 6-4. Summary of Comparison Between the Sioutas PCIS, DCI-6, and PEM for Particle Sizes from Test Aerosol.....	48
Table 6-5. Comparison of Sioutas PCIS, DCI-6, and PEM (10 µm cutpoint) Sampler Gravimetric Results for TPM.....	49
Table 6-6. Comparison of Sioutas PCIS and DCI-6 Sampler Gravimetric Results for Similar Aerodynamic Diameter Cutpoints.....	50
Table 6-7. Summary of Comparison Between 48-hour Ambient Air PM _{2.5} Metal/Element Levels Collected Using the Test (Sioutas PCIS) and Reference (PEM) Samplers.....	55

Table 6-8. Summary of Ease of Use, Reliability, and Subject Acceptability Questionnaire Responses (n = 7 Subjects)57

Table 6-9. Subjects' and Laboratory Technicians' Comments and Suggestions Regarding the Sioutas PCIS Sampler59

Appendices

Appendix A. PCIS Questionnaire A-1

Appendix B. Time/Activity DiaryB-1

List of Abbreviations

A/C	alternating current
ACH	air changes per hour
AMS	Advanced Monitoring Systems
DCI-6	Delron cascade impactor, model DCI-6
cm ²	square centimeter(s)
CTHC	constant temperature and humidity chamber
dB	decibel(s)
EPA	U.S. Environmental Protection Agency
ETV	Environmental Technology Verification
FRM	federal reference method
ft	foot/feet
GC/ECD	gas chromatograph with electron capture detection
H ₂ O	water
inch	inch or inches
KCl	potassium chloride
L/min	liter(s) per minute
µm	micrometer(s)
µg/m ³	microgram(s) per cubic meter
m ³	cubic meter(s)
mg/m ³	milligram(s) per cubic meter
mm	millimeter(s)
NERL	National Exposure Research Laboratory
NIST	National Institute of Standards and Technology
PCIS	personal cascade impactor sampler
PE	performance evaluation
PEM	personal environmental monitor
PM	particulate matter
PT	performance test
PTFE	Polytetrafluoroethylene (Teflon [®])
QA	quality assurance
QC	quality control
QMP	quality management plan
QS	quality assurance standard

RPD	relative percent difference
RSD	relative standard deviation (standard deviation ÷ mean x 100%)
SD	standard deviation
SOP	standard operating procedure
SRM	standard reference material
TPM	total particulate matter
TSA	technical systems audit
Vdc	volts direct current
XRF	X-ray fluorescence

Chapter 1 Background

The U.S. Environmental Protection Agency (EPA) supports the Environmental Technology Verification (ETV) Program to facilitate the deployment of innovative environmental technologies through performance verification and dissemination of information. The goal of the ETV Program is to further environmental protection by accelerating the acceptance and use of improved and cost-effective technologies. ETV seeks to achieve this goal by providing high-quality, peer-reviewed data on technology performance to those involved in the design, distribution, financing, permitting, purchase, and use of environmental technologies.

ETV works in partnership with recognized testing organizations; with stakeholder groups consisting of buyers, vendor organizations, and permittees; and with the full participation of individual technology developers. The program evaluates the performance of innovative technologies by developing test plans that are responsive to the needs of stakeholders, conducting field or laboratory tests (as appropriate), collecting and analyzing data, and preparing peer-reviewed reports. All evaluations are conducted in accordance with rigorous quality assurance (QA) protocols to ensure that data of known and adequate quality are generated and that the results are defensible.

The EPA's National Exposure Research Laboratory and its verification organization partner, Battelle, operate the Advanced Monitoring Systems (AMS) Center under ETV. The AMS Center recently evaluated the performance of the SKC Inc. Sioutas Personal Cascade Impactor Sampler (PCIS) with the Leland Legacy[®] pump for measuring ambient particulate matter (PM). Personal cascade impactor samplers were identified as a priority technology category for verification through the AMS Center stakeholder process.

Chapter 2 Technology Description

The objective of the ETV AMS Center is to verify the performance characteristics of environmental monitoring technologies for air, water, and soil. This verification report provides results for testing the Sioutas PCIS. The following is a description of the Sioutas PCIS and the Leland Legacy[®] pump, based on information provided by the vendor (SKC Inc.). The information provided below was not verified in this test.

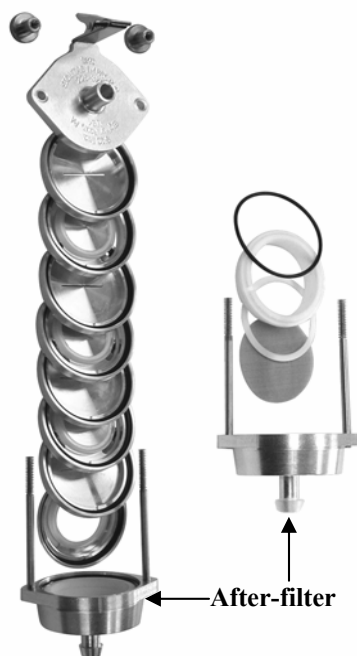

Figure 2-1. Components of SKC Sioutas PCIS.

The Sioutas PCIS consists of four impaction stages (with a collector plate and an accelerator plate) followed by an after-filter (see Figure 2-1). Each impaction stage holds a 25 mm (0.5 μm pore size) impaction substrate that collects particles above a specific size (50% cut-point) starting from the largest particles with aerodynamic diameters $>2.5 \mu\text{m}$, Stage A; and going smaller: 2.5 – 1.0 μm , Stage B; 1.0 – 0.5 μm , Stage C; and 0.5 – 0.25 μm , Stage D. The smallest particles ($<0.25 \mu\text{m}$) collect on a 37-mm (2.0 μm pore size) after-filter. The Sioutas PCIS, which is clipped onto a shirt lapel or pocket, is connected with tubing to a calibrated Leland Legacy[®] constant flow sample pump (Figure 2-2) that draws air through the impactor at 9 L/min. The 9 L/min flow rate must remain constant for

The Sioutas PCIS is designed to separate and collect airborne PM in specific size ranges, generally referred to as coarse, fine, and ultrafine. Results of the micro-environmental sampling performed with the Sioutas PCIS can be used to characterize particle mass, particle size, and chemical composition (constituents) of PM pollutants in air.

The Sioutas PCIS was designed to be operated with the Leland Legacy[®] pump, which allows for 24-hour sampling on battery power.



Figure 2-2. Sioutas PCIS and Leland Legacy[®] Pump.

precise particle separation. The chemically inert Teflon[®] impaction substrates and after-filter recommended for use in the Sioutas PCIS are well suited for both gravimetric analysis of PM mass and chemical analyses of PM constituents.

The Sioutas PCIS is 3.4 inches tall by 2.2 inches wide (9.0 by 5.6 cm); its inlet is 3/8-inch outer diameter (0.95 cm), 1/4-inch inner diameter (0.63 cm); and its outlet is 3/8-inch outer diameter, 1/4-inch inner diameter. It weighs 5.6 ounces (159 grams). The price of the Sioutas PCIS is \$505 and the Leland Legacy[®] pump costs \$1,249. Together the pump and PCIS costs \$1,754. Additionally, impaction substrates are approximately \$195 per 100 (each sampling requires four of these), and 50 collection filters cost approximately \$230 (each sampling requires one of these). An optional noise reducing nylon case is also available at a cost of \$87.

Chapter 3 Test Design

The objective of this verification test was to evaluate the Sioutas PCIS, coupled to the Leland Legacy[®] pump, on the basis of comparability with the sampling efficiency of three more well-known reference samplers; its ability to collect detectable levels of metals in ambient air; and its ease of use, reliability, and acceptance among volunteer subjects. Additionally, the verification test included an evaluation of the Leland Legacy[®] pump on the basis of duration of operation on a single battery charge sampling at different pressure drops, and 24-hour performance sampling under moderate and extreme temperature and humidity conditions. Prior to its introduction to the marketplace, the PCIS was characterized in the laboratory to corroborate the manufacturer's stated cutpoints, and evaluate collection efficiency and particle loading.⁽¹⁾ This verification test will not repeat the manufacturer's characterizations, but will instead proceed to the next logical step and conduct the evaluations described above.

Ambient PM as an air pollutant has become a major public health concern in the past 10 years. Health effects studies have used ambient monitors to represent human exposures. Using personal monitors, which incorporate the effects of factors such as indoor pollutants and human time/activity patterns, can significantly improve the understanding of individual exposures to PM. Newly introduced into the marketplace, miniaturized PCISs are worn in a subject's breathing zone, commonly clipped to a shirt collar, and separate and collect airborne particles onto a substrate in several size ranges, typically from 0.1 to 10 µm. These samplers are coupled to small, high-efficiency, battery-operated pumps that are designed to be capable of sampling for 24 hours on a single battery charge, and rugged enough to operate in hot, humid weather.

The manufacturer's operating specifications for the Leland Legacy[®] Pump⁽²⁾ and the Sioutas PCIS⁽³⁾ are shown in Table 3-1. During this verification test, the performance of the Leland Legacy[®] pump was monitored in terms of flow rate while the pump sampled under increasing pressure drop levels ranging from normal to extreme (1.7 times the manufacturer's recommended compensation range). Time and magnitude of flow rate fluctuations and termination of operation were summarized. Sound level data for the pump operating in the noise-reducing case was measured at a distance of 0.5 meter from the pump in decibels (dB) and logged to a file during the testing of the pump performance under increasing pressure drop loads. Pump performance was also monitored in high temperature-moderate humidity (40°C-60%) and high temperature-high humidity (40°C-90%) environments. Again, time and magnitude of flow rate fluctuations and termination of operation were summarized.

Table 3-1. Manufacturer’s Operating Specifications for the Leland Legacy[®] pump and Sioutas PCIS.

<i>Leland Legacy[®] Pump</i>		
No.	Description	Specification
L1	Flow Range	5 – 15 L/min
L2	Compensation Range	15 L/min at 5 inch H ₂ O
		10 L/min at 12 inch H ₂ O
		5 L/min at 20 inch H ₂ O
L3	Operating Temperature Range	0 - 45°C
L4	Typical Run Time	
	–Sioutas PCIS (13 inch H ₂ O at 9 L/min) –PEM (2.0 µm PTFE filter at 10 L/min)	24 hours 24 hours
L5	Noise Level (measured 1 meter distance from pump operating at 10 L/min and 12 inch H ₂ O)	
	–Without case	64.1 dB
	–Housed in noise-reducing case	55.7 dB
<i>Sioutas PCIS</i>		
No.	Description	Specification
S1	Recommended After-Filter	37 mm diameter, 2.0 µm pore size PTFE ^a
S2	Recommended Impaction Substrate	25 mm diameter, 0.5 µm pore size PTFE ^b
S3	Flow Rate	9 L/min
S4	Maximum Particle Load	3.16 mg per stage
S5	After-Filter Maximum Operating Temperature	240°C

^a SKC Cat. No. 225-1709

^b SKC Cat. No. 225-1708

Three of the Leland Legacy[®] pumps failed during the extreme pressure drop tests, and one failed during the high temperature, moderate relative humidity test. Testing was halted after the fourth pump failure. The vendor, SKC, examined the four failed pumps and found that in each case the crank-arm pivot pin came loose from the diaphragm yoke assembly. SKC stated that the failures were due to operating the pumps at conditions outside the recommendations shown in Table 3-1, and that this problem had never been evidenced under normal field conditions. Nevertheless, SKC retrofitted the pumps with a new pin that has a hexagonal head designed to prevent this type of failure. In order to evaluate the retrofitted pumps, Battelle repeated all of the pump testing on the newly retrofitted pumps. SKC will incorporate this new pin design into Leland Legacy pumps manufactured by them.

The sampling efficiency of the Sioutas PCIS was compared with that of several reference samplers, and comparisons were reported as a relative percent difference of the means. Reference and test samplers were collocated in an environmental chamber where they sampled a test potassium chloride (KCl) aerosol for a defined period of time. Sampling efficiency determinations were made gravimetrically for all stages. The reference samplers employed in

this comparison included four Federal Reference Methods (FRMs) for PM with particle diameters of $\leq 2.5 \mu\text{m}$ (PM_{2.5} FRMs), four personal environmental monitors (PEMs, 10 μm cutpoint), and four Delron Cascade Impactor (DCI-6) samplers (16, 8, 4, 2, 1, and 0.5 μm cutpoints). This task involved four of each test and reference impactor samplers and was repeated three times to measure inter- and intra-sampler variability.

The verification test for the Sioutas PCIS was conducted by Battelle from January 16, 2006 through February 7, 2007, according to procedures specified in the *Test/QA Plan for Verification of Personal Cascade Impactor Samplers (PCISs) for Measuring Ambient Particulate Matter (PM)*.⁽⁴⁾ X-ray fluorescence (XRF) analyses were carried out by Chester LabNet according to EPA Compendium Method IO-3.31.⁽⁵⁾ Table 3-2 shows the verification schedule by month and year and test activity. The longer than normal period of testing resulted from the necessity to repeat the pump testing on pumps that were newly retrofitted by the manufacturer to improve performance under extreme operating conditions.

The Leland Legacy[®] pump, in both its original and retrofitted form, was evaluated for the following performance parameters:

- Sampling duration
- Operation in extreme temperature/humidity
- Sampling performance at different pressure drops.

The Sioutas PCIS, coupled to the Leland Legacy[®] pump, was evaluated for the following performance parameters:

- Comparability of sampling efficiency
- Ability to collect detectable levels of metals in ambient air
- Operational factors (ease of use, reliability, etc.)
- Subject acceptability/compliance.

Table 3-2. Verification Test Activities.

Month (Year)	Test Activity	Parameters
	Pump Testing – Original Pumps	Pump Evaluation
January - August (2006)	<ul style="list-style-type: none"> • Set up/installed PCISs in constant temperature and humidity chamber • Selected critical orifices to equal impactor pressure drop (11 inch H₂O) • Equipped pumps with data-logging flow meters • Measured pre- and post-experiment pressure drop and flow rate • Equipped chamber with data-logging sound-level meter 	<ul style="list-style-type: none"> • Duration of operation (monitored via flow rate) on single battery charge at moderate-temperature and low-humidity (25°C, 30%) conditions • Flow rate for 24 hours of battery operation in high-temperature, moderate-humidity (40°C, 60%) and high-temperature, high-humidity (40°C, 90%) conditions • Flow rate and noise level for duration of operation (single battery charge) under three pressure drops, ranging from 11 to 19 inch H₂O

Table 3-2. Verification Test Activities (continued)

Month (Year)	Test Activity	Parameters
	Sampling Efficiency Comparison	Comparing PCISs to Reference Samplers
January - March (2006)	<ul style="list-style-type: none"> • Set up/installed PCISs in environmental chamber • Set up/installed reference samplers in environmental chamber • Generated test KCl aerosol • Measured pre- and post-experiment pressure drop and flow rate • Determined mass associated with each particle size range 	<ul style="list-style-type: none"> • Mass associated with each particle size range ($\mu\text{g}/\text{m}^3$) • Pre- and post-experiment pressure drop (inch H_2O) and flow rate (L/min)
	Sampling Metals in Ambient Air	Comparing PCISs to PEMs
March - February (2006-2007)	<ul style="list-style-type: none"> • Set up/installed PCISs in chamber • Set up/installed PEMs in chamber • Collected ambient air for 48 hours • Measured pre- and post-experiment pressure drop and flow rate • Analyzed substrate filters for metals 	<ul style="list-style-type: none"> • Pre- and post-experiment pressure drop (inch H_2O) and flow rate (L/min) • Target metal concentrations (ng/m^3) associated with each particle size range in 48-hour ambient air sample
	• Sampler Ease of Use, Reliability, and Subject Acceptability/ Compliance	PCIS Evaluation Parameters
April - May (2006)	<ul style="list-style-type: none"> • Recruited 7 subjects • Explained sampling protocol, basic pump operation, time/activity diary to each subject • Characterized pump/PCIS and equipped with accelerometer; released to subject • After 48-hour sampling period, characterized pump/PCIS, downloaded accelerometer data • Subject provided time/activity diary and written response to questionnaire • Compensated subject for participation in study 	<ul style="list-style-type: none"> • Pre- and post-experiment pressure drop (inch H_2O) and flow rate (L/min) • Qualitative subject acceptance and compliance with sampling protocol (questionnaire) • Semi-quantitative subject compliance with sampling protocol (compare gross accelerometer data with time/activity diary)
June - July (2006)	Vendor performs analysis of failed pumps, retrofits original pumps with a specially designed pin, performs short- and long-term performance tests on retrofitted pumps and then sends retrofitted pumps to Battelle for ETV verification testing.	
	Pump Testing - Retrofitted Pumps	Pump Evaluation
August - September (2006)	<ul style="list-style-type: none"> • Set up/installed PCISs in constant temperature and humidity chamber • Selected critical orifices to equal impactor pressure drop (11 inch H_2O) • Equipped pumps with data-logging flow meters • Measured pre- and post-experiment pressure drop and flow rate • Equipped chamber with data-logging sound-level meter 	<ul style="list-style-type: none"> • Duration of operation (monitored via flow rate) on single battery charge at moderate-temperature and low-humidity (25°C, 30%) conditions • Flow rate for 24 hours of battery operation in high-temperature, moderate-humidity (40°C, 60%) and high-temperature/high-humidity (40°C, 90%) conditions • Flow rate and noise level for duration of operation (single battery charge) under three pressure drops, ranging from 11 to 19 inch H_2O

3.1 Pump Testing

All of the pump testing was performed on the group of four original pumps and four retrofitted pumps, with the exception of the high temperature, high humidity testing; the fourth original pump failed prior to the completion of this testing, prompting SKC's re-design and retrofit of all of the pumps. Each group of pumps (original and retrofitted) was tested in triplicate for each completed evaluation; these replicates are referred to in the discussion as Test 1, Test 2, and Test 3. All pump testing was performed with each pump clad in a noise-reducing nylon case (Model No. 224-89, SKC). Moderate temperature and humidity conditions were selected to mimic typical indoor environments, and high temperature and humidity conditions were selected to mimic outdoor summertime environments.

3.1.1 Moderate Temperature and Humidity (25°C, 30%)

To evaluate sampling duration, four Leland Legacy[®] pumps were placed inside a constant temperature and humidity chamber, as shown in Figure 3-1, under moderate temperature and low humidity conditions (25°C, 30%) and evaluated to determine the duration that each pump sampled on a single battery charge. Prior to their being placed in the chamber, the four pumps were allowed to operate using battery power until the battery charge decayed such that the pumps no longer functioned. The batteries were then charged for 15 hours. After the batteries were charged, the pumps were placed inside the chamber and configured with a flow meter (TopTrak, Sierra Instruments) external to the chamber and allowed to sample the chamber environment, as shown in Figure 3-2. The length and diameter of the tubing was chosen to yield a pressure drop of 11 inch H₂O to simulate the pressure drop of the Sioutas impactor. Analog data (0-5 Vdc) were collected from each of the flow meters using a PCMCIA data acquisition card (DAQCard 1200, National Instruments), laptop personal computer (Latitude 6100, Dell), and LabView (ver. 6.1, National Instruments) software. The pumps were allowed to run until the battery charge decayed and the pumps stopped functioning. The flow rate for each pump was logged electronically (analog output, 0-5 Vdc corresponding to 0-10 L/min) throughout the test.



Figure 3-1. Leland Legacy[®] Pumps (4) Inside the Constant Temperature and Humidity Chamber.

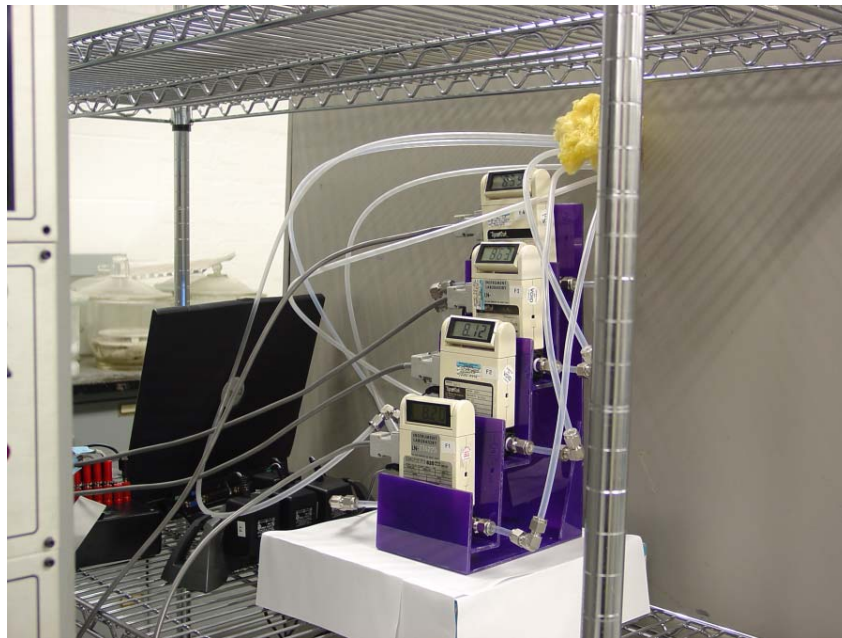

Figure 3-2. Leland Legacy[®] Pumps (4) Inside the Constant Temperature and Humidity Chamber (top) Connected to Electronic Flow Meters External to the Chamber (bottom).

3.1.2 Sampling Performance at Different Pressure Loads.

To evaluate sampling at different pressure loads, four Leland Legacy[®] pumps were outfitted with flow meters and precision orifices and/or tubing lengths and allowed to discharge and charge as described above. A series of tests were conducted in which the pumps were independently connected to three different critical orifices and/or tubing lengths, yielding pressure drops of 11, 15, and 19 inch H₂O. The pumps were allowed to run in an unoccupied (to limit noise

interference) laboratory held at $24 \pm 1^\circ\text{C}$ and $29 \pm 17\%$ relative humidity, until the battery charge decayed and all of the pumps stopped functioning. Flow rate (analog output, 0 – 5 Vdc corresponding to 0-10 L/min) for each pump and overall sound level data (analog output, 0 – 4 Vdc corresponding to a dynamic range of 0-80 dB) was logged electronically throughout the experiment. Three of the original pumps stopped functioning during the course of these tests. The tests were also performed on the retrofitted pumps.

3.1.3 High Temperature and Moderate/High Humidity (40°C, 60/90%)

Four Leland Legacy[®] pumps were allowed to discharge and charge as described above. They were then outfitted with precision orifices and connected to flow cells containing hot wire anemometer data logging velocity meters (435, Testo), as shown in Figure 3-3.



Figure 3-3. Leland Legacy[®] Pumps (4) Connected to Flow Cells Equipped with Hot Wire Anemometers in a Constant Temperature and Humidity Chamber (top) for the Extreme Temperature (40°C) and Moderate/High Humidity (60/90%) Tests. Data Logging Velocity Meters Used to Monitor the Pumps' Flow Performance Were Located Outside the Chamber (bottom).

The pumps' battery-powered operation was evaluated for 24 hours in high-temperature, moderate-humidity (40°C, 60%) and high-temperature, high-humidity (40°C, 90%) atmospheres. Flow rate data were logged electronically throughout the 24-hour period. When conducting these tests on the original pumps, only the first test was completed, at which point testing of the original pumps was halted due to the failure of the fourth pump. The tests were also performed on the retrofitted pumps.

3.2 Sampling Efficiency Comparison

The sampling efficiency of the PCIS “test” samplers was evaluated through comparisons with three “reference” samplers using a laboratory generated test aerosol (KCl) in a well-mixed environmental chamber (17.3 m³). The sampling efficiency chamber tests were conducted in triplicate for each completed comparison; these replicates are referred to in the discussion as Test 1, Test 2, and Test 3. The reference samplers were chosen based on the following parameters: 1) similar flow rates, 2) similar aerodynamic diameter cutpoints, 3) well characterized in the literature, and 4) availability to the study. The number and type of air samplers used to collect samples, the particle size cutpoint ranges, the number of samples collected for gravi-metric analyses, and the pumps and flow rates for the samplers are summarized in Table 3-3. The PEM, shown in an exploded diagram in Figure 3-4, is a personal

Table 3-3. Experimental Matrix for Sioutas PCIS Sampling Efficiency Comparison.

Sampler	Pump, Flow Rate	No. of Samplers in Chamber	Particle Diameter Cutpoints (µm)	No. of Samples for Gravimetric Analysis
Sioutas Personal Cascade Impactor Sampler (Test)	Leland Legacy [®] , 9 L/min	4	> 2.5	4
			≥1.0 and ≤2.5	4
			≥0.5 and ≤1.0	4
			≥0.25 and ≤0.5	4
			<0.25	4
			Total	20
PEMS Environmental Monitor (Reference)	SKC, 10 L/min	4	≤10	4
PM _{2.5} FRM (Reference)	Internal, 16.7 L/min	4	≤2.5	4
Delron DCI-6 Cascade Impactor (Reference)	Gast, 3 pumps at 12.5 L/min, 1 at 28.0 L/min	4	>16	4
			≥8.0 and ≤16	4
			≥4.0 and ≤2.5	4
			≥2.0 and ≤4.0	4
			≥1.0 and ≤2.0	4
			≥0.5 and ≤1.0	4
			<0.5	4
			Total	28

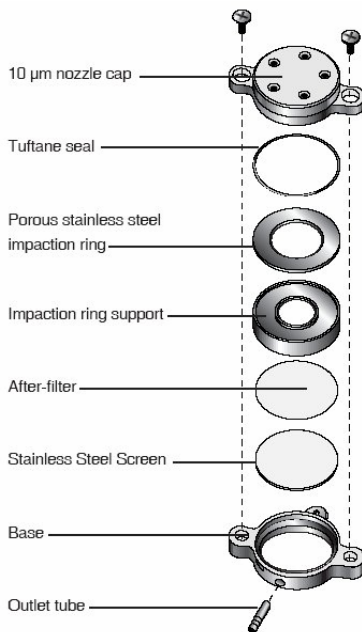

Figure 3-4. Exploded Diagram of the PEM.

air sampler that is well characterized and has been used extensively in the field for human exposure studies.⁽⁶⁻²³⁾ The FRM is the federal standard instrument used for regulatory purposes in the United States.^(24, 25) The DCI-6, shown schematically in Figure 3-5, was introduced in the late 1950s,⁽²⁶⁾ and its glass plate impaction substrates that don't require temperature and humidity conditioning make it a convenient tool for measuring particle size distribution.⁽²⁷⁻³⁵⁾ Each test was conducted in triplicate to establish precision, and four of each of the samplers were used in each test in order to measure inter- and intra-sampler variability.

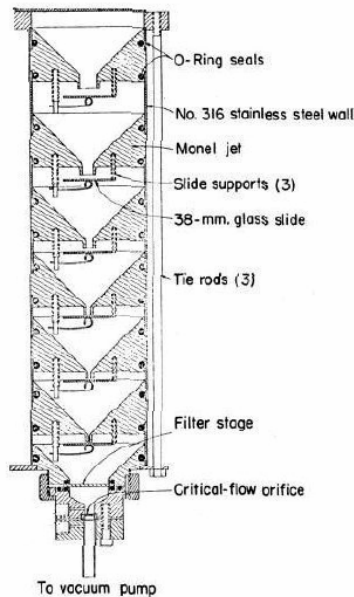

Figure 3-5. Schematic of the DCI-6.

3.2.1 Nozzle Selection

Three nozzles (Air Atom, Airlife, and 3Jet Collision) were evaluated on the basis of their ability to produce gravimetrically measurable quantities of particles on all of the test sampler's aerodynamic diameter cutpoints, which range from <0.25 to >2.5 μm . The nozzles were evaluated using an aqueous KCl solution (5 %) by spraying the resulting aerosols into a static box while the particle distribution was monitored using a wide-range particle spectrometer (WPS, 1000 XP, MSP Corp.) operated by scanning the entire particle diameter size range, 10 nm – 10 μm . The mass mean diameters, geometric standard deviations, number mean diameters, and aerosol generation (solution consumption) rates were measured for each of the three nozzles, and are shown in Table 3-3. The Airlife (002002, Baxter) nozzle was chosen because it had a midrange aerosol generation rate of particles distributed across the entire targeted range of 0.1 - 10 μm .

The final aerosol for the three sampling efficiency tests was generated by pressurizing (60 psi) a nebulizer container (~1 L) filled with an aqueous KCl solution (5%) and equipped with the Airlife nozzle, with a solution consumption rate of 0.57 mL/min. For Test 1, the aerosol was generated during the first 15 minutes of the one-hour sampling period. This aerosol generation period resulted in a heavy loading on the PEM's filters that was sufficient to produce a post-sampling pressure drop greater than 20 inch H₂O for three of the four PEMs. For this reason, the aerosol generation time was reduced to 10 minutes for Tests 2 and 3. Although pressure drops continued to exceed 20 inch H₂O, the time could not be reduced any further since the 10 minute aerosol generation time resulted in particle quantities on the lowest Sioutas cutpoint (<0.25 μm) that were at or below the balance detection limit. It should be noted that the aerosol concentrations for these tests are several orders of magnitude higher than those typically collected in the field; however, this was done so that measurable quantities of material could be obtained on all stages of the Sioutas PCIS.

Table 3-4. Mass Mean Diameter, Geometric Standard Deviation, Number Mean Diameter, and Aerosol Generation Rate for Evaluated Nozzles.

Nozzle	Mass Mean Diameter (μm)	Geometric Standard Deviation	Number Mean Diameter (μm)	Aerosol Generation Rate (mL/min)
Air Atom (1/4 J SS, Spray Systems Co.)	1.545	2.56	0.122	12.6
Airlife (002002, Baxter)	1.014	2.79	0.104	0.57
3Jet Collision (CN24, BGI)	0.573	2.39	0.104	0.38

3.2.2 Sampler Placement

Four Sioutas PCISs were equally spaced in Battelle’s environmental chamber. Four PEM samplers (10 μm cutpoint), four FRMs, and four Delron (DCI-6) samplers were also placed similarly inside the chamber with their sampling inlets ~1 meter from the Sioutas PCISs. The air inlets for each of the FRMs were 1.2 meters from the floor of the chamber, and 1.8 meters away from one another. The two-dimensional spatial location of the test and reference samplers is depicted schematically in Figure 3-6, and a photograph of the setup is shown in Figure 3-7. To avoid generating aerosols other than the test aerosol inside the chamber, the DCI-6 pumps were placed outside the chamber and tubing was connected to the DCI-6 samplers inside the chamber via feedthrough ports in the chamber’s south wall. It was not practical to place the Sioutas, PM_{2.5} FRM, and PEMs sampling pumps outside the chamber, and thus these pumps were located inside the chamber and were powered by A/C outlets, also located inside the chamber. To account for the air drawn out of the chamber by the DCI-6 pumps, the environmental chamber was balanced with ADCO clean air at an approximate replenishment rate of 65 L/min; 35 L/min of this was used to produce the test aerosol and 30 L/min was makeup air. The air exchange rate for all three tests, measured using SF₆ tracer gas and Gas Chromatography/ Electron Capture Detection (GC/ECD) analysis (one measurement every 5 min), was 0.26 ± 0.1 air changes per hour (ACH).

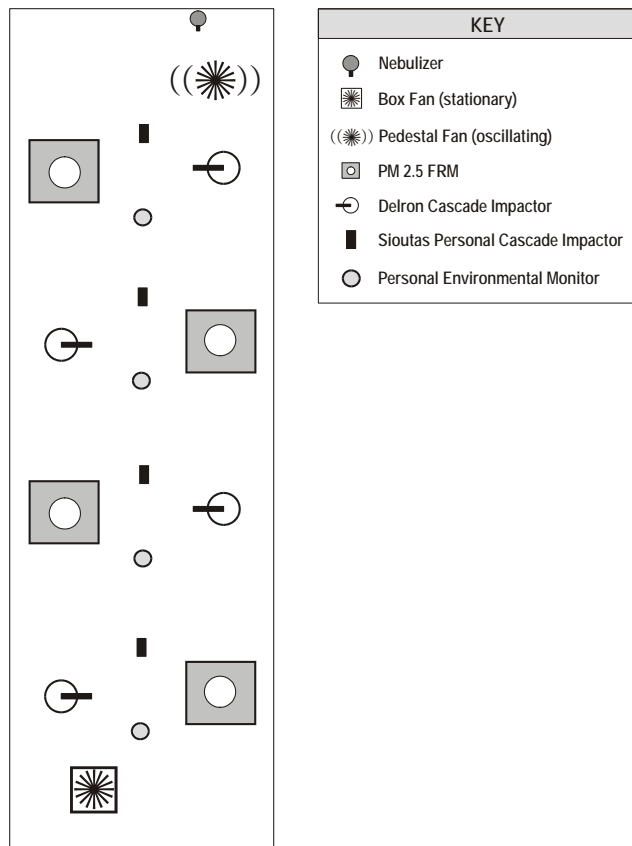

Figure 3-6. Schematic Diagram Showing the Location of the Test and Reference Particle Samplers in the Large Environmental Chamber for the Sampling Efficiency Testing.



Figure 3-7. Test and Reference Particle Samplers Inside the Battelle Environmental Chamber Just Prior to Aerosol Generation for the Sampling Efficiency Testing.

Preliminary Chamber Characterization. The environmental chamber (L x W x H = 4.88 x 1.52 x 2.32 m) is constructed of aluminum and was equipped with two large fans to promote mixing. Prior to testing, preliminary experiments were conducted to verify that the aerosol was uniformly mixed throughout the chamber. During these experiments, four DCI-6 samplers were equally spaced on the floor (5 x 16 ft) of the chamber at a height of ~1.1 m and allowed to sample the chamber environment while the test aerosol was generated for one hour. The cascade impactor glass plates were then recovered and the mass of the particulate was determined gravimetrically. Inter-sampler coefficients of variation did not exceed 10% for the three particle aerodynamic diameter cutpoints of interest, namely <math><0.5 \mu\text{m}</math>: 8.5%;

3.3 Sampling Metals in Ambient Air

The ability of the Sioutas PCIS to collect sufficient sample to detect metals in ambient air during a 48-hour sampling period was evaluated and compared with collocated PEM reference samplers. The sampling metals in ambient air tests were conducted in triplicate; these replicates are referred to in the discussion as Test 1, Test 2, and Test 3. Four test Sioutas PCISs and four PEMs (2.5 μm cutpoint) were placed in the chamber with their pumps located outside the chamber, as shown in Figure 3-8. Clean sample handling techniques for trace metals analysis, including the use of stainless steel tweezers, powder-free gloves, and Tyvek body suits (Micro-Clean 2-1-2 Frocks, VWR), were used to load, and collect substrates from these samplers.



Figure 3-8. The Leland Legacy[®] Pumps Were Placed Outside the Large Environmental Chamber (left), and Were Connected via Feedthroughs to the Test Sioutas PCIS and Reference PEM Samplers Inside the Chamber (right).

Ambient air drawn from the outside flowed through the environmental chamber for a period of 48 hours and was sampled by the Sioutas PCIS and PEM samplers. The air exchange rate of the chamber was measured at the beginning and end of each test using SF₆ tracer gas and continuous GC/ECD analysis (5 measurements, 1 per hour). The average air exchange rate for the three tests was 0.93 ±0.05 ACH. At the beginning and end of the 48-hour sampling period, the pressure drop and flow rate were measured for all samplers. After sampling, the exposed substrates corresponding to the different particle size ranges were analyzed for the 38 target metals and elements shown in Table 3-4 using XRF. Approximate instrument and method detection limits (MDLs) for these techniques are also listed in Table 3-5. Although the focus of the test was on characterizing metals in ambient air, we have included data in the discussion that follows from other non-metallic elements that were also observed.

3.4 Sampler Ease of Use, Reliability, and Subject Acceptability/Compliance

In addition to the performance evaluation described above, this verification test established a qualitative and semi-quantitative assessment of the burden human subjects associate with using the Sioutas PCIS. Although this portion of the verification included the use of human subjects, Battelle's Internal Review Board (IRB) reviewed the protocol and determined on October 25, 2005, that this portion of the testing did not require the preparation of a Human Subject's Committee application, because wearing the Sioutas PCISs would not expose study participants to risk, and time/activity diaries and questionnaire responses would not be directly linked to the study participants' names or other unambiguous identifying information. Battelle received formal notification via e-mail from EPA on March 20, 2006, stating that the EPA Exposure Research Laboratory (NERL) Division Director Human Exposure and Atmospheric Sciences Division, and the NERL Human Subjects Research Official agreed with the Battelle IRB assessment.

Seven non-smoking subjects were recruited to wear the PCIS for a period of 48 hours and keep a simple time/activity diary for that period. Subjects were compensated \$75 for their participation in the study. The subjects were each fitted with a Sioutas PCIS and Leland Legacy[®] pump at Battelle. Each pump was clad in a noise-reducing nylon case (Model No. 224-89, SKC). The subjects were instructed to wear the Sioutas PCIS during all the activities they conducted for the next 48-hour period, with the exception of sleeping and showering/bathing. Subjects were instructed to put the Sioutas PCIS and Leland Legacy[®] pump on the nightstand and plug it into the A/C adaptor at bedtime so that the PCIS would continue to sample their environment while they slept. Likewise, the subjects were instructed to place the Sioutas PCIS and Leland Legacy[®] pump on the bathroom counter, or other suitable surface, with the pump still operating during showering/bathing.

At the end of the sampling period, subjects returned to Battelle and turned in their pumps and their completed time/activity diaries. They were then asked to fill out a questionnaire to gather information about the pump's ease of operation, reliability, and their acceptance of the device. Ease of use and reliability was also evaluated by our Battelle laboratory technicians during sampler setup and return.

Table 3-5. Instrument and Method Detection Limits (MDLs) for Metal/Element Analyses Using XRF.

Metal	Instrument Detection Limit (ng/filter)	Approximate Method Detection Limit (ng/m³)^a
Mg	140	5.6
Na	1200	47
Al	64	2.5
Si	45	1.7
P	39	1.5
S	32	1.2
Cl	39	1.5
K	24	0.9
Ca	16	0.6
Ti	11	0.4
V	8.0	0.3
Cr	8.0	0.3
Mn	13	0.5
Fe	10	0.4
Co	6.8	0.3
Ni	6.8	0.3
Cu	6.8	0.3
Zn	8.0	0.3
Ga	17	0.7
Ge	16	0.6
As	14	0.5
Se	11	0.4
Br	10	0.4
Rb	11	0.4
Sr	18	0.7
Y	17	0.7
Zr	21	0.8
Mo	28	1.1
Pd	58	2.2
Ag	61	2.4
Cd	63	2.4
Sn	110	4.2
Sb	88	3.4
I	160	6.1
Ba	680	26
La	410	16
Hg	28	1.1
Pb	32	1.2

^aAssume 48-hour sampling period, 9 L/min sampling flow rate.

The pumps were equipped with small, data-logging multidirectional accelerometers (AW-64, Mini Mitter Co., Inc.) that measured and logged occurrence and intensity of activity. These data provided an objective measure of subject protocol compliance during the 48-hour sampling period. Subjects were not made aware of the fact that the pump contained a device that recorded its movements, and the device was hidden inside the pump's noise-reducing jacket. At the beginning and end of the sampling period the pressure drop and flow rate of each sampler was measured. As this portion of the testing was designed to evaluate sampler ease of use, reliability, and subject acceptability/ compliance, no gravimetric or analytical determinations were performed on the substrates collected during this testing.

Chapter 4

Quality Assurance/Quality Control

Quality Assurance/Quality Control (QA/QC) procedures were performed in accordance with the quality management plan (QMP) for the AMS Center⁽³⁶⁾ and the test/QA plan⁽⁴⁾ for this verification test.

Fixed site air sampling and gravimetric analyses were performed based on guidelines specified in EPA's PM_{2.5} method^(24, 25) for monitoring ambient air, and metals analyses were performed based on guidelines specified in EPA's Compendium Method IO-3.3.⁽⁵⁾ These measurements were subject to the data quality control requirements summarized in the test/QA plan.⁽⁴⁾

4.1 Flow Rate Checks

The flow rate of each reference sampler and each Sioutas PCIS was measured at the beginning of each test as described in Sections 3.1 through 3.4. When, at the beginning of each test, the measured flow rate varied by more than 10% from the manufacturer's recommended values, the reference sampler or Sioutas PCIS was removed from the test, and repair or maintenance was performed according to the vendor's recommendations. Leland Legacy[®] pump maintenance consisted of recalibrating the pump using a piston calibrator (SKC, DC-Lite, model 717-03) and an automatic calibration device (SKC, Calchek Communicator Smart Adapter). Sioutas PCIS maintenance consisted of disassembling the sampler and making sure the plastic filter retainer rings were pressed flush to the impaction plate. The sampler was re-included in the test once the initial flow rate fell within the 10% limits. The flow rate of each reference sampler and each Sioutas PCIS was also measured at the end of each sampling period and recorded. When the flow rate varied by more than 10% from the manufacturer's recommended values, the data from the reference sampler or Sioutas PCIS were flagged. Initial and final flow rate and pressure drop data for the tests described in Section 3.1 are summarized in Table 4-1. Initial and final flow rate and pressure drop data for the tests described in Sections 3.2 – 3.4 are summarized in Table 4-2.

4.2 Pressure Drop Checks

The pressure drop of each Sioutas PCIS was measured at the start of each sampling period. Prior to conducting the tests described in Section 3.1, the initial pressure drop was adjusted to within 10% of the target pressure drop. For the remaining tests described in Sections 3.2 – 3.4, when the measured pressure drop for the Sioutas PCIS was less than 11 or exceeded 16 inch H₂O, the PCIS was removed from the test, and leak checks, repair, or maintenance was performed

Table 4-1. Summary of Section 3.1 Pump Testing Flow Rate and Pressure Drop Data.

Test Design Section	Test Cond. ^a	Test No.	Date (MMDDYY)	Summary of Flow Rate and Pressure Drop Checks
3.1.1O ^b	Normal	1	011606	Initial flow and pressure drop data within 10% variance; no Final data collected (batteries were discharged)
		2	012006	
		3	012306	
3.1.1R	Normal	1	080806	Initial flow and pressure drop data within 10% variance; no Final data collected (batteries were discharged)
		2	081006	
		3	081506	
3.1.2O-11"	Normal	1	040306	Initial flow and pressure drop data within 10% variance; no Final data collected (batteries were discharged)
		2	040606	
		3	041006	
3.1.2.R-11"	Normal	1	081806	Initial flow and pressure drop data within 10% variance; no Final data collected (batteries were discharged)
		2	082106	
		3	082306	
3.1.2.O-15"	Extreme	1	042406	Initial flow and pressure drop data within 10% variance; no final data collected (batteries were discharged); SN 14359 ^{c,d} failed during Test 2
		2	042806	
		3	050206	
3.1.2R-15"	Extreme	1	082506	Initial flow and pressure drop data within 10% variance; no final data collected (batteries were discharged)
		2	083006	
		3	090106	
3.1.2O-19"	Extreme	1	051106	SN 16042 ^d failed during test
		2	051606	Initial flow and pressure drop data within 10% variance
		3	051806	SN 14407 ^d failed during test
3.1.2R-19"	Extreme	1	090506	Initial flow and pressure drop data within variance; no final data collected (batteries were discharged)
		2	090706	
		3	091106	
3.1.3O 40°C, 60%	Normal	1	061506	Initial and Final flow and pressure drop data within 10% variance; SN 20993 ^d failed after test was completed
3.1.3R 40°C, 60%	Normal	1	091706	Initial and Final flow data within 10% variance; Final pressure drop for 4 pumps was outside variance: SN 16159 23%, 13%, -23% for Tests 1-3, SN 16177 -16% for Test 2
		2	091906	
		3	092006	
3.1.3O 40°C, 90%	Testing for the original pumps was halted on 9/21/06 due to 4 pump failures			
3.1.3R 40°C, 90%	Normal	1	092206	Initial and Final flow data within 10% variance; Final pressure drop for 5 pumps was outside variance: SN 16159 -23%, -14%, -14% for Tests 1-3, SN 16177 -18%, -23% for Tests 1, 2
		2	092506	
		3	092606	

^b Test Conditions; "Normal" = test conditions within manufacturer's operating specifications L1 – L5, shown in Table 3-1; "Extreme" = test conditions outside manufacturer's operating specification L2, shown in Table 3-1.

^b "O" denotes test was performed on original pumps, "R" denotes test was performed on retrofitted pumps.

^c "SN12345" identifies a Leland Legacy[®] pump having a manufacturer's serial number of 12345.

^d Increased backpressure broke the crank-arm pivot pin loose from the diaphragm yoke assembly.

Table 4-2. Summary of Sections 3.2-3.4 Sioutas PCIS Testing Flow Rate and Pressure Drop Data.

Test Design Section	Test Cond. ^a	Test No.	Date (MMDDYY)	Summary of Flow Rate and Pressure Drop Checks
3.2	Extreme L2	1	020106	Final flow for 1 PEM pump was outside variance: SN16042 -17%; Final pressure drop was outside variance for all PEMs: SN 20960 ^b 23.8" H ₂ O, SN 20982 20.0" H ₂ O, SN 20993 22.1" H ₂ O, SN 16042 21.2" H ₂ O
		2	020206	Initial and Final flows within variance; Final pressure drop was outside variance for all PEMs: SN 20960 19.6" H ₂ O, SN 20982 21.5" H ₂ O, SN 20993 19.9" H ₂ O, SN 16042 20.0" H ₂ O
	3	020306	Initial and Final flows within variance; Final pressure drop was outside variance for all PEMs: SN 20960 22.0" H ₂ O, SN 20982 23.0" H ₂ O, SN 20993 21.2" H ₂ O, SN 16042 20.8" H ₂ O	
3.3	Extreme L4	1	020207	Initial and Final flows and pressure drops within variance
		2	020407	Initial and Final flows and pressure drops within variance
	3	020707	Initial and Final flows and pressure drops within variance	
3.4	Extreme L4	F01 ^c	042706	Initial and Final flows and pressure drops within variance
		F02	042706	
	Normal S1-S5	M03	050506	Initial and Final flows within variance, Final pressure drop outside variance: SN 20993 17.5" H ₂ O
		F04	050206	Initial and Final flows and pressure drops within variance
		F05	051006	Initial and Final flows within variance, Final pressure drop outside variance: SN 20982 17.5" H ₂ O
		F06	051606	Initial and Final flows and pressure drops within variance
		F07	052206	Initial and Final flows within variance, Final pressure drop outside variance: SN 20982 18.0" H ₂ O

^a Test Conditions; "Normal" = test conditions within manufacturer's operating specifications for Leland Legacy[®] pump and Sioutas PCIS shown in Table 3-1; "Extreme" = test conditions outside manufacturer's operating specifications shown in Table 3-1.

^b "SN12345" identifies a Leland Legacy[®] pump having a manufacturer's serial number of 12345.

^c "F01" refers to subject identification code F01.

according to the vendor's recommendations. Sioutas PCIS maintenance consisted of disassembling the sampler and making sure the plastic filter retainer rings were pressed flush to the impaction plate. The PCIS was re-included in the test once the initial pressure drop fell within the 11 to 16 inch H₂O range.

The pressure drop of each Sioutas PCIS was also measured at the end of each sampling period and recorded. When the pressure drop fell outside the 11 to 16 inch H₂O range, the data were flagged. For reference samplers used in the tests described in Sections 3.2 and 3.3, if the initial pressure drop exceeded the manufacturer's recommended value by more than 10%, maintenance was performed on the sampler until the measured pressure drop fell within the 10% range. If the final pressure drop fell outside the 10% range, the data were recorded and flagged. This happened routinely for the PEM samplers in the sampling efficiency comparison test (i.e., Section 3.2). The aerosol generation time, originally set at 15 minutes for Test 1, was reduced to 10 minutes for Tests 2 and 3 in an effort to reduce the sample loading of the PEMs. However, pressure drops continued to exceed 20 inch H₂O for the PEMs, but the time could not be reduced any further since the 10 minute aerosol generation time resulted in particle quantities on the lowest Sioutas cutpoint (<0.25 µm) that were at or below the balance detection limit.

It should be noted that the aerosol concentrations for the sampling efficiency comparison testing are several orders of magnitude higher than those typically collected in the field; however, this was done so that we would obtain measurable quantities of material on all stages of the Sioutas PCIS. Although these filter loadings did not exceed the manufacturer's specified maximum particle load for the Sioutas PCIS, 3.16 mg per stage, they did result in pressure drops that were outside the manufacturer's specified compensation range for the Leland Legacy[®] pump, as shown previously in Table 3-1, No. L2.

SKC states that the extended operation of the pumps at higher than specified backpressures was the cause of the pump failures during testing. The increased backpressure of the initial tests was great enough to break the crank-arm pivot pin loose from the diaphragm yoke assembly. Although this has never been evidenced under normal field conditions, SKC designed a new hexagonal-shaped pin head to ensure that this failure would not occur. The new pin design will be incorporated into all Leland Legacy pumps manufactured by SKC.

4.3 Field Replicates

For the sampling efficiency comparison test, four replicates for test and reference samplers were collected to establish the variability of the test and reference samplers. The data for the first test are summarized in Table 4-3. The relative standard deviation from the mean for all cutpoints shown in Table 4-3 fell within 30%, verifying the well-mixed state of the chamber. The variability exhibited by each set of four samplers is below 15% in all instances, with the exception of the ≥ 2.0 and ≤ 4.0 μm cutpoint for the DCI-6 sampler. This is due to the fact that the amount of material on these slides for that stage was at or near the gravimetric detection limit. The low variability of these data indicate a well-mixed chamber.

Table 4-3. Field Replicates for the Sampling Efficiency Comparison Test.

Sampler	Cutpoint (μm)	Test Aerosol KCl Concentration (mg/m^3)				R.S.D (%)
		Rep A	Rep B	Rep C	Rep D	
Sioutas PCIS	<0.25	1.08	0.82	1.05	0.93	12.3
	≥ 0.25 and ≤ 0.50	1.38	1.34	1.28	1.23	5.0
	≥ 0.50 and ≤ 1.0	0.89	0.95	0.96	0.98	4.2
	≥ 1.0 and ≤ 2.5	0.63	0.76	0.76	0.76	9.1
	>2.5	0.23	0.23	0.07 ^a	0.27	9.0
DCI-6	<0.50	2.97	3.84	3.36	3.18	11.0
	≥ 0.50 and ≤ 1.0	0.60	0.79	0.59	0.66	14.3
	≥ 1.0 and ≤ 2.0	0.61	0.66	0.62	0.74	9.0
	≥ 2.0 and ≤ 4.0	0.27	0.23	0.19	0.14	28.4
PEM	≤ 10	4.37	4.62	4.47	4.31	3.1
FRM	≤ 2.5	4.08	3.89	4.58	4.60	8.4

^aSample pellet broke; most of the sample was lost and therefore this data point was not included in the analysis.

4.4 Field Blanks

To verify that the detectable metals/elements determined for the tests described in Section 3.3 were not a result of contamination, field blanks were processed at a rate of 10% of the real samples collected. Field blank substrates were stored and treated exactly like actual samples, with the exception that no sampling was performed on these substrates. Two types of field blanks were analyzed: (1) a PTFE 37 mm filter, which is used for sample collection in the PEM and is also used for the Sioutas PCIS after-filter, and (2) a 25 mm PTFE, which is used for sample collection in the first four stages of the Sioutas PCIS. Tables 4-4, 4-5, and 4-6 present the analytical results for the collected air samples and the field blanks for the PEM, the Sioutas PCIS after-filter, and the smaller Sioutas PCIS substrates, respectively. Only those metals/

Table 4-4. PEMs Field Blank (PTFE, 37 mm) Summary for Detectable Metals/Elements.

Metal	Test No. ^a	(µg/filter)			Comments
		Sample Level	Average Field Blank Level (n = 3)	10x MDL	
Si	1	2.23 ± 0.08	0.10 ± 0.06	0.6	Blank subtracted samples
	2	2.13 ± 0.04			
	3	1.21 ± 0.03			
S	1	9.16 ± 0.44	< 0.02	0.2	Blank subtraction not needed
	2	9.30 ± 0.27			
	3	12.2 ± 0.40			
Cl	1	4.30 ± 0.14	<0.05	0.5	Blank subtraction not needed
	2	5.93 ± 0.25			
	3	1.72 ± 0.14			
K	1	1.06 ± 0.07	0.02 ± 0.01	0.2	Blank subtracted samples
	2	1.33 ± 0.06			
	3	1.27 ± 0.05			
Ca	1	1.93 ± 0.17	0.02 ± 0.01	0.2	Blank subtracted samples
	2	2.22 ± 0.10			
	3	1.26 ± 0.13			
Fe	1	1.40 ± 0.10	0.07 ± 0.05	0.2	Blank subtracted samples
	2	1.98 ± 0.11			
	3	1.39 ± 0.03			
Zn	1	0.53 ± 0.05	< 0.02	0.2	Blank subtraction not needed
	2	2.35 ± 0.14			
	3	0.56 ± 0.04			
Na	1	4.16 ± 0.49	<0.39	3.9	Blank subtraction not needed
	2	6.65 ± 0.69			
	3	3.05 ± 0.37			
Al	1	0.85 ± 0.04	0.08 ± 0.04	0.9	Blank subtracted samples; field blank > 10%, flagged data
	2	0.68 ± 0.08			
	3	0.34 ± 0.07			

^a The 48-hour ambient air sampling tests were conducted on the following days: Test 1, 2/2/07; Test 2, 2/4/07; Test 3, 2/7/07. N = 4 for each sampler and test.

Table 4-5. Sioutas PCIS After-Filter Field Blank (PTFE, 37 mm) Summary of Detectable Metals/Elements.

Metal	Test No. ^a	(µg/filter)			Comments
		Sample Level	Average Field Blank Level (n = 3)	10x MDL	
Si	1	0.23 ± 0.06	0.10 ± 0.06	0.6	Blank subtracted samples; field blank > 10%, flagged data
	2	0.27 ± 0.02			
	3	0.28 ± 0.02			
S	1	4.08 ± 0.19	< 0.02	0.2	Blank subtraction not needed
	2	4.45 ± 0.35			
	3	6.30 ± 0.26			
Cl	1	0.11 ± 0.10	<0.05	0.5	Blank subtraction not needed
	2	0.07 ± 0.00			
	3	0.08 ± 0.00			
K	1	0.36 ± 0.02	0.02 ± 0.01	0.2	Blank subtracted samples
	2	0.48 ± 0.02			
	3	0.55 ± 0.03			
Ca	1	0.11 ± 0.02	0.02 ± 0.01	0.2	Blank subtracted samples; field blank > 10%, flagged data
	2	0.13 ± 0.04			
	3	0.13 ± 0.01			
Fe	1	0.08 ± 0.02	0.07 ± 0.05	0.2	Blank subtracted samples; field blank > 10%, flagged data
	2	0.14 ± 0.02			
	3	0.31 ± 0.04			
Zn	1	0.10 ± 0.03	< 0.02	0.2	Blank subtraction not needed
	2	0.15 ± 0.01			
	3	0.18 ± 0.03			
Na	1	0.56 ± 0.29	<0.39	3.9	Blank subtraction not needed
	2	0.59 ± 0.26			
	3	0.57 ± 0.27			
Al	1	0.08 ± 0.02	0.08 ± 0.04	0.9	Field blank ≈ Sample Level, flagged data
	2	0.08 ± 0.02			
	3	0.07 ± 0.00			

^a The 48-hour ambient air sampling tests were conducted on the following days: Test 1, 2/2/07; Test 2, 2/4/07; Test 3, 2/7/07. N = 4 for each sampler and test.

Table 4-6. Sioutas PCIS Field Blank (PTFE, 25 mm) Summary of Detectable Metals/Elements.

Metal	Test No. ^a	(µg/filter)			Comments
		Sample Level ^b	3x Average Field Blank Level (n = 3) ^c	10x MDL	
Si	1	0.73 ± 0.06	0.09 ± 0.03	0.6	Blank subtracted samples; field blank > 10%, flagged data
	2	0.78 ± 0.09			
	3	0.42 ± 0.05			
S	1	1.75 ± 0.15	< 0.01	0.2	Blank subtraction not needed
	2	2.08 ± 0.09			
	3	1.93 ± 0.22			
Cl	1	2.44 ± 0.15	< 0.20	2.8	Blank subtraction not needed
	2	3.36 ± 0.22			
	3	1.46 ± 0.04			
K	1	0.47 ± 0.06	0.13 ± 0.06	1.4	Blank subtracted samples; field blank > 10%, flagged data
	2	0.56 ± 0.06			
	3	0.43 ± 0.05			
Ca	1	1.18 ± 0.07	0.14 ± 0.07	1.1	Blank subtracted samples; field blank > 10%, flagged data
	2	1.43 ± 0.03			
	3	0.78 ± 0.06			
Fe	1	0.86 ± 0.06	0.09 ± 0.02	1.1	Blank subtraction not needed
	2	1.64 ± 0.06			
	3	0.83 ± 0.09			
Zn	1	0.34 ± 0.06	< 0.05	0.7	Blank subtraction not needed
	2	2.60 ± 0.30			
	3	0.35 ± 0.07			
Na	1	1.96 ± 0.15	0.24 ± 0.01	3.4	Blank subtracted samples; field blank > 10%, flagged data
	2	0.98 ± 0.32			
	3	1.15 ± 0.18			
Al	1	0.29 ± 0.05	0.08 ± 0.04	1.0	Blank subtracted samples; field blank > 10%, flagged data
	2	0.27 ± 0.03			
	3	0.19 ± 0.02			

^a The 48-hour ambient air sampling tests were conducted on the following days: Test 1, 2/2/07; Test 2, 2/4/07; Test 3, 2/7/07. N = 4 for each sampler and test.

^b Sample consists of the sum of the levels found in three substrates: ≥0.25 and ≤0.5, ≥0.5 and ≤1.0, and ≥1.0 and ≤2.5 µm.

^c Numbers in this column are the average concentration found in a set of three filters multiplied by three in order to facilitate comparison with the Sample Level column, which shows the sum of the levels found in three substrates.

elements for which detectable levels were measured in the majority of the recovered substrates are included in these tables. Sample results were field blank-corrected, as indicated in Table 4-4 through 4-6, in any instance where the field blank average was above the method detection limit and determined to be statistically higher than zero.

When the field blanks showed contamination that was above the MDL and greater than 10% of the samples' metal/element concentration, sample collection materials were examined until the source of contamination was found or eliminated. This was the case for Si, K, and Na in the 25 mm substrates, and Si and Ca in the 37 mm substrates, and Al in all of the substrates. Na and Al levels measured in the test and reference sampler substrates were at the MDL, and thus were not included in the analyses. Although the field blank contamination levels of Si, K, and Ca were low, either at or slightly above the MDL, comparatively they were 10-20% of the levels found in the ambient air samples. To reduce this type of crustal element contamination, it is recommended to perform impactor loading and unloading in a Class 100 (or better) cleanroom, which was not available for this verification test.

None of the field blanks had metal/element concentrations that exceeded 10 times the MDL; therefore the levels included in the sampler comparability analysis are genuine and not due to contamination of the filters.

4.5 Checks of Metal/Element Analysis Accuracy

Three types of QA/QC samples were analyzed to ensure the accuracy of the metal/element analysis using XRF: 1) quality assurance standards (Qs), 2) National Institute of Standards and Technology (NIST)-certified standard reference materials (SRMs), and 3) blind performance evaluation (PE) samples. The results are summarized in Table 4-7. All of the QA/QC standards analyzed during the testing passed the acceptance criterion, which is discussed in further detail for each type of QA/QC standard below.

The XRF was calibrated only when fluorescers, X-ray tubes, or detectors were changed or a serious malfunction occurred. Calibration verification Qs, or multi-element thin film vapor-deposited standards on mylar, were analyzed every analytical run as a check of the instrument's operation. When the results were not within 10% of the expected value, the analysis was terminated and the cause of the QS failure was determined. Repeated failures required a recalibration of any excitation condition not meeting the required limits, and the samples associated with the failed QS were reanalyzed.

NIST-certified SRMs were analyzed alongside the samples. When the percent recovery for any of the target metals/elements in the SRM fell outside the NIST-certified uncertainty, analysis was terminated and the cause of the SRM failure was determined. The excitation condition in which the failure occurred was recalibrated and the samples associated with the failed SRM were reanalyzed. The percent recovery (R) of a given metal was calculated using Equation (1):

$$R = \frac{C_M}{C_T} \times 100\% \quad (1)$$

where:

C_M = measured concentration ($\mu\text{g}/\text{cm}^2$)
 C_T = theoretical or certified concentration ($\mu\text{g}/\text{cm}^2$)

Blind performance evaluation (PE) samples were analyzed as part of the PE audit (see Section 4.8.1) to assess the quality of the metal/element measurements made in this verification test. When the percent recovery measured for any target metal/element in the PE sample fell outside the 80 to 120% range, the instrumentation was examined and serviced or maintained as needed, and the PE samples were reanalyzed. During the verification testing, none of the QA/QC sample results fell outside of the acceptable range.

Table 4-7. Summary of Quality Assurance Standards (QS), NIST-Certified Standard Reference Materials (SRMs), and Blind Performance Evaluation (PE) Samples Analyzed using XRF.

Type	Analysis Date (MMDDYY)	Metal/Element	Theoretical/Certified	Measured	Recovery (%)
QS 285 ^a (n=1)	030606	Si(0)	1757	1794	102
		Si(1)	41.13	38.10	93
		Fe(3)	1915	1935	101
QS 285 (n = 7)	021507 thru 022307	Si(0)	1684	1681	100
		Fe(3)	1809	1818	101
NIST ^b 1832 (n = 4)	030606	Si	34.0 ± 1.1	33.0 ± 1.3	97
		Ca	19.4 ± 1.3	20.0 ± 0.1	103
	021507 thru 022307	Si	34.0 ± 1.1	35.1 ± 0.5	103
		Ca	19.4 ± 1.3	21.1 ± 0.5	109
NIST 1833 (n = 4)	030606	Si	31.5 ± 2.1	30.4 ± 1.2	96
		K	16.4 ± 1.6	16.8 ± 0.9	102
		Fe	13.6 ± 0.4	13.4 ± 0.6	99
		Zn	3.9 ± 0.3	3.8 ± 0.2	97
	021507 thru 022307	Si	31.5 ± 2.1	33.1 ± 0.3	105
		K	16.4 ± 1.6	15.5 ± 0.2	94
		Fe	13.6 ± 0.4	13.2 ± 0.2	97
		Zn	3.9 ± 0.3	3.9 ± 0.1	101
NIST 2708 (n = 4)	030606	S	2.5 ± 0.2	2.4 ± 0.1	98
	021507 thru 022307	S	2.5 ± 0.2	2.4 ± 0.04	96
Blind PE NIST ^c 2783 (n = 3)	030606, 033006 thru 040506, 021507 thru 022307	Ca	13.2 ± 1.7	13.9 ± 1.0	106
		Fe	26.5 ± 1.6	28.3 ± 0.51	107
		K	5.28 ± 0.52	5.44 ± 0.21	103
		Zn	1.79 ± 0.13	2.10 ± 0.22	117
		S	1.05 ± 0.26	1.09 ± 0.11	104
		Si	58.6 ± 1.6	54.6 ± 7.1	93

^a QS data is reported in counts per second.

^b NIST SRM certified mass loadings for SRMs 1832, 1833, and 2708 are reported in µg/cm²

^c NIST SRM certified and reference mass loadings for SRM2783 are reported in µg/filter

4.6 Gravimetric Measurement Checks

Samples were conditioned for at least 24 hours in a microbalance laboratory that was kept at $22 \pm 1^\circ\text{C}$ and $44 \pm 2.5\%$ relative humidity, and these limits were not exceeded during the gravimetric testing period. The calibration of the analytical balances was checked using NIST-traceable mass reference standards that spanned the range of weights measured, i.e., 100 to 300 mg, prior to and at the completion of gravimetric determinations. Balances were also checked with these weights after the measurement of every 10 actual samples. The measurement of the certified weights fell within the $\pm 10 \mu\text{g}$ acceptability criterion, and thus the balance did not require recalibration or repair during the testing period. A summary of the gravimetric precision data collected during the three sampling efficiency comparison tests is presented in Table 4-8.

The stability of the substrates was also checked by reweighing 10% of the samples from the previous batch of samples. Table 4-9 shows the mean of the differences between original and reweighed results for the various samples and substrates. For several of the substrate types, laboratory and field blank re-weighs did not fall within $\pm 15 \mu\text{g}$ of the previously made measurements. The standard deviations of the differences are also presented to indicate the variability in the measurements. The temperature and humidity logs for the balance room were examined for those periods during which sample conditioning or sample weighing occurred, and no anomalies in these records were found. For the DCI-6 backup filter (DCI-F), some of the variability in the weighing results can be explained by the fact that these filters were too large to be weighed on the 6-decimal place precision balance, and were instead weighed on a 4-decimal place precision balance. Although the substrate stability varies as much as two times the specified range for the 6-decimal place measurements, and as much as 14 times the 4-decimal place measurements, this variability, when compared to the gravimetric comparison levels, which are at milligram levels (2-3 orders of magnitude larger), is negligible. Within a given weighing session, all of the replicate weights were well within $\pm 5 \mu\text{g}$ of the previously made measurements.

Table 4-8. Summary of the Gravimetric Precision Data Collected During the Sampling Efficiency Comparison Testing.

Test	Measured (Mean \pm Std Dev, mg)	
	100 mg Std (n = 8)	200 mg Std (n = 24)
1	100.003 \pm 0.003	200.006 \pm 0.004
2	100.004 \pm 0.002	200.006 \pm 0.003
3	100.003 \pm 0.003	200.007 \pm 0.002

Table 4-9. Summary of the Substrate Stability Data from Weighing and Re-Weighing Substrates Collected During the Sampling Efficiency Comparison Testing.

Sample Type	n ^a	Sampler ^b	Original Weight – Reweigh (Mean ± Std Dev, µg)
Laboratory Blank	3	PCIS	3 ± 6
	3	FRM	-6 ± 11
	3	PEM/PCIS-L	-11 ± 11
	1 ^c	DCI-6	-40
	3	DCI-F	0 ± 100 ^d
Field Blank	6	PCIS	7 ± 18
	6	FRM	18 ± 20
	8	PEM/PCIS-L	20 ± 12
	10	DCI-6	31 ± 21
	3	DCI-F	-200 ± 200
Session Replicate	16	PCIS	0 ± 3
	6	FRM	2 ± 4
	8	PEM/PCIS-L	1 ± 4
	17	DCI-6	1 ± 2
	2	DCI-F	-1 ± 1

^a n = number of observations

^b PCIS = Sioutas personal cascade impactor sampler (25 mm PTFE substrate), FRM = Federal Reference Method sampler (47 mm PTFE substrate), PEM/PCIS-L = Personal Environmental Monitor and Sioutas PCIS after-filter (both use a 37 mm PTFE substrate), DCI-6 = Delron Cascade Impactor (37 mm glass plate), and DCI-F = Delron Cascade Impactor backup filter (80 mm PTFE substrate)

^c Two of the laboratory blank glass slides broke before they were re-weighed.

^d DCI-F filters were too large to weigh on the 6-decimal place balance; and thus were weighed on a 4-decimal place balance.

4.7 Audits

4.7.1 Performance Evaluation Audit

Several PE audits were conducted during the verification test. These PE audits included checks of the test and reference sampler flow rates, checks of the analytical balance, and blind PESs for metals analyses. The PE criteria for flow, mass, and blind PESs are summarized in Sections 4.1, 4.6, and 4.5, respectively.

During the pump testing, a flow audit of all of the pumps was conducted. During the sampling efficiency comparison testing, a flow audit of all of the FRM samplers and one of the DCI-6 reference samplers was conducted using a flow standard independent of that used to calibrate the reference samplers, and the results are shown in Table 4-10. None of the measured flow rates exceeded the manufacturer's recommended values by more than 10%.

Table 4-10. Summary of Performance Evaluation Flow Audits.

Date (MMDDYY)	Sampler	Target ± Tolerance (L/min)	A (L/min)	B (L/min)
012306	FRM-SN 200FB206850507	16.7 ± 1.67	16.7 ^a	16.76 ^b
	FRM-SN 200FB206840507		16.7	16.86
	FRM-SN 200FB205120107		16.7	16.86
	FRM-BGI BPN X-57397		16.65	16.65
020306	DCI-6 A	12.5 ± 1.25	11.60 ^c	11.67 ^b
			11.62	11.62
			11.57	11.67
050206	Leland Legacy [®] Pump-SN 14168 (n=3)	9.0 ± 0.9	8.95 ± 0.06 ^c	8.97 ± 0.02 ^b
	Leland Legacy [®] Pump-SN 16042 (n=3)		9.67 ± 0.02	9.75 ± 0.01
	Leland Legacy [®] Pump-SN 14140 (n=3)		8.96 ± 0.09	9.05 ± 0.02
	Leland Legacy [®] Pump-SN 14407 (n=3)		9.22 ± 0.06	9.21 ± 0.04

^a “A” flows measured using each FRM’s internal flow meter

^b “B” flows measured with Dry Cal DC-2 DC-HC-1, 500 mL/min – 30 L/min, S/N 104947, Cert #32242

^c “A” flows measured with Dry Cal DC-Lite, S/N 104345, Cert #29915

Audits of the analytical balance were conducted using certified mass standards independent of those used for calibration or routine calibration checks, and the results are summarized in Table 4-11. The audit measurement of the certified weights fell within ±10 µg of the certified value.

During the sampling metals in ambient air testing, blind PE samples were analyzed to assess the quality of the measurements made in this verification test, and the results for the metals/elements that were detected in the 48-hr ambient air samples are shown in Table 4-7. None of the percent recoveries measured for the blind PE sample fell outside the 80 – 120% range. The blind PE samples were purchased from NIST (SRM 2783) and provided as unknowns by the Verification Test Coordinator to Chester LabNet, who was responsible for analyzing them.

Table 4-11. Performance Evaluation Audit of the Analytical Balance.

Date	Target ± Tolerance (mg)	A (mg) ^a	B (mg) ^b
2/3/06	100 ± 0.010	100.002	100.000
	200 ± 0.010	200.008	200.010

^a “A” weights = Rice Lakes, SN 0T1X, Met. Lab. Control # C17826.

^b “B” weights = Rice Lakes, SN 1H1B, Met. Lab. Control # C16471.

4.7.2 Technical Systems Audit

The Battelle Quality Manager conducted two technical systems audits (TSAs) on 2/3/06 and 5/2/06, to ensure that the verification test was performed in accordance with the AMS Center QMP,⁽³⁶⁾ the test/QA plan,⁽⁴⁾ published reference methods, and any standard operating procedures (SOPs) used by Battelle. As part of the audit, the Battelle Quality Manager reviewed the reference methods, compared actual test procedures to those specified or referenced in this plan, and reviewed data acquisition and handling procedures. The Battelle Quality Manager also toured the environmental chamber laboratory and observed the fixed site sampling or human subject chamber testing; inspected documentation of sample chain of custody; and reviewed PCIS-specific record books. In addition, the Battelle Quality Manager checked calibration certifications for test measurement devices. Observations and findings from this audit were documented and submitted to the Battelle Verification Test Coordinator for response. During the Pump Testing TSA, the Battelle Quality Manager noted that the pump testing that included measurement and logging of sound level was conducted in a vacated laboratory, instead of the constant temperature and humidity chamber, as stated in the test/QA plan. As a result of this finding, a deviation to the test/QA plan, described more fully in Section 4.10 of this report, was submitted by the Verification Test Coordinator to the Battelle Quality Manager. The records concerning the TSA are permanently stored with the Battelle Quality Manager.

4.7.3 Audit of Data Quality

At least 10% of the data acquired during the verification test were audited. The Battelle Quality Manager or designee traced the data from initial acquisition, through reduction and statistical comparisons, to final reporting. All calculations performed on the data undergoing the audit were checked.

4.8 QA/QC Reporting

Each assessment and audit was documented in accordance with Section 3.3.4 of the AMS Center QMP.⁽³⁵⁾ Once the assessment report was prepared, the Battelle Verification Test Coordinator responded to each potential problem and implemented any necessary follow-up corrective action. The Battelle Quality Manager ensured that follow-up corrective action was taken. The results of the TSA were sent to the EPA.

4.9 Data Review

Records generated in the verification test were reviewed before they were used to calculate, evaluate, or report verification results. Table 4-12 summarizes the types of data recorded. The review was performed by a technical staff member involved in the verification test, but not the staff member who originally generated the record. The person performing the review added his/her initials and the date to a hard copy of the record being reviewed.

Table 4-12. Summary of Data Recording Process.

Data to Be Recorded	Responsible Party	Where Recorded	How Often Recorded	Disposition of Data
Dates, times, and details of each test procedure, PCIS maintenance, down time, etc.	Battelle	ETV laboratory record book	Start/end of experiments	Summarized and incorporated into verification report
Initial and final flow rate, pressure drop	Battelle	Sampler run data sheet	Start/end of experiments	Incorporated into verification report
Pre- and post-sampling substrate mass	Battelle	Substrate preparation and analysis data sheet	Start/end of gravimetric analyses	Incorporated into verification report
XRF QS calibration verification information	Chester LabNet	Prior to use of XRF to quantify metals content of substrates	With every enumeration	Incorporated into verification report
Subject time/activity diary	Participant	Handwritten on time/activity diary form	Recorded continuously throughout 48-hour field study	Summarized in the verification report
Subject questionnaire responses	Participant	Handwritten on questionnaire form	At the completion of the field study	Summarized in the verification report

4.10 Deviation from the Test/QA Plan

The following deviation from the test/QA plan was documented and approved by the AMS Center Manager. The pump testing that measured duration of operation and sound level when the pumps sampled across pressure drops of 11, 15, and 19 inch H₂O was not conducted inside a constant temperature and humidity chamber. This deviation did not compromise the validity of the verification data. The deviation from our original experimental design was necessary because the noise level of the circulation fan (87 dB) that operates inside the constant temperature and humidity chamber exceeded the combined noise level of the four pumps. Therefore, changes in the noise level of the pumps operating inside that chamber were not discernable. This testing was instead conducted in a vacated laboratory with stable room temperatures (23-25°C) and ambient humidity (12-45%), as measured using a microprocessor-based temperature and humidity recorder (Omega, CT485B). The laboratory allowed us to measure changes in noise level when sampling across different pressure drops.

Chapter 5

Statistical Methods and Reported Parameters

The methods presented in this chapter were used to verify the performance parameters listed in Section 3.1.

5.1 Comparability of Sampling Efficiency

The comparability of the Sioutas PCISs was assessed in terms of the relative percent difference (RPD) of the mean of four replicate Sioutas PCIS measurements with respect to the mean of the four replicate measurements of the reference samplers, using Equation (2):

$$RPD = \frac{|\bar{C}_{PCIS} - \bar{C}_{REF}|}{\bar{C}_{REF}} \times 100\% \quad (2)$$

where:

\bar{C}_{PCIS} = mean particle or metal mass concentration ($\mu\text{g}/\text{m}^3$) measured by the PCISs

\bar{C}_{REF} = mean particle or metal mass concentration ($\mu\text{g}/\text{m}^3$) measured by reference samplers.

The RPD was calculated and reported separately for comparisons of each PCIS with the $\text{PM}_{2.5}$ FRM and the PEM, as well as for the corresponding stages of the Battelle impactor.

5.2 Variability

Inter-pump/sampler variability (V) was assessed in terms of relative standard deviation from the mean of four replicate pumps/samplers, according to Equation (3):

$$V = \frac{1}{n} \sum_{i=1}^n C_i \pm \frac{SD}{\left[\frac{1}{n} \sum_{i=1}^n C_i \right]} \times 100 \quad (3)$$

where:

C_i = duration of pump operation for pump i , or particle or metal mass concentration ($\mu\text{g}/\text{m}^3$) for sampler i

SD = standard deviation of the sample ($n=4$)

The intra-pump/sampler variability (V_i) was assessed in terms of relative standard deviation from the mean of three replicate test runs, according to Equation (4):

$$V_i = \frac{1}{n} \sum_{j=1}^n C_{i,j} \pm \frac{SD_i}{\left[\frac{1}{n} \sum_{j=1}^n C_{i,j} \right]} \times 100 \quad (4)$$

where:

- $C_{i,j}$ = duration of pump operation for pump i , or particle or metal mass concentration ($\mu\text{g}/\text{m}^3$) for sampler during Test Run j
 SD_i = standard deviation of the sample ($n=3$).

5.3 Metal/Element Detection

The collection ability of the PCIS for a given metal/element was judged against the analytical method detection limits for each target analyte divided by the volume of air sampled by the PCIS during a 48-hour period. The analytical method detection limits (ng/filter) were determined according to EPA Compendium Method IO-3.3,⁽⁴⁾ and are presented in Table 3-5. The concentration (C_M) of the PCIS (ng/m^3) for a given metal/element in ambient air was calculated using Equation (5):

$$C_M = \frac{S_M}{F_A \times T} \times 1000 \quad (5)$$

where:

- S_M = concentration (ng/filter) of the metal/element in the collected substrate sample
 F_A = average flow rate (L/min) during the 48-hour sampling period
 T = time period air was sampled (min).

Target metals/elements were reported as detectable if C_M was greater than the analytical detection limit. The analytical detection limits of the XRF analyses are three times the uncertainty for each given metal/element. All detectable analytical results for the test and reference sampler substrates collected are presented and compared.

5.4 Ease of Use, Reliability, and Subject Acceptance/Compliance

Aspects of the PCIS performance such as ease of use, reliability, and subject acceptance and compliance are discussed in Section 6. Also addressed are qualitative observations of the verification staff pertaining to the performance of the PCIS.

Chapter 6 Test Results

The performance of the Sioutas PCIS and the Leland Legacy[®] pump is discussed in the following sections.

6.1 Pump Testing

As described in Section 3, during testing half of the Leland Legacy pumps failed under extreme testing conditions. As a result, the pumps were retrofitted with new pins to correct the source of failure. In the following section we report the results of testing with the original and the retrofitted pumps.

6.1.1 Moderate Temperature and Humidity (25°C, 30%)

The results of the moderate temperature and humidity tests for the original pumps are summarized in Table 6-1. In general, all pumps operated on battery power at the specified flow rate (9 L/min, corresponding to ~4.5 Vdc) for 28 – 34 hours. Among the four pumps, inter-pump duration of operation deviated by less than 7% for all three tests. Across the three tests, intra-pump duration of operation deviated by less than 6%.

During their period of operation, flow rates, measured indirectly as the analog output of the flow meters, deviated by less than 1% for all pumps in all tests. Inter- and intra-pump flow rates deviated less than 4% during each test and among the three tests

The results of the moderate temperature and humidity tests for the retrofitted pumps are summarized in Table 6-2. In general, all pumps operated on battery power at the required flow rate for 31 – 35 hours. Among the four pumps, inter-pump duration of operation deviated by less than 5% for all three tests. Across the three tests, intra-pump duration of operation deviated by less than 6%.

During their period of operation, flow rates deviated by less than 2% for all pumps in all tests, indicating that the pump flows stayed steady throughout the testing until the battery died and then the flow dropped to zero. Inter- and intra-pump flow rates deviated less than 2% during each test and among the three tests. The retrofitted pumps show a slightly longer duration of battery operation than the original pumps, circa 6%, as shown in Figure 6-1, but approximately the same flow variation.

Table 6-1. Flow Rate Variability (L/min) and Duration of Battery-Powered *Original* Pump Operation (Hours) at 25°C and 30% Relative Humidity After a 15-hour Battery Charge.

	Pump ID ^a				Inter-Pump Mean ± SD, Vdc (RSD, %)
	1	2	3	4	
Test 1, 1/16/06					
Mean ± SD, L/min (RSD, %)	8.22 ± 0.04 (0.4%)	8.18 ± 0.05 (0.6%)	8.65 ± 0.05 (0.5%)	8.60 ± 0.04 (0.4%)	8.41 ± 0.25 (2.9%)
Operation (hrs)	30.8	31.9	34.2	33.3	32.5 ± 1.5 (4.6%)
Test 2, 1/20/06					
Mean ± SD, L/min (RSD %)	8.71 ± 0.05 (0.6%)	8.21 ± 0.06 (0.8%)	8.68 ± 0.06 (0.6%)	8.65 ± 0.06 (0.7%)	8.56 ± 0.24 (2.8%)
Operation (hrs)	30.0	33.5	32.1	31.5	31.8 ± 1.5 (4.6%)
Test 3, 1/23/06					
Mean ± SD, L/min (RSD %)	8.70 ± 0.04 (0.5%)	8.29 ± 0.05 (0.6%)	8.76 ± 0.05 (0.6%)	8.60 ± 0.04 (0.5%)	8.59 ± 0.21 (2.4%)
Operation (hrs)	28.4	33.4	30.4	32.2	31.1 ± 2.2 (7.0%)
Intra-Pump Summary					
Mean ± SD, L/min (RSD %)	8.54 ± 0.28 (3.3%)	8.23 ± 0.06 (0.7%)	8.69 ± 0.06 (0.7%)	8.62 ± 0.03 (0.3%)	
Operation (hrs)	29.7 ± 1.2 (4.0%)	32.9 ± 0.9 (2.8%)	32.2 ± 1.9 (5.9%)	32.3 ± 0.9 (2.9%)	

^a Pump IDs match to the following serial numbers: 1 = SN14168, 2 = SN14359, 3 = SN14140, and 4 = SN14407.

Table 6-2. Flow Rate Variability (L/min) and Duration of Battery-Powered *Retrofitted* Pump Operation (Hours) at 25°C and 30% Relative Humidity After a 15-hour Battery Charge.

	Pump ID ^a				Inter-Pump Mean ± SD, Vdc (RSD, %)
	1	2	3	4	
Test 1, 8/8/06					
Mean ± SD, Vdc (RSD, %)	8.83 ± 0.06 (0.6%)	8.59 ± 0.05 (0.6%)	8.66 ± 0.06 (0.7%)	8.58 ± 0.13 (1.5%)	8.67 ± 0.11 (1.3%)
Operation (hrs)	32.2	34.7	34.1	31.4	33.1 ± 1.6 (4.8%)
Test 2, 8/10/06					
Mean ± SD, Vdc (RSD %)	8.78 ± 0.05 (0.5%)	8.58 ± 0.03 (0.3%)	8.64 ± 0.03 (0.4%)	8.57 ± 0.03 (0.4%)	8.64 ± 0.10 (1.1%)
Operation (hrs)	33.7	35.0	33.6	35.1	34.4 ± 0.8 (2.4%)
Test 3, 8/15/06					
Mean ± SD, Vdc (RSD %)	8.81 ± 0.07 (0.8%)	8.57 ± 0.03 (0.4%)	8.63 ± 0.03 (0.4%)	8.51 ± 0.04 (0.4%)	8.63 ± 0.13 (1.5%)
Operation (hrs)	34.0	34.5	33.8	32.8	33.8 ± 0.7 (2.2%)
Intra-Pump Summary					
Mean ± SD, Vdc (RSD %)	8.81 ± 0.02 (0.3%)	8.58 ± 0.01 (0.1%)	8.64 ± 0.02 (0.2%)	8.56 ± 0.04 (0.4%)	
Operation (hrs)	33.3 ± 1.0 (3.1%)	34.8 ± 0.2 (0.7%)	33.8 ± 0.3 (0.9%)	33.1 ± 1.9 (5.7%)	

^a Pump IDs match to the following serial numbers: 1 = SN14168, 2 = SN14359, 3 = SN14140, and 4 = SN14407.

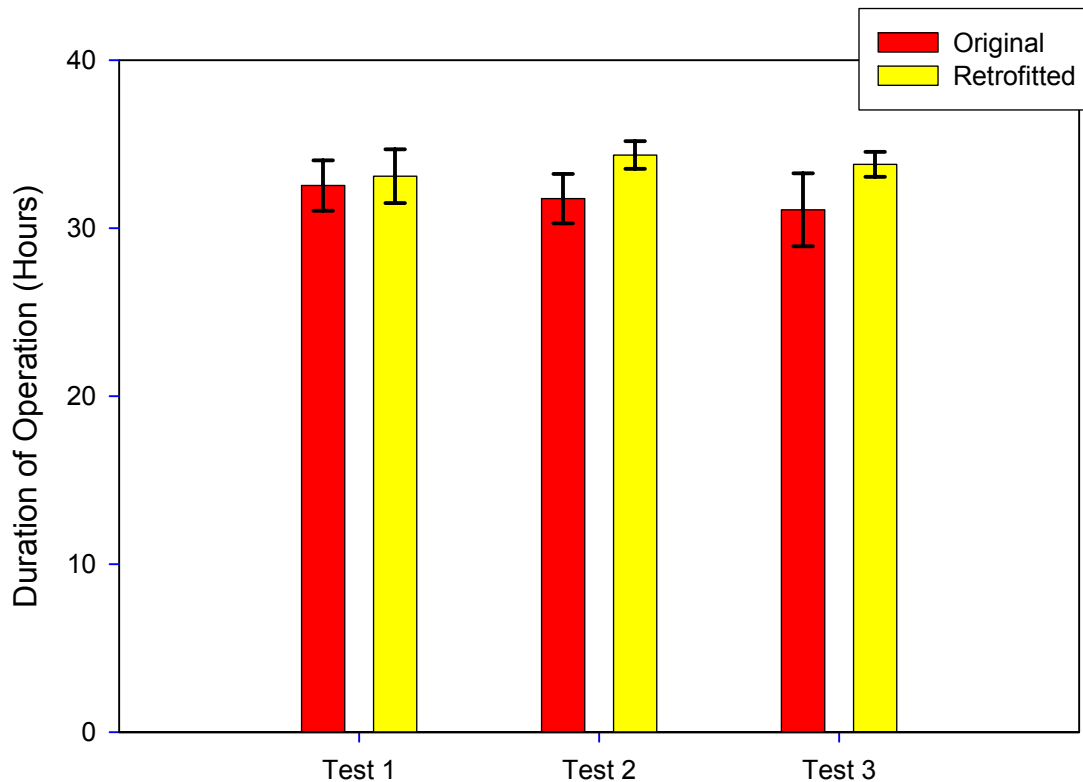

Figure 6-1. Battery Operation Duration for Original and Retrofitted Pumps in 25°C, 30% Relative Humidity Environment, Error Bars Represent One Standard Deviation from the Mean (n = 4 pumps per test).

6.1.2 Sampling Performance at Different Pressure Loads

Duration of Operation

The results of the battery-powered duration of operation sampling under three different pressure drops are shown for the original and retrofitted pumps in Figure 6-2. All of the original and retrofitted pumps sampled for 30 hours or longer under a pressure drop of 11 inch H₂O. When sampling under a 15 inch H₂O pressure drop, all of the retrofitted pumps sampled for 30 hours or more, whereas 3 of the 12 original pumps failed to sample for at least 24 hours. When sampling under the highest pressure drop tested, 19 inch H₂O, all of the retrofitted pumps sampled for 26 hours or longer; whereas 5 of the 12 original pumps failed to sample for a least 24 hours.

For each of the three pressure drops, the retrofitted pumps sampled much more consistently and for a longer period of time. This trend was more pronounced at 15 and 19 inch H₂O, where the retrofitted pumps sampled for 20% longer and with 90% less variation among the pump sampling periods in a given test, as compared to 11 inch H₂O, which showed a 7% longer sampling period and 50% less variation. This is largely due to the fact that three of the original

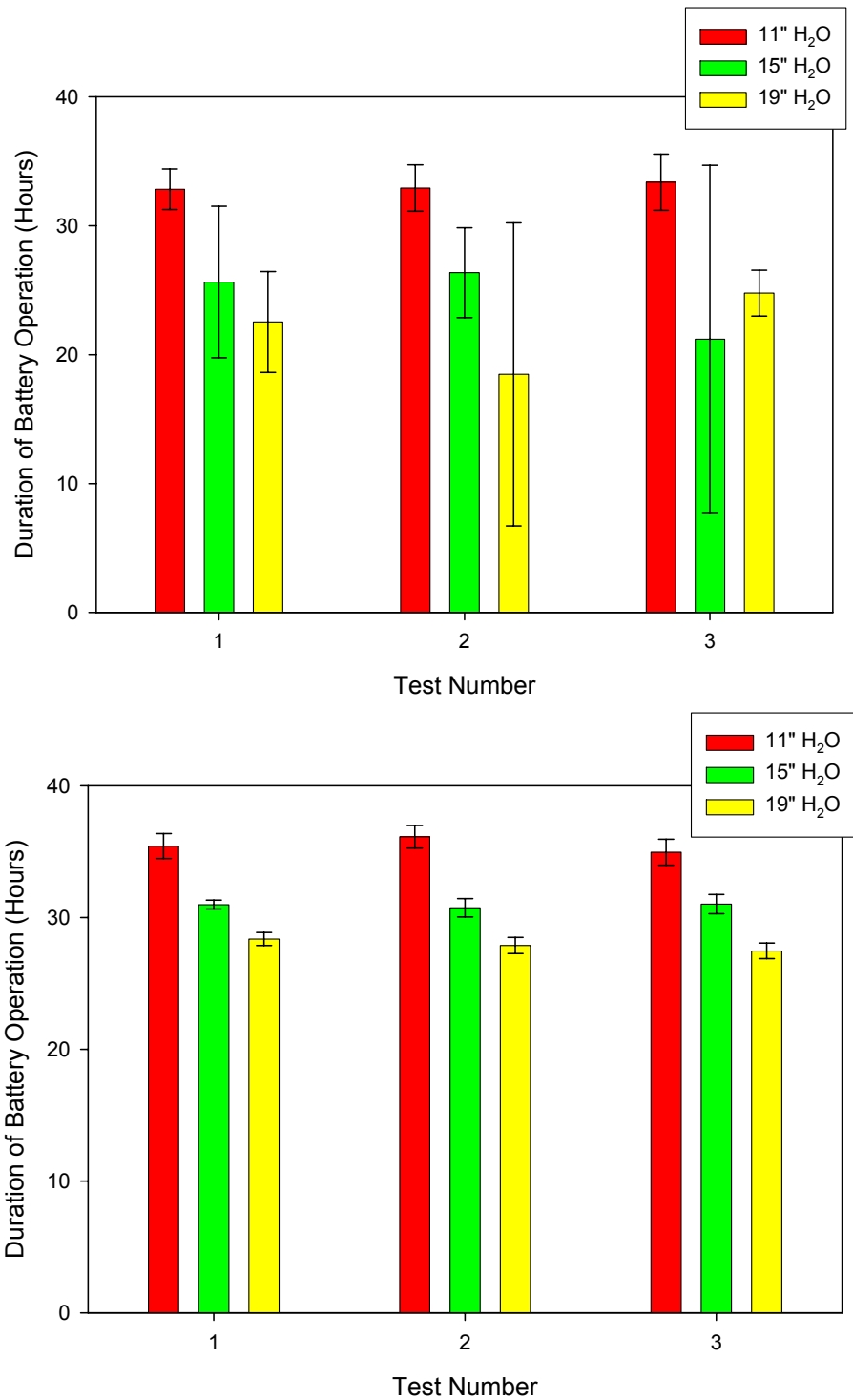

Figure 6-2. Battery Operation Duration for Original (top) and Retrofitted (bottom) Pumps Sampling Under Different Pressure Drops, Error Bars Represent One Standard Deviation from the Mean (n = 4 pumps per test).

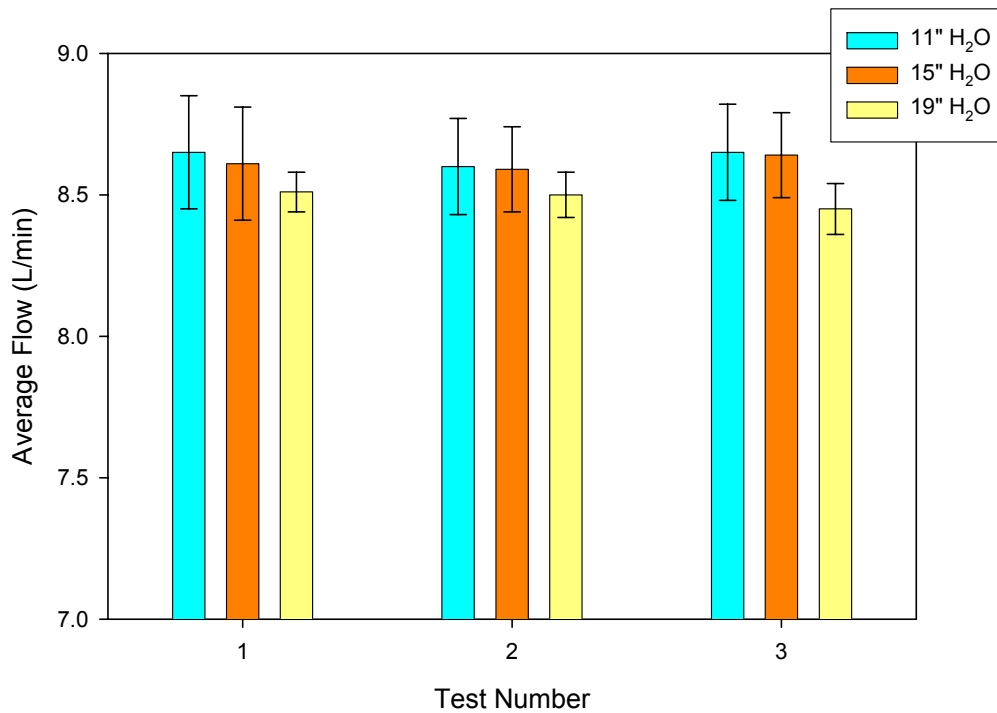
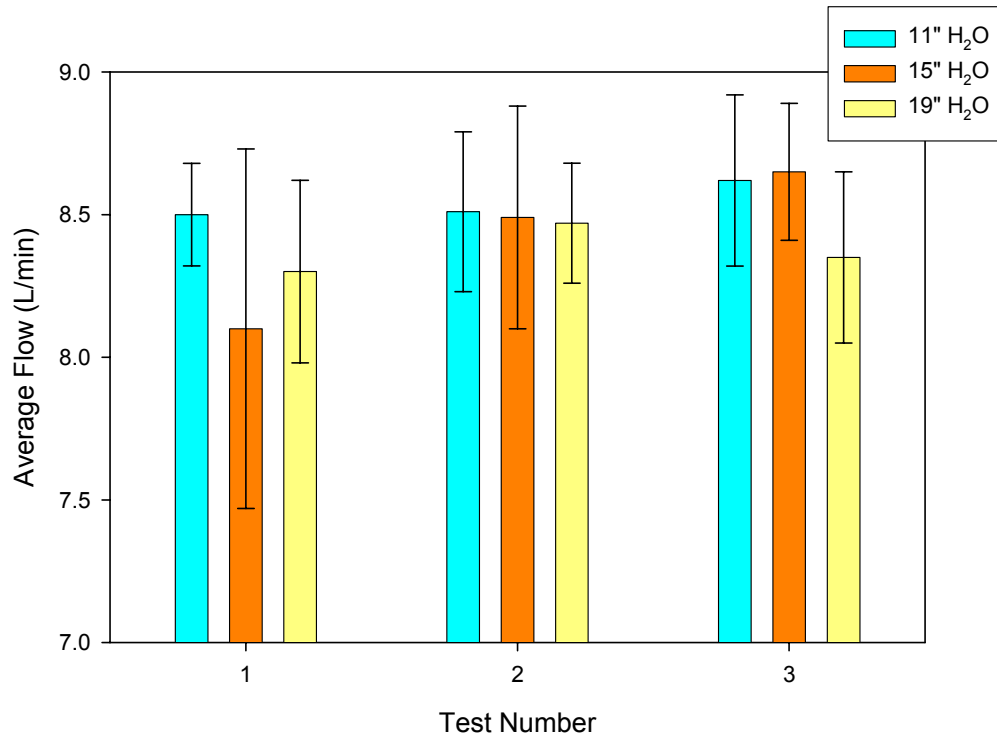

Figure 6-3. Average Flow (L/min) for Original (top) and Retrofitted (bottom) Pumps Sampling Under Different Pressure Drops, Error Bars Represent One Standard Deviation from the Mean (n = 4 pumps per test).

pumps failed during the 15 and 19 inch H₂O tests, but none of the retrofitted pumps failed during any of the pump testing.

Flow Rate

The average inter-pump flow rate for the original and retrofitted pumps sampling under the three different pressure drops is shown in Figure 6-3. In general, the flow rate for the original pumps showed two to five times more fluctuation than that measured for the retrofitted pumps. Again this is due to the fact that three of the original pumps failed during the 15 and 19 inch H₂O tests, but none of the retrofitted pumps failed during any of the pump testing. According to the Leland Legacy[®] Operating Instructions, when the pump's flow rate drops by more than 5%, the pump will stop and attempt to restart every 20 seconds for up to ten tries. The flow rate data for Pump's 1-3, shown in Figure 6-4, reflect this, especially for Pump 2 which appears to have started and stopped several times. These data are typical of the flow pattern for battery expiration, whereas the flow rate data for Pump 4 shows that the pump never tries to restart itself, which is typical of the failure being caused by the breaking loose of the pump's crank-arm pivot pin from the diaphragm yoke assembly.

During their period of operation within a given test, the average intra-pump flow rates for the original and retrofitted pumps deviated by less than 1% for the 11 and 15 inch H₂O pressure drop testing. The exception was the original Pump 2, SN 14359, which deviated by 10% and ultimately stopped functioning during the 15 inch H₂O test. Intra-pump flow rate deviation increased for the 19 inch H₂O pressure drop testing to an average of 5% for the original and 2% for the retrofitted pumps.

Sound Level

Sound level was recorded throughout these experiments until all of the pumps ceased operating due to battery drain. All pumps were clad in the manufacturer's noise reducing nylon cases during these experiments. A summary of the sound levels recorded for the original and retrofitted pumps during this testing is shown in Figure 6-5 as a function of the number of

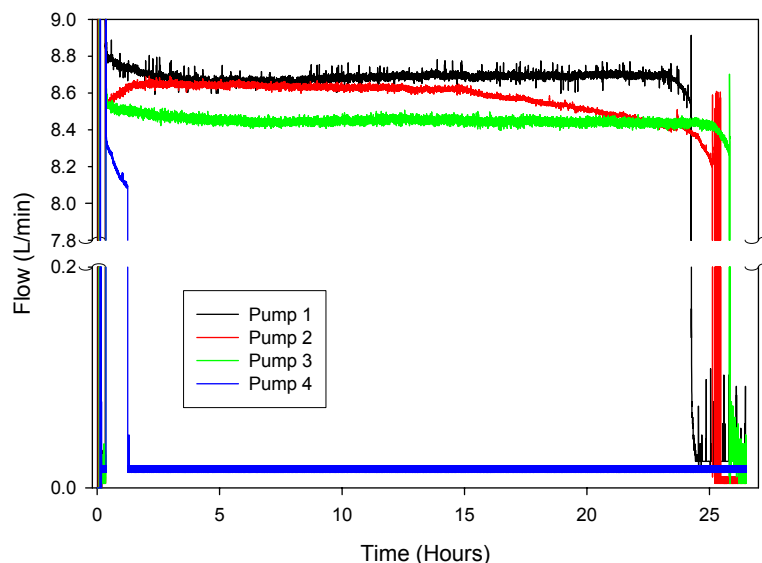

Figure 6-4. Flow Rate (L/min) for Original Pump Test #2 at 19 inch H₂O pressure drop.

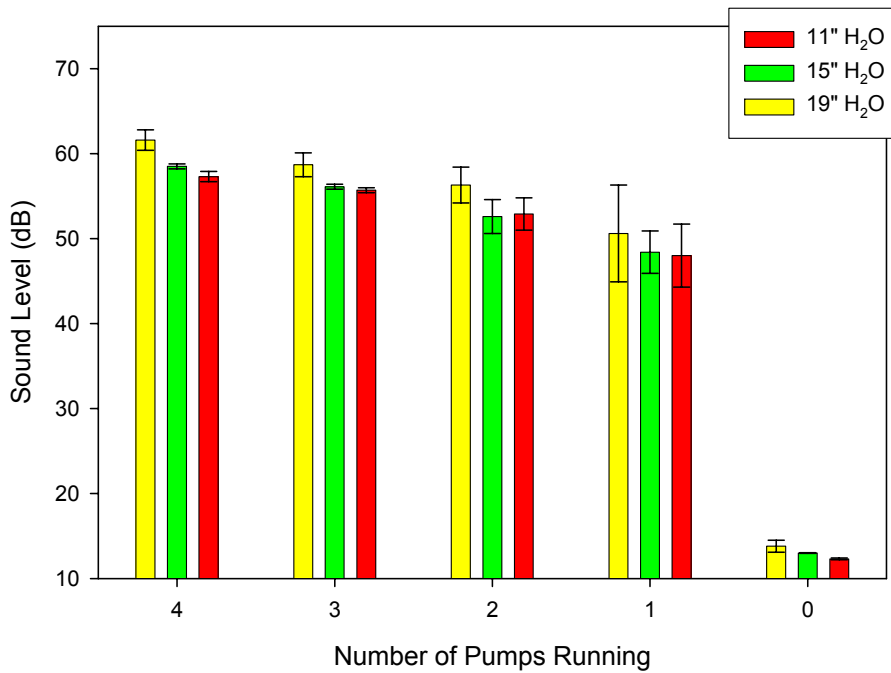
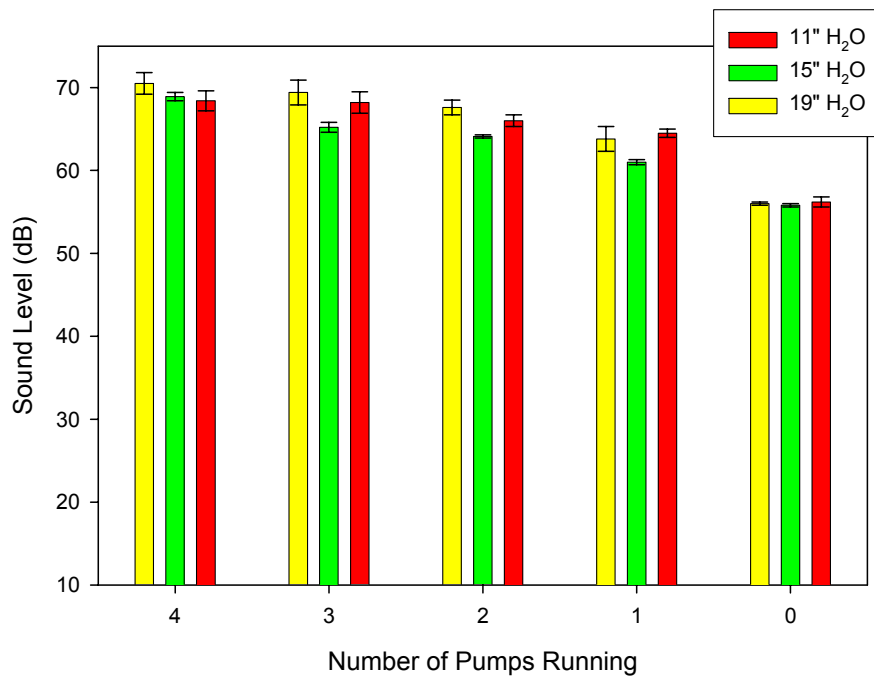

Figure 6-5. Sound Level (dB) for Original (top) and Retrofitted (bottom) Pumps Sampling Under Different Pressure Drops, Error Bars Represent One Standard Deviation from the Mean (n = 4 pumps per test).

pumps operating. The sound level for four pumps increased from operating at the manufacturer's recommended 11 inch H₂O pressure drop. At first glance it appears that the retrofitted pumps were quieter, but in fact, the retrofitted pump testing was conducted in a different vacant laboratory that was more remote from daily people traffic, and thus the background noise level was significantly lower by about 45 dB.

6.1.3 High Temperature and Moderate/High Humidity (40°C, 60/90%)

40°C and 60% Relative Humidity

Only one test was performed on the original pumps at high temperature and moderate humidity, after which the fourth pump failed and testing of the original pumps was halted. During that single test, all of the original pumps ran for the required 24 hours, and initial and final flow rates and pressure drops were within the $\pm 10\%$ variance. All of the retrofitted pumps ran for the required 24 hours for each of the three tests, and initial and final flow rates were also within variance. The final pressure drops for four of the pumps fell outside the variance, as summarized in Table 4-1. The recorded flow rate data for both pumps showed no more variance than that exhibited during the moderate temperature and humidity test conditions.

40°C and 90% Relative Humidity

All of the retrofitted pumps ran for the required 24 hours for each of the three tests, and initial and final flow rates were also within variance. The final pressure drops for 5 of the 12 pumps fell outside the variance. The recorded flow rate data for the retrofitted pumps showed slightly more variance, 4%, than that exhibited during the moderate temperature and humidity test conditions.

6.2 Sampling Efficiency Comparison

Sampling efficiency was determined gravimetrically as described in Section 3.2, and five comparisons were made between the test and reference samplers for four particle sizes, including total particulate matter (TPM), 0.5 – 1.0 μm , <0.5 μm , and PM_{2.5}, as shown in Table 6-3. A summary of the sampling efficiency comparisons made between the test and reference samplers for the four different particle sizes collected is presented in Table 6-4.

Table 6-3. Test and Reference Sampler Gravimetric Comparisons.

			Test and Reference Sampler Comparisons				
Sampler	Stage ID	Cutpoint (µm)	PCIS:DCI-6 TPM	PCIS:PEM TPM	PCIS:DCI-6 0.5 – 1.0 µm	PCIS:DCI-6 <0.5 µm	PCIS:FRM PM_{2.5}
PCIS	A	> 2.5	Sum all stages and after-filter	Sum all stages and after-filter	Stage C	Sum of Stage D and AF	Sum of stages B-D and after-filter
	B	1.0 – 2.5					
	C	0.5 – 1.0					
	D	0.25 – 0.50					
	AF	<0.25					
DCI-6	A	>16	Sum of all stages and after-filter		Stage F	After-filter	
	B	8.0 - 16					
	C	4.0 – 8.0					
	D	2.0 – 4.0					
	E	1.0 – 2.0					
	F	0.5 – 1.0					
	AF	<0.50					
PEM	Single PEM	10		Single PEM			
FRM	Single FRM	2.5					Single FRM

Table 6-4. Summary of Comparison Between the Sioutas PCIS, DCI-6, and PEM for Particle Sizes from Test Aerosol.

Samplers Compared	Particle Sizes (μm)	Mean \pm S.D. ^a of the Ratios	Mean Diff. \pm S.D., mg/m^3 (mean rel. diff.) ^b	<i>p</i> -Value ^c
PCIS:DCI-6	TPM	0.87 ± 0.09	-0.49 ± 0.40 (15%)	0.900
PCIS:PEM	TPM	0.85 ± 0.09	-0.47 ± 0.29 (17%)	0.036 ^d
PCIS:DCI-6	0.5 – 1.0	1.32 ± 0.20	0.17 ± 0.12 (26%)	0.009 ^e
PCIS:DCI-6	≤ 0.5	0.72 ± 0.15	-0.68 ± 0.45 (35%)	0.931
PCIS:FRM	≤ 2.5	0.88 ± 0.13	-0.39 ± 0.36 (16%)	0.843

^a S.D. = standard deviation

^b Diff. = difference; mean rel. diff. = mean relative difference

^c Mann-Whitney rank sum test

^d Statistically significant difference in values at the $p = 0.036$ level

^e Statistically significant difference in values at the $p = 0.009$ level; data normally distributed ($p = 0.084$), t-test used, power = 0.737.

6.2.1 PCIS:DCI-6 and PCIS:PEM TPM Comparisons

For the PCIS:DCI-6 TPM comparison, the summed gravimetric data for all six stages and the after-filter of the DCI-6 were used as “reference” data and were compared to the summed gravimetric data for all four stages and the after-filter of the Sioutas PCIS. The results of those comparisons are shown in Figure 6-6 and are summarized in Table 6-4. The variability among the PCISs is less than 10% for each test run. Likewise, the reference samplers show similar variability suggesting that the aerosol was well mixed in the chamber. Although ordinarily not directly comparable because of size cutpoint differences, the PEM (10 μm cutpoint) data are also included because our characterization of the test aerosol showed particle size ranged from 0.1 – 10 μm ; which is confirmed by the DCI-6 data for aerodynamic sizes ≥ 8.0 μm presented in Table 6-5. These results indicate that the Sioutas PCIS data show a negative bias of 15% compared to the DCI-6 data for TPM, and a negative bias of 17% compared to the PEM.

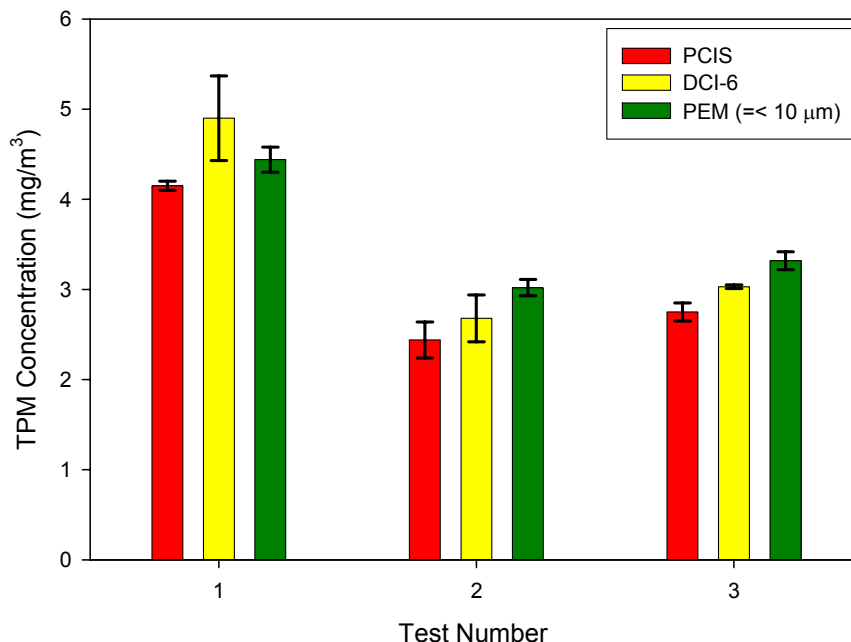

Figure 6-6. Comparison of TPM Collected Using Test (Sioutas PCIS) and Reference (DCI-6 and PEM 10 μm cutpoint) Samplers.

Table 6-5. Comparison of Sioutas PCIS, DCI-6, and PEM (10 μm cutpoint) Sampler Gravimetric Results for TPM.

Sampler	Cutpoint (μm)	Test Aerosol KCl Concentration (mg/m ³)		
		Test 1	Test 2	Test 3
Sioutas PCIS	<0.25	0.97 ± 0.12	0.26 ± 0.11	0.28 ± 0.08 ^a
	≥0.25 and ≤0.50	1.31 ± 0.07	0.97 ± 0.05	1.20 ± 0.03
	≥0.50 and ≤1.0	0.94 ± 0.04	0.57 ± 0.03	0.63 ± 0.06
	≥1.0 and ≤2.5	0.73 ± 0.07	0.48 ± 0.05	0.46 ± 0.01
	>2.5	0.20 ± 0.09	0.16 ± 0.03	0.09 ± 0.06
	TPM	4.15 ± 0.05	2.44 ± 0.20	2.75 ± 0.10
DCI-6	<0.50	3.34 ± 0.37	1.67 ± 0.24	1.91 ± 0.08
	≥0.50 and ≤1.0	0.66 ± 0.09	0.46 ± 0.07	0.52 ± 0.07
	≥1.0 and ≤2.0	0.66 ± 0.06	0.43 ± 0.05	0.46 ± 0.06
	≥2.0 and ≤4.0	0.21 ± 0.06	0.12 ± 0.04	0.12 ± 0.05
	≥4.0 and ≤8.0	0.04 ± 0.01	0.01 ± 0.01	0.01 ± 0.01
	≥8.0 and ≤16	0.01 ± 0.01	0.00 ± 0.01	0.00
	>16	0.00	0.00 ± 0.01	0.00 ± 0.01
TPM	4.90 ± 0.47	2.68 ± 0.26	3.03 ± 0.02	
PEM	≤10	4.44 ± 0.14	3.02 ± 0.09 ^b	3.32 ± 0.10

^a Filter damaged during removal, n = 3.

^b Pump failure, n = 3.

6.2.2 PCIS:DCI-6 0.5 – 1.0 μm and <0.5 μm Comparisons

For evaluating sampling efficiency for the individual impactor stages, the DCI-6 sampler provides “reference” gravimetric data for two of the five stages of the Sioutas PCIS. For particles that are ≥ 0.5 and ≤ 1.0 μm , gravimetric results from the sixth DCI-6 stage were compared to gravimetric data for the third stage of the Sioutas PCIS. These results are presented in Table 6-6. Likewise, the results from the final stage of the DCI-6 provides “reference” gravimetric data for particles that are <0.5 μm , which are compared to the sum of gravimetric data for the bottom two stages of the Sioutas PCIS, and are presented in Table 6-6. Although not directly comparable, the DCI-6 data for the ≥ 1.0 and ≤ 2.0 μm stage are also included in Table 6-6. These results indicate that the Sioutas PCIS data show a negative bias of 35% compared to the DCI-6 data for the smaller particles (≤ 0.5 μm), and a positive bias of 26% for particles in the 0.5 to 1.0 μm size range.

6.2.3 PCIS:FRM $\text{PM}_{2.5}$ Comparison

For $\text{PM}_{2.5}$ comparisons, the $\text{PM}_{2.5}$ FRMs were used as “reference” gravimetric data and were compared to the summed gravimetric data for stages B – D and the after-filter of the Sioutas PCIS. The results of those comparisons are shown in Figure 6-7. Although not directly comparable because of size cutpoint differences between the DCI-6 sampler and the Sioutas PCIS, the DCI-6 sampler data for the bottom 3 stages, representing particles that were ≤ 2.0 μm , are also included in Figure 6-7. The Sioutas PCIS results show a negative bias compared to the data for all of the reference samplers, including the DCI-6 sampler. The inter-sampler variations were less than 15% in all instances. Intra-sampler variation was not evaluated because the aerosol generation time for Test 1 (15 minutes) was longer than for Tests 2 and 3 (10 minutes).

Table 6-6. Comparison of Sioutas PCIS and DCI-6 Sampler Gravimetric Results for Similar Aerodynamic Diameter Cutpoints.

Test #	Mean \pm Std Dev, mg/m^3 (RSD)					
	PCIS, ≤ 0.5 μm	DCI-6, <0.5 μm	PCIS, ≥ 0.5 and ≤ 1.0 μm	DCI-6, ≥ 0.5 and ≤ 1.0 μm	PCIS, ≥ 1.0 and ≤ 2.5 μm	DCI-6, ≥ 1.0 and ≤ 2.0 μm
1	2.28 \pm 0.15 (6.4%)	3.34 \pm 0.37 (11%)	0.94 \pm 0.04 (4.2%)	0.66 \pm 0.09 (14%)	0.73 \pm 0.07 (9.1%)	0.66 \pm 0.06 (9.0%)
2	1.23 \pm 0.14 (14%)	1.67 \pm 0.24 (14%)	0.57 \pm 0.03 (4.9%)	0.46 \pm 0.07 (14%)	0.48 \pm 0.05 (10%)	0.43 \pm 0.05 (13%)
3	1.57 \pm 0.21 (14%)	1.91 \pm 0.08 (4.1%)	0.63 \pm 0.06 (9.8%)	0.52 \pm 0.07 (13%)	0.46 \pm 0.01 (1.4%)	0.46 \pm 0.06 (12%)

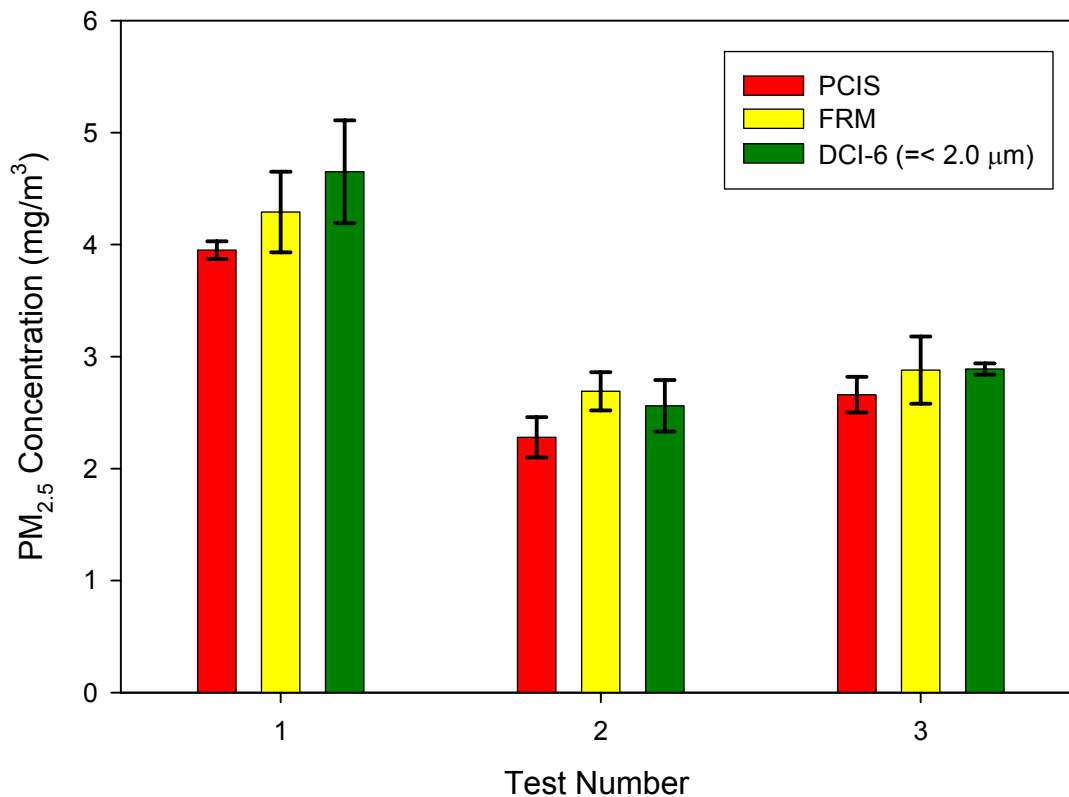

Figure 6-7. Comparison of PM_{2.5} Collected Using Test (Sioutas PCIS) and Reference (FRM PM_{2.5} and DCI-6) Samplers.

Rank sum tests between the PCIS and reference samplers indicate that the concentrations are not statistically significant at the specified p level for TPM (collected using the DCI-6 sampler), and the $\leq 0.5 \mu\text{m}$ and $\leq 2.5 \mu\text{m}$ particle size diameters. Concentrations were statistically different for TPM collected using the PEM, and the $0.5 - 1.0 \mu\text{m}$ size range. The reason for the positive bias between the Sioutas PCIS and the DCI-6 for the $0.5 - 1.0 \mu\text{m}$ size range is not apparent. Although the PEM sampler pumps operated at pressure drops that are greater than recommended by the manufacturer, the negative bias between the Sioutas PCIS and PEM measurements for TPM are not likely due to particle bounce or cutpoint changes due to flow degradation, because the test aerosol size range did not exceed $10 \mu\text{m}$.

6.3 Sampling Metals in Ambient Air

The test (Sioutas PCIS) and reference (PEM, 2.5 μm cutpoint) samplers sampled ambient air in Columbus, Ohio, for a period of 48 hours, and the substrates were collected and analyzed for the 38 target metals/elements listed in Table 3-5 using XRF. Only nine target metals/elements showed detectable levels in the first four stages of the Sioutas PCIS, corresponding to particles with diameters $\leq 2.5 \mu\text{m}$. Of those nine metals/elements, Al and Na levels were right at the MDL and thus were excluded from this discussion. The concentrations for the after-filter and bottom three stages were summed and those values are compared to the single-stage PEM $\text{PM}_{2.5}$ results for each of the three tests conducted in Figures 6-8, 6-9, and 6-10. For each test, the variability among the Sioutas PCIS samplers was comparable to the variability among the PEMs, and in most cases ranged from 1-13%. Note that the y-axis for Figures 6-8 through 6-10 is on a logarithmic scale.

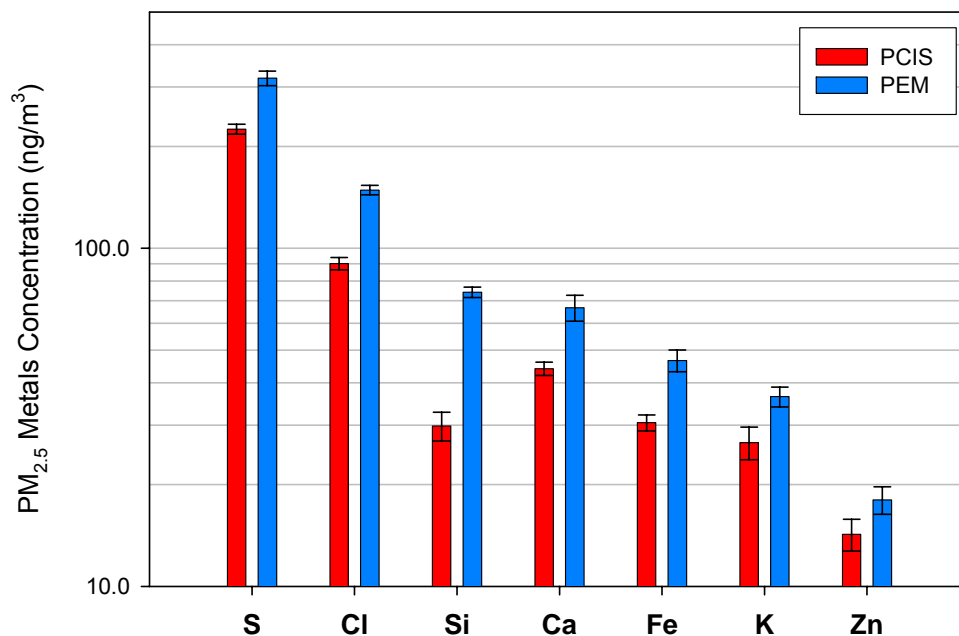

Figure 6-8. Detectable Metals/Elements Found in Ambient Air $\text{PM}_{2.5}$ Collected Over a 48-hour Period using Test (Sioutas PCIS) and Reference (PEM) Samplers for Test 1, the Error Bars Represent One Standard Deviation from the Mean.

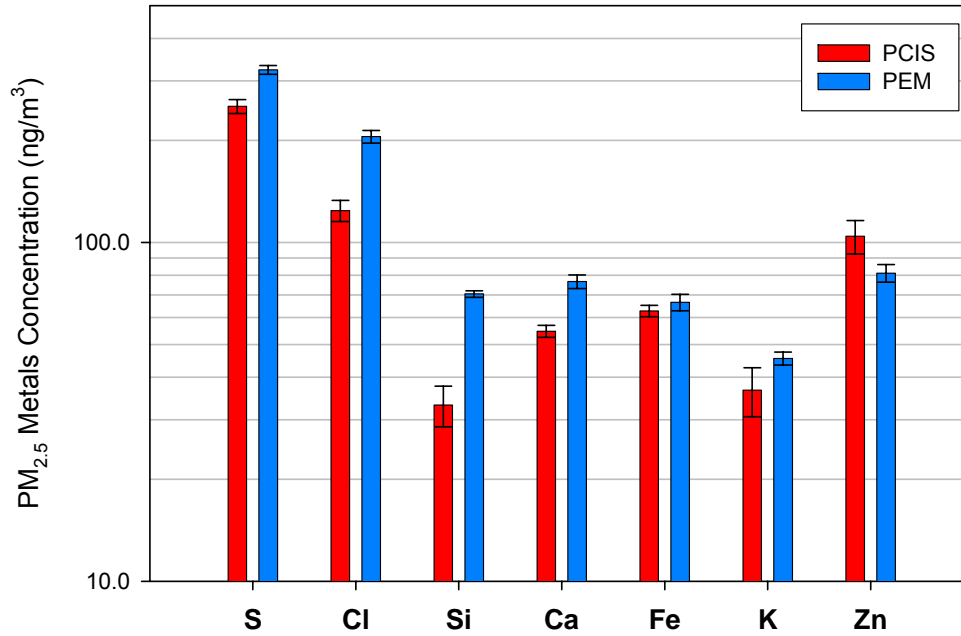

Figure 6-9. Detectable Metals/Elements Found in Ambient Air PM_{2.5} Collected Over a 48-hour Period using Test (Sioutas PCIS) and Reference (PEM) Samplers for Test 2, the Error Bars Represent One Standard Deviation from the Mean.

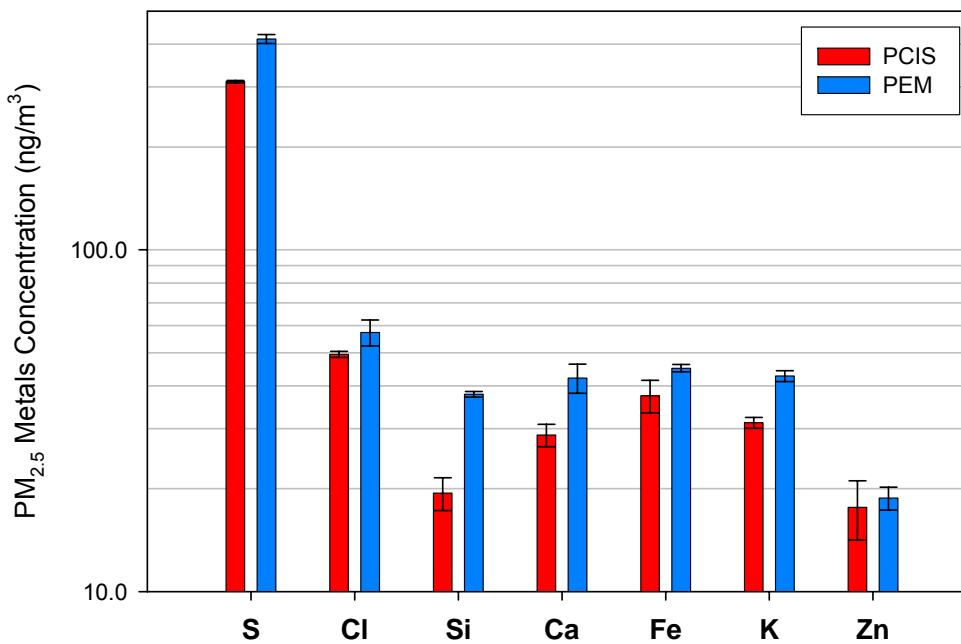

Figure 6-10. Detectable Metals/Elements Found in Ambient Air PM_{2.5} Collected Over a 48-hour Period using Test (Sioutas PCIS) and Reference (PEM) Samplers for Test 3, the Error Bars Represent One Standard Deviation from the Mean.

Comparability between the Sioutas PCIS and the PEM was assessed from a linear regression of the concentration for each detected target metal/element using the PEM data as the independent variable and the Sioutas PCIS results as the dependent variable. The results of this analysis are presented in Figure 6-11, where comparability is expressed in terms of the slope and intercept between the Sioutas PCIS and PEM data, and the degree of correlation between the two.

The dataset falls along a line that is significantly statistically different from the unity line, and the y-intercept, -0.54, is not significantly different from zero. Note that the x- and y-axis for Figure 6-11 is on a logarithmic scale. The majority of the data falls below the unity line indicating a negative bias of the Sioutas PCIS results as compared to those obtained using the reference PEMs. This ambient air low concentration of metal/element result is similar to that found in the test aerosol high concentration of particulate result discussed in the sampling efficiency comparisons, Section 6.2. At both concentration levels, sub- $\mu\text{g}/\text{m}^3$ of metal/element versus mg/m^3 of particulate, the Sioutas PCIS results show a negative bias compared to the data for the reference samplers.

The individual comparisons, including the ratio and differences between each metal/element concentration measured in the collected $\text{PM}_{2.5}$ for the test and reference samplers are summarized in Table 6-7. Si shows the highest bias, 74%, between the Sioutas PCIS and PEM. The levels collected on and measured for each Sioutas PCIS impactor stage for Si metals were at, or less than five times the MDL, as shown in Table 4-6. Because the $\text{PM}_{2.5}$ particles are collected onto 4 stages for the Sioutas PCIS, if the level collected on each stage is at or near the

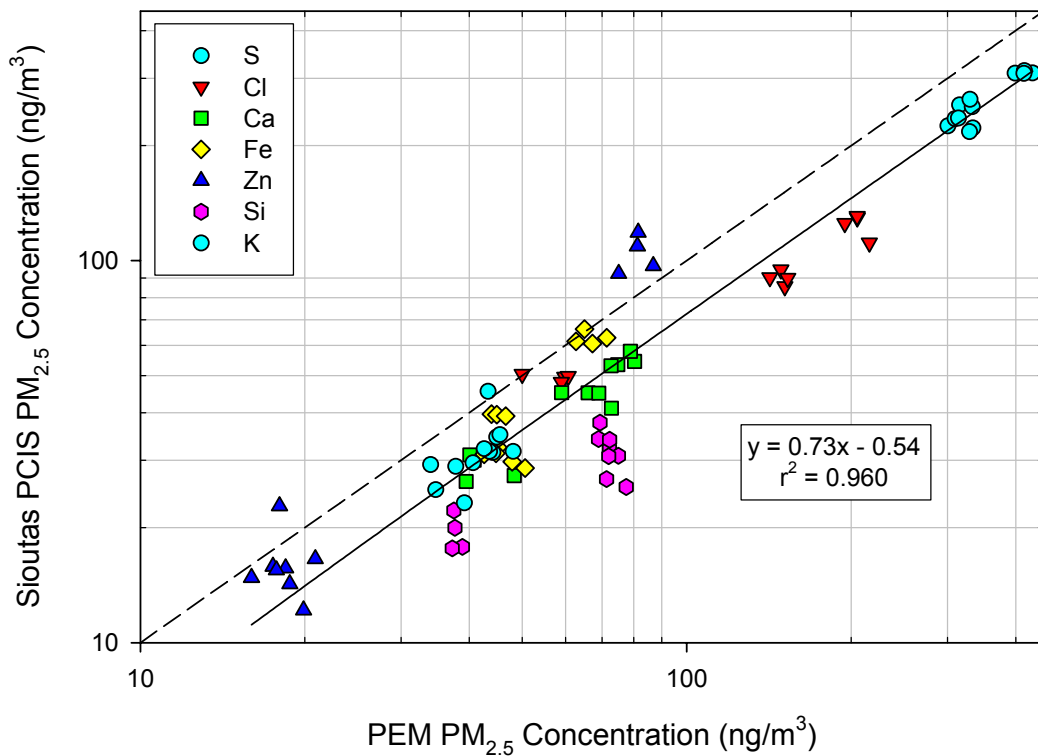

Figure 6-11. Metal/Element Levels Detected in 48-hour Ambient Air $\text{PM}_{2.5}$ Samples Collected Using Test (Sioutas PCIS) and Reference (PEM) samplers.

Table 6-7. Summary of Comparison Between 48-hour Ambient Air PM_{2.5} Metal/Element Levels Collected using the Test (Sioutas PCIS) and Reference (PEM) Samplers.

Metal	Mean of the PCIS:PEM Ratio	Mean Difference ± S.D., ng/m ³ (mean relative difference)
S	0.75 ± 0.05	89 ± 20 (29%)
Cl	0.69 ± 0.14	49 ± 33 (38%)
Si	0.46 ± 0.07	33 ± 12 (74%)
Ca	0.69 ± 0.07	19 ± 6.6 (37%)
Fe	0.81 ± 0.14	9.2 ± 6.7 (22%)
K	0.76 ± 0.11	10 ± 4.9 (29%)
Zn	1.01 ± 0.26	-6 ± 14 (22%)

MDL, results do not correlate as well with a single stage PEM impactor that collects all of the PM_{2.5} onto one filter. The particle distribution of metals/elements analyzed in PM_{2.5} collected using the Sioutas PCIS samplers is presented in Figure 6-12. Si appears to be detected equally in ambient air PM_{2.5} particles with aerodynamic diameters <0.25 μm and ranging from 0.25 – 2.5 μm. Since the particle distribution of Si virtually matches that measured for Zn, and Zn appears to have the least amount of bias between the two samplers, the negative bias does not seem to be related to the size of the particles collected.

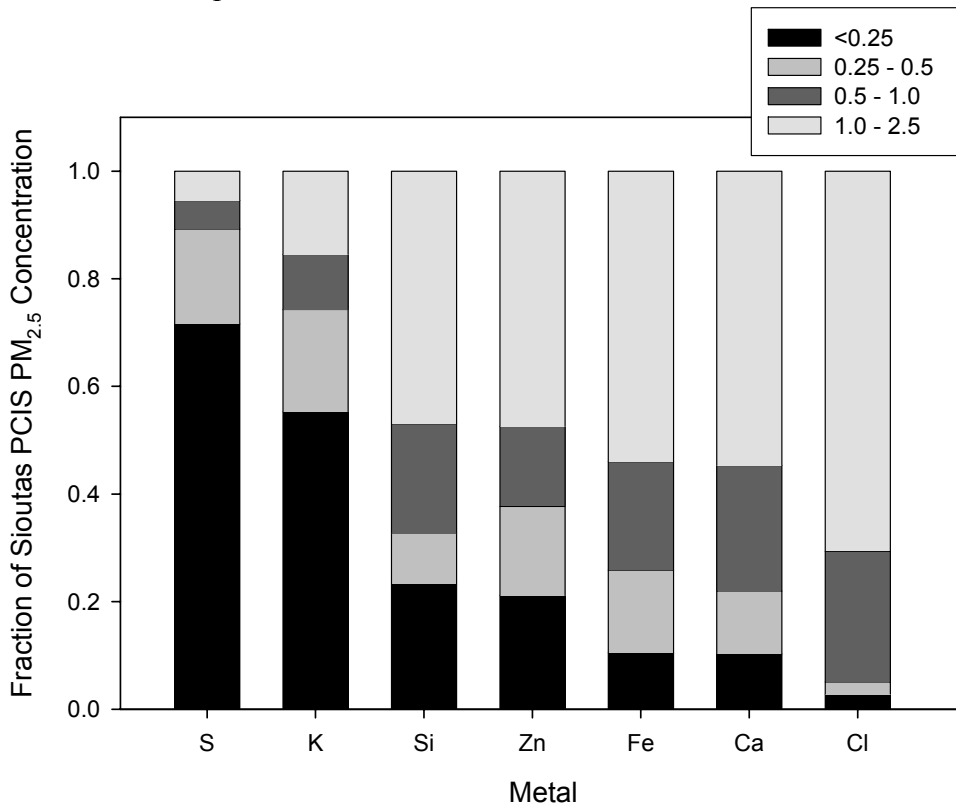

Figure 6-12. Particle Distribution of Detectable Metals/Elements Measured in 48-hour Ambient Air (Columbus, OH) PM_{2.5} Samples Collected Using Sioutas PCIS Samplers.

It should be noted that the Sioutas PCIS is designed with slit-like accelerator plates that produce a thin rectangular deposition pattern on a portion of the substrates, which results in a very small area of the filter that has an even particle distribution. The exception is the PCIS after-filter, which has no accelerator plate in front of it and collects particles that are $<0.25\ \mu\text{m}$. The deposition pattern on this filter is therefore more evenly distributed over the entire area of the filter. Since the XRF instrument is calibrated to measure x-ray fluorescence in $\mu\text{g}/\text{cm}^2$, it is necessary to estimate the area of the deposition pattern in order to report $\mu\text{g}/\text{filter}$ concentrations. Because the area was estimated and were not measured exactly, these results are classified as semi-quantitative. For the circular distributions, those collected on the PEMs and after-filter for the Sioutas PCIS, the area of the entire filter minus that of the supporting ring was used as the area of the deposition pattern ($8.01\ \text{cm}^2$ for the 37 mm substrates); for the slit-like distribution collected on Stages B-D of the Sioutas PCIS the area was estimated at $1.0\ \text{cm}^2$ (for the 25 mm substrates). This estimation of deposition pattern area may have contributed significantly to the observed negative bias between the Sioutas PCIS and the PEM.

To quantify the variability associated with using XRF to measure metals/elements distributed on a filter from a slit-like nozzle, one sample was run in triplicate, and each analysis was done with the deposition pattern having a different orientation: horizontal, diagonal, and vertical. RSDs among the different orientations for all metals/elements averaged to 22%, with the exception of Fe and Zn, which showed much higher RSDs, 41% and 84% respectively. The 22% average is slightly higher than the within-test intersampler variability, which ranged from 1-13%, as shown by the error bars in Figures 6-8 thru 6-10. All of the ambient air filter samples with slit-like patterns were analyzed with the deposition pattern in the horizontal position.

6.4 Sampler Ease of Use, Reliability, and Subject Acceptability/Compliance

Prior to allowing subjects to participate in the study, a Battelle technician described the air sampling protocol, answered any of the subject's questions, and obtained signed informed consent; the Informed Consent Form that all subjects read and signed is provided in Appendix A. Seven non-smoking subjects were recruited to wear the PCIS for a period of 48 hours and keep a simple time/activity diary, included in this report as Appendix B, for that period. At the end of the sampling period, subjects returned to the laboratory and turned in their pumps and completed time/activity diaries. They then filled out a questionnaire, which is presented in Appendix C, to gather information about the pump's ease of operation, reliability, and their acceptance of the device. The pumps were equipped with small, data-logging multidirectional accelerometers that measured and logged occurrence and intensity of activity. These data provided an objective measure of subject protocol compliance during the 48-hour sampling period. Ease of use and reliability was also evaluated by our Battelle laboratory technicians during sampler setup and return.

6.4.1 Ease of Use and Subject Acceptability

Questionnaire Responses

Questionnaire responses for the seven subjects, including the parameter each question was designed to evaluate, are summarized in Table 6-8. Evaluation parameters include pump noise,

Table 6-8. Summary of the Ease of Use, Reliability, and Subject Acceptability Questionnaire Responses (n = 7 Subjects).

No.	Question	Param. ^a	Mean	Mode
1.	The pump noise was too loud.	N	2.3 ^b	3
2.	The weight of the pump was uncomfortable.	A	3.6	5
3.	It was easy to wear the sampler clipped to my shirt.	A	3.9	2
4.	I could talk on the phone easily while wearing the sampler.	N	2.6	2
5.	I would volunteer to wear this sampler for another 24 hours.	A	2.7	2
6.	I could not tell if the sampler was operating.	N	5.0	6
7.	I was always conscious of the sampler.	N, A	2.6	1
8.	I had problems putting the sampler back on.	E	5.3	6
9.	I slept well while the sampler was operating near me. ³	N	3.8	5
10.	It was hard to take the sampler off in order to shower or bathe.	E	5.3	6
11.	I was comfortable wearing the pump.	A	3.4	3
12.	Sometimes I forgot that I was wearing the sampler.	A	5.0	6
13.	I was not able to wear this sampler for longer than 4 hours.	A	5.6	6
14.	It was hard to think while wearing the sampler.	A	4.6	5
15.	I like wearing the sampler.	A	4.9	4
16.	It was easy to plug the pump into the wall outlet at night	E	1.9	1
17.	I did not wear the sampler for approximately ___ hours during the 48-hr sampling period.	C	18.2 ± 5.1	16
18.	I was able to follow the air sampling instruction that Battelle gave me exactly.	E	Y = 3	N = 4
19.	The sampler drew attention to me so that I had to explain to people what I was doing.	A	Y = 6	N = 1
20.	I felt comfortable wearing the inlet clipped to my shirt.	A	Y = 3	N = 4
21.	The sound of the pump sometimes got louder and/or softer	N	Y = 4	N = 3
22.	The pump stopped running even though I didn't do anything to it.	E	Y = 1	N = 6
23.	I accidentally dropped the pump.	E	Y = 0	N = 7
24.	I could not sleep with the sampler operating near me.	N	Y = 1	N = 4 ^c

^aParam. = parameter question was designed to evaluate; N = pump noise, A = subject acceptability, E = ease of use, C = protocol compliance.

^bSubject could circle one number ranging from 1 – 6, where 1 = Strongly Agree, and 6 = Strongly Disagree.

^cTwo subjects turned off the pumps during their sleeping time.

subject acceptance, and ease of use. Subjects were primarily female (6 of the 7 subjects), and ranged in ages from 25 – 56 years old. For the first 16 questions, subjects were instructed to circle a number from 1 to 6, with 1 representing Strongly Agree, and 6 representing Strongly Disagree. Question 17, aimed at evaluating sampling protocol compliance, required the subject to input the number of hours (s)he did not wear the sampler. The remainder of the questions required the subject to give True/False responses.

Most of the responses given for questions 1-16 were not unanimously strong; however, there were several exceptions, which are further described below according to their evaluation parameter:

Noise

Most subjects felt strongly that the pump was loud (Q1), they were always conscious of the sampler and could tell it was operating (Q6, Q7, Q12), and they were able to sleep (Yes/No Q 24) but could not sleep very well with it operating near them (Q9). However, they also indicated that they could easily talk on the phone while wearing the sampler (Q4).

Ease of Use

Most subjects felt strongly that the sampler was easy to use; they had no problems putting it on or taking it off (Q8, Q10) and it was easy to plug the pump into A/C power at night (Q16). Nobody indicated that they accidentally dropped the sampler (Yes/No Q23).

Acceptance

Most subjects felt strongly that they were always aware of the sampler (Q7, Q12), that they did not like wearing the sampler (Q15), but they were able to wear it for at least four hours (Q13). They felt less strongly, but indicated a positive response to wearing the pump for another 24 hours (Q5) and that they had no trouble thinking while wearing the sampler (Q14).

Subject Comments

In addition to the close-ended and Yes/No questions, subjects were asked to add any comments or suggestions they had about the sampler; those responses are summarized in Table 6-9. Also included in Table 6-9 are the Battelle Laboratory Technicians' comments about the pump's ease of use and reliability. The majority of the subjects' responses were complaints about the noisiness of the sampler, whereas the majority of the technicians' responses had to do with the design of the pump and impactor. The comment made by Technician T3 regarding the plastic filter retainers highlights a limitation of the Sioutas PCIS. The plastic filter retainers require quite a bit of force to place them flush on the impaction plate. In our experience, if the retainers were not completely flush to the plate, the pressure drop of the impactor measured greater than 16 inch H₂O. As there is no special tool provided to accomplish this, it has to be done very carefully with a gloved thumbnail to avoid damaging the filter. Because the pre-testing pressure drop measurements specified in Section 4.2 were a part of our sampling protocol, our data quality was not affected by the difficulty in securing the plastic retainer rings. Following the two instances where initial pressure drop readings exceeded 16 inch water, the impactor was disassembled, the plastic retainers re-seated, and sampling was conducted only after the pressure drop readings fell within the stated range (11 – 16 inch H₂O).

Table 6-9. Subjects' and Laboratory Technicians' Comments and Suggestions Regarding the Sioutas PCIS Sampler.

Subject/Tech ID	Comments/Suggestions
M03	<ul style="list-style-type: none"> • Noise varied when hose crimped or inlet was blocked. • Charging inlet should be accessible from outside pump case. • Belt attachment should be horizontal instead of vertical. • Arena security denied access to football game due to suspicion of pump.
F04	<ul style="list-style-type: none"> • This needs to be lighter and less noisy. • The impactor is heavy and awkward, it cuts into the skin after a while and is too heavy to clip to a shirt, I had to clip it to the strap of the pump case. • It could work better as a backpack. • The impactor should be padded. • Compensation should be increased.
F05	<ul style="list-style-type: none"> • It was a little noisy. • More clear operating instructions on how to turn it back on. • Also, I felt like I didn't want to go to public places as much due to people staring at me.
F06	<ul style="list-style-type: none"> • At times I couldn't tell if the sampler was operating. • Slept but kept waking up. • Clip was a little heavy/awkward to wear attached to certain clothing. • Liked belt strap and should strap – would use either as needed.
F07	<ul style="list-style-type: none"> • The noise in work related setting was disruptive but the device didn't really get in the way. • The vibration of the motor bothered me.
T1	<ul style="list-style-type: none"> • Pump software was easy to install, but the user interface is not intuitive. • Pump is difficult to calibrate because of all the sequenced button pushing. • The bottom of the pump is not stable – a broader base would make the pump less “tippy”.
T2	<ul style="list-style-type: none"> • It is difficult to remove the pump battery without damaging the plastic casing. • Automatic calibration with the CalChek makes calibrating the pump easy! • The plastic piece that covers the A/C plug-in port is too flimsy and susceptible to breaking off. • Downloaded pump history data is difficult to understand. • Pump is not user-friendly because the keys have no wording on them; for example, “ON” or “OFF”.
T3	<ul style="list-style-type: none"> • Impactor operating instructions are mostly informative and very user-friendly. • Changed one figure to show the placement of the after-filter. • Filter retainers are too snug – need a special tool to install them properly because they have a tendency to stick up instead of seating flush to the collector plate. • The 37 mm after-filter fits too snugly inside the outlet plate – it is too easy to damage the filter when removing it. • The 0-ring between the impactor stages was difficult to retrieve – some of the notches were too shallow and did not allow easy access.

6.4.2 *Reliability and Subject Compliance*

One subject indicated that her pump stopped operating during the test, although she did nothing to it. When the pump was returned to Battelle, it operated without problem, so it is unclear why it stopped operating in the field. Because it is incomplete, this subject's data is not included in the analysis. Two subjects misunderstood the air sampling protocol, and plugged their pumps in but then shut them off while they slept at night instead of allowing them to sample while they slept. Otherwise, all subjects indicated that they followed the sampling protocol, described in Section 3.4 of this report.

Time Activity Diary versus Accelerometer Data

Although all subjects indicated that they followed the sampling protocol, comparing the pump movement data logged by the accelerometers with the subjects' time/activity diary data indicated differently for several of the subjects. Approximately half of the subjects followed the sampling protocol for the entire 48-hour test period, and the other half followed it for the first day and then stopped carrying the pump with them.

Comparisons of the three compliant subjects' time/activity level data to the occurrence and intensity of activity automatically logged by the accelerometers attached to their individual pumps are shown in Figure 6-13. The time/activity diary data, graphed on the secondary y-axis in Figures 6-13 and 6-14, shows the subject's self-rated level of activity, which ranges from low (1) to high (5), in quarter-hour increments over the 48-hour period. Examples of activities and the scalar provided in the time/activity diary to quantify them are: 1 = sleeping, 2 = eating, 3 = sitting, 4 = walking, and 5 = jogging. All of these graphs indicate that not only did each subject wear the pump during their waking activities, they also appear to have kept a fairly accurate time/activity diary.

This same comparison for the three non-compliant subjects is presented in Figure 6-14. The accelerometer data indicates that, in general, these subjects stopped wearing the pump after the first 24 hours of the 48-hour sampling period. None of the subjects were told that their pumps contained a device that logged its movement.

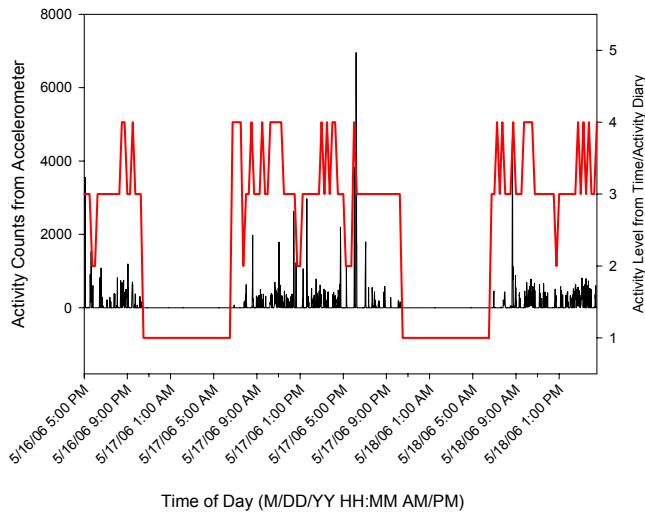
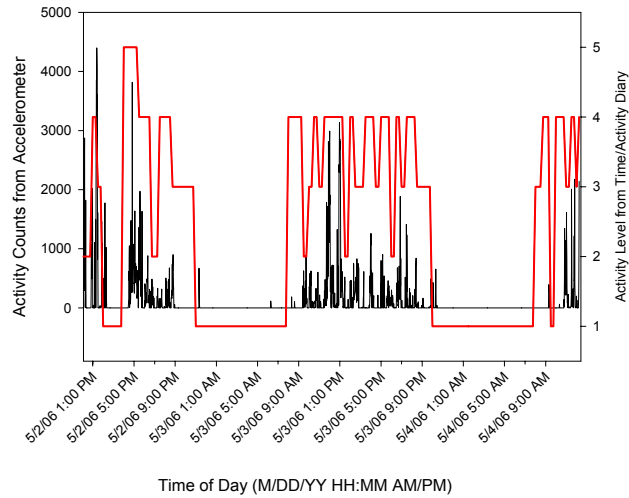
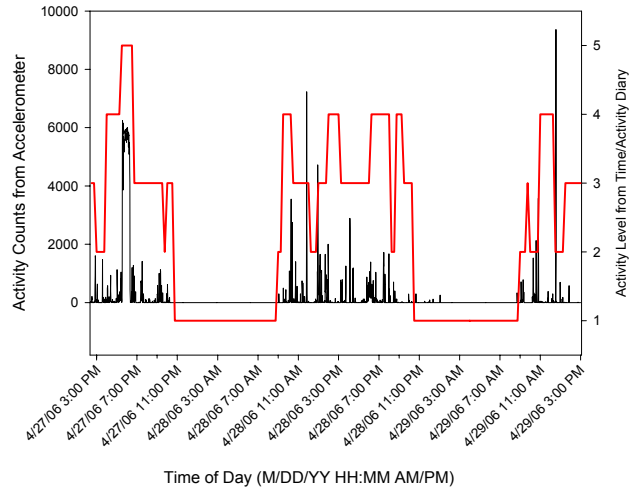

Figure 6-13. Comparison of the Pump Movement Data Logged by the Accelerometers with the Time/Activity Diary Data (Shown in Red, 5=High Activity) for Three Subjects Who Appeared to Follow the Sampling Protocol for the 48-hour Period.

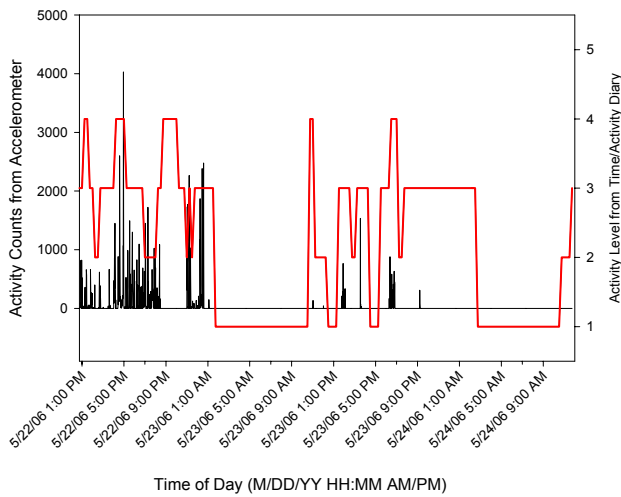
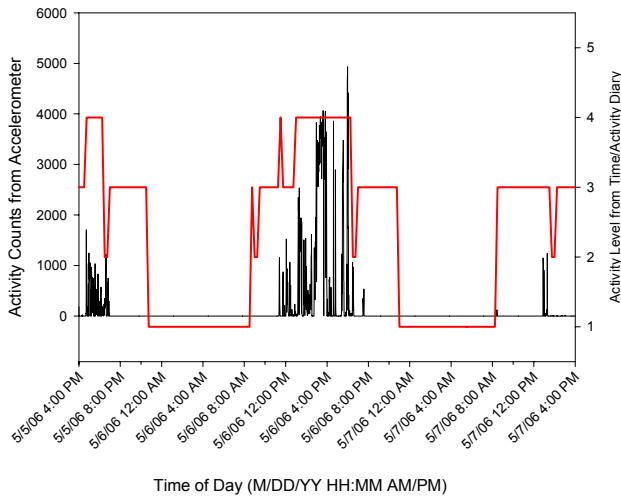
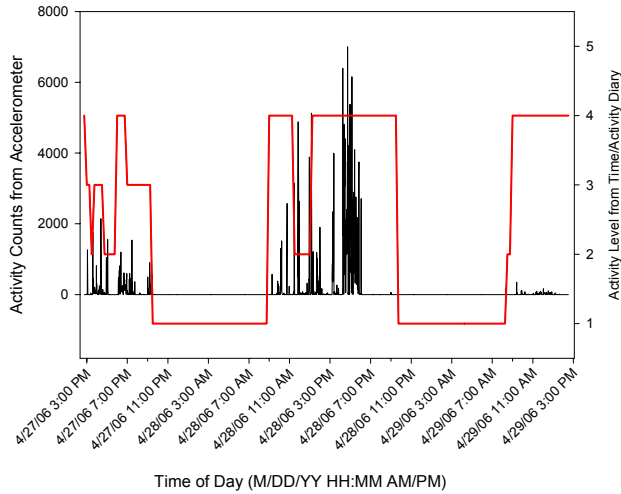

Figure 6-14. Comparison of the Pump Movement Data Logged by the Accelerometers with the Time/Activity Diary Data (Shown in Red, 5 = Hi Activity) for Three Subjects Who Appeared to Stop Following the Sampling Protocol After About 24 Hours.

Chapter 7

Performance Summary

The Sioutas PCIS, operating in conjunction with the Leland Legacy[®] pump, is designed to separate and collect airborne PM in specific size ranges. The Sioutas PCIS was evaluated on the basis of comparability with the sampling efficiency of more well-known reference samplers; its ability to collect detectable levels of metals in ambient air; and its ease of use, reliability, and acceptance among volunteer subjects. Additionally, the Leland Legacy[®] pump was evaluated by itself on the basis of duration of operation on a single battery charge sampling at different pressure drops, and 24-hour performance sampling under moderate and extreme temperature and humidity conditions.

During the pump testing, four of the pumps failed and were returned to the vendor, SKC, for analysis. SKC examined the four failed pumps and found that the same internal pin had dislodged in each case. To solve the problem, SKC retrofitted the pumps with a new pin that has a hexagonal head. Both the original and retrofitted pumps were evaluated. This verification test included four separate evaluation phases and the results from each phase are summarized below.

7.1 Pump Testing

Both the original and retrofitted pumps sampled under an 11 inch H₂O pressure drop via battery power for 28-35 hours in a moderate temperature and humidity (25°C and 30%) environment after a 15-hour battery charge. Due to repeated pump failures, the original pumps were not evaluated at high temperature-moderate humidity (40°C-60%) and high temperature-high humidity (40°C-90%) sampling environments. However, the retrofitted pumps sampled for the prescribed 24-hour period in both environments and maintained flow rates that were within 10% of the manufacturer's recommended values.

None of the retrofitted pumps failed; even when sampling under extreme conditions that included backpressures and sampling periods that exceeded the manufacturer's specifications. When sampling in extreme conditions, all of the retrofitted pumps sampled for longer than 26 hours before battery drain occurred. When sampling under a 15 inch H₂O pressure drop, all of the retrofitted pumps sampled for 30 hours or more, whereas 3 of the 12 original pumps failed to sample for at least 24 hours. When sampling under the highest pressure drop tested, 19 inch

H₂O, all of the retrofitted pumps sampled for 26 hours or longer; whereas 5 of the 12 original pumps failed to sample for a least 24 hours.

On average, the original pumps operated for about 9-10 fewer hours when sampling under a 19 inch H₂O pressure drop than under an 11 inch H₂O, and sound levels increased by 2.1 dB. On average, the retrofitted pumps operated for about 6-7 fewer hours when sampling under a 19 inch H₂O pressure drop than under an 11 inch H₂O, and sound levels increased by 4.3 dB. The sound level of a single pump clad in the noise-reducing jacket and operating at the manufacturer's recommended pressure drop ranged from 48 -64 dB, which is a level similar to normal conversational speech (~60 dB). Sound levels measured for all four pumps operating at the highest pressure drop 19 inch H₂O never exceeded 72 dB, which is equivalent to the sound level of a typical household vacuum cleaner.

The retrofitted pumps showed less variability than the original pumps in terms of flow rates and duration of operation over the sampling periods. Average duration of operation for the retrofitted pumps never deviated by more than 2.6% for the 11, 15, and 19 inch H₂O tests; whereas it deviated by 5.6%, 33%, and 29%, respectively for the same tests, for the original pumps. Differences in average flow rate variability between the original and retrofitted pumps were less pronounced as average flow rates never deviated by more than 5.0% for the original pumps and not more than 2.1% for the retrofitted pumps.

7.2 Sampling Efficiency Comparison

Sampling efficiency of the impactors was gravimetrically evaluated for total PM_{2.5} as well as for individual impaction stages, as appropriate, by sampling a test aerosol generated in a large environmental chamber. The test conditions for the sampling efficiency test were, although optimal for obtaining gravimetrically measurable levels of particles on all stages of the Sioutas PCIS, were several orders of magnitude higher than those experienced in most real-world settings. These aerosol concentrations caused the PEM pumps to operate at backpressures that were greater than the manufacturer's specifications, although the pump logs did not report any pump failure.

Because the upper particle loading limit is a complex function of the ambient particle size distribution and type, humidity, individual filter used, capacity of the sampler flow rate control system, and possibly other parameters, it is not known whether these high concentrations resulted in particle bounce and/or affected the cutpoints of the particles collected for the DCI-6 and PEM reference samplers. The humidity in the environmental chamber did not exceed 29% and the temperature did not increase by more than 1.7°C during the one hour sampling period. The particle loadings did not exceed the manufacturer's operating specifications for the maximum particle load per stage for the Sioutas PCIS, 3.16 mg/stage, nor did they exceed the federally mandated capability of the FRM, 4.8 mg PM_{2.5}/filter. These particle loadings resulted in backpressures greater than those recommended for the Leland Legacy[®] pump. However, the samplers performed consistently, as the inter-sampler variability for all samplers in each of the three tests did not exceed 11% for the FRMs, 4% for the PEMs, 15% for the DCI-6, and 10% for the PCISs for each cutpoint in which the gravimetric masses were above three times the method detection limit.

For TPM collected, Sioutas PCIS data show a negative bias of 15% compared to the DCI-6 and 17% compared to the PEM data. TPM inter-sampler relative standard deviations among all the PCIS, DCI-6, and PEM samplers for each test were comparable and generally in the 1-10% range. When comparing particles in the $\leq 0.5 \mu\text{m}$ size range, the PCIS data show a negative bias of 35% compared to the DCI-6 data. For slightly larger particles in the $0.5 - 1.0 \mu\text{m}$ size range, the trend is reversed: the Sioutas PCIS data show a positive bias of 26% compared to the DCI-6 data. The inter-sampler variations for both of these size ranges varied from 4.1 – 14% for both samplers. The PCIS $\text{PM}_{2.5}$ results show a negative bias of 16% compared to the data for both of the reference samplers, including the DCI-6 which is only collecting particles that are $\leq 2.0 \mu\text{m}$ in diameter. The $\text{PM}_{2.5}$ inter-sampler variations for all test and reference samplers were less than 15% in all instances.

7.3 Sampling Metals in Ambient Air

The ability of the PCIS to sample $\text{PM}_{2.5}$ with detectable levels of metals/elements in ambient air was evaluated in comparison to reference PEM samplers for a 48-hour sampling period. Seven of the 38 metals/elements analyzed using XRF showed detectable levels in the $\text{PM}_{2.5}$ collected. The dataset of S, Cl, Si, Ca, Fe, K and Zn results falls along a line that is significantly statistically different from the unity line, although the y-intercept, -0.54, is not significantly different from zero. The majority of the data falls below the unity line indicating an overall negative bias, 36%, for the Sioutas PCIS results as compared to those obtained using the reference PEMs. This ambient air low concentration of metal/element result is similar to that found in the test aerosol high concentration of particulate result discussed in the sampling efficiency comparisons, Section 6.2. At both concentration levels, $\text{sub-}\mu\text{g}/\text{m}^3$ of metal/element versus mg/m^3 of particulate, the Sioutas PCIS results show a negative bias compared to the data for the reference samplers.

Si showed the highest bias, 74%, between the Sioutas PCIS and PEM. The levels collected on and measured for each Sioutas PCIS impactor stage for Si metals were at, or less than five times the MDL. Because the $\text{PM}_{2.5}$ particles are collected onto 4 stages for the Sioutas PCIS, if the level collected on each stage is at or near the MDL, results may not correlate as well with a single stage PEM impactor that collects all of the $\text{PM}_{2.5}$ onto one filter.

The slit-like accelerator plate nozzles in the Sioutas PCIS generated thin deposition patterns on the sampling substrates which made accurate quantitative analysis of the metals/elements by XRF difficult. Because of the shape of the deposition pattern, analysis by ICP-MS is recommended over XRF, although this technique would require an additional wet chemical extraction step.

7.4 Ease of Use, Reliability and Subject Acceptance/Compliance

Seven non-smoking subjects were recruited to wear the PCIS for a period of 48 hours and keep a simple time/activity diary. At the end of the sampling period, subjects completed a questionnaire to gather information about the pump's ease of operation, reliability, and their acceptance of the device. The pumps were equipped with small, data-logging multidirectional accelerometers.

Questionnaire responses showed that subjects felt strongly that the PCIS noise was too loud and that they did not like wearing the pump, however; the noise wasn't loud enough to prevent them from thinking or talking on the phone while wearing the sampler. As discussed in Section 7.1, the sound level of a single pump operating at the manufacturer's recommended pressure drop ranged from 48 -64 dB, which is a level similar to normal conversational speech (~60 dB). Sound levels measured for all four pumps operating at the highest pressure drop 19 inch H₂O never exceeded 72 dB, which is equivalent to the sound level of a typical household vacuum cleaner. Subjects also felt strongly that the sampler (Leland Legacy[®] pump and Sioutas PCIS combination) was easy to take on and off and plug into the wall to run on A/C power while they slept. Examination of the accelerometer and time/activity diary data showed that although all of the subjects said they followed the sampling protocol, only half of the subjects followed the sampling protocol, and the other half stopped wearing the pump roughly after the first 24 hours.

The Sioutas PCIS's plastic filter retainers require quite a bit of force to place them flush on the impaction plate. It is important that this be accomplished, because if the retainers are not completely flush to the plate, the pressure drop of the impactor was greater than 16 inch H₂O. A special tool designed to accomplish this may speed up and improve the quality of substrate loading and unloading.

Chapter 8

References

1. *Development and evaluation of a personal cascade impactor sampler (PCIS)*, Misra C., Singh M., Shen S., Sioutas C., and P.M. Hall, J. Aerosol Science, **33**, p. 1027-47, 2002.
2. *Test/QA Plan for Verification of Personal Cascade Impactor Samplers (PCISs) for Measuring Ambient Particulate Matter (PM)*, Battelle, Columbus, Ohio, Jan. 2006.
3. *Quality Management Plan (QMP) for the ETV Advanced Monitoring Systems Center*, Version 6.0, U.S. EPA Environmental Technology Verification Program, Battelle, Columbus, Ohio, Nov. 2005.
4. *Quality Assurance Guidance Document 2.12, "Monitoring PM_{2.5} in Ambient Air Using Designated Reference or Class I Equivalent Methods,"* U.S. Environmental Protection Agency, Nov. 1998.
5. *Operating Instructions Leland Legacy*, SKC, Form #40075 Rev 0701.
6. *Operating Instructions Sioutas Cascade Impactor*, SKC, Form #40086 Rev 0701.
7. *Compendium Method IO-3.3, Determination of Metals in Ambient Particulate Matter Using X-Ray Fluorescence (XRF) Spectroscopy*, U.S. Environmental Protection Agency, Center for Environmental Research Information, Office of Research and Development, June 1999.
8. *Personal exposure to particulate matter less than 2.5 micron in Mexico City: a pilot study*, Vallejo M., Lerma C., Infante O., Hermosillo A.G., Riojas-Rodriguez H., and M. Cardenas, J Expo Anal Environ Epidemiol, 14(4), p. 323-9, July 2004.
9. *Assessing truck driver exposure at the World Trade Center disaster site: personal and area monitoring for particulate matter and volatile organic compounds during October 2001 and April 2002*, Geyh A.S., Chillrud S., Williams D.L., Herbstman J., Symons J.M., Rees K., Ross J., Kim S.R., Lim H.J., Turpin B., and P. Breyse, J Occup Environ Hyg, 2(3), p. 179-93, Mar. 2005.

-
10. *Participants' exposure to PM_{2.5} and gaseous/particulate polycyclic aromatic hydrocarbons during the Ma-tsu Goddess parade*, Lung S.C., Guo K.J., Chen P.Y., Tsai P.F., and Chen P.C., *J Expo Anal Environ Epidemiol*, 14(7), p. 536-43, Nov. 2004.
 11. *Customers' exposure to PM_{2.5} and polycyclic aromatic hydrocarbons in smoking/nonsmoking sections of 24-h coffee shops in Taiwan*, Lung S.C., Wu M.J., and C.C. Lin, *J Expo Anal Environ Epidemiol*, 14(7), p. 529-35, Nov. 2004.
 12. *Contribution of incense burning to indoor PM₁₀ and particle-bound polycyclic aromatic hydrocarbons under two ventilation conditions*, Lung S.C., Kao M.C., and S.C. Hu, *Indoor Air*, 13(2), p. 194-9, June 2003.
 13. *Generation rates and emission factors of particulate matter and particle-bound polycyclic aromatic hydrocarbons of incense sticks*, Lung S.C., and S.C. Hu, *Chemosphere*, 50(5), p. 673-9, Feb. 2003.
 14. *Worshippers' exposure to particulate matter in two temples in Taiwan*, Lung S.C., and M.C. Kao, *J Air Waste Manag Assoc*, 53(2), p.130-5, Feb. 2003.
 15. *Fine PM measurements: personal and indoor air monitoring*, Jantunen M., Hanninen O., Koistinen K., and J.H. Hashim, *Chemosphere*, 49(9), p. 993-1007, Dec. 2002.
 16. *Comparison of light scattering devices and impactors for particulate measurements in indoor, outdoor, and personal environments*, Liu L.J., Slaughter J.C., and T.V. Larson, *Environ Sci Technol*, 1;36(13), p. 2977-86, July 2002.
 17. *Particulate matter and particle-attached polycyclic aromatic hydrocarbons in the indoor and outdoor air of Tokyo measured with personal monitors*, Sakai R., Siegmann H.C., Sato H., and A.S. Voorhees, *Environ Res*, 89(1), p. 66-71, May 2002.
 18. *The influence of human activity patterns on personal PM exposure: a comparative analysis of filter-based and continuous particle measurements*, Rea A.W., Zufall M.J., Williams R.W., Sheldon L., and C. Howard-Reed, *J Air Waste Manag Assoc*, 51(9), p. 1271-9, Sep. 2001.
 19. *Comparison of PM_{2.5} and PM₁₀ monitors*, Williams R., Suggs J., Rodes C., Lawless P., Zweidinger R., Kwok R., Creason J., and L. Sheldon, *J Expo Anal Environ Epidemiol*, 10(5), p.497-505, Sep.-Oct. 2000.
 20. *Personal exposure to particles in Banska Bystrica, Slovakia*, Brauer M., Hruby F., Mihalikova E., Fabianova E., Miskovic P., Plzikova A., Lendacka M., Vandenberg J., and A. Cullen, *J Expo Anal Environ Epidemiol*, 10(5), p.478-87, Sep.-Oct. 2000.
 21. *Exposure of chronic obstructive pulmonary disease patients to particulate matter: relationships between personal and ambient air concentrations*, Ebel S.T., Petkau A.J.,

-
- Vedal S., Fisher T.V., and M. Brauer, *J Air Waste Manag Assoc*, 50(7), p. 1081-94, July 2000.
22. *Indoor/outdoor PM₁₀ and PM_{2.5} in Bangkok, Thailand*, Tsai F.C., Smith K.R., Vichit-Vadakan N., Ostro B.D., Chestnut L.G., and N. Kungskulniti, *J Expo Anal Environ Epidemiol*, 10(1), p. 15-26, Jan.-Feb. 2000.
23. *Investigations of the proximity effect for pollutants in the indoor environment*, McBride S.J., Ferro A.R., Ott, W.R., Switzer P., and L.M. Hildemann, *J Expo Anal Environ Epidemiol*, 9(6), p. 602-21, Nov.-Dec. 1999.
24. *Fine particle (PM_{2.5}) measurement methodology, quality assurance procedures, and pilot results of the EXPOLIS study*, Koistinen K.J., Kousa A., Tenhola V., Hanninen O., Jantunen M.J., Oglesby L., Kuenzli N., and L. Georgoulis, *J Air Waste Manag Assoc*, 49(10), p. 1212-20, Oct. 1999.
25. *Combination of direct and indirect approaches for exposure assessment*, Duan N. and D.T. Mage, *J Expo Anal Environ Epidemiol*, 7(4), p. 439-70, Oct.-Dec. 1997.
26. *Reference Method for the Determination of Fine Particulate Matter as PM_{2.5} in the Atmosphere*, Federal Register, Appendix L to Part 50, Vol. 62, No. 138, 1997.
27. *Quality Assurance Guidance Document 2.12, Monitoring PM_{2.5} in Ambient Air Using Designated Reference or Class I Equivalent Methods*, U.S. Environmental Protection Agency, Nov. 1998.
28. *Improved cascade impactor for measuring aerosol particle sizes in air pollutants, commercial aerosols, and cigarette smoke*, R.I. Mitchell and J.M. Pilcher, *Ind. Eng. Chem.*, Vol. 51, No. 9, p. 1039-42, Sep. 1959.
29. *Next generation pharmaceutical impactor (a new impactor for pharmaceutical inhaler testing)*, Part I: Design, *Journal of Aerosol Medicine*, Vol. 16, No. 3, p. 283-99, Sep. 2003.
30. *Formation of polyketones in irradiated toluene/propylene/NO_x/air mixtures*, E.O. Edney, D.J. Driscollo, W.S. Weathers, T.E. Kleindienst, T.S. Conner, C.D. McIver and W. Li, *Aerosol Sci. and Tech.*, Vol. 35, p. 998-1008, 2001.
31. *Pulmonary distribution and kinetics of inhaled [¹¹C]triamcinolone acetonide*, M.S. Berridge, Z. Lee and D.L. Heald, *The J of Nuclear Medicine*, Vol. 41 No. 10, p. 1603-11, 2000.
32. *Technetium 99m radiolabeling of aerosolized drug particles from metered dose inhalers*, C. Aug, R.J. Perry and GC Smaldone, *J Aerosol Med.*, 4(2), p. 127-38, 1991.

-
33. *Optimized inhalation aerosols. II. Inertial testing methods for particle size analysis of pressurized inhalers*, E.M. Phillips, P.R. Byron, K. Fults and A.J. Hickey, *Pharm Res.*, 7(12), p. 1228-33, Dec. 1990.
 34. *A Comparison of Exposure to Airborne Dust in Cotton Processing Plants Estimated from Personal and Workzone Samples*, F.F. Cinkotai, A.C.C. Gibbs and T.C. Sharpe, *Ann. Occup. Hyg.*, Vol. 28, No. 3, p. 347-52, 1984.
 35. *Growth of hygroscopic aerosols in a model of bronchial airways*, P.W. Scherer, F.R. Haselton, L.M. Hanna and D.R. Stone, *Journal of Applied Physiology*, Vol 47, Issue 3 544-50, 1979.
 36. *Design and evaluation of new low-pressure impactor. 1*, S.V. Hering, R.C. Flagan and S.K. Friedlander, *Env. Sci. & Tech. Research*, Vol. 12, No. 6, p. 667-73, June 1978.
 37. *Design and evaluation of new low-pressure impactor. 2*, S.V. Hering, S.K. Friedlander, J.J. Collins and L.W. Richards, *Env. Sci. & Tech. Research*, Vol. 13, No. 2, p. 184-88, 1979.

Appendix A
PCIS Questionnaire

PCIS Questionnaire	Strongly Agree	(please circle one number)	Strongly Disagree
1. The pump noise was too loud.	Strongly Agree	1 2 3 4 5 6	Strongly Disagree
2. The weight of the pump was uncomfortable.	Strongly Agree	1 2 3 4 5 6	Strongly Disagree
3. It was easy to wear the sampler clipped to my shirt.	Strongly Agree	1 2 3 4 5 6	Strongly Disagree
4. I could talk on the phone easily while wearing the sampler.	Strongly Agree	1 2 3 4 5 6	Strongly Disagree
5. I would volunteer to wear this sampler for another 24 hours.	Strongly Agree	1 2 3 4 5 6	Strongly Disagree
6. I could not tell if the sampler was operating.	Strongly Agree	1 2 3 4 5 6	Strongly Disagree
7. I was always conscious of the sampler.	Strongly Agree	1 2 3 4 5 6	Strongly Disagree
8. I had problems putting the sampler back on.	Strongly Agree	1 2 3 4 5 6	Strongly Disagree
9. I slept well while the sampler was operating near me.	Strongly Agree	1 2 3 4 5 6	Strongly Disagree
10. It was hard to take the sampler off in order to shower.	Strongly Agree	1 2 3 4 5 6	Strongly Disagree
11. I was comfortable wearing the pump.	Strongly Agree	1 2 3 4 5 6	Strongly Disagree
12. Sometimes I forgot that I was wearing the sampler.	Strongly Agree	1 2 3 4 5 6	Strongly Disagree
13. I was not able to wear this sampler for longer than 4 hours.	Strongly Agree	1 2 3 4 5 6	Strongly Disagree
14. It was hard to think while wearing the sampler.	Strongly Agree	1 2 3 4 5 6	Strongly Disagree
15. I like wearing the sampler.	Strongly Agree	1 2 3 4 5 6	Strongly Disagree
16. I did not wear the sampler for approximately _____ hours during the 24-hr sampling period.			
17. I was able to follow the air sampling instructions that Battelle gave me exactly. Yes No (circle one)			
PCIS Questionnaire		Page 1 of 2	

Appendix B
Time/Activity Diary

Time/Activity Diary

Day 1

Activity Number: _____

1 = Sleeping

2 = Eating





3 = Sitting

4 = Moderate Activity (e.g., walking)

5 = Intense Activity (e.g., jogging)

Subject ID:

Date:

		midnight	12:30 am	1 am	1:30 am	2 am	2:30 am	3 am	3:30 am	4 am
Activity Number(s): Do NOT leave blank		<input type="text"/>	<input type="text"/>	<input type="text"/>	<input type="text"/>	<input type="text"/>	<input type="text"/>	<input type="text"/>	<input type="text"/>	<input type="text"/>
Location: Inside Home  Outside  At Work  Fill in the name of locations not listed; examples: gym, tennis court <input type="text"/> <input type="text"/> <input type="text"/> <input type="text"/> <input type="text"/>	<input type="checkbox"/>	<input type="checkbox"/>	<input type="checkbox"/>	<input type="checkbox"/>	<input type="checkbox"/>	<input type="checkbox"/>	<input type="checkbox"/>	<input type="checkbox"/>	<input type="checkbox"/>	
	<input type="checkbox"/>	<input type="checkbox"/>	<input type="checkbox"/>	<input type="checkbox"/>	<input type="checkbox"/>	<input type="checkbox"/>	<input type="checkbox"/>	<input type="checkbox"/>	<input type="checkbox"/>	
	<input type="checkbox"/>	<input type="checkbox"/>	<input type="checkbox"/>	<input type="checkbox"/>	<input type="checkbox"/>	<input type="checkbox"/>	<input type="checkbox"/>	<input type="checkbox"/>	<input type="checkbox"/>	
	<input type="checkbox"/>	<input type="checkbox"/>	<input type="checkbox"/>	<input type="checkbox"/>	<input type="checkbox"/>	<input type="checkbox"/>	<input type="checkbox"/>	<input type="checkbox"/>	<input type="checkbox"/>	
	<input type="checkbox"/>	<input type="checkbox"/>	<input type="checkbox"/>	<input type="checkbox"/>	<input type="checkbox"/>	<input type="checkbox"/>	<input type="checkbox"/>	<input type="checkbox"/>	<input type="checkbox"/>	
	<input type="checkbox"/>	<input type="checkbox"/>	<input type="checkbox"/>	<input type="checkbox"/>	<input type="checkbox"/>	<input type="checkbox"/>	<input type="checkbox"/>	<input type="checkbox"/>	<input type="checkbox"/>	
	<input type="checkbox"/>	<input type="checkbox"/>	<input type="checkbox"/>	<input type="checkbox"/>	<input type="checkbox"/>	<input type="checkbox"/>	<input type="checkbox"/>	<input type="checkbox"/>	<input type="checkbox"/>	
Bath/Shower 	<input type="checkbox"/>	<input type="checkbox"/>	<input type="checkbox"/>	<input type="checkbox"/>	<input type="checkbox"/>	<input type="checkbox"/>	<input type="checkbox"/>	<input type="checkbox"/>	<input type="checkbox"/>	
Pump Not Operating	<input type="checkbox"/>	<input type="checkbox"/>	<input type="checkbox"/>	<input type="checkbox"/>	<input type="checkbox"/>	<input type="checkbox"/>	<input type="checkbox"/>	<input type="checkbox"/>	<input type="checkbox"/>	

Notes:

Time/Activity Diary

Day 1

Activity Number: _____

1 = Sleeping

2 = Eating





3 = Sitting

4 = Moderate Activity (e.g., walking)

5 = Intense Activity (e.g., jogging)

Subject ID:

Date:

		4 am	4:30 am	5 am	5:30 am	6 am	6:30 am	7 am	7:30 am	8 am
Activity Number(s): Do NOT leave blank		<input type="text"/>	<input type="text"/>	<input type="text"/>	<input type="text"/>	<input type="text"/>	<input type="text"/>	<input type="text"/>	<input type="text"/>	<input type="text"/>
Location: Inside Home  Outside  At Work  Fill in the name of locations not listed; examples: gym, tennis court <input type="text"/> <input type="text"/> <input type="text"/> <input type="text"/> <input type="text"/>	<input type="checkbox"/>	<input type="checkbox"/>	<input type="checkbox"/>	<input type="checkbox"/>	<input type="checkbox"/>	<input type="checkbox"/>	<input type="checkbox"/>	<input type="checkbox"/>	<input type="checkbox"/>	
	<input type="checkbox"/>	<input type="checkbox"/>	<input type="checkbox"/>	<input type="checkbox"/>	<input type="checkbox"/>	<input type="checkbox"/>	<input type="checkbox"/>	<input type="checkbox"/>	<input type="checkbox"/>	
	<input type="checkbox"/>	<input type="checkbox"/>	<input type="checkbox"/>	<input type="checkbox"/>	<input type="checkbox"/>	<input type="checkbox"/>	<input type="checkbox"/>	<input type="checkbox"/>	<input type="checkbox"/>	
	<input type="checkbox"/>	<input type="checkbox"/>	<input type="checkbox"/>	<input type="checkbox"/>	<input type="checkbox"/>	<input type="checkbox"/>	<input type="checkbox"/>	<input type="checkbox"/>	<input type="checkbox"/>	
	<input type="checkbox"/>	<input type="checkbox"/>	<input type="checkbox"/>	<input type="checkbox"/>	<input type="checkbox"/>	<input type="checkbox"/>	<input type="checkbox"/>	<input type="checkbox"/>	<input type="checkbox"/>	
	<input type="checkbox"/>	<input type="checkbox"/>	<input type="checkbox"/>	<input type="checkbox"/>	<input type="checkbox"/>	<input type="checkbox"/>	<input type="checkbox"/>	<input type="checkbox"/>	<input type="checkbox"/>	
Bath/Shower 	<input type="checkbox"/>	<input type="checkbox"/>	<input type="checkbox"/>	<input type="checkbox"/>	<input type="checkbox"/>	<input type="checkbox"/>	<input type="checkbox"/>	<input type="checkbox"/>	<input type="checkbox"/>	
Pump Not Operating	<input type="checkbox"/>	<input type="checkbox"/>	<input type="checkbox"/>	<input type="checkbox"/>	<input type="checkbox"/>	<input type="checkbox"/>	<input type="checkbox"/>	<input type="checkbox"/>	<input type="checkbox"/>	

Notes:

Time/Activity Diary

Day 1

Activity Number: _____

1 = Sleeping

2 = Eating





3 = Sitting

4 = Moderate Activity (e.g., walking)

5 = Intense Activity (e.g., jogging)

Subject ID:

Date:

		8 am	8:30 am	9 am	9:30 am	10 am	10:30 am	11 am	11:30 am	noon
Activity Number(s): Do NOT leave blank		<input type="text"/>	<input type="text"/>	<input type="text"/>	<input type="text"/>	<input type="text"/>	<input type="text"/>	<input type="text"/>	<input type="text"/>	<input type="text"/>
Location: Inside Home  Outside  At Work  Fill in the name of locations not listed; examples: gym, tennis court <input type="text"/> <input type="text"/> <input type="text"/> <input type="text"/> <input type="text"/>	<input type="checkbox"/>	<input type="checkbox"/>	<input type="checkbox"/>	<input type="checkbox"/>	<input type="checkbox"/>	<input type="checkbox"/>	<input type="checkbox"/>	<input type="checkbox"/>	<input type="checkbox"/>	
	<input type="checkbox"/>	<input type="checkbox"/>	<input type="checkbox"/>	<input type="checkbox"/>	<input type="checkbox"/>	<input type="checkbox"/>	<input type="checkbox"/>	<input type="checkbox"/>	<input type="checkbox"/>	
	<input type="checkbox"/>	<input type="checkbox"/>	<input type="checkbox"/>	<input type="checkbox"/>	<input type="checkbox"/>	<input type="checkbox"/>	<input type="checkbox"/>	<input type="checkbox"/>	<input type="checkbox"/>	
	<input type="checkbox"/>	<input type="checkbox"/>	<input type="checkbox"/>	<input type="checkbox"/>	<input type="checkbox"/>	<input type="checkbox"/>	<input type="checkbox"/>	<input type="checkbox"/>	<input type="checkbox"/>	
	<input type="checkbox"/>	<input type="checkbox"/>	<input type="checkbox"/>	<input type="checkbox"/>	<input type="checkbox"/>	<input type="checkbox"/>	<input type="checkbox"/>	<input type="checkbox"/>	<input type="checkbox"/>	
	<input type="checkbox"/>	<input type="checkbox"/>	<input type="checkbox"/>	<input type="checkbox"/>	<input type="checkbox"/>	<input type="checkbox"/>	<input type="checkbox"/>	<input type="checkbox"/>	<input type="checkbox"/>	
Bath/Shower 	<input type="checkbox"/>	<input type="checkbox"/>	<input type="checkbox"/>	<input type="checkbox"/>	<input type="checkbox"/>	<input type="checkbox"/>	<input type="checkbox"/>	<input type="checkbox"/>	<input type="checkbox"/>	
Pump Not Operating	<input type="checkbox"/>	<input type="checkbox"/>	<input type="checkbox"/>	<input type="checkbox"/>	<input type="checkbox"/>	<input type="checkbox"/>	<input type="checkbox"/>	<input type="checkbox"/>	<input type="checkbox"/>	

Notes:

Time/Activity Diary

Day 1

Activity Number: _____

1 = Sleeping

2 = Eating





3 = Sitting

4 = Moderate Activity (e.g., walking)

5 = Intense Activity (e.g., jogging)

Subject ID:

Date:

	noon	12:30 pm	1 pm	1:30 pm	2 pm	2:30 pm	3 pm	3:30 pm	4 pm
Activity Number(s): Do NOT leave blank	<input type="text"/>	<input type="text"/>	<input type="text"/>	<input type="text"/>	<input type="text"/>	<input type="text"/>	<input type="text"/>	<input type="text"/>	<input type="text"/>
Location: Inside Home  Outside  At Work  Fill in the name of locations not listed; examples: gym, tennis court <input type="text"/> <input type="text"/> <input type="text"/> <input type="text"/> <input type="text"/>	<input type="checkbox"/>	<input type="checkbox"/>	<input type="checkbox"/>	<input type="checkbox"/>	<input type="checkbox"/>	<input type="checkbox"/>	<input type="checkbox"/>	<input type="checkbox"/>	<input type="checkbox"/>
Bath/Shower 	<input type="checkbox"/>	<input type="checkbox"/>	<input type="checkbox"/>	<input type="checkbox"/>	<input type="checkbox"/>	<input type="checkbox"/>	<input type="checkbox"/>	<input type="checkbox"/>	<input type="checkbox"/>
Pump Not Operating	<input type="checkbox"/>	<input type="checkbox"/>	<input type="checkbox"/>	<input type="checkbox"/>	<input type="checkbox"/>	<input type="checkbox"/>	<input type="checkbox"/>	<input type="checkbox"/>	<input type="checkbox"/>

Notes:

Time/Activity Diary

Day 1

Activity Number: _____

1 = Sleeping

2 = Eating





3 = Sitting

4 = Moderate Activity (e.g., walking)

5 = Intense Activity (e.g., jogging)

Subject ID:

Date:

	4 pm	4:30 pm	5 pm	5:30 pm	6 pm	6:30 pm	7 pm	7:30 pm	8 pm
Activity Number(s): Do NOT leave blank	<input type="text"/>	<input type="text"/>	<input type="text"/>	<input type="text"/>	<input type="text"/>	<input type="text"/>	<input type="text"/>	<input type="text"/>	<input type="text"/>
Location: Inside Home  Outside  At Work  Fill in the name of locations not listed; examples: gym, tennis court <input type="text"/> <input type="text"/> <input type="text"/> <input type="text"/> <input type="text"/>	<input type="checkbox"/>	<input type="checkbox"/>	<input type="checkbox"/>	<input type="checkbox"/>	<input type="checkbox"/>	<input type="checkbox"/>	<input type="checkbox"/>	<input type="checkbox"/>	<input type="checkbox"/>
Bath/Shower 	<input type="checkbox"/>	<input type="checkbox"/>	<input type="checkbox"/>	<input type="checkbox"/>	<input type="checkbox"/>	<input type="checkbox"/>	<input type="checkbox"/>	<input type="checkbox"/>	<input type="checkbox"/>
Pump Not Operating	<input type="checkbox"/>	<input type="checkbox"/>	<input type="checkbox"/>	<input type="checkbox"/>	<input type="checkbox"/>	<input type="checkbox"/>	<input type="checkbox"/>	<input type="checkbox"/>	<input type="checkbox"/>

Notes:

Time/Activity Diary

Day 1

Activity Number: _____

1 = Sleeping

2 = Eating





3 = Sitting

4 = Moderate Activity (e.g., walking)

5 = Intense Activity (e.g., jogging)

Subject ID:

Date:

	8 pm	8:30 pm	9 pm	9:30 pm	10 pm	10:30 pm	11 pm	11:30 pm	midnight
Activity Number(s): Do NOT leave blank	<input type="text"/>	<input type="text"/>	<input type="text"/>	<input type="text"/>	<input type="text"/>	<input type="text"/>	<input type="text"/>	<input type="text"/>	<input type="text"/>
Location: Inside Home  Outside  At Work  Fill in the name of locations not listed; examples: gym, tennis court <input type="text"/> <input type="text"/> <input type="text"/> <input type="text"/> <input type="text"/>	<input type="checkbox"/>	<input type="checkbox"/>	<input type="checkbox"/>	<input type="checkbox"/>	<input type="checkbox"/>	<input type="checkbox"/>	<input type="checkbox"/>	<input type="checkbox"/>	<input type="checkbox"/>
Bath/Shower 	<input type="checkbox"/>	<input type="checkbox"/>	<input type="checkbox"/>	<input type="checkbox"/>	<input type="checkbox"/>	<input type="checkbox"/>	<input type="checkbox"/>	<input type="checkbox"/>	<input type="checkbox"/>
Pump Not Operating	<input type="checkbox"/>	<input type="checkbox"/>	<input type="checkbox"/>	<input type="checkbox"/>	<input type="checkbox"/>	<input type="checkbox"/>	<input type="checkbox"/>	<input type="checkbox"/>	<input type="checkbox"/>

Notes:

Time/Activity Diary

Day 2

Activity Number: _____

1 = Sleeping

2 = Eating





3 = Sitting

4 = Moderate Activity (e.g., walking)

5 = Intense Activity (e.g., jogging)

Subject ID:

Date:

		midnight	12:30 am	1 am	1:30 am	2 am	2:30 am	3 am	3:30 am	4 am
Activity Number(s): Do NOT leave blank		<input type="text"/>	<input type="text"/>	<input type="text"/>	<input type="text"/>	<input type="text"/>	<input type="text"/>	<input type="text"/>	<input type="text"/>	<input type="text"/>
Location: Inside Home  Outside  At Work  Fill in the name of locations not listed; examples: gym, tennis court <input type="text"/> <input type="text"/> <input type="text"/> <input type="text"/> <input type="text"/>	<input type="checkbox"/>	<input type="checkbox"/>	<input type="checkbox"/>	<input type="checkbox"/>	<input type="checkbox"/>	<input type="checkbox"/>	<input type="checkbox"/>	<input type="checkbox"/>	<input type="checkbox"/>	
	<input type="checkbox"/>	<input type="checkbox"/>	<input type="checkbox"/>	<input type="checkbox"/>	<input type="checkbox"/>	<input type="checkbox"/>	<input type="checkbox"/>	<input type="checkbox"/>	<input type="checkbox"/>	
	<input type="checkbox"/>	<input type="checkbox"/>	<input type="checkbox"/>	<input type="checkbox"/>	<input type="checkbox"/>	<input type="checkbox"/>	<input type="checkbox"/>	<input type="checkbox"/>	<input type="checkbox"/>	
	<input type="checkbox"/>	<input type="checkbox"/>	<input type="checkbox"/>	<input type="checkbox"/>	<input type="checkbox"/>	<input type="checkbox"/>	<input type="checkbox"/>	<input type="checkbox"/>	<input type="checkbox"/>	
	<input type="checkbox"/>	<input type="checkbox"/>	<input type="checkbox"/>	<input type="checkbox"/>	<input type="checkbox"/>	<input type="checkbox"/>	<input type="checkbox"/>	<input type="checkbox"/>	<input type="checkbox"/>	
	<input type="checkbox"/>	<input type="checkbox"/>	<input type="checkbox"/>	<input type="checkbox"/>	<input type="checkbox"/>	<input type="checkbox"/>	<input type="checkbox"/>	<input type="checkbox"/>	<input type="checkbox"/>	
	<input type="checkbox"/>	<input type="checkbox"/>	<input type="checkbox"/>	<input type="checkbox"/>	<input type="checkbox"/>	<input type="checkbox"/>	<input type="checkbox"/>	<input type="checkbox"/>	<input type="checkbox"/>	
Bath/Shower 	<input type="checkbox"/>	<input type="checkbox"/>	<input type="checkbox"/>	<input type="checkbox"/>	<input type="checkbox"/>	<input type="checkbox"/>	<input type="checkbox"/>	<input type="checkbox"/>	<input type="checkbox"/>	
Pump Not Operating	<input type="checkbox"/>	<input type="checkbox"/>	<input type="checkbox"/>	<input type="checkbox"/>	<input type="checkbox"/>	<input type="checkbox"/>	<input type="checkbox"/>	<input type="checkbox"/>	<input type="checkbox"/>	

Notes:

Time/Activity Diary

Day 2

Activity Number: _____

1 = Sleeping

2 = Eating





3 = Sitting

4 = Moderate Activity (e.g., walking)

5 = Intense Activity (e.g., jogging)

Subject ID:

Date:

	4 am	4:30 am	5 am	5:30 am	6 am	6:30 am	7 am	7:30 am	8 am
Activity Number(s): Do NOT leave blank	<input type="text"/>	<input type="text"/>	<input type="text"/>	<input type="text"/>	<input type="text"/>	<input type="text"/>	<input type="text"/>	<input type="text"/>	<input type="text"/>
Location: Inside Home  Outside  At Work  Fill in the name of locations not listed; examples: gym, tennis court <input type="text"/> <input type="text"/> <input type="text"/> <input type="text"/> <input type="text"/>	<input type="checkbox"/>	<input type="checkbox"/>	<input type="checkbox"/>	<input type="checkbox"/>	<input type="checkbox"/>	<input type="checkbox"/>	<input type="checkbox"/>	<input type="checkbox"/>	<input type="checkbox"/>
Bath/Shower 	<input type="checkbox"/>	<input type="checkbox"/>	<input type="checkbox"/>	<input type="checkbox"/>	<input type="checkbox"/>	<input type="checkbox"/>	<input type="checkbox"/>	<input type="checkbox"/>	<input type="checkbox"/>
Pump Not Operating	<input type="checkbox"/>	<input type="checkbox"/>	<input type="checkbox"/>	<input type="checkbox"/>	<input type="checkbox"/>	<input type="checkbox"/>	<input type="checkbox"/>	<input type="checkbox"/>	<input type="checkbox"/>

Notes:

Time/Activity Diary

Day 2

Activity Number: _____

1 = Sleeping

2 = Eating





3 = Sitting

4 = Moderate Activity (e.g., walking)

5 = Intense Activity (e.g., jogging)

Subject ID:

Date:

	8 am	8:30 am	9 am	9:30 am	10 am	10:30 am	11 am	11:30 am	noon
Activity Number(s): Do NOT leave blank	<input type="text"/>	<input type="text"/>	<input type="text"/>	<input type="text"/>	<input type="text"/>	<input type="text"/>	<input type="text"/>	<input type="text"/>	<input type="text"/>
Location: Inside Home  Outside  At Work  Fill in the name of locations not listed; examples: gym, tennis court <input type="text"/> <input type="text"/> <input type="text"/> <input type="text"/> <input type="text"/>	<input type="checkbox"/>	<input type="checkbox"/>	<input type="checkbox"/>	<input type="checkbox"/>	<input type="checkbox"/>	<input type="checkbox"/>	<input type="checkbox"/>	<input type="checkbox"/>	<input type="checkbox"/>
Bath/Shower 	<input type="checkbox"/>	<input type="checkbox"/>	<input type="checkbox"/>	<input type="checkbox"/>	<input type="checkbox"/>	<input type="checkbox"/>	<input type="checkbox"/>	<input type="checkbox"/>	<input type="checkbox"/>
Pump Not Operating	<input type="checkbox"/>	<input type="checkbox"/>	<input type="checkbox"/>	<input type="checkbox"/>	<input type="checkbox"/>	<input type="checkbox"/>	<input type="checkbox"/>	<input type="checkbox"/>	<input type="checkbox"/>

Notes:

Time/Activity Diary

Day 2

Activity Number: _____

1 = Sleeping

2 = Eating





3 = Sitting

4 = Moderate Activity (e.g., walking)

5 = Intense Activity (e.g., jogging)

Subject ID:

Date:

	noon	12:30 pm	1 pm	1:30 pm	2 pm	2:30 pm	3 pm	3:30 pm	4 pm
Activity Number(s): Do NOT leave blank	<input type="text"/>	<input type="text"/>	<input type="text"/>	<input type="text"/>	<input type="text"/>	<input type="text"/>	<input type="text"/>	<input type="text"/>	<input type="text"/>
Location: Inside Home  Outside  At Work  Fill in the name of locations not listed; examples: gym, tennis court <input type="text"/> <input type="text"/> <input type="text"/> <input type="text"/> <input type="text"/>	<input type="checkbox"/>	<input type="checkbox"/>	<input type="checkbox"/>	<input type="checkbox"/>	<input type="checkbox"/>	<input type="checkbox"/>	<input type="checkbox"/>	<input type="checkbox"/>	<input type="checkbox"/>
Bath/Shower 	<input type="checkbox"/>	<input type="checkbox"/>	<input type="checkbox"/>	<input type="checkbox"/>	<input type="checkbox"/>	<input type="checkbox"/>	<input type="checkbox"/>	<input type="checkbox"/>	<input type="checkbox"/>
Pump Not Operating	<input type="checkbox"/>	<input type="checkbox"/>	<input type="checkbox"/>	<input type="checkbox"/>	<input type="checkbox"/>	<input type="checkbox"/>	<input type="checkbox"/>	<input type="checkbox"/>	<input type="checkbox"/>

Notes:

Time/Activity Diary

Day 2

Activity Number: _____

1 = Sleeping

2 = Eating





3 = Sitting

4 = Moderate Activity (e.g., walking)

5 = Intense Activity (e.g., jogging)

Subject ID:

Date:

	4 pm	4:30 pm	5 pm	5:30 pm	6 pm	6:30 pm	7 pm	7:30 pm	8 pm
Activity Number(s): Do NOT leave blank	<input type="text"/>	<input type="text"/>	<input type="text"/>	<input type="text"/>	<input type="text"/>	<input type="text"/>	<input type="text"/>	<input type="text"/>	<input type="text"/>
Location: Inside Home  Outside  At Work  Fill in the name of locations not listed; examples: gym, tennis court <input type="text"/> <input type="text"/> <input type="text"/> <input type="text"/> <input type="text"/>	<input type="checkbox"/>	<input type="checkbox"/>	<input type="checkbox"/>	<input type="checkbox"/>	<input type="checkbox"/>	<input type="checkbox"/>	<input type="checkbox"/>	<input type="checkbox"/>	<input type="checkbox"/>
Bath/Shower 	<input type="checkbox"/>	<input type="checkbox"/>	<input type="checkbox"/>	<input type="checkbox"/>	<input type="checkbox"/>	<input type="checkbox"/>	<input type="checkbox"/>	<input type="checkbox"/>	<input type="checkbox"/>
Pump Not Operating	<input type="checkbox"/>	<input type="checkbox"/>	<input type="checkbox"/>	<input type="checkbox"/>	<input type="checkbox"/>	<input type="checkbox"/>	<input type="checkbox"/>	<input type="checkbox"/>	<input type="checkbox"/>

Notes:

Time/Activity Diary





Day 2

Activity Number: _____

- 1 = Sleeping
- 2 = Eating
- 3 = Sitting
- 4 = Moderate Activity (e.g., walking)
- 5 = Intense Activity (e.g., jogging)

Subject ID:

Date:

	8 pm	8:30 pm	9 pm	9:30 pm	10 pm	10:30 pm	11 pm	11:30 pm	midnight
Activity Number(s): Do NOT leave blank	<input type="text"/>	<input type="text"/>	<input type="text"/>	<input type="text"/>	<input type="text"/>	<input type="text"/>	<input type="text"/>	<input type="text"/>	<input type="text"/>
Location: Inside Home  Outside  At Work  Fill in the name of locations not listed; examples: gym, tennis court <input type="text"/> <input type="text"/> <input type="text"/> <input type="text"/> <input type="text"/>	<input type="checkbox"/>	<input type="checkbox"/>	<input type="checkbox"/>	<input type="checkbox"/>	<input type="checkbox"/>	<input type="checkbox"/>	<input type="checkbox"/>	<input type="checkbox"/>	<input type="checkbox"/>
Bath/Shower 	<input type="checkbox"/>	<input type="checkbox"/>	<input type="checkbox"/>	<input type="checkbox"/>	<input type="checkbox"/>	<input type="checkbox"/>	<input type="checkbox"/>	<input type="checkbox"/>	<input type="checkbox"/>
Pump Not Operating	<input type="checkbox"/>	<input type="checkbox"/>	<input type="checkbox"/>	<input type="checkbox"/>	<input type="checkbox"/>	<input type="checkbox"/>	<input type="checkbox"/>	<input type="checkbox"/>	<input type="checkbox"/>

Notes: