

Protein Structure Analysis & Protein-Protein Interactions

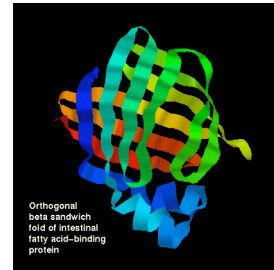
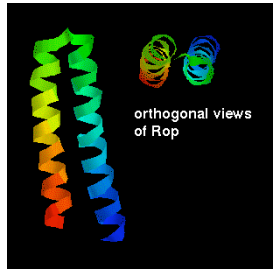

David Wishart

University of Alberta, Edmonton, Canada

david.wishart@ualberta.ca

Much Ado About Structure

- Structure ↔ Function
- Structure ↔ Mechanism
- Structure ↔ Origins/Evolution
- Structure-based Drug Design
- Solving the Protein Folding Problem

Routes to 3D Structure

- X-ray Crystallography (the best)
- NMR Spectroscopy (close second)
- Cryoelectron microscopy (distant 3rd)
- Homology Modelling (sometimes VG)
- Threading (sometimes VG)
- Ab initio prediction (getting better)

X-ray Crystallography

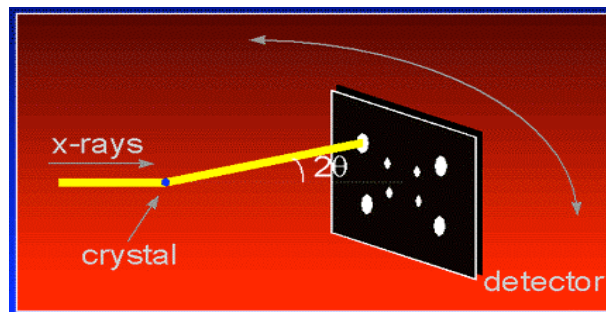

X-ray Crystallography

- Crystallization
- Diffraction Apparatus
- Diffraction Principles
- Conversion of Diffraction Data to Electron Density
- Resolution
- Chain Tracing

Diffraction Apparatus

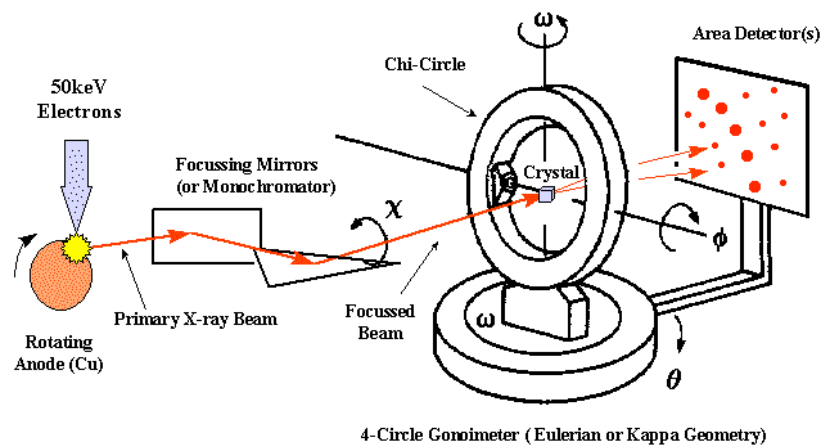

Protein Crystal Diffraction

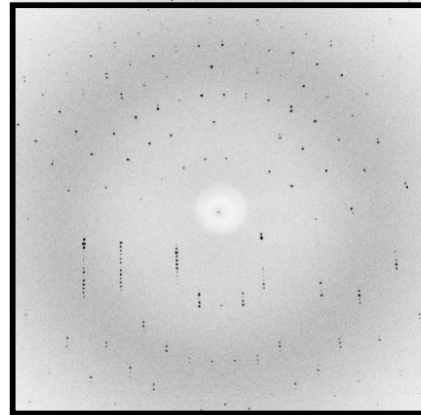
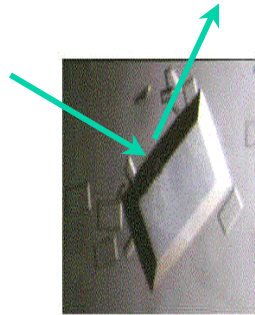

Diffraction Pattern

Converting Diffraction Data to Electron Density

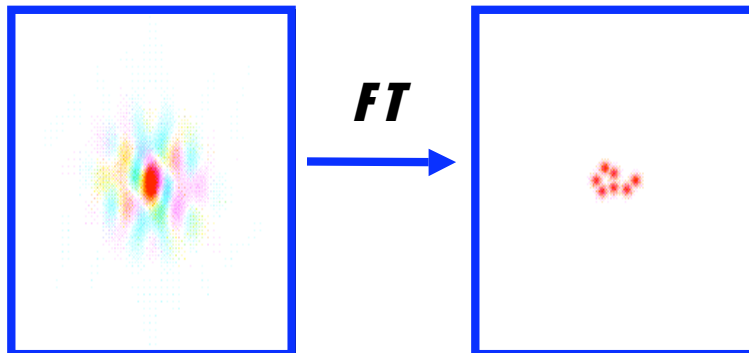

Resolution

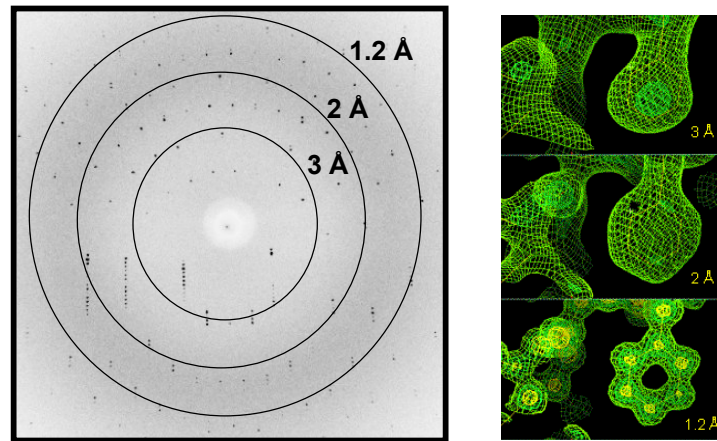

The Final Result

```
ORIGX2      0.000000  1.000000  0.000000      0.000000      2TRX 147
ORIGX3      0.000000  0.000000  1.000000      0.000000      2TRX 148
SCALE1      0.011173  0.000000  0.004858      0.000000      2TRX 149
SCALE2      0.000000  0.019585  0.000000      0.000000      2TRX 150
SCALE3      0.000000  0.000000  0.018039      0.000000      2TRX 151
ATOM       1  N   SER A  1      21.389  25.406  -4.628  1.00  23.22  2TRX 152
ATOM       2  CA  SER A  1      21.628  26.691  -3.983  1.00  24.42  2TRX 153
ATOM       3  C   SER A  1      20.937  26.944  -2.679  1.00  24.21  2TRX 154
ATOM       4  O   SER A  1      21.072  28.079  -2.093  1.00  24.97  2TRX 155
ATOM       5  CB  SER A  1      21.117  27.770  -5.002  1.00  28.27  2TRX 156
ATOM       6  OG  SER A  1      22.276  27.925  -5.861  1.00  32.61  2TRX 157
ATOM       7  N   ASP A  2      20.173  26.028  -2.163  1.00  21.39  2TRX 158
ATOM       8  CA  ASP A  2      19.395  26.125  -0.949  1.00  21.57  2TRX 159
ATOM       9  C   ASP A  2      20.264  26.214   0.297  1.00  20.89  2TRX 160
ATOM      10  O   ASP A  2      19.760  26.575   1.371  1.00  21.49  2TRX 161
ATOM      11  CB  ASP A  2      18.439  24.914  -0.856  1.00  22.14  2TRX 162
```

<http://www-structure.llnl.gov/Xray/101index.html>

NMR Spectroscopy

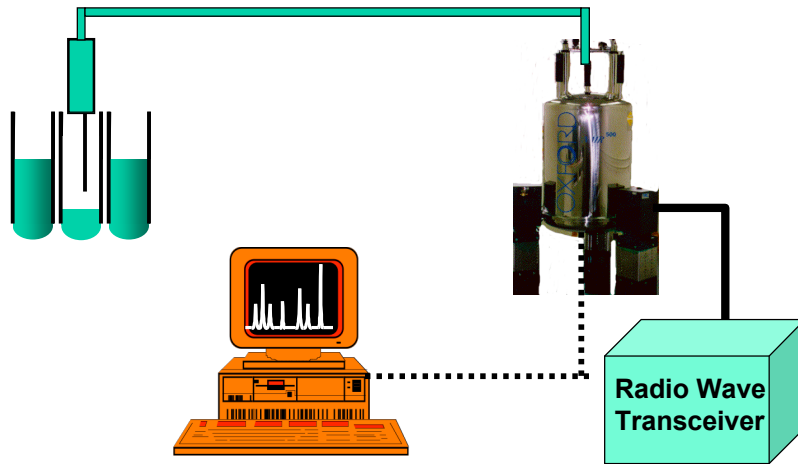

Principles of NMR

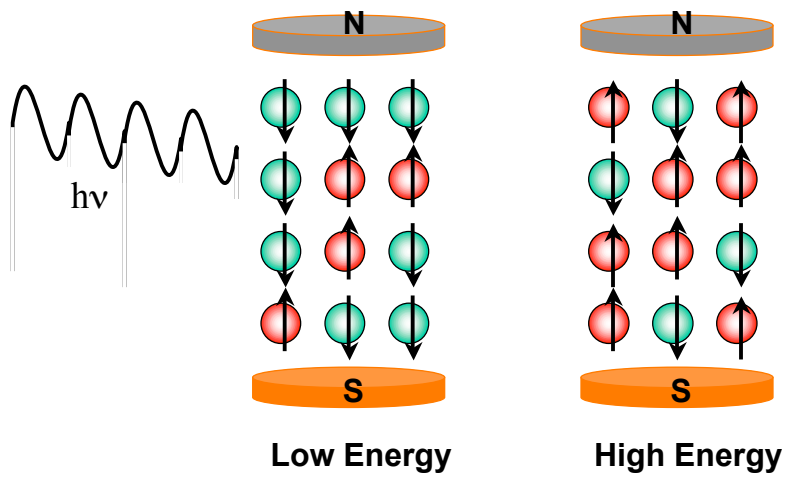

Multidimensional NMR

1D

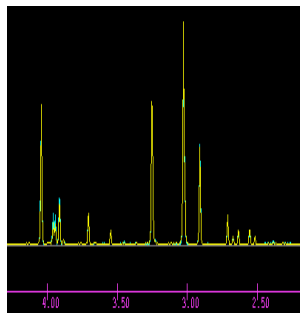

MW ~ 500

2D

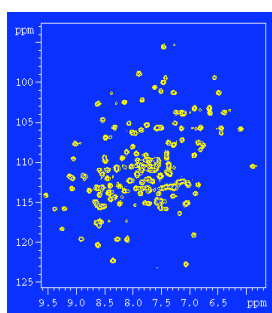

MW ~ 10,000

3D

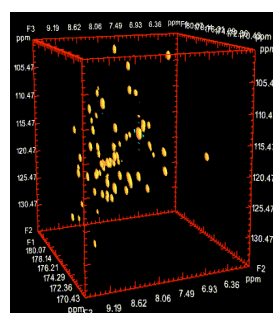

MW ~ 30,000

The NMR Process

- Obtain protein sequence
- Collect TOCSY & NOESY data
- Use chemical shift tables and known sequence to assign TOCSY spectrum
- Use TOCSY to assign NOESY spectrum
- Obtain inter and intra-residue distance information from NOESY data
- Feed data to computer to solve structure

NMR Spectroscopy

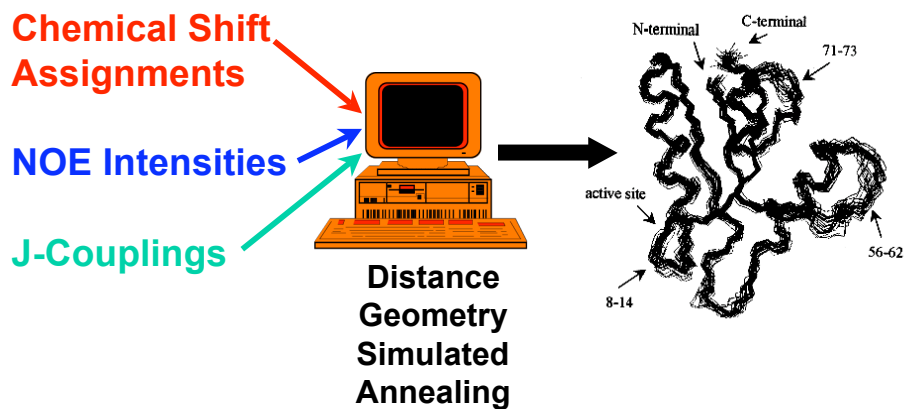

The Final Result

```

ORIGX2      0.000000  1.000000  0.000000      0.000000      2TRX 147
ORIGX3      0.000000  0.000000  1.000000      0.000000      2TRX 148
SCALE1      0.011173  0.000000  0.004858      0.000000      2TRX 149
SCALE2      0.000000  0.019585  0.000000      0.000000      2TRX 150
SCALE3      0.000000  0.000000  0.018039      0.000000      2TRX 151
ATOM       1  N   SER A  1    21.389  25.406  -4.628  1.00  23.22  2TRX 152
ATOM       2  CA  SER A  1    21.628  26.691  -3.983  1.00  24.42  2TRX 153
ATOM       3  C   SER A  1    20.937  26.944  -2.679  1.00  24.21  2TRX 154
ATOM       4  O   SER A  1    21.072  28.079  -2.093  1.00  24.97  2TRX 155
ATOM       5  CB  SER A  1    21.117  27.770  -5.002  1.00  28.27  2TRX 156
ATOM       6  OG  SER A  1    22.276  27.925  -5.861  1.00  32.61  2TRX 157
ATOM       7  N   ASP A  2    20.173  26.028  -2.163  1.00  21.39  2TRX 158
ATOM       8  CA  ASP A  2    19.395  26.125  -0.949  1.00  21.57  2TRX 159
ATOM       9  C   ASP A  2    20.264  26.214   0.297  1.00  20.89  2TRX 160
ATOM      10  O   ASP A  2    19.760  26.575   1.371  1.00  21.49  2TRX 161
ATOM      11  CB  ASP A  2    18.439  24.914  -0.856  1.00  22.14  2TRX 162
    
```

X-ray Versus NMR

X-ray

- Producing enough protein for trials
- Crystallization time and effort
- Crystal quality, stability and size control
- Finding isomorphous derivatives
- Chain tracing & checking

NMR

- Producing enough labeled protein for collection
- Sample “conditioning”
- Size of protein
- Assignment process is slow and error prone
- Measuring NOE’s is slow and error prone

Comparative (Homology) Modelling

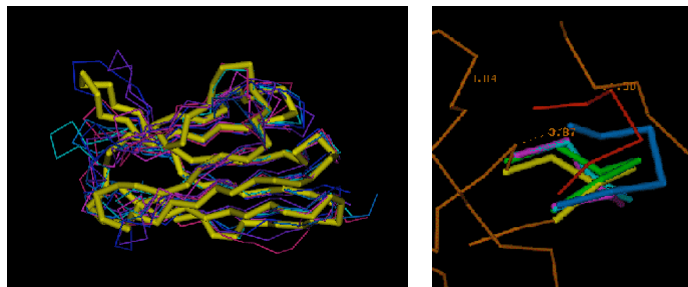

```

ACDEFGHIKLMNPQRST--FGHQWERT-----TYREWYEGHADS
ASDEYAHLRILD PQRSTVAYAYE--KSFAPPGSFKWEYEAHADS
MCDEYAHIRLMNPERSTVAGGHQWERT-----GSFKEWYAAHADD
  
```

Homology Modelling

- Offers a method to “Predict” the 3D structure of proteins for which it is not possible to obtain X-ray or NMR data
- Can be used in understanding function, activity, specificity, etc.
- Of interest to drug companies wishing to do structure-aided drug design
- A keystone of Structural Proteomics

Homology Modelling

- Identify homologous sequences in PDB
- Align query sequence with homologues
- Find Structurally Conserved Regions (SCRs)
- Identify Structurally Variable Regions (SVRs)
- Generate coordinates for core region
- Generate coordinates for loops
- Add side chains (Check rotamer library)
- Refine structure using energy minimization
- Validate structure

Modelling on the Web

- Prior to 1998 homology modelling could only be done with commercial software or command-line freeware
- The process was time-consuming and labor-intensive
- The past few years has seen an explosion in automated web-based homology modelling servers
- Now anyone can homology model!

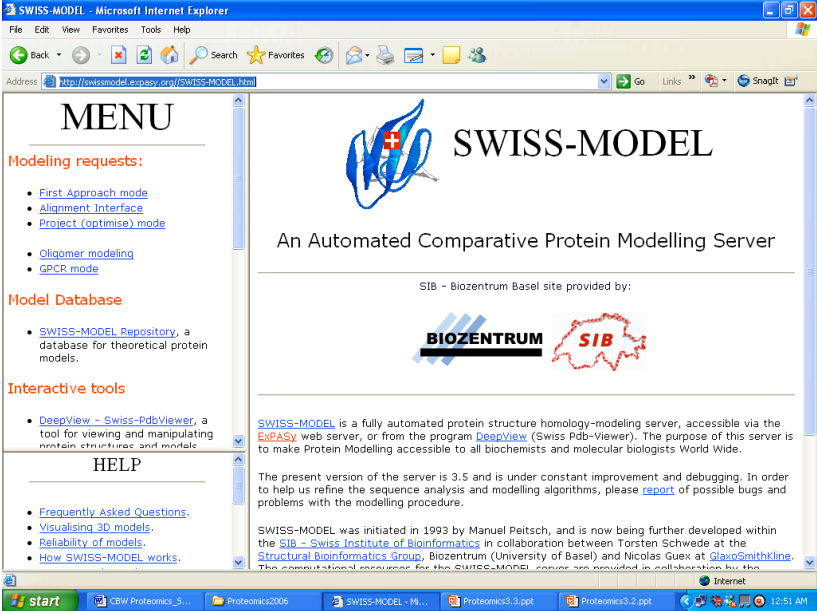

The screenshot shows a web browser window titled "SWISS-MODEL - Microsoft Internet Explorer". The address bar displays "http://swissmodel.expasy.org//SWISS-MODEL.html". The page content includes a "MENU" section with links for "Modeling requests" (First Approach mode, Alignment Interface, Project (optimise) mode, Oligomer modeling, GPCR mode), "Model Database" (SWISS-MODEL Repository), and "Interactive tools" (DeepView - Swiss-PdbViewer). A "HELP" section contains links for "Frequently Asked Questions", "Visualising 3D models", "Reliability of models", and "How SWISS-MODEL works". The main content area features the SWISS-MODEL logo, the text "An Automated Comparative Protein Modelling Server", and logos for BIOCENTRUM and SIB. A paragraph describes the server's purpose and version (3.5), and another paragraph mentions its initiation in 1993 by Manuel Peitsch and its development by the SIB - Swiss Institute of Bioinformatics.

<http://swissmodel.expasy.org//SWISS-MODEL.html>

The screenshot shows a web browser window titled "The WHAT IF Web Interface - Microsoft Internet Explorer". The address bar contains the URL <http://swift.cmbi.kun.nl/WIWWWI/>. The page content is as follows:

Classes

- [Help](#)
- [Administration](#)
- [Build/check/repair model](#)
- [Structure validation](#)
- [Analyse a residue](#)
- [Protein analysis](#)
- [2-D graphics](#)
- [3-D graphics](#)
- [Hydrogen \(bonds\)](#)
- [Accessibility](#)
- [Atomic contacts](#)
- [Coordinate manipulations](#)
- [Rotamer related](#)
- [Cysteine related](#)
- [Water](#)
- [Ions](#)
- [Docking](#)
- [Crystal symmetry](#)
- [mutation prediction](#)
- [NMR](#)
- [Other options](#)

Homology Modelling

Introduction

Build a model on a template structure.

Methods

WHAT IF will not align your sequences. You have to align the sequences before you give them to this server. Read the notes of the file formats and the notes on how this server works.

Please use the browse function rather than typing file names.

Give the template pir-file

Give the template pdb-file

Give the aligned sequence pir-file

If you have detected any error, or have any question or suggestion, please send us a mail, Roland Krause, Jens Erik Nielsen, [Gert Vriend](#)

Last modified Sat Jan 14 22:10:09 2006 by [JN](#)

<http://swift.cmbi.kun.nl/WIWWWI/>

The Final Result

```

ORIGX2      0.000000  1.000000  0.000000      0.000000      2TRX 147
ORIGX3      0.000000  0.000000  1.000000      0.000000      2TRX 148
SCALE1      0.011173  0.000000  0.004858      0.000000      2TRX 149
SCALE2      0.000000  0.019585  0.000000      0.000000      2TRX 150
SCALE3      0.000000  0.000000  0.018039      0.000000      2TRX 151
ATOM        1  N   SER A  1      21.389  25.406  -4.628  1.00  23.22      2TRX 152
ATOM        2  CA  SER A  1      21.628  26.691  -3.983  1.00  24.42      2TRX 153
ATOM        3  C   SER A  1      20.937  26.944  -2.679  1.00  24.21      2TRX 154
ATOM        4  O   SER A  1      21.072  28.079  -2.093  1.00  24.97      2TRX 155
ATOM        5  CB  SER A  1      21.117  27.770  -5.002  1.00  28.27      2TRX 156
ATOM        6  OG  SER A  1      22.276  27.925  -5.861  1.00  32.61      2TRX 157
ATOM        7  N   ASP A  2      20.173  26.028  -2.163  1.00  21.39      2TRX 158
ATOM        8  CA  ASP A  2      19.395  26.125  -0.949  1.00  21.57      2TRX 159
ATOM        9  C   ASP A  2      20.264  26.214   0.297  1.00  20.89      2TRX 160
ATOM       10  O   ASP A  2      19.760  26.575   1.371  1.00  21.49      2TRX 161
ATOM       11  CB  ASP A  2      18.439  24.914  -0.856  1.00  22.14      2TRX 162

```

The PDB

- **PDB - Protein Data Bank**
- **Established in 1971 at Brookhaven National Lab (7 structures)**
- **Primary archive for macromolecular structures (proteins, nucleic acids, carbohydrates – now 40,000 structures)**
- **Moved from BNL to RCSB (Research Collaboratory for Structural Bioinformatics) in 1998**

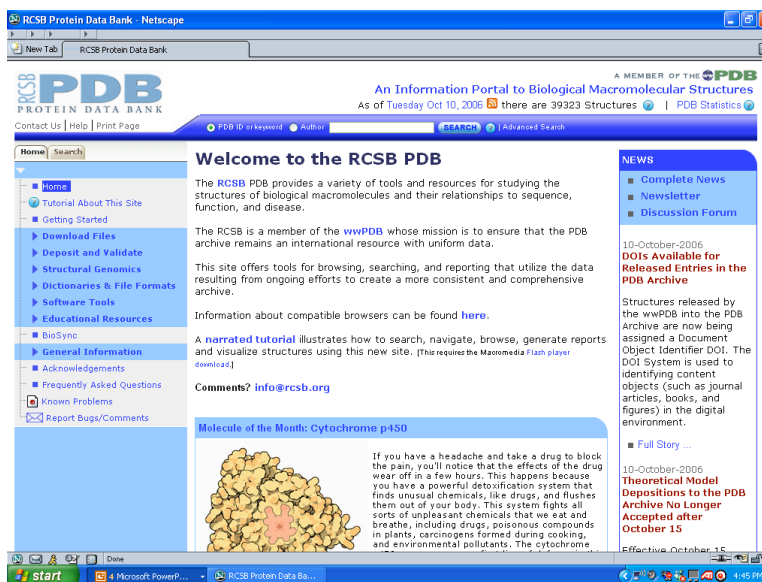

The screenshot shows the RCSB Protein Data Bank website in a Netscape browser window. The page features a navigation menu on the left with links such as Home, Tutorial, Getting Started, Download Files, Deposit and Validate, Structural Genomics, Dictionaries & File Formats, Software Tools, Educational Resources, BioSync, General Information, Acknowledgements, Frequently Asked Questions, Known Problems, and Report Bugs/Comments. The main content area includes a welcome message, a search bar, and a 'Molecule of the Month' section for Cytochrome p450. A sidebar on the right contains a 'NEWS' section with links to Complete News, Newsletter, and Discussion Forum, along with recent news items dated 10-October-2006.

<http://www.rcsb.org/pdb/>

Viewing 3D Structures

The screenshot shows the RCSB PDB Structure Explorer interface. The main content area displays the structure summary for 2TRX, including the title "CRYSTAL STRUCTURE OF THIOREDIXIN FROM ESCHERICHIA COLI AT 1.68 ANGSTROMS RESOLUTION", authors "Kattl, S.K., Lemaster, D.M., Eklund, H.", and primary citation "Kattl, S.K., Lemaster, D.M., Eklund, H. Crystal structure of thioredoxin from Escherichia coli at 1.68 Å resolution. J Mol Biol. v212 pp.167-184, 1990 [Abstract]". The experimental method is X-RAY DIFFRACTION, and the resolution is 1.68 Å. The unit cell parameters are listed as Length [Å] a: 89.50, b: 51.06, c: 80.45 and Angles [°] alpha: 90.00, beta: 113.50, gamma: 90.00. The molecular description is Polymer: 1, Molecule: THIOREDIXIN, Chains: A,B, and the functional class is Electron Transport.

The "Images and Visualization" section on the right shows a 3D ribbon model of the protein structure. Below the image, the "Display Options" menu is highlighted with a red circle, listing the following options: King, Jmol, WebMol, Protein Workshop, QuickPDB, and All Images.

KiNG (Kinemage) 1.39

The screenshot shows the KiNG 1.39 software interface. The main window displays a 3D ribbon model of the protein structure. The left sidebar contains a list of objects to be displayed, including 2TRXa, 2TRXb, 2TRXc, hets, atoms, ribbon, coil, beta, and alpha. The bottom of the window features a control panel with a zoom slider, a clipping slider, and buttons for "Pick center", "Show text", "Markers", and "Show hierarchy". The status bar at the bottom indicates the current window is "KiNG 1.39".

KiNG (Kinemage)

- Both a (signed) Java Applet and a downloadable application
- Application is compatible with most Operating systems
- Compatible with most Java (1.3+) enabled browsers including:
 - Internet Explorer (Win32)
 - Mozilla/Firefox (Win32, OSX, *nix)
 - Safari (Mac OS X) and Opera 7.5.4

JMol Applet

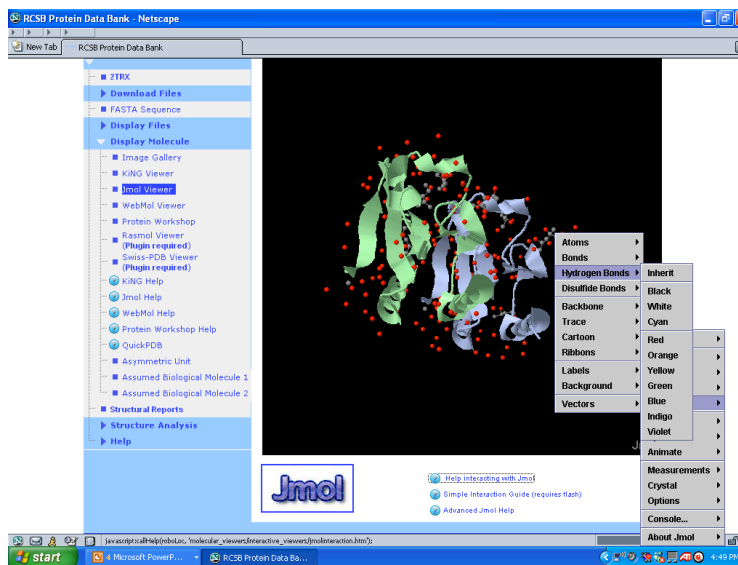

JMol

- **Java-based program**
- **Open source applet and application**
 - **Compatible with Linux, MacOS, Windows**
- **Menus access by clicking on Jmol icon on lower right corner of applet**
- **Supports all major web browsers**
 - **Internet Explorer (Win32)**
 - **Mozilla/Firefox (Win32, OSX, *nix)**
 - **Safari (Mac OS X) and Opera 7.5.4**

WebMol

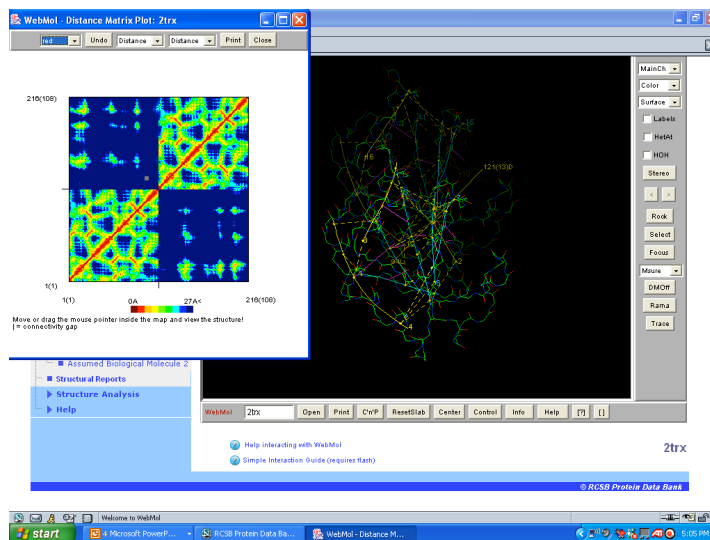

WebMol

- Both a Java Applet and a downloadable application
- Offers many tools including distance, angle, dihedral angle measurements, detection of steric conflicts, interactive Ramachandran plot, diff. distance plot
- Compatible with most Java (1.3+) enabled browsers including:
 - Internet Explorer 6.0 on Windows XP
 - Safari on Mac OS 10.3.3
 - Mozilla 1.6 on Linux (Redhat 8.0)

Analyzing and Assessing 3D Structures

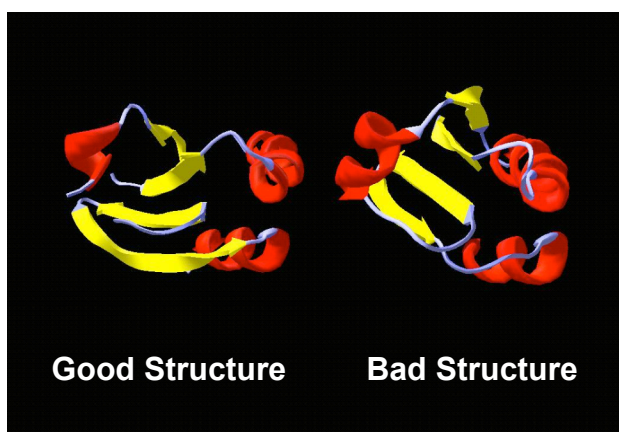

Why Assess Structure?

- A structure can (and often does) have mistakes
- A poor structure will lead to poor models of mechanism or relationship
- Unusual parts of a structure may indicate something important (or an error)

Famous “bad” structures

- Azobacter ferredoxin (**wrong space group**)
- Zn-metallothionein (**mistraced chain**)
- Alpha bungarotoxin (**poor stereochemistry**)
- Yeast enolase (**mistraced chain**)
- Ras P21 oncogene (**mistraced chain**)
- Gene V protein (**poor stereochemistry**)

How to Assess Structure?

- Assess experimental fit (look at R factor {X-ray} or rmsd {NMR})
- Assess correctness of overall fold (look at disposition of hydrophobes, location of charged residues)
- Assess structure quality (packing, stereochemistry, bad contacts, etc.)

A Good Protein Structure..

X-ray structure

- R = 0.59 random chain
- R = 0.45 initial structure
- R = 0.35 getting there
- R = 0.25 typical protein
- R = 0.15 best case
- R = 0.05 small molecule

NMR structure

- rmsd = 4 Å random
- rmsd = 2 Å initial fit
- rmsd = 1.5 Å OK
- rmsd = 0.8 Å typical
- rmsd = 0.4 Å best case
- rmsd = 0.2 Å dream on

Cautions...

- A low R factor or a good RMSD value does not guarantee that the structure is “right”
- Differences due to crystallization conditions, crystal packing, solvent conditions, concentration effects, etc. can perturb structures substantially
- Long recognized need to find other ways to ID good structures from bad (not just assessing experimental fit)

Structure Variability



X-ray to X-ray
Interleukin 1 β
(41bi vs 2mlb)

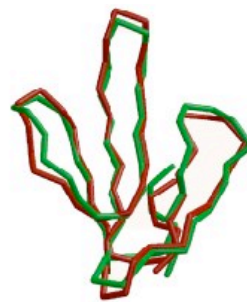

NMR to X-ray
Erabutoxin
(3ebx vs 1era)

A Good Protein Structure..

- **Minimizes disallowed torsion angles**
- **Maximizes number of hydrogen bonds**
- **Maximizes buried hydrophobic ASA**
- **Maximizes exposed hydrophilic ASA**
- **Minimizes interstitial cavities or spaces**

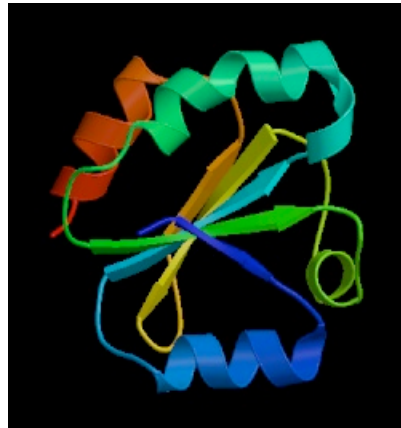

A Good Protein Structure..

- **Minimizes number of "bad" contacts**
- **Minimizes number of buried charges**
- **Minimizes radius of gyration**
- **Minimizes covalent and noncovalent (van der Waals and coulombic) energies**



Structure Validation Servers

- **WhatIf Web Server** - <http://swift.cmbi.kun.nl/WIWWWI/>
- **Biotech Validation Suite** - <http://biotech.ebi.ac.uk:8400/cgi-bin/sendquery>
- **Verify3D** - http://www.doe-mbi.ucla.edu/Services/Verify_3D/
- **VADAR** - <http://redpoll.pharmacy.ualberta.ca>

Classes

- [Help](#)
- [Administration](#)
- [Build/check/repair model](#)
- [Structure validation](#)
- [Analyse a residue](#)
- [Protein analysis](#)
- [2-D graphics](#)
- [3-D graphics](#)
- [Hydrogen \(bonds\)](#)
- [Accessibility](#)
- [Atomic contacts](#)
- [Coordinate manipulations](#)
- [Rotamer related](#)
- [Cysteine related](#)
- [Water](#)
- [Ions](#)
- [Docking](#)
- [Crystal symmetry](#)
- [mutation prediction](#)
- [NMR](#)
- [Other options](#)

WHAT IF Web Interface

Click on one of the classes in the left side column to activate those servers.

You can also read the [help page](#), or you can read about the [output formats](#) used by all servers. We also made one [page](#) with notes for people who want to make their own servers.

W A R N I N G Results are only kept on this server till Saturday, midnight in The Netherlands. This is mainly a safety feature, but also saves us disk space. Feel free to look at the [WHAT IF website](#) too.

In case a server fails, first check your input PDB file "Last sequence of a PDB file" server that can be found in the "Administration" section of the servers. If this server gives you a long list of administrative information, and no obvious error messages, then look at the [EDBREPORT](#) database to see if there are other obvious problems with the PDB file. If that also does not provide an answer, mail the PDB file (and other files when needed) to Gert Vriend. Please mention the server class (mentioned in the left-hand column of the server page) and the title of the actual server (you click on that in the right-hand part of the server page to get at that server).

Last software update on April 30, 2006. Please report any 'funnies'.

If you have detected any errors, or have any question or suggestion, please send us a mail, Roland Krause, Jens Erik Nielsen, [Gert Vriend](#).

Last modified Sat Jan 14 22:10:10 2006 by [IN](#)

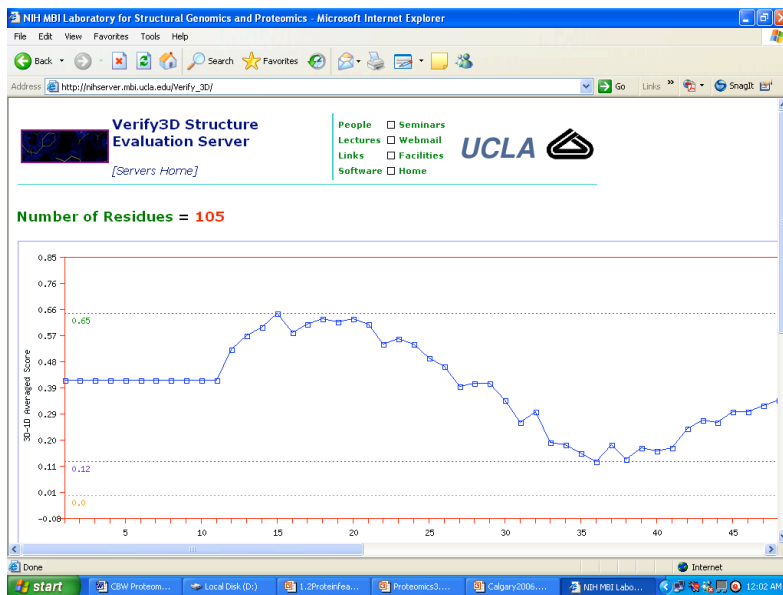

High scores = good Low scores = bad

http://redpoll.pharmacy.ualberta.ca

Structure Validation Programs

- **PROCHECK** -
<http://www.biochem.ucl.ac.uk/~roman/procheck/procheck.html>
- **PROSA II** -
<http://lore.came.sbg.ac.at/People/mo/Prosa/prosa.html>
- **VADAR** -
<http://www.pence.ualberta.ca/ftp/vadar/>
- **DSSP** -
<http://www.embl-heidelberg.de/dssp/>

Procheck

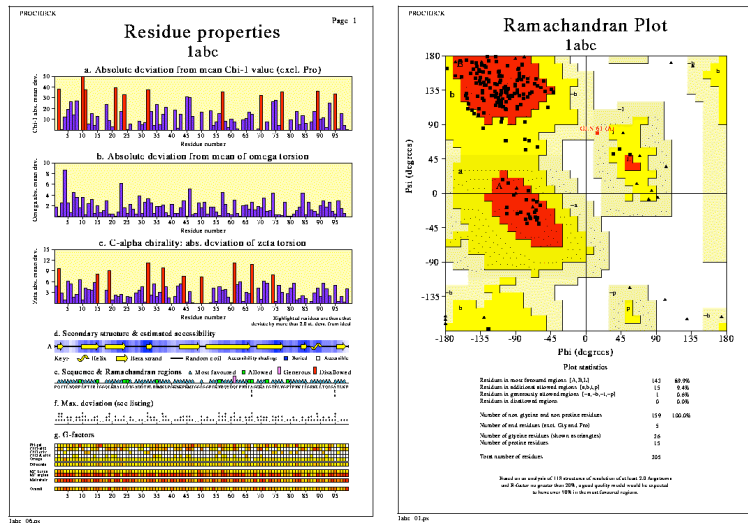

Comparing 3D Structures

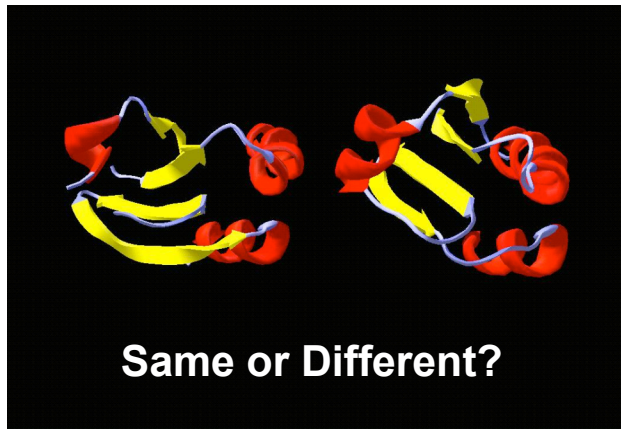

Same or Different?

Qualitative vs. Quantitative

Rigid Body Superposition



Superposition

- Objective is to match or overlay 2 or more similar objects
- Requires use of translation and rotation operators (matrices/vectors)
- Least squares or conjugate gradient minimization (McLachlan/Kabsch)
- Lagrangian multipliers
- Quaternion-based methods (**fastest**)

SuperPose Web Server

SuperPose Version 1.0

SuperPose is a protein superposition server. SuperPose calculates using a modified quaternion approach. From a superposition of two or more structures, SuperPose generates sequence alignments, structure alignments, RMS statistics, Difference Distance Plots, and interactive images of the superposition. The SuperPose web server supports the submission of either PDB-format accession numbers.

Please cite the following: [Rajarshi Maib, Gary H. Van Domselaar, Haiyan Zhang, and David S. Wishart "SuperPose: a simple server for sophisticated structural superposition" Nucleic Acids Res. 2004 July 1; 32 \(Web Server issue\): W590W594](#)

If your PDB file contains multiple copies of a structure (ie. NMR files) you only need to enter one file or accession number. For additional information on how to run SuperPose, click [HELP](#)

PDB Entry A:

Select the first PDB file:

SuperPose Output Images

SuperPose Output Text Files

<http://wishart.biology.ualberta.ca/SuperPose/>

Superposition - Applications

- Ideal for comparing or overlaying two or more protein structures
- Allows identification of structural homologues (CATH and SCOP)
- Allows loops to be inserted or replaced from loop libraries (comparative modelling)
- Allows side chains to be replaced or inserted with relative ease

Measuring Superpositions

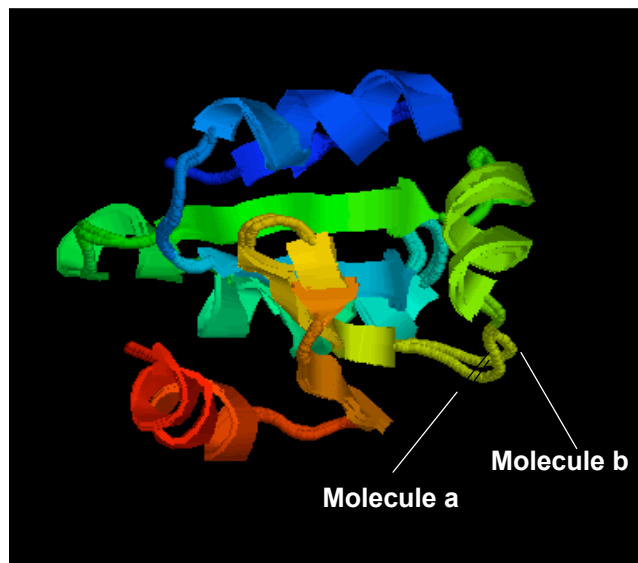

RMSD - Root Mean Square Deviation

- Method to quantify structural similarity - same as standard deviation
- Requires 2 superimposed structures (designated here as “a” & “b”)
- N = number of atoms being compared

$$\text{RMSD} = \frac{\sqrt{\sum_i (x_{ai} - x_{bi})^2 + (y_{ai} - y_{bi})^2 + (z_{ai} - z_{bi})^2}}{\sqrt{N}}$$

RMSD

- 0.0-0.5 Å → Essentially Identical
- <1.5 Å → Very good fit
- < 5.0 Å → Moderately good fit
- 5.0-7.0 Å → Structurally related
- > 7.0 Å → Dubious relationship
- > 12.0 Å → Completely unrelated

Detecting Unusual Relationships

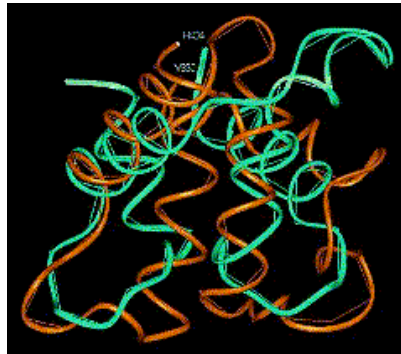

Similarity between Calmodulin and Acetylcholinesterase

Classifying Protein Folds

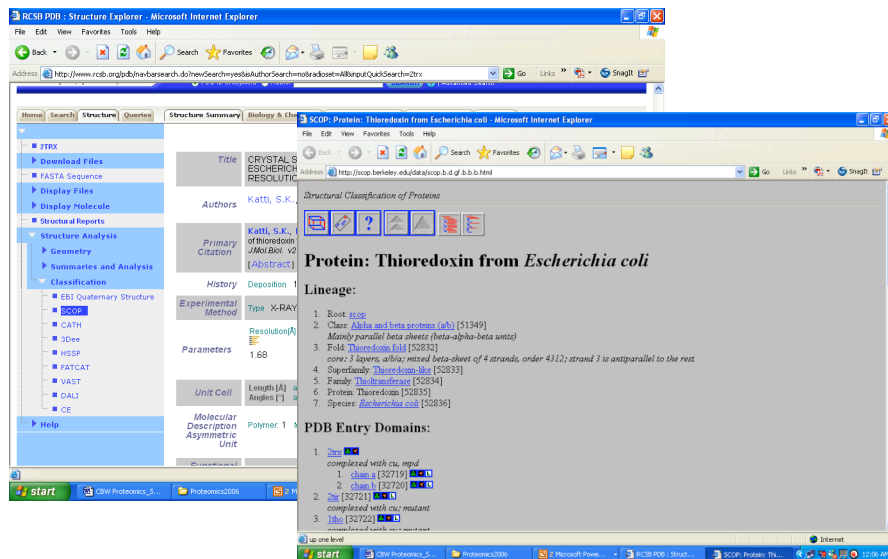

The screenshot displays the RCSB PDB Structure Explorer interface for the protein Thioredoxin from *Escherichia coli*. The left sidebar shows navigation options like 'Download Files', 'Display Molecule', and 'Structure Analysis'. The main content area includes the following information:

- Title:** CRYSTALS OF THIUREDOXIN FROM *ESCHERICHIA COLI*
- Authors:** KATO, S. K.
- Primary Citation:** KATO, S. K., et al. *J Mol Biol* 2002, 316, 1-10
- History:** Deposition 1
- Experimental Method:** Type X-RAY, Resolution 1.68 Å
- Parameters:** Length [Å] 100, Angles [°] 90, 90, 90
- Molecular Description:** Asymmetric Unit, Polymer: 1

Structural Classification of Proteins:

Protein: Thioredoxin from *Escherichia coli*

Lineage:

- Root: scop
- Class: Alpha and beta proteins (alph) [51349]
- Major class: Parallel beta sheets (beta-alpha-beta units) [52832]
- Family: Thioredoxin fold [52833]
- Superfamily: Thioredoxin-like [52833]
- Family: Thioredoxin [52834]
- Protein: Thioredoxin [52835]
- Species: *Escherichia coli* [52836]

PDB Entry Domains:

- 1: [1scop](#) [32719] [MOL]
- 2: [1scop](#) [32720] [MOL]
- 3: [1scop](#) [32721] [MOL]

SCOP Database



<http://scop.mrc-lmb.cam.ac.uk/scop>

SCOP

- **Class** folding class derived from secondary structure content
- **Fold** derived from topological connection, orientation, arrangement and # 2° structures
- **Superfamily** clusters of low sequence ID but related structures & functions
- **Family** clusters of proteins with seq ID > 30% with v. similar struct. & function

SCOP Structural Classification

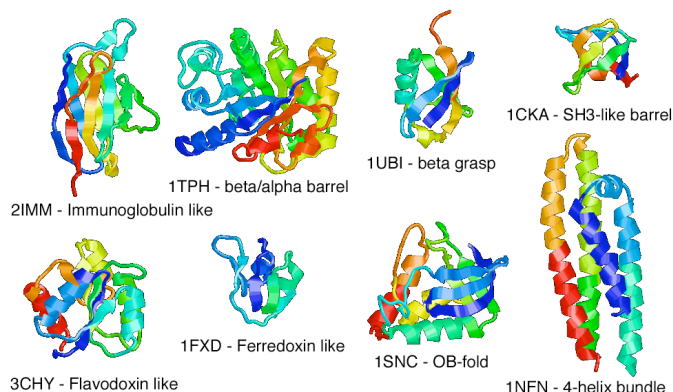

The eight most frequent SCOP superfolds

The CATH Database

CATH Protein Structure Classification Database (UCL) - Microsoft Internet Explorer

Address: <http://www.cathdb.info/latest/index.html>

CATH
Protein Structure Classification

Navigation: Home, Top of hierarchy

CATH Protein Structure Classification

Version 3.0.0: Released May 2006

CATH Group

Dr. Lesley Greene, Dr. Frances M.G. Peart, Dr. Ian Siliboe, Dr. Mark Dibley, Mr. Tony Lewis, Mr. Oliver Redfern, Dr. Alison Cuff

Contributors to the CATH Version 3.0.0 Release

Dr. Reekha Nambudry, Dr. Azara Janmohamed, Dr. Janet Moloney, Dr. Kanchan Phadwal, Dr. Corin Yeats, Ms. Sarah Adoku, Mr. Tim Dallman, Mr. Adam Reid, Ms. Elisabeth Rieker, Dr. Russell L. Maraden, Dr. David Lees, Prof. Janet Thornton, Prof. Christine A. Orengo

Links

- Browse or search the classification
- CATH statistics and release information
- General information on CATH
 - CATH lists and FTP site
- [NEW]** Raw data files for CATH (including CATH Domain PDB files)
- DHS - Dictionary of Homologous Superfamilies. Summary of structural and functional features for CATH Homologous Superfamilies
- CATH File Formats (for FTP files)

Introduction

<http://www.cathdb.info/latest/index.html>

CATH

- **Class [C]** derived from secondary structure content (automatic)
- **Architecture (A)** derived from orientation of 2° structures (manual)
- **Topology (T)** derived from topological connection and # 2° structures
- **Homologous Superfamily (H)** clusters of similar structures & functions

CATH - Class

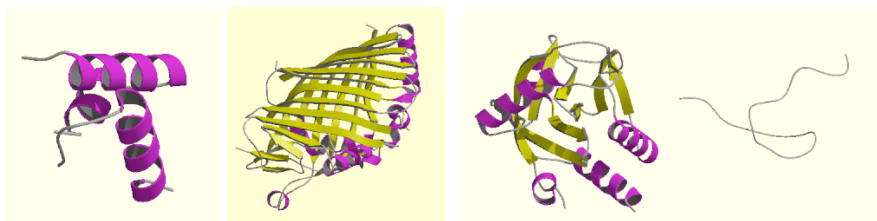

Class 1:
Mainly Alpha

Class 2:
Mainly Beta

Class 3:
Mixed
Alpha/Beta

Class 4:
Few Secondary
Structures

Secondary structure content (automatic)

CATH - Architecture

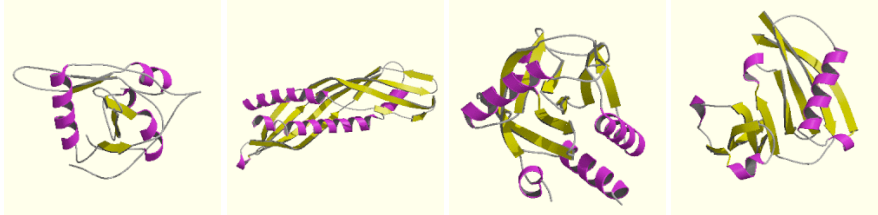

Roll

Super Roll

Barrel

2-Layer
Sandwich

Orientation of secondary structures (manual)

CATH - Topology

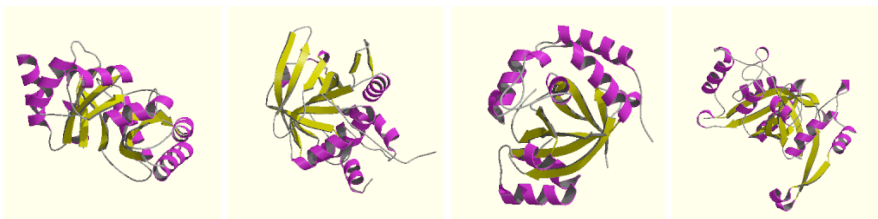

L-fucose Isomerase

Serine Protease

Aconitase,
domain 4

TIM Barrel

Topological connection and number of secondary structures

CATH - Homology

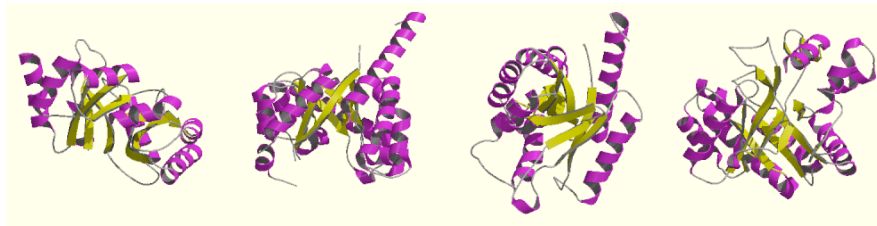

Alanine racemase

Dihydropteroate (DHP) synthetase

FMN dependent fluorescent proteins

7-stranded glycosidases

Superfamily clusters of similar structures & functions

Other Servers/Databases

- **Dali** - <http://www.ebi.ac.uk/dali/>
- **VAST** - www.ncbi.nlm.nih.gov/Structure/VAST/vast.shtml
- **CE** - <http://cl.sdsc.edu/ce.html>
- **FSSP** - <http://www.ebi.ac.uk/dali/fssp/fssp.html>
- **PDBsum** - www.biochem.ucl.ac.uk/bsm/pdbsum/

Protein Interactions



The Protein Parts List

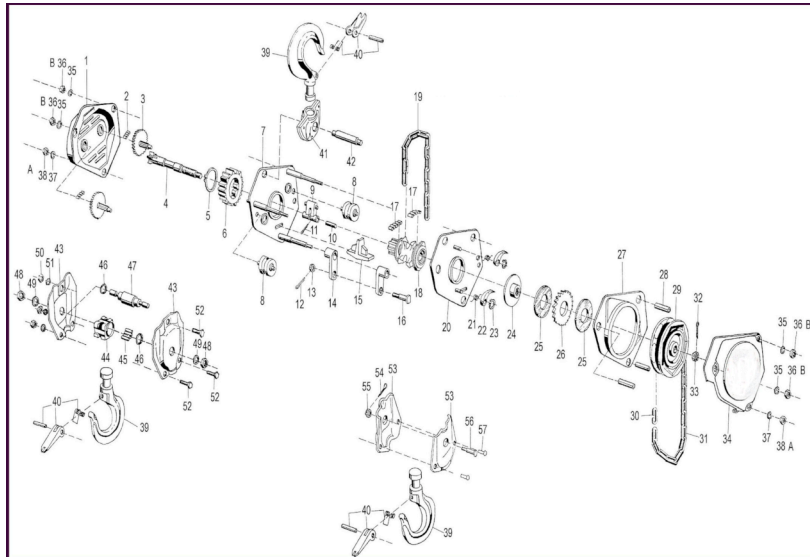

The Parts List

- Sequencing gives “serial number”
- Sequence alignment gives a name
- Microarrays give # of parts
- X-ray and NMR give a picture
- However, having a collection of parts and names doesn't tell you how to put something together or how things connect -- *this is biology*

Remember: *Proteins Interact*

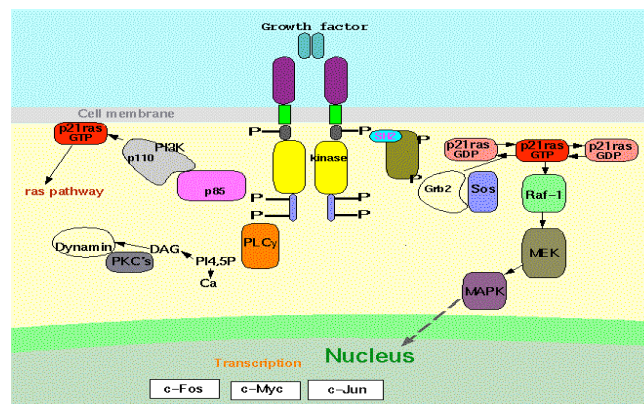

Protein Interaction Tools and Techniques - Experimental Methods

3D Structure Determination

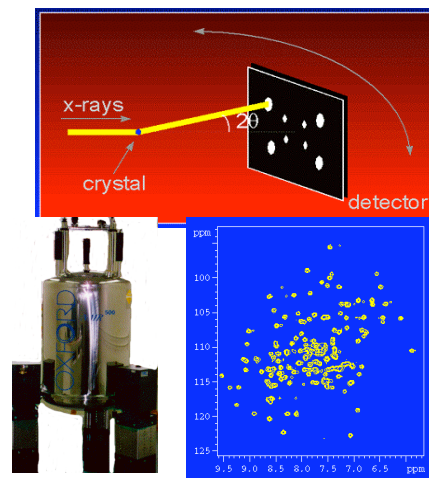

- **X-ray crystallography**
 - grow crystal
 - collect diffract. data
 - calculate e- density
 - trace chain
- **NMR spectroscopy**
 - label protein
 - collect NMR spectra
 - assign spectra & NOEs
 - calculate structure using distance geom.

Quaternary Structure

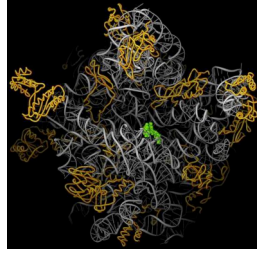
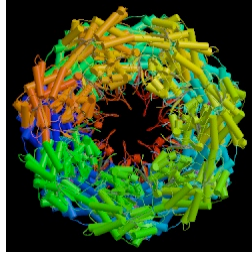

Some interactions
are real

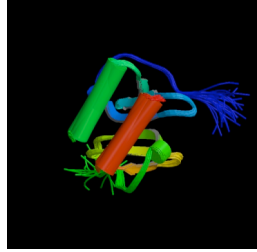
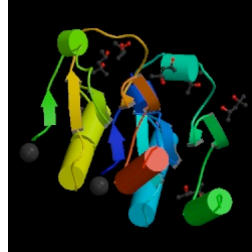

Others are not

Protein Interaction Domains

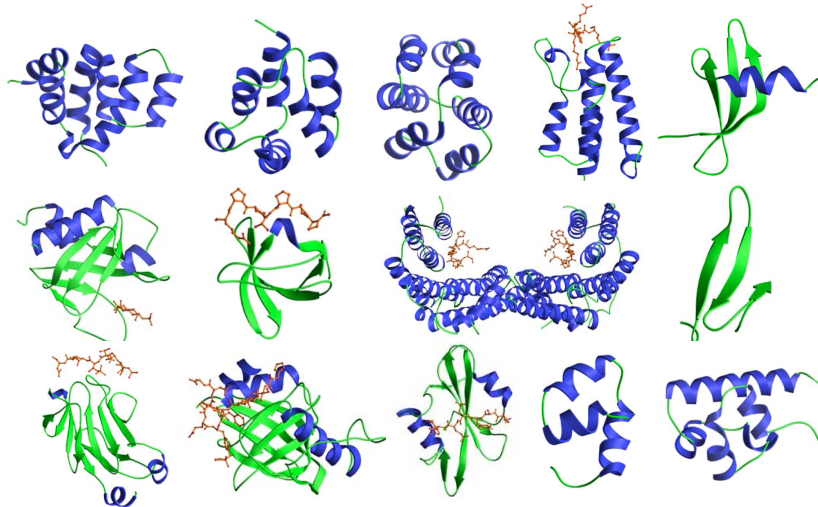

<http://www.mshri.on.ca/pawson/domains.html>

Yeast Two-Hybrid Analysis

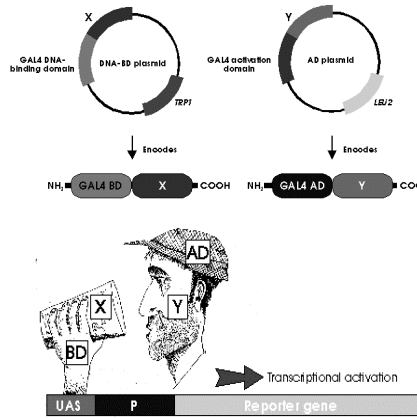

- Yeast two-hybrid experiments yield information on protein protein interactions
- GAL4 Binding Domain
- GAL4 Activation Domain
- X and Y are two proteins of interest
- If X & Y interact then reporter gene is expressed

Affinity Pull-down

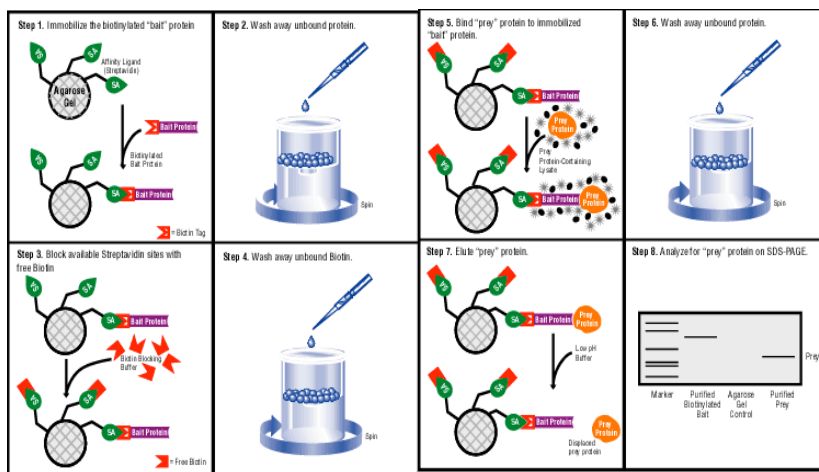

Protein Arrays

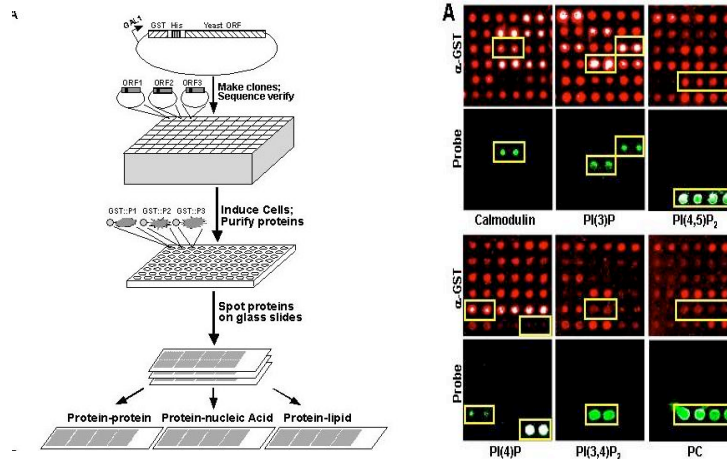

A Flood of Data

- High throughput techniques are leading to more and more data on protein interactions
- Very high level of false positives – need tools to sort and rationalize
- This is where bioinformatics can play a key role
- Some suggest that this is the “future” for bioinformatics

Interaction Databases

- **BIND**
 - <http://www.bind.ca/>
- **DIP**
 - <http://dip.doe-mbi.ucla.edu/>
- **MINT**
 - <http://160.80.34.4/mint/>
- **IntAct**
 - <http://www.ebi.ac.uk/intact/index.jsp>



More Protein Interaction Databases
<http://www.hgmp.mrc.ac.uk/GenomeWeb/prot-interaction.html>

Reliability of HT Interaction Data

(Patil & Nakamura, BMC Bioinf. 6:100, 2005)

- **Assessed reliability using known interacting Pfam domains, Gene Ontology annotations and sequence homology**
- **56% of HT data for yeast are reliable**
- **27% of HT data for C. elegans are reliable**
- **18% of HT data for D. melanogaster are reliable**
- **68% of HT data for H. sapiens are reliable**

Protein Interaction Tools and Techniques - Computational Methods

Interologs, Homologs, Paralogs...

- **Homolog**
 - Common Ancestors
 - Common 3D Structure
 - Common Active Sites
- **Ortholog**
 - Derived from Speciation
- **Paralog**
 - Derived from Duplication
- **Interolog**
 - Protein-Protein Interaction

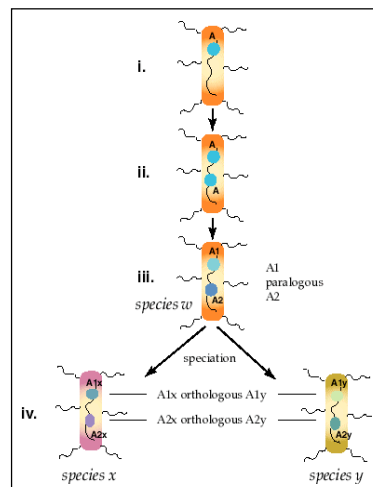

Sequence Searching Against Known Domains

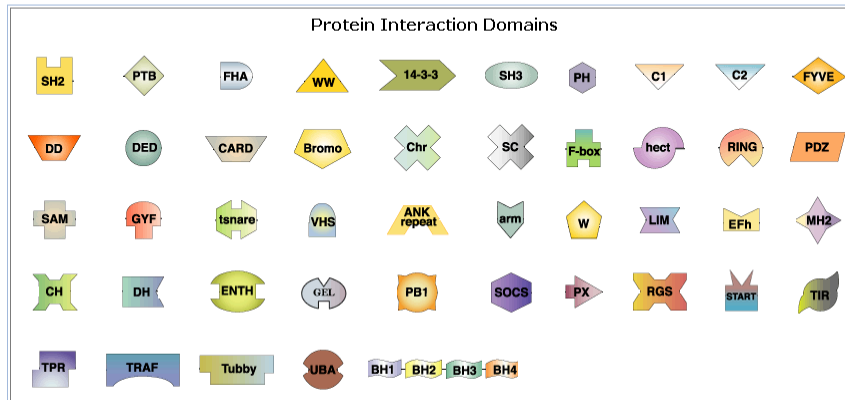

<http://www.mshri.on.ca/pawson/domains.html>

Rosetta Stone Method

Monomeric proteins that are fused in other organisms tend to be functionally related and physically interacting.

For example, using the Rosetta Stone™ method, it was found that human Nit and Fhit proteins are:

- fused in invertebrates
- form a heterocomplex in mammals

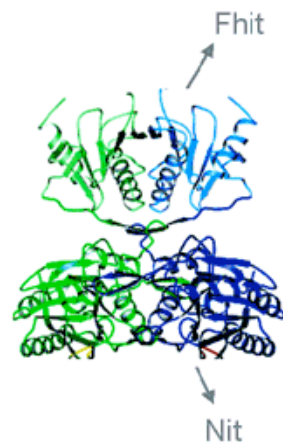

Text Mining

- Searching Medline or Pubmed for words or word combinations
- “X binds to Y”; “X interacts with Y”; “X associates with Y” etc. etc.
- Requires a list of known gene names or protein names for a given organism (a protein/gene thesaurus)

iHOP (Information hyperlinked over proteins)

The screenshot shows the iHOP web application interface. The main content area displays a network diagram with nodes and connecting lines, labeled "PHYSIOLOGY" and "INTERACT". To the right of the diagram is a large text block containing scientific information, including a search bar and a "Show overview" link. The browser's address bar at the bottom shows the URL <http://www.ihop-net.org/UniPub/iHOP/>.

<http://www.ihop-net.org/UniPub/iHOP/>

Visualizing Interactions

 **MINT** a Molecular *INTERactions* database

#754
CELLULAR TUMOR ANTIGEN P53

Interactions Pathways Complexes

ID: 754

AC: 52637 (D)

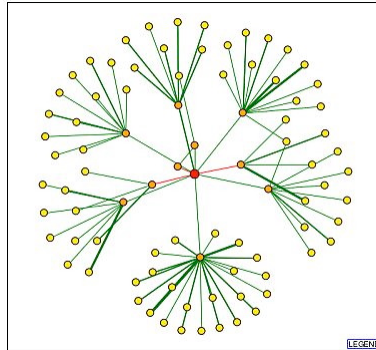

DIP

MINT Viewer v1.1
File Edit View Favorites Help
Cellular Tumor Antigen P53

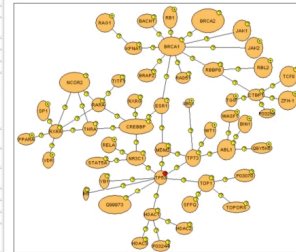

MINT

Visualizing Interactions

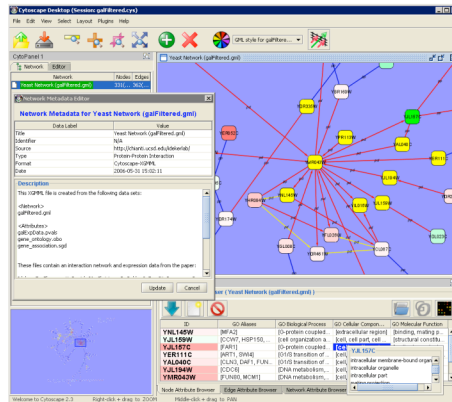

Cytoscape (www.cytoscape.org)

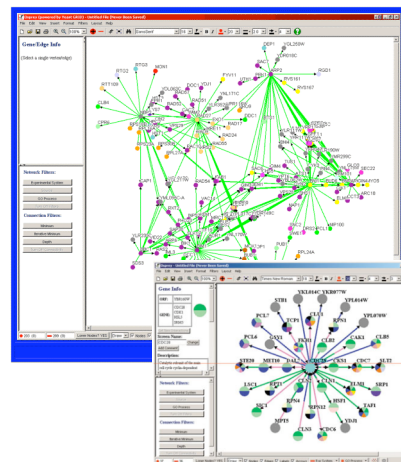

Osprey <http://biodata.mshri.on.ca/osprey/servlet/Index>

Pathway Visualization with TRANSPATH

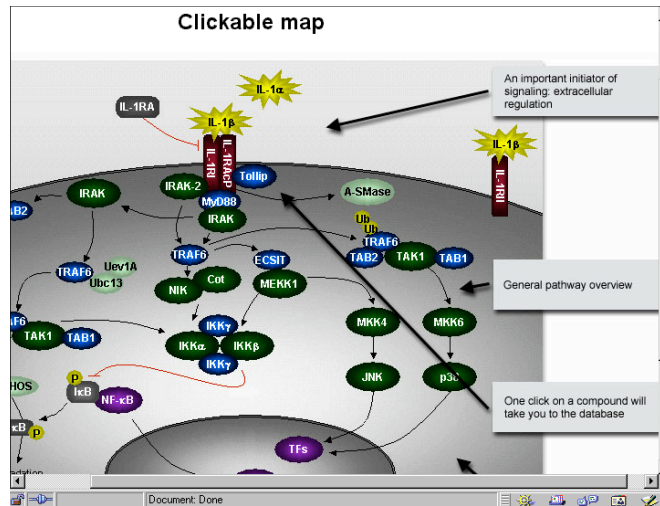

<http://www.biobase.de/pages/products/transpath.html>

Pathway Visualization with BioCarta

The screenshot displays the BioCarta website interface. On the right, a detailed signaling pathway diagram is shown, similar to the one in the TRANSPATH screenshot, but with a different color scheme and layout. On the left, the 'PATHWAYS' section is visible, listing various biological pathways such as:

- Acetylation and Deacetylation of F-actin in The Nucleus
- Adhesion and Diapedesis of Granulocytes
- Adhesion and Diapedesis of Lymphocytes
- Adhesion Molecules on Lymphocytes
- ADP-Ribosylation Factor
- Agonin in Postsynaptic Differentiation
- Akt Signaling Pathway
- AKAP95 role in mitosis and chromosome dynamics
- ALT Signaling Pathway
- Alpha-synuclein and Parkin-mediated proteolysis in Parkinson's disease
- Alternative Complement Pathway
- Angiotensin II mediated activation of JNK Pathway via Pyk2 dependent signaling
- Angiogenesis-inhibiting enzyme 2 regulated heart function
- Anthrax Toxin Mechanism of Action

www.biocarta.com

Dynamic Simulations using SimCell

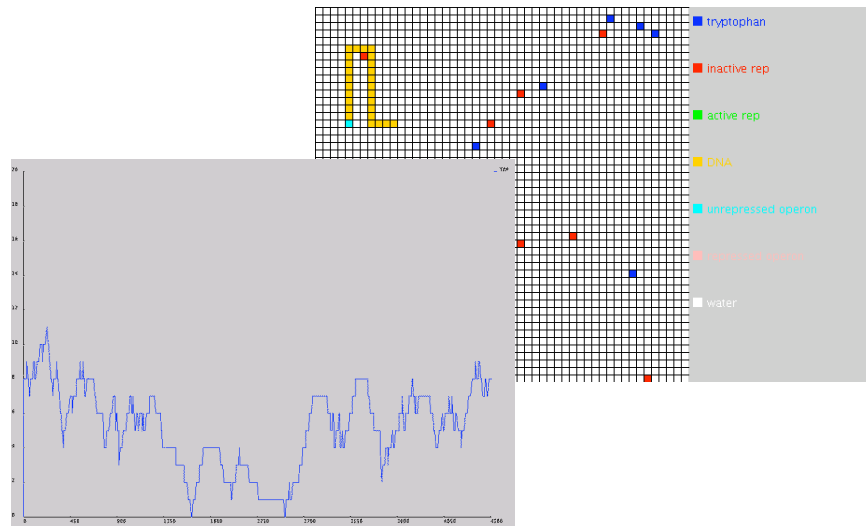

Summary

- **First application of bioinformatics was probably in protein structure (the PDB)**
- **Structural biology continues to be a rich source for bioinformatics innovation and bioinformaticians**
- **Next “big” step in bioinformatics is to go from the “parts list” to figuring out how to put it all together**