



# User's Guide on Security Seals for Domestic Cargo

January 2007

**DOD LOCK PROGRAM**  
**Technical Support Hotline**  
**1-800-290-7607**  
**DSN: 551-1212**

**website: <https://portal.navfac.navy.mil/go/locks>**



## REPORT DOCUMENTATION PAGE

*Form Approved*  
OMB No. 0704-0811

The public reporting burden for this collection of information is estimated to average 1 hour per response, including the time for reviewing instructions, searching existing data sources, gathering and maintaining the data needed, and completing and reviewing the collection of information. Send comments regarding this burden estimate or any other aspect of this collection of information, including suggestions for reducing the burden to Department of Defense, Washington Headquarters Services, Directorate for Information Operations and Reports (0704-0188), 1215 Jefferson Davis Highway, Suite 1204, Arlington, VA 22202-4302. Respondents should be aware that notwithstanding any other provision of law, no person shall be subject to any penalty for failing to comply with a collection of information, if it does not display a currently valid OMB control number.

**PLEASE DO NOT RETURN YOUR FORM TO THE ABOVE ADDRESS.**

<b>1. REPORT DATE (DD-MM-YYYY)</b> 02-01-2007		<b>2. REPORT TYPE</b> User's Guide (UG)		<b>3. DATES COVERED (From - To)</b>	
<b>4. TITLE AND SUBTITLE</b> User's Guide on Security Seals for Domestic Cargo			<b>5a. CONTRACT NUMBER</b>		
			<b>5b. GRANT NUMBER</b>		
			<b>5c. PROGRAM ELEMENT NUMBER</b>		
<b>6. AUTHOR(S)</b> Gary R. Cook, PE Senior Project Manager, LJT and Associates, Inc Mike Farrar, NFESC			<b>5d. PROJECT NUMBER</b>		
			<b>5e. TASK NUMBER</b>		
			<b>5f. WORK UNIT NUMBER</b>		
<b>7. PERFORMING ORGANIZATION NAME(S) AND ADDRESSES</b> DoD Lock Program 1100 23 <sup>rd</sup> Avenue Port Hueneme, Ca 23043			<b>8. PERFORMING ORGANIZATION REPORT NUMBER</b>		
<b>9. SPONSORING/MONITORING AGENCY NAME(S) AND ADDRESS(ES)</b>			<b>11. SPONSOR/MONITOR'S REPORT NUMBER(S)</b>		
			<b>12. DISTRIBUTION/AVAILABILITY STATEMENT</b> Approved for public release; distribution is unlimited.		
<b>13. SUPPLEMENTARY NOTES</b>					
<b>14. ABSTRACT</b> This guide provides information on the different types of security seals available for use in securing and controlling containers, doors, and equipment. While this guide is not intended as a precise procedure for developing a comprehensive seal control program, instead, the objective is to provide information and procedures that will support the development of a seal control program that will meet site-specific requirements. This guide broadly uses References 1 (Federal Specification FF-S-2738) and 9 (Defense Transportation Regulation, Part II, Cargo Security) for Federal Government seal procurement and References 2 (ISO 17712) and 11 (World Customs Organization "Framework of Standards to Facilitate Global Trade" - Version 2.0; ANNEX 1 Standard 1- Integrated Supply Chain Management, para 1.2.4 Sealing and Appendix to ANNEX 1; Seal Integrity Programme for Secure Container Shipments) for Intermodal Transportation procurement and use. For DOD shipments only, if there is a conflict between this guide and references 1 and 9, those references will take precedence. References 2 and 11 are used to provide additional most effective practice guidelines for commercial shipments, but are not mandated or required to be used.					
<b>15. SUBJECT TERMS</b>					
<b>16. SECURITY CLASSIFICATION OF:</b>			<b>17. LIMITATION OF ABSTRACT</b>	<b>18. NUMBER OF PAGES</b>	<b>19a. NAME OF RESPONSIBLE PERSON</b>
<b>a. REPORT</b>  U	<b>b. ABSTRACT</b>  U	<b>c. THIS PAGE</b>  U			<b>19b. TELEPHONE NUMBER (include area code)</b>

Standard Form 298 (Rev. 8/98)  
Prescribed by ANSI Std. Z39.18



## FOREWORD

The purpose of this document is to provide guidance on the use of security seals for Federal Government personnel and for all domestic commercial organizations/entities that transport goods throughout the inter-modal cargo supply chain, including, but not limited to manufacturers, shippers, importers, consolidators, and freight forwarders.

Subjects covered on the use of seals include:

- Role in protecting cargo
- Selection of the correct seal for the application
- Types of seals that are available
- Identification markings to ensure seal uniqueness
- Control during the life of the seal
- Installation of seals on container or door
- Inspection of seals during the shipping process
- Container inspection
- Removal of seals
- Disposal of seals

This guide provides information on the different types of security seals available for use in securing and controlling containers, doors, and equipment. This guide is not intended as a precise procedure for developing a comprehensive seal control program. Instead, the objective is to provide information and procedures that will support the development of a seal control program that will meet site-specific requirements. This guide broadly uses References 1 (Federal Specification FF-S-2738) and 9 (Defense Transportation Regulation, Part II, Cargo Security) for Federal Government seal procurement and References 2 (ISO 17712) and 11 (World Customs Organization “Framework of Standards to Facilitate Global Trade” - Version 2.0 ANNEX 1 Standard 1- Integrated Supply Chain Management, para 1.2.4 Sealing and Appendix to ANNEX 1; Seal Integrity Programme for Secure Container Shipments) for Intermodal Transportation procurement and use. NOTE: For DOD shipments only, if there is a conflict between this guide and references 1 and 9, those references will take precedence. References 2 and 11 are used to provide additional most effective practice guidelines for commercial shipments, but are not mandated or required to be used.

The guide is organized into seven sections:

- Section 1: Provides general information on seals and the scope of the guide.
- Section 2: Provides a description of seal types that are called out in Federal Specification FF-S-2738A “Seals Antipilferage”. These seals can be used for commercial as well as federal specifications. Additional seal types not covered under the Federal Specification (Labels and Tapes) are contained in Section 6.
- Section 3: Provides generic guidance on selection and appropriate application of security seals.

- Section 4: Provides a general framework and suggested most effective practices upon which a company/facility can design a comprehensive seal control program.
- Section 5: Contains requirements for DoD shipments (pages 5-1 through 5-8) and requirements for other Federal organizations (by regulation) or voluntary requirements (pages 5-9 through 5-12).
- Section 6: Contains a discussion on recommended most effective practices that can be employed across the supply chain that will bolster intermodal container security as well as specific most effective practices for security seals. Also, a discussion on seal types not included in the federal specification (Labels and Tapes) is contained here as well.
- Section 7: Contains reference information.

Two appendices provide a glossary and a partial listing of seal manufacturers.

The practices and procedures in this document contribute to the overall security of the global supply chain and can be incorporated into company programs which address supply chain security. Further guidance on supply chain security in general can be found in References 14 and 15 and in the Customs-Trade Partnership against Terrorism (C-TPAT) that can be found at the [www.cbp.gov](http://www.cbp.gov) website.

NOTE: This guide serves as a tool for domestic transportation. Any reference to international cargo, which includes in-bond movements, remains under the jurisdictional purview of U.S. Customs and Border Protection (CBP). Any evidence of tampering, seal anomalies or any other security concerns involving international cargo will be brought to the attention of the closest CBP Office for appropriate action.

For cargo not associated with an international/in-bond movement, the discovery of a seal discrepancy should be reported in accordance with agency or company policy/procedures.

This guide is a product of collaboration between the Department of Defense, the Naval Facilities Engineering Service Center (NFESC), Department of Homeland Security, and the Transportation Security Administration (TSA). Other DHS agencies providing valuable and key input included U.S. Customs and Border Protection (CBP) and U.S. Coast Guard (USCG). This is a "living document". Industry stakeholders were, and are solicited for comment to provide continual improvement for most effective practices. Please provide comments to:

Naval Facilities Engineering Service Center  
1100 23rd Ave.  
Port Hueneme, CA 93043-4370  
Attn: DOD Lock Program

<p><b>Disclaimer:</b> Any reference to a manufacturer or product in this guide is intended for illustration purposes only and should not be interpreted as a recommendation or endorsement of any kind.</p>
-------------------------------------------------------------------------------------------------------------------------------------------------------------------------------------------------------------

## TABLE OF CONTENTS

	<u>Page</u>
<b>SECTION 1 – INTRODUCTION</b>	
<i>Definition</i> .....	1-1
<i>Role of Seals</i> .....	1-1
<i>When Seals should be Used</i> .....	1-1
<i>Using Seals Effectively</i> .....	1-2
<b>Seal Control Program</b> .....	1-2
<i>Seals Addressed</i> .....	1-3
<i>Seals versus Locks</i> .....	1-3
<b>SECTION 2 – SEAL TYPES</b>	
<i>Introduction</i> .....	2-1
<i>Seal Terms</i> .....	2-1
<b>Seal Description</b> .....	2-1
<b>Tamper Resistance</b> .....	2-1
<b>Installation</b> .....	2-1
<b>Control</b> .....	2-1
<b>Relative Value</b> .....	2-2
<i>Wire Style Seals</i> .....	2-3
<b>Crimp Wire Seal</b> .....	2-3
<b>Fold Wire Seal</b> .....	2-7
<b>Cup Wire Seal</b> .....	2-9
<i>Padlock Style Seals</i> .....	2-11
<b>Wire Shackle Padlock Seal</b> .....	2-11
<b>Rotating Wire Shackle Padlock Seal</b> .....	2-13

Plastic Shackle Padlock Seal -----	2-14
Steel Shackle Padlock Seal -----	2-15
<i>Strap Style Seals</i> -----	2-17
Box Car Strap Seal-----	2-17
Car Plastic Strap Seal -----	2-18
Car Ball End Strap Seal -----	2-21
Strap Crimp Seal-----	2-21
<i>Cable Style Seals</i> -----	2-23
One Piece Cable Seal -----	2-23
Two Piece Cable Seal -----	2-25
<i>Bolt Style Seals</i> -----	2-27
Unthreaded Bolt Seal -----	2-27
<i>Pull-Up (Cinch) Style Seals</i> -----	2-29
Plastic Tie Seal-----	2-29

### SECTION 3 – SEAL SELECTION AND APPLICATION

<i>Selecting the Proper Seal</i> -----	3-1
<i>Purpose of a Seal</i> -----	3-1
<i>Type of Application</i> -----	3-1
<i>Size and Shape of the Seal</i> -----	3-2
<i>Durability of the Seal</i> -----	3-2
Environmental Compatibility and Length of Use -----	3-2
Activity of the Stored Container -----	3-2
Seal Flexibility -----	3-2
Strength Capability -----	3-2
<i>Ease of Installation and Removal</i> -----	3-3
<i>Tamper Resistance Qualities</i> -----	3-3
<i>Tamper Indication Qualities</i> -----	3-3



<i>Uniqueness</i> .....	3-3
<i>Cost Effectiveness</i> .....	3-3
<i>Integrating Capabilities</i> .....	3-3
<i>Disposition of Used Seals</i> .....	3-4
<i>Seal Applications</i> .....	3-5

**SECTION 4 – SEAL CONTROL**

<i>Introduction</i> .....	4-1
<i>Documentation</i> .....	4-1
<i>Training</i> .....	4-1
<i>Responsibilities</i> .....	4-1
<b>Manufacturer</b> .....	4-1
<b>Seal Administrator</b> .....	4-2
<b>Seal Custodian</b> .....	4-2
<b>Personnel Assigned for Seal Installation/Removal</b> .....	4-2
<b>Seal Inspector</b> .....	4-2
<i>Procurement</i> .....	4-3
<i>Seal Storage</i> .....	4-6
<i>Accountability</i> .....	4-6
<i>Installation</i> .....	4-6
<i>Inspection</i> .....	4-7
<i>Response to Seal Anomalies</i> .....	4-8
<i>Removal</i> .....	4-8
<i>Container Security and Inspection</i> .....	4-9
<i>Disposal</i> .....	4-9
<i>Accounting</i> .....	4-10

**SECTION 5 – FEDERAL GOVERNMENT SEAL REQUIREMENTS**

*Introduction* ----- 5-1

*DoD Seal Requirements* ----- 5-1

*Terms and Definitions* ----- 5-1

    Security Seal ----- 5-1

    Tamper Indicating Device (TID)----- 5-1

*Seals for Conventional Arms, Ammunition and Explosives (AA&E) and Classified Shipments* ----- 5-1

    Seals Approved by DoD ----- 5-2

*Other DoD Shipments* ----- 5-6

*Other Federal Seal Requirements* ----- 5-9

    Food and Drug Administration ----- 5-9

    Department of Agriculture ----- 5-9

    Department of Energy ----- 5-9

    Customs and Border Protection ----- 5-9

*Voluntary Seal Standard through Customs Trade Partnership against Terrorism (CTPAT)* ----- 5-9

*Transportation Security Administration Pilot Program* ----- 5-12

**SECTION 6 – INTERMODAL TRANSPORTATION MOST EFFECTIVE PRACTICES**

*Introduction* ----- 6-1

*Terms and Definitions* ----- 6-1

    High Security Seal ----- 6-1

    Security Seal ----- 6-1

    Indicative Seal ----- 6-1

*Seals for Commercial Applications* ----- 6-2

Self Adhesive Security Tape and Tamper Evident Label Seals .....	6-2
Barrier Seal .....	6-4
Twist Seal .....	6-5
<i>General Requirements for Commercial Application of Seals</i> .....	6-5
Identification Marks .....	6-6
Evidence of Tampering .....	6-6
<i>Most Effective Practices for Container Security and Inspection</i> .....	6-7
<i>Most Effective Practices for Using Security Seals</i> .....	6-8
General .....	6-8
Seal Development Phase .....	6-8
Seal Manufacturing.....	6-8
Seal Product Certification and Control .....	6-9
Distribution and Reselling .....	6-9
User Knowledge and Discipline .....	6-10
Chain of Custody .....	6-10

## SECTION 7 – REFERENCES

<i>References</i> .....	7-1
-------------------------	-----

## APPENDICES

<i>Appendix A – Seal Glossary</i> .....	A-1
<i>Appendix B – Seal Manufacturers</i> .....	B-1

## LIST OF FIGURES

<b>Figure 2-1. Roll Type Crimp Seal Installation</b> .....	2-5
<b>Figure 2-2. Aluminum Sleeve Crimp Seal Installation</b> .....	2-6
<b>Figure 2-3. Fold Wire (Flag) Seal</b> .....	2-8
<b>Figure 2-4. Seal Press Tool</b> .....	2-8
<b>Figure 2-5. Fold Wire Seal</b> .....	2-9
<b>Figure 2-6. Cup Seal</b> .....	2-10

**LIST OF FIGURES (continued)**

<b>Figure 2-7. Cup Seal Components</b> .....	<b>2-10</b>
<b>Figure 2-8. Wire Shackle Seal Installation</b> .....	<b>2-12</b>
<b>Figure 2-9. Rotating Wire Seal with Tool</b> .....	<b>2-14</b>
<b>Figure 2-10. Tool-less Rotating Wire Seal</b> .....	<b>2-14</b>
<b>Figure 2-11. Plastic Shackle Padlock Seal Installation</b> .....	<b>2-15</b>
<b>Figure 2-12. Steel Shackle Padlock Seal</b> .....	<b>2-16</b>
<b>Figure 2-13. Box Car Seal</b> .....	<b>2-17</b>
<b>Figure 2-14. Car Plastic Seal with Tamper Indicating Window</b> .....	<b>2-19</b>
<b>Figure 2-15. Car Plastic Seal Installation</b> .....	<b>2-20</b>
<b>Figure 2-16. Car Ball End Strap Seal</b> .....	<b>2-21</b>
<b>Figure 2-17. Strap Crimp Seals with Special Markings</b> .....	<b>2-22</b>
<b>Figure 2-18. Cable Seals</b> .....	<b>2-23</b>
<b>Figure 2-19. Cable Seal Installation</b> .....	<b>2-24</b>
<b>Figure 2-20. Cable Seal with Twist-off Installation Wrench</b> .....	<b>2-25</b>
<b>Figure 2-21. Two Piece Cable Seal</b> .....	<b>2-26</b>
<b>Figure 2-22. Flag Type Cable Seal</b> .....	<b>2-26</b>
<b>Figure 2-23. Bolt Seal Installation</b> .....	<b>2-28</b>
<b>Figure 2-24. Pull-Up (Cinch) Seal</b> .....	<b>2-30</b>
<b>Figure 4-1. Example of Seal Control System</b> .....	<b>4-4</b>
<b>Figure 4-2. Example of Manufacturer Statement</b> .....	<b>4-5</b>
<b>Figure 4-3. Sample Seal Installation and Removal Form</b> .....	<b>4-11</b>
<b>Figure 4-4. Sample Seal Accountability Log</b> .....	<b>4-12</b>
<b>Figure 5-1. Cable Lock<sup>®</sup> Seal by E.J. Brooks</b> .....	<b>5-3</b>
<b>Figure 5-2. Cone-Loc<sup>®</sup> Seal by Tyden Brammel</b> .....	<b>5-4</b>
<b>Figure 5-3. Intermodal II<sup>®</sup> Seal by E.J. Brooks</b> .....	<b>5-4</b>
<b>Figure 5-4. Trans-Lok<sup>®</sup> Seal by E.J. Brooks</b> .....	<b>5-5</b>
<b>Figure 5-5. Econo Bolt Seal by Tyden Brammel</b> .....	<b>5-5</b>
<b>Figure 5-6. Tyden Ball Seal by Tyden Brammel</b> .....	<b>5-6</b>
<b>Figure 5-7. Cable Seal Applications</b> .....	<b>5-7</b>

**LIST OF FIGURES (continued)**

**Figure 5-8. Strap (Car Ball) Seal Applications ----- 5-7**  
**Figure 5-9. Bolt Seal Applications ----- 5-8**  
**Figure 5-10. Plastic Strap and Pull Tight Seal Applications ----- 5-8**  
**Figure 6-1. Typical Label Seal ----- 6-3**  
**Figure 6-2. Elastic Label (before) ----- 6-3**  
**Figure 6-3. Elastic Label (after) ----- 6-3**  
**Figure 6-4. Barrier Seal ----- 6-4**  
**Figure 6-5. Twist Seal ----- 6-5**

**LIST OF TABLES**

**Table 2-1. Seal Types Based on Federal Specifications ----- 2-1**  
**Table 3-2. Seal Applications ----- 3-5**  
**Table 5-1. Approved Seals for AA&E Shipments ----- 5-2**



## SECTION 1 - INTRODUCTION

### DEFINITION

A security seal is a manufactured product that is used to indicate tampering or unauthorized opening of a container, door, or item. Mechanical security seals and label seals are usually designed for one-time use. All one-time use seals, some reusable and non-reusable barrier seals, and label seals are used for commercial applications. For the purposes of this guide, the term *seal* will be synonymous with the terms security seal, anti-tamper device, and tamper indicating device.

### ROLE OF SEALS

- A seal is a closure device that serves as a check against tampering or unauthorized opening. If designed and attached properly, a seal should be severed or mutilated before entry is possible.
- Seals designed to delay intrusion are commonly constructed of solid steel or cable.
- Seals can provide a psychological deterrent by ensuring that evidence of forced entry or tampering is clearly visible and that the crime can not be subsequently hidden or covered up.
- Seals can be used for material control, accountability, and inventory by associating the seal identification number with the contents.
- An intact seal applied within the context of a strong seal control program provides for an increased level of fidelity of cargo security. This reduces the number of personnel needed to control secured items and minimizes the potential of exposure to possible hazardous contents.
- Seals are intended to be part of an integrated security program. Seals should not be used as stand-alone protection.

### WHEN SEALS SHOULD BE USED

- When there is a written requirement (see Section 5).
- When there is concern about pilferage by in-house personnel or crime by outsiders. If the threat is from outsiders, seals with some level of forced entry protection should be selected.
- If a damaged or broken seal can be discovered in a timely manner and appropriate countermeasures can be implemented to prevent further criminal activity.

- As part of a comprehensive security program.

## **USING SEALS EFFECTIVELY**

To be effective, seal types should be appropriate for the application and be used in conjunction with a comprehensive seal control program (see Sections 2 and 3).

### **Seal Control Program**

Seals should be used in conjunction with a seal control program that is part of an integrated security system. Security systems can consist of multiple components (intrusion detection, closed circuit television, access control, security personnel, lighting, barriers, etc.). Integration produces a system that will provide a high level of confidence and protection in depth (multiple layers of protection). If a security system component fails to function in an integrated system, the other components and layers will continue to provide some level of protection until the failed component is repaired or replaced. Seals and a seal control program are examples of components that can be important to an integrated security system by providing additional layers of protection.

As an example, the use of seals can aid in determining how to respond to an alarm. Evidence of a broken or mutilated seal would indicate possible tampering or unauthorized entry into a secured area or container while an intact seal would indicate that a false alarm had occurred.

Seals do have limitations that should be recognized. They can be easily defeated by a forced entry attack and can be covertly defeated by one of the following methods:

- Counterfeiting the seals or seal parts
- Forced entry and repair to the seal
- Careful manipulation of the seal

Seals can be counterfeited by substituting a similar seal procured from the manufacturer and marked with the same identifier, such as a serial number. Substitute seals can be used to replace a broken seal after unauthorized entry. Good record keeping of seal identification marks can minimize this threat.

Seals can be defeated and reassembled by using the broken parts or parts from another seal. Careful inspection of the seals before, during, and after use is necessary to mitigate this attack scenario.

Some seals can be defeated by manipulation with special tools and then reattached to give the appearance that no unauthorized entry had taken place. Careful examination of the seal should be done to discover any anomalies.



An effective seal control program should include the following elements:

- Procurement
- Storage
- Accountability
- Installation
- Inspection
- Response to seal anomalies
- Removal and Inspection

These issues are covered in depth in Section 4.

## **SEALS ADDRESSED**

This document covers mechanical seals that meet the requirements of Reference 1 for Federal Government use. It also covers the standards described in Reference 2, as a recommended most effective practice, for commercial applications. References 1 and 2 both use References 3 through 6 as a basis for classifying, testing, and controlling seals.

This document does not cover reusable seals (except for barrier seals used for commercial purposes in Section 6), seals that do not provide clear evidence of tampering or entry, or active seals that are electronic or electro-optic devices using batteries or electrical power to monitor for tampering. Active security seals are usually more expensive than passive ones, but can be reused. Another type of electronic seal is a transponder security seal that is passive while watching for tampering, but briefly powered up by (or for) a reader to check if tampering has occurred. Examples include devices that incorporate passive radio frequency (RF) transponders, or contact memory buttons. Electronic seals are more properly classified as intrusion detection systems with a local alarm capability.

## **SEALS VERSUS LOCKS**

There are a number of conditions where a seal should be used instead of a lock.

1. All locks with the possible exception of high security locking systems can usually be surreptitiously (using picking and bypassing) or forcibly defeated (with readily available hand tools) very quickly. Replacement locks are easily obtainable and can be used to replace the removed lock. Lock failure would normally be blamed unless an examination was performed on the suspect lock. Locks do not normally have serial numbers or unique identifying marks.
2. Locks often require complicated and expensive key-control programs. Usually, the key or combination must be available at the receiving location. This can create a vulnerability through compromise of the key or combination in route.

3. Seals (especially passive seals) are usually less expensive than locks.
4. Seals are typically easier and faster to remove than locks. This can improve operations and is particularly important in emergencies.
5. Seals are usually lighter and smaller than locks, which can be particularly important for air cargo shipments and courier packages.
6. There are many applications where knowing that tampering has occurred may be more useful and practical than trying to stop it (e.g., tampering with over-the-counter pharmaceuticals or consumer food products).
7. Locks can be surreptitiously bypassed without leaving indications of tampering (picking and bypassing).
8. A robust lock may force an adversary to damage the container, vehicle, or railcar to gain entry. A seal may encourage the adversary to enter through the door, causing no damage except to the seal. There may be additional security, safety, and economic reasons why it would be preferable for the adversary to enter through a given portal, rather than from a random direction.
9. Seals give security personnel a reason to carefully inspect the container and surrounding area, with a potential improvement to overall security.
10. Many seals are more resistant to corrosion than locks and seals (especially passive seals) may perform better under extreme environmental conditions where a lock may fail to operate properly.

## SECTION 2 - SEAL TYPES

### INTRODUCTION

The following seals are appropriate for Federal Government applications. For commercial application, these seals (**except those without unique serial numbers such as roll over (Figure 2-1) and strap (Figure 2-16) seals**) can be used. Additional seals used for commercial applications including **label seals and tapes** are covered in Section 6. In this Section, seals are grouped according to styles and types based on Reference 1 as shown in Table 2-1.

**Table 2-1. Seal Types Based on Federal Specifications**

Style A - Wire Type 1 –Crimp 2 -Fold 3 -Cup	Style B - Padlock (keyless) Type 4 -Wire Shackle 5 -Plastic Shackle 6 -Steel Shackle	Style C - Strap Type 7 -Car/Box End 8 -Car/Plastic 9 -Car/Ball End 10 -Crimp, Special Marking
Style D - Cable Type 11 - One Piece 12 - Two Piece	Style E - Bolt Type 13 - Unthreaded	Style F - Pull-Up (Cinch) Type 14 - Plastic Tie

Seals are covered in general terms (description, tamper resistance, installation, control, and cost) common to the style. For exact descriptions of a specific seal, consult the manufacturer’s product catalog. Appendix B provides a partial list of seal manufacturers.

### SEAL TERMS

**Seal Description** – A short narrative that supplements the seal image and provides information on the design features of the seal.

**Tamper-Resistance** – The time to open and re-close the seal using the original parts with commercially available hand tools or very simple instruments.

The minimum time estimates in the tamper-resistance summary are based the results of actual attacks on a specific seal in optimal conditions using personnel proficient in techniques used to covertly defeat the seal.

**Installation** – Contains information about seal installation.

**Control** – Includes information on checking the seal for indications of tampering and a reminder to: (1) check the seal to determine if it is properly installed and (2) record information about the seal. If possible, seals with sequential serial numbers should be used (Note: Some users apply randomly from their supply to avoid predicting the series to be applied). In situations when seals

can't be procured with sequential serial numbers (i.e. because they are already in use) proper documentation is critical.

**Relative Value** – A relative value of each seal unit based upon a certain quantity (usually based on quantity of 1000) purchased at one time is provided. This information is not intended for procurement purposes. This figure does not include related cost of personnel training, installation, inspection, removal, disposal, or any tools that may be needed to install or remove the seal.

## WIRE STYLE SEALS

Sealing wires 1 through 5 are described below:

**Wire 1** - Used for light sealing requirements. Available in 1/2-pound and 2-1/2-pound spools of 0.034 mm diameter galvanized, stainless, or copper spiral wound steel wire, with approximate break strength of 7 pounds.

**Wire 2** - Most popular for general sealing purposes. Available in 1/2-pound and 2-1/2-pound spools of 0.044 mm diameter galvanized or stainless spiral wound steel wire, with approximate break strength of 17 pounds.

**Wire 3** - Heavy-duty wire for applications where seals and wire are exposed to rough handling. Available in 1/2-pound and 2-1/2-pound spools of 0.034 mm diameter galvanized or stainless spiral wound steel wire, with approximate break strength of 34 pounds.

**Wire 4** - Galvanized steel for heavy duty sealing where greatest tensile strength is needed. Available in 1/2-pound and 2-1/2-pound spools of 0.038 mm spiral wound galvanized or stainless steel wire, with approximate break strength of 40 pounds.

**Wire 5** - Single strand wire is used where small diameter and strength are important. Diameter Galvanized steel wire is 0.035 mm diameter and has an approximate break strength is 45 pounds.

## Crimp Wire Seals

Crimp wire seals consist of a small piece of metal or plastic with holes for the passage of the sealing wire. The wire is passed through the closure hasp on the container to be sealed and then through the holes in the metal piece, which is then compressed to grasp the wire.

Crimp wire seals are either aluminum or steel sheet with formed holes. Crimp wire seals are furnished with or without marking. Wire furnished with crimp wire seals is spiral wound, single strand, two, or 3 ply galvanized or stainless steel wire, specified by the user.

**Roll-Over Crimp Seal.** The aluminum roll-over type crimp seal is an aluminum stamping where the compression of the seal over the wire is accomplished with a special tool that wraps the aluminum around the wire (Figure 2-1). Roll-over seals cannot be procured with sequential serial numbers.

- **Tamper-Resistance Summary** - Surreptitious defeat of the aluminum roll-over seal takes a minimum of 30 seconds.
- **Installation Guidelines** - The aluminum roll-over seal (also available in steel) is installed with a crimping tool as shown in Figure 2-1.

Minimize the length of the wire loop, making the seal a tight fit around the item being sealed. Pass the loose ends of the wire through the seal as many times as possible before crimping. Spirally wound wire is recommended to prevent slipping.

- **Check, Inspect, and Record** - Once the seal is properly installed, ensure there is no free play between the seal body and the wire.

During the post-mortem examination, compare the removed seal with an unused sample seal, side by side. Examine the seal to determine if the seal and wire are glued back together. Examine the seal for evidence of crimping with tools other than the designated crimping or pressing tool. Be aware that crimping and pressing dies are easy to duplicate, making most of these seals relatively easy to counterfeit.

- **Relative Value** - .02 to .07.

Additional Costs: Crimp tool.

**Aluminum Sleeve Seal.** The aluminum sleeve seal (Figures 2-2) is applied by a seal press. The press contains dies that provide numbers, letters, or other details that are embossed on the aluminum and compresses the aluminum around the wire. These seals cannot be procured with sequential serial numbers.

- **Tamper-Resistance Summary** - Surreptitious defeat of the aluminum sleeve will take a minimum of 30 seconds. Evidence of tampering most likely will be detected during careful examination of the installed seal.
- **Installation Guidelines** - A seal press (Figure 2-2) or a standard crimping tool can be used to install this seal.

Minimize the length of the wire loop, making the seal a tight fit around the item being sealed. Pass the loose ends of the wire through the seal as many times as possible before crimping. Spirally wound wire is recommended to ensure non-slip sealing.

- **Check, Inspect, and Record** - Once the seal is properly installed, ensure that there is no free play between the seal body and the wire.

During post-mortem examination, compare the removed seal with an unused sample seal, side by side. Examine the seal to determine if the seal and the wire have been glued back together. Examine the seal for evidence of crimping with tools other than the designated crimping or pressing tool. Be aware that crimping and pressing dies are easy to duplicate, making most of these seals relatively easy to counterfeit.

- **Relative Value** -.02 to .04.

Additional costs: Crimp tool and blank dies.

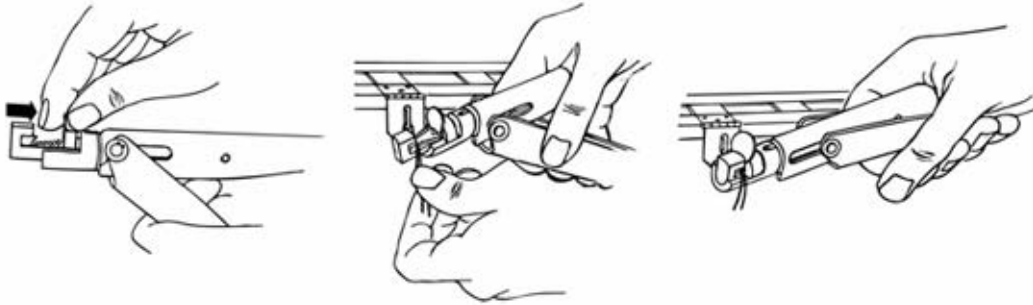
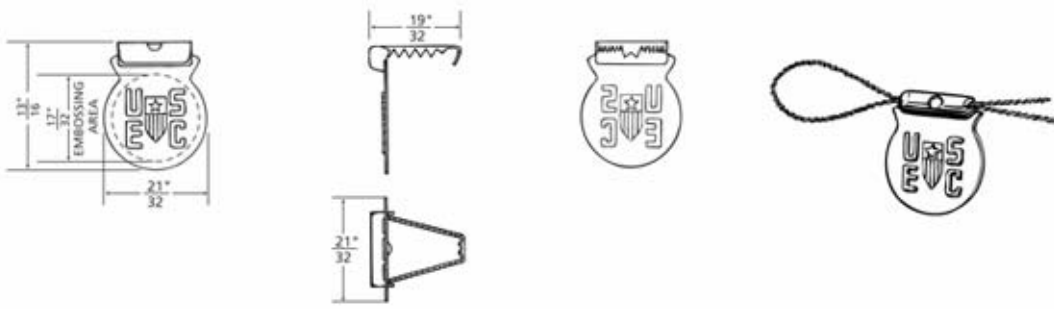

1. Fit seal into head of sealer by pressing seal backwards against the spring slider until point of seal lies under
2. Hook wire behind point of seal. Close press a little to secure it. Be sure point of the seal curls
3. Now press handles of sealer all the way to a firm stop.

**Figure 2-1. Roll Type Crimp Seal Installation.**

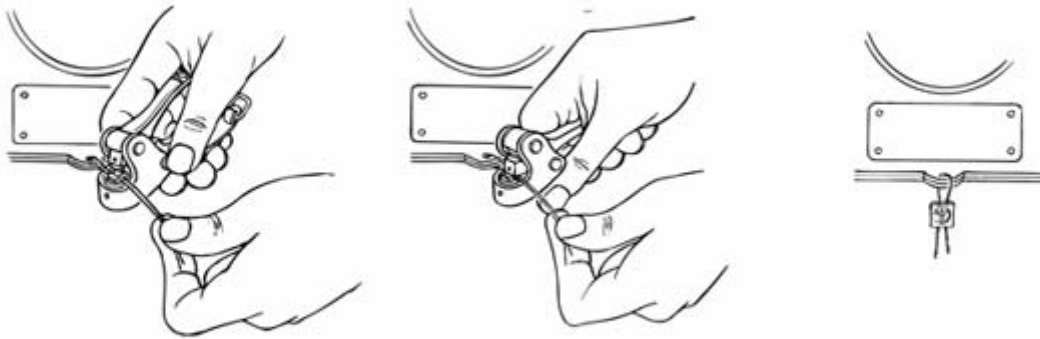
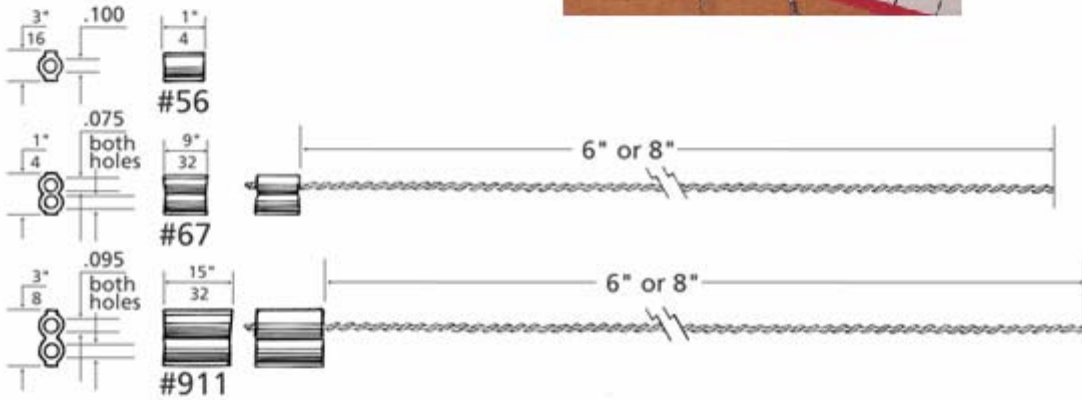
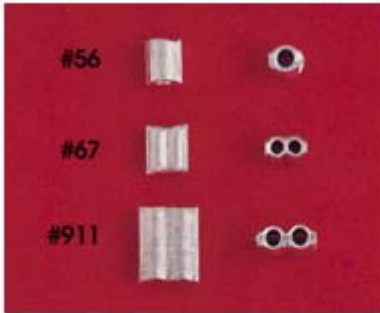

1. Pass wire through item to be sealed. Insert wire end or ends into the Alucast seal. Pull wire tight to decrease loop size.
2. Fit seal into jaws of sealing tool and firmly compress handles.
3. Pull on seal to insure the wire is firmly crimped in the seal.

**Figure 2-2. Aluminum Sleeve Crimp Seal Installation.**



**Aluminum Crimp Seal.** The aluminum crimp or “flag seal” (Figure 2-3) is an aluminum stamping that is rectangular in shape and contains wire receptacles similar to a solderless connector. The seal is applied by means of a seal press (Figure 2-4) or solderless connector crimping tool. This seal can be supplied with a company identification and sequential serial numbers.

- **Tamper-Resistance Summary** - Surreptitious defeat of the aluminum crimp seal will take a minimum of 30 seconds.
- **Installation Guidelines** - A seal press similar to that in Figure 2-4 is used to install this seal.

Minimize the length of the wire loop, making the seal a tight fit around the item being sealed. Pass the loose ends of the wire through the seal as many times as possible before crimping. Spirally wound wire is recommended to ensure non-slip sealing.

- **Check, Inspect, and Record** - Once the seal is properly installed, ensure that there is no free play between the seal body and the wire. Verify and record the serial number.

During post-mortem examination, compare the removed seal with an unused sample seal, side by side. Examine the seal to determine if the seal and the wire have been glued back together. Examine the seal for evidence of crimping with tools other than the designated crimping or pressing tool. Be aware that crimping and pressing dies are easy to duplicate, making most of these seals relatively easy to counterfeit.

- **Relative Value** - .02 to .11 depending upon logo.

Additional Costs:

1. Seal press (Figure 2-4) with female engraved dies including 8 characters. Additional cost for each additional character. Male engraved die available at additional cost.
2. Tongue and groove dies.
3. Blank dies.

## **Fold Wire Seal**

The fold wire seal is a sheet metal stamping designed to fold together and securely hold a wire (Figure 2-5). The fold lines of the seal are scored so that unfolding will cause the seal to break along the fold lines. This seal can be procured with sequential serial numbers.

- **Tamper-Resistance Summary** - Surreptitious defeat of all the fold wire seals will take a minimum of 30 seconds.
- **Installation Guidelines** - Spirally wound wire is recommended to reduce slippage. Minimize the length of the wire, making the seal a tight fit around the item being sealed. Pass the loose ends of the wire through the seal body as many times as possible before the seal is snapped shut.

- **Check, Inspect, and Record** - Once the seal is properly installed, make sure that there is no free play between the seal body and the wire. Verify and record the serial number.

During a post-mortem examination, compare the removed seal with a sample seal. Carefully examine the parts after unfolding to reveal if there is evidence of tampering, such as scratches on the internal and external surfaces. Examine the side flaps next to the wire for deformation and for scratches that differ from those on the sample. The metal box will fracture upon reopening. Look for discoloration on the boxes due to heating when an attempt is made to weld the boxes back together when opened.

- **Relative Value** - .11.



**Figure 2-3. Fold Wire (Flag) Seal.**



**Figure 2-4. Seal Press Tool.**



**Figure 2-5. Fold Wire Seal.**

### **Cup Wire Seal**

The cup wire seal (Figures 2-6 and 2-7) consists of three sheet metal stampings. Two of the stampings are fastened together to form the bottom of the seal that is composed of the shell and crown. The third stamping forms a solid top piece. The seal is installed by threading the wire through the item to be sealed and then through the holes in the seal bottom. Fasten the two wire ends together with a crimp type sleeve or other device. The top is snapped into the bottom, thereby capturing the wire juncture within the metal cup enclosure.

The cup wire seal may be ordered in three sizes. Fingerprinting techniques and verification procedures were developed for this seal by Brookhaven National Laboratory.

- **Tamper-Resistance Summary** - Covert defeat of the cup wire seal, whether it is fingerprinted or not, will take a minimum of 30 seconds. It will require the use of special tools as well as substitution of the wire and sleeve.
- **Installation Guidelines** - To minimize accidental breakage, use stainless steel wire with a minimum of 15 strands. A metal sleeve may be used to crimp the wire ends together within the

cup. Imprint both the top and bottom of the seal with the same serial number. Minimize the length of the wire loop, making the seal a tight fit around the item being sealed, to prevent the insertion of covert tools.

- **Check, Inspect, and Record** - Once the seal is properly installed, verify and record the serial number.

Before removing the seal, inspect for physical damage or signs of tampering.

During a post-mortem examination, compare the removed seal with a lot sample, and compare the top serial numbers with the bottom seal numbers. Compare the metal sleeve that is used to hold the ends of the wire together with the lot samples. Examine the surface areas of the shell, crown, and top for abrasions. Compare the shape of the seal with the sample parts to determine if dies other than the production dies were used to form the seal parts, particularly the bottom section of the seal.

- **Relative Value** - .40 to .59.

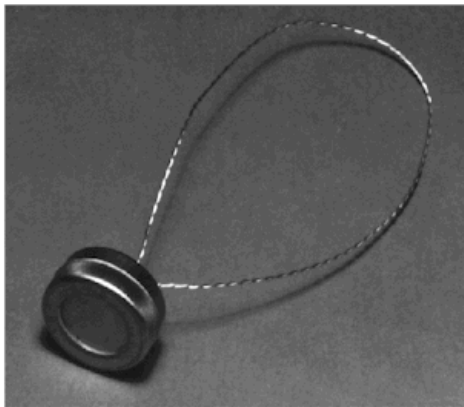

**Figure 2-6. Cup Seal.**



**Figure 2-7. Cup Seal Components.**

## PADLOCK STYLE SEALS

Padlock (keyless) style seals can be separated into four categories, depending on the shackle construction as follows:

- Wire Shackle
- Rotating Wire Shackle
- Plastic Shackle
- Steel Shackle

### Wire Shackle Padlock Seal

The plastic body wire shackle padlock seals consist of a plastic body with a solid steel (galvanized or stainless) wire shackle that is pushed into the plastic body. Attempts to withdraw the shackle cause the ends of the wire to become embedded in the plastic. The metal body wire shackle padlock uses the same principle as the plastic body wire shackle padlock except that the wire ends become trapped in the body by the configuration of the metal stamping. These seals can be purchased with sequential serial numbers. Examples of wire padlock seals are shown in Figure 2-8.

- **Tamper-Resistance Summary** - The stamped metal body seal will resist tampering for a period of at least 60 seconds. The plastic body seal will resist tampering for a period of at least 15 seconds.
- **Installation Guidelines** - During installation of the wire hasp padlocks, pull the seal body to ensure the wire is firmly embedded within the body of the padlock. Remove with cutter or by hand if scored style.
- **Check, Inspect, and Record** - With the plastic body wire shackle padlock in place, there should be a minimum amount of free play between the wire and the plastic body. When the metal body wire shackle padlock is in place, make sure that 1/4 inch of free play is between the metal body and the wire. Verify the serial numbers for both plastic and steel padlocks.

During post-mortem examination, compare the removed seal with a sample seal. Carefully examine the parts to ensure that there are no signs of forced entry. Examine the wire for abrasions that do not appear on the sample. Post-mortem examination of these seals may not provide conclusive evidence of tampering.

A version of the wire padlock seal called a scored seal consisting of a metal or plastic body which is scored parallel to the length of the body. The wire shackle is passed into the locking body and locked in place. Removal of the seal requires bending at the score mark which results in breakage of the seal along the score line.

- **Relative Value** - .03 to .27.

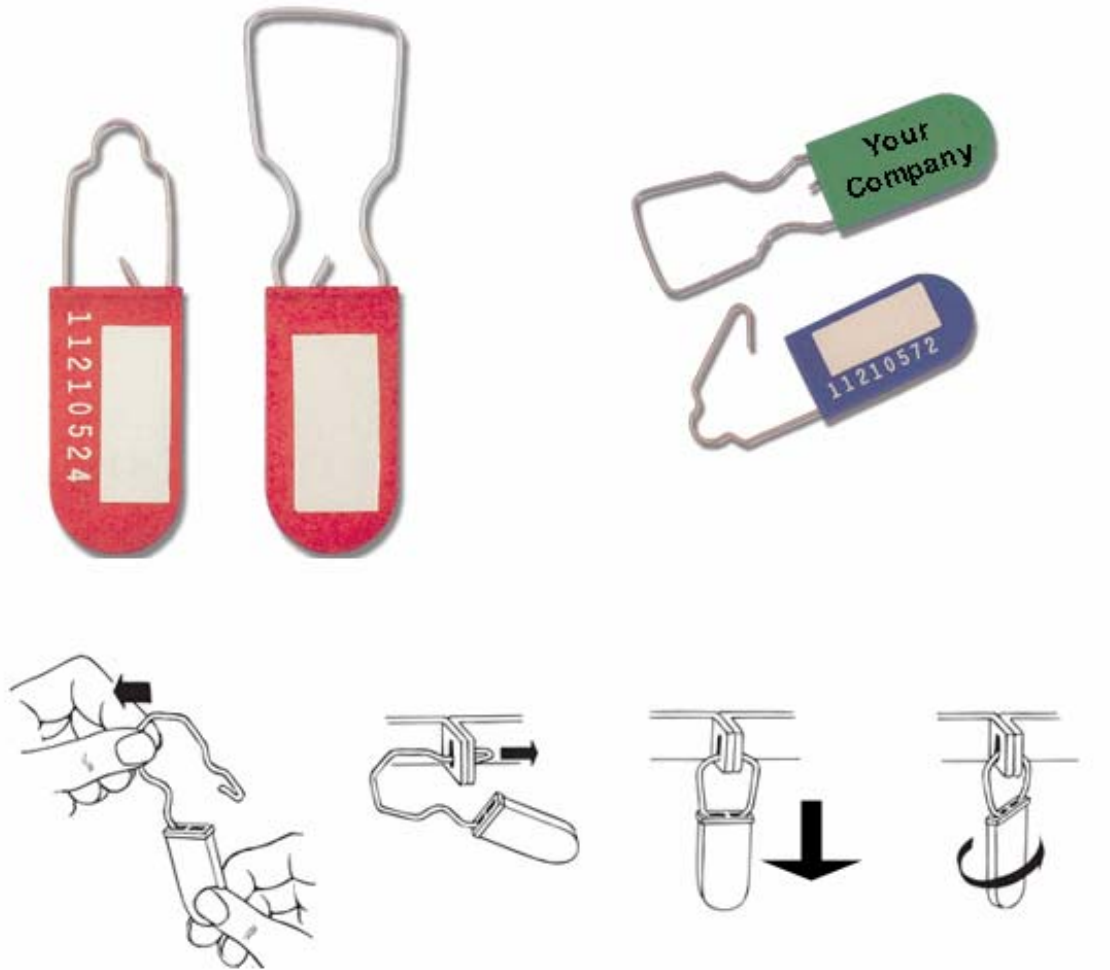

1. Pull on wire to remove loose hasp end from seal body.
2. Pass open end through opening of object to be sealed.
3. Re-insert hasp end into slot seal body. Firmly push down hasp until it is securely seated. Pull on the seal to insure locking mechanism is engaged.
4. Twist seal body to remove.

**Figure 2-8. Wire Shackle Seal Installation.**

## Rotating Wire Shackle Padlock Seal

The rotating wire padlock seal is a unique version of the wire padlock seal that is one of several seals that have been tested and approved as a replacement for lead wire seals. The rotating seal is a two-piece acrylic body through which wire is threaded and then crimped like traditional lead wire seals. A unique crimping press (Figure 2-9) or built-in thumb turn (Figure 2-10) rotates and secures the wire inside the rotating seal while, at the same time, putting an impression on the colored insert. The positive sealing action of the rotating seal makes certain each seal is crimped securely.

These seals come with the following:

1. Heat stamped consecutive numbers
  2. Transparent body for see-through inspection
  3. Color coded inserts
  4. Inserts accept die impressions from the press (where applicable)
  5. Wire available in 4 x.014 inch
  6. Wire types –galvanized steel spiral wound or stainless steel (Toolless seal uses stainless steel wire only)
- **Tamper-Resistance Summary** - Covert defeat of this seal will take a minimum of 30 seconds. Evidence of tampering most likely can be detected during careful examination of the installed seal.
  - **Installation Guidelines** - Minimize the length of the wire loop, making the seal a tight fit around the item being sealed.
  - **Check, Inspect, and Record** - Once the seal is properly installed, ensure that there is no free play between the seal body and the wire. Verify and record the serial number.

The body of this seal is clear plastic, so look carefully before removing the seal to detect any break in the wire. Look for any discoloration of the plastic.

During the post-mortem examination, look at the seal carefully to determine if the seal and the wire have been glued back together.

- **Relative Value** - .25.

Additional costs: Press with blank or engraved die (where applicable).

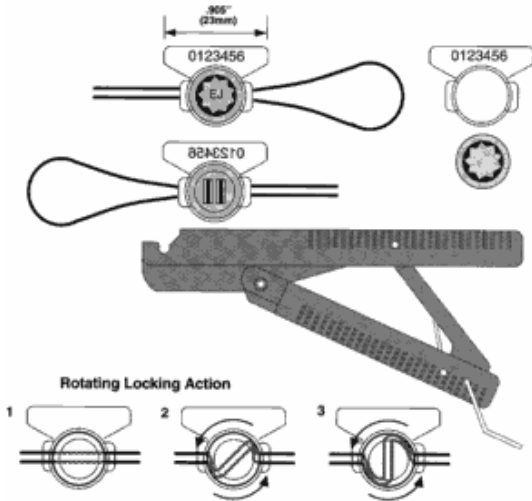

**Figure 2-9. Rotating Wire Seal with Tool.**



**Figure 2-10. Tool-less Rotating Wire Seal.**

### **Plastic Shackle Padlock Seal**

The plastic padlock seals (Figure 2-11) are constructed of a one-piece plastic molded part that uses various locking mechanisms to secure the shackle. All padlock seals are self-locking. The materials generally used are polypropylene, polyethylene, or nylon.

- **Tamper-Resistance Summary** - Covert defeat of these seals will take a minimum of 15 seconds. Evidence of tampering will most likely be detected during careful examination of the seal.
- **Installation Guidelines** - During installation of the plastic padlock seals, pull the locking mechanism to verify that it is locked (Figure 4-10).
- **Check, Inspect, and Record** - Verify and record the serial number. Once the seal is properly installed, the shackle should have free play in the body.  
 During post-mortem examination, compare the removed seal with a sample seal. The shackle should be smooth-textured without signs of heat welding. All parts of the latching mechanism should be present. The shackle should break before the latching mechanism fails.
- **Relative Value** - .02 to .04.



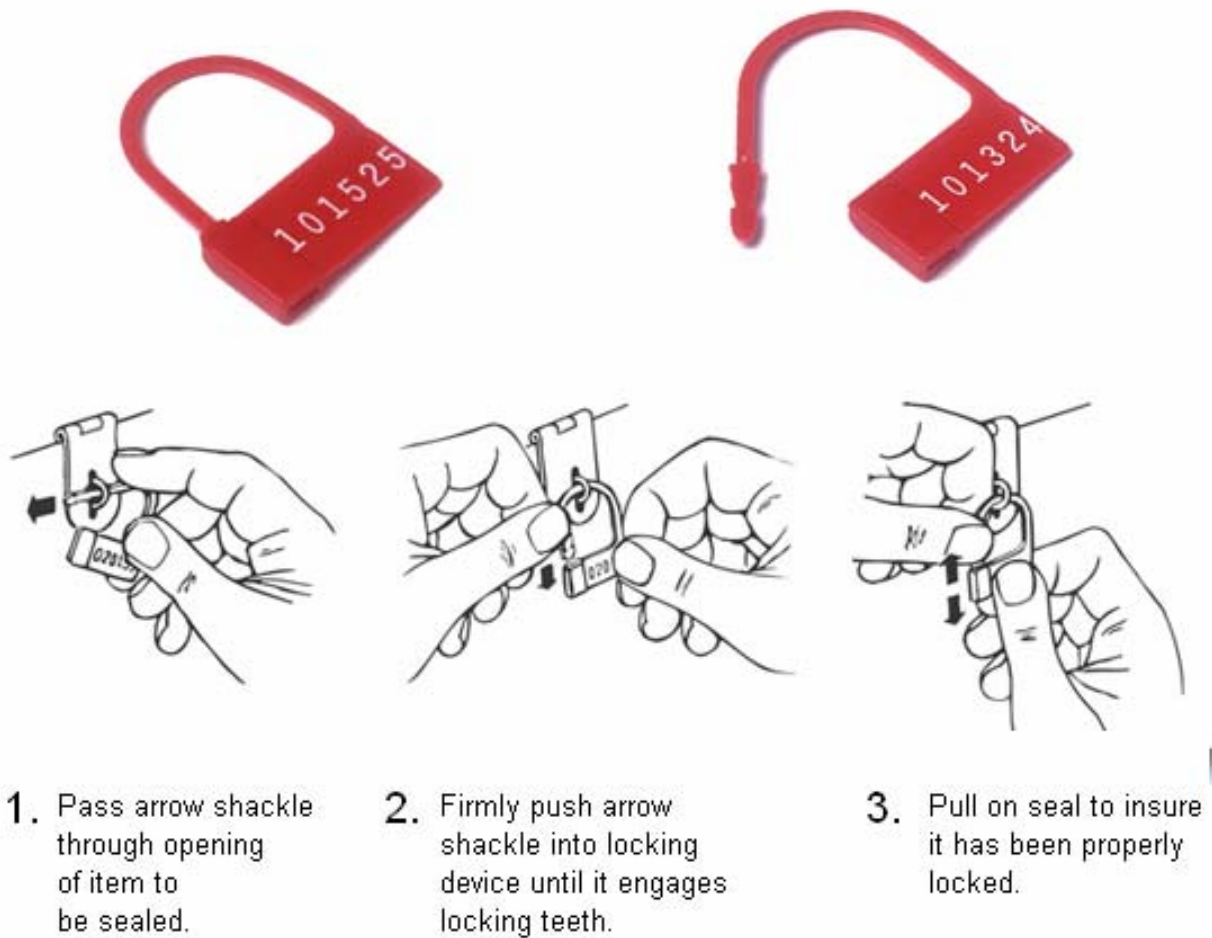

**Figure 2-11. Plastic Shackle Padlock Seal Installation.**

### **Steel Shackle Padlock Seal**

Steel padlock seals are similar to padlocks but without a key cylinder. The body a steel padlock seal contains the locking mechanism and a hardened shackle is used with consecutive serial numbers stamped on the body (Figure 2-12).

- **Tamper-Resistance Summary** - Covert defeat of this seal will take 15 seconds.
- **Installation Guidelines** - Purchase with serial numbers on both the shackle and body of the lock seals. Install these seals according to the manufacturer's instructions. Remove by hand.
- **Check, Inspect, and Record** - Once the seal is properly installed, verify and record the serial number.

During post-mortem examination, compare the removed seal with a sample seal. The external seal surfaces should be free of any marks that might indicate forcible entry or tampering. Look for discoloration of the plastic. Look for heat weld spots. Compare the shackle and internal parts of the seal body with a sample seal. Examine for evidence of part replacement and repainting.

- **Relative Value** - 1.35 to 3.75.



**Figure 2-12. Steel Shackle Padlock Seal.**

## STRAP STYLE SEALS

### Box Car Strap Seal

The box car end strap seals (Figure 2-13) are steel strap seals. The latching mechanism is contained within a folded box located on one end of the strap. All of these seals can be procured with the company name or logo and sequential serial numbers stamped in the strap. This seal has space for 17 letters and 7 digits. Letters cannot be substituted for numbers. The box car seal comes in several grades ranging from light gauge (FC1) to heavy gauge (FC4).

- **Tamper-Resistance Summary** - Covert defeat of the box car end seals will take a minimum of 30 seconds. Evidence of tampering may not be detected by post-mortem examination.
- **Special Installation Guidelines** – This seal is self locking and requires no tools for installation. The box car strap seal should be applied according to manufacturer’s instructions. Remove with cutter.
- **Check, Inspect, and Record** - Once the box car seal is in place, verify and record the serial number and any other identifying characteristics. Check for the proper amount of end play in the latching mechanism. There should be about 1/8-inch but no more than 3/8-inch free play.

During post-mortem examination, compare the removed seal with a sample seal to detect tampering. Examine the seal latching surfaces for evidence of abrasions that do not appear on the sample seal. Post-mortem examination may not provide conclusive evidence of tampering.

- **Relative Value** - .04 to .11.



Figure 2-13. Box Car Seal.

## Car Plastic Strap Seal

Car plastic strap seals (Figures 2-14 and 2-15) are seals manufactured as single-piece or double-piece plastic molded parts. The seal latching mechanism is contained in a cylinder at one end of the strap. All of these seals can be procured with the company name or logo and sequential serial numbers stamped on the strap.

- **Tamper-Resistance Summary** - Surreptitious defeat of these seals takes a minimum of 15 seconds. Evidence of tampering will most likely be detected during careful examination. Some plastic strap seals are designed with an “Inspection Window” – a transparent cap that makes it possible to visibly check the internal locking mechanism for tampering even while the seal is applied (Figure 2-12).
- **Installation Guidelines** - Install the car plastic seal according to the manufacturer’s instructions.
- **Check, Inspect, and Record** - Once the seal is properly installed, verify and record the serial number and any other identifying characteristics. Inspect the seal to ensure that the strap has free rotation in the body and the proper amount of end play. Look for a smooth texture. Twist the seal to test the strength.

During post-mortem examination, compare the external surface of the removed seal with a sample seal. The strap should break before it can be pulled out of the seal body. Open the body and the internal parts to inspect and carefully compare with the sample. Examine the strap for evidence of heat welding.

- **Relative Value** - .03 to .07.



**Figure 2-14. Car Plastic Seal with Tamper Indicating Window.**

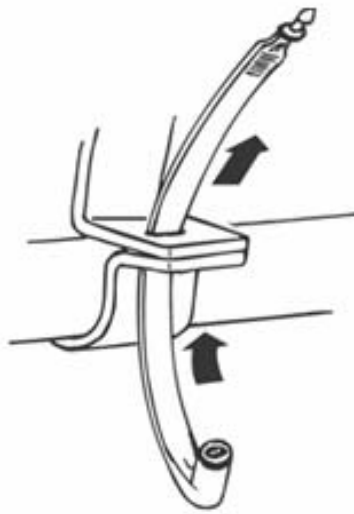

1. Insert the arrow end of seal through opening of item to be sealed.

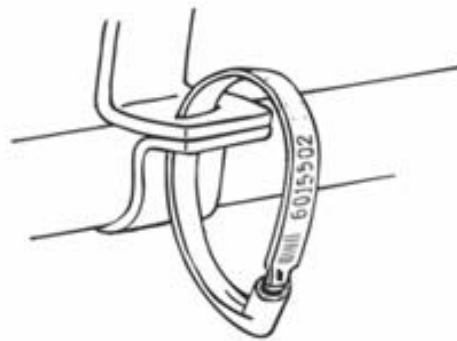

2. Bend around and insert the arrow end into locking chamber. Push firmly until arrow is engaged and you



3. Tug on seal to insure seal is locked.

**Figure 2-15. Car Plastic Seal Installation.**

## Car Ball End Strap Seal

The car ball end seals are steel strap seals (Figures 2-16). The latching mechanism is a piano wire loop that captures both ends of the strap. These seals can be procured with the company name or logo and sequential serial numbers stamped in the strap, bar coded.

- **Tamper-Resistance Summary** - Covert defeat of car ball seals will take a minimum of 30 seconds and require the use of special tools.
- **Installation Guidelines** – The car ball seal is self locking and requires no tools for installation. The car ball seal should be applied according to manufacturer’s instructions.
- **Check, Inspect, and Record** - Once the seal is properly installed, verify and record the serial number and any other identifying characteristics. Ensure that there is a proper amount of end play in the latching mechanism.

During post-mortem examination, compare the removed seal with a sample seal. Carefully inspect the exterior and interior surfaces to determine if dies other than production dies were used to form the ball enclosure. Open the ball housing to verify that all the internal parts are present.

- **Relative Value** - .03 to .04.



**Figure 2-16. Car Ball End Strap Seal.**



## Strap Crimp Seal

The strap crimp seals are standard steel strapping closures with controlled lithographic design and with special marking as shown in Figure 2-17. Straps crimps seals should conform to Reference 7. The crimp is attached to the strap using standard crimping tools. These seals can be procured with the company name or logo.

- **Tamper-Resistance Summary** - Covert defeat of the seal strap will take a minimum of 5 minutes and require the use of special tools.
- **Installation Guidelines** - Install the crimp seal strap according to the manufacturer's instructions.

**Check, Inspect, and Record** - During post-mortem examination, compare the removed seal with an unused sample seal, side by side. Examine the seal for evidence of crimping with tools other than the designated crimping or pressing tool.

- **Relative Value** - .03 to .04.



**Steel Strap Seal**



**Crimp Tool**

**Figure 2-17. Strap Crimp Seals with Special Markings.**



## CABLE STYLE SEALS

### One Piece Cable Seal

One Piece cable seals (Figure 2-18) are high-strength security seals that use a galvanized 3/16-inch or 1/4-inch aircraft cable to secure the container or door. Some cable seals are self-locking and employ locking mechanisms that consist of roller-incline, ball-incline, locking rings, and screw locks contained within the aluminum or zinc body (Figures 2-19 to 2-20). All the seals can be procured with the company names and sequential serial number identification. The use of non-pre-formed cable is becoming standard.

- **Tamper-Resistance Summary** - Surreptitious defeat of cable seals will take a minimum of 30 seconds and most likely will not be detected by post-mortem examination.
- **Installation Guidelines** - Install a cable seal so that the length of the cable threaded through the hasp is minimized, making a tight fit on the object being sealed. Pull on seal body to activate the locking mechanism.
- **Check, Inspect, and Record** - Once the seal is properly installed, verify and record the serial numbers and any other identification.

During post-mortem examination, compare the removed seal with a sample seal and carefully inspect the exterior and interior surfaces to detect tampering (abrasion and tool marks). Examine the body of the seal for any small drilled holes. Obtain tensile test data for the cable seals in use and perform a tensile test on seals that have been removed even if they do not show any evidence of tampering. A significant drop in tensile strength is a good indicator of seal defeat. Look for frayed edges of the metal wire that could indicate tampering.

- **Relative Value** - .55 to 1.60.

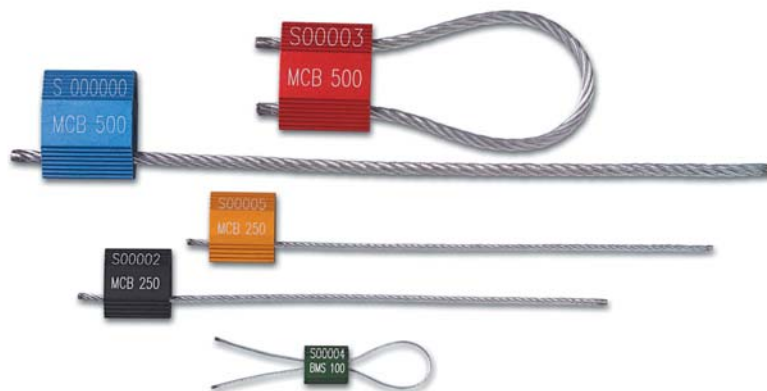

**Figure 2-18. Cable Seals.**

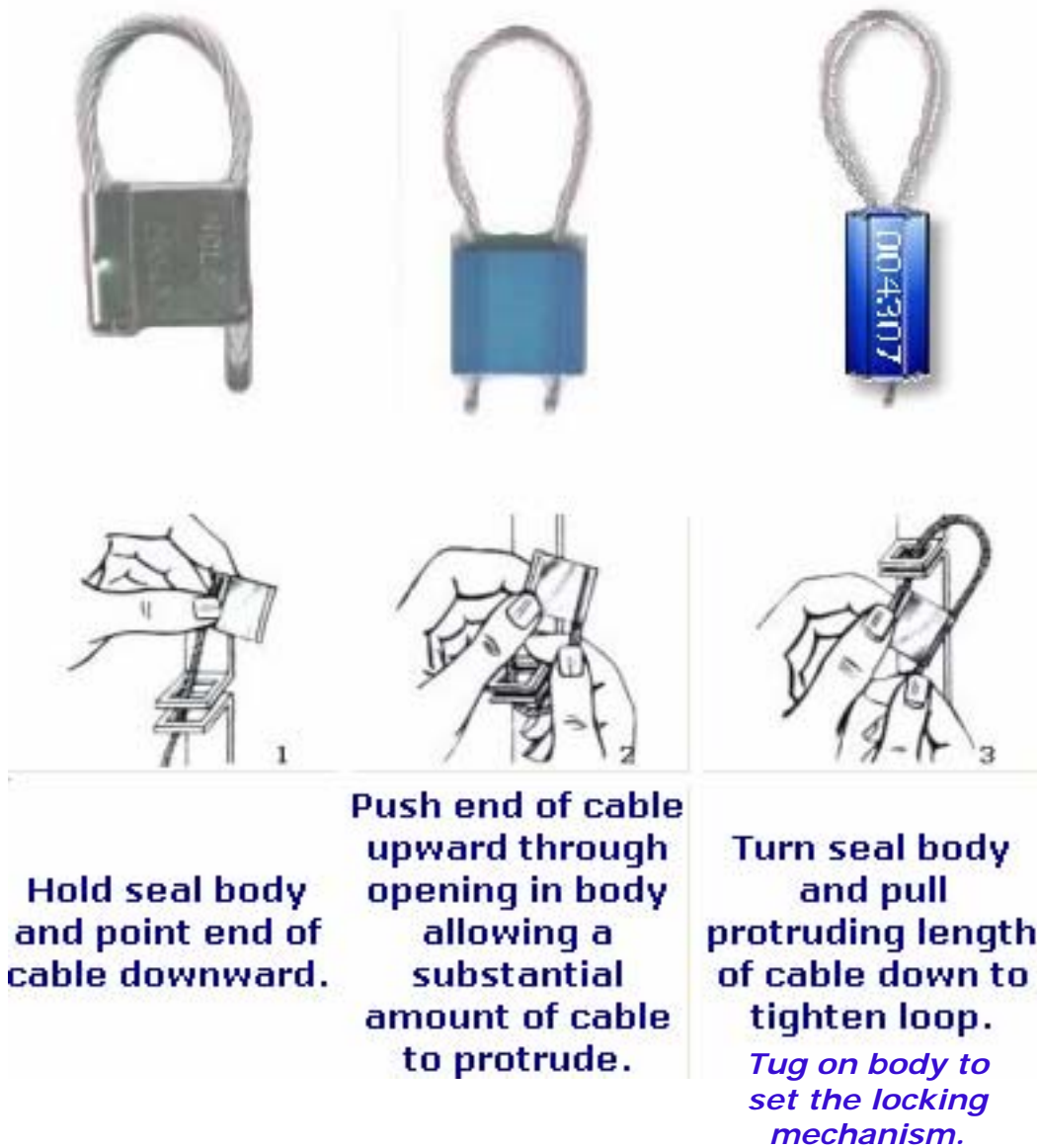

**Figure 2-19. Cable Seal Installation.**



**Figure 2-20. Cable Seal with Twist-off Installation Wrench.**

### **Two Piece Cable Seal**

Two Piece cable seals (Figures 2-21 and 2-22) are high-strength security seals that use a galvanized 3/16-inch or 1/4-inch aircraft cable to secure the container or door. These cable seals are self-locking and employ locking mechanisms that consist of roller-incline, ball-incline, or locking rings within the steel body. All the two piece seals can be procured with the company names and sequential serial number identification.

- **Tamper-Resistance Summary** - Covert defeat of cable seals will take a minimum of 30 seconds and may not be detected by post-mortem examination.
- **Installation Guidelines** - Install a cable seal so that the length of the cable threaded through the hasp is minimized, making a tight fit on the object being sealed. Two piece seals should be purchased with serial numbers on both parts.
- **Check, Inspect, and Record** - Once the seal is properly installed, verify and record the serial numbers and any other identification.

During post-mortem examination, compare the removed seal with a sample seal and carefully inspect the exterior and interior surfaces to detect tampering (abrasion and tool marks). Examine the body of the seal for any small drilled holes. Obtain tensile test data for the cable seals in use and perform a tensile test on seals that have been removed even if they do not show any evidence of tampering. A significant drop in tensile strength is a good indicator of seal defeat.

- **Relative Value** - .55 to 1.60.

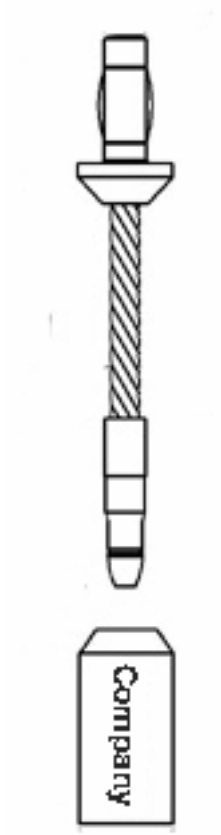

Figure 2-21. Two Piece Cable Seal.

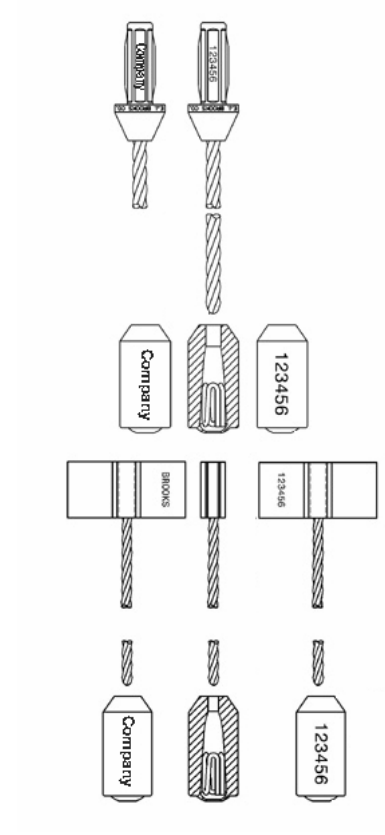

Figure 2-22. Flag Type Cable Seal.

## **BOLT STYLE SEALS**

### **Unthreaded Bolt Seal**

Unthreaded bolt seals (snap bolt shown in Figure 2-23) are two-piece seals that have an unthreaded pin which is inserted into a cylinder that contains a C-ring or clip, as the locking mechanism. These seals can be procured with sequential serial numbers and both pieces are marked. The seals come in a variety of colors.

- **Tamper-Resistance Summary** - Covert defeat of the bolt seal will take a minimum of 30 seconds.
- **Installation Guidelines** - Install the bolt seal according to the manufacturer's instructions. Both parts should have serial numbers.
- **Check, Inspect, and Record** - Once the seal is properly installed, verify and record the serial numbers and any other identification (such as color).

During post-mortem examination, compare the removed seal with a sample seal. Inspect the internal parts for signs of abrasion. Examine the head of the bolt to verify that it has not been removed and replaced. If marked, the same manufacturer's name should be on both parts.

- **Relative Value** - .20 to 1.35.

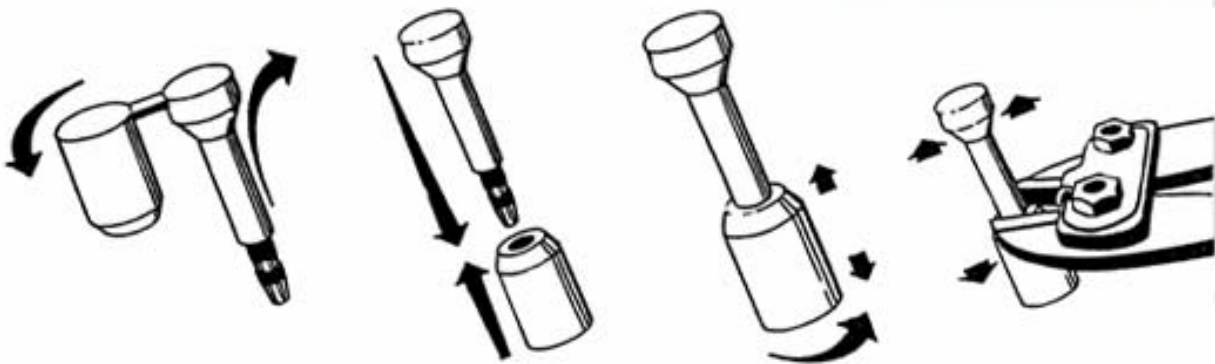

1. Twist plastic between bolt and body to separate.
2. Fit to item to be sealed and lock together.
3. Test that the seal is locked.
4. Remove with bolt cutters. The use of eye protection is recommended.

**Figure 2-23. Bolt Seal Installation.**

## **PULL-UP (CINCH) STYLE SEALS**

### **Plastic Tie Seal**

Plastic tie seals are constructed of a one-piece plastic molded part (Figure 2-24). They consist of a serrated plastic strap that is pulled through the hole of the seal body which contains a spring latching mechanism. The latching mechanism grasps the serrated strap and prevents removal. Smooth style seals use a steel clip or washer to grip the tail.

- **Tamper-Resistance Summary** - Covert defeat of the plastic tie seals will take a minimum of 10 seconds.
- **Installation Guidelines** - When plastic seals are used, minimize the length of the closed loop, making the seal a tight fit around the item being sealed. Do not remove the extra length of the serrated strap.
- **Check, Inspect, and Record** - Once the seal is properly installed, verify and record the serial number. The extra length of serrated string should be present. The serrated string should have free play in the seal body and should not pull loose from the body before it breaks, either when in place or during post-mortem examination.

During post-mortem examination, compare the removed seal with a sample seal and carefully examine for signs of heat welding.

- **Relative Value** - .05 to .06.

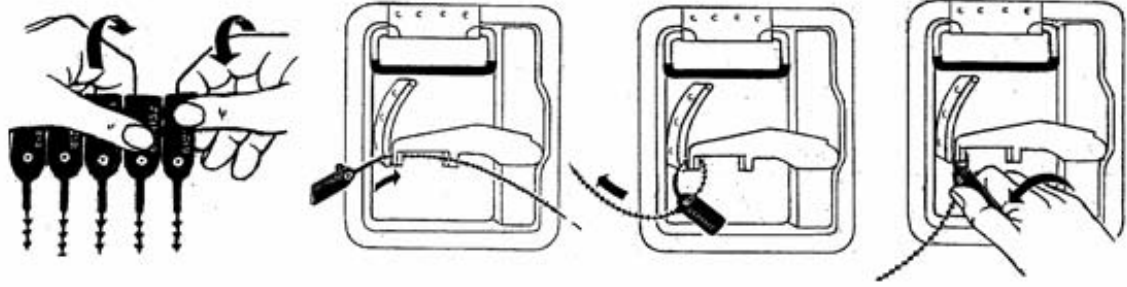

1. Hold seal strip as shown. Bend seal flag and detach from strip.
2. Insert seal strap through door latch, then through hole marked ENTER on numbered side of flag.
3. Pull strap through locking mechanism until tight.
4. Remove seal by grasping flag with thumb and twisting as shown.

**Figure 2-24. Pull-Up (Cinch) Seal.**



## **SECTION 3 – SEAL SELECTION AND APPLICATION**

### **SELECTING THE PROPER SEAL**

Consider the following when selecting a seal for a particular application:

- Purpose of the seal
- Type of application and environment
- Size and shape of the seal
- Durability of the seal
- Ease of installation and removal
- Tamper resistance qualities
- Tamper indicating qualities
- Uniqueness
- Cost effectiveness
- Integrating capabilities
- Disposition of used seals
- Seal control program (see Section 4)

Selection of seals that are certified to meet the quality assurance provisions stated in References 1 or 2 will ensure they will meet minimum quality, environmental, and performance standards. See Section 4 for information on seal control and procurement.

### **PURPOSE OF A SEAL**

Determine if the seal will be used for tamper indication or forced entry protection. If a seal is used for tamper indication and for inventory control and accountability, consider a seal with bar codes (requires scanners at custody points) or other automatic identification. Ensure the identification system on the seals is compatible with the existing inventory system of the facility where it will be used. For example, there are different types of bar code configurations or symbols as well as different types of bar code readers. Standard DoD symbols are detailed in Reference 8. The serial number of a seal can also be linked to the inventory in a container or area.

If the seal needs to give some protection against forced entry, use a padlock (Figure 2-11), cable (Figure 2-17), or bolt (Figure 2-22) style seal because they require more effort and tools to remove.

### **TYPE OF APPLICATION**

Select a type of seal that is compatible with the application. The seal should fit snugly so it cannot be opened or partially opened without breaking the seal. The object being sealed should also be tamper resistant if seal used is to be effective. For example, container door hinges (fixed hinge pin or hinge side protection) should be designed to prevent removal of the door without disturbing the seal or leaving evidence of entry.

## **SIZE AND SHAPE OF THE SEAL**

The size and shape of a seal selected will be determined by the type of container it will protect and the seal may need to be designed to accommodate bar codes, serial numbers, or other information (Figure 2-13). If bar codes are used for identification purposes, scanners should be available at each custody point to ensure the code has not changed or been altered.

## **DURABILITY OF THE SEAL**

### **Environmental Compatibility and Length of Use**

A seal should be selected that will survive any hostile environments where it will be used. For example, an environment near salt water may warrant the use of a plastic or stainless steel seal (Figures 2-7 or 2-13) rather than a metal seal that is prone to corrosion over a long period of time. Seal corrosion could impair the detection of tampering.

If a metal seal is required in a corrosive environment (i.e. forced entry requirement), it could corrode in a short period of time. Length of use is an important factor in the selection process to avoid corrosion issues. Consider using a bolt seal that is encased in a plastic covering that protects against corrosion such as the one in Figure 2-22. Seals procured using Reference 1 are required to meet minimum levels of corrosion resistance.

### **Activity of the Stored Container**

The expected activity of the container and its surroundings should be considered when selecting a seal. A seal can be broken if the container is in frequent contact with other cargo. A history of accidental destruction can be used to conceal tampering. Padlock (Figure 2-11), cable (Figure 2-17), or bolt (Figure 2-22) style seals should have the necessary strength and toughness to prevent breakage in these conditions.

### **Seal Flexibility**

Consider the flexibility of a seal. For example, a cable seal (Figure 2-17) may be flexible enough to withstand contact with other cargo without breaking. If resistance to forced entry is not a primary factor, consider using a plastic seals such as a plastic strap style seal (2-13) or a pull-tight style seal (2-23) because of its flexibility.

### **Strength Capability**

The strength of seals is determined by testing using standard specifications. Any seal selected should meet the testing requirements detailed in References 1 or 2 and seal manufacturers should ensure conformance to the requirements through verification by a certified testing laboratory.

## **EASE OF INSTALLATION AND REMOVAL**

Some seals, such as the pull tight plastic seal shown in Figure 2-23, are easily installed with no tools. Some seals require an installation tool(s) (Figures 2-8 and 2-16). Make sure that the facility has the necessary tool and personnel are trained in the proper installation of those seals. If a container is shipped with a seal that requires a removal tool, verify that the receiver has the necessary tool. Access to these specialized tools need to be controlled in the same manner and level as the seals.

## **TAMPER RESISTANCE QUALITIES**

Tamper resistance of seals in terms of defeat times is provided in Section 2.

## **TAMPER INDICATION QUALITIES**

Seals differ in tamper indicating properties. Some tampering is easily identified with visual inspection. Other seals require close examination using an established post-mortem procedure. Determine what examination procedures best fit inspection capabilities and require training inspection personnel to ensure a high level of assurance that seal tampering can be effectively detected and controlled.

## **UNIQUENESS**

All seals and any separate parts (i.e. two piece bolt and cable seals) should be individually distinguishable by serial numbers, scratches, logos, random marks, or other unique signature features (Figure 2-15). The seal identification marks should be recorded and those records carefully controlled. This feature will make seal counterfeiting difficult.

## **COST EFFECTIVENESS**

Consider the cost of the seal compared to the importance of the material being protected. Consider the overall seal control system cost, such as the cost of inspection, disposal, extra tools, scanners, and training of personnel. For DoD applications, the cost should not dictate the use of a seal that does not meet the requirements of Reference 1.

## **INTEGRATING CAPABILITIES**

Choose a seal that integrates with the existing or planned security system. For example, a seal can be threaded through a hasp with a padlock needed for forced entry protection or a container to provide tamper protection for the padlock.

## **DISPOSITION OF USED SEALS**

Determine if the user or the receiver of the seal has the capability to properly dispose of the seal using written seal disposal procedures provided by the shipping facility. See Section 4 for more information on developing a seal control program.

## SEAL APPLICATIONS

Table 3-2 provides a list of applications for various types of seals.

**Table 3-2. Seal Applications**

<b>Seal Type</b>	<b>Applications</b>	<b>Strength</b>
Security Tapes	Corrugated boxes, totes, fiberboard drums, metal ammunition boxes, container doors and aircraft doors (See Section 6 for descriptions)	Minimal
Label Seals	Sealing small boxes, and courier parcels, aircraft, clinical trial containers, cash boxes in transit, agricultural and chemical pails, pallet sealing, bung covers on barrels, container and trailer doors and in applications for most any small parcel where tampering or concealed theft is an issue (See Section 6 for descriptions)	Minimal
Crimp Wire	Containers, trucks, trailers, railcars, air cargo, customs, warehouse, fire protection, stock rooms, meters	Minimal to Low
Fold Wire	Containers, trucks, trailers, railcars, air cargo, customs, warehouse, stock rooms, meters	Minimal to Low
Cup Wire	Containers, trucks, trailers, railcars, air cargo, customs, warehouse, stock rooms, meters	Minimal to Low
Padlock – Wire Shackle	Containers, trucks, trailers, railcars, air cargo, customs, warehouse, fire protection, stock rooms, meters	Minimal to Low
Padlock – Plastic Shackle	Containers, trucks, trailers, railcars, customs, warehouse, fire protection, stock rooms, meters	Minimal
Padlock – Steel Shackle	Containers, trucks, trailers, railcars, customs, warehouse	Medium to High
Strap – Box End	Containers, trucks, trailers, railcars, air cargo, customs, warehouse, valves	Low
Strap – Plastic	Containers, trucks, trailers, railcars, air cargo, customs, warehouse, fire protection, stock rooms, meters, valves	Low
Strap – Ball End	Containers, trucks, trailers, railcars, air cargo, customs, warehouse, stock rooms, meters, valves	Low
Strap - Crimp	Pallets, customs, warehouse	Low to Medium
Cable – One Piece	Containers, trucks, trailers, railcars, air cargo, customs, warehouse, valves	Medium to Very High
Cable – Two Piece	Containers, trucks, trailers, railcars, air cargo, customs, warehouse	Medium to Very High
Bolt – Unthreaded	Containers, trucks, trailers, railcars, customs, warehouse	High to Very High

**Table 3-2. Seal Applications (continued)**

<b>Seal Type</b>	<b>Applications</b>	<b>Strength</b>
Pull-Tight Plastic Tie	Containers, trucks, trailers, railcars, air cargo, customs, warehouse, fire protection, stock rooms, meters, valves	Minimal

## **SECTION 4 - SEAL CONTROL**

### **INTRODUCTION**

This section provides a general framework for developing procedures and other components of a comprehensive seal control program. These general procedures and components can be modified to fit site specific requirements and individual facility security programs.

### **DOCUMENTATION**

Develop written instructions for all aspects of the seal control program, detailing responsibilities and duties for all assigned personnel.

### **TRAINING**

Develop a comprehensive training program for assigned personnel. Maintain a log of all seals training. Some suggestions for training are included in this section under “Responsibilities.”

### **RESPONSIBILITIES**

All personnel involved in the seal program should be identified specifically by name and title. The size of the facility and level of seal usage will determine the number of personnel that will be required. At a small facility, personnel can be assigned more than one responsibility (i.e., the seal administrator and seal custodian can be the same person and the person installing and removing the seal can also be the seal inspector).

#### **Manufacturer**

The seal manufacturer should establish procedures to assure that duplicate seals are not produced and that all seals that have been produced are strictly accounted for from the production line to delivery to the customer. Manufacturers should also properly dispose of any unused or scrap seal products to ensure they can not be used to construct counterfeit seals. As described in “Most Effective Practices for using Security Seals” in Section 6, manufacturers should protect seals prior to distribution to customers. All seals delivered to the customer should have:

- Serial numbers or other identifying marks (user name or logo) embossed on the seal.
- Crimping tools or tools used to apply the seals should be embossed with the user name or logo.
- Manufacturers should provide certificates of compliance with Reference 2. Non-compliant manufacturers should be avoided

## **Seal Administrator**

- Approves the procurement of seals
- Accepts seals shipped from the vendor.
- Maintains procurement documentation including manufacturer certifications, catalog cuts (for distribution to other seal personnel) and seal samples.
- Maintains the seal supply and the associated records concerning the receipt and distribution of the seals.
- Reviews and approves all forms and procedures used for the accountability of seals.
- Periodically reviews seal control procedures to ensure compliance with approved seal procedures.
- Designates authorized seal users.
- Should be a more senior, vetted person (i.e., background check), in the organization.

## **Seal Custodian**

- Receives seals from the seal administrator.
- Maintains a seal issuance log to record distribution of seals to subordinate units.
- Protects unused seals and seal accountability records to prevent unauthorized seal substitution or illegal use.
- Controls keys for seal containers and accountability record containers.
- Protects installation tools at the same level as the seals.
- Should be a vetted person (i.e., background check)

## **Personnel Assigned for Seal Installation/Removal**

- Receives training on the proper procedures for installing and removing seals. Assigned personnel should be capable of demonstrating seal knowledge, skill, and ability by correctly installing, testing the integrity, and removing two seals in succession. The level of proficiency should be rechecked periodically to ensure a high level of seal knowledge, skill, and ability is maintained.
- Accepts seals from the seal custodian.
- Installs seals on the container, door or item.
- Records seal serial numbers.
- Removes seals prior to opening the container or door.
- Provides a report to the seal custodian on all seal operations including receipt, installation, and removal.

## **Seal Inspector**

- Receives training on inspection procedures and seal defeat methods.
- Inspects installed seals.
- Audits seal records.



- Reviews procedures.
- Checks inventory.
- Performs post-mortem inspection of removed seals.
- Destroys seals or returns them to the seal administrator.
- Provides a report to the seal custodian on seal inspections and destruction.
- Log destroyed seals against the seal inventory.

## **PROCUREMENT**

Figure 4-1 is a seal control measure that could be used for seal procurement. In this illustration, the seals are shipped from the manufacturer in sealed plastic bags that have tamper indicating features and inventory and control logs supplied by the manufacturer.

As a most effective practice, any seal that does not meet the specifications, quality assurance, and identification requirements of Reference 1 or 2 should not be accepted. All seals should be tested and certified by a certified laboratory. A statement should be requested from the manufacturer that the seals being shipped meet performance and quality assurance requirements of Reference 1 or 2. Reputable manufacturers are usually willing to provide certificates of compliance and test data to support their claims. An example of a manufacturer's statement is shown in Figure 4-2. Return all seals that are of questionable quality or have not been properly certified.

All seals procured under Reference 1 or 2 should have unique characteristics such as sequential serial numbers, logos, etc. Certification from the manufacturer that these unique characteristics will not be provided to another customer without prior approval should be required.

Ensure that there are security procedures in place at the seal manufacturing facility, such as stock control, die or mold control, access control, item accounting, and background investigations of employees.



Dispenser box contains strip of 30 pouches, seal log sheets, and seal assignment cards. Perforations separate each tamper evident pouch.

SEAL ISSUE LOG & INVENTORY CONTROL							
EL CUADERNO DE SELLO EXPEDIDO Y DE INSPECCION DE INVENTARIO							
INVENTORY SEAL # # DE SELLO DE INVENTARIO	ISSUED SEAL # # DE SELLO EXPEDIDO	ISSUED DATE FECHA DE EXPEDICION	CONTAINER NUMBER # DE ENVASE	CUSTOMER CLIENTE	ISSUER EMISOR	DRIVER CONDUCTOR	✓
42040E	/ /	/ /					
42041E	/ /	/ /					
42042E	/ /	/ /					
42043E	/ /	/ /					
42044E	/ /	/ /					
42045E	/ /	/ /					
42046E	/ /	/ /					
42047E	/ /	/ /					
42048E	/ /	/ /					
42049E	/ /	/ /					
42050E	/ /	/ /					
42051E	/ /	/ /					
42052E	/ /	/ /					
42053E	/ /	/ /					
42054E	/ /	/ /					
42055E	/ /	/ /					
42056E	/ /	/ /					
42057E	/ /	/ /					
42058E	/ /	/ /					
42059E	/ /	/ /					
42060E	/ /	/ /					
42061E	/ /	/ /					
42062E	/ /	/ /					
42063E	/ /	/ /					
42064E	/ /	/ /					
42065E	/ /	/ /					
42066E	/ /	/ /					
42067E	/ /	/ /					
42068E	/ /	/ /					
42069E	/ /	/ /					

BOX NUMBER 1 of 4      BAG NUMBER 11 of 20  
# DATA      # BAGO

SEAL ASSIGNMENT CARD	OUTBOUND SEAL NUMBER
ISSUED SEAL #	ISSUED SEAL #
ISSUED DATE	ISSUED DATE
CONTAINER NUMBER	CONTAINER NUMBER
CUSTOMER	CUSTOMER
ISSUER	ISSUER
DRIVER	DRIVER
SEAL VERIFICATION	SEAL VERIFICATION
SHIPPER VERIFICATION	SHIPPER VERIFICATION
TRUCK DRIVER VERIFICATION	TRUCK DRIVER VERIFICATION
ENTRANCE GATE VERIFICATION	ENTRANCE GATE VERIFICATION
SHIPPER VERIFICATION	SHIPPER VERIFICATION

Figure 4-1. Example of Seal Control System.

<b>MANUFACTURER STATEMENT</b>	
<b>CUSTOMER NAME AND ADDRESS</b>	
Seal Identification	
Seal Model Number	_____
Type of Seal	_____
Manufacturer's Part Number	_____
<p>An artist's rendition or other pictorial representation of the seal is attached to this attestation. Also, six or more samples and advertising material for the seal are forwarded herewith for your inspection</p> <p>Tests of this seal were performed by (show name and address of the company or testing laboratory performing the test):</p>   	
<p>I hereby attest that the designated seal described above and depicted on the attachment meets or exceeds the United States Department of Defense seal standards, specification, and identification requirements of the Department of Defense Regulations or ISO 17712, as applicable.</p>	
Signature and title of the person making the attestation	
Name:	_____
Title:	_____
Date:	_____

**Figure 4-2. Example of Manufacturer Statement.**

## **SEAL STORAGE**

- Secure all unused seals in a controlled area.
- Develop a list of personnel who require access to the seal storage area.
- Establish access control procedures to prevent unauthorized access.
- Maintain a record of all seal serial numbers.
- Maintain a file of “Letters of Authority” for using seals.

## **ACCOUNTABILITY**

- Only designated employees should distribute container seals for integrity purposes.
- Maintain one distribution log (hard copy or computer file) for issued seals.
- Use bound books (not loose-leaf) for hard copy logs.
- Seal distribution log (hard copy or computer file) should contain the following fields:
  - Seal identification number or mark
  - Date and time of the seal installation
  - Description or number of the item sealed
  - Destination, if the sealed item is being shipped
  - Name of the person installing the seal
  - Driver’s name, if applicable

If the item is being delivered and the driver is not part of the shipper’s organization, make the goods-inventory count and the seal installation in the presence of the shipper’s representative. The driver should write the seal number installed on the shipped item, truck, container, or train, on the bill of lading, or on the shipping order, and then sign it. Send the seal information electronically to the receiving station.

Information technology (IT) can be extremely helpful in setting up a seal control program. Laptop computers, tablet computers and Personal Digital Assistants (PDA) with simple spreadsheet programs can be used in the field to record seal data, track shipments, and control inventory. If used to support a seal control program, IT systems should be protected in the same manner and level as hard copy systems. Follow recommended IT security procedures to ensure data integrity. Seal program data should be backed up and stored separately by the Seal Administrator.

## **INSTALLATION**

Once seals are distributed for use, they should be installed as soon as possible. When installing a seal, record the seal data as follows:

- Type of seal (brief description)
- Seal number
- Material identification
- Location and identification of container

- Identification of person installing the seal
- Identification of person witnessing the installation where a two-party program is in place
- Date installed
- Color of the seal

Obtain verification from the seal custodian that the information is correct and complete. Establish detailed procedures for installing each seal type of seal based on manufacturer recommendations. All unused seals should be returned to the seal custodian.

## **INSPECTION**

A regular schedule should be established for the inspection of installed seals or a sample inspection if there are a large number of seals in use. Seal records should be audited periodically along with a review of procedures, and an inventory count. A post-mortem examination should be required on at least a 10% sampling of the seals, and any seal that exhibits any of the following irregularities:

- Missing seal
- Open seal
- Seal number discrepancy
- Improperly installed seal
- Unauthorized seal
- Uncontrolled seal
- Easy opening of the seal under hand pressure
- Presence of free play or rotation
- Frayed appearance of wire or cable
- Evidence of glue or application of heat
- Blushing or color change of the plastic coating
- Scratches or nicks adjacent to the locking mechanism
- Deformation of the locking mechanism
- Apparent rebuilding or substitution of component parts
- Suspect printed or embossed letters or numbers

Personnel discovering a seal irregularity should notify the seal administrator immediately and provide a description of the seal condition, location, and seal identification number. If a seal irregularity has occurred, verify the contents of the container or the sealed item have not been pilfered or modified. If the condition that caused the seal irregularity has been determined, install a replacement seal immediately. Hold a suspect seal until a post-mortem examination and investigation has resolved the condition and the seal administrator has approved disposal of the seal.

NOTE: Any evidence of tampering, seal anomalies, or any other security concerns involving international cargo, which includes in-bond movements, will be brought to the attention of the closest CBP Office for appropriate action.

If at any time it is necessary to remove a seal before arrival at the final destination, the following information should be recorded:

- The name of the person breaking the seal
- The reason for breaking the seal
- The time and date the seal was broken
- The serial number or identifying mark of the broken seal
- The serial number or identifying mark of the replacement seal
- The names of witnesses to the breaking of the seal

Report the seal removal to security personnel, in accordance with company policy/procedures, regardless of where the shipment is in transit. For specific reporting recommendations, see Section 6.

## **RESPONSE TO SEAL ANOMALIES**

Written procedures should stipulate how seals are to be controlled and affixed to loaded containers. Procedures should be in place for recognizing and reporting compromised seals and/or containers.

NOTE: Any evidence of tampering, seal anomalies, or any other security concerns involving international cargo, which includes in-bond movements, will be brought to the attention of the closest CBP Office for appropriate action. For cargo not associated with an international/in-bond movement, the discovery of a seal discrepancy should be reported in accordance with company policy/procedures.

## **REMOVAL**

To ensure the integrity of a seal, they should be inspected prior to removal. Some duties of personnel assigned for seal installation/removal may overlap with the seal inspector because the seal inspector should determine if there are any seal anomalies before the seal is removed. Before removing a seal, personnel assigned to the removal process should:

1. Review manufacturer recommendations for removal of the seal.
2. Enter the seal type, serial number, and all seal coding information on the seal log. Verify that it is the original seal recorded on the manifest. An example of a Seal Installation and Removal Form is shown in Figure 4-3.
3. Check for unusual marks and tampering and that the seal has not been shortened or resealed.
4. Pull and twist the seal to the left and right to ensure that the seal head is still in tact and no tampering is evident.

5. Report any irregularity to the proper personnel, and record the irregularity in the seal log.
6. Report any evidence of theft to the security department and start an investigation immediately.
7. Document all irregularities with photographs.
8. Have a witness to the seal removal.
9. Keep all removed seals for 30 days in case they are needed as evidence.

## **CONTAINER SECURITY AND INSPECTION**

Container integrity should be maintained to protect against the introduction of unauthorized material, contraband, or people. At loading point, procedures should be in place to properly seal and maintain the integrity of the shipping containers. A high security seal should be affixed to all loaded containers bound for the United States. All seals should meet or exceed the requirements of Reference 2.

Procedures should be in place to verify the physical integrity of the container structure prior to loading and off-loading, including the reliability of the locking mechanism that secures the doors. A seven-point inspection process is recommended for all containers that includes all walls, floor, ceiling, undercarriage, and doors. Of particular interest is a careful inspection for the doors to determine if the container has been modified or an attempt has been made to bypass the seal by detaching or cutting the boltwork, or removing the hinges. Methods commonly used include drilling out attachment bolts, bending boltwork components, or cutting the boltwork. After the container contents have been removed (or unauthorized material inserted) the boltwork is reattached leaving little or no evidence of entry. The use of specialized non-removable bolts or break-off bolts along with lock-tight on the threads can make this kind of attack more difficult.

Containers should be stored in a secure area to prevent unauthorized access and/or manipulation. Procedures should be in place for reporting and neutralizing unauthorized entry into containers or container storage areas.

Access controls prevent unauthorized entry to facilities, maintain control of employees and visitors, and protect company assets. Access controls should include the positive identification of all employees, visitors, and vendors at all points of entry.

## **DISPOSAL**

Destroy or store seals after use so the parts of a removed seal cannot be used to tamper with other seals of the same make and model. For example, with metal seals, significant destruction such as massive smashing, crushing, cutting, or drilling is necessary to prevent seal reuse. Dispose of any contaminated seals with other contaminated waste. Some seals can be disposed with classified or sensitive parts waste.

## ACCOUNTING

Design information, serial numbers, identifying marks, or logo so they can not be duplicated or counterfeited. Use a Chain of Custody Log or Seal Accountability Log when a seal is transferred from one area of custody to another or from one person to another. Figure 4-5 is an example of a Seal Accountability Log.

Annual or semi-annual audits should be used to uncover weaknesses in the seal program. Auditors should not be associated with the seal program. Auditors should:

- Check the serial numbers of the seals against the log books and seal inventory of unused seals.
- Investigate discrepancies in the seal inventory.
- Verify seal installation, removal, and destruction procedures.
- Review post-mortem investigation documentation.
- Check for a deviation from established procedures.
- Provide recommendations for seal program improvement.

Once the audit is complete, any weaknesses in the seal program uncovered during the audit should be corrected immediately.



## SEAL INSTALLATION AND REMOVAL FORM

Serial Number	Container Identification	Location	Check One		Seal Type/Description	Installer	Witness	Date
			Date Installed	Date Removed				

Seal Custodian Signature \_\_\_\_\_ Date \_\_\_\_\_

**Figure 4-3. Sample Seal Installation and Removal Form.**

### SEAL ACCOUNTABILITY LOG

						<b>Check One</b>			
Seal Identification Number	Signature of Recipient	Badge Number	Location Issued	Date	Time	Disassembly	New Receipt	Seal Replacement	Voided (Broken during Installation)

**Figure 4-4. Sample Seal Accountability Log.**

## **SECTION 5 – FEDERAL GOVERNMENT SEAL REQUIREMENTS**

### **INTRODUCTION**

The following chapter sets forth specific Department of Defense (DoD) as well as certain other federal agency requirements for Security seals. Conditions that may require the use of seals are presented in this Section. More than one seal type may be needed depending on the factors presented in Section 2.

### **DoD SEAL REQUIREMENTS**

References 9 (Section 203 contains requirements for shippers, transhippers and receivers and 205 contains requirements for shipping arms ammunition and explosives (AA & E) and classified information) and 10 provide requirements for the use of seals to protect the contents of DoD shipments.

Sections 3 and 4 provide a framework for selection, application, and control of seals and should be used to develop a comprehensive seal program.

### **TERMS AND DEFINITIONS**

For this Section, a seal is defined as a mechanical device marked with a unique identifier and designed to secure containers or doors. Depending on construction, seals provide varying degrees of resistance to an intentional or unintentional attempt to remove the seal.

**Security Seal** - A seal that is constructed and manufactured of solid metal or metal cable designed to delay intrusion. Security seals generally should be removed with quality bolt or cable cutters. As with all security seals, they require inspection to indicate whether tampering has occurred or entry has been attempted.

**Tamper Indicating Device (TID)** -A seal that is constructed and manufactured of material that can be easily broken by hand or by using a simple snipping tools or scissors. As with all security seals, TID seals require inspection to indicate whether tampering has occurred or entry has been attempted.

### **SEALS FOR CONVENTIONAL ARMS, AMMUNITION & EXPLOSIVES (AA&E), AND CLASSIFIED SHIPMENTS**

Seals used by DoD components shipping and storing AA&E must meet the requirements of Reference 1, be serially numbered, tamper resistant, and safeguarded before being installed. Seal serial numbers should be entered on the Bills of Lading (BL) and tracked, documented and inspected at each stage of shipment (loading point, intermediate stop, and offloading point). Selection of the proper seal based on operational and environmental factors is discussed in Section 3.

DoD activities involved with AA&E and classified material shipments should have a seal control program to ensure accountability and control of seals used to secure shipments. The seal control program should include the information detailed in Section 4:

Seal checks and inspections for evidence of breakage or tampering should be made a part of regular patrol or surveillance procedures and of pier loading procedures. Seals applied to Category I and II and classified shipments should be verified by seal number once every eight hours during non-duty hours.

### Seals Approved by DoD

Several seals that have been procured by the Defense Logistics Agency (DLA) using Reference 1 are shown in Table 5-1. These seals are required for the protection of AA&E and classified shipments.

**Table 5-1. Approved Seals for AA&E Shipments.**

Description	National Stock Number (NSN)*
Cable Seal Lock (Figure 5-1)	NSN 5340-00-084-1570
Cable Seal Lock (Figure 5-2)	NSN 5340-01-177-7405
Bolt Seal (Figure 5-3)	NSN 5340-01-260-9935
Bolt Seal (Figure 5-4)	NSN 5340-01-334-0791
Bolt Seal (Figure 5-5)	NSN 5340-01-318-6771
Car Ball Seal (Figure 5-6)	NSN 5340-01-237-7646

\*Current information on National Stock Numbers can be obtained by contacting the DLA at:

Toll Free: 1-877-DLA-CALL (352-2255)

DSN: 661-7766

Commercial: 269-961-7766

DLA Web Site: [http://www.supply.dla.mil/dla\\_call.asp](http://www.supply.dla.mil/dla_call.asp)

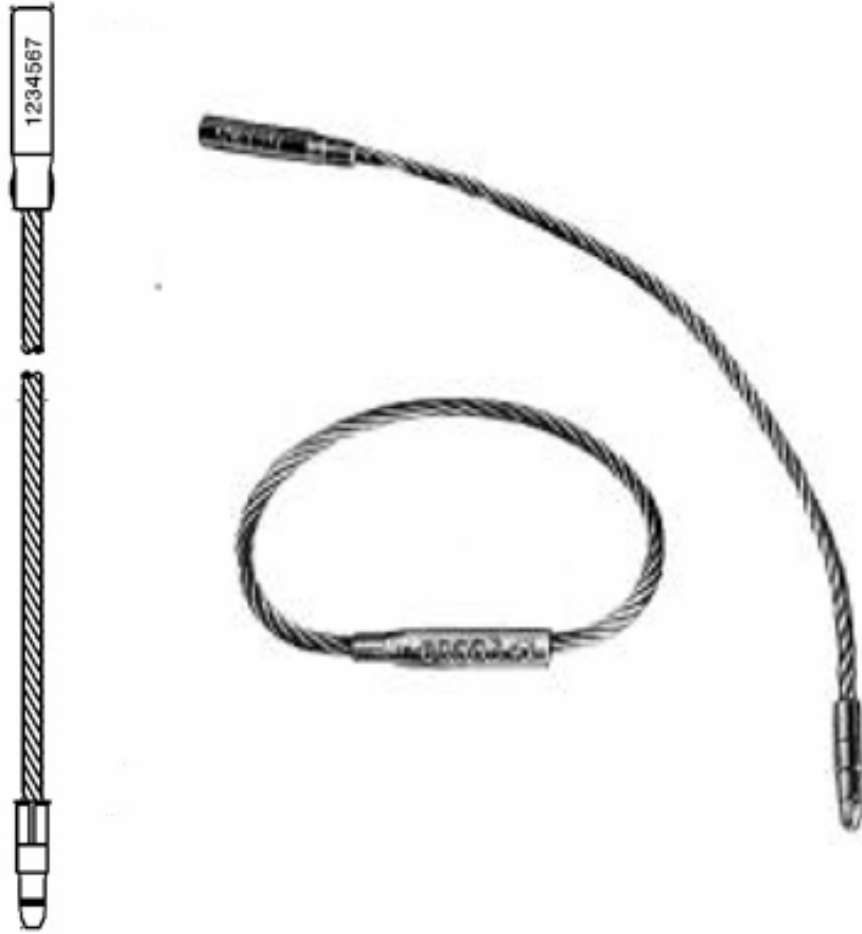

**Figure 5-1. Cable Lock<sup>®</sup> Seal by E.J. Brooks.**



Figure 5-2. Cone-Loc<sup>®</sup> Seal by Tyden Brammel.



Figure 5-3. Intermodal II<sup>®</sup> Seal by E.J. Brooks.



**Figure 5-4. Trans-Lok® Seal by E.J. Brooks.**

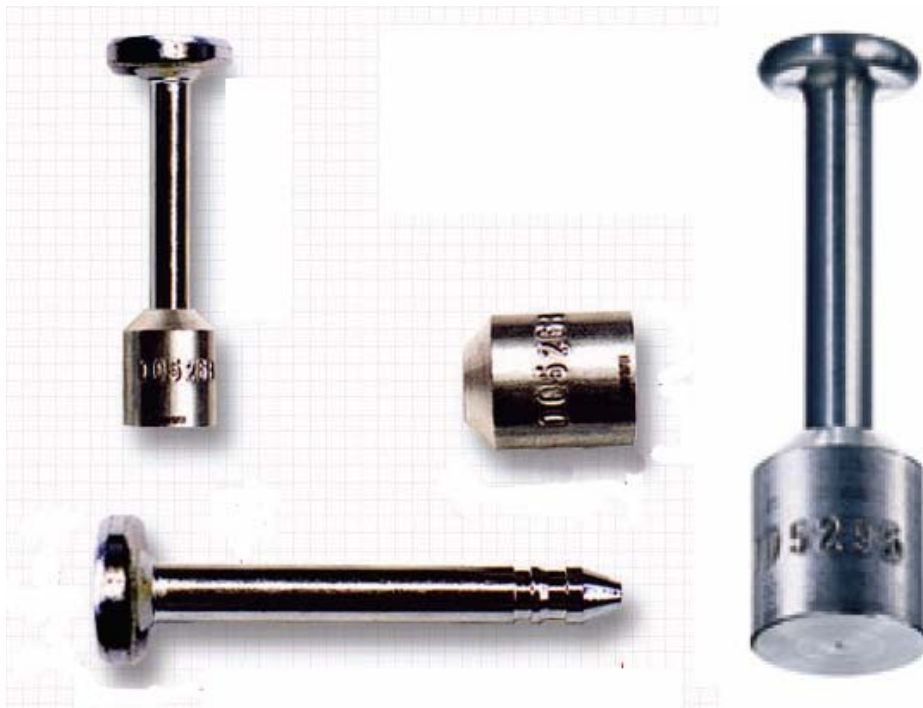

**Figure 5-5. Econo Bolt Seal by Tyden Brammel.**

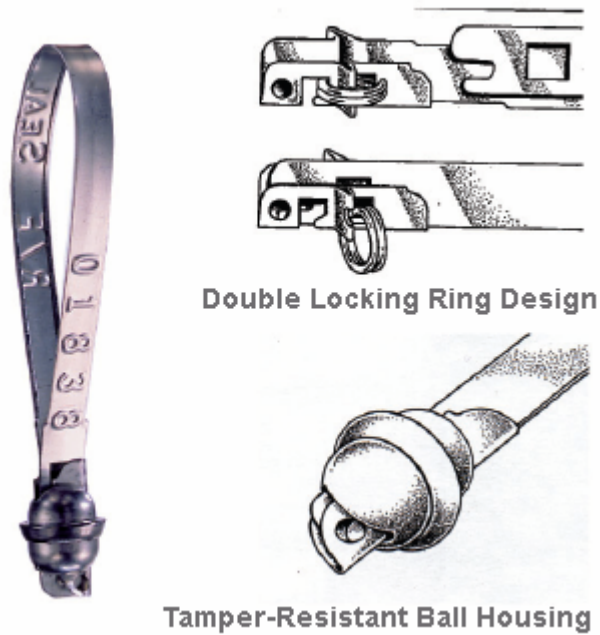

**Figure 5-6. Tyden Ball Seal by Tyden Brammel.**

## **OTHER DOD SHIPMENTS**

Reference 9 requires the use of tamper evident seals but does not designate quality assurance requirements for seals. Seals selected to meet the requirements of Reference 9 should be procured using Reference 1 and be certified by independent or certified laboratory testing to have met those requirements. Styles that can be used to meet the requirements of Reference 9 include Styles A through F, described in Reference 1 and shown in Section 2. Figures 5-7 through 5-10 shows how various types of seals can be used to secure containers, doors, valves, etc.





**Figure 5-7. Cable Seal Applications.**

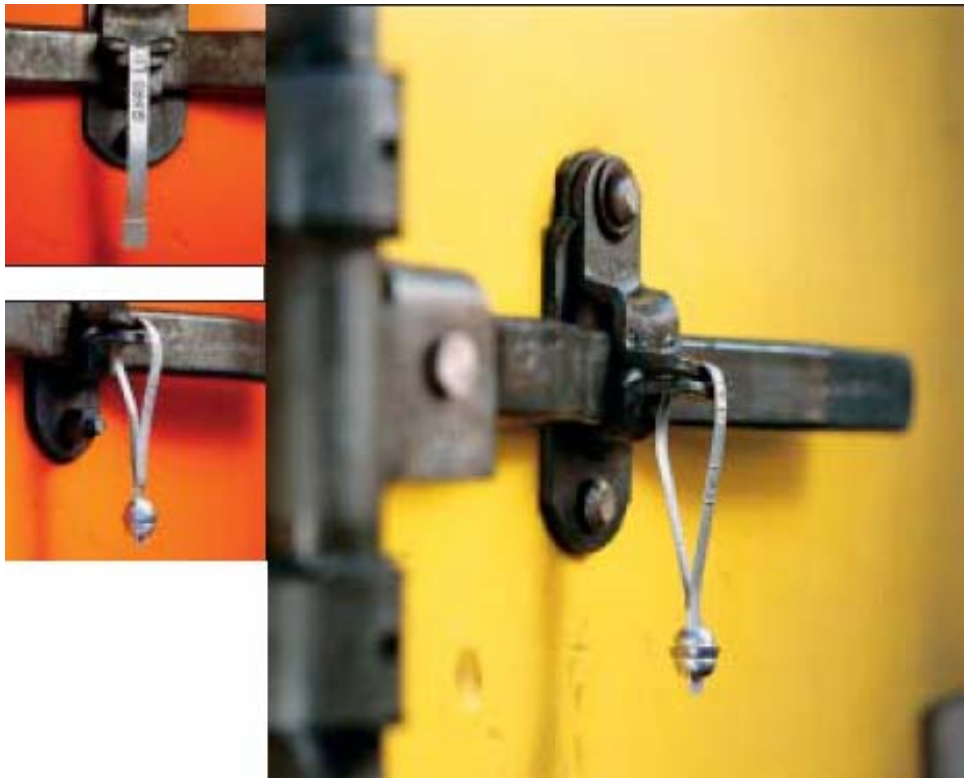

**Figure 5-8. Strap (Car Ball) Seal Applications.**



**Figure 5-9. Bolt Seal Applications.**

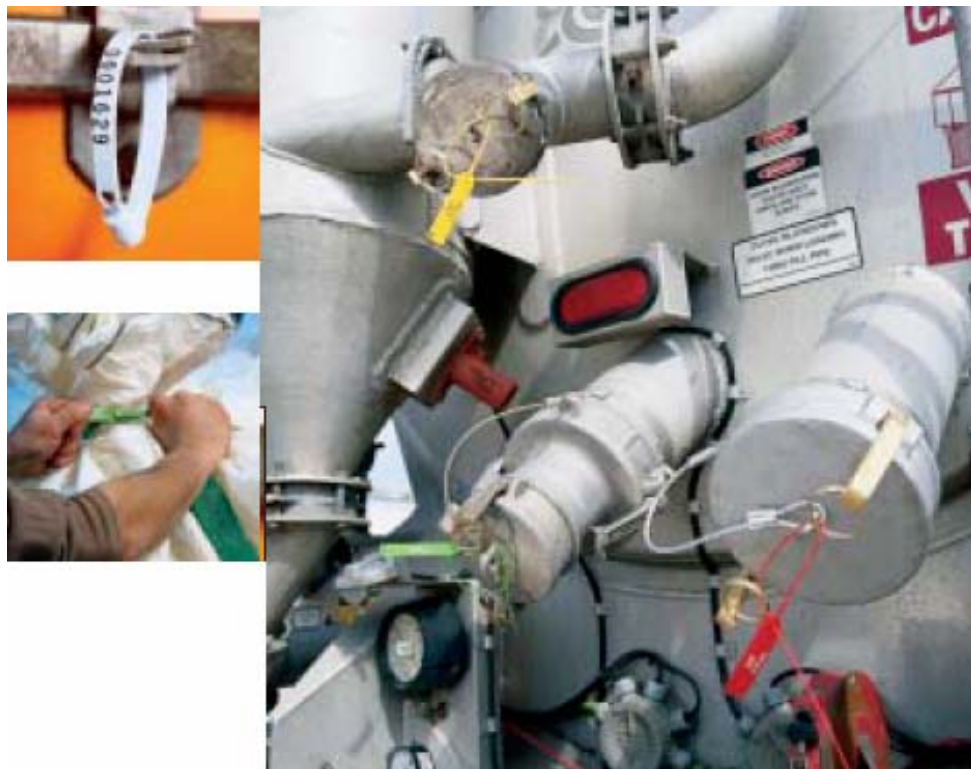

**Figure 5-10. Plastic Strap and Pull Tight Seal Applications.**

## **OTHER FEDERAL SEAL REQUIREMENTS**

### **Food and Drug Administration**

The Food and Drug Administration (FDA) requires seals for certain food shipments. FDA has also provided “Food Security Preventive Measures Guidance” that is available online at <http://www.fda.gov>. This guidance is designed as an aid to operators of food importing establishments, storage warehouses, and filers. It identifies the kinds of preventive measures that they may take to minimize the risk that food under their control will be subject to tampering or other malicious, criminal, or terrorist actions. Operators of food importing establishments are encouraged by the FDA to review their current procedures and controls in light of the potential for tampering or other malicious, criminal, or terrorist actions and make appropriate improvements.

### **Department of Agriculture**

The Department of Agriculture (USDA) requires that selected food stuffs delivery units, trucklot and less-than-trucklot (LTL) quantities, must be secured at all times prior to unloading with tamperproof, tamper resistant, serially numbered, high security seals that meet the ISO 17712 standard for high security. Failure to seal or maintain the delivery unit under seal in accordance with these requirements may subject the shipment to rejection. Further information is available online at <http://www.usda.gov>.

### **Department of Energy**

The Department of Energy requires seals for sensitive energy material shipments such as Category II “Foreign Spent Research Reactor Fuel.”

### **Customs and Border Protection**

Reference 12 calls for a red in-bond Customs seal to be used on "conveyances or compartments in which carload lots of bonded merchandise are transported." Also, "High-security Customs seals are recommended on carload or containerized shipments where the Customs officer reviewing the in-bond entry determines it is needed to adequately protect the revenue and prevent violations of Customs laws."

## **VOLUNTARY SEAL STANDARD THROUGH CUSTOMS-TRADE PARTNERSHIP AGAINST TERRORISM (C-TPAT)**

Importers enrolled with the CBP in the C-TPAT program should conduct a comprehensive assessment of their international supply chains based upon C-TPAT security criteria. Where an importer contracts some elements of their supply chain, such as a foreign facility, conveyance, domestic warehouse, or other elements, the importer should work with these business partners to ensure that pertinent security measures are in place and adhered to throughout their supply chain. The supply chain for C-TPAT purposes is defined from point of origin (manufacturer/supplier/vendor) through to point of distribution

– and recognizes the diverse business models C-TPAT members employ. The process is described in detail in Reference 13. For container seals, Reference 13 provides the following most effective practice guidance (the practices listed below are suggested most effective practices per Reference 13, but are not mandatory):

### **Domestic**

**Verifying and Disposing of Seals:** Seal numbers are verified at the distribution center by writing the number of the actual seal next to the seal number listed on the shipping documentation. This procedure provides a written record that the actual seal was checked and verified against the seal number listed on the shipping documentation. The shipping supervisor should be present to verify the seal before it is broken. He/she gathers and secures broken seals to prevent their misuse.

### **Sea Carrier**

**Logos on Seals:** Sea Carrier requires the use of individually numbered high security bolt seals that bear its logo. The Sea Carrier also requires that its seal be placed all empty containers laden on its vessels. Each dispatched container is assigned a specific seal that facilitates tracking the origin of the container.

**Modifying Containers:** Sea Carrier requires seal checks at every interchange throughout the container's transport. In addition, the Sea Carrier has modified the structure of its ocean containers. Rather than use the hasps on the door to affix the seal, carrier uses a locking point mounted on the lower sill of the container structure. This prevents the drilling of the round-head bolt used to secure the hasp, a method used to open container doors while keeping the seal "intact."

### **Highway Carrier**

**Utilizing Plastic Seals to Secure Empty Containers:** Plastic seals are placed on empty inspected containers that are stored in the truck yard. Seals are verified when the guard conducts his or her rounds. Unused plastic seals are secured in a locked cabinet, logged, and reconciled.

### **Highway Carrier**

**Trading Seals Given to Drivers:** During long haul transport, an extra seal is maintained inside the trailer in a tamper evident envelope in case the trailer needs to be opened for government examinations while in route. If the seal is used, the original seal should be placed inside the trailer, the new seal number is called in to the dispatcher, and all concerned parties are notified of the seal change. If the seal is not used, the envelope should be returned to the dispatcher.

**Seal Control and Verification:** Highway Carrier issues high security

bolt seals and cable seals to their customers before drivers' pick-up cargo. The seals are secured, tracked, and verified. At cargo pick-up, the company guard, shipping manager, and driver are present when the seal is placed on the container. All parties present for the affixing of the seal should initial the bill of lading to document their verification. The shipping manager then calls in the seal number to the trucking company dispatcher and the customer in the United States. The seal number should be within the range of seal numbers issued to the customer by the highway carrier.

## **Factory**

**Establishing Seal Control Policy:** Factory has comprehensive written policies and procedures regarding container seals that include: accountability and responsibility for how seals are controlled, issued, secured, affixed, and verified throughout the supply chain. The policy also specifies how the seal inventory is maintained and reconciled.

**Holistic Approach to Seal Control:** Seal numbers are electronically transmitted by the factory to the Highway Carrier and the importer of record before the truck's arrival at the factory. The truck driver and security guard witness the placement of the seal by the shipping manager and check the integrity of the seal. The seal number is documented on the bill of lading. The guard and driver should initial next to the seal number on the bill of lading to attest to their verification of the seal. Before leaving the factory, the driver calls in the seal number to his or her dispatcher, who verifies the seal number against the electronically transmitted number. The guard stationed at the gate verifies the trailer number and seal number before the driver leaves the factory. The guard also initials the bill of lading and records the seal number on the truck exit log.

## **Multi-National Corporation**

**Global Seal Control:** Company established a uniform policy for all its subsidiaries and service providers regarding seal issuance, control, and verification to ensure product integrity and security throughout the supply chain. Tamper evident seals are affixed and repeatedly verified throughout all changes in custody and seal changes are communicated to all parties (shipper, importer, highway carrier, terminal, freight forwarder, etc.). The seal number is transmitted to each handling point via secure electronic data transmissions and is verified before acceptance at each handling point.

## **Consolidator**

**Segregating and Sealing Less Than Truck loads (LTLs):** Consolidator's trailers have been modified with several partitions to segregate each consignee's cargo to enhance the security of Lit cargo while in route from the factory/shipper to the Consolidator's warehouse. The seal number is recorded on the pick-up order and the factory calls in the seal

number to the consolidator at the time of pick-up. The consolidator verifies the seal numbers upon the truck's arrival.”

Container integrity should be maintained to protect against the introduction of unauthorized material and/or persons. At point of stuffing, procedures should be in place to properly seal and maintain the integrity of the shipping containers. According to C-TPAT security criteria, a high security seal should be affixed to all loaded containers bound for the U.S.. All seals should meet or exceed the current PAS ISO 17712 standards for high security seals. For more information on the C-TPAT program, visit the CBP web site at [www.cbp.gov](http://www.cbp.gov).

## **TRANSPORTATION SECURITY ADMINISTRATION PILOT PROGRAM**

The Transportation Security Administration (TSA) is gathering information from industry regarding various forms of tamper-evident and tamper-resistant label seals and tape to be used to secure air cargo. TSA is contemplating requiring the use of security label seals and tape to enhance air cargo security throughout the supply chain.

## SECTION 6 – INTERMODAL TRANSPORTATION MOST EFFECTIVE PRACTICES

### INTRODUCTION

This section provides “most effective practice” recommendations for installation and chain of custody for seals used for intermodal transportation. It provides a source of information on mechanical seals which are acceptable for securing international commerce containers, doors, or items. More than one seal type may be needed depending on the factors presented in Section 3.

A consensus most effective practice with respect to container seals would be to use a seal that meets the requirements of Reference 2 developed by the International Organization for Standardization (ISO). Requirements for seals described in Reference 2 are similar to the testing requirements in Reference 3 developed by the American Society for Testing Materials (ASTM). These requirements are not applicable to special-purpose seals, such as fibre-optic and sophisticated electronic seals.

The primary differences between References 2 and 3 are as follows:

- The ASTM standard (Reference 3) requires an average of 5 tests to determine the relative strength of the seal and the ISO standard (Reference 2) currently requires each seal to stand on its own. If one seal fails the test, all seals in that test fail.
- Reference 3 requires 1,000 to 3,000 pounds of tensile strength while Reference 2 currently requires 2,250 pounds.
- Reference 3 requires elevated and reduced temperature impact tests and Reference 2 currently requires specific impact tests at 18 and -29 degrees centigrade which are more severe than the ASTM testing requirements.

### TERMS AND DEFINITIONS

For use on intermodal transportation systems, a seal is defined as a mechanical device marked with a unique identifier and designed to secure a closed container, door, or opening. Depending on construction, seals provide varying degrees of resistance to an intentional or unintentional attempt to remove the seal.

**High Security Seal (H)** - A seal that is constructed and manufactured of metal or metal cable and designed to delay intrusion. High security seals should be removed with quality bolt or cable cutters. Seals designated as high security should be marked with an “H” as required by Reference 2.

**Security Seal (S)** - A seal that is constructed and manufactured of spiral, wound or solid wire that provides limited resistance to removal and requires only lightweight wire cutters or tin snips for removal. Seals designated as a security seal should be marked with an “S” as required by Reference 2.

**Indicative Seal (I)** - A seal that is constructed and manufactured of material that can

easily be broken by hand, twisting off, or by using a scissors or knife. Seals designated as indicative security should be marked with an “T” as required by Reference 2.

NOTE: All seals regardless of construction or design require inspection to indicate whether tampering has occurred or entry has been attempted.

## **SEALS FOR COMMERCIAL APPLICATIONS**

In addition to the seal types described in Section 2, the following seals are allowed for intermodal transportation use by Reference 2:

**Self Adhesive Security Tape and Tamper Evident Label Seal** – Label type seals and tapes are defined by their physical characteristics. While security tape is any continuous product, security labels are typically die cut or butt cut (edge to edge), thereby making each label seal unique and separate on a liner. There are currently no specifications (Federal, ANSI, ASTM, etc.) that establish requirements for the manufacture of label seals and tapes.

Label seals (Figure 6-1) are voiding seals consisting of a paper or plastic backing with adhesive. The combination of backing and adhesive are chosen to cause the seal to void when removal is attempted.

To be a true security seal, tapes, and label seals should be have some type of customization in the form of sequential numbering, custom graphics, colors, and printing, unique identity through the use of visual or covert techniques, customizable self voiding or self destructive characteristics if removed and the clear inability to reseal or surreptitiously remove the tape, or label seal from its surface without obvious visual evidence of tampering.

There are three types of label seals generally available:

- **Partial Transfer System** - Adhesives will be partially transferred to the applied surface. Suitable when sealing evidence is required on the applied surface for audit purpose.
- **Full Transfer System** - Adhesives will be totally transferred to the applied surface. Suitable when the applied surface is fibrous.
- **Non Transfer System** - Virtually no adhesives or residual will be transferred to the applied surface. Suitable when the seal needs to be periodically broken and subsequently resealed again.



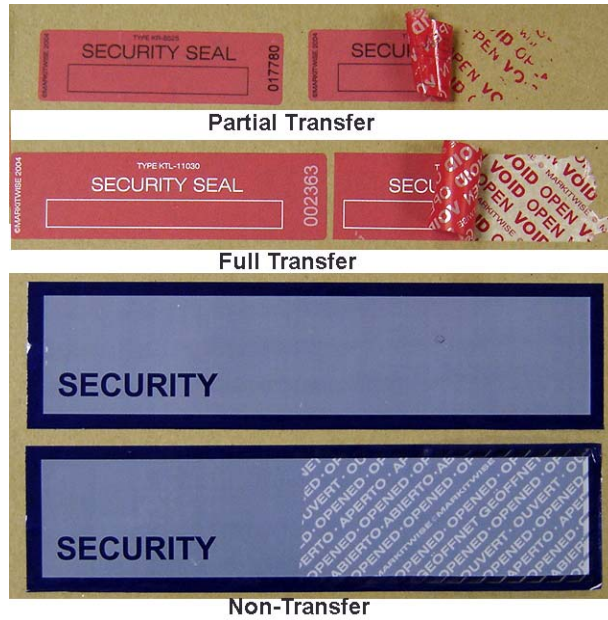

**Figure 6-1. Typical Label Seal.**

An elastic label is shown in Figures 6-2 and 6-3. This label stretches and distorts if attempts are made to remove or bypass the label. This type of label has the potential for addressing the tampering vulnerabilities found in other types of labels. This label should resist heat, cold and harsh environments.



**Figure 6-2. Elastic Label (before).**



**Figure 6-3. Elastic Label (after).**

When used on container doors, label seals should cover the area between doors by applying at least 6 inches of adhesive to each side of the door and if used on the hinge side of the doors, should be placed with 6 inches of adhesive on the door and the frame to indicate door removal.

**Barrier Seal** - Barrier seals (Figure 6-4) are designed to provide a significant barrier to container entry. A barrier seal may, for example, enclose a portion of the inner locking rods on a container. Barrier seals may be designed to be reusable.

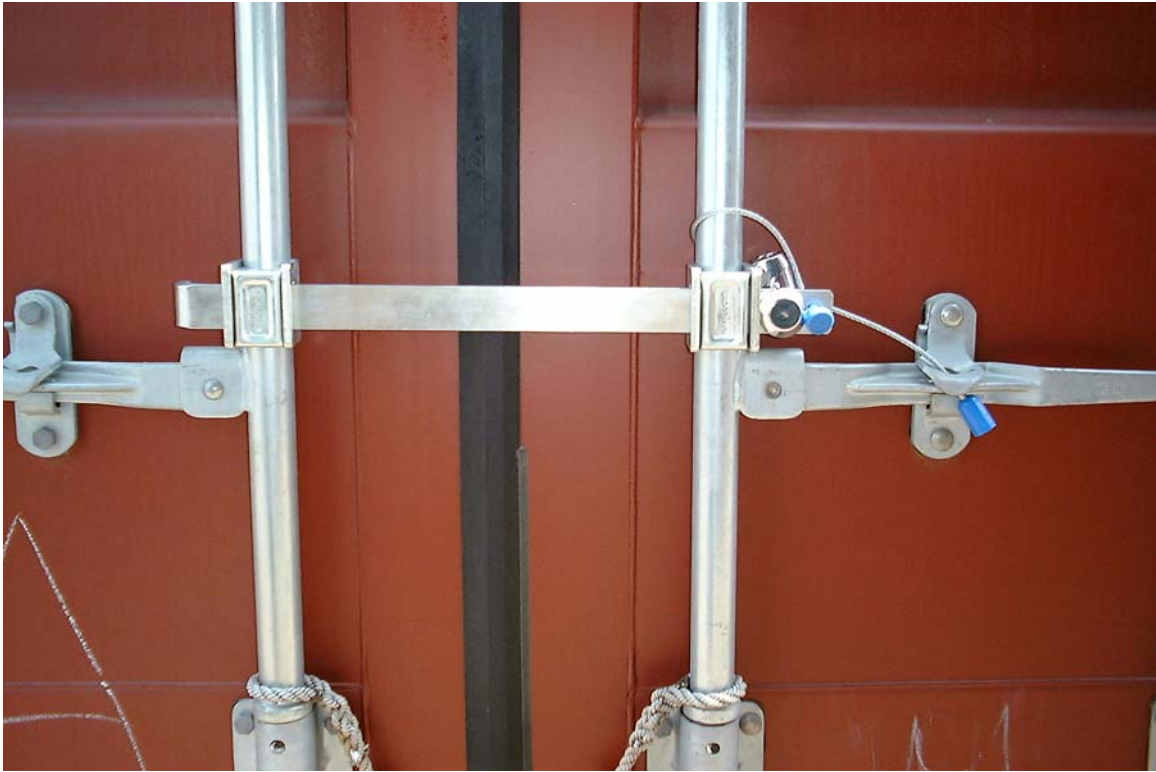

**Figure 6-4. Barrier Seal.**

**Twist Seal** - Twist seals (Figure 6-5) are made of steel rod or heavy-gauge wire of various diameters, which is inserted through the locking fixture and twisted around itself by use of a special tool.



**Figure 6-5. Twist Seal.**

## **GENERAL REQUIREMENTS FOR COMMERCIAL APPLICATION OF SEALS**

Seals used for intermodal transportation purposes should meet the requirements of Reference 2 and should be selected and controlled based on the guidelines provided in Sections 3 and 4, respectively. A program of testing seals to meet the requirements of Reference 2, and a review of the seal supply process is recommended to ensure quality and integrity of procured seals. Documentation of testing and verification of the supply process can be aided by use of a “Manufacturers Statement” as depicted in Figure 4-2 (see page 4-5).

All seals, with the exception of barrier seals, should be designed for single use only.

## **Identification marks**

Regulatory authorities and private customers may require identifiers that go beyond the requirements of Reference 2. Examples are as follows:

- Seals intended for use on freight containers moving under U.S. Customs and Border Protection (CBP) laws as instruments of international trade should be separately approved and marked as determined by CBP.
- The U.S. Coast Guard (USCG) has a container inspection program that is designed to identify containerized shipments of hazardous materials that are not in compliance with shipping regulations. As part of this safety-oriented program, USCG inspectors may open HAZMAT cargo containers that have been imported by a vessel, or are destined for export on a vessel. After inspection, the Coast Guard personnel will reseal the container with a seal that is marked either "U.S. Coast Guard", or "USCG." The seal's number will be recorded by the local USCG unit (usually located in the local port).
- If the seal is to be purchased and used by CBP, the seal or fastening, as appropriate, should be marked to show that it is a CBP seal by application of unique words or markings designated by the CBP and a unique identification number.
- If the seal is to be used by private industry (i.e. a manufacturer or carrier), it should be clearly and legibly marked with a unique identification number. It may also be marked with a company name or logo.
- A red "in-bond" Customs seal is required by Reference 12 on "conveyances or compartments in which carload lots of bonded merchandise are transported." In-bond is a Customs program for inland ports. It provides for cargo arriving at a seaport to be shipped under a Customs bond to a more conveniently located inland port where the entry documents have been filed. Customs clears the shipment there, which normally is close to the inland port.

## **Evidence of tampering**

A regular schedule should be established for the inspection of installed seals or a sample inspection if there are a large number of seals in use. A post-mortem examination should be required on at least a 10% sampling of the seals, and also on any seal that exhibits any of the following common irregularities that could show evidence of tampering:

- Missing seal
- Open seal
- Seal number discrepancy
- Improperly installed seal

- Unauthorized seal
- Uncontrolled seal
- Easy opening of the seal under hand pressure
- Presence of free play or rotation
- Frayed appearance of wire or cable
- Evidence of glue or application of heat
- Blushing or color change of the plastic coating
- Scratches or nicks adjacent to the locking mechanism
- Deformation of the locking mechanism
- Apparent rebuilding or substitution of component parts

## **MOST EFFECTIVE PRACTICES FOR CONTAINER SECURITY AND INSPECTION**

As part of a layered approach to supply chain security, container integrity should be maintained to protect against the introduction of unauthorized material, contraband, or people. At loading point, procedures should be in place to properly seal and maintain the integrity of the shipping containers. According to C-TPAT criteria, a high security seal should be affixed to all loaded containers bound for the United States. All seals should meet or exceed the requirements of Reference 2.

Procedures should be in place to verify the physical integrity of the container structure prior to loading, and off loading, including the reliability of the locking mechanism that secures the doors. A seven-point inspection process is recommended for all containers that includes all walls, floor, ceiling, undercarriage, and doors. Of particular interest is a careful inspection of the doors to determine if the container has been modified or an attempt has been made to bypass the seal by detaching or cutting the boltwork, or removing the hinges. Methods commonly used include drilling out attachment bolts, bending boltwork components, or cutting the boltwork. After the container contents have been removed (or unauthorized material inserted) the boltwork is reattached leaving little or no evidence of entry. The use of specialized, non-removable bolts or break-off bolts along with lock-tight on the threads can make this kind of attack more difficult.

Containers should be stored in a secure area to prevent unauthorized access and/or manipulation. Procedures should be in place for reporting and neutralizing unauthorized entry into containers or container storage areas.

Access control systems deter unauthorized entry to facilities, maintain control of employees and visitors, and protect company assets. Access controls should include the positive identification of all employees, visitors, and vendors at all points of entry.

Requirements for container security and inspection are described in US Coast Guard (USCG) regulations 33CFR, Navigation and Navigable Waters; Chapter I, Subchapter H-Maritime Security, Part 104, Maritime Security: Vessels; Section 104.275,

Security Measures for Handling Cargo, and Part 105, Maritime Security: Facilities; Section 105.265, Security Measures for Handling Cargo.

## **MOST EFFECTIVE PRACTICES FOR USING SECURITY SEALS**

The following pages describe recommended “most effective practices” that should be followed when employing a seal control program (see Section 4 for additional guidance).

### **General**

A well structured seal program will assist in providing for an extra layer of security and help to ensure the integrity of shipped items by providing for a specific means of detecting tampering/cargo modification from the shipping point to the final destination. A properly applied and controlled seal will help to deter terrorists or criminals from introducing materials that could be damaging to citizens, facilities, and infrastructure at the receiving point. These materials could include hazardous chemicals or weapons, biological weapons, nuclear waste or weapons, radiological weapons, explosives, drugs, and undesirable individuals.

A well managed seal program will also provide additional benefits by reducing the opportunity for theft and pilferage of shipped goods and import tax evasion. A seal program will also reduce the necessity for supervision, and help to pinpoint the time and place where seal compromise occurs.

The following was developed using information from References 1 through 12.

### **Seal Development Phase**

Seals developed by manufacturers should be manufactured and classified according Reference 2. This document establishes uniform procedures for classification of mechanical seals for containers, doors, and other items. The specification defines physical parameters for different levels of seal performance (High Security, Security, and Indicative).

Manufacturers should ensure through independent test and evaluation that seals used for the protection of shipped material provide effective tamper resistance and will show evidence of tampering if an attempt is made.

Manufacturers should develop and distribute guidance for the user to show where to use a particular seal that will best serve their security interest.

### **Seal Manufacturing**

Seal manufacturers should:

- Maintain all Government certifications.

- Agree to random and unannounced inspections.
- Conduct periodic internal risk assessment of all facilities.
- Establish a program to implement countermeasures to mitigate vulnerabilities revealed by the risk assessments.
- Assign responsibility for security and product integrity to a specific individual (in writing).
- Develop a written plan for responding to tampering, criminal, or terrorist actions.
- Promote security awareness.
- Perform company background checks on individuals responsible for the design, handling, control, and shipping of seals.

### **Seal Product Certification and Control**

All seals used should be tested by a certified 3<sup>rd</sup> party testing facility/laboratory to ensure conformance with Reference 2. The testing laboratory should be certified according to the standards outlined in the ISO/IEC 17025, “General Requirements for the Competence of Testing and Calibration Laboratories,” issued by the ISO.

Seal manufacturers should also:

- Mark seals with the company name or logo.
- Produce seals with unique numbers and identifiers.
- Track seal numbers and identifiers of all seals produced (by seal type, number and identifier, date of finished production, date of order, date seals were shipped, and names of importer(s)).
- Retain tracking information for a period of at least seven (7) years.
- Restrict the distribution of custom-designed seal application and/or removal tools.
- Destroy unused or scrap seal products.
- Control access to production and storage areas and loading docks and stores seals in secure areas.
- Lock and seal all outdoor loaded trailers or containers.
- Verify driver identification and the load and count of inbound seal components.
- Implement a policy for off-hour deliveries to ensure prior notice is received.

### **Distribution and Reselling**

Seal distributors or resellers can have a substantial affect on the integrity and control of seals. Seal distributors or resellers should be aware of the manufacturer’s seal security requirements and have established policy and guidance in place to ensure:

- Security procedures are periodically (at least annually) reviewed by the manufacturer.
- Implementation of security improvements recommended by the manufacturer to ensure oversight and accountability of seals.
- Seals are not sold without the manufacturer’s identity marked on the seal.

- Records accurately reflect all aspects of a seal shipment, including source, seal numbers and identifiers, description and the name and address of the individual placing the order and the importer for the order.
- Retention of all records for a period of at least seven (7) years.
- Records are made available to Government agencies upon request, to assist in the investigation of a cargo shipment incident.
- Distributions of custom-designed seal application and/or removal tools are restricted to facilities authorized by the *bona fide* user.
- An initial security risk assessment of facilities is conducted and countermeasures and/or policies implemented to overcome potential vulnerabilities or threats.
- Access to storage areas and loading docks is controlled, and seals are stored in secure areas.
- All loaded trailers or containers on the premises are securely locked and sealed.
- Driver identification, load, and count of inbound seal components are verified where applicable.
- Policy requiring prior notice is in place for off-hour deliveries and authorized personnel are available to accept delivery.

## **User Knowledge and Discipline**

By supplying educational material and training, manufacturers can help educate users in the:

- Proper control of seals (also see Section 4 – Seal Control)
- Record-keeping (also see Section 4 – Seal Control)
- Effective use of seals (also see Section 3 – Seal Selection and Applications)
- Conformance requirements for applicable standards and regulations.

## **Chain of custody**

### **1. Responsibility for seal custody**

Chain of custody of the seal from the installation point to the receiving point will ensure the contents of the container or integrity of other items have not been modified, stolen, or damaged.

Security seals are an integral part of the chain of custody. Security seals should be inspected by the receiving party at each change of custody for a cargo-laden container (see “Evidence of Tampering” discussed above). If the seal is missing, or shows signs of tampering, or shows a different identification number than the cargo documentation, a number of actions are necessary as follows:

- The receiving party should bring the discrepancy to the attention of the party tendering the container and the cargo supplier.
- The receiving party should note the discrepancy on the cargo documentation.
- International cargo, which includes in-bond movements, remains under the jurisdictional purview of the U.S. Customs and Border Protection (CBP). Any evidence of tampering, seal anomalies, or any other security concerns involving



international cargo will be brought to the attention of the closest CBP Office for appropriate action. For cargo not associated with an international/in-bond movement, the discovery of a seal discrepancy should be reported in accordance with company policy/procedures.

- Where no such notification requirements exist, the receiving party should refuse custody of the container pending communication with the party tendering the container and until such discrepancies can be resolved.

Once discrepancies have been resolved, the receiving party should install a new security seal on the container and note the new seal number on all shipping documentation.

Written procedures should stipulate how seals are to be controlled and affixed to loaded containers. Procedures should be in place for recognizing and reporting compromised seals and/or containers. Only authorized personnel should distribute container seals.

## **2. Cargo supplier responsibilities**

The cargo supplier should be responsible for the sealed container/trailer until such a time as the carrier assumes control.

Seals are to be affixed at the cargo supplier point of origin (loading). Seals will be of the high security type as per ISO specification (ISO 17712, Freight Containers-Mechanical Seals), adopted May 2003.

Establish verifiable security procedures for cargo storage and handling facilities and container yards in order to prevent the improper manipulation and transportation or handling of cargo and/or containers/trailers.

Ensure a system is in place to verify seal numbers, weights, and quantity of cargo received, when practical.

Safeguard the use of seals and maintain a log of seal numbers issued and used.

Ensure that all manifests and/or bills of lading or other documentation (including electronic data transmissions) submitted for cargo to be shipped are complete and includes all pertinent seal information.

## **3. Cargo supplier seal integrity responsibilities**

Seals are to be affixed by a responsible, designated representative of the manufacturing entity. (**NOTE:** A responsible, designated representative is defined as an employee who maintains a position of trust (i.e. security personnel) within the business and has received appropriate instruction and training in the proper use and application of high security seals).

Access to seals will be strictly controlled by the responsible party and seals should be issued at random in order to avoid seals being affixed in sequential order.

Seals should be stored in a secure location (locked cabinet, safe, etc.) until such a time as their use is warranted.

Access to such secure locations should be restricted to those parties responsible for the inventory and affixing of seals.

A log should be maintained in order to account for all seals under the control of the cargo supplier/importer. **NOTE:** A standardized log is currently under development. In the interim, any entity responsible for the sealing of cargo should use and maintain an accounting system of its own design or use the examples of logs depicted in Section 4.

#### **4. Seal custody requirements at the loading site**

The cargo supplier is responsible for loading a container, ensuring unauthorized cargo is not introduced into the container, and for the accurate and complete description of the cargo. The cargo supplier is also responsible for installing a security seal immediately after loading is completed and preparing the necessary documentation for the shipment. Shipping documentation should include the seal number.

The cargo security seal should comply with the requirements of Reference 2 and be installed on the container in a manner that restricts covert tampering of the seal. Among the acceptable ways to do this are to install seals at locations that prevent the outer door locking cam from swiveling or the use of cable seals across the door locking bars.

#### **5. Carrier responsibilities**

Upon receipt of container/trailer, ensure that all seal information is true and correct as reflected on manifests, bills of lading, or other documentation related to the movement of cargo.

Establish verifiable security procedures for cargo storage and handling facilities, container yards, and conveyances operated by the carrier to prevent the improper manipulation and transportation of cargo and/or containers/trailers.

Establish procedures for reporting any discrepancies or anomalies related to seal integrity.

#### **6. Carrier seal integrity responsibilities**

Seals will be of the high security type as per ISO specification (ISO/PSA 17712, Freight Containers-Mechanical Seals), adopted May 2003.

All seals that are removed from a cargo container/trailer for legitimate intermediate examinations (CBP inspection and USCG HAZMAT container inspection, conveyance damage surveys, law enforcement activity, etc.) should be placed in the container just inside the doors, in plain view, before a new seal is affixed to the container.

Establish a procedure for annotating and reporting any changes due to legitimate intermediate examination purposes as described above.

Seals are to be affixed by a responsible, designated representative of the carrier.

**NOTE:** A responsible, designated representative is defined as an employee who maintains a position of trust (i.e., security personnel) within the business and has received appropriate instruction and training in the proper use, inspection, and application of high security seals.

Access to seals will be strictly controlled by the responsible party and should be issued at random in order to avoid seals being affixed in sequential order.

Seals should be stored in a secure location (locked cabinet, safe, etc.) until such a time as their use is warranted.

Access to such secure locations should be restricted to those parties responsible for the control of seals (designated seal control officer).

A log should be maintained in order to account for all seals under the control of the carrier. **NOTE:** A standardized log is currently under development. In the interim, any entity responsible for the sealing of cargo should use and maintain an accounting system of their own design.

Establish a system to ensure verification of seal numbers and types and that all pertinent seal information is reflected on all manifests, bills of lading or other documentation (including electronic data transmissions) related to the movement of cargo.

## **7. Seal custody requirements for the land transport operator**

The land transport operator receives the documentation from the cargo supplier, inspects the seal, and notes the condition on the documentation before leaving the cargo supplier location. If the container goes to an intermediate terminal, the land transport operator transfers custody of the container to the terminal operator.

## **8. Seal custody requirements at the intermediate terminal**

The terminal operator receives the documentation from the transport operator, inspects the seal, and notes the condition on the documentation. The terminal operator usually sends an electronic notification of receipt (status report) to the cargo supplier and importer. The terminal operator prepares the container for movement by road, rail, or

barge. Similar verification and documentation processes usually take place upon pickup or departure of the container from the intermediate terminal.

### **9. Seal custody requirements at ocean terminals**

Upon arrival at an ocean terminal, the land transport operator transfers custody of the container to the ocean terminal operator. The ocean terminal operator receives the documentation and normally sends an electronic notification of receipt (status report) to the cargo supplier and importer. The ocean terminal operator prepares or stages the container for loading upon the ship.

Before loading the container on the ship, the ocean terminal operator should inspect the condition of the seal, and note it accordingly on the shipping documentation. Public agencies in the exporting nation are responsible for reviewing export documentation, assuming necessary export control, and providing safety certifications. Before a container is loaded on the ship, CBP is notified of the shipment and either approves the container for loading (explicitly or tacitly) or issues a “do not load” message for containers that cannot be loaded pending further screening.

The ocean carrier should require documentation that the cargo supplier has complied with the relevant requirements before loading the cargo for export. The ocean carrier should file all manifest information with CBP prior to shipment.

### **10. Seal custody requirements at transshipment terminals**

The transshipment terminal operator should inspect the security seal between the off-loading and re-loading operations. This requirement may be waived for transshipment terminals which have security plans that conform to the International Ship and Port Facility Security Code (ISPS Code produced by the International Maritime Organization).

### **11. Seal custody requirements at off-loading ocean terminals**

The importer usually arranges for a Customhouse broker to assist in clearing the shipment through CBP at the off-loading ocean terminal. Generally, this requires that the cargo supplier provide documentation to the broker in advance of arrival. The ocean carrier provides advance electronic cargo manifest information to the terminal operator and to CBP. CBP may select containers for different levels of inspection immediately upon off-loading or later. CBP may inspect the condition of the seal and related documentation in addition to the cargo itself. If the container is required to travel under CBP control to another location for clearance, then the CBP at the off-loading terminal should affix a CBP seal to the container and note it on the shipping documentation accordingly.

The importer or CBP broker pays any duties and taxes due to CBP and arranges the CBP release of the shipment. Upon pickup for departure from the ocean terminal, the

land transport operator inspects and notes the condition of the seal, and receives documentation from the ocean terminal operator.

## **12. Importer responsibilities**

Ensure that all related parties are aware of security guidelines and procedures as they relate to the use of seals and seal integrity.

Establish a process to ensure all related parties/business partners adhere to established security guidelines and procedures relating to the use of seals and seal integrity.

Establish procedures for reporting any seal discrepancies or anomalies.

## **13. Seal custody requirements at unloading sites**

Upon receipt of the container, the importer or importer agent inspects the seal and notes any discrepancy on the documentation. The importer unloads the container and verifies the count and condition of the lading against the documentation. If there is a shortage, damage, or an overage discrepancy, it is noted for claims or insurance purposes, and the shipment and its documentation are subject to audit and review.

NOTE: Any evidence of tampering, seal anomalies, or any other security concerns involving international cargo, which includes in-bond movements, will be brought to the attention of the closest CBP Office for appropriate action. For cargo not associated with an international/in-bond movement, the discovery of a seal discrepancy should be reported in accordance with company policy/procedures.

## **14. Post-shipment chain-of-custody**

Most of the post-shipment uses of a seal relates to maintaining chain-of-custody information about the shipment of goods.

The practices and procedures described above contribute to the overall security of the global supply chain and can be incorporated into company programs which address supply chain security. Further guidance on supply chain security in general can be found in References 14 and 15 and in the Customs-Trade Partnership against Terrorism (C-TPAT) found at [www.cbp.gov](http://www.cbp.gov).



## SECTION 7 - REFERENCES

1. Federal Specification FF-S-2738A: “Seals, Antipilferage.”
2. Amendment 1 on “Mechanical Seal Design, Test and Strength Parameters” to ISO 17712 “Freight Containers” prepared by Technical Committee ISO/TC 104.
3. American Society for Testing and Materials, ASTM F1157 ('04): “Standard Practice for Classifying the Relative Performance of the Physical Properties of Security Seals.”
4. American Society for Testing and Materials, ASTM Standard F832-90 ('01): “Standard Classification for Security Seals.”
5. American Society for Testing and Materials, ASTM F1158 ('01): “Standard Guide for Evaluation of Tampering of Security Seals.”
6. American Society for Testing and Materials, ASTM F946 ('04): “Guide for establishing security seal control and accountability.”
7. Federal Specification QQ-S-781, “Strapping Steel and Seals”.
8. MIL-STD-1189A (B) – “Standard Department of Defense Bar Code Symbology.”
9. DoD 4500.9-R, “Defense Transportation Regulation, Part II, Cargo Movement,” November 2004.
10. DoD 5100.76 M, “Physical Security of Arms, Ammunition, and Explosives,” June 13, 2003 (draft).
11. World Customs Organization “Framework of Standards to Facilitate Global Trade – Version 2.0, ANNEX 1 Standard 1- Integrated Supply Chain Management, para 1.2.4 Sealing and Appendix to ANNEX 1; Seal Integrity Programme for Secure Container Shipments;” June 2005.
12. Code of Federal Regulations, Title 19—“Customs Duties,” Chapter I -“United States Customs Service, Department of The Treasury,” Part 18- “Transportation in Bond and Merchandise in Transit,” Sec. 18.4 – “Sealing Conveyances And Compartments; Labeling Packages; Warning Cards.”
13. Customs and Border Protection, “Supply Chain Security Best Practices Catalog,” C-TPAT Document.
14. ISO/PAS 28000 “Specifications for Security Management Systems for the Supply Chain.”
15. ISO/PAS 28001 “Implementing Supply Chain Security Management, Assessment and Plans-Requirements, and Guidance.”





## APPENDIX A – SEAL GLOSSARY (Terms used in the Seal User’s Guide)

<b>Anomaly</b>	Change in the seal appearance that would not normally be expected.
<b>Attack</b>	An attempt to gain access to merchandise being protected by a seal.
<b>Compromise</b>	Any action where a seal can be opened and re-closed, using the original parts, with commercially available hand tools, or very simple instruments (shims, wire, etc.).
<b>CBP</b>	Customs and Border Protection
<b>Container</b>	Vessel or object used for holding, carrying, or shipping material, an enclosure, or an enclosed area.
<b>Control</b>	Verification and regulation of the use of seals.
<b>Covert Attack</b>	Removing a seal and replacing it with a counterfeit seal or to changing the seal control records to conceal that the seal was replaced.
<b>Defeat</b>	A successful attack on a seal, undetected by trained personnel.
<b>Fingerprinting</b>	Unique marks inside or outside a seal.
<b>In-Bond</b>	A CBP program that allows the movement of imported merchandise from a gateway airport, seaport, pipeline, or and border crossing to destination U.S. port where it is entered for consumption or admitted to a bonded warehouse or foreign trade zone.
<b>Locks</b>	A mechanical fastening device which may be used on a door, vehicle, or container. Commonly, it can be released by using a key or combination.
<b>Post-Mortem Examination</b>	A careful examination of a seal after removal to determine if there are any anomalies.
<b>Seal</b>	A security seal is a manufactured product that is used to indicate tampering or unauthorized opening of a container, door, or item. Mechanical security

seals, label seals, and tapes are usually designed for one-time use.

**Seal Control Program**

A set of procedures that will control the storage, issue, installation, removal, and disposal of seals.

**Security Seal**

A device or material that indicates tampering or entry into a secured area. Also termed seal, tamper indication device (TID), antipilferage seal.

**Surreptitious Attack**

Opening and reattaching a seal without leaving any detectable evidence of entry. This is similar to picking and bypassing of a lock.

**Tags**

Device or material used to identify, classify, or label.

**Tamper**

A failed attempt to compromise a seal.

**Unauthorized Seal**

A seal that has not been approved for use under the seal control program. A counterfeit seal substituted for an authorized seal.

**Uncontrolled Seal**

A seal that is not listed and documented in the seal control program.

**Verification**

Assuring a seal is properly installed and identifying markings (logo or serial number) match seal control records. Verification of seal integrity will help to confirm the contents of a container have not been disturbed or modified.

## Appendix B - SEAL MANUFACTURERS

**NOTE:** This is not a complete list of manufacturers and the list should not be considered a recommendation or an endorsement of any product or company. Before purchasing a seal from any manufacturer, a “Certificate of Compliance” and test data from a certified test laboratory should be requested to ensure the seal has been tested to meet the requirements of Reference 1 or 2 (see Figure 4-2).

### MANUFACTURERS:

#### **Acme Seals Limited**

22D Waterside Business Park

Eastways

Witham

Essex

UK

CM8 3YQ

Phone: +44 1376 521841

Fax: +44 1376 521617

<http://www.acmeseals.com>

#### **Acme Seals (Malaysia) Sdn Bhd**

No 37 Jalan Layang-Layang 4

Bandar Puchong Jaya

Puchong

47100 Selangor D.E.

Phone: +603 5882 8244/8744/9344

Fax: +603 5882 8344

<http://www.acmeseals.com>

#### **Andfel Corp.**

P.O. Box 6688

Bloomington, IN 47407-6688

**Phone:** 812-825-6840, 800-622-7525 (toll free)

**Fax:** 800-761-1296

<http://www.andfel.com>

#### **American Casting & Mfg. Corp.**

51 Commercial St.

Plainview, NY 11803

**Phone:** 516-349-7010, 800-342-0333 (toll free)

**Fax:** 516-349-8389

<http://www.americancasting.com>

**Alpha Cargo Technology, LLC**  
10421 Shelter Cove  
Minneapolis, MN 55347 USA  
**Phone:** 952-942-7618  
**Fax:** 952-942-9002  
**E-mail:**[information@actseals.com](mailto:information@actseals.com)  
<http://www.actseals.com>

**American Seal Co.**  
9230 W. Grand Ave.  
Franklin Park, IL 60131  
**Phone:** 847-455-8050  
**Fax:** 847-455-4319

**Brooks, E. J. Co.**  
8 Microlab Rd.  
Livingston, NJ 07039  
**Phone:** 973-483-0335, 800-458-SEAL (toll free)  
**Fax:** 973-597-2919  
<http://www.brooksseals.com>

**Canada Mayer Sealing Devices Reg'd.**  
2180 Michelin St.  
Laval, QC H7L5C3  
**Phone:** 514-745-4102, 800-567-5382 (toll free)  
**Fax:** 450-686-8568  
<http://www.canadamayer.com>

**Consolidated Graphic Materials**  
223 Churchill Ave.  
Somerset, NJ 08873  
**Phone:** 732-448-1400, 800-899-2246 (toll free)  
**Fax:** 732-448-1406

**Dickey Manufacturing Co.**  
1315 E. Main St.  
St. Charles, IL 60174  
**Phone:** 630-584-2918  
**Fax:** 630-584-0261  
<http://www.securityseals.com>

**ELC Security Products Inc.**  
8252 NW 30th Terrace  
Miami, FL 33122  
**Phone:** 305-477-2303, 800-377-3257 (toll free)  
**Fax:** 305-477-0186  
<http://www.elcsecurity.com>

**Evans & Convery, Inc.**

134 Tyson Ave.  
Glenside, PA 19038  
**Phone:** 215-576-1717  
**Fax:** 215-576-1719

**Kuehn**

2208 S. 38th St.  
Milwaukee, WI 53215-0535  
**Phone:** 414-672-3000  
**Fax:** 414-672-3009  
<http://www.kuehncorp.com>

**Mega Fortris Marketing, Inc.**

197 Route 8 South, Suite 3000  
East Brunswick, NJ 08816  
**Phone:** 732-230-3015, 866-MFSEALS (toll free)  
**Fax:** 732-909-2301  
<http://www.megafortris.com>

**Porter Safety Seal Co.**

9230 W. Grand Ave.  
Franklin Park, IL 60131  
**Phone:** 847-455-8050  
**Fax:** 847-455-4319

**Sealect Security Seals, A Spirent Co.**

7930 N. Faulkner Rd., P.O. Drawer 245017  
Milwaukee, WI 53223  
**Phone:** 414-355-1130, 800-822-4352 (toll free)  
**Fax:** 414-355-7341  
<http://www.sealectseals.com>

**Sekuworks**

9487 Dry Fork Road  
Harrison, OH 45030  
**Phone:** 1-513-202-1210  
**Fax:** 1-513-202-1215  
[www.sekuworks.com](http://www.sekuworks.com)

**Stoffel Seals Corp.**

400 High Ave.  
Nyack, NY 10960  
**Phone:** 800-422-8247, 800-345-3503 (toll free)  
**Fax:** 800-551-8545  
<http://www.stoffel.com>

**T & T Graphics, Inc.**

2563 Technical Dr.

Dayton, OH 45342

**Phone:** 937-847-6000, 800-557-9914 (toll free)

**Fax:** 937-847-6014

<http://www.ttgraphicsinc.com>

**Tyden Brammall, Inc.**

409 Hoosier Dr.

Angola, IN 46703

**Phone:** 260-665-8609, 800-348-4777 (toll free)

**Fax:** 260-665-8309

<http://www.tydenbrammall.com>

**United Seal Co.**

2000 Fairwood Ave.

Columbus, OH 43207-1607

**Phone:** 614-443-7633

**Fax:** 614-443-4875

<http://www.usealco.com>