



U.S. Department
of Transportation
Federal Railroad
Administration

Passenger Train Grade Crossing Impact Tests: Test Procedures, Instrumentation and Data

Office of Research and
Development
Washington, D.C. 20590

DOT/FRA/ORD-03/18

October 2003
Final Report

This document is available to the
U.S. public through the National
Technical Information Service
Springfield, Virginia 22161

Disclaimer: This document is disseminated under the sponsorship of the Department of Transportation in the interest of information exchange. The United States Government assumes no liability for the contents or use thereof. The United States Government does not endorse products or manufacturers. Trade or manufacturer's names appear herein solely because they are considered essential to the object of the report.

REPORT DOCUMENTATION PAGE			<i>Form approved</i> OMB No. 0704-0188
Public reporting burden for this collection of information is estimated to average 1 hour per response, including the time for reviewing instructions, searching existing data sources, gathering and maintaining the data needed, and completing and reviewing the collection of information. Send comments regarding this burden estimate or any other aspect of this collection of information, including suggestions for reducing this burden to Washington Headquarters Services, Directorate for Information Operations and Reports, 1215 Jefferson Davis Highway, Suite 1204, Arlington, VA 22202-4302, and to the Office of Management and Budget, Paperwork Reduction Project (0702-0288), Washington, D.C. 20503			
1. AGENCY USE ONLY (Leave blank)	2. REPORT DATE October 2003	3. REPORT TYPE AND DATES COVERED Test Report — June 4 and 7, 2002	
4. TITLE AND SUBTITLE Passenger Train Grade Crossing Impact Tests: Test Procedures, Instrumentation, and Data		5. FUNDING NUMBERS DTFR53-93-C-00001 Task Order No. 125 Modification No. 05	
6. AUTHOR(S) Barrie Brickle and Russell Walker		8. PERFORMING ORGANIZATION REPORT NUMBERS	
7. PERFORMING ORGANIZATION NAME(S) AND ADDRESS(ES) Transportation Technology Center, Inc. P.O. Box 11130 Pueblo, CO 81001			
9. SPONSORING/MONITORING AGENCY NAME(S) AND ADDRESS(ES) U.S. Department of Transportation Federal Railroad Administration Office of Research and Development 1120 Vermont Avenue, NW Washington, DC 20590		10. SPONSORING/MONITORING AGENCY REPORT NUMBER FRA/ORD – 03/18.II	
11. SUPPLEMENTARY NOTES			
12a. DISTRIBUTION/AVAILABILITY STATEMENT This document is available through National Technical Information Service, Springfield, VA 22161		12b. DISTRIBUTION CODE	
13. ABSTRACT Two full-scale impact tests performed June 4 and June 7, 2002, involved single Budd Company Pioneer-type cab car impacts into a heavy steel coil on a frangible support. For the first test on June 4, a cab car was fitted with a 1990's design front end, and for the second test on June 7, with a state-of-the-art front end. For the 1990's design front end, there was a large amount of damage to the corner post, which pulled out of the anti-telescoping plate at the top and sheared away from the buffer beam at the bottom. For the state-of-the-art design front end, the corner post was left permanently deformed with a maximum deformation of 8.25 inches.			
14. SUBJECT TERMS Impact test Passenger rail car Grade crossing impact			15. NUMBER OF PAGES 312
			16. PRICE CODE
17. SECURITY CLASSIFICATION UNCLASSIFIED	18. SECURITY CLASSIFICATION OF THIS PAGE UNCLASSIFIED	19. SECURITY CLASSIFICATION OF ABSTRACT UNCLASSIFIED	20. LIMITATION OF ABSTRACT SAR

METRIC CONVERSION FACTORS

Approximate Conversions to Metric Measures

Symbol	When You Know	Multiply by	To Find	Symbol
LENGTH				
in	inches	*2.54	centimeters	cm
ft	feet	30.00	centimeters	cm
yd	yards	0.90	meters	m
mi	miles	1.60	kilometers	km
AREA				
in ²	square inches	6.50	square centimeters	cm ²
ft ²	square feet	0.09	square meters	m ²
yd ²	square yards	0.80	square meters	m ²
mi ²	square miles	2.60	square kilometers	km ²
	acres	0.40	hectares	ha
MASS (weight)				
oz	ounces	28.00	grams	g
lb	pounds	0.45	kilograms	kg
	short tons (2000 lb)	0.90	tonnes	t
VOLUME				
tsp	teaspoons	5.00	milliliters	ml
Tbsp	tablespoons	15.00	milliliters	ml
fl oz	fluid ounces	30.00	milliliters	ml
c	cups	0.24	liters	l
pt	pints	0.47	liters	l
qt	quarts	0.95	liters	l
gal	gallons	3.80	liters	l
ft ³	cubic feet	0.03	cubic meters	m ³
yd ³	cubic yards	0.76	cubic meters	m ³
TEMPERATURE (exact)				
°F	Fahrenheit temperature	5/9 (after subtracting 32)	Celsius temperature	°C

Approximate Conversions from Metric Measures

Symbol	When You Know	Multiply by	To Find	Symbol
LENGTH				
mm	millimeters	0.04	inches	in
cm	centimeters	0.40	inches	in
m	meters	3.30	feet	ft
m	meters	1.10	yards	yd
km	kilometers	0.60	miles	mi
AREA				
cm ²	square centim.	0.16	square inches	in ²
m ²	square meters	1.20	square yards	yd ²
km ²	square kilom.	0.40	square miles	mi ²
ha	hectares (10,000 m ²)	2.50	acres	
MASS (weight)				
g	grams	0.035	ounces	oz
kg	kilograms	2.2	pounds	lb
t	tonnes (1000 kg)	1.1	short tons	
VOLUME				
ml	milliliters	0.03	fluid ounces	fl oz
l	liters	2.10	pints	pt
l	liters	1.06	quarts	qt
l	liters	0.26	gallons	gal
m ³	cubic meters	36.00	cubic feet	ft ³
m ³	cubic meters	1.30	cubic yards	yd ³
TEMPERATURE (exact)				
°C	Celsius temperature	9/5 (then add 32)	Fahrenheit temperature	°F

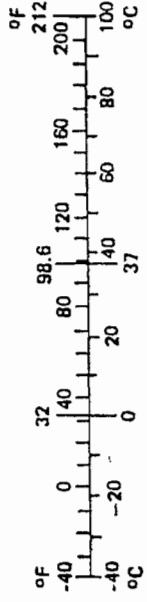
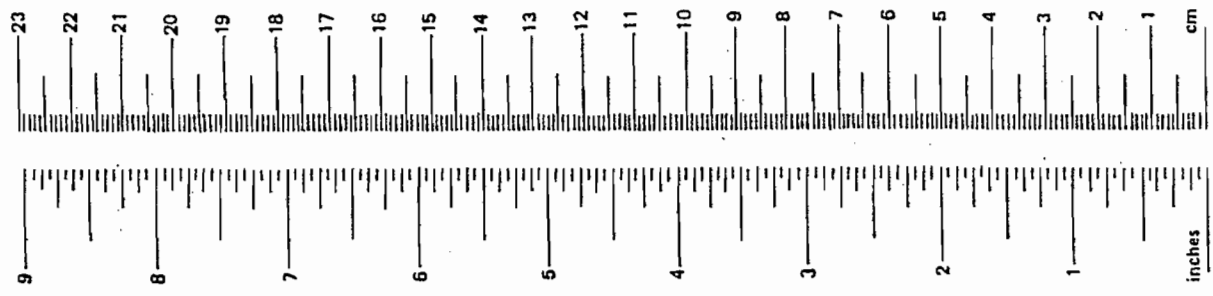

* 1 in. = 2.54 cm (exactly)

Acknowledgements

This work was performed as part of the Equipment Safety Research Program sponsored by the Office of Research and Development of the Federal Railroad Administration. Tom Tsai, Program Manager, and Claire Orth, Division Chief, Equipment and Operating Practices Division, Office of Research and Development, Federal Railroad Administration, supported this effort. Gunars Spons, Federal Railroad Administration Engineering Manager at the Transportation Technology Center, directed and coordinated the activities of all the parties involved in the test. Barrie Brickle, Scientist, Transportation Technology Center, Inc., implemented the equipment related portions of the test. David Tyrell, Program Manager, Volpe National Transportation Systems Center, coordinated technical requirements with the support of the American Public Transportation Association (APTA).

Southeastern Pennsylvania Transit Authority (SEPTA) donated the cab cars used in the tests.

Arthur D. Little designed the end-frames attached to the front end of the cab cars.

EXECUTIVE SUMMARY

Two full-scale impact tests were performed June 4 and June 7, 2002, at the Federal Railroad Administration's (FRA) Transportation Technology Center (TTC), Pueblo, Colorado, by Transportation Technology Center, Inc. (TTCI), a subsidiary of the Association of American Railroads (AAR). Both tests involved single Budd Company Pioneer-type cab cars impacting into a heavy steel coil on a frangible support. For the first test on June 4, the cab car was fitted with a 1990's design front end, and for the second test on June 7, the cab car was fitted with a state-of-the-art (SOA) front end.

The main results of each test are:

1990's Design Cab car

- The speed of impact, as measured by the laser speed trap, was 14.35 mph.
- There was a large amount of damage to the corner post, which pulled out of the anti-telescoping plate at the top and sheared away from the buffer beam at the bottom. The corner post buckled and ended up at a point 14 inches off the floor level with the top of the post 56 inches off the floor and leaning back against the back of the door-post.
- The maximum longitudinal acceleration recorded on the buffer beam of the cab car was 322 g. When filtered using a low-pass filter, with a corner frequency of 100 Hz ($F_c = 100$ Hz), the peak acceleration was reduced to 101 g.
- The maximum longitudinal acceleration recorded on the center sill of the cab car was 20 g. When filtered to $F_c = 100$ Hz, the peak acceleration was reduced to 7 g.
- The maximum longitudinal, lateral, and vertical accelerations recorded in the center of the stationary coil were 5 g, 4 g and 2 g, respectively. When filtered to $F_c = 100$ Hz the peaks were reduced to 3 g, 1 g, and 1 g, respectively.

SOA Design Cab car

- The speed of impact, as measured by the laser speed trap, was 14.00 mph
- The maximum permanent deformation of the corner post was 8.25 inches, which occurred just below the mid-section of the post.
- The maximum longitudinal acceleration recorded on the buffer beam of the cab car was 200 g. When filtered to $F_c = 100$ Hz, the peak acceleration was reduced to 41 g.
- The maximum longitudinal acceleration recorded on the center sill of the cab car was 26 g. When filtered to $F_c = 100$ Hz, the peak acceleration was reduced to 9 g.
- The maximum longitudinal, lateral, and vertical accelerations recorded in the center of the stationary coil were 9 g, 18 g and 6 g, respectively. When filtered to $F_c = 100$ Hz the peaks were reduced to 7 g, 7 g, and 1 g, respectively.

Table of Contents

1.0	INTRODUCTION AND OBJECTIVES	1
2.0	DESCRIPTION OF TEST VEHICLES	1
3.0	TEST METHODOLOGY.....	4
4.0	RESULTS.....	4
4.1	Quasi-Static Load Tests	4
4.2	Items Measured Before The Test.....	6
4.2.1	1990's Design Cab Car	6
4.2.2	SOA Design Cab Car	7
4.2.3	Weights.....	8
4.2.4	Weather Conditions.....	8
4.3	Items Measured During The Test.....	8
4.3.1	Speed	8
4.3.2	Vehicle Accelerations	9
4.3.3	Vehicle Displacements	10
4.3.4	Vehicle Strains	10
4.3.5	Vehicle Velocity, Displacement, and Force.....	11
4.3.6	Measurements in Coil.....	11
4.3.7	High Speed and Video Photography	12
4.4	Items Measured After The Test.....	13
4.4.1	1990's Design Cab Car	13
4.4.2	SOA Design Cab Car	14
5.0	CONCLUSIONS.....	16
5.1	1990's Design Cab Car	16
5.2	SOA Design Cab Car	17
Appendix A:	Test Implementation Plan	A-1
Appendix B:	Quasi-Static Load Test for 1990's Design Passenger Car	B-1
Appendix C:	Quasi-Static Load Test for SOA Design Passenger Car	C-1
Appendix D:	Acceleration Data, Test 4, CFC=1000Hz.....	D-1
Appendix E:	Acceleration Data, Test 4, Fc=100Hz	E-1
Appendix F:	Acceleration Data, Test 4, Fc=25Hz	F-1
Appendix G:	Displacement Data, Test 4.....	G-1
Appendix H:	Strain Data, Test 4	H-1
Appendix I:	Synthetic Channels, Test 4	I-1
Appendix J:	Acceleration Data, Test 5, CFC=1000Hz.....	J-1
Appendix K:	Acceleration Data, Test 5, Fc=100Hz	K-1
Appendix L:	Acceleration Data, Test 5, Fc=25Hz	L-1
Appendix M:	Displacement Data, Test 5.....	M-1
Appendix N:	Strain Data, Test 5	N-1
Appendix O:	Synthetic Channels, Test 5	O-1

List of Figures

Figure 1	1990's Cab Car Before Impact.....	2
Figure 2	SOA Cab Car Before Impact.....	2
Figure 3	Steel Coil on Frangible Support	3
Figure 4	Collision Post Longitudinal Load Test, 1990's Design Cab Car	4
Figure 5	Corner Post Lateral Load Test, 1990's Design Cab Car	5
Figure 6	1990's Cab Car Door Dimensions	6
Figure 7	SOA Cab Car Door Dimensions	7
Figure 8	1990's Design Cab Car After Impact With Steel Coil.....	13
Figure 9	Deformation of Corner Post After Impact with Steel Coil.....	14
Figure 10	SOA Design Cab Car After Impact With Steel Coil.....	14
Figure 11	Deformation of Corner Post After Impact with Steel Coil.....	15

List of Tables

Table 1	Summary of Quasi-Static Load Cases.....	5
Table 2	Peak Acceleration at Selected Car Body Locations	9
Table 3	Peak Collision Post Displacements	10
Table 4	Peak Strains on Various Components for each Test.....	11
Table 5	Peak Acceleration at the Center of the Steel Coil.....	12

This page left blank intentionally

1.0 INTRODUCTION AND OBJECTIVES

Transportation Technology Center, Inc. (TTCI) performed two full-scale impact tests on June 4 and June 7, 2002. Both tests involved Budd Company Pioneer-type cab cars impacting into a heavy steel coil on a frangible support. For the first test on June 4, the cab car was fitted with a 1990's design front end, and for the second test on June 7, a similar cab car was fitted with state-of-the-art (SOA) design front-end. The speed of impact for the first test was 14.35 mph, and the speed of impact for the second test was 14.00 mph.

The 1990's design front end was designed to pre-1999 industry practice, which includes the provision of a step-well in the cab. The SOA design was designed to current Federal Railroad Administration (FRA) regulations and American Public Transportation Association (APTA) standards, which has a continuous side sill and front facing sheets. The purpose of each test was to measure the:

- performance of the structural elements,
- gross motions of the cab car,
- gross motions of the steel coil,
- cab car/steel coil interaction,
- load paths, and
- structural response of the cab car.

The measurements will be used to validate computer models of the end structures.

2.0 DESCRIPTION OF TEST VEHICLES

Tests were conducted using Budd Company Pioneer-type cab cars provided by the Southeastern Pennsylvania Transportation Authority (SEPTA).

Each cab car was fitted with an end-frame designed by Arthur D. Little, Inc. For the first test, the cab car was fitted with a 1990's design front end, and for the second test a similar cab car was fitted with a SOA design front-end. The original seats were removed from both cars together with under-floor and ancillary equipment. Approximately 10,000 pounds of concrete had been added to each car, mostly under the floor in the center of the car, to make up for this equipment. Both cars had been used in previous impact tests and the damaged ends had been cut away. For these tests the end-frames were mounted on the opposite, undamaged ends.

Neither the pneumatic secondary suspension nor the air brakes worked on either vehicle. The 1990's test car is shown in Figure 1 and the SOA test car is shown in Figure 2.

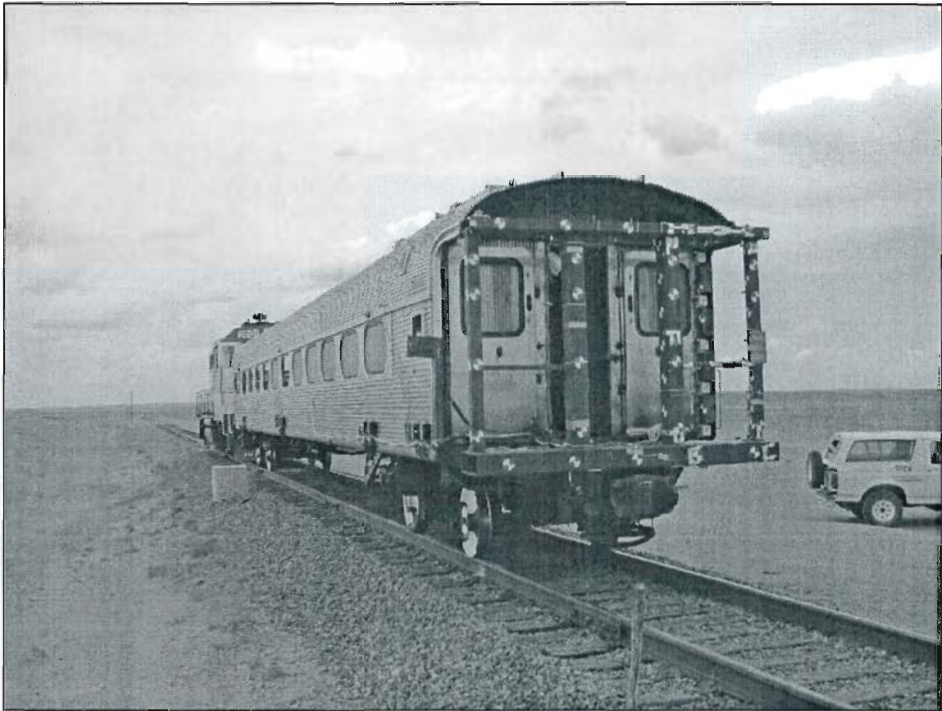

Figure 1. 1990's Cab Car Before Impact

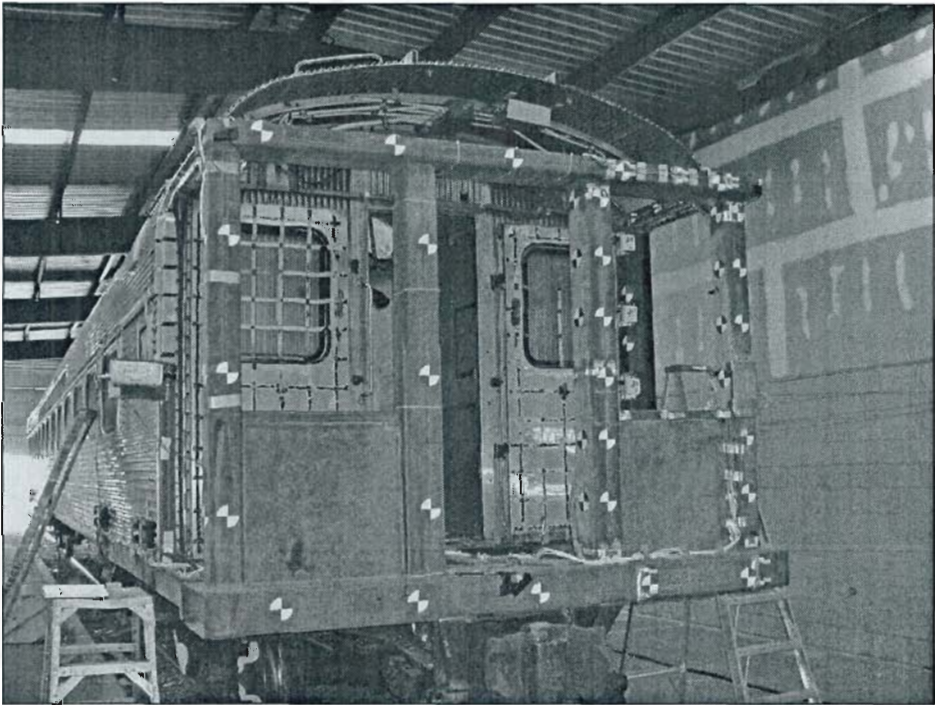

Figure 2. SOA Cab Car Before Impact

The steel coil on its frangible support is shown in Figure 3.

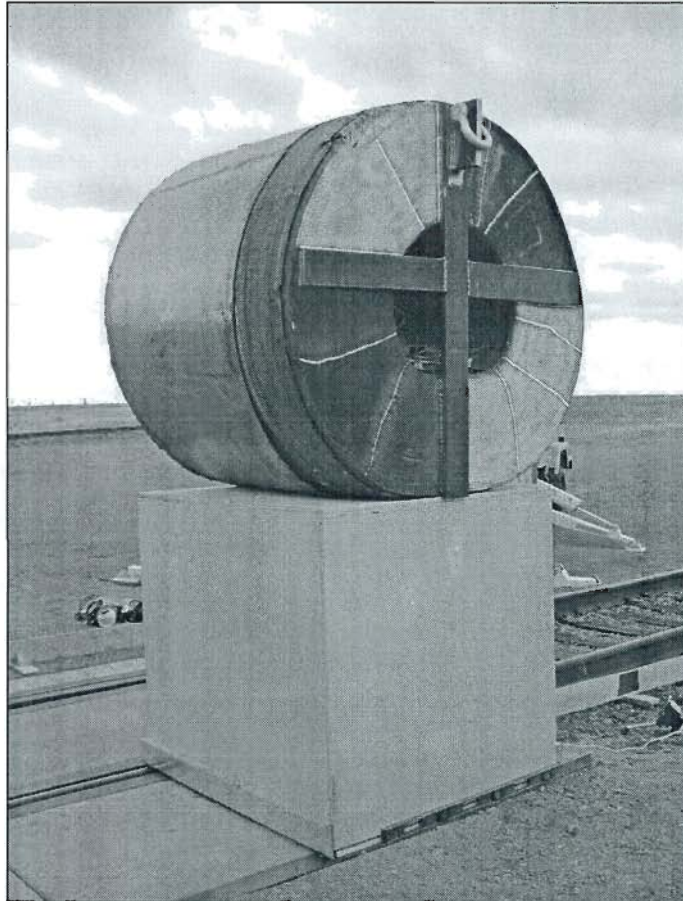

Figure 3. Steel Coil on Frangible Support

The coupler was left installed at the impact end of each cab car. Flat plates were welded to the corner post of each test car in order to mount Tape Switches to trigger the instrumentation at impact with the steel coil.

3.0 TEST METHODOLOGY

Tests were performed at the Federal Railroad Administration's (FRA) Transportation Technology Center (TTC), Pueblo, Colorado, according to the procedures outlined in the Test Implementation Plan for the Grade Crossing Impact Tests, Appendix A of this report.

Prior to the impact tests, quasi-static load tests were carried out on each end frame to assure compliance with the appropriate standards. Loads were applied to the collision post and corner post as described in Appendix B for the 1990's design and in Appendix C for the SOA design.

The impact tests were performed by pushing the test car with a locomotive, releasing it at a pre-determined point then letting it run along the track and into the stationary steel coil on its frangible support. The release distances, and the speed of the locomotive at release, were calculated from a series of speed calibration tests carried out over the actual test site. Calculations were also performed using TOES™ (TTCI's train action model). The target speed for each test was 14–14.5 mph.

4.0 RESULTS

4.1 Quasi-Static Load Tests

Strain gauges were attached to the end frames and the cab car center sills, side sills, and cant rails for both the 1990's cab car and the SOA cab car, as described in the Test Implementation Plan, Appendix A. Loads were applied to the collision post and corner post, as described in Appendix B for the 1990's design and in Appendix C for the SOA design.

Each car in turn was coupled to a reaction car and the longitudinal loads applied using an actuator between the reaction car and the corner post or collision post as Figure 4 shows.

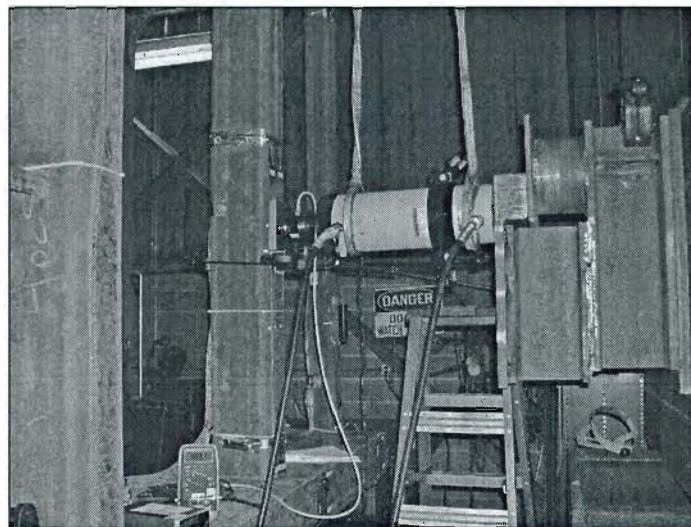

Figure 4. Collision Post Longitudinal Load Test, 1990's Design Cab Car

The lateral load to the corner post was applied using an actuator between a reaction block and the corner post, as Figure 5 shows. Table 1 summarizes the actual maximum loads applied during the quasi-static tests.

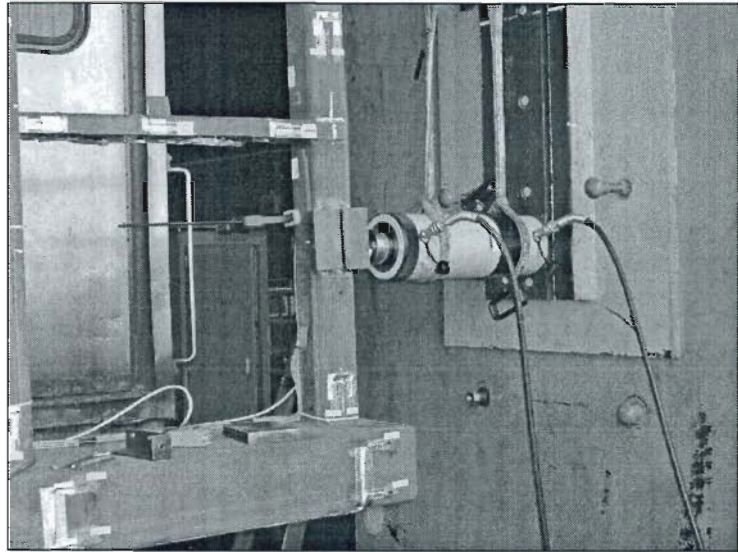

Figure 5. Corner Post Lateral Load Test, 1990's Design Cab Car

Table 1. Summary of Quasi-Static Load Cases

	1990's Design	SOA Design
Test 1: Collision Post Longitudinal Load	100 kips @ 30 inches from the floor	100 kips @ 30 inches from the floor
Test 2: Corner Post Longitudinal Load	30 kips @ 18 inches from the floor	100 kips @ 18 inches from the floor
Test 3: Corner Post Lateral Load	30 kips @ 18 inches from the floor	100 kips @ 18 inches from the floor
Test 4: Lateral Member Longitudinal Load	9.5 kips @ center of lateral member	10 kips @ center of lateral member

In all cases, the loads applied were within the elastic limits of the material, and no permanent deformation occurred to the structure. The welds all remained intact, without any cracking occurring. In view of these results, it was decided to go ahead with the impact tests for both cars.

4.2 Items Measured Before The Test

4.2.1 1990's Design Cab Car

The distances between the targets on the corner posts and the gutter rail extension across the doorway are given in Figure 6.

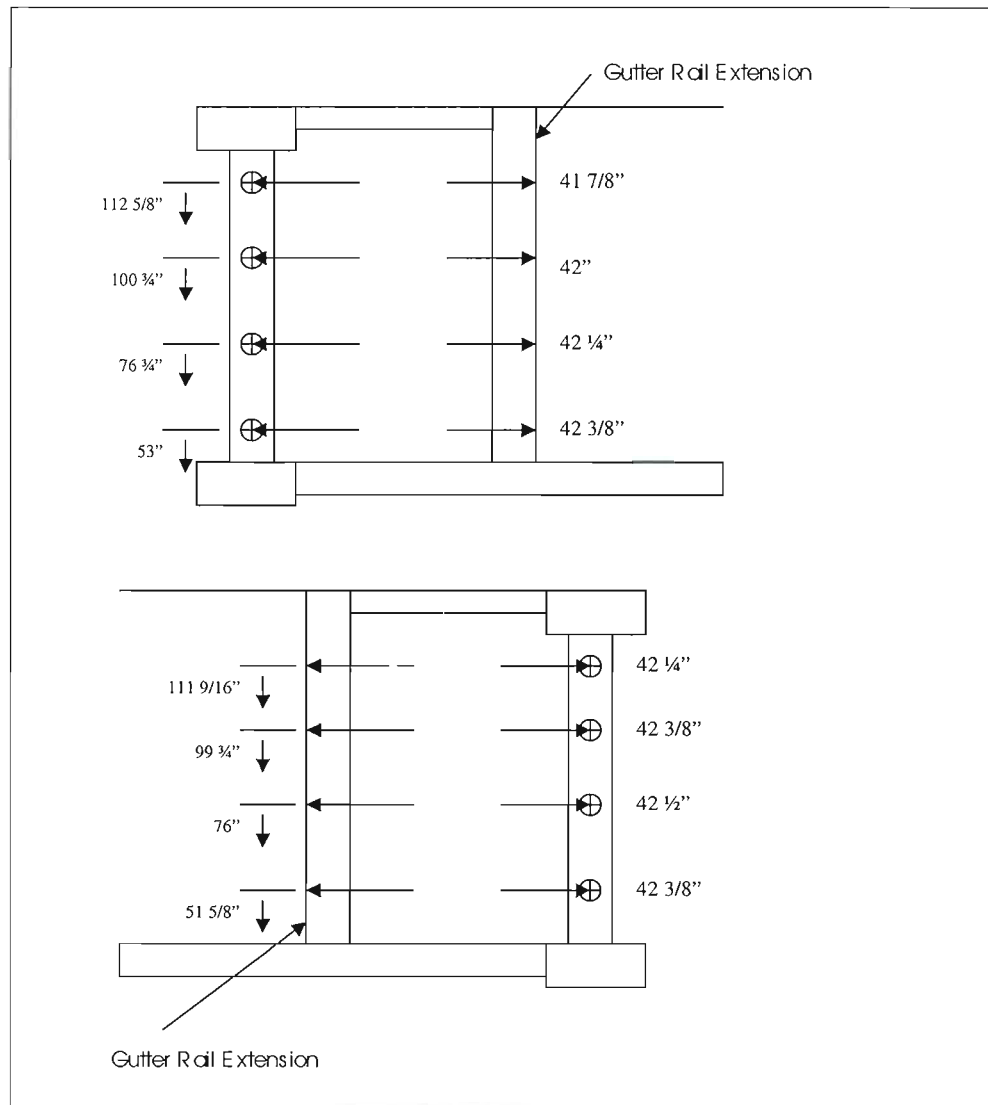

Figure 6. 1990's Cab Car Door Dimensions

4.2.2 SOA Design Cab Car

The distances between the targets on the corner posts and the gutter rail extension across the doorway are given in Figure 7.

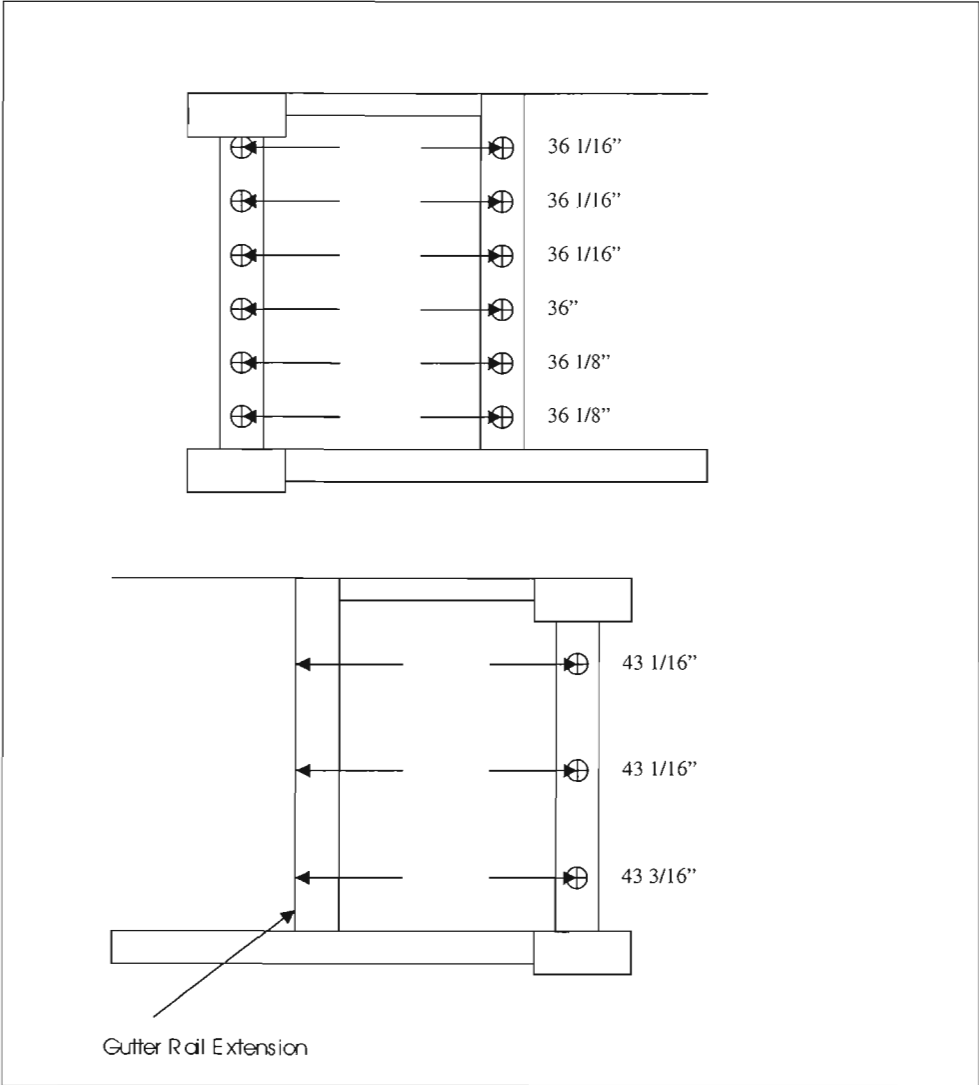

Figure 7. SOA Cab Car Door Dimensions

4.2.3 Weights

Weight of 1990's design cab car = 58,050 lb

Weight of SOA cab car = 59,518 lb

(Note: The accuracy of the weighbridge is within 50 lb)

Weight of steel coil = 41,300 lb

4.2.4 Weather Conditions

The weather conditions just before each test were:

1990's cab car impact test:

- Temperature = 60°F
- Wind speed = less than 10 mph

SOA cab car impact test:

- Temperature = 82°F
- Wind speed = less than 10 mph

4.3 Items Measured During the Test

The following anomalies occurred with the data acquisition system:

1990's Design Cab Car:

- None

SOA Design Cab Car:

- One Data Brick (Serial Number 90073) experienced a trigger failure resulting in eight strain gauge channels on the AT plate not being acquired. The lost channels were SG-ATP-MFT, SG-ATP-MFB, SG-ATP-MRT, SG-ATP-MRB, SG-ATP-LFT, SG-ATP-LFB, SG-ATP-LRT, SG-ATP-LRB

4.3.1 Speed

The cab car was accelerated from the test train by a locomotive and released at a point 1,000 feet from the steel coil. The speed of the consist just before impact, as measured by the laser based speed trap was:

1990's Design Cab Car

Laser 1	21.04 ft/s
Laser 2	21.07 ft/s
Average	21.06 ft/s = 14.36 mph

SOA Design Cab Car

Laser 1	20.54 ft/s
Laser 2	20.53 ft/s
Average	20.54 ft/s = 14.00 mph

4.3.2 Vehicle Accelerations

Vehicle accelerations were measured on the buffer beam, AT plate, center sill, side sill, and sole bars. The Test Implementation Plan (Appendix A) shows the location of the accelerometers used for the test. The Data Bricks were set for a sampling rate of 7,945 Hz, a pre-trigger of 1s, and post-trigger of 7s. Table 2 compares the peak longitudinal acceleration at several positions on car for both tests. These statistics are computed from the time of impact to 1 s after impact. Locations on the right side were chosen because the coil struck the right side of the cars. Time plots for all channels are located in Appendices D (1000Hz), E (100Hz), and F (25Hz), for the 1990's design end frame and Appendices J (1000Hz), K (100Hz), and L (25Hz), for the SOA design end frame.

Table 2. Peak Acceleration at Selected Car Body Locations

Channel/Location	Frequency	Peak amplitude for the 1990's design (g)	Peak amplitude for the SOA design (g)
R1X-Right side of buffer beam	1000Hz	322	200
	100Hz	-101	41
	25Hz	25	11
TR1X-Right side of AT plate	1000Hz	286	391
	100Hz	40	100
	25Hz	17	39
R2X-Right side sill, just behind the body bolster	1000Hz	18	28
	100Hz	7	14
	25Hz	3	4
TR2X-Right roof line, just behind the body bolster	1000Hz	-38	-135
	100Hz	6	15
	25Hz	2	6
C2-Centersill, just behind the body bolster	1000Hz	20	26
	100Hz	7	9
	25Hz	2	5

The amplitude of the accelerations were generally higher on the test of the SOA end frame. This is likely because the corner post on the SOA design end frame could support a higher peak force than the 1990's design end frame, resulting in higher accelerations.

4.3.3 Vehicle Displacements

The vertical displacement across each secondary suspension of the cab car (4) and the longitudinal displacement of the corner post (5) were measured using string potentiometers. The Data Brick for the string potentiometers was set for a sample rate of 7945 Hz, a pre-trigger of 1 s, and a post-trigger of 7 s. Table 3 shows a comparison of the displacements on the corner post of the 1990's design end frame and the SOA design end frame. Time plots of all displacement channels are shown in appendix G for the 1990's design and Appendix M for the SOA design.

Table 3. Peak Collision Post Displacements

Location	Peak displacement 1990's Design (in)	Peak displacement SOA design (in)
CP5 – Top of Corner Post	Saturated at -27.3	-1.4
CP4	Saturated at -27.1	-5.4
CP3	-19.0	-9.1
CP2	Saturated at -27.7	-6.1
CP1 – Bottom of Corner Post	-2.4	-0.6

4.3.4 Vehicle Strains

Vehicle strains were measured on the corner post, buffer beam, anti-telescoping plate, cant rail, and side sill (side sill measurements were only on the SOA Design Cab Car). The Data Bricks measuring strain were set for a sampling rate of 7,945 Hz, a pre-trigger of 1s, and post-trigger of 7s. Time plots of all displacement channels are shown in Appendix H for the 1990's design and appendix N for the SOA design.

The data measured in the test of the 1990's design shows saturation on two channels on the buffer beam (BBEFB and BBFT), all of the channels on the corner post, and six of the channels on the lateral member (LMLFT, LMLRB, LMLRT, LMRRB, and LMRRT). Saturation of these channels was due to cable damage.

The data measured in the test of the SOA design shows saturation on three channels on the lateral member (LMLRT, LMRRB, and LMRRT). Eight of the strain channels on the AT plate were not recorded due to a data collection problem.

Table 4 shows the highest amplitude strains on various vehicle components for the 1990's and the SOA design.

Table 4. Peak Strains on Various Components for Each Test

Vehicle Component	Peak strain 1990's Design (ustr)	Peak strain SOA design (ustr)
Buffer beam	1,379 on BBCFB	588 on BBEBB
Corner Post	-2,002 on CORTL	41,445 on CORBFR
AT Plate	-6,695 on ATPLRB	-4,708 on ATPRRT
Collision Post	-2,130 on COLBRL	2,430 on COLMRL
Lateral Member	-13,095 on LMLRT	21,070 on LMLRB
Cant Rail	2,821 on CRTLF	-1,219 on CRBLF
Draft Sill	-1,849 on DSTRF	773 on DSTRF
Side Sill	Not measured	-3,265 on SS3

4.3.5 Vehicle Velocity, Displacement, and Force

The x-axis (longitudinal) acceleration time histories for all the center sill accelerometers have been integrated to give velocity and double integrated to give displacement. Time plots of all velocity, displacement, and force channels are shown in Appendix I for the 1990's design and Appendix O for the SOA design.

4.3.6 Measurements in Coil

Acceleration was measured in several locations inside the steel coil to measure the rigid body motions of the coil during the impact. The Data Bricks inside the coil were set for a sampling rate of 7,945 Hz, a pre-trigger of 1s, and post-trigger of 7s. Table 5 shows a summary of the peak accelerations for the test.

Table 5. Peak Acceleration at the Center of the Steel Coil

Channel/Location	Frequency	Peak amplitude for the 1990's design (g)	Peak amplitude for the SOA design (g)
A0X-Center of coil, longitudinal accel.	1000Hz	-5	-9
	100Hz	-3	-7
	25Hz	-2	-6
A0Y-Center of coil, lateral accel.	1000Hz	-4	18
	100Hz	-1	7
	25Hz	1	2
A0Z-Center of coil, vertical accel.	1000Hz	-2	-6
	100Hz	-1	-1
	25Hz	-1	-1

4.3.7 High Speed and Video Photography

Both impact tests were visually recorded by eight high-speed film cameras and four video cameras. Camera coverage was selected to provide good views of the impact between the corner post and the steel coil. Two of the high-speed cameras were mounted on board.

Schematic layouts of the film and video cameras are shown in Appendix A as Figures 9 and 10.

Setup sheets for the film cameras are presented in Appendix D.

Both onboard cameras did not run for the 1990's test due to a problem with the relays. And one of the onboard cameras did not run for the SOA test due to a mechanical problem inside the camera.

4.4 Items Measured after the Test

4.4.1 1990's Design Cab Car

Figure 8 shows the 1990's design cab car after impact with the steel coil.



Figure 8. 1990's Design Cab Car After Impact With Steel Coil

The deformation to the corner post after impact with the steel coil is shown in Figure 9.

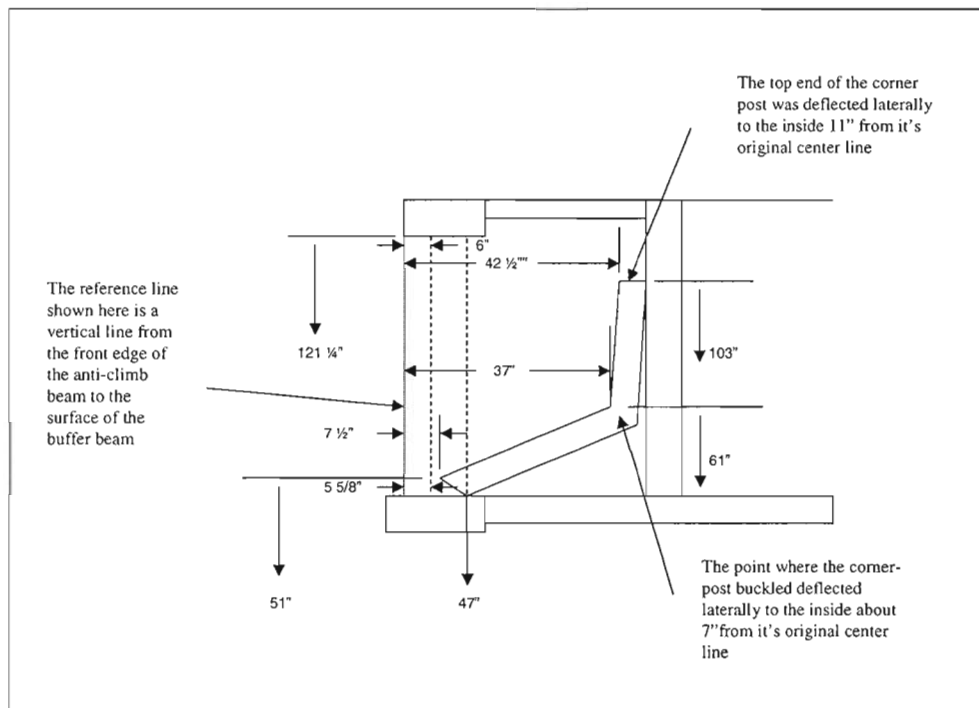

Figure 9. Deformation of Corner Post After Impact with Steel Coil

4.4.2 SOA Design Cab Car

Figure 10 shows the SOA design cab car after impact with the steel coil.



Figure 10. SOA Design Cab Car After Impact With Steel Coil

The deformation to the corner post after impact with the steel coil is shown in Figure 11.

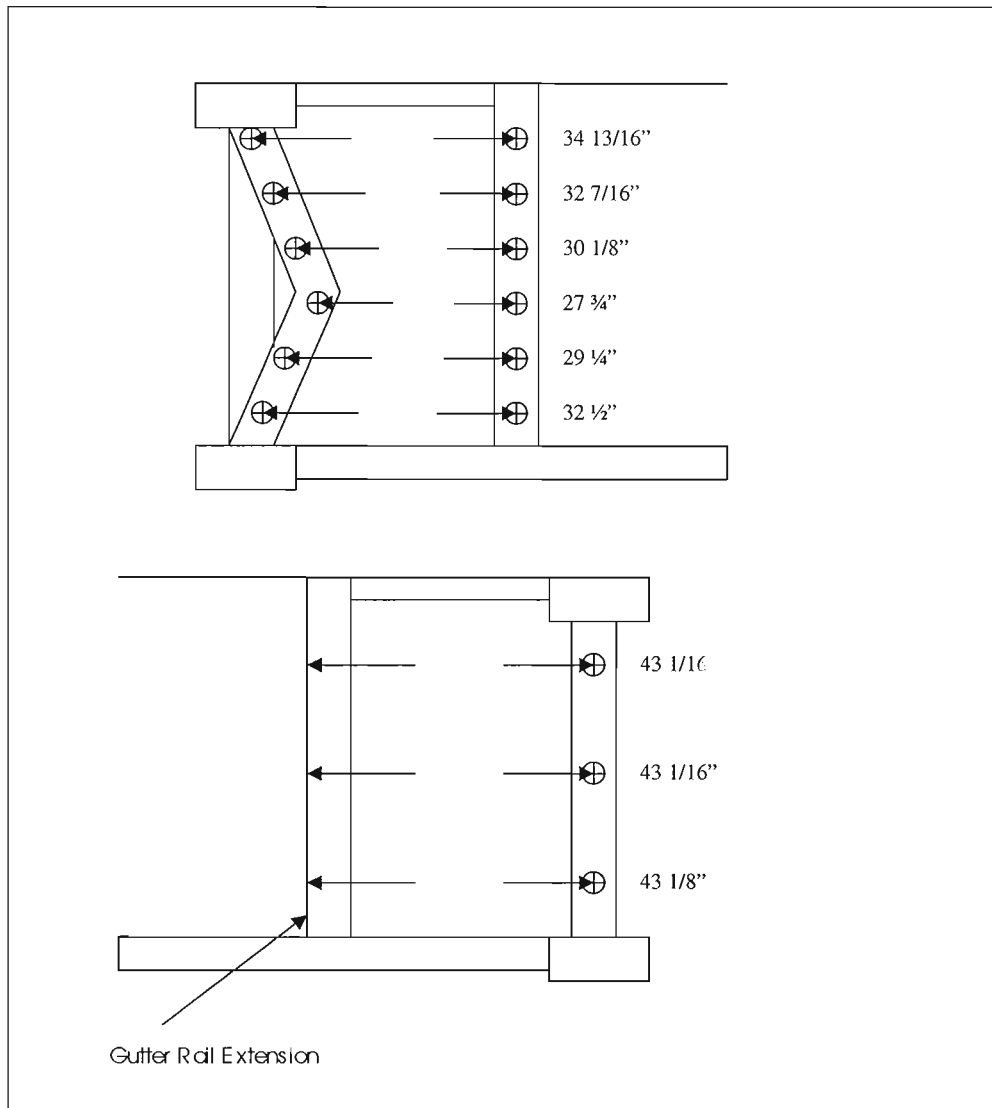

Figure 11. Deformation of Corner Post After Impact with Steel Coil

5.0 CONCLUSIONS

5.1 1990's Design Cab Car

There was a large amount of damage to the corner post, which pulled out of the anti-telescoping plate at the top and sheared away from the buffer beam at the bottom. The corner post buckled, and ended up at a point 14 inches off the floor level with the top of the post 56 inches off the floor, leaning back against the back of the doorpost.

The following are the main results achieved during this test:

- The speed of the moving consist at impact with the steel coil was 14.36 mph.
- The cab car remained on the track after impact with the steel coil.
- The maximum longitudinal acceleration recorded on the buffer beam of the cab car was 320 g at position R-1. When filtered to $F_c = 100$ Hz, the peak acceleration was reduced to 100 g.
- The maximum longitudinal acceleration recorded on the center sill of the cab car was 20 g at position C-2. When filtered to $F_c = 100$ Hz, the peak acceleration was reduced to 7.5 g.
- The maximum lateral acceleration recorded on the buffer beam of the cab car was 360 g at position R-1. When filtered to $F_c = 100$ Hz, the peak lateral acceleration was reduced to 60 g.
- The maximum lateral acceleration recorded on the center sill of the cab car was 10 g at position C-2. When filtered to $F_c = 100$ Hz, the peak lateral acceleration was reduced to 8 g.
- The maximum vertical acceleration recorded on the buffer beam of the cab car was 300 g at position R-1. When filtered to $F_c = 100$ Hz, the peak acceleration was reduced to 150 g.
- The maximum vertical acceleration recorded on the center sill of the cab car was 15 g at position C-2. When filtered to $F_c = 100$ Hz, the peak acceleration was reduced to 5 g.
- The maximum longitudinal acceleration recorded in the center of the stationary coil was 5 g. When filtered to $F_c = 100$ Hz, the peak acceleration was reduced to 3 g.
- The maximum lateral acceleration recorded in the center of the stationary coil was 4 g. When filtered to $F_c = 100$ Hz, the peak acceleration was reduced to 1 g.
- The maximum vertical acceleration recorded in the center of the stationary coil was 2 g. When filtered to $F_c = 100$ Hz, the peak acceleration was reduced to 1 g.

5.2 SOA Design Cab Car

The maximum permanent deformation of the corner post was 8.25 inches, which occurred just below the mid section of the post.

The following are the main results achieved during this test:

- The speed of the moving consist at impact with the steel coil was 14.00 mph.
- The cab car remained on the track after impact with the steel coil although the steel coil ended up wedged under the car.
- The maximum longitudinal acceleration recorded on the buffer beam of the cab car was 200 g at position R-1. When filtered to $F_c = 100$ Hz, the peak acceleration was reduced to 50 g.
- The maximum longitudinal acceleration recorded on the center sill of the cab car was 26 g at position C-2. When filtered to $F_c = 100$ Hz, the peak acceleration was reduced to 9 g.
- The maximum lateral acceleration recorded on the buffer beam of the cab car was 75 g at position R-1. When filtered to $F_c = 100$ Hz, the peak lateral acceleration was reduced to 28 g.
- The maximum lateral acceleration recorded on the center sill of the cab car was 8 g at position C-2. When filtered to $F_c = 100$ Hz, the peak lateral acceleration was reduced to 3 g.
- The maximum vertical acceleration recorded on the buffer beam of the cab car was 200 g at position R-1. When filtered to $F_c = 100$ Hz, the peak acceleration was reduced to 95 g.
- The maximum vertical acceleration recorded on the center sill of the cab car was 15 g at position C-2. When filtered to $F_c = 100$ Hz, the peak acceleration was reduced to 4 g.
- The maximum longitudinal acceleration recorded in the center of the stationary coil was 9 g. When filtered to $F_c = 100$ Hz, the peak acceleration was reduced to 7 g.
- The maximum lateral acceleration recorded in the center of the stationary coil was 18 g. When filtered to $F_c = 100$ Hz, the peak lateral acceleration was reduced to 7 g.
- The maximum vertical acceleration recorded in the center of the stationary coil was 6 g. When filtered to $F_c = 100$ Hz, the peak acceleration was reduced to 1 g.

This page left blank intentionally

**APPENDIX A:
Test Implementation Plan**

**Test Implementation Plan for
Grade Crossing Impact Tests 1990's Design Passenger Car and
State of the Art Design Passenger Car**

(Contract No. DTFR53-93-C-00001)

April 2002

Presented by:
Transportation Technology Center, Inc.
55500 DOT Road
P.O. Box 11130
Pueblo, Colorado, USA, 81001

This page left blank intentionally

1.0 Purpose

To carry out two impact tests; one on a passenger car with a front-end structure built to the requirements and practice of the 1990's and the other on a passenger car designed and built with a state-of-the-art (SOA) front end structure. Both tests involve an impact with a "heavy" object so that one of the corner posts is struck above the floor attachment. The impacts will take place on level tangent track at a defined speed. Each passenger car will be instrumented to measure material strains, structural accelerations, and suspension displacements in sufficient quantity to allow correlation with analytical predictions.

2.0 Requirements

To conduct two impact tests where a passenger cab car collides with a stationary 40,000-pound steel coil mounted on a frangible support platform at a defined impact speed. Prior to the dynamic impact tests, quasi-static linear elastic tests will be conducted on each end frame design to assure compliance of the integrated structures response with the developed design load requirements.

3.0 Test Cars

The impact tests will be conducted using passenger cars, provided by SEPTA, and modified:

1. 1990's design: To bring it up to the standard as outlined in 49 CFR 238.213 (Test # 4)
2. SOA design: To conform with current best practice design (Test # 5)

4.0 Test Method

The tests will be performed at the TTC by impacting the passenger test car into a stationary steel coil mounted on a frangible support at the defined impact speed. The final speed will be provided prior to the test by the Volpe Center. The cab car will be pushed by a locomotive to a predefined speed and then released allowing the car to roll along the track and into the stationary steel coil. The release distance and the speed of the locomotive at the release point, will be determined from a series of speed calibration runs carried out before the test. Figure 1 shows the test arrangement.

A radar speed measuring system will be used for speed calibration of the test car. Calculations will be performed using TOES to estimate the speed versus distance for the car using the measured track profile. The ambient temperature and wind speed will be measured during the calibration tests and during the actual test. A laser speed trap will be used on the actual test to measure the speed of the test car just before impact.

On-board instrumentation will record accelerations, displacements and strains at various points on the test car during and after the impact. The acceleration of the steel coil during and after impact will also be measured. Eight high-speed film cameras and four video cameras will be used to record the impact.

5.0 Measured Items

The weight of the passenger car and the position of all the transducers will be measured before the test.

Strains and accelerations will be measured during the test using a battery powered on-board data acquisition system which will provide excitation to the strain gages and accelerometers, analog anti-aliasing filtering of the signals, analog-to-digital conversion and recording. Data acquisition will be in accordance with SAE J211/1, Instrumentation for Impact Tests (revised March 1995). Data from each channel will be recorded at a sample rate of 8000 Hz. All data will be synchronized with a time reference applied to all systems simultaneously at the time of impact. The time reference will come from a closure of a tape switch on the front of the impacting cab car. The following items will be measured during Test # 4 (1990's design):

1. The speed of the cab car just before impact using a laser based speed trap.
2. Longitudinal strains at the cant rail at the impact end of the passenger car as shown in Figure 2 (12 uniaxial strain gauges).
3. Longitudinal strains at draft/center sill at the impact end of the passenger car as shown in Figure 3 (12 uniaxial strain gauges)
4. Longitudinal strains at the Corner Post (12 uniaxial strain gauges for quasi-static testing of which 8 uniaxial strain gauges will also be used for the dynamic test), longitudinal strains at the Collision Post (12 uniaxial strain gauges for both the quasi-static and dynamic tests), and longitudinal strains at the Buffer Beam (8 uniaxial strain gauges used for both the quasi-static and dynamic testing). Figure 4 shows the general placement of the strain gauges to be used for these components.
5. Longitudinal strains at the Anti-Telescoping Plate and Lateral Member, the shelf below the window frame, as shown in Figure 5. Twelve uniaxial strain gauges will be used on the Anti-telescoping plate for both the quasi-static and dynamic tests. Twelve uniaxial strain gauges will be used on the Lateral Member/shelf below the window for the quasi-static testing and only 4 uniaxial strain gauges will be used for the dynamic test (the other eight uniaxial strain gauges will be destroyed by the impact and hence will not be used during the dynamic test).
6. Triaxial accelerations measured at the side sills and cant rails on the cab car on the side of impact (12 accelerometers/channels) plus additional triaxial accelerations measured on draft and center sills along the center line of the cab car at the trucks

and at the mid-length of the cab car (9 accelerometers/channels). Biaxial accelerometers, measuring longitudinal and vertical accelerations, will be placed on the side sills and cant rails at the position of the cab car trucks as well as on the side sills at the mid-length of the cab car (12 accelerometers/channels). Finally, vertical accelerations will be measured at the cant rail at the mid-length of the cab car as well as at the side sills and cant rails at the rear trucks (6 accelerometers/channels). Figure 6 depicts the relative locations and types of accelerometers required to capture the cab car body rigid modes, local deformation modes, and flexible modes.

7. Vertical and lateral accelerations will be measured on the trucks (4 accelerometers)
8. Accelerations of the steel coil as shown in Figure 7 (9 accelerometers).
9. Displacement across each secondary suspension of the passenger car as shown in Figure 8 (4 string potentiometers).
10. Displacement of corner posts as shown in Figure 8 (5 high elongation string potentiometers).

In summary, 80 channels are required for the quasi-static testing. For the dynamic tests, 52 channels are required for the accelerometers (39 on the cab car body, 4 on the trucks, and 9 on the steel coil), 5 channels are required for the high elongation string potentiometers, 4 channels for the string potentiometers across the secondary suspension, and 59 channels for the strain gauges. That is a total of 120 channels for the dynamic tests. The sampling rate is 8,000 Hz. The timing required for the dynamic test is 1 seconds of pre-trigger data collection and 7 seconds of post trigger data collection.

For the SOA design, Test # 5, there will be 12 extra strain gauges required on the side sill that extends from the body bolster and connects with the buffer beam. Hence for the quasi-static test 92 channels are required. The dynamic test will require the same number of channels for the accelerometers and string potentiometers. The placement of these items is the same as discussed in detail above for Test #4. The total number of channels required for the dynamic test is 132. The sampling rate is 8,000 Hz. The timing required for the dynamic test is 1 seconds of pre-trigger data collection and 7 seconds of post trigger data collection.

Eight high-speed film cameras and four video cameras will be used to record the impact for each test. A reference signal will be placed on the film so that analysis of the film after the event will give the velocity and displacement of each vehicle during impact. The placement of the high-speed film and video cameras are shown in Figures 9 and 10.

6.0 Instrumentation

6.1 Strain measurements, Passenger Car

Figures 2 and 3 shows the general arrangement of strain gauges on the draft/center sill and cant rail at the impact end of the passenger car.

Table 1 lists the locations and strain gauge types for these strain gages.

Table 1 Strain gauge location and type on draft sill and cant rail

Location	Strain Gauge	Channel
SG-DS-TRF	Standard	1
SG-DS-TLF	Standard	2
SG-DS-BRF	Standard	3
SG-DS-BLF	Standard	4
SG-DS-TRM	Standard	5
SG-DS-TLM	Standard	6
SG-DS-BRM	Standard	7
SG-DS-BLM	Standard	8
SG-DS-TRR	Standard	9
SG-DS-TLR	Standard	10
SG-DS-BRR	Standard	11
SG-DS-BLR	Standard	12
SG-CR-TRF	Standard	13
SG-CR-TLF	Standard	14
SG-CR-BRF	Standard	15
SG-CR-BLF	Standard	16
SG-CR-TRM	Standard	17
SG-CR-TLM	Standard	18
SG-CR-BRM	Standard	19
SG-CR-BLM	Standard	20
SG-CR-TRR	Standard	21
SG-CR-TLR	Standard	22
SG-CR-BRR	Standard	23
SG-CR-BLR	Standard	24

Figure 4 shows the general arrangement of strain gauges on the corner post, collision post and end beam/buff wing at the impact end of the passenger car.

Table 2 lists the locations and strain gauge types for these strain gauges. Those gauges followed by an * denote gauges used only for the quasi-static tests.

Table 2 Strain gauge location and type on corner post, collision post and end beam/buff wing

Location	Strain Gauge	Channel
SG-COL-TFR	Standard	25
SG-COL-TFL	Standard	26
SG-COL-TRR	Standard	27
SG-COL-TRL	Standard	28
SG-COL-MFR	Standard	29
SG-COL-MFL	Standard	30
SG-COL-MRR	Standard	31
SG-COL-MRL	Standard	32
SG-COL-BFR	Standard	33
SG-COL-BFL	Standard	34
SG-COL-BRR	Standard	35
SG-COL-BRL	Standard	36
SG-COR-TFR	High Elongation	37
SG-COR-TFL	High Elongation	38
SG-COR-TRR	High Elongation	39
SG-COR-TRL	High Elongation	40
SG-COR-MFR	Standard*	41
SG-COR-MFL	Standard*	42
SG-COR-MRR	Standard*	43
SG-COR-MRL	Standard*	44
SG-COR-BFR	High Elongation	45
SG-COR-BFL	High Elongation	46
SG-COR-BRR	High Elongation	47
SG-COR-BRL	High Elongation	48
SG-BB-CFT	Standard	49
SG-BB-CFB	Standard	50
SG-BB-CBT	Standard	51

SG-BB-CBB	Standard	52
SG-BB-EFT	Standard	53
SG-BB-EFB	Standard	54
SG-BB-EBT	Standard	55
SG-BB-EBB	Standard	56

Figure 5 shows the general arrangement of strain gauges on the anti-telescoping plate and lateral member below the window frame at the impact end of the passenger car.

Table 3 lists the locations and strain gauge types for these strain gauges. Those gauges followed by an * denote gauges used only for the quasi-static tests.

Table 3 Strain gauge location and type on the anti-telescoping plate and lateral member

Location	Strain Gauge	Channel
SG-ATP-RFT	Standard	57
SG-ATP-RFB	Standard	58
SG-ATP-RRT	Standard	59
SG-ATP-RRB	Standard	60
SG-ATP-MFT	Standard	61
SG-ATP-MFB	Standard	62
SG-ATP-MRT	Standard	63
SG-ATP-MRB	Standard	64
SG-ATP-LFT	High Elongation	65
SG-ATP-LFB	High Elongation	66
SG-ATP-LRT	High Elongation	67
SG-ATP-LRB	High Elongation	68
SG-LM-RFT	Standard	69
SG-LM-RFB	Standard	70
SG-LM-RRT	Standard	71
SG-LM-RRB	Standard	72
SG-LM-MFT	Standard*	73
SG-LM-MFB	Standard*	74
SG-LM-MRT	Standard*	75
SG-LM-MRB	Standard*	76
SG-LM-LFT	Standard	77
SG-LM-LFB	Standard	78

SG-LM-LRT	Standard	79
SG-LM-LRB	Standard	80

For the SOA design, Test # 5, there will be 12 extra strain gauges attached to the side sill. Table 4 lists these gauges.

Table 4 Extra strain gauge location and type for Test #5

Location	Strain Gauge	Channel
SG-SS -1	Standard	81
SG-SS -2	Standard	82
SG-SS-3	Standard	83
SG-SS-4	Standard	84
SG-SS-5	Standard	85
SG-SS-6	Standard	86
SG-SS-7	Standard	87
SG-SS-8	Standard	88
SG-SS-9	Standard	89
SG-SS-10	Standard	90
SG-SS-11	Standard	91
SG-SS-12	Standard	92

6.2 Acceleration measurements, Passenger Car

The car-body gross and flexible motions will be measured using accelerometers. The gross motions of the car-body are the longitudinal, lateral, and vertical translational displacements, as well as the pitch, yaw and roll angular displacements. The flexible modes include vertical and lateral bending as well as torsional displacement about axis of the body. Measurements of these motions are required to fully characterize the collision environment.

All the accelerometers are critically damped. The accelerometers will be calibrated prior to installation. The accelerometers possess natural frequencies sufficiently high to meet the requirements of SAE J211/1, *Instrumentation for Impact Test (Revised MAR95)*, class 1000, which requires that the frequency response is essentially flat to 1000 Hz.

Figure 6 shows the general arrangement of accelerometers on the draft sill, center sill, side sills and cant rails of the Passenger Car.

Table 4 lists the accelerometer locations, accelerometer types, and data channels for the Passenger Car.

Table 4 Passenger Cab Car, Accelerometers

Location	Accelerometer	Measurement	Channel		
C-2	Three axis	Longitudinal	X	1	400g
		Lateral	Y	2	200g
		Vertical	Z	3	200g
C-3	Three axis	Longitudinal	X	4	400g
		Lateral	Y	5	200g
		Vertical	Z	6	200g
C-4	Three axis	Longitudinal	X	7	200g
		Lateral	Y	8	100g
		Vertical	Z	9	100g
L-1	Three axis	Longitudinal	X	10	400g
		Lateral	Y	11	200g
		Vertical	Z	12	200g
R-1	Three axis	Longitudinal	X	13	1000g
		Lateral	Y	14	400g
		Vertical	Z	15	400g
L-2	Two axis	Longitudinal	X	16	400g
		Vertical	Z	17	200g

R-2	Two axis	Longitudinal	X	18	400g
		Vertical	Z	19	200g
L-3	Two axis	Longitudinal	X	20	200g
		Vertical	Z	21	100g
R-3	Two axis	Longitudinal	X	22	200g
		Vertical	Z	23	100g
L-4	Single axis	Vertical	Z	24	100g
R-4	Single axis	Vertical	Z	25	100g
TL-1	Three axis	Longitudinal	X	26	400g
		Lateral	Y	27	200g
		Vertical	Z	28	400g
TR-1	Three axis	Longitudinal	X	29	400g
		Lateral	Y	30	200g
		Vertical	Z	31	400g
TL-2	Two axis	Longitudinal	X	32	400g
		Vertical	Z	33	200g
TR-2	Two axis	Longitudinal	X	34	400g
		Vertical	Z	35	400g
TL-3	Single axis	Vertical	Z	36	200g
TR-3	Single axis	Vertical	Z	37	200g
TL-4	Single axis	Vertical	Z	38	200g
TR-4	Single axis	Vertical	Z	39	200g
B1	Two axis	Lateral	Y	40	200g
		Vertical	Z	41	200g
B2	Two axis	Lateral	Y	42	200g
		Vertical	Z	43	200g

6.3 Accelerometer measurements, Stationary Steel Coil

Figure 7 shows the position of the accelerometers on the Steel Coil.

Table 5 lists the accelerometer locations, accelerometer types, and data channels for the Steel Coil.

Table 5 Stationary Steel Coil, Accelerometer

Location	Accelerometer	Measurement	Channel
A0	Three axis	Longitudinal X	1 400g
		Lateral Y	2 400g
		Vertical Z	3 400g
A1	Two axis	Lateral Y	4 400g
		Vertical Z	5 400g
A2	Two axis	Longitudinal X	6 400g
		Vertical Z	7 400g
A3	Two axis	Longitudinal X	8 400g
		Lateral Z	9 400g

6.4 String Potentiometers

Four string potentiometers will be fixed on the passenger car between body bolster and bogie bolster to measure the relative vertical displacement of the suspension.

Five string potentiometers will be fixed to measure the longitudinal deflection of the corner post.

6.5 High-speed and real-time photography

Eight high-speed film cameras and four video cameras will document the impact test. The position of the high-speed film cameras is shown in Figure 8 and the position of the video cameras is shown in Figure 9. All the cameras are equipped with sights that allow the photographer to view the expected image. The final siting of cameras will be carried out at the time of camera setup. Adjustments will be made, if necessary, to achieve the optimum views.

A 100 Hz reference signal will be placed on the film so that accurate frame speed can be determined for film analysis. An electronic signal generator provides the calibrated 100-Hz pulse train to light emitting diodes (LEDs) in the high-speed cameras. Illumination of the LEDs exposes a small red dot on the edge of the film, outside the normal field of view. During film analysis, the precise film speed is determined from the number of frames and fractions thereof that pass between two adjacent LED marks. Battery powered on-board lights will illuminate the on-board camera view. Battery packs use 30-v NiCad batteries.

Color negative film for the ground-based cameras will be Kodak 16-mm 7246, ISO 250, for daylight on 100-ft spools. Film speed will be pushed in processing if necessary to compensate for light conditions at test time.

Four-in. diameter targets will be placed on the vehicles and the ground to facilitate post-test film analysis to determine speed and displacement during the test. The targets are divided into four quadrants with adjacent colors contrasting to provide good visibility. At least three targets will be placed on each side of each vehicle and the ground. During film analysis, the longitudinal and vertical coordinates of the targets are determined from projections on a film analyzer on a frame-by-frame basis. The distances between the targets, which are known from pre-test measurements, provide distance reference information for the film analysis. The differences in locations between vehicle-mounted targets and ground-based targets quantify the motion of the vehicle during the test. By taking the position differences between vehicle-mounted and ground-based targets, the effects of film registration jitter in the high-speed cameras are minimized. The 100-Hz LED reference marks provide an accurate time base for the film analysis. Test vehicle position is determined directly as indicated above, and vehicle speed is determined by dividing displacement between adjacent frames by the time difference between the adjacent frames. If necessary, smoothing is applied to the displacement and speed data to compensate for digitization and other uncertainties.

The ground-based cameras will be started simultaneously from a central relay box triggered manually. The cameras will run at the determined nominal speed of 300-500 frames per second for about eight seconds before the 100-ft film is entirely exposed. The appropriate nominal speed will be defined prior to the test.

6.6 Data Acquisition

At least twenty, 8-channel battery-powered on-board data acquisition systems will provide excitation to the strain gauges, accelerometers and displacement transducers, analog anti-aliasing filtering of the signals, analog-to-digital conversion, and recording on the passenger car. Another two data acquisition systems will be located inside the steel coil.

Data acquisition will be in compliance with SAE J211. Data from each channel will be recorded at 8000 Hz. Parallel redundant systems will be used for all accelerometer channels. Data recorded on the four systems will be synchronized with a time reference applied to all systems simultaneously at the time of impact. The time reference will come from closure of the tape switches on the front of the test vehicle. The data acquisition systems are GMH Engineering Data Brick Model II. Each Data Brick is ruggedized for shock loading up to at least 100 g. On-board battery power will be provided by GMH Engineering 1.7 A-HR 14.4 volt NiCad Packs. Tape Switches, Inc., model 1201-131-A tape switches will provide event markers.

Software in the Data Brick will be used to determine zero levels and calibration factors rather than relying on set gains and expecting no zero drift. The Data Bricks will be set to record 1 seconds of pre-trigger data and 7 seconds of post-trigger data.

6.7 Speed Trap

A dual channel speed trap will accurately measure the impact speed of the cab car when it is within 0.5 meter impact point. The speed trap is a GMH Engineering Model 400, 4 Interval Precision Speed Trap with an accuracy of 0.1%. Passage of a rod affixed to the vehicle will interrupt laser beams a fixed and known distance apart. The first interruption starts a precision counter, and the second interruption stops the counter. Speed is calculated from distance and time. Tentatively, the rod will be attached at the aft end of the impact cab car. Final rod location will be determined prior to installation.

7.0 Test Procedure

- One of the passenger cars will be modified to bring it up to current FRA standards as outlined in FRA 238.213. The other will be modified to conform with current best practice design.
- Strain gauges will be attached to the center sills, side sills, cant rails and end-frames as described above.
- A quasi-static load test will be performed on each vehicle by applying loads to the collision post and corner post as described in Appendix A for the 1990's design and in Appendix B for the SOA design.
- Speed calibration runs will be carried out using one of the test cars. The test car will be pushed by a locomotive and then released at points of varying distance from the impact point. The speed of the test car will be measured as it passes the impact point, using a laser speed trap. Having passed the impact point, the test car will be stopped by a locomotive catching it up, catching the coupler, and then slowing down and bringing the car back to the start point. A calibration chart of speed versus distance will be produced from these tests and compared with simulation results using TOES.
- The test equipment, including the accelerometers and data acquisition system will be mounted on the test car and steel coil. The transducers will be connected to the data acquisition system and tested.
- The cameras will be set up.
- The weight of the test car will be measured just prior to the test.
- All instruments will be calibrated and a zero reading carried out.
- A trial low speed soft impact (less than 1 mph) of the test car will be carried out to confirm all the instruments work properly.

- The instruments will be re-calibrated, the Tape Switches replaced and the test car pulled back.
- The test car will be pushed by a locomotive and released at the appropriate distance from the stationary steel coil, triggering the cameras just before impact.
- The instrumentation will be triggered on impact.
- Visual inspection of the passenger car body will be carried out after impact. Still photographs will be taken.
- The data will be downloaded onto lap-top computers from the on-board data acquisition system.

A checklist based on the above tasks will be signed by key personnel as each task is completed.

8.0 Data Analysis

8.1 Data Post Processing

Each data channel will be offset adjusted in post processing. The procedure is to average the data collected just prior to the test vehicle's impact with the barrier and subtract the offset from the entire data set for each channel. It is expected that between 0.05 and 1.0 second of pre-impact data will be averaged to determine the offsets. The precise duration of the averaging period cannot be determined with certainty until the data are reviewed. The offset adjustment procedure assures that the data plotted and analyzed contains impact-related accelerations and strains but not electronic offsets or steady biases in the data. The post-test offset adjustment is independent of, and in addition to, the pre-test offset adjustment made by the data acquisition system.

Plots of all data channels recorded and combinations of data channels will be produced as described below. Post-test filtering of the data will be accomplished with a two-pass phaseless four-pole digital filter algorithm consistent with the requirements of SAE J211. In the filtering process, data are first filtered in the forward direction with a two-pole filter. The first pass of the filtering process introduces a phase lag in the data. In the next pass, the data are filtered in the reverse direction with the same filter. Because the data are filtered in the reverse direction, a phase lead is introduced into the data. The phase lead of the reverse-direction filtering cancels the phase lag from the forward-direction filtering. The net effect is to filter the data without a change in phase with a four-pole filter.

8.2 Data Output

Every channel as recorded (raw data) will be plotted against time (where time = 0 is defined as the impact of the steel coil with the passenger cab car cornerpost).

The acceleration records during the impacts will be plotted against time.

The longitudinal acceleration will be integrated and the derived velocity plotted against time.

The longitudinal velocity will be integrated to give the crush displacement against time.

The longitudinal accelerations at the center of gravity of the car body will be averaged and multiplied by the mass of the car body to give the force against time during the impact.

The strain gage time histories will be presented.

All data recorded by the Data Bricks, and the derived values mentioned above, will be presented to the FRA in digital form on a CD as well as on paper.

The film from each camera will be analyzed frame by frame and the velocity during the impact calculated. A 100 Hz reference signal will be placed on the film so that accurate frame speed can be determined for film analysis. An electronic signal generator provides the calibrated 100-Hz pulse train to light emitting diodes (LEDs) in the high-speed cameras. Illumination of the LEDs exposes a small red dot on the edge of the film, outside the normal field of view. During film analysis, the precise film speed is determined from the number of frames and fractions thereof that pass between two adjacent LED marks.

All the data output described in this section will be presented in a report and submitted to the FRA. The report will also contain general information about the crash test and describe how it was conducted.

9.0 Safety

All Transportation Technology Center, Inc. (TTCI) safety rules will be observed during the preparation and performance of the crash tests. All personnel participating in the tests will be required to comply with these rules when visiting the TTC, including wearing appropriate personal protective equipment. A safety briefing for all test personnel and visitors will be held prior to testing.

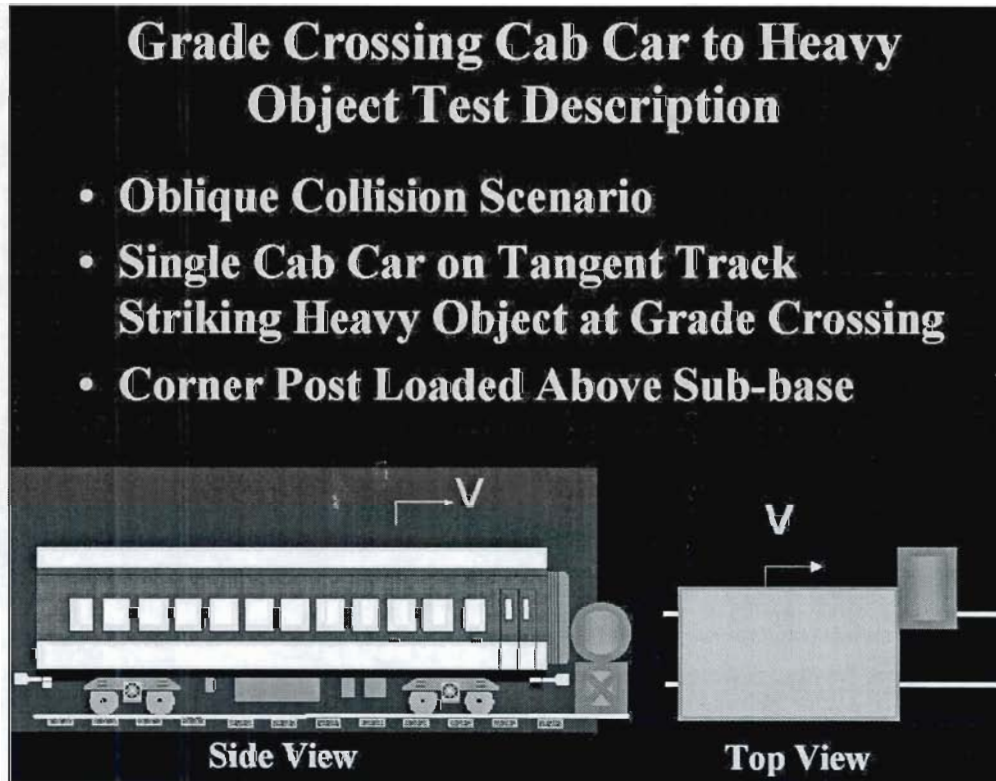

Figure 1. Grade Crossing Test Overview

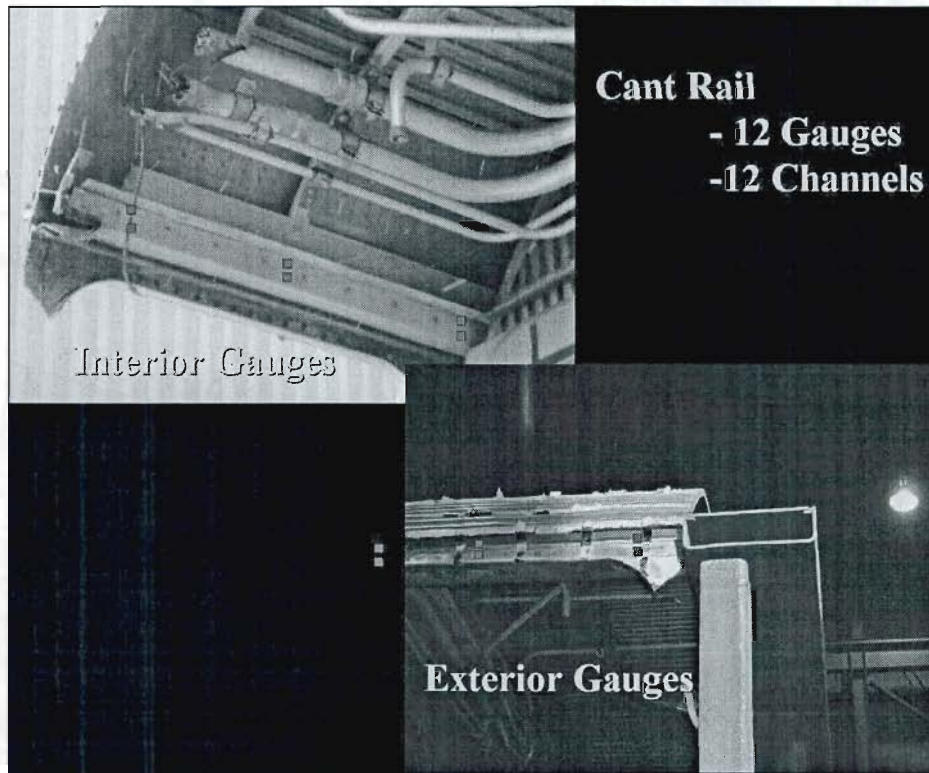

Figure 2. Placement of Strain Gauges on Cant Rail (Impacted Side)

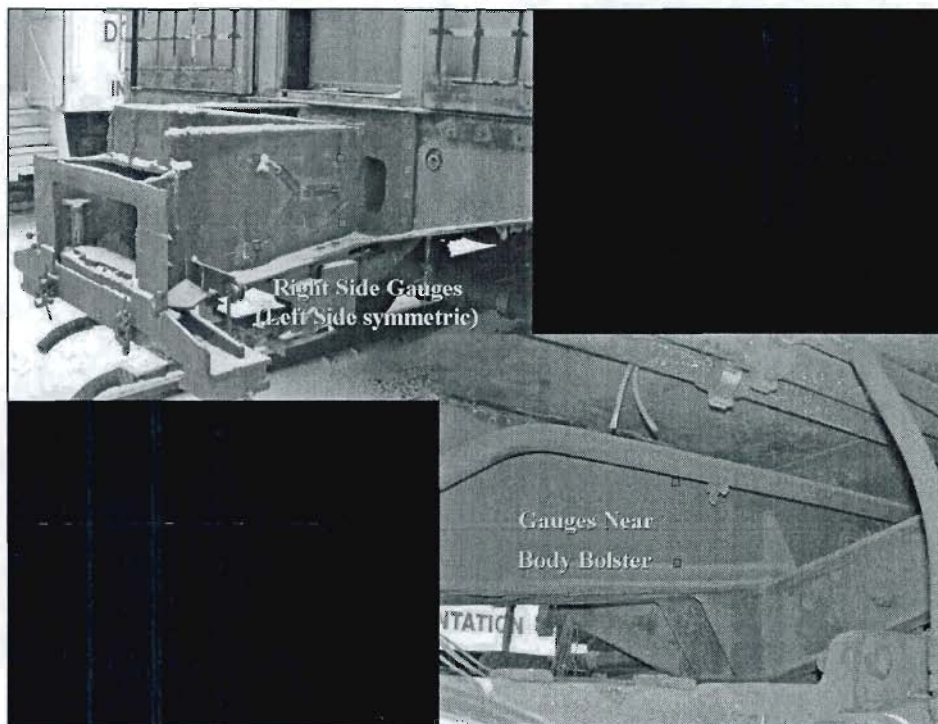

Figure 3. Placement of Strain Gauges on Draft Sill

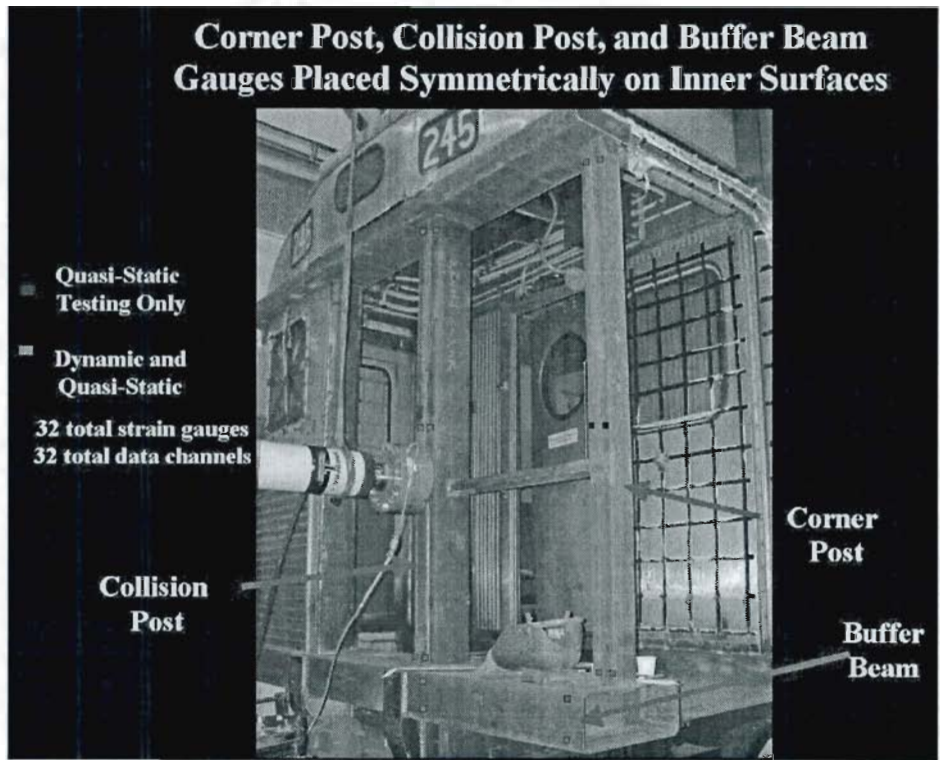

Figure 4. Placement of Strain Gauges on Corner Post, Collision Post, and Buffer Beam

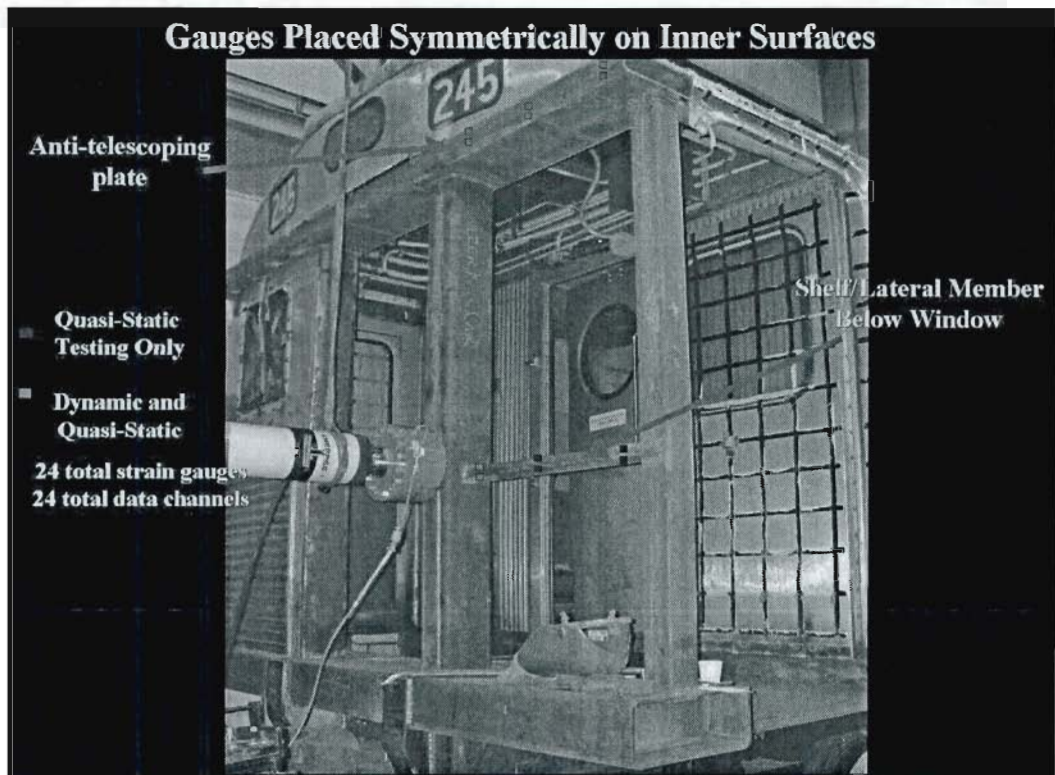

Figure 5. Placement of Strain Gauges on the Anti-telescoping Plate and the Shelf/Lateral Member Below the Window

47

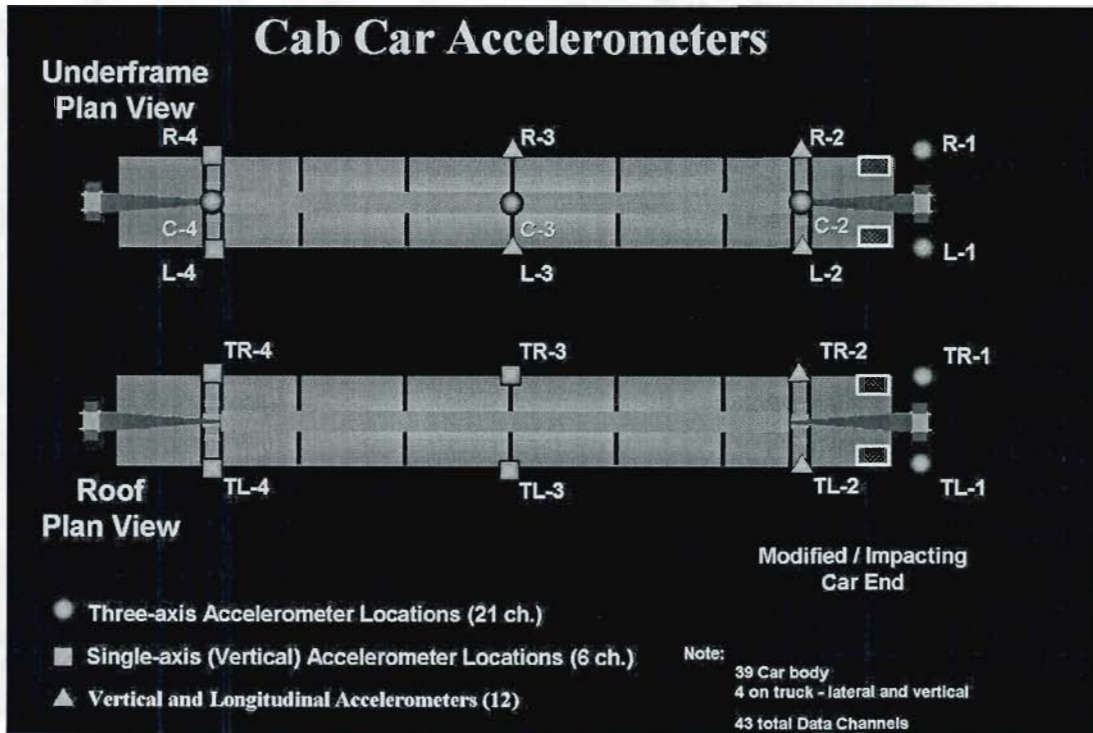

Figure 6. Placement of the Accelerometers on the Cab Car

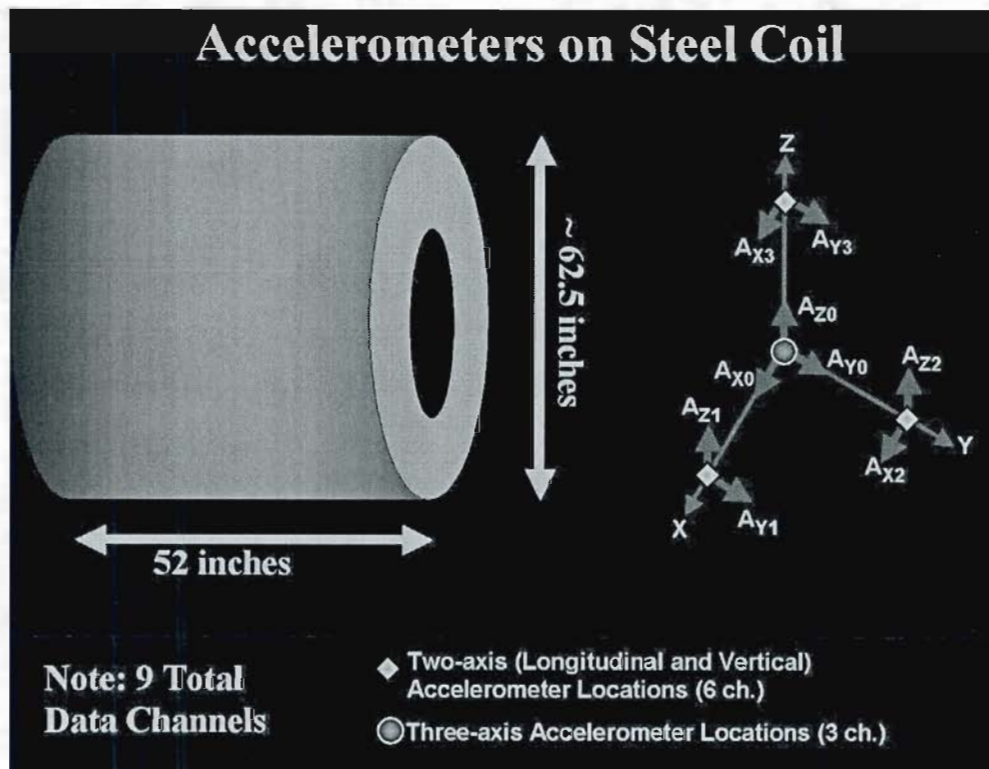

Figure 7. Placement of Accelerometers on Coil

148

Cab Car String Potentiometers

- **Structural Elements of Interest to Capture Deformation**
 - End Beam/Buf Wing
 - Corner Posts
- **Displacement across each secondary suspension of cab car (4 channels total)**

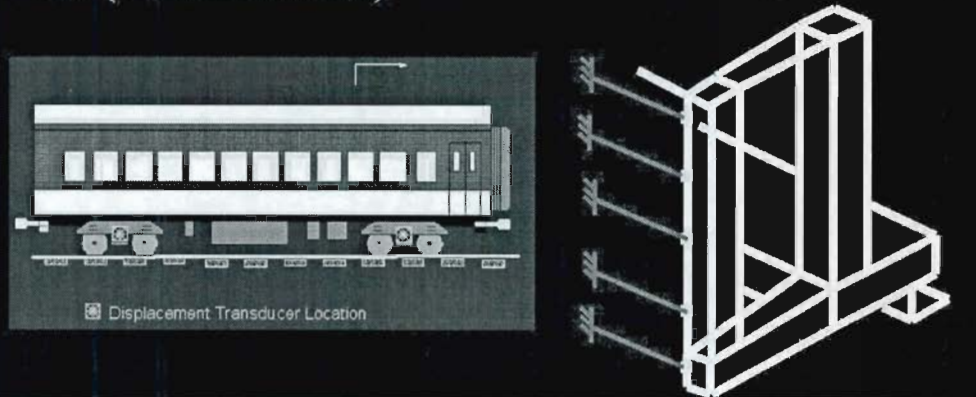

Figure 8. Placement of String Potentiometers on Cab car

Schematic Layout of Structural High Speed Camera Locations (8)

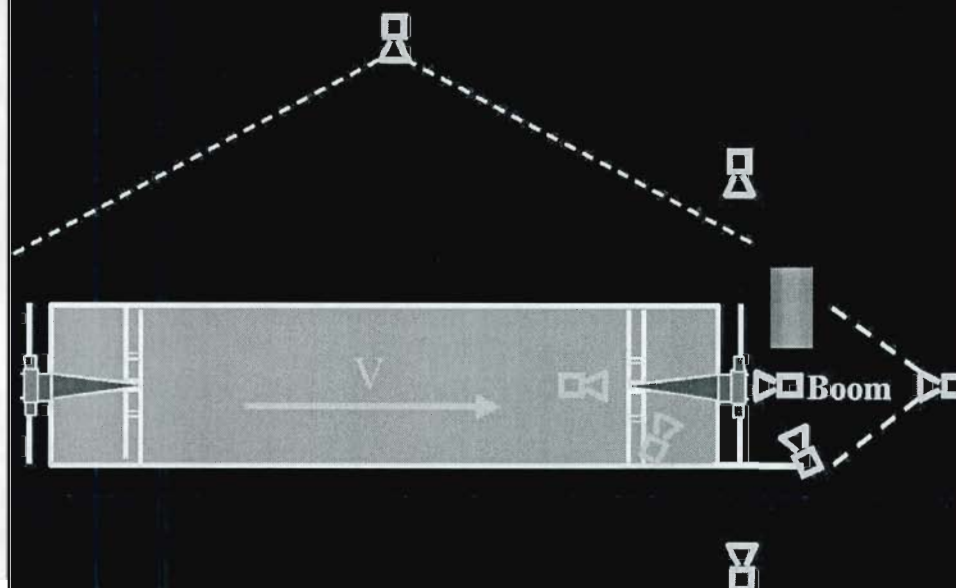

Figure 9. Placement of High Speed Film Cameras

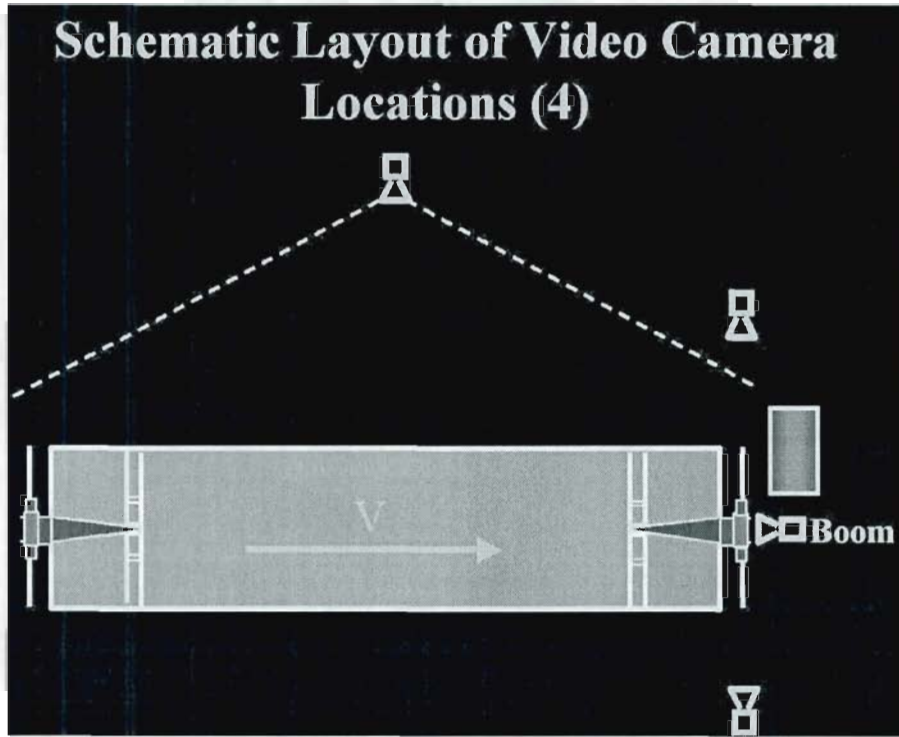

Figure 10. Placement of Video Cameras

APPENDIX B:
Quasi-static Load Test for
1990's Design Passenger Car

- **Test 1: Collision Post Longitudinal Load Test (Figure B1)**
100 kips in a longitudinal direction, 30 inches above floor level
- **Test 2: Corner Post Longitudinal Load Test (Figure B2)**
30 kips in a longitudinal direction, 18 inches above floor level
- **Test 3: Corner Post Lateral Load Test (Figure B3)**
30 kips in a lateral direction, 18 inches above floor level
- **Test 4: Lateral Member Load Test (Figure B4)**
10 kips in a longitudinal direction, load applied at mid point of member

This page left blank intentionally

Test 1: Collision Post Longitudinal Load Test

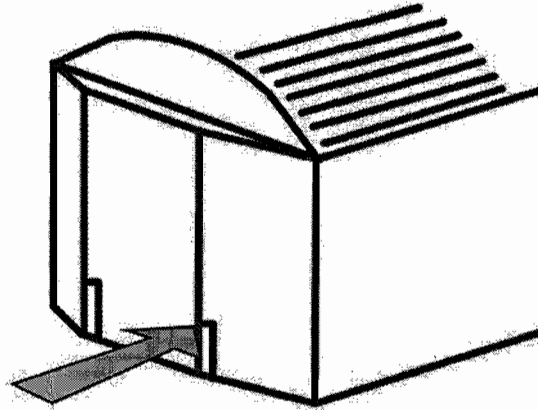

100 Kips @30 inches

2049-2-1

Figure B1

Test 2: Corner Post Longitudinal Test

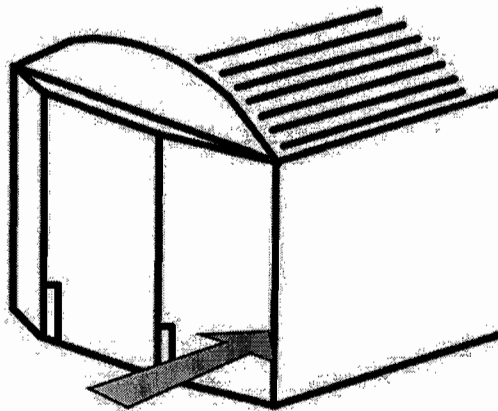

30 Kips @18 inches

2049-2-2

Figure B2

Test 3: Corner Post Lateral Load Test

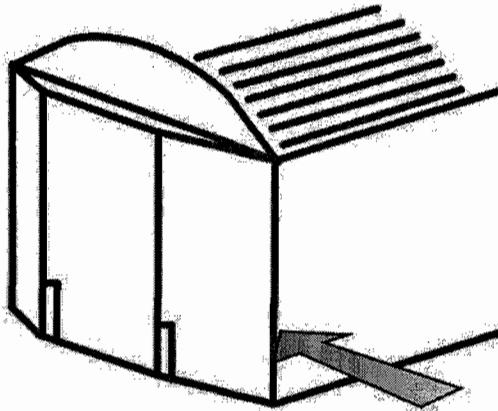

30 Kips @18 inches

2049-2-3

Figure B3

Test 3: Corner Post

Test 4: Lateral Member Load Test

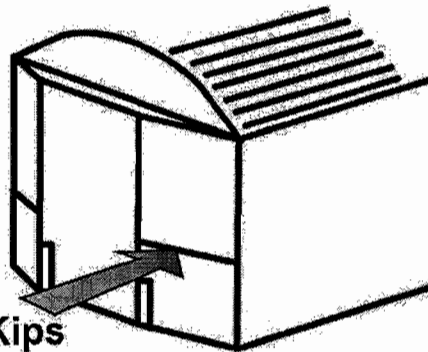

10 Kips

2049-2-4

Figure B4

APPENDIX C:

**Quasi-Static Load Test
for SOA Design Passenger Car**

- **Test 1: Collision Post Longitudinal Load Test (Figure C1)**
100 kips in a longitudinal direction, 30 inches above floor level
- **Test 2: Corner Post Longitudinal Load Test (Figure C2)**
100 kips in a longitudinal direction, 18 inches above floor level
- **Test 3: Corner Post Lateral Load Test (Figure C3)**
100 kips in a lateral direction, 18 inches above floor level
- **Test 4: Lateral Member Load Test (Figure C4)**
10 kips in a longitudinal direction, load applied at mid-point of member

This page left blank intentionally

Test 1: Collision Post Longitudinal Load Test

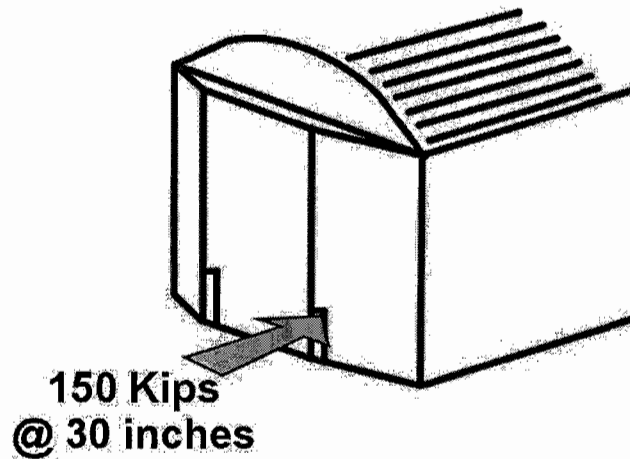

2049-2-6

Figure C1

Test 2: Corner Post Longitudinal Load Test

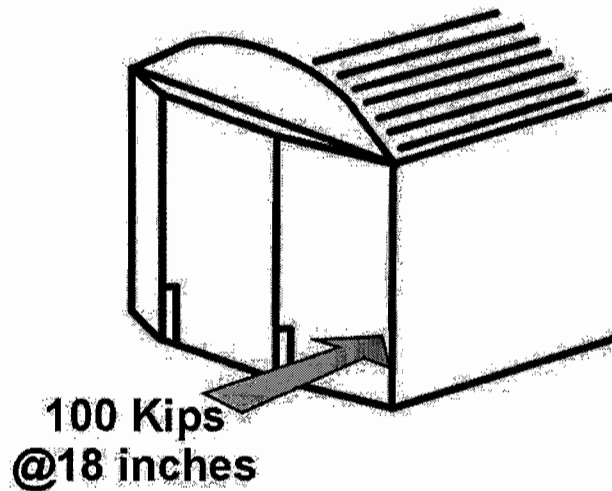

2049-2-6

Figure C2

Test 3: Corner Post Lateral Load Test

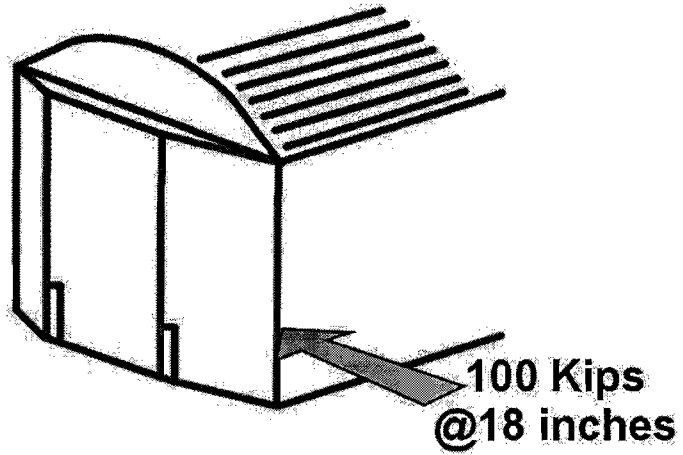

Figure C3

2049-2-7

Test 4: Lateral Member Load Test

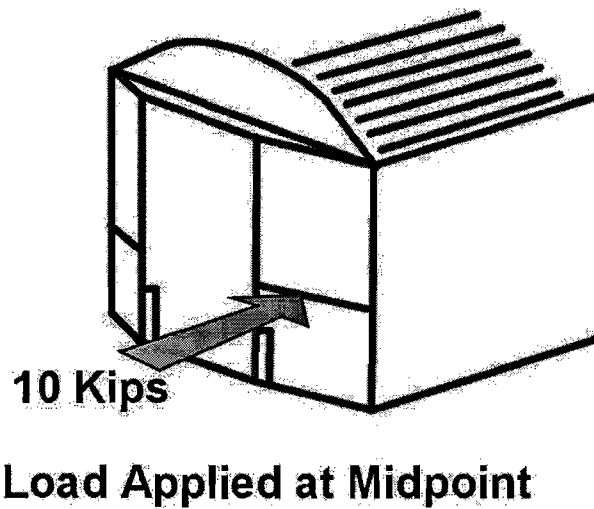

Figure C4

2049-2-8

Appendix D

Test 4
Acceleration Data, CFC = 1000Hz

This page left blank intentionally

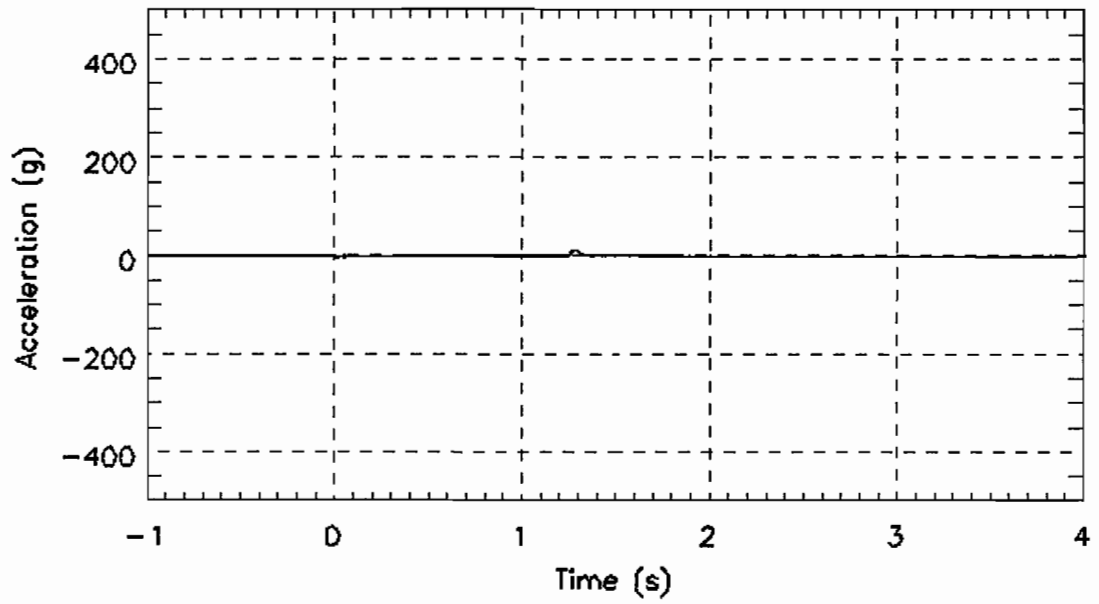

Figure D- 1. Steel coil, centered, longitudinal acceleration, no digital filter, A0X_1000Hz.txt

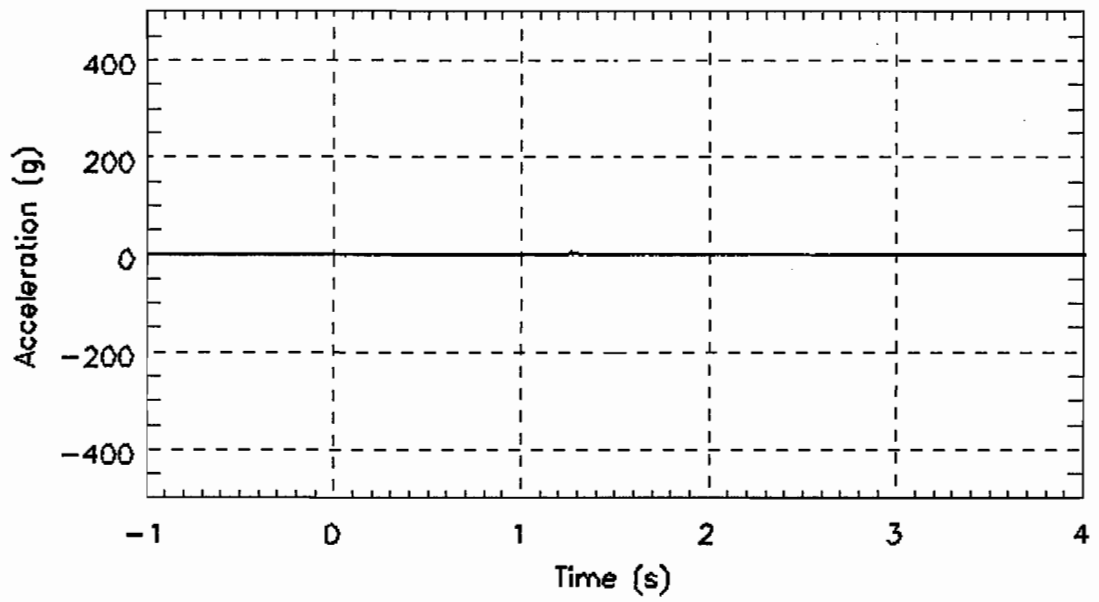

Figure D- 2. Steel coil, centered, lateral acceleration, no digital filter, A0Y_1000Hz.txt

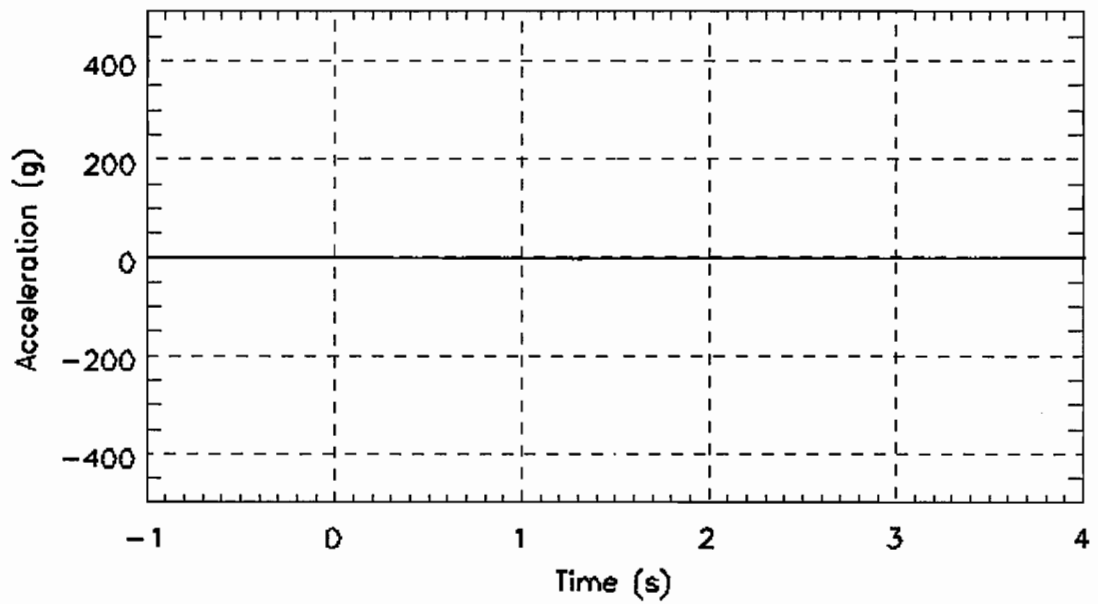

Figure D- 3. Steel coil, centered, vertical acceleration, no digital filter, A0Z_1000Hz.txt

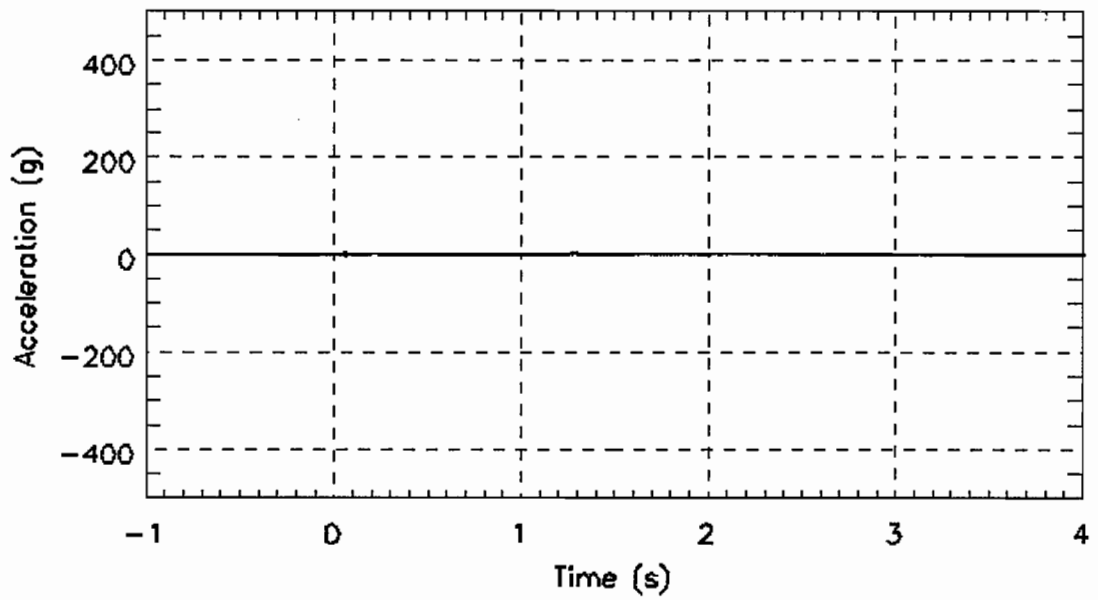

Figure D- 4. Steel coil, offset along X axis, lateral acceleration, no digital filter, A1Y_1000Hz.txt

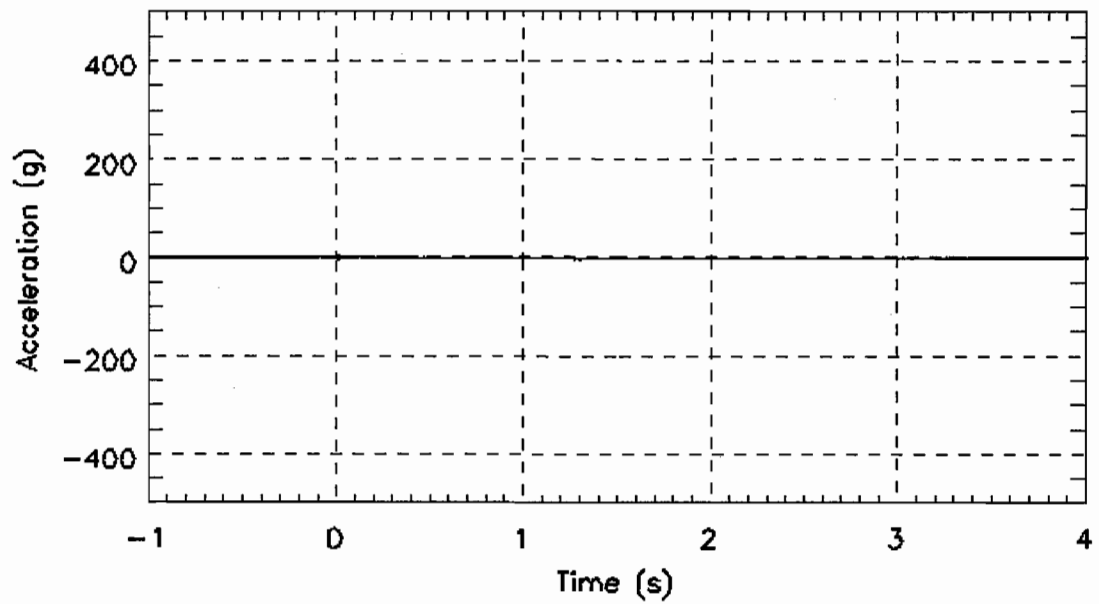

Figure D- 5. Steel coil, offset along X axis, vertical acceleration, no digital filter, A1Z_1000Hz.txt

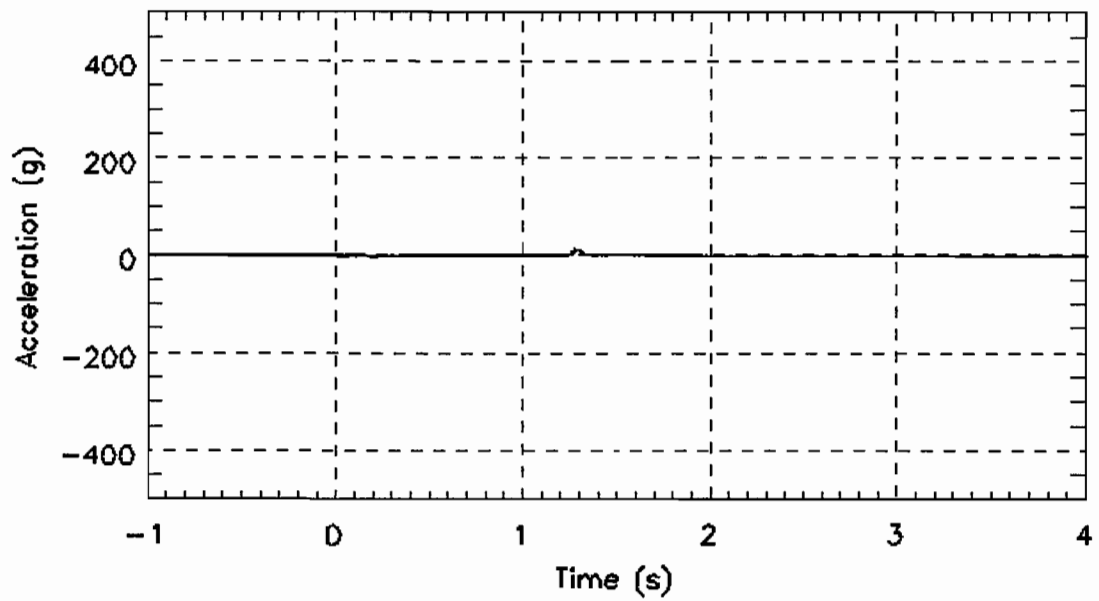

Figure D- 6. Steel coil, offset along Y axis, longitudinal acceleration, no digital filter, A2X_1000Hz.txt

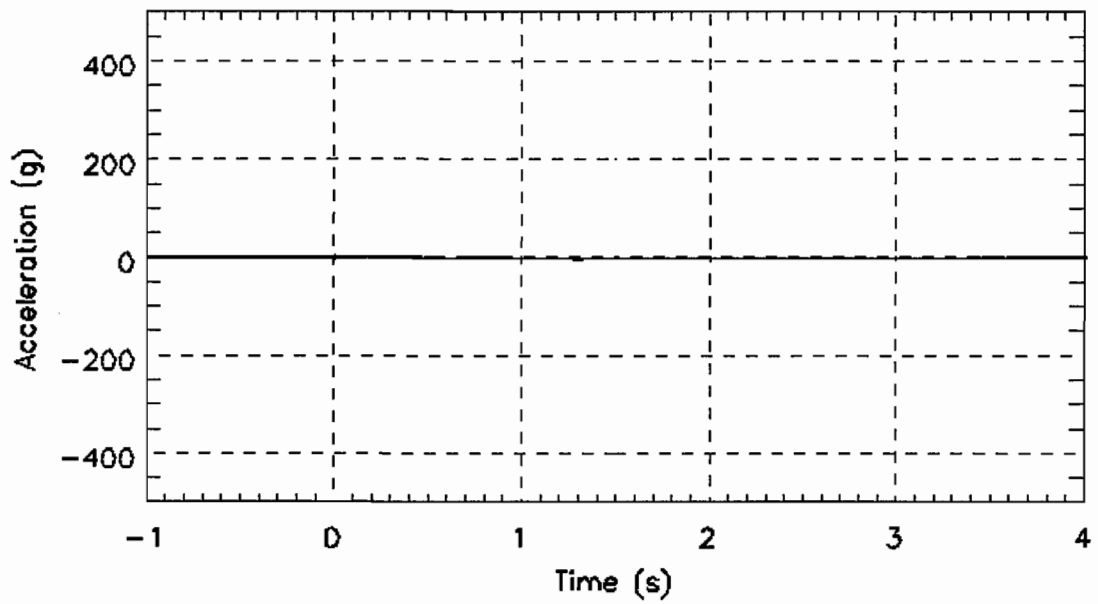

Figure D- 7. Steel coil, offset along Y axis, vertical acceleration, no digital filter, A2Z_1000Hz.txt

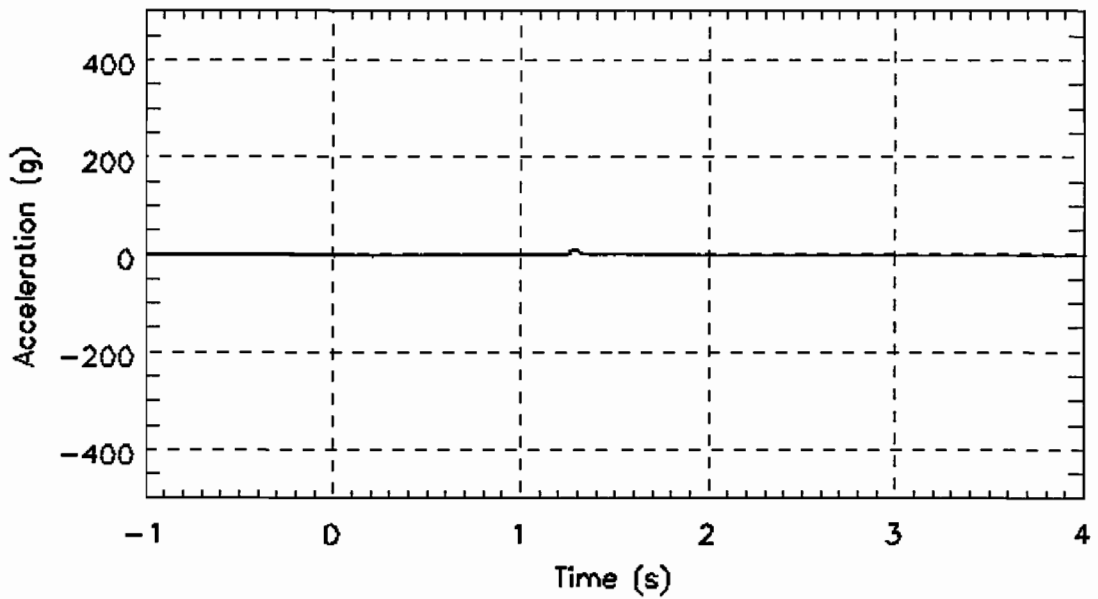

Figure D- 8. Steel coil, offset along Z axis, longitudinal acceleration, no digital filter, A3X_1000Hz.txt

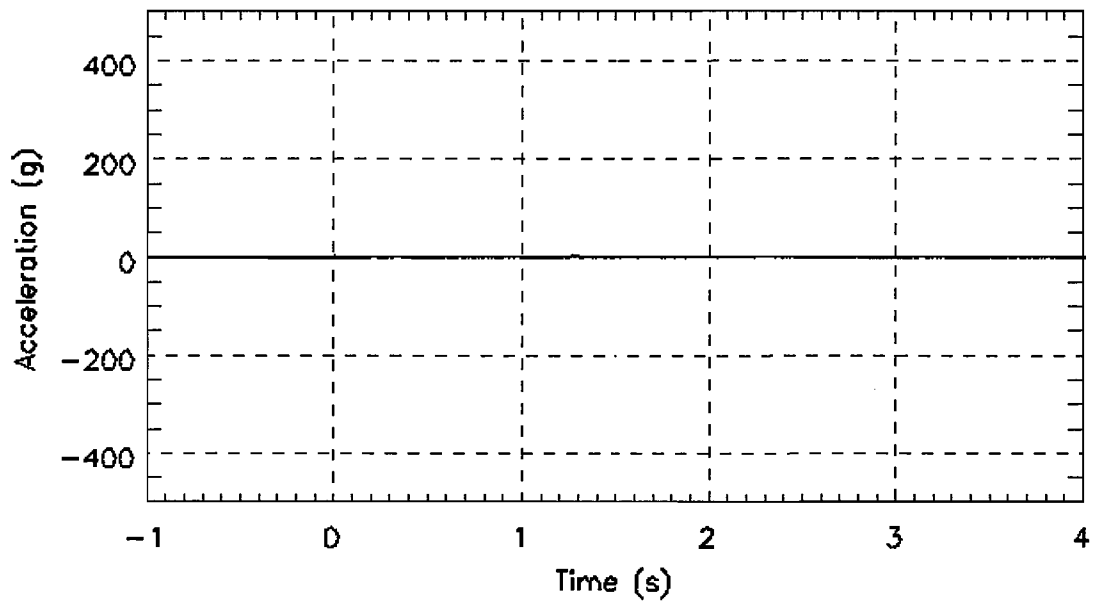

Figure D- 9. Steel coil, offset along Z axis, lateral acceleration, no digital filter, A3Y_1000Hz.txt

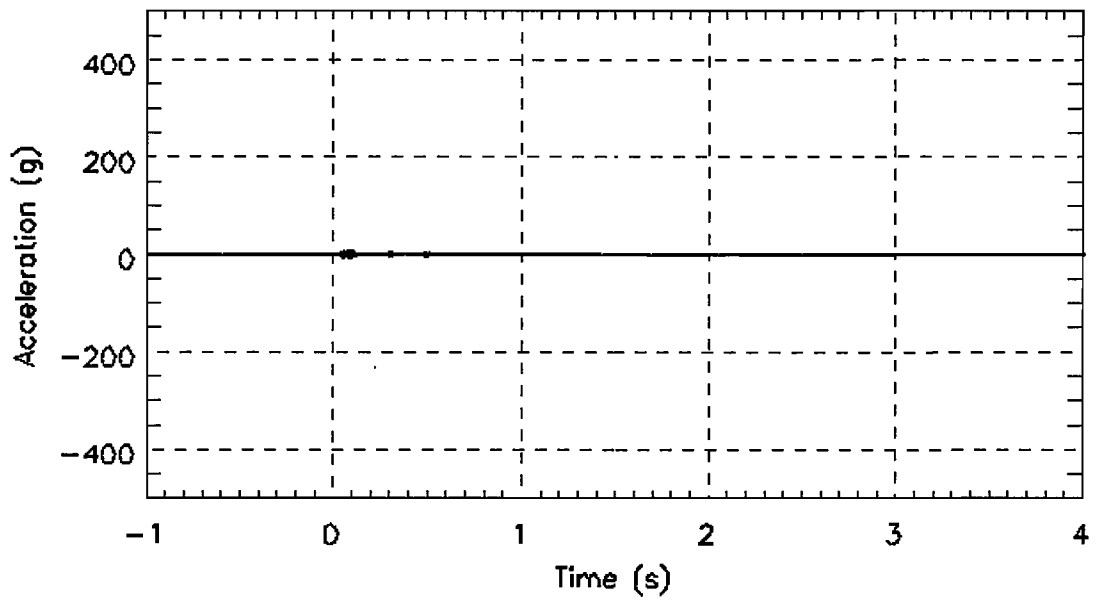

Figure D- 10. Lead bogie, lateral acceleration, no digital filter, BAY_1000Hz.txt

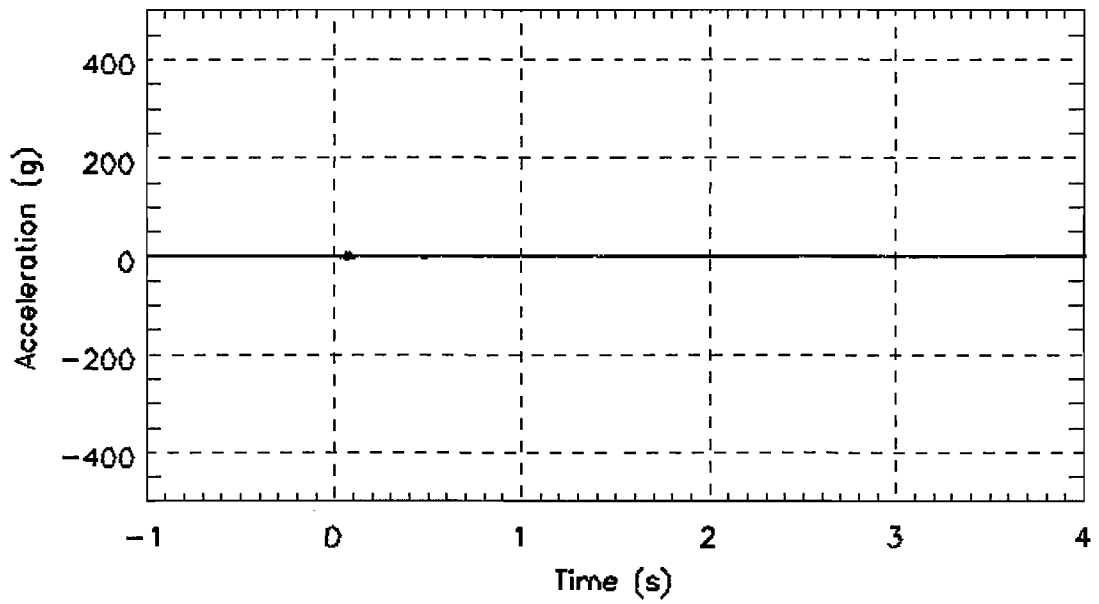

Figure D- 11. Lead bogie, vertical acceleration, no digital filter, BAZ_1000Hz.txt

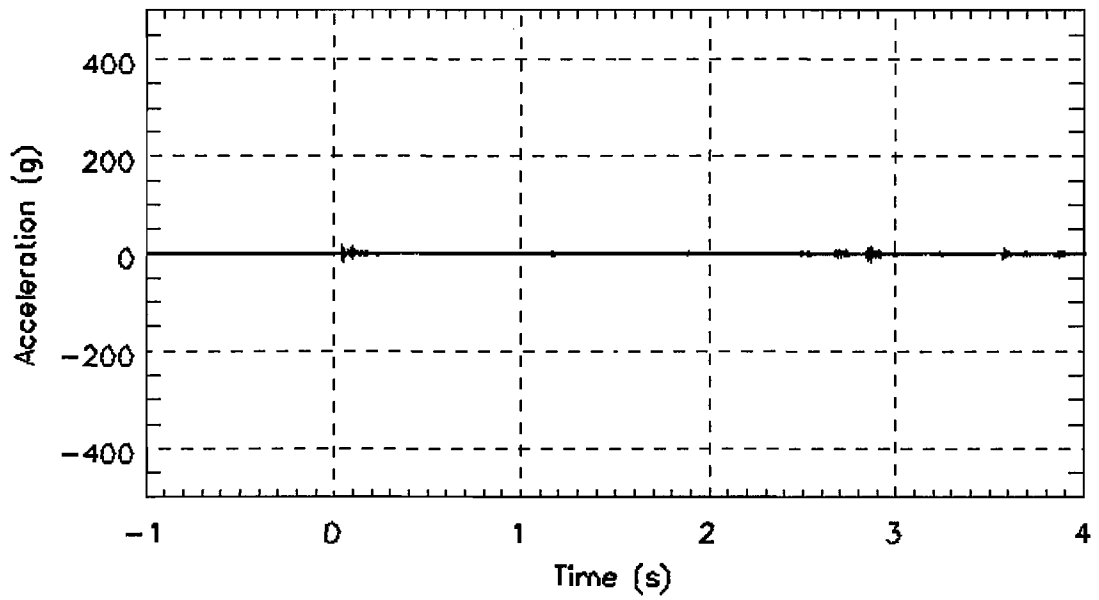

Figure D- 12. Trail bogie, lateral acceleration, no digital filter, BBY_1000Hz.txt

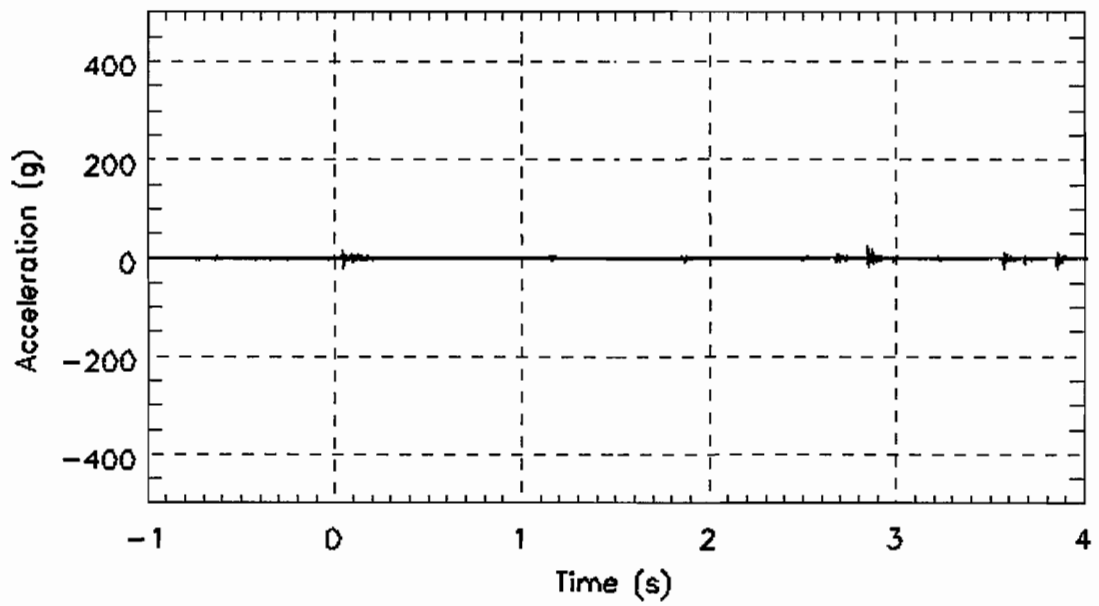

Figure D- 13. Trail bogie, vertical acceleration, no digital filter, BBZ_1000Hz.txt

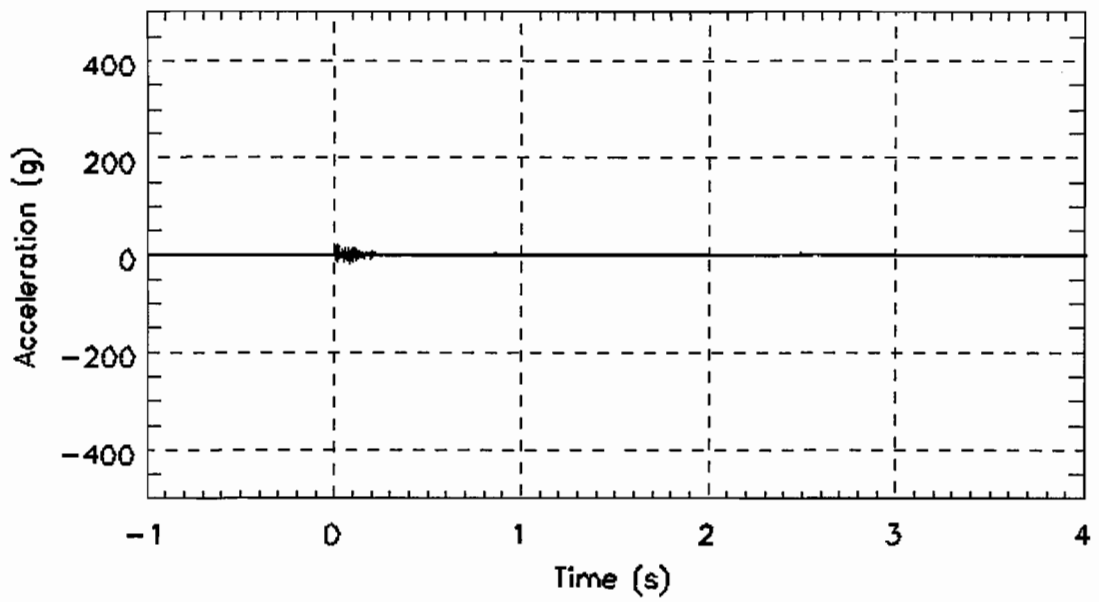

Figure D- 14. Bullet car, position 2, centersill, longitudinal acceleration, no digital filter, C2X_1000Hz.txt

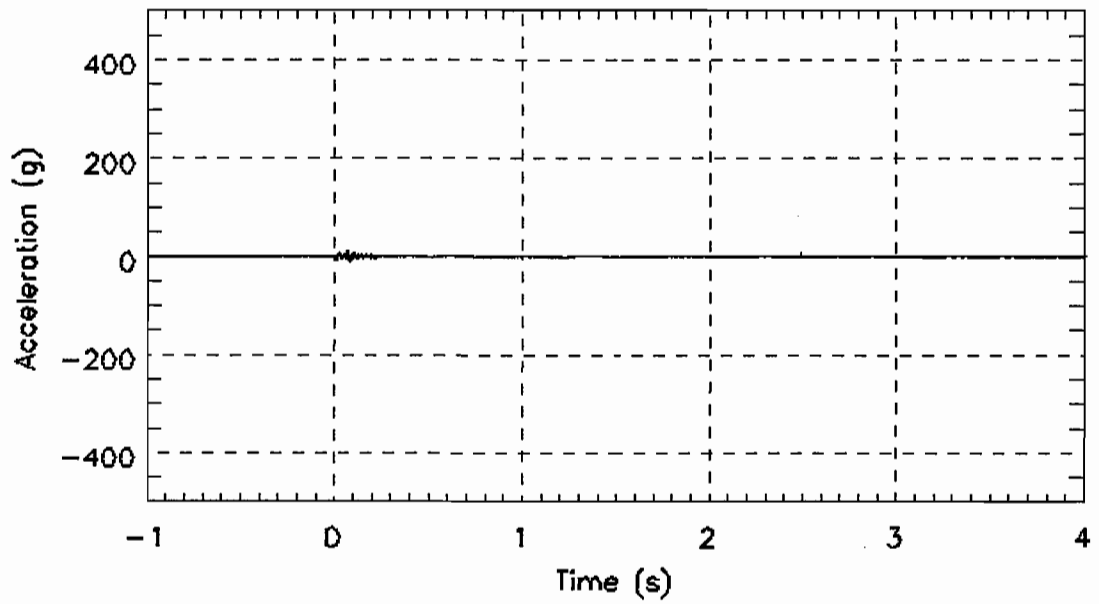

Figure D- 15. Bullet car, position 2, centersill, lateral acceleration, no digital filter, C2Y_1000Hz.txt

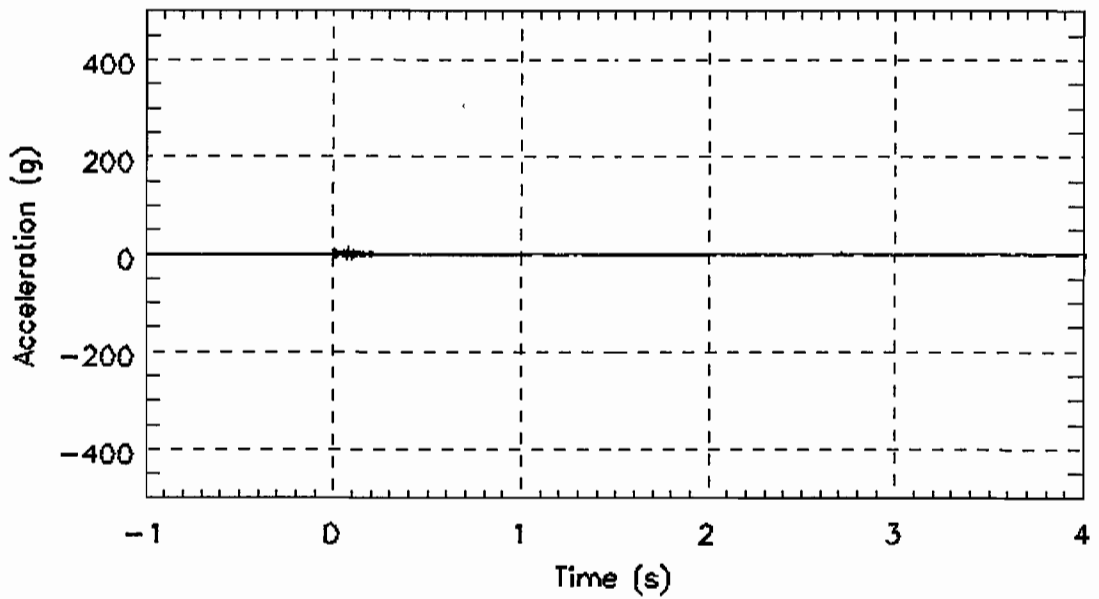

Figure D- 16. Bullet car, position 2, centersill, vertical acceleration, no digital filter, C2Z_1000Hz.txt

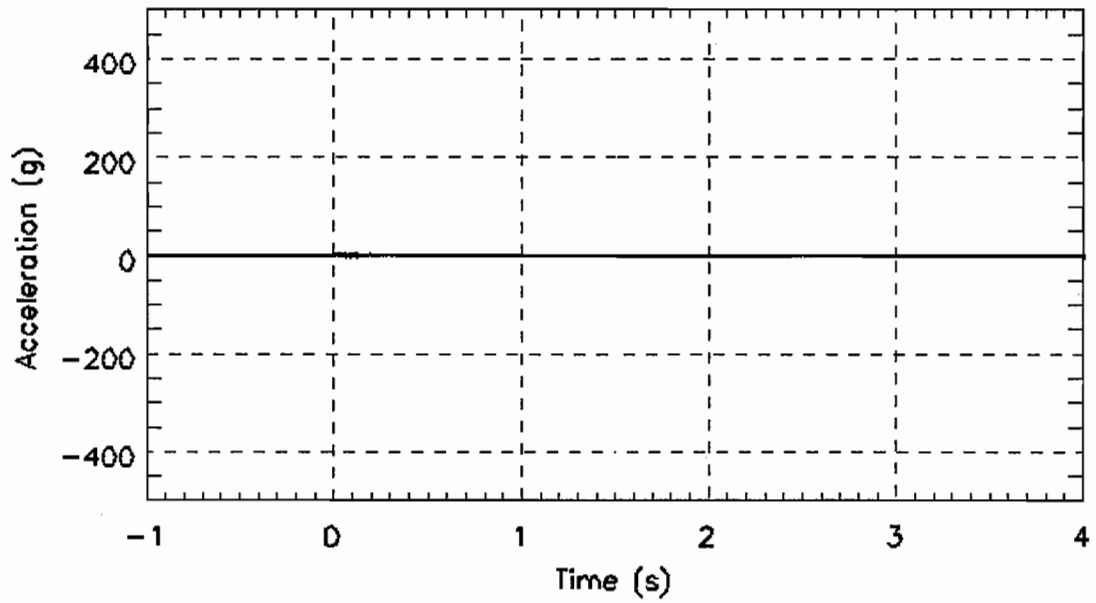

Figure D- 17. Bullet car, position 3, centersill, longitudinal acceleration, no digital filter, C3X_1000Hz.txt

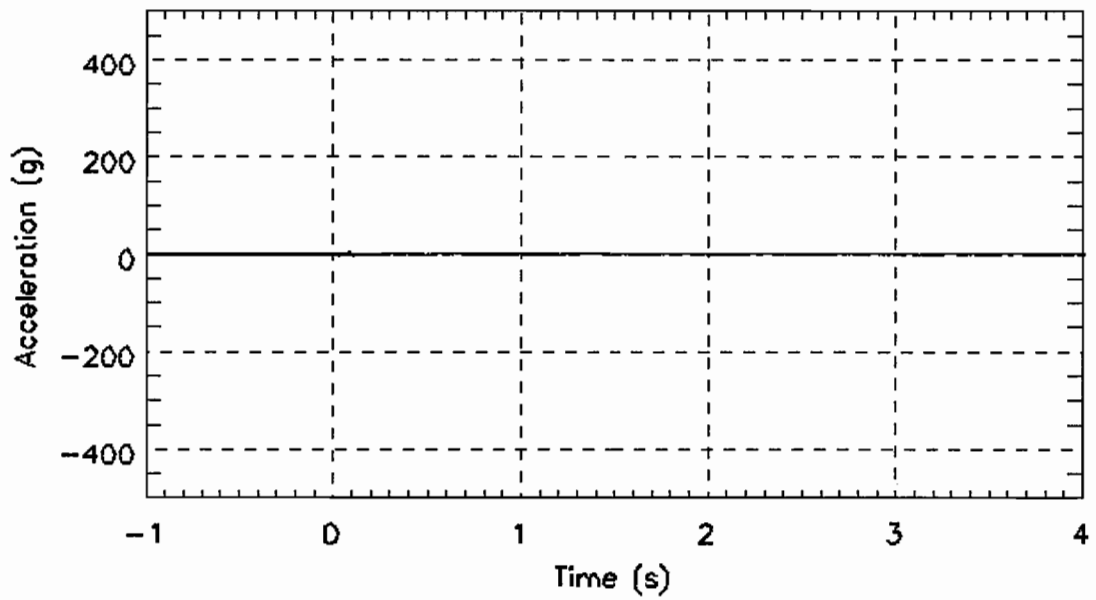

Figure D- 18. Bullet car, position 3, centersill, lateral acceleration, no digital filter, C3Y_1000Hz.txt

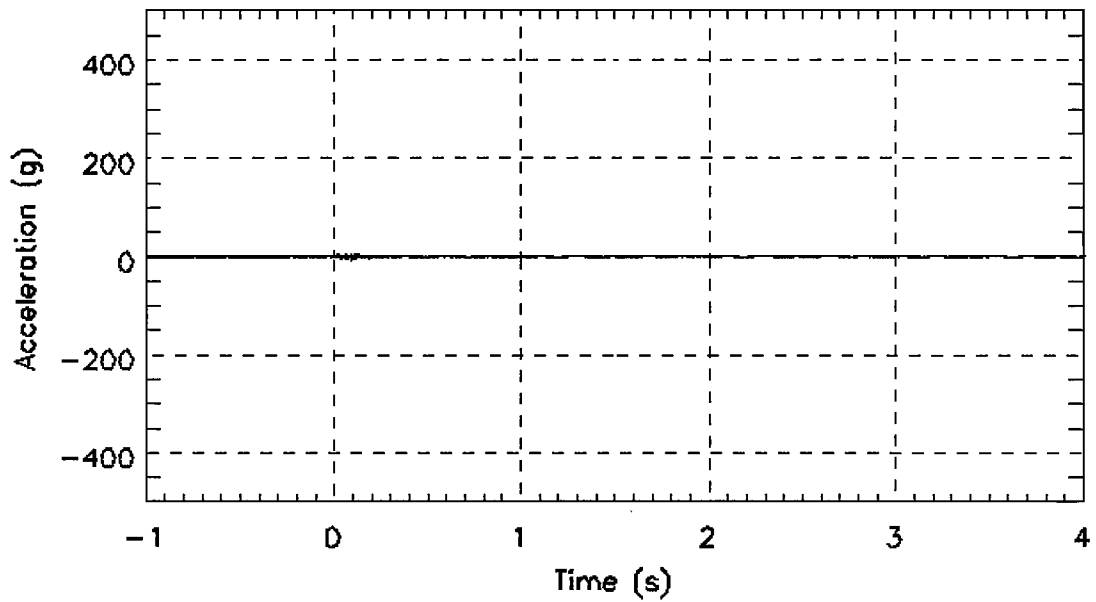

Figure D- 19. Bullet car, position 3, centersill, vertical acceleration, no digital filter, C3Z_1000Hz.txt

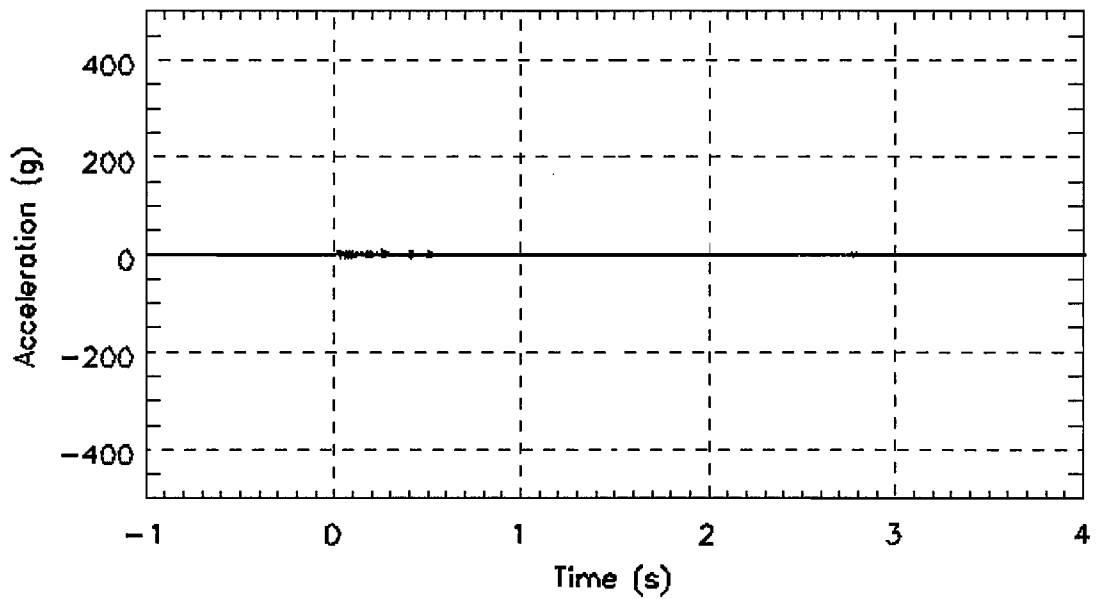

Figure D- 20. Bullet car, position 4, centersill, longitudinal acceleration, no digital filter, C4X_1000Hz.txt

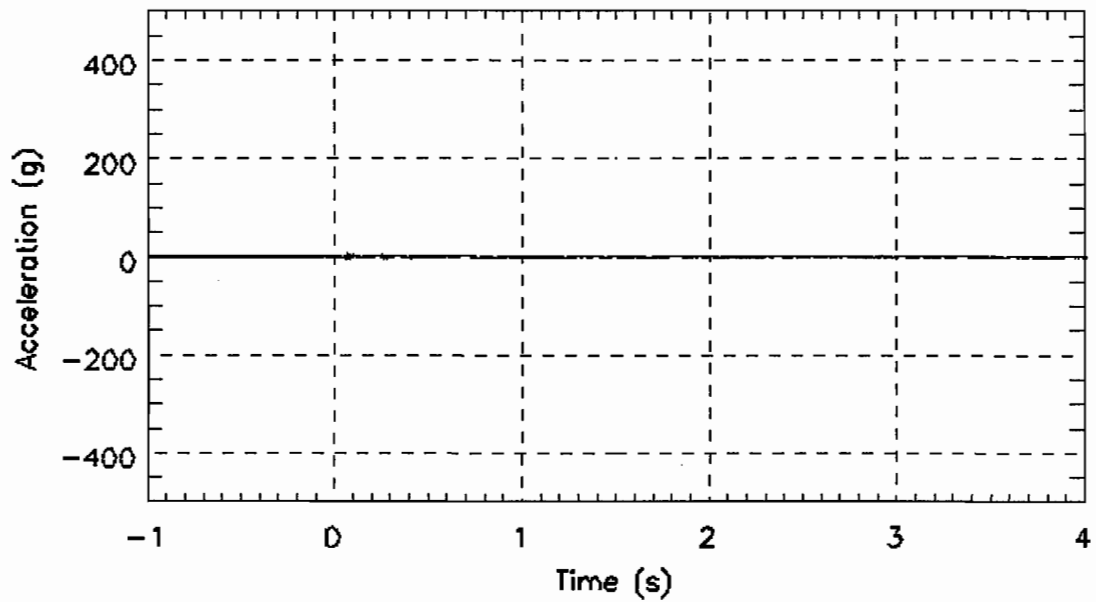

Figure D- 21. Bullet car, position 4, centersill, lateral acceleration, no digital filter, C4Y_1000Hz.txt

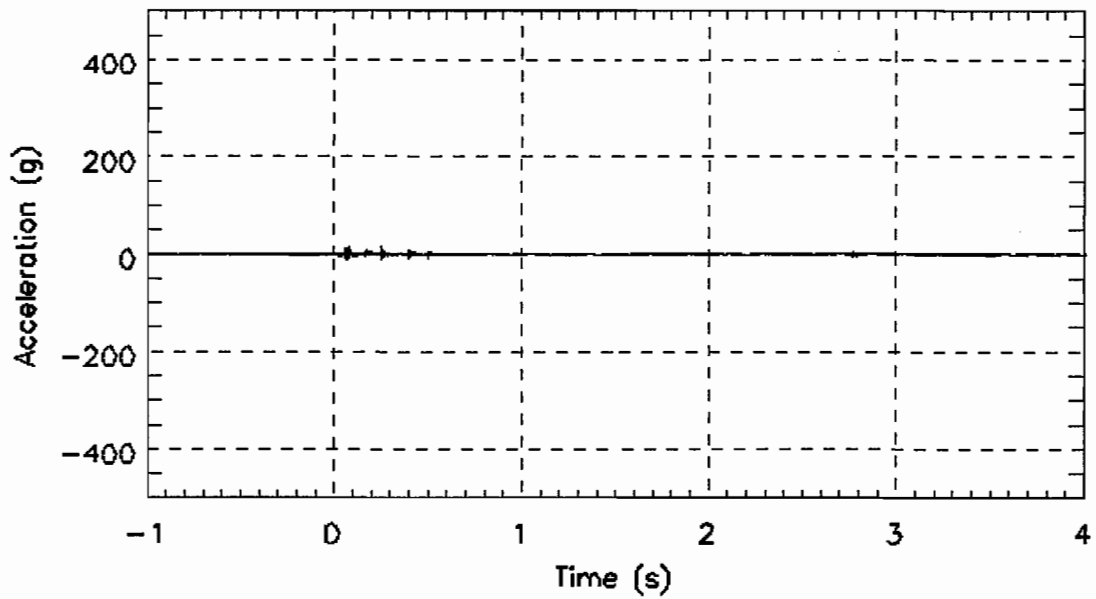

Figure D- 22. Bullet car, position 4, centersill, vertical acceleration, no digital filter, C4Z_1000Hz.txt

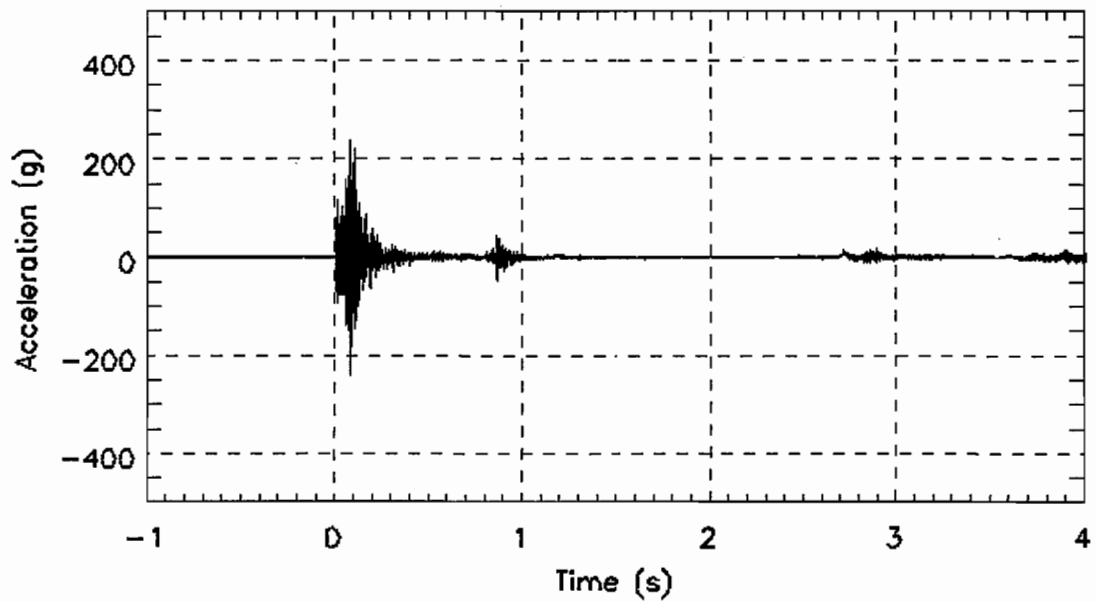

Figure D- 23. Bullet car, underframe level, left side, position 1, longitudinal acceleraion, no digital filter, L1X_1000Hz.txt

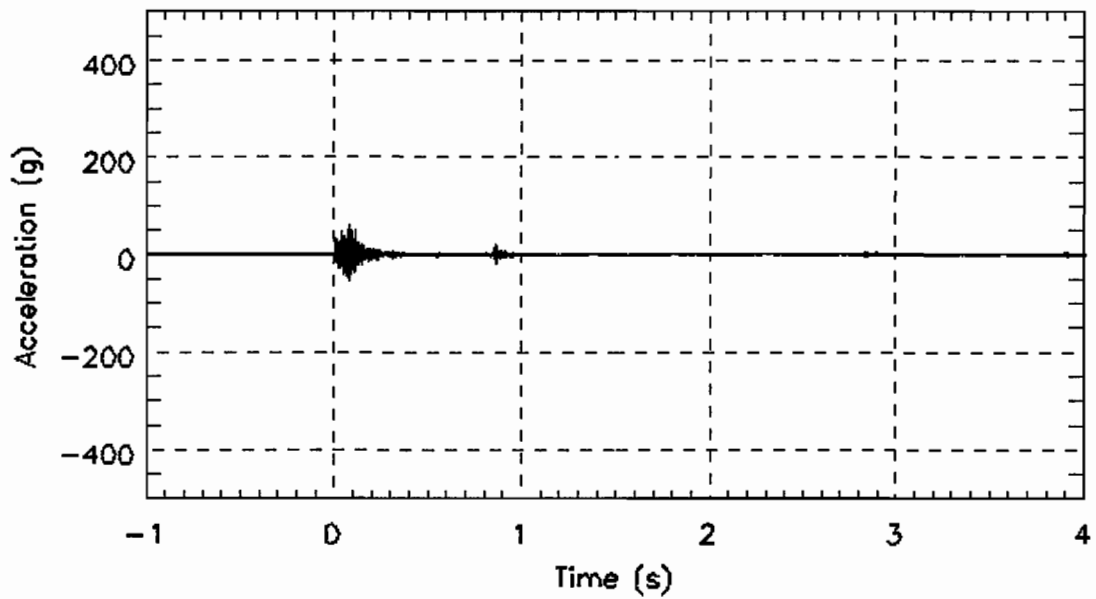

Figure D- 24. Bullet car, underframe level, left side, position 1, lateral acceleraion, no digital filter, L1Y_1000Hz.txt

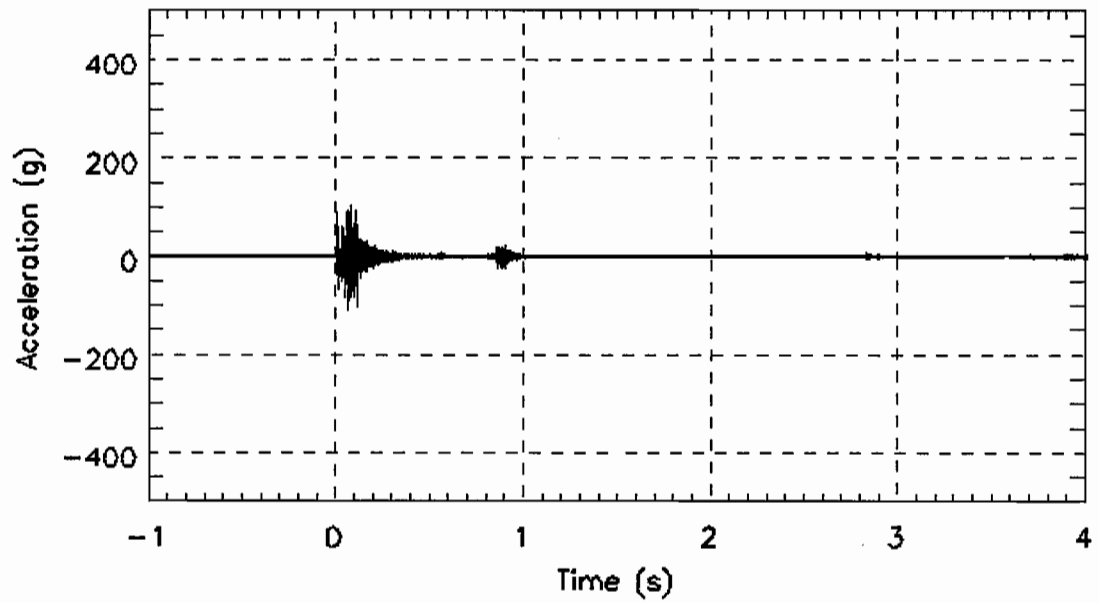

Figure D- 25. Bullet car, underframe level, left side, position 1, vertical acceleraion, no digital filter, L1Z_1000Hz.txt

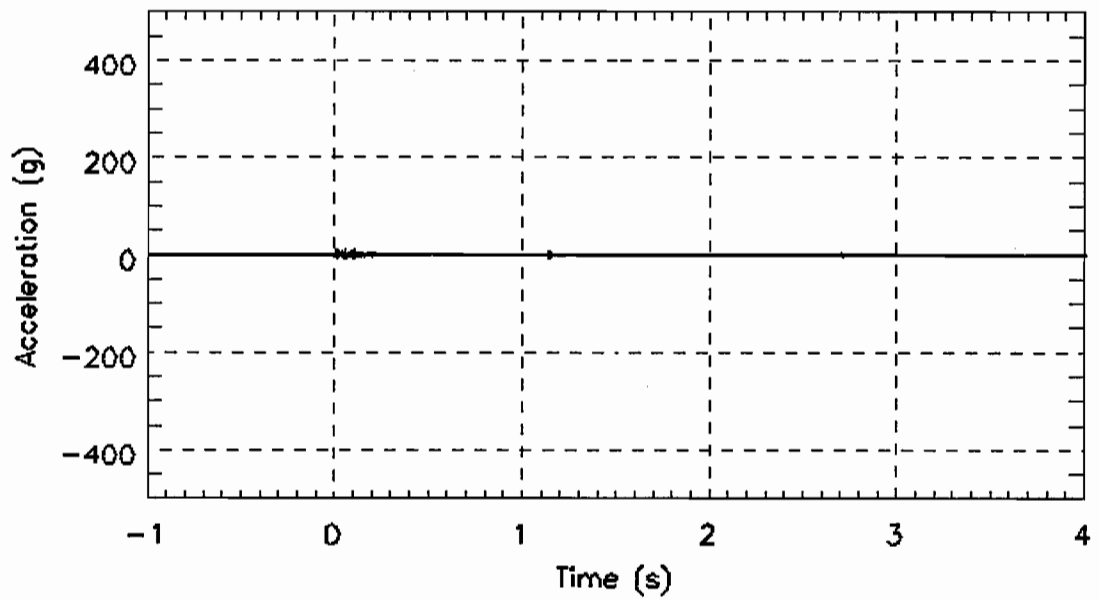

Figure D- 26. Bullet car, underframe level, left side, position 2, longitudinal acceleraion, no digital filter, L2X_1000Hz.txt

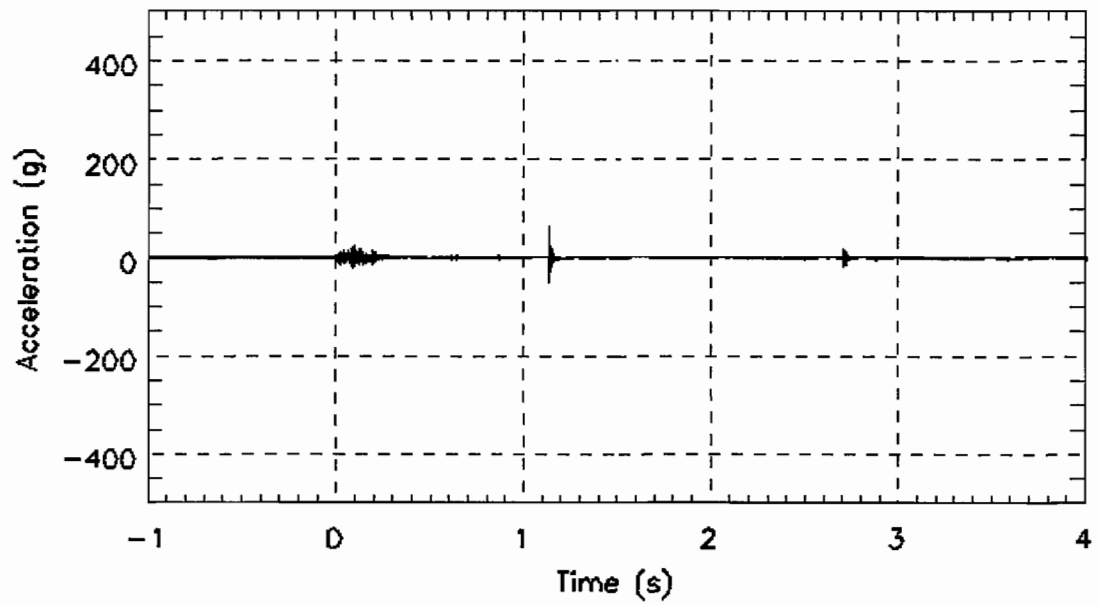

Figure D- 27. Bullet car, underframe level, left side, position 2, vertical acceleraion, no digital filter, L2Z_1000Hz.txt

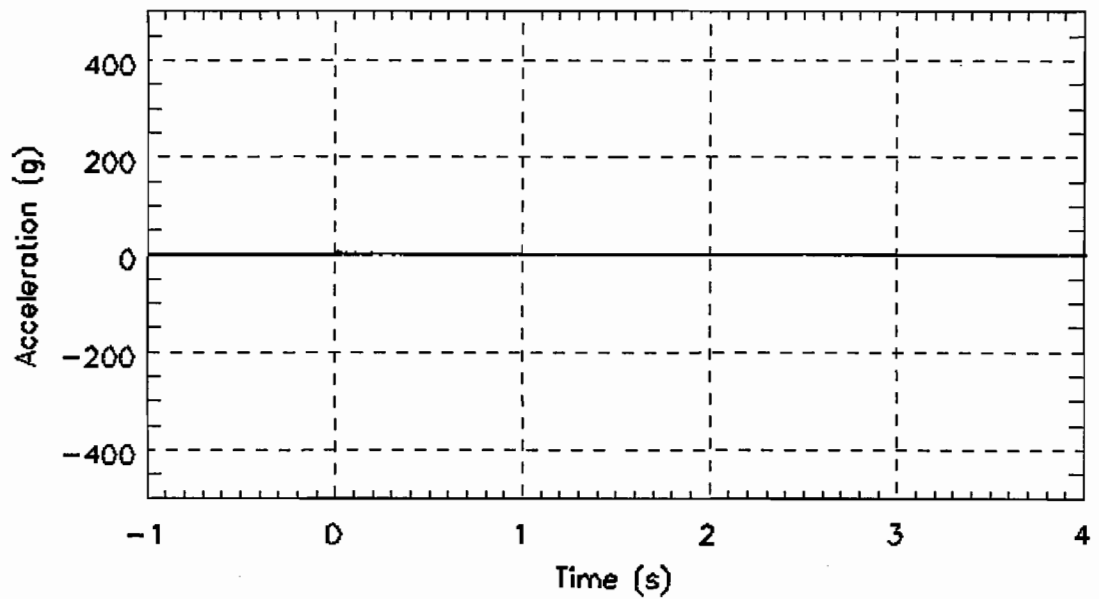

Figure D- 28. Bullet car, underframe level, left side, position 3, longitudinal acceleraion, no digital filter, L3X_1000Hz.txt

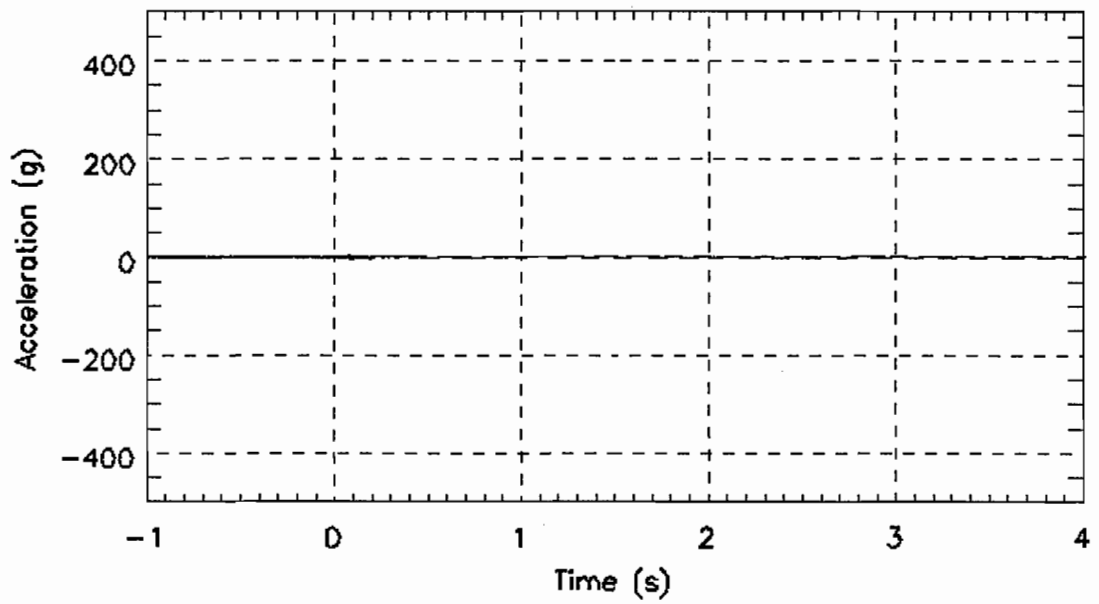

Figure D- 29. Bullet car, underframe level, left side, position 3, vertical acceleraion, no digital filter, L3Z_1000Hz.txt

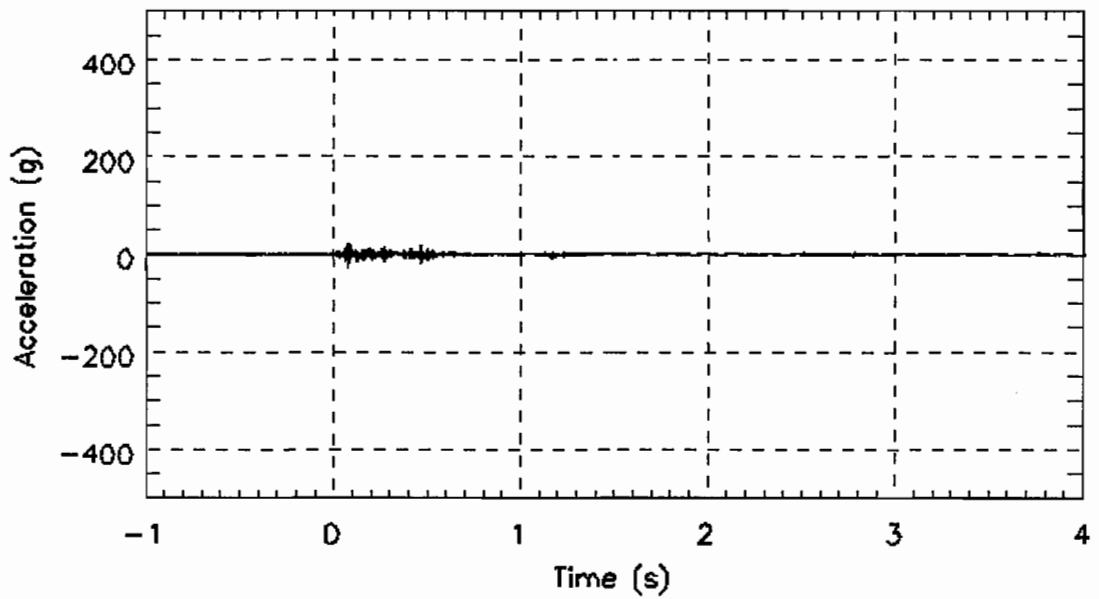

Figure D- 30. Bullet car, underframe level, left side, position 4, vertical acceleraion, no digital filter, L4Z_1000Hz.txt

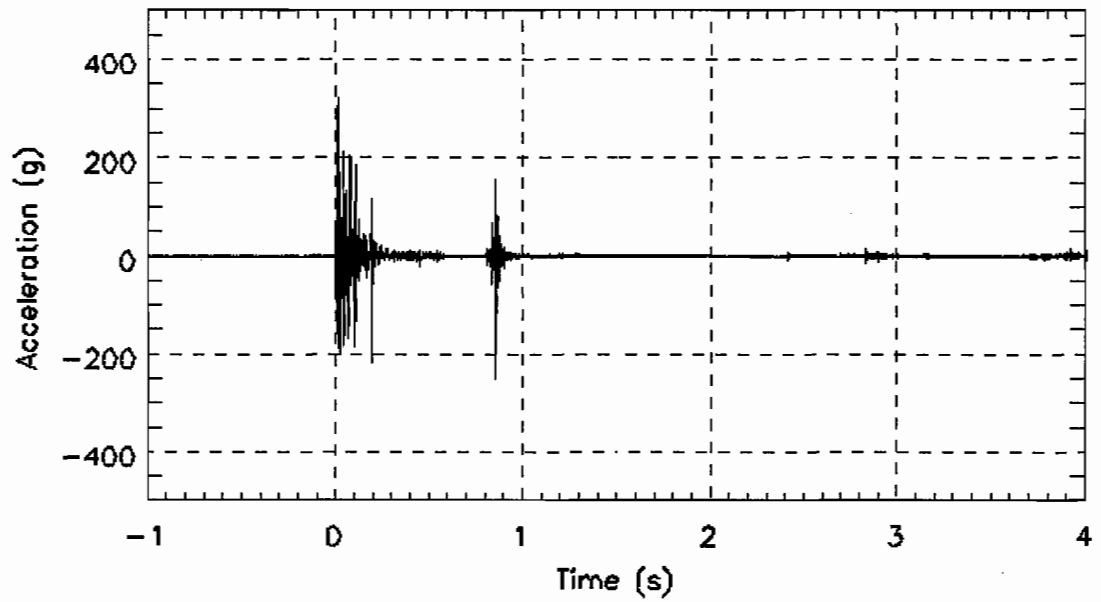

Figure D- 31. Bullet car, underframe level, right side, position 1, longitudinal acceleraion, no digital filter, R1X_1000Hz.txt

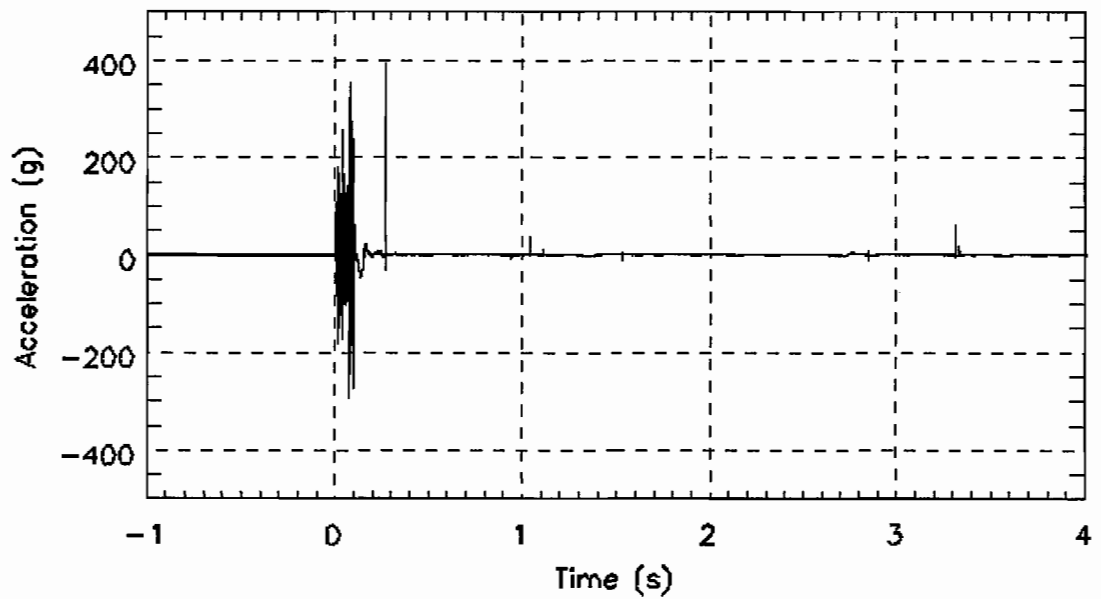

Figure D- 32. Bullet car, underframe level, right side, position 1, lateral acceleraion, no digital filter, R1Y_1000Hz.txt

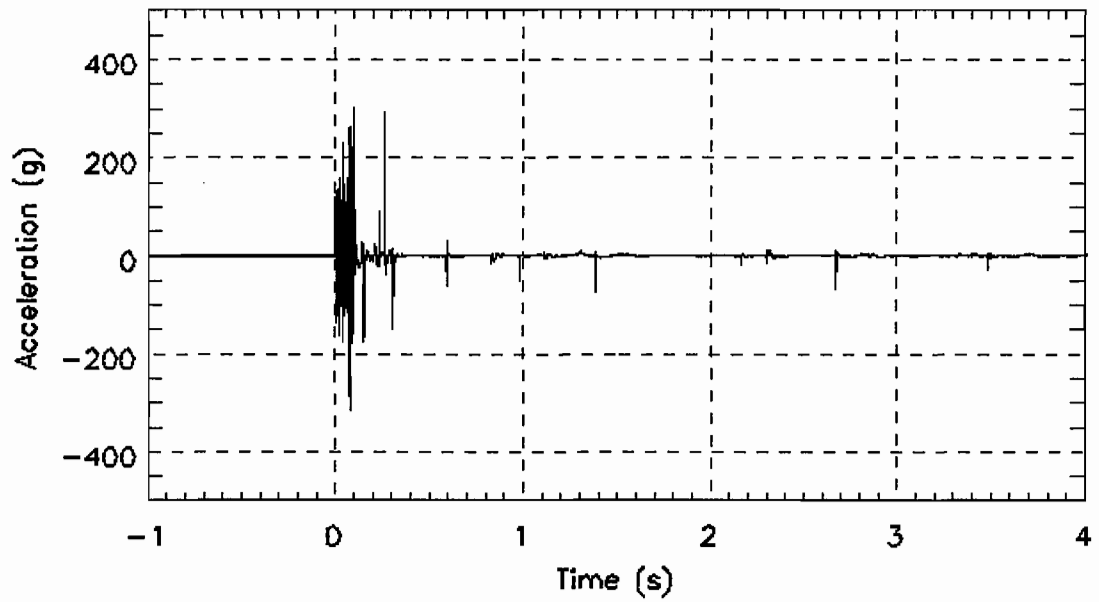

Figure D- 33. Bullet car, underframe level, right side, position 1, vertical acceleraion, no digital filter, R1Z_1000Hz.txt

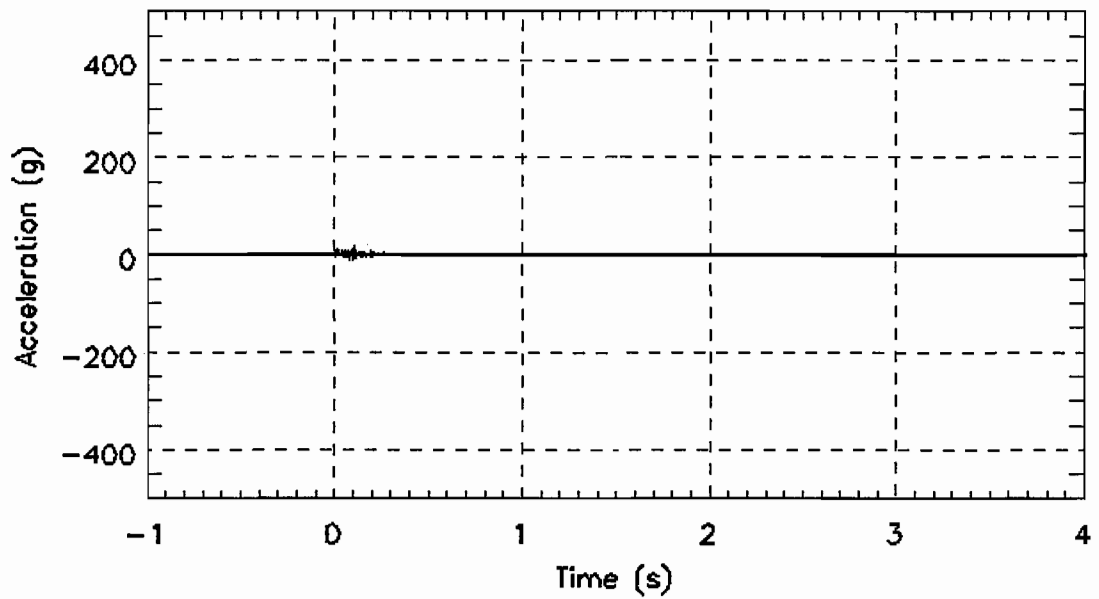

Figure D- 34. Bullet car, underframe level, right side, position 2, longitudinal acceleraion, no digital filter, R2X_1000Hz.txt

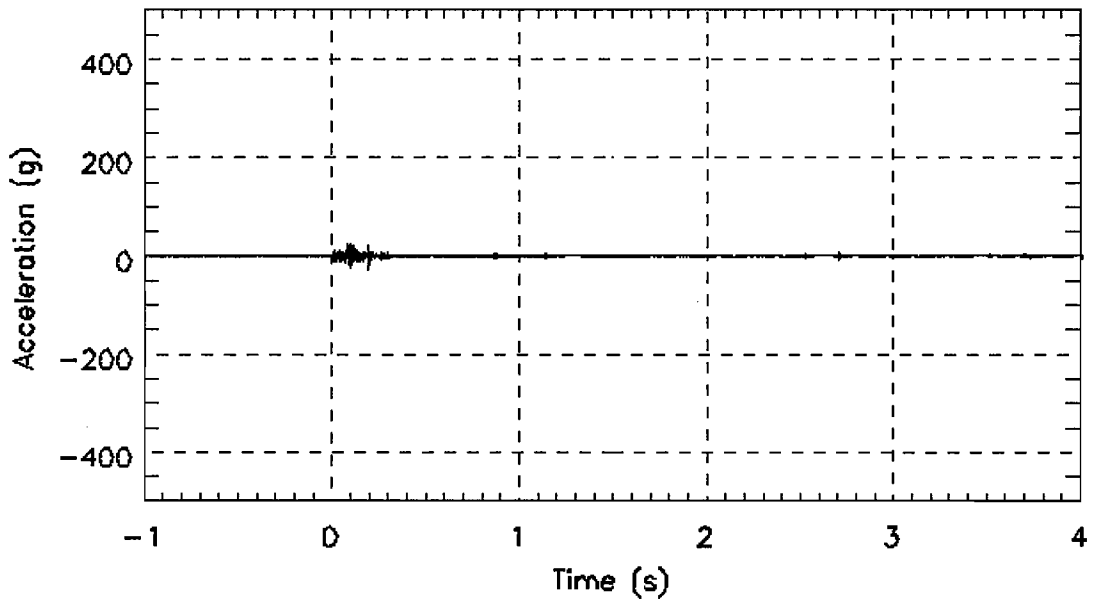

Figure D- 35. Bullet car, underframe level, right side, position 2, vertical acceleraion, no digital filter, R2Z_1000Hz.txt

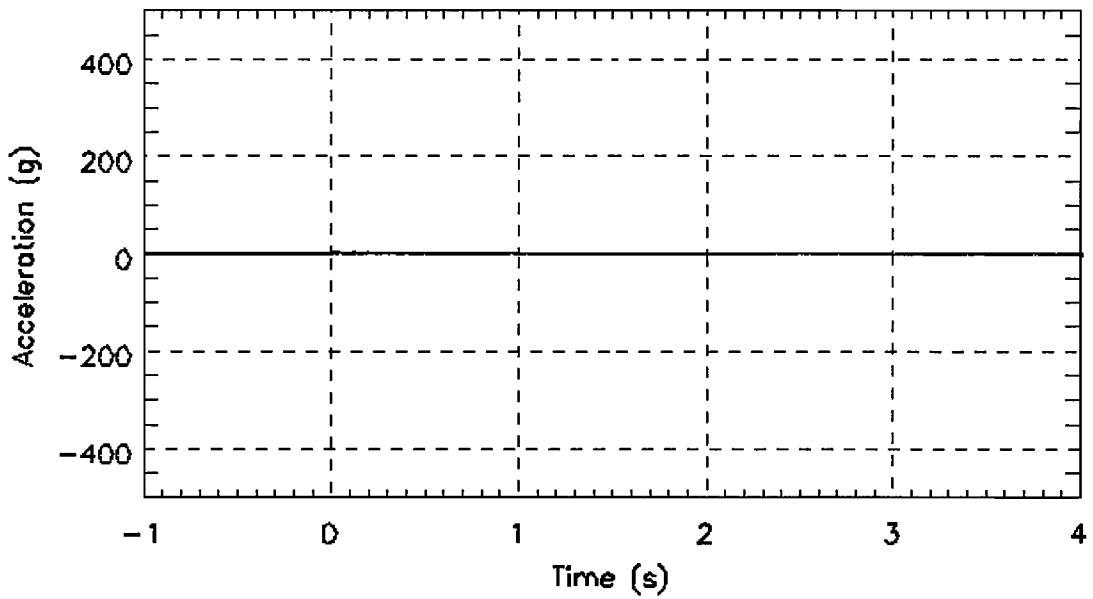

Figure D- 36. Bullet car, underframe level, right side, position 3, longitudinal acceleraion, no digital filter, R3X_1000Hz.txt

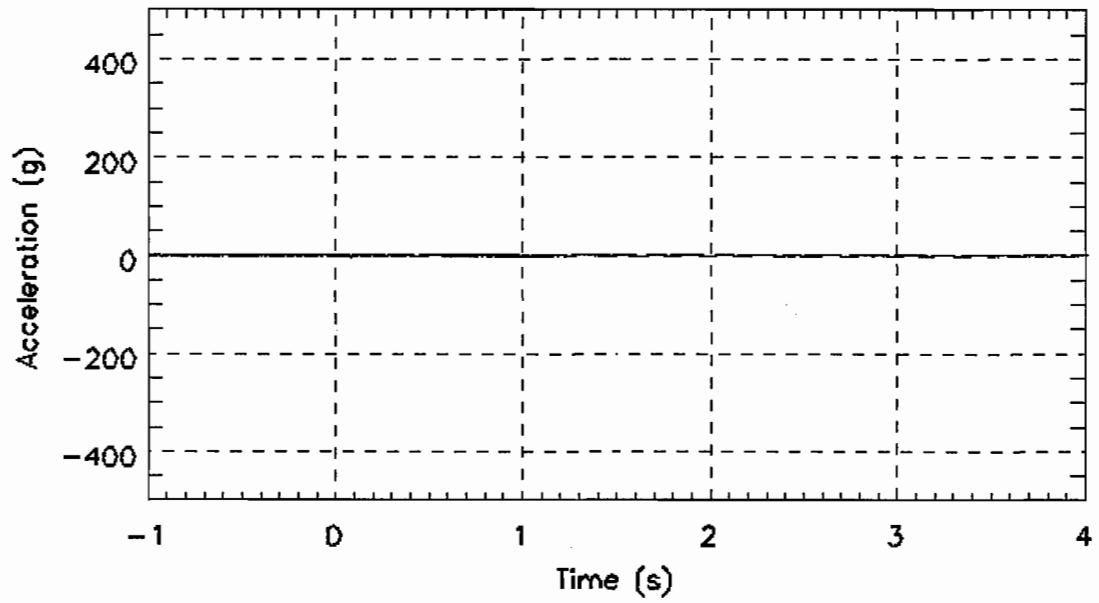

Figure D- 37. Bullet car, underframe level, right side, position 3, vertical acceleraion, no digital filter, R3Z_1000Hz.txt

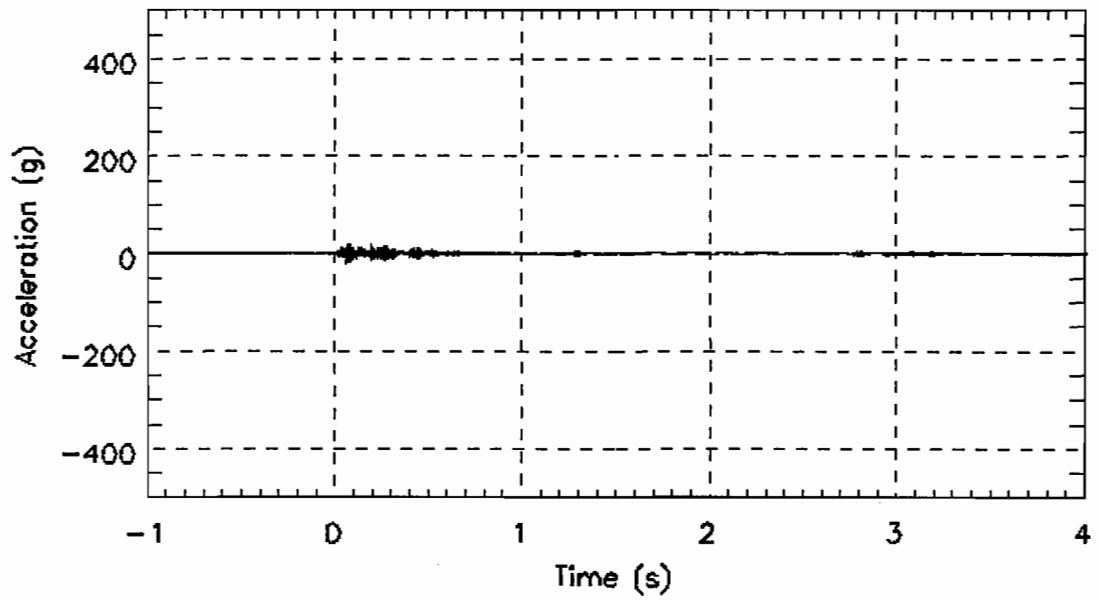

Figure D- 38. Bullet car, underframe level, right side, position 4, vertical acceleraion, no digital filter, R4Z_1000Hz.txt

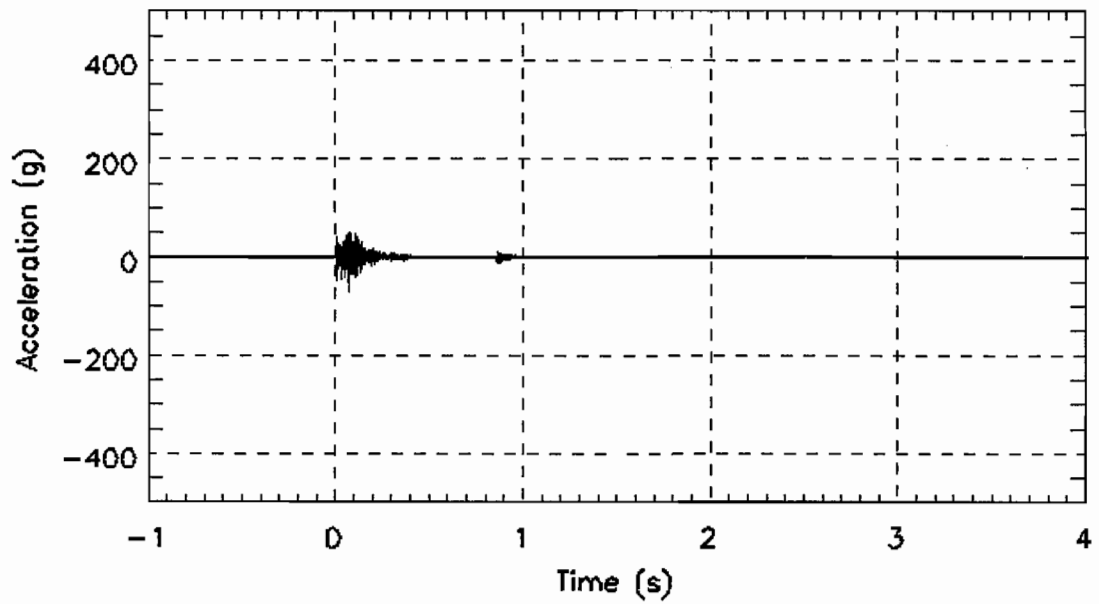

Figure D- 39. Bullet car, cant rail level, left side, position 1, longitudinal acceleraion, no digital filter, TL1X_1000Hz.txt

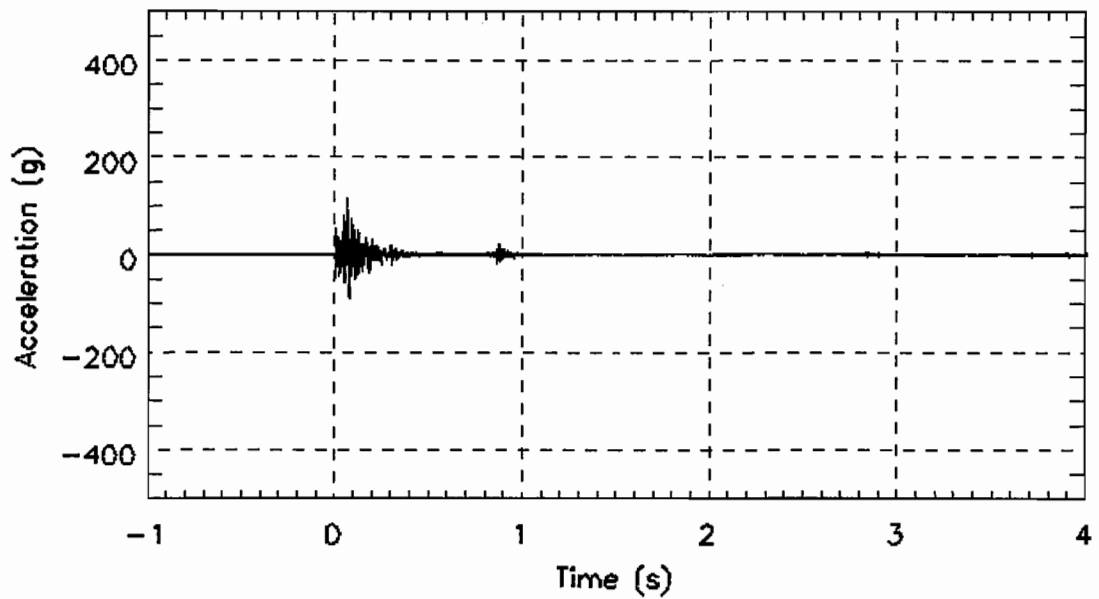

Figure D- 40. Bullet car, cant rail level, left side, position 1, lateral acceleraion, no digital filter, TL1Y_1000Hz.txt

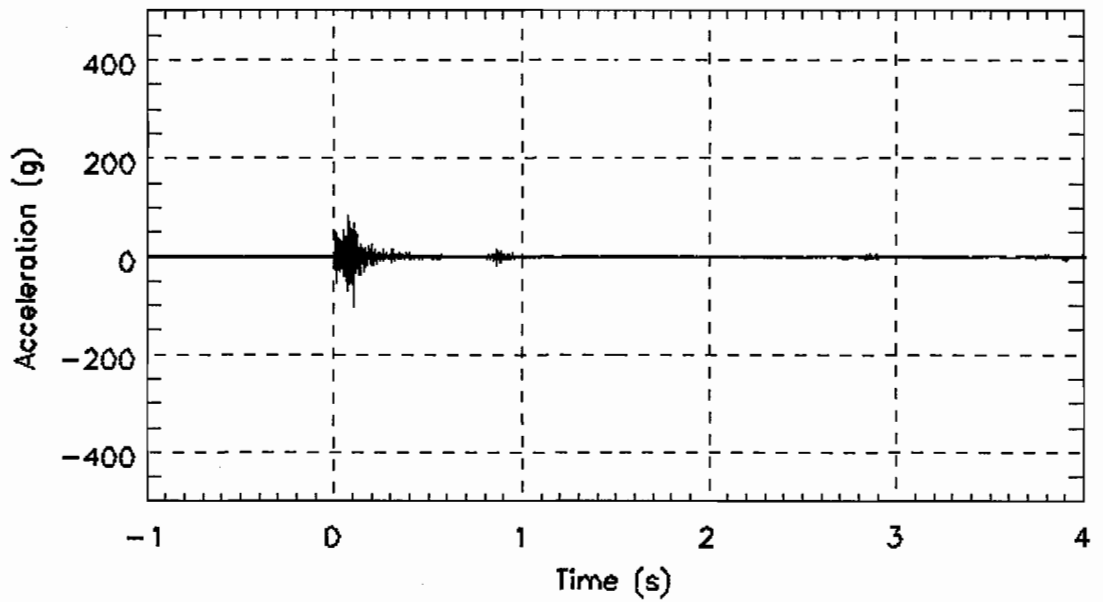

Figure D- 41. Bullet car, cant rail level, left side, position 1, vertical acceleraion, no digital filter, TL1Z_1000Hz.txt

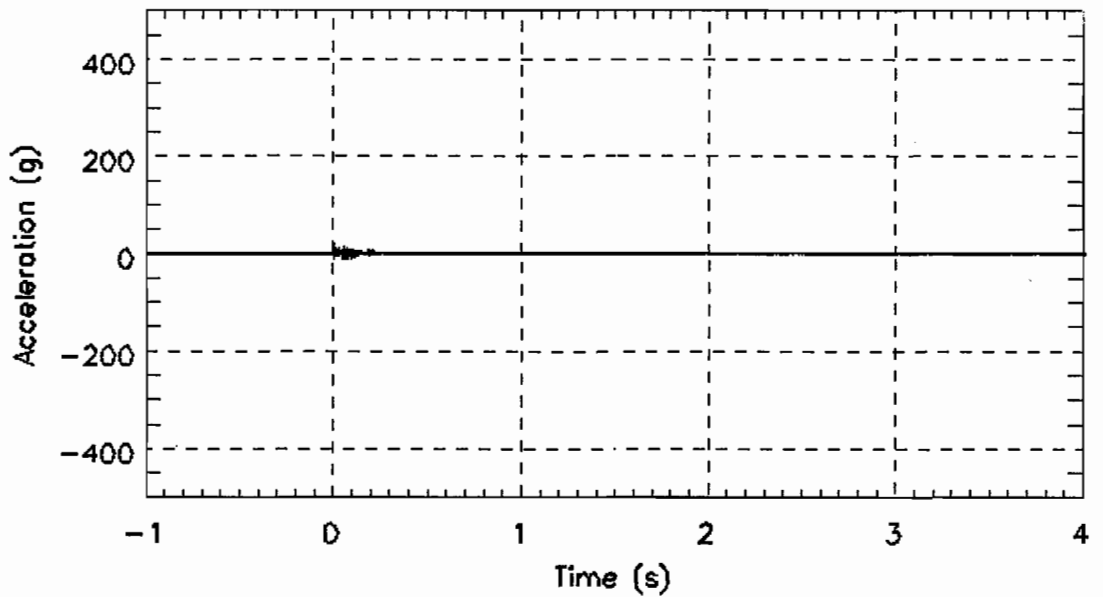

Figure D- 42. Bullet car, cant rail level, left side, position 2, longitudinal acceleraion, no digital filter, TL2X_1000Hz.txt

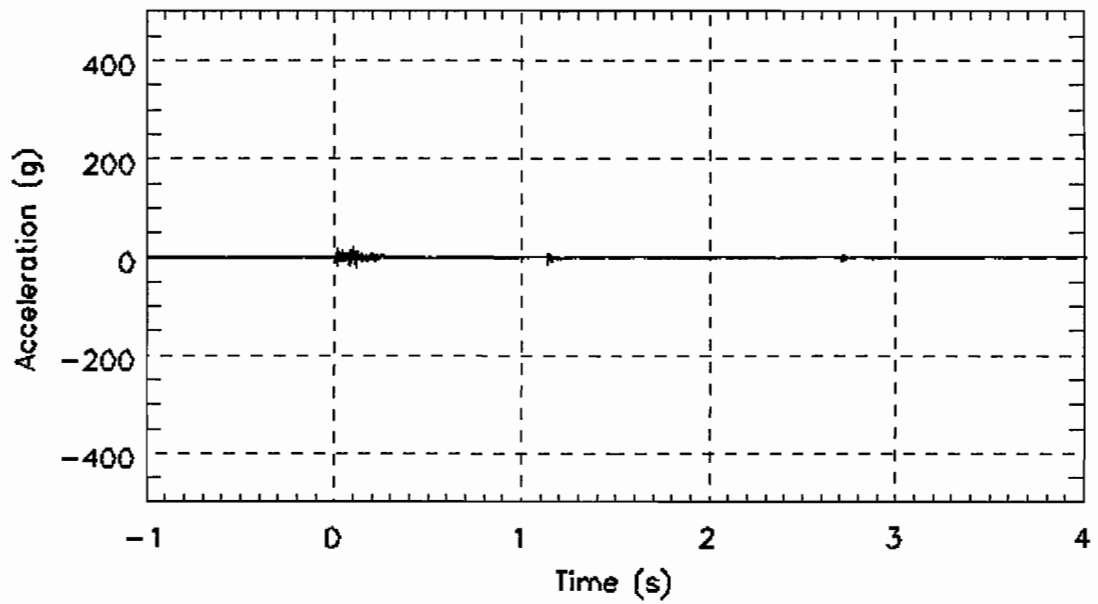

Figure D- 43. Bullet car, cant rail level, left side, position 2, vertical acceleraion, no digital filter, TL2Z_1000Hz.txt

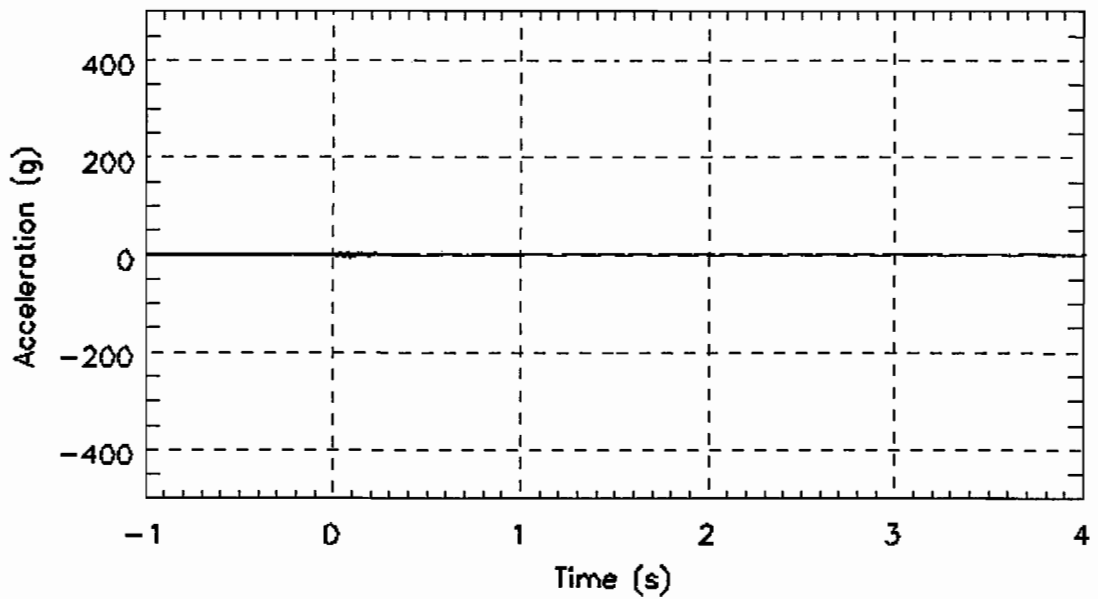

Figure D- 44. Bullet car, cant rail level, left side, position 3, vertical acceleraion, no digital filter, TL3Z_1000Hz.txt

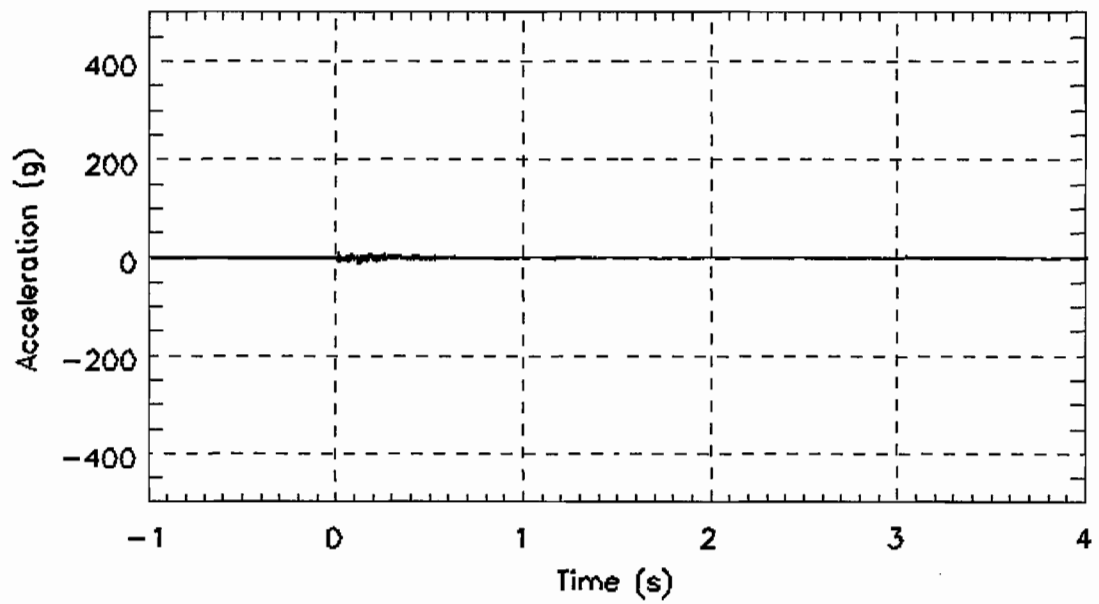

Figure D- 45. Bullet car, cant rail level, left side, position 4, vertical acceleraion, no digital filter, TL4Z_1000Hz.txt

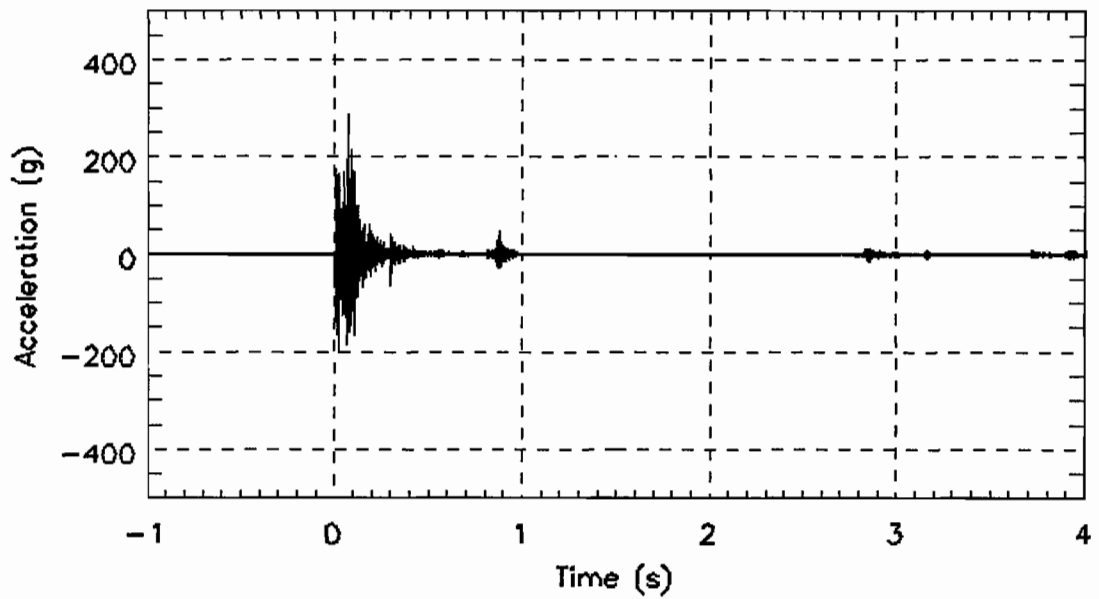

Figure D- 46. Bullet car, cant rail level, right side, position 1, longitudinal acceleraion, no digital filter, TR1X_1000Hz.txt

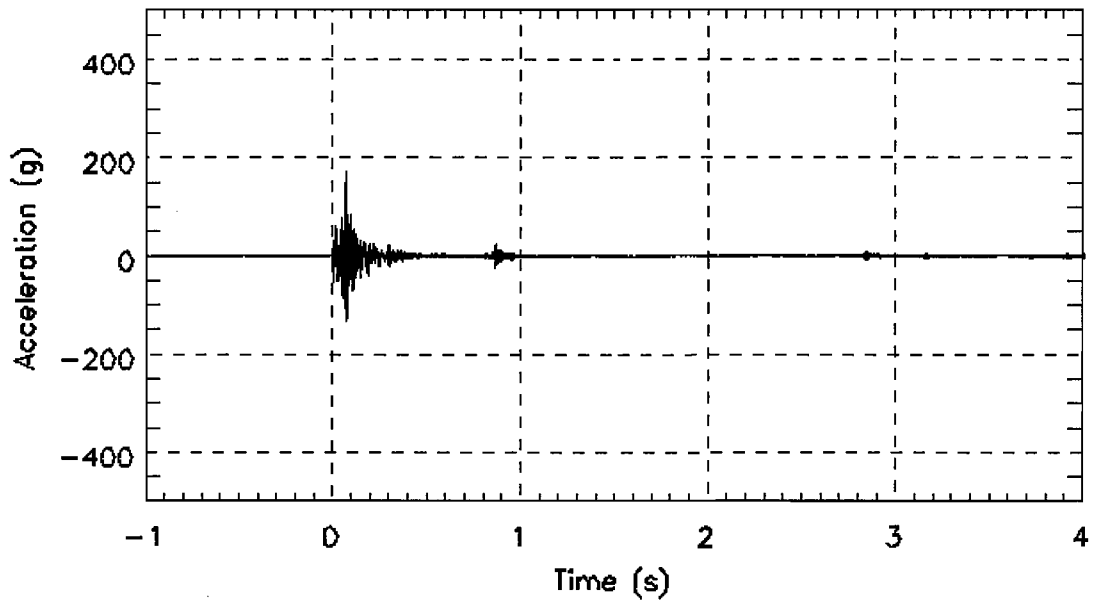

Figure D- 47. Bullet car, cant rail level, right side, position 1, lateral acceleraion, no digital filter, TR1Y_1000Hz.txt

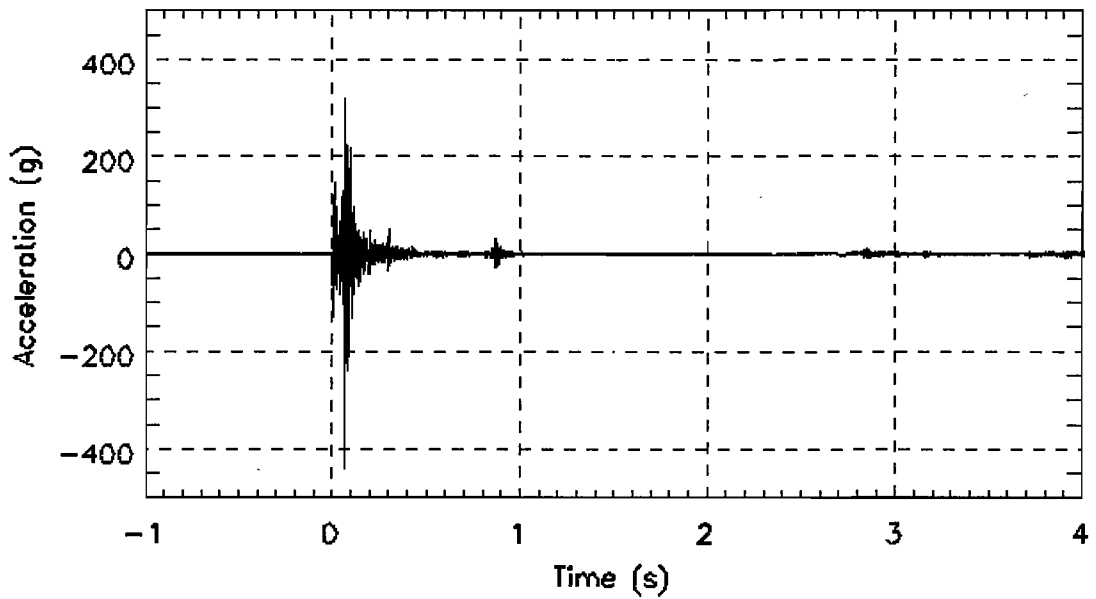

Figure D- 48. Bullet car, cant rail level, right side, position 1, vertical acceleraion, no digital filter, TR1Z_1000Hz.txt

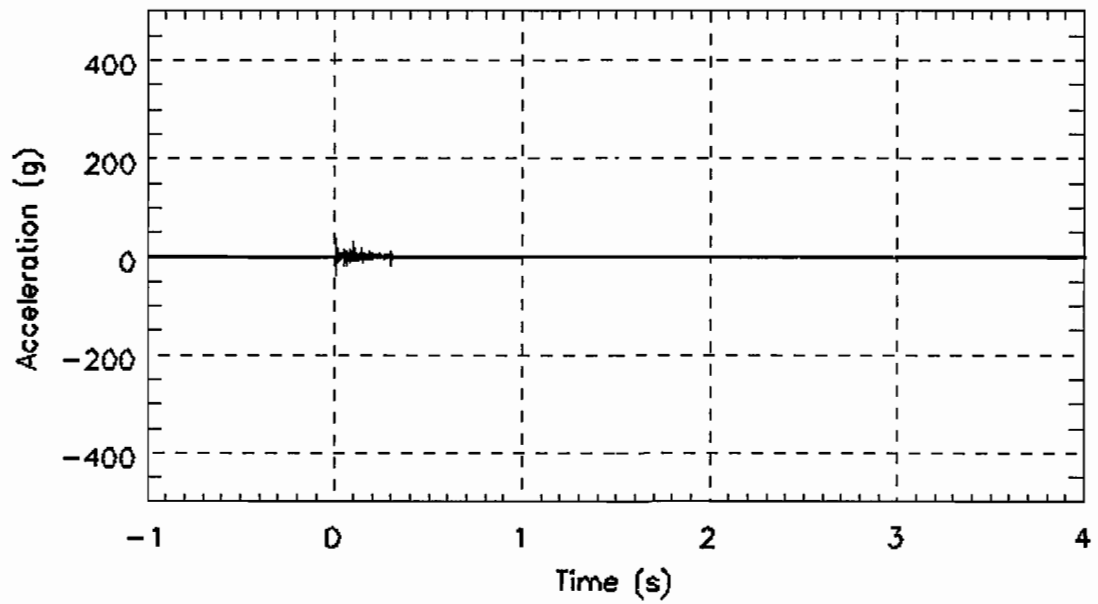

Figure D- 49. Bullet car, cant rail level, right side, position 2, longitudinal acceleraion, no digital filter, TR2X_1000Hz.txt

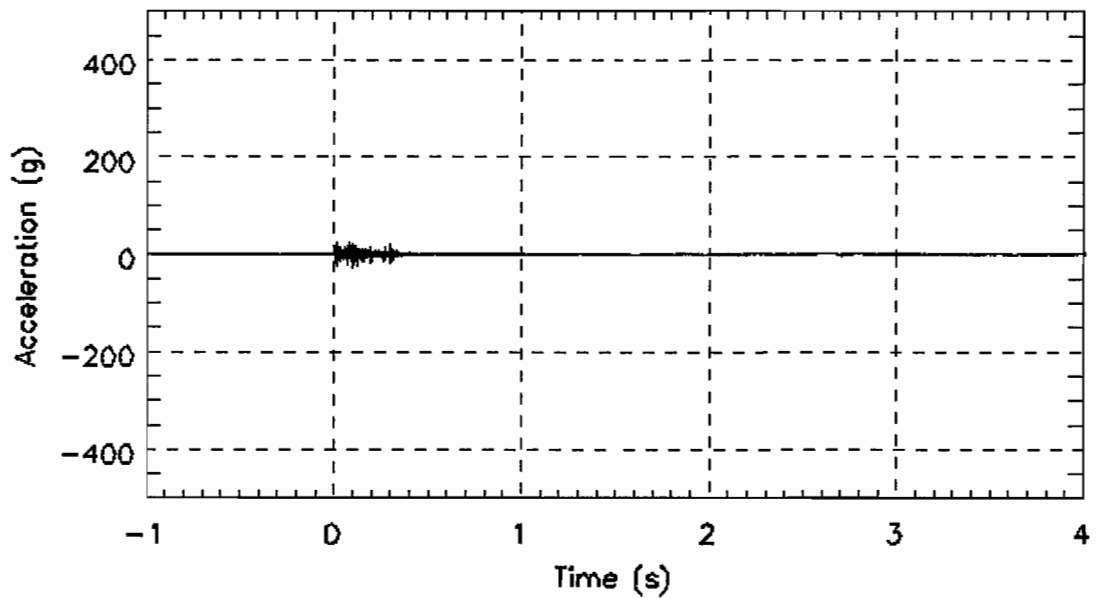

Figure D- 50. Bullet car, cant rail level, right side, position 2, vertical acceleraion, no digital filter, TR2Z_1000Hz.txt

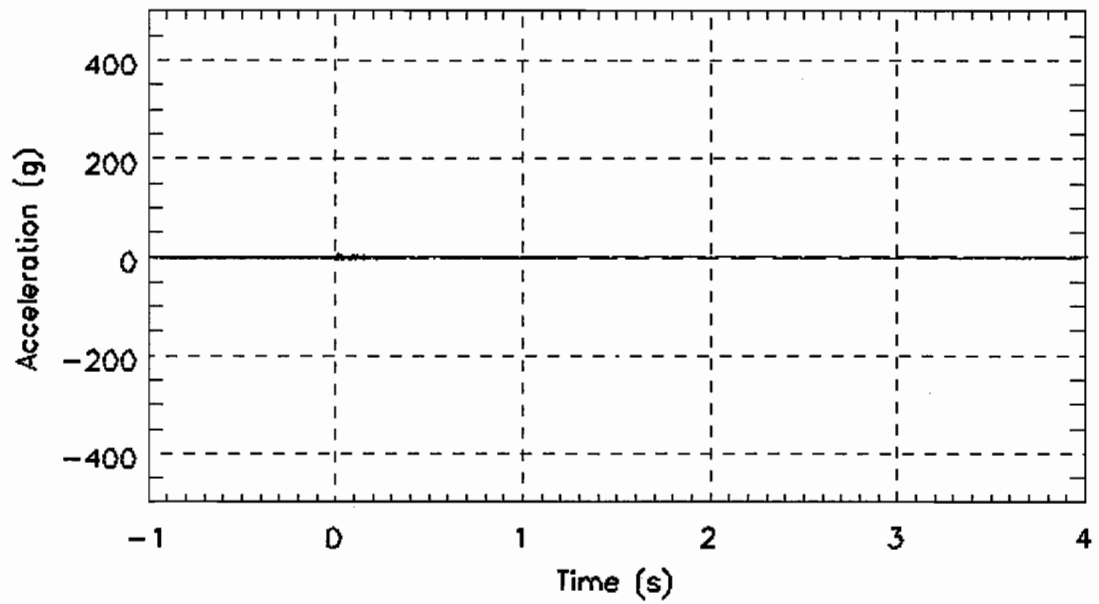

Figure D- 51. Bullet car, cant rail level, right side, position 3, vertical acceleraion, no digital filter, TR3Z_1000Hz.txt

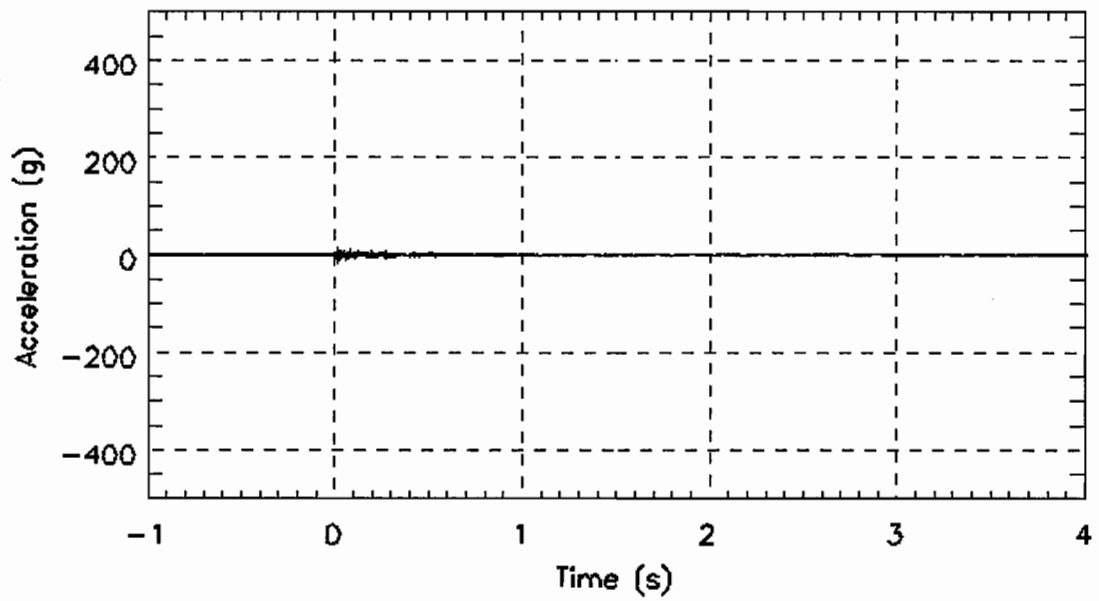

Figure D- 52. Bullet car, cant rail level, right side, position 4, vertical acceleraion, no digital filter, TR4Z_1000Hz.txt

Appendix E

Test 4
Acceleration Data, $F_c = 100\text{Hz}$

This page left blank intentionally

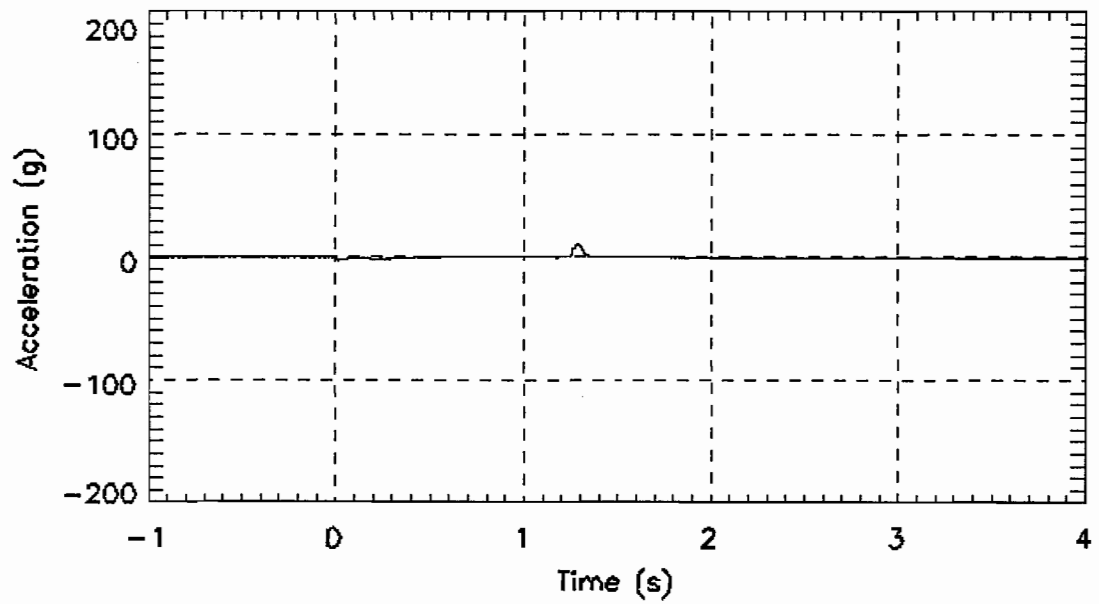

Figure E- 1. Steel coil, centered, longitudinal acceleration, digitally filtered ar $F_c=100\text{Hz}$, A0X_100Hz.txt

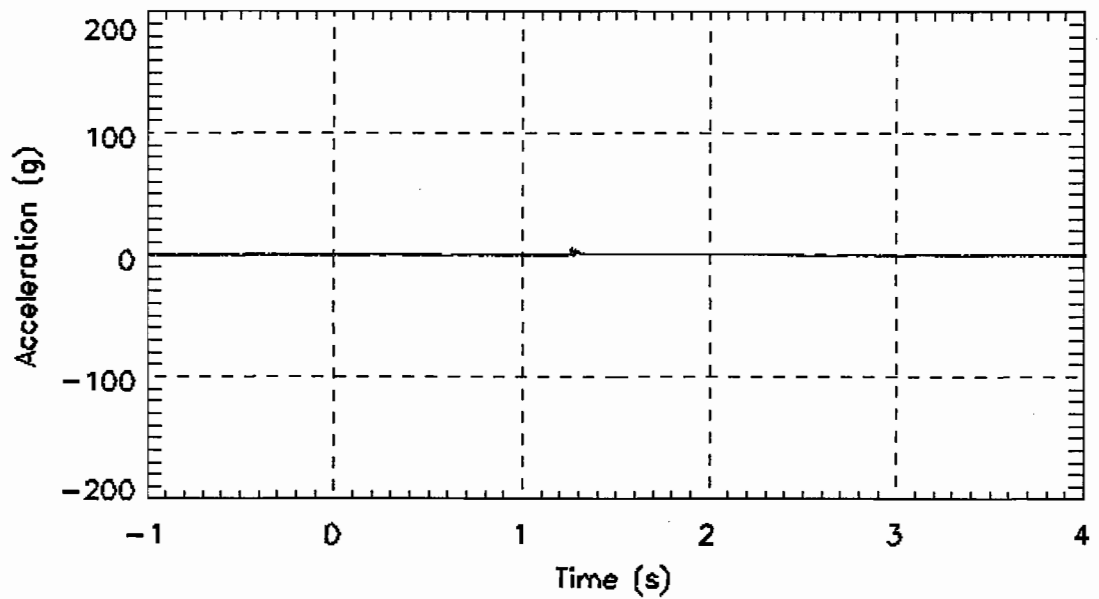

Figure E- 2. Steel coil, centered, lateral acceleration, digitally filtered ar $F_c=100\text{Hz}$, A0Y_100Hz.txt

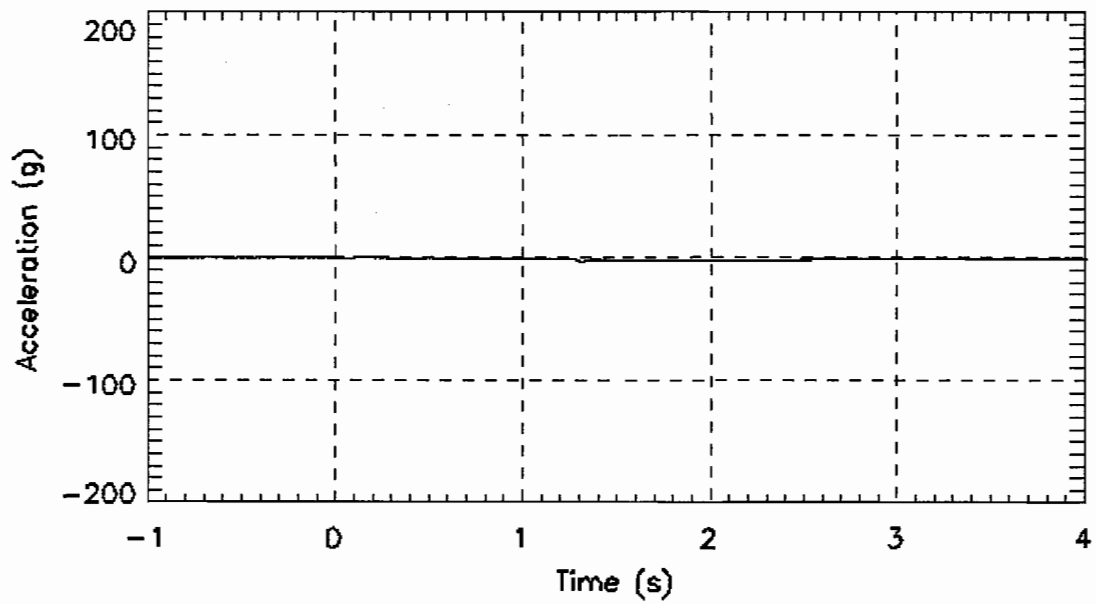

Figure E- 3. Steel coil, centered, vertical acceleration, digitally filtered ar Fc=100Hz, A0Z_100Hz.txt

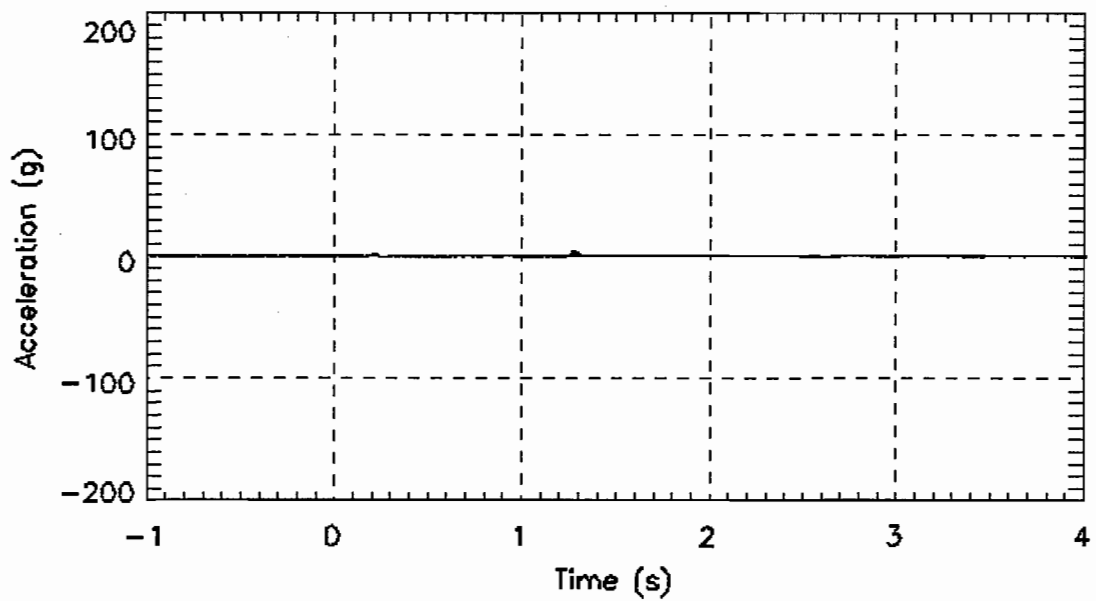

Figure E- 4. Steel coil, offset along X axis, lateral acceleration, digitally filtered ar Fc=100Hz, A1Y_100Hz.txt

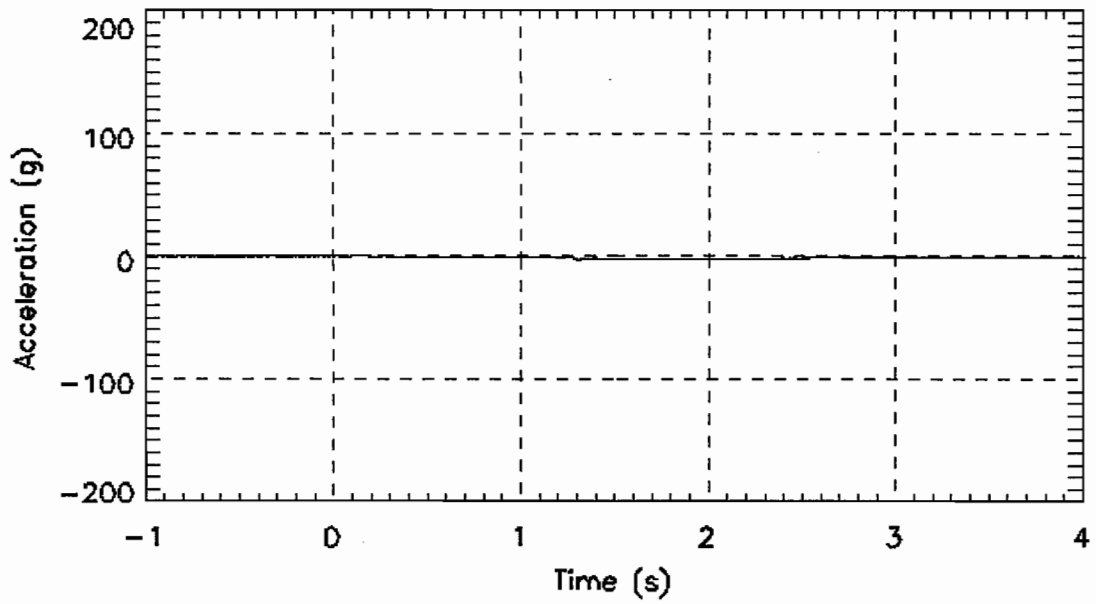

Figure E- 5. Steel coil, offset along X axis, vertical acceleration, digitally filtered ar Fc=100Hz, A1Z_100Hz.txt

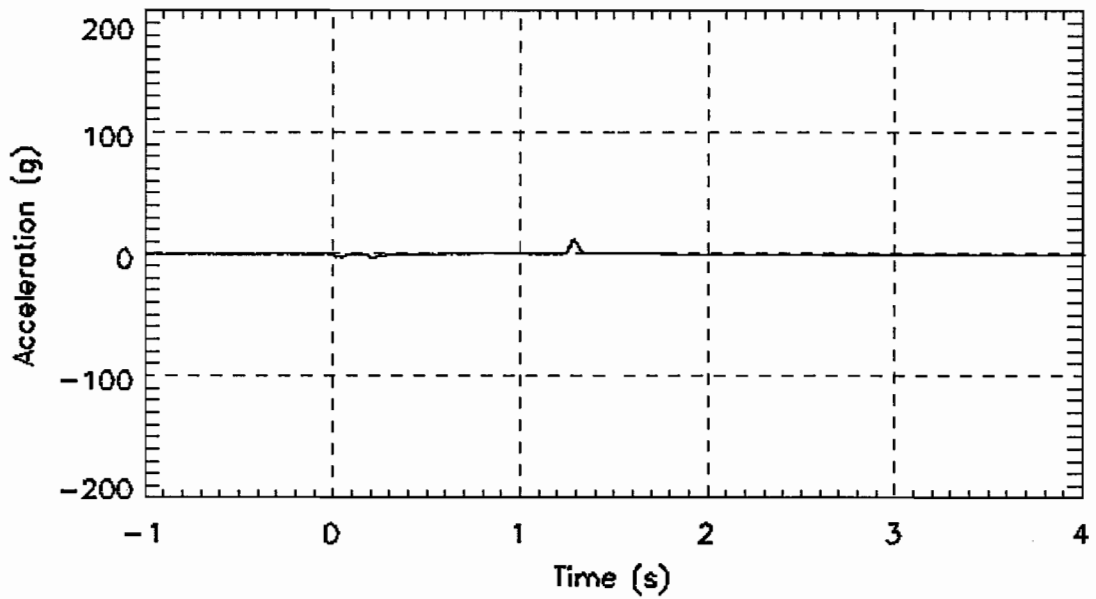

Figure E- 6. Steel coil, offset along Y axis, longitudinal acceleration, digitally filtered ar Fc=100Hz, A2X_100Hz.txt

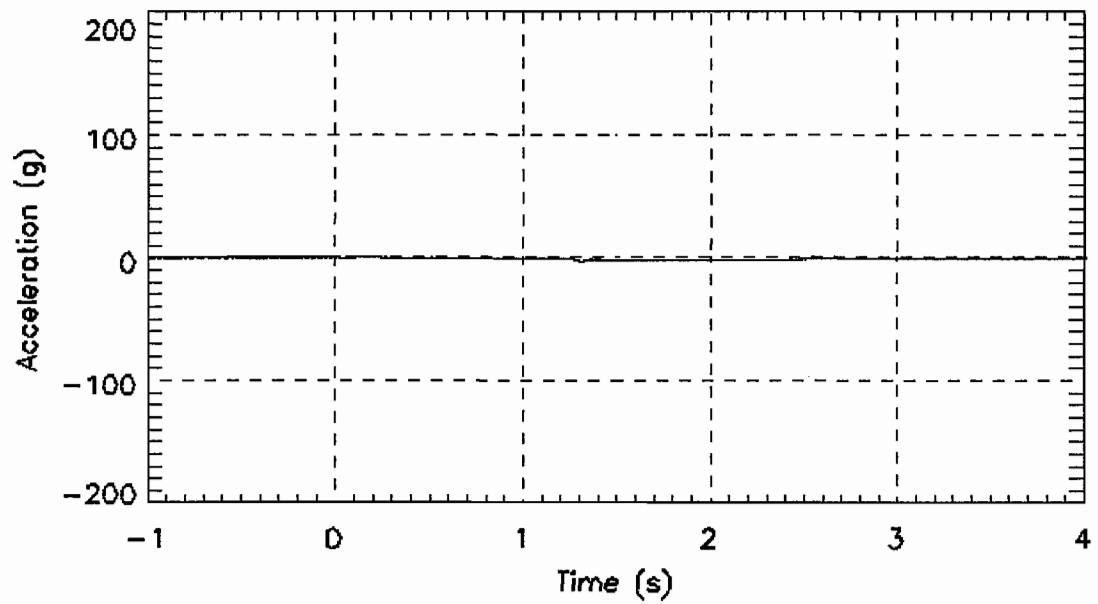

Figure E- 7. Steel coil, offset along Y axis, vertical acceleration, digitally filtered ar Fc=100Hz, A2Z_100Hz.txt

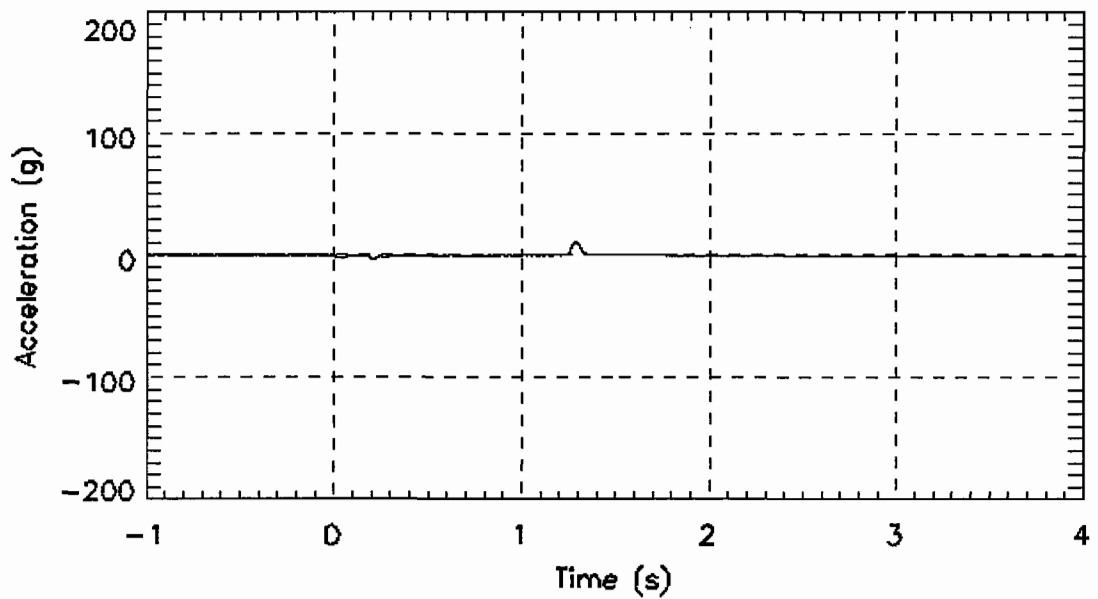

Figure E- 8. Steel coil, offset along Z axis, longitudinal acceleration, digitally filtered ar Fc=100Hz, A3X_100Hz.txt

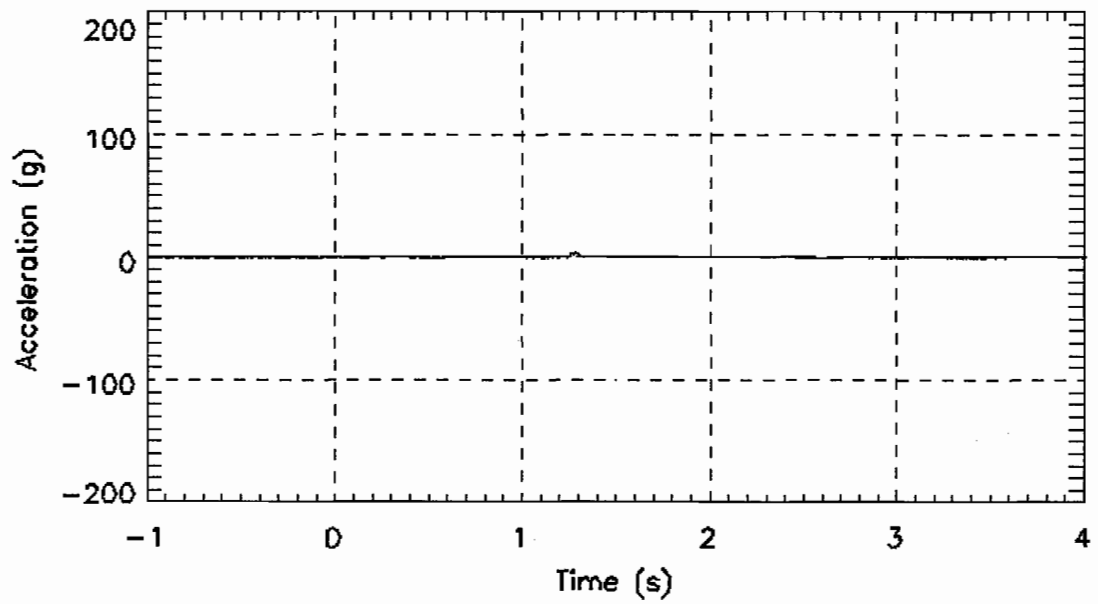

Figure E- 9. Steel coil, offset along Z axis, lateral acceleration, digitally filtered ar $F_c=100\text{Hz}$, A3Y_100Hz.txt

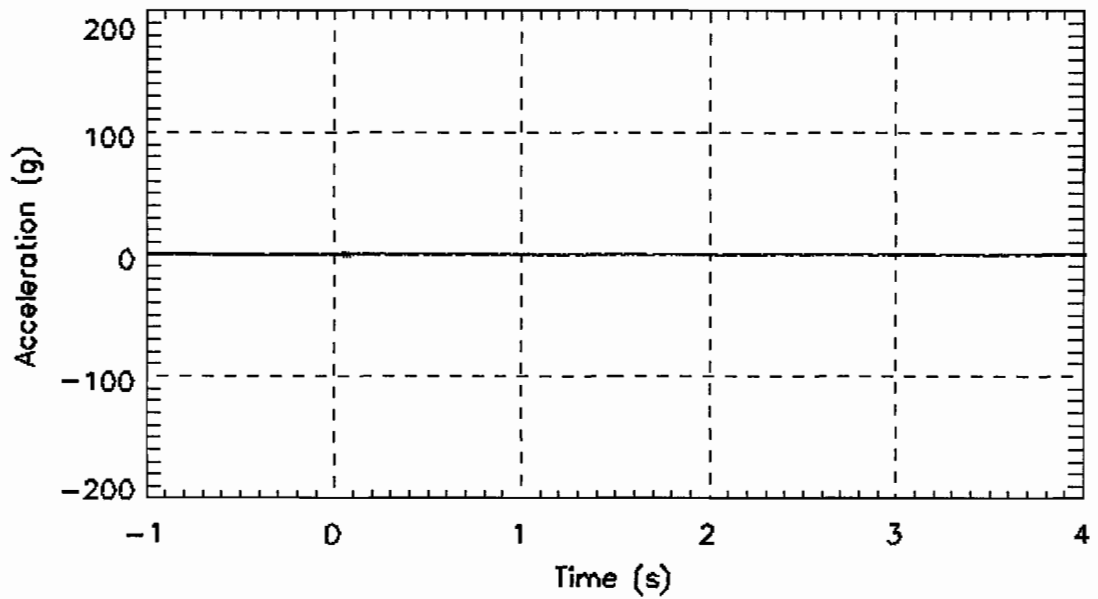

Figure E- 10. Lead bogie, lateral acceleration, digitally filtered ar $F_c=100\text{Hz}$, BAY_100Hz.txt

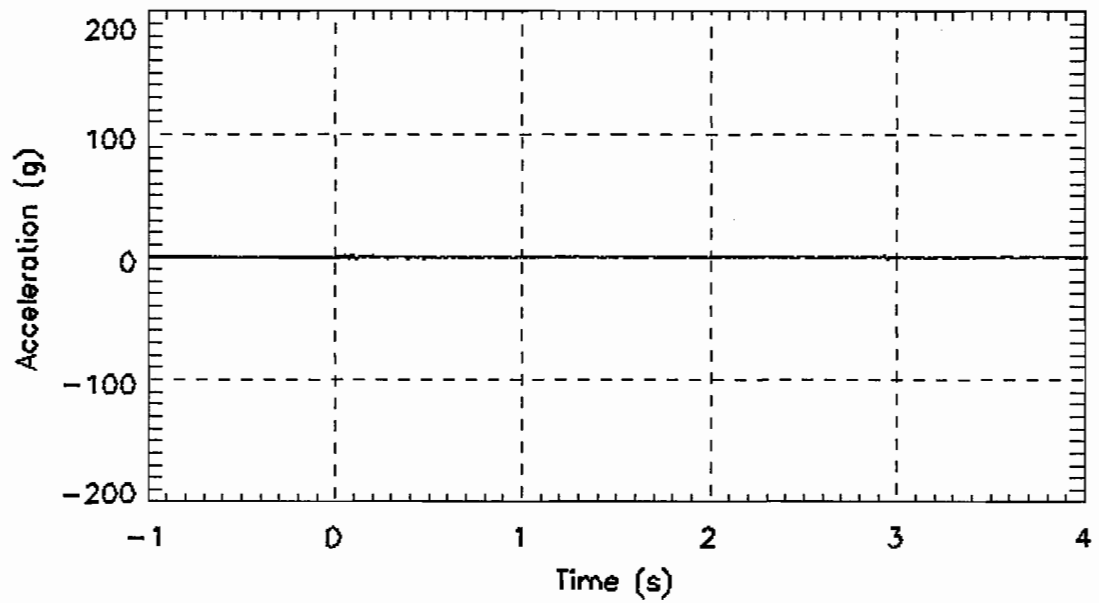

Figure E- 11. Lead bogie, vertical acceleration, digitally filtered at $F_c=100\text{Hz}$, BAZ_100Hz.txt

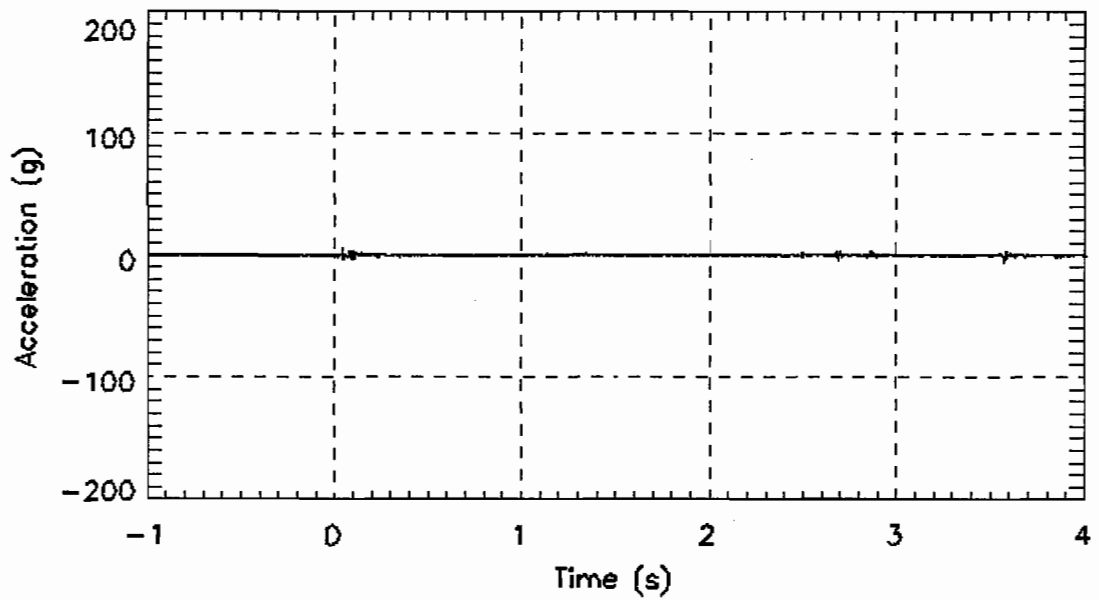

Figure E- 12. Trail bogie, lateral acceleration, digitally filtered at $F_c=100\text{Hz}$, BBY_100Hz.txt

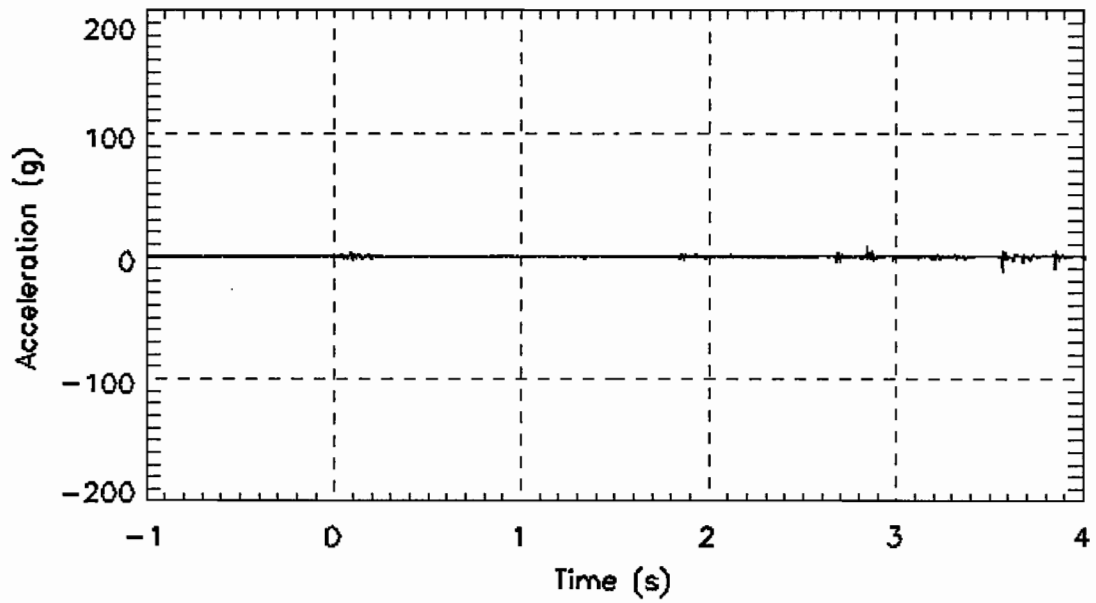

Figure E- 13. Trail bogie, vertical acceleration, digitally filtered ar Fc=100Hz, BBZ_100Hz.txt

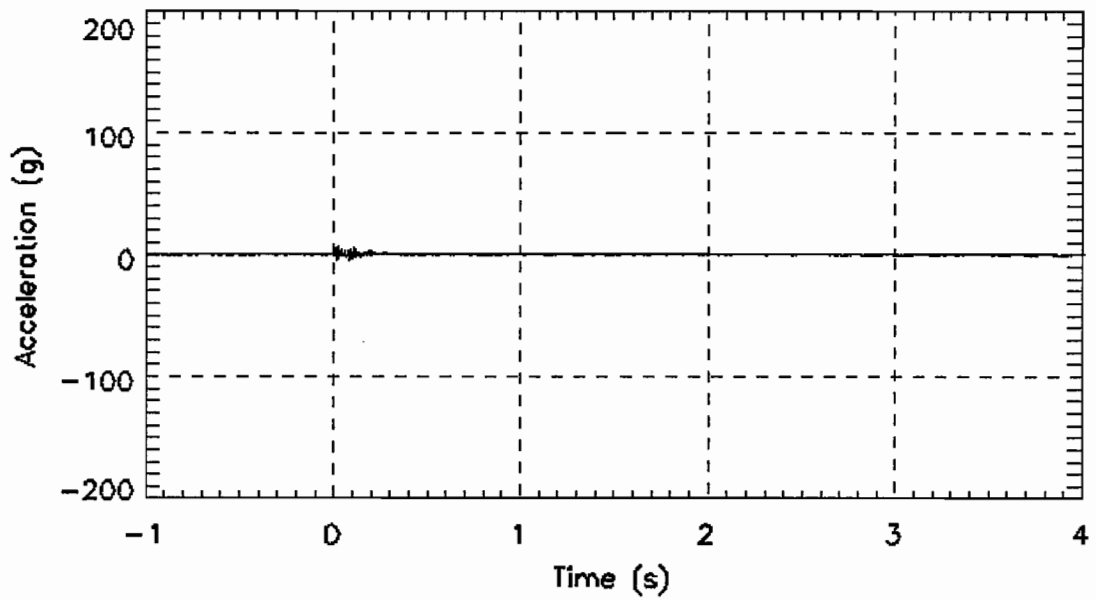

Figure E- 14. Bullet car, position 2, centersill, longitudinal acceleration, digitally filtered ar Fc=100Hz, C2X_100Hz.txt

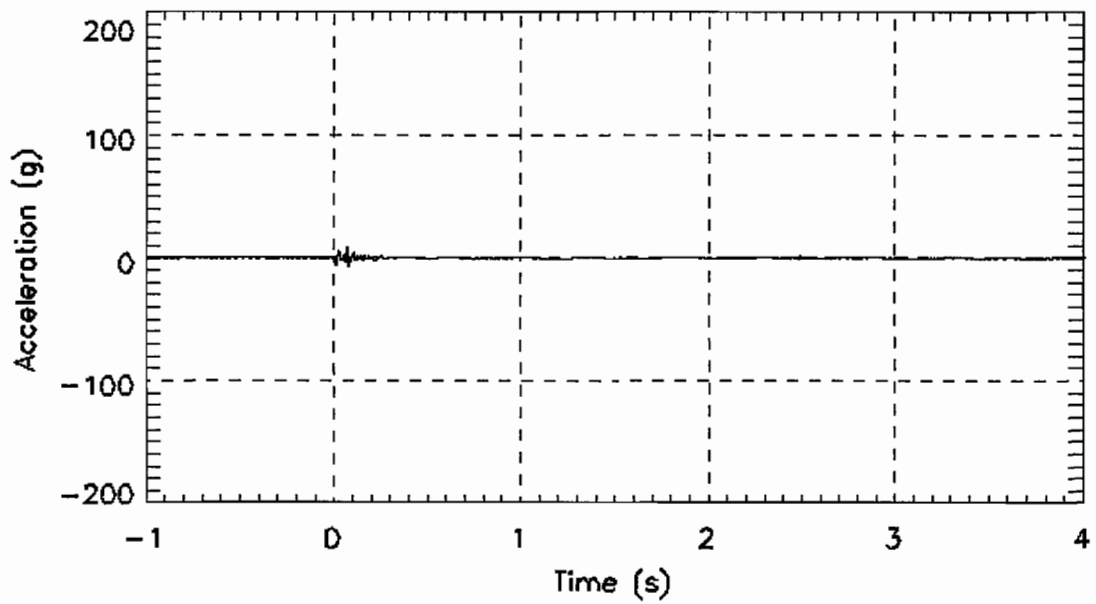

Figure E- 15. Bullet car, position 2, centersill, lateral acceleration, digitally filtered ar Fc=100Hz, C2Y_100Hz.txt

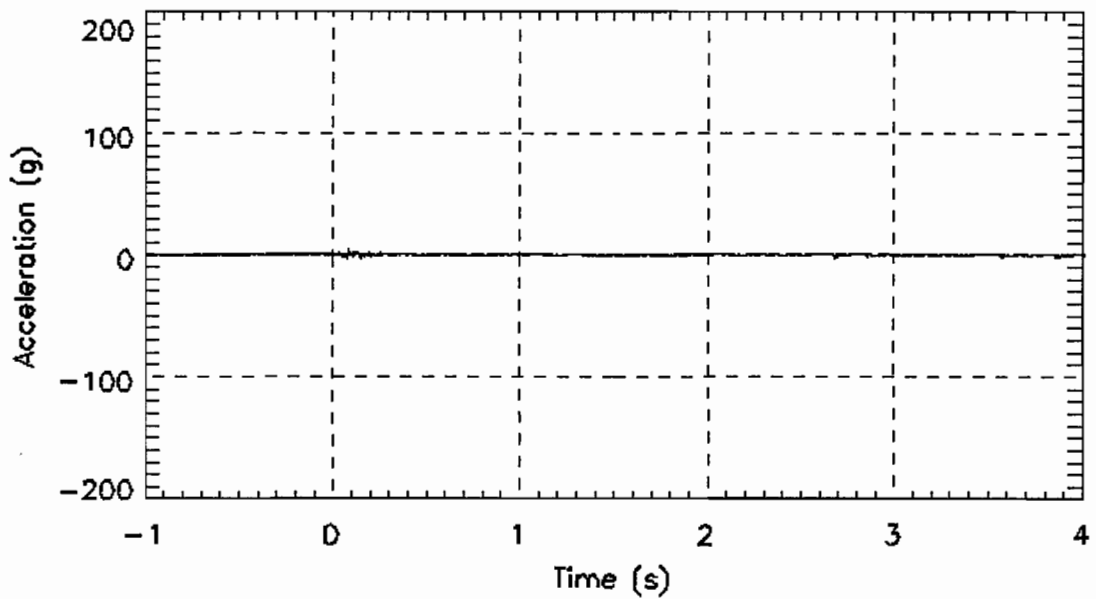

Figure E- 16. Bullet car, position 2, centersill, vertical acceleration, digitally filtered ar Fc=100Hz, C2Z_100Hz.txt

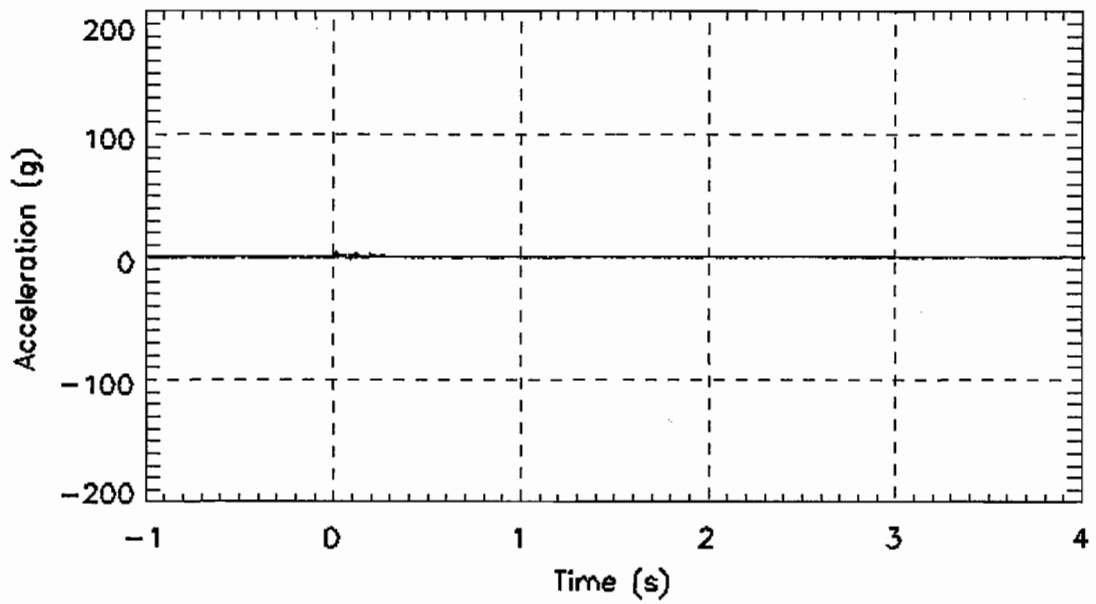

Figure E- 17. Bullet car, position 3, centersill, longitudinal acceleration, digitally filtered ar Fc=100Hz, C3X_100Hz.txt

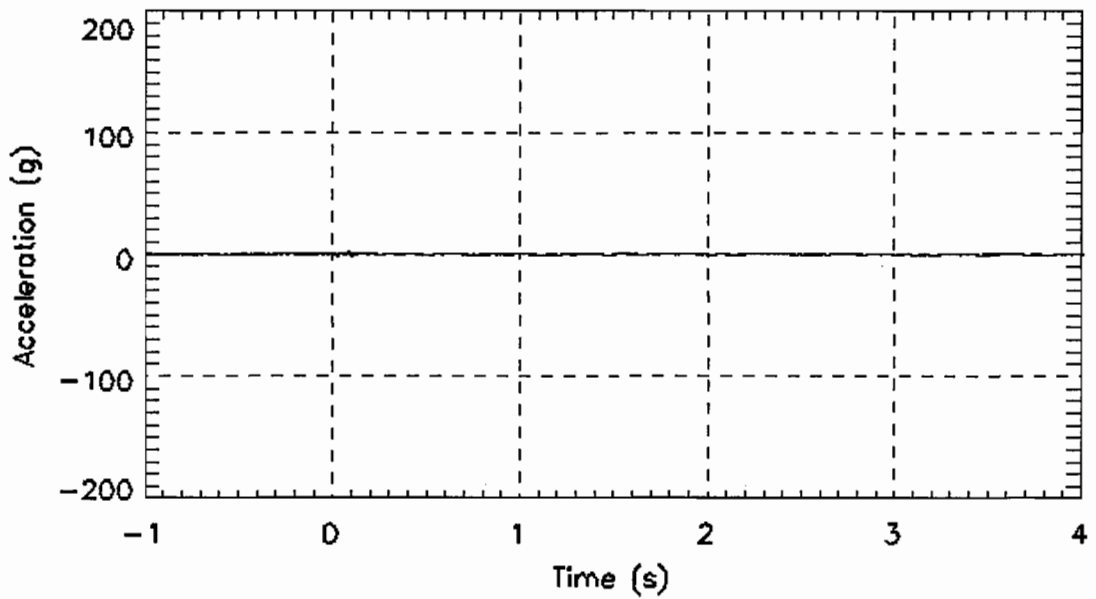

Figure E- 18. Bullet car, position 3, centersill, lateral acceleration, digitally filtered ar Fc=100Hz, C3Y_100Hz.txt

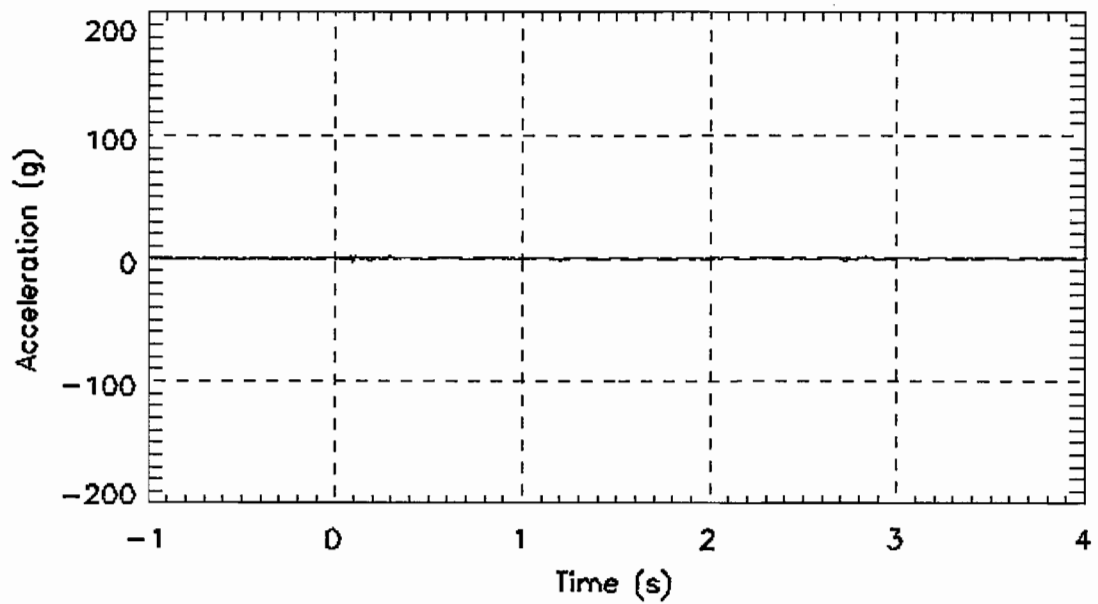

Figure E- 19. Bullet car, position 3, centersill, vertical acceleration, digitally filtered ar Fc=100Hz, C3Z_100Hz.txt

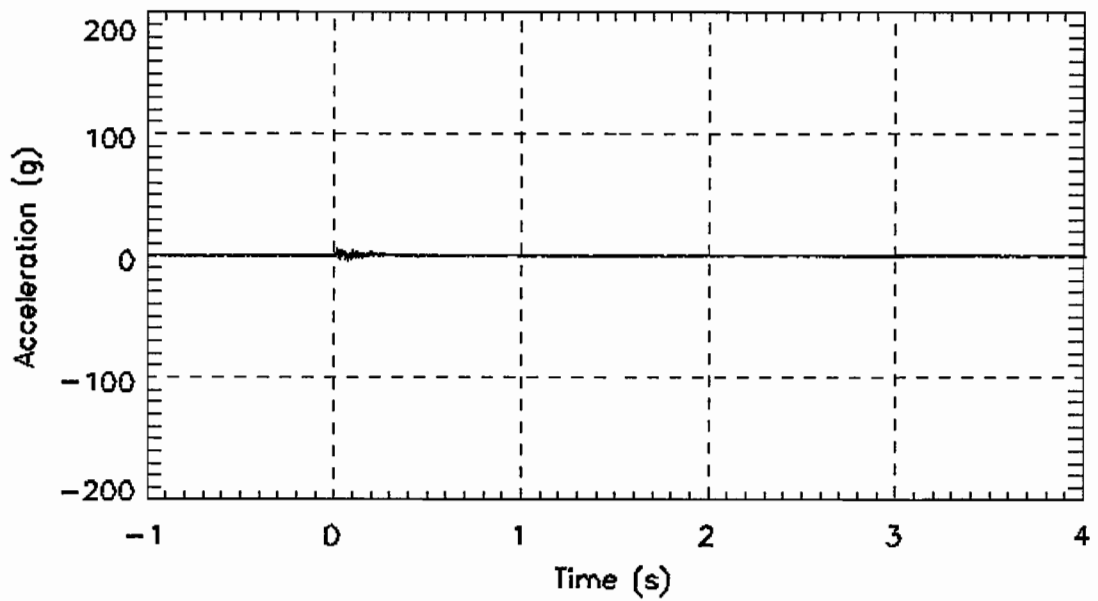

Figure E- 20. Bullet car, position 4, centersill, longitudinal acceleration, digitally filtered ar Fc=100Hz, C4X_100Hz.txt

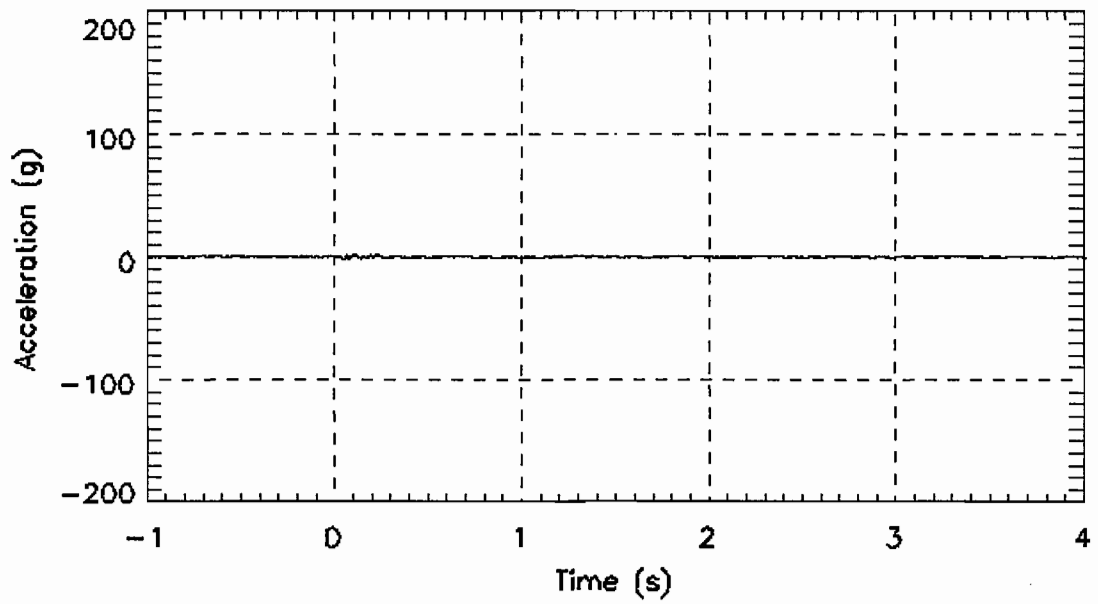

Figure E- 21. Bullet car, position 4, centersill, lateral acceleration, digitally filtered ar Fc=100Hz, C4Y_100Hz.txt

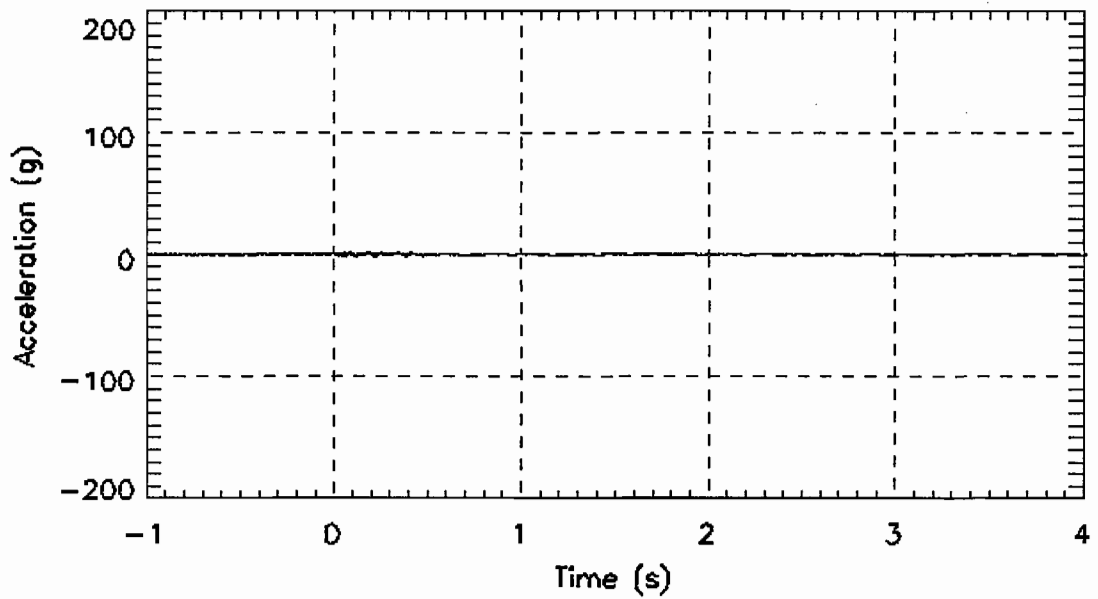

Figure E- 22. Bullet car, position 4, centersill, vertical acceleration, digitally filtered ar Fc=100Hz, C4Z_100Hz.txt

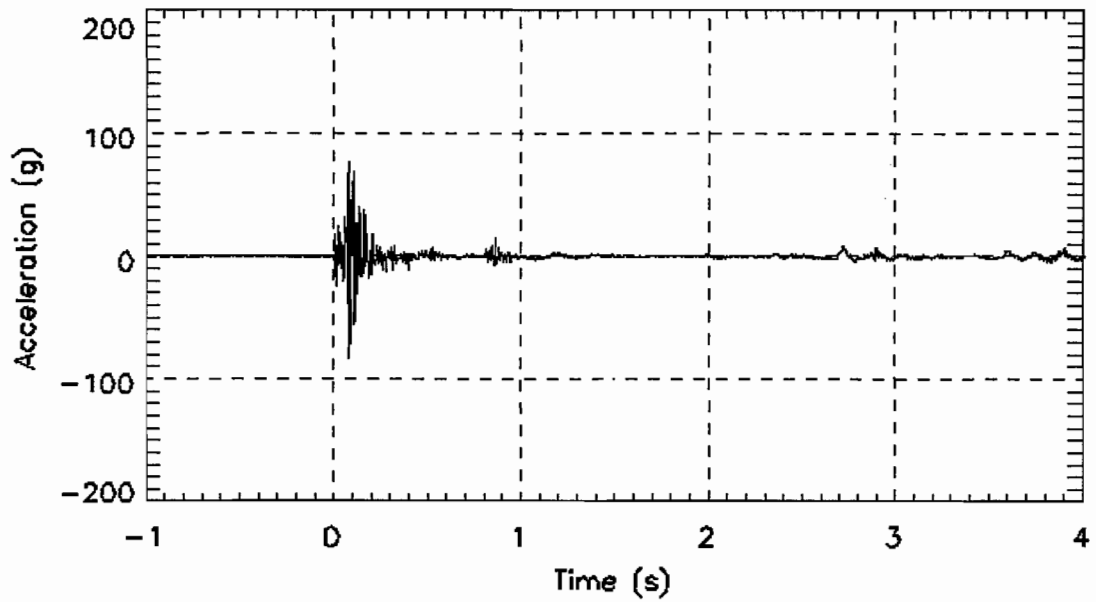

Figure E- 23. Bullet car, underframe level, left side, position 1, longitudinal acceleraion, digitally filered ar Fc=100Hz, L1X_100Hz.txt

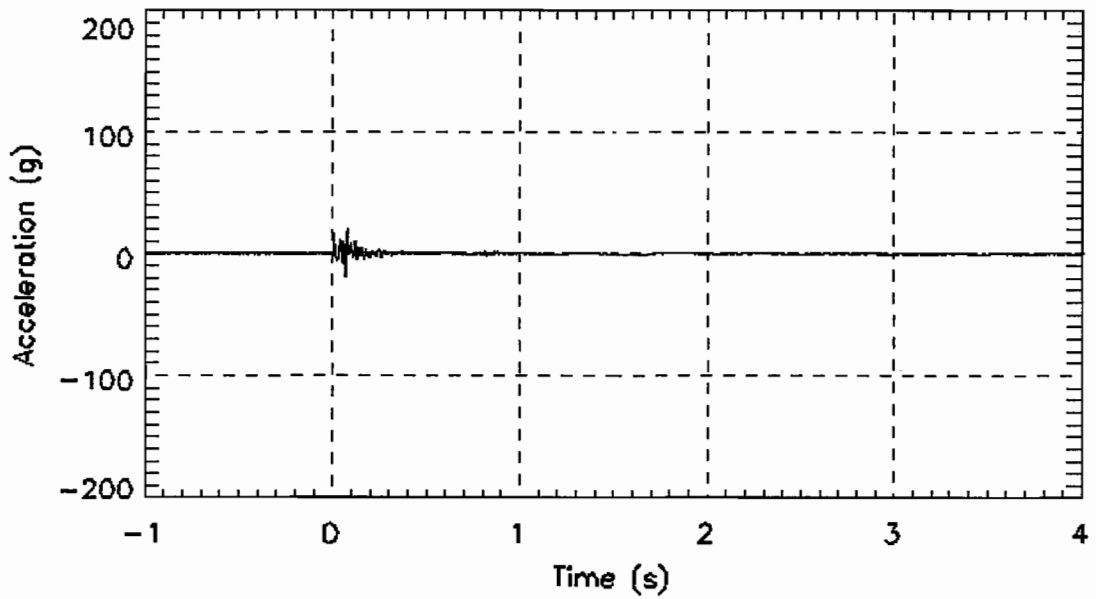

Figure E- 24. Bullet car, underframe level, left side, position 1, lateral acceleraion, digitally filered ar Fc=100Hz, L1Y_100Hz.txt

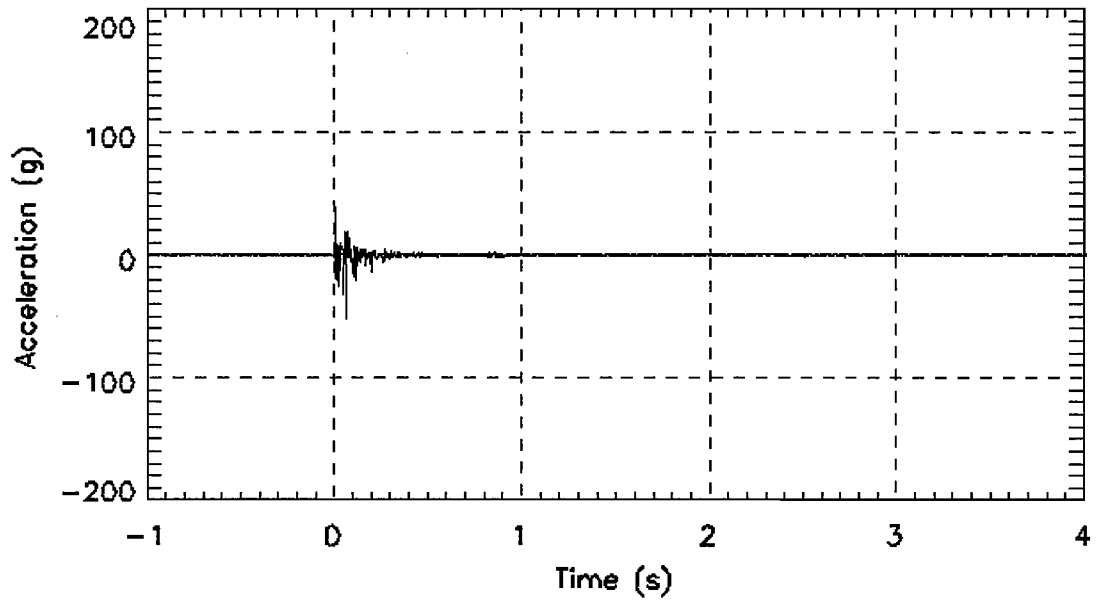

Figure E- 25. Bullet car, underframe level, left side, position 1, vertical acceleraion, digitally filered ar Fc=100Hz, L1Z_100Hz.txt

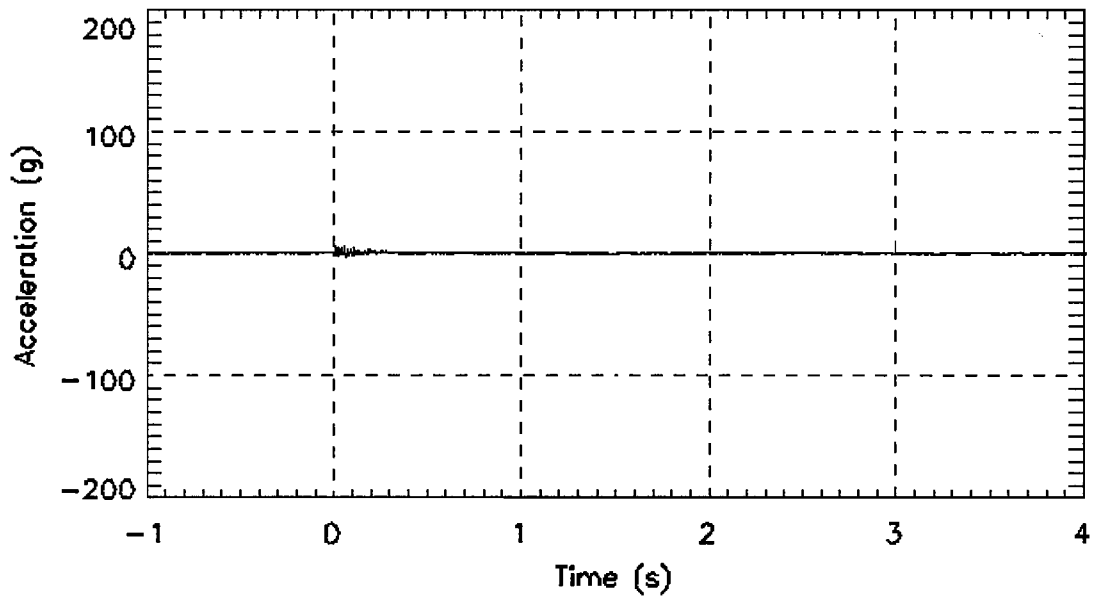

Figure E- 26. Bullet car, underframe level, left side, position 2, longitudinal acceleraion, digitally filered ar Fc=100Hz, L2X_100Hz.txt

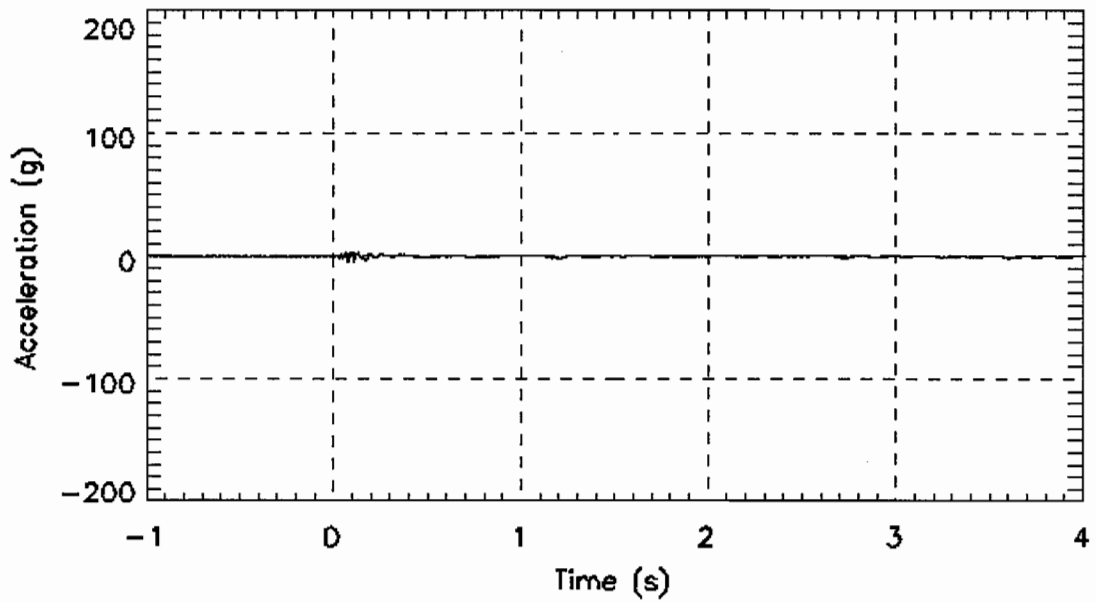

Figure E- 27. Bullet car, underframe level, left side, position 2, vertical acceleraion, digitally filered ar Fc=100Hz, L2Z_100Hz.txt

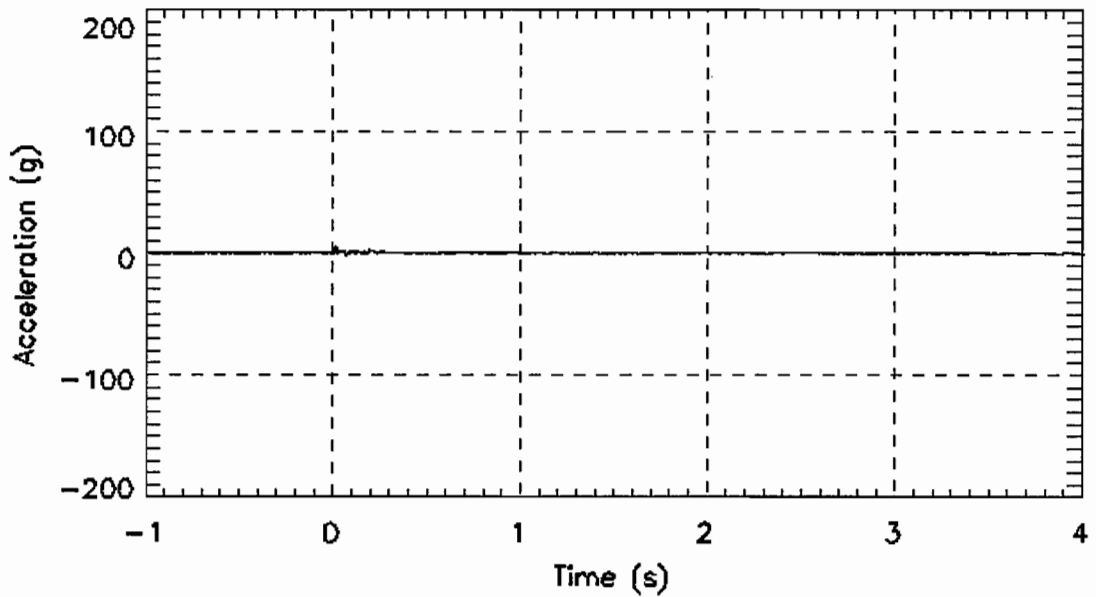

Figure E- 28. Bullet car, underframe level, left side, position 3, longitudinal acceleraion, digitally filered ar Fc=100Hz, L3X_100Hz.txt

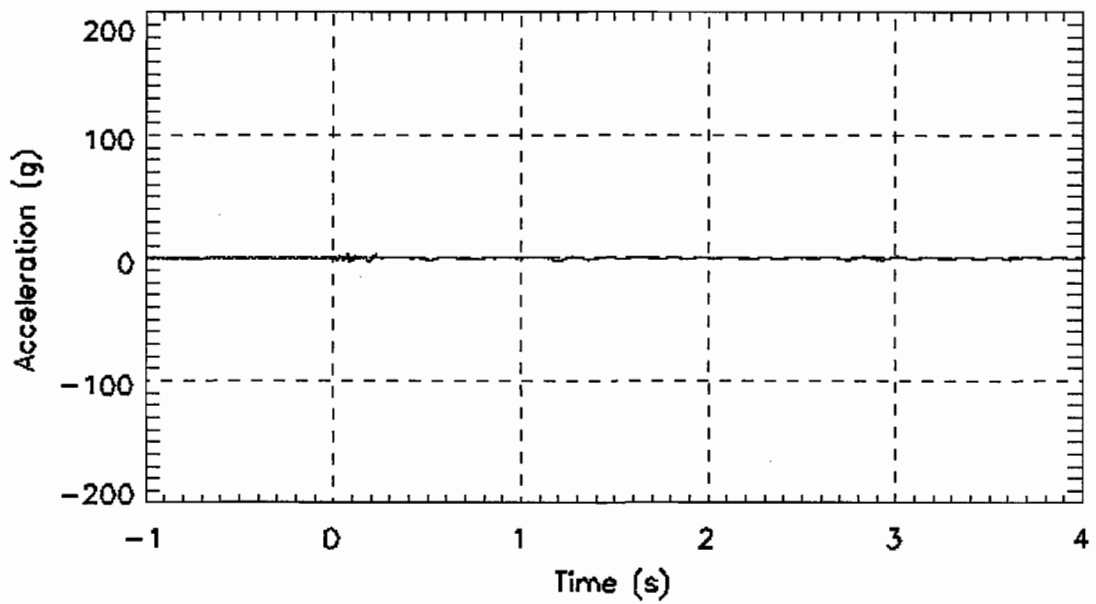

Figure E- 29. Bullet car, underframe level, left side, position 3, vertical acceleraion, digitally filered ar Fc=100Hz, L3Z_100Hz.txt

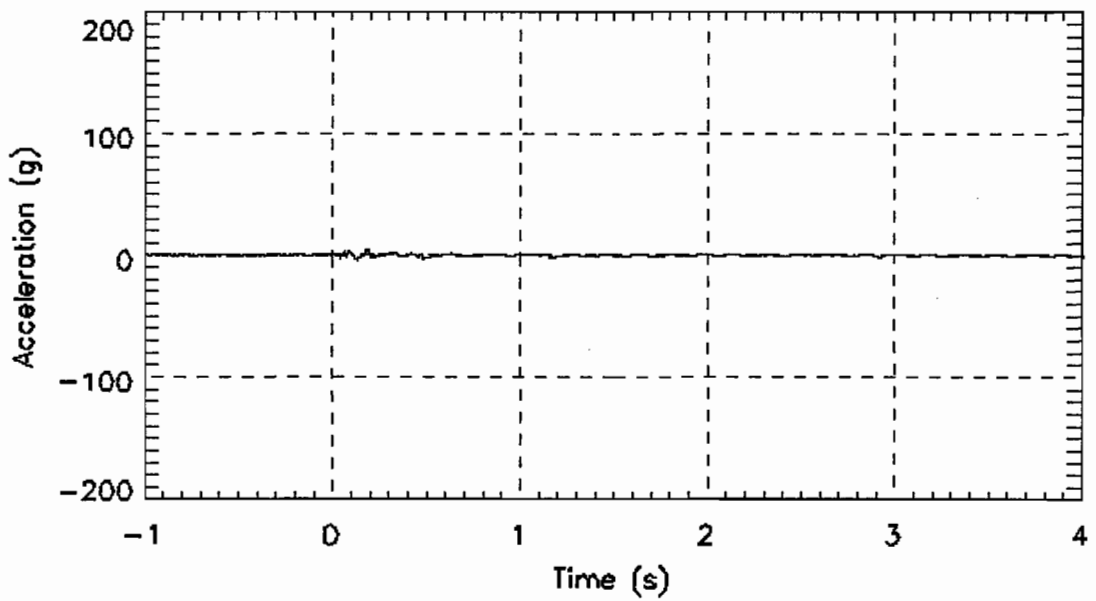

Figure E- 30. Bullet car, underframe level, left side, position 4, vertical acceleraion, digitally filered ar Fc=100Hz, L4Z_100Hz.txt

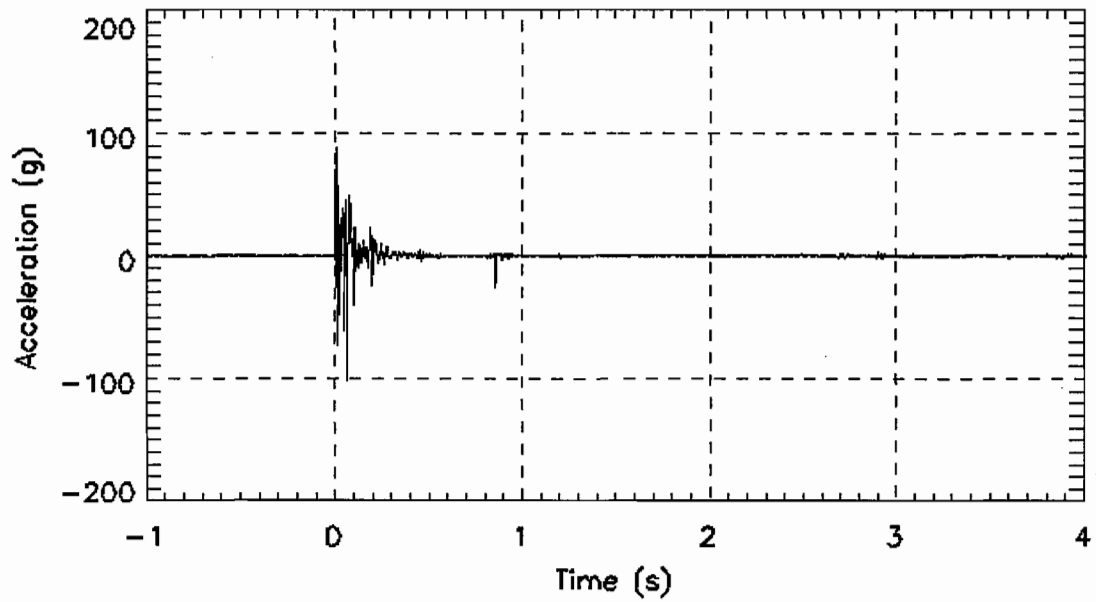

Figure E- 31. Bullet car, underframe level, right side, position 1, longitudinal acceleraion, digitally filered ar Fc=100Hz, R1X_100Hz.txt

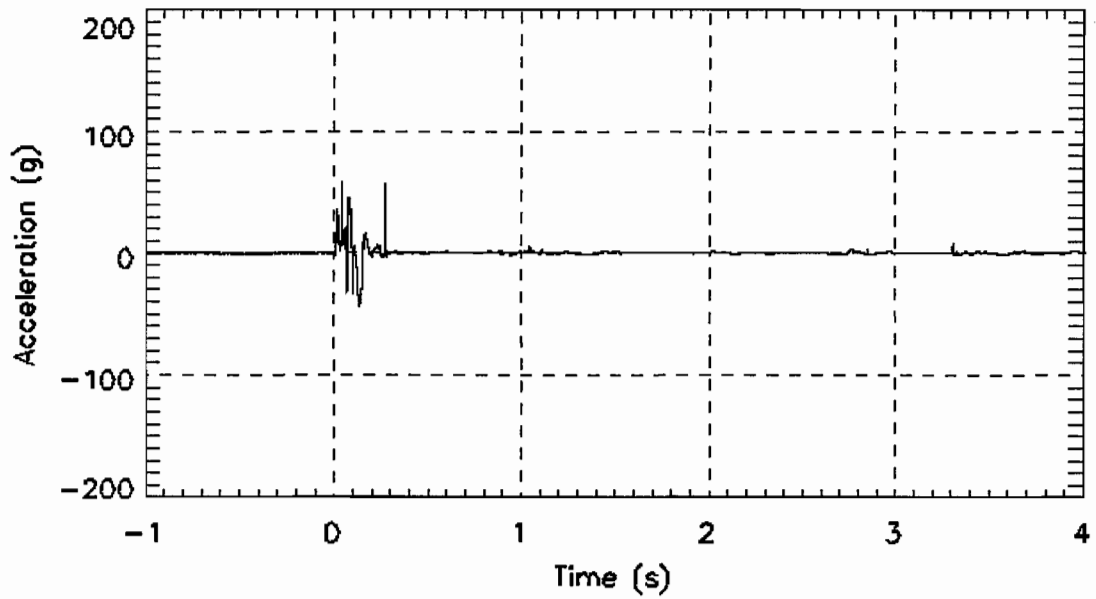

Figure E- 32. Bullet car, underframe level, right side, position 1, lateral acceleraion, digitally filered ar Fc=100Hz, R1Y_100Hz.txt

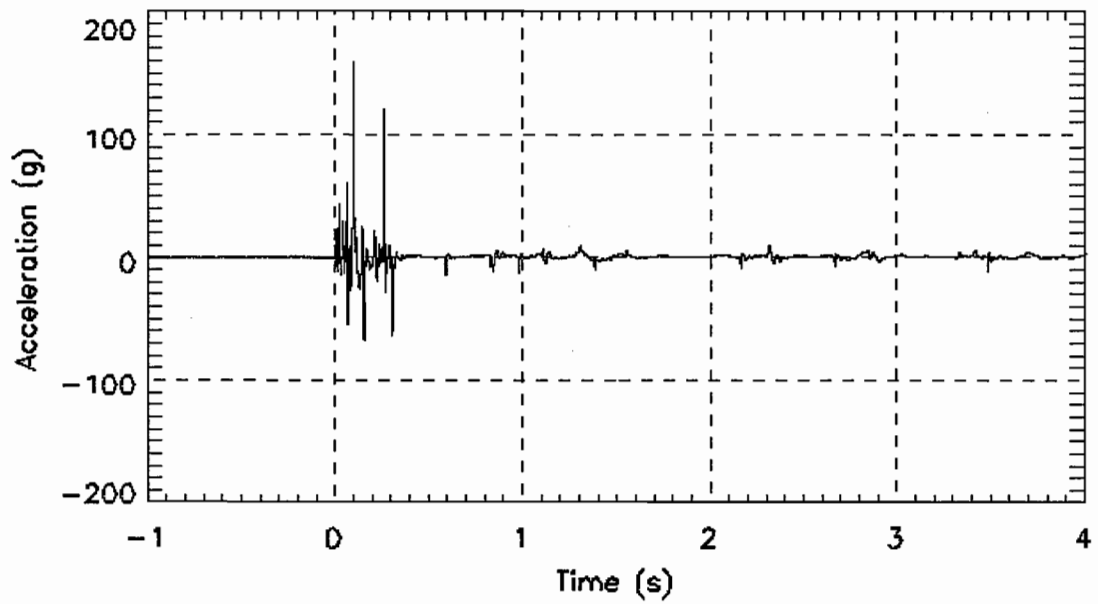

Figure E- 33. Bullet car, underframe level, right side, position 1, vertical acceleraion, digitally filered ar Fc=100Hz, R1Z_100Hz.txt

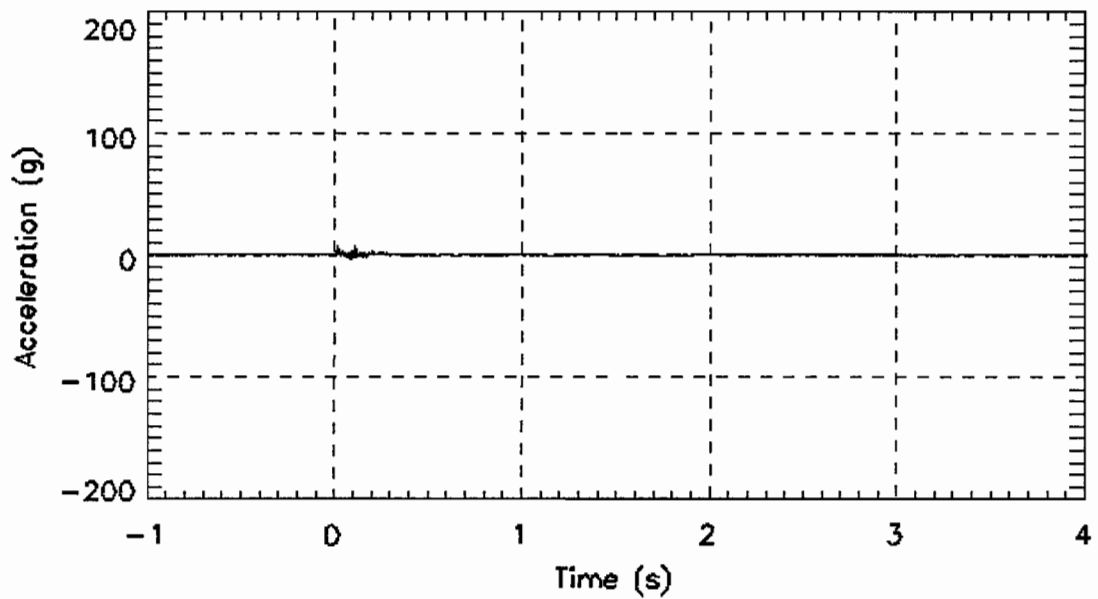

Figure E- 34. Bullet car, underframe level, right side, position 2, longitudinal acceleraion, digitally filered ar Fc=100Hz, R2X_100Hz.txt

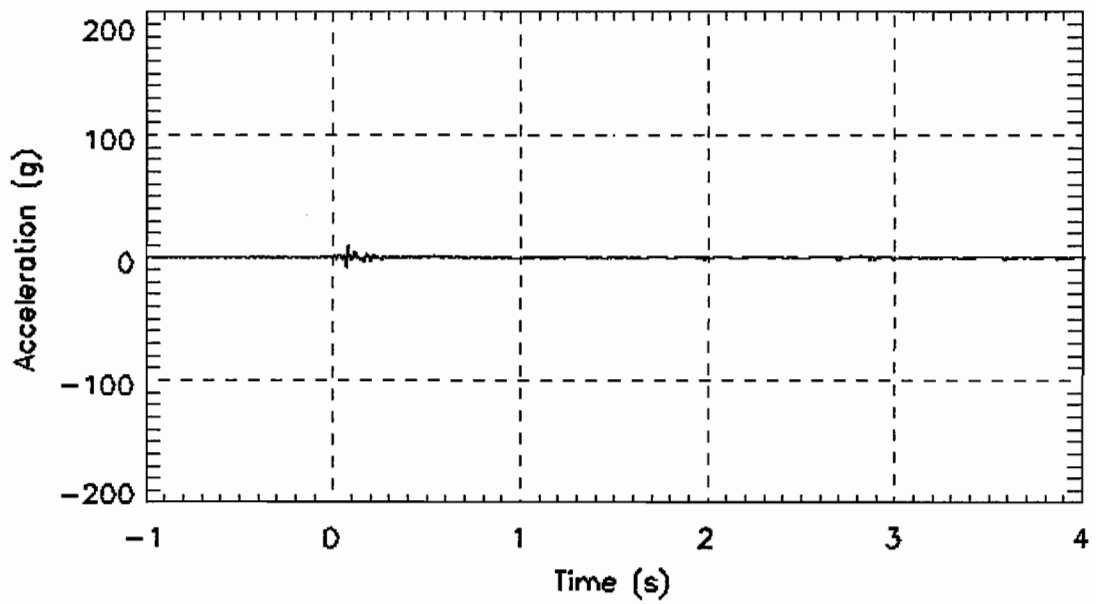

Figure E- 35. Bullet car, underframe level, right side, position 2, vertical acceleraion, digitally filered ar Fc=100Hz, R2Z_100Hz.txt

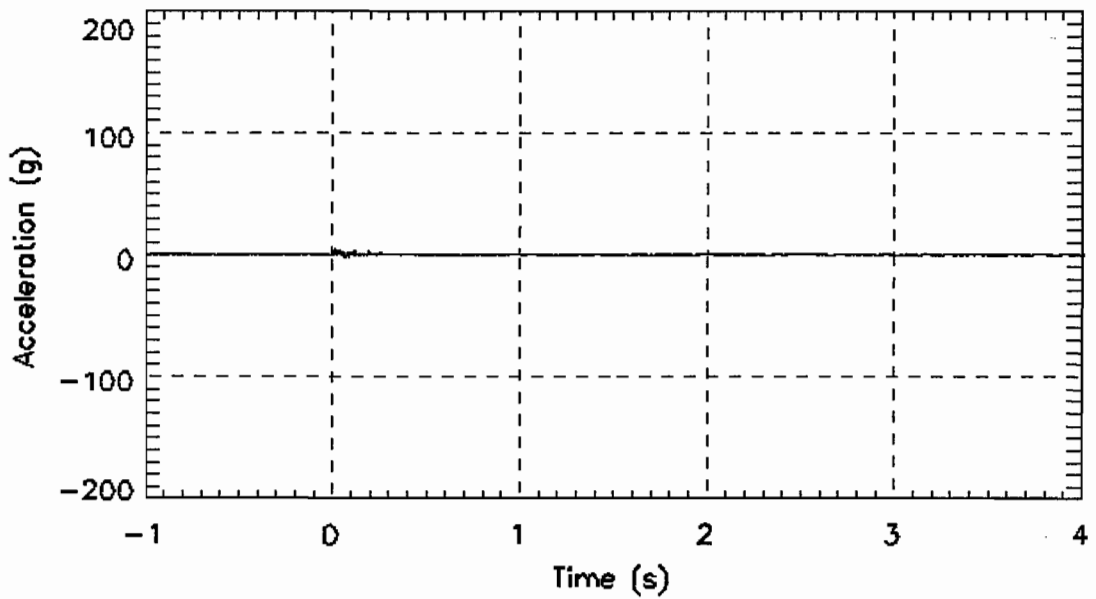

Figure E- 36. Bullet car, underframe level, right side, position 3, longitudinal acceleraion, digitally filered ar Fc=100Hz, R3X_100Hz.txt

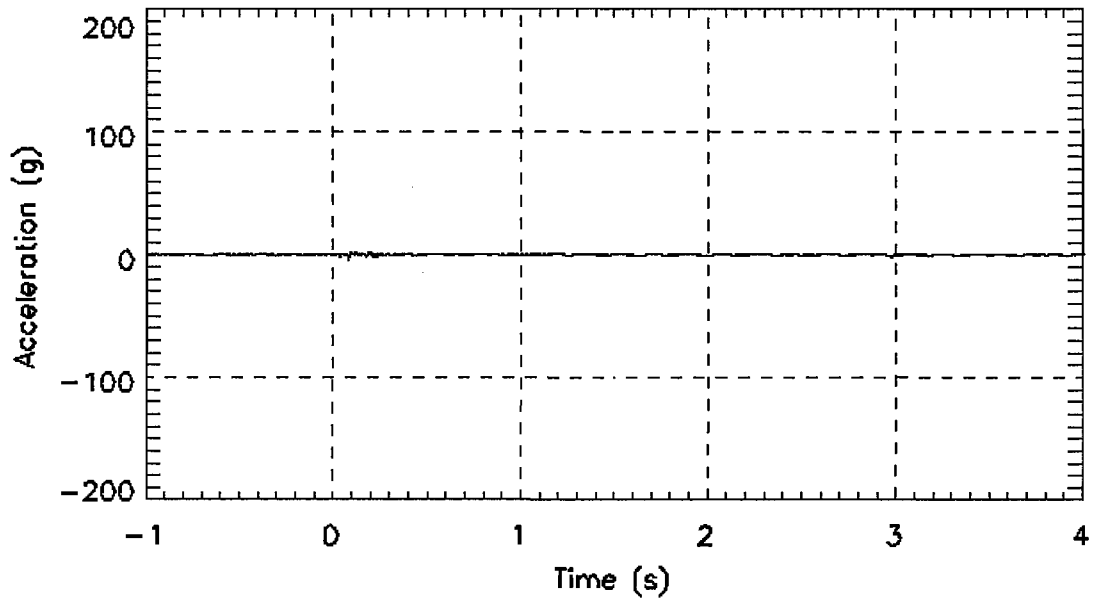

Figure E- 37. Bullet car, underframe level, right side, position 3, vertical acceleraion, digitally filered ar Fc=100Hz, R3Z_100Hz.txt

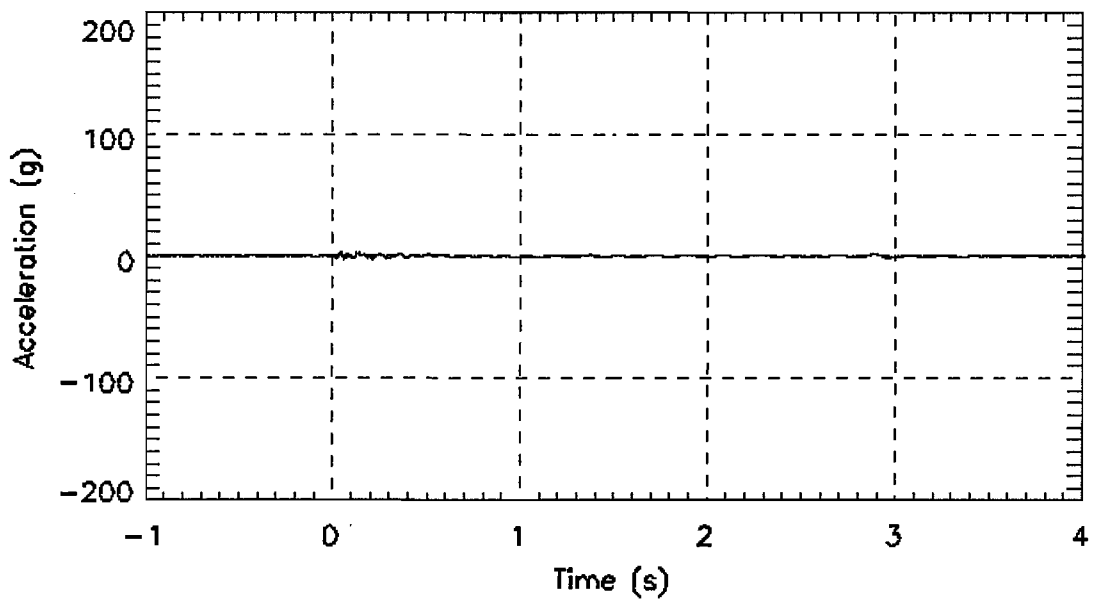

Figure E- 38. Bullet car, underframe level, right side, position 4, vertical acceleraion, digitally filered ar Fc=100Hz, R4Z_100Hz.txt

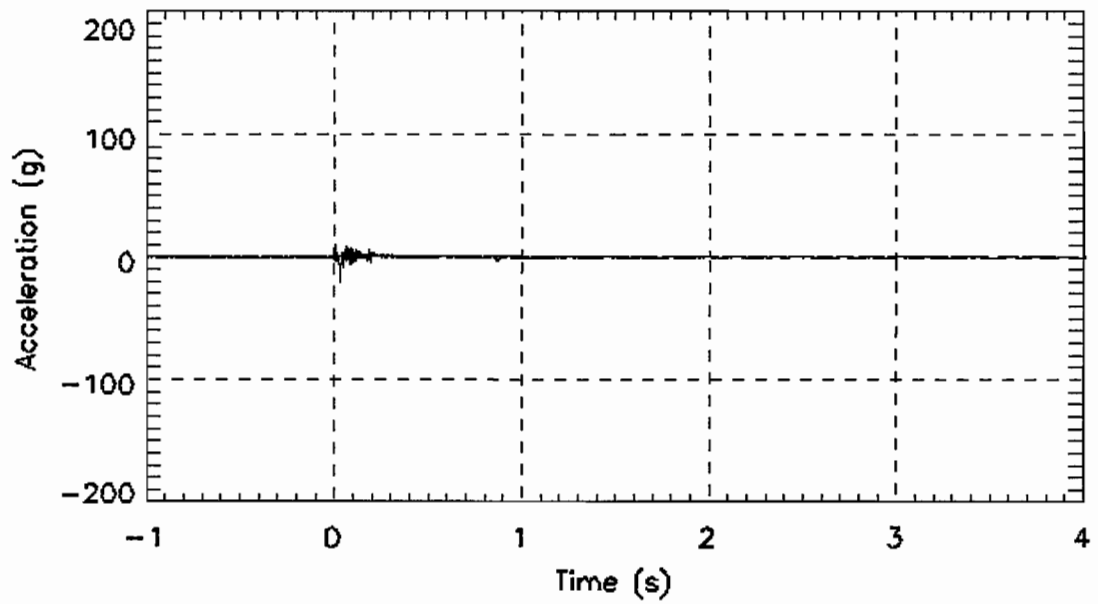

Figure E- 39. Bullet car, cant rail level, left side, position 1, longitudinal acceleraion, digitally filered ar Fc=100Hz, TL1X_100Hz.txt

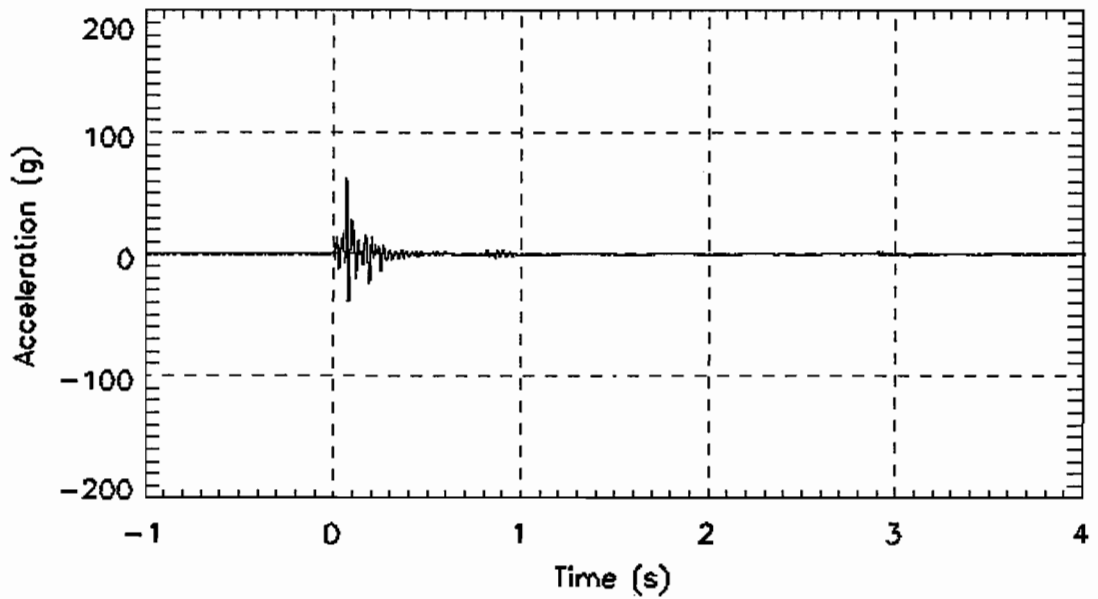

Figure E- 40. Bullet car, cant rail level, left side, position 1, lateral acceleraion, digitally filered ar Fc=100Hz, TL1Y_100Hz.txt

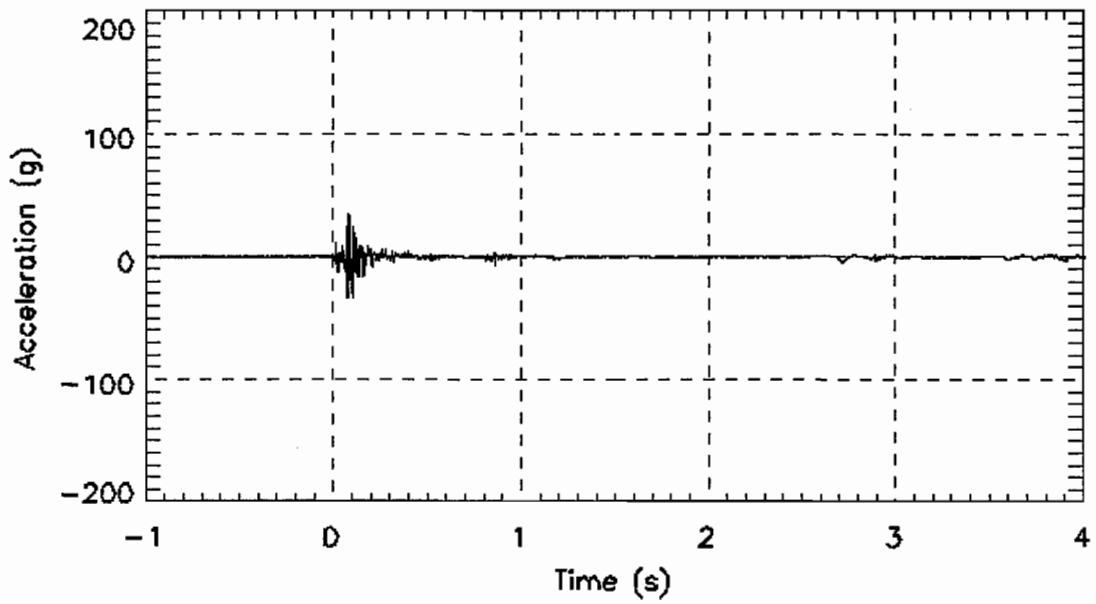

Figure E- 41. Bullet car, cant rail level, left side, position 1, vertical acceleraion, digitally filered ar Fc=100Hz, TL1Z_100Hz.txt

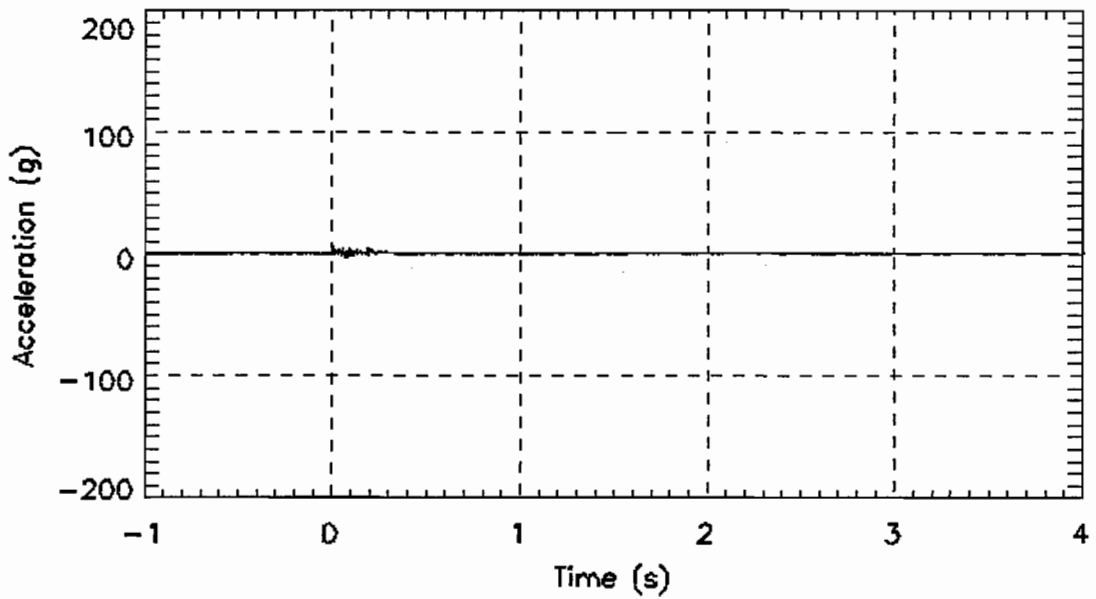

Figure E- 42. Bullet car, cant rail level, left side, position 2, longitudinal acceleraion, digitally filered ar Fc=100Hz, TL2X_100Hz.txt

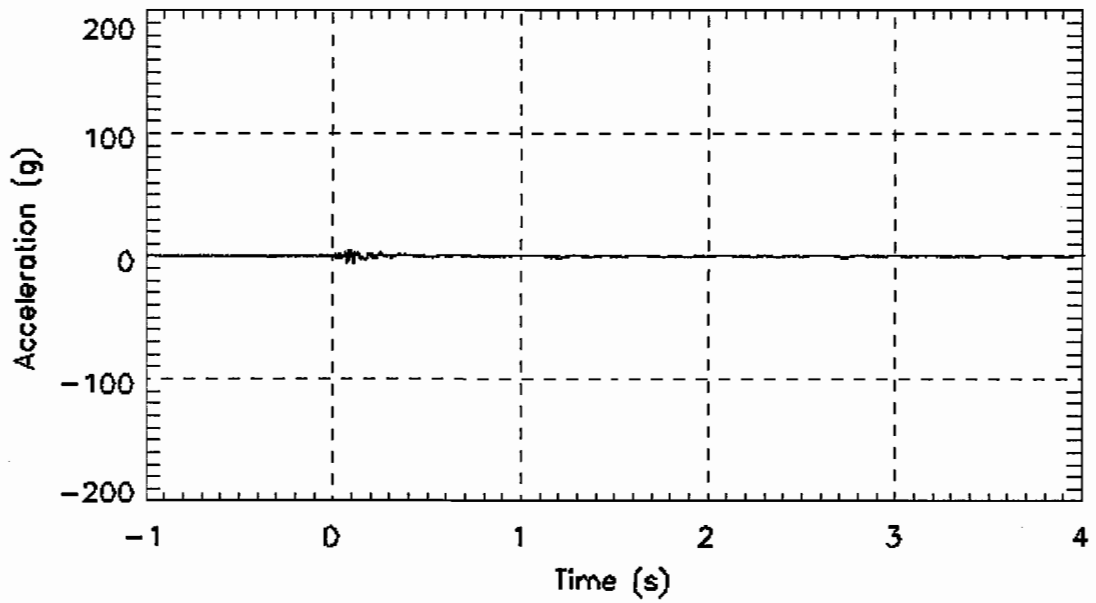

Figure E- 43. Bullet car, cant rail level, left side, position 2, vertical acceleraion, digitally filtered ar Fc=100Hz, TL2Z_100Hz.txt

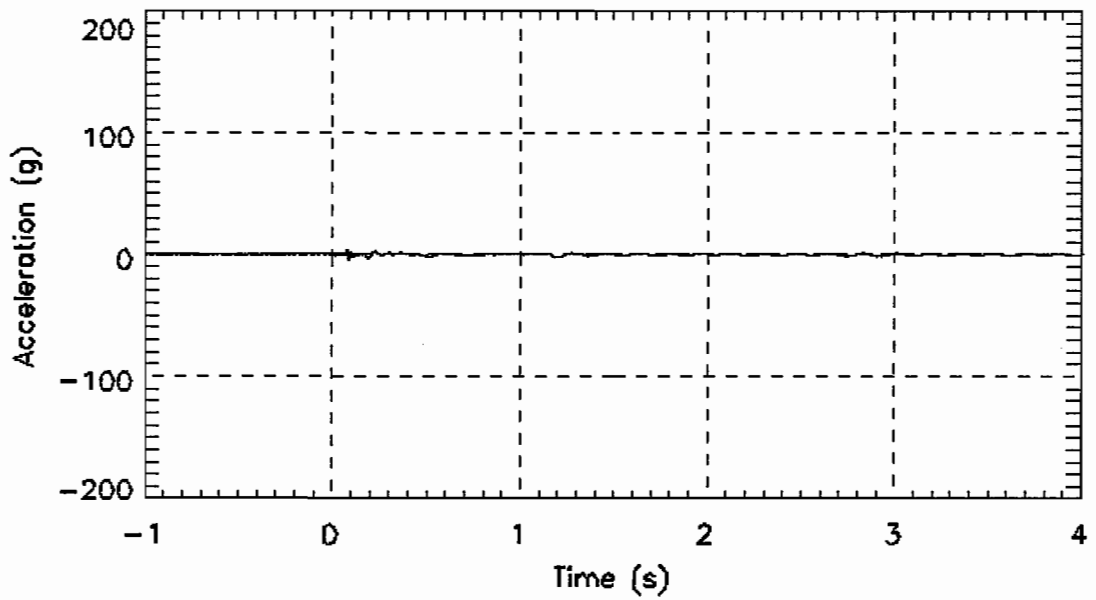

Figure E- 44. Bullet car, cant rail level, left side, position 3, vertical acceleraion, digitally filtered ar Fc=100Hz, TL3Z_100Hz.txt

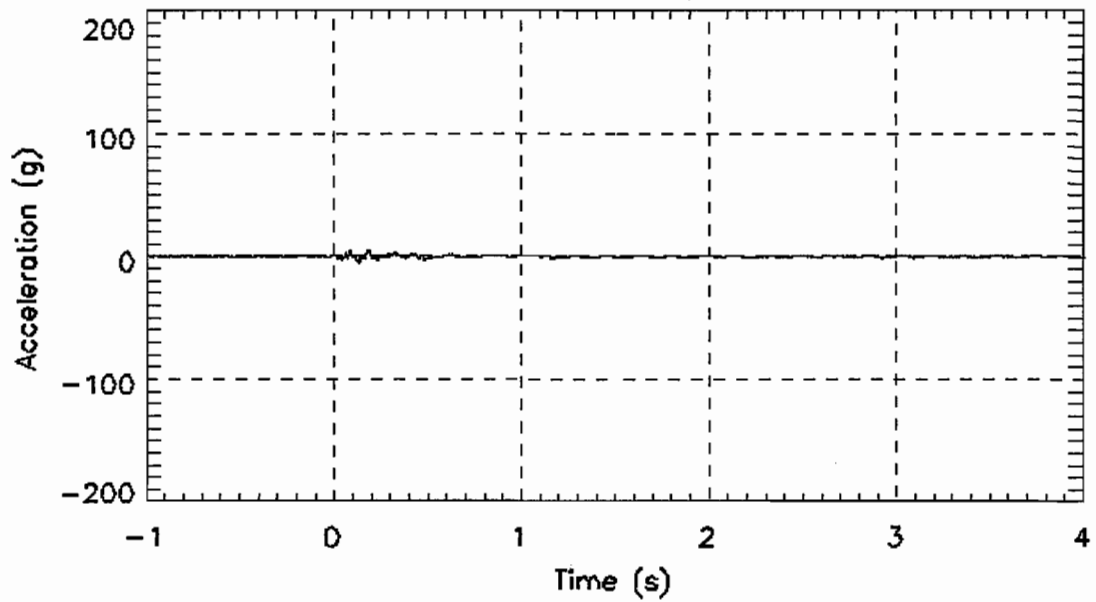

Figure E- 45. Bullet car, cant rail level, left side, position 4, vertical acceleraion, digitally filered ar Fc=100Hz, TL4Z_100Hz.txt

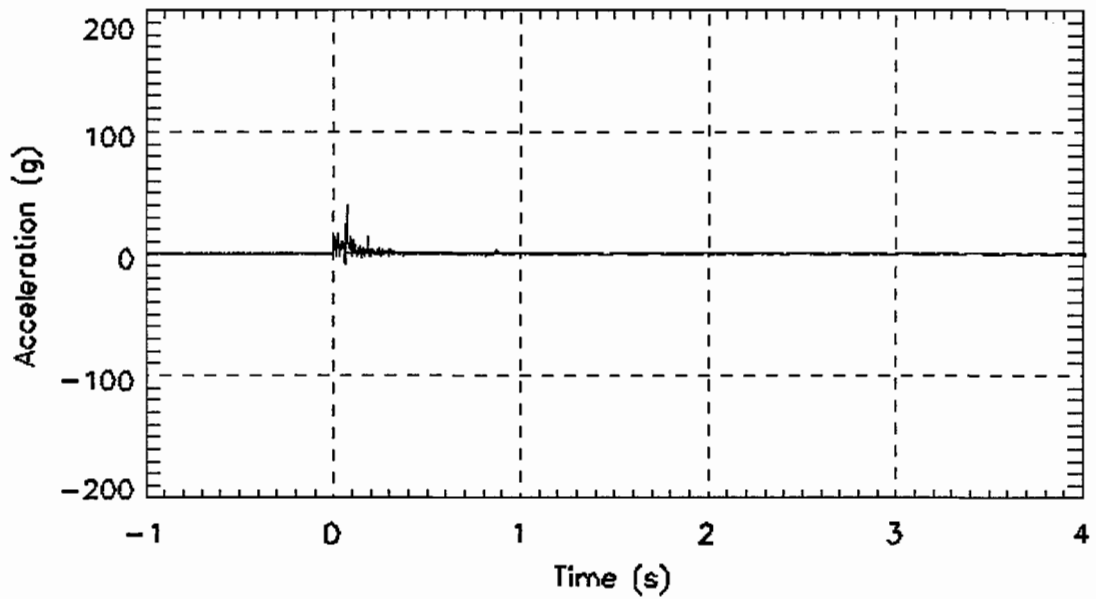

Figure E- 46. Bullet car, cant rail level, right side, position 1, longitudinal acceleraion, digitally filered ar Fc=100Hz, TR1X_100Hz.txt

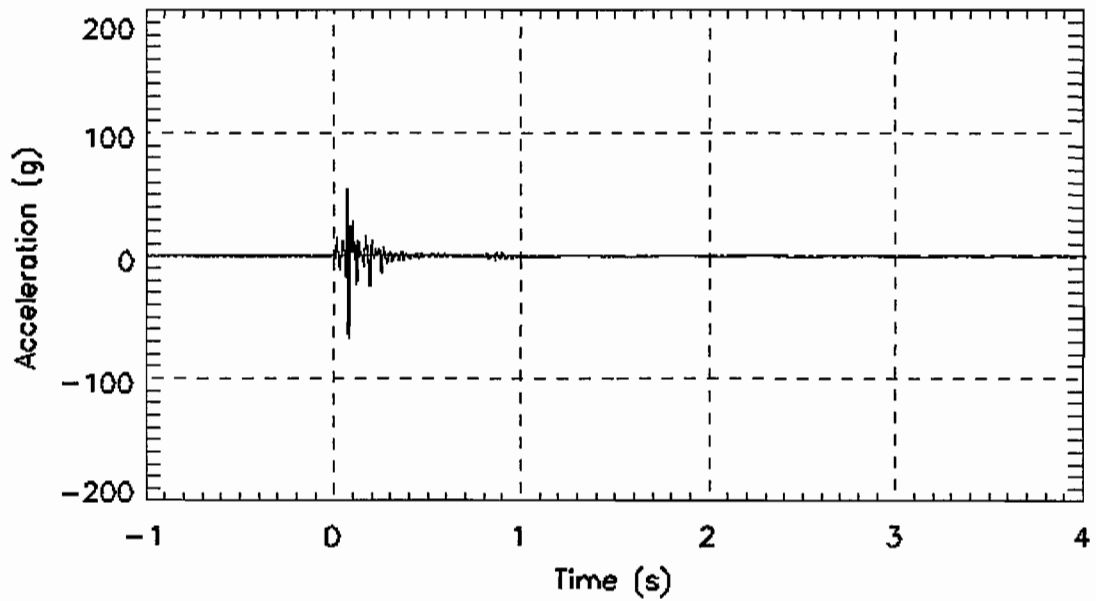

Figure E- 47. Bullet car, cant rail level, right side, position 1, lateral acceleraion, digitally filtered ar Fc=100Hz, TR1Y_100Hz.txt

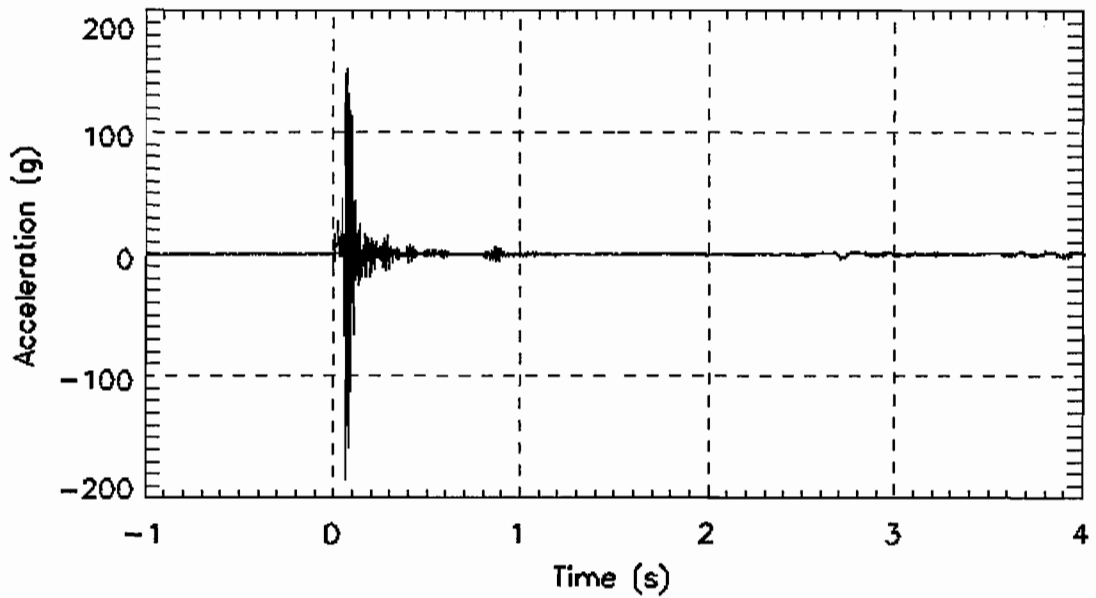

Figure E- 48. Bullet car, cant rail level, right side, position 1, vertical acceleraion, digitally filtered ar Fc=100Hz, TR1Z_100Hz.txt

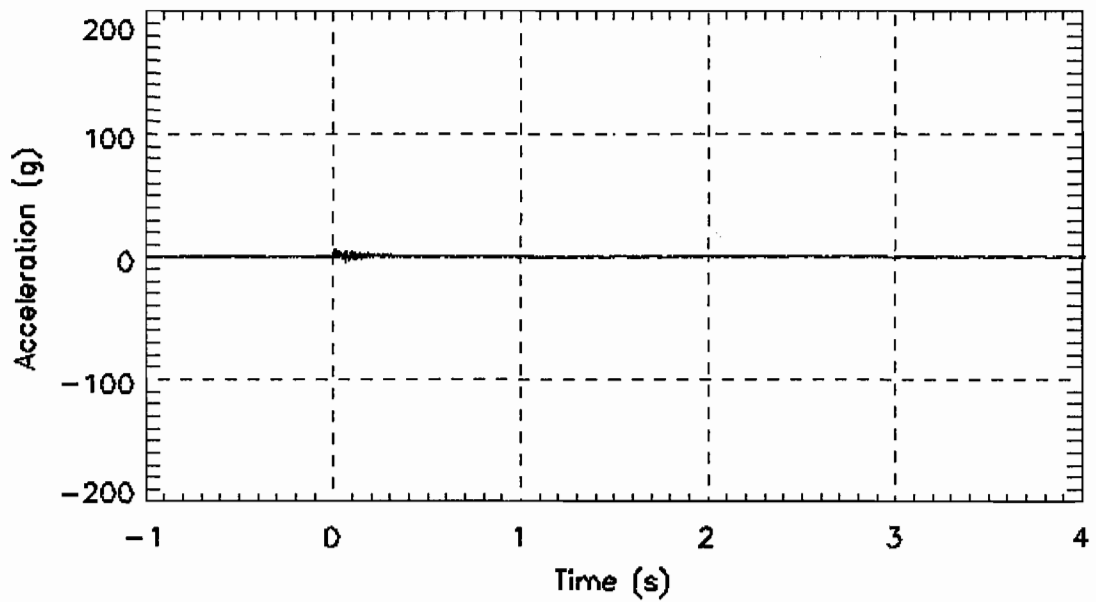

Figure E- 49. Bullet car, cant rail level, right side, position 2, longitudinal acceleraion, digitally filtered ar Fc=100Hz, TR2X_100Hz.txt

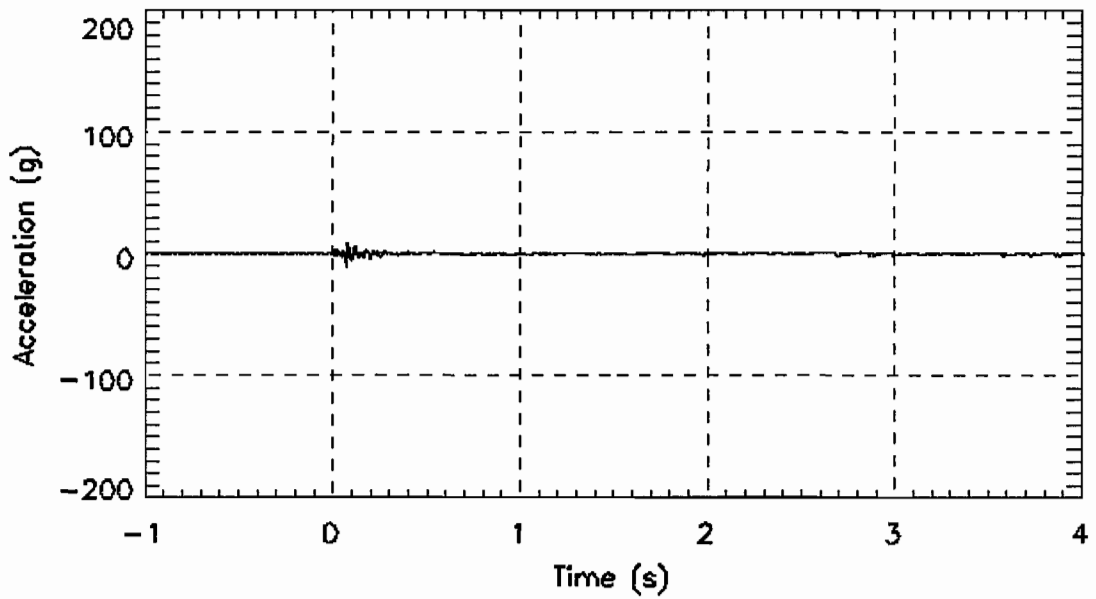

Figure E- 50. Bullet car, cant rail level, right side, position 2, vertical acceleraion, digitally filtered ar Fc=100Hz, TR2Z_100Hz.txt

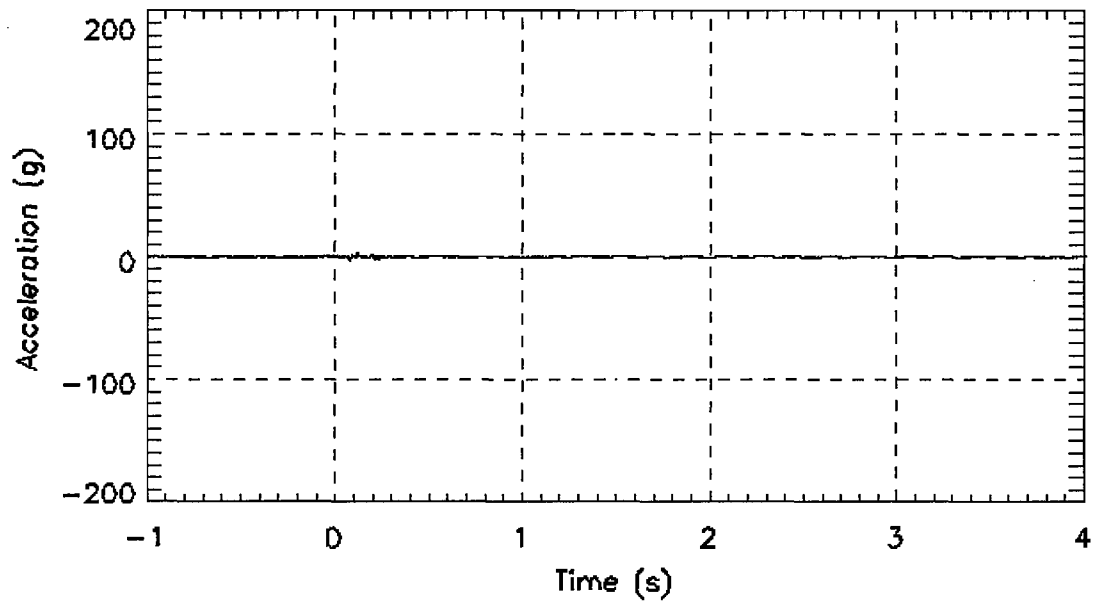

Figure E- 51. Bullet car, cant rail level, right side, position 3, vertical acceleraion, digitally filtered ar Fc=100Hz, TR3Z_100Hz.txt

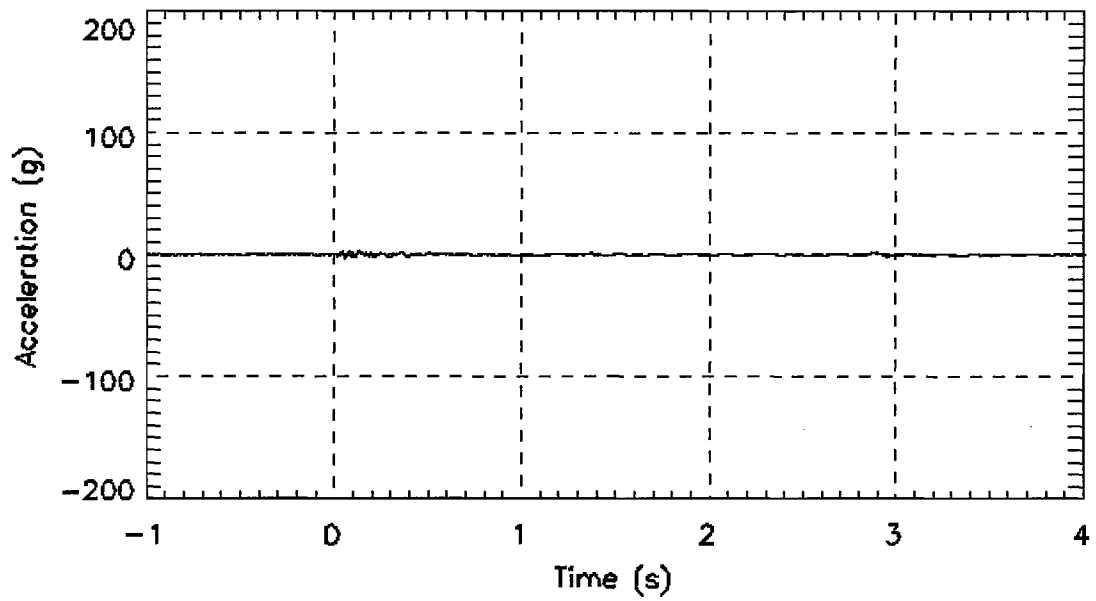

Figure E- 52. Bullet car, cant rail level, right side, position 4, vertical acceleraion, digitally filtered ar Fc=100Hz, TR4Z_100Hz.txt

Appendix F

Test 4
Acceleration Data, $F_c = 25\text{Hz}$

This page left blank intentionally

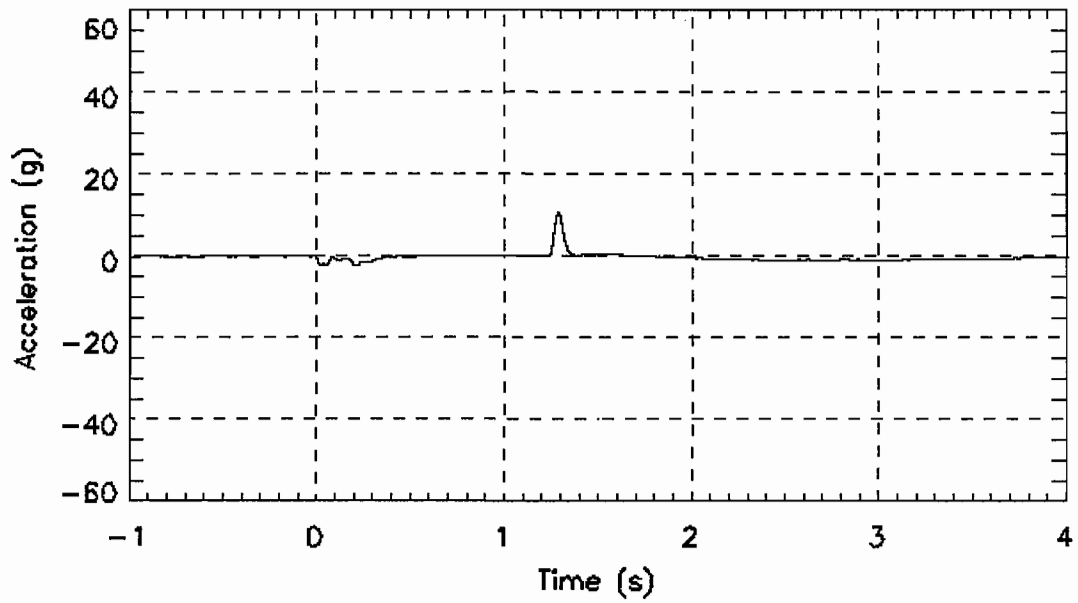

Figure F- 1. Steel coil, centered, longitudinal acceleration, digitally filtered ar Fc=25Hz, A0X_25Hz.txt

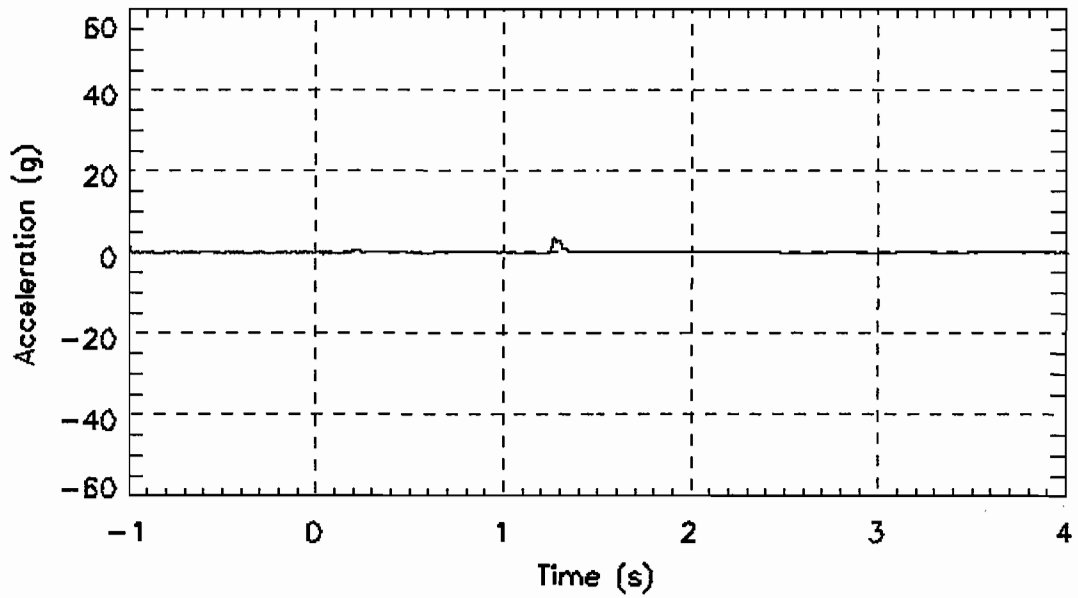

Figure F- 2. Steel coil, centered, lateral acceleration, digitally filtered ar Fc=25Hz, A0Y_25Hz.txt

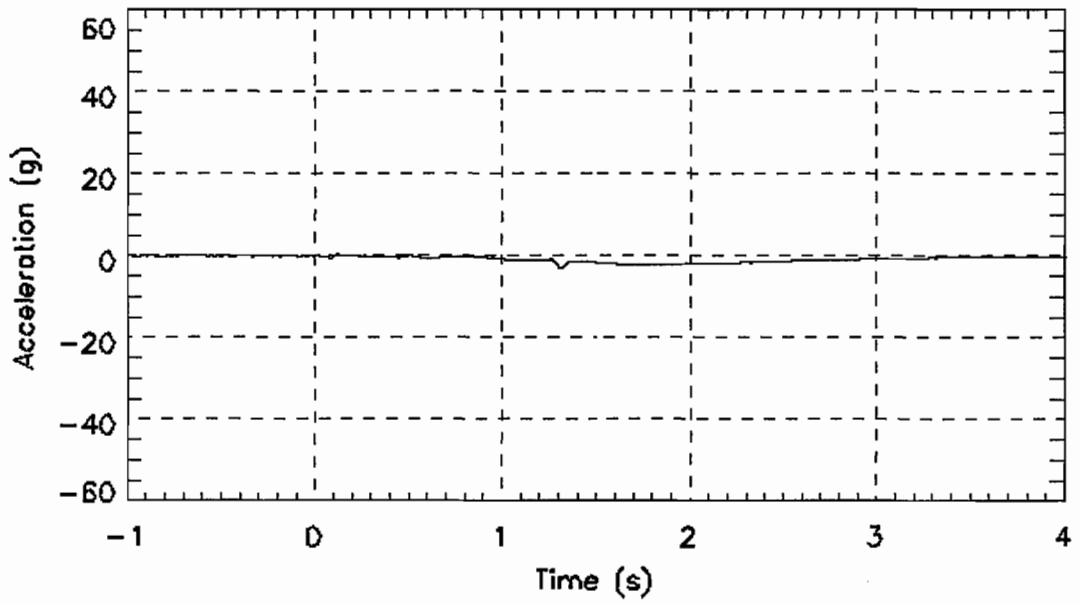

Figure F- 3. Steel coil, centered, vertical acceleration, digitally filtered ar $F_c=25\text{Hz}$, A0Z_25Hz.txt

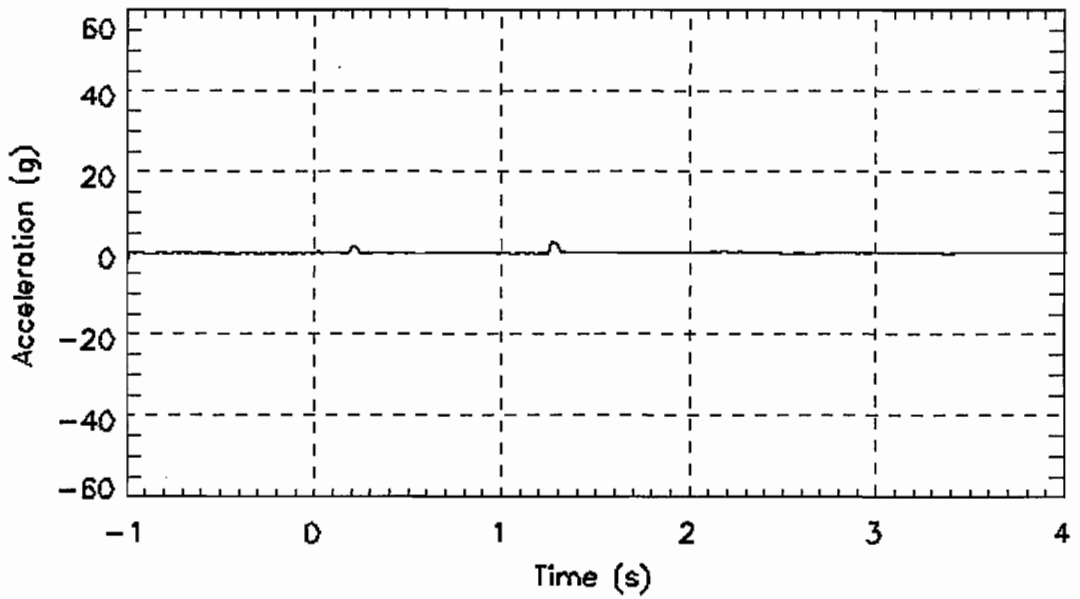

Figure F- 4. Steel coil, offset along X axis, lateral acceleration, digitally filtered ar $F_c=25\text{Hz}$, A1Y_25Hz.txt

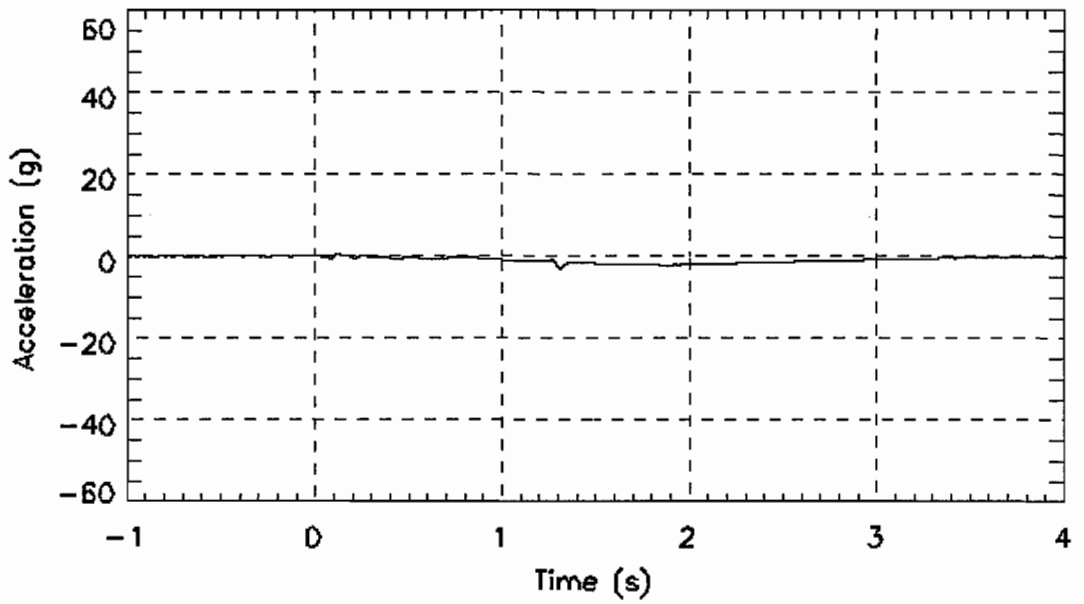

Figure F- 5. Steel coil, offset along X axis, vertical acceleration, digitally filtered ar Fc=25Hz, A1Z_25Hz.txt

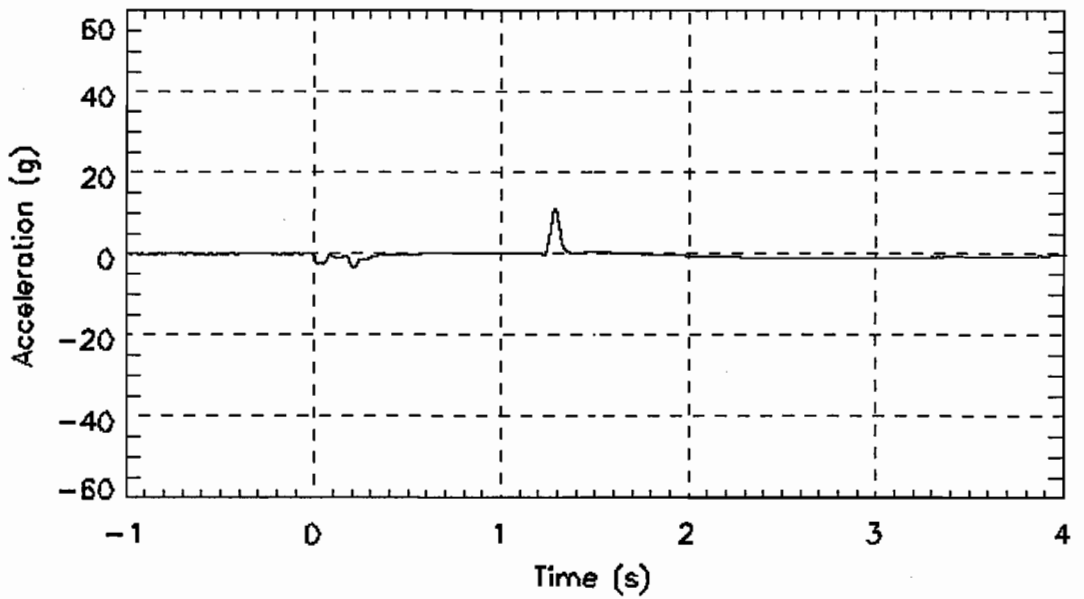

Figure F- 6. Steel coil, offset along Y axis, longitudinal acceleration, digitally filtered ar Fc=25Hz, A2X_25Hz.txt

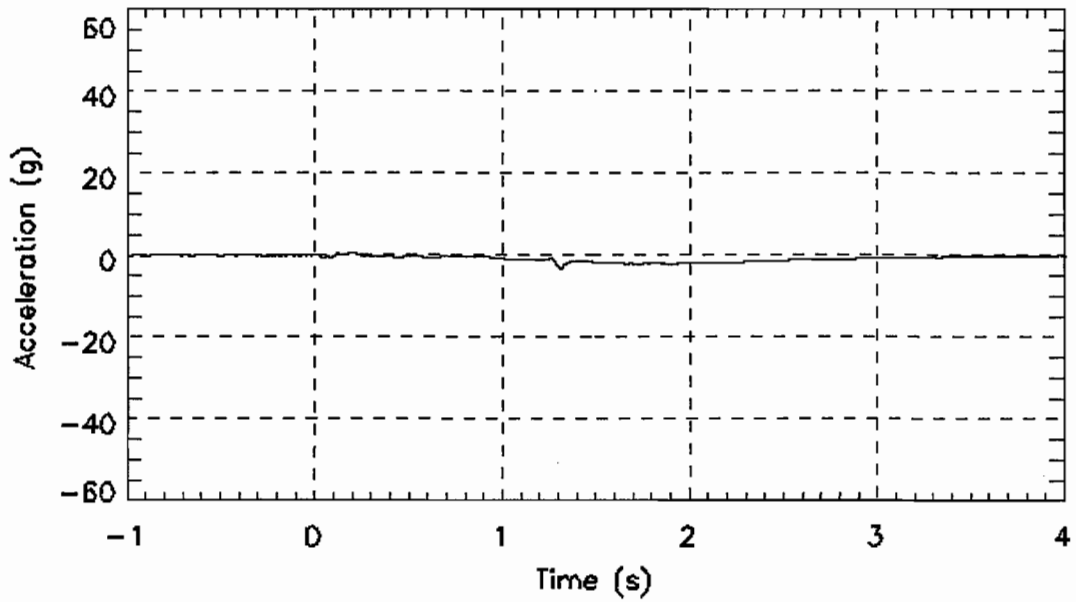

Figure F- 7. Steel coil, offset along Y axis, vertical acceleration, digitally filtered ar Fc=25Hz, A2Z_25Hz.txt

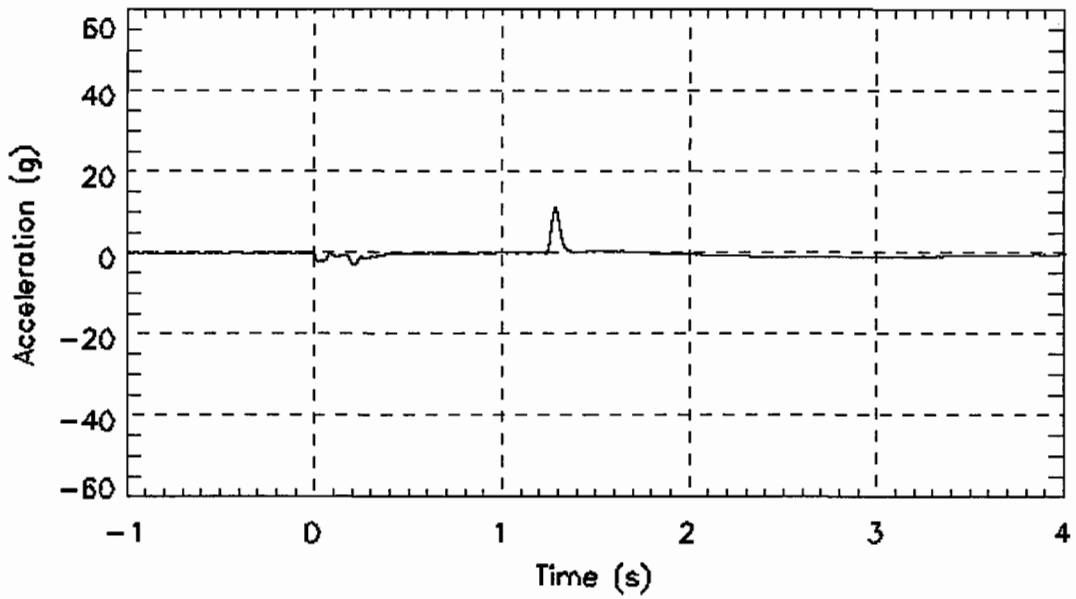

Figure F- 8. Steel coil, offset along Z axis, longitudinal acceleration, digitally filtered ar Fc=25Hz, A3X_25Hz.txt

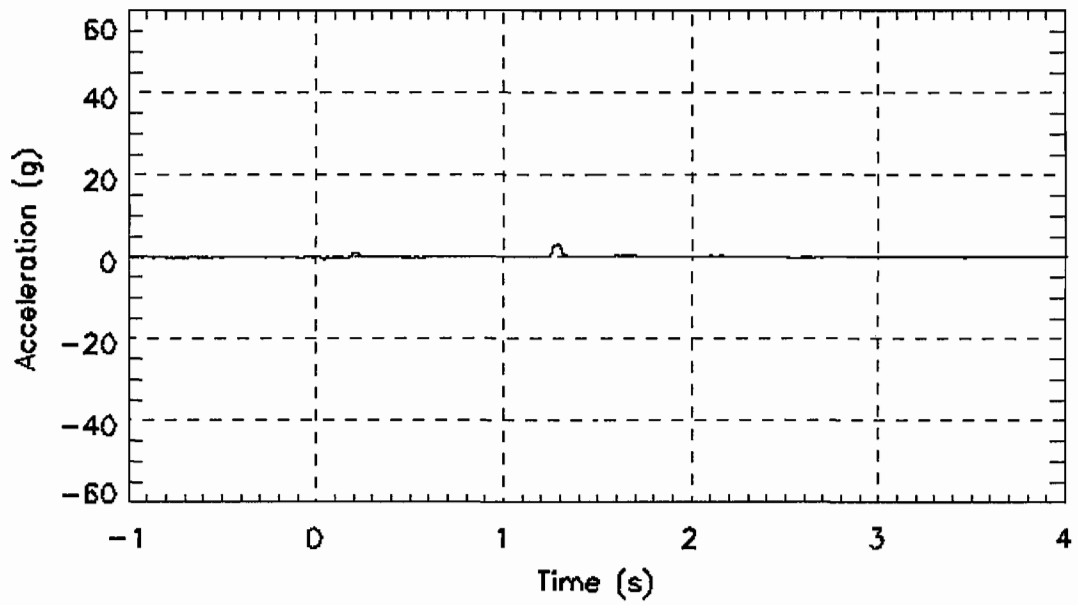

Figure F- 9. Steel coil, offset along Z axis, lateral acceleration, digitally filtered ar Fc=25Hz, A3Y_25Hz.txt

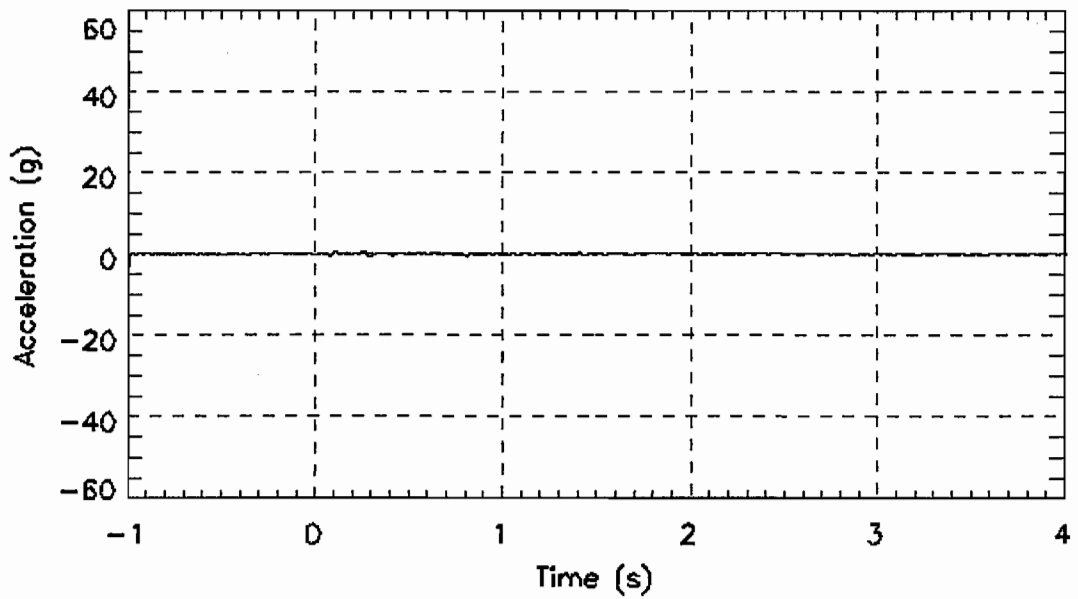

Figure F- 10. Lead bogie, lateral acceleration, digitally filtered ar Fc=25Hz, BAY_25Hz.txt

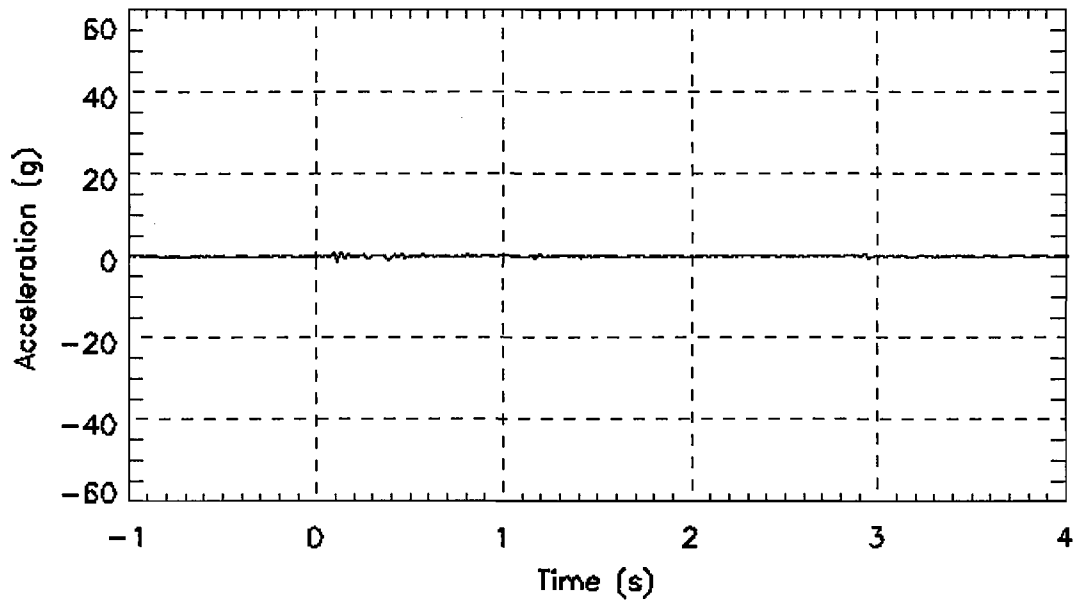

Figure F- 11. Lead bogie, vertical acceleration, digitally filtered ar $F_c=25\text{Hz}$, BAZ_25Hz.txt

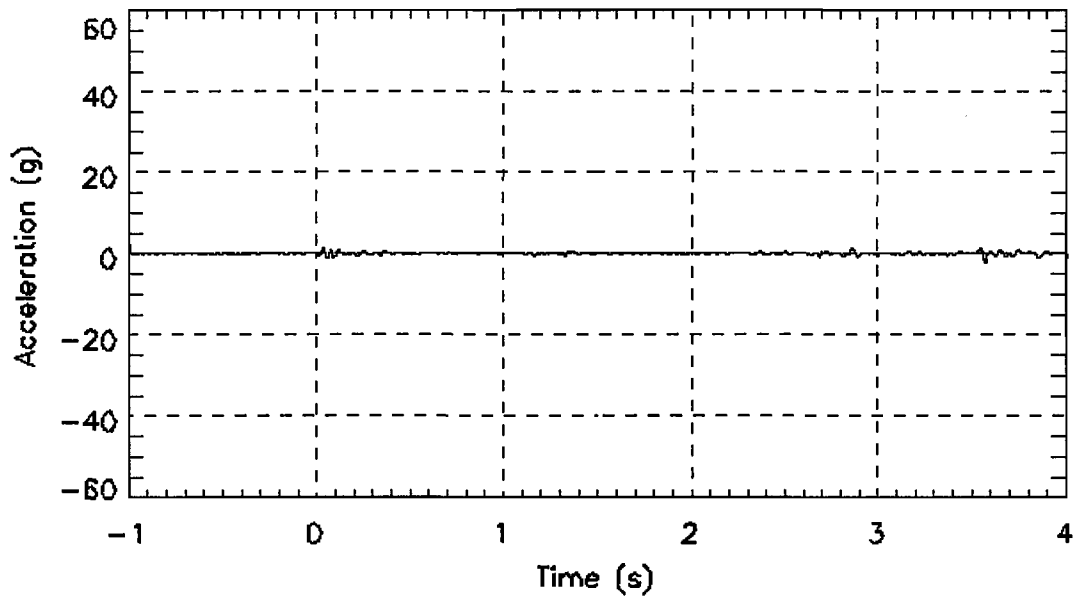

Figure F- 12. Trail bogie, lateral acceleration, digitally filtered ar $F_c=25\text{Hz}$, BBY_25Hz.txt

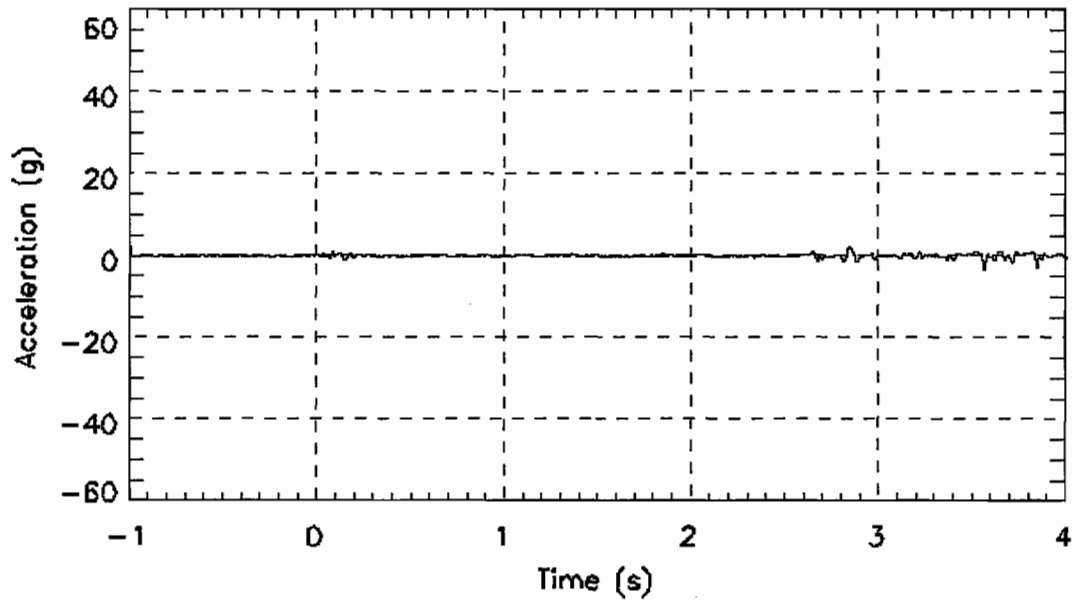

Figure F- 13. Trail bogie, vertical acceleration, digitally filtered ar Fc=25Hz, BBZ_25Hz.txt

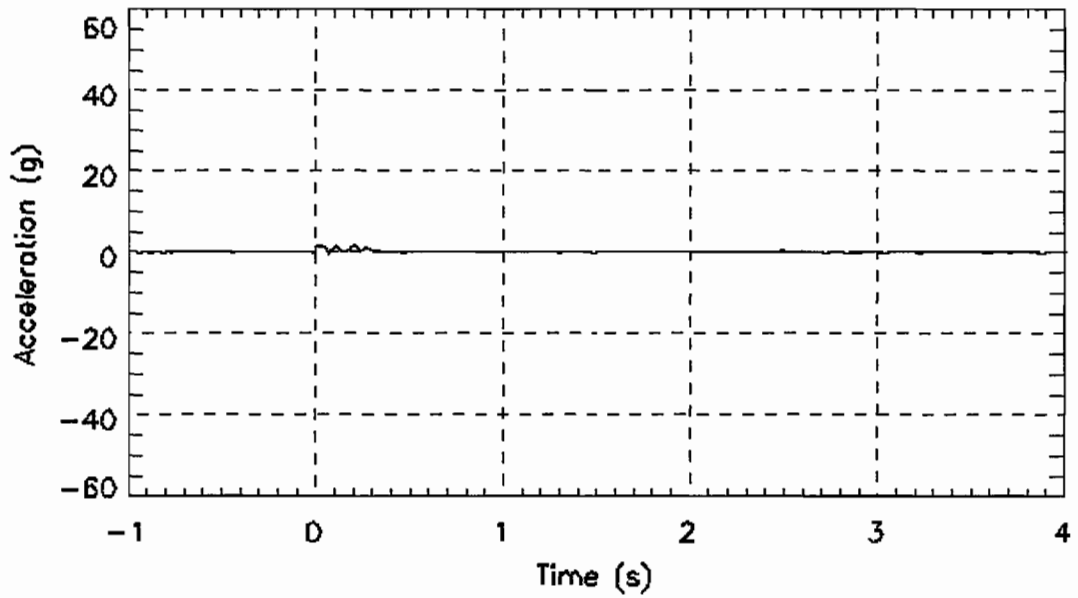

Figure F- 14. Bullet car, position 2, centersill, longitudinal acceleration, digitally filtered ar Fc=25Hz, C2X_25Hz.txt

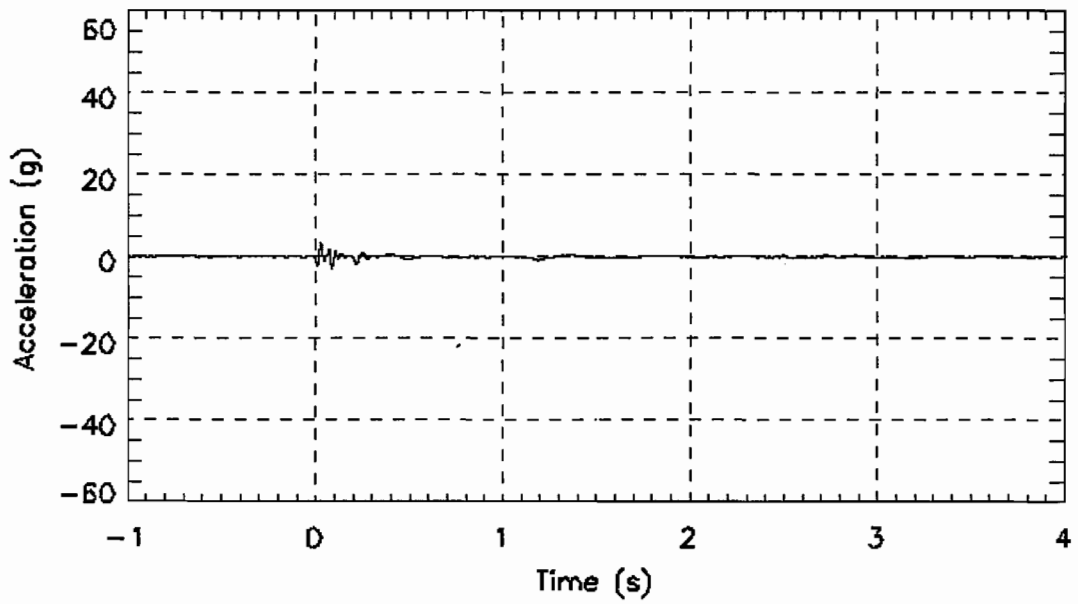

Figure F- 15. Bullet car, position 2, centersill, lateral acceleration, digitally filtered ar Fc=25Hz, C2Y_25Hz.txt

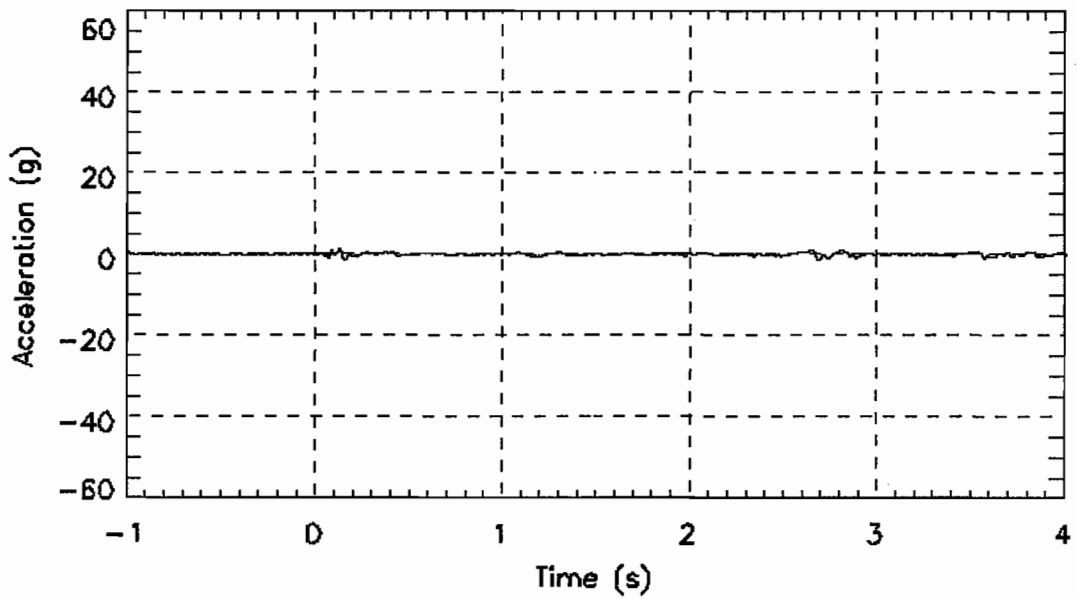

Figure F- 16. Bullet car, position 2, centersill, vertical acceleration, digitally filtered ar Fc=25Hz, C2Z_25Hz.txt

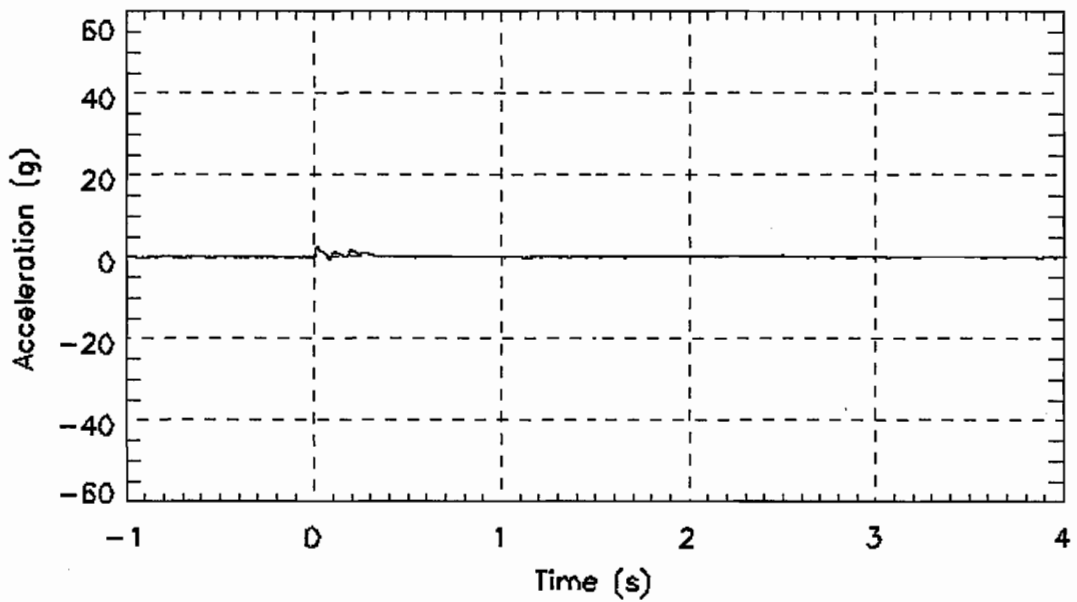

Figure F- 17. Bullet car, position 3, centersill, longitudinal acceleration, digitally filtered ar Fc=25Hz, C3X_25Hz.txt

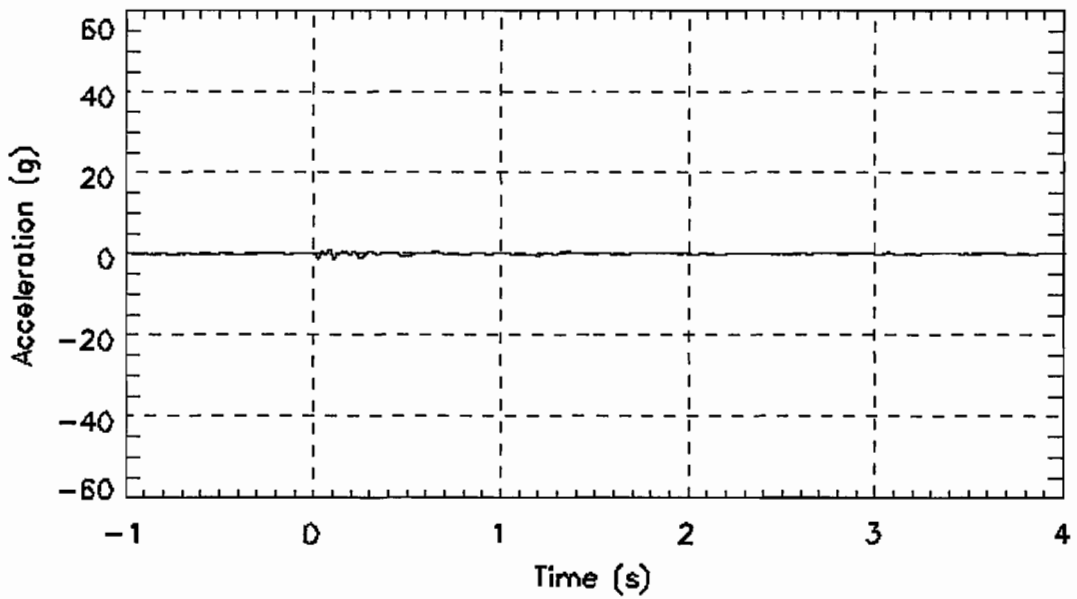

Figure F- 18. Bullet car, position 3, centersill, lateral acceleration, digitally filtered ar Fc=25Hz, C3Y_25Hz.txt

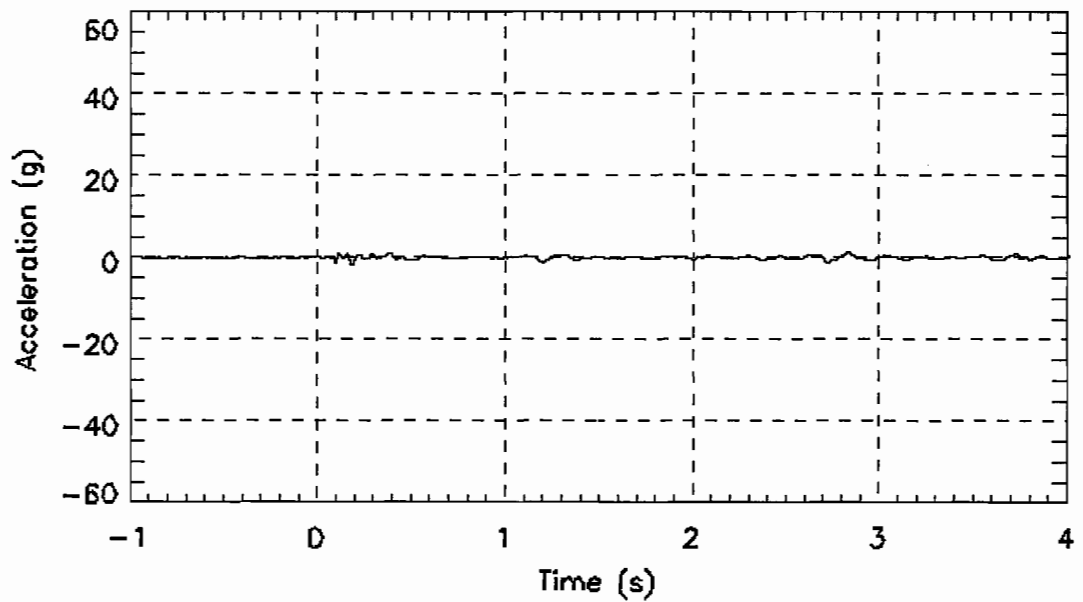

Figure F- 19. Bullet car, position 3, centersill, vertical acceleration, digitally filtered ar Fc=25Hz, C3Z_25Hz.txt

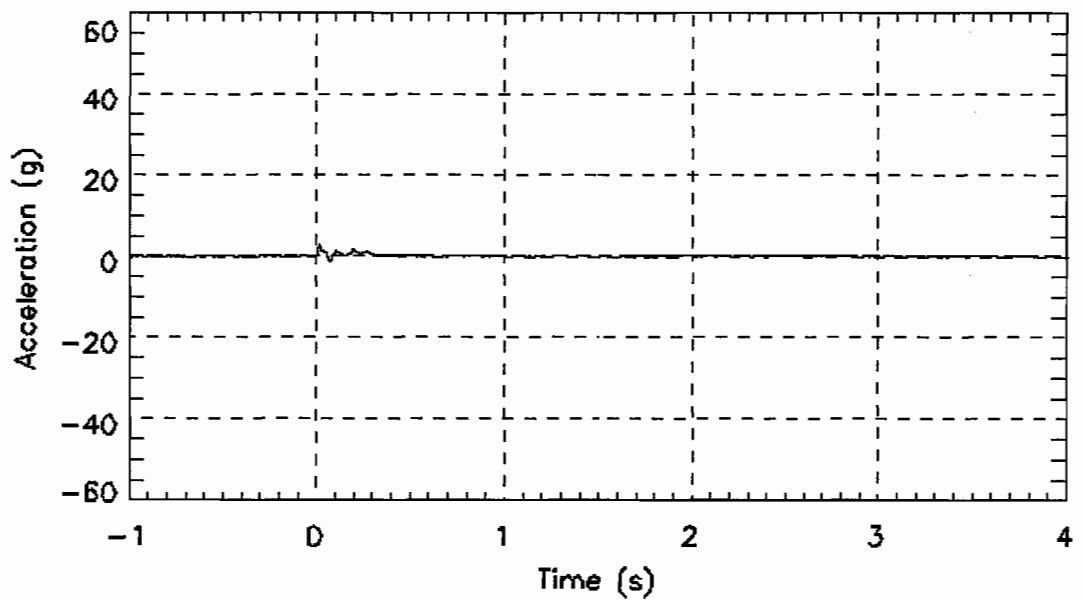

Figure F- 20. Bullet car, position 4, centersill, longitudinal acceleration, digitally filtered ar Fc=25Hz, C4X_25Hz.txt

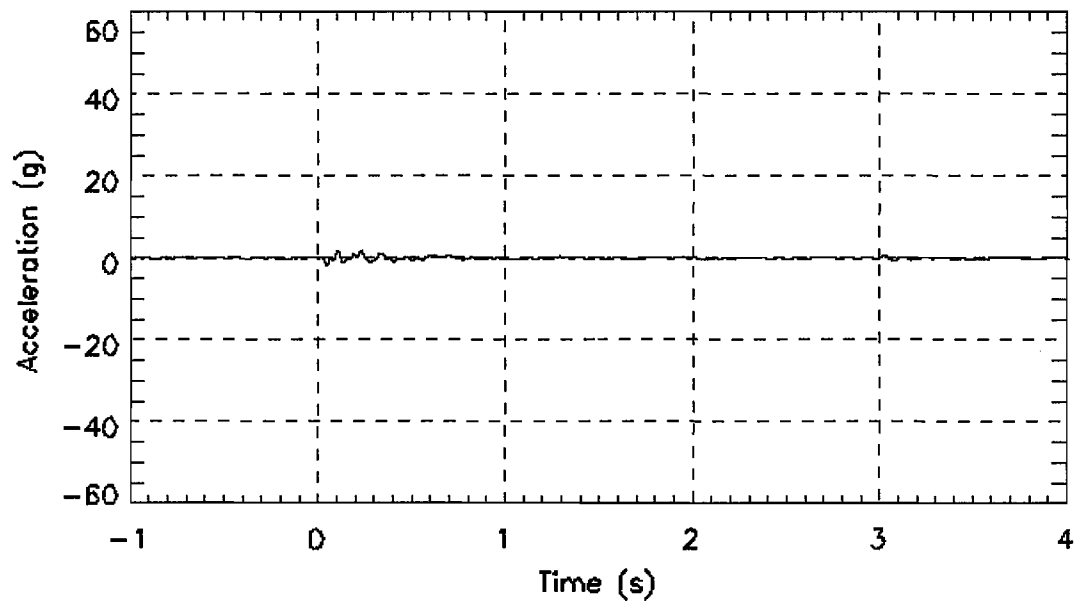

Figure F- 21. Bullet car, position 4, centersill, lateral acceleration, digitally filtered ar Fc=25Hz, C4Y_25Hz.txt

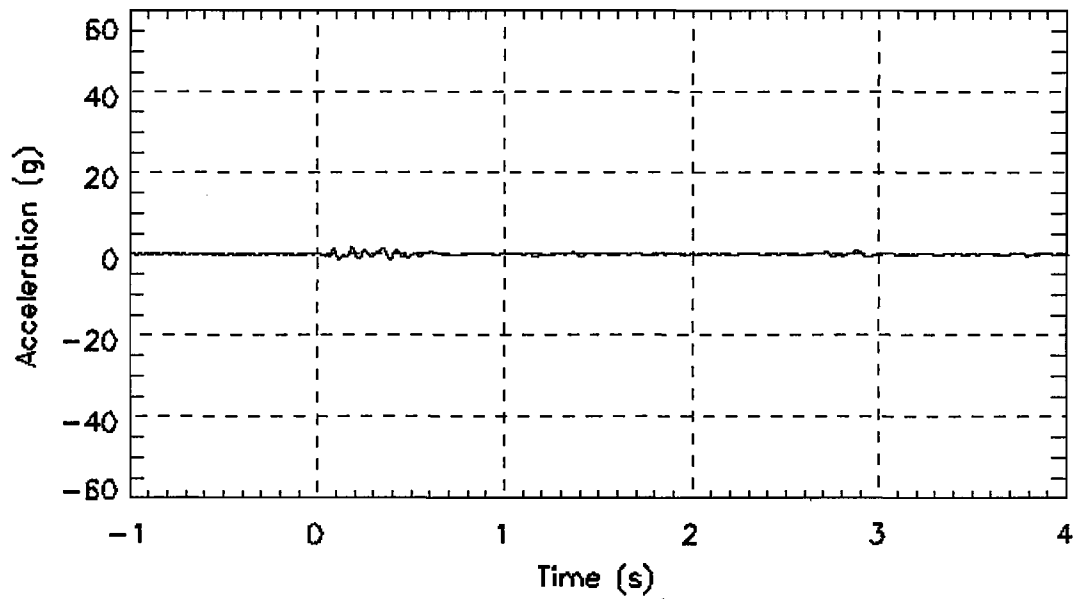

Figure F- 22. Bullet car, position 4, centersill, vertical acceleration, digitally filtered ar Fc=25Hz, C4Z_25Hz.txt

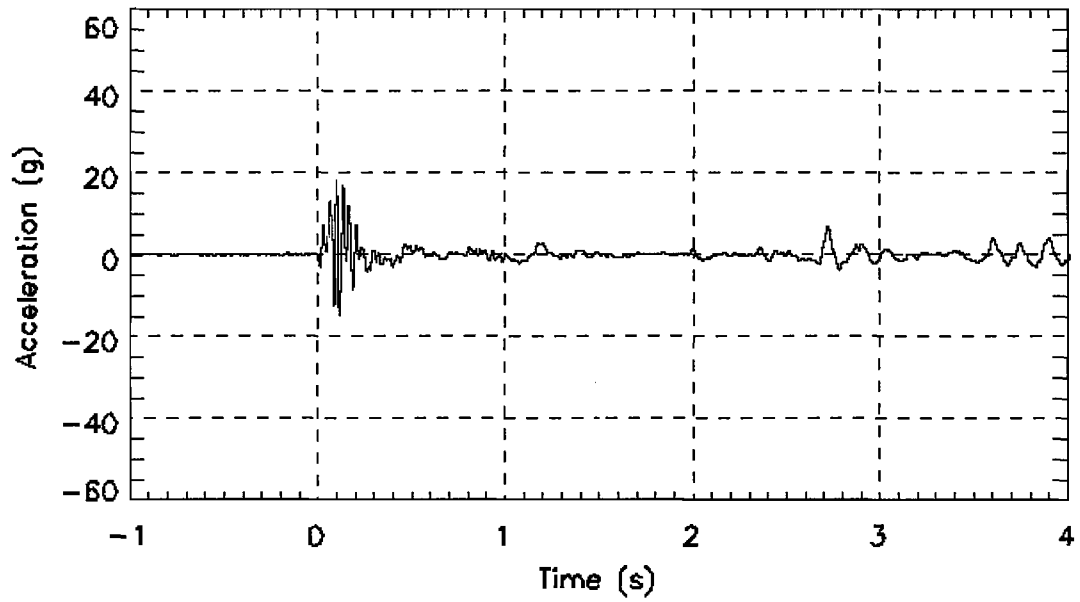

Figure F- 23. Bullet car, underframe level, left side, position 1, longitudinal acceleraion, digitally filered ar Fc=25Hz, L1X_25Hz.txt

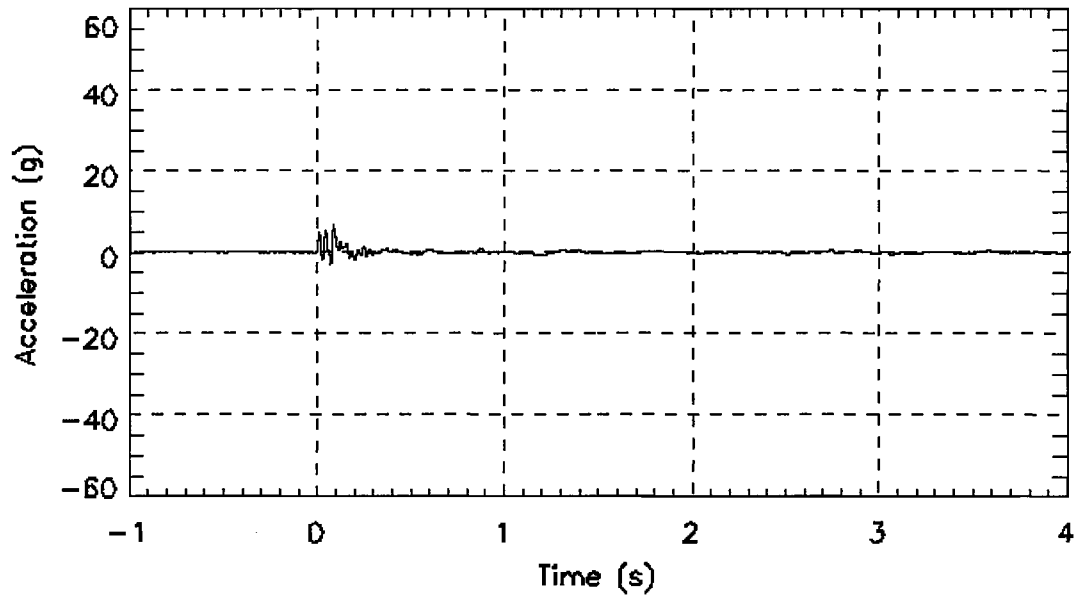

Figure F- 24. Bullet car, underframe level, left side, position 1, lateral acceleraion, digitally filered ar Fc=25Hz, L1Y_25Hz.txt

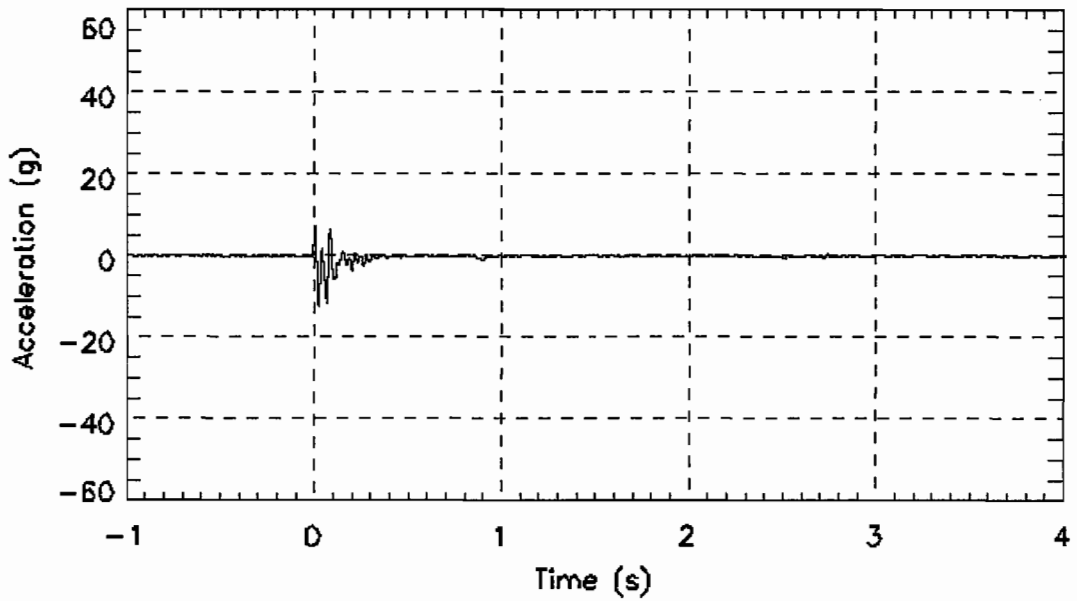

Figure F- 25. Bullet car, underframe level, left side, position 1, vertical acceleraion, digitally filered ar Fc=25Hz, L1Z_25Hz.txt

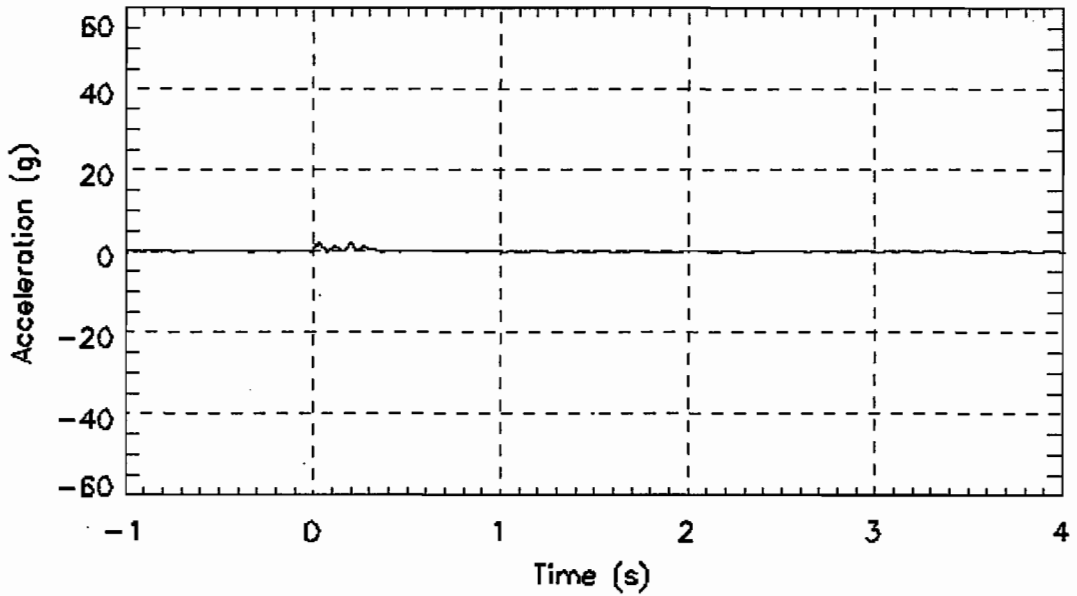

Figure F- 26. Bullet car, underframe level, left side, position 2, longitudinal acceleraion, digitally filered ar Fc=25Hz, L2X_25Hz.txt

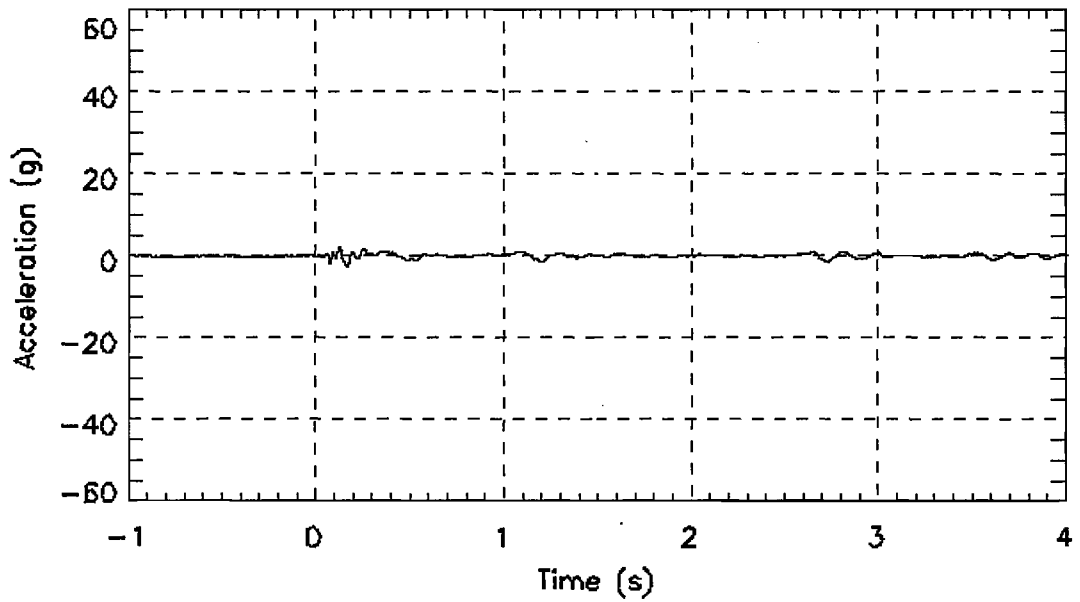

Figure F- 27. Bullet car, underframe level, left side, position 2, vertical acceleraion, digitally filered ar Fc=25Hz, L2Z_25Hz.txt

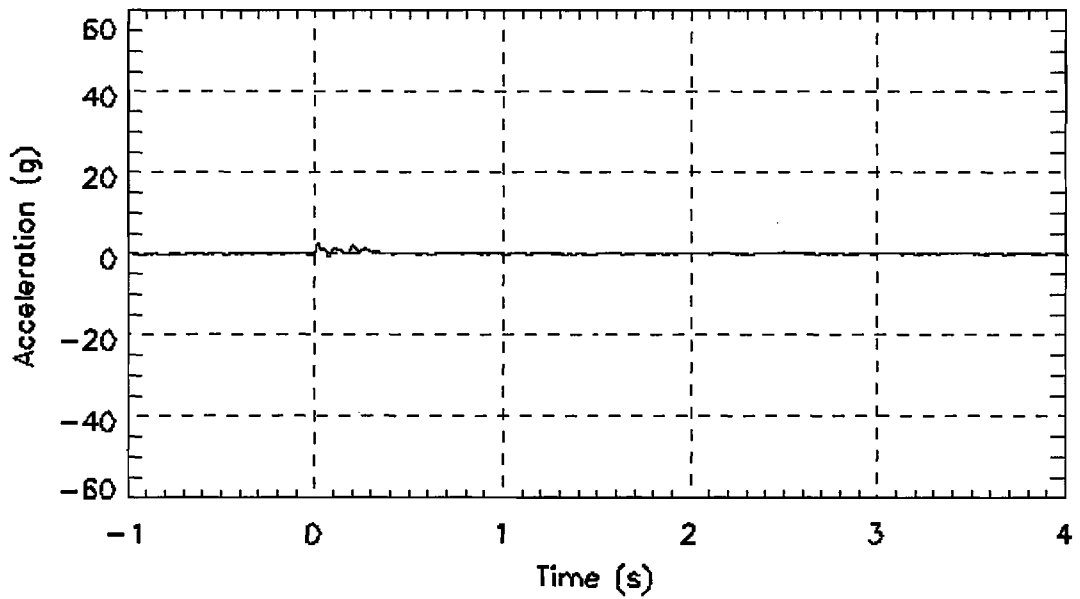

Figure F- 28. Bullet car, underframe level, left side, position 3, longitudinal acceleraion, digitally filered ar Fc=25Hz, L3X_25Hz.txt

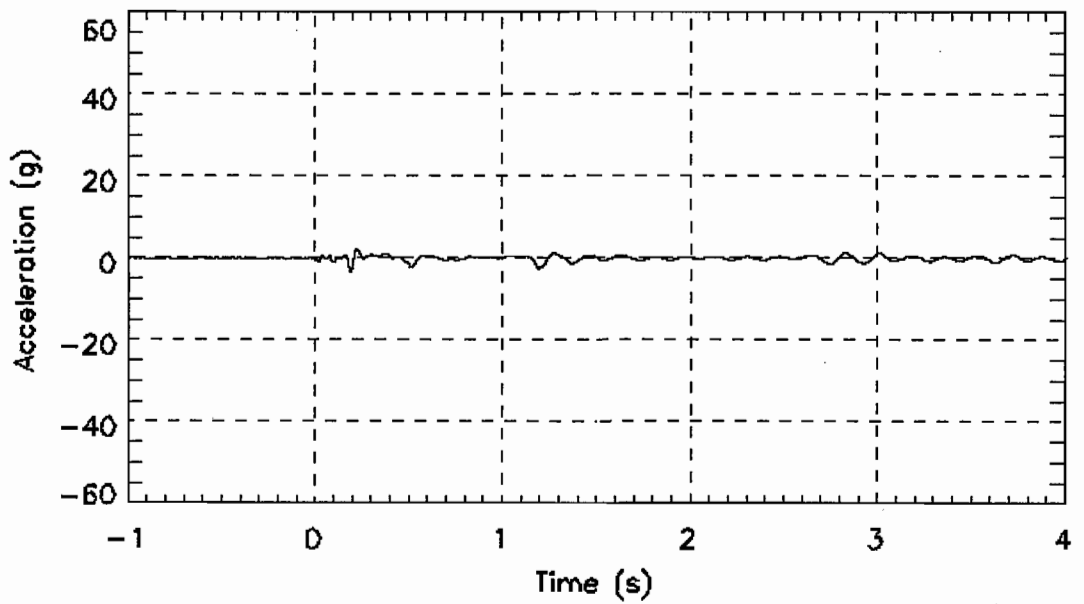

Figure F- 29. Bullet car, underframe level, left side, position 3, vertical acceleraion, digitally filered ar Fc=25Hz, L3Z_25Hz.txt

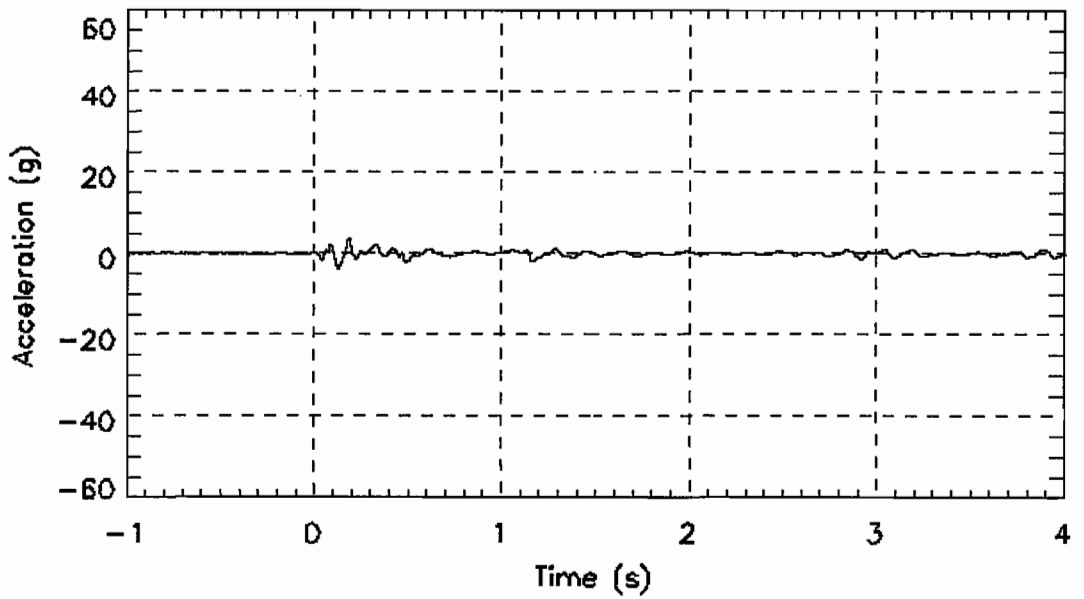

Figure F- 30. Bullet car, underframe level, left side, position 4, vertical acceleraion, digitally filered ar Fc=25Hz, L4Z_25Hz.txt

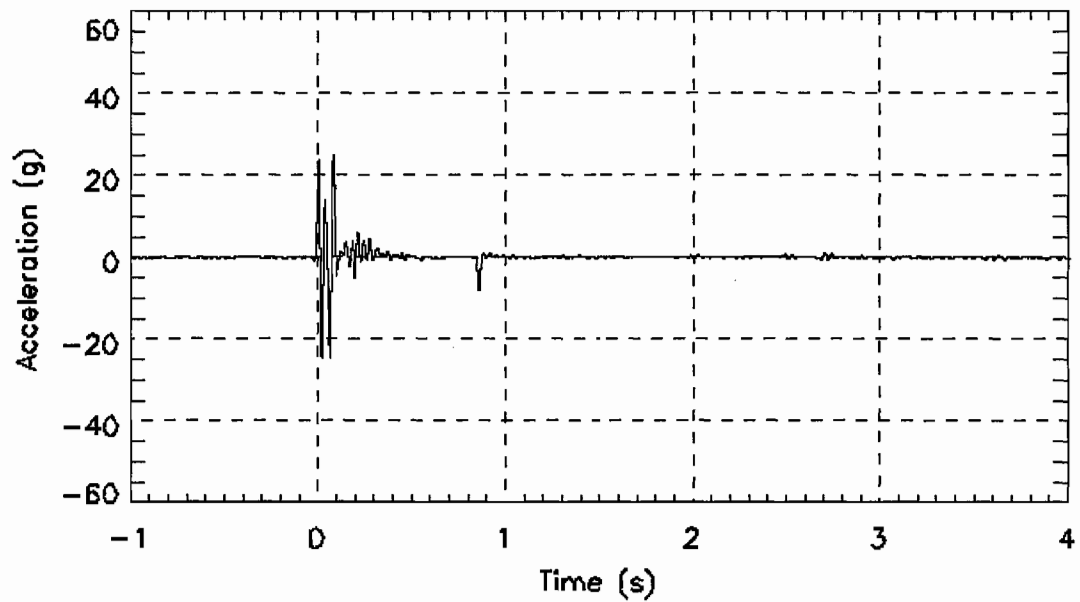

Figure F- 31. Bullet car, underframe level, right side, position 1, longitudinal acceleraion, digitally filered ar Fc=25Hz, R1X_25Hz.txt

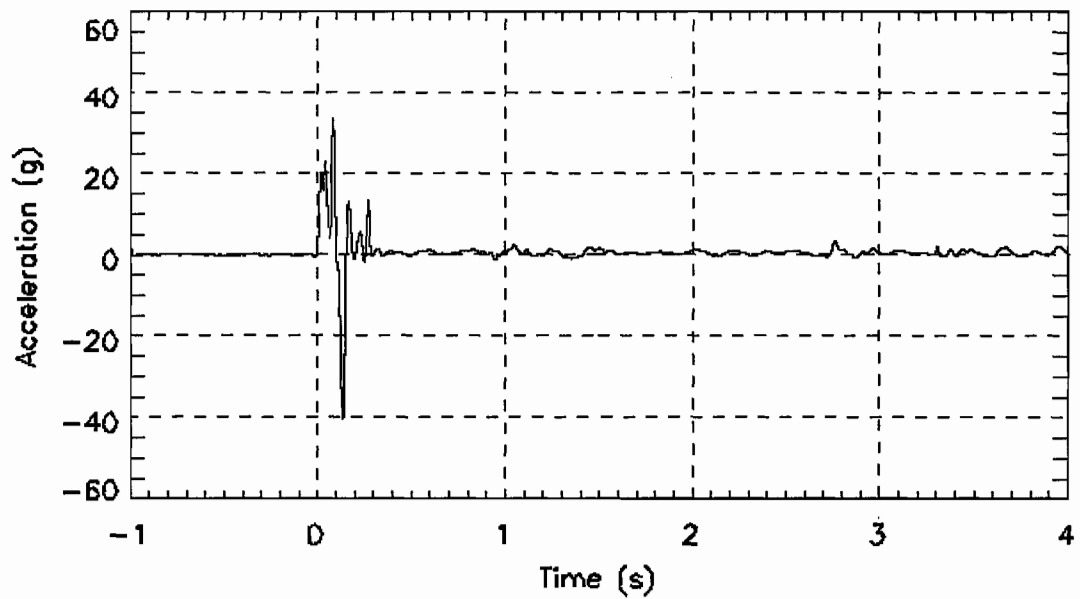

Figure F- 32. Bullet car, underframe level, right side, position 1, lateral acceleraion, digitally filered ar Fc=25Hz, R1Y_25Hz.txt

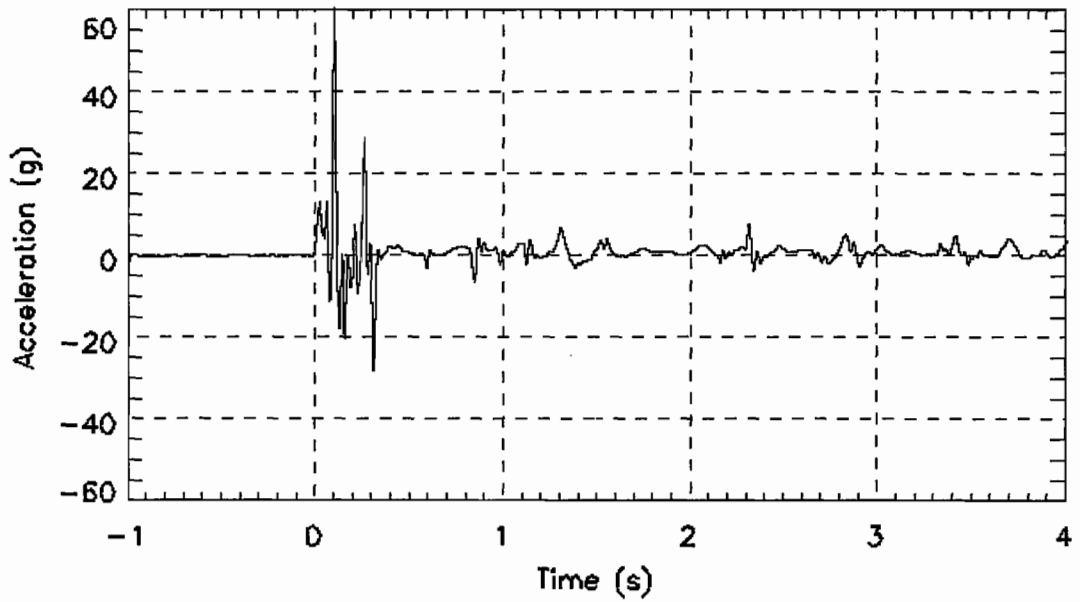

Figure F- 33. Bullet car, underframe level, right side, position 1, vertical acceleraion, digitally filered ar Fc=25Hz, R1Z_25Hz.txt

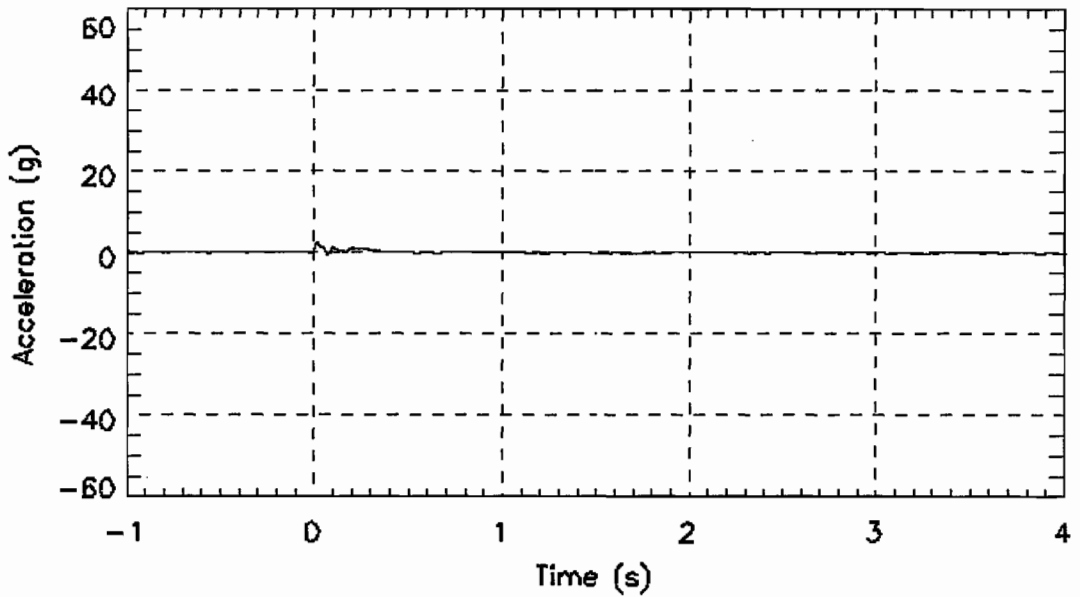

Figure F- 34. Bullet car, underframe level, right side, position 2, longitudinal acceleraion, digitally filered ar Fc=25Hz, R2X_25Hz.txt

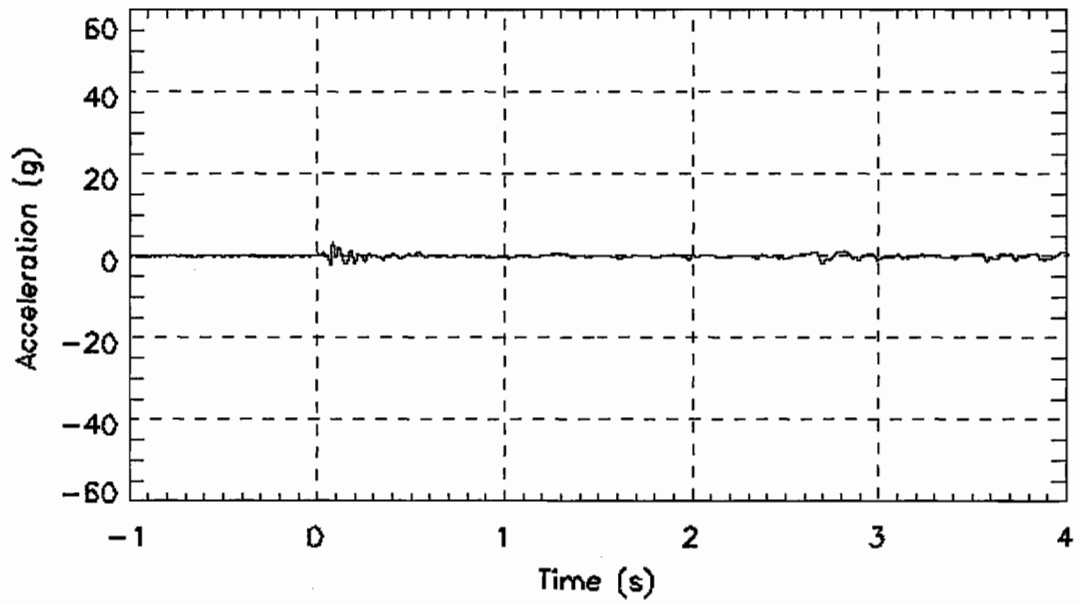

Figure F- 35. Bullet car, underframe level, right side, position 2, vertical acceleraion, digitally filered ar Fc=25Hz, R2Z_25Hz.txt

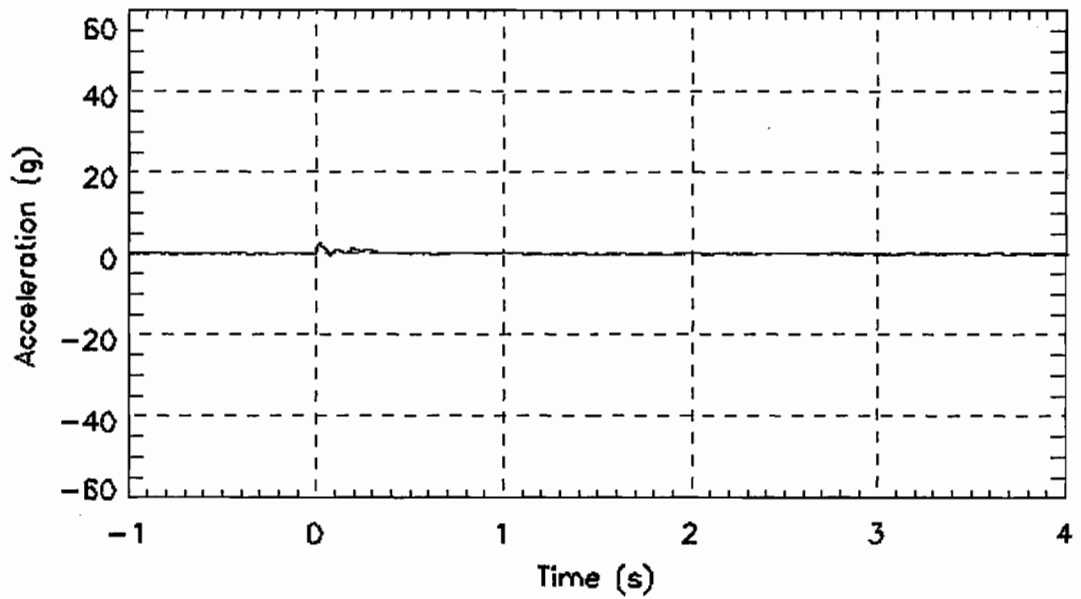

Figure F- 36. Bullet car, underframe level, right side, position 3, longitudinal acceleraion, digitally filered ar Fc=25Hz, R3X_25Hz.txt

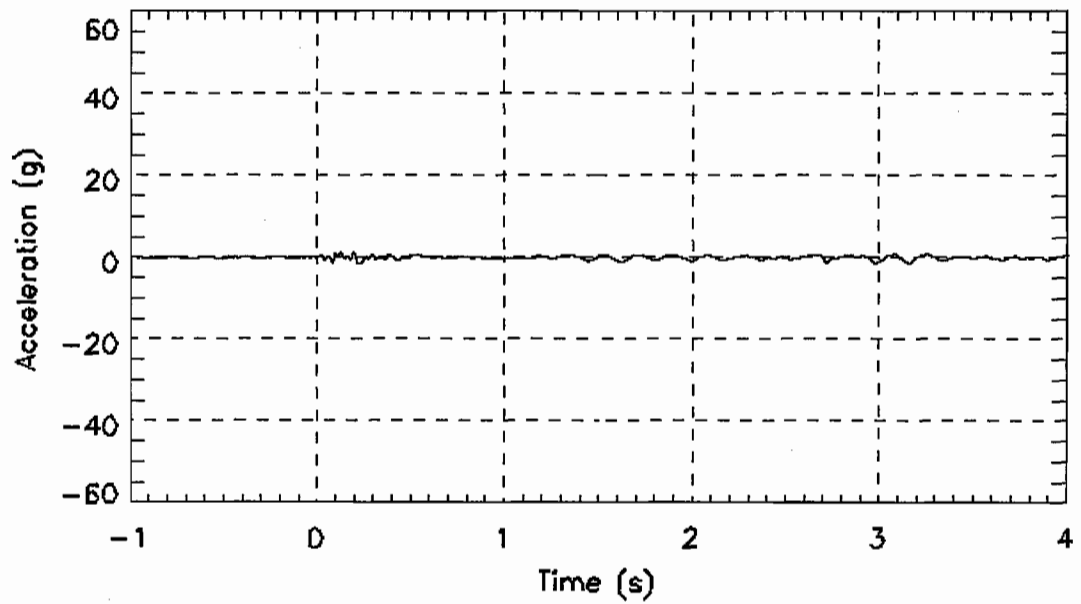

Figure F- 37. Bullet car, underframe level, right side, position 3, vertical acceleraion, digitally filered ar Fc=25Hz, R3Z_25Hz.txt

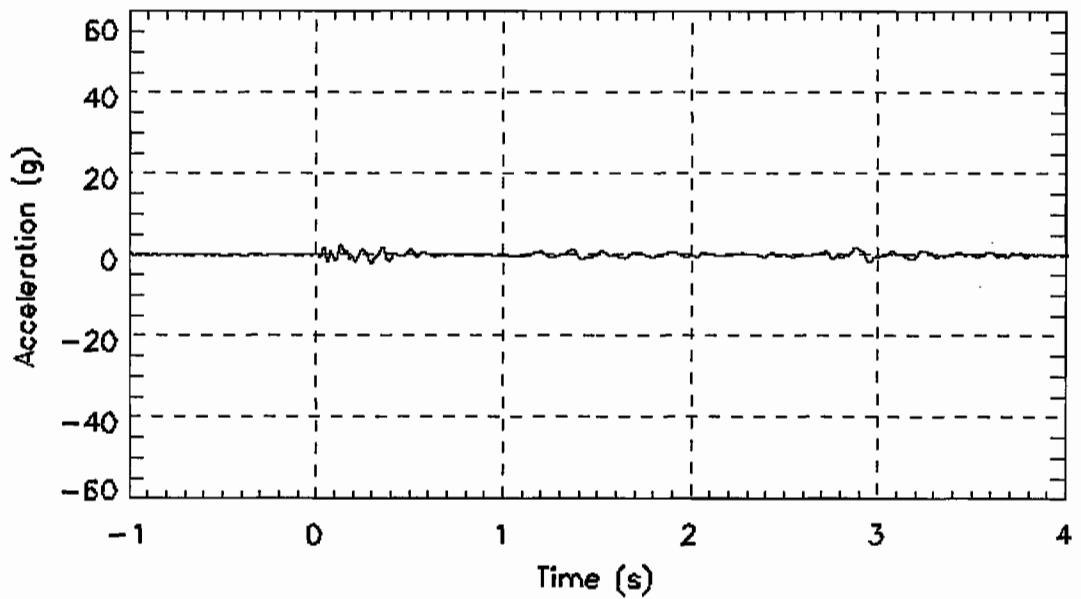

Figure F- 38. Bullet car, underframe level, right side, position 4, vertical acceleraion, digitally filered ar Fc=25Hz, R4Z_25Hz.txt

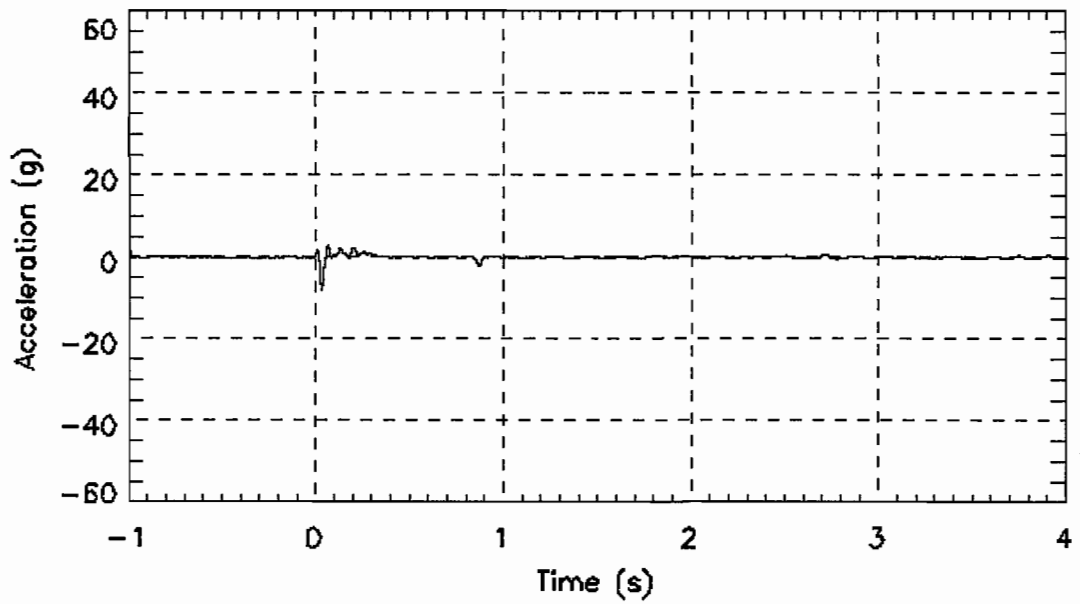

Figure F- 39. Bullet car, cant rail level, left side, position 1, longitudinal acceleraion, digitally filered ar Fc=25Hz, TL1X_25Hz.txt

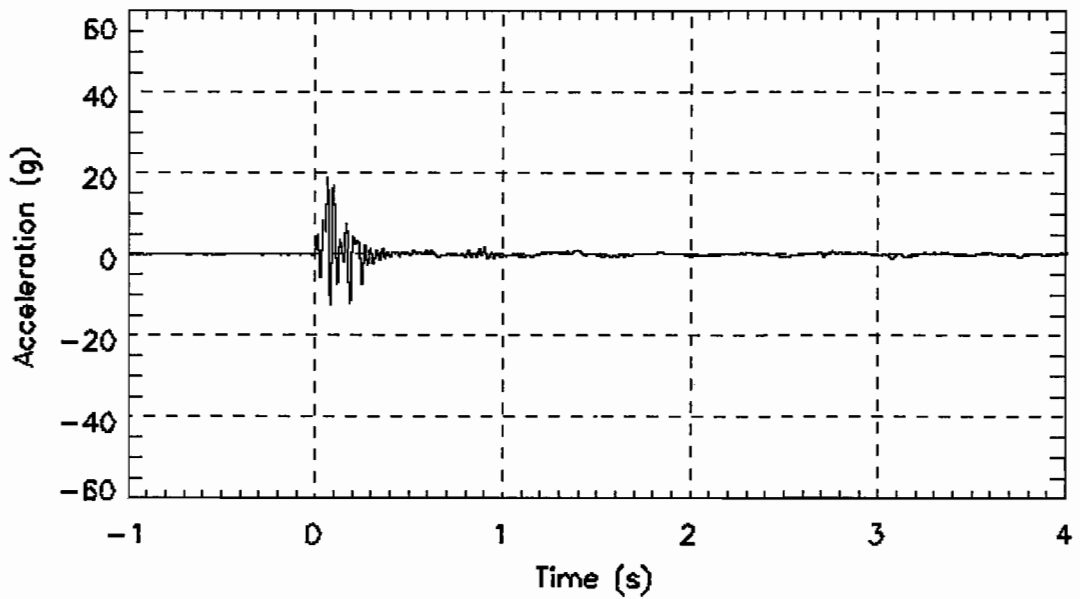

Figure F- 40. Bullet car, cant rail level, left side, position 1, lateral acceleraion, digitally filered ar Fc=25Hz, TL1Y_25Hz.txt

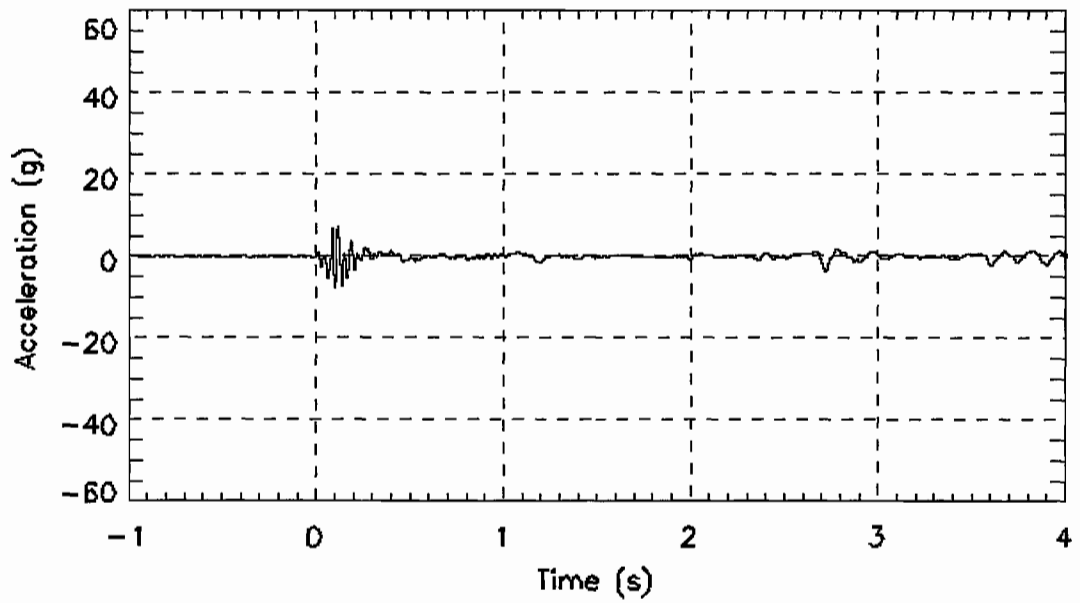

Figure F- 41. Bullet car, cant rail level, left side, position 1, vertical acceleraion, digitally filered ar Fc=25Hz, TL1Z_25Hz.txt

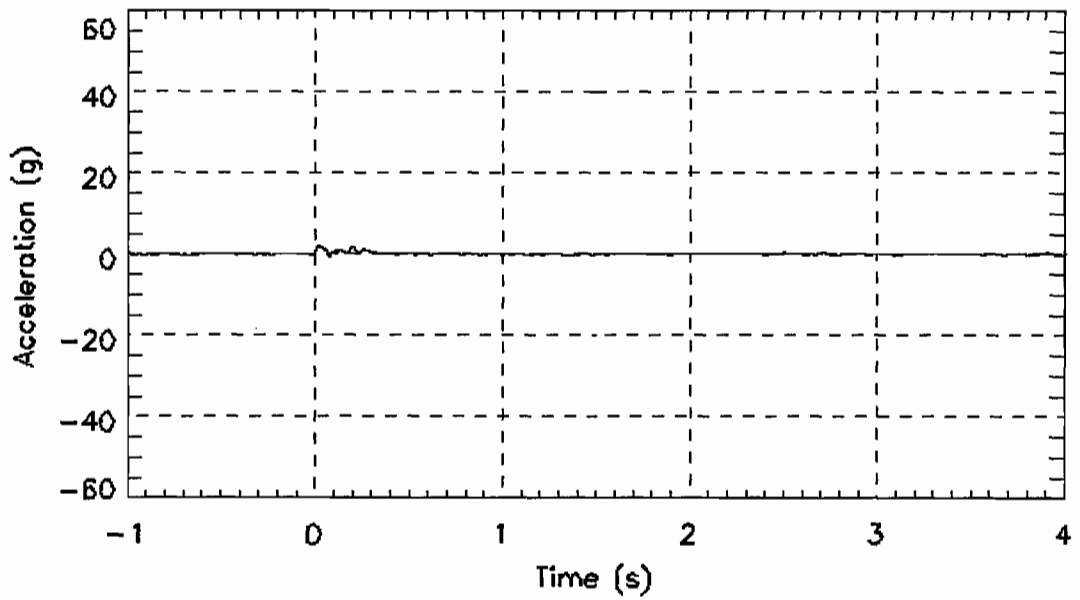

Figure F- 42. Bullet car, cant rail level, left side, position 2, longitudinal acceleraion, digitally filered ar Fc=25Hz, TL2X_25Hz.txt

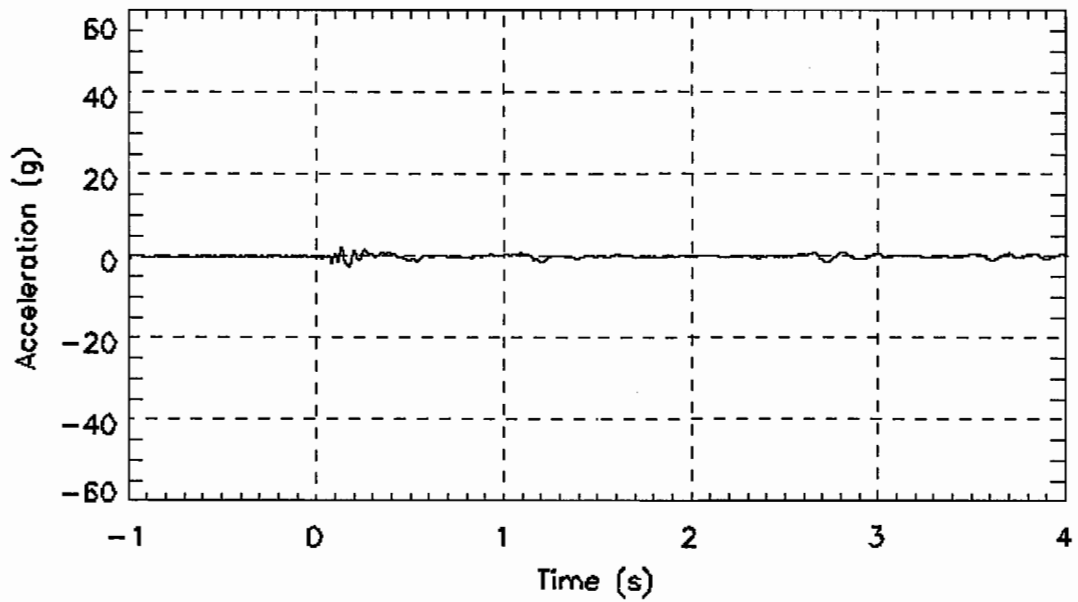

Figure F- 43. Bullet car, cant rail level, left side, position 2, vertical acceleraion, digitally filtered ar Fc=25Hz, TL2Z_25Hz.txt

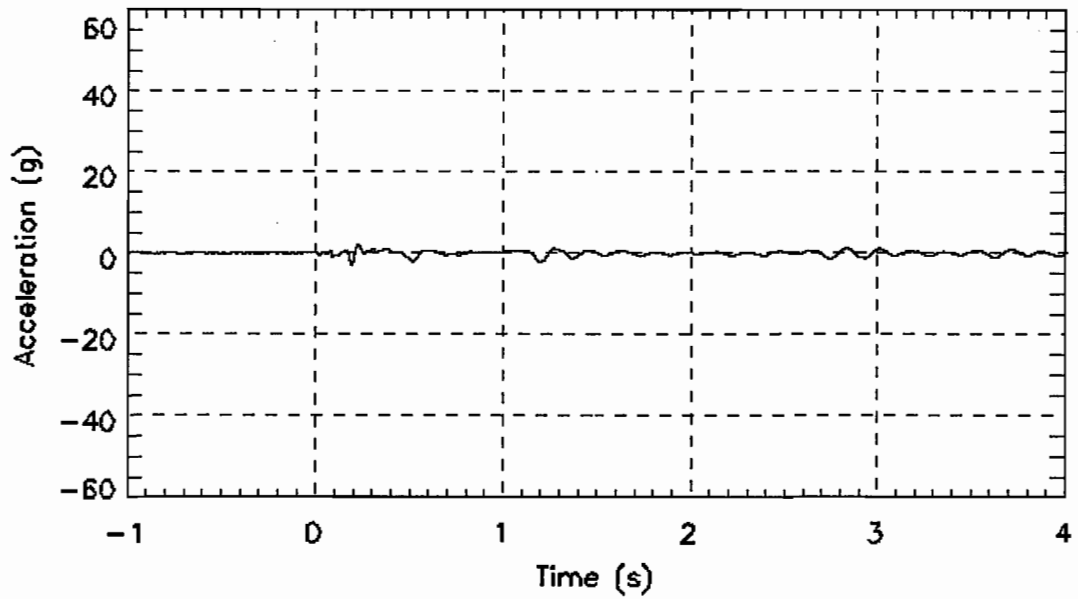

Figure F- 44. Bullet car, cant rail level, left side, position 3, vertical acceleraion, digitally filtered ar Fc=25Hz, TL3Z_25Hz.txt

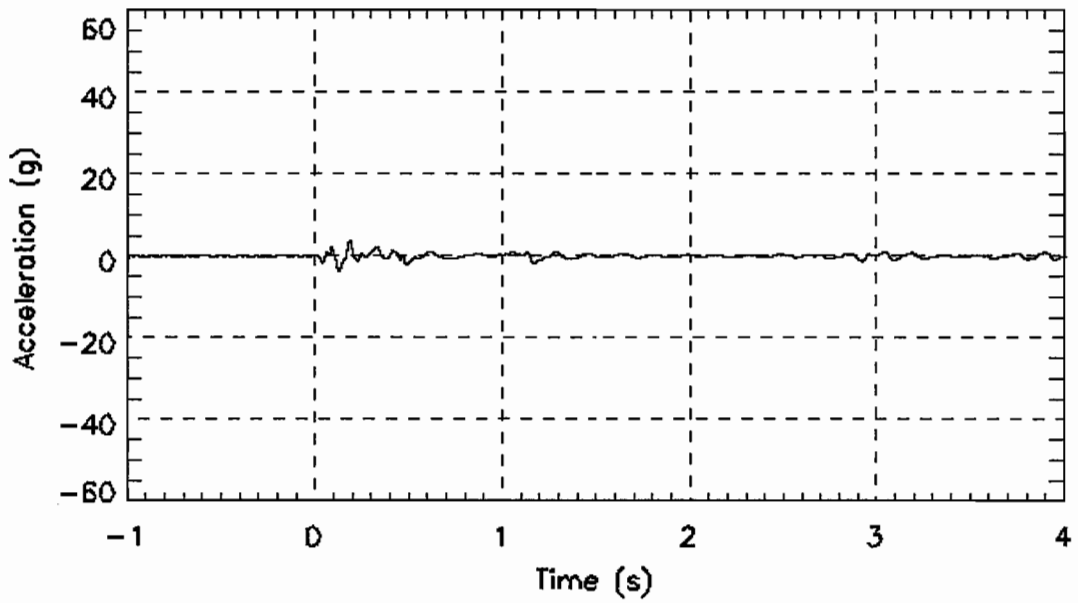

Figure F- 45. Bullet car, cant rail level, left side, position 4, vertical acceleraion, digitally filered ar Fc=25Hz, TL4Z_25Hz.txt

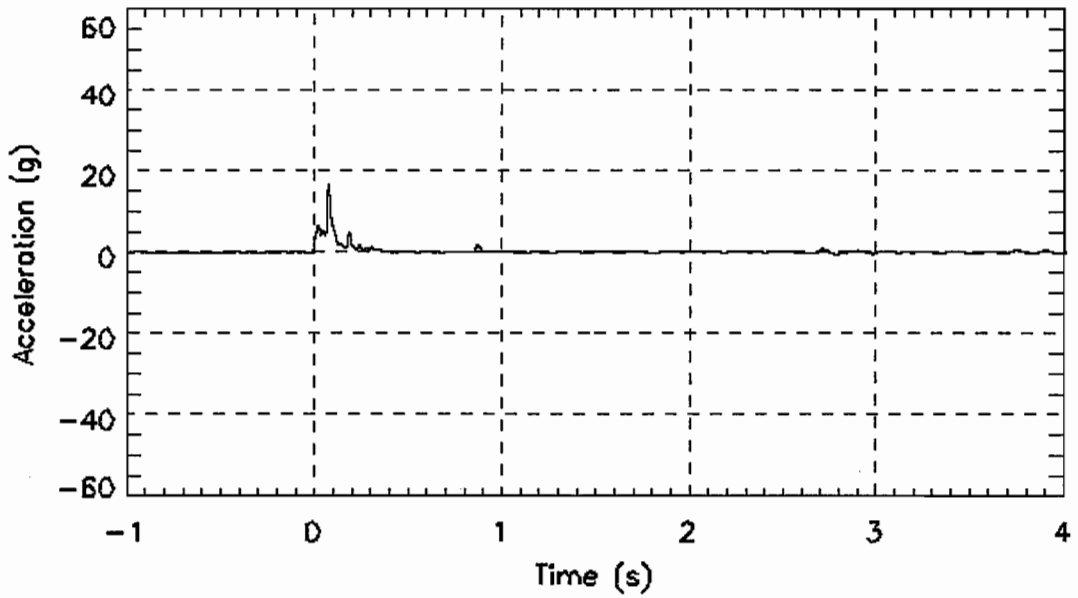

Figure F- 46. Bullet car, cant rail level, right side, position 1, longitudinal acceleraion, digitally filered ar Fc=25Hz, TR1X_25Hz.txt

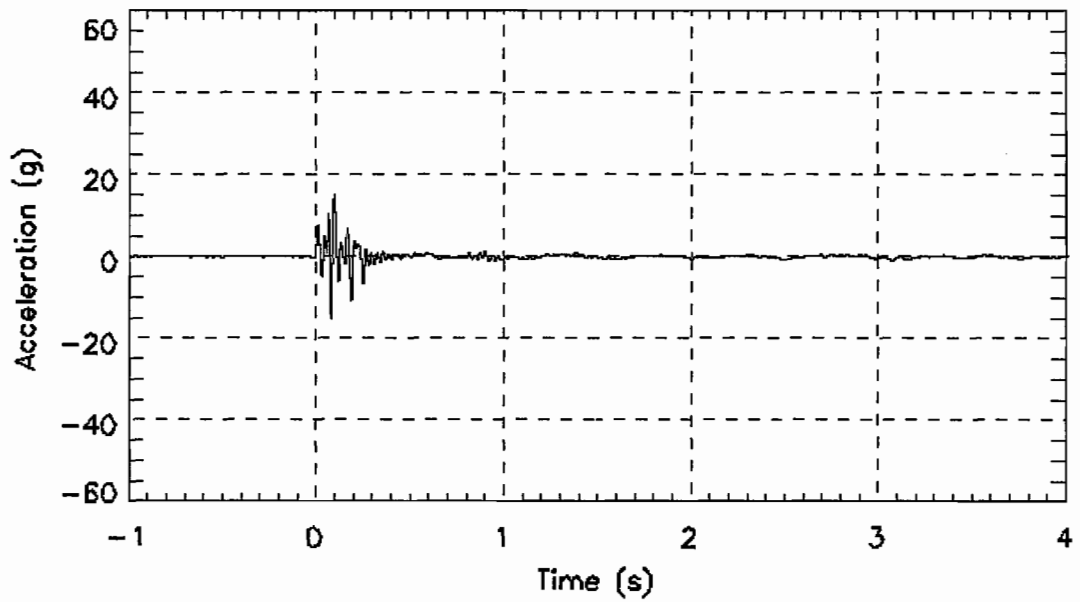

Figure F- 47. Bullet car, cant rail level, right side, position 1, lateral acceleraion, digitally filtered ar Fc=25Hz, TR1Y_25Hz.txt

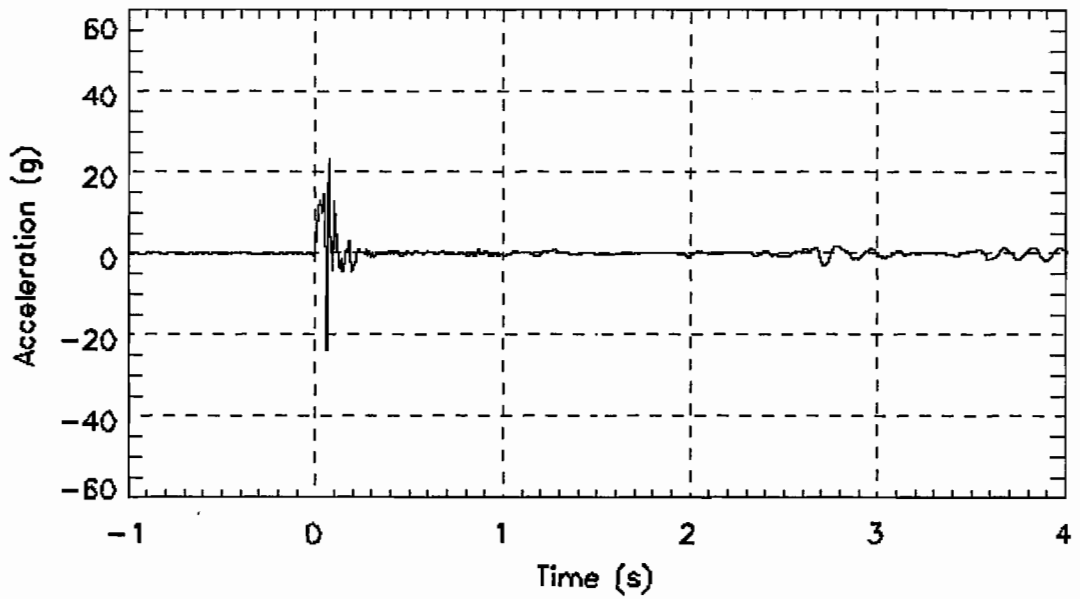

Figure F- 48. Bullet car, cant rail level, right side, position 1, vertical acceleraion, digitally filtered ar Fc=25Hz, TR1Z_25Hz.txt

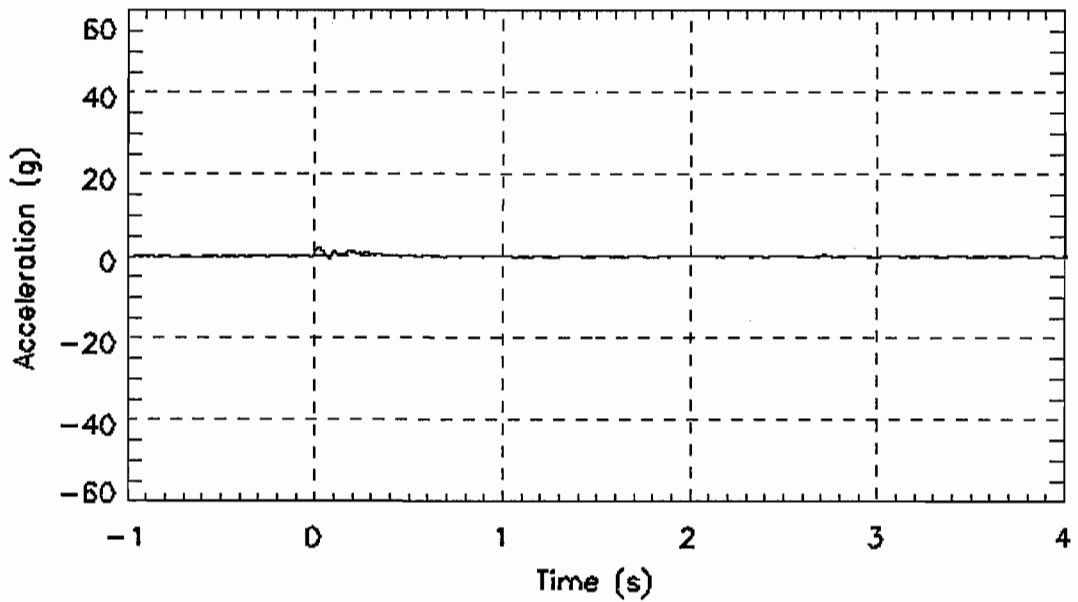

Figure F- 49. Bullet car, cant rail level, right side, position 2, longitudinal acceleraion, digitally filered ar Fc=25Hz, TR2X_25Hz.txt

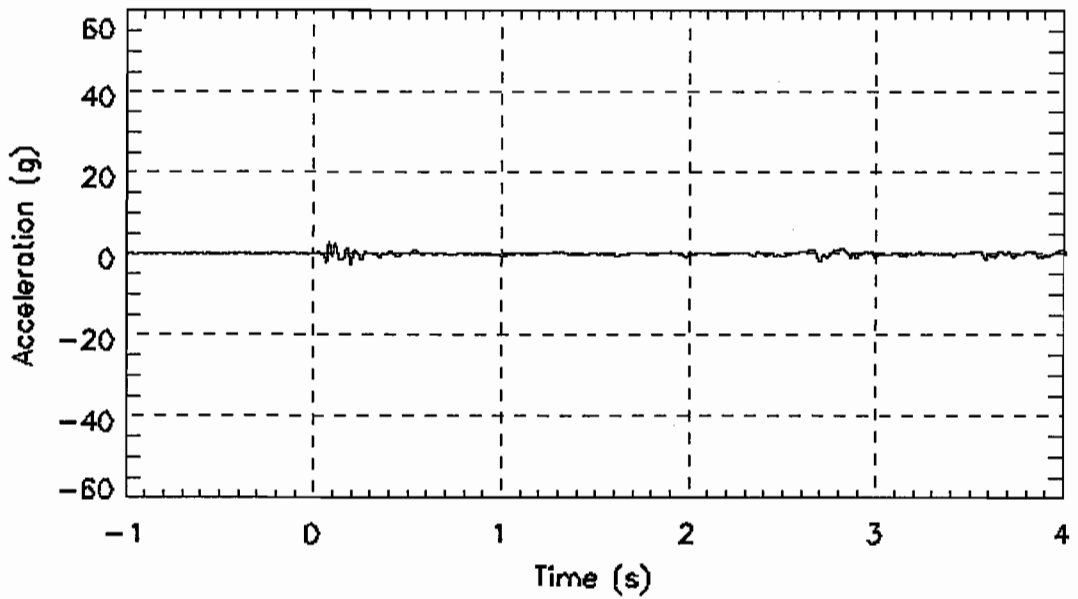

Figure F- 50. Bullet car, cant rail level, right side, position 2, vertical acceleraion, digitally filered ar Fc=25Hz, TR2Z_25Hz.txt

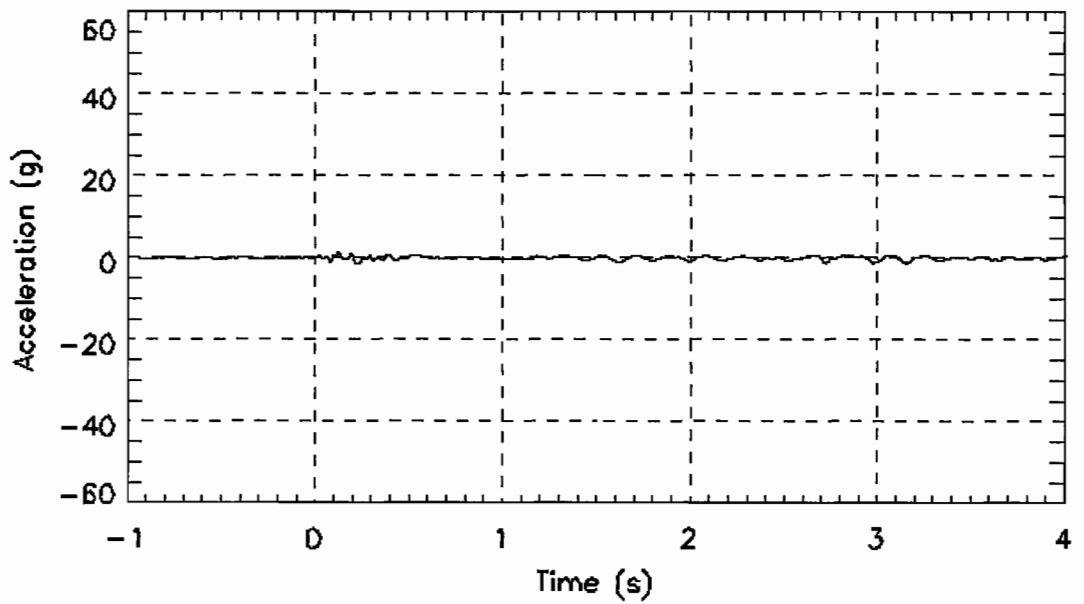

Figure F- 51. Bullet car, cant rail level, right side, position 3, vertical acceleraion, digitally filtered ar Fc=25Hz, TR3Z_25Hz.txt

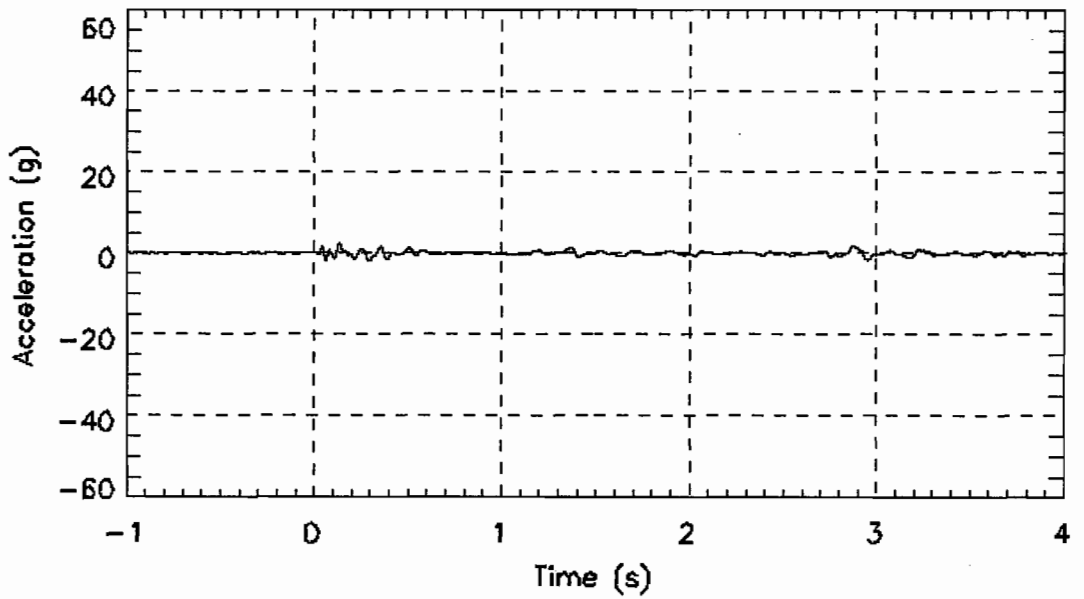

Figure F- 52. Bullet car, cant rail level, right side, position 4, vertical acceleraion, digitally filtered ar Fc=25Hz, TR4Z_25Hz.txt

Appendix G

Test 4 Displacement Data

This page left blank intentionally

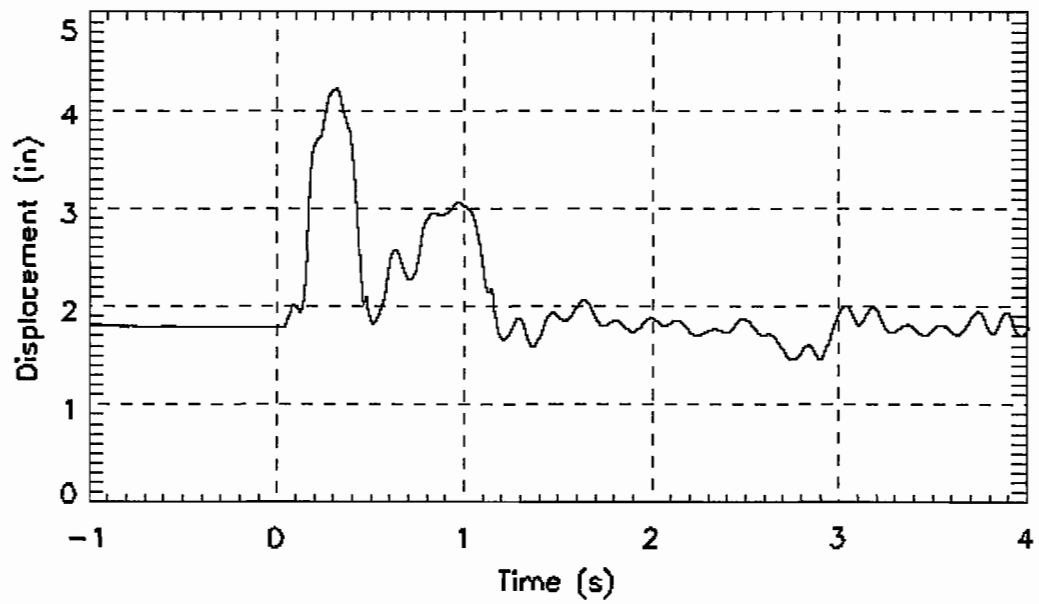

Figure G- 1. Leading end, left side suspension displacement, AL.txt

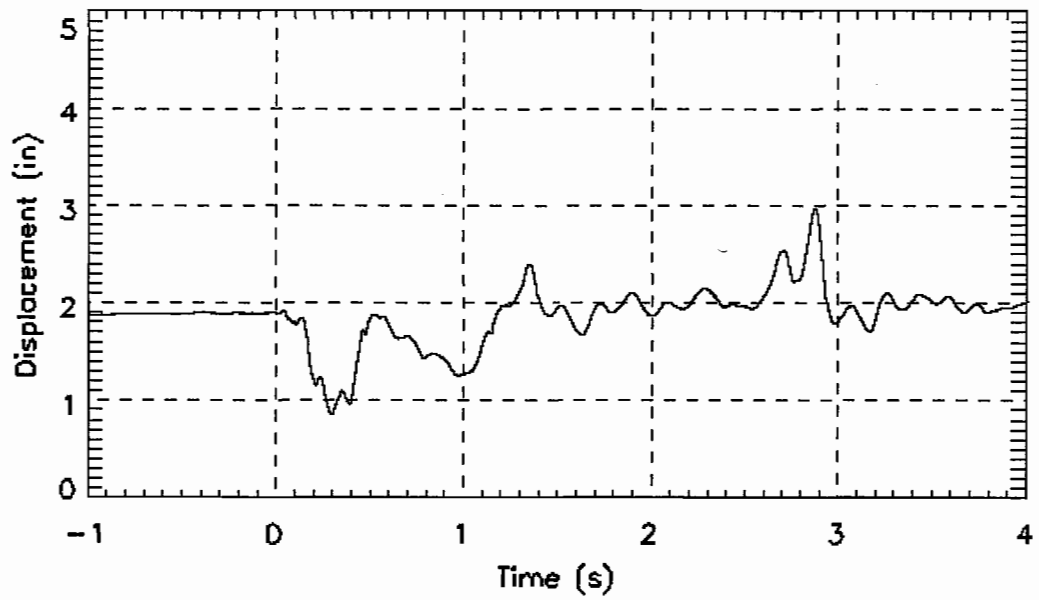

Figure G- 2. Leading end, right side suspension displacement, AR.txt

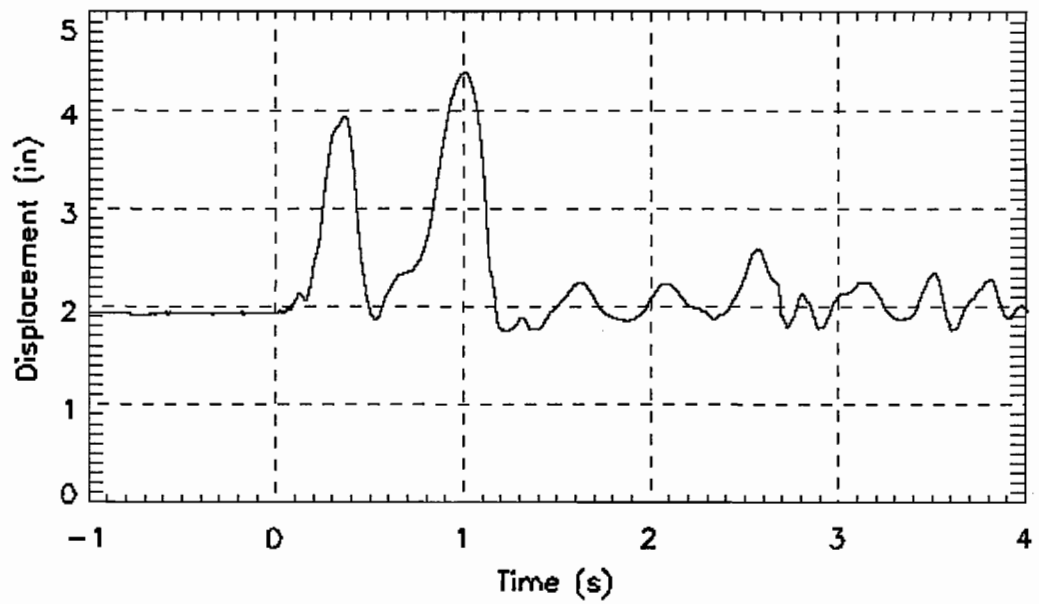

Figure G- 3. Trailing end, left side suspension displacement, BL.txt

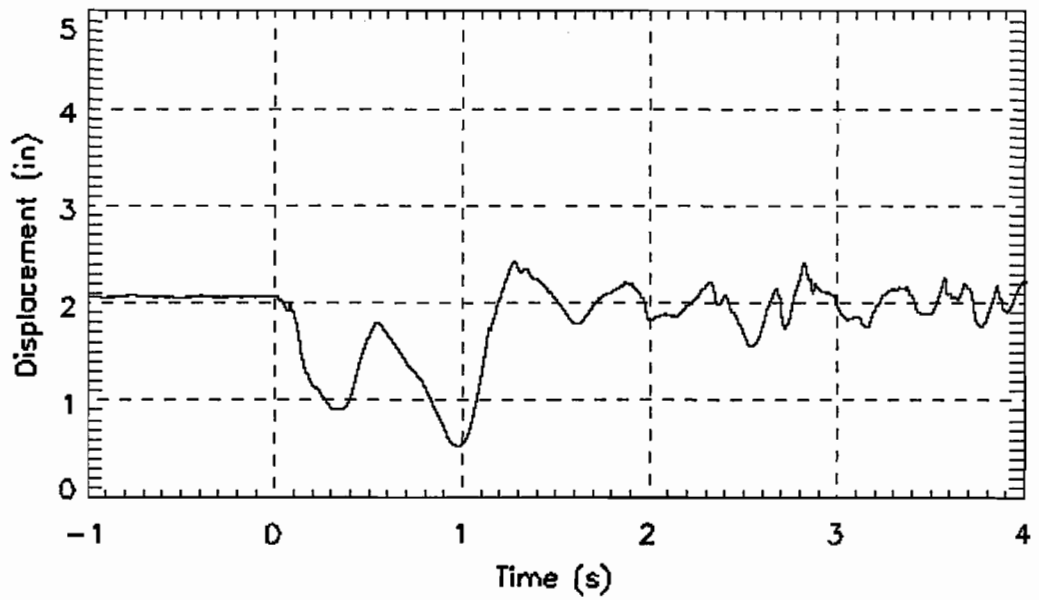

Figure G- 4. Trailing end, right side suspension displacement, BR.txt

6

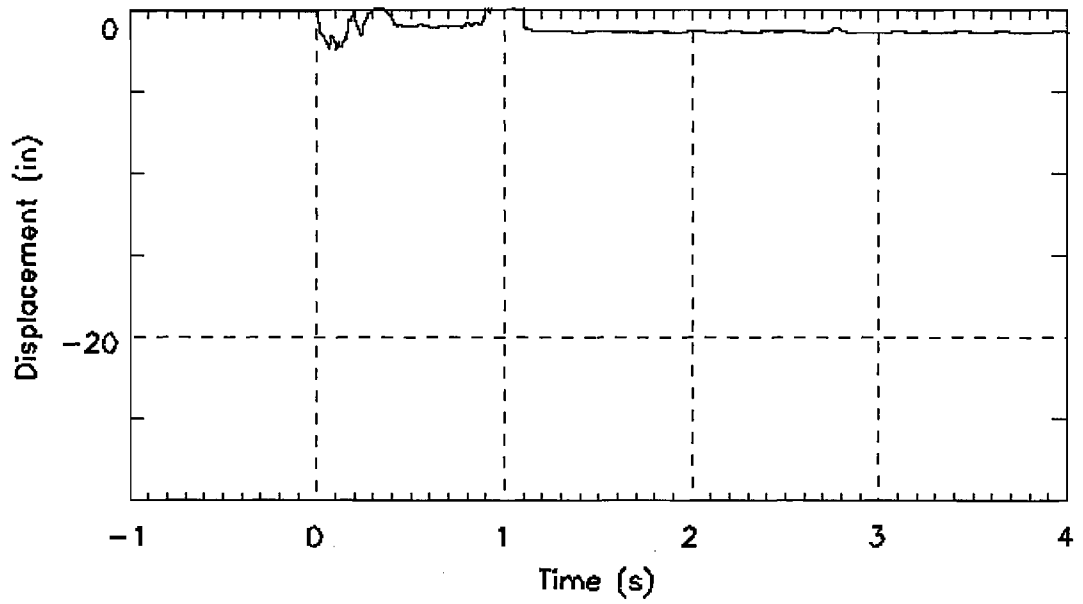

Figure G- 5. Corner post displacement, 3 3/8-in above buffer beam, CP1.txt

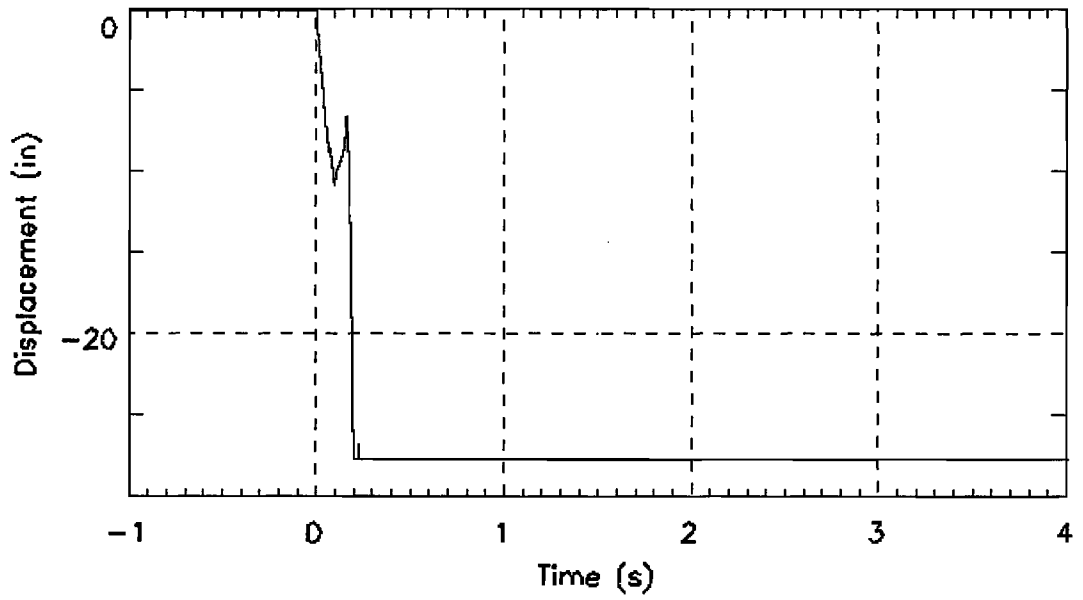

Figure G- 6. Corner post displacement, 20 5/8-in above buffer beam, CP2.txt

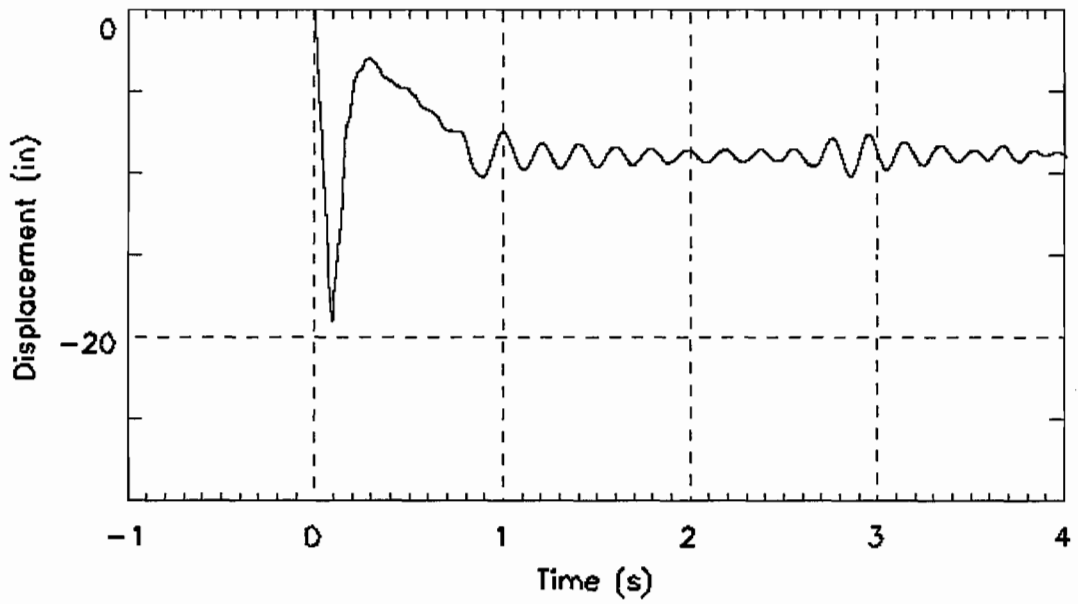

Figure G- 7. Corner post displacement, 38 1/8-in above buffer beam, CP3.txt

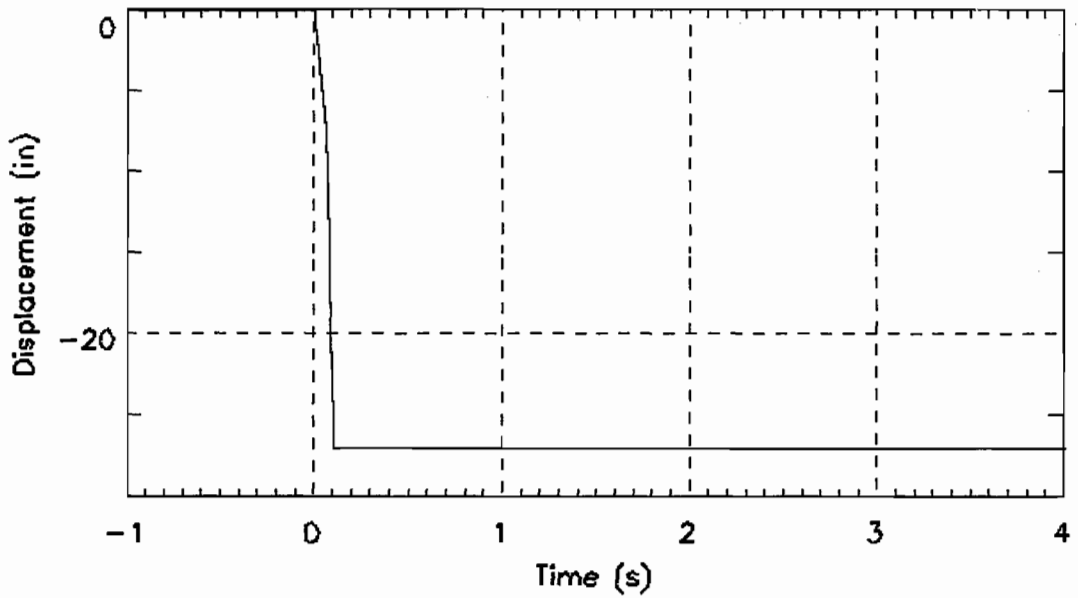

Figure G- 8. Corner post displacement, 55 7/8-in above buffer beam, CP4.txt

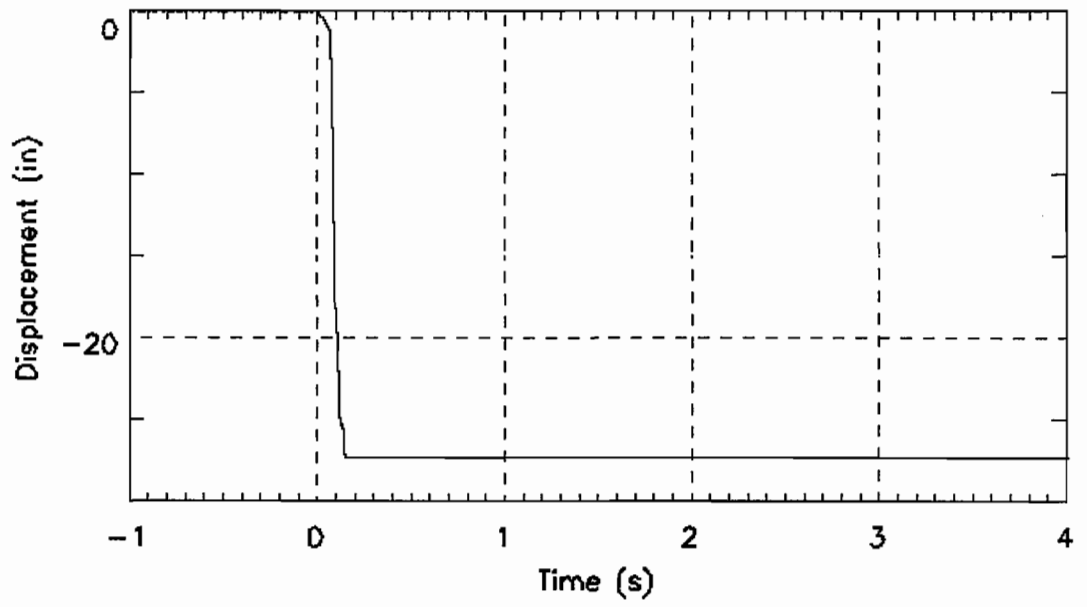

Figure G- 9. Corner post displacement, 73 5/8-in above buffer beam, CP5.txt

This page left blank intentionally

Appendix H

Test 4
Strain Data, CFC = 1000Hz

This page left blank intentionally

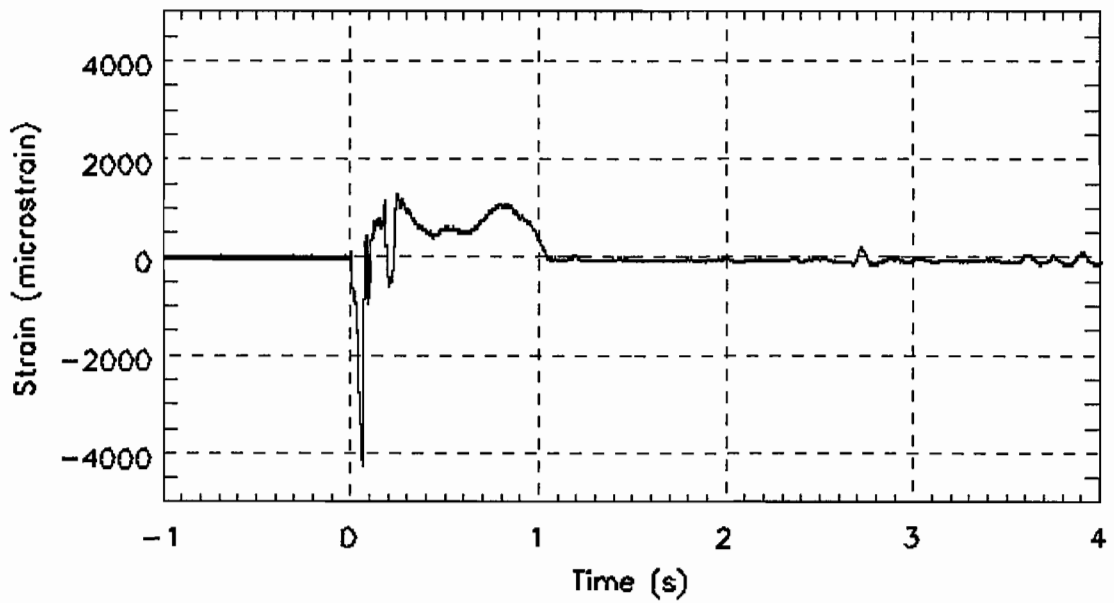

Figure H- 1. Strain measurement on the front of the AT plate, 1" from the bottom edge, 34 1/2" in from the outside edge, ATPLFB.txt

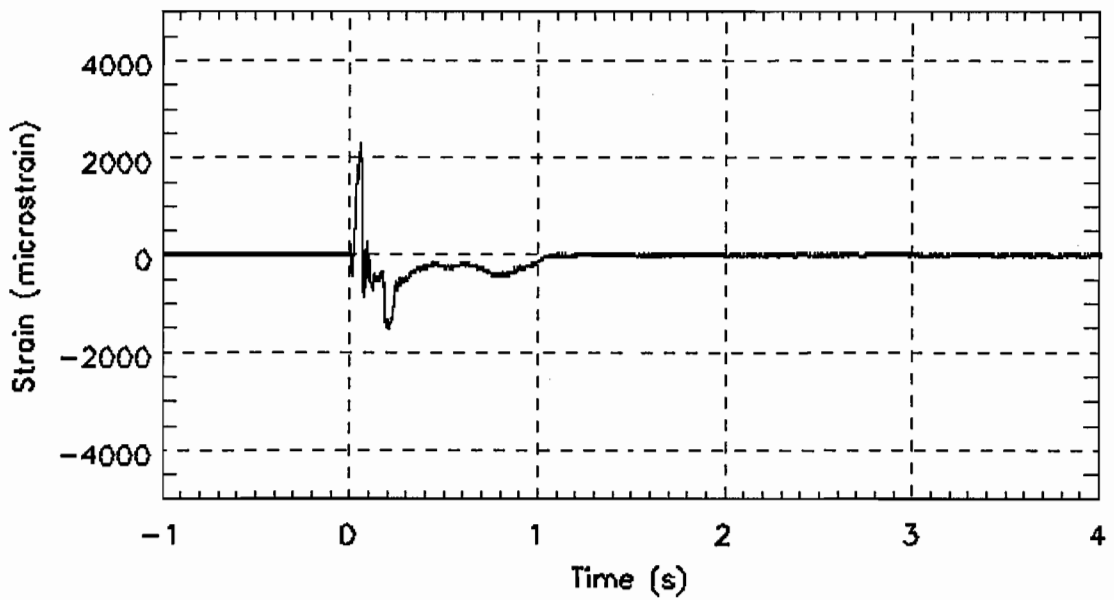

Figure H- 2. Strain measurement on the front of the AT plate, 13/16" from the top edge, 34 1/2" in from the outside edge, ATPLFT.txt

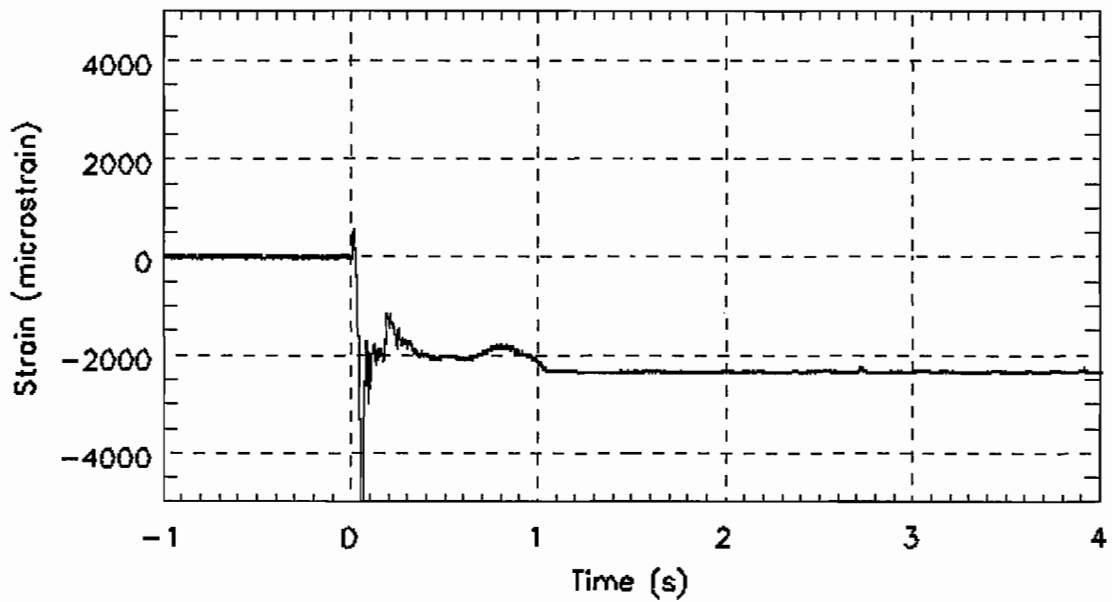

Figure H- 3. Strain measurement on the rear of the AT plate, 1" from the bottom edge, 34 1/2" in from the outside edge, ATPLRB.txt

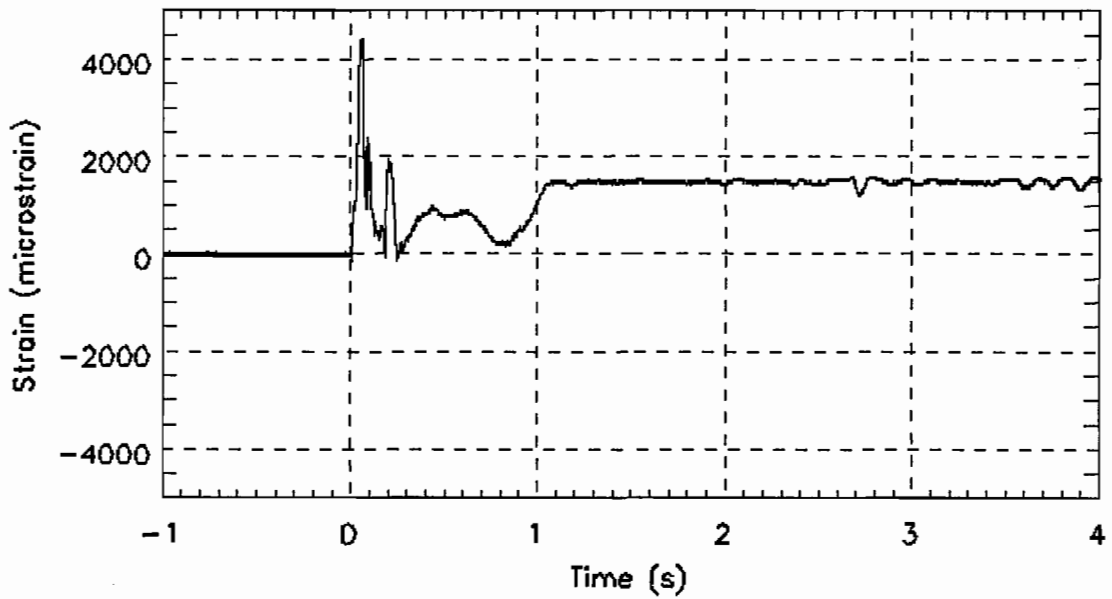

Figure H- 4. Strain measurement on the rear of the AT plate, 13/16" from the top edge, 34 1/2" in from the outside edge, ATPLRT.txt

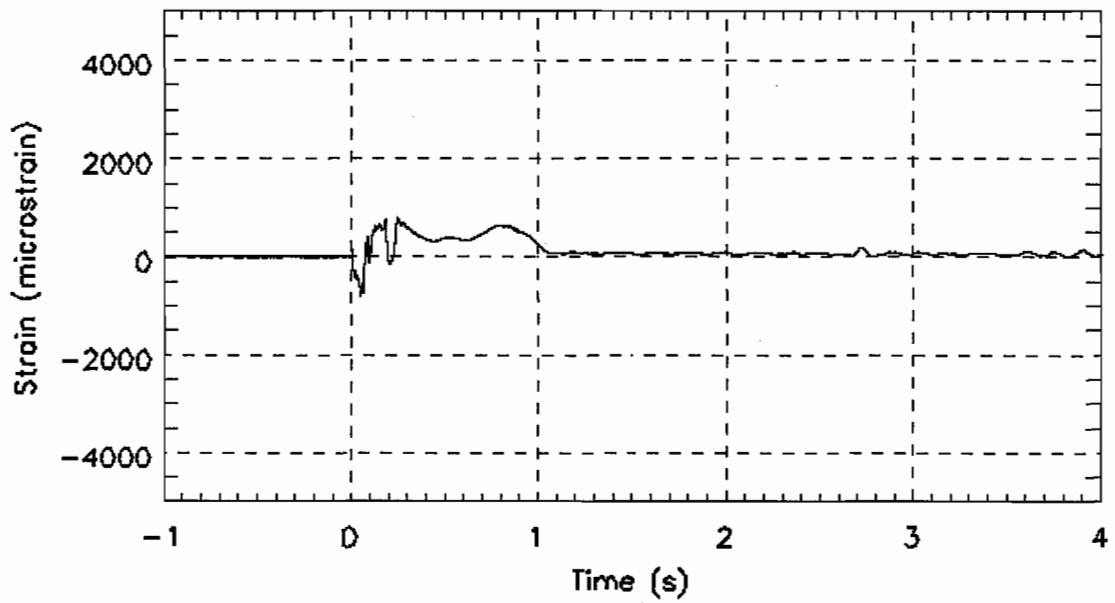

Figure H- 5. Strain measurement on the front of the AT plate, 1" from the bottom edge, 21 7/16" in from the outside edge, ATPMFB.txt

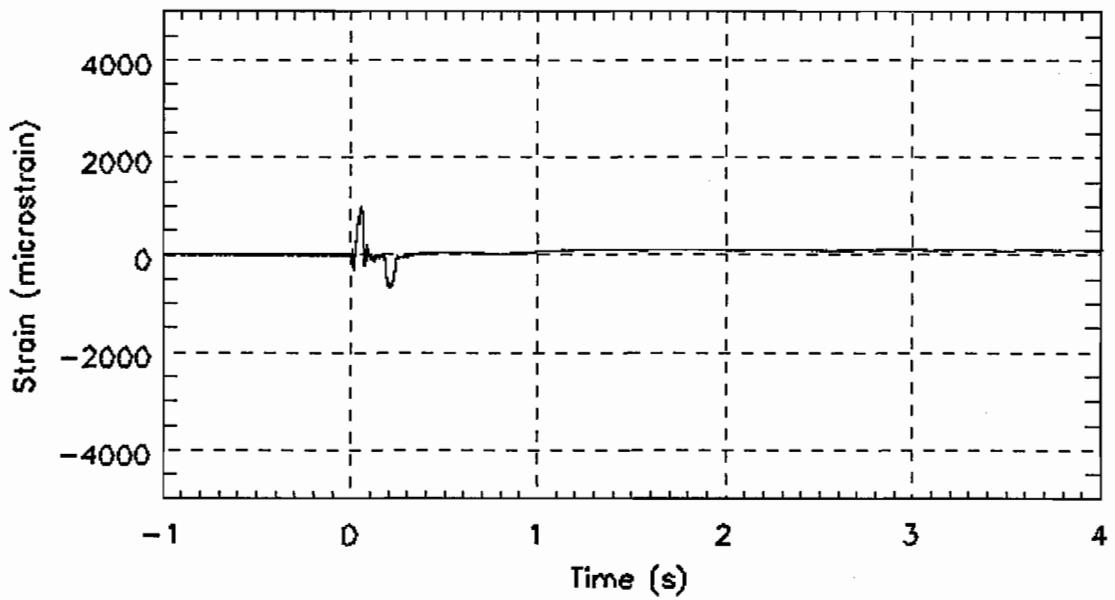

Figure H- 6. Strain measurement on the front of the AT plate, 13/16" from the top edge, 21 7/16" in from the outside edge, ATPMFT.txt

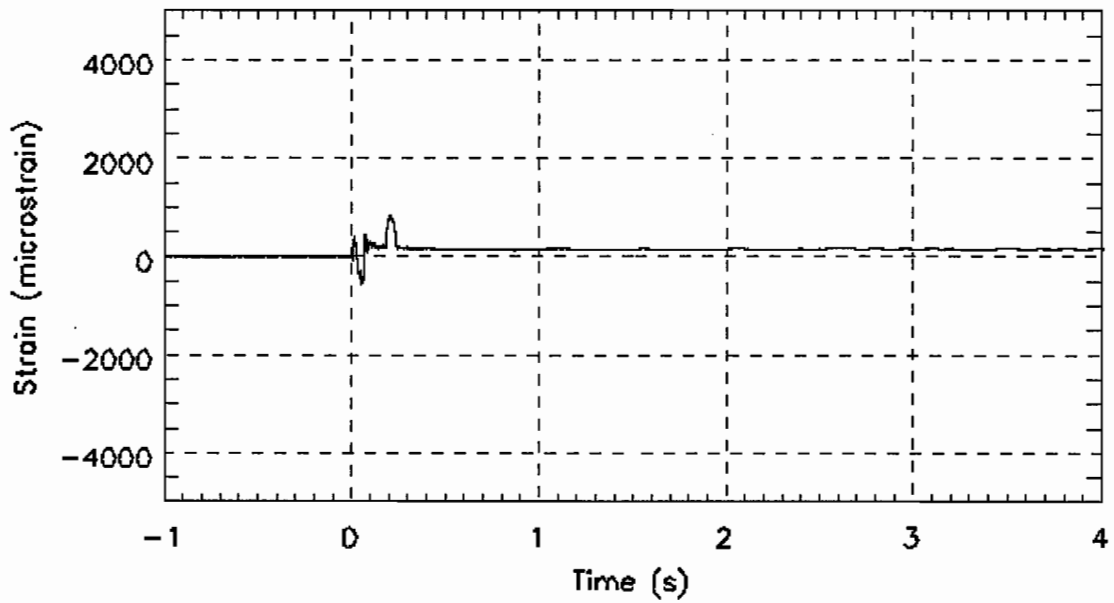

Figure H- 7. Strain measurement on the rear of the AT plate, 1" from the bottom edge, 21 7/16" in from the outside edge, ATPMRB.txt

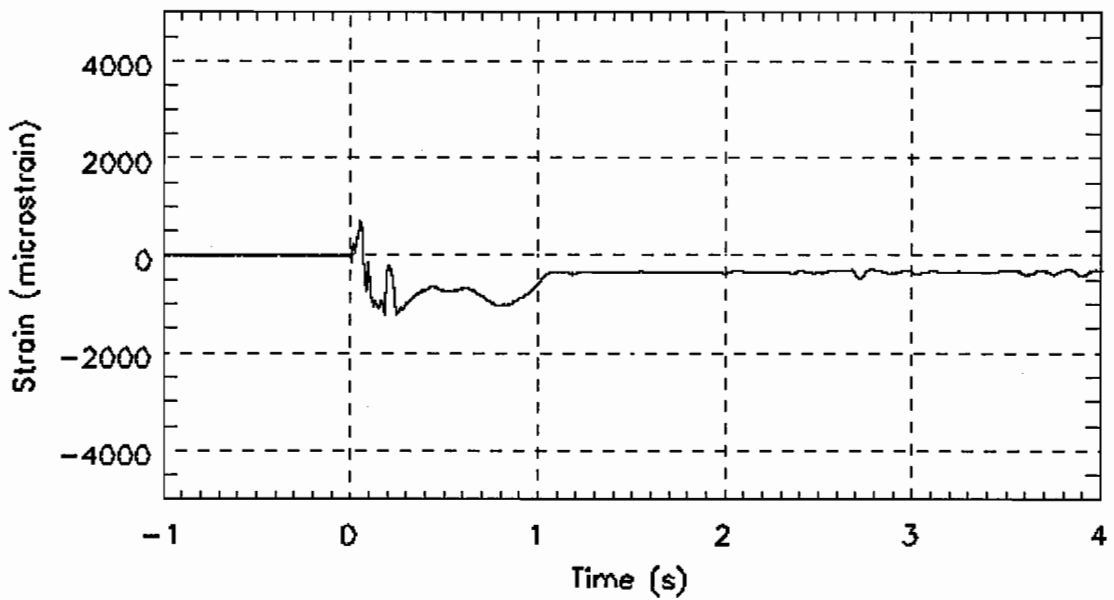

Figure H- 8. Strain measurement on the rear of the AT plate, 13/16" from the top edge, 21 7/16" in from the outside edge, ATPMRT.txt

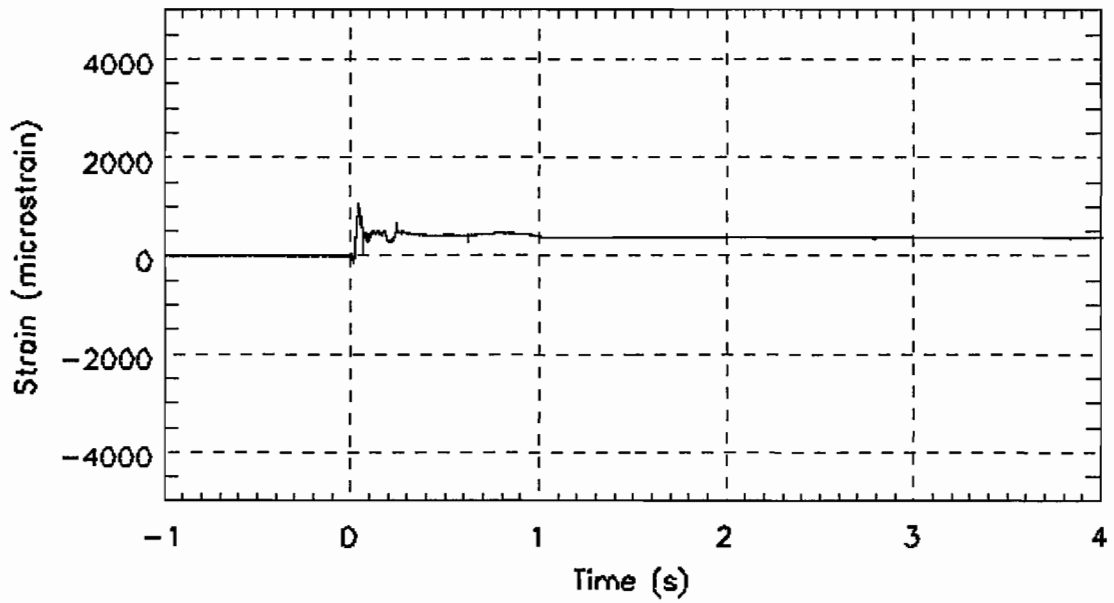

Figure H- 9. Strain measurement on the front of the AT plate, 1" from the bottom edge, 9 1/4" in from the outside edge, ATPRFB.txt

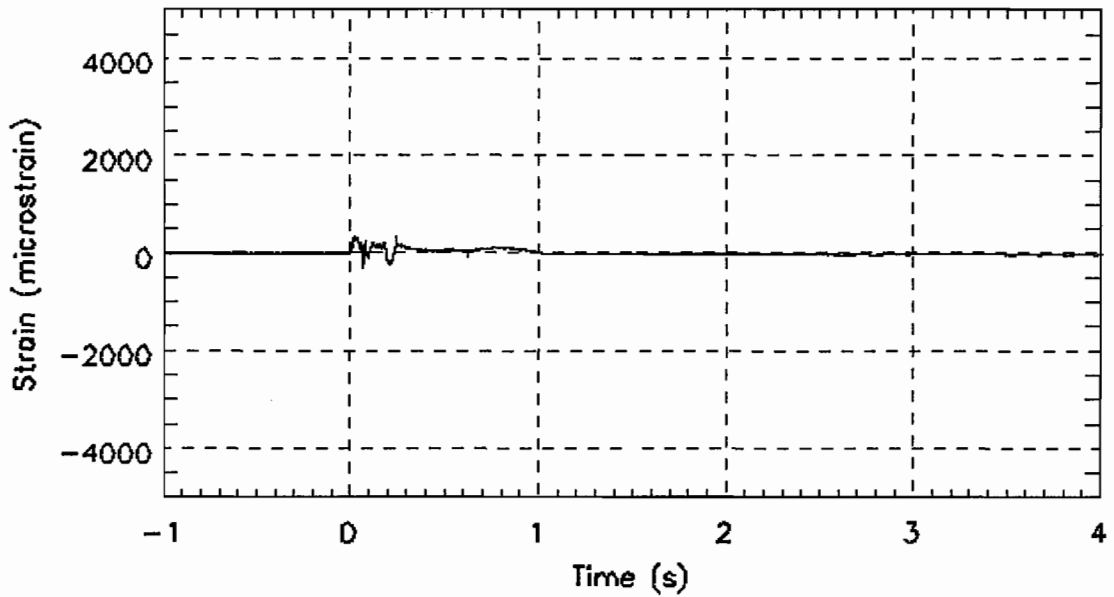

Figure H- 10. Strain measurement on the front of the AT plate, 13/16" from the top edge, 9 1/4" in from the outside edge, ATPRFT.txt

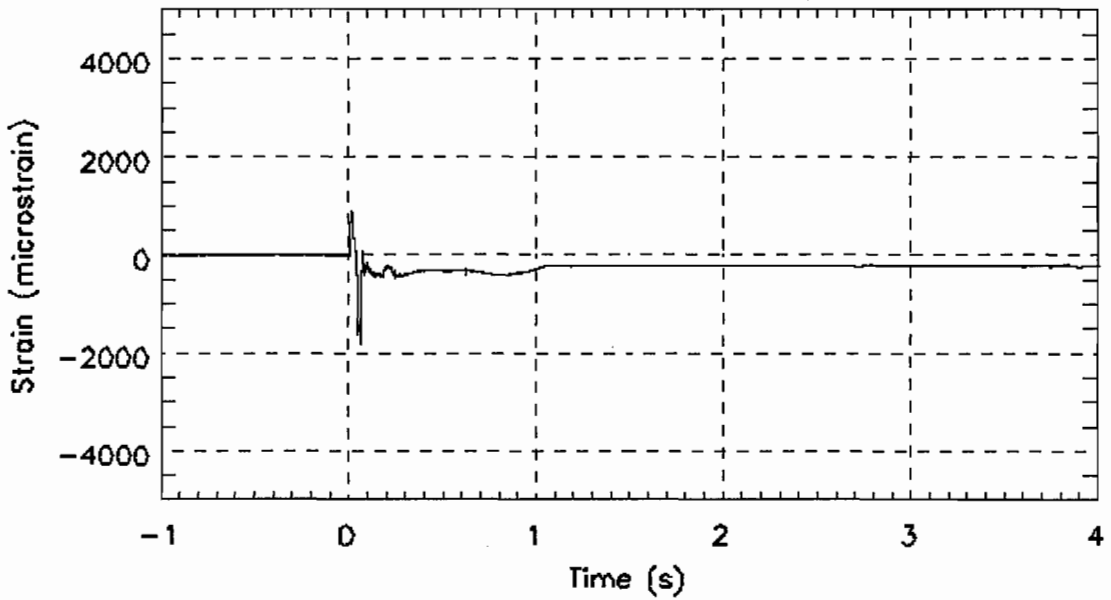

Figure H- 11. Strain measurement on the rear of the AT plate, 1" from the bottom edge, 9 1/4" in from the outside edge, ATPRRB.txt

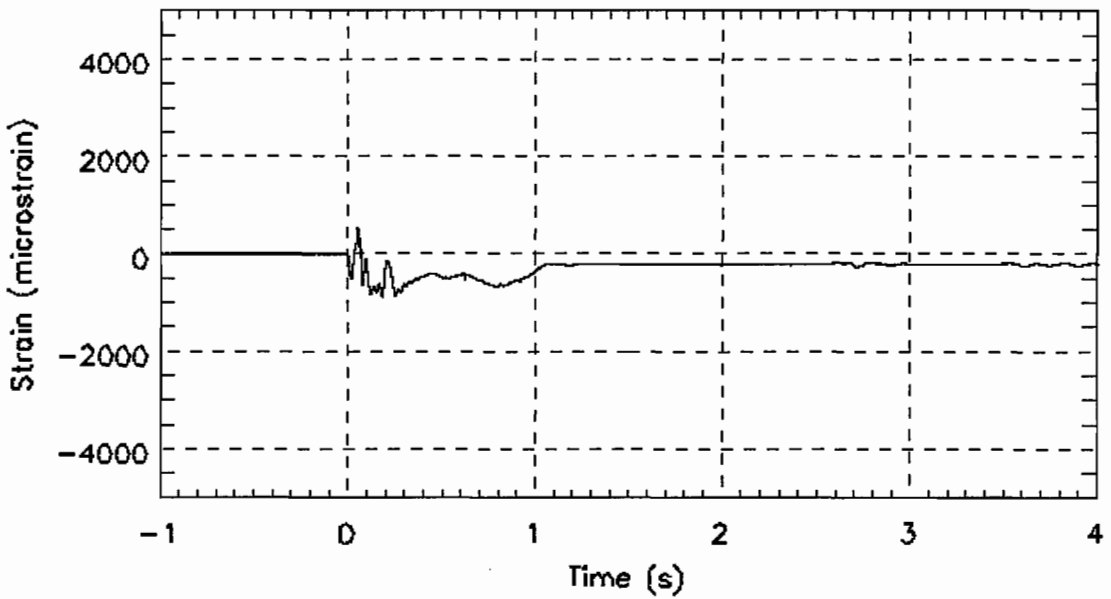

Figure H- 12. Strain measurement on the rear of the AT plate, 13/16" from the top edge, 9 1/4" in from the outside edge, ATPRRT.txt

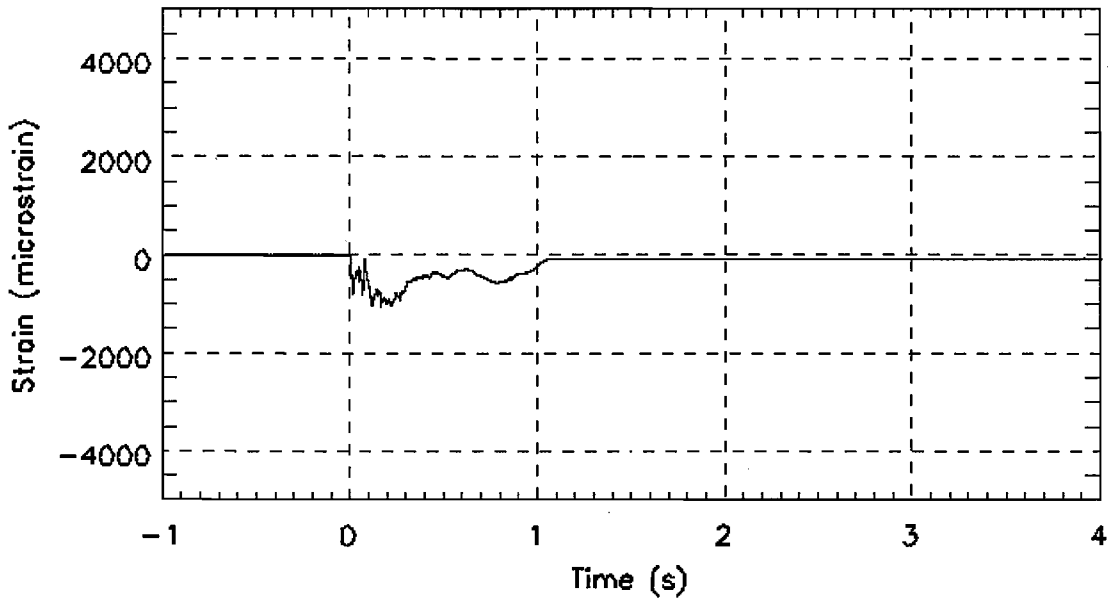

Figure H- 13. Strain measurement on the rear of the buffer beam, 1 3/8" from the bottom edge, 34 5/8" from the outside edge, BBCBB.txt

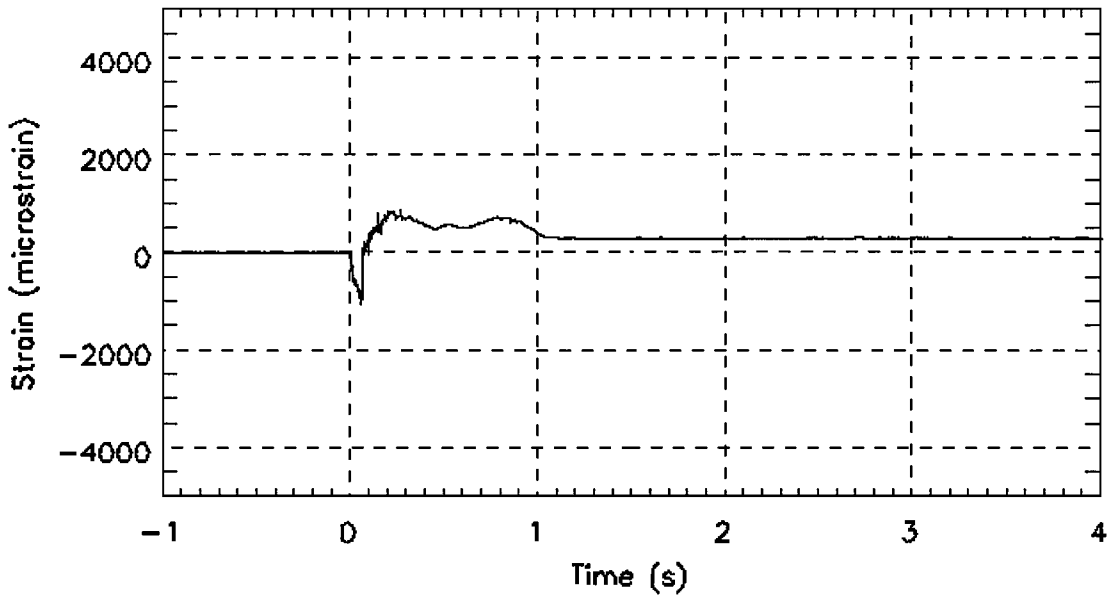

Figure H- 14. Strain measurement on the rear of the buffer beam, 1 3/8" from the top edge, 34 5/8" from the outside edge, BBCBT.txt



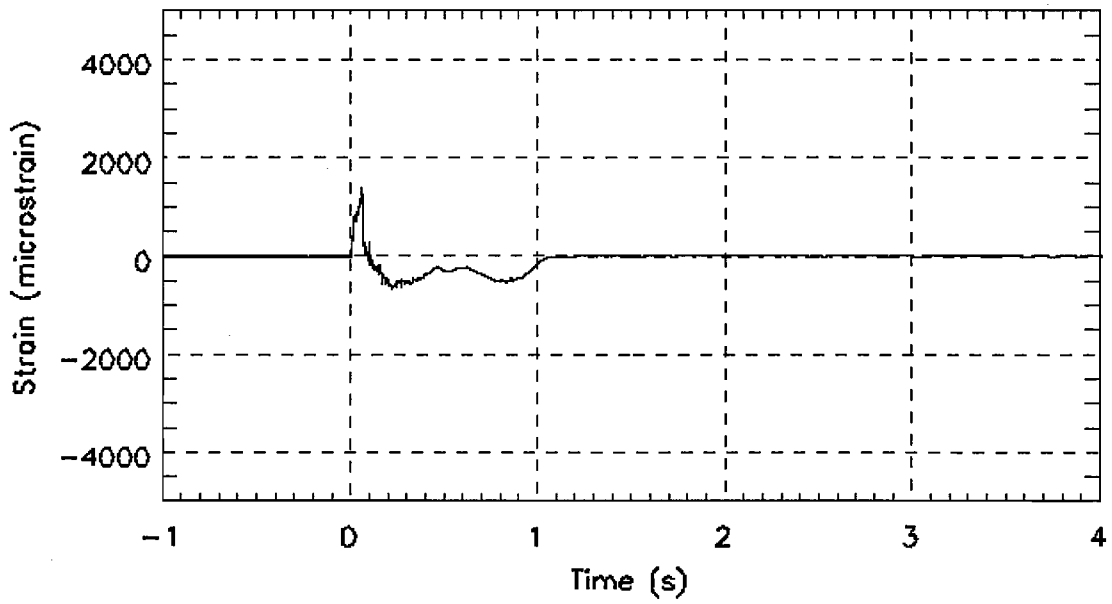

Figure H- 15. Strain measurement on the front of the buffer beam, 1 3/8" from the bottom edge, 34 5/8" from the outside edge, BBCFB.txt

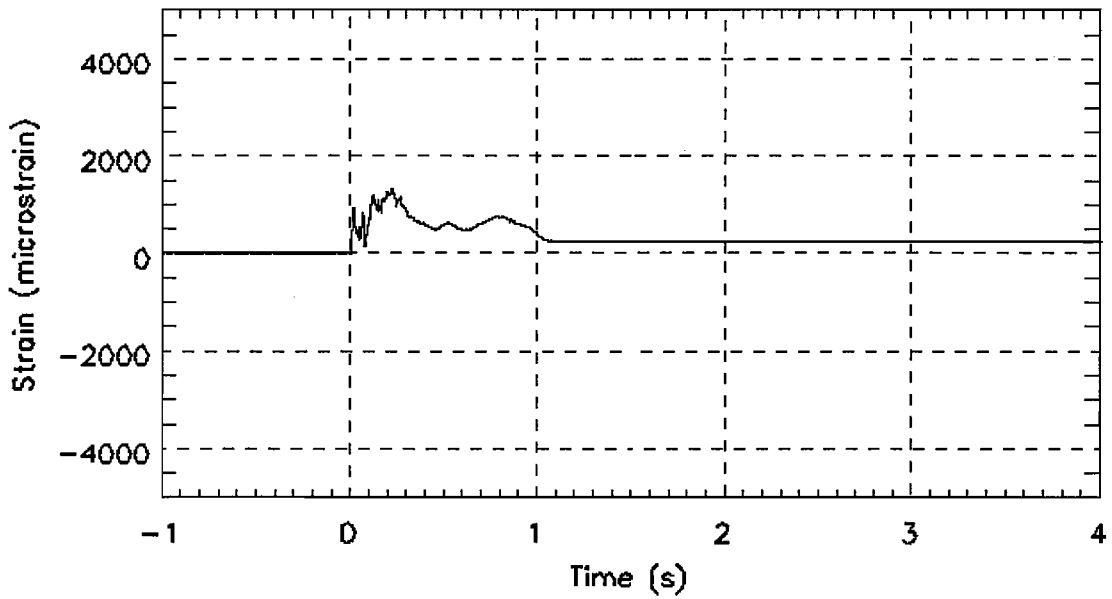

Figure H- 16. Strain measurement on the front of the buffer beam, 1 3/8" from the top edge, 34 5/8" from the outside edge, BBCFT.txt

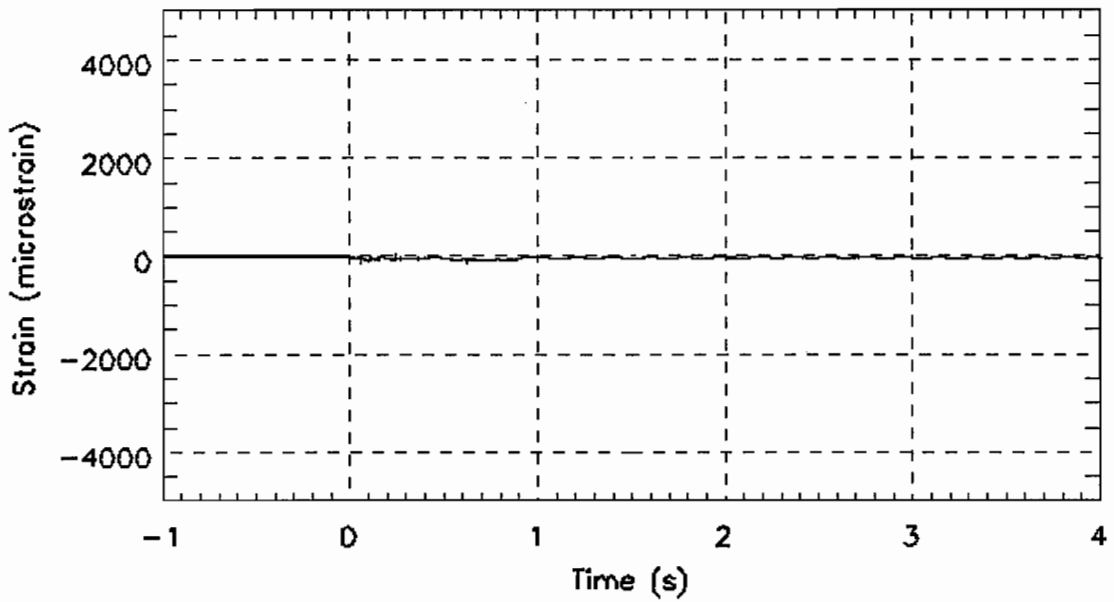

Figure H- 17. Strain measurement on the rear of the buffer beam, 1 3/8" from the bottom edge, 3 3/16" from the outside edge, BBEBB.txt

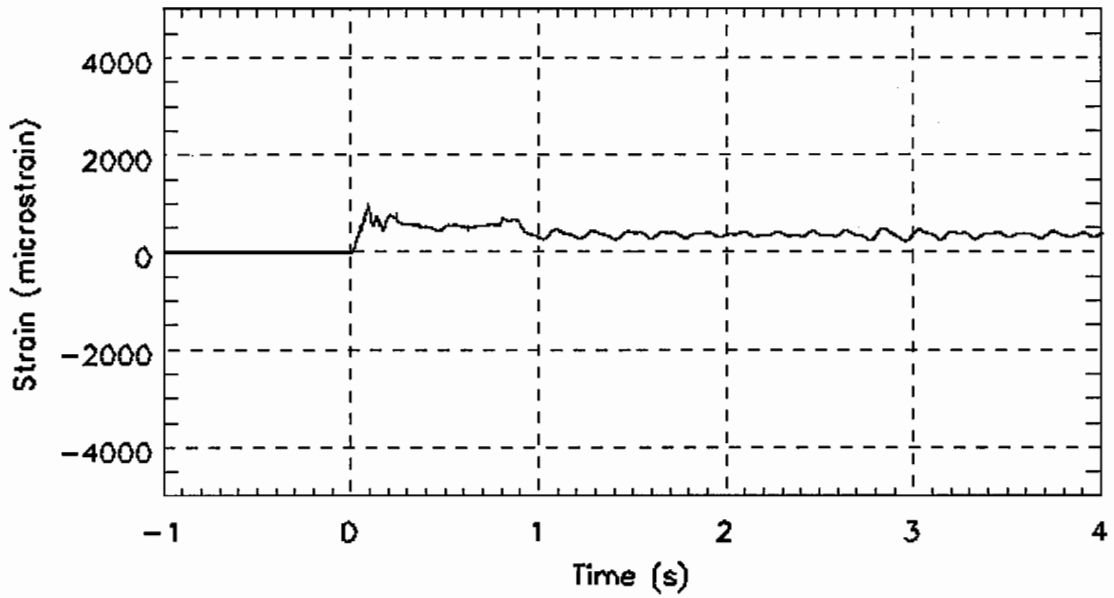

Figure H- 18. Strain measurement on the rear of the buffer beam, 1 3/8" from the top edge, 3 3/16" from the outside edge, BBEBT.txt

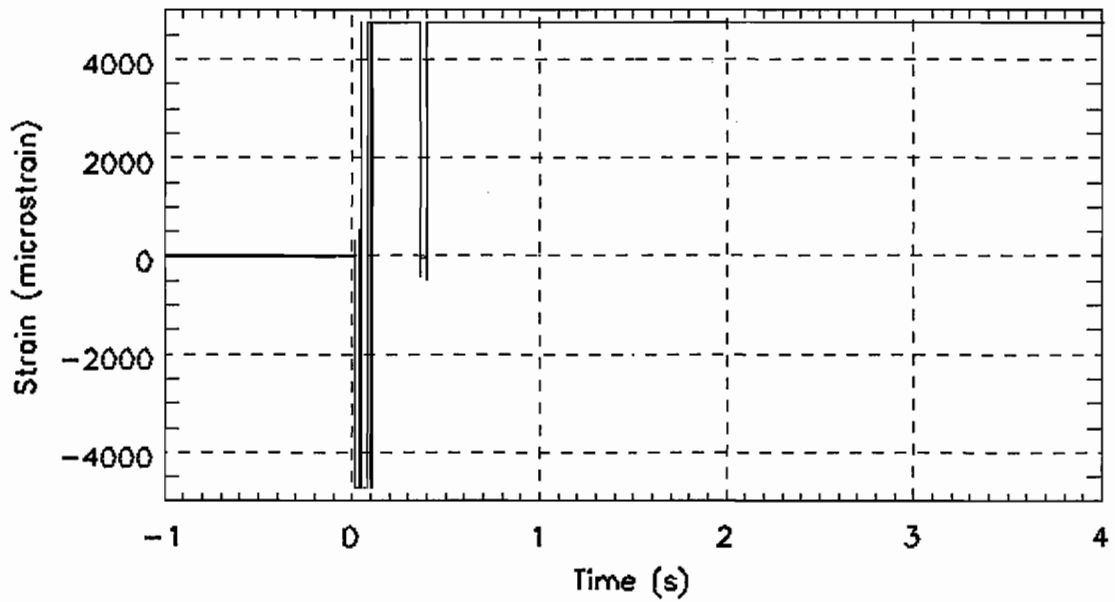

Figure H- 19. Strain measurement on the front of the buffer beam, 1 3/8" from the bottom edge, 3 3/16" from the outside edge, BBEFB.txt

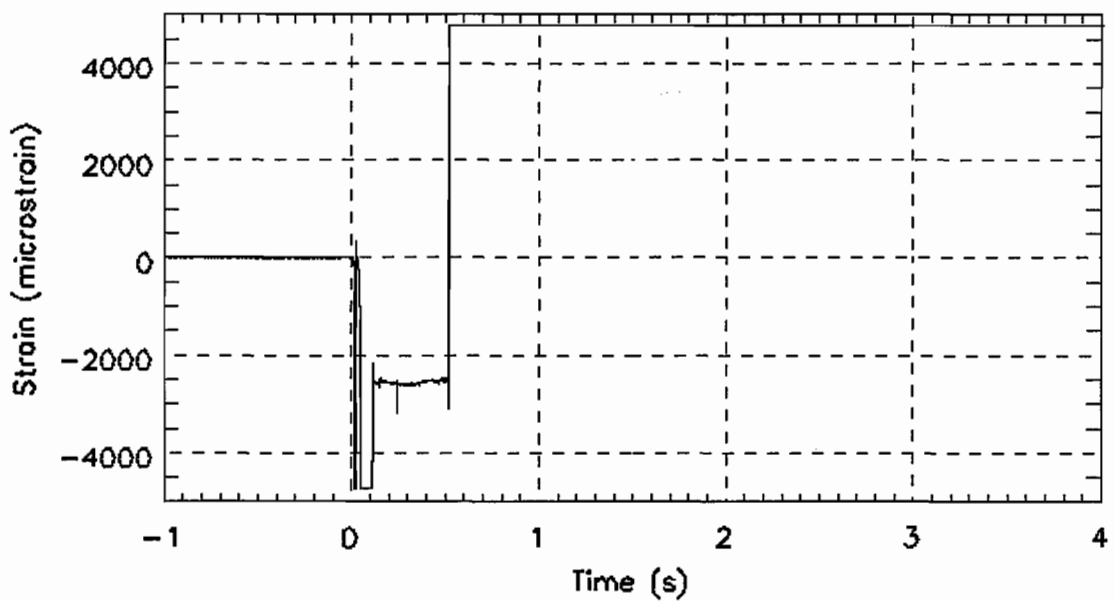

Figure H- 20. Strain measurement on the front of the buffer beam, 1 3/8" from the top edge, 3 3/16" from the outside edge, BBEFT.txt

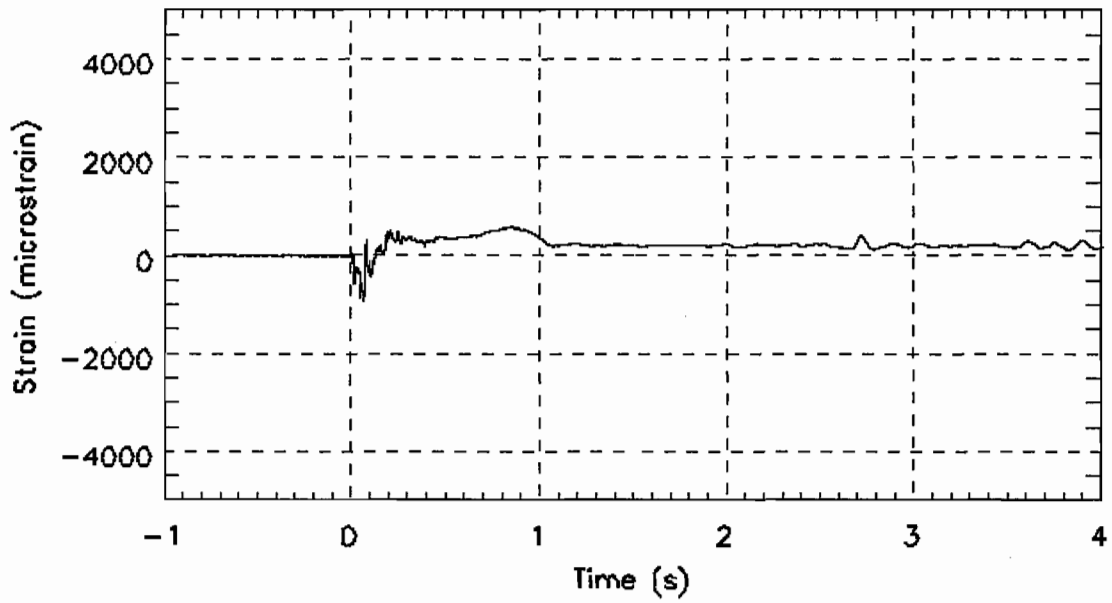

Figure H- 21. Strain measurement on the front of the collision post, 2" up from the buffer beam, 1 7/8" from the inside edge of the collision post, COLBFL.txt

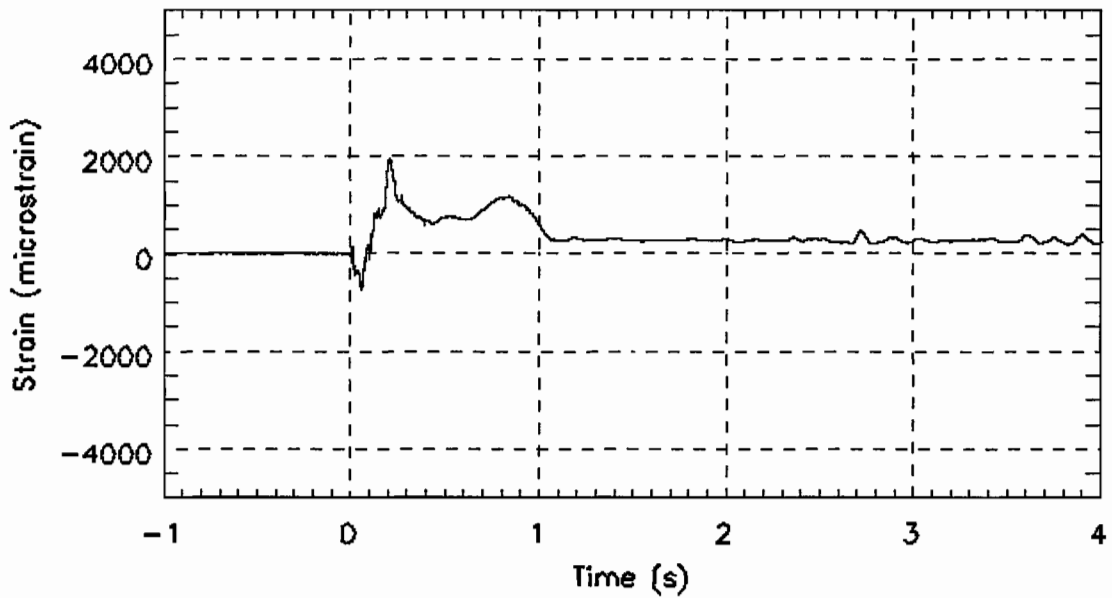

Figure H- 22. Strain measurement on the front of the collision post, 2" up from the buffer beam, 1 7/8" from the outside edge of the collision post, COLBFR.txt

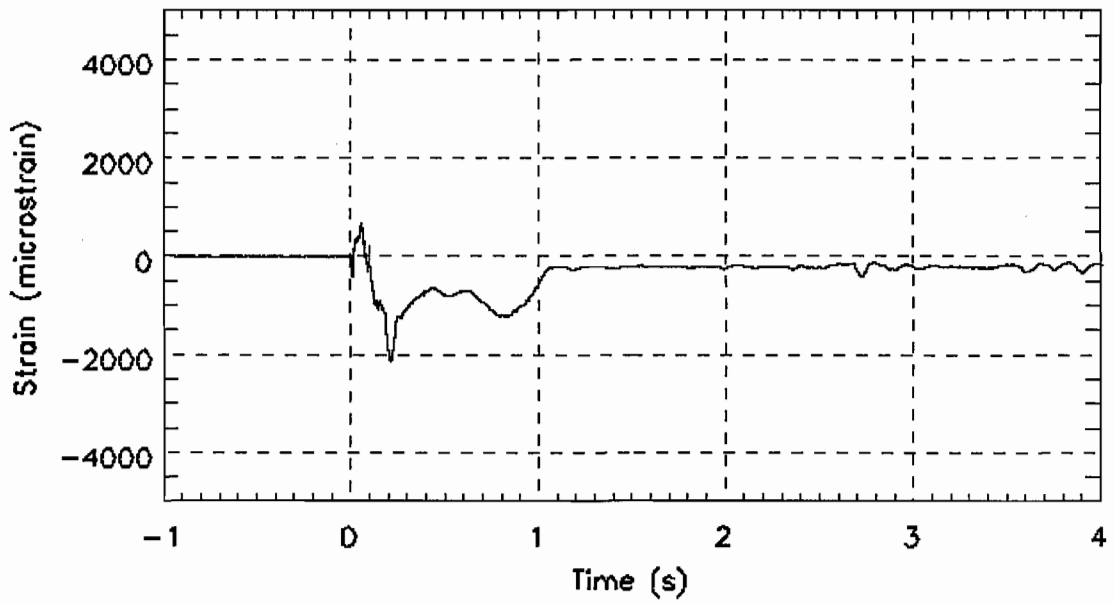

Figure H- 23. Strain measurement on the rear of the collision post, 2" up from the buffer beam, 1 7/8" from the inside edge of the collision post, COLBRL.txt

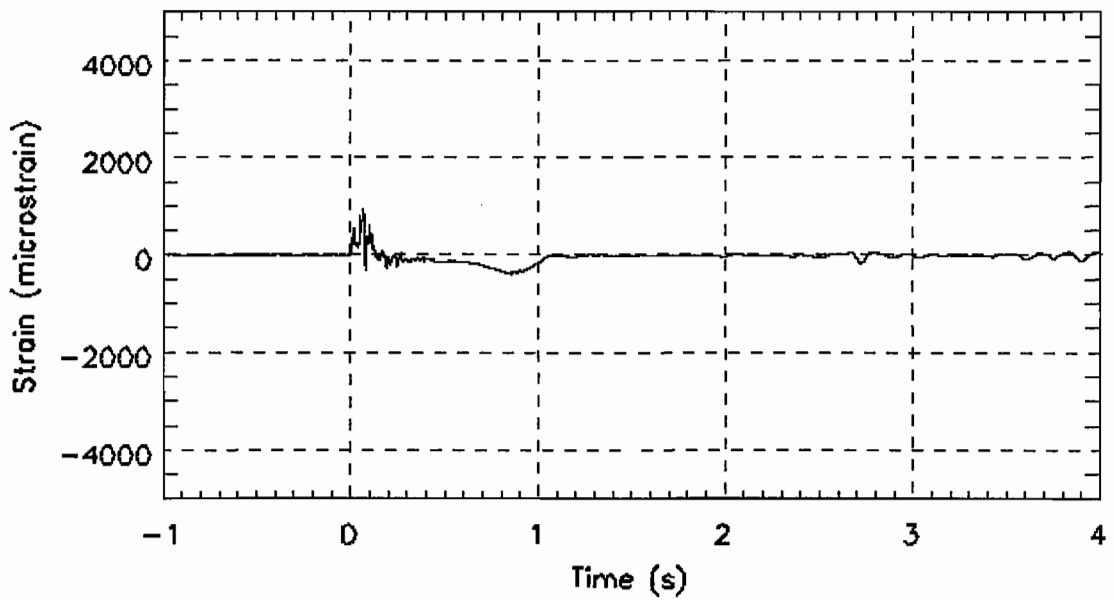

Figure H- 24. Strain measurement on the rear of the collision post, 2" up from the buffer beam, 1 7/8" from the outside edge of the collision post, COLBRR.txt

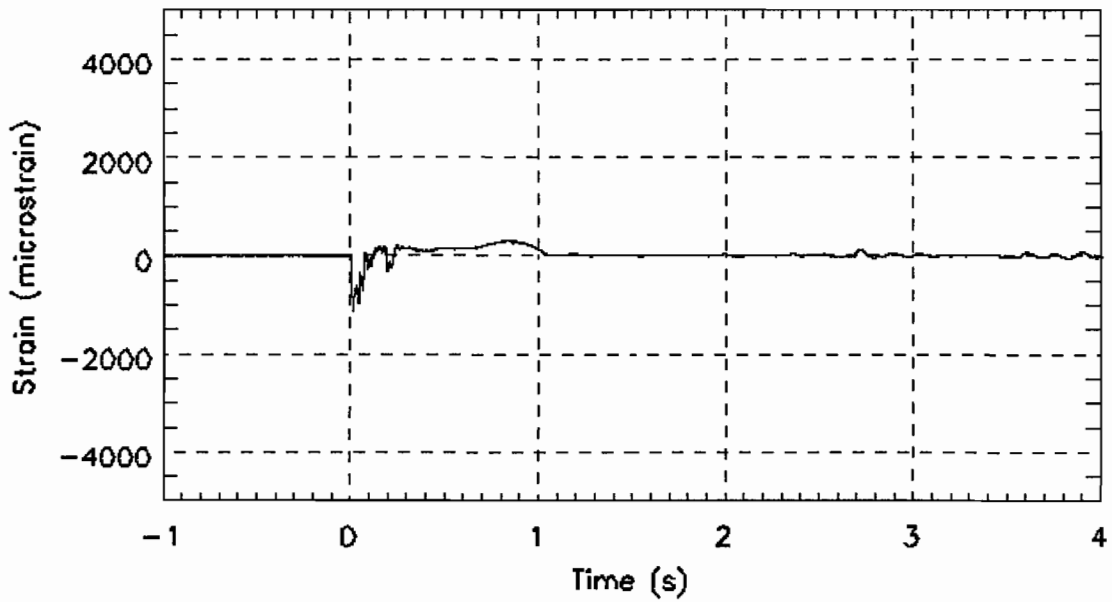

Figure H- 25. Strain measurement on the front of the collision post, 37 3/4" up from the buffer beam, 1 7/8" from the inside edge of the collision post, COLMFL.txt

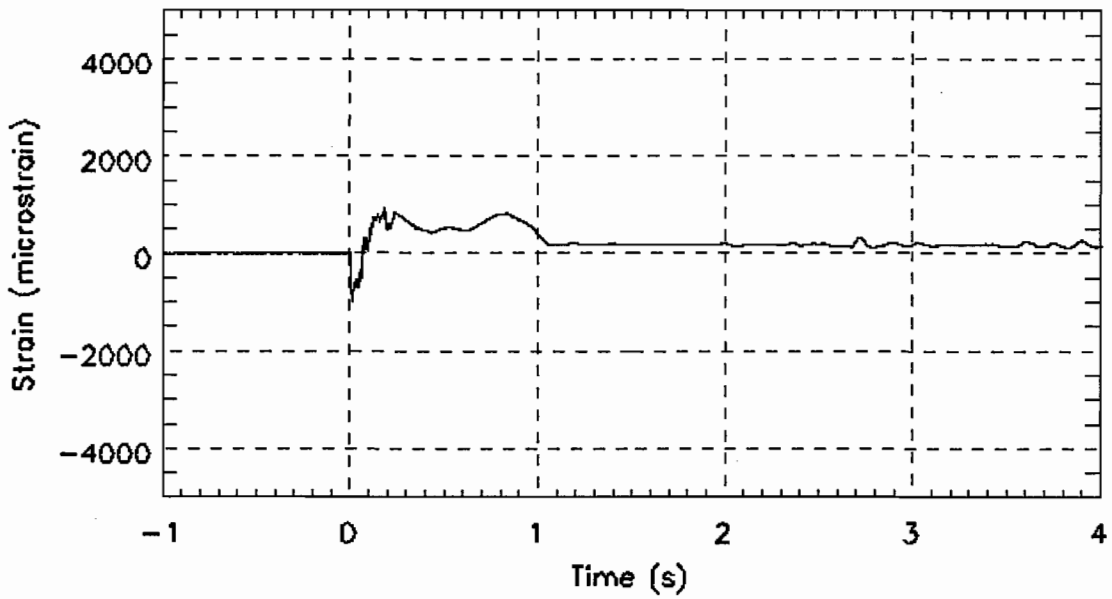

Figure H- 26. Strain measurement on the front of the collision post, 37 3/4" up from the buffer beam, 1 7/8" from the outside edge of the collision post, COLMFR.txt

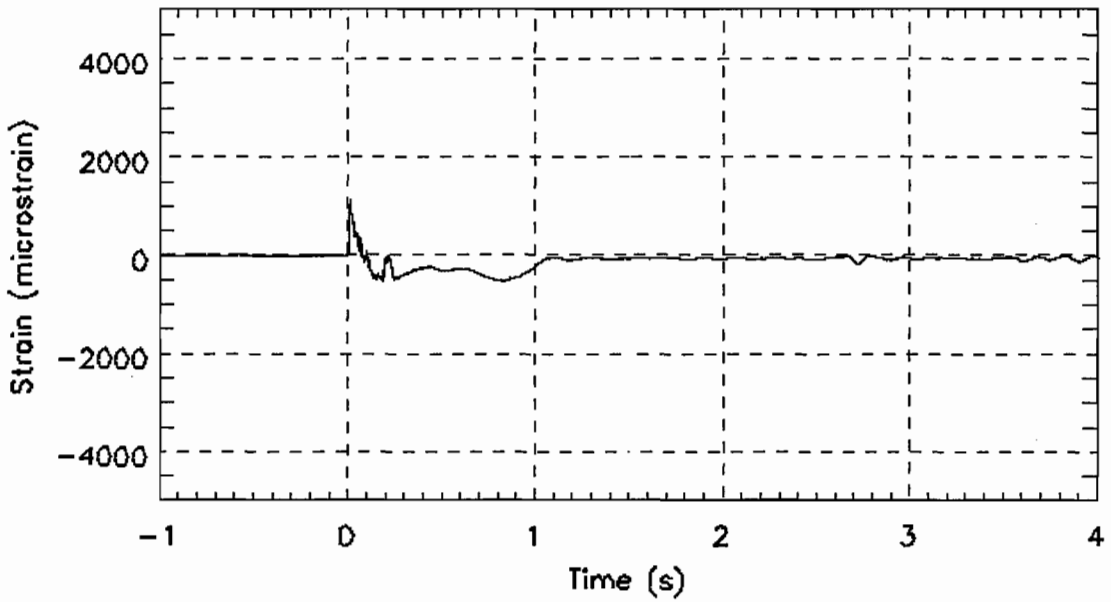

Figure H- 27. Strain measurement on the rear of the collision post, 37 3/4" up from the buffer beam, 1 7/8" from the inside edge of the collision post, COLMRL.txt

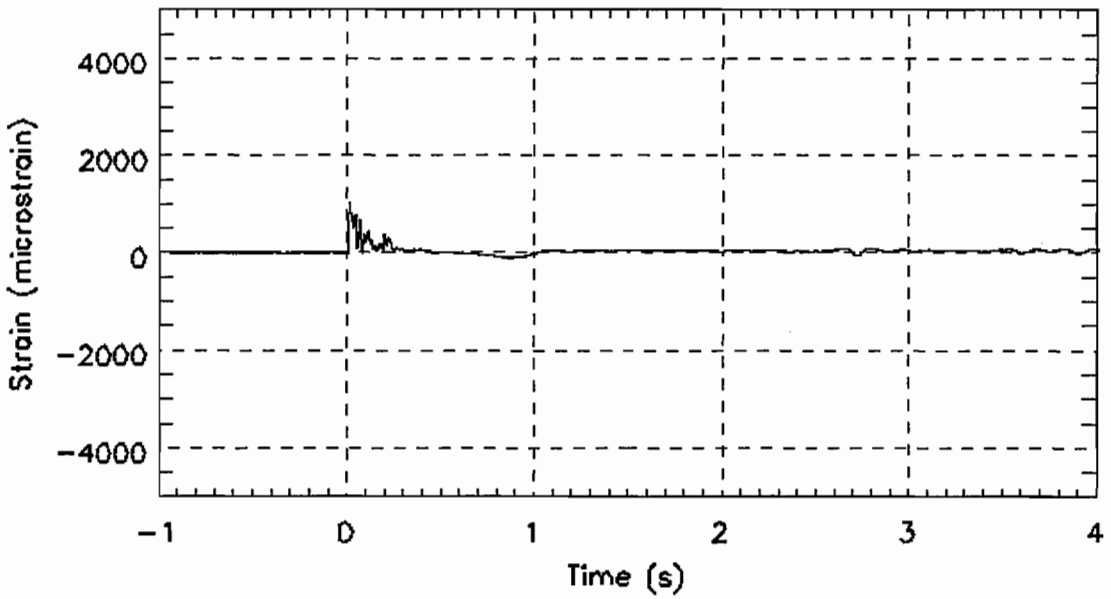

Figure H- 28. Strain measurement on the rear of the collision post, 37 3/4" up from the buffer beam, 1 7/8" from the outside edge of the collision post, COLMRR.txt

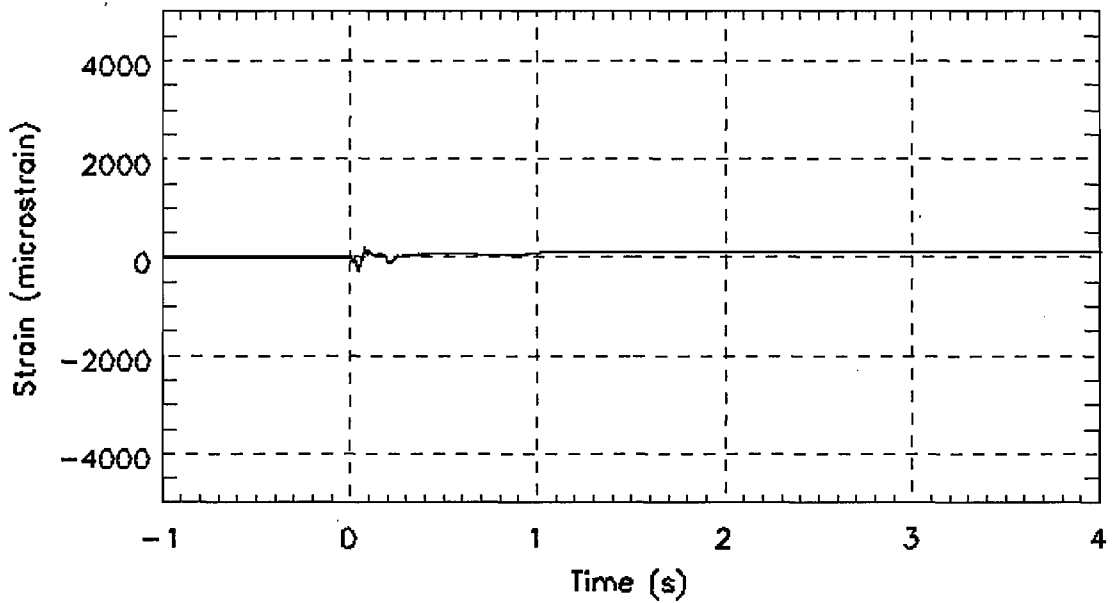

Figure H-29. Strain measurement on the front of the collision post, 2" down from the AT Plate, 1 7/8" from the inside edge of the collision post, COLTFL.txt

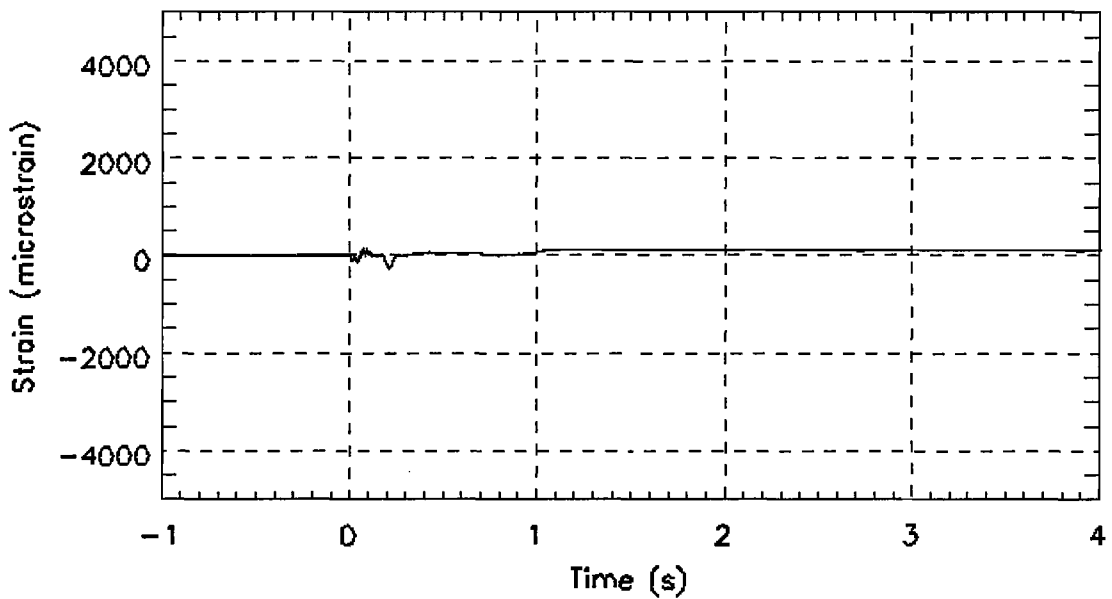

Figure H-30. Strain measurement on the front of the collision post, 2" down from the AT Plate, 1 7/8" from the outside edge of the collision post, COLTFR.txt

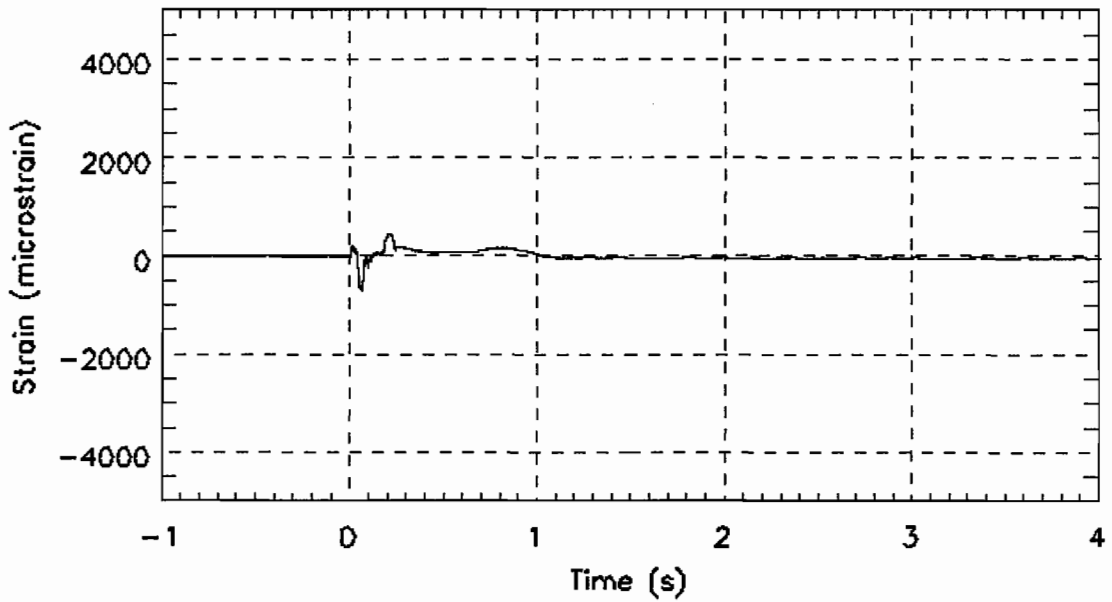

Figure H- 31. Strain measurement on the rear of the collision post, 2" down from the AT Plate, 1 7/8" from the inside edge of the collision post, COLTRL.txt

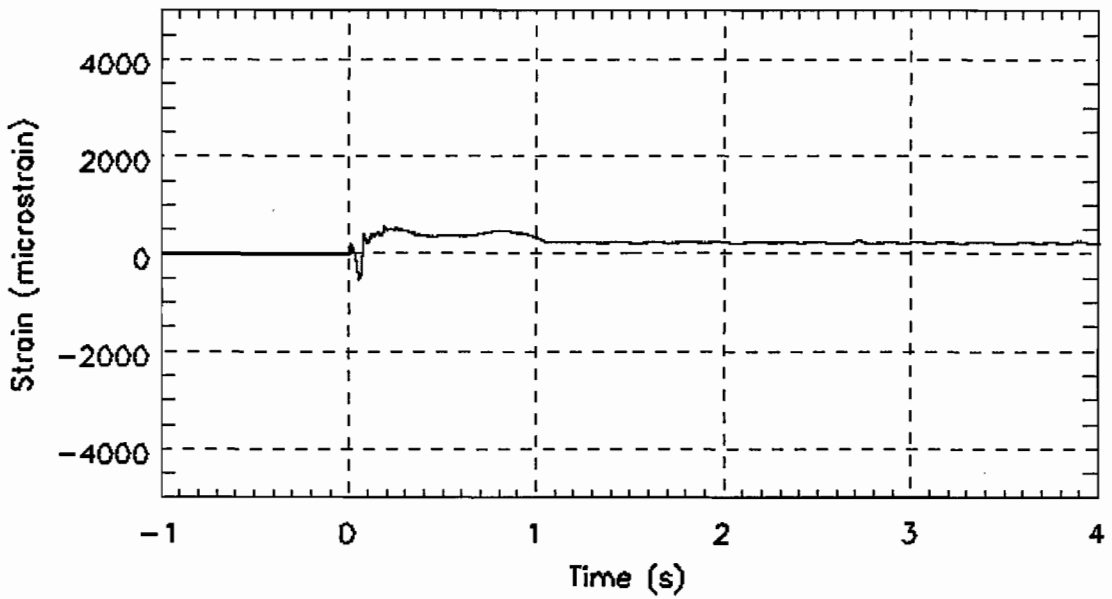

Figure H- 32. Strain measurement on the rear of the collision post, 2" down from the AT Plate, 1 7/8" from the outside edge of the collision post, COLTRR.txt

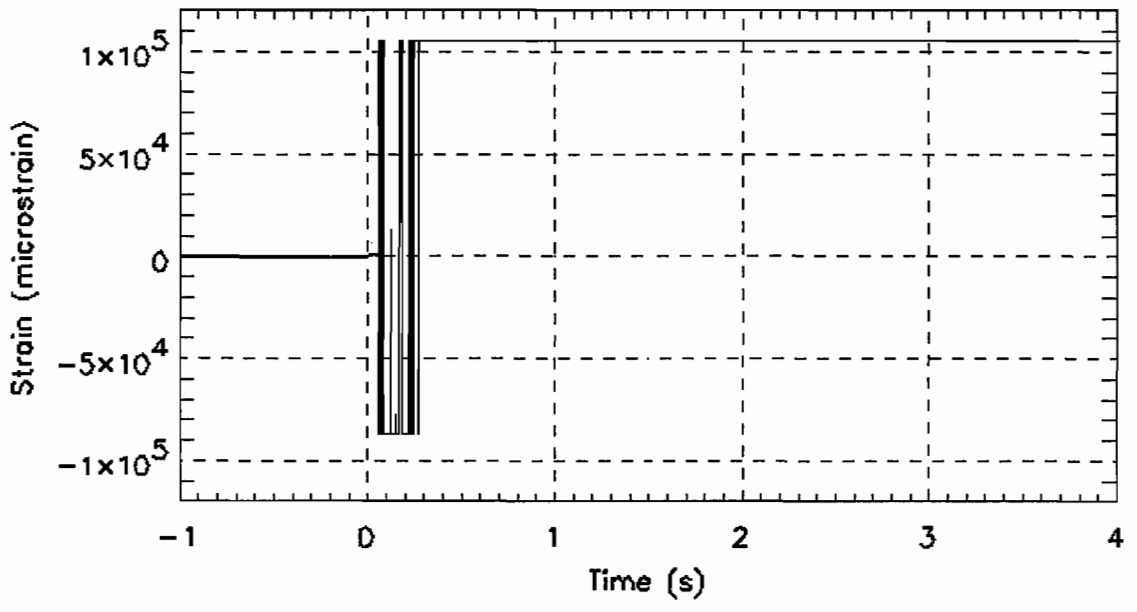

Figure H- 33. Strain measurement on the front of the corner post, 2" up from the buffer beam, 1" from the inside edge of the corner post, CORBFL.txt

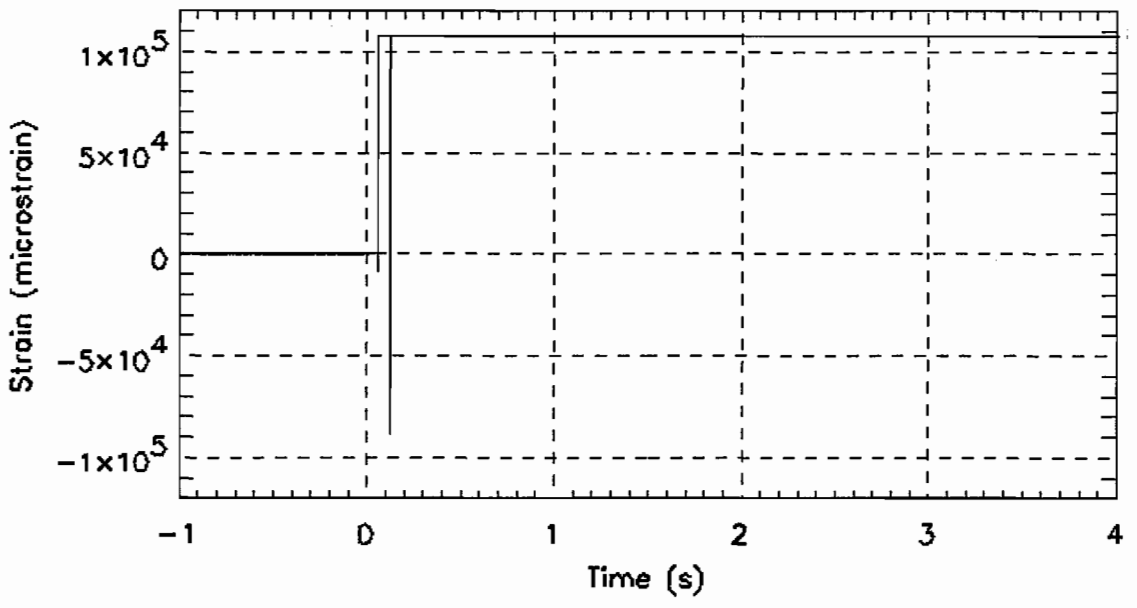

Figure H- 34. Strain measurement on the front of the corner post, 2" up from the buffer beam, 1" from the outside edge of the corner post, CORBFR.txt

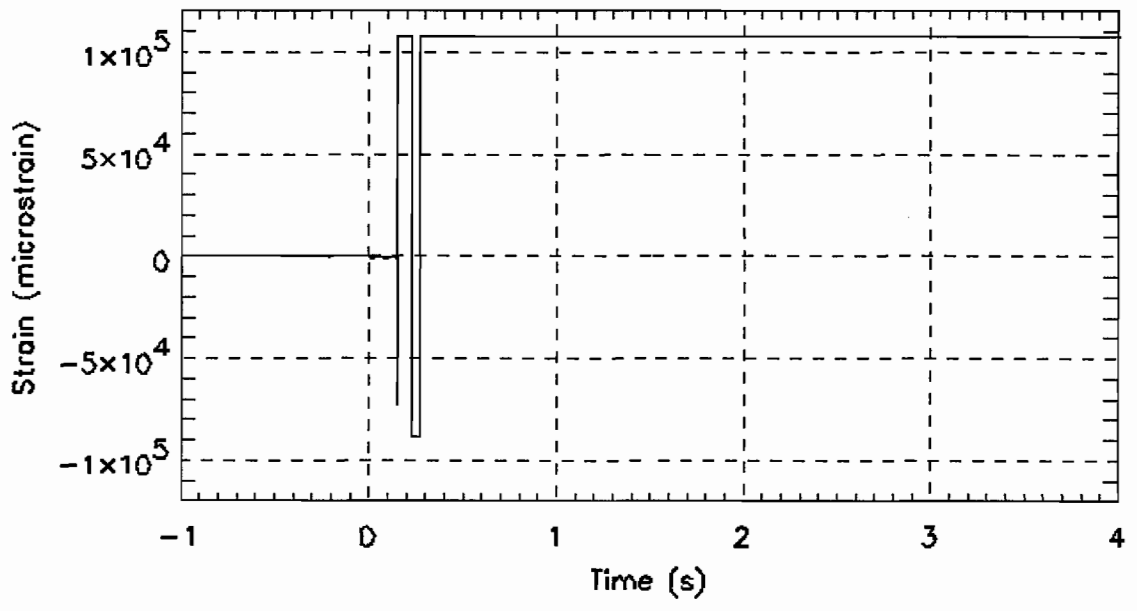

Figure H- 35. Strain measurement on the rear of the corner post, 2" up from the buffer beam, 1" from the inside edge of the corner post, CORBRL.txt

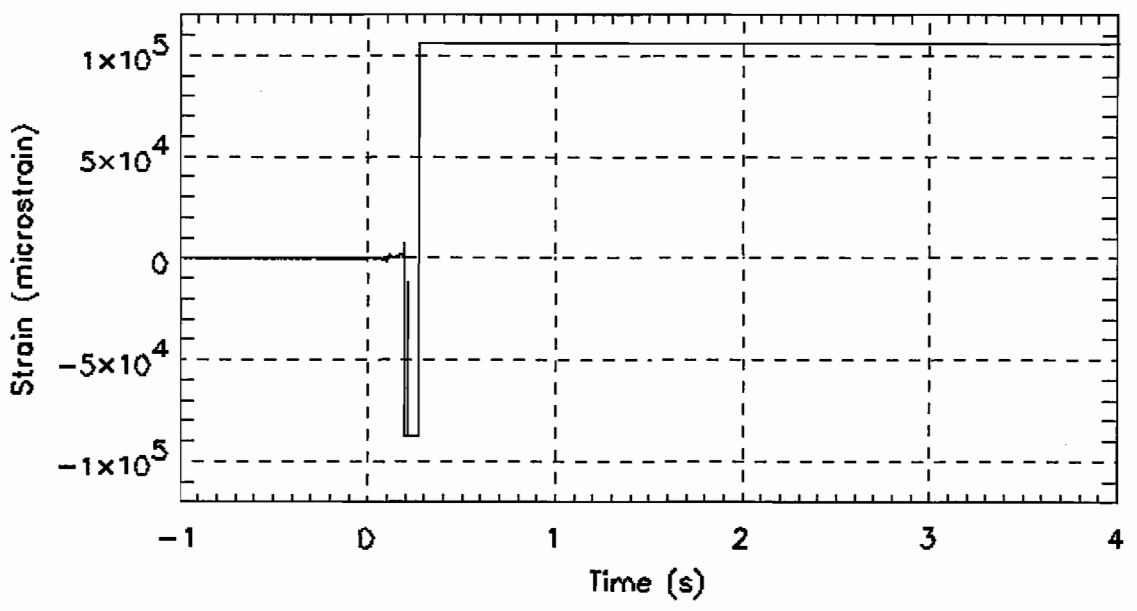

Figure H- 36. Strain measurement on the rear of the corner post, 2" up from the buffer beam, 1" from the outside edge of the corner post, CORBRR.txt

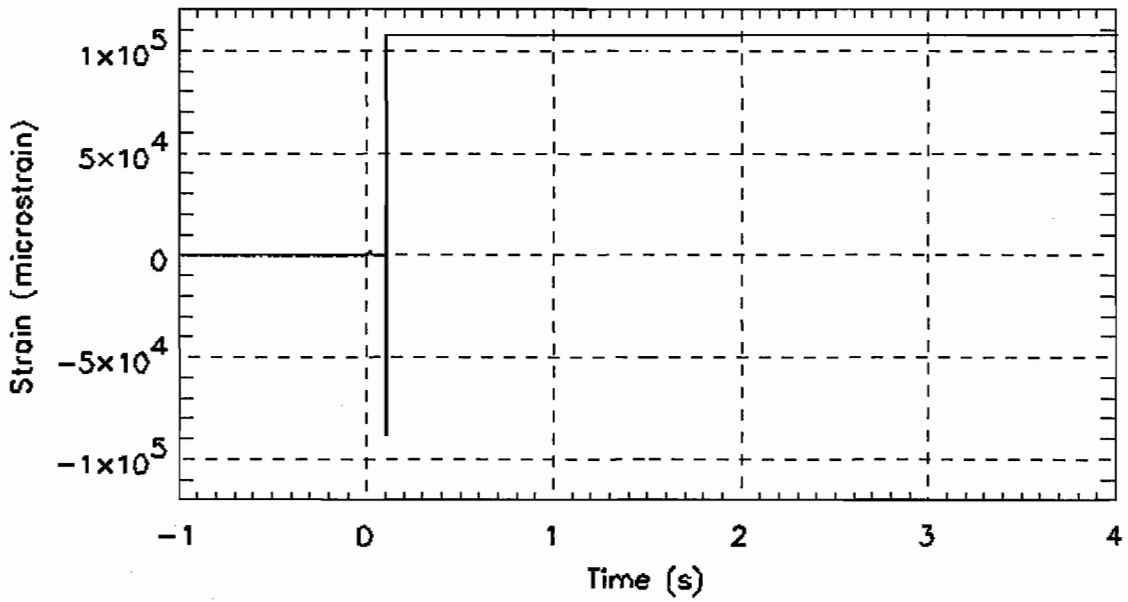

Figure H- 37. Strain measurement on the front of the corner post, 2" down from the AT Plate, 1" from the inside edge of the corner post, CORTFL.txt

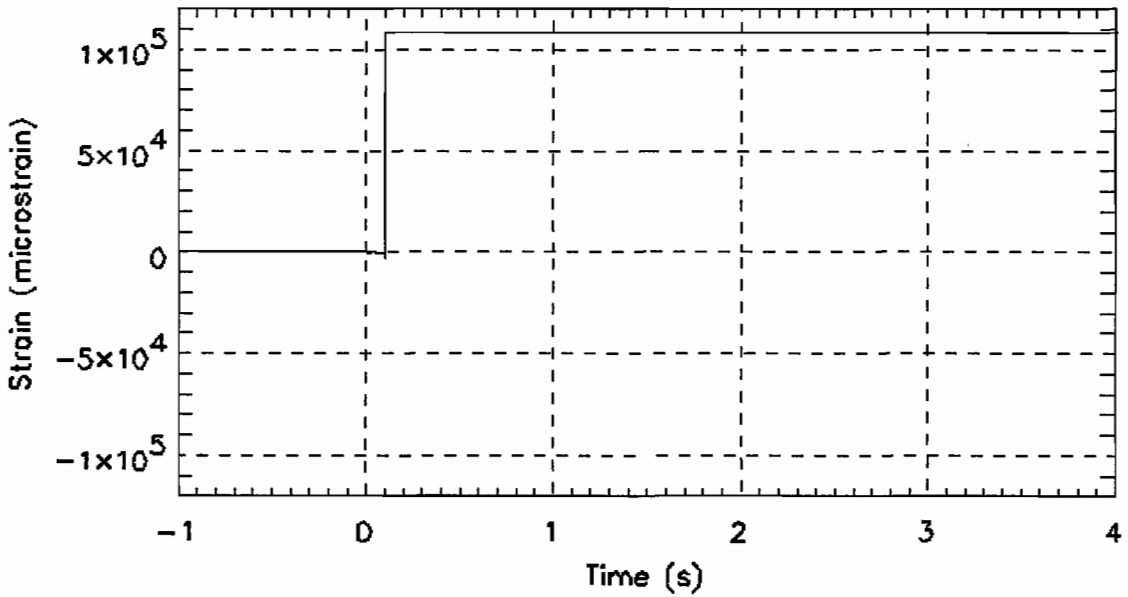

Figure H- 38. Strain measurement on the front of the corner post, 2" down from the AT Plate, 1" from the outside edge of the corner post, CORTFR.txt

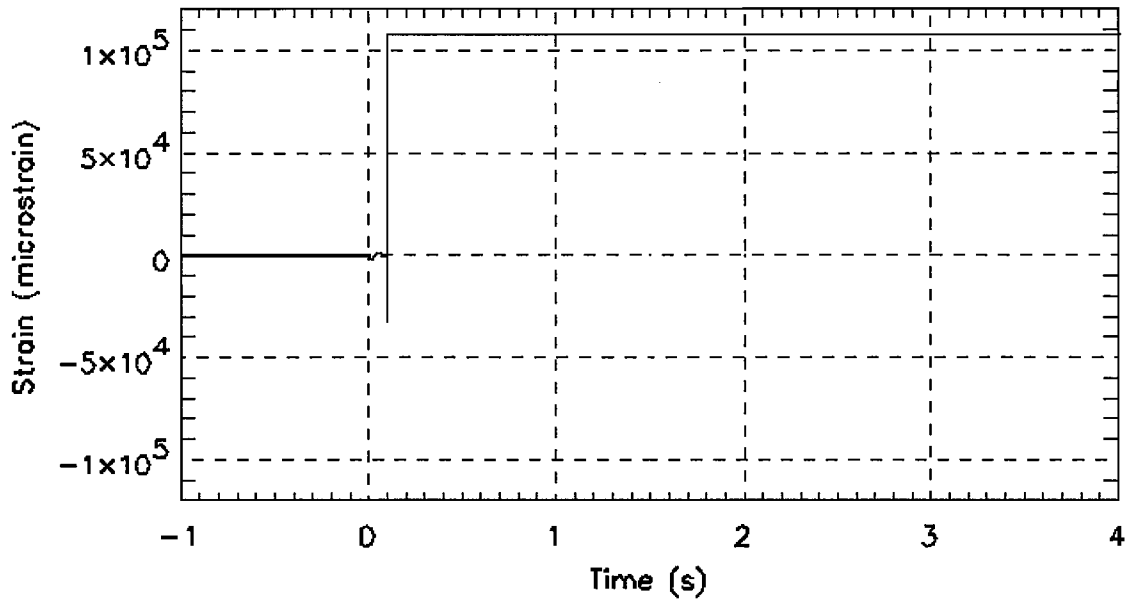

Figure H- 39. Strain measurement on the rear of the corner post, 2" down from the AT Plate, 1" from the inside edge of the corner post, CORTRL.txt

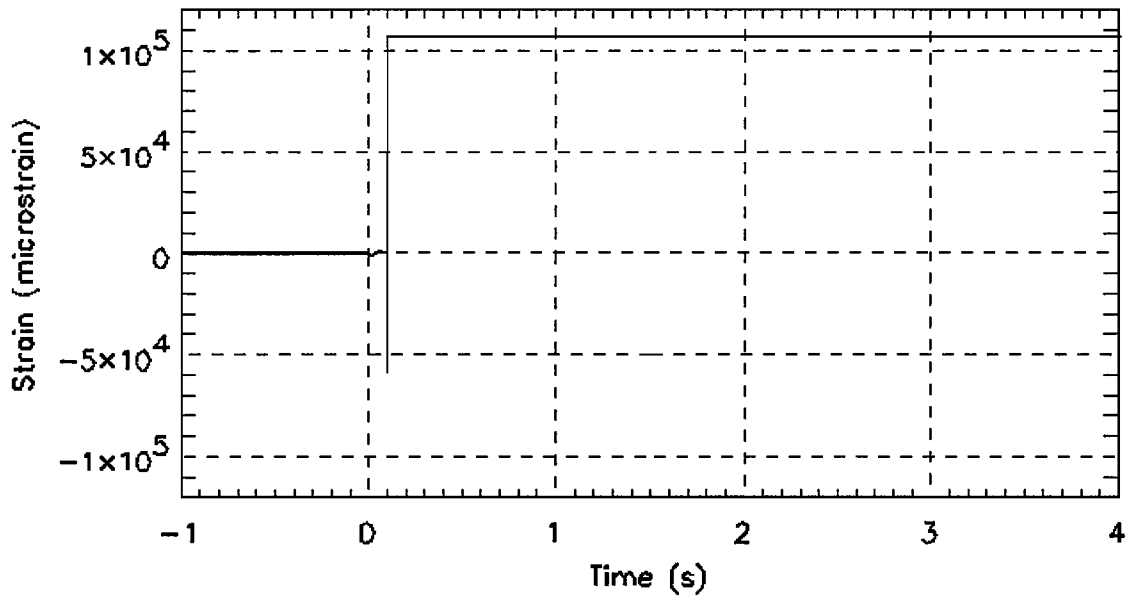

Figure H- 40. Strain measurement on the rear of the corner post, 2" down from the AT Plate, 1" from the outside edge of the corner post, CORTRR.txt

2

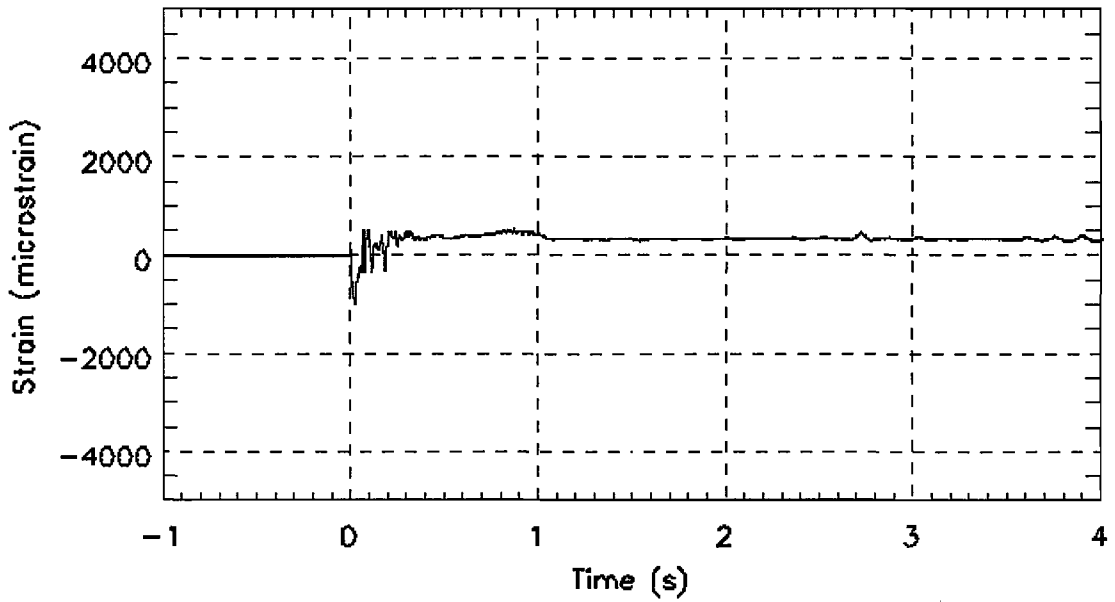

Figure H- 41. Strain measurement on the front of the corner post, 2" down from the AT Plate, 1" from the inside edge of the corner post, CRBLF.txt

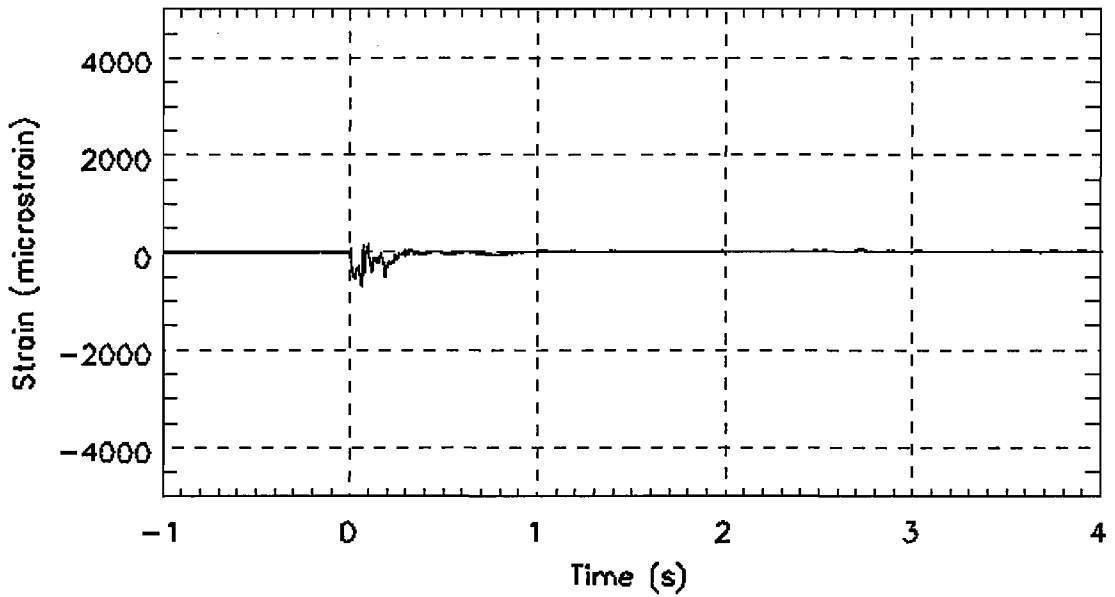

Figure H- 42. Strain measurement on the front of the corner post, 2" down from the AT Plate, 1" from the outside edge of the corner post, CRBLM.txt

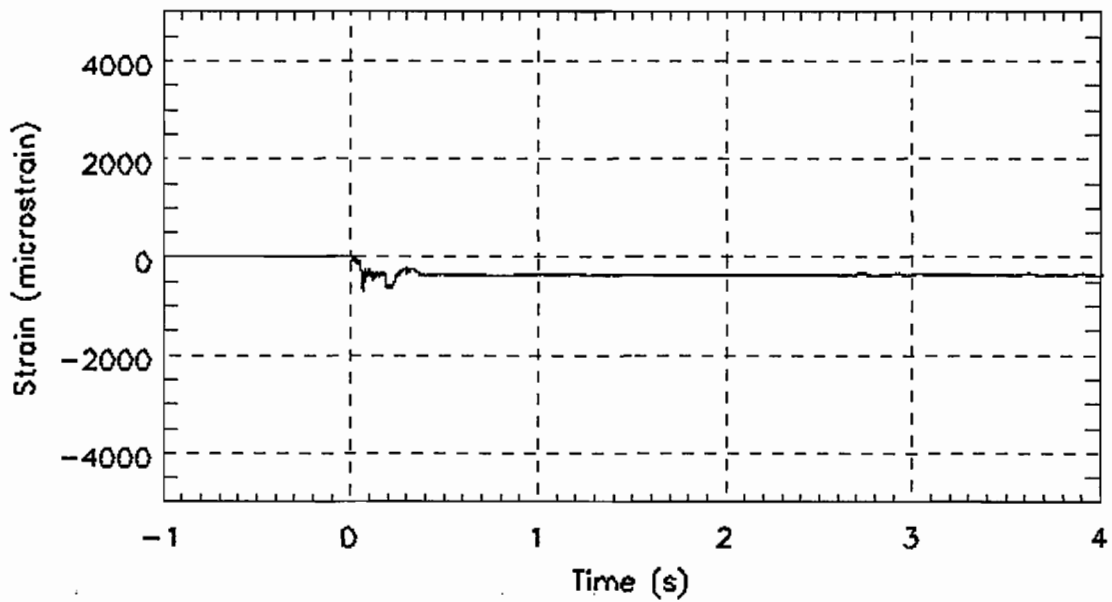

Figure H- 43. Strain measurement on the rear of the corner post, 2" down from the AT Plate, 1" from the inside edge of the corner post, CRBLR.txt

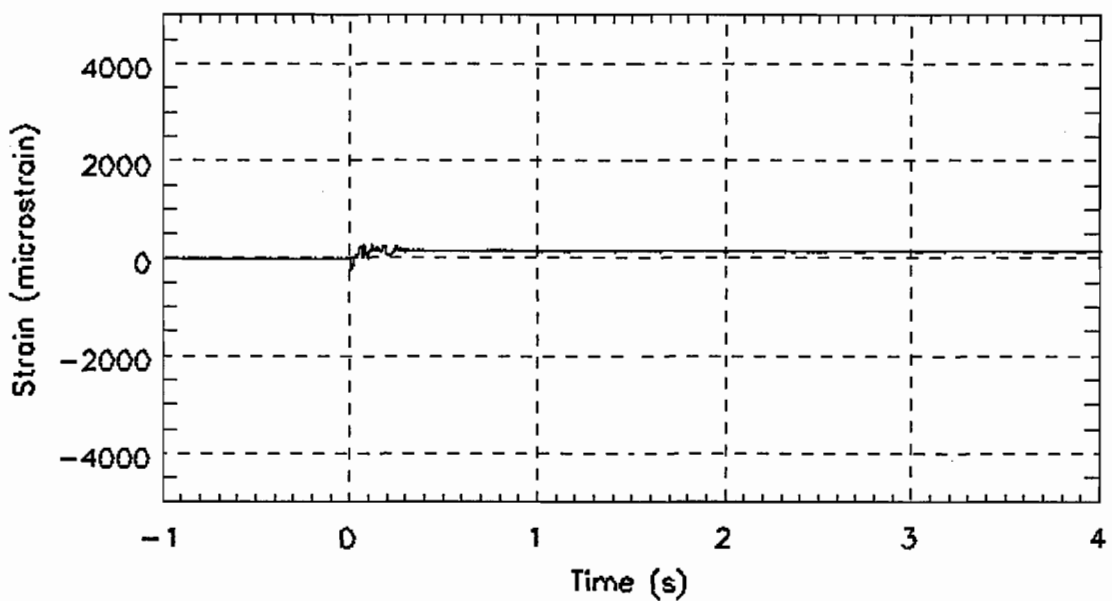

Figure H- 44. Strain measurement on the rear of the corner post, 2" down from the AT Plate, 1" from the outside edge of the corner post, CRBRF.txt

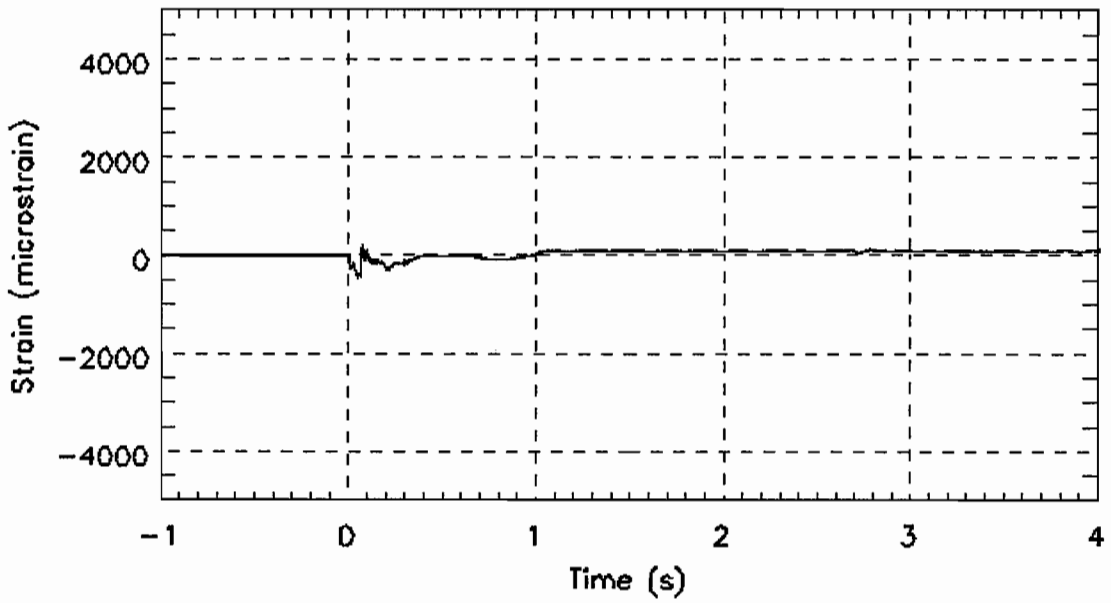

Figure H- 45. Strain measurement on the outside of the cant rail, bottom edge, midway across door opening, CRBRM.txt

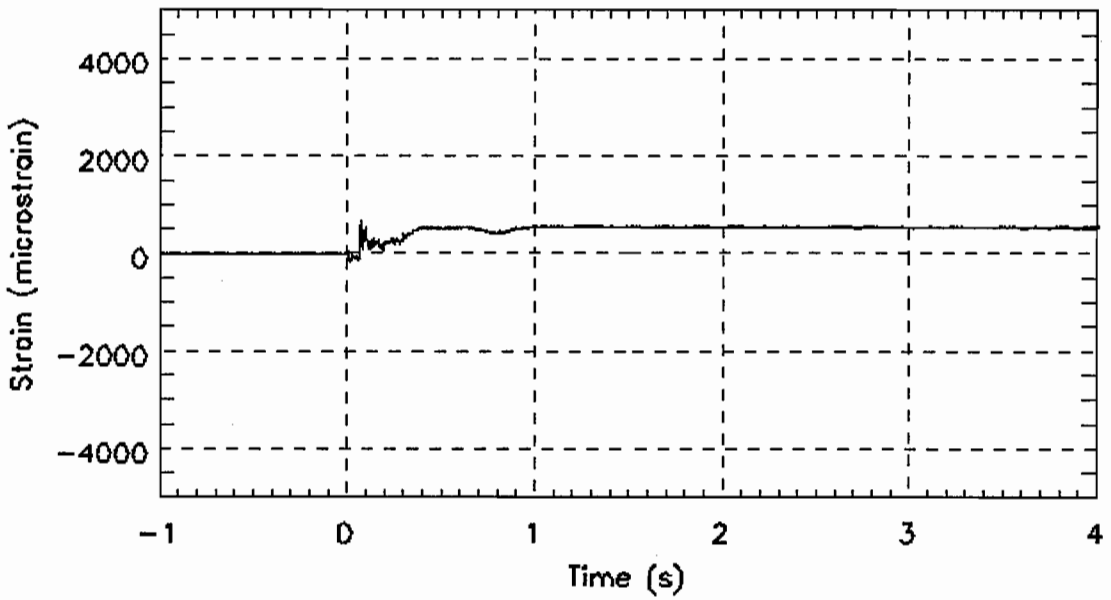

Figure H- 46. Strain measurement on the outside of the cant rail, bottom edge, midway across door opening, CRBRR.txt

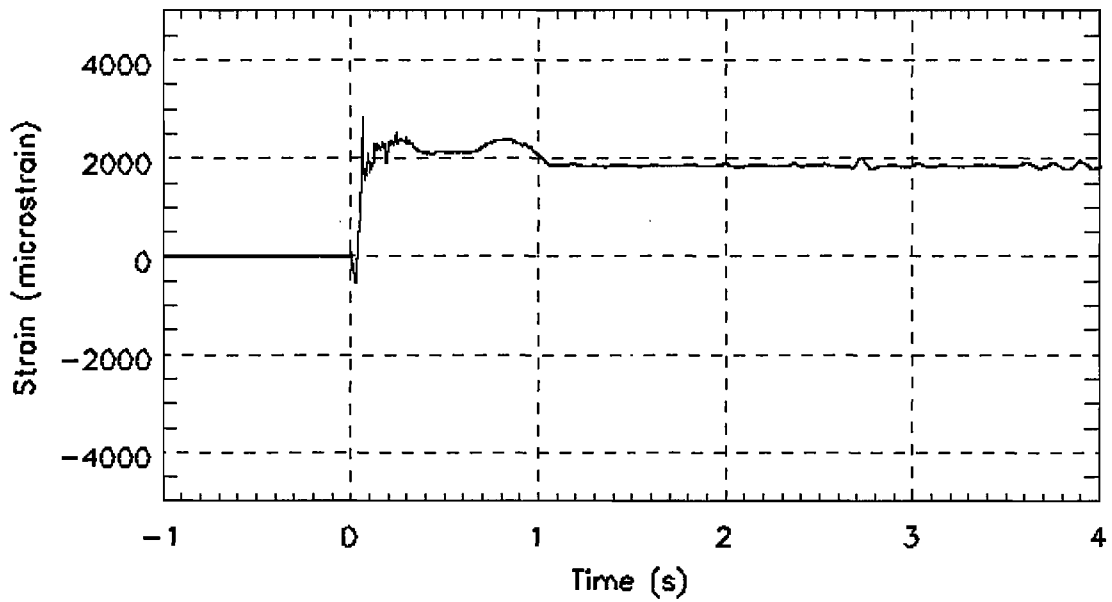

Figure H- 47. Strain measurement on the inside of the cant rail, top edge, just behind the AT plate, CRTLF.txt

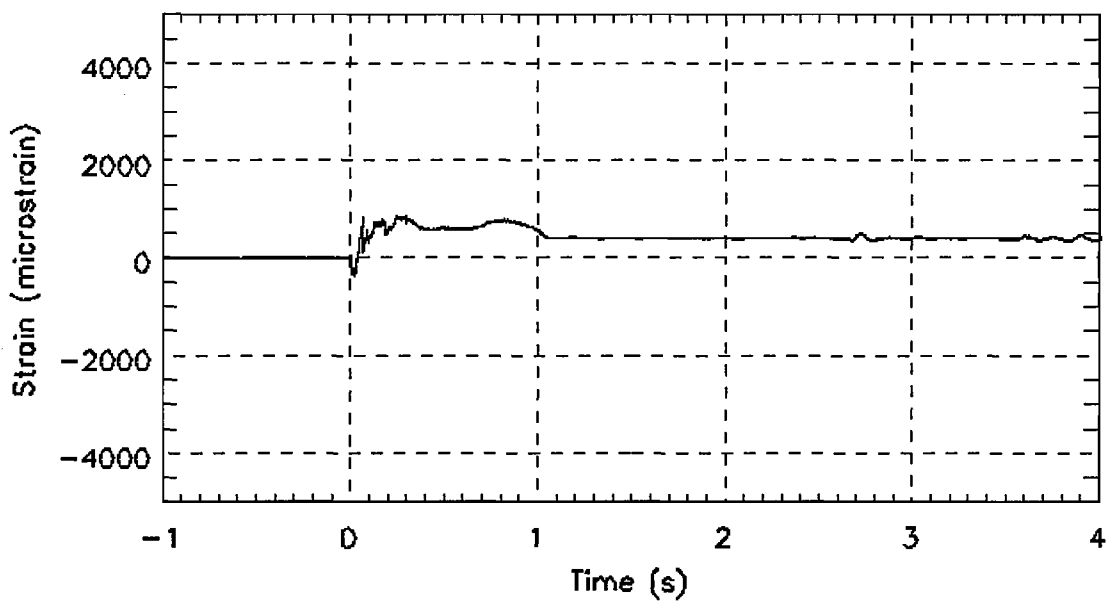

Figure H- 48. Strain measurement on the inside of the cant rail, top edge, midway across door opening, CRTLM.txt

1/6

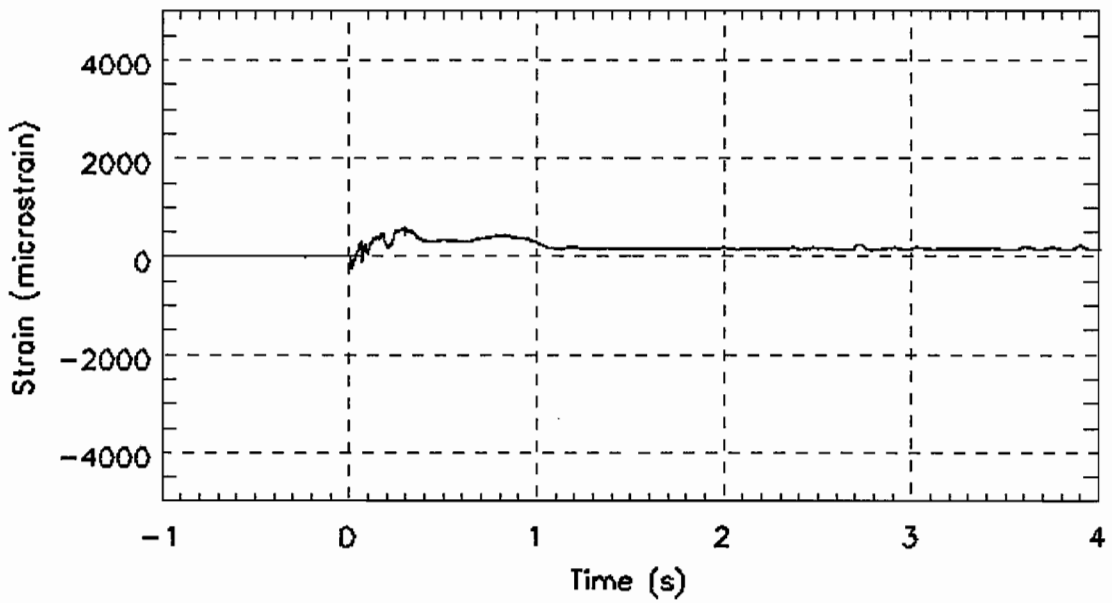

Figure H- 49. Strain measurement on the inside of the cant rail, top edge, midway across door opening, CRTLR.txt

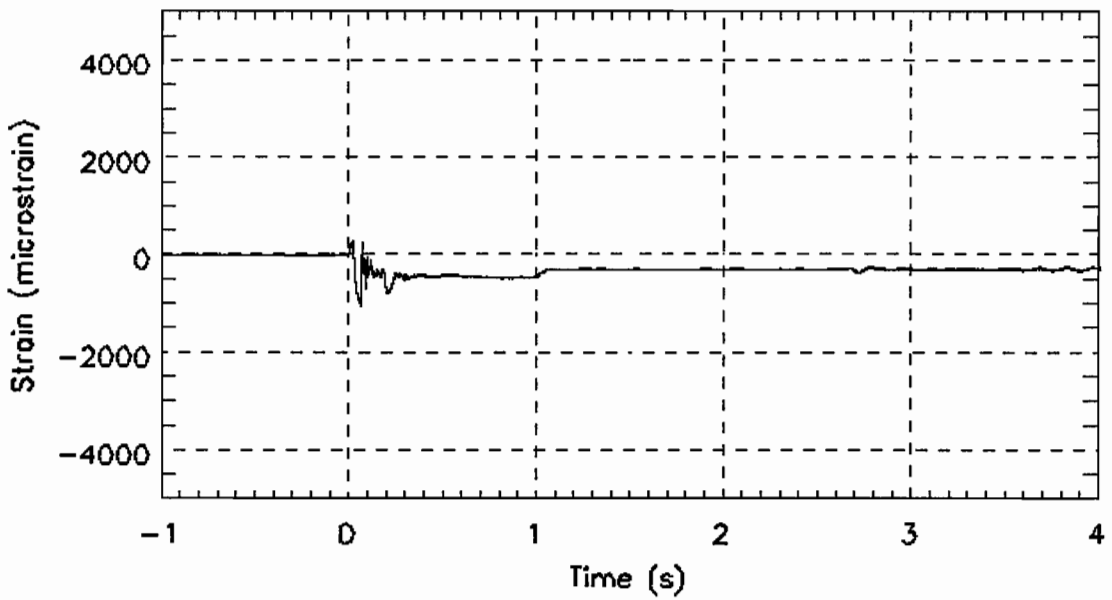

Figure H- 50. Strain measurement on the outside of the cant rail, top edge, just behind the AT plate, CRTRF.txt

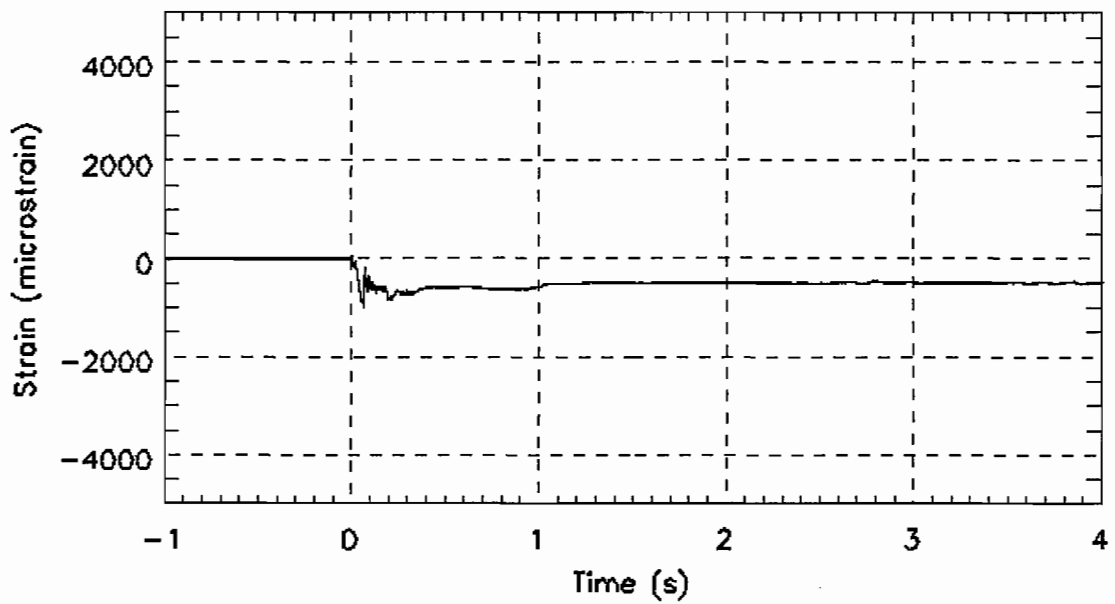

Figure H- 51. Strain measurement on the outside of the cant rail, top edge, midway across door opening, CRTRM.txt

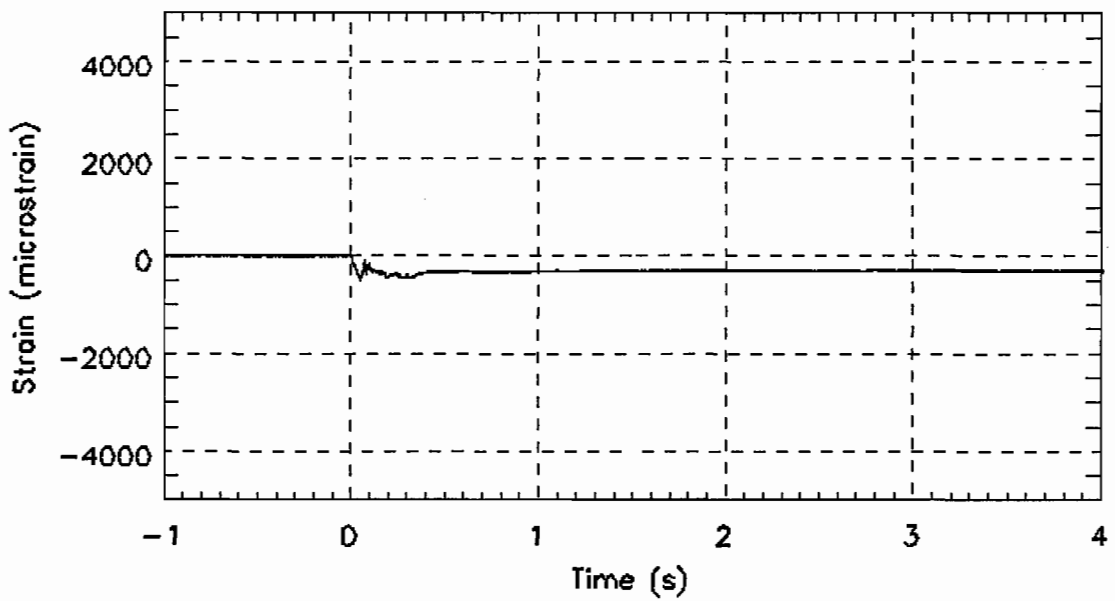

Figure H- 52. Strain measurement on the outside of the cant rail, top edge, midway across door opening, CRTRR.txt

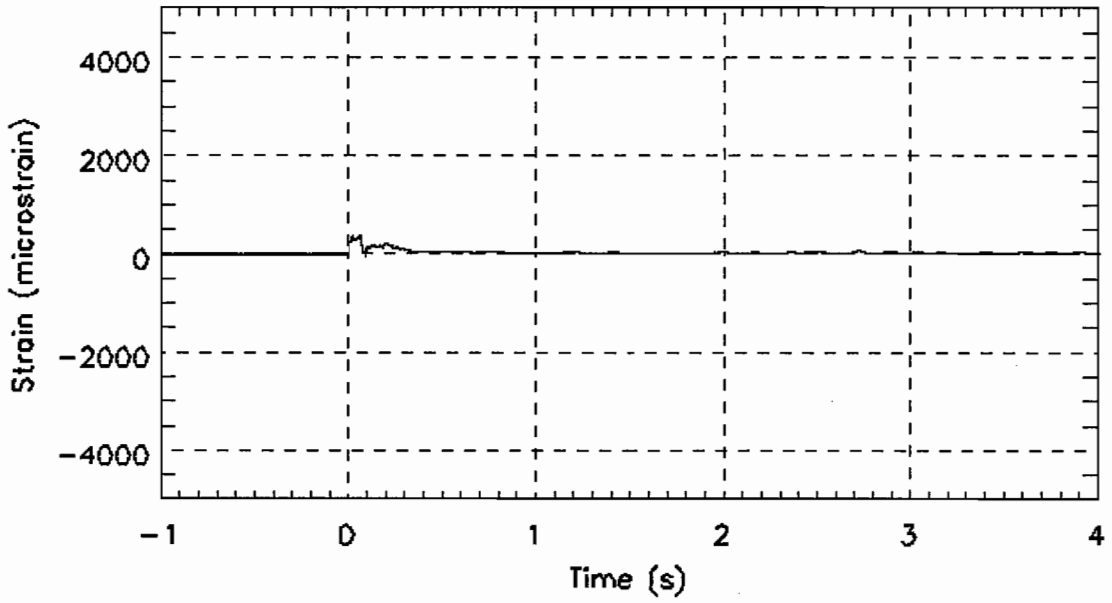

Figure H- 53. Strain measurement on the left side of the draft sill, 7" behind the buffer beam, 15 3/8" below the top edge of the sill, DSBLF.txt

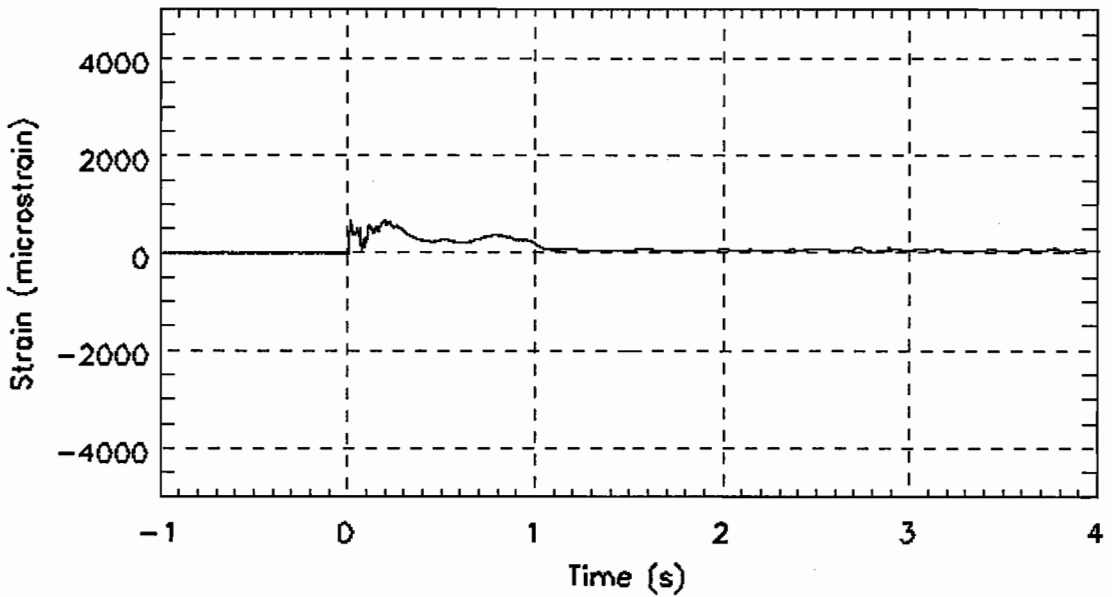

Figure H- 54. Strain measurement on the left side of the draft sill, 18 1/2" behind the buffer beam, 14" below the top edge of the sill, DSBLM.txt

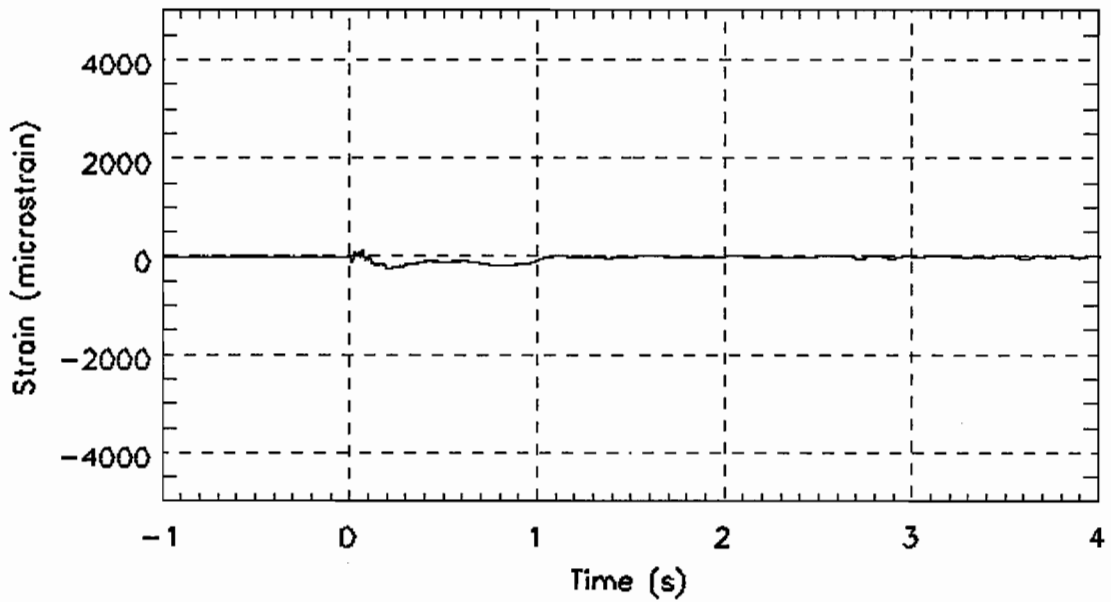

Figure H- 55. Strain measurement on the left side of the draft sill, 13 1/2" in front of the body bolster, 6 1/2" below the top edge of the sill, DSBLR.txt

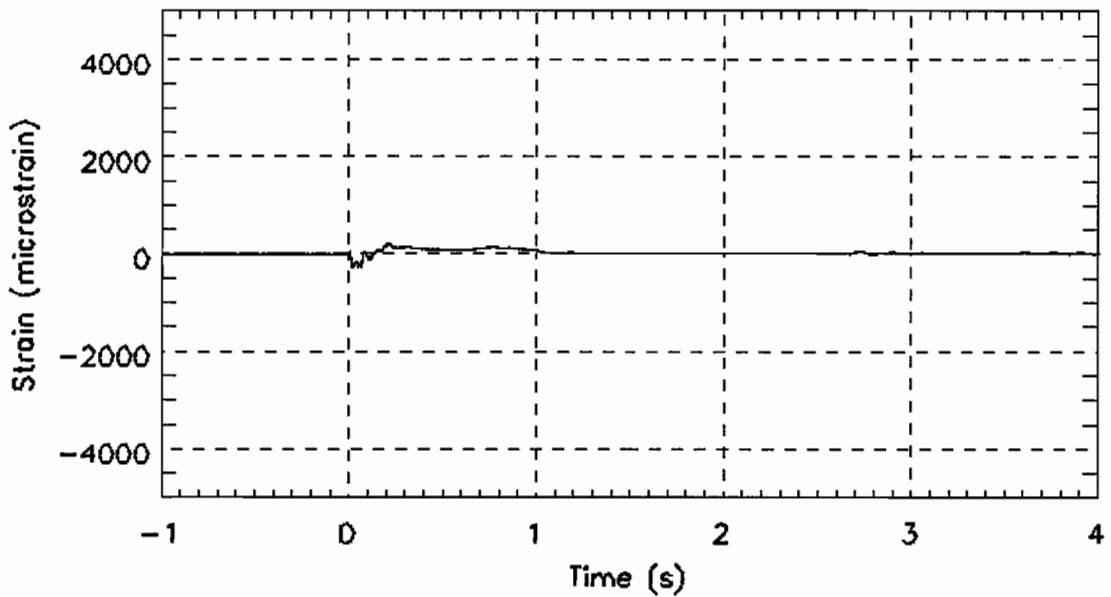

Figure H- 56. Strain measurement on the right side of the draft sill, 7" behind the buffer beam, 15 3/8" below the top edge of the sill, DSBRF.txt

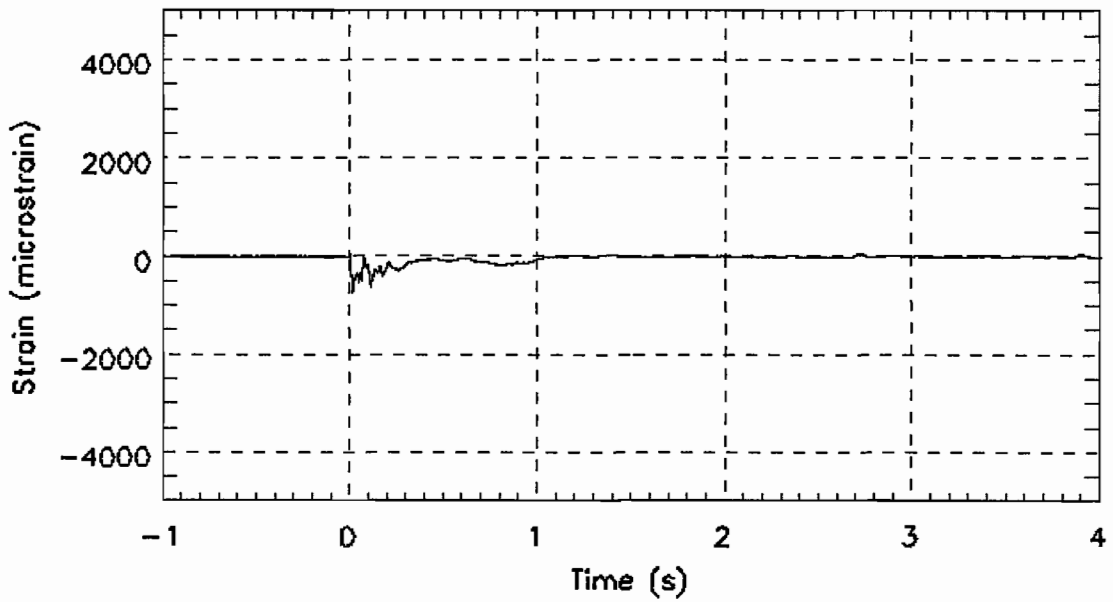

Figure H- 57. Strain measurement on the right side of the draft sill, 18 1/2" behind the buffer beam, 14" below the top edge of the sill, DSBRR.txt

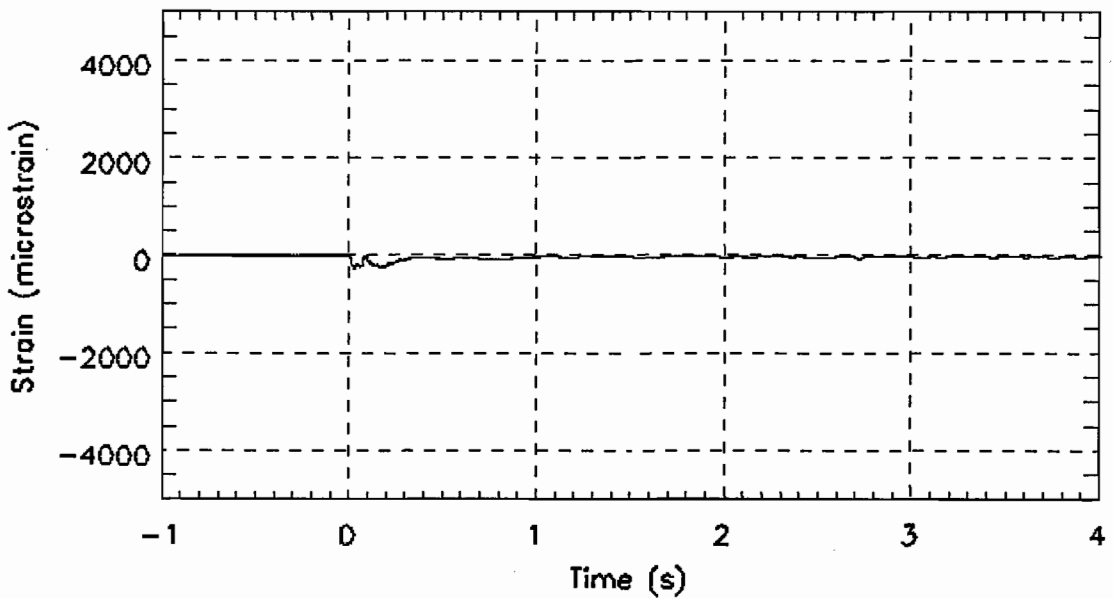

Figure H- 58. Strain measurement on the right side of the draft sill, 13 1/2" in front of the body bolster, 6 1/2" below the top edge of the sill, DSBRR.txt

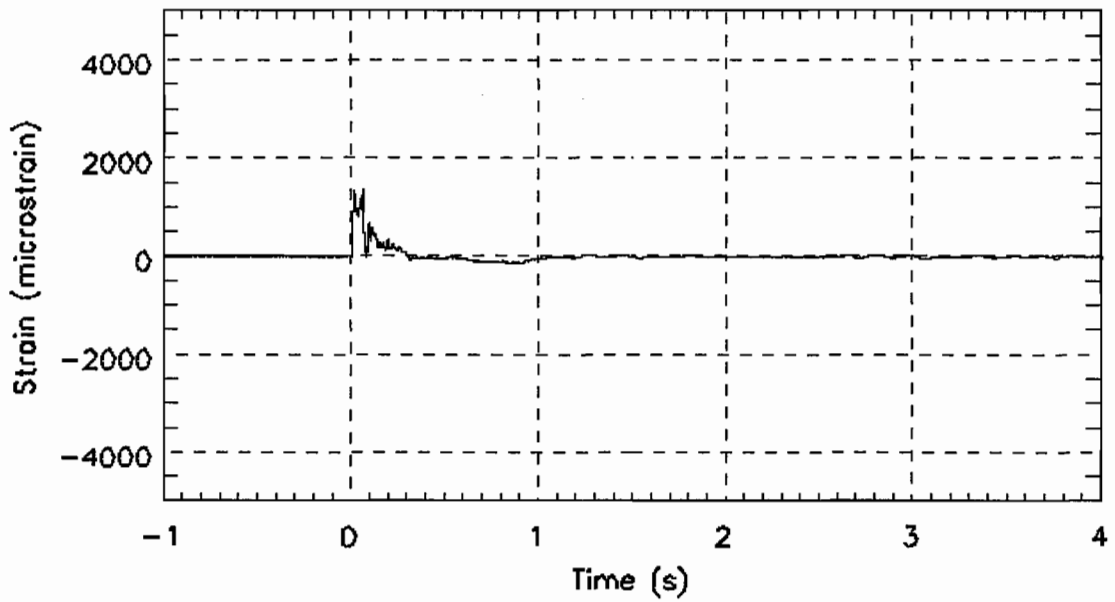

Figure H- 59. Strain measurement on the left side of the draft sill, 7" behind the buffer beam, 3" below the top edge of the sill, DSTLF.txt

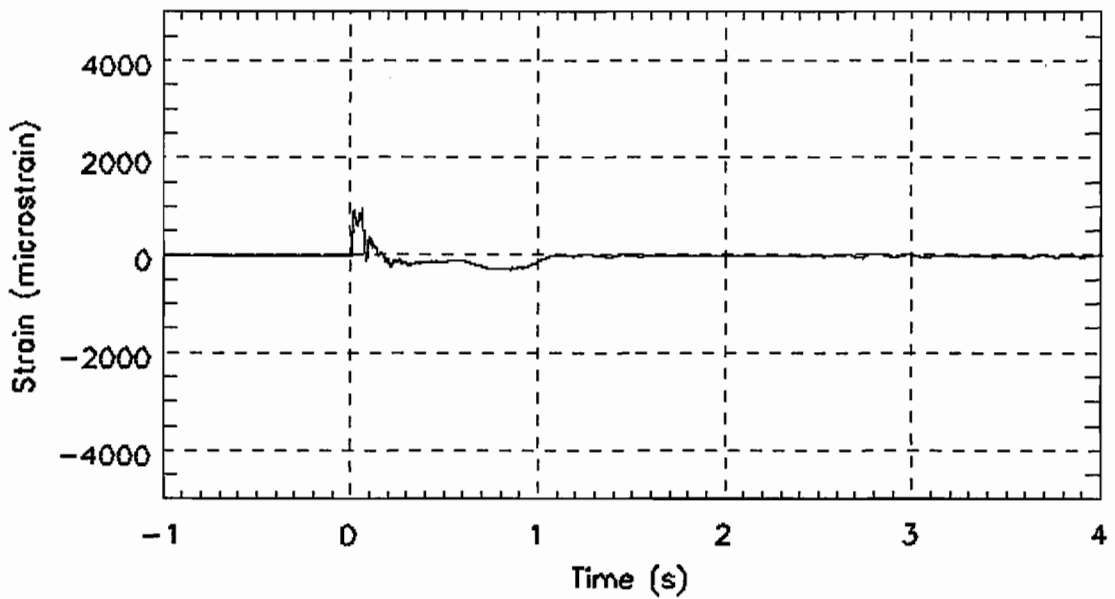

Figure H- 60. Strain measurement on the left side of the draft sill, 18 1/2" behind the buffer beam, 3" below the top edge of the sill, DSTLM.txt

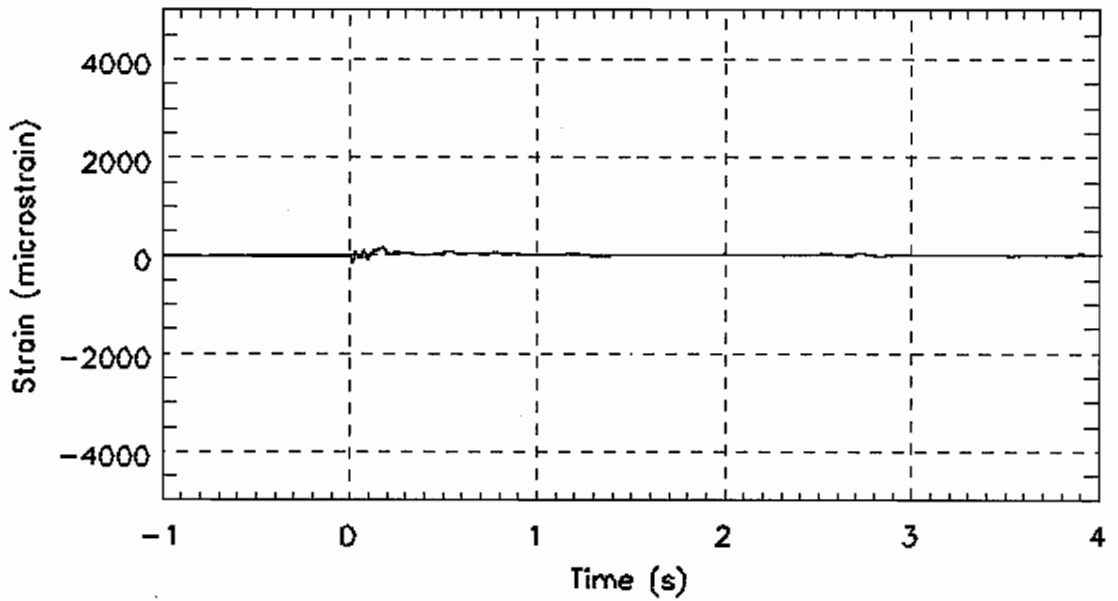

Figure H- 61. Strain measurement on the left side of the draft sill, 13 1/2" in front of the body bolster, 2 3/4" below the top edge of the sill, DSTLR.txt

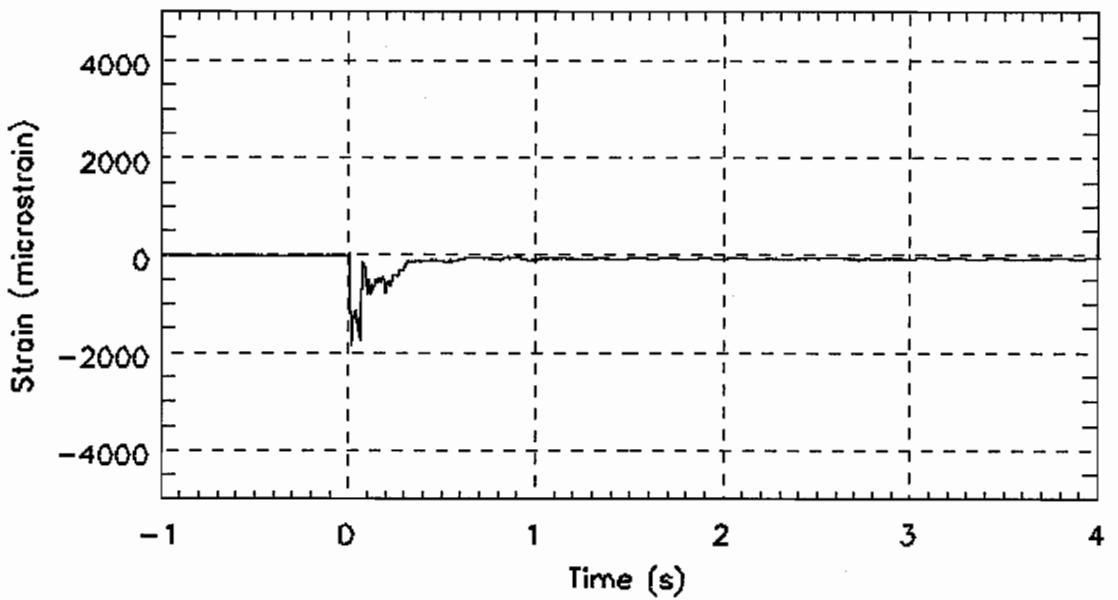

Figure H- 62. Strain measurement on the right side of the draft sill, 7" behind the buffer beam, 3" below the top edge of the sill, DSTRF.txt

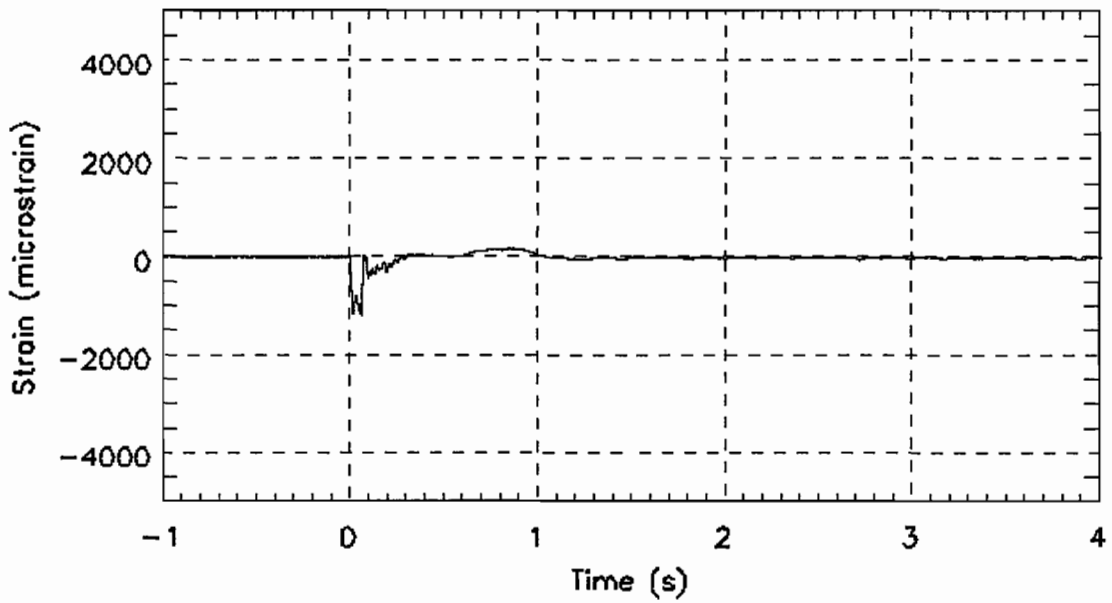

Figure H- 63. Strain measurement on the right side of the draft sill, 18 1/2" behind the buffer beam, 3" below the top edge of the sill, DSTRM.txt

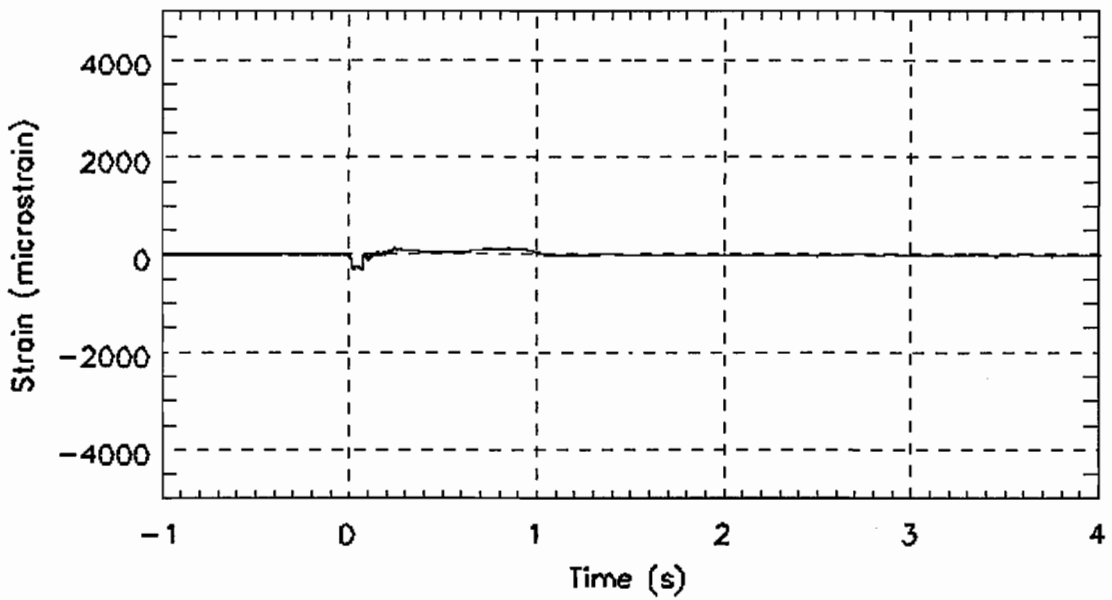

Figure H- 64. Strain measurement on the right side of the draft sill, 13 1/2" in front of the body bolster, 2 3/4" below the top edge of the sill, DSTRR.txt

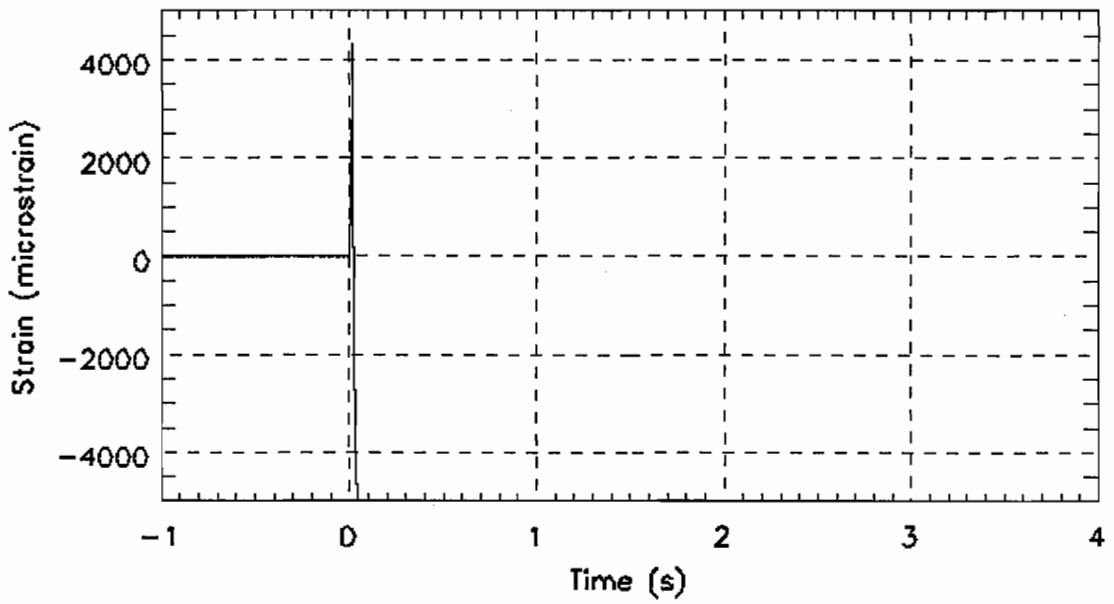

Figure H- 65. Strain measurement on the front of the lateral member, near the collision post, 5/32" above the bottom edge, LMLFB.txt

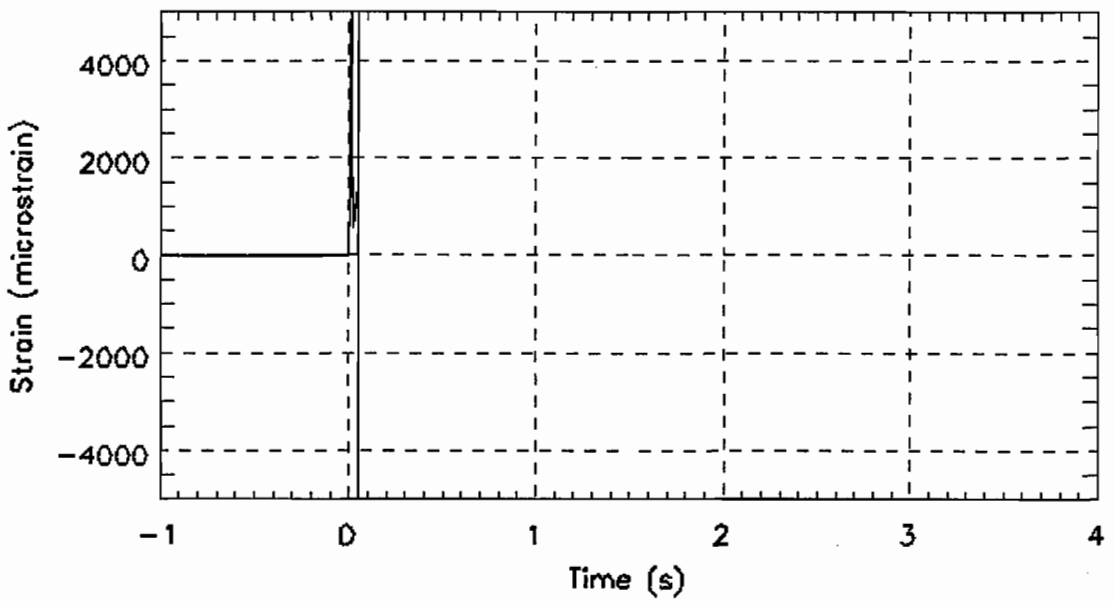

Figure H- 66. Strain measurement on the front of the lateral member, near the collision post, 15/16" below the top edge, LMLFT.txt

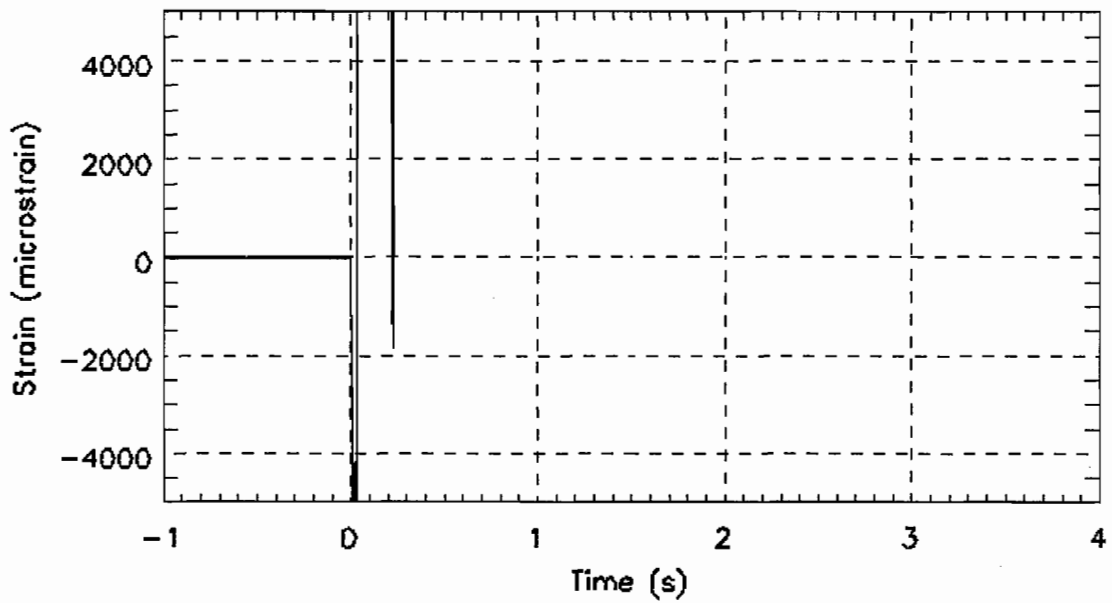

Figure H- 67. Strain measurement on the rear of the lateral member, near the collision post, 5/32" above the bottom edge, LMLRB.txt

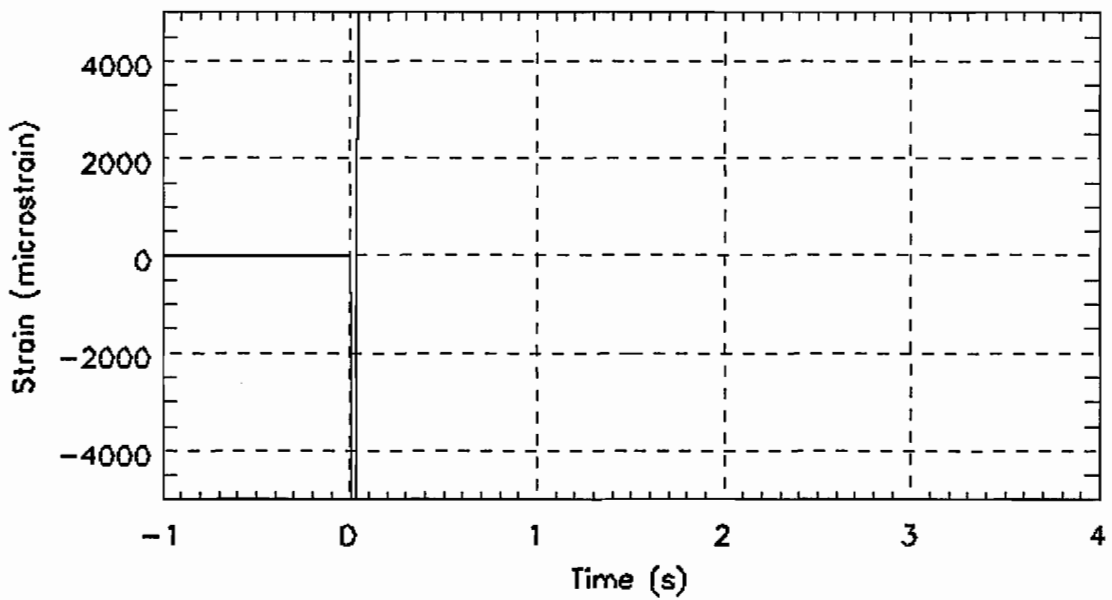

Figure H- 68. Strain measurement on the rear of the lateral member, near the collision post, 15/16" below the top edge, LMLRT.txt

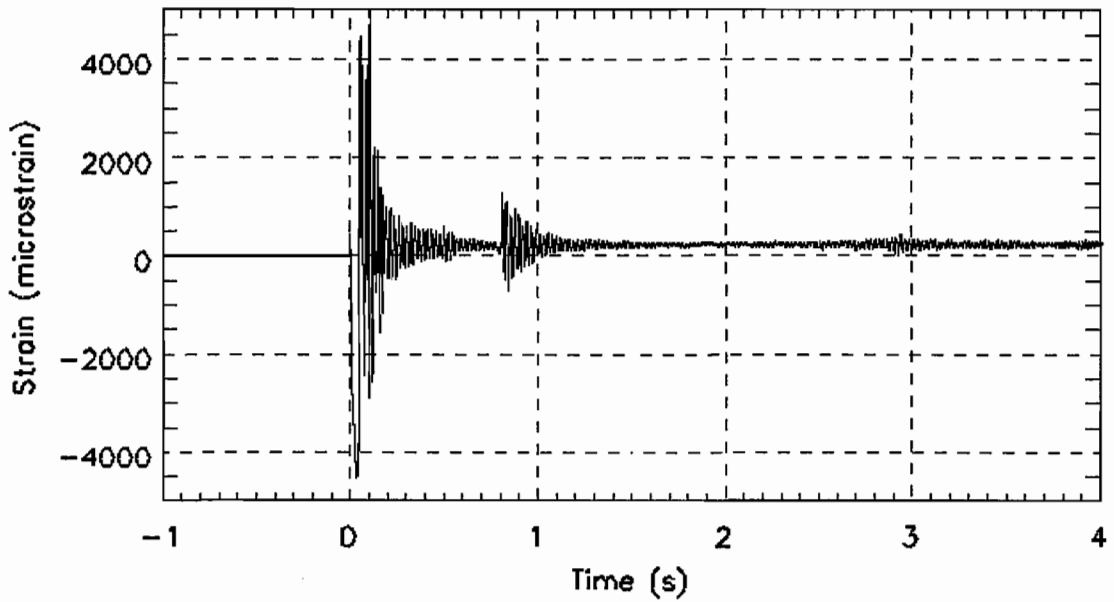

Figure H- 69. Strain measurement on the front of the lateral member, near the corner post, 5/32" above the bottom edge, LMRFB.txt

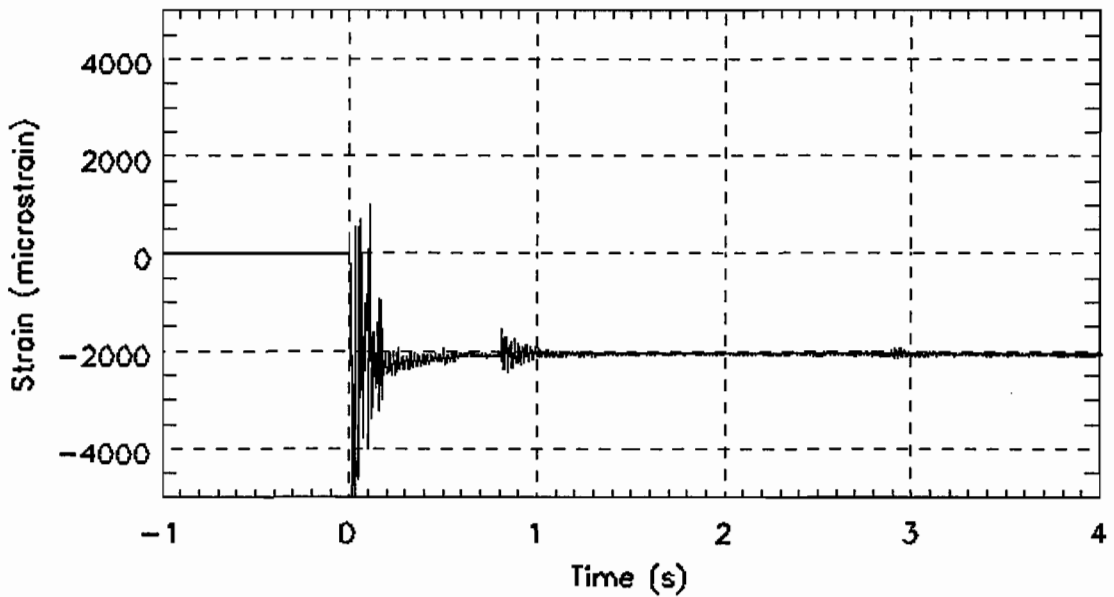

Figure H- 70. Strain measurement on the front of the lateral member, near the corner post, 15/16" below the top edge, LMRFT.txt

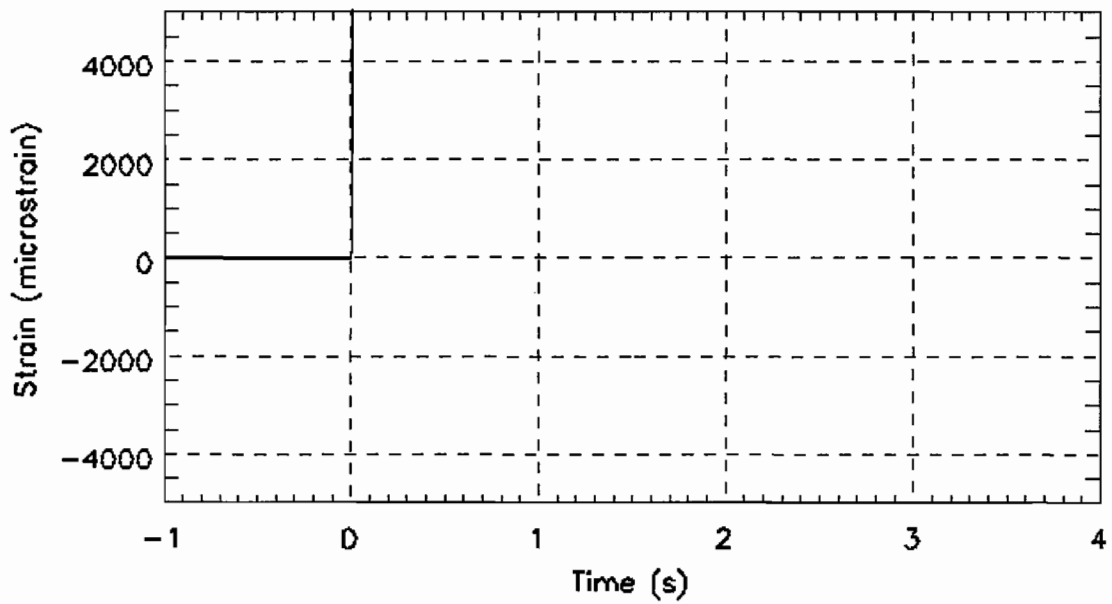

Figure H- 71. Strain measurement on the rear of the lateral member, near the corner post, 5/32" above the bottom edge, LMRRB.txt

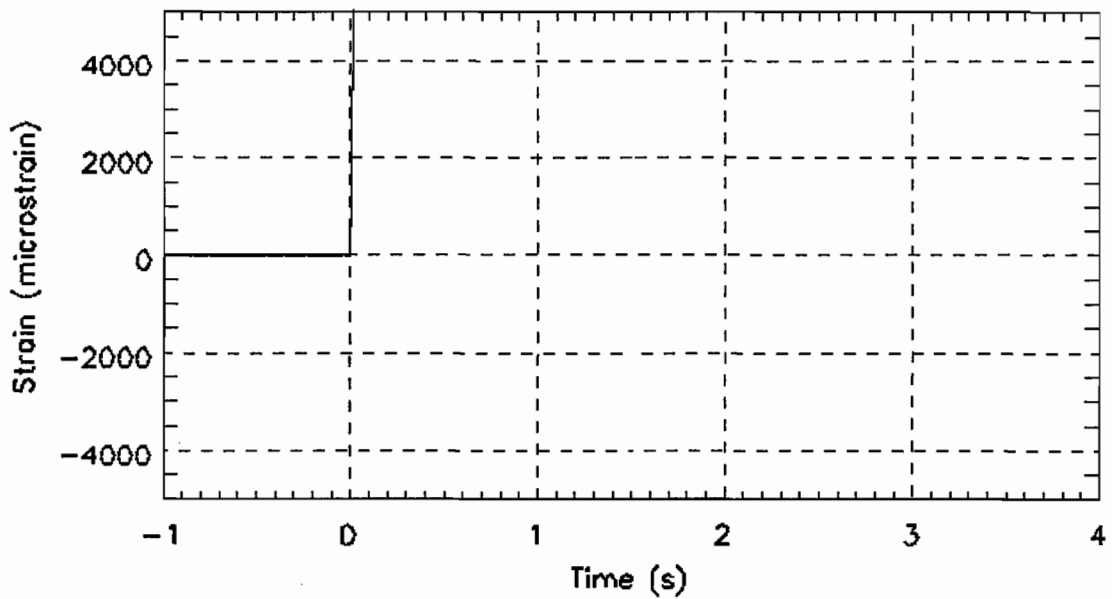

Figure H- 72. Strain measurement on the rear of the lateral member, near the corner post, 15/16" below the top edge, LMRRT.txt

Appendix I

Test 4 Synthetic Channels

This page left blank intentionally

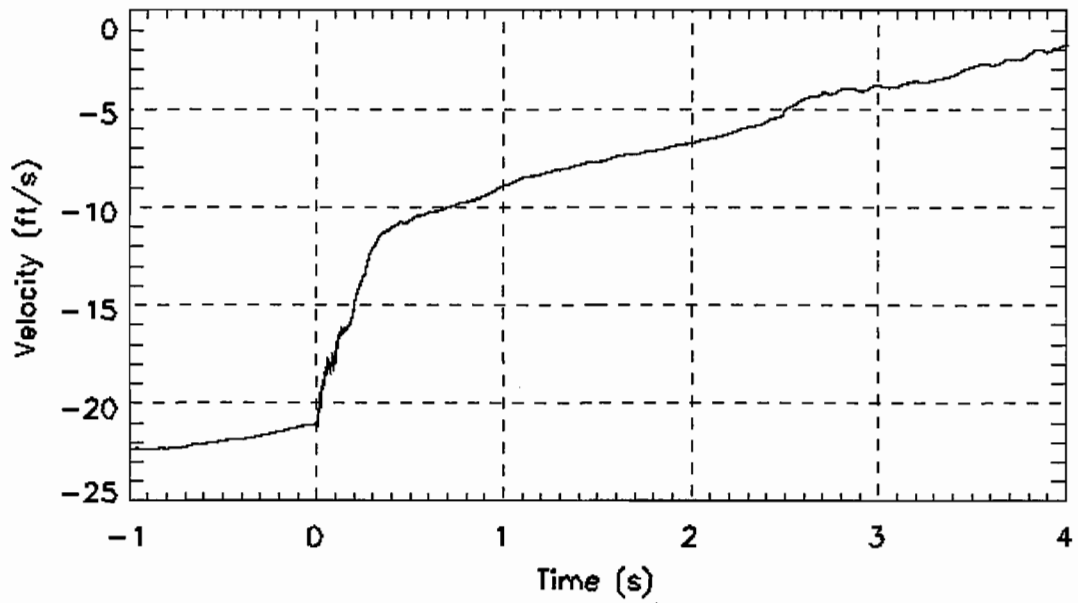

Figure I-1. Velocity derived from integration of acceleration data at the C2 location - C2X_Vel.txt

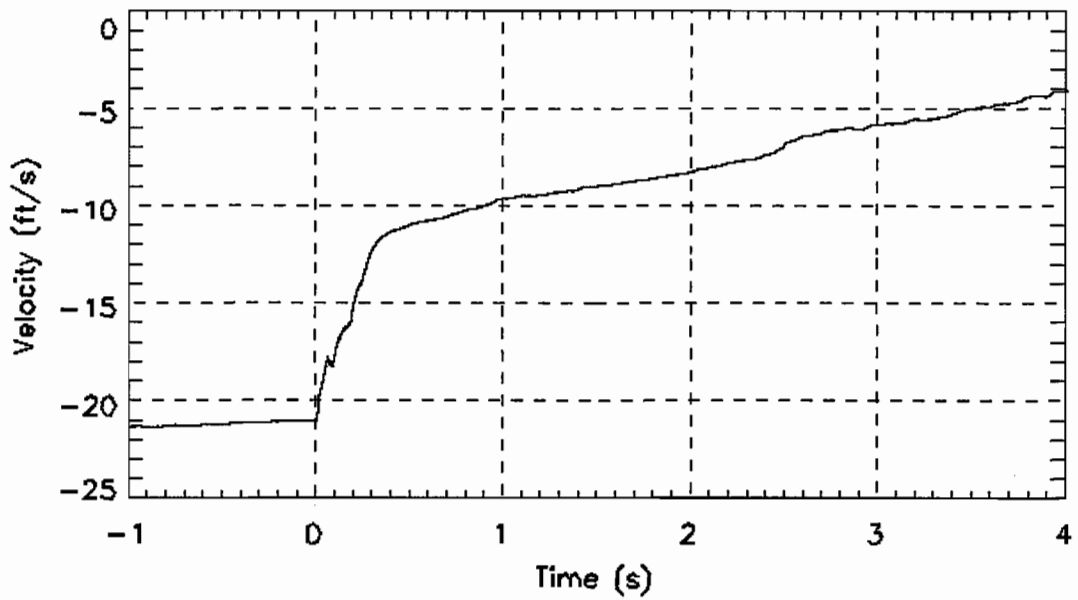

Figure I-2. Velocity derived from integration of acceleration data at the C3 location - C3X_Vel.txt

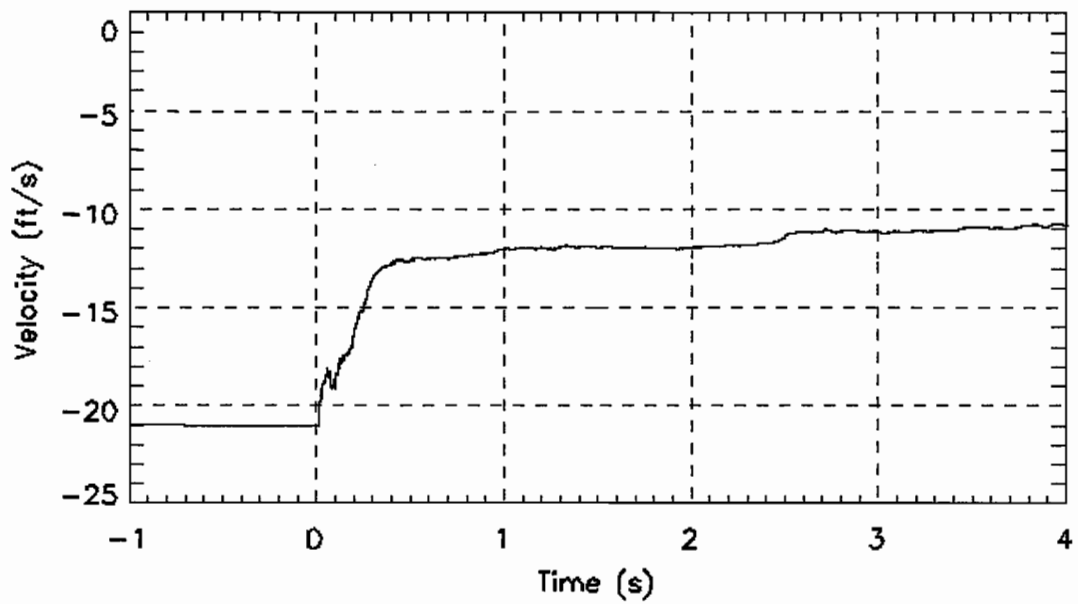

Figure I-3. Velocity derived from integration of acceleration data at the C4 location - C4X_Vel.txt

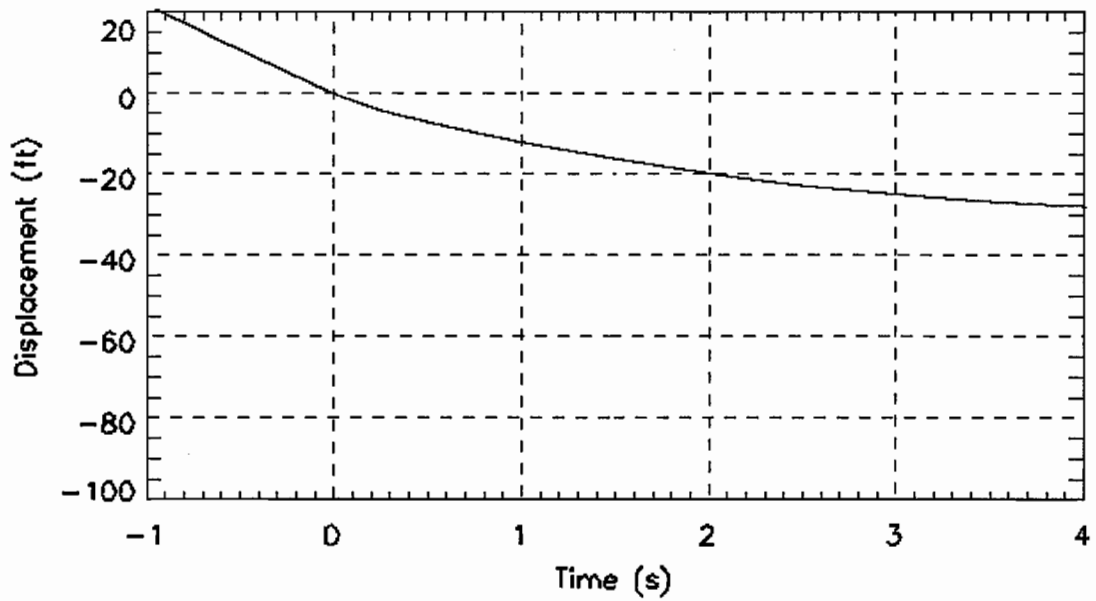

Figure I-4. Displacement derived from integration of velocity data at the C2 location - C2X_Displ.txt

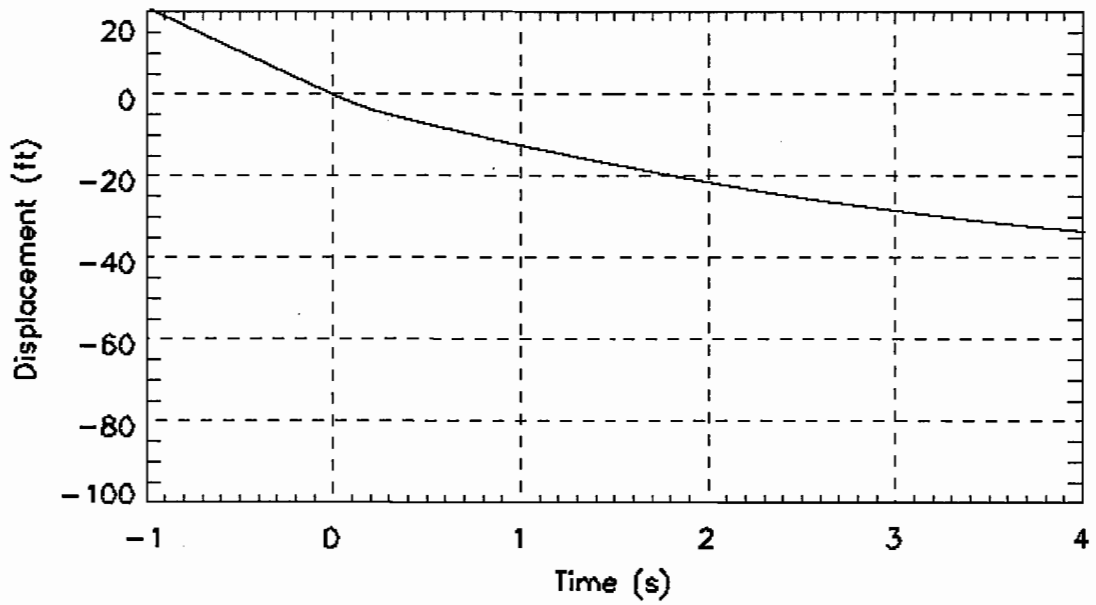

Figure I- 5. Displacement derived from integration of velocity data at the C3 location - C3X_Displacement.txt

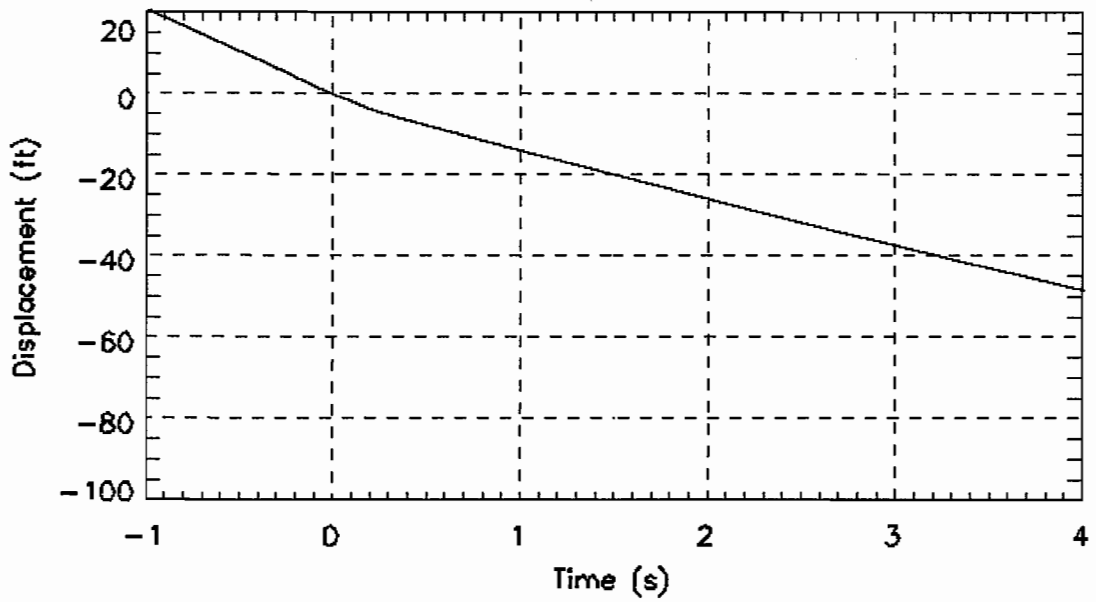

Figure I- 6. Displacement derived from integration of velocity data at the C4 location - C4X_Displacement.txt

4

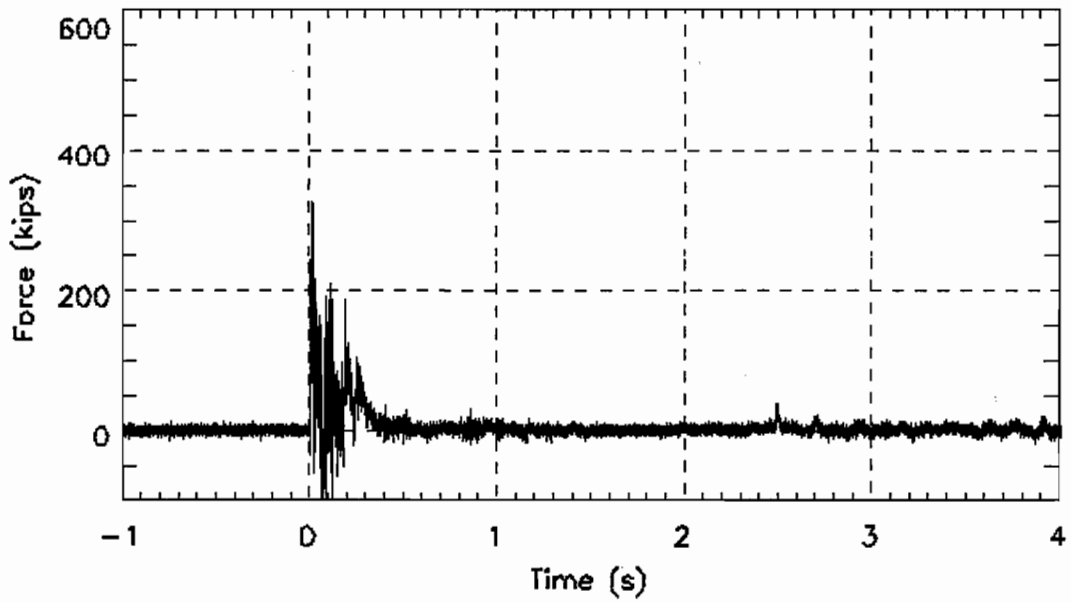

Figure I-7. Force data derived from the acceleration of the CG, 1000Hz - CG_X_Force_1000Hz.txt

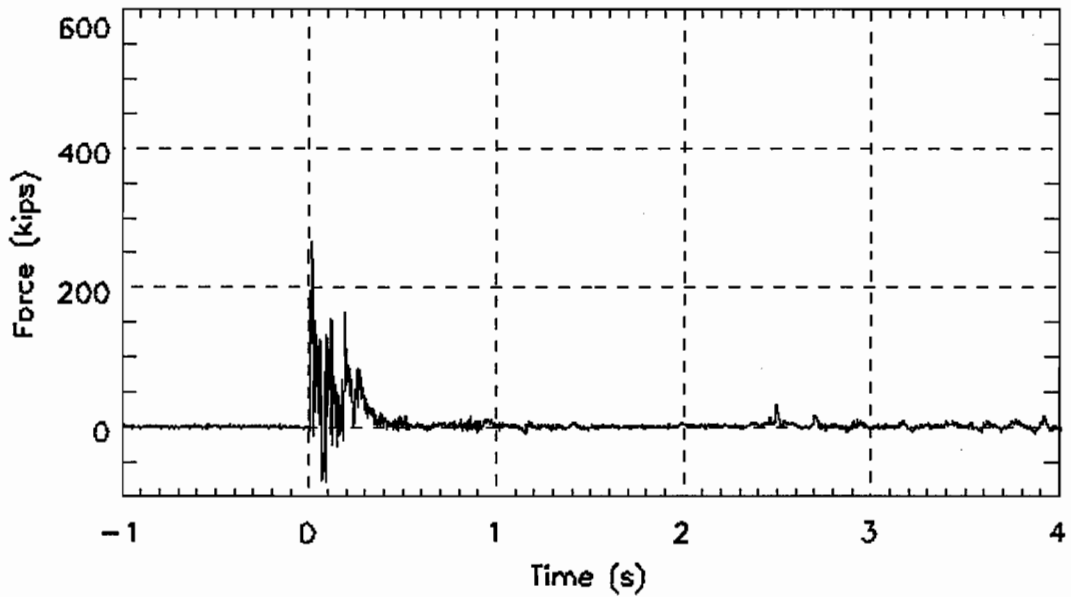

Figure I-8. Force data derived from the acceleration of the CG, 100Hz - CG_X_Force_100Hz.txt

5

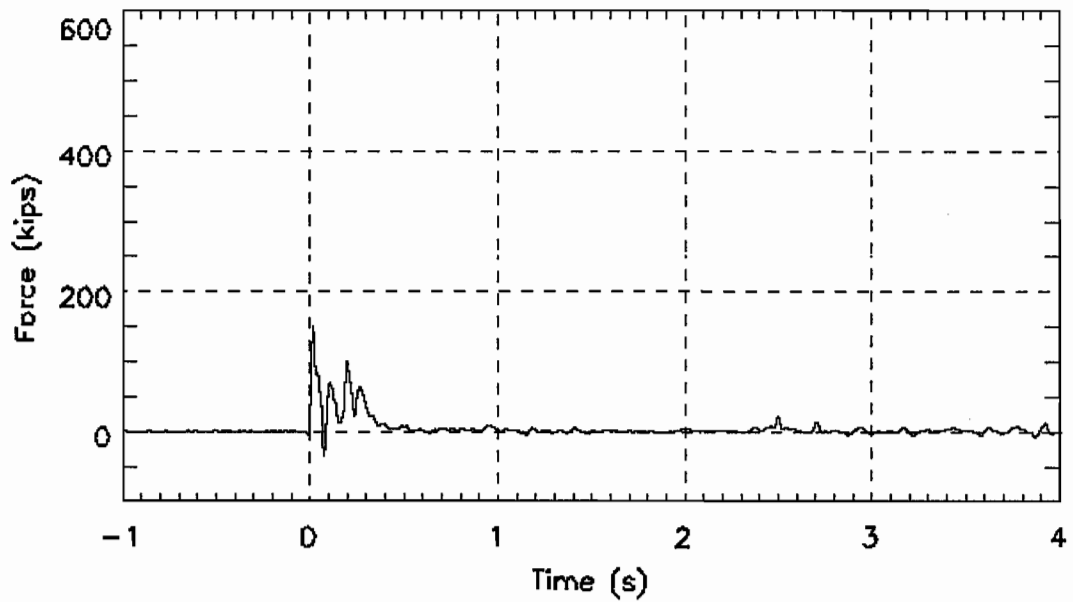

Figure I- 9. Force data derived from the acceleration of the CG, 25Hz - CG_X_Force_25Hz.txt

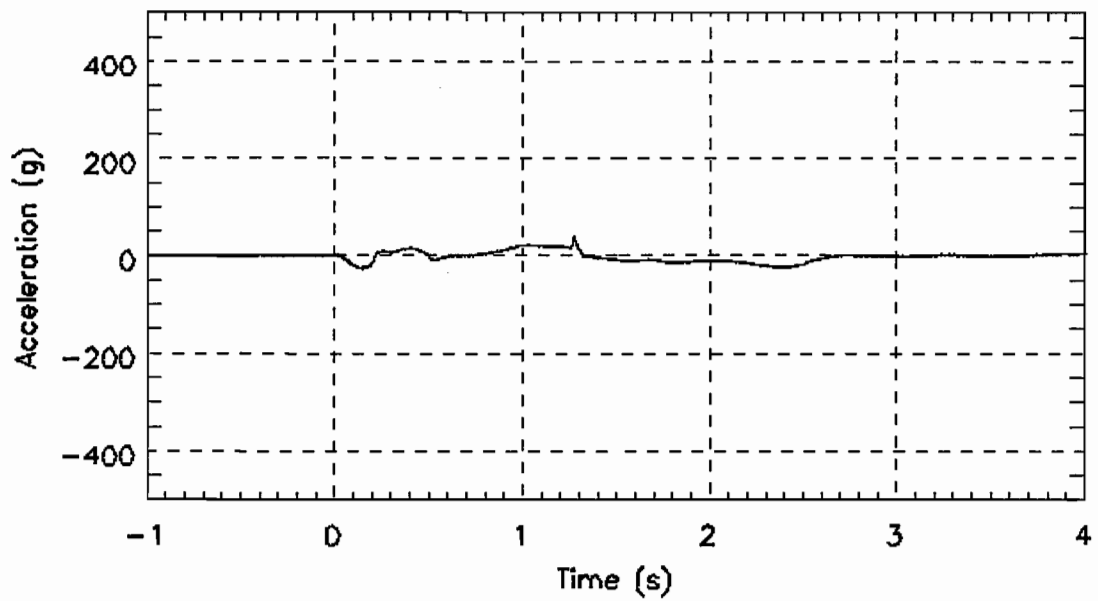

Figure I- 10. Coil rotation about the X-axis, ROTX_1000Hz.txt

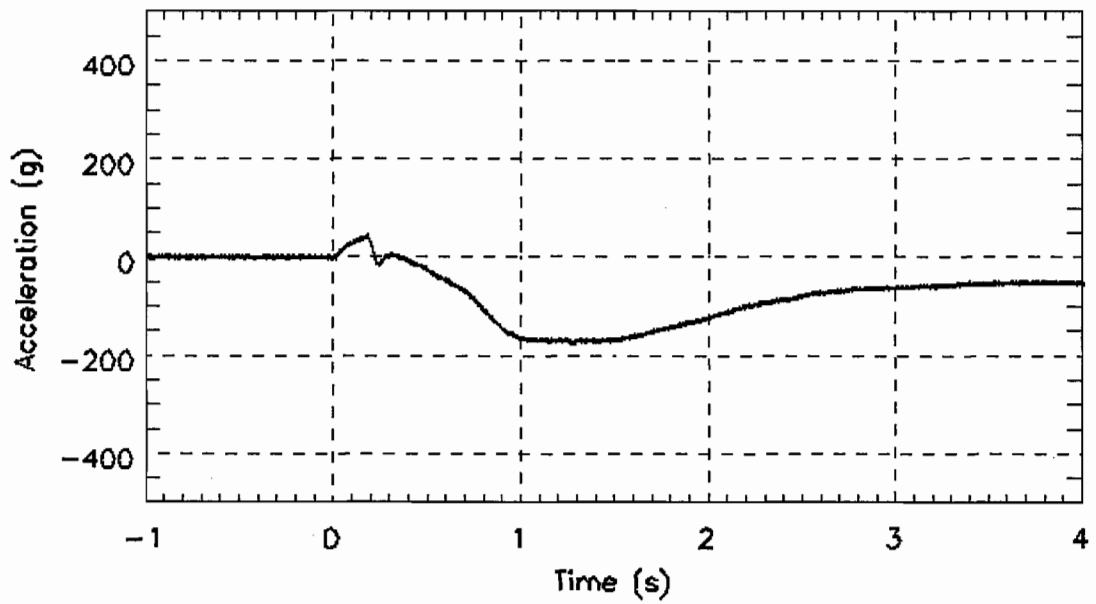

Figure I-11. Coil rotation about the Y-axis, ROTY_1000Hz.txt

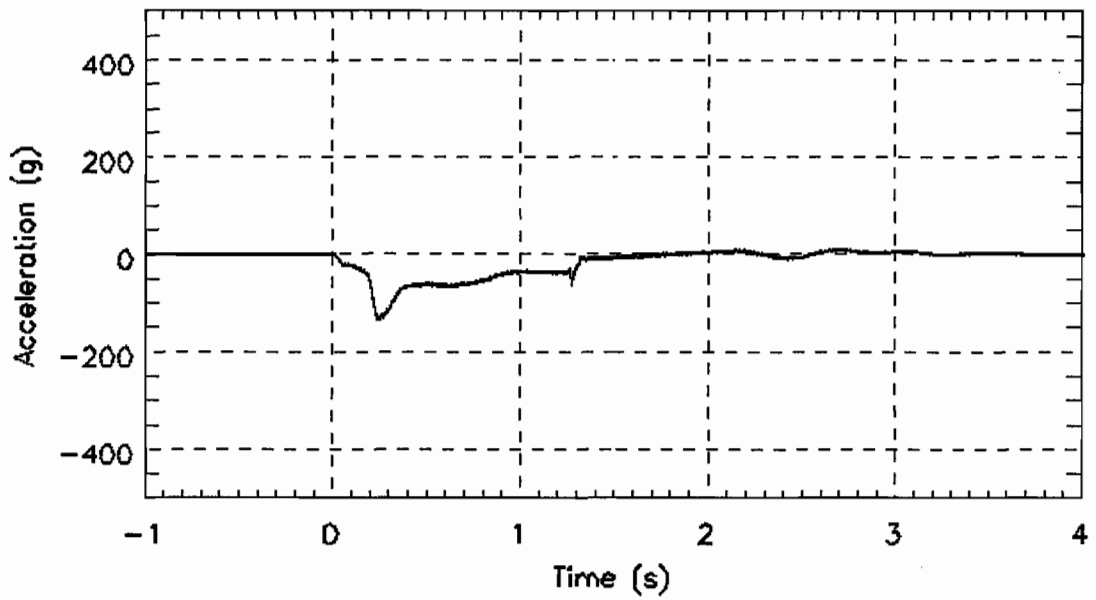

Figure I-12. Coil rotation about the Z-axis, ROTZ_1000Hz.txt

Appendix J

Test 5
Acceleration Data, CFC = 1000Hz

This page left blank intentionally

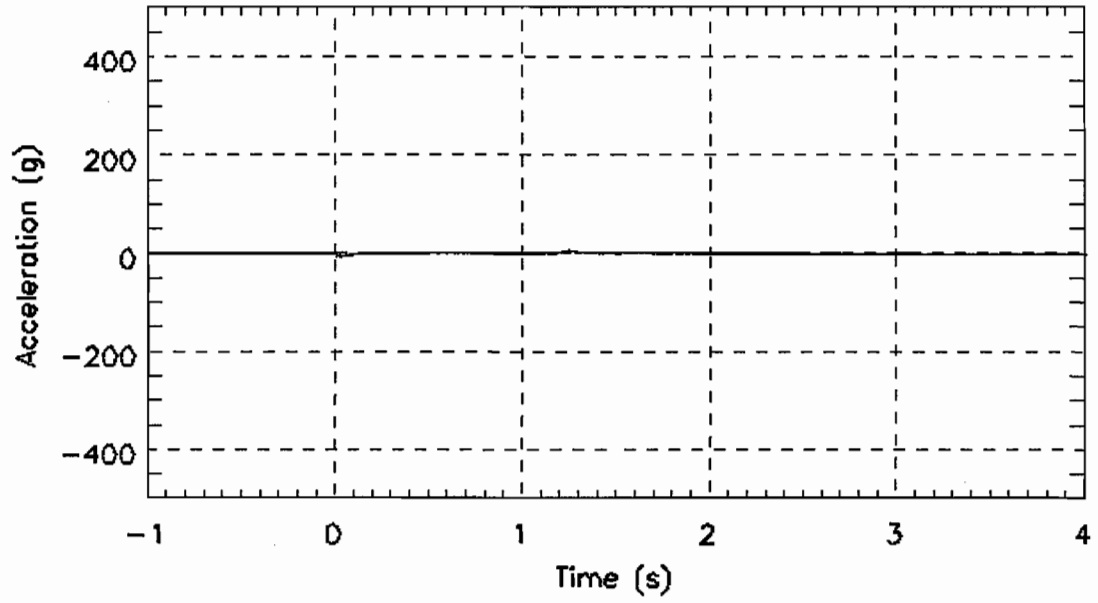

Figure J- 1. Steel coil, centered, longitudinal acceleration, no digital filter, A0X_1000Hz.txt

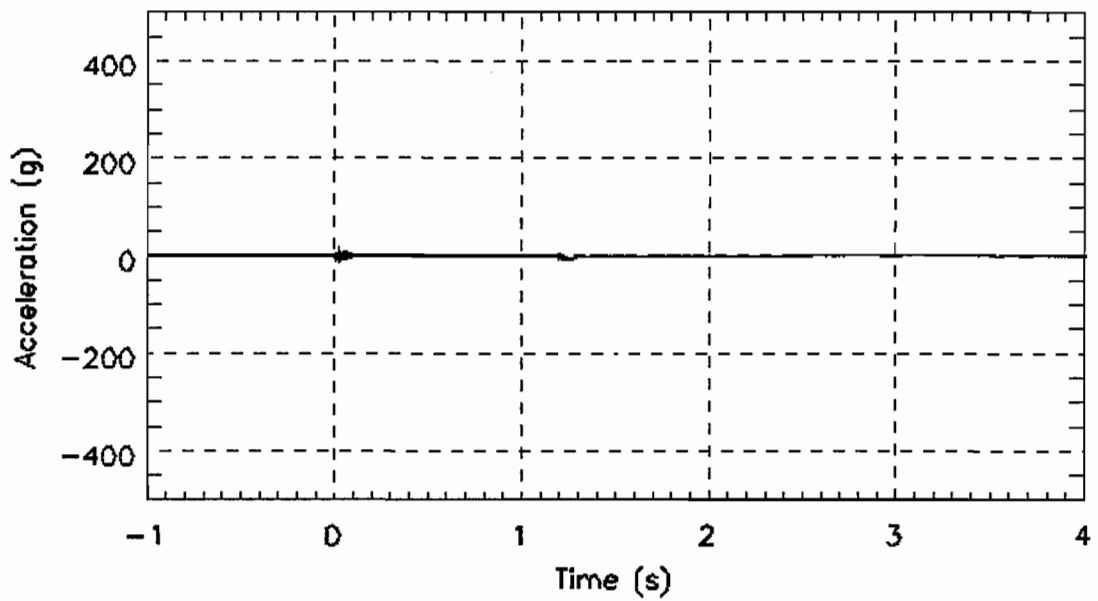

Figure J- 2. Steel coil, centered, lateral acceleration, no digital filter, A0Y_1000Hz.txt

0

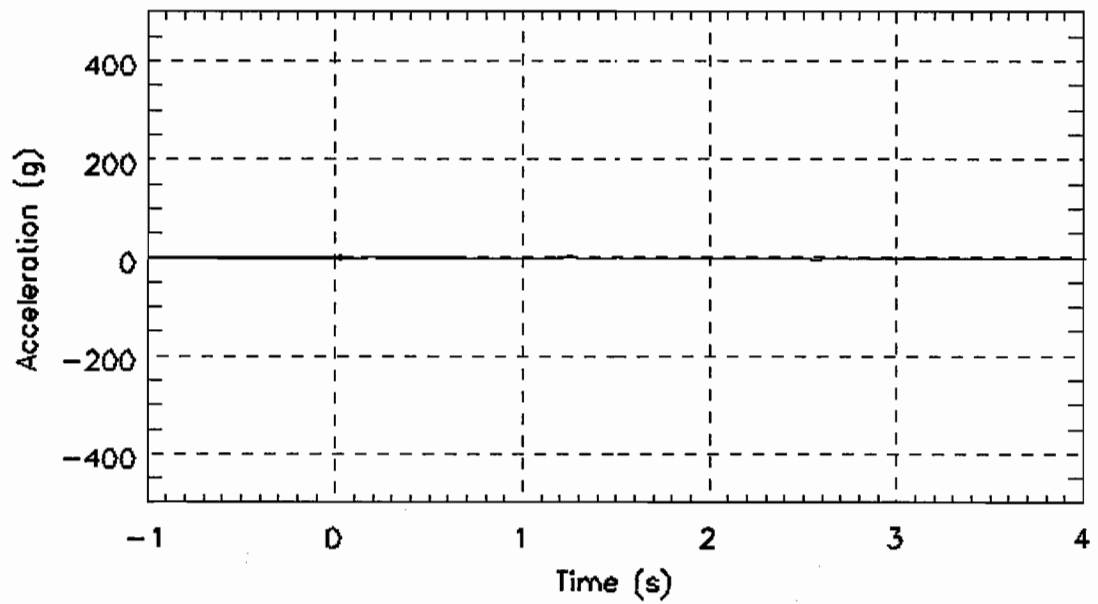

Figure J- 3. Steel coil, centered, vertical acceleration, no digital filter, A0Z_1000Hz.txt

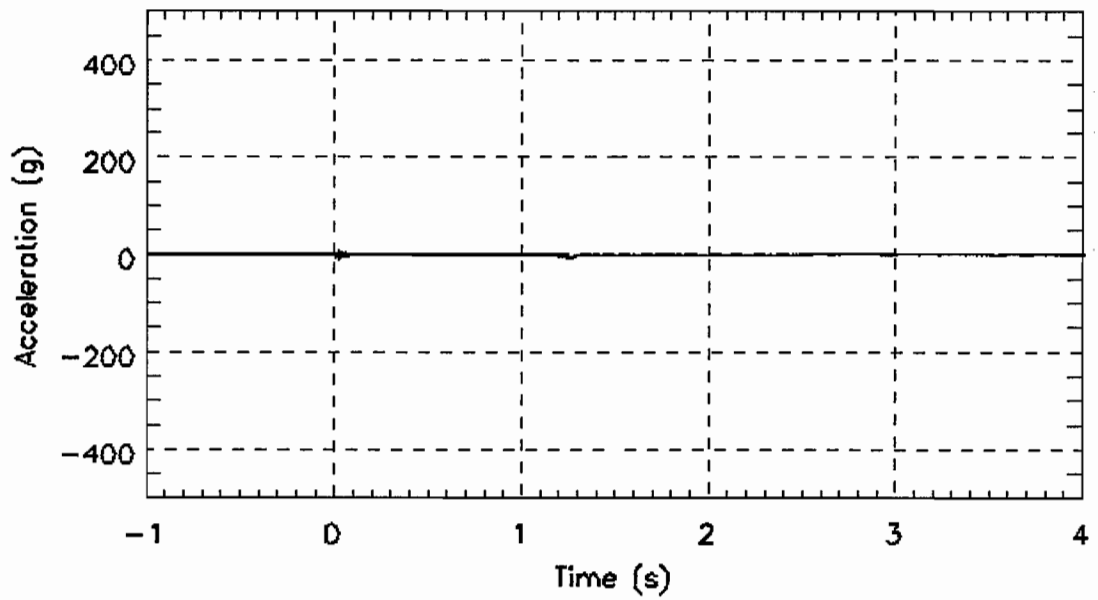

Figure J- 4. Steel coil, offset along X axis, lateral acceleration, no digital filter, A1Y_1000Hz.txt

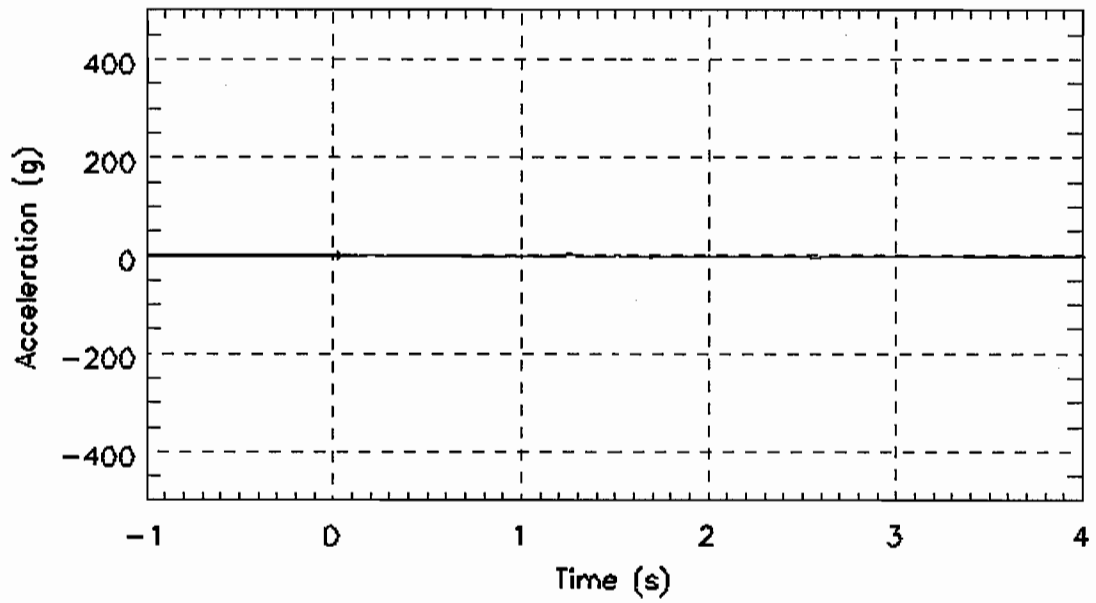

Figure J- 5. Steel coil, offset along X axis, vertical acceleration, no digital filter, A1Z_1000Hz.txt

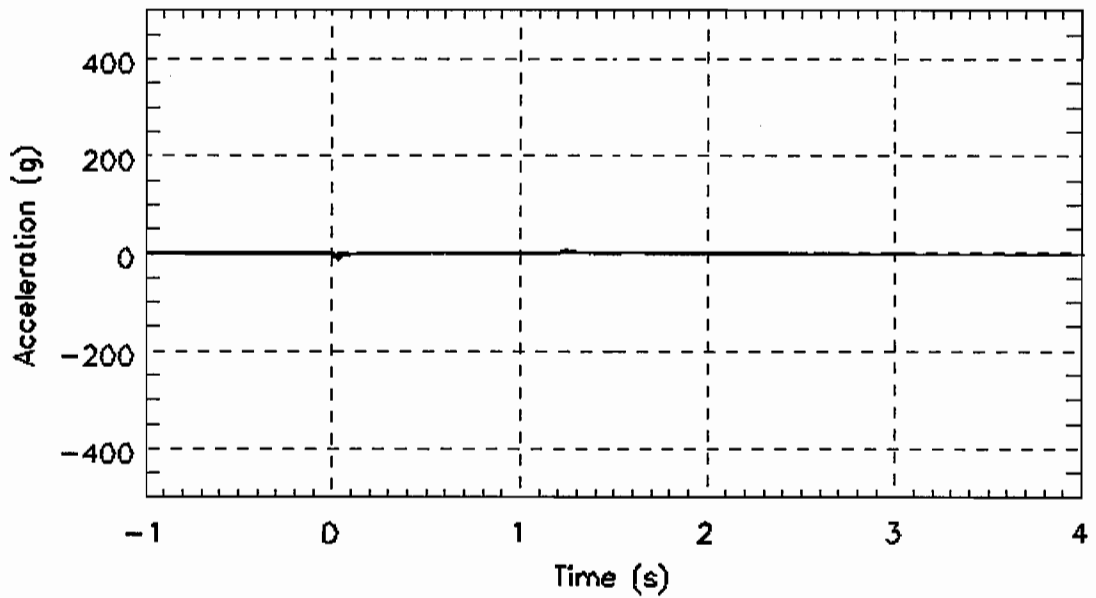

Figure J- 6. Steel coil, offset along Y axis, longitudinal acceleration, no digital filter, A2X_1000Hz.txt

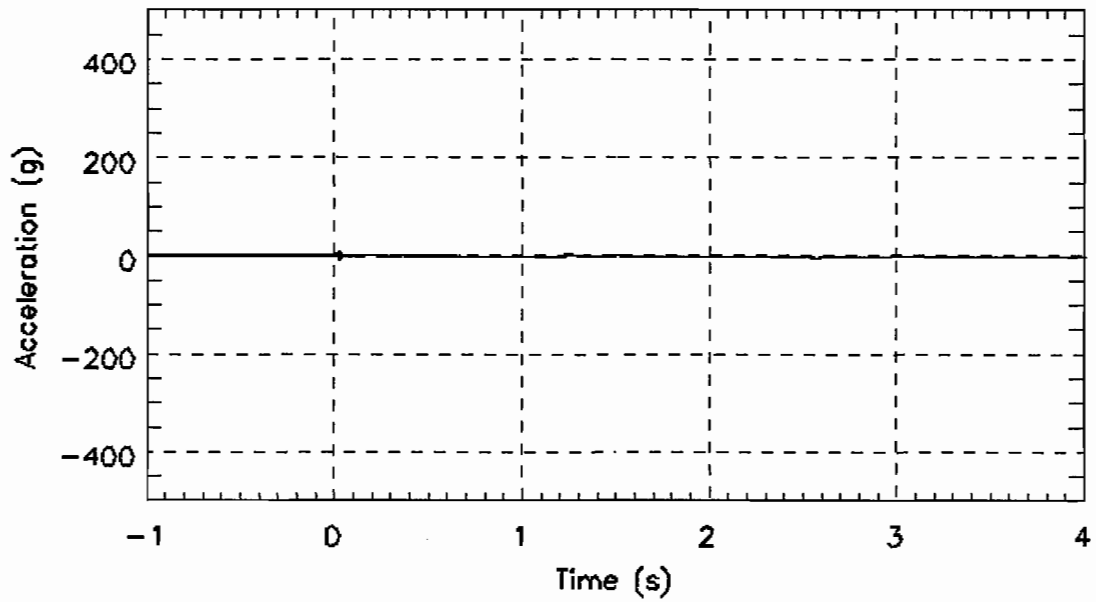

Figure J- 7. Steel coil, offset along Y axis, vertical acceleration, no digital filter, A2Z_1000Hz.txt

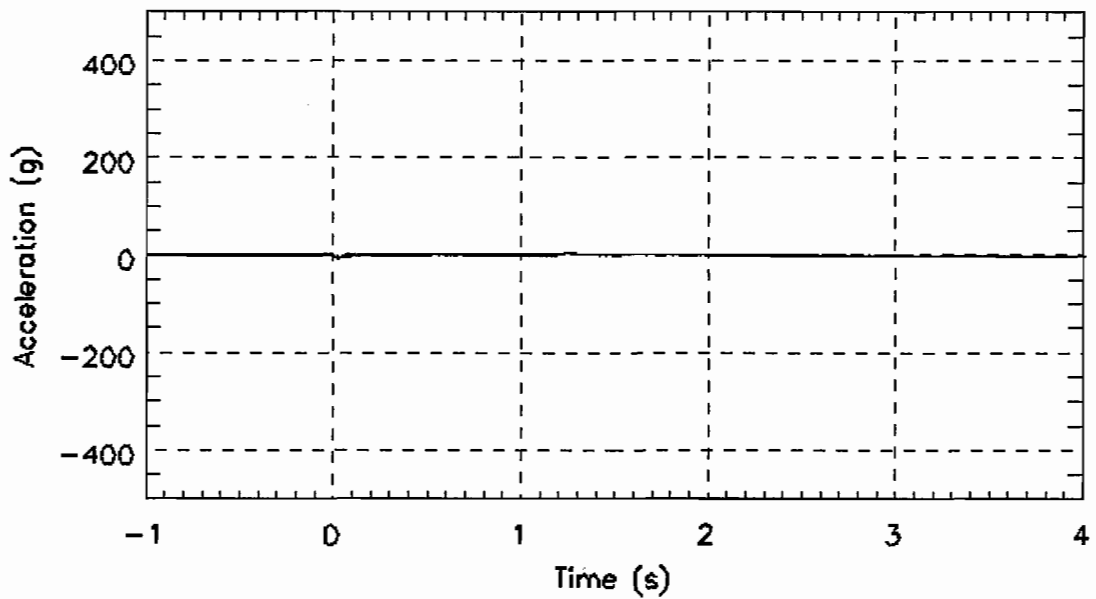

Figure J- 8. Steel coil, offset along Z axis, longitudinal acceleration, no digital filter, A3X_1000Hz.txt

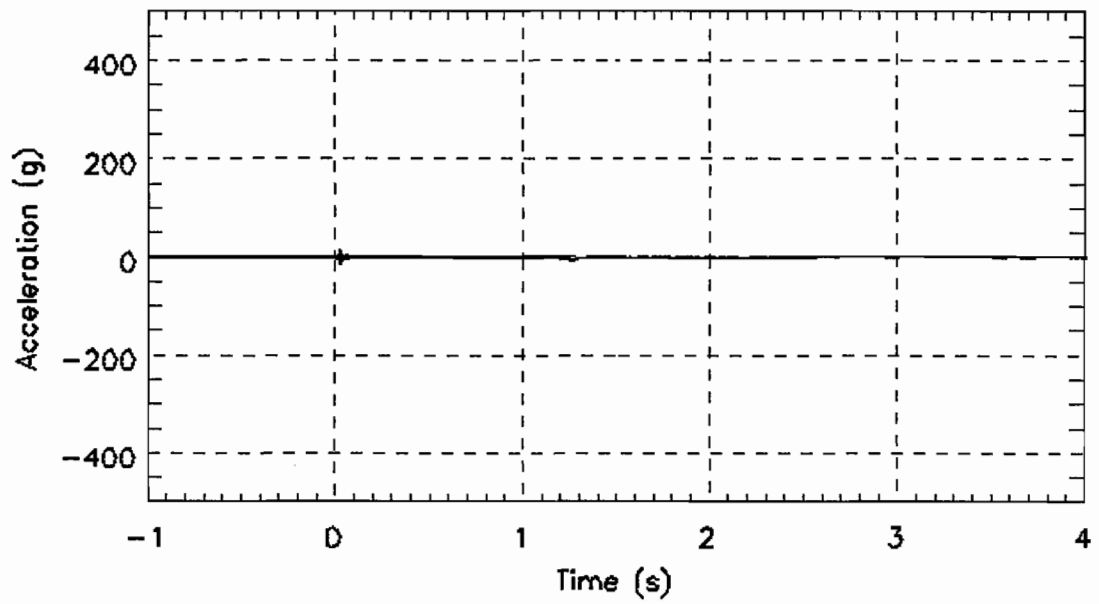

Figure J- 9. Steel coil, offset along Z axis, lateral acceleration, no digital filter, A3Y_1000Hz.txt

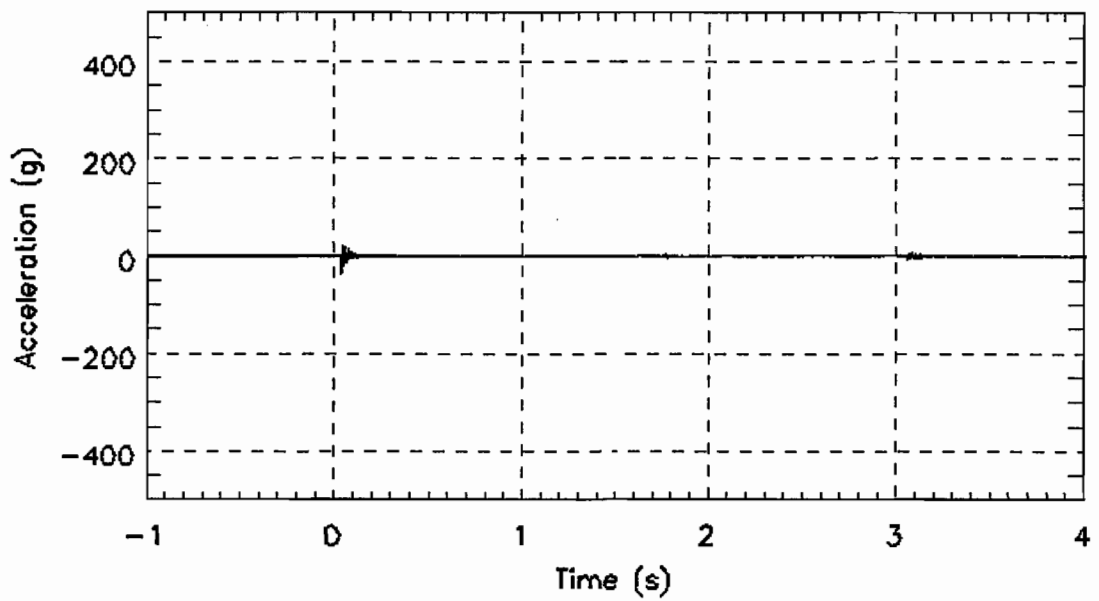

Figure J- 10. Lead bogie, lateral acceleration, no digital filter, BAY_1000Hz.txt

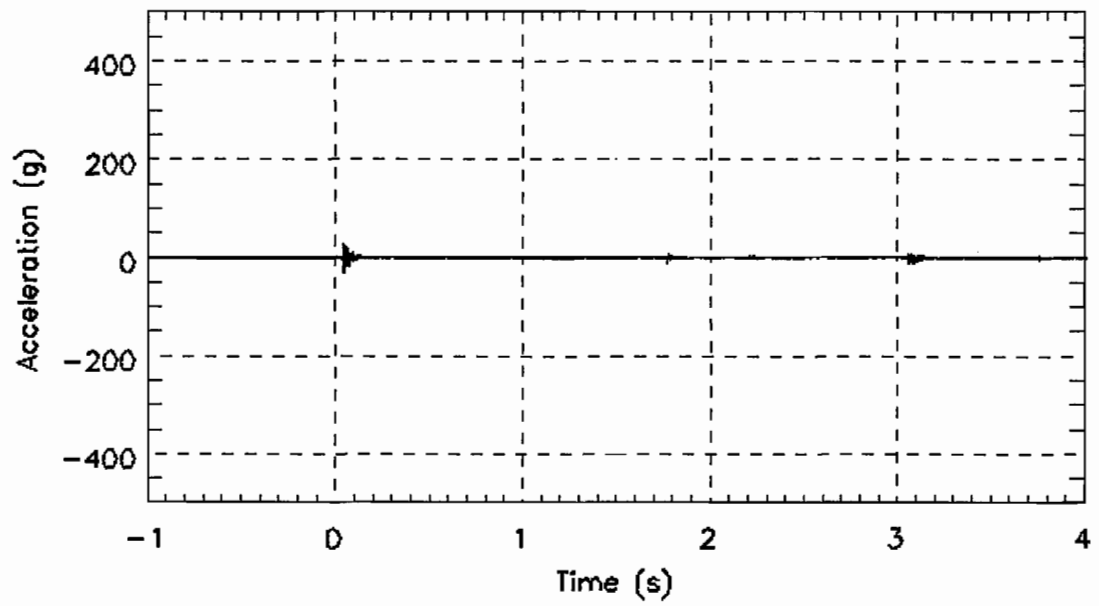

Figure J- 11. Lead bogie, vertical acceleration, no digital filter, BAZ_1000Hz.txt

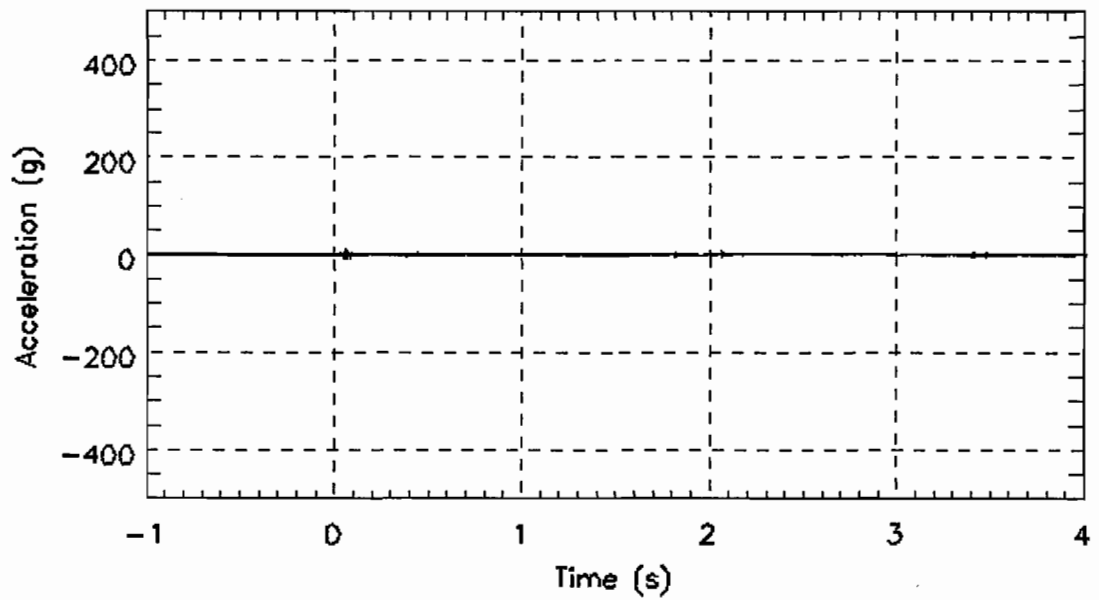

Figure J- 12. Trail bogie, lateral acceleration, no digital filter, BBY_1000Hz.txt

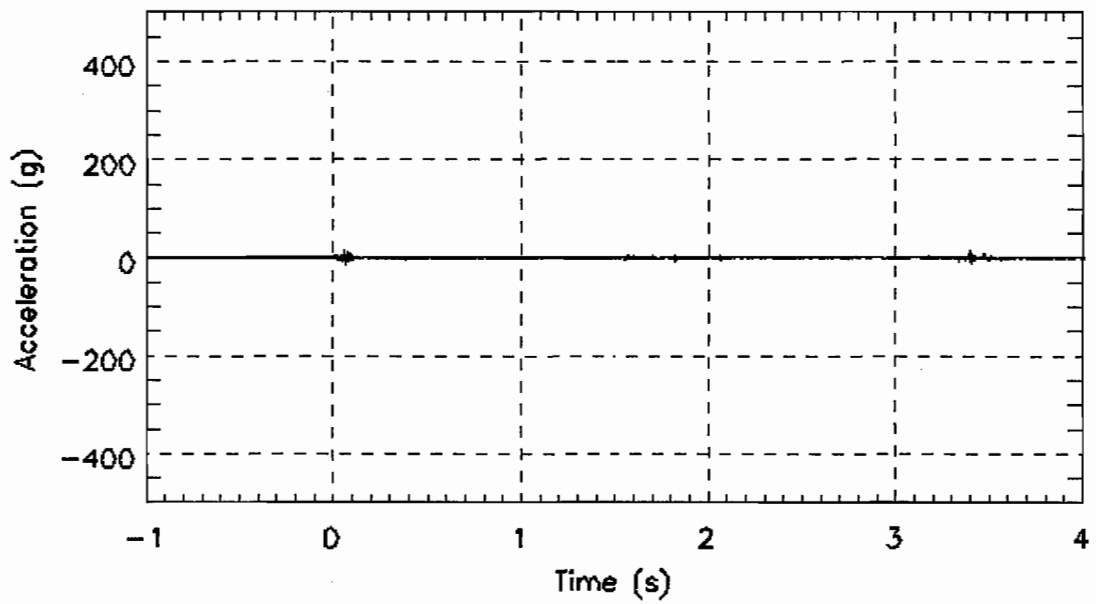

Figure J- 13. Trail bogie, vertical acceleration, no digital filter, BBZ_1000Hz.txt

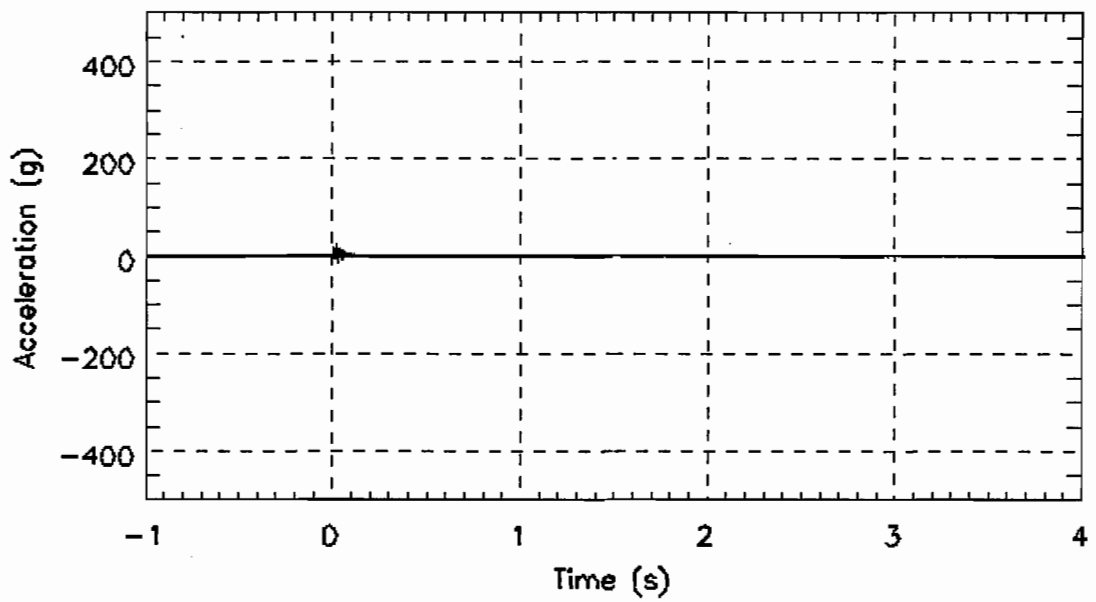

Figure J- 14. Bullet car, position 2, centersill, longitudinal acceleration, no digital filter, C2X_1000Hz.txt

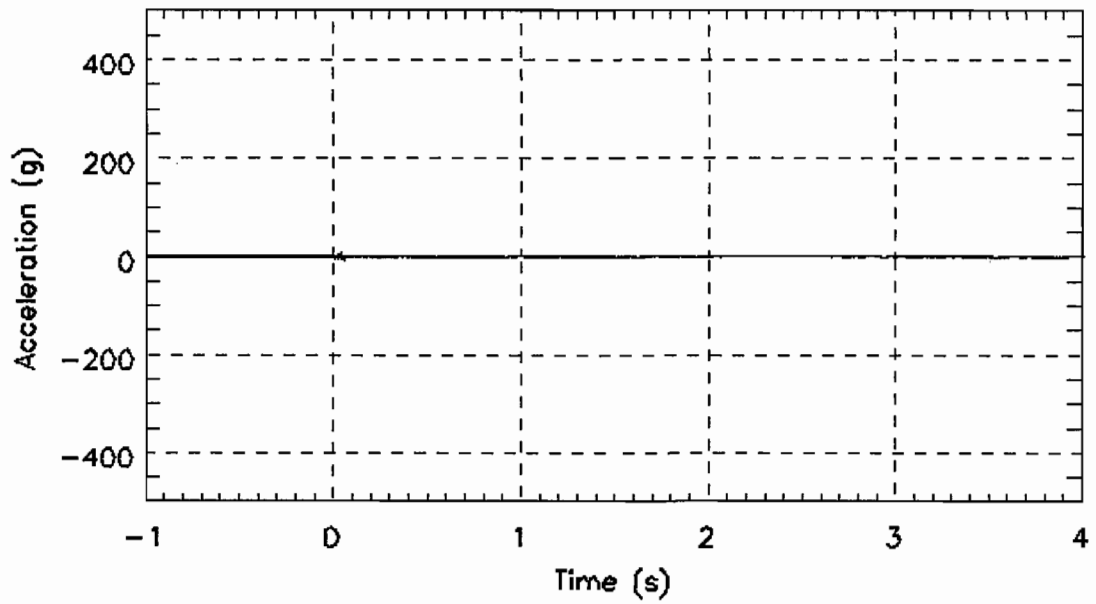

Figure J- 15. Bullet car, position 2, centersill, lateral acceleration, no digital filter, C2Y_1000Hz.txt

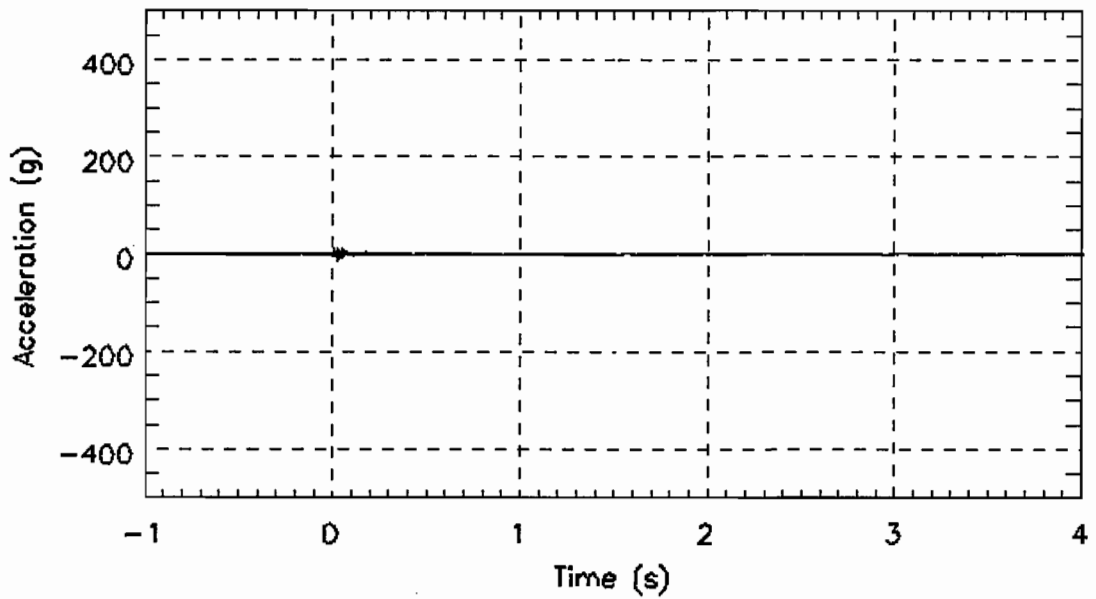

Figure J- 16. Bullet car, position 2, centersill, vertical acceleration, no digital filter, C2Z_1000Hz.txt

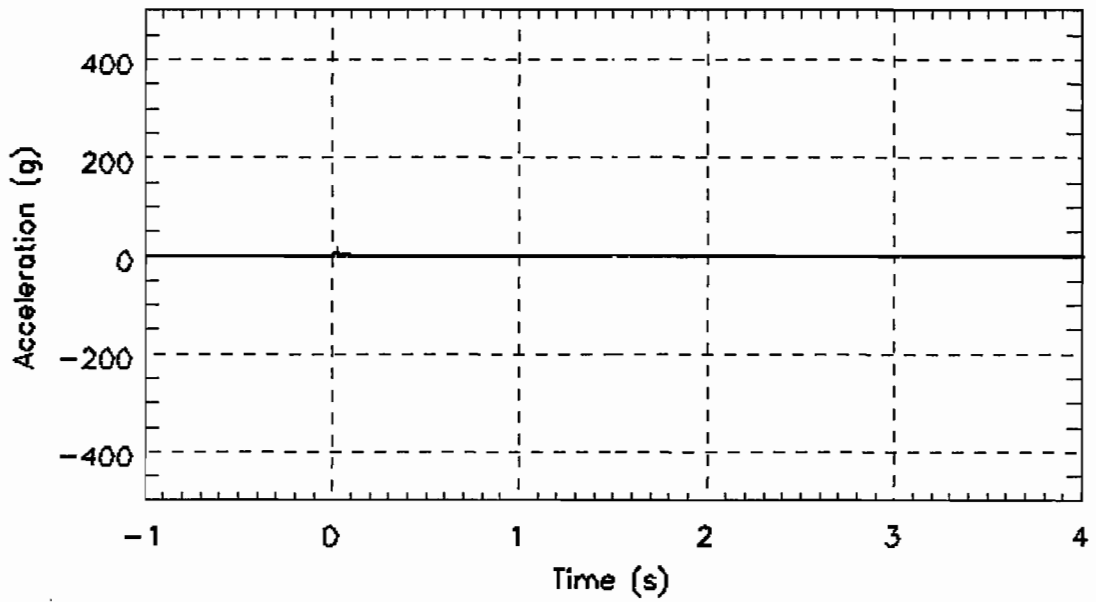

Figure J- 17. Bullet car, position 3, centersill, longitudinal acceleration, no digital filter, C3X_1000Hz.txt

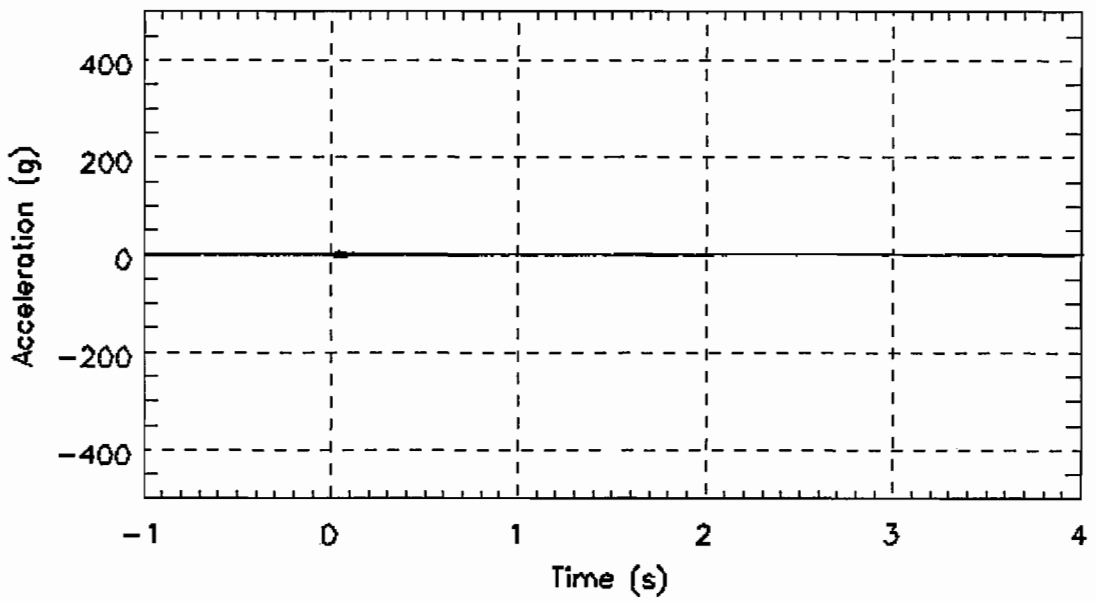

Figure J- 18. Bullet car, position 3, centersill, lateral acceleration, no digital filter, C3Y_1000Hz.txt

08

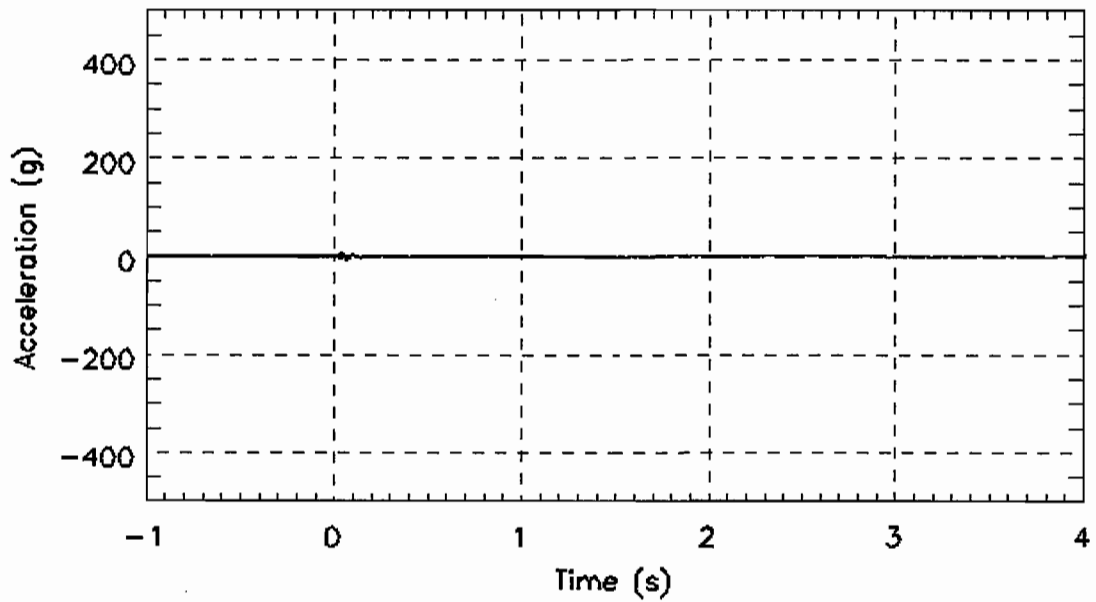

Figure J- 19. Bullet car, position 3, centersill, vertical acceleration, no digital filter, C3Z_1000Hz.txt

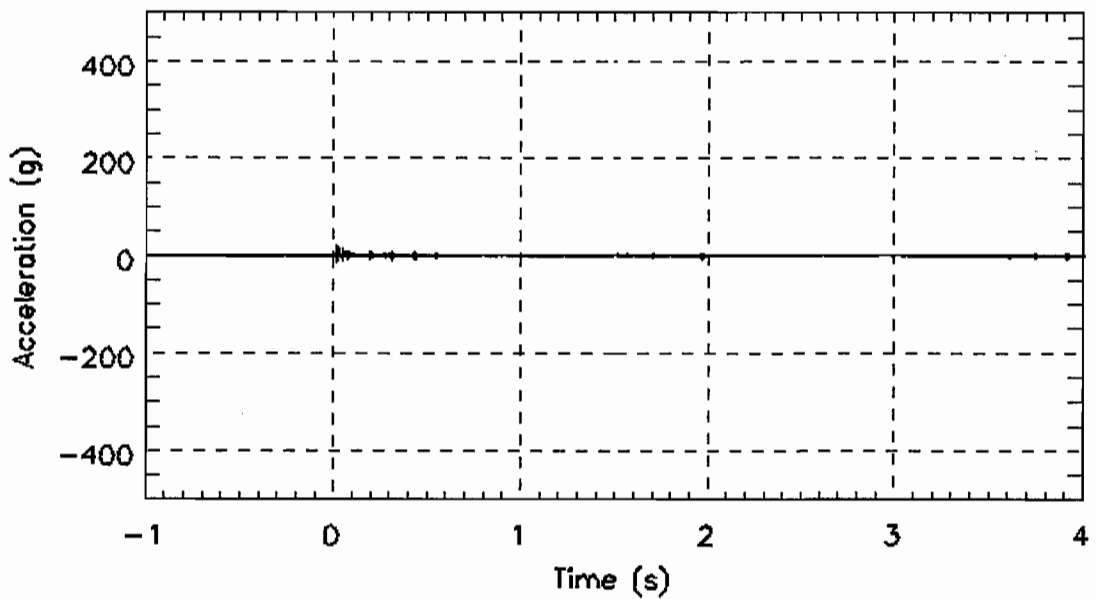

Figure J- 20. Bullet car, position 4, centersill, longitudinal acceleration, no digital filter, C4X_1000Hz.txt

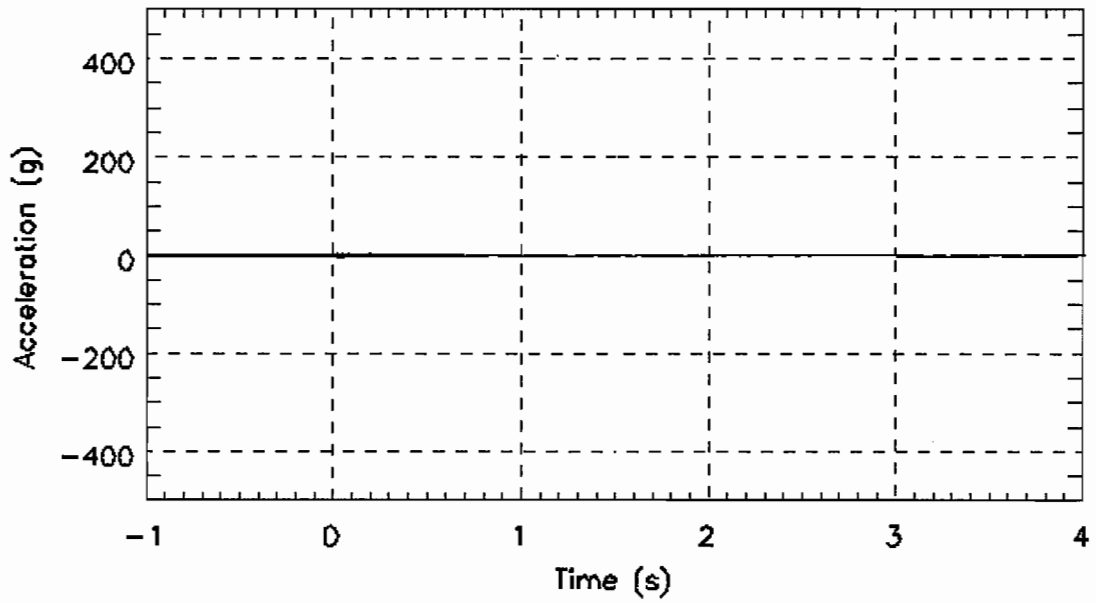

Figure J- 21. Bullet car, position 4, centersill, lateral acceleration, no digital filter, C4Y_1000Hz.txt

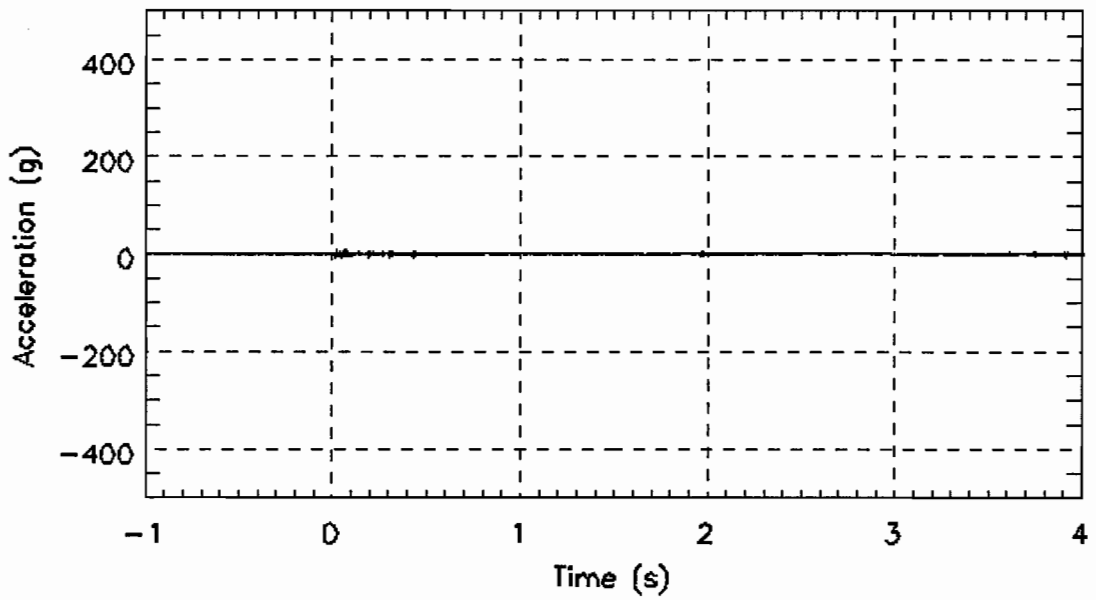

Figure J- 22. Bullet car, position 4, centersill, vertical acceleration, no digital filter, C4Z_1000Hz.txt

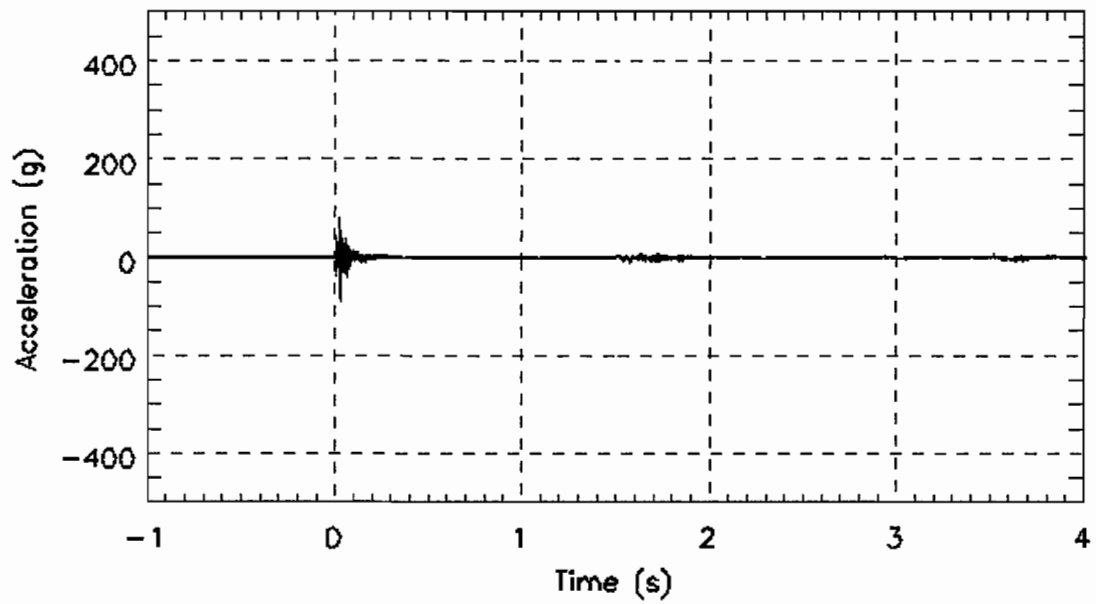

Figure J- 23. Bullet car, underframe level, left side, position 1, longitudinal acceleraion, no digital filter, L1X_1000Hz.txt

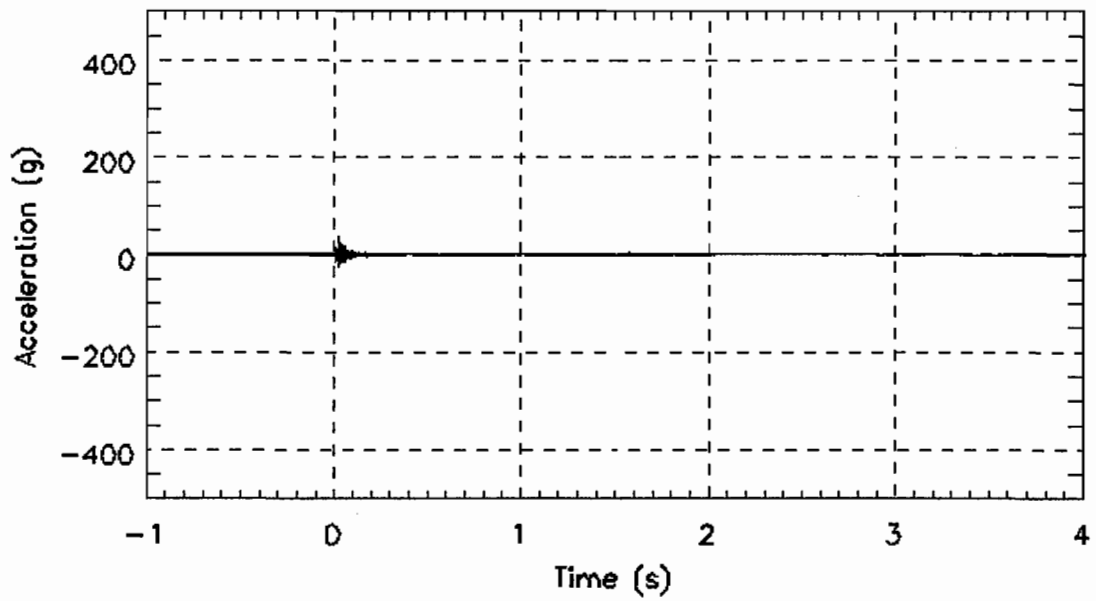

Figure J- 24. Bullet car, underframe level, left side, position 1, lateral acceleraion, no digital filter, L1Y_1000Hz.txt

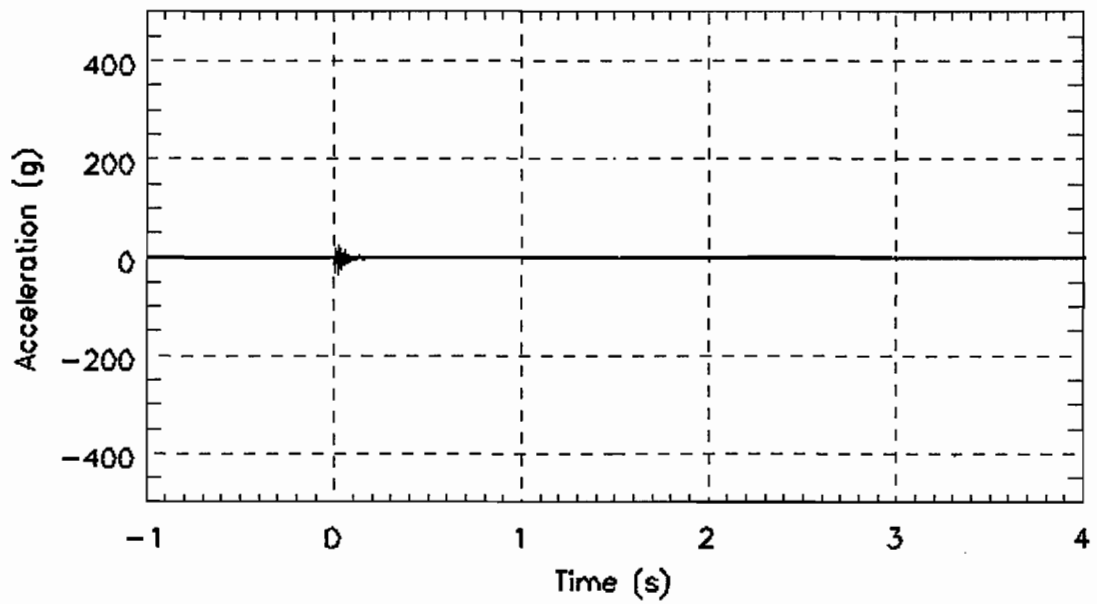

Figure J- 25. Bullet car, underframe level, left side, position 1, vertical acceleraion, no digital filter, L1Z_1000Hz.txt

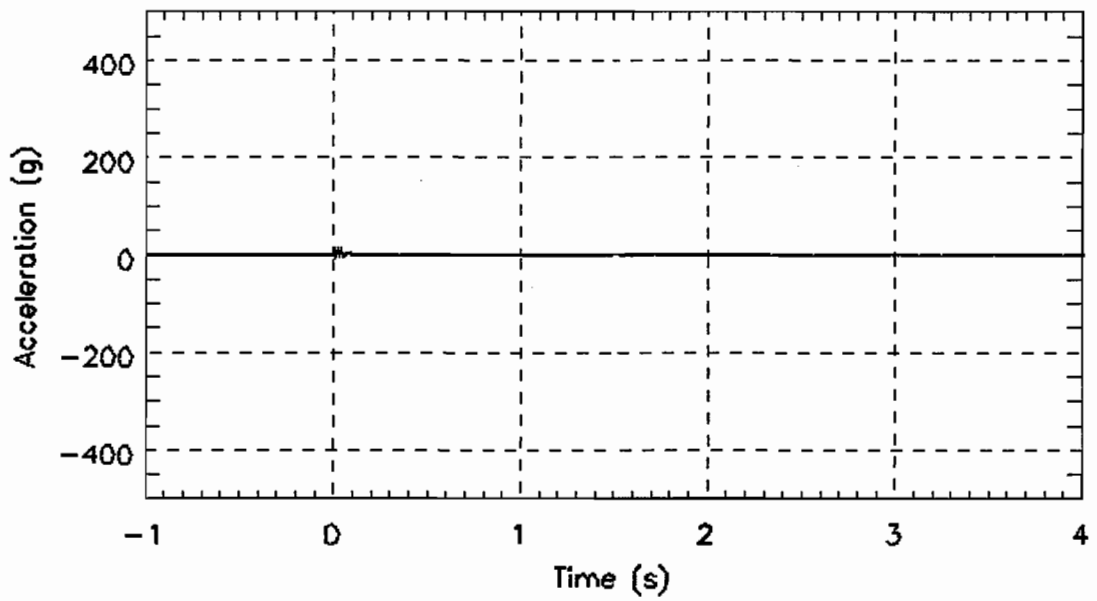

Figure J- 26. Bullet car, underframe level, left side, position 2, longitudinal acceleraion, no digital filter, L2X_1000Hz.txt

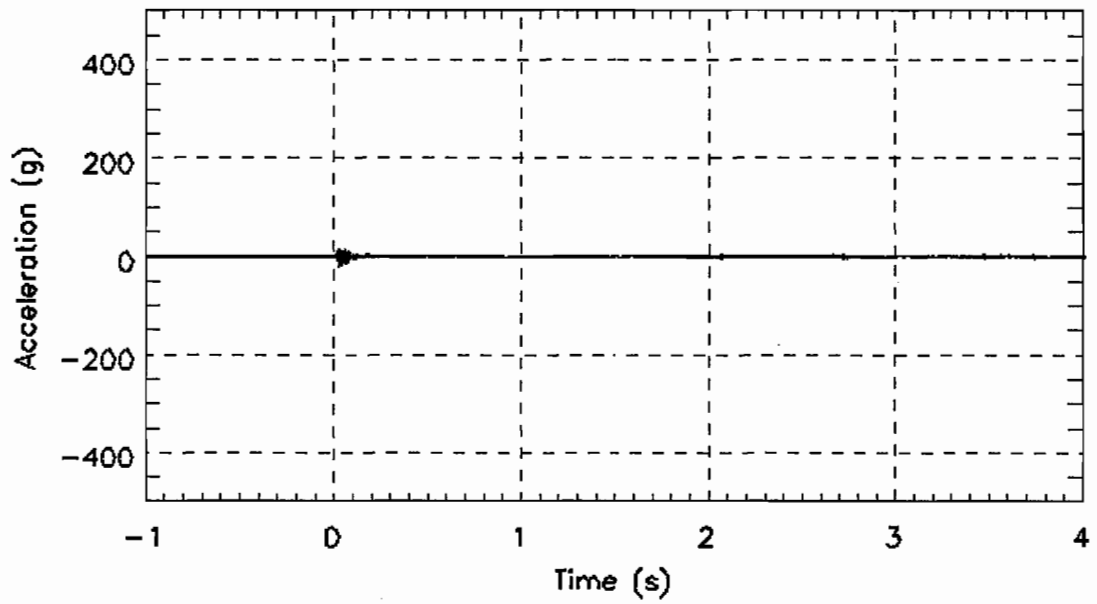

Figure J- 27. Bullet car, underframe level, left side, position 2, vertical acceleraion, no digital filter, L2Z_1000Hz.txt

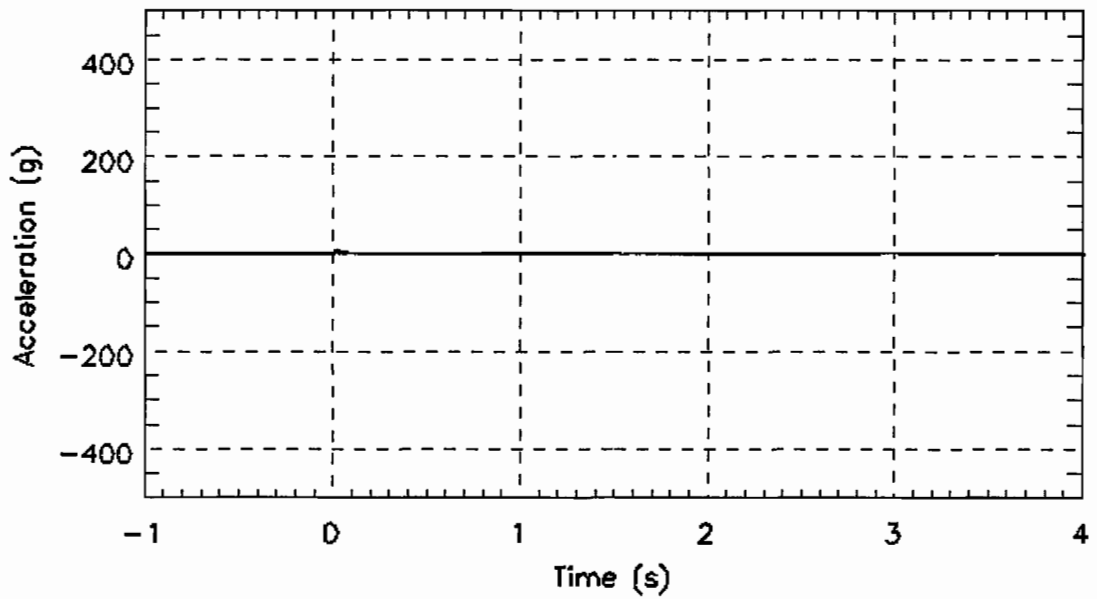

Figure J- 28. Bullet car, underframe level, left side, position 3, longitudinal acceleraion, no digital filter, L3X_1000Hz.txt

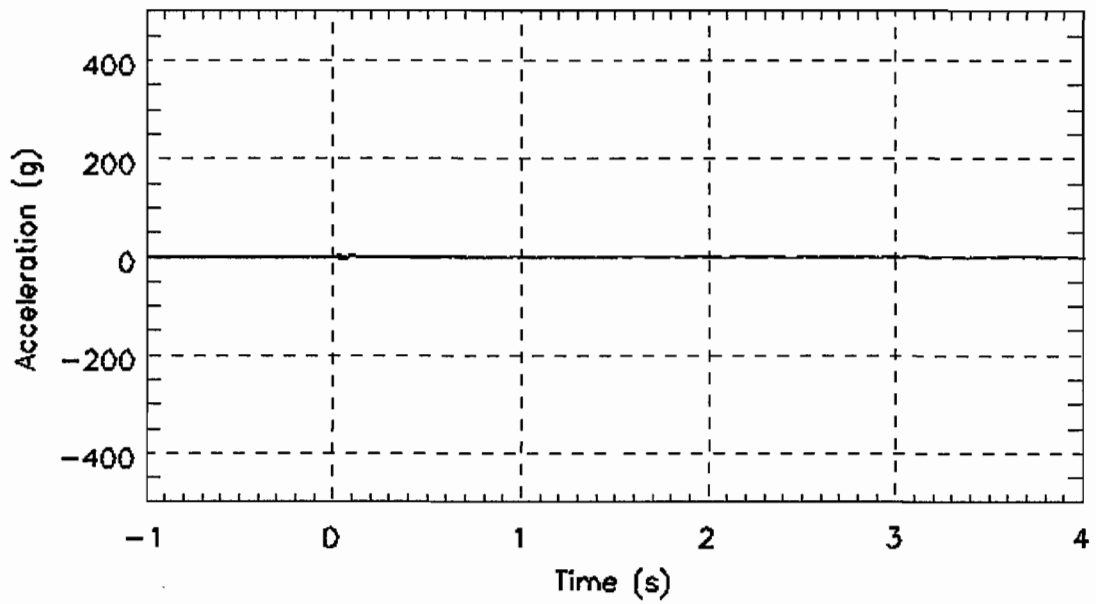

Figure J- 29. Bullet car, underframe level, left side, position 3, vertical acceleraion, no digital filter, L3Z_1000Hz.txt

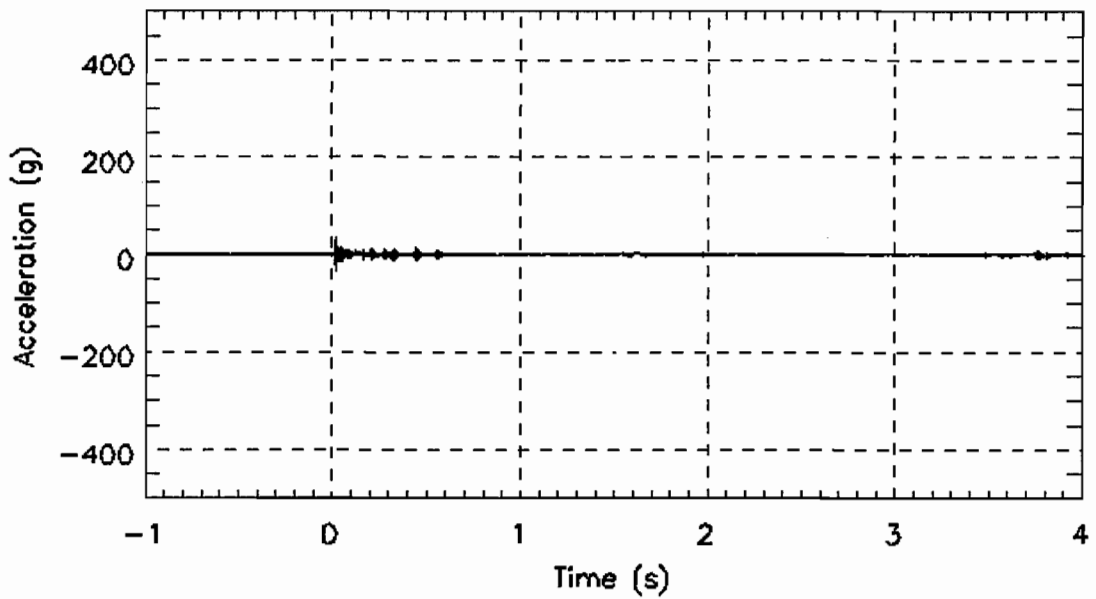

Figure J- 30. Bullet car, underframe level, left side, position 4, vertical acceleraion, no digital filter, L4Z_1000Hz.txt

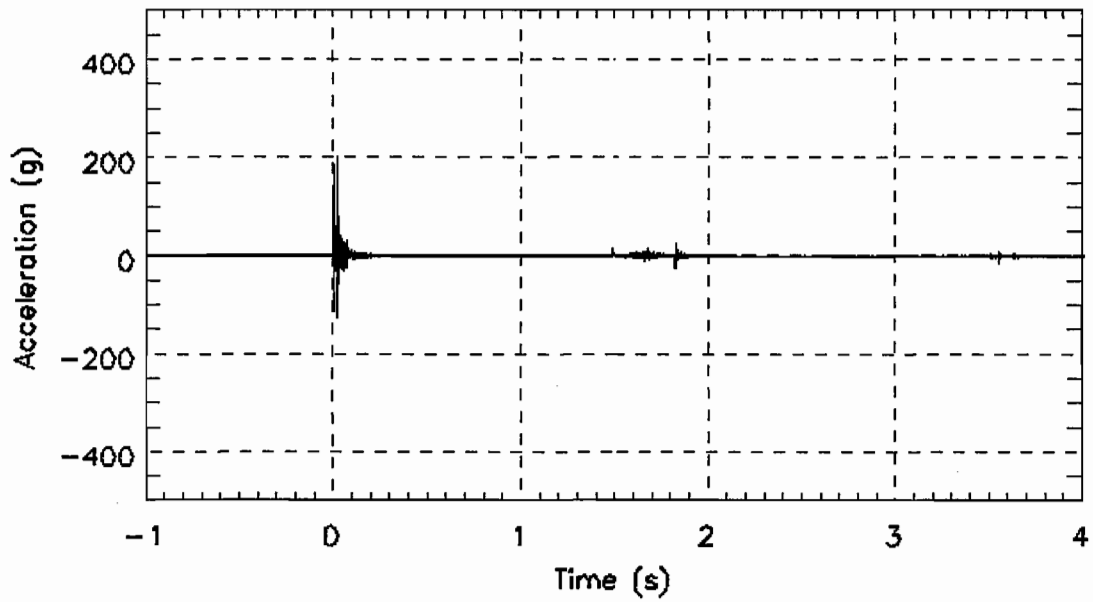

Figure J- 31. Bullet car, underframe level, right side, position 1, longitudinal acceleraion, no digital filter, R1X_1000Hz.txt

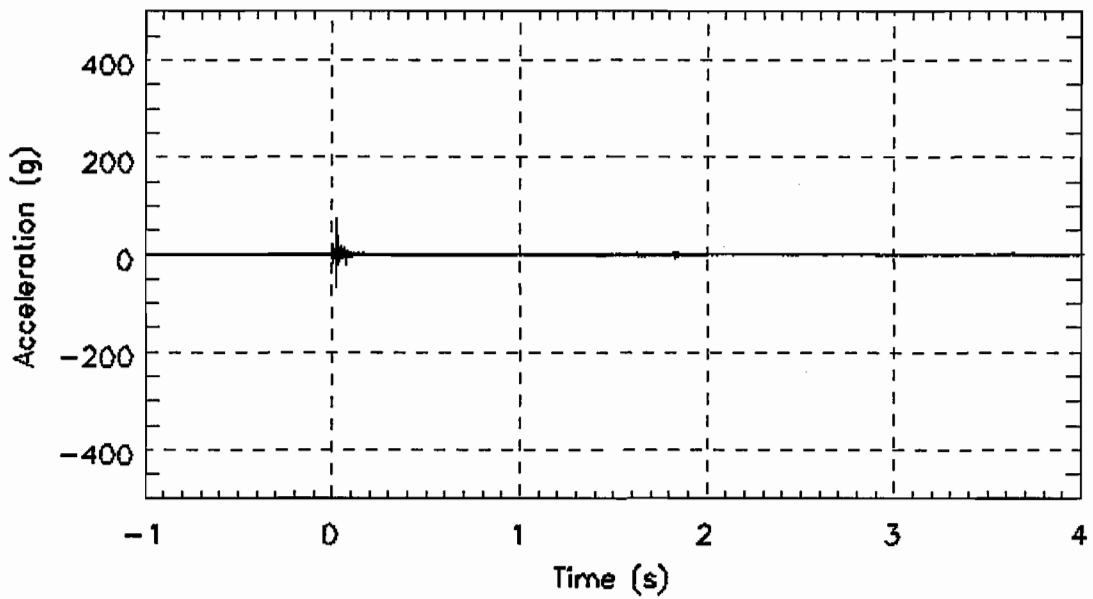

Figure J- 32. Bullet car, underframe level, right side, position 1, lateral acceleraion, no digital filter, R1Y_1000Hz.txt

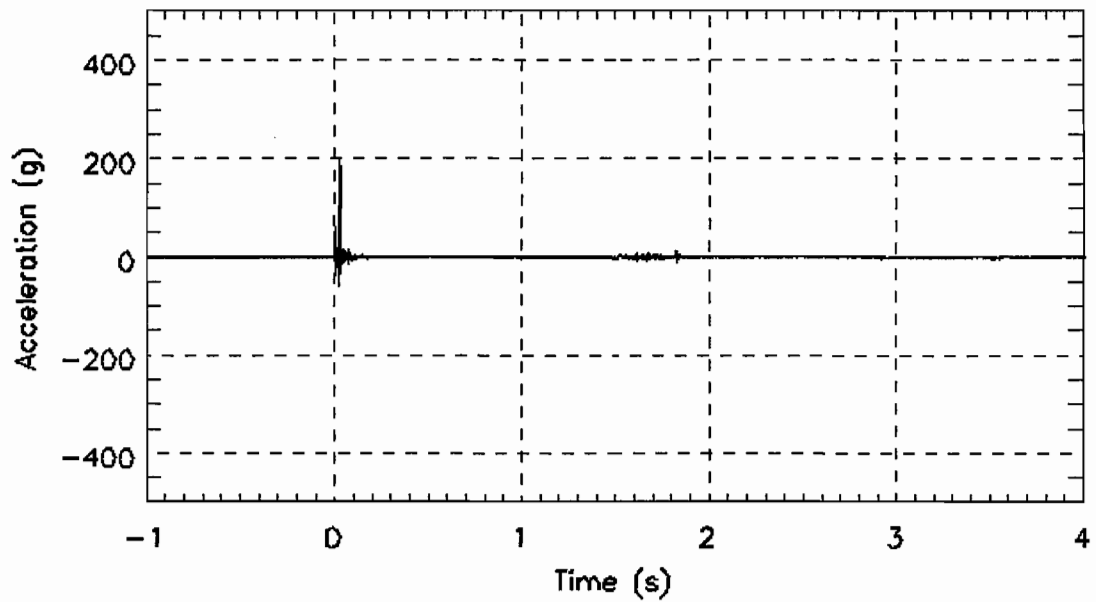

Figure J- 33. Bullet car, underframe level, right side, position 1, vertical acceleraion, no digital filter, R1Z_1000Hz.txt

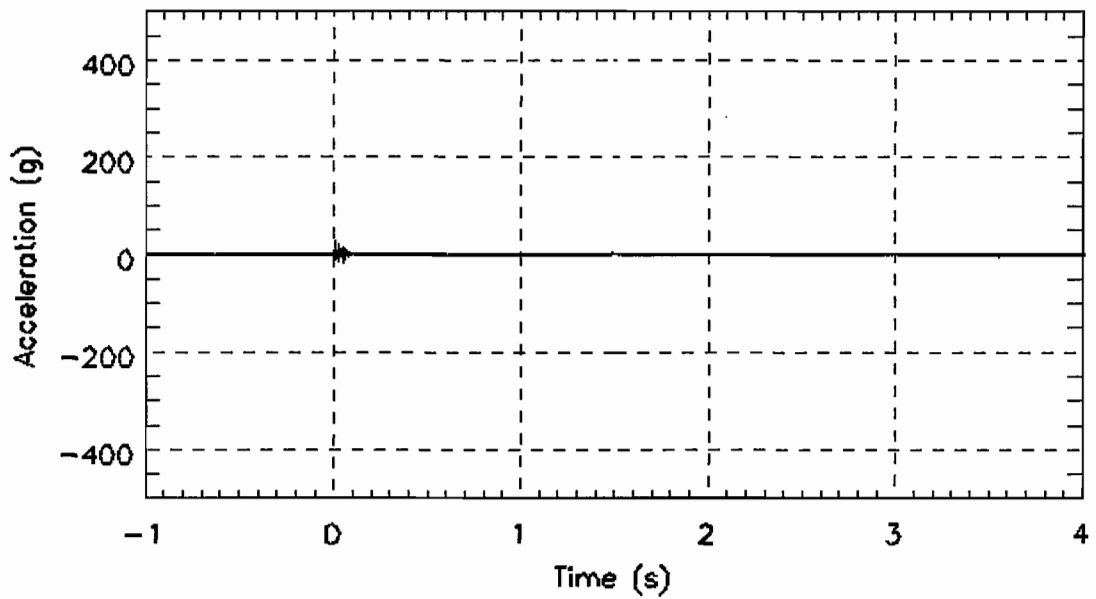

Figure J- 34. Bullet car, underframe level, right side, position 2, longitudinal acceleraion, no digital filter, R2X_1000Hz.txt

116

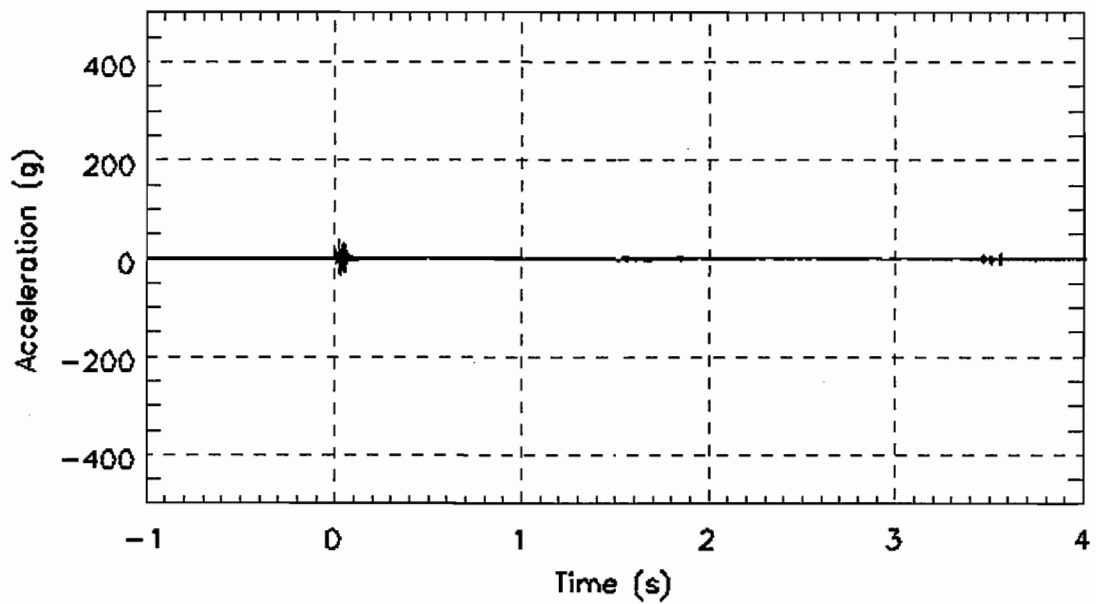

Figure J- 35. Bullet car, underframe level, right side, position 2, vertical acceleraion, no digital filter, R2Z_1000Hz.txt

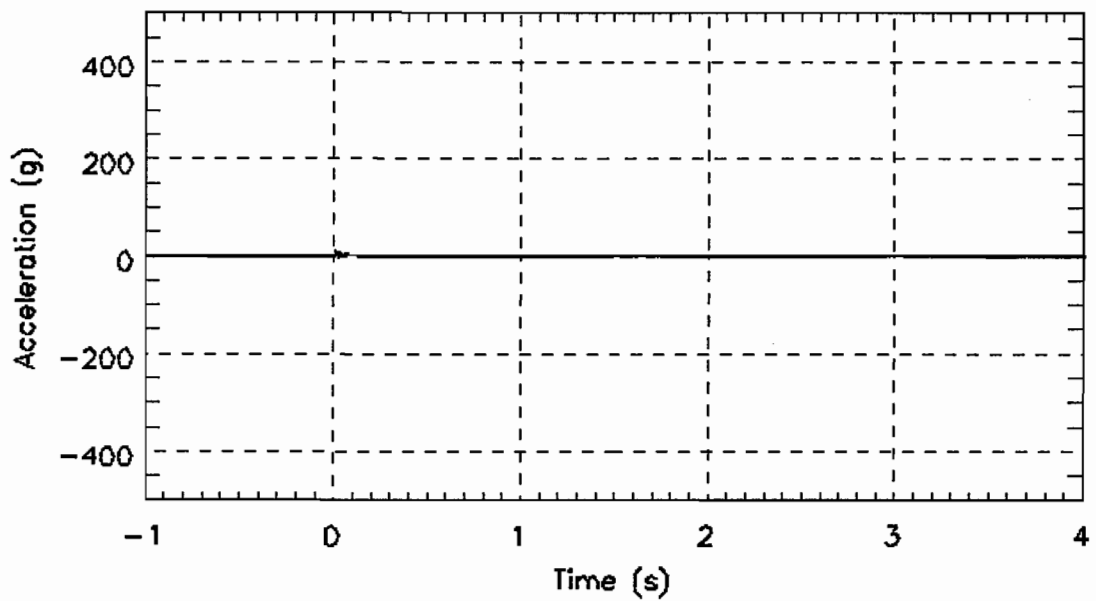

Figure J- 36. Bullet car, underframe level, right side, position 3, longitudinal acceleraion, no digital filter, R3X_1000Hz.txt

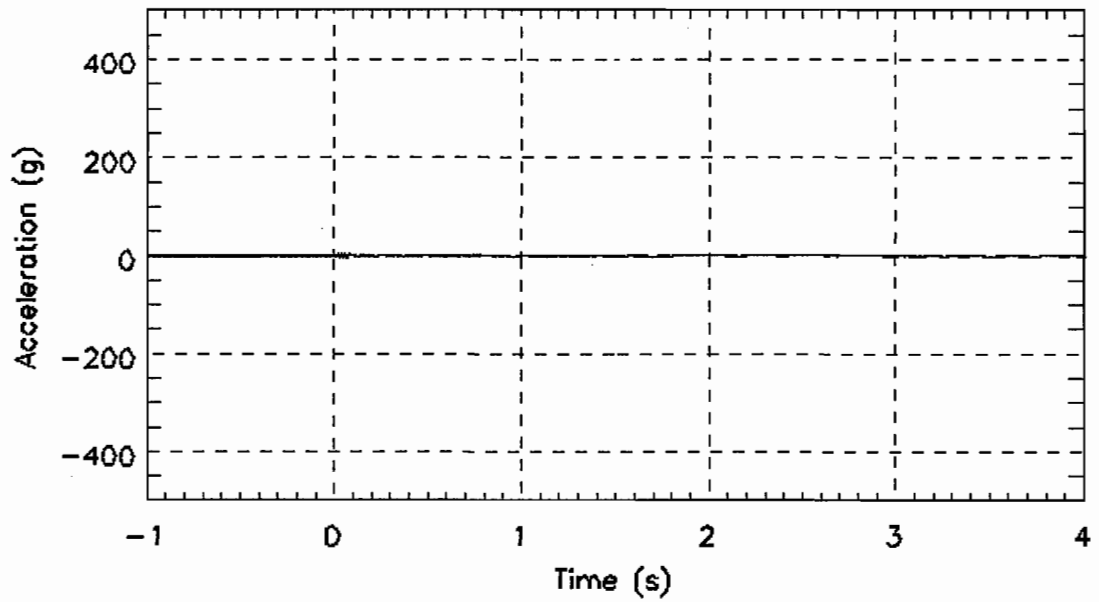

Figure J- 37. Bullet car, underframe level, right side, position 3, vertical acceleraion, no digital filter, R3Z_1000Hz.txt

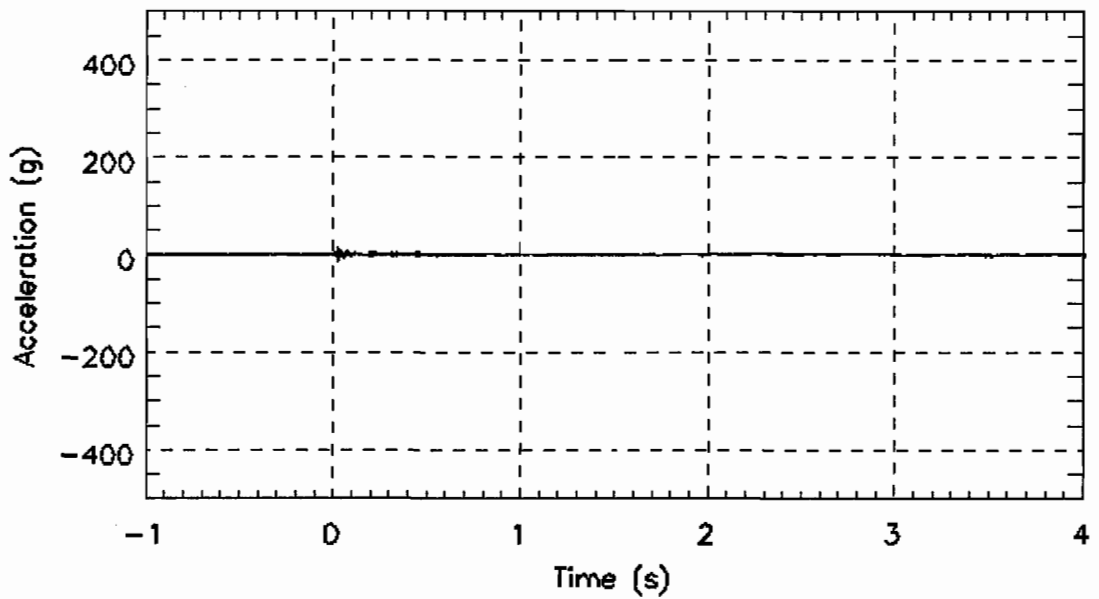

Figure J- 38. Bullet car, underframe level, right side, position 4, vertical acceleraion, no digital filter, R4Z_1000Hz.txt

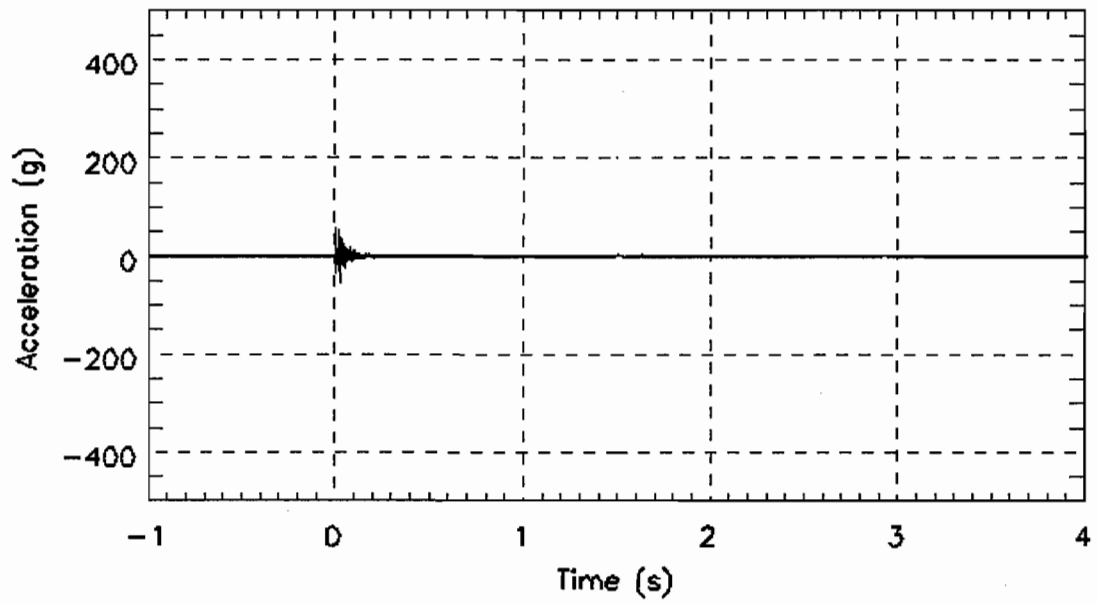

Figure J- 39. Bullet car, cant rail level, left side, position 1, longitudinal acceleraion, no digital filter, TL1X_1000Hz.txt

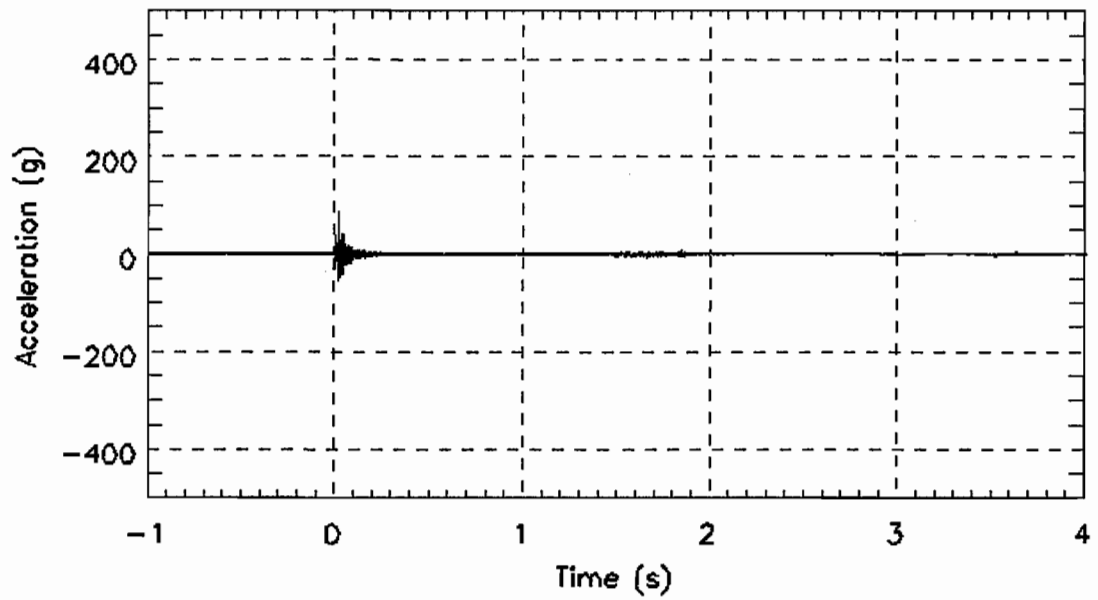

Figure J- 40. Bullet car, cant rail level, left side, position 1, lateral acceleraion, no digital filter, TL1Y_1000Hz.txt

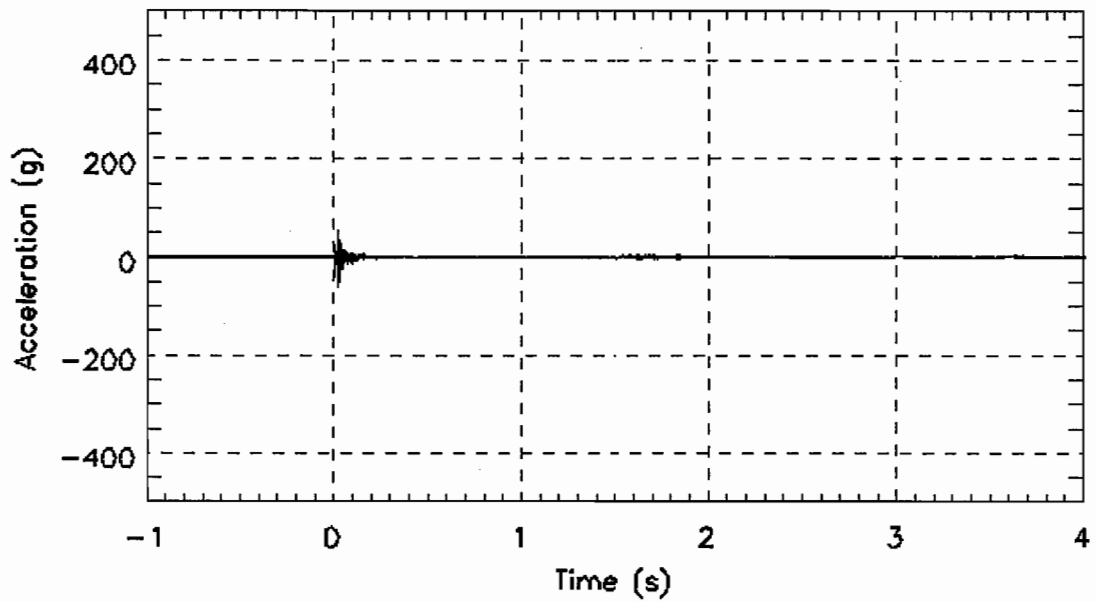

Figure J- 41. Bullet car, cant rail level, left side, position 1, vertical acceleraion, no digital filter, TL1Z_1000Hz.txt

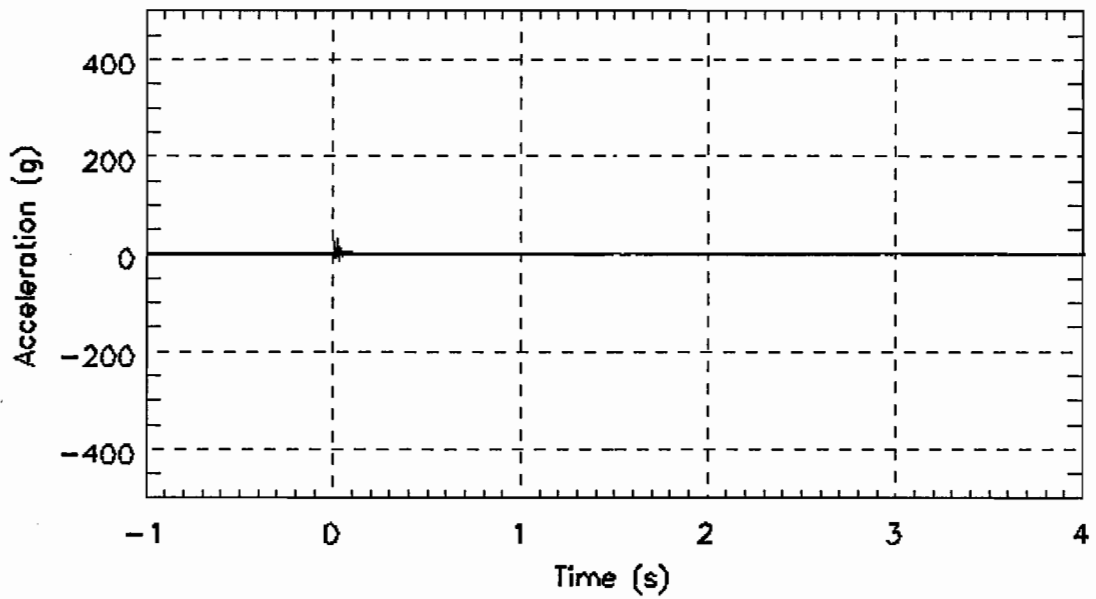

Figure J- 42. Bullet car, cant rail level, left side, position 2, longitudinal acceleraion, no digital filter, TL2X_1000Hz.txt

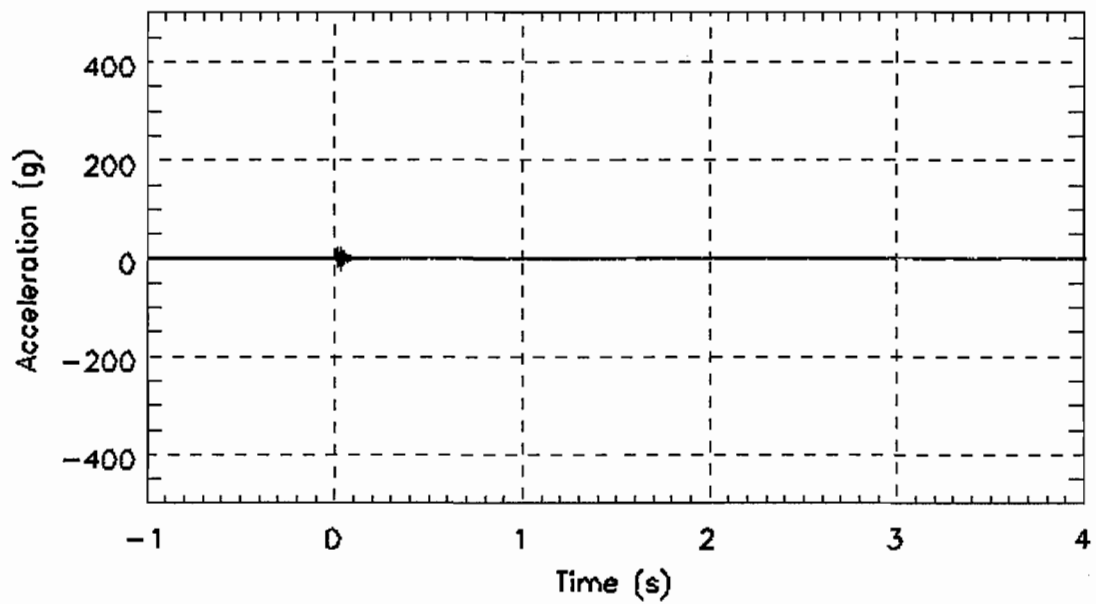

Figure J- 43. Bullet car, cant rail level, left side, position 2, vertical acceleraion, no digital filter, TL2Z_1000Hz.txt

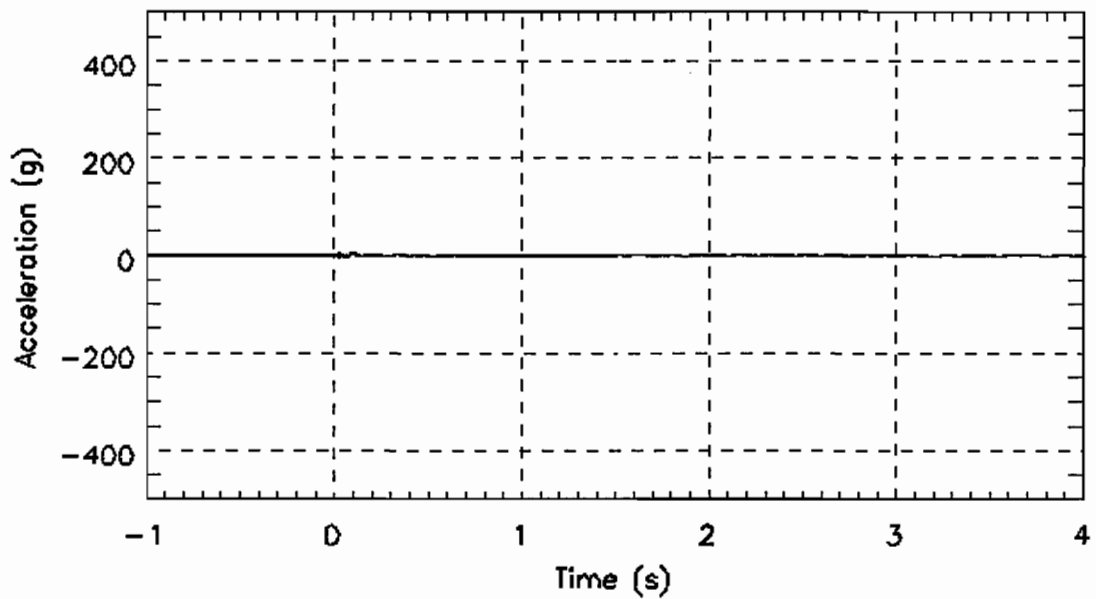

Figure J- 44. Bullet car, cant rail level, left side, position 3, vertical acceleraion, no digital filter, TL3Z_1000Hz.txt

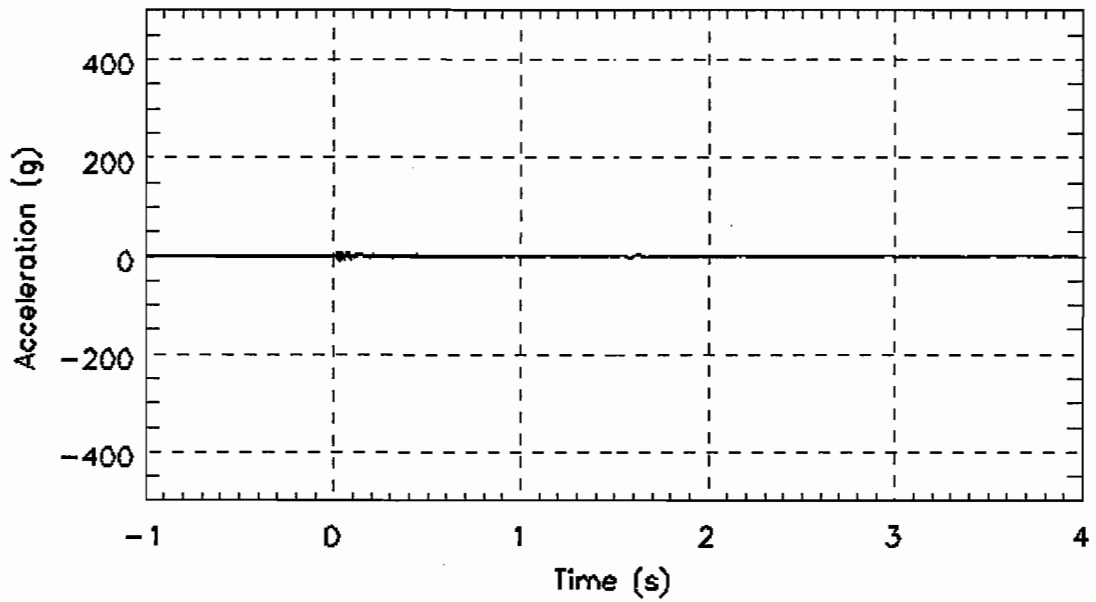

Figure J- 45. Bullet car, cant rail level, left side, position 4, vertical acceleraion, no digital filter, TL4Z_1000Hz.txt

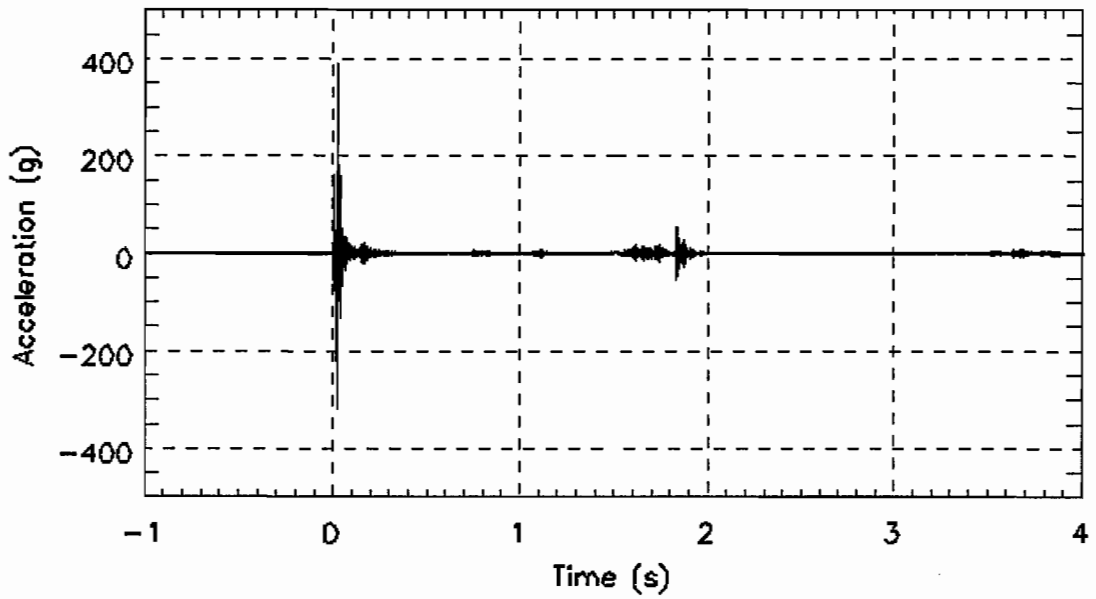

Figure J- 46. Bullet car, cant rail level, right side, position 1, longitudinal acceleraion, no digital filter, TR1X_1000Hz.txt

R

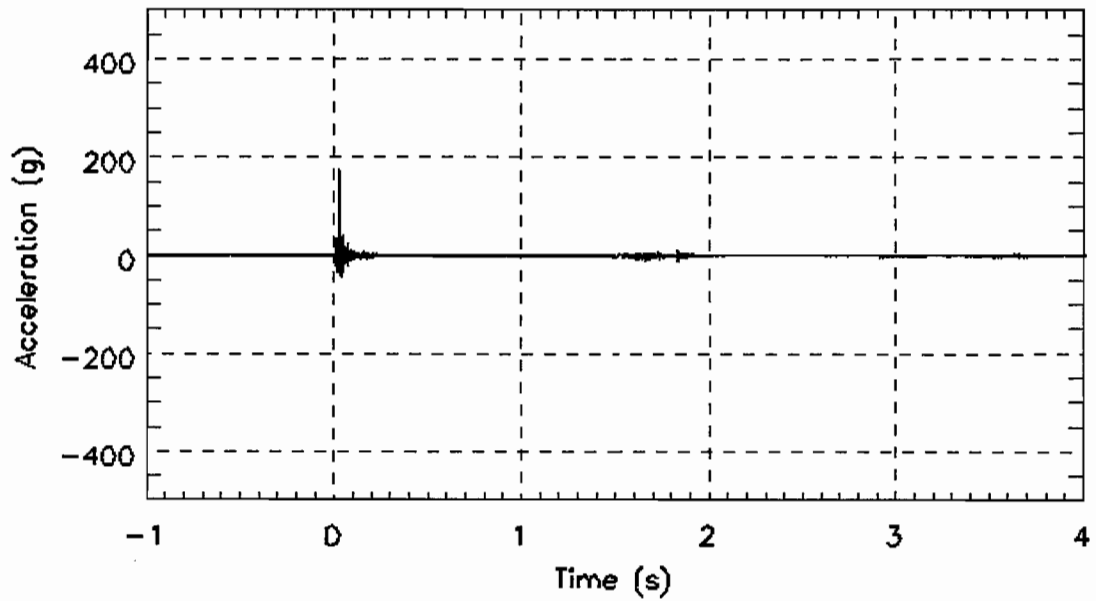

Figure J- 47. Bullet car, cant rail level, right side, position 1, lateral acceleraion, no digital filter, TR1Y_1000Hz.txt

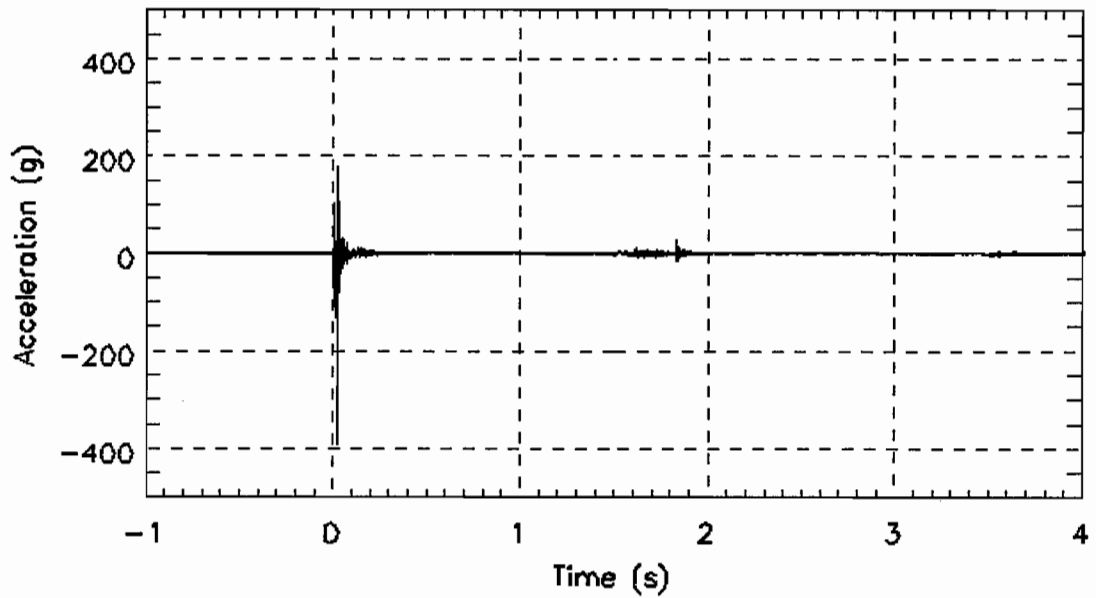

Figure J- 48. Bullet car, cant rail level, right side, position 1, vertical acceleraion, no digital filter, TR1Z_1000Hz.txt

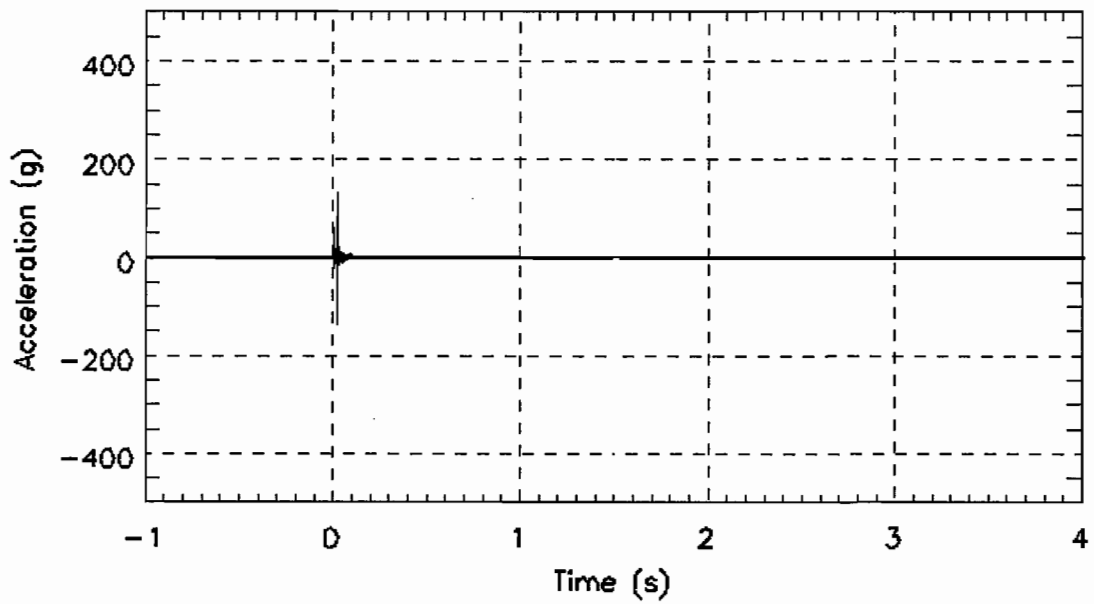

Figure J- 49. Bullet car, cant rail level, right side, position 2, longitudinal acceleraion, no digital filter, TR2X_1000Hz.txt

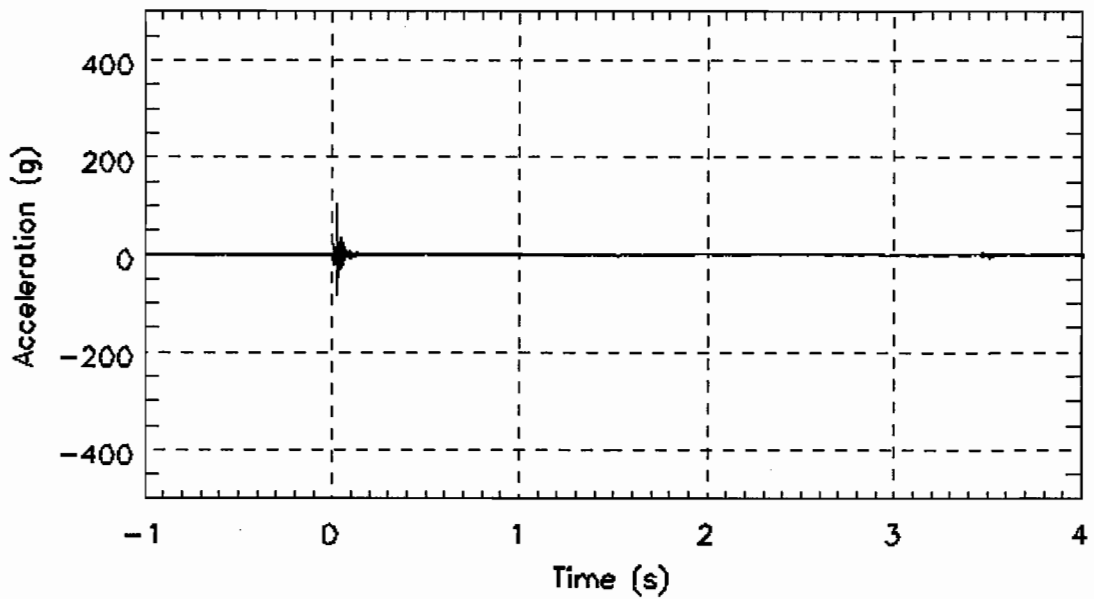

Figure J- 50. Bullet car, cant rail level, right side, position 2, vertical acceleraion, no digital filter, TR2Z_1000Hz.txt

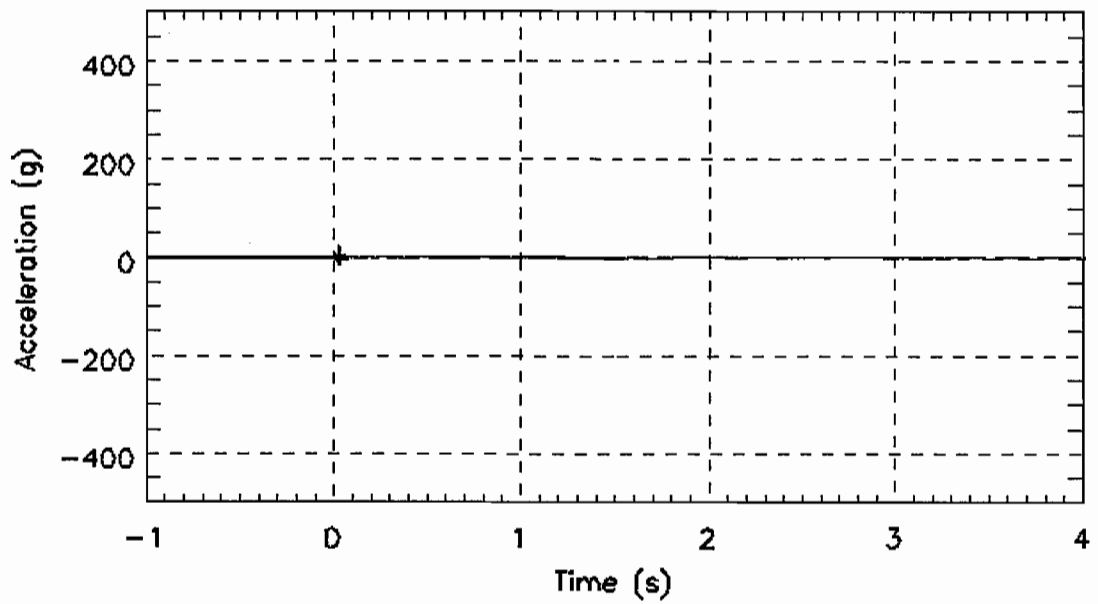

Figure J- 51. Bullet car, cant rail level, right side, position 3, vertical acceleraion, no digital filter, TR3Z_1000Hz.txt

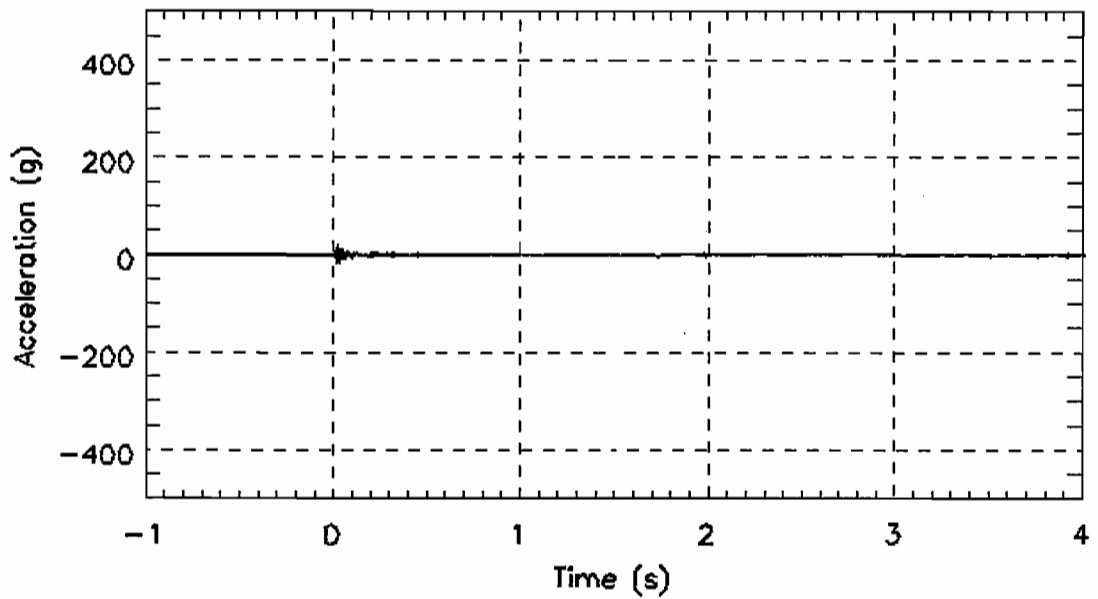

Figure J- 52. Bullet car, cant rail level, right side, position 4, vertical acceleraion, no digital filter, TR4Z_1000Hz.txt

5

Appendix K

Test 5
Acceleration Data, $F_c = 100\text{Hz}$

This page left blank intentionally

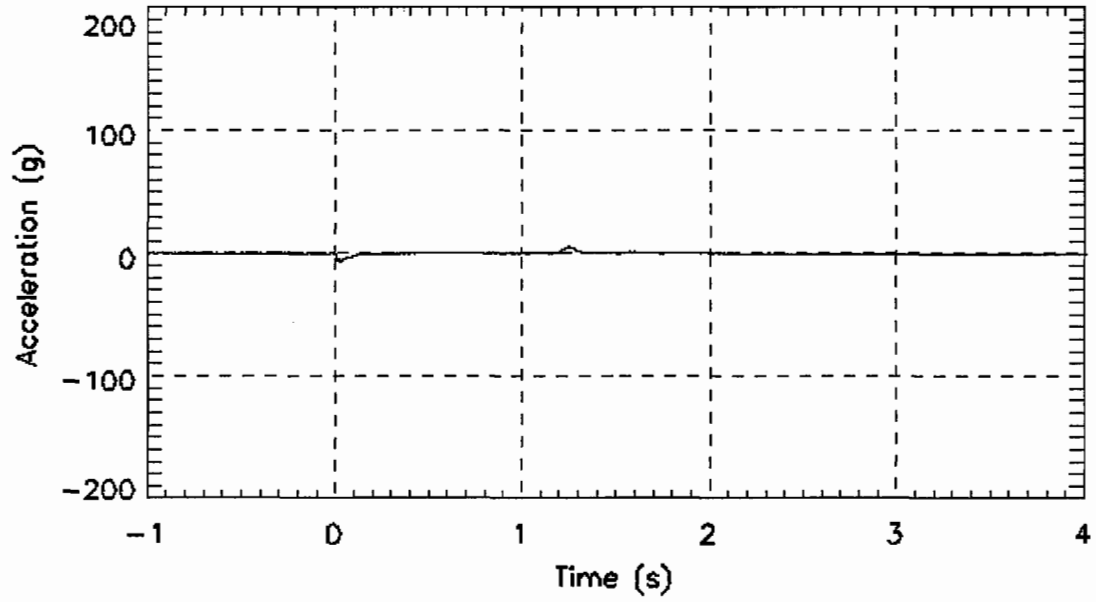

Figure K- 1. Steel coil, centered, longitudinal acceleration, digitally filtered at Fc=100Hz, A0X_100Hz.txt

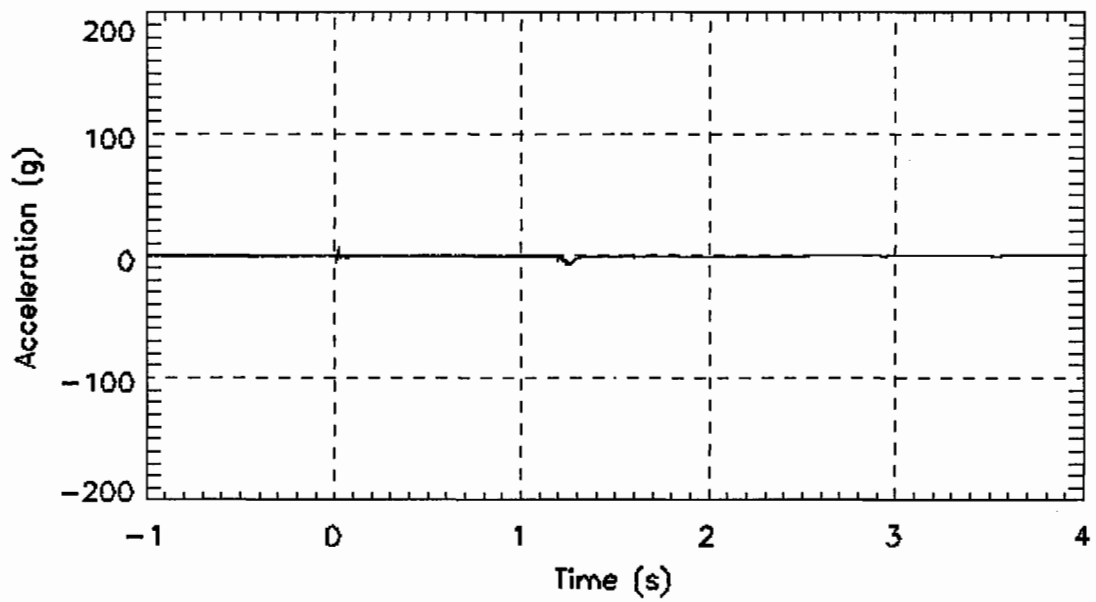

Figure K- 2. Steel coil, centered, lateral acceleration, digitally filtered at Fc=100Hz, A0Y_100Hz.txt

28

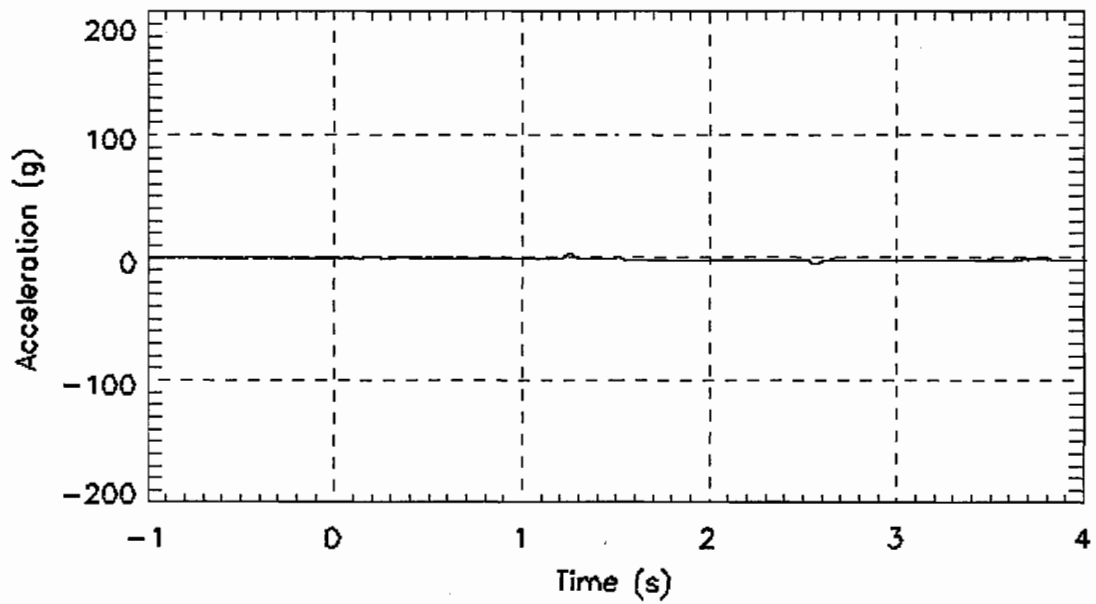

Figure K- 3. Steel coil, centered, vertical acceleration, digitally filtered at $F_c=100\text{Hz}$, A0Z_100Hz.txt

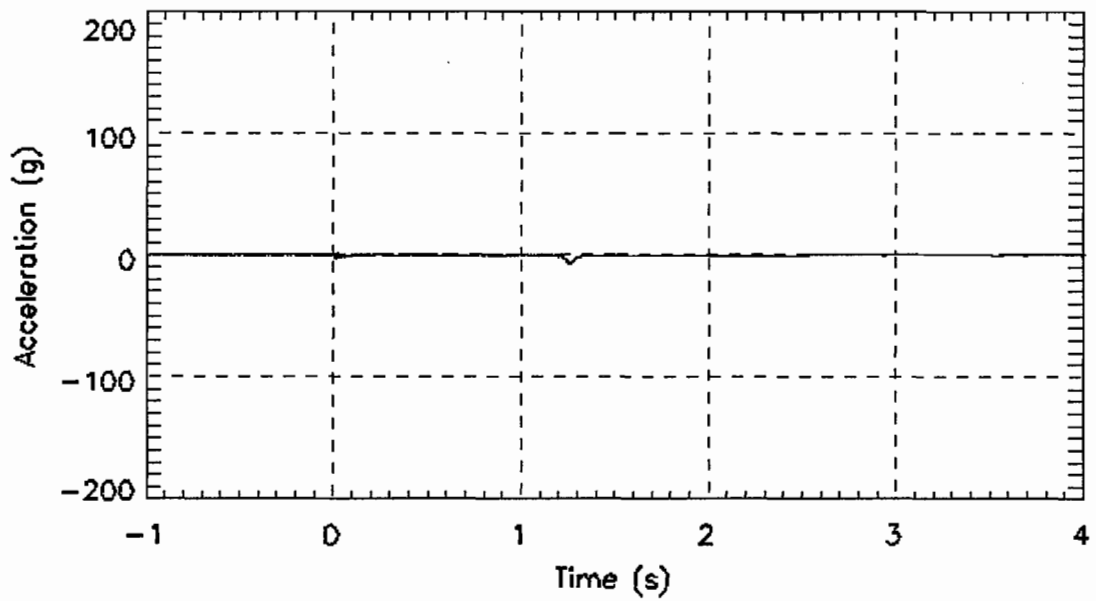

Figure K- 4. Steel coil, offset along X axis, lateral acceleration, digitally filtered at $F_c=100\text{Hz}$, A1Y_100Hz.txt

217

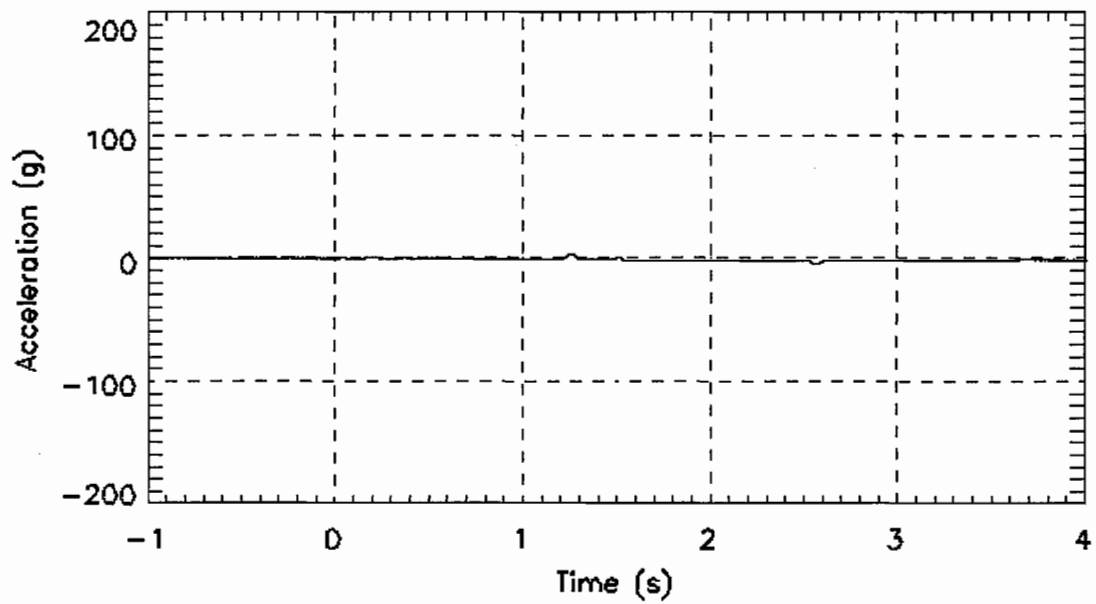

Figure K- 5. Steel coil, offset along X axis, vertical acceleration, digitally filtered at $F_c=100\text{Hz}$, A1Z_100Hz.txt

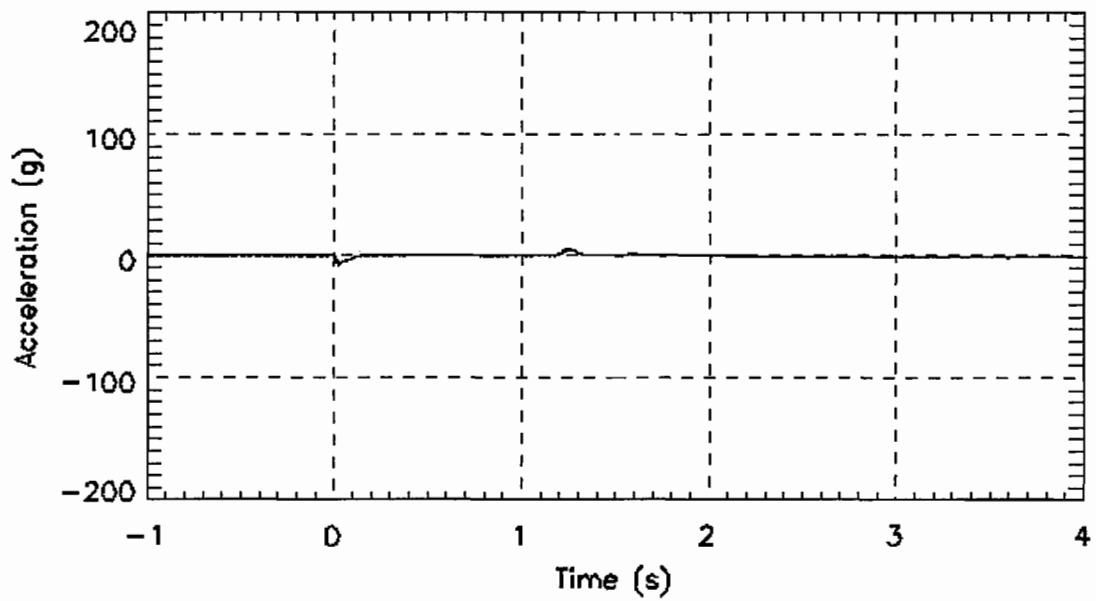

Figure K- 6. Steel coil, offset along Y axis, longitudinal acceleration, digitally filtered at $F_c=100\text{Hz}$, A2X_100Hz.txt

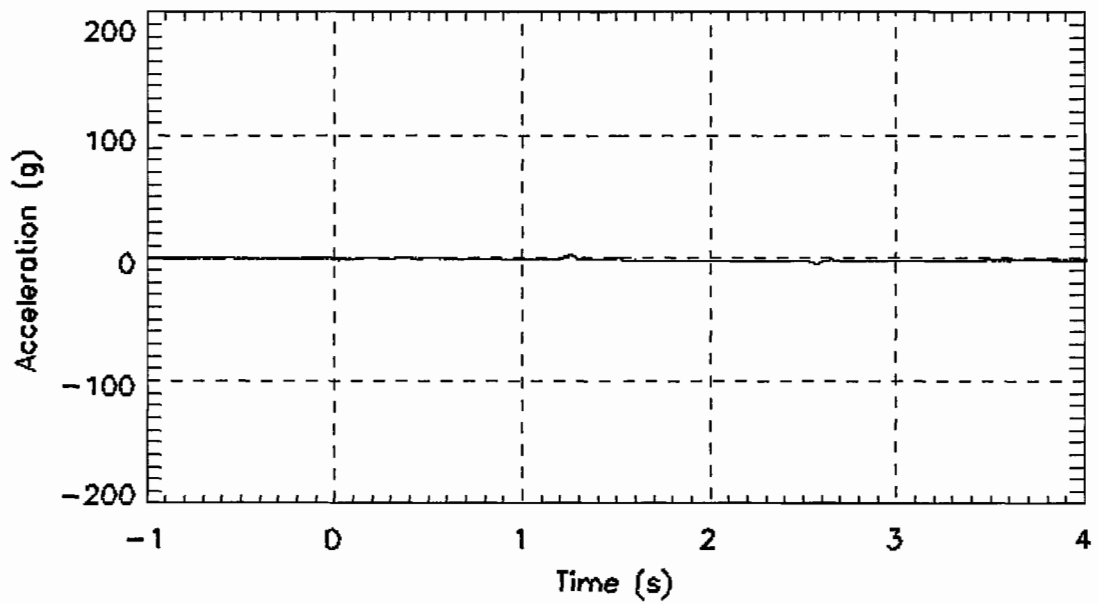

Figure K- 7. Steel coil, offset along Y axis, vertical acceleration, digitally filtered at Fc=100Hz, A2Z_100Hz.txt

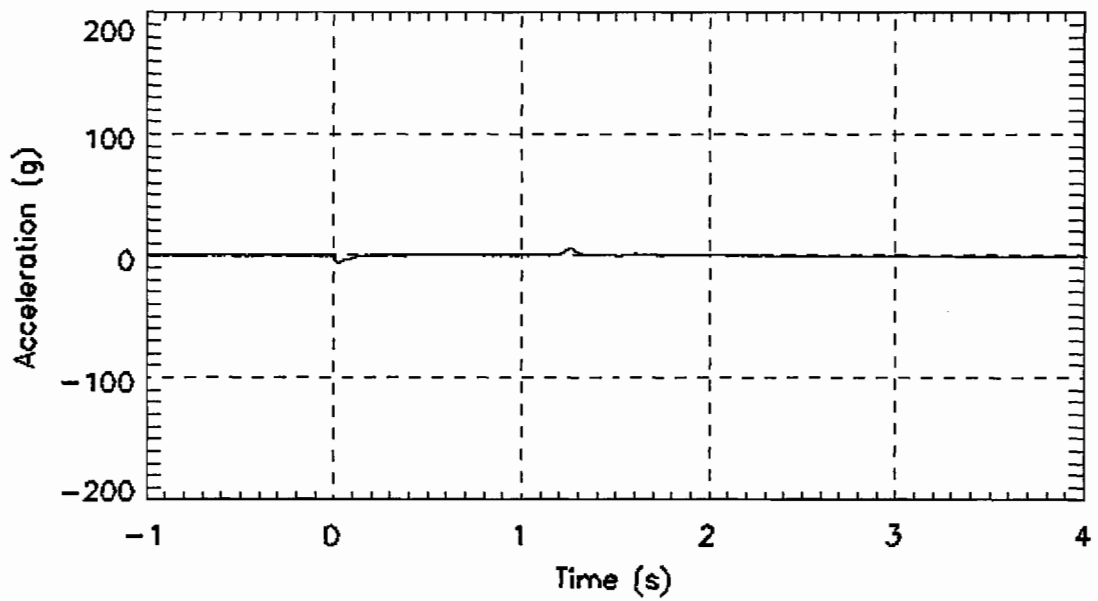

Figure K- 8. Steel coil, offset along Z axis, longitudinal acceleration, digitally filtered at Fc=100Hz, A3X_100Hz.txt

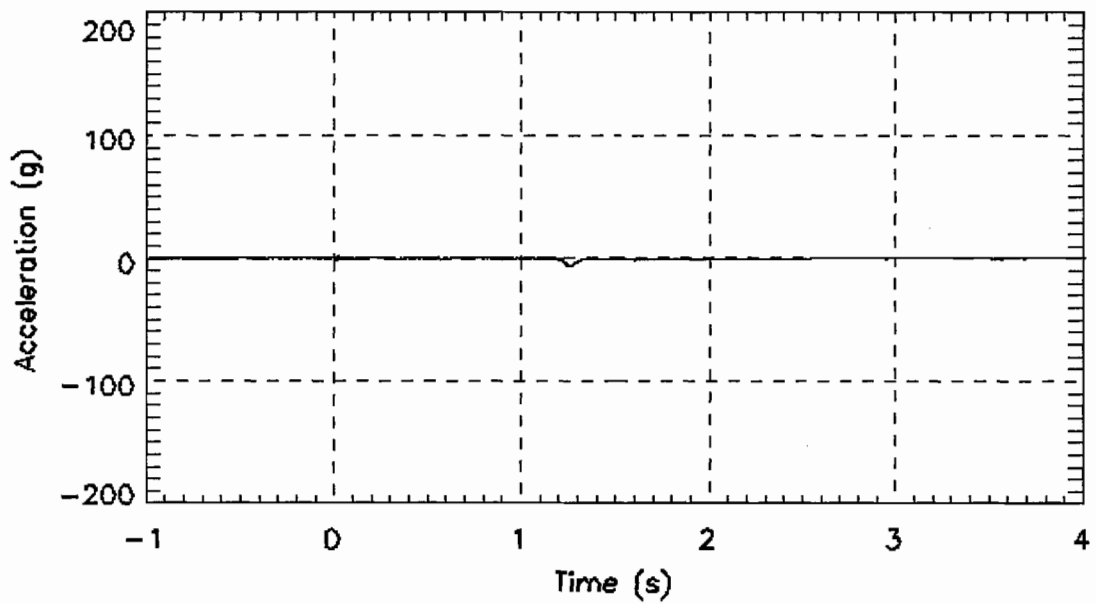

Figure K- 9. Steel coil, offset along Z axis, lateral acceleration, digitally filtered at $F_c=100\text{Hz}$, A3Y_100Hz.txt

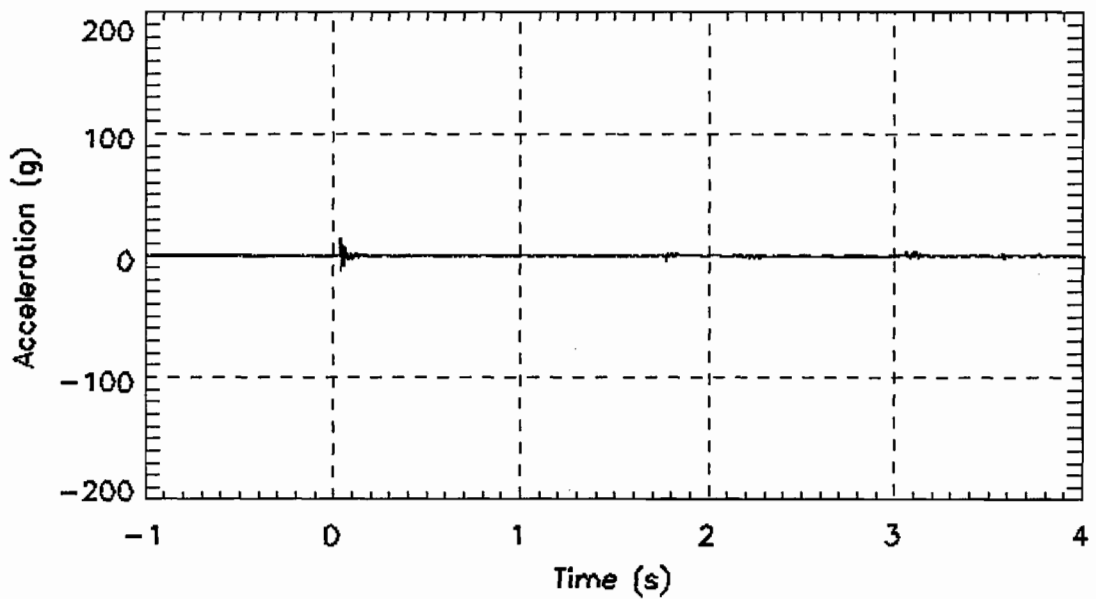

Figure K- 10. Lead bogie, lateral acceleration, digitally filtered at $F_c=100\text{Hz}$, BAY_100Hz.txt

8

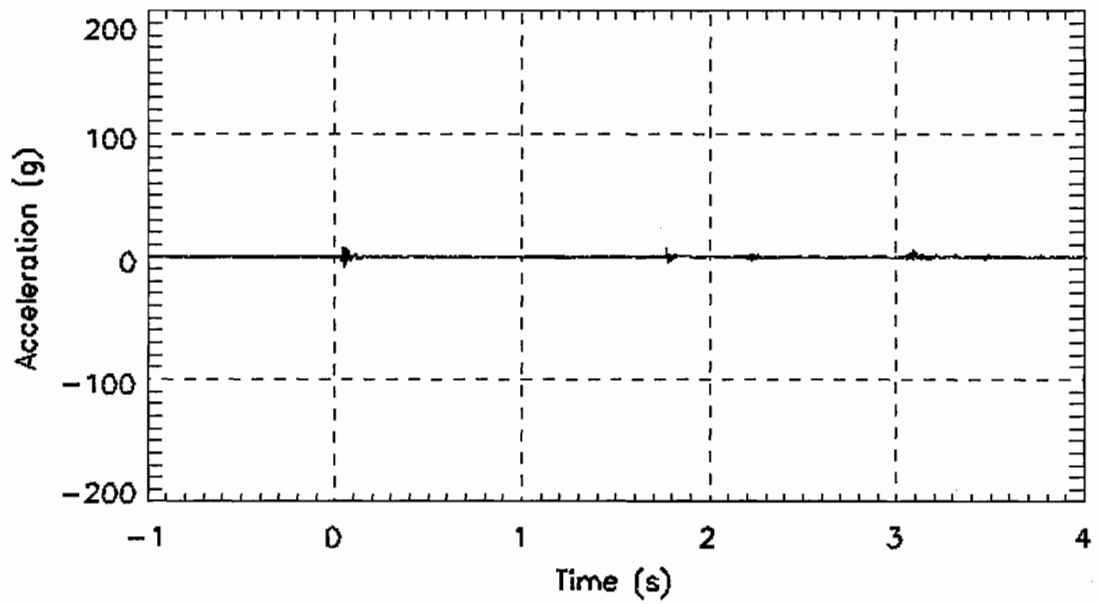

Figure K- 11. Lead bogie, vertical acceleration, digitally filtered at $F_c=100\text{Hz}$, BAZ_100Hz.txt

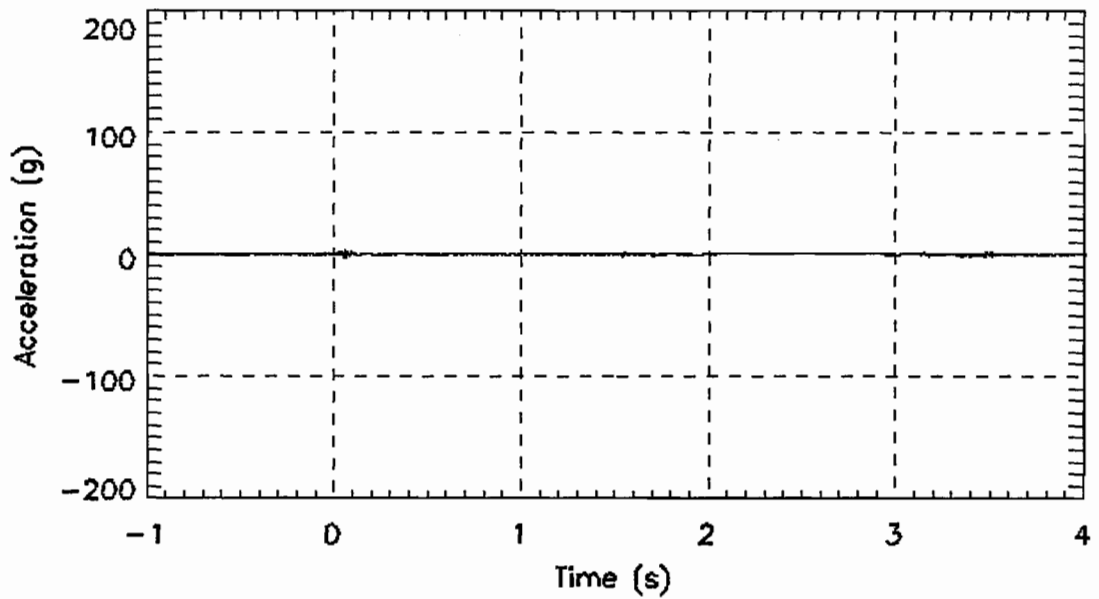

Figure K- 12. Trail bogie, lateral acceleration, digitally filtered at $F_c=100\text{Hz}$, BBY_100Hz.txt

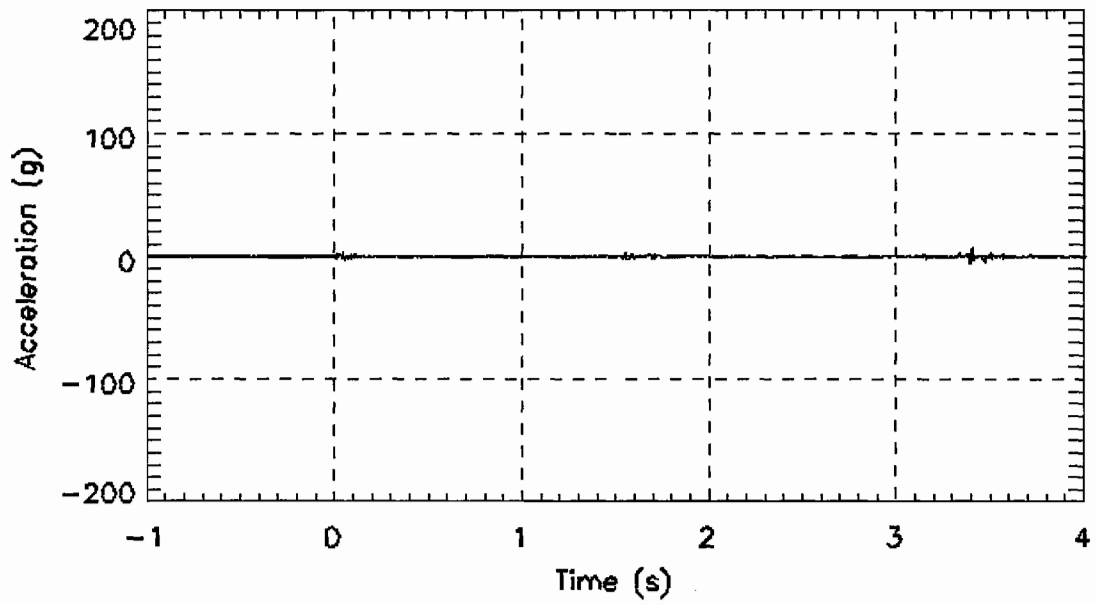

Figure K- 13. Trail bogie, vertical acceleration, digitally filtered at $F_c=100\text{Hz}$, BBZ_100Hz.txt

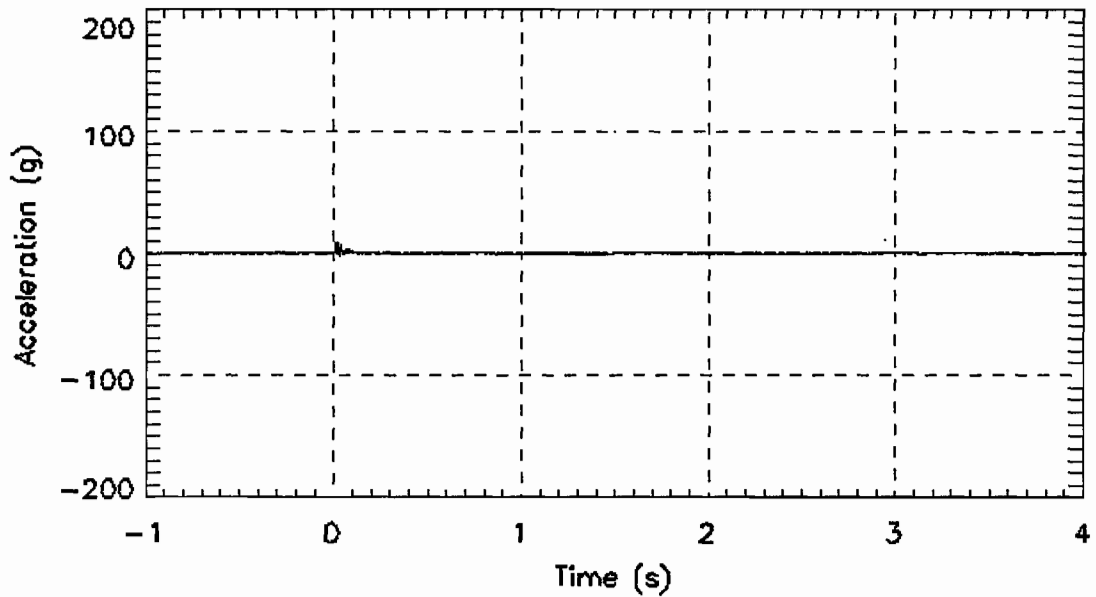

Figure K- 14. Bullet car, position 2, centersill, longitudinal acceleration, digitally filtered at $F_c=100\text{Hz}$, C2X_100Hz.txt

4

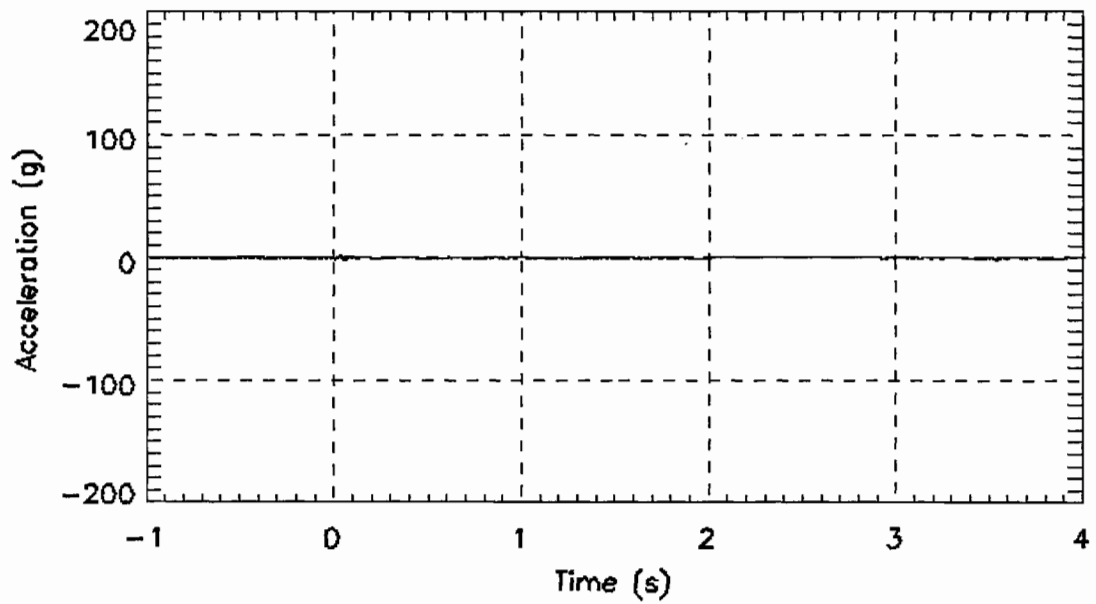

Figure K- 15. Bullet car, position 2, centersill, lateral acceleration, digitally filtered at Fc=100Hz, C2Y_100Hz.txt

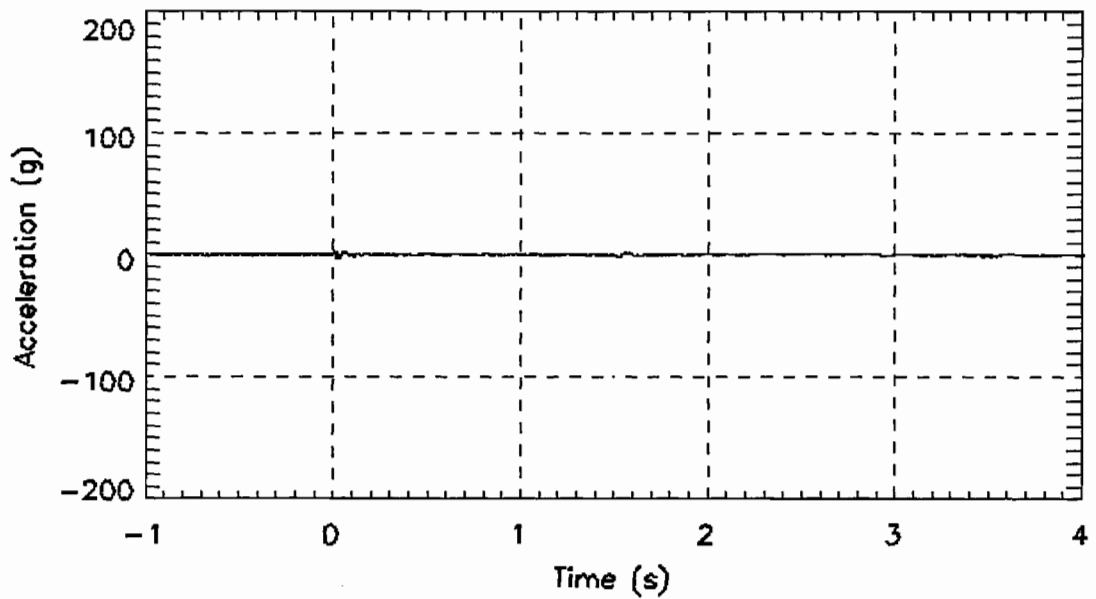

Figure K- 16. Bullet car, position 2, centersill, vertical acceleration, digitally filtered at Fc=100Hz, C2Z_100Hz.txt

5

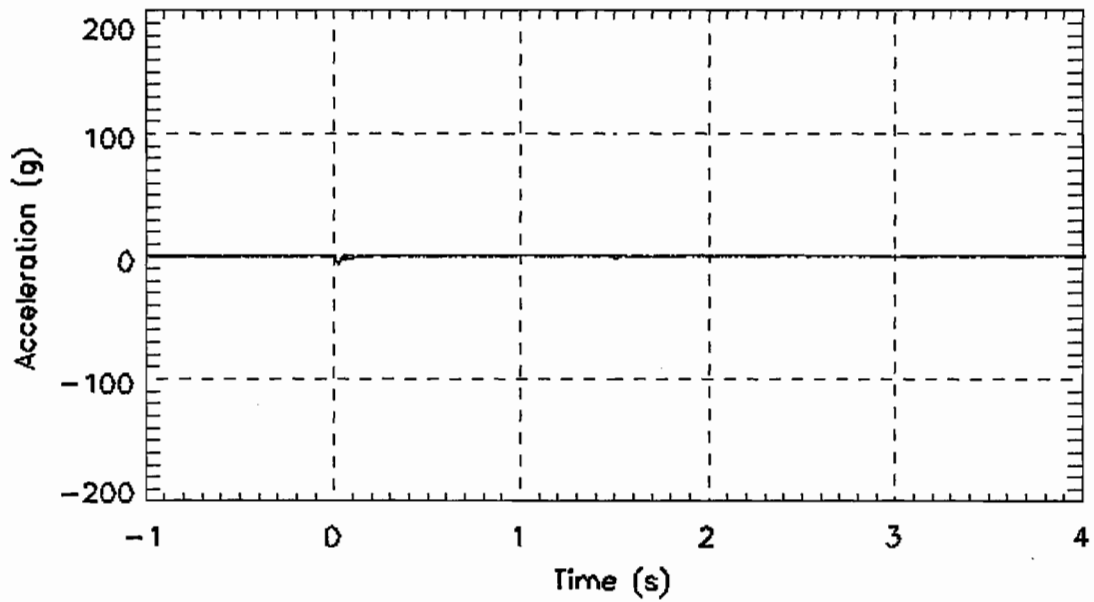

Figure K- 17. Bullet car, position 3, centersill, longitudinal acceleration, digitally filtered at Fc=100Hz, C3X_100Hz.txt

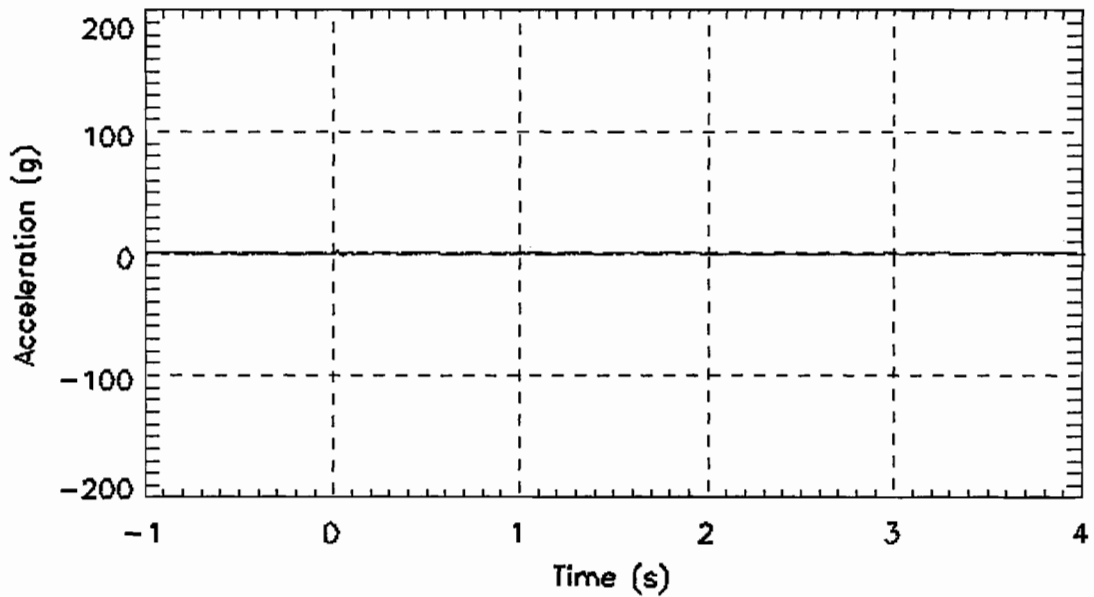

Figure K- 18. Bullet car, position 3, centersill, lateral acceleration, digitally filtered at Fc=100Hz, C3Y_100Hz.txt

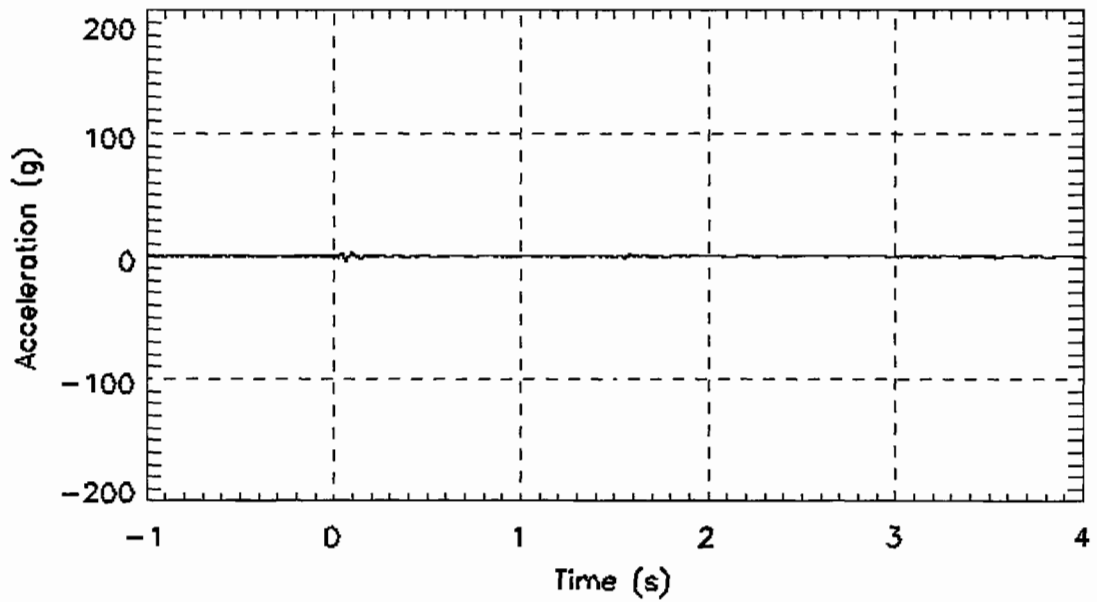

Figure K- 19. Bullet car, position 3, centersill, vertical acceleration, digitally filtered at Fc=100Hz, C3Z_100Hz.txt

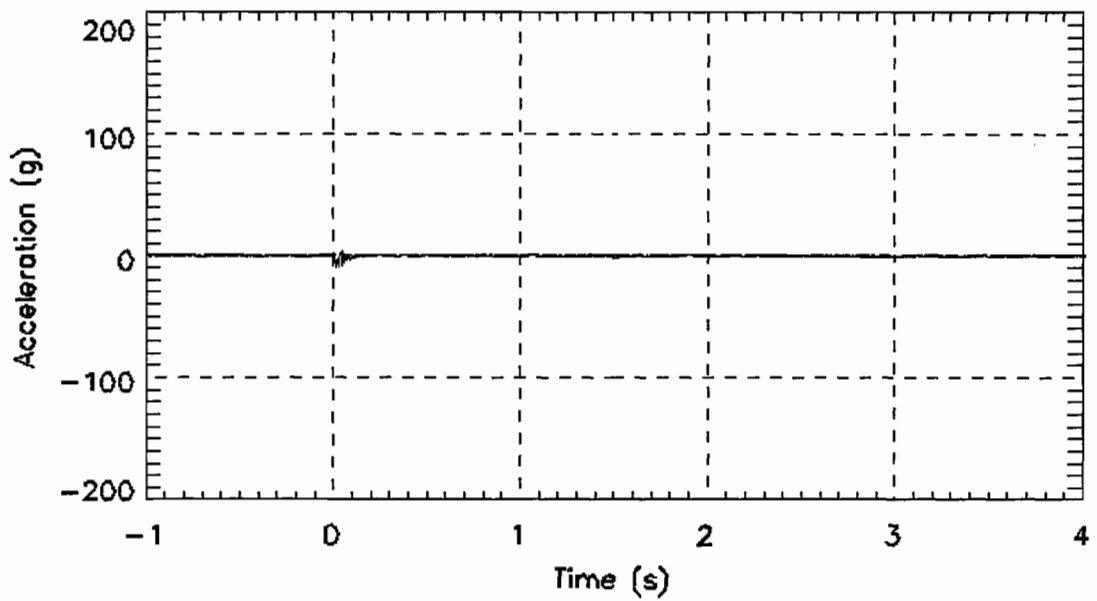

Figure K- 20. Bullet car, position 4, centersill, longitudinal acceleration, digitally filtered at Fc=100Hz, C4X_100Hz.txt

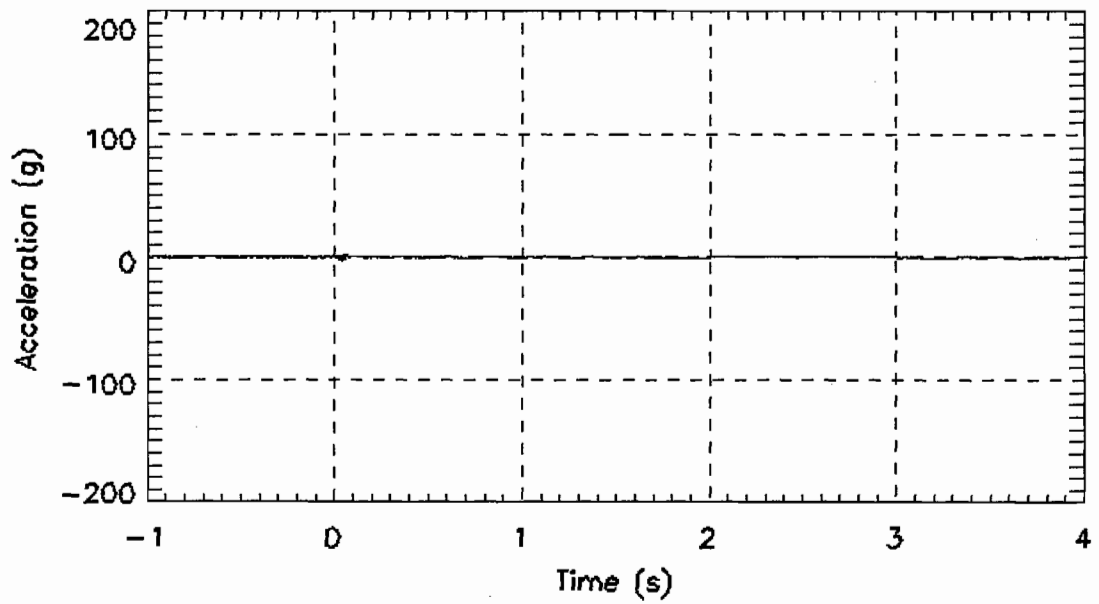

Figure K- 21. Bullet car, position 4, centersill, lateral acceleration, digitally filtered at Fc=100Hz, C4Y_100Hz.txt

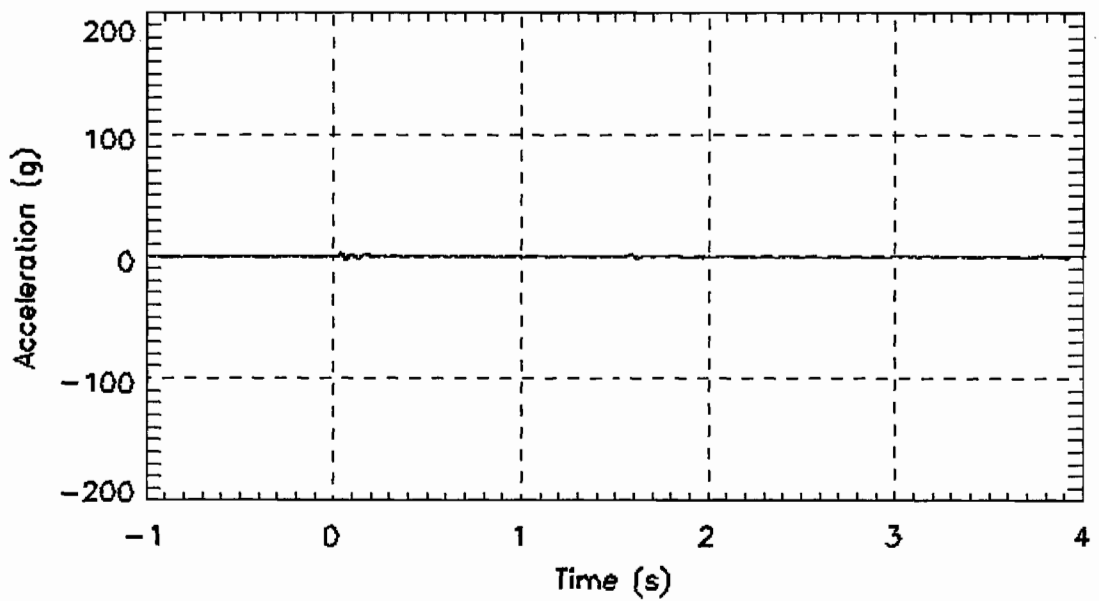

Figure K- 22. Bullet car, position 4, centersill, vertical acceleration, digitally filtered at Fc=100Hz, C4Z_100Hz.txt

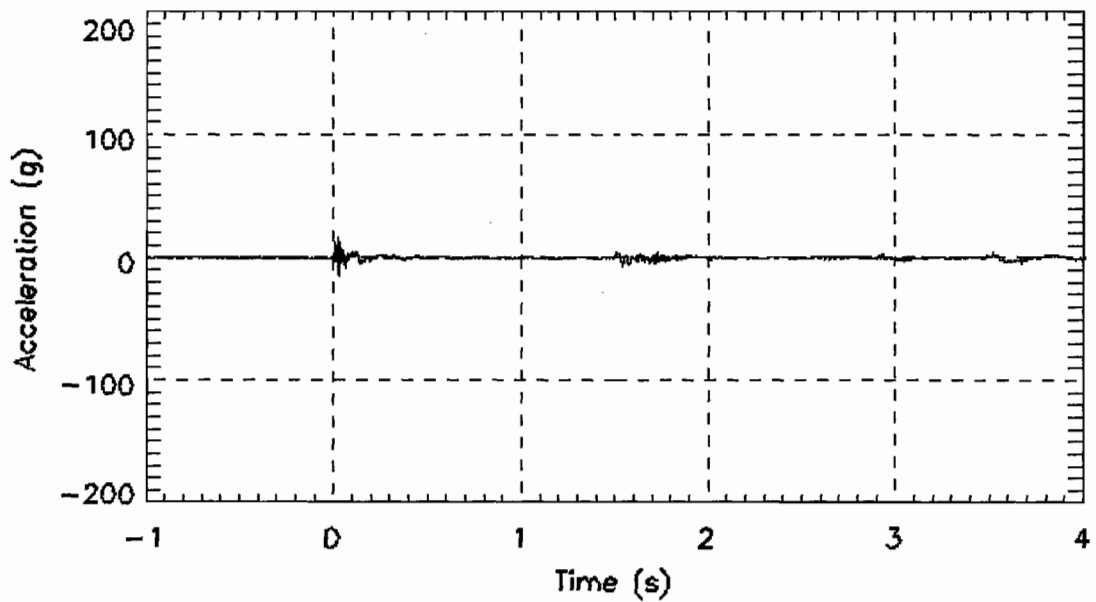

Figure K- 23. Bullet car, underframe level, left side, position 1, longitudinal acceleraion, digitally filtered at Fc=100Hz, L1X_100Hz.txt

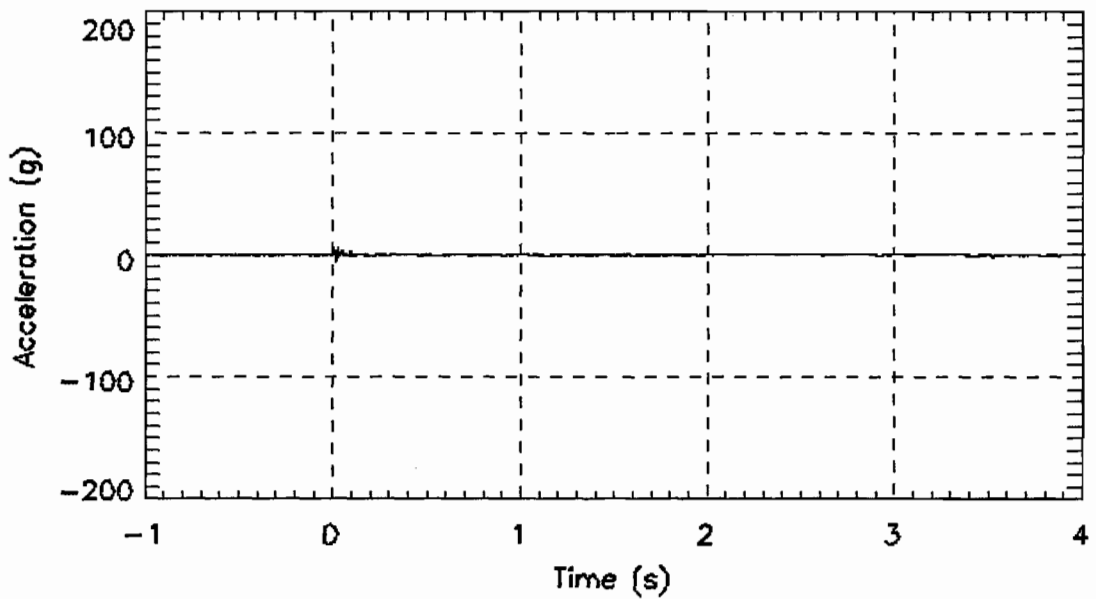

Figure K- 24. Bullet car, underframe level, left side, position 1, lateral acceleraion, digitally filtered at Fc=100Hz, L1Y_100Hz.txt

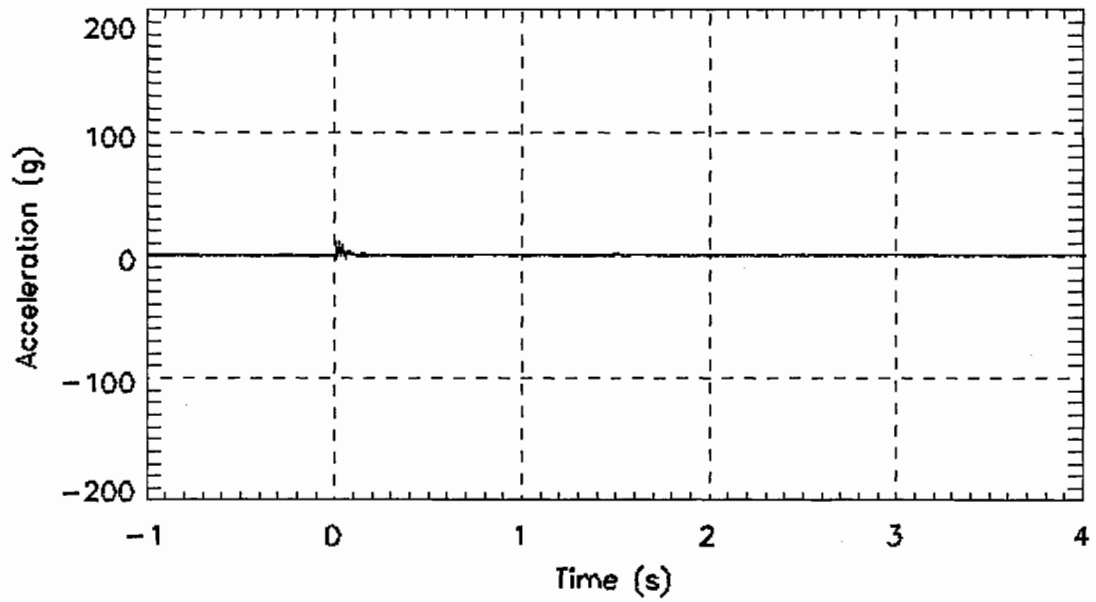

Figure K- 25. Bullet car, underframe level, left side, position 1, vertical acceleraion, digitally filtered at Fc=100Hz, L1Z_100Hz.txt

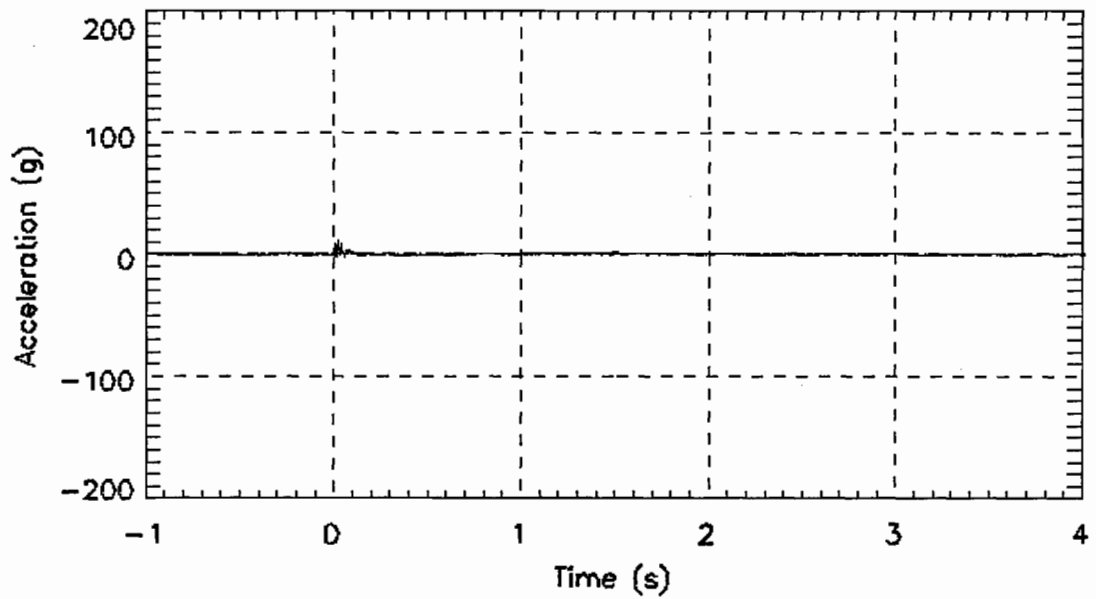

Figure K- 26. Bullet car, underframe level, left side, position 2, longitudinal acceleraion, digitally filtered at Fc=100Hz, L2X_100Hz.txt

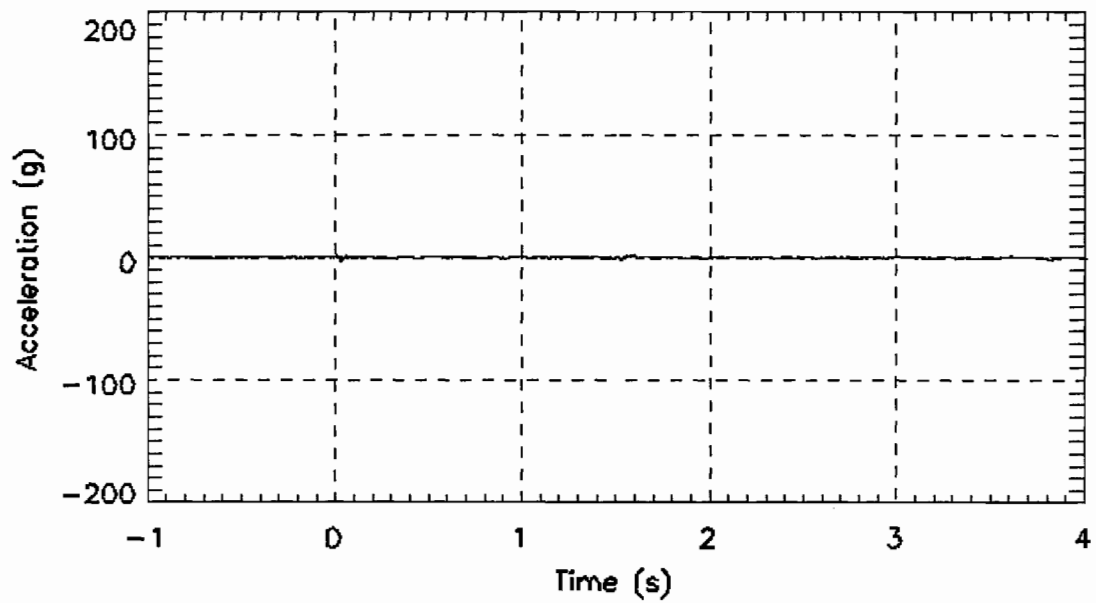

Figure K- 27. Bullet car, underframe level, left side, position 2, vertical acceleraion, digitally filtered at Fc=100Hz, L2Z_100Hz.txt

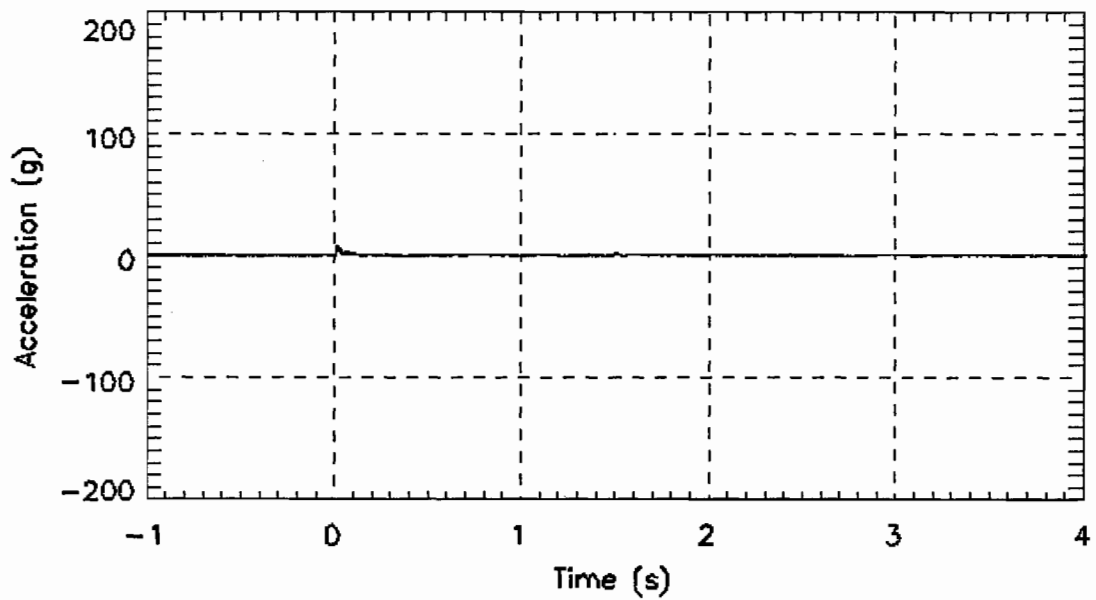

Figure K- 28. Bullet car, underframe level, left side, position 3, longitudinal acceleraion, digitally filtered at Fc=100Hz, L3X_100Hz.txt

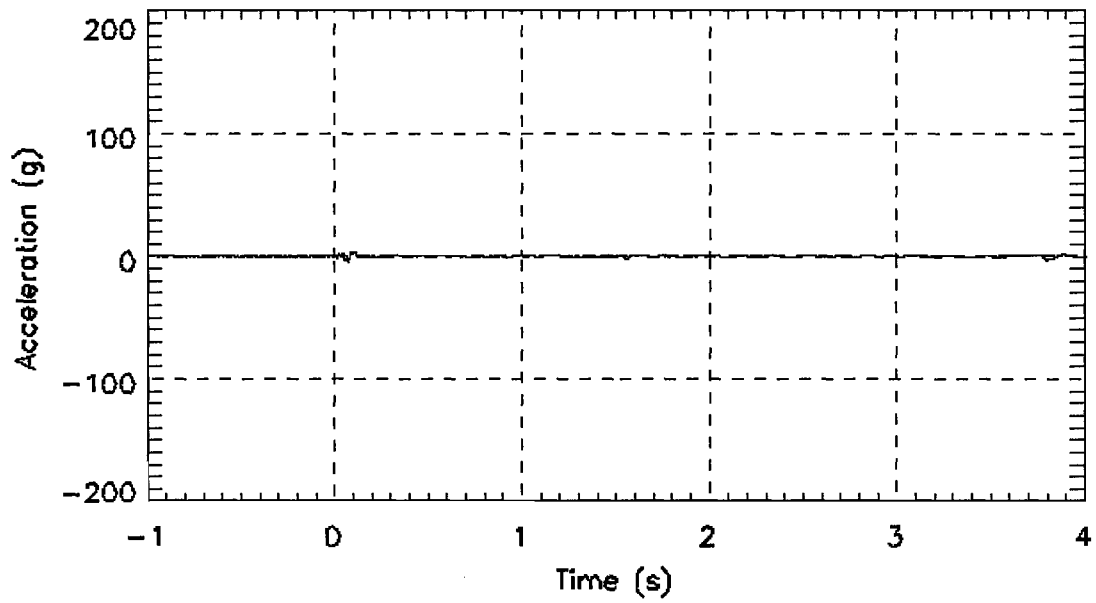

Figure K- 29. Bullet car, underframe level, left side, position 3, vertical acceleraion, digitally filtered at Fc=100Hz, L3Z_100Hz.txt

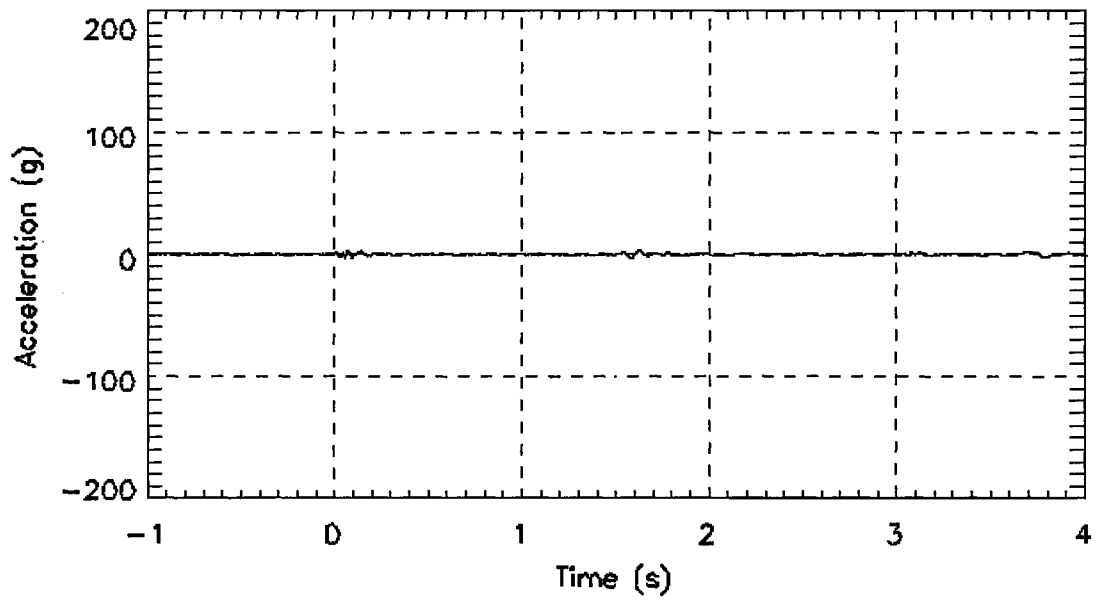

Figure K- 30. Bullet car, underframe level, left side, position 4, vertical acceleraion, digitally filtered at Fc=100Hz, L4Z_100Hz.txt

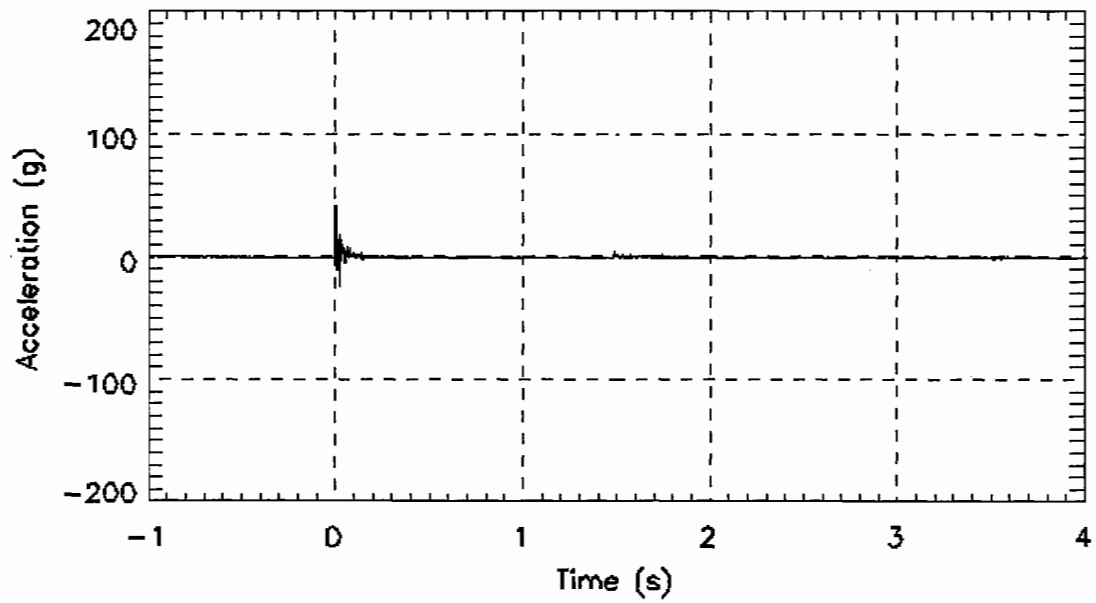

Figure K- 31. Bullet car, underframe level, right side, position 1, longitudinal acceleraion, digitally filtered at $F_c=100\text{Hz}$, R1X_100Hz.txt

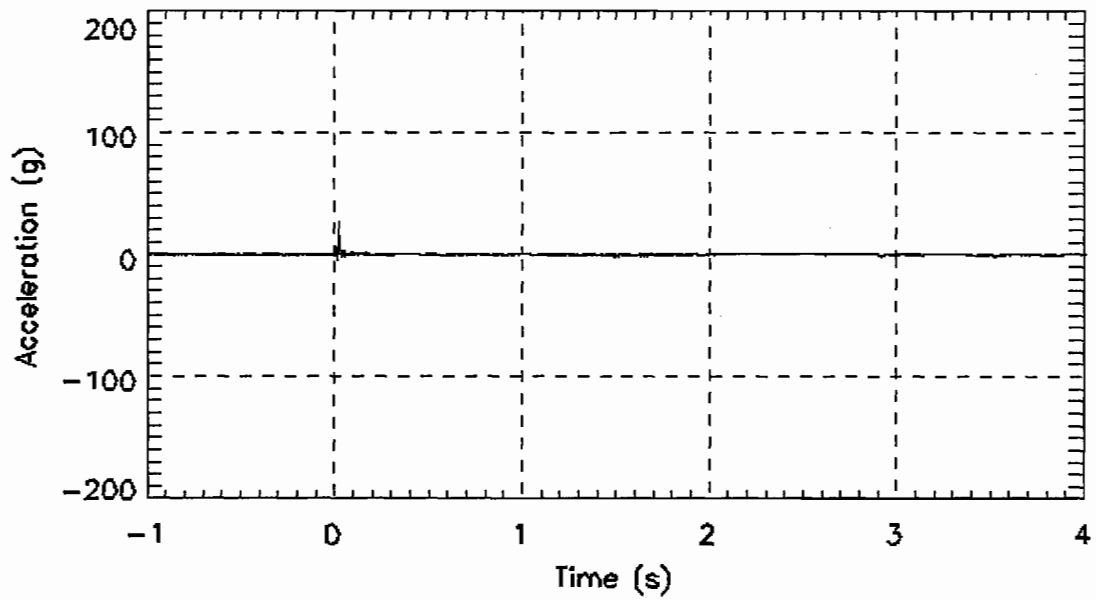

Figure K- 32. Bullet car, underframe level, right side, position 1, lateral acceleraion, digitally filtered at $F_c=100\text{Hz}$, R1Y_100Hz.txt

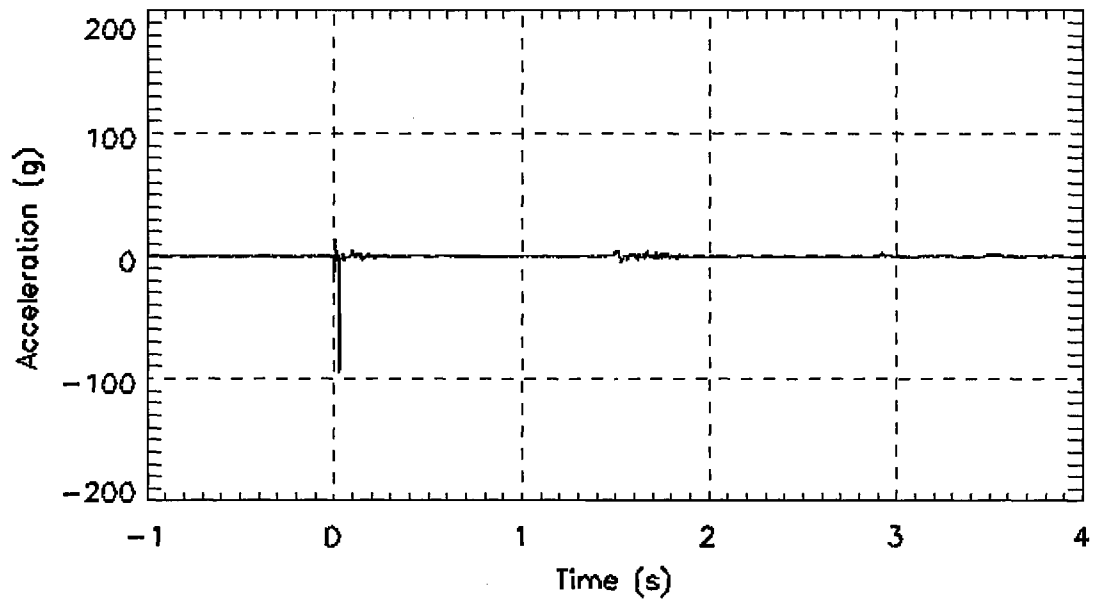

Figure K- 33. Bullet car, underframe level, right side, position 1, vertical acceleraion, digitally filtered at Fc=100Hz, R1Z_100Hz.txt

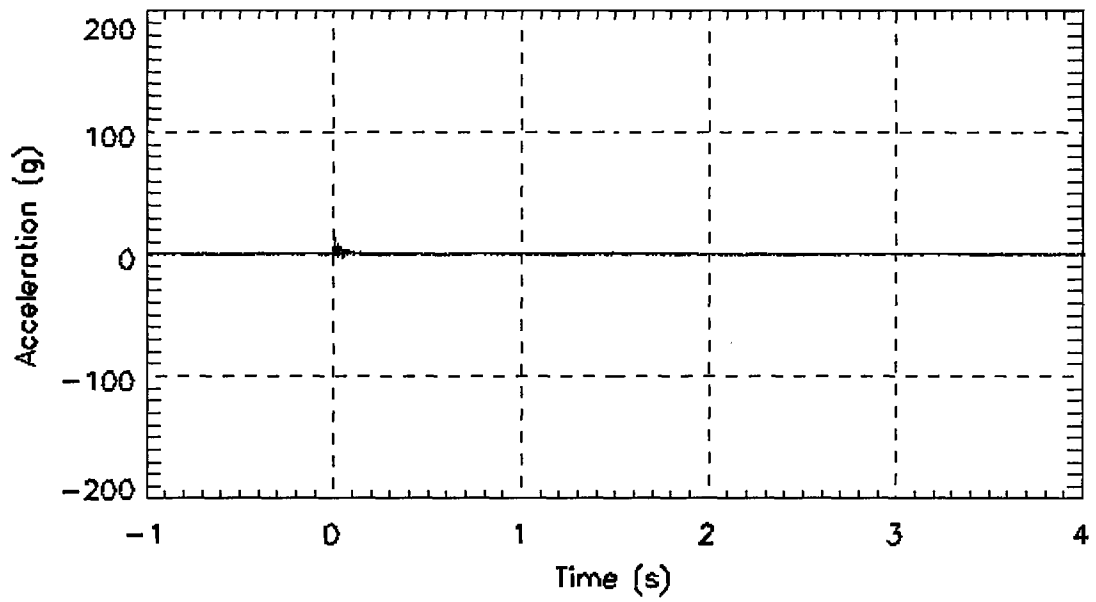

Figure K- 34. Bullet car, underframe level, right side, position 2, longitudinal acceleraion, digitally filtered at Fc=100Hz, R2X_100Hz.txt

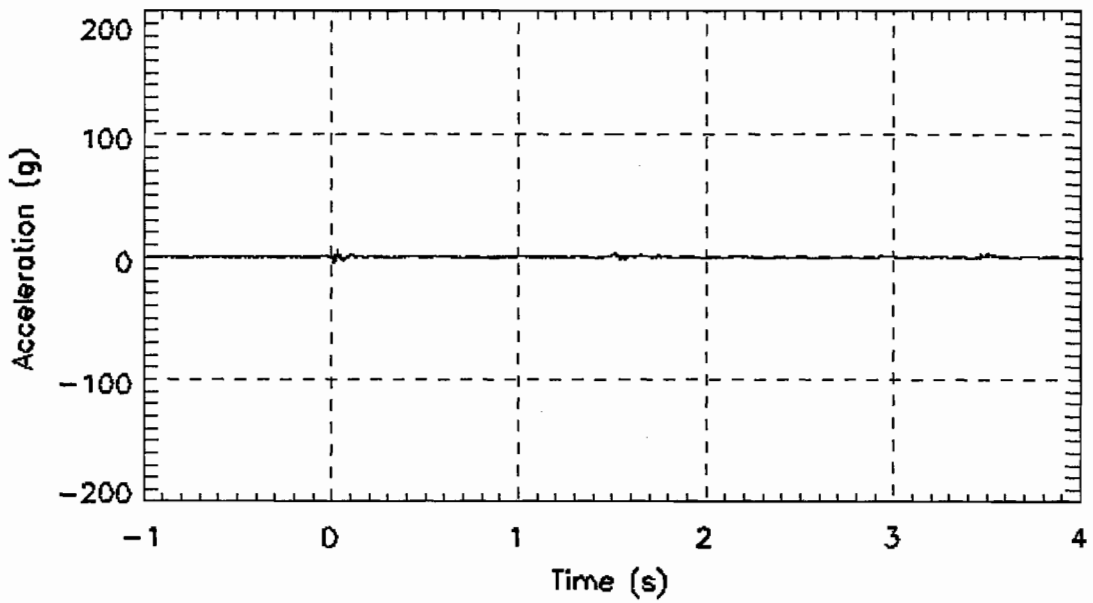

Figure K- 35. Bullet car, underframe level, right side, position 2, vertical acceleraion, digitally filtered at $F_c=100\text{Hz}$, R2Z_100Hz.txt

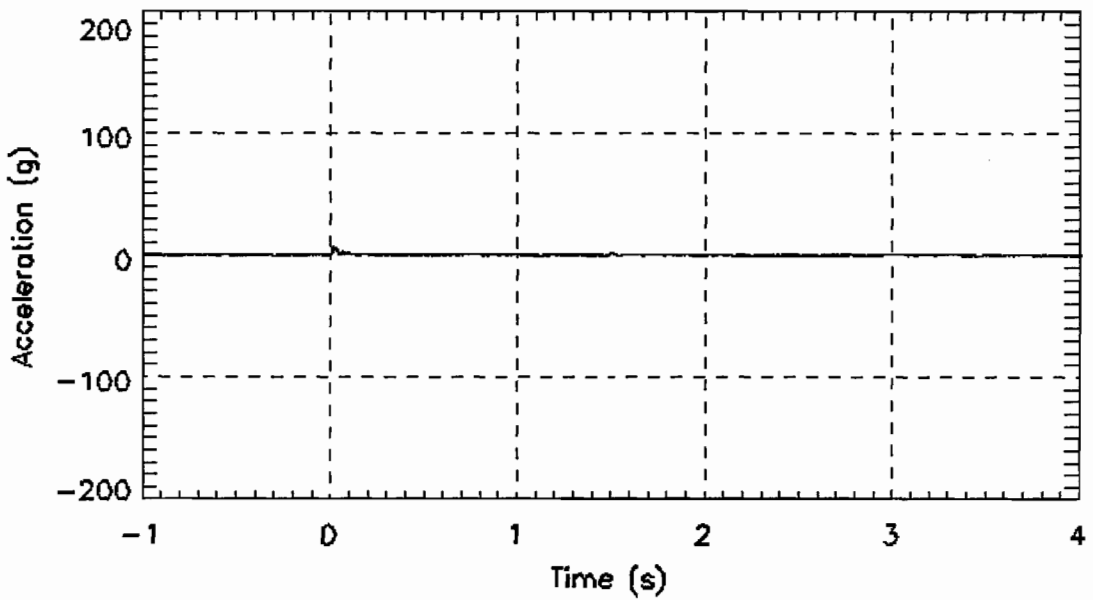

Figure K- 36. Bullet car, underframe level, right side, position 3, longitudinal acceleraion, digitally filtered at $F_c=100\text{Hz}$, R3X_100Hz.txt

5

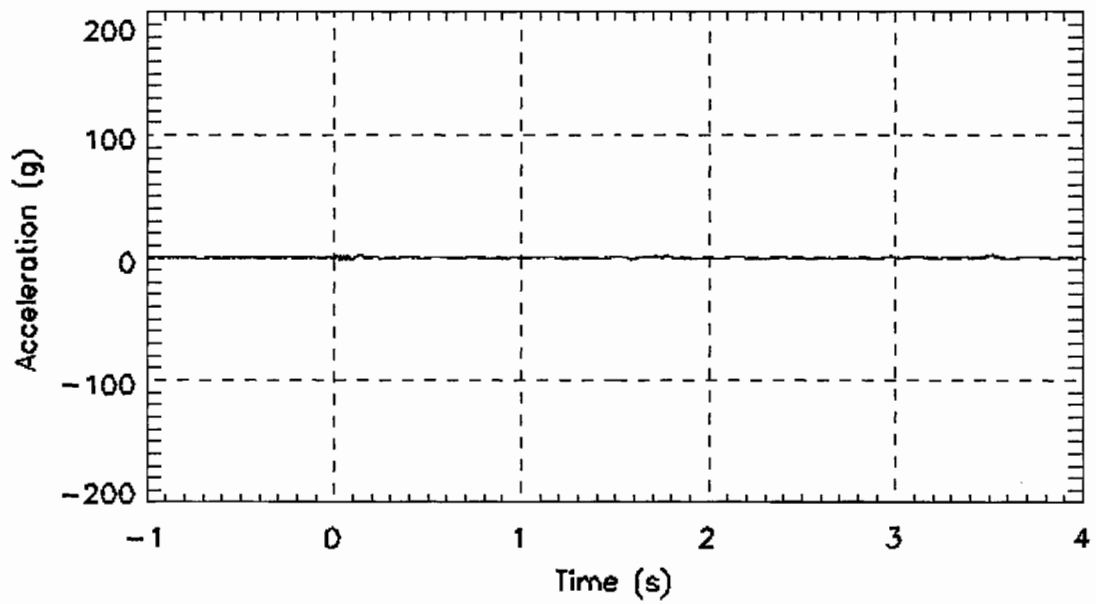

Figure K- 37. Bullet car, underframe level, right side, position 3, vertical acceleraion, digitally filtered at $F_c=100\text{Hz}$, R3Z_100Hz.txt

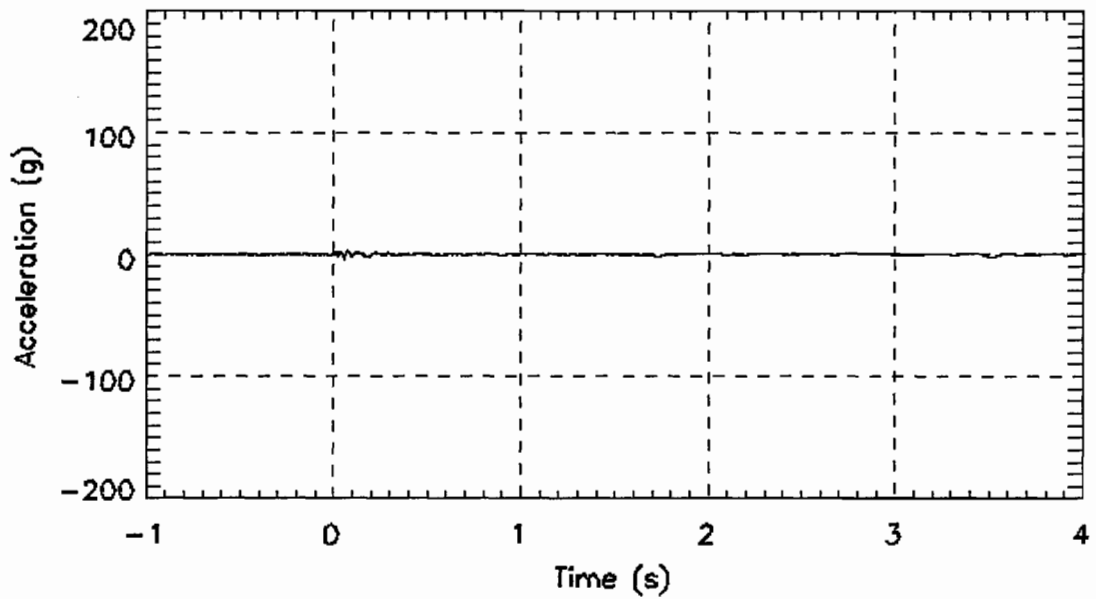

Figure K- 38. Bullet car, underframe level, right side, position 4, vertical acceleraion, digitally filtered at $F_c=100\text{Hz}$, R4Z_100Hz.txt

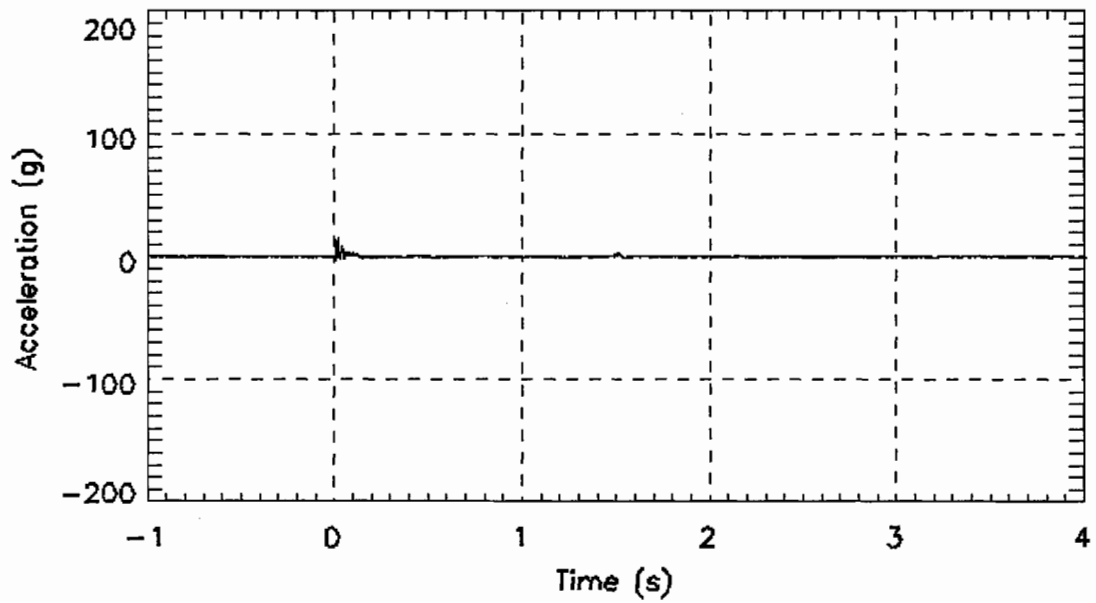

Figure K- 39. Bullet car, cant rail level, left side, position 1, longitudinal acceleraion, digitally filtered at Fc=100Hz, TL1X_100Hz.txt

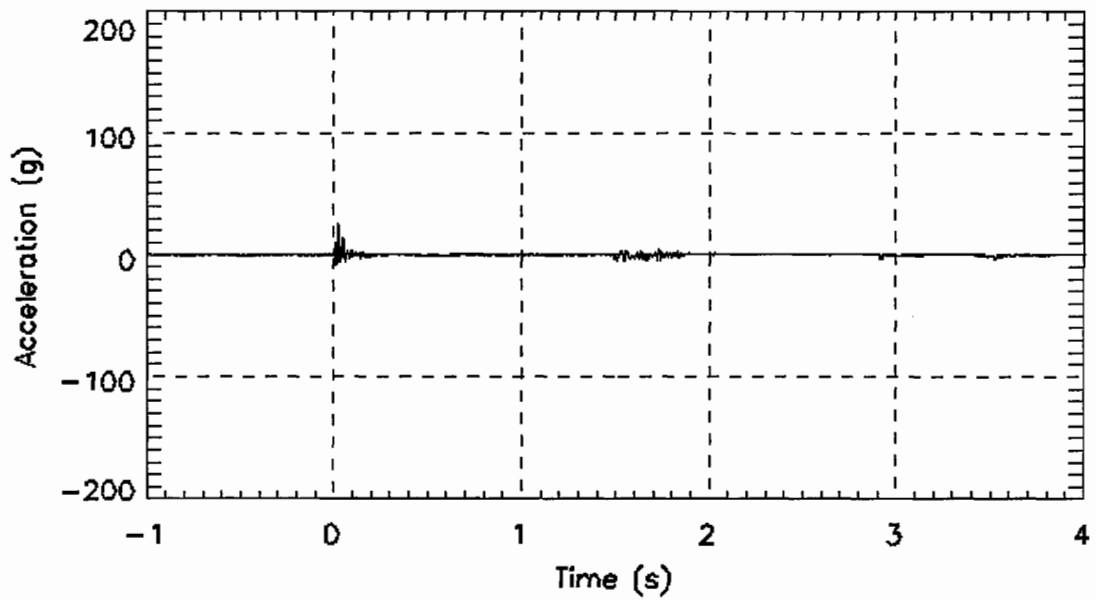

Figure K- 40. Bullet car, cant rail level, left side, position 1, lateral acceleraion, digitally filtered at Fc=100Hz, TL1Y_100Hz.txt

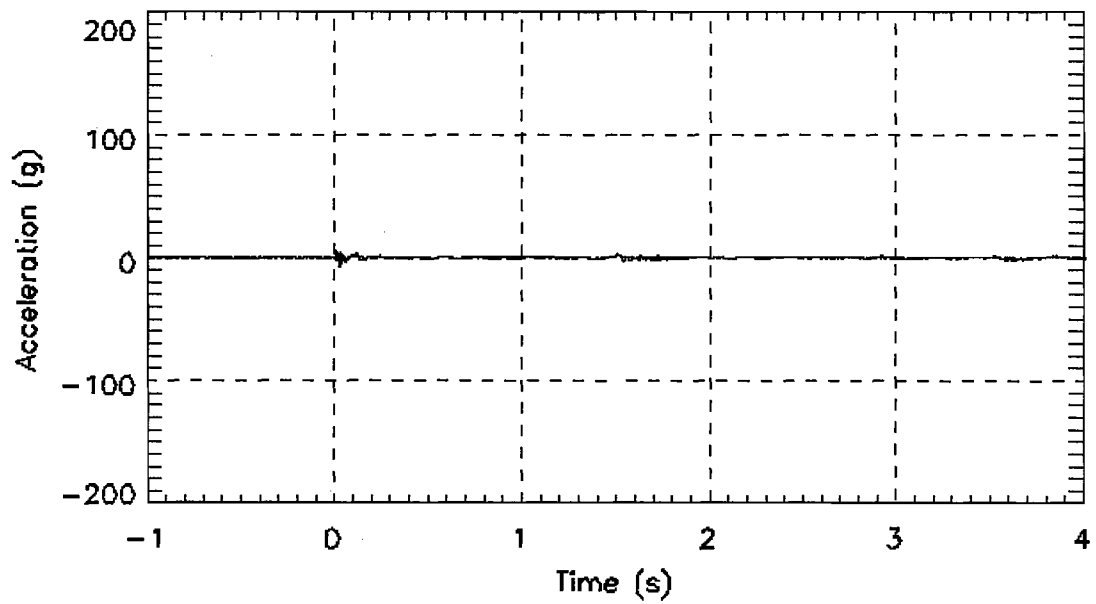

Figure K- 41. Bullet car, cant rail level, left side, position 1, vertical acceleraion, digitally filtered at $F_c=100\text{Hz}$, TL1Z_100Hz.txt

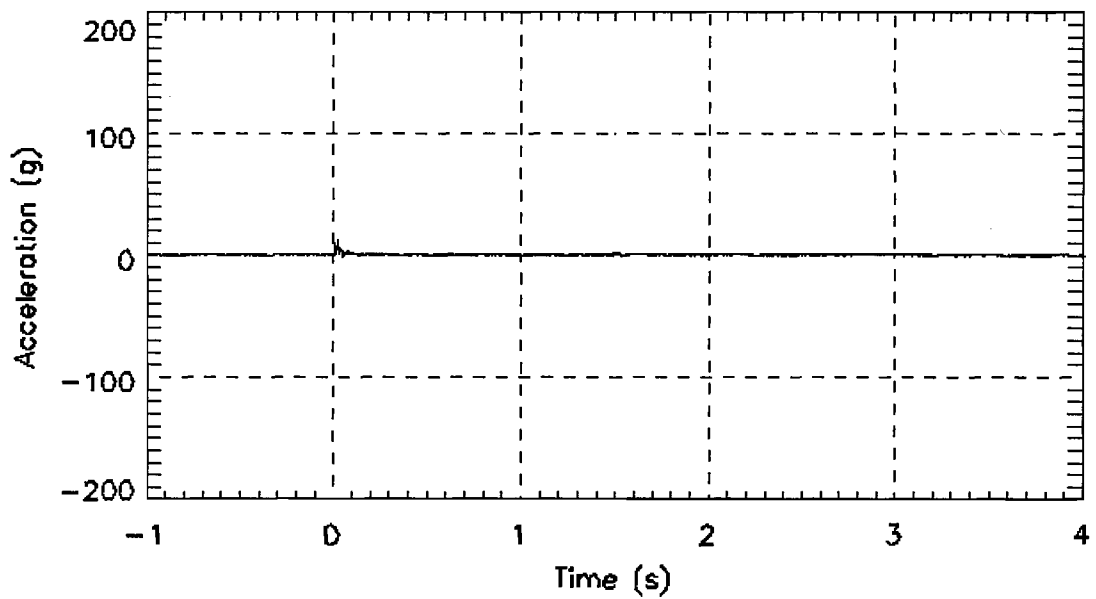

Figure K- 42. Bullet car, cant rail level, left side, position 2, longitudinal acceleraion, digitally filtered at $F_c=100\text{Hz}$, TL2X_100Hz.txt

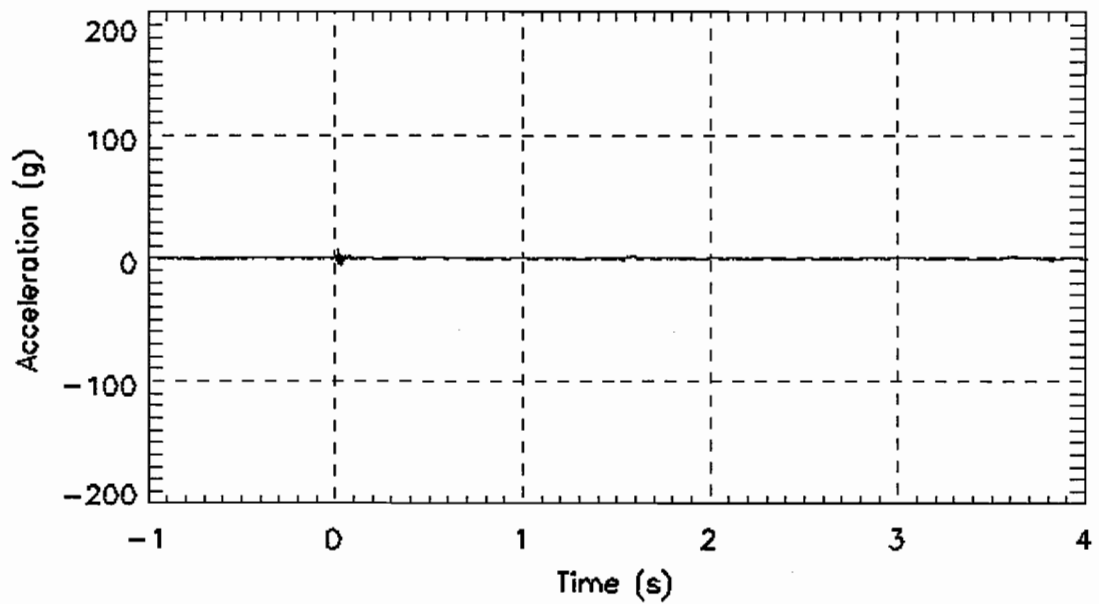

Figure K- 43. Bullet car, cant rail level, left side, position 2, vertical acceleraion, digitally filtered at Fc=100Hz, TL2Z_100Hz.txt

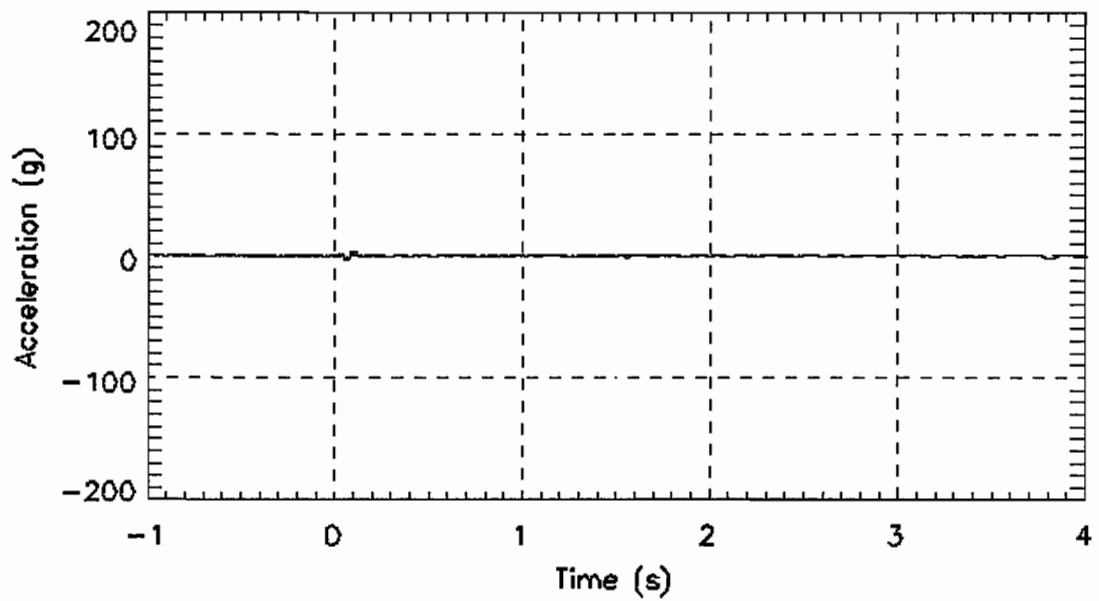

Figure K- 44. Bullet car, cant rail level, left side, position 3, vertical acceleraion, digitally filtered at Fc=100Hz, TL3Z_100Hz.txt

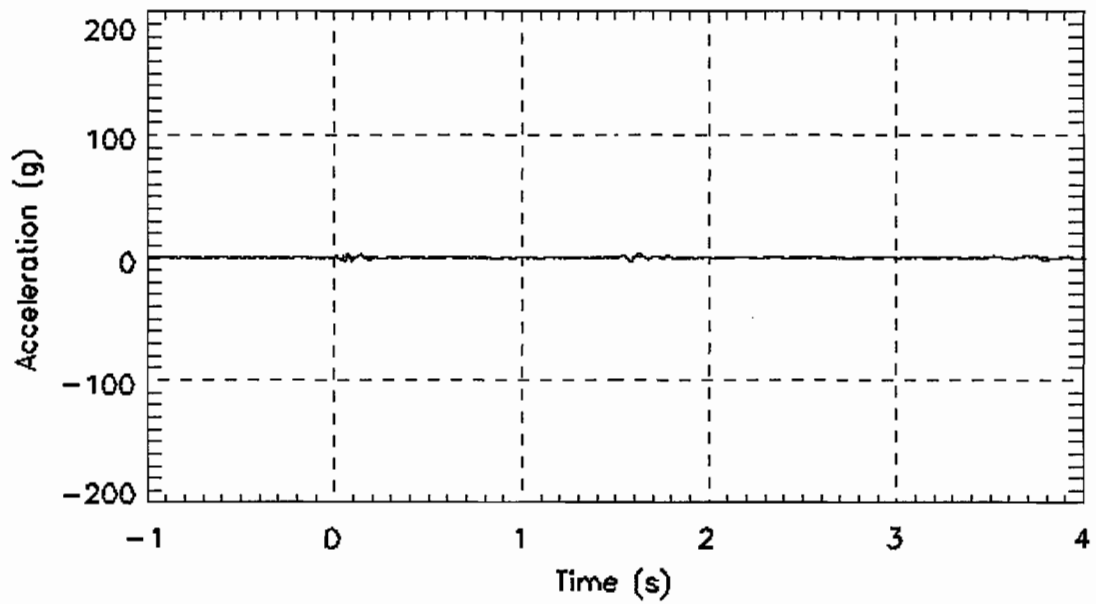

Figure K- 45. Bullet car, cant rail level, left side, position 4, vertical acceleraion, digitally filtered at Fc=100Hz, TL4Z_100Hz.txt

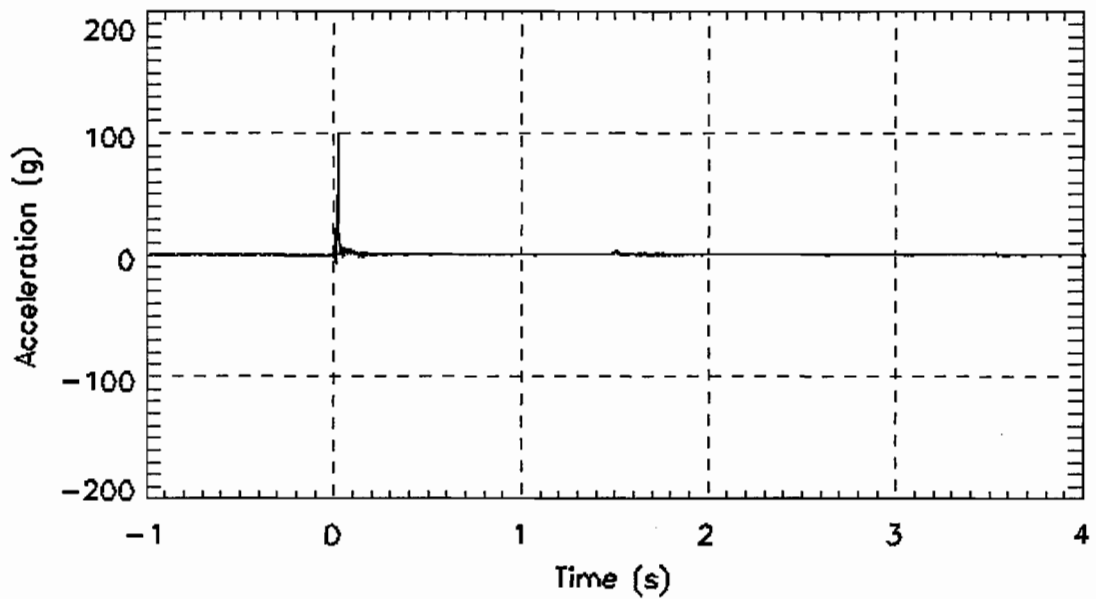

Figure K- 46. Bullet car, cant rail level, right side, position 1, longitudinal acceleraion, digitally filtered at Fc=100Hz, TR1X_100Hz.txt



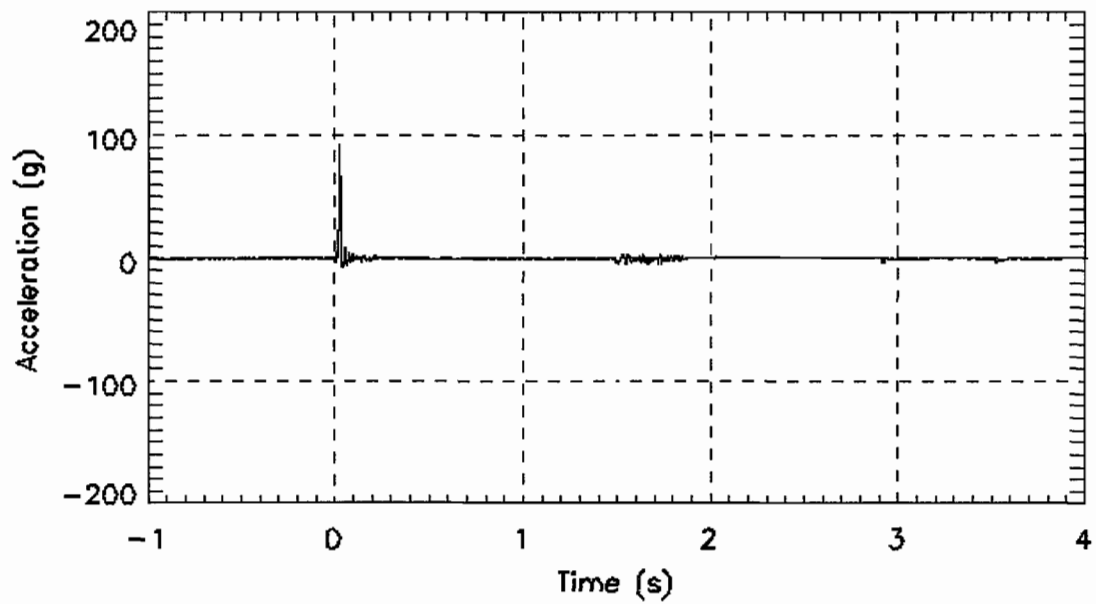

Figure K- 47. Bullet car, cant rail level, right side, position 1, lateral acceleraion, digitally filtered at Fc=100Hz, TR1Y_100Hz.txt

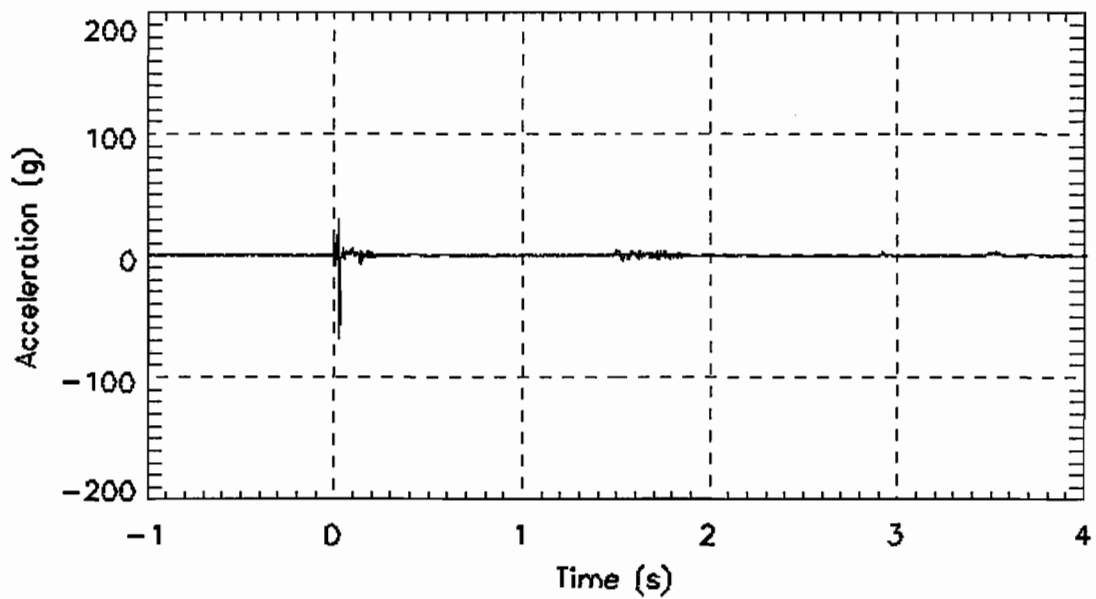

Figure K- 48. Bullet car, cant rail level, right side, position 1, vertical acceleraion, digitally filtered at Fc=100Hz, TR1Z_100Hz.txt

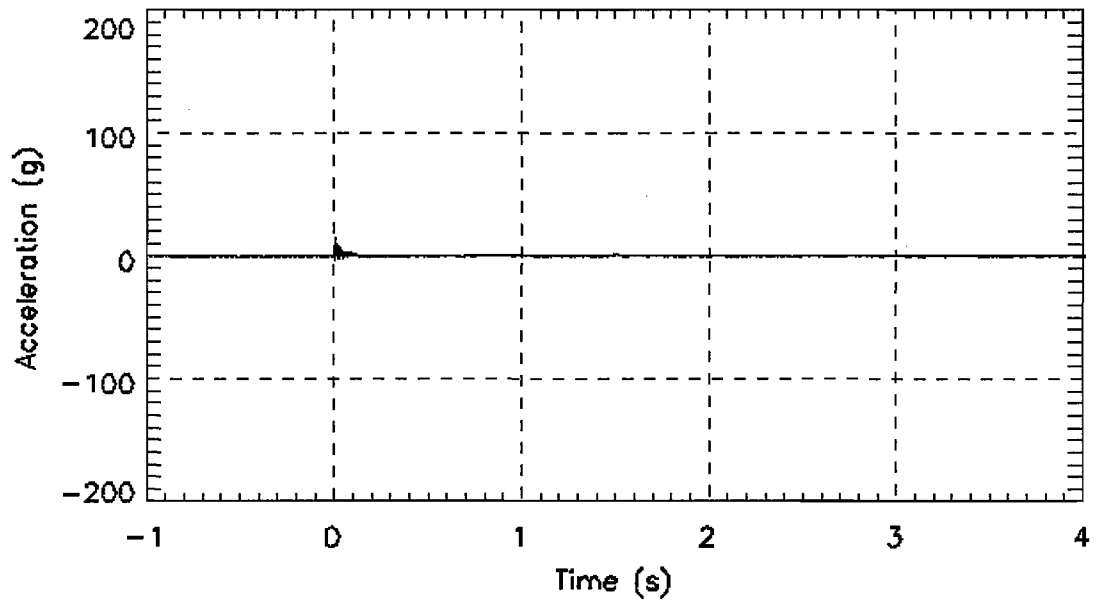

Figure K- 49. Bullet car, cant rail level, right side, position 2, longitudinal acceleraion, digitally filtered at Fc=100Hz, TR2X_100Hz.txt

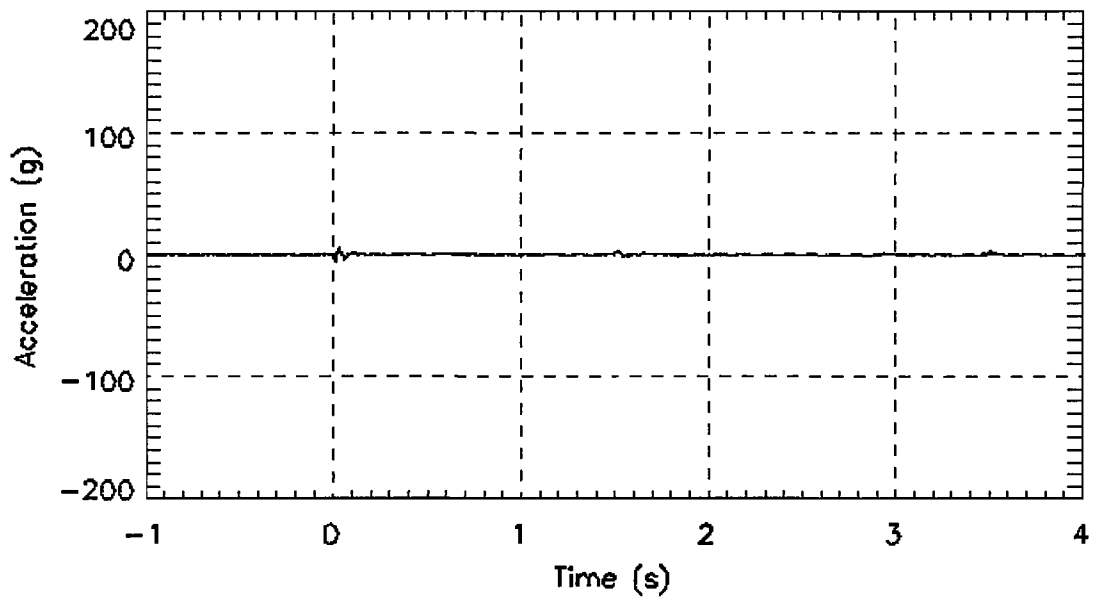

Figure K- 50. Bullet car, cant rail level, right side, position 2, vertical acceleraion, digitally filtered at Fc=100Hz, TR2Z_100Hz.txt

2

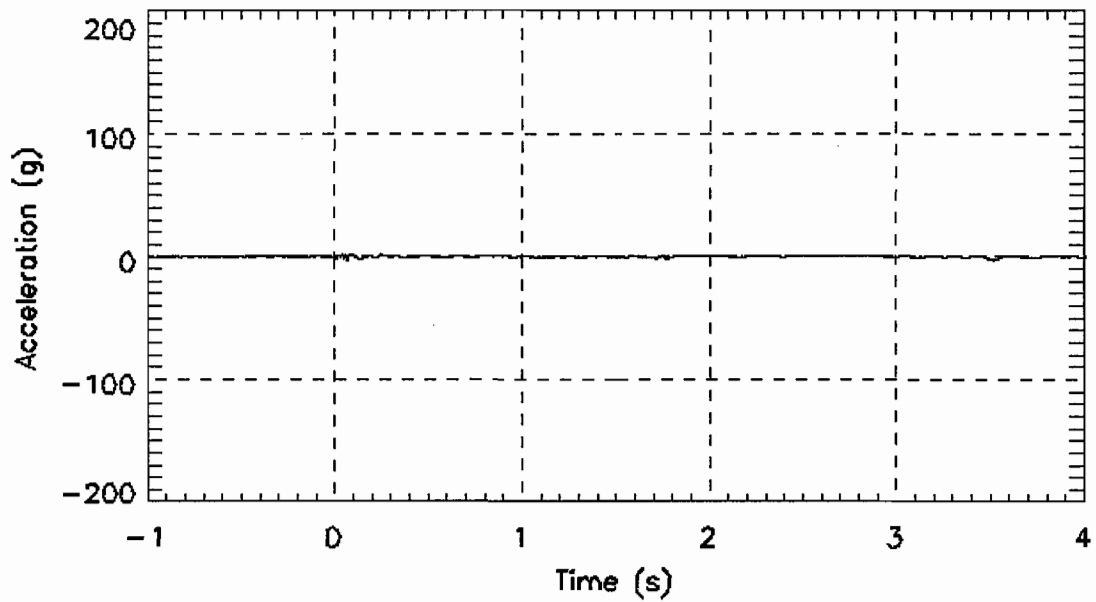

Figure K- 51. Bullet car, cant rail level, right side, position 3, vertical acceleraion, digitally filtered at Fc=100Hz, TR3Z_100Hz.txt

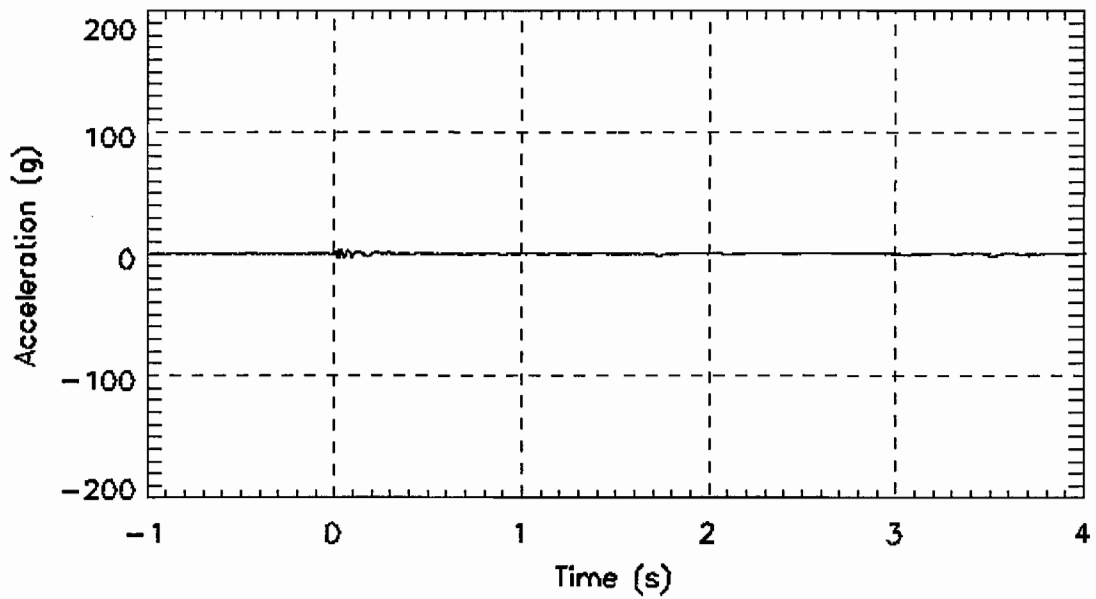

Figure K- 52. Bullet car, cant rail level, right side, position 4, vertical acceleraion, digitally filtered at Fc=100Hz, TR4Z_100Hz.txt

Appendix L

Test 5
Acceleration Data, $F_c = 25\text{Hz}$

This page left blank intentionally

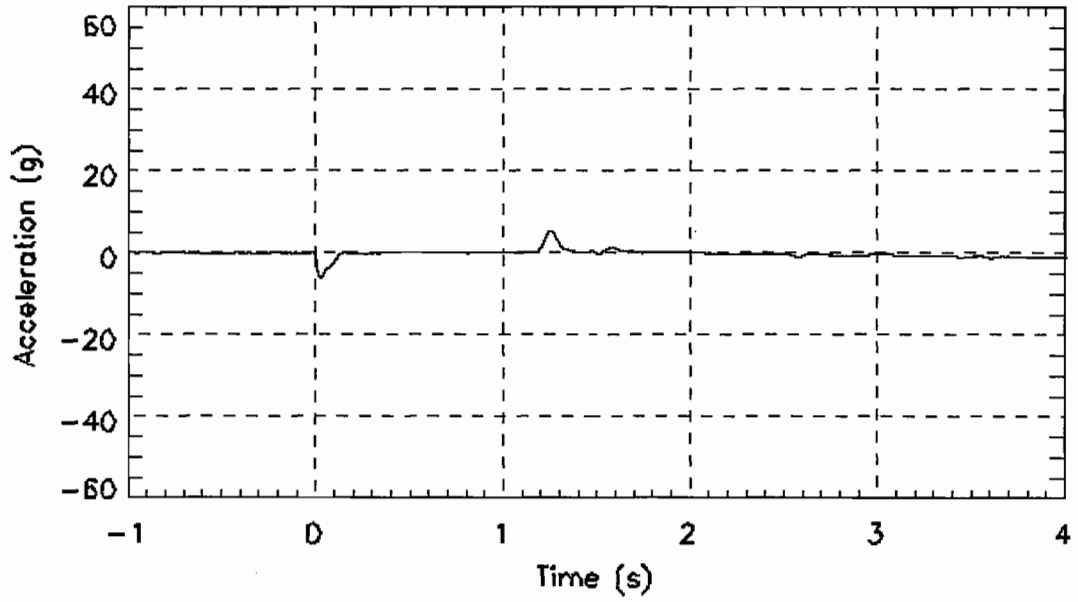

Figure L- 1. Steel coil, centered, longitudinal acceleration, digitally filtered at $F_c=25\text{Hz}$, A0X_25Hz.txt

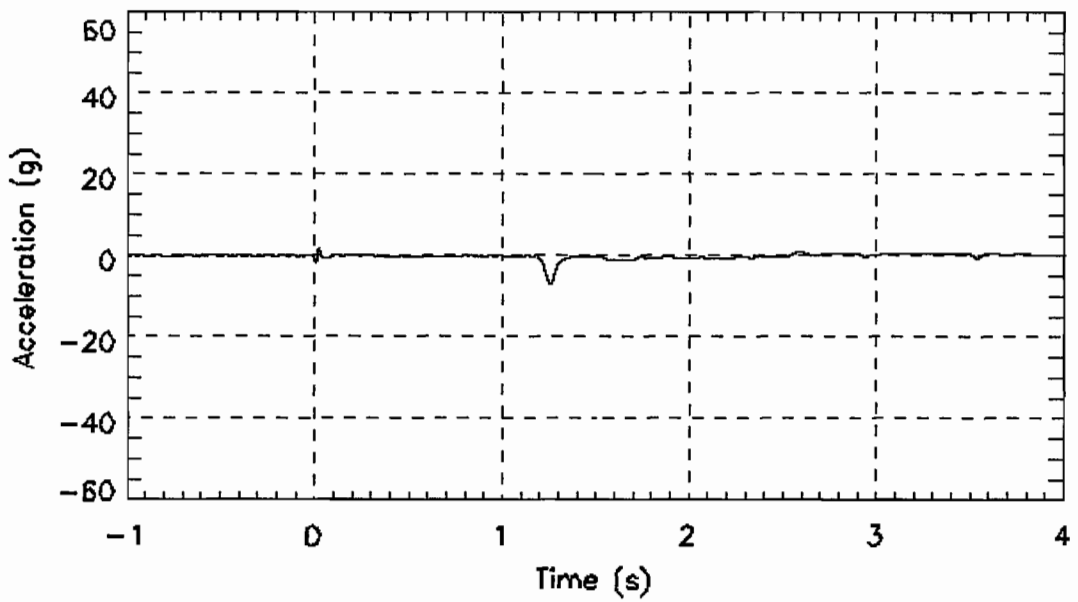

Figure L- 2. Steel coil, centered, lateral acceleration, digitally filtered at $F_c=25\text{Hz}$, A0Y_25Hz.txt

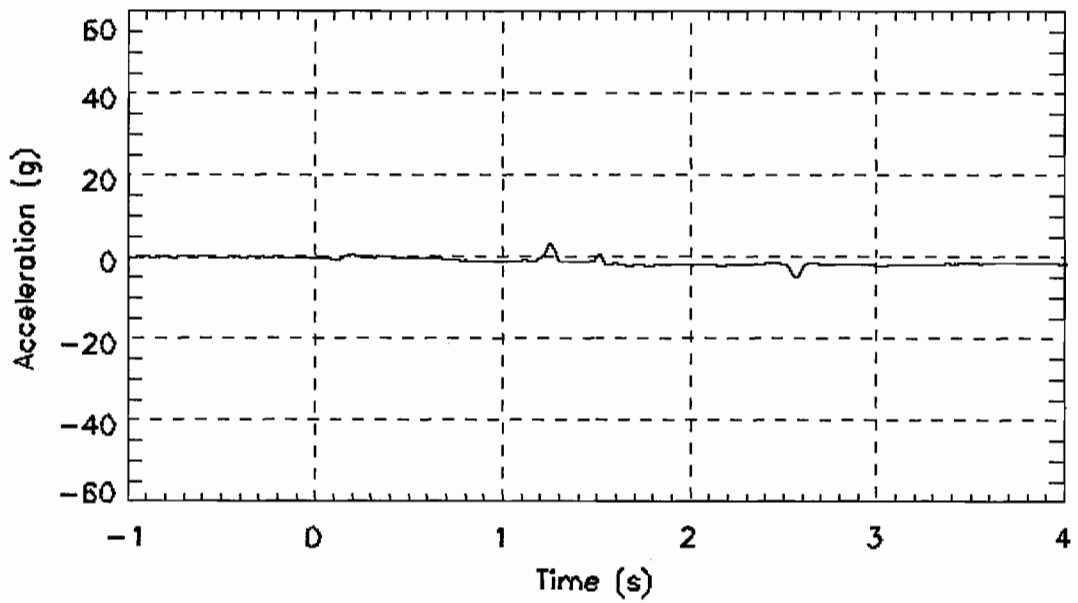

Figure L- 3. Steel coil, centered, vertical acceleration, digitally filtered at $F_c=25\text{Hz}$, A0Z_25Hz.txt

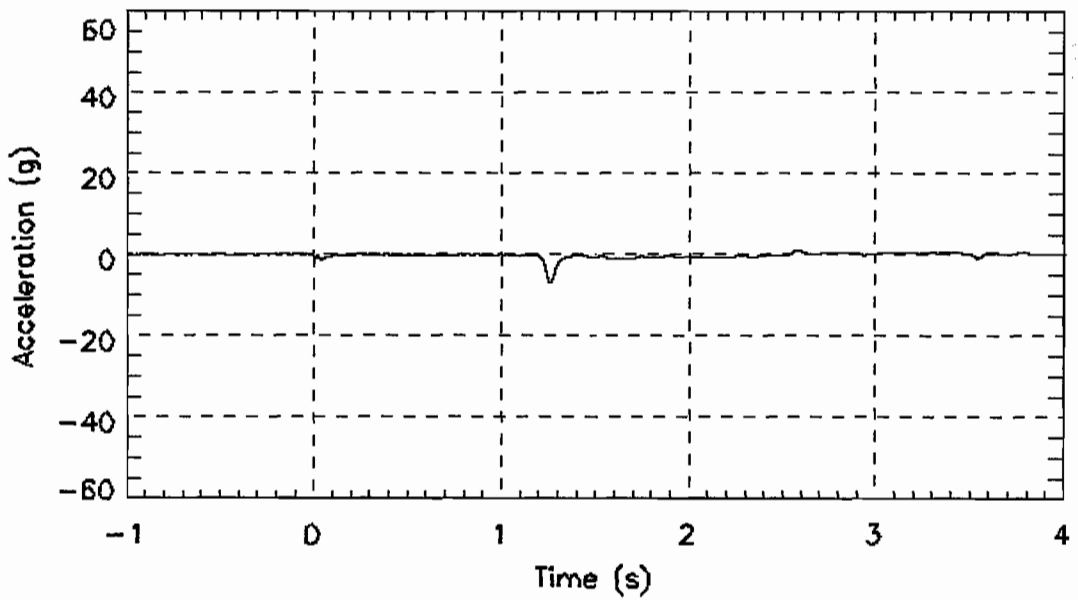

Figure L- 4. Steel coil, offset along X axis, lateral acceleration, digitally filtered at $F_c=25\text{Hz}$, A1Y_25Hz.txt

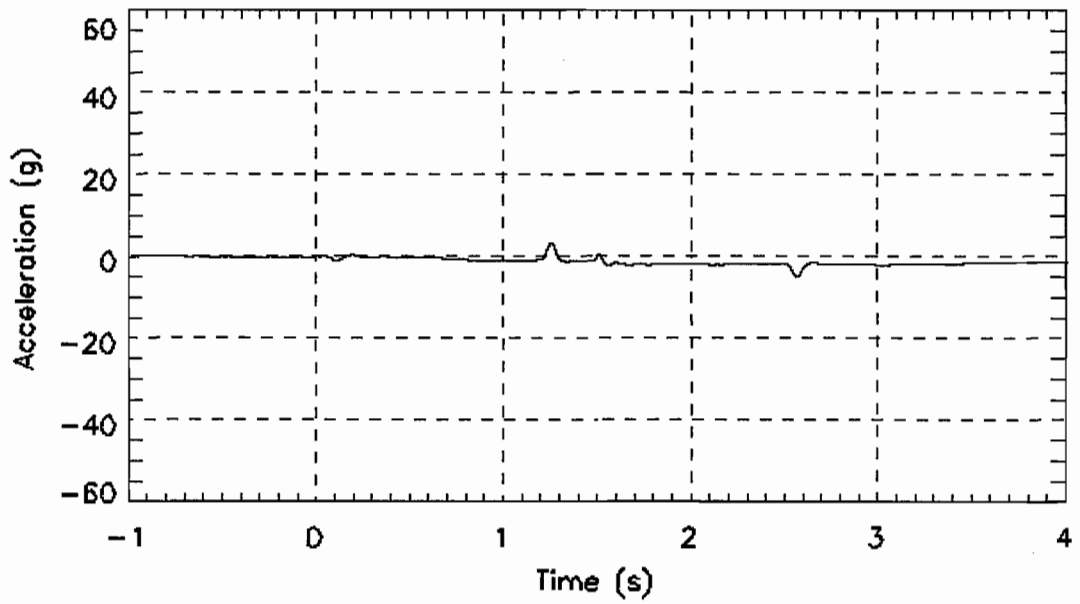

Figure L- 5. Steel coil, offset along X axis, vertical acceleration, digitally filtered at Fc=25Hz, A1Z_25Hz.txt

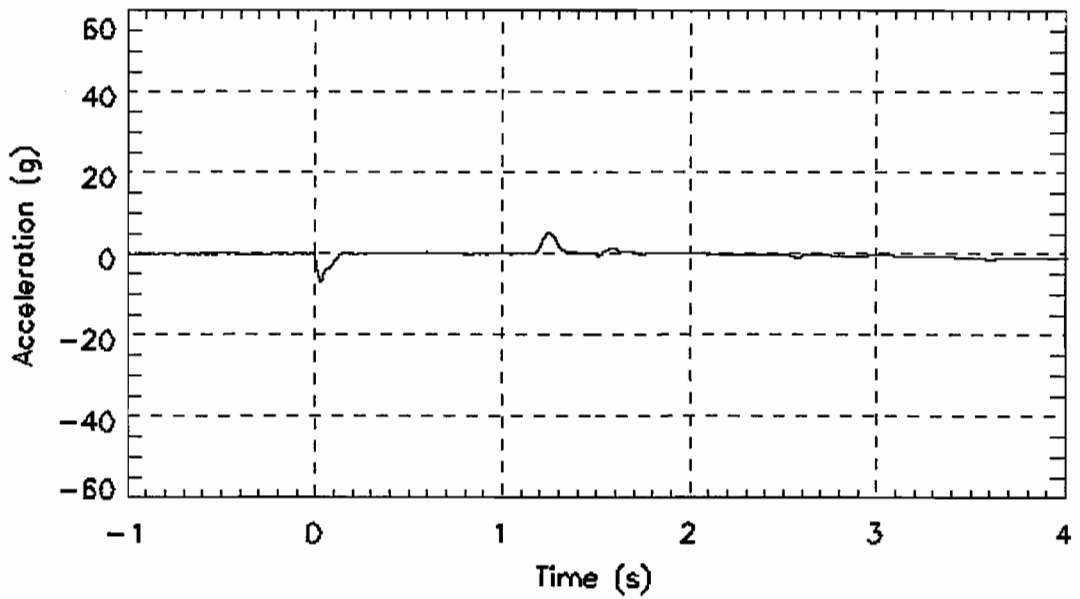

Figure L- 6. Steel coil, offset along Y axis, longitudinal acceleration, digitally filtered at Fc=25Hz, A2X_25Hz.txt

58

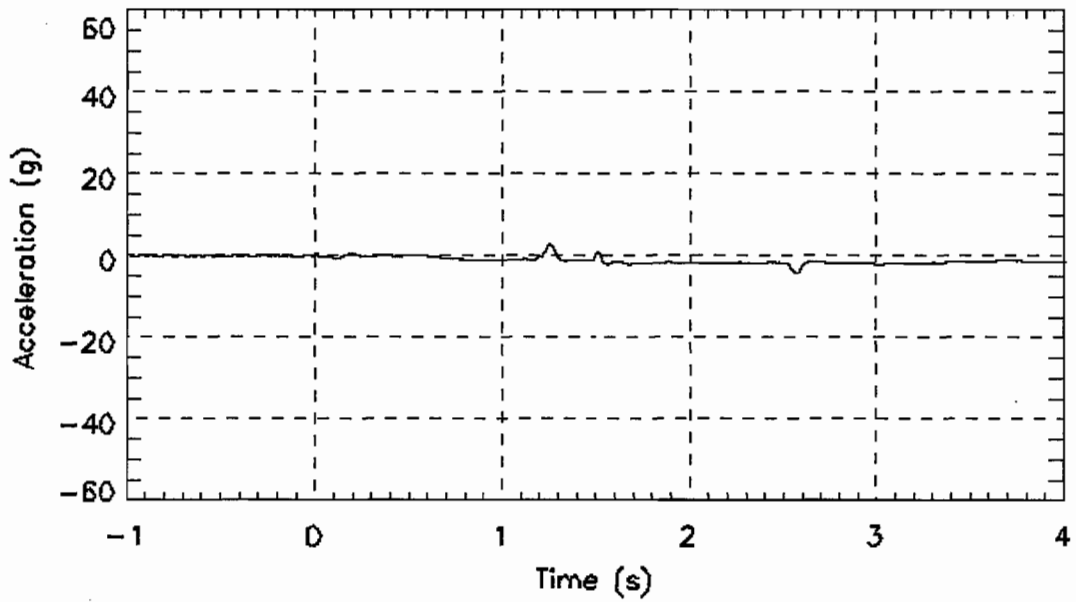

Figure L- 7. Steel coil, offset along Y axis, vertical acceleration, digitally filtered at Fc=25Hz, A2Z_25Hz.txt

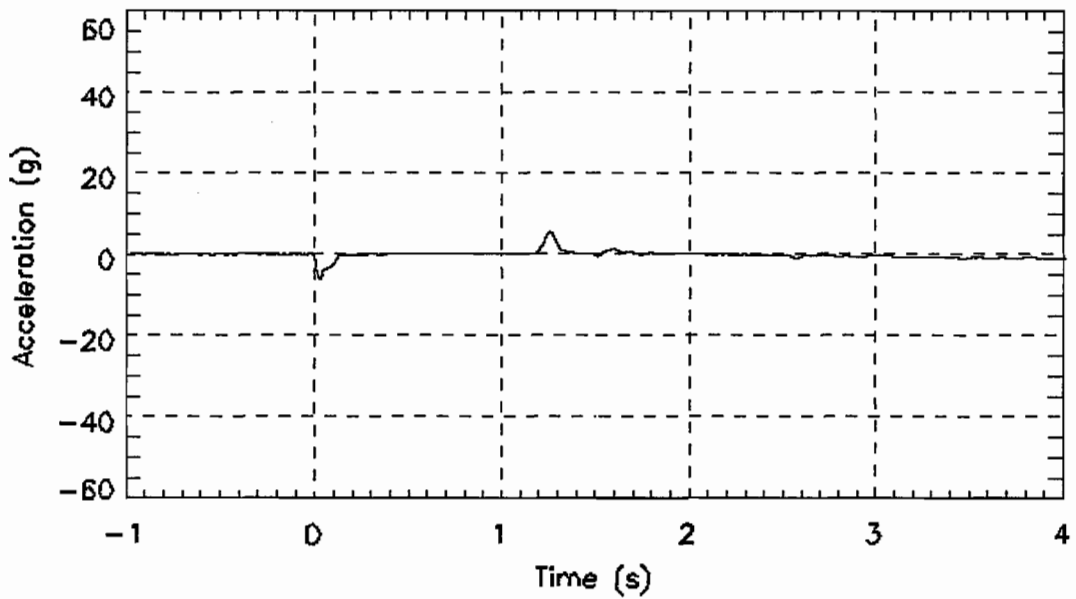

Figure L- 8. Steel coil, offset along Z axis, longitudinal acceleration, digitally filtered at Fc=25Hz, A3X_25Hz.txt

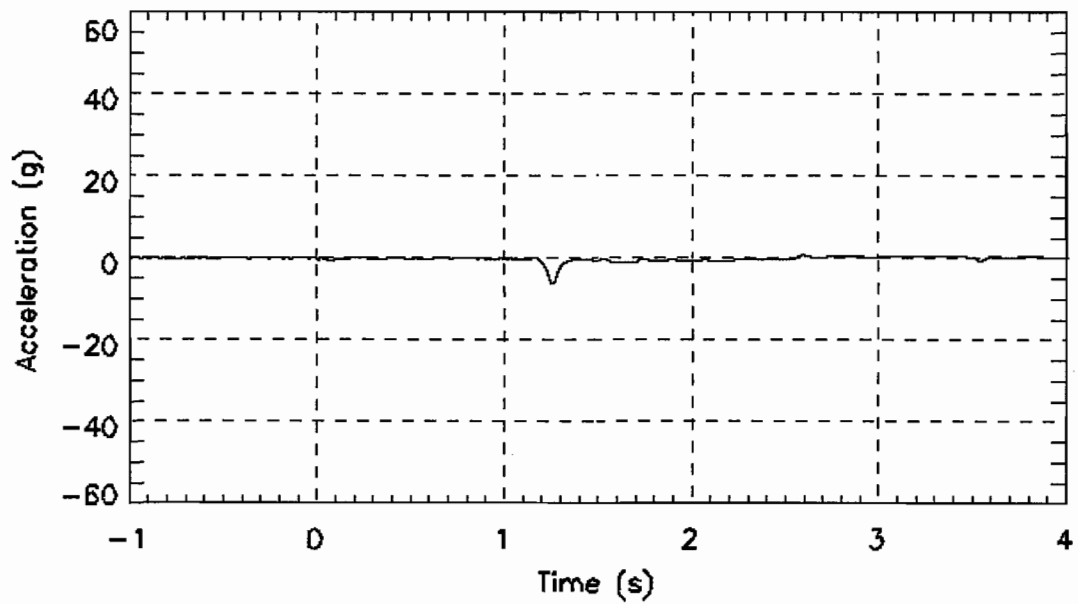

Figure L- 9. Steel coil, offset along Z axis, lateral acceleration, digitally filtered at $F_c=25\text{Hz}$, A3Y_25Hz.txt

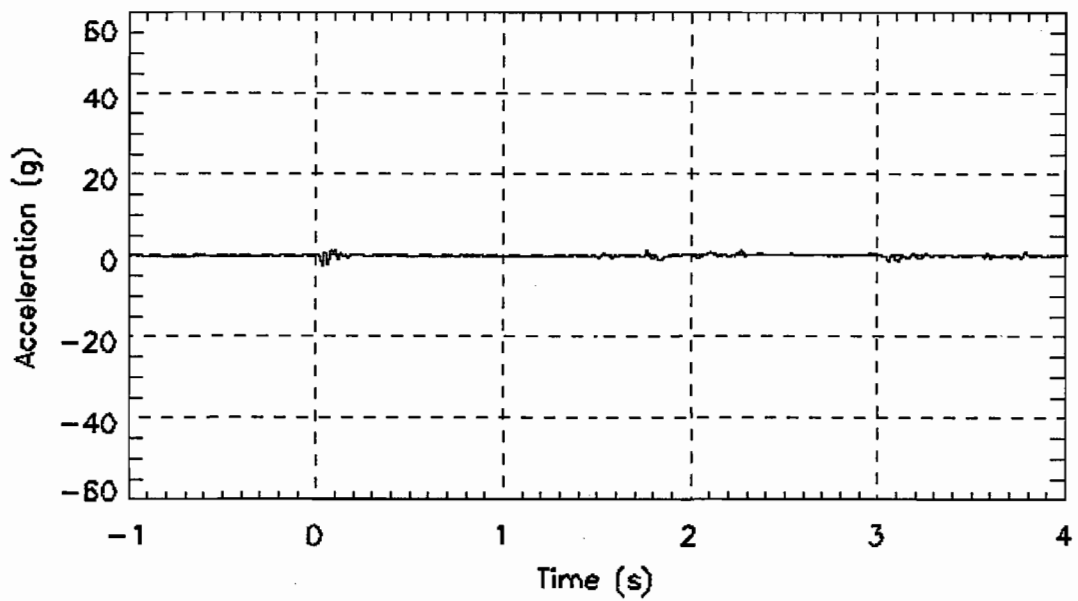

Figure L- 10. Lead bogie, lateral acceleration, digitally filtered at $F_c=25\text{Hz}$, BAY_25Hz.txt

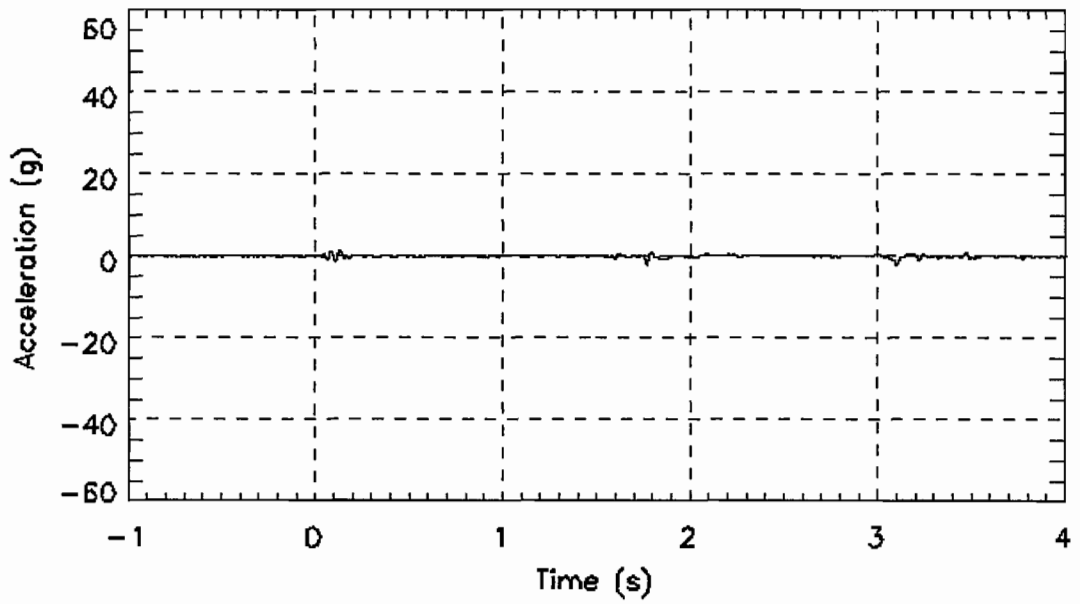

Figure L- 11. Lead bogie, vertical acceleration, digitally filtered at $F_c=25\text{Hz}$, BAZ_25Hz.txt

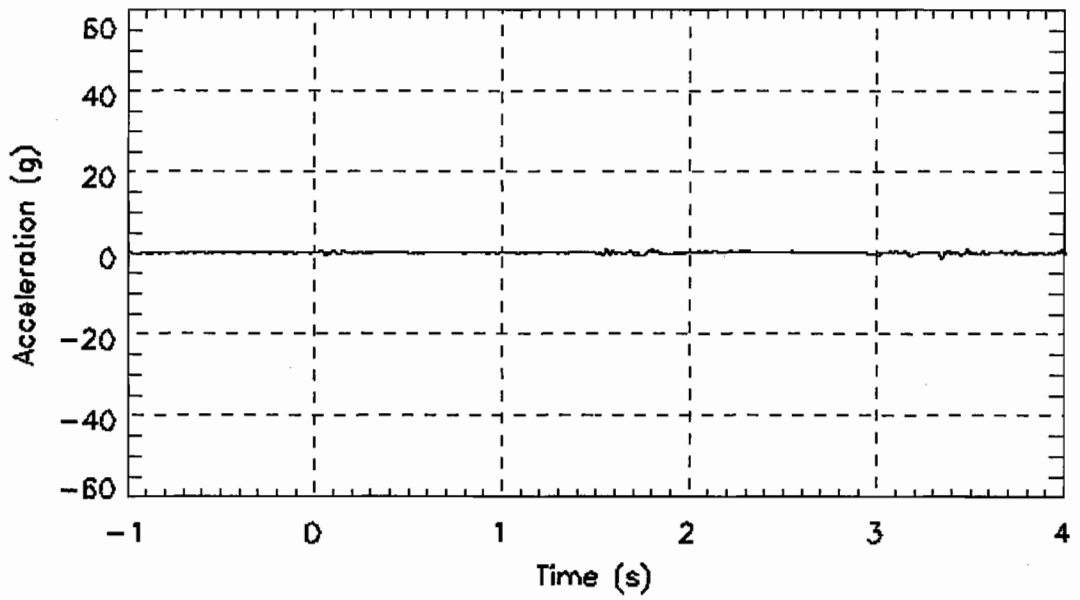

Figure L- 12. Trail bogie, lateral acceleration, digitally filtered at $F_c=25\text{Hz}$, BBY_25Hz.txt

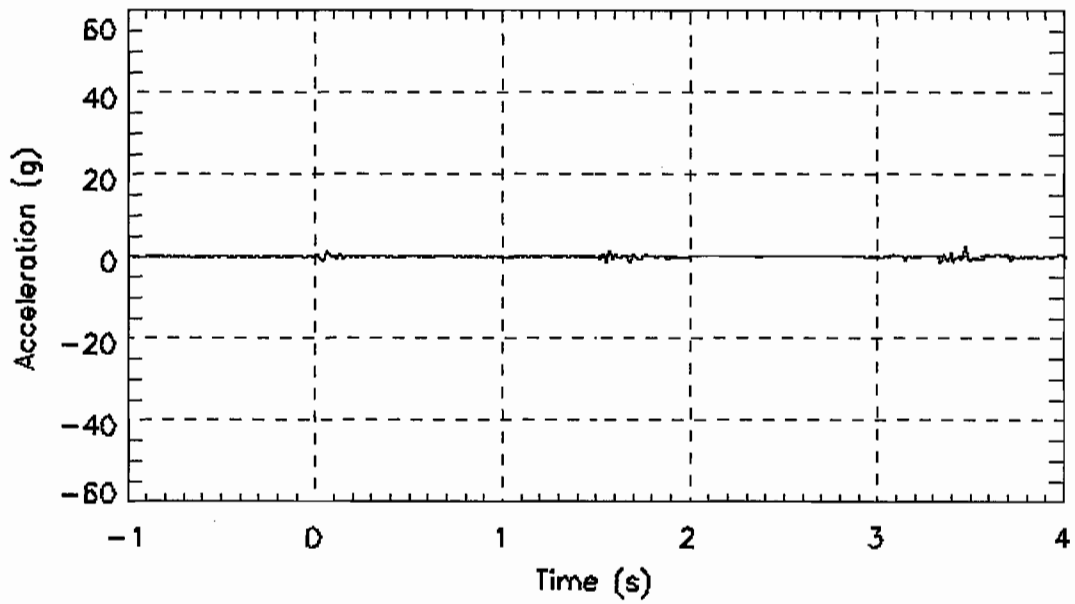

Figure L- 13. Trail bogie, vertical acceleration, digitally filtered at Fc=25Hz, BBZ_25Hz.txt

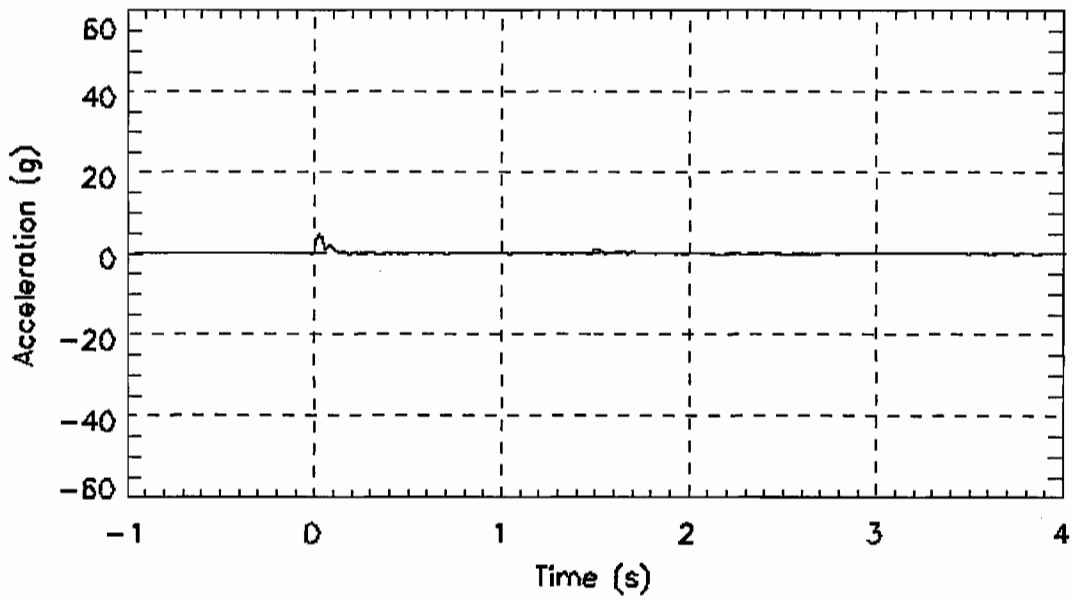

Figure L- 14. Bullet car, position 2, centersill, longitudinal acceleration, digitally filtered at Fc=25Hz, C2X_25Hz.txt

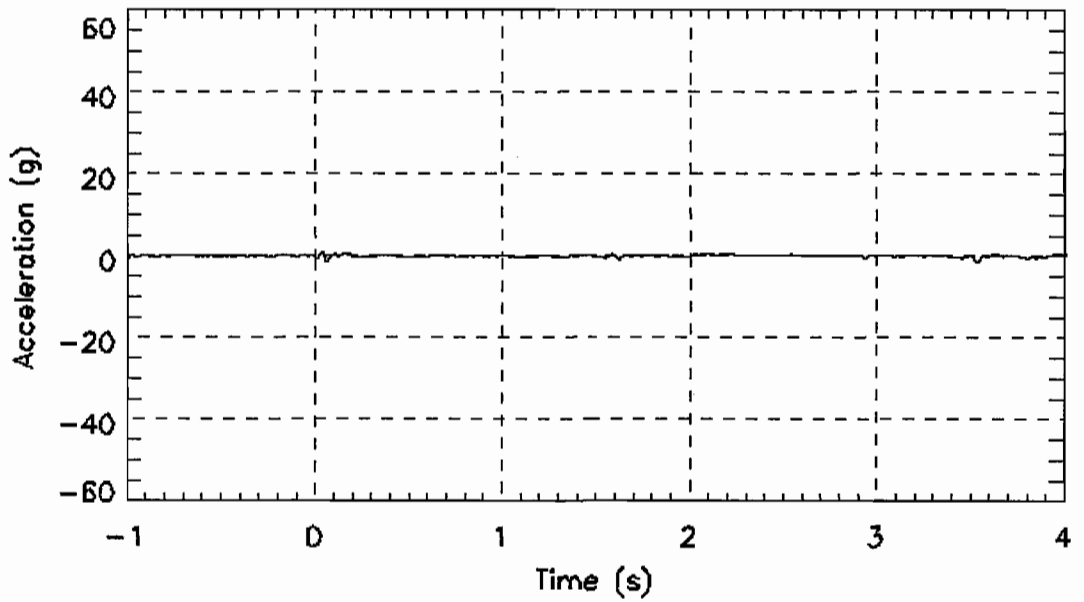

Figure L- 15. Bullet car, position 2, centersill, lateral acceleration, digitally filtered at Fc=25Hz, C2Y_25Hz.txt

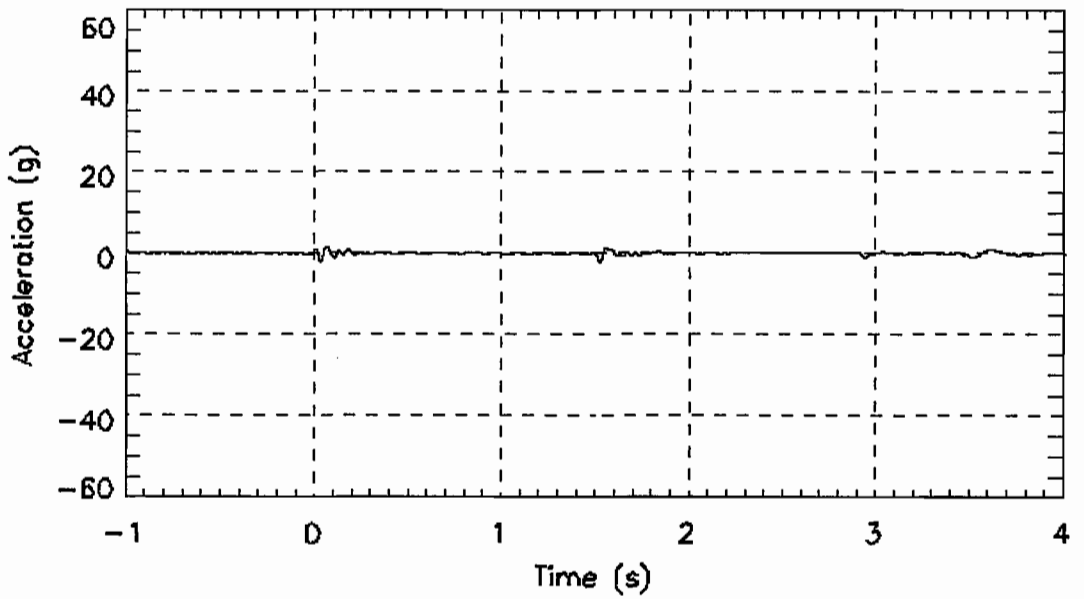

Figure L- 16. Bullet car, position 2, centersill, vertical acceleration, digitally filtered at Fc=25Hz, C2Z_25Hz.txt

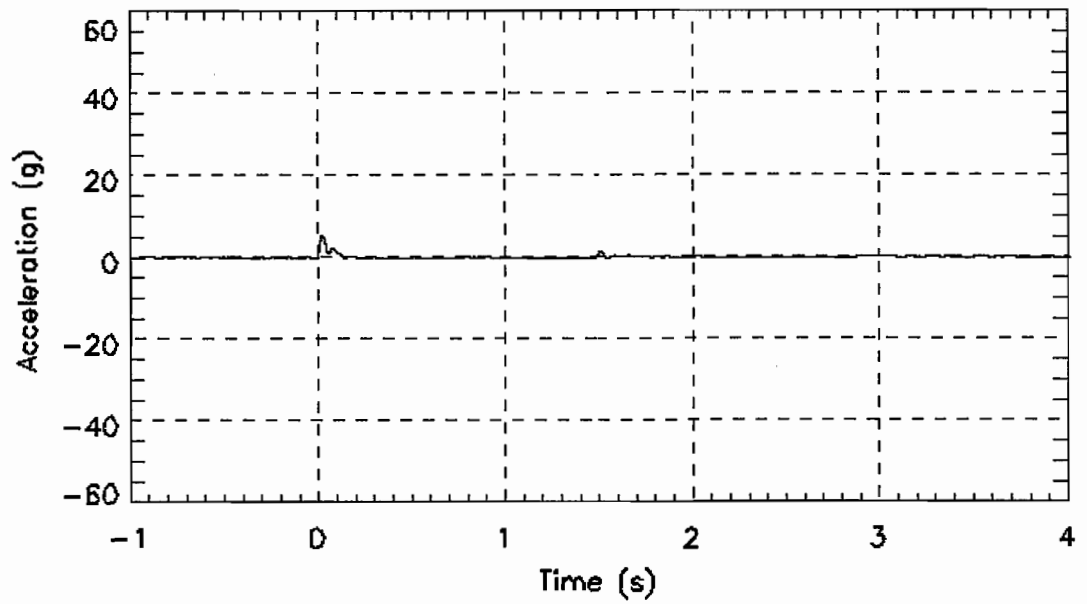

Figure L- 17. Bullet car, position 3, centersill, longitudinal acceleration, digitally filtered at Fc=25Hz, C3X_25Hz.txt

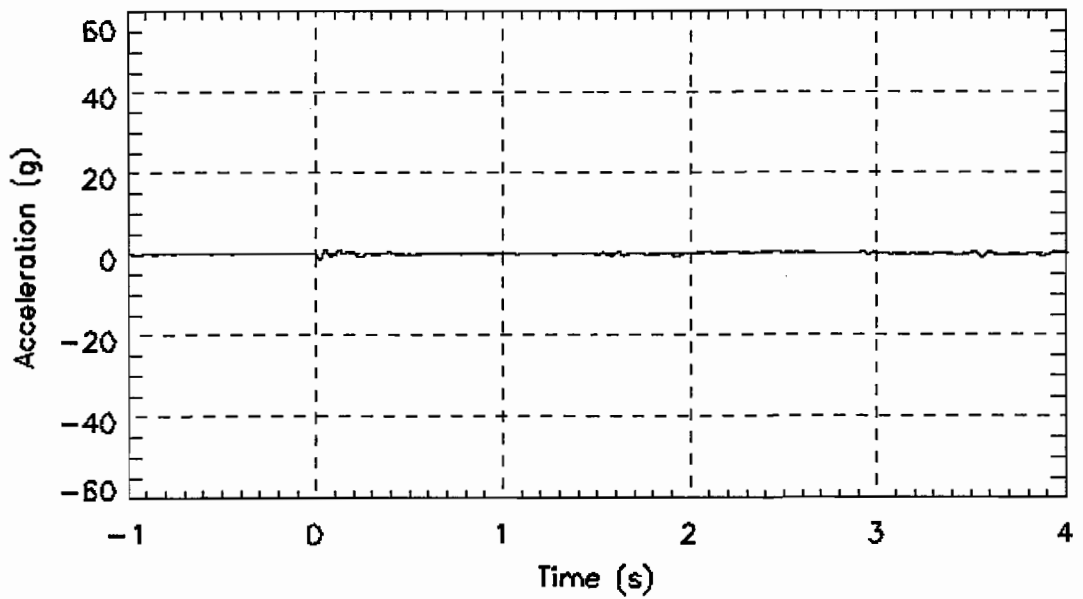

Figure L- 18. Bullet car, position 3, centersill, lateral acceleration, digitally filtered at Fc=25Hz, C3Y_25Hz.txt

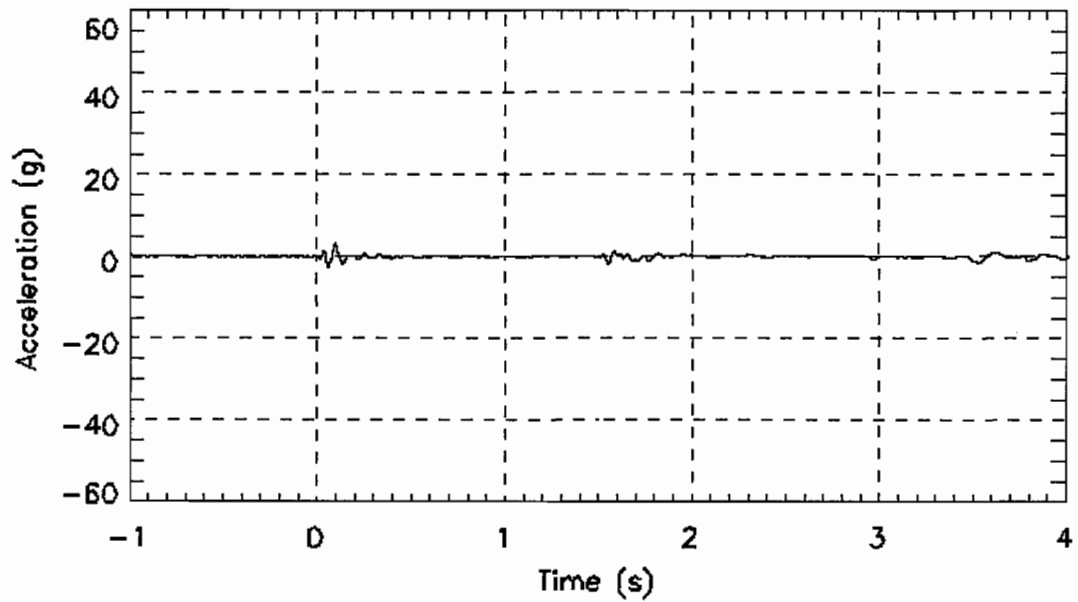

Figure L- 19. Bullet car, position 3, centersill, vertical acceleration, digitally filtered at $F_c=25\text{Hz}$, C3Z_25Hz.txt

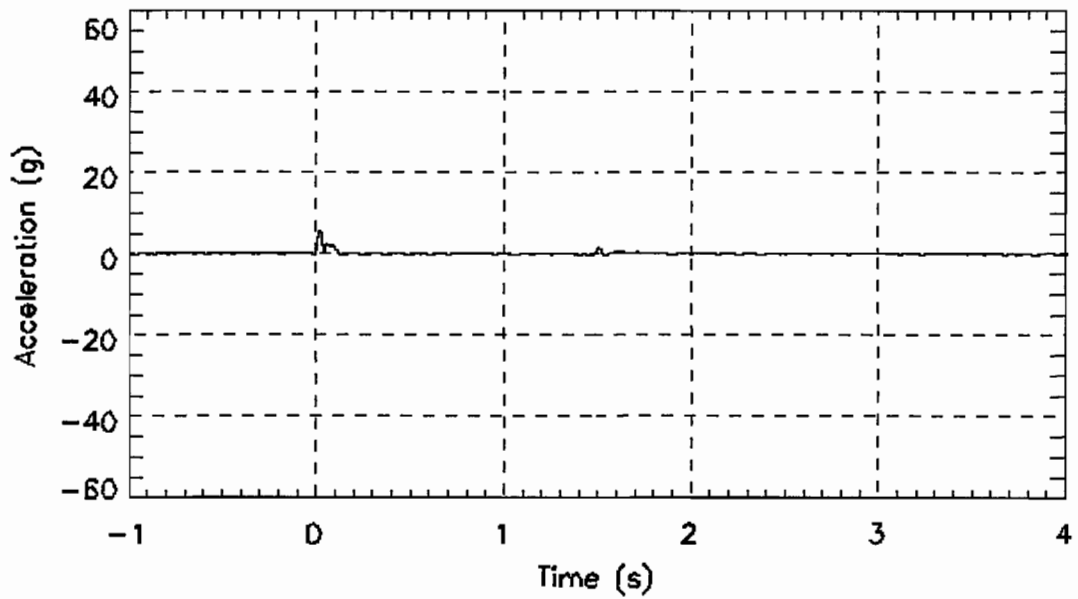

Figure L- 20. Bullet car, position 4, centersill, longitudinal acceleration, digitally filtered at $F_c=25\text{Hz}$, C4X_25Hz.txt

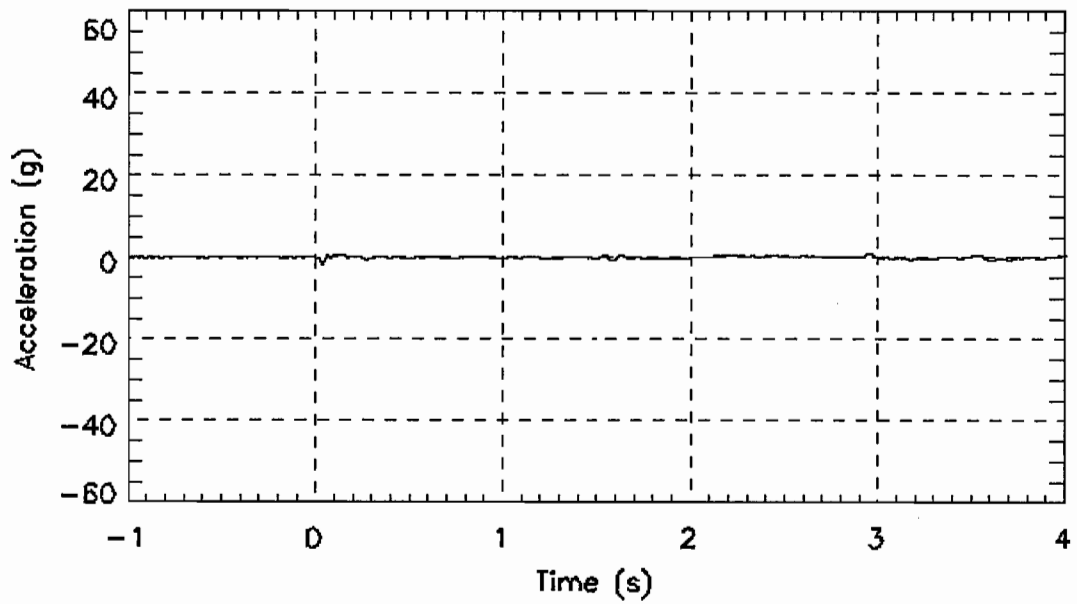

Figure L- 21. Bullet car, position 4, centersill, lateral acceleration, digitally filtered at Fc=25Hz, C4Y_25Hz.txt

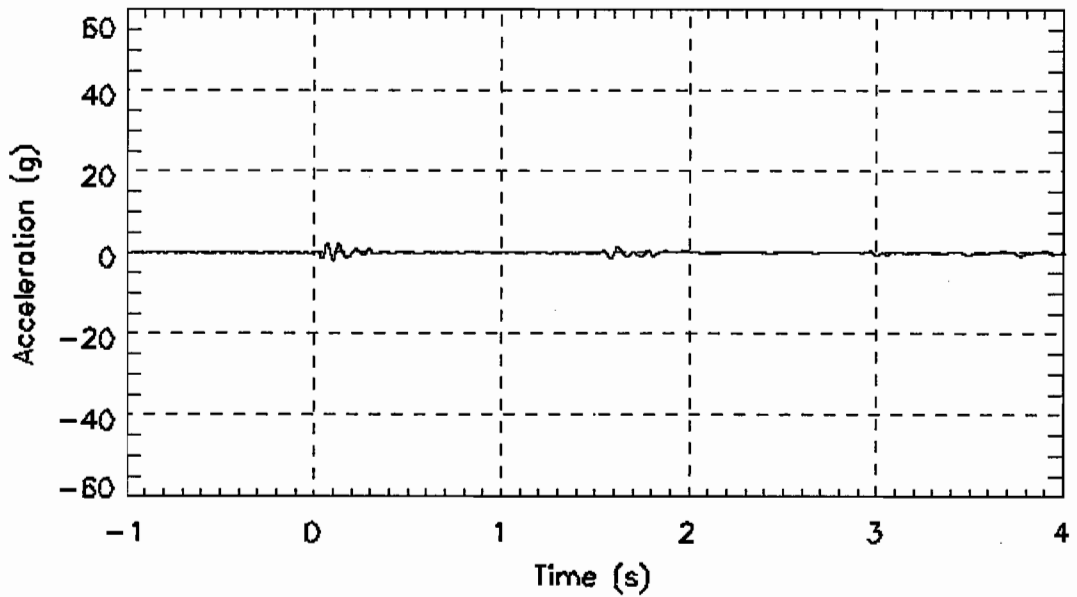

Figure L- 22. Bullet car, position 4, centersill, vertical acceleration, digitally filtered at Fc=25Hz, C4Z_25Hz.txt

6

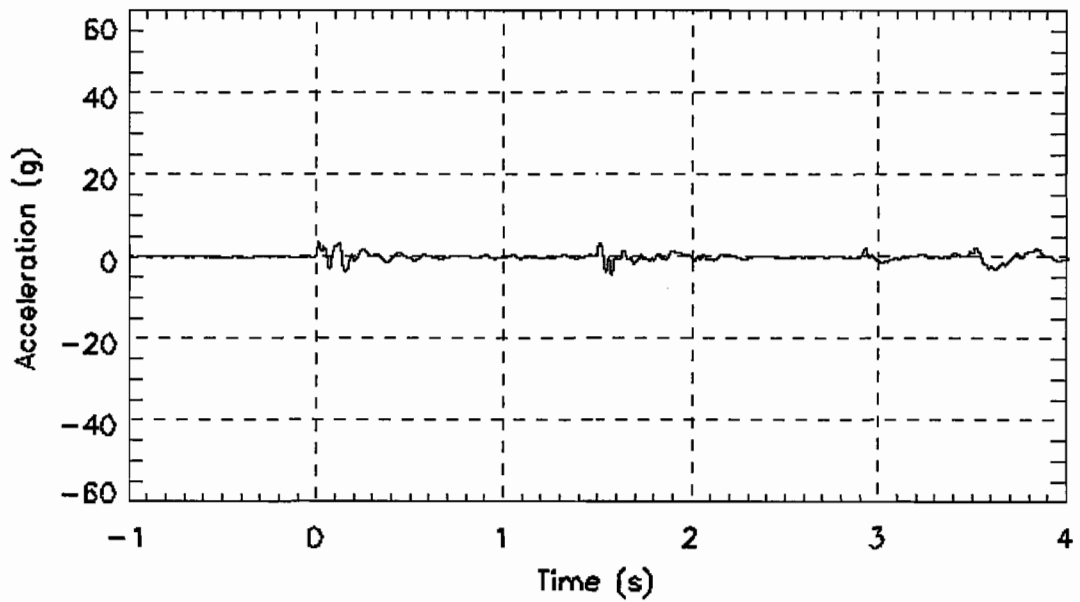

Figure L- 23. Bullet car, underframe level, left side, position 1, longitudinal acceleraion, digitally filtered at $F_c=25\text{Hz}$, L1X_25Hz.txt

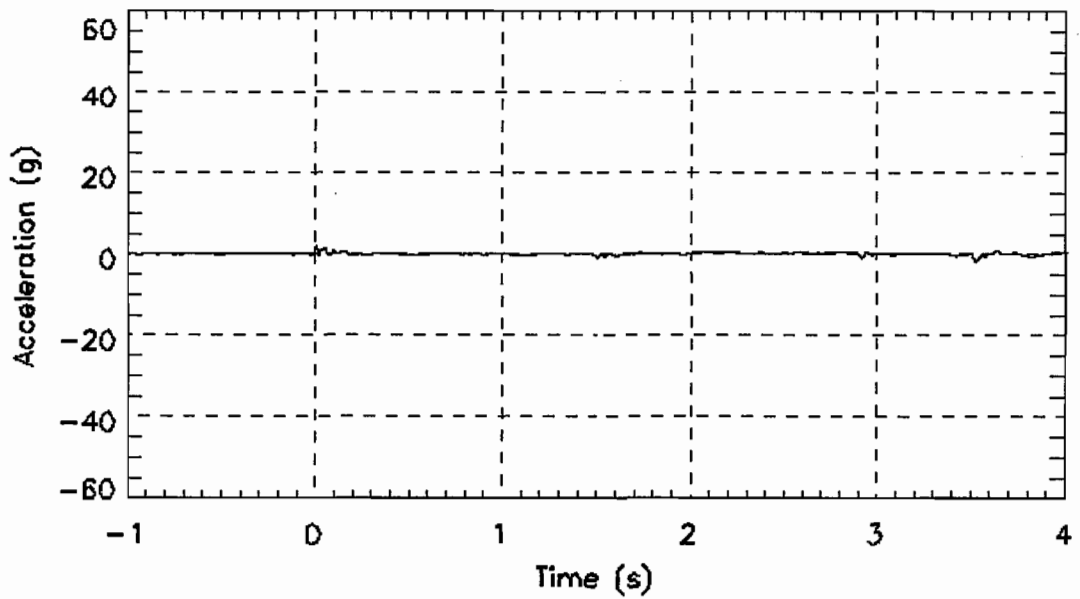

Figure L- 24. Bullet car, underframe level, left side, position 1, lateral acceleraion, digitally filtered at $F_c=25\text{Hz}$, L1Y_25Hz.txt

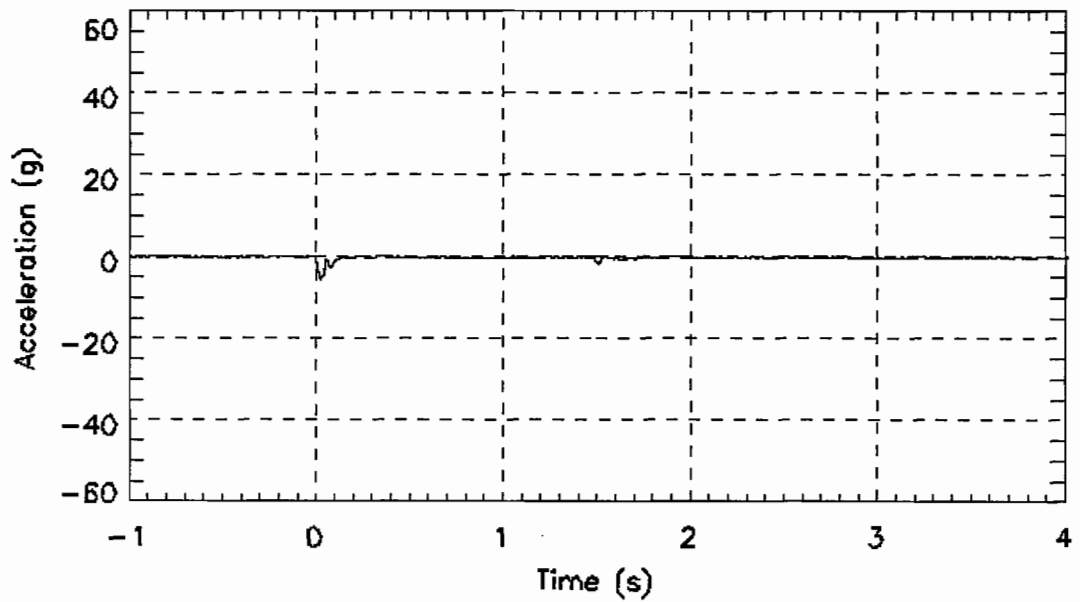

Figure L- 25. Bullet car, underframe level, left side, position 1, vertical acceleraion, digitally filtered at $F_c=25\text{Hz}$, L1Z_25Hz.txt

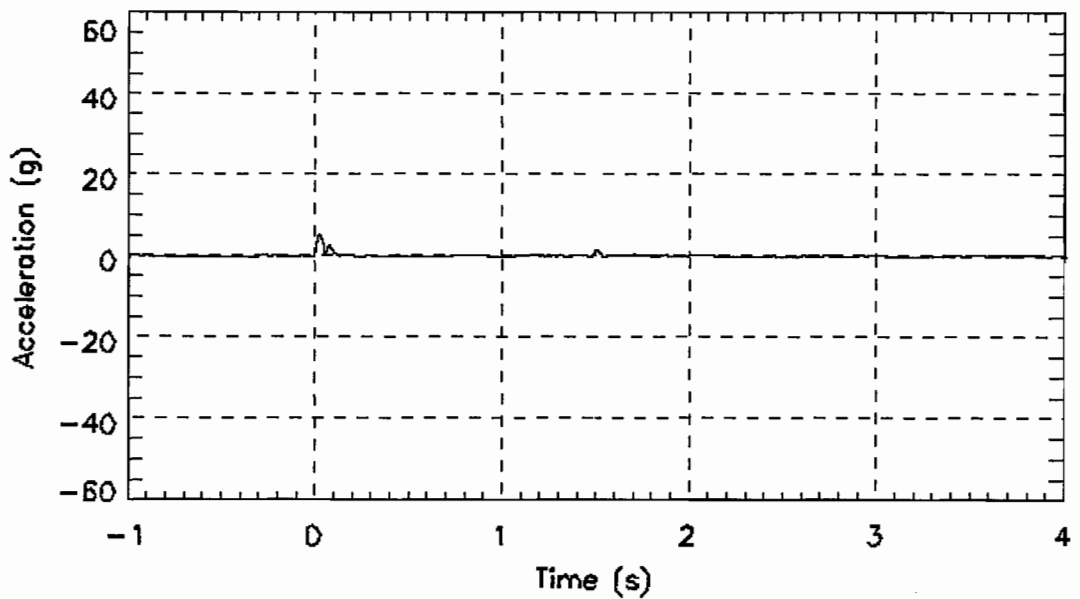

Figure L- 26. Bullet car, underframe level, left side, position 2, longitudinal acceleraion, digitally filtered at $F_c=25\text{Hz}$, L2X_25Hz.txt

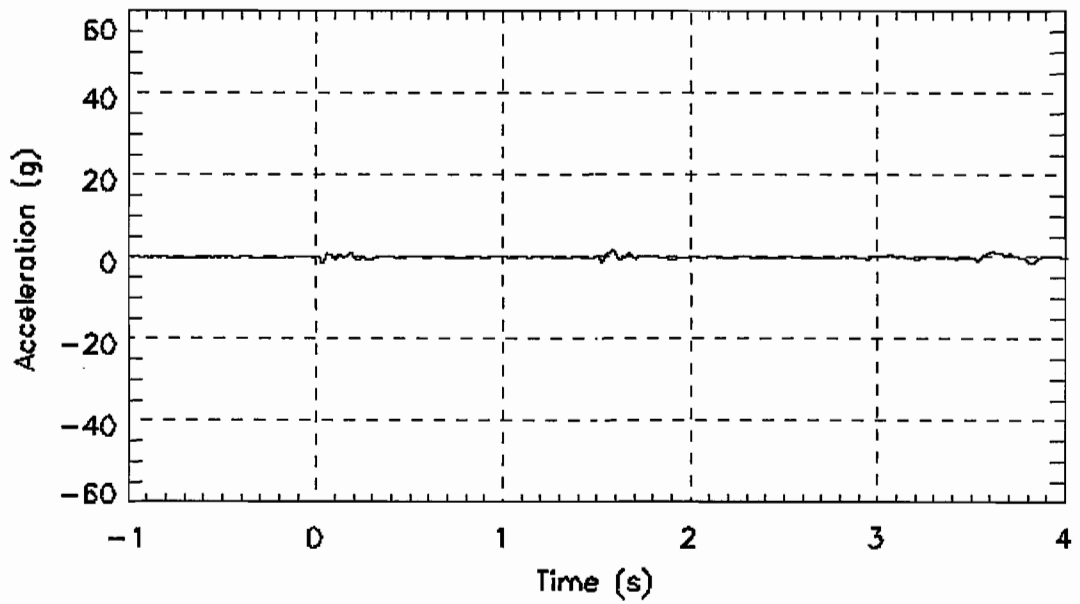

Figure L- 27. Bullet car, underframe level, left side, position 2, vertical acceleraion, digitally filtered at Fc=25Hz, L2Z_25Hz.txt

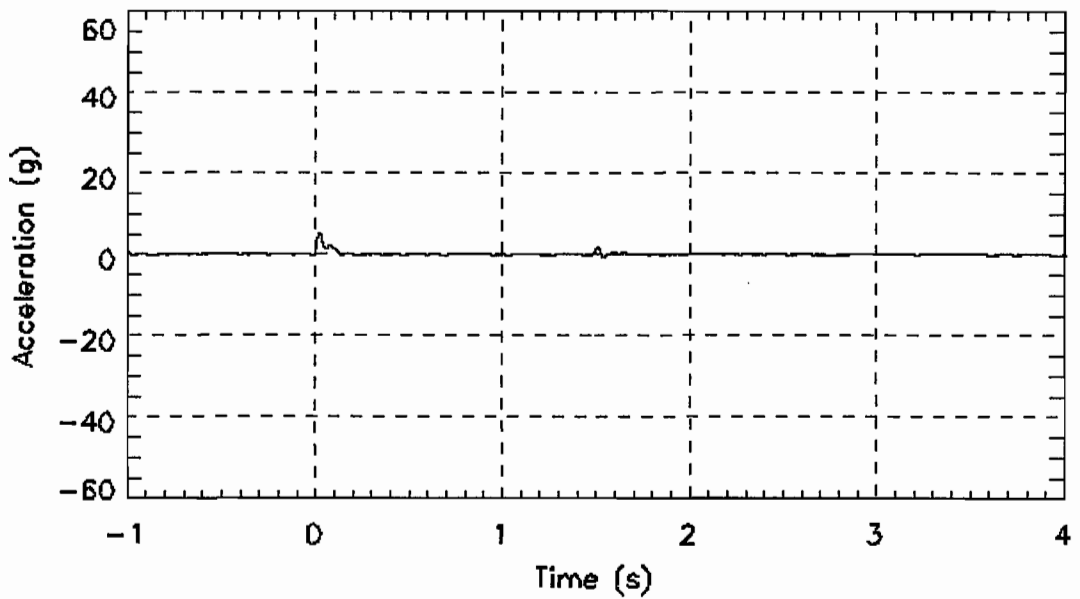

Figure L- 28. Bullet car, underframe level, left side, position 3, longitudinal acceleraion, digitally filtered at Fc=25Hz, L3X_25Hz.txt

269

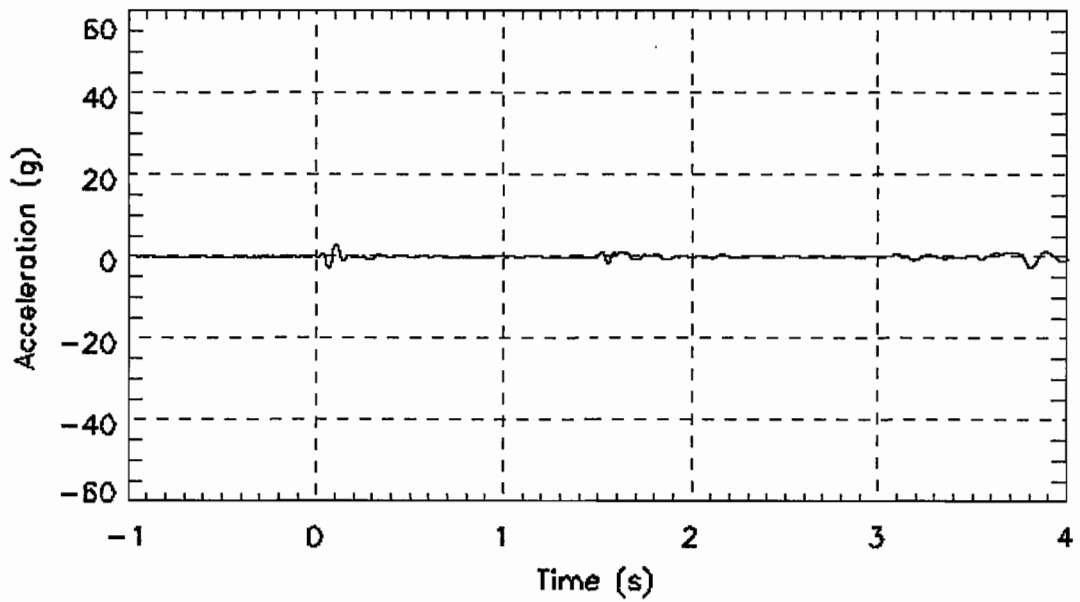

Figure L- 29. Bullet car, underframe level, left side, position 3, vertical acceleraion, digitally filtered at $F_c=25\text{Hz}$, L3Z_25Hz.txt

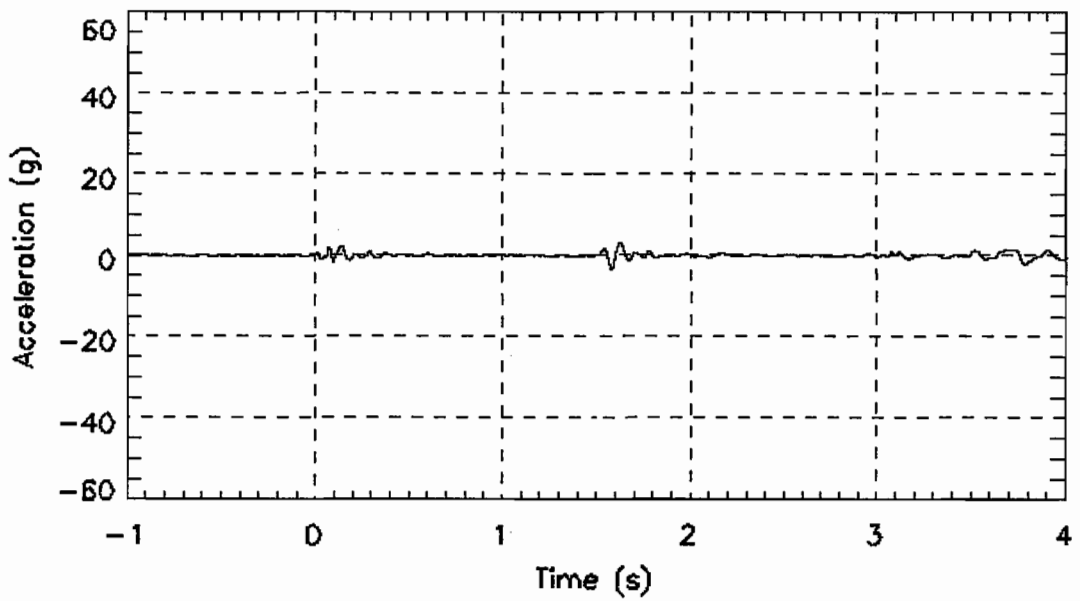

Figure L- 30. Bullet car, underframe level, left side, position 4, vertical acceleraion, digitally filtered at $F_c=25\text{Hz}$, L4Z_25Hz.txt

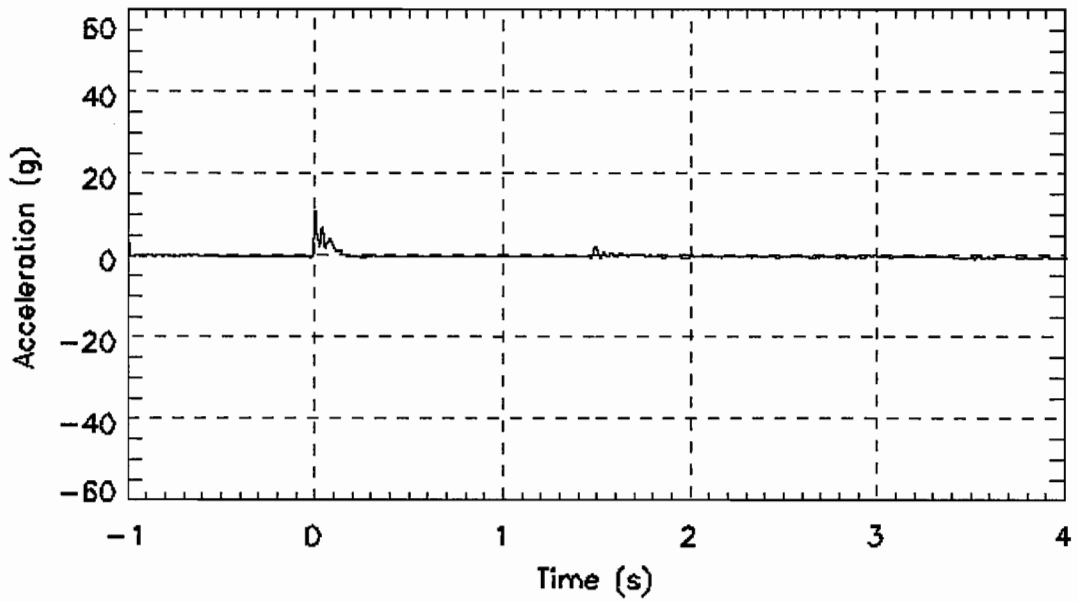

Figure L- 31. Bullet car, underframe level, right side, position 1, longitudinal acceleraion, digitally filtered at Fc=25Hz, R1X_25Hz.txt

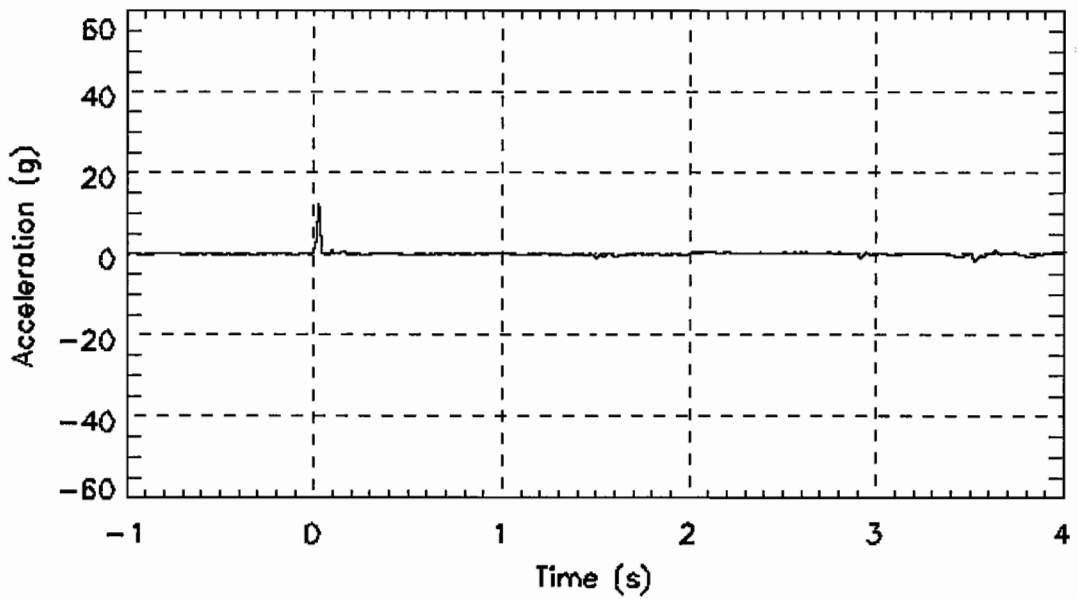

Figure L- 32. Bullet car, underframe level, right side, position 1, lateral acceleraion, digitally filtered at Fc=25Hz, R1Y_25Hz.txt

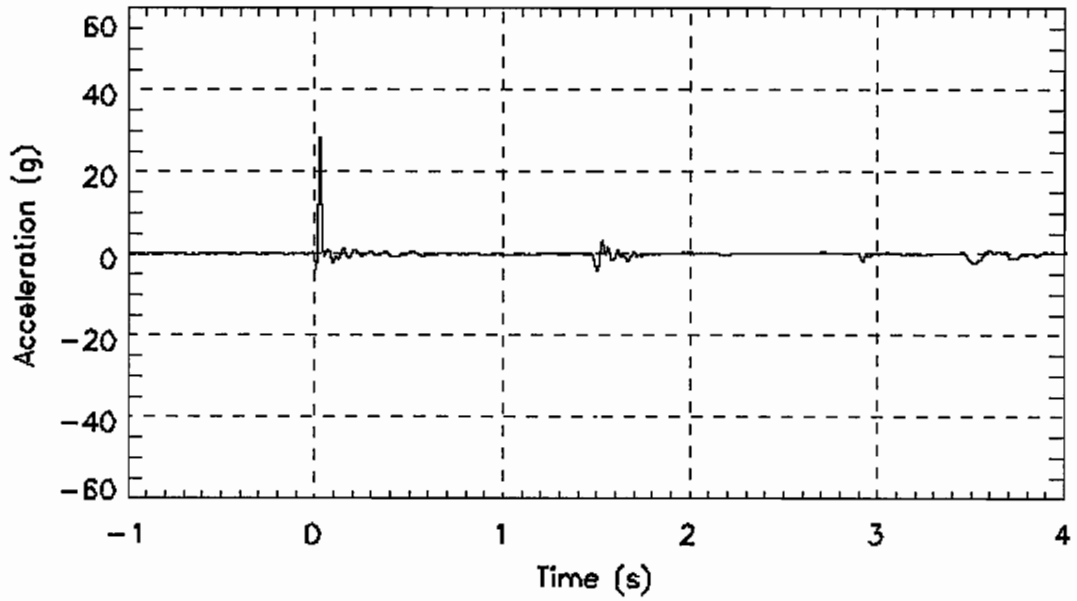

Figure L- 33. Bullet car, underframe level, right side, position 1, vertical acceleraion, digitally filtered at $F_c=25\text{Hz}$, R1Z_25Hz.txt

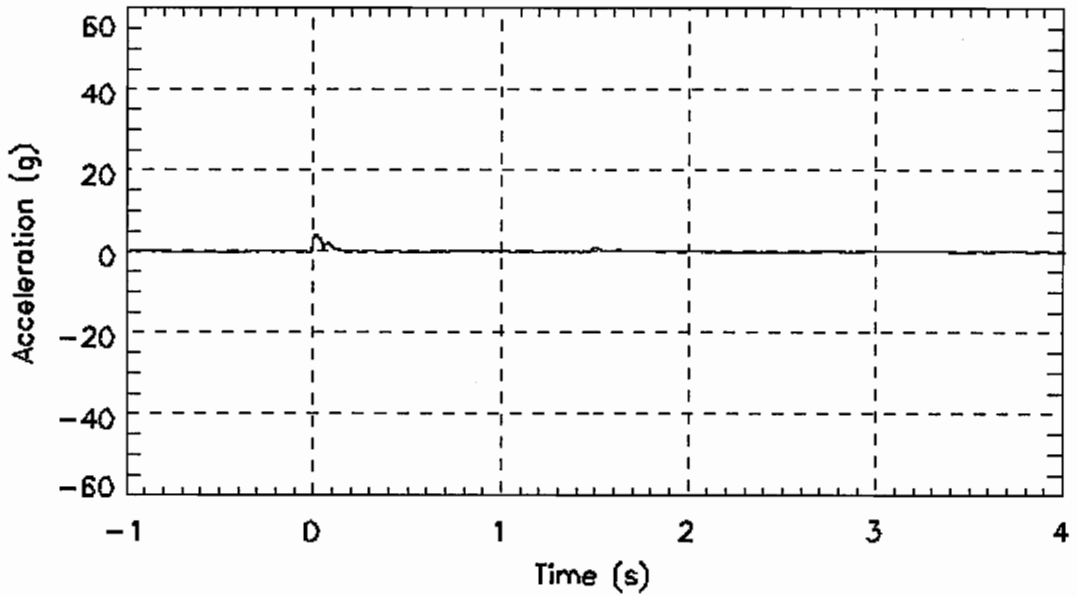

Figure L- 34. Bullet car, underframe level, right side, position 2, longitudinal acceleraion, digitally filtered at $F_c=25\text{Hz}$, R2X_25Hz.txt

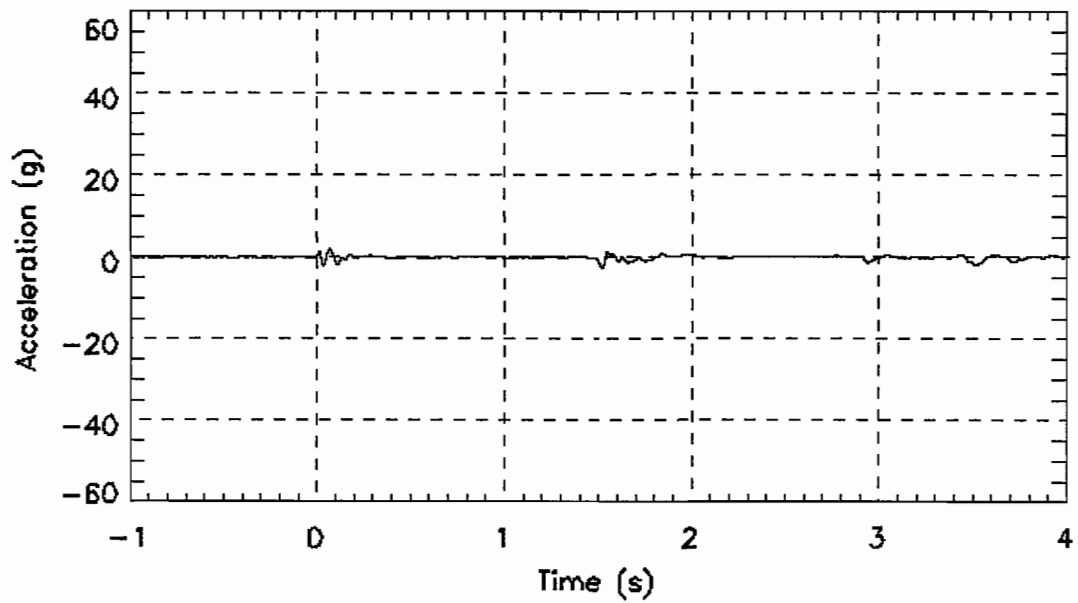

Figure L- 35. Bullet car, underframe level, right side, position 2, vertical acceleraion, digitally filtered at Fc=25Hz, R2Z_25Hz.txt

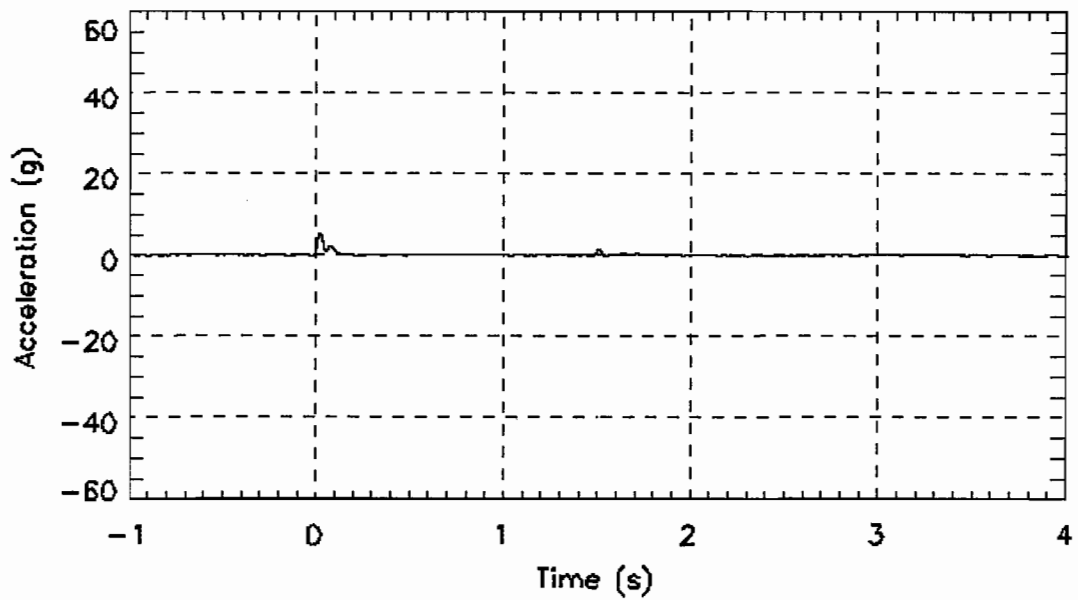

Figure L- 36. Bullet car, underframe level, right side, position 3, longitudinal acceleraion, digitally filtered at Fc=25Hz, R3X_25Hz.txt

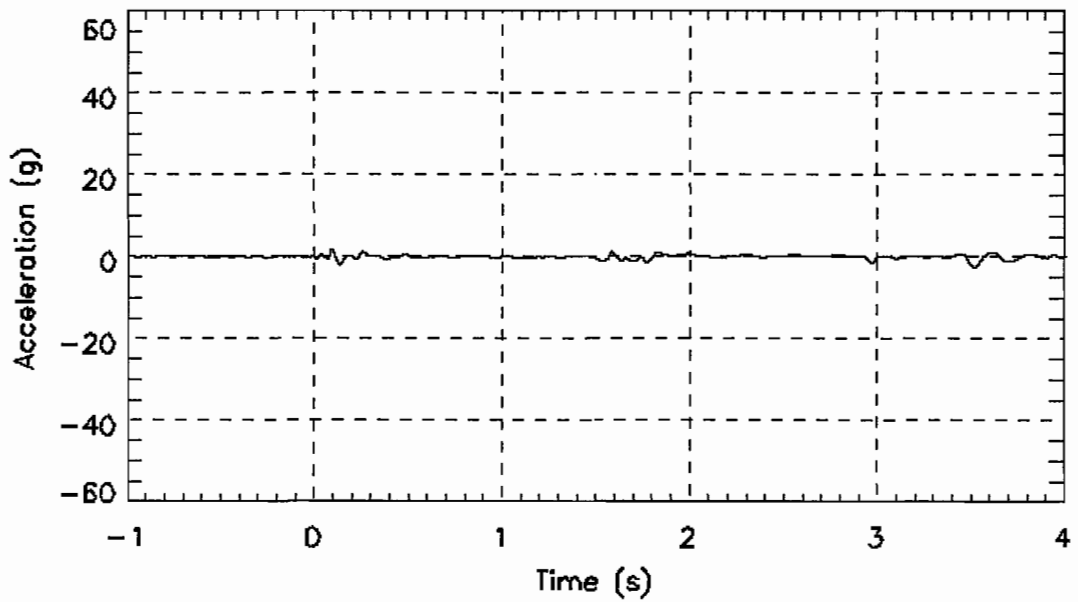

Figure L- 37. Bullet car, underframe level, right side, position 3, vertical acceleraion, digitally filtered at Fc=25Hz, R3Z_25Hz.txt

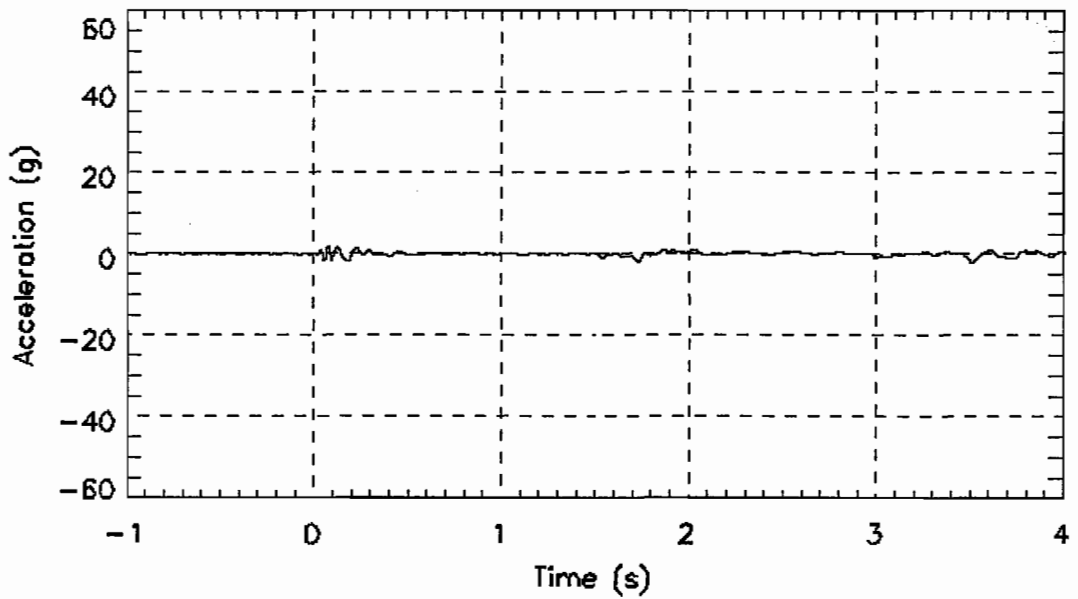

Figure L- 38. Bullet car, underframe level, right side, position 4, vertical acceleraion, digitally filtered at Fc=25Hz, R4Z_25Hz.txt

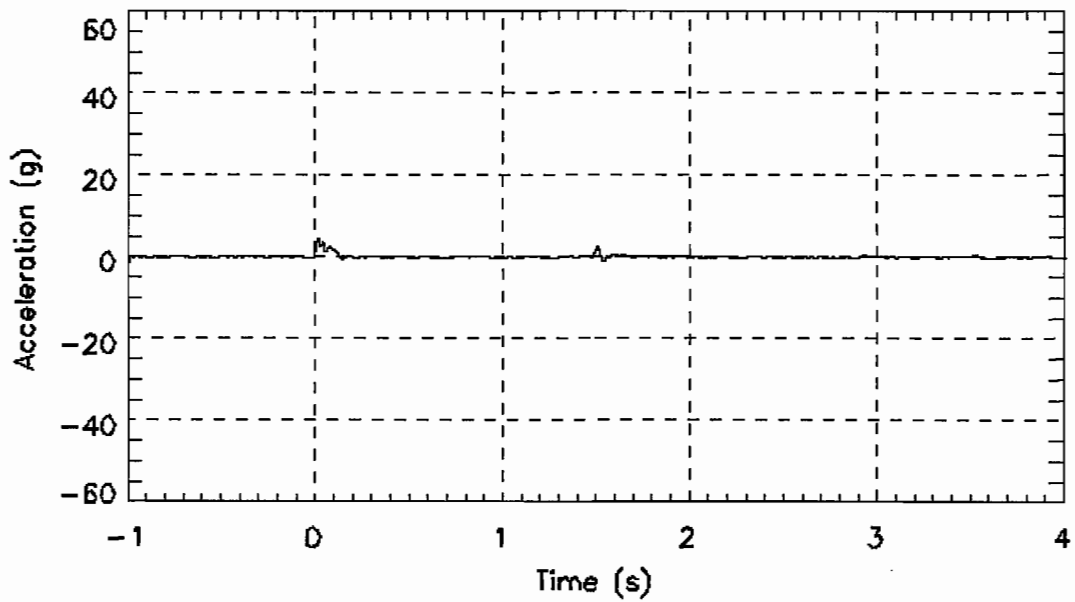

Figure L- 39. Bullet car, cant rail level, left side, position 1, longitudinal acceleraion, digitally filtered at Fc=25Hz, TL1X_25Hz.txt

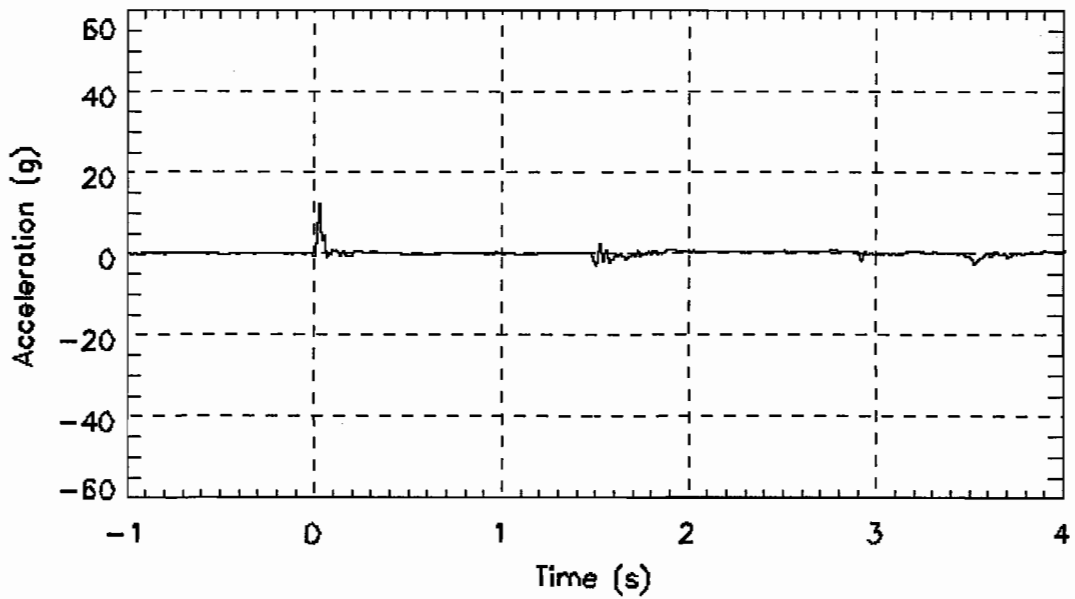

Figure L- 40. Bullet car, cant rail level, left side, position 1, lateral acceleraion, digitally filtered at Fc=25Hz, TL1Y_25Hz.txt

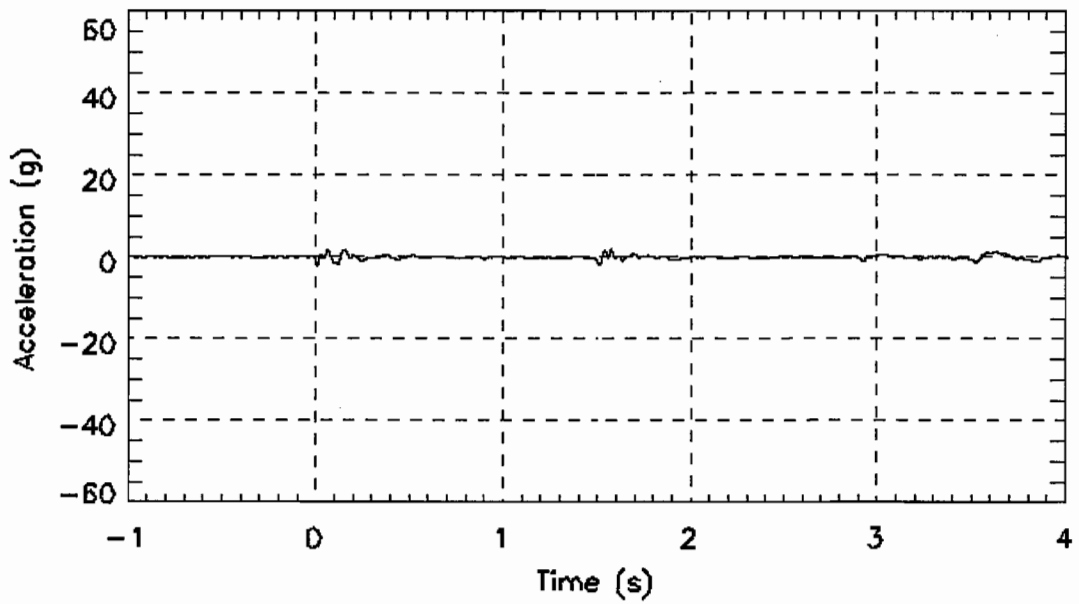

Figure L- 41. Bullet car, cant rail level, left side, position 1, vertical acceleraion, digitally filtered at Fc=25Hz, TL1Z_25Hz.txt

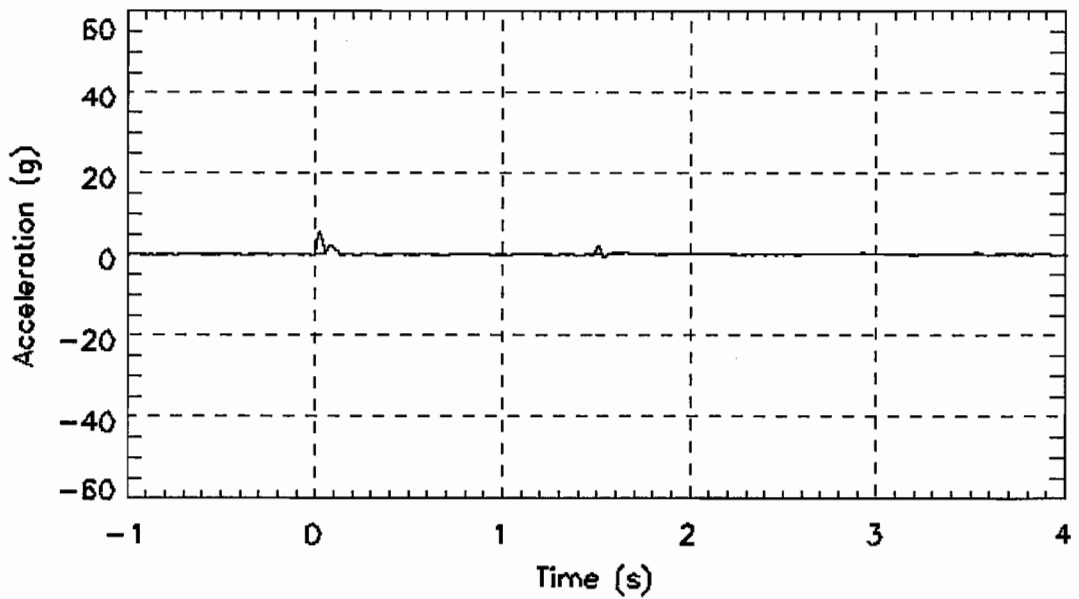

Figure L- 42. Bullet car, cant rail level, left side, position 2, longitudinal acceleraion, digitally filtered at Fc=25Hz, TL2X_25Hz.txt

6

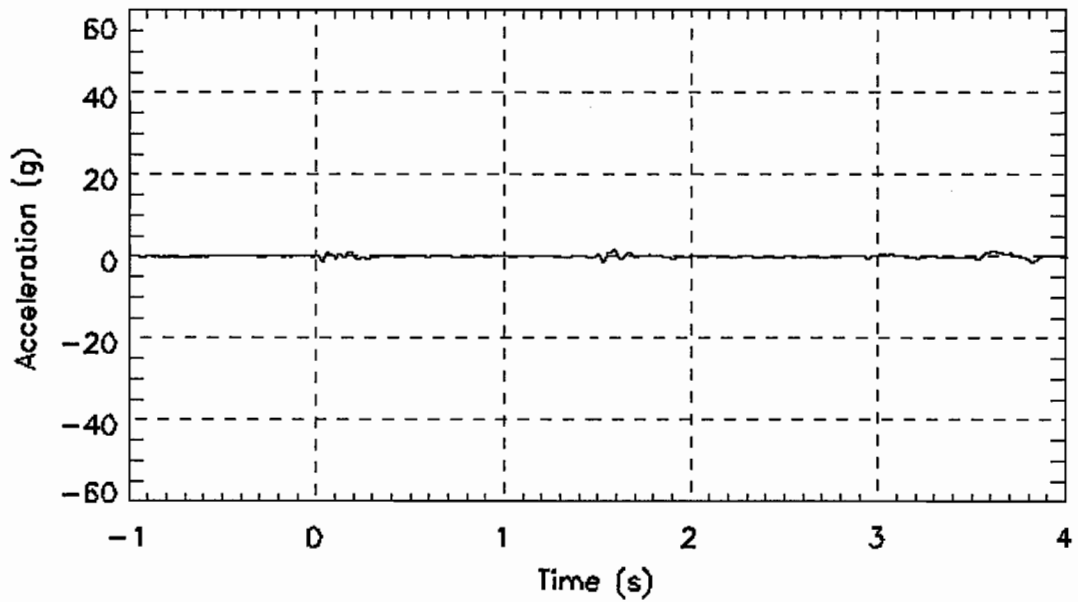

Figure L- 43. Bullet car, cant rail level, left side, position 2, vertical acceleraion, digitally filtered at Fc=25Hz, TL2Z_25Hz.txt

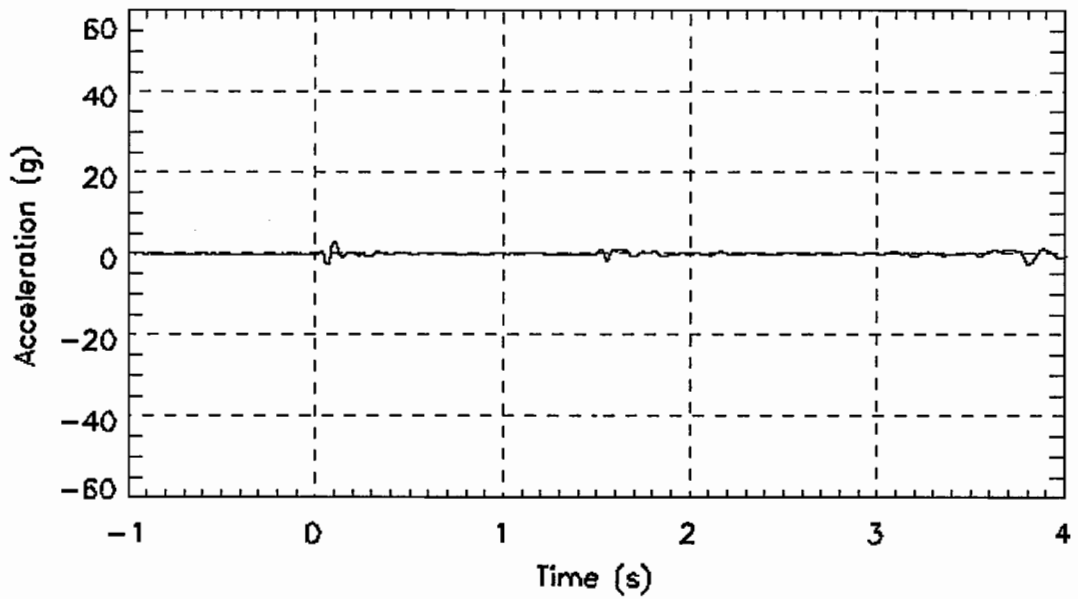

Figure L- 44. Bullet car, cant rail level, left side, position 3, vertical acceleraion, digitally filtered at Fc=25Hz, TL3Z_25Hz.txt

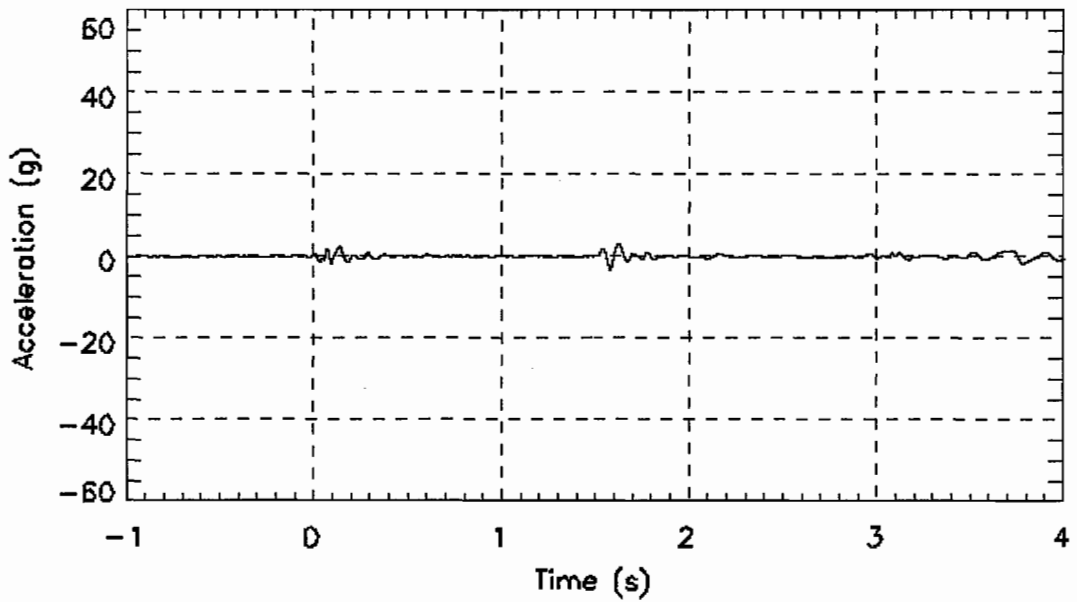

Figure L- 45. Bullet car, cant rail level, left side, position 4, vertical acceleraion, digitally filtered at Fc=25Hz, TL4Z_25Hz.txt

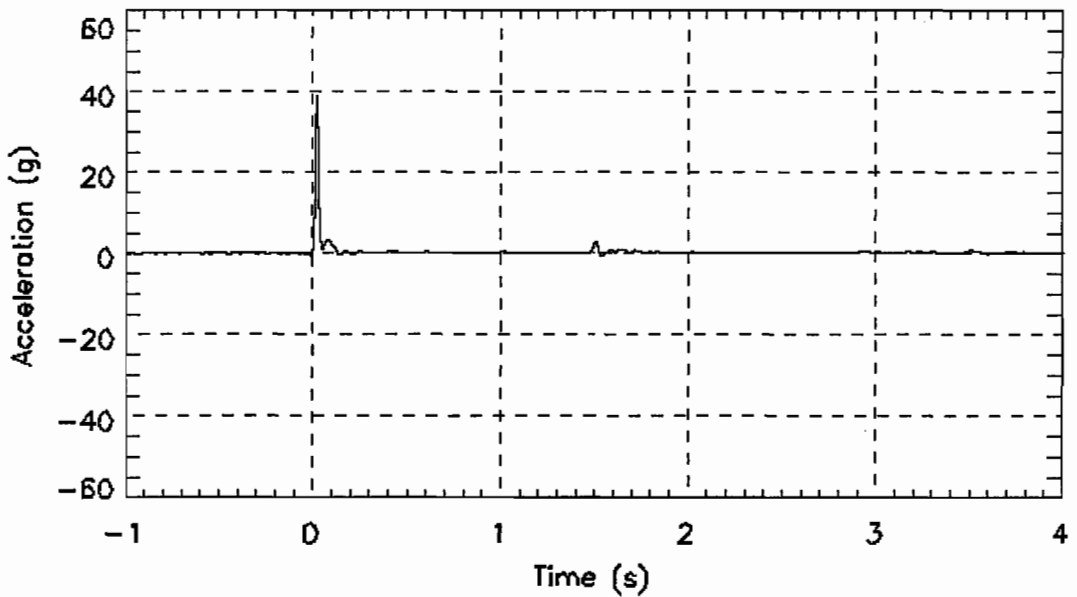

Figure L- 46. Bullet car, cant rail level, right side, position 1, longitudinal acceleraion, digitally filtered at Fc=25Hz, TR1X_25Hz.txt

178

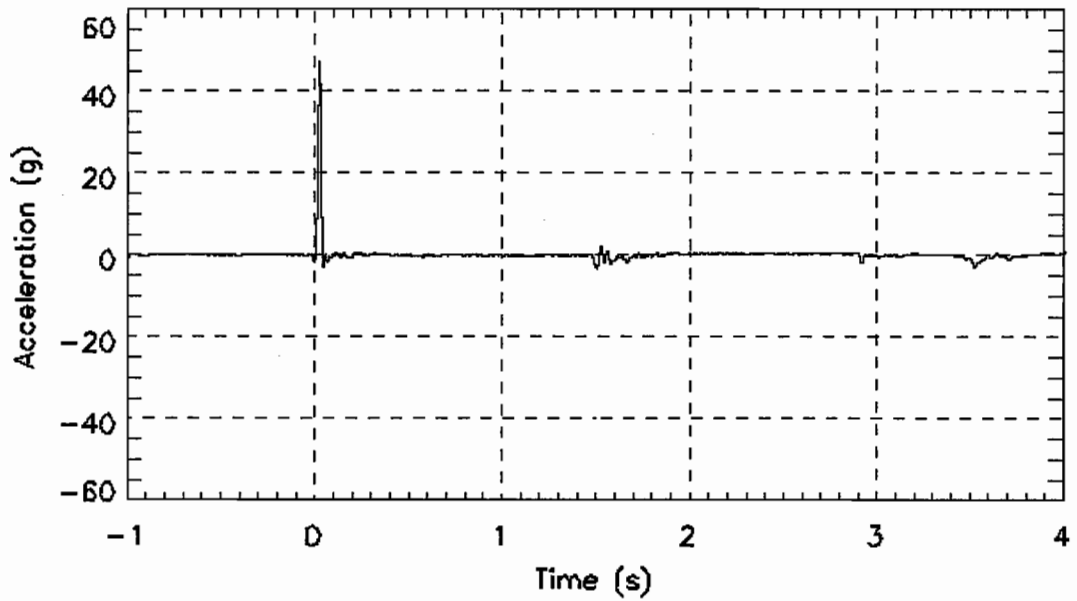

Figure L- 47. Bullet car, cant rail level, right side, position 1, lateral acceleraion, digitally filtered at Fc=25Hz, TR1Y_25Hz.txt

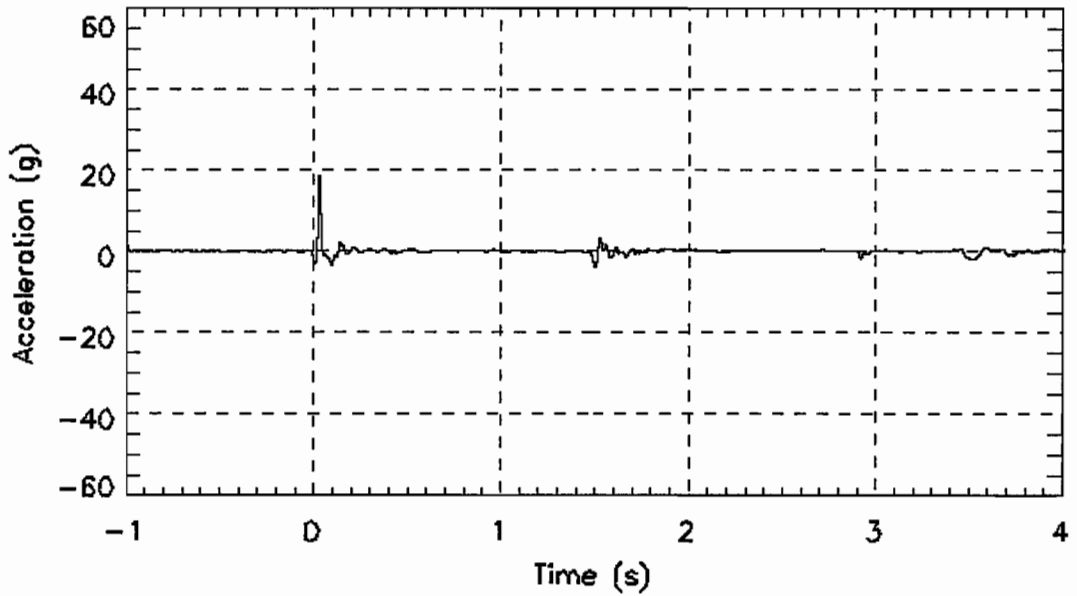

Figure L- 48. Bullet car, cant rail level, right side, position 1, vertical acceleraion, digitally filtered at Fc=25Hz, TR1Z_25Hz.txt

19

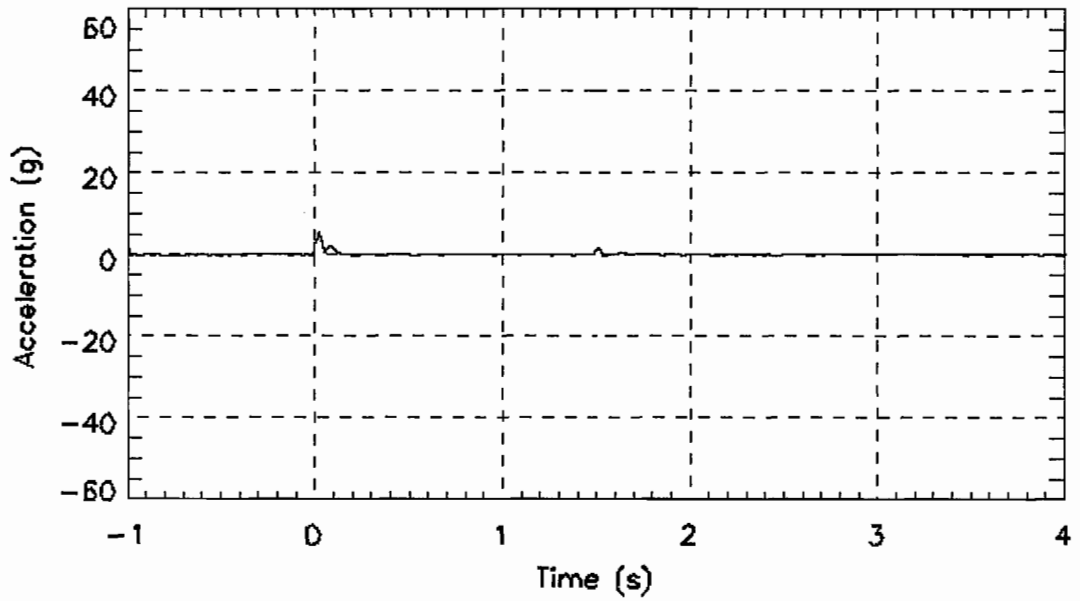

Figure L- 49. Bullet car, cant rail level, right side, position 2, longitudinal acceleraion, digitally filtered at Fc=25Hz, TR2X_25Hz.txt

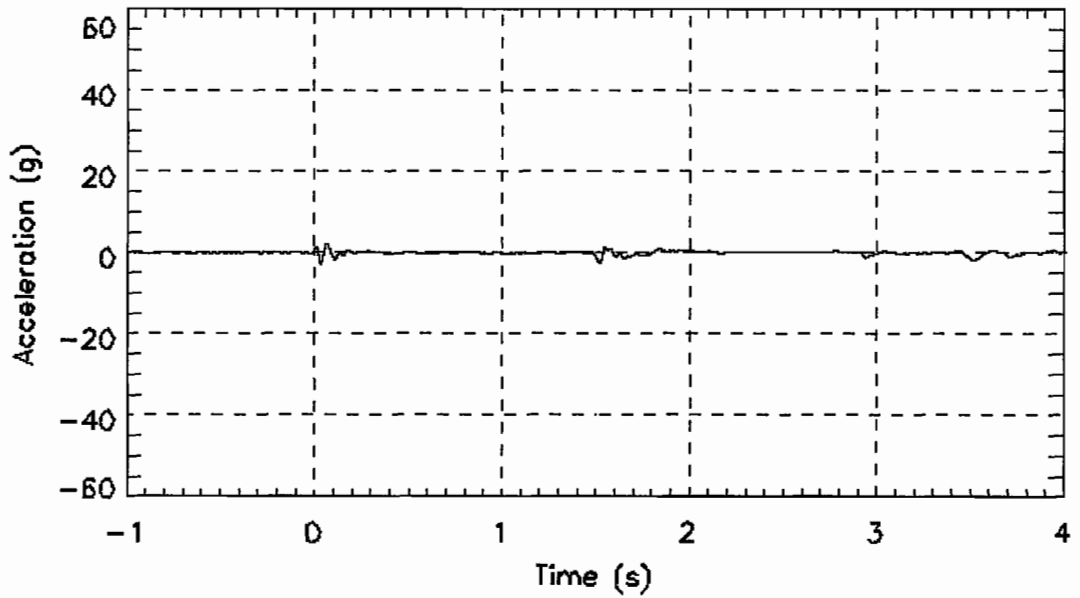

Figure L- 50. Bullet car, cant rail level, right side, position 2, vertical acceleraion, digitally filtered at Fc=25Hz, TR2Z_25Hz.txt

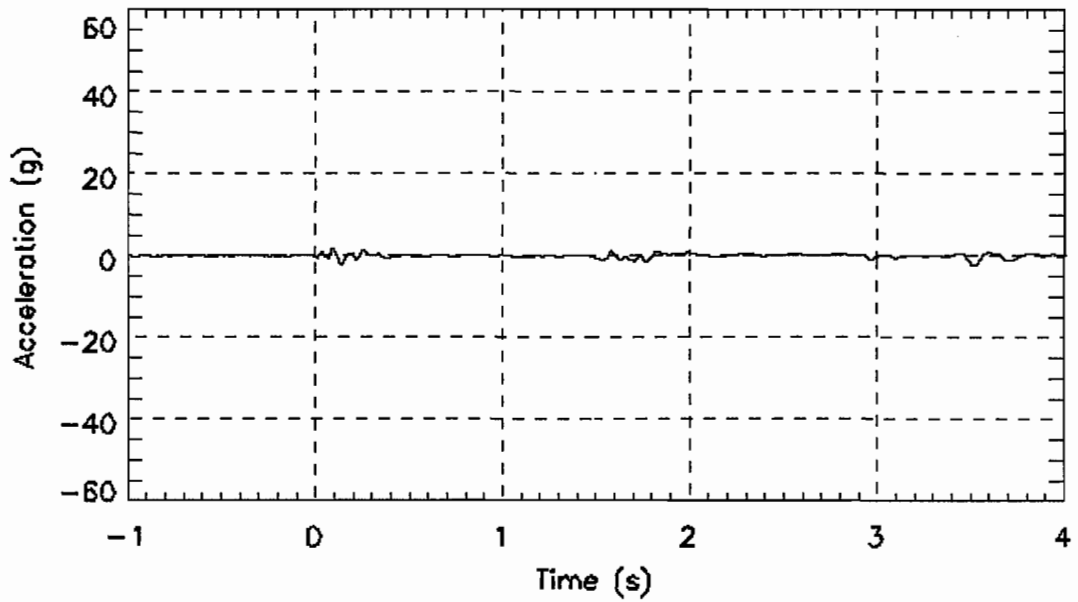

Figure L- 51. Bullet car, cant rail level, right side, position 3, vertical acceleraion, digitally filtered at Fc=25Hz, TR3Z_25Hz.txt

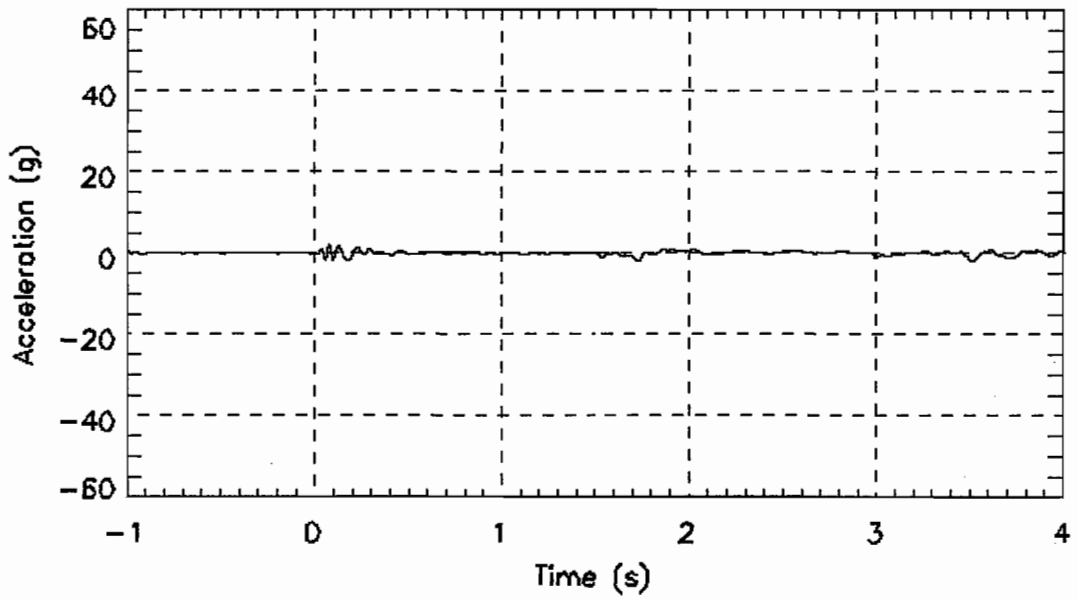

Figure L- 52. Bullet car, cant rail level, right side, position 4, vertical acceleraion, digitally filtered at Fc=25Hz, TR4Z_25Hz.txt

Appendix M

Test 5 Displacement Data

This page left blank intentionally

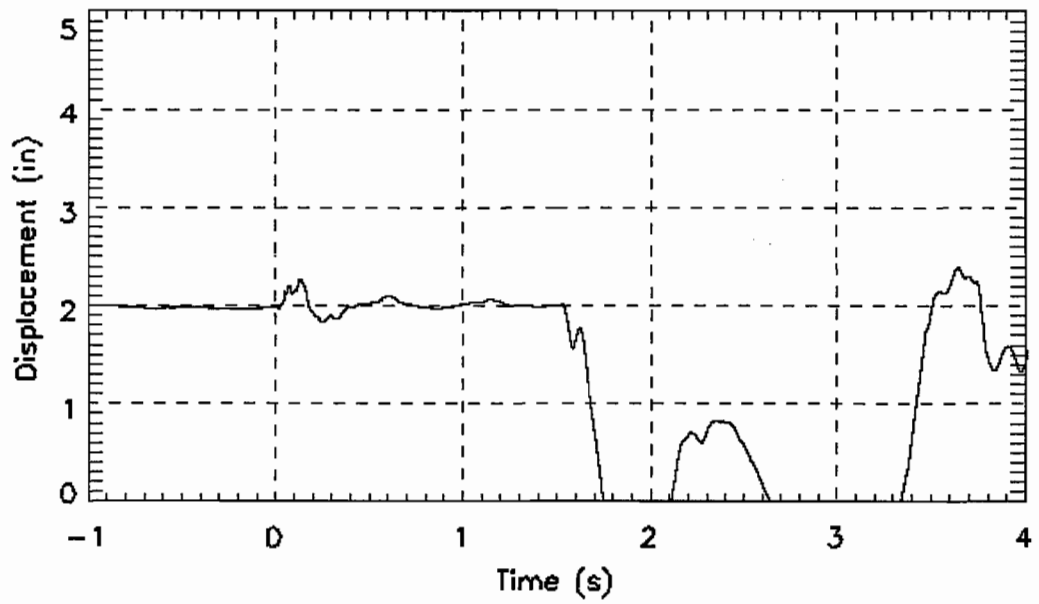

Figure M- 1. Leading end, left side suspension displacement, AL.txt

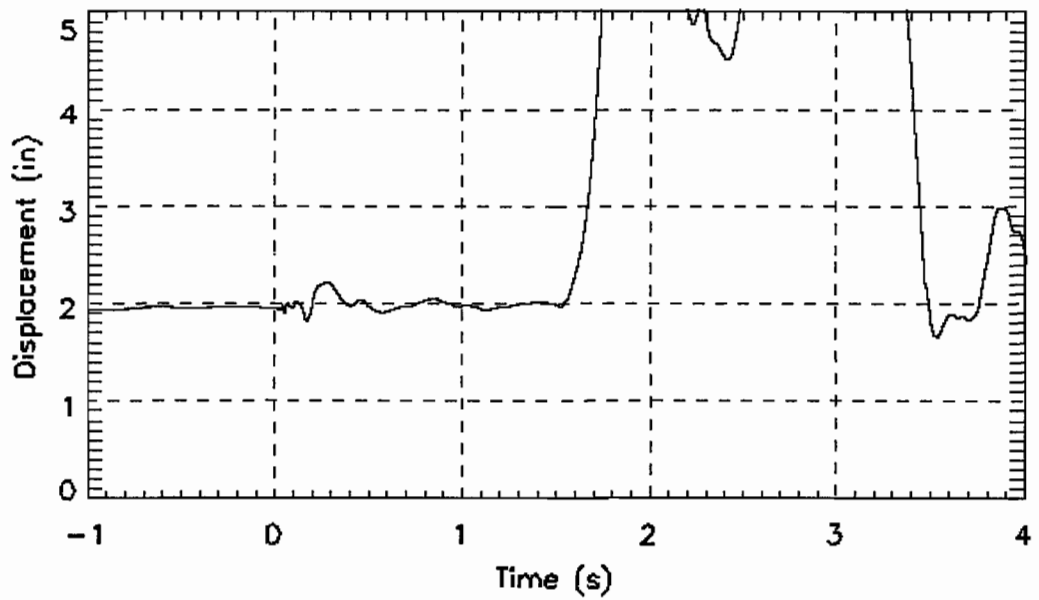

Figure M- 2. Leading end, right side suspension displacement, AR.txt

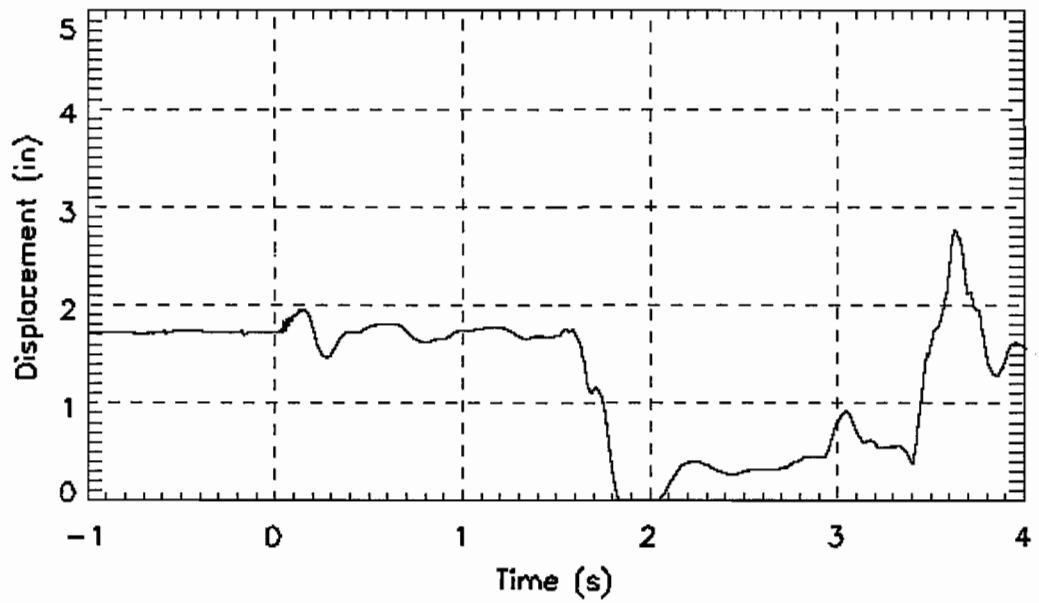

Figure M- 3. Trailing end, left side suspension displacement, BL.txt

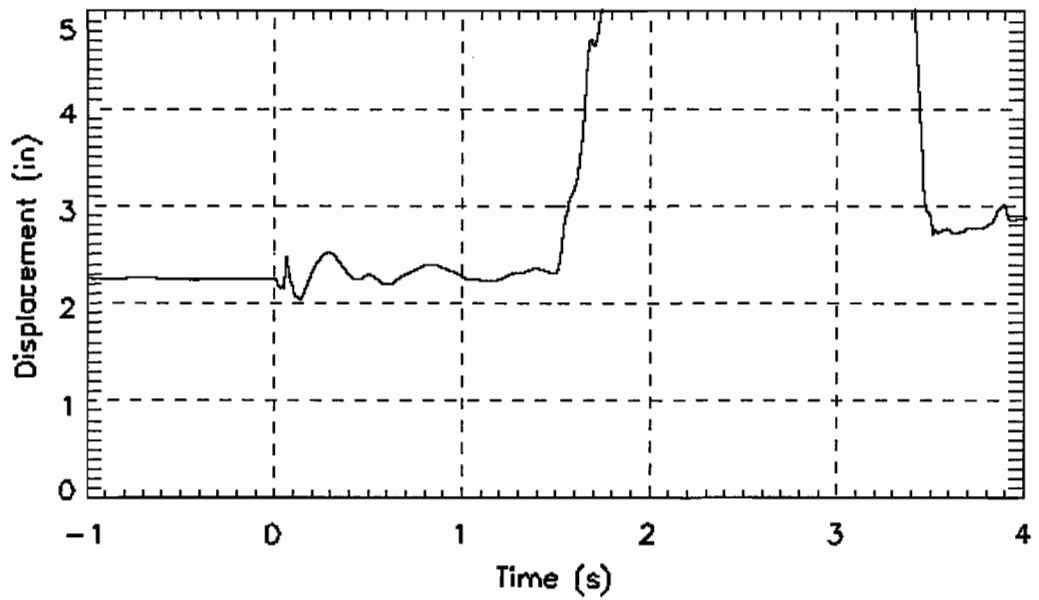

Figure M- 4. Trailing end, right side suspension displacement, BR.txt

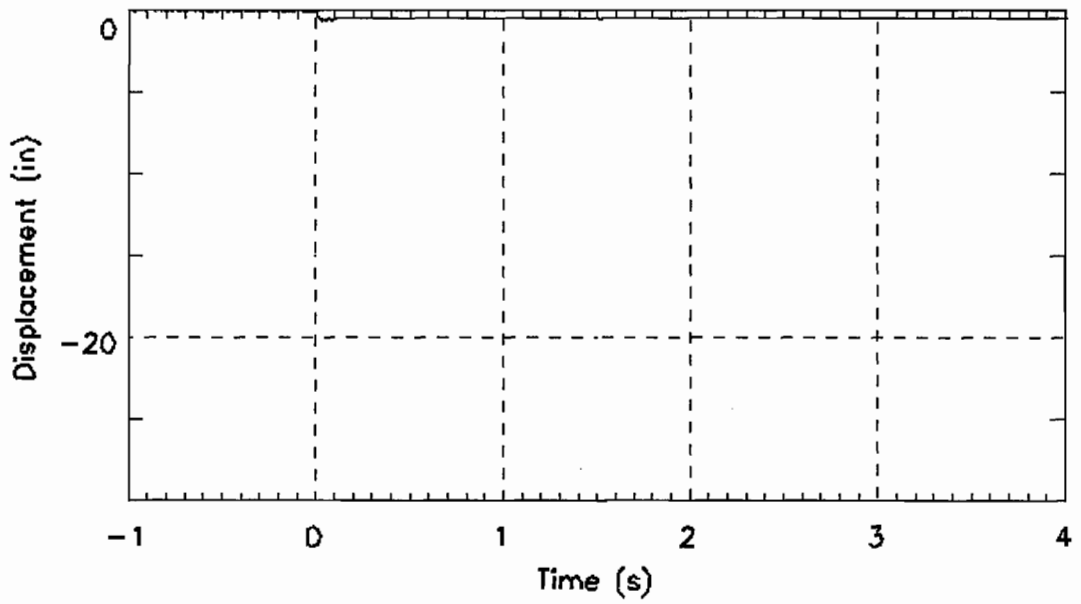

Figure M- 5. Corner post displacement, 3 3/8" above buffer beam, CP1.txt

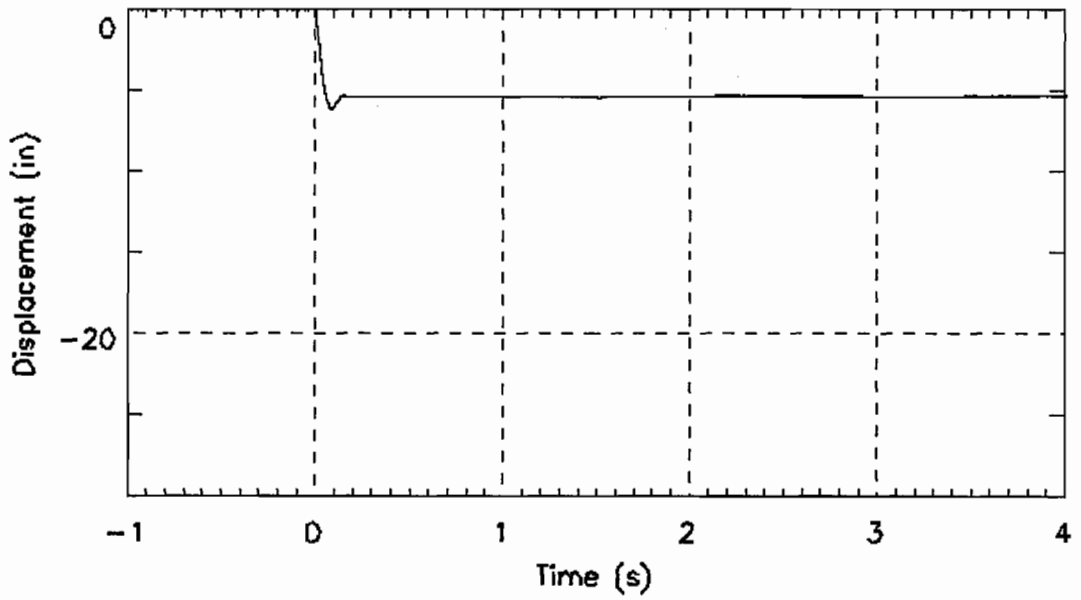

Figure M- 6. Corner post displacement, 20 5/8" above buffer beam, CP2.txt

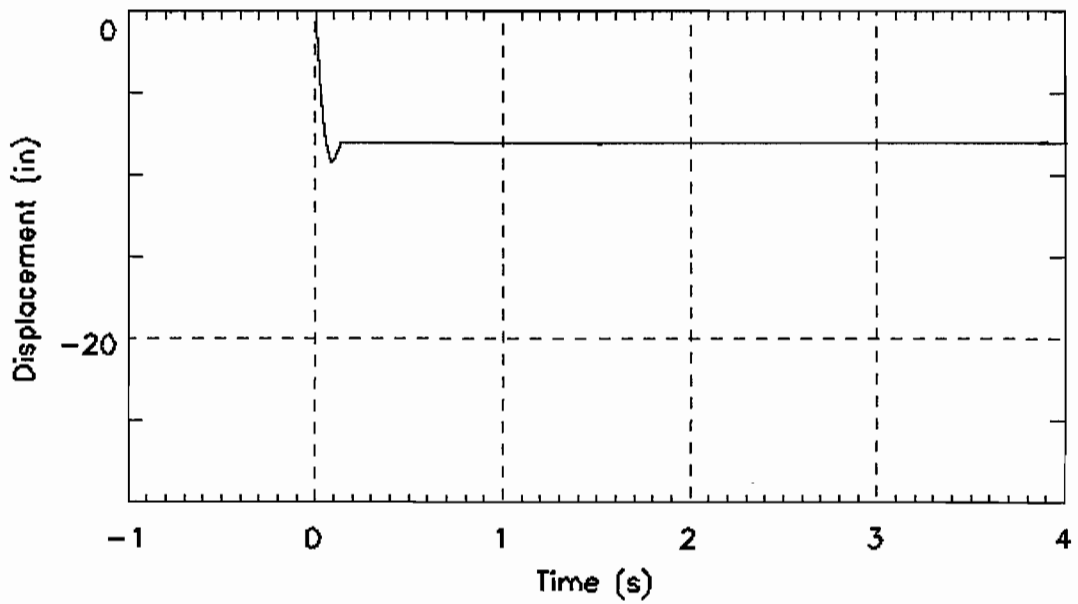

Figure M- 7. Corner post displacement, 38 1/8" above buffer beam, CP3.txt

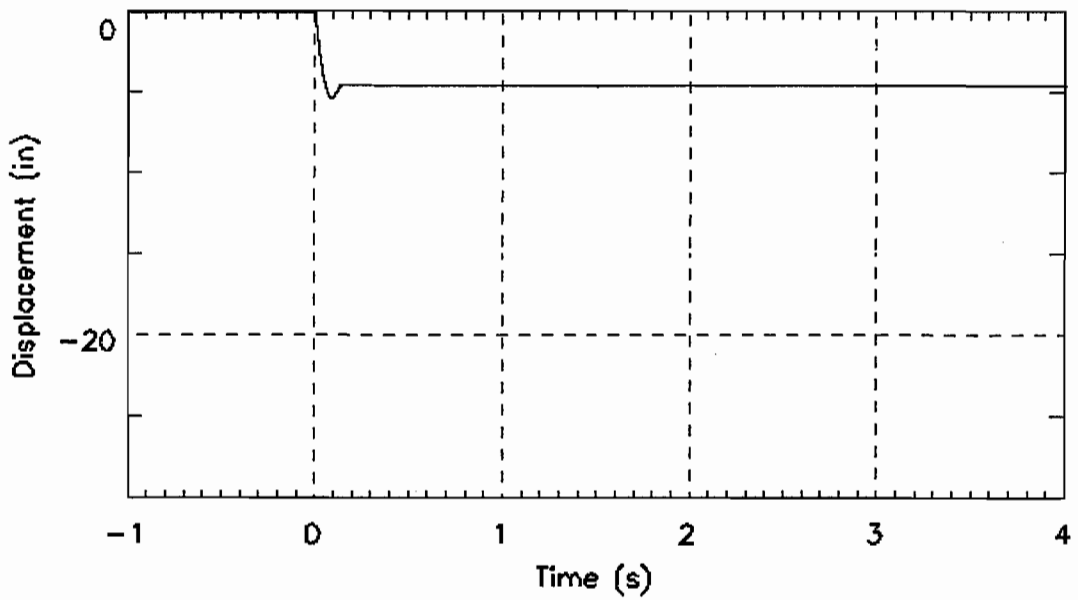

Figure M- 8. Corner post displacement, 55 7/8" above buffer beam, CP4.txt

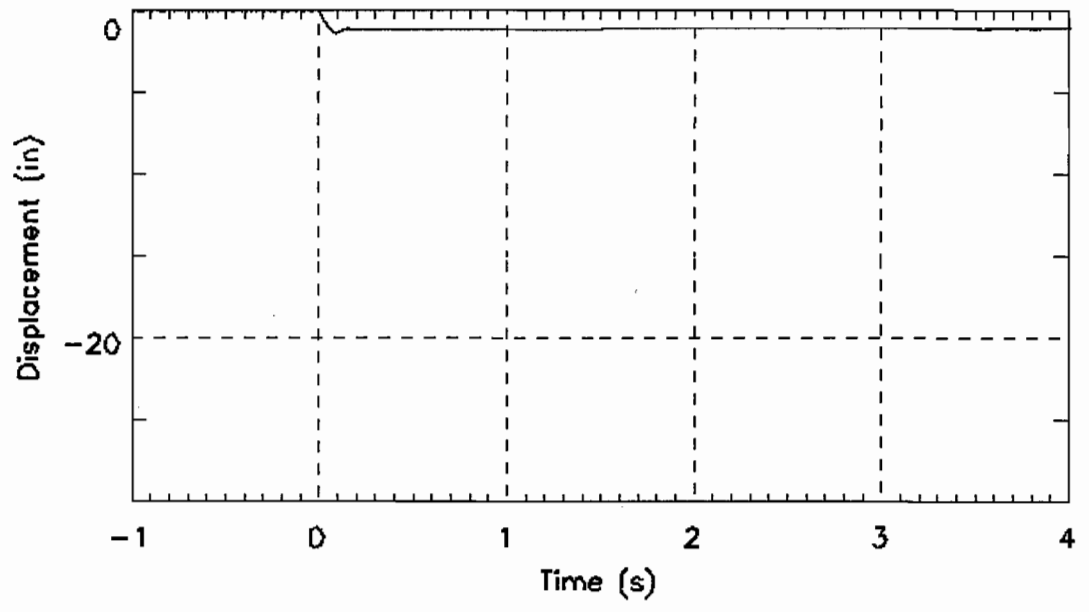

Figure M- 9. Corner post displacement, 73 5/8" above buffer beam, CP5.txt

This page left blank intentionally

Appendix N

Test 5 Strain Data

This page left blank intentionally

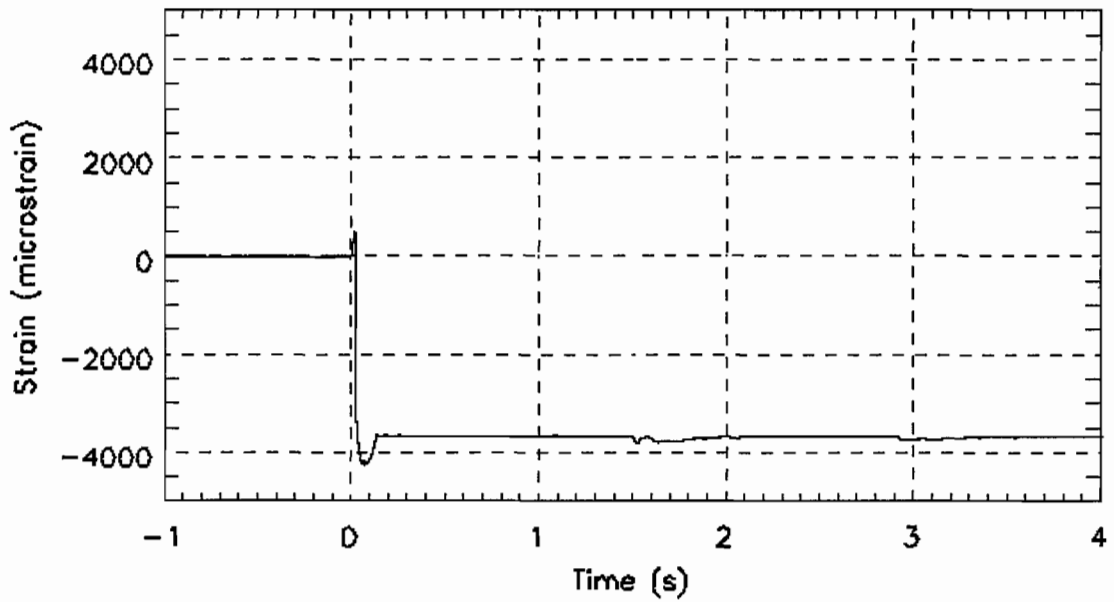

Figure N-1. Strain measurement on the front of the AT plate, 1" from the bottom edge, 9 1/4" in from the outside edge, ATPRFB.txt

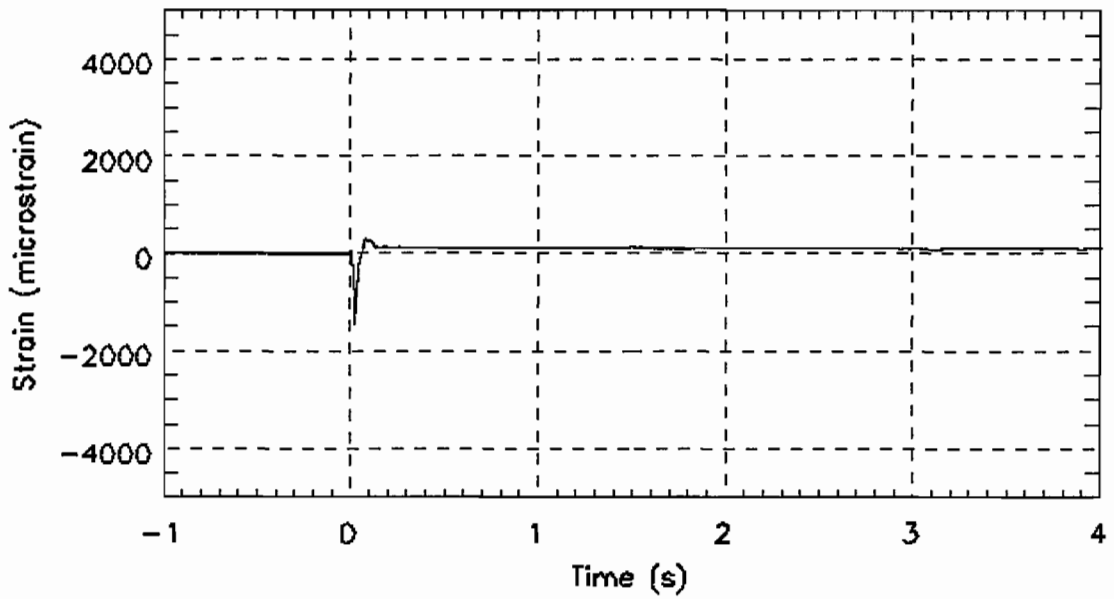

Figure N-2. Strain measurement on the front of the AT plate, 13/16" from the top edge, 9 1/4" in from the outside edge, ATPRFT.txt

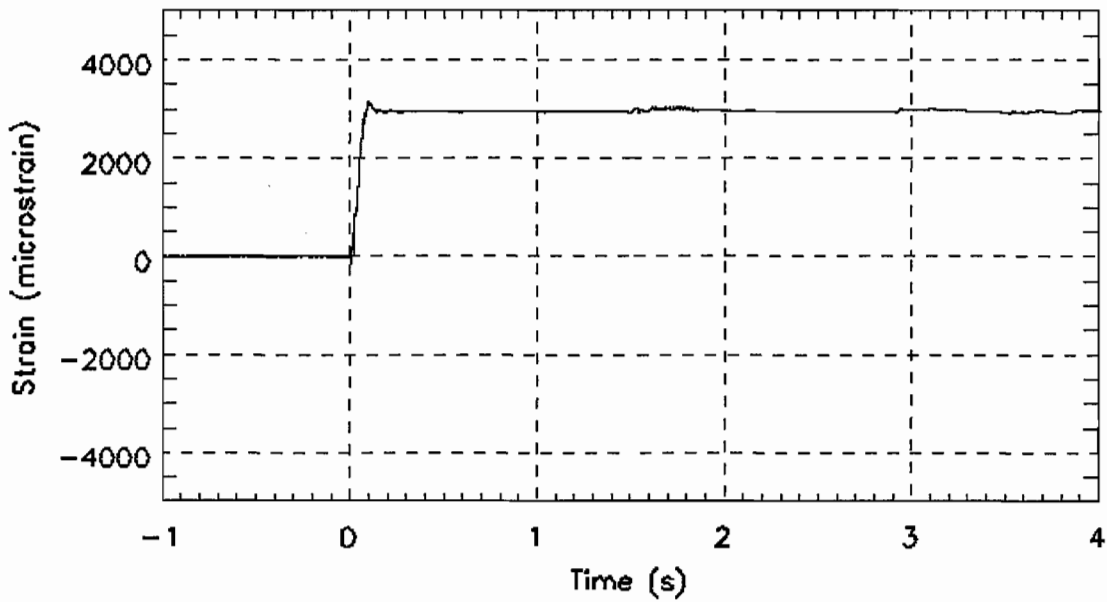

Figure N- 3. Strain measurement on the rear of the AT plate, 1" from the bottom edge, 9 1/4" in from the outside edge, ATPRRB.txt

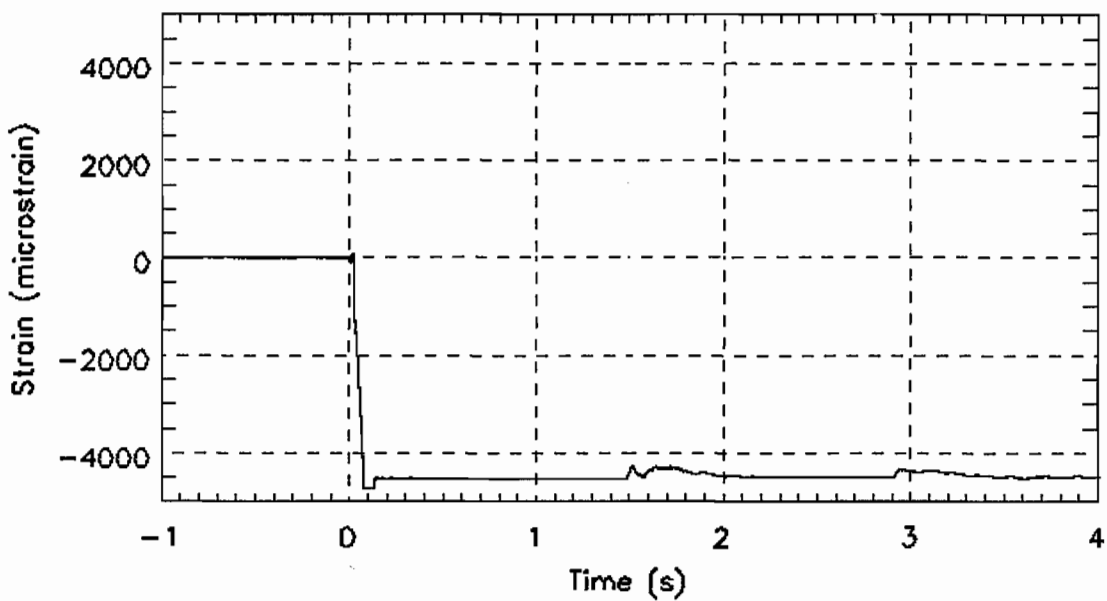

Figure N- 4. Strain measurement on the rear of the AT plate, 13/16" from the top edge, 9 1/4" in from the outside edge, ATPRRT.txt

63

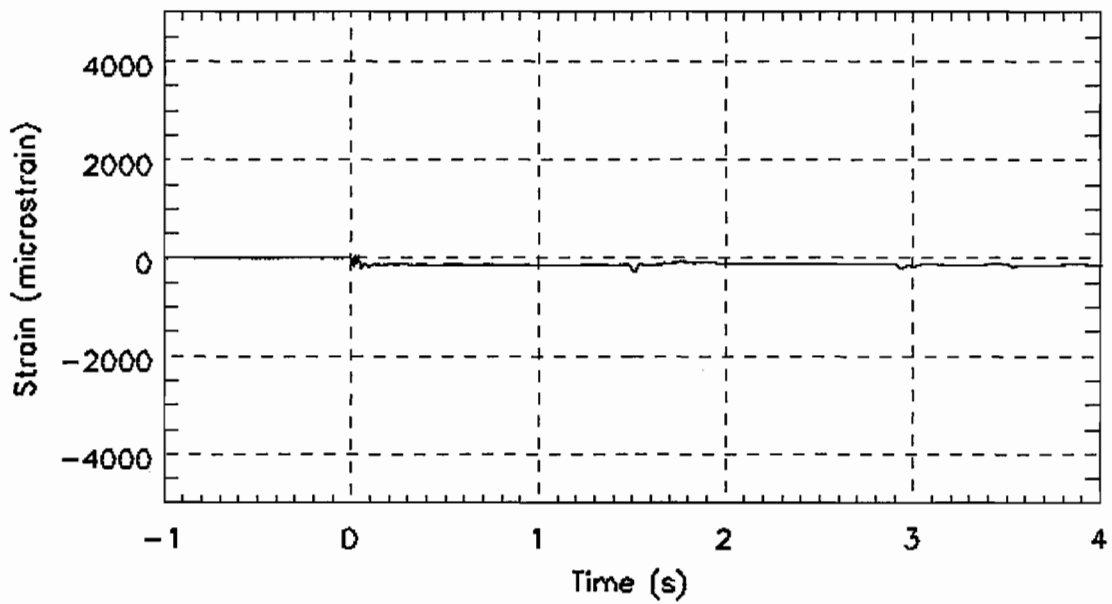

Figure N- 5. Strain measurement on the rear of the buffer beam, 1 3/8" from the bottom edge, 34 5/8" from the outside edge, BBCBB.txt

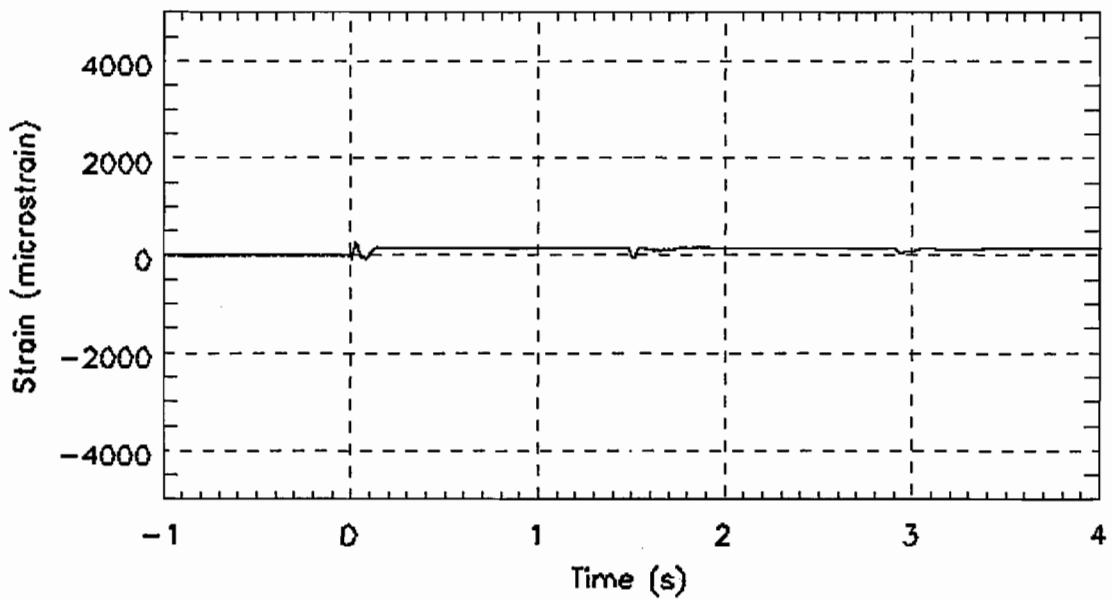

Figure N- 6. Strain measurement on the rear of the buffer beam, 1 3/8" from the top edge, 34 5/8" from the outside edge, BBCBT.txt

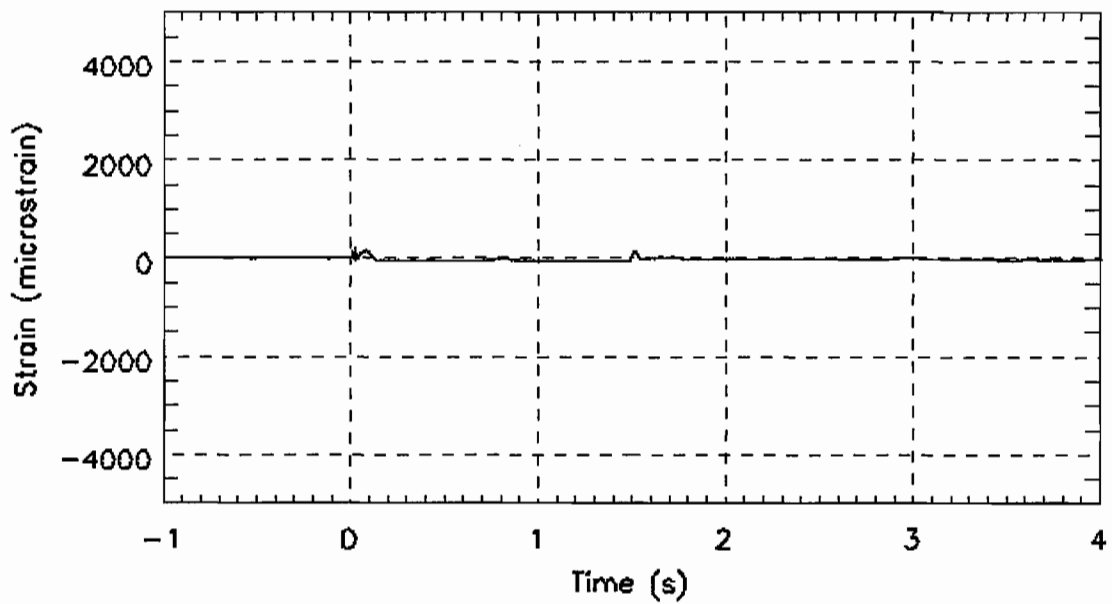

Figure N- 7. Strain measurement on the front of the buffer beam, 1 3/8" from the bottom edge, 34 5/8" from the outside edge, BBCFB.txt

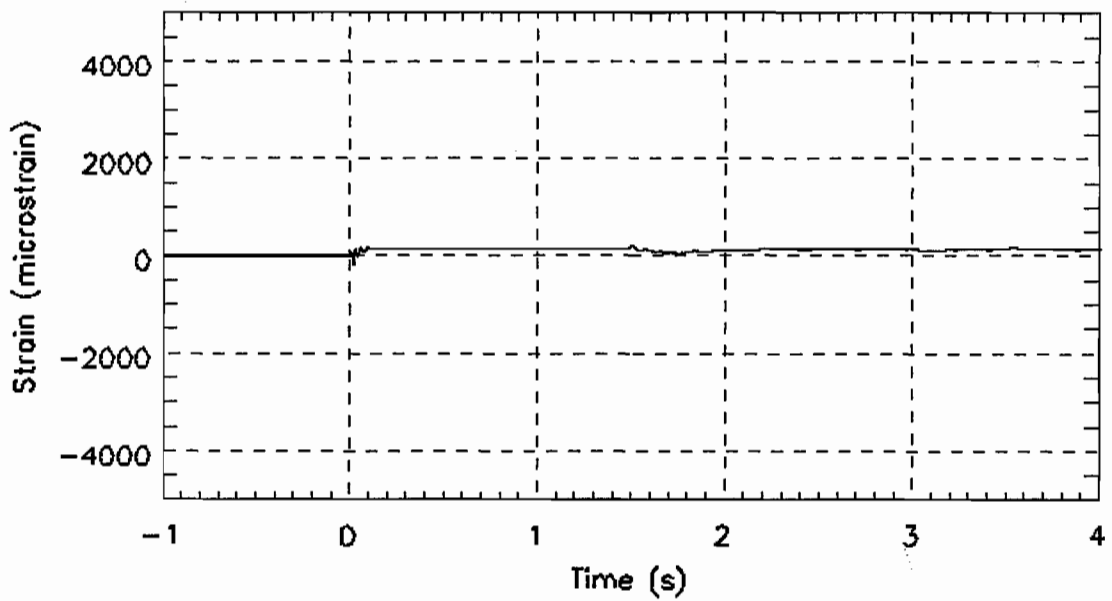

Figure N- 8. Strain measurement on the front of the buffer beam, 1 3/8" from the top edge, 34 5/8" from the outside edge, BBCFT.txt

5

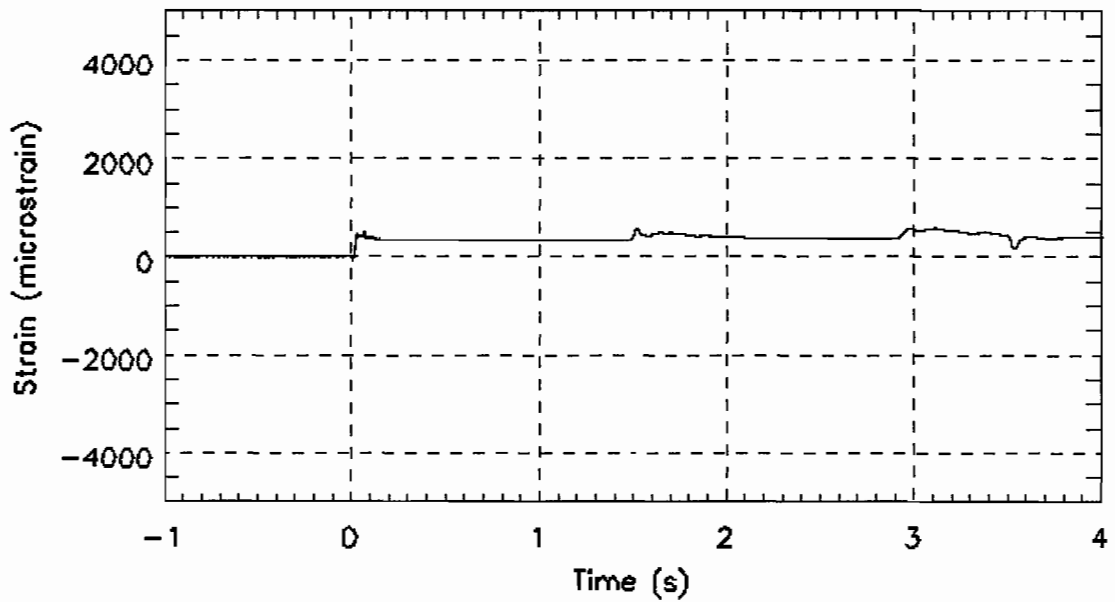

Figure N- 9. Strain measurement on the rear of the buffer beam, 1 3/8" from the bottom edge, 3 3/16" from the outside edge, BBEBB.txt

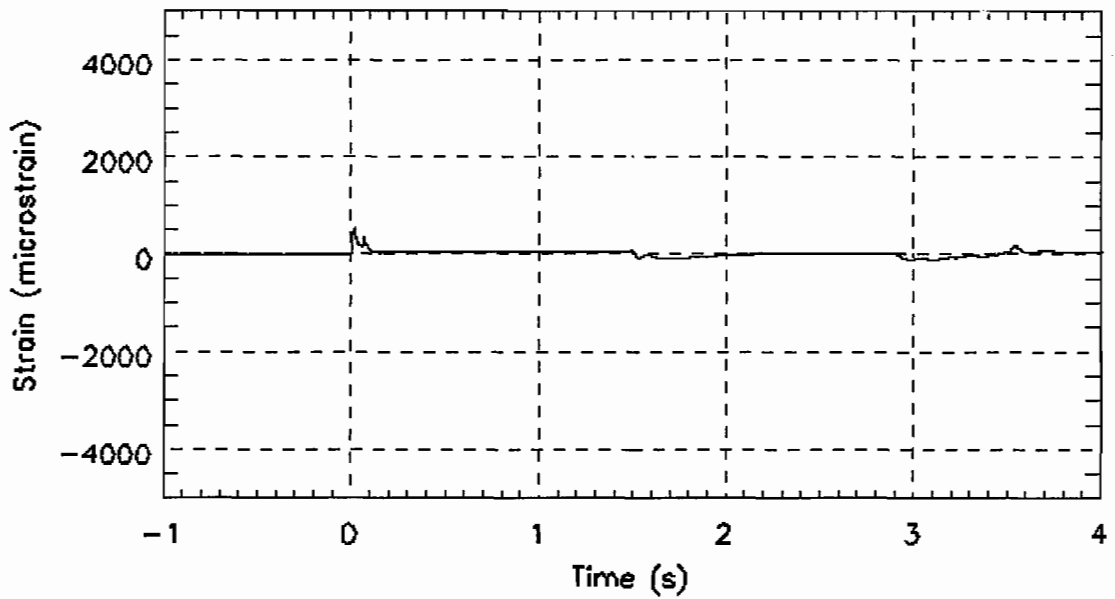

Figure N- 10. Strain measurement on the rear of the buffer beam, 1 3/8" from the top edge, 3 3/16" from the outside edge, BBEBT.txt

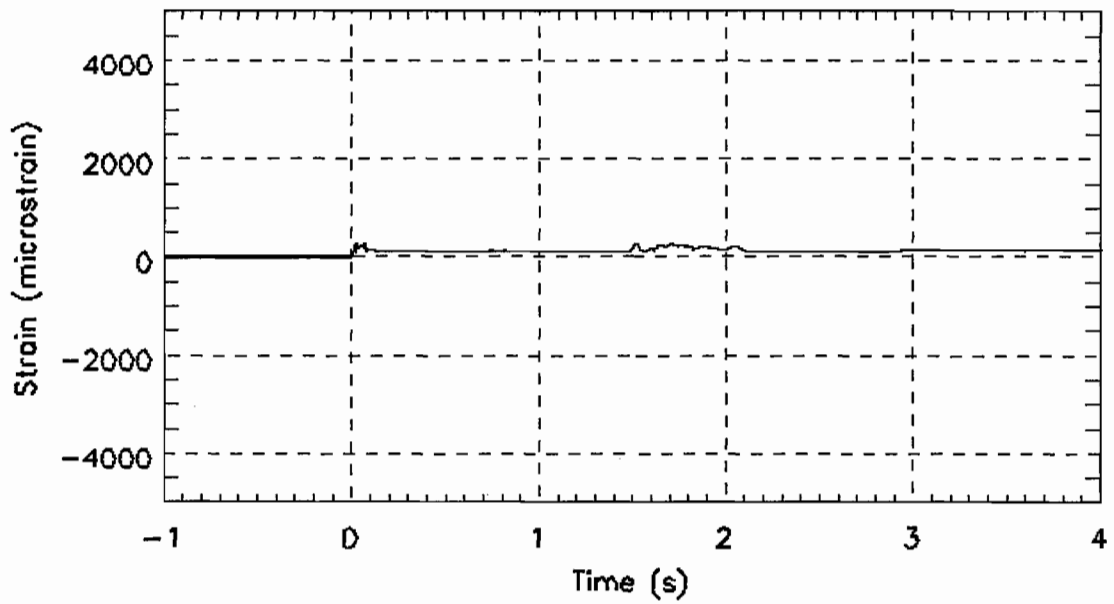

Figure N- 11. Strain measurement on the front of the buffer beam, 1 3/8" from the bottom edge, 3 3/16" from the outside edge, BBEFB.txt

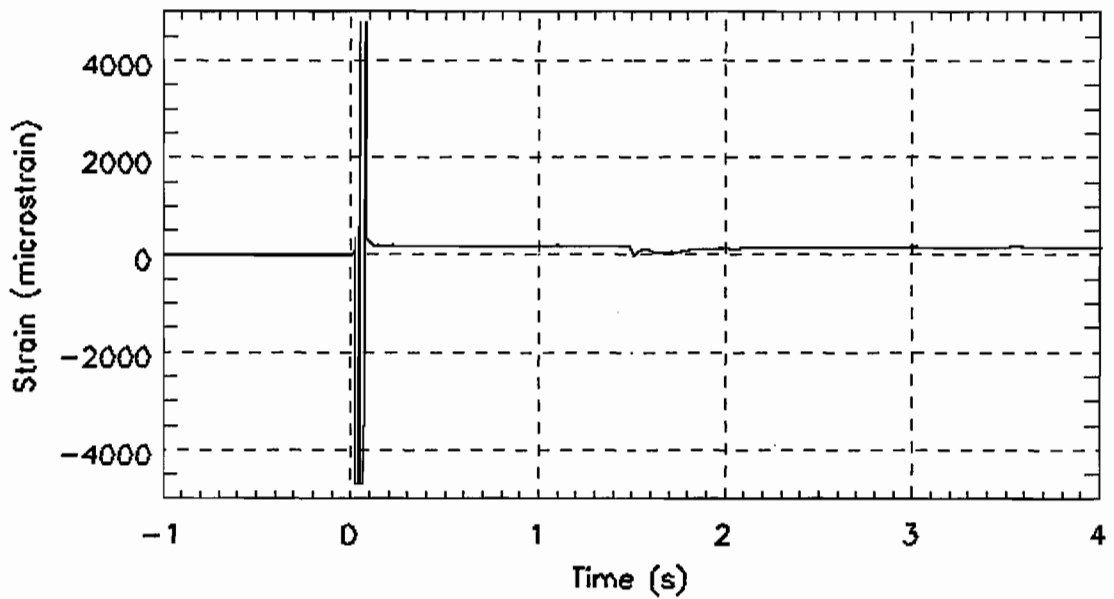

Figure N- 12. Strain measurement on the front of the buffer beam, 1 3/8" from the top edge, 3 3/16" from the outside edge, BBEFT.txt

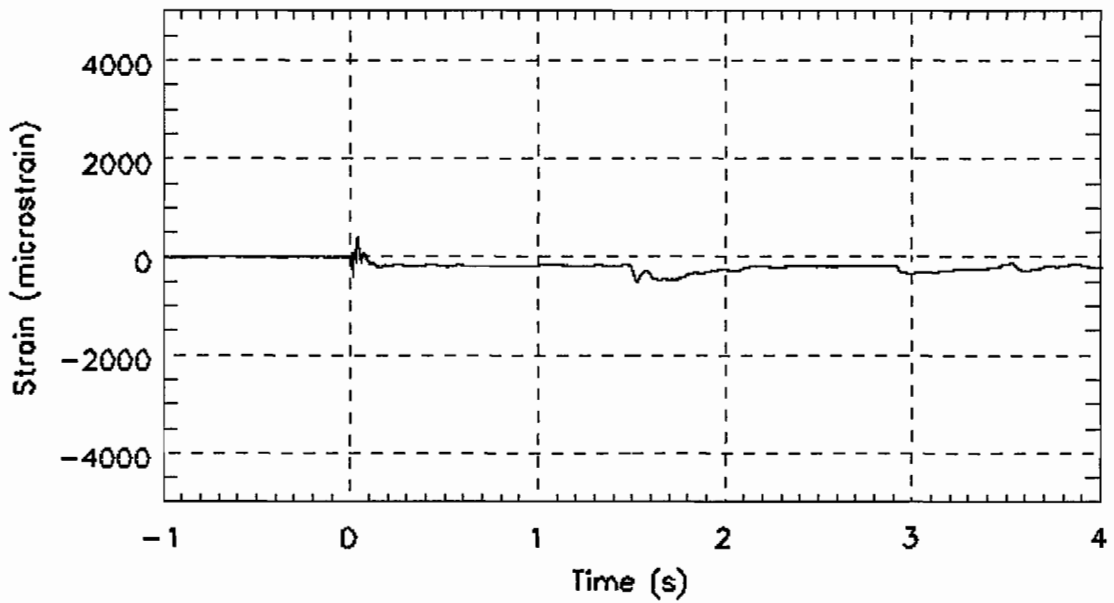

Figure N- 13. Strain measurement on the front of the collision post, 2" up from the buffer beam, 1 7/8" from the inside edge of the collision post, COLBFL.txt

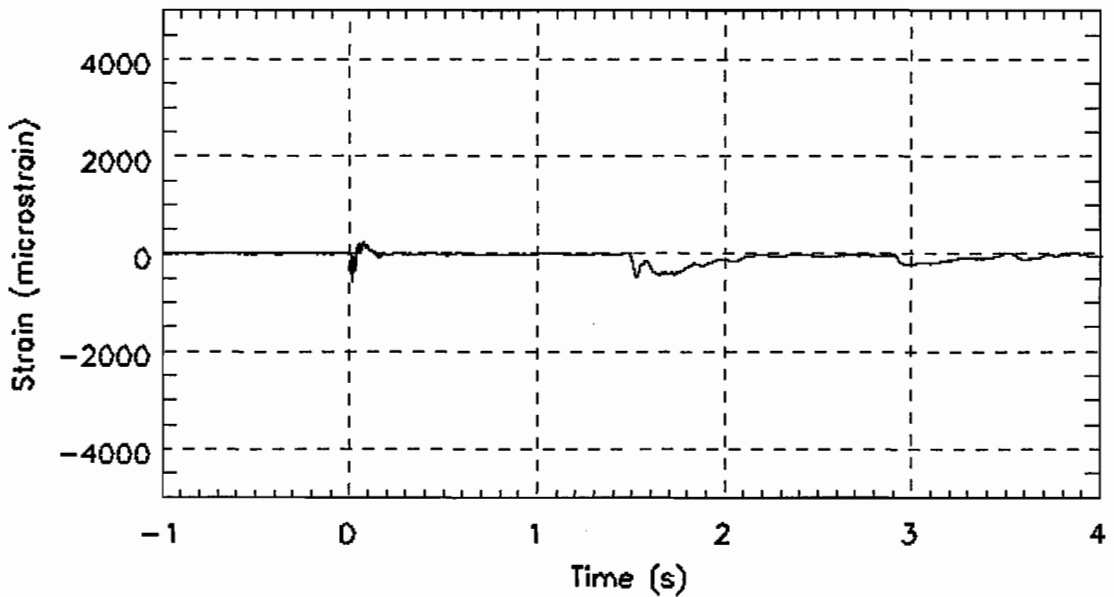

Figure N- 14. Strain measurement on the front of the collision post, 2" up from the buffer beam, 1 7/8" from the outside edge of the collision post, COLBFR.txt

812

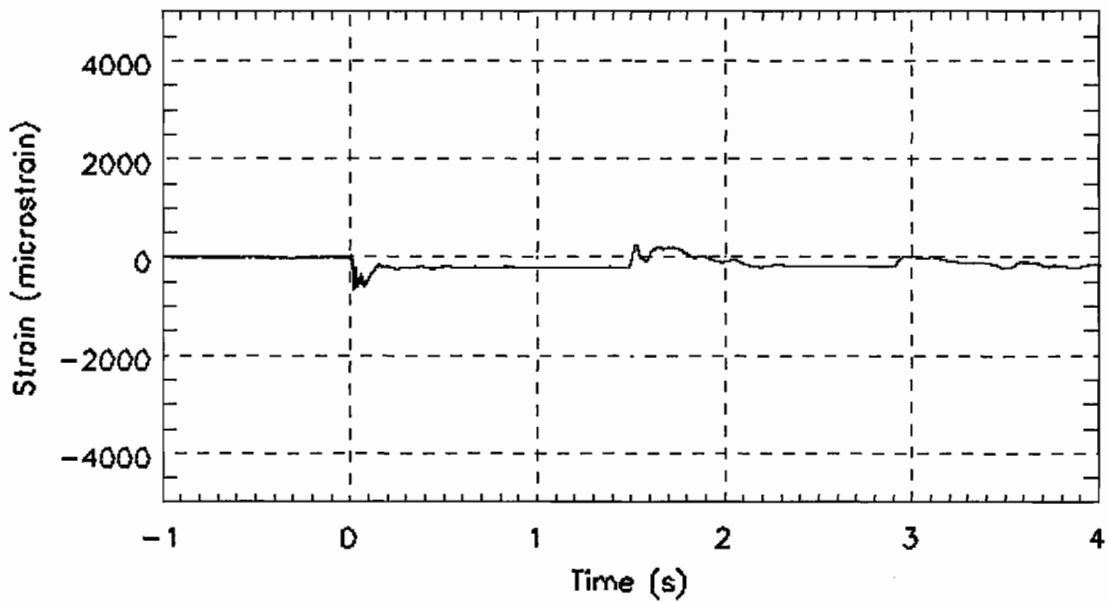

Figure N- 15. Strain measurement on the rear of the collision post, 2" up from the buffer beam, 1 7/8" from the inside edge of the collision post, COLBRL.txt

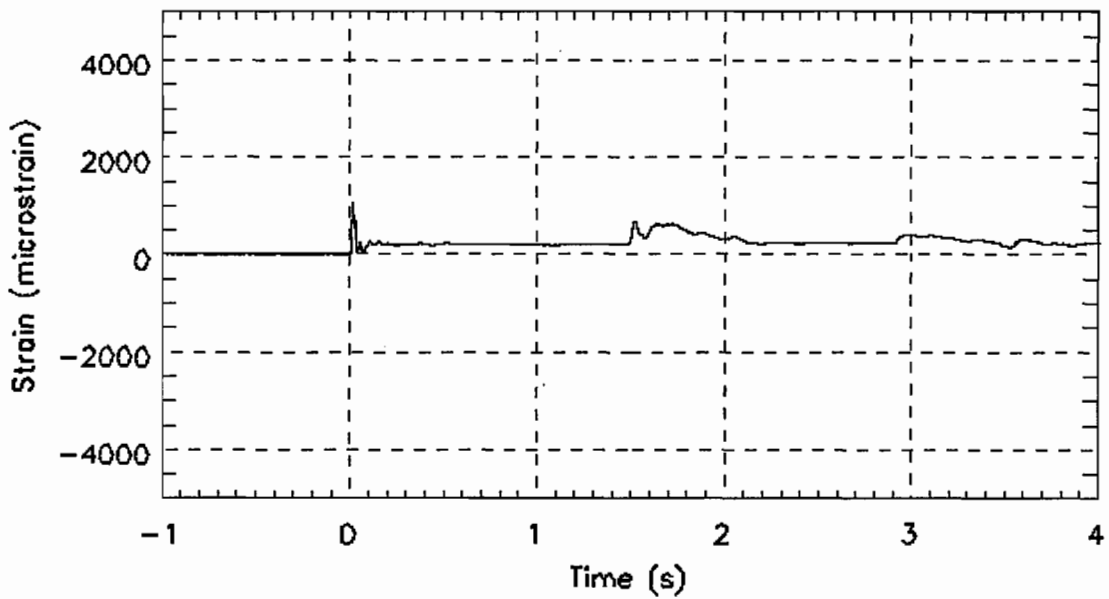

Figure N- 16. Strain measurement on the rear of the collision post, 2" up from the buffer beam, 1 7/8" from the outside edge of the collision post, COLBRR.txt

2019

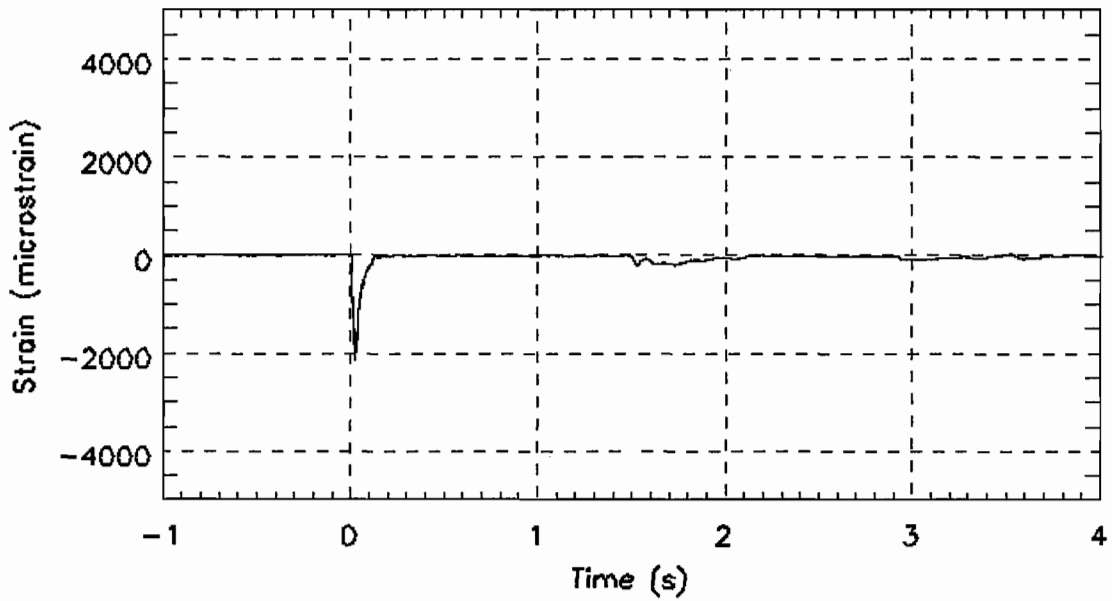

Figure N- 17. Strain measurement on the front of the collision post, 37 3/4" up from the buffer beam, 1 7/8" from the inside edge of the collision post, COLMFL.txt

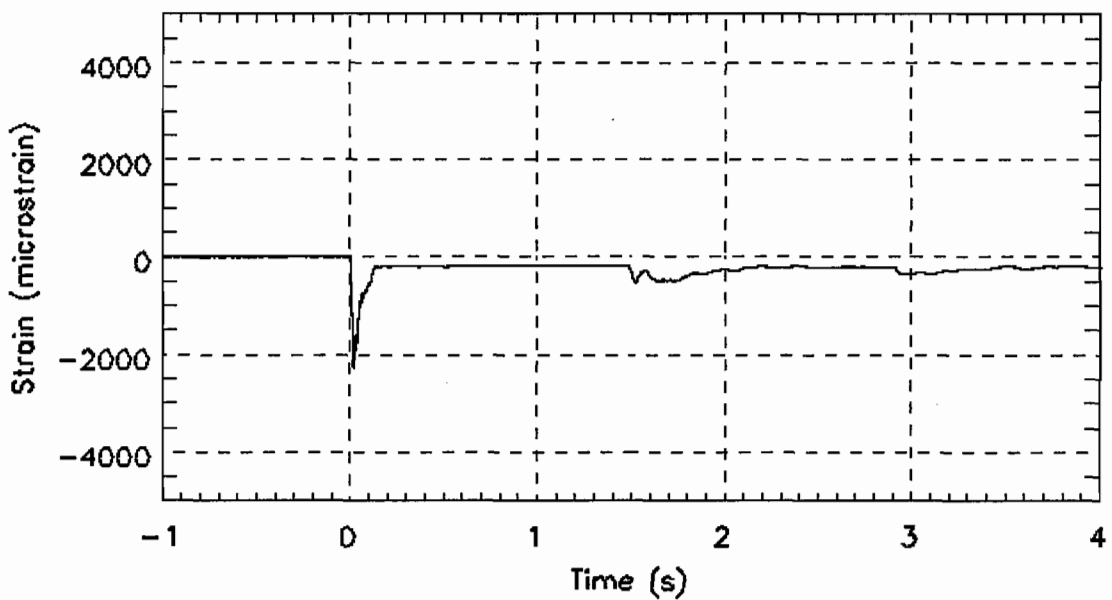

Figure N- 18. Strain measurement on the front of the collision post, 37 3/4" up from the buffer beam, 1 7/8" from the outside edge of the collision post, COLMFR.txt

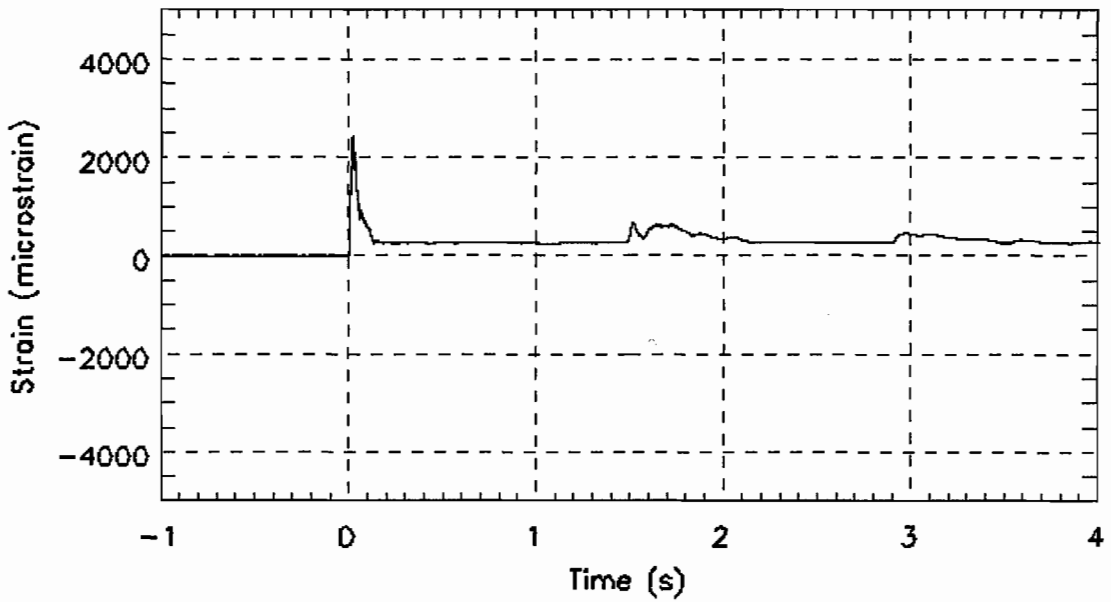

Figure N- 19. Strain measurement on the rear of the collision post, 37 3/4" up from the buffer beam, 1 7/8" from the inside edge of the collision post, COLMRL.txt

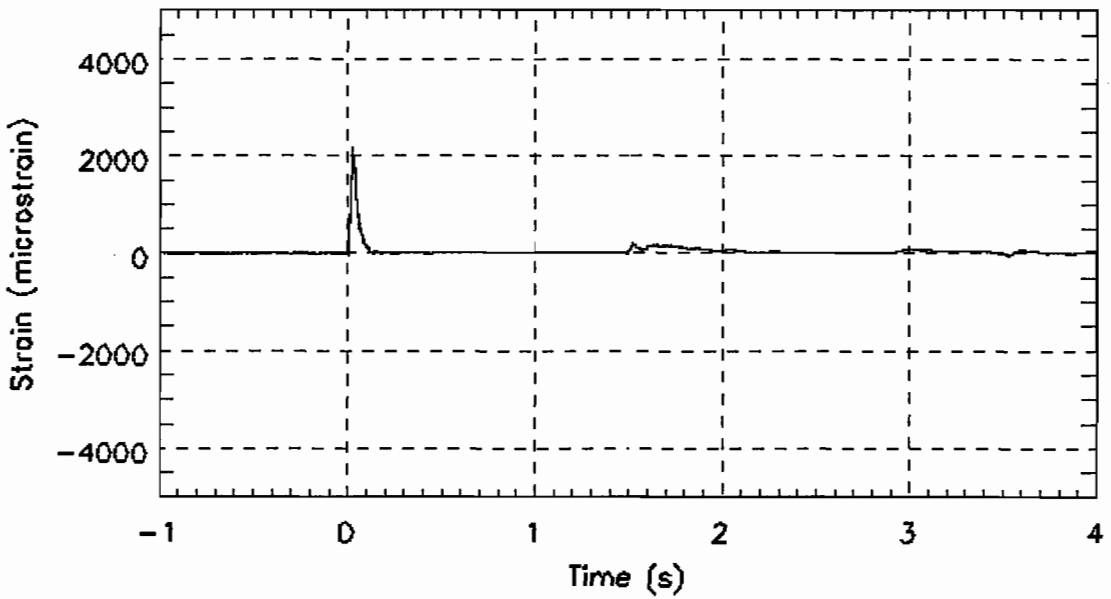

Figure N- 20. Strain measurement on the rear of the collision post, 37 3/4" up from the buffer beam, 1 7/8" from the outside edge of the collision post, COLMRR.txt

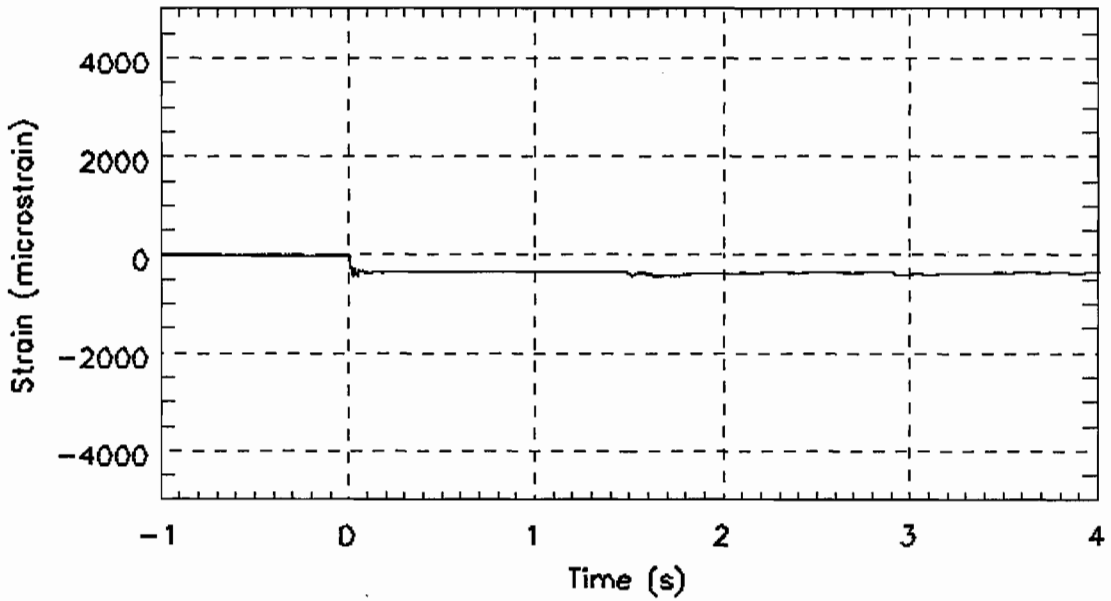

Figure N-21. Strain measurement on the front of the collision post, 2" down from the AT Plate, 1 7/8" from the inside edge of the collision post, COLTFL.txt

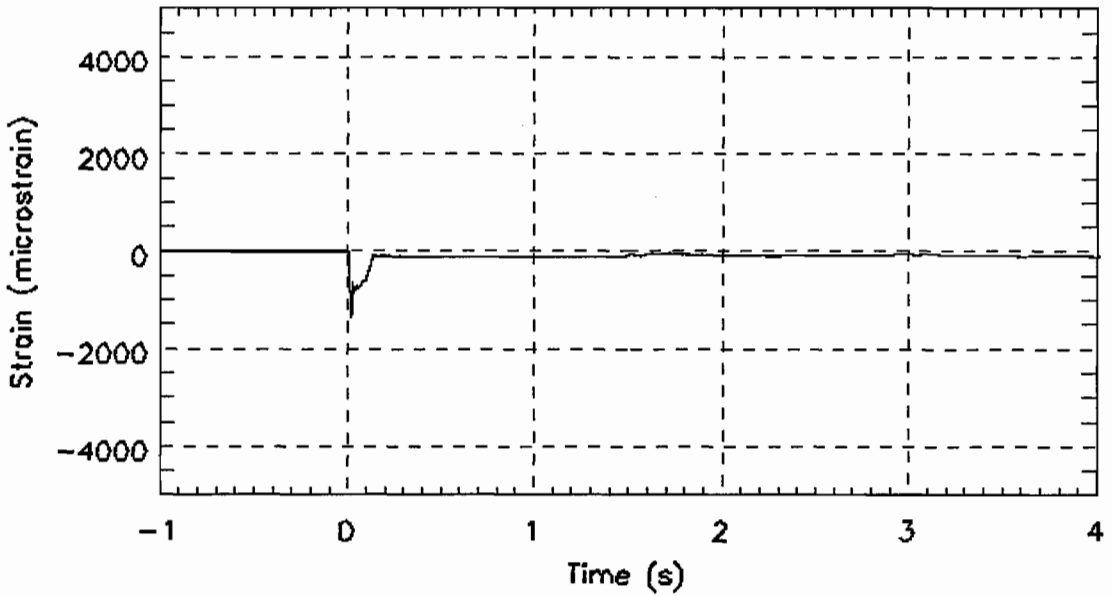

Figure N-22. Strain measurement on the front of the collision post, 2" down from the AT Plate, 1 7/8" from the outside edge of the collision post, COLTFR.txt

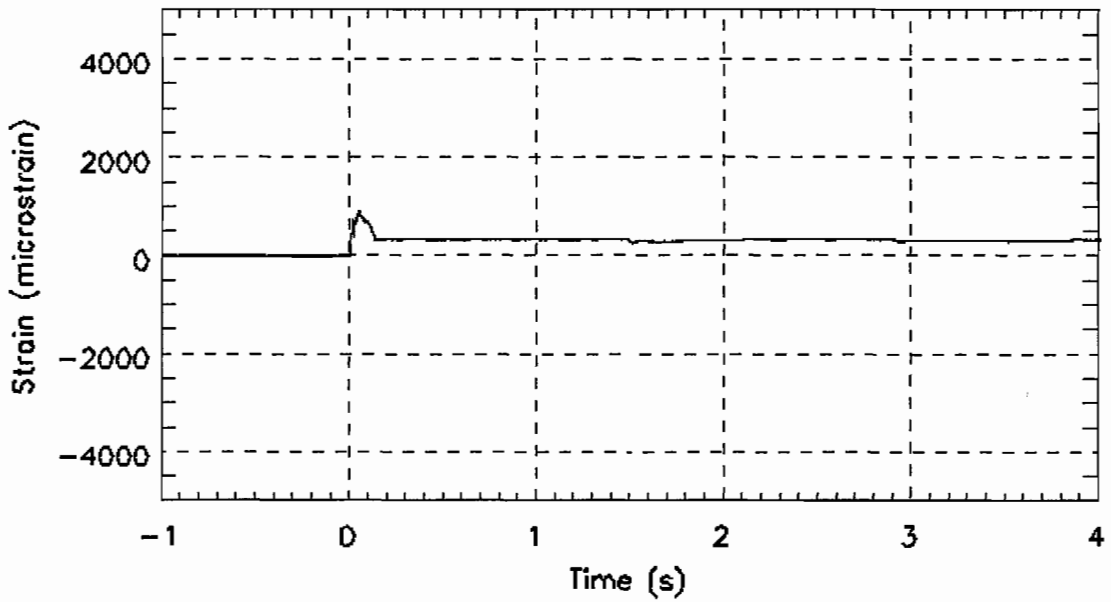

Figure N- 23. Strain measurement on the rear of the collision post, 2" down from the AT Plate, 1 7/8" from the inside edge of the collision post, COLTRL.txt

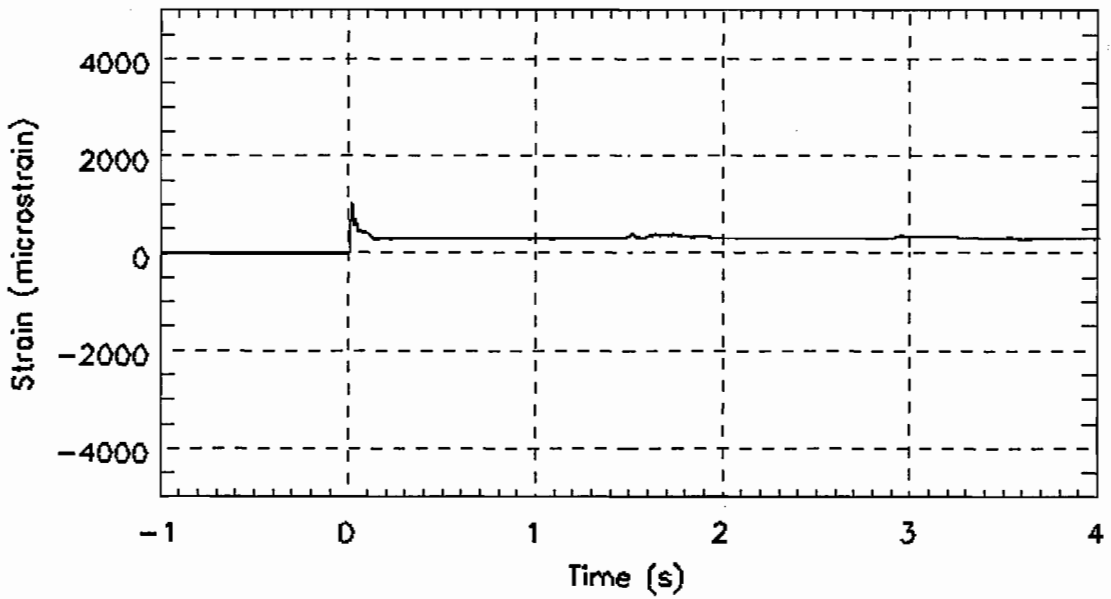

Figure N- 24. Strain measurement on the rear of the collision post, 2" down from the AT Plate, 1 7/8" from the outside edge of the collision post, COLTRR.txt

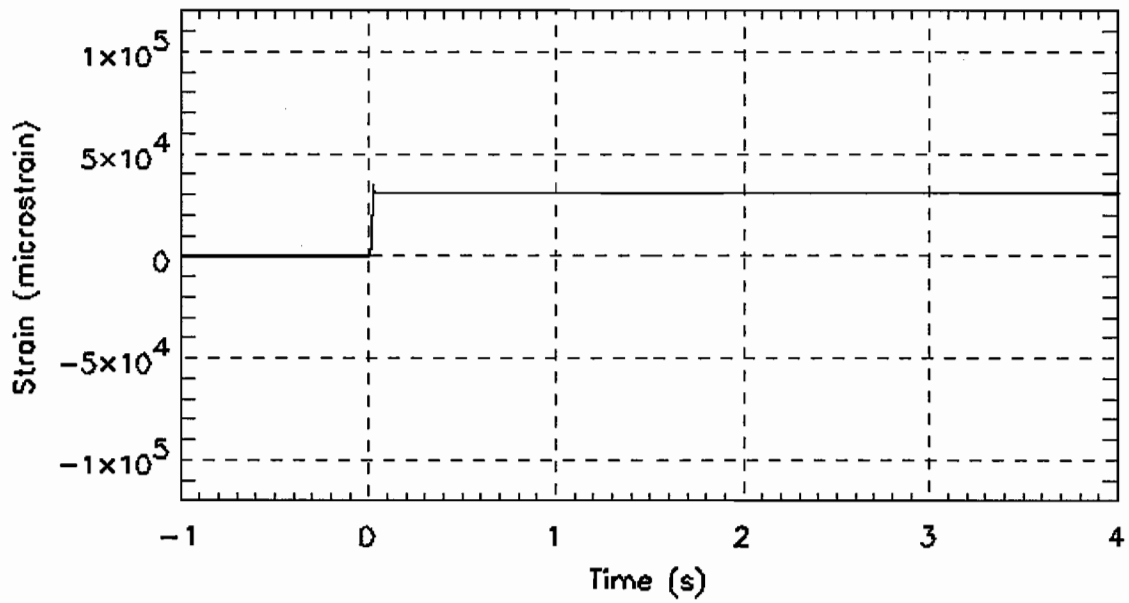

Figure N- 25. Strain measurement on the front of the corner post, 2" up from the buffer beam, 1" from the inside edge of the corner post, CORBFL.txt

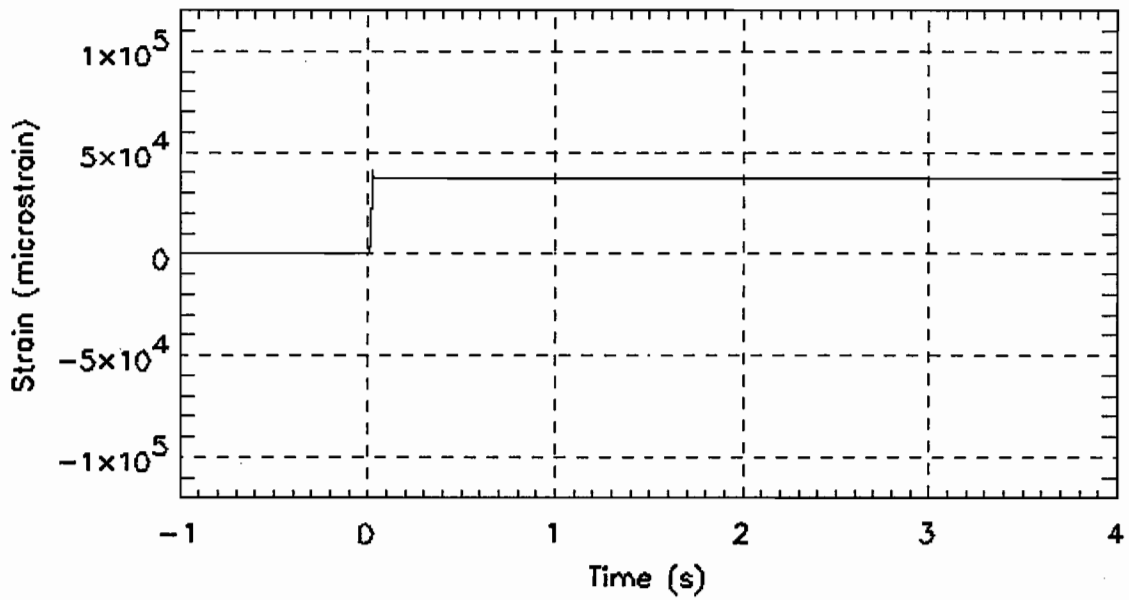

Figure N- 26. Strain measurement on the front of the corner post, 2" up from the buffer beam, 1" from the outside edge of the corner post, CORBFR.txt

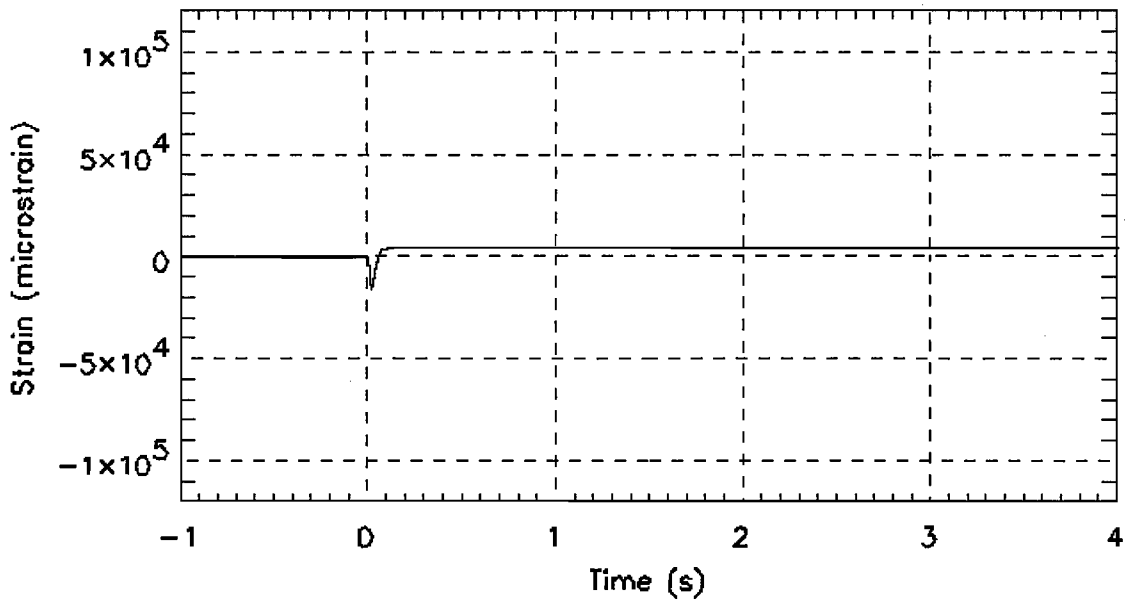

Figure N- 27. Strain measurement on the rear of the corner post, 2" up from the buffer beam, 1" from the inside edge of the corner post, CORBRL.txt

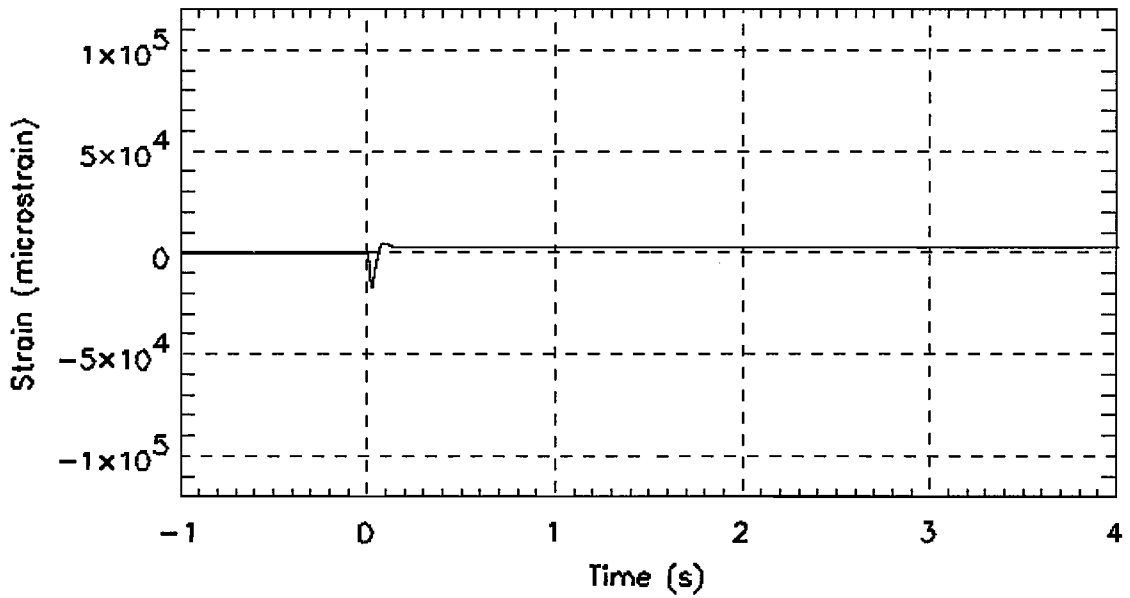

Figure N- 28. Strain measurement on the rear of the corner post, 2" up from the buffer beam, 1" from the outside edge of the corner post, CORBRR.txt

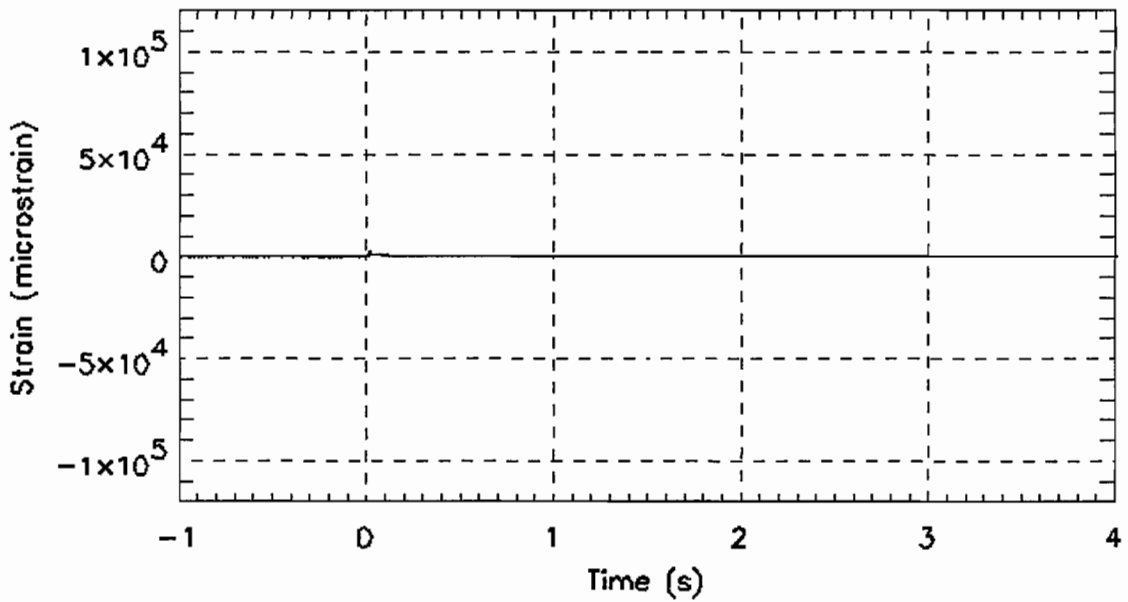

Figure N- 29. Strain measurement on the front of the corner post, 2" down from the AT Plate, 1" from the inside edge of the corner post, CORTFL.txt

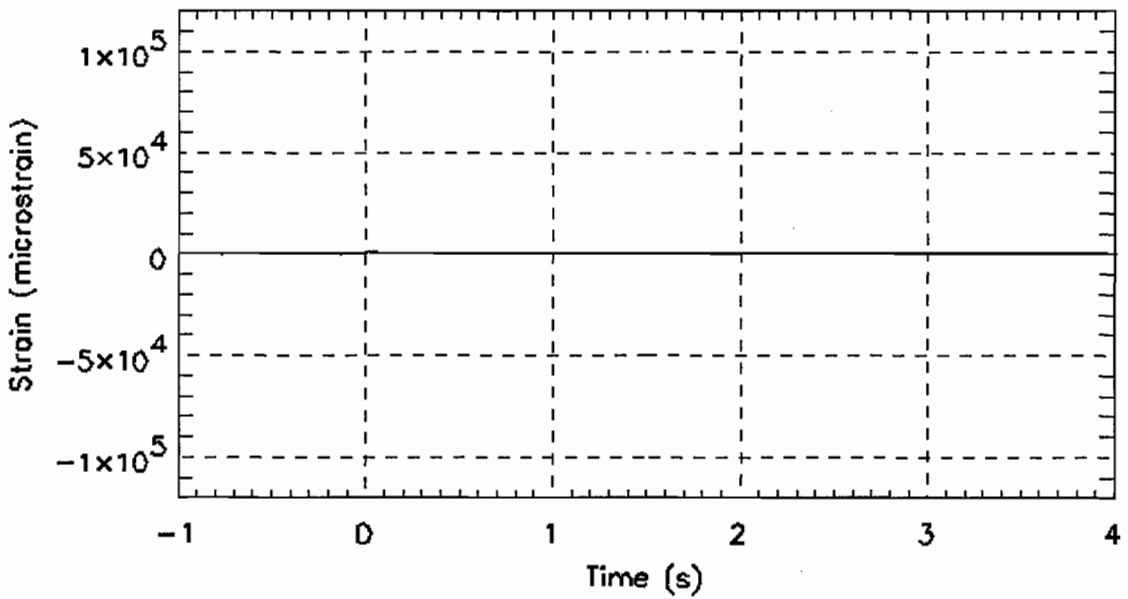

Figure N- 30. Strain measurement on the front of the corner post, 2" down from the AT Plate, 1" from the outside edge of the corner post, CORTFR.txt

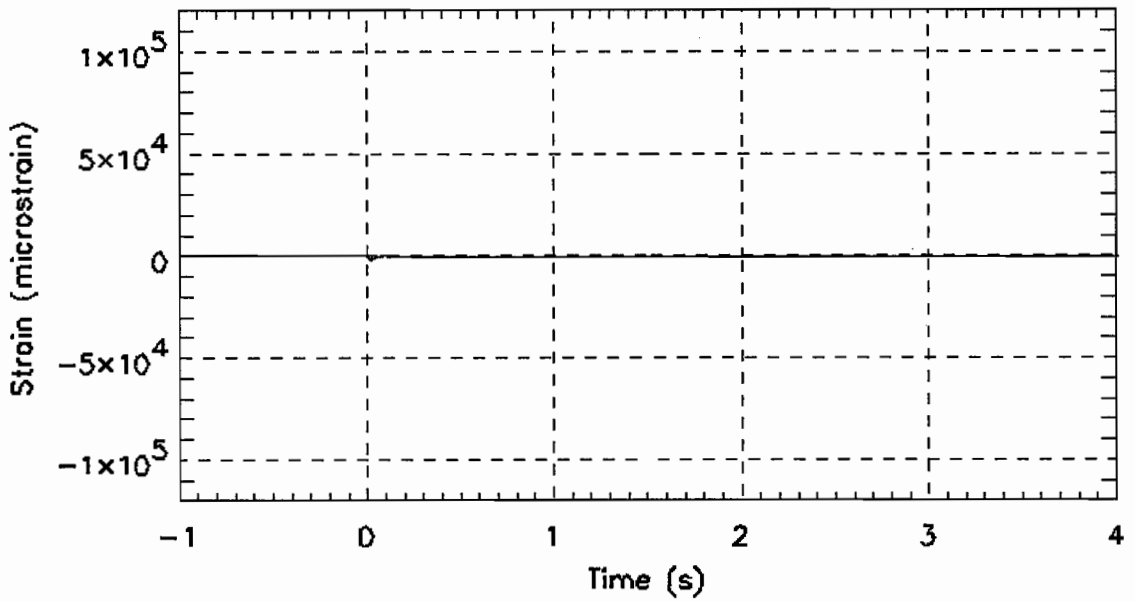

Figure N- 31. Strain measurement on the rear of the corner post, 2" down from the AT Plate, 1" from the inside edge of the corner post, CORTRL.txt

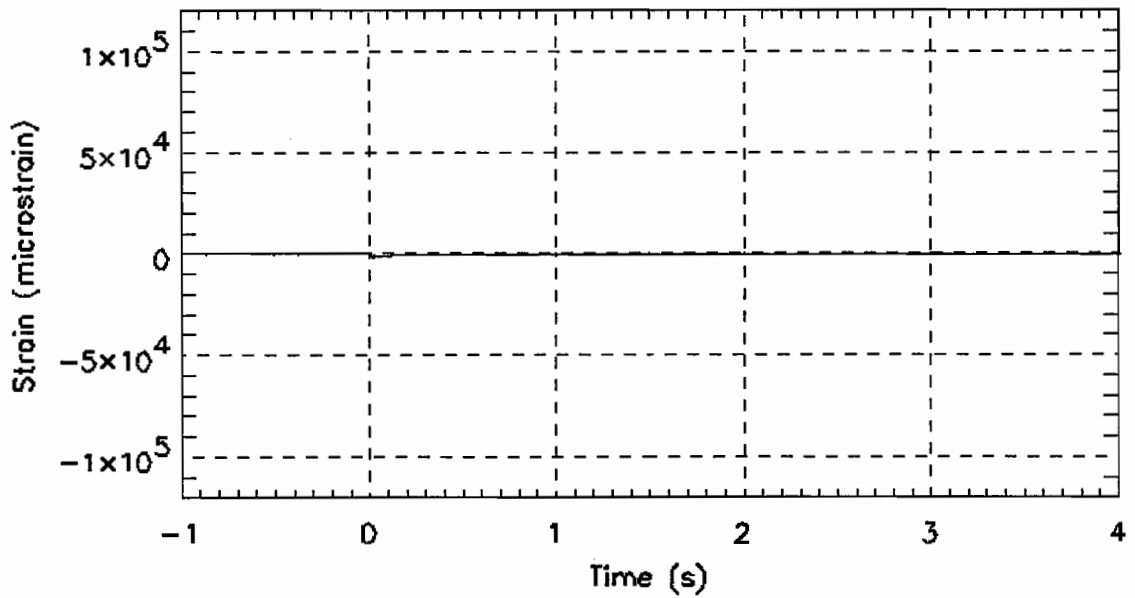

Figure N- 32. Strain measurement on the rear of the corner post, 2" down from the AT Plate, 1" from the outside edge of the corner post, CORTRR.txt

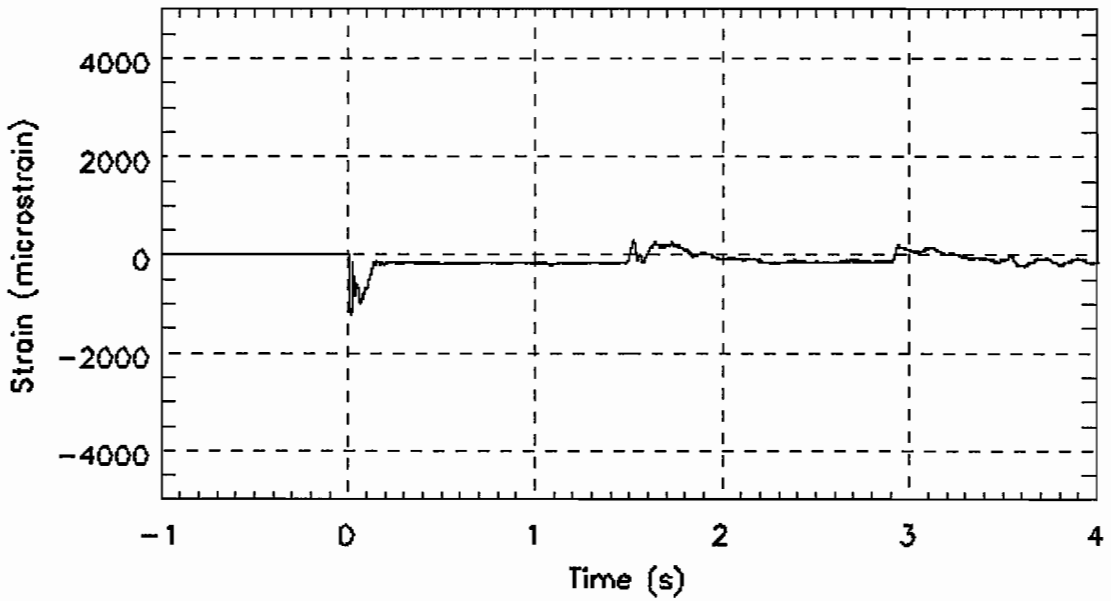

Figure N- 33. Strain measurement on the front of the corner post, 2" down from the AT Plate, 1" from the inside edge of the corner post, CRBLF.txt

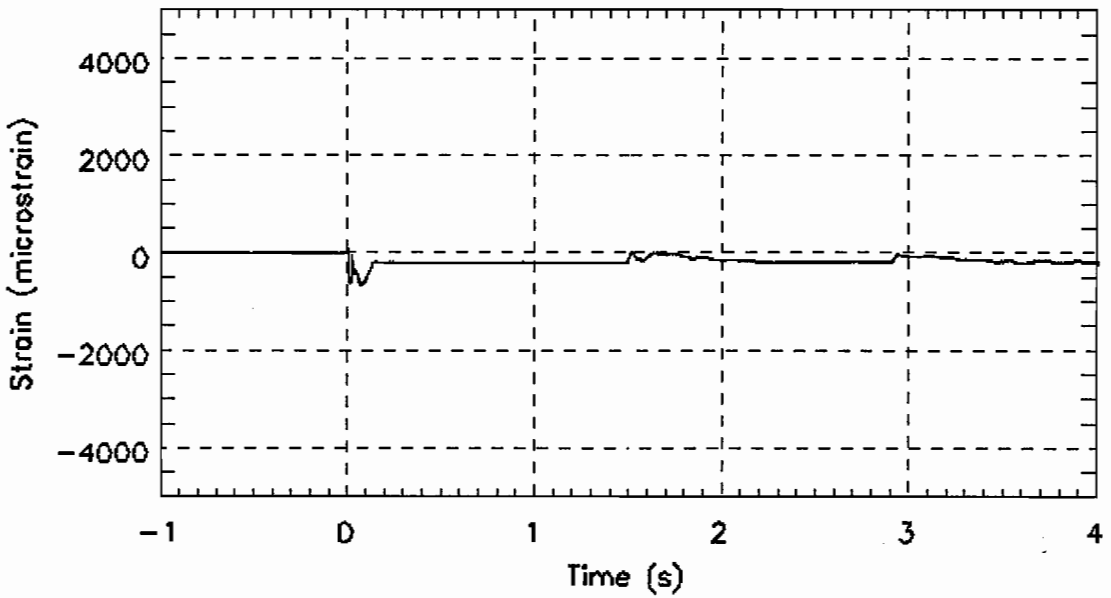

Figure N- 34. Strain measurement on the front of the corner post, 2" down from the AT Plate, 1" from the outside edge of the corner post, CRBLM.txt

08

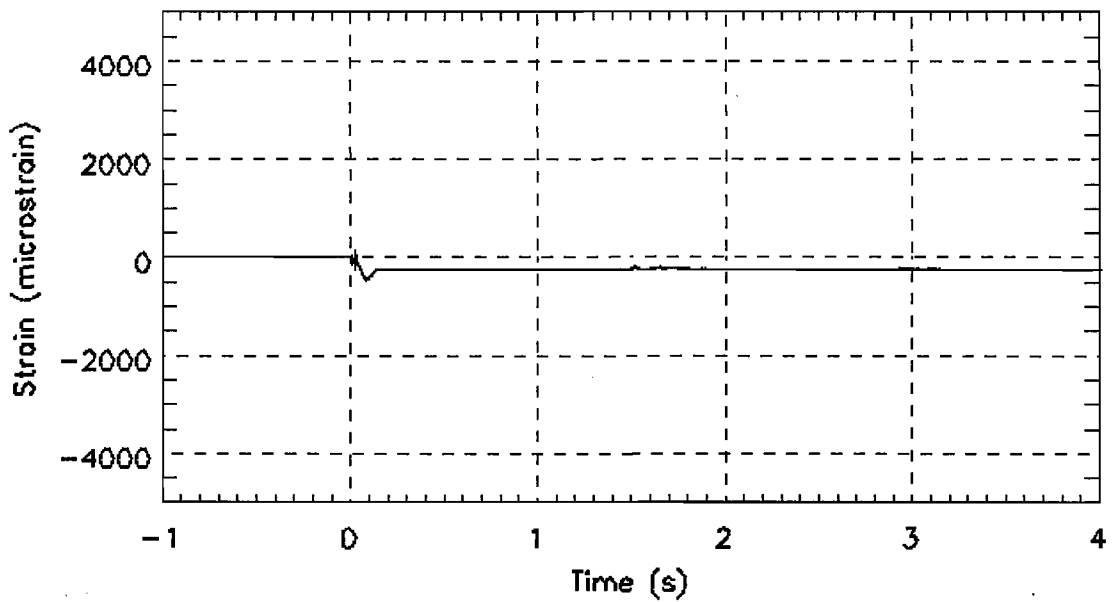

Figure N- 35. Strain measurement on the rear of the corner post, 2" down from the AT Plate, 1" from the inside edge of the corner post, CRBLR.txt

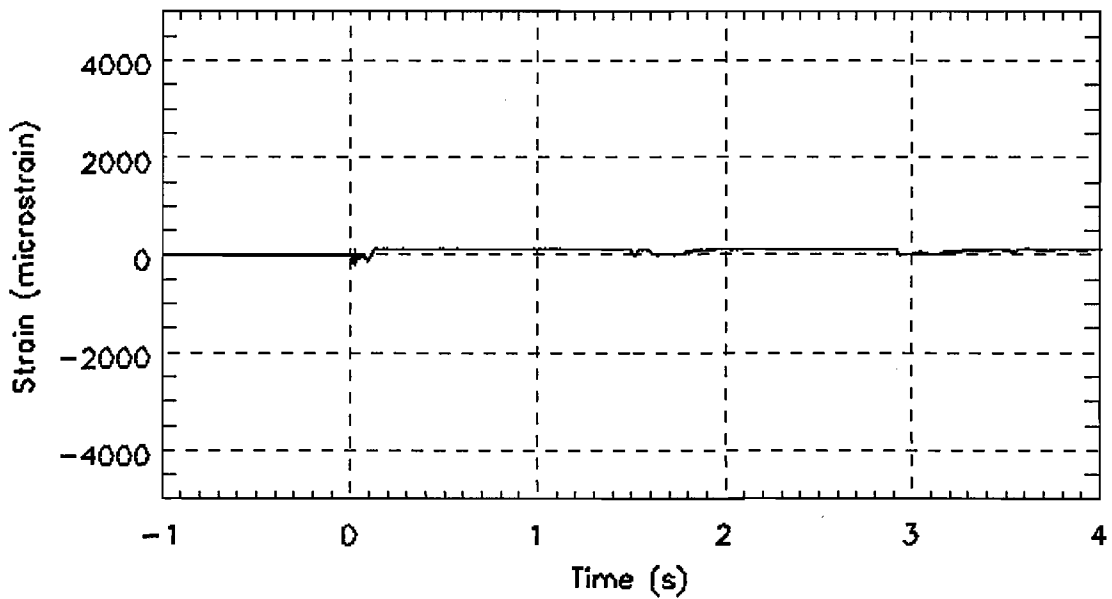

Figure N- 36. Strain measurement on the rear of the corner post, 2" down from the AT Plate, 1" from the outside edge of the corner post, CRBRF.txt

17

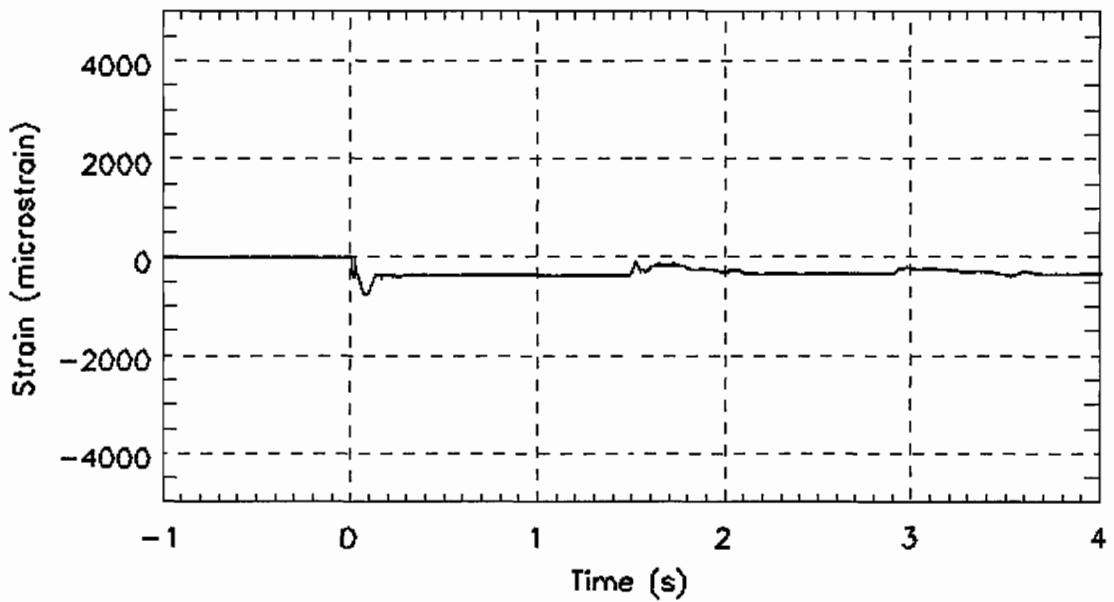

Figure N- 37. Strain measurement on the outside of the cant rail, bottom edge, midway across door opening, CRBRM.txt

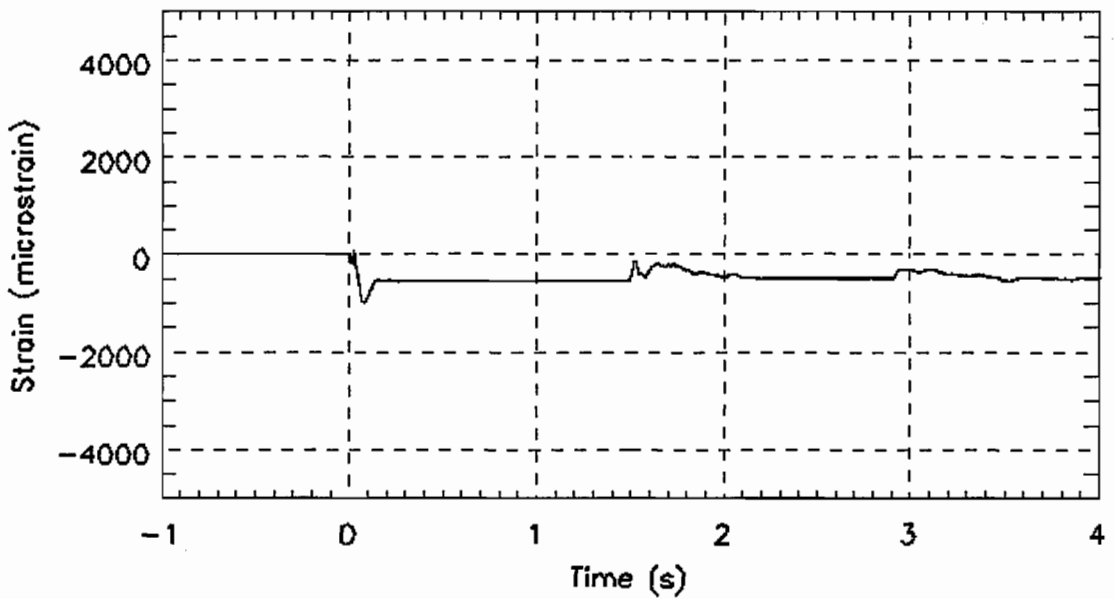

Figure N- 38. Strain measurement on the outside of the cant rail, bottom edge, midway across door opening, CRBRR.txt

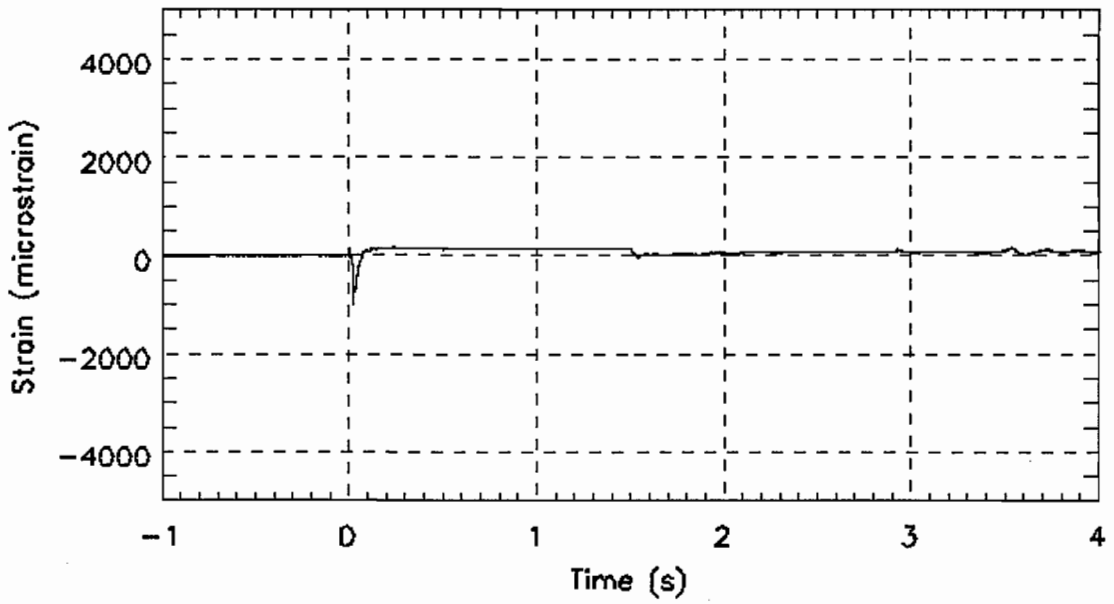

Figure N- 39. Strain measurement on the inside of the cant rail, top edge, just behind the AT plate, CRTLF.txt

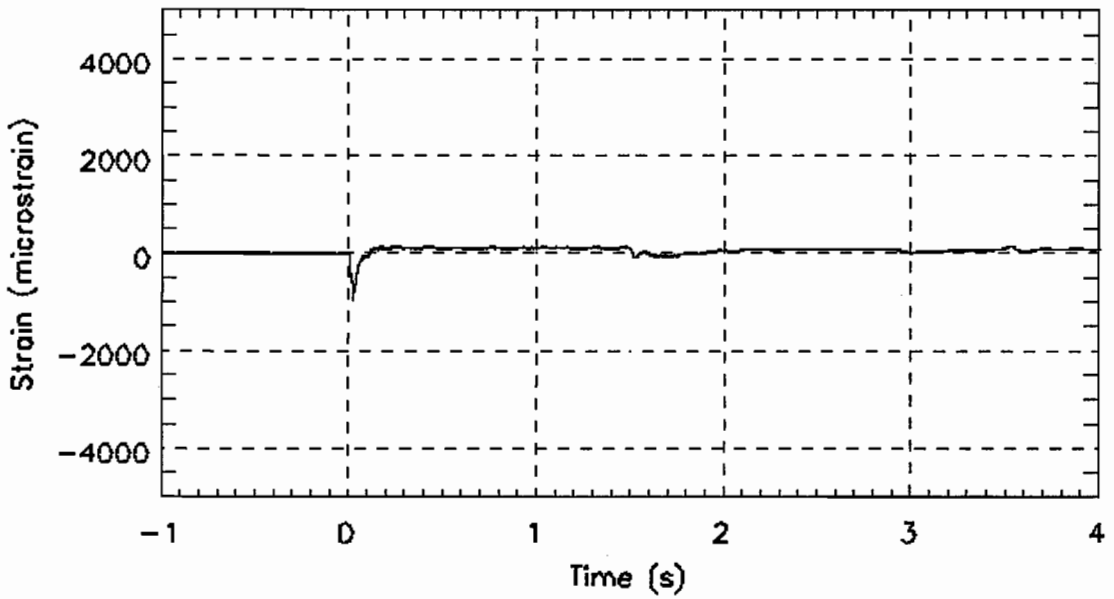

Figure N- 40. Strain measurement on the inside of the cant rail, top edge, midway across door opening, CRTLM.txt

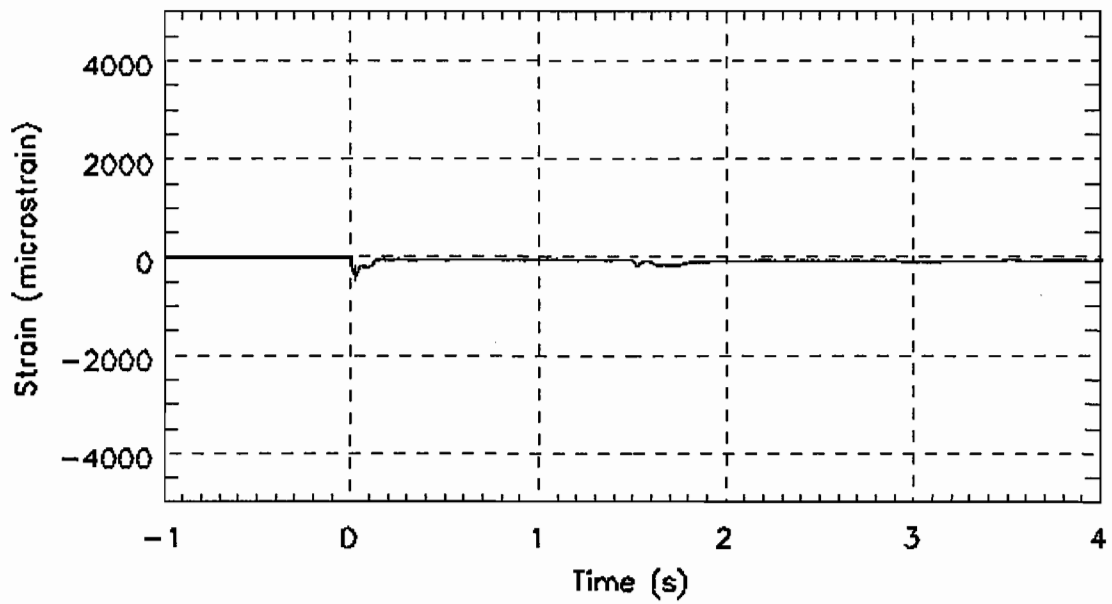

Figure N- 41. Strain measurement on the inside of the cant rail, top edge, midway across door opening, CRTLR.txt

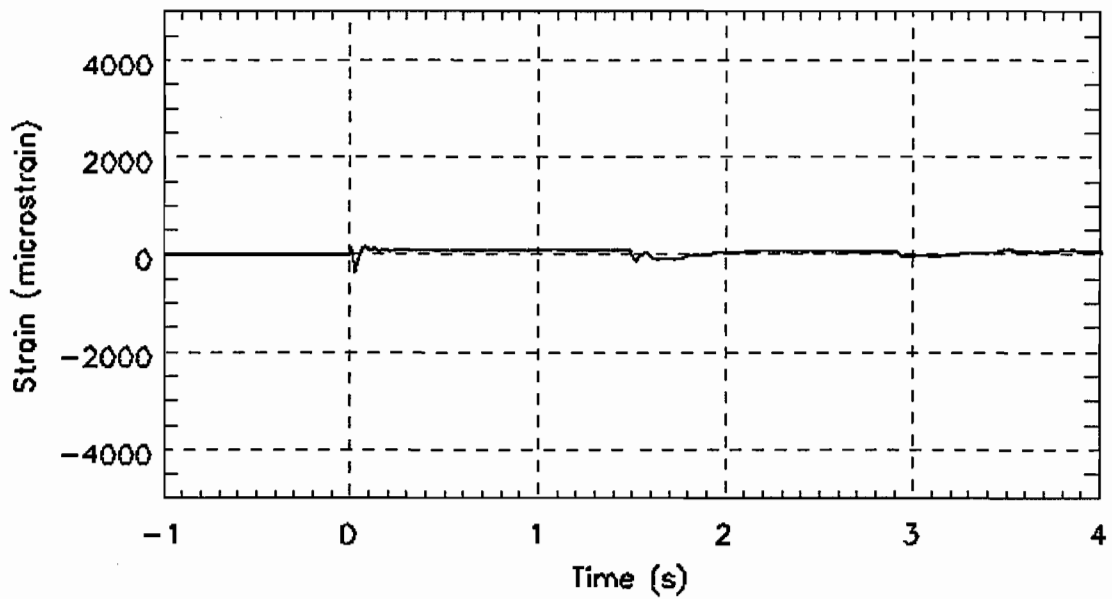

Figure N- 42. Strain measurement on the outside of the cant rail, top edge, just behind the AT plate, CRTRF.txt

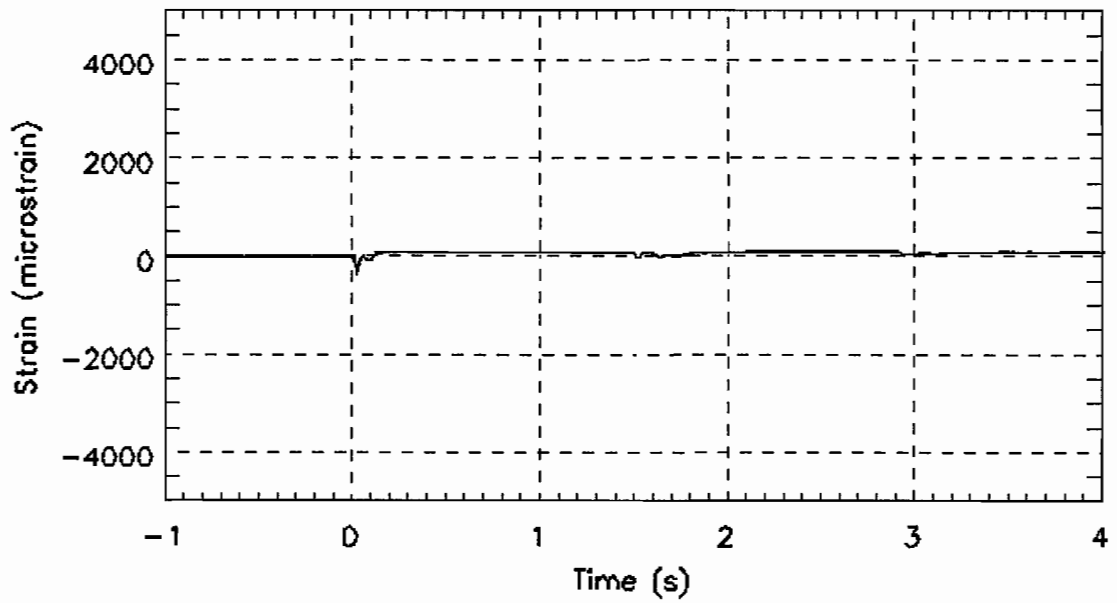

Figure N- 43. Strain measurement on the outside of the cant rail, top edge, midway across door opening, CRTRM.txt

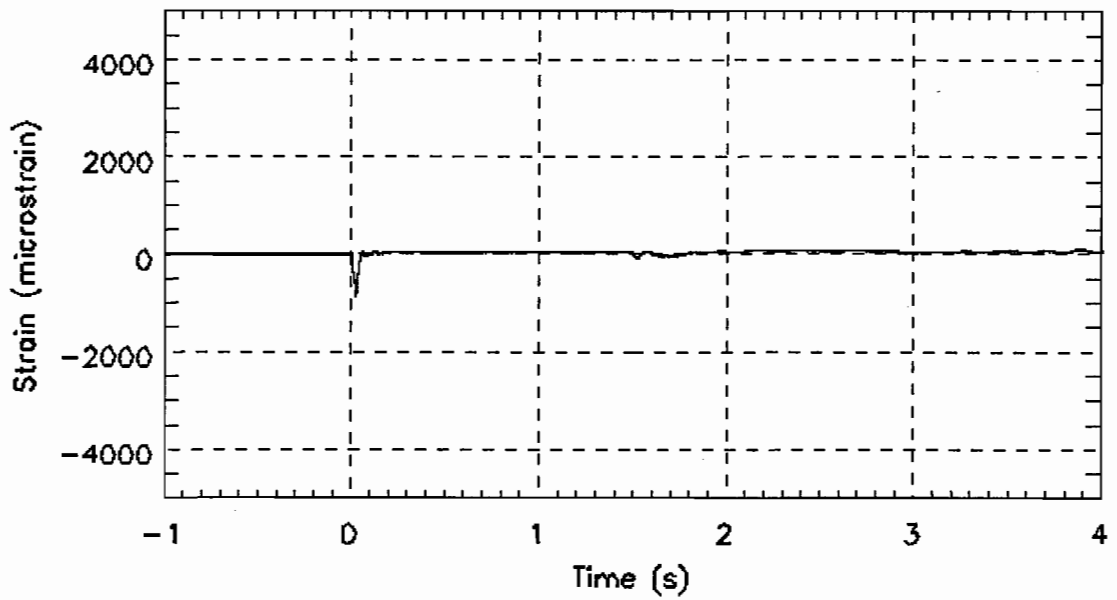

Figure N- 44. Strain measurement on the outside of the cant rail, top edge, midway across door opening, CRTRR.txt

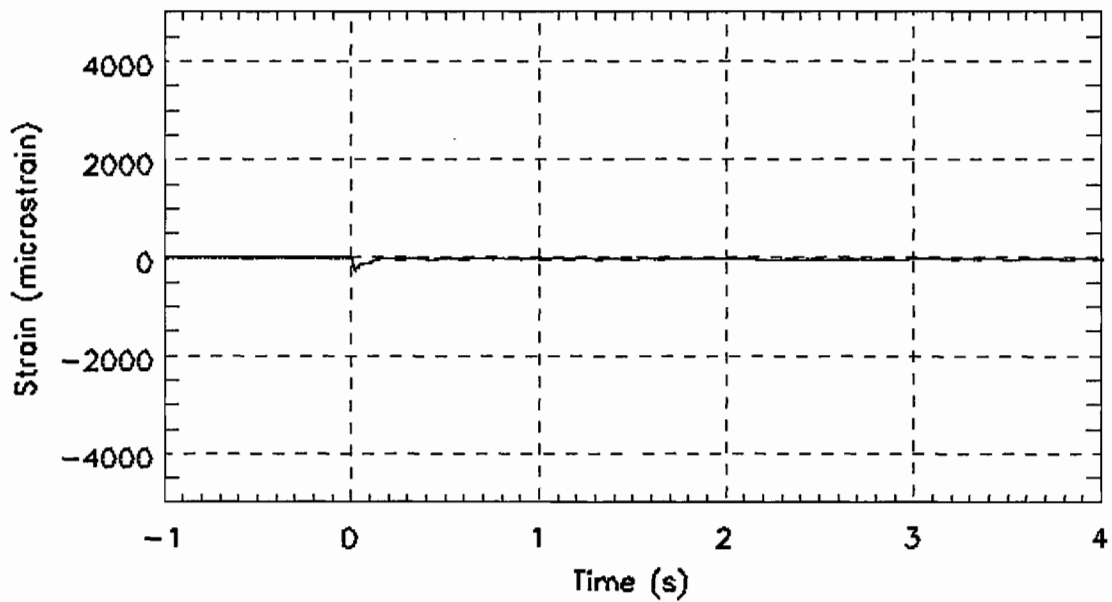

Figure N- 45. Strain measurement on the left side of the draft sill, 7" behind the buffer beam, 15 3/8" below the top edge of the sill, DSBLF.txt

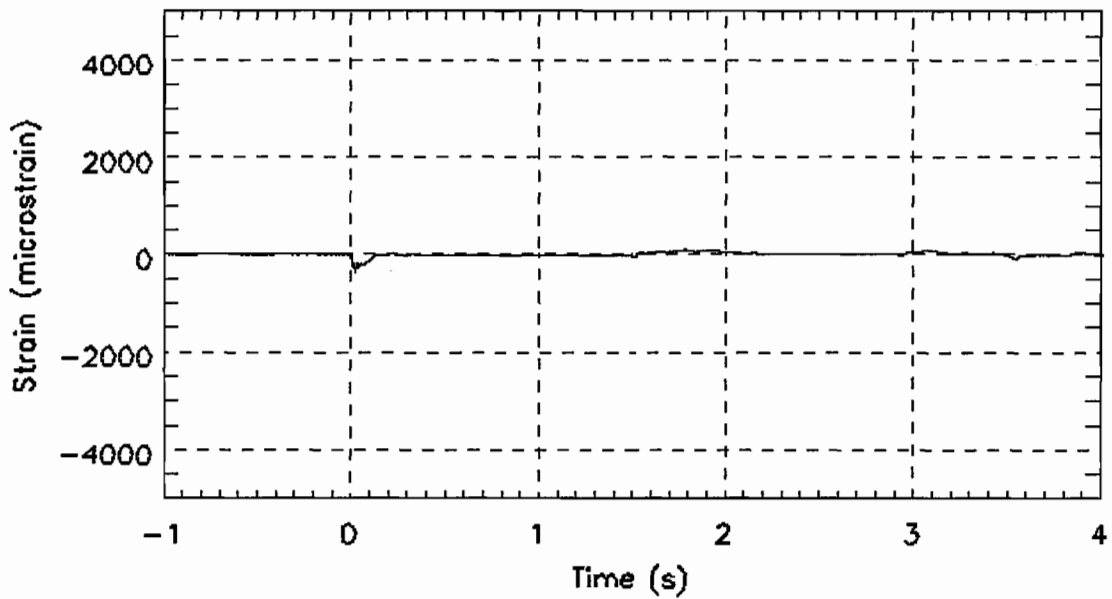

Figure N- 46. Strain measurement on the left side of the draft sill, 18 1/2" behind the buffer beam, 14" below the top edge of the sill, DSBLM.txt

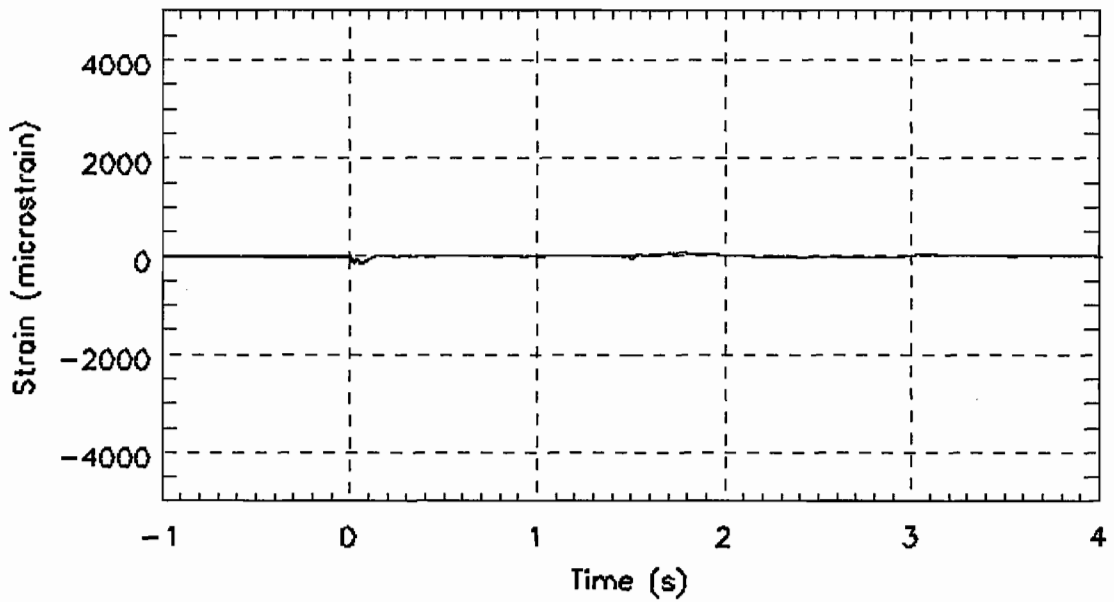

Figure N- 47. Strain measurement on the left side of the draft sill, 13 1/2" in front of the body bolster, 6 1/2" below the top edge of the sill, DSBLR.txt

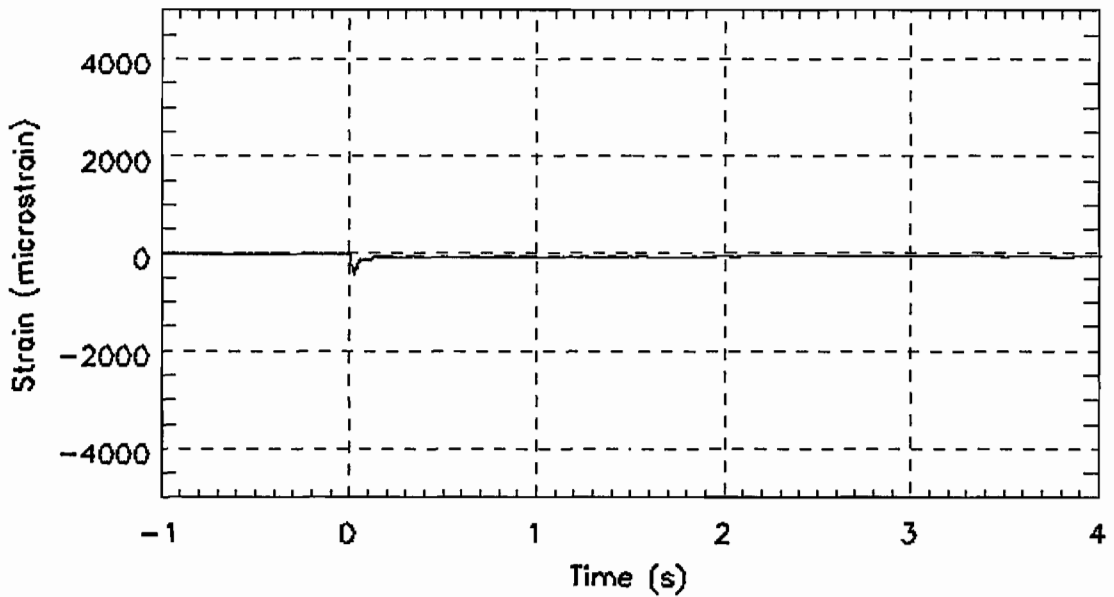

Figure N- 48. Strain measurement on the right side of the draft sill, 7" behind the buffer beam, 15 3/8" below the top edge of the sill, DSBRF.txt

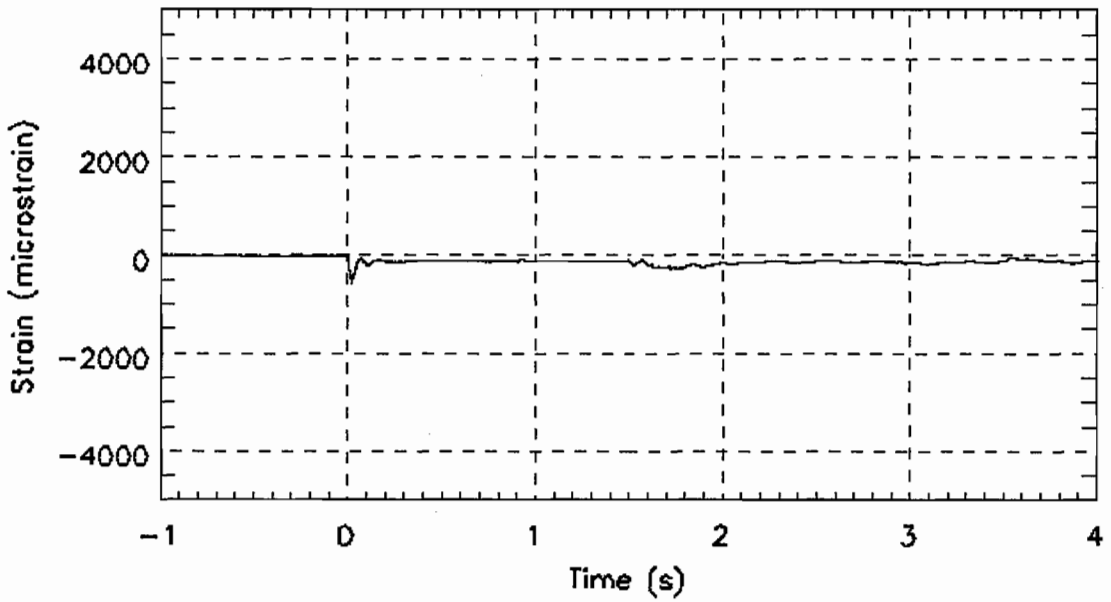

Figure N- 49. Strain measurement on the right side of the draft sill, 18 1/2" behind the buffer beam, 14" below the top edge of the sill, DSBRR.txt

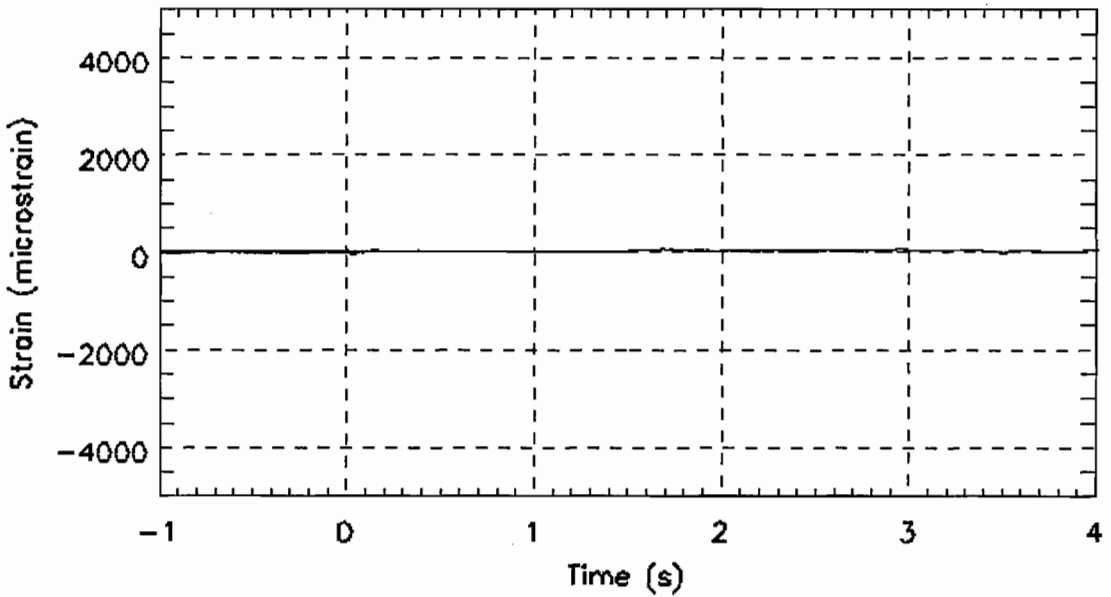

Figure N- 50. Strain measurement on the right side of the draft sill, 13 1/2" in front of the body bolster, 6 1/2" below the top edge of the sill, DSBRR.txt

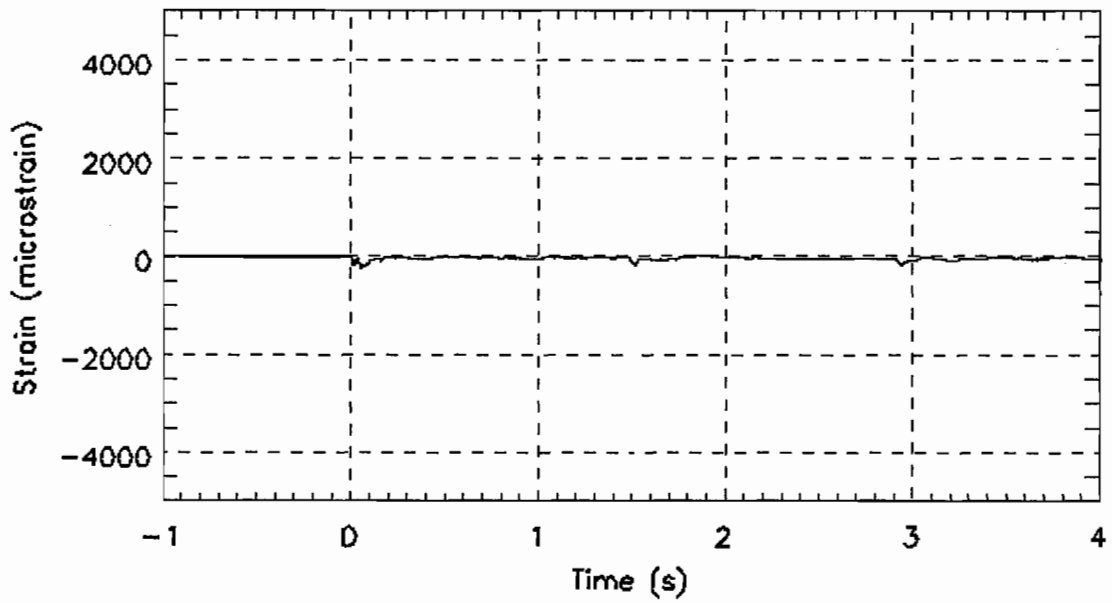

Figure N- 51. Strain measurement on the left side of the draft sill, 7" behind the buffer beam, 3" below the top edge of the sill, DSTLF.txt

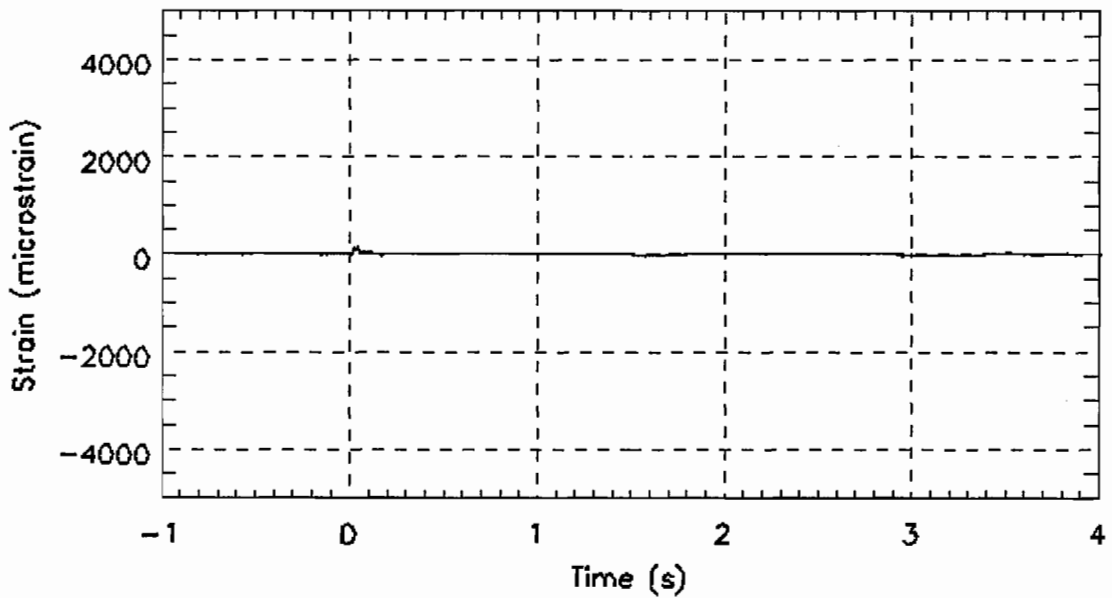

Figure N- 52. Strain measurement on the left side of the draft sill, 18 1/2" behind the buffer beam, 3" below the top edge of the sill, DSTLM.txt

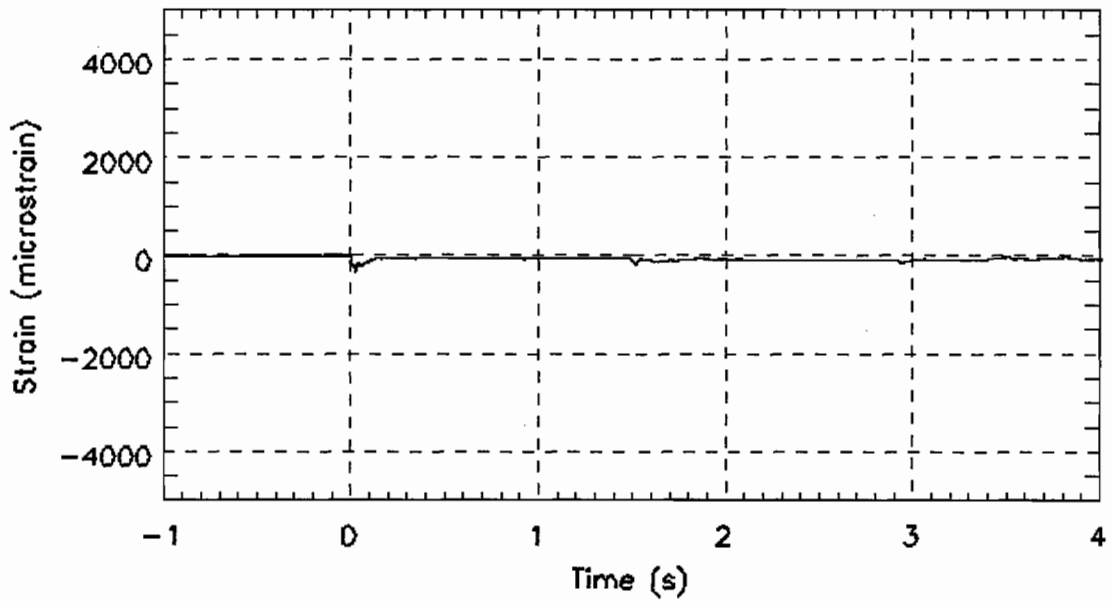

Figure N- 53. Strain measurement on the left side of the draft sill, 13 1/2" in front of the body bolster, 2 3/4" below the top edge of the sill, DSTLR.txt

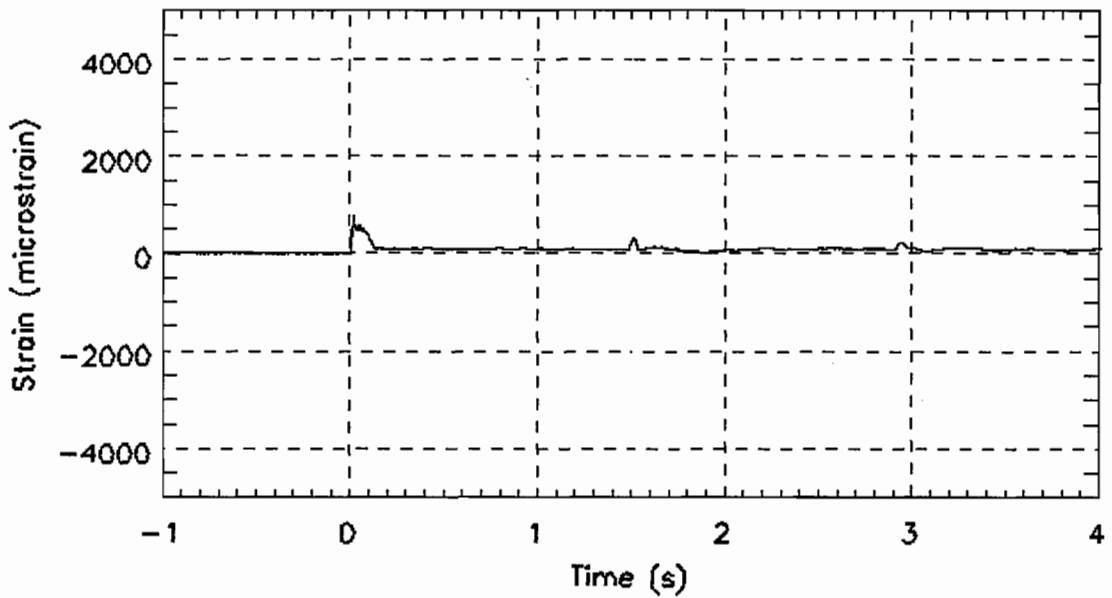

Figure N- 54. Strain measurement on the right side of the draft sill, 7" behind the buffer beam, 3" below the top edge of the sill, DSTRF.txt

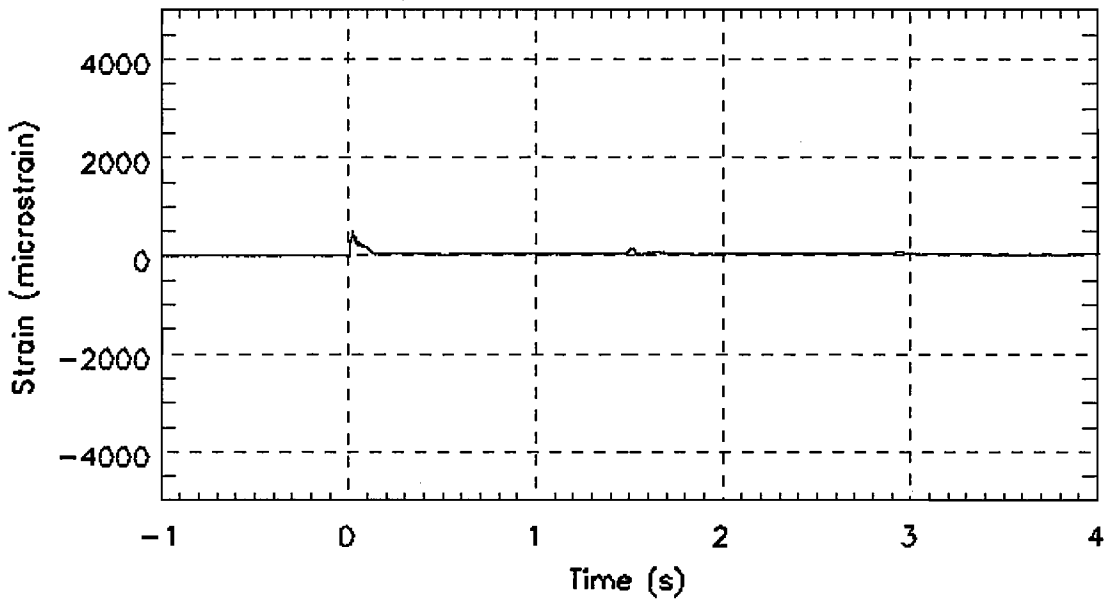

Figure N- 55. Strain measurement on the right side of the draft sill, 18 1/2" behind the buffer beam, 3" below the top edge of the sill, DSTRM.txt

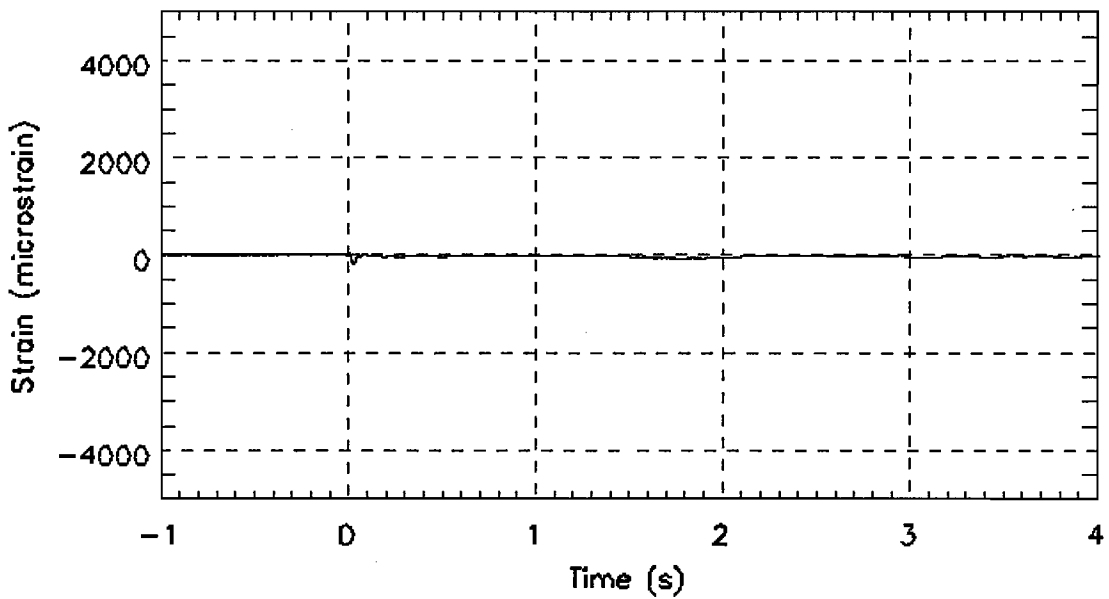

Figure N- 56. Strain measurement on the right side of the draft sill, 13 1/2" in front of the body bolster, 2 3/4" below the top edge of the sill, DSTRR.txt

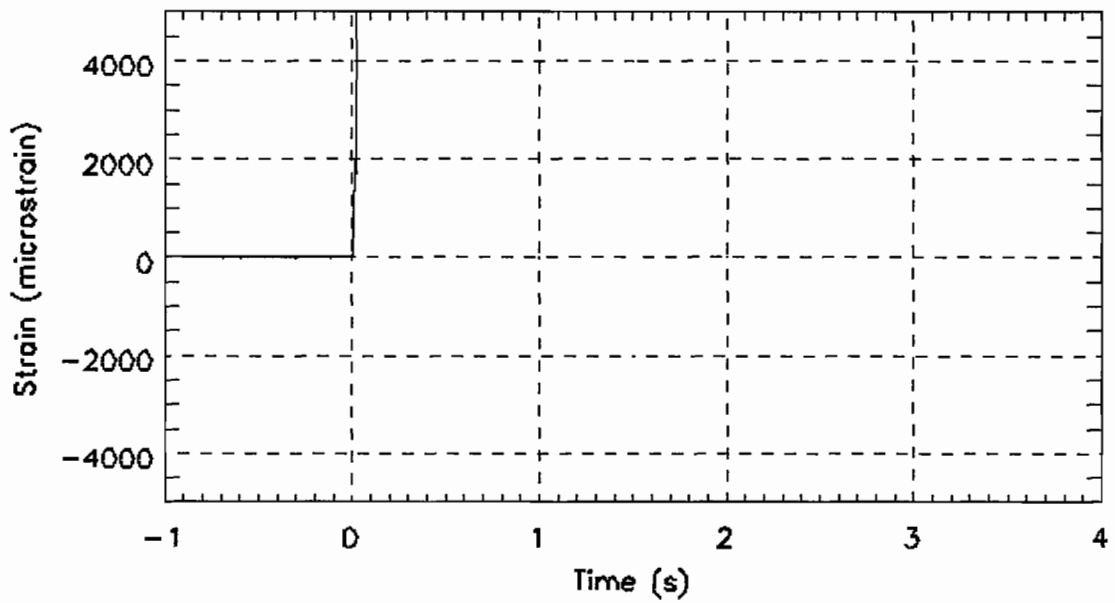

Figure N- 57. Strain measurement on the front of the lateral member, near the collision post, 5/32" above the bottom edge, LMLFB.txt

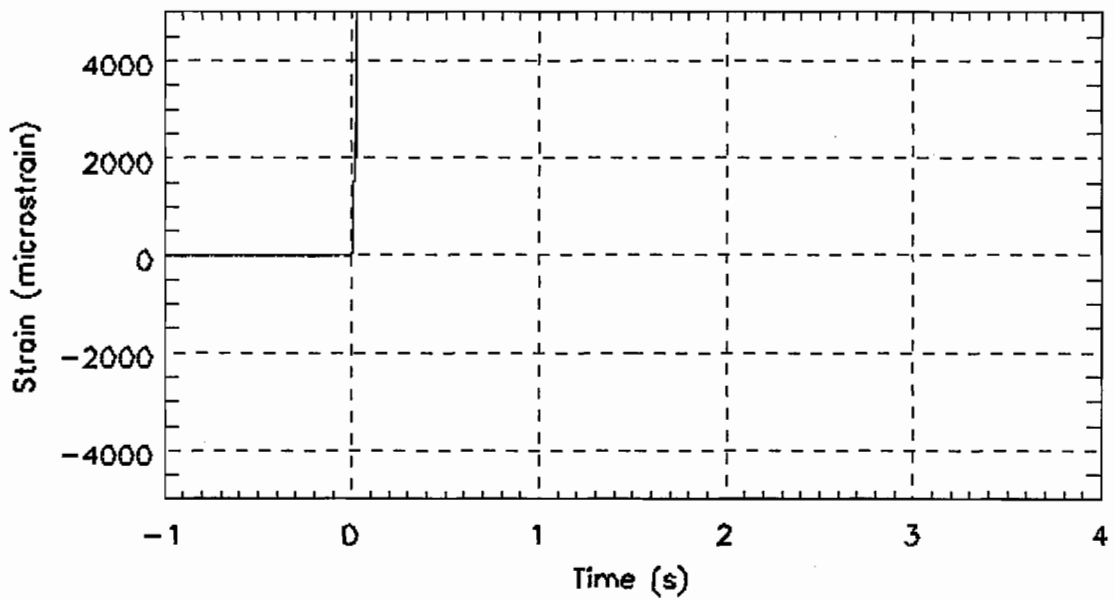

Figure N- 58. Strain measurement on the front of the lateral member, near the collision post, 15/16" below the top edge, LMLFT.txt

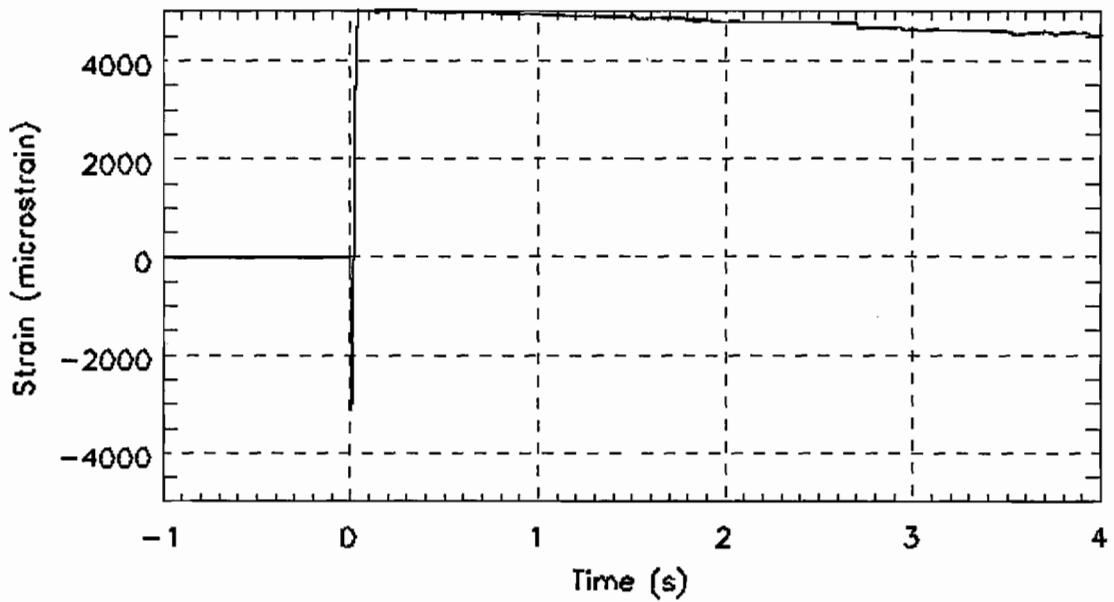

Figure N- 59. Strain measurement on the rear of the lateral member, near the collision post, 5/32" above the bottom edge, LMLRB.txt

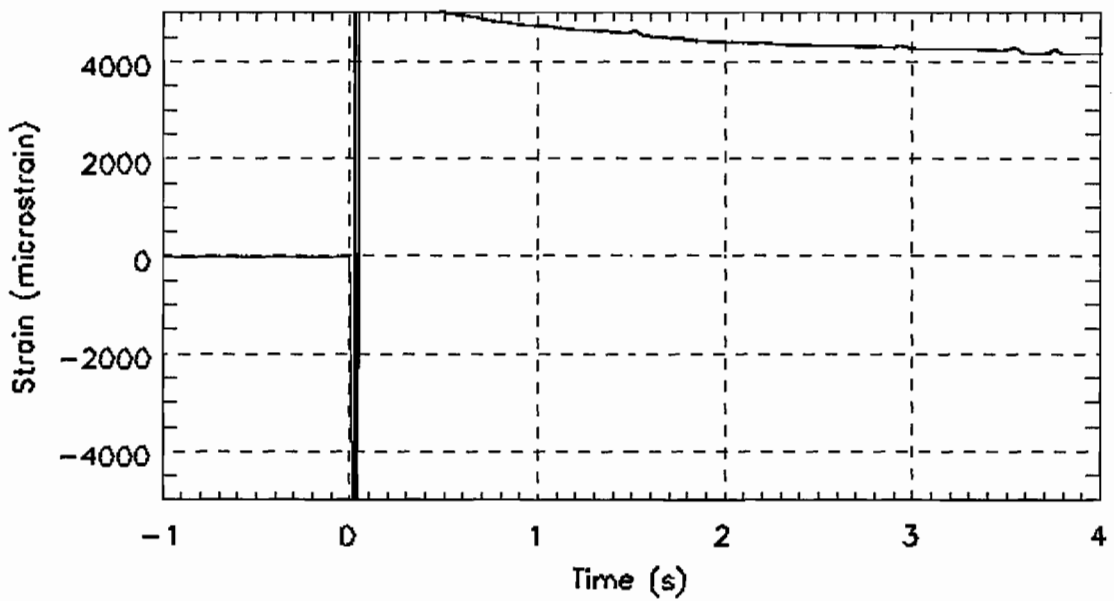

Figure N- 60. Strain measurement on the rear of the lateral member, near the collision post, 15/16" below the top edge, LMLRT.txt

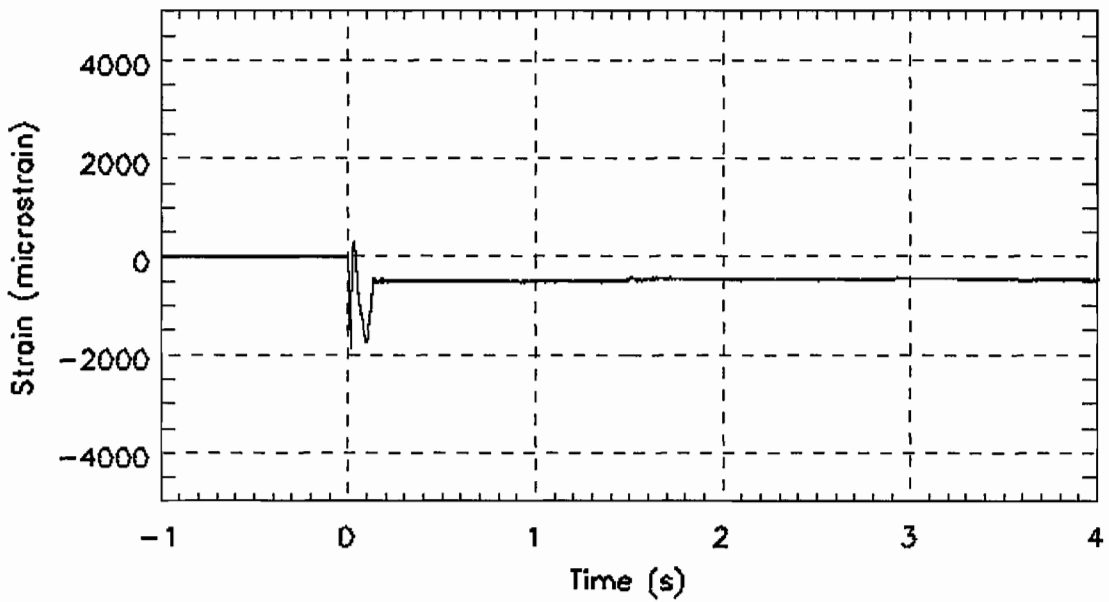

Figure N- 61. Strain measurement on the front of the lateral member, near the corner post, 5/32" above the bottom edge, LMRFB.txt

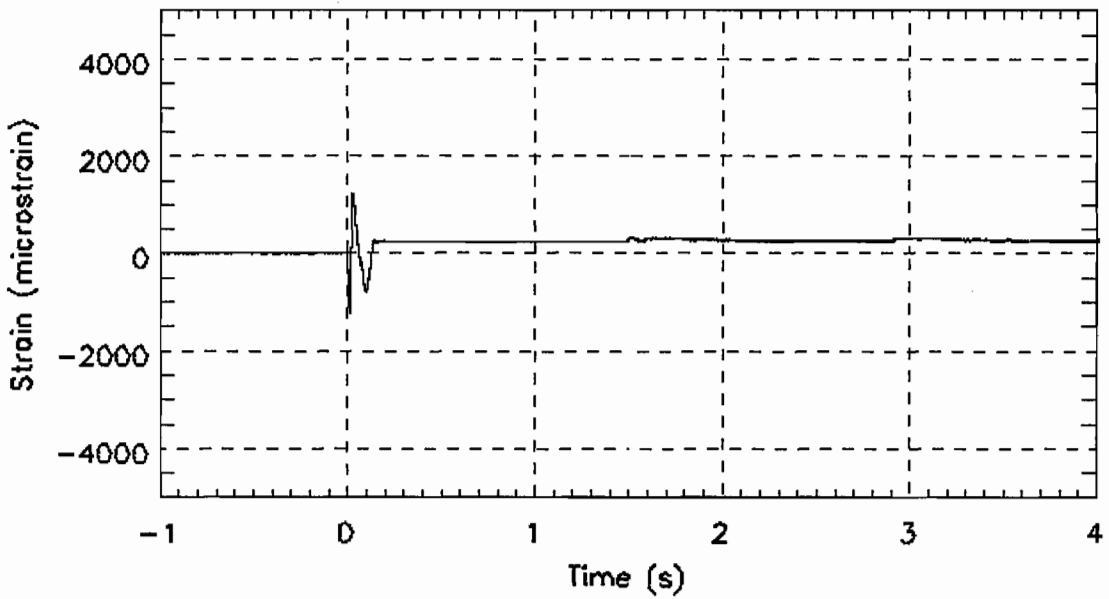

Figure N- 62. Strain measurement on the front of the lateral member, near the corner post, 15/16" below the top edge, LMRFT.txt

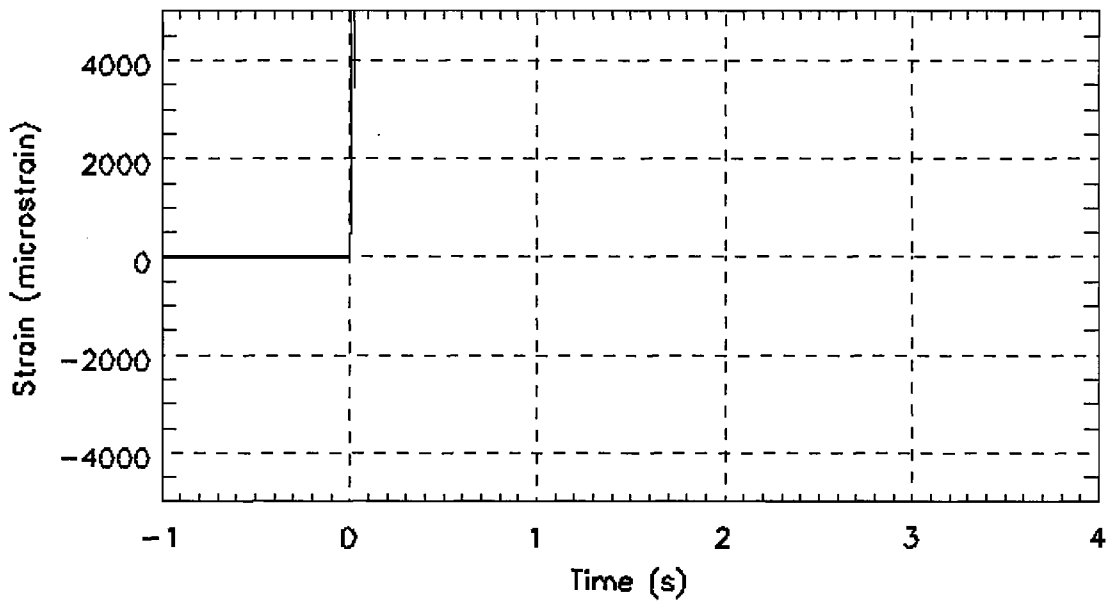

Figure N- 63. Strain measurement on the rear of the lateral member, near the corner post, 5/32" above the bottom edge, LMRRB.txt

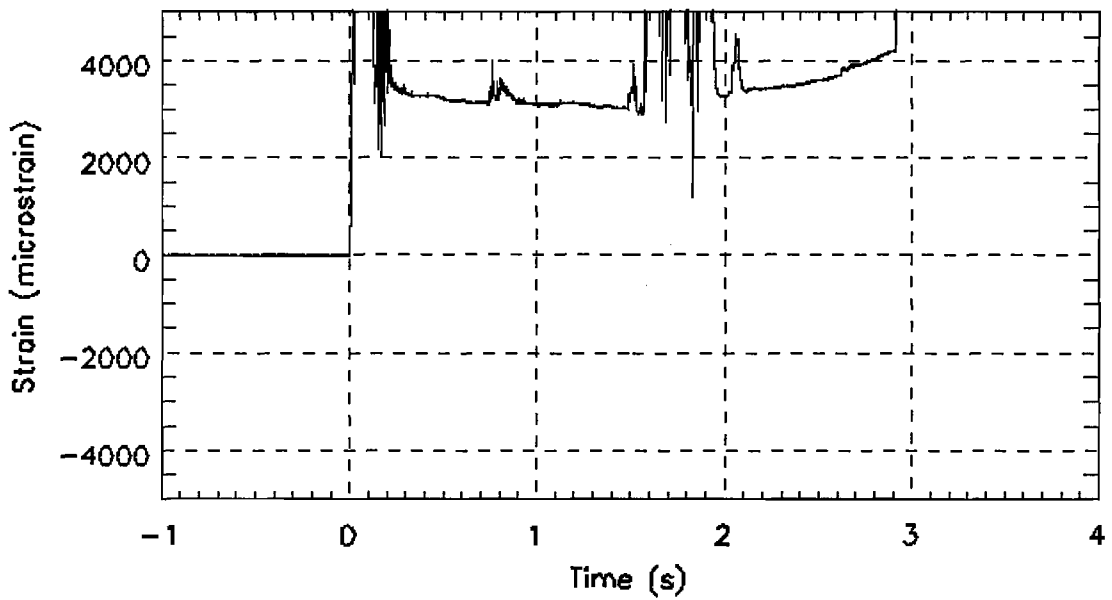

Figure N- 64. Strain measurement on the rear of the lateral member, near the corner post, 15/16" below the top edge, LMRRB.txt

3

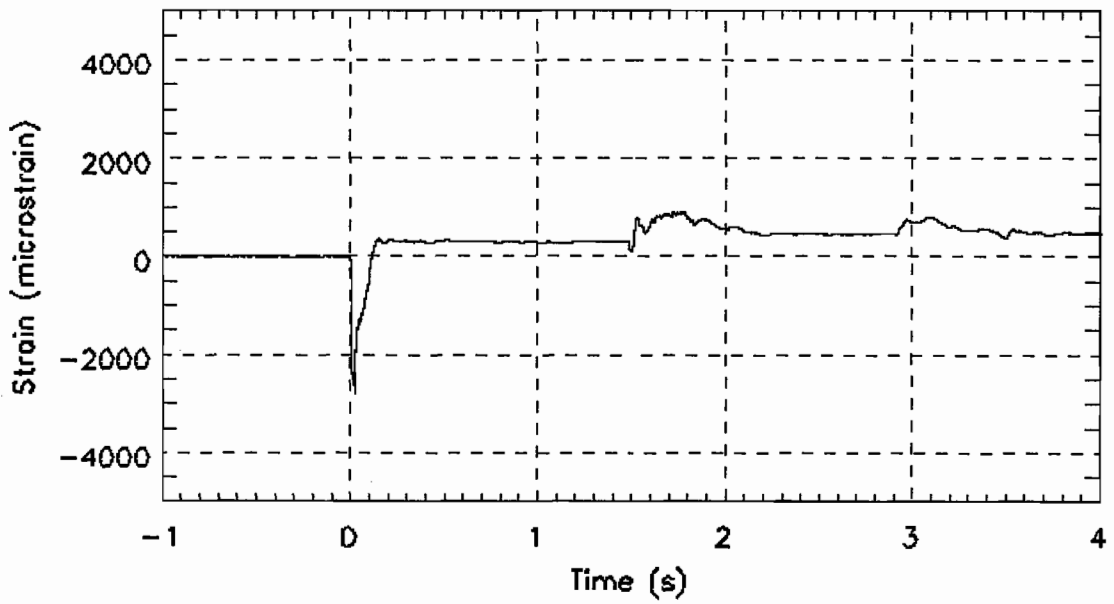

Figure N- 65. Strain measurement on the outside of the left sidesill, top edge, 3" behind the buffer beam, SS1.txt

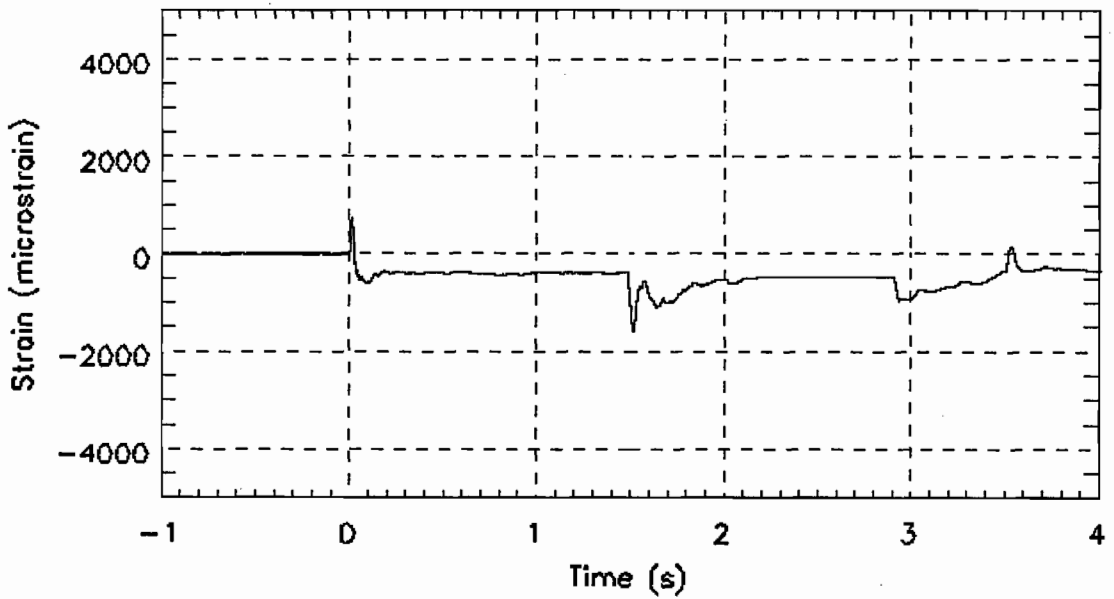

Figure N- 66. Strain measurement on the outside of the left sidesill, bottom edge, 3" behind the buffer beam, SS2.txt

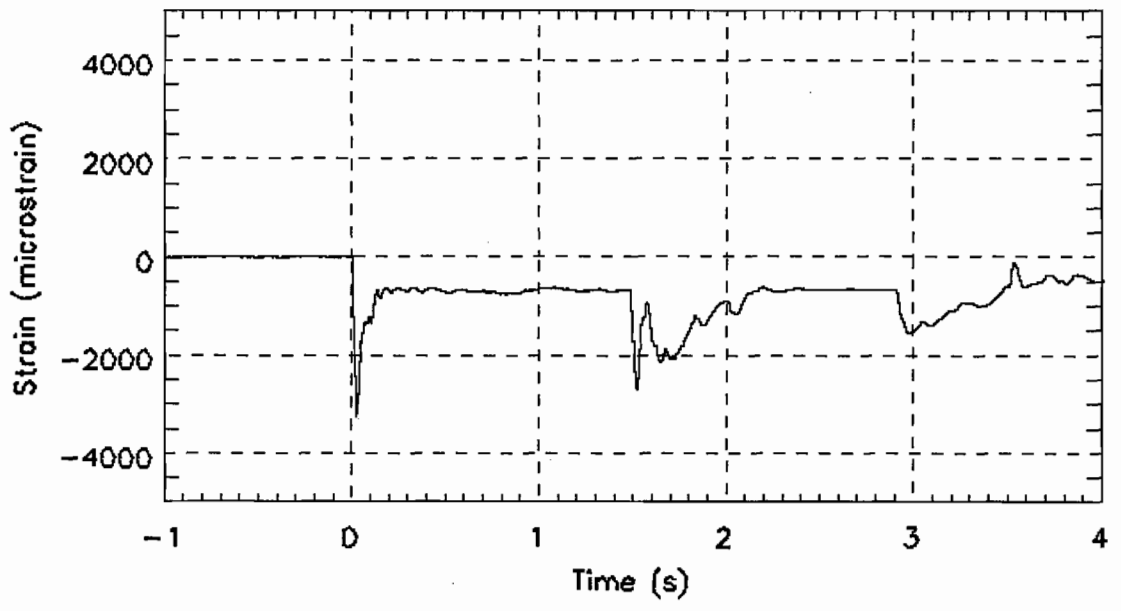

Figure N- 67. Strain measurement on the outside of the left sidesill, top edge, 29" behind the buffer beam, SS3.txt

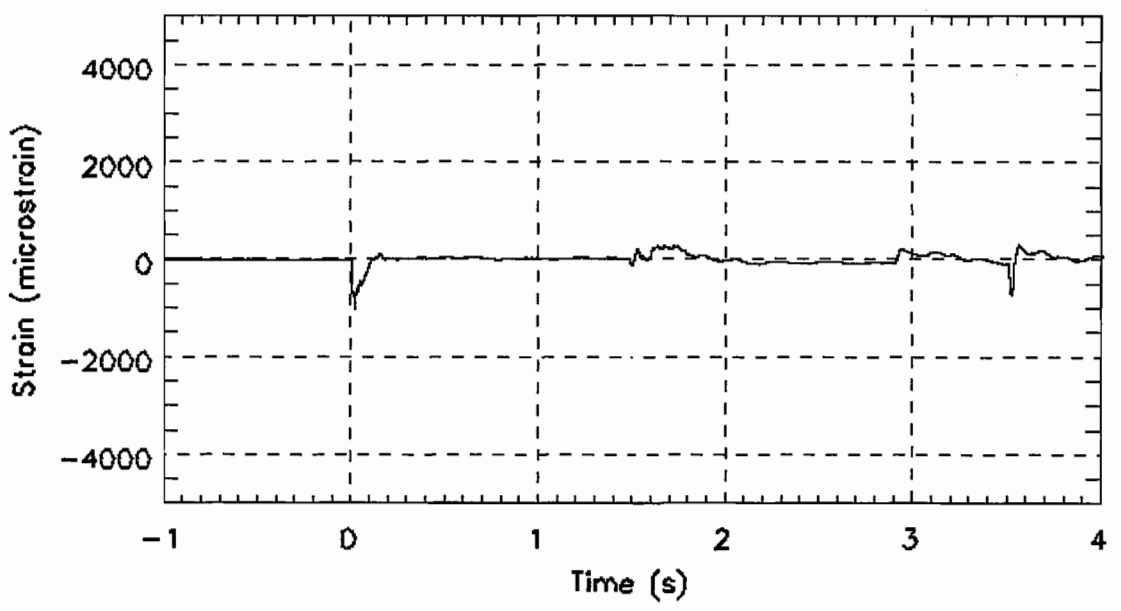

Figure N- 68. Strain measurement on the outside of the left sidesill, bottom edge, 29" behind the buffer beam, SS4.txt

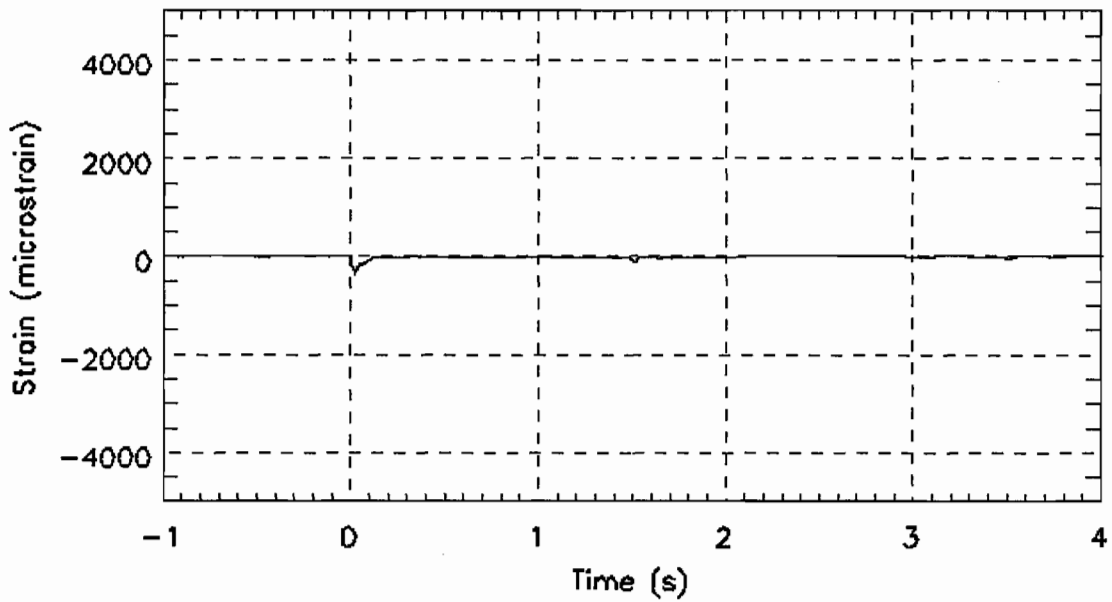

Figure N- 69. Strain measurement on the outside of the left sidesill, top edge, 127" behind the buffer beam, SS5.txt

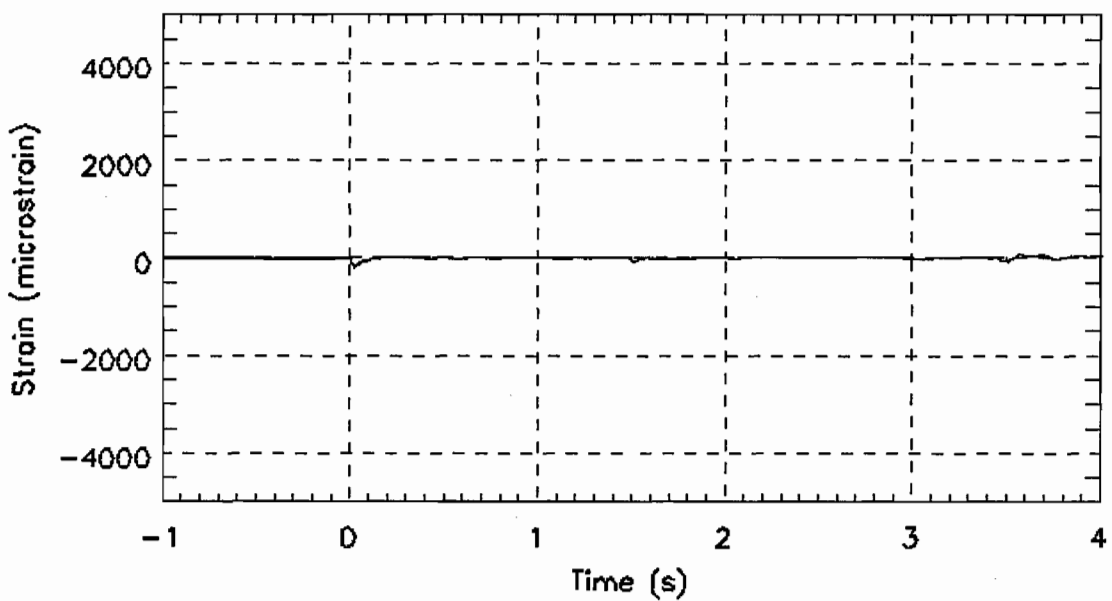

Figure N- 70. Strain measurement on the outside of the left sidesill, bottom edge, 127" behind the buffer beam, SS6.txt

6

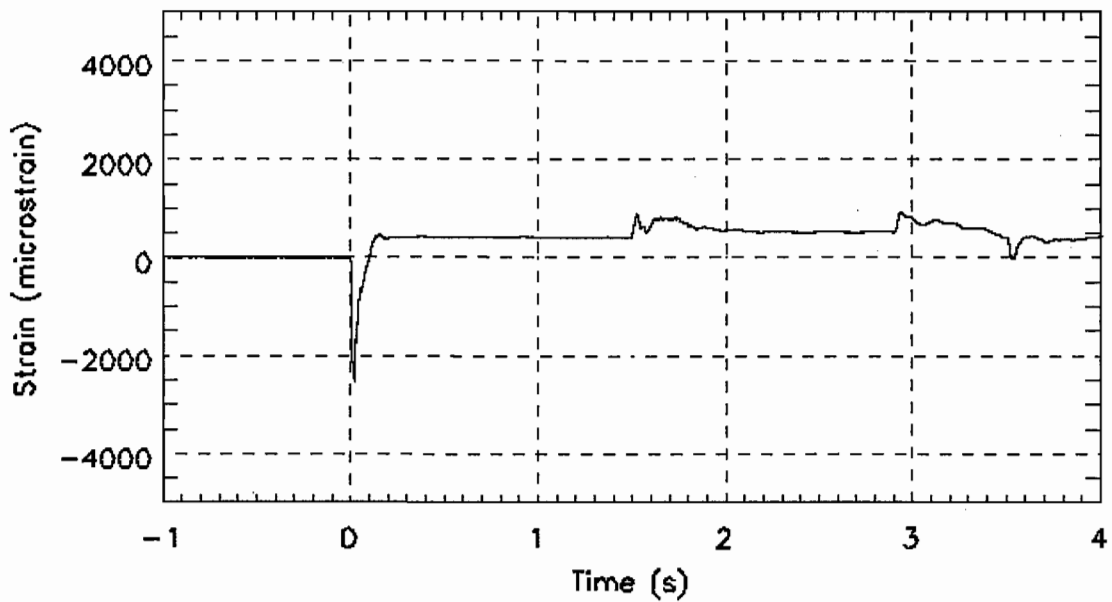

Figure N- 71. Strain measurement on the inside of the left sidesill, top edge, 3" behind the buffer beam, SS7.txt

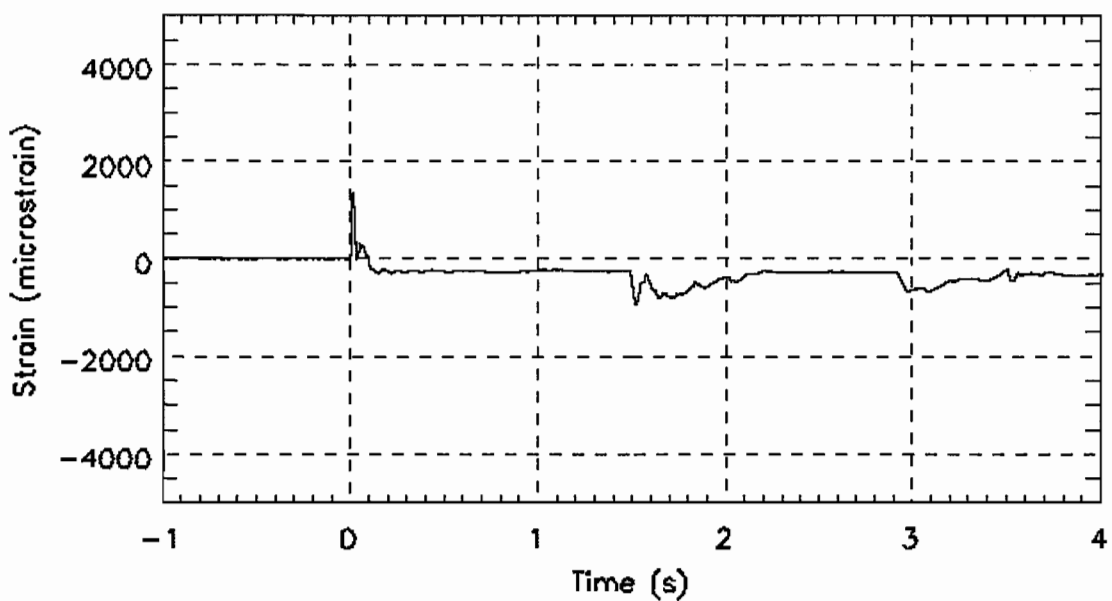

Figure N- 72. Strain measurement on the inside of the left sidesill, bottom edge, 3" behind the buffer beam, SS8.txt

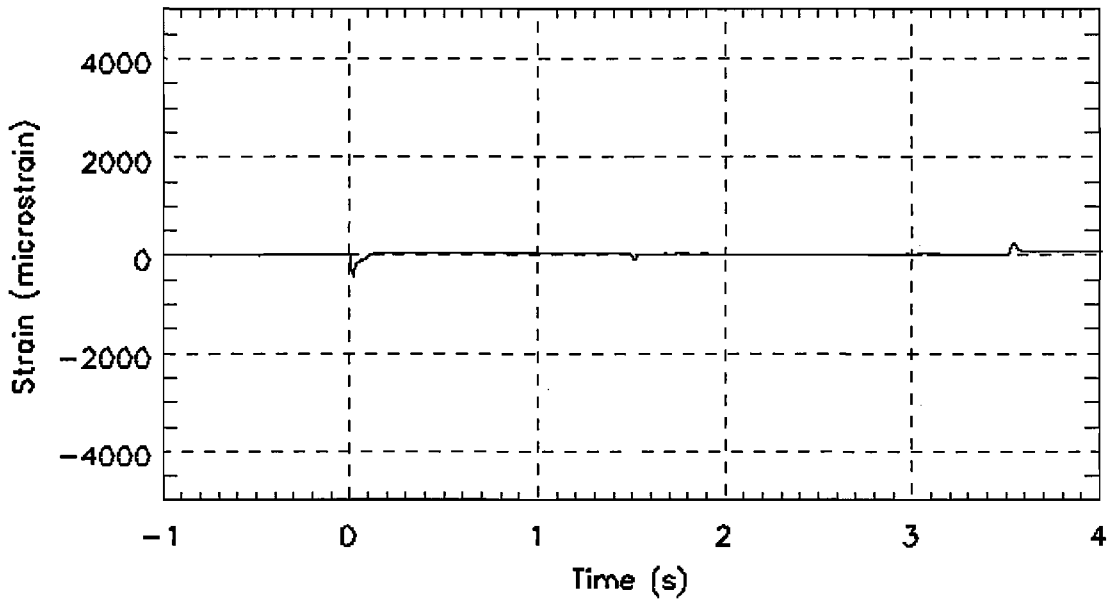

Figure N- 73. Strain measurement on the inside of the left sidesill, top edge, 29" behind the buffer beam, SS9.txt

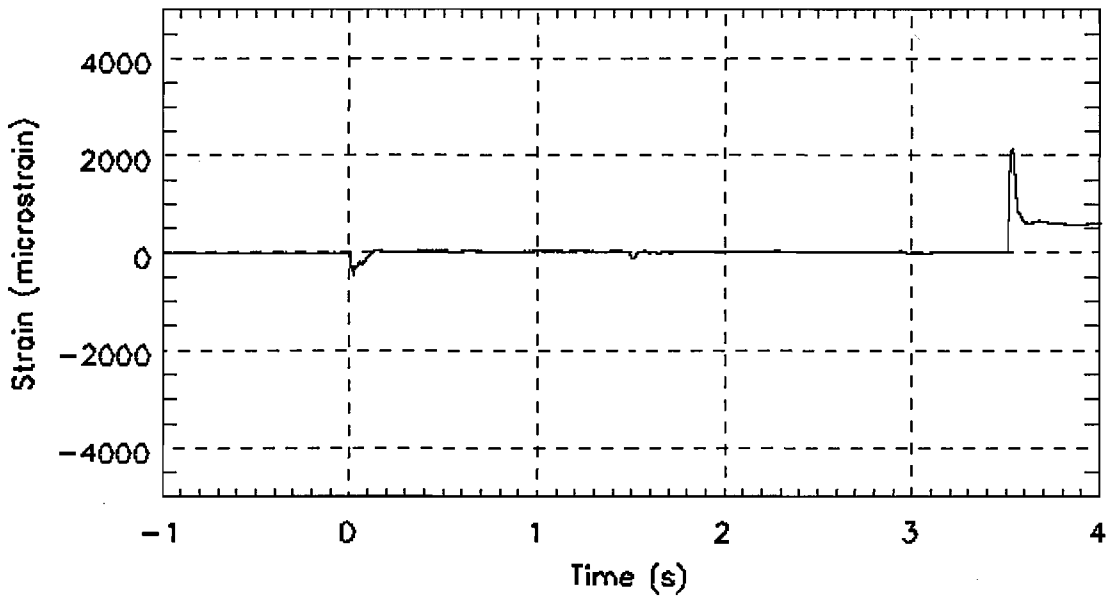

Figure N- 74. Strain measurement on the inside of the left sidesill, bottom edge, 29" behind the buffer beam, SS10.txt

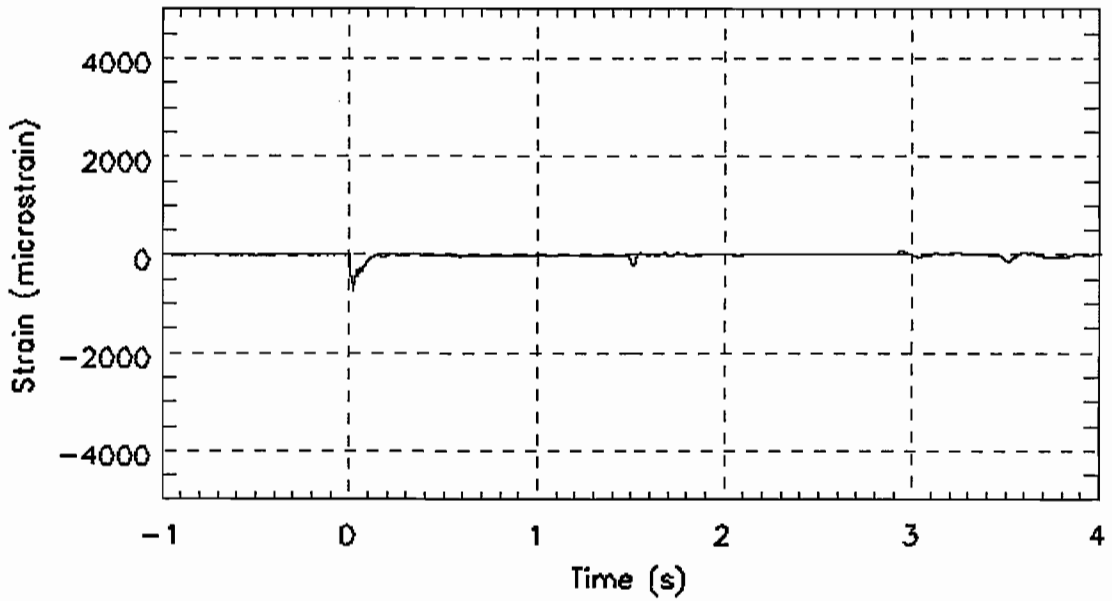

Figure N- 75. Strain measurement on the outside of the left sidesill, top edge, 174" behind the buffer beam, SS11.txt

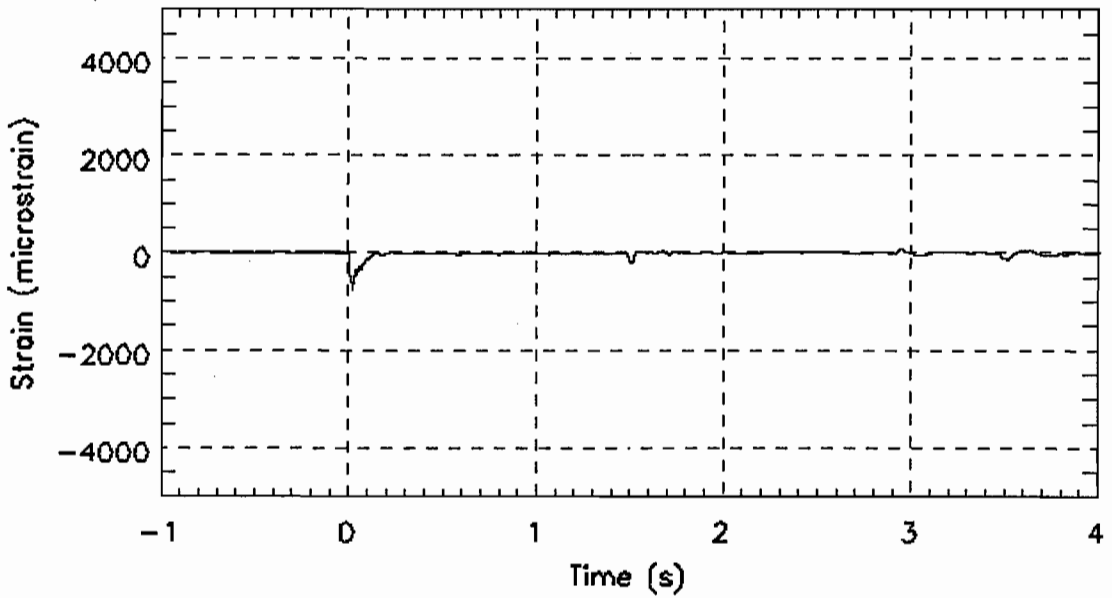

Figure N- 76. Strain measurement on the outside of the left sidesill, bottom edge, 174" behind the buffer beam, SS12.txt

Appendix O

Test 5 Synthetic Channels

This page left blank intentionally

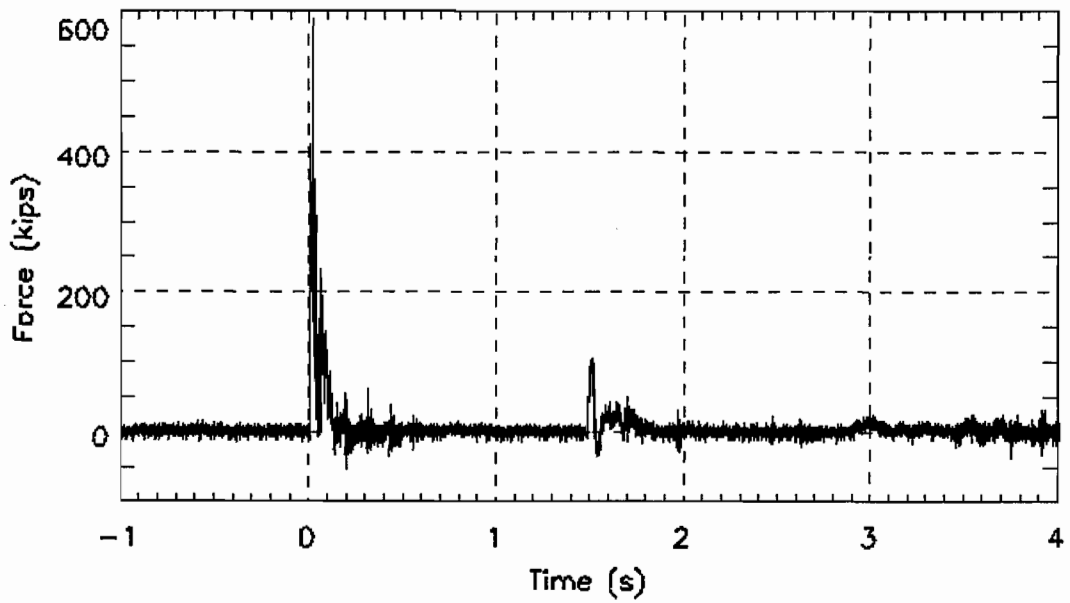

Figure O- 1. Impact force derived from longitudinal acceleration, no digital filter, CG_X_Force_1000Hz.txt

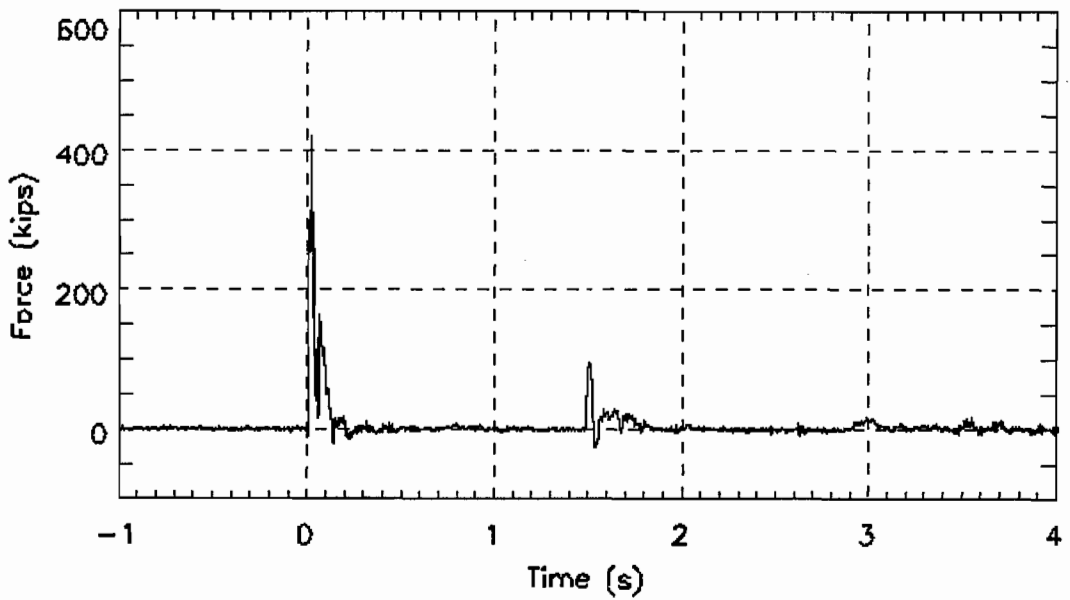

Figure O- 2. Impact force derived from longitudinal acceleration, digitally filtered at $F_c=100\text{Hz}$, CG_X_Force_100Hz.txt

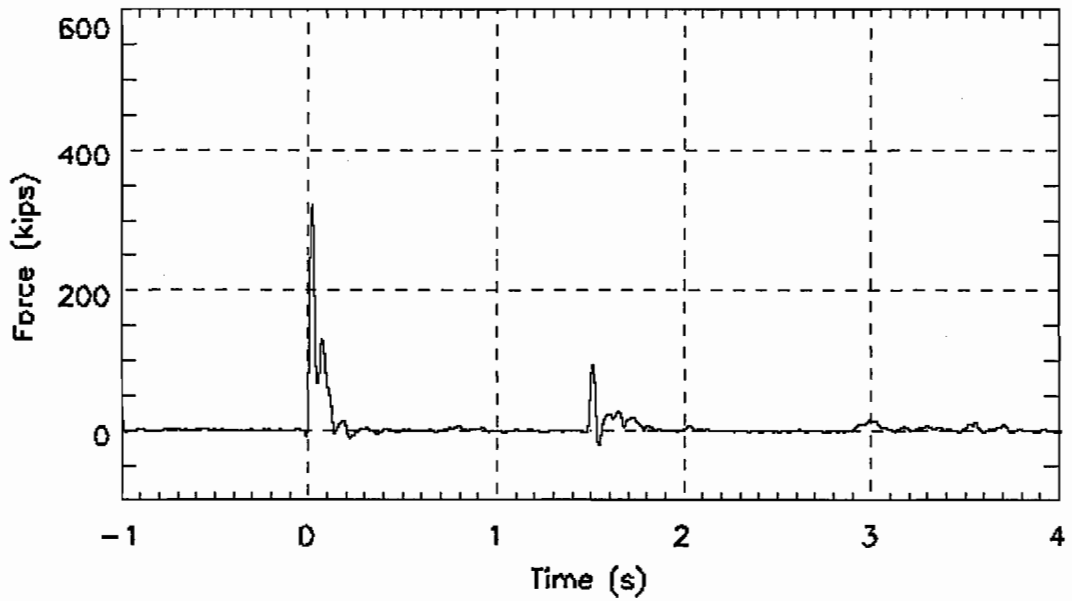

Figure O-3. Impact force derived from longitudinal acceleration, digitally filtered at $F_c=25\text{Hz}$, CG_X_Force_25Hz.txt

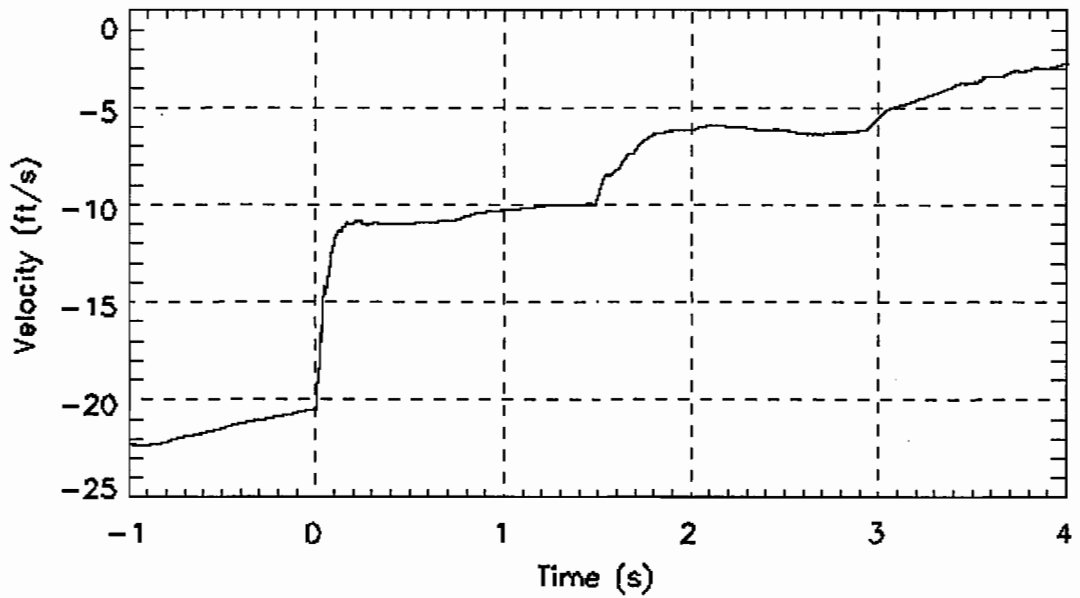

Figure O-4. Bullet car velocity, derived from center sill accelerometer at position 2, C2X_Vel.txt

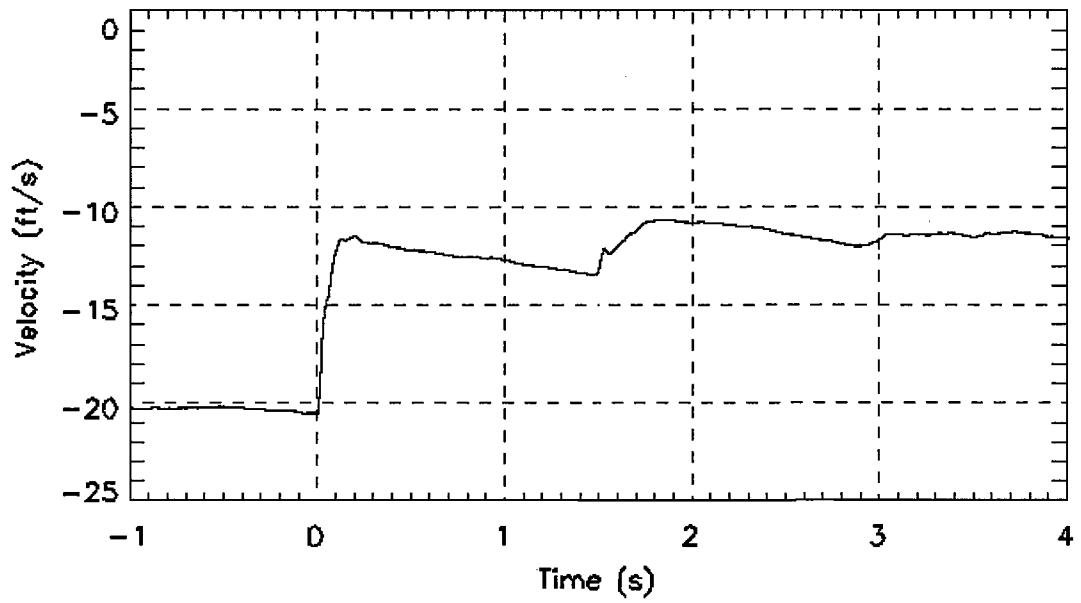

Figure O- 5. Bullet car velocity, derived from center sill accelerometer at position 3, C3X_Vel.txt

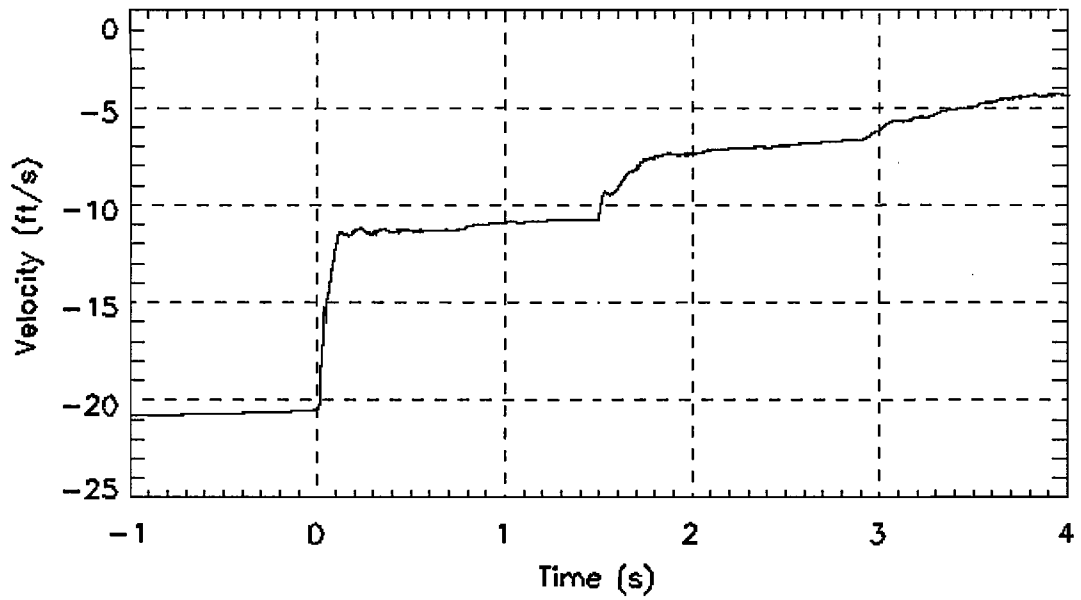

Figure O- 6. Bullet car velocity, derived from center sill accelerometer at position 4, C4X_Vel.txt

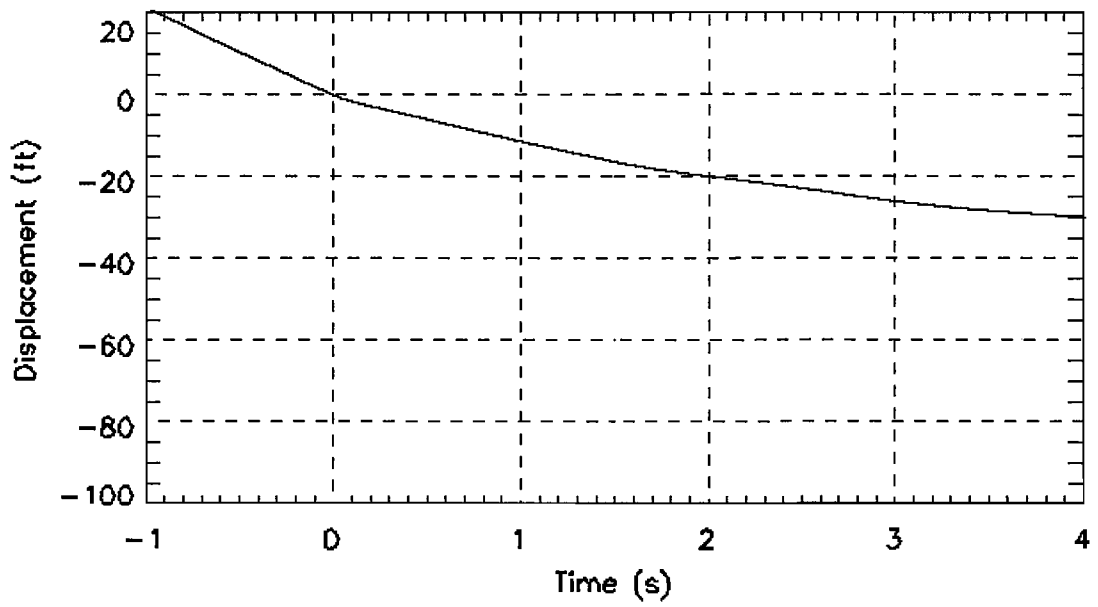

Figure O- 7. Bullet car displacement, derived from center sill accelerometer at position 2, C2X_Displacement.txt

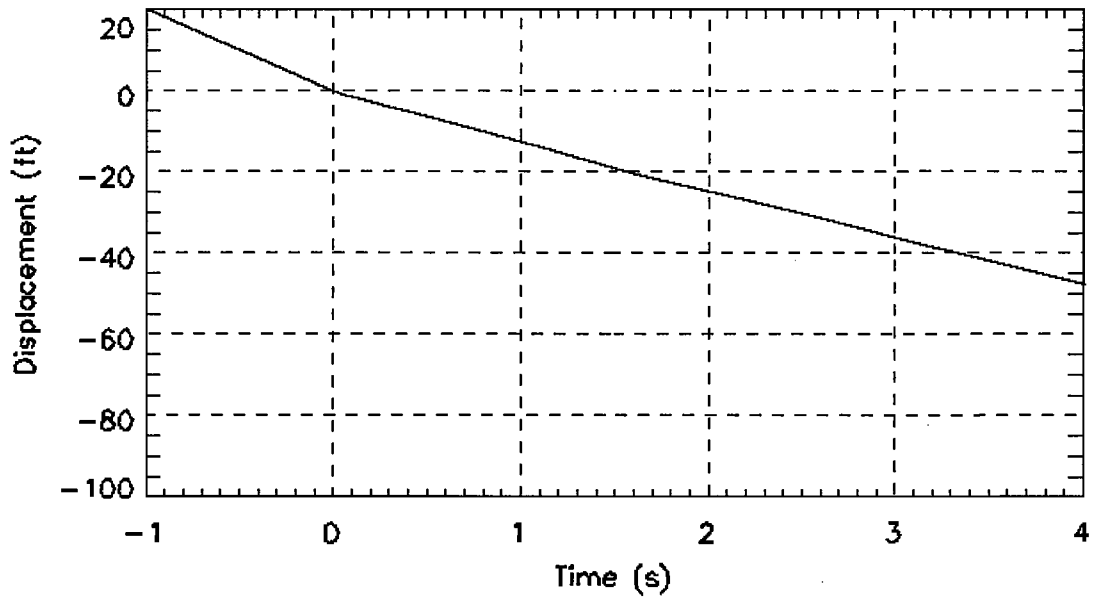

Figure O- 8. Bullet car displacement, derived from center sill accelerometer at position 3, C3X_Displacement.txt

5

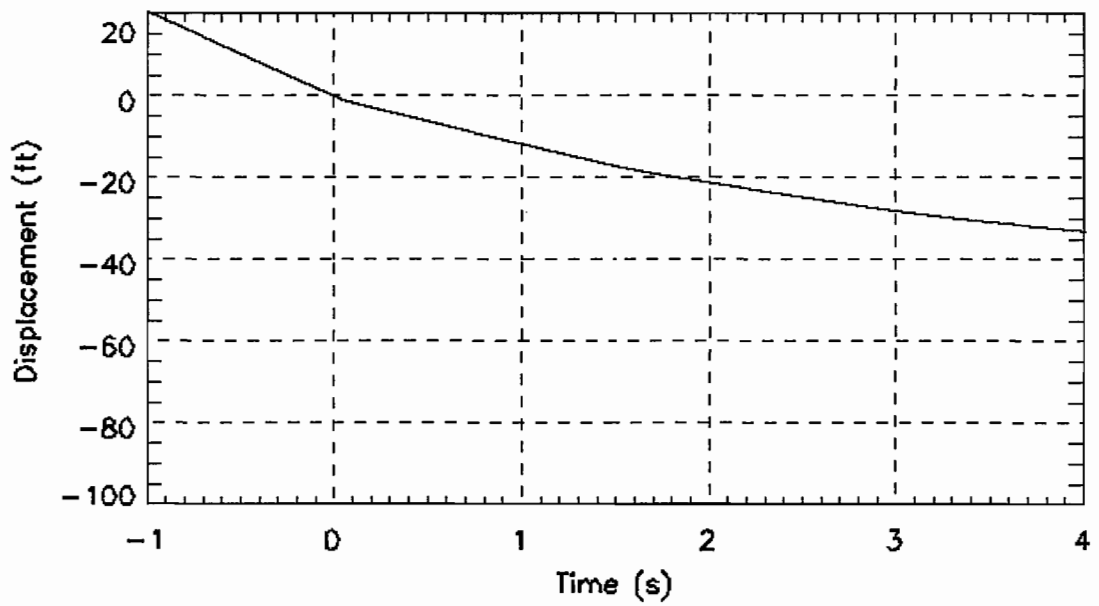

Figure O- 9. Bullet car displacement, derived from center sill accelerometer at position 4, C4X_Displacement.txt

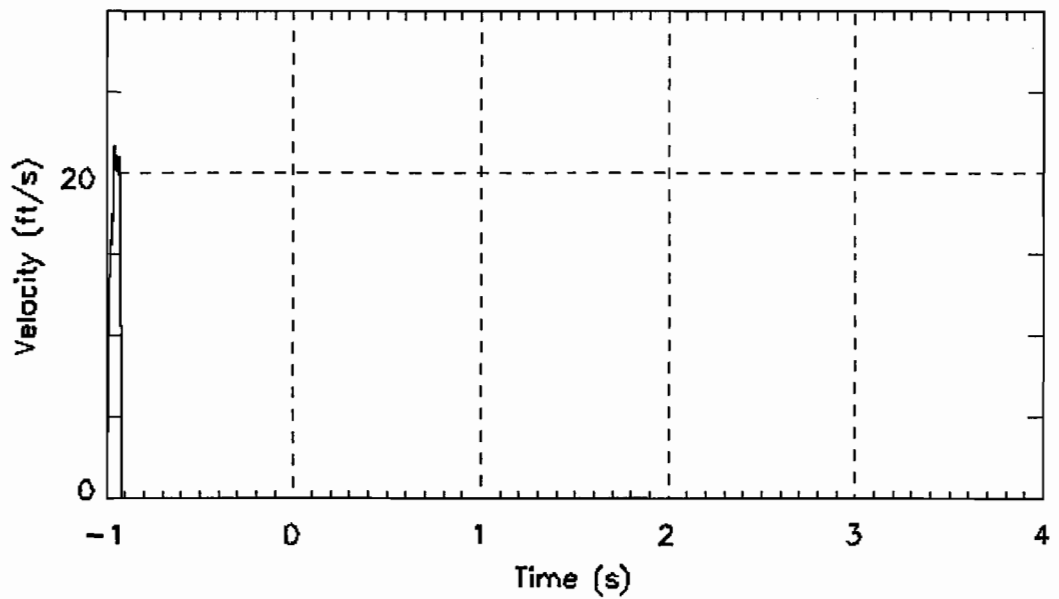

Figure O- 10. Bullet car speed as measured from the onboard radar sensor, Vehicle_Speed.txt

6

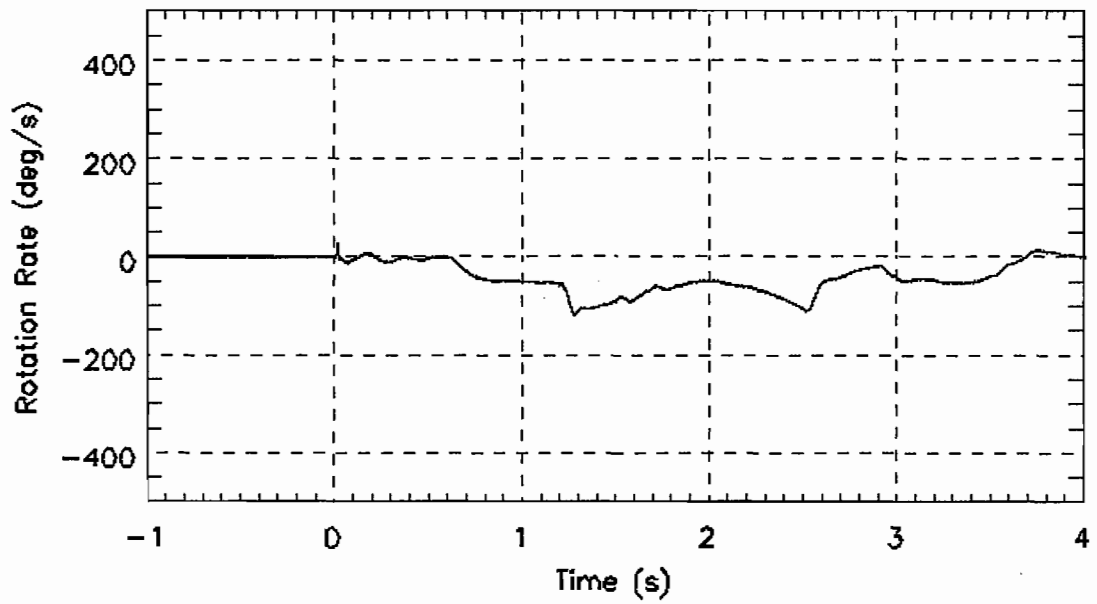

Figure O- 11. Coil rotation about the X-axis, ROTX_1000Hz.txt

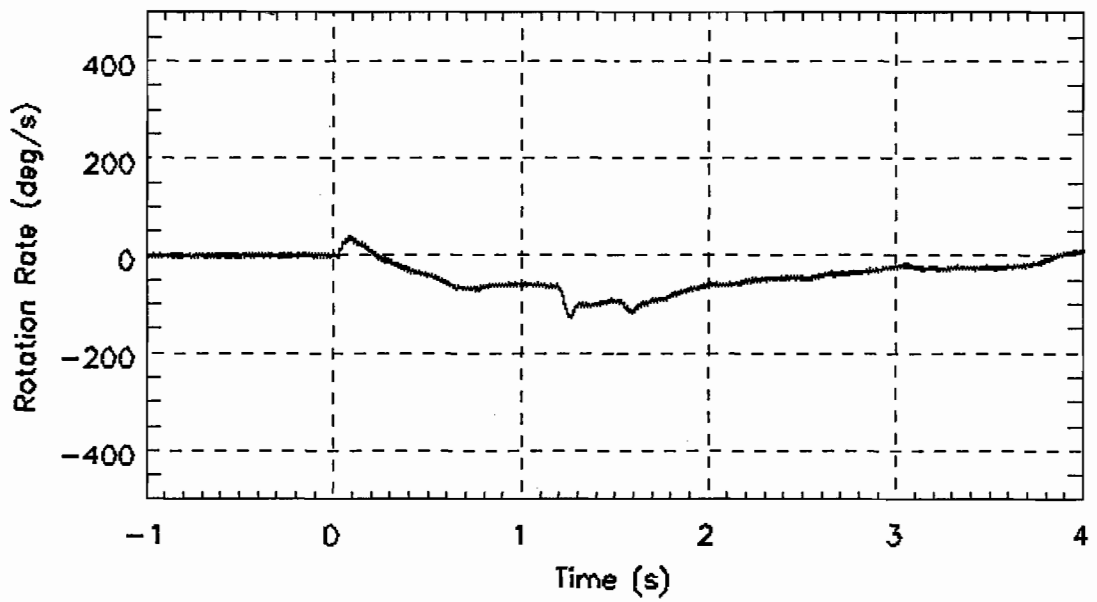

Figure O- 12. Coil rotation about the Y-axis, ROTY_1000Hz.txt

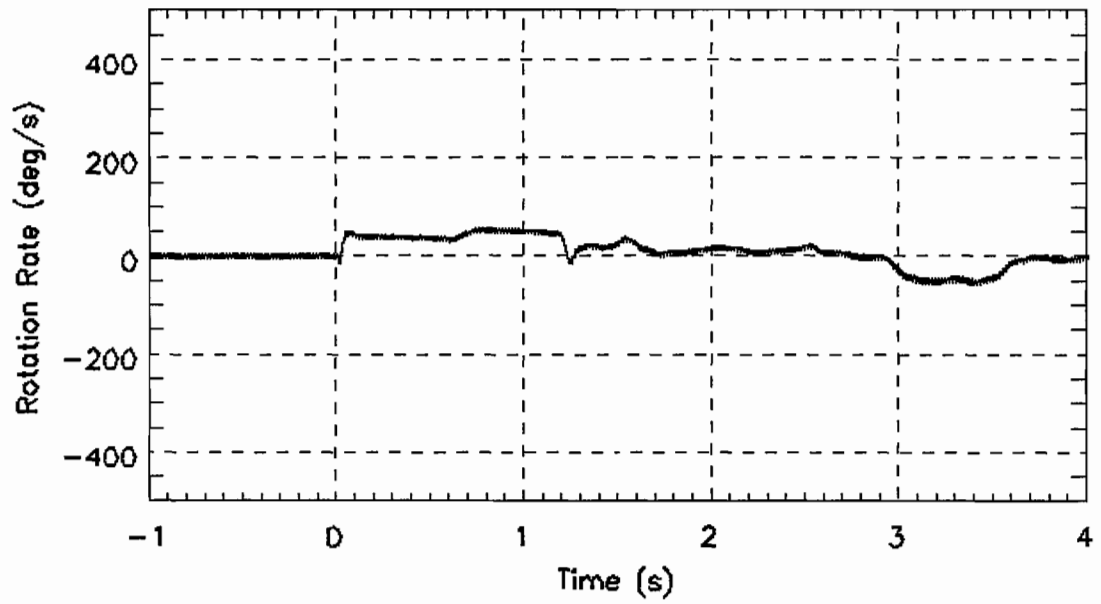

Figure O- 13. Coil rotation about the Z-axis, ROTZ_1000Hz.txt