

## CHAPTER 2E. GUIDE SIGNS—FREEWAYS AND EXPRESSWAYS

### Section 2E.01 Scope of Freeway and Expressway Guide Sign Standards

Support:

These standards provide a uniform and effective system of highway signing for high-volume, high-speed motor vehicle traffic on freeways and expressways. The requirements and specifications for expressway signing exceed those for conventional roads (see Chapter 2D), but are less than those for freeway signing. Since there are many geometric design variables to be found in existing roads, a signing concept commensurate with prevailing conditions is the primary consideration. Section 2A.01 includes definitions of freeway and expressway.

Guide signs for freeways and expressways are primarily identified by the name of the sign rather than by an assigned sign code. Guidelines for the design of guide signs for freeways and expressways are provided in Chapter 8 (Design Guidelines) of the "Standard Highway Signs" book (see Section 1A.11).

**Standard:**

**The standards prescribed herein for freeway or expressway guide signing shall apply to any highway that meets the definition of such facilities.**

### Section 2E.02 Freeway and Expressway Signing Principles

Support:

The development of a signing system for freeways and expressways is approached on the premise that the signing is primarily for the benefit and direction of road users who are not familiar with the route or area. The signing furnishes road users with clear instructions for orderly progress to their destinations. Sign installations are an integral part of the facility and, as such, are best planned concurrently with the development of highway location and geometric design. For optimal results, plans for signing are analyzed during the earliest stages of preliminary design, and details are correlated as final design is developed. The excessive signing found on many major highways usually is the result of using a multitude of signs that are too small and that are poorly designed and placed to accomplish the intended purpose.

Freeway and expressway signing is to be considered and developed as a planned system of installations. An engineering study is sometimes necessary for proper solution of the problems of many individual locations, but, in addition, consideration of an entire route is necessary.

Guidance:

Road users should be guided with consistent signing on the approaches to interchanges, when they drive from one State to another, and when driving through rural or urban areas. Because geographical, geometric, and operating factors regularly create significant differences between urban and rural conditions, the signing should take these conditions into account.

Guide signs on freeways and expressways should serve distinct functions as follows:

- A. Give directions to destinations, or to streets or highway routes, at intersections or interchanges;
- B. Furnish advance notice of the approach to intersections or interchanges;
- C. Direct road users into appropriate lanes in advance of diverging or merging movements;
- D. Identify routes and directions on those routes;
- E. Show distances to destinations;
- F. Indicate access to general motorist services, rest, scenic, and recreational areas; and
- G. Provide other information of value to the road user.

### Section 2E.03 General

Support:

Signs are designed so that they are legible to road users approaching them and readable in time to permit proper responses. Desired design characteristics include: (a) long visibility distances, (b) large lettering and symbols, and (c) short legends for quick comprehension.

**Standard:**

**Standard shapes and colors shall be used so that traffic signs can be promptly recognized by road users.**

### Section 2E.04 Color of Guide Signs

**Standard:**

**Guide signs on freeways and expressways, except as noted herein, shall have white letters, symbols, and borders on a green background.**

**Support:**

Color requirements for route signs and trailblazers, signs with blank-out or changeable messages, signs for services, rest areas, park and recreational areas, and for certain miscellaneous signs are specified in the individual sections dealing with the particular sign or sign group.

**Section 2E.05 Retroreflection or Illumination****Standard:**

**Letters, numerals, symbols, and borders of all guide signs shall be retroreflectORIZED. The background of all guide signs that are not independently illuminated shall be retroreflective.**

**Support:**

Where there is no serious interference from extraneous light sources, retroreflectORIZED ground-mounted signs usually provide adequate nighttime visibility.

On freeways and expressways where much driving at night is done with low-beam headlights, the amount of headlight illumination incident to an overhead sign display is relatively small.

**Guidance:**

Overhead sign installations should be illuminated unless an engineering study shows that retroreflectORIZATION alone will perform effectively. The type of illumination chosen should provide effective and reasonably uniform illumination of the sign face and message.

**Section 2E.06 Characteristics of Urban Signing****Support:**

Urban conditions are characterized not so much by City limits or other arbitrary boundaries, as by the following features:

- A. Mainline roadways with more than two lanes in each direction;
- B. High traffic volumes on the through roadways;
- C. High volumes of traffic entering and leaving interchanges;
- D. Interchanges closely spaced;
- E. Roadway and interchange lighting;
- F. Three or more interchanges serving the major City;
- G. A loop, circumferential, or spur serving a sizable portion of the urban population; and
- H. Visual clutter from roadside development.

Operating conditions and road geometrics on urban freeways and expressways usually make special sign treatments desirable, including:

- A. Use of Interchange Sequence signs (see Section 2E.37);
- B. Use of sign spreading to the maximum extent possible (see Section 2E.10);
- C. Elimination of service signing (see Section 2E.51);
- D. Reduction to a minimum of post-interchange signs (see Section 2E.35);
- E. Display of advance signs at distances closer to the interchange, with appropriate adjustments in the legend (see Section 2E.30);
- F. Use of overhead signs on roadway structures and independent sign supports (see Section 2E.22);
- G. Use of diagrammatic signs in advance of intersections and interchanges (see Section 2E.19); and
- H. Frequent use of street names as the principal message in guide signs.

Lower speeds which are often characteristic of urban operations do not justify lower signing standards. Typical traffic patterns are more complex for the road user to negotiate, and large, easy-to-read legends are, therefore, just as necessary as on rural highways.

**Section 2E.07 Characteristics of Rural Signing****Support:**

Rural areas ordinarily have greater distances between interchanges, which permits adequate spacing for the sequences of signs on the approach to and departure from each interchange. However, the absence of traffic in adjoining lanes and on entering or exiting ramps often adds monotony or inattention to rural driving. This increases the importance of signs that call for decisions or actions.

**Guidance:**

Where there are long distances between interchanges and the alignment is relatively unchanging, signs should be positioned for their best effect on road users. The tendency to group all signing in the immediate vicinity of rural interchanges should be avoided by considering the entire route in the development of sign plans. Extra effort should be given to the placement of signs at natural target locations to command the attention of the road user, particularly when the message requires an action by the road user.

**Section 2E.08 Memorial Highway Signing****Guidance:**

Freeways and expressways should not be signed as memorial highways. If a route, bridge, or highway component is officially designated as a memorial, and if notification of the memorial is to be made on the highway right-of-way, such notification should consist of installing a memorial plaque in a rest area, scenic overlook, recreational area, or other appropriate location where parking is provided with the signing inconspicuously located relative to vehicle operations along the highway.

**Option:**

If the installation of a memorial plaque off the main roadway is not practical, a memorial sign may be installed on the mainline.

**Standard:**

**Where such memorial signs are installed on the mainline, (1) memorial names shall not appear on directional guide signs, (2) memorial signs shall not interfere with the placement of any other necessary highway signing, and (3) memorial signs shall not compromise the safety or efficiency of traffic flow. The memorial signing shall be limited to one sign at an appropriate location in each route direction.**

**Section 2E.09 Amount of Legend on Guide Signs****Guidance:**

No more than two destination names or street names should be shown on any Advance Guide sign or Exit Direction sign. A City name and street name on the same sign should be avoided. Where two or three signs are placed on the same supports, destinations or names should be limited to one per sign, or to a total of three in the display. Sign legends should not exceed three lines of copy.

**Option:**

Sign legends may include symbols, route numbers, arrows, cardinal directions, and exit instructions.

**Section 2E.10 Number of Signs at an Overhead Installation and Sign Spreading****Guidance:**

If overhead signs are warranted, as set forth in Section 2A.17, the number of signs at these locations should be limited to only those essential in communicating pertinent destination information to the road user. Exit Direction signs for a single exit and the Advance Guide signs should have only one panel with one or two destinations. Regulatory signs, such as speed limits, should not be used in conjunction with overhead guide sign installations. Because road users have limited time to read and comprehend sign messages, there should not be more than three guide signs displayed at any one location either on the overhead structure or its support.

**Option:**

At overhead locations, more than one sign may be installed to advise of a multiple exit condition at an interchange. If the roadway ramp or crossing roadway has complex or unusual geometrics, additional signs with confirming messages may be provided to properly guide the road user.

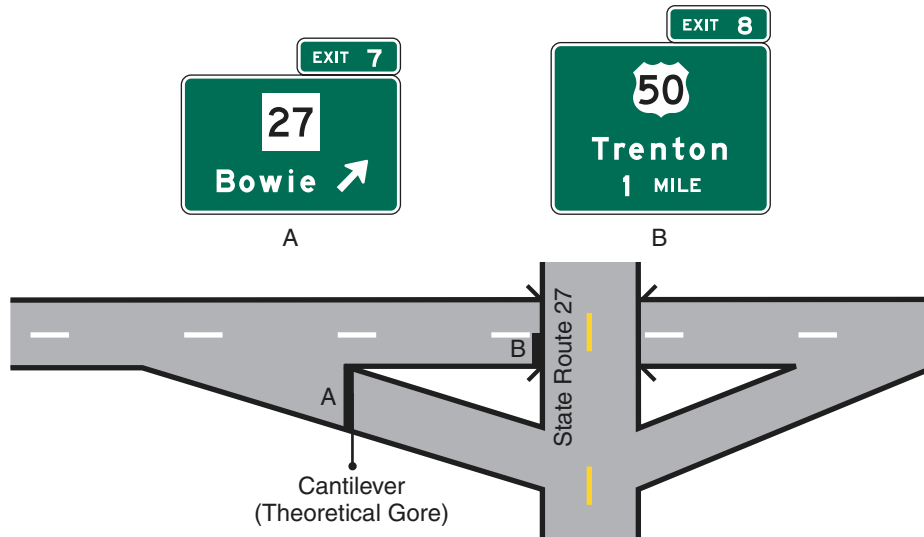
**Support:**

Sign spreading is a concept where major overhead signs are spaced so that road users are not overloaded with a group of signs at a single location. Figure 2E-1 illustrates an example of sign spreading.

**Guidance:**

Where overhead signing is used, sign spreading should be used at all single exit interchanges and to the extent possible at multi-exit interchanges. Sign spreading should be accomplished by use of the following:

- A. The Exit Direction sign should be the only sign used in the vicinity of the gore (other than the Gore sign). It should be located overhead near the theoretical gore and generally on an overhead sign support structure.
- B. The Advance Guide sign to indicate the next interchange exit should be placed near the crossroad location. If the crossroad goes over the mainline, the Advance Guide sign should be placed on the overcrossing structure.

**Figure 2E-1. Example of Guide Sign Spreading****Figure 2E-2. Pull-Through Signs****Section 2E.11 Pull-Through Signs****Support:**

Pull-Through signs (see Figure 2E-2) are overhead lane use signs intended for through traffic.

**Guidance:**

Pull-Through signs should be used where the geometrics of a given interchange are such that it is not clear to the road user as to which is the through roadway, or where additional route guidance is desired. Pull-Through signs with down arrows should be used where the alignment of the through lanes is curved and the exit direction is straight ahead, where the number of through lanes is not readily evident, and at multi-lane exits where there is a reduction in the number of through lanes.

**Section 2E.12 Designation of Destinations****Standard:**

The direction of a freeway and the major destinations or control cities (see Section 2D.34) along it shall be clearly identified through the use of appropriate destination legends. Successive freeway guide signs shall provide continuity in destination names and consistency with available map information. At any decision point, a given destination shall be indicated by way of only one route.

**Guidance:**

Control city legends should be used in the following situations along a freeway:

- A. At interchanges between freeways;
- B. At separation points of overlapping freeway routes;
- C. On directional signs on intersecting routes, to guide traffic entering the freeway;
- D. On Pull-Through signs; and
- E. On the bottom line of post-interchange distance signs.

**Support:**

Continuity of destination names is also useful on expressways serving long-distance or intrastate travel.

The determination of major destinations or control cities is important to the quality of service provided by the freeway. Control cities on freeway guide signs are selected by the States and are contained in the “List of Control Cities for Use in Guide Signs on Interstate Highways,” published and available from American Association of State and Highway Transportation Officials (see Page i for AASHTO’s address).

**Section 2E.13 Size and Style of Letters and Signs****Standard:**

**With all freeway and expressway signs, the message dimensions shall be determined first, and the outside sign dimensions secondarily. Word messages in the legend of expressway guide signs shall be in letters at least 200 mm (8 in) high. Larger lettering shall be used for major guide signs at or in advance of interchanges and for all overhead signs. Minimum numeral and letter sizes for expressway guide signs according to interchange classification, type of sign and component of sign legend are shown in Tables 2E-1 and 2E-2. Minimum numeral and letter sizes for freeway guide signs, according to interchange classification, type of sign, and component of sign legend, appear in Tables 2E-3 and 2E-4. All names of places, streets, and highways on freeway and expressway guide signs shall be composed of lower-case letters with initial upper-case letters. The letters and the numerals used shall be Series E(M) of the “Standard Highway Signs” book (see Section 1A.11). Other word legends shall be in capital letters. Interline and edge spacing shall be as specified in Section 2E.14.**

**Lettering size on freeway and expressway signs shall be the same for both rural and urban conditions.**

**Support:**

Sign size is determined primarily in terms of the length of the message and the size of the lettering necessary for proper legibility. Letter style and height, and arrow design have been standardized for freeway and expressway signs to assure uniform and effective application.

Designs for upper-case, lower-case, and capital alphabets together with tables of recommended letter spacing, are shown in the “Standard Highway Signs” book.

**Guidance:**

Where upper- and lower-case lettering is used, the initial upper-case letters should be approximately 1.33 times the “loop” height of the lower-case letters. Freeway lettering sizes (see Tables 2E-3 and 2E-4) should be used when expressway geometric design is comparable to freeway standards.

Other sign letter size requirements not specifically identified elsewhere in this Manual should be guided by these specifications. Abbreviations should be kept to a minimum.

**Support:**

A sign mounted over a particular roadway lane to which it applies might have to be limited in horizontal dimension to the width of the lane, so that another sign can be placed over an adjacent lane. The necessity to maintain proper vertical clearance might also place a further limitation on the size of the overhead sign and the legend that can be accommodated.

**Section 2E.14 Interline and Edge Spacing****Guidance:**

Interline spacing of upper-case letters should be approximately three-fourths the average of upper-case letter heights in adjacent lines of letters.

The spacings to the top and bottom borders should be equal to the average of the letter height of the adjacent line of letters. The lateral spacing to the vertical borders should be essentially the same as the height of the largest letter.

**Table 2E-1. Minimum Letter and Numeral Sizes for Expressway Guide Signs According to Interchange Classification**  
(sizes shown in millimeters)

Type of Sign	Type of Interchange (see Section 2E.29)				Overhead
	Major		Intermediate	Minor	
	Category a	Category b			
<b>A. Advance Guide, Exit Direction, and Overhead Guide Signs</b>					
Exit Plaque					
Word	250	250	250	200	250
Numeral & Letter	375	375	375	300	375
Interstate Route Sign					
Numeral	450	—	—	—	450
1 or 2 Digit Shield	900 x 900	—	—	—	900 x 900
3 Digit Shield	1125 x 900	—	—	—	1125 x 900
U.S. or State Route Sign					
Numeral	450	450	450	300	450
1 or 2 Digit Shield	900 x 900	900 x 900	900 x 900	600 x 600	900 x 900
3 Digit Shield	1125 x 900	1125 x 900	1125 x 900	750 x 600	1125 x 900
Alternate (Example: U.S. Alt. 56)					
Letters	375	300	300	250	300
Numeral	450	375	375	300	375
Cardinal Direction					
First Letter	450	375	300	250	375
Rest of Word	375	300	250	200	300
Name of Destination					
Upper-Case Letters	500	400	330	265	400
Lower-Case Letters	375	300	250	200	300
Distance Number	450	375	300	250	375
Distance Fraction	300	250	250	200	250
Distance Word	300	250	250	200	250
Action Message Word	250	250	250	200	250
<b>B. Gore Signs</b>					
Word	250	250	250	200	—
Numeral & Letter	300	300	300	250	—

## Section 2E.15 Sign Borders

### Standard:

Signs shall have a border of the same color as the legend in order to outline their distinctive shape and thereby give them easy recognition and a finished appearance.

### Guidance:

For guide signs larger than 3000 x 1800 mm (120 x 72 in), the border should have a width of 50 mm (2 in). For smaller guide signs, a border width of 31 mm (1.25 in) should be used, but the width should not exceed the stroke width of the major lettering on the sign.

Corner radii of sign borders should be one-eighth of the minimum sign dimension on guide signs, except that the radii should not exceed 300 mm (12 in) on any sign.

### Option:

The sign material in the area outside of the corner radius may be trimmed.



**Table 2E-1. Minimum Letter and Numeral Sizes for Expressway Guide Signs According to Interchange Classification**  
(sizes shown in inches)

Type of Sign	Type of Interchange (see Section 2E.29)				Overhead
	Major		Intermediate	Minor	
	Category a	Category b			
<b>A. Advance Guide, Exit Direction, and Overhead Guide Signs</b>					
Exit Plaque					
Word	10	10	10	8	10
Numeral & Letter	15	15	15	12	15
Interstate Route Sign					
Numeral	18	—	—	—	18
1 or 2 Digit Shield	36 x 36	—	—	—	36 x 36
3 Digit Shield	45 x 36	—	—	—	45 x 36
U.S. or State Route Sign					
Numeral	18	18	18	12	18
1 or 2 Digit Shield	36 x 36	36 x 36	36 x 36	24 x 24	36 x 36
3 Digit Shield	45 x 36	45 x 36	45 x 36	30 x 24	45 x 36
Alternate (Example: U.S. Alt. 56)					
Letters	15	12	12	10	12
Numeral	18	15	15	12	15
Cardinal Direction					
First Letter	18	15	12	10	15
Rest of Word	15	12	10	8	12
Name of Destination					
Upper-Case Letters	20	16	13.3	10.6	16
Lower-Case Letters	15	12	10	8	12
Distance Number	18	15	12	10	15
Distance Fraction	12	10	10	8	10
Distance Word	12	10	10	8	10
Action Message Word	10	10	10	8	10
<b>B. Gore Signs</b>					
Word	10	10	10	8	—
Numeral & Letter	12	12	12	10	—

### Section 2E.16 Abbreviations

#### Guidance:

Abbreviations should be kept to a minimum; however, they are useful when complete destination messages produce excessively long signs. If used, abbreviations should be unmistakably recognized by road users (see Section 1A.14).

Periods should not be used unless a cardinal direction is abbreviated as part of a destination name.

#### Standard:

The words **NORTH**, **SOUTH**, **EAST**, and **WEST** shall not be abbreviated when used with route signs to indicate cardinal directions on guide signs.

### Section 2E.17 Symbols

#### Standard:

Symbol designs shall be essentially like those shown in this Manual and in the “Standard Highway Signs” book (see Section 1A.11).

**Table 2E-2. Minimum Letter and Numeral Sizes for Expressway Guide Signs According to Sign Type (Sheet 1 of 2)**

Type of Sign	Minimum Size (mm)	Minimum Size (inches)
<b>A. Pull-Through Signs</b>		
Destination — Upper-Case Letters	330	13.3
Destination — Lower-Case Letters	250	10
Route Sign as Message		
Cardinal Direction	250	10
1- or 2-Digit Shield	900 x 900	36 x 36
3-Digit Shield	1125 x 900	45 x 36
<b>B. Supplemental Guide Signs</b>		
Exit Number Word	200	8
Exit Number Numeral and Letter	300	12
Place Name — Upper-Case Letters	265	10.6
Place Name — Lower-Case Letters	200	8
Action Message	200	8
<b>C. Changeable Message Signs</b>		
Characters	265*	10.6*
<b>D. Interchange Sequence Signs</b>		
Word — Upper-Case Letters	265	10.6
Word — Lower-Case Letters	200	8
Numeral	250	10
Fraction	200	8
<b>E. Next X Exits Sign</b>		
Place Name — Upper-Case Letters	265	10.6
Place Name — Lower-Case Letters	200	8
NEXT X EXITS	200	8
<b>F. Distance Signs</b>		
Word — Upper-Case Letters	200	8
Word — Lower-Case Letters	150	6
Numeral	200	8
<b>G. General Services Signs</b>		
Exit Number Word	200	8
Exit Number Numeral and Letter	300	12
Services	200	8
<b>H. Rest Area and Scenic Area Signs</b>		
Word	250	10
Distance Numeral	300	12
Distance Fraction	200	8
Distance Word	250	10
Action Message Word	250	10



**Table 2E-2. Minimum Letter and Numeral Sizes for Expressway Guide Signs According to Sign Type (Sheet 2 of 2)**

Type of Sign	Minimum Size (mm)	Minimum Size (inches)
<b>I. Reference Location Signs</b>		
Word	100	4
Numeral	250	10
<b>J. Boundary and Orientation Signs</b>		
Word — Upper-Case Letters	200	8
Word — Lower-Case Letters	150	6
<b>K. Next Exit and Next Services Signs</b>		
Word and Numeral	200	8
<b>L. Exit Only Signs</b>		
Word	300	12

\*Changeable Message Signs may often require larger sizes than the minimum. A size of 450 mm (18 in) should be used where traffic speeds are greater than 90 km/h (55 mph), in areas of persistent inclement weather, or where complex driving tasks are involved.

**Guidance:**

A special effort should be made to balance legend components for maximum legibility of the symbol with the rest of the sign.

**Option:**

Educational plaques may be used below symbol signs where needed.

**Section 2E.18 Arrows for Interchange Guide Signs**

**Standard:**

**On all Exit Direction signs, both overhead and ground mounted, arrows shall be upward slanting and shall be located on the side of the sign consistent with the direction of the exiting movement.**

**Downward pointing arrows shall be used only for overhead guide signs to prescribe lane assignment for traffic bound for a destination or route that can be reached only by being in the designated lane(s).**

**Option:**

Downward pointing arrows may be tilted where it is desired to emphasize the separation of roadways.

**Support:**

Examples of arrows for use on guide signs are shown in Figure 2D-2. Detailed dimensions of arrows are provided in the “Standard Highway Signs” book (see Section 1A.11).

**Section 2E.19 Diagrammatic Signs**

**Support:**

Diagrammatic signs are guide signs that show a graphic view of the exit arrangement in relationship to the main highway. Use of such guide signs has been shown to be superior to conventional guide signs for some interchanges.

**Standard:**

**Diagrammatic signs shall be designed in accordance with the following criteria:**

- A. The graphic legend shall be of a plan view showing the off-ramp arrangement (see Figure 2E-3).**
- B. No other symbols or route shields shall be used as a substitute for arrowheads.**
- C. They shall not be installed at the exit direction location (see Section 2E.33).**
- D. The EXIT ONLY panel shall not be used on diagrammatic signs at any major split.**

**Table 2E-3. Minimum Letter and Numeral Sizes for Freeway Guide Signs According to Interchange Classification**  
(sizes shown in millimeters)

Type of Sign	Type of Interchange (see Section 2E.29)				Overhead
	Major		Intermediate	Minor	
	Category a	Category b			
<b>A. Advance Guide, Exit Direction, and Overhead Guide Signs</b>					
Exit Plaque					
Word	250	250	250	250	250
Numeral & Letter	375	375	375	375	375
Interstate Route Sign					
Numeral	600/450	—	—	—	450
1- or 2-Digit Shield	1200 x 1200/ 900 x 900	—	—	—	900 x 900
3-Digit Shield	1500 x 1200/ 1125 x 900	—	—	—	1125 x 900
U.S. or State Route Sign					
Numeral	600/450	450	450	300	450
1- or 2-Digit Shield	1200 x 1200/ 900 x 900	900 x 900	900 x 900	600 x 600	900 x 900
3-Digit Shield	1500 x 1200/ 1125 x 900	1125 x 900	1125 x 900	750 x 600	1125 x 900
Alternate (Example: U.S. Alt. 56)					
Letters	375	375/300	300	250	300
Numeral	450	450/375	375	300	375
Cardinal Direction					
First Letter	450	375	375	250	300
Rest of Word	375	300	300	200	300
Name of Destination					
Upper-Case Letters	500	500	400	330	400
Lower-Case Letters	375	375	300	250	300
Distance Number	450	450/375	375	300	375
Distance Fraction	300	300/250	250	200	250
Distance Word	300	300/250	250	200	250
Action Message Word	300	300/250	250	200	250
<b>B. Gore Signs</b>					
Word	300	300	300	200	—
Numeral & Letter	375	375	375	250	—

Note: (/) Slanted bar signifies separation of desirable and minimum sizes.

**Table 2E-3. Minimum Letter and Numeral Sizes for Freeway Guide Signs According to Interchange Classification**  
(sizes shown in inches)

Type of Sign	Type of Interchange (see Section 2E.29)				Overhead
	Major		Intermediate	Minor	
	Category a	Category b			
<b>A. Advance Guide, Exit Direction, and Overhead Guide Signs</b>					
Exit Plaque					
Word	10	10	10	10	10
Numeral & Letter	15	15	15	15	15
Interstate Route Sign					
Numeral	24/18	—	—	—	18
1- or 2-Digit Shield	48 x 48/ 36 x 36	—	—	—	36 x 36
3-Digit Shield	60 x 48/ 45 x 36	—	—	—	45 x 36
U.S. or State Route Sign					
Numeral	24/18	18	18	12	18
1- or 2-Digit Shield	48 x 48/ 36 x 36	36 x 36	36 x 36	24 x 24	36 x 36
3-Digit Shield	60 x 48/ 45 x 36	45 x 36	45 x 36	30 x 24	45 x 36
Alternate (Example: U.S. Alt. 56)					
Letters	15	15/12	12	10	12
Numeral	18	18/15	15	12	15
Cardinal Direction					
First Letter	18	15	15	10	15
Rest of Word	15	12	12	8	12
Name of Destination					
Upper-Case Letters	20	20	16	13.3	16
Lower-Case Letters	15	15	12	10	12
Distance Number	18	18/15	15	12	15
Distance Fraction	12	12/10	10	8	10
Distance Word	12	12/10	10	8	10
Action Message Word	12	12/10	10	8	10
<b>B. Gore Signs</b>					
Word	12	12	12	8	—
Numeral & Letter	15	15	15	10	—

Note: (/) Slanted bar signifies separation of desirable and minimum sizes.

**Table 2E-4. Minimum Letter and Numeral Sizes for Freeway Guide Signs According to Sign Type (Sheet 1 of 2)**

Type of Sign	Minimum Size (mm)	Minimum Size (inches)
<b>A. Pull-Through Signs</b>		
Destination — Upper-Case Letters	400	16
Destination — Lower-Case Letters	300	12
Route Sign as Message		
Cardinal Direction	300	12
1- or 2-Digit Shield	900 x 900	36 x 36
3-Digit Shield	1125 x 900	45 x 36
<b>B. Supplemental Guide Signs</b>		
Exit Number Word	250	10
Exit Number Numeral and Letter	375	15
Place Name — Upper-Case Letters	330	13.3
Place Name — Lower-Case Letters	250	10
Action Message	250	10
<b>C. Changeable Message Signs</b>		
Characters	265*	10.6*
<b>D. Interchange Sequence Signs</b>		
Word — Upper-Case Letters	330	13.3
Word — Lower-Case Letters	250	10
Numeral	330	13.3
Fraction	250	10
<b>E. Next X Exits Sign</b>		
Place Name — Upper-Case Letters	330	13.3
Place Name — Lower-Case Letters	250	10
NEXT X EXITS	250	10
<b>F. Distance Signs</b>		
Word — Upper-Case Letters	200	8
Word — Lower-Case Letters	150	6
Numeral	200	8
<b>G. General Service Signs</b>		
Exit Number Word	250	10
Exit Number Numeral and Letter	375	15
Services	250	10
<b>H. Rest Area and Scenic Area Signs</b>		
Word	300	12
Distance Numeral	375	15
Distance Fraction	250	10
Distance Word	300	12
Action Message Word	300	12

**Table 2E-4. Minimum Letter and Numeral Sizes for Freeway Guide Signs According to Sign Type (Sheet 2 of 2)**

Type of Sign	Minimum Size (mm)	Minimum Size (inches)
<b>I. Reference Location Signs</b>		
Word	100	4
Numeral	250	10
<b>J. Boundary and Orientation Signs</b>		
Word — Upper-Case Letters	200	8
Word — Lower-Case Letters	150	6
<b>K. Next Exit and Next Services Signs</b>		
Word and Numeral	200	8
<b>L. Exit Only Signs</b>		
Word	300	12
<b>M. Diagrammatic Signs</b>		
Lane Widths	125	5
Lane Line Segments	25 x 150	1 x 6
Gap Between Lane Lines	150	6
Stem Height (up to upper point of departure)	750	30
Arrowhead (standard “up” arrow)	200	8
Space Between Arrowhead and Route Shield	300	12

\*Changeable Message Signs may often require larger sizes than the minimum. A size of 450 mm (18 in) should be used where traffic speeds are greater than 90 km/h (55 mph), in areas of persistent inclement weather, or where complex driving tasks are involved.

#### Guidance:

Diagrammatic signs should be designed in accordance with the following additional criteria:

- A. The graphic should not depict deceleration lanes.
- B. No more than one destination should be shown for each arrowhead, and no more than two destinations should be shown per sign.
- C. A black on yellow EXIT ONLY panel should be used to supplement a lane drop graphic.
- D. The shaft for the exit ramp movement should be shorter than, but not separated from, the through movement graphic. Where the movements are freeway splits rather than exits, the shafts should be equal in length.
- E. Arrow shafts should contain lane lines where appropriate.
- F. Route shields, cardinal directions, and destinations should be clearly related to the arrowhead, and the arrowhead should point toward the route shield for the off movement.
- G. The cardinal direction should be placed adjacent to the route shield, and the destination should be placed below and justified with the route shield.

Diagrammatic signs should be used at the Advance Guide sign location(s) for the following:

- A. Left exits (see Figure 2E-3).
- B. Splits where the off-route movement is to the left (see Figure 2E-4).
- C. Optional lane splits for non-overlapping routes (see Figure 2E-5).
- D. Where a two-lane exit has an optional lane that carries the through route (see Figures 2E-6 and 2E-7). These interchanges create serious expectancy problems for drivers who are unfamiliar with the interchange.
- E. Left exit interchange lane drop situations. In this situation, an EXIT ONLY (E11-1c) panel should be used without a down arrow for Advance Guide signs (see Figure 2E-8).

**Figure 2E-3. Diagrammatic Sign for a Single-Lane Left Exit**

\* The upper half of a Left Exit plaque, which contains the word LEFT, may have a black legend and border on a yellow background.

**Standard:**

Diagrammatic signs have been shown to be inferior to conventional signs at cloverleaf interchanges and shall not be used at these locations.

**Support:**

Specific guidelines for more detailed design of diagrammatic signs are contained in the “Standard Highway Signs” book (see Section 1A.11).

**Section 2E.20 Signing for Interchange Lane Drops****Standard:**

Major guide signs for all lane drops at interchanges shall be mounted overhead. An EXIT ONLY panel shall be used for all interchange lane drops at which the through route is carried on the mainline.

**Guidance:**

The EXIT ONLY (down arrow) (E11-1) panel (see Figure 2E-9) should be used on all signing of lane drops on all Advance Guide signs for right exits (see Figure 2E-10). For lane drops on the left side, diagrammatic signing with the EXIT ONLY (E11-1c) panel (see Figure 2E-9) should be used without a down arrow for Advance Guide signs (see Figure 2E-8).

**Standard:**

The Exit Direction sign (see Figure 2E-20) and E11-1a panel (see Figure 2E-9) shall be of the format shown in Figures 2E-8 and 2E-10 for all lane drops. The standard slanted up arrow (left or right side) shall be included on the Exit Direction sign.

**Option:**

EXIT ONLY messages of either E11-1b or E11-1c formats may be used to retrofit existing signing to warn of a lane drop situation ahead.

**Standard:**

If used on an existing sign, the E11-1b panel (see Figure 2E-9) shall be placed on either side of a white down arrow. The E11-1c panel, if used on an existing nondiagrammatic sign, shall be placed between the lower destination message and the white down arrow.

**Guidance:**

Advance Guide signs for lane drops within 2 km or 1 mile of the interchange should not contain the distance message.

Wherever the dropped lane carries the through route, diagrammatic signs should be used without the EXIT ONLY panel.

Figure 2E-4. Diagrammatic Signs for Split with Dedicated Lanes

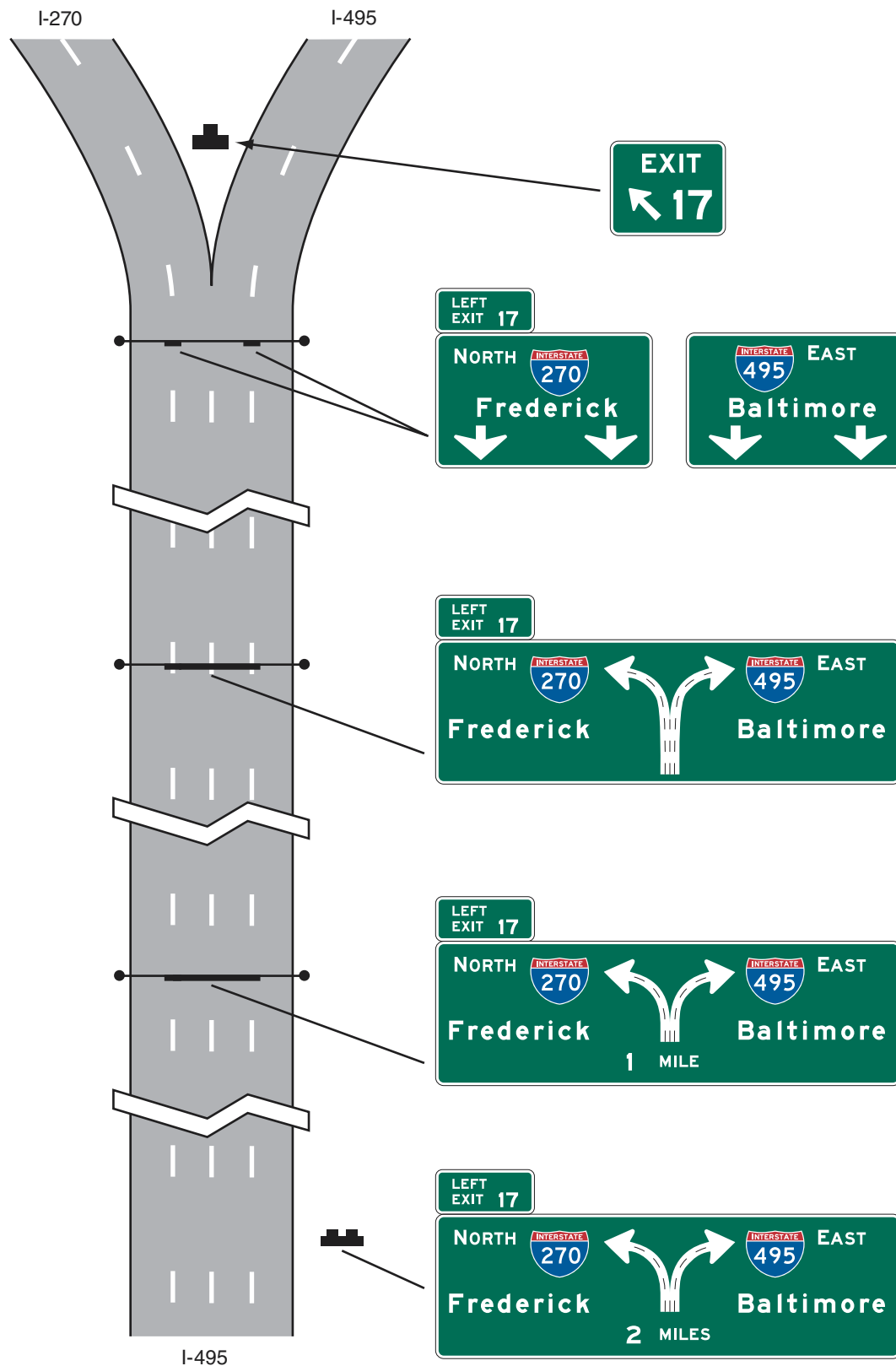




Figure 2E-5. Diagrammatic Signs for Split with Optional Lane

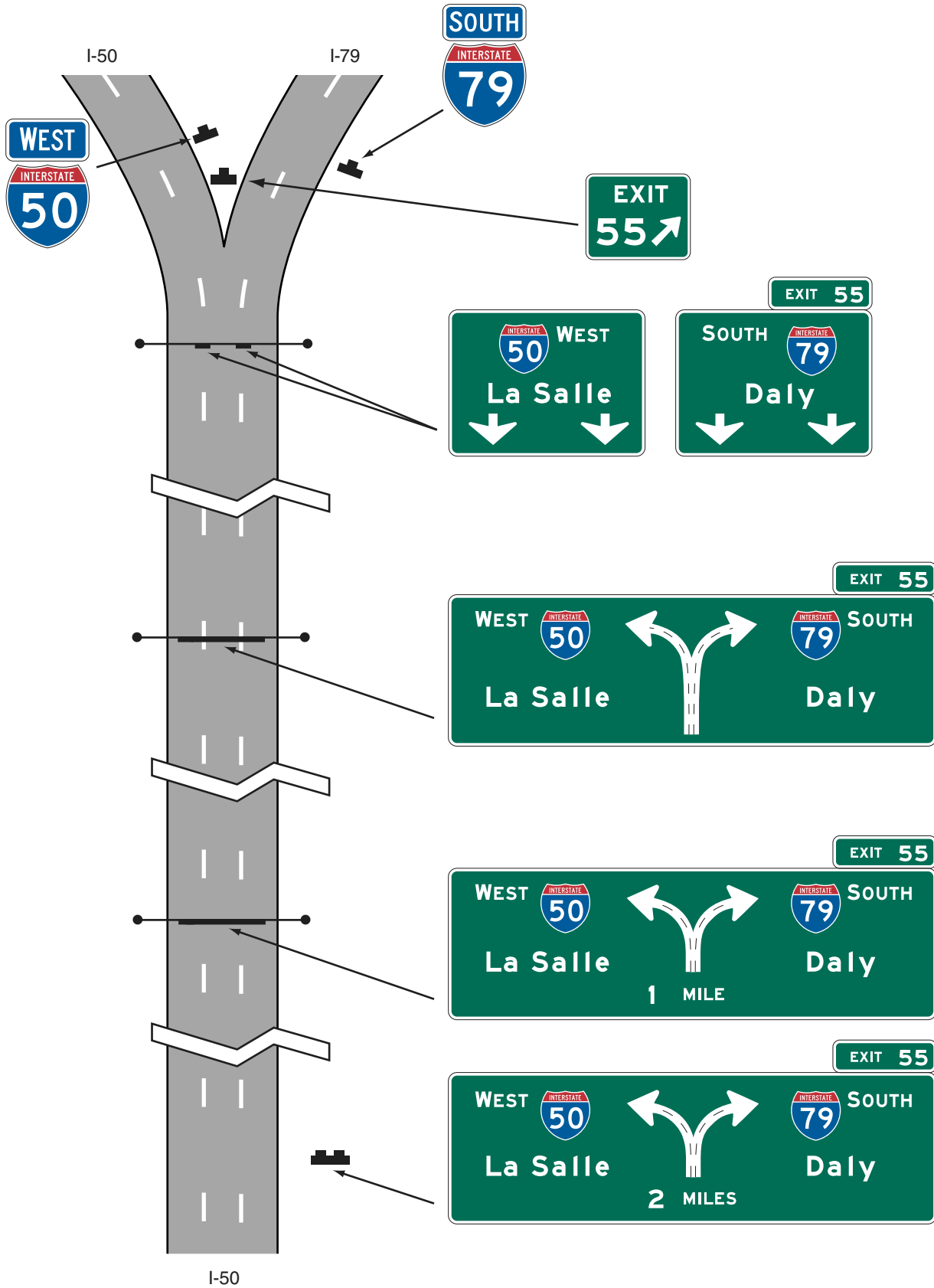


Figure 2E-6. Diagrammatic Signs for Two-Lane Exit with Optional Lane

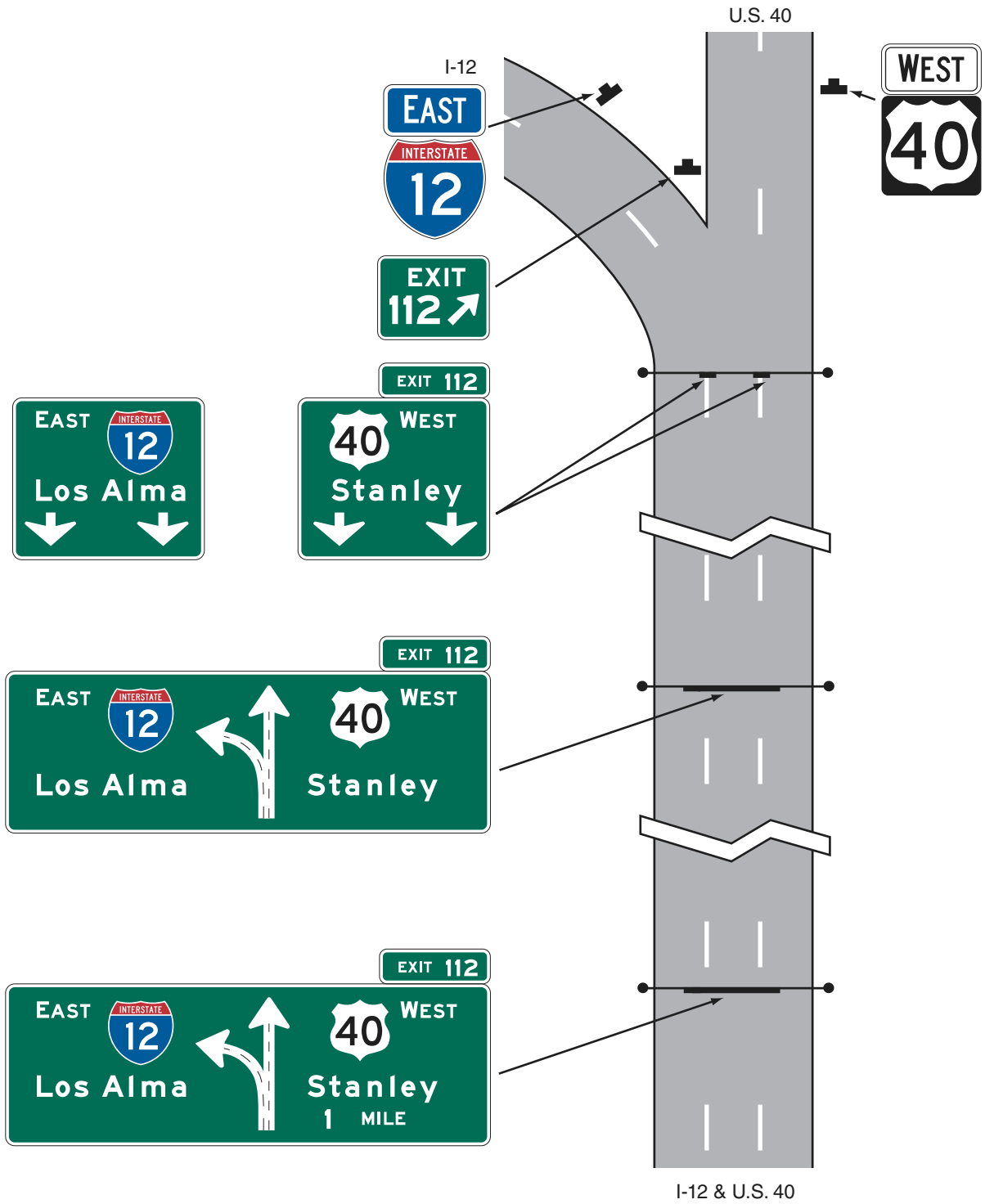
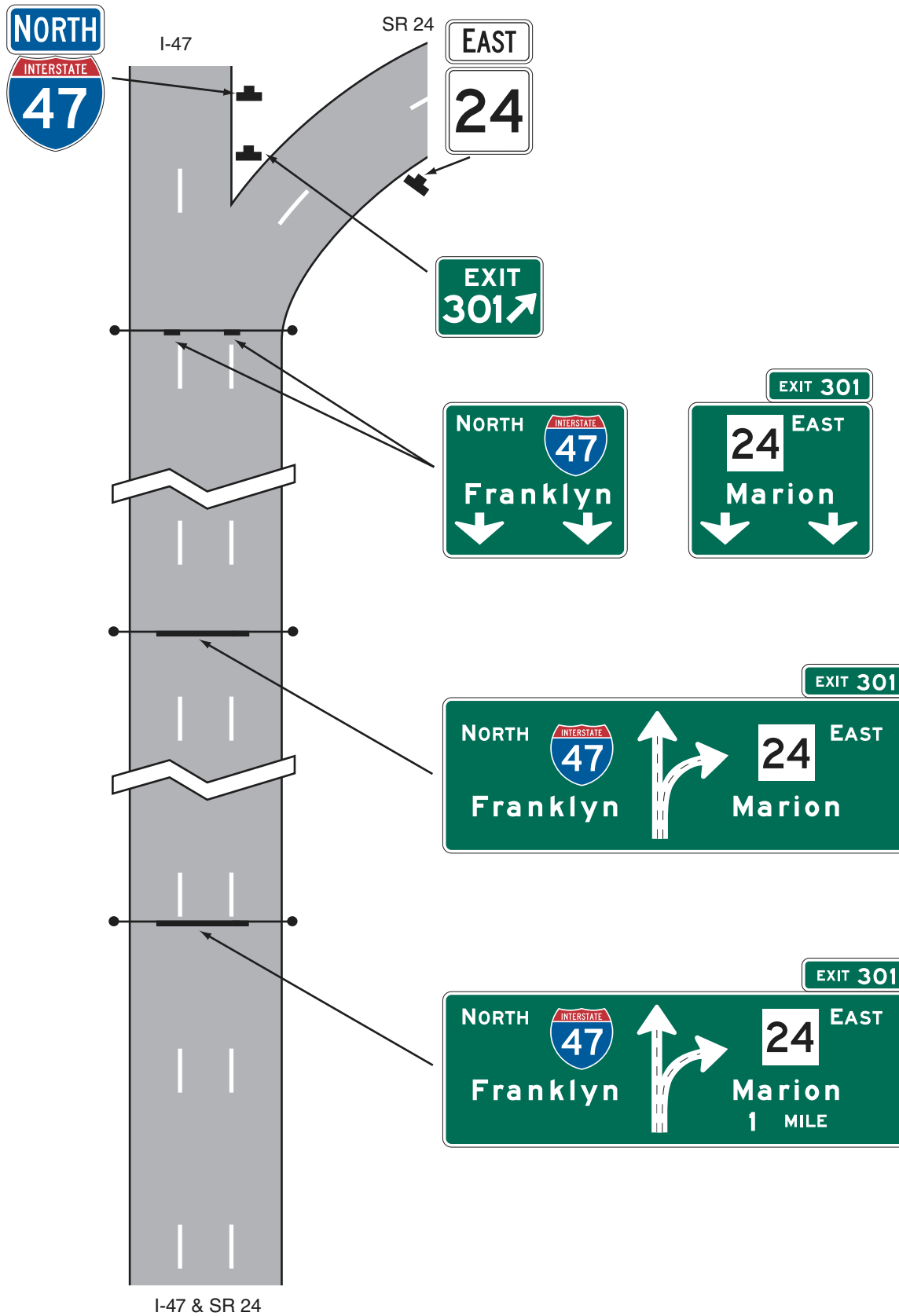
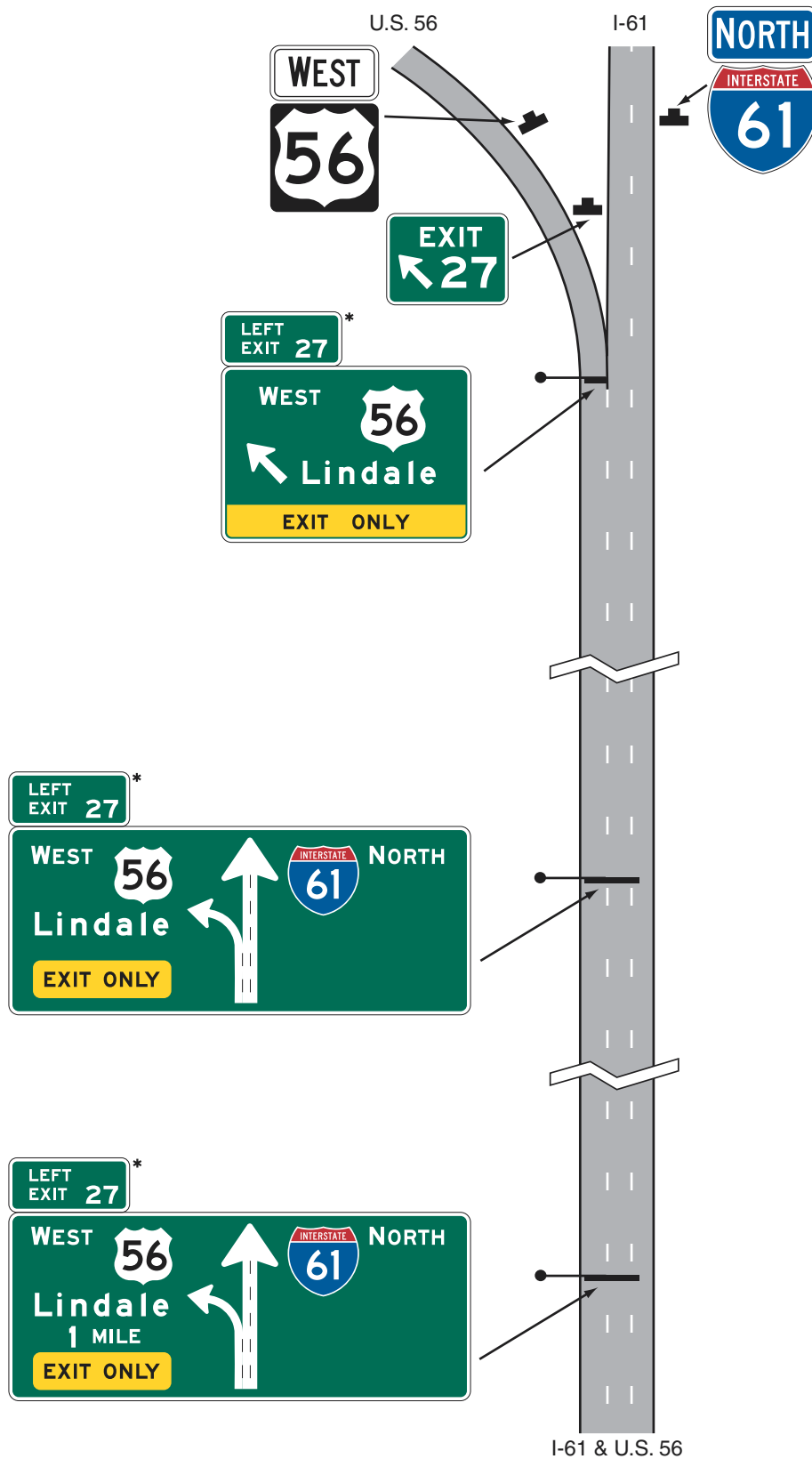


Figure 2E-7. Diagrammatic Signs for Two-Lane Exit with Optional Lane



**Figure 2E-8. EXIT ONLY on Left with Diagrammatic Sign for Left Lane Dropped at an Interchange**



\* The upper half of a Left Exit plaque, which contains the word LEFT, may have a black legend and border on a yellow background.

**Figure 2E-9. EXIT ONLY Panels**

E11-1



E11-1a



E11-1b



E11-1c

**Section 2E.21 Changeable Message Signs****Standard:**

Changeable message signs shall be capable of displaying several messages in a sequence. Such messages shall be changed manually, by remote control, or by automatic controls. Changeable message signs shall display pertinent traffic operational and guidance information only, not advertising.

**Support:**

Because technology for changeable message signs continues to advance, a specific standard for changeable message signs is not practical. Considerations that influence the selection of the best sign for a particular application include conspicuity, legibility, operation, and maintenance of the changeable message sign. This Section applies to signs for use on freeway and expressway mainlines. It is recognized that similar signs might be used on ramps and at ramp terminals where smaller letter heights and the number of messages might differ from the provisions of this Section.

**Guidance:**

To the extent practical, the design and application of changeable message signs should conform to the general principles of this Manual. Within the context of Section 2A.07, these practices should be followed for mainline freeway and expressway applications:

- A. Changeable message signs should be capital letters and have a desirable letter size of 450 mm (18 in) or a minimum letter size of 265 mm (10.6 in). Signs should be limited to not more than 3 lines with not more than 20 characters per line.
- B. No more than two displays should be used within any message cycle.
- C. Each display should convey a single thought.
- D. The entire message cycle should be readable at least twice by drivers traveling at the posted speed, the off-peak 85th-percentile speed, or the operating speed.

**Standard:**

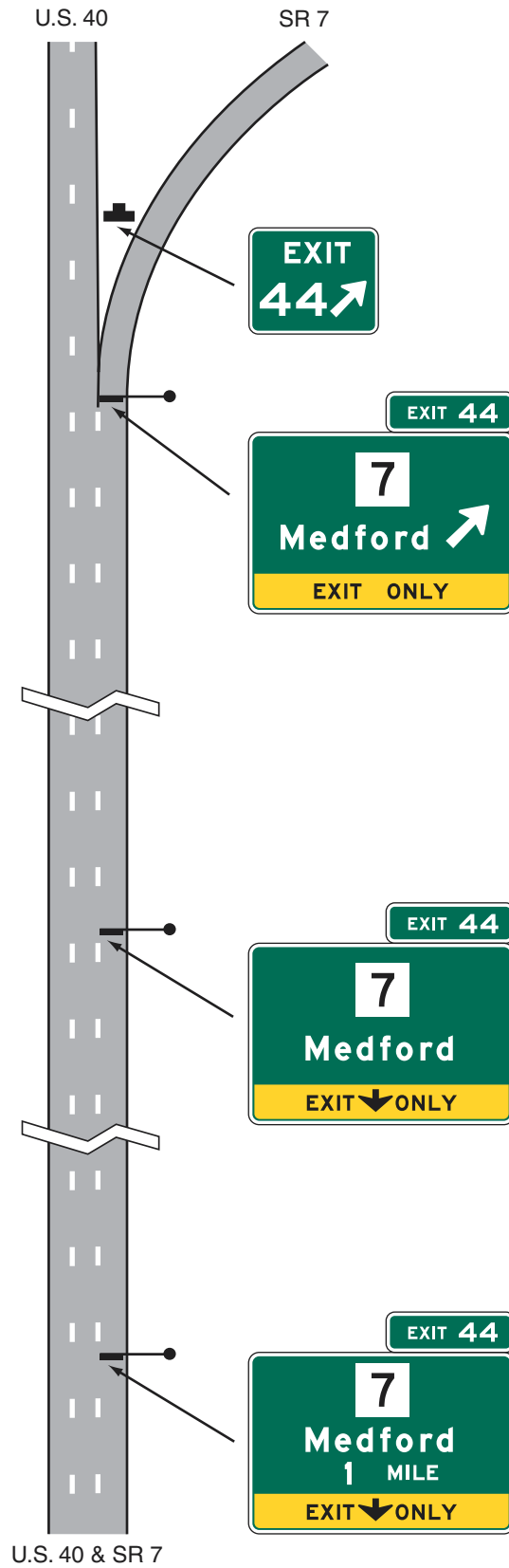
Messages shall be centered within each line of legend. If more than one changeable message sign is visible to road users, then only one such sign shall display a sequential message at any given time.

A three-line changeable message sign shall be limited to not more than two messages. Techniques of message display such as fading, exploding, dissolving, or moving messages shall not be used.

**Section 2E.22 Overhead Sign Installations****Support:**

Specifications for the design and construction of structural supports for highway signs have been standardized by the American Association of State Highway and Transportation Officials (AASHTO). Overcrossing structures can often serve for the support of overhead signs, and might in some cases be the only practical location that will provide adequate viewing distance. Use of these structures as sign supports will eliminate the need for additional sign supports along the roadside. Factors justifying the installation of overhead signs are given in Section 2A.17. Vertical clearance of overhead signs is discussed in Section 2A.18.

**Figure 2E-10. EXIT ONLY Panels for Right Lane Dropped at an Interchange**



### **Section 2E.23 Lateral Offset**

#### **Standard:**

**The minimum lateral clearance outside the usable roadway shoulder for ground-mounted freeway and expressway signs or for overhead sign supports, either to the right or left side of the roadway, shall be 1.8 m (6 ft). This minimum clearance shall also apply outside of a barrier curb. If located within the clear zone, the signs shall be mounted on crashworthy supports or shielded by appropriate crashworthy barriers.**

#### **Guidance:**

Where practical, a sign should not be less than 3 m (10 ft) from the edge of the nearest traffic lane. Large guide signs especially should be farther removed, preferably 9 m (30 ft) or more from the nearest traffic lane.

Where an expressway median is 3.7 m (12 ft) or less in width, consideration should be given to spanning both roadways without a center support.

Where overhead sign supports cannot be placed a reasonably safe distance away from the line of traffic or in an otherwise protected site, they should either be designed to minimize the impact forces, or be adequately shielded by a physical barrier or guardrail of suitable design.

#### **Standard:**

**Butterfly-type sign supports and other overhead noncrashworthy sign supports shall not be installed in gores or other unprotected locations within the clear zone.**

#### **Option:**

Lesser clearances, but not generally less than 1.8 m (6 ft), may be used on connecting roadways or ramps at interchanges.

### **Section 2E.24 Guide Sign Classification**

#### **Support:**

Freeway and expressway guide signs are classified and treated in the following categories:

- A. Route signs and Trailblazer Assemblies (see Section 2E.25);
- B. At-Grade Intersection signs (see Section 2E.26);
- C. Interchange signs (see Sections 2E.27 through 2E.36);
- D. Interchange Sequence signs (see Section 2E.37);
- E. Community Interchanges Identification signs (see Section 2E.38);
- F. NEXT X EXITS signs (see Section 2E.39);
- G. General Service signs (see Section 2E.51);
- H. Rest and Scenic Area signs (see Section 2E.52);
- I. Tourist Information and Welcome Center signs (see Section 2E.53);
- J. Reference Location Signs (see Section 2E.54);
- K. Miscellaneous guide signs (see Section 2E.55);
- L. Radio Information signing (see Section 2E.56);
- M. Carpool and Ridesharing signing (see Section 2E.57);
- N. Weigh Station signing (see Section 2E.58);
- O. Specific Service signs (see Chapter 2F); and
- P. Recreational and Cultural Interest Area signs (see Chapter 2H).

### **Section 2E.25 Route Signs and Trailblazer Assemblies**

#### **Standard:**

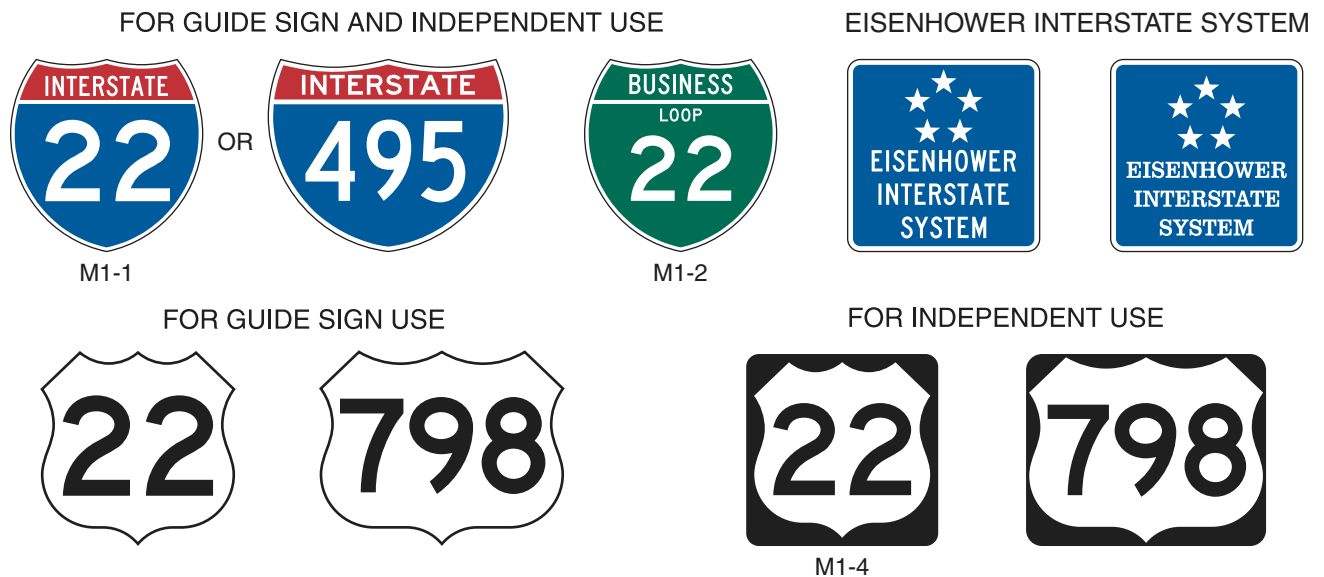
**The official Route sign for the Interstate Highway System shall be the red, white, and blue retroreflective distinctive shield adopted by the American Association of State Highway and Transportation Officials (see Section 2D.11).**

#### **Guidance:**

Route signs (see Figure 2E-11) should be incorporated as cut-out shields or other distinctive shapes on large directional guide signs. Where the Interstate shield is displayed in an assembly or on the face of a guide sign with U.S. or State Route signs, the Interstate numeral should be at least equal in size to the numerals on the other Route signs. The use of independent Route signs should be limited primarily to route confirmation assemblies.

Route signs and auxiliary signs showing junctions and turns should be used for guidance on approach roads, for route confirmation just beyond entrances and exits, and for reassurance along the freeway or expressway. When used along the freeway or expressway, the Route signs should be enlarged as shown in the "Standard Highway Signs" book (see Section 1A.11). When independently mounted Route signs are used in place of Pull-Through signs, they should be located just beyond the exit.



**Figure 2E-11. Interstate and U.S. Route Signs****Option:**

The standard Trailblazer Assembly (see Section 2D.32) may be used on roads leading to the freeway or expressway. Component parts of the Trailblazer Assembly may be included on a single sign panel. Independently mounted Route signs may be used instead of Pull-Through signs as confirmation information (see Section 2E.11). The commonly used name or trailblazer symbol for a toll facility may be displayed on nontoll sections of the Interstate Highway System at:

- A. The last exit before entering a toll section of the Interstate Highway System;
- B. The interchange or connection with a toll facility, whether or not the toll facility is a part of the Interstate Highway System; and
- C. Other locations within a reasonable approach distance of toll facilities when the name or trailblazer symbol for the toll facility would provide better guidance to road users unfamiliar with the area than would place names and route numbers.

The toll facility name or symbol may be included as a part of the guide sign installations on intersecting highways and approach roads to indicate the interchange with a toll section of an Interstate route. Where needed for the proper direction of traffic, a trailblazer for a toll facility that is part of the Interstate Highway System may be displayed with the Interstate Trailblazer Assembly.

**Section 2E.26 Signs for Intersections at Grade****Guidance:**

If there are intersections at grade within the limits of an expressway, guide sign types specified in Chapter 2D should be used. However, such signs should be of a size compatible with the size of other signing on the expressway.

**Option:**

Advance Guide signs for intersections at grade may take the form of diagrammatic layouts depicting the geometrics of the intersection along with essential directional information.

**Section 2E.27 Interchange Guide Signs****Standard:**

**The signs at interchanges and on their approaches shall include Advance Guide signs and Exit Direction signs. Consistent destination messages shall be displayed on these signs.**

**Guidance:**

New destination information should not be introduced into the major sign sequence for one interchange, nor should destination information be dropped.

Reference should be made to Section 2E.10 and Sections 2E.30 through 2E.39 for a detailed description of the signs in the order that they should appear at the approach to and beyond each interchange. Guide signs placed in advance of an interchange deceleration lane should be spaced at least 245 m (800 ft) apart.

Supplemental guide signing should be used sparingly as provided in Section 2E.32.

### **Section 2E.28 Interchange Exit Numbering**

Support:

Interchange exit numbering provides valuable orientation for the road user on a freeway or expressway. The feasibility of numbering interchanges or exits on an expressway will depend largely on the extent to which grade separations are provided. Where there is appreciable continuity of interchange facilities, interrupted only by an occasional intersection at grade, the numbering will be helpful to the expressway user.

**Standard:**

**Interchange numbering shall be used in signing each freeway interchange exit. Interchange exit numbers shall be displayed with each Advance Guide sign, Exit Direction sign, and Gore sign. The exit number shall be displayed on a separate plaque at the top of the Advance Guide or Exit Direction sign. The standard exit number plaque shall include the word EXIT, the appropriate exit number, and the suffix letter (on multi-exit interchanges) separated from the exit number by a space in a single-line format on a plaque 750 mm (30 in) in height. Exit numbers shall not include the cardinal initials corresponding to the directions of the cross route. Minimum numeral and letter sizes are given in Tables 2E-1 through 2E-4. If used, the interchange numbering system for expressways shall conform to the provisions prescribed for freeways.**

Option:

There are two approaches to interchange exit numbering that the State and local highway agencies may use: (1) reference location sign numbering or (2) consecutive numbering.

Support:

Reference location sign exit numbering is preferred over consecutive exit numbering for two reasons: (1) if new interchanges are added to a route, the highway agencies do not have to change the numbering sequence; and (2) reference location sign numbering assists road users in determining their destination distances and travel mileage.

Exit numbers may also be used with Supplemental Guide signs and Road User Service signs.

Guidance:

Exit number plaques should be located toward the top left edge of the sign for a left exit and toward the top right edge for right exits.

Because road users might not expect a left exit and might have difficulty in maneuvering to the left, the word LEFT should be added to the exit number plaque (see Figure 2E-3). Where a left exit is not numbered (no exit number plaque), a plaque with the word LEFT should be added to the top left edge of the sign.

Option:

The portion of the exit number plaque containing the word LEFT may have a black legend and border on a yellow background.

Support:

The general plan for numbering interchange exits is shown in Figures 2E-12 through 2E-14.

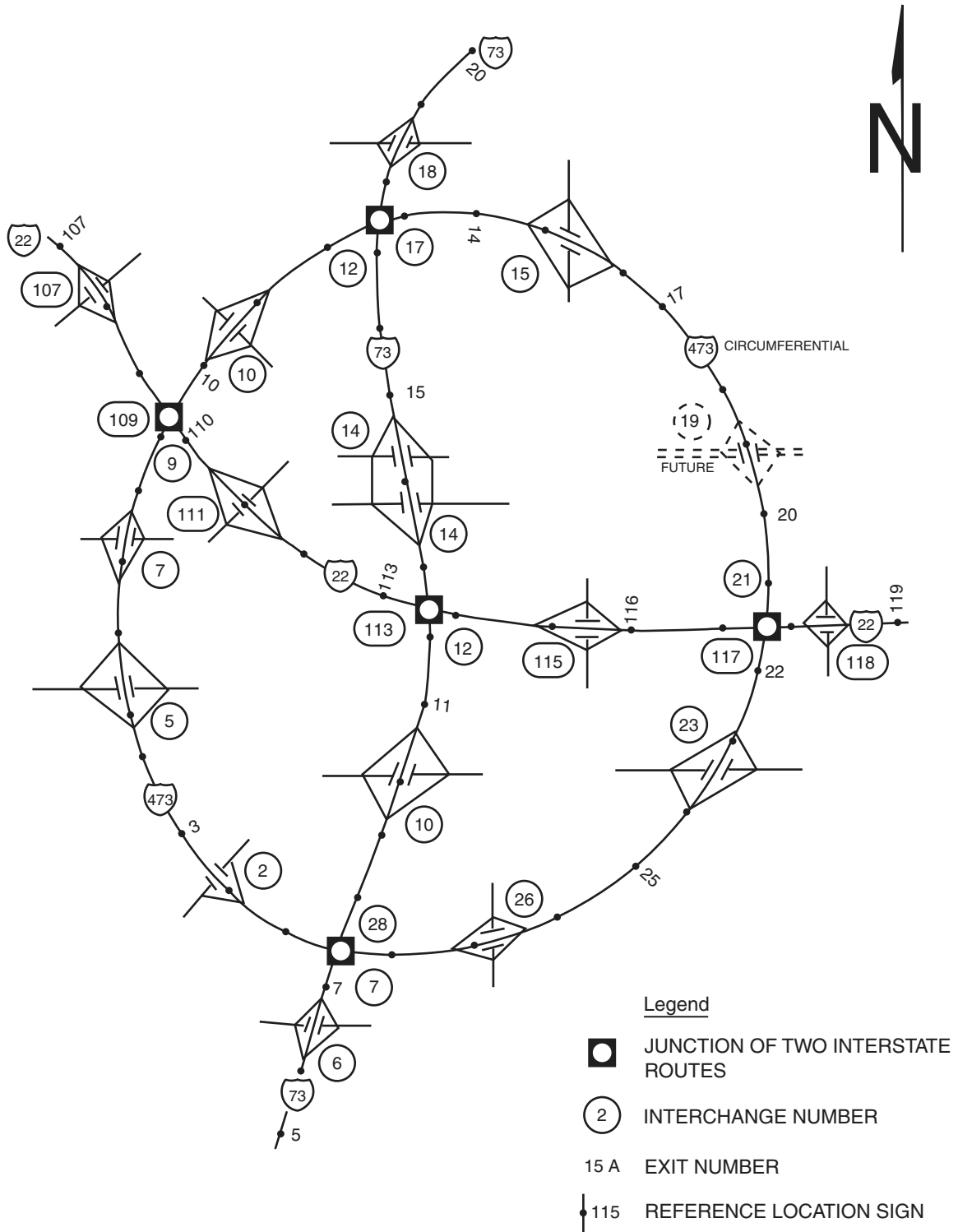
Example exit number plaque designs are shown in Figures 2E-3 and 2E-15. Figures 2E-1, 2E-20, 2E-23, 2E-27 through 2E-32, and 2E-42 illustrate the incorporation of exit number plaques on guide signs.

**Standard:**

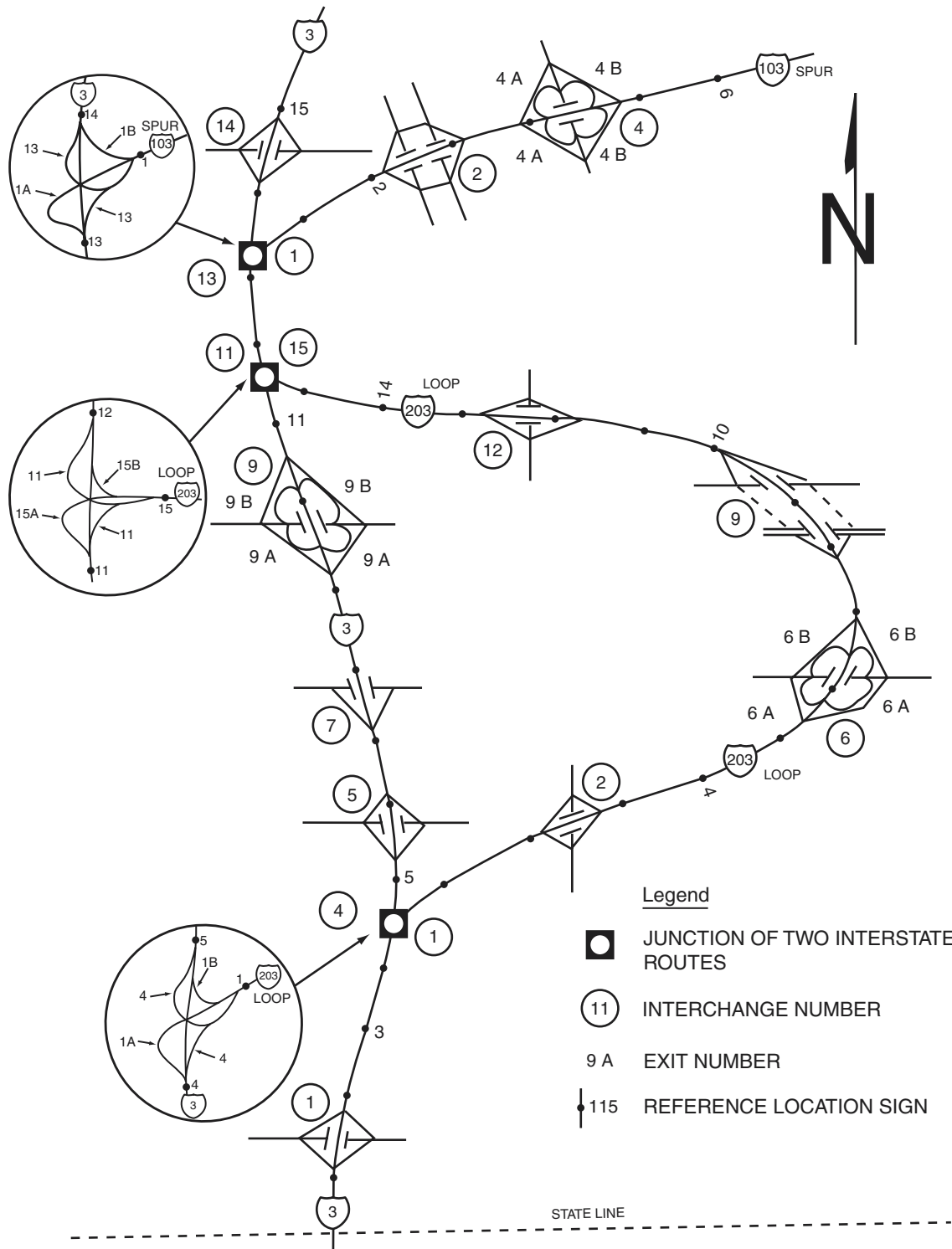
**Where a route originates within a State, the southernmost or westernmost terminus shall be the beginning point for numbering. If a loop, spur, or circumferential route crosses State boundaries, the sequence of numbering shall be coordinated by the States to provide continuous numbering.**

**For circumferential routes, the numbering of interchanges shall be in a clockwise direction. The numbering shall begin with the first interchange west of the south end of an imaginary north-south line bisecting the circumferential route, at a radial freeway or other Interstate route, or some other conspicuous landmark in the circumferential route near a south polar location (see Figure 2E-12). The interchange numbers on loop routes shall begin at the loop interchange nearest the south or west mainline junction and increase in magnitude toward the north or east mainline junction (see Figure 2E-13). Spur route interchanges shall be numbered in ascending order starting at the interchange where the spur leaves the mainline of the principal route (see Figure 2E-13).**

**Figure 2E-12. Example of Interchange Numbering for Mainline and Circumferential Routes**



**Figure 2E-13. Example of Interchange Numbering for Mainline, Loop, and Spur Routes**



**Where numbered routes overlap, continuity of interchange numbering shall be established for only one of the routes (see Figure 2E-14). If one of the routes is an Interstate, the Interstate route shall maintain continuity of interchange numbering.**

Guidance:

The route chosen for continuity of interchange numbering should also have reference location sign continuity (see Figure 2E-14).

### **Section 2E.29 Interchange Classification**

Support:

For signing purposes, interchanges are classified as major, intermediate, and minor. The minimum alphabet sizes contained in Tables 2E-1 and 2E-3 are based on this classification. Descriptions of these classifications are as follows:

- A. Major interchanges are subdivided into two categories: (a) interchanges with other expressways or freeways, or (b) interchanges with high-volume multi-lane highways, principal urban arterials, or major rural routes where the volume of interchanging traffic is heavy or includes many road users unfamiliar with the area.
- B. Intermediate interchanges are those with urban and rural routes not in the category of major or minor interchanges.
- C. Minor interchanges include those where traffic is local and very light, such as interchanges with land service access roads. Where the sum of exit volumes is estimated to be lower than 100 vehicles per day in the design year, the interchange is classified as minor.

### **Section 2E.30 Advance Guide Signs**

Support:

The Advance Guide sign gives notice well in advance of the exit point of the principal destinations served by the next interchange and the distance to that interchange (see Figure 2E-15).

Guidance:

For major and intermediate interchanges (see Section 2E.29), Advance Guide signs should be placed at 1 km or 0.5 miles and at 2 km or 1 mile in advance of the exit with a third Advance Guide sign placed at 4 km (2 mi) in advance of the exit if spacing permits. At minor interchanges, only one Advance Guide sign should be used. It should be located 1 to 2 km or 0.5 to 1 mile from the exit gore. If the sign is located less than 1 km or 0.5 miles from the exit, the distance shown should be to the nearest 400 m or 1/4 mile. Fractions of kilometers or decimals of kilometers should not be used. Fractions of a mile, rather than decimals, should be shown in all cases.

Where Advance Guide signs are provided for a left exit, diagrammatic signs should be used (see Figure 2E-3).

**Standard:**

**When used, Advance Guide signs shall contain the distance message. The legend on the Advance Guide signs shall be the same as the legend on the Exit Direction sign, except that the last line shall read EXIT X km (EXIT X MILES). If the interchange has two or more exit roadways, the bottom line shall read EXITS X km (EXITS X MILES).**

Option:

Where interchange exit numbers are used, the word EXIT may be omitted from the bottom line. Where the distance between interchanges is more than 2 km or 1 mile, but less than 4 km or 2 miles, the first Advance Guide sign may be closer than 4 km or 2 miles, but not placed so as to overlap the signing for the previous exit. Duplicate Advance Guide signs or Interchange Sequence Series signs may be placed in the median on the opposite side of the roadway and are not included in the minimum requirements of interchange signing.

Guidance:

Where there is less than 245 m (800 ft) between interchanges, Interchange Sequence Series signs should be used instead of Advance Guide signs for the affected interchanges.

### **Section 2E.31 Next Exit Supplemental Signs**

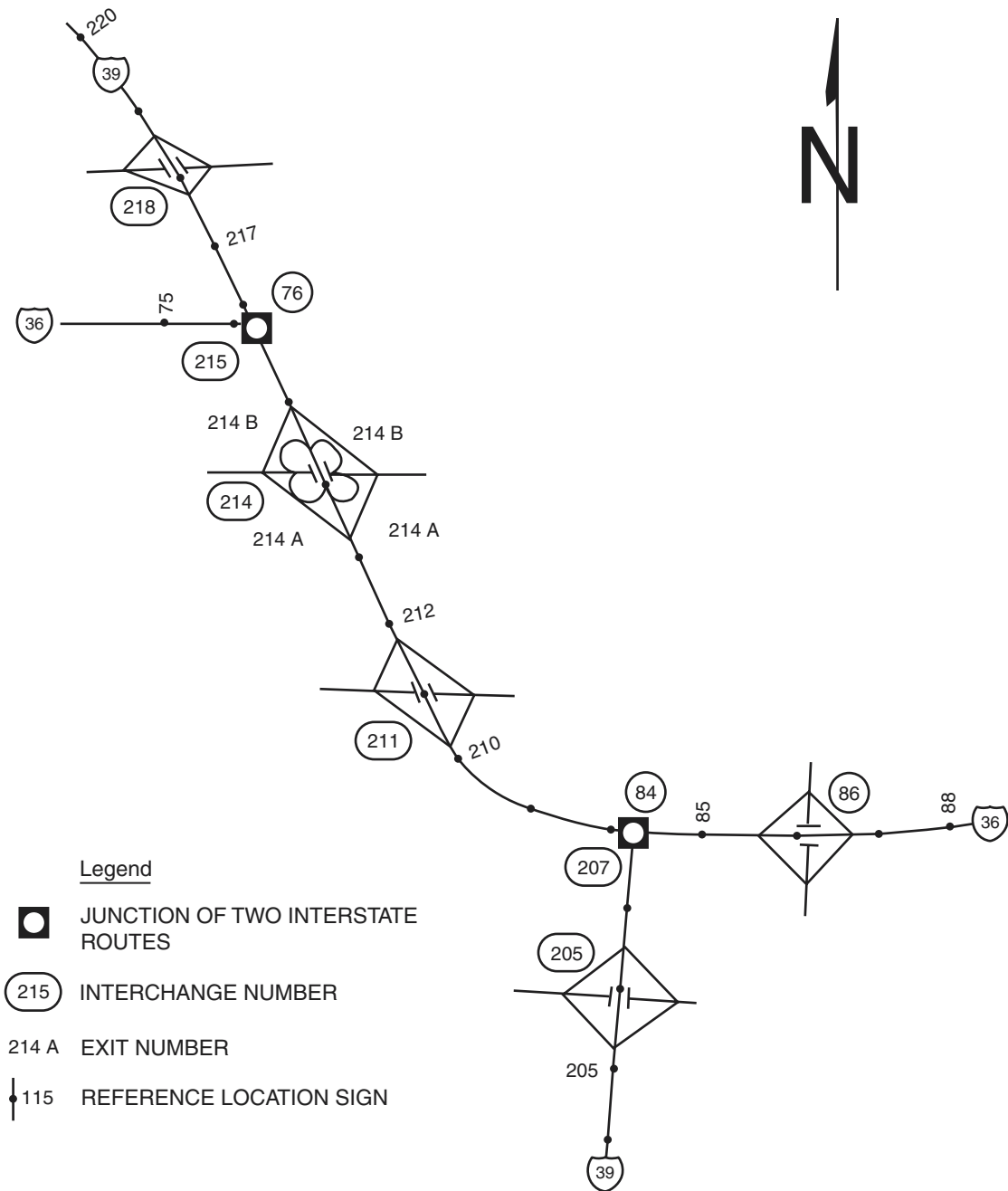
Option:

Where the distance to the next interchange is unusually long, Next Exit supplemental signs may be installed to inform road users of the distance to the next interchange (see Figure 2E-16).

Guidance:

The Next Exit supplemental sign should not be used unless the distance between successive interchanges is more than 8 km (5 mi).

**Figure 2E-14. Example of Interchange Numbering If Routes Overlap**



**Figure 2E-15. Examples of Interchange Advance Guide Signs**



E1-1

E1-1a

Note: Delete word EXIT(S) if exit number is used.



E1-2

E1-2a



E1-5  
Exit Number Plaque



**Figure 2E-16. Next Exit Supplemental Advance Guide Signs**

E2-1



E2-1A

**Standard:**

The Next Exit supplemental sign shall carry the legend NEXT EXIT X km (X MILES). If the Next Exit supplemental sign is used, it shall be placed below the Advance Guide sign nearest the interchange. It shall be mounted so as to not adversely affect the breakaway feature of the sign support structure.

**Option:**

The legend for the Next Exit supplemental sign may be displayed in either one or two lines. The one-line message is the more desirable choice unless the message causes the sign to have a horizontal dimension greater than that of the Advance Guide sign.

**Section 2E.32 Other Supplemental Guide Signs****Support:**

Supplemental Guide signs can be used to provide information regarding destinations accessible from an interchange, other than places shown on the standard interchange signing. However, such Supplemental Guide signing can reduce the effectiveness of other more important guide signing because of the possibility of overloading the road user's capacity to receive visual messages and make appropriate decisions. "The AASHTO Guidelines for the Selection of Supplemental Guide Signs for Traffic Generators Adjacent to Freeways" is incorporated by reference in this section (see Page i for AASHTO's address).

**Guidance:**

No more than one Supplemental Guide sign should be used on each interchange approach.

A Supplemental Guide sign (see Figure 2E-17) should not list more than two destinations. Destination names should be followed by the interchange number (and suffix), or if interchanges are not numbered, by the legend NEXT RIGHT or SECOND RIGHT or both, as appropriate. The Supplemental Guide sign should be installed as an independent guide sign assembly.

Where two or more Advance Guide signs are used, the Supplemental Guide sign should be installed approximately midway between two of the Advance Guide signs. If only one Advance Guide sign is used, the Supplemental Guide sign should follow it by at least 245 m (800 feet). If the interchanges are numbered, the interchange number should be used for the action message.

States and other agencies should adopt an appropriate policy for installing supplemental signs using "The AASHTO Guidelines for the Selection of Supplemental Guide Signs for Traffic Generators Adjacent to Freeways." In developing policies for such signing, such items as population, amount of traffic generated, distance from the route, and the significance of the destination should be taken into account.

**Standard:**

Guide signs directing drivers to park and ride facilities shall be considered as Supplemental Guide signs (see Figures 2E-18 and 2E-19).

**Figure 2E-17. Supplemental Guide Signs for Multi-exit Interchanges**



**Figure 2E-18. Supplemental Guide Sign for a Park and Ride Facility  
(Route without Exit Numbering)**



**Figure 2E-19. Supplemental Guide Sign for a Park and Ride Facility  
(Route with Exit Numbering)**



**Figure 2E-20. Interchange Exit Direction Sign**



### **Section 2E.33 Exit Direction Signs**

#### **Support:**

The Exit Direction sign repeats the route and destination information that was shown on the Advance Guide sign(s) for the next exit, and thereby assures road users of the destination served and indicates whether they exit to the right or the left for that destination.

#### **Standard:**

**Exit Direction signs (see Figure 2E-20) shall be used at major and intermediate interchanges. Population figures or other similar information shall not be used on Exit Direction signs.**

#### **Guidance:**

Exit Direction signs should be used at minor interchanges.

Ground-mounted Exit Direction signs should be installed at the beginning of the deceleration lane. If there is less than 90 m (300 ft) from the beginning of the deceleration lane to the theoretical gore (see Figure 3B-8), the Exit Direction sign should be installed overhead over the exiting lane in the vicinity of the theoretical gore.

#### **Standard:**

**Where a through lane is being terminated (dropped) at an exit, the Exit Direction sign shall be placed overhead at the theoretical gore (see Figures 2E-8 and 2E-10).**

**The following provisions shall govern the design and application of the overhead Exit Direction sign:**

- A. The sign shall carry the exit number (if used), the route number, cardinal direction, and destination with an appropriate upward slanting arrow (see Figure 2E-20).**
- B. The message EXIT ONLY in black on a yellow panel shall be used on the overhead Exit Direction sign to advise road users of a lane drop situation. The sign shall conform to the provisions of Section 2E.20.**
- C. Diagrammatic signs shall not be employed at the exit direction location.**

#### **Guidance:**

Exit number plaques should be located toward the left edge of the sign for a left exit and toward the right edge for right exits.

#### **Option:**

In some cases, principally in urban areas, where restricted sight distance because of structures or unusual alignment make it impossible to locate the Exit Direction sign without violating the required minimum spacing (see Section 2E.30) between major guide signs, Interchange Sequence signs (see Section 2E.37) may be substituted for an Advance Guide sign.

#### **Guidance:**

At multi-exit interchanges, the Exit Direction sign should be located directly over the exiting lane for the first exit. At the same location, and normally over the right through lane, an Advance Guide sign for the second exit should be located. Only for those conditions where the through movement is not evident should a confirmatory message (Pull-Through sign as shown in Figure 2E-2) be used over the left lane(s) to guide road users traveling through an interchange. In the interest of sign spreading, three signs on one structure should not be used. When the freeway or expressway is on an overpass, the Exit Direction sign should be installed on an overhead support over the exit lane in advance of the gore point.

#### **Option:**

If the second exit is beyond an underpass, the Exit Direction sign may be mounted on the face of the overhead structure.

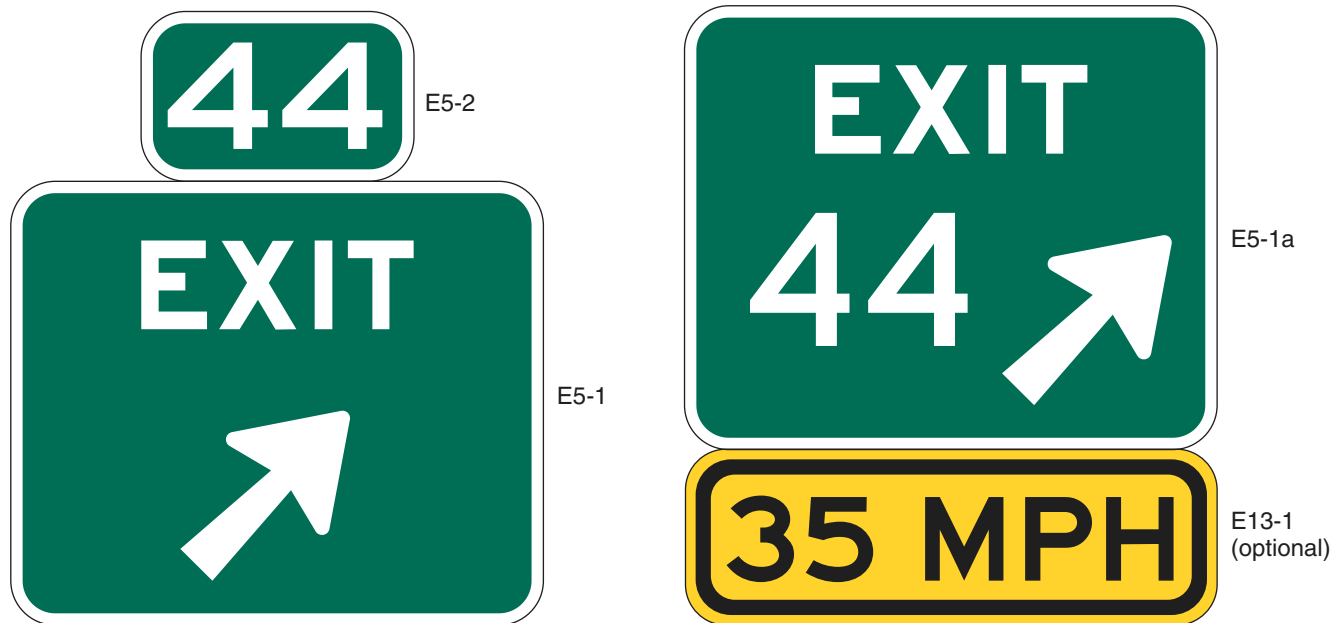
### **Section 2E.34 Exit Gore Signs**

#### **Support:**

The Exit Gore sign in the gore indicates the exiting point or the place of departure from the main roadway. Consistent application of this sign at each exit is important.

#### **Standard:**

**The gore shall be defined as the area located between the main roadway and the ramp just beyond where the ramp branches from the main roadway. The Exit Gore sign shall be located in the gore and shall carry the word EXIT or EXIT XX (if interchange numbering is used) and an appropriate upward slanting arrow (see Figure 2E-21). Breakaway or yielding supports shall be used.**

**Figure 2E-21. Exit Gore Signs****Guidance:**

The arrow should be aligned to approximate the angle of departure. Each gore should be treated similarly, whether the interchange has one exit roadway or multiple exits.

**Option:**

Where extra emphasis of an especially low advisory ramp speed is needed, an E13-1 panel indicating the advisory speed may be mounted below the Exit Gore sign (see Figure 2E-21) to supplement, but not to replace, the exit or ramp advisory speed warning signs.

**Section 2E.35 Post-Interchange Signs****Guidance:**

If space between interchanges permits, as in rural areas, and where undue repetition of messages will not occur, a fixed sequence of signs should be displayed beginning 150 m (500 ft) beyond the end of the acceleration lane. At this point a Route sign assembly should be installed followed by a Speed Limit sign and a Distance sign, each at a spacing of 300 m (1,000 ft).

If space between interchanges does not permit placement of these three post-interchange signs without encroaching on or overlapping the Advance Guide signs necessary for the next interchange, or in rural areas where the interchanging traffic is primarily local, one or more of the post-interchange signs should be omitted.

**Option:**

Usually the Distance sign will be of less importance than the other two signs and may be omitted, especially if Interchange Sequence signs are used. If the sign for through traffic on an overhead assembly already contains the route sign, the post-interchange route sign assembly may also be omitted.

**Section 2E.36 Distance Signs****Standard:**

If used, the post-interchange Distance sign shall consist of a two- or three-line sign carrying the names of significant destination points and the distances to those points. The top line of the sign shall identify the next meaningful interchange with the name of the community near or through which the route passes, or if there is no community, the route number or name of the intersected highway (see Figure 2E-22).

**Support:**

The minimum sizes of the route shields identifying a significant destination point are prescribed in Tables 2E-1 through 2E-4.

**Figure 2E-22. Post-Interchange Distance Sign****Option:**

The text identification of a route may be shown instead of a route shield, such as "US XX", "State Route XX", or "County Route X".

**Guidance:**

If a second line is used, it should be reserved for communities of general interest that are located on or immediately adjacent to the route or for major traffic generators along the route.

**Option:**

The choice of names for the second line, if it is used, may be varied on successive Distance signs to give road users maximum information concerning communities served by the route.

**Standard:**

**The third, or bottom line, shall contain the name and distance to a control city (if any) that has national significance for travelers using the route.**

**Guidance:**

Distances to the same destinations should not be shown more frequently than at 8 km (5 mi) intervals. The distances displayed on these signs should be the actual distance to the destination points and not to the exit from the freeway or expressway.

**Section 2E.37 Interchange Sequence Signs****Guidance:**

If there is less than 245 m (800 ft) between interchanges, Interchange Sequence signs should be used instead of the Advance Guide signs for the affected interchanges. If used, Interchange Sequence signs should be used over the entire length of a route in an urban area. They should not be used on a single interchange basis.

**Option:**

If interchanges are closely spaced, particularly through large urban areas, so that guide signs cannot be adequately spaced, Interchange Sequence signs identifying the next two or three interchanges may be used.

**Support:**

Interchange Sequence signs are generally supplemental to Advance Guide signs. Signing of this type is illustrated in Figures 2E-23 and 2E-24, and is compatible with the sign spreading concept.

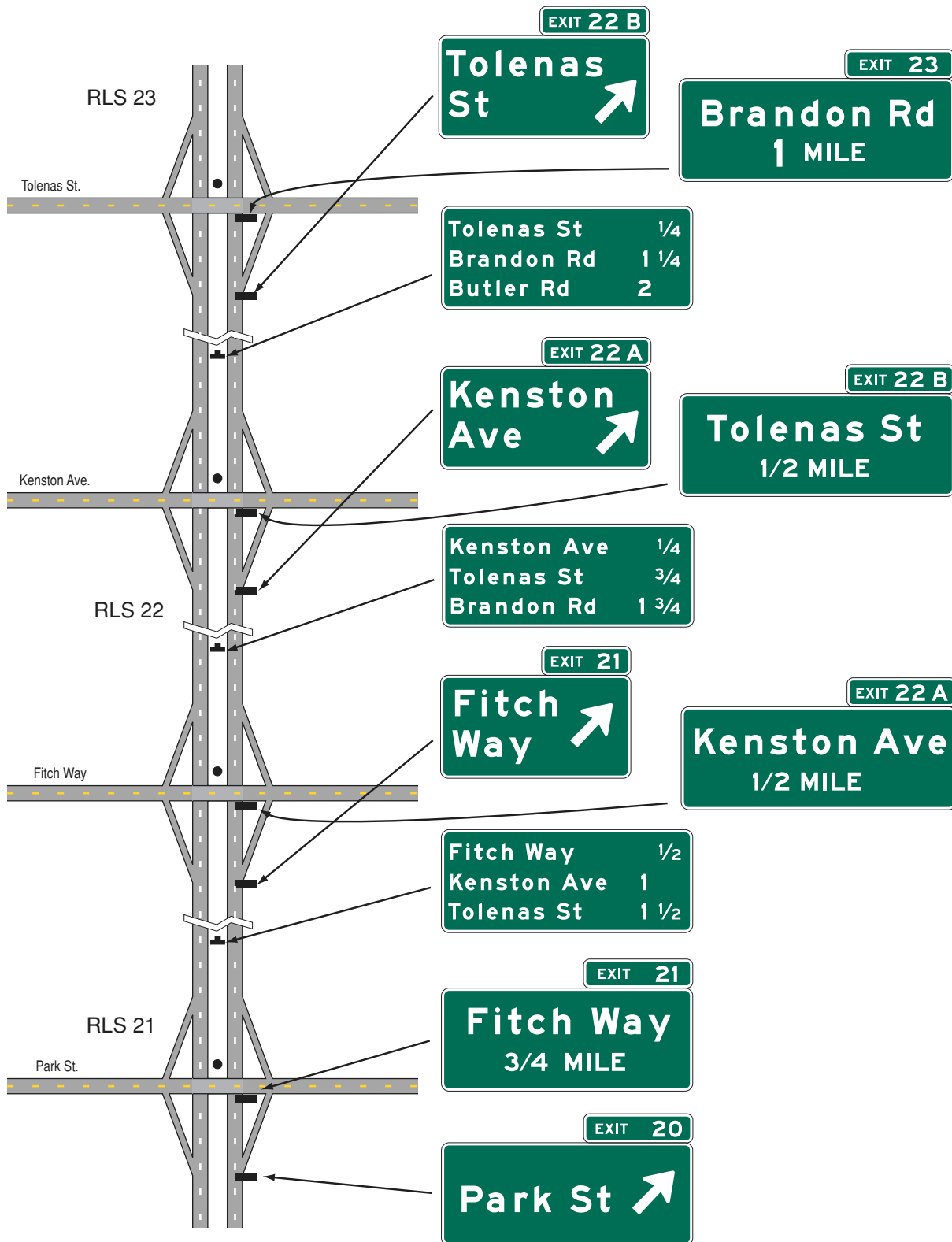
These signs are installed in a series and display the next two or three interchanges by name or route number with distances to the nearest 400 m or 1/4 mile.

**Standard:**

**If used, the first sign in the series shall be located in advance of the first Advance Guide sign for the first interchange.**

**Where the exit direction is to the left, interchange names or route numbers shown on such signs shall be followed by the legend LEFT or LEFT EXIT in black letters on a yellow rectangular background.**

**Figure 2E-23. Signing of Closely Spaced Interchanges Using Interchange Sequence Signs**





*Figure 2E-24. Interchange Sequence Sign**Figure 2E-25. Community Interchanges Identification Sign**Figure 2E-26. NEXT EXITS Sign*

**Interchange Sequence signs shall not be substituted for Exit Direction signs.**

**Guidance:**

Interchange Sequence signs should be located in the median. After the first of the series, Interchange Sequence signs should be placed approximately midway between interchanges.

**Standard:**

**Interchange Sequence signs located in the median shall be installed at overhead sign height.**

**Option:**

Interchange numbers may be shown to the left of the interchange name or route number.

**Section 2E.38 Community Interchanges Identification Signs**

**Support:**

For suburban or rural communities served by two or three interchanges, Community Interchanges Identification signs are useful (see Figure 2E-25).

**Guidance:**

In these cases, the name of the community followed by the word EXITS should be shown on the top line; the lines below should display the destination, road name or route number, and the corresponding distances to the nearest 400 m or 1/4 mile.

The sign should be located in advance of the first Advance Guide sign for the first interchange within the community.

**Option:**

If interchanges are not conveniently identifiable or if there are more than three interchanges to be identified, the NEXT X EXITS sign (see Section 2E.39) may be used.

**Section 2E.39 NEXT X EXITS Sign**

**Support:**

Many freeways or expressways pass through historical or recreational regions, or urban areas served by a succession of several interchanges.

**Option:**

Such regions or areas may be indicated by a NEXT X EXITS sign (see Figure 2E-26) located in advance of the Advance Guide sign or signs for the first interchange.

**Guidance:**

The sign legend should identify the region or area followed by the words NEXT X EXITS.

**Section 2E.40 Signing by Type of Interchange**

**Support:**

Road users need signs to help identify the location of the exit, as well as to obtain route, direction, and destination information for specific exit ramps. Figures 2E-27 through 2E-32 show examples of guide signs for common types of interchanges. The interchange layouts shown in most of the figures illustrate only the major guide signs for one direction of traffic on the through road and on the crossroad.

**Standard:**

**Interchange guide signing shall be consistent for each type of interchange along a route.**

**Guidance:**

The signing layout for all interchanges having only one exit ramp in the direction of travel should be similar, regardless of the interchange type (see Figures 2E-8, 2E-10, and Figures 2E-27 through 2E-32). For the sake of uniform application, the significant features of the signing plan for each of the more frequent kinds of interchanges (illustrated in Figures 2E-27 through 2E-32) should be followed as closely as possible. Even when unusual geometric features exist, variations in signing layout should be held to a minimum.

**Section 2E.41 Freeway-to-Freeway Interchange**

**Support:**

Freeway-to-freeway interchanges are major decision points where the effect of taking a wrong ramp cannot be easily corrected. Reversing direction on the connecting freeway or reentering to continue on the intended course is usually not possible. Figure 2E-27 shows examples of guide signs at a freeway-to-freeway interchange.

Figure 2E-27. Examples of Freeway-to-Freeway Interchange Guide Signs

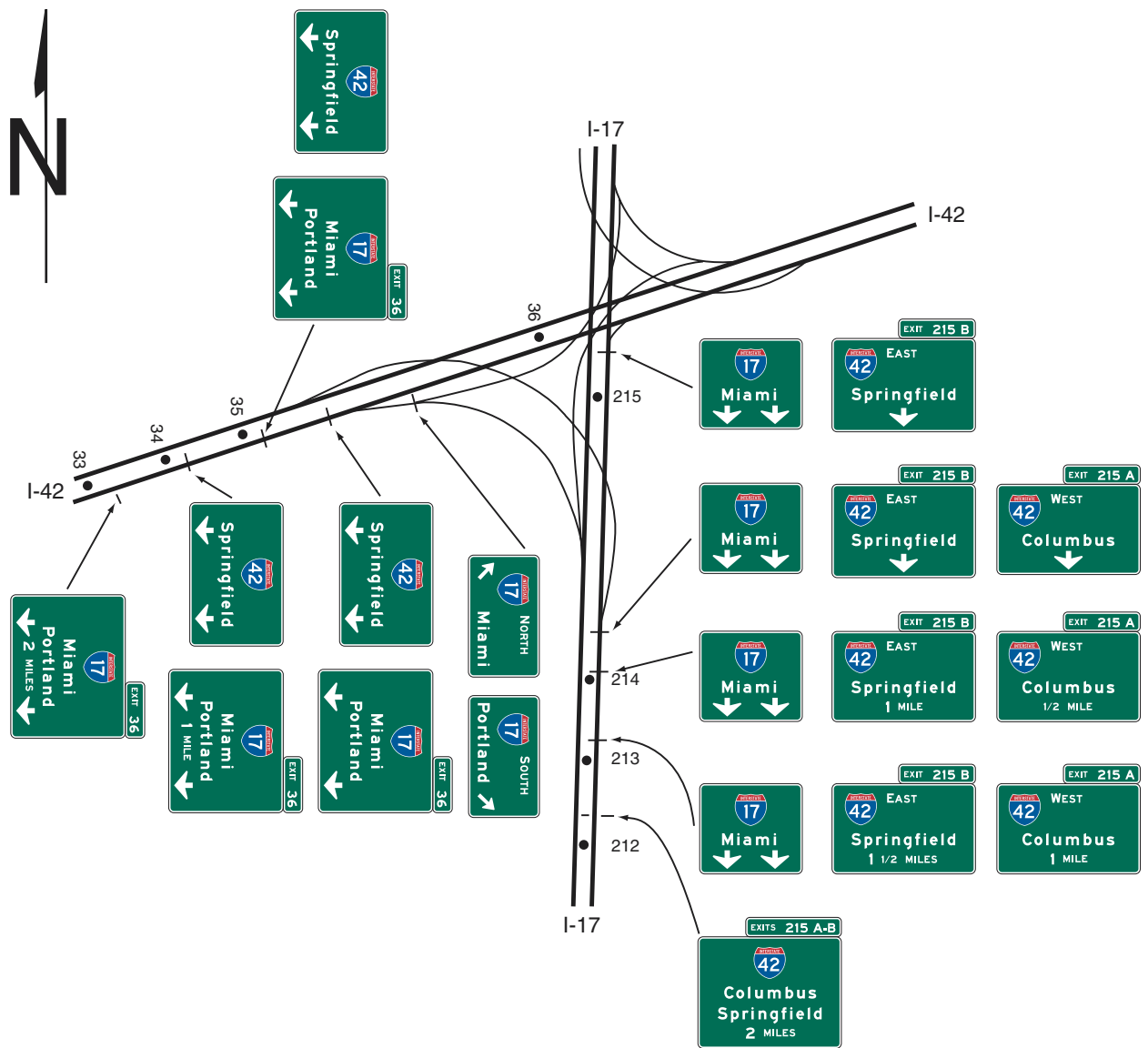
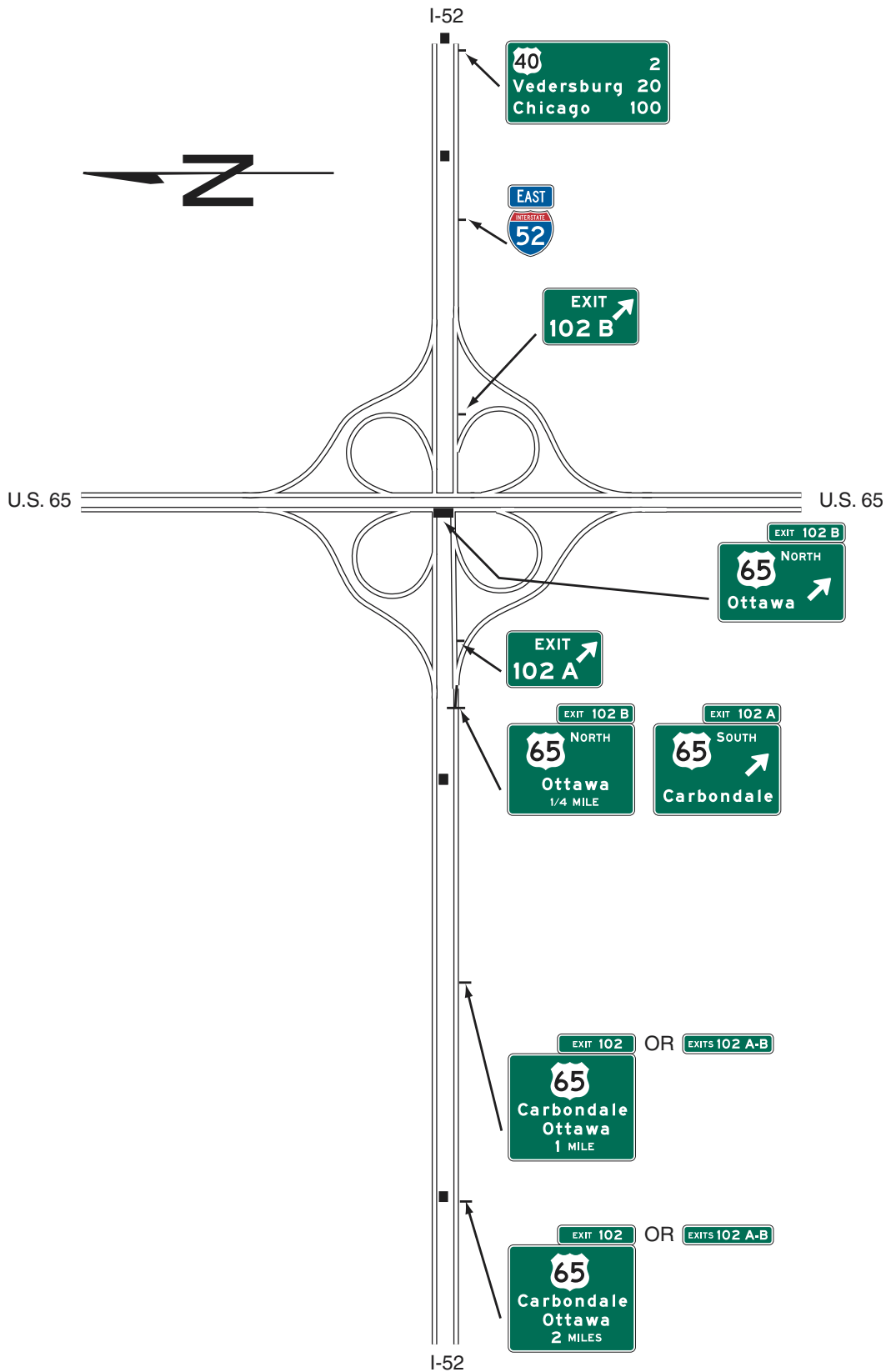
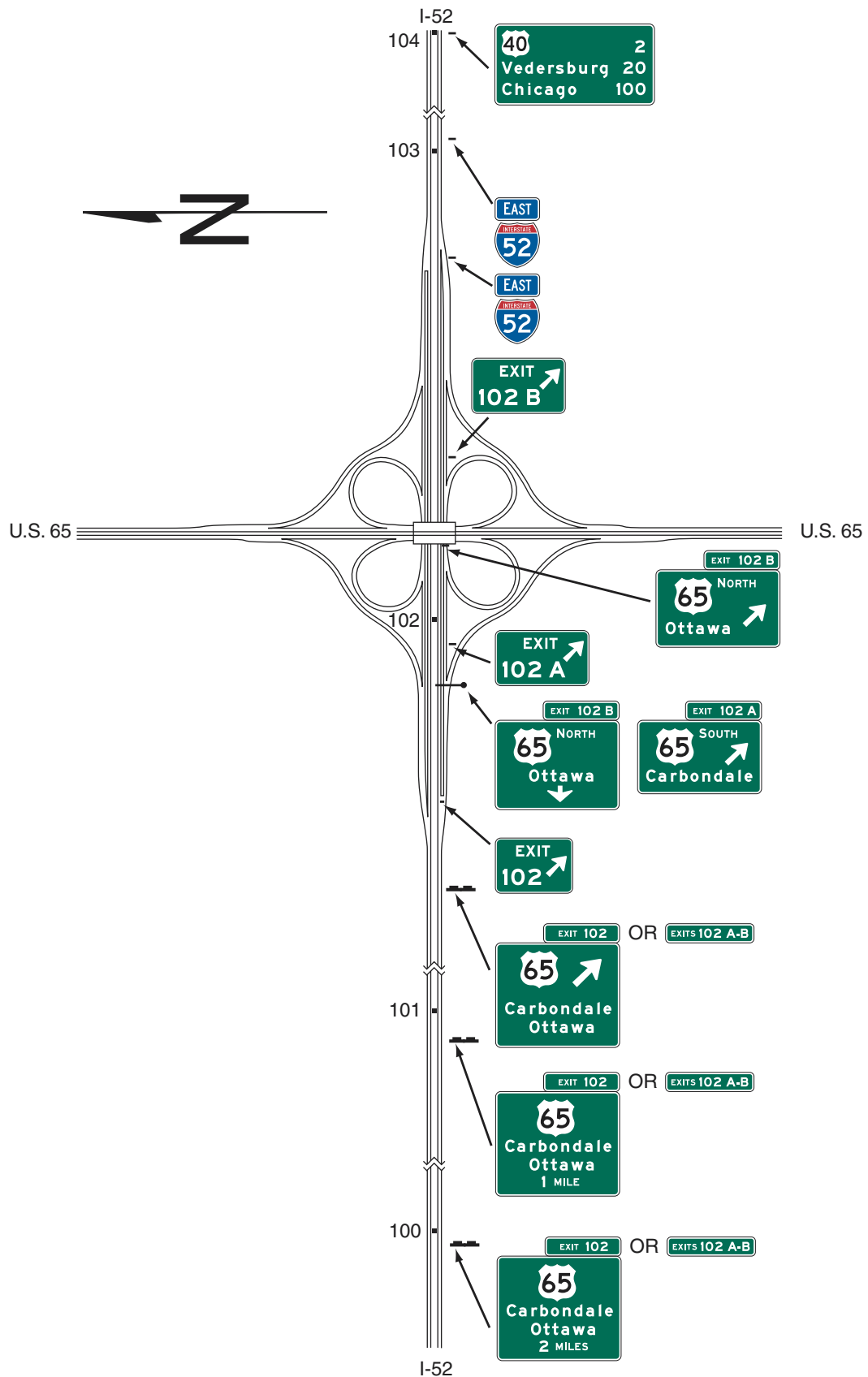


Figure 2E-28. Examples of Guide Signs for Full Cloverleaf Interchange



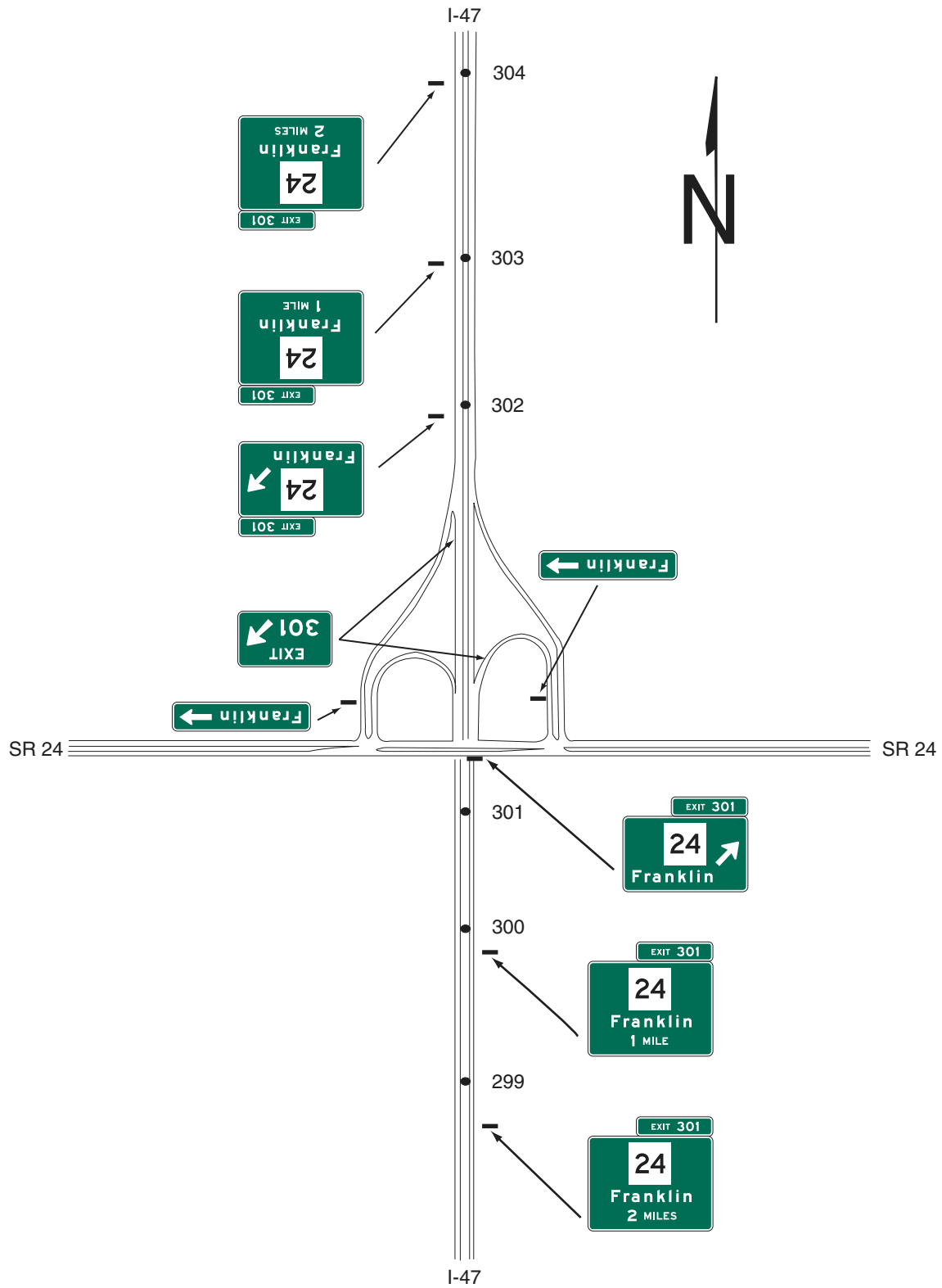
Note: See Figure 2E-38 for examples of multi-lane crossroad signing for cloverleaf interchanges

**Figure 2E-29. Examples of Guide Signs for Full Cloverleaf Interchange With Collector-Distributor Roadways**



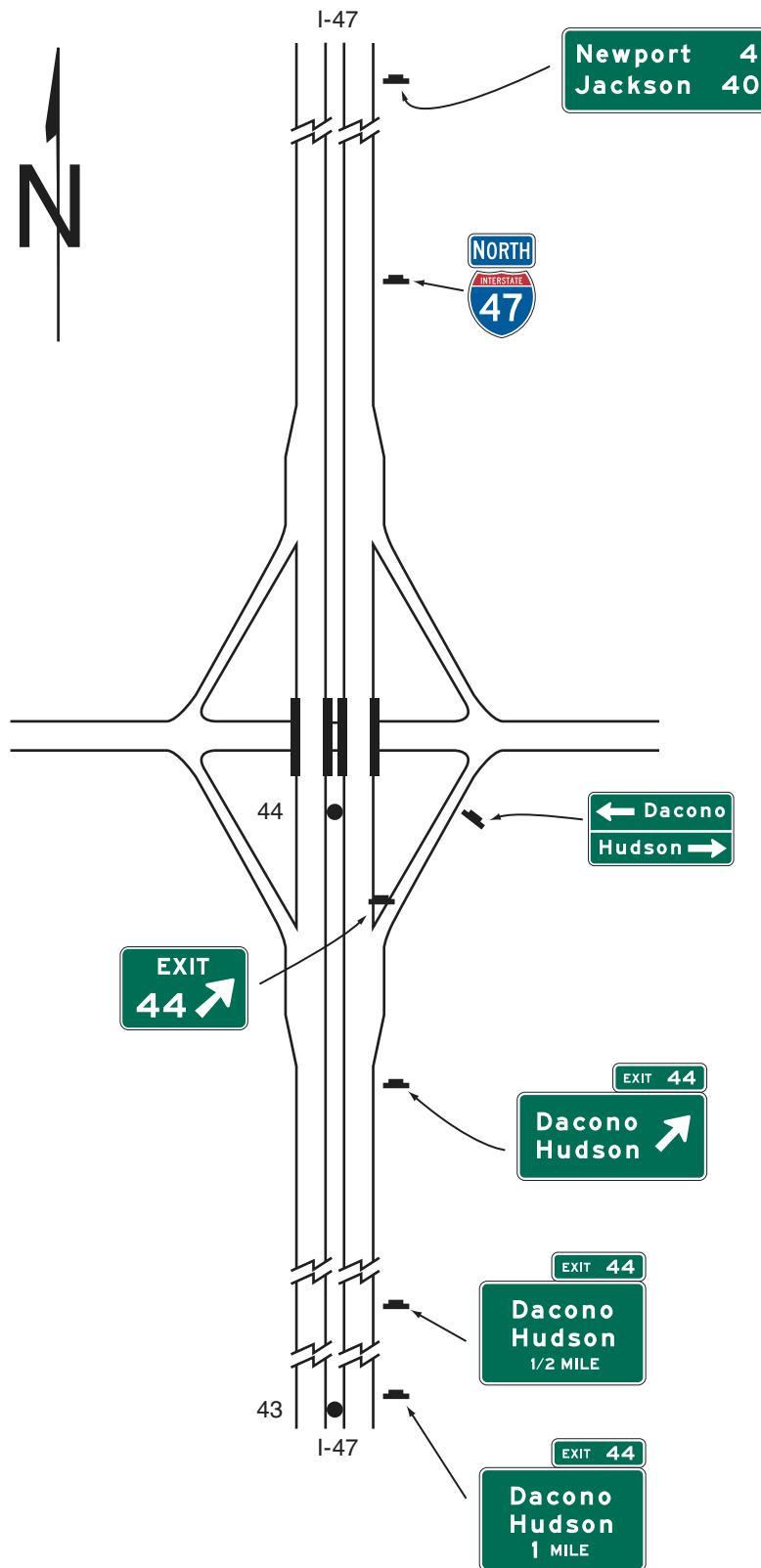
Note: See Figure 2E-38 for examples of multi-lane crossroad signing for cloverleaf interchanges

Figure 2E-30. Examples of Partial Cloverleaf Interchange Guide Signs



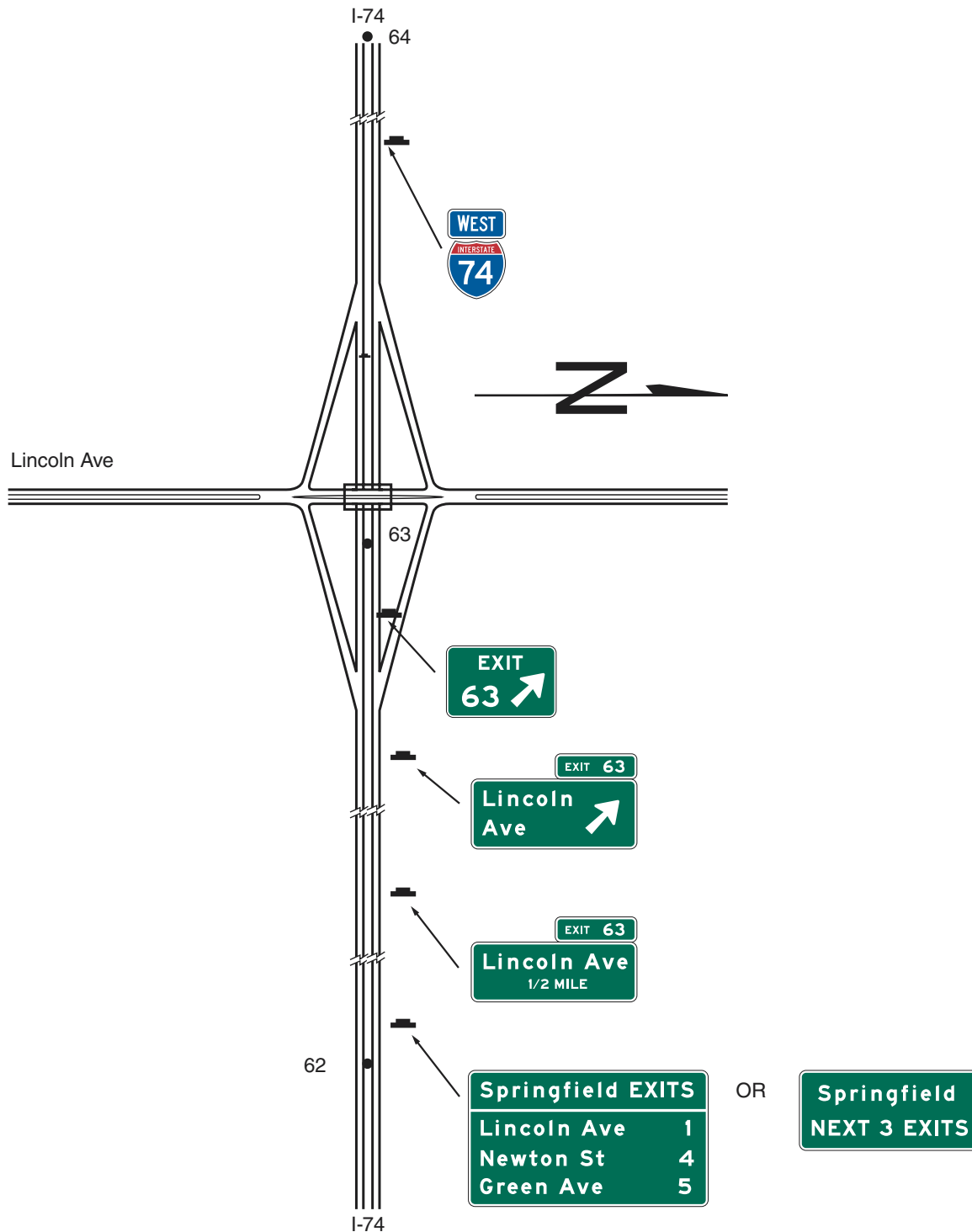
Note: See Figure 2E-37 for examples of multi-lane crossroad signing for partial cloverleaf interchanges

**Figure 2E-31. Examples of Diamond Interchange Guide Signs**



Note: See Figures 2E-34 and 2E-36 for examples of crossroad signing for one-lane approaches and examples of multi-lane crossroad signing for diamond interchanges

**Figure 2E-32. Examples of Diamond Interchange Guide Signs in an Urban Area**



Note: See Figures 2E-34 and 2E-36 for examples of crossroad signing for one-lane approaches and examples of multi-lane crossroad signing for diamond interchanges



**Guidance:**

The sign messages should contain only the route shield, cardinal direction, and the name of the next control city on the route. Arrows should point as indicated in Section 2D.08, unless a diagrammatic representation of the interchange layout requires otherwise.

At splits where the off-route movement is to the left or where there is an optional lane split, expectancy problems usually result, and diagrammatic signs should be used at the Advance Guide sign location. Diagrammatic signs (see Section 2E.19) also should be used at the Advance Guide sign locations for interchanges where two-lane exits with an optional lane carry the through route on the exiting lanes.

**Standard:**

**Overhead signs shall be used at a distance of 2 km or 1 mile and at the theoretical gore of each connecting ramp. When diagrammatic signs are used, they shall conform to the provisions of Section 2E.19.**

**Option:**

Overhead signs may also be used at the 1 km or 0.5 mile and 4 km or 2 mile points.

The arrow and/or the name of the control city may be omitted on signs that indicate the straight-ahead continuation of a route.

An Exit Speed sign may be used where an engineering study shows that it is necessary to display a speed reduction message for ramp signing (see Section 2C.36).

**Section 2E.42 Cloverleaf Interchange****Support:**

A cloverleaf interchange has two exits for each direction of travel. The exits are closely spaced and have common Advance Guide signs. Examples of guide signs for cloverleaf interchanges are shown in Figure 2E-28.

**Guidance:**

The Advance Guide signs should include two place names, one corresponding to each exit ramp, with the name of the place served by the first exit on the upper line.

**Standard:**

**An Overhead Guide sign shall be placed at the theoretical gore point of the first exit ramp, with an upward slanting arrow on the exit direction sign for that exit and the message XX km (XX MILE) on the Advance Guide sign for the second exit, as shown in Figure 2E-28. The second exit shall be indicated by an overhead Exit Direction sign over the auxiliary lane. An Exit sign shall also be used at each gore (see Section 2E.34).**

**Interchanges with more than one exit from the main line shall be numbered as described in Section 2E.28 with an appropriate suffix.**

**Diagrammatic signs shall not be used for cloverleaf interchanges.**

**Guidance:**

As shown in Figure 2E-28, the overhead Exit Direction sign for the second exit should be mounted on the structure if the mainline passes under the crossroad and the exit roadway is located beyond the structure.

**Section 2E.43 Cloverleaf Interchange with Collector-Distributor Roadways****Support:**

Examples of guide signs for full cloverleaf interchanges with collector-distributor roadways are shown in Figure 2E-29.

**Guidance:**

Signing on the collector-distributor roadways should be the same as the signing on the mainline of a cloverleaf interchange.

**Standard:**

**Guide signs at exits from the collector-distributor roadways shall be overhead and located at the theoretical gore of the collector-distributor roadway and the exit ramp.**

**Option:**

Exits from the collector-distributor roadways may be numbered with an appropriate suffix. The Advance Guide signs may include two place names and their corresponding exit numbers or may use the singular EXIT.

### **Section 2E.44 Partial Cloverleaf Interchange**

#### **Support:**

Examples of guide signs for partial cloverleaf interchanges are shown in Figure 2E-30.

#### **Guidance:**

As shown in Figure 2E-30, the overhead Exit Direction sign should be placed on the structure if the mainline passes under the crossroad and the exit roadway is located beyond the structure.

#### **Standard:**

**A ground-mounted Exit Gore sign shall also be installed in the ramp gore.**

### **Section 2E.45 Diamond Interchange**

#### **Support:**

Examples of guide signs for diamond interchanges are shown in Figure 2E-31.

#### **Standard:**

**The singular message EXIT shall be used on the Advance Guide and Exit Direction signs. Exit numbers shall not include the cardinal initials corresponding to the direction of the cross route.**

#### **Support:**

The typical diamond interchange ramp departs from the mainline roadway such that a speed reduction generally is not necessary in order for a driver to reasonably safely negotiate an exit maneuver from the mainline onto the ramp roadway.

#### **Guidance:**

When a speed reduction is not necessary, an exit speed sign should not be used.

#### **Option:**

An Exit Speed sign may be used where an engineering study shows that it is necessary to display a speed reduction message for ramp signing (see Section 2C.36).

#### **Guidance:**

The Exit Speed sign should be located along the deceleration lane or along the ramp such that it is visible to the driver far enough in advance so that a reasonably safe slowing and exiting maneuver can be made.

#### **Option:**

A Stop Ahead or Signal Ahead warning sign may be placed, where engineering judgment indicates a need, along the ramp in advance of the cross street, to give notice to the driver (see Section 2C.29).

#### **Guidance:**

When used on two-lane ramps, Stop Ahead or Signal Ahead signs should be used in pairs with one sign on each side of the ramp.

### **Section 2E.46 Diamond Interchange in Urban Area**

#### **Support:**

Examples of guide signs for diamond interchanges in an urban area are shown in Figure 2E-32. This example includes the use of the Community Interchanges Identification sign (see Section 2E.38) which might be useful if two or more interchanges serve the same community.

In urban areas, street names are often shown as the principal message in destination signs.

#### **Option:**

If interchanges are too closely spaced to properly locate the Advance Guide signs, they may be placed closer to the exit, and the distance figures adjusted accordingly.

### **Section 2E.47 Closely Spaced Interchanges**

#### **Option:**

When a series of interchanges is closely spaced, the advance guide sign for the next interchange may be mounted on an overhead structure located downstream from the gore of the preceding interchange.

#### **Guidance:**

Interchange Sequence signs should be used at closely spaced interchanges. When used, they should identify and show street names and distances for the next two or three exits as shown in Figure 2E-23.

#### **Standard:**

**Advance Guide signs for closely spaced interchanges shall show information for only one interchange.**

### **Section 2E.48 Minor Interchange**

**Option:**

Less signing may be used for minor interchanges because such interchanges customarily serve low volumes of local traffic.

**Support:**

Examples of guide signs for minor interchanges are shown in Figure 2E-33.

**Standard:**

**At least one Advance Guide sign and an Exit Gore sign shall be placed at a minor interchange.**

**Guidance:**

An Exit Direction sign should also be used.

### **Section 2E.49 Signing of Approaches and Connecting Roadways**

**Support:**

Because there are a number of different ramp configurations that are commonly used at interchanges with conventional roads, drivers on the conventional road cannot reliably predict whether they will be required to turn left or right in order to enter the correct ramp to access the freeway or expressway in the desired direction of travel. Consistently applied signing for conventional road approaches to freeway or expressway interchanges is highly desirable.

**Guidance:**

The signing of conventional roads with one lane of traffic approaching an interchange should consist of a sequence containing the following signs (see Figure 2E-34):

- A. Junction Assembly
- B. Destination sign
- C. Directional Assembly or Entrance Direction sign for the first ramp
- D. Advance Route Turn Assembly or Advance Entrance Direction sign with an advance turn arrow
- E. Directional Assembly or Entrance Direction sign for the second ramp

**Standard:**

**If used, the Entrance Direction sign shall consist of a white legend and border on a green background. It shall contain the freeway or expressway route shield(s), cardinal direction, and directional arrow(s).**

**Option:**

The Entrance Direction sign may contain a destination(s) and/or an action message such as NEXT RIGHT.

At minor interchanges, the following sequence of signs may be used (see Figure 2E-35):

- A. Junction Assembly
- B. Directional Assembly for the first ramp
- C. Directional Assembly for the second ramp

**Guidance:**

On multi-lane conventional roads approaching an interchange, the sign sequence should contain the following signs (see Figures 2E-36, 2E-37, and 2E-38):

- A. Junction Assembly
- B. Advance Entrance Direction sign(s) for both directions (if applicable) of travel on the freeway or expressway
- C. Entrance Direction sign for first ramp
- D. Advance Turn Assembly
- E. Entrance Direction sign for the second ramp

**Support:**

Advance Entrance signs are used to direct road users to the appropriate lane(s).

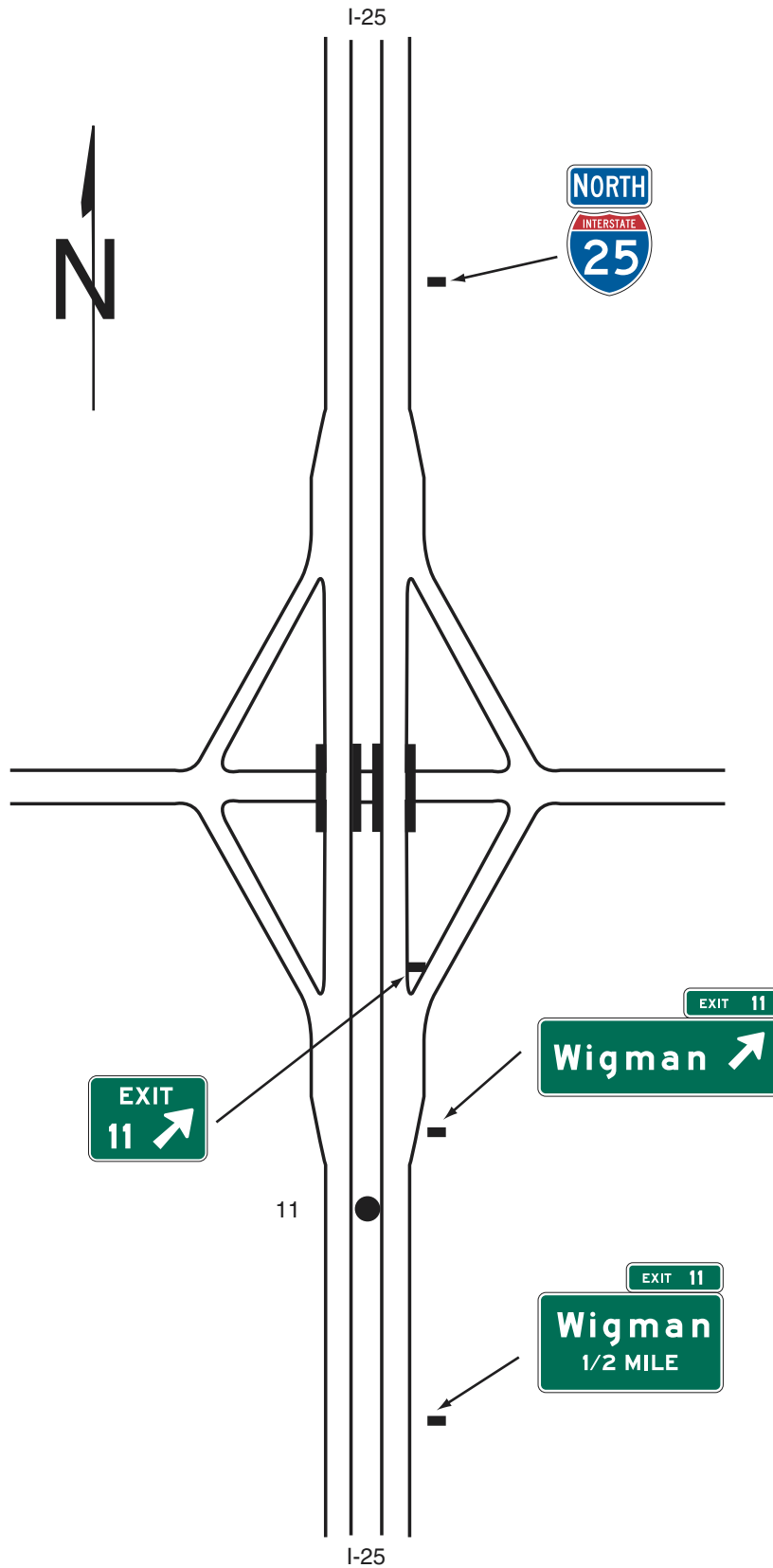
**Standard:**

**The Advance Entrance sign shall consist of a white legend and border on a green background. It shall contain the freeway or expressway route shield(s) and cardinal direction(s).**

**Option:**

The Advance Entrance sign may have destinations, directional arrows, and/or an action message such as LEFT LANE, NEXT LEFT, or SECOND RIGHT. Signs in this sequence may be mounted overhead to improve visibility.

Figure 2E-33. Examples of Minor Interchange Guide Signs

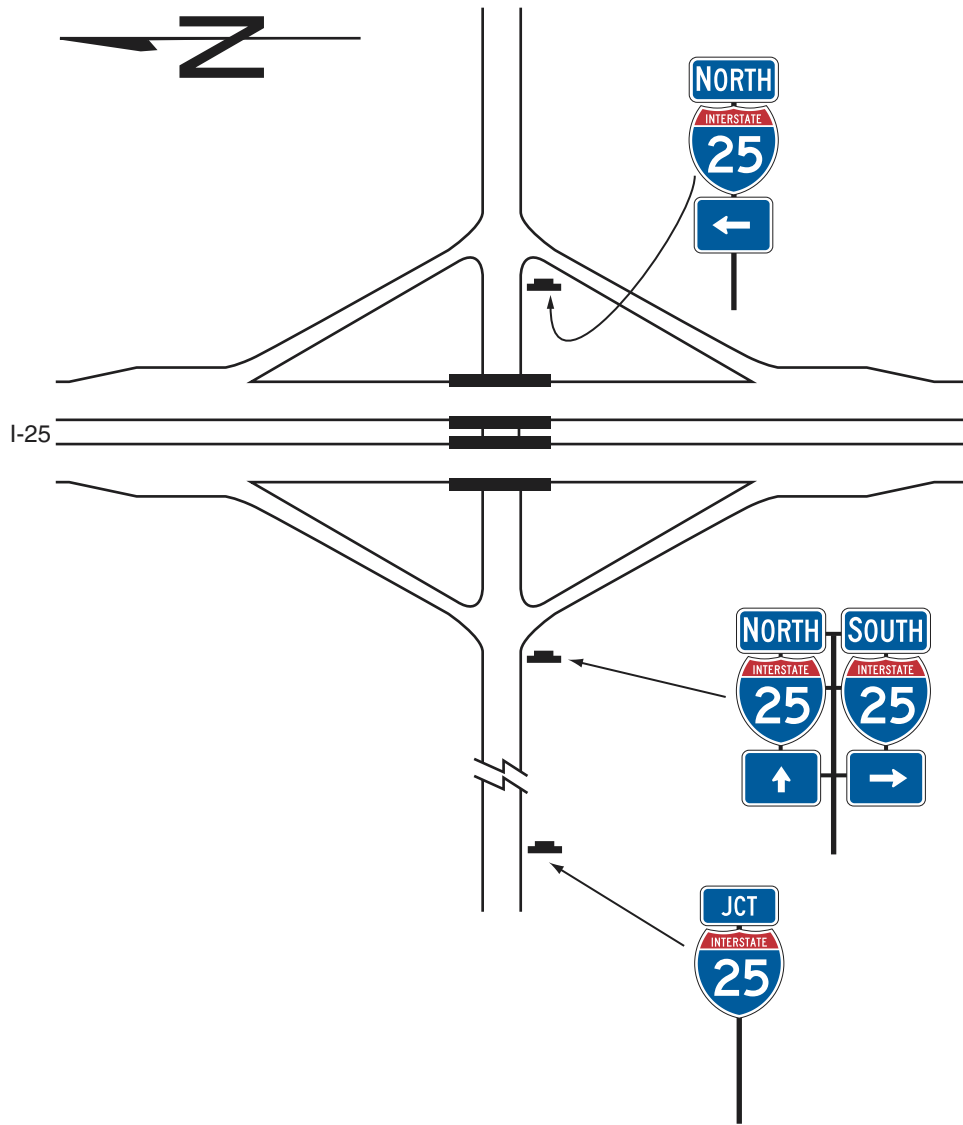


Note: See Figure 2E-35 for example of minor interchange crossroad signing

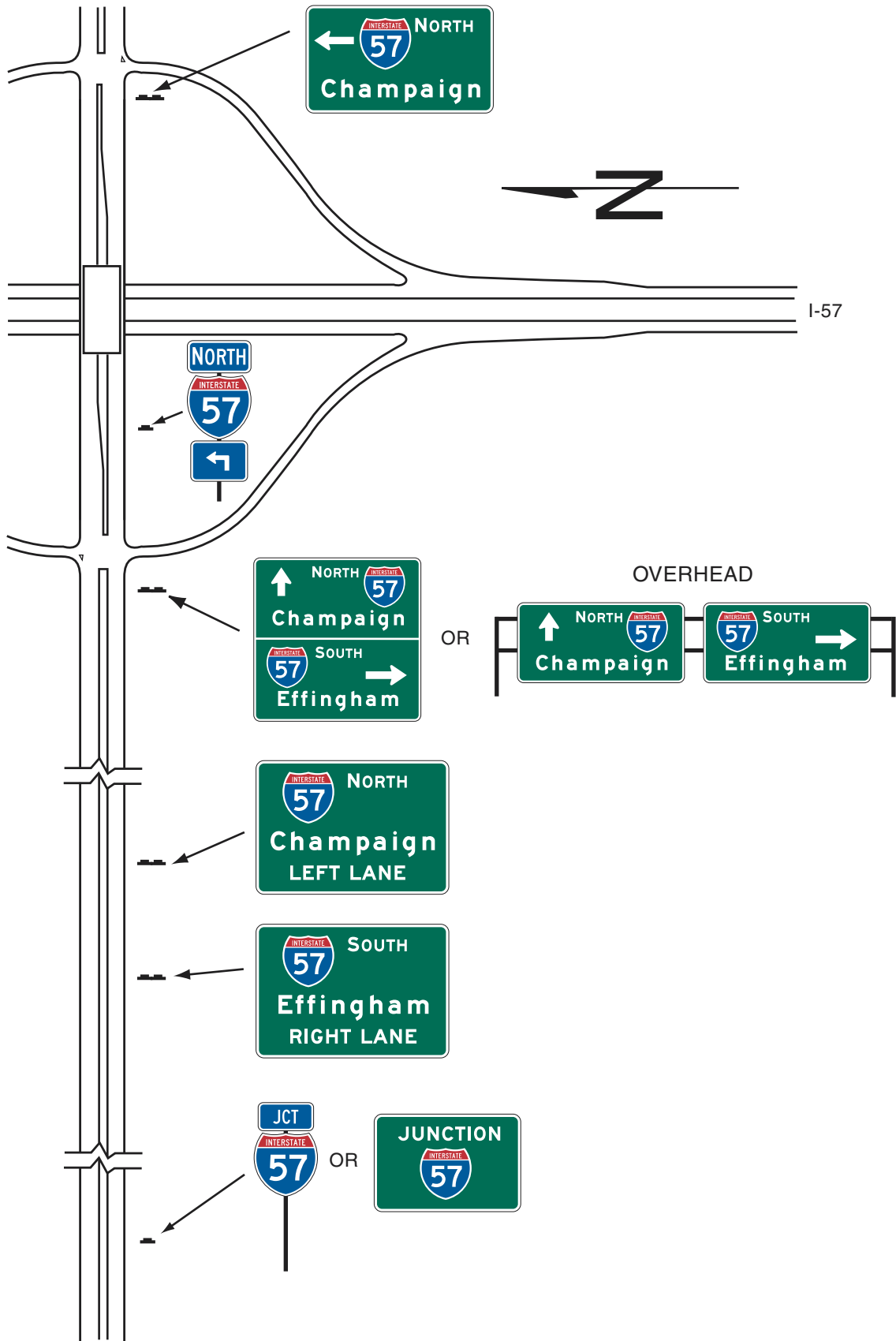
Figure 2E-34. Example of Crossroad Signing for One-Lane Approach



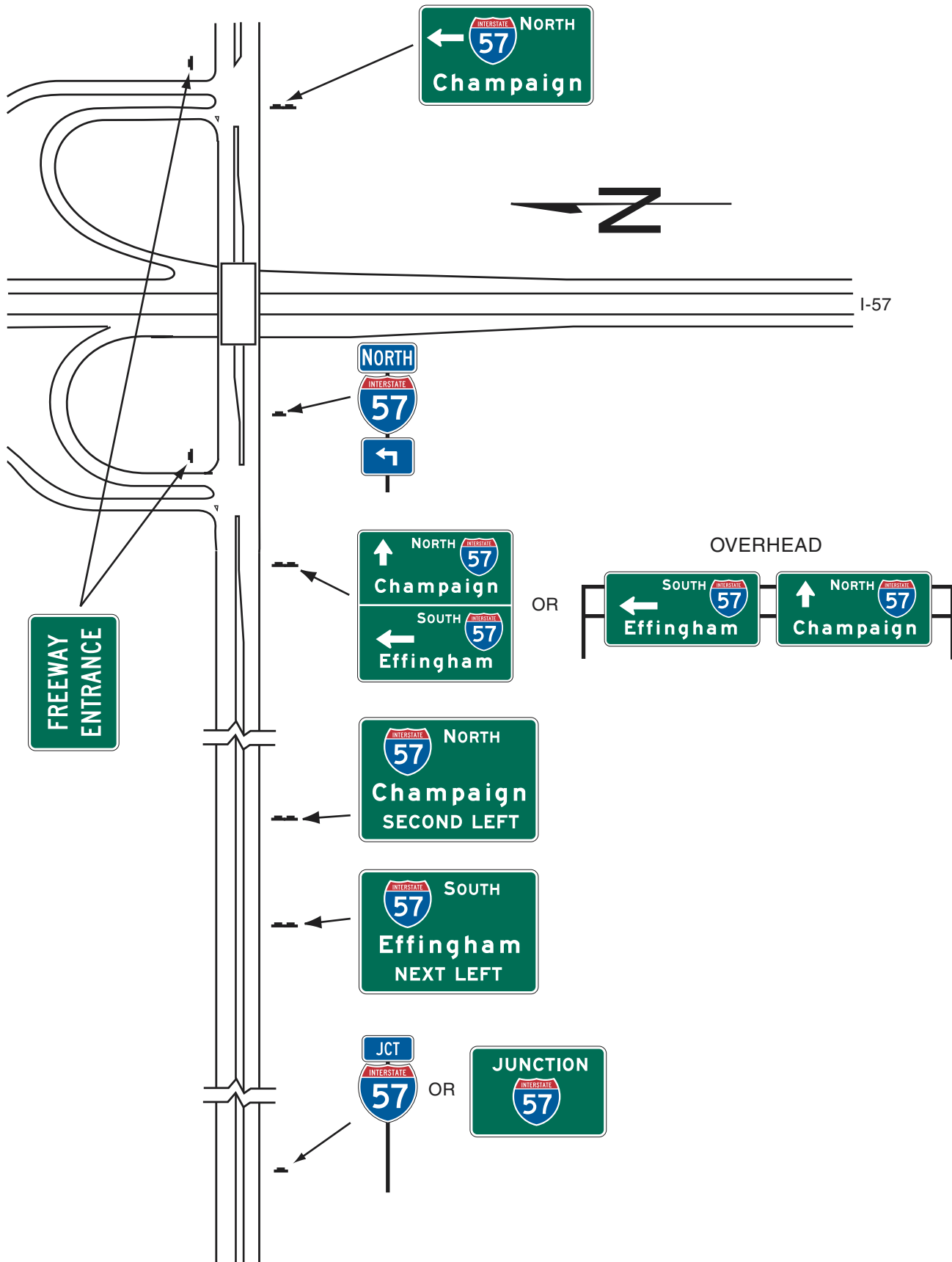
**Figure 2E-35. Example of Minor Interchange Crossroad Signing**



**Figure 2E-36. Examples of Multi-lane Crossroad Signing for Diamond Interchange**

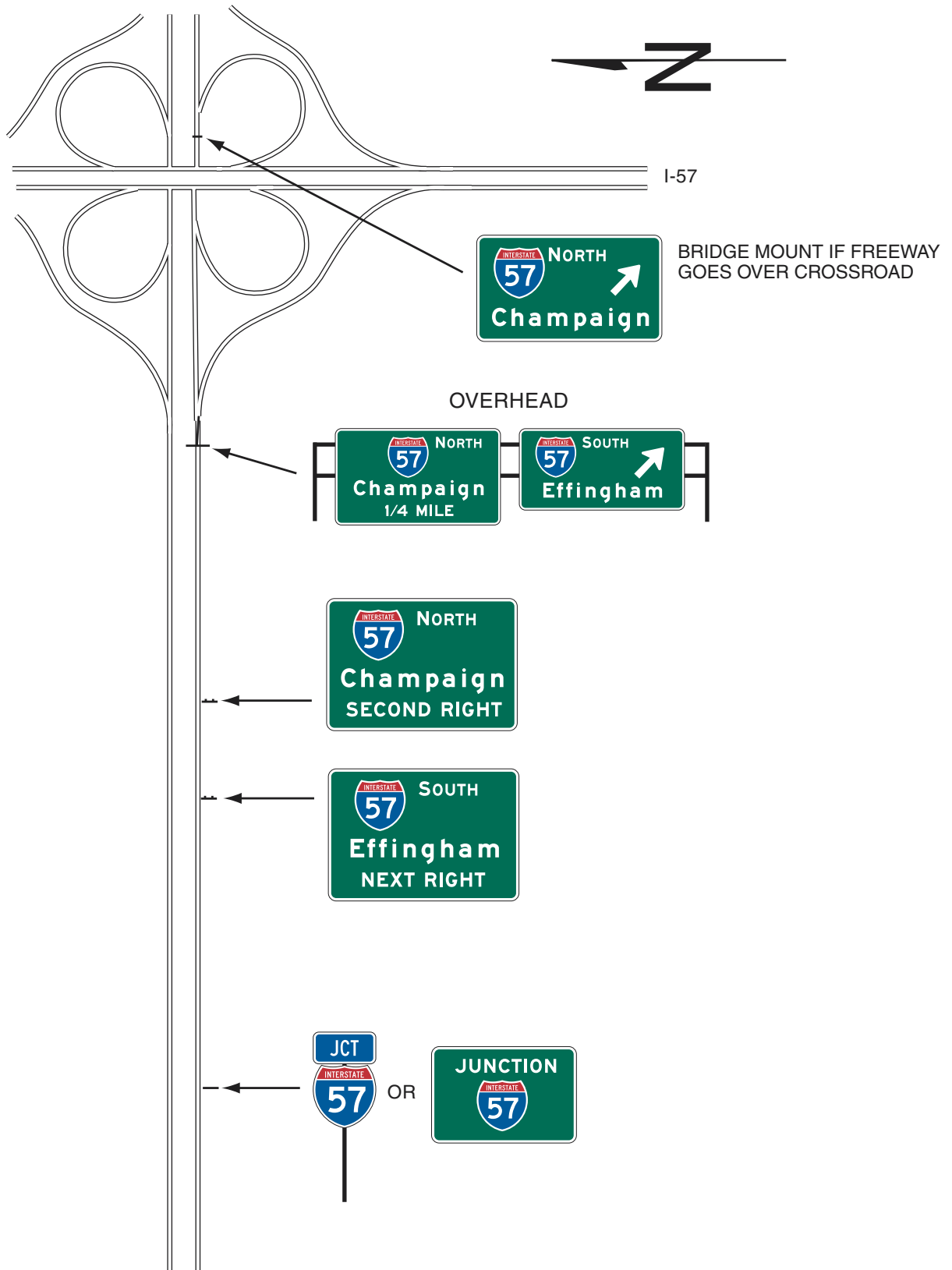


**Figure 2E-37. Examples of Multi-lane Crossroad Signing for Partial Cloverleaf Interchange**





**Figure 2E-38. Examples of Multi-lane Crossroad Signing for Cloverleaf Interchange for Cloverleaf Interchange**



## **Section 2E.50 Wrong-Way Traffic Control at Interchange Ramps**

### **Standard:**

At interchange exit ramp terminals where the ramp intersects a crossroad in such a manner that wrong-way entry could inadvertently be made, the following signs shall be used (see Figure 2E-39):

- A. At least one ONE WAY sign for each direction of travel on the crossroad shall be placed where the exit ramp intersects the crossroad.
- B. At least one DO NOT ENTER sign shall be conspicuously placed near the end of the exit ramp in positions appropriate for full view of a road user starting to enter wrongly.
- C. At least one WRONG WAY sign shall be placed on the exit ramp facing a road user traveling in the wrong direction.

### **Guidance:**

In addition, the following pavement markings should be used (see Figure 2E-39):

- A. On two-lane paved crossroads at interchanges, double solid yellow lines should be used as a centerline for an adequate distance on both sides approaching the ramp intersections.
- B. Where crossroad channelization or ramp geometrics do not make wrong-way movements difficult, a lane-use arrow should be placed in each lane of an exit ramp near the crossroad terminal where it will be clearly visible to a potential wrong-way road user.

### **Option:**

The following traffic control devices may be used to supplement the above signs and pavement markings:

- A. Additional ONE WAY signs may be placed, especially on two-lane rural crossroads, appropriately in advance of the ramp intersection to supplement the required ONE WAY sign(s).
- B. Additional WRONG WAY signs may be used.
- C. Slender, elongated wrong-way arrow pavement markings (see Figure 3B-21) intended primarily to warn wrong-way road users that they are traveling in the wrong direction may be placed upstream from the ramp terminus (see Figure 2E-39) to indicate the correct direction of traffic flow. Wrong-way arrow pavement markings may also be placed on the exit ramp at appropriate locations near the crossroad junction to indicate wrong-way movement. The wrong-way arrow markings may consist of pavement markings or bidirectional red-and-white raised pavement markers or other units that show red to wrong-way road users and white to other road users (see Figure 3B-21).
- D. Lane-use arrow pavement markings may be placed on the exit ramp and crossroad near their intersection to indicate the permissive direction of flow.
- E. Guide signs may be used on entrance ramps near the crossroad to inform road users of the freeway or expressway entrance, as appropriate (see Figure 2E-37).

### **Guidance:**

On interchange entrance ramps where the ramp merges with the through roadway and the design of the interchange does not clearly make evident the direction of traffic on the separate roadways or ramps, a ONE WAY sign visible to traffic on the entrance ramp and through roadway should be placed on each side of the through roadway near the entrance ramp merging point as illustrated in Figure 2E-40.

### **Option:**

At locations where engineering judgment determines that a special need exists, other standard warning or prohibitive methods and devices may be used as a deterrent to the wrong-way movement.

### **Support:**

Section 2B.35 contains further information on signing to avoid wrong-way movements at at-grade intersections on expressways.

## **Section 2E.51 General Service Signs**

### **Support:**

General Service signs (see Figure 2D-11) are generally not appropriate at major interchanges (see Section 2E.29 for definition) and in urban areas.

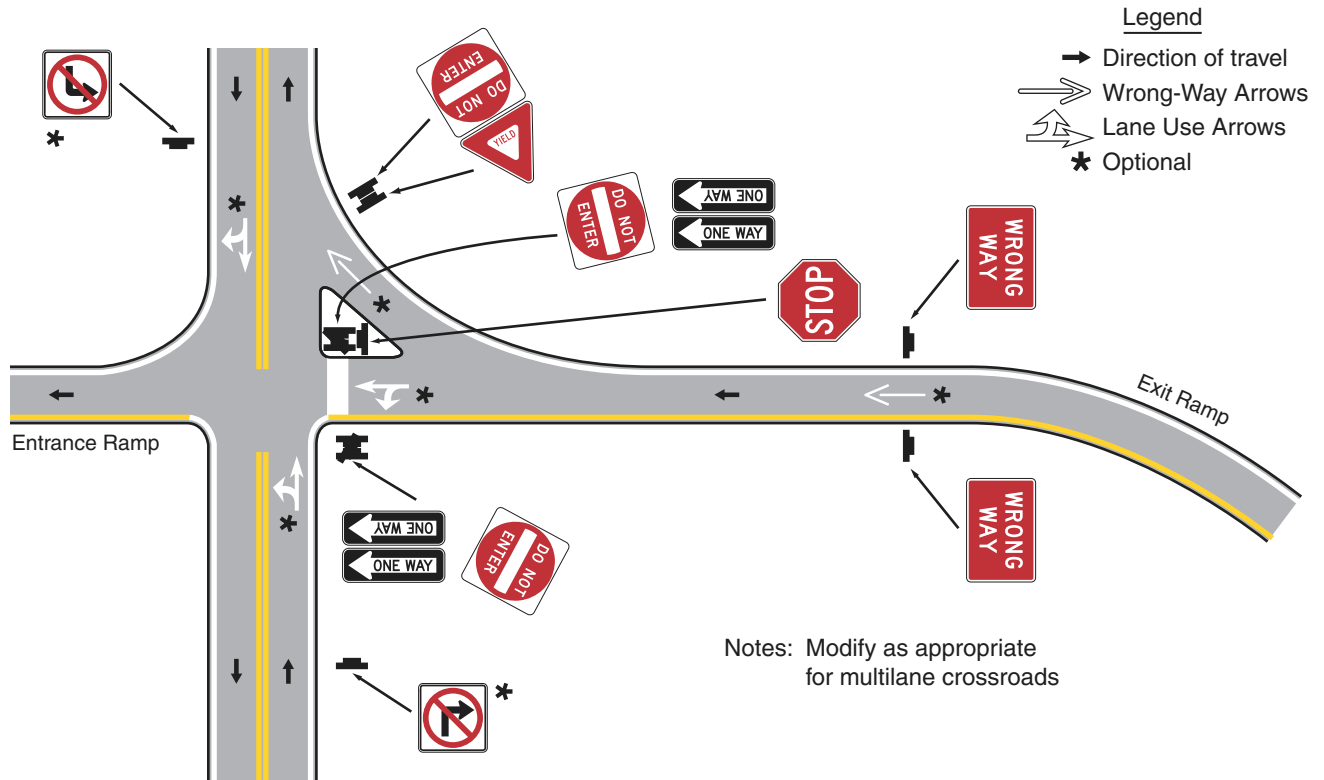
### **Option:**

If interchanges are not numbered, an action message such as NEXT EXIT or SECOND RIGHT may be used (see Figure 2E-41).

### **Standard:**

**General Service signs shall have white letters, symbols, and borders on a blue background. Letter and numeral sizes shall conform to the minimum requirements of Tables 2E-1 through 2E-4. All approved**

**Figure 2E-39. Examples of Regulatory Signing and Pavement Markings at Exit Ramp Termination to Deter Wrong-Way Entry**



symbols shall be permitted as alternatives to word messages, but symbols and word service messages shall not be intermixed. If the services are not visible from the ramp of a single-exit interchange, the service signing shall be repeated in smaller size at the intersection of the exit ramp and the crossroad. Such service signs shall use arrows to indicate the direction to the services.

**Guidance:**

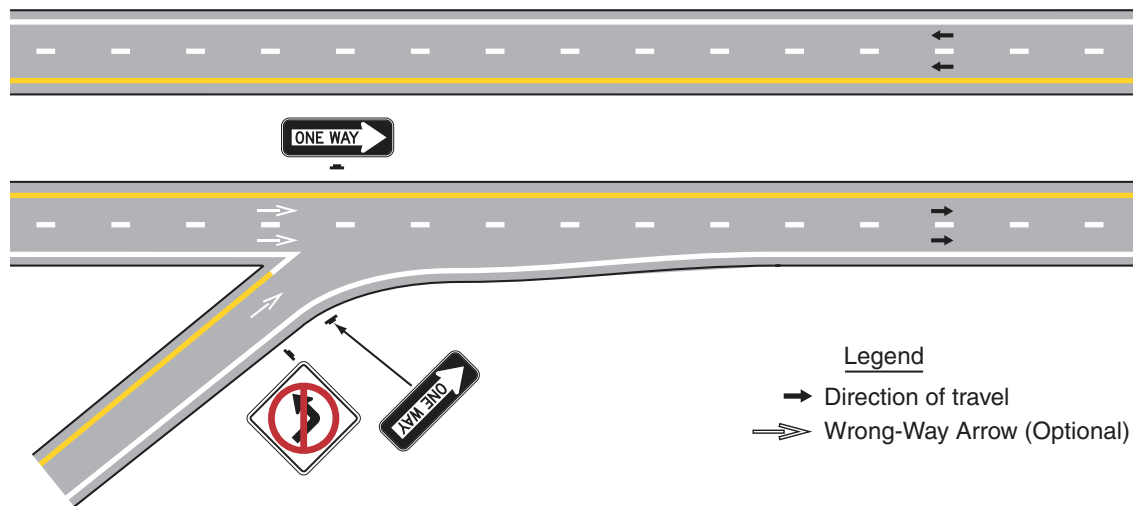
Distance to services should be shown on General Service signs where distances are more than 2 km or 1 mile.

General Service signing should only be provided at locations where the road user can return to the freeway or expressway and continue in the same direction of travel.

Only services that fulfill the needs of the road user should be shown on General Service signs. If State or local agencies elect to provide General Service signing, there should be a statewide policy for such signing and criteria for the availability of the various types of services. The criteria should consider the following:

- A. Gas, Diesel, LP Gas, EV Charging, and/or other alternative fuels if all of the following are available:
  1. Vehicle services such as gas, oil, and water;
  2. Modern sanitary facilities and drinking water;
  3. Continuous operations at least 16 hours per day, 7 days per week; and
  4. Public telephone.
- B. Food if all of the following are available:
  1. Licensing or approval, where required;
  2. Continuous operation to serve at least two meals per day, at least 6 days per week;
  3. Public telephone; and
  4. Modern sanitary facilities.
- C. Lodging if all of the following are available:
  1. Licensing or approval, where required;
  2. Adequate sleeping accommodations;
  3. Public telephone; and
  4. Modern sanitary facilities.

**Figure 2E-40. Examples of Regulatory Signing and Pavement Markings at Entrance Ramp Terminal Where Design Does Not Clearly Indicate the Direction of Flow**



- D. Public Telephone if continuous operation, 7 days per week is available.
- E. Hospital if continuous emergency care capability, with a physician on duty 24 hours per day, 7 days per week is available. A physician on duty would include the following criteria and should be signed in accordance with the priority as follows:
1. Physician on duty within the emergency department;
  2. Registered nurse on duty within the emergency department, with a physician in the hospital on call; or
  3. Registered nurse on duty within the emergency department, with a physician on call from office or home.
- F. Camping if all of the following are available:
1. Licensing or approval, where required;
  2. Adequate parking accommodations; and
  3. Modern sanitary facilities and drinking water.

**Standard:**

For any service that is operated on a seasonal basis only, the General Service signs shall be removed or covered during periods when the service is not available.

The General Service signs shall be mounted in an effective location, between the Advance Guide sign and the Exit Direction sign, in advance of the exit leading to the available services.

**Guidance:**

The General Service sign should contain the interchange number, if any, as illustrated in Figure 2E-42.

**Option:**

If the distance to the next point where services are available is greater than 16 km (10 miles), a NEXT SERVICES XX km (XX MILES) (D9-17) sign (see Figure 2E-43), may be used as a separate sign panel installed below the Exit Direction sign.

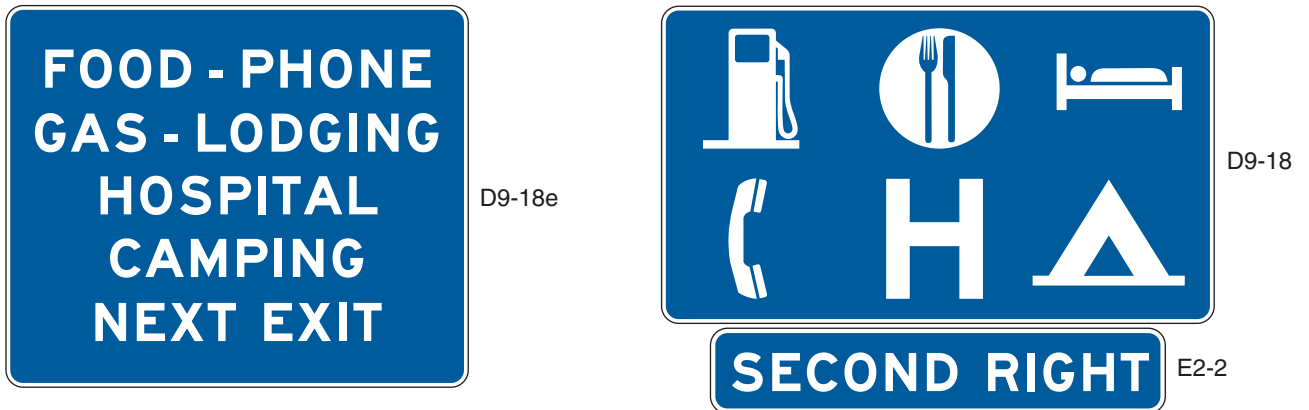
**Standard:**

Signs for services shall conform to the format for General Service signs (see Section 2D.45) and as specified herein. Letter and numeral sizes shall be as shown in Tables 2E-1 through 2E-4. No more than six general road user services shall be displayed on one sign, which includes any appended sign panels. General Service signs shall carry the legends for one or more of the following services: Food, Gas, Lodging, Camping, Phone, Hospital, or Tourist Information.

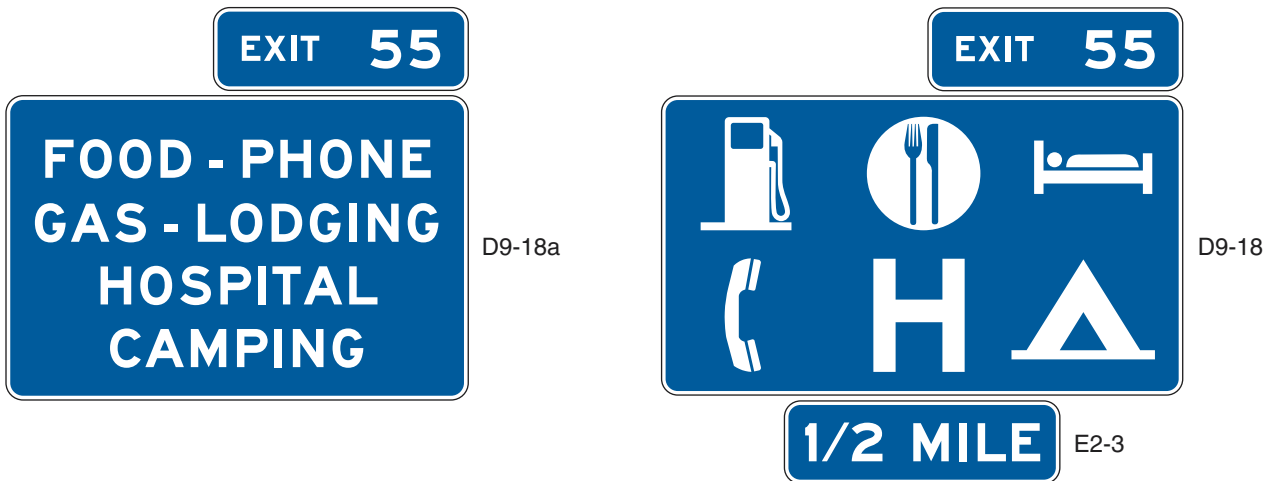
The qualified services available shall be shown at specific locations on the sign.

To provide flexibility for the future when the service might become available, the sign space normally reserved for a given service symbol or word shall be left blank when that service is not present.

**Figure 2E-41. Examples of General Service Signs  
(without Exit Numbering)**



**Figure 2E-42. Examples of General Service Signs  
(with Exit Numbering)**



**Figure 2E-43. Example of Next Services Sign**



**Guidance:**

The standard display of word messages should be FOOD and PHONE in that order on the top line, and GAS and LODGING on the second line. If used, HOSPITAL and CAMPING should be on separate lines (see Figure 2E-42).

**Option:**

Signing for DIESEL, LP-Gas, or other alternative fuel services may be substituted for any of the general services or appended to such signs. The International Symbol of Accessibility for the Handicapped (D9-6) sign may be used for facilities that qualify.

**Guidance:**

When symbols are used for the road user services, they should be displayed as follows:

- A. Six services:
  1. Top row—GAS, FOOD, and LODGING
  2. Bottom row—PHONE, HOSPITAL, and CAMPING
- B. Four services:
  1. Top row—GAS and FOOD
  2. Bottom row—LODGING and PHONE
- C. Three services:
  1. Top row—GAS, FOOD, and LODGING

**Option:**

Substitutions of other services for any of the services shown above may be made by placing the substitution in the lower right (four services) or extreme right (three services) portion of the sign panel. An action message or an interchange number may be used for symbol signs in the same manner as they are used for word message signs. The Diesel Fuel (D9-11) symbol or the LP-Gas (D9-15) symbol may be substituted for the symbol representing fuel or appended to such assemblies. The information (D9-10) symbol may be substituted on any of the above configurations.

At rural interchange areas where limited road user services are available and where it is unlikely that additional services will be provided within the near future, a sign panel having one to three services (words or symbols) may be appended to ground mounted interchange guide signs.

**Standard:**

**If more than three services become available at rural interchange areas where limited road user services were anticipated, any appended sign panel shall be removed and replaced with an independently mounted General Service sign as described in this Section.**

**Option:**

A separate Telephone Service (D9-1) sign may be installed if telephone facilities are located adjacent to the route at places where public telephones would not normally be expected.

The Recreational Vehicle Sanitary Station (D9-12) sign may be used as needed to indicate the availability of facilities designed for dumping wastes from recreational vehicle holding tanks.

In some locations, signs may be used to indicate that services are not available.

A TRUCK PARKING (D9-16) sign may be used on a separate sign panel below the other general road user services to direct truck drivers to designated parking areas.

**Section 2E.52 Rest and Scenic Area Signs****Guidance:**

Signing for rest areas and scenic areas should conform to the provisions set forth in Sections 2D.42 and 2D.43. However, the signs should be suitably enlarged for freeway or expressway application. A roadside area that does not contain restroom facilities should be signed to indicate the major road user service that is provided. For example, an area with only parking should be signed with a PARKING AREA (D5-4) sign (see Figure 2E-44). An area with picnic tables and parking should be signed with a PICNIC AREA (D5-5c) sign or a Picnic Table Area (D5-5a) symbol sign.

Rest areas that have tourist information and welcome centers should be signed as discussed in Section 2E.53.

Scenic area signing should be consistent with that specified for rest areas. Standard messages should read SCENIC AREA (D6-1), SCENIC VIEW (D6-2), SCENIC OVERLOOK (D6-3), or the equivalent.

**Figure 2E-44. Examples of Rest Area, Scenic Overlook, and Welcome Center Signs**



D5-1



D5-1a



D5-1b



D5-2



D5-2a



D5-3



D5-4



D5-7



D5-7a



D5-8



D5-9



D5-9a



D5-10



D5-11



**Standard:**

**All signs for rest and scenic areas shall have white letters, symbols, and borders on a blue background. Letter and numeral sizes shall conform to the minimum requirements of Tables 2E-1 through 2E-4. On the approach to rest areas, a REST AREA advance guide sign shall be placed 2 km or 1 mile and/or 4 km or 2 miles in advance of the rest area. At the rest area exit gore, there shall be a sign with a message REST AREA together with an arrow indicating the appropriate turn as shown in Figure 2E-44.**

**Option:**

If the rest area has facilities for the physically impaired (see Section 2D.45), the International Symbol of Accessibility for the Handicapped (D9-6) sign may be placed with or beneath the REST AREA advance guide sign.

Between the REST AREA advance guide sign and the gore of the rest area exit, there may be a REST AREA (D5-1b) sign (see Figure 2E-44). The words NEXT RIGHT (E2-2) or an arrow may be included as part of the message.

To provide the road user with information on the location of succeeding rest areas, a NEXT REST AREA XX km (XX MILES) (D5-6) sign (see Figure 2E-44) may be installed independently or as a supplemental sign panel mounted below one of the REST AREA advance guide signs.

**Section 2E.53 Tourist Information and Welcome Center Signs****Support:**

Tourist information and welcome centers have been constructed within rest areas on freeways and expressways and are operated by either a State or a private organization. Others have been located within close proximity to these facilities and operated by civic clubs, chambers of commerce, or private enterprise.

**Guidance:**

An excessive number of supplemental panels should not be installed with Tourist Information or Welcome Center signs so as not to overload the road user.

**Standard:**

**Tourist Information or Welcome Center signs (see Figure 2E-44) shall have a white legend and border on a blue background. Continuously staffed or unstaffed operation at least 8 hours per day, 7 days per week, shall be required.**

**If operated only on a seasonal basis, the Tourist Information or Welcome Center signs shall be removed or covered during the off seasons.**

**Guidance:**

For freeway or expressway rest area locations that also serve as tourist information or welcome centers, the following signing criteria should be used:

- A. The locations for tourist information and welcome center Advance Guide, Exit Direction, and Exit Gore signs should meet the General Service signing requirements described in Section 2E.51.
- B. If the signing for the tourist information or welcome center is to be accomplished in conjunction with the initial signing for the rest areas, the message on the Advance Guide sign should be REST AREA, TOURIST INFO CENTER, XX km (XX MILES) or REST AREA, WELCOME CENTER XX km (XX MILES). On the Exit Direction sign the message should be REST AREA, TOURIST INFO CENTER with an upward sloping arrow (or NEXT RIGHT), or REST AREA, WELCOME CENTER with an upward sloping arrow (or NEXT RIGHT).
- C. If the initial rest area Advance Guide and Exit Direction signing is in place, these signs should include, on supplemental sign panels, the legend TOURIST INFO CENTER or STATE NAME (optional), WELCOME CENTER.
- D. The Gore sign should contain only the legend REST AREA with the arrow and should not be supplemented with any legend pertaining to the tourist information center or welcome center.

**Option:**

An alternative to the supplemental TOURIST INFO CENTER legend is the Information Symbol (D9-10) sign, which may be appended beneath the REST AREA advance guide sign. The name of the State or local jurisdiction may appear on tourist information/welcome center signs if the jurisdiction controls the operation of the tourist information or welcome center and the center meets the operating criteria set forth herein and is consistent with State policies. The State name may be used on the Advance Guide and the Exit Direction signs.



**Guidance:**

For tourist information centers located off the freeway or expressway facility, additional signing criteria should be as follows:

- A. Each State should adopt a policy establishing the maximum distance that a tourist information center can be located from the interchange in order to be included on official signs.
- B. The location of signing should be in accordance with requirements pertaining to General Service signing (see Section 2E.51).
- C. Signing along the crossroad should be installed to guide the road user from the interchange to the tourist information center and back to the interchange.

**Option:**

As an alternative, the Information Symbol (D9-10) sign may be appended to the guide signs for the exit providing access to the tourist information center. As a second alternative, the Information Symbol sign may be combined with General Service signing.

**Section 2E.54 Reference Location Signs and Enhanced Reference Location Signs (D10-4, D10-5)****Support:**

Reference Location (D10-1 through D10-3) signs and Intermediate Reference Location (D10-1a through D10-3a) signs and their applications are described in Section 2D.46.

There are two types of enhanced reference location signs:

- A. Enhanced Reference Location signs (D10-4), and
- B. Intermediate Enhanced Reference Location signs (D10-5).

**Standard:**

**Except as provided in the option below, Reference Location (D10-1 through D10-3) signs (see Section 2D.46) shall be placed on all expressway facilities that are located on a route where there is reference location sign continuity and on all freeway facilities to assist road users in estimating their progress, to provide a means for identifying the location of emergency incidents and traffic crashes, and to aid in highway maintenance and servicing.**

**Option:**

Enhanced Reference Location (D10-4) signs (see Figure 2E-45), which enhance the reference location sign system by identifying the route, may be placed on freeways or expressways (instead of Reference Location signs) or on conventional roads.

To augment an enhanced reference location sign system, Intermediate Enhanced Reference Location (D10-5) signs (see Figure 2E-45), which show the tenth of a kilometer (mile) with a decimal point, may be installed along any section of a highway route or ramp at one tenth of a kilometer (mile) intervals, or at some other regular spacing.

**Standard:**

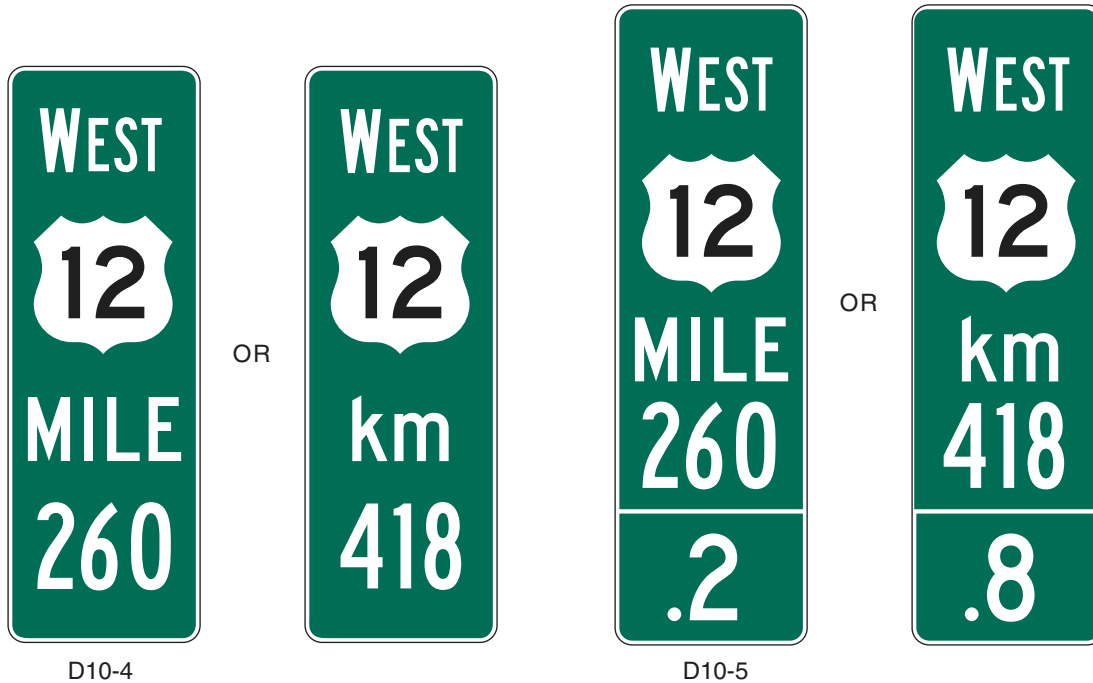
**If enhanced reference location signs are used, they shall be vertical panels having blue or green backgrounds with white numerals, letters, and borders, except for the route shield, which shall be the standard color and shape. The top line shall consist of the cardinal direction for the roadway. The second line shall consist of the applicable route shield for the roadway. The third line shall identify the kilometer (mile) reference for the location and the bottom line of the Intermediate Enhanced Reference Location sign shall give the tenth of a kilometer (mile) reference for the location. The bottom line of the Intermediate Enhanced Reference Location sign shall contain a decimal point. The height of the legend on enhanced reference location signs shall be a minimum of 150 mm (6 in). The height of the route shield on enhanced reference location signs shall be a minimum of 300 mm (12 in).**

**The background color shall be the same for all enhanced reference location signs within a jurisdiction.**

**The design details for enhanced reference location signs shall be as shown in the "Standard Highway Signs" book (see Section 1A.11).**

**Enhanced reference location signs shall have a minimum mounting height of 1.2 m (4 ft) to the bottom of the sign in accordance with the mounting height requirements of delineators (see Section 3D.04), and shall not be governed by the mounting height requirements prescribed in Section 2A.18.**

**The distance numbering shall be continuous for each route within any State, except where overlaps occur (see Section 2E.28). Where routes overlap, enhanced reference location sign continuity shall be established for only one of the routes. If one of the overlapping routes is an Interstate route, that route shall be selected for continuity of distance numbering.**

**Figure 2E-45. Enhanced Reference Location Signs**

The distance measurement shall be made on the northbound and eastbound roadways. The enhanced reference location signs for southbound or westbound roadways shall be set at locations directly opposite the enhanced reference location signs for the northbound or eastbound roadways.

Guidance:

The route selected for continuity of distance numbering should also have continuity in interchange exit numbering (see Section 2E.28). On a route without enhanced reference location sign continuity, the first enhanced reference location sign beyond the overlap should indicate the total distance traveled on the route so that road users will have a means of correlating their travel distance between enhanced reference location signs with that shown on their odometer.

**Standard:**

**Except as provided in the option below, enhanced reference location signs shall be installed on the right side of the roadway.**

Option:

Where conditions limit or restrict the use of enhanced reference location signs on the right side of the roadway, they may be installed in the median. In urban areas, Intermediate Enhanced Reference Location signs may be installed on the right side of the roadway, in the median, or on ramps to replace or to supplement the reference location signs. Enhanced Reference Location signs may be installed back-to-back in median locations.

### **Section 2E.55 Miscellaneous Guide Signs**

Support:

Miscellaneous Guide signs are used to point out geographical features, such as rivers and summits, and other jurisdictional boundaries (see Section 2D.48).

Option:

Miscellaneous Guide signs may be used if they do not interfere with signing for interchanges or other critical points.

Guidance:

Miscellaneous Guide signs should not be installed unless there are specific reasons for orienting the road users or identifying control points for activities that are clearly in the public interest. If Miscellaneous Guide signs are to be of value to the road user, they should be consistent with other freeway or expressway guide signs in design and legibility. On all such signs, the design should be simple and dignified, devoid of any tendency toward flamboyant advertising, and in general conformance with other freeway and expressway signing.

## **Section 2E.56 Radio Information Signing**

### **Option:**

Radio-Weather Information (D12-1) signs may be used in areas where difficult driving conditions commonly result from weather systems. Radio-Traffic Information signs may be used in conjunction with traffic management systems.

### **Standard:**

**Radio-Weather and Radio-Traffic Information signs shall have a white legend and border on a blue background. Only the numerical indication of the radio frequency shall be used to identify a station broadcasting travel-related weather or traffic information. No more than three frequencies shall be shown on each sign. Only radio stations whose signal will be of value to the road user and who agree to broadcast either of the two items below shall be identified on Radio-Weather and Radio-Traffic Information signs:**

- A. Periodic weather warnings at no more than 15-minute intervals during periods of adverse weather; or**
- B. Driving condition information (affecting the roadway being traveled) at a rate of at least once every 15 minutes, or when required, during periods of adverse traffic conditions, and when supplied by an official agency having jurisdiction.**

**If a station to be considered operates only on a seasonal basis, its signs shall be removed or covered during the off season.**

### **Guidance:**

The radio station should have a signal strength to adequately broadcast 110 km (70 mi) along the route. Signs should be spaced as needed for each direction of travel at distances determined by an engineering study. The stations to be included on the signs should be selected in cooperation with the association(s) representing major broadcasting stations in the area to provide: (1) maximum coverage to all road users on both AM and FM frequencies; and (2) consideration of 24 hours per day, 7 days per week broadcast capability.

### **Option:**

In roadway rest area locations, a smaller sign using a greater number of radio frequencies, but of the same general design, may be used.

### **Standard:**

**Radio-Weather and Radio-Traffic Information signs installed in rest areas shall be positioned such that they are not visible from the main roadway.**

### **Option:**

A Channel 9 Monitored (D12-3) sign or cellular phone sign may be installed as needed.

### **Standard:**

**Only official public agencies or their designee shall be shown as the monitoring agency on the Channel 9 Monitored sign.**

### **Support:**

Section 2D.45 contains information about the use and application of TRAVEL INFO CALL 511 (D12-5) signs.

## **Section 2E.57 Carpool and Ridesharing Signing**

### **Option:**

In areas having carpool matching services, Carpool Information (D12-2) signs (see Figure 2D-12) may be provided adjacent to highways with preferential lanes or along any other highway.

Carpool Information signs may include Internet addresses or telephone numbers of more than four characters within the legend.

### **Guidance:**

Because this is an information sign related to road user services, the Carpool Information sign should have a white legend and border on a blue background.

### **Standard:**

**If a local transit logo or carpool symbol is incorporated into the Carpool Information sign, the maximum vertical dimension of the logo or symbol shall not exceed 450 mm (18 in).**

## **Section 2E.58 Weigh Station Signing**

### **Standard:**

**Weigh Station signing on freeways and expressways shall be the same as that specified in Section 2D.44, except for lettering size and the advance posting distance for the Exit Direction sign, which shall be located a minimum of 450 m (1,500 ft) in advance of the gore.**

### **Support:**

Weigh Station sign layouts for freeway and expressway applications are shown in the “Standard Highway Signs” book (see Section 1A.11).

## **Section 2E.59 Preferential Only Lane Signs**

### **Support:**

Additional guidance and standards related to the designation, operational considerations, signing, pavement markings, and other considerations for preferential only lanes is provided in Sections 2B.26, 2B.27, 2B.28, 2C.52, 3B.22, and 3B.23.

### **Standard:**

**Ground-mounted advance guide signs shall be provided at least 800 m (0.5 mi) prior to the beginning or initial entry point to all types of preferential only lanes (including barrier-separated, buffer-separated, and concurrent flow). Ground-mounted guide signs shall be provided at the beginning or initial entry point and at intermediate access points to all types of preferential only lanes.**

**A combination of guide and regulatory signs shall be used in advance of all preferential only lanes. The advance guide signs for preferential only lanes shall be consistent with the requirements of Section 2E.30.**

**Reversible flow or express lanes that do not have any specific vehicle occupancy or designation restrictions shall be consistent with the requirements of Chapters 2B and 3B.**

**Overhead preferential only lane guide signs shall be used only as a supplement to ground-mounted preferential only lane guide signs unless an engineering study identifies that ground-mounted guide signs are not appropriate for a particular situation or location.**

**Either the HOV abbreviation or the diamond symbol shall appear in the legend of each preferential only lane sign at the designated entry and exit points for all types of HOV lanes (including barrier- and buffer-separated, concurrent flow, and direct access ramps) in order to alert motorists that there is a minimum allowable vehicle occupancy requirement for vehicles to use the HOV lanes and to inform them of the times during which these vehicle occupancy requirements are in effect.**

### **Guidance:**

Because consistency in signing and pavement markings for preferential only lanes within a State or metropolitan area plays a critical role in building public awareness, understanding, and acceptance, and makes enforcement more effective, an engineering study should be conducted to determine the appropriate combinations of overhead signs, ground-mounted signs, and pavement markings for a specific preferential only lane application.

Existing sign and bridge structures should be used to the extent practical for the installation of preferential only lane signs. Where possible, advance guide and guide signs that are provided for preferential only lanes should share sign structures spanning the preferential only lanes and the adjoining freeway facility.

The preferential only lane signing should be designed to avoid overloading the road user. Based on the importance of the sign, the following priority should be given: regulatory, advance regulatory, guide, then next exit supplemental signs.

### **Option:**

Overhead advance guide signs and overhead guide signs may be used in advance of, at the beginning or initial entry point, and at designated intermediate access points to any type of preferential only lane. Advance guide signs may be installed and located approximately 1.6 km (1 mi) and 3.2 km (2 mi) in advance of the beginning or initial entry point to any type of preferential only lane.

### **Guidance:**

Where conditions restrict the ability to provide more than one advance guide sign in advance of any type of preferential only lane, the advance guide sign that is installed should be placed at least 800 m (0.5 mi) in advance of the beginning or entry point to the preferential only lane.

Advance destination guide signs, identifying downstream exit locations, should be installed in advance of designated entry points and along the length of access restricted preferential only lanes (such as barrier- and buffer-separated). In addition to the routes that typically appear on advance destination guide signs, these signs

should also include destinations. These signs should be located based on the priority of the message, the available space, the existing signs on adjoining general purpose traffic lanes, roadway and traffic characteristics, the proximity to existing overhead signs, the ability to install overhead signs, and other unique local factors.

Option:

Advance guide signs may be provided for preferential only lanes with unrestricted access, such as concurrent flow preferential only lanes.

Guidance:

The use of guide signs for preferential only lanes at freeway interchanges should conform to the regulatory and guide sign requirements established in this Manual.

Option:

Changeable message signs may be used to supplement static signs where travel conditions change or where multiple types of operational strategies (such as variable occupancy requirements, vehicle types, or pricing policies) are used and varied throughout the day or week to manage the use of, control of, or access to preferential only lanes.

**Standard:**

**When changeable message signs (see Section 2A.07) are used as regulatory or guide signs for preferential only lanes, they shall be the required sign size and shall display the required letter height and legend format that corresponds to the type of roadway facility and design speed.**

**Ground-mounted and overhead advance guide signs, guide signs, and exit signs applicable to HOV lanes and direct access ramps to HOV lanes shall contain the HOV diamond symbol in the upper left corner of the sign as shown in Figures 2E-46 through 2E-52. The diamond symbol shall not be used with lanes designated for bus or taxi traffic.**

Option:

Agencies may select from either the HOV abbreviation or the diamond symbol to reference the HOV lane designation.

Guidance:

Where lateral clearance is limited, such as when a ground-mounted Preferential Only Lane sign is installed on a median barrier, the edges of the sign should not project beyond the outer edges of the barrier.

Option:

Where lateral clearance is limited, Preferential Only Lane (R3-10, R3-11, and R3-12 series) signs that are 1800 mm (72 in) or less in width may be skewed up to 45 degrees in order to fit within the barrier width or may be mounted at a height of 4.3 m (14 ft) or more above the roadway.

Guidance:

Where lateral clearance is limited, Preferential Only Lane signs that are wider than 1800 mm (72 in) should be mounted at a height of at least 4.3 m (14 ft) above the roadway.

**Standard:**

**For barrier-separated preferential only lanes, overhead advance guide and overhead guide signs shall be provided in advance of and at the beginning or initial entry point to the preferential only lanes (see Figure 2E-46 for HOV lanes). Overhead guide signs shall also be used at all intermediate entry points to barrier-separated preferential only lanes (see Figure 2E-47 for HOV lanes).**

**For barrier-separated preferential only lanes, ground-mounted advance exit and ground-mounted exit signs shall be installed prior to and at the intermediate exit points of the preferential only lanes (see Figure 2E-47 for HOV lanes). Ground-mounted guide signs shall be mounted in the median or on median barriers that separate two directions of traffic.**

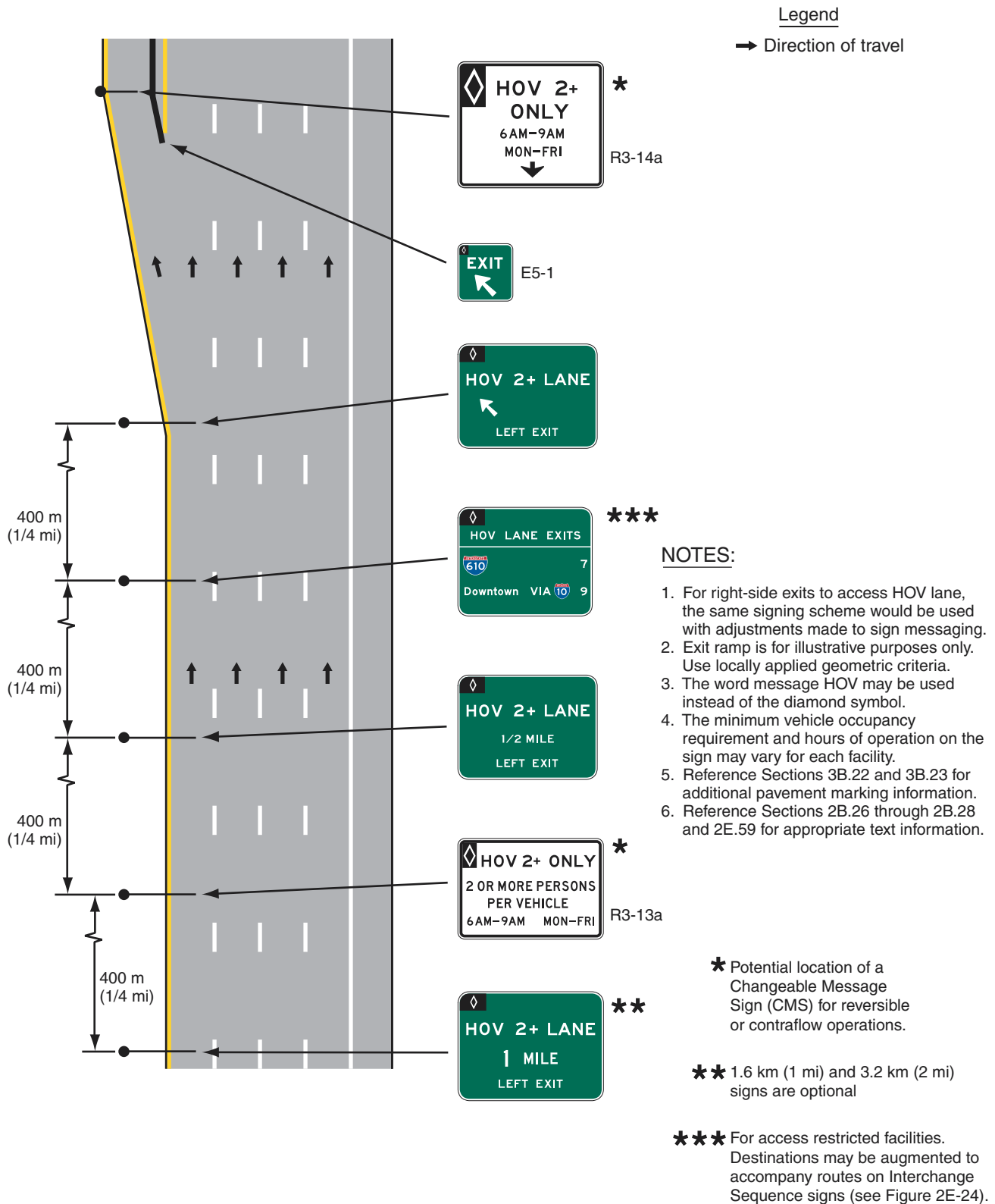
Option:

For barrier-separated preferential only lanes, an advance destination guide sign may be used in the vicinity of designated intermediate entry and exit points.

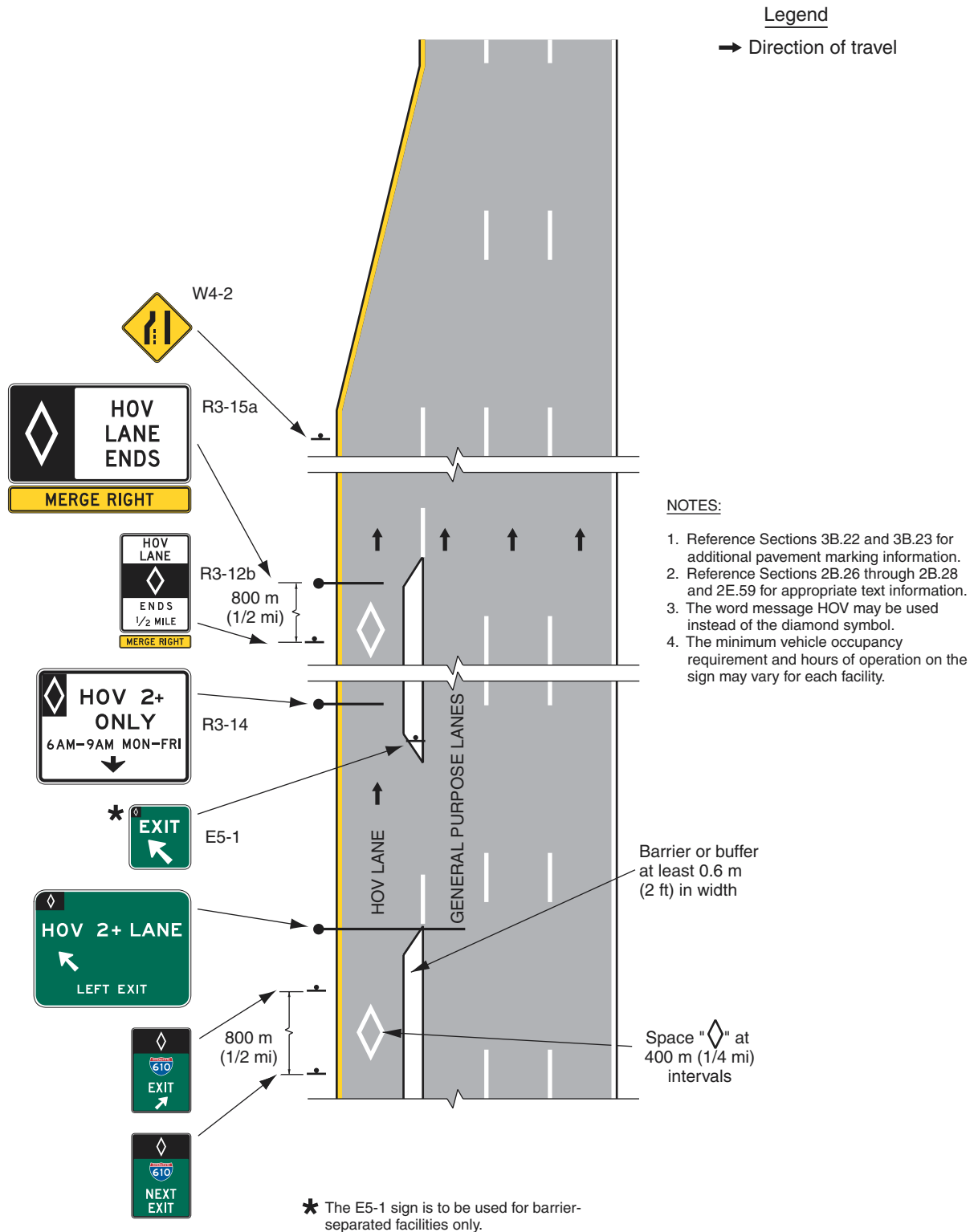
Guidance:

For barrier-separated preferential only lanes where conditions restrict the ability to provide more than one advance guide sign prior to the entrance to the preferential only lane, the sign should be placed approximately 800 m (0.5 mi) in advance of the exit. In these situations, the installation of the corresponding regulatory and next exit supplemental signs should be located based on the priority of the message and the available space.

**Figure 2E-46. Example of Signing for the Entrance to Barrier-Separated HOV Lanes**



**Figure 2E-47. Example of Signing for the Intermediate Entry to and Exit from Barrier- or Buffer-Separated HOV Lanes**





**Standard:**

**For buffer-separated preferential only lanes (painted buffer of 0.6 m (2 ft) or more) where access is restricted to designated entry points, ground-mounted guide signs shall be mounted in the median or on median barriers separating two directions of traffic. Ground-mounted advance exit and ground-mounted exit signs shall be installed prior to and at the intermediate exit points of buffer-separated preferential only lanes (see Figure 2E-47 for HOV lanes).**

**Option:**

For buffer-separated preferential only lanes, an advance destination guide sign may be used in the vicinity of designated intermediate entry and exit points.

**Guidance:**

For buffer-separated HOV lanes, guide and regulatory signs should be provided to alert HOV lane users and non-users of the minimum allowable vehicle occupancy requirement and the locations of the designated entry and exit points.

**Standard:**

**For concurrent flow preferential only lanes, including those where a preferential only lane is added to the roadway (see Figure 2E-48 for HOV lanes) and those where a general purpose lane transitions into a preferential only lane on the roadway (see Figure 2E-49 for HOV lanes), an overhead regulatory (R3-14 or R3-14a) sign shall be used.**

**For concurrent flow HOV lanes on the left side of the roadway with unrestricted access, advance guide and guide signs shall only be used on direct access ramps, such as HOV lane only ramps or ramps to park & ride lots (see Figures 2E-50 and 2E-51 for HOV lanes).**

**For direct access ramps to HOV lanes, advance guide signs shall be provided along the adjoining surface streets to direct traffic into a transit facility (such as a park & ride lot or a transit station or terminal) that ultimately leads to HOV lanes (see Figure 2E-50 for HOV lanes).**

**Because direct access ramps for preferential only lanes at interchanges connecting two freeways are typically left side exits and typically have design speeds similar to the preferential only lane, overhead advance guide signs and overhead guide signs shall be provided in advance of and at the entry point to each preferential only lane ramp (see Figure 2E-52 for HOV lanes).**

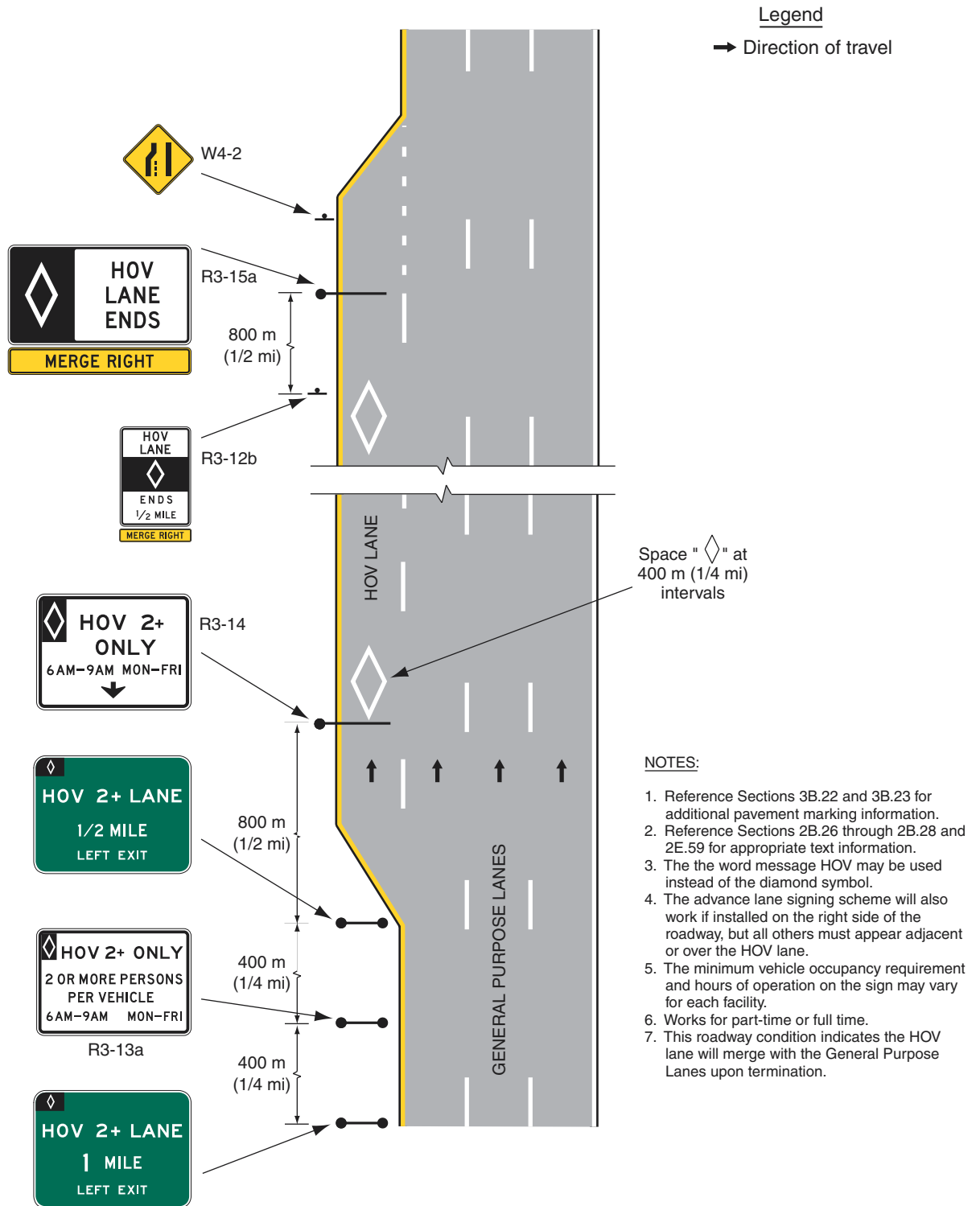
**Support:**

Figures 2E-50 through 2E-52 provide examples of recommended uses and layouts of signs for HOV lanes for direct access ramps, park & ride lots, access from surface streets, and exclusive preferential only lane ramps at interchanges that directly connect two freeway facilities. Direct access ramps to preferential only lanes sometimes form a three or four-legged intersection that is controlled by either static signs or traffic control signals.

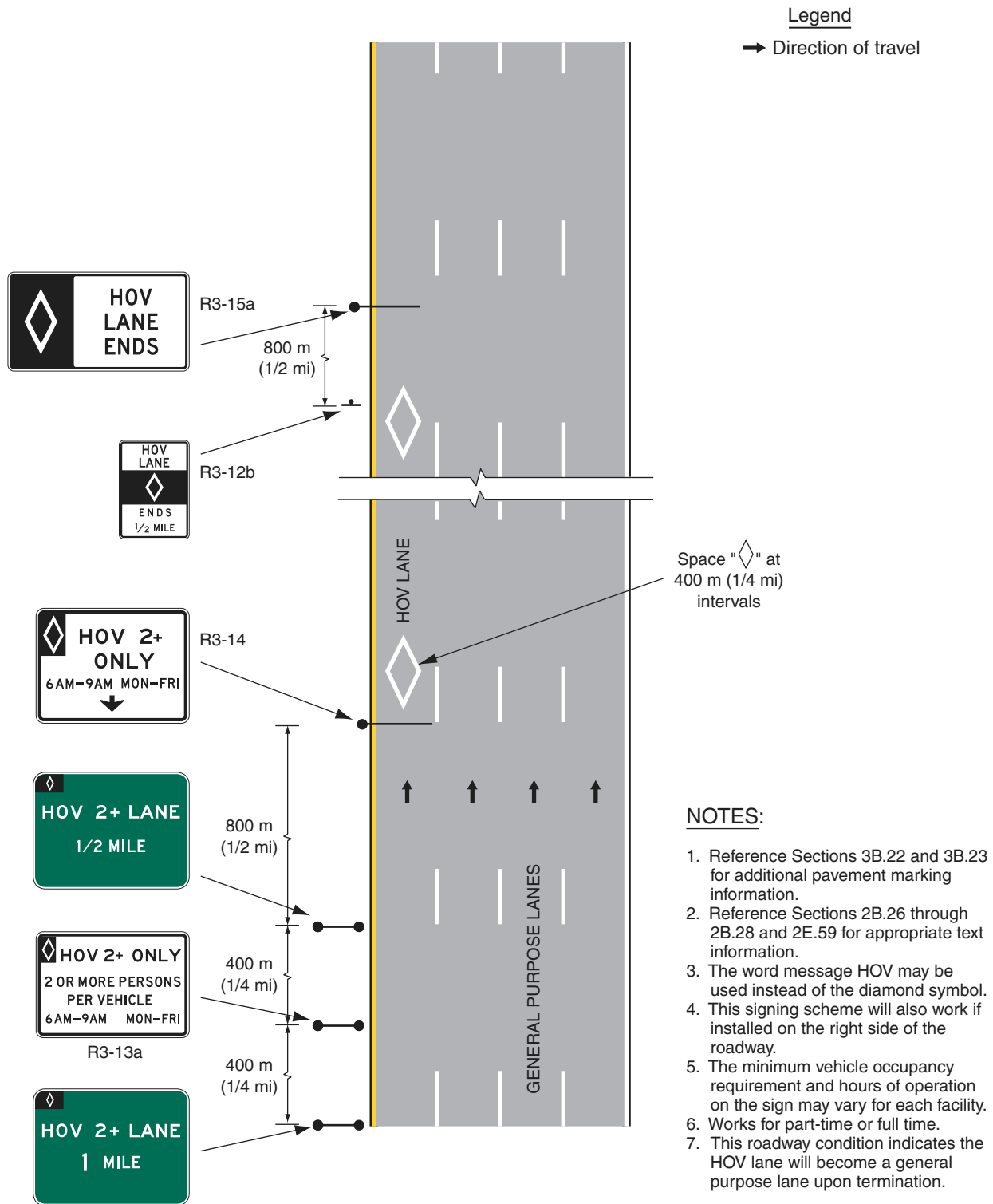
The use of advance guide and guide signs for direct access ramps for preferential only lanes at interchanges connecting two freeways is similar to a connecting ramp between two freeway facilities.



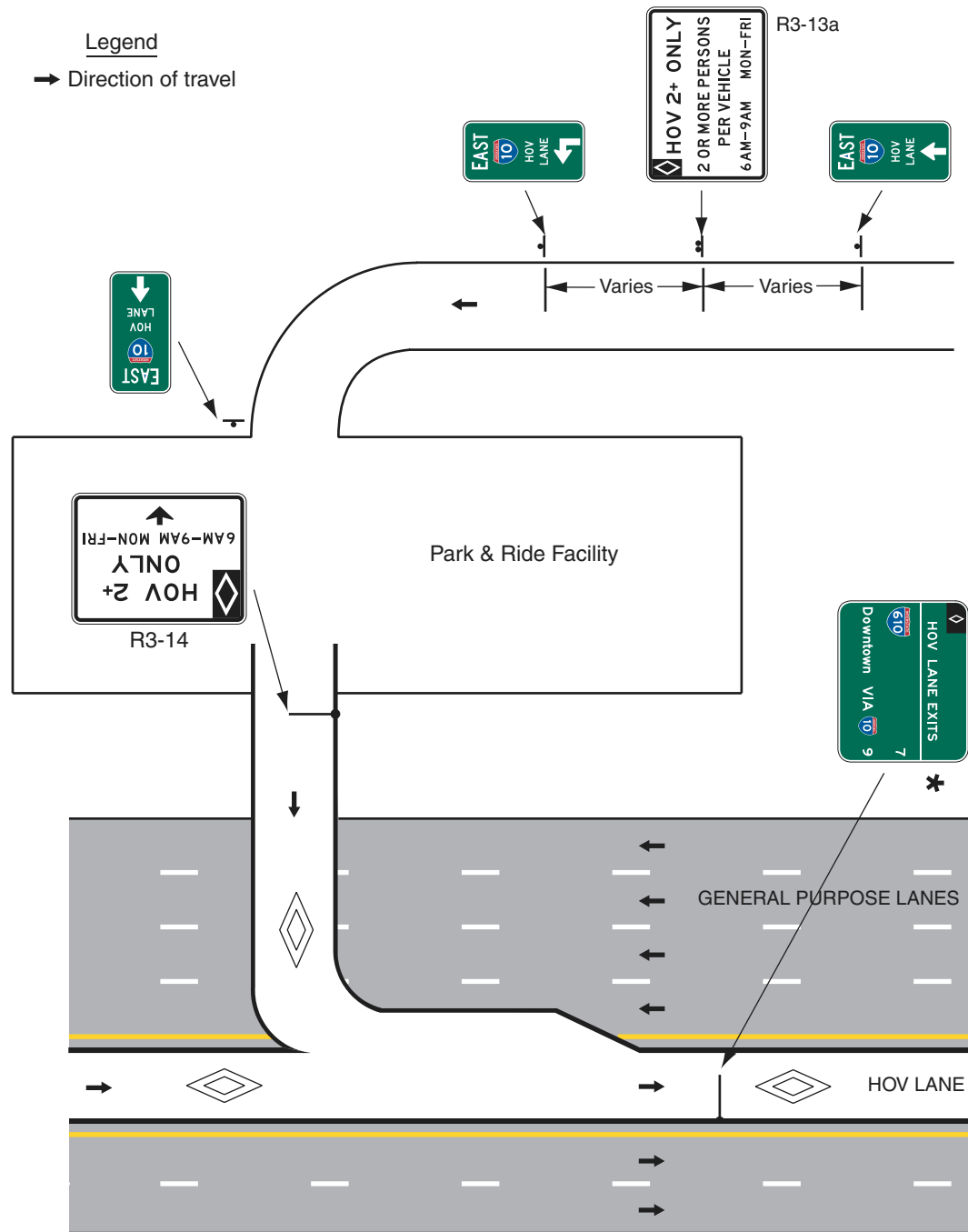
**Figure 2E-48. Example of Signing for the Entrance to and Exit from an Added HOV Lane**



**Figure 2E-49. Example of Signing for the Entrance to and Exit from a General Purpose Lane that Becomes an HOV Lane**



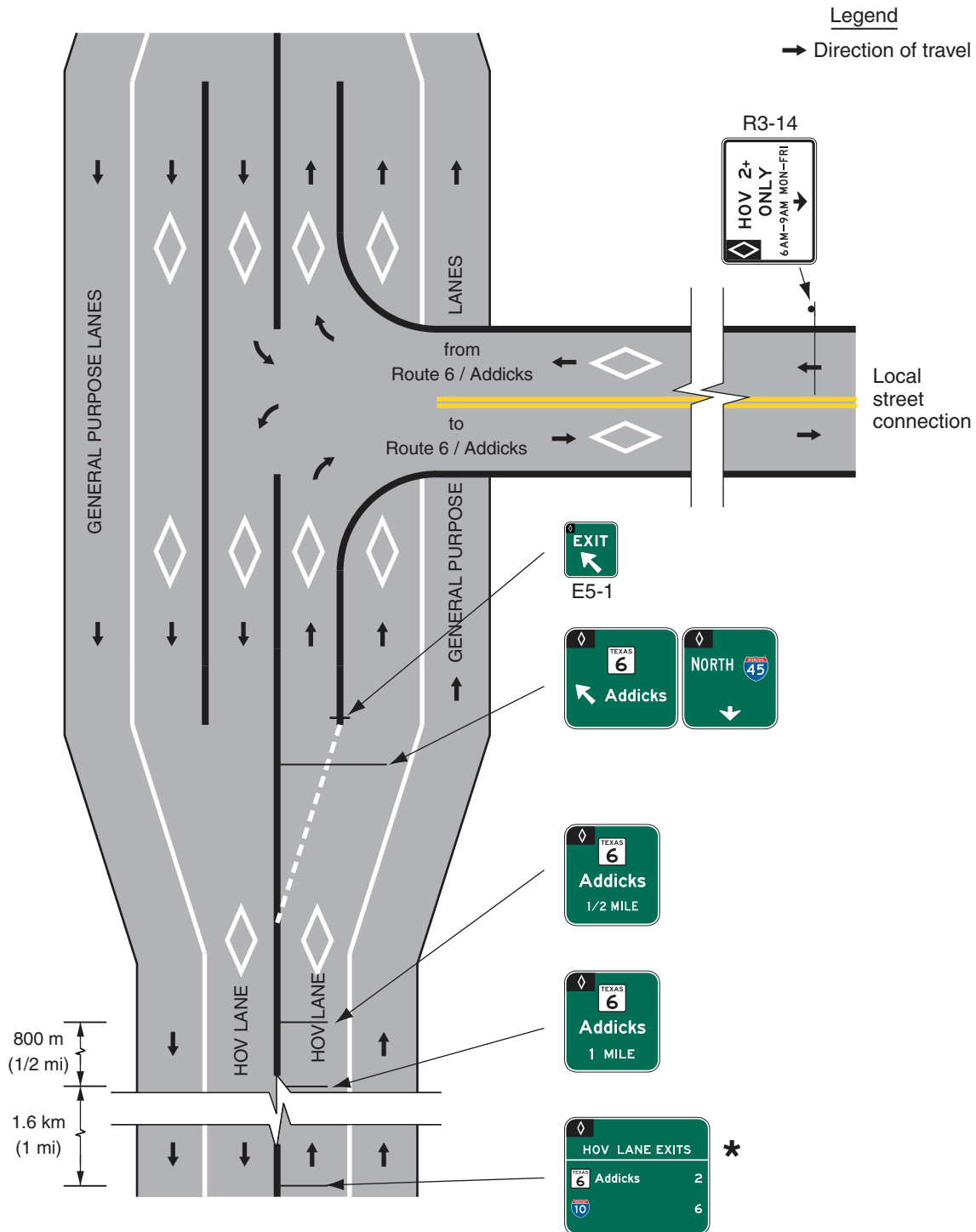
**Figure 2E-50. Example of Signing for a Direct Access Ramp to an HOV Lane from a Park & Ride Facility**



NOTES:

1. Reference Sections 3B.22 and 3B.23 for additional pavement marking information.
  2. Reference Sections 2B.26 through 2B.28 and 2E.59 for appropriate text information.
  3. Additional advisory and warning signs are required.
  4. Direction of HOV traffic is inbound.
  5. Sign locations are approximate.
  6. The word message HOV may be used instead of the diamond symbol.
  7. The minimum vehicle occupancy requirement on the sign may vary for each facility.
  8. Overhead HOV signs should supplement ground-mounted HOV signs.
  9. Additional signs may be required to direct drivers from the surrounding streets into the park & ride lot and HOV lane.
  10. Additional signs are required on the adjoining surface streets to inform non-HOVs that they should not enter the HOV facility.
- \* For access restricted facilities. Destinations may be augmented to accompany routes on Interchange Sequence signs (see Figure 2E-24).

**Figure 2E-51. Example of Signing for a Direct Access Ramp to an HOV Lane from a Local Street**



**NOTES:**

1. Reference Sections 3B.22 and 3B.23 for additional pavement marking information.
2. Reference Sections 2B.26 through 2B.28 and 2E.59 for appropriate text information.
3. Additional advisory and warning signs are required.
4. Sign locations are approximate.
5. HOV facility could be barrier-separated, buffer-separated, or concurrent flow.

\* For access restricted facilities. Destinations may be augmented to accompany routes on Interchange Sequence signs (see Figure 2E-24).

**Figure 2E-52. Example of Signing for a Direct Access Ramp between HOV Lanes on Separate Freeways**

