

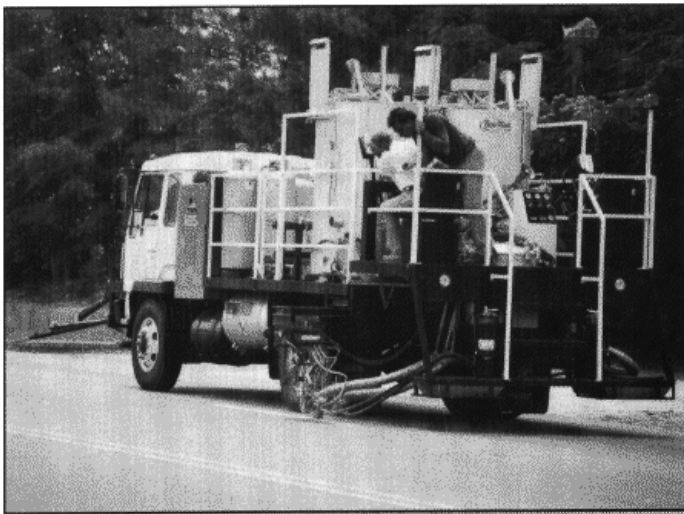

U.S. Department
of Transportation

**Federal Highway
Administration**

Publication No. FHWA-SA-93-001



ROADWAY DELINEATION PRACTICES HANDBOOK

August 1994



Innovation Through Partnerships

Roadway Delineation Practices Handbook

Technical Report Documentation Page

1. Report No. FHWA-SA-93-001		2. Government Accession No.		3. Recipient's Catalog No.	
4. Title and Subtitle Roadway Delineation Practices Handbook				5. Report Date August 1994	
				6. Performing Organization Code	
7. Author(s) James Migletz, Joseph K. Fish, and Jerry L. Graham				8. Performing Organization Report No.	
9. Performing Organization Name and Address Graham-Migletz Enterprises, Inc. P.O. Box 348 Independence, MO 64050				10. Work Unit No. (TRAIS)	
				11. Contract or Grant No. DTFH61-90-C-00028	
12. Sponsoring Agency Name and Address Office of Safety and Office of Technology Applications Federal Highway Administration 400 Seventh Street, SW Washington, DC 20590				13. Type of Report and Period Covered Handbook	
				14. Sponsoring Agency Code	
15. Supplementary Notes The Contracting Officer's Technical Representatives were Peter J. Hatzi and James T. Brooks. Drawings and editorial work by Scientific and Commercial Systems Corporation.					
16. Abstract <p>The <i>Roadway Delineation Practices Handbook</i> was developed to assist design, traffic, and maintenance engineering personnel in making determinations about roadway delineation systems, including the appropriate system for a given situation, when a system has reached the end of its useful life, and how to maintain a quality delineation system. It may also be valuable to consulting engineers, educators, and students.</p> <p>A companion videotape, <i>Testing and Field Inspection of Roadway Delineation</i>, was produced to assist engineers with field inspection of the quality of delineation projects. This videotape is available separately as publication number FHWA-SA-93-002.</p> <p>This Handbook supplements the policies and standards provided in the <i>Manual on Uniform Traffic Control Devices</i> by offering implementation guidelines for the standards. The contents cover current and newly developed devices, materials, and installation equipment, presenting each item's expected performance based on actual experience or field and laboratory tests. The Handbook draws on the experiences of Federal, State, county, and city agencies and summarizes future directions and developments as reported in recent research and by industry's technical representatives. Individual chapters cover the characteristics of retroreflection and quality assurance, driver visibility needs, traffic paints, preformed tapes, raised pavement markers and other marking materials, post-mounted delineators and other delineation devices, and administrative and management issues and practices. The appendices provide detailed technical information, including cost analysis techniques; sources of materials and equipment; and a list of standards, specifications, and test methods related to delineation.</p>					
17. Key Words Roadway Delineation, Pavement Markings, Retroreflection, Driver Visibility, Traffic Paints, Thermoplastic, Preformed Tapes, Raised Pavement Markers			18. Distribution Statement No restrictions. This document is available to the public from the National Technical Information Service, Springfield, VA 22161		
19. Security Classification (of this report) Unclassified		20. Security Classification (of this page) Unclassified		21. No. of Pages 266	22. Price

SI* (MODERN METRIC) CONVERSION FACTORS									
APPROXIMATE CONVERSIONS TO SI UNITS					APPROXIMATE CONVERSIONS FROM SI UNITS				
Symbol	When You Know	Multiply By	To Find	Symbol	Symbol	When You Know	Multiply By	To Find	Symbol
LENGTH									
in	inches	25.4	millimeters	mm	mm	millimeters	0.039	inches	in
ft	feet	0.305	meters	m	m	meters	3.28	feet	ft
yd	yards	0.914	meters	m	m	meters	1.09	yards	yd
mi	miles	1.61	kilometers	km	km	kilometers	0.621	miles	mi
AREA									
in ²	square inches	645.2	square millimeters	mm ²	mm ²	square millimeters	0.0016	square inches	in ²
ft ²	square feet	0.093	square meters	m ²	m ²	square meters	10.764	square feet	ft ²
yd ²	square yards	0.836	square meters	m ²	m ²	square meters	1.195	square yards	yd ²
ac	acres	0.405	hectares	ha	ha	hectares	2.47	acres	ac
mi ²	square miles	2.59	square kilometers	km ²	km ²	square kilometers	0.386	square miles	mi ²
VOLUME									
fl oz	fluid ounces	29.57	milliliters	mL	mL	milliliters	0.034	fluid ounces	fl oz
gal	gallons	3.785	liters	L	L	liters	0.264	gallons	gal
ft ³	cubic feet	0.028	cubic meters	m ³	m ³	cubic meters	35.71	cubic feet	ft ³
yd ³	cubic yards	0.765	cubic meters	m ³	m ³	cubic meters	1.307	cubic yards	yd ³
NOTE: Volumes greater than 1000 l shall be shown in m ³ .									
MASS									
oz	ounces	28.35	grams	g	g	grams	0.035	ounces	oz
lb	pounds	0.454	kilograms	kg	kg	kilograms	2.202	pounds	lb
T	short tons (2000 lb)	0.907	megagrams (or "metric ton")	Mg (or "t")	Mg (or "t")	megagrams (or "metric ton")	1.103	short tons (2000 lb)	T
TEMPERATURE (exact)									
°F	Fahrenheit temperature	5(F-32)/9 or (F-32)/1.8	Celcius temperature	°C	°C	Celcius temperature	1.8C + 32	Fahrenheit temperature	°F
ILLUMINATION									
fc	foot-candles	10.76	lux	lx	lx	lux	0.0929	foot-candles	fc
fl	foot-Lamberts	3.426	candela/m ²	cd/m ²	cd/m ²	candela/m ²	0.2919	foot-Lamberts	fl
FORCE and PRESSURE or STRESS									
lbf	poundforce	4.45	newtons	N	N	newtons	0.225	poundforce	lbf
lbf/in ²	poundforce per square inch	6.89	kilopascals	kPa	kPa	kilopascals	0.145	poundforce per square inch	lbf/in ²

* SI is the symbol for the International System of Units. Appropriate rounding should be made to comply with Section 4 of ASTM E380.

(Revised September 1993)

CONTENTS

	<i>Page</i>
CHAPTER 1. INTRODUCTION	1
BACKGROUND	1
Definition of Delineation	1
Initiatives to Improve Highway Safety	2
Cost-Effective Markings	2
SCOPE OF THE RESEARCH	3
HANDBOOK ORGANIZATION	3
CHAPTER 2. CHARACTERISTICS OF RETROREFLECTION AND	

Roadway Delineation Practices Handbook

QUALITY ASSURANCE	5
INTRODUCTION	5
RETROREFLECTION	5
General Principles	5
Measuring Retroreflection	7
Units of Measure	7
Glass Beads	11
Prismatic Cube-Corner Retroreflection	17
QUALITY ASSURANCE	18
Vendor Certification.....	18
Regional Test Facilities	19
CHAPTER 3. DRIVER VISIBILITY NEEDS	21
INTRODUCTION	21
Driver Visibility	21
Older Drivers	21
VISIBILITY CRITERIA	22
Luminance	22
Contrast.....	23
Conspicuity.....	23
Legibility.....	23
PAVEMENT MARKING VISIBILITY DISTANCE	24
Driver Events	24
Guidelines for Effective Delineation	24
VISIBILITY PARAMETERS	25
Physical Parameters	25
Psychophysical Parameters	27
DELINEATION VARIABLES	29
Roadway Geometry	30
Weather and Climate	31
Traffic Volume and Composition.....	32
Substrate Material	33
Implication of Variables	34
CHAPTER 4. TRAFFIC PAINTS	35
INTRODUCTION	35
TYPES AND APPLICATIONS OF PAINTED MARKINGS.....	35

Roadway Delineation Practices Handbook

MATERIALS	35
Categories	35
Types.....	38
Essential Properties	39
Paint Formulation	40
Purchase of Materials	40
Testing	41
PERFORMANCE	42
Performance Descriptors	42
Causes of Failure	43
Ranges of Service Life	43
INSTALLATION, MAINTENANCE, AND REMOVAL	44
Application Equipment	45
Crew Size for Installation	50
Pretreatment of Pavement.....	51
Premarking of Roadway	51
Scheduling of Marking Activities.....	52
Warehousing and Storing of Materials.....	53
Removal of Painted Markings	54
New Techniques	56
INSPECTION	57
Preapplication Inspections	57
Application Inspections	57
Postapplication Inspections	58
ENVIRONMENTAL CONCERNS	58
State and Local Regulation.....	59
Hazardous Materials.....	59
Lead-Based Pigments	59
CHAPTER 5. THERMOPLASTIC MATERIALS	61
INTRODUCTION	61
USES	61
MATERIALS	62
Types.....	62
Properties of Thermoplastics	63
PERFORMANCE	64
Service Life.....	64
Determining Service Life	65
INSTALLATION, MAINTENANCE, AND REMOVAL.....	66

Roadway Delineation Practices Handbook

Installation	66
Maintenance	72
Removal	73
INSPECTION	73
Clean and Dry Pavement	74
Air Temperature	74
Pavement Temperature.....	74
Material Temperature	74
Other Tests	75
CHAPTER 6. PREFORMED TAPES	79
INTRODUCTION	79
USES	79
Properties of Cold-Applied Plastic	79
Cost Considerations	80
Illuminated Streets	80
TYPES	80
Permanent	80
Temporary	80
PERFORMANCE	81
Retroreflectivity	81
Durability	81
INSTALLATION AND REMOVAL	81
Installation	81
Removal	84
INSPECTION	84
CHAPTER 7. RAISED PAVEMENT MARKERS	85
INTRODUCTION	85
USES	85
Functional Applications	85
Considerations for Application	92
Guidelines for Application	92
Special Locations	93
MATERIALS	94
Types.....	94
Adhesives and Characteristics	110

Roadway Delineation Practices Handbook

Temporary Delineation.....	111
PERFORMANCE	112
Conventional RPMs	112
Snowplowable Markers	113
INSTALLATION AND MAINTENANCE	114
General Practices	114
Application of Self-Adhesive RPMs	114
Epoxy Adhesive	115
Bitumen Adhesive	116
Routine Maintenance	116
Immediate Maintenance	117
RPM Replacement Process	118
Specific Maintenance Concerns	119
Cleaning	120
Retroreflective Tabs	120
INSPECTION	120
CHAPTER 8. OTHER MARKING MATERIALS	121
INTRODUCTION	121
USES	121
TYPES	121
Latex Paint	121
Epoxy Paint.....	122
Polyester, Solids	122
Epoxy Thermoplastic	122
Methyl Methacrylate.....	123
Marking Powder	123
Other Materials.....	124
PERFORMANCE	124
Latex Paint	124
Epoxy Paint.....	124
Polyester	125
Epoxy Thermoplastic	126
Methyl Methacrylate.....	127
INSTALLATION, MAINTENANCE, AND REMOVAL.....	127
Latex Paint	127
Epoxy Paint.....	127
Polyester	128
Epoxy Thermoplastic	129
Methyl Methacrylate.....	129
OTHER CONSIDERATIONS	129

Roadway Delineation Practices Handbook

Cost Considerations	130
Potential For Future Use.....	131
CHAPTER 9. POST-MOUNTED DELINEATORS	133
INTRODUCTION	133
USES	133
MATERIALS	134
Retroreflective Element	134
Mounting Post.....	135
PERFORMANCE	136
INSTALLATION AND MAINTENANCE	137
Spacing and Placement.....	137
Retroreflective Element Installation.....	137
Post Installation and Equipment.....	139
Replacement	140
Cleaning	140
Winter Maintenance	140
Crew Size and Safety	140
Colored Posts	140
Removal	141
CHAPTER 10. OTHER DELINEATION DEVICES	143
INTRODUCTION	143
USES	143
Object Markers	143
Warning Signs	145
Barrier Delineators	148
Pavement Symbols	148
PERFORMANCE	165
INSTALLATION, MAINTENANCE, AND REMOVAL.....	165
Object Markers	165
Warning Signs	165
Barrier Delineators	172
Pavement Symbols	173
CHAPTER 11. ROADWAY DELINEATION MANAGEMENT	175
INTRODUCTION	175
SAFETY AND YEAR-ROUND MAINTENANCE	175
MINIMUM RETROREFLECTIVITY	175
INVENTORY	176
Computerized	176

Roadway Delineation Practices Handbook

Photo Log	176
Other Techniques	178
INSPECTION	178
Daytime.....	178
Nighttime	179
Equipment and Facilities	179
FIELD TESTING.....	179
Instruments	179
Portable Equipment	180
Mobile Equipment	181
TORT LIABILITY	181
CHAPTER 12. ADMINISTRATION	185
INTRODUCTION	185
LEGAL CONSIDERATIONS.....	185
Definition of Tort Liability	186
Legal Duty and Liability	187
Notice of Defect	188
Maintenance of Delineation Systems	188
Implications of Tort Liability	189
SOURCES OF FUNDING	190
PROCUREMENT PROTECTION	190
Quantity Purchase of Materials	190
Inventory and Recordkeeping.....	191
Use of Model Specifications	191
Use of Contractors	192
COORDINATION OF ACTIVITIES	192
COST CONSIDERATIONS	192
Pavement Markings	193
Raised Pavement Markers	194
Post-Mounted Delineators	194
Signing	195
Conditions for Cost-Effective Applications	195
INSPECTION OF PAVEMENT MARKING PROJECTS	196
Inspector Training and Certification	196
Sources of Sample Specifications	196
REFERENCES.....	197
APPENDIX A. COST ANALYSIS TECHNIQUES	205

STATISTICAL ANALYSIS	205
Economic Analysis Models	206
Delineation Guidelines	207
COMMENTS ON THE RESEARCH	208
APPENDIX B. SOURCES OF MATERIALS AND EQUIPMENT	211
APPENDIX C. LIST OF STANDARDS, SPECIFICATIONS, AND TEST METHODS RELATED TO DELINEATION	215
GLOSSARY	219
BIBLIOGRAPHY	231
INDEX	247

LIST OF FIGURES

<i>Figure</i>		<i>Page</i>
CHAPTER 2.CHARACTERISTICS OF RETROREFLECTION AND QUALITY ASSURANCE		
1.	Types of reflection.....	5
2.	Comparison of point and directed light sources	6
3.	Comparison of theoretical and actual retroreflection	7
4.	Intensity of a light source	8
5.	Distribution of light through space	9
6.	Physical quantities related to roadway retroreflection measurement	10
7.	Glass bead retroreflection	12
8.	Effect of refractive index on glass bead retroreflection	13
9.	Focusing effect of glass beads.....	13
10.	Optimum glass bead embedment	14
11.	Large vs. standard bead performance in epoxy pavement markings	14
12.	Water films' effect on retroreflection	14
13.	Flotation beads	16
14.	Prismatic cube-corner retroreflection	18
15.	Retroreflection test geometry	18
CHAPTER 3. DRIVER VISIBILITY NEEDS		
16.	Threshold contrast requirements as age increases	22
17.	Light return by pavement markings	23
18.	Subjective ratings of visibility vs. retroreflectometer readings on a linear and a logarithmic scale	29
19.	Effect of ADT on service life of thermoplastic markings.....	33
CHAPTER 4. TRAFFIC PAINTS		

Roadway Delineation Practices Handbook

20.	Typical applications for longitudinal roadway delineation.....	37
21.	Small paint applications units	46
22.	Layout of large-scale paint striper	47
23.	Truck-mounted paint application units.....	48
24.	Paint and glass bead spray applicator.....	49
25.	Paint control panel	49
26.	Coning for paint application	50
27.	Premarking technique	52
28.	Portable Tristimulus colorimeter	58

CHAPTER 5. THERMOPLASTIC MATERIALS

29.	Average thermoplastic life vs. annual snowfall	64
30.	Life of thermoplastic markings as a function of volume.....	64
31.	Performance of thermoplastic markings as a function of traffic flow.....	65
32.	Small thermoplastic application equipment	69
33.	Large-scale thermoplastic application equipment	70
34.	Loading and extruding thermoplastic	71
35.	Typical melting kettles used in thermoplastic application	72

CHAPTER 6. PREFORMED TAPES

36.	Basic methods of installing preformed tapes	82
37.	Installation and removal of cold-applied preformed tapes	83

CHAPTER 7. RAISED PAVEMENT MARKERS

38.	Nighttime visibility with RPMs	86
39.	List of symbols	87
40.	Use of RPMs to show roadway alignment on tangent sections and horizontal curves	88
41.	Centerline patterns	89
42.	Lane line patterns	90
43.	Marking patterns for solid lines	91
44.	Marking patterns for two-way roads.....	95
45.	Marking patterns for transition situations.....	96
46.	Marking patterns for intersection approaches	97
46.	Marking patterns for intersection approaches (continued).....	98
47.	Marking patterns for horizontal curves having 6° or greater curvature.....	99
48.	Marking patterns for left-turn lanes	100
48.	Marking patterns for left-turn lanes (continued)	101
49.	Marking patterns for freeway ramps.....	102
50.	Marking patterns for work zones	103
50.	Marking patterns for work zones (continued)	104
50.	Marking patterns for work zones (continued)	105
51.	Ceramic raised pavement markers	106
52.	Principle and structure of corner-cube retroreflectors	107
53.	Typical raised marker configurations	108
54.	Snowplowable retroreflective pavement marker	109
55.	Bonding surface of ceramic RPM.....	110
56.	Application of pressure-sensitive RPM	115

CHAPTER 9. POST-MOUNTED DELINEATORS

Roadway Delineation Practices Handbook

57.	Post-mounted delineator retroreflective techniques	134
58.	Typical dimensions for flexible delineator posts	135
59.	Typical delineator installation on horizontal curve	139
60.	Encasing center-mount retroreflector in aluminum back case	139
61.	Typical delineator positioning	140

CHAPTER 10. OTHER DELINEATION DEVICES

62.	Object markers	144
63.	Alignment series and advisory speed plate	146
64.	Large arrow and chevron alignment signs	148
65.	Barrier delineators	149
66.	Typical crosswalk markings	150
67.	Typical crosswalk markings for exclusive pedestrian phase	152
68.	Typical parking space limit markings	153
69.	Typical lane-use-control word and symbol markings	154
70.	Lane-use and wrong-way arrows for pavement markings	155
71.	Narrow turning and lane-use arrows	156
72.	Elongated letters for pavement marking	157
73.	Typical placement of warning signs and pavement markings at railroad-highway grade crossings	159
74.	Alternate (narrow) typical pavement marking supplement for railroad-highway grade crossings	160
75.	Typical pavement markings-designated bicycle lane, two-way traffic with parking and low right-turn volume	162
76.	Intersection pavement markings-designated bicycle lane with left turn area, heavy turn volumes, parking, one-way traffic or divided roadway	163
77.	Word and symbol pavement markings for bicycle facilities	164
78.	Typical marking in advance of drainage hazard	165
79.	Typical installation of warning signs	166
80.	Recommended safe curve speed	167
81.	Ball bank indicator	168
82.	Electronic data acquisition system	169
83.	Vandalized signs	171
84.	Daytime inspection of sign retroreflectivity	171
85.	Warning sign with deteriorated retroreflectivity	172
86.	Use of a portable retroreflectometer	173

CHAPTER 11. ROADWAY DELINEATION MANAGEMENT

87.	Examples of sun/shadow technique	178
88.	Pocket microscope	179
89.	Mirolux 12 retroreflectometer	180
90.	Schematic of laser retroreflectometer	182
91.	Pictures of the truck-mounted laser retroreflectometer	183
92.	Retroreflection of pavement marking tape as a function of observation angle and two entrance angles	184

APPENDIX A. COST ANALYSIS TECHNIQUES

93.	Schematic representation of “Benefit-Cost” and “Cost-Analysis” model	207
-----	--	-----

LIST OF TABLES

<i>Table</i>	<i>Page</i>
CHAPTER 2. CHARACTERISTICS OF RETROFLECTION AND QUALITY ASSURANCE	
1. Gradations for FHWA Type 3, Type 4, and Type 5 large glass beads.....	15
CHAPTER 4. TRAFFIC PAINTS	
2. Types of pavement markings	36
3. Effectiveness of removal methods	56
4. Application characteristics for inspection	59
CHAPTER 5. THERMOPLASTIC MATERIALS	
5. Warranty requirements for thermoplastic	65
6. Common problems with thermoplastic.....	76-77
CHAPTER 7. RAISED PAVEMENT MARKERS	
7. Adhesives and installed costs for RPMs in a variety of States	113
CHAPTER 8. OTHER MARKING MATERIALS	
8. White ETP composition	123
9. Estimated service life by class (median lifetimes in days)	125
10. Durability of polyester marking materials	126
11. Service lives of methyl methacrylate marking materials	127
12. Comparison of installed costs	131
CHAPTER 9. POST-MOUNTED DELINEATORS	
13. Suggested spacing for delineators on horizontal curves.....	138
14. Equations for calculating optimum PMD spacings	138
CHAPTER 10. OTHER DELINEATION DEVICES	
15. Typical placement distances for general warning signs	170
16. Replacement coefficients of retroreflectance using US-type low beam headlights	172
CHAPTER 11. ROADWAY DELINEATION MANAGEMENT	
17. Correlation coefficients between pavement marking retroreflectometers	176
Appendix A	
18. Treatment applications used in cost-benefit calculations	212

ABBREVIATIONS

AASHTO: American Association of State Highway and Transportation Officials

Roadway Delineation Practices Handbook

AC:	Asphaltic Concrete
ADT:	Average Daily Traffic
ASTM:	American Society for Testing and Materials
ATSSA:	American Traffic Safety Services Association
BTU:	British thermal unit
DOT:	Department of Transportation
E:	Rate of superelevation
EPA:	Environmental Protection Agency
ETP:	Epoxy Thermoplastic Paint
F:	Coefficient of friction
FHWA:	Federal Highway Administration
id:	Inner Diameter
L:	Length
mil:	One-thousandth of an inch
MUTCD:	Manual on Uniform Traffic Control Devices for Streets and Highways
NASHTO:	Northeastern Association of State Highway and Transportation Officials
NCHRP:	National Cooperative Highway Research Program
NCSHS:	National Conference on Street and Highway Safety
od:	Outer diameter
PCC:	Portland Cement Concrete
PIEV:	Perception, Identification, Emotion, and Volition Time
r,R:	Radius
RI:	Refractive Index
R_A :	Specific intensity per unit area
R_L :	Coefficient of Retroreflected Luminance
RPM:	Raised Pavement Marker
S:	Spacing of delineators on curves
SASHTO:	Southeastern Association of State Highway and Transportation Officials
SRTF:	Southeastern Regional Test Facility
V:	Velocity
VOC:	Volatile Organic Compound

CHAPTER 1. INTRODUCTION

BACKGROUND

Motor vehicle ownership and use continue to rise in all sectors of the nation. The corresponding increase in accidents, delays, and inconvenience has posed a critical challenge to highway and traffic operations and safety engineers. In seeking solutions, the emphasis has shifted from new road construction to improvement of existing roadways.

Roadway delineation techniques have generally kept pace with the development of the national highway and street systems. Delineation has long been considered essential for effective guidance of the driver. This guidance enhances traffic flow, driving comfort, and traffic safety. Shrinking highway budgets, however, make it important to use new and

Roadway Delineation Practices Handbook

improved economical delineation methods. A thorough knowledge of the technology and prudent application of cost-effective techniques are needed.

Definition of Delineation

Delineation refers to any method of defining the roadway operating area for the driver. In this Handbook, delineation is defined as one, or a combination of devices (excluding guide signs), that regulate, warn, or provide tracking information and guidance to the driver. These devices include the following delineation materials: painted markings, thermoplastic and other durable markings, raised pavement markers, and post-mounted delineators. Warning signs are also considered part of the delineation system. They are used to complement standard delineation in special areas, such as at horizontal curves.

The function of roadway markings, as stated in the *Manual on Uniform Traffic Control Devices (MUTCD)*, part 3, is to “supplement the regulations and warnings of other devices such as traffic signs or signals. In other instances, they are used alone and produce results that cannot be obtained by the use of any other device... [by] conveying certain regulations and warnings that could not otherwise be made clearly understandable.”⁽¹⁾

The *MUTCD* presents standard ways of conveying information to the driver (design, color, pattern, and width). For example, yellow lines separate traffic flowing in opposing directions, whereas white lines denote traffic flowing in the same direction. Broken lines are permissive in character; solid lines are restrictive. Width of the line indicates its emphasis. Detailed standards related to color, pattern, and width are presented in *MUTCD* sections 3A-2 through 3A-6, where it is stressed that “each standard marking shall be used only to convey the meaning prescribed for it in this Manual [MUTCD].” In this Handbook, it is assumed that personnel who design roadway delineation will be familiar with the *MUTCD* or its State-mandated equivalent.

In a properly designed traffic control system, markings have specific functions. Pavement markings guide the movement of traffic and promote safety on the highway. In some cases, they are used to supplement the messages of other traffic control devices. In other cases, markings are the only way to convey a message without distracting the driver. In addition, a highway's capacity increases from orderly traffic flow. Pavement markings encourage this kind of capacity increase.

Markings must be readily understood, and this can be achieved only by a uniform system of markings. A motorist should see the same type of markings in different localities and these markings should impart the same message wherever they are encountered.

Initiatives to Improve Highway Safety

Because highway agencies are beginning to concentrate on increasing capacity for existing roadways, safety has become more important than ever.

While the 1990 rate of 2.1 traffic fatalities per 100 million vehicle miles traveled is the lowest in United States history, much work remains.⁽²⁾ There were almost 6.5 million police-reported traffic accidents resulting in more than 44,000 fatalities in 1990.⁽³⁾

One of the primary goals of engineers is the application of new technology to old problems. Engineers attempt to make life easier and safer for the public. The use of innovative delineation techniques and treatments can have safety benefits for drivers in ways that may not be realized with any other method.

On October 3, 1983, the Secretary of Transportation announced a series of new initiatives directed toward improving highway safety. The Secretary's initiatives included several items directed specifically toward actions in the Federal Highway Administration's (FHWA's) area of program responsibilities. The FHWA's memo, dated October 25, 1983, set forth objectives and methods for implementing the initiative on highway safety delineation and markings.⁽⁴⁾ One hundred percent Federal funding was made available for implementing the delineation initiative.

Roadway Delineation Practices Handbook

Cost-Effective Markings

The best known way to improve capacity and safety on highways is to provide cost-effective delineation. This means applying markings that provide the longest service life per unit cost, provided performance is equal.

Benefit-Cost Ratio

Markings should be evaluated by the use of the benefit-cost ratio. First, all options must provide nearly equal visibility for their effective service lives. This is of paramount importance. If this criterion is not adhered to, the most cost-effective option will seem to be a low-cost, low-performance system that may eventually create a hazard because of its rapid failure or degraded visibility early in its lifetime.

Appendix A (Cost Analysis Techniques) gives a quantitative definition of how the benefit-cost ratio may be used to evaluate marking alternatives.

Conditions for Cost-Effective Systems

Cost-effectiveness will be obtained by considering all variables and by thinking of delineation as a system that consists of the pavement material, the marking material, and the retroreflective material. It is vital that the delineation variables for each application (discussed in chapter 2) are treated with an appropriate marking system.

In addition, there are a multitude of other variables that enter the equation. The length of time the markings will be needed, local availability of materials and equipment, and the marking agency's policies and liabilities are just a few. The highway engineer must realize that trade-offs must often be made among a multitude of divergent and often conflicting concerns. This is the only way that the optimum cost-effective delineation system can be attained.

SCOPE OF THE RESEARCH

The FHWA, National Cooperative Highway Research Program (NCHRP), and other agencies have sponsored research to improve roadway delineation. In addition, many States and some large cities have conducted laboratory and field tests of new delineation techniques. Many of these small agencies, however, do not have the resources to investigate the devices, materials, or equipment that are a part of an effective roadway delineation system. These agencies need guidance that is more objective than the persuasiveness of the local vendor.

Recognizing this need, the FHWA initiated a project to develop a Handbook on roadway delineation systems. This Handbook would be intended to assist the practicing engineer in determining the appropriate system for a particular situation.

This Handbook does not establish FHWA policies or standards. Rather, it is meant to supplement the *Manual on Uniform Traffic Control Devices*, offering guidelines for implementing the standards presented in the *MUTCD*. This Handbook is not intended to be a technical report on research into the latest delineation technologies. However, major research findings used to develop guidelines are clearly referenced. Those interested in the details of a particular research project should seek them independently.

This Handbook is intended primarily for use by design, traffic, and maintenance engineering personnel. It may also prove valuable to consulting engineers, educators, and students. The contents cover current and newly developed devices, materials, and installation equipment, presenting each item's expected performance based on actual experience or field and laboratory tests.

While this Handbook is not meant to reflect the state of the art in delineation technology, it does provide fundamental concepts. The materials used to develop the Handbook reflect the experience of Federal, State, county, and city agencies. It also summarizes future directions and developments as reported in recent research and by industry's

Roadway Delineation Practices Handbook

technical representatives.

HANDBOOK ORGANIZATION

The *Roadway Delineation Practices Handbook* provides the practicing engineer with a guide for selecting the best delineation technique for a given set of circumstances. The subject matter falls into six parts:

- Introduction and background (chapter 1).
- Delineation visibility factors (chapters 2 and 3).
- Technical description of current delineation practices (chapters 4 through 10).
- Summary of administrative and management issues and practices (chapters 11 and 12).
- Technical supplement (appendices).

When possible, the chapters with technical descriptions of delineation techniques have been written in a common format. To avoid redundancy, material that is similar for many techniques is detailed in chapter 4 and referenced in subsequent chapters.

The appendices provide detailed technical information to supplement the basic practices described in the text. Of particular interest to the practicing traffic or maintenance engineer will be the appendix A, which explains the cost analysis technique for evaluating pavement markings. Appendix B gives the names and addresses of agencies that sell delineation-related products. Finally, appendix C gives information about delineation specifications.

CHAPTER 2. CHARACTERISTICS OF RETROREFLECTION AND QUALITY ASSURANCE

INTRODUCTION

Today, delineation is an established component of the highway system. The question is no longer one of whether delineation is effective, but rather one of how to provide the best system of delineation for the least cost.

Retroreflectivity is vital for a delineation system to be effective at night. Delineation is intended for visual guidance of the driver; nighttime visibility is almost directly proportional to retroreflectivity. This chapter, therefore, covers the most important aspect of roadway delineation: achieving durable retroreflective markings to ensure long-life visibility. Also discussed are quality assurance through material testing and the programs sponsored by the Federal Highway Administration (FHWA) to encourage testing.

RETROREFLECTION

Highway agencies' recognition of the importance of retroreflection have made its use nearly universal. According to the *Manual on Uniform Traffic Control Devices (MUTCD)*, markings that must be visible at night should be retroreflective unless ambient illumination assures adequate visibility.⁽¹⁾ Because the percentage of well-illuminated roadways is so small, the trend among highway agencies is to make all pavement markings retroreflective. The common exceptions are painted curbs and parking lines.

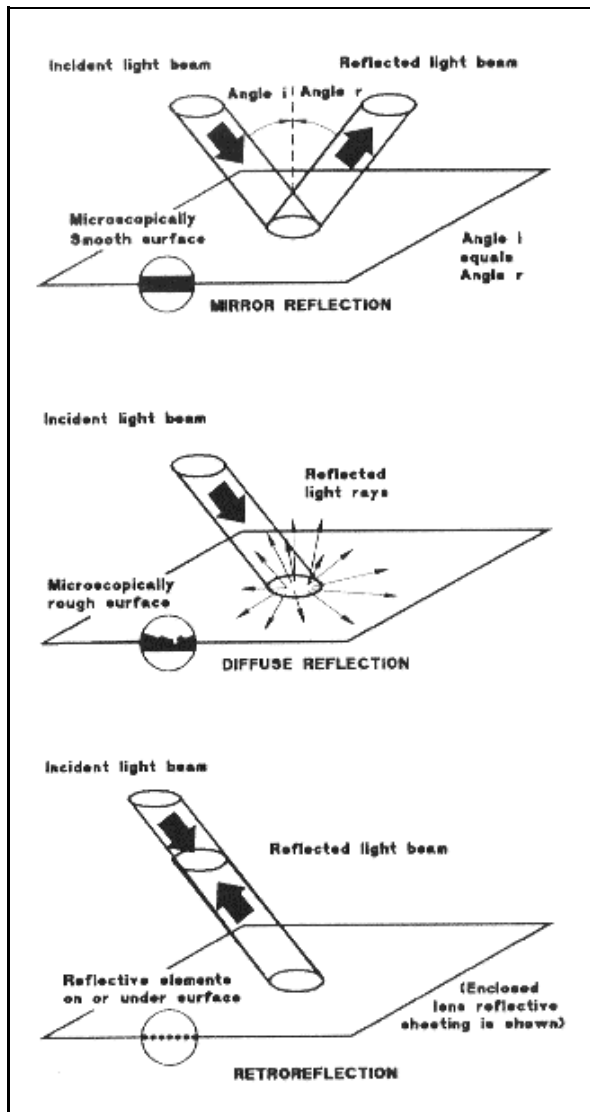

Figure 1. Types of reflection

General Principles

A 1987 FHWA report by McGee and Mace defines *retroreflection* as the phenomenon of light rays striking a surface and being redirected directly back to the source of light.⁽⁵⁾ (See figure 1.)

To understand this phenomenon, a discussion of optical characteristics is necessary. Light sources emit some amount of energy in the form of visible light. An ideal point light source directs its light equally in all directions (figure 2a). If a perfect point light source were enclosed in a perfect sphere, every point on the sphere would be illuminated by an equal amount of brightness, or intensity.

A directed light source, such as a flashlight, will direct its light in a cone around the direction that it is pointed, as seen in figure 2b. If the flashlight puts out an amount of light energy equal to the point source,

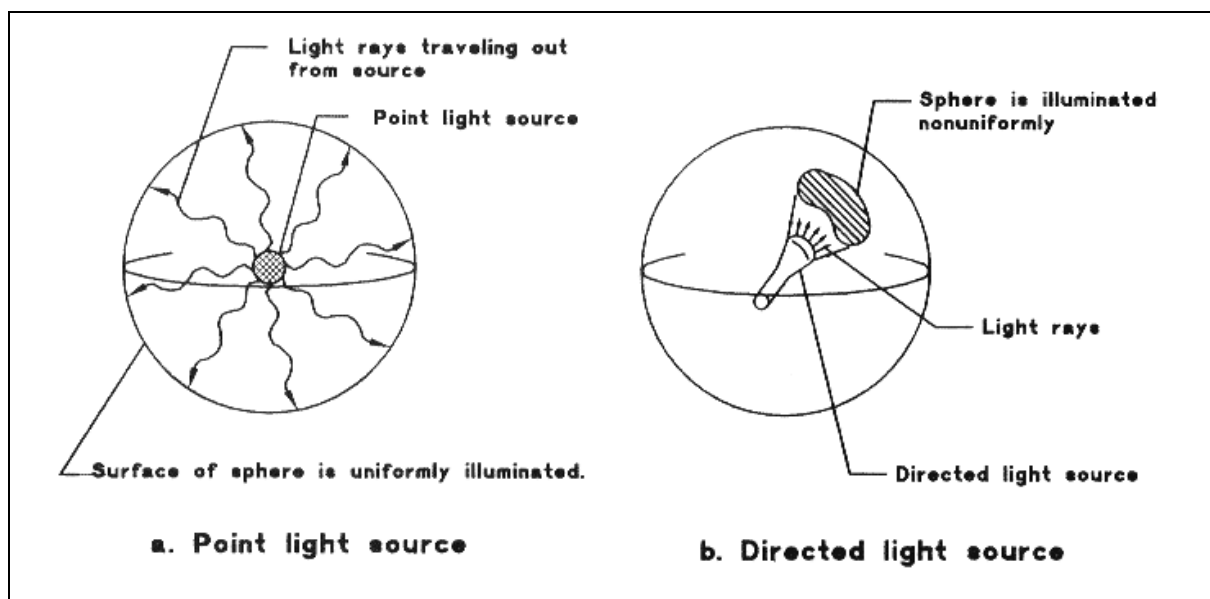

Figure 2. Comparison of point and directed light sources

and is enclosed in an identical perfect sphere, the intensity of light from the flashlight falling on each point will be greater than that of each identical point on the sphere with the point source. Simply put, the points on which the flashlight shines will be brighter than each point illuminated by the point source.

For the sake of complete accuracy, *light flux* and how it relates to energy are described, since these two concepts are not strictly identical. Rather, light flux is a flow rate of light energy. Light flux can be compared to the flow rate of water; it describes how much light is flowing per unit of time.

Using the same analogy, intensity is like the velocity of water flow. If there are two pipes that discharge equal amounts of water every second, and one pipe's cross-sectional area is half that of the other pipe, it is clear that the velocity of water in the smaller pipe must be twice that of the water flowing from the larger pipe.

The same is true for light. If there are two directed light sources that release the same total light flux, but the first source illuminates twice the area of the second, the intensity of the second source will be twice that of the first. This may be visualized as "squeezing" the light rays together to get the same amount of light onto a smaller area. As a result, the area illuminated by the second source will appear brighter, just as the water in the smaller pipe will travel faster and flow with more water per unit of area.

These concepts can aid in an understanding of the phenomenon of retroreflectivity. A point light source, like the one described above, has a uniform distribution of light flux in all directions around it, as shown in figure 2a. A perfect retroreflector would simply reverse the direction of the light incident upon it. In all directions except that of the source, the intensity of light emitted from the reflector is zero.

A perfect retroreflector would not be useful for roadway delineation, since all reflected light would be returned directly to the auto headlights. (See figure 3a.)

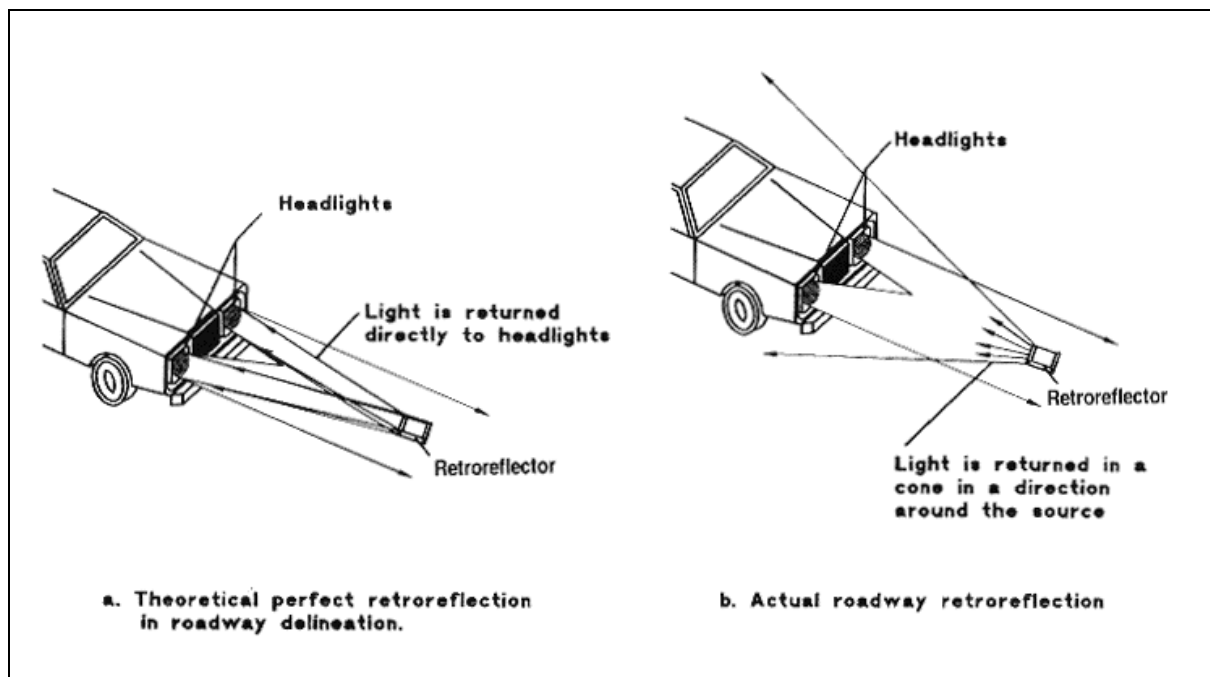

Figure 3. Comparison of theoretical and actual retroreflection

Fortunately, retroreflectors are not perfect. Some light is absorbed by the reflector. More importantly, there is a scattering of light intensity in directions around that of the source, as in figure 3b. It is this imperfectly retroreflected light that returns to the driver's eyes and allows retroreflection to be useful for pavement markings.

Measuring Retroreflection

Hoffman and Firth suggest an ideal way to measure the retroreflective properties of a device.⁽⁶⁾ It seems intuitively correct to measure retroreflection as a ratio of the intensity of light returned in the direction of the driver to the intensity of the source. This would give a scale for retroreflection that consisted of a dimensionless number between 0 and 1.

Unfortunately, there are pragmatic problems with this approach and there must therefore be a system of units to define light flux, intensity, and other optical quantities. The following sections show how these units have been used to establish standard test methods for measuring retroreflection.

Units of Measure

Metric Units

To aid this discussion of units, the concept of a *solid angle* will be defined. A solid angle is a measure of how large an object "looks" from a certain vantage point. The solid angle subtended by an object (or arbitrary area) is a function of the object's area projection in the direction of the vantage point and its distance from the vantage point.

Solid angles are measured in units called steradians (s). Steradians are defined so that there are a total of 4π steradians in a complete sphere around a source. This is analogous to the two-dimensional case where 2π radians equals a complete circular angle around a point.

In figure 4, the solid angle subtended by Area ABCD is equal to the area of ABCD, divided by the total area of the concentric sphere, times the total number of steradians in the sphere.

Roadway Delineation Practices Handbook

$$= \frac{1\text{m}^2}{4\pi(1\text{m})^2} \times 4\pi(\text{s}) = 1 \text{ steradian}$$

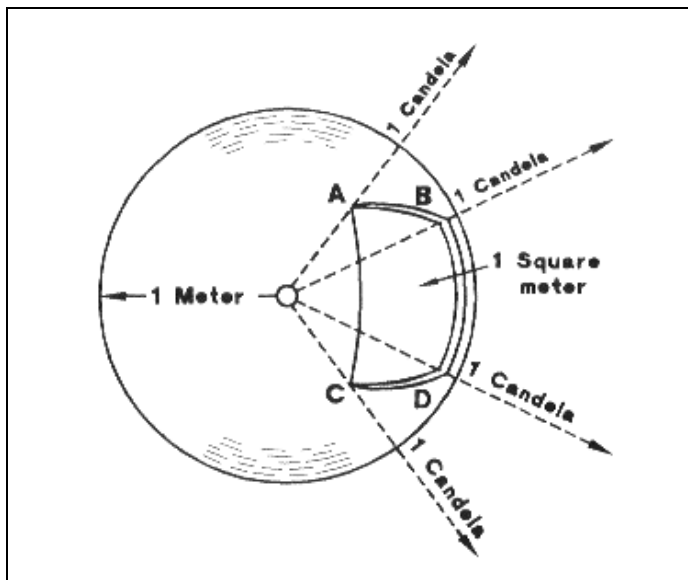

Figure 4. Intensity of a light source

Having defined the solid angle, the definition of optical quantities can be presented. The basic optical quantity is the *candela*. It is a measure of luminous intensity. The concept of intensity was discussed in the previous section. The official definition adopted in 1979 by the General Conference on Weights and Measures is: “The candela is the luminous intensity in a given direction of a source emitting a monochromatic radiation of frequency 540×10^{12} Hertz, the radiant intensity of which in that direction is $1/683$ watts per steradian.” This definition, while not helpful for an intuitive grasp of the nature of luminous intensity, does provide a physical means to establish optical units.

With this definition to establish the candela as the basic optical unit, a unit of flux can be defined. As described earlier, *flux* is a measure of total light energy emitted per unit of time. The unit of flux is called the *lumen*. One lumen is defined as that amount of light energy flowing through a solid angle of one steradian from a source having a luminous intensity of 1 candela.

Illuminance is defined as the luminous flux per unit area. It is measured in units of *lux*, or lumens per square meter. In other words, if a uniform light flux of 1 lumen is falling on an area of 1 square meter, then the illuminance at any point on the surface is 1 lux. (See figure 4.) The illuminance on area ABCD is 1 lux (1 lumen per square meter).

In figure 4, the area ABCD is 1 square meter. Its solid angle with respect to the point source at the center of the sphere is 1 steradian. If the point source is uniform with an intensity of 1 candela, then the flux falling on area ABCD is 1 lumen. The illuminance at any point on area ABCD is 1 lumen per square meter or 1 lux. The sphere has a total area of 4π or 12.57 square meters. A flux of 1 lumen falls on each square meter, so the total power output of the source is 12.57 lumens.⁽⁶⁾

Figure 5 illustrates the difference between *intensity* and *illuminance*. Suppose the lines passing through A,B,C, and D in figure 4 are extended until they subtend an area of 4 square meters. A sphere with a radius equal to their distances from the source will have a radius of 2 meters.

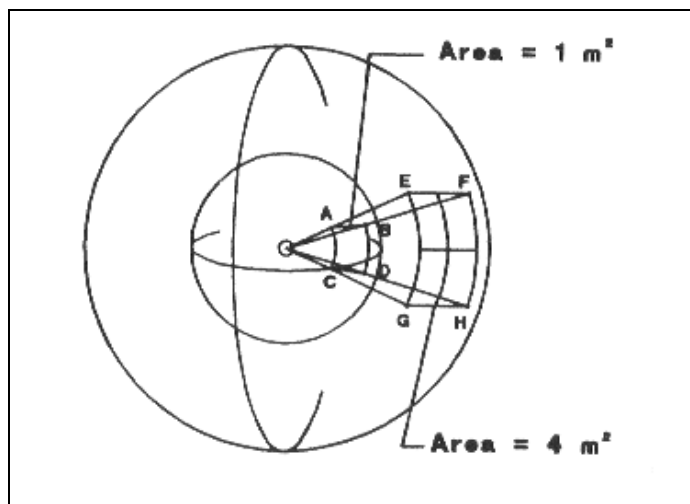

Figure 5. Distribution of light through space

The solid angle subtended by EFGH will be equal to that of ABCD:

$$\text{solid angle} = \frac{4\text{m}^2}{4\pi(2\text{m})^2} \times 4\pi(\text{s}) = 1 (\text{s})$$

And, since the source's intensity equals 1 candela, or 1 lumen per steradian, there is still a total flux of 1 lumen on Area EFGH. However, the illuminance at any point on EFGH is now:

$$= \frac{1 \text{ lumen}}{4 \text{ m}^2} = 0.25 \text{ lumen/m}^2 = 0.25 \text{ lux.}$$

Obviously, the illuminance on a surface decreases with the square of the distance from the source.

In simpler terms, intensity measures the brightness of a source, and illuminance measures the brightness of light on a surface that is illuminated. These are not the same because the light that a source puts out is spread out over a larger region as it radiates through space. These statements are generalizations for a spatially uniform point source. They do not apply to a directed source, because the light is not spread out over so large a region of space, but they do serve to help illustrate a concept.

English Units

English units are similar to Metric units. Candelas and lumens are identical in the English system. Illuminance, however, is measured with units of lumens per square foot rather than per square meter. One lumen per square foot is a footcandle and one footcandle equals 10.76 lux (lumens per square meter).

Coefficient of Retroreflected Luminance—Markings

The most commonly used measure of retroreflectivity for markings is *coefficient of retroreflected luminance*, R_L . It is defined by the American Society for Testing and Materials (ASTM) to be the ratio of the luminance, L , of a surface to the normal illuminance, E , on the surface. Luminance is defined as the luminous flux of a light ray on a surface per unit of projected area of that surface, per unit of solid angle.⁽⁷⁾ One of the main problems with measuring retroreflection in the past has been that standards like these were written with laboratory testing procedures in mind. These standards do not translate well into test methods that work in the field, however.

Roadway Delineation Practices Handbook

In the field, this definition of R_L would translate to measuring the luminance of the marking to the normal illuminance of the incident light on the marking. In this context, the luminance would be the luminous flux of a light ray from the marking to the driver, per unit of projected area of the marking in the direction of the driver, per unit of solid angle. Additionally, since luminous intensity is just luminous flux per unit solid angle, the luminance is simply the luminous intensity of the light returned by the marking per unit area. The normal illuminance, E_n , is the illuminance of the headlights on the marking, measured on a plane perpendicular to the direction of the headlight beams.

Figure 6 helps visualize these quantities. If the car shown is frozen at a specific instant of time, then the observation and illumination angles are fixed. The headlights direct light of a specific intensity along the illumination axis. Since the quantities defined in the standards are directional, a single point must be identified on the marking where R_L will be examined. This point will be point B in figure 6. Having established this, a precise definition of the illumination axis is possible, directed along line AB in figure 6.

By the time the light reaches point B, it has been “spread out” through space and will have a certain illuminance associated with it. A plane is placed at point B with an area of 1 square meter, and a normal vector in the same direction as line AB. The value of illuminance at B will equal the amount of light that would fall on this plane if it were all illuminated by the same intensity of light as that directed at point B.

The light will be reflected back in a cone shape around the direction of the source. It will have a certain intensity in the observation direction, along line BC.

At this point, the standards are no longer helpful. Using the two values just mentioned, a value for coefficient of luminous intensity can be calculated. To calculate luminance and derive a value for R_L , the luminous intensity per unit area must be found. The problem is in selection of the appropriate area to divide by. Up to this point, all the quantities have been directional, dealing with infinitesimal areas. If a very small area is chosen, the illuminance will be uniform, but how large should the area chosen be, and at what angle? If a larger area is chosen, illuminance will not be uniform and the flux must be integrated over the area and then divided by the total area. If a unit area is chosen, then its inclusion does not affect the value of the coefficient at all. If the entire area illuminated by the headlights is used, there is again the problem of nonuniform illuminance, since some areas illuminated are much farther from the headlights than other areas.

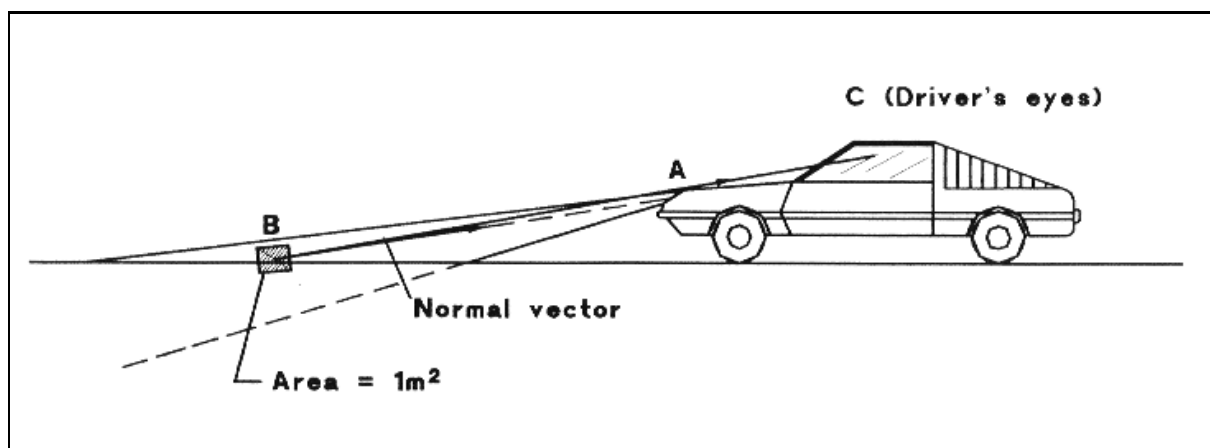

Figure 6. Physical quantities related to roadway retroreflection measurement

What really happens is decided by the manufacturer of the retroreflection-measuring instrument. The illuminance on some arbitrary area is measured and this is used as the sample area. The problem of non-uniform illuminance is not so important because the scale of the instrument is usually much smaller than that of automobile headlights, and the instruments therefore shine light on a small area.

Roadway Delineation Practices Handbook

Such decisions result in coefficients of retroreflection that differ from one instrument to another, depending on each instrument's sample area and method of measuring intensity and illuminance. Care must be taken to prevent use of these values interchangeably for different instruments.

Each instrument can usually be relied upon to be consistent with itself. The method used by each should be constant, and will result in units of candelas per lux per square meter. The unit of 1 candela per lux per square meter, however, is too large to be practical. The unit used in actual practice is millicandelas per lux per square meter, which is equal to one-one thousandth of the basic unit.

As was originally mentioned, much of this problem arises from the attempt to apply laboratory test methods to field testing. The lack of flexibility in the standards, and incompleteness of terms and methods defined by the standards result in makeshift, inconsistent retroreflection-measuring instruments. At the time of publication of this Handbook, no official ASTM standard exists for a field test method for measuring retroreflection, but plans are reportedly being made to develop one.

Coefficient of Retroreflection—Signs

Coefficient of retroreflection (R_A) is the standard used for signs and is described by *ASTM Standard E808-91*.⁽⁸⁾ It is defined as the coefficient of luminous intensity, R_p , of a plane retroreflecting surface to its area, expressed in metric units of candelas per lux per square meter. The coefficient of luminous intensity is defined as the luminous intensity, I , of the retroreflector in the direction of observation to the illuminance at the retroreflector on a plane perpendicular to the direction of the incident light. After all of the units and other considerations are taken into account, R_A is conceptually identical to coefficient of retroreflected luminance, but is simpler to implement for signs. Also, the English units of candelas per footcandle per square foot are often used for R_A , and it is also often referred to as specific intensity per unit area (SIA).

R_A is still a ratio of returned intensity to incident illuminance divided by the area of the retroreflector. Signs make the measurement of these quantities simpler, however, because they have a fixed area. The measuring geometry is arranged so that the plane of the sign is perpendicular to the incident illumination; the illuminance is uniform across the face of the sign. This makes measurement much simpler and more accurate.

Glass Beads

Definition

Glass beads are small glass spheres used in highway signs and pavement markings to provide the necessary retroreflectivity. The beads are applied to pavement markings in one of three ways. They can be dropped on, they can be premixed in marking materials before application, or a portion can be dropped onto premixed materials.

The most commonly used technique is spraying (under pressure) or dropping (by gravity) a quantity of beads onto the wet material. The bead nozzle is located immediately behind the paint nozzle or extrusion shoe so that the beads are sprayed or dropped almost simultaneously with the paint application. For beads to retroreflect light, two bead properties are necessary: transparency and roundness. Beads made of glass have both of these properties. Early experiments in the use of crushed glass and aluminum or brass beads proved these materials to be unacceptable because they failed to meet these criteria.

The need for transparency and roundness can be explained by examining the path of light as it enters a bead embedded in a painted marking. First, the glass bead must be transparent so that light can pass into the sphere. As the light ray enters the bead, it is bent (refracted) downward by the rounded surface of the bead to a point below where the bead is embedded in the paint. Light striking the back of the paint-coated bead surface is reflected back toward the path of entry (figure 7). If the paint were not present, the light would continue through the bead and bounce in many directions. Characteristics, typical uses, and major factors influencing the application of glass beads are discussed in the following sections.

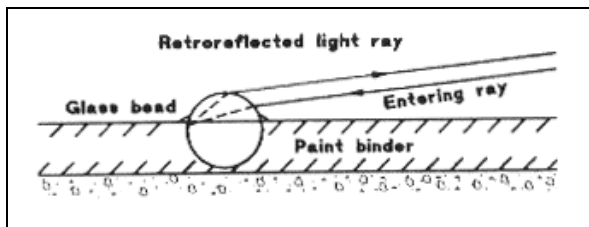

Figure 7. Glass bead retroreflection

Physical Description

The light that glass beads retroreflect is a function of three variables: index of refraction; bead shape, size, and surface characteristics; and the number of beads present and exposed to light rays.

The *refractive index* (RI) is a function of the chemical makeup of the beads. The higher the RI, the more light is retro-reflected. Beads used in traffic paint commonly have an RI of 1.50. There are some 1.65 RI beads used with thermoplastic; 1.90 RI beads are often used in retroreflective airport markings.

The chemical composition of glass beads differs for each refractive index. The 1.50 RI bead is a hard soda lime glass made from crushed scrap windowpane glass, called cullet. Both 1.65 and 1.90 RI beads are manufactured from raw materials.

Despite the increased brightness gained with the higher refractive index, most State and local highway agencies use 1.50 RI beads. Because these beads are made from cullet, a recycled product, they are less expensive than those manufactured from raw materials. They are more stable chemically and require fewer pounds per gallon of marking material because they are less dense than higher RI beads. Also, the higher index beads are more brittle and therefore need to be replaced more often. Some highway agencies use a mixture of 1.50 and 1.65 RI beads on roadways, and a few supplement the 1.50 RI beads with 1.90 RI beads.

Glass beads range in size from 60 micrometers (0.0024 inches) to 850 micrometers (0.034 inches). Bead size usually is expressed in terms of U.S. sieve number, or the size of the mesh screen that a bead will pass through. For example, a U.S. Sieve Number 20 will permit beads with a diameter of 840 micrometers (0.033 inches) or less to pass through the mesh; a number 200 mesh will allow only those beads of 74 micrometers (0.0029 inches) or less to pass.

A typical application of drop-on beads will use from 20 to 100 mesh. The specified gradation, or percentage of weight for each size bead, is a subject of some debate. It is usually a local policy decision based on several factors. First, the realities of marking application and the uncertainties of weather and material control must be considered when selecting bead gradations. Second, the drying time of the marking material affects settlement of the beads into the binder. Obtaining equal embedment in a quick-drying material requires smaller beads. Third, service life of the material and number of beads applied affect bead gradation. A durable thermoplastic material application with 10 pounds per gallon of premix and drop-on beads requires a wide range of bead gradation. Conversely, a painted marking with an expected service life fewer than four months and an application rate of 4 pounds per gallon of beads has a narrower range of sizes. Finally, beads that are too small (80 to 100 mesh) are very light and may be blown away. Also, very large beads may be lost early because they are poorly anchored. New binder materials alleviate this problem.

Retroreflective Properties

Each glass sphere works like a light-focusing lens. Each has a definite focal point outside the back of the bead. The closer the focal point is to the back surface of the sphere, the brighter the light return. For example, as shown in figure 8, the 1.50 RI bead has a focal point further behind the back of the bead than does the 1.65 RI bead. With the 1.90 RI bead, the focal point is very close to the bead's back surface. Consequently, a marking with 1.90 RI beads will be brighter than one using 1.65 or 1.50 RI beads.

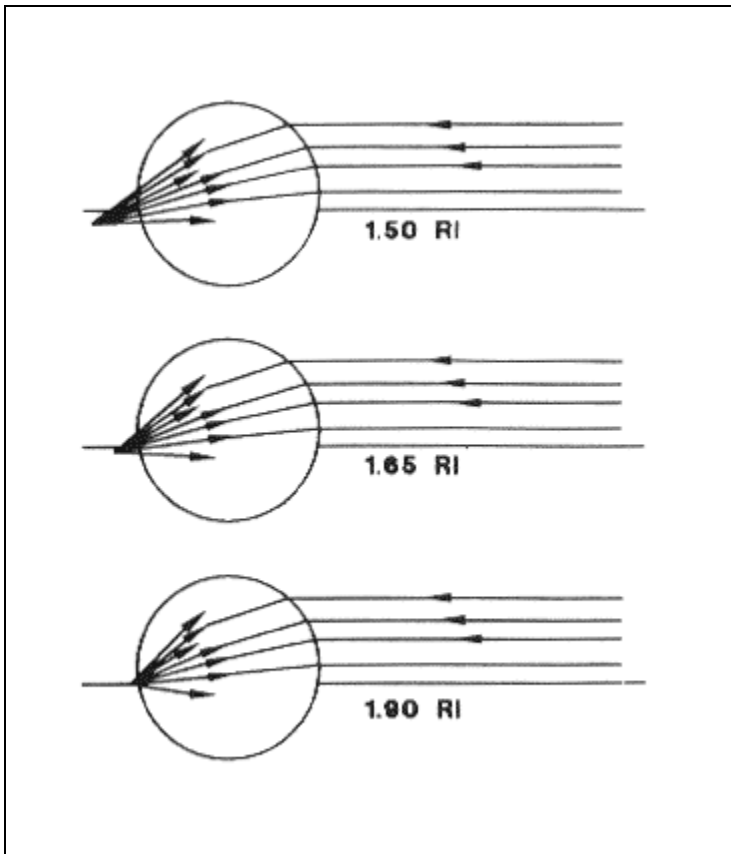

Figure 8. Effect of refractive index on glass bead retroreflection

Since the light is actually focused outside the back of the sphere, the light that is incident on the back of the bead is in the shape of a semicircular bright “spot.” (See figure 9.)

This light passes through to the paint binder, where it is scattered. This makes the binder act as another light source, located on the side of the bead opposite the driver. Good retroreflection, therefore, is dependent not only on the quality and quantity of beads, but also on the quality and quantity of high index pigment in the pavement marking’s binder.

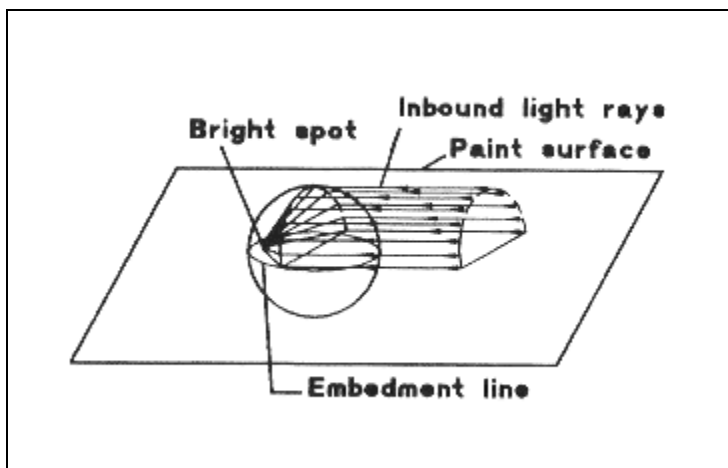

Figure 9. Focusing effect of glass beads

The light that is retroreflected forms a cone directed toward the driver, after it is focused by the glass bead. As a direct result of the glass bead's optical characteristics, the bright spot on the back of the glass bead turns out to be about 60 percent of the diameter's distance from the top.⁽⁹⁾ Accordingly, the bead's retroreflectivity should rise sharply at about 60 percent embedment, as the bright spot must strike the binder and undergo diffuse reflection for the bead's proper functioning. Also, retroreflectivity would be expected to fall off gradually as embedment increases and the proportion of the reflected cone that is returned toward the driver decreases. This is in fact what occurs for a single bead. (See figure 10.)

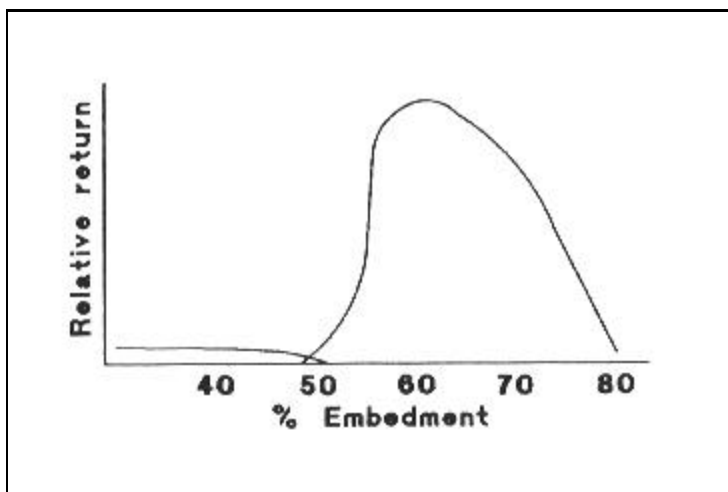

Figure 10. Optimum glass bead embedment

For a marking on the road with many beads, other factors (such as meniscus formation of paint on the bead, and collected light being passed on to beads farther away from the driver) change the optimum value. For a pavement marking, the actual value for optimum performance is between 55 and 60 percent embedment.⁽⁹⁾

Bead Size

Until recently, the use of very large glass beads to increase retroreflectivity of pavement markings has been limited. The materials experienced a significant loss in retroreflectivity over time due to increased wearing away of the large glass beads.

Roadway Delineation Practices Handbook

In recent study, Kalchbrenner investigated the feasibility of using these very large glass beads in a pavement marking system implementing improved synthetic binders and resin materials, especially thermoplastic, polyester, and epoxy markings.⁽⁹⁾ He found that large beads (40 mesh or greater) enhance a marking's retroreflectivity. When used with an appropriate binder system, they can be quite durable as well. Figure 11 shows large versus standard bead performance as measured with a Mirolux retroreflectometer.

Large glass beads are especially effective when roads are wet. Figure 12 shows how a water film (thickness equal to 10 percent of the bead's diameter) influences the lens effect of a glass bead. The top figure shows the same bead in dry conditions. Calculations show that a bead having a diameter two or three times larger will make the effect of the same thickness of film negligible, as this thickness will be very small compared to the large bead's diameter.⁽¹⁰⁾

Large glass beads can have a beneficial effect under certain conditions. Once again, it is stressed that delineation systems must consider all the important variables when selecting bead gradations.

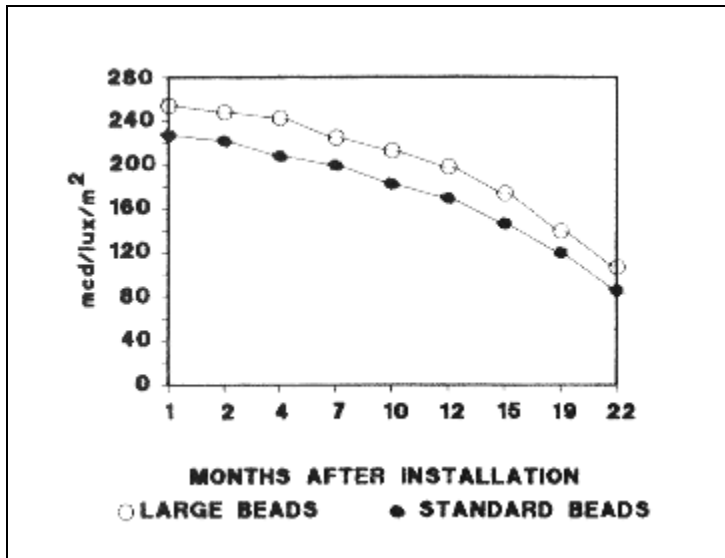

Figure 11. Large vs. standard bead performance in epoxy pavement markings

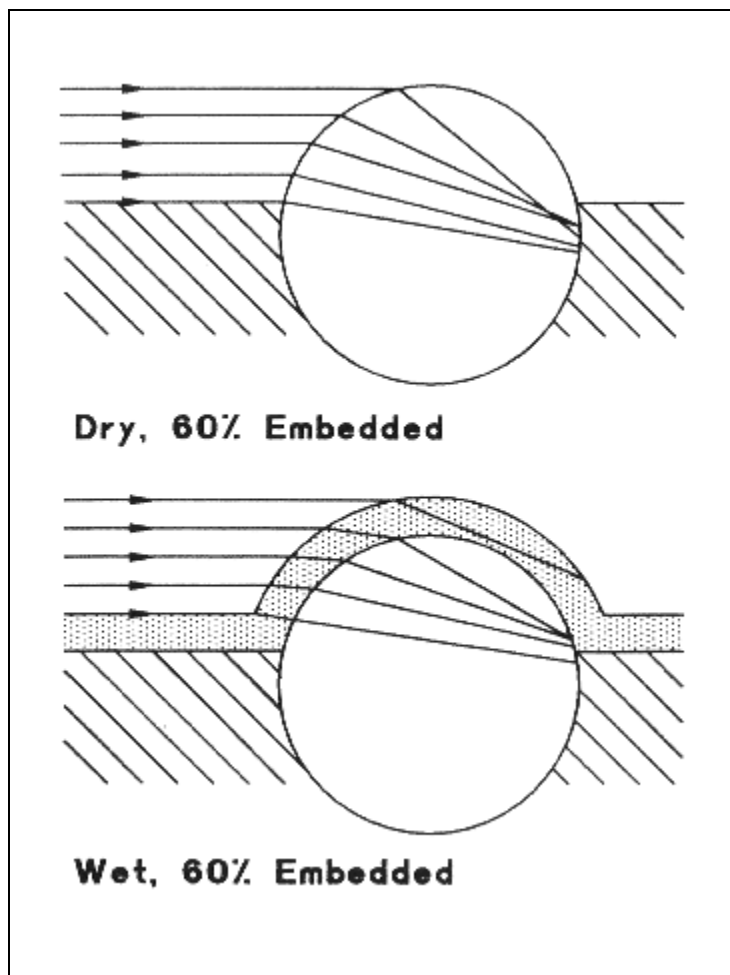

Figure 12. Water films' effect on retroreflection

In an effort to provide for all-weather pavement markings, the FHWA has developed three new gradations of large glass beads, as alternative beads, for use in water base paint, epoxy, polyester, and thermoplastic marking materials. These gradations, which range from sieve size No. 8 to No. 25, are shown in table 1. Application rates of the larger size beads in the above materials are shown in FHWA's FP-92.⁽¹¹⁾ Field tests show use of the larger beads provides good visibility of markings at night in the rain.

Premixed Paint

To obtain greater durability and better distribution of beads, fine gradation beads (60 to 200 mesh) can be added to the paint formulation to produce a "retroreflective paint." The initial retroreflectivity of premixed paint is poor since very few beads are exposed. As the marking is subjected to traffic, the thin coating covering the beads is worn away. The retroreflectivity improves markedly and is retained for a significantly longer period of time. Initial retroreflectivity can be achieved by dropping coarse gradation beads on the premixed paint.

Table 1. Gradations for FHWA Type 3, Type 4, and Type 5 large glass beads.

<u>Percent by Weight Passing</u>
<u>Designated Sieve</u>

Roadway Delineation Practices Handbook

Sieve Size	<u>(ASTM D 1214)</u>		
	<u>Grading Designations</u>		
	<u>Type 3</u>	<u>Type 4</u>	<u>Type 5</u>
No. 8 (2.36 mm)			100
No. 10 (2.0 mm)		100	95 - 100
No. 12 (1.7 mm)	100	95 - 100	80 - 95
No. 14 (1.4 mm)	95 - 100	80 - 95	10 - 40
No. 16 (1.18 mm)	80 - 95	10 - 40	0 - 5
No. 18 (1.0 mm)	10 - 40	0 - 5	0 - 2
No. 20 (850 μm)	0 - 5	0 - 2	
No. 25 (710 μm)	0 - 2		

During the 1960s and early 1970s, about 20 percent of the State highway agencies used premixed paint supplemented by drop-on beads. Although the durability and brightness of the markings was judged superior, a number of problems were reported. The settlement of beads in the paint during storage was an acute problem at first, but was solved in part by using smaller beads and a suitable suspension agent in the paint formulation. Drum rolling equipment and stirring devices were also developed to alleviate the problem.

A number of premix users reported excessive wear of paint spray nozzles. Paint crews generally exhibit little enthusiasm for this technique as they perceive it to be “more trouble than it’s worth.” As a result, only a few major premix users remain despite the technique’s superior performance.

Flotation Beads

To improve the performance of conventional glass beads, manufacturers have developed a *flotation bead*. Flotation beads are standard glass beads treated with a special chemical substance that causes all of them, large and small, to float in wet paint rather than sink completely into the paint film (figure 13). Because all the beads are thereby exposed, a brighter marking is theoretically attained.

The two major advantages associated with flotation beads involve application and performance. Flotation beads provide a more consistent level of brightness. All beads float so that half of the bead is exposed regardless of variations in paint film thickness. With standard beads, a heavy application of paint will submerge a large portion of beads, thereby reducing initial brightness.

Flotation beads are more expensive than standard beads by several cents per pound, which could be significant to highway agencies purchasing millions of pounds of beads annually. This additional cost can be partially recovered, however, because fewer pounds of the smaller beads are required to provide the same level of retroreflectivity. For example, 4 pounds (1.8 kilograms) of the smaller beads produce more reflective bodies than 6 pounds (2.7 kilograms) of the mixed gradation.

Roadway Delineation Practices Handbook

Knowing this, a highway agency can specify a lower number of pounds of beads per gallon of marking material, with an increased percentage by weight of smaller beads. This will effectively increase, or at least keep constant, the total number of retroreflective bodies in the marking. This technique would be ineffective with a standard-beaded marking because many of the smaller bodies would sink below 50 percent of their diameter, and therefore become nonretroreflective, especially in thicker marking materials.

A problem with flotation beads arises under certain conditions. In areas where roads are often wet and the markings are covered by a water film, flotation beaded markings might experience decreased retroreflectivity. If the percentage by weight of smaller beads is increased, wet retroreflectivity will be reduced due to the effect of the water films discussed in the previous sections.

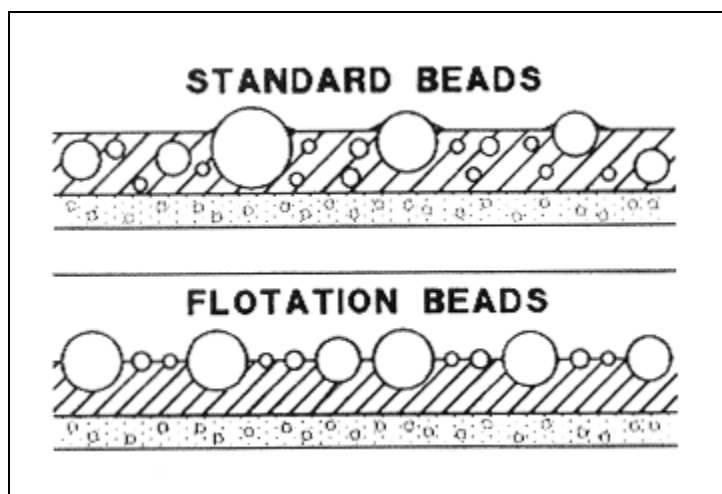

Figure 13. Flotation beads

Also, flotation beads are of limited use in systems requiring the application of beads by pressure spray. For example, in systems using hot-applied, fast-drying paints, the paint skins over so rapidly that the beads are applied only partly into the paint spray under pressure. Some of the beads are therefore covered by the paint and will not float.

Because no flotation beads are sunk under the surface of the marking, a flotation beaded marking is often not as durable as a standard beaded marking. As the paint film wears, the larger beads will be lost quickly because they are not embedded as deeply as they might be in a standard beaded or premixed marking. There are no beads under the surface to become exposed as the paint wears. As a result, flotation beads normally are used as a means to increase initial retroreflectivity when a long service life is not as important.

Common Problems

In areas of high humidity, drop-on glass beads tend to absorb moisture and lose their free-flowing property. Moisture absorption is due to the bead's large ratio of surface area to volume. The beads stick together, falling as a mass rather than as individual beads, thus clumping in the paint film. It is not uncommon for beads to clog the dispensing equipment, which often must then be cleaned for marking to continue. To avoid clumping, beads can be moisture-proofed by adding a small amount of absorbent powder, such as china clay, or by coating the beads with a proprietary silicone-based material.

As with the gradation of beads, the proper rate of bead application for a given quantity of marking material is uncertain. It is generally agreed, however, that factors such as the size of beads, the thickness of the binder, the type of bead (flotation or nonflotation), and the expected service life of the retroreflective marking all exert an undeniable influence on optimum rate of application. Numerous research studies involving both field and laboratory tests have

addressed the effect of each of these factors in terms of durability and cost-effectiveness.^(12,13)

Prismatic Cube-Corner Retroreflection

The most common use for prismatic cube-corner retroreflection is in raised pavement markers (RPMs). Prismatic sheeting is also used for retroreflective buttons for post-mounted delineators. For simplicity, this discussion will concentrate on the use of prismatic retroreflection in RPMs.

Physical Description

Raised pavement markers (RPMs) come in a variety of configurations, some with the characteristic wedge shape, some round or oval markers, markers with and without replaceable retroreflective inserts, and so on. A more complete review of the physical characteristics of RPMs is found in chapter 7.

Most retroreflective RPMs employ prismatic cube-corner reflectors to achieve the necessary retroreflective properties, but some also use glass beads. Glass beads used in RPMs function in much the same way as those for pavement markings, except that the bright spot created by the beads' focusing effect is diffusely reflected by the RPM's plastic housing, or base layer of the retroreflective element, instead of the pigments in the paint binder. Since the physical characteristics of retroreflection of glass beads have been discussed in the previous sections, the following discussion will focus on prismatic cube-corner retroreflectors and their use in RPMs.

Retroreflective Properties

Prismatic retroreflection of RPMs is achieved through the use of many tiny cube-corner retroreflective elements in an insert or retroreflective sheeting on the face of the marker. Each element is a tiny half-cube, open in the direction of the driver. When a light ray enters the cube, it bounces off each mirrored face of the cube-corner element. The beam's directional component perpendicular to the plane of the surface is reversed. Eventually, all three components of direction have been reversed, and the exit direction of the light ray is nearly equal, but opposite, to that of the incident light ray. (See figure 14.)

Laboratory measurement of retroreflection of RPMs is similar, but simpler, than for pavement markings. Each marker tested will have definite area and geometry in each test, which will probably be more consistent between different testing agencies. The ASTM standards originally were written with the intention that they be used for testing retroreflectors of finite area with a fixed test geometry. The geometry and area must be constant to ensure

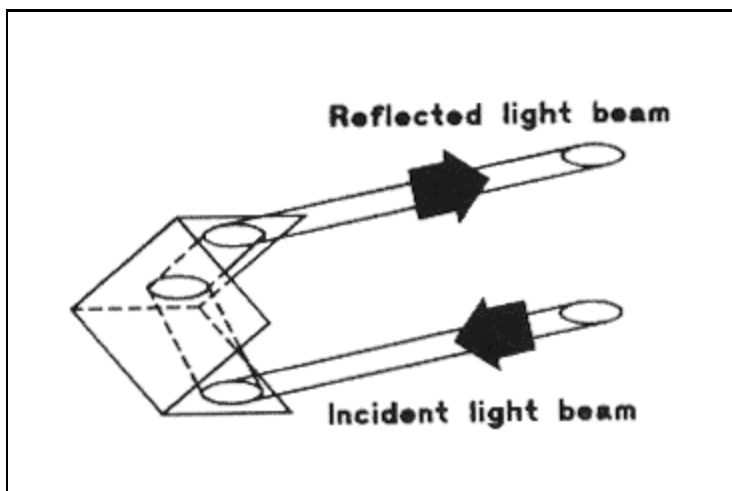

Figure 14. Prismatic cube-corner retroreflection consistent results for coefficients of retroreflection.

Roadway Delineation Practices Handbook

Figure 15, taken from the *Standard Practice for Describing Retroreflection (ASTM Standard E808-91)*, illustrates a method of testing retroreflection that is naturally compatible with laboratory testing of RPMs or their retroreflective inserts.⁽⁸⁾ The figure again makes it clear that the test methods were not developed with pavement markings as a primary consideration. Care should be exercised not to compare results for coefficient of retroreflection for RPMs to coefficient of retroreflected luminance, R_L , for pavement markings. These coefficients are measured differently; results will not be consistent.

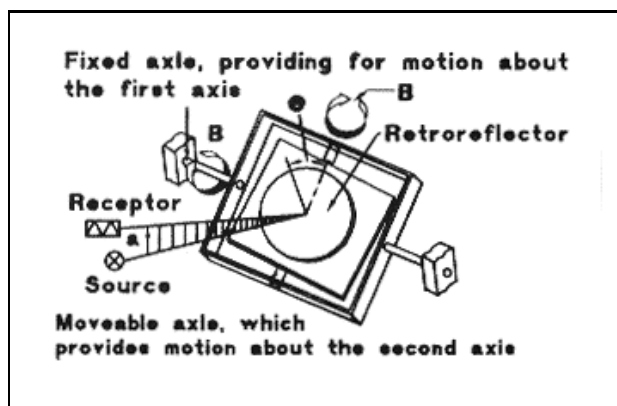

Figure 15. Retroreflection test geometry

Though the standards are suited to measurement in the laboratory of RPMs' retroreflectivity, there is still difficulty with field measurements. There are numerous problems with creating a device that will measure the retroreflectivity of RPMs in the field because of the need for collimation and problems with placement and light exclusion.

One erroneous method that is often used by researchers and highway agencies entails simply measuring the distance at which RPMs are visible under the illumination of standard automobile high-beam headlights. This method is discouraged because drivers seldom drive with high beams, and the results for visibility distance are very misleading. There is little evidence that correlates performance of RPMs under high-beam illumination to their performance when viewed using low beams.

The main problem with the retroreflective performance of RPMs is how quickly their performance is degraded. Van Gorkum states that markers, on average, lose 95 percent of their retroreflectivity in the first six months of use.⁽¹⁴⁾ However, much of this loss is recovered during periods of wet weather when water fills in surface scratches on the face of the RPMs. More information on retroreflectivity problems with RPMs and possible solutions is given in chapter 7.

QUALITY ASSURANCE

One of the problems with pavement markings is their inconsistency. Highway agencies cannot reliably predict performance. Some of the methods that have been instituted to remedy inconsistency and ensure quality of materials are discussed in the following sections.

Vendor Certification

Vendor certification for marking materials is of increasing concern. Retroreflective performance is probably the main barometer of overall effectiveness of pavement markings. However, it is difficult to test, as well as costly to implement testing for all markings applied.

Many State DOTs now maintain a list of "prequalified" vendors. Prequalification is accomplished through procurement and testing of many different vendors' products on a regular basis, and keeping a list of those vendors whose materials can be relied upon to perform well. An improved marking system is obtained, less rigorous pavement

Roadway Delineation Practices Handbook

marking inspection is required, marking uniformity is increased across the State, and, it is hoped overall cost-effectiveness is achieved.

Procurement

To maintain a comprehensive list of qualified vendors, a variety of vendors, products, and marking materials must be sampled. Therefore, the procurement of materials to be tested is an important process. Obtaining a variety of materials to test can be costly. Sources must be reviewed carefully so that only promising vendors and materials are selected to minimize waste of time and money.

Testing

After a list of potential sources is created and samples obtained, tests must be conducted on the material's performance. Evaluation usually consists of both laboratory tests and field tests of actual performance.

Laboratory testing consists of chemical and other types of testing to be sure that the materials used meet State specifications for composition, brightness, resistance to gelling and caking, and so on. Each State normally has some type of materials or chemistry laboratory where those tests can be performed.

Each State also will normally have a paint test facility where markings are painted on the road and observed for durability and visibility. Often these markings are painted transversely so that wear is accelerated. There are correlative equations to compensate for durability in the wheel path versus durability of longitudinal markings.

Markings also can be tested for retroreflectivity and skid resistance in the laboratory and in the field. The results of all the tests will be collated to produce a list of vendors and products that meet State standards.

Regional Test Facilities

Procurement and testing can be expensive and time-consuming. A program has been initiated to develop regional test facilities so that States within that region will not perform redundant testing.

Regional test facilities have the responsibility of performing testing and specifications writing to be used by all the States in their respective region. The number of regional test facilities should be large enough that the conditions in each region would be similar for all its component States with regard to delineation needs, climatic characteristics, and price of materials and contractors. Two regional test facilities have been established, one in the Northeast and one in the Southeast.

In the Northeast, there is a single test facility, established by the Northeastern Association of State Highway and Transportation Officials (NASHTO), which resides with the Pennsylvania Department of Transportation (PennDOT). NASHTO does not now maintain its own list of prequalified vendors, but it cooperates with 11 other Northeastern States to test possible material sources for use by all.⁽¹⁵⁾ The facility is located in the PennDOT materials testing laboratory, keeping costs at a minimum. PennDOT acts as an organizing force to coordinate and collate testing efforts throughout the Northeastern States. It was funded initially in part by a FHWA contract on testing of pavement traffic marking materials.

The Southeastern Regional Test Facility (SRTF) was created by a Southeastern Association of State Highway and Transportation Officials (SASHTO) Ad Hoc committee in 1988 with the objective of organizing the States' separate material testing efforts.⁽¹⁶⁾ The SRTF differs from the NASHTO facility in that it has no central location. Rather, it is simply an organization of existing highway personnel, buildings, and equipment within the SASHTO region. Of the 12 SASHTO States, 11 are currently involved in some type of material testing for the program. By combining the States' resources in this manner, the program encourages cost-effectiveness for the participating States. It also creates a uniform marking system throughout the participating States.

One problem with pavement marking systems in the past has been inadequate technology transfer between highway

Roadway Delineation Practices Handbook

agencies. Much of this has been caused by a lack of standards addressing the pavement marking issue, and the inconsistency of the standards that do exist. The wide variety of laboratory and field test methods used by States has also contributed to the problem. The regional test facility network promoted by the FHWA should alleviate these problems.

CHAPTER 3. DRIVER VISIBILITY NEEDS

INTRODUCTION

The primary purpose of a roadway delineation system is to provide the visual information needed by the driver to steer a vehicle safely in a variety of situations. The delineation technique used must define the field of safe travel, and it must be visible in daylight and darkness, as well as in periods of adverse weather such as rain and fog.

This chapter will discuss how to accomplish the task of providing adequate delineation, and what physical parameters, such as luminance and contrast, affect the communication of visual information. Recommendations will be made about minimum values for these parameters and visibility distances for a variety of situations. Also discussed is why visibility should be increased to its maximum level (increased brightness needed by older drivers, for example).

Finally, roadway and traffic characteristics that affect the retroreflectivity of delineation systems are reviewed. The properties of retroreflective materials (and the pavement surface) affect many of the pavement marking materials and devices. A short discussion of these variables also is included to provide the background for subsequent chapters.

Driver Visibility

The ideal form of delineation is that which provides the most guidance and warning to the driver. Research has been directed at defining the behavioral and perceptual characteristics of drivers and relating these human factors to the safety and operational efficiency of the nation's roadway system. This research has played a major role in the development of new materials, specifications, and standards. The field of human factors research related to the driving task is much too complex to be included as part of this Handbook. This discussion is limited to a summary of driver characteristics that influence the design and installation of delineation systems.

Generally, the ability of the driver to operate a vehicle safely is based on the driver's perception of a situation, level of alertness, the amount of information available, and the driver's ability to assimilate the available information. The driver's tasks are the following:

- Control; the physical manipulation of the vehicle. By this overt action, the driver uses the steering wheel to maintain lateral and longitudinal control of the vehicle.
- Guidance; the selection of safe speed and path. In this decision process, the driver must first evaluate the situation to determine the speed and path appropriate to existing conditions. Then the driver must translate these decisions into control actions (lane positioning, headway, passing, and so on).
- Navigation; the planning and execution of the trip, from origin to destination.

Of these three tasks, failure in control has the most severe consequences of accident potential.

Older Drivers

In addition to the stringent requirements for delineation created by the general populace, there are individuals whose visibility needs are even greater. These include persons with reduced or impaired vision, color vision deficiencies, or

Roadway Delineation Practices Handbook

those driving under the influence of intoxicants. But perhaps the most important group is drivers 55 years and older. This group is the most rapidly growing segment of our country's population and there is significant research indicating that they need improved visibility on highways.

A recent study for the Transportation Research Board gives a quantitative measure of the difference in visual capability due to age.⁽¹⁷⁾ The report defines *threshold contrast* as the minimum difference between luminance of a target and the luminance of its background for detection. In figure 16, the threshold value for a 65-year-old is seen to be an average of about twice the value for a less than 23-year-old.

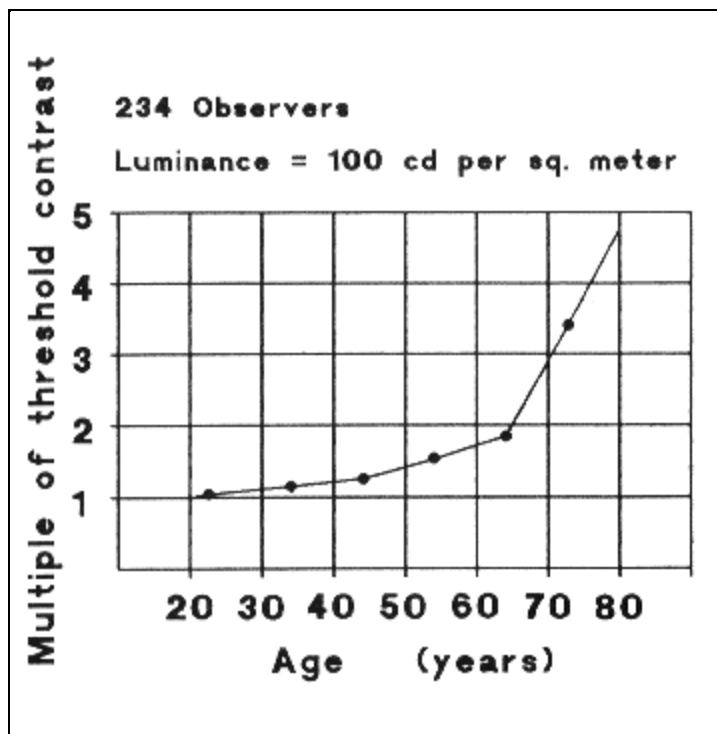

Figure 16. Threshold contrast requirements as age increases

Mace showed that a driver's perception-reaction time continually increases with age.⁽¹⁸⁾ This means that the minimum required visibility distance for older drivers also increases with complexity of decisional tasks. These changes are caused by the decreased cognitive abilities and psycho-motor skills associated with advanced age. In terms of roadway delineation, these demands require the use of brighter delineators to increase visibility distances and additional types and amounts of delineation to increase available information.

For these reasons, highway marking, signing, and other safety features provided for roads may not work adequately for all ages of drivers. In some cases, drivers aged 65 and older may require four times as much light to see as well as a 39-year-old. Also, evidence supports the fact that older drivers adopt a less flexible searching strategy. They look at fewer items in the roadway in a given time than do younger drivers. It is important to provide older drivers with more redundant and brighter forms of delineation. Recommended delineation treatments to supply older drivers the visibility they require include such enhancements as 8-inch (20-centimeter) edgelines, special posts for post-mounted delineators, and improved retroreflectivity to increase the brightness of pavement markings and their contrast with the pavement.

VISIBILITY CRITERIA

Several criteria determine delineation visibility. These criteria are used in a similar manner to those for traffic

Roadway Delineation Practices Handbook

signs. The following discussion of these criteria is derived from a FHWA research program concerning visibility of highway signs.⁽¹⁹⁾

Luminance

Luminance, in the context of delineation visibility, is the total amount of light the driver receives from a marking. As shown in figure 17, light from automobile head-lights is retroreflected by the marking back in a cone around the direction of the head-lights. Luminance of the marking is directly proportional to the amount of this light energy that is directed toward the driver's eyes.

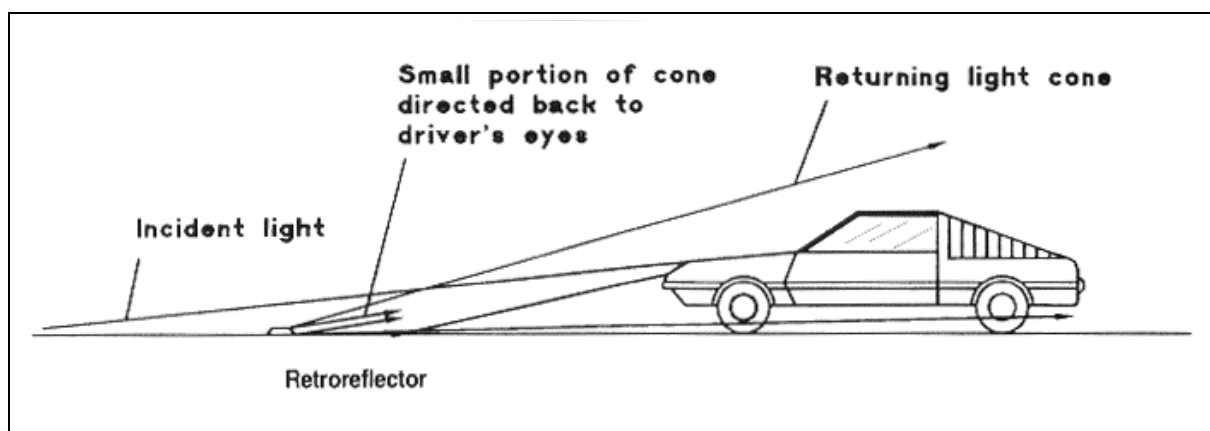

Figure 17. Light return by pavement markings

Contrast

Contrast is the ratio of luminance from the marking to luminance from its surroundings, measured from the driver's position. Much more important for overall visibility than luminance, contrast tells how clearly a target stands out from its background. Therefore, contrast is a much better measure of a marking's visibility.

Conspicuity

Conspicuity refers to the likelihood that a driver will notice a certain target at a given distance. It is probably the best measure of visibility, but also the most difficult to quantify. Unlike luminance and contrast, conspicuity is not a simply determined optical quantity. It is dependent on a variety of factors, many of them unpredictable.

Conspicuity is probably more related to contrast than to luminance, since contrast defines how easily an object can be seen against its background. Unfortunately, it depends also on the driver's capabilities, mood, and degree to which the target is expected. It also is directly related, but in a cryptic manner, to the visual complexity of the scene that the driver views.

Like many of the other conspicuity factors, visual complexity is an enigmatic phenomenon. It is difficult even to determine an estimate for the conspicuity factors and very difficult to combine them in a way that will yield a numerical measure of conspicuity. Conspicuity is a quantity that can be tested only empirically.

However, Schwab and Mace researched the effects that a complex background has upon sign visibility.⁽²⁰⁾ Those interested in the methods of this research may refer to the original work.

Legibility

Legibility refers to the probability that a driver will understand the message that delineation is meant to convey. It is

Roadway Delineation Practices Handbook

an even less tangible quantity than conspicuity.

Legibility relies upon a nearly infinite number of factors, few of which are well-understood. Further, the criteria by which legibility may be judged differ for different types of delineation.

In the field of highway signing, empirical relationships have been found for legibility based on such variables as character height, color, spacing, and stroke width. These same criteria apply to such forms of delineation, including Chevron, Large Arrow, Turn and Curve signs, etc.

These variables have little or no meaning, however, when applied to pavement markings or raised pavement markers (RPMs). For these types of delineation, it may be much more important that they have sufficient contrast with the pavement, are consistent with other similar markings, and do not conflict with other types of delineation or signing nearby.

PAVEMENT MARKING VISIBILITY DISTANCE

Visibility distance refers to the range at which a marking can be seen. It does not guarantee that a given driver will actually notice the marking or correctly perceive its meaning. Those actions are related to conspicuity and legibility. Visibility distance specifies only the distance at which a given driver is *capable* of seeing a marking.

Since visibility distance does not incorporate human reaction into its definition, it is quantifiable and is directly dependent on the luminance and contrast of the marking and on the contrast sensitivity of the driver.

Driver Events

In highway signing, minimum visibility distance is determined by certain driver events. The visibility distance must be large enough for all the driver events to occur before the information conveyed by the sign must be acted upon.

Delineation markings are different from highway signing because markings convey a continuous message. However, delineation is similar to highway signing because visibility distance of pavement markings is vital for giving ample warning of changing roadway alignment. Based on the driver events that must occur for signing, the following driver events apply to delineation:⁽¹⁹⁾

- Detect change in delineation (turn, curve, freeway exit ramp).
- Recognize message that delineation conveys.
- Decide appropriate reaction.
- Initiate response.
- Complete vehicle maneuver.

Adequate visibility distance will provide the driver sufficient time to perform all of these actions.

Guidelines for Effective Delineation

A 1988 FHWA study combined use of computer simulations, observational field studies, and laboratory experiments to determine requirements for effective delineation.⁽²¹⁾ Two conclusions were reached about the preview distance that delineation should provide.

First, delineation should provide a minimum of 2 seconds of preview distance for short-range guidance in extreme situations. This value agrees with that established by Allen for short-range visibility distance.⁽²²⁾ This value applies to extreme situations, including heavy rain or fog or glare from opposing headlights. Preview distance is important because the view of the road ahead is very limited, forcing drivers to rely on roadway and traffic information that is visible from only a short distance. The driver must respond quickly to perceived hazards or changes in alignment, making frequent steering and speed changes to correct for errors. Driver response requires heightened attention and

Roadway Delineation Practices Handbook

concentration on brief glimpses of delineation from one moment to the next. The visibility distance to the delineation must provide sufficient time for the driver to detect it, recognize the roadway features and alignment ahead, and respond with steering and speed adjustments. A preview time of 2 seconds has been found to be the safe minimum acceptable limit. At 25 miles per hour (40 kilometers per hour), delineation must be visible at least 75 feet (25 meters) ahead; at 55 miles per hour (90 kilometers per hour), delineation must be visible at least 160 feet (48 meters) ahead. Surface pavement markings typically are adequate to provide these visibility distances.

Second, delineation should provide a minimum of 3 seconds of preview distance so that drivers are provided long-range guidance information. This value agrees with that established for long-range delineation in earlier research done by Godthelp and Riemersma.⁽²³⁾ When drivers are provided 3 seconds or more to view delineation, the task of guiding the vehicle is substantially easier. The driver is no longer constantly making rapid compensations for guidance errors, but can rely more on roadway information farther ahead. Long-range information enables well-learned and more automatic driving skills that result in smoother steering and speed control. At 25 miles per hour (40 kilometers per hour), delineation must be visible at least 110 feet (34 meters) ahead; at 55 miles per hour (90 kilometers per hour), delineation must be seen at least 250 feet (76 meters) ahead. RPMs or PMDs are usually needed for this length of visibility distance.

VISIBILITY PARAMETERS

There are a number of parameters that limit delineation visibility. The first category, physical parameters, are created by limits of the driver's sensory perception. A particular driver's sight and hearing are capable only of perceiving a certain threshold of sensory phenomena. An important concern when designing delineation systems is how adverse weather and other conditions decrease the stimuli available for the driver.

The second category of parameters limiting delineation visibility, psychophysical parameters, are the limitations of driver performance created by the driver's own limited ability to assimilate and understand the available stimuli that his senses are capable of perceiving.

Physical Parameters

Visual perception is critical to the driving task. To be effective, pavement markings must present the appropriate visual clues. As a basis for vehicle control, the ability to see and perceive is a function of contrast between background and the roadway, particularly at night. The need for contrast decreases with greater background luminance; therefore, there is better detection in daylight. During clear daylight hours, visibility presents little problem because visual information is indirectly available from roadway features and surrounding terrain; hence, delineation is less important to the driving task. At night, these indirect delineators are less effective and the motorist must rely on pavement markings to perceive a safe route of travel. Long-range visibility is restricted when contrast and luminance are reduced. Rain and other adverse weather conditions further degrade the visibility of delineation to the driver.

Recommendations for Physical Parameters

Because visibility is crucial to the driving task, significant research has been devoted to defining minimum values for physical parameters that will result in adequate visibility. Freedman and associates concluded that delineation should provide a minimum luminance contrast of 1.0 for drivers to have adequate visual guidance when there is glare on dry pavement surfaces.⁽²¹⁾ Analytical studies indicated that under ideal conditions, a contrast of 0.5 is necessary for the average driver. However, conditions are seldom ideal. In fact, wet pavement conditions can become much worse than dry glare conditions. A study at the University of North Carolina showed the importance of retroreflection for wet night visibility.⁽²⁴⁾ The minimum visibility established for dry conditions corresponded to a Mirolux reading of 93 millicandelas per lux per square meter. However, another marking would need a dry reading of 180 millicandelas per lux per square meter, nearly double that for the first marking, to receive an equivalent subjective effectiveness rating when the pavement was wet.

In addition, older or impaired drivers often require longer preview times. Freedman and associates recommended

Roadway Delineation Practices Handbook

doubling the value for luminance contrast to account for these factors.⁽²¹⁾ Or, to achieve 3 seconds of preview distance for older drivers, or for younger drivers on wet roadways, a contrast of 2.0 to 3.0 is acceptable. For dry roadways, this can be achieved if the markings provide a retroreflectivity of 64 to 127 millicandelas per lux per square meter.

In other research, both Henry and Attaway established 100 millicandelas per lux per square meter as the minimum level of retroreflectivity on dry roads.^(25,26) A higher value for retroreflectivity is recommended to account for less-than-favorable conditions and drivers with reduced visual or psychophysical capabilities. Where such levels of retroreflectivity cannot be achieved or maintained, supplemental delineation, such as special surface markings or RPMs, may be appropriate.

Effect of Adverse Visibility

Because adequate visibility has proven to be vital to driver performance, much research has been devoted to the effect that decreased visibility will have on the driver.

Simulation experiments and field tests conducted by Allen and associates provided several insights into driver performance under adverse visibility.⁽²²⁾

First, as visibility distance is reduced, delineation configuration or pattern becomes more important. Solid edgelines, longer dashes, and shorter cycle length tend to counteract some of the effects of reduced visibility.

Second, the automobile hood restricts minimum forward view to approximately 20 feet (6 meters) ahead of the driver's position. When one marking segment disappears below the hood line before a succeeding segment is visible, steering performance becomes erratic. Delineation gap length is a key variable.

Third, longer marking segments can give some indication of road curvature even though only one segment is visible. Retroreflective RPMs do not provide curvature information unless more than one marker is visible. Thus, RPMs should be spaced more closely on curved sections. Finally, preferred speed decreases with reduced visibility or, at constant speed, steering performance degrades.

In summary, the simulation experiments indicated that steering performance is related to the combined effects of reduced visibility and delineation configuration. Thus, steering performance degrades with decreased visibility distance and with a reduction in the total amount of information available to the driver. This suggests that visibility distance and delineation configurations are important variables in the design of delineation systems.

Under good visibility conditions, drivers tend to position their vehicles somewhat to the left of the center of the lane. This is because the driver is sitting on the left and has a better view of the left side of the vehicle. This position also permits the driver to maintain a relatively constant lateral position in relation to the left lane or centerline.

The field test revealed interesting variations on this expected behavior. When delineation visibility was degraded, either by reduced contrast or by a covering film of water, the drivers shifted their vehicles' mean lateral lane positions away from the left lanelines to approximately the center of their traffic lanes. An increase in the vehicles' lateral position variation showed a decrease in lateral control performance. Mean speed was not affected significantly except in rain conditions. In the rain, average speed reduction was about 2 miles per hour (3.2 kilometers per hour) under the worst visibility condition. Finally, speed control seemed to be unaffected generally although the vehicles' speed variability was uniformly higher in the rain.

These experiments demonstrated a systematic relationship between pavement marking contrast and the ability of the driver to constantly maintain the position of the vehicle on the travel path. The expression for this relationship may be used to predict inadvertent vehicular excursions from a traffic lane as a function of marking contrast. Thus, a relationship between contrast and accident potential can be established.

The rain experiment indicated the effectiveness of retroreflective RPMs and the inadequacy of pavement markings

Roadway Delineation Practices Handbook

for guiding drivers in the rain. With only pavement markings for guidance, wet-weather drivers demonstrated a potentially dangerous combination of increasing lateral placement variability and decreasing mean distance from the laneline. At the same time, they showed signs of heightened agitation, indicating they were exerting greater effort. When they returned to a roadway section where RPMs supplemented the pavement markings, their performance recovered and their psychophysiological stress returned to normal levels. Even in dry weather, lateral position variation was lessened when RPMs were used with markings. It can not be concluded that the addition of RPMs improves driver performance under all circumstances, though it is likely that such improvement occurs.

Advances in material technology may improve the performance of pavement markings alone. The delineation research at the University of North Carolina studied the effectiveness of large glass beads for increased retroreflectivity.⁽²⁴⁾ The study evaluated the performance of pavement marking materials under wet, nighttime conditions. Seven different marking tapes and one formulation of thermoplastic marking were evaluated under wet and dry conditions with a MiroLux retroreflectometer. According to the study, “under actual rainfall conditions in the field, VISIBEAD™ (Potters Industries, Parsippany, NJ) markings gave visibility distance double or greater than visibility distances for similar lines with standard beads.”

In the past, the use of these large glass beads has been restricted to materials with strong binders and resins, such as thermoplastic, epoxy, and polyester. Potters Industries has formulated a line of VISIBEADS™ for use with latex traffic paint. The formulation has just completed a nine-month evaluative test in which the beads held firmly in the marking after three snowplowings.⁽²⁷⁾

These types of advances in marking technology may eventually make markings alone as good as markings with RPMs but at a lower cost.

Psychophysical Parameters

A FHWA report defines the following psychophysical parameters that affect driver performance: driver perceptual abilities, driver cognitive abilities, and driver psychomotor abilities.⁽¹⁹⁾ The field of human factors research attempts to define how these parameters affect drivers so that a more effective delineation system can be designed.

However, this Handbook will concentrate simply on empirical relationships to determine how these parameters affect performance in specific roadway conditions. By comparing performance with a variety of delineation treatments, relative levels of effectiveness can be determined. Research conducted in this manner is discussed below.

Freedman and associates made observations concerning effects of psycho-physical parameters, focusing on the effect that visual complexity of a scene has on driver performance.⁽²¹⁾

Their laboratory studies indicated that in situations where few demands are made for the driver’s attention, the presence of stationary roadside objects, such as lights, signs, and buildings, tends to reduce the need for high-level delineation. However, where visual complexity coexists with demanding traffic operations, high-level delineation, including more visually prominent markings, RPMs, and post-mounted delineators (PMDs) (where appropriate), are preferred by drivers.

For simulated horizontal curves on wet and dry surfaces, the combinations of markings with RPMs and markings with PMDs were associated with smoother vehicle control and better lane tracking. The presence of simulated visual complexity did not reduce driver performance. For simulated bifurcations on wet surfaces, delineation treatments containing markings and RPMs or markings and PMDs were associated with smooth vehicle control, especially where background visual complexity was high. For simulated left-turn lanes on wet surfaces, delineation treatments containing RPMs were associated with smooth driver performance, especially where surrounding visual complexity was high.

The researchers noted that current guidelines for the selection of delineation treatments do not account for visual complexity of the surroundings.

Roadway Delineation Practices Handbook

The results of the laboratory tests agreed with results from the researchers' observational field study on a horizontal curve. Markings compared to markings with RPMs, PMDs, and chevron signs produced findings similar to previous speed and lane-tracking studies. The individual effects of RPMs, PMDs, and signs could not be analyzed separately, but their combination with highly visible pavement markings demonstrated improved lane tracking and suggested that drivers more easily obtained proper visual guidance with the upgraded delineation.

Hoffman and Firth studied visibility of pavement markings.⁽⁶⁾ They found that instrument readings for retroreflectivity corresponded linearly with observers' ratings of appearance of markings if plotted on a logarithmic scale. (See figure 18.) This finding suggests there is an optimal value, near the break of the curve, after which increasing retroreflectivity will do little for increasing visual performance.

Hoffman and Firth also noted that a marking's visual performance was not a function solely of its retroreflectivity. Their studies confirmed that a wider marking of lesser brightness can be just as visible as a narrower marking of greater brightness. Therefore, it is necessary to examine all options and match a delineation system with all aspects of the roadway and application equipment, including marking width, color of pavement, climatic characteristics, pavement substrate type, and marking cost.

In light of these findings, it is vital to adopt a "systems" approach to delineation design. Delineation effectiveness depends largely upon the complex interaction of many variables that affect visibility. Recognizing the importance of the interaction of these variables, Kalchbrenner stated: "The term 'system' implies design and synergy. Improved roadway performance and service life have been demonstrated at multiple locations in durable materials by properly sizing and treating beads for the thickness and type of binder used."⁽¹⁰⁾

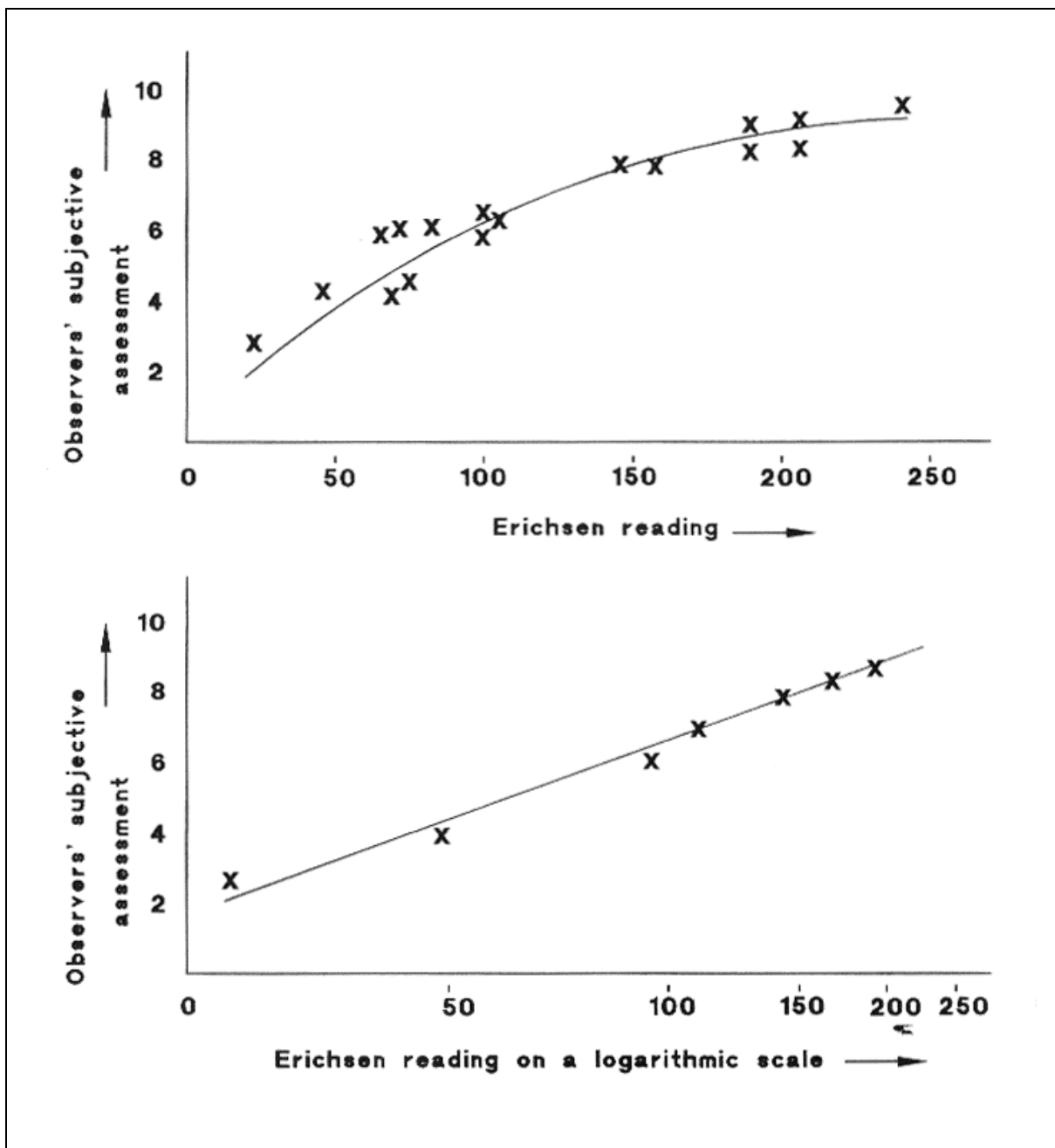

Figure 18. Subjective ratings of visibility vs. retroreflectometer readings on a linear and a logarithmic scale.

In a general sense, effectiveness may be drastically increased by treating the roadway itself as a system. Consideration of factors, such as visibility demands on drivers, pavement material, visual complexity and luminance of surroundings, and types of marking materials available and their differing properties, is critical to selecting a roadway marking system appropriate for a particular application.

DELINEATION VARIABLES

When adopting a systems approach to delineation design, key variables that should be considered in determining the

Roadway Delineation Practices Handbook

most appropriate delineation treatment and technique are roadway geometry, weather and climate, traffic volume and composition, and type of substrate. The way that these variables interact with the marking material and application technique will determine the marking's visibility and durability. A review of the significant effects of these variables follows a discussion of each variable. Detailed descriptions of the research and demonstration projects are available in the referenced reports.

Roadway Geometry

Roadway geometry has more effect on the delineation treatment than on the various delineation techniques. In this context, *treatment* refers to centerlines, edgelines, PMDs, including width, spacing, gap-to-segment ratio, and colors. *Technique* refers to the various delineation devices, materials, and application procedures.

In a definitive study of roadway delineation systems conducted by the National Cooperative Highway Research Program (NCHRP), the research centered on the following set of geometric situations: tangent sections, horizontal curves, no-passing zones, pavement width transitions, merging-diverging areas, turns, turns with deceleration and/or storage lanes, stop approaches, railroad crossings, and crosswalks.⁽²⁸⁾

Each geometric design aspect studied had a unique set of driver information needs and associated delineation requirements. These "classic" situations were used to evaluate the safety of various delineation treatments and their impact on driver behavior and traffic performance.

The study showed that areas with no previous delineation were made safer by application of standard delineation treatments. Accident rates were reduced significantly. Major changes in delineation treatments can produce measurable changes in traffic performance. However, minor variations of delineation treatments, such as spacing, gap-to-segment ratio and color, did not affect accident rates or show significant differences in traffic performance measures. It was concluded that minor variations of delineation treatments must be judged on factors other than accident reduction.

In addition to the NCHRP research, there have been a series of before-and-after studies of the effect of edgelines on traffic performance and accident rates. In general, these studies are not comparable even though most of them concentrated on rural two-lane roads. The inability to make direct comparison was a result of the vastly different conditions that were present, such as lane width, the absence or presence of shoulders, and other environmental factors.

Nonetheless, the studies indicated that edgelines on tangent sections tend to decrease variability in lateral placement. Average lateral placement shifted away from the roadway edge. Because of the increased potential for head-on collisions inherent in shifting vehicles toward the centerline, many States prohibit edgeline pavements narrower than 18 feet (5.5 meters).

Another study showed that edgelines reduce speed through horizontal curves and minimize centerline straddling.⁽²⁹⁾

The safety and cost-effectiveness of six delineation treatments for various geometric situations was studied.⁽³⁰⁾ The treatments consisted of no delineation, centerline, centerline plus edgeline, centerline plus PMDs, and centerline plus guardrail. The study examined the effect of the various combinations of delineation treatments on mean accident rates. The more sophisticated treatments, such as centerline plus edgeline, or centerline plus PMDs, produced a decrease in accident rates.

It should be noted that some recent experience on winding and/or mountainous roadways demonstrated a driver tendency to increase speed beyond safe levels where edgelines were provided. The decrease in head-on collisions was offset by an increase in run-off-the-road accidents. It has been suggested that enhanced guidance provided by edgeline gives the driver a false sense of security. It may result in overconfidence in the driver's ability to control the vehicle and maintain a safe position in the roadway.

Weather and Climate

Roadway Delineation Practices Handbook

Prevailing climate and weather conditions influence the effectiveness of delineation. Durability of materials and installation techniques are also influenced by weather.

During daylight hours, rain reduces the driver's ability to see the surroundings. At night, headlight glare from oncoming vehicles, windshield wiper action, and the slippery pavement surface, coupled with degraded retroreflectivity of pavement markings, makes driving particularly hazardous and difficult. RPMs and PMDs are much more effective than pavement markings in these conditions. Markings quickly lose their retroreflectivity due to surface-water film. During daytime rainy periods, RPMs do little to improve visibility, but the audible rumble when passing over the markers alerts the driver of lane straddling.

Rain does not affect the durability of pavement markings. Tire action on wet thermoplastic has been known to clean the markings. Maintenance personnel cite numerous incidents of improved visibility of thermoplastic lane lines after several hours of rain. Conversely, PMDs are subject to splashing from wet highways, which degrades their retroreflectivity. Cleaning of the retroreflective tabs may be needed.

More than rain, snow reduces the driver's visibility. Even moderate snowfall usually obliterates all pavement markings. Also, pavement markings can be damaged from snowplow activity and the use of chemicals and deicing salts. PMDs (with extension posts where drifts are high) provide effective edgeline and roadway alignment delineation, but are vulnerable to knockdowns by snowplows.

Fog also reduces a driver's visibility. No cost-effective delineation techniques are adequate in dense fog. However, experiments with various forms of surface highway lighting have been undertaken.^(31,32) Roadway delineation has been improved by closely spaced, high-intensity, retroreflective RPMs combined with nonretroreflective RPMs to create a rumble effect when passing over the marking. Similarly, where short-range visibility is a recurring problem, the gap in a skip line has been decreased in the problem location so that at least one or two marking segments are always visible.

Like fog, blowing sand reduces the driver's visibility. It can also collect on the roadway and obscure pavement markings. The abrasive effect may damage paint and thermoplastic markings. Some agencies close highways or provide platoon escorts through areas affected by fog or blowing sand.

The reduced visibility associated with the effects of weather, such as rain, snow, and fog, makes driving difficult. In these situations, safety considerations always transcend cost-effectiveness concerns.

In addition to the physical presence of rain, snow, fog or blowing sands, or temperature extremes can influence delineation. Thermoplastic materials and some paints are often formulated to withstand specific temperature extremes. For example, a thermoplastic product formulated for the Northeast would not be applicable in the Southwest. In cold climates, the freeze-thaw cycle can cause early failures by weakening the marking's bond with the pavement surface.

Summer heat also affects pavement markings. In parts of Arizona, California, Nevada, Texas, and other States with hot climates, surface temperatures frequently exceed 120 degrees Fahrenheit (49 degrees Celsius). Under such thermal stress, thermoplastic on asphalt pavement will "crawl," distort, and become badly marked with tire tracks, resulting in reduced daytime visibility. However, tire tracks on the markings will not significantly affect nighttime retroreflectivity. In addition, the ultraviolet rays of strong sunlight can affect the color and life of conventional delineation materials.

Traffic Volume and Composition

Traffic volume and composition can affect the choice of delineation treatments and techniques. Traffic volume is important because average daily traffic (ADT) is often the major criterion used to select delineation techniques. For example, roadways with high-traffic density may be better served by the installation of highly durable devices, such as RPMs, hot-laid thermoplastic materials, or epoxy. These durable materials will provide long-term delineation, thus avoiding the need for frequent maintenance. They also reduce the exposure of maintenance crews to traffic and the disruption of traffic. The higher initial cost can be balanced against the safety and long-term economic benefits of the more-durable techniques.

Roadway Delineation Practices Handbook

Low ADT may indicate that painted markings alone or in combination with RPMs or PMDs are adequate and may last one or more years without repainting. States must experiment to determine the optimum periods for repainting in these locations.

Traffic composition can affect the service life of delineation materials. A high percentage of trucks, buses, and other heavy equipment can damage or wear out markings much faster than passenger vehicle traffic. For example, rural, farm-to-market, low-density roads or industrial access roadways may need more durable applications than their ADT might indicate.

Another characteristic of traffic flow that influences selection of delineation systems is location of the markings. Longitudinal markings last longer than transverse markings, and edgelines last longer than lanelines because of fewer crossovers.

As a guideline for selection, ADT is loosely correlated with service life. A graph is developed, like the example shown in figure 19. Some agencies develop more complex correlations. Rather than simple ADT, the District of Columbia uses the number of wheels crossing a point on the road as an indicator. The reasoning is that traffic abrasion occurs only when the wheels of a vehicle pass over a marking. Edgelines or heavily traveled freeway lane-lines may not experience the same wear as markings in areas with lower ADTs, but in the latter, crisscrossing or encroachment is often more pronounced.⁽³³⁾

The technique used by Washington, D.C. for calculating the expected service life as a function of traffic flow is based on several assumptions.

- Expected service life is measured by the total number of vehicles per lane that have passed over the marking when it is worn completely from the wheel paths.
- Wear of pavement marking materials is a function of the second power of the number of vehicles per lane passing over the materials laid normal to the direction of traffic flow.
- Service life is a measure of the number of vehicles per lane that have passed over the material when the marking is no longer serviceable on account of having lost its luster, lost its retro-reflectivity, or of having been worn completely from the surface in the wheel paths.
- Markings of conventional traffic paint or other quick-drying materials should be renewed when material in the wheel paths has been worn to half its original area. It is approximately at this point that the marking can be expected to lose its luster, and beads to lose their retroreflectivity.

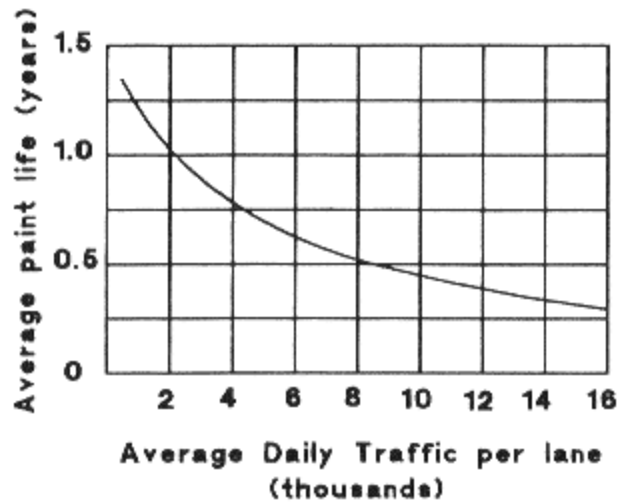

a) Paint striping as affected by traffic density for both bituminous and concrete pavement (Ref. 29)

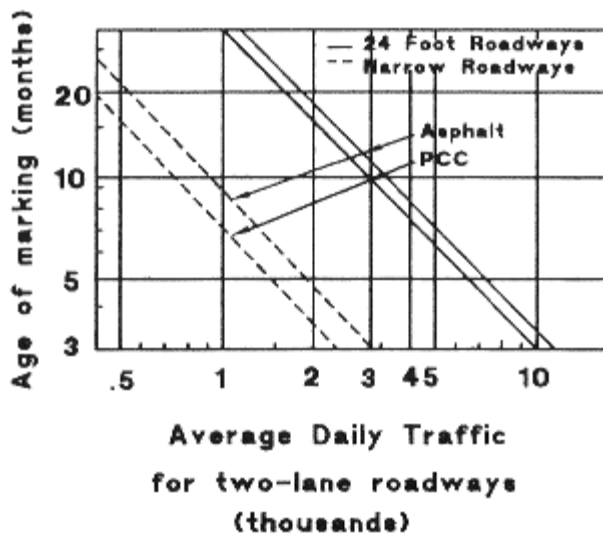

b) Conditions for noticeable traffic stripe wear (white traffic paint placed at 15 mile wet with 6 pounds of beads per gallon) (Ref. 29)

Figure 19. Effect of ADT on service life of thermoplastic markings

- Thermoplastic markings retain brightness and beads and are still retroreflective until all the material in the wheel paths has been worn away from the pavement.
- Cost-effectiveness is the ratio of the cost per linear foot of marking to service life. The service life is expressed in millions of vehicles per lane of traffic.

This technique appears to work well for high-density facilities. Whether simple or sophisticated correlations are developed depends on the type and function of each specific site. Different traffic characteristics for a site can greatly

Roadway Delineation Practices Handbook

affect service life. Traffic characteristics are important when judging the cost-effectiveness of the more durable delineation techniques.

Substrate Material

Variations in type and condition of the substrate determine, to a large extent, the durability and visibility of the pavement marking. The substrate materials upon which pavement markings are applied fall into two categories: asphaltic concrete (AC) or Portland cement concrete (PCC). *Asphaltic concrete* denotes a dense-graded road surface made of hot mineral aggregates plant-mixed with hot asphalt. *Bituminous concrete* includes both asphaltic concrete and similar mixtures made with refined tar. The coarse aggregate is generally crushed stone, crushed slag, or crushed gravel. Sand and filler or sand only is usually added. Bituminous concrete has the advantage that it can be driven on immediately after construction.⁽³⁴⁾

Another form of asphaltic concrete is *open-graded*, which uses only coarse aggregate. When applied as a surface course, it has a high porosity and permeability, as well as a rough surface texture. The porous feature minimizes the potential for hydroplaning by allowing numerous escape channels for water beneath a moving tire. Water ponding prevents markings from retroreflecting incident light. Therefore, use of open-graded asphalt minimizes the time during a rainstorm that the delineation is ineffective.

Portland cement concrete consists of a relatively rich mixture of Portland cement, sand, coarse aggregate, and water. It is laid as a single course. When properly designed and constructed, it has a long service life and relatively low maintenance requirements. A minimum of five to seven days curing time is required before the pavement is ready to be driven on.

Because the service life of AC is dependent on so many variables (for example, type of aggregate, type of base, traffic density, climate conditions), an average value for expected service life is of little value. In general, PCC pavement will last about twice as long as AC. PCC is much smoother than AC. The PCC often is scored or treated to increase its skid resistance.

The life of pavement is significant particularly when considering the application of long-term delineation. For example, RPMs or thermoplastic markings could outlive an aging AC surface under certain circumstances. The high initial cost of these treatments is justified by their durability and longevity. Since imminent resurfacing or reconditioning of AC pavement cancels out this advantage, alternate methods should be considered for the interim period.

Greater quantities of paint or hot-applied thermoplastic materials are required with the open-graded AC pavement surface because of its porous nature. However, such a surface provides better wet-night visibility. With RPMs, the problems in obtaining a secure bond with the rough surface results in a higher percentage of dislodged markers.

Implication of Variables

The ideal form of delineation is that which performs best based on driver behavior, safety, free movement of traffic, and cost. Various marking and delineation techniques may be used individually or collectively as appropriate.

The advantages or disadvantages of each of these techniques and treatments and their general characteristics are described in the following chapters. Highway designers must be knowledgeable in this area in order to specify economical, effective delineation.

The selection and purchase of delineation techniques and materials is a recurring activity for highway agencies. There is no universal delineation configuration that equally serves all needs. To achieve the best balance among driver requirements, safety aspects, and economic considerations, each of the variables discussed must be assessed to determine its impact on effectiveness. The following chapters place current practices in perspective and clarify the rationale used in the decision process.

CHAPTER 4. TRAFFIC PAINTS

INTRODUCTION

The use of painted markings on the roadway surface to divide the traffic stream and provide guidance to the driver has existed since the dirt road gave way to the paved road. Today, painted markings used alone or in combination with other devices comprise the most commonly used delineation technique. This chapter covers the various uses, materials, equipment, installation procedures, and other factors associated with painted pavement markings.

TYPES AND APPLICATIONS OF PAINTED MARKINGS

Painted markings are classified as either longitudinal or transverse. They provide positive guidance by defining the limits of a driver's field of safe travel, such as lanelines, centerlines, edgelines or crosswalks, and stop bars. They also provide negative guidance, which defines where drivers are not permitted to travel, such as gore areas, islands, and painted medians.

The specific application of standard colors, widths, patterns, and placement are defined in the Manual of Uniform Traffic Control Devices (MUTCD).⁽¹⁾ Some basic concepts are addressed in this Handbook, but the MUTCD should be consulted for more precise installation information.

In addition, table 2 presents definitions of the basic types of pavement markings. This includes guidelines for selecting the physical characteristics of a marking depending on the purpose of its application.

Figure 20 illustrates basic patterns and colors that are used in a variety of common roadway situations.

Table 2. Types of pavement markings

DESCRIPTION		COLOR	WIDTH	APPLICATION
Single Broken	White	4 in (100 mm)	Separation of lanes upon which travel is in the same direction, with crossing from one to the other permitted; i.e., lane lines on permanent multilane roadways.	
	Yellow	4 in (100 mm)	Separation of lanes upon which travel is in opposite direction, and where overtaking with care is permitted; such as centerlines on 2-lane, 2-way roadways.	
Single Solid	White	4 in (100 mm)	Separation of lanes, or of a lane and shoulder, where lane changing is discouraged; such as lane lines at intersection approaches, right edgelines.	
		6 in (150 mm)	Lane lines separating a motor vehicle lane from a bike lane.	
		8 in (200 mm)	Delineation of locations where crossing is strongly discouraged; such as separation of special turn lanes from through lanes, gore areas at ramp terminals, paved turnouts.	
Double Solid	White	4-4-4 in*	Separation of lanes on which travel is in the same direction, with crossing from one side to the other prohibited in both directions. Left turn maneuvers across this marking are permitted. Also used to delineate edges of a continuous left turn lane -- solid lines on the outside, broken lines on the inside.	
	Yellow	4-4-4 in*	Separation of lanes upon which travel is in opposite directions, where	

Roadway Delineation Practices Handbook

			overtaking is prohibited in both directions. Left turn maneuvers across this marking are permitted. Also used in advance of obstructions which may be passed only on the right side.
Solid plus Broken	Yellow	4-4-4 in*	Separation of lanes on which travel is in opposite directions, where overtaking is permitted with care for traffic adjacent to the broken line, but prohibited for traffic adjacent to solid line. Used on 2-way roadways with 2 or 3 lanes. Also used to delineate edges of a continuous left turn lane -- solid lines on the outside, broken lines on the inside.
Double Broken	Yellow	4-4-4 in*	Delineates the edges of reversible lanes.
Single Dotted	Either	4 in (100 mm)	Extension of lane lines through intersections. Color same as than of line being extended. Also used to extend right edgeline of freeway shoulder lanes through off-ramp diverging areas in problem locations.
	White	8 in (200 mm)	Separation of freeway through lane and auxiliary lane or exit lane.
Transverse	White	12 in (300 mm)	Limit lines or STOP bars; also crosswalk edgelines (minimum 6 feet [1.8 meters] apart) when not in the vicinity of school grounds.
	Yellow	12 in (300 mm)	Crosswalk edgelines contiguous to school buildings and grounds; also optional for crosswalk edgelines located within 600 feet (183 meters) of school buildings or grounds and, under special circumstances, within 2,800 feet (854 meters).
Diagonal	White	12 in (300 mm)	Crosshatch markings, placed at an angle of 45 degrees, 200 feet (61meters) apart, on shoulders or channelization islands to add emphasis to these roadway features.

* 4-4-4 in indicates width of stripes and gap between them. Metric equivalent is 100-100-100 mm.

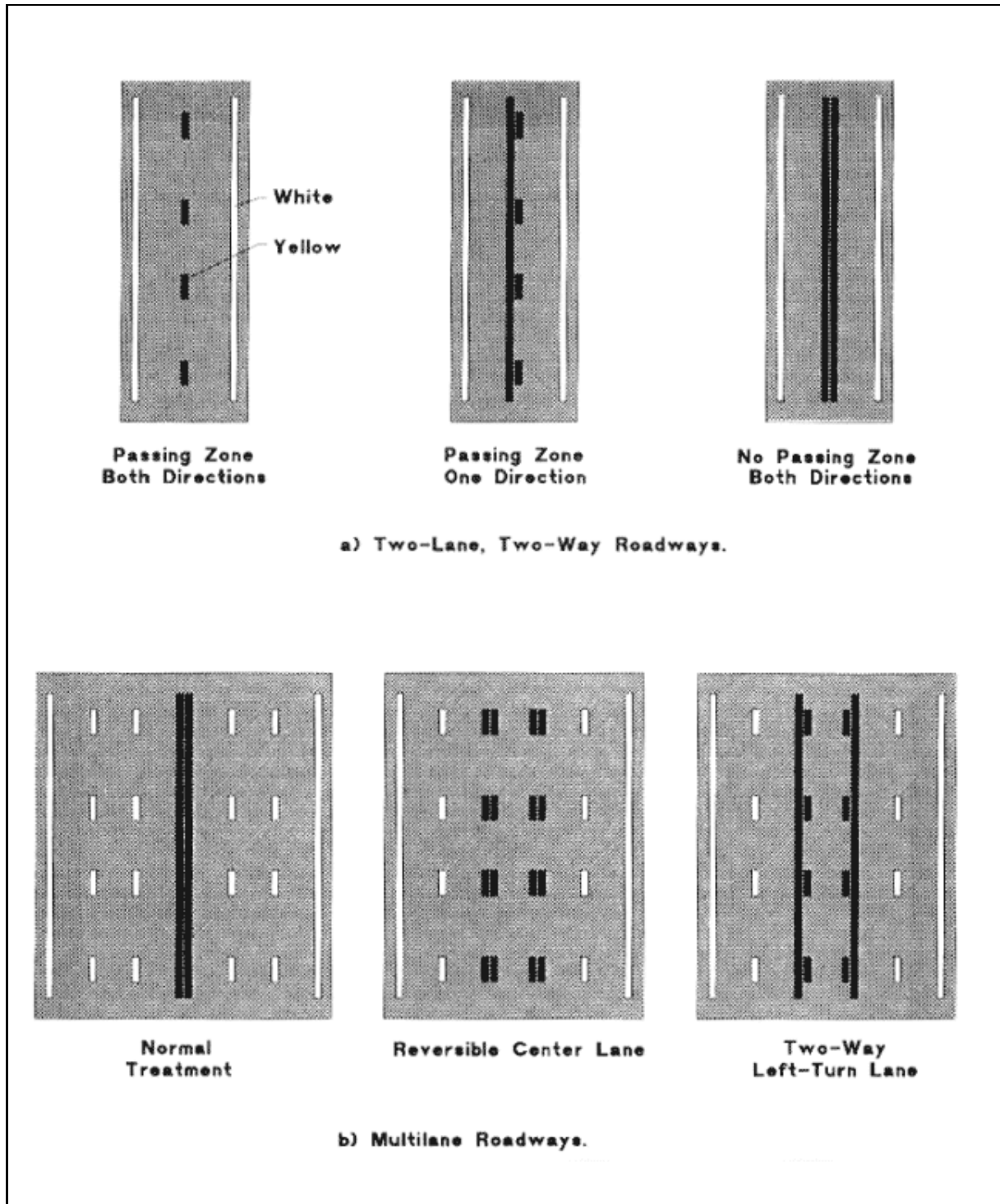

Figure 20. Typical applications for longitudinal roadway delineation.

MATERIALS

Conventional traffic paint continues to provide the nucleus of the nation's roadway delineation system.

Roadway Delineation Practices Handbook

Continual improvements have been made in paint composition and application techniques to provide increased cost-effectiveness. A number of factors interact to determine the performance of the various types of traffic paint.

Any discussion of the materials used in painted markings must consider the three interactive elements of the paint system: the paint itself (pigment and binder), beads (retroreflective glass spheres), and pavement surface (substrate). For example, different paints react differently on asphaltic and concrete pavements. Glass beads reflect differently depending on the binder used, its thickness, and percentage of pigment.

The following background on painted markings will provide the substance for a subsequent discussion of the major factors that influence selection of a good paint for a given situation. It includes a review of the categories of paint, essential properties, and performance criteria. The use of glass beads to create retroreflective pavement markings is discussed in chapter 2.

Categories

There are several ways to classify paint. It can be classified by retroreflectivity, that is, whether glass beads have been added for nighttime visibility. Paint without beads generally is used for markings not requiring night visibility, such as parking spaces and curbs.

Paint can be classified by whether it is cold-applied or hot-applied. The temperature at which paint is applied has a direct relationship to drying time which is the third method of classification. Drying time is influenced by the atmospheric dew point, the paint's chemical composition, the temperature of the paint and pavement during application, wind velocity, and paint thickness.

The categories of paint based on drying time are defined as follows:⁽³⁵⁾

- Conventional. Cold-applied paints with a standard value of viscosity. They require more than 7 minutes to dry.
- Fast Dry. Hot-applied paints that dry to a no-track condition within 2 to 7 minutes.
- Quick Dry. Hot-applied paints that dry to a no-track condition within 30 to 120 seconds.
- Instant Dry. Hot-applied, heavy-bodied paints that dry in less than 30 seconds.

Types

The three main components of paint are binder (base material), pigment (for color and retroreflectivity), and solvent. While in containers, paint maintains its liquid form because of the solvent. When applied to pavement, the solvent evaporates, leaving a hard film. Paint is sometimes classified according to the base material used in the paint composition. The base material also is vital to a paint's drying time. Some commonly used base materials are oil (alkyd resin), oleoresin (modified alkyd, drying oil [dispersion] varnish), rubber base (chlorinated rubber), and water.

In this chapter, we will also briefly discuss some aspects of the environmental impact of the use of traffic paints. The high Volatile Organic Compound (VOC) content of traffic paints employing aliphatic and other thinners has resulted in increased use of water-based latex paints in recent years.

Alkyd and Modified Alkyd Paint

The alkyd and modified alkyd paints are generally the cheapest and fastest-drying of common materials. Experience shows them, however, to be the least durable. Though there have been attempts to increase their durability through formula variations, these usually are achieved only at the cost of increased price and/or drying time.

Roadway Delineation Practices Handbook

Alkyd paint is the workhorse material normally referred to as traffic paint. It is the most widely used material, and its lack of durability (less than three months in harsh conditions) has given rise to the development of the numerous new technologies.

Chlorinated-Rubber Paint

Chlorinated-rubber paint is an experiment into varying the base materials for paints to increase their durability. This material became available around 1964. One of the major users of this type of paint is the Texas DOT, which switched to the use of chlorinated rubber in 1966. At that time, the State was displeased with the long no-track times for alkyd traffic paints. Recently, Texas DOT has switched paints again, this time to a formulation of chlorinated polyolefin that is similar to chlorinated rubber. This material is often still referred to as chlorinated rubber.

The State has been pleased with the performance of this material, though environmental concerns with its use have created plans for the State to switch to water-based latex paints in the future. Currently, the chlorinated polyolefin is applied by the State's maintenance forces at a cost of 6 to 7 cents per linear foot. Durability is approximately 1.5 times that of standard alkyd traffic paints, with 1- to 2-minute no-track times.

The New York State DOT is another major user of this type of paint. In 1987, 90,000 gallons of the paint were applied as part of a research project.⁽³⁶⁾ The NYSDOT's goal has been to achieve a paint system that will provide year-round durability at a price similar to its current modified alkyd paint. Though not all the installations in 1987 lasted 12 full months, all lasted at least nine months, including a winter season.⁽³⁶⁾ This is about three times longer than the standard paint would be expected to last under similar conditions.⁽³⁷⁾

The only problems cited with the chlorinated rubber paint were its drying time and odor. The methyl ethyl ketone (MEK) solvent in the paint is strong, with an olfactory detection threshold about eight times lower than that of the toluene normally used in alkyd traffic paints.⁽³⁸⁾ However, chlorinated rubber paint does not appear to pose any more of a hazard to workers since concentrations are approximately equal.

Chlorinated rubber paint has a drying time of 3 to 6 minutes. NYSDOT personnel found that this could be reduced to about 1.5 minutes by varying application temperature and pressure. These no-track times, which are still longer than times for modified alkyd paint, may make the application of the chlorinated rubber paint impractical in areas with high traffic volumes or complex traffic patterns.

Water-Based Latex Paint

One type of paint that is constantly experiencing increased usage is latex paint. More importance has been placed on the environmental considerations involved in the use of traffic paint. Alkyd paints, and any other materials employing toluene or similar thinners as a solvent, release volatile organic compounds (VOCs) into the atmosphere when they are used. As a result, State highway agencies are mandating the use of VOC-free paints, such as latex formulations, on their roadways.

Specific concerns related to performance, application, and maintenance of water-based latex paints are examined in detail with other marking materials in chapter 8.

Essential Properties

In general, there are two criteria by which paint performance is judged: durability and visibility. Durability involves service life of the painted marking. This is measured as the amount of material remaining on the pavement surface over time. Visibility relates to brightness of the material, particularly at night. These properties are described by the American Society for Testing of Materials (ASTM) Standard D-7B-66T.⁽³⁹⁾

Drying time also is a major performance consideration. Faster-drying paints reduce coning for an extended drying period, decrease the exposure of the paint crew to traffic, and lessen the disruption to traffic. Other requirements

Roadway Delineation Practices Handbook

typically included when specifying traffic paint are:

- *Before Application.* Paint should be chemically stable with an adequate storage life. It should maintain a constant viscosity, and be able to resist caking, settling, gelling, skinning, or color changes.
- *During Application.* The paint should adapt easily to application by commercial marking equipment. Clean-up should be kept simple. It should have a strong wetting action to permit penetration of a contaminated substrate, such as by dirt, oil, or sand. This will help provide good adhesion.
- *After Application.* The paint should not bleed or become discolored on bituminous surfaces and should resist the chemical action of alkalis characteristic of PCC surfaces. Paint also must be able to withstand chemicals used for snow and ice control. Traffic paint must be flexible enough to expand and contract with day and night temperature changes. It should be resistant to sunlight and water but sufficiently permeable to allow moisture to escape from the substrate.

The importance of each of these requirements may vary among highway agencies. Their degree of emphasis in the paint specification may also vary.

Additionally, formulation of the paint will be affected by the delineation variables discussed in chapter 3. As noted in chapter 3, roadway geometry affects treatment more than technique, and as such will not influence paint formulation. However, substrate, climate, and traffic characteristics should be carefully considered when selecting a paint.

Paint Formulation

The major elements of paint formulations are *binder*, pigment, and solvent. The binder provides bulk for the film. It is made of drying oils, resins, or plasticizer in a formula that provides adhesion to the substrate and cohesion to hold the paint together. It also provides most of the resistance properties. The pigments give opacity, color, hardness, and special weathering properties. Optimum pigment volume concentration for good durability lies in the 42- to 59-percent range.⁽⁴⁰⁾ Solvents dissolve the binder and regulate the rate of film drying by controlling the rate of evaporation. They are also associated with adjusting the film solids and with the ease of application.

Modified alkyd paints, like the paint used in New York, are probably the most common marking material. These paints are normally heated to 122 degrees Fahrenheit (50 degrees Celsius) for application. They dry to the no-track condition in 1 to 5 minutes due to fast solvent release. The hard and durable resin produces a tough, wear-resistant film. It works in extreme climates as demonstrated by successful use in Saudi Arabia, Finland, and Brazil. Modified alkyd paints have good adhesion on asphalt, bitumen, and concrete surfaces.

Traditionally, the paint-bead combination used is on the order of 15 to 17 mil (0.38 to 0.43 millimeters) wet paint thickness with 5 to 7 pounds per gallon (0.6 to 0.8 kilograms per liter) of beads within the No. 20 to No. 100 mesh range. The FHWA recommends the use of 16-mil (0.4-millimeter) wet film thickness of paint, with 6 pounds per gallon (0.7 kilograms per liter) of applied beads.

Many States seek a retroreflective painted marking with equal performance at a reduced cost. Some agencies have tried 10 to 11 mil (0.25 to 0.28 millimeters) wet paint thickness with 4 pounds per gallon (.48 kilograms per liter) of No. 40 to No. 80 mesh beads, with good results.^(40,41,42) A number of States, including California, Pennsylvania, Colorado, and Kansas, have adopted this paint-bead combination and have reported significant cost savings and no appreciable loss of effectiveness.

Purchase of Materials

Specifications for purchasing pavement marking paint are usually written in the form of a chemical composition or performance specification. The cost and availability of some of the chemical components used in the

Roadway Delineation Practices Handbook

manufacture of paint vary radically from week to week, and detailed composition specifications favored by highway agencies in the past are being replaced by performance specifications. In some cases, a combination performance-composition specification is used that indicates the percentage by weight of each ingredients by generic classification without specifying a brand name or chemical formula.

Each specification has its own unique advantages and disadvantages. One study surveyed 24 States and 15 national paint manufacturers.⁽⁴³⁾ The majority of the States surveyed still use composition specifications, but the manufacturers favored the performance specifications.

The performance specification enables a user to realize the advantage of current paint manufacturing technology. The state of the art in paint manufacturing has progressed so rapidly that it is difficult for the engineer to understand this technology and keep pace with the paint chemist. Furthermore, manufacturers indicated that the best way to lower cost is through their own research and development technology. For example, during the 1978-79 study, the average bid price for the chemical composition specification was \$3.60 per gallon (\$0.95 per liter) for yellow and \$3.36 per gallon (\$0.89 per liter) for white paint. With the performance specification, the average bid price was \$3.15 per gallon (\$0.83 per liter) for yellow and \$2.95 per gallon (\$0.78 per liter) for white paint.

The major problem with using the performance specification is in judging performance. Most States use a point system for evaluating the paint. The method is highly subjective and depends on the opinions of the individual members of the evaluation team. During the study, values assigned to color, durability, contrast, and appearance varied in many States depending on the priorities of the specific highway agency.⁽⁴³⁾

Another disadvantage is the potential difficulty in getting suppliers to replace paint that does not meet the performance specification. This can be time-consuming and may require legal action.

The advantage of a composition specification is the assurance that the purchasers are getting a paint based on their own formulations. The development of a composition specification is normally the function of the materials or testing department of each highway agency. In this process, several different paints are applied on asphalt and concrete pavement surfaces for evaluation. Based on the results, a composition specification is then written to ensure that the user obtains the product that gives the longest service life. Quality control testing in the laboratory is included in the specification to ensure that the product furnished is the same as was requested.

After carefully weighing the advantages and disadvantages associated with paint specification, the previously mentioned specification study concluded that, "paint purchased using performance specifications appears to result in a lower average price than paint using chemical compound specifications."⁽⁴³⁾

It also concluded that when the composition specification is used, chemical components should be reviewed annually to determine the most cost-effective composition. It is frequently possible to substitute or reduce the quality of a chemical compound without sacrificing performance or color.

Testing

The prediction of the service life of paint is a critical factor in evaluating candidate paints. Field tests of various paint compositions is time-consuming and conventional laboratory tests, such as falling sand, the Taber abrasion test, and the WeatherOmeter, do not produce the best results.

A major study has been undertaken to develop an economical and practical accelerated laboratory test to estimate pavement marking material durability.⁽⁴⁴⁾ Two conclusions emerged from this study. First, field tests can be performed to give an overall durability ranking. Second, laboratory tests can be performed to provide data that can predict field test results with a high degree of reliability. If field tests are performed in parallel with the laboratory tests, statistical methods can be used to select the least number of tests required and provide the coefficients for predictive equations.

Roadway Delineation Practices Handbook

If field tests and subsequent regression analysis are not performed, laboratory test data for the predictive equations can be obtained from the study.

The testing and laboratory analyses to be performed can be time-consuming and costly. Furthermore, the work is essentially the same for nearly all the States. At the very least, those States that have nearly the same delineation variables, such as climate, affecting their paints would benefit if some type of technology transfer program were initiated.

The FHWA recognized these concerns several years ago when it began the regional test facility program. The concept began simply as a way to reduce the redundancy of testing. The regional test facility at the Pennsylvania DOT resulted from a FHWA contract that concerned material testing the department had been awarded. Gradually, with encouragement from the FHWA, the program began to evolve into a regional facility that all the States in the Northeastern Association of State Highway and Transportation Officials (NASHTO) Region could access.

The concept has been extended so that all the NASHTO States have begun to coordinate their efforts in the field of material testing. There are now cooperative testing programs, administered by the central Pennsylvania DOT facility, where results of tests on different materials by separate States are shared by all.⁽¹⁵⁾

Similarly, the Southeastern Association of State Highway and Transportation Officials (SASHTO) has created an organization to promote technology transfer among its constituents' States. The SASHTO facility is a more cooperative venture, comprised simply of an organizational plan to coordinate testing efforts of existing highway agencies' personnel.

PERFORMANCE

A great deal of attention has been paid the properties of traffic paint. This has aided research aimed at developing a paint formulation that will produce improved durability, appearance, and visibility. As a result, a number of paint families effectively meet agency specifications.

There are three reasons for evaluating the performance of paint. First, performance evaluations help assess the cost-effectiveness of painted markings compared with other forms of delineation. Second, if paint is selected, it is necessary to evaluate paint samples to determine the best product to purchase. Third, it must be known how long a pavement marking will provide adequate delineation so that repainting can be scheduled.

Research indicates that the precise composition of paint is not as important as precise application of paint. It has been suggested that "a poor paint properly applied will out-perform a good paint improperly applied."⁽⁴⁵⁾ It is also well-documented that 90 percent of all paint failures are due to the type of substrate and the condition of the surface.⁽⁴⁴⁾

Performance Descriptors

A number of terms are used by various highway agencies to describe paint performance. Some of these terms such as "service life," "expected life," "lifespan or useful life," and "paint failure," often have different meanings and should not be used interchangeably. It is difficult to define these descriptors in quantitative terms since they are normally judged on a subjective basis.

Any pavement marking deteriorates gradually with time and exposure to traffic and weather. Highway agencies often define the service life of the marking as the time between application and the time the marking should be replaced. Hence, the service life is dependent upon the extent of deterioration that can be tolerated before replacement is necessary.

As mentioned earlier, the service lives are used to evaluate painted test markings and to compute the economy of various materials. Evaluation is based on appearance, durability, and night visibility of sample materials placed on test sections. Each of these three characteristics are rated numerically from 0 to 10. A rating of 10 indicates perfect condition and 0 represents complete failure (that is, no appreciable paint remaining). Many highway agencies assume

Roadway Delineation Practices Handbook

that service life is at an end when the combined weighted ratings fall to 4 or below. This is sometimes referred to as "effective life."

It has been suggested that using a rating scale with 11 grades (0 through 10, inclusive) is somewhat cumbersome. For example, on this type of scale, the difference between 7 and 8 is so small that it is difficult to maintain consistency for different ratings. Accordingly, it might be desirable to use a rating scale with fewer grades between "perfect" and "complete failure."⁽⁴⁶⁾

Performance is a function of numerous variables, not just the paint itself. The performance of identical materials will depend on the interaction of the delineation variables discussed in chapter 3. In addition, several factors involved in the application of the material affect its performance. These reasons make it impossible to determine a quick and simple formula for service life.

Causes of Failure

The integrity of a pavement marking can suffer from at least three mechanisms: loss of substance by abrasive wear on the upper surface, cohesive failure of the paint (within the paint layer), and/or adhesive failure at the interface with the concrete substrate.

Another possible cause of failure often overlooked is within the PCC or asphaltic concrete (AC) region just below the paint-concrete interface. Stresses that cause such failures arise from the reaction of the pavement surface to the forward forces and the weight of vehicles.⁽⁴⁴⁾

Since single stresses obviously do not cause failures, fatigue must be the mechanism. Factors contributing to loss of strength of the paint, interface, and concrete may include temperature and humidity cycling, light radiation damage, chemical attack by salt and acids (from nitrogen and sulfur oxides in the air), physical attack by solvents (such as gasoline and oil), tire studs and chains, and snowplows.

With so many possible failure mechanisms, it is not surprising that there is a wide variation in the performance of various types of material. It is also the reason that abrasion tests have not been completely successful in predicting the service life of painted markings.

Ranges of Service Life

Although the estimated service life of painted markings is a function of numerous site-specific variables, average daily traffic (ADT) is more commonly used than any other variable. Most highway agencies consider a reasonable target to be 6 to 12 months under "normal" conditions. Three months' service may be acceptable for roadways with very high traffic density, whereas some paints may last well more than a year on roadways with low ADTs.

The amount of wear experienced by the paint is a function of the interaction between the delineation variables discussed in chapter 3. The variables that affect paint in particular are discussed below.

As presented in chapter 3, roadway geometry and traffic characteristics will determine the number of wheels passing over a certain portion of the marking. Also, the traffic composition will determine the average loading cycle for each wheel pass. These factors are directly proportional to wear of the marking. In combination with the effects of the other delineation variables, they will usually correlate well with service life.

The type and condition of pavement surface is another variable that affects service life. Paint normally lasts longer on bituminous asphalt than on PCC. On the average, centerlines placed on PCC may require repainting each year, whereas similar markings placed on AC may require remarking every two years. It has also been found that paint laid over paint will perform better than on new installations, assuming that the base layer of paint is in fair condition and is on a stable substrate.

Roadway Delineation Practices Handbook

The climate will have a direct effect on service life of a painted marking. It is particularly important for paint, which often has a service life of less than a full weather cycle of four seasons. Paint wear is especially heavy in cold weather. In certain climates, painted markings applied in the fall will have a shorter service life than those applied in the spring.

Aside from the rate of wear, the marking's service life will be determined by the mode of failure and the paint's formulation and thickness. Different paint formulations affect service life, but the more durable paints tend to be proportionately more expensive.

Thicker paint films on stable pavement surfaces usually provide increased durability. However, this is not a linear relationship. The additional service life of a marking thicker than 15 mil (0.4 millimeters) is proportionally less than the increase in thickness.

Additional thickness of paint will lengthen service life only if the failure is caused by wear. Sometimes the failure mode is by loss of bond within the paint or at the paint-substrate interface. In this case, the additional thickness of paint normally does not extend service life.

Because of the variations in the parameters associated with service life of paint, each highway agency should develop its own estimated service life based on local conditions and experience. An "average" service life based on a compilation of nationwide experience has little meaning.

INSTALLATION, MAINTENANCE, AND REMOVAL

The equipment, procedures, and policies involved in the application of paint have a profound influence on the ultimate performance. This is equally true for all forms of delineation treatments. Among the major concerns are compatibility of materials and equipment, size and capabilities of crew, protection of crew, and traffic control during the application process.

While it might be assumed that the material chosen would dictate the type of equipment, in practice the opposite is usually true. That is, the material is often selected based on the capabilities of available equipment. This is one reason for the resistance in State highway agencies to the use of new materials.

For example, it may be determined that a rapid-drying, hot-applied paint will be economical, durable, and safely applied for a certain project. If the highway agency's equipment is compatible only to cold-applied paint, most highway agencies will use the cold-applied materials. Capital expenditures for new equipment or the use of a contractor are often beyond available budgets.

This illustrates that compromises must be made among all elements of the delineation treatment. Few decisions are simple enough that they can be made independent of other concerns.

Application Equipment

Painted markings can be applied with a variety of equipment. Selection of the proper equipment will depend on the size of community, miles of roadway, geographic characteristics, pavement surfaces, and the types of markings.

Equipment falls into two broad categories. The first is the small, self-propelled, manually-controlled striper with very low material capacity. The other is the heavy-duty, multilane, truck-mounted striper.

The smaller striper is generally used for marking crosswalks and other transverse markings and legends. Commercially developed stripers may have several unique characteristics. One type may be self-contained with a small engine to propel and operate the air compressors, paint and bead tanks, spray gun, and bead dispenser. In other stripers, the compressor may be an auxiliary unit with a hose connecting it to the spray gun. Typical small-scale stripers are

illustrated in figure 21.



Figure 21. Small paint application units

The larger truck-mounted striper is almost always used for longitudinal markings. These stripers are available commercially or can be customized to a highway agency's specifications. While the specifics may differ, heavy-duty stripers typically have the following characteristics. The bed must be large enough to carry all the necessary marking equipment. The engine should have sufficient power to maintain a steady speed up grades. This is needed for the spray equipment to produce a uniform marking. The striper is equipped with special warning lights. Arrow panels should be mounted on the striper if it is not followed by a shadow vehicle. The front of the striper is usually equipped with a device, such as a small caster, that will enable the operator to follow a target on the pavement or to follow a previous marking. The device must be retractable so that it can be lifted free of the pavement when the marking operation is discontinued or the device is not in use. A typical layout of a large-scale striper is shown in figure 22. Photographs of some current models of stripers are shown in figure 23.

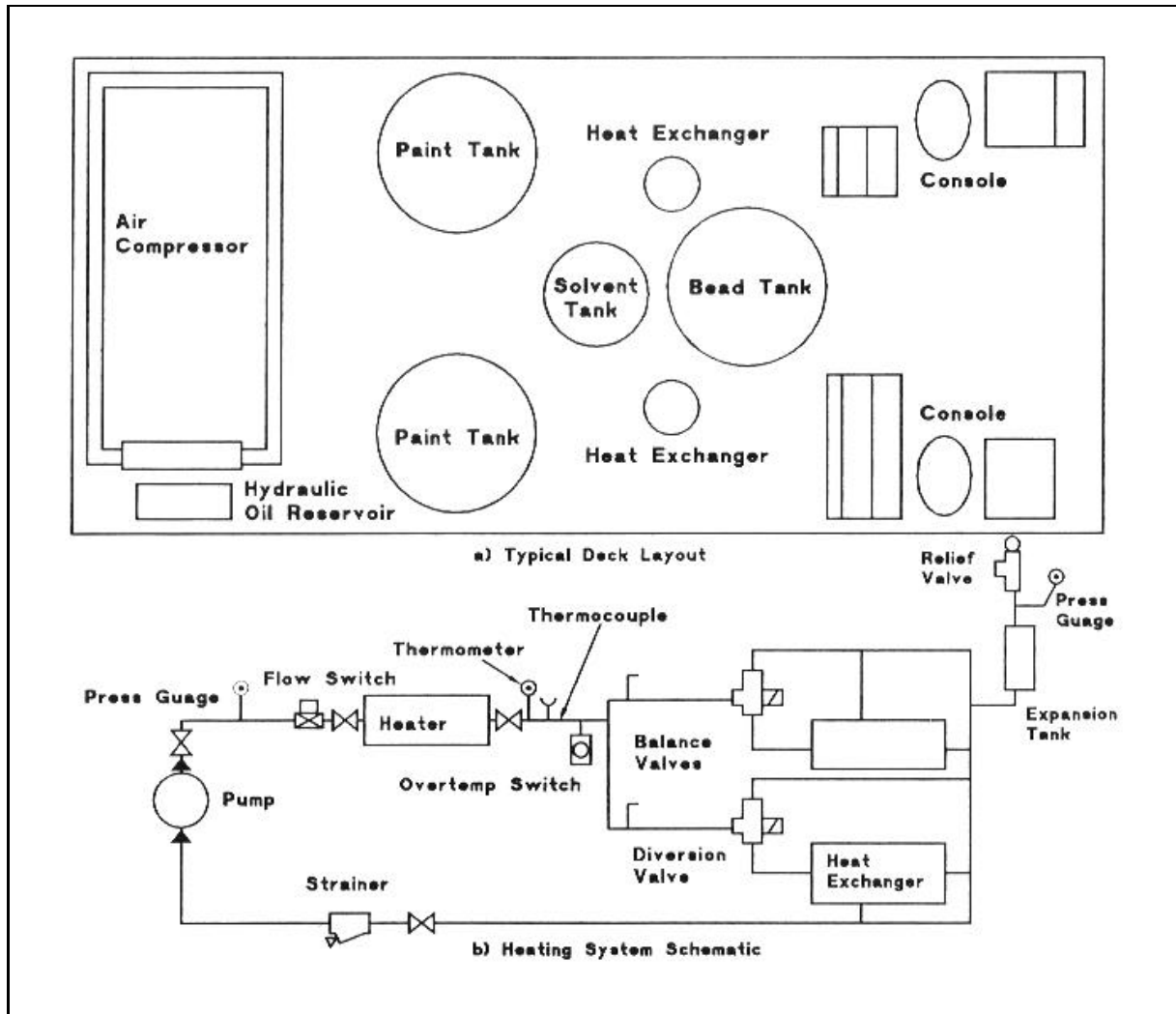

Figure 22. Layout of large-scale paint striper



Figure 23. Truck-mounted paint application units

Roadway Delineation Practices Handbook

Two different methods are used to supply the traffic paint to the spray guns. In the first, the paint drums are lifted from a supply truck to the striper by a hoist and the paint is pumped directly from the drums to the paint guns. A valve in the hose permits pumping from either of two drums. In the second method, paint tanks are located on the striper. These may be filled from drums or tankers by either mechanical pumps or air pressure. In both methods, screens must be used in the lines to help prevent contaminants in the paint. The screens must be freely accessible so they can be cleaned frequently. Additional screens should be located close to the paint spray guns. The hoses must be resistant to the cleaning solvent and to the solvent used in the paint.

The striper should be equipped with an accurate speedometer so that a consistent speed can be maintained. A volume meter for each paint supply is valuable for monitoring the quantity of paint applied.

An air pressure system transports the paint to the spray guns at a pressure determined by the quantity of paint to be delivered. It also supplies air at a lower pressure to a jet at the paint nozzle to atomize the paint. Air also moves the glass beads from the bead tank to the gravity-type bead dispensers. When hot paint is used, the glass beads are applied pneumatically. Air is also used in control valves for the paint guns. Some highway agencies use an air blast just ahead of the paint gun to blow loose paint chips and other debris from the area being painted.

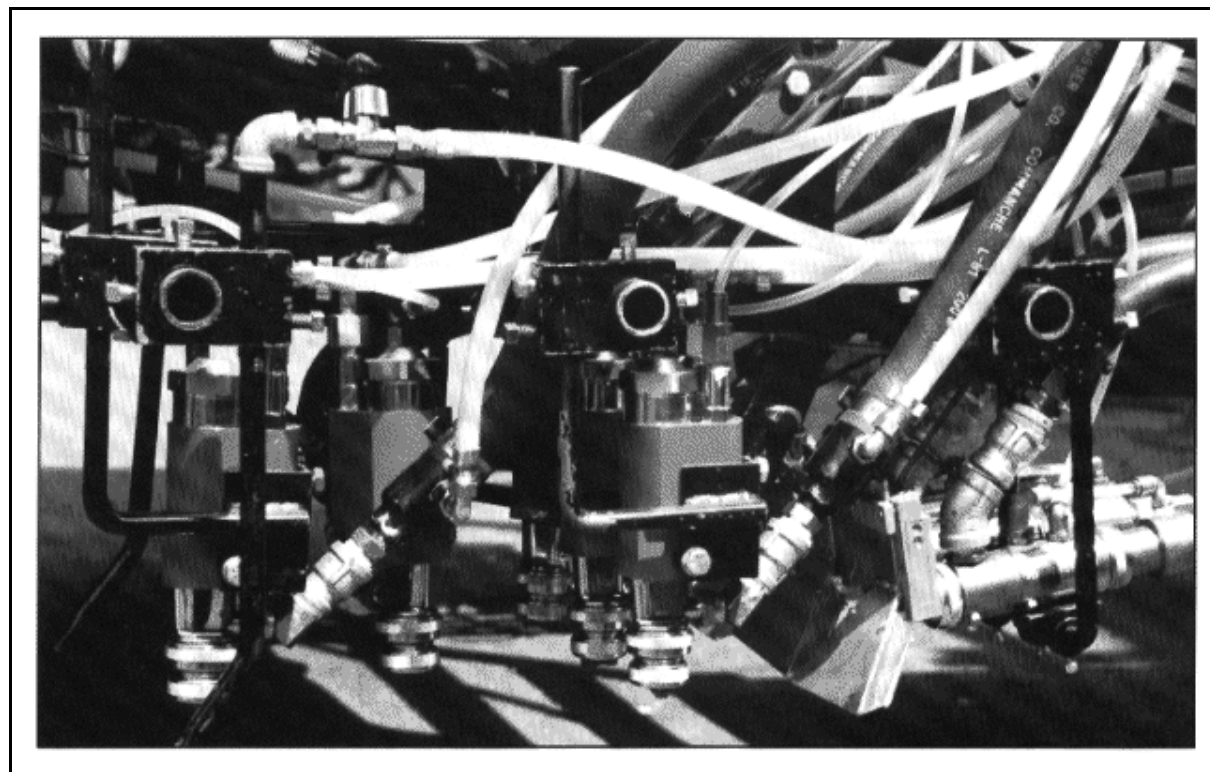

Figure 24. Paint and glass bead spray applicator

The air supply comes from a compressor that is driven by a gasoline or diesel engine. This is mounted on a skid frame bolted to the bed. There should be instrumentation to ensure that the engine power matches the load on the compressor. Protective devices are desirable to shut down the engine in the event of a malfunction.

The air pressure is also connected to the cleaning system, which is a tank of paint solvent that can be connected to the paint lines and nozzles by supply valves. The lines, nozzles, and screens must be cleaned only after use. The cleaning solvent is returned to a drum on the striper.

Roadway Delineation Practices Handbook

The paint spray guns and bead dispensers are mounted on carriages underneath the truck bed; they attach just behind the rear axle. This is illustrated in figure 24. The carriages can be moved laterally by the spray gun operator. A positive placement of the carriage is applied. If edgelineing is done at the same time as centerlineing, two carriages are needed.

The paint spray guns and bead applicators are timed so that the bead applicator starts at the appropriate time after the paint spray gun starts. All spray guns and bead applicators are controlled by an intermittent timer. This device consists of a timing mechanism driven by a ground contact wheel. A typical control panel for these devices is shown in figure 25.

Heating the paint prior to application has proven effective at achieving more uniform consistency under changing temperature conditions and in reducing drying time. Low temperatures (up to about 120 degrees Fahrenheit/49 degrees Celsius) can be obtained by using a heat exchanger in the paint supply tank. This uses hot water from the truck radiator or from the compressor radiator. Temperatures higher than this require that the paint supply lines be jacketed and hot water must be supplied to the jackets.

Temperatures above 180 degrees Fahrenheit (82 degrees Celsius) generally require an external heating system to supply heated liquid (a coolant or special fluid) to the heat exchanger and to heat the paint lines. Some striper that are used for application of quick-drying heated paint have a compressor located behind the operator and a heat exchanger mounted on the bed.

One type of striper is capable of applying material at pressures up to 2,000 pounds per square inch (14,000 kilopascals) and temperatures up to 350 degrees Fahrenheit (177 degrees Celsius). A striper used by the Florida DOT has a million-Btu (293-kilowatt) heater, a 250-cubic feet per minute (0.12 cubic meters per second) compressor, dual steering, and a paint temperature capability of 225 degrees Fahrenheit (108 degrees Celsius) while painting three markings.

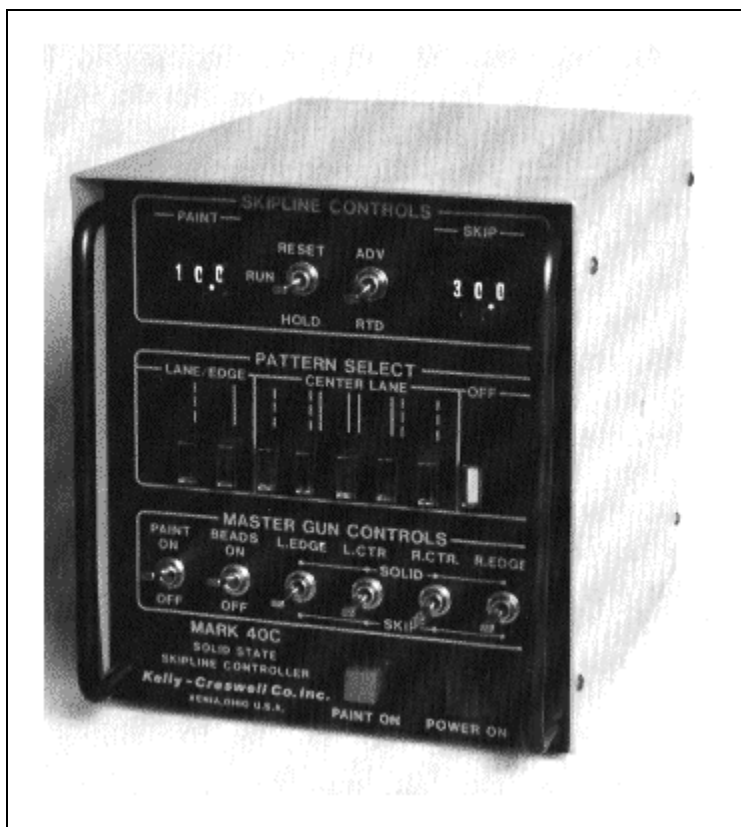

Figure 25. Paint control panel

One type of California striper generates heat in a rotational mechanism that uses mechanical energy to heat paint. No heat exchanger is needed. Temperatures can be controlled to within 1 degree Fahrenheit (0.6 degrees Celsius) over a range of ambient to 400 degrees Fahrenheit (204 degrees Celsius). It has been used with various materials and at speeds up to 20 miles per hour (32 kilometers per hour). Paint drying time, depending on material, ranges from 6 to 90 seconds. Operation is by a two-person crew plus a follow-up truck with warning sign. This striper can mark from the right or left side (retractable spray guns at the centerline of tandem axles) or straddling the marking (sulky in front of truck). Up to three markings can be applied simultaneously. Another feature of this striper is a multiple-nozzle airless spray gun capable of layer operation; e.g., two thin layers of paint, followed by beads, then another layer of paint and a top course of beads. Because it is not necessary to clear the paint lines and spray guns at the end of a day's work, a full day of marking is possible. This striper is reported to reduce bead use by 15 percent and paint by 10 percent over older designs.⁽⁴⁷⁾

Missouri, North Carolina, and several other States have stripers that use a high fluid pressure (1,400 to 1,800 pounds per square inch/9,600 to 12,400 kilopascals) spray system. Air atomization of the paint is not required. Wyoming has stripers with motors to drive the high-pressure pumps.

Crew Size for Installation

Although heated and quick-drying cold-applied paints do not require protection of the freshly painted marking from traffic, slower drying paint materials require some form of protection. The type of protection required dictates the size of the crew.

The most common form of protection is traffic cones. The striper may be equipped with an apparatus that sets the cones. Alternately, a platform at the rear or side of the striper can accommodate a crew member who sets the cones

Roadway Delineation Practices Handbook

manually. In other operations, the cones are placed from a following truck equipped with an arrow board. An example of how these cones may be placed is shown in figure 26.

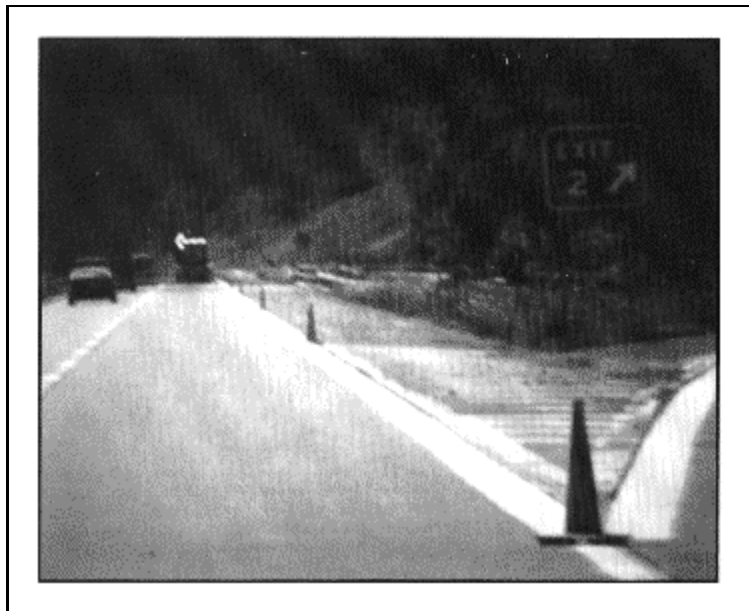

Figure 26. Coning for paint application

Some highway agencies pick up cones manually. In other States, machines for picking up cones have been developed. One such machine developed by ADDCO (St. Paul, MN) and marketed commercially, consists of a large wheel that will pick up or set down cones, allowing the operator to remain in the bed of a standard pickup truck.

On heavily used roadways, some highway agencies will use one or more trucks with arrow boards following the striper. These following trucks direct traffic and protect the marking from traffic. Extreme care and caution in these situations are required to protect the work crew.

The size of the crew depends on the nature of the operation and on each highway agency's policy. If centerlines, edgelines, and no-passing lines are applied simultaneously, two spray gun operators are needed. Thus, considering that the striper has a driver and assistant, a crew of four is required. A supply truck and operator is required for most operations. If cones are needed, another worker is required. The crew coordinator usually follows the striper. The cones must be retrieved by another truck with two or three workers. If cones are not needed, supporting trucks are used for protection of the marking and generally follow at intervals of about 500 feet (150 meters).

The simplest marking operation requires about five workers and two trucks, in addition to the striper. Considerable planning and coordination are needed to attain an efficient and low-cost operation. Because the marking operation is seasonal in many States, the markings should be placed as early in the morning as possible, but not before conditions are suitable. Because of rigid work hours, marking is too often started in the morning before the pavement surface has dried.

As in many other fields, quality is often sacrificed because of the push for increased production. Shortcuts in application are seldom cost-effective. Materials can be wasted, machinery clogged, and the quality of the marking degraded if proper attention to detail is abandoned in favor of a few additional miles of marking.

Pretreatment of Pavement

Early experience with traffic paints suggested that better adhesion might result from pretreatment. It was fairly

Roadway Delineation Practices Handbook

well-documented that repainted markings performed better than the initial application on bare pavement. It was hypothesized that pretreatment, particularly on PCC, would lengthen the service life of paint.

However, actual performance of pretreatments has been erratic; several methods have been used without significantly increasing durability. Applying a light coating of paint without beads as a sealer on new pavement surfaces has proved a successful practice used in some States.

The first (primer) coat, laid at 4 to 5 gallons per mile (9.4 to 11.8 liters per kilometer), dries rapidly and seals the pavement. This eliminates discoloration of asphalt from the solvent in traffic paint. It also improves adhesion on PCC.⁽⁴⁸⁾

Another problem is inadequate cleaning of pavement surfaces. Tests have shown that clean surfaces improve adhesion. A field study was conducted to assess the various types of surface preparation techniques.⁽⁴⁸⁾ The techniques studied included grinding, airblasting, sandblasting, burning, washing (hydroblasting), acid etching, and wire brushing.

Of the different methods, wire brushing worked best with the application technique used. It was easy to use, worked well on irregular surfaces, did not damage the surface, had no logistics or time lapse problems, and effectively removed road film. In this method, a wire brush is mounted in front of the centerline spray gun and is controlled by the same circuit. The gun and brush thus activate and deactivate simultaneously.

Brushing pressure on the road is controlled by a regulator on the air supply. It appeared that optimum brushing occurred when the brush was at its highest speed (600 revolutions per minute) and a broom pressure that caused a 0.25-inch (0.17-millimeter) deflection of the side bristles. Too much pressure resulted in excessive fiber deflection, early failure, poor cleaning action, and unnecessary strain on the drive parts.

The cost for the wire brushing operation during this 1979 study totaled about \$0.26 per mile (\$0.16 per kilometer). It was concluded that the service life of paint was not noticeably improved by brushing under the conditions of the field tests (hot, dry weather, relatively clean roads). It may still be useful for other road conditions and is probably more important when applying spray or extruded thermoplastic markings, since they do not have the wetting capabilities of solvent-based paint.

Premarking of Roadway

It is generally necessary to premark the pavement surface before applying a new pavement marking. The customary method of premarking is to use a string or pieces of pavement marking tape and make spots approximately every 5 feet (1.5 meters). When working in traffic, the workers applying premarkings must be protected with signing, flaggers, and lane closures. Another procedure is to premark the pavement with a dribble line using a small-scale striper. Using the striper ensures rapid placement of a guideline with a minimum number of control points (figure 27).

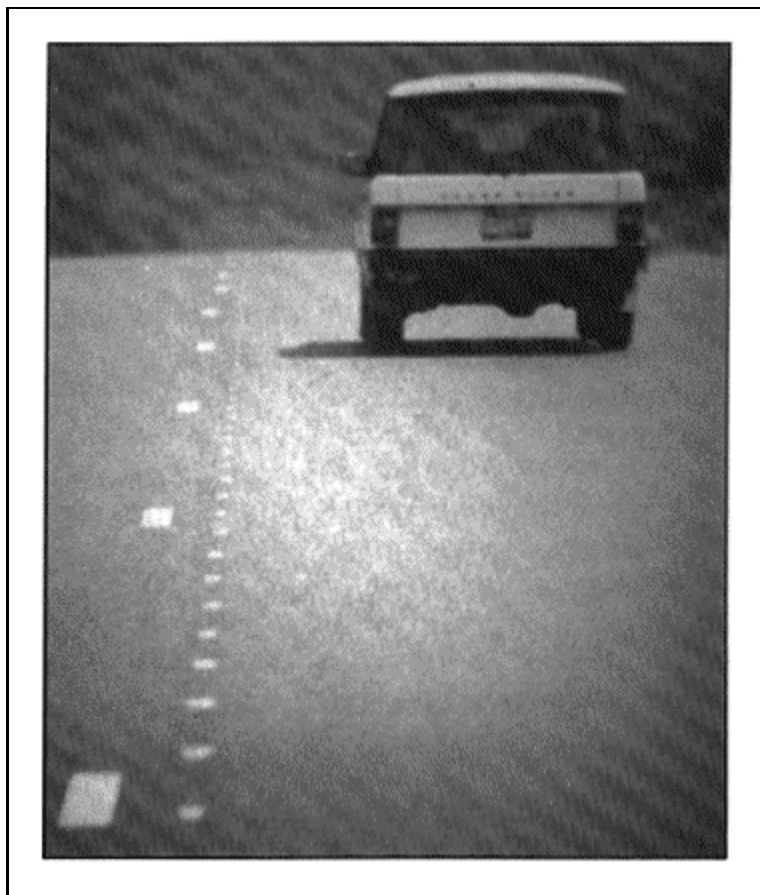

Figure 27. Premarking technique

For resurfacing jobs, a temporary offset marking is painted on the shoulder before the overlay is placed. The striper then paints the marking on the new surface using the offset marking as a guide. This method has proven itself in the past.

If a pavement marking has been obliterated by resurfacing, FHWA policy requires that markings be in place before the roadway is opened to traffic. In some States, heavy dribble lines are placed to serve traffic until the surface is cured and the standard markings can be painted. If used, dribble lines should not be more than 3 inches (7.6 millimeters) wide, so that they can be completely covered when the standard marking is applied. Use of dribble lines is discouraged by the FHWA, however.

Scheduling of Marking Activities

Proper maintenance requires repainting of markings when the contrast, base film, or retroreflectivity is lost. The decision to repaint and schedule the activity are duties of the highway agency's maintenance chief. The highway agency usually has an established policy to help in this process. The availability of materials, equipment, and crews is also important. Materials must be selected, purchased, and stored. Equipment must be serviced and maintained to ensure proper operations and prevent breakdowns while on the road. Trained crews must be available and appropriately scheduled.

Some highway agencies have predetermined schedules that identify sections of roadway to be marked periodically. A computerized marking program should be used for a large volume of roadways to assure a cost-effective allocation of equipment, crew, and materials. When less mileage is involved, a manual scheduling process is commonly

Roadway Delineation Practices Handbook

used. In either case, past experience and the highway agency's policy define the number of times a roadway must be marked per year.

Other highway agencies may prefer to schedule remarking based on night inspection of the various facilities. In some cases, residential streets and other low ADT roadways are simply marked on a periodic basis. The busier, higher ADT roads are scheduled on an as-needed basis using night appearance to judge overall performance.

Determining when to replace painted markings is, at best, an inexact science vulnerable to subjective judgement and budgetary pressures. Several highway agencies have reported that overtime cost for night inspection cannot be justified, especially since the resulting evaluation is based on a subjective opinion.

Whatever the method used, maintenance personnel should have knowledge of local traffic and climatic conditions and must be experienced with a variety of delineation materials. These two criteria are considered equally important for scheduling remarking activities.

The weather patterns of the area determine, to a large extent, the time period available for maintenance. In high snowfall areas, for example, painting is usually limited to the late spring, summer, and early fall months. The treatments and techniques used reflect the short service life of painted markings under heavy winter conditions.

Repainting activities should be scheduled in coordination with major improvement programs and with other maintenance activities. Resurfacing, realignment, or changes in traffic patterns that would require new or repainted markings may render previously scheduled repainting unnecessary. If marking activities are not coordinated with other maintenance, new markings may have to be removed. This is an expensive mistake. Unfortunately, this type of oversight is a common occurrence.

This is not to suggest that repainting should be indefinitely postponed because of planned changes or improvements, particularly if the markings are significantly degraded in a hazardous location. Other options are available, such as varying the type of paint, reducing the marking's thickness, or using temporary markings. These options should be carefully considered when changes are anticipated. If a highway agency is planning to postpone remarking, it should be aware of the potential safety hazard and legal implications from the lack of adequate delineation.

Warehousing and Storing of Materials

Traffic paint is usually furnished in accordance with a highway agency's specifications. It is tested at the factory, placed in sealed containers, and shipped ready to be used. The size of containers is specified by the highway agency and will usually be 5-gallon (19-liter), 30-gallon (114-liter), or 55-gallon (208-liter) drums.

Specifications for traffic paint are written to ensure against caking and excessive settling of the pigment. However, it may be necessary to stir the paint to ensure complete remixing prior to use. Paint that has settled and formed a hard cake at the bottom of the container should not be used. Instead, full data regarding lot number, quantity, and other pertinent information should be reported and arrangements made for such paint to be returned to the manufacturer.

Traffic paint that will remain in storage for some time should be stored upside down so that any deposit or settling will occur on the lid of the container. When it is opened, the settled pigment may easily be scraped off the cover and incorporated with the balance of the mix.

Occasionally a container of traffic paint will show a green film on the top and along the edges of the container. This discoloration, which disappears immediately upon mixing, is of no significance in the performance of the paint. However, sometimes traffic paint will contain "skins." Specifications usually require the lining of traffic paint containers to be resistant to the solvent and prevent skins from forming. A skin might form as a result of a manufacturer using the wrong materials for liners in paint containers. This lining will loosen and form skins. Paint containing skins of this character should not be used, and arrangements made to return it to the vendor.

Roadway Delineation Practices Handbook

Paint should be mixed thoroughly before being placed in the paint tank of the application equipment. Thinner should not be necessary. (The wash thinner usually furnished is intended solely for cleaning equipment and not for thinning the paint).

A 1979 study of the cost-effectiveness of various storage and warehousing practices specifically addressed the economic feasibility of recycling drums for shipment and storage of paint, the use of 55-gallon (208-liter) drums versus 30-gallon (114-liter) drums, and bulk paint storage versus drum storage.⁽⁴³⁾

Several States tried using recycled drums, but the drums had a significant leakage problem because the lids did not fit properly. It was concluded that this did not represent an economically feasible alternative, considering the loss of paint through leakage and the relatively small cost saving realized by using recycled drums.

The study showed that the use of 55-gallon (208-liter) drums in lieu of 30-gallon (114-liter) drums resulted in a 40 percent reduction in the number of drums. Based on a comparison of drum costs and their resale values for both sizes, it was determined that considerable savings in purchasing costs alone could be realized.

In addition to the obvious savings of about \$0.35 per gallon (\$0.09 per liter) afforded by eliminating the cost of the drums, it was estimated that about 3 gallons (11.4 liters) of paint remain in each discarded barrel. Thus, there would be an additional saving due to reduction in waste. The installation, maintenance, and energy costs of storage facilities will offset some of these potential savings.

The main problem in converting to the larger drums lies in handling these drums at the various storage areas. The full 30-gallon (114-liter) drums can be loaded by hand into supply trucks. To handle the 55-gallon (208-liter) drums, forklifts or other equipment are needed. Additional cost for equipment may therefore offset some of the initial savings.

A real potential for saving appears to exist in the bulk paint storage concept. Possible cost saving, as well as the ability to store large quantities of paint in a small area, make the bulk storage method an attractive alternative.

Removal of Painted Markings

Every highway agency needs to provide a capability for removing existing markings that no longer define the safe path of travel. The difficulties involved in the removal of markings have been compounded by the increasingly successful effort to improve paint durability and adhesion.

Traditional Methods

A 1986 study by the New York State DOT investigated the traditional methods of pavement marking removal.⁽⁴⁹⁾ Those methods are discussed below.

Chemical. Chemical paint remover can be applied to the unwanted pavement marking by hand or machine. It is allowed to react for 10 to 20 minutes, depending on pavement temperature. A water jet--500 to 2,500 pounds per square inch (3,400 to 17,000 kilopascals)--then flushes the chemical and paint from the pavement. This method was claimed effective on both AC and PCC pavements, but damage may result if the chemical is left on the pavement too long or if water jet pressure is too high. This procedure is limited to temperatures above freezing and is most effective for markings 10 to 20 mil (0.26 to 0.53 millimeters) thick. Thick paint buildups require a second or third application, thus slowing the operation and increasing cost.

Grinding. This method was reported to remove markings effectively from both concrete and asphalt pavements. Because pavement marking thickness does not affect the extent of removal, grinding may also be effective on thermoplastic. However, pavement damage is a problem because grinding alters pavement surface texture and appearance and may even gouge the surface, thus creating a scar in place of the obliterated marking. Grinding was

Roadway Delineation Practices Handbook

reported to be slow and expensive, and not recommended for open-graded asphalt or rough-textured pavements.

High-Pressure Water Jet. A high-pressure water jet--2000 to 3000 pounds per square inch (13,700 to 20,500 kilo-pascals)--was reportedly effective in removing pavement markings from PCC. It was claimed to remove about 90 percent of the marking from AC, but an outline of the obliterated painted marking may remain. This method, which is restricted to temperatures above freezing, may also remove some fine aggregate from asphalt pavement.

Hot Compressed-Air Burning. This method uses a high-temperature blast (more than 2400 degrees Fahrenheit/1315 degrees Celsius) of exhaust gases from propane combustion in a high-velocity compressed-air steam to oxidize the marking. Good results were reported in removing the marking, but the air blast also removed some pavement material. The obliterated paint and beads remain bonded to the pavement surface, creating a scar. A wire brush removes some of this smudge, but the scar is still visible during the day as well as at night. Weathering and traffic wear tend to make this pavement discoloration less obvious, but it may still be visible after three months. As in any burning method, asphalt pavement and preformed expansion joint material in concrete pavement may be damaged if the burner head moves too slowly.

Excess-Oxygen Burning. In this system, two wide, flat burner heads are mounted in tandem on a simple hand-propelled cart. The first burner creates a high-temperature flame (4,500 to 5,000 degrees Fahrenheit/ 3,800 to 2,760 degrees Celsius) of propane and oxygen directed at the pavement surface. A second burner tip directs pure oxygen at the burning surface to accelerate oxidation of the marking. Best results are achieved on paint layers that are thin, and markings more than 20 mil (0.53 milli-meter) usually require more than one pass. Obliterated paint and beads remain bonded to the pavement surface, but can be removed using a wire brush. After a few weeks of weathering and traffic wear, this scar normally blends into the surrounding pavement and is no longer visible. The rate of removal varies with the thickness of the marking. Up to 20 mil (.53 millimeters) of a typical alkyd-chlorinated rubber paint marking can be removed each pass at a rate of 7 to 15 feet (2 to 5 meters) per minute. For thicker paint, more than one pass may be necessary. As the ash residue accumulates, it shields the marking from further penetration of the flame.

Hydroblasting. This method uses a high-pressure water blast in combination with sand to sandblast pavement markings hydraulically. Blasting is performed at pressures of 5,000 to 10,000 pounds per square inch (34,250 to 68,500 kilopoascals), and sand is used at a rate of 300 pounds per hour (136 kilograms per hour). Hydroblasting reportedly removes all paint and beads from PCC with no apparent damage. A thin, white-gray slurry remains on the pavement, but after a few weeks of weathering and traffic wear, the scar is no longer evident. This method is less effective on AC than on PCC, and in some cases surface aggregate may be scoured or polished, resulting in a scar that can be visible at night and during conditions of low visibility. Weathering and traffic abrasion eventually remove this scar. Hydroblasting, which requires a long equipment train and is confined to temperatures above freezing, is slow. However, some promise has been reported for removing painted markings from asphalt pavement.

Sandblasting. One of the more widely used methods for marking removal, sandblasting achieves fair to excellent results on both AC and PCC. However, operator skill is necessary for effective removal of markings without pavement damage. Sandblasting is not effective on open-graded asphalt pavement because it is difficult to remove markings completely without damaging the pavement surface. It is generally slow, requiring a large equipment train, and leaves residue that must be cleaned up.

Table 3 compares the effectiveness of the various methods in removing different types of marking materials.

Painting over incorrect markings with black paint or bituminous solutions is specifically prohibited by the MUTCD. Such treatment has proved unsuitable because the original marking eventually reappears as the overlaying material wears away under traffic. In addition, markings that were covered in this way are still visible under certain conditions (low angles of illumination) due to preferential reflection from the two contrasting surfaces--the painted marking and the adjacent road.

Table 3. Effectiveness of removal methods

Removal method	Paint	Thermoplastic	Epoxy	Plastic Tape	Foil Tape
----------------	-------	---------------	-------	--------------	-----------

Roadway Delineation Practices Handbook

Sandblasting	Good	Slow	Good	Ineffective	Very slow
High-Pressure Water	Good	Slow	Good	Ineffective	Ineffective
Hydroblasting	Good	Slow	Good	Ineffective	Ineffective
Grinding	Good*	Good*	Good*	Ineffective	Ineffective
Excess-Oxygen Burning	Thin only	Ineffective	Ineffective	Ineffective	Good
Chemicals	Slow	Ineffective	Ineffective	Ineffective	Ineffective
Hand Removal	NA	Very slow	NA	Very slow	Ineffective

* - Heavy scarring to pavement
NA - Not applicable to this material

The best method for marking removal is a treatment that affects the roadway surface as little as possible. It should not materially damage the pavement surface or texture. Because chemical treatment may cause damage to the pavement surface or drainage channels, it is seldom completely satisfactory. Removal of markings by grinding is not considered completely successful as some remnants of the marking usually remain. Sandblasting has been the preferred method of treatment.

Sandblasting is effective particularly when the pavement is rough and porous. The process does little damage to asphalt and the resulting scarring is barely noticeable. Sand deposited on the pavement should be removed to prevent drainage problems or a traffic hazard.

New Techniques

A new method similar to excess oxygen burning was developed by an independent contractor a few years ago. It consists of a specially designed burner to combust propane and oxygen in a wide flame composed of a large number of separate tips.⁽⁵⁰⁾ After combustion, the marking is treated with a mild scarifier. The field tests indicated that use of the cooler flame results in scarification and more damage to the pavement than excess oxygen burning. Field experience has been limited.

Another independent contractor developed a new mechanical removal technique.⁽⁵¹⁾ This method applies hardened steel cutter wheels to the marking to weaken the paint-pavement bond. Application of high-pressure water jets completes the paint removal. This method showed significant promise in small-scale tests but has not been used in large-scale application.

INSPECTION

Inspection of painted markings is vital for cost-effective applications. Inspectors must be on the job site to ensure that the contractor is correctly applying the markings. Use of performance specifications has reduced the importance of inspection. However, there are legal problems with trying enforcement of performance specifications. The main points for inspection of painted markings is discussed in this section.

Preapplication Inspections

Before application, the inspector must check the following:

- Materials used must be from a prequalified vendor or must be specifically approved by the State's material laboratory.
- The pavement being marked must be in appropriate condition for the material being applied. Some materials, such as two-component epoxy paints, have different requirements. They may be applied on damp pavements at low temperatures. However, they may not be applied over other pavement marking materials. The material being applied will dictate the pavement condition requirements. It is most important that the pavement be clean and dry. If marking is

Roadway Delineation Practices Handbook

begun early in the morning, moisture tests should be performed. Marking should be postponed until these tests are successfully completed.

- Premarkings should be adequate to guide the marking truck operator in applying well-aligned markings. They should be less than 3 inches (7.6 millimeters) wide to ensure complete coverage by the pavement marking application.
- Air and pavement temperatures must match the requirements of the material being applied. Again, different materials will have different requirements. Check actual conditions against the manufacturer's recommendations. Table 3 gives typical ranges of temperatures allowed for various materials. If any temperatures are outside the recommended values, marking should be postponed.

Application Inspections

Inspectors must check the following during application:

- Exposure to traffic should be minimized. Coning or other measures must provide good protection for both workers and the new pavement marking.
- New markings must be protected for all of their no-track times. No-track times for the different classes of materials are listed in table 3. These values will vary slightly based on specific material formulation.
- Tests should be made of application rate of glass beads by putting bags over the bead dispenser and driving a predetermined distance at normal marking speeds. The beads can then be weighed and application rate calculated.
- Material application temperatures should be within the manufacturer's recommended ranges.
- Inspection of handling procedures and safety measures is vital for liability reasons. Many paints, such as polyester, involve handling of potentially hazardous solvents or other materials.

Postapplication Inspections

After the marking has been applied, the following should be checked to test the application technique:

- Color should be checked with a standard highway color chip or a Tristimulus colorimeter (figure 28). Colors must conform to FHWA requirements for standard highway colors.



Figure 28. Portable Tristimulus colorimeter

- Thickness can be checked by placing duct tape in the marking truck's path, removing the duct tape and measuring thickness with a micrometer. The contract will probably specify the thickness to be applied and allowable tolerances. Typical thicknesses for paint systems are shown in table 4.
- The marking can be checked for adequate retroreflectivity using the sunlight/shadow technique or a portable retroreflectometer; the embedment and distribution of glass beads can be checked using a pocket microscope.

For detailed material on inspection, see chapter 11.

ENVIRONMENTAL CONCERNS

The use of volatile organic compounds (VOCs) in oil-based paint formulations is the subject of increasing concern to environmentalists. In fact, according to the California Air Resources Board, petroleum-based solvents used in paint and for cleanup purposes are the third largest source of air pollution in Los Angeles, San Diego, San Francisco, and Sacramento.⁽⁵²⁾

Because of the VOCs released in marking operations, they can be subject to certain environmental regulations. In fact, certain governmental agencies have begun to develop regulations specifically to regulate VOC release from marking activities. Some of these agencies and the regulations they have developed are discussed here.

State and Local Regulation

Following the lead of the Environmental Protection Agency and the latest research, the States have begun their own programs for instituting regulation of the environmental hazards created by marking activities. States that have done the majority of the work to date have been those with a serious pollution problem, such as California (Los Angeles) and New York (New York City). These regions have a particularly high population density and, therefore, correspondingly high pollution. The release of VOCs and other hazards from pavement marking operations only worsens the problem. These States have, therefore, begun to exercise control over these activities.

The need to reduce pollution resulting from the use of solvents, such as toluene, led to the development of a Model Rule in California for the control of hydrocarbon emissions. Approved by the California Air Resources Board in

Roadway Delineation Practices Handbook

July 1977, the Rule prohibits selling or applying any coating containing more than 250 grams of VOCs per liter of coating (1.92 pounds per gallon). This ruling became effective September 2, 1982.⁽⁵³⁾ In most cases, exemptions were granted that extended this date to September 1984.

In 1982, The South Coast Air Quality Management District (Los Angeles basin) enforced Rule 442, which limits VOC emissions to 600 pounds (272 kilograms) per day. This limits the application of solvent-based paint to 175 gallons (662 liters) per day for each marking truck.

The trend to restrict the volume of VOCs in commonly used solvents indicates that paint formulations are changing dramatically. Commercial paint manufacturers, as well as State materials laboratories, are seeking to reduce organic gas emissions. They are shifting from the conventional formulations to those using nonvolatile solvents. They are also using materials with solvent ratios, such as water-based or epoxy coatings.

Hazardous Materials

Before the development of the 1984 Model Rule by the State of California, Los Angeles had introduced Rule 66, which specified the type of solvent that could be used in white and yellow traffic paint for air pollution control districts.

Table 4. Application characteristics for inspection

Marking Material	Recommended Temperatures (°F)			No-Track Time* (Minutes)	Typical Thickness (Mil)
	Pavement	Air	Material		
Alkyd or Modified Alkyd Traffic Paint	>50	>50	120	7 or more	15
Chlorinated-Rubber Paint	55-85	55-85	110-130		3-6 15

* Note: These are typical values only, for standard applications. Actual experience varies greatly depending on material type and formulation.

Type I solvents, based on toluene and aliphatic thinner, can be used in all areas of the State, except in counties that comprise air pollution control districts. For counties located in air pollution control districts, Type II solvents consisting of methyl ethyl ketone, ethyl amyl ketone, and special aliphatic thinners have been specified.

Lead-Based Pigments

In addition to the hazard created by the solvents used in traffic paint, there is another environmental problem from the lead-based yellow pigment that has traditionally been used. The State of California recognized this problem also and initiated a research program to investigate lead-free yellow pigments.⁽⁵³⁾

The research found that it was simple to match the yellow color required for traffic paints with a lead-free pigment. However, in an exposure test with a lead-based pigment as a control, only the lead chromate pigment retained a positive yellow color after an appreciable exposure time.

CHAPTER 5. THERMOPLASTIC MATERIALS

INTRODUCTION

The search for highly durable markings as an alternative to conventional traffic paint has been under way for more than 20 years. The growing popularity of thermoplastic has been attributed to its readiness for immediate use, superior

Roadway Delineation Practices Handbook

durability, and potential for long-term economy and traffic safety. While the initial cost of thermoplastic can be as much as 15 times the cost of conventional painted markings, its long service life and improved visibility make it an attractive alternative in many situations. This chapter summarizes the current uses and suggested procedures for installation of hot-applied thermoplastic materials.

Hot-applied thermoplastic materials have been in use for many years and are considered a cost-effective alternative to conventional paint markings when durability is a prime concern. Because of the wide operational experience, the emphasis in this chapter is on the traditional applications of thermoplastic.

USES

Thermoplastic materials have the same basic uses as traffic paint (chapter 4). The application guidelines provided in the *Manual for Uniform Traffic Control Devices (MUTCD)* concerning standard colors, widths, patterns, and placement of painted markings also apply to thermoplastic.⁽¹⁾

Experience has shown that various thermoplastic materials serve some uses better than others. The most cost-effective and safest use is a function of the site-dependent variables. Hydrocarbon-based thermoplastic should not be used as transverse markings because oil drippings tend to dissolve them. This limits their use for crosswalk or stop bar applications. The decision to use thermoplastic must weigh the site and material characteristics against the increased cost.

Because of the long service life and inherent difficulties in removing permanent thermoplastic markings, exercise care in their application. Changes in marking patterns should be kept to a minimum. Maintenance programs, permit work, and utility repair programs are examples of projects that may disrupt the marking schedule. All these possibilities should be considered for the roadway that is to be marked. This will help avoid installation of thermoplastic on a roadway that will be resurfaced soon after marking.

There are several clear-cut advantages of thermoplastic markings when compared with paint. Perhaps the most apparent advantage lies in the replacement factor. A single application of thermoplastic might replace 20 or more applications of paint (dependent upon site-specific variables and application characteristics). Thus, even though thermoplastic materials may cost 15 times as much as paint, they can be cost-effective when used properly. In addition, there is an advantage to having constant delineation on the road, as opposed to a short-lived paint. With a nondurable material, a significant fraction of the marking cycle takes place when a marking is no longer adequate and the roadway is simply waiting to be marked.

Various agencies have reported that thermoplastic markings typically last 3 to 15 times longer than paint. This number depends on the paint replacement policy and the specifications for the thermoplastic installation. The break-even point ranges from three to six years. That is, to be cost-effective, the thermoplastic markings must remain in place, with satisfactory retroreflectivity, for a minimum of three to six years. By carefully selecting material and application technique for a given installation, a balance can be achieved between service life and the higher initial cost.

While thermoplastic installations are frequently practical in terms of durability and visibility, users agree that it should not be assumed that such installations are appropriate for all situations. The following observations represent a summary of experience to date as reported by user agencies.

- Thermoplastic should not be applied on new Portland cement concrete (PCC) facilities. A one-year curing period is recommended prior to installing thermoplastic. Even after this one-year period, a primer-sealer should always be used when applying thermoplastic to PCC.
- Alkyd-based thermoplastic markings perform exceedingly well as transverse markings. Hydrocarbon-based transverse markings, however, tend to deteriorate rapidly because of motor oil drippings.
- Thermoplastic materials are rated as the best marking material by more highway agencies (36.5 percent) than any

Roadway Delineation Practices Handbook

other. However, highway agencies generally consider it to be one of the more sensitive materials to apply.⁽⁵⁴⁾

MATERIALS

Hot-applied thermoplastic materials are synthetic resins that soften when heated and harden when cooled without changing the inherent properties of the material. The formulation of thermoplastic pavement markings includes three basic components: plastic and plasticizer (binder); pigment and fillers; and glass beads. The exact chemical composition varies considerably. Formulas of commercially available materials are proprietary and continually change as the price of chemical components fluctuates. For this reason, composition is usually specified in terms of minimum percentage by weight of each basic component. A list of specification sources is given in appendix C.

Although the percentage by weight of the components varies among specifications, a typical range is as follows:

Binder	15 to 35%
Glass beads	14 to 33%
Titanium dioxide (TiO ₂)	8 to 12%
Calcium carbonate (or other inert filler)	48 to 50%

Types

Thermoplastic materials are classified by the type of binder used. Two materials receive the majority of use in current applications. Alkyd-based thermoplastic markings have probably the largest variety of uses. They use synthetic alkyd resins for a binder. For this reason, they do not deteriorate from motor oil drippings in the way that hydrocarbon-based thermoplastic does. Hydrocarbon-based thermoplastic markings are generally used for longitudinal marking applications because of their susceptibility to oil droplets. They use petroleum-based organic compounds as a binder.

Properties of Thermoplastics

Thermoplastic materials are, by definition, materials that can be heated to a liquid state, reshaped, and cooled to form a new object. For thermoplastic materials, this cycle can be repeated any number of times without significantly influencing material properties.

In early uses, thermoplastic was heated to above 375 degrees Fahrenheit (191 degrees Celsius) and extruded onto the pavement at approximately 90- to 125-mil (2.2- to 3.2-millimeter) thickness. Retroreflective glass beads were premixed in the base material and a top dressing of beads was applied as the molten plastic was extruded. The material solidified, ready for use, within minutes. This marking was at least six times the thickness of conventional traffic paint. In addition to the inherent durability of the plastic itself, these markings provided a limited level of wet night visibility. The thick markings extended above the surface water film, negating some of the focusing effects of the film. This water film forms on wet roads, causing markings to lose their retroreflective properties. The physical mechanisms by which this phenomenon occurs, and how it affects retroreflectivity, are discussed more thoroughly in chapter 2.

Early hot-extruded installations had problems. Performance was erratic on PCC. Poor bonding and the formation of blisters within the marking were problems in high snowfall areas. Because of the poor bond, snowplow blades severely damaged the markings, especially on PCC.⁽⁵⁵⁾ Many of these problems were due to a lack of standard installation procedures. Pavement pretreatments were widely varied. Often the pavement was left uncleaned except for surface sweeping. Where primer coatings were used, their formulations also varied considerably. Given these circumstances, the performance of the early thermoplastic was unpredictable. Even when the major factors were held constant, unexplainable variations in performance remained.

One of the main contributors to erratic performance of thermoplastic is the lack of quality control over temperature

Roadway Delineation Practices Handbook

variables during the application process. Because of their flexibility, temperatures are probably the single most important concern when dealing with thermoplastic. Thermoplastic is designed to be easily melted and reformed. To accomplish this successfully, the required temperatures must be closely monitored. In addition, the material formulation must be exact to ensure that the material responds correctly to the predetermined temperatures.

Temperatures that are too high during the melting process can scorch the material. Inadequate temperatures may not melt the material fully, resulting in inadequate bonding. In addition, thicknesses must be monitored to ensure a good bond. If an application is not thick enough, the material on the pavement will not retain heat long enough for the thermoplastic to penetrate the substrate and become well-bonded.⁽⁵⁵⁾ Pavement and air temperatures that are too high or low will obviously affect heat transfer characteristics and thus adversely affect bonding.

Thermoplastic can be the most successful of all marking materials when properly applied. However, the material properties (melting temperature, formability, heat retention characteristics, and so on) that make them so useful also make them possibly the most sensitive material to apply. Control of application variables must be meticulous to achieve excellent marking performance.

Despite its problems, hot-applied thermoplastic shows much promise for improvement. Research continues into improved material formulations and application techniques. As a result, thermoplastic markings have changed and evolved. In addition to improvements in the base thermoplastic materials and primer, modern equipment has made control of application variables much more precise. Hot-spray application may solve some of the problems with the process. Also, with more operational experience, performance and cost-effectiveness can be predicted more accurately.

PERFORMANCE

Thermoplastic markings, when properly applied, perform excellently. They are probably the most durable delineation technique, and their thickness also gives them some capability of providing delineation at night on wet roads. This section will discuss methods of measuring the performance of thermoplastic markings.

Service Life

Under some situations, hot-extruded thermoplastic pavement markings may be severely damaged by snowplow operations. Early research related the intensity of snowplow activity, as measured by mean annual snowfall, to thermoplastic durability.⁽⁵⁵⁾ This relationship is shown in figure 29. No correlation was found between other variables, such as traffic density, pavement pretreatment, primer type, and pavement age in this 1969 survey.

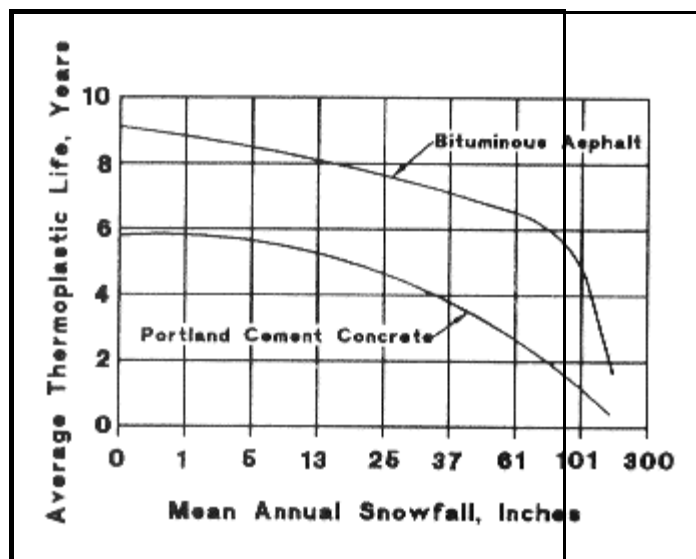

Figure 29. Average thermoplastic life vs. annual snowfall

The variety of opinions, procedures, and experiences implies that the service life of thermoplastic markings depends on the installation site. Also, research project results should be tempered by the judgment and experience of personnel at each highway agency.

Although thermoplastic markings have been in use for a number of years, there is little agreement on their service life. Their excellent durability is established. However, establishing an expected service life for a particular material on a particular roadway is difficult. There are too many factors influencing performance to permit an average service life to be predicted with any confidence. Figures 30 and 31 express average service life as a function of volume and the durability of material as a function of traffic flow, respectively. These figures are representative of two of the more common methods used to predict service life.

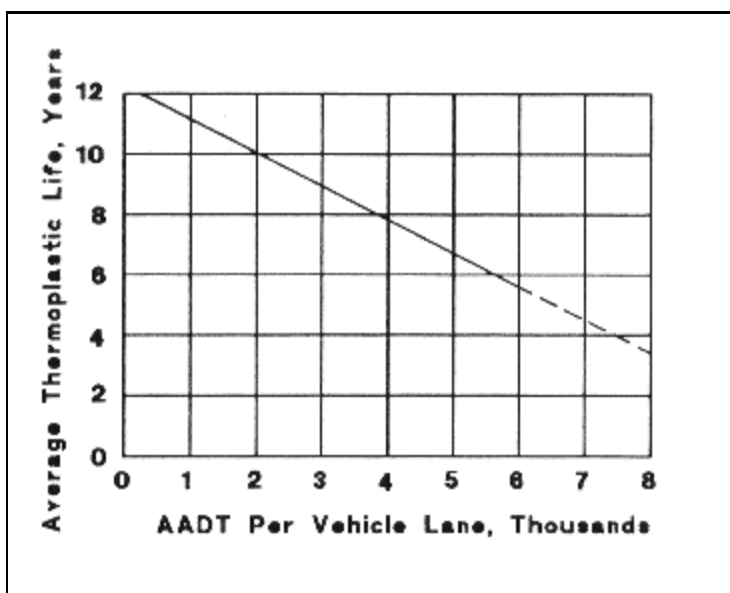

Figure 30. Life of thermoplastic markings as a function of volume

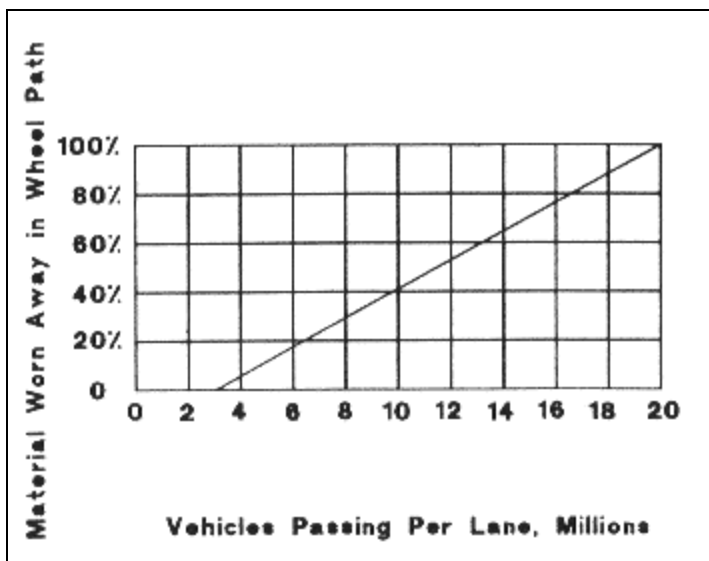

Figure 31. Performance of thermoplastic markings as a function of traffic flow

The remaining thickness or the percentage of retained area are the most common measures of service life. For example, the marking is assumed to be ineffective when the thickness falls below 10 to 15 mil (0.25 to 0.38 millimeters). The longitudinal loss of area is used more often in determining service life, as well as loss of retroreflectivity.

Determining Service Life

Laboratory tests suggest that where an adequate bond is established, the action of the snowplow is only a minor contributor to thermoplastic marking loss.⁽⁵⁷⁾ The failure is probably caused by the freeze-thaw cycle characteristic of many snowfall areas. In any case, winter failures are more frequent on PCC than on AC because thermoplastic bonds better to asphalt surfaces. Thermoplastic is considered impervious to deicing chemicals and sands.

One survey of State highway agencies in a 1969 study reported a wide variation in thermoplastic performance and in agency expectations.⁽⁵⁵⁾ A suggested percentage of retention for contract warranty is given in table 5. This requirement is based on a hot-extruded application with 90- to 125-mil (2.3- to 3.2-millimeter) thickness.

Table 5. Warranty requirements for thermoplastic

Duration After Acceptance	Minimum Retention	
	Longitudinal Lines	Transverse Lines
12 Months	90%	90%
24 Months	80%	75%
36 Months	60%	50%

The Texas Transportation Institute developed the following technique for determining percentage of thermoplastic retained.⁽⁵⁷⁾ The percentage retained is defined as the nominal area of the marking, minus the area of loss, divided by the nominal area, multiplied by 100.

Edge loss is loss from one edge that does not continue entirely across the marking. The area of loss is one half of the nominal width, minus the minimum remaining width in the loss area, times the length of loss along the edge.

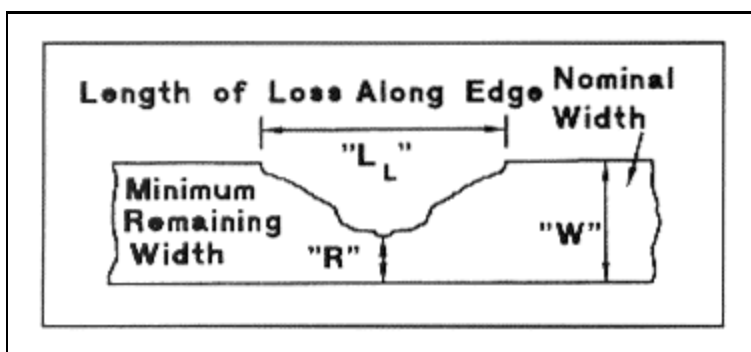

$$\text{Edge Loss} = L_1 = 1/2(W - R) L_1$$

End loss is defined as the loss of thermoplastic at the end of the marking. The area of loss is the product of the

Roadway Delineation Practices Handbook

remaining length measured along the centerline multiplied by the nominal width of the marking and divided by the nominal area.

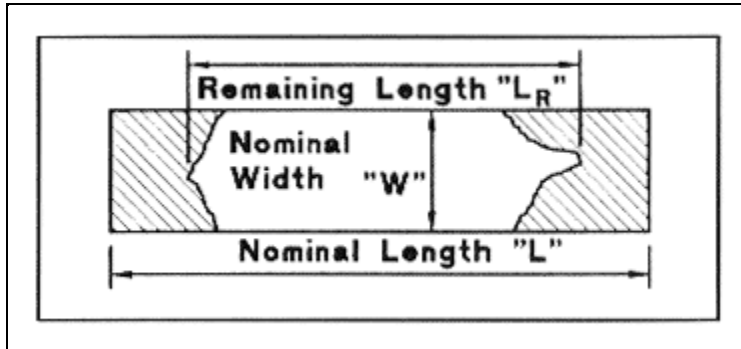

$$\text{End Loss} = L_2 = (L \times W) - (L_R \times W)$$

Center loss is defined as any loss of thermoplastic that extends entirely across the marking between its two ends. The loss is determined as the length of loss along the centerline multiplied by the nominal width of the marking.

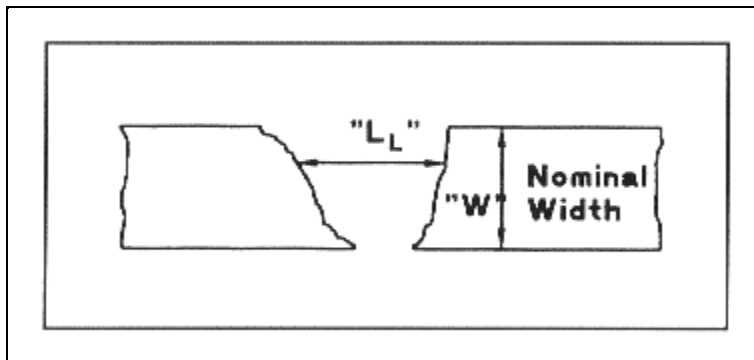

$$\text{Center Loss} = L_3 = (L_L \times W)$$

Interior loss is the loss of thermoplastic contained entirely within the edges of the marking. The area of loss is calculated as the length of loss in the longitudinal direction multiplied by the width measured in the transverse direction.

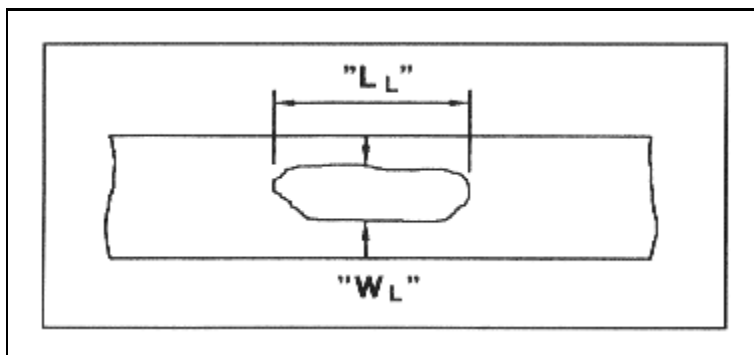

$$\text{Interior Loss} = L_4 = L_L \times W_L$$

Total Percentage Retained Calculation:

$$\text{Total Loss} = L_1 + L_2 + L_3 + L_4$$

Roadway Delineation Practices Handbook

$$\% \text{ Retained} = \frac{\text{Nominal Area} - \text{Total Loss}}{\text{Nominal Area}} \times 100$$

INSTALLATION, MAINTENANCE, AND REMOVAL

Thermoplastic is regarded as the most durable delineation technique. Evidence also suggests that this durability is traded at the expense of ease of handling. Thermoplastic probably requires more care for installation, maintenance, and removal than any other material. The most important concerns for proper handling of this material are discussed below.

Installation

Thermoplastic installation is a delicate process. The high temperatures involved and the material's extreme heat sensitivity require that a high quality control level in a thermoplastic marking operation. The following discussions provide guidance on the most critical aspects of thermoplastic application.

Primer-Sealers

The type and condition of the pavement during application on AC pavements is important for a good bond. Experience shows that adhesion on AC pavements is improved over PCC. The bituminous surface probably softens from the heat of application, and the thermoplastic then fuses more completely with the road. Good adhesion may require cleaning and/or application of a primer-sealer to the surface before marking.

If the type of pavement and the recommendation of the supplier warrant, a primer-sealer should be used. The New York State Department of Transportation (NYSDOT), with a number of other agencies, reported no difference in performance with or without primers when applied to AC pavements.⁽⁵⁵⁾ However, most material suppliers recommend the use of a primer-sealer on PCC and old bituminous pavements.

After tests of hot-extruded thermoplastic installations, the NYSDOT specified the use of epoxy primer on PCC. The large, automated, hot-spray equipment used in California is equipped to lay a two-component epoxy directly ahead of the spray thermoplastic.⁽⁵⁸⁾ The most commonly used primer in recent years is an epoxy resin. Synthetic rubber-based primers have not proven as effective.

Careful application of rapid-drying epoxy primer coatings is necessary for good bonding. For example, evidence suggests that the thermoplastic materials should be applied when the primer is still tacky.⁽⁵⁹⁾ Failures have been reported when the primer was too dry or wet. One specification requires that the spray-applied primer remain tacky for at least 10 minutes at 73 degrees Fahrenheit (23 degrees Celsius).⁽⁵⁷⁾ One form of epoxy (with linseed oil) requires 24 hours of curing time.

There is also little agreement on whether thermoplastic should be applied over paint. There is evidence to suggest that a better bond is achieved on bare pavement. The highway agencies that maintain their own equipment and use their own forces for application appear to have developed unique methods. In some instances, neither PCC nor AC surfaces are pretreated, despite the supplier's recommendations. Yet some highway agencies will confidently estimate an 8- to 10-year service life based on past experience.

There appears to be no agreement on whether priming or cleaning of the pavement is the better method of pretreatment. There is also little agreement on the optimum application rate of primer. It depends on age, porosity, and texture of the pavement, as well as on the active solid contents of the epoxy solution used. Wet film thickness of primers ranges from 2 to 5 mil (0.3 to 0.13 millimeter) and is normally based on the manufacturer's recommendation. One study recommends 2 mil (.05 millimeter) as adequate.⁽⁵⁸⁾

Storage and Field-Handling of Materials

Roadway Delineation Practices Handbook

Hot-applied thermoplastic materials are available in block or granular form. They are packaged in cardboard containers or heavy-duty bags weighing 20 to 50 pounds (9 to 23 kilograms). The containers should be stacked flat and stored on pallets in a dry place. Water or dampness will not harm the materials but may weaken or otherwise damage the cardboard containers.

Dirt, residue from the cardboard, or the polyethylene liner will contaminate the material. Take care to protect the material so that these pollutants are not accidentally loaded into the melting kettle.

The daily supply of cartons or bags to be carried on the truck bed should be covered. If the cardboard containers do get wet, all paper and other residue should be removed and the material allowed to dry before use.

Before loading, the bulk material should be broken up with a hammer while still in the carton. The carton should then be opened, placed over the kettle, and tilted to empty the material into the melting pot.

Sometimes thermoplastic will be supplied in containers that are made of thermoplastic material compatible with the marking material. In this case, the whole container is simply loaded into the melting kettle, and there are no problems with liners or other related contaminants. However, the outsides of the containers should be checked for dirt and other contaminants.

Application Methods

Formulations differ for application by extrusion or hot spray. They also differ for use in hot or cold climates. Often, an alkyd-based (synthetic resin) material is used in northern areas, applied by extrusion. A hydrocarbon-based (organic compound) material is used for spray application in more temperate climates. Suppliers will make a compound according to a highway agency's specifications, though they may recommend minor variations.

The various categories of thermoplastic installations require different application techniques. In selecting the most appropriate thermoplastic materials, consider the physical requirements for each application to achieve a proper bond, as well as the equipment and staffing requirements.

The type of installation (transverse or longitudinal markings), type of facility (urban or rural), type of pavement, magnitude of the installation, and other project characteristics will influence the method of application. For example, a small intersection project to install crosswalks or stop bars will differ from a major improvement project in which delineation markings are a line item in the construction contract.

Extrusion

Extrusion application of thermoplastic had been the method of choice for several years, until the advent of hot-spray application. Hot-extruded thermoplastic marking operations take place at about 3 miles per hour (5 kilometers per hour), and are ready for traffic 2 to 10 minutes after application. Typical application thickness is 125 mil (3.2 millimeters).

In small-scale stripers, extrusion is typically accomplished with an extrusion die, or shoe. Material is heated in a jacketed kettle. The machine then passes a predetermined amount of material from the kettle into the die. The die contains a gate that is sized so that a certain thickness of material is deposited on the pavement. Then the process repeats itself. In this way, the temperature of the remaining material is kept constant, without having to incorporate the extrusion die into the heating mechanisms. This process is called *gravity extrusion*.

Ribbon extrusion, more common on large-scale stripers, uses a pressurized gun to lay the material. Ribbon extrusion is capable of producing the same sharp, crisp edges as those marked by using gravity extrusion.

Spray

Roadway Delineation Practices Handbook

The development of the hot-spray application technique for thermoplastic is considered by many to represent a significant breakthrough in delineation technology.⁽⁵⁷⁾ The spray process differs in that the hot thermoplastic is combined with pressurized air. The combination forces the material onto the pavement. Typical applications from large-scale strippers can take place at 9 to 12 miles per hour (15 to 19 kilometers per hour), and are ready for traffic in less than one minute. Spray applications are typically thinner than hot-extruded applications, usually between 60 and 90 mil (1.5 to 2.3 millimeters) thickness.

Major advantages with hot-sprayed thermoplastic include the ability to apply thinner coatings, better bond with the pavement, and better distribution and retention of glass beads. Also, the difficulties of maintaining a high temperature in the material during extrusion is largely eliminated by the spray process. Moreover, the hot-sprayed material hardens quickly upon application, lessening the sensitivity to pavement temperature.

Application Equipment

Molten thermoplastic can be extruded or sprayed onto the pavement by means of a manually operated device for small runs (figure 32), or by large automated strippers for major construction projects (figure 33). Typically, 2,000 pounds (908 kilograms) of thermoplastic materials supplied in granular or block form will yield approximately 6,600 feet (2 kilometers) of 4-inch (10-centimeter) marking with a 90-mil (2.3-millimeter) thickness.

The small-scale, manual stripper usually has a melting pot that holds a manual mixing paddle to keep the thermoplastic from segregating or scorching. There is also a spigot and die, and a bead hopper and dispenser. In one design, the stripper is equipped with a propane tank to fuel the burner under the melting pot. Another stripper has an auxiliary unit for heating the materials after which they are transferred to the dispensing unit (figure 34). An infrared burner over the extrusion die can be used to maintain the temperature during application. For manual, hot-spray application, the stripper draws its compressed air supply through a long hose from a small truck-mounted machine. Small-scale strippers have an average capacity of about 12 gallons (45.4 liters) or about 100 pounds (45 kilograms) of molten thermoplastic.

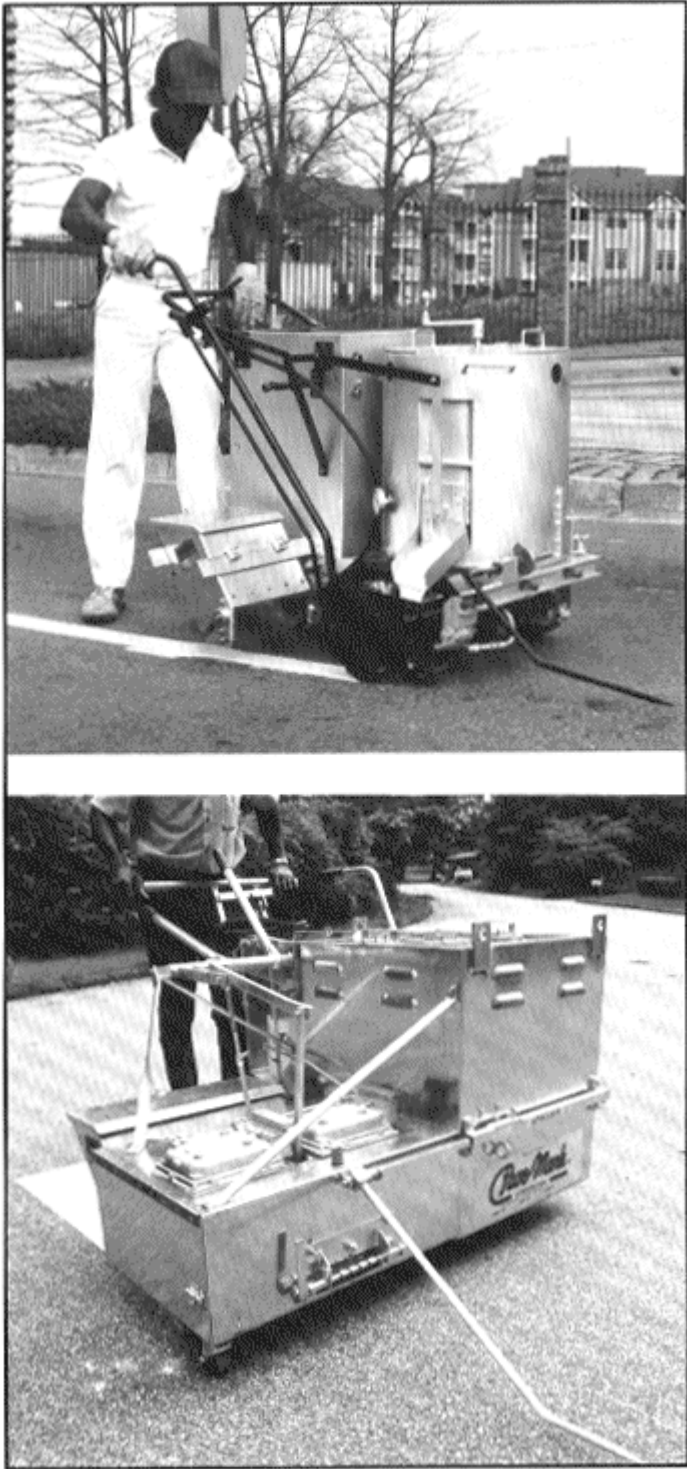

Figure 32. Small thermoplastic application equipment

Truck- or skid-mounted thermoplastic striper are self-contained units with large melters, automatic agitators,

Roadway Delineation Practices Handbook

heaters, electronic controls, intermittent timers that control the flow of spray to form solid or broken markings, material dispensers (extrusion die or spray nozzle), bead hoppers, and bead dispensers. Large-scale strippers range in size from a 1,000-pound (454-kilogram) to a 3,000-pound (1,360-kilogram) capacity melting pot (figure 35). Applications using these strippers are often contracted. The equipment costs can exceed \$150,000 and local staffs are seldom experienced in operating such complex machinery.

Some highway agencies maintain a small-scale stripper for maintenance jobs or small installations, such as new crosswalks or stop bars. Large installations are either bid separately (for existing pavements) or are included as part of a new construction or resurfacing contract. There are, however, a number of highway agencies that prefer to purchase medium-sized strippers and conduct their own marking activities, with assistance from the material's supplier, if needed. Crew sizes range from two workers for manual application to as many as five workers for the largest operations. This does not include following vehicles or other protection and traffic control personnel.

Thickness of Applied Material

Correct application thickness is the subject of some debate. If durability is a function of thickness, thicker markings will last longer but require more material, thus more cost. It can be argued that this extended service life may outlast the retroreflective properties, and, in some cases, the pavement itself. The value of a 6- to 10-year service life is minimal if the pavement is subject to resurfacing during this time. Similarly, bead loss may render the marking ineffective at night before this time elapses.

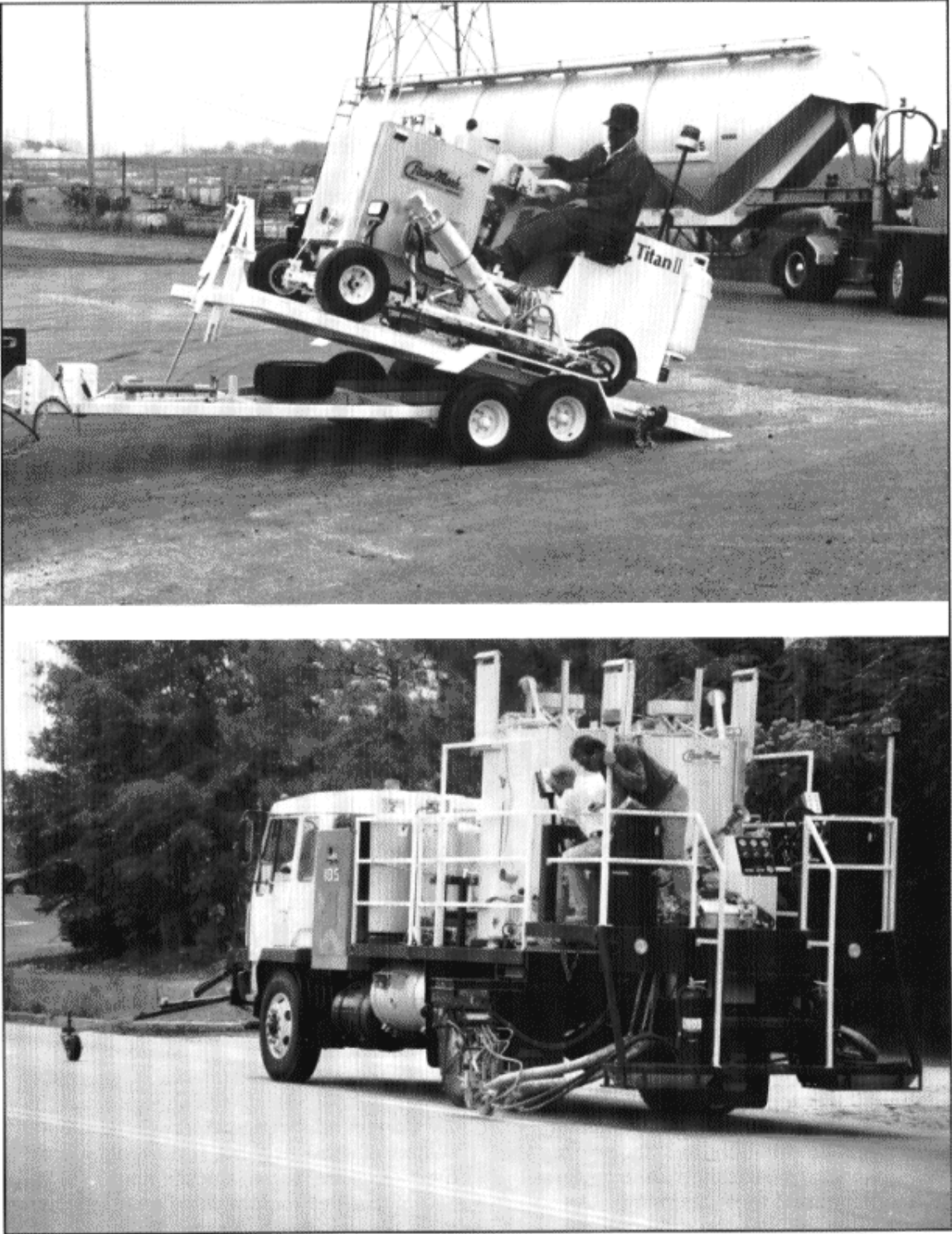

Figure 33. Large-scale thermoplastic application equipment

Roadway Delineation Practices Handbook

Thicker markings (90 to 125 mil/2.3 to 3.2 millimeters) provide better wet night visibility when the beads are still in place, but are more vulnerable to snowplow activity. In practice, the thicker applications continue to be used more than thinner markings. This approach is more flexible in that the markings can then be either extruded or sprayed.

However, the extrusion process is more compatible with thick applications, especially if 125 mil (3.2 millimeters) is desired. The spray process is best suited to applications of 90 mil (2.3 millimeters) or less. The thinner coatings have generally performed well and are usually more cost-effective.

Proponents of thinner applications (40 to 60 mil/1.0 to 1.5 millimeters) report acceptable retroreflectivity and durability over service lives of 3 to 4 years. Material costs are lower, application is faster, and damage from snowplow activity is less. Wear of thermoplastic material has been estimated at an average of 10 mil (0.25 millimeter) loss per year. Normal wear includes studded tire damage, traffic abrasion, and losses to snowplow activity. Thus, a marking of 40 mil (1 millimeter) could be expected to survive three to four years.⁽⁵⁷⁾

However, the thicker applications have a higher profile, and may therefore provide better wet night visibility. The thinner applications do not extend as far above the pavement and are more easily covered by surface water film. However, new advances in binder technologies have made use of a much larger sieve size of glass beads to be used with good durability. Large glass beads enhancement of wet night visibility is discussed in chapter 2. With these advances, the most cost-effective technique is probably a spray process with a combination of intermix beads and large drop-on glass beads.

When selecting a thickness for a thermoplastic marking, there are a myriad of variables to be considered. A thickness must be selected that will enable the marking to perform especially well in the environment for which it is intended. It should be noted that this process must *not* be performed independent of the other variables. All aspects of application (material used, application method, type of pavement, and so on) must be considered interactively in order to achieve cost-effectiveness.

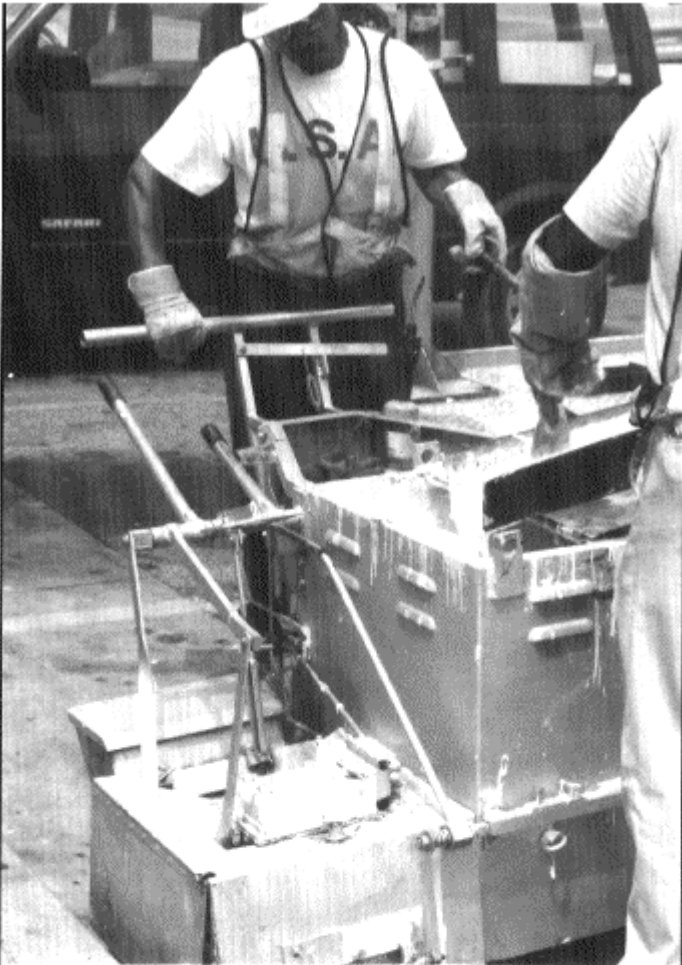

Figure 34. Loading and extruding thermoplastic

Maintenance

One of the advantages of thermoplastic is its durability. Depending on the material used and the roadway characteristics, thermoplastic can provide virtually maintenance-free delineation for years. Some of the maintenance concerns related to thermoplastic are discussed below.

Staining

In hot climates, thermoplastic markings can become discolored or badly stained by tire tracks, particularly on bituminous pavements. This degrades the daytime contrast and visibility. Thermoplastic materials are, however, somewhat self-cleaning during rainy weather. That is, the tire action on wet markings will remove most of the stains. In hot, dry areas, it may be desirable to consider cleaning the markings by washing with a mild detergent.

Patching

Thick, extruded thermoplastic installations are especially vulnerable to chipping if the pavement bond is weak, the pavement bond is faulty, or the internal cohesion of the pavement itself is unstable. Almost all thermoplastic materials, hot- and cold- applied, can be patched by placing a thin overlay of compatible material onto the missing portion of the old marking. This is usually accomplished with a manual applicator.

Replacement

When thermoplastic markings are no longer effective and must be replaced, it is common practice to renew the markings with an overlay of compatible material. This can be treated as a scheduled maintenance activity, as a separate project, or as part of a larger improvement program. Depending on the size of the installation and agency policy, the work may be performed by a highway agency's forces or a contractor can be hired.

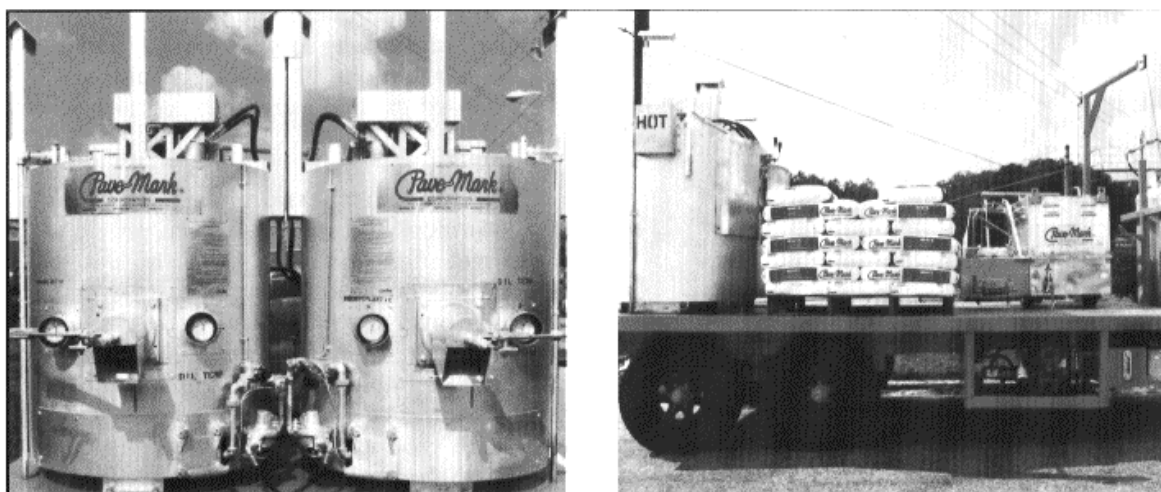

Figure 35. Typical melting kettles used in thermoplastic application

In some cases, thermoplastic markings outlive their retroreflective properties. One highway agency experimented with using paint and glass beads overlaying the old thermoplastic to obtain night visibility. The paint was used as a binder to retain the beads since much of the thermoplastic marking was still in place. If the paint adheres to the thermoplastic and if the thermoplastic base is securely bonded to the pavement, this could be an inexpensive method of upgrading markings with inadequate retroreflectivity. However, there is no available information on the performance of

Roadway Delineation Practices Handbook

this combination.

Removal

Thermoplastic markings can be difficult to remove. The properties that enhance durability, such as thickness and integral bond with the pavement, deter easy removal.

On both PCC and AC, removal of thermoplastic markings scars the pavement. The extent of the scar will depend on the method of removal employed.

Markings in place will be completely covered during any type of roadway resurfacing or rehabilitation project.

Sandblasting

Sandblasting is used frequently for large-scale removal jobs. The physical characteristics of this method were discussed in chapter 4. One operation features a high-pressure water jet used in conjunction with sandblasting. This minimizes the residual sand on the pavement and enhances the effects of the sandblasting.

Excess Oxygen

The excess oxygen paint removal equipment described in chapter 4 has also been used to remove hot-sprayed thermoplastic. In this case, the hot flame melts the thermoplastic, and the molten thermoplastic is removed with a straight hoe. Subsequently, the residual marking is reburned and the burned residue is brushed away leaving only a slight indication of where the marking had been. This will disappear with traffic wear.

Grinding or Chipping

For smaller jobs, an air hammer and chipping blade can be used. Take care on asphalt surfaces to prevent excessive damage to the pavement. To remove an occasional arrow or legend, manual removal using a hammer and chisel can do a satisfactory job.

In recent years, improvements in cutter wheels and other technologies have made large-scale grinders feasible. These are marketed by a variety of vendors, several of which also sell products for pavement marking. Highway agencies' experience with these large-scale grinders has been mixed for different products, and little formal research has been made available for evaluating different models of grinders.

INSPECTION

The operational procedures for the application of hot-applied thermoplastic markings are quite similar to those for application of paint. Where no previous markings exist, the roadway must be premarked with guidelines using the same methods described for paint application (see chapter 4). Although highway agencies' specifications differ, most call for application on dry and clean pavement. Pavements should be tested for dryness, using the litmus or other tests. More often, a subjective judgment is made by the engineer in charge. Morning dampness can cause early failure of the markings.

The techniques for removing loose dirt, old paint, oils, and other contaminants include sandblasting, airblasting, hydro-blasting, brooming, acid etching and grinding. Some agencies report no precleaning requirement for bituminous pavements. The most appropriate technique depends on the condition of the surface and whether any residual paint must be removed. Sandblasting and acid etching are usually restricted to concrete pavements. Better adhesion is reported for installations in which the concrete was subjected to light grinding before application.

Clean and Dry Pavement

Roadway Delineation Practices Handbook

The pavement should be dry with no surface dampness, dew, or subsurface wetness. As mentioned in chapter 4, marking is too often begun before the pavement is sufficiently dry for application.

Thermoplastic should not be applied over old preformed tape markings. If thermoplastic materials are being applied on top of old thermoplastic markings, the base layer must be in stable condition and the old material should still have an adequate bond with the pavement. Thermoplastic applied on top of markings that failed from inadequate bond strength will simply peel off the pavement with the old markings.

If the old layer of markings still has an appreciable quantity of surface beads, it should be roughened by brooming or light grinding. The same applies to premarkings that were applied with a top dressing of glass beads.

Air Temperature

Ambient air temperature should be at least 55 degrees Fahrenheit (13 degrees Celsius) for application of the majority of thermoplastic materials. If the manufacturer specifies some other temperature, that value should be used. The wind chill factor should be considered when determining whether it is warm enough to begin marking operations. The wind chill factor will help determine how quickly the material on the pavement will cool. If the wind chill is too low, the material will cool before it has had an opportunity to bond with the pavement. If the wind chill factor is below 45 degrees Fahrenheit (7 degrees Celsius), thermoplastic materials should not be applied.

Pavement Temperature

The pavement temperature is probably the single most important factor in applying thermoplastic materials. The pavement temperature will govern the rate of cooling of the material, even more than the air temperature. This is because the rate of heat transfer to the pavement from the material is by conduction and transfer to the air is by convection. Under any normal conditions, heat transfer by conduction is much quicker than by convection.

The pavement should be at a temperature of at least 55 degrees Fahrenheit (13 degrees Celsius). This may be measured with a standard surface temperature thermometer.

Material Temperature

Material temperature required will vary more than any other parameter. The optimum value may vary for different materials, and the laws of heat transfer dictate that maintaining close tolerances at the high temperatures required for thermoplastic application is difficult. These are often hundreds of degrees higher than temperatures for paint application. Normal operating temperatures are in the range of 400 to 450 degrees Fahrenheit (204 to 232 degrees Celsius), with the optimal value between 425 and 435 degrees Fahrenheit (218 and 224 degrees Celsius).

Other Tests

Other than pavement pretreatment and temperature concerns, inspection of thermoplastic markings is essentially the same as for paint. Markings should first be visually inspected for crisp edges and minimal deviation or overspray. The same tests as for paint may then be performed. These include material thickness, pocket microscope inspection for bead quantity and distribution, and the sun-shadow retroreflection test.

Thermoplastic materials are very sensitive to the variables governing application. Table 6 has been included to help diagnose problems that may exist in the application process. It also presents some possible solutions to these problems. This table is taken directly from manufacturers' literature for correcting problems that occur with their materials.

Table 6. Common problems with thermoplastic

If Line Appears:	Problem Is:	To Correct:
-------------------------	--------------------	--------------------

Roadway Delineation Practices Handbook

Smooth, shiny, glossy	No beads in marking, resulting in no retroreflectivity, caused by bead gun malfunction	<ul style="list-style-type: none"> - Repair bead applicator - Increase bead application rate - Move point of bead application
Smooth, with slight dimples	Drop-on beads sunk too low, resulting in lower retroreflectivity, caused by material being too hot	<ul style="list-style-type: none"> - Increase bead application rate - Cool material, staying above 425 degrees Fahrenheit
Glazed or “icy”	Beads too high, not adhered well, will wear off quickly, caused by material being too cold or bead gun too far from application point	<ul style="list-style-type: none"> - Ensure thermoplastic temperature is 425-435 degrees Fahrenheit - Move point of bead application
Cratered	Beads popped out, resulting in lower retroreflectivity, caused by material being too cold and/or poor bead adhesion	<ul style="list-style-type: none"> - Ensure thermoplastic temperature is 425-435 Fahrenheit
Rough around edges	Inconsistent bond, resulting in less durability, caused by material being applied too cold/and too thin	<ul style="list-style-type: none"> - Ensure marking is proper thickness - Ensure thermoplastic temperature is 425-435 degrees Fahrenheit
Wavy, with irregular edges	Flow-out of material edge is not well-defined, caused by material being too hot or too liquid, application pressure being too high, extrusion gate open too wide, and/or road surface being too uneven	<ul style="list-style-type: none"> - Ensure thermoplastic temperature is 425-435 degrees Fahrenheit - Adjust application equipment - Slow application rate on rough surface
Greenish yellow	Scorching resulting in thermoplastic becoming brittle and less durable, caused by overheating or too many reheats	<ul style="list-style-type: none"> - Discard material
Dingy, dull yellow	Scorching resulting in thermoplastic becoming brittle and less durable, caused by overheating or too many reheats	<ul style="list-style-type: none"> - Discard material
Pitted	Trapped moisture, trapped primer or trapped air, all of which weaken bonding	<ul style="list-style-type: none"> - Perform moisture test - If moisture is present, STOP OPERATION - If moisture test is negative, determine if surface is open-graded. To avoid air entrapment on open-graded surfaces, slow application rate and ensure thermoplastic temperature is 425-435 degrees Fahrenheit.
Lumpy	Charred material or unblended pigments	<ul style="list-style-type: none"> - Determine problem by

Roadway Delineation Practices Handbook

	and filler resulting in lower durability	removing a lump from the melter and cutting it open - If the lump appears burnt or dark in color, material is charring inside heating system. Remove all visible lumps from melter and screen material before applying - If the lump appears grainy or unmixed, the resin and/or pigments are unmelted. Hold the thermoplastic in the melter at 425-435 degrees Fahrenheit until the lumps dissolve
Stretched or pulled	Inconsistent bond and poor durability caused by material being applied too cold and too rapidly	- Ensure thermoplastic temperature is 425-435 degrees Fahrenheit - Adjust application speed
Scarred or gapped	Weakened bond caused by charred material or a rock drug through the marking	- Remove lump from melter and cut open to determine if the materials is charred. If so, remove all visible lumps and screen material before applying - Clean Surface
Uneven at beginning or end of marking	Poor appearance, cut-off not sharp because applicator is not adjusted correctly	- Adjust applicator - Ensure thermoplastic temperature is 425-435 degrees Fahrenheit
Too much dribbling between skips	Poor appearance caused by poorly adjusted applicator	- Adjust applicator - Ensure thermoplastic temperature is 425-435 degrees Fahrenheit
Marked by tire tracks	Road opened to traffic before thermoplastic has cured or an insufficient amount of beads has been used	- Keep traffic off of marking for longer period of time - Increase bead application rate

CHAPTER 6. PREFORMED TAPES

INTRODUCTION

Hot-applied thermoplastic materials require a high temperature to achieve a molten state for application. This

Roadway Delineation Practices Handbook

requires expensive installation equipment and experienced operators. However, cold-applied plastic marking material requires neither of these things, requires no hardening time, and, under certain circumstances, exhibits a high-level of durability.

Cold-applied plastic pavement marking tapes are supplied in continuous rolls of various lengths and widths. These preformed tapes can be supplied in yellow or white, and in precut shapes to form standard lengths and symbols. Cold-applied plastic is also supplied in sheets from which special shapes, forms, or letters can be customized.

USES

Preformed tapes are most frequently used for crosswalks, stop bars, words and symbols, and other specialized treatments. Some local agencies have also indicated a preference for preformed tapes as center-lines and lanelines in areas of low traffic density. As with the hot-applied thermoplastic, cold-applied preformed tapes are reported to perform better on bituminous asphalt surfaces than on Portland cement concrete.

Properties of Cold-Applied Plastic

Preformed plastic tapes are generally recognized for their durability, especially abrasion resistance. They are ideal for sites that involve small quantities of marking materials, particularly under severe conditions requiring frequent replacement. The ease of installation and repair for preformed tapes, which requires no equipment, makes them nearly as inexpensive for these applications as other materials. This is because the costs for other materials often includes the operation or rental cost of large-scale application equipment, which is difficult to use for small installations, particularly transverse and special markings.⁽⁶⁰⁾

Preformed tapes are nearly always fabricated as roll or sheet stock in a factory. These marking tapes consist of the same materials as are in thermoplastic markings: resin binder, pigment, glass beads, and fillers. The tapes differ in composition in that they are often backed with an adhesive for pavement bond. A surface coat of glass beads is often included for retroreflectivity.

While preformed tapes have been cited by some highway agencies as having very good abrasion resistance, other agencies complain that preformed tapes distort in areas with heavy turning movements.⁽⁵⁴⁾ Preformed tapes must be applied in areas where a good bond can be ensured. Application procedures must be strictly followed. Clean pavements are more important for preformed tapes than for any other material.

See the subsection on durability in the performance section in this chapter for a more thorough discussion of the conditions under which tapes will bond well. These are the conditions where the tapes' durability may make them cost-effective.

Cost Considerations

Preformed tapes cost more per linear foot than any other marking material. Contract prices for installation in New York in 1984 were found to be about \$1.25 per foot (\$4.10 per meter).⁽⁶⁰⁾ This compares unfavorably with \$0.04 per foot (\$0.013 per meter) for paint. Thermoplastic is only about \$0.32 per foot (\$1.05 per meter).

A comparison of expected costs and service lives should always be performed before specifying the use of preformed tapes. The tapes must be useful over their long service lives to justify their initial high cost.

Illuminated Streets

Preformed tapes often do not provide adequate retroreflectivity throughout their whole service lives. This fact, along with the material's very high cost, has limited tape use to installations such as urban intersections and urban markings. These areas, where installation of small quantities of markings is needed, are cost-effective. Tapes used in these areas have good durability, and urban markings are generally on well-illuminated streets. Installation of tapes is

Roadway Delineation Practices Handbook

much simpler for these applications. Many standard marking materials require large, difficult-to-handle equipment for the same purpose.

TYPES

Preformed tapes are generally classified by expected service life and by material composition. Only two classifications of service life are distinguished: permanent and temporary. The major difference in these two types of preformed tapes is their thickness and method of adhesion to the pavement.

Permanent

Permanent preformed tapes are any inlaid installation, or a thick overlaid installation that has achieved good bond with the surface. All preformed tapes whose manufacturers report lifetimes of more than one year are considered permanent pavement marking tapes. Two types of plastic are used in the majority of formulations of permanent tapes, urethane and pliant polymers.

Urethane

The first preformed tape material, urethane, is an extruded cold flow plastic with embedded glass beads, with or without a top surface coat of glass beads. It generally has a thickness of 60 or 90 mil (1.5 or 2.3 millimeter). It is precoated with pressure-sensitive adhesive for self-bonding and/or supplied with a separate adhesive.

Pliant Polymer

The second cold-applied plastic material is a polymer material that is somewhat more pliant than the cold extruded type. A top dressing of beads is recommended for areas where immediate retroreflectivity is required. Standard thickness of these films is 30 or 60 mil (0.76 or 1.5 millimeter). Pliant polymer tapes are precoated with pressure-sensitive adhesive for self-bonding or applied with a contact cement.

Temporary

Temporary preformed tapes are normally used in overlay installations. The inlay and overlay installation techniques are discussed under Installation and Removal. They are thinner than the permanent tapes, are foil-backed, with a precoating of adhesive for self-bonding.

Temporary preformed plastic tape is used often for temporary markings in construction work zones. The advantage of this material is its easy removability. It can be removed intact (or in large pieces) from either asphaltic concrete (AC) or Portland cement concrete (PCC) pavements. Removal can be manual or with a roll-up device without the use of heat, solvents, grinding, or sandblasting.

The material consists of a single layer of pigmented binder and glass beads applied to a backing layer of metal foil.⁽⁶⁰⁾ These foil-backed tapes range from temporary tapes with high initial brightness but low durability to tapes offering several years of service. In addition to the adhesive applied to the tape in the factory, a primer may be recommended in some cases to enhance pavement bond.

PERFORMANCE

Like any other pavement marking material, preformed tapes' performance is judged in terms of their visibility and durability. Some basic characteristics of tapes' performance in these two areas are discussed in following two sections. In particular, discussion concerns preformed tapes' particular problems concerning long-life retention of sufficient glass beads for good retroreflectivity.

Retroreflectivity

Roadway Delineation Practices Handbook

One of the main reasons that preformed tapes, though highly durable, have not been cost-effective is their lack of good retroreflectivity throughout their service lives. Most tapes are so lacking in adequate night visibility that many State highway agencies specify their use only on well-illuminated roadways. This significantly restricts their use.

Some highway agencies have searched without success for a tape that provides adequate retroreflectivity.^(61,62) Some promise has been shown by tapes employing 1.75 RI (refractive index) beads, but the tape itself still outlasted its retroreflectivity. In most cases, the tape's initial good retroreflectivity retained for some time, but eventually it deteriorates to an unacceptable level due to insufficient matrix beads.

Durability

A 1983 study by the New York State Department of Transportation (NYSDOT) attempted to identify the surfaces upon which preformed tapes performed well.⁽⁶¹⁾ Their experience resulted in several observations. Inlaid markings outperform overlaid markings if a good bond is achieved with the pavement. (See the Installation and Removal section of this chapter.) Tapes must be installed quickly on inlaid installations to achieve good bond with the pavement (that is, while pavement is still warm). Tire traffic over the markings clearly helps ensure good bond with the pavement. Adhesion failures are more likely to occur in areas receiving little traffic. Tapes should not be installed on fine-textured PCC pavements, as this will cause delamination failure between the tape and its adhesive backing. Finally, both abrasion and adhesion failures are accelerated if the tape is installed over asphaltic concrete in a deteriorated condition.

INSTALLATION AND REMOVAL

The value of preformed tapes is their extraordinarily simple installation and removal procedures. Special or complex equipment is usually not required for installation. Sometimes a rolling applicator device is used for longitudinal marking applications. A paving roller often is employed to ensure even contact with the pavement, thus ensuring good adhesion. Crosswalk and stop bar applications normally do not even require this equipment.

Installation

Preformed tapes can be installed by the inlay method or the overlay method (figure 36) depending on type and condition of the pavement. With either of these methods, the markings are ready to receive traffic immediately after installation.

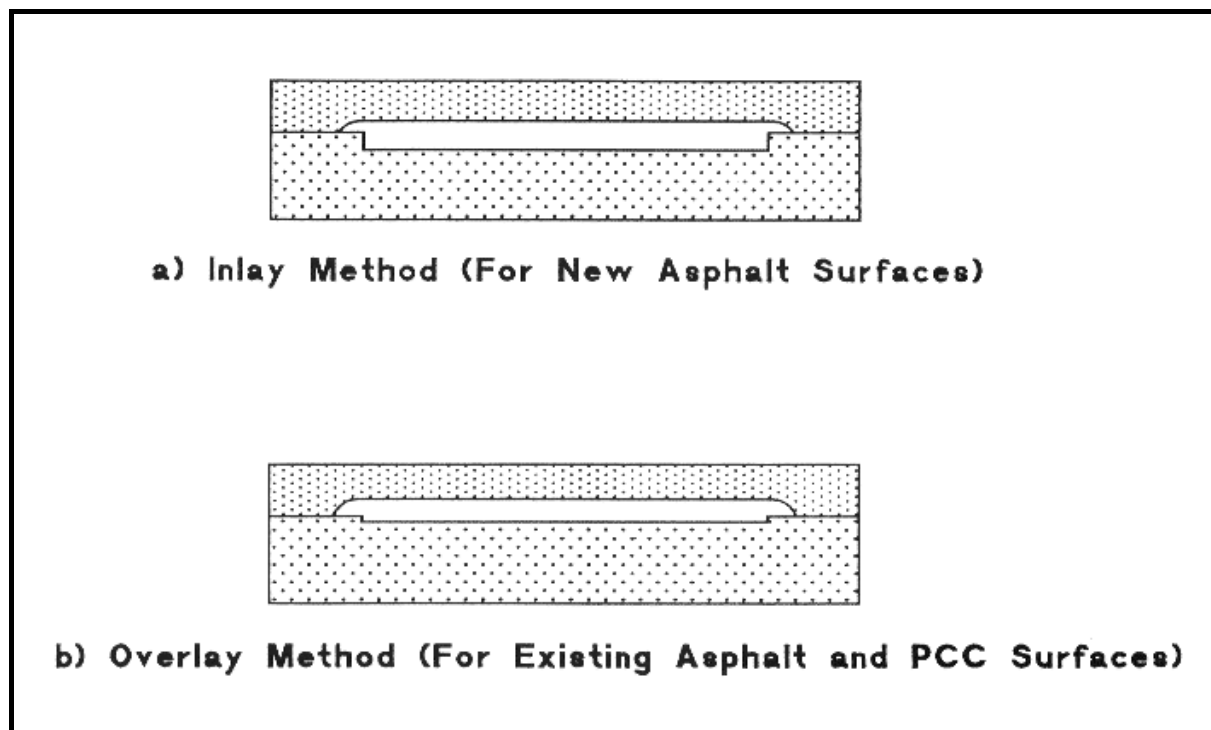

Figure 36. Basic method of installing preformed tapes.

Inlay Method

The inlay method is used in new construction or resurfacing of hot-melt asphalt concrete (HMAC) surfaces. The pressure-sensitive, self-bonding tape is positioned in place and is rolled firmly into the asphalt during the final compaction while the asphalt is still warm (at least 130 degrees Fahrenheit/54 degrees Celsius). This operation is normally performed using a paving roller.⁽⁶⁰⁾

For longitudinal markings, a tape applicator device follows the breakdown rollers and automatically lays skip lines, double yellow lines, and solid white edge lines. It can be powered with a 12-volt truck battery and is equipped with a compressed air cutoff mechanism. The tape as positioned is securely bonded to the pavement by the finish roller that follows. Precut shapes and letters must be positioned manually before compaction. The roller tends to bevel the plastic strip into the pavement. This enhances the bond and seals out moisture.

Overlay Method

Overlaying refers to any method of installing preformed tapes on existing pavements by applying them to the surface and then creating some kind of bond with the pavement.

Permanent

Pressure-sensitive films work well for relatively new AC surfaces that are to receive permanent installations of overlaid preformed tape. When overlaying permanent preformed tapes onto old AC surfaces or PCC, better bond is achieved when contact cement is applied prior to installation. In this case, manufacturers may recommend two coats on the pavement and one on the film. This is true also for intersection markings with heavy turning movements. The markings are positioned initially by simply stepping on them and creating slight adhesion to the pavement. A light hand-roller (or vehicle tire) is used then to partially bond the tape to the pavement to prevent movement until the continuous tire pressure of traffic ensures a secure bond.

Roadway Delineation Practices Handbook

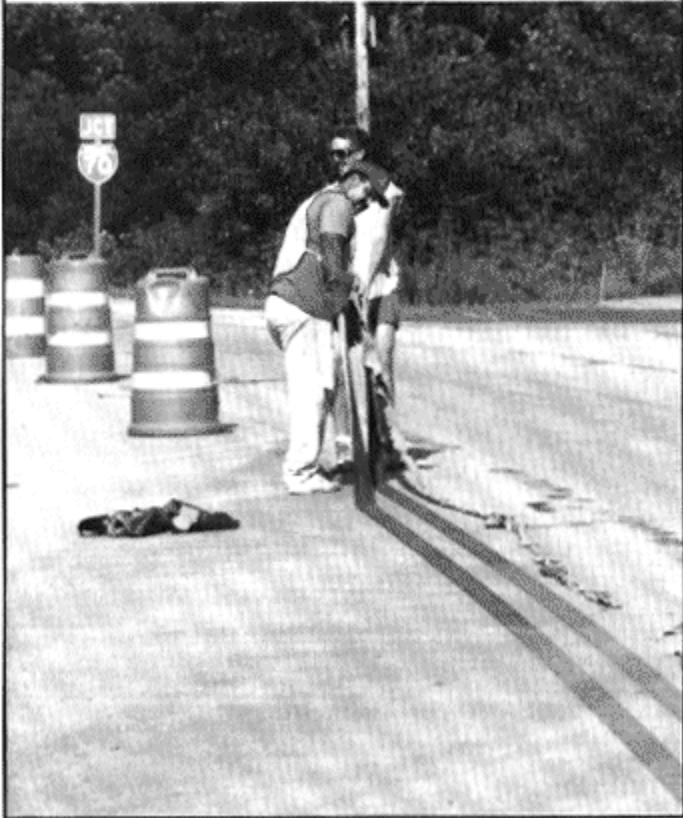

Roadway Delineation Practices Handbook

Figure 37. Installation and removal of cold-applied preformed tapes

Temporary

For construction or maintenance jobs that require the temporary delineation of new or altered travel lanes through the work zone, a thinner, self-adhesive tape can be applied directly on the pavement. Two forms of temporary marking tape are available. One form is intended for use in those construction projects where marking removal will not be required. The other form is designed for easy removability. Major advantages of the latter material include its high retroreflectivity. It can be installed quickly by a two-person crew. It can also be removed easily when the construction project is completed and traffic flow must revert to the original configuration.

The self-adhesive tape specified for temporary markings in construction zones can be removed with relative ease. The material can simply be dislodged and removed by hand or rolled up on the applicator, as shown in figure 37.

This type of operation will leave no lasting scar. A dim indication may be left by the residual adhesive, but this will be eradicated by traffic film in a short time.

Heat-fused

One relatively new method of overlaying preformed tapes has been marketed by Pave-Mark Corporation (Atlanta, GA). It consists of a special formulation of pliant polymer preformed tape used with a propane torch to create a pavement bond.

The installation process is simple. The markings are laid out in their proper locations and heat is applied to their top surfaces with a propane torch. Pave-Mark claims that the material solves previous problems encountered with preformed tapes such as distortion and early loss of retroreflectivity. Research has yet to establish the validity of these claims.

Symbols

Cold-applied, preformed legends or symbols must be installed by hand, but this is a relatively simple operation. It consists of laying out the markings in their desired locations and securing them to the pavement with a roller or vehicle tire.

Removal

Removal of preformed tapes is a special problem because removal varies widely with the type of material and, more importantly, the installation method. Therefore, removal of permanent and temporary tapes is discussed separately. Also, table 2, in the chapter concerning traffic paints, details the effectiveness of various methods of removing preformed tapes.

Permanent

Removal of permanent preformed tapes can be difficult. If a good bond was achieved upon application, few methods to remove the material are effective, particularly if the material has been in place a long time.

The NYSDOT found that the best method of removing tapes was by excess oxygen burning. The heating of the material breaks its adhesive bond to the pavement. A scraping mechanism is normally used in conjunction with this method. This is similar to a method used in the past whereby the material was simply heated and the markings manually scraped from the pavement.

Temporary

Roadway Delineation Practices Handbook

Because temporary tapes do not have strong adhesives, they are very easy to remove. They simply are gathered up on a simple mechanical roller, or can usually be torn from the pavement by hand. There are no special factors or equipment to be considered.

INSPECTION

Permanent preformed tapes are composed of basically the same materials as hot-applied thermoplastic markings. Many of the inspection characteristics for thermoplastic are similar for preformed tapes. In fact, the stripping and peeling often associated with preformed tape installations make the percentage of material retained calculations described in chapter 5 particularly useful for cold-applied tapes.

Certain characteristics of permanent preformed tapes make other aspects of their inspection problematic. For example, preformed tapes should be checked especially closely for large-scale bonding failures with the substrate and also for distortion in heavy turning areas.

If it is necessary to use tapes for longitudinal markings on nonilluminated highways, they must be inspected regularly for adequate retroreflectivity.

Temporary preformed tapes are typically not in use long enough for inspection to become a major concern. Any program to inspect and identify sections of temporary preformed tape could not be implemented quickly enough to provide any benefit before the installation's lifetime has expired.

CHAPTER 7. RAISED PAVEMENT MARKERS

INTRODUCTION

The use of glass beads in pavement markings was the first breakthrough in providing low-cost night time visibility. However, pavement markings disappear when the surface of the roadway becomes wet. The loss of visibility occurs when it is needed most—during adverse weather, particularly rainy or foggy nights.

During the past several decades, emphasis has been placed on research to develop a durable marking device to provide both day and night visibility during adverse weather. As a result of research, raised pavement markers (RPMs), retroreflective and nonretroreflective, have emerged as a highly effective alternative. As can be seen in figure 38, RPMs provide excellent night visibility. This chapter addresses the uses, types, and characteristics of RPMs in use today and those planned for the future.

USES

RPMs can be used to show roadway alignment, or to replace, or to supplement other pavement markings. RPMs are discussed in part 3 of the *Manual on Uniform Traffic Control Devices (MUTCD)* and are defined under marking materials (section 3A-3) as a variation to paint.⁽¹⁾

The same principles that govern the use of painted markings are used for RPMs in terms of color, application, and configuration. The *MUTCD* sections 3B-14, 15, and 16 address the pattern and spacing of RPMs for supplementing other markings and substituting for other markings. The *MUTCD* gives general guidelines for spacing in terms of N, the normal cycle length of a pavement marking used in the location where the markers are to be used.

In this Handbook, figures are presented to illustrate the principles that the *MUTCD* outlines and also specifically to

Roadway Delineation Practices Handbook

address the placement and spacing of RPMs in special or hazardous situations. Figure 39 presents the list of symbols for pavement markings and RPMs. Figure 40 illustrates the use of RPMs to show roadway alignment for tangent sections and horizontal curves. Figures 41, 42 and 43 illustrate the patterns commonly used for centerlines, lane lines, and solid lines, respectively (edgelines and no passing zones). These figures apply the 3-to-1 gap-to-segment ratio, and assume a 40-foot (12-meter) cycle length of N (gap plus segment), a gap of 30 feet (9 meters), and a marking segment length of 10 feet (3 meters).

Functional Applications

There are several different types of RPMs. The characteristics of each type relate to the function they must perform for their specific applications.

Nonretroreflective RPMs are used in some installations to completely replace painted longitudinal markings. Retroreflective RPMs are interspersed to provide night visibility where there is no overhead lighting. The higher initial cost of a complete RPM system is justified on the basis of the long service life and increased wet weather visibility. More frequently, however, agencies tend to use retroreflective RPMs in conjunction with painted stripes for longitudinal delineation. Because retroreflective RPMs provide increased visibility at night, especially during rain, they are particularly desirable at high hazard locations, such as exit ramps, bridge approaches, lane transitions, horizontal curves, and construction zones.

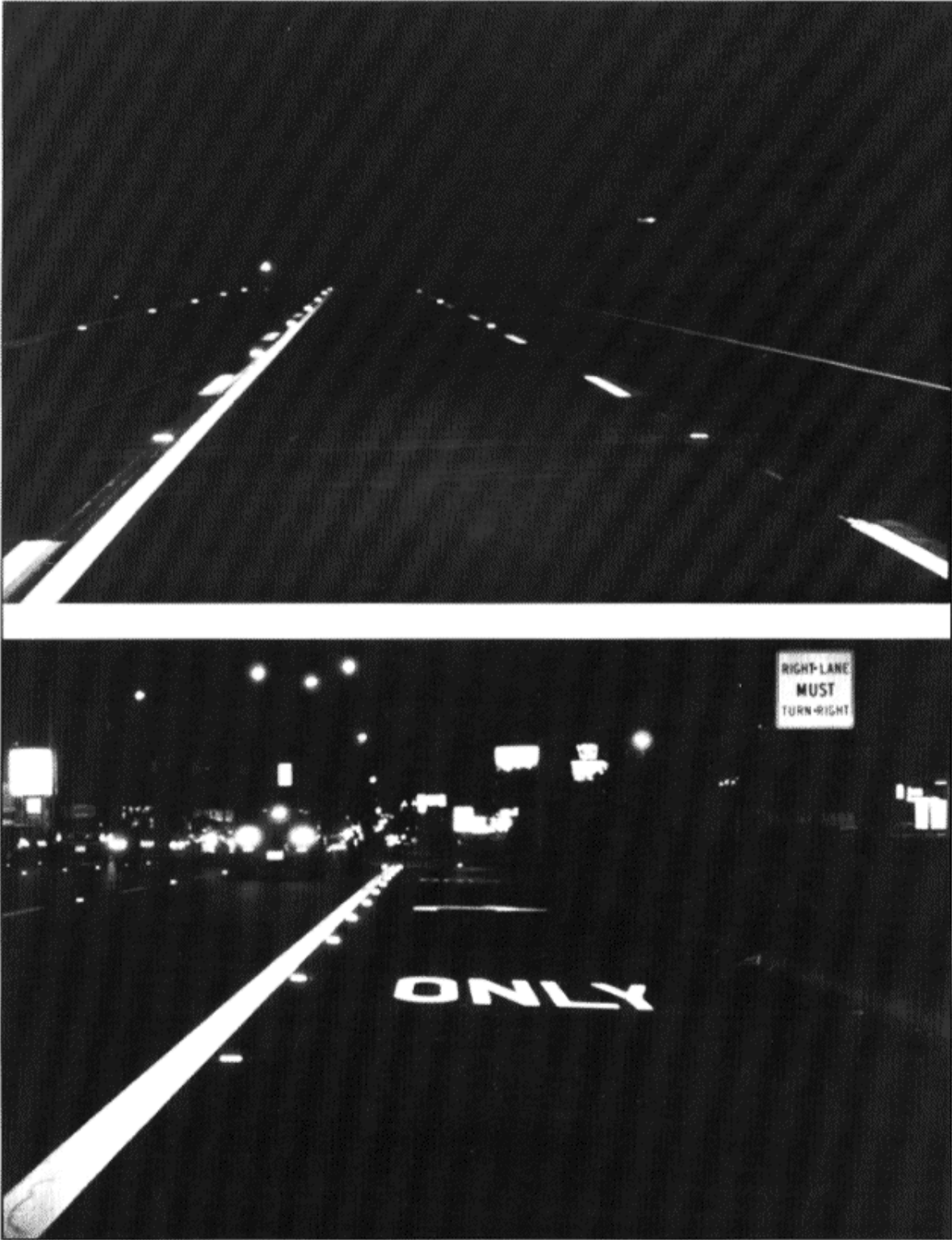

Figure 38. Nighttime visibility with RPMs











Symbols	
	Yellow Stripe
	White Stripe
	Two - Way Yellow Raised Pavement Marker
	Two - Way White Raised Pavement Marker
	One - Way Yellow Raised Pavement Marker
	One - Way White Raised Pavement Marker
	Non - Retroreflective Yellow Raised Pavement Marker
	Non - Retroreflective White Raised Pavement Marker
	White / Red Raised Pavement Marker
	Yellow / Red Raised Pavement Marker
N	Normal Spacing
L	Length of Transition / Taper
	Directional Arrow

Figure 39. List of symbols

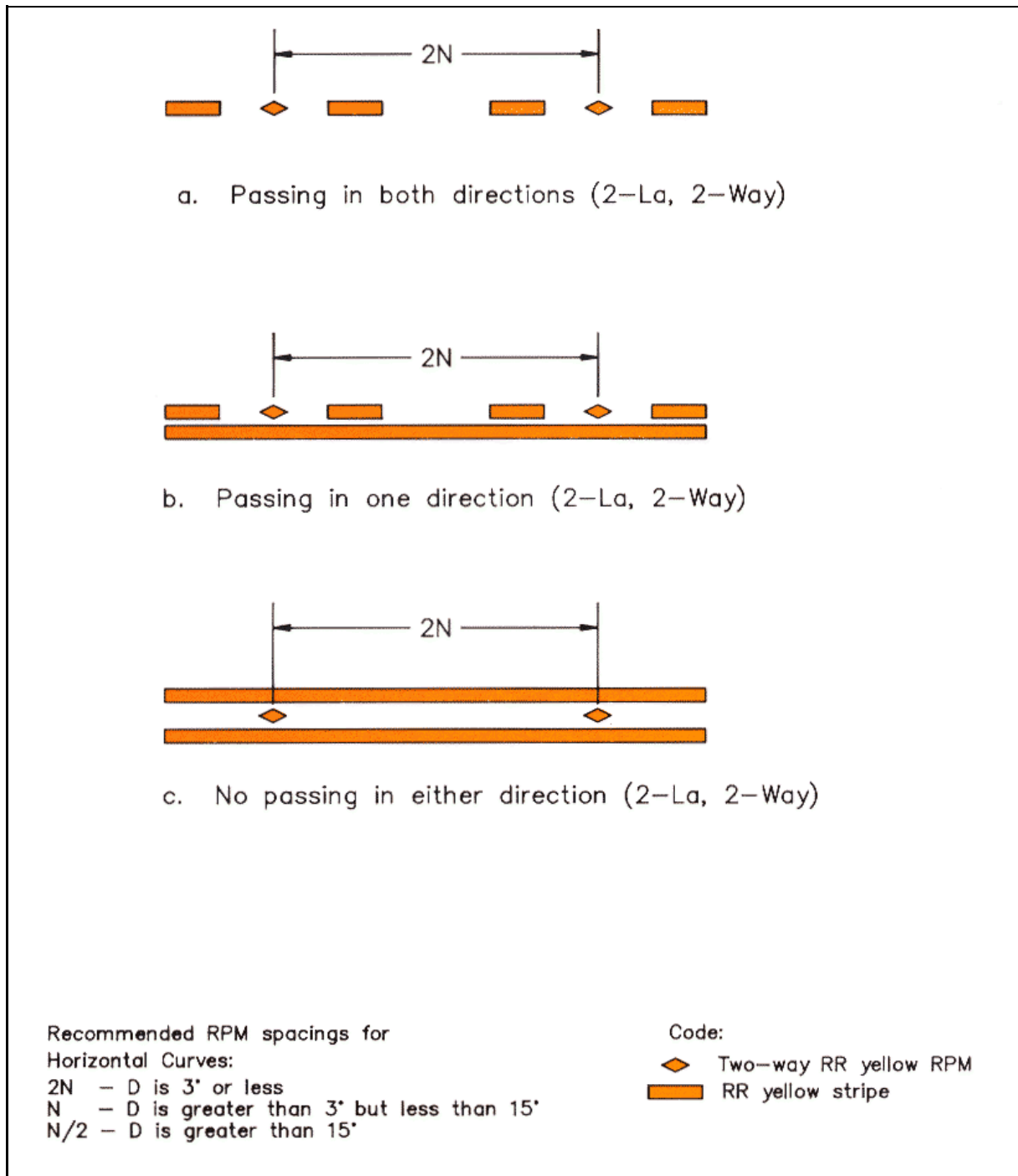
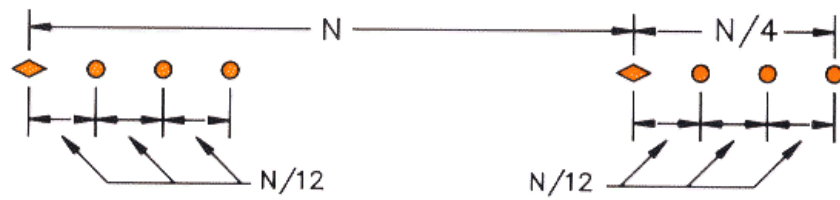
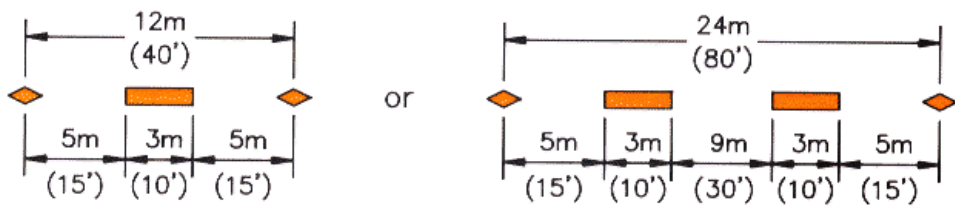

Figure 40. Use of RPMs to show roadway alignment on tangent sections and on horizontal curves



a) RPM System (2-La, 2-Way)



b) Combination RPM/Stripe System (2-La, 2-Way)

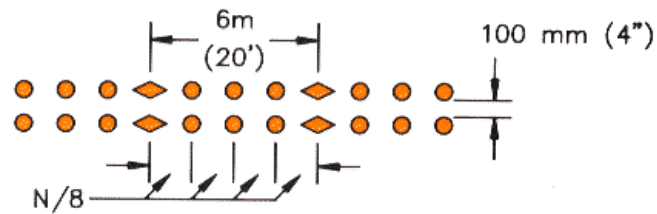

c) RPM System (Multi-La, 2-Way)

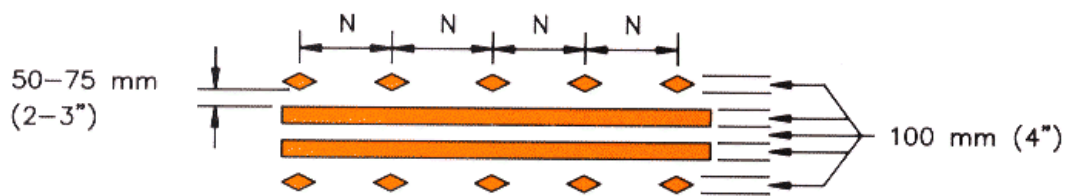

d) Combination RPM/Stripe System (Multi-La, 2-Way)

- Code:
- Non-Ref. Yellow
 - ◇ Double Yellow
 - ▬ Yellow Stripe

FIGURE 41. Centerline Patterns

Roadway Delineation Practices Handbook

Figure 41. Centerline patterns

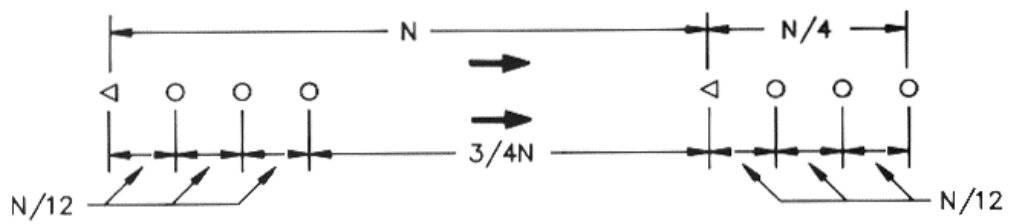

a) RPM System

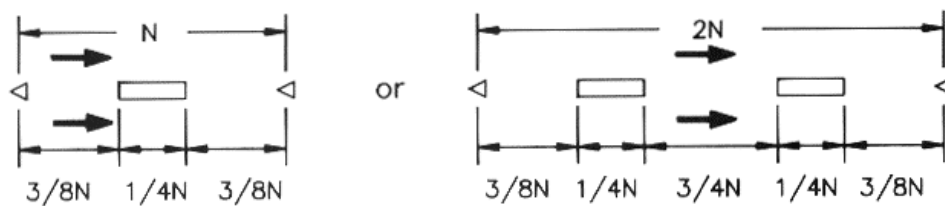

b) Combination RPM/Stripe System

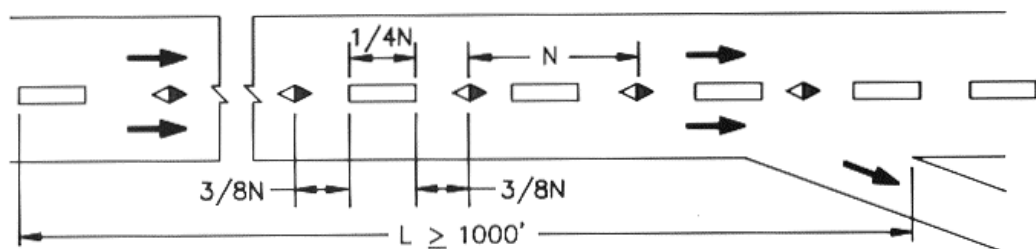

c) Combination RPM/Stripe System in Advance of Exit Ramp

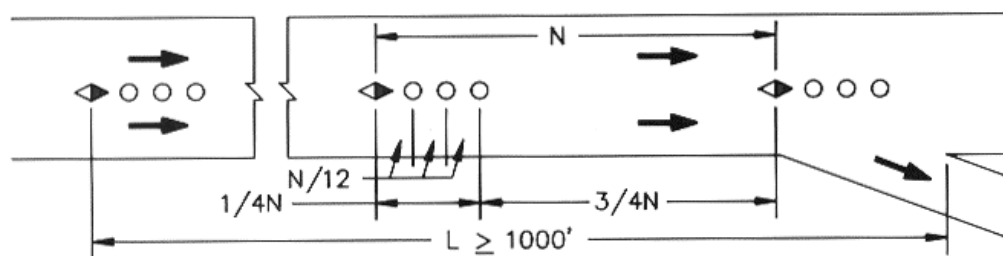

d) RPM System in Advance of Exit Ramp

Code:	◁	Refl single white	▭	White stripe
	◄	Refl white-red	→	Direction of Traffic
	○	Non-refl white		

Roadway Delineation Practices Handbook

Figure 42. Lane line patterns

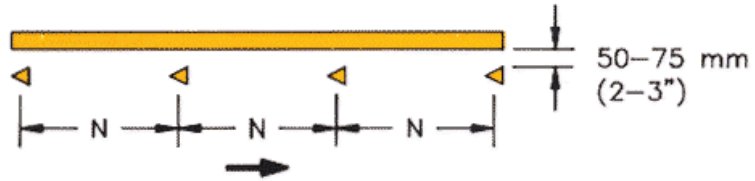

a) Combination RPM/Stripe for Left Edge Line
(RPMs normally not recommended for right edge line)

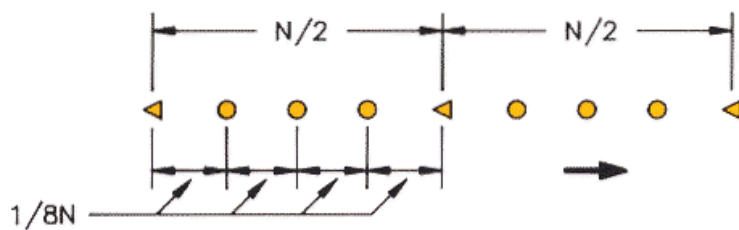

b) RPM System for No Passing Barrier

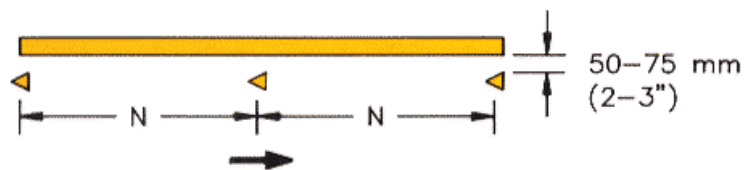

c) Combination RPM/Stripe System for No Passing Barrier

- Code:
- ◄ Refl Single Yellow
 - Non-Refl Yellow
 - ▬ Yellow Stripe
 - ➔ Direction of Traffic

Roadway Delineation Practices Handbook

Figure 43. Marking Patterns for Solid Lines

The three colors of RPMs in use are white, yellow, and red. White and yellow RPMs have the same meaning as pavement markings of the same colors. Red retroreflective RPMs convey the message "wrong way." Blue retroreflective RPMs are used by towns and cities to indicate the location of a nearby fire hydrant.

Considerations for Application

RPMs have the following advantages over standard painted markings:

- Retroreflective RPMs provide increased retroreflectivity under wet weather conditions.
- Both retroreflective and nonretroreflective RPMs are more durable than painted lines. Replacement is much less frequent and repainting operations under heavy traffic conditions can often be avoided.
- The vehicle vibration and audible tone produced by vehicles crossing over the RPMs creates a secondary warning.
- The capability of providing directional control of retroreflected color permits their use in conveying a wrong way message.
- Nonretroreflective RPMs can be used as transverse rumble stripes.

The principal disadvantage in using RPMs is their high initial cost. Their application, therefore, tends to be limited to important roadways, where additional delineation is needed, and roadways having a surface that will not soon be subject to major repair, replacement, or excavation. It is only under these conditions that an agency can recover the high initial investment and realize the full benefit of the durable RPMs.

Another concern is RPM vulnerability to snowplow activity. All pavement markings are obliterated by heavy snowfall. The RPM has the added disadvantage of being damaged or removed by the snowplow blade. A snowplowable marker has been developed that has demonstrated some effectiveness in resisting snowplow damage. The types, capabilities, and features of RPMs currently in use are described under Materials.

Guidelines for Application

Part 3B of the *MUTCD* provides definitive guidelines for road markings in a variety of situations.⁽¹⁾ *The Traffic Control Devices Handbook* has a similar section on the application of RPMs.⁽⁶³⁾ Guidelines for applying RPMs are presented in figures 44 through 50. Since policies may differ among agencies, the patterns shown are dimensionless. In these figures the normal spacing, N , represents the length of the segment plus the gap. The color of the RPMs should match the pavement markings being replaced or supplemented.

Figure 44 presents marking patterns for two-way roads, including a) two-lane roads, b) no passing zones, and c) four-lane roads.

Figure 45 presents marking patterns for transition sections, including a) four to two lanes (right) and b) four to two lanes (left).

Figure 46 presents marking patterns for intersection approaches, including a) two-lane, one-way roads, b) two-lane, two-way roads, and c) four-lane, two-way roads.

Figure 47 presents marking patterns for horizontal curves having a degree of curvature of 6 degree or greater, including a) two-lane, two-way roads, and b) four-lane, two-way roads.

Roadway Delineation Practices Handbook

Figure 48 presents marking patterns for left turn lanes, including a) center lane of a three-lane road, b) center lane of a five-lane road, and c) a protected left turn lane.

Figure 49 presents marking patterns for freeway ramps, including a) the combination of RPMs and painted markings at an exit ramp and b) the combination of RPMs and painted markings at an entrance ramp.

Figure 50 presents typical marking patterns for work zones, including a) two-lane, two-way road (3 days or less); b) two-lane, two-way road (14 days or less); c) two-lane, two-way road (more than 14 days); d) two-lane, two-way road with severe curvature (14 days or less), stripe centerline; e) two-lane, two-way road with severe curvature (14 days or less), RPM centerline; f) undivided multilane roads; and g) divided multilane roads.

The RPM pattern for construction zones that appears to provide the driver with the best visual perception on tangent sections is when RPMs of a spacing of 40 feet (12 meters) supplement painted lines. That is, a retroreflective RPM is placed midway between each 10 feet (3 meters) paint stripe, as shown in figure 50b and c.

For replacement of painted skip lines, a cluster of four nonretroreflective RPMs with a retroreflective RPM every 40 feet (12.2 meters) is recommended. The nonretroreflective RPMs should be placed 3 1/3 feet (1 meter) apart to provide the daytime appearance of a skip line. (See figure 50b and c.)

Special Locations

Because of the high initial cost of RPMs, several States use them only in locations where additional delineation is needed. A study of this phenomenon was performed for the Federal Highway Administration (FHWA).⁽⁶⁴⁾ It investigated before-and-after RPM installation studies performed in a number of States. The types of locations studied were narrow bridges, two-lane roadways, stop approaches, through approaches, two-lane with left-turn lane, interchange gores, four- and six-lane undivided, multilane undivided, and four-lane transitions to two lanes.

A total of 12 State reports were summarized. In many cases the accident data were insufficient. In others, the accident reduction between the before-and-after period was not statistically significant. Also, some sites included speed and lateral placement data. Several conclusions came from these reports.

For narrow bridges on two-lane rural roads, an RPM spacing of 80 feet (24.4 meters) decreasing to 40 feet (12.2 meters) approaching the bridge results in a significant reduction in the nighttime 85th percentile speed. Encroachments over the centerline are also reduced significantly. RPMs are found to be needed on both the edgeline and centerline. The edgeline RPMs are necessary to delineate the decrease in pavement width.

On two-lane rural curves, the double yellow centerline should be supplemented with one row of RPMs between the two centerlines. The spacing of the RPMs should be 80 feet (24.4 meters) on 3-degree curves. For curves between 3 and 15 degrees, a spacing of 40 feet (12.2 meters) or less is ideal; for curves greater than 15 degrees, spacing of 20 feet (6.1 meters) is recommended (see figure 40c for example of application). Visual observations indicate that two RPMs may be needed to provide adequate delineation for locations with curves greater than 20 degrees. The mixture of centerline and edgeline RPMs appears to be confusing on some sharp curves.

RPMs significantly reduce instances of erratic maneuvers in two-axle vehicles with and without the presence of overhead lighting. This effect especially is pronounced through painted gores at exits and bifurcations.

The RPMs should be introduced slightly in advance of the highway problem area to prepare drivers for the guidance technique that is to be encountered.

RPMs provide improved nighttime delineation when compared to and used in conjunction with painted markings.

Finally, although RPMs are a valuable guidance system, they are not a panacea for reducing the potential hazards at

Roadway Delineation Practices Handbook

all locations.

MATERIALS

A number of concepts have been applied in developing a low-cost, durable RPM. The RPM should 1) provide both day and night visibility at least equal to that of a retroreflective painted stripe, 2) be highly visible under wet night conditions, and 3) not be damaged by snowplow activity or cause damage to the snowplow blade.

Commercially available RPMs vary in all aspects of size, shape and composition, and exhibit a wide range of capabilities. No one type of RPM satisfies all the capabilities mentioned above. Size, shape, retroreflective properties, and materials used are considered when selecting a RPM. There is a trade-off between performance and cost, but it is not linear. After a certain point, paying more for RPMs will not significantly increase performance. RPMs should be selected on the basis of site-specific characteristics.

In addition to the commonly used RPMs, there are several experimental designs. The following discussion highlights the commonly used RPMs, special use RPMs, and RPM designs in the planning stage.

Types

The forerunner of the RPM was a convex button with glass beads on top for nighttime visibility. Named "Botts Dots" after their developer, these RPMs were introduced in California in 1954.⁽⁶⁵⁾ They were cemented to the pavement with epoxy adhesive, one each in the center of the 15-foot (4.6-meter) gap of a skip line. These RPMs were not readily submerged. They were used as auxiliary devices to provide delineation during periods of darkness and wet weather. The service life of these RPMs was estimated to be 20 years on Portland cement concrete (PCC) pavement.

Variations of the convex button have been developed. A nonretroreflective ceramic button is now used as an alternative to painted markings. However, these should be used in combination with retroreflective RPMs for both day and night visibility. Another variation is the ceramic button with a glass or plastic retroreflective insert. Examples of these "button" RPMs are shown in figure 51.

The rectangular RPM was developed around 1955 to improve durability on asphalt pavement. Like the Botts Dots, these early wedges had a polyester resin base with glass beads as the retroreflective element. The wedge shed water and extended above the water film found in wet weather. It also allowed one- and two-way delineation.

More recently, developments in precision molding technologies have made possible a trihedral angled mirror (cube-corner) retroreflector to use with the wedge-shaped RPM. In this system, three mirrored surfaces are arranged at 90-degree angles.

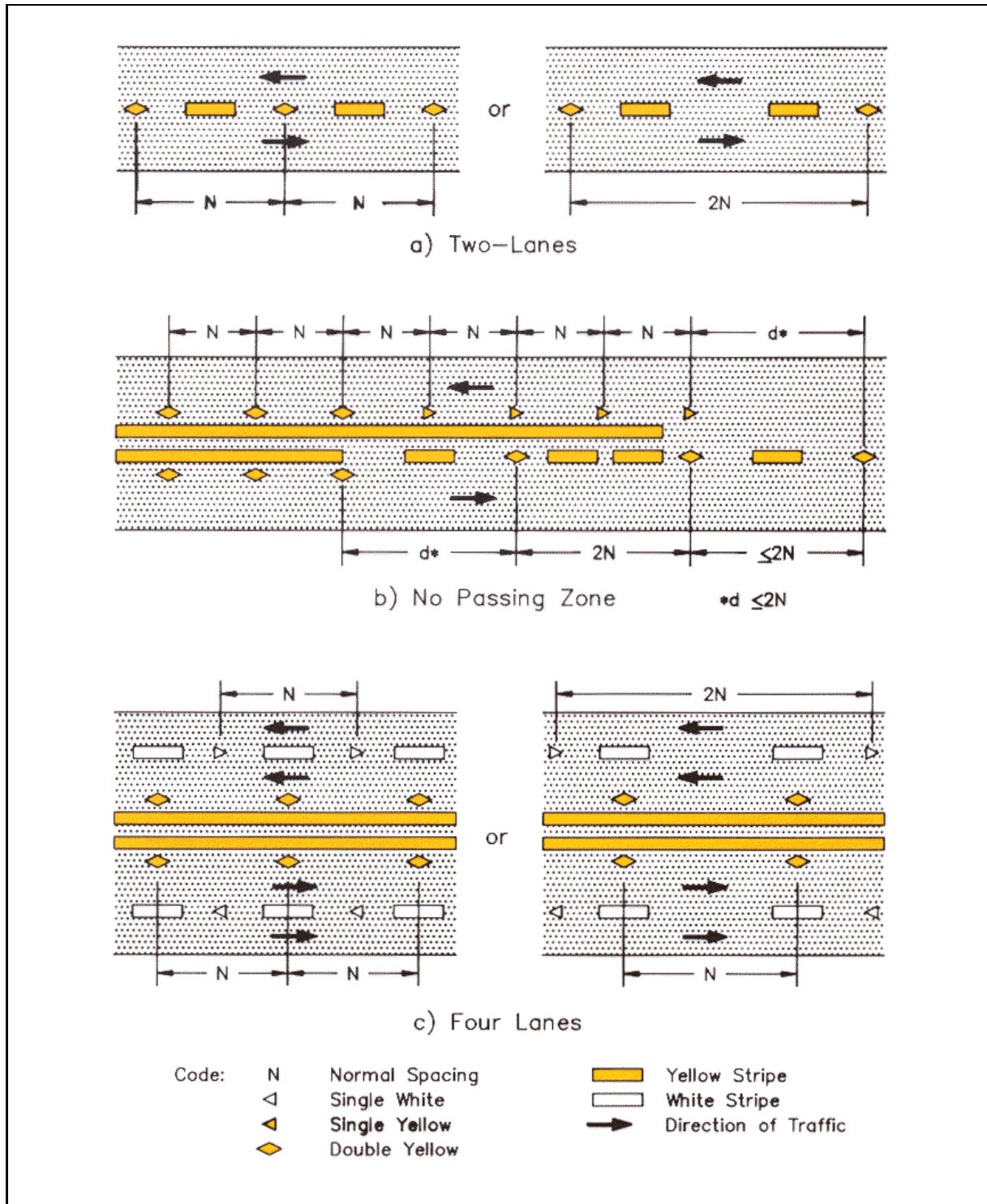

Figure 44. Marking patterns for two-way roads

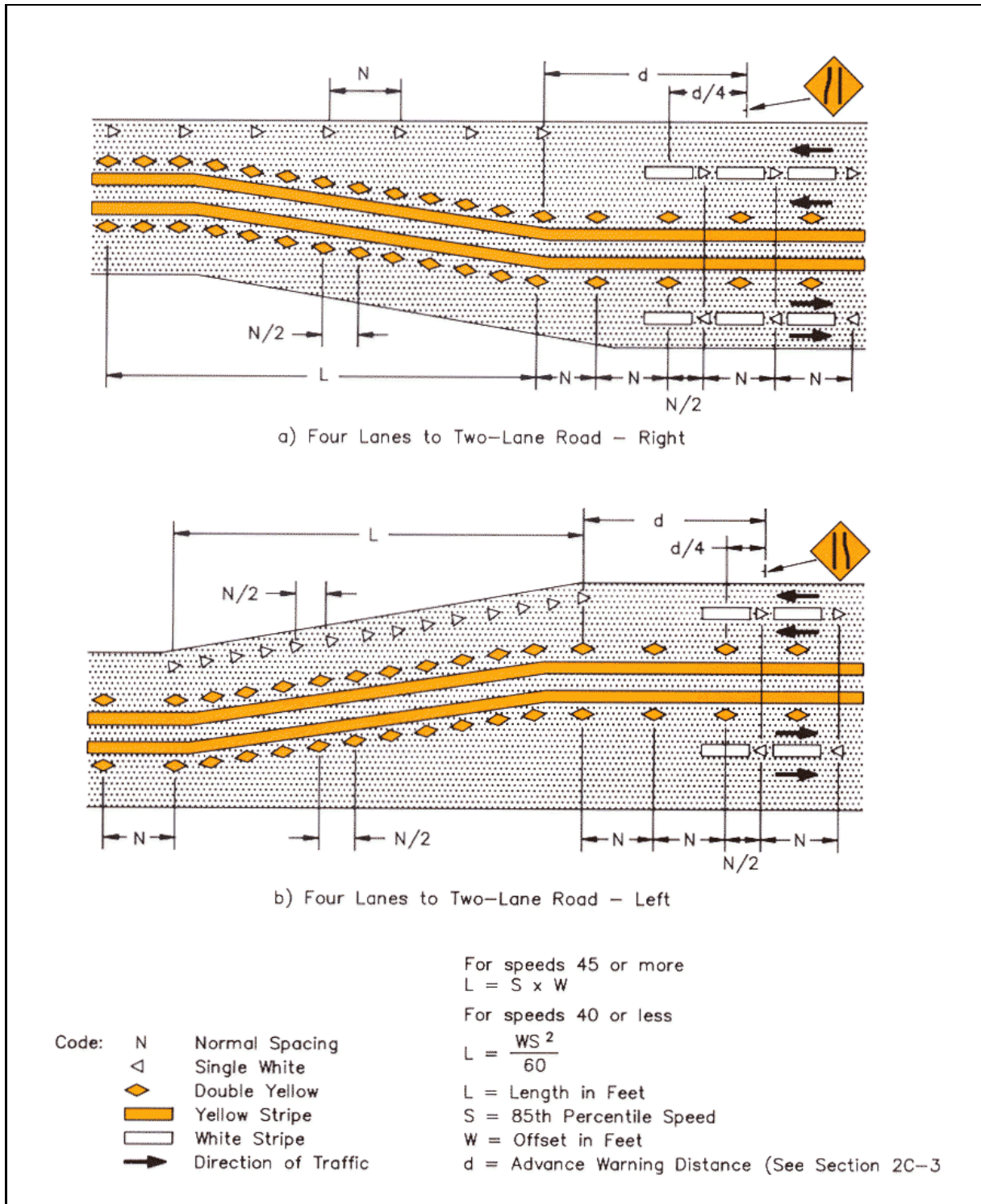

Figure 45. Marking patterns for transition situations

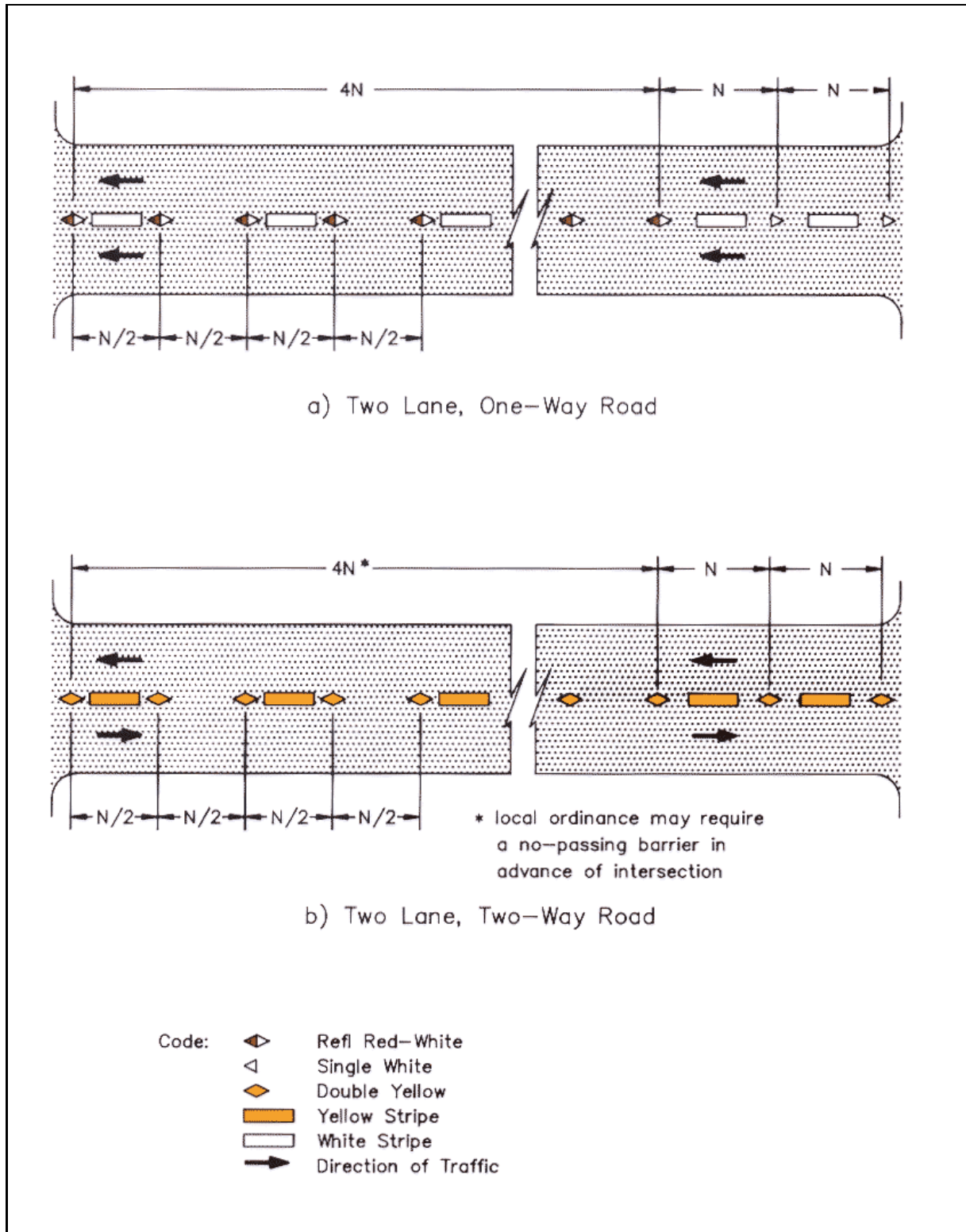

Figure 46. Marking patterns for intersection approaches

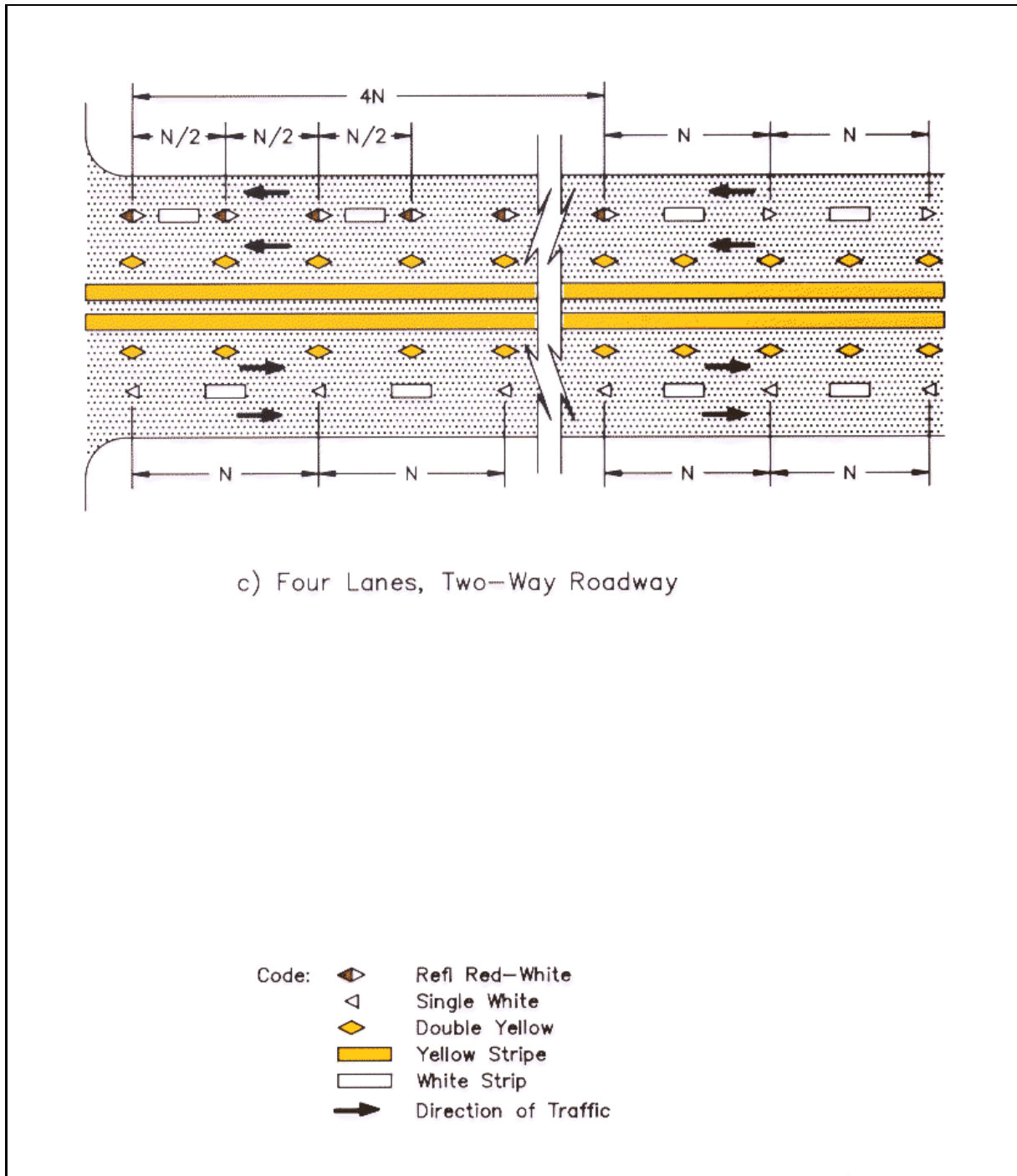

Figure 46. Marking patterns for intersection approaches (continued)

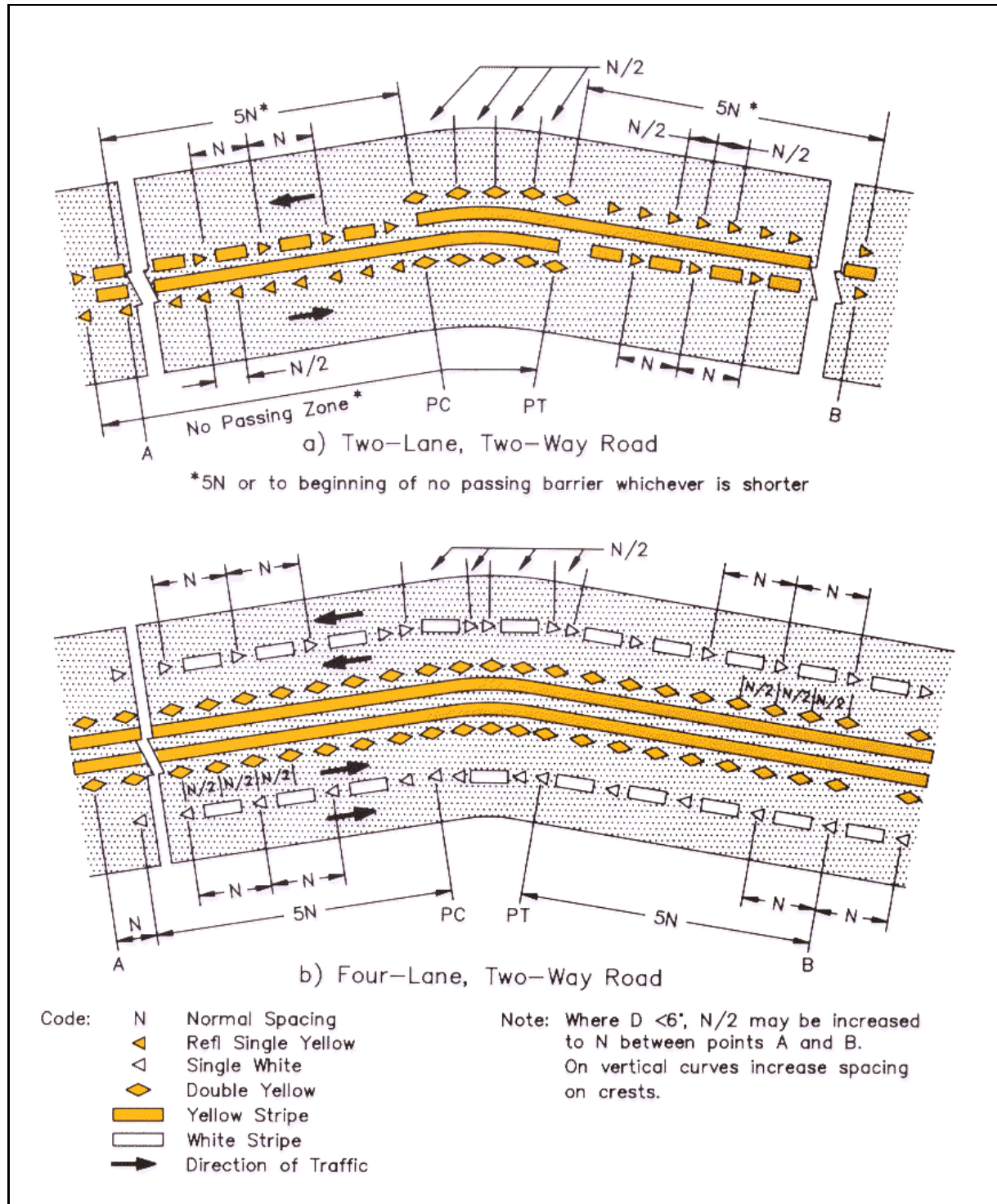
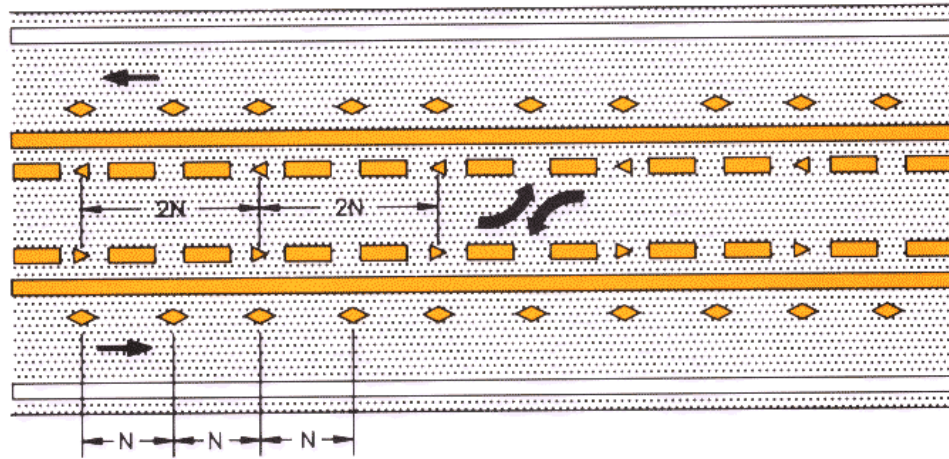
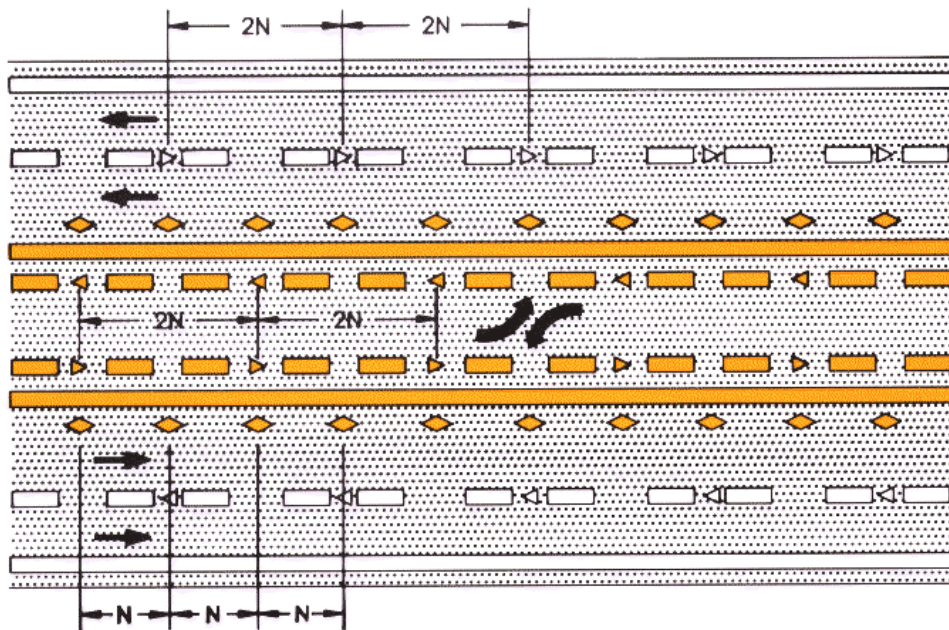

Figure 47. Marking patterns for horizontal curves having 6° or greater curvature



a) Center Lane of Three-Lane Road



b) Center Lane of Five-Lane Road

- | | | |
|-------|----------------------|------------------------|
| Code: | ▶ Refl Single Yellow | ▬ Yellow Stripe |
| | ◁ Single White | ▭ White Stripe |
| | ◊ Double Yellow | ➔ Direction of Traffic |

Figure 48. Marking patterns for left-turn lanes

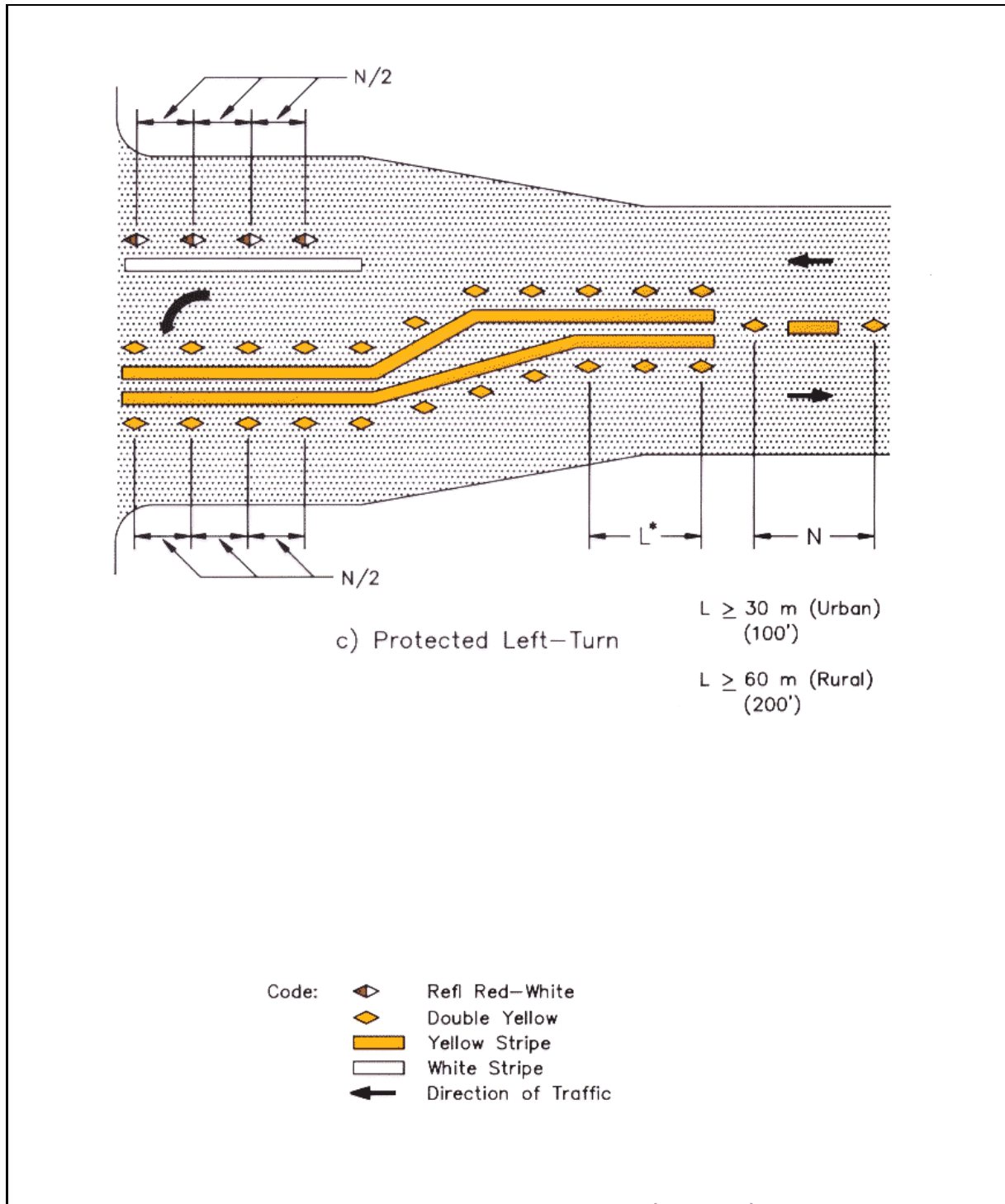
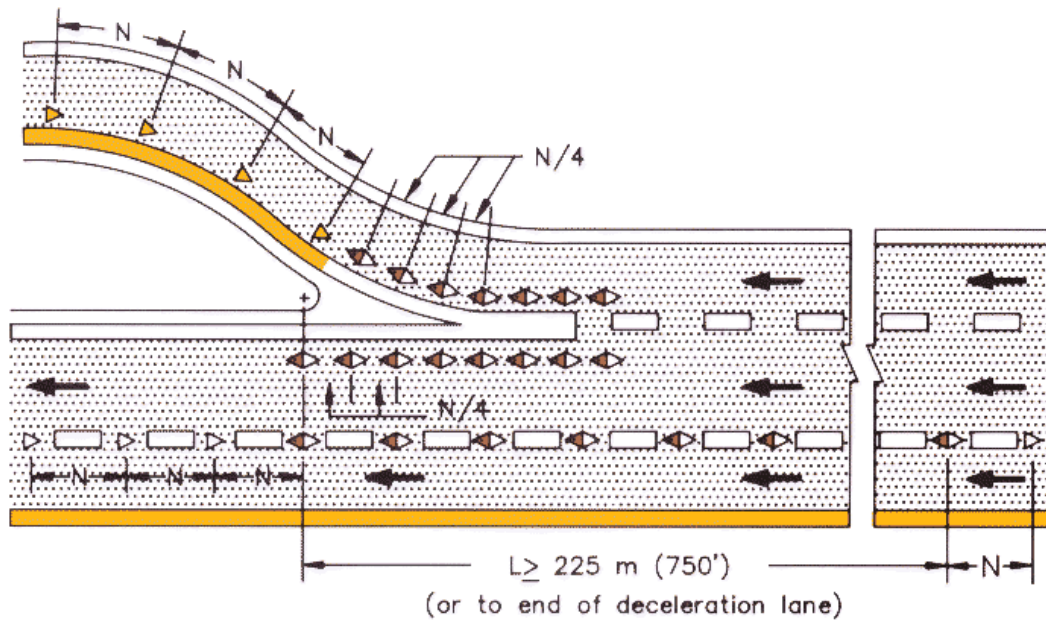
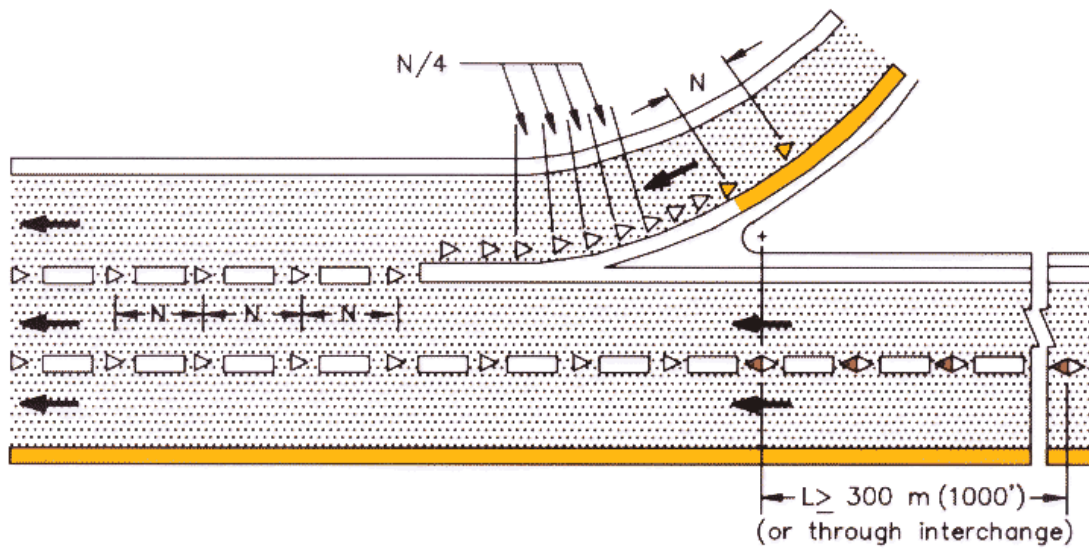

Figure 48. Marking patterns for left-turn lanes (continued)



a) Exit Ramp



b) Entrance Ramp







Code:		Double Yellow		Refl Red-White
		Yellow Stripe		Refl Single Yellow
		White Stripe		Single White
				Direction of Traffic

Figure 49. Marking patterns for freeway ramps

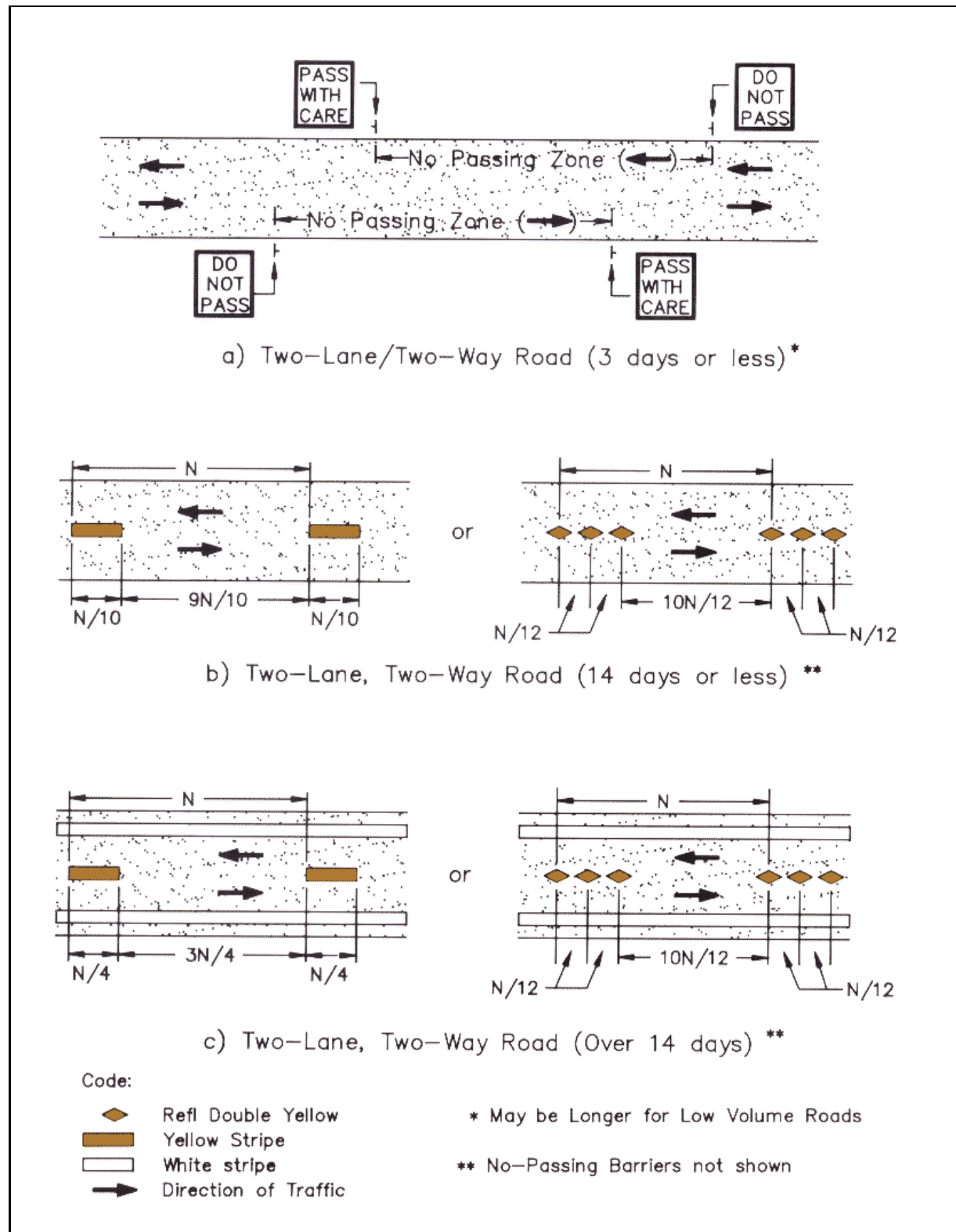
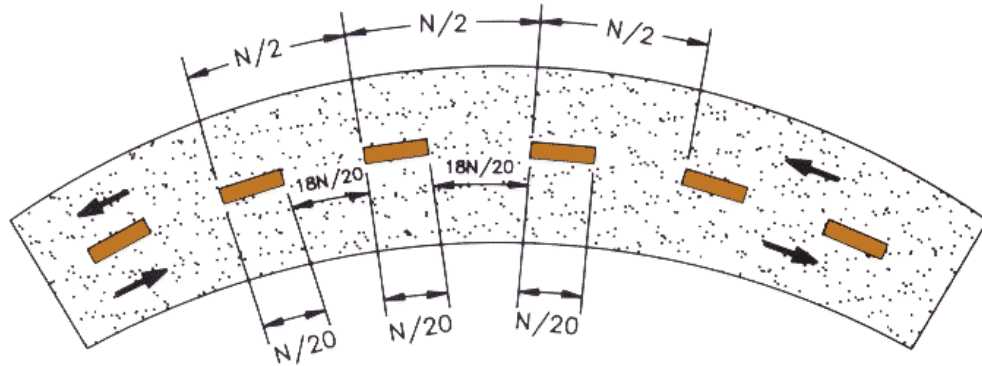
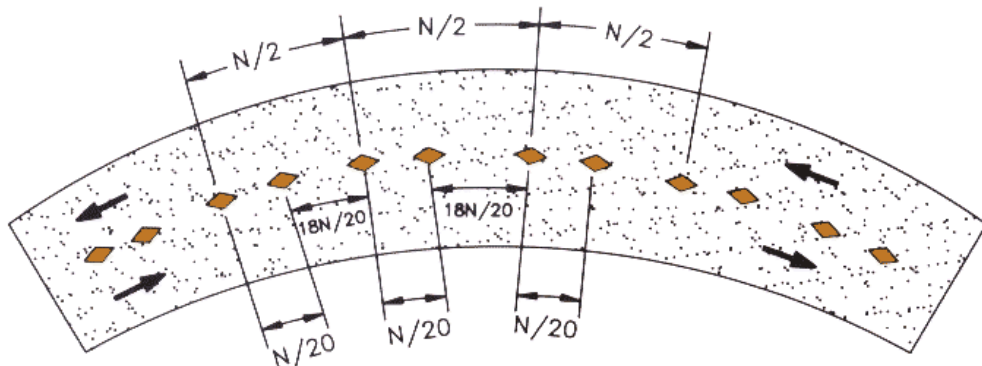

Figure 50. Marking patterns for work zones



d) Two-Lane, Two-Way Road with Severe curvature (14 Days or Less), Stripe Centerline**



e) Two-Lane, Two-Way Road with Severe curvature (14 Days or Less), RPM Centerline**

** No-Passing Barriers not shown

Code:



-  Double Yellow
-  Yellow Stripe
-  Direction of Traffic

Figure 50. Marking patterns for work zones (continued)

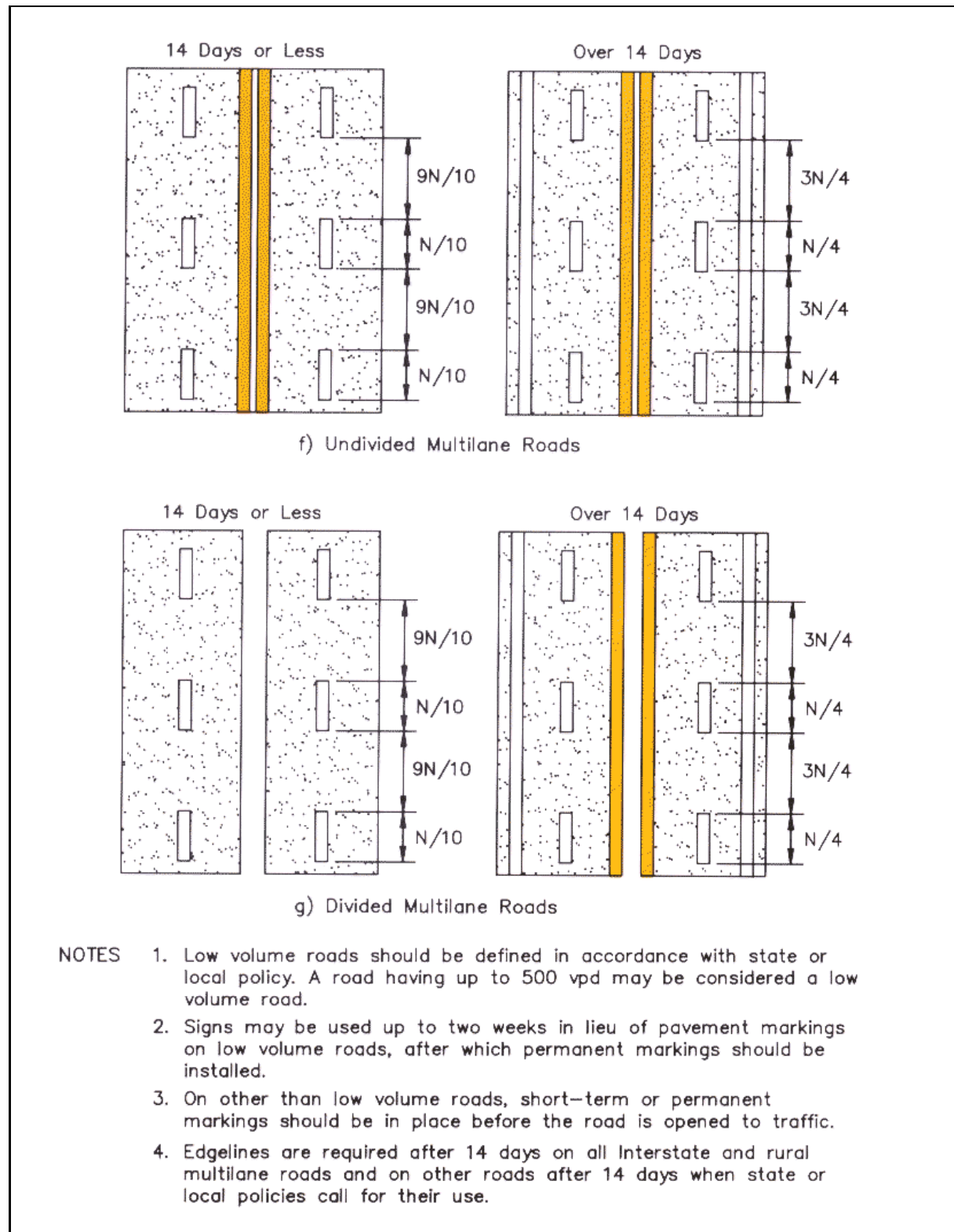

Figure 50. Marking patterns for work zones (continued)

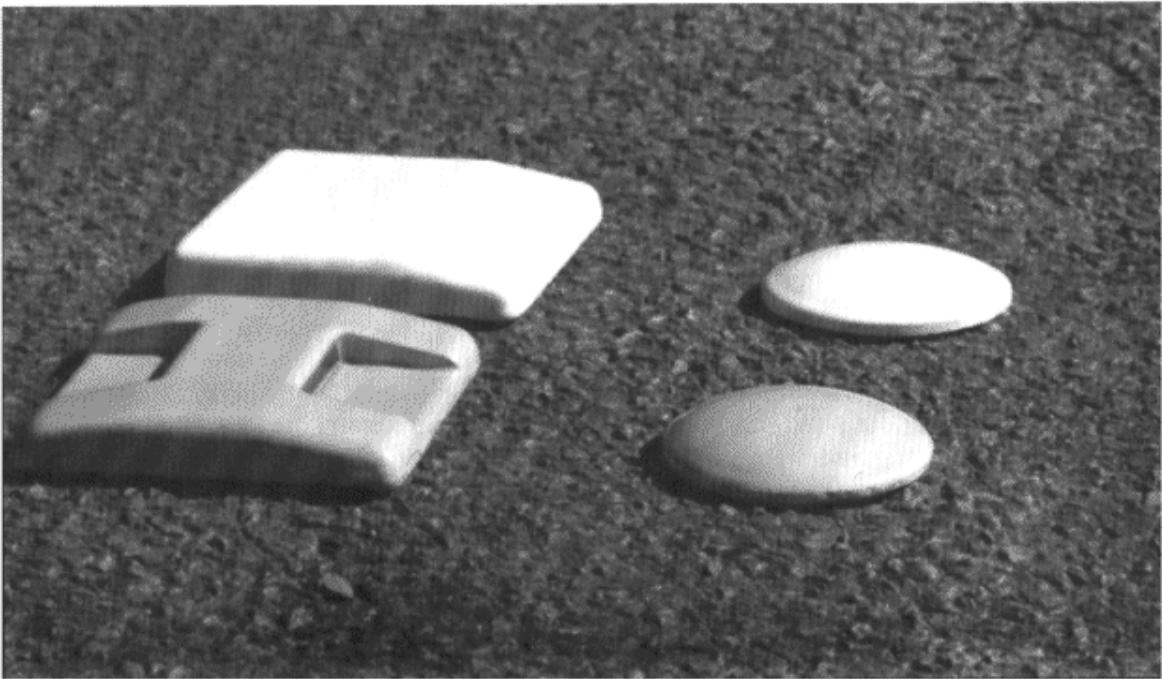
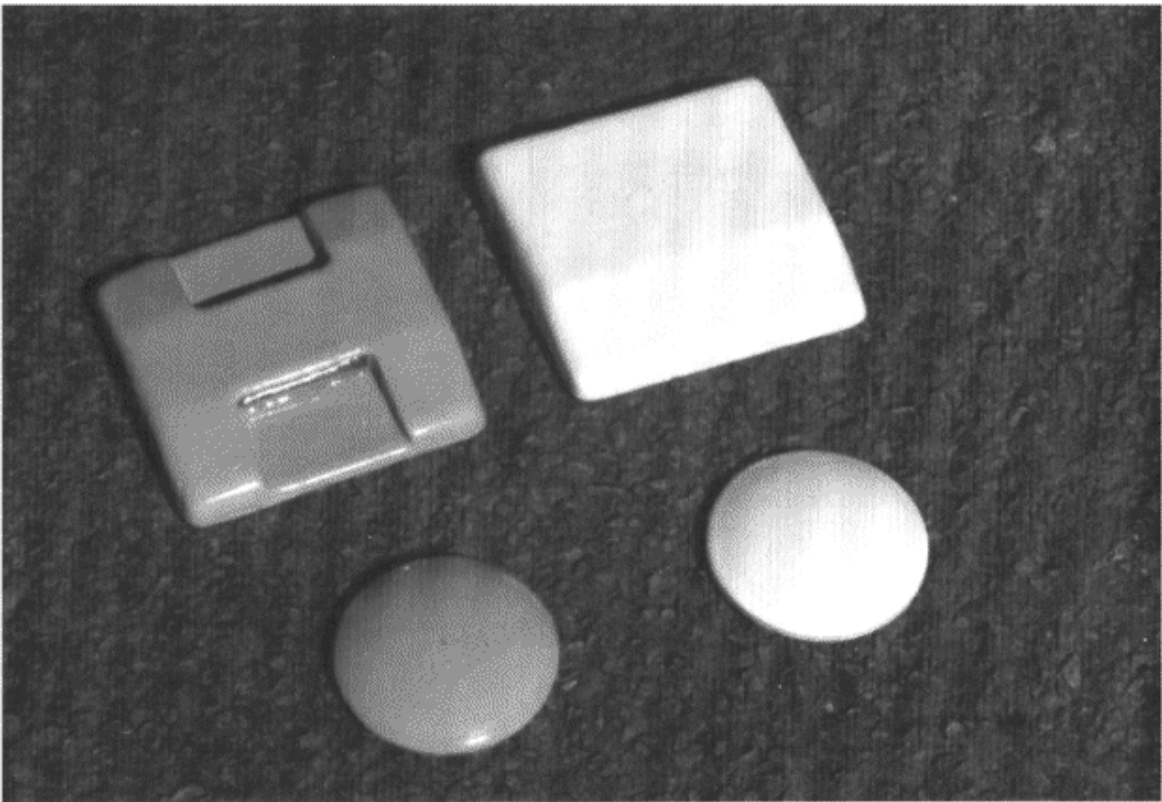
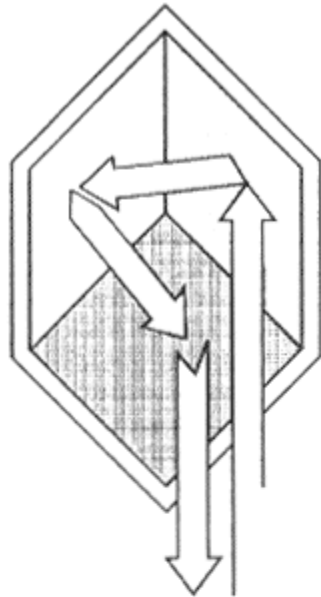
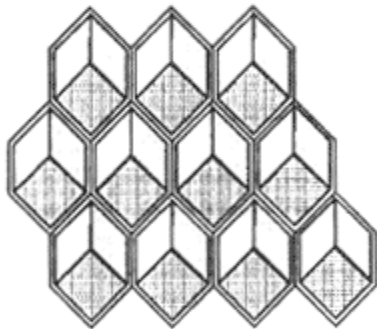

Figure 51.



a) Light Path for Trihedral Surface (Corner-Cube)



b) Structural Arrangement

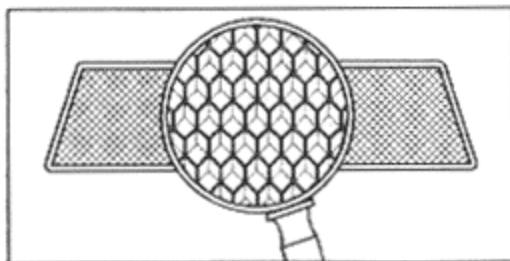

c) Magnified View of Precision Molded Corner-Cube Reflex Elements

Figure 52. Principle and structure of corner-cube retroreflectors

They receive the rays of headlights on one of the three mirrors. From there the ray is reflected to a second mirrored surface, and then to the third. This results in the ray being returned in exactly the opposite direction from which it entered. These tiny tri-mirrored surfaces are arranged as shown in Figure 52 to provide the retroreflective unit for the RPM. Approximately 360 retroreflective corner cubes are contained in the face of a RPM measuring 3 5/8 by 1 inches (9.14 by 25.4 millimeters).

Prismatic RPMs are available for one- or two-way delineation in any combination of the three standard colors. One RPM design has a retroreflective surface covering the entire slanted face of the wedge. The face of another version is divided into two retroreflective surfaces bounded by the base material.

The difference between these two versions is their daytime visibility. The full-face retroreflective element normally has a dull, silver-grey housing. It is amply visible in both clear and rainy night conditions, but almost vanishes during the day. The dual element retroreflectors cover a smaller area of the face and are encased in white or yellow plastic. As a result, they are visible during the day and at night. Specifications for the round and wedge-shaped RPMs are given in figure 53.

Snowplowable Markers

The use of conventional RPMs has increased dramatically in areas of minimal snowfall. Damage from snowplow blades has been the major deterrent to their installation in snow areas. The damage from and losses to snowplow activity is costly and has led to the development of a snowplowable marker. The snowplowable marker has a two-way replaceable retroreflector assembly protected by a metal casing as shown in figure 54.

Snowplowable markers are installed in a three-step process. First, double grooves are cut in the pavement. Next, the grooved area is filled with an adhesive. Finally, the casing is set into these grooves, as shown in figure 55.

During snowplowing, the snowplow blade rides up and over the shallow tapered planes on the casing, which prevents damage to the retroreflector unit, casing, or snowplow blade. Because of the low profile of the casing (6-degree slope), rise and fall of snowplow blade are hardly discernible to the snowplow operator if the snowplow is moving slowly. One model permits snowplowing from both directions and usually has two retroreflective faces that are available in the standard colors.

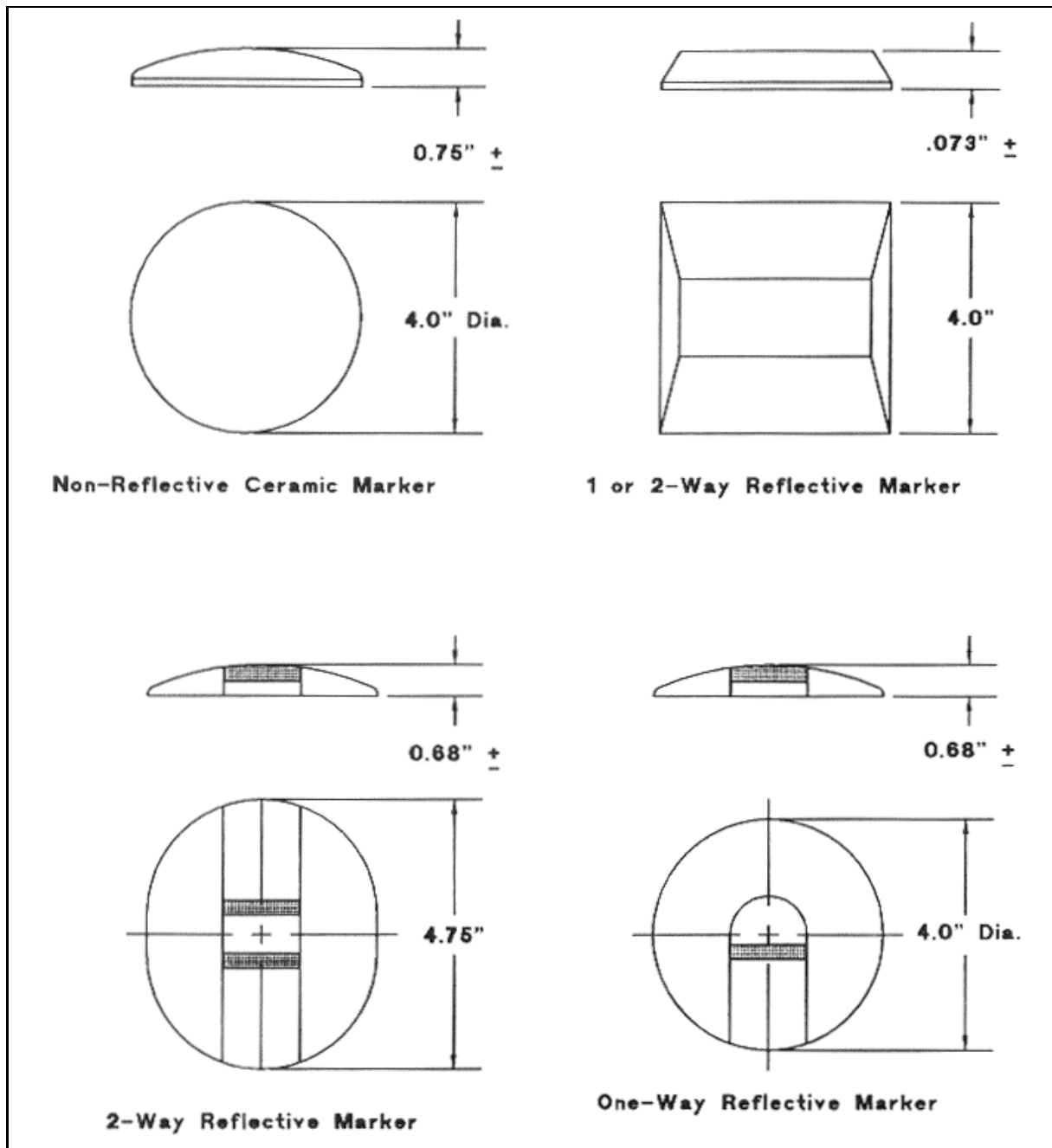

Figure 53. Typical raised marker configuration

The cast-iron housing of the snowplowable marker measures $9 \frac{1}{4}$ by $5 \frac{7}{8}$ by $1 \frac{3}{4}$ inches (235 by 149 by 44 millimeters). The maximum projection above the roadway is $\frac{7}{16}$ inch (10 millimeters). The acrylic prismatic retroreflector element provides 1.62 square inches (104.5 square millimeters) of retroreflective surface for each face.

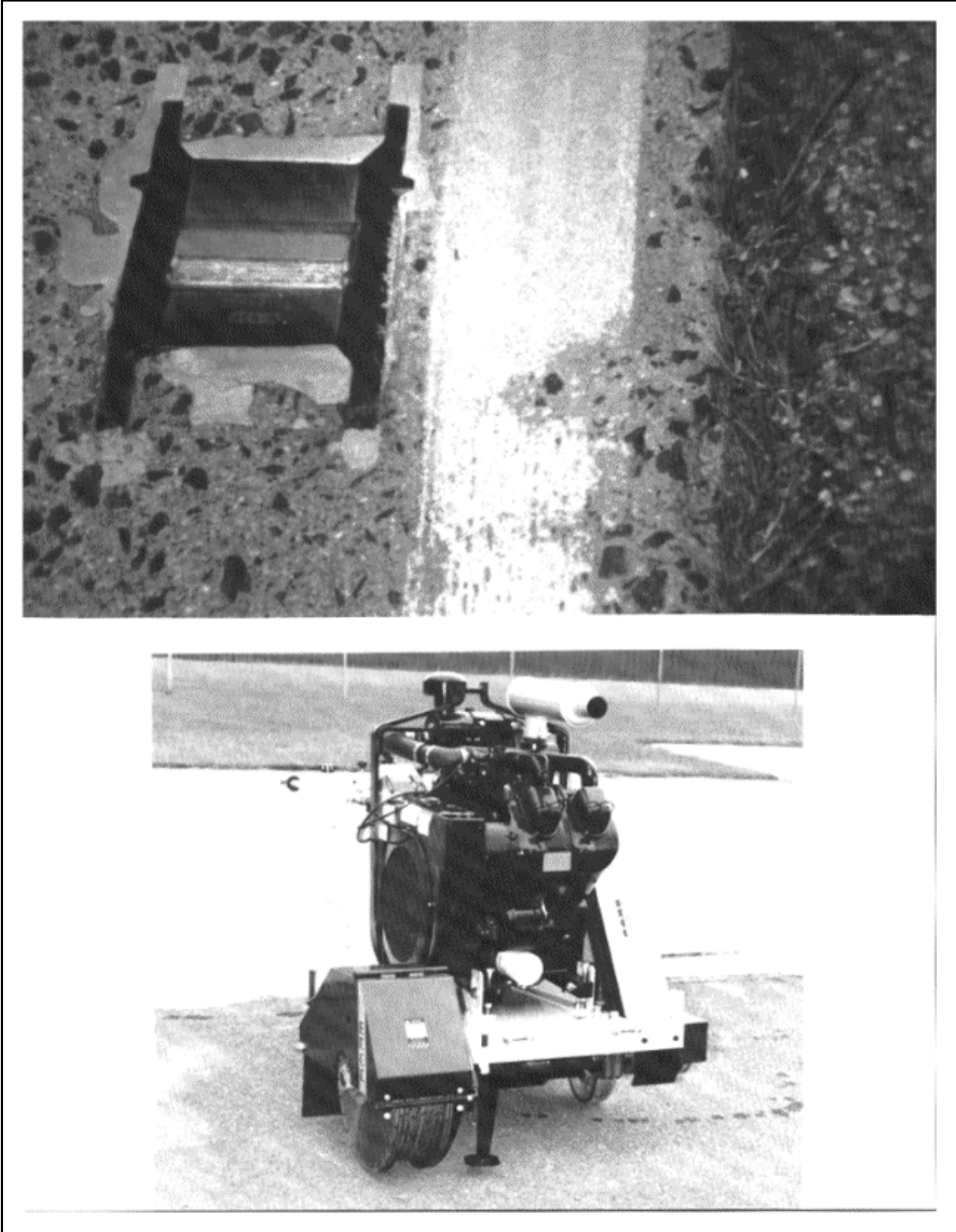

Figure 54. Snowplowable retroreflective pavement marker

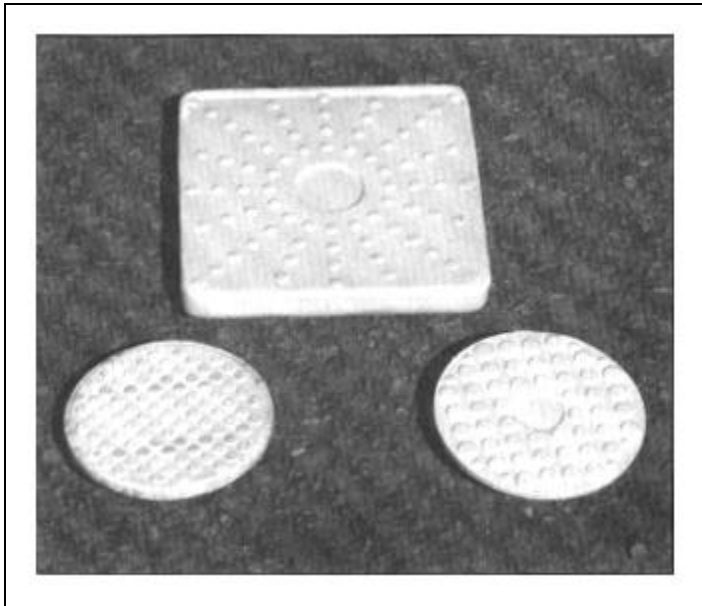

Figure 55. Bonding surface of ceramic RPM

Adhesives and Characteristics

The service life of any roadway delineation device is directly proportional to the bond strength between the material and the pavement. Ideally, the bond strength will equal the shear strength of the pavement itself. The physical strengths of the epoxy resins used today far surpass the internal physical strength of either Portland cement or asphalt concrete (AC) pavement. Surface preparation is often needed for a proper bond since road films, laitance in concrete, and other conditions often keep the epoxy resin bonding material from good contact with the pavement surface.

Good adhesion is the single most important determinant of RPMs' durability. The major factors that affect pavement bond are properties of the bonding agent, design of the RPM's bonding surface, type of pavement, temperature, and the care in application.

Epoxy adhesives are proportioned, mixed, and extruded by automatic mixing equipment. Flow properties (viscosity) of the adhesive at various temperatures are important not only for proportioning, mixing, and extruding but also to prevent the adhesive from flowing out from under the RPM when placed in position.

There are numerous formulations for epoxy bonding agents used to affix RPMs to the pavement surface. These formulations are classified by drying time. Standard set epoxy may take several hours to cure, whereas rapid set epoxy may be ready for traffic in 10 to 15 minutes.⁽⁵⁸⁾ Manufacturers of RPMs recommend and supply epoxies compatible to their products. Some States, however, formulate and manufacture or contract the manufacture of their own adhesive.

There are some forms of RPMs that are pressure sensitive and do not require adhesive. These RPMs require an application of primer before placement. The RPM is ready for traffic immediately. This type of RPM is used by small municipalities, or for work zones, detours, and other such applications.

The adhesion characteristics of RPMs depend on the base material. That is, ceramic materials do not bond as well as the acrylic shell. For this reason, several States ceramic RPMs have a textured surface to improve their bond with the pavement. After trying different types, California DOT (Caltrans) selected the textured surface shown in figure 55. The specification used by Caltrans reads:

Roadway Delineation Practices Handbook

"The bottoms of the ceramic markers shall be free from gloss or glaze and shall have a number of integrally formed protrusions approximately 0.05 inches (1.27 millimeters) projecting from the surface in a uniform pattern of parallel rows.

Each protrusion shall have a flat surface parallel to the bottom of the marker. The area of each parallel face shall be between 0.101 and 0.065 square inches (65.2 and 41.9 square millimeters) and the combined areas of these faces shall be between 2.2 and 4 square inches (1,419 and 2,581 square millimeters).

The protrusions shall be circular in section. The number of protrusions should be not less than 50 nor more than 200.

To facilitate forming and mold release, the sides of each protrusion may be tapered and shall not exceed radius (15 degrees) from perpendicular to the marker bottom. Markers manufactured with protrusions whose diameter is less than 0.15 inch (0.38 centimeter) may have an additional taper not exceeding rad (30 degrees) from perpendicular to the marker bottom and extending no more than one-half the total height of the protrusion.

The overall height of the marker shall be between 0.68 and 0.80 inches (1.72 and 2.03 centimeters)."⁽⁵⁸⁾

Materials for asphalt pavements vary considerably in physical properties. They can be made from various crude stocks and still meet specifications. Materials will affect bond strength with RPMs, but as pavements age these differences diminish. As a result, some agencies adopt a waiting period before placing RPMs. Similarly, rejuvenating agents soften asphalt so that good RPM retention cannot be expected. The softened asphalt will harden with time. It is recommended that no installation of RPMs be made for one year after the application of a rejuvenating agent.

Temporary Delineation

To safely carry traffic through construction and maintenance zones, the contractor should use good signing and delineation to maintain normal traffic flow while guiding the driver through the work zone.

A system of RPMs is one alternative. They are easy to install and remove and after removal do not leave a misleading indication to confuse drivers. Despite these apparent safety benefits, the high cost of RPMs has discouraged their use. Accordingly, the FHWA conducted a study to solve this dilemma. The costs, spacing, ease of application and removal, and ability of the RPMs to guide traffic and produce public acceptance were evaluated.⁽⁶⁶⁾

Nine States found RPMs to be effective, providing positive day and nighttime guidance in both wet and dry conditions. Also justifying their use is the additional safety, improved operations, reduced vandalism, and unanimous acceptance by the public, government, and construction personnel. On an economic basis, the cost of RPMs and paint was equal to or less than the cost of installation and removal of a painted marking alone. Most significantly, RPMs tended to reduce accidents on construction detours.

Several types of temporary RPMs have become available in recent years for a reduced cost. These RPMs are designed to be durable enough to last through most construction projects, yet are easily removed. A study of specific brands of these RPMs was performed by the Ohio DOT, which found that two brands of temporary RPMs provided adequate day and night visibility.⁽⁶⁷⁾ One of these RPMs, however, did not have sufficient durability to be useful except in the very shortest of applications. All the other RPMs investigated were inadequate or needed to be combined with another type of RPM to be visible both during the day and at night.

It is recommended that the following features be incorporated for construction zone RPMs to ensure adequacy for both day and night use:

- A streamlined profile.
- A microscopic, cube-corner, sealed prismatic air cell; cube-corner reflex; or multiple glass lens reflector.

Roadway Delineation Practices Handbook

- The area exposed to the driver's normal line of vision balanced between the casing itself and the retroreflective insert.⁽⁶⁸⁾

PERFORMANCE

As with other forms of delineation, the performance of RPMs is usually judged by durability and visibility. Various RPMs provide different forms of visibility. For example, nonretroreflective ceramic RPMs are used to provide daytime visibility and supplement retroreflective RPMs in providing nighttime visibility. The cube-corner, retroreflective RPM provides excellent night visibility, especially in adverse weather conditions, but does not perform well in daylight. When combined for day and night visibility, these conventional RPMs perform well where there is little or no snow.

As described earlier, conventional RPMs are vulnerable to snowplow use. A snowplowable retroreflective marker is available that consists of a steel casing that guides the snowplow blade up and over the plastic retroreflective unit. Because of their inherent differences, performance experience for conventional and snowplowable markers is discussed separately.

Conventional RPMs

The reported performance from agencies using RPMs depends on the delineation variables. Findings and observations concerning the use of nonretroreflective ceramic RPMs and retroreflective RPMs are highlighted in the following section.

Nonretroreflective RPMs

- White and yellow ceramic RPMs may be expected to last more than 10 years. Although they may become severely pitted, they will still be visible.
- The ceramic RPM system gives good daytime visibility when clean. When wet, it supplements the cube-corner RPM to produce good results at night. By itself, the white ceramic RPM provides night delineation only in dry weather.
- During hot, dry months, considerable road film can accumulate on ceramic RPMs. The visual delineation is less than desired in the daytime and is inadequate at night. This condition normally corrects itself after periods of wet weather.
- Poor bonding is the cause of most RPM losses. The best way to combat this problem is to use a RPM with a textured bottom, which creates better adhesion to the pavement surface.

Retroreflective RPMs

- Within a few months, the retroreflectivity of the cube-corner RPM drops to as little as 1/20 to 1/50 of its original value due to factors such as buildup of road film and surface abrasion. However, the retroreflectivity is adequate and remains relatively constant after the large initial loss.
- When the RPM is seriously damaged, or when the retroreflective lens is obscured by tire stain, retroreflectivity is degraded seriously. However, during wet weather, the lens is covered with water film, which tends to fill in cracks on the face of the retroreflective insert. Visibility is excellent, nearly one-fourth to one-third its original value. Thus, the system is at its best when it is needed most.
- Expected service life for retroreflective RPMs varies greatly. No more than 1 1/2 years can be expected under severe conditions. Up to eight years of service life will result on most freeway locations. Ten years can be obtained on rural low density roads.

Roadway Delineation Practices Handbook

Generally, the cube-corner lens will provide some retroreflectivity unless the lens face has been completely destroyed.

When the specific intensity of RPMs drops to about 0.05, dry night visibility is not as good as a conventional marking.⁽⁶⁶⁾ Typical minimum brightness requirements for prismatic RPMs at an observation angle of 0.2 degree are as follows:

Entrance Angle (degrees)		
<i>Color</i>	<i>0</i>	<i>20</i>
White	3.00	1.20
Yellow	1.50	0.60
Red	0.75	0.30

Table 7 gives installed costs for RPMs in a variety of States and the installation adhesive used.⁽²¹⁾ The higher costs seen in Texas may be attributed to labor or equipment rather than to materials. The bituminous adhesive is cheaper than epoxy or thermoplastic. It is obvious that an installation of RPMs at these unit prices can be an expensive proposition. This is one of the reasons their use has been limited to important roadways and areas where damage from snowplow activity is not expected.

Table 7. Adhesives and installed costs for RPMs in a variety of States

State	Adhesive Used	Installed Cost Per Unit (\$)	
		Conventional	Snowplowable
California	Epoxy	2.50 to 3.00	-----
Florida	Thermoplastic or Epoxy	2.50	-----
Massachusetts	Epoxy	-----	16.50
Michigan	Epoxy	-----	18.00
New Jersey	Thermoplastic or Butyl	-----	23.98
Pennsylvania	Butyl	-----	20.00
Texas	Bituminous	3.20	-----

Snowplowable Markers

A practical, durable marker compatible with snowplow activity has been under development since 1967. A number of prototype models have been fabricated and tested extensively in the last 10 years. The latest production model can be

Roadway Delineation Practices Handbook

plowed in either direction and features a replaceable retroreflective lens (figure 55). Performance data are needed from long-term, large-scale installations. Typical installed costs can be seen in table 7.⁽²¹⁾

Evaluation of a previous model was conducted in New Jersey where annual snowfall ranges from 15 to 20 inches (381 to 508 millimeters).⁽⁶⁹⁾ This marker provided excellent wet night delineation and a good maintenance record when steel snowplows were used. Under severe conditions, when tungsten carbide inserts were sometimes used on the snowplow blades, the results were mixed. Both the markers and the snowplow inserts were damaged more often under these conditions, though it may be questioned whether the plow insert damage actually affects plowing efficiency or is merely cosmetic. The study suggested that the expected life of the steel-hardened casing could be conservatively estimated at 10 years and the life of the replaceable lens insert at 3 to 4 years.

INSTALLATION AND MAINTENANCE

Installation of RPMs is not difficult. It requires neither complex equipment nor specialized staff capability. However, new installations are commonly part of a construction or improvements project. Maintenance, however, usually is performed by State or local highway agencies' personnel.

General practice and specific procedures related to each type of RPM are discussed in the following sections.

General Practices

On two-way roads, RPMs should be installed with the same traffic control plans as any other operation that requires working in the roadway. Traffic should not be allowed to pass along both sides of the operation.

Most highway agencies specify that the pavement to be bonded should be free of dirt, curing compound, grease, oil, moisture, loose or unsound layers, paint, and any other material that would adversely affect interaction with the adhesive. PCC and old AC pavement should be cleaned prior to application of the device. Newly placed AC need not be blast cleaned unless the surface contains an abnormal amount of asphalt or the surface is contaminated with dirt, grease, paint, oil, or other material.

The adhesive should be placed uniformly on the pavement surface. It may also be put on the bottom of the marker. The quantity should be sufficient to completely cover the area of contact between RPM and pavement. A slight excess should be present, with no voids, after the RPM has been pressed into place. The RPM should be placed in position and pressure applied until firm contact is made with the pavement.

Excess adhesive around the edge of the RPM, on the pavement, or on the retroreflective surfaces of the RPMs should be removed. A soft rag moistened with mineral spirits (conforming to Federal Specification TT-T-291) or kerosene may be used to remove any excess adhesive. The RPM must be protected against traffic impact until the adhesive has hardened. Traffic control and protection of the RPMs are similar to the techniques used for pavement marking operations.

Retroreflective RPMs should be placed so that their retroreflective face is perpendicular to a line parallel to the roadway centerline. RPMs should not be placed over longitudinal or transverse joints of the pavement surface.

When RPMs are used to supplement a solid painted or thermoplastic pavement marking, they are generally offset 2 to 3 inches (50 to 75 millimeters) from the edge of the marking. The offset permits repainting the marking without degrading the retroreflective properties of the RPMs.

Application of Self-Adhesive RPMs

The self-adhesive RPM (figure 56) has a pressure-sensitive butyl backing that provides a satisfactory bond with the pavement. This type of RPM is suited for use on detours. It is easy to install and maintain because no application equipment is necessary. The self-adhesive RPM is cost-effective because it takes less time for installation and is ready

for traffic as soon as it is installed.

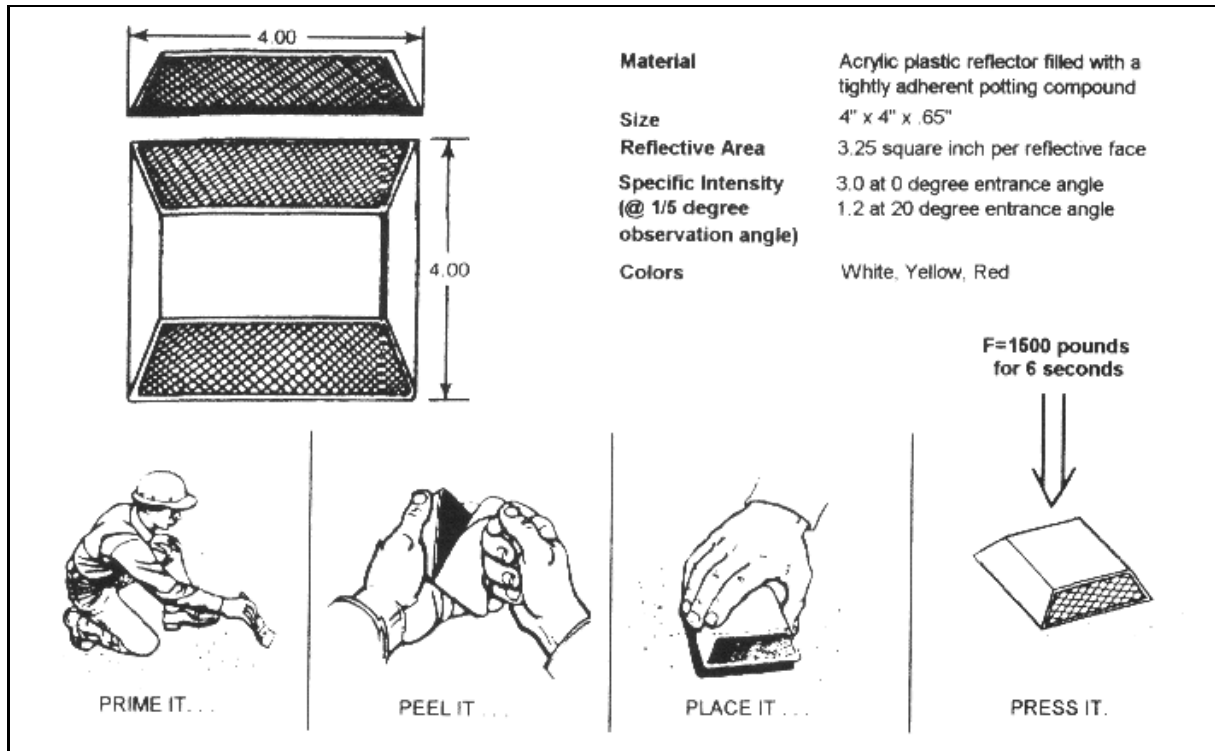

Figure 56. Application of pressure-sensitive RPM

Surprisingly, the self-adhesive RPM is durable under normal traffic conditions. There is no significant difference in loss rate for RPMs placed with epoxy and the butyl pads when used in this manner. It should be noted, however, that the butyl padded ceramic RPM does not perform as well as the acrylic shell RPM. Also, lower temperatures below 50 degrees Fahrenheit (10 degrees Celsius) seem to reduce the bonding capability of the butyl pads. The basic installation procedure is to mark and sweep the location of the RPM. Using a RPM-size cardboard template, an adhesive primer is applied with a paint brush to each pre-marked location. The paper backing is removed from the RPM and is placed on the cured primer. A following vehicle then sets the RPM by slowly driving over it. A force of 1,500 pounds (680 kilograms) for 6 seconds is required.

Epoxy Adhesive

There are numerous formulations of epoxy bonding agents. The proper proportioning, mixing, and extruding are the most critical parts of the application procedure.

Essentially, all two-component epoxies require that the mixing operation and the placement of the RPM on the pavement be done quickly. Whether hand mixing or machine mixing is used, most standard types of epoxy require that the RPM be coated, aligned, and pressed into place within minutes after mixing is started. Consequently, no more than a quart of adhesive should be hand mixed at one time.

Rapid-set adhesive is usually mixed by a two-component automatic mixing and extrusion apparatus. For a typical large-scale installation, a crew member sits on a platform on the side of the truck between the two axles. The mixing and extruding apparatus is installed nearby. A predetermined amount of the mixed epoxy is expelled onto the bottom surface of the RPM that the operator then places on the pavement.

Roadway Delineation Practices Handbook

To achieve a proper bond, the adhesive should be used according to manufacturer's instructions. For example, some standard set adhesives require that the pavement and air temperature be above 50 degrees Fahrenheit (10 degrees Celsius). Rapid-set formulas can usually be applied at temperatures as low as 30 degrees Fahrenheit (-1 degree Celsius). RPMs should not be set if the relative humidity is more than 80 percent or if the pavement surface is not dry.

Epoxy adhesives can cause severe dermatitis if proper precautions are not taken. Crews should use gloves and protective cream to prevent contact with the adhesive. If contact with the skin occurs, the area of contact should be washed thoroughly with soap and water as soon as possible.

Solvents should not be used to remove adhesive from skin. (Toluene or equivalent may be used to clean tools and equipment.)

Bitumen Adhesive

RPMs are the most expensive marking material to install. For this reason, researchers are constantly trying to find ways to increase the durability of RPMs, particularly on softer bituminous pavements. One study examined the use of bitumen adhesives as an alternative to epoxy adhesives that have traditionally been used on these pavements.⁽⁷⁰⁾ The study was originated because bituminous adhesives were observed to be performing better than epoxy. In some cases, the retention percentage of RPMs attached with bitumen was twice as high as that of the RPMs attached with epoxy.

RPMs are nearly always lost to failure of the pavement, rather than a failure of the adhesive or breakup of the RPM. Missing RPMs are often found by the road intact, with a "divot" of pavement attached to the base. RPM loss does not occur as a result of single loadings, so it is assumed that the fatigue strength of the pavement is involved.

The study showed that the fatigue strength of pavements is actually affected by the physical characteristics of the adhesive used. In general, the maximum fatigue strength is obtained by matching softer adhesives with softer pavements; stiffer pavements require stronger adhesives.

The study concluded that the use of bituminous adhesives is warranted on new, softer asphalt pavements. As the age and stiffness of the pavement increases, the benefits from this adhesive decline. Also, the bitumen adhesive generally is not as effective on high-volume roadways.

These findings indicate that it eventually will be possible to match physical characteristics of an adhesive to those of the pavement, thus making it possible to optimize the RPM cost-retention ratio.

Routine Maintenance

The routine maintenance of RPMs is almost always a function of State or local highway agencies. No complex equipment or special crew capabilities are needed for the replacement of conventional RPMs. The only critical element involves the proportioning and mixing of the two-component epoxy. Contractors will normally install such RPMs as part of a resurfacing contract.

Maintenance on the snowplowable marker consists of simple replacement of the removable retroreflective lens, provided the housing is still in good shape and properly seated in the pavement. To date, most installations of snowplowable markers have been for field-test or demonstration purposes. Data on routine maintenance procedures are not available.

Research into maintenance procedures shows that each highway agency has developed methods that are effective for its own needs. What works well for one highway agency or individual crew might not produce the same results for another under the same circumstances. Effective maintenance is due to each individual crew's experiences and familiarity with equipment and local conditions. As a result, maintenance manuals are general, leaving the step-by-step procedures to the responsible agency, so long as they are within the limitations of established policy.

Roadway Delineation Practices Handbook

There are two categories of maintenance, periodic or preventive maintenance (routine), and immediate or emergency repairs (as needed). Periodic maintenance is performed to maintain the system at a safe operational level, which is defined by established policy or standards. Emergency maintenance usually involves returning a hazardous situation to a safe condition shortly after it occurs or is identified.

The approach to routine maintenance varies among highway agencies. If service life is used to schedule marker replacement, the performance history of the particular RPM and the traffic characteristics of the individual roadway sections must be known. As an example, if a certain type of laneline RPM will remain effective for six years on long sections of high-speed multilane freeways and three years in areas of heavy turning movements, then replacement of RPMs can be scheduled accordingly. Replacement is not always a cost-effective procedure even though it does not require night inspection. The number of RPMs that must be replaced may not warrant the effort, or the RPM system may be deteriorated below safe levels.

A more commonly used criterion for replacement establishes the number of missing RPMs that can be tolerated without seriously degrading drivers' visibility, particularly under adverse weather conditions. For example, the Caltrans specifies that RPMs should be replaced when eight or more nonretroreflective RPMs are missing in a 100-foot (30-meter) section and when two successive retroreflective RPMs are missing. The policy used in Florida is similar, specifying replacement if eight or more consecutive RPMs are missing. Another approach is taken in Massachusetts, where all roadways are inspected and RPMs replaced only if 30 percent or more are missing in the inspected section.⁽²¹⁾

The determination of the acceptable level of missing or damaged RPMs is based on the spacing, pattern, whether painted markings are present, and the roadway geometry. Once the level is specified, inspections must be conducted, usually at night, to identify areas where the number of missing RPMs exceeds the acceptable level. Such night inspections are usually scheduled near the end of the expected service life. In some cases, spot checks are conducted annually prior to the onset of adverse weather cycles. Inspection of roadway markings may also be included as part of regularly scheduled traffic control device inventories.

A simpler approach has been adopted by some highway agencies, such as the Pennsylvania DOT. Its policy specifies that visual inspections be conducted by maintenance workers while they are performing other roadwork; they replace retroreflective lenses as needed.⁽²¹⁾

Immediate Maintenance

Sometimes RPMs must be replaced as soon as possible because roadway delineation has severely deteriorated. Immediate maintenance is important from the standpoint of legal responsibility, as discussed in chapter 12. Though it does not occur often, major accidents or natural disasters may damage or remove a large number of RPMs in a short time period. The most common instances of this situation are in construction work zones or unexpected snow or ice storms. In areas of regular seasonal snowfall where RPMs are used, inspection and maintenance of RPMs after the snowfall season is usually considered routine maintenance.

In addition, areas where immediate maintenance is required can be determined by a routine inspection. A high-accident or other potentially dangerous situation may be discovered where delineation is locally degraded below acceptable levels, while the overall roadway section inspected may be adequate.

When self-adhesive RPMs are used for temporary delineation on roadways through, or adjacent to construction work zones, inspection and maintenance are critical safety considerations. In particular, areas of heavy construction traffic should be carefully monitored and missing RPMs replaced. RPM inspection is often a shared responsibility with the contractor; some highway agencies attempt to make it the sole responsibility of the contractor. The courts, historically, have not been lenient toward highway agencies in accident litigation. The cost of monitoring locations where delineation is often deteriorated is minuscule compared with the cost of legal judgments in accident cases.

RPM Replacement Process

Roadway Delineation Practices Handbook

Efficient replacement of damaged RPMs is becoming vital for cost-effectiveness in States that employ RPMs. Caltrans is probably the largest user of RPMs in the United States. State policy mandates a system of RPMs for all freeways and a majority of secondary roads. There is also little snowplowing in the State. Caltrans now replaces more than 1.6 million retroreflective and nonretroreflective RPMs each year.⁽²¹⁾

While not applicable to all situations, the various Caltrans districts have developed several interesting shortcuts in RPM replacement. For example, on some freeways where two successive retroreflective RPMs are badly damaged, another retroreflective RPM will be placed immediately in front of the defective RPM. Replacement can be accomplished quickly, since time is not expended in removing the original RPM. It is not unusual to find random groups of two and three damaged retroreflective RPMs lined up near a new RPM.

Caltrans districts also schedule replacement on long sections of roadway for early mornings on weekends when the process will not be too disruptive to traffic. Whenever possible, other site maintenance is scheduled for the same period to take advantage of lane closure and other protective activities. The simplest form of operation consists of a crew member walking alongside the epoxy-dispensing truck and indicating what RPMs are to be replaced. Another worker, located in the well of the truck, activates the epoxy dispenser that extrudes a measured quantity of the mixed epoxy onto the bottom side of the RPM. It is then firmly placed next to the damaged RPM or near the location where a RPM has been lost. A third worker follows the truck and removes the old RPM by hammer and chisel with one or two taps and disposes of it in a hopper in the back of the truck. Cones and protective vehicles are used as needed to protect the crew and the RPMs from traffic. The replacement operation can move at 1 to 3 miles per hour (2 to 5 kilometer/hour) depending on the number of RPMs to be removed and replaced.

A new mobile system for replacing RPMs lost to traffic wear is saving the Washington State DOT more than \$2 million per year.⁽⁷¹⁾ Washington, where more than two million RPMs need to be replaced each year, obviously has a costly portion of its budget invested in RPMs. The contracted price for replacement in the past has been \$2.40 per unit.

As implemented, the new system has resulted in savings of approximately \$1.05 per unit. The previous method, which was similar to the Caltrans process just discussed, was time-consuming, and therefore costly. Traffic patterns were altered by deploying cones, and each RPM was fastened with a two-part epoxy. Traffic restrictions were in effect until the RPMs were in place and the epoxy adhesive was fully set. The installation process in a given area could take as long as 3 1/2 to 5 hours. A crew of six workers was used.

With the new system, a crew of four workers with three vehicles does the same area in 20 to 25 minutes. The replacement operation is performed by pulling a special trailer forward over the designated area for the new RPM. A quick-setting bituminous adhesive is squirted onto the pavement. The operator uses a wand with a 1 square inch (645 square millimeters) vacuum pad to pick up a RPM, place it firmly on the adhesive spot, press it to the spot, and then cut off the vacuum to let go. The truck then moves to the next gap in the RPMs.

A vacuum is used for the application because it is cheaper than a mechanical means of picking up and placing the RPM. A vacuum is also easy for the operator to turn on and off precisely. The advantage of the bituminous adhesive over two-component epoxy is that it sets in 7 to 15 seconds, allowing placement to be a continuously moving operation. Traffic control and costly engineering work, such as lane closure, are not needed. The crew does not cause the inconvenience to the traveling public that the previous technique caused.

Whatever means are used for replacement, semiannual night inspection of sections containing RPMs is necessary. The highway sections chosen are those with RPMs nearing the end of their expected service life. Inspections are normally conducted by the maintenance engineer and staff who determine the scheduling priority. The criteria by which States judge that replacement operations are warranted is discussed in the section on Routine Maintenance levels.

Specific Maintenance Concerns

When RPMs are used to supplement painted markings, a problem may occur during repainting operations. Regardless of the RPM's location in relation to the marking, there is a potential for painting over the RPM, rendering it

Roadway Delineation Practices Handbook

ineffective.

Many large-scale stripers have an electronic skip line timer device. The device allows the operator to set a particular pattern for retracing. The retracing pattern is not always effective because patterns may change within a section or may not have been applied perfectly originally. In these cases, the operator must use the off-on toggle switch to activate the spray gun. Manual operation slows the project and requires such concentration from the operator that replacement operators must be available to alternate after short periods of operation.

In recognition of the retracting pattern problem, the FHWA initiated a research project with the State of California to develop an instrument that would detect the presence of a retroreflective RPM and terminate painting accordingly.⁽⁷²⁾ An optical Retro-Skip Device (Caltrans, Sacramento, CA) was developed and successfully tested at speeds up to 65 miles per hour (105 kilometers per hour) with approximately 99 percent accuracy. The only drawback was that the paint guns could not operate fast enough at higher speeds.

The Retro-Skip device works well on either PCC or AC pavement. Retroreflective RPMs in poor condition cannot be detected and will be painted. Therefore they can be easily detected and replaced. The Retro-Skip device is installed easily on any marking equipment that has a gun control. The detector box is mounted 6 inches (150 millimeters) above the pavement and was designed to fit typical paint trucks.

The equipment is in use currently in California and shows promise in decreasing the number of RPMs that are painted over.

Cleaning

During hot, dry periods, road film, oil, grease, and other debris will seriously degrade the retroreflectivity of RPMs. It is also noted that tire marks can stain nonretroreflective ceramic RPMs so that they are no longer visible during the day or at night. Most of the commonly used RPMs are self-cleaning when wet, to some extent. Loss of delineation from staining is therefore not a critical problem in geographic areas that normally experience summer rains. It can become significant in hot, dry areas of the West and Southwest.

Because of the long, hot, dry summers experienced in parts of California, the feasibility of cleaning RPMs was investigated. RPM film was not easily cleaned with any of the common organic solvents, but was easily removed with a cleanser containing a fine abrasive, indicating that the film was primarily rubber from tires.

Knowing that the RPMs were covered with rubber residue, a RPM washing unit was developed in the State's equipment shop. The unit consists of a brush 14 inches (355 millimeters) wide and 18 feet (5.5 meters) long with 4-inch (100-millimeter) nylon bristles impregnated with an abrasive. The washing is mounted to the side of a 2-ton truck. A detergent water solution is carried on the truck and supplied to the brush during the cleaning operation. The device folds into three sections for easy transport. The unit was successfully used in five Caltrans districts. The State reported that, though effective, the equipment had not been developed beyond the experimental stage.

Retroreflective Tabs

Recently, use of temporary retroreflective RPMs has expanded. These RPMs are small flexible tabs, backed with an adhesive pad, that are applied by hand to the pavement. A small strip of retroreflective material is attached to the tops.

States have begun to find these inexpensive tabs as effective as removable tape for short-term (less than two weeks) marking applications. This mainly applies to construction and maintenance zones.⁽⁷³⁾

Short-Term Chip Seal

One highway agency found a good use for retroreflective tabs. In a bituminous surface treatment, such as a chip or

Roadway Delineation Practices Handbook

slurry seal, existing pavement markings are completely destroyed. The process of putting the flexible tabs over the existing markings before the seal coat is applied is now being used.⁽⁷²⁾

The seal coat will not usually destroy the tabs, which provide some guidance to the driver until permanent markings can be provided. The tabs also guide the operator of the marking equipment.

INSPECTION

Inspection of RPMs is simple. Most highway agencies have inspectors drive a roadway section at night and subjectively rate visibility and count the number of missing RPMs. Some highway agencies maintain photographic or videotaped inventories of roadways that can be used to inspect RPMs.

One inspection system proposed in Texas includes a photographic inventory combined with panel evaluations of retroreflective effectiveness. This system is discussed in more detail in chapter 11.⁽⁷⁴⁾

CHAPTER 8. OTHER MARKING MATERIALS

INTRODUCTION

In addition to the conventional paints, thermoplastic, and preformed tapes used as pavement marking materials, a number of other materials are used less-widely. Also, recent years have seen the introduction of a number of experimental materials. These materials have grown out of a variety of problems with current materials that have unacceptably high costs to environmental concerns.

This chapter describes some of the alternative materials, and also introduces a few of the new materials that have been tried. Where available, evaluations of each material's effectiveness and economy are included.

USES

The uses of other marking materials are the same as those of conventional pavement marking materials. These materials may be more or less well-suited to a particular area, based on the delineation variables. For example, water-based paints are often not recommended for application during periods of high humidity. More of these concerns are discussed for each material.

TYPES

A wide variety of materials have been tried as pavement markings. Alternatives have been tried for many reasons, from environmental to the desire for year-round durability in a standard pavement marking. Not all these attempts have been successful. In this chapter, we will cover only those materials that have met with some success.

Latex Paint

One of the major concerns with traffic paint has been the environmental hazard created by its use. Volatile organic compounds (VOCs) are released into the atmosphere by the solvents in paints, and the pigments used are often lead based. There have been concerns that the lead from these pigments may end up in the water table after the markings have worn off the roadway.

These environmental concerns are discussed in more detail in chapter 4. These environmental problems are important, because traffic paint is by far the most widely used marking material. While thermoplastic materials do not

Roadway Delineation Practices Handbook

cause the same types of environmental concerns as paints, they are significantly more expensive.

One widely publicized material, proposed as a solution to the environmental problems with paint, has been water-based, or latex paints. These materials are similar to conventional paints in theory of operation, but the hazardous materials have been removed.

The study discussed in chapter 4 investigated alternatives to conventional lead-based pigments. Currently, no definitive alternative has been established to lead-based pigments. None of the materials tested exhibited the excellent yellow color durability achieved by the paints using lead-chromate pigments.

Epoxy Paint

Two-component epoxy paints were developed in the early 1970s by the Minnesota DOT, in conjunction with the H.B. Fuller Company. Their objectives were to create a durable, sprayable material that would adhere to both bituminous asphalt and Portland cement concrete (PCC) pavements with good abrasion resistance. Major concerns about formulating the product involved acceptable cure times, bonding characteristics, and color retention.

Twenty years later, epoxy paints have become a major alternative among pavement marking techniques. Much research has gone into their development and testing. A variety of formulations are on the market now, their manufacturers vying to be at the forefront of the technology.

Polyester, Solids

The evaluation of polyester marking materials was initiated in 1975 by the Ohio DOT in cooperation with the Federal Highway Administration (FHWA). The project was designed to evaluate color, durability, and retroreflective performance of this type of material for a three-year period.

Polyester markings have not been used extensively nationwide. Experience with the material has been limited to the Mid-Western States. Michigan DOT is a principal user. It is recommended for asphalt roads having medium- to high-volume traffic. Highway agencies have not shown much enthusiasm for polyester material because of its slow drying time. In cooperation with a major paint manufacturer, Michigan DOT has developed a new material that dries to no track in 60 seconds. The fast-dry polyester material should find an increased usage throughout the nation.

Epoxy Thermoplastic

Epoxy thermoplastic (ETP) is a generic pavement marking material composed of epoxy resins, pigment, filler, and glass beads. This material differs from most epoxies in that no hardener is used.

Two formulations have been field-tested extensively. These formulations vary in the ratio of the two epoxy resins—one a solid, the other a liquid—used in the material. A 1-to-1 solid-to-liquid ratio yields a flexible material designed for localities experiencing moderate-to-severe winter conditions. A 3-to-2 solid-to-liquid ratio was designed for regions with hot, dry summer weather. A harder material results, which is less susceptible to summer road film pickup.

Actual field testing showed that both formulations perform about equally well under severe winter conditions. However, because of its ability to resist road film pickup, the 3-to-2 solid-to-liquid formula was selected for further study.

The specifics of the original formulation for white ETP is given in table 8.⁽⁷⁵⁾ The total weight shown in the table represents a volume of 12.8 gallons (48.5 liters). This will yield a weight per gallon of 13.1 pounds (5.9 kilograms per liter).

Since the original formulation was released, many FHWA-sponsored ETP demonstration projects have been

Roadway Delineation Practices Handbook

attempted. However, ETP has not experienced large-scale use because of its disappointing cost-service life ratio. According to one of the material's producers, Pave-Mark, (Atlanta, GA) the price of one of the epoxy resins making up ETP nearly doubled shortly after the material's inception. This price increase forced the material's selling price beyond the point where its use could possibly be cost-effective.

Table 8. White ETP composition

Component	Weight	
	Pounds	Kilograms
Ciba-Geigy 7097 Araldite epoxy resin or equivalent	60	27
Ciba-Geigy 6010 Araldite epoxy resin or equivalent	40	18
Dupont R900 titanium dioxide or equivalent	20	9
Georgia Marble Cal White Pigment Grade Calcium Carbonate	20	9
Cataphote Division (Ferro Corp.) Premixed Gradation reflective glass beads or equivalent	28	13
TOTAL	168	76

The majority of the ETP demonstration projects took place from 1980 to 1986. In terms of the material's cost-effectiveness, the high-priced materials in its formulation, the results of these tests were not promising. Currently, there are no major users of this marking material. However, Pave-Mark announced another change in the price of the epoxy resins used in the past to manufacture the material and released a new ETP product in 1992.

Methyl Methacrylate

Methyl methacrylate has been introduced and publicized as a nonhazardous, field-reacted, two-component, cold-curing material. Vendors recommend that the material be applied in a 4-to-1 resin-to-catalyst mixing ratio. It is a 100 percent solids formulation that is mixed in a static mixer just before application. The material can be applied by either a spray or extrusion process. The mixing reaction at the time of application is exothermic. As the material cools, it bonds to the pavement.

Marking Powder

One new material has been promoted by vendors in the marking industry. It consists of a form of powder that is combusted as it is deposited on the pavement. The heat and phase change associated with the high heat of application cause the material to bond to the substrate. This material is easy to handle and apply, but obviously requires special installation equipment. The material is also claimed to be economical at about \$0.08 per foot (\$0.24 per meter) of

Roadway Delineation Practices Handbook

marking, assuming a marking thickness of 10 mil (0.25 millimeters). It is also claimed that the material has nearly instantaneous no-track times. The powder material is claimed to be hereby as durable as the most durable traffic paints. Subjective evaluations of performance, cost-effectiveness, and durability are not yet available.

Other Materials

Much of the formal research into other marking materials has been performed in New York. One study by the New York State Department of Transportation investigated a variety of materials for pavement markings.⁽⁷⁶⁾ The study was part of New York's commitment to providing a roadway delineation system with year-round durability. The NYSDOT was attempting to find a marking material with a 12-month service life, at a price similar to that of conventional traffic paint. A coal-tar and polysulfide epoxy formulation, among other unique ideas, was attempted. To date, none of these new materials has exhibited a favorable cost-service life ratio as compared with conventional traffic paint.

PERFORMANCE

Performance is a very important factor for other marking materials. Since so many of the materials discussed in this chapter require specialized installation equipment, they must have good cost-to-service life ratios, or highway agencies will not be interested in experimenting with them.

Though few of these materials have undergone appreciable formal research into their performance, some characteristics relating to the performance of each type of material are discussed in the following sections.

Latex Paint

To date, the results of research concerning latex paints have been mixed. One NYSDOT study examined water-based synthetic resin emulsions that solve some of the environmental problems with traffic paint.⁽⁶⁰⁾ The study found that use of water-based paint looks promising. It cited latex paints as having the following appealing characteristics: easy cleanup and recycling of containers, minimal environmental impact, and decreased safety hazards to workers. The study of its durability, drying times, and costs were promising, but successful large-scale field experience was limited at the time of the report.

A study at the Pennsylvania DOT (Northeastern Association of State Highway and Transportation Officials [NASHTO] Regional test facility) resulted in similarly promising results.⁽²⁵⁾ Table 9 is a comparison of service lives for latex paints versus conventional paints and other materials. These are given as estimated median useful lifetimes in days. As the table shows, the water-based formulations demonstrated service lives considerably longer than those of other formulations of traffic paint in the test. However, the usefulness of these paints has been questioned in actual applications.

A survey of highway agency engineers reported in a recent issue of *Better Roads* magazine cited several problems with installation and performance of latex paints.⁽⁵⁴⁾ The engineers complained that the material does not dry as quickly as it is supposed to, especially in foggy or humid weather. One highway agency representative is quoted as saying that the water-based paint came off the road in sheets and washed away during the first rain after installation.

Further research is needed to establish what factors definitely influence the performance of water-based paint, and when it can be used in a cost-effective manner.

Epoxy Paint

In the search for a viable low-cost, year-round delineation material, NYSDOT conducted durability testing of epoxy paints.⁽⁶¹⁾ It was found to be a durable material in certain tests. In fact, their test of epoxy paint on low-volume roadways or rural expressways managed service lives of five years or more.

Table 9. Estimated service life by class (median lifetimes in days)

Roadway Delineation Practices Handbook

	<u>Arizona</u>		<u>Florida</u>		<u>Pennsylvania</u>	
	OGAFC	PCC	DGAFC	OGAFC	DGAFC	PCC
Alkyd--White	163	>900	>900	101	341	390
Alkyd--Yellow	293	>900	>900	173	258	284
Chlor Rubber--White	478	>900	>900	255	444	470
Chlor Rubber--Yellow	159	>900	368	83	389	470
Water-base--White	>703	>900	>900	>900	505	823
Water-base--Yellow	>765	>900	>900	>900	474	684
Solv. Borne Epoxy--White	755	>900	>900	436	>1100	>1100
Solv. Borne Epoxy-- Yellow	>900	>900	>900	400	>1100	>1100
Urethane--White	883	>900	>900	577	630	>1100
Urethane--Yellow	617	>900	>900	607	578	>1100
Thermoplastic--White	>900	>900	>900	824	>1100	413*
Thermoplastic--Yellow	>900	>900	>900	420	>1100	354*
Cold Plastic--White	>900	>900	>900	377	386	>1100
Cold Plastic--Yellow	>765	>900	>803	625	298	365
Foil Tape--White	>900	>900	>900	>900	NA	NA
Foil Tape--Yellow	>900	>900	>900	>836	NA	NA

NA - Not Available
OGAFC - Open-graded asphaltic concrete

DGAFC - Dense-graded asphaltic concrete
PCC - Portland cement concrete

* - Data may not be reliable due to snowplow damage

Because of these promising results, NYSDOT conducted more extensive tests, marking 3,500 miles (5,635 kilometers) of roadway with the epoxy paint material.⁽⁷⁷⁾ Most of these installations performed well, but a few showed little or no durability. In most cases the epoxy seemed less sensitive to application factors than did thermoplastic materials. These results suggest that the problem might lie with unknown environmental factors or improper marking practices. Because field experience with epoxy paint is so limited, it is difficult to tell what may have caused these early failures.

Polyester

Field observation of this product indicated that the material is generally performing well and should continue to be serviceable for several years. In some areas with heavy traffic volumes, the polyester markings were worn out after one year of service. In these areas, paint lasts only three months.

The project demonstrated that polyester markings are more opaque than paint applied under similar conditions and look better during the daytime than two coats of paint. Nighttime visibility of polyester markings also is superior to that

Roadway Delineation Practices Handbook

of paint because of the increased number of beads used.

A more recent research project in Pennsylvania tested 11 different samples of polyester marking materials. The estimated service lives derived for the white and yellow markings can be seen in table 10. These can be compared with the values for the other classes of materials tested, shown in table 9.

Table 10. Durability of polyester marking materials

WHITE

Material Class	Material Number	Estimated service life in days on DGAFC	Estimated service life in days on PCC
Polyester	91		1082
Polyester	92	>1100	
Polyester	97	>1100	
Polyester	98		>1100
Polyester	99	>1100	
Polyester	100		>1100
Polyester	101		>1100
Average White		>1100	>1096
Median White		>1100	>1100

YELLOW

Material Class	Material Number	Estimated service life in days on DGAFC	Estimated service life in days on PCC
Polyester	93	447	
Polyester	94		1024
Polyester	95	769	
Polyester	96		722
Average Yellow		608	873
Median Yellow		608	873

Epoxy Thermoplastic

Roadway Delineation Practices Handbook

Despite the woeful cost-service life ratio for ETP reported in the previous section of this chapter, the recent pricing change in epoxy resins in the material's formulation has caused the Pavemark Corporation to re-enter the market with an ETP product.

Pavemark estimates the new material will last about six times as long as conventional alkyd traffic paints under similar traffic and climatic conditions, at a contracted cost about 4.5 to 5 times that of standard paints. If this ratio can be achieved, ETP's fast no-track times and ability to work equally well on nearly any surface may again make it an attractive alternative to conventional traffic paints.

Methyl Methacrylate

Vendors cite methyl methacrylate as a durable material that is a viable option for environmental concerns. They claim service lives of from 3 to 10 years at costs similar to those of epoxy. In addition, the material is designed to be resistant to oils, antifreeze, and other common chemicals found on the roadway. Actual experience has been limited.

Various formulations of methyl methacrylate were tested by the Pennsylvania study.⁽²⁵⁾ The service lives obtained for these materials are shown in table 11.

The other materials discussed have not shown significant merit, or experience is so limited that performance factors are not discussed here.

INSTALLATION, MAINTENANCE, AND REMOVAL

Installation, maintenance, and removal concerns for the marking materials discussed in this chapter are the same as for standard traffic paints. Factors, such as line protection, crew safety, application width and geometry, and warehousing and storing of material, are fairly standard for longitudinal marking applications. Some concerns, such as protection of the new marking, will depend more on each specific material's formulation (drying time) than on the class of materials to which it belongs. Some specific information related to each class of material is given in the following sections.

Table 11. Service lives of methyl methacrylate marking materials

State of Test	Estimated Service Lives (Days)			
	<u>Arizona</u>		<u>Florida</u>	
	OGAFC	PCC	DGAFC	OGAFC
Average (White)	>900	>900	868	>900
Average (Yellow)	803		>900	
Median (White)	>900	>900	>900	>900
Median (Yellow)	835		>900	

Latex Paint

Handling of latex paints is simpler than for standard paints since the water base in these paints is not toxic.

Latex paints are a particularly attractive option because they do not require special installation equipment. In

Roadway Delineation Practices Handbook

addition, the equipment that is used is much easier to clean up because of the lack of environmental hazard from these paints. These factors do not generally apply to new, experimental materials.

Epoxy Paint

Epoxy compounds are supplied in both white and yellow and normally are applied at a thickness of about 15 mil (0.38 millimeter). It can be installed without coning depending on the amount of glass beads used. The slower curing, less expensive formulas are intended for edgelines. The curing time varies according to the temperature of the pavement. The higher the temperature, the faster the material cures. It can be applied, however, at temperatures as low as 35 degrees Fahrenheit (2 degrees Celsius). If free surface water is removed first, epoxy can even be applied to wet pavements.

To obtain the best bond, the surface must be clean. Because this material is not affected by dampness, the surface may be cleaned by a hot-water 150 degrees Fahrenheit (66 degrees Celsius), high-pressure 2000 pounds per square inch 13,800 KPa spray. The spray gun can be located just ahead of the epoxy spray gun. Between the water spray and the epoxy spray, there should be an air nozzle to remove free water. Epoxy paint cannot be placed over markings made from other materials.

Equipment

Epoxy paints cannot be applied from standard stripers. In the initial attempts, the two-part epoxy could only be applied with Fuller's striper. Now, contractors that apply epoxy markings for DOTs normally have their own specially designed stripers for epoxy application. These stripers usually have a high-pressure water nozzle, followed by an air blast nozzle, and finally the epoxy and bead nozzles. The epoxy must be mixed immediately before being sprayed onto the pavement. This requires additional hardware for the separation of the epoxy components before application, and mixing nozzles ahead of the spray nozzles.

However, there are some methods for modifying standard stripers. A number of highway agencies and contractors customize their own stripers to meet the needs for epoxy application.

Polyester

Polyester marking material is applied at a thickness of 15 mil (0.38 millimeters) with a drop-on bead application rate of 20 pounds per gallon (34 kilograms per liter). The two-component polyester system (resin and catalyst) will dry to a no-track condition in less than 30 minutes, provided the pavement is dry and the temperature is at least 60 degrees Fahrenheit (13 degrees Celsius). Faster drying times are achieved at higher temperatures. Typical drying times range from 8 to 12 minutes at 75 degrees (24 degrees Celsius). Because the film-forming mechanism is not an evaporation process, it can be applied at temperatures as low as 0 degrees Fahrenheit (-18 degrees Celsius) with proportionately longer drying times. Michigan DOT has developed a fast-drying polyester material for use.

This product does not adequately bond to PCC and its indicated use is for asphaltic pavements. However, it can be applied, however, over existing markings.

When polyester markings are applied to new asphalt surfaces, the polyester flakes off with the surface aggregate particles due to the presence of free oils. This creates a marking that appears full of holes when closely examined. This "Swiss cheese" effect does not harm visibility when viewed from a normal distance. This effect usually occurs within two months of application. After this initial loss, no further deterioration occurs. Michigan DOT does not apply its fast-dry polyester on AC pavements less than one year old.

Safety of workers is of prime concern when handling and applying polyester marking material. While the resin is not much more difficult to handle than paint, the methyl ethyl ketone peroxide catalyst is a noxious chemical requiring careful handling. Gloves and safety goggles should be worn when handling the material and during the marking operation.

Roadway Delineation Practices Handbook

Equipment

Like all field-reacted materials, polyester markings require special equipment for installation. Truck-mounted equipment is recommended. Conventional marking trucks can be modified for about \$4,500 to \$6,000.⁽⁷⁸⁾ A speed of 8 to 10 miles per hour (13 to 16 kilometers per hour) can be maintained when applying longitudinal markings.

Epoxy Thermoplastic

ETP is applied by the hot spray process at a temperature of 425 to 450 degrees (217 to 232 degrees Celsius). A top dressing of drop-on beads is applied almost simultaneously with the spray gun operation. Under certain conditions, no-track times of 5 seconds have been measured in the field. These fast no-track times often require that drop-on glass beads be heated so that they can sink to the proper depth in the film.

Application thickness ranging from 15 to 25 mil (0.40 to 0.64 millimeters) have proved durable on both asphalt and concrete pavements. Primer is not required for this application.

While the optimum application pressure and temperature have not been determined, the ETP demonstration projects discussed earlier found that the material was very sensitive to these variables. If new formulations of the material prove to be cost-effective, research will be needed to establish more precisely the optimum values for these variables. It appears that, though the material is very sensitive, it also can give excellent results if the application variables are properly determined and closely controlled.

As an example, one early project even managed to successfully apply ETP in below-freezing weather by varying application characteristics. For an installation in Denver, Colorado, the application temperature of the material was elevated to 485 degrees Fahrenheit (251 degrees Celsius), and was applied to a surface at a temperature of 22 degrees Fahrenheit (-5 degrees Celsius). The air temperature was 31 degrees Fahrenheit (4 degrees Celsius). No problems were experienced with this application. After one year, the site showed excellent bead retention and no discernible wear. If this performance could be repeated reliably, the range of climatic conditions under which pavements can be marked could be significantly expanded.

Methyl Methacrylate

Methyl methacrylate shows promise for ease of application. A variety of temperatures can be tolerated, and the material can be sprayed at a 40-mil (1.0- millimeter) thickness or extruded at 90 mil (2.3 millimeters) for transverse applications. Methyl Methacrylate is claimed to bond well to PCC pavements.

Equipment

Methyl methacrylate is a field-reacted material that cannot be applied using standard strippers. However, companies that sell methyl methacrylate marking materials will often also vendor their own special equipment for application of the material. This is similar for marking powders. The equipment it requires is similar to that required for epoxy application but is specialized nonetheless. Though the initial cost for buying these types of special equipment may be high, equipment costs are usually negligible when they are amortized over the life of the marking.

OTHER CONSIDERATIONS

The major factor inhibiting the use of new types of pavement marking materials is inertia. State and local highway agencies often are reluctant to change from products that they have used for a long period of time unless they can be convinced that the change will save a considerable amount of money.

In addition, many of these new materials require special installation equipment for field testing. As a result of the high initial investment required, highway agencies have been sluggish in adopting materials that seem to be more

Roadway Delineation Practices Handbook

cost-effective than their current materials.

The following sections discuss some of the cost concerns with the marking materials discussed in this chapter, and also the ways in which some of the materials have shown promise for increased use in the future.

Cost Considerations

Determining the optimum marking material for a given application can be complicated, even if exact costs are known for all possible materials. Of more concern to highway agencies is the ratio of cost-to-service life, and it always is difficult to predict how long a marking might last on a particular roadway. In addition, disruption to traffic and worker safety must be considered. Markings with very short service lives are not acceptable, even if they are very inexpensive, because a major portion of their marking cycles is spent simply waiting to be marked over after they have deteriorated to an unacceptable visibility level.

Keeping in mind that the following is a very superficial treatment of a very complex subject, some of the major cost issues are covered in the following sections for each of the marking materials discussed in this chapter.

The Minnesota DOT reported that a typical lane mile of skip markings could be painted five and one half times for the cost of one application of epoxy paint.⁽⁷⁸⁾ If the epoxy is serviceable for two years on high-volume roadways that are normally painted three times a year, the higher cost would be justified. Moreover, the marking crew would be exposed to traffic once instead of five to seven times. It would also provide a traffic delineation system throughout the winter season, which is not possible with paint.

Polyester

It is apparent that polyester markings perform better on asphalt pavements than conventional or fast-drying paints and some plastic materials. The initial cost is higher than that for paint and lower than that for two-part epoxy. Experience at the NYSDOT puts the price at about \$0.07 per linear foot (22 cents per linear meter) in 1984.⁽⁶⁰⁾ The Michigan DOT has been using polyester for urban materials in the Detroit area at a cost of 6.5 cents per linear foot (21 cents per linear meter).

It is obvious that if the service lives demonstrated in the Pennsylvania DOT study (shown in table 10) can be consistently repeated, polyester will be one of the most cost-effective materials available.

Epoxy Paint

A cost comparison of conventional paint, epoxy paint, and thermoplastic material is given in table 12. These costs are taken from a revision to the Kansas DOT marking policy executed in 1988.⁽⁷⁹⁾ The material cost for epoxy ranges between thermoplastic and paint at about 17 to 25 cents per linear foot (54 to 80 cents per linear meter).

Epoxy Thermoplastic

Pave-Mark estimated that the new formulation of ETP marketed in 1992 could be contract-installed for a price of around \$0.18 cents per linear foot (\$0.59 per linear meter). However, costs for retrofitting State marking equipment to use ETP would require a high initial investment in the new technology by highway agencies. However, if the funds are amortized over the life of the equipment, ETP may attain a favorable cost ratio when compared with conventional traffic paints. The higher initial costs for ETP are balanced by the reduction in marking operations.

At \$0.17 to \$0.18 per linear foot (\$0.57 per linear meter), ETP would cost about 4.5 to 5 times as much as contract-installation of conventional traffic paint. If the material can be made to last six times as long traffic paints, the material will be cost-effective. Manufacturing and retrofitting costs will be negligible for large-scale use of ETP.

Table 12. Comparison of installed costs

Installed Cost	Paint*	Thermoplastic**	Epoxy**
Per Linear Foot	\$0.04 to \$0.06	\$0.40 to \$0.60	\$0.40 to \$0.45
Per Linear Meter	\$0.13 to \$0.20	\$1.31 to \$1.97	\$1.31 to \$1.48
Service Life (Years)	0.25 to 1	3 to 5	1 to 2
Cost Per Linear Foot	\$0.04 to \$0.24	\$0.08 to \$0.20	\$0.40 to \$0.225
Cost Per Linear Meter	\$0.13 to \$0.79	\$0.26 to \$0.66	\$1.31 to \$0.74

* - Costs in Kansas for installation by KDOT workers

** - Costs in Kansas for contracted installation

Potential For Future Use

Technology transfer is one of the problems with any new material or device designed to save money or increase safety on highways. It always is difficult to get highway agencies to change established practices, and the high initial investment in new equipment for alternative marking technologies further discourage their use. The following sections discuss the promise shown in the past by each material, and its prospects for the future.

Epoxy Paint

Though epoxy paints have been around since the early 1970s, to date they have not experienced large-scale use. Unfamiliarity with the application equipment and procedures may be a factor. Research suggests that the two-part epoxy marking system is a cost-effective alternative to alkyd paint, even in contract applications. Areas with harsh winter seasons particularly should consider using epoxy paint, because it is so resistant to abrasion from the usual snow and ice control activities.

Polyester

Experience with polyester materials is limited, and not much information about their use has been disseminated. The service lives demonstrated in the field studies may be unrealistic to achieve on a regular basis. More basic research is needed on the factors and delineation variables that most profoundly affect this marking. When this research is completed, more widespread use of the material may become feasible.

Epoxy Thermoplastic

In addition to its extremely short no-track time and its excellent performance on all pavement types. ETP has several other distinct advantages. It is a 100 percent solids formulation and is virtually smokeless at application temperatures. These properties are helpful when considering environmental impact of marking operations.

EPT has shown promise for large-scale implementation. Efforts to encourage increased use by State DOTs and other highway agencies are under way. A model ETP composition specification has been produced and work continues on retrofitting designs for existing marking equipment.

CHAPTER 9. POST-MOUNTED DELINEATORS

INTRODUCTION

Daytime delineation of the roadside generally can be accomplished effectively with pavement markings. Night visibility, however, often requires a different approach to provide long-range delineation of the roadway alignment. Another problem is providing visibility during periods of rain or snow when most pavement markings are obscured. Post-mounted delineators (PMDs) of various forms have gained widespread acceptance as a roadway delineation treatment.

This chapter addresses the uses and types of retroreflective PMDs as defined in the *Manual on Uniform Traffic Control Devices (MUTCD)*.⁽¹⁾ Object marking is not included here but is addressed in chapter 10.

USES

The purpose of post delineation is to outline the edges of the roadway and to accent critical locations. The use of PMDs as a delineation device has been accepted by the Federal Highway Administration (FHWA), The Institute of Transportation Engineers, and the American Association of State Highway and Transportation Officials. As a result, PMDs are recommended for the entire Interstate System.

The *MUTCD* (section 3D-1) defines these devices as follows: “Road delineators are light-retroreflecting devices mounted at the side of the roadway, in series, to indicate the roadway alignment.”

These delineators usually are mounted on posts 4 feet (1.2 meters) above the pavement. Under normal atmospheric conditions, they should be visible at a distance of 1,000 feet (305 meters) when illuminated by the high beams of standard automobile headlights. The retroreflective element should have a minimum dimension of 3 inches (76 millimeters).

The *MUTCD* further states that “delineators shall be provided on the right side of expressway roadways and on at least one side of interchange ramps.” They also are recommended for use on certain median crossovers, acceleration or deceleration lanes, and transition situations.

One study reported that drivers react most favorably to delineators on curves of 7 degrees (0.122 radian) or less.⁽⁸⁰⁾ For sharper curves, some other form of extra delineation should be used, such as chevron alignment signs.

Between interchanges on well-lit roadways, PMDs are optional. Fixed overhead lighting tends to wash out the retroreflection from PMDs, rendering them ineffective at night.

Large white-faced target plates have been used on PMDs where daylight route guidance is needed. Where post delineation is required in the vicinity of a guardrail, as on a horizontal curve, the pattern should continue uninterrupted through the guard-rail section. The PMDs should be placed behind the guardrail. In these cases, the guardrail retroreflectors may be eliminated.

In all cases, the color of PMDs must conform to the color of edgelines stipulated in the *MUTCD* section 3B-6. The *MUTCD* standardizes certain characteristics, such as mounting height, number, spacing, and color of retroreflectors; criteria for retroreflective elements; and required locations. It specifically does not address physical characteristics. The types of posts used and other functional considerations are to be determined by the State or local highway agency. Nonetheless, the *MUTCD* should be consulted to ensure uniformity and consistency in usage.

Roadway Delineation Practices Handbook

In actual practice, there appears to be little consistency in the use of PMDs. Requirements, such as height and placement in relation to the shoulder, are standardized. Most inconsistencies are found in the size, shape, and color of the retroreflective unit, spacing between PMDs, and the warrants for installation. Since the *MUTCD* is relatively permissive in these areas, PMD systems vary not only from State to State but between districts and even within districts.

Although PMDs have proven safe, standardization of PMD use is unlikely in this era of tight budgets. Tradeoffs must be made when selecting a delineation technique to get the best value for a certain cost. In this context, the value of long-range delineation and night visibility attained with PMDs should be recognized. This is especially true considering these devices' low ratio of cost-to-service life.

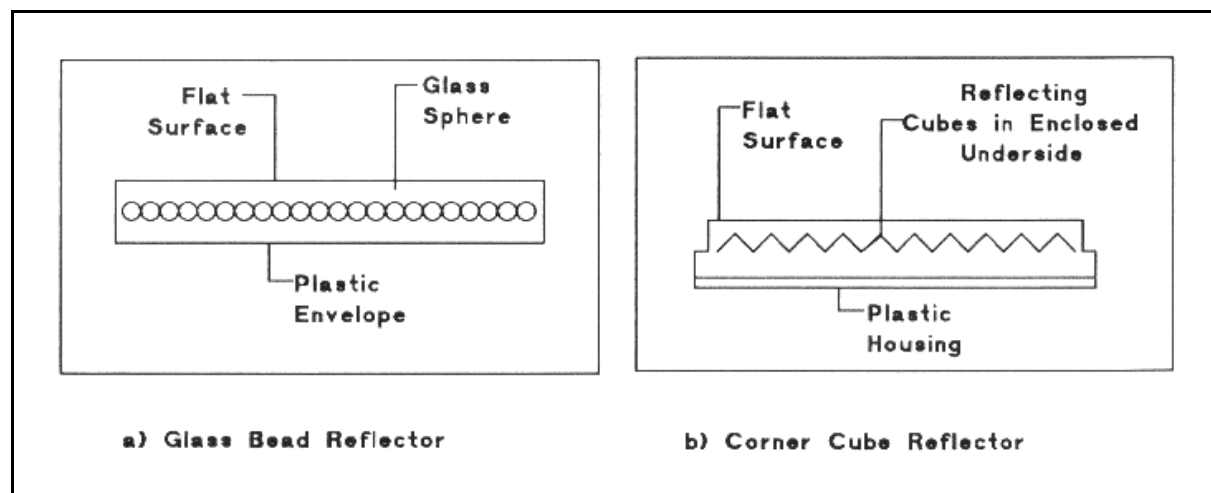

Figure 57. Post-mounted delineator retroreflective techniques

MATERIALS

A PMD usually consists of a retroreflective element, the support or mounting post, and possibly a backplate. A variety of materials is available for each of these components. The basic components and their physical characteristics are discussed below.

Retroreflective Element

The most common retroreflective devices use either a glass-bead impregnated sheeting or cube-corner prismatic unit to provide retroreflection. In both cases, the optical elements are enclosed and sealed in a plastic housing or envelope (figure 57) to retain retroreflective properties when exposed to rain. The cube-corner units are much brighter than those with retroreflective sheeting; white retroreflectors of either type are brighter than yellow. A variety of optical elements are used by manufacturers to obtain wide-angle retroreflection.

The retroreflective inserts for PMDs are available as pressure-sensitive disks or they are mounted within an aluminum case. One version of this device is characterized by a honeycomb pattern. It provides an air gap between the top surface and the beaded layer.

The typical cube-corner retroreflector consists of a clear and transparent plastic face covering approximately 7 square inches (4,375 millimeters squared) of retroreflective area. A plastic-coated metallic foil backing is fused by heat and pressure to the retroreflective surface. The entire unit, including the 3/16-inch (4.8-millimeter) grommet for center mounting, is permanently sealed against dust and moisture.

A new type of PMD using retroreflective sheeting for visibility is gaining popularity with the States. It consists of

Roadway Delineation Practices Handbook

rectangular sheeting material attached directly to a flexible delineator post. A typical delineator post is illustrated in figure 58. These delineators are used widely because of their ease of maintenance and their ability to survive more than one impact from a vehicle.

Mounting Post

The materials of the support element of PMDs traditionally have been limited to a 3.5-inch (88-millimeter) U-channel iron post (usually galvanized), 0.75-inch (19 millimeter) standard black pipe, or 2- by 2-inch (50- by 50-millimeter) timber post, preferably cedar or redwood. Because they are close to the roadway, vehicles often hit PMDs. These knockdowns present a costly maintenance problem and are a hazard to the impacting vehicle.

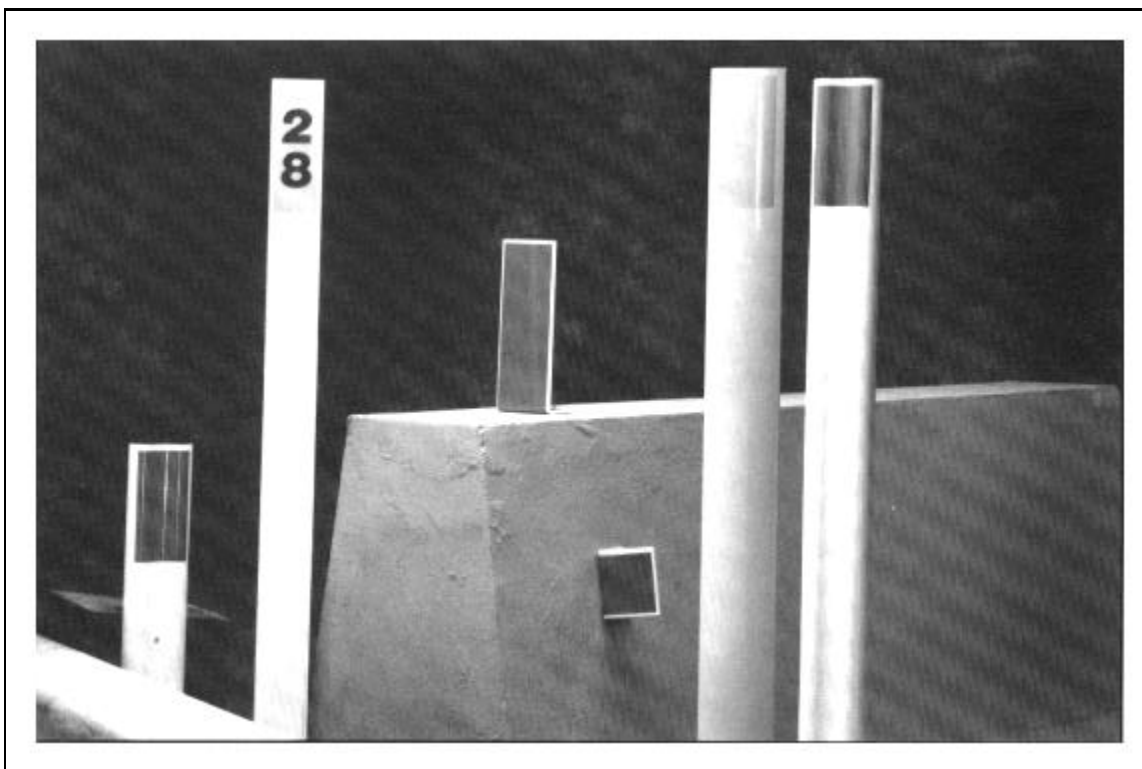

Figure 58. Typical dimensions for flexible delineator posts

For these reasons, the flexible delineator posts mentioned are becoming more widely used. These new posts reduce the hazard to impacting vehicles as well as the replacement cost. The most promising approaches include impact-resistant flexible posts. A yielding system that will stay down after impact, and colored posts to help prevent impacts.

The use of flexible PMDs has grown because the cost of replacement often reached unacceptable levels. By the late 1970s, for example, California had approximately 600,000 PMDs in place that required 300,000 repairs annually. Many PMDs are hit several times a year. In 1978, California budgeted almost \$1.6 million for PMD system maintenance. Replacement cost ranged from \$6 to \$8 each.⁽⁸¹⁾

Because costs for PMD maintenance were becoming so exorbitant, the CaliforniaDOT (Caltrans) tested a number of commercially developed plastic posts of two basic types: driveable, and nondriveable.⁽⁸²⁾ The driveable post is forced into the ground like a metal post and requires considerably less work and time to install than the nondriveable post. Nondriveable posts are of two types: those that require back filling in the interior and around the outside of the post and those that do not. Flexible units also are equipped with retroreflective sheeting rather than prismatic buttons. This helps

Roadway Delineation Practices Handbook

prevent damage to the retroreflective unit upon impact.

Each post was subjected to up to 10 vehicular impacts at 55 miles per hour (89 kilometers per hour). Although some posts reacted better than others, the test program conclusively demonstrated that impact-resistant plastic delineation posts are a viable alternative to rigid steel posts.

After the 1978 study, Caltrans recommended flexible posts where the life of a metal post is less than one year. Locations with short radius curves and high approach speeds also warrant their installation.

Since Caltrans's early tests, many commercial models of flexible PMDs have become available. Many States use these delineators, and some have created their own designs. A Colorado study tested six different models of flexible delineators by subjecting them to both warm and cold weather impact tests as well as a one-year roadside evaluation.⁽⁸³⁾ The results were used to determine a cost-per-hit index based on delineator initial and replacement costs. A specification for use in Colorado is proposed for the testing and prequalification of flexible delineator posts.

The Wyoming Highway Department, in cooperation with the FHWA, developed a two-part delineator post that has no recoil and stays down after impact. The anchor is a triplex socket consisting of a shaft and stabilizer fins to hold it rigid in the ground. The post, which slips into the anchor, may be a 1 1/2-inch (37.5-millimeter) outer-diameter thin-walled electrical metal conduit or a 1 1/2-inch (37.5-millimeter) inner-diameter high-density polyethylene tubing fitted over a 24-inch (61-millimeter) metal conduit.

Three holes are punched in the pipe 4 inches (102 millimeters) from the bottom to ensure that it will lie flat when hit. A small portion of the pipe is bent rather than broken, which keeps the pieces together and prevents them from flying through the air after impact.

The electrical metal conduit may be reused up to three times when installed in areas with speed limits of 40 miles per hour (64 kilometers per hour) or less. The broken end is simply cut square, new holes are punched, and the post is reinserted in the anchor. The polyethylene assembly may be reused a number of times by replacing the 24-inch (610-millimeter) metal sleeve.

Wyoming estimated a cost of \$3.25 per unit for the metal conduit post and \$4.25 for the polyethylene unit. Labor included, the total cost should be about \$4.50 and \$5.75, respectively. The cost of replacement, including labor, is expected to be less than \$2.00 per unit. The Wyoming Highway Department has recommended that other highway agencies consider implementation of this system as a safe and cost-effective alternative to the steel post.⁽⁸⁰⁾

PERFORMANCE

When rated for visibility and durability, most PMDs rate highly in both categories. The cube-corner retroreflector provides more nighttime brightness than reflective sheeting, but both provide adequate long-range delineation. PMDs usefulness is particularly evident in adverse weather and low visibility conditions. They are not effective in areas with moderate to high ambient light levels; they are not recommended for use with reliable fixed roadway illumination.

Roadway film and dirt have an important effect on the performance of PMDs. A field study conducted in Australia showed that dirt accumulation and aging could reduce night visibility from about 1,000 feet (305 meters) to 100 feet (30.5 meters) under low-beam headlights.⁽⁸⁴⁾ This is not a permanent condition; washing the retroreflectors is possible. Rain will also clean them to some extent.

PMDs have long service lives provided they are kept clean and are not damaged by encroaching vehicles. A PMD can be expected to obtain a service life of about 10 years if knockdown or vandalism do not occur.

INSTALLATION AND MAINTENANCE

PMDs can be cost-effective if they are installed and maintained correctly. This section will discuss some

Roadway Delineation Practices Handbook

recommended procedures for these operations.

Spacing and Placement

In tangent sections PMDs should be placed 200 to 500 feet (61 to 153 meters) apart in a continuous line not less than 2 feet (0.6 meters) or more than 8 feet (2.4 meters) outside the edge of the usable shoulder. Delineators should also be placed on the outside of curves having a radius of 1,000 feet (305 meters) or less, including medians in divided highways and freeway ramp curves. The recommended spacing for delineators on curves is given in table 13. Three PMDs should be placed in advance of the curve and three beyond the curve. Curve spacing should be such that three PMDs are always visible to the driver. The spacing of delineators on curves should not exceed 300 feet (90 meters) or be less than 20 feet (6 meters). A typical installation is shown in figure 59.

Recently, an analytical computer optimization of the height, spacing, and lateral offset of PMDs for tangent sections and horizontal curves on two- and four-lane roadways was performed in Ohio.⁽⁸⁴⁾ The project included a small-scale field demonstration and evaluation. The study concluded that PMDs with 18 square inches (116 centimeters squared) of encapsulated lens sheeting material with a specific intensity per unit area (SIA) of 309 candelas per foot-candle per square foot should be placed every 275 feet along tangent sections of four-lane divided highways. PMDs with prismatic sheeting material, with SIAs of 825 and 1,483 candelas per foot-candle per square foot, should be placed every 350 and 400 feet (107 and 122 meters). These values for SIA are to be measured at an entrance angle of -4 degrees and an observation angle of 0.2 degrees.

The study presents the mathematical relationships from which optimum spacing can be calculated for curves of any radii on two- and four-lane roadways. These are repeated here for convenience in table 14. Height and lateral offset effects on visual detection are negligible for typical placements of PMDs.

Retroreflective Element Installation

Conventional roadside PMDs are formed by affixing a 3-inch (75-millimeter) retroreflective button on the face of a 4-foot (1.2-meter) delineator post. Retroreflective buttons also may be placed on 8- by 24-inch (203- by 610-millimeter) metal target plates. The target plate should have one, two, or three holes drilled for fastening the retroreflector to the plate with aluminum rivets.

Roadway Delineation Practices Handbook

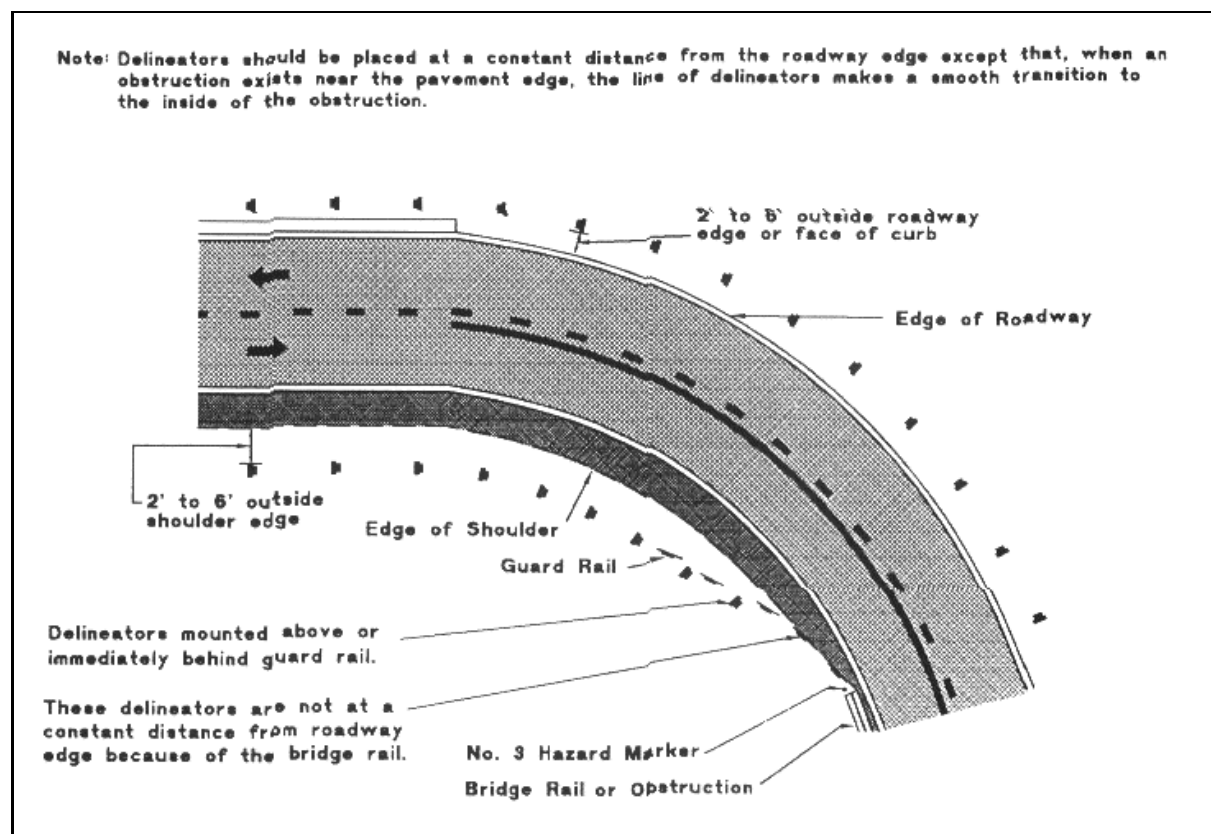

Figure 59. Typical delineator installation on horizontal curve

If the center-mounted retroreflective unit is to be enclosed in an aluminum back case, the retroreflector is slipped into the rim of the case and snapped into place for permanent locking (figure 60).

The circular, enclosed, honeycombed, plastic retroreflective sheeting disk is pressure sensitive and is applied simply by removing the backing and pressing it into place on the target.

Table 13. Suggested spacing for delineators on horizontal curves

Curve Radius, R	Spacing on Curve, S*	Spacing Before and Beyond		
		1st PMD 2S	2nd PMD 3S	3rd PMD 6S
50 ft (15 m)	20 ft (6 m)	40 ft (12 m)	60 ft (18 m)	120 ft (37 m)
150 ft (46 m)	30 ft (9 m)	60 ft (18 m)	90 ft (27 m)	180 ft (55 m)
200 ft (61 m)	35 ft (11 m)	70 ft (21 m)	105 ft (32 m)	210 ft (64 m)
250 ft (76 m)	40 ft (12 m)	80 ft (24 m)	120 ft (37 m)	240 ft (73 m)
300 ft (92 m)	50 ft (15 m)	100 ft (31 m)	150 ft (46 m)	300 ft (92 m)

Roadway Delineation Practices Handbook

400 ft (122 m)	55 ft (17 m)	110 ft (34 m)	165 ft (50 m)	300 ft (92 m)
500 ft (153 m)	65 ft (20 m)	130 ft (40 m)	195 ft (59 m)	300 ft (92 m)
600 ft (183 m)	70 ft (21 m)	140 ft (43 m)	210 ft (64 m)	300 ft (92 m)
700 ft (214 m)	75 ft (23 m)	150 ft (46 m)	225 ft (69 m)	300 ft (92 m)
800 ft (244 m)	80 ft (24 m)	160 ft (49 m)	240 ft (73 m)	300 ft (92 m)
900 ft (275 m)	85 ft (26 m)	170 ft (52 m)	255 ft (78 m)	300 ft (92 m)
1,000 ft (305 m)	90 ft (27 m)	180 ft (54 m)	270 ft (82 m)	300 ft (92 m)

Table 14. Equations for calculating optimum PMD spacings

Type of sheeting	Assumed Value for Specific Intensity (candelas per foot candle per square foot)	Type of Highway	Spacing Equation *
Encapsulated Lens	309	Two-Lane	$10*(R-43)^{1/3}$
Prismatic	825	Two-Lane	$11.5*(R-44)^{1/3}$
High-Intensity Prismatic	1483	Two-Lane	$13*(R-46)^{1/3}$
Encapsulated	309	Four-Lane	$9.8*(R-40)^{1/3}$
Prismatic	825	Four-Lane	$11.5*(R-45)^{1/3}$
High-Intensity Prismatic	1483	Four-Lane	$13.5*(R-47)^{1/3}$

* - In these equations, R equals the radius of the curve

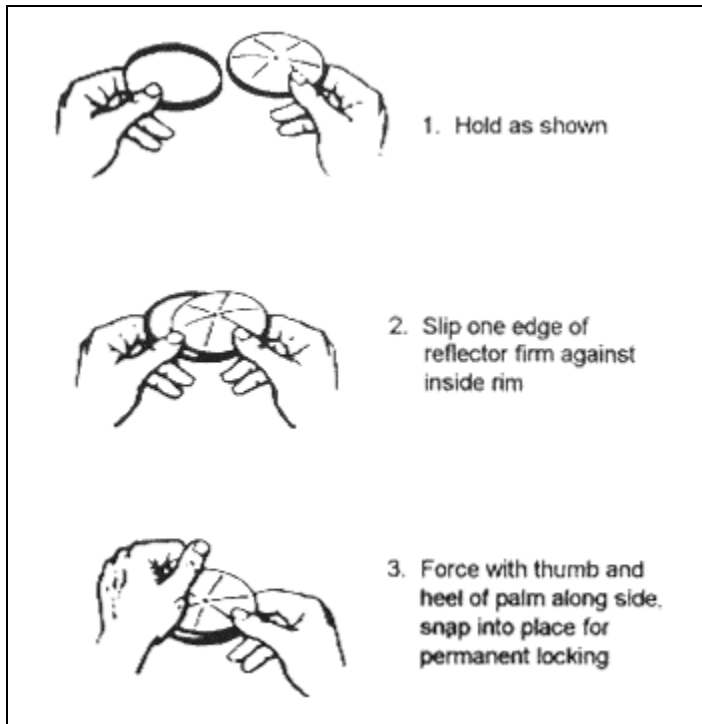

Figure 60. Encasing center-mount retroreflector in aluminum back case

Post Installation and Equipment

Special equipment is available to mechanically drive the steel post into the ground. This is expensive equipment, usually used only for large installations. Normally, maintenance forces will install the posts with a hammer and driving head or with some form of top-weighted driving head that has handles on each side to exert the necessary downward force.

Posts are usually driven 2 feet (0.6 meters) below the surface, with 4 feet (1.2 meters) remaining above the pavement at the outer edge. Figure 61 is a cross-section of delineator placement with and without a curb.

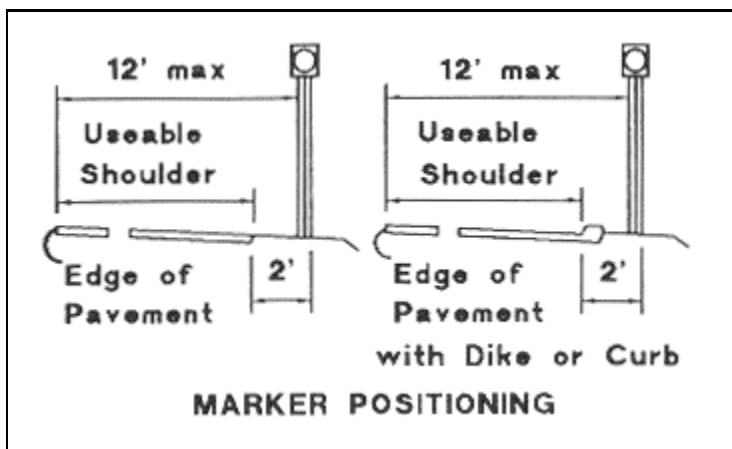

Figure 61. Typical delineator positioning

Roadway Delineation Practices Handbook

Replacement

PMDs are highly susceptible to knockdowns, vandalism, and theft. Bent or missing PMDs that obviously need attention should be repaired promptly. This is urgent when the bent or knocked-down post protrudes in or near the roadway.

PMDs' long service lives sometimes cause agencies to overlook their maintenance. Prompt replacement of missing PMDs or damaged posts is important to avoid future costs. In extreme weather, PMDs often are the only means of guidance available to the driver. These devices have high priority for installation; therefore, an equally effective level of maintenance should be maintained.

Cleaning

Road film and dirt can ruin the visibility of PMDs. This happens even to units that perform well when they are clean. Some highway agencies have developed methods for washing these retroreflectors during dry periods. These techniques range from simple watering under pressure to a complete revolving brush device.

Winter Maintenance

PMDs also are vulnerable to damage from heavy snowdrifts, snowplows, or other roadside maintenance vehicles. Maintenance crews should repair posts that are hit inadvertently by equipment doing other maintenance activities.

In high snowfall areas, the condition of PMDs should be observed at the end of the snow season. Replacement and maintenance should be scheduled for damaged PMDs.

Before the snowfall season, some highway agencies install snow poles to extend above the top of the expected snow drift. Attaching the snow pole is a simple procedure. It is done with two brackets, and their associated bolts and washers, which fit existing holes. The removal of extended snow poles in the spring can be combined with cleaning, replacement, or other PMD maintenance.

Crew Size and Safety

Maintenance for PMDs requires neither a large crew nor complex equipment. Because the posts are located slightly off the shoulder, some crews tend to forego proper safety procedures for the work. Whereas lane closure or coning may not be required in all cases, workers should be protected by signing or a strategically placed service vehicle, or both. Vehicles encroaching the shoulder should be properly marked with work zone devices.

Colored Posts

It is obvious that both the safety hazards and replacement costs associated with repair of knocked-down posts would be eliminated if the post was not hit in the first place. Recognizing this fact, several highway agencies have experimented with using a colored delineator post in an attempt to prevent knockdowns.

Sign post tests conducted in Houston, Texas, indicated a 49 percent increase in daytime visibility distance and a 30 percent increase at night.⁽⁸⁶⁾ Knockdowns decreased from 24 to 10 sign posts in a 20-month before-and-after study. Later studies at different sites in Texas have reported a 50 percent reduction in knock-downs. After a year of testing, yellow sign and delineator posts became standard in Texas and have attracted interest nationally.

Removal

Removal of PMDs usually is not necessary. Normally, the retroreflective units are normally replaced and the posts left in place. Removal occurs only when the post is struck by a vehicle. If a construction project or other program does require removal of a PMD, standard steel post PMDs can make the removal operation difficult. Removal of these

Roadway Delineation Practices Handbook

standard PMDs will require equipment and can be costly.

Removal cost is another reason that the flexible post PMD is becoming popular. Many of these devices are mounted in a pre-made hole in the ground to the side of the pavement. Removal consists of simply rotating the post one quarter-turn by hand and lifting it from the hole.

CHAPTER 10. OTHER DELINEATION DEVICES

INTRODUCTION

Other types of delineation devices are used to supplement standard pavement markings. This chapter addresses object markers, warning signs, barrier delineators, and pavement symbols.

USES

Object markers, warning signs, and barrier delineators give warnings and are used where pavement markings alone do not provide enough information on road alignment or roadside features for a driver to negotiate a road section or avoid obstructions. Pavement symbols are used to reinforce regulations, warn drivers, and provide guidance information.

Object Markers

Object markers identify obstructions within or adjacent to the roadway. The three types of object markers are illustrated in figure 62. When used, these markers should be arranged in one or more of these three designs.

Type 1. Either a marker consisting of nine yellow retroreflectors, each with a minimum dimension of about 3 inches (76 millimeters), mounted symmetrically on an 18-inch (457-millimeter) yellow or black diamond-shaped panel; or an all-yellow retroreflective diamond-shaped panel of the same size. Type 1 markers may be larger if conditions warrant.

Type 2. Either a marker consisting of three yellow retroreflectors, each with a minimum dimension of about 3 inches (76 millimeters), arranged either horizontally or vertically; or an all-yellow retroreflective panel, 6 by 12 inches (150 by 300 milli-meters). Type 2 markers may be larger if conditions warrant.

Type 3. A marker consisting of a vertical rectangle about 1 by 3 feet (0.3 by 0.9 meter) in size with alternating black and retroreflective yellow stripes sloping downward at an angle of 45 degrees (0.785 radian) toward the side of the obstruction on which traffic is to pass. The minimum width of the yellow stripe should be 3 inches (76 millimeters). A better appearance can be achieved if the black stripes are wider than the yellow stripes.

Left object markers (OM-3L) have stripes that begin at the upper left side and slope downward to the lower right side. Right object (OM-3R) marker stripes begin at the upper right side and slope downward to the lower left.

Objects in the Roadway

Obstructions in the roadway should be marked with a Type 1 or Type 3 object marker. A large surface, such as a bridge pier, may be painted with diagonal stripes, 12 inches (300 centimeters) or greater in width, similar in design to the Type 3 object marker. Alternating black and yellow retroreflective stripes should slope down-ward at a 45 degree angle toward the side of the obstruction that traffic is to pass.

Roadway Delineation Practices Handbook

Appropriate signs (*MUTCD* sections 2B-25 and 2C-33) directing traffic to one or both sides of the obstruction may be used in lieu of the object marker. In addition to markings on the face of an obstruction in the roadway, warning of approach to the obstruction should be given by appropriate pavement markings (*MUTCD* section 3B-13).

Typical Type 1 Object Markers

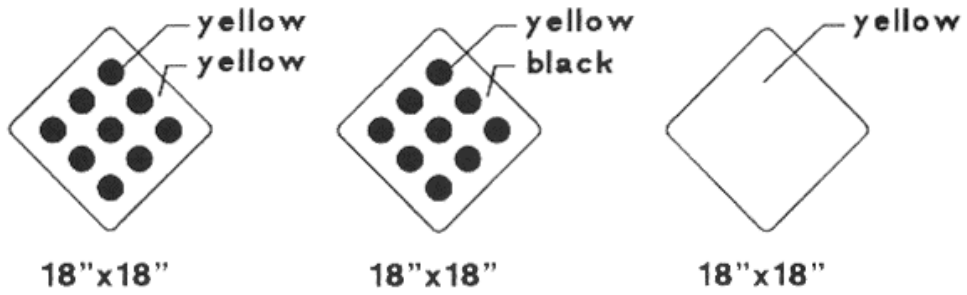

Typical Type 2 Object Markers

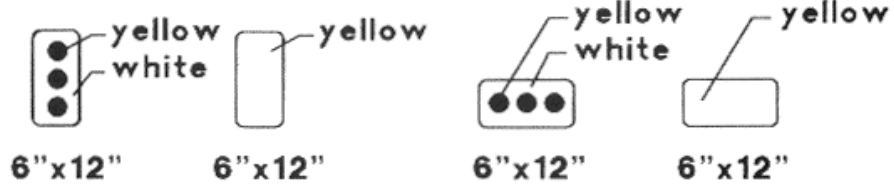

Typical Type 3 Object Markers

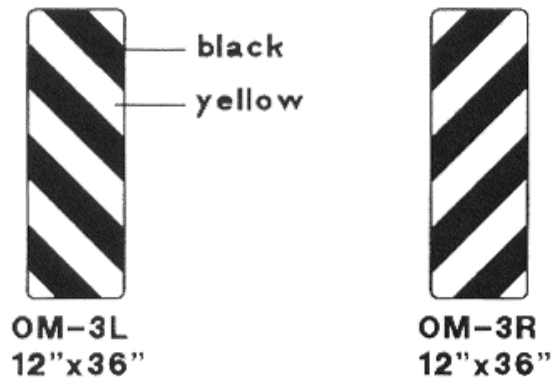

Typical End of Road Markers

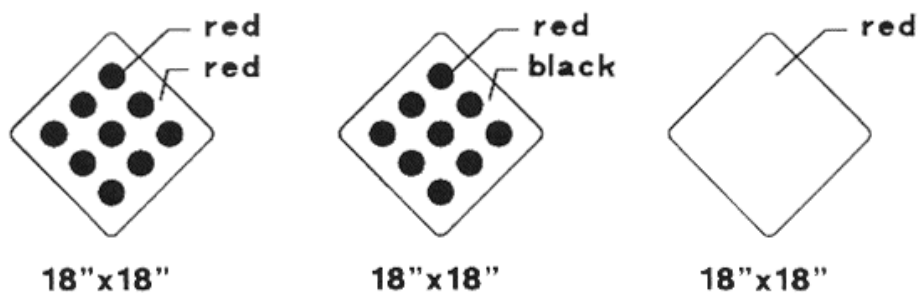

Roadway Delineation Practices Handbook

Figure 62. Object markers

Where the vertical clearance of an overhead structure exceeds the maximum legal height of a vehicle by less than 1 foot (0.3 meters), the clearance in feet and inches should be clearly marked on the structure (*MUTCD* section 2C-34).

Objects Adjacent to Roadway

Objects not actually in the roadway may be so close to the edge of the road that they need a marker. Such objects include under-pass piers, bridge abutments, handrails, and culvert headwalls. In some cases, there may not be a physical object involved, but other roadside conditions, such as narrow shoulder drop-offs, gores, small islands, and abrupt changes in the roadway alignment, may make it undesirable for a driver to leave the roadway. Type 2 or Type 3 object markers are intended for use at these locations. The inside edge of the marker should be in line with the inner edge of the obstruction.

Standard warning signs (*MUTCD* section 2C) should also be used where applicable.

End of Roadway

When it is determined that object markers should be placed at the end of a roadway where there is no alternate vehicular path, either a marker consisting of nine red retroreflectors, each with a minimum dimension of approximately 3 inches (76 millimeters), mounted symmetrically on an 18-inch (457 millimeter) diamond-shaped, red or black panel; or an 18-inch (45.7-centimeter) diamond-shaped retroreflective red panel should be used. More than one marker or a larger marker may be used at the end of the roadway where conditions warrant. Appropriate advance warning signs should be used.

Warning Signs

Warning signs supplement pavement markings and consist of the alignment series and the Advisory Speed plate, Large Arrow and Chevron Alignment signs. Figure 63 shows the alignment series warning signs.



W1-1R
30"x30"
Turn



W1-2R
30"x30"
Curve



W1-3R
30"x30"
Reverse Turn



W1-4R
30"x30"
Reverse Curve



W1-5R
30"x30"
Winding Road



W13-1
18"x18"
24"x24"
Advisory Speed Plate

Roadway Delineation Practices Handbook

Figure 63. Alignment series and advisory speed plate

Turn Sign (W1-1)

The Turn sign (W1-1R or W1-1L) is used where engineering investigations of roadway, geometric, and operating conditions show the recommended speed on a turn to be 30 miles per hour (48 kilometers per hour) or less, and this recommended speed is equal to or less than the speed limit established by law or regulation for that section of roadway. Where a Turn sign is warranted, a Large Arrow sign (*MUTCD* section 2C-9) may be used on the outside of the turn. Additional protection may be provided by use of the Advisory Speed plate (*MUTCD* section 2C-35).

Curve Sign (W1-2)

The Curve sign (W1-2R or W1-2L) may be used where engineering investigations of roadway, geometric, and operating conditions show the recommended speed on the curve to be greater than 30 miles per hour (48 kilometers per hour) and equal to or less than the speed limit established by law or by regulation for that section of roadway. Additional protection may be provided by use of the Advisory Speed plate (*MUTCD* section 2C-35).

Reverse Turn Sign (W1-3)

The Reverse Turn sign is used to mark two turns or a curve and a turn in opposing directions, as defined in the warrants for Turn and Curve signs (*MUTCD* sections 2C-4 and 2C-5) that are separated by a tangent of less than 600 feet (183 meters). If the first turn is to the right, a Right Reverse Turn sign (W1-3R) should be used; if the first turn is to the left, a Left Reverse Turn sign (W1-3L) should be used. For additional protection the Advisory Speed plate (*MUTCD* section 2C-35) may be used.

Reverse Curve Sign (W1-4)

The Reverse Curve sign is used to mark two curves in opposite directions, as defined in the warrants for Curve signs (*MUTCD* section 2C-5) that are separated by a tangent of less than 600 feet (183 meters). If the first curve is to the right, a Right Reverse Curve sign (W1-4R) should be used; if the first curve is to the left, a Left Reverse Curve sign (W1-4L) should be used.

Winding Road Sign (W1-5)

The Winding Road sign is used where there are three or more turns or curves, as defined in the warrants for Turn and Curve signs (*MUTCD* Sections 2C-4 and 5), separated by tangent distances of less than 600 feet (183 meters). The Winding Road sign should be erected in advance of the first curve. Where the three or more turns or curves extend over a roadway section of 1 mile (1.6 kilometers) or more, the supplemental plaque Next X Miles (W7-3a) may be installed below the Winding Road sign. Additional warning may be provided by the installation of raised pavement markers (*MUTCD* section 3D-4) and by use of the Advisory Speed plate (*MUTCD* section 2C-35).

Advisory Speed Plate (W13-1)

The Advisory Speed plate, shown in figure 63, is used to supplement warning signs. The standard size of the Advisory Speed plate is 18 by 18 inches (457 by 457 millimeters). Advisory Speed plates used with 36-inch (914-millimeters) and larger warning signs should be 24 by 24 inches (610 by 610 millimeters).

The Advisory Speed plate should carry the speed message in black letters on a yellow background (*MUTCD* section 6B-34). When used for construction or maintenance work zones, the message should be in black on an orange background. The speed shown should be a multiple of 5 miles per hour (8 kilometers per hour). The plate may be used in conjunction with any standard yellow warning sign to indicate the maximum recommended speed on a curve or through a hazardous location. It should not be used in conjunction with any sign other than a warning sign, nor should it be used alone. It should be mounted on the same assembly and normally below the standard warning sign. Except

Roadway Delineation Practices Handbook

in emergencies or at construction or maintenance sites, where the situation calling for an Advisory Speed plate is temporary, an Advisory Speed plate should not be erected until the recommended speed has been determined by accepted traffic engineering procedures. Because changes in surface characteristics, sight distance, and other factors may alter the recommended speed, each location should be periodically checked and the plate corrected if necessary.

Large Arrow Sign (W1-6, W1-7)

The Large Arrow sign is used to give notice of a sharp change of alignment in the direction of travel. It is not to be used where there is no change in the direction of travel (ends of medians, center piers, etc.). The Large Arrow sign should be a horizontal rectangle with a standard size of 48 by 24 inches (1,220 by 610 millimeters), having a large arrow (W1-6) or a double head arrow (W1-7). It should have a yellow background with the symbol in black. Figure 64 shows the Large Arrow signs. The Large Arrow sign should be erected on the outside of a curve or on the far side of an intersection in line with, and at right angles to, approaching traffic.

The Large Arrow sign should be visible for at least 500 feet (153 meters). Trial runs by day and night may be desirable to determine final positioning.

Chevron Alignment Sign (W1-8)

A Chevron Alignment sign (figure 64) may be used as an alternative or supplement to standard delineators and to the Large Arrow sign. The Chevron Alignment sign gives notice of a sharp change in roadway alignment. The Chevron Alignment sign provides additional emphasis and guidance for drivers as to changes in horizontal alignment of the roadway.

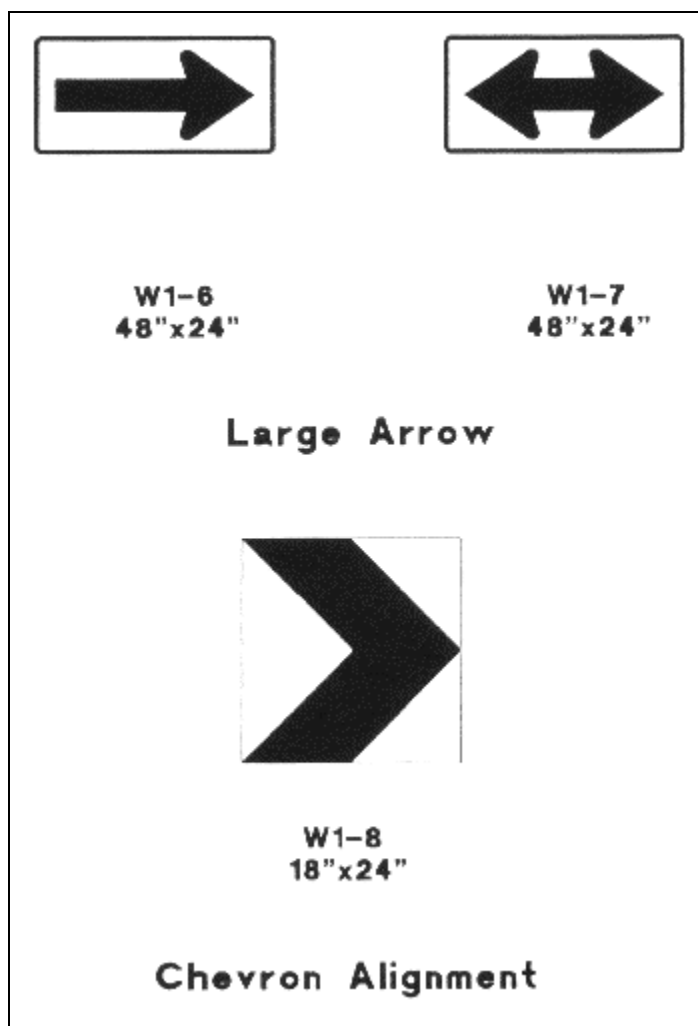

Figure 64. Large arrow and chevron alignment signs

The Chevron Alignment sign should be a vertical rectangle with a minimum size of 12 by 18 inches (305 by 457 millimeters). It should have a yellow background with chevron symbol in black. The size of sign used will be determined by an engineering investigation.

The Chevron Alignment sign is erected on the outside of a curve, sharp turn, or on the far side of an intersection, in line with and at right angles to approaching traffic. Signs should be spaced so that two of the signs will always be visible to the driver, until the change in alignment eliminates the need for the signs. Chevron Alignment signs should be visible for at least 500 feet (153 meters); trial runs by day and night may be desirable to determine final positioning.

Barrier Delineators

Barrier delineators are retroreflective units that mount on guardrails, concrete barriers, and bridge parapets. They are white or amber to conform with the pavement marking they supplement. Figure 65 shows examples of barrier delineators. The reflective units are made of high-intensity retroreflective sheeting or cube corner retroreflectors. Barrier delineators should not be substituted for post-mounted delineators.

Pavement Symbols

Roadway Delineation Practices Handbook

Word and symbol markings on the pavement guide, warn, or regulate traffic. They should be limited to not more than three lines of information. They shall be white and, if used at nighttime, should be retroreflective. They consist of crosswalk markings, parking space markings, turning and lane use arrows, pavement and word symbols, curb markings for parking restrictions, wrong way arrows, preferential lane use markings, speed measurement markings, railroad crossing markings, bicycle markings, and other markings.

Crosswalk Markings

Crosswalk markings at signalized intersections, and across intersectional approaches on which traffic stops, serve primarily to guide pedestrians in the proper paths. Crosswalk markings across roadways on which traffic is not controlled by traffic signals or Stop signs also warn drivers of a pedestrian crossing point. At nonintersectional locations, these markings legally establish the crosswalk.

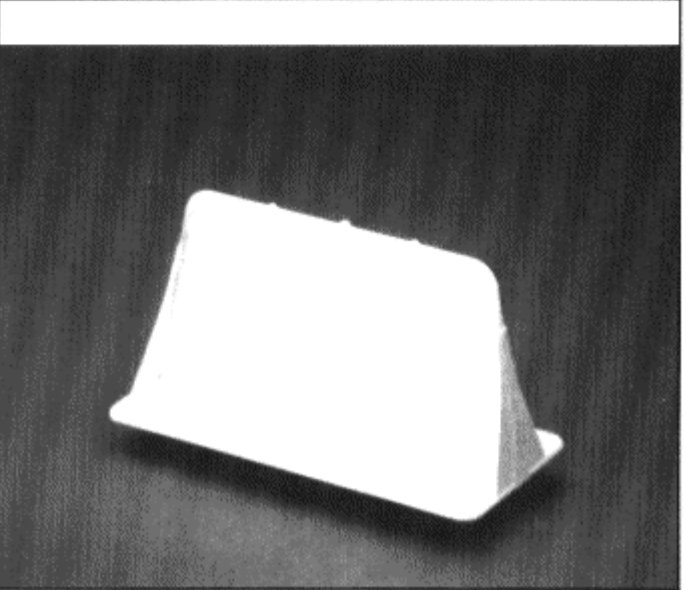
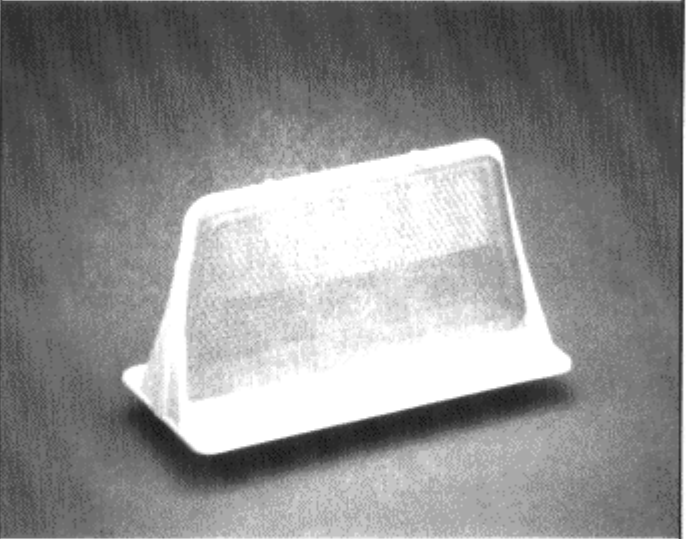
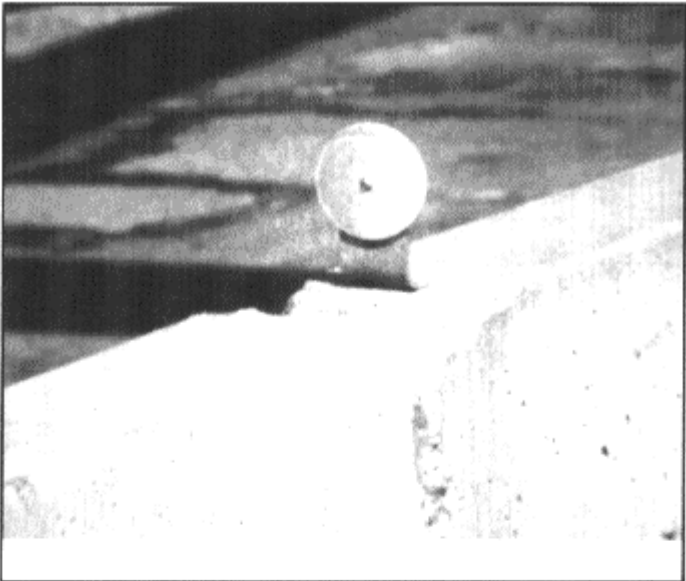

Roadway Delineation Practices Handbook

Figure 65. Barrier delineators

Crosswalk markings shall be solid white, marking both edges of the crosswalk. They should be not less than 6 inches (152 millimeters) wide and should not be spaced less than 6 feet (1.8 meters) apart. Under special circumstances where a stop bar is not provided, or where vehicular speeds exceed 35 miles per hour (56 kilometers per hour), or where crosswalks are unexpected, it may be desirable to increase the width of the crosswalk marking to 24 inches (610 millimeters). Crosswalk markings on both sides of the crosswalk should extend across the full width of pavement to discourage diagonal walking between crosswalks. Crosswalk markings are shown in figure 66.

a - Standard crosswalk marking.

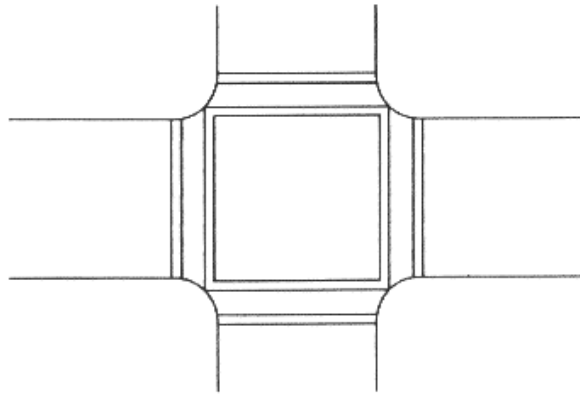

b - Crosswalk marking with diagonal lines for added visibility.

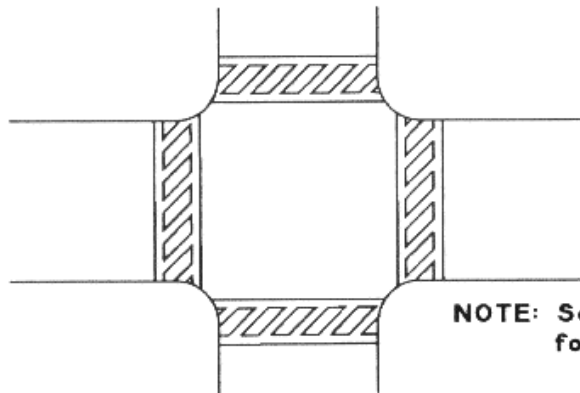

NOTE: See MUTCD Sec. 3B-15
for line dimensions.

c - Crosswalk marking with longitudinal lines for added visibility.

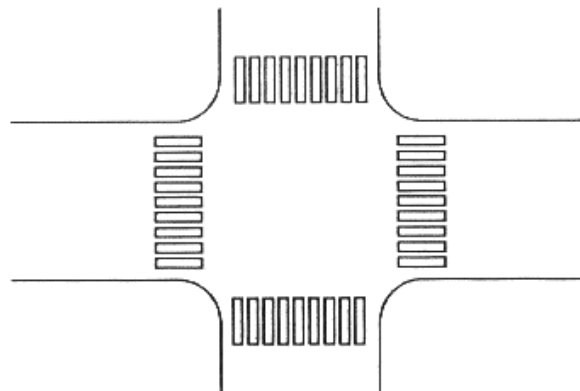

Roadway Delineation Practices Handbook

Figure 66. Typical crosswalk markings

Crosswalks should be marked at all intersections where there is substantial conflict between vehicle and pedestrian movements. Marked crosswalks should also be provided at other appropriate points of pedestrian concentration, such as at loading islands, midblock pedestrian crossing, or where pedestrians could not otherwise recognize the proper place to cross.

Crosswalk markings should not be used indiscriminately. An engineering study should be performed before they are installed at locations away from traffic signals or stop signs.

Since nonintersectional pedestrian crossings generally are unexpected by the driver, warning signs (*MUTCD* section 2C-31) should be installed and adequate visibility provided by parking prohibitions.

For added visibility, the area of the crosswalk may be marked with white diagonal markings at a 45-degree angle or with white longitudinal markings at a 90-degree angle to the line of the crosswalk. These markings should be 12 to 24 inches (305 to 610 centimeters) wide and spaced 12 to 24 inches (305 to 610 centimeters) apart. When diagonal or longitudinal markings are used to mark a crosswalk, the transverse crosswalk markings may be omitted. This type of marking is used at locations where substantial numbers of pedestrians cross without any other traffic control device, at locations where physical conditions are such that added visibility of the crosswalk is desired, or in locations where a pedestrian crosswalk might not be expected. Take care to ensure that crosswalks with diagonal or longitudinal markings used at some locations do not weaken or detract from other crosswalks (where special emphasis markings are not used).

When an exclusive pedestrian phase signal, which permits diagonal crossing, is installed at an intersection, a unique marking may be used for the crosswalk (figure 67).

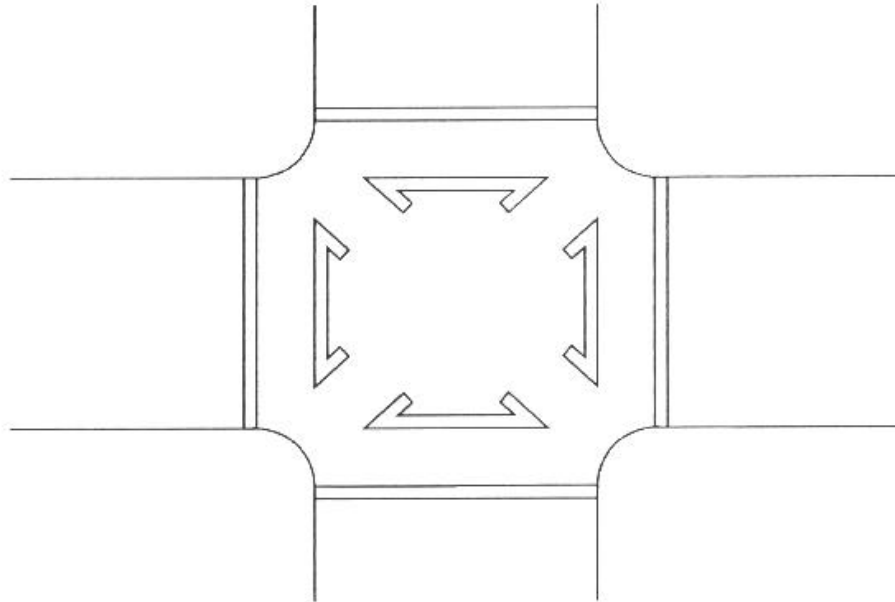

a - Crosswalk marking that outlines pedestrian travel paths.

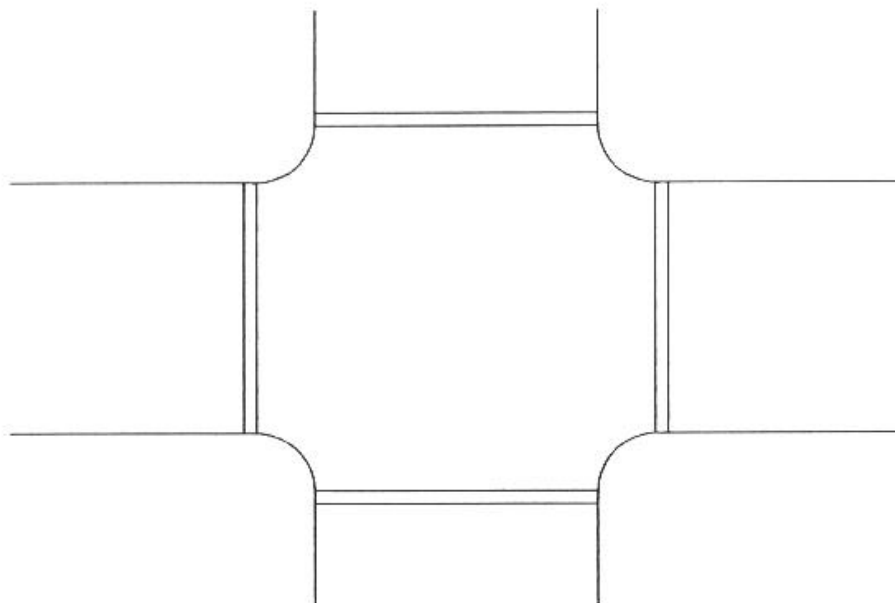

b - Crosswalk marking that outlines the edge of pedestrian travel area.

Figure 67. Typical crosswalk markings for exclusive pedestrian phase

Roadway Delineation Practices Handbook

Parking Space Markings

Parking space markings on urban streets encourage orderly and efficient use of parking spaces. They tend to prevent encroachment on fire hydrant zones, bus stops, loading zones, approaches to corners, clearance spaces for islands and other zones where parking is prohibited. Parking space markings should be white. Typical parking space markings are shown in figure 68.

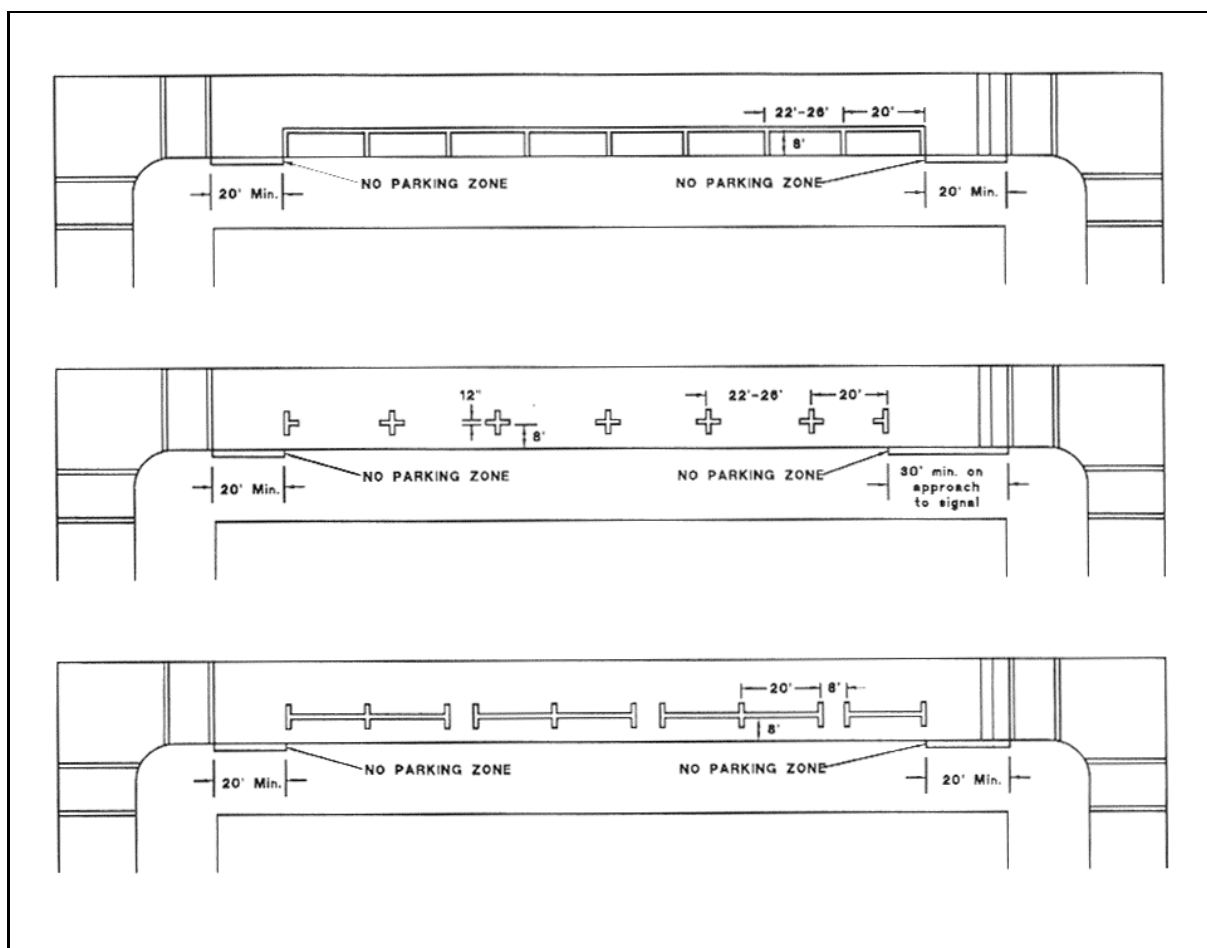

Figure 68. Typical parking space limit markings

Turning and Lane Use Arrows

Lane use arrows may be used to convey either guidance or mandatory messages. However, where symbol arrows are used to convey a mandatory movement, lane-use arrow markings should be used and must be accompanied by standard signs and the word marking “ONLY.” Lane use arrows may also be used in two-way left turn lanes and in all right and left turn bays. Signs or markings should be repeated in advance of mandatory turn lanes when necessary to prevent entrapment and to help drivers select the appropriate lane before reaching the end of the line of waiting vehicles.

Pavement Letters and Numerals

All letters, numerals and symbols should conform to the *Standard Alphabets for Highway Signs and Pavement Markings*.⁽⁸⁷⁾ Use large letters and numerals, 8 feet (2.4 meters) or more in height. If the message consists of more than one word, the message should read “up”; that is, the first word should be nearest to the driver. Symbol messages

Roadway Delineation Practices Handbook

are preferable to word messages. Figure 69 shows the use of word and symbol markings on the pavement.

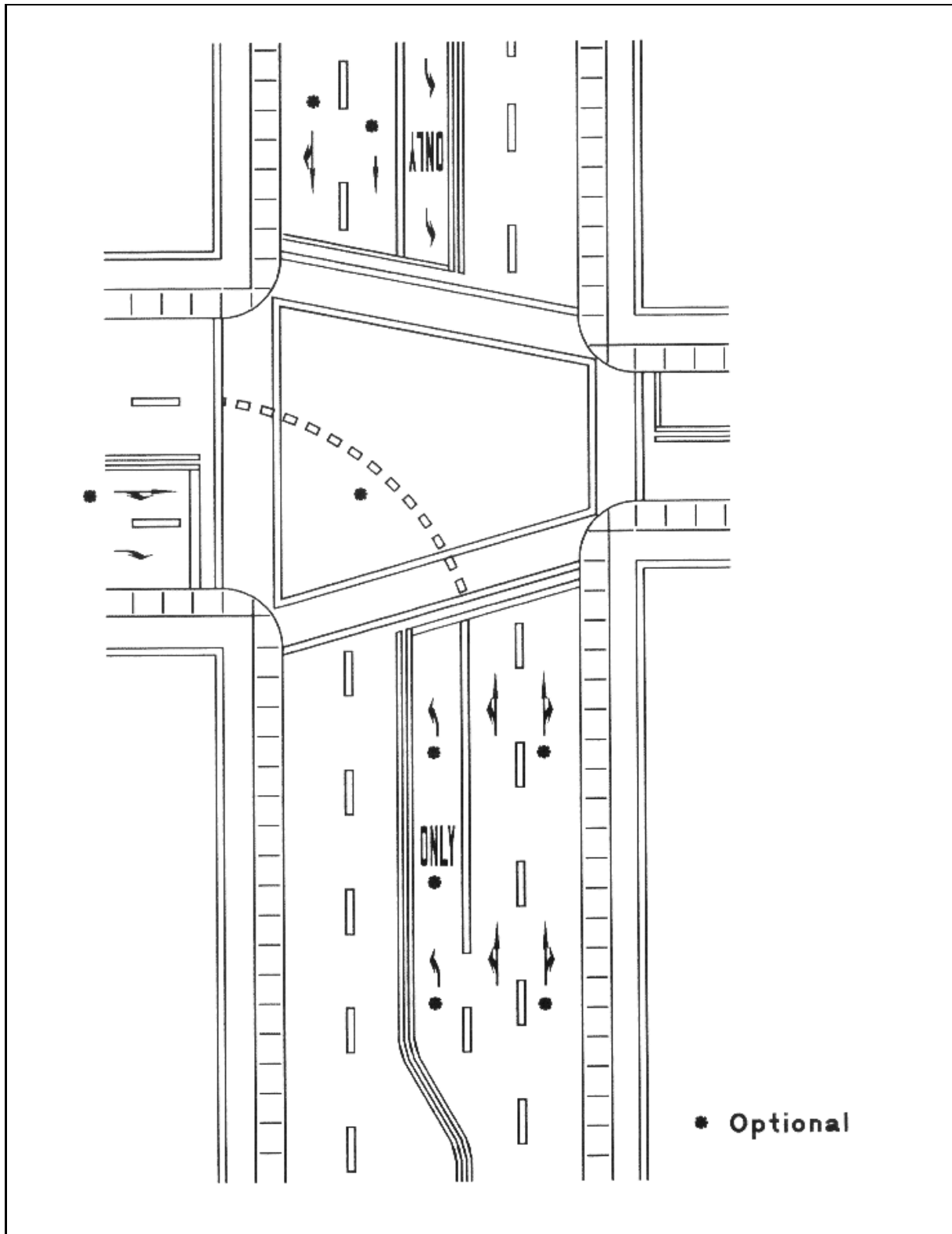

Figure 69. Typical lane-use-control word and symbol markings

Roadway Delineation Practices Handbook

Where speeds are low, the sizes of letters, numerals, and symbol arrows may be reduced approximately one-third. The longitudinal space between word or symbol messages, including arrows, should be at least 4 times the height of the character for low speed roads but not more than 10 times the height of the character under any conditions. Examples of standard words and arrow pavement markings are shown in figures 70 through 72. Alternate (narrower) symbol arrows may be used in lieu of standard arrows.

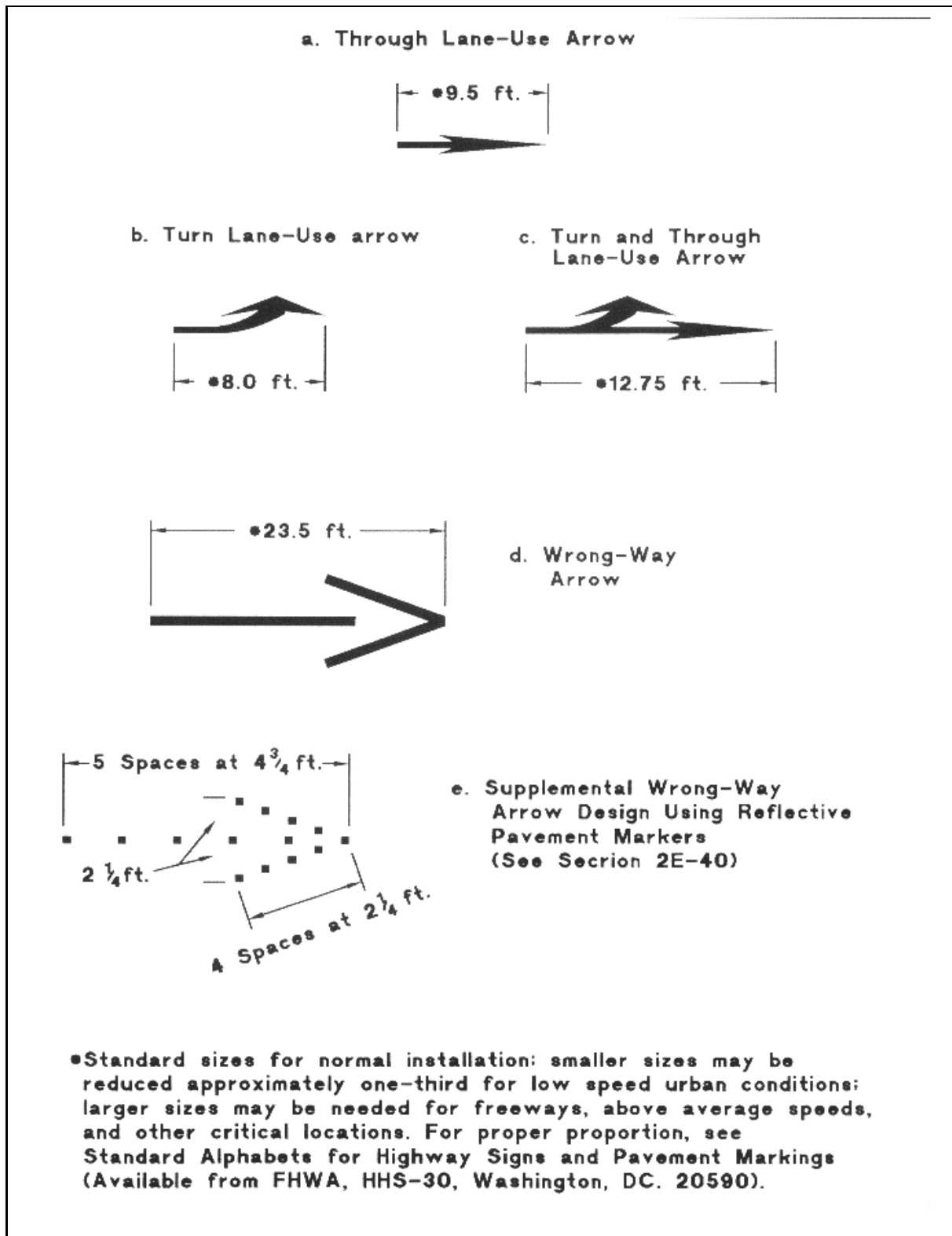

Figure 70. Lane-use and wrong-way arrows for pavement markings

Roadway Delineation Practices Handbook

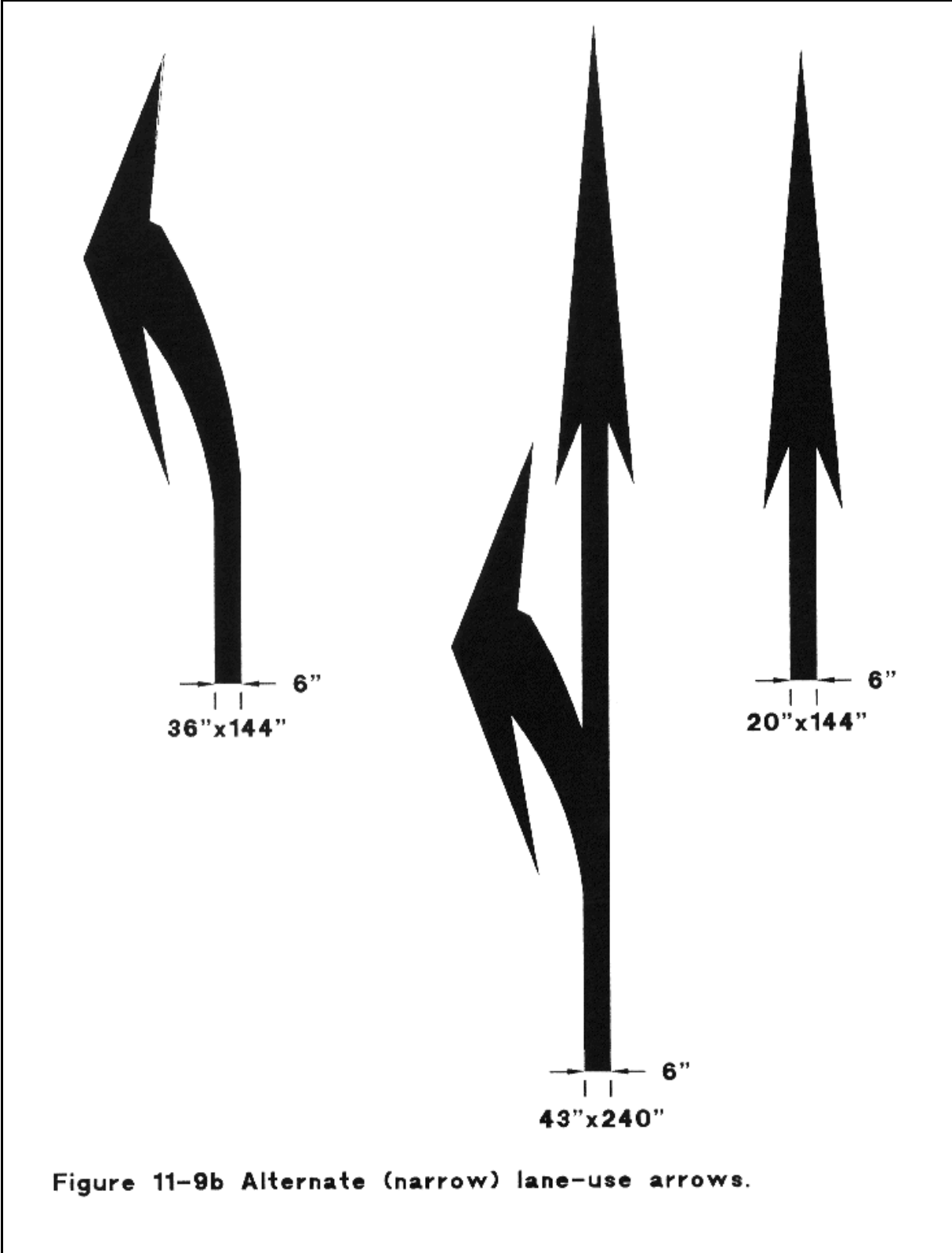

Figure 11-9b Alternate (narrow) lane-use arrows.

Roadway Delineation Practices Handbook

Figure 71. Elongated letters for pavement marking

Word and symbol markings considered appropriate for use when warranted include the following:

Regulatory

STOP SYMBOL ARROWS
RIGHT TURN ONLY 25 MPH, OPTIONAL
LEFT TURN ONLY SYMBOL ARROWS

Warning

STOP AHEAD SCHOOL XING
SIGNAL AHEAD PED XING
SCHOOL R X R

Guide

US 40 STATE 135
ROUTE 81 HWY 21

Other words or symbols may be necessary under certain conditions.

Because uncontrolled use of pavement markings can confuse drivers, the number of different word and symbol markings should be minimized.

The word “STOP” should not be used on the pavement unless accompanied by a stop bar (*MUTCD* section 3B-17) and Stop sign (*MUTCD* section 2B-4). The word “STOP” should not be used on the pavement in advance of a stop bar, unless every vehicle is required to stop at all times.

Except for the “SCHOOL” message, pavement messages should be no more than one lane in width (*MUTCD* section 7C-6).

Curb Markings for Parking Restrictions

Because curb markings in yellow and white are used for delineation and visibility, it is usually advisable to establish parking regulations through the installation of standard signs (*MUTCD* sections 2B-31 to 2B-33). However, when local authorities prescribe special colors for curb markings as supplemental to standard signs, they may be used. When signs are not used, the intended meaning should be stenciled on the curb. Signs should always be used with curb markings in those areas where curb markings are frequently obliterated by accumulations of snow and ice.

Preferential Lane Markings

Preferential Lane markings convey a restriction on the class or classes of vehicles permitted to use the lane, and they supplement signs or signals conveying the specific restrictions. Signs or signals should be used with the preferential lane markings.

When a lane is assigned full time or part time to a particular class or several classes of vehicles, the preferential lane marking should be used. Preferential lanes may operate for only certain periods of the day and may occupy portions of the roadway not normally designed for that purpose. In these cases, markings should conform to the purpose the lane serves a majority of the time. Engineering judgment should be exercised to determine the need for supplemental devices such as tubular markers, traffic cones, and flashing lights.

Preferential Lane markings should be the elongated diamond shape detailed in the *Standard Alphabets for Highway Signs and Pavement Markings*.⁽⁸⁷⁾ The diamond should be formed by white markings at least 6 inches (152

millimeters) wide. The diamond shape should be at least 2 1/2 feet (0.76 meters) wide and 12 feet (3.7 meters) long, and should be placed coincident with the longitudinal center of each restricted lane.

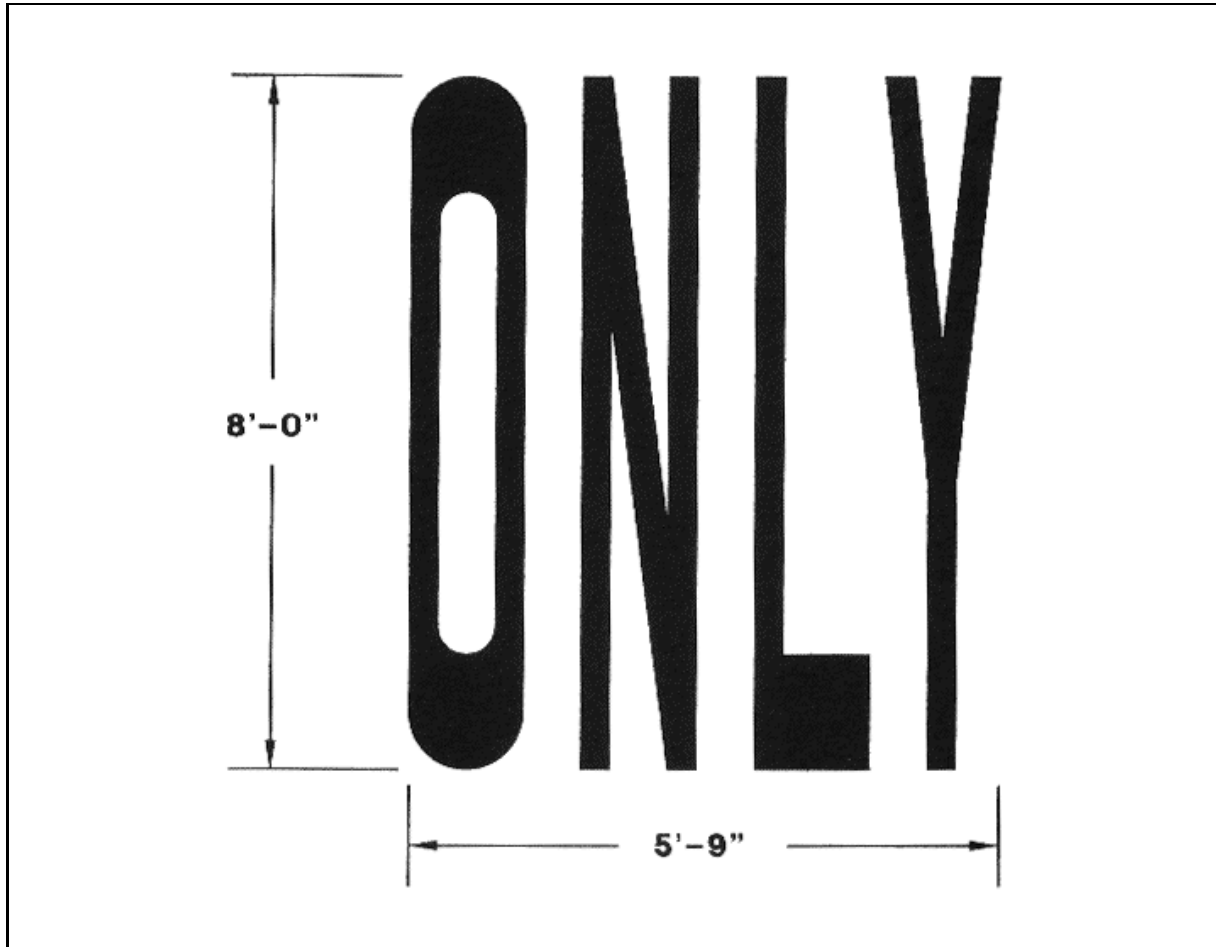

Figure 72. Elongated letters for pavement marking

The frequency with which the marking is placed is a matter for engineering judgment based on prevailing speed, block lengths, distance from intersections, and other considerations necessary to adequately communicate with the driver. Spacing as close as 80 feet (24 meters) may be appropriate for a city street, while a spacing of 1,000 feet (305 meters) may be appropriate for a freeway.

Word markings may be used to supplement, but not substitute for, the preferential lane markings.

Speed Measurement Markings

Speed Measurement markings are transverse markings placed on the pavement to enforcement of speed regulations. Speed measurement markings should be white, and should be not greater than 24 inches (610 millimeters) wide. They may extend about 2 feet (0.6 meters) on either side of the centerline or edgeline of the roadway at 1/4-mile (0.8-kilometer) intervals more than a 1-mile (1.6-kilometer) section of roadway. Advisory speed plates may be used in conjunction with these markings.

Railroad Crossing Markings

Roadway Delineation Practices Handbook

Pavement symbols in advance of a railroad crossing should consist of an “X,” the letters “RR,” a no passing marking (two-lane roadways), and transverse markings. Identical markings should be placed in each approach lane on all paved approaches to railroad crossings where crossing signals or automatic gates are located, and at all other railroad crossings where the prevailing traffic speed is 40 miles per hour (64 kilometers per hour) or greater. A portion of the pavement marking symbol should be directly opposite the advance warning sign. If needed, supplemental pavement markings may be placed between the advance warning sign and the crossing.

The marking should also be placed at railroad crossings where the engineering studies indicate there is a significant potential conflict between vehicles and trains. At minor crossings or in urban areas, these markings may be omitted if engineering study indicates that other devices installed provide suitable control.

The design of railroad crossing pavement markings should be as illustrated in figure 73. The symbols and letters are elongated to allow for the low angle at which they are viewed. All markings should be retroreflective white except for the no-passing markings that should be retroreflective yellow. Figure 74 shows the alternate narrow X and the letters RR.

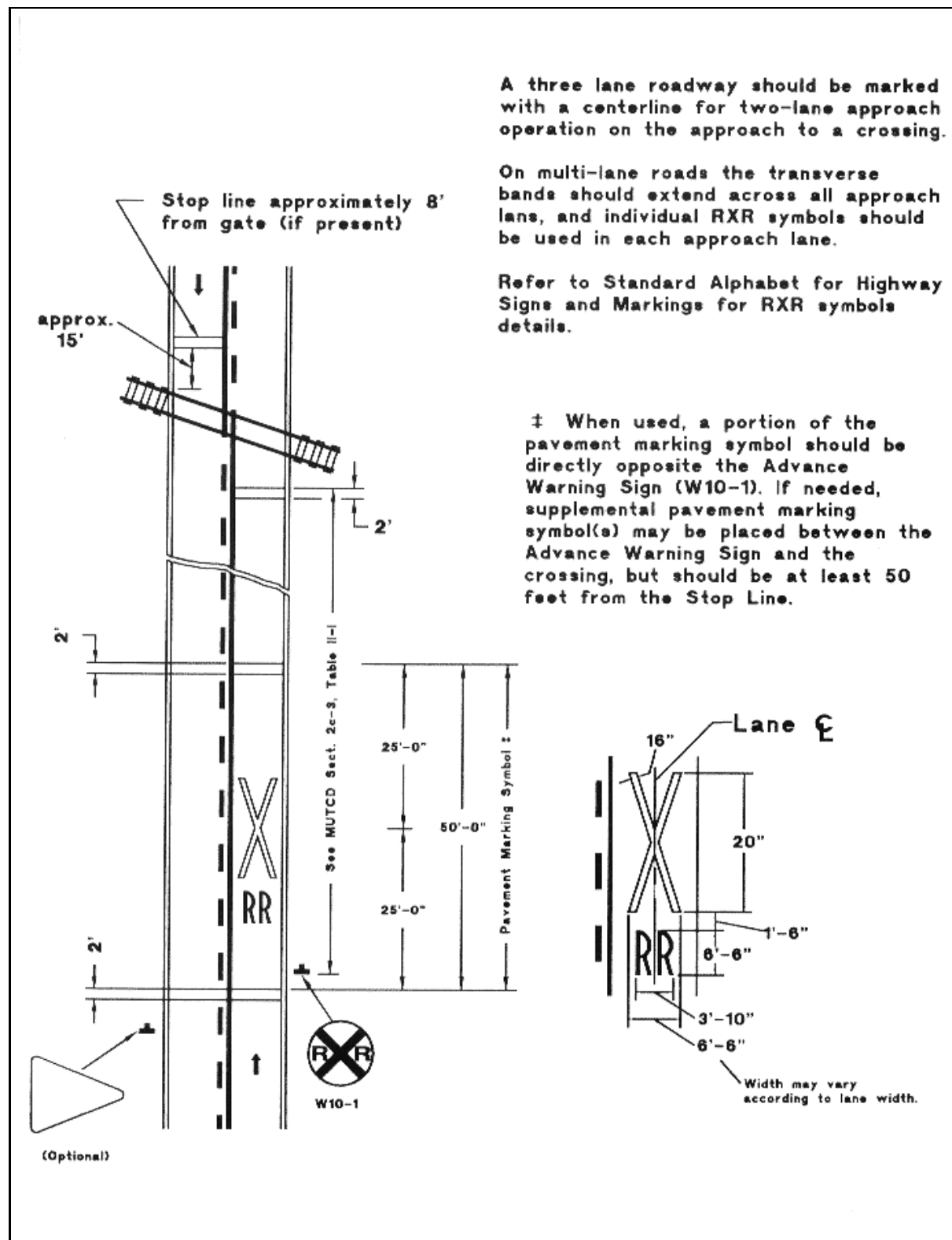

A three lane roadway should be marked with a centerline for two-lane approach operation on the approach to a crossing.

On multi-lane roads the transverse bands should extend across all approach lanes, and individual RXR symbols should be used in each approach lane.

Refer to Standard Alphabet for Highway Signs and Markings for RXR symbols details.

‡ When used, a portion of the pavement marking symbol should be directly opposite the Advance Warning Sign (W10-1). If needed, supplemental pavement marking symbol(s) may be placed between the Advance Warning Sign and the crossing, but should be at least 50 feet from the Stop Line.

Figure 73. Typical placement of warning signs and pavement markings at railroad-highway grade crossings

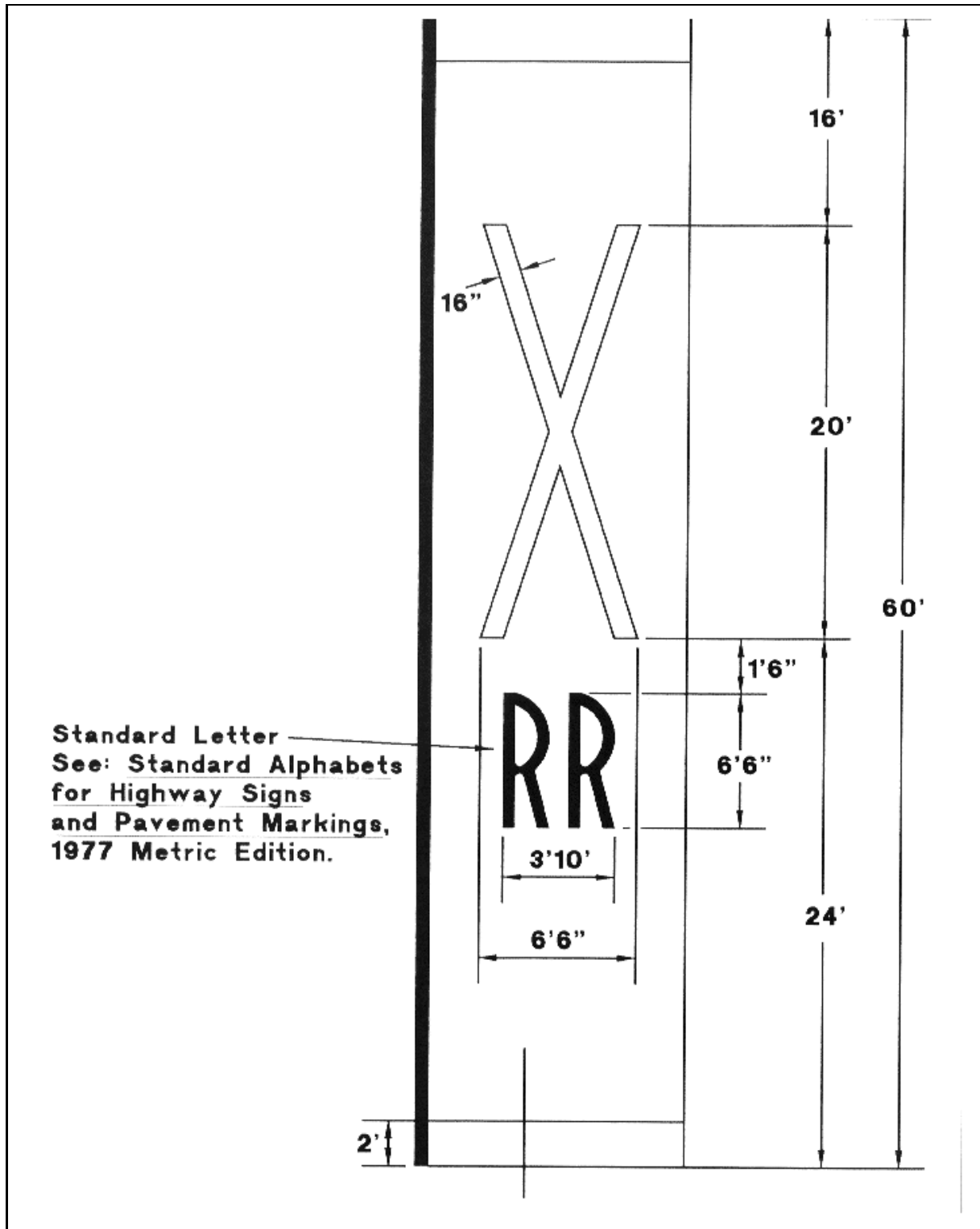

Figure 74. Alternate (narrow) typical pavement marking supplement for railroad-highway grade crossings

Roadway Delineation Practices Handbook

Bicycle Markings

Pavement markings are important on roadways that have a designated bicycle lane. Markings indicate the separation of the lanes for automobiles and bicycles, assist the bicyclist by indicating assigned travel paths, and can provide advance information for turning and crossing maneuvers.

General Principles

Although bicycles are not equipped with strong lighting, the added visibility of retroreflective pavement markings is desirable even where there is exclusive use by bicyclists. Markings should be retroreflective on bicycle trails and on facilities used by both motor vehicles and bicycles. Recognized bicycle lane design guides should be used when laying out markings for a bicycle lane on a highway facility (*MUTCD* section 9A-8).

The frequent use of symbols and word messages stenciled in the bicycle lanes is a desirable method of supplementing sign messages. Figures 75 through 77 show acceptable examples of the application of markings, word messages, and symbols on designated bicycle lanes with and without parking for automobiles. If a specific path for a bicyclist crossing an intersection is to be designated, a dotted marking may be used to define such a path.

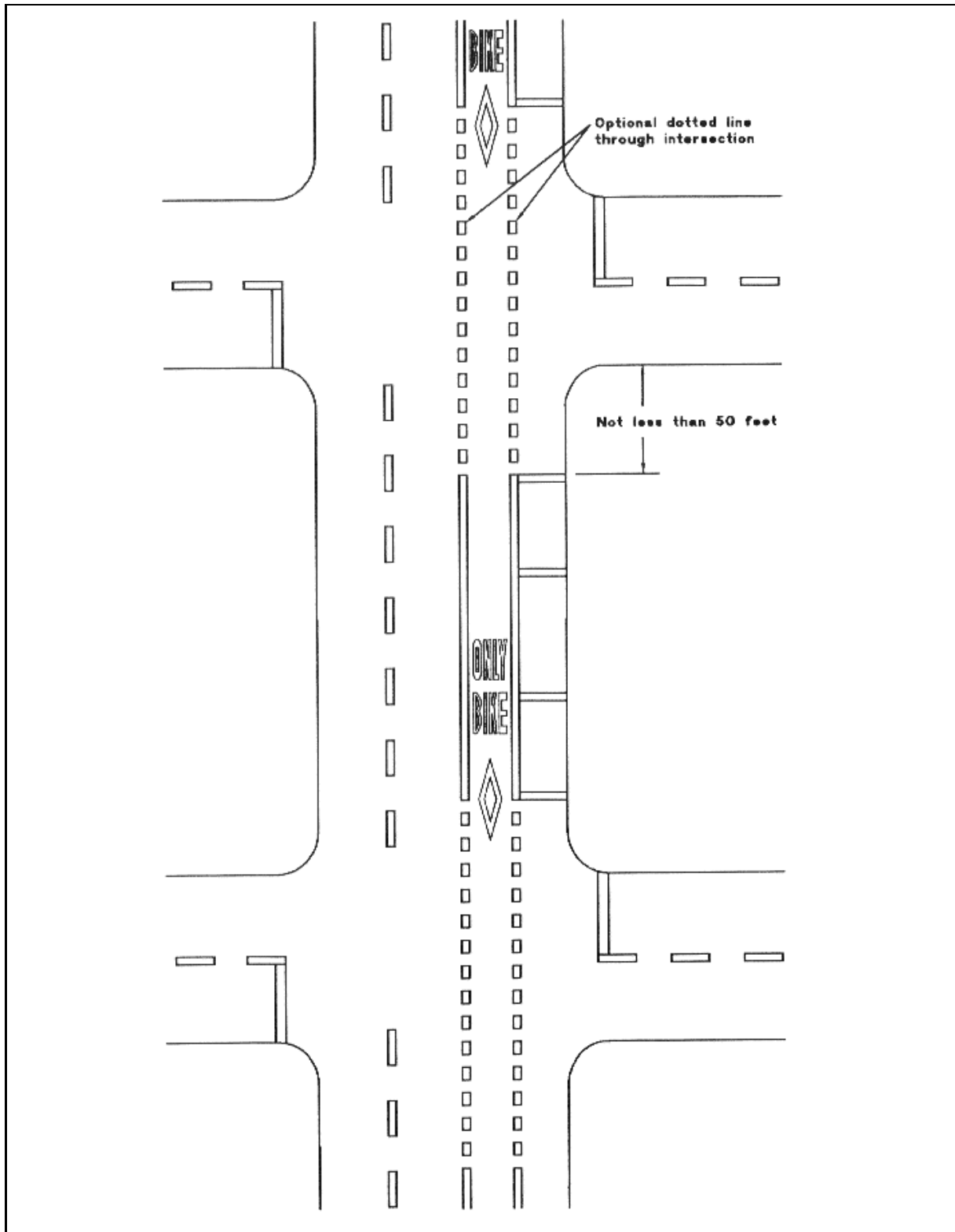

Figure 75. Typical pavement markings-designated bicycle lane, two-way traffic with parking and low

Roadway Delineation Practices Handbook

right-turn

volume

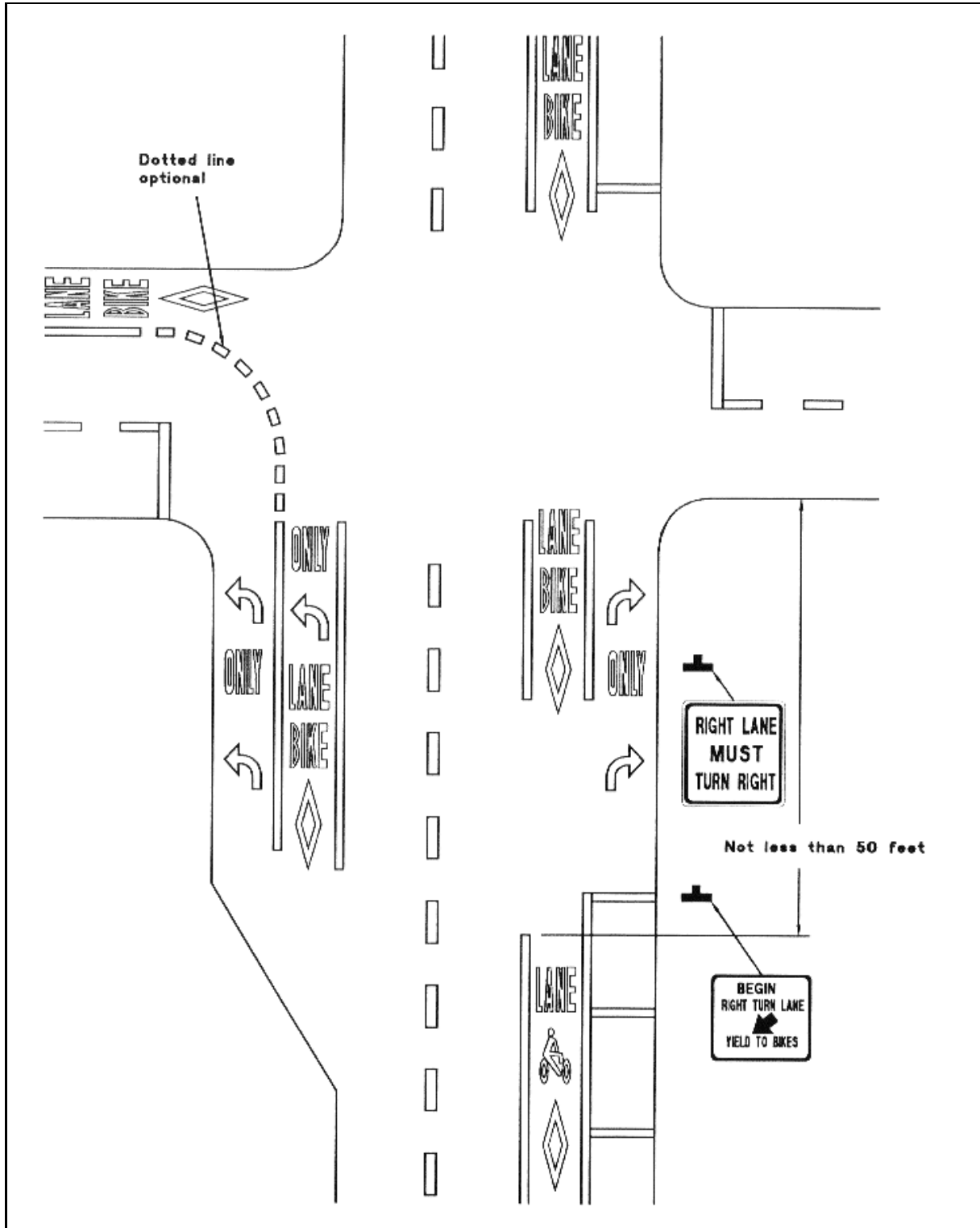
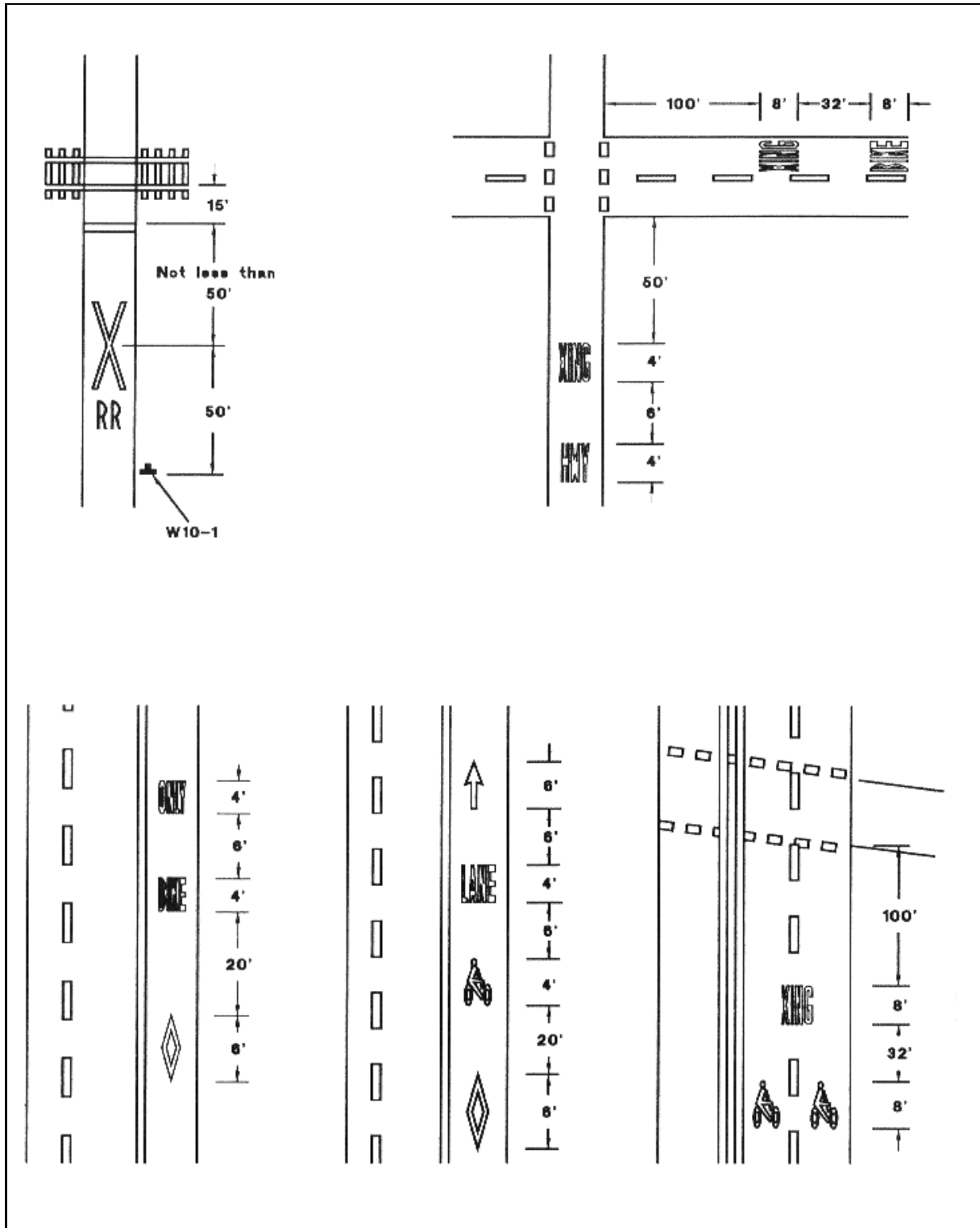

Figure 76. Intersection pavement markings-designated bicycle lane with left-turn area, heavy turn volumes, parking, one-way traffic or divided roadway



Roadway Delineation Practices Handbook

Figure 77. Word and symbol pavement markings for bicycle facilities

Marking Patterns and Colors

The color and type of markings used for marking bicycle facilities are defined in *MUTCD* section 3A-7. Normally, centerlines would not be required on bicycle paths. Where conditions make it desirable to separate opposing directions of travel at particular locations, a double solid yellow marking should be used to indicate no passing or no traveling to the left of the marking.

Where bicycle paths are wide enough to designate two minimum width lanes, a broken yellow marking may be used to separate the two directions of travel.

Broken markings used on bicycle paths should have the normal 3-to-1 gap-to-segment ratio. To avoid excessively long gaps, a nominal 3-foot (1-meter) segment with a 9-foot (3-meter) gap is recommended.

Where bicycles and pedestrians use a common facility, it may be desirable to separate the two traffic flows. Use a solid white marking to mark this separation of path use. The *MUTCD* R9-7 sign may be used to supplement the pavement marking (*MUTCD* section 9B-9).

Marking of Designated Bicycle Lanes

The diamond-shaped Preferential Lane Symbol is used on roadways where lanes are reserved for exclusive use by a particular class of vehicle. Designated bikeways are considered as this type of lane and should include use of the Preferential Lane Symbol as a pavement marking, with the appropriate signing (*MUTCD* section 9B-8). The pavement marking symbols should be white and should be used just after an intersection to inform drivers of the lane restriction. If the Preferential Lane Symbol is used in conjunction with other word or symbol messages, it should precede them. The supplemental lane symbol or word may be used as shown in figures 75 through 77.

Word Messages and Symbols

Where messages are to be applied on the pavement, smaller letters can be used on exclusive bicycle lanes than are used on regular highways. Use half-size layouts of the arrows where arrows can be used (*MUTCD* section 3B-17). Word and symbol markings appropriate for use with the Preferential Lane Symbol marking are shown in figure 77. Standard pavement marking alphabets and symbols have been prepared.

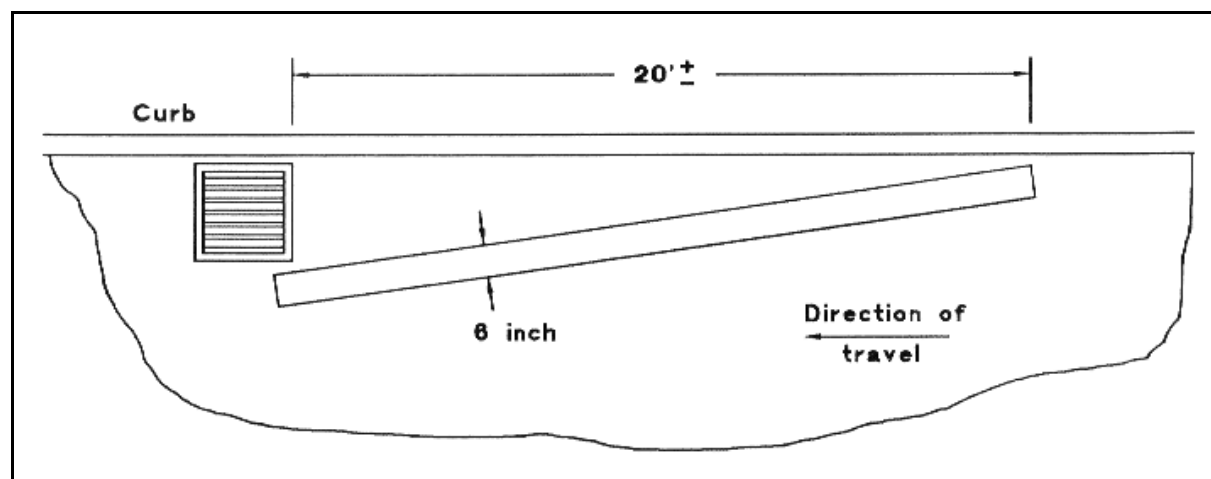

Figure 78. Typical marking in advance of drainage hazard

Roadway Delineation Practices Handbook

Object Markers on Bicycle Trails

There may be hazardous objects located adjacent to bicycle trails that, if visible to the bicyclist, can be avoided with little difficulty. Such objects should be demarcated by highly visible markings to make the hazard they present more easily seen. Care should be taken to avoid having object markers become hazardous objects. Corners of object markers, as well as designs, should be rounded to prevent their becoming a hazard. All object markers should be designed using retroreflective materials or coatings. Where practical, markers, such as those described above, should be used.

Inlets, Grates, and Other Hazards

Where a storm drain hazard cannot be eliminated, it may be made more visible to bicyclists by defining with a white marking applied as shown in figure 78.

PERFORMANCE

Pavement symbols and other delineation devices have the same visibility and durability as other pavement markings. That is, object markers and signs may lose their retroreflectivity and their night visibility will be reduced considerably. The previous chapters discuss performance for the specific delineation materials.

INSTALLATION, MAINTENANCE, AND REMOVAL

Installation, maintenance, and removal techniques for other delineation devices vary greatly depending on the class of the device. The following sections discuss major factors for object markers, warning signs, barrier delineators, and pavement symbols.

Object Markers

Inspect object markings on a regular basis for deterioration and vandalism. Also, the retroreflectivity of the markers can be checked using standard auto low beams for adequate visibility distances.

When used for marking objects in the roadway 8 feet (2.4 meters) or less from the shoulder or curb, the mounting height to the bottom of the object marker should be 4 feet (1.2 meters) above the surface of the nearest traffic lane. When used for marking objects more than 8 feet (2.4 meters) from the shoulder or curb, the mounting height to the bottom of the object marker may be 4 feet (1.2 meters) above the ground.

When object markers or markings are applied to a hazardous object that by its nature requires a lower or higher mounting, the vertical mounting height may vary according to need.

Warning Signs

Warning signs should be erected in accordance with the requirements for sign position as shown in figure 79.

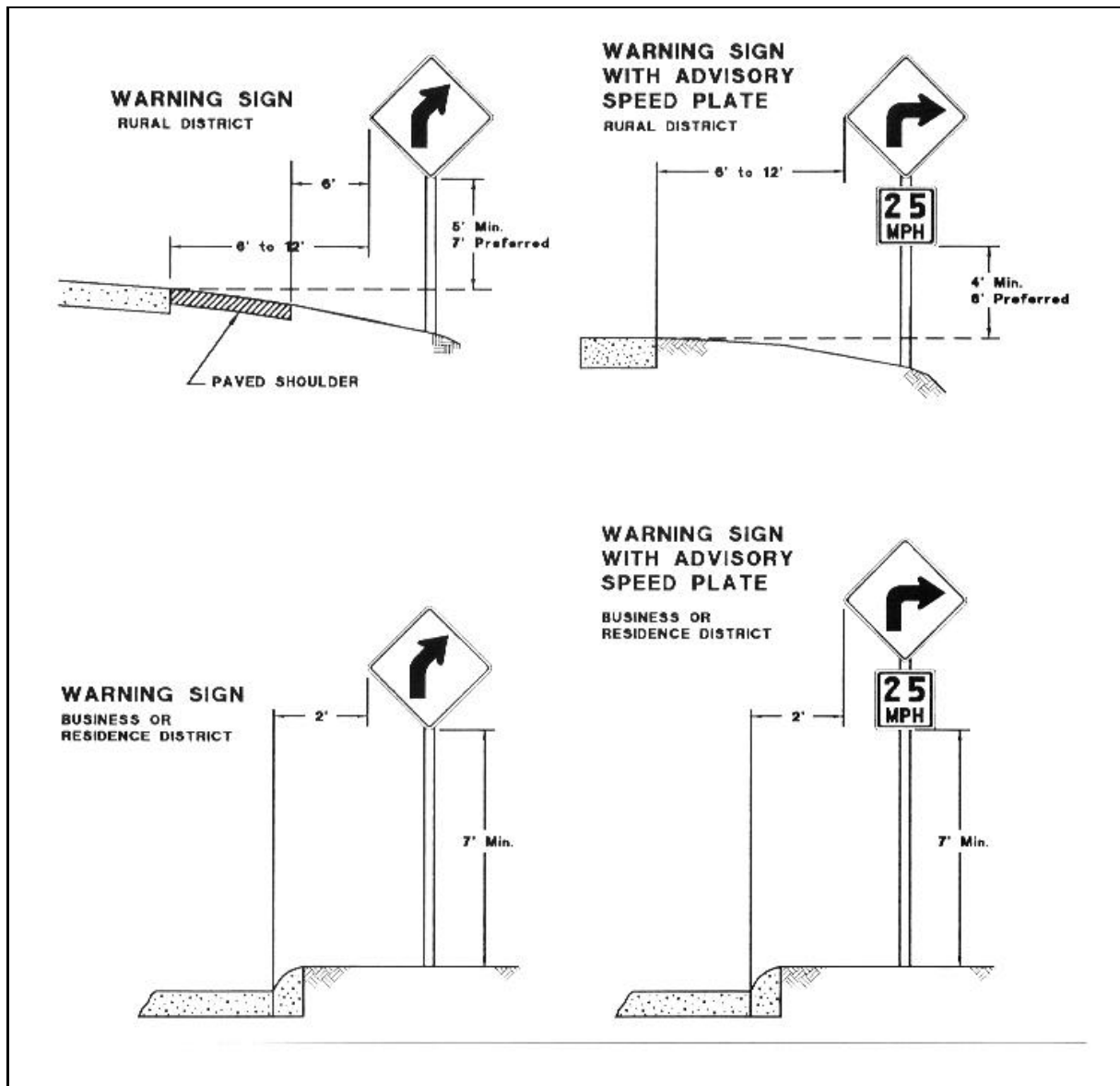
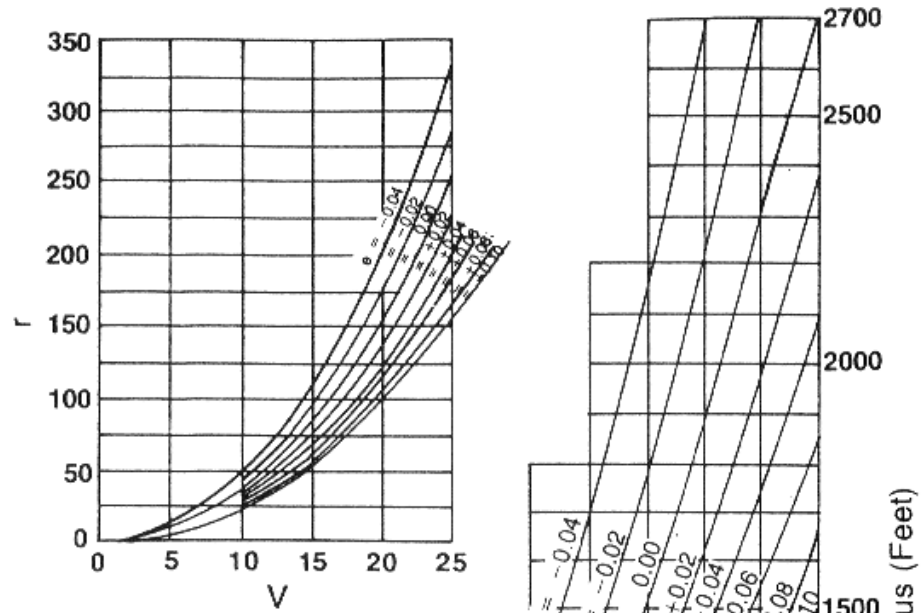

Figure 79. Typical installation of warning signs

Determining whether a particular curve needs to be signed depends on the speed at which the curve may be safely traversed. This safe speed may be determined by any of three methods.⁽⁶³⁾

The first method is a graphical technique. By knowing the curve radius and rate of superelevation, the recommended safe speed can be obtained from the graph in figure 80. Enter the vertical scale axis at radius, R. Move horizontally to the curve representing the superelevation, E. Then move down the horizontal scale to get the safe speed.



INSTRUCTIONS

1. Enter vertical scale at radius, r .
2. Move horizontally to curve representing super-elevation, e .
3. Move vertically down to horizontal scale to obtain safe speed, V .

SEE LARGE SCALE ABOVE

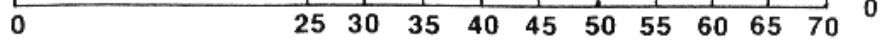

V = Recommended Speed (MPH)

Figure 80. Recommended safe curve speed

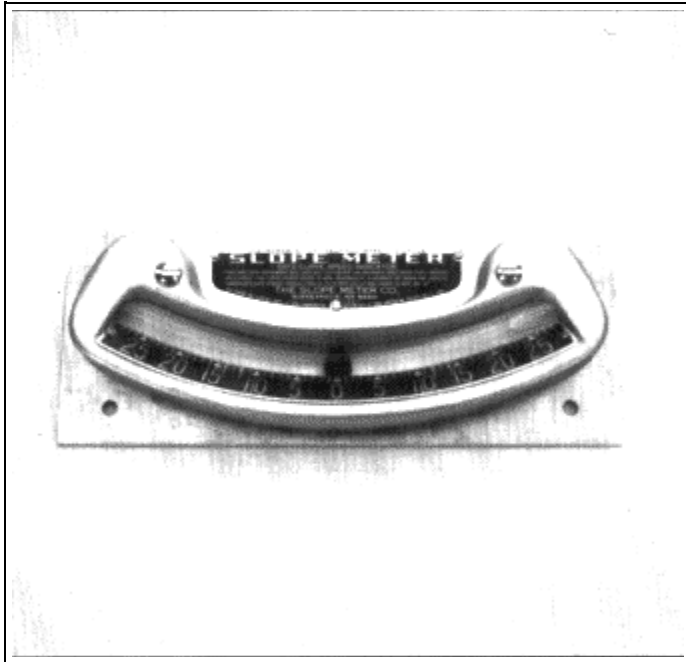

Figure 81. Ball bank indicator

The second method employs a mechanical device, the ball bank indicator. The ball bank indicator is mounted inside the 4-wheel vehicle and the safe speed around a curve is determined through a series of trial speed runs. The ball bank indicator's reading will show the combined effects of the body rolling angle, centrifugal force, and superelevation angle. Figure 81 shows pictures of a ball bank indicator. The vehicle is driven in a series of test runs, in both directions, parallel to the centerline of the curve. The curve should not be flattened out by driving the inside edge at the center of the curve.

The first trial run is made at a speed somewhat below the anticipated maximum safe speed. Subsequent trial runs are bank conducted with 5 mile per hour (8 kilometer per hour) speed increments. If a reading of 14 degrees or greater occurs at 20 miles per hour (32.2 kilometers per hour) or less, then the safe speed is below 20 miles per hour (32.2 kilometers per hour). The curve should be signed for 10 or 15 miles per hour (16 or 24 kilometers per hour), wherever a 14-degree reading occurs. For a safe trial speed of 20, 25, or 30 miles per hour (32.2, 40, or 48.3 kilometers per hour), a reading of 12 degrees is required. At trial speeds of 35 miles per hour (56.4 kilometers per hour) or greater, a reading of 10 degrees indicates the safe speed.

Evaluate curves in both directions when using this method. Many times it is preferable to use the lower speed condition for signing both approaches.

While many highway agencies use the 14-, 12-, and 10-degree system for signing curves, others use more conservative criteria. In some States for example, a 10-degree reading at any speed indicates the maximum safe speed. Prior to applying the ball bank indicator procedure, check the accepted criterion for the area in question.

The data acquisition system (shown in figure 82) is an electronic version of the ball bank indicator. It mounts in the test vehicle and is operated by the driver. The data acquisition system is used to establish highway posted curve speeds. The unit provides a printed reading of left and right curves; records distance, speed, and degrees of the test zone; records horizontal cross slope; records incline-testing information; and provides the data and time of tests. It is also personal-computer compatible.

Roadway Delineation Practices Handbook

A third method for determining the safe speed of a curve is to apply the following formula:

$$V^2 = 15 R (E + F)$$

Where:

- V = speed in miles per hour (kilometers per hour)
- R = radius of curve in feet (meters)
- E = rate of superelevation in feet per foot (meters per meter)
- F = safe coefficient of side friction

The recommended speed for the curve is determined by any one of the above methods, which in turn determines whether a turn or curve sign should be used.



Figure 82. Electronic data acquisition system

Since warning signs are primarily for the benefit of the driver who is unacquainted with the road, it is important to place signs carefully. Warning signs should provide adequate time for the driver to perceive, identify, decide, and perform any necessary maneuver. This total time to perceive and complete a reaction to a sign is the sum of the times necessary for perception, identification/understanding, emotion/decision-making, and volition/ execution of decision, and is referred to as the PIEV time. The PIEV time can vary from about 3 seconds for general warning signs to 10 seconds for warning signs used in areas requiring high driver judgment.

Table 15 lists suggested minimum sign placement distances that may be used for three conditions:

Condition A. Driver will need extra time to make and execute a decision because of a complex driving situation (lane changing, passing, or merging).

Condition B. Driver will likely be required to stop.

Roadway Delineation Practices Handbook

Condition C. Driver will likely be required to decelerate to a specific speed.

Table 15 is an aid for determining warning sign location. The values in the table are for guidance only and should be applied with engineering judgment. The placement of temporary warning signs used at roadway construction and maintenance sites is covered in part 6 of the MUTCD. The minimum sign placement distances given in table 15 may not apply to that group of signs.

The effectiveness of the placement of any warning sign should be tested periodically under both day and night conditions. Guidelines for inspecting and maintaining signs are presented in a FHWA report by McGee and Mace.⁽⁵⁾ Inspection should include the following:

- Condition of sign face—major cracking, blistering, or missing message, visible from the roadway.
- Orientation and structural stability of the post.
- Discoloration, streaking, or fading of the sign.

Table 15. Typical placement distances for general warning signs

Posted or 85th Percentile Speed (mi/h) (km/h)	Listed Advisory Speed or Desired Speed at Hazard (mi/h)				
	10	20	30	40	50
20 32 ⁽²⁾	---	---	---	---	---
25 40	100 ⁽³⁾ /30.5	---	---	---	---
30 48	150/46	100/30.5	---	---	---
35 56	200/61	175/53	---	---	---
40 64	275/84	250/76	175/53	---	---
45 72	350/107	300/91.5	250/16	---	---
50 81	425/130	400/122	325/99	225	---
55 89	500/152.5	475/145	400/122	300/91.5	---
60 97	575/175	550/168	500/152.5	400/122	300/91.5
65 105	650/198	625/191	575/175	500/152.5	375/114

Placement Distance of Sign in Front of Hazard (feet/meters)⁽¹⁾

Typical signs used in this manner include Turn and Curve. Placement distances shown are for level roadways. Corrections should be made for grades. If 48-inch signs are used, the legibility distance may be increased to 200 feet. This would allow reducing the above distance by 75 feet.

(1) Distance provides for 3-second PIEV, 125-foot sign legibility distance, braking distance as indicated in *A Policy on Geometric Design of Highways and Streets*, AASHTO, Figure 11-13, 1984.

(2) No suggested minimum distance provided. At these speeds, sign location depends on physical conditions at the site.

(3) In urban areas, a supplementary plate underneath the warning sign should be used specifying the distance to the hazard if there is an intersection which might confuse the driver between the sign and hazard.

- Visibility of the sign—roadside plantings or a new structure may be hiding the sign.
- Dirt or other substance on sign.
- Vandalism or accident that has damaged or removed the sign.
- Poor retroreflectivity.

All signs will experience diminishing retroreflectivity. The deterioration is a result of the sun's rays, moisture, pollutants, and even chemical reactions between the sheeting and the substrate. Loss of retroreflectivity also occurs from gun shots, spray paints, and vehicle impacts. Figure 83 shows vandalized signs.

Techniques to inspect for the loss of retroreflectivity from simple visual observations to the use of complex optical

Roadway Delineation Practices Handbook

and electronic equipment. The most simple method is to drive at night and look for obviously deficient retroreflectivity. An experienced inspector can determine when a sign is ineffective.

Daytime inspection procedures also exist. A 200,000-candlepower spotlight is pointed at the sign as the vehicle moves along the road. The hand-held beam, powered by the vehicle's battery, is flickered across the sign face by the driver or passenger. With a little training, the inspector can detect failing signs. Figure 84 shows the spotlight, which plugs into the vehicle's cigarette lighter, and an application of its daytime use to check a sign's retroreflectivity.

Figure 85 shows an example of a warning sign with deteriorated retroreflectivity. The high-powered spotlight shining on the signs illustrates that the older, deteriorated sign on the left (ICE ON BRIDGE) exhibits little retroreflectivity. The newer sign on the right (CAUTION BRIDGE MAY ICE IN WINTER) is bright and appears to glow.

The most accurate method is to use a portable retroreflectometer to measure the sign's retroreflectivity in the field. The procedure is time-consuming and should be limited to questionable signs detected by a visual inspection or for those signs identified for possible replacement by a sign inventory. In figure 86, the retroreflectivity of warning signs are being checked with the portable retroreflectometer.

The FHWA has developed a mobile unit for measuring sign retroreflectivity. The Traffic Sign Evaluator (TSE) is mounted in a van and records the sign retroreflectivity as the van travels along the roadway during daylight hours. The device is well-suited for highway agency sign management programs.



Figure 83. Vandalized signs

Sivak and Olson found that the geometric mean of replacement luminance value recommended in seven other research studies was 0.23 candelas per square foot (2.4 candelas per square meter).⁽⁸⁸⁾ This is the suggested replacement value. This would apply to light legends with dark (green, blue, red, and brown) backgrounds of up to 0.04 candelas per square foot (0.4 candelas per square meter) and to light (white, yellow and orange) backgrounds with black legends. Also, it assumes a 50-feet-per-inch (6-meters-per-centimeter) letter height for studies that use younger subjects and 40 feet per inch (4.7 meters per centimeter) for older subjects. Assuming an optimal sign luminance of 7.0 candelas per square foot (75 candelas per square meter), they suggest the coefficients of retroreflection for four sign locations as

shown in table 16.

Table 16. Replacement coefficients of retroreflectance using US-type low beam headlights

<i>Sign Location</i>	<i>Replacement Coefficient of Retroreflection (candelas per lux per square meter)</i>
Left-hand side	90
Overhead-mounted	114
Right-hand side	24
Ground-mounted guide side	27

Using the median value of 0.23 candelas per square foot (2.4 candelas per square meter) relates to a replacement percentile of only 50 percent. Factors that suggest an upward adjustment include headlight systems using European-type low beam, high-luminance surroundings and environmental glare, driver age, truck drivers' observation angle, drivers under the influence of alcohol or otherwise impaired, dirty signs, and dirty or misaligned headlights.



Figure 84. Daytime inspection of sign retroreflectivity

Sign maintenance is important to keeping the retroreflectivity at acceptable levels. Signs should be checked for damage and cleanliness during regular inspections.⁽⁸⁹⁾ Damaged signs may be repaired using overlay techniques. Small signs may be recycled by stripping the sign face and applying new sheeting.



Figure 85. Warning sign with deteriorated retroreflectivity

Most permanent warning signs do not need to be washed. However, in some locations a mild nondetergent solution can be used, if needed, to remove dirt. Other methods exist for cleaning special problems.⁽⁸⁹⁾

Barrier Delineators

Barrier delineators actually comprise a variety of different techniques of mounting or attaching retroreflective delineation to portable concrete barriers (PCBs). As such, the installation techniques used may vary widely from one brand of delineator to another. Also, the highway agency must decide whether the barrier delineators must be top or side mounted, and how far apart they will be spaced.

Barrier delineators are similar to raised pavement markers (RPMs) in that the primary problem with their use is how quickly they become dirty. When dirty, barrier delineators' performance can degrade to the point where they are no longer considered effective. Side-mounted delineators aggravate this problem since they are closer to the road surface and have a tendency to collect more dirt and road splash from passing vehicles.

Top-mounted barrier delineators relieve the problem with collection of road splash somewhat, but their effectiveness is decreased with the side-mounted delineators in the presence of headlight glare from opposing vehicles.⁽⁸⁹⁾ Obviously, some compromise must be made between these two conflicting factors.



Figure 86. Use of a portable retroreflectometer

Even when delineators are top mounted, cleanliness remains a problem. A research study at the Texas Transportation Institute (TTI) by Ullman, Dudek, and Allen concluded that delineators are effective in improving driver performance, but that they must be cleaned to be most effective.⁽⁹⁰⁾ They conducted a survey of all the Texas DOT districts in an attempt to identify how this process was being accomplished. At the time of the report (1988), no viable methods were being used in place of hand cleaning was found.

Hand cleaning of barrier delineators is labor-intensive and usually involves a dangerously high level of exposure for the workers involved. The TTI study also reviewed alternate, safer methods of delineator cleaning. Three of the most promising are presented in the report, including a self-propelled rotating brush system, a truck-mounted brush head system, and a high-pressure water sprayer. The researchers found that the performance data were inconclusive at the time and that further research was needed in the area of fabrication and testing of these systems.

Barrier delineators are similar to PMDs in that they are not normally removed during their lifetimes. Barrier delineators are also not directly subjected to traffic wear, so knockdowns are not a concern as with PMDs. Maintenance and cleaning of the retroreflective faces is usually the prime concern.

Pavement Symbols

Since pavement symbols are a form of pavement markings, their installation, maintenance, and removal follow the guidelines for the particular type of material. See the appropriate chapter for specific details.

Roadway Delineation Practices Handbook

Zehn/PS	.959	.856	--	--	--	--	--	--	--	--	--	--	--
Zehntner	.845	.56	.86	--	--	--	--	--	--	--	--	--	--
Optronik	.947	.802	.992	.916	--	--	--	--	--	--	--	--	--
Etichsen	.986	.838	.989	.858	.978	--	--	--	--	--	--	--	--
Ohio #1	.916	.919	.98	.757	.953	.952	--	--	--	--	--	--	--
Ohio #2	.902	.853	.986	.833	.98	.95	.986	--	--	--	--	--	--
New York	.723	.752	.887	.723	.884	.81	.918	.95	--	--	--	--	--
Penn #1	.761	.756	.899	.82	.915	.826	.907	.953	.976	--	--	--	--
Penn #2	.812	.826	.931	.808	.934	.866	.947	.974	.974	.993	--	--	--
Penn #3	.769	.699	.898	.876	.927	.832	.881	.943	.939	.992	.977	--	--
Virginia	.711	.561	.866	.829	.893	.809	.834	.907	.939	.927	.903	.947	--
Hercules	.656	.722	.826	.723	.838	.733	.86	.904	.975	.986	.973	.965	.895

In general, the average highway agency need not be concerned with problems in the standards. It should instead focus on selecting an appropriate instrument and using that instrument consistently to obtain reliable values.

INVENTORY

Each highway agency's management staff should establish a system to inventory all roadway delineation applied within the agency's jurisdiction. In this way, the agency can monitor any section of roadway and determine what techniques and treatments seem most effective on it. Also, a regular system of inventorying roads will help a highway agency identify problem spots or locations that have become hazardous.

Computerized

Computer data bases that track information on delineation is one method of inventorying roads. These systems consist of a computer that tracks each delineation application's characteristics and vital information. Each entry in the data base might consist of a particular marking project. Alternately, the roadway system could be divided into sections, with each section being monitored separately. Information included could be type of delineation devices, location, materials used, and current state of the devices. These systems will normally rely on subjective nighttime evaluations of retroreflectivity or readings taken with a portable instrument. The following section discusses just how these subjective

Roadway Delineation Practices Handbook

evaluations should be performed.

Photo Log

The concept of photo log inventory can be illustrated with an example. A study performed in Texas proposed a system to evaluate effectiveness of raised pavement markers (RPMs).⁽⁷⁴⁾ The procedure has four possible steps: creation of a photographic inventory, site evaluations of RPMs' effectiveness, use of maintenance photo-graphs, and decision of appropriate actions.

1. *Photographic inventory.* Sites to be evaluated should be photographically inventoried from a vehicle. The appropriate camera setting should be either a 1/60-second shutter, f-stop 1.4, or 1/30-second shutter, f-stop 1.8. A high-speed 35-mm film, such as ASA 400 pushed two stops, or a night 8-mm movie film such as Type G should be used.

2. *Site evaluation.* A panel of five, seven, or nine individuals selected by district personnel should examine the photographs from the sites to be evaluated. This panel is not so large that the members cannot adjust their schedules to perform the evaluation. The odd number prevents ties.

The subject site will be evaluated with respect to the effectiveness of its RPMs. An acceptable rule of thumb is that if 50 percent of the markers are missing, the system is ineffective. A system is semi-effective when 20 to 30 percent of the markers are missing. Markers become ineffective when their specific intensity is 0.05 candle power per foot candle or less for 75 percent of the remaining markers. A system is semi-effective when 75 percent of the remaining markers have a specific intensity between 0.2 and 0.4 candle power per foot candle. At the time of the study, the only way to determine the specific intensity of the markers was to either remove several randomly selected markers for analysis in a laboratory or use a photometric van.

3. *Maintenance photographs.* When the panel cannot decide the effectiveness of the markers based on their physical properties, a set of maintenance slides should be used. A suggested procedure is for each member of the panel to view the slide of the site in question individually and to consider the set of maintenance standards. After each member selects the most appropriate standard, the panel would reconvene. A decision would be reached by using the standard set of photographs.

4. *Appropriate actions.* If a site is judged to be semi-effective or ineffective, the appropriate action would be taken and that the maintenance activity decided on by the evaluation panel would begin.

Expert panel members should rate the effectiveness of the sites based on the following guidelines:

Effective. A site would be effective if, in the mind of the rater, the RPM system provided sufficient information to drivers without any maintenance needed at the site. The rater should judge the effectiveness based on the number of missing markers, visibility of the markers remaining, test conditions, color of the markers, spacing of the markers, and intended purpose of the pattern.

Semi-effective. A site would be semi-effective if would need maintenance within the following 6 to 12 months to establish it as effective. Completion of the necessary maintenance would depend on the availability of funds and the placement of the site in the maintenance schedule. Semi-effective systems are those that, at the time the location was rated, the drivers considered the RPMs to provide marginally sufficient information.

Ineffective. A site is ineffective if the RPMs are not providing sufficient information to the driver and immediate maintenance is required. No other treatment except total maintenance of the site can be used to provide the required positive route guidance needed by drivers.

The system explained here could be applied easily to an overall management program for an agency's delineation projects.

Other Techniques

There are a few new methods for inventorying roadways. One combines videotaping all of the roads within a highway agency and cataloging the tapes on a computer laser videodisc system. In the past, this system has been used to maintain video records of all roadways and would be used mainly during design of new construction projects. However, once the system has been created, application of the technique to other departments in the highway agency, such as delineation management, would be very simple.

A program like this has begun in the State of Connecticut and is discussed in a Federal Highway Administration report on innovative techniques for traffic control devices.⁽⁹¹⁾

INSPECTION

Inspection is vital to management of delineation programs for those agencies that do not maintain an inventory of all roadways. Highway agencies should institute a policy for periodic inspection of all delineation projects after their installation and throughout their service lives. Some recommended methods of inspecting delineation are discussed in the following sections.

Daytime

Daytime inspections of delineation will consist normally of tests that require the inspector's presence on the roadway or well-lit conditions for good visibility of the material itself. These include testing of percentage of material remaining, color durability, and cleanliness of RPMs and other retroreflective devices. The method for determining percentage of material remaining is presented in chapter 5. Color durability is tested using a comparison guide with standard highway colors.

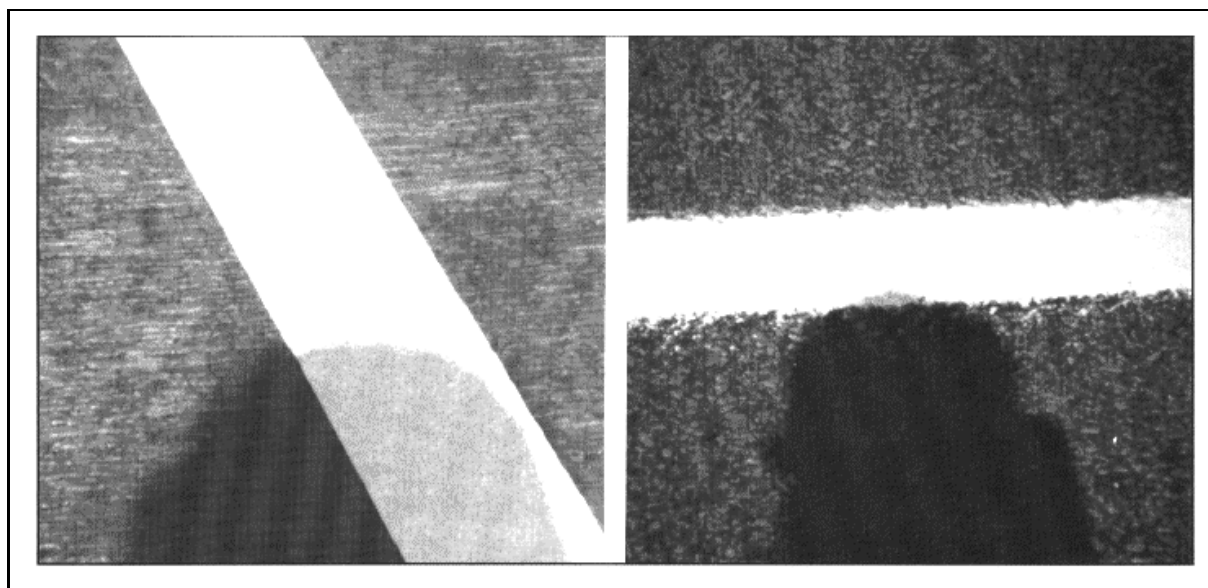

Figure 87. Examples of sun/shadow technique

Sometimes retroreflection also will be tested during the daytime. For pavement markings, this may be done manually with the sun/shadow technique or by using a pocket microscope or portable retroreflectometer. With the sun/shadow technique, the marking is viewed at an angle so that the shadow of the viewer's head is directly on the marking, as shown in figure 87. From this position, light from the sun will be directed back to the viewer, causing the marking to "glow." Using this method, an experienced inspector can make a reliable estimate of nighttime effectiveness

Roadway Delineation Practices Handbook

of the marking.

For warning signs and other types of delineation devices, the Q-beam method of testing discussed in chapter 10 may be employed during daylight.

Nighttime

Research has established that reduced nighttime visibility is normally the first sign of failure for a delineation device. For this reason, retroreflection is tested most often through simple nighttime inspections of a device's brightness and visibility distance. These inspections often are made simply using automobile headlights for illumination. Highway agencies often establish formal guidelines for minimum visibility distances of delineation devices at night. Devices that do not meet the visibility distance requirement are identified for repair, cleaning, or replacement.

A word of caution is included with the use of this practice. Almost all night driving is with low-beam illumination. Most drivers will not use high beams unless oncoming traffic drops below one vehicle every two minutes. Some highway agencies, however, have used high beams at night to establish visibility distances. This practice is discouraged by the FHWA, since it does not represent the average driving situation.

Equipment and Facilities

One of the advantages of the methods described previously is that the equipment and facilities required are minimal. For nighttime inspections of the type discussed, only an automobile and an inspector are needed. Some of the daytime inspections require instruments for measurement. These instruments are discussed in the next section.

FIELD TESTING

Many of the inspection techniques discussed require some form of field testing of installed delineation. This section will discuss the instruments and procedures related to performing field tests.

Instruments

A variety of instruments can be used in the field to test retroreflectivity. These devices range in price from a few dollars for a pocket microscope to \$10,000 to \$15,000 for a portable retroreflectometer.

Microscope

A pocket microscope, shown in figure 88, may be used to test distribution, quantity, and proper embedment of glass beads in the pavement marking. A pocket microscope is a small, inexpensive, lensed apparatus with magnifying power sufficient for the inspector to discern individual beads.

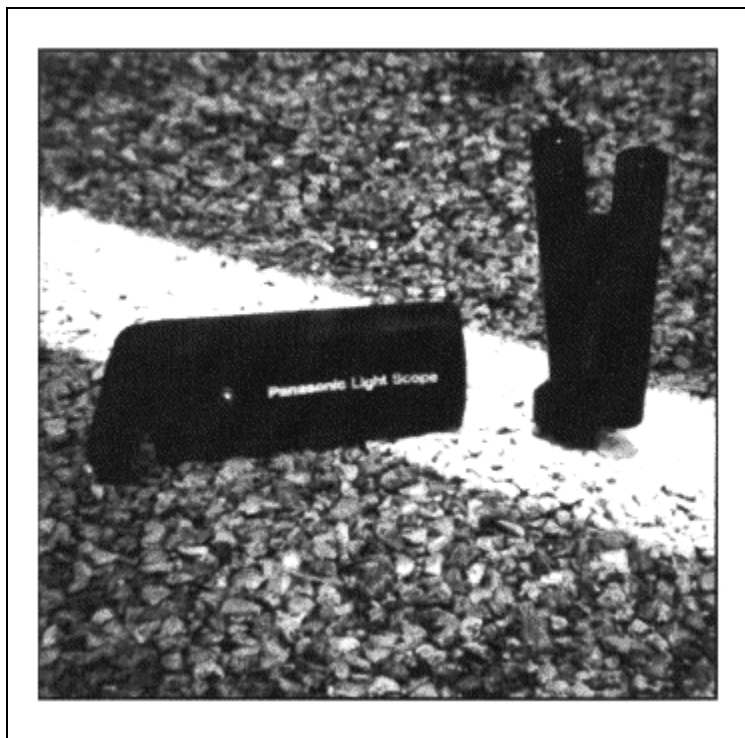

Figure 88. Pocket microscope

Beads should appear uniformly distributed over the marking, densely packed to give good retroreflection. They should not be packed so closely that they obscure the surface of the pigmented binder. Embedment should be about 55-60 percent of the bead's diameter.

Retroreflectometer

A variety of instruments to test the retroreflectivity of pavement markings electronically are now available commercially. Most of those used are small, hand-held, portable units. These instruments are simply small box-like apparatus with optical devices mounted upon their undersides. The unit is set upon the marking to be tested, the instrument shines a light at a fixed sample area and then measures the percentage of light returned. Most are calibrated to read in units of millicandelas (0.001 candelas) per lux per square meter.

For more information on optical units and some of the problems with current testing standards, see chapter 2.

Portable Equipment

Portable retroreflectometers are used to obtain performance estimates through measurements of retroreflectivity.

These instruments are usually classified by fine and coarse geometry. Fine geometry instruments closely simulate the entrance and observation angles experienced by a driver, while coarse geometry instruments do not. Therefore, the fine geometry instruments are much better at predicting subjective ratings of effectiveness.

These are often used as evaluation criteria, as discussed in the section on Safety and Year-Round Maintenance. Some characteristics of the most popular equipment are given below.

Mirolux 12

Roadway Delineation Practices Handbook

Many studies use the MiroLux 12 retroreflectometer, pictured in figure 89, in an attempt to establish minimum retroreflectivity standards. It is a fine geometry instrument with illumination and observation angles of 86 1/2 and 1 1/2 degrees, respectively. The recommended procedure for use consists of the following steps:

1. Zero and calibrate the instrument.
2. Check the battery voltage.
3. Take reading(s). Three readings should be taken at each location. Each reading should be within 10 percent of the average reading. If any of the readings are not, two more readings should be taken.

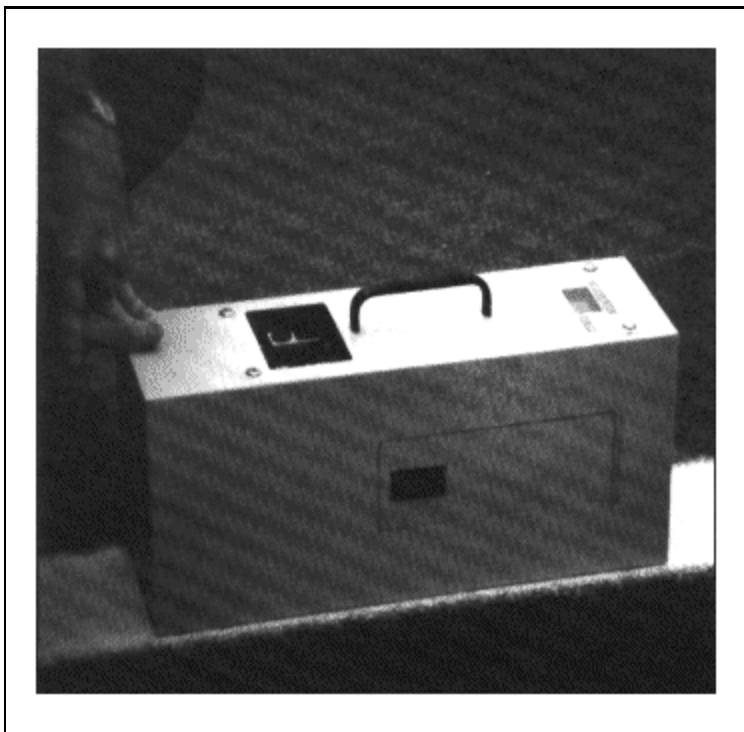

Figure 89. MiroLux 12 retroreflectometer

The instrument is manufactured by MiroBran Assemblers, Inc. (Clifton, NJ). The price is about \$4,500. It is considered one of the more cost-effective portable instruments.⁽²⁵⁾

Other Instruments

A number of other foreign-built, fine-geometry instruments are being used in the United States. These include the Ecolux, Erichsen, and Optronik brands. Studies have attempted to establish the correlation of readings of these instruments with one another, with other instruments, and with subjective panel ratings.^(25,6)

In general, the fine-geometry instruments correlate with one another, and with subjective ratings, much more closely than the coarse-geometry instruments.⁽⁶⁾ When the instruments have been properly calibrated, the fine-geometry retroreflectometers usually correlate within 10 percent of other fine-geometry instruments (table 17).

Mobile Equipment

One of the limitations with even the fine-geometry instruments has been their lack of flexibility. For most of these instruments, there have always been problems due to the instrument's fixed geometry, sample area, and sensitivity to background light and other environmental interference. A new laser retroreflectometer will rectify some of these

Roadway Delineation Practices Handbook

deficiencies. Advanced Retro Technology (La Mesa, CA) has developed such a device in cooperation with Potters Industries (Parsippany, NJ); it is described in a study performed by J.J. Rennilson.⁽⁹²⁾

Figure 90 shows a schematic diagram of the laser retroreflectometer. In order to block ambient light and enable day/night retroreflectivity measurement, this new device makes use of a specific wavelength of laser light and a narrow band-pass filter. The filter blocks reception by the photoreceptor of all other wavelengths of light. Thus, it makes possible day/night, wet/dry variable geometry retroreflectivity measurements.

Figure 91 shows the laser retroreflectometer mounted on a pickup truck. The laser beam exits through the lower lens and is aimed so that, on level ground, it strikes the pavement marking at a distance of 33 feet (12 meters). The retroreflected light from the marking enters the device through the upper lens. The test vehicle can travel at normal highway speeds while recording data. A video camera mounted on the seat is aimed at the marking being evaluated. The retroreflectometer's alignment is shown on a video monitor and is used by the driver to guide the vehicle. Data captured on a laptop microcomputer mounted on the passenger seat is later analyzed on a microcomputer at the Advanced Retro Technology office.

Initial tests of the device have been highly successful. The results of readings taken in the field under high sun daylight and nighttime conditions for the same marking materials were compared for each marking material tested, yielding a correlation within 2.5 percent. The correlation of the laser retroreflectometer results with laboratory readings for pavement marking tape can be seen in figure 92.

Plans are being made to market and sell this device to highway agencies. At this point, revisions and improvements are being made to the computer hardware and software that facilitate data collection for the system.

When available, this device should be an aid to highway agencies in determining the quality of markings. The device yields good results for retroreflectivity; it is easily mounted on a small truck or van and can be used during the daytime at highway speeds without the need for traffic controls.

The device can be used even to scan retroreflectivity across the face of the marking to measure the uniformity of its retroreflective properties. This ability may allow it to be used on a striping machine as a method of quality control for the pavement marking process.

TORT LIABILITY

Tort liability claims have risen dramatically in recent years (chapter 12). Because of the huge awards that have resulted when these claims have gone against highway agencies, many of these highway agencies have been searching for ways to limit their tort liability.

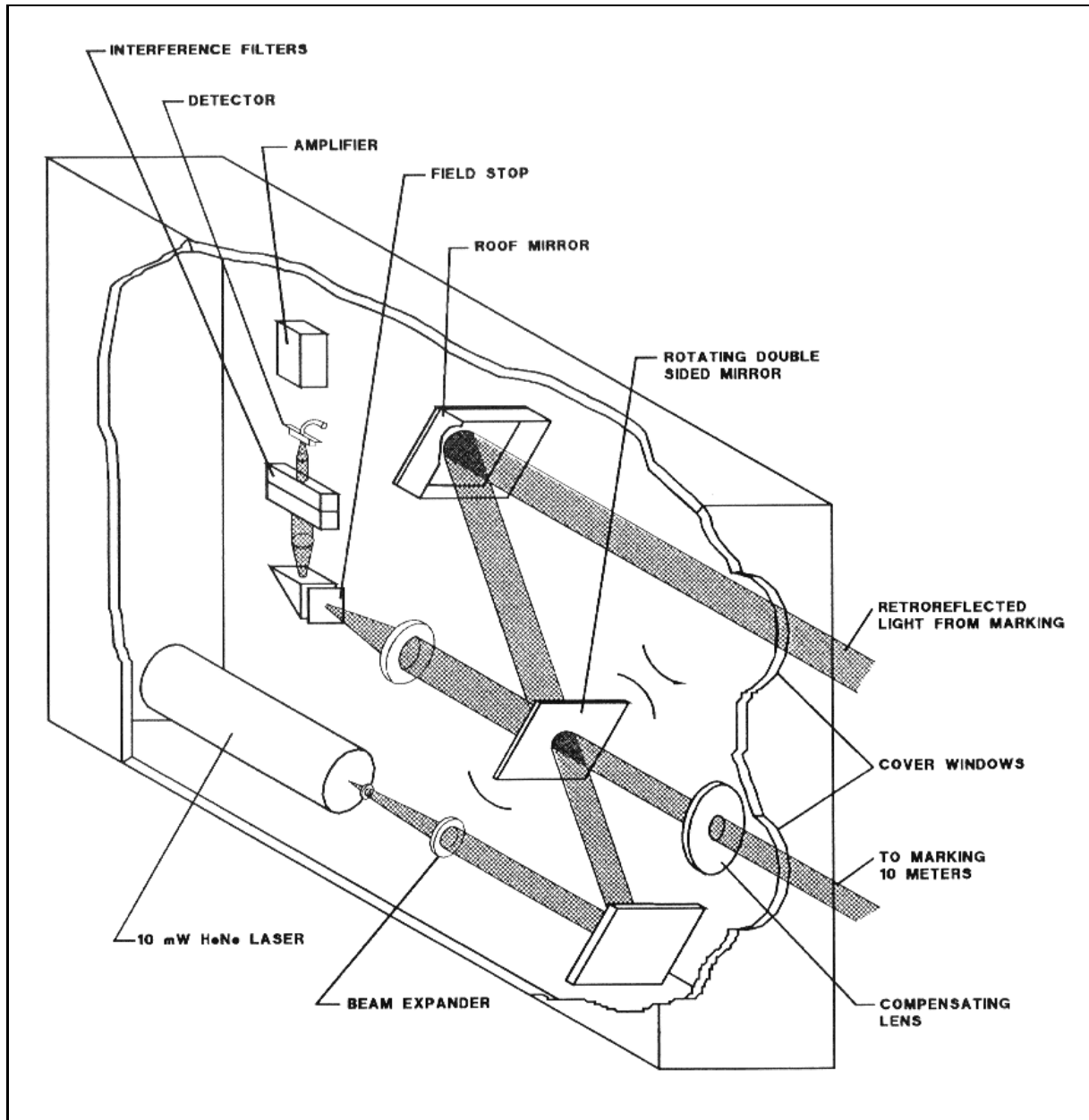

Figure 90. Schematic of laser retroreflectometer

One of the most effective methods available to a highway agency for reducing exposure to tort claims related to delineation is a comprehensive, efficient roadway delineation management system. This system establishes a reasonable standard of care for a highway agency's activities. If a highway agency has an FHWA-approved policy for management of delineation systems, following the policy takes on the force of a statute governing the actions of the agency.



Figure 91. Pictures of the truck-mounted laser retroreflector

This is not meant to imply that following a delineation inventorying and management program will guarantee

immunity from prosecution. Each court will make a ruling based on the specific concerns of the case. The management system should be used instead to establish the safest roadways possible, thus establishing the highway agency's paramount concern for the safety of the traveling public.

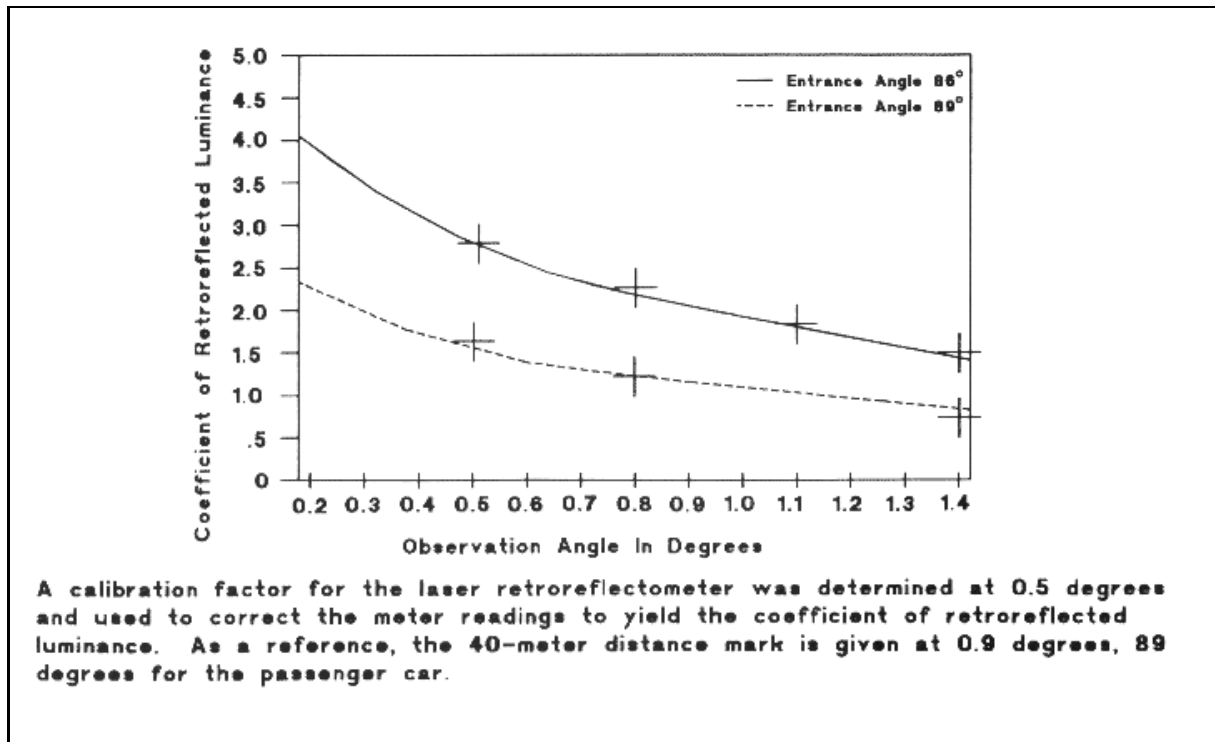

Figure 92. Retroreflection of pavement marking tape as a function of observation angle and two entrance angles.

CHAPTER 12. ADMINISTRATION

INTRODUCTION

The design, application, and maintenance of an effective roadway delineation system requires a thorough knowledge of drivers' needs. General concerns are important, as well as those dictated by the geometry and traffic characteristics of the particular roadway. Standards, warrants, and legal implications of the agency's responsibility to maintain the highway in a reasonably safe condition make administration of a safe delineation system difficult. The task is made more complex by the array of delineation techniques and technologies. If liability is to be avoided, the best method must be selected for a particular situation. It is often difficult to determine the level of visibility for delineation that will be adequate for all drivers' needs on a specific roadway.

If funds were unlimited, it would be relatively easy to maintain safe roadways. Technology can meet the challenge, highway agencies have the skills they need, and research is continual and the state of the art always improves. Unfortunately, funds are not unlimited. In reality, cost-effectiveness of delineation alternatives is as important as overall performance. A delicate balance exists between the need for overall frugality and the use of extreme measures where they are needed. Consequently, the role of administration and management becomes more demanding and complex.

Roadway Delineation Practices Handbook

This chapter focuses on some of the administrative considerations associated with roadway delineation. These include the implication of legal responsibilities, the availability of Federal funding, cost-saving procurement practices, the use of highway agency forces versus contracted work, and special treatments associated with the field of delineation.

LEGAL CONSIDERATIONS

In the past, government entities were all but immune from lawsuits on the theory of “sovereign immunity,” derived from English common law. Under the sovereign immunity doctrine, a government entity may be sued only if it consents to the suit in advance. During the past 30 to 40 years, this situation has changed dramatically. Sovereign immunity has now been eroded through the actions of courts and/or legislatures. Consequently, many State highway agencies have become vulnerable to lawsuits for damages resulting from highway accidents.

Because of these changes in legal doctrine, highway agencies’ personnel increasingly are involved in a field of litigation that was previously of concern only to attorneys. Today, it is necessary that State and local highway agency staffs keep abreast of current highway law practices. Accordingly, the basic legal considerations involved in roadway delineation practices have been included here to provide a basic understanding of the purpose, intent, and direction of current tort liability.

This discussion is a basic treatment of a complex subject. It is not meant to interpret the law or establish guidelines. It is intended only to help highway agencies recognize the possible consequences of failure to maintain and safeguard their roadways.

There are numerous reports and references prepared by legal staffs that can be consulted for more definitive information. The Institute of Transportation Engineers has developed a one-day seminar as part of its Continuing Education Program entitled *Traffic Improvements—Legal Aspects and Liability*. It is intended to upgrade and expand awareness among highway agencies’ personnel.⁽⁹³⁾ In addition, the legal staffs of State agencies often are called upon by operating units to interpret the statutes that concern them and suggest ways to avoid tort litigation.

Definition of Tort Liability

The legal responsibilities of highway agencies arise from the principles of tort law. This section defines some basic terms.

A *tort* is a “civil wrong, other than breach of contract, for which a court of law will provide a remedy in the form of an action for money damages.”⁽⁹⁴⁾ Torts can be either intentional (assault and battery, false imprisonment, trespass, and theft) or unintentional (negligence). Torts claiming negligence are the most common to highway agencies.

Liability means the legal obligation of the tort-feasor (the negligent party) to pay damages to the victim. More than one person or organization may be liable for damages arising out of the same event. In the case of negligent conduct by an employee, both the employee and the employer may be held liable for damage, even when the employer is a public entity.

Negligence is defined as the failure to do something that a reasonable person would ordinarily do, or the doing of something that a reasonably prudent person would not do. Negligent conduct creates risk of harm to someone who is owed a duty of exercising care.

Comparative negligence is a modern alteration of the strict contributory negligence rule that bars recovery by negligent plaintiffs. Under the modern system, the defendant is liable for that portion of the damages that his or her own negligence caused. Thus, if an accident is judged to be 40 percent plaintiff’s negligence and 60 percent defendant’s negligence, and the plaintiff suffered \$10,000 damages, the plaintiff would receive from the defendant \$10,000 less 40 percent, or \$6,000 total. In a jurisdiction that has not adopted the comparative negligence procedure, the plaintiff would recover nothing. The plaintiff’s contributory negligence (in any proportion) prevents his or her collection of any damages.

Roadway Delineation Practices Handbook

The *reasonable person* (sometimes called the “reasonable man,” the “reasonably prudent person,” or the “ordinary man”) is used to establish the level of care that is judged to be negligent. In effect, this definition imposes a test of negligence as being the “failure to use ordinary care.” This is the test most often used in determining liability. In the context of this Handbook, an engineer would be found negligent if his or her conduct did not measure up to that of a hypothetical engineer who acts in a reasonably prudent and careful manner under the same circumstances.

Duty in tort law is an obligation to conduct oneself in a way that will protect others from unreasonable risks. Negligence is a breach of the duty to exercise reasonable care owed to those persons to which the duty applies. In this context, a highway agency owes a duty to all drivers on its roadways. The highway agency’s duty is to avoid creating unreasonable risks for drivers and to meet the standard of care imposed on that particular highway agency.

The *standard of care* for any person is set by a multitude of factors. At the bare minimum, all persons are required to avoid the creation of unreasonable risks, where feasible. In addition, statutes and regulations help define the standard of care by which conduct is judged. For example, failing to observe a Stop sign is not only an infraction, but also failure to meet the standard of care that sets the boundaries of liability. Violation of a safety statute is considered to be negligence in itself.

Finally the accepted standards and practices of a profession, trade, or industry also define the standard of care by which conduct is judged. Included in the definition of “accepted standards and practices” is the *Manual on Uniform Traffic Control Devices (MUTCD)*⁽¹⁾ and other similar documents. In general, “a violation of a uniform law or regulation may be evidence of negligence or may constitute negligence per se.”⁽⁸⁶⁾ In the Highway Safety Act of 1966, the *MUTCD* was adopted as a national engineering standard. Although it is a Federal regulation, not a statute, the *MUTCD* standards have been adopted by many States into their own laws, thereby giving them the full force of statutes. A failure by highway agency personnel to conform with the requirements of the *MUTCD* would probably be sufficient to establish negligence (and therefore liability), if an accident results from that failure to conform.

To place these concepts in perspective, it is necessary to recognize several characteristics of tort liability. First, the most common tort is negligence, which is the failure to use reasonable care in one’s actions. Next, court decisions in tort claims are based on the concept of the existence of a “reasonably prudent person” exercising “ordinary care.” Finally, negligence is established by a failure to meet the standard of conduct set by the hypothetical “reasonable person” exercising “ordinary care.”

In effect, the injured plaintiff bringing suit must prove the following in a negligence case arising from a highway accident:

- The defendant (highway agency or its agents) had a legal duty to exercise reasonable care toward the plaintiff (victim).
- The defendant was negligent (defendant’s conduct failed to meet the standard of reasonable, ordinary care), thus breaching that duty.
- The plaintiff’s damages (injuries, property damage, pain and suffering, or loss of income) were caused by the breach (defendant’s negligence), and were the foreseeable result of that breach.
- The plaintiff must not have been contributorily negligent to recover all the damages suffered.

Legal Duty and Liability

Highway agency personnel have definite obligations to the public. These duties are imposed specifically or generally by law. Basically, their duty is to maintain the roadway in a reasonably safe condition. This involves inspection, anticipation of defects, and conformity with generally accepted standards and practices. There is no requirement for perfect conditions of repair or for actions beyond the limits of human ingenuity.

Roadway Delineation Practices Handbook

To understand the application of the concepts of legal duty, it is necessary to recognize the distinctions between discretionary acts and nondiscretionary (ministerial) acts. Many States that no longer retain the sovereign immunity doctrine have enacted Tort Claims Acts, which prescribe the conditions under which States, their agencies, and their employees may be held accountable for their torts. These acts include some exemption from liability during the performance of so-called discretionary activities.

The term *discretionary* refers to making a choice from a number of alternatives; it requires consideration and independent judgment to choose a course of action. On the other hand, *ministerial* duties involve mandatory tasks that require little personal judgment. The difference between discretionary and ministerial functions is very important in tort claims against public entities. In general, a public entity and its employees are not liable for negligence in the performance of discretionary activities. However, the courts constantly revise the law in this area. Classification of an activity as either discretionary or ministerial is subject to constantly shifting legal interpretations.

Also, the limited exemptions from liability for discretionary activities do not provide absolute protection from legal liability. If discretion is abused, courts may substitute their own discretion for that of the defendant to reach a result in a particular case.

The courts normally consider the design of roadways to be a discretionary government function, since it involves high-level planning activity and evaluation of policies, competing alternatives, and other factors. Many decisions support this, holding that design is quasi-legislative in character and must be protected from the “second guessing” of inexpert courts. Unless there is an abuse of discretion that justifies a court resorting to second guessing, most roadway design issues remain within the control of highway agency personnel. To help protect State highway agencies and employees from tort liability, some legislatures have passed design immunity statutes. Designs that have been properly approved are further isolated from possible tort claims.

Notice of Defect

The highway agency has a duty to correct a dangerous condition when it receives notice of the hazard. Most courts say the State must have had notice of the hazard for a sufficient time to afford them a reasonable opportunity to repair the condition or take precautions against the danger. When a dangerous condition is the result of the State’s own negligence, the notice requirement does not apply. The State does not need notice of faulty construction, maintenance, or repair of its roadways, because the State should know its own actions. However, if the danger did not result from the active negligence of the public entity, it must perform repairs once it has notice of the defect.

Statutes may require that a highway agency have notice of the condition for a specified period of time. If the notice period is five days, and an accident is caused by a defect that originated the same day of the accident, the statutory notice period would not be satisfied and the highway agency would not have had a reasonable opportunity to make repairs. The notice must be of the particular defect that caused the accident, not merely of conditions that may produce the defect. In this example, the statutory period may be considered satisfied if the State had knowledge of the unsafe condition.

Finally, it is possible that a condition has existed for such a time and is of such a nature that the State should have discovered the condition by reasonable diligence. In this case, the notice is said to be constructive, and the State’s knowledge of the condition is implied. The courts may consider whether the defect was difficult to discover. That is, the court will consider the nature of the defect, its location and duration, the amount of use the roadway receives, and whether the defect would easily be perceived. This will aid the court in deciding if the State had reasonable notice.

Maintenance of Delineation Systems

The wording of *MUTCD* suggests some of the legal implications of delineation maintenance. Only the Interstate system is required to have delineation markings (by use of the word *shall*). In most cases, the *MUTCD* does not specifically state that markings are required. It appears to leave the decision to the discretion of the individual highway agencies.

Roadway Delineation Practices Handbook

The duties of highway agencies with regard to pavement markings are summarized as follows:

- “In the absence of a statute, it has been held that there is no general duty of a State or other governmental unit to install or provide highway signs, lights, or markings.”
- “However, the duty to provide warnings, lights, or markings may arise where the particular highway presents an unusual, dangerous condition.”
- “Although there may be no duty to install warnings, signals, or markings in the first instance, once installed, there is a duty to maintain them in good serviceable condition.”⁽⁹⁵⁾

Implications of Tort Liability

Civil litigation suits, especially tort law cases, have increased dramatically in the last decade. This is a logical result of the trend toward large awards to litigants. The June 6, 1977, issue of *Business Week* noted that Federal court civil cases have increased 84 percent in the last ten years. A February 20, 1978, article in *TIME* is quoted as saying that the first million-dollar tort judgement was awarded in 1962, with 59 more from 1962 to 1972. Another 145 such judgments were recorded in the five-year period from 1972 to 1977. These facts, coupled with the erosion of sovereign immunity for governmental agencies, pose critical problems for highway departments. The State of California has experienced this.

The State of California lost its sovereign immunity in a 1961 ruling of the State supreme court. At that time, there was one full-time attorney assigned to handle damage claims for the Department of Transportation (Caltrans). In the year 1960-61, there were 193 claims totaling \$10 million. These claims increased following approval of the California Tort Claims Act in 1963. By 1976, Caltrans employed 40 full-time attorneys and 18 full-time investigators. In early 1978, Caltrans had 65 attorneys assigned to handle the department's tort claims. There were 1,048 lawsuits pending, representing damage claims totaling \$981 million. A 1978 American Association of State Highway and Transportation Officials survey reported more than 8,000 tort claims against all State highway agencies totalling \$2.4 billion.⁽⁹⁶⁾

This trend toward increased tort litigation has shown no signs of ceasing, or even decreasing. A research paper presented at the 71st annual meeting of the Transportation Research Board estimated the total number of tort claims levelled at highway agencies during 1990 to be 33,000 to 35,000. The report does not give the total dollar amount of claims, but it does estimate that the total amount of money lost to claims, plus the amount spent researching and defending against the claims, as being more than one-half billion dollars.⁽⁹⁷⁾

The increase in claims and awards has also resulted in an increase in the cost of liability insurance, where it was not canceled outright. Deductibles have been raised to multimillion-dollar levels in some cases, and some States have had to self-insure.

Obviously, States would rather spend public funds on proper maintenance of roadways than in paying off tort claims. States should therefore review maintenance and reporting procedures to limit exposure to tort liability. Highway agency employees involved in such activities should be well-informed of the legal implications of their functions.

SOURCES OF FUNDING

One of the major concerns facing highway agencies is obtaining adequate funding for their various programs. While the courts are quick to point out inefficiencies by making judgments against highway agencies, these problems often stem from lack of adequate funds rather than from inattention to standard engineering practices. In many cases, there is simply not enough money available to support all the desired programs.

In recognition of this nationwide problem, Federal funds have been available for several years to assist States under

Roadway Delineation Practices Handbook

various programs. These funds were in addition to the Federal funding for research and development. A significant Federal program that provided funding for delineation-related activities was the Highway Safety Act of 1973 (23 U.S.C. 151). The Act emphasized improving safety on rural roads, where about two thirds of all severe traffic accidents occur.

Under Section 205, Pavement Marking Demonstration Program of the Highway Safety Act 1973, 100 percent Federal funds were made available for painting centerlines and edgelines on roadways whether they were on the Federal-Aid System or not. Any hard surface roadway was eligible for funding. The Pavement Marking Demonstration Program used Federal funds to encourage wider application of pavement markings. The installation of such roadway markings have clearly reduced fatalities and injury accidents. 23 U.S.C. 120(c) allows 100 percent funding for safety U.S.C. improvements including markings.

In addition to painted centerlines and edgelines, other forms and types of pavement markings were eligible under the program. These included thermoplastic markings and raised pavement markers; markers in advance of railroad crossings; roadside delineators; and school zone, pedestrian crossing, and stop bar markings. According to the Secretary of Transportation's 1979 *Annual Report on Highway Safety Improvement Programs*,⁽⁹⁸⁾ about 25 percent of Pavement Marking Demonstration Program funds were used for these eligible items.

A significant change was made to the Federal-aid program by the 1982 Surface Transportation Assistance Act and the 1987 Surface Transportation and Uniform Relocation Assistance Act. Federal funds now can be used for refurbishing or replacing traffic signs or markings that have exceeded their service life and are no longer effective.

PROCUREMENT PROTECTION

Standard procedures for procurement of materials have been used for years, often without periodic review. In addition, procurement policies have not been updated to reflect changing conditions. This section discusses some of the aspects of material purchase and use of contractor's forces.

Quantity Purchase of Materials

When purchasing materials, such as paint, thermoplastic, raised pavement markers, or post-mounted delineators, quantity discounts are generally available from suppliers. For example, a one-way retroreflective raised pavement marker might cost \$1.75 per unit when purchased in quantities of 1 to 99. When purchased in lots of 5,000, the unit price may be reduced to about \$1.25, resulting in a \$2,500 savings when purchased in lots of 5,000. Extremely large-scale purchases would reduce the unit cost even more.

Many States negotiate with suppliers so that local highway agencies can buy materials at the quantity prices quoted for the State. This "buying off the State contract" requires an estimate of quantity needed and acceptance of the materials by the State.

Interagency purchases is another method used by State and local highway agencies to obtain lower unit prices. In this case, the State prepares the specifications, tests the materials, and selects the contractor. Local highway agencies then are allowed to buy material directly from the State. There is frequently a small surcharge to cover the State's administrative expenses.

The State of Wisconsin allows city and county highway agencies to purchase materials that are distributed from State warehouses for cost plus a 5 percent surcharge. New York, however, allows local highway agencies to order through the State without surcharge. When the State makes no provisions, local highway agencies can band together to purchase material in bulk quantities.

Even if a small, local highway agency purchases directly from the supplier, it is best to buy materials with a long shelf life in sufficient quantity to obtain the unit discount. Storage problems may arise using this method. Small highway agencies can purchase many years supply of paint (depending on shelf life) to be delivered at specified times throughout that period. Because material may be damaged or may deteriorate in storage, the savings in unit cost must be

Roadway Delineation Practices Handbook

balanced against the potential waste.

Something else that will affect the cost of materials is their packaging. Small sacks, pails, or cartons may prove easier to handle and store but may cost too much to justify their use. (See Warehousing and Storing of Materials, chapter 4.)

Inventory and Recordkeeping

Good business practice requires maintenance of an inventory of supplies and materials, which requires proper planning and scheduling. Shortages can interfere with scheduled maintenance activities and/or require emergency purchases at inflated prices. In practice, the anticipated volume of materials is established in budget preparation activities. Unfortunately, the item is often budgeted based on some “rule of thumb,” such as last year’s use plus a percentage increase. Where good historical records are available as a basis, this practice may suffice.

Estimating future costs accurately based on previous years’ use is difficult. In addition, smaller highway budgets encourage highway agencies to rank individual marking projects’ importance in order to select affordable options. The benefits from careful planning, scheduling, and balancing the inventory of needed materials will normally offset the effort involved.

Use of Model Specifications

The American Association of State Highway and Transportation Officials, the American Society for Testing of Materials, the Institute of Transportation Engineers, and individual highway agencies have expended a great deal of time and effort to develop specifications for the purchase of various categories of materials and equipment. Model specifications are available for most commonly used delineation devices or components. These models reflect extensive research and field experience and can be easily adapted for local use. Appendix C lists various sources of model specifications.

State highway agencies usually circulate copies of their standard specifications to local highway agencies. This usually saves staff time and usually produces a comprehensive and complete specification. In addition, this practice encourages uniformity of marking practices within the State.

The most critical issue in the preparation of specifications is the choice between a composition (formulation) specification or a functional (performance) specification. This issue is discussed in chapter 4 under Purchase of Materials, page 36.

Use of Contractors

The use of private contractors for delineation instead of highway agency forces is another significant consideration in the procurement process. Contractors are typically used in the following circumstances:

- Roadway delineation installation is part of a larger project under contract and it is more economic and efficient for the contractor to be responsible for the whole job.
- Installation requires special equipment and staff skills not available within the highway agency.
- The magnitude or immediacy of the work is beyond the resources of the highway agency.

Cost of services is most important in deciding the best course of action. It should be stressed, however, that other factors may play an important role in the decision. For example, some delineation techniques require sophisticated installation procedures in order to perform as expected. Under contract, performance warranties will protect the highway agency against early failures and can be more economical in the long run. Moreover, manufacturers who provide contract installation will probably be better at applying their own product.

Roadway Delineation Practices Handbook

However, there is little doubt that State or local highway agency personnel can perform the work cheapest if they have the proper equipment. They are more familiar with the condition and characteristics of the roadways to be marked and often can adapt application procedures to the specific need of an area. It is not unusual for a maintenance crew, for example, to adjust the amount of glass beads applied to provide higher retroreflectivity in a troublesome area. The experience of the field crew is often overlooked at administrative levels; yet, it is a valuable resource that cannot be purchased under contract.

At a higher planning level, the cost of equipping and staffing internal forces to provide all the necessary installation and maintenance services must be balanced against the cost of using contractors. Mileage of roadways, the time available for marking activities, other maintenance activities that must be accomplished, and the amount of existing staff and equipment must all be considered in the decision-making process.

COORDINATION OF ACTIVITIES

The activities of other highway agencies and of other departments within the same highway agency need to be coordinated to avoid conflicts. For example, where maintenance is scheduled on a regular basis, such as repainting, a section might accidentally be marked just prior to other work that may destroy the markings.

The installation of long-term delineation, such as raised pavement markers or thermoplastic markings, is justifiable only on the basis of durability, safety, and service life. These benefits are negated if these markings are placed on roadways scheduled for resurfacing. This happens too often, usually from lack of departmental communication. This also occurs when roadway activities of utility companies are not known by the maintenance forces.

There are advantages in scheduling delineation work with other roadwork that requires crew protection. This requires coordination among activities, especially if the other work is managed by someone else.

COST CONSIDERATIONS

Administrators and managers responsible for roadway delineation systems are extremely concerned with the increasing costs of delineation and diminishing budgets. As other programs and functions compete for available funds, it is vital to justify expenditures in terms of the costs and benefits of planned activities.

Several studies have tried to determine the cost-effectiveness of various delineation techniques.^(29,30) Other studies have attempted to quantify the benefits from the accident reduction.⁽⁹⁹⁾ Still other studies have tried to find ways of reducing the costs of using common materials, equipment, and procedures.⁽⁵⁸⁾

It has been hard to predict the costs associated with application of pavement markings. Funds spent by one highway agency are dissimilar to funds used for a similar application by a different highway agency. Not only do costs of materials and labor vary in different regions of the country, but accounting procedures and policies also vary.

To be realistic, cost should be based not only on initial expenditure, but on total cost amortized over the life of the marking. However, because of the numerous site-dependent variables, there is little agreement on the service life of a particular delineation technique.

Also, a problem arises when trying to quantify benefits. Benefits are assigned a dollar value based on accident reduction. Accident reporting systems are upgraded constantly to provide the necessary information for such studies, but so far accident data remains sketchy. It is difficult to identify precisely improvements associated with delineation based on accident data. At best, the figures are only approximations.

It is hoped that Federal Pavement Marking Demonstration Program will provide additional information in determining costs and benefits of delineation systems. When all the projects in this program are documented, better

Roadway Delineation Practices Handbook

evaluations will be possible. In the meantime, there are statistical analysis techniques available for use. There are also economic analysis models developed to evaluate the costs and benefits and cost-effectiveness of the individual delineation techniques.

Research has attempted to provide some insight into the effect of delineation on accidents. (See references 22, 29, 30, 41, 99.) The major findings are summarized below.

Pavement Markings

The most common type of delineation is the painted marking. One of the first issues addressed in the research program was the need for pavement markings. Although the need for marking, especially for a centerline, is rarely questioned, there are many miles of low-volume, two-lane roadways without any markings.

Markings reduced accidents approximately 30 percent; the data were significant at the .05 level. If this finding is extrapolated to traffic volumes lower than those observed in the study, centerlines can be cost-effective at ADT volumes as low as 50 vehicles.

Driver behavior studies have shown that adding a centerline to a previously unmarked roadway reduced the roadway's predicted hazard level by almost 50 percent. This implies that the centerline should be used whenever a roadway has a paved surface that will retain a pavement marking and is wide enough to carry two-way traffic.

Although their effectiveness has been questioned, edgelines are generally accepted practice on major roadways. Accident analyses showed that edgelines improved safety, but this major improvement was greater on straight roads than on winding roads. This finding was not expected. It appears to show the importance of stress on driver attentiveness. A driver is less attentive on straight roads and appears to rely on edgelines. On winding roads where a driver is under stress and paying attention to the driving task, edgelines do not appear to be so vital for guidance.

It can be concluded that edgelines are important in a roadway delineation system and should be used on major roadways wider than 20 feet (6 meters). If traffic safety is the only consideration, an ADT volume of 1,000 vehicles is necessary to make edge lines cost-effective. If other factors are considered, such as reduced costs for shoulder maintenance, edgelines may be justified on roadways having ADT volumes lower than 1,000 vehicles.

The *MUTCD* requires a 3-to-1 gap-to-segment ratio for both centerlines and lanelines. Although this ratio is normally adequate, situations where forward visibility is reduced may require a lower gap-to-segment ratio. In mountainous terrain, or where climatic conditions commonly cause limited visibility, the 3-to-1 ratio should be supplemented by raised pavement markers.

Raised Pavement Markers

Raised pavement markers (RPMs) basically have replaced painted centerlines and lanelines, especially in the Sunbelt States. Typically, four nonretroreflective RPMs and one retroreflective RPM are used in place of each marking segment. In other cases, RPMs are used to show roadway alignment and to supplement existing pavement markings.

Use of RPMs as lanelines reduces the amount of lane changing and discourages encroachments onto adjacent lanes. There is a rumble effect produced by running over the markers. Research has shown that RPMs reduce a vehicle's lateral placement variance and lessen driver stress at night in wet weather.

Accident analysis studies showed that when painted centerlines were replaced with RPMs there was a reduction of approximately 0.05 accidents per million vehicle-miles (0.03 accidents per million vehicle-kilometers). If an area receives no snow, RPMs are cost beneficial at an ADT volume of 3,000 vehicles. These markers are assumed to have a service life of at least five years and that they cost less than \$4,000 per mile (\$2,500 per kilometer) to install.

Because of the high initial cost of RPMs, especially the snowplowable types, highway agencies have supplemented

Roadway Delineation Practices Handbook

painted centerlines and lanelines with RPMs every 80 feet (25 meters) to develop an all-weather delineation system at low cost. The cost of such a supplemental system, \$1,000 to \$1,500 per lane mile, (\$620 to \$930 per lane kilometer) is considerably lower than the cost of complete replacement. In the human factors and traffic performance studies, hazards were reduced 30 to 40 percent with this type of treatment.

Traffic performance studies indicated that RPMs are more effective than post-mounted delineators on isolated horizontal curves. RPMs' guidance is near the driver where actual steering is done, though they also provide the long-distance visibility needed to see road alignment changes. RPMs also provide better understanding of the driving situation to the driver than do most forms of supplemental delineation. Research suggests that one-way RPMs along the outside of each driving path are more effective than two-way RPMs on curved roadways. The cost-effectiveness of such an installation depends on the particular site.

Post-Mounted Delineators

Post-mounted delineators (PMDs) of various shapes, colors, and retroreflective characteristics are used widely throughout the United States. PMDs are especially effective at night and in adverse weather when standard markings are covered by ice, snow, or water. They provide the driver with a preview of roadway direction, but do not provide much steering information because of their offset location.

Accident rates are significantly lower where PMDs are used. A reduction of approximately 1 accident per million vehicle-miles (0.6 accidents per million vehicle-kilometers) has been demonstrated. If safety is the only benefit considered, PMDs are cost-effective (with any reasonable cost-to-life ratio) for ADT volumes exceeding 1,000 vehicles. In many cases, depending on local specifics, such treatments can be justified for ADT volumes as low as 500 vehicles.

As with RPMs, the selective use of PMDs are effective for all weather conditions. Driver performance improves significantly with the use of PMDs on horizontal curves. Accident analyses demonstrate a lower accident rate at isolated horizontal curves where PMDs supplemented the standard painted markings. However, the sample size was too small to make a definite conclusion.

Signing

The use of signing, such as Chevron Alignment, large arrow, and turn and curve signs, to supplement other delineation devices has been used mostly for those roadway areas judged to be particularly hazardous or high-accident locations. They are used generally to inform the driver of a potentially dangerous condition that may not be obvious to casual observation.

A manual on treatment of high-accident locations for the Missouri Highway and Transportation Department collated the results of a variety of accident studies. The manual derives accident reduction rates for a variety of countermeasure treatments, including the use of general warning and regulatory signing.⁽¹⁰⁰⁾

The data presented in the manual demonstrate that accident rates can be reduced by about 30 percent over the no-signing condition when using warning signs in advance of curves. An accident reduction rate of up to 40 percent can reasonably be expected when warning signs are used in advance of rural intersections.

The manual does not derive cost-effectiveness relationships in terms of ADT. However, warning signs have relatively low installation costs, simple maintenance, and require replacement infrequently. From these factors it would appear that the use of warning signs should be cost-effective wherever their use is appropriate. The proper areas where warning signs should be used are discussed in chapter 10.

Conditions for Cost-Effective Applications

The most cost-effective delineation system will be achieved by carefully considering the delineation variables and applying good engineering judgement for each individual project. In other words, it is important to consider all aspects

Roadway Delineation Practices Handbook

of an area to be delineated, not just the roadway type or immediate surroundings.

For example, if a horizontal curve on a rural two-lane road has been identified as a high-accident location, many factors must be considered before a delineation treatment is determined. One of the first considerations in this case is the type of accidents that occur. If, for example, the majority of the accidents are run-off-the-road type accidents, and they occur mostly at night during rainy weather, then it is obvious that the existing delineation probably is not bright enough for these adverse visibility conditions. RPMs may be an effective solution in areas where winter maintenance activities are not a primary operation. In snowy areas, PMDs or warning signs, such as Chevron Alignment, may be the most cost-effective technique.

The benefit-cost analysis technique presented in appendix A is a quantitative method for examining delineation alternatives to obtain cost-effectiveness. However, the key to optimizing benefit-cost ratio for different types of delineation projects lies in combining the cost factors with a thorough application of engineering judgment. Only thoughtful engineering judgement and common sense will ensure accurate estimates for service lives to be used in the benefit-cost calculations. The basic treatment of delineation variables in chapter 3 gives an overview of how these and other variables must be considered for delineation projects. All pertinent variables must be considered to achieve the best durability for delineation, and hence the highest level of cost-effectiveness.

INSPECTION OF PAVEMENT MARKING PROJECTS

One of the most effective methods of decreasing tort liability risk is a comprehensive program of pavement marking inspection. This was discussed somewhat in chapter 11. In this chapter we will focus on the administrative portion of implementing such a program.

Inspector Training and Certification

Each State should have its own program for certifying inspectors. This is often done through a series of training sessions and workshops for inspectors about the important aspects of inspecting pavement markings. Some organizations, such as the American Traffic Safety Services Association (ATSSA) have developed training videotapes to aid in this effort. Some States, such as Ohio, have developed their own videotapes, which are more specific to in-State concerns.

Sources of Sample Specifications

In addition, a number of organizations have developed sample composition and performance specifications for pavement marking materials. These can be useful to State and local highway agencies in developing their own standards. Often, a State will adopt one set or a combination of the specifications produced by these independent sources and modify them for their own purposes. The local highway agencies can then adopt the State standards, which more closely apply to the conditions experienced within the local jurisdictions. Some of the organizations that produce specifications are the American Society for Testing of Materials (ASTM), American Association of State and Highway Transportation Officials (AASHTO), Federal Highway Administration (FHWA), General Services Administration (GSA).

Information on these and other highway agencies that supply sample specifications can be found in appendix C.

REFERENCES

1. *Manual on Uniform Traffic Control Devices for Streets and Highways*, U.S. Department of Transportation, Federal Highway Administration, Washington, DC, 1988.

Roadway Delineation Practices Handbook

2. *FARS 90*, Report No. DOT HS 807 794, U.S. Department of Transportation, National Highway Traffic Safety Administration, Washington, DC, December 1991.
3. *General Estimates 1990*, Report No. DOT HS 807 781, U.S. Department of Transportation, National Highway Traffic Safety Administration, Washington, DC, November 1991.
4. Implementation of Secretary Dole's Initiatives to Improve Highway Safety through Special Delineation and Pavement Markings, Federal Highway Administration Memo, Code HHS-H, dated Oct. 25, 1993
5. H.W. McGee, and D.L. Mace, *Retroreflectivity of Roadway Signs for Adequate Visibility: A Guide*, Report No. FHWA/DF-88/001, United States Department of Transportation, Federal Highway Administration, Washington, DC, November 1978.
6. A.G. Hoffman, and B.W. Firth, *State-of-the-Practice Retroreflective Measurement Devices for Pavement Markings*, Report No. FHWA-TS-84-222, United States Department of Transportation, Federal Highway Administration, Washington, DC, December 1985.
7. *Standard Definitions of Terms Relating to Appearance of Materials*, ASTM Standard E284-89c, American Society for Testing and Materials, Philadelphia, PA, November 1989.
8. *Standard Practice for Describing Retroreflection*, ASTM Standard E808-81, American Society for Testing and Materials, Philadelphia, PA, 1981.
9. J. Kalchbrenner, *Large Glass Beads for Pavement Markings*, Transportation Research Record No. 1230, Transportation Research Board, Washington, DC, 1989, 28-36.
10. J. Dejaiffe, *Retroreflectivity—Wet and Dry*, Presented at the Annual Meeting of the Transportation Research Board, Potters Industries, Parsippany, NJ, 1986.
11. *Standard Specifications for Construction of Roads and Bridges on Federal Highway Projects*, FP-92, Federal Highway Administration, Washington, D.C., 1992.
12. K. Vedam, and L. Shuler, *Use of Hemispherical Beads as Pavement Marking Retroreflectors*, Pennsylvania State University, University Park, PA, April 1975.
13. *Investigation of Paints and Glass Beads Used in Traffic Delineation Markings (13 Phases)*, Missouri State Highway Department, Jefferson City, MO, 1972.
14. F. Van Gorkum, "Night-Time Visibility of Seven Road-Marking Materials," *Traffic Engineering and Control*, Vol. 25, No. 4, Printerhall Limited, London, England, April 1984, 176-181.
15. R.L. Davidson, *Pavement Marking Test and Evaluation Procedures—Phase II*, Report No. FHWA-TS-88-016, Federal Highway Administration, McLean, VA, March 1988.
16. R.W. Mosely, *SASHTO Regional Test Facility*, Workshop on Field Inspection and Rehabilitation of Traffic Control Devices, United States Department of Transportation, Federal Highway Administration, McLean, VA, June 1990.
17. W. Adrian, *Visibility of Targets*, Transportation Research Record No. 1247, Transportation Research Board, Washington, DC, 1989, 39-45.
18. Transportation Research Board Special Report, *Transportation in an Aging Society. Improving Mobility and*

Roadway Delineation Practices Handbook

- Safety For Older Persons*, Volume 2—Technical Papers, Transportation Research Board, Washington, DC, 1988.
19. *The Road To Better Highway Signing Training Course*, Federal Highway Administration, Office of Traffic Operations, Washington, DC, March 1990.
 20. Schwab and Mace, "Luminance Requirements for Signs with Complex Backgrounds," *Public Roads*, Volume 2, Number 51, 48-55.
 21. M. Freedman, L.K. Staplin, D.P. Gilfillan, and A.M. Byrnes, *Noticeability Requirements for Delineation on Non-Illuminated Highways*, Report No. FHWA-RD-88-028, Federal Highway Administration, Washington, DC, July 1988.
 22. R.W. Allen, et al., *Drivers' Visibility Requirements for Roadway Delineation (2 Vols.)*, Report No. FHWA RD-77-165 & 166, Systems Technology & Human Factors Research, Inc., Goleta, CA, November 1977.
 23. H. Godthelp, and J.B.J. Riemersma, *Perception of Delineation Devices in Road Work Zones During Nighttime*, Report No. 820413, Society of Automotive Engineers, New York, NY, 1982.
 24. E. King, and J.R. Graham, *Evaluation of Pavement Marking Materials for Wet Night Conditions*, Report No. FHWA/NC/89-004, United States Department of Transportation, Federal Highway Administration, Washington, DC, October 1989.
 25. J.J. Henry, C.A. Antle, and J.L. Carroll, *Service Life and Cost of Pavement Marking Materials*, Contract No. HR 4-16, National Cooperative Highway Research Program, Pennsylvania Transportation Institute, University Park, PA, March 1990.
 26. R.W. Attaway, and P.O. Adeleke-Sheidun, *Pavement Marking Materials Program*, Report No. FHWA/NC/89-005, North Carolina Department of Transportation, Raleigh, NC, January 1990.
 27. "New Products," *ATSSA Flash*, July 1990, 4.
 28. J.I. Taylor, H.W. McGee, E.L. Siguin, and R.S. Hostetler, *Highway Delineation Systems*, Pennsylvania University NCHRP Report No. 130, National Cooperative Highway Research Program, Pennsylvania Transportation Institute, University Park, PA, 1972.
 29. D.G. Capelle, *An Overview of Roadway Delineation Research, Final Report*, Report No. FHWA-RD-78-111, United States Department of Transportation, Federal Highway Administration, McLean, VA, June 1978.
 30. S.G. Bali, et al., *Cost-Effectiveness and Safety of Alternative Roadway Delineation Treatments for Rural Two-Lane Highways (5 Vols.)*, Report No. FHWA-RD-50 through 55, Systems Applications, Inc., CA, April 1978.
 31. F.S. Shepard, *Traffic Flow Evaluation of Pavement Insert Lights for Use During Fog*, Virginia Highway and Transportation Research Council Report 78-R-25, Charlottesville, VA, December 1977.
 32. M.F. Creech, *Installation of Fog Guidance Lights on Afton Mountain*, Virginia Highway and Transportation Research Council Report 77-R12, Charlottesville, VA, August 1976.
 33. D.G. Azar, *Evaluation of Thermoplastic Materials*, Louisiana Department of Highways, Baton Rouge, LA, April 1975.
 34. C.H. Oglesby, *Highway Engineering*, (3rd ed.), John Wiley and Sons, New York, NY, 1975.

Roadway Delineation Practices Handbook

35. *Pavement Traffic Marking Materials and Application*, NCHRP Synthesis of Highway Practice-17, Transportation Research Board, Washington, DC, 1973.
36. J.E. Disbro, and J.E. Bryden, *Performance of Chlorinated Rubber Traffic Paint*, Research Report No. 146, Engineering Research and Development Bureau, New York State Department of Transportation, Albany, NY, June 1988.
37. J.E. Bryden, and R.A. Lorini, *Traffic Paint Performance in Accelerated Wear Tests*, Research Report No. 137, Engineering Research and Development Bureau, New York State Department of Transportation, Albany, NY, May 1987.
38. ———. *Test Installation of Chlorinated-Rubber Traffic Paint*, Research Report No. 125, Engineering Research and Development Bureau, New York State Department of Transportation, Albany, NY, August 1985.
39. *Book of ASTM Standards—Part 27*, American Society for Testing and Materials, Philadelphia, PA, 1978.
40. F.M. Frank, "Traffic Paints (2 parts)," *Paint and Varnish Production*, V.58, Nos.3&4, March and April 1968, part 1, 23-28, part 2, 31-36.
41. T. Miller, *Optimization of Traffic Lane Delineation (2 Vols.)*, Report No. FHWA-TS-77 and 200, United States Department of Transportation, Federal Highway Administration, Washington, DC, December 1976.
42. *National Cooperative Highway Research Program, Summary of Progress through 1976*, Transportation Research Board, Washington, DC, 1976.
43. C.W. Niessner, *Traffic Striping: Combined State Studies of Selected Maintenance Activities*, United States Department of Transportation, Federal Highway Administration, Washington, DC, 1979.
44. E.M. Buras, et al., *Accelerated Tests of Traffic Marking Material Durability*, Report No. FHWA-RD-78-93, U.S. Department of Transportation, Federal Highway Administration, Washington, DC, 1978.
45. C.W. Niessner, *Delineation Conference: Narration Summary Part I-IV*, Report No. FHWA-TS-78-219, United States Department of Transportation, Federal Highway Administration, Washington, DC, 1978.
46. C.T. Van Vechten, *Selecting Pavement Marking Materials Based on Service Life*, Report No. PB-243 377, District of Columbia Department of Highways and Traffic, Washington, DC, 1974.
47. *Highway Maintenance Manual*, (8th ed. updated), California Department of Transportation, Sacramento, CA, 1975.
48. J.M. Dale, *Surface Preparation of Pavements Prior to Application of Pavement Markings*, Report No. DOT-FH-9298, Southwest Research Institute, San Antonio, TX, 1979.
49. J.E. Bryden, and W.D. Kenyon, *Methods for Removal of Pavement Markings*, Research Report No. 130, Engineering Research and Development Bureau, New York State Department of Transportation, Albany, NY, May 1986.
50. *Stripe Removal by High Temperature Burning with Excess Oxygen (2 parts)*, FHWA Implementation Package No. 77-16, Southwest Research Institute (Part 1), San Antonio, TX, Midwest Research Institute (Part 2), Kansas City, MO, June 1977.
51. J.L. Cricher, *Removal of Pavement Markings by Scoring-Jetting*, Report No. FHWA-TS-77-213, United States

Roadway Delineation Practices Handbook

- Department of Transportation, Federal Highway Administration, Washington, DC, June 1977.
52. C.E. Forbes, *Striping Materials*, California Department of Transportation, Sacramento, CA, April 1978.
 53. D.R. Chatto, and T.L. Shelly, *Investigate Alternatives for Solvent-Borne Traffic Paint*, Report No. TL-604187, California Department of Transportation, Sacramento, CA, January 1983.
 54. "Striping and Marking: What Works Best?," *Better Roads*, Vol. 59, No. 12, December 1989, 18-23.
 55. B. Chaiken, "Comparison of the Performance and Economy of Hot-Extruded Thermoplastic Highway Striping Materials and Conventional Paint Striping," *Public Roads*, Vol. 35, No. 6, February 1969, 135-136.
 56. B. Ryan, "Precise Application Means Long Life For Thermoplastics," *Roads and Bridges*, Vol. 27, No. 7, July 1989, 70-71.
 57. S.D. Hofener, and D.L. Woods, *Thermoplastic Striping with Improved Durability & Snowplow Resistance—Executive Summary & Draft Specifications* (Summary), Report No. FHWA-RD-79-14, Texas Transportation Institute, College Station, TX, August 1977.
 58. *Thermoplastic/Primer Systems* (Handout), United States Department of Transportation, Federal Highway Administration, Washington, DC, November 1979.
 59. J.E. Bryden, *Pavement Marking Materials: A Summary of New York State Research*, New York Department of Transportation Research Report—48, New York DOT, Albany, NY, May 1977.
 60. J.E. Bryden, and G.F. Gurney, *Pavement-Marking Materials: New York's Experience*, Research Report No. 112, Engineering Research and Development Bureau, New York, State Department of Transportation, Albany, NY, April 1984.
 61. J.E. Bryden, R.A. Lorini, and G.F. Gurney, *Performance of Preformed Pavement-Marking Tapes*, Research Report No. 104, Engineering Research and Development Bureau, New York State Department of Transportation, Albany, NY, November 1983.
 62. Bryden, J.E., and G.F. Gurney, *Evaluation of Long-Life Pavement Markings*, Research Report No. 114, Engineering Research and Development Bureau, New York State Department of Transportation, Albany NY, March 1984.
 63. *Traffic Control Devices Handbook*, United States Department of Transportation, Federal Highway Administration, Washington, DC, 1983.
 64. C.W. Niessner, *Raised Pavement Markers at Hazardous Location*, Report No. FHWA-TS-84-215, United States Department of Transportation, Federal Highway Administration, McLean, VA, December 1984.
 65. T.R. Broyhill, *Reflective Marker Paint Stripe Skipper Instrument (Retro-Skip Device)*, Report No. CA-DOT-EQ-6251-1-777, California Department of Transportation, Sacramento, CA, November 1977.
 66. J.E. Bryden, J.R. Allison, and G.F. Gurney, *Grooved Stripes for Plow-Resistant Wet-Night Lane Delineation, Phase II: Recessed Reflector Delineation*, Report No. FHWA-RD-78-131, New York Department of Transportation, Albany, NY, August 1976.
 67. M.M. Khan, *Evaluation of Temporary Raised Pavement Markers in Work Zones*, Report No. Ohio/Hwy-01/87, Ohio Department of Transportation, Columbus, OH, February 1987.

Roadway Delineation Practices Handbook

68. "Traffic Safety: Better Road Delineation Needed for Older Drivers," *Better Roads*, Vol. 57, No. 12, December 1987, 34-36.
69. J.E. Bryden, *Long-Term Performance of Grooved Stripe-Reflective Markers*, New York State Department of Transportation, Albany, NY, 1979.
70. J.T. Tielking, and J.S. Noel, "Texas Study Focuses on Marker Retention," *Roads and Bridges*, Vol. 26, No. 7, July 1988, 66-67, 89.
71. F. Raycon, "Marker Placement Process Performs for Washington," *Roads and Bridges*, Vol. 26, No. 4, April 1988, 70-71.
72. J.H. Williams, Jr., *Development and Evaluation of Mechanized Equipment for Installation of the Recessed Reflective Marker (RPM) Delineation Systems: Interim Report*, HH Aerospace Design Co., New York, NY, June 1978.
73. P.A. Speer, "Flexible Markers Guide Drivers in Chip Seals," *Roads and Bridges*, Vol. 28, No. 12, December 1990, 38.
74. R.W. McNeese, *Establishing a Minimum Functional Reflectance for Raised Pavement Markers*, Transportation Research Record No. 1149, Transportation Research Board, Washington, DC.
75. E.T. Harrigan, *Epoxy Thermoplastic Pavement Marking Material* (Technical Note), United States Department of Transportation, Federal Highway Administration, Washington, DC, May 1977.
76. J.E. Bryden, and R.A. Lorini, *Experimental Pavement Delineation Treatments*, Research Report No. 87, Engineering Research and Development Bureau, New York State Department of Transportation, Albany, NY, June 1981.
77. F.E. Bryden, R.A. Lorini, and P.D. Kelly, *Reflectivity and Durability of Epoxy Pavement Markings. Second Interim Report*, Report No. FHWA/NY/RR-85/127, Engineering Research and Development Bureau, New York State Department of Transportation, Albany, NY, October 1985.
78. H.J. Gillie, *Epoxy Striping*, Minnesota Department of Transportation, St. Paul, MN, March 1977.
79. *Pavement Marking Policy for the Kansas Department of Transportation*, Kansas State Department of Transportation, Topeka, KS, March 1988.
80. B.E. Jennings, and M.J. Demetsky, *Evaluation of Curve Delineation Signs*, Transportation Research Record No. 1010, Transportation Research Board, Washington, DC, 1985, 53-61.
81. "New Delineators Add to Highway Safety," *Public Works*, Vol. 108, No. 11, December 1977, 50-51.
82. S.N. Bailey, *Evaluation of Flexible Plastic Guide Marker and Clearance Marker Posts*, Report No. CA-TL-6317-77-26, California Department of Transportation, Sacramento, CA, September 1977.
83. J.C. Powers, *Center Barrier Delineator Spacing Study*, Report No. FHWA/NJ-88-013-7714, Bureau of Transportation Systems Research, Trenton, NJ, April 1988.
84. E.N. Vincent, "A Trial Installation of Corner-Cube Delineators: Colder Highway, Gisborne to Woodend," *Australian Road Research*, Vol. 8, No. 3, September 1978, 38-40.
85. H.T. Zwahlen, M.E. Miller, M. Khan, and R. Dunn, *Optimization of Post Delineator Placement From a*

Roadway Delineation Practices Handbook

- Visibility Point of View*, Transportation Research Record No. 1172, Transportation Research Board Publications, Washington, DC, 1988, 78-87.
86. "YELLOW Sign Supports Improve Traffic Safety in Houston," *Rural and Urban Roads*, Vol. 16, No. 11, November 1978, 46-47.
 87. *Standard Alphabets for Highway Signs and Pavement Markings* (1977 edition), U.S. Department of Transportation, Federal Highway Administration (HHS-31), Washington, D.C. 1977.
 88. M. Sivak, and P.L. Olson, *Optimal and Minimal Luminance Characteristics for Retroreflective Highway Signs*, Transportation Research Record No. 1027, Transportation Research Board, Washington, DC, 1985.
 89. T. Nettleton, *Signs Maintenance Guide*, U.S. Department of Agriculture, Forest Service, Equipment Development Center, Missoula, MT, October 1979.
 90. G.L. Ullman, C.L. Dudek, and C.J. Allen, *Delineation of Concrete Safety-Shaped Barriers, Interim Report*, Report No. FHWA/TX-87/408-1, Texas Transportation Institute, College Station, TX, April 1988.
 91. *Workshop on Field Inspection and Rehabilitation of Traffic Control Devices*, Report No. FHWA-TS-90-048, United States Department of Transportation, Federal Highway Administration, Office of Implementation, McLean, VA.
 92. J.J. Rennilson, *Measuring Retroreflectivity of Pavement Markings*, Contract No. DTRS-57-86-C, Advanced Retro Technology, La Mesa, CA, April 1987.
 93. S.J. Pivnik, and D.C. Oliver, *Traffic Improvements—Legal Aspects and Liability*, Institute of Transportation Engineers, Arlington, VA, 1978.
 94. R.O. Jones, *Tort Liability in Traffic Control Activities*, Paper for the Western ITE Meeting, Denver, CO, 1978.
 95. L.W. Thomas, "Liability of State and Local Governments for Negligence Arising Out of the Installation and Maintenance of Warning Signs, Traffic Lights, and Pavement Markings," *NCHRP-Research Results Digest-110*, Transportation Research Board, Washington, DC, April 1979.
 96. R.O. Jones, *Sovereign Immunity: Where We've Been, Where We are Now, and Where We're Going*, Paper for 64th Annual Meeting of AASHTO, Louisville, KY, October 1978.
 97. D.S. Turner, and J.D. Wheeler, *1991 Overview of Highway Tort Liability*, Paper presented at the 71st Annual Meeting of the Transportation Research Board, Washington, DC, January 1992.
 98. *Highway Safety Improvement Programs: 1979 Report*, Communication from the Secretary of Transportation to the U.S. Congress, U.S. Government Printing Office, Washington, DC, 1979.
 99. W.A. Stimpson, W.K. Kittleson, and W.D. Berg, *Methods for Field Evaluation of Roadway-Delineation Treatments*, Transportation Research Record No. 630, Transportation Research Board, Washington, DC, 1977, 25-32.
 100. *Manual on Identification, Analysis, and Correction of High-Accident Locations*, Technology Transfer Assistance Program, Missouri Highway and Transportation Department, Jefferson City, MO, December 1990.

APPENDIX A. COST ANALYSIS TECHNIQUES

Roadway Delineation Practices Handbook

This Appendix provides a short review of the statistical analysis and economic models developed in a major FHWA research effort entitled “Cost Effectiveness and Safety of Alternative Roadway Delineation Treatments.”⁽²⁹⁾ The complete documentation of this research is available through the National Technical Information Service, Springfield, VA 22161.

The summary included here was adapted from “An Overview of Roadway Delineation Research.”⁽²⁸⁾

STATISTICAL ANALYSIS

This element of the research was designed to evaluate the effect of alternative delineation treatments on accident experience in various highway situations and under varying environmental conditions. To meet this objective, more than 500 test sites were selected in 10 states, and accident, geometric, traffic and environmental data for these sites were collected. These data were then statistically analyzed to identify important parameters that alter the effects of delineation on accident occurrence and to assess the reduction in accidents associated with various treatments.

In carrying out this analysis, both hypothesis testing and estimation procedures were used. Hypothesis testing procedures were used to assess whether the changes in accident rate resulting from changes in site delineation treatment were statistically significant. These procedures used the t-test, one-way analysis of variance, two-way and higher-order analysis of variance, and covariance analysis. The t-test and one-way analysis of variance provided a means to test for statistical differences in mean accident rate under different treatment categories. Two-way and higher-order analysis of variance and covariance analysis provided a means for studying how these differences were affected by other variables such as roadway geometrics, traffic operations, and climatic parameters. The estimation procedures included the t-test and regression analysis and were used to quantify the changes in the accident rate resulting from different delineation treatments, changes in geometrics, and traffic operational conditions.

Within this study, two types of highway sites were used. The first, termed “matching-control” sites, were those for which the delineation treatment remained unaltered over the analysis period. The second, termed “before-and-after,” were those sites for which accident data were available for both before and after the installation of a test delineation treatment.

The general findings resulting from the statistical testing using matching-control sites and using accident rate as a dependent variable were as follows:

For Tangent and/or Winding Sites

- Highways with centerlines have lower accident rates than those with no treatment at all.
- Highways with raised pavement marker (RPM) centerlines have lower accident rates than those with painted centerlines.
- Edgelines seem to have no significant effect on traffic accidents.
- Highways with post-mounted delineators (PMDs) have lower accident rates than those without PMDs.

For Isolated Horizontal Curves

- There is a slight indication that sites with PMDs have lower accident rates than sites without PMDs.
- Accident rates appeared to be somewhat lower at horizontal curve sites with centerlines than at horizontal curve sites with no delineation treatment.

Roadway Delineation Practices Handbook

The analysis of the before-and-after sites yielded insignificant results for all the tests and therefore could not be accepted with any degree of confidence. It was felt that the small sample (31 pairings) was a major contributing factor to the lack of positive results.

Economic Analysis Models

This element of the research involved the development of two economic models that could be used to evaluate roadway delineation treatments. The first, a cost-benefit model, was designed to compare major delineation treatment applications. The second, a cost-analysis model, was designed to evaluate treatments for which the benefits are assumed constant and independent of minor treatment variations, i.e., paint versus thermoplastic.

The geometric, traffic, and climatic parameters are not entered directly into either of the models, but these variables do enter through their effect on traffic accidents and the cost and service life of candidate treatments. The two models are also supplemented by installation-costing procedures designed to provide a uniform basis for computing treatment installation costs.

The mathematical expressions for the two models are:

* Cost-Benefit Model

(NPW) = Net Present Worth

(PWB) = New Present Worth of Benefit

(PWC) = Present Worth of Cost

$$NPW = \frac{PWB - PWC}{N}$$

$$PWB = \frac{AADT (365)}{10^6} \sum_{n=0}^N \left[RAR \times CA \times \frac{1+v}{1+i} \right]$$

$$PWC = \sum_{n=0}^N \left[\left[\frac{(TIC)_n}{(1+i)^n} + \frac{(MC)_n}{(1+i)^n} \right] + \frac{TC}{(1+i)^n} \right]$$

* Cost-Analysis Model

PWC = Present Worth of Cost

$$PWC = \sum_{n=0}^N \left[\left[\frac{(TIC)_n}{(1+i)^n} + \frac{(MC)_n}{(1+i)^n} \right] + \frac{TC}{(1+i)^n} \right]$$

where:

- AADT = annual average daily traffic in year zero
- RAR = estimated reduction in accident rate in year zero
- CA = cost of accident
- v = annual percent increase in traffic volume
- i = discount rate
- N = analysis period
- (TIC)_n = total installed cost in year n

Roadway Delineation Practices Handbook

TC = terminal cost at the end of analysis period
(MC)_n = maintenance cost in year n

The block flow diagram shown in figure 93 indicates the procedure for executing the models. First, the highway situation and the candidate treatments are identified. Next, appropriate dates are compiled for each candidate treatment. Either the cost-benefit or the cost-analysis model is then utilized to compute NPW or PWC (as appropriate). NPW and PWC are indices of economic desirability and are interpreted as follows:

- Treatments with NPW zero are all economically desirable; the economic desirability increases with an increasing value of NPW.
- The treatment with the least PWC value is most economical.

Delineation Guidelines

This element of the research involved the application of the cost-benefit model to a set of delineation situations to determine the desirability of certain treatments applied under specific roadway and traffic conditions. The scope of the cost-benefit calculations included continuous delineation applications along both tangent and winding sections, as well as spot improvement at two horizontal curve sites. The types of treatment applications considered are shown in table 18.

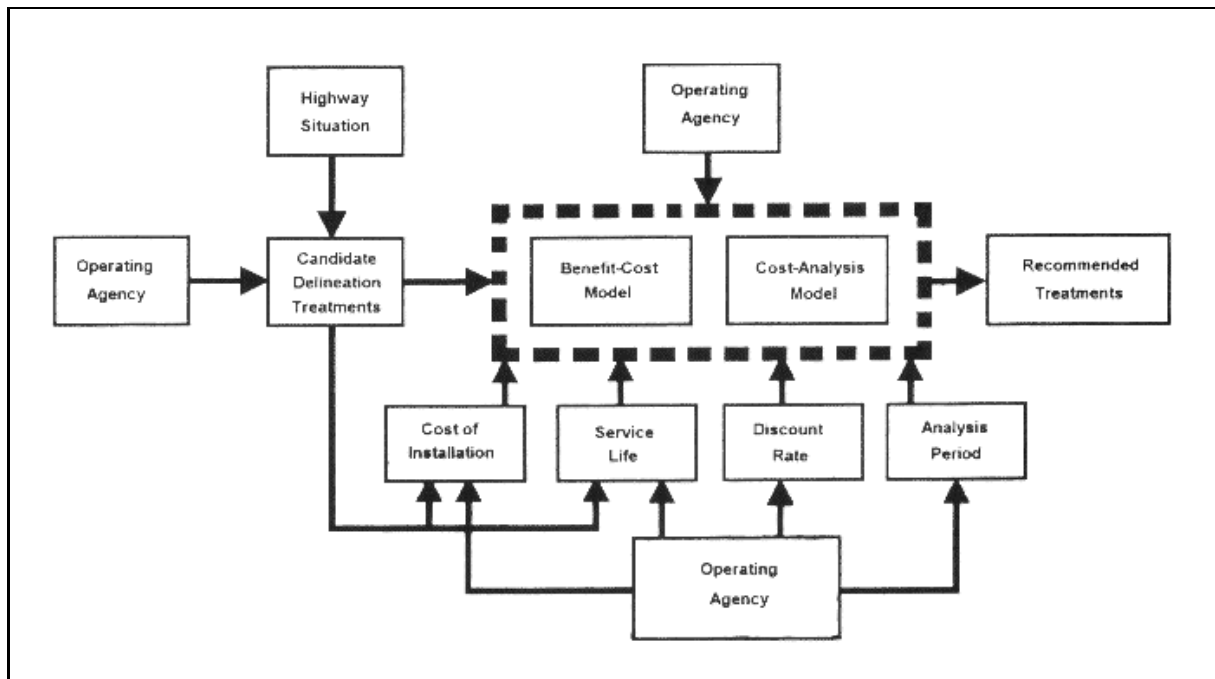

Figure 93. Schematic representation of "Benefit-Cost" and "Cost-Analysis" model.

The cost-benefit calculations were carried out parametrically where ranges of values for all costs, service lives, etc., were chosen for each selected treatment application. Economics was the sole basis for the evaluation of the various treatments with reduction in traffic accidents as the sole measure of benefits to be derived from the delineation systems. One fallacy in this procedure is the uncertainty associated with the selected accident model. If the accident model is questionable, then the cost-benefit is likely to produce questionable results. Utilizing the cost-benefit model, a series of calculations were performed to develop the benefits and costs for each combination of parameters for each treatment type. Some general conclusions based on the calculations are:

Table 18. Treatment applications used in cost-benefit calculations

Type of Site	Description of Treatment
Tangent Sections	Painted centerline added to no treatment RPMs added to painted centerline PMDs added to painted or RPM centerline Edgeline added to centerline with PMDs RPM centerline added to painted centerline Edgeline added to centerline (PMDs optional)
Winding Sections	PMDs added to centerline with edgeline Painted centerline added to no treatment RPM centerline added to no treatment Centerline added to no treatment (mountainous) Centerline added to no treatment (level terrain)
Horizontal Curves	PMDs added to centerline at sites in Georgia and Louisiana

- A painted centerline added to tangent and winding sections with no previous treatment was cost-beneficial for all values of cost, service life, and ADT considered.
- RPM centerlines were more cost-effective than painted centerlines where a service life of five years or more is expected from the RPMs and the ADT exceeds 3,000 vehicles per day.
- PMDs were cost-effective at all ADTs above 1,000 vehicles per day and under most combinations of installation costs and service lives for ADTs as low as 500 vehicles per day.
- Edgelines with service lives of five years or more were cost-effective for most highways with an ADT of 500 vehicles or more per day. If this installation cost is less than \$165 per mile, they are cost-effective with service lives of two years. If the ADT exceeds 1,000 vehicles per day, they are almost always cost-effective with a one-year service life.

COMMENTS ON THE RESEARCH

Although this was a very extensive and comprehensive analysis of the cost-effectiveness of various delineation treatments, it is important to recognize that the results of this research were obtained through the statistical analysis of accident data and therefore are subject to all the strengths and drawbacks which a statistical analysis entails. Of particular concern are the shortcomings of statistical analysis related to the accident data base. Accident data take a long time to accumulate. Over this period, the roadway environment can change, driving population may alter, and traffic

Roadway Delineation Practices Handbook

regulations can be modified. In addition to such changes over time, no two roadway sites are exactly alike, causing a variation in data from site to site. These variations make it extremely difficult to conduct a controlled study, a prerequisite for good statistical results. Other problems encountered in statistical analysis of accident data relate to the variation in accident reporting procedures from state to state and county to county, anomalies in the data base, and the time and cost involved in selecting highway sites with specified characteristics.

It is therefore important that the statistical results be used with some care. The t-test results estimate the mean reduction in accidents for a particular delineation treatment but these results do not take into account roadway geometrics, operational conditions and climatic conditions.

Regression models, like the t-test results, also estimate accident reduction associated with various delineation treatments, but unlike the t-test, they provide a measure of its dependence on other roadway characteristics and climatic parameters. It is important to remember, however, that although the regression models provide estimates of the average accident rate on a particular section of highway, the application of these models to an individual highway section can be subject to rather large variations and should be used only as a general guide.

General recommendations on the use of the results of this accident modeling research are:

- If the intended objective is to assess the overall reduction in accidents from the installation of a particular delineation treatment without regard to consideration of roadway features, then the t-test results should be applicable.
- If the effect of delineation treatment is to be assessed for a given highway and geometric and operational characteristics are of concern, then the regression models should be considered.
- Among the regression models available, preference should be given to the one which best reflects the highway environment. For example, if the objective is to assess the effect of delineation on California roads, the models developed for the Western states are more appropriate.

The economic models developed to evaluate various roadway delineation treatments include all the important variables that need to be considered and seem to provide a good basis for computing the costs and benefits of different systems. As better accident models are developed, the economic models can become better planning and research tools for evaluating different forms of delineation treatments.

APPENDIX B. SOURCES OF MATERIALS AND EQUIPMENT

3M Company
3M Center, Bldg. 223-3N-01
St. Paul, MN 59144
ATTN: Ron A. Weber
Telephone: 612-733-8523

ADDCO Manufacturing Company
69 Empire Drive
St. Paul, MN 55103-1856
ATTN: Michael E. Granger

Roadway Delineation Practices Handbook

Telephone: 612-224-8800

American Traffic Safety
Services Association (ATSSA)
5440 Jefferson Davis Highway
Fredricksburg, VA 22401
ATTN: Robert M. Garrett
Telephone: 703-898-5400

Astro Optics Corporation
906 Morse Avenue
Schaumburg, IL 60193
ATTN: Virginia C. Schueler
Telephone: 312-893-2460

Bent Manufacturing
12819 S. Alameda Street
Compton, CA 90222
ATTN: Bruce C. Bent
Telephone: 213-638-5141

Caltex Industry, Inc.
400 Palm Valley Drive W.
Arlington, TX 78552
ATTN: Dick Beard
Telephone: 214-272-7746

Carsonite International
1301 Hot Springs Road
Carson City, NV 89706
ATTN: Donald Schmanski
Telephone: 800-648-7974

Cataphote, Inc.
P.O. Box 2369
Jackson, MS 39225-2369
ATTN: Michael Jefferies
Telephone: 800-221-2574

Davidson Plastics Company
18226 E. Valley Highway
Kent, WA 98032
ATTN: Peter A. Speer
Telephone: 206-251-8140

Degussa Corporation
4 Pearl Court
Allendale, NJ 07401
ATTN: Joseph D. Bilotti
Telephone: 201-818-3706

Dickson Industries, Inc.
P.O. Box 684

Roadway Delineation Practices Handbook

Tecumseh, OK 74873
ATTN: Wayne E. Dickson
Telephone: 405-598-6547

Masco Industries
40 Corporate Drive
Auburn Hills, MI 48057
ATTN: Dean Paulos
Telephone: 313-332-9393

Equipment Development
100 Thomas Johnson Drive
Frederick, MD 21701
ATTN: Paul J. Gorgol
Telephone: 800-638-3326

Flex-O-Lite
601 Indian Hill Parkway
Marietta, GA 30068
ATTN: Steve Walker
Telephone: 800-325-9525

Flint Trading Co.
P.O. Box 19147
Greensboro, NC 27407
ATTN: Hans Falkner Jensen
Telephone: 919-294-4911

Graco, Inc.
P.O. Box 1441
Minneapolis, MN 55440
ATTN: Dale D. Johnson
Telephone: 612-623-6000

Highway Safety Products
P.O. Box 4169
Napa, CA 94558
ATTN: Warren J. Wetterlund
Telephone: 800-358-9130

Hiway Marking Systems, Inc.
P.O. Box 91568
Long Beach, CA 90809-1568
ATTN: George Gonzales
Telephone: 213-537-7444

Intermark Corporation
8032-7 Phillips Hwy.
Jacksonville, FL 32216
ATTN: Helmut Makosch
Telephone: 904-737-8082

Linear Dynamics Coating Division

Roadway Delineation Practices Handbook

1240 Airport Drive
Ballground, GA 30107
ATTN: David Miller
Telephone: 201-884-0300

M-B Company, Inc. of Wisconsin
1200 Park Street
Chilton, WI 53014
ATTN: Steve Muellenback
Telephone: 800-558-5800

Marion Steele Company
912 Cheney Avenue
Marion, OH 43302
ATTN: Mark S. Granger
Telephone: 614-383-4011

MDI Traffic Control Products
P.O. Box 576
Farmington Hills, MI 48018
ATTN: Brian Manwaring
Telephone: 800-521-6776

Norris Paint
1675 Commercial Street N.W.
Salem, OR 97303
ATTN: Robert O. Yates
Telephone: 503-364-2277

Northeastern Safety Products
P.O. Box 444
East Rutherford, NJ 07073
ATTN: Joan Sonn
Telephone: 201-438-2313

PAR Marketing Associates
P.O. Box 12468
Wichita, KS 67277
ATTN: Paul A. Logan
Telephone: 316-722-2231

Pave-Mark Corporation
P.O. Box 94108
Atlanta, GA 30318
ATTN: Martin A. Smith
Telephone: 404-351-9780

Plastic Safety Systems
P.O. Box 20140
Cleveland, OH 44120-0140
ATTN: David E. Cowan
Telephone: 216-231-8590

Roadway Delineation Practices Handbook

Poly Enterprises, Inc.
230 E. Pomona Avenue
Monrovia, CA 91016
ATTN: Al Provence
Telephone: 818-358-7862

Polycarb, Inc.
33095 Bainbridge Road
Cleveland, OH 44139
ATTN: Ratanjit S. Sondhe
Telephone: 800-225-5649

Potters Industries
Waterview Corporate Center
20 Waterview Boulevard
Parsippany, NJ 07054
ATTN: Charles A. Schneider
Telephone: 201-299-2900

Radiator Specialty
P.O. Box 34689
Charlotte, N.C. 28234-6080
ATTN: Tom Koernig
Telephone: 800-438-4532

Ray-O-Lite
P.O. Box 877
New Mark, OH 43056
ATTN: Douglas Forrer
Telephone: 800-848-7025

Reflexite Corporation
315 South Street, P.O. Box 1200
New Britain, CT 06050
ATTN: David McDonald
Telephone: 203-223-9297

Roadmaker Company
P.O. Box 1887
Reno, NV 89505
ATTN: Bill Thurston
Telephone: 800-331-2332

Scientific Developments
P.O. Box 2522
175 South Danebo
Eugene, OR 97402
ATTN: Dan L. Walden
Telephone: 800-824-6853

Seibulite International
3136 E. Victoria Street
Rancharo Dominguez, CA 90221

Roadway Delineation Practices Handbook

ATTN: Vincent J. Arico
Telephone: 213-632-7500

Services and Materials
220 South "J" Street
Elwood, IN 46036
ATTN: Joe Mausar
Telephone: 317-552-3352

Swarco Industries
23 Village Green Court
Jackson, MS 39211
ATTN: Dana Burney
Telephone: 615-388-5900

Trafcon Industries
81 Texaco Road
Mechanicsburg, PA 17055
ATTN: George R. Park
Telephone: 717-691-8007

WLI Industries, Inc.
844 Kay Avenue
Addison, IL 60101
ATTN: Don Tauchen
Telephone: 708-932-4600

Work Area Protection
4020 Wrens Way
Kennesaw, GA 30144
ATTN: Charles Dunn
Telephone: 312-377-9100

APPENDIX C. LIST OF STANDARDS, SPECIFICATIONS, AND TEST METHODS RELATED TO DELINEATION

Federal Highway Administration (FHWA)

For ordering information on these publications, contact FHWA, Office of Highway Safety (HHS-30), Washington, D.C. 20590.

1. *Standard Specifications for Construction of Roads and Bridges on Federal Highway Projects (FP-92).*
2. *Federal Test Method Standard 370—Instrumental Photometric Measurements of Retroreflective Materials and Retroreflective Devices*, General Services Administration, March 1977.
3. *Federal Test Method Standard 141—Paint, Varnish, Lacquer and Related Materials, Methods of Inspection*,

Roadway Delineation Practices Handbook

Sampling & Testing.

4. Federal Specification LS 300 C, *Federal Specification Sheeting and Tape, Reflective: Non-exposed lens*, General Services Administration, March 10, 1979.
5. *Standard Highway Color Tolerance Charts*.
6. *Standard Alphabets for Highway Signs*, 1966 Edition.
7. *Standard Alphabets for Highway Signs and Pavement Markings*, Metric Edition, 1977.
8. *U.S. Road Symbol Signs Brochure*-Stock No. 050-000-00152-1 (limit maximum quantity to 5 for any one request). Additional copies are available from the Government Printing Office (see address below).
9. *Specifications for Standard Highway Sign Colors*, May 1979.
10. *Outdoor Testing of Reflective Sign Materials*, Reprinted with Permission from the U.S. Forest Service, September 1985.
11. *Pavement Marking Test and Evaluation Procedures*, Final Report (Report No. FHWA-TS-89-006), dated March 1989.
12. *Traffic Control Devices on Federal-Aid and Other Streets and Highways*, Federal-Aid Highway Program Manual 6-8-3-1, November 1983.
13. TT-B-1325B, Federal Specification Beads (Glass Spheres) Retro-Reflective, General Services Administration, April 1978.

American Society for Testing and Materials (ASTM)

For these publications, contact ASTM at 1916 Race Street, Philadelphia, PA 19103.

1. *B 117 Method of Salt Spray (Fog) Testing*.
2. *B 209 Specifications for Aluminum and Aluminum-Alloy Sheet and Plate*.
3. *D 523 Standard Test Method for Specular Gloss*.
4. *D 711 No Pick-Up Time (Drying Time) on Traffic Paint Test*.
5. *D 713 Conducting Road Service Tests on Fluid Traffic Marking Materials*.
6. *D 868 Evaluating Degree of Bleeding in Traffic Paint in Road Service Tests*.
7. *D 869 Evaluating Degree of Settling and Ease of Remixing in Traffic Paint*.
8. *D 913 Method for Evaluating Degree of Chipping of Traffic Paint*.
9. *D 969 Evaluating Degree of Bleeding in Traffic Paint in Laboratory Tests*.
10. *D 1155 Test for Roundness of Glass Spheres in Traffic Paint*.

Roadway Delineation Practices Handbook

11. *D 1214 Sieve Analysis of Glass Spheres in Traffic Paint.*
12. *D 1309 Laboratory Test for Settling Properties in Traffic Paint During Storage.*
13. *D 2205 Practices for Testing of Traffic Paint.*
14. *D 2743 Standard Practice for Selection and Use of Test Procedures on Uniformity of Vehicle Solids (by Spectroscopy/Gas Chromatography) in Traffic Paint.*
15. *D 2792 Test for Solvent and Fuel Resistance in Traffic Paint.*
16. *D 2794 Standard Methods of Test for Resistance of Organic Coatings to Effects of Rapid Deformation (Impact).*
17. *D 4061 Test for Retroreflectance/Specific Luminance in Traffic Paint.*
18. *D 4451 Test for Pigment Content of Paint/Traffic Marking Material by Low-Temperature Furnace Ashing.*
19. *D 4505 Standard Specification for Preformed Plastic Pavement Marking Tape for Extended Service Life.*
20. *D 4507 Specifications for Thermoplastic Polyester (TPES) Materials.*
21. *D 4592 Specifications for Preformed Plastic Pavement Marking Tape for Limited Service Life.*
22. *D 4796 Test for Bond Strength of Thermoplastic Traffic Marking Materials Using Cement Bricks/Steel Cubes.*
23. *D 4956 Standard Specifications for Retroreflective Sheeting for Traffic Control.*
24. *E 97 Standard Test Method for Directional Reflectance Factor, 45-deg 0-deg, of Opaque Specimens by Broad-Band Filter Reflectometry.*
25. *E 284 Standard Definition of Terms Relating to Appearance of Materials.*
26. *E 808 Standard Practice for Describing Retroreflection.*
27. *E 809 Standard Practice for Measuring Photometric Characteristics of Retroreflectors.*
28. *E 810 Standard Test Method for Coefficient of Retroreflection of Retroreflective Sheeting.*
29. *E 811 Standard Practice of Measuring Colorimetric Characteristics of Retroreflectors under Nighttime Conditions.*
30. *G 23 Recommended Practice for Operating Light-and-Water Exposure Apparatus (Carbon-Arc Type) for Exposure of Non-Metallic Materials.*

American Association of State Highway and Transportation Officials (AASHTO)

For these publications, contact the AASHTO at 444 N. Capitol Street, Suite 225, Washington, D.C. 20001.

1. *M247-81 (1986) Standard Specification for Glass Beads Used in Traffic Paint.*
2. *M268-841 Retroreflective Sheeting for Traffic Control.*

Roadway Delineation Practices Handbook

3. *T 257 Test Method for Instrumental Photometric Measurements of Retroreflective Materials and Retroreflective Devices.*
4. *Standard Specifications for Transportation Materials, 1990 Edition* (\$75.00 prepaid).
5. *M249-39 (1986) Standard Specification for White and Yellow Reflective Thermoplastic Striping Material (Solid Form).*

Government Printing Office (GPO)

For these publications, contact the Superintendent of Documents, U.S. Government Printing Office, Washington, D.C. 20402, telephone: 202-783-3238. Make check or money order payable to Superintendent of Documents.

1. *Manual on Uniform Traffic Control Devices for Streets and Highways* (MUTCD 1988 Edition), Stock No. 050-001-00308-2. Price: \$22, Domestic and \$27.50, Foreign.
2. *Standard Highway Signs Book*, Stock No. 950-044-00000-4. Price: \$30, Domestic and \$37.50, Foreign. Price includes subscription service for revisions.
3. *Standard Specifications for Construction of Roads and Bridges on Federal-Aid Highways (FP-92)*, Stock No. 050-001-00313-9.

Miscellaneous Publications

1. *Standards for Work Zone Traffic Control*, 1988 Edition, is available from the American Traffic Safety Services Association (ATSSA), 5440 Jefferson Davis Highway, Fredericksburg, VA 22401, telephone: 703-898-5400. This handbook contains all the material from Part VI of the 1988 Edition of the MUTCD. Price: \$4.50 per copy for nonmembers and \$3 per copy for ATSSA members and public agencies. Bulk quantity discounts are available by contacting ATSSA.
2. Standard Color Tolerance Charts are available from Hale Color Consultants, Inc., 1505 Phoenix Road, Phoenix, MD 21131, telephone: 301-472-4850.
3. *Uniform Vehicle Code and Model Traffic Ordinance* is available from the National Committee on Uniform Traffic Laws and Ordinances, 405 Church Street, Evansont, IL, 60201, telephone: 708-491-5280. This publication is designed as a comprehensive guide for developing uniform State and local motor vehicle and traffic laws. It is based on actual experience under various State and local laws throughout the United States.
4. *A Model Performance Specification for the Purchase of Pavement Marking Paints and Powder*, September 1977. Institute of Transportation Engineers, 535 School Street SW, Suite 411, Washington, DC 20024.
5. *A Model Performance Specification for the Purchase of Thermoplastic and Preformed Plastic Pavement Marking Materials*, September 1981. Institute of Transportation Engineers, 535 School Street SW, Suite 411, Washington, DC 20024.
6. *A Model Performance Specification for the Purchase of Pavement Marking Paints*, January 1992. Institute of Transportation Engineers, 535 School Street SW, Suite 411, Washington, DC 20024.

GLOSSARY

Abrasion: A condition manifested in pavement markings by more or less gradual surface erosion, thinning, and disappearance of the film due to wind, water, sand, and vehicle tire wear.

Acrylic: Any of a class of transparent, thermosetting plastics or resins made from acrylic acid.

Air Atomizing Spray: Spray atomization of a liquid compound accomplished through supplied air pressure only.

Airless Spray: Spray atomization of the liquid compound accomplished through hydraulic fluid pressure only. No atomizing air is used.

Aliphatic Solvent: Solvents, such as mineral spirits and heptane, used in thinning paints.

Alkyd: Synthetic resin used as a bonding agent in paints and lacquers.

Ambient Pavement Temperature: Temperature of the pavement. (May or may not be the same as ambient air temperature.)

Applied Line: Pavement marking material in place on the substrate.

Asphaltic Concrete (AC): A dense-graded pavement made of hot mineral aggregates plant-mixed with hot asphalt.

Average Daily Traffic (ADT): The number of vehicles that pass over a roadway on an average day. Usually calculated by counting the number of vehicles that pass over a roadway for a longer period of time, such as a year, and then dividing by the number of days in that period. For this reason, ADT is also often referred to as Average Annual Daily Traffic (AADT).

Aromatic Solvents: Solvents, such as xylol and toluene, used in thinning traffic paints.

Binder: In painted markings, the binder is the hard base material that is left on the road after the solvent has evaporated. Common paint binders are alkyd resins and chlorinated rubber materials. In thermoplastic markings, the binder is the actual thermoplastic material that melts when heated and hardens into the film that is left on the road. Binders are also often referred to as the base material or base vehicle.

Bituminous Concrete: A more general term than asphaltic concrete, this term may refer to asphaltic concrete that employs hot asphalt or other similar mixtures using refined tar. The coarse aggregate is usually crushed stone, crushed slag, or crushed gravel.

Bisymmetric: Having double symmetry, i.e. in floating bead context. It means that the bead surface embedded in the paint is symmetrical with the exposed surface.

Bleeding: Conditions in which asphalt substrate is softened, due to heat or solvents, causing the oils to rise to the surface and producing black spots in the marking material.

Bond: Adhesive quality of a coating to a substrate.

Brightness: Brightness is the term that refers to human perception of luminance. Whereas luminance is a photometrically measured quantity, brightness describes how intense a light source or lighted surface appears to the human eye.

Roadway Delineation Practices Handbook

Broken Line: A pavement marking consisting of a cycle of marking segments and gaps. Broken lines are permissive; drivers are being informed that they are permitted to cross a broken line. Also referred to as a skip line.

Candela: The basic unit for optical quantities, the candela is a measure of luminous intensity. One candela is defined as the luminous intensity in a given direction of a source emitting a monochromatic radiation of frequency 540×10^{12} Hertz, the radiant intensity of which in that direction is 1/683 watts per steradian.

Centerline: A yellow marking indicating the division of the roadway between traffic traveling in opposite directions.

Ceramic: Baked clay.

Chemical Composition Specification: A specification written for pavement marking material that describes what components and what percentage of each component are to be used in the formulation.

Chevron Alignment Sign: A warning sign used to delineate sharp roadway alignment changes.

Chipping: The breaking away of small fragments of the pavement marking from the substrate.

Chlorinated Rubber: Hard resin that speeds up drying of varnish or alkyd paints; dries by solvent evaporation only.

Coefficient of Luminous Intensity (R_l): The ratio of the luminous intensity (I) of a retroreflector in the direction of observation to the illuminance E, at the retroreflector on a plane perpendicular to the direction of the incident light, expressed in candelas per lux.

Coefficient of Retroreflected Luminance (R_L): A measure of retroreflection most often used to describe the retroreflectivity of pavement markings. Coefficient of retroreflected luminance is defined as the coefficient of luminous intensity per unit area.

Coefficient of Retroreflection (R_A): A measure of retroreflection used more often to refer to the retroreflectivity of highway signs. Coefficient of retroreflection is defined as the ratio of the coefficient of luminous intensity (R_l) of a plane retroreflecting surface to its area (A), expressed in candelas per lux per square meter.

Cold-Applied Thermoplastic: Preformed tapes composed of thermoplastic materials. Applied to the pavement using an adhesive.

Conspicuity: A measure of the likelihood that a driver will notice a certain target at a given distance against a certain background.

Contrast: The ratio of luminance from a target to the luminance from the target's surroundings.

Cost-Effectiveness: A ratio of a delineation device's service life to the total costs it incurs over its service life.

Crosswalk Marking: Markings at intersections that serve primarily to guide pedestrians along the proper paths through the intersection.

Curb Marking: A marking used to delineate the location of a curb.

Curing: Commonly identified as the hydraulic hardening of PCC. It also refers to the hardening of pavement marking materials.

Curve Sign: A warning sign used to inform drivers of an upcoming change in roadway alignment where the recommended speed is greater than 30 miles per hour and equal to or less than the posted speed limit.

Roadway Delineation Practices Handbook

Curing Compound: A coating material applied to freshly placed PCC to retain moisture in the concrete.

Delineation: One, or a combination of several types of devices (excluding guide signs) that regulate, warn, or provide tracking information and guidance to the driver.

Dense-Graded: Refers to a type of pavement that makes use of a coarse aggregate, such as crushed stone or gravel, mixed with particles of a finer material, such as sand, to create a smooth, dense pavement surface. See also, Open-Graded.

Discretionary: Refers to making a choice from a number of alternatives.

Double Line: A pavement marking used on two-way undivided roadways to inform the driver of a no-passing zone in both directions of travel.

Dry Film Thickness: Thickness of line when dry and without glass beads.

Durability: A measure of traffic line's resistance to the wear and deterioration associated with abrasion and chipping. For standard methods of evaluation of durability, refer to the ASTM Bulletins D913 for Chipping and D821 for Abrasion (erosion).

Duty: An obligation to conduct oneself in a way that will protect others from unreasonable risks.

Edgeline: A line that indicates the edge of the roadway.

Edge Loss: A loss of pavement marking material at the edge of a marking that does not go all the way across the face of the marking.

End Loss: A loss of pavement marking material at the end of a marking.

Entrance Angle (or Incidence Angle): The angle between the light source and a line normal to the retroreflector surface.

Epoxy: Bonding of different atoms to form durable epoxy resins used in adhesives and varnishes.

Exothermic: Refers to a chemical reaction in which heat is produced.

Film Integrity: The properties of a film that result in the film's ability to resist scuffing, marring, etc.; cohesive strength.

Flotation Bead: A retroreflective glass bead coated with a special chemical substance so that it will float to half of its diameter in a pavement marking.

Flux: The rate of transfer of fluid, particles or energy across a given surface.

Footcandle: The English system's unit of illuminance, one footcandle is the illuminance on a surface that is everywhere one foot from a uniform point source of light of one candle and equal to one lumen per square foot. One footcandle equals 10.76 lux.

Gap-to-Segment Ratio: The ratio of the length of the gap in a broken line to the length of the marking segment.

Glass Beads: Spheres used in conjunction with binder to produce retroreflectivity in pavement markings:

Roadway Delineation Practices Handbook

- (a) Conventional—Glass composition with approximate refractive index of 1.52 with no surface treatment.
- (b) Low refractive index—Spheres with refractive index between 1.50 and 1.64.
- (c) Medium refractive index—Spheres with refractive index between 1.65 and 1.89.
- (d) High refractive index—Spheres with refractive index greater than 1.89.
- (e) Plastic—Spheres manufactured from organic materials
- (f) Glass—Spheres manufactured from a soda lime glass material.
- (g) Premix—Spheres dispersed in the binder prior to application.
- (h) Drop-on—Spheres applied to a pavement marking after the material has been applied to the pavement.
- (i) Moisture resistant (moistureproof)—Spheres treated to reduce conglomeration in the bead dispenser.
- (j) Floating—Spheres treated to control depth to which they will sink into the binder.
- (k) Static charge—Force tending to cause erratic flow of beads caused by attraction between unlike-charged beads and repulsion between like-charged beads.
- (l) Retroreflective—Spheres that return light along a path parallel to the entrance path.
- (m) Observation angle—Angle formed by a line extending from the light source to a point on the retroreflector and a line extending from the eye to the same point on the retroreflector (light-sign-eye angle). Brightness is maximum when observation angle is zero.
- (n) Entrance angle—Angle formed by a line extending from the light source to a point on the retroreflector and a line forming a 90-degree angle with the retroreflector at the same point.

Gradation: A measure of the sizing of an application of glass beads. The two variables are the overall range of sizes and the percentage by weight of each size.

Gravity Extrusion: A method of applying a pavement marking material that uses gravity to force the material out of a specifically sized die.

Guideline: A premarking applied to the pavement to guide the operator of a striper in applying the final pavement markings.

Heat Exchanger: A device used to transfer heat from the hot heat transfer fluid to the cold product prior to spraying. It generally consists of multiple lines passing product through the heat transfer fluid-filled line.

Heat Transfer Fluid: Fluid capable of reaching high temperature and transferring much of its heat by means of conduction to the cold product.

Hot-Applied Thermoplastic: Thermoplastic materials that are melted to liquid form at about 425 degrees Fahrenheit (218 degrees Celsius) and applied to the pavement using an extrusion of spray technique.

Hydrocarbon: A class of thermoplastic materials based on organic petroleum compounds.

Illuminance: Luminous flux incident per unit of area.

Index of Refraction: For a given material, the index of refraction is equal to the ratio of the speed of light in a vacuum to the speed of light as it travels through the material. Describes the "light bending" property of a glass as the light wave passes from the air to glass or vice versa. It is a measure of the brilliance of retroreflectivity for glass spheres.

Inlay Installation: A method of applying preformed tapes to newly applied asphaltic concrete that embeds the tape into the pavement.

Interior Loss: Any loss of pavement marking material that does not reach any of the edges of the marking.

Lane Line: A line separating two lanes of traffic traveling in the same direction.

Legibility: Legibility of a delineation device is the likelihood that a driver will understand the message that the

Roadway Delineation Practices Handbook

delineation device is meant to convey.

Liability: The legal obligation of a negligent party to pay victims for damages resulting from the party's negligence.

Large Arrow Sign: A warning sign intended to inform drivers of a sharp change in roadway alignment.

Liquid Heater: A device used to heat transfer fluid to its required temperature before it enters the heat exchanger.

Longitudinal: Running lengthwise; placed lengthwise; opposite of transverse.

Lumen: The metric unit of luminous flux, 1 lumen is equal to the luminous flux emitted within one steradian by a point source having a spatially uniform luminous intensity of 1 candela.

Luminance: The luminous flux in a light ray, emanating from a surface or falling on a surface, in a given direction, per unit of projected area of the surface as viewed from that direction, per unit of solid angle.

Luminance Contrast: See contrast.

Luminous Intensity: Light flux per unit solid angle.

Lux: The metric unit of illuminance, 1 lux is equal to the illuminance corresponding to a luminous flux density of one lumen per square meter.

Manual on Uniform Traffic Control Devices (MUTCD): A Federal Highway Administration publication intended to standardize traffic control devices throughout the nation.

Methyl Methacrylate: A two-component pavement marking material similar to epoxy materials.

Mil: Unit of length equivalent to 0.001 inches.

Ministerial: Refers to mandatory tasks that involve a minimum of personal judgment.

Negative Delineation: Provides information to vehicle driver on where not to go.

Negligence: The omission to do something that a reasonable person would ordinarily do, or the doing of something that a reasonable person ordinarily would not do.

No-Track Time: The time required for the applied marking to resist being picked up by vehicle tires and transferred to the adjacent pavement.

Observation Angle: The angle at the retroreflector position between the observer's eye and the light source.

Older Driver: A driver aged 55 years or older.

Oleoresinous: Refers to a type of paint binder that is composed of some type of essential oil, mixed with either a natural or synthetic resin.

Open-Graded: Refers to a type of pavement in which only a coarse aggregate is mixed with hot asphalt to create a pavement with a rough surface texture. This type of pavement has a high porosity and permeability, reducing the incidence of water ponding. See also, Dense-Graded.

Orbitrol Control: A brand name device, located at the base of the platform operator's steering columns and powered by a hydraulic mechanism, which acts as a power steering unit for control of the outriggers.

Roadway Delineation Practices Handbook

Orientation Angle (Rotation Angle): This is related to rotation of the retroreflective unit in its own plane or the plane normal to the line of observation.

Outrigger: A mechanism, powered by hydraulic action, that extends and supports the outrigger carriages, which, in turn, support the spray guns.

Overlay Installation: A method of installation of a preformed pavement marking tape that merely uses adhesive to bond the tape to the surface of the pavement.

Overspray: Spray pattern exceeding the desired pattern; e.g., spraying of product in a fine mist beyond the proposed edges of the line being marked.

Paints: Classified by, among other things, drying times:

- (a) Instant dry—less than 30-second no-track time
- (b) Quick dry—30- to 120-second no-track time
- (c) Fast dry—2- to 7-minute no-track time
- (d) Conventional—over 7-minute no-track time

Parking Space Marking: Markings intended to inform drivers where they are permitted to park.

Pavement: The physical surface of the roadway.

Pavement Marking: A colored marking applied to the pavement to provide drivers with roadway alignment information.

Performance Specification: A specification written to describe pavement marking materials based on their performance.

Permissive: Refers to areas where a driver is permitted to travel.

Phenolics (Resins): A large class of synthetic plastics made from aldehydephenol base.

Pigment: White or yellow material in a pavement marking that provides the marking with its color and also provides the necessary diffuse reflection at the back of the glass beads in a pavement marking to create retroreflectivity.

Plastic: Anything moldable; any material, natural or synthetic, which may be fabricated into a variety of shapes by application of heat or pressure.

Polyester (Polyethylene): Tough, flexible thermoplastic resin made by polymerization of ethylene and used in making moisture-proof plastics.

Portland Cement Concrete (PCC): A pavement material composed of Portland cement, sand, coarse aggregate, and water. This material is smoother and longer-lasting than bituminous concrete.

Positive Delineation: Provides information as to where vehicle driver is permitted to drive.

Post-Mounted Delineator: A delineation device that consists of retroreflective material mounted on a four-foot post to provide long-range information on roadway alignment.

Preformed Tape: A pavement marking material that is made of preformed thermoplastic material. It is applied to the pavement cold, employing a self-adhesive backing material, or it is applied with a separate adhesive.

Roadway Delineation Practices Handbook

Premix: A paint that contains glass beads held in suspension throughout the paint.

Pretreatment: Preparation of a pavement surface for installation of delineation devices. Usually consists of cleaning and/or priming.

Preview Distance: The distance that the delineation provides the driver to see upcoming changes in roadway alignment.

Prismatic Cube-Corner Marker: A raised pavement marker that employs prismatic cube-corner elements to achieve retroreflection.

Psychophysical Parameter: A limitation in the driver's ability to assimilate roadway information.

Railroad Crossing Marking: A pavement marking symbol that consists of two "R"s and an "X," which informs drivers of an upcoming intersection with a set of railroad tracks.

Raised Pavement Marker (RPM): A ceramic or plastic marking device placed on the road to substitute for or act as a supplement to standard pavement markings. Raised pavement markers are comprised of a variety of configurations including retroreflective and nonretroreflective markers, and markers that employ prismatic retroreflection and those that employ spherical retroreflection.

Reasonable Person: A concept used in legal circles to establish what actions, or lack of actions, are considered to be negligent. The concept applies a test of what a reasonably prudent person, in the eyes of the jury, would do in a particular situation to determine if a certain party has been negligent.

Refractive Index (RI): See index of refraction.

Reflective: Bending or turning light.

Resin: Substance made by chemical synthesis, especially those used in the making of plastics.

Restrictive: Refers to areas where a driver is not permitted to travel.

Retroreflective: Capable of returning light to its source.

Ribbon Extrusion: A method of applying pavement markings whereby the material is forced onto the pavement under pressure.

Roadway: A term used to refer to the paved paths that drivers use for transportation. Refers to the transportation system in a more macroscopic way than "pavement" or "substrate."

Service Life: The time required for a pavement marking to become ineffective due to its having lost its luster, lost its retroreflectivity, or having been worn completely from the pavement.

Sieve Size: The sieve size refers to the sizing or mesh of a sieve or screen used to determine size of glass beads. The larger the U.S. Mesh number, the more threads there are and the smaller the openings are.

Silica: Silicon dioxide is one of the major oxide constituents of glass used for manufacturing glass beads.

Skinning: A condition commonly occurring with paints in the container and when applied as a line or strip where the immediate surface dries first or "skins" and the under surface remains wet (as opposed to through set of a film).

Roadway Delineation Practices Handbook

Solid Angle: The three-dimensional angular spread at the vertex of a cone measured by the cone on a unit sphere whose center is the vertex of the cone.

Solid Line: A continuous pavement marking. Solid lines are restrictive; drivers are being informed that they are not to cross a solid line.

Solvent: Usually a liquid that, when added to paint, will reduce the viscosity of the paint and may also dissolve the resin (binder).

Specific Intensity per Unit Area (SIA): See Coefficient of Retroreflection.

Speed Measurement Marking: A transverse pavement marking intended to aid law enforcement officers in measuring the speeds of vehicles.

Spotting: A technique for premarking pavement at predetermined intervals to guide the operator of the striping machine when applying permanent pavement markings.

Spraying: A procedure for applying marking material to a surface:

- (a) Air atomizing spray—Spraying atomization of the liquid paint through air pressure only.
- (b) Airless spray—Spraying atomization of the liquid paint is accomplished through hydraulic fluid pressure only. No atomization air is used.

Staining: The obscuration of thermoplastic pavement markings due to the combined effects of tire rubber, oil, and other contaminants.

Standard of Care: A certain level of consideration that one party owes as a legal duty to another party. The standard of care sets the boundaries of a party's liability.

Steradian: The unit by which solid angles are measured. There are 4π steradians in a complete sphere.

Stop Bar: A pavement marking applied at an intersection to inform drivers where they should stop.

Striper: A self-contained marking system mounted on a truck chassis and used on the road to apply pavement markings.

Substrate: The surface to which the marking material is applied.

Surface: Refers to the top of the pavement material or substrate—the area where pavement markings are applied.

Sulky: A mechanism consisting of a guide wheel and its support structure, attached to the front of a truck-mounted striping machine, intended to guide the striping operator in applying the markings in the proper lateral location.

Symbol Marking: A pavement marking used in a specific location to guide, warn, regulate, or inform drivers where standard pavement markings are not sufficient.

Technique: Refers to the methods chosen to accomplish effective delineation. Selection of an appropriate marking material and method of application are part of delineation technique.

Temporary Pavement Marking: Pavement markings to be used for a period of less than two weeks.

Thermoplastic: A class of pavement marking materials whose main component is a plastic material that becomes pliable or liquid at high temperatures.

Roadway Delineation Practices Handbook

Threshold Contrast: The minimum difference in luminance of a target and luminance of that target's background at which the target is visible.

Through Set: Property of a marking material to be uniformly dry or set through its entire thickness from the line surface to the substrate surface (as opposed to skinning).

Tip Life: The length of time that a spray gun tip will continue to function properly. The tip is no longer useful when the orifice elongates and the applied marking deviates from its desired appearance.

Tort: A civil wrong, other than breach of contract, for which a court of law will provide a remedy in the form of an action for money damages.

Traffic Control Device: A device intended to provide for the orderly and predictable movement of traffic and to provide such guidance and warnings as are needed for the safe and informed operation of individual elements of the traffic stream.

Traffic Paint: A pavement marking material that consists mainly of a binder and a solvent. The material is kept in liquid form by the solvent, which evaporates upon installation to the pavement, leaving the binder to form a hard film.

Transverse: Lying, situated, placed across from side-to-side; crosswise. Also, perpendicular to the center line.

Treatment: Refers to the higher-level decision process of designing delineation to be installed. Such issues as use of raised pavement markers and post-mounted delineators are part of delineation treatment.

Turn Sign: A warning sign used to inform drivers of an upcoming change in roadway alignment where the recommended speed is less than 30 miles per hour and equal to or less than the posted speed limit.

Viscosity: A measure of a fluid's tendency to resist flow. Also, the constant ratio of the shearing stress to the rate of shear in the liquid.

Volatile Organic Compound (VOC): An environmentally hazardous material that is released into the atmosphere during many marking operations, especially those that employ chemical solvents, such as alkyd traffic paints.

Warning Sign: Signs used to supplement roadway markings where those markings are not considered adequate to convey all necessary information to the driver.

Water-Based Paint: A pavement marking material that employs water as a solvent, thus nullifying the environmental concerns with many traffic paints. Also referred to as latex paint.

Wet Film Thickness: Thickness of a pavement marking at the time of application without glass beads.

Wetting: A prime requisite for good adhesion, it is the flow of liquid pavement marking over the surface of the substrate to yield complete coverage. Wetting, and hence adhesion, is poor over dirty or oily surfaces.

Wide Line: A line wider than the standard 4-inch width.

BIBLIOGRAPHY

Roadway Delineation Practices Handbook

1984 Research Problem Statements—Operational Effects of Geometrics, Transportation Research Circular No. 285, Transportation Research Board, Washington, DC, October 1984.

"A Quick Way to Measure Marking Reflection," *Better Roads*, Vol. 59, No. 12, December 1989, 40-41.

AASHTO Maintenance Manual 1987, AASHTO, Washington, DC, 1987.

Accelerated Tests of Traffic Marking Material Durability, Report No. FHWA-RD-78-93, Federal Highway Administration, Washington, DC, 1978.

Adrian, W., *Visibility of Targets*, Transportation Research Record No. 1247, Transportation Research Board, Washington, DC, 1989, 39-45.

Agent, K.R., and J.G. Pigman, *Evaluation of Extruded Thermoplastics as Lane Delineation*. Final Report, Report No. UKTRP-88-10, Transportation Research Program, Kentucky University College of Engineering, Lexington, KY, May 1988.

———. *Evaluation and Application of Roadway Marking Materials*. Final Report, Report No. UKTRP-87-10, Transportation Research Program, Kentucky University Transportation Research Program, Lexington, KY, May 1987.

———. *Evaluation of Durable Lane Delineation Materials—Interim Report*, Report No. UKTRP-84-31, Transportation Research Program, Kentucky University Transportation Research Program, Lexington, KY, December 1984.

Allen, R.W., *Reflectorization of Curves*, Transportation Research Circular No. 306, Transportation Research Board, Washington, DC, June 1986, 7.

Allen, R.W., et al., *Drivers' Visibility Requirements for Roadway Delineation*, (2 Vols.), Report No. FHWA-RD-77-165 and 166, Systems Technology and Human Factors Research, Inc., Goleta, CA, November 1977.

Anderson, R.W., "Booby Trapped: Work Zones," *TranSafety Reporter*, Vol. 3, No. 1, TranSafety Incorporated, Washington, DC, January 1985, 4.

"Anderson Stresses Importance of Highway Signs," *ATSSA Signal*, May 1989, 3.

Arrowsmith, G., and T. Mulroy, "The Right Road is Matter of Opinion," *Surveyor*, Vol. 163, No. 4799, Specialist and Professional Press, June 1984, 7-10.

Attaway, R.W., *In-Service Evaluation of Thermoplastic and Tape Pavement Markings Using a Portable Retroreflectometer*, Transportation Research Record No. 1230, Transportation Research Board, Washington, DC, 1989, 45-55.

Attaway, R.W., and P.O. Adeleke-Sheidun, *Pavement Marking Materials Program*, Report No. FHWA/NC/89-005, North Carolina Department of Transportation, Raleigh, NC, January 1990.

Azar, D.G., *Evaluation of Thermoplastic Materials*, Louisiana Department of Highways, Baton Rouge, LA, April 1975.

Aurand, G.A., 1988, *Reduction of Volatile Organic Compound Emissions from the Applications of Traffic Markings*, U.S. Environmental Protection Agency, Control Technology Center, Research Triangle Park, NC, 1988.

Roadway Delineation Practices Handbook

Bailey, S.N., *Evaluation of Flexible Plastic Guide Marker and Clearance Marker Posts*, Report No. CA-TL-6317-77-26, California Department of Transportation, Sacramento, CA, September 1977.

Bali, S.G., et al., *Cost-Effectiveness and Safety of Alternative Roadway Delineation Treatments for Rural Two-Lane Highways* (5 Vols.), Report Nos. FHWA-RD-50 through 55, Systems Applications, Inc., CA, April 1978.

Barnes, J.W., *Night Time Delineation of New Zealand Open Roads*. *New Zealand Roding Symposium 1987*, Vol 3, National Roads Board, Wellington, New Zealand, 1987, 637-654.

Baxter, G.L., *Evaluation of Short-Range Roadway Delineation*, Melbourne University, Victoria, Australia, 1983.

"Better Sign Inspection and Maintenance," *Better Roads*, Vol. 59, No. 1, January 1989, 38-40.

Blaauw, G.J., *Vehicle Guidance By Delineation Systems at Night*, Institute for Perception, Soesterberg, Netherlands, 1984, 121-136.

Blaauw, G.J., M. Buist, S. Burrij, and F. Hoogeweg, *Delineation at Night*, Report No. 1984-C-4, Institute Voor Zintuigfysiologie, Soesterberg, Netherlands, 1984.

Blaauw, G.J., and P. Padmos, *Night-Time Visibility of Roadway Delineation On Dry and Wet Roads*, Report No. 1981 C-20, Soesterberg, Netherlands, 1981.

Bodenheimer, B.A., *Recessed Reflective Markers Feasibility Study*, Final Report, Report No. FHWA-TS-86-207, Bodenheimer (BA) & Company, Stamford, CT, September 1985.

Book of ASTM Standards—Part 27, American Society for Testing and Materials, Philadelphia, PA, 1978.

Bowman, B.L., *Inexpensive Accident Countermeasures at Narrow Bridges*. Research Report, Report No. FHWA/RD-87/024, Goodell-Grivas, Incorporated, Southfield, MI, April 1987.

Bowman, B.L. and P. Brinkman, *Effect of Low-Cost Accident Countermeasures on Vehicle Speed and Lateral Placement*, Transportation Research Record No. 1185, Transportation Research Board, Washington, DC, 1988, 11-23.

Bragdon Jr., J.A., *Management Approach to Traffic Control in Work Zones: The Glenwood Canyon Experience*, Institute of Transportation Engineers, 57th Annual Meeting Compendium of Technical Papers.

Brinkman, C.P., "Safety Studies Related to RRR Projects," *ASCE Journal of Transportation Engineering*, Vol. 108, No. TE4, July 1982, 307-312.

Brooks, J.T., *Pavement Marking Inspection Training Course*, Federal Highway Administration, Office of Traffic Operations, Washington, DC, July 1988.

———. *An Overview of Current Pavement Marking Practices and Recommendations for Establishing a Conceptual Procedure for Procurement, Application and Maintenance of Pavement Markings Using the Turnkey Project Method and a National Testing Center for Evaluating Pavement Marking Materials and for Dissemination of Testing Results*, Federal Highway Administration, Washington, DC, August 1986.

Broyhill, T.R., *Reflective Marker Paint Stripe Skipper Instrument (Retro-Skip Device)*, Report No. CA-DOT-EQ-6251-1-77, California Department of Transportation, Sacramento, CA, November 1977.

Bryden, J.E., *Development of a Statewide Pavement Marking Policy*, Research Report No. 143, Engineering Research and Development Bureau, New York State Department of Transportation, Albany, NY, July 1988.

Roadway Delineation Practices Handbook

———. *Effectiveness of Flashing Arrow Boards During Moving Maintenance Operations*, Research Report No. 73, Engineering Research and Development Bureau, New York State Department of Transportation, Albany, NY, May 1979.

———. *Long-Term Performance of Grooved Stripe-Reflective Markers*, New York State Department of Transportation, Albany, NY, 1979.

———. *Pavement Marking Materials: A Summary of New York State Research*, Research Report No. 48, New York State Department of Transportation, Albany, NY, May 1977.

———. *Performance of Shoulder and Median Contrast Treatments*, Research Report No. 71, Engineering Research and Development Bureau, New York State Department of Transportation, Albany, NY, March 1987.

Bryden, J.E., J.R. Allison, and G.F. Gurney, *Grooved Stripes for Plow-Resistant Wet-Night Lane Delineation, Phase II: Recessed Reflector Delineation*, Report No. FHWA-RD-78-131, New York Department of Transportation, Albany, NY, August 1976.

Bryden, J.E., and N.J. Bruno, *Construction Zone Barrel Evaluation*, Client Report No. 3, Engineering Research and Development Bureau, New York Department of Transportation, Albany, NY, March 1987.

Bryden, J.E., and G.F. Gurney, *Evaluation of Long-Life Pavement Markings*, Research Report No. 114, Engineering Research and Development Bureau, New York Department of Transportation, Albany, NY, April 1984.

———. *Pavement-Marking Materials: New York's Experience*, Research Report No. 112, Engineering Research and Development Bureau, New York DOT, Albany, NY, April 1984.

———. *Performance of Thermoplastic Pavement Markings*, Research Report No. 120, Engineering Research and Development Bureau, New York State Department of Transportation, Albany, NY, April 1985.

Bryden, J.E., and P.D. Kelly, *Installation of Chlorinated Rubber Traffic Paint*, Client Report No. 21, Engineering Research and Development Bureau, New York State Department of Transportation, Albany, NY, April 1984.

Bryden, J.E., and W.D. Kenyon, *Methods for Removal of Pavement Markings*, Research Report No. 130, Engineering Research and Development Bureau, New York State Department of Transportation, May 1986.

Bryden, J.E., and R.A. Lorini, *Experimental Pavement Delineation Treatments*, Research Report No. 87, Engineering Research and Development Bureau, New York State Department of Transportation, Albany, NY, June 1981.

———. *Test Installation of Chlorinated-Rubber Traffic Paint*, Research Report No. 125, Engineering Research and Development Bureau, New York State Department of Transportation, Albany, NY, August 1985.

———. Bryden, J.E., and R.A. Lorini, *Traffic Paint Performance in Accelerated Wear Tests*, Research Report No. 137, Engineering Research and Development Bureau, New York State Department of Transportation, Albany, NY, May 1987.

Bryden, J.E., R.A. Lorini, and G.F. Gurney, *Performance of Preformed Pavement-Marking Tapes*, Research Report No. 104, Engineering Research and Development Bureau, New York Department of Transportation, Albany, NY, November 1983.

Bryden, J.E., R.A. Lorini, and P.D. Kelly, *Reflectivity and Durability of Epoxy Pavement Markings*, Transportation Research Record No. 1086, Transportation Research Board, Washington, DC, November 1983, 1-7.

Roadway Delineation Practices Handbook

———. *Reflectivity and Durability of Epoxy Pavement Markings*. Second Interim Report, Report No. FHWA/NY/RR-85/127, Engineering Research & Development Bureau, New York State Department of Transportation, Albany, NY, October 1985.

Buras, E.M., et al., *Accelerated Test of Traffic Marking Material Durability*, Harris Research Labs, Gillette Research Institute, Rockville, MD, 1978.

Burns, E.N., and Fellow, *Techniques for Separating Opposing Traffic in Rural Construction Work Zones*, Institute of Transportation Engineers, 55th Annual Meeting, Compendium of Technical Papers.

Capelle, D.G., *An Overview of Roadway Delineation Research, Final Report*, Report No. FHWA-RD-78-111, U.S. Department of Transportation, Federal Highway Administration, Washington, DC, June 1978.

Capelli, J.T., *Audible Roadway Delineators*, Research Report No. 14, Engineering Research and Development Bureau, New York State Department of Transportation, Albany, NY, May 1973.

Chaiken, B., "Comparison of the Performance and Economy of Hot-Extruded Thermoplastic Highway Striping Materials and Conventional Paint Striping," *Public Roads*, Vol. 35, No. 6, February 1969, 135-146.

Chatto, D.R., and T.L. Shelly, *Investigate Alternatives for Solvent-Borne Traffic Paint*, Report No. TL-604187, California Department of Transportation, Sacramento, CA, January 1983.

Chollar, B.H., and B.R. Appleman, *Epoxy Thermoplastic Pavement Marking Material: Summary of Research Results and Revised Specification*, Report No. FHWA-RD-81-144, Federal Highway Administration, Washington, DC, September 1982.

Collins, B.L., *Color Appearance of Traffic Control Devices Under Different Illuminants*, Transportation Research Record No. 1247, Transportation Research Board, Washington, DC, 1989, 23-31.

Corben, B.F., *The Incidence of Alcohol in Accidents at Signalized Intersections*, Report No. 82/12, Monash University, Wellington, Australia, December 1982.

Conference on Pavement Markings and Signing Materials, Summary Report Southeastern Region, September-October 1987.

Corben, B.F., and W. Young, *The Incidence of Alcohol in Accidents at Signalized Intersections*, Monash University, Wellington, Australia, November 1983.

"Cost-Effectiveness of Roadway Delineation As a Countermeasure For Accidents Involving Impaired Drivers—Volume 1: Main Report," *Transport Canada*, Ottawa, Canada, October 1985.

Cottrell, B.H., *Temporary Asphalt Medians for Two-Lane, Two-Way Operation, Final Report*, Report No. FHWA/VA-89-R24, Virginia Transportation Research Council.

Creasey, F.T., G.L. Ullman, and C.L. Dudek, *Delineation of Urban Freeway Gore Area Crash Cushions in Texas*, Presented at the 68th Annual Meeting of the Transportation Research Board, Federal Highway Administration, Office of Safety and Traffic Operations, Washington, DC, January 1989.

Creech, M.F., *Installation of Fog Guidance Lights on Afton Mountain*, Virginia Highway and Transportation Research Council Report 77-R12, Charlottesville, VA, August 1976.

Cricher, J.L., *Removal of Pavement Markings by Scoring-Jetting*, Report No. FHWA-TS-77-213, U.S. Department of Transportation, Federal Highway Administration, Washington, DC, June 1977.

Roadway Delineation Practices Handbook

Dale, J.M., Pavement Markings: Materials and Application for Extended Service Life, *NCHRP Synthesis Number 138*, June 1988.

———. *Surface Preparation of Pavements Prior to Application of Pavement Markings*, Report No. DOT-FH-9298, Southwest Research Institute, San Antonio, TX, 1979.

Davidson, R.L., *Pavement Marking Test and Evaluation Procedures—Phase I*, Report No. FHWA-TS-88-016, Federal Highway Administration, McLean, VA, March 1988.

———. *Pavement Marking Test and Evaluation Procedures—Phase II*, Report No. FHWA-TS-88-016, Federal Highway Administration, McLean, VA, March 1988.

Davis, T.D., *Construction-Zone Delineation*, Transportation Research Record No. 811, Transportation Research Board, Washington, DC, 1981.

Deer, R., and C.E. Mansfield, *Inlaid Traffic Lane Lines: I-90, Edgewick Road to Hyak. Post Construction, Annual Report*, Report No. WA-RD 184.1, Washington State Department of Transportation, Olympia, WA, May 1989.

Dejaiffe, R., *Measuring Wet-Night Delineation Reflectivity*, Transportation Research Record No. 1149, Transportation Research Board, Washington, DC, 1987, 46-49.

———. *Retroreflectivity—Wet and Dry*, Presented at the Annual Transportation Research Board Meeting, Potters Industries, Parsippany, NJ, 1986.

Design For Safety: Materials and Information System, Report No. CSIR-S-343-VOL-F-2, Annual Transportation Convention, Council for Scientific and Industrial Research, Pretoria, South Africa, August 1984.

Disbro, J.E., and J.E. Bryden, *Evaluation of Median Barrier Delineators*, Client Report No. 29, Engineering Research and Development Bureau, New York State Department of Transportation, Albany, NY, June 1988.

———. *Field Performance of Chlorinated-Rubber Traffic Paint*, Client Report No. 28, Engineering Research and Development Bureau, New York State Department of Transportation, Albany, NY.

———. *Performance of Chlorinated-Rubber Traffic Paint*, Research Report No. 146, Engineering Research and Development Bureau, New York State Department of Transportation, Albany, NY.

———. *Performance of Chlorinated-Rubber Traffic Paint, Final Report*, Report No. FHWA/JY/RR-89/146, Engineering Research & Development Bureau, New York State Department of Transportation, Albany, NY, June 1988.

Dowden, H.W., *Evaluation of Delineation System for Temporary Traffic Barriers in Work Zones*, Report No. FHWA-TS-86-XX, Federal Highway Administration, Washington, DC, December 1985.

Doyle, K.F., *Performance Testing of Road Markings Using Portable Reflectometers*, New Zealand Roading Symposium 1987, Volume 2, National Roads Board, Wellington, New Zealand, 1987, 377-385.

Dudek, C.L., R.D. Huchingson, and D.L. Woods, *Evaluation of Temporary Pavement Marking Patterns in Work Zones: Proving Ground Studies*, Presented at the Annual Meeting of the Transportation Research Board, Washington, DC, Texas Transportation Institute, College Station, TX, January 1986.

———. *Human Factors Design of Dynamic Visual and Auditory Displays for Metropolitan Traffic Management, Vol. 1—Summary Report*, Report No. FHWA-RD-81-39, Texas Transportation Institute, College Station, TX, May 1982.

Roadway Delineation Practices Handbook

Dudek, C.L., R.D. Huchingson, F.R. Creasey, and O. Pendleton, *Field Studies of Temporary Pavement Markings for Work Zones on Two-Lane Rural Highways*," Presented at the 67th Annual Meeting of the Transportation Research Board, Washington, DC, January 1988.

Dudek, C.L., R.D. Huchingson, and W.R. Stockton, *Human Factors Design of Dynamic Visual and Audio Displays for Metropolitan Traffic Management, Vol. 3—Highway Advisory Radio*, Report No. FHWA-RD-81-41, Texas Transportation Institute, College Station, TX, January 1981.

Effect of Road Cross-Section on Vehicle Lateral Placement, Australian Road Research, Vol. 15, No. 1, Australian Research Board, Victoria, Australia, March 1985, 30-40.

Eyler, D.R., C.Z. Beltt, and R.D. Borson, *The I-394 Interim HOV Lane a Valuable Construction Zone Traffic Management System*, Institute of Transportation Engineers, 56th Annual Meeting, Compendium of Technical Papers.

Farber, E., *Improving Analytical Approaches for Evaluating Visibility*, Transportation Research Circular No. 297, Transportation Research Board, Washington, DC, December 1985, 7.

Forbes, C.E., *Striping Materials*, California Department of Transportation, Sacramento, CA, April 1978.

Frank, F.M., Traffic Paints (2 parts), *Paint and Varnish Production*, Vol. 58, Nos. 3 and 4, part 1, March and April 1968, 23-28, part 2, March and April 1968, 31-36.

Franklin, J.D., et al., *Traffic Controls for Construction and Maintenance Work Zones*, Volume I, Office Function, Report No. FHWA-TS-77-204, American Public Works Association, Chicago, IL, May 1977.

Freedman, M., L.K. Staplin, D.P. Gilfillan, and A.M. Byrnes, *Noticeability Requirements for Delineation on Non-illuminated Highways*, Report No. FHWA-RD-88-028, Federal Highway Administration, Washington, DC, September 1981.

Fullerton, I.J., *Roadway Delineation Practices Handbook*, Report No. FHWA-IP-81-5, JHK and Associates, San Francisco, CA, September 1981.

George, D., *Evaluation of Stimsonite 96 Pavement Markers for Safety Related Delineation*, Alberta Transportation, Edmonton, Canada, March 1987.

———. *Products For Sharp Shoulder Delineation*, Alberta Transportation, Edmonton, Canada, March 1987.

Gilbert, K.C., E.C. Shirley, F. Campbell, and J. Lobenberg, *Establishing Evaluation of Pavement Delineation Alternatives to Solvent-Based Paint*, California Department of Transportation, Sacramento, CA, 1982.

Gillie, H.J., *Epoxy Striping*, Minnesota Department of Transportation, St. Paul, MN, March 1977.

Godthelp, H., and J.B.J. Riemersma, *Perception of Delineation Devices in Road Work Zones During Nighttime*, Report No. SAE 820413, Society of Automotive Engineers, New York, NY, 1982.

———. *Vehicle Guidance in Road Work Zones*, Report No. HS-033 852, Taylor and Francis Limited, London, England, October 1982.

Gordon, D., *Evaluation of Diamond Pattern for Use on Work Zone Barricade Rails*, Report No. FHWA/RD-82/109, Federal Highway Administration, Washington, DC, August 1982.

Gurney, G.F., E.D. McNaught, and J.E. Bryden, *Evaluation of Adirondack Park Signs*, Research Report No. 56,

Roadway Delineation Practices Handbook

Engineering Research and Development Bureau, New York State Department of Transportation, Albany, NY, December 1977.

Harlow, W.A., and D.H. Matthews, *Safety at Roadways*, Report No. HS-035 092, Printerhall Limited, London, England, April 1983.

Harrigan, E.T., *Epoxy Thermoplastic Pavement Marking Material (Technical Note)*, U.S. Department of Transportation, Federal Highway Administration, Washington, DC, May 1977.

Henry, J.J., D.A. Anderson, and G.F. Hayhoe, *Skid Resistance of Pavement Marking Materials*, FHWA Report No. FHWA-RD-80-199, Vol. 1, Federal Highway Administration, Washington, DC, March 1981.

Henry, J.J., C.A. Antle, and J.L. Carroll, Marking Materials Study Explores Cost, Service Life, *Roads and Bridges*, Vol. 26, No. 9, 83-86, 144.

———. *Service Life and Cost of Pavement Marking Materials*, Contract No. HR 416, National Cooperative Highway Research Program, Pennsylvania Transportation Institute, University Park, PA, March 1990.

Highway Maintenance Manual (8th ed. updated), California Department of Transportation, Sacramento, CA, 1975.

Highway Markings (Citations From the NTIS DataBase), National Technical Information Service, Springfield, VA, January 1970 through August 1988.

Highway Safety Improvement Programs: 1979 Report, Communication from the Secretary of Transportation to the U.S. Congress, U.S. Government Printing Office, Washington, DC, 1979.

Hildebrand, E., and F.R. Wilson, *An Assessment of Elderly Accident Patterns*, Presented at the Annual Meeting of the Transportation Research Board, Washington, DC, Transportation Group, University of New Brunswick, January 1990.

Hofener, S.D., and D.L. Woods, *Thermoplastic Striping with Improved Durability and Snowplow Resistance—Executive Summary and Draft Specifications*, Report No. FHWA-RD-79-14, Texas Transportation Institute, College Station, TX, August 1977.

Hoffman, A.G., and B.W. Firth, *State-of-the-Practice Retroreflective Measurement Devices for Pavement Markings*, Report No. FHWA-TS-84-222, Federal Highway Administration, Washington, DC, December 1985.

Information Problems on Major Roads, Report No. 1982:5, Stockholm, Sweden, December 1985.

Instrumental Photometric Measurements of Retroreflective Materials and Retroreflective Devices, Federal Test Method Standard 370, U.S. Government Printing Office, Washington, DC, May 1982.

Investigation of Paints and Glass Beads Used in Traffic Delineation Markings (13 Phases), Missouri State Highway Department, Jefferson City, MO, March 1977.

Iowa Department of Transportation, *Evaluation of Delineation System for Temporary Traffic Barriers in Work Zones*, Contract No. FH-11-8559, Federal Highway Administration, Washington, DC, 1972.

Jennings, B.E., and M.J. Demetsky, *Evaluation of Curve Delineation Signs*, Transportation Research Record No. 1010, Transportation Research Board, Washington, DC, 1985, 53-61.

Jobson, A.J., and W.H.J. Sator, *Signs for Roadworks: Evaluation of Experimental Signs*, Report No. CSIR-RR-464, National Institute for Transportation and Road Research, Pretoria, South Africa, August 1986.

Roadway Delineation Practices Handbook

Johnston, I.R., *Alcohol-Related Accidents: Characteristics, "Causes" and Counter-Measure Implications*, Victoria Road Safety and Traffic Authority, Victoria, Australia, 1981.

Johnston, I.R., *The Effects of Roadway Delineation on Curve Negotiation by Both Sober and Drinking Drivers*, Report No. ARR128, Australian Road Research Board, April 1983.

Jones, R.O., *Tort Liability in Traffic Control Activities*, Paper for the 1978 Western ITE Meeting, Denver, CO, 1978.

———. *Sovereign Immunity: Where We've Been, Where We Are Now, and Where We're Going*, Paper for the 67th Annual Meeting of the American Association of State Highway and Transportation Officials, Louisville, KY, October 1978.

Kalchbrenner, J., *Large Glass Beads for Pavement Markings*, Transportation Research Record No. 1230, Transportation Research Board, Washington, DC, 1989, 28-36.

Keck, M.E., *Effect of Luminaire Arrangement on Object Visibility*, Transportation Research Record No. 1247, Transportation Research Board, Washington, DC, 1989, 17-22.

Keith-Lucas, T., *Strobes Versus Rotating Beacons*, University of the South, Seawee, TN.

Kelly, P.D., and J.E. Bryden, *Evaluation of Epoflex Pavement Markings*, Research Report No. 139, Engineering Research and Development Bureau, New York State Department of Transportation, Albany, NY, June 1987.

Kenyon, W.D., G.F. Gurney, and J.E. Bryden, *Maintenance of Reflective Signs*, Research Report No. 101, Engineering Research and Development Bureau, New York State Department of Transportation, Albany, NY, December 1982.

Ketola, W.D., *Durability Testing for Retroreflective Sheetings*, Transportation Research Record No. 1230, Transportation Research Board, Washington, DC, 1989, 67-76.

Khan, M.M., *Evaluation of Delineation Systems for Temporary Traffic Barriers in Work Zones*, Contract No. DOT-FH-11-8561, Ohio Department of Transportation, Columbus, OH, December 1985.

———. *Evaluation of Temporary Raised Pavement Markers in Work Zones*, Report No. Ohio/Hwy-01/87, Ohio Department of Transportation, Columbus, OH, February 1987.

King, E., and J.R. Graham, *Evaluation of Pavement Marking Materials for Wet Night Conditions*, Report No. FHWA/NC/89-004, Federal Highway Administration, Washington, DC, October 1989.

Lack of Adequate Road Markings and Signs Held Against County, *TranSafety Reporter*, Vol. 3, No. 11, TranSafety, Incorporated, Fairfax, VA, November 1985, 1-2.

Latchford, J.C.R., et. al., *Transportation in the 80's. Highways, Bridges and Traffic Management. (CONDT.)*, Telford Limited, London, England, 1982.

Lee, R.B., N. Bellizzi, and W. Allen, *Speed Control on High Speed Roadways*, Report No. FHWA/RD-81/096, Urbitran Associates, Inc., New York, NY, March 1981.

Lerner, N.D., and B.K. Turner, *Laboratory Evaluation of Crash Cushion Delineation*, Transportation Research Record No. 1093, Transportation Research Board, Washington, DC, 1986, 28-36.

Lewis, R.M., *Some Rambling Thoughts Related to Warrants and Performance Criteria for Safety Appurtenances*

Roadway Delineation Practices Handbook

Used in Work Zones, Presented at the Transportation Research Board Summer Meeting on Work Zone Appurtenances, Northwestern University Traffic Institute, Evanston, IL, July 1986.

Lowe, J., *Retractable Pavement Marker: Animation, Inc., Model EZC*, Alberta Transportation and Utilities, Alberta, Canada, January 1988.

Lum, H.S., *Use of Road Markings to Narrow Lanes for Controlling Speed in Residential Areas*, Report No. HS-037 383, Institute of Transportation Engineers, Federal Highway Administration, June 1984.

Lumia, J.J., *Mobile System for Measuring the Retroreflectance of Traffic Signs*, Transportation Research Record No. 1247, Transportation Research Board, Washington, DC, 1989, 69-78.

Lundkrist, S.O., and K. Sorenson, Reflection Properties of Road Surfaces and Road Markings in Headlight Illumination, *CIE Journal*, Vol. 4, No. 2, 1985.

Mace, P.J., K. Perchonok, and L. Pollack, *Luminous Requirements for Traffic Signs: The Dimensions and Importance of Visual Complexity*, Report No. FHWA/RD-82/102, Federal Highway Administration Washington, DC, May 1982.

Manual of Uniform Traffic Control Devices—Part 3—Traffic Control Devices For Works on Road, Report No. AS1742-3-1985, Standards Association of Australia, New South Wales, Australia, 1985.

Manual on Uniform Traffic Control Devices for Streets and Highways, U.S. Department of Transportation, Federal Highway Administration, Washington, DC, 1988.

McGee, H.W., and D.L. Mace, *Retroreflectivity of Roadway Signs for Adequate Visibility: A Guide*, Report No. FHWA/DF-88/001, Federal Highway Administration, Washington, DC, November 1977.

McNees, R.W., *Establishing a Minimum Functional Reflectance for Raised Pavement Markers*, Transportation Research Record No. 1149, Transportation Research Board, Washington, DC.

Merritt, J.O., and S.K. Kerr, *Driver's Visibility Requirements for Roadway Delineation, Vol. II: Color Identification of Yellow Highway Paint as a Function of Yellow/White Pigment Mixture Ratio*, Report No. FHWA-RD-77-166, Federal Highway Administration, Washington, DC, November 1987.

Miller, T., *Optimization of Traffic Lane Delineation (2 Vols.)*, Report No. FHWA-TS-77 and 200, U.S. Department of Transportation, Federal Highway Administration, Washington, DC, December 1976.

Minimum Height of Flexible Post Traffic Channelizers, California Department of Transportation, Sacramento, CA, September 1983.

Morren, L., "The Photometry of Retroreflective Surfaces at Large Angles of Incidence," *CIE Journal*, Vol. 1, No. 1, 1982.

Moseley, R.W., *SASHTO Regional Test Facility*, Workshop on Field Inspection and Rehabilitation of Traffic Control Devices, U.S. Department of Transportation, Federal Highway Administration, Washington, DC.

———. "SASHTO Testing Boosts Product Specification Process," *Roads and Bridges*, Vol. 27, No. 4, 84-85.

National Cooperative Highway Research Program, Summary of Progress through 1976, Transportation Research Board, Washington, DC, 1976.

Nemeth, Z.A., T.H. Rockwell, and G.L. Smith, *Recommended Delineation Treatments at Selected Situations on*

Roadway Delineation Practices Handbook

Rural State Highways—Part I, Final Report, Report No. FHWA/OH-86/009, Ohio State University Engineering Experiment Station, Columbus, OH, September 1985.

Nettleton, T., *Signs Maintenance Guide*, U.S. Department of Agriculture, Forest Service, Equipment Development Center, Missoula, MT, October 1979.

"New Delineators Add to Highway Safety," *Public Works*, Vol. 108, No. 11, December 1977, 50-51.

"New York State Thruway Begins Program For Older Drivers," *TranSafety Reporter*, Vol. 7, No. 7, TranSafety, Incorporated, Springfield, VA, July 1989, 6.

"New Products," *ATSSA Flash*, July 1990, 4.

Niessner, C.W., *Construction Zone Delineation (Raised Pavement Markers)*, Report No. FHWA-TS-78-222, Federal Highway Administration, Washington, DC, June 1978.

———. *Delineation Conference: Narration Summary Part I-IV*, Report No. FHWA-TS-78-219, U.S. Department of Transportation, Federal Highway Administration, Washington, DC, 1978.

———. *Post Mounted Delineators*, Report No. FHWA-TX-83-208, Federal Highway Administration, McLean, VA, July 1983.

———. *Raised Pavement Markers at Hazardous Locations*, Report No. FHWA-TS-84-215, Federal Highway Administration, McLean, VA, December 1984.

Noel, E.C., Z.A. Sabra, and C.L. Dudek, *Barrier Delineation Treatments Used in Work Zones*, Draft Report, Daniel Consultants, Inc., Columbia, MD, December 1988.

———. *Work Zone Traffic Management Synthesis: Barrier Delineation Treatments Used in Work Zones*, Draft Report, Contract No. DTFH61-88-X-00007, Federal Highway Administration, McLean, VA.

Oglesby, C.H., *Highway Engineering*, (3rd. ed.), John Wiley & Sons, New York, NY, 1975.

Oliver, D.C., "Liability and Highway Safety Practices," *Traffic Engineering*, Vol. 47, No. 5, Arlington, VA, May 1977.

O'Brien, J., *Embedment and Retroreflectivity of Drop-on Glass Spheres in Thermoplastic Markings*, Transportation Research Record No. 1230, Transportation Research Board, Washington, DC, 1989, 37-44.

Olsen, P.L., *Minimum Photometric Properties of Retroreflective Signing Materials*, Transportation Research Record No. 1247, Transportation Research Board, Washington, DC, 1989, 56-68.

Pavement Marking Policy for the Kansas Department of Transportation, Kansas State Department of Transportation, Topeka, KS, March 1988.

Pagan, A.R., "Illumination vs. Delineation—An Evaluative Study," *Better Roads*, Vol. 58, No. 5, May 1988, 47.

Pant, P.D., and Y. Park, *Effectiveness of Steady Burn Lights for Traffic Control in Tangent Sections of Highway Work Zones*, Presented at the Annual Meeting of the Transportation Research Board, Washington, DC, University of Cincinnati, Cincinnati, OH, January 1990.

Pavement Marking Policy, Technical Services Division, New York State Department of Transportation, Albany, NY,

Roadway Delineation Practices Handbook

June 1987.

"Pavement Marking Tests Final Report Available," *ATSSA Signal*, September 1989, 3.

Pavement Traffic Marking Materials and Application, NCHRP Synthesis of Highway Practice 17, Transportation Research Board, Washington, DC, 1973.

Pigman, J.G., and K.R. Agent, *Field Evaluation of Snowplowable Pavement Markers*, Transportation Research Record No. 933, Transportation Research Board, Washington, DC, 1983, 18-24.

———. *Review of Work Zone Literature*, Report No. UKTRP-88-5, Kentucky Transportation Cabinet, Frankfort, KY, February 1988.

Pivnik, S.J., and D.C. Oliver, *Traffic Improvements—Legal Aspects and Liability*, Institute of Transportation Engineers, Arlington, VA, 1978.

Powers, J.C., *Center Barrier Delineator Spacing Study*, Report No. FHWA/NJ-88-013-7714, Bureau of Transportation Systems Research, Trenton, NJ, April 1988.

Proceedings of the Symposium on Work Zone Traffic Control, Report No. DOT-1-86-05. U.S. Department of Transportation, February 1985.

Providing Visibility and Visual Guidance to the Road User, Transportation Research Circular No. 297, Transportation Research Board, Washington, DC, December 1985.

Ranney, T.A. and V.J. Gawron, *Identification and Testing of Countermeasures for Specific Alcohol Accident Types and Problems—Volume I: Executive Summary*, Report No. 6551-Y-1, Calspan Field Services, Inc., Buffalo, NY, December 1984.

———. *Identification and Testing of Countermeasures for Specific Alcohol Accident Types and Problems—Volume II: General Driver Alcohol Problem*, Report No. 6551-Y-1, Calspan Field Services, Inc., Buffalo, NY, December 1984.

———. *Identification and Testing of Countermeasures for Specific Alcohol Accident Types and Problems—Volume IV: Appendices*, Report No. 6551-Y-1, Calspan Field Services, Inc., Buffalo, NY, December 1984.

Raycon, F., "Marker Placement Process Performs for Washington," *Roads and Bridges*, Vol. 26, No. 4, April 1988, 70-71.

Rea, M.S., *Visibility Criteria and Application Techniques of Roadway Lighting*, Transportation Research Record No. 1247, Transportation Research Board, Washington, DC, 1989, 12-16.

Rennilson, J.J., *Measuring Retroreflectivity of Pavement Markings*, Contract No. DTRS-57-86-C, Advanced Retro Technology, La Mesa, CA, April 1987.

Rhudy, H.C., and J.R. Ritter, *New-Old Cost-Cutting Concept in Traffic Marking*, Transportation Research Record No. 933, Transportation Research Board, Washington, DC, 1983, 9-14.

Riemersma, J.B.J., *Visual Control During Straight Road Driving*, Report No. HS-033 207, North-Holland Publishing Company, Amsterdam, Netherlands, August 1981.

Roberts, A.W., and K.N. Satija, *Interactive Video For Traffic Control Device Testing*, Transportation Research Circular No. 324, Transportation Research Board, Washington, DC, October 1987, 12-16.

Roadway Delineation Practices Handbook

- Rumar, K., *The Human Factor in Road Safety*, Australian Road Research Board, South Victoria, Australia, 1982.
- Ryan, B., "Precise Application Means Long Life For Thermoplastics," *Roads and Bridges*, Vol. 27, No. 7, July 1989, 70-71.
- Safety Devices and Methods That Work, *Better Roads*, Vol. 58, No. 7, July 1988, 48-49.
- Safety Manual*, Office of Employee Safety and Health, 2nd Ed., California Department of Transportation, Sacramento, CA, 1987.
- Schaber, D., and E.U. Hiersche, *Development of the Programme System For The Perspective Film. Part: At-Grade Junction*, Bonn, West Germany, 1986.
- Schreuder, D.A., et al., *International Symposium. Visual Aspects of Road Markings*, Reports and Papers, Central Laboratory of Bridges & Highways, Paris, France, May 1983.
- Schwab and Mace, "Luminance Requirements for Signs with Complex Backgrounds," *Public Roads*, Volume 2, Number 51, 48-55.
- Shepard, F.D., *Improving Work Zone Delineation on Limited Access Highways*, Presented at the Annual Meeting of the Transportation Research Board, Washington, DC, January 1990.
- . *Improving Work Zone Delineation on Limited Access Highway. Final Report*, Report No. FHWA/VA-89/16, Virginia Transportation Research Council, Charlottesville, VA, January 1989.
- . *Traffic Flow Evaluation of Pavement Insert Lights for Use During Fog*, Virginia Highway and Transportation Research Council Report 78-R-25, Charlottesville, VA, December 1977.
- Shepard, F.D., and B.H. Cottrell, *Benefits and Safety Impact of Night Work Zone Activities*, Report No. FHWA/RD-851067, Federal Highway Administration, Washington, DC, June 1988.
- Shimogami, T., *Efficiency Analysis of Traffic Safety Countermeasures*, Japan Road Association Annual Report of Roads, Japan Road Association, Tokyo, Japan, 1987, 51-57.
- "Signs and Safety. Federal Funds Used For Local Signs," *Better Roads*, Vol. 57, No. 8, August 1987, 36-37.
- Sivak, M., and P.L. Olson, *Optimal and Minimal Luminance Characteristics for Retroreflective Highway Signs*, Transportation Research Record No. 1027, Transportation Research Board, Washington, DC, 1985.
- Special Committee for the Study of Traffic Paint and Glass Beads and Their Usage*, Special Committee's Report, Kansas Department of Transportation, Topeka, KS, January 1989.
- Special Committee for the Study of Traffic Paint and Glass Beads and Their Usage*, Follow-Up Report No. 1, Kansas Department of Transportation, Topeka, KS, January 1990.
- Speed Enforcement, Visibility, and Effects of Traffic Control Measures on Drivers*, Transportation Research Record No. 811, Transportation Research Board, Washington, DC, 1981.
- Speer, P.A., "Flexible Markers Guide Drivers in Chip Seals," *Roads and Bridges*, Vol. 28, No. 12, December 1990, 38.
- Standard Alphabets for Highway Signs and Pavement Markings*, U.S. Department of Transportation, Federal

Roadway Delineation Practices Handbook

Highway Administration, Washington, DC, April 1984.

Standard Definitions of Terms Relating to Appearance of Materials, ASTM Standard E284-89c, American Society for Testing and Materials, Philadelphia, PA, November 1989.

Standard Practice for Describing Retroreflection, ASTM Standard E808-81, American Society for Testing and Materials, Philadelphia, PA, 1981.

Stimpson, W.A., W.K. Kittleson, and W.D. Berg, *Methods for Field Evaluation of Roadway Delineation Treatments*, Transportation Research Record No. 630, Transportation Research Board, Washington, DC, 1977, 25-32.

Stripe Removal by High Temperature Burning with Excess Oxygen (2 parts), FHWA Implementation Package No. 77-16, Southwest Research Institute (Part 1), San Antonio, TX, Midwest Research Institute, (Part 2), Kansas City, MO, June 1977.

"Striping and Marking: What Works Best?," *Better Roads*, Vol. 59, No. 12, December 1989, 18-23.

Swanson, H.N., and D.B. Woodham, *Flexible Roadside Delineator Post Evaluation, Final Report*, Report No. CDOH-DTD-R-88-17, Colorado Department of Highways, Denver, CO, August 1988.

Taylor, J.I., H.W. McGee, E.L. Seguin, and R.S. Hostetter, *Roadway Delineation Systems*, NCHRP Report No. 130, National Cooperative Highway Research Program, Washington, DC, 1972.

The Road to Better Highway Signing Training Course, Federal Highway Administration, Office of Traffic Operations, Washington, DC, March 1990.

Thermoplastic/Primer Systems, (Handout), U.S. Department of Transportation, Federal Highway Administration, Washington DC, November 1979.

Thomas, L.W., *Liability of State and Local Governments for Negligence Arising Out of the Installation and Maintenance of Warning Signs, Traffic Lights, and Pavement Markings*, NCHRP Research Results Digest No. 110, Transportation Research Board, Washington, DC, April 1979.

Tielking, J.T., and J.S. Noel, *Research on Raised Pavement Markers*, Transportation Research Record No. 1230, Transportation Research Board, Washington, DC, 1989, 56-66.

———. "Texas Study Focuses on Marker Retention," *Roads and Bridges*, Vol. 26, No. 7, July 1988, 66-67, 89.

"Traffic Control Devices Shed Light On Work," *Roads and Bridges*, Vol. 27, No. 7, July 1989, 74.

"Traffic Safety: Better Road Delineation Needed For Older Drivers," *Better Roads*, Vol. 57, No. 12, December 1981, 34-36.

Traffic Control Devices Handbook, U.S. Department of Transportation, Federal Highway Administration, Washington, DC, 1983.

Transportation Research Board Special Report, *Transportation and an Aging Society, Improving Mobility and Safety For Older Persons, Volume 2—Technical Papers*, Transportation Research Board, Washington, DC, 1988.

Ugwoaba, G.U., *Evaluation of Delineation Systems for Temporary Traffic Barriers in Work Zones, Final Report*, Report No. WA-RD-115.1, Washington University, Seattle, WA, May 1987.

Ullman, G., and C. Dudek, *Delineation of Concrete Safety-Shaped Barriers*, Presented at the 67th Annual Meeting of

Roadway Delineation Practices Handbook

the Transportation Research Board, Washington, DC, January 1988.

Ullman, G.L., C.L. Dudek, and C.J. Allen, *Delineation of Concrete Safety-Shaped Barriers, Interim Report*, Report No. FHWA/TX-87/408-1, Texas Transportation Institute, College Station, TX, April 1988.

Upchurch, J., "New MUTCD Standards," *ITE Journal*, Vol. 57, No. 3, March 1987, 41-44.

U.S. Department of Transportation, News Release, Office of Public Affairs, Washington, DC, October 1983.

Van Gorkum, F., "Night-Time Visibility of Seven Road-Marking Materials," *Traffic Engineering and Control*, Vol. 25, No. 4, Printerhall Limited, London, England, April 1984, 176-181.

Van Vechten, C.T., *Selecting Pavement Marking Materials Based on Service Life*, Report No. PB-243 377, District of Columbia Department of Highways and Traffic, Washington, DC, 1974.

Vedam, K., and L. Shuler, *Use of Hemispherical Beads as Pavement Marking Retroreflectors*, Pennsylvania State University, University Park, PA, April 1975.

Vincent, E.N., "A Trial Installation of Corner-Cube Delineators: Colder Highway, Gisborne to Woodend," *Australian Road Research*, Vol. 8, No. 3, September 1978, 38-40.

Virkler, M.R., and D.L. Guell, *The Need to Stripe No-Passing Zones During Resurfacing of Low-Volume Rural Roads*, Submitted for Presentation at the Annual Transportation Research Board Meeting, University of Missouri, Columbia, MO, 1990.

Visibility In Construction and Maintenance Work Zones, Transportation Research Circular No. 232, Transportation Research Board, Washington, DC, 1981.

Wambold, J.C., R.A. Zimmer, H.E. Ross Jr., and D.L. Ivey, *Roughness, Holes, and Bumps, Chapter 3*, Transportation Research Board, Washington, DC, 1984, 5-10.

Williams, J.H., Jr., *Development and Evaluation of Mechanized Equipment for Installation of the Recessed Reflective Marker (RPM) Delineation Systems; Interim Report*, HH Aerospace Design Co., New York NY, June 1978.

Woods, D.L., Huchingson, and C.L. Dudek, *Improvements and New Concepts for Traffic Control in Work Zones; Abbreviated Marking Patterns for Work Zones*, Interim Report, Contract No. DTFH61-81-C-00102, Texas A&M Research Foundation, College Station, TX.

Woodward-Clyde Consultants, *Paint Performance Testing, Final Report*, Report No. AK-RD-83-28, Alaska Department of Transportation and Public Facilities, Fairbanks, AK, February 1983.

Workshop on Field Inspection and Rehabilitation of Traffic Control Devices, Report No. FHWA-TS-90-048, U.S. Department of Transportation, Federal Highway Administration, Office of Implementation, McLean, VA.

Work Zone Traffic Control Delineation for Channelization, Laboratory Testing Report, Center for Applied Research, Great Falls, VA, January 1989.

Wright, P.H., J.W. Hall, and P.L. Zador, *Low-Cost Countermeasures for Ameliorating Run-Off-the-Road Crashes*, Transportation Research Record No. 926, New Mexico University, Albuquerque, NM, 1983.

"YELLOW Sign Supports Improve Traffic Safety in Houston," *Rural and Urban Roads*, Vol. 16, No. 11, November 1978, 46-47.

Roadway Delineation Practices Handbook

Zador, P., H.S. Stein, P. Wright, and J. Hall, *Effects of Chevrons, Post-Mounted Delineators, and Raised Pavement Markers on Driver Behavior at Roadway Curves*, Transportation Research Record No. 1114, Transportation Research Board, Washington, DC, 1987, 1-10.

Zimmer, R.A., *A Mobile Illumination Evaluation System*, Transportation Research Record No. 1172, Transportation Research Board, Washington, DC, 1988, 68-73.

Zwahlen, H.T., M.E. Miller, M. Khan, and R. Dunn, *Optimization of Post Delineator Placement From a Visibility Point of View*, Transportation Research Record No. 1172, Transportation Research Board, Washington, DC, 1988, 78-87.

Zwahlen, H.T., M.E. Miller, and J. Yu, *Effects of Misaimed Low Beams and High Beams on Visual Detection of Reflectorized Targets at Night*. Transportation Research Record No. 1247, Transportation Research Board, Washington, DC, 1989, 1-11.

INDEX

Acid Etching	51, 75
Airblasting	51, 75
Alkyd Paint	38-40, 55, 59, 125, 126, 131
Alkyd Thermoplastic	62, 67
Ambient Air Temperature	63, 74, 114, 115
Asphaltic Concrete (AC), Description of	33
ASTM	9, 11, 17, 18, 39, 196
ATSSA	196
Average Daily Traffic.....	32, 43, 52, 193-195
Ball Bank Indicator	166, 168
Barrier Delineators.....	143, 1478, 149, 165, 172, 173
Bead Applicator	47, 76
Benefit-Cost Ratio	2, 195, 196
Bicycle Markings	148, 158, 161-165
Binder	13, 14, 17, 27, 28, 35, 38, 40, 62, 71, 73, 79, 179
Bitumen Adhesive	116
Bituminous Concrete, Description of.....	33
Broken Line	1, 36
Candela	8, 9, 11, 138, 170, 172
Center Loss	66
Chemical Marking Removal	54, 56
Chipping	72, 73
Coefficient of Retroreflection.....	11, 18, 172
Coefficient of Retroreflection Luminance	9, 11, 18, 175
Colorimeter.....	58
Comparative Negligence	186
Composition Specification	40, 41, 131
Conspicuity.....	23, 24
Contrast	21-27, 41, 52, 72
Cost Analysis	2, 3, 195, 196
Cost-Effective Markings	2
Crosswalk Markings.....	148-151, 152
Curb Markings	157
Delineation Inventory.....	123, 175, 176-178

Roadway Delineation Practices Handbook

Delineation Inventory, Photo Log	176-177
Delineation Inventory Computerized	176
Delineation Technique	3, 21, 29, 30, 31, 35, 64, 66, 134, 175, 193
Delineation Treatment	27, 29, 30, 44, 133, 195
Delineation Variables	2, 29-34, 40, 42, 43, 44, 112, 121, 131, 195
Dense-Graded	33, 125
Diffuse Reflection	5, 13
Directed Light Source	6
Discretionary	188
Driver Events	24
Drop-On Glass Beads	17, 72, 129
Duty	186-189
Edge Loss	65
Electronic Data Acquisition System	168-- , 169
End Loss	65
Epoxy Adhesive	94, 110, 113, 114, 115, 116, 118
Epoxy Paint	57, 122, 124-125, 127-128, 130, 131
Epoxy Thermoplastic	122-123, 126, 129-132
Exces-Oxygen Burning	55, 56
Federal Funding	2, 185, 190
Flexible Delineators	135-136, 141
Flotation Bead	16, 17
Flux	8, 9
Foil-Basked Tape	81
Footcandle	9, 11
Gap-to-Segment Ratio	30, 85, 161, 194
Glass Beads	11-17, 27, 35, 45, 57, 58, 62, 63, 68, 71, 73, 74, 79, 80, 10, 85, 94, 122, 127, 129, 179, 192
Gradation	12, 15, 16, 17
Gravity Extrusion	68
Grinding	51, 54 , 55, 56, 73, 74
GSA	196
Hydroblasting	51, 55, 56, 75
Hydrocarbon Thermoplastic.....	61, 62, 67
Illuminance	8-11
Illuminance Angle	10
Inlay	80, 81, 82
Intensity	5-11, 64, 137, 138, 177
Interior Loss	66
Lane Use Arrows	148, 151, 154-156
Large Glass Beads	14, 15, 27, 71
Laser Retroreflector	181, 182
Latex Paint	38, 39, 121, 124, 127
Legibility.....	23, 24, 170
Liability.....	57, 181, 185-189, 196
Light Flux	6, 7, 9
Litmus Test.....	74
Lumen.....	8, 9
Luminance	9-11, 21-26, 29, 170-172, 175
Lux	8, 9, 11, 26, 175, 180
Marking Powder.....	123
Material Temperature.....	74-75
Methyl Methacrylate.....	123, 127, 129
Millicandelas	11, 25, 26, 175, 180

Roadway Delineation Practices Handbook

Ministerial	187, 188
Mirolux Retroreflector	14, 27, 180
Mirror Reflection	5
Mobile Retroreflector 181-183
Model Specifications	191
Modified Alkyd Paint	38-39, 59
MUTCD	1, 3, 5, 35, 56, 61, 85, 92, 133, 134, 143, 145, 147, 149, 157, 161, 169, 187, 188, 194
NASHTO	19, 20, 42, 124
Negligence	186-188
No-track Time	38, 39, 57, 122, 123, 126, 129
Nonretroreflective RPM	85, 92, 93, 94, 106, 112, 118
Object Markers 143-145, 161, 165
Observation Angle	137, 172, 184
Open-Graded	33, 34, 55, 56, 76, 125
Overlay	52, 72, 80-82
Parking Space Markings	151, 153
Pavement Symbols	143, 148-165, 166, 173
Pavement Temperature	54, 57, 58, 74
Perception-Reaction Time	22
Performance Specification	40, 41, 57, 196
PIEV Time	169
Pigment	13, 35, 38, 40, 53, 59, 62, 79, 122
Pliant Polymer Tape	80
PMD Post Materials	135-136
PMD Spacing and Placement	137, 138
PMD Colored Posts	140-141
PMD Retroreflective Element Materials	134-135
Pocket Microscope	75, 178, 179
Point Light Source	6-7
Polyester Marking Material	122, 125, 128-129, 130, 131
Portable Retroreflector	58, 170, 173, 179, 180-181
Portland Cement Concrete (PCC), Description of	34
Preferential Lane Markings157-158
Preformed Tape	74, 79-84
Premarking	51-52, 57, 73
Premixed Paint	15
Primer	51, 62, 63, 64, 66-67, 76, 81, 110, 115, 129
Prismatic Retroreflection	17-18
Quality Assurance	5, 18-20
Railroad Crossing Markings	148, 158-160
Raised Pavement Marker (RPM), Materials	94-112
Raised Pavement Marker, Appl. Guidelines	92-93, 95-105
Raised Pavement Marker, Configuration	108
Reasonable Person	186, 187
Recommended Curve Speed	165-168
Reflection, Types of	5
Refraction Index, Definition of	12
Retro-Skip Device	119
Retroreflection, Definition of	5
Retroreflection, Metric Units	7-9
Retroreflection, English Units 9-11
Retroreflector, Minimum Values	175-176
Retroreflector 14, 27, 180-183

Roadway Delineation Practices Handbook

Retroreflector	7, 11, 94, 107, 134-140
Ribbon Extrusion	68
Roadway Geometry	30-31, 40, 44, 117
Roundness	11-12
RPM, Ceramic	97, 106, 110, 112
Sandblasting	51, 56, 73, 74, 81
SASHTO	20, 42
Service Life, Definition of	32-33, 43-44
Sign Inventory	170, 176-178
Skip Line	31, 82, 93, 94, 119
Snowplowable RPM	92, 107-110, 113-114, 116
Spray-Applied Thermoplastic	68
Solid Angle	7-8, 9
Solvent	38, 39, 40, 43, 53, 46, 51, 53, 58, 59, 81, 116, 121
Speed Measurement Markings	148, 158
Spray Gun	45, 46, 47, 50, 51, 119, 128, 129
Standard of Care	182, 186-187
Steradian	8, 9
Stop Bar	35, 61, 68, 69, 79, 81, 149, 157, 190
Striper	45-50, 51, 52, 68-69, 119, 128
Threshold Contrast	22
Tort	181-182, 186-187, 188, 189, 196
Traffic Composition	32, 44
Traffic Sign Evaluator	171
Traffic Volume	30, 32, 39, 124, 193
Transparency	11
Turning Arrows	151, 156
Type 1 Object Markers	143, 144
Type 2 Object Markers	143, 144
Type 3 Object Markers	143, 144
Urethane Tape	80
VISIBEAD	27
Visibility Distance	18, 21, 22, 24-25, 26, 27, 140, 179
Visual Complexity	23, 28-29
VOC	38, 39, 58, 59, 121
Warning Signs, Placement Distance	165, 166, 168-169, 170
Warning Signs, Types	145-148
Warning Signs, Maintenance	165, 167-172
Warning Signs, Installation	165-166
Wire Brushing	51