

**Arsenic Removal from Drinking Water by Adsorptive Media  
U.S. EPA Demonstration Project at  
Webb Consolidated Independent School District in Bruni, TX  
Six-Month Evaluation Report**

by

**Shane Williams  
Abraham S.C. Chen  
Lili Wang**

**Battelle  
Columbus, OH 43201-2693**

**Contract No. 68-C-00-185  
Task Order No. 0029**

for

**Thomas J. Sorg  
Task Order Manager**

**Water Supply and Water Resources Division  
National Risk Management Research Laboratory  
Cincinnati, OH 45268**

**National Risk Management Research Laboratory  
Office of Research and Development  
U.S. Environmental Protection Agency  
Cincinnati, OH 45268**

## **DISCLAIMER**

The work reported in this document was funded by the United States Environmental Protection Agency (EPA) under Task Order 0029 of Contract 68-C-00-185 to Battelle. It has been subjected to the Agency's peer and administrative reviews and has been approved for publication as an EPA document. Any opinions expressed in this paper are those of the author(s) and do not, necessarily, reflect the official positions and policies of the EPA. Any mention of products or trade names does not constitute recommendation for use by the EPA.

## FOREWORD

The U.S. Environmental Protection Agency (EPA) is charged by Congress with protecting the nation's land, air, and water resources. Under a mandate of national environmental laws, the Agency strives to formulate and implement actions leading to a compatible balance between human activities and the ability of natural systems to support and nurture life. To meet this mandate, EPA's research program is providing data and technical support for solving environmental problems today and building a science knowledge base necessary to manage our ecological resources wisely, understand how pollutants affect our health, and prevent or reduce environmental risks in the future.

The National Risk Management Research Laboratory (NRMRL) is the Agency's center for investigation of technological and management approaches for preventing and reducing risks from pollution that threaten human health and the environment. The focus of the Laboratory's research program is on methods and their cost-effectiveness for prevention and control of pollution to air, land, water, and subsurface resources; protection of water quality in public water systems; remediation of contaminated sites, sediments and groundwater; prevention and control of indoor air pollution; and restoration of ecosystems. NRMRL collaborates with both public and private sector partners to foster technologies that reduce the cost of compliance and to anticipate emerging problems. NRMRL's research provides solutions to environmental problems by developing and promoting technologies that protect and improve the environment; advancing scientific and engineering information to support regulatory and policy decisions; and providing the technical support and information transfer to ensure implementation of environmental regulations and strategies at the national, state, and community levels.

This publication has been produced as part of the Laboratory's strategic long-term research plan. It is published and made available by EPA's Office of Research and Development to assist the user community and to link researchers with their clients.

Sally Gutierrez, Director  
National Risk Management Research Laboratory

## ABSTRACT

This report documents the activities performed and the results obtained from the first six months of the arsenic removal treatment technology demonstration project at the Webb Consolidated Independent School District (Webb CISD) site at Bruni, TX. The main objective of the project is to evaluate the effectiveness of AdEdge Technologies' AD-33 media in removing arsenic to meet the new arsenic maximum contaminant level (MCL) of 10 µg/L. Additionally, this project evaluates 1) the reliability of the treatment system (Arsenic Package Unit [APU]-50LL-CS-S-2-AVH), 2) the required system operation and maintenance (O&M) and operator skills, and 3) the capital and O&M cost of the technology. The project also characterizes the water in the distribution system and residuals produced by the treatment process. The types of data collected include system operation, water quality (both across the treatment train and in the distribution system), process residuals, and capital and O&M cost.

The APU-50LL-CS-S-2-AVH treatment system consisted of two 42-in-diameter, 72-in-tall carbon steel vessels in series configuration, each containing approximately 22 ft<sup>3</sup> of AD-33 pelletized media, which is an iron-based adsorptive media developed by Bayer AG and marketed under the name of AD-33 by AdEdge. The treatment system was designed for a peak flowrate of 40 gal/min (gpm) and an empty bed contact time (EBCT) of approximately 4.1 min per vessel. The actual average flowrate for the six-month operational period was 44 gpm, based on readings of the hour meter interlocked to the well pump and the electromagnetic flow meter/totalizer installed on each adsorption vessel.

As part of the water treatment system, a pH adjustment/control system was used to adjust the pH value of raw water from as high as 8.2 to a target value of 7.0. A prechlorination system also was used to oxidize As(III) to As(V) and maintain a target chlorine residual level of 1.2 mg/L (as Cl<sub>2</sub>) in the distribution system. The pH adjustment/control system consisted of a carbon dioxide (CO<sub>2</sub>) supply assembly, an automatic pH control panel, a CO<sub>2</sub> membrane module (that injected CO<sub>2</sub> into a CO<sub>2</sub> loop), and an in-line pH probe. The prechlorination system, which was upgraded from the preexisting system, included a chemical feed pump, a sodium hypochlorite (NaOCl) feed tank, and an inject port located downstream of the CO<sub>2</sub> loop and in-line pH probe.

The AdEdge treatment system began regular operation on December 8, 2005. The data collected included system operation, water quality (both across the treatment train and in the distribution system), process residuals, and capital and O&M cost. Between December 8, 2005, and June 9, 2006, the system operated an average of 4.3 hr/day, treating approximately 2,070,000 gal of water. This volume throughput was equivalent to 12,600 bed volumes (BV) based on the 22 ft<sup>3</sup> of media in one adsorption vessel or 6,300 BV based on the 44 ft<sup>3</sup> of media in the two adsorption vessels in series.

Since system start-up, the APU system has experienced component failures associated with the pH control system and flow meters/totalizers. Leaks were detected in the CO<sub>2</sub> supply line; the proportional flow control valve malfunctioned; and the in-line pH probe failed. There were periods when the pH control system was switched from automatic to manual mode until replacement of certain system components were performed to address the problems encountered. In addition to the pH control system problems, errors were encountered with the system flow meters/totalizers. On two occasions, the system totalizers reset and began totalizing from zero, likely caused by a programming error. As of the end of the first six months of the evaluation period, the issues with the pH control system appeared to have been resolved and programming updates are being prepared to prevent future totalizer errors.

Total arsenic concentrations in raw water ranged from 46.2 to 62.9 µg/L. As(III) was the predominating species, ranging from 35.8 to 40.8 µg/L. Chlorination effectively oxidized As(III) to As(V), reducing

As(III) concentrations to an average value of 1.7 µg/L. As of June 6, 2006, the total arsenic level in the treated water following the lead adsorption vessel was 1.1 µg/L at approximately 12,100 BV. The arsenic level from the lag vessel at the time was 0.8 µg/L. Concentrations of phosphorus and silica, which could interfere with arsenic adsorption by competing with arsenate for adsorption sites, ranged from <0.01 to 0.03 mg/L (as PO<sub>4</sub>) and from 40.6 to 43.9 mg/L (as SiO<sub>2</sub>), respectively, in raw water. Concentrations of iron, manganese, and other ions in raw water were not high enough to impact arsenic removal by the media.

Comparison of the distribution system sampling results before and after operation of the system showed a significant decrease in arsenic concentration (from an average of 68.7 µg/L to an average of 2.4 µg/L). The arsenic concentrations in the distribution system were similar to those in the system effluent. Lead and copper concentrations did not appear to have been affected by the operation of the treatment system.

The capital investment cost of \$138,642 included \$94,662 for equipment, \$24,300 for site engineering, and \$19,680 for installation. Using the system's rated capacity of 40 gpm (or 57,600 gal/day [gpd]), the capital cost was \$3,466/gpm (or \$2.41/gpd) of design capacity. The capital cost also was converted to an annualized cost of \$13,086/yr using a capital recovery factor (CRF) of 0.09439 based on a 7% interest rate and a 20-year return period. Assumed that the system operated 24 hours a day, 7 days a week at the system design flowrate of 40 gpm to produce 21,024,000 gal of water per year, the unit capital cost would be \$0.62/1,000 gal. Because the system operated an average of 4.3 hr/day at 44 gpm, producing 2,070,000 gal of water during the six-month period, the unit capital cost increased to \$3.16/1,000 gal at this reduced rate of use.

The O&M cost included only the cost associated with the adsorption system, such as media replacement and disposal, CO<sub>2</sub> and chlorine usage, electricity consumption, and labor. Although media replacement did not occur during the first six months of system operation, the media replacement cost would represent the majority of the O&M cost and was estimated to be \$11,190 to change out one vessel (including 22 ft<sup>3</sup> AD-33 media and associated labor for media change out and disposal). This cost was used to estimate the media replacement cost per 1,000 gal of water treated as a function of the projected media run length to the 10 µg/L arsenic breakthrough.

# CONTENTS

DISCLAIMER .....	ii
FOREWORD .....	iii
ABSTRACT.....	iv
APPENDICES .....	vii
FIGURES.....	vii
TABLES .....	vii
ABBREVIATIONS AND ACRONYMS .....	ix
ACKNOWLEDGMENTS .....	xi
1.0 INTRODUCTION .....	1
1.1 Background.....	1
1.2 Treatment Technologies for Arsenic Removal .....	2
1.3 Project Objectives .....	2
2.0 SUMMARY AND CONCLUSIONS .....	5
3.0 MATERIALS AND METHODS.....	7
3.1 General Project Approach.....	7
3.2 System O&M and Cost Data Collection .....	8
3.3 Sample Collection Procedures and Schedules .....	8
3.3.1 Source Water Sample Collection.....	10
3.3.2 Treatment Plant Water Sample Collection .....	10
3.3.3 Backwash Water/Solid Sample Collection.....	10
3.3.4 Distribution System Water Sample Collection.....	10
3.4 Sampling Logistics.....	10
3.4.1 Preparation of Arsenic Speciation Kits.....	10
3.4.2 Preparation of Sampling Coolers.....	10
3.4.3 Sample Shipping and Handling .....	11
3.5 Analytical Procedures .....	11
4.0 RESULTS AND DISCUSSION .....	12
4.1 Facility Description and Preexisting Treatment System Infrastructure .....	12
4.1.1 Source Water Quality .....	12
4.1.2 Treated Water Quality .....	15
4.1.3 Distribution System .....	16
4.2 Treatment Process Description .....	16
4.3 System Installation.....	25
4.3.1 Permitting .....	25
4.3.2 Building Preparation.....	25
4.3.3 Installation, Shakedown, and Startup .....	25
4.4 System Operation.....	27
4.4.1 Operational Parameters.....	27
4.4.2 Residual Management .....	28
4.4.3 System/Operation Reliability and Simplicity .....	30
4.5 System Performance .....	31
4.5.1 Treatment Plant Sampling .....	31
4.5.2 Backwash Water Sampling.....	39
4.5.3 Distribution System Water Sampling .....	39
4.6 System Cost .....	39

4.6.1	Capital Cost .....	39
4.6.2	Operation and Maintenance Cost.....	41
5.0	REFERENCES .....	44

## APPENDICES

APPENDIX A:	OPERATIONAL DATA .....	A-1
APPENDIX B:	ANALYTICAL DATA .....	B-1

## FIGURES

Figure 4-1.	Existing Water Treatment Facility .....	12
Figure 4-2.	Wellhead at Webb CISD.....	13
Figure 4-3.	Existing Chlorine Addition System .....	13
Figure 4-4.	Process Flow Diagram for the APU-50LL-CS-S-2-AVH system.....	18
Figure 4-5.	Process Flow Diagram and Sampling Schedule and Locations .....	19
Figure 4-6.	Process Diagram of (top) CO <sub>2</sub> pH Adjustment System and (bottom) pH/PID Control Panel.....	21
Figure 4-7.	Carbon Dioxide Gas Flow Control System for pH Adjustment.....	22
Figure 4-8.	Chlorination System.....	23
Figure 4-9.	Adsorption System Valve Tree and Piping Configuration.....	24
Figure 4-10.	Maintenance Shop Building.....	26
Figure 4-11.	System Being Delivered to Site .....	26
Figure 4-12.	System Instantaneous and Calculated Flowrates .....	29
Figure 4-13.	System Operational Pressures .....	29
Figure 4-14.	Concentrations of Various Arsenic Species at IN, AP, TA, and TB Sampling Locations.....	35
Figure 4-15.	Total Arsenic Breakthrough Curves.....	36
Figure 4-16.	Silica (as SiO <sub>2</sub> ) Breakthrough Curves.....	37
Figure 4-17.	pH Values Measured Throughout Treatment Train .....	38
Figure 4-18.	Media Replacement and Operation and Maintenance Cost .....	43

## TABLES

Table 1-1.	Summary of Round 1 and Round 2 Arsenic Removal Demonstration Locations, Technologies, and Source Water Quality.....	3
Table 3-1.	Predemonstration Study Activities and Completion Dates .....	7
Table 3-2.	Evaluation Objectives and Supporting Data Collection Activities .....	8
Table 3-3.	Sampling Schedule and Analytes.....	9
Table 4-1.	Water Quality Data for Webb CISD, Bruni, TX.....	14
Table 4-2.	TCEQ Treated Water Quality Data.....	15
Table 4-3.	Physical and Chemical Properties of AD-33 Media .....	16
Table 4-4.	Design Features of AdEdge APU-50LL-CS-S-2-AVH System.....	20
Table 4-5.	Properties of Celgard, X50-215 Microporous Hollow Fiber Membrane .....	22
Table 4-6.	System Punch-List/Operational Issues.....	27
Table 4-7.	Summary of APU-50LL-CS-S-2-AVH System Operation .....	28
Table 4-8.	Summary of Analytical Results for Arsenic, Iron, and Manganese .....	32

Table 4-9.	Summary of Water Quality Parameter Sampling Results .....	33
Table 4-10.	Distribution System Sampling Results.....	40
Table 4-11.	Capital Investment Cost for the APU-50LL-CS-S-2-AVH System.....	41
Table 4-12.	Operation and Maintenance Cost for the APU-50LL-CS-S-2-AVH System.....	42



## ABBREVIATIONS AND ACRONYMS

$\Delta p$	differential pressure
AAL	American Analytical Laboratories
AM	adsorptive media
APU	arsenic package unit
As	arsenic
ATS	Aquatic Treatment Systems
ATSI	Applied Technology Systems Inc.
BET	Brunauer, Emmett, and Teller
BV	bed volume
Ca	calcium
C/F	coagulation/filtration process
CISD	Consolidated Independent School District
Cl	chlorine
CRF	capital recovery factor
Cu	copper
DO	dissolved oxygen
EBCT	empty bed contact time
EPA	U.S. Environmental Protection Agency
F	fluorine
Fe	iron
gpd	gallons per day
gpm	gallons per minute
HDPE	high-density polyethylene
hp	horse power
ICP-MS	inductively coupled plasma-mass spectrometry
ID	identification
ISFET	Ion Sensitive Field Effect Transistor
IX	ion exchange
LCR	Lead and Copper Rule
MCL	maximum contaminant level
MDL	method detection limit
MEI	Magnesium Elektron, Inc.
Mg	magnesium
Mn	manganese
mV	millivolts
Na	sodium
NA	not analyzed

## ABBREVIATIONS AND ACRONYMS (Continued)

ND	not detectable
NRMRL	National Risk Management Research Laboratory
NSF	NSF International
O&M	operation and maintenance
OIT	Oregon Institute of Technology
ORD	Office of Research and Development
ORP	oxidation-reduction potential
PID	Proportional Integral Derivative
PLC	programmable logic controller
PO <sub>4</sub>	phosphate
POU	point of use
psi	pounds per square inch
PVC	polyvinyl chloride
QA	quality assurance
QAPP	Quality Assurance Project Plan
QA/QC	quality assurance/quality control
RO	reverse osmosis
RPD	relative percent difference
SDWA	Safe Drinking Water Act
SiO <sub>2</sub>	silica
SMCL	secondary maximum contaminant level
SO <sub>4</sub> <sup>2-</sup>	sulfate
STS	Severn Trent Services
TCEQ	Texas Commission on Environmental Quality
TCLP	toxicity characteristic leaching procedure
TDS	total dissolved solids
U	uranium
V	vanadium
VOC	volatile organic compound

## **ACKNOWLEDGMENTS**

The authors wish to extend their sincere appreciation to Webb Consolidated Independent School District and Mr. George Gonzales, who monitored the treatment system and collected samples from the treatment and distribution systems throughout this study period. This performance evaluation would not have been possible without his efforts.

## 1.0 INTRODUCTION

### 1.1 Background

The Safe Drinking Water Act (SDWA) mandates that the United States Environmental Protection Agency (EPA) identify and regulate drinking water contaminants that may have adverse human health effects and are known or anticipated to occur in public water supply systems. In 1975 under the SDWA, EPA established a maximum contaminant level (MCL) for arsenic at 0.05 mg/L. Amended in 1996, the SDWA required that EPA develop an arsenic research strategy and publish a proposal to revise the arsenic MCL by January 2000. On January 18, 2001, EPA finalized the arsenic MCL at 0.01 mg/L (EPA, 2001). In order to clarify the implementation of the original rule, EPA revised the rule text on March 25, 2003, to express the MCL as 0.010 mg/L (10 µg/L) (EPA, 2003). The final rule requires all community and non-transient, non-community water systems to comply with the new standard by January 23, 2006.

In October 2001, EPA announced an initiative for additional research and development of cost-effective technologies to help small community water systems (<10,000 customers) meet the new arsenic standard, and to provide technical assistance to operators of small systems in order to reduce compliance cost. As part of this Arsenic Rule Implementation Research Program, EPA's Office of Research and Development (ORD) proposed a project to conduct a series of full-scale, on-site demonstrations of arsenic removal technologies, process modifications, and engineering approaches applicable to small systems. Shortly thereafter, an announcement was published in the *Federal Register* requesting water utilities interested in participating in Round 1 of this EPA-sponsored demonstration program to provide information on their water systems. In June 2002, EPA selected 17 sites from a list of 115 sites to be the host sites for the demonstration studies.

In September 2002, EPA solicited proposals from engineering firms and vendors for cost-effective arsenic removal treatment technologies for the 17 host sites. EPA received 70 technical proposals for the 17 host sites, with each site receiving from one to six proposals. In April 2003, an independent technical panel reviewed the proposals and provided its recommendations to EPA on the technologies that it determined were acceptable for the demonstration at each site. Because of funding limitations and other technical reasons, only 12 of the 17 sites were selected for the Round 1 demonstration program. Using the information provided by the review panel, EPA, in cooperation with the host sites and the drinking water programs of the respective states, selected one technical proposal for each site. As of April 2007, 11 of the 12 systems were operational and the performance evaluation of eight systems was completed.

In 2003, EPA initiated Round 2 arsenic technology demonstration projects that were partially funded with Congressional add-on funding to the EPA budget. In June 2003, EPA selected 32 potential demonstration sites and the Webb Consolidated Independent School District (CISD) in Bruni, TX was one of those selected.

In September 2003, EPA again solicited proposals from engineering firms and vendors for arsenic removal technologies. EPA received 148 technical proposals for the 32 host sites, with each site receiving from two to eight proposals. In April 2004, another technical panel was convened by EPA to review the proposals and provide recommendations to EPA with the number of proposals per site ranging from none (for two sites) to a maximum of four. The final selection of the treatment technology at the sites that received at least one proposal was made, again, through a joint effort by EPA, the state regulators, and the host site. Since then, four sites have withdrawn from the demonstration program, reducing the number of sites to 28. AdEdge Technologies (AdEdge), using the Bayoxide E33 (AD-33) media developed by Bayer AG, was selected for demonstration at the Webb CISD site in April 2004.

## **1.2 Treatment Technologies for Arsenic Removal**

The technologies selected for the Round 1 and Round 2 demonstration host sites include 25 adsorptive media (AM) systems (the Oregon Institute of Technology [OIT] site has three AM systems), 13 coagulation/filtration systems, two ion exchange (IX) systems, 17 point-of-use (POU) units (including nine residential reverse osmosis [RO] units at the Sunset Ranch Development site and eight AM units at the OIT site), and one process modification. Table 1-1 summarizes the locations, technologies, vendors, system flowrates, and key source water quality parameters (including arsenic, iron, and pH) at the 40 demonstration sites. An overview of the technology selection and system design for the 12 Round 1 demonstration sites and the associated capital cost is provided in two EPA reports (Wang et al., 2004; Chen et al., 2004), which are posted on the EPA Web site at <http://www.epa.gov/ORD/NRMRL/wswrd/dw/arsenic/index.html>.

## **1.3 Project Objectives**

The objective of the Round 1 and Round 2 arsenic demonstration program is to conduct 40 full-scale arsenic treatment technology demonstration studies on the removal of arsenic from drinking water supplies. The specific objectives are to:

- Evaluate the performance of the arsenic removal technologies for use on small systems.
- Determine the required system operation and maintenance (O&M) and operator skill levels.
- Characterize process residuals produced by the technologies.
- Determine the capital and O&M cost of the technologies.

This report summarizes the performance of the AdEdge system at the Webb CISD in Bruni, TX during the first six months from December 8, 2005, through June 9, 2006. The data collected included system operational data, water quality data (both across the treatment train and in the distribution system), and capital and preliminary O&M cost data.

**Table 1-1. Summary of Round 1 and Round 2 Arsenic Removal Demonstration  
Locations, Technologies, and Source Water Quality**

Demonstration Location	Site Name	Technology (Media)	Vendor	Design Flowrate (gpm)	Source Water Quality		
					As (µg/L)	Fe (µg/L)	pH (S.U.)
<i>Northeast/Ohio</i>							
Wales, ME	Springbrook Mobile Home Park	AM (A/I Complex)	ATS	14	38 <sup>(a)</sup>	<25	8.6
Bow, NH	White Rock Water Company	AM (G2)	ADI	70 <sup>(b)</sup>	39	<25	7.7
Goffstown, NH	Orchard Highlands Subdivision	AM (E33)	AdEdge	10	33	<25	6.9
Rollinsford, NH	Rollinsford Water and Sewer District	AM (E33)	AdEdge	100	36 <sup>(a)</sup>	46	8.2
Dummerston, VT	Charette Mobile Home Park	AM (A/I Complex)	ATS	22	30	<25	7.9
Felton, DE	Town of Felton	C/F (Macrolite)	Kinetico	375	30 <sup>(a)</sup>	48	8.2
Stevensville, MD	Queen Anne's County	AM (E33)	STS	300	19 <sup>(a)</sup>	270 <sup>(c)</sup>	7.3
Houghton, NY <sup>(d)</sup>	Town of Caneadea	C/F (Macrolite)	Kinetico	550	27 <sup>(a)</sup>	1,806 <sup>(c)</sup>	7.6
Buckeye Lake, OH	Buckeye Lake Head Start Building	AM (ARM 200)	Kinetico	10	15 <sup>(a)</sup>	1,312 <sup>(c)</sup>	7.6
Springfield, OH	Chateau Estates Mobile Home Park	AM (E33)	AdEdge	250 <sup>(e)</sup>	25 <sup>(a)</sup>	1,615 <sup>(c)</sup>	7.3
<i>Great Lakes/Interior Plains</i>							
Brown City, MI	City of Brown City	AM (E33)	STS	640	14 <sup>(a)</sup>	127 <sup>(c)</sup>	7.3
Pentwater, MI	Village of Pentwater	C/F (Macrolite)	Kinetico	400	13 <sup>(a)</sup>	466 <sup>(c)</sup>	6.9
Sandusky, MI	City of Sandusky	C/F (Aeralater)	Siemens	340 <sup>(e)</sup>	16 <sup>(a)</sup>	1,387 <sup>(c)</sup>	6.9
Delavan, WI	Vintage on the Ponds	C/F (Macrolite)	Kinetico	40	20 <sup>(a)</sup>	1,499 <sup>(c)</sup>	7.5
Greenville, WI	Town of Greenville	C/F (Macrolite)	Kinetico	375	17	7827 <sup>(c)</sup>	7.3
Climax, MN	City of Climax	C/F (Macrolite)	Kinetico	140	39 <sup>(a)</sup>	546 <sup>(c)</sup>	7.4
Sabin, MN	City of Sabin	C/F (Macrolite)	Kinetico	250	34	1,470 <sup>(c)</sup>	7.3
Sauk Centre, MN	Big Sauk Lake Mobile Home Park	C/F (Macrolite)	Kinetico	20	25 <sup>(a)</sup>	3,078 <sup>(c)</sup>	7.1
Stewart, MN	City of Stewart	C/F&AM (E33)	AdEdge	250	42 <sup>(a)</sup>	1,344 <sup>(c)</sup>	7.7
Lidgerwood, ND	City of Lidgerwood	Process Modification	Kinetico	250	146 <sup>(a)</sup>	1,325 <sup>(c)</sup>	7.2
<i>Midwest/Southwest</i>							
Arnaudville, LA	United Water Systems	C/F (Macrolite)	Kinetico	770 <sup>(e)</sup>	35 <sup>(a)</sup>	2,068 <sup>(c)</sup>	7.0
Alvin, TX	Oak Manor Municipal Utility District	AM (E33)	STS	150	19 <sup>(a)</sup>	95	7.8
Bruni, TX	Webb Consolidated Independent School District	AM (E33)	AdEdge	40	56 <sup>(a)</sup>	<25	8.0
Wellman, TX	City of Wellman	AM (E33)	AdEdge	100	45	<25	7.7
Anthony, NM	Desert Sands Mutual Domestic Water Consumers Association	AM (E33)	STS	320	23 <sup>(a)</sup>	39	7.7
Nambe Pueblo, NM	Nambe Pueblo Tribe	AM (E33)	AdEdge	145	33	<25	8.5
Taos, NM	Town of Taos	AM (E33)	STS	450	14	59	9.5
Rimrock, AZ	Arizona Water Company	AM (E33)	AdEdge	90 <sup>(b)</sup>	50	170	7.2
Tohono O'odham Nation, AZ	Tohono O'odham Utility Authority	AM (E33)	AdEdge	50	32	<25	8.2
Valley Vista, AZ	Arizona Water Company	AM (AAFS50/ARM 200)	Kinetico	37	41	<25	7.8

**Table 1-1. Summary of Round 1 and Round 2 Arsenic Removal Demonstration Locations, Technologies, and Source Water Quality (Continued)**

Demonstration Location	Site Name	Technology (Media)	Vendor	Design Flowrate (gpm)	Source Water Quality		
					As (µg/L)	Fe (µg/L)	pH
<i>Far West</i>							
Three Forks, MT	City of Three Forks	C/F (Macrolite)	Kinetico	250	64	<25	7.5
Fruitland, ID	City of Fruitland	IX (A300E)	Kinetico	250	44	<25	7.4
Homedale, ID	Sunset Ranch Development	POU RO <sup>(f)</sup>	Kinetico	75 gpd	52	134	7.5
Okanogan, WA	City of Okanogan	C/F (Electromedia-I)	Filtronics	750	18	69 <sup>(c)</sup>	8.0
Klamath Falls, OR	Oregon Institute of Technology	POE AM (Adsorbisia/ARM 200/ArsenX <sup>np</sup> ) and POU AM (ARM 200) <sup>(g)</sup>	Kinetico	60/60/30	33	<25	7.9
Vale, OR	City of Vale	IX (Arsenex II)	Kinetico	525	17	<25	7.5
Reno, NV	South Truckee Meadows General Improvement District	AM (GFH)	Siemens	350	39	<25	7.4
Susanville, CA	Richmond School District	AM (A/I Complex)	ATS	12	37 <sup>(a)</sup>	125	7.5
Lake Isabella, CA	Upper Bodfish Well CH2-A	AM (HIX)	VEETech	50	35	125	7.5
Tehachapi, CA	Golden Hills Community Service District	AM (Isolux)	MEI	150	15	<25	6.9

AM = adsorptive media process; C/F = coagulation/filtration; HIX = hybrid ion exchanger; IX = ion exchange process; RO = reverse osmosis  
ATS = Aquatic Treatment Systems; MEI = Magnesium Elektron, Inc.; STS = Severn Trent Services

- (a) Arsenic existing mostly as As(III).
- (b) Design flowrate reduced by 50% due to system reconfiguration from parallel to series operation.
- (c) Iron existing mostly as Fe(II).
- (d) Replaced Village of Lyman, NE site which withdrew from program in June 2006.
- (e) Facilities upgraded systems in Springfield, OH from 150 to 250 gpm, Sandusky, MI from 210 to 340 gpm, and Arnaudville, LA from 385 to 770 gpm.
- (f) Including nine residential units.
- (g) Including eight under-the-sink units.

## 2.0 SUMMARY AND CONCLUSIONS

AdEdge's APU-50-LL-CS-S-AVH treatment system with AD-33 pelletized media was installed and has operated at the Webb CISD site in Bruni, TX since December 8, 2005. Based on the information collected during the first six months of system operation, the following conclusions were made relating to the overall objectives of the treatment technology demonstration study.

### *Performance of the arsenic removal technology for use on small systems:*

- Chlorine was effective in oxidizing As(III) to As(V). Analytical data confirmed that average As(III) concentrations decreased from 38.5 µg/L in raw water to 1.7 µg/L after chlorination and that average As(V) concentrations increased correspondingly from 14.9 µg/L in raw water to 51.9 µg/L after chlorination. Because no iron was present in raw water, little or no particulate As was produced upon chlorination.
- AD-33 media effectively lowered arsenic concentrations to below the 10 µg/L MCL during the first six months of system operation. The volume throughput recorded in this study period was 12,600 bed volumes (BV) (based on 22 ft<sup>3</sup> of media in one vessel) or 6,300 BV (based on 44 ft<sup>3</sup> of media in both vessels), which was about 27% of the media run length projected by the vendor.
- The operation of the system significantly lowered arsenic concentrations in the distribution system (i.e., from 68.7 to 2.4 µg/L, on average); however, the system did not appear to have impacted lead or copper concentrations in the distribution system.
- Some operational problems related to the CO<sub>2</sub> Gas Flow Control System were encountered during the first six months of system operation. Primary problems included a faulty proportioning valve and failure of the in-line pH probe. A reoccurring problem unrelated to the pH adjustment system was associated with the electromagnetic water flow meters/totalizers, which randomly reset to zero.

### *Required system O&M and operator skill levels:*

- The daily demand on the operator was typically 20 min to visually inspect the system and record operational parameters, although additional time and effort was required to troubleshoot the problems associated with the CO<sub>2</sub> system.
- Operation of the system did not appear to require additional skills beyond those necessary to operate the existing water supply equipment, with the exception of the CO<sub>2</sub> and pH control portion of the system. The CO<sub>2</sub> system required additional operator training and safety awareness.
- Texas Commission on Environmental Quality (TCEQ) requires that the operator of the treatment system holds at least a Class D TCEQ waterworks operator license.

### *Process residuals produced by the technology:*

- The pressure differential ( $\Delta p$ ) measured across the media vessels, during the first six months of operation, did not warrant a backwash. Therefore, no backwash residuals were produced.

### *Cost-effectiveness of the technology:*

- Based on the system's rated capacity of 40 gpm (or 57,600 gpd), the capital cost was \$3,466/gpm (or \$2.41/gpd) of design capacity.



- Media replacement and disposal did not occur during the first six months of system operation, although the cost to change out one vessel (22 ft<sup>3</sup> AD-33 media) was estimated to be \$11,190, which includes the replacement media, spent media disposal, shipping, labor, and travel.

### 3.0 MATERIALS AND METHODS

#### 3.1 General Project Approach

Following the predemonstration activities summarized in Table 3-1, the performance evaluation study of the AdEdge treatment system began on December 8, 2005. Table 3-2 summarizes the types of data collected and considered as part of the technology evaluation process. The overall performance of the system was determined based on its ability to consistently remove arsenic to below the arsenic MCL of 10 µg/L through the collection of water samples across the treatment plant, as described in the Study Plan (Battelle, 2005). The reliability of the system was evaluated by tracking the unscheduled system downtime and the frequency and extent of repair and replacement. The unscheduled downtime and repair information were recorded by the plant operator on a Repair and Maintenance Log Sheet.

**Table 3-1. Predemonstration Study Activities and Completion Dates**

Activity	Date
Introductory Meeting Held	November 15, 2004
Project Planning Meeting Held	February 17, 2005
Draft Letter of Understanding Issued	February 23, 2005
Final Letter of Understanding Issued	March 24, 2005
Request for Quotation Issued to Vendor	March 14, 2005
Vendor Quotation Received by Battelle	April 1, 2005
Purchase Order Completed and Signed	April 18, 2005
Engineering Plans Submitted to TCEQ	June 8, 2005
System Permit Issued by TCEQ	August 31, 2005
APU System Shipped and Arrived	October 13, 2005
System Installation Completed	November 19, 2005
System Shakedown Completed	November 19, 2005
Final Study Plan Issued	November 30, 2005
Performance Evaluation Begun	December 8, 2005

TCEQ = Texas Commission on Environmental Quality

The O&M and operator skill requirements were evaluated based on a combination of quantitative data and qualitative considerations, including the need for pre- and/or post-treatment, level of system automation, extent of preventive maintenance activities, frequency of chemical and/or media handling and inventory, and general knowledge needed for relevant chemical processes and related health and safety practices. The staffing requirements for the system operation were recorded on an Operator Labor Hour Log Sheet.

The quantity of aqueous and solid residuals generated is estimated by tracking the amount of backwash water produced during each backwash cycle. Backwash water is sampled and analyzed for chemical characteristics.

The cost of the system was evaluated based on the capital cost per gal/min (gpm) (or gal/day [gpd]) of design capacity and the O&M cost per 1,000 gal of water treated. This requires the tracking of the capital cost for equipment, site engineering, and installation, as well as the O&M cost for media replacement and disposal, CO<sub>2</sub> and chlorine consumption, electrical power usage, and labor. Data on Webb CISD's O&M cost were limited to CO<sub>2</sub> and chlorine consumption, electricity usage, and labor because media replacement did not take place during the first six months of system operation.

**Table 3-2. Evaluation Objectives and Supporting Data Collection Activities**

<b>Evaluation Objective</b>	<b>Data Collection</b>
Performance	-Ability to produce treated water that consistently meets 10 µg/L of arsenic MCL
Reliability	-Unscheduled system downtime -Frequency and extent of repairs including a description of problems, materials and supplies needed, and associated labor and cost
System O&M and Operator Skill Requirements	-Pre- and post-treatment requirements -Level of automation for system operation and data collection -Staffing requirements including number of operators and laborers -Task analysis of preventive maintenance including number, frequency, and complexity of tasks -Chemical handling and inventory requirements -General knowledge needed for relevant chemical processes and health and safety practices
Residual Management	-Quantity and characteristics of aqueous and solid residuals generated by system operation
Cost-Effectiveness	-Capital cost for equipment, engineering, and installation -O&M cost for chemical usage, electricity consumption, and labor

### 3.2 System O&M and Cost Data Collection

The plant operator performed daily, biweekly, and monthly system O&M and data collection according to instructions provided by the vendor and Battelle. On a daily basis, the plant operator recorded system operational data, such as pressure, flowrate, totalizer, and hour meter readings on a Daily System Operation Log Sheet and conducted visual inspections to ensure normal system operations. If any problem occurred, the plant operator contact the Battelle Study Lead, who determined if the vendor should be contacted for troubleshooting. The plant operator recorded all relevant information, including the problem encountered, course of action taken, materials and supplies used, and associated cost and labor, on the Repair and Maintenance Log Sheet. Every other week, the plant operator measured pH, temperature, dissolved oxygen (DO), and oxidation-reduction potential (ORP), and recorded the data on a Weekly Water Quality Parameters Log Sheet.

The capital cost for the arsenic removal system consisted of the cost for equipment, site engineering, and system installation. The O&M cost consisted of the cost for chemical usage, electricity consumption, and labor. CO<sub>2</sub> and chlorine consumption was tracked through daily measurements and recorded on Daily System Operation Log Sheets. Electricity consumption was tracked through the on-site electric meter. Labor for various activities, such as routine system O&M, system troubleshooting and repair, and demonstration-related work, were tracked using Operator Labor Hour Log Sheets. The routine O&M included activities such as completing field logs, replenishing chemical solutions, ordering supplies, performing system inspections, and others as recommended by the vendor. The demonstration-related work, including activities such as performing field measurements, collecting and shipping samples, and communicating with the Battelle Study Lead and vendor, was recorded, but not used for the cost analysis.

### 3.3 Sample Collection Procedures and Schedules

To evaluate the performance of the system, samples were collected from the wellhead, across the treatment plant, from the backwash discharge line, and from the distribution system. Table 3-3 provides the sampling schedule and analytes measured during each sampling event. Specific sampling requirements for analytical methods, sample volumes, containers, preservation, and holding times are presented in Table 4-1 of the EPA-endorsed Quality Assurance Project Plan (QAPP) (Battelle, 2004).

**Table 3-3. Sampling Schedule and Analytes**

Sample Type	Sampling Locations <sup>(a)</sup>	No. of Sampling Locations	Frequency	Analytes	Sampling Date
Source Water	At Wellhead (IN)	1	Once during initial site visit	On-site: pH, temperature, DO, and ORP Off-site: As (total and soluble), As(III), As(V), Fe (total and soluble), Mn (total and soluble), U (total and soluble), V (total and soluble), Na, Ca, Mg, Cl, F, NO <sub>3</sub> , NO <sub>2</sub> , NH <sub>3</sub> , SO <sub>4</sub> , SiO <sub>2</sub> , PO <sub>4</sub> , turbidity, alkalinity, TDS, and TOC.	11/15/04
Treatment Plant Water	At Wellhead (IN), After pH Adjustment (AP), After Lead Vessel (TA), and After Lag Vessel (TB)	4	First week of each four-week cycle	On-site: pH, temperature, DO, ORP, and Cl <sub>2</sub> (free and total) <sup>(b)</sup> Off-site: As (total and soluble), As(III), As(V), Fe (total and soluble), Mn (total and soluble), Ca, Mg, F, NO <sub>3</sub> , SO <sub>4</sub> , SiO <sub>2</sub> , P, turbidity, and alkalinity.	12/08/05, 01/05/06, 02/01/06, 03/14/06, 04/11/06, 05/09/06, 06/06/06
		4	Third week of each four-week cycle	On-site: pH, temperature, DO, ORP, and Cl <sub>2</sub> (free and total) <sup>(b)</sup> Off-site: As (total), Fe (total), Mn (total), SiO <sub>2</sub> , P, turbidity, and alkalinity	12/13/05, 01/17/06, 02/15/06, 02/28/06, 03/28/06, 04/25/06, 05/23/06
Distribution Water	Three LCR Locations within School	3	Monthly <sup>(c)</sup>	pH, alkalinity, As, Fe, Mn, Pb, and Cu	Baseline sampling: 06/15/05, 07/21/05, 08/24/05, 09/19/05 Monthly sampling: 01/05/06, 02/01/06, 03/14/06, 04/11/06, 05/09/06, 06/06/06
Backwash Water	Backwash Discharge Line from Each Vessel	2	Monthly or as needed	pH, TDS, TSS, As (total and soluble), Fe (total and soluble), and Mn (total and soluble)	To be determined

(a) Abbreviations in parentheses corresponding to sample locations shown in Figure 4-5.

(b) Except at IN location.

(c) Four baseline sampling events performed from June to September 2005 before system became operational.

**3.3.1 Source Water Sample Collection.** During the initial visit to the site on November 15, 2004, one set of source water samples was collected and speciated using an arsenic speciation kit (see Section 3.4.1). The sample tap was flushed for several minutes before sampling; special care was taken to avoid agitation, which might cause unwanted oxidation. Analytes for the source water samples are listed in Table 3-3.

**3.3.2 Treatment Plant Water Sample Collection.** During the system performance evaluation study, biweekly water samples were collected across the treatment train by the plant operator for on- and off-site analyses. During the first week of each four-week cycle, samples were collected at the wellhead [IN], after pH adjustment and chlorination [AP], after the lead adsorption vessel [TA], and after the lag adsorption vessel [TB] and analyzed for the analytes listed on Table 3-3. During the third week of the four-week cycle, samples were taken from the same four locations and analyzed for the analyte list shown on Table 3-3.

**3.3.3 Backwash Water/Solid Sample Collection.** Because the system did not require backwash during the first six months of operation, no backwash residuals were produced. Further, because media replacement did not take place, there were no spent media samples collected.

**3.3.4 Distribution System Water Sample Collection.** Samples were collected from the distribution system by the plant operator to determine the impact of the arsenic treatment system on the water chemistry in the distribution system, specifically, the arsenic, lead, and copper levels. From June to September 2005, prior to the startup of the treatment system, four baseline distribution sampling events were conducted at three locations within the distribution system. Following startup of the arsenic adsorption system, distribution system sampling continued on a monthly basis at the same three locations.

The three locations selected were sample taps within the Webb CISD that had been included in the Lead and Copper Rule (LCR) sampling in the past. The baseline and monthly distribution system samples were collected following an instruction sheet developed according to the *Lead and Copper Monitoring and Reporting Guidance for Public Water Systems* (EPA, 2002). The date and time of last water use before sampling and the date and time of sample collection were recorded for calculation of the stagnation time. All samples were collected from a cold water faucet that had not been used for at least 6 hr to ensure that stagnant water was sampled. Analytes for the baseline samples coincided with the monthly distribution system water samples as described in Table 3-3. Arsenic speciation was not performed for the distribution system water samples.

### **3.4 Sampling Logistics**

All sampling logistics including preparation of arsenic speciation kits and sample coolers, and sample shipping and handling are discussed as follows:

**3.4.1 Preparation of Arsenic Speciation Kits.** The arsenic field speciation method used an anion exchange resin column to separate the soluble arsenic species, As(V) and As(III) (Edwards et al., 1998). Resin columns were prepared in batches at Battelle laboratories according to the procedures detailed in Appendix A of the EPA-endorsed QAPP (Battelle, 2004).

**3.4.2 Preparation of Sampling Coolers.** For each sampling event, a sample cooler was prepared with the appropriate number and type of sample bottles, disc filters, and/or speciation kits. All sample bottles were new and contained appropriate preservatives. Each sample bottle was affixed with a pre-printed, color-coded, and waterproof label, consisting of the sample identification (ID), date and time of sample collection, collector's name, site location, sample destination, analysis required, and preservative. The sample ID consisted of a two-letter code for the specific water facility, sampling date, a two-letter

code for a specific sampling location, and a one-letter code designating the arsenic speciation bottle (if necessary). The sampling locations at the treatment plant were color-coded for easy identification. For example, red, orange, yellow, and blue were used to designate sampling locations for IN, AP, TA, and TB, respectively. The pre-labeled bottles for each sampling location were placed in separate ziplock bags and packed in the cooler.

When appropriate, the sample cooler was packed with bottles for the three distribution system sampling locations. In addition, all sampling and shipping-related materials, such as latex gloves, sampling instructions, chain-of-custody forms, prepaid FedEx air bills, and bubble wrap, were included. Except for the operator's signature, the chain-of-custody forms and prepaid FedEx air bills had already been completed with the required information. The sample coolers were shipped via FedEx to the facility approximately 1 week prior to the scheduled sampling date.

**3.4.3 Sample Shipping and Handling.** After sample collection, samples for off-site analyses were packed carefully in the original coolers with wet ice and shipped to Battelle. Upon receipt, the sample custodian verified that all samples indicated on the chain-of-custody forms were included and intact. Sample IDs were checked against the chain-of-custody forms and the samples were logged into the laboratory sample receipt log. Discrepancies noted by the sample custodian were addressed with the plant operator by the Battelle Study Lead.

Samples for metal analyses were stored at Battelle's inductively coupled plasma-mass spectrometry (ICP-MS) Laboratory. Samples for other water quality analyses were packed in separate coolers and picked up by couriers from American Analytical Laboratories (AAL) in Columbus, OH and TCCI Laboratories in Lexington, OH, both of which were under contract with Battelle for this demonstration study. The chain-of-custody forms remained with the samples from the time of preparation through analysis and final disposition. All samples were archived by the appropriate laboratories for the respective duration of the required hold time and disposed of properly thereafter.

### **3.5 Analytical Procedures**

The analytical procedures described in detail in Section 4.0 of the EPA-endorsed QAPP (Battelle, 2004) were followed by Battelle ICP-MS, AAL, and TCCI Laboratories. Laboratory quality assurance/quality control (QA/QC) of all methods followed the prescribed guidelines. Data quality in terms of precision, accuracy, method detection limits (MDLs), and completeness met the criteria established in the QAPP (i.e., relative percent difference [RPD] of 20%, percent recovery of 80 to 120%, and completeness of 80%). The quality assurance (QA) data associated with each analyte will be presented and evaluated in a QA/QC Summary Report to be prepared under separate cover upon completion of the Arsenic Demonstration Project.

Field measurements of pH, temperature, DO, and ORP were conducted by the plant operator using a VWR Symphony SP90M5 Handheld Multimeter, which was calibrated for pH and DO prior to use following the procedures provided in the user's manual. The ORP probe also was checked for accuracy by measuring the ORP of a standard solution and comparing it to the expected value. The plant operator collected a water sample in a clean, plastic beaker and placed the Symphony SP90M5 probe in the beaker until a stable value was obtained. The plant operator also performed free and total chlorine measurements using Hach chlorine test kits following the user's manual.

## 4.0 RESULTS AND DISCUSSION

### 4.1 Facility Description and Preexisting Treatment System Infrastructure

Located at 619 Avenue F in Bruni, Texas, the Webb CISD water system supplies water to approximately 230 students and staff members during the academic year. Figure 4-1 shows the preexisting water treatment facility. The water system is served by a single well that is 7-in in diameter and approximately 345 ft deep. The supply well, shown in Figure 4-2, is equipped with a 5-horsepower (hp), 15-in submersible pump rated for 40 gpm at 300 ft H<sub>2</sub>O or 130 lb/in<sup>2</sup> (psi). The preexisting system typically operated for 6 to 8 hr/day, with an average daily demand of 10,000 gpd and an estimated peak daily demand of 15,000 gpd. The preexisting treatment included only chlorination with a 10% sodium hypochlorite (NaOCl) solution to reach a target residual level of 1.2 mg/L (as Cl<sub>2</sub>). Figure 4-3 shows the chlorine addition system at the site. Following chlorination, the treated water was stored in a 15,000-gal storage tank located in a fenced area in the immediate vicinity of the well and chlorine addition system.



**Figure 4-1. Existing Water Treatment Facility**

*(from Left to Right: Wellhead in front of White Storage Shed, Chlorine Addition System in Black Rectangular Box, and White Storage Tank for Treated Water)*

**4.1.1 Source Water Quality.** Source water samples were collected and speciated on November 15, 2004, for on- and off-site analyses with analytes listed on Table 4-1. The results are presented in Table 4-1 and compared to those taken by the facility for the EPA demonstration site selection.

**Arsenic.** Total arsenic concentrations of source water ranged from 55.6 to 59 µg/L. Based on Battelle's speciation results, out of 55.6 µg/L of total arsenic, 19.6 µg/L existed as As(V) and 35.6 µg/L as As(III). Therefore, preoxidizing was needed to oxidize As(III) to As(V) prior to adsorption.



**Figure 4-2. Wellhead at Webb CISD**



**Figure 4-3. Existing Chlorine Addition System**



**Table 4-1. Water Quality Data for Webb CISD, Bruni, TX**

Parameter	Unit	Raw Water		Treated Water
		Facility Data <sup>(a)</sup>	Battelle Data	TCEQ Data
<i>Date</i>		-	11/15/04	01/12/98–10/26/04
pH	S.U.	8.1	8.0	6.8–8.2
Temperature	°C	NA	25.3	NA
DO	mg/L	NA	1.5	NA
ORP	mV	NA	-122	NA
Total Alkalinity (as CaCO <sub>3</sub> )	mg/L	323	325	232–297
Hardness (as CaCO <sub>3</sub> )	mg/L	24	23.5	25–27.2
Turbidity	NTU	NA	0.7	NA
TDS	mg/L	NA	1,060	781–795
TOC	mg/L	NA	0.9	NA
Nitrate (as N)	mg/L	NA	<0.04	0.3–1.2
Nitrite (as N)	mg/L	NA	<0.01	0.01
Ammonia (as N)	mg/L	NA	<0.05	NA
Chloride	mg/L	188	130	180–229
Fluoride	mg/L	NA	1.0	0.7–0.8
Sulfate	mg/L	104	98.0	97.4–113
Silica (as SiO <sub>2</sub> )	mg/L	NA	42.3	NA
Orthophosphate (as PO <sub>4</sub> )	mg/L	NA	<0.06	NA
As(total)	µg/L	59	55.6	75.9–104
As (total soluble)	µg/L	NA	55.2	NA
As (particulate)	µg/L	NA	0.4	NA
As(III)	µg/L	NA	35.6	NA
As(V)	µg/L	NA	19.6	NA
Fe (total)	µg/L	27	<25	10–51
Fe (soluble)	µg/L	NA	<25	NA
Mn (total)	µg/L	8	4.5	1–8
Mn (soluble)	µg/L	NA	4.3	NA
U (total)	pCi/L	NA	10.6	<25
U (soluble)	pCi/L	NA	10.2	NA
V (total)	µg/L	NA	4.4	NA
V (soluble)	µg/L	NA	4.4	NA
Na (total)	mg/L	301	333	272–293
Ca (total)	mg/L	7	6.1	7.1–8.0
Total Mg	mg/L	2	2.0	1.0–2.3

(a) Provided by facility to EPA for demonstration site selection.

TCEQ = Texas Commission on Environmental Quality

NA = not analyzed

**Iron.** Iron concentrations in source water were low, typically less than its detection limit of 25 µg/L. In general, adsorptive media technologies are best suited to sites with relatively low iron levels (e.g., less than 300 µg/L of iron, which is the secondary maximum contaminant level [SMCL] for iron). Above 300 µg/L, taste, odor, and color problems can occur in treated water, along with an increased potential for fouling of the adsorption system components with iron particulates.

**pH.** pH values of raw water were between 8.0 and 8.1. At pH values greater than 8.0 to 8.5, the technology vendor recommends that the pH values be lowered to enhance the adsorptive capacity of the media. The treatment process for the Webb CISD site included a CO<sub>2</sub> injection and pH monitoring and control module prior to arsenic adsorption. The target pH level after pH adjustment was 7.0.

**Competing Anions.** Arsenic adsorption can be influenced by the presence of competing anions such as silica and phosphate. Analysis of source water indicated silica levels at 42.3 mg/L and orthophosphate levels less than its detection limit (i.e., <0.06 mg/L). The effect of silica on arsenic adsorption was monitored closely during the demonstration study.

**Other Water Quality Parameters.** Other water quality parameters in source water were below their respective primary MCLs, including nitrate, nitrite, and ammonia. Also, chloride, fluoride, sulfate, and manganese were below their respective SMCLs. Total dissolved solids (TDS) were measured at 1,060 mg/L, which is above the SMCL of 500 mg/L.

**4.1.2 Treated Water Quality.** In addition to the source water quality data, Table 4-1 also presents historic treated water quality data collected by TCEQ from January 1998 through October 2004. These treated water quality data were similar to the source water quality data provided by the facility and collected by Battelle. Total arsenic concentrations of the treated water were slightly higher and ranged from 75.9 to 104 µg/L. No arsenic speciation data were available for the water following chlorination. pH values ranged from 6.8 to 8.2. Additional analytes including several metals and radionuclides are summarized in Table 4-2.

**Table 4-2. TCEQ Treated Water Quality Data**

Parameter	Unit	TCEQ Data
<i>Date</i>		01/12/98–10/26/04
Aluminum	µg/L	4–50
Antimony	µg/L	1–4
Barium	µg/L	39.7–40
Beryllium	µg/L	<1
Cadmium	µg/L	0.2–1.2
Chromium	µg/L	<10
Copper	µg/L	2.2–7.7
Lead	µg/L	1–12
Mercury	µg/L	<0.4
Nickel	µg/L	1–20
Selenium	µg/L	8.5–12.7
Silver	µg/L	1–10
Thallium	µg/L	<1
Zinc	µg/L	<4–20
Gross Alpha	pCi/L	26.2–28.3 <sup>(a)</sup>
Gross Beta	pCi/L	11.8–12.5
Radium 226	pCi/L	<1
Tritium	pCi/L	500

(a) over 15 pCi/L MCL

**4.1.3 Distribution System.** Based on the information provided by the facility, the distribution system is constructed primarily of polyvinyl chloride (PVC) piping and some galvanized piping. The piping within the building is copper. The distribution system is supplied directly from the 15,000-gal storage tank.

The three locations selected for distribution sampling include one location each in the middle school, high school, and cafeteria. These locations represent the distribution system sampling and also are part of the school's historic LCR sampling network. The site also samples for coliform once a month and volatile organic compounds (VOCs), inorganics, nitrate, and radionuclides as directed by the TCEQ, typically once every two to three years.

**4.2 Treatment Process Description**

The arsenic package unit (APU) marketed by AdEdge is a fixed-bed, down-flow adsorption system used for small water systems in the flow range of 5 to 100 gpm. It uses Bayoxide E33 media (branded as AD-33 by AdEdge), an iron-based adsorptive media developed by Bayer AG, for the removal of arsenic from drinking water supplies. Table 4-3 presents physical and chemical properties of the media. AD-33 media is delivered in a dry crystalline form and listed by NSF International (NSF) under Standard 61 for use in drinking water applications. The media exist in both granular and pelletized forms, which have similar physical and chemical properties, except that pellets are denser than granules (i.e., 35 lb/ft<sup>3</sup> vs. 28 lb/ft<sup>3</sup>). For the Webb CISD site, pellets were selected for use.

**Table 4-3. Physical and Chemical Properties of AD-33 Media<sup>(a)</sup>**

<i>Physical Properties</i>	
<b>Parameter</b>	<b>Value</b>
Matrix	Iron oxide composite
Physical form	Dry pellets
Color	Amber
Bulk Density (lb/ft <sup>3</sup> )	35
BET Area (m <sup>2</sup> /g)	142
Attrition (%)	0.3
Moisture Content (%)	<15 (by weight)
Particle size distribution (U.S. Standard mesh)	10 × 35
Crystal Size (Å)	70
Crystal Phase	α – FeOOH
<i>Chemical Analysis</i>	
<b>Constituents</b>	<b>Weight (%)</b>
FeOOH	90.1
CaO	0.27
MgO	1.00
MnO	0.11
SO <sub>3</sub>	0.13
Na <sub>2</sub> O	0.12
TiO <sub>2</sub>	0.11
SiO <sub>2</sub>	0.06
Al <sub>2</sub> O <sub>3</sub>	0.05
P <sub>2</sub> O <sub>5</sub>	0.02
Cl	0.01

(a) Provided by AdEdge  
 BET = Brunauer, Emmett, and Teller

For series operation, when the media in the lead vessel completely exhausts its capacity and/or the effluent from the lag vessel reaches 10 µg/L of arsenic, the spent media in the lead vessel is removed and disposed of. After rebedding, the lead vessel is switched to the lag position and the lag vessel is switched to the lead position. In general, the series operation better utilizes the media capacity when compared to the parallel operation because the media in the lead vessel may be allowed to exhaust completely prior to change-out.

When comparing the performance of the lead vessel (series operation) with that of two smaller parallel vessels of a similarly-sized system (parallel operation), the number of BV treated by the system is calculated based on the media volume in the lead vessel for the series operation and in the two parallel vessels for the parallel operation. The calculation does not use the media volume in the lead and lag vessels because this approach considers the two vessels as one large vessel, which has twice as much media than the in-parallel system. The media volume in the lead vessel is equal to the sum of the media volume in each of the two vessels in parallel; the flow through the lead vessel is equal to the sum of the flow through each of the two vessels in parallel; and the empty bed contact time (EBCT) in the lead vessel is the same as EBCT in each of the two vessels in parallel.

The arsenic treatment system at the Webb CISD site (specifically referred to as the APU-50LL-CS-S-2-AVH system) consists of two pressure vessels, Vessel A and Vessel B, operating in series. The piping and valve configuration of the pressure vessels allow electrically actuated butterfly valves to divert raw water flow into either Vessel A or Vessel B depending on which is operating as the lead vessel. A simplified process flow diagram of the treatment system is shown in Figure 4-4. The system is located in the maintenance building, which provides sufficient space available to house the system. Figure 4-5 is a generalized process flow sampling diagram of the system that illustrates sampling locations and parameters analyzed during the demonstration study. Table 4-4 presents key system design parameters.

The key process steps and major components of the water treatment system include:

- **Intake.** Raw water is pumped from the supply well and fed to the treatment system.
- **pH adjustment.** The pH of raw water is lowered to a target pH value of 7.0 using CO<sub>2</sub>, which was selected for use for pH adjustment because 1) CO<sub>2</sub> is less corrosive than mineral acids, such as H<sub>2</sub>SO<sub>4</sub>, and 2) when the treated water is depressurized after exiting the adsorption vessels, some CO<sub>2</sub> may degas, thereby raising the pH of the treated water and reducing its corrosivity to the distribution piping.

A Carbon Dioxide Gas Flow Control System manufactured by Applied Technology Systems, Inc. (ATSI) in Souderton, PA is used for pH adjustment. Figure 4-6 presents a process diagram of the system, which is designed to introduce gaseous CO<sub>2</sub> into water in a side-stream configuration, or a CO<sub>2</sub> loop. The system, illustrated in Figure 4-7 as a composite of photographs, consists of a liquid CO<sub>2</sub> supply assembly, an automatic pH control panel, a CO<sub>2</sub> membrane assembly, and a pH probe located downstream of the membrane module:

- Liquid CO<sub>2</sub> in two 50-lb cylinders vaporizes into gaseous CO<sub>2</sub> via a feed vaporizer prior to entering the pH control panel.
- As the CO<sub>2</sub> gas flows to the pH control panel, its gas flowrate is automatically controlled and adjusted by a JUMO pH/Proportional Integral Derivative (PID) controller and an Alicat mass flowmeter (Figure 4-6) to reach a desired pH setpoint. The gas flowrate also may be regulated manually through the use of a three-way ball

**Process Flow Diagram**  
**AdEdge Arsenic Reduction System**  
**Model APU50LL-CS-2-AVH**  
**Reversible Lead/Lag Configuration**

**Webb Consolidated School**  
**Bruni, Texas**  
**(Series Operation: Vessel A**  
**shown as Lead Vessel)**

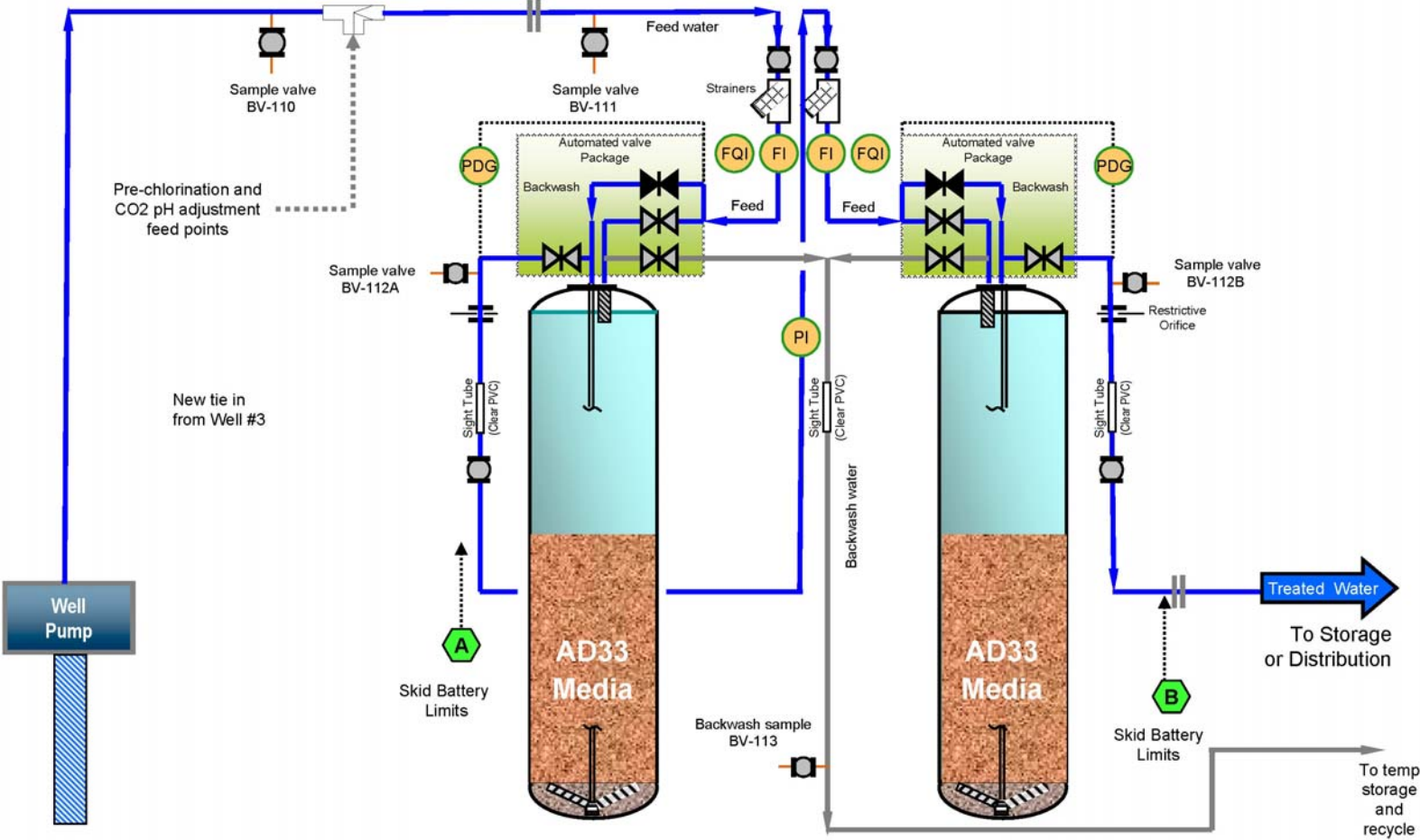

**Figure 4-4. Process Flow Diagram for APU-50LL-CS-S-2-AVH System**

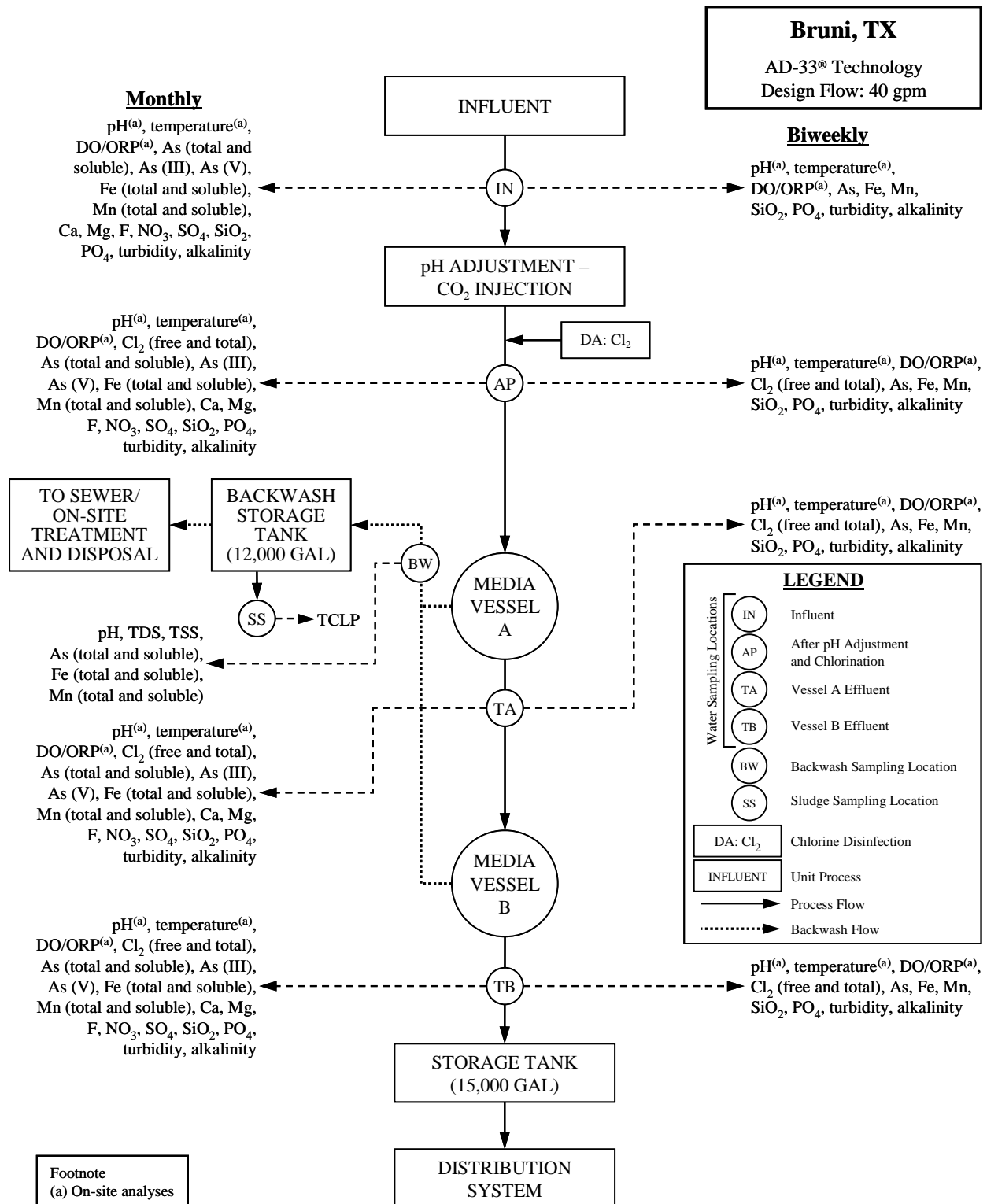
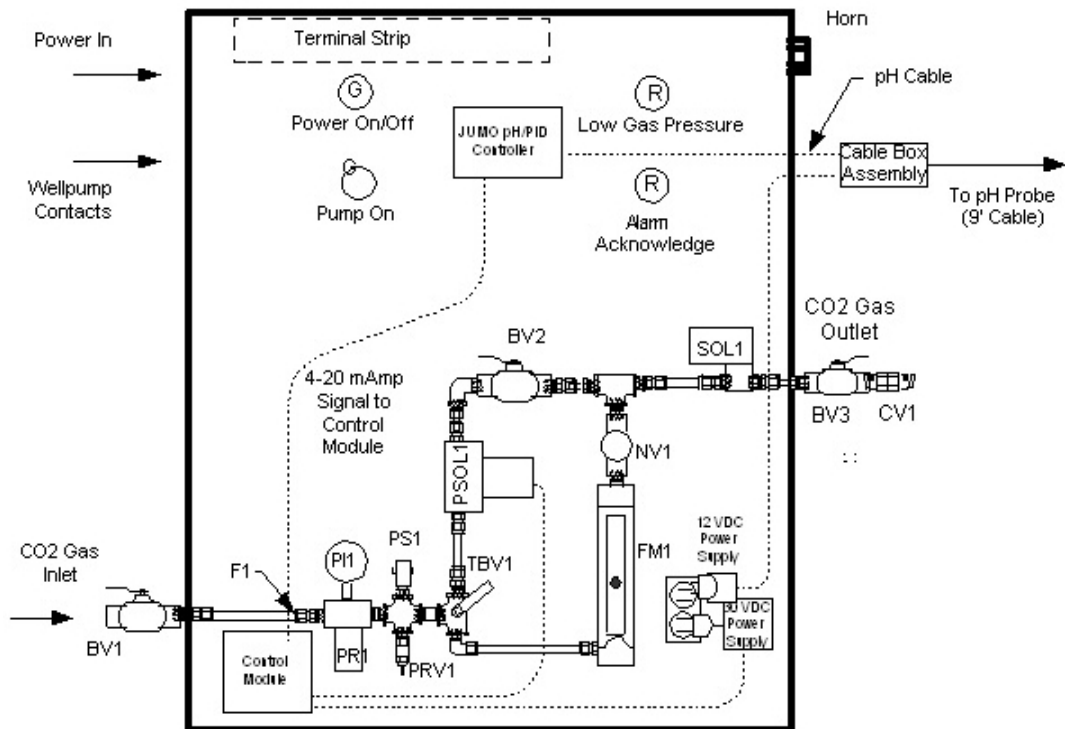
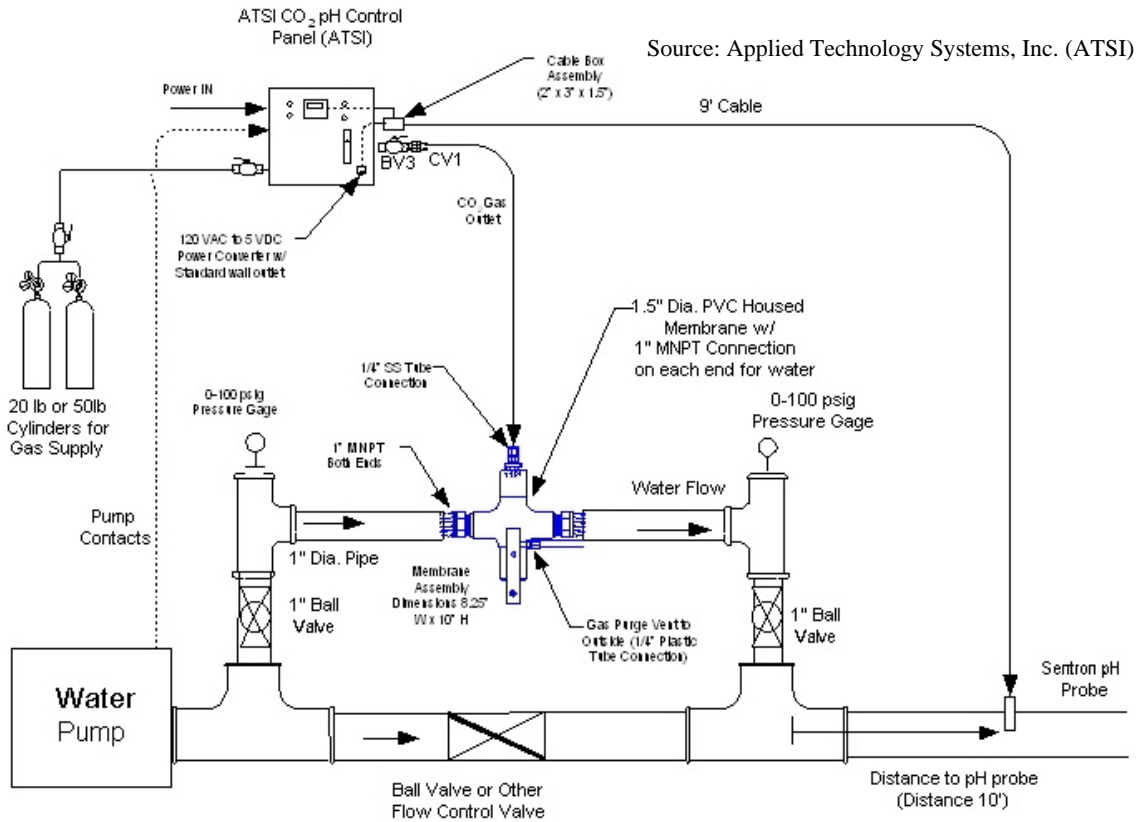

Figure 4-5. Process Flow Diagram and Sampling Schedule and Locations

**Table 4-4. Design Specifications for AdEdge APU-50LL-CS-S-2-AVH System**

Parameter	Value	Remarks
<b>Pre-treatment</b>		
Target pH Value after Adjustment (S.U.)	7.0	Using CO <sub>2</sub>
Target Chlorine Residual (as Cl <sub>2</sub> )	1.2	Using NaClO
<b>Adsorption Vessels</b>		
Vessel Size (in)	42 D × 72 H	–
Cross-Sectional Area (ft <sup>2</sup> /vessel)	9.6	–
Number of Vessels	2	–
Configuration	Series	–
<b>AD-33 Adsorption Media</b>		
Media Bed Depth (in)	27.5	
Media Quantity (lb)	1,540	770 lb/vessel
Media Volume (ft <sup>3</sup> )	44	22 ft <sup>3</sup> /vessel
Media Type	AD-33	In pelletized form
<b>Service</b>		
Design Flowrate (gpm)	40	–
Hydraulic Loading Rate (gpm/ft <sup>2</sup> )	4.2	–
EBCT (min/vessel)	4.1	Based on flowrate of 40 gpm per vessel (8.2 min total EBCT for both lead and lag vessels)
Estimated Working Capacity (BV)	46,900	Bed volumes to 10 µg/L total As breakthrough from lag vessel based on vendor estimate
Throughput to Breakthrough (gal)	7,725,000	1 BV = 22 ft <sup>3</sup> = 164 gal
Average Use Rate (gal/day)	12,000	Based on 5 hr/day operation at 40 gpm
Estimated Media Life (months)	21.5	Estimated frequency of media change-out from lead vessel based on 12,000 gal/day use rate
<b>Backwash</b>		
Pressure Differential Set Point (psi)	10	–
Backwash Flowrate (gpm)	90	–
Hydraulic Loading Rate (gpm/ft <sup>2</sup> )	9.4	–
Backwash Frequency (month/backwash)	3–4	Actual backwash frequency to be determined
Backwash Duration (min/vessel)	20	–
Service-to-Waste Fast Rinse Flowrate (gpm)	90	–
Fast Rinse Duration (min/vessel)	1–4	–
Wastewater Production (gal/vessel)	1,890–2,160	–

- valve and a rotameter. Further, a solenoid valve interlocked with the well pump allows gas to flow only when the well pump is turned on.
- After flowing out of the control panel, CO<sub>2</sub> is injected into water through a Celgard<sup>®</sup> microporous hollow fiber membrane module housed in a 1.5-in stainless steel sanitary cross. Table 4-5 lists the properties and specifications of the hollow fiber membrane module. The sanitary cross is located in a side stream from the main water line to allow only a portion of water to flow through the membrane module to minimize the pressure drop. The membrane introduces CO<sub>2</sub> gas into water at a near molecular level for rapid mixing/reaction with water to achieve a quick pH response/change.
- Located downstream from the sanitary cross, a Sentron Ion Sensitive Field Effect Transistor (ISFET) type silicon chip sanitary pH probe with automatic temperature compensation continuously monitors pH levels of the treated water and sends signals back to the pH/PID controller for pH control.



**Figure 4-6. Process Diagram of (top) CO<sub>2</sub> pH Adjustment System and (bottom) pH/PID Control Panel**





**Figure 4-7. Carbon Dioxide Gas Flow Control System for pH Adjustment**  
*(Clockwise from Top Left: Liquid CO<sub>2</sub> Supply Assembly;  
 Automatic pH Control Panel; CO<sub>2</sub> Membrane Module; Port for pH Probe)*

**Table 4-5. Properties of Celgard<sup>®</sup>, X50-215 Microporous Hollow Fiber Membrane**

Parameter	Value
Porosity (%)	40
Pore Dimensions (μm)	0.04 × 0.10
Effective Pore Size (μm)	0.04
Minimum Burst Strength (psi)	400
Tensile Break Strength (g/filament)	≥300
Average Resistance to Air Flow (Gurley sec)	50
Axial Direction Shrinkage (%)	≤5
Fiber Internal Diameter, nominal (μm)	220
Fiber Wall Thickness, nominal (μm)	40
Fiber Outer Diameter, nominal (μm)	300
Module Dimensions (in)	1.5 × 3.0

Data Source: Celgard<sup>®</sup>

- Throughout the first six-month operational period, the CO<sub>2</sub> pH control system supplied CO<sub>2</sub> at approximately 14.2 ft<sup>3</sup>/hr, using about 7 lb/day (based on a gas density of 0.117 lb/ft<sup>3</sup> and an average operating time of 4.3 hr/day). The CO<sub>2</sub> gas supplied from two 50-lb cylinders provided CO<sub>2</sub> for about 14 days before requiring change-out.
- **Prechlorination.** The existing chlorination system, as shown in Figure 4-3, was upgraded and installed inside the maintenance building along with the APU-50LL-CS-S-2-AVH system. The chlorine addition system oxidizes As(III) to As(V) prior to the adsorption vessels and provides a target chlorine residual of 1.2 mg/L (as Cl<sub>2</sub>) for disinfection in the distribution system. The chlorine feed system, illustrated in Figure 4-8, includes a solenoid-driven, diaphragm-type metering pump with a capacity range of 0.19 to 8.4 gal/hr (gph), a 50-gal high-density polyethylene (HDPE) chemical feed tank to store the 10% NaClO solution, and a chlorine injection port. The chlorine is injected into raw water line following the CO<sub>2</sub> injection and pH probe, but prior to the AP sampling location. Operation of the chlorine feed system is linked to the well pump so that chlorine is injected only when the well is on. Chlorine consumption is measured using volumetric markings on the outside of the feed tank.



**Figure 4-8. Chlorination Feed System**  
(Clockwise from Top Left: Chlorine Metering Pump;  
HDPE Chemical Feed Tank with Secondary Containment; Chlorine Injection Port)

- **Adsorption.** The AdEdge APU-50LL-CS-S-2-AVH system consists of two 42-in-diameter, 72-in-tall pressure vessels configured in series, each containing 22 ft<sup>3</sup> of AD-33 media. The tanks are carbon steel construction, skid mounted, and rated for 100-psi working pressure. EBCT for the system is 4.1 min in each vessel. The hydraulic loading rate to each vessel is approximately 4.2 gpm/ft<sup>2</sup>, based on the design flowrate of 40 gpm.

Each pressure vessel is interconnected with schedule 80 PVC piping and five electrically actuated butterfly valves, which make up the valve tree as shown in Figure 4-9. In addition to the ten butterfly valves, the system has two manual diaphragm valves on the backwash line and six isolation ball valves to divert raw water flow into either vessel, which reverse the lead lag vessel configuration. Each valve operates independently and the butterfly valves are controlled by a Square D Telemechanique programmable logic controller (PLC) with a Magelis G2220 color touch interface screen.



**Figure 4-9. Adsorption System Valve Tree and Piping Configuration**

- **Backwash.** The vendor recommended that the APU-50LL-CS-S-2-AVH system be backwashed, either manually or automatically, on a regular basis to remove particulates and media fines that accumulate in the media beds. Automatic backwash can be initiated by either timer or differential pressure ( $\Delta p$ ) across the vessels. During the backwash cycle, each vessel is backwashed individually, while the second vessel remains off-line. Backwash is performed upflow at a flowrate of 90 gpm to achieve a hydraulic loading rate of about 9.3 gpm/ft<sup>2</sup>. Because the incoming flowrate from the supply well is insufficient to provide the necessary flow for backwash, supplemental water is supplied from the treated water storage tank to the head of the system. Each backwash cycle is set to last for about 20 min/vessel of backwash followed by 1 to 4 min/vessel of service-to-waste fast rinse, generating a combined total of approximately 1,890 to 2,160 gal/vessel of wastewater.

The backwash water produced is pumped to a 12,000-gal fiberglass backwash storage tank located adjacent to the treated water storage tank (see Figure 4-1). Water from the backwash storage tank is sent to an on-site wastewater plant and then to a series of four stabilization ponds, which provide approximately 120 days of storage capacity. If the storage capacity of the stabilization ponds is exceeded, the discharge goes to a normally dry streambed, where it ultimately evaporates or percolates into the ground. However, due to the minimal pressure drop across the vessels throughout the first six months of system operation, system backwash was not necessary. The pressure drop and the arsenic concentrations across the vessels will continue to be monitored and a backwash will be scheduled, when needed, during the next six months of system operation.

- **Media Replacement.** The media in the lead vessel will be replaced once the arsenic concentration from the lag vessel reaches 10 µg/L. After the media replacement in the lead vessel, flow through the vessels will be switched such that the lag vessel is placed into the lead position and the former lead vessel with the virgin media is placed in the lag position. The spent media will be tested for EPA's toxicity characteristic leaching procedure TCLP before disposal.

### 4.3 System Installation

The installation of the APU system was completed by AdEdge on November 19, 2005. The following briefly summarizes some of the predemonstration activities, including permitting, building preparation, and system offloading, installation, shakedown, and startup.

**4.3.1 Permitting.** An exception submittal package was submitted to TCEQ by Webb CISD on April 18, 2005, requesting an exception to use data from an alternative site in lieu of conducting an on-site pilot study as required under Title 30 Texas Administrative Code (30 TAC) §290.42(g). The exception submittal included a written description of the treatment technology along with a schematic of the system and relevant pilot- and full-scale data. In addition, a permit application submittal package including a process flow diagram of the treatment system, mechanical drawings of the treatment equipment, and a schematic of the building footprint and equipment layout also was submitted to TCEQ for permit approval on April 18, 2005. TCEQ requested supplemental information, in a response letter dated June 3, 2005, to complete their review of the request. In response, supplementary data were provided by the vendor on July 14, 2005, Battelle on August 22, 2005, and Littlefield of Southwest Engineers, Inc. on August 29, 2005. Based on a review of the submitted data (which included revised engineering plans and specifications, dated August 19, 2005) and discussions with the vendor, Battelle, and EPA, TCEQ granted an exception request and approval to construct the arsenic removal treatment system on August 31, 2005.

**4.3.2 Building Preparation.** The existing maintenance shop building as shown in Figure 4-10 had adequate space to house the planned arsenic treatment system. The maintenance building is a single-story metal structure with concrete flooring. Additional preparation required the installation of a lockable wire cage enclosure around the treatment system.

**4.3.3 Installation, Shakedown, and Startup.** The treatment system arrived on-site on October 13, 2005. Figure 4-11 shows a photograph of the system arriving at the site. AdEdge and ATSI were on-site for the system installation during the week of November 14, 2005. ATSI performed the installation and shakedown of the Carbon Dioxide Gas Flow Control System for pH adjustment. Meanwhile, AdEdge and the local operator performed the arsenic treatment system installation and shakedown work, which included hydraulic testing, media loading (by hand), and media backwash. The system officially went online and was put into regular service on December 7, 2005. Battelle was on-site on December 8 and 9,



**Figure 4-10. Maintenance Shop Building**



**Figure 4-11. System Being Delivered to Site**

2005, to inspect the system and provide training to the operator for sampling and data collection. As a result of the system inspections, a punch-list of items was identified, some of which were quickly resolved and did not affect system operations or data collection, although several problems related to the pH adjustment system and the media vessel flow meters surfaced throughout the six-month study period. Table 4-6 summarizes the items identified and corrective actions taken. In addition, these problems are discussed in detail in Section 4.4.3.

**Table 4-6. System Punch-List/Operational Issues**

<b>Item No.</b>	<b>Punch-List/ Operational Issues</b>	<b>Corrective Action(s) Taken</b>	<b>Resolution Date</b>
1	Well pump hour meter not provided	<ul style="list-style-type: none"> <li>Installed hour meter for well pump</li> </ul>	01/09/06
2	Leak in CO <sub>2</sub> supply system	<ul style="list-style-type: none"> <li>Checked and tightened all connections and fittings</li> </ul>	01/11/06
3	Flow totalizer for Vessels A and B reset to zero	<ul style="list-style-type: none"> <li>Vendor notified</li> <li>No corrective action taken</li> </ul>	01/12/06
4	In-line pH probe reporting pH >8	<ul style="list-style-type: none"> <li>Flushed pH probe by-pass line and increased flowrate through by-pass line</li> </ul>	03/13/06
5	Malfunctioning proportioning valve restricted CO <sub>2</sub> injection	<ul style="list-style-type: none"> <li>Replaced proportioning valve</li> </ul>	04/24/06
6	In-line pH probe not reporting pH reading	<ul style="list-style-type: none"> <li>Replaced pH probe</li> </ul>	05/30/06 02/22/06
7	Flow totalizer for Vessels A and B reset to zero	<ul style="list-style-type: none"> <li>Vendor notified</li> <li>Problem likely due to a programming error; a flash memory card with necessary programming updates to be provided by vendor</li> </ul>	05/23/06 TBD

TBD = to be determined

#### 4.4 System Operation

**4.4.1 Operational Parameters.** The operational parameters for the first six months of system operation were tabulated and are attached as Appendix A. Key parameters are summarized in Table 4-7. From December 8, 2005, through June 9, 2006, the system operated for approximately 787 hr. Because the well pump hour-meter was not installed during the first 32 days of operation, the average daily operational time and flowrate over the last 151 days of operation were used to estimate approximate overall operational time. This cumulative operating time represents a use rate of approximately 18% during the first six months of system operation. The system typically operated for a period of approximately 4.3 hr/day.

Flowrates of the system were tracked by instantaneous flowrate readings from the electromagnetic flow meter/totalizer on each adsorption vessel, and calculated flowrate values based on hour meter and flow totalizer readings from the same electromagnetic flow meters/totalizers and a preexisting positive displacement type master totalizer installed at the wellhead. As shown in Figure 4-12, the instantaneous readings for Vessels A and B, denoted by “■” and “▲,” respectively, were significantly higher than the corresponding calculated values, denoted by “□” and “Δ,” respectively, with an average value of 52 gpm for the instantaneous readings and 44 gpm for the calculated values. In addition, the calculated values based on the electromagnetic flow meters/totalizers were significantly higher than those based on the master totalizer (denoted by “◆” in the figure). Although the results produced by the master totalizer were closer to the design flowrate of 40 gpm, the calculated values by the electromagnetic flow meters/totalizers were used as system flowrates. This was based on the belief that readings from the

**Table 4-7. Summary of APU-50LL-CS-S-2-AVH System Operation**

<b>Operational Parameter</b>	<b>Value/Condition</b>
Duration	12/08/05–06/09/06
Cumulative Operating Time (hr)	787
Average Daily Operating Time (hr)	4.3
Throughput (gal)	2,070,000
Bed Volumes (BV) <sup>(a)</sup>	12,625
Average (Range) of Flowrate (gpm)	44 (39–53)
Average (Range) of EBCT per Vessel (min) <sup>(a)</sup>	3.7 (3.1–4.2)
Average (Range) of EBCT for System (min) <sup>(a)</sup>	7.5 (6.2–8.4)
Average (Range) of Inlet Pressure (psi)	41.2 (34–60)
Average (Range) of Outlet Pressure (psi)	30.1 (24–50)
Average (Range) of $\Delta p$ across System (psi)	11.2 (8–14)
Average (Range) of $\Delta p$ across Vessel A (psi)	3.2 (1–6)
Average (Range) of $\Delta p$ across Vessel B (psi)	4.3 (0–6)

(a) Calculated based on 22 ft<sup>3</sup> of media in one vessel.

factory-calibrated electromagnetic flow meters/totalizers were more reliable than those from the master totalizer, for which little information was available regarding its accuracy and installation specifications. Therefore, for performance evaluation purposes, the data produced by the electromagnetic flow meter/totalizer on the lag vessel was used to determine system flowrates and total volume treated.

Figure 4-12 also identifies flowrate data that were not consistent with normal operations and caused by an unintentional resetting of the electromagnetic flow meters/totalizers on two separate occasions. Detailed discussions regarding the resetting of the totalizers are provided in Section 4.4.3.

During the first six months, the system treated approximately 2,070,000 gal of water based on the totalizer readings from the lag vessel. The amount of water treated was equivalent to approximately 12,600 BV based on the 22 ft<sup>3</sup> of media in one vessel or 6,300 BV based on the 44 ft<sup>3</sup> of media in both vessels. Flowrates to the system ranged from 39 to 53 gpm and averaged 44 gpm. The average system flowrate was 10% higher than the 40-gpm design value (Table 4-4), which was derived from the 40-gpm supply well flowrate based on the pump curve provided by the facility. Based on the flows to the system, the EBCT for the lag vessel varied from 3.1 to 4.2 min and averaged 3.7 min, which was 11% lower than the design EBCT of 4.1 min.

The APU system pressures were monitored at the system inlet and outlet and between the lead and lag vessels. The average pressure differential ( $\Delta p$ ) across the treatment train, lead vessel, and lag vessel for the first month of system operation was 10, 3, and 4 psi, respectively. By the end of the first six months of system operation, the average  $\Delta p$  across the treatment train, lead vessel, and lag vessel were 11, 3, and 4 psi, respectively. As such, no pressure increase was observed after 787 hr of system operation or after treating approximately 2,070,500 gal of water. Noticeable pressure spikes were observed during the last four months of system operation; however, none of these spikes caused significant increase in  $\Delta p$  across the treatment train or adsorption vessels. As a result, no media backwash was performed during the first six months of system operation. Figures 4-13 shows total and differential pressures for each vessel and the system.

**4.4.2 Residual Management.** Because neither backwash nor media replacement was performed during the first six months of system operation, no residual was produced in this reporting period.

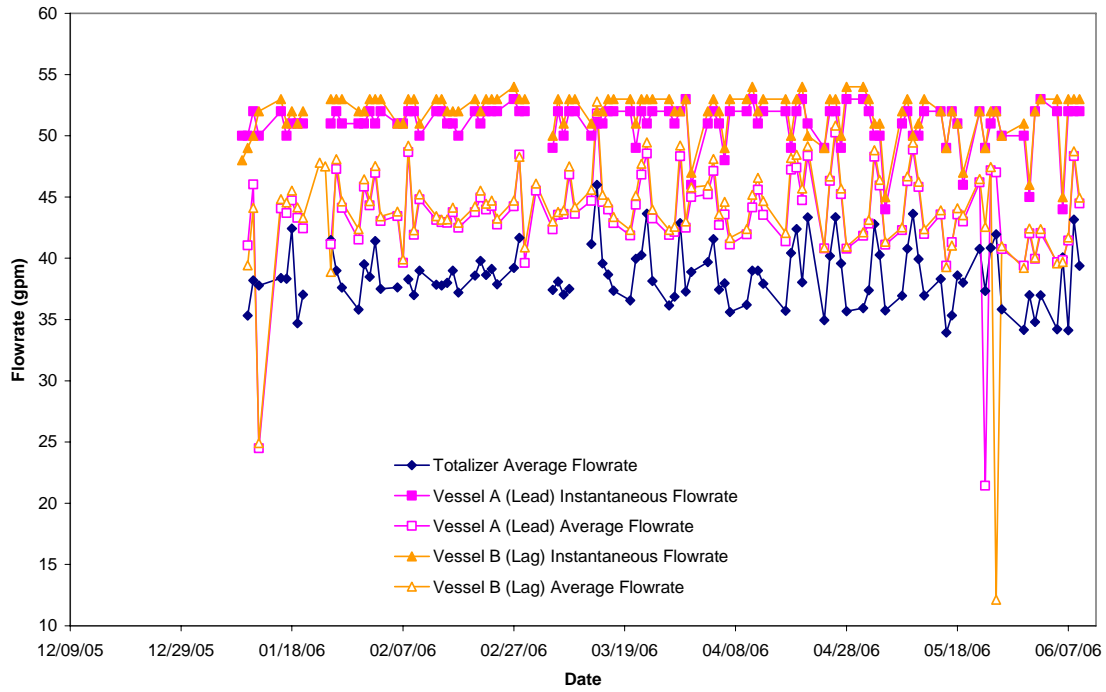

**Figure 4-12. System Instantaneous and Calculated Flowrates**

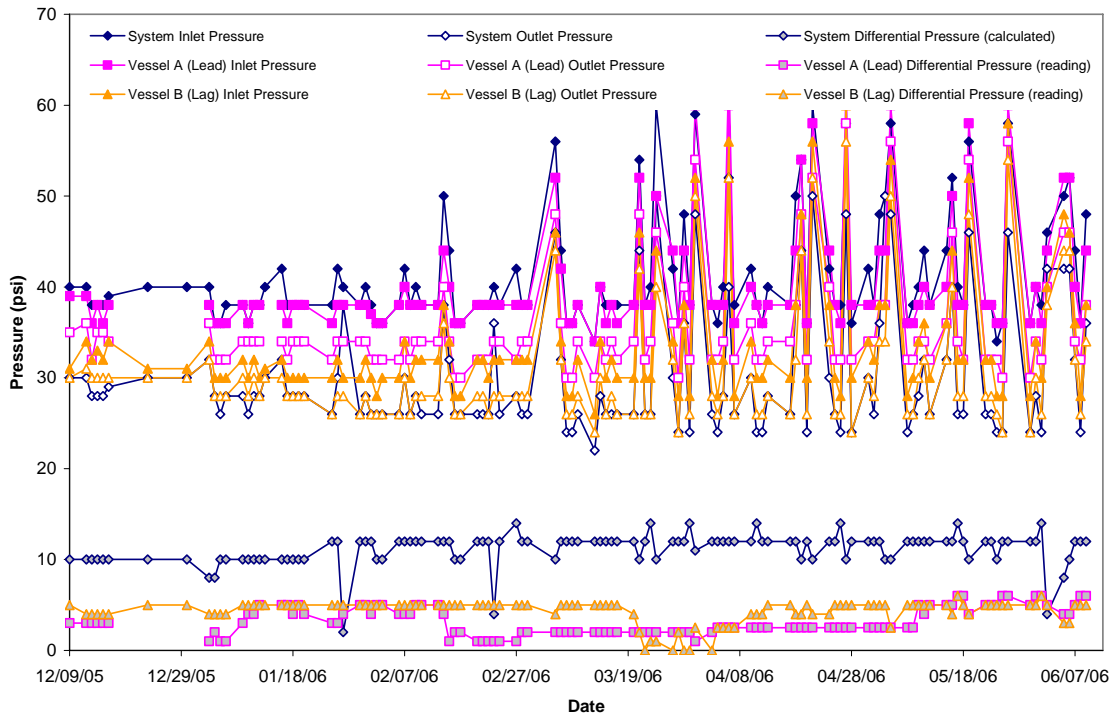

**Figure 4-13. System Operational Pressures**



**4.4.3 System/Operation Reliability and Simplicity.** Operational irregularities experienced during the first six months of the demonstration study were related to the pH adjustment system and the media vessel flow meters/totalizers.

As described in Section 4.2, pH adjustment using a CO<sub>2</sub> injection module is a process component. On January 11, 2006, leaks were detected in the CO<sub>2</sub> system, resulting in an additional change-out of a CO<sub>2</sub> gas cylinder during the sixth week of the system operations. The leaks were tracked to the supply line where loose fittings were discovered. During the week of March 13, 2006 (the 15th week of operation), the proportional flow control valve that regulates the CO<sub>2</sub> injection rate began operating improperly. The failure caused the pH levels to remain higher than desired. Based on in-line probe readings, the pH values averaged 7.8 during that week of operation. The pH control system was switched to operate in the manual mode until the control valve was replaced on April 24, 2006. On May 3, 2006, the digital screen on the JUMO pH/PID controller was not displaying the pH measurement. A replacement in-line pH probe was installed on May 30, 2006, which restored the digital display on the JUMO pH/PID controller. The CO<sub>2</sub> system failed to consistently adjust the pH to the target value of 7.0, with the pH values measured by the in-line pH probe varying between 6.5 and 8.2.

On two separate occasions, January 12, 2006, and May 23, 2006, both electromagnetic flow meters/totalizers malfunctioned, causing the meters to reset and begin totalizing from zero. The failure was thought to have been caused by a programming error. A flash memory card with the necessary programming updates was provided by the vendor; and on June 15, 2006, the operator integrated the upgrades to prevent future reoccurrences of the problems.

Due to the malfunction of the electromagnetic flow meters/totalizers, an effort was made to evaluate their accuracy by comparing cumulative totalizer readings from each electromagnetic flow meter/totalizer. The cumulative totalizer readings from the electromagnetic flow meters/totalizers on the lead and lag vessels were 2,086,700 and 2,070,000, respectively. Based on those cumulative measurements, a variation of less than 1% was measured through the first six-month operational period.

The system O&M and operator skill requirements are discussed below in relation to pre- and post-treatment requirements, levels of system automation, operator skill requirements, preventive maintenance activities, and frequency of chemical/media handling and inventory requirements.

***Pre- and Post-Treatment Requirements.*** Two forms of pre-treatment were required at the Webb CISD site, i.e., pH adjustment and prechlorination. CO<sub>2</sub> was used to lower the pH value of raw water from as high as 8.2 (Table 4-1) to a target value of 7.0 in order to maintain effective adsorption by the AD-33 media. The CO<sub>2</sub> injection point and in-line pH probe used to monitor and control the adjusted pH level, were installed upstream of the prechlorination injection point. O&M of the pH adjustment system required routine system pressure checks and regular changesout of the CO<sub>2</sub> supply bottles as pressure was depleted. The operator also recorded a daily pH reading from the in-line probe and performed calibration of the pH probe, as needed. The use of CO<sub>2</sub> for pH adjustment also required additional safety training and awareness for the operator, due to the added hazards.

For prechlorination, the existing chlorination system was upgraded and installed inside the maintenance building, which housed the APU-50LL-CS-S-2-AVH system. The upgraded chlorination system, as discussed in Section 4.2 and shown on Figure 4-8, utilized a 10% NaOCl solution to reach a target residual level of 1.2 mg/L (as Cl<sub>2</sub>). The upgraded chlorination system did not require maintenance or skills other than those required by the previous system. The operator monitored chlorine tank levels, consumption rates, and residual chlorine levels.

**System Automation.** The system was fitted with automated controls that would allow for the backwash cycle to be controlled automatically. The system is also equipped with an automated Carbon Dioxide Gas Flow Control System, which includes a liquid CO<sub>2</sub> supply assembly, an automatic pH control panel, a CO<sub>2</sub> membrane module and an in-line pH probe located downstream of the membrane module. Each media vessel is equipped with five electrically actuated butterfly valves which are controlled by a Square D Telemecanique PLC with a Magelis G2220 color touch interface screen. Although not automated, the system is also equipped with six isolation ball valves to allow for reversible lead lag configuration.

The automated portion of the system did not require regular O&M; however operator awareness and an ability to detect unusual system measurements were necessary when troubleshooting system automation failures. The equipment vendor provided hands-on training and a supplemental operations manual to the operator.

**Operator Skill Requirements.** The skill requirements to operate the system demand a higher level of awareness and attention than the previous system. The system offers increased operational flexibility, which, in turn, requires increased monitoring of system parameters. The operator's knowledge of the system limitations and typical operational parameters is key in achieving system performance objectives. The operator was on-site typically five times a week and spent approximately 20 min each day to perform visual inspections and record the system operating parameters on the daily log sheets. The basis for the operator skills began with on-site training and a thorough review of the system operations manual; however, increased knowledge and invaluable system troubleshooting skills are gained through hands on operational experience.

TCEQ requires that the operator of the treatment system hold at least a Class D TCEQ waterworks operator license. The TCEQ public water system operator certifications are classified by Class D through A. Licensing eligibility requirements are based on education, experience, and related training. The minimum requirements for a Class D license are high school graduate or GED and 20 hr of related training. Licensing requirements incrementally increase with each licensing level, with Class A being the highest requiring the most education, experience, and training.

**Preventive Maintenance Activities.** Preventive maintenance tasks included periodic checks of flowmeters and pressure gauges and inspection of system piping and valves. Checking the CO<sub>2</sub> cylinders and supply lines for leaks and adequate pressure and calibrating the in-line pH probe also were performed. Typically, the operator performed these duties while on-site for routine activities.

**Chemical/Media Handling and Inventory Requirements.** NaOCl was used for prechlorination; the operator ordered chemicals as done prior to the installation of the APU-50LL-CS-S-2-AVH system. CO<sub>2</sub> used for pH adjustment was ordered on an as needed basis. Typically, four 50-lb cylinders were used per month. As the CO<sub>2</sub> cylinders were delivered to the site by the CO<sub>2</sub> supplier, empty cylinders were returned for reuse.

## **4.5 System Performance**

The performance of the system was evaluated based on analyses of water samples collected from raw and treated water and distribution system.

**4.5.1 Treatment Plant Sampling.** Table 4-8 summarizes the analytical results of arsenic, iron, and manganese concentrations measured at the four sampling locations across the treatment train. Table 4-9 summarizes the results of other water quality parameters. Appendix B contains a complete set of analytical results through the first six months of operation. The results of the water samples collected throughout the treatment plant are discussed below.

**Table 4-8. Summary of Analytical Results for Arsenic, Iron, and Manganese**

Parameter	Sampling Location	Unit	Sample Count	Concentration			Standard Deviation
				Minimum	Maximum	Average	
As (total)	IN	µg/L	15	46.2	62.9	56.9	4.6
	AP	µg/L	15	50.2	64.4	58.6	4.3
	TA	µg/L	15	- (a)			
	TB	µg/L	15				
As (soluble)	IN	µg/L	7	51.5	56.5	53.4	1.7
	AP	µg/L	7	50.8	61.0	53.6	3.6
	TA	µg/L	7	- (a)			
	TB	µg/L	7				
As (particulate)	IN	µg/L	7	<0.1	8.6	4.9	3.7
	AP	µg/L	7	1.2	8.9	6.3	2.7
	TA	µg/L	7	- (a)			
	TB	µg/L	7				
As (III)	IN	µg/L	7	35.8	40.8	38.5	2.1
	AP	µg/L	7	0.5	3.3	1.7	1.1
	TA	µg/L	7	- (a)			
	TB	µg/L	7				
As (V)	IN	µg/L	7	13.2	17.3	14.9	1.4
	AP	µg/L	7	47.7	57.7	51.9	3.3
	TA	µg/L	7	- (a)			
	TB	µg/L	7				
Fe (total)	IN	µg/L	15	<25	28.8	<25	6.0
	AP	µg/L	15	<25	<25	<25	2.4
	TA	µg/L	15	<25	<25	<25	0.0
	TB	µg/L	15	<25	<25	<25	0.0
Fe (soluble)	IN	µg/L	7	<25	<25	<25	0.0
	AP	µg/L	7	<25	<25	<25	0.0
	TA	µg/L	7	<25	<25	<25	0.0
	TB	µg/L	7	<25	<25	<25	0.0
Mn (total)	IN	µg/L	15	2.6	5.4	3.9	0.8
	AP	µg/L	15	2.9	4.6	3.5	0.6
	TA	µg/L	15	<0.1	1.8	0.3	0.5
	TB	µg/L	15	<0.1	5.0	0.5	1.3
Mn (soluble)	IN	µg/L	7	2.6	4.2	3.6	0.5
	AP	µg/L	7	3.0	3.5	3.2	0.2
	TA	µg/L	7	<0.1	1.6	0.3	0.6
	TB	µg/L	7	<0.1	5.1	0.8	1.9

One-half of detection limit used for samples with concentrations less than detection limit for calculations.

(a) Statistics not provided; see Figure 4-15 for arsenic breakthrough curves.

**Table 4-9. Summary of Water Quality Parameter Sampling Results**

Parameter	Sampling Location	Unit	Sample Count	Concentration			Standard Deviation
				Minimum	Maximum	Average	
Alkalinity (as CaCO <sub>3</sub> )	IN	mg/L	15	305	334	320	9
	AP	mg/L	15	306	344	322	10
	TA	mg/L	15	294	342	321	12
	TB	mg/L	15	312	352	325	12
Fluoride	IN	mg/L	7	0.5	0.9	0.6	0.2
	AP	mg/L	7	0.6	1.2	0.8	0.2
	TA	mg/L	7	0.5	1.5	0.8	0.3
	TB	mg/L	7	0.4	1.0	0.7	0.2
Sulfate	IN	mg/L	7	104	111	106	2.4
	AP	mg/L	7	104	112	107	3.6
	TA	mg/L	7	98	114	108	5.9
	TB	mg/L	7	100	136	111	11.9
Nitrate (as N)	IN	mg/L	7	<0.05	<0.05	<0.05	0.00
	AP	mg/L	7	<0.05	<0.05	<0.05	0.00
	TA	mg/L	7	<0.05	<0.05	<0.05	0.00
	TB	mg/L	7	<0.05	<0.05	<0.05	0.00
Phosphorus (as PO <sub>4</sub> )	IN	mg/L	14	<0.01	0.03	0.01	0.01
	AP	mg/L	14	<0.01	0.06	0.01	0.01
	TA	mg/L	14	<0.01	<0.03	0.01	0.01
	TB	mg/L	14	<0.01	<0.03	0.01	0.01
Silica (as SiO <sub>2</sub> )	IN	mg/L	15	40.6	43.9	41.9	1.1
	AP	mg/L	15	40.2	43.5	41.9	1.0
	TA	mg/L	15	13.5	44.4	38.4	8.3
	TB	mg/L	15	1.7	45.3	35.4	13.1
Turbidity	IN	NTU	15	<0.1	1.1	0.5	0.3
	AP	NTU	15	<0.1	1.5	0.4	0.4
	TA	NTU	15	<0.1	1.1	0.4	0.3
	TB	NTU	15	<0.1	2.0	0.5	0.5
pH	IN	S.U.	12	8.0	8.3	8.2	0.1
	AP	S.U.	12	7.1	8.1	7.4	0.3
	TA	S.U.	12	7.1	7.6	7.3	0.1
	TB	S.U.	12	7.1	7.5	7.3	0.1
Temperature	IN	°C	12	21.3	27.1	25.6	1.7
	AP	°C	12	21.2	27.2	25.7	1.9
	TA	°C	12	21.4	27.5	25.6	1.9
	TB	°C	12	21.4	27.4	25.4	2.0
Dissolved Oxygen	IN	mg/L	12	1.1	3.1	1.7	0.6
	AP	mg/L	12	1.4	4.1	2.0	0.7
	TA	mg/L	12	0.9	3.4	1.8	0.6
	TB	mg/L	12	1.3	3.5	2.0	0.6

**Table 4-9. Summary of Water Quality Parameter Sampling Results (Continued)**

Parameter	Sampling Location	Unit	Sample Count	Concentration			Standard Deviation
				Minimum	Maximum	Average	
ORP	IN	mV	12	234	378	280	44.1
	AP	mV	12	309	679	535	89.0
	TA	mV	12	387	690	594	85.1
	TB	mV	12	371	700	608	104
Free Chlorine (as Cl <sub>2</sub> )	AP	mg/L	12	0.5	2.0	1.0	0.5
	TA	mg/L	-	-	-	-	-
	TB	mg/L	10	0.6	1.7	1.1	0.4
Total Chlorine (as Cl <sub>2</sub> )	AP	mg/L	11	0.7	2.1	1.3	0.4
	TA	mg/L	-	-	-	-	-
	TB	mg/L	10	0.7	2.1	1.2	0.5
Total Hardness (as CaCO <sub>3</sub> )	IN	mg/L	7	17.1	30.1	22.8	4.9
	AP	mg/L	7	19.1	30.0	23.0	4.7
	TA	mg/L	7	11.6	33.0	24.3	6.9
	TB	mg/L	7	15.8	47.2	26.3	10.7
Ca Hardness (as CaCO <sub>3</sub> )	IN	mg/L	7	11.3	22.7	15.5	4.4
	AP	mg/L	7	11.9	22.8	15.9	4.2
	TA	mg/L	7	7.6	25.1	16.7	5.7
	TB	mg/L	7	9.9	29.4	17.9	6.8
Mg Hardness (as CaCO <sub>3</sub> )	IN	mg/L	7	5.8	9.0	7.3	1.0
	AP	mg/L	7	5.3	9.1	7.1	1.2
	TA	mg/L	7	4.0	10.7	7.7	2.0
	TB	mg/L	7	3.3	17.9	8.4	4.5

One-half of detection limit used for samples with concentrations less than detection limit for calculations.

**Arsenic.** Water samples were collected on 15 occasions (including one duplicate sampling event), with field speciation performed during seven of the 15 occasions from IN, AP, TA, and TB sampling locations. Figure 4-14 contains four bar charts showing the concentrations of particulate arsenic, As(III), and As(V) at four locations for each of the seven speciation events.

Total arsenic concentrations in raw water ranged from 46.2 to 62.9 µg/L and averaged 56.9 µg/L. As(III) was the predominating species, ranging from 35.8 to 40.8 µg/L and averaging 38.5 µg/L. As(V) also was present in source water, ranging from 13.2 to 17.3 µg/L and averaged 14.9 µg/L. Particulate As concentrations were lower, ranging from <0.1 to 8.6 µg/L and averaging 4.9 µg/L. The arsenic concentrations measured were consistent with those collected previously during source water sampling (Table 4-1).

Chlorination effectively oxidized As(III) to As(V) prior to the adsorption vessels. After chlorination the average As(III) and As(V) concentrations were 1.7 and 51.9 µg/L, respectively. Free and total chlorine were monitored at the AP and TB sampling locations to ensure that the target chlorine residual levels were properly maintained for disinfection purposes. Free chlorine levels at the AP location ranged from 0.5 to 2.0 mg/L (as Cl<sub>2</sub>) and averaged 1.0 mg/L (as Cl<sub>2</sub>); total chlorine levels ranged from 0.7 to 2.1 mg/L (as Cl<sub>2</sub>) and averaged 1.3 mg/L (as Cl<sub>2</sub>) (Table 4-9). The residual chlorine levels measured at the TB

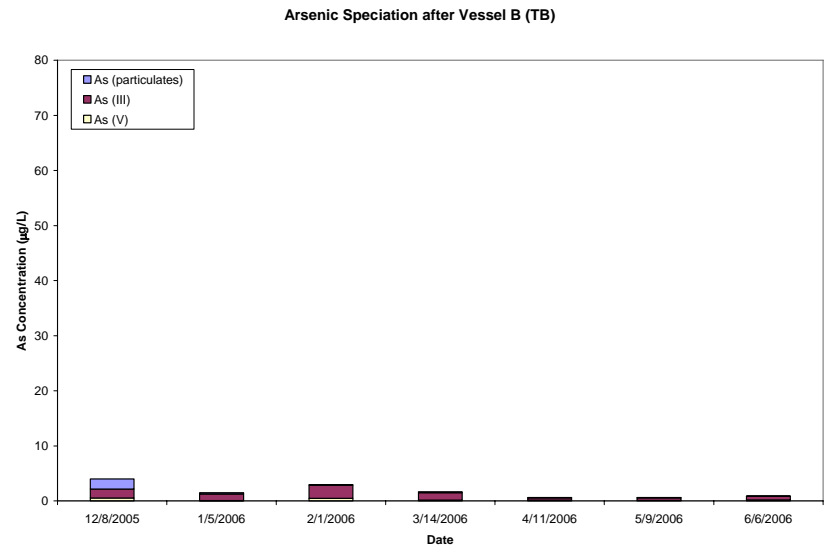
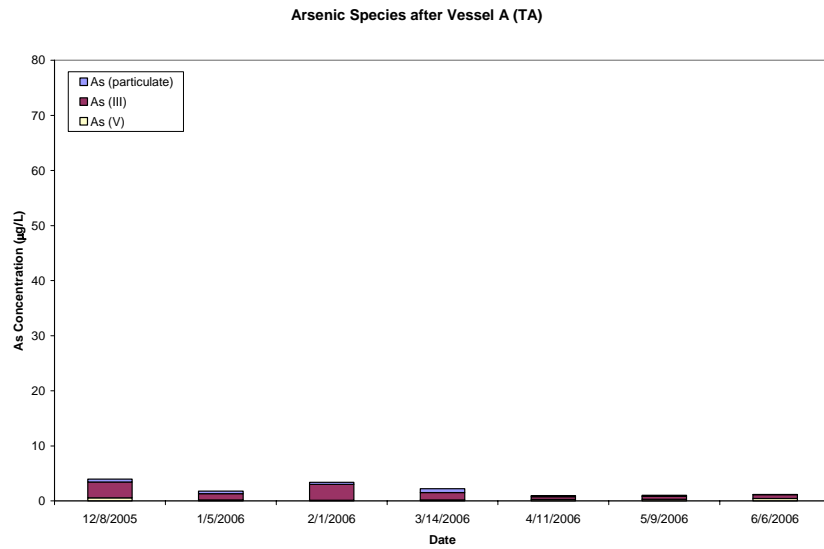
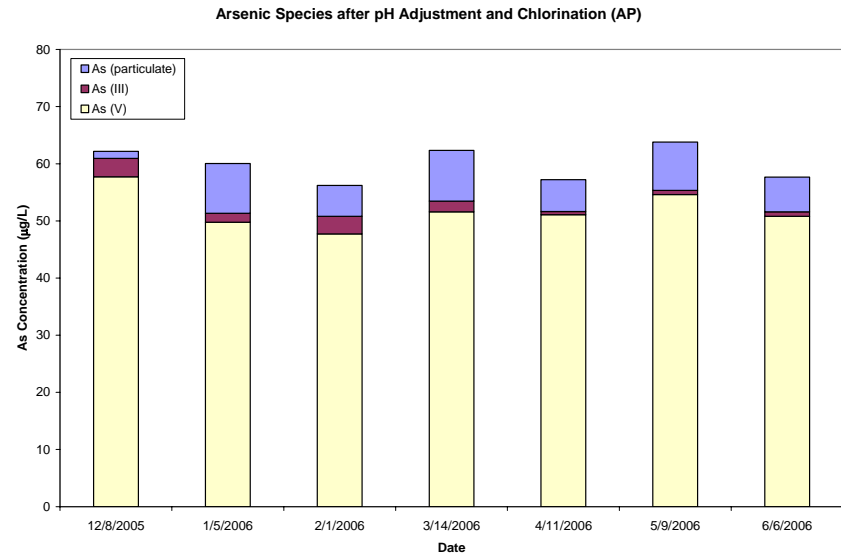
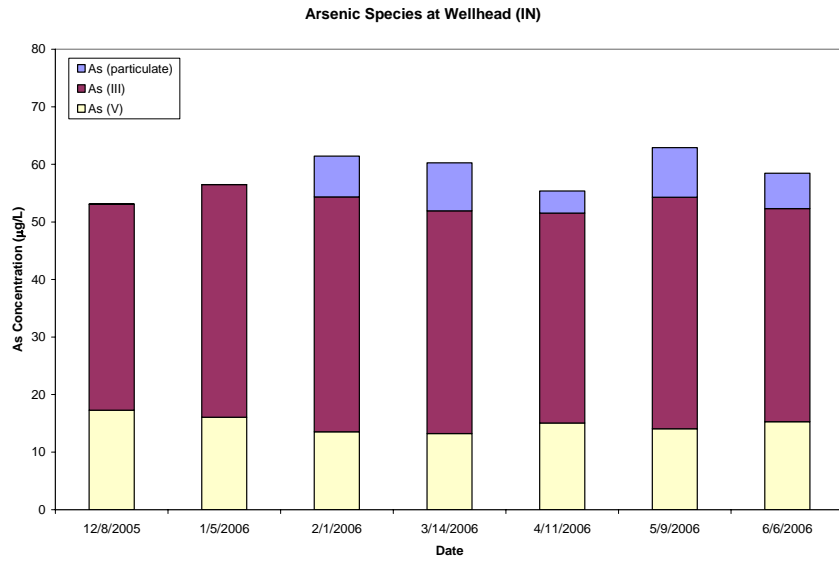
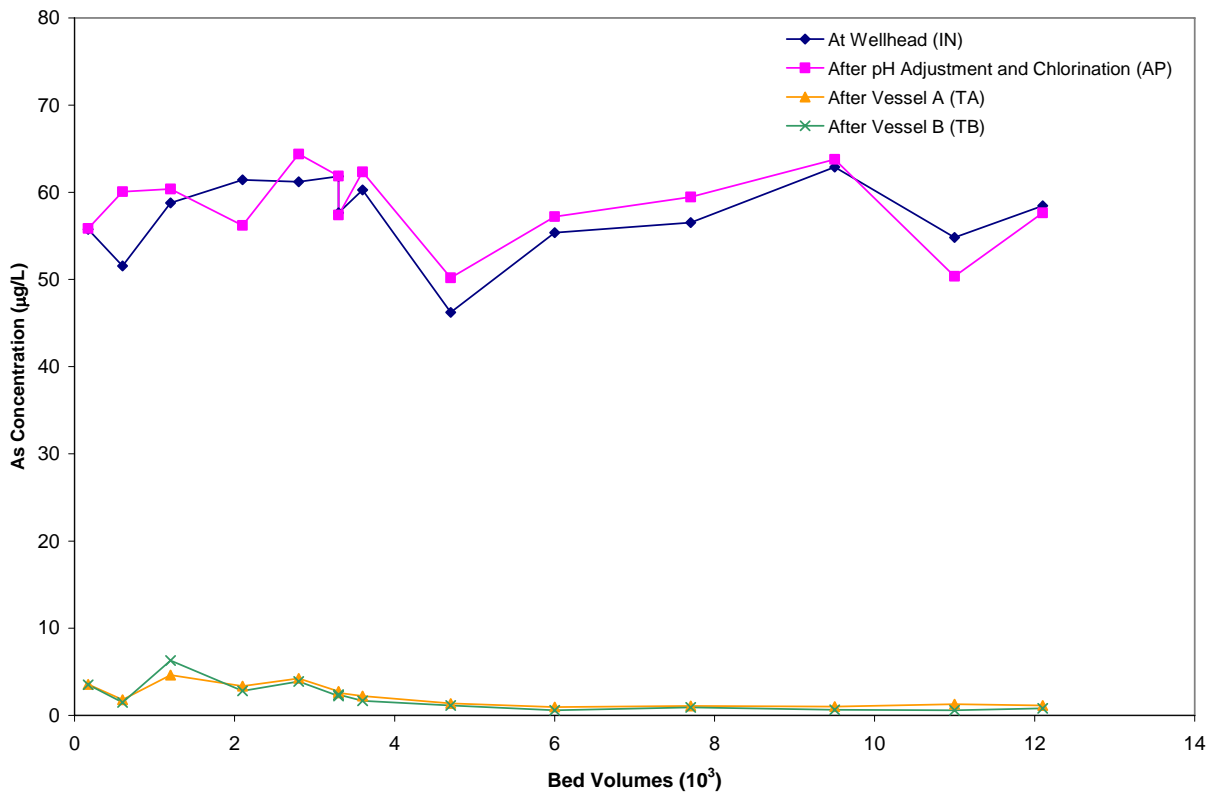

**Figure 4-14. Concentrations of Various Arsenic Species at IN, AP, TA, and TB Sampling Locations**

location were similar to those measured at the AP location, indicating little or no chlorine consumption through the AD-33 vessels.

The total arsenic breakthrough curves shown in Figure 4-15 indicate that the lead vessel removed the majority of arsenic, existing predominately as As(V), following chlorination. Through the end of the first six months of system operation, the system has treated approximately 2,070,000 gal of water, equivalent to 12,600 BV based on the 22 ft<sup>3</sup> of media in one adsorption vessel or 6,300 BV based on the 44 ft<sup>3</sup> of media in both vessels. Arsenic breakthrough, based on laboratory analysis of samples collected on June 6, 2006 (approximately 12,100 BV) was 1.1 and 0.8 µg/L for the lead and lag vessels, respectively. The 12,600 BV of throughput represents approximately 27% of the media capacity estimated to be 46,900 BV by the vendor (Table 4-4).

The average total arsenic breakthrough was significantly higher in both the lead and lag vessels during the first three months of system operation. For the eight samples collected from December 8, 2005, through February 28, 2006, the average total arsenic concentrations following the lead and lag vessels were 3.4 and 3.3 µg/L, respectively. In contrast, for the seven samples collected from March 14, 2006 through June 6, 2006, the average total arsenic concentrations following the lead and lag vessels were 1.3 and 0.9 µg/L, respectively. Further, laboratory results from two of the first four sampling events (December 8, 2005 and January 17, 2006) showed higher total arsenic concentrations following the lag vessel than following the lead vessel. System operations are ongoing and the media in the lead vessel will be recharged once it is completely exhausted or the breakthrough of the lag vessel approaches 10 µg/L, whichever comes first.



**Figure 4-15. Total Arsenic Breakthrough Curves**  
(Based on 22 ft<sup>3</sup> of Media in Each Vessel)

**Competing Anions.** Phosphate and silica, which can influence arsenic adsorption, were measured at the four sampling locations across the treatment train throughout the first six months of the demonstration study. Phosphorus concentrations were low ranging from <0.01 to 0.06 mg/L (as PO<sub>4</sub>). Silica concentrations ranged from 1.7 to 45.3 mg/L. Significant silica concentration reductions (96%, 85%, and 24%, respectively) were noted in samples collected during the first three weeks of operation. Following the third week of operation the maximum silica concentration reduction was less than 10%. Figure 4-16 represents the silica breakthrough curves from the treatment train.

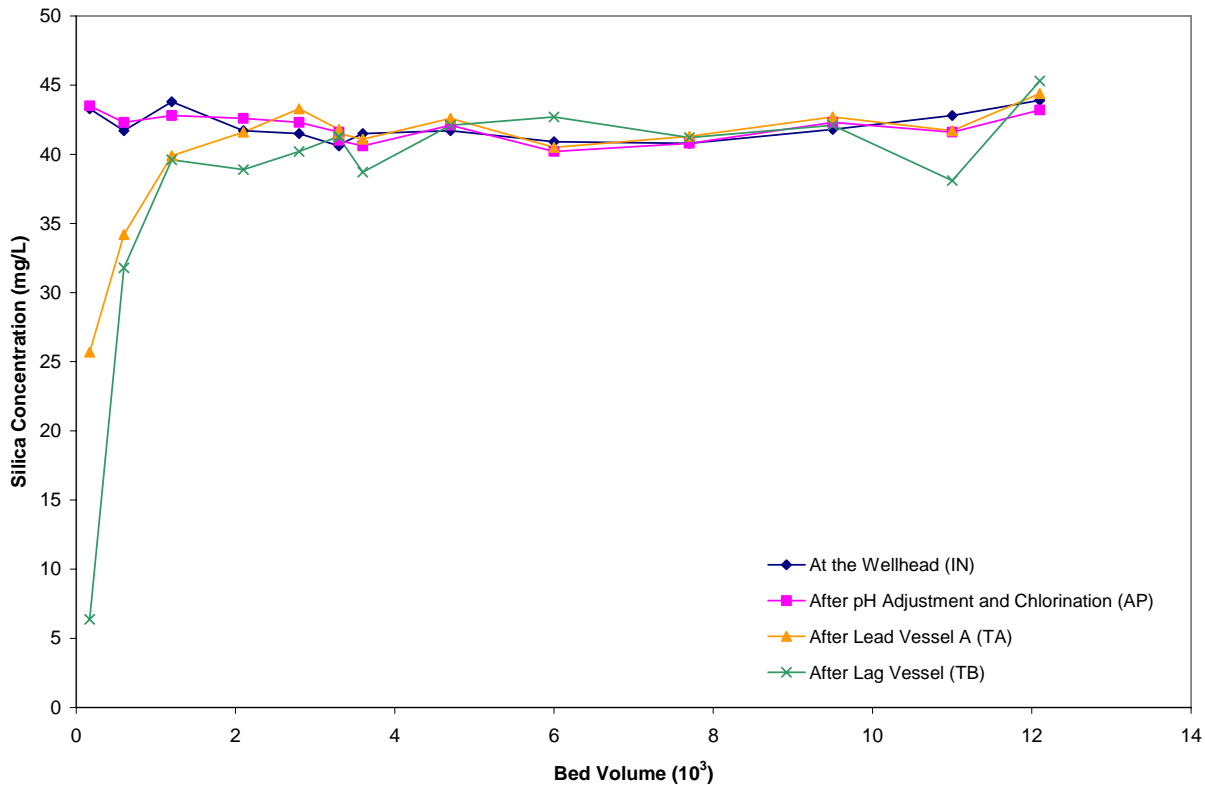

**Figure 4-16. Silica (as SiO<sub>2</sub>) Breakthrough Curves**  
(Based on 22 ft<sup>3</sup> of Media in Each Vessel)

**Iron and Manganese.** Total iron concentrations in raw water were below its detection limit of 25 µg/L (Table 4-8). Total iron concentrations across the treatment train also were below the detection limit, except for two occasions. One total iron concentration was detected on January 17, 2006, at 28.8 µg/L and the second on May 23, 2006, at 28.4 µg/L, both at the IN location. Total manganese levels ranged from 2.6 to 5.4 µg/L and averaged 3.9 µg/L in raw water. Total manganese concentrations in the effluent from the adsorption vessels showed a slight increasing trend, with ≤1.8 µg/L measured after the lead vessel and ≤5.0 µg/L after the lag vessel. Soluble manganese concentrations were similar for the four sample locations averaging 3.6 µg/L, 3.2 µg/L, 0.3 µg/L and 0.8 µg/L for IN, AP, TA, and TB, respectively.

**Other Water Quality Parameters.** As shown in Table 4-9, pH values of raw water measured at the IN sample location varied from 8.0 to 8.3 and averaged 8.2. The pH values, following CO<sub>2</sub> injection for pH adjustment, at the AP location, varied from 7.1 to 8.1 and averaging 7.4. The average adjusted pH value



of 7.0, at the AP location prior to the adsorption media, is desirable for adsorptive media which, in general, have a greater arsenic removal capacity when treating water at near neutral pH values. Figure 4-17 presents the pH values measured throughout the treatment train.

On two separate occasions on January 5 and 17, 2006, the pH values were not reduced following CO<sub>2</sub> injection, as indicated by the second and third sets of IN (denoted by “◆”) and AP data points (denoted by “■”) shown in Figure 4-17. The pH values measured, with a portable VWR meter, at the IN sampling location were 8.1 and 8.0, respectively and the pH values measured at the AP location also were 8.1 and 8.0, respectively. In contrast, the pH values (denoted by “\*”) measured at the AP location by the in-line probe were approximately 1.0 unit less than those measured at the same location by the VWR meter. pH measurements prior to and following these two isolated events suggest that pH values measured by the VWR meter at the AP location on January 5 and 17, 2006, most likely were the result of instrument or measurement errors.

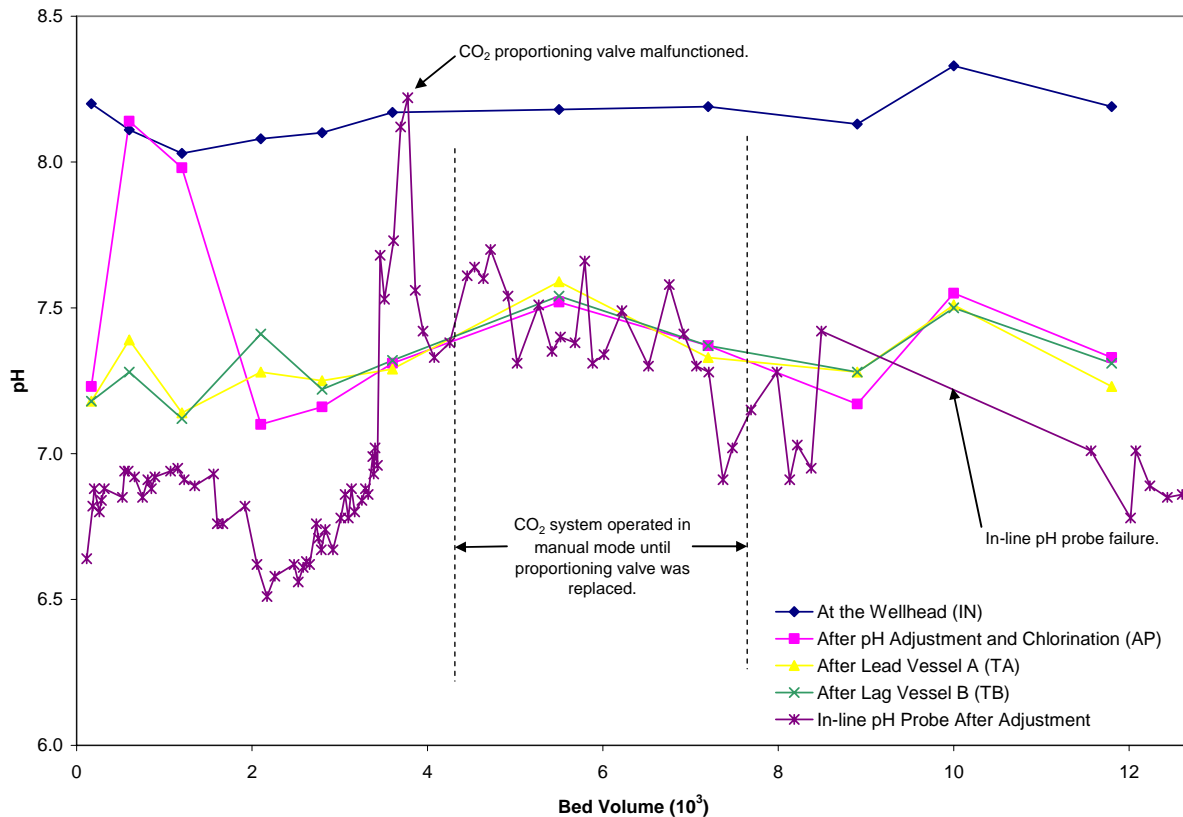

**Figure 4-17. pH Values Measured throughout Treatment Train**  
(Based on 22 ft<sup>3</sup> of Media in Each Vessel)

Throughout the first six month operational period, pH values reported by the VWR meter were approximately 0.4 pH units (on average) higher than those reported by the in-line pH probe; however a common trend is obvious, as illustrated in Figure 4-17. A possible explanation for the variations might be degassing of dissolved CO<sub>2</sub> when the water samples were collected from the AP location, thus resulting in elevated readings measured by the portable VWR meter.

Alkalinity, reported as CaCO<sub>3</sub>, ranged from 294 to 352 mg/L. The results indicated that the adsorptive media did not affect the amount of alkalinity in the water after treatment. The treatment plant samples were analyzed for hardness only on speciation weeks. Total hardness ranged from 11.6 to 47.2 mg/L (as CaCO<sub>3</sub>), and also remained constant throughout the treatment train. Sulfate concentrations ranged from 98 to 136 mg/L, and remained constant throughout the treatment train. Fluoride results ranged from 0.4 to 1.5 mg/L in all samples. The results indicated that the adsorptive media did not affect the amount of fluoride in the water after treatment. DO levels ranged from 0.9 to 4.1 mg/L and averaged 1.9 mg/L. ORP readings averaged 280 mV in raw water, but increased to an average of 579 mV after chlorination.

**4.5.2 Backwash Water Sampling.** Backwash was not performed during the first six-month operational period; however, a backwash is anticipated to occur during the second six-month operation period.

**4.5.3 Distribution System Water Sampling.** Prior to the installation/operation of the treatment system, baseline distribution system water samples were collected from the middle school, high school, and cafeteria on June 15, July 21, August 24, and September 19, 2005. Following the installation of the treatment system, distribution system water sampling continued on a monthly basis at the same three locations, with samples collected on January 5, February 1, March 14, April 11, May 9, and June 6, 2006. The results of the distribution system sampling are summarized on Table 4-10.

The most noticeable change in the distribution system samples since the system began operation was a decrease in arsenic concentration. Baseline arsenic concentrations ranged from 49.6 to 99.9 µg/L and averaged 68.7 µg/L for all three locations. After the performance evaluation began, arsenic concentrations were reduced to ≤5.0 µg/L (or 2.4 µg/L on average), which were similar to the arsenic concentrations in the system effluent.

Lead concentrations ranged from 0.3 to 2.3 µg/L, with none of the samples exceeding the action level of 15 µg/L. Copper concentrations ranged from 6.5 to 565 µg/L, with no samples exceeding the 1,300 µg/L action level. Measured pH values ranged from 7.6 to 8.1 and averaged 7.8, which were ½ of a pH unit higher than the average pH value immediately after the adsorption vessels. Compared to an average value of 8.2 before the treatment system became operational, the lowered pH values did not appear to have affected the Pb or Cu concentrations in the distribution system.

Alkalinity levels ranged from 305 to 348 mg/L (as CaCO<sub>3</sub>). Iron was not detected in any of the samples; manganese concentrations ranged from <0.1 to 2.4 µg/L. The arsenic treatment system did not seem to affect these water quality parameters in the distribution system.

## **4.6 System Cost**

System cost is evaluated based on the capital cost per gpm (or gpd) of the design capacity and the O&M cost per 1,000 gal of water treated. The capital cost includes the cost for equipment, site engineering, and installation. The O&M cost includes the cost for media replacement and disposal, electrical power use, and labor.

**4.6.1 Capital Cost.** The capital investment for equipment, site engineering, and installation of the Bruni treatment system was \$138,642 (see Table 4-11). The equipment cost was \$94,662 (or 68% of the total capital investment), which included \$77,082 for the skid-mounted APU-50LL-CS-S-2-AVH unit, \$13,200 for the AD-33 media (\$300/ft<sup>3</sup> or \$8.57/lb to fill two vessels), \$2,580 for shipping, and \$1,800 for labor.

**Table 4-10. Distribution System Sampling Results**

Sampling Events	Location	Middle School									High School							Cafeteria							
	Sampling Date	Stagnation Time (hr)	pH	Alkalinity	As	Fe	Mn	Pb	Cu	Stagnation Time (hr)	pH	Alkalinity	As	Fe	Mn	Pb	Cu	Stagnation Time (hr)	pH	Alkalinity	As	Fe	Mn	Pb	Cu
BL1	06/15/05	14.5	8.3	334	52.0	<25	1.9	1.9	114	14.8	8.3	330	53.0	<25	1.2	2.3	115	15.0	8.3	330	77.7	<25	5.9	11.5	381
BL2	07/21/05	15.0	8.1	330	54.4	70.9	13.5	1.2	7.3	15.3	8.2	330	79.2	32.8	6.0	2.0	44.8	15.5	8.1	330	53.3	<25	6.8	2.9	106
BL3	08/24/05	15.6	8.2	317	83.1	<25	2.2	0.3	23.9	15.7	8.2	321	85.8	<25	1.2	0.9	72.5	15.8	8.2	321	84.7	<25	2.1	0.3	23.2
BL4	09/19/05	13.0	8.1	330	49.6	<25	3.3	1.9	40.1	13.3	8.1	330	51.4	<25	1.5	1.5	77.3	13.5	8.1	326	99.9	<25	2.4	1.9	44.4
1	01/05/06	14.8	7.7	343	2.1	<25	<0.1	0.8	209	14.5	7.7	348	3.5	<25	2.4	2.3	308	15.0	7.6	334	1.4	<25	<0.1	0.5	15.4
2	02/01/06	15.0	7.9	312	3.4	<25	0.4	0.3	119	15.2	8.1	312	4.4	<25	0.2	0.8	214	15.0	8.1	312	3.8	<25	0.6	0.6	250
3	03/14/06	15.0	7.6	310	1.4	<25	0.8	0.9	278	15.2	7.8	314	2.0	<25	0.8	1.8	259	15.3	7.8	318	1.3	<25	0.9	0.9	19.7
4	04/11/06	15.3	7.9	323	3.1	<25	0.3	1.0	113	15.0	7.9	311	5.0	<25	0.6	1.6	337	15.2	7.9	315	3.6	<25	0.3	0.8	16.0
5	05/09/06	10.8	7.6	326	1.3	<25	0.3	0.4	86.3	14.8	7.7	331	2.0	<25	0.7	0.7	164	14.7	7.7	322	1.2	<25	0.1	0.4	6.5
6	06/06/06	14.7	7.8	305	1.0	<25	0.1	1.0	234	14.8	7.7	309	2.0	<25	1.9	0.7	565	14.6	8.0	322	0.7	<25	0.2	0.6	14.9

Lead action level = 15 µg/L; copper action level = 1.3 mg/L  
 µg/L as unit for all analytes except for pH (S.U.) and alkalinity (mg/L [as CaCO3]).  
 BL = Baseline Sampling; NA = Not Available

**Table 4-11. Capital Investment Cost for APU-50LL-CS-S-2-AVH System**

Description	Quantity	Cost	% of Capital Investment
<i>Equipment Cost</i>			
APU Skid-Mounted System (Unit)	1	\$77,082	–
AD-33 Media (ft <sup>3</sup> )	44	\$13,200	–
Shipping	–	\$2,580	–
Vendor Labor	–	\$1,800	–
<b>Equipment Total</b>	–	<b>\$94,662</b>	<b>68</b>
<i>Engineering Cost</i>			
Vendor Labor/Travel	–	\$11,800	–
Subcontractor Labor/Travel	–	\$12,500	–
<b>Engineering Total</b>	–	<b>\$24,300</b>	<b>18</b>
<i>Installation Cost</i>			
Subcontractor Labor	–	\$12,574	–
Vendor Labor	–	\$4,860	–
Vendor/ Subcontractor Travel	–	\$2,246	–
<b>Installation Total</b>	–	<b>\$19,680</b>	<b>14</b>
<b>Total Capital Investment</b>	–	<b>\$138,642</b>	<b>100</b>

The engineering cost included the cost for preparing three submittal packages for the exception request, permit application, and supplemental information for the permit (see Section 4.3.1). The engineering cost was \$24,300, or 18% of the total capital investment.

The installation cost included the equipment and labor to unload and install the skid-mounted unit, perform piping tie-ins and electrical work, load, and backwash the media, perform system shakedown and startup, and conduct operator training. The installation cost was \$19,680, or 14% of the total capital investment.

The total capital cost of \$138,642 was normalized to the system’s rated capacity of 40 gpm (57,600 gpd), which resulted in \$3,466/gpm of design capacity (\$2.41/gpd). The capital cost also was converted to an annualized cost of \$13,086/yr using a capital recovery factor (CRF) of 0.09439 based on a 7% interest rate and a 20-year return period. Assuming that the system operated 24 hours a day, 7 days a week at the system design flowrate of 40 gpm to produce 21,024,000 gal of water per year, the unit capital cost would be \$0.62/1,000 gal. Because the system operated an average of 4.3 hr/day at 44 gpm (see Table 4-7), producing 2,070,000 gal of water during the six-month period, the unit capital cost increased to \$3.16/1,000 gal at this reduced rate of use.

**4.6.2 Operation and Maintenance Cost.** The O&M cost included the cost for such items as media replacement and disposal, CO<sub>2</sub> usage, electricity consumption, and labor (Table 4-12). Although media replacement did not occur during the first six months of system operation, the media replacement cost would represent the majority of the O&M cost and was estimated to be \$11,190 to change out the lead vessel. This media change-out cost would include the cost for media, underbedding, freight, labor, travel, spent media analysis, and media disposal fee. This cost was used to estimate the media replacement cost per 1,000 gal of water treated as a function of the projected lead vessel media run length at the 10 µg/L arsenic breakthrough from the lag vessel (Figure 4-18).

The chemical cost associated with the operation of the treatment system included the cost for NaClO for prechlorination and CO<sub>2</sub> gas for pH adjustment. NaClO was already being used at the site prior to the

installation of the APU unit for disinfection purposes prior to distribution. The presence of the APU system did not affect the use rate of the sodium hypochlorite solution. Therefore, the incremental chemical cost for chlorine was negligible. The 50-lb CO<sub>2</sub> cylinder was replaced weekly during the first six months of system operation. Each change-out costs \$31.52 and includes the replacement and delivery charges. The CO<sub>2</sub> costs for the first six months of operation were calculated to be \$828 or \$0.40/1,000 gallons of water treated.

Comparison of electrical bills supplied by the utility prior to system installation and since startup did not indicate a noticeable increase in power consumption. Therefore, electrical cost associated with operation of the system was assumed to be negligible.

Under normal operating conditions, routine labor activities to operate and maintain the system consumed 20 min per day, 5 days per week, as noted in Section 4.4.3. Therefore, the estimated labor cost was \$0.41/1,000 gal of water treated.

**Table 4-12. Operation and Maintenance Cost for APU-50LL-CS-S-2-AVH System**

<b>Cost Category</b>	<b>Value</b>	<b>Assumptions</b>
Volume Processed (gal)	2,070,000	Through June 9, 2006
<b><i>Media Replacement and Disposal Cost</i></b>		
Media Replacement (\$)	\$6,600	\$300/ft <sup>3</sup> for 22 ft <sup>3</sup> (one media vessel)
Underbedding and Freight for Media and Gravel Shipping (\$)	\$330	
Travel and per diem (\$)	\$1,000	
Vendor and Subcontractor Labor (\$)	\$2,160	
Media Disposal (\$)	\$1,100	Including spent media analysis
Subtotal	\$11,190	
Media Replacement and Disposal (\$/1,000 gal)	See Figure 4-18	Based upon lead vessel media run length at 10-μg/L arsenic breakthrough from lag vessel
<b><i>CO<sub>2</sub> Usage</i></b>		
CO <sub>2</sub> Gas (\$/1,000 gal)	\$0.40	Based on consumption of CO <sub>2</sub> for pH adjustment (50-lb bottles)
<b><i>Electricity Cost</i></b>		
Electricity (\$/1,000 gal)	\$0.001	Electrical costs assumed negligible
<b><i>Labor Cost</i></b>		
Average Weekly Labor (min)	100	20 min/day
Labor (\$/1,000 gal)	\$0.41	Labor rate = \$19.50/hr
<b>Total O&amp;M Cost/1,000 gal</b>	See Figure 4-18	Based upon lead vessel media run length at 10-μg/L arsenic breakthrough from lag vessel

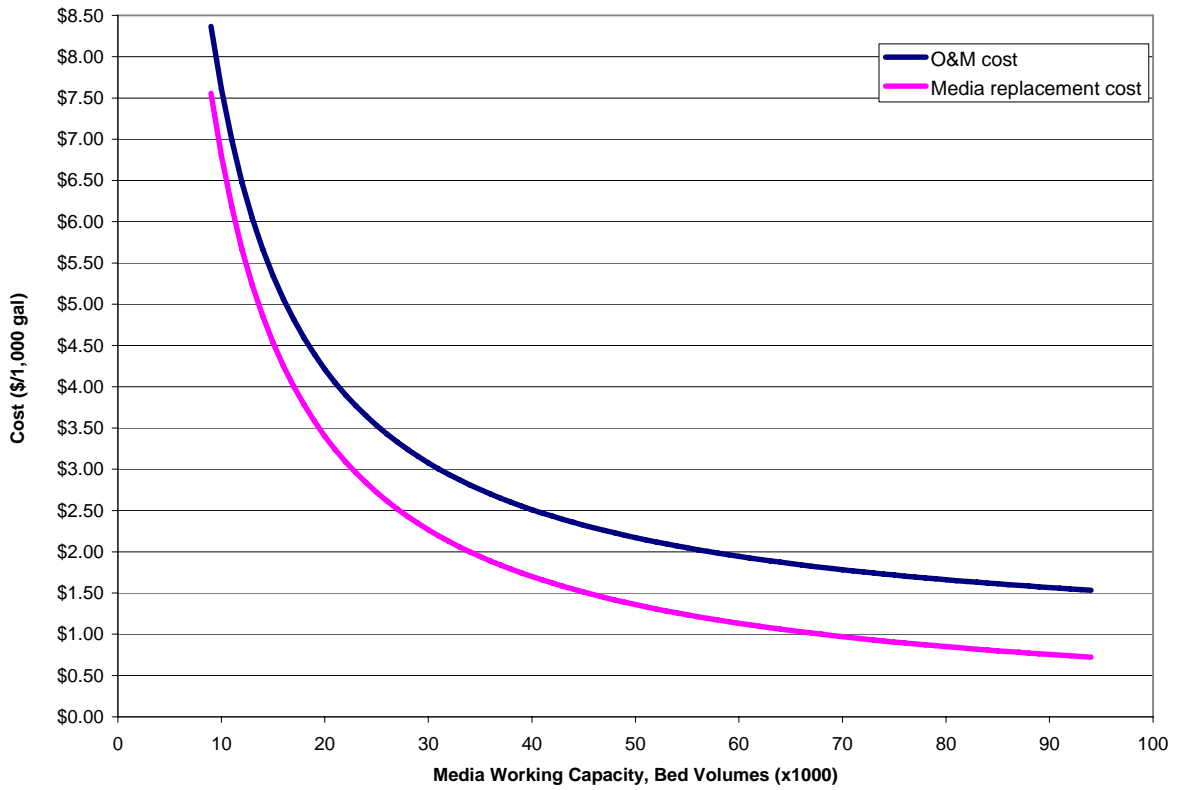

Note: One bed volume equals 22 ft<sup>3</sup> (165 gal)

**Figure 4-18. Media Replacement and Operation and Maintenance Cost**

## 5.0 REFERENCES

- Battelle. 2004. *Revised Quality Assurance Project Plan for Evaluation of Arsenic Removal Technology*. Prepared under Contract No. 68-C-00-185, Task Order No. 0029, for U.S. Environmental Protection Agency, National Risk Management Research Laboratory, Cincinnati, OH.
- Battelle. 2005. *Final System Performance Evaluation Study Plan: U.S. EPA Demonstration of Arsenic Removal Technology at the Webb Consolidated Independent School District in Bruni, Texas*. Prepared under Contract No. 68-C-00-185, Task Order No. 0029 for U.S. Environmental Protection Agency, National Risk Management Research Laboratory, Cincinnati, OH.
- Chen, A.S.C., L. Wang, J. Oxenham, and W. Condit. 2004. *Capital Costs of Arsenic Removal Technologies: U.S. EPA Arsenic Removal Technology Demonstration Program Round 1*. EPA/600/R-04/201. U.S. Environmental Protection Agency, National Risk Management Research Laboratory, Cincinnati, OH.
- Edwards, M., S. Patel, L. McNeill, H. Chen, M. Frey, A.D. Eaton, R.C. Antweiler, and H.E. Taylor. 1998. "Considerations in As Analysis and Speciation." *J. AWWA*, 90(3):103-113.
- EPA. 2001. National Primary Drinking Water Regulations: Arsenic and Clarifications to Compliance and New Source Contaminants Monitoring. *Fed. Register*, 40 CFR Parts 9, 141, and 142.
- EPA. 2002. *Lead and Copper Monitoring and Reporting Guidance for Public Water Systems*. EPA/816/R-02/009. U.S. Environmental Protection Agency, Office of Water, Washington, DC.
- EPA. 2003. Minor Clarification of the National Primary Drinking Water Regulation for Arsenic. *Federal Register*, 40 CFR Part 141.
- Wang, L., W. Condit, and A. Chen. 2004. *Technology Selection and System Design: U.S. EPA Arsenic Removal Technology Demonstration Program Round 1*. EPA/600/R-05/001. U.S. Environmental Protection Agency, National Risk Management Research Laboratory, Cincinnati, OH.

**APPENDIX A**

**OPERATIONAL DATA**



Table A-1. EPA Arsenic Demonstration Project at Bruni, TX - Daily System Operation Log Sheet

Week No.	Day of Week	Date	Well Operational Hours hr	Vessel A					Vessel B					System						
				Flowrate	Cumulative Totalizer	Usage	Average Flowrate	Pressure Differential	Flowrate	Cumulative Totalizer	Usage	Average Flowrate	Pressure Differential	Inlet Pressure	Outlet Pressure	Pressure Differential	Cumulative Volume Treated	Cumulative Bed Volumes Treated <sup>a,b</sup>	pH	
				gpm	gal	gal	gpm	psi	gpm	gal	gal	gpm	psi	psi	psi	psi	gal	BV		
1	Thu	12/08/05	NA	NA	NA	NA	NA	NA	NA	NA	NA	NA	NA	NA	NA	NA	NA	NA	NA	NA
	Fri	12/09/05	NA	53	23,794	23,794	NA	3.0	51	19,174	19,174	NA	5.0	40	30	10	19,174	117	6.64	
2	Mon	12/12/05	NA	50	35,319	11,525	NA	3.0	48	30,304	11,130	NA	4.0	40	30	10	30,304	185	6.82	
	Tue	12/13/05	NA	50	38,069	2,750	NA	3.0	48	32,962	2,658	NA	4.0	38	28	10	32,962	201	6.88	
	Wed	12/14/05	NA	50	48,075	10,006	NA	3.0	48	42,634	9,672	NA	4.0	38	28	10	42,634	260	6.80	
	Thu	12/15/05	NA	50	51,866	3,791	NA	3.0	49	46,290	3,656	NA	4.0	38	28	10	46,290	282	6.84	
	Fri	12/16/05	NA	49	57,415	5,549	NA	3.0	48	51,661	5,371	NA	4.0	39	29	10	51,661	315	6.88	
3	Mon	12/19/05	NA	NA	NA	NA	NA	NA	NA	NA	NA	NA	NA	NA	NA	NA	NA	NA	NA	NA
	Tue	12/20/05	NA	NA	NA	NA	NA	NA	NA	NA	NA	NA	NA	NA	NA	NA	NA	NA	NA	NA
	Wed	12/21/05	NA	NA	NA	NA	NA	NA	NA	NA	NA	NA	NA	NA	NA	NA	NA	NA	NA	NA
	Thu	12/22/05	NA	NA	NA	NA	NA	NA	NA	NA	NA	NA	NA	NA	NA	NA	NA	NA	NA	NA
	Fri	12/23/05	NA	NA	NA	NA	NA	NA	NA	NA	NA	NA	NA	5.0	40	30	10	NA	NA	NA
4	Mon	12/26/05	NA	NA	NA	NA	NA	NA	NA	NA	NA	NA	NA	NA	NA	NA	NA	NA	NA	NA
	Tue	12/27/05	NA	NA	NA	NA	NA	NA	NA	NA	NA	NA	NA	NA	NA	NA	NA	NA	NA	NA
	Wed	12/28/05	NA	NA	NA	NA	NA	NA	NA	NA	NA	NA	NA	NA	NA	NA	NA	NA	NA	NA
	Thu	12/29/05	NA	NA	NA	NA	NA	NA	NA	NA	NA	NA	NA	NA	NA	NA	NA	NA	NA	NA
	Fri	12/30/05	NA	NA	NA	NA	NA	NA	NA	NA	NA	NA	NA	5.0	40	30	10	NA	NA	NA
5	Mon	01/02/06	NA	NA	NA	NA	NA	NA	NA	NA	NA	NA	NA	NA	NA	NA	NA	NA	NA	NA
	Tue	01/03/06	NA	50	92,686	35,271	NA	1.0	48	85,630	33,969	NA	4.0	40	32	8	85,630	522	6.85	
	Wed	01/04/06	NA	50	96,835	4,149	NA	2.0	49	89,621	3,991	NA	4.0	36	28	8	89,621	546	6.94	
	Thu	01/05/06	NA	50	103,668	6,833	NA	1.0	48	96,210	6,589	NA	4.0	36	26	10	96,210	587	6.94	
	Fri	01/06/06	NA	50	116,084	12,416	NA	1.0	48	108,229	12,019	NA	4.0	38	28	10	108,229	660	6.92	
6	Mon	01/09/06	NA	50	131,789	15,705	NA	3.0	48	123,309	15,080	NA	5.0	38	28	10	123,309	752	6.85	
	Tue	01/10/06	4.2	50	142,134	10,345	41	4.0	49	133,247	9,938	39	5.0	36	26	10	133,247	812	6.91	
	Wed	01/11/06	2.4	52	148,763	6,629	46	4.0	50	139,601	6,354	44	5.0	38	28	10	139,601	851	6.88	
	Thu	01/12/06 <sup>(c,d)</sup>	4.5	50	6,614	6,614	24	5.0	52	6,727	6,727	25	5.0	38	28	10	146,328	892	6.92	
	Fri	01/13/06	NA	NA	NA	NA	NA	NA	NA	NA	NA	NA	NA	5.0	40	30	10	NA	NA	NA
7	Mon	01/16/06	10.9	52	35,434	28,820	44	5.0	53	36,043	29,316	45	5.0	42	32	10	175,644	1,071	6.94	
	Tue	01/17/06	5.0	50	48,544	13,110	44	5.0	51	49,412	13,369	45	5.0	38	28	10	189,013	1,153	6.95	
	Wed	01/18/06	4.4	51	60,350	11,806	45	4.0	52	61,429	12,017	46	5.0	38	28	10	201,030	1,226	6.91	
	Thu	01/19/06	4.9	51	73,080	12,730	43	5.0	51	74,407	12,978	44	5.0	38	28	10	214,008	1,305	NM	
	Fri	01/20/06	2.7	51	79,955	6,875	42	4.0	52	81,422	7,015	43	5.0	38	28	10	221,023	1,348	6.89	
8	Mon	01/23/06	6.6	NA	98,481	18,526	NA	NA	NA	100,350	18,928	48	NA	NA	NA	NA	239,951	1,463	NA	
	Tue	01/24/06	2.9	NA	106,034	7,553	NA	NA	NA	108,614	8,264	47	NA	NA	NA	NA	248,215	1,514	NA	
	Wed	01/25/06	3.4	51	114,427	8,393	41	3.0	53	116,547	7,933	39	5.0	38	26	12	256,148	1,562	6.93	
	Thu	01/26/06	2.4	52	121,235	6,808	47	3.0	53	123,472	6,925	48	5.0	42	30	12	263,073	1,604	6.76	
	Fri	01/27/06	3.9	51	131,558	10,323	44	4.0	53	133,918	10,446	45	5.0	40	38	2	273,519	1,668	6.76	
9	Mon	01/30/06	4.7	51	143,267	11,709	42	5.0	52	145,866	11,948	42	5.0	38	26	12	285,467	1,741	6.82	
	Tue	01/31/06	10.5	51	172,144	28,877	46	5.0	52	175,129	29,263	46	5.0	40	28	12	314,730	1,919	6.82	
	Wed	02/01/06	8.4	52	194,479	22,335	44	4.0	53	197,638	22,509	45	5.0	38	26	12	337,239	2,056	6.62	
	Thu	02/02/06	6.6	51	213,083	18,604	47	5.0	53	216,459	18,821	48	5.0	36	26	10	356,060	2,171	6.51	
	Fri	02/03/06	5.6	52	227,540	14,457	43	5.0	53	231,048	14,589	43	5.0	36	26	10	370,649	2,260	6.58	
10	Mon	02/06/06	13.6	51	262,989	35,449	43	4.0	51	266,801	35,753	44	5.0	38	26	12	406,402	2,478	6.62	
	Tue	02/07/06	3.4	51	271,073	8,084	40	4.0	51	274,942	8,141	40	5.0	42	30	12	414,543	2,528	6.56	
	Wed	02/08/06	3.0	52	279,832	8,759	49	4.0	53	283,796	8,854	49	5.0	38	26	12	423,397	2,582	6.61	
	Thu	02/09/06	2.5	52	286,120	6,288	42	5.0	53	290,139	6,343	42	5.0	40	28	12	429,740	2,620	6.63	
	Fri	02/10/06	2.2	50	292,035	5,915	45	5.0	51	296,107	5,968	45	5.0	38	26	12	435,708	2,657	6.62	
11	Mon	02/13/06	4.8	52	304,459	12,424	43	5.0	53	308,620	12,513	43	5.0	38	26	12	448,221	2,733	6.76	
	Tue	02/14/06	1.5	52	308,325	3,866	43	4.0	53	312,504	3,884	43	5.0	50	38	12	452,105	2,757	6.71	
	Wed	02/15/06	2.0	51	313,473	5,148	43	1.0	52	317,684	5,180	43	5.0	44	32	12	457,285	2,788	6.67	
	Thu	02/16/06	2.9	51	321,089	7,616	44	2.0	52	325,362	7,678	44	5.0	36	26	10	464,963	2,835	6.74	
	Fri	02/17/06	5.6	50	335,365	14,276	42	2.0	52	339,775	14,413	43	5.0	36	26	10	479,376	2,923	6.67	

Table A-1. EPA Arsenic Demonstration Project at Bruni, TX - Daily System Operation Log Sheet (Continued)

Week No.	Day of Week	Date	Well Operational Hours	Vessel A					Vessel B					System						
				Flowrate	Cumulative Totalizer	Usage	Average Flowrate	Pressure Differential	Flowrate	Cumulative Totalizer	Usage	Average Flowrate	Pressure Differential	Inlet Pressure	Outlet Pressure	Pressure Differential	Cumulative Volume Treated	Cumulative Bed Volumes Treated <sup>a,b</sup>		
				gpm	gal	gal	gpm	psi	gpm	gal	gal	gpm	psi	psi	psi	psi	gal	BV	pH	
12	Mon	02/20/06	5.4	52	349,543	14,178	44	1.0	53	354,107	14,332	44	5.0	38	26	12	493,708	3,010	6.78	
	Tue	02/21/06	3.1	51	357,906	8,363	45	1.0	52	362,573	8,466	46	5.0	38	26	12	502,174	3,062	6.86	
	Wed	02/22/06	2.2	52	363,712	5,806	44	1.0	53	368,442	5,869	44	5.0	38	26	12	508,043	3,098	6.78	
	Thu	02/23/06	2.3	52	369,820	6,108	44	1.0	53	374,611	6,169	45	5.0	40	36	4	514,212	3,135	6.88	
	Fri	02/24/06	2.2	52	375,462	5,642	43	1.0	53	380,319	5,708	43	5.0	38	26	12	519,920	3,170	6.80	
13	Mon	02/27/06	5.1	53	388,999	13,537	44	1.0	54	393,999	13,680	45	5.0	42	28	14	533,600	3,254	6.84	
	Tue	02/28/06	2.2	52	395,397	6,398	48	2.0	53	400,371	6,372	48	5.0	38	26	12	539,972	3,293	6.88	
	Wed	03/01/06	2.1	52	400,388	4,991	40	2.0	53	405,522	5,151	41	5.0	38	26	12	545,123	3,324	6.86	
	Thu	03/02/06	NA	NA	NA	NA	NA	NA	NA	NA	NA	NA	NA	NA	NA	NA	NA	NA	NA	NA
	Fri	03/03/06	1.3	NA	403,939	3,551	46	NA	NA	409,117	3,595	46	NA	NA	NA	NA	548,718	3,346	NA	
14	Mon	03/06/06	1.9	49	408,768	4,829	42	2.0	50	413,981	4,864	43	4.0	56	46	10	553,582	3,376	6.99	
	Tue	03/07/06	0.7	52	410,597	1,829	44	2.0	53	415,820	1,839	44	5.0	44	32	12	555,421	3,387	6.93	
	Wed	03/08/06	0.9	50	412,952	2,355	44	2.0	51	418,191	2,371	44	5.0	36	24	12	557,792	3,401	7.02	
	Thu	03/09/06	1.6	52	417,448	4,496	47	2.0	53	422,751	4,560	48	5.0	36	24	12	562,352	3,429	6.96	
	Fri	03/10/06	1.9	52	422,421	4,973	44	2.0	53	427,788	5,037	44	5.0	38	26	12	567,389	3,460	7.68	
15	Mon	03/13/06	3.0	50	430,465	8,044	45	2.0	51	435,993	8,205	46	5.0	34	22	12	575,594	3,510	7.53	
	Tue	03/14/06	5.4	51	447,253	16,788	52	2.0	52	453,096	17,103	53	5.0	40	28	12	592,697	3,614	7.73	
	Wed	03/15/06	4.8	51	460,094	12,841	45	2.0	52	466,107	13,011	45	5.0	38	26	12	605,708	3,693	8.12	
	Thu	03/16/06	5.0	52	473,291	13,197	44	2.0	53	479,476	13,369	45	5.0	38	26	12	619,077	3,775	8.22	
	Fri	03/17/06	5.4	52	487,179	13,888	43	2.0	53	493,527	14,051	43	5.0	38	26	12	633,128	3,861	7.56	
16	Mon	03/20/06	5.7	52	501,498	14,319	42	2.0	53	507,994	14,467	42	4.0	38	26	12	647,595	3,949	7.42	
	Tue	03/21/06	7.8	49	522,266	20,768	44	2.0	51	529,111	21,117	45	2.0	54	44	10	668,712	4,078	7.33	
	Wed	03/22/06	10.1	52	550,641	28,375	47	2.0	53	558,031	28,920	48	0.0	38	26	12	697,632	4,254	7.38	
	Thu	03/23/06	11.0	51	582,679	32,038	49	2.0	53	590,675	32,644	49	1.0	40	26	14	730,276	4,453	7.61	
	Fri	03/24/06	5.2	52	596,177	13,498	43	2.0	53	604,398	13,723	44	1.0	60	50	10	743,999	4,537	7.64	
17	Mon	03/27/06	6.5	52	612,520	16,343	42	2.0	53	620,897	16,499	42	0.0	42	30	12	760,498	4,637	7.60	
	Tue	03/28/06	5.2	51	625,670	13,150	42	2.0	52	634,183	13,286	43	2.0	36	24	12	773,784	4,718	7.70	
	Wed	03/29/06	7.7	52	647,997	22,327	48	2.0	52	656,918	22,735	49	0.0	48	36	12	796,519	4,857	NA	
	Thu	03/30/06	3.8	53	657,686	9,689	42	2.0	53	666,722	9,804	43	0.0	38	24	14	806,323	4,917	7.54	
	Fri	03/31/06	6.3	46	674,693	17,007	45	1.0	47	684,032	17,310	46	2.5	59	48	11	823,633	5,022	7.31	
18	Mon	04/03/06	14.7	51	714,575	39,882	45	2.0	52	724,554	40,522	46	0.0	38	26	12	864,155	5,269	7.51	
	Tue	04/04/06	8.5	52	738,606	24,031	47	2.5	53	749,092	24,538	48	2.5	36	24	12	888,693	5,419	7.35	
	Wed	04/05/06	6.1	51	754,237	15,631	43	2.5	52	765,045	15,953	44	2.5	40	28	12	904,646	5,516	7.40	
	Thu	04/06/06	10.1	48	780,646	26,409	44	2.5	49	792,082	27,037	45	2.5	52	40	12	931,683	5,681	7.38	
	Fri	04/07/06	7.3	52	798,657	18,011	41	2.5	53	810,333	18,251	42	2.5	38	26	12	949,934	5,792	7.66	
19	Mon	04/10/06	5.8	52	813,257	14,600	42	2.5	53	825,086	14,753	42	4.0	42	30	12	964,687	5,882	7.31	
	Tue	04/11/06	7.9	53	834,182	20,925	44	2.5	54	846,505	21,419	45	4.0	38	24	14	986,106	6,013	7.34	
	Wed	04/12/06	12.0	51	867,024	32,842	46	2.5	52	880,032	33,527	47	4.0	36	24	12	1,019,633	6,217	7.49	
	Thu	04/13/06	18.5	52	915,364	48,340	44	2.5	53	929,620	49,588	45	5.0	40	28	12	1,069,221	6,520	7.30	
20	Mon	04/17/06	15.4	52	953,590	38,226	41	2.5	53	968,494	38,874	42	5.0	38	26	12	1,108,095	6,757	7.58	
	Tue	04/18/06	9.4	49	980,223	26,633	47	2.5	50	995,672	27,178	48	4.0	50	38	12	1,135,273	6,922	7.41	
	Wed	04/19/06	8.1	52	1,003,256	23,033	47	2.5	53	1,019,217	23,545	48	4.0	54	44	10	1,158,818	7,066	7.30	
	Thu	04/20/06	8.5	53	1,026,074	22,818	45	2.5	54	1,042,523	23,306	46	5.0	36	24	12	1,182,124	7,208	7.28	
	Fri	04/21/06	9.0	51	1,052,191	26,117	48	2.5	50	1,069,065	26,542	49	4.0	60	50	10	1,208,666	7,370	6.91	
21	Mon	04/24/06	7.2	49	1,069,814	17,623	41	2.5	49	1,086,721	17,656	41	4.0	42	30	12	1,226,322	7,478	7.02	
	Tue	04/25/06	12.4	52	1,104,268	34,454	46	2.5	53	1,121,440	34,719	47	5.0	38	26	12	1,261,041	7,689	7.15	
	Wed	04/26/06	15.8	52	1,151,908	47,640	50	2.5	53	1,169,626	48,186	51	5.0	38	24	14	1,309,227	7,983	7.28	
	Thu	04/27/06	8.8	49	1,175,787	23,879	45	2.5	50	1,193,750	24,124	46	5.0	58	48	10	1,333,351	8,130	6.91	
	Fri	04/28/06	5.7	53	1,189,735	13,948	41	2.5	54	1,207,751	14,001	41	5.0	36	24	12	1,347,352	8,216	7.03	

**Table A-1. EPA Arsenic Demonstration Project at Bruni, TX - Daily System Operation Log Sheet (Continued)**

Week No.	Day of Week	Date	Well Operational Hours	Vessel A					Vessel B					System					
				Flowrate	Cumulative Totalizer	Usage	Average Flowrate	Pressure Differential	Flowrate	Cumulative Totalizer	Usage	Average Flowrate	Pressure Differential	Inlet Pressure	Outlet Pressure	Pressure Differential	Cumulative Volume Treated	Cumulative Bed Volumes Treated <sup>a,b</sup>	pH
				gpm	gal	gal	gpm	psi	gpm	gal	gal	gpm	psi	psi	psi	psi	gal	BV	
22	Mon	05/01/06	10.3	53	1,215,584	25,849	42	2.5	54	1,233,777	26,026	42	5.0	42	30	12	1,373,378	8,374	6.95
	Tue	05/02/06	7.4	52	1,234,603	19,019	43	2.5	53	1,252,930	19,153	43	5.0	38	26	12	1,392,531	8,491	7.42
	Wed	05/03/06	11.3	50	1,267,350	32,747	48	2.5	51	1,286,025	33,095	49	5.0	48	36	12	1,425,626	8,693	NA <sup>(a)</sup>
	Thu	05/04/06	9.6	50	1,293,809	26,459	46	2.5	51	1,312,756	26,731	46	5.0	60	50	10	1,452,357	8,856	NA <sup>(a)</sup>
	Fri	05/05/06	10.4	44	1,319,455	25,646	41	2.5	45	1,338,555	25,799	41	2.5	58	48	10	1,478,156	9,013	NA <sup>(a)</sup>
23	Mon	05/08/06	16.6	51	1,361,583	42,128	42	2.5	52	1,380,917	42,362	43	5.0	36	24	12	1,520,518	9,271	NA <sup>(a)</sup>
	Tue	05/09/06	9.4	52	1,387,691	26,108	46	2.5	53	1,407,248	26,331	47	5.0	38	26	12	1,546,849	9,432	NA <sup>(a)</sup>
	Wed	05/10/06	11.5	50	1,421,409	33,718	49	5.0	50	1,441,360	34,112	49	5.0	40	28	12	1,580,961	9,640	NA <sup>(a)</sup>
	Thu	05/11/06	10.1	50	1,449,175	27,766	46	4.0	51	1,469,389	28,029	46	5.0	44	32	12	1,608,990	9,811	NA <sup>(a)</sup>
	Fri	05/12/06	10.1	52	1,474,621	25,446	42	5.0	53	1,495,067	25,678	42	5.0	38	26	12	1,634,668	9,967	NA <sup>(a)</sup>
24	Mon	05/15/06	21.4	52	1,530,575	55,954	44	5.0	52	1,551,451	56,384	44	5.0	44	32	12	1,691,052	10,311	NA <sup>(a)</sup>
	Tue	05/16/06	2.8	49	1,537,194	6,619	39	5.0	49	1,558,049	6,598	39	4.0	52	40	12	1,697,650	10,352	NA <sup>(a)</sup>
	Wed	05/17/06	2.5	52	1,543,390	6,196	41	6.0	52	1,564,205	6,156	41	6.0	40	26	14	1,703,806	10,389	NA <sup>(a)</sup>
	Thu	05/18/06	7.6	51	1,563,262	19,872	44	6.0	51	1,584,309	20,104	44	5.0	38	26	12	1,723,910	10,512	NA <sup>(a)</sup>
	Fri	05/19/06	8.9	46	1,586,222	22,960	43	4.0	47	1,607,542	23,233	44	4.0	56	46	10	1,747,143	10,653	NA <sup>(a)</sup>
25	Mon	05/22/06	13.9	52	1,624,747	38,525	46	5.0	52	1,646,303	38,761	46	5.0	38	26	12	1,785,904	10,890	NA <sup>(a)</sup>
	Tue	05/23/06 <sup>(c)</sup>	7.5	49	9,644	9,644	21	5.0	49	1,665,455	19,152	43	5.0	38	26	12	1,805,056	11,006	NA <sup>(a)</sup>
	Wed	05/24/06	9.3	51	35,965	26,321	47	5.0	52	1,691,932	26,477	47	5.0	34	24	10	1,831,533	11,168	NA <sup>(a)</sup>
	Thu	05/25/06	20.5	52	93,797	57,832	47	6.0	52	14,918	14,918	12	5.0	36	24	12	1,846,451	11,259	NA <sup>(a)</sup>
	Fri	05/26/06 <sup>(d)</sup>	6.7	50	110,177	16,380	41	6.0	50	31,398	16,480	41	5.0	58	46	12	1,862,931	11,359	NA <sup>(a)</sup>
26	Tue	05/30/06	14.3	50	143,981	33,804	39	5.0	51	65,035	33,637	39	5.0	36	24	12	1,896,568	11,564	7.01
	Wed	05/31/06	10.9	45	171,468	27,487	42	6.0	46	92,786	27,751	42	5.0	40	28	12	1,924,319	11,734	NA <sup>(a)</sup>
	Thu	06/01/06	5.7	52	185,133	13,665	40	6.0	52	106,485	13,699	40	6.0	38	24	14	1,938,018	11,817	NA <sup>(a)</sup>
	Fri	06/02/06	7.3	53	203,556	18,423	42	5.0	53	125,055	18,570	42	5.0	46	42	4	1,956,588	11,930	NA <sup>(a)</sup>
27	Mon	06/05/06	5.7	52	217,127	13,571	40	4.0	53	138,591	13,536	40	3.0	50	42	8	1,970,124	12,013	6.78
	Tue	06/06/06	4.2	44	227,171	10,044	40	4.0	45	148,595	10,004	40	3.0	52	42	10	1,980,128	12,074	7.01
	Wed	06/07/06	10.6	52	253,528	26,357	41	5.0	53	175,113	26,518	42	5.0	44	32	12	2,006,646	12,236	6.89
	Thu	06/08/06	11.2	52	286,015	32,487	48	6.0	53	207,864	32,751	49	5.0	36	24	12	2,039,397	12,435	6.85
	Fri	06/09/06	10.2	52	313,234	27,219	44	6.0	53	235,373	27,509	45	5.0	48	36	12	2,066,906	12,603	6.86

NOTE : <sup>(a)</sup> Bed volume = 22 cu.ft. or 164 gallons (equivalent to the volume of media in one vessel)  
<sup>(b)</sup> Bed volumes calculated based on Vessel B usage  
<sup>(c)</sup> Totalizer for Vessel A re-set on 01/12/06 and 05/23/06.  
<sup>(d)</sup> Totalizer for Vessel B re-set on 01/12/06 and 05/26/06.  
<sup>(e)</sup> In-line pH probe not operational.

NA = not available  
 Highlighted cells indicate calculated values.

**APPENDIX B**  
**ANALYTICAL DATA**

**Table B-1. Analytical Results from Treatment Plant Sampling at Bruni, TX**

Sampling Date		12/08/05 <sup>(a)</sup>				12/13/05 <sup>(b)</sup>				01/05/06				01/17/06				02/01/06			
Sampling Location	Parameter	IN	AP	TA	TB	IN	AP	TA	TB	IN	AP	TA	TB	IN	AP	TA	TB	IN	AP	TA	TB
Bed Volume	10 <sup>3</sup>	-	-	NA	NA	-	-	0.2	0.2	-	-	0.6	0.6	-	-	1.2	1.2	-	-	2.0	2.0
Alkalinity (CaCO <sub>3</sub> )	mg/L	317	321	330	352	326	330	330	321	334	334	312	312	334	330	321	312	320	320	342	325
Fluoride	mg/L	0.5	0.6	0.5	0.4	-	-	-	-	0.5	0.6	0.6	0.7	-	-	-	-	0.5	0.6	0.5	0.6
Sulfate	mg/L	104	104	103	100	-	-	-	-	104	104	112	114	-	-	-	-	105	104	98	103
Nitrate (as N)	mg/L	<0.05	<0.05	<0.05	<0.05	-	-	-	-	<0.05	<0.05	<0.05	<0.05	-	-	-	-	<0.05	<0.05	<0.05	<0.05
Total P (as PO <sub>4</sub> )	mg/L	0.03	0.1	<0.03	<0.03	<0.03	<0.03	<0.03	<0.03	<0.03	<0.03	<0.03	<0.03	<0.03	<0.03	<0.03	<0.03	<0.03	<0.03	<0.03	<0.03
Silica (as SiO <sub>2</sub> )	mg/L	41.8	41.5	13.5	1.7	43.3	43.5	25.7	6.4	41.7	42.3	34.2	31.8	43.8	42.8	39.9	39.6	41.7	42.6	41.6	38.9
Turbidity	NTU	0.3	<0.1	<0.1	<0.1	<0.1	0.1	0.2	0.2	0.2	0.4	0.2	0.2	1.1	0.4	0.6	0.3	0.7	0.3	0.2	0.3
pH	S.U.	8.2	7.4	7.1	7.3	8.2	7.2	7.2	7.2	8.1	8.1	7.4	7.3	8.0	8.0	7.1	7.1	8.1	7.1	7.3	7.4
Temperature	°C	26.6	26.7	24.8	24.7	24.1	24.0	24.0	23.0	23.5	23.5	23.2	23.1	25.7	25.9	25.1	24.2	26.7	26.5	26.2	26.2
DO	mg/L	1.8	2.3	0.9	1.3	1.5	1.5	1.8	2.0	2.1	2.2	2.1	2.0	2.4	1.6	1.5	1.4	1.3	1.4	1.5	1.3
ORP	mV	325	679	387	371	379	592	499	425	234	533	671	686	257	538	690	700	239	465	605	680
Free Chlorine (as Cl <sub>2</sub> )	mg/L	-	1.0	0.1	-	-	0.6	-	-	-	2.0	-	1.5	-	1.5	-	1.7	-	1.6	-	1.7
Total Chlorine (as Cl <sub>2</sub> )	mg/L	-	1.6	0.3	-	-	-	-	-	-	2.1	-	2.1	-	1.8	-	1.7	-	1.5	-	1.7
Total Hardness (as CaCO <sub>3</sub> )	mg/L	17.1	19.3	27.9	47.2	-	-	-	-	19.4	19.1	11.6	15.8	-	-	-	-	23.7	22.2	33.0	17.1
Ca Hardness (as CaCO <sub>3</sub> )	mg/L	11.3	13.4	17.2	29.4	-	-	-	-	12.0	11.9	7.6	9.9	-	-	-	-	17.0	16.9	25.1	13.8
Mg Hardness (as CaCO <sub>3</sub> )	mg/L	5.8	5.9	10.7	17.9	-	-	-	-	7.4	7.2	4.0	5.9	-	-	-	-	6.7	5.3	7.9	3.3
As (total)	µg/L	51.4	62.2	3.9	4.0	55.7	55.8	3.6	3.5	51.5	60.1	1.8	1.5	58.8	60.4	4.6	6.3	61.4	56.2	3.4	2.8
As (soluble)	µg/L	53.1	61.0	3.4	2.2	-	-	-	-	56.5	51.3	1.3	1.3	-	-	-	-	54.3	50.8	3.0	2.9
As (particulate)	µg/L	<0.1	1.2	0.5	1.8	-	-	-	-	<0.1	8.7	0.4	0.2	-	-	-	-	7.1	5.4	0.4	<0.1
As (III)	µg/L	35.8	3.3	2.9	1.6	-	-	-	-	40.4	1.5	1.2	1.2	-	-	-	-	40.8	3.1	2.9	2.4
As (V)	µg/L	17.3	57.7	0.6	0.5	-	-	-	-	16.1	49.8	0.2	<0.1	-	-	-	-	13.5	47.7	0.1	0.5
Fe (total)	µg/L	<25	<25	<25	<25	<25	<25	<25	<25	<25	<25	<25	<25	28.8	<25	<25	<25	<25	<25	<25	<25
Fe (soluble)	µg/L	<25	<25	<25	<25	-	-	-	-	<25	<25	<25	<25	-	-	-	-	<25	<25	<25	<25
Mn (total)	µg/L	4.3	4.3	1.8	5.0	3.7	3.4	1.1	1.1	3.9	3.3	<0.1	<0.1	4.5	4.4	0.5	0.2	3.2	3.4	<0.1	<0.1
Mn (soluble)	µg/L	4.2	3.4	1.6	5.1	-	-	-	-	3.7	3.3	<0.1	0.2	-	-	-	-	3.6	3.5	<0.1	<0.1

(a) Chlorine measurements taken on 12/09/05.

(b) Water quality measurements taken on 12/15/05.

IN = at wellhead; AP = after pH adjustment; TA = after Tank A; TB = after Tank B.

NA = not available.

**Table B-1. Analytical Results from Treatment Plant Sampling at Bruni, TX (Continued)**

Sampling Date		02/15/06				02/28/06 <sup>(a)</sup>				03/14/06				03/28/06 <sup>(b)</sup>				04/11/06 <sup>(c)</sup>				
Sampling Location		IN	AP	TA	TB	IN	AP	TA	TB	IN	AP	TA	TB	IN	AP	TA	TB	IN	AP	TA	TB	
Parameter	Unit																					
Bed Volume	10 <sup>3</sup>	-	-	2.8	2.8	-	-	3.3	3.3	-	-	3.6	3.6	-	-	4.7	4.7	-	-	6.0	6.0	
Alkalinity (CaCO <sub>3</sub> )	mg/L	324	324	316	328	322	314	322	335	314	310	322	327	325	321	325	325	311	307	315	315	
		-	-	-	-	314	318	310	327	-	-	-	-	-	-	-	-	-	-	-	-	
Fluoride	mg/L	-	-	-	-	-	-	-	-	0.7	0.8	0.8	0.8	-	-	-	-	0.7	0.8	0.8	0.8	
Sulfate	mg/L	-	-	-	-	-	-	-	-	107	107	106	106	-	-	-	-	106	106	107	108	
Nitrate (as N)	mg/L	-	-	-	-	-	-	-	-	<0.05	<0.05	<0.05	<0.05	-	-	-	-	<0.05	<0.05	<0.05	<0.05	
Total P (as PO <sub>4</sub> )	mg/L	<0.03	<0.03	<0.03	<0.03	<0.03	<0.03	<0.03	<0.03	<0.01	<0.01	<0.01	<0.01	-	-	-	-	<0.01	<0.01	<0.01	<0.01	
		-	-	-	-	<0.03	<0.03	<0.03	<0.03	-	-	-	-	-	-	-	-	-	-	-	-	
Silica (as SiO <sub>2</sub> )	mg/L	41.5	42.3	43.3	40.2	40.6	41.6	41.8	41.3	41.5	40.6	41.1	38.7	41.7	42.1	42.6	42.1	40.9	40.2	40.5	42.7	
		-	-	-	-	40.7	41.0	41.5	41.2	-	-	-	-	-	-	-	-	-	-	-	-	
Turbidity	NTU	1.0	1.5	1.1	2.0	0.4	0.2	0.2	0.2	0.6	0.4	0.3	0.7	0.9	0.9	0.9	0.8	0.7	0.5	0.5	0.6	
		-	-	-	-	0.4	0.2	0.3	0.2	-	-	-	-	-	-	-	-	-	-	-	-	
pH	S.U.	8.1	7.2	7.3	7.2	NA	NA	NA	NA	8.2	7.3	7.3	7.3	8.2	7.5	7.6	7.5	NA	NA	NA	NA	
Temperature	°C	26.7	26.9	27.0	27.1	NA	NA	NA	NA	26.3	26.7	26.5	26.6	26.5	27.2	27.4	27.4	NA	NA	NA	NA	
DO	mg/L	1.1	1.6	1.5	2.1	NA	NA	NA	NA	1.6	1.7	1.3	2.3	1.5	1.8	1.8	1.9	NA	NA	NA	NA	
ORP	mV	258	546	631	663	NA	NA	NA	NA	238	569	657	662	259	309	532	587	NA	NA	NA	NA	
Free Chlorine (as Cl <sub>2</sub> )	mg/L	-	0.6	-	0.9	-	NA	-	NA	-	0.8	-	1.0	-	0.5	-	0.9	-	NA	-	NA	
Total Chlorine (as Cl <sub>2</sub> )	mg/L	-	0.7	-	1.0	-	NA	-	NA	-	1.1	-	1.2	-	1.2	-	1.0	-	NA	-	NA	
Total Hardness (as CaCO <sub>3</sub> )	mg/L	-	-	-	-	-	-	-	-	20.1	21.2	22.2	24.2	-	-	-	-	30.1	30.0	27.9	29.6	
Ca Hardness (as CaCO <sub>3</sub> )	mg/L	-	-	-	-	-	-	-	-	13.3	13.9	14.3	15.6	-	-	-	-	22.7	22.8	21.3	22.6	
Mg Hardness (as CaCO <sub>3</sub> )	mg/L	-	-	-	-	-	-	-	-	6.8	7.3	8.0	8.5	-	-	-	-	7.4	7.2	6.6	6.9	
As (total)	µg/L	61.2	64.4	4.2	3.9	61.8	61.9	2.7	2.2	60.3	62.3	2.2	1.7	46.2	50.2	1.4	1.1	55.4	57.2	1.0	0.6	
		-	-	-	-	57.6	57.4	2.6	2.4	-	-	-	-	-	-	-	-	-	-	-	-	
As (soluble)	µg/L	-	-	-	-	-	-	-	-	51.9	53.5	1.5	1.5	-	-	-	-	51.5	51.6	0.8	0.6	
As (particulate)	µg/L	-	-	-	-	-	-	-	-	8.3	8.9	0.7	0.2	-	-	-	-	3.8	5.6	0.2	<0.1	
As (III)	µg/L	-	-	-	-	-	-	-	-	38.7	1.9	1.3	1.3	-	-	-	-	36.5	0.5	0.5	0.4	
As (V)	µg/L	-	-	-	-	-	-	-	-	13.2	51.6	0.2	0.2	-	-	-	-	15.0	51.1	0.3	0.2	
Fe (total)	µg/L	<25	<25	<25	<25	<25	<25	<25	<25	<25	<25	<25	<25	<25	<25	<25	<25	<25	<25	<25	<25	
		-	-	-	-	<25	<25	<25	<25	-	-	-	-	-	-	-	-	-	-	-	-	
Fe (soluble)	µg/L	-	-	-	-	-	-	-	-	<25	<25	<25	<25	-	-	-	-	<25	<25	<25	<25	
Mn (total)	µg/L	3.2	3.1	0.6	0.3	5.1	3.2	<0.1	<0.1	4.1	3.2	0.3	0.2	4.9	3.7	0.3	0.1	3.5	3.5	<0.1	<0.1	
		-	-	-	-	5.4	4.6	<0.1	<0.1	-	-	-	-	-	-	-	-	-	-	-	-	
Mn (soluble)	µg/L	-	-	-	-	-	-	-	-	4.1	3.1	0.3	0.2	-	-	-	-	3.6	3.4	<0.1	<0.1	

(a) Water quality parameters not measured.

(b) Water quality measurements taken on 04/05/06.

IN = at wellhead; AP = after pH adjustment; TA = after Tank A; TB = after Tank B.

NA = not available.

**Table B-1. Analytical Results from Treatment Plant Sampling at Bruni, TX (Continued)**

Sampling Date		04/25/06 <sup>(a)</sup>				05/09/06 <sup>(b)</sup>				05/23/06 <sup>(c)</sup>				06/06/06 <sup>(d)</sup>			
Sampling Location		IN	AP	TA	TB	IN	AP	TA	TB	IN	AP	TA	TB	IN	AP	TA	TB
Parameter	Unit																
Bed Volume	10 <sup>3</sup>	-	-	7.7	7.7	-	-	9.5	9.5	-	-	11.0	11.0	-	-	12.1	12.1
Alkalinity (CaCO <sub>3</sub> )	mg/L	331	344	331	344	310	306	294	314	313	326	338	318	305	318	313	318
Fluoride	mg/L	-	-	-	-	0.9	1.2	1.5	1.0	-	-	-	-	0.7	0.8	0.8	0.8
Sulfate	mg/L	-	-	-	-	111	112	113	113	-	-	-	-	107	112	114	136
Nitrate (as N)	mg/L	-	-	-	-	<0.05	<0.05	<0.05	<0.05	-	-	-	-	<0.05	<0.05	<0.05	<0.05
Total P (as PO <sub>4</sub> )	mg/L	<0.01	<0.01	<0.01	<0.01	<0.03	<0.03	<0.01	<0.01	<0.01	<0.01	<0.01	<0.01	<0.01	<0.01	<0.01	<0.01
Silica (as SiO <sub>2</sub> )	mg/L	40.8	40.8	41.3	41.2	41.8	42.3	42.7	42.1	42.8	41.6	41.7	38.1	43.9	43.2	44.4	45.3
Turbidity	NTU	0.2	0.2	0.7	0.1	0.2	0.2	0.2	0.3	0.3	0.5	0.3	0.2	0.6	0.5	0.7	0.8
pH	S.U.	8.2	7.4	7.3	7.4	8.1	7.2	7.3	7.3	8.3	7.6	7.5	7.5	8.2	7.3	7.2	7.3
Temperature	°C	26.5	26.3	26.7	26.6	27.1	27.2	27.5	27.3	21.3	21.2	21.4	21.4	26.4	26.6	27.1	27.1
DO	mg/L	1.3	1.6	1.6	2.0	1.3	1.8	2.1	2.4	3.1	4.1	3.4	3.5	2.1	2.6	2.1	2.2
ORP	mV	327	603	650	623	279	499	610	643	271	546	597	636	299	537	594	620
Free Chlorine (as Cl <sub>2</sub> )	mg/L	-	0.8	-	0.7	-	1.1	-	1.5	-	0.5	-	0.6	-	0.9	-	0.7
Total Chlorine (as Cl <sub>2</sub> )	mg/L	-	1.1	-	0.8	-	1.2	-	1.5	-	0.8	-	0.7	-	0.9	-	0.8
Total Hardness (as CaCO <sub>3</sub> )	mg/L	-	-	-	-	28.6	29.3	26.8	29.8	-	-	-	-	20.2	19.8	21.0	20.5
Ca Hardness (as CaCO <sub>3</sub> )	mg/L	-	-	-	-	19.7	20.2	18.3	21.1	-	-	-	-	12.4	12.2	13.0	12.7
Mg Hardness (as CaCO <sub>3</sub> )	mg/L	-	-	-	-	9.0	9.1	8.5	8.8	-	-	-	-	7.8	7.6	8.0	7.8
As (total)	µg/L	56.5	59.5	1.1	0.9	62.9	63.8	1.0	0.6	54.8	50.4	1.3	0.6	58.5	57.6	1.1	0.8
As (soluble)	µg/L	-	-	-	-	54.3	55.4	0.8	0.6	-	-	-	-	52.3	51.6	1.1	0.8
As (particulate)	µg/L	-	-	-	-	8.6	8.4	0.2	<0.1	-	-	-	-	6.2	6.1	<0.1	<0.1
As (III)	µg/L	-	-	-	-	40.2	0.7	0.5	0.5	-	-	-	-	37.0	0.8	0.7	0.6
As (V)	µg/L	-	-	-	-	14.1	54.6	0.3	0.1	-	-	-	-	15.3	50.8	0.5	0.2
Fe (total)	µg/L	<25	<25	<25	<25	<25	<25	<25	<25	28.4	<25	<25	<25	<25	<25	<25	<25
Fe (soluble)	µg/L	-	-	-	-	<25	<25	<25	<25	-	-	-	-	<25	<25	<25	<25
Mn (total)	µg/L	3.1	2.9	<0.1	<0.1	3.3	3.1	<0.1	<0.1	3.9	2.9	<0.1	<0.1	2.6	3.0	<0.1	0.1
Mn (soluble)	µg/L	-	-	-	-	3.3	3.1	<0.1	<0.1	-	-	-	-	2.6	3.0	<0.1	<0.1

(a) Water quality measurements taken on 04/20/06.

(b) Water quality measurements taken on 05/04/06.

(c) Water quality measurements taken on 05/12/05.

(d) Water quality measurements taken on 06/01/06.

IN = at wellhead; AP = after pH adjustment; TA = after Tank A; TB = after Tank B.

NA = not available.