

**Arsenic Removal from Drinking Water by Iron Removal
EPA Demonstration Project at
Big Sauk Lake Mobile Home Park in Sauk Centre, MN
Six-Month Evaluation Report**

by

**H. Tien Shiao
Abraham S.C. Chen
Wendy E. Condit
Lili Wang**

**Battelle
Columbus, OH 43201-2693**

**Contract No. 68-C-00-185
Task Order No. 0029**

for

**Thomas J. Sorg
Task Order Manager**

**Water Supply and Water Resources Division
National Risk Management Research Laboratory
Cincinnati, Ohio 45268**

**National Risk Management Research Laboratory
Office of Research and Development
U.S. Environmental Protection Agency
Cincinnati, Ohio 45268**

DISCLAIMER

The work reported in this document was funded by the United States Environmental Protection Agency (EPA) under Task Order 0029 of Contract 68-C-00-185 to Battelle. It has been subjected to the Agency's peer and administrative reviews and has been approved for publication as an EPA document. Any opinions expressed in this paper are those of the author(s) and do not, necessarily, reflect the official positions and policies of the EPA. Any mention of products or trade names does not constitute recommendation for use by the EPA.

FOREWORD

The U.S. Environmental Protection Agency (EPA) is charged by Congress with protecting the nation's land, air, and water resources. Under a mandate of national environmental laws, the Agency strives to formulate and implement actions leading to a compatible balance between human activities and the ability of natural systems to support and nurture life. To meet this mandate, EPA's research program is providing data and technical support for solving environmental problems today and building a science knowledge base necessary to manage our ecological resources wisely, understand how pollutants affect our health, and prevent or reduce environmental risks in the future.

The National Risk Management Research Laboratory (NRMRL) is the Agency's center for investigation of technological and management approaches for preventing and reducing risks from pollution that threaten human health and the environment. The focus of the Laboratory's research program is on methods and their cost-effectiveness for prevention and control of pollution to air, land, water, and subsurface resources; protection of water quality in public water systems; remediation of contaminated sites, sediments and groundwater; prevention and control of indoor air pollution; and restoration of ecosystems. NRMRL collaborates with both public and private sector partners to foster technologies that reduce the cost of compliance and to anticipate emerging problems. NRMRL's research provides solutions to environmental problems by developing and promoting technologies that protect and improve the environment; advancing scientific and engineering information to support regulatory and policy decisions; and providing the technical support and information transfer to ensure implementation of environmental regulations and strategies at the national, state, and community levels.

This publication has been produced as part of the Laboratory's strategic long-term research plan. It is published and made available by EPA's Office of Research and Development to assist the user community and to link researchers with their clients.

Sally Gutierrez, Director
National Risk Management Research Laboratory

ABSTRACT

This report documents the activities performed and the results obtained from the first six months of the arsenic removal treatment technology demonstration project at the Big Sauk Lake Mobile Home Park (BSLMHP) in Sauk Centre, MN. The objectives of the project are to evaluate the effectiveness of Kinetico's Macrolite[®] pressure filtration process in removing arsenic to meet the new arsenic maximum contaminant level (MCL) of 10 µg/L, the reliability of the treatment system, the required system operation and maintenance (O&M) and operator skill levels, and the capital and O&M cost of the technology. The project also is characterizing water in the distribution system and process residuals produced by the treatment system.

The Macrolite[®] CP-213f arsenic removal system at BSLMHP consisted of two 36-in diameter by 57-in tall contact tanks (205 gal each) and four 13-in diameter by 54-in tall pressure tanks (two for each duplex unit), all configured in parallel. Each pressure tank contained 20 in (or 1.5 ft³) of Macrolite[®] filter media. The maximum design flowrate was 20 gpm, which yielded at least 20 min of contact time prior to pressure filtration and at least 5.4 gpm/ft² of hydraulic loading to the Macrolite[®] filters. Because the system operated in an on-demand configuration, the actual flowrates ranged from 1 to 15 gpm, corresponding to 27 to 410 min of contact time and 0.3 to 4.1 gpm/ft² of hydraulic loading. From July 13, 2005, through January 17, 2006, the system operated for a total of 617 hr at approximately 3.4 hr/day. Based on the totalizer readings, the system treated approximately 863,470 gal of water with an average daily demand of 4,617 gal during this time period.

Total arsenic concentrations in source water ranged from 20.6 to 36.6 µg/L with As(III) being the predominating species at an average concentration of 23.0 µg/L. Potassium permanganate (KMnO₄) was used to oxidize As(III) and Fe(II) prior to Macrolite[®] pressure filtration. KMnO₄ was selected as the oxidant because of the presence of elevated total organic carbon (TOC) levels (at 3.2 to 4.8 mg/L) in source water and high formation potential of disinfection byproducts with the use of chlorine.

After the contact tanks, As(III) concentrations were reduced to an average value of 1.9 µg/L, suggesting effective oxidation of As(III) to As(V) with KMnO₄. Meanwhile, arsenic was present primarily in the particulate form at an average value of 22.9 µg/L, presumably, by being bound to iron particles. During the first six months from July 13, 2005, through January 17, 2006, total arsenic levels in the treated water were reduced to 2.9 to 17.7 µg/L (averaged 7.6 µg/L). Out of 24 sampling occasions, arsenic concentrations exceeded the 10-µg/L MCL for a total of eight times, with all but one due to particulate breakthrough. Two samples exceeded total arsenic concentrations of 10 µg/L due to low KMnO₄ dosage, resulting in incomplete oxidation of As(III) and Fe(II). In order to address particulate arsenic breakthrough, the backwash frequency was increased from every 2,743 gal to every 1,714 gal of throughput during this time period.

Total iron concentrations averaged 2,760 µg/L in source water, which is above the secondary MCL of 300 µg/L. With an average soluble iron to soluble arsenic ratio of 100:1, there was sufficient natural iron present in source water for effective arsenic removal. After the contact tanks, iron was present primarily in the particulate form, suggesting effective oxidation even in the presence of elevated TOC levels. Total iron concentrations in the treated water ranged from <25 to 1,067 µg/L and averaged 259 µg/L. An increase in particulate iron correlated with an increase in particulate arsenic, indicating iron breakthrough from the Macrolite[®] filters.

Total manganese concentrations averaged 144 µg/L in source water, existing primarily in the soluble form as Mn(II) at 132 µg/L. After the addition of 2.6 to 3.8 mg/L of KMnO₄ and after the contact tanks, manganese was present primarily in the soluble form based on the use of 0.45-µm disc filters, with levels

ranging from 337 to 946 µg/L before November 15, 2005. The high levels of TOC in source water appeared to have inhibited the formation of filterable manganese solids. Based on the results of a series of jar tests, the KMnO₄ dosage applied to the treatment system was increased to 5.6 mg/L. The increased KMnO₄ dosage enabled most manganese to precipitate after the contact tanks, leaving only 108 to 166 µg/L measured as soluble manganese. Further adjustments will be made to the KMnO₄ dosing in the next six-month period to further lower the soluble manganese levels.

During this time period, the backwash water production rates ranged from 2.8 to 7.2%. The control disc on top of each set of duplex units was changed out twice to increase the backwash frequency in order to address the particulate arsenic, iron, and manganese breakthrough. The backwash frequency was increased from the initial field setting of every 2,743 gal to every 1,714 gal. If needed, further adjustments will be made in the next six-month study period. After November 15, 2006, when the modified backwash procedure was implemented, total arsenic concentrations in the backwash water ranged from 114 to 417 µg/L; total iron concentrations ranged from 14,069 to 77,641 µg/L; and total manganese concentrations ranged from 1,595 to 16,178 µg/L. Using 130 gal of backwash water produced, this equates to approximately 0.17 lb of solids, including 4.4×10^{-4} lb of arsenic, 0.08 lb of iron, and 0.01 lb manganese, generated per backwash event.

Comparison of the distribution system sampling results before and after system startup showed a significant decrease in arsenic and iron levels and a significant increase in manganese levels at all three sampling locations. The distribution water sampling results essentially mirrored the treatment results of the Macrolite[®] filters. Neither lead nor copper concentrations at the sample sites appear to have been affected by the operation of the system.

The capital investment cost was \$63,547, which included \$22,422 for equipment, \$20,227 for engineering, and \$20,898 for installation. Using the system's rated capacity of 20 gal/min (gpm) (28,800 gal/day [gpd]), the capital cost was \$3,177/gpm (\$2.21/gpd).

The O&M cost for the Macrolite[®] CP-213f system included only incremental cost associated with the chemical supply, electricity consumption, and labor. The O&M cost was estimated in this report at \$0.43/1,000 gal and will be refined at the end of the one-year evaluation period.

CONTENTS

| | |
|---|-----|
| DISCLAIMER | ii |
| FOREWORD | iii |
| ABSTRACT | iv |
| FIGURES | vii |
| TABLES | vii |
| ABBREVIATIONS AND ACRONYMS | ix |
| ACKNOWLEDGMENTS | xi |
| | |
| Section 1.0: INTRODUCTION | 1 |
| 1.1 Treatment Technologies for Arsenic Removal | 2 |
| 1.2 Project Objectives | 2 |
| | |
| Section 2.0: SUMMARY AND CONCLUSIONS | 5 |
| | |
| Section 3.0: MATERIALS AND METHODS | 7 |
| 3.1 General Project Approach | 7 |
| 3.2 System O&M and Cost Data Collection | 8 |
| 3.3 Sample Collection Procedures and Schedules | 8 |
| 3.3.1 Source Water | 11 |
| 3.3.2 Treatment Plant Water | 11 |
| 3.3.3 Special Study - KMnO ₄ Jar Tests | 11 |
| 3.3.4 Backwash Water | 11 |
| 3.3.5 Residual Solids | 12 |
| 3.3.6 Distribution System Water | 12 |
| 3.4 Sampling Logistics | 12 |
| 3.4.1 Preparation of Arsenic Speciation Kits | 12 |
| 3.4.2 Preparation of Sampling Coolers | 12 |
| 3.4.3 Sample Shipping and Handling | 12 |
| 3.5 Analytical Procedures | 13 |
| | |
| Section 4.0: RESULTS AND DISCUSSION | 14 |
| 4.1 Facility Description and Pre-Existing Treatment System Infrastructure | 14 |
| 4.1.1 Source Water Quality | 14 |
| 4.1.2 Distribution System and Treated Water Quality | 16 |
| 4.2 Treatment Process Description | 17 |
| 4.3 System Installation | 22 |
| 4.3.1 Permitting | 22 |
| 4.3.2 Building Construction | 22 |
| 4.3.3 System Installation, Shakedown, and Startup | 22 |
| 4.4 System Operation | 23 |
| 4.4.1 Operational Parameters | 23 |
| 4.4.2 Backwash | 23 |
| 4.4.3 Residual Management | 25 |
| 4.4.4 System/Operation Reliability and Simplicity | 25 |
| 4.5 System Performance | 26 |
| 4.5.1 Treatment Plant Sampling | 26 |
| 4.5.2 Backwash Water Sampling | 37 |
| 4.5.3 Distribution System Water Sampling | 38 |

| | | |
|------------------------------------|--------------------------------------|-----|
| 4.6 | System Cost | 41 |
| 4.6.1 | Capital Cost | 41 |
| 4.6.2 | Operation and Maintenance Cost | 42 |
| Section 5.0: REFERENCES | | 44 |
| APPENDIX A: OPERATIONAL DATA | | A-1 |
| APPENDIX B: ANALYTICAL DATA | | B-1 |

FIGURES

| | | |
|--------------|---|----|
| Figure 3-1. | Process Flow Diagram and Sampling Locations..... | 10 |
| Figure 4-1. | Pre-Existing Pump House at BSLMHP, MN Site..... | 14 |
| Figure 4-2. | Existing Well Piping and Pressure Tanks at BSLMHP, MN Site..... | 15 |
| Figure 4-3. | Process Schematic of Macrolite® Pressure Filtration System | 18 |
| Figure 4-4. | Photograph of Macrolite® Pressure Filtration System | 18 |
| Figure 4-5. | KMnO ₄ Feed System..... | 20 |
| Figure 4-6. | Kinetico's Mach 1250 Control Valve | 20 |
| Figure 4-7. | Backwash Flow Path for One Duplex Unit with Control Disc No. 8 and a Throughput of 1,714 gal between Backwash Cycles | 21 |
| Figure 4-8. | Concentrations of Arsenic Species at IN, AC, and TT Sampling Locations | 30 |
| Figure 4-9. | Total Arsenic Concentrations at TA/TB, TC/TD, and TT Sampling Locations | 31 |
| Figure 4-10. | Total Iron Concentrations at TA/TB, TC/TD, and TT Sampling Locations | 31 |
| Figure 4-11. | Total and Soluble Manganese Concentrations at AC Sampling Location | 33 |
| Figure 4-12. | Total Manganese Concentrations at TA/TB, TC/TD, and TT Sampling Locations | 34 |
| Figure 4-13. | Jar Test Setup | 36 |
| Figure 4-14. | Total Phosphorous Concentrations at IN, AC, TA/TB, TC/TD and TT Sampling Locations..... | 38 |

TABLES

| | | |
|------------|--|----|
| Table 1-1. | Summary of Round 1 and Round 2 Arsenic Removal Demonstration Locations, Technologies, and Source Water Quality..... | 3 |
| Table 3-1. | Predemonstration Study Activities and Completion Dates | 7 |
| Table 3-2. | Evaluation Objectives and Supporting Data Collection Activities | 7 |
| Table 3-3. | Sample Collection Schedule and Analyses | 9 |
| Table 3-4. | Summary of Jar Test Parameters..... | 11 |
| Table 4-1. | BSLMHP, MN Water Quality Data | 16 |
| Table 4-2. | Physical Properties of M2 Macrolite® Media..... | 17 |
| Table 4-3. | Design Specifications for Macrolite® CP-213f Pressure Filtration System | 19 |
| Table 4-4. | System Operation from July 13, 2005 to January 17, 2006 | 24 |
| Table 4-5. | Control Disc Size and Throughput between Backwash Cycles | 25 |
| Table 4-6. | Summary of Arsenic, Iron, and Manganese Analytical Results..... | 27 |
| Table 4-7. | Summary of Other Water Quality Parameter Sampling Results..... | 28 |
| Table 4-8. | Control Disc Sizes and Corresponding Occurrences with High Total Arsenic and Iron Concentrations..... | 32 |

| | | |
|-------------|---|----|
| Table 4-9. | Correlations Between Pump Stroke Length, KMnO_4 Dosage, and Total and Soluble Manganese Concentrations | 33 |
| Table 4-10. | Jar Test Results for Macrolite [®] -Treated Water | 35 |
| Table 4-11. | Backwash Water Sampling Results | 39 |
| Table 4-12. | Distribution Sampling Results | 40 |
| Table 4-13. | Summary of Capital Investment for BSLMHP Treatment System..... | 42 |
| Table 4-14. | O&M Cost for BSLMHP, MN Treatment System..... | 43 |

ABBREVIATIONS AND ACRONYMS

| | |
|--------|--|
| AAL | American Analytical Laboratories |
| Al | aluminum |
| AM | adsorptive media |
| As | arsenic |
| BSLMHP | Big Sauk Lake Mobile Home Park |
| BTU-hr | British Thermal Units per hour |
| Ca | calcium |
| Cu | copper |
| DO | dissolved oxygen |
| DOM | dissolved organic matter |
| EPA | U.S. Environmental Protection Agency |
| F | fluoride |
| Fe | iron |
| FRP | fiberglass reinforced plastic |
| GFH | granular ferric hydroxide |
| gpd | gallons per day |
| gpm | gallons per minute |
| HDPE | high-density polyethylene |
| hp | horsepower |
| ICP-MS | inductively coupled plasma-mass spectrometry |
| ID | identification |
| IX | ion exchange |
| LCR | Lead and Copper Rule |
| MCL | maximum contaminant level |
| MDL | method detection limit |
| MDH | Minnesota Department of Health |
| Mg | magnesium |
| Mn | manganese |
| Mo | molybdenum |
| mV | millivolts |
| Na | sodium |
| NA | not applicable |
| NaOCl | sodium hypochlorite |
| NRMRL | National Risk Management Research Laboratory |
| NTU | nephelometric turbidity units |
| O&M | operation and maintenance |

| | |
|-------|--|
| OIT | Oregon Institute of Technology |
| ORD | Office of Research and Development |
| ORP | oxidation-reduction potential |
| PE | professional engineer |
| P&ID | pipng and instrumentation diagrams |
| POU | point-of-use |
| psi | pounds per square inch |
| PVC | polyvinyl chloride |
| QA | quality assurance |
| QAPP | quality assurance project plan |
| QA/QC | quality assurance/quality control |
| RO | reverse osmosis |
| RPD | relative percent difference |
| Sb | antimony |
| SDWA | Safe Drinking Water Act |
| SMCL | Secondary Maximum Contaminant Level |
| TBD | to be determined |
| TCLP | Toxicity Characteristic Leaching Procedure |
| TDS | total dissolved solids |
| TOC | total organic carbon |
| TSS | total suspended solids |
| TTHM | total trihalomethane |
| V | vanadium |

ACKNOWLEDGMENTS

The authors wish to extend their sincere appreciation to the operator, Mr. Bill Tix of the Big Sauk Lake Mobile Home Park (BSLMHP) in Sauk Centre, MN. Mr. Tix monitored the treatment system daily and collected samples from the treatment and distribution system on a regular schedule throughout this reporting period. This performance evaluation would not have been possible without his efforts.

1.0: INTRODUCTION

The Safe Drinking Water Act (SDWA) mandates that U.S. Environmental Protection Agency (EPA) identify and regulate drinking water contaminants that may have adverse human health effects and that are known or anticipated to occur in public water supply systems. In 1975 under the SDWA, EPA established a maximum contaminant level (MCL) for arsenic at 0.05 mg/L. Amended in 1996, the SDWA required that EPA develop an arsenic research strategy and publish a proposal to revise the arsenic MCL by January 2000. On January 18, 2001, EPA finalized the arsenic MCL at 0.01 mg/L (EPA, 2001). In order to clarify the implementation of the original rule, EPA revised the rule on March 25, 2003 to express the MCL as 0.010 mg/L (10 µg/L) (EPA, 2003). The final rule requires all community and non-transient, non-community water systems to comply with the new standard by January 23, 2006.

In October 2001, EPA announced an initiative for additional research and development of cost-effective technologies to help small community water systems (<10,000 customers) meet the new arsenic standard and to provide technical assistance to operators of small systems in order to reduce compliance costs. As part of this Arsenic Rule Implementation Research Program, EPA's Office of Research and Development (ORD) proposed a project to conduct a series of full-scale, on-site demonstrations of arsenic removal technologies, process modifications, and engineering approaches applicable to small systems. Shortly thereafter, an announcement was published in the *Federal Register* requesting water utilities interested in participating in Round 1 of this EPA-sponsored demonstration program to provide information on their water systems. In June 2002, EPA selected 17 out of 115 sites to be the host sites for the demonstration studies.

In September 2002, EPA solicited proposals from engineering firms and vendors for cost-effective arsenic removal treatment technologies for the 17 host sites. EPA received 70 technical proposals for the 17 host sites, with each site receiving one to six proposals. In April 2003, an independent technical panel reviewed the proposals and provided its recommendations to EPA on the technologies that it determined were acceptable for the demonstration at each site. Because of funding limitations and other technical reasons, only 12 of the 17 sites were selected for the demonstration project. Using the information provided by the review panel, EPA, in cooperation with the host sites and the drinking water programs of the respective states, selected one technical proposal for each site. As of February 2007, 11 of the 12 systems have been operational and the performance evaluation of six systems has been completed.

In 2003, EPA initiated Round 2 arsenic technology demonstration projects that were partially funded with Congressional add-on funding to the EPA budget. In June 2003, EPA selected 32 potential demonstration sites and the Big Sauk Lake Mobile Home Park (BSLMHP) in Sauk Centre, MN was one of them.

In September 2003, EPA, again solicited proposals from engineering firms and vendors for arsenic removal technologies. EPA received 148 technical proposals for the 32 host sites, with each site receiving from two to eight proposals. In April 2004, another technical panel was convened by EPA to review the proposals and provide recommendations to EPA with the number of proposals per site ranging from none (for two sites) to a maximum of four. The final selection of the treatment technology at the sites that received at least one proposal was made, again through a joint effort by EPA, the state regulators, and the host site. Since then, four sites have withdrawn from the demonstration program, reducing the number of sites to 28. Kinetico's Macrolite[®] Arsenic Removal Technology was selected for demonstration at the BSLMHP site.

1.1 Treatment Technologies for Arsenic Removal

The technologies selected for the Round 1 and Round 2 demonstration host sites include 25 adsorptive media (AM) systems (the Oregon Institute of Technology [OIT] site has three AM systems), 13 coagulation/filtration (C/F) systems, two ion exchange (IX) systems, and 17 point-of-use (POU) units (including nine under-the-sink reverse osmosis [RO] units at the Sunset Ranch Development site and eight AM units at the OIT site), and one system modification. Table 1-1 summarizes the locations, technologies, vendors, system flowrates, and key source water quality parameters (including As, Fe, and pH) at the 40 demonstration sites. An overview of the technology selection and system design for the 12 Round 1 demonstration sites and the associated capital costs is provided in two EPA reports (Wang et al., 2004 and Chen et al., 2004), which are posted on the EPA website at <http://www.epa.gov/ORD/NRMRL/wswrd/dw/arsenic/index.html>.

1.2 Project Objectives

The objective of the Round 1 and Round 2 arsenic demonstration program is to conduct 40 full-scale arsenic treatment technology demonstration studies on the removal of arsenic from drinking water supplies. The specific objectives are to:

- Evaluate the performance of the arsenic removal technologies for use on small systems.
- Determine the required system operation and maintenance (O&M) and operator skill levels.
- Characterize process residuals produced by the technologies.
- Determine the capital and O&M cost of the technologies.

This report summarizes the performance of the Kinetico Macrolite[®] CP-213f arsenic removal system at BSLMHP in Sauk Centre, MN from July 13, 2005, through January 17, 2006. The types of data collected included system operation, water quality (both across the treatment train and in the distribution system), residuals, and capital and preliminary O&M cost.

Table 1-1. Summary of Round 1 and Round 2 Arsenic Removal Demonstration Locations, Technologies, and Source Water Quality

| Demonstration Location | Site Name | Technology (Media) | Vendor | Design Flowrate (gpm) | Source Water Quality | | |
|------------------------------------|--|----------------------|----------|-----------------------|----------------------|----------------------|-----------|
| | | | | | As (µg/L) | Fe (µg/L) | pH (S.U.) |
| <i>Northeast/Ohio</i> | | | | | | | |
| Wales, ME | Springbrook Mobile Home Park | AM (A/I Complex) | ATS | 14 | 38 ^(a) | <25 | 8.6 |
| Bow, NH | White Rock Water Company | AM (G2) | ADI | 70 ^(b) | 39 | <25 | 7.7 |
| Goffstown, NH | Orchard Highlands Subdivision | AM (E33) | AdEdge | 10 | 33 | <25 | 6.9 |
| Rollinsford, NH | Rollinsford Water and Sewer District | AM (E33) | AdEdge | 100 | 36 ^(a) | 46 | 8.2 |
| Dummerston, VT | Charette Mobile Home Park | AM (A/I Complex) | ATS | 22 | 30 | <25 | 7.9 |
| Felton, DE | Town of Felton | C/F (Macrolite) | Kinetico | 375 | 30 ^(a) | 48 | 8.2 |
| Stevensville, MD | Queen Anne's County | AM (E33) | STS | 300 | 19 ^(a) | 270 ^(c) | 7.3 |
| Houghton, NY ^(d) | Town of Caneadea | C/F (Macrolite) | Kinetico | 550 | 27 ^(a) | 1,806 ^(c) | 7.6 |
| Newark, OH | Buckeye Lake Head Start Building | AM (ARM 200) | Kinetico | 10 | 15 ^(a) | 1,312 ^(c) | 7.6 |
| Springfield, OH | Chateau Estates Mobile Home Park | AM (E33) | AdEdge | 250 ^(e) | 25 ^(a) | 1,615 ^(c) | 7.3 |
| <i>Great Lakes/Interior Plains</i> | | | | | | | |
| Brown City, MI | City of Brown City | AM (E33) | STS | 640 | 14 ^(a) | 127 ^(c) | 7.3 |
| Pentwater, MI | Village of Pentwater | C/F (Macrolite) | Kinetico | 400 | 13 ^(a) | 466 ^(c) | 6.9 |
| Sandusky, MI | City of Sandusky | C/F (Aeralater) | Siemens | 340 ^(e) | 16 ^(a) | 1,387 ^(c) | 6.9 |
| Delavan, WI | Vintage on the Ponds | C/F (Macrolite) | Kinetico | 40 | 20 ^(a) | 1,499 ^(c) | 7.5 |
| Greenville, WI | Town of Greenville | C/F (Macrolite) | Kinetico | 375 | 17 | 7827 ^(c) | 7.3 |
| Climax, MN | City of Climax | C/F (Macrolite) | Kinetico | 140 | 39 ^(a) | 546 ^(c) | 7.4 |
| Sabin, MN | City of Sabin | C/F (Macrolite) | Kinetico | 250 | 34 | 1,470 ^(c) | 7.3 |
| Sauk Centre, MN | Big Sauk Lake Mobile Home Park | C/F (Macrolite) | Kinetico | 20 | 25 ^(a) | 3,078 ^(c) | 7.1 |
| Stewart, MN | City of Stewart | C/F&AM (E33) | AdEdge | 250 | 42 ^(a) | 1,344 ^(c) | 7.7 |
| Lidgerwood, ND | City of Lidgerwood | Process Modification | Kinetico | 250 | 146 ^(a) | 1,325 ^(c) | 7.2 |
| <i>Midwest/Southwest</i> | | | | | | | |
| Arnaudville, LA | United Water Systems | C/F (Macrolite) | Kinetico | 770 ^(e) | 35 ^(a) | 2,068 ^(c) | 7.0 |
| Alvin, TX | Oak Manor Municipal Utility District | AM (E33) | STS | 150 | 19 ^(a) | 95 | 7.8 |
| Bruni, TX | Webb Consolidated Independent School District | AM (E33) | AdEdge | 40 | 56 ^(a) | <25 | 8.0 |
| Wellman, TX | City of Wellman | AM (E33) | AdEdge | 100 | 45 | <25 | 7.7 |
| Anthony, NM | Desert Sands Mutual Domestic Water Consumers Association | AM (E33) | STS | 320 | 23 ^(a) | 39 | 7.7 |
| Nambe Pueblo, NM | Nambe Pueblo Reservation | AM (E33) | AdEdge | 145 | 33 | <25 | 8.5 |
| Taos, NM | Town of Taos | AM (E33) | STS | 450 | 14 | 59 | 9.5 |
| Rimrock, AZ | Arizona Water Company | AM (E33) | AdEdge | 90 ^(b) | 50 | 170 | 7.2 |
| Tohono O'odham Nation, AZ | Tohono O'odham Utility Authority | AM (E33) | AdEdge | 50 | 32 | <25 | 8.2 |
| Valley Vista, AZ | Arizona Water Company | AM (AAFS50/ARM 200) | Kinetico | 37 | 41 | <25 | 7.8 |

Table 1-1. Summary of Round 1 and Round 2 Arsenic Removal Demonstration Locations, Technologies, and Source Water Quality (Continued)

| Demonstration Location | Site Name | Technology (Media) | Vendor | Design Flowrate (gpm) | Source Water Quality | | |
|------------------------|--|---|------------|-----------------------|----------------------|-------------------|-----|
| | | | | | As (µg/L) | Fe (µg/L) | pH |
| <i>Far West</i> | | | | | | | |
| Three Forks, MT | City of Three Forks | C/F (Macrolite) | Kinetico | 250 | 64 | <25 | 7.5 |
| Fruitland, ID | City of Fruitland | IX (A300E) | Kinetico | 250 | 44 | <25 | 7.4 |
| Homedale, ID | Sunset Ranch Development | POU RO ^(f) | Kinetico | 75 gpd | 52 | 134 | 7.5 |
| Okanogan, WA | City of Okanogan | C/F (Electromedia-I) | Filtronics | 750 | 18 | 69 ^(c) | 8.0 |
| Klamath Falls, OR | Oregon Institute of Technology | POE AM (Adsorbisia/ARM 200/ArsenX ^{np}) and POU AM (ARM 200) ^(g) | Kinetico | 60/60/30 | 33 | <25 | 7.9 |
| Vale, OR | City of Vale | IX (Arsenex II) | Kinetico | 525 | 17 | <25 | 7.5 |
| Reno, NV | South Truckee Meadows General Improvement District | AM (GFH) | Siemens | 350 | 39 | <25 | 7.4 |
| Susanville, CA | Richmond School District | AM (A/I Complex) | ATS | 12 | 37 ^(a) | 125 | 7.5 |
| Lake Isabella, CA | Upper Bodfish Well CH2-A | AM (HIX) | VEETech | 50 | 35 | 125 | 7.5 |
| Tehachapi, CA | Golden Hills Community Service District | AM (Isolux) | MEI | 150 | 15 | <25 | 6.9 |

AM = adsorptive media process; C/F = coagulation/filtration; HIX = hybrid ion exchanger; IX = ion exchange process; RO = reverse osmosis

ATS = Aquatic Treatment Systems; MEI = Magnesium Elektron, Inc.; STS = Severn Trent Services

(a) Arsenic existing mostly as As(III).

(b) Design flowrate reduced by 50% due to system reconfiguration from parallel to series operation.

(c) Iron existing mostly as Fe(II).

(d) Replaced Village of Lyman, NE site which withdrew from program in June 2006.

(e) Facilities upgraded systems in Springfield, OH from 150 to 250 gpm, Sandusky, MI from 210 to 340 gpm, and Arnaudville, LA from 385 to 770 gpm.

(f) Including nine residential units.

(g) Including eight under-the-sink units.

Section 2.0: SUMMARY AND CONCLUSIONS

Based on the information collected during the first six months of system operation, the following conclusions were made relating to the overall objectives of the treatment technology demonstration study.

Performance of the arsenic removal technology for use on small systems:

- KMnO_4 , selected over chlorine due to the presence of elevated total organic carbon (TOC) levels (i.e., 3.2 to 4.8 mg/L) and high formation potential of disinfection byproducts in source water, was effective in oxidizing As (III), reducing its concentrations from an average of 23 $\mu\text{g/L}$ to an average of 1.9 $\mu\text{g/L}$ after the contact tanks. Arsenic after the contact tanks was converted mostly to particulate arsenic, which was ready to be removed by the Macrolite[®] filters. KMnO_4 also was effective in oxidizing soluble iron despite the presence of high TOC levels in raw water.
- Even at significantly reduced loading rates of 0.3 to 4.1 gpm/ft^2 , the Macrolite[®] filters did not consistently remove arsenic to the 10- $\mu\text{g/L}$ level. The removal at the target level was achieved during only 16 of the 24 weekly sampling events. Breakthrough of particulate arsenic and iron at concentrations as high as 21.5 and 2,363 $\mu\text{g/L}$, respectively, from the Macrolite[®] filters was the main reason for not meeting the target arsenic MCL.
- Because of the observed particulate breakthrough, the filter backwash frequency had to be repeatedly increased from the initial field setting of once every 2,743 gal to once every 1,714 gal during the first six-month study period. As a result, the backwash water generation ratios were increased correspondingly from 5.5 to 7.2%. Further adjustments to the backwash frequency will have to be implemented during the next six-month study period because of continuing particulate breakthrough.
- Oxidation of Mn(II) with KMnO_4 was affected by the presence of dissolved organic matter (DOM) in raw water, forming fine colloidal particles not retainable by 0.45- μm disc filters. A dosage of at least 4.58 mg/L appeared to be needed to form filterable manganese solids, thus reducing the “soluble” manganese levels, as measured by using 0.45- μm disc filters, from as high as 946 $\mu\text{g/L}$ to below 166 $\mu\text{g/L}$ after the contact tanks.
- Elevated total phosphorous levels ranging from 0.4 to 0.6 mg/L (as P) were detected in raw water. Total phosphorous existed primarily as total hydrolysable phosphorous, including polyphosphorous and some organic phosphorous according to EPA Method 365.4. No organopesticides, however, were present in source water according the EPA Method 507. Potential sources of elevated phosphorous included non-point source discharge from septic systems, agriculture, and urban runoff.

The Macrolite[®] filtration process was able to remove about 80% of total phosphorous.

Simplicity of required system O&M and operator skill levels:

- The daily demand on the operator was about 5 min, which included performing O&M activities such as mixing the KMnO_4 solution, measuring the KMnO_4 consumption, installing the hour meter, and working with the vendor to troubleshoot and perform minor on-site repairs.

- The system experienced some operational issues, which were related primarily to the backwash frequency. The throughput between backwash cycles had to be reduced repeatedly by using different control discs installed on top of the duplex units.
- There was no significant downtime during the first six months of system operation. However, the primary well pump developed a leak on January 4, 2006, which was repaired within a day. Further, a backwash malfunction occurred on August 9, 2005, which necessitated repairs by the vendor.

Process residuals produced by the technology:

- Based on the average of samples taken during several backwash events, the amount of solids produced per backwash event was 0.17 lb, which was composed of approximately 0.08 lb of iron and 4.4×10^{-4} lb of arsenic.

Cost-effectiveness of the technology:

- Using the system's rated capacity of 20 gal/min (gpm) (or 28,800 gal/day [gpd]), the capital cost was \$3,177 per gpm (or \$2.21 per gpd). The unit capital cost was \$0.57/1,000 gal if the system operated at 100% utilization rate. The system's real unit cost was 3.47/1,000 gal, based on 3.4 hr/day of system operation and 863,470 of water production.
- The O&M cost was \$0.43/1000 gal, based on labor, chemical usage, and electricity consumption.

3.0: MATERIALS AND METHODS

3.1 General Project Approach

Following the pre-demonstration activities summarized in Table 3-1, the performance evaluation of the Macrolite[®] treatment system began on July 13, 2005. Table 3-2 summarizes the types of data collected and/or considered as part of the technology evaluation process. The overall system performance was evaluated based on its ability to consistently remove arsenic to below the target MCL of 10 µg/L through the collection of water samples across the treatment train. The reliability of the system was evaluated by tracking the unscheduled system downtime and frequency and extent of repair and replacement. The unscheduled downtime and repair information were recorded by the plant operator on a Repair and Maintenance Log Sheet.

Table 3-1. Predemonstration Study Activities and Completion Dates

| Activity | Date |
|--|----------|
| Introductory Meeting Held | 08/31/04 |
| Request for Quotation Issued to Vendor | 12/06/04 |
| Vendor Quotation Received | 02/17/05 |
| Purchase Order Established | 02/24/05 |
| Letter of Understanding Issued | 01/10/05 |
| Letter Report Issued | 03/09/05 |
| Engineering Package Submitted to MDH | 03/28/05 |
| Permit Granted by MDH | 06/14/05 |
| Study Plan Issued | 06/21/05 |
| Macrolite [®] Unit Shipped | 06/10/05 |
| Macrolite [®] Unit Delivered | 06/16/05 |
| System Installation Completed | 06/24/05 |
| System Shakedown Completed | 07/03/05 |
| Performance Evaluation Begun | 07/13/05 |

MDH = Minnesota Department of Health

Table 3-2. Evaluation Objectives and Supporting Data Collection Activities

| Evaluation Objective | Data Collection |
|--|--|
| Performance | -Ability to consistently meet 10 µg/L of arsenic in treated water |
| Reliability | -Unscheduled system downtime -Frequency and extent of repairs including a description of problems, materials and supplies needed, and associated labor and cost |
| System O&M and Operator Skill Requirements | -Pre- and post-treatment requirements -Level of automation for system operation and data collection -Staffing requirements including number of operators and laborers -Task analysis of preventive maintenance including number, frequency, and complexity of tasks -Chemical handling and inventory requirements -General knowledge needed for relevant chemical processes and health and safety practices |
| Residual Management | -Quantity and characteristics of aqueous and solid residuals generated by system operation |
| Cost-Effectiveness | -Capital cost for equipment, engineering, and installation -O&M cost for chemical usage, electricity consumption, and labor |

The O&M and operator skill requirements were evaluated based on a combination of quantitative data and qualitative considerations, including the need for pre- and/or post-treatment, level of system automation, extent of preventative maintenance activities, frequency of chemical and/or media handling and inventory, and general knowledge needed for relevant chemical processes and related health and safety practices. The staffing requirements for the system operation were recorded on an Operator Labor Hour Log Sheet.

The quantity of aqueous and solid residuals generated was estimated by tracking the volume of backwash water produced during each backwash cycle. Backwash water was sampled and analyzed for chemical characteristics.

The cost of the system was evaluated based on the capital cost per gal/min (gpm) (or gal/day [gpd]) of design capacity and the O&M cost per 1,000 gal of water treated. This task required tracking the capital cost for equipment, engineering, and installation, as well as the O&M cost for media replacement and disposal, chemical supply, electricity usage, and labor.

3.2 System O&M and Cost Data Collection

The plant operator performed daily, weekly and monthly system O&M and data collection according to instructions provided by the vendor and Battelle. On a daily basis, with the exception of Saturdays and Sundays, the plant operator recorded system operational data, such as pressure, flowrate, volume, and hour meter readings on a Daily System Operation Log Sheet; checked the potassium permanganate (KMnO₄) tank level; and conducted visual inspections to ensure normal system operations. If any problem occurred, the plant operator contacted the Battelle Study Lead, who determined if the vendor should be contacted for troubleshooting. The plant operator recorded all relevant information, including the problems encountered, corrective actions taken; materials and supplies used, and associated cost and labor required, on a Repair and Maintenance Log Sheet. On a weekly basis, the plant operator measured several water quality parameters on-site, including temperature, pH, dissolved oxygen (DO), and oxidation-reduction potential (ORP), and recorded the data on a Weekly Water Quality Parameters Log Sheet. During the six-month study period, the system was backwashed automatically, except during the monthly backwash sampling events when the system was backwashed manually to capture the required backwash samples. Monthly backwash data also were recorded on a Backwash Log Sheet.

The capital cost for the arsenic removal system consisted of the cost for equipment, site engineering, and system installation. The O&M cost consisted of the cost for chemical usage, electricity consumption, and labor. Consumption of KMnO₄ was tracked on the Daily System Operation Log Sheet. Electricity usage was estimated based on the hours of operation and the chemical feed pump motor size. Labor for various activities, such as routine system O&M, troubleshooting and repairs, and demonstration-related work, were tracked using an Operator Labor Hour Log Sheet. The routine system O&M included activities such as completing field logs, replenishing the KMnO₄ solution, ordering supplies, performing system inspections, and others as recommended by the vendor. The labor for demonstration-related work, including activities such as performing field measurements, collecting and shipping samples, and communicating with the Battelle Study Lead and the vendor, was recorded, but not used for the cost analysis.

3.3 Sample Collection Procedures and Schedules

To evaluate system performance, samples were collected at the wellhead, across the treatment system, during Macrolite[®] filter backwash, and from the distribution system. The sampling schedules and analytes measured during each sampling event are listed in Table 3-3. In addition, Figure 3-1 presents a flow diagram of the treatment system along with the analytes and schedules at each sampling location.

Table 3-3. Sample Collection Schedule and Analyses

| Sample Type | Sample Locations ^(a) | No. of Samples | Frequency | Analytes | Date(s) Samples Collected |
|-----------------------|---|----------------|----------------------------------|---|---|
| Source Water | At Wellhead (IN) | 1 | Once (during initial site visit) | On-site: pH, temperature, DO, and ORP Off-site: As(III), As(V), As (total and soluble), Fe (total and soluble), Mn (total and soluble), U (total and soluble), V (total and soluble), Na, Ca, Mg, Cl, F, NO ₃ , NO ₂ , NH ₃ , SO ₄ , SiO ₂ , P, turbidity, alkalinity, TDS, and TOC | 08/31/04 |
| Treatment Plant Water | At Wellhead (IN), After Contact Tanks (AC), After Tanks A/B (TA/TB), After Tank C/D (TC/TD) | 4 | Weekly | On-site: pH, temperature, DO, and ORP Off-site: As(total), Fe(total), Mn(total), SiO ₂ , P, turbidity, and alkalinity | 07/20/05, 07/26/05, 08/02/05, 08/24/05, 08/31/05, 09/07/05, 09/14/05, 09/27/05, 10/05/05, 10/12/05, 10/26/05, 11/02/05, 11/09/05, 11/29/05, 12/14/05, 01/10/06, 01/17/06 |
| | At Wellhead (IN), After Contact Tanks (AC), After Tanks TA/TB and TC/TD Combined (TT) | 3 | Monthly | Same as weekly analytes shown above plus the following: Off-site: As (soluble), As(III), As(V), Fe (soluble), Mn (soluble), Ca, Mg, F, NO ₃ , SO ₄ , and TOC | 07/13/05, 08/18/05, 09/20/05, 10/19/05, 11/15/05, 12/08/05, 01/05/06 |
| Distribution Water | Three LCR Residences | 3 | Monthly | As (total), Fe (total), Mn (total), Cu, Pb, pH, and alkalinity | Baseline Sampling ^(b) 02/16/05, 03/23/05 04/19/05, 05/23/05 Monthly Sampling: 07/26/05, 09/07/05, 09/27/05, 11/02/05, 11/29/05, 12/15/05, 01/17/06 |
| Backwash Water | Backwash Discharge Line | 2 | Monthly | As (total and soluble), Fe (total and soluble), Mn (total and soluble), pH, turbidity, TDS, and TSS | 09/08/05, 09/20/05, 10/12/05, 11/15/05, 12/08/05, 01/10/06 |
| Residual Sludge | At Backwash Discharge Point | 2-3 | TBD | TCLP Metals | TBD |

(a) Abbreviation corresponding to sample location in Figure 3-1.

(b) Sampling events performed before system startup.

TBD = to be determined.

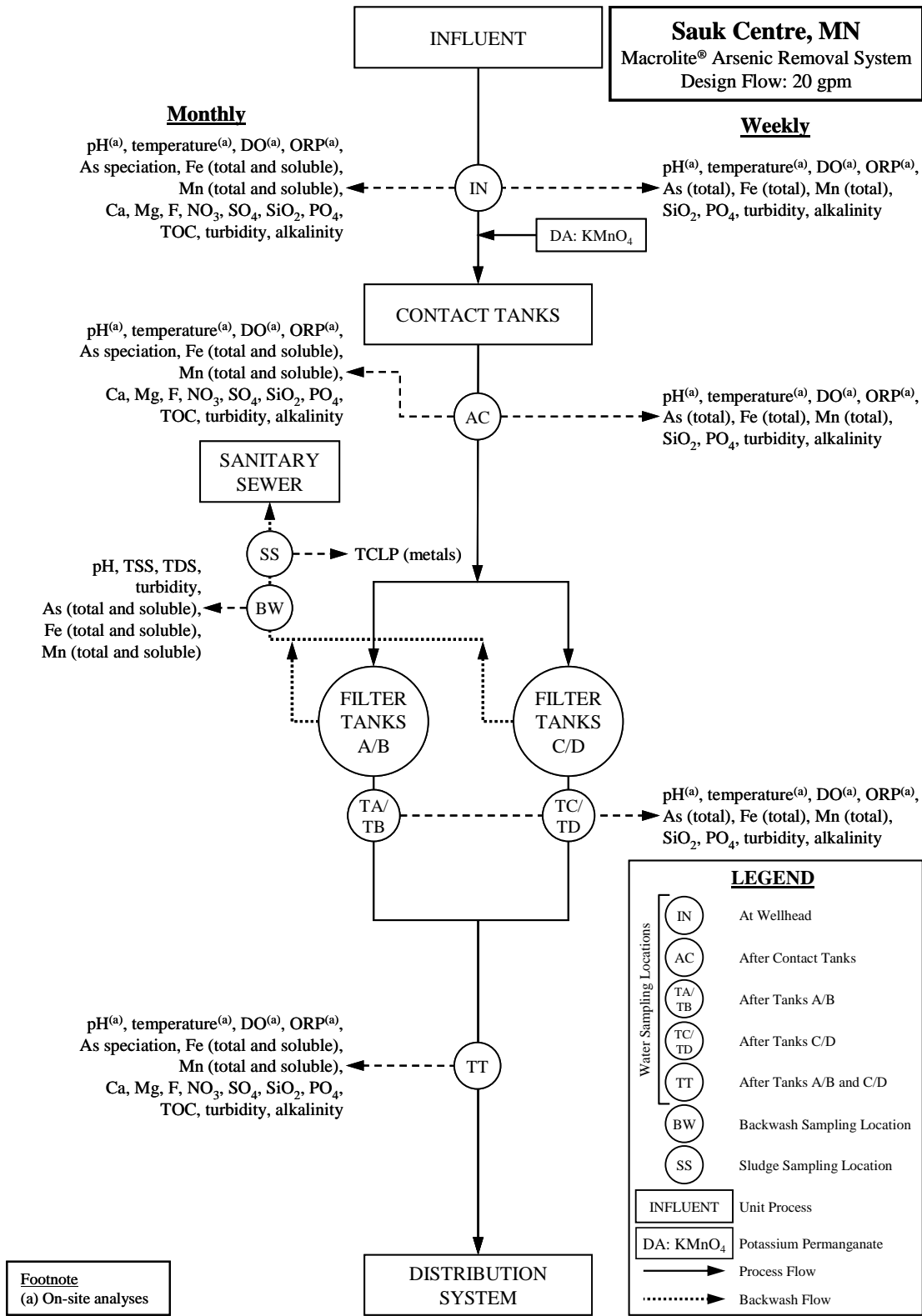

Figure 3-1. Process Flow Diagram and Sampling Locations

Specific sampling requirements for analytical methods, sample volumes, containers, preservation, and holding times are presented in Table 4-1 of the EPA- Quality Assurance Project Plan (QAPP) (Battelle, 2004). The procedure for arsenic speciation is described in Appendix A of the QAPP.

3.3.1 Source Water. During the initial visit to the site, one set of source water samples was collected and speciated using an arsenic speciation kit (see Section 3.4.1). The sample tap was flushed for several minutes before sampling; special care was taken to avoid agitation, which might cause unwanted oxidation. Analytes for the source water samples are listed in Table 3-3.

3.3.2 Treatment Plant Water. During the system performance evaluation study, the plant operator collected samples weekly, on a four-week cycle, for on- and off-site analyses. For the first week of each four-week cycle, samples taken at the wellhead (IN), after the contact tanks (AC), and after Tanks A/B and Tanks C/D combined (TT), were speciated on-site and analyzed for the analytes listed in Table 3-3 for monthly treatment plant water. For the next three weeks, samples were collected at IN, AC, after Tanks A/B (TA/TB) and after Tanks C/D (TC/TD) and analyzed for the analytes listed in Table 3-3 for the weekly treatment plant water.

3.3.3 Special Study - KMnO₄ Jar Tests. Because significantly elevated soluble manganese concentrations were measured in the treated water after the Macrolite[®] filters, a series of jar tests were conducted at Battelle’s laboratories on November 7, 2005, using the treated water taken at the TT location from the site to determine an appropriate KMnO₄ dosage for complete oxidation of Mn(II) and formation of filterable manganese solids.

The jar tests consisted of six 1-L jars of the treated water with increasing dosages of KMnO₄ ranging from 1.0 to 3.0 mg/L (Table 3-4). One jar was used as a control with no KMnO₄ addition. The jars were placed on a Phipps & Byrd overhead stirrer/jar tester with an illuminated base. The jars were mixed for a total of 31 min at various mixing speeds: 200 rpm for 1 min immediately after the KMnO₄ addition, followed by 100 rpm for 19 min and 28 rpm for 11 min. After the specified contact time, the supernatant in each jar was filtered with 0.20-µm disc filters and analyzed for arsenic, iron, and manganese using Inductively Coupled Plasma-Mass Spectrometry (ICP-MS). The pH and ORP values of the content in each jar also were measured using a VWR Symphony SP90M5 Handheld Multimeter at the beginning and end of each jar test. The results of the jar tests are discussed in Section 4.5.1.

Table 3-4. Summary of Jar Test Parameters

| Parameter | Jar 1 | Jar 2 | Jar 3 | Jar 4 | Jar 5 | Jar 6 |
|-------------------------------|-------|-------|-------|-------|-------|-------|
| Mix Time (min) ^(a) | 31 | 31 | 31 | 31 | 31 | 31 |
| KMnO ₄ (mg/L) | 0 | 1.0 | 1.5 | 2.0 | 2.5 | 3.0 |

(a) Mixing Speeds: 1 min at 200 rpm, 19 min at 100 rpm, and 11 min at 28 rpm.

3.3.4 Backwash Water. Backwash samples were collected monthly by the plant operator. One backwash water sample was collected as one of the tanks in each duplex unit was backwashed during each of the first six monthly sampling events. For the first three sampling events, one grab sample was taken as the bulk of solids/water mixture was being discharged from the sample tap located on the backwash water discharge line but before the backwash totalizer. Unfiltered samples sent to American Analytical Laboratories (AAL) for pH, total dissolved solids (TDS), and turbidity measurements. Filtered samples using 0.45-µm disc filters were sent to Battelle’s ICP-MS laboratory for soluble As, Fe, and Mn analyses. Starting from November 15, 2005, during the fourth sampling event, the sampling procedure

was modified to include the collection of composite samples for total As, Fe, and Mn as well as TSS analyses. This modified procedure involved diverting a portion of backwash water at approximately 1 gpm into a clean, 32-gal plastic container over the duration of the backwash for each set of duplex tanks. After the content in the container was thoroughly mixed, composite samples were collected and /or filtered on-site with a 0.45- μ m filters. Analytes for the backwash samples are listed in Table 3-3.

3.3.5 Residual Solids. Residual solids produced by the treatment process included backwash solids, which were not collected during the initial six months of this demonstration.

3.3.6 Distribution System Water. Samples were collected from the distribution system to determine the impact of the arsenic treatment system on the water chemistry in the distribution system, specifically, the arsenic, lead, and copper levels. Prior to the system startup, from February to May 2005, four sets of baseline distribution water samples were collected from three residences within the distribution system. Following the system startup, distribution system sampling continued on a monthly basis at the same three locations.

The three homes selected for the sampling had been included in the Park's Lead and Copper Rule (LCR) sampling. The homeowners collected samples following an instruction sheet developed according to the *Lead and Copper Monitoring and Reporting Guidance for Public Water Systems* (EPA, 2002). First draw samples were collected from a cold-water faucet located upstream of the softener in each home. (Note that the samples thus collected were not from a frequently used kitchen or bathroom faucet nor from a faucet that was commonly used for human consumption.) To ensure collection of stagnant water, the faucet were not used for at least 6 hr. Dates and times of sample collection and last water usage were recorded for calculations of the stagnation time. Analytes for the distribution system water are listed in Table 3-3. Arsenic speciation was not performed for the distribution water samples.

3.4 Sampling Logistics

3.4.1 Preparation of Arsenic Speciation Kits. The arsenic field speciation method uses an anion exchange resin column to separate the soluble arsenic species, As(V) and As(III) (Edwards et al., 1998). Resin columns were prepared in batches at Battelle laboratories according to the procedures detailed in Appendix A of the EPA-endorsed QAPP (Battelle, 2004).

3.4.2 Preparation of Sample Coolers. For each sampling event, a sample cooler was prepared with the appropriate number and type of sample bottles, disc filters, and/or speciation kits. All sample bottles were new and contained appropriate preservatives. Each sample bottle was affixed with a pre-printed, colored-coded label consisting of the sample identification (ID), date and time of sample collection, collector's name, site location, sample destination, analysis required, and preservative. The sample ID consisted of a two-letter code for a specific water facility, sampling date, a two-letter code for a specific sampling location, and a one-letter code designating the arsenic speciation bottle (if necessary). The sampling locations at the treatment plant were color-coded for easy identification. The labeled bottles for each sampling locations were placed in separate ZiplockTM bags and packed in the cooler.

In addition, all sampling-and shipping-related materials, such as disposable gloves, sampling instructions, chain-of-custody forms, prepaid/addressed FedEx air bills, and bubble wrap, was included. The chain-of-custody forms and air bills were complete except for the operator's signature and the sample dates and times. After preparation, the sample cooler was sent to the site via FedEx for the following week's sampling event.

3.4.3 Sample Shipping and Handling. After sample collection, samples for off-site analyses were packed carefully in the original coolers with wet ice and shipped to Battelle. Upon receipt, the sample

custodian verified that all samples indicated on the chain-of-custody forms were included and intact. Sample IDs were checked against the chain-of-custody forms and the samples were logged into the laboratory sample receipt log. Discrepancies noted by the sample custodian were addressed with the plant operator by the Battelle Study Lead.

Samples for metal analyses were stored at Battelle's ICP-MS Laboratory. Samples for other water quality analyses were packed in separate coolers and picked up by couriers from American Analytical Laboratories (AAL) in Columbus, OH and TCCI Laboratories (TCCI) in Lexington, OH, both of which were under contract with Battelle for this demonstration study. The chain-of-custody forms remained with the samples from the time of preparation through analysis and final disposition. All samples were archived by the appropriate laboratories for the respective duration of the required hold time and disposed of properly thereafter.

3.5 Analytical Procedures

The analytical procedures described in detail in Section 4.0 of the EPA-endorsed QAPP (Battelle, 2004) were followed by Battelle ICP-MS, AAL, and TCCI Laboratories. Laboratory quality assurance/quality control (QA/QC) of all methods followed the prescribed guidelines. Data quality in terms of precision, accuracy, method detection limits (MDL), and completeness met the criteria established in the QAPP (i.e., relative percent difference [RPD] of 20%, percent recovery of 80-120%, and completeness of 80%). The quality assurance (QA) data associated with each analyte will be presented and evaluated in a QA/QC Summary Report to be prepared under separate cover upon completion of the Arsenic Demonstration Project.

Field measurements of pH, temperature, DO, and ORP were conducted by the plant operator using a VWR Symphony SP90M5 Handheld Multimeter, which was calibrated for pH and DO prior to use following the procedures provided in the user's manual. The ORP probe also was checked for accuracy by measuring the ORP of a standard solution and comparing it to the expected value. The plant operator collected a water sample in a clean, plastic beaker and placed the Symphony SP90M5 probe in the beaker until a stable value was obtained. The plant operator also performed free and total chlorine measurements using Hach chlorine test kits following the user's manual.

4.0: RESULTS AND DISCUSSION

4.1 Facility Description and Pre-Existing Treatment System Infrastructure

Located at 43987 County Road 24 in Sauk Centre, MN, BSLMHP had a water supply system sized for up to 50 mobile home connections or approximately 100 residents. There were 37 mobile homes in the park during the study period. Prior to the demonstration study, the facility reported the average daily demand of 7,500 gpd and the peak daily demand of 16,000 gpd. The system typically operated approximately 6 hr/day. Figure 4-1 shows the pre-existing well house at the facility.

The system was supplied intermittently by groundwater from two wells installed at a depth of approximately 90 ft below ground surface (bgs). The new well (Well No. 2) was used as the primary well and the old well (Well No. 1) used as a backup well. The new well was equipped with a 1½-horsepower (hp), 4-in submersible pump installed on a 60-ft drop pipe and rated for 25 gpm at 180 ft H₂O (or 78 psi). The pump installed in the backup well reportedly had a similar capacity, but records were no longer available. Figure 4-2 shows the existing piping and two 62-gal Champion pressure tanks in the wellhouse. There was no disinfection or other treatment at the wellheads, although most residents had water softeners in their homes.

4.1.1 Source Water Quality. Source water samples were collected on August 31, 2004, and subsequently analyzed for the analytes shown in Table 3-3. The results of source water analyses, along with those provided by the facility to EPA for the demonstration site selection and those independently collected and analyzed by EPA, MDH, and the vendor are presented in Table 4-1.

As shown in Table 4-1, total arsenic concentrations in source water extracted from both wells ranged from 17.0 to 32.0 µg/L. Based on the August 31, 2004, speciation results, as much as 54% of the total arsenic, or 13.6 µg/L, was found to exist as As(III) and 18% existed as particulate arsenic.



Figure 4-1. Pre-Existing Pump House at BSLMHP, MN Site



Figure 4-2. Existing Well Piping and Pressure Tanks at BSLMHP, MN Site

Iron concentrations in source water extracted from both wells ranged from 3,000 to 3,400 $\mu\text{g/L}$, existing entirely as soluble iron based on August 31, 2004 results. A rule of thumb is that the soluble iron concentration, expressed in mg/L , should be at least 20 times the soluble arsenic concentration, also expressed in mg/L , for effective removal of arsenic onto iron solids (Sorg, 2002). Based on the best and worst case scenarios, the results indicate that iron levels are 94 to 200 times higher than total arsenic levels. As such, there is no need to supplement the natural iron for arsenic removal. The proposed treatment process is designed to reduce iron levels in the filtered water to below the secondary MCL of 300 $\mu\text{g/L}$.

Manganese levels of 130 to 150 $\mu\text{g/L}$ were elevated above the secondary MCL of 50 $\mu\text{g/L}$. The pH values ranged from 7.1 to 7.4, which were within the target range of 5.5 to 8.5 for the iron removal process. Total organic carbon (TOC) levels at 3.9 to 4.9 mg/L were high and because of the high levels, KMnO_4 was used to oxidize iron and arsenic. The use of KMnO_4 should help eliminate the formation potential of disinfection byproducts, which could occur if pre-chlorination was implemented. In April 2005, EPA conducted a disinfection byproduct formation test on source water and found that after 96 hr of maintaining a chlorine residual, the total trihalomethane (TTHM) level was 0.11 mg/L , existing almost completely as chloroform. Note that the MCL for TTHM is 0.080 mg/L . This further confirmed the need to use an alternate oxidant to chlorine. Ammonia levels at 1.2 mg/L also were elevated and could significantly increase the chlorine demand should chlorine be used as an oxidant. The turbidity of the water at 30 NTU was high, presumably caused by iron precipitation during sample collection and transit. Hardness ranged from 300 to 360 mg/L , silica from 21 to 25 mg/L , and sulfate from <4 to 5.4 mg/L . Based on the historical data provided by MDH, there was no apparent difference in water quality between Wells No. 1 and No. 2. Total arsenic concentrations ranged from 26.0 to 32.0 $\mu\text{g/L}$ for Well No. 1 and from 26.0 to 28.0 $\mu\text{g/L}$ for Well No. 2; total iron concentrations were 3,400 for Well No. 1 and 3,000 $\mu\text{g/L}$ for Well No. 2; and total manganese concentrations were 140 $\mu\text{g/L}$ for Well No. 1 and 130 $\mu\text{g/L}$ for Well No. 2.

Table 4-1. BSLMHP, MN Water Quality Data

| Parameter | Unit | Facility Well 2 Data | Kinetico Well 2 Data | Battelle Well 2 Data | MDH Well 1 Data | MDH Well 2 Data | MDH Distribution Water Data ^(a) |
|--|-------|----------------------|----------------------|----------------------|---------------------|---------------------|--|
| <i>Date</i> | | Not specified | 10/14/03 | 08/31/04 | 01/25/01 – 08/10/04 | 01/25/01 – 08/10/04 | 01/25/01 – 08/10/04 |
| pH | – | 7.4 | 7.3 | 7.1 | 7.3 | 7.4 | NS |
| Temperature | °C | NS | NS | NS | NS | NS | NS |
| DO | mg/L | NS | NS | 1.48 | NS | NS | NS |
| ORP | mV | NS | NS | -98 | NS | NS | NS |
| Total Alkalinity (as CaCO ₃) | mg/L | 355 | 364 | 363 | 350 | 360 | NS |
| Hardness (as CaCO ₃) | mg/L | 305 | 330 | 360 | 310 | 300 | 340 |
| Turbidity | NTU | NS | NS | 30 | <1–22 | <1–20 | <1–22 |
| TDS | mg/L | NS | NS | 338 | NS | NS | NS |
| TOC | mg/L | 4.9 | NS | 3.9 | NS | 4.9 | NS |
| Total N (Nitrite + Nitrate) (as N) | mg/L | NS | NS | NS | NS | NS | <0.05–0.01 |
| Nitrate (as N) | mg/L | NS | NS | <0.04 | NS | NS | NS |
| Nitrite (as N) | mg/L | NS | NS | <0.01 | NS | NS | NS |
| Ammonia (as N) | mg/L | NS | NS | 1.2 | NS | NS | NS |
| Chloride | mg/L | 1.5 | <1.0 | <1.0 | 1.5 | 1.5 | NS |
| Fluoride | mg/L | NS | 0.46 | <0.1 | NS | NS | 0.29 |
| Sulfate | mg/L | 5.2 | <4.0 | <5.0 | 5.0 | 5.4 | 6.6 |
| Silica (as SiO ₂) | mg/L | 24 | 21.4 | 25 | 23 | 24 | 23.0–24.0 |
| Orthophosphate (as P) | mg/L | 0.02 | <0.5 | <0.1 | NS | NS | NS |
| As (total) | µg/L | 26 | 17 | 25.3 | 26.0–32.0 | 26.0–28.0 | 18.4–28.0 |
| As (soluble) | µg/L | NS | NS | 20.7 | NS | NS | NS |
| As (particulate) | µg/L | NS | NS | 4.6 | NS | NS | NS |
| As(III) | µg/L | NS | NS | 13.6 | NS | NS | NS |
| As(V) | µg/L | NS | NS | 7.1 | NS | NS | NS |
| Fe (total) | µg/L | 3,200 | 3,060 | 3,078 | 3,400 | 3,000 | 2,900 |
| Fe (soluble) | µg/L | NS | NS | 3,149 | NS | NS | NS |
| Mn (total) | µg/L | 140 | 150 | 150 | 140 | 130 | 140 |
| Mn (soluble) | µg/L | NS | NS | 154 | NS | NS | NS |
| U (total) | µg/L | NS | NS | <0.1 | NS | NS | NS |
| U (soluble) | µg/L | NS | NS | <0.1 | NS | NS | NS |
| V (total) | µg/L | NS | NS | 0.17 | <2 | <2 | NS |
| V (soluble) | µg/L | NS | NS | <0.1 | NS | NS | NS |
| Na (total) | mg/L | 14 | 13 | 17 | 15 | 14 | 13.6 |
| Ca (soluble) | mg/L | 72 | 81 | 87 | 72 | 72 | 80 |
| Mg (total) | mg/L | 30 | 32 | 35 | 31 | 29 | 33 |
| Gross-Alpha | pCi/L | NS | NS | NS | NS | NS | <1.00–<1.5 |
| Gross-Beta | pCi/L | NS | NS | NS | NS | NS | <0.40–<0.91 |
| Radon | pCi/L | NS | NS | NS | NS | NS | 50–470 |
| Radium-228 | pCi/L | NS | NS | NS | NS | NS | <0.59 |

NS = not sampled.

(a) Samples taken from various residences.

4.1.2 Distribution System and Treated Water Quality. Water extracted from both wells blends within the pressure tanks and the distribution system. The park owner indicated that the distribution system is solely constructed of polyvinyl chloride (PVC). Prior to this demonstration project, the treatment system had no disinfection or other treatment at the wellheads, although most residents had water softeners in their homes. The historic arsenic levels detected within the distribution system at

several different sampling points, including residences and the wellhouse distribution entry piping, ranged from 18.4 to 28.0 µg/L based on MDH treated water sampling data shown in Table 4-1.

4.2 Treatment Process Description

The treatment train for the BSLMHP system includes KMnO₄ oxidation, co-precipitation/adsorption, and Macrolite[®] pressure filtration. Macrolite[®] is an engineered ceramic filtration media manufactured by Kinetico and approved for use in drinking water applications under NSF International (NSF) Standard 61. Macrolite[®] is a low-density, spherical media, designed to allow for filtration rates, as claimed by the vendor, up to 10 gpm/ft², a hydraulic loading rate higher than that for most conventional filtration media. The physical properties of this media are summarized in Table 4-2. The vendor considers Macrolite[®] media chemically inert and compatible with chemicals such as oxidants and ferric chloride.

Table 4-2. Physical Properties of M2 Macrolite[®] Media

| Property | Value |
|---|-----------------------|
| Color | Variable |
| Uniformity Coefficient | 1.1 |
| Sphere Size Range (mm) [mesh] | 0.21 – 0.42 [40 × 70] |
| Nominal Size (mm) | 0.3 |
| Bulk Density (g/cm ³) [lb/ft ³] | 0.86 [54] |
| Specific Gravity | 2.05 |

Figure 4-3 is a schematic and Figure 4-4 a photograph of the Macrolite[®] CP-213f arsenic removal system. The treatment system was operated as an on-demand system and the volume of water treated was based on water usage. The well pump turned on when the pressure tank pressure reached 45 psi and shut off at 60 psi. The primary system components consisted of a KMnO₄ feed system (with the metering pump interlocked with a totalizer located after the pressure tanks and prior to the treatment system), two contact tanks, four pressure filtration tanks (two each within each duplex unit), and associated pressure and flow instrumentation. Various instruments were installed to track system performance, including the inlet and outlet pressure after each filter, flowrate to the distribution system, and backwash flowrate. All plumbing for the system was Schedule 80 PVC with the necessary valves, sampling ports, and other features. Table 4-3 summarizes the design features of the Macrolite[®] pressure filtration system. The major process steps and system components are presented as follows:

- Potassium Permanganate Oxidation** – KMnO₄ was used to oxidize As(III), Fe(II), and Mn(II) in source water. KMnO₄ was selected to help reduce the formation potential of disinfection by-products due to the presence of high TOC levels in source water. The KMnO₄ addition system consisted of a 150-gal day tank, a Pulsatron metering pump, and an overhead mixer (Figure 4-5). The working solution was prepared by adding 0.75 gal (or 10 lb) of KMnO₄ crystals with 97% minimum purity into 40 gal of water to form a 3% KMnO₄ solution. During the six-month study period, the 21-in diameter and 31.5-in tall KMnO₄ tank was re-filled a total of four times when the tank level reached an average of 17.4 in. The KMnO₄ feed pump was sized with a maximum capacity of 44 gpd or 6.9 L/hr. However, the pump was flow-paced and the actual rate of KMnO₄ addition varied based on the influent

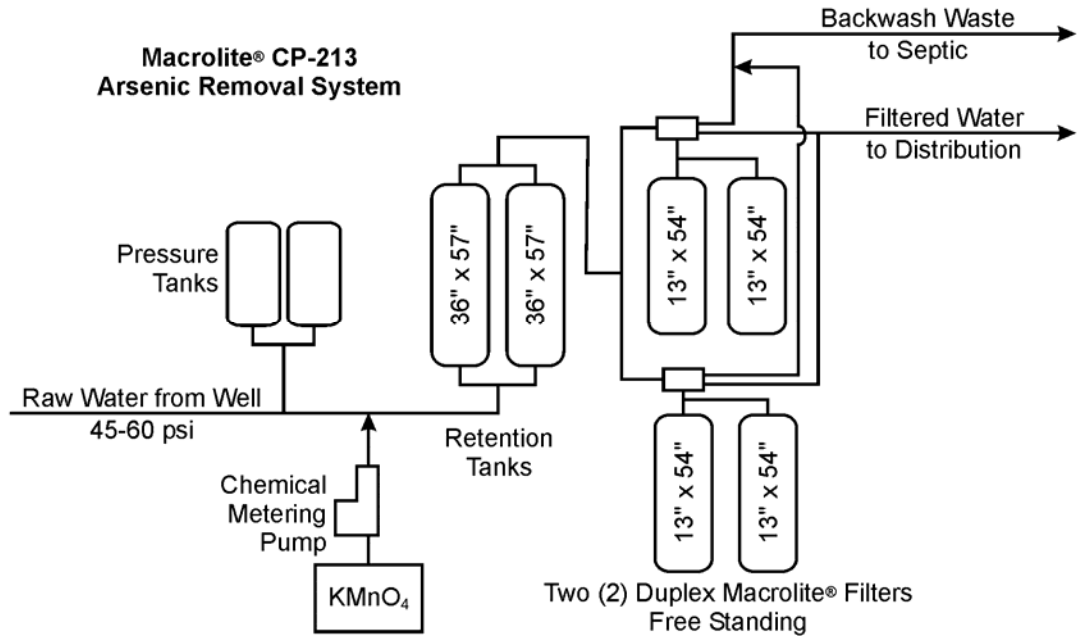

Figure 4-3. Process Schematic of Macrolite® Pressure Filtration System



Figure 4-4. Photograph of Macrolite® Pressure Filtration System
 (1. Duplex Units, 2. Contact Tanks, 3. Pressure Tanks,
 4. Chemical Day Tank, and 5. Totalizer on Raw Water Line)

Table 4-3. Design Specifications for Macrolite® CP-213f Pressure Filtration System

| Parameter | Value | Remarks |
|---|-------------|--|
| Pretreatment | | |
| KMnO ₄ Dosage (mg/L as [KMnO ₄]) | 3.3 | Calculated KMnO ₄ demand based on arsenic, iron, and manganese in source water; actual demand higher due to presence of TOC in source water |
| Contact Tanks | | |
| Tank Size (in) | 36 D × 57 H | 205 gal each tank |
| No. of Tanks | 2 | – |
| Configuration | Parallel | – |
| Contact Time (min/tank) | 20 | Based on peak flowrate of 20 gpm; actual contact time based on on-demand flowrate |
| Filtration Tanks | | |
| Tank Size (in) | 13 D × 54 H | – |
| Cross-Sectional Area (ft ² /tank) | 0.92 | – |
| No. of Tanks | 4 | – |
| Configuration | Parallel | Between two duplex units and between two filtration tanks within each duplex unit. |
| Media Type | Macrolite® | 40/60 mesh media |
| Media Quantity (ft ³ /tank) | 1.5 | 20-in bed depth in each tank |
| Freeboard Measurements (in/tank) | 28 | Measurements taken by vendor's contractor on 12/07/05 from top of filtration tank to top of media bed |
| Filtration Rate (gpm/ft ²) | 5.4 | Based on a 5 gpm system flowrate through each filtration tank; actual filtration rate based on demand |
| Pressure Drop (psi) | 15 | Across a clean bed |
| Throughput before Backwash (gal) | 2,743 | Based on initial field design |
| Backwash Hydraulic Loading Rate (gpm/ft ²) | 6.5 | Based on a 6-gpm backwash flowrate through each filtration tank |
| Backwash Duration (min/tank) | 20 | – |
| Wastewater Production (gal) | 130 | For each tank |
| System Design Flowrate (gpm) | 20 | Peak flowrate; actual flowrate based on demand |
| Maximum Daily Production (gpd) | 28,800 | Based on peak flowrate, 24 hr/day |
| Hydraulic Utilization (%) | 56 | Estimated based on peak daily demand ^(a) |

(a) Based on historic peak daily demand of 16,000 gpd.

flowrate to the treatment system. During the first six months of system operation, KMnO₄ dosages varied from 2.1 to 6.1 mg/L. The operator indicated that the mixer was only turned on when the KMnO₄ crystals was mixed initially with water in the day tank.

- Contact** – Two 36-in by 57-in fiberglass reinforced plastic (FRP) contact tanks arranged in parallel provided at least 20 min of contact time when operating at the design (or peak) flowrate of 20 gpm. The longer retention time was designed to aid in the formation of manganese particles before Macrolite® filtration.
- Pressure Filtration** – The filtration system consisted of downflow filtration through two sets of dual-pressure filtration tanks arranged in parallel. Each duplex unit was comprised of two 13-in by 54-in FRP tanks and a control valve. Each filtration tank was filled with approximately 20-in (1.5 ft³) of 40/60 mesh Macrolite® media supported by 3-in (0.25 ft³) of garnet underbedding. The standard operation had both tanks of a pair online with each pressure tank treating a maximum of 5 gpm for a hydraulic loading rate



Figure 4-5. KMnO₄ Feed System

of 5.4 gpm/ft². With four tanks online, the maximum system flowrate was 20 gpm. However, as shown in Figure 4-3, the system had an on-demand configuration with two pressure tanks located ahead of the treatment system. The actual flowrate through the system varied based on water demand, but was limited to less than 20 gpm by flow restrictors located on the duplex units.

The control valve (Kinetico Mach 1250) located on top of each duplex unit (Figure 4-6) consisted of a gear stack, which determines the throughput between two consecutive backwash cycles. The control valve consisted of three chambers: inlet, outlet, and regeneration and only the influent water was measured/recorded by the gear stack.

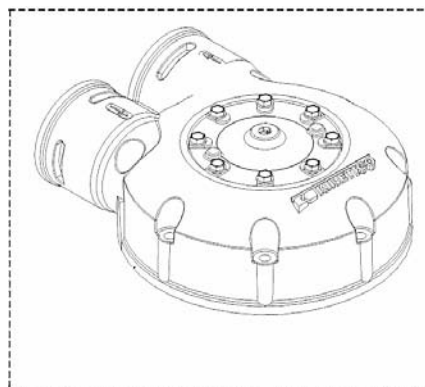
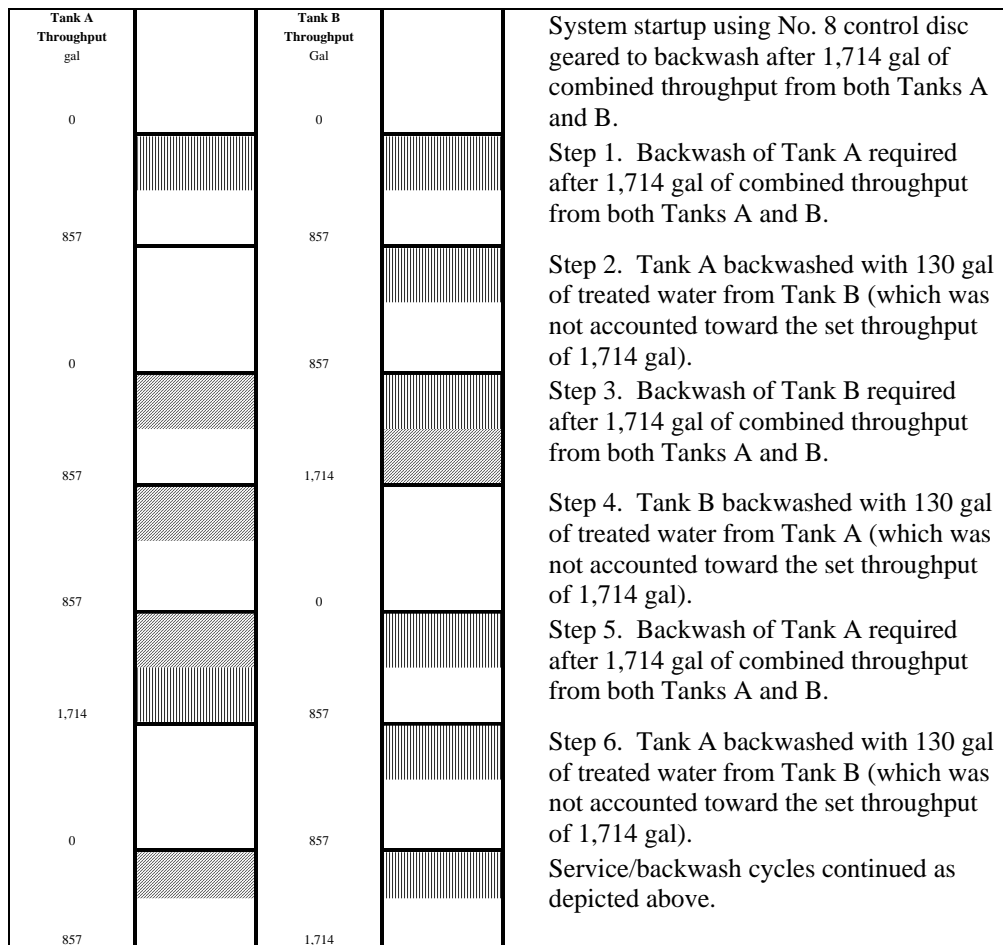

Figure 4-6. Kinetico's Mach 1250 Control Valve

- Backwash Operations** – Backwash was a fully automated process triggered by a pre-set volume throughput measured by the control valve located on top of each duplex unit. The spent filtration tank was backwashed with the treated water from the other tank within the duplex unit and the resulting wastewater was discharged to a sanitary sewer. The backwash duration for each tank was 20 min from start to finish including 15 min of backwash at a flowrate of 6 gpm and a 5 min filter-to-rinse cycle at 6 gpm. The backwash used about 130 gal of the treated water per tank. As discussed in section 4.4.2, it was necessary to increase the frequency of backwash from the initial field setting of every 2,743 gal to every 1,714 gal over the six-month study period. Figure 4-7 depicts the backwash flow paths for one duplex unit (labeled as Tank A and Tank B), which were backwashed on an alternating basis after a pre-set throughput of 1,714 gal. The major steps involved in the backwash process are discussed as follows:



Key

- ||||| Throughput through Tanks A and B before Tank A Was Backwashed
- //// Throughput through Tanks A and B before Tank B Was Backwashed
- Clean Bed

Figure 4-7. Backwash Flow Path for One Duplex Unit with Control Disc No. 8 and a Throughput of 1,714 gal between Backwash Cycles

Again, both Tank A and Tank B provide the treated water in parallel. The backwash cycles were continuously repeated as shown in Steps 4 through 6 during the treatment system operation. One set of duplex tanks functioned as one unit and always had a filtration capacity between 25% (immediately after backwash of one tank at Step 4) and 75% (right before backwash of the other tank at Step 5).

4.3 System Installation

This section provides a summary of system installation activities including permitting, building construction, and system shakedown.

4.3.1 Permitting. Engineering plans for the system permit application were prepared by the vendor. The plans included diagrams and specifications for the Macrolite[®] CP-213f arsenic removal system, as well as drawings detailing the connections of the new unit to the pre-existing facility infrastructure. The plans were submitted to MDH on March 28, 2005, and MDH granted its approval of the application on June 14, 2005.

4.3.2 Building Construction. The existing well house had an adequate footprint to house the arsenic treatment system. The permit approval issued by MDH on June 14, 2005, indicated a need for an air gap two times the diameter of the filter-to-waste line and a need for all chemicals to be injected on the lower half of the influent pipe. Figure 4-6 shows the chemical injection line located on the top half of the influent pipe. In addition, MDH required the drain line and sewer connection to have at least a 50-ft distance from Well No. 1 and Well No. 2 wellheads and at a lower elevation.

4.3.3 System Installation, Shakedown, and Startup. The Macrolite[®] system was shipped on June 10, 2005 and delivered to the site on June 16, 2005. A subcontractor to the vendor off-loaded and installed the system, including piping connections to the existing entry and distribution system. The system installation was completed by June 24, 2005, and the system shakedown was completed by July 3, 2005.

Shakedown activities included disinfection of the contact and filtration tanks and backwash of Macrolite[®] filtration media. The bacteriological test was passed on July 1, 2005. During the startup trip in July, the vendor conducted operator training for system O&M. Battelle arrived on-site on July 13, 2005, to perform system inspections and conduct operator training for system sampling and data collection. The first set of samples for the one year performance evaluation study was taken on July 13, 2005. No major mechanical or installation issues were noted at system startup; however, several pieces of equipment shown in the vendor's June 16, 2005 piping and instrumental diagrams (P&ID) were missing and several installed items did not meet the permit requirements. A list of punch-list items was summarized as follows:

- Install an hour meter.
- Install one raw water sample tap.
- Install one backwash sample tap.
- Install one sample tap after duplex units TA/TB and after duplex units TC/TD.
- Install one pressure gauge after duplex units TA/TB and after duplex units TC/TD.
- Replace the defective pressure gauge beneath the left most pressure tank.
- Install a level sensor on the KMnO₄ day tank.
- Install a ½-inch ball valve on the KMnO₄ injection tube.
- Move the KMnO₄ injection port from the top half of the influent pipe to the lower half per permit requirements.

- Verify that the air gap was two times the filter-to-waste pipe between the drain and the filter-to-waste pipe.

All punch-list items were resolved by the vendor by September 30, 2005.

4.4 System Operation

4.4.1 Operational Parameters. Table 4-4 summarizes the operational parameters for the first six months of system operation, including operational time, throughput, flowrate, and pressure. Detailed daily operational information also is provided in Appendix A.

Between July 13, 2005, and January 17, 2006, the primary well pump operated for approximately 617 hr, with an average daily operating time of 3.4 hr/day (compared to 6 hr/day provided by the park owner prior to the demonstration study) based on the readings of an hour meter installed on the primary well on September 28, 2005. Prior to this time period, the operational time was estimated based on the wellhead totalizer readings and an average well pump flowrate of 25 gpm. The total system throughput during the first six months was approximately 863,470 gal based on the totalizer before entering the distribution system. The average daily demand was 4,617 gal (vs. 7,500 gal provided by the park owner) and the peak daily demand occurred on July 21, 2005, at 14,300 gal (compared to 16,000 gpd provided by the park owner).

The flowrates through the CP-213f system varied due to the on-demand system configuration. Withdrawn from the two pressure tanks located upstream of the system, the on-demand flowrates ranged from 1 to 15 gpm and averaged 4.4 gpm, corresponding to a contact time of 27 to 410 min compared to a design value of 20 min. At these flowrates, the hydraulic loading rates to the filter ranged from 0.3 to 4.1 gpm/ft² compared to the design value of 5.4 gpm/ft². Note that Macrolite[®] filter media is rated for a maximum hydraulic loading rate of 10 gpm/ft².

At flowrates of 1 to 15 gpm, the inlet pressure to the system ranged from 40 to 60 psi (compared to the pressure tank set points from 45 to 60 psi) and the outlet pressure ranged from 22 to 55 psi. The total pressure differential (ΔP) readings across the system ranged from 0 to 25 psi depending on the flowrates. The ΔP across Tanks A and B ranged from 0 to 25 psi and across Tanks C and D from 2 to 16 psi based on inlet and outlet pressure gauge readings.

During this time period, a total number of 431 backwash cycles took place. The throughput values between two consecutive backwash cycles ranged from 1,714 to 6,857 gal depending on the settings of the control disc located on top of each set of duplex units. The backwash frequency ranged from 0 to 5 tanks backwashed per day. There was one outlier on August 9, 2005, when over 1,720 gal of backwash water was produced (equivalent to 13 backwash events in a single day). The vendor's contractor determined that sediment was lodged in the purge/control valve on one of the duplex units, preventing the valve from being closed; therefore, the duplex unit was stuck in the backwash mode before the operator bypassed the system.

4.4.2 Backwash. The backwash was initiated by throughput. The control disc located on top of each duplex unit determined the throughput before backwash. Table 4-5 summarizes the backwash frequency based on four control disc sizes installed over the six-month study period. The vendor switched out the control discs four times (although one was done in error) due to observations of particulate arsenic, iron, and manganese breakthrough through the Macrolite[®] filters. Control disc No. 5 geared to backwash after a throughput of 2,743 gal was used from system startup on July 13, 2005, through September 20, 2005. The actual throughput values between two consecutive backwash cycles averaged 2,449 gal based on the total volume of water treated and the total number of tanks

Table 4-4. System Operation from July 13, 2005 to January 17, 2006

| Parameter | Values |
|--|----------------------------|
| <i>Primary Well Pump (Well No. 2)</i> | |
| Total Operating Time (hr) | 617.3 ^(a) |
| Average Daily Operating Time (hr) | 3.4 ^(a) |
| Range of Flowrates (gpm) | 23–31 ^(b) |
| Average Flowrate (gpm) | 25 ^(b) |
| <i>System Throughput/Demand</i> | |
| Throughput to Distribution (gal) | 863,470 |
| Average Daily Demand (gpd) | 4,617 |
| Peak Daily Demand (gpd) | 14,300 |
| <i>CP-213f System – Service Mode</i> | |
| Range of Flowrates (gpm) | 1–15 ^(c) |
| Average Flowrate (gpm) | 4.4 ^(c) |
| Range of Contact Times (min) | 27–410 |
| Average Contact Time (min) | 114 |
| Range of Hydraulic Loading Rates to Filters (gpm/ft ²) | 0.3–4.1 |
| Average Hydraulic Loading Rate to Filters (gpm/ft ²) | 2.2 |
| Range of System Inlet Pressure (psi) | 40–60 |
| Range of System Outlet Pressure (psi) | 22–55 |
| Range of Δp Readings across System (psi) | 0–25 |
| <i>CP-213 System – Backwash Mode</i> | |
| Number of Backwash Cycles | 431 ^(d) |
| Throughput between Backwash Cycles (gal) | 1,714–6,857 ^(e) |
| Number of Backwash Cycles Per Day | 0–5 |

- (a) Hour meter installed on September 28, 2005. Run time before this period estimated based on wellhead totalizer readings and average well flowrate of 25 gpm.
- (b) Based on totalizer on raw water line and hour meter readings; excluding data from September 29, October 5, and October 6, 2005.
- (c) Based on flow meter readings located on treated water line recorded starting September 28, 2005.
- (d) Based on totalizer readings on backwash water discharge line and 130 gal of wastewater produced during backwash of each tank.
- (e) Backwash triggered by volume of water treated based on settings of control discs located on top of each set of duplex filtration tanks.

backwashed. The number of tanks backwashed per day ranged from 0 to 5 except for the outlier on August 9, 2005, discussed in Section 4.4.1. Because breakthrough of particulate arsenic, iron, and manganese was observed, the vendor dispatched its contractor to the site to install a new control disc in an attempt to curb the particulate breakthrough. While a higher number disc should have been used, a disc with a lower number (i.e., No. 2 geared to backwash after a throughput of 6,857 gal) was inadvertently installed by the contractor between September 21 through 29, 2005. On September 30, 2005, No. 2 disc was replaced with a No. 7 disc, which was geared for a throughput of 1,957 gal. The average throughput for the No. 7 disc was 1,932 gal and the number of tanks backwashed per day ranged from 0 to 5. For this reason, control disc No. 8 was subsequently installed on December 7, 2005 to further reduce the throughput to 1,714 gal. The actual throughput was 1,684 gal and the number of tanks backwashed per day ranged from 1 to 5.

Table 4-5. Control Disc Size and Throughput between Backwash Cycles

| Duration | Control Disc | Design Throughput between Consecutive Backwash Cycles (gal) | Average Throughput between Consecutive Backwash Cycles (gal) | Number of Tanks Backwashed (No./day) | Backwash Water Generation Ratio (%) |
|-------------------|---------------------|--|---|---|--|
| 07/13/05-09/20/05 | No. 5 | 2,743 | 2,449 | 0-5 | 5.5 |
| 09/21/05-09/29/05 | No. 2 | 6,857 | 3,469 | 0-3 | 2.8 |
| 09/30/05-12/06/05 | No. 7 | 1,957 | 1,932 | 0-5 | 6.6 |
| 12/07/05-01/17/06 | No. 8 | 1,714 | 1,684 | 1-5 | 7.2 |

However, after the disc No. 8 changeout, particulate breakthrough continued to be observed. Except for disc No. 2, the ratios of backwash water generated ranged from 5.5% to 7.2% and averaged 6.4%.

4.4.3 Residual Management. Residuals produced by the operation of the Macrolite[®] system included backwash water and associated solids, which were discharged to a nearby septic system for disposal.

4.4.4 System/Operation Reliability and Simplicity. During the first six months of system operation, several instances of total arsenic and iron breakthrough were observed in service mode and the backwash frequency had to be increased twice by switching out the control valve on top of each set of duplex units. The required system O&M and operator skill levels are discussed according to pre- and post-treatment requirements, levels of system automation, operator skill requirements, preventive maintenance activities, and frequency of chemical/media handling and inventory requirements.

Pre- and Post-Treatment Requirements. Pre-treatment included KMnO₄ addition for the oxidation of arsenic and iron. Specific chemical handling requirements are further discussed below under chemical handling and inventory requirements. KMnO₄ was selected as an alternative oxidant due to the high TOC levels in source water and the potential to form disinfection byproducts should chlorine be used as an oxidant. However, as discussed in Section 4.5.1, it was determined that source water had a relatively elevated KMnO₄ demand, which resulted in some difficulty in controlling the effluent manganese levels (both particulate and soluble forms) and ensuring that the MnO₄⁻ added was completely reduced to form MnO₂ solids.

System Automation. All major functions of the treatment system were automated and would require only minimal operator oversight and intervention if all functions were operating as intended. Automated processes included system startup in service mode when the well energized, backwash cycling based on throughput, fast rinse cycling, and system shutdown when the well pump shut down. However, as noted in Section 4.4.1, an operational issue did arise with the automated system backwash on August 9, 2005. Due to the small size of the arsenic treatment system, the operational data was collected manually by the operator mentioned in the next paragraph.

Operator Skill Requirements. Under normal operating conditions, the skill set required to operate the Macrolite[®] system was limited to observation of the process equipment integrity and operating parameters such as pressure and flow. The daily demand on the operator was about 5 min to visually inspect the system and record operating parameters on the log sheets. Other skills needed including performing O&M activities such as replenishing the KMnO₄ solution in the chemical drum, monitoring backwash operational issues, and working with the vendor to troubleshoot and perform minor on-site repairs.

For the state of Minnesota, there are five water operator certificate class levels, i.e., A, B, C, D, and E, with Class A being highest. The certificate levels are based on education, experience, and system characteristics, such as water source, treatment processes, water storage volume, number of wells, and population affected. The operator for the BSLMHP system has a Class D certificate. Class D requires a high school diploma or equivalent with at least one year of experience in operating a Class A, B, C, or D system or a postsecondary degree from an accredited institution.

Preventive Maintenance Activities. Preventive maintenance tasks recommended by the vendor included daily to monthly visual inspection of the piping, valves, tanks, flow meters, and other system components. The pump on the primary well (Well No. 2) developed a leak and had to be shut down temporarily on January 4, 2006 for repairs. Meanwhile, Well No. 1 was turned on as the backup well. The leak on the Well No. 2 pump was repaired the next day and the primary well resumed its normal operation thereafter..

Chemical/Media Handling and Inventory Requirements. KMnO_4 addition was implemented since the system startup on July 13, 2005. The mixing of the KMnO_4 solution required only 10 min to complete, as reported by the operator. The chemical consumption was checked each day as part of the routine operational data collection. Several adjustments were made over time to optimize the KMnO_4 dosage for the oxidation of arsenic, iron, and manganese.

4.5 System Performance

The performance of the Macrolite[®] CP-213f arsenic removal system was evaluated based on analyses of water samples collected from the treatment plant, backwash lines, and distribution system.

4.5.1 Treatment Plant Sampling. Water samples were collected at five locations across the treatment train: at the wellhead (IN), after the contact tanks (AC), after the first set of duplex unit tanks A and B (TA/TB), after the second set of duplex tanks C and D (TC/TD), and after the two sets of duplex tanks combined (TT). Sampling was conducted on 26 occasions (including two duplicate sampling events) during the first six months of system operation, with field speciation performed on samples collected from the IN, AC, and TT locations for 7 of the 26 occasions. Table 4-6 summarizes the arsenic, iron, and manganese analytical results. Table 4-7 summarizes the results of the other water quality parameters. Appendix B contains a complete set of analytical results through the first six months of system operation. The results of the water treatment plant samples with the addition of a varying amount of KMnO_4 before and after the November 7, 2005, manganese jar tests are discussed below.

Arsenic and Iron Removal. Total arsenic concentrations in raw water ranged from 20.6 to 36.6 $\mu\text{g/L}$ and averaged 27.7 $\mu\text{g/L}$. As(III) was the predominant species with concentrations ranging from 13.9 to 27.4 $\mu\text{g/L}$ and averaging 23.0 $\mu\text{g/L}$ (Table 4-6 and Figure 4-8). Only trace amounts of particulate As and As(V) existed in raw water, with concentrations averaging 2.1 and 4.0 $\mu\text{g/L}$, respectively. The total arsenic concentrations measured during this six-month period were consistent with those of the historical source water sampling (Table 4-1), although the As(III) concentrations were significantly higher, representing over 83% of the total concentrations in source water (compared to 54% during the August 31, 2004, source water sampling). The existence of As(III) as the predominating arsenic species was consistent with the low DO concentrations (averaged 1.2 mg/L, Table 4-7) and low ORP values (ranged from -76 to -23 mV and averaged -46 mV) in source water.

As shown in Table 4-6, total iron concentrations in raw water ranged from 1,069 to 3,758 $\mu\text{g/L}$ and averaged 2,760 $\mu\text{g/L}$. Iron in raw water existed almost entirely in the soluble form with an average value of 2,691 $\mu\text{g/L}$. The presence of predominating soluble iron also was consistent with the presence of

Table 4-6. Summary of Arsenic, Iron, and Manganese Analytical Results

| Parameter | Sampling Location | Sample Count | Concentration (µg/L) | | | Standard Deviation |
|------------------|-------------------|------------------|----------------------|---------|---------|--------------------|
| | | | Minimum | Maximum | Average | |
| As (total) | IN | 26 | 20.6 | 36.6 | 27.7 | 4.0 |
| | AC | 26 | 5.6 | 36.1 | 26.3 | 5.5 |
| | TA/TB | 17 | 2.0 | 29.8 | 8.8 | 7.5 |
| | TC/TD | 17 | 2.1 | 17.5 | 7.3 | 4.4 |
| | TT | 9 | 2.9 | 17.7 | 7.6 | 5.7 |
| As (soluble) | IN | 7 | 24.4 | 30.3 | 27.0 | 2.1 |
| | AC | 7 | 2.7 | 8.7 | 4.4 | 2.1 |
| | TT | 7 ^(a) | 2.0 | 6.2 | 3.5 | 1.5 |
| As (particulate) | IN | 7 | 0.1 | 6.1 | 2.1 | 2.6 |
| | AC | 7 | 18.4 | 26.3 | 22.9 | 2.6 |
| | TT | 7 ^(a) | 0.1 | 10.9 | 2.2 | 3.9 |
| As(III) | IN | 7 | 13.9 | 27.4 | 23.0 | 4.5 |
| | AC | 7 | 0.3 | 5.4 | 1.9 | 1.8 |
| | TT | 7 ^(a) | 0.4 | 4.4 | 1.8 | 1.5 |
| As(V) | IN | 7 | <0.1 | 16.5 | 4.0 | 5.7 |
| | AC | 7 | 1.7 | 3.3 | 2.6 | 0.6 |
| | TT | 7 ^(a) | 1.3 | 2.4 | 1.7 | 0.3 |
| Fe (total) | IN | 26 | 1,069 | 3,758 | 2,760 | 441 |
| | AC | 26 | 247 | 3,173 | 2,598 | 521 |
| | TA/TB | 17 | 12 | 2,363 | 394 | 635 |
| | TC/TD | 17 | <25 | 1,140 | 259 | 364 |
| | TT | 9 | <25 | 1,067 | 308 | 361 |
| Fe (soluble) | IN | 7 | 2,263 | 2,954 | 2,691 | 255 |
| | AC | 7 | <25 | 306 | 56.3 | 110 |
| | TT | 7 ^(a) | <25 | 40.7 | <25 | <25 |
| Mn (total) | IN | 26 | 110 | 430 | 144 | 59.7 |
| | AC | 26 | 416 | 1,506 | 955 | 235 |
| | TA/TB | 17 | 203 | 1,002 | 648 | 254 |
| | TC/TD | 17 | 187 | 971 | 650 | 257 |
| | TT | 9 | 331 | 1,091 | 644 | 256 |
| Mn (soluble) | IN | 7 | 110 | 145 | 132 | 12.2 |
| | AC | 7 | 108 | 946 | 492 | 317 |
| | TT | 7 ^(a) | 138 | 1,062 | 565 | 363 |

One-half of detection limit used for non-detect samples for calculations.

Duplicate samples included calculations.

(a) On December 28, 2005, arsenic speciation results taken at IN, AC, TA/TB, and TC/TD locations. Average concentration used for TT location.

predominating As(III) as well as low DO concentrations and low ORP values. Given the average soluble iron and soluble arsenic levels in source water, this corresponded to an iron:arsenic ratio of 100:1, which was well above the target ratio of 20:1 for effective removal of arsenic (Sorg, 2002).

After KMnO₄ addition and the contact tanks, As(III) concentrations ranged from 0.3 to 5.4 µg/L and averaged 1.9 µg/L (Table 4-6 and Figure 4-8), suggesting effective oxidation of As(III) to As(V) with KMnO₄. Particulate arsenic concentrations after the contact tanks ranged from 18.4 to 26.3 µg/L and averaged 22.9 µg/L, representing most of the total arsenic (averaged 26.3 µg/L) after the contact tanks. After KMnO₄ addition and the contact tanks, total iron concentrations averaged 2,598 µg/L, existing almost entirely in particulate form. This data suggested effective oxidation of arsenic and iron even in the

Table 4-7. Summary of Other Water Quality Parameter Sampling Results

| Parameter | Sampling Location | Unit | Sample Count | Concentration/Unit | | | Standard Deviation |
|---------------------------------------|-------------------|------|------------------|--------------------|---------|---------|--------------------|
| | | | | Minimum | Maximum | Average | |
| Alkalinity (as CaCO ₃) | IN | mg/L | 26 | 352 | 383 | 366 | 11 |
| | AC | mg/L | 26 | 321 | 383 | 368 | 11 |
| | TA/TB | mg/L | 17 | 352 | 378 | 369 | 8 |
| | TC/TD | mg/L | 17 | 352 | 383 | 369 | 9 |
| | TT | mg/L | 9 | 361 | 383 | 371 | 7 |
| Fluoride | IN | mg/L | 7 | 0.2 | 0.2 | 0.2 | 0 |
| | AC | mg/L | 7 | 0.2 | 0.2 | 0.2 | 0 |
| | TT | mg/L | 7 ^(a) | 0.2 | 0.2 | 0.2 | 0 |
| Sulfate | IN | mg/L | 7 | <1 | <1 | <1 | 0 |
| | AC | mg/L | 7 | <1 | <1 | <1 | 0 |
| | TT | mg/L | 7 ^(a) | <1 | <1 | <1 | 0 |
| Nitrate (as N) | IN | mg/L | 7 | <0.05 | 0.06 | 0.03 | 0 |
| | AC | mg/L | 7 | <0.05 | 0.06 | 0.03 | 0 |
| | TT | mg/L | 7 ^(a) | <0.05 | 0.25 | 0.06 | 0.1 |
| Orthophosphate (as P) | IN | mg/L | 12 | <0.05 | <0.05 | <0.05 | 0 |
| | AC | mg/L | 12 | <0.05 | <0.05 | <0.05 | 0 |
| | TA/TB | mg/L | 6 | <0.05 | <0.05 | <0.05 | 0 |
| | TC/TD | mg/L | 6 | <0.05 | <0.05 | <0.05 | 0 |
| | TT | mg/L | 6 | <0.05 | <0.05 | <0.05 | 0 |
| P (total) (as P) | IN | mg/L | 15 | 0.4 | 0.6 | 0.5 | 0.04 |
| | AC | mg/L | 15 | 0.1 | 0.5 | 0.4 | 0.1 |
| | TA/TB | mg/L | 12 | <0.03 | 0.4 | 0.1 | 0.1 |
| | TC/TD | mg/L | 12 | <0.03 | 0.2 | 0.1 | 0.1 |
| | TT | mg/L | 3 | 0.1 | 0.2 | 0.1 | 0.1 |
| Silica (as SiO ₂) | IN | mg/L | 26 | 22.6 | 29.4 | 24.3 | 1.4 |
| | AC | mg/L | 26 | 22.5 | 28.6 | 24.4 | 1.3 |
| | TA/TB | mg/L | 17 | 22.5 | 28.4 | 24.4 | 1.4 |
| | TC/TD | mg/L | 17 | 22.7 | 28.2 | 24.6 | 1.3 |
| | TT | mg/L | 9 | 21.7 | 24.7 | 23.4 | 1.0 |
| Turbidity | IN | NTU | 26 | 13.0 | 35.0 | 30.0 | 5.0 |
| | AC | NTU | 26 | 2.8 | 6.5 | 4.0 | 1.1 |
| | TA/TB | NTU | 17 | <0.1 | 14.0 | 1.5 | 3.4 |
| | TC/TD | NTU | 17 | <0.1 | 14.0 | 2.0 | 3.4 |
| | TT | NTU | 9 | 0.1 | 11.0 | 1.9 | 3.5 |
| TOC | IN | mg/L | 4 | 3.2 | 4.8 | 4.0 | 0.7 |
| | AC | mg/L | 4 | 3.1 | 4.6 | 3.7 | 0.7 |
| | TT | mg/L | 4 | 3.0 | 4.8 | 3.9 | 0.7 |
| pH | IN | S.U. | 23 | 7.2 | 7.5 | 7.3 | 0.1 |
| | AC | S.U. | 23 | 7.2 | 7.6 | 7.4 | 0.1 |
| | TA/TB | S.U. | 14 | 7.2 | 7.4 | 7.3 | 0.1 |
| | TC/TD | S.U. | 14 | 7.2 | 7.5 | 7.4 | 0.1 |
| | TT | S.U. | 9 | 7.2 | 7.7 | 7.3 | 0.2 |
| Temperature | IN | °C | 23 | 9.3 | 14.9 | 10.7 | 1.4 |
| | AC | °C | 23 | 9.4 | 14.1 | 10.9 | 1.5 |
| | TA/TB | °C | 14 | 9.3 | 12.5 | 10.2 | 0.8 |
| | TC/TD | °C | 14 | 9.2 | 12.8 | 10.3 | 0.9 |
| | TT | °C | 9 | 9.5 | 13.8 | 11.6 | 1.5 |

Table 4-7. Summary of Other Water Quality Parameter Sampling Results (Continued)

| Parameter | Sampling Location | Unit | Sample Count | Concentration/Unit | | | Standard Deviation |
|---|-------------------|------|------------------|--------------------|---------|---------|--------------------|
| | | | | Minimum | Maximum | Average | |
| DO | IN | mg/L | 23 | 0.7 | 3.6 | 1.2 | 0.7 |
| | AC | mg/L | 23 | 0.5 | 3.1 | 1.1 | 0.5 |
| | TA/TB | mg/L | 14 | 0.5 | 1.6 | 0.9 | 0.3 |
| | TC/TD | mg/L | 14 | 0.5 | 1.3 | 0.9 | 0.2 |
| | TT | mg/L | 9 | 0.7 | 1.2 | 0.9 | 0.2 |
| ORP | IN | mV | 23 | -76 | -23 | -46 | 14 |
| | AC | mV | 23 | -22 | 196 | 62 | 56 |
| | TA/TB | mV | 14 | -9 | 177 | 67 | 51 |
| | TC/TD | mV | 14 | -12 | 183 | 72 | 55 |
| | TT | mV | 9 | 5.8 | 219 | 106 | 78 |
| Total Hardness (as CaCO ₃) | IN | mg/L | 7 | 296 | 383 | 319 | 28.8 |
| | AC | mg/L | 7 | 295 | 330 | 315 | 10.9 |
| | TT | mg/L | 7 ^(a) | 305 | 338 | 319 | 12.0 |
| Ca Hardness (as CaCO ₃) | IN | mg/L | 7 | 177 | 228 | 191 | 16.6 |
| | AC | mg/L | 7 | 178 | 197 | 189 | 6.8 |
| | TT | mg/L | 7 ^(a) | 176 | 212 | 191 | 11.5 |
| Mg Hardness (as CaCO ₃) | IN | mg/L | 7 | 112 | 155 | 128 | 14.0 |
| | AC | mg/L | 7 | 114 | 133 | 126 | 6.4 |
| | TT | mg/L | 7 ^(a) | 120 | 136 | 128 | 5.3 |

One-half of detection limit used for non-detect samples for calculations.

Duplicate samples included calculations.

(a) On December 8, 2005, arsenic speciation results taken at IN, AC, TA/TB, and TC/TD locations.

presence of elevated TOC levels at 3.2 to 4.8 mg/L (Table 4-7) in raw water. Researchers have reported that Fe(II)-KMnO₄ reaction rates are more rapid than KMnO₄-DOC interactions (Knocke et al., 1994). Based on the presence of primarily particulate arsenic and iron after the contact tanks, it appears that the elevated TOC levels did not have a significant effect on As(III) and Fe(II) oxidation. Note that KMnO₄ dosages used during the six-month study period ranged from 2.1 to 6.1 mg/L (as KMnO₄) and averaged 4.8 mg/L. The effects of KMnO₄ dosage on Mn(II) oxidation are discussed in the next subsection.

From July 13, 2005, to January 17, 2006, total arsenic concentrations in the treated water ranged from 2.0 to 29.8 µg/L and averaged 7.9 µg/L (Table 4-6). Soluble arsenic concentrations in the treated water ranged from 2.0 to 6.2 µg/L and averaged 3.5 µg/L. Out of the 26 sampling occasions, total arsenic concentrations in the treated water exceeded the 10-µg/L MCL for a total of 8 times due to particulate breakthrough from the Macrolite[®] filters (Figure 4-9). As shown in Figure 4-10, the elevated total arsenic concentrations were accompanied by elevated total iron concentrations. The iron concentrations in the treated water ranged from <25 to 2,363 µg/L and averaged 323 µg/L, with most existing as particulate iron (Table 4-6). The soluble iron levels were below the method detection limit of <25 µg/L as measured in water samples filtered with 0.45-µm disc filters. On September 7, 2005, the total arsenic concentration in the treated water exceeded 10 µg/L due to low KMnO₄ dosage, which can be seen by the negative ORP readings across the treatment train, resulting in incomplete oxidation of As(III) and Fe(II). A study has shown that Fe(II) complexed with dissolved organic matter (DOM) was very difficult to remove via oxidation and subsequent precipitation of Fe(OH)₃(s). This was due to the formation of colloidal iron that had a size fraction small enough to pass through 0.2-µm disc filters. However, this phenomenon would be affected by the concentration and nature of the DOM in water (Knocke et al., 1994). The formation of colloidal iron did not appear to be an issue at BSLMHP with primarily particulate iron present after the

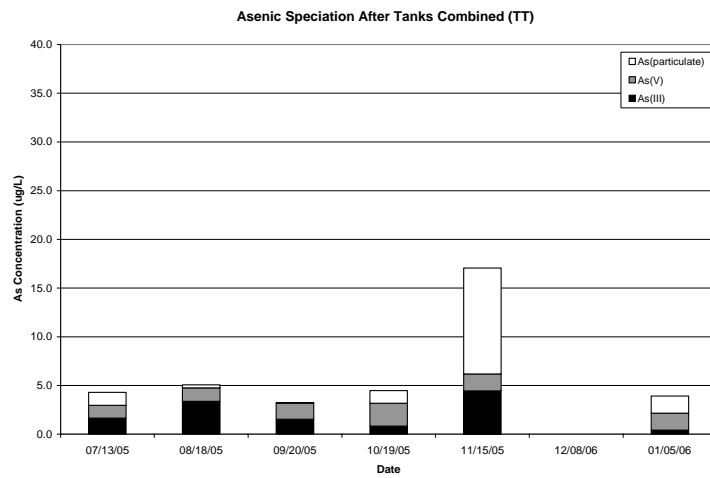
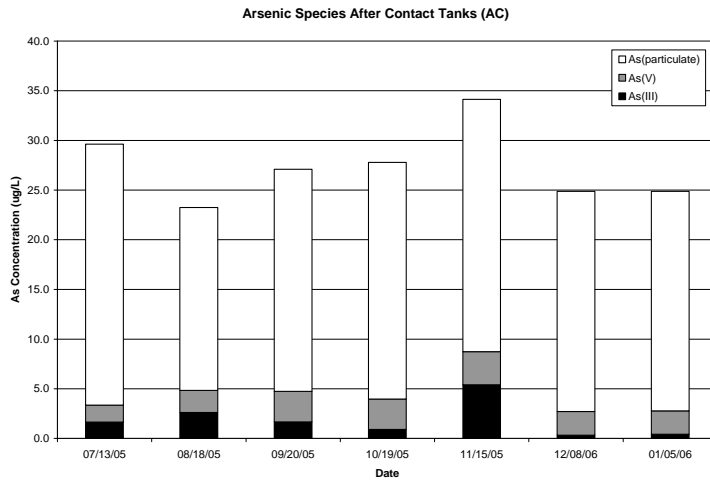
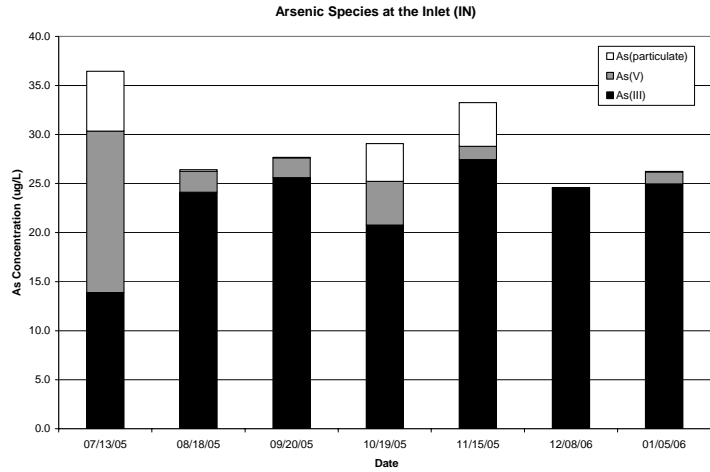

Figure 4-8. Concentrations of Arsenic Species at IN, AC, and TT Sampling Locations

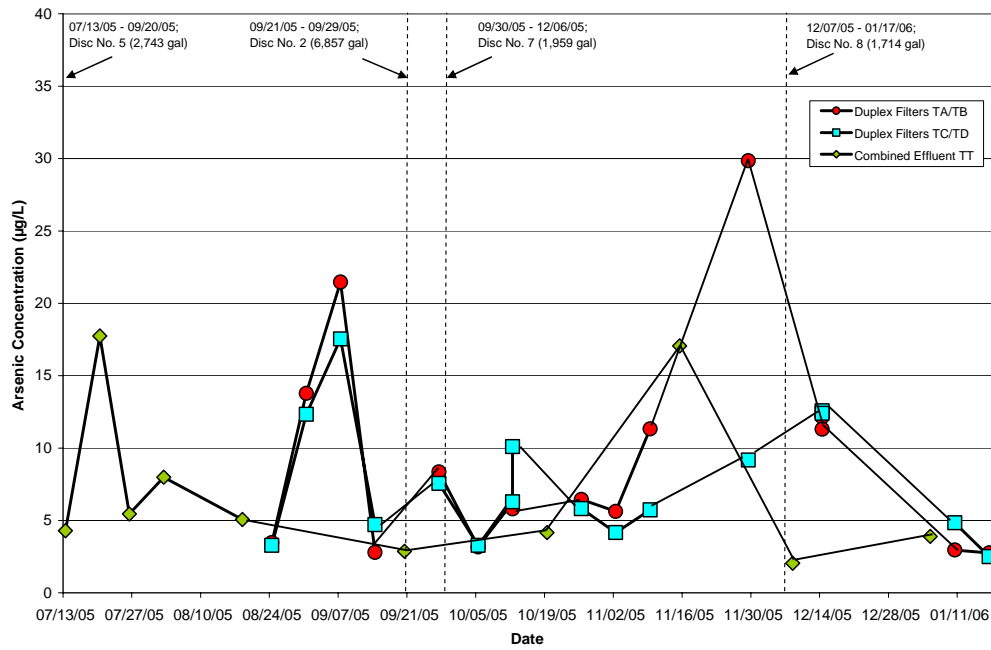

Figure 4-9. Total Arsenic Concentrations at TA/TB, TC/TD, and TT Sampling Locations

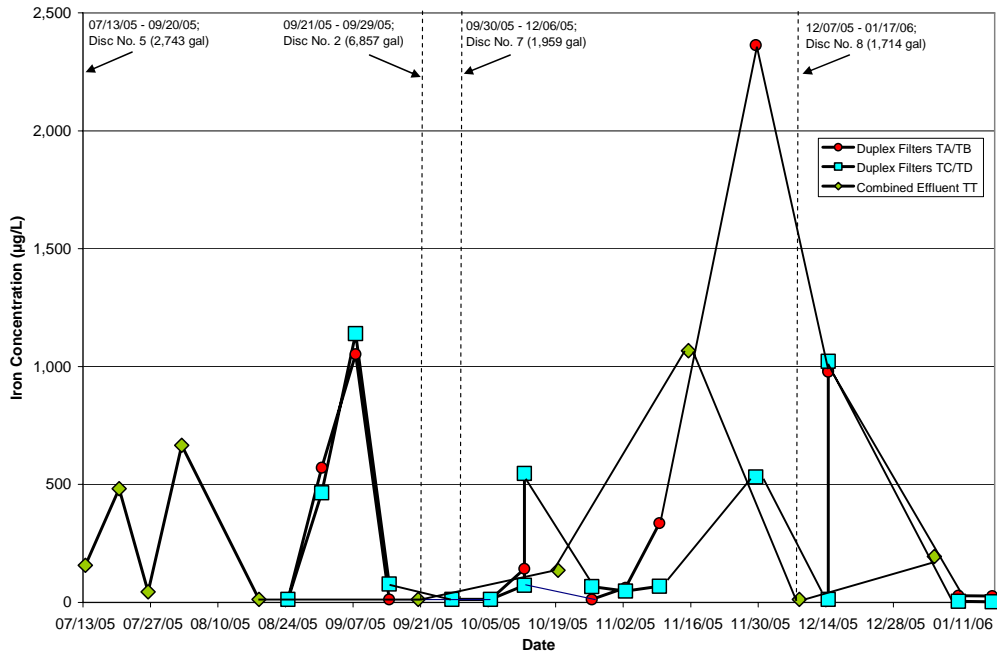

Figure 4-10. Total Iron Concentrations at TA/TB, TC/TD, and TT Sampling Locations

contact tanks and after the Macrolite® filters (e.g. a size fraction large enough to be retained by a 0.45 µm disc filter). The increase in particulate iron also corresponded with an increase in particulate arsenic, indicating iron breakthrough from the Macrolite® filters.

In order to better control particulate breakthrough from the filtration tanks, the control discs located on top of the two duplex units were replaced twice from Discs No. 5 to No. 7 and, then, from Discs No. 7 to No. 8 during the six-month duration to allow for more frequent backwash. (Note that Disc No. 2 was erroneously installed for a short duration before the mistake was caught and corrected). Table 4-8 lists the disc number, operating duration, total arsenic concentrations exceeding 10 µg/L, and total iron concentrations with arsenic exceeding 10 µg/L. The use of Discs No. 5 and No. 7 resulted in three and four occurrences, respectively, with arsenic concentrations measured as high as 29.8 µg/L and iron concentrations measured as high as 2,363 µg/L. Disc No. 8 was installed on December 7, 2005, and the treated water samples collected during December 7, 2005, through January 17, 2006, contained an average of 4.0 and 194 µg/L of total arsenic and iron, respectively, which were the lowest for the six-month period. However, due to particulate arsenic and iron breakthrough observed on December 14, 2005, control disc No. 8 will be switched out to allow even more frequent backwash during the next six-month period.

Table 4-8. Control Disc Sizes and Corresponding Occurrences with High Total Arsenic and Iron Concentrations

| Duration | Control Disc | Occurrence | Total Arsenic Concentration Exceeding 10 µg/L | | | Total Iron Concentration with Arsenic Exceeding 10 µg/L | | |
|-------------------|----------------------|------------|---|---------------------|------|---|----------------------|-------|
| | | | TA/TB | TC/TD | TT | TA/TB | TC/TD | TT |
| 07/13/05–09/20/05 | No. 5 | 1 | N/A | N/A | 17.7 | N/A | N/A | 482 |
| | | 2 | 13.8 | 12.3 | N/A | 571 | 465 | N/A |
| | | 3 | 21.5 | 17.5 | N/A | 1,052 | 1,140 | N/A |
| 09/21/05–09/29/05 | No. 2 ^(a) | N/A | N/A | | | N/A | | |
| 09/30/05–12/06/05 | No. 7 | 4 | N/A | 10.1 | N/A | N/A | 547 | N/A |
| | | 5 | 11.3 | N/A | N/A | 336 | N/A | N/A |
| | | 6 | N/A | N/A | 17.1 | N/A | N/A | 1,067 |
| | | 7 | 29.8 | N/A | N/A | 2,363 | N/A | N/A |
| 12/07/05–01/17/06 | No. 8 | 8 | 12.1 | 12.6 | None | 983 | 1,001 | None |
| | | | 11.3 ^(b) | 12.4 ^(b) | | 978 ^(b) | 1,023 ^(b) | |

(a) Incorrect disc inadvertently installed and replaced soon after installation.

(b) Field duplicate.

N/A = data not available

Manganese. As shown in Table 4-6, total manganese concentrations in raw water ranged from 110 to 430 µg/L and averaged 144 µg/L, which existed primarily in the soluble form at levels ranging from 110 to 145 µg/L and averaging 132 µg/L. The manganese levels in raw water exceeded its secondary MCL of 50 µg/L.

Figure 4-11 shows the concentrations of total and soluble manganese after KMnO₄ addition and after the contact tanks over time. Before November 15, 2005, total manganese levels after the contact tanks ranged from 416 to 1,126 µg/L, 38 to 94% of which was present in the soluble form based on the use of 0.45-µm disc filters. As noted in the figure and Table 4-9, the KMnO₄ dosage was incrementally decreased from the initial level of 3.8 mg/L to 1.4 mg/L, and then increased to 2.6 mg/L by adjusting the

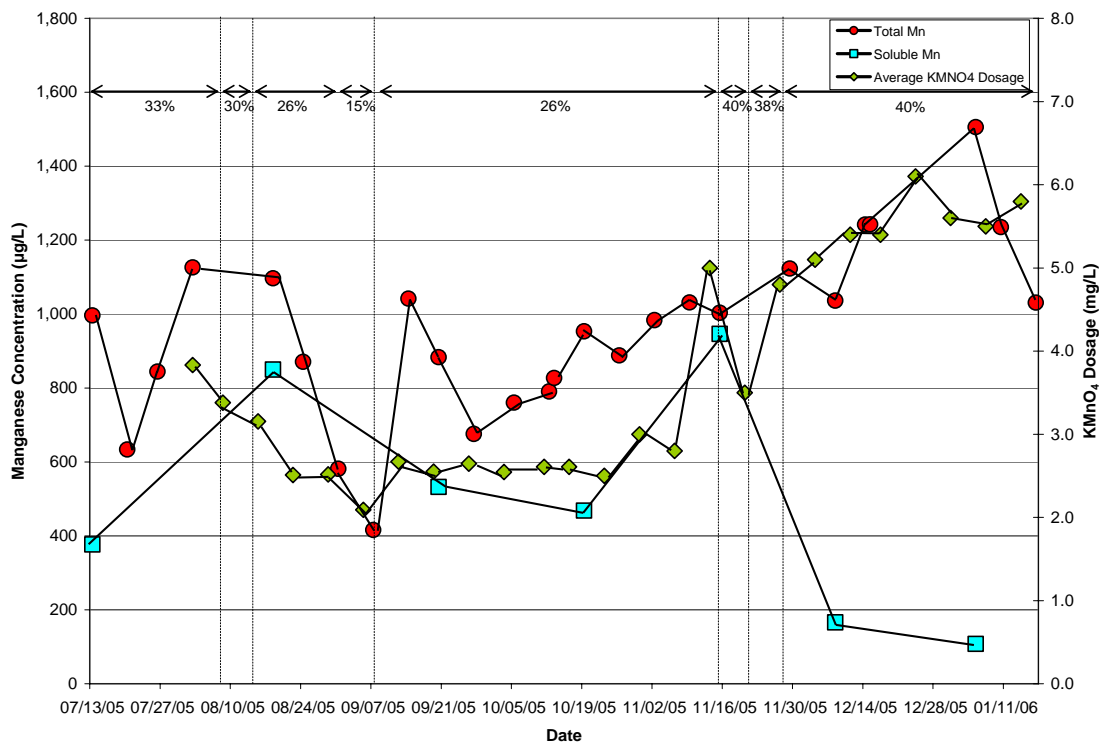

Figure 4-11. Total and Soluble Manganese Concentrations at AC Sampling Location

Table 4-9. Correlations Between Pump Stroke Length, KMnO₄ Dosage, and Total and Soluble Manganese Concentrations

| Duration | Stroke Length (%) | Average KMnO ₄ Dosage (mg/L) | Total Mn at AC Location (mg/L) | Soluble Mn at AC Location (mg/L) | Total Mn at TA/TB, TC/TD, and TT Location (mg/L) | Soluble Mn at TA/TB, TC/TD, and TT Location (mg/L) |
|----------------------|-------------------|---|--------------------------------|----------------------------------|--|--|
| 07/13/05 to 08/07/05 | 33 | 3.8 | 634–1,126 | 337 | 428–727 | 391 |
| 08/08/05 to 08/13/05 | 30 | 3.4 | N/A | | N/A | |
| 08/14/05 to 08/30/05 | 26 | 3.0 | 871–1,097 | 850 | 467–1,010 | 1,000 |
| 08/31/05 to 09/07/05 | 15 | 1.4 | 416–581 | N/A | 430–906 | N/A |
| 09/08/05 to 11/15/05 | 26 | 2.6 | 676–1,042 | 468–946 | 548–1,091 | 535–1,062 |
| 11/16/05 to 11/20/05 | 40 | 5.4 | N/A | | N/A | |
| 11/21/05 to 12/04/05 | 38 | 3.1 | 1,123 | N/A | 432 | N/A |
| 12/05/05 to 01/17/06 | 40 | 5.6 | 1,031–1,506 | 108–166 | 201–673 | 138–202 |

N/A = Data not available

stroke length of the paced-pump from 33 to 15%, then to 26%. The KMnO₄ dosage was decreased from the initial level of 3.8 mg/L because elevated total and soluble manganese levels at 996 (average) and 377 µg/L, respectively, were measured after KMnO₄ addition and thought, at the time, to have been caused by overdosing of KMnO₄. Decreasing the KMnO₄ dosage from 3.8 to 3.4 and then to 3.0 mg/L did not appear to help reduce the manganese concentrations, with total and soluble levels measured, for example, at 1,097 and 850 µg/L, respectively, on August 18, 2005. A further decrease in KMnO₄ dosage

to 1.4 mg/L helped reduce the total manganese levels, which, however, were still higher than those in raw water at 581 and 416 µg/L, respectively, on August 31 and September 7, 2005. This low level of KMnO_4 addition also caused significantly elevated arsenic and iron concentrations in the treated water due to incomplete oxidation of As(III) and Fe(II) also discussed in Section 4.5.1. Resuming the KMnO_4 dosage at 2.6 mg/L returned the total manganese concentrations to 676 to 1,042 µg/L, with most (i.e., 468 to 946 µg/L) existing in the soluble form, as determined by the use of 0.45-µm disc filters.

The addition of 1.4 mg/L to 3.8 mg/L of KMnO_4 during July 13 through November 15, 2005, resulted in significantly elevated manganese levels not only after the contact tanks, as discussed above, but also after the Macrolite® filters (ranging from 428 to 1,091 µg/L and averaging 722 µg/L, Figure 4-12). Further, manganese in the treated water existed almost entirely (i.e., 535 to 1,062 µg/L) in the soluble form based on the use of 0.45-µm filter discs for obtaining the soluble fractions.

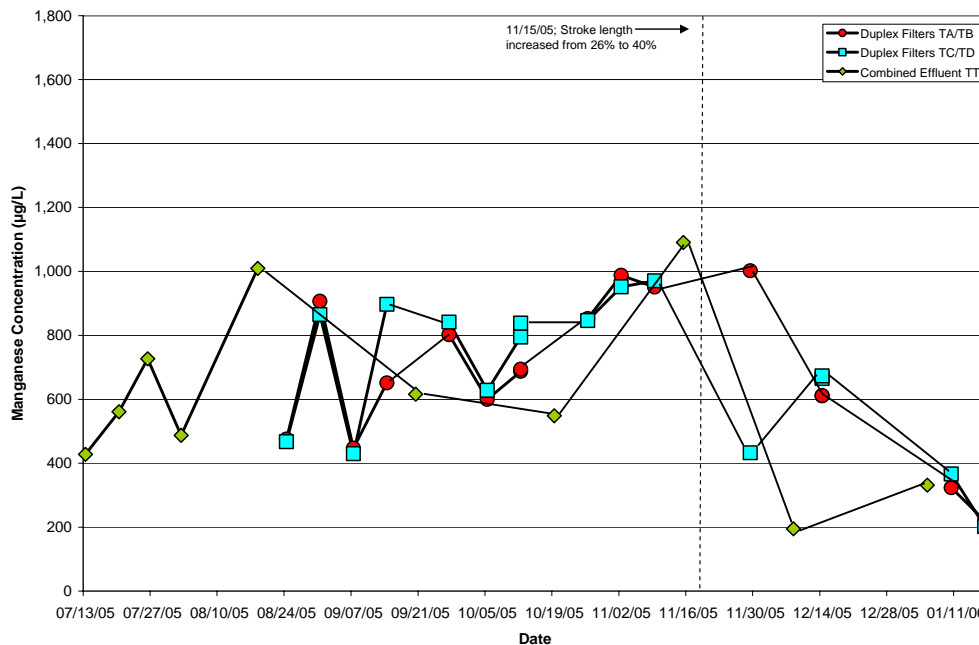

Figure 4-12. Total Manganese Concentrations at TA/TB, TC/TD, and TT Sampling Locations

Mn(II) oxidation by KMnO_4 is dependent on the KMnO_4 dosage, pH, temperature, and DOM in raw water. The reaction of KMnO_4 with Mn(II) is typically rapid and complete at pH values ranging from 5.5 to 9.0. However, elevated DOM levels can increase the KMnO_4 demand due to competition between these species and resulting kinetic effects (Knocke et al., 1987). Some researchers suggest that DOM can interfere with the formation of $\text{MnO}_2(\text{s})$ solids by exerting KMnO_4 demand and, possibly, forming complexes with fractions of Mn(II), thus rendering it less likely to be oxidized (Gregory and Carson, 2003). When modeling the Mn(II) oxidation with KMnO_4 , Carlson and co-workers (1999) determined that incorporating a term in the model to account for the DOM demand for MnO_4^- significantly improved the prediction of the MnO_4^- consumption. The incorporation of DOM into the oxidation term to account for complexation between DOM and Mn(II) also was postulated but no data was collected as part of that study. Further, high levels of DOM in source water also can form fine colloidal MnO_2 particles, which may not be filterable by conventional gravity or pressure filters. Knocke et al. (1991) defined colloidal particles as those passing through 0.20-µm filters and requiring ultrafiltration for removal.

The presence of significantly elevated soluble manganese levels after the contact tanks and after the Macrolite[®] filters, even with the use of insufficient KMnO₄, prompted the speculation that the soluble manganese measured might, in fact, be colloidal particles that had passed through the 0.45-μm disc filters. Therefore, jar tests were performed on November 7, 2005, to determine if higher KMnO₄ dosages might help overcome the DOM effect and form larger filterable MnO₂ solids in the treated water. Prior to the start of the jar tests, the additional KMnO₄ demand of a Macrolite[®]-treated water sample (to which 3.0 mg/L of KMnO₄ had been added based on the KMnO₄ consumption in the chemical day tank during the week of sampling) was pre-determined by titrating 1 L of the water with a 1-g/L KMnO₄ titrant. After 2.5 mL of the titrant was added, the water being titrated developed a dark yellow color, and was filtered, after about 10 min, with 0.20-μm disc filters to remove any suspended solids including MnO₂. The filtrate was observed to have a pink color, indicating the presence of KMnO₄ residual.

Five KMnO₄ dosages ranging from 1.0 to 3.0 mg/L were then selected for the jar tests using the same Macrolite[®]-treated water sample mentioned above. (These dosages would be in addition to the KMnO₄ already added to the water to be treated). After 31 min of mixing time (including 1 min at 200 rpm, 19 at 100 rpm, and 11 min at 28 rpm), the water in the jars was filtered separately with 0.20-μm disc filters and analyzed for soluble arsenic, iron, and manganese. Table 4-10 summarizes the results of the jar tests.

Table 4-10. Jar Test Results for Macrolite[®]-Treated Water

| Parameter | 1 | 2 | 3 | 4 | 5 | 6 |
|--|-------|------|------|------|------|------|
| Potassium Permanganate Added (mg/L) ^(a) | 0 | 1.0 | 1.5 | 2.0 | 2.5 | 3.0 |
| Mixing Time (min) | 31 | 31 | 31 | 31 | 31 | 31 |
| Initial pH ^(b) | 7.70 | 7.80 | 7.81 | 7.71 | 7.74 | 7.76 |
| Final pH ^(c) @ 16.8°C | 7.68 | 7.67 | 7.70 | 7.62 | 7.60 | 7.61 |
| Initial ORP ^(b) @ 16.8°C | 283 | 292 | 400 | 440 | 509 | 521 |
| Final ORP ^(c) | 353 | 360 | 363 | 369 | 493 | 515 |
| Residual KMnO ₄ (mg/L) ^(d) | 0.04 | 0.01 | 0.05 | 0.07 | 0.35 | 0.63 |
| As (soluble) ^(e) (μg/L) | 5.5 | 4.5 | 3.3 | 3.3 | 3.2 | 3.1 |
| Fe (soluble) ^(e) (μg/L) | <25 | <25 | <25 | <25 | <25 | <25 |
| Mn (soluble) ^(e) (μg/L) | 1,090 | 102 | 0.8 | 11.0 | 399 | 469 |

(a) Dosage on top of 3.0 mg/L already added to the water prior to jar tests.

(b) Taken approximately 15 min into jar test.

(c) Taken at end of 31 min jar test.

(d) CAIROX[®] Method 103 (DPD Spectrophotometry) for determination of KMnO₄ residual.

(e) Filtered with 0.20-μm filters.

During mixing, jars No. 2 to 4 formed large brown flocs in a pale to dark yellow solution (Figure 4-13). Jars No. 5 to 6 had smaller brown flocs in a dark copper solution. As shown in Table 4-10, the soluble iron levels in all jars were below the method detection limit of 25 μg/L, suggesting that effective oxidation and removal of iron had already been achieved prior to the jar tests. Soluble arsenic levels decreased slightly from 5.5 μg/L to 3.1 μg/L in jar No. 6 (the one with the highest KMnO₄ dosage 3.0 mg/L). Only soluble manganese concentrations varied significantly, decreasing from 1,090 μg/L in jar No. 1 to <1 μg/L in jar No. 3 and then increasing to 469 μg/L in jar No. 6. Knocke et al. (1990) reported that the kinetics for Fe(II) oxidation are faster than for Mn(II) oxidation when KMnO₄ is used as the oxidant. The relevant stoichiometric equations are shown as follows:

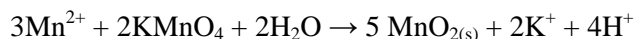
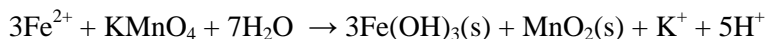

In the control sample, the soluble manganese level was high due to the slower Mn(II) oxidation kinetics and the presence of DOM as discussed above. The 1,090 $\mu\text{g/L}$ of “soluble” manganese in the control sample confirmed that the manganese most likely was present as colloidal particles since the sample analyzed had already been filtered with 0.2 μm disc filters. Increasing the KMnO_4 dosage to 1.5 mg/L (on top of the 3.0 mg/L already added to the water prior to the jar tests) appeared to be sufficient to overcome the effects of DOM, allowing filterable manganese particles to form. As a result, only 0.8 $\mu\text{g/L}$ of manganese that passed through the 0.2- μm filters was reported as “soluble” manganese. Further, increasing the KMnO_4 dosage up to 3 mg/L increased the soluble manganese level up to 469 $\mu\text{g/L}$, suggesting that excess KMnO_4 was present in the treated water. The presence of KMnO_4 was supported by the elevated residual KMnO_4 levels and the elevated ORP readings (see results of jars No. 4 and 5).



Figure 4-13. Jar Test Setup

Based on the jar tests results, it was determined that an additional 1.5 mg/L of KMnO_4 was needed to attain filterable manganese solids. Therefore, the KMnO_4 dosage to the treatment system was increased on November 15, 2005 for a target dosage of 4.5 mg/L. The actual dosage after adjusting the stroke length from 26 to 40% was 5.4 mg/L (Table 4-9). After the increase in dosage, manganese was present primarily in the particulate form, with concentrations ranging from 1,031 to 1,506 $\mu\text{g/L}$. The soluble manganese was decreased significantly to 108 to 166 $\mu\text{g/L}$ (Figure 4-11). (Note that as before, 0.45- μm filters were used to obtain these treatment results). After November 15, 2005, the speciation results indicated that approximately 7 to 16% was present as soluble manganese in the Macrolite[®] treated water: the total manganese concentrations ranged from 201 to 673 $\mu\text{g/L}$ and the soluble manganese concentrations ranged from 138 to 202 $\mu\text{g/L}$. Based on an average soluble manganese concentration of 177 $\mu\text{g/L}$ and total manganese concentration of 673 $\mu\text{g/L}$, particulate manganese breakthrough of up to 496 $\mu\text{g/L}$ was experienced from the Macrolite[®] filters. In the next six-month period, further fine-tuning will be made to the KMnO_4 dosing to determine if soluble manganese may be further reduced to less than the Secondary Maximum Contaminant Level (SMCL) of 50 $\mu\text{g/L}$.

TOC. TOC levels in raw water were elevated, ranging from 3.2 to 4.8 mg/L. KMnO_4 was used as the oxidant to prevent the formation of disinfection byproducts. Before November 15, 2005, the effluent TOC levels ranged from 3.8 to 4.8 mg/L and there was little or no TOC removal across the treatment train. After November 15, 2005, the influent TOC level was 3.2 mg/L (average) and the effluent TOC level was 3.0 mg/L (average) with approximately 6% removal. Research has shown that only minimal organic carbon removal occurs (at less than 10%) via KMnO_4 oxidation in source water containing Mn(II) and DOC (Salbu and Steinnes, 1995; Knocke et al., 1990). However, significant DOC removal with colloidal iron particles produced by Fe(II) oxidation was observed (Knocke et al., 1994). The complexation of iron with organic carbon does not appear to be a significant factor at the BSLMHP site as discussed previously.

Other Water Quality Parameters. DO levels remained low across the treatment train (with average values ranging from 1.2 to 0.9 mg/L), but ORP values increased across the treatment train (ranging from -76 to -23 mV before versus 1 to 196 mV after KMnO_4 addition). There were two outliers on September 7 and October 26, 2005, where the ORP values after the contact tanks were negative. The ORP on September 7, 2005, was negative because the stroke on the KMnO_4 pump was turned down to 15% on August 30, 2005. The pH in raw water had an average value of 7.3 and the pH in the treated water had an average value of 7.3. Average alkalinity results ranged from 366 to 369 mg/L (as CaCO_3) across the treatment train. Average total hardness results ranged from 315 to 319 mg/L (as CaCO_3) across the treatment train (the total hardness is the sum of calcium hardness and magnesium hardness). The water had an almost even split of calcium and magnesium hardness. Fluoride concentrations were 0.2 mg/L in raw water and after contact tanks and were not affected by the Macrolite[®] filtration. The average nitrate concentration was <0.05 mg/L (as N) across the treatment train. There was no detection of sulfate and the silica concentrations remained at approximately 24 mg/L (as SiO_2) across the treatment train.

Orthophosphate was analyzed between July 13, 2005, and October 5, 2005, and there was no detection. However, total phosphorous analyzed between October 12, 2005 and January 17, 2006, showed an elevated average of 0.5 mg/L (as P) in raw water and 0.1 mg/L (as P) in the treated water (Figure 4-14). This indicates a removal rate of approximately 80% most likely through adsorption onto iron solids. The elevated total phosphorous levels were further confirmed by analyzing a raw water sample taken on December 14, 2005, for the various phosphorous species according to EPA Method 365.3 by Sierra Environmental Monitoring, Inc. It was determined that the total phosphorous level in raw water was at 0.58 mg/L (as P), which was present primarily as total hydrolyzable phosphorous at 0.51 mg/L (as P). According to the EPA Method 365.3, total hydrolyzable phosphorous includes both polyphosphorous and some organic phosphorous. It also was later confirmed that no organopesticides were present in source water by EPA Method 507. There were other potential sources for elevated phosphorous in groundwater. Based on research conducted by the Sauk River Watershed District, the Sauk River and Big Sauk Lake have sediment, phosphorous, and nitrates caused by non-point source discharges from septic systems, agriculture, and urban runoff (Post, 2005). The historical monitoring data for the surface water of Big Sauk Lake shows a maximum total phosphorous level of 0.4 mg/L (as P) (Big Sauk Lake River Watershed District, 2006) and the Big Sauk Lake is located approximately 1000 ft from the BSLMHP wellhouse.

4.5.2 Backwash Water Sampling. Table 4-11 summarizes the analytical results from the six backwash water sampling events. For the first three sampling events, only pH, turbidity, TDS, and soluble As, Fe, and Mn were analyzed for the grab samples collected at the backwash water discharge line. Soluble arsenic concentrations in the backwash water ranged from 3.5 to 8.5 $\mu\text{g/L}$; soluble iron concentrations ranged from <25 to 63 $\mu\text{g/L}$; and soluble manganese concentrations ranged from 560 to 736 $\mu\text{g/L}$ based on the use of 0.45- μm filters. Starting from November 15, 2005, TSS and total As, Fe, and Mn also were analyzed for the composite sample collected using the modified backwash procedure discussed in Section 3.3.4. After the modified backwash procedure was implemented, total arsenic

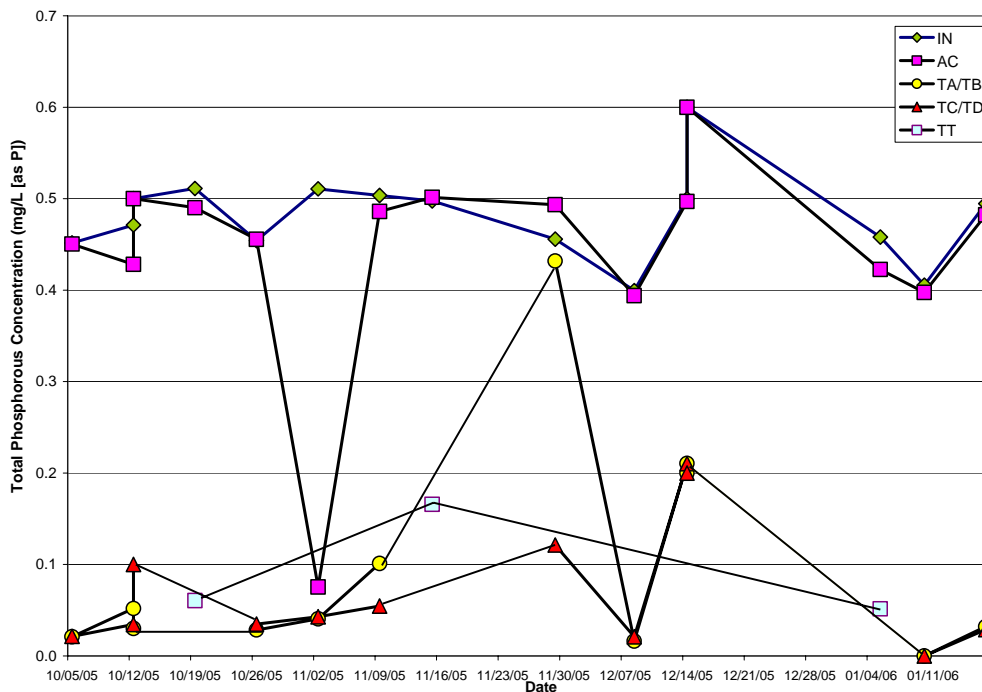

Figure 4-14. Total Phosphorous Concentrations at IN, AC, TA/TB, TC/TD and TT Sampling Locations

concentrations in the backwash water ranged from 114 to 417 $\mu\text{g/L}$; total iron concentrations ranged from 14,069 to 77,641 $\mu\text{g/L}$; and total manganese concentrations ranged from 1,595 to 16,178 $\mu\text{g/L}$. Note that November 15, 2005, BW2 data had uncharacteristically high total and soluble As and Fe, and, therefore, were excluded from all calculations. TSS levels in the backwash water ranged from 102 to 210 mg/L and averaging 154 mg/L (excluding November 15, 2005 BW2 data that had uncharacteristically high As and Fe and the January 10, 2006, BW2 data that had uncharacteristically low TSS). Using 130 gal of backwash water produced, this equates to approximately 0.17 lb of solids generated per backwash event including 4.4×10^{-4} lb of arsenic, 0.08 lb of iron, and 0.01 lb manganese.

4.5.3 Distribution System Water Sampling. The results of the distribution system sampling are summarized in Table 4-12. The main differences observed before and after the operation of the system were decreases in arsenic, iron, and manganese concentrations at each of the three sampling locations. Arsenic concentrations in the baseline samples ranged from 15.3 to 26.3 $\mu\text{g/L}$. Since the treatment system started operation, arsenic levels in the distribution system samples ranged from 3.6 to 14.2 $\mu\text{g/L}$ with an average of 6.6 $\mu\text{g/L}$. Arsenic concentrations mirrored the treatment results after the Macrolite[®] filters, except for an outlier at 24.1 $\mu\text{g/L}$ on January 17, 2006, when the homeowner did not sufficiently flush the tap the night before sampling. Total arsenic concentrations exceeded 10 $\mu\text{g/L}$ at all three sampling locations on September 7, 2005, due to particulate arsenic and iron breakthrough from the Macrolite[®] filters described in Section 4.4.2. Iron concentrations in the baseline samples were high, ranging from 2.1 to 5.0 mg/L . Since system startup, iron levels in the distributed water decreased significantly to an average value of 128 $\mu\text{g/L}$ (not including the outlier at DS1 on January 17, 2006). Particulate breakthrough was observed on September 7, November 29, and December 15, 2005 with elevated iron concentrations ranging from 532 to 2,363 $\mu\text{g/L}$ after the Macrolite[®] filters. Iron concentrations in the distribution system during those days ranged from <25 to 279 $\mu\text{g/L}$, indicating

Table 4-11. Backwash Water Sampling Results

| Sampling Event | | BW1 | | | | | | | | | | | | | BW2 | | | | | | | | | | |
|----------------|----------------------------|--------------------------|--------------|------|-----------|------|------|----------|------------|----------------|----------|------------|----------|------------|----------|-----------|------|-----|----------|------------|----------------|----------|------------|----------|------------|
| | | Tank A/B | | | | | | | | | | | | | Tank C/D | | | | | | | | | | |
| | | KMnO ₄ Dosage | Control Disc | pH | Turbidity | TDS | TSS | Total As | Soluble As | Particulate As | Total Fe | Soluble Fe | Total Mn | Soluble Mn | pH | Turbidity | TDS | TSS | Total As | Soluble As | Particulate As | Total Fe | Soluble Fe | Total Mn | Soluble Mn |
| No. | Date | mg/L | No. | S.U. | NTU | mg/L | µg/L | | | | | | | S.U. | NTU | mg/L | µg/L | | | | | | | | |
| 1 | 09/08/05 | 2.6 | 5 | 7.2 | 170 | 576 | NS | NS | 3.9 | NS | NS | <25 | NS | 624 | 7.3 | 120 | 544 | NS | NS | 3.5 | NS | NS | <25 | NS | 560 |
| 2 | 09/20/05 | 2.6 | 5 | 7.3 | 160 | 550 | NS | NS | 3.6 | NS | NS | <25 | NS | 624 | 7.3 | 17 | 368 | NS | NS | 8.5 | NS | NS | <25 | NS | 736 |
| 3 | 10/12/05 ^(a) | 2.6 | 7 | 7.3 | 120 | 356 | NS | NS | 4.4 | NS | NS | <25 | NS | 685 | 7.3 | 410 | 350 | NS | NS | 4.3 | NS | NS | 63 | NS | 656 |
| 4 | 11/15/05 ^(b, c) | 2.6 | 7 | 7.5 | NS | 54 | 102 | 329 | 6.9 | 322 | 63,108 | 163 | 1,595 | 836 | 7.5 | NS | 346 | 348 | 1,325 | 206 | 1,119 | 214,211 | 29,992 | 3,835 | 1,175 |
| 5 | 12/08/05 | 5.6 | 8 | 7.4 | NS | 224 | 210 | 417 | 0.5 | 416 | 77,641 | 201 | 16,178 | 350 | 7.6 | NS | 334 | 175 | 397 | 2.9 | 394 | 75,485 | 39 | 14,159 | 348 |
| 6 | 01/10/06 | 5.6 | 8 | 7.4 | NS | 360 | 130 | 363 | 3.3 | 360 | 43,384 | 128 | 12,265 | 341 | 7.6 | NS | 326 | 16 | 114 | 5.3 | 109 | 14,069 | 304 | 4,016 | 376 |

TDS = total dissolved solids; TSS = total suspended solids; NS = not sampled.

- (a) Manual backwash performed after Tank A/B had just been backwashed; less particles visually observed
- (b) Samples taken on November 15, 2005 re-analyzed with similar results for both samples on this date.
- (c) Modified backwash procedures implemented starting November 15, 2005.

Table 4-12. Distribution Sampling Results

| Sampling Events | | As at Entry Point | DS1 | | | | | | | | DS2 | | | | | | | | DS3 | | | | | | | |
|-----------------|----------|-------------------|-----------------|------|------------|------|-------|-----|-----|------|-----------------|------|------------|------|-------|-----|------|------|-----------------|------|------------|------|-------|-----|------|-----|
| | | | Stagnation Time | pH | Alkalinity | As | Fe | Mn | Pb | Cu | Stagnation Time | pH | Alkalinity | As | Fe | Mn | Pb | Cu | Stagnation Time | pH | Alkalinity | As | Fe | Mn | Pb | Cu |
| No. | Date | µg/L | hr | S.U. | mg/L | µg/L | | | | | hr | S.U. | mg/L | µg/L | | | | | hr | S.U. | mg/L | µg/L | | | | |
| BL1 | 02/16/05 | NA | 7.0 | 7.2 | 382 | 24.3 | 2,649 | 128 | 0.6 | 4.1 | 8.3 | 7.4 | 374 | 19.8 | 2,792 | 129 | 0.6 | 0.2 | NS | NS | NS | NS | NS | NS | NS | NS |
| BL2 | 03/23/05 | NA | 6.0 | 7.3 | 362 | 21.9 | 2,175 | 130 | 0.4 | 2.2 | 8.3 | 7.4 | 367 | 26.2 | 4,986 | 147 | 0.3 | 2.5 | 7.3 | 7.5 | 376 | 26.3 | 2,590 | 128 | <0.1 | 1.9 |
| BL3 | 04/19/05 | NA | 6.2 | 7.0 | 377 | 25.3 | 2,878 | 141 | 2.4 | 3.9 | 10.0 | 7.2 | 395 | 15.3 | 2,137 | 127 | 1.6 | 3.4 | 8.4 | 7.4 | 386 | 24.6 | 2,751 | 133 | 0.2 | 0.4 |
| BL4 | 05/23/05 | NA | 5.8 | 7.3 | 384 | 25.7 | 2,578 | 124 | 0.5 | 0.7 | 7.3 | 7.3 | 370 | 24.2 | 2,639 | 123 | <0.1 | 0.4 | 8.8 | 7.3 | 379 | 22.6 | 2,649 | 119 | 0.1 | 0.9 |
| 1 | 07/26/05 | 5.5 | 7.3 | 7.2 | 365 | 5.1 | 73 | 722 | 0.5 | 0.4 | 9.3 | 7.3 | 374 | 5.4 | 84 | 617 | 0.4 | 0.2 | 9.3 | 7.3 | 370 | 6.3 | 162 | 612 | 0.4 | 0.6 |
| 2 | 09/07/05 | 21.5/ 17.5 | 8.5 | 7.4 | 356 | 14.2 | 52 | 438 | 0.3 | 0.2 | 9.0 | 7.5 | 352 | 12.7 | <25 | 516 | <0.1 | 1.7 | 8.0 | 7.6 | 365 | 13.9 | 84 | 525 | <0.1 | 1.4 |
| 3 | 09/27/05 | 8.4/ 7.6 | 8.3 | 7.3 | 370 | 4.3 | 72 | 687 | 2.1 | 11.0 | 7.3 | 7.4 | 361 | 5.1 | 127 | 717 | 0.2 | <0.1 | 9.5 | 7.4 | 374 | 4.2 | 98 | 659 | 1.1 | 1.0 |
| 4 | 11/02/05 | 5.6/ 4.2 | 12.5 | 7.6 | 361 | 6.8 | <25 | 976 | 0.2 | 8.8 | 7.0 | 7.6 | 352 | 7.9 | 142 | 950 | <0.1 | 0.2 | 9.3 | 7.6 | 365 | 8.5 | 37 | 935 | 0.2 | 0.3 |
| 5 | 11/29/05 | 9.2 | 8.0 | 7.4 | 365 | 4.1 | 266 | 367 | 0.9 | 6.2 | 6.0 | 7.5 | 365 | 3.6 | 57 | 369 | 0.1 | 0.2 | 9.3 | 7.5 | 361 | 3.7 | 222 | 478 | 1.1 | 2.4 |
| 6 | 12/15/05 | 11.7/ 12.5 | 11.3 | 7.5 | 374 | 4.1 | 57 | 400 | 1.2 | 3.9 | 8.0 | 7.6 | 374 | 5.7 | 184 | 443 | 0.8 | 0.2 | 9.0 | 7.5 | 374 | 6.3 | 279 | 468 | 1.0 | 0.7 |
| 7 | 01/17/06 | 2.8/ 2.5 | 9.0 | 7.5 | 383 | 24.1 | 1,999 | 923 | 1.0 | 21.8 | 8.5 | 7.5 | 383 | 4.9 | 187 | 267 | 0.2 | 0.7 | 7.5 | 7.6 | 383 | 4.9 | 342 | 226 | 4.7 | 3.2 |

NS = not sampled; NA = not analyzed/applicable.

settling of iron solids within the distribution system piping. On January 17, 2006, due to insufficient flushing of the sampling tap, the iron concentration at DS1 was 1,999 µg/L while iron concentrations after the Macrolite® filters were very close to the detection limit of 25 µg/L. Manganese levels in the distribution system baseline samples averaged 130 µg/L and increased to an average of 569 µg/L after the treatment system became operational. The manganese concentrations in the distribution system mirrored the results after the Macrolite® filters.

There was no major change in pH values in the distribution system, which ranged from 7.0 to 7.5 before system startup and 7.2 to 7.6 after startup. Alkalinity levels in the distribution system ranged from 362 to 395 mg/L (as CaCO₃) before and 352 to 383 (as CaCO₃) after.

Lead and copper levels in the distribution system did not appear to have been affected by the operation of the arsenic treatment system. Lead levels in the distribution system ranged from <0.1 to 4.7 µg/L with no samples exceeding the action level of 15 µg/L. Copper concentrations ranged from <0.1 to 21.8 µg/L with no samples exceeding the 1,300 µg/L action level.

4.6 System Cost

The cost of the system was evaluated based on the capital cost per gpm (or gpd) of design capacity and the O&M cost per 1,000 gal of water treated. This required the tracking of the capital cost for equipment, engineering, and installation cost and the O&M cost for chemical supply, electrical power use, and labor. However, the cost associated with improvements to the building and any other discharge-related infrastructure were not included in the treatment system cost. While not included in the scope of the demonstration project, these activities were funded by the demonstration host site.

4.6.1 Capital Cost. The capital investment was \$63,547, which included \$22,422 for equipment, \$20,227 for site engineering, and \$20,898 for installation. Table 4-13 presents the breakdown of the capital cost as provided by the vendor in its proposal to Battelle dated February 17, 2005. The equipment cost was about 35% of the total capital investment, which included the CP-213f filtration tanks, Macrolite® media, contact tanks, process valves and piping, instrumentation and controls, a chemical feed system (including a storage tank with a secondary containment), additional sample taps and totalizer/meters, shipping, and equipment assembly labor.

The engineering cost included the cost for preparing a process design report and required engineering plans, including a general arrangement drawing, piping and instrumentation diagrams (P&IDs), interconnecting piping layouts, tank fill details, an electrical on-line diagram, and other associated drawings. After certification by a Minnesota-registered professional engineer (PE), the plans were submitted to the MDH for permit review and approval (Section 4.3.1). The engineering cost was \$20,227, which was 32% of the total capital investment.

The installation cost included the cost for labor and materials for system unloading and anchoring, plumbing, and mechanical and electrical connections (Section 4.3.3). The installation cost was \$20,898 or 33% of the total capital investment.

Using the system's rated capacity of 20 gpm (or 28,800 gpd), the capital cost was normalized to be \$3,177/gpm (or \$2.21/gpd). The capital cost of \$63,547 was converted to an annualized cost of \$5,998/year using a capital recovery factor of 0.09439 based on a 7% interest rate and a 20-year return. Assuming that the system was operated 24 hours a day, 7 days a week at the design flow rate of 20 gpm to produce 10,500,000 gal of water per year, the unit capital cost would be \$0.57/1,000 gal. However, since the system operated an average of 3.4 hr/day at just under 4.4 gpm (see Table 4-4), producing 863,470 gal of water during the six-month period, the unit capital cost was increased to \$3.47/1000 gal at this reduced rate of production.

Table 4-13. Summary of Capital Investment for BSLMHP Treatment System

| Description | Quantity | Cost | % of Capital Investment Cost |
|--|----------|-----------------|------------------------------|
| <i>Equipment Cost</i> | | | |
| Media and Tanks | 1 | \$8,549 | – |
| Process Valves and Piping | 1 | \$1,935 | – |
| Chemical Feed | 1 | \$1,150 | – |
| Chemical Storage and Secondary Containment | 1 | \$680 | – |
| Instrumentation and Controls | 1 | \$1,079 | – |
| Additional Flowmeter/Totalizers | 1 | \$359 | – |
| Shipping | – | \$750 | – |
| Labor | – | \$7,920 | – |
| Equipment Total | – | \$22,422 | 35% |
| <i>Engineering Cost</i> | | | |
| Labor | – | \$15,620 | – |
| Travel | – | \$1,750 | – |
| Subcontractor | – | \$2,857 | – |
| Engineering Total | – | \$20,227 | 32% |
| <i>Installation Cost</i> | | | |
| Labor | – | \$5,000 | – |
| Travel | – | \$2,913 | – |
| Subcontractor | – | \$12,985 | – |
| Installation Total | – | \$20,898 | 33% |
| Total Capital Investment | – | \$63,547 | 100% |

4.6.2 Operation and Maintenance Cost. The O&M cost primarily included cost associated with chemical supply, electricity consumption, and labor (Table 4-14). The usage rate for the KMnO₄ stock solution was approximately 7.5 gal or 100 lb/yr. Incremental electrical power consumption was calculated for the chemical feed pump. The power demand was calculated based on the total operational hours throughout the duration of the six-month study, the chemical feed pump horsepower, and the unit cost from the utility bills. The routine, non-demonstration related labor activities consumed about 5 min per day, 5 days a week, as noted in Section 4.4.4. Based on this time commitment and a labor rate of \$21/hr, the labor cost was \$0.27/1,000 gal of water treated. In sum, the total O&M cost was approximately \$0.43/1,000 gal. The O&M cost will be verified during the next reporting period.

Table 4-14. O&M Cost for BSLMHP, MN Treatment System

| Cost Category | Value | Assumption |
|-------------------------------------|---------------|---|
| Projected Volume Processed (gal) | 863,470 | From 07/13/05 through 01/17/06 (see Table 4-4) |
| <i>Chemical Usage</i> | | |
| Chemical Unit Price (\$/lb) | \$2.07 | 97% KMnO ₄ in a 55-lb pail (approximately 4 gal) |
| Total Chemical Consumption (lb) | 50 | 7.5 gal or 100 lb of KMnO ₄ per year |
| Chemical Usage (lb/1,000 gal) | 0.058 | |
| Total Chemical Cost (\$) | \$103.5 | |
| Unit Chemical Cost (\$/1,000 gal) | \$0.12 | |
| <i>Electricity</i> | | |
| Electricity Unit Cost (\$/kwh) | 0.067 | |
| Estimated Electricity Usage (kwh) | 515 | Calculated based on 617 hr of operation of a 0.17-hp chemical feed pump |
| Estimated Electricity Cost (\$) | \$34.54 | |
| Estimated Power Use (\$/1,000 gal) | \$0.04 | |
| <i>Labor</i> | | |
| Average Weekly Labor (hr) | 0.42 | 5 min/day; 5 days a week |
| Total Labor Hours (hr) | 11 | 26 weeks |
| Total Labor Cost (\$) | \$231 | Labor rate = \$21/hr |
| Labor Cost (\$/1,000 gal) | \$0.27 | |
| Total O&M Cost/1,000 gal | \$0.43 | - |

Section 5.0: REFERENCES

- Battelle. 2004. *Quality Assurance Project Plan for Evaluation of Arsenic Removal Technology*. Prepared under Contract No. 68-C-00-185, Task Order No. 0029, for U.S. Environmental Protection Agency, National Risk Management Research Laboratory, Cincinnati, OH.
- Carlson, Kenneth H., and William R. Knocke. 1999. "Modeling Manganese Oxidation with KMnO_4 for Drinking Water Treatment." *JAWWA* 125(10): 892-896.
- Chen, A.S.C., L. Wang, J. Oxenham, and W. Condit. 2004. *Capital Costs of Arsenic Removal Technologies: U.S. EPA Arsenic Removal Technology Demonstration Program Round 1*. EPA/600/R-04/201. U.S. Environmental Protection Agency, National Risk Management Research Laboratory, Cincinnati, OH.
- Edwards, M., S. Patel, L. McNeill, H. Chen, M. Frey, A.D. Eaton, R.C. Antweiler, and H.E. Taylor. 1998. "Considerations in As Analysis and Speciation." *JAWWA* 90(3): 103-113.
- EPA. 2001. National Primary Drinking Water Regulations: Arsenic and Clarifications to Compliance and New Source Contaminants Monitoring. *Federal Register*, 40 CFR Part 9, 141, and 142.
- EPA. 2002. *Lead and Copper Monitoring and Reporting Guidance for Public Water Systems*. EPA/816/R-02/009. U.S. Environmental Protection Agency, Office of Water, Washington, D.C.
- EPA. 2003. Minor Clarification of the National Primary Drinking Water Regulation for Arsenic. *Federal Register*, 40 CFR Part 141.
- Gregory, D., and K. Carlson. 2003. "Effect of Soluble Mn Concentration on Oxidation Kinetics ." *JAWWA* 95(1): 98-108.
- Knocke, William R., Hoehn, Robert C.; Sinsabaugh, Robert L. 1987. "Using Alternative Oxidants to Remove Dissolved Manganese from Waters Laden with Organics." *JAWWA*, 79(3): 75-79.
- Knocke, William R., John E. Van Benschoten, Maureen J. Kearney, Andrew W. Soborski, and David A. Reckhow. 1990. *Alternative Oxidants for the Remove of Soluble Iron and Manganese*. Final report prepared for the AWWA Research Foundation, Denver, CO.
- Knocke, William R., John E. Van Venschoten, Maureen J. Kearney, Andrew W, Soborski, and David A. Reckhow. 1991. "Kinetics of Manganese and Iron Oxidation by Potassium Permanganate and Chlorine Dioxide." *JAWWA* 83(6): 80-87.
- Knocke, William R., Holly L. Shorney, and Julia D. Bellamy. 1994. "Examining the Reactions Between Soluble Iron, DOC, and Alternative Oxidants During Conventional Treatment." *JAWWA* 86(1): 117-127.
- Post, Tim. 2005. "Pollution Cleanup Cost is Hard to Comprehend." *Minnesota Public Radio*. Available at: http://news.minnesota.publicradio.org/features/2005/10/10_postt_impairedcleanup/.
- Salbu, B. and E. Steinnes. 1995. *Trace Elements in Natural Waters*. CRC Press, Boca Raton, Florida.

Sauk River Watershed District. 2006. "Monitoring Our Resources." Available at:
<http://www.srwdmn.org/monitoring/html>.

Sorg, T.J. 2002. "Iron Treatment for Arsenic Removal Neglected." *Opflow*, AWWA, 28(11): 15.

Wang, L., W. Condit, and A.S.C. Chen. 2004. *Technology Selection and System Design: U.S. EPA Arsenic Removal Technology Demonstration Program Round 1*. EPA/600/R-05/001. U.S. Environmental Protection Agency, National Risk Management Research Laboratory, Cincinnati, OH.

APPENDIX A
OPERATIONAL DATA

US EPA Arsenic Demonstration Project at BSLMHP, MN – Daily System Operation Log Sheet

| Week No. | Date | Time | New Well | | Volume to Treatment | | Pressure Tanks | | Pressure Filtration | | | | | Volume to Distribution | | Backwash | | KMnO ₄ Application | | |
|----------|----------------------------|-------|-----------------|----------------------|---------------------|------------------------|------------------------|------------------------|---------------------|--------------|--------------|------------|-------------------------|------------------------|--------------------|-------------------------|---------------------------|-----------------------------------|---------------------------------------|----|
| | | | Hour Meter (hr) | Daily Operation (hr) | Daily Volume (gal) | Average Flowrate (gpm) | Pressure Tank 1 (psig) | Pressure Tank 2 (psig) | IN (psig) | TA/TB (psig) | TC/TD (psig) | OUT (psig) | ΔP Across System (psig) | Flowrate (gpm) | Daily Volume (gal) | No. of Tanks Backwashed | Wastewater Produced (gal) | KMnO ₄ Tank Level (in) | Average KMnO ₄ Dose (mg/L) | |
| 1 | 07/13/05 | 21:13 | NM | NA | NA | NA | NM | NM | 42 | NM | NM | 30 | 12 | NM | NA | NM | NA | NM | NA | |
| | 07/14/05 | 20:10 | NM | NA | 6,980 | NA | NM | NM | 54 | NM | NM | 37 | 17 | NM | 7,000 | 1 | 110 | NM | NA | |
| | 07/15/05 | 20:00 | NM | NA | 6,880 | NA | NM | NM | 40 | NM | NM | 30 | 10 | NM | 6,700 | 2 | 240 | NM | NA | |
| | 07/16/05 | NM | NM | NA | NA | NA | NM | NM | NM | NM | NM | NM | NA | NM | NA | NM | NA | NM | NA | |
| | 07/17/05 | NM | NM | NA | NA | NA | NM | NM | NM | NM | NM | NM | NA | NM | NA | NM | NA | NM | NA | |
| 2 | 07/18/05 | 18:45 | NM | NA | NA | NA | NM | NM | 58 | NM | NM | 45 | 13 | NM | NA | NM | NA | NM | NA | |
| | 07/19/05 | 19:10 | NM | NA | 9,125 | NA | NM | NM | 40 | NM | NM | 36 | 4 | NM | 8,900 | 3 | 350 | NM | NA | |
| | 07/20/05 | 19:00 | NM | NA | 11,075 | NA | NM | NM | 45 | NM | NM | 22 | 23 | NM | 10,800 | 3 | 440 | NM | NA | |
| | 07/21/05 | 18:30 | NM | NA | 14,470 | NA | NM | NM | 45 | NM | NM | 35 | 10 | NM | 14,300 | 4 | 490 | NM | NA | |
| | 07/22/05 | 20:00 | NM | NA | 7,680 | NA | NM | NM | 48 | NM | NM | 42 | 6 | NM | 7,400 | 3 | 360 | NM | NA | |
| | 07/23/05 | NM | NM | NA | NA | NA | NM | NM | NM | NM | NM | NM | NA | NM | NA | NM | NA | NM | NA | |
| 07/24/05 | NM | NM | NA | NA | NA | NA | NM | NM | NM | NM | NM | NA | NM | NA | NM | NA | NM | NA | | |
| 3 | 07/25/05 | 19:30 | NM | NA | 14,250 | NA | NM | NM | 47 | NM | NM | 45 | 2 | NM | 13,900 | 4 | 470 | NM | NA | |
| | 07/26/05 | 20:10 | NM | NA | 4,020 | NA | NM | NM | 41 | NM | NM | 40 | 1 | NM | 3,900 | 1 | 130 | NM | NA | |
| | 07/27/05 | 23:15 | NM | NA | 4,030 | NA | NM | NM | 58 | NM | NM | 55 | 3 | NM | 3,900 | 1 | 110 | NM | NA | |
| | 07/28/05 | 20:15 | NM | NA | 4,180 | NA | NM | NM | 41 | NM | NM | 40 | 1 | NM | 3,900 | 2 | 240 | NM | NA | |
| | 07/29/05 | 18:15 | NM | NA | 3,340 | NA | NM | NM | 56 | NM | NM | 53 | 3 | NM | 3,200 | 1 | 120 | NM | NA | |
| | 07/30/05 | NM | NM | NA | NA | NA | NM | NM | NM | NM | NM | NM | NM | NM | NM | NM | NA | NM | NA | |
| | 07/31/05 | NM | NM | NA | NA | NA | NA | NM | NM | NM | NM | NM | NM | NM | NM | NM | NA | NM | NA | |
| 4 | 08/01/05 | 19:05 | NM | NA | 18,670 | NA | 52 | 72 | 58 | NM | NM | 48 | 10 | NM | 18,100 | 5 | 710 | 30.0 | NA | |
| | 08/02/05 | 20:30 | NM | NA | 6,057 | NA | 46 | 72 | 42 | NM | NM | 40 | 2 | NM | 5,900 | 2 | 240 | 29.6 | 3.8 | |
| | 08/03/05 | 23:55 | NM | NA | 4,733 | NA | 45 | 72 | 41 | NM | NM | 38 | 3 | NM | 4,500 | 1 | 120 | 29.3 | | |
| | 08/04/05 | 23:55 | NM | NA | 3,635 | NA | 53 | 72 | 49 | NM | NM | 46 | 3 | NM | 3,600 | 1 | 120 | 28.9 | | |
| | 08/05/05 | 22:00 | NM | NA | 3,985 | NA | 45 | 72 | 42 | NM | NM | 40 | 2 | NM | 3,700 | 2 | 240 | 28.7 | | |
| | 08/06/05 | NM | NM | NA | NA | NA | NM | NM | NM | NM | NM | NM | NM | NM | NM | NM | NA | NM | | NA |
| | 08/07/05 | NM | NM | NA | NA | NA | NM | NM | NM | NM | NM | NM | NM | NM | NM | NM | NA | NM | | NA |
| 08/08/05 | 21:30 | NM | NA | 12,020 | NA | 60 | 72 | 58 | NM | NM | 50 | 8 | NM | 11,600 | 4 | 490 | 27.8 | | | |
| 5 | 08/09/05 ^(a, b) | 21:30 | NM | NA | 7,195 | NA | 55 | 72 | 55 | 44 | 38 | 42 | 13 | NM | 5,100 | 13 | 1,720 | 27.4 | 3.4 | |
| | 08/10/05 | NM | NM | NA | NA | NA | NM | NM | NM | NM | NM | NM | NM | NM | NM | NM | NA | NM | | NA |
| | 08/11/05 ^(c) | 18:00 | NM | NA | 4,885 | NA | 50 | 46 | 42 | 40 | 34 | 40 | 2 | NM | 4,200 | 6 | 740 | 27.1 | | |
| | 08/12/05 | 20:30 | NM | NA | 5,200 | NA | 56 | 50 | 48 | 38 | 30 | 37 | 11 | NM | 5,000 | 1 | 150 | 26.8 | | |
| | 08/13/05 | NM | NM | NA | NA | NA | NM | NM | NM | NM | NM | NM | NA | NM | NA | NM | NA | NM | | NA |
| | 08/14/05 | NM | NM | NA | NA | NA | NM | NM | NM | NM | NM | NM | NA | NM | NA | NM | NA | NM | | NA |
| 6 | 08/15/05 | 21:00 | NM | NA | 15,090 | NA | 54 | 49 | 46 | 42 | 34 | 40 | 6 | NM | 14,600 | 4 | 490 | 25.8 | 3.2 | |
| | 08/16/05 | 21:30 | NM | NA | 5,410 | NA | 45 | 40 | 43 | 38 | 30 | 39 | 4 | NM | 5,100 | 1 | 120 | 25.4 | | |
| | 08/17/05 | 20:00 | NM | NA | 3,360 | NA | 55 | 54 | 55 | 30 | 22 | 30 | 25 | NM | 3,400 | 2 | 320 | 25.3 | | |
| | 08/18/05 | 19:15 | NM | NA | 5,860 | NA | 49 | 45 | 42 | 36 | 30 | 36 | 6 | NM | 5,530 | 1 | 130 | 24.9 | | |
| | 08/19/05 | 20:30 | NM | NA | 4,620 | NA | 54 | 50 | 47 | 42 | 38 | 43 | 4 | NM | 4,205 | 3 | 380 | 24.6 | | |
| | 08/20/05 | NM | NM | NA | NA | NA | NM | NM | NM | NM | NM | NM | NA | NM | NA | NM | NA | NM | | NA |
| 08/21/05 | NM | NM | NA | NA | NA | NM | NM | NM | NM | NM | NM | NA | NM | NA | NM | NA | NM | NA | | |
| 7 | 08/22/05 | 20:20 | NM | NA | 11,460 | NA | 54 | 51 | 48 | 45 | 40 | 42 | 6 | NM | 10,315 | 6 | 790 | 23.9 | 2.5 | |
| | 08/23/05 | 22:10 | NM | NA | 5,140 | NA | 60 | 59 | 50 | 46 | 40 | 47 | 3 | NM | 5,110 | 1 | 120 | 23.8 | | |
| | 08/24/05 | 21:00 | NM | NA | 4,400 | NA | 46 | 44 | 42 | 40 | 34 | 40 | 2 | NM | 3,930 | 3 | 370 | 23.5 | | |
| | 08/25/05 | 21:15 | NM | NA | 3,680 | NA | 48 | 44 | 40 | 34 | 30 | 33 | 7 | NM | 3,640 | 0 | 0 | 23.4 | | |
| | 08/26/05 | NM | NM | NA | 2,970 | NA | 53 | 50 | 48 | 43 | 40 | 46 | 2 | NM | 2,535 | 3 | 380 | 23.1 | | |
| | 08/27/05 | NM | NM | NA | NA | NA | NM | NM | NM | NM | NM | NM | NA | NM | NA | NM | NA | NM | | NA |
| | 08/28/05 | NM | NM | NA | NA | NA | NM | NM | NM | NM | NM | NM | NA | NM | NA | NM | NA | NM | | NA |

US EPA Arsenic Demonstration Project at BSLMHP, MN – Daily System Operation Log Sheet (continued)

| Week No. | Date | Time | New Well | | Volume to Treatment | | Pressure Tanks | | Pressure Filtration | | | | | Volume to Distribution | | Backwash | | KMnO ₄ Application | | |
|----------|--------------------------|-------|-----------------|----------------------|---------------------|------------------------|------------------------|------------------------|---------------------|--------------|--------------|------------|-------------------------|------------------------|--------------------|-------------------------|---------------------------|-----------------------------------|---------------------------------------|----|
| | | | Hour Meter (hr) | Daily Operation (hr) | Daily Volume (gal) | Average Flowrate (gpm) | Pressure Tank 1 (psig) | Pressure Tank 2 (psig) | IN (psig) | TA/TB (psig) | TC/TD (psig) | OUT (psig) | ΔP Across System (psig) | Flowrate (gpm) | Daily Volume (gal) | No. of Tanks Backwashed | Wastewater Produced (gal) | KMnO ₄ Tank Level (in) | Average KMnO ₄ Dose (mg/L) | |
| 8 | 08/29/05 | 21:00 | NM | NA | 13,980 | NA | 50 | 48 | 44 | 40 | 32 | 40 | 4 | NM | 13,775 | 5 | 660 | 22.4 | 2.5 | |
| | 08/30/05 | 21:00 | NM | NA | 7,290 | NA | 48 | 43 | 42 | 40 | 30 | 39 | 3 | NM | 5,900 | 4 | 520 | 22.0 | | |
| | 08/31/05 | 22:30 | NM | NA | 4,530 | NA | 55 | 50 | 49 | 48 | 40 | 46 | 3 | NM | 4,095 | 2 | 250 | 21.9 | | |
| | 09/01/05 | 21:30 | NM | NA | 3,240 | NA | 48 | 46 | 43 | 40 | 32 | 40 | 3 | NM | 3,125 | 1 | 140 | 21.8 | | |
| | 09/02/05 | 21:15 | NM | NA | 3,190 | NA | 45 | 42 | 40 | 38 | 36 | 38 | 2 | NM | 3,120 | 2 | 200 | 21.6 | | |
| | 09/03/05 | NM | NM | NA | NA | NA | NM | NM | NM | NM | NM | NM | NA | NM | NA | NM | NA | NM | | NA |
| | 09/04/05 | NM | NM | NA | NA | NA | NM | NM | NM | NM | NM | NM | NA | NM | NA | NM | NA | NM | | NA |
| 9 | 09/05/05 | 20:00 | NM | NA | 15,955 | NA | 51 | 50 | 46 | 42 | 35 | 44 | 2 | NM | 14,625 | 7 | 850 | 21.4 | 2.1 | |
| | 09/06/05 | 21:30 | NM | NA | 5,155 | NA | 50 | 49 | 45 | 43 | 34 | 42 | 3 | NM | 4,725 | 3 | 390 | 21.2 | | |
| | 09/07/05 | 20:15 | NM | NA | 4,320 | NA | 50 | 46 | 40 | 40 | 32 | 40 | 0 | NM | 4,205 | 1 | 140 | 21.1 | | |
| | 09/08/05 | 21:15 | NM | NA | 4,750 | NA | 60 | 55 | 59 | 55 | 48 | 54 | 5 | NM | 4,275 | 3 | 390 | 20.9 | | |
| | 09/09/05 | 20:30 | NM | NA | 5,010 | NA | 54 | 50 | 55 | 52 | 46 | 50 | 5 | NM | 5,040 | 1 | 120 | 20.6 | | |
| | 09/10/05 | NM | NM | NA | NA | NA | NM | NM | NM | NM | NM | NM | NA | NM | NA | NM | NA | NM | | NA |
| | 09/11/05 | NM | NM | NA | NA | NA | NM | NM | NM | NM | NM | NM | NA | NM | NA | NM | NA | NM | | NA |
| 10 | 09/12/05 | 21:00 | NM | NA | 10,840 | NA | 46 | 44 | 41 | 36 | 30 | 38 | 3 | NM | 9,645 | 5 | 660 | 20.1 | 2.7 | |
| | 09/13/05 | 22:15 | NM | NA | 4,675 | NA | 45 | 43 | 45 | 40 | 35 | 44 | 1 | NM | 4,255 | 2 | 270 | 19.9 | | |
| | 09/14/05 | 23:50 | NM | NA | 4,990 | NA | 48 | 48 | 43 | 41 | 34 | 41 | 2 | NM | 4,435 | 3 | 390 | 19.6 | | |
| | 09/15/05 | 22:00 | NM | NA | 3,020 | NA | 60 | 60 | 55 | 52 | 46 | 52 | 3 | NM | 2,925 | 0 | 0 | 19.5 | | |
| | 09/16/05 | 21:00 | NM | NA | 2,715 | NA | 55 | 53 | 52 | 50 | 45 | 50 | 2 | NM | 2,700 | 1 | 130 | 19.4 | | |
| | 09/17/05 | NM | NM | NA | NA | NA | NM | NM | NM | NM | NM | NM | NA | NM | NA | NM | NA | NM | | NA |
| | 09/18/05 | NM | NM | NA | NA | NA | NM | NM | NM | NM | NM | NM | NA | NM | NA | NM | NA | NM | | NA |
| 11 | 09/19/05 | 20:00 | NM | NA | 13,405 | NA | 51 | 50 | 46 | 42 | 34 | 42 | 4 | NM | 12,265 | 6 | 770 | 18.7 | 2.6 | |
| | 09/20/05 | 17:30 | NM | NA | 4,860 | NA | 45 | 48 | 45 | 52 | 46 | 44 | 1 | NM | 4,095 | 5 | 660 | 18.5 | | |
| | 09/21/05 ^(a) | 20:00 | NM | NA | 4,940 | NA | 62 | 60 | 55 | 46 | 43 | 52 | 3 | NM | 4,495 | 2 | 280 | 18.2 | | |
| | 09/22/05 | 20:15 | NM | NA | 4,665 | NA | 60 | 58 | 53 | 55 | 50 | 52 | 1 | NM | 4,445 | 0 | 0 | 18.0 | | |
| | 09/23/05 | 20:00 | NM | NA | 2,890 | NA | 45 | 43 | 43 | 40 | 32 | 38 | 5 | NM | 3,000 | 0 | 0 | 17.9 | | |
| | 09/24/05 | NM | NM | NA | NA | NA | NM | NM | NM | NM | NM | NM | NA | NM | NA | NM | NA | NM | | NA |
| | 09/25/05 | NM | NM | NA | NA | NA | NM | NM | NM | NM | NM | NM | NA | NM | NA | NM | NA | NM | | NA |
| 12 | 09/26/05 | 21:15 | NM | NA | 12,350 | NA | 54 | 51 | 47 | 42 | 34 | 43 | 4 | NM | 11,670 | 4 | 480 | 31.8 | 2.7 | |
| | 09/27/05 | 20:30 | NM | NA | 4,190 | NA | 50 | 47 | 45 | 43 | 40 | 43 | 2 | NM | 4,185 | 0 | 0 | 31.6 | | |
| | 9/28/2005 ^(e) | 19:15 | 0.3 | NA | 3,105 | NA | 60 | 60 | 55 | 50 | 44 | 51 | 4 | 6.0 | 2,755 | 0 | 0 | 31.5 | | |
| | 09/29/05 | 19:30 | 3.2 | 2.9 | 3,255 | 19 | 52 | 50 | 43 | 40 | 32 | 40 | 3 | 5.5 | 3,840 | 3 | 360 | 31.3 | | |
| | 09/30/05 ^(f) | 21:30 | 6.1 | 2.9 | 5,345 | 31 | 50 | 50 | 45 | 42 | 40 | 43 | 2 | 1.0 | 3,850 | 2 | 250 | 31.0 | | |
| | 10/01/05 | NM | NM | NA | NA | NA | NM | NM | NM | NM | NM | NM | NA | NM | NA | NM | NA | NM | | NA |
| 10/02/05 | NM | NM | NA | NA | NA | NM | NM | NM | NM | NM | NM | NA | NM | NA | NM | NA | NM | NA | | |
| 13 | 10/03/05 | 21:30 | 15.8 | 9.7 | 14,010 | 24 | 60 | 57 | 54 | 50 | 50 | 52 | 2 | 0.0 | 12,880 | 7 | 890 | 30.3 | 2.6 | |
| | 10/04/05 | 21:30 | 18.9 | 3.1 | 4,493 | 24 | 55 | 52 | 50 | 46 | 44 | 49 | 1 | 3.0 | 4,060 | 3 | 390 | 30.1 | | |
| | 10/05/05 | 23:30 | 21.0 | 2.1 | 4,377 | 35 | 65 | 60 | 57 | 56 | 52 | 55 | 2 | 1.0 | 4,175 | 1 | 170 | 29.9 | | |
| | 10/06/05 | 18:30 | 23.7 | 2.7 | 2,313 | 14 | 60 | 56 | 55 | 40 | 42 | 50 | 5 | 3.0 | 2,295 | 0 | 0 | 29.8 | | |
| | 10/07/05 | 18:30 | 26.2 | 2.5 | 3,617 | 24 | 45 | 43 | 43 | 38 | 38 | 37 | 6 | 10.0 | 3,350 | 1 | 80 | 29.6 | | |
| | 10/08/05 | NM | NM | NA | NA | NA | NM | NM | NM | NM | NM | NM | NA | NM | NA | NM | NA | NM | | NA |
| | 10/09/05 | NM | NM | NA | NA | NA | NM | NM | NM | NM | NM | NM | NA | NM | NA | NM | NA | NM | | NA |
| 14 | 10/10/05 | NM | NM | NA | NA | NA | NM | NM | NM | NM | NM | NM | NA | NM | NA | NM | NA | NM | NA | |
| | 10/11/05 | 18:45 | 38.1 | 11.9 | 17,050 | 24 | 50 | 48 | 42 | 38 | 36 | 38 | 4 | 9.0 | 15,975 | 7 | 870 | 28.8 | 2.6 | |
| | 10/12/05 | 17:15 | 40.9 | 2.8 | 3,900 | 23 | 64 | 60 | 57 | 54 | 53 | 54 | 3 | 2.5 | 3,503 | 3 | 380 | 28.6 | | |
| | 10/13/05 | 20:00 | 43.9 | 3.0 | 4,280 | 24 | 50 | 47 | 44 | 38 | 36 | 38 | 6 | 9.0 | 3,862 | 3 | 390 | 28.4 | | |
| | 10/14/05 | 20:00 | 47.2 | 3.3 | 4,870 | 25 | 50 | 49 | 45 | 40 | 40 | 40 | 5 | 2.5 | 4,500 | 2 | 250 | 28.2 | | |
| | 10/15/05 | NM | NM | NA | NA | NA | NM | NM | NM | NM | NM | NM | NA | NM | NA | NM | NA | NM | | NA |
| 10/16/05 | NM | NM | NA | NA | NA | NM | NM | NM | NM | NM | NM | NA | NM | NA | NM | NA | NM | NA | | |

US EPA Arsenic Demonstration Project at BSLMHP, MN – Daily System Operation Log Sheet (continued)

| Week No. | Date | Time | New Well | | Volume to Treatment | | Pressure Tanks | | Pressure Filtration | | | | | Volume to Distribution | | Backwash | | KMnO ₄ Application | |
|----------|----------|-------|-----------------|----------------------|---------------------|------------------------|------------------------|------------------------|---------------------|--------------|--------------|------------|-------------------------|------------------------|--------------------|-------------------------|---------------------------|-----------------------------------|---------------------------------------|
| | | | Hour Meter (hr) | Daily Operation (hr) | Daily Volume (gal) | Average Flowrate (gpm) | Pressure Tank 1 (psig) | Pressure Tank 2 (psig) | IN (psig) | TA/TB (psig) | TC/TD (psig) | OUT (psig) | ΔP Across System (psig) | Flowrate (gpm) | Daily Volume (gal) | No. of Tanks Backwashed | Wastewater Produced (gal) | KMnO ₄ Tank Level (in) | Average KMnO ₄ Dose (mg/L) |
| 15 | 10/17/05 | 20:30 | 59.3 | 12.1 | NA | NA | 55 | 52 | 48 | 45 | 44 | 45 | 3 | 3.0 | 16,780 | 10 | 1,260 | 27.3 | 2.6 |
| | 10/18/05 | 20:15 | 62.5 | 3.2 | NA | NA | 58 | 54 | 51 | 43 | 42 | 45 | 6 | 7.5 | 4,390 | 2 | 260 | 27.0 | |
| | 10/19/05 | 20:15 | 66.1 | 3.6 | 5,625 | 26 | 65 | 60 | 56 | 52 | 50 | 52 | 4 | 2.5 | 5,195 | 2 | 250 | 26.8 | |
| | 10/20/05 | 21:30 | 70.5 | 4.4 | 6,975 | 26 | 50 | 48 | 52 | 48 | 45 | 46 | 6 | NM | 6,335 | 3 | 360 | 26.4 | |
| | 10/21/05 | 20:30 | 74.0 | 3.5 | 5,530 | 26 | 54 | 50 | 55 | 40 | 40 | 40 | 15 | NM | 5,055 | 2 | 250 | 26.2 | |
| | 10/22/05 | NM | NM | NA | NA | NA | NA | NM | NM | NM | NM | NM | NM | NA | NM | NA | NM | NA | |
| 10/23/05 | NM | NM | NA | NA | NA | NA | NM | NM | NM | NM | NM | NM | NA | NM | NA | NM | NA | NM | NA |
| 16 | 10/24/05 | 20:00 | 82.4 | 8.4 | 13,260 | 26 | 65 | 60 | 56 | 52 | 50 | 50 | 6 | 5.0 | 12,265 | 4 | 520 | 25.5 | 2.5 |
| | 10/25/05 | 22:15 | 85.1 | 2.7 | 4,100 | 25 | 55 | 52 | 50 | 46 | 44 | 47 | 3 | 1.0 | 3,750 | 3 | 350 | 25.3 | |
| | 10/26/05 | 18:30 | 87.4 | 2.3 | 3,570 | 26 | 52 | 49 | 44 | 30 | 30 | 31 | 13 | 15.0 | 3,360 | 1 | 120 | 25.1 | |
| | 10/27/05 | 18:30 | 89.9 | 2.5 | 3,430 | 23 | 60 | 55 | 53 | 45 | 44 | 48 | 5 | 0.0 | 3,105 | 2 | 250 | 24.9 | |
| | 10/28/05 | 21:30 | 92.6 | 2.7 | 3,890 | 24 | 60 | 55 | 54 | 50 | 50 | 50 | 4 | 0.0 | 3,635 | 1 | 120 | 24.8 | |
| | 10/29/05 | NM | NM | NA | NA | NA | NM | NM | NM | NM | NM | NM | NA | NM | NA | NM | NA | NM | |
| 10/30/05 | NM | NM | NA | NA | NA | NA | NM | NM | NM | NM | NM | NA | NM | NA | NM | NA | NM | NA | |
| 17 | 10/31/05 | 18:30 | 100.5 | 7.9 | 11,440 | 24 | 55 | 50 | 48 | 45 | 44 | 46 | 2 | 0.0 | 10,480 | 5 | 610 | 24.3 | 3.0 |
| | 11/01/05 | 18:30 | 103.1 | 2.6 | 4,793 | 31 | 64 | 60 | 58 | 54 | 52 | 53 | 5 | 1.0 | 3,643 | 1 | 120 | 24.0 | |
| | 11/02/05 | 18:00 | 105.9 | 2.8 | 3,357 | 20 | 55 | 50 | 46 | 42 | 40 | 41 | 5 | 2.5 | 3,927 | 3 | 360 | 23.8 | |
| | 11/03/05 | 16:30 | 108.0 | 2.1 | 3,080 | 24 | 65 | 60 | 57 | 52 | 52 | 53 | 4 | 2.5 | 2,930 | 1 | 120 | 23.7 | |
| | 11/04/05 | 19:00 | 111.0 | 3.0 | 4,760 | 26 | 56 | 54 | 51 | 44 | 44 | 45 | 6 | 2.5 | 4,315 | 2 | 240 | 23.4 | |
| | 11/05/05 | NM | NM | NA | NA | NA | NM | NM | NM | NM | NM | NM | NA | NM | NA | NM | NA | NM | |
| 11/06/05 | NM | NM | NA | NA | NA | NA | NM | NM | NM | NM | NM | NA | NM | NA | NM | NA | NM | NA | |
| 18 | 11/07/05 | 18:30 | 117.5 | 6.5 | 10,057 | 26 | 60 | 55 | 48 | 44 | 44 | 45 | 3 | 2.5 | 8,826 | 5 | 690 | NM | 2.8 |
| | 11/08/05 | 17:00 | 120.8 | 3.3 | 4,836 | 24 | 54 | 50 | 46 | 38 | 38 | 40 | 6 | 6.0 | 4,749 | 1 | 140 | 22.6 | |
| | 11/09/05 | 19:30 | 124.4 | 3.6 | 5,449 | 25 | 65 | 60 | 57 | 48 | 48 | 50 | 7 | 8.0 | 5,050 | 3 | 360 | 22.3 | |
| | 11/10/05 | 21:15 | 127.8 | 3.4 | 5,168 | 25 | 55 | 45 | 41 | 40 | 39 | 40 | 1 | 2.5 | 4,640 | 2 | 240 | 22.1 | |
| | 11/11/05 | 23:15 | 130.4 | 2.6 | 4,081 | 26 | 56 | 54 | 51 | 45 | 44 | 46 | 5 | 1.0 | 3,705 | 2 | 240 | 21.9 | |
| | 11/12/05 | NM | NM | NA | NA | NA | NM | NM | NM | NM | NM | NM | NA | NM | NA | NM | NA | NM | |
| 11/13/05 | NM | NM | NA | NA | NA | NA | NM | NM | NM | NM | NM | NA | NM | NA | NM | NA | NM | NA | |
| 19 | 11/14/05 | 17:00 | 138.0 | 7.6 | 10,986 | 24 | 55 | 53 | 48 | 33 | 32 | 35 | 13 | 2.5 | 10,081 | 6 | 820 | 21.3 | 5.0 |
| | 11/15/05 | 18:00 | 141.0 | 3.0 | 4,743 | 26 | 55 | 50 | 47 | 42 | 42 | 40 | 7 | 6.0 | 4,209 | 2 | 240 | 20.9 | |
| | 11/16/05 | 18:30 | 144.3 | 3.3 | 5,648 | 29 | 55 | 49 | 53 | 50 | 50 | 49 | 4 | 5.0 | 5,095 | 3 | 380 | 20.4 | |
| | 11/17/05 | 18:00 | 146.8 | 2.5 | 3,782 | 25 | 63 | 60 | 58 | 54 | 54 | 55 | 3 | 1.0 | 3,470 | 1 | 130 | 20.0 | |
| | 11/18/05 | 17:30 | 149.5 | 2.7 | 4,226 | 26 | 63 | 60 | 56 | 54 | 52 | 55 | 1 | 0.0 | 3,860 | 2 | 250 | 19.6 | |
| | 11/19/05 | NM | NM | NA | NA | NA | NM | NM | NM | NM | NM | NM | NA | NM | NA | NM | NA | NM | |
| 11/20/05 | NM | NM | NA | NA | NA | NA | NM | NM | NM | NM | NM | NA | NM | NA | NM | NA | NM | NA | |
| 20 | 11/21/05 | 10:15 | 159.5 | 10.0 | 14,983 | 25 | 62 | 60 | 60 | 55 | 54 | 55 | 5 | 7.5 | 13,405 | 9 | 1,160 | 18.3 | 3.5 |
| | 11/22/05 | 18:00 | 162.9 | 3.4 | 5,391 | 26 | 65 | 62 | 58 | 54 | 53 | 55 | 3 | 5.0 | 4,805 | 3 | 390 | 18.0 | |
| | 11/23/05 | 21:00 | 167.3 | 4.4 | 7,070 | 27 | 65 | 60 | 58 | 52 | 52 | 55 | 3 | 7.5 | 6,240 | 5 | 640 | 17.5 | |
| | 11/24/05 | 17:30 | 169.8 | 2.5 | 3,665 | 24 | 58 | 60 | 52 | 50 | 48 | 50 | 2 | 1.0 | 3,250 | 2 | 260 | 17.3 | |
| | 11/25/05 | 18:30 | 173.4 | 3.6 | 5,928 | 27 | 55 | 50 | 42 | 40 | 40 | 38 | 4 | 1.5 | 5,330 | 2 | 250 | NM | |
| | 11/26/05 | NM | NM | NA | NA | NA | NM | NM | NM | NM | NM | NM | NA | NM | NA | NM | NA | NM | |
| 11/27/05 | NM | NM | NA | NA | NA | NA | NM | NM | NM | NM | NM | NA | NM | NA | NM | NA | NM | NA | |

US EPA Arsenic Demonstration Project at BSLMHP, MN – Daily System Operation Log Sheet (continued)

| Week No. | Date | Time | New Well | | Volume to Treatment | | Pressure Tanks | | Pressure Filtration | | | | | Volume to Distribution | | Backwash | | KMnO ₄ Application | | | |
|----------|-------------------------|-------|-----------------|----------------------|---------------------|------------------------|------------------------|------------------------|---------------------|--------------|--------------|------------|-------------------------|------------------------|--------------------|-------------------------|---------------------------|-----------------------------------|---------------------------------------|----|----|
| | | | Hour Meter (hr) | Daily Operation (hr) | Daily Volume (gal) | Average Flowrate (gpm) | Pressure Tank 1 (psig) | Pressure Tank 2 (psig) | IN (psig) | TA/TB (psig) | TC/TD (psig) | OUT (psig) | ΔP Across System (psig) | Flowrate (gpm) | Daily Volume (gal) | No. of Tanks Backwashed | Wastewater Produced (gal) | KMnO ₄ Tank Level (in) | Average KMnO ₄ Dose (mg/L) | | |
| 21 | 11/28/05 | 17:00 | 183.2 | 9.8 | 15,655 | 27 | 55 | 52 | 46 | 41 | 40 | 40 | 6 | 1.0 | 14,115 | 8 | 1,020 | 29.6 | 4.8 | | |
| | 11/29/05 | 18:30 | 187.2 | 4.0 | 5,872 | 24 | 55 | 50 | 46 | 42 | 40 | 42 | 4 | 3.0 | 5,230 | 3 | 370 | 29.1 | | | |
| | 11/30/05 | 14:30 | 189.9 | 2.7 | 4,010 | 25 | 54 | 50 | 44 | 40 | 39 | 40 | 4 | 1.0 | 3,350 | 4 | 490 | 28.8 | | | |
| | 12/01/05 | 18:00 | 193.8 | 3.9 | 6,390 | 27 | 55 | 50 | 41 | 39 | 38 | 39 | 2 | 7.5 | 5,855 | 2 | 250 | 28.3 | | | |
| | 12/02/05 | 21:00 | 197.9 | 4.1 | 6,161 | 25 | 54 | 50 | 44 | 40 | 40 | 41 | 3 | 1.5 | 5,250 | 4 | 510 | 27.8 | | | |
| | 12/03/05 | NM | NM | NA | NA | NA | NM | NM | NM | NM | NM | NM | NM | NA | NM | NA | NM | NA | | NM | NA |
| | 12/04/05 | NM | NM | NA | NA | NA | NA | NM | NM | NM | NM | NM | NM | NA | NM | NA | NM | NA | | NM | NA |
| 22 | 12/05/05 | 21:30 | 210.0 | 12.1 | 18,880 | 26 | 55 | 50 | 41 | 38 | 36 | 37 | 4 | 3.0 | 16,870 | 11 | 1,390 | 26.0 | 5.1 | | |
| | 12/06/05 | 20:00 | 213.1 | 3.1 | 4,700 | 25 | 54 | 50 | 49 | 42 | 42 | 45 | 4 | 5.0 | 4,345 | 1 | 130 | 25.6 | | | |
| | 12/07/05 | 19:00 | 216.7 | 3.6 | 5,966 | 28 | 54 | 50 | 44 | 39 | 36 | 37 | 7 | 3.0 | 5,445 | 2 | 250 | 25.1 | | | |
| | 12/08/05 | 13:00 | 219.0 | 2.3 | 4,068 | 29 | 65 | 60 | 57 | 52 | 50 | 52 | 5 | 3.0 | 3,220 | 4 | 480 | 24.7 | | | |
| | 12/09/05 | 18:00 | 224.1 | 5.1 | 8,590 | 28 | 64 | 60 | 56 | 51 | 50 | 52 | 4 | 6.0 | 7,310 | 5 | 700 | 23.9 | | | |
| | 12/10/05 | NM | NM | NA | NA | NA | NM | NM | NM | NM | NM | NM | NM | NA | NM | NA | NM | NA | | NM | NA |
| | 12/11/05 | NM | NM | NA | NA | NA | NA | NM | NM | NM | NM | NM | NM | NA | NM | NA | NM | NA | | NM | NA |
| 23 | 12/12/05 | 18:00 | 235.4 | 11.3 | 16,425 | 24 | 64 | 60 | 59 | 56 | 54 | 55 | 4 | 3.0 | 15,230 | 7 | 970 | 22.3 | 5.4 | | |
| | 12/13/05 | 19:30 | 239.4 | 4.0 | 5,975 | 25 | 55 | 50 | 48 | 46 | 44 | 45 | 3 | 5.0 | 5,500 | 2 | 250 | 21.7 | | | |
| | 12/14/05 | 19:30 | 242.8 | 3.4 | 4,790 | 23 | 65 | 60 | 56 | 52 | 50 | 52 | 4 | 2.5 | 4,360 | 1 | 120 | 21.3 | | | |
| | 12/15/05 | 18:00 | 246.3 | 3.5 | 4,624 | 22 | 65 | 60 | 55 | 49 | 47 | 49 | 6 | 4.0 | 4,170 | 3 | 370 | 20.6 | | | |
| | 12/16/05 | 07:12 | 249.4 | 3.1 | 4,651 | 25 | 55 | 50 | 40 | 30 | 30 | 30 | 10 | 10.0 | 4,200 | 2 | 210 | 20.4 | | | |
| | 12/17/05 | NM | NM | NA | NA | NA | NM | NM | NM | NM | NM | NM | NM | NA | NM | NA | NM | NA | | NM | NA |
| | 12/18/05 | NM | NM | NA | NA | NA | NA | NM | NM | NM | NM | NM | NM | NA | NM | NA | NM | NA | | NM | NA |
| 24 | 12/19/05 | 21:00 | 266.2 | 16.8 | 26,100 | 26 | 55 | 48 | 45 | 39 | 38 | 40 | 5 | 6.0 | 23,690 | 10 | 1,320 | 17.8 | 5.4 | | |
| | 12/20/05 | 18:00 | 270.9 | 4.7 | 7,760 | 28 | 59 | 55 | 53 | 48 | 47 | 48 | 5 | 7.5 | 6,970 | 4 | 470 | 17.0 | | | |
| | 12/21/05 | 19:00 | 277.3 | 6.4 | 9,970 | 26 | 62 | 56 | 53 | 48 | 47 | 48 | 5 | 4.0 | 8,900 | 5 | 590 | 30.6 | | | |
| | 12/22/05 | 19:30 | 281.7 | 4.4 | 6,250 | 24 | 60 | 60 | 59 | 52 | 52 | 54 | 5 | 4.0 | 5,690 | 3 | 350 | 30.0 | | | |
| | 12/23/05 | NM | NM | NA | NA | NA | NM | NM | NM | NM | NM | NM | NM | NA | NM | NA | NM | NA | | NM | NA |
| | 12/24/05 | NM | NM | NA | NA | NA | NA | NM | NM | NM | NM | NM | NM | NA | NM | NA | NM | NA | | NM | NA |
| | 12/25/05 | NM | NM | NA | NA | NA | NA | NM | NM | NM | NM | NM | NM | NA | NM | NA | NM | NA | | NM | NA |
| 25 | 12/26/05 | 18:30 | 300.8 | 19.1 | 29,172 | 25 | 54 | 50 | 42 | 37 | 36 | 37 | 5 | 5.0 | 25,740 | 14 | 1,770 | 27.4 | 6.1 | | |
| | 12/27/05 | 18:00 | 304.9 | 4.1 | 6,770 | 28 | 65 | 60 | 55 | 43 | 42 | 45 | 10 | 5.0 | 4,900 | 4 | 470 | 26.8 | | | |
| | 12/28/05 | 19:15 | 309.7 | 4.8 | 5,908 | 21 | 54 | 50 | 45 | 40 | 38 | 40 | 5 | 3.0 | 5,925 | 3 | 350 | 26.1 | | | |
| | 12/29/05 | 19:30 | 313.5 | 3.8 | 5,570 | 24 | 54 | 47 | 44 | 40 | 39 | 40 | 4 | 2.0 | 4,845 | 3 | 350 | 25.6 | | | |
| | 12/30/05 | 19:00 | 316.9 | 3.4 | 4,650 | 23 | 55 | 45 | 42 | 40 | 40 | 40 | 2 | 3.0 | 2,320 | 1 | 140 | 25.2 | | | |
| | 12/31/05 | NM | NM | NA | NA | NM | NM | NM | NM | NM | NM | NM | NM | NA | NM | NA | NM | NA | | NM | NA |
| | 01/01/06 | NM | NM | NA | NA | NM | NM | NM | NM | NM | NM | NM | NM | NA | NM | NA | NM | NA | | NM | NA |
| 26 | 01/02/06 | 10:30 | 331.5 | 14.6 | 23,050 | 26 | 65 | 60 | 57 | 56 | 55 | 55 | 2 | 2.0 | 21,300 | 12 | 1,620 | 23.0 | 5.6 | | |
| | 01/03/06 ⁽⁹⁾ | 12:30 | 336.2 | 4.7 | NA | NA | 60 | 55 | 58 | 53 | 52 | 52 | 6 | 2.0 | 6,080 | 4 | 470 | 22.4 | | | |
| | 01/04/06 | 17:00 | 336.4 | 0.2 | 4,550 | NA | 65 | 59 | 55 | 52 | 50 | 50 | 5 | 3.0 | 3,940 | 3 | 350 | 21.9 | | | |
| | 01/05/06 | 10:00 | 341.2 | 4.8 | 7,365 | 26 | 56 | 53 | 50 | 44 | 44 | 45 | 5 | 2.5 | 6,130 | 4 | 460 | 21.1 | | | |
| | 01/06/06 | 19:30 | 345.8 | 4.6 | 7,290 | 26 | 55 | 52 | 48 | 40 | 40 | 40 | 8 | 7.5 | 6,000 | 4 | 470 | 20.5 | | | |
| | 01/07/06 | NM | NM | NA | NA | NM | NM | NM | NM | NM | NM | NM | NM | NA | NM | NA | NM | NA | | NM | NA |
| | 01/08/06 | NM | NM | NA | NA | NM | NM | NM | NM | NM | NM | NM | NM | NA | NM | NA | NM | NA | | NM | NA |

US EPA Arsenic Demonstration Project at BSLMHP, MN – Daily System Operation Log Sheet (continued)

| Week No. | Date | Time | New Well | | Volume to Treatment | | Pressure Tanks | | Pressure Filtration | | | | | Volume to Distribution | | Backwash | | KMnO ₄ Application | |
|----------|--------------------------|-------|-----------------|----------------------|---------------------|------------------------|------------------------|------------------------|---------------------|--------------|--------------|------------|-------------------------|------------------------|--------------------|-------------------------|---------------------------|-----------------------------------|---------------------------------------|
| | | | Hour Meter (hr) | Daily Operation (hr) | Daily Volume (gal) | Average Flowrate (gpm) | Pressure Tank 1 (psig) | Pressure Tank 2 (psig) | IN (psig) | TA/TB (psig) | TC/TD (psig) | OUT (psig) | ΔP Across System (psig) | Flowrate (gpm) | Daily Volume (gal) | No. of Tanks Backwashed | Wastewater Produced (gal) | KMnO ₄ Tank Level (in) | Average KMnO ₄ Dose (mg/L) |
| 27 | 01/09/06 | 18:00 | 362.3 | 16.5 | 25,483 | 26 | 55 | 50 | 45 | 40 | 38 | 40 | 5 | 4.0 | 21,500 | 12 | 1,520 | 17.9 | 5.5 |
| | 01/10/06 | 17:00 | 366.4 | 4.1 | 6,060 | 25 | 65 | 60 | 55 | 51 | 52 | 53 | 2 | 1.0 | 4,835 | 5 | 690 | 17.3 | |
| | 01/11/06 | 17:00 | 370.5 | 4.1 | 6,400 | 26 | 65 | 60 | 59 | 52 | 50 | 52 | 7 | 12.0 | 5,495 | 2 | 250 | 31.0 | |
| | 01/12/06 | 19:15 | 376.1 | 5.6 | 8,635 | 26 | 54 | 50 | 43 | 39 | 38 | 38 | 5 | 5.0 | 7,125 | 5 | 650 | 30.2 | |
| | 01/13/06 | 19:00 | 380.5 | 4.4 | 6,385 | 24 | 55 | 50 | 45 | 38 | 36 | 38 | 7 | 3.0 | 5,465 | 3 | 380 | 29.6 | |
| | 01/14/06 | NM | NM | NA | NM | NM | NM | NM | NM | NM | NM | NM | NM | NA | NM | NA | NM | NA | |
| 28 | 1/16/2006 ^(b) | 17:00 | 394.7 | 14.2 | 21,965 | 26 | 65 | 60 | 59 | 52 | 50 | 52 | 7 | 8.0 | NA | 13 | 1,640 | 27.6 | 5.9 |
| | 01/17/06 | 21:00 | 399.8 | 5.1 | 7,757 | 25 | 65 | 60 | 57 | 50 | 50 | 52 | 5 | 12.5 | 6,280 | 5 | 620 | 26.9 | |

Note:

- (a) On 08/09/05, both sets of duplex filters stuck in backwash mode due to sediment dislodged in purge/control valve, preventing it from closing. System bypassed.
- (b) On 08/09/06, a pressure gauge after each set of duplex filters installed.
- (c) On 08/11/05, pressure gauge on pressure tank 2 replaced.
- (d) On 09/21/05, two flow meters, one on treated water line and one on backwash discharge line, installed although readings not recorded until 09/28/05.
- (e) On 09/28/05 hour meter installed.
- (f) On 09/30/06, pressure gauge changed out for duplex units TC/TD.
- (g) On 01/03/06, totalizer to treatment re-set.
- (h) Totalizer to distribution re-set.

NM = not measured

NA = not available

APPENDIX B
ANALYTICAL DATA

Analytical Results from Long Term Sampling at BSLMHP, MN

| Sampling Date | | 07/13/05 | | | 07/20/05 | | | 07/26/05 | | | 08/02/05 | | | 08/18/05 ^(a, b) | | | 08/24/05 | | | |
|--|------|----------|-------|-------|----------|-------|-------|----------|-------|-------|----------|-------|-------|----------------------------|-------|-------|----------|-------|-------|-------|
| Sampling Location | | IN | AC | TT | IN | AC | TT | IN | AC | TT | IN | AC | TT | IN | AC | TT | IN | AC | TA/TB | TC/TD |
| Parameter | Unit | | | | | | | | | | | | | | | | | | | |
| Stroke Length | % | 33 | | | 33 | | | 33 | | | 33 | | | 26 | | | 26 | | | |
| Alkalinity (as CaCO ₃) | mg/L | 352 | 374 | 374 | 365 | 365 | 361 | 365 | 370 | 365 | 352 | 365 | 374 | 352 | 365 | 361 | 352 | 365 | 361 | 374 |
| Fluoride | mg/L | 0.2 | 0.2 | 0.2 | - | - | - | - | - | - | - | - | - | 0.2 | 0.2 | 0.2 | - | - | - | - |
| Sulfate | mg/L | <1 | <1 | <1 | - | - | - | - | - | - | - | - | - | <1 | <1 | <1 | - | - | - | - |
| Nitrate (as N) | mg/L | 0.1 | 0.1 | 0.3 | - | - | - | - | - | - | - | - | - | <0.05 | <0.05 | <0.05 | - | - | - | - |
| Orthophosphate (as PO ₄) | mg/L | <0.05 | <0.05 | <0.05 | <0.05 | <0.05 | <0.05 | <0.05 | <0.05 | <0.05 | <0.05 | <0.05 | <0.05 | <0.05 | <0.05 | <0.05 | <0.05 | <0.05 | <0.05 | <0.05 |
| P (total) (as P) | mg/L | - | - | - | - | - | - | - | - | - | - | - | - | - | - | - | - | - | - | - |
| Silica (as SiO ₂) | mg/L | 23.3 | 23.3 | 22.7 | 24.7 | 24.4 | 24.2 | 23.5 | 23.6 | 23.9 | 23.8 | 24.0 | 23.6 | 24.1 | 24.2 | 23.9 | 29.4 | 28.6 | 28.4 | 28.2 |
| Turbidity | NTU | 25.0 | 3.1 | 0.6 | 23.0 | 2.8 | 0.5 | 25.0 | 2.9 | 0.1 | 26.0 | 4.7 | 11.0 | 33.0 | 3.7 | 0.4 | 24.0 | 2.9 | 0.7 | 0.2 |
| TOC | mg/L | - | - | - | - | - | - | - | - | - | - | - | - | 4.1 | 3.9 | 4.0 | - | - | - | - |
| pH | S.U. | | 7.5 | 7.7 | 7.3 | 7.2 | 7.2 | 7.4 | 7.3 | 7.2 | 7.4 | 7.3 | 7.3 | 7.2 | 7.3 | 7.3 | 7.3 | 7.4 | 7.3 | 7.4 |
| Temperature | °C | 14.9 | 12.7 | 12.3 | 11.4 | 12.3 | 11.9 | 10.4 | 11.0 | 11.0 | 11.2 | 12.1 | 12.1 | 1.0 | 14.1 | 13.8 | 12.3 | 12.8 | 12.5 | 12.8 |
| DO | mg/L | 2.0 | 0.7 | 1.1 | 2.5 | 0.5 | 0.7 | 3.6 | 1.7 | 0.9 | 3.5 | 1.0 | 1.2 | 0.9 | 0.9 | 0.7 | 10.4 | 0.8 | 0.7 | 1.1 |
| ORP | mV | -23 | 196 | 219 | -29 | 85 | 144 | -40 | 144 | 173 | -35 | 154 | 196 | -76 | 2 | 43 | -48 | 138 | 159 | 181 |
| Total Hardness (as CaCO ₃) | mg/L | 383 | 330 | 329 | - | - | - | - | - | - | - | - | - | 320 | 317 | 323 | - | - | - | - |
| Ca Hardness (as CaCO ₃) | mg/L | 228 | 197 | 197 | - | - | - | - | - | - | - | - | - | 188 | 190 | 187 | - | - | - | - |
| Mg Hardness (as CaCO ₃) | mg/L | 155 | 133 | 132 | - | - | - | - | - | - | - | - | - | 131 | 128 | 137 | - | - | - | - |
| As (total) | µg/L | 36.4 | 29.6 | 4.3 | 34.7 | 26.7 | 17.7 | 26.6 | 24.8 | 5.5 | 25.7 | 23.0 | 8.0 | 26.4 | 23.2 | 5.1 | 30.4 | 31.5 | 3.5 | 3.3 |
| As (soluble) | µg/L | 30.3 | 3.3 | 3.0 | - | - | - | - | - | - | - | - | - | 26.2 | 4.8 | 4.8 | - | - | - | - |
| As (particulate) | µg/L | 6.1 | 26.3 | 1.3 | - | - | - | - | - | - | - | - | - | 0.2 | 18.4 | 0.3 | - | - | - | - |
| As (III) | µg/L | 13.9 | 1.6 | 1.7 | - | - | - | - | - | - | - | - | - | 24.1 | 2.6 | 3.4 | - | - | - | - |
| As (V) | µg/L | 16.5 | 1.7 | 1.3 | - | - | - | - | - | - | - | - | - | 2.1 | 2.2 | 1.4 | - | - | - | - |
| Fe (total) | µg/L | 3,315 | 3,173 | 157 | 2,786 | 2,766 | 482 | 2,864 | 2,704 | 45 | 2,964 | 2,578 | 666 | 2,895 | 2,773 | <25 | 2,764 | 2,706 | <25 | <25 |
| Fe (soluble) | µg/L | 2,792 | <25 | <25 | - | - | - | - | - | - | - | - | - | 2,954 | <25 | <25 | - | - | - | - |
| Mn (total) | µg/L | 154 | 996 | 428 | 139 | 634 | 561 | 137 | 844 | 727 | 135 | 1,126 | 487 | 139 | 1,097 | 1,010 | 130 | 871 | 475 | 467 |
| Mn (soluble) | µg/L | 133 | 377 | 391 | - | - | - | - | - | - | - | - | - | 142 | 850 | 1,000 | - | - | - | - |

(a) Onsite water quality parameters taken on 08/17/05. (b) System bypassed on 08/09/05 and samples not collected that week.

Analytical Results from Long Term Sampling at BSLMHP, MN (continued)

| Sampling Date | | 08/31/05 ^(a) | | | | 09/07/05 ^(b) | | | | 09/14/05 | | | | 09/20/05 | | | 09/27/05 ^(c) | | | |
|--|------|-------------------------|-------|-------|-------|-------------------------|-------|-------|-------|----------|-------|-------|-------|----------|-------|-------|-------------------------|-------|-------|-------|
| Sampling Location | | IN | AC | TA/TB | TC/TD | IN | AC | TA/TB | TC/TD | IN | AC | TA/TB | TC/TD | IN | AC | TT | IN | AC | TA/TB | TC/TD |
| Parameter | Unit | | | | | | | | | | | | | | | | | | | |
| Stroke Length | % | 15 | | | | 15 | | | | 26 | | | | 26 | | | 26 | | | |
| Alkalinity (as CaCO ₃) | mg/L | 383 | 370 | 374 | 374 | 361 | 365 | 361 | 365 | 356 | 370 | 370 | 352 | 374 | 374 | 370 | 378 | 374 | 374 | 374 |
| Fluoride | mg/L | - | - | - | - | - | - | - | - | - | - | - | - | 0.2 | 0.2 | 0.2 | - | - | - | - |
| Sulfate | mg/L | - | - | - | - | - | - | - | - | - | - | - | - | <1 | <1 | <1 | - | - | - | - |
| Nitrate (as N) | mg/L | - | - | - | - | - | - | - | - | - | - | - | - | <0.05 | <0.05 | <0.05 | - | - | - | - |
| Orthophosphate (as PO ₄) | mg/L | <0.05 | <0.05 | <0.05 | <0.05 | <0.05 | <0.05 | <0.05 | <0.05 | <0.05 | <0.05 | <0.05 | <0.05 | <0.05 | <0.05 | <0.05 | <0.05 | <0.05 | <0.05 | <0.05 |
| P (total) (as P) | mg/L | - | - | - | - | - | - | - | - | - | - | - | - | - | - | - | - | - | - | - |
| Silica (as SiO ₂) | mg/L | 25.8 | 25.6 | 25.8 | 25.8 | 24.1 | 24.3 | 24.0 | 24.2 | 22.6 | 22.9 | 22.5 | 22.7 | 22.6 | 22.5 | 22.2 | 25.7 | 25.7 | 25.6 | 25.3 |
| Turbidity | NTU | 32.0 | 5.3 | 4.2 | 4.2 | 13.0 | 6.0 | 14.0 | 14.0 | 32.0 | 3.4 | 0.2 | 0.3 | 31.0 | 3.4 | 0.5 | 32.0 | 4.1 | <0.1 | <0.1 |
| TOC | mg/L | - | - | - | - | - | - | - | - | - | - | - | - | 4.8 | 4.6 | 4.8 | - | - | - | - |
| pH | S.U. | NA | NA | NA | NA | 7.3 | 7.4 | 7.3 | 7.5 | 7.3 | 7.2 | 7.2 | 7.2 | 7.2 | 7.3 | 7.2 | 7.4 | 7.4 | 7.4 | 7.4 |
| Temperature | °C | NA | NA | NA | NA | 10.8 | 11.3 | 10.7 | 11.5 | 11.5 | 10.9 | 11.2 | 10.7 | 10.7 | 13.4 | 13.6 | 9.5 | 9.8 | 9.9 | 10.0 |
| DO | mg/L | NA | NA | NA | NA | 0.9 | 0.5 | 0.9 | 0.7 | 1.5 | 0.7 | 0.5 | 0.5 | 0.7 | 1.0 | 0.9 | 0.8 | 1.6 | 0.7 | 0.7 |
| ORP | mV | NA | NA | NA | NA | -63 | -22 | -9 | -12 | -49 | 101 | 96 | 101 | -66 | 18 | 6 | -54 | 1 | 6 | 8 |
| Total Hardness (as CaCO ₃) | mg/L | - | - | - | - | - | - | - | - | - | - | - | - | 307 | 307 | 306 | - | - | - | - |
| Ca Hardness (as CaCO ₃) | mg/L | - | - | - | - | - | - | - | - | - | - | - | - | 177 | 178 | 176 | - | - | - | - |
| Mg Hardness (as CaCO ₃) | mg/L | - | - | - | - | - | - | - | - | - | - | - | - | 131 | 129 | 130 | - | - | - | - |
| As (total) | µg/L | 27.0 | 27.9 | 13.8 | 12.3 | 20.6 ^(g) | 28.8 | 21.5 | 17.5 | 23.7 | 24.8 | 2.8 | 4.7 | 27.4 | 27.1 | 2.9 | 26.7 | 25.4 | 8.4 | 7.6 |
| As (soluble) | µg/L | - | - | - | - | - | - | - | - | - | - | - | - | 27.6 | 4.7 | 3.2 | - | - | - | - |
| As (particulate) | µg/L | - | - | - | - | - | - | - | - | - | - | - | - | <0.1 | 22.4 | <0.1 | - | - | - | - |
| As (III) | µg/L | - | - | - | - | - | - | - | - | - | - | - | - | 25.6 | 1.7 | 1.5 | - | - | - | - |
| As (V) | µg/L | - | - | - | - | - | - | - | - | - | - | - | - | 2.0 | 3.1 | 1.7 | - | - | - | - |
| Fe (total) | µg/L | 2,888 | 3,096 | 571 | 465 | 1069 | 2,619 | 1,052 | 1,140 | 2,716 | 2,795 | <25 | 78 | 3,094 | 2,911 | <25 | 2,934 | 2,796 | <25 | <25 |
| Fe (soluble) | µg/L | - | - | - | - | - | - | - | - | - | - | - | - | 2,883 | <25 | <25 | - | - | - | - |
| Mn (total) | µg/L | 133 | 581 | 906 | 865 | 430 | 416 | 447 | 430 | 131 | 1,042 | 651 | 897 | 149 | 883 | 616 | 141 | 676 | 802 | 841 |
| Mn (soluble) | µg/L | - | - | - | - | - | - | - | - | - | - | - | - | 145 | 533 | 634 | - | - | - | - |

(a) Operator not able to take onsite water quality parameters due to busy work schedule. (b) Onsite water quality parameters taken on 09/06/05. (c) Onsite water quality parameters taken on 09/28/05.

Analytical Results from Long Term Sampling at BSLMHP, MN (continued)

| Sampling Date | | 10/05/05 ^(a) | | | | 10/12/05 ^(b) | | | | 10/19/05 ^(c) | | | 10/26/05 ^(d) | | | | 11/02/05 ^(e) | | | | |
|--|------|-------------------------|--------------------|--------------------|--------------------|-------------------------|----------------|--------------|--------------|-------------------------|-------|-------|-------------------------|-------|-------|-------|-------------------------|------|-------|-------|-----|
| Sampling Location | | IN | AC | TA/TB | TC/TD | IN | AC | TA/TB | TC/TD | IN | AC | TT | IN | AC | TA/TB | TC/TD | IN | AC | TA/TB | TC/TD | |
| Parameter | Unit | | | | | | | | | | | | | | | | | | | | |
| Stroke Length | % | 26 | | | | 26 | | | | 26 | | | 26 | | | | 26 | | | | |
| Alkalinity (as CaCO ₃) | mg/L | 356 | 321 | 352 | 374 | 365 365 | 374 370 | 374 374 | 365 365 | 383 | 378 | 383 | 352 | 365 | 361 | 361 | 361 | 352 | 356 | 352 | 352 |
| Fluoride | mg/L | - | - | - | - | - | - | - | - | 0.2 | 0.2 | 0.2 | - | - | - | - | - | - | - | - | |
| Sulfate | mg/L | - | - | - | - | - | - | - | - | <1 | <1 | <1 | - | - | - | - | - | - | - | - | |
| Nitrate (as N) | mg/L | - | - | - | - | - | - | - | - | <0.05 | <0.05 | <0.05 | - | - | - | - | - | - | - | - | |
| Orthophosphate (as PO ₄) | mg/L | <0.05 | <0.05 | <0.05 | <0.05 | - | - | - | - | - | - | - | - | - | - | - | - | - | - | - | |
| P (total) (as P) | mg/L | 0.5 | 0.5 | 0.02 | 0.02 | 0.5 0.5 | 0.4 0.5 | 0.1 0.03 | 0.03 0.1 | 0.5 | 0.5 | 0.1 | 0.5 | 0.5 | 0.03 | 0.03 | 0.5 | 0.1 | 0.04 | 0.04 | |
| Silica (as SiO ₂) | mg/L | 23.1 | 22.6 | 23.6 | 25.6 | 23.2 23.3 | 23.6 23.6 | 23.2 23.3 | 23.2 23.0 | 23.0 | 23.2 | 21.7 | 24.5 | 25.1 | 24.1 | 24.5 | 24.7 | 24.5 | 24.0 | 23.9 | |
| Turbidity | NTU | 28.0 | 4.6 | 1.2 | <0.1 | 34.0 34.0 | 3.0 3.3 | 0.4 0.5 | 0.5 0.5 | 34.0 | 4.0 | 1.3 | 33.0 | 3.3 | 0.2 | 1.3 | 33.0 | 3.1 | 0.1 | 0.3 | |
| TOC | mg/L | - | - | - | - | - | - | - | - | 3.7 | 3.3 | 3.8 | - | - | - | - | - | - | - | - | |
| pH | S.U. | 7.4 | 7.5 | 7.4 | 7.5 | 7.4 | 7.4 | 7.4 | 7.4 | 7.4 | 7.4 | 7.3 | 7.3 | 7.4 | 7.4 | 7.4 | 7.4 | 7.4 | 7.4 | 7.4 | |
| Temperature | °C | 10.0 | 10.0 | 10.0 | 10.0 | 10.5 | 10.2 | 10.3 | 10.3 | 10.8 | 10.8 | 10.8 | 10.6 | 10.5 | 10.5 | 10.6 | 10.0 | 10.1 | 10.1 | 10.2 | |
| DO | mg/L | 0.9 | 1.5 ^(e) | 1.2 ^(e) | 1.3 ^(e) | 0.7 | 1.1 | 0.8 | 0.8 | 0.8 | 1.0 | 0.7 | 1.1 | 1.3 | 1.1 | 1.0 | 0.7 | 0.7 | 1.0 | 0.8 | |
| ORP | mV | -64 | 175 | 177 | 183 | -58 | 28 | 35 | 45 | -56 | 23 | 29 | -50 | -1 | 28 | 33 | -30 | 55 | 71 | 78 | |
| Total Hardness (as CaCO ₃) | mg/L | - | - | - | - | - | - | - | - | 315 | 315 | 313 | - | - | - | - | - | - | - | - | |
| Ca Hardness (as CaCO ₃) | mg/L | - | - | - | - | - | - | - | - | 188 | 189 | 184 | - | - | - | - | - | - | - | - | |
| Mg Hardness (as CaCO ₃) | mg/L | - | - | - | - | - | - | - | - | 128 | 126 | 129 | - | - | - | - | - | - | - | - | |
| As (total) | µg/L | 22.8 | 21.8 | 3.2 | 3.3 | 27.2 28.7 | 25.8 27.6 | 6.3 5.8 | 6.3 10.1 | 29.1 | 27.8 | 4.2 | 26.0 | 26.6 | 6.4 | 5.8 | 25.1 | 5.6 | 5.6 | 4.2 | |
| As (soluble) | µg/L | - | - | - | - | - | - | - | - | 25.2 | 4.0 | 2.9 | - | - | - | - | - | - | - | - | |
| As (particulate) | µg/L | - | - | - | - | - | - | - | - | 3.8 | 23.8 | 1.3 | - | - | - | - | - | - | - | - | |
| As (III) | µg/L | - | - | - | - | - | - | - | - | 20.8 | 0.9 | 0.8 | - | - | - | - | - | - | - | - | |
| As (V) | µg/L | - | - | - | - | - | - | - | - | 4.5 | 3.1 | 2.4 | - | - | - | - | - | - | - | - | |
| Fe (total) | µg/L | 2,596 | 2,523 | <25 | <25 | 2,820 2,874 | 2,562 2,707 | 142 74 | 72 547 | 2,680 | 2,624 | 136 | 2,979 | 2,968 | <25 | 67 | 3,758 | 247 | 62 | 48 | |
| Fe (soluble) | µg/L | - | - | - | - | - | - | - | - | 2,594 | <25 | <25 | - | - | - | - | - | - | - | - | |
| Mn (total) | µg/L | 119 | 760 | 600 | 628 | 128 130 | 791 827 | 687 694 | 794 838 | 128 | 953 | 548 | 134 | 888 | 852 | 846 | 176 | 984 | 988 | 952 | |
| Mn (soluble) | µg/L | - | - | - | - | - | - | - | - | 132 | 468 | 535 | - | - | - | - | - | - | - | - | |

(a) Onsite water quality parameters taken on 10/06/05. (b) Duplicate sampling week. (c) Onsite water quality parameters taken on 10/18/05. (d) Onsite water quality parameters taken on 10/27/05. (e) Onsite water quality parameters taken on 11/01/05.

Analytical Results from Long Term Sampling at BSLMHP, MN (continued)

| Sampling Date | | 11/09/05 | | | | 11/15/05 ^(a,b) | | | 11/29/05 ^(c) | | | | 12/08/05 ^(d) | | | | 12/14/05 ^(e) | | | | |
|--|------|----------|-------|-------|-------|---------------------------|-------|-------|-------------------------|-------|-------|-------|-------------------------|-------|-------|-------|-------------------------|-------|-------|-------|-------|
| Sampling Location | | IN | AC | TA/TB | TC/TD | IN | AC | TT | IN | AC | TA/TB | TC/TD | IN | AC | TA/TB | TC/TD | IN | AC | TA/TB | TC/TD | |
| Parameter | Unit | | | | | | | | | | | | | | | | | | | | |
| Stroke Length | % | 26 | | | | 40 | | | 38 | | | | 40 | | | | 40 | | | | |
| Alkalinity (as CaCO ₃) | mg/L | 370 | 370 | 365 | 370 | 352 | 365 | 370 | 352 | 370 | 361 | 356 | 374 | 374 | 370 | 370 | 374 | 365 | 378 | 378 | 378 |
| Fluoride | mg/L | - | - | - | - | 0.2 | 0.2 | 0.2 | - | - | - | - | 0.2 | 0.2 | 0.2 | 0.2 | - | - | - | - | - |
| Sulfate | mg/L | - | - | - | - | <1 | <1 | <1 | - | - | - | - | <1 | <1 | <1 | <1 | - | - | - | - | - |
| Nitrate (as N) | mg/L | - | - | - | - | <0.05 | <0.05 | <0.05 | - | - | - | - | <0.05 | <0.05 | <0.05 | <0.05 | - | - | - | - | - |
| Orthophosphate (as PO ₄) | mg/L | - | - | - | - | - | - | - | - | - | - | - | - | - | - | - | - | - | - | - | - |
| P (total) (as P) | mg/L | 0.5 | 0.5 | 0.1 | 0.1 | 0.5 | 0.5 | 0.2 | 0.5 | 0.5 | 0.4 | 0.1 | 0.4 | 0.4 | 0.02 | 0.02 | 0.5 | 0.5 | 0.2 | 0.2 | 0.2 |
| Silica (as SiO ₂) | mg/L | 23.9 | 23.6 | 24.0 | 24.0 | 23.5 | 23.7 | 23.7 | 24.3 | 24.6 | 24.7 | 25.0 | 23.5 | 23.9 | 23.9 | 23.8 | 25.4 | 25.6 | 25.1 | 25.8 | 25.8 |
| Turbidity | NTU | 33.0 | 3.2 | 0.1 | 0.7 | 34.0 | 3.2 | 0.9 | 32.0 | 4.2 | 1.3 | 0.5 | 26.0 | 3.9 | 0.1 | 0.5 | 34.0 | 5.1 | 0.7 | 1.9 | 1.9 |
| TOC | mg/L | - | - | - | - | NA | NA | NA | - | - | - | - | NA | NA | NA | NA | - | - | - | - | - |
| pH | S.U. | 7.4 | 7.4 | 7.4 | 7.4 | 7.3 | 7.3 | 7.2 | 7.3 | 7.3 | 7.3 | 7.3 | 7.3 | 7.3 | 7.3 | 7.3 | 7.3 | 7.3 | 7.3 | 7.3 | 7.3 |
| Temperature | °C | 10.0 | 10.2 | 10.2 | 10.4 | 9.4 | 9.5 | 9.5 | 9.8 | 9.6 | 9.6 | 9.7 | 9.6 | 9.4 | 9.3 | 9.4 | 9.3 | 9.5 | 9.3 | 9.3 | 9.2 |
| DO | mg/L | 0.9 | 0.8 | 0.9 | 0.8 | 1.3 | 1.0 | 1.0 | 1.2 | 1.6 | 0.9 | 1.0 | 1.1 | 1.1 | 0.9 | 1.1 | 1.2 | 1.1 | 1.6 | 0.9 | 0.9 |
| ORP | mV | -38 | 39 | 65 | 68 | -39 | 62 | 76 | -39 | 55 | 65 | 71 | -42 | 54 | 65 | 68 | -26 | 52 | 59 | 64 | 64 |
| Total Hardness (as CaCO ₃) | mg/L | - | - | - | - | 311 | 321 | 338 | - | - | - | - | 296 | 295 | 304 | 307 | - | - | - | - | - |
| Ca Hardness (as CaCO ₃) | mg/L | - | - | - | - | 186 | 192 | 212 | - | - | - | - | 184 | 182 | 185 | 185 | - | - | - | - | - |
| Mg Hardness (as CaCO ₃) | mg/L | - | - | - | - | 125 | 129 | 126 | - | - | - | - | 112 | 114 | 119 | 122 | - | - | - | - | - |
| As (total) | µg/L | 36.6 | 36.1 | 11.3 | 5.7 | 33.2 | 34.1 | 17.1 | 30.3 | 34.1 | 29.8 | 9.2 | 24.2 | 24.9 | 2.0 | 2.1 | 26.4 | 25.6 | 12.1 | 12.6 | 12.6 |
| As (soluble) | µg/L | - | - | - | - | 28.8 | 8.7 | 6.2 | - | - | - | - | 24.4 | 2.7 | 2.0 | 2.0 | - | - | - | - | - |
| As (particulate) | µg/L | - | - | - | - | 4.4 | 25.4 | 10.9 | - | - | - | - | <0.1 | 22.2 | <0.1 | 0.1 | - | - | - | - | - |
| As (III) | µg/L | - | - | - | - | 27.4 | 5.4 | 4.4 | - | - | - | - | 24.5 | 0.3 | 0.3 | 0.4 | - | - | - | - | - |
| As (V) | µg/L | - | - | - | - | 1.4 | 3.3 | 1.7 | - | - | - | - | <0.1 | 2.4 | 1.6 | 1.6 | - | - | - | - | - |
| Fe (total) | µg/L | 2,549 | 2,425 | 336 | 68 | 2,774 | 2,830 | 1,067 | 2,793 | 2,761 | 2,363 | 532 | 2,258 | 2,247 | <25 | <25 | 2,655 | 2,564 | 983 | 1,001 | 1,001 |
| Fe (soluble) | µg/L | - | - | - | - | 2,873 | 306 | 41 | - | - | - | - | 2,263 | <25 | <25 | <25 | 2,832 | 2,558 | 978 | 1,023 | 1,023 |
| Mn (total) | µg/L | 117 | 1,031 | 951 | 971 | 130 | 1,004 | 1,091 | 124 | 1,123 | 1,002 | 432 | 110 | 1,037 | 203 | 187 | 123 | 1,242 | 611 | 665 | 665 |
| Mn (soluble) | µg/L | - | - | - | - | 138 | 946 | 1,062 | - | - | - | - | 110 | 166 | 202 | 190 | - | - | - | - | - |

(a) TOC samples broke during transit to laboratory. (b) Onsite water quality parameters taken 11/16/06. (c) Onsite water quality parameters taken on 11/30/05. (d) TOC samples out of hold time. (e) Onsite water quality parameters taken on 12/15/05.

Analytical Results from Long Term Sampling at BSLMHP, MN (continued)

| Sampling Date | | 01/05/06 ^(a) | | | 01/10/06 ^(b) | | | | 01/17/06 ^(c) | | | |
|--|------|-------------------------|-------|-------|-------------------------|-------|-------|-------|-------------------------|-------|-------|-------|
| Sampling Location | | IN | AC | TT | IN | AC | TA/TB | TC/TD | IN | AC | TA/TB | TC/TD |
| Parameter | Unit | | | | | | | | | | | |
| Stroke Length | % | 40 | | | 40 | | | | 40 | | | |
| Alkalinity (as CaCO ₃) | mg/L | 378 | 383 | 378 | 374 | 378 | 378 | 383 | 383 | 378 | 378 | 378 |
| Fluoride | mg/L | 0.2 | 0.2 | 0.2 | - | - | - | - | - | - | - | - |
| Sulfate | mg/L | <1 | <1 | <1 | - | - | - | - | - | - | - | - |
| Nitrate (as N) | mg/L | <0.05 | <0.05 | <0.05 | - | - | - | - | - | - | - | - |
| Orthophosphate (as PO ₄) | mg/L | - | - | - | - | - | - | - | - | - | - | - |
| P (total) (as P) | mg/L | 0.5 | 0.4 | 0.1 | 0.4 | 0.4 | <0.01 | <0.01 | 0.5 | 0.5 | 0.03 | 0.03 |
| Silica (as SiO ₂) | mg/L | 24.9 | 25.3 | 24.7 | 24.4 | 24.2 | 23.8 | 24.2 | 25.3 | 25.4 | 24.1 | 24.7 |
| Turbidity | NTU | 31.0 | 5.8 | 1.4 | 31.0 | 4.3 | 0.2 | 4.6 | 32.0 | 6.5 | 0.3 | 3.3 |
| TOC | mg/L | 3.2 | 3.1 | 3.0 | - | - | - | - | 3.1 | 2.9 | 2.8 | 2.8 |
| pH | S.U. | 7.3 | 7.4 | 7.3 | 7.3 | 7.3 | 7.3 | 7.3 | 7.3 | 7.3 | 7.3 | 7.3 |
| Temperature | °C | 9.7 | 10.0 | 9.8 | 9.8 | 9.6 | 10.0 | 9.8 | 9.6 | 9.8 | 9.8 | 10.1 |
| DO | mg/L | 0.9 | 1.0 | 1.0 | 0.9 | 1.2 | 0.9 | 1.0 | 1.0 | 1.1 | 1.0 | 0.9 |
| ORP | mV | -42 | 58 | 68 | -38 | 62 | 57 | 61 | -45 | 59 | 55 | 57 |
| Total Hardness (as CaCO ₃) | mg/L | 305 | 316 | 318 | - | - | - | - | - | - | - | - |
| Ca Hardness (as CaCO ₃) | mg/L | 190 | 195 | 193 | - | - | - | - | - | - | - | - |
| Mg Hardness (as CaCO ₃) | mg/L | 114 | 121 | 125 | - | - | - | - | - | - | - | - |
| As (total) | µg/L | 25.9 | 24.9 | 3.9 | 24.6 | 24.0 | 3.0 | 4.8 | 25.6 | 25.9 | 2.8 | 2.5 |
| As (soluble) | µg/L | 26.2 | 2.8 | 2.2 | - | - | - | - | - | - | - | - |
| As (particulate) | µg/L | <0.1 | 22.1 | 1.7 | - | - | - | - | - | - | - | - |
| As (III) | µg/L | 25.0 | 0.4 | 0.4 | - | - | - | - | - | - | - | - |
| As (V) | µg/L | 1.2 | 2.4 | 1.7 | - | - | - | - | - | - | - | - |
| Fe (total) | µg/L | 2,737 | 2,566 | 194 | 2,581 | 2,629 | 28 | 307 | 2,593 | 2,427 | 27 | <25 |
| Fe (soluble) | µg/L | 2,474 | <25 | <25 | - | - | - | - | - | - | - | - |
| Mn (total) | µg/L | 125 | 1,506 | 331 | 135 | 1,235 | 324 | 366 | 130 | 1,031 | 220 | 201 |
| Mn (soluble) | µg/L | 121 | 108 | 138 | - | - | - | - | - | - | - | - |

(a) Onsite water quality parameters taken on 01/04/06. (b) Onsite water quality parameters taken on 01/11/06. (c) Onsite water quality parameters taken on 01/17/06.