



# Preparation of Soil Sampling Protocols: Sampling Techniques and Strategies



**PREPARATION OF SOIL SAMPLING PROTOCOLS:  
SAMPLING TECHNIQUES AND STRATEGIES**

by

Benjamin J. Mason, Ph.D.

Environmental Research Center  
University of Nevada-Las Vegas  
Las Vegas, Nevada 89154

Cooperative Agreement Number  
CR 814701

Project Officers

Kenneth W. Brown  
Brian A. Schumacher  
Exposure Assessment Research Division  
Environmental Monitoring Systems Laboratory  
Las Vegas, Nevada 89193

ENVIRONMENTAL MONITORING SYSTEMS LABORATORY  
OFFICE OF RESEARCH AND DEVELOPMENT  
U.S. ENVIRONMENTAL PROTECTION AGENCY  
LAS VEGAS, NEVADA 89193

## NOTICE

The information in this document has been funded wholly or in part by the United States Environmental Protection Agency under Cooperative agreement CR 814701 to the Environmental Research Center, University of Nevada, Las Vegas. It has been subjected to the Agency's peer and administrative review, and it has been approved for publication as an EPA document. Mention of trade names or commercial products does not constitute endorsement or recommendation for use.

## TABLE OF CONTENTS

List of Tables . . . . .	iv
List of Figures . . . . .	v
List of Examples . . . . .	vi

<u>Section Title</u>	<u>Page Number</u>	
1	Introduction	
	Background of Report . . . . .	1-1
	The Soil System . . . . .	1-6
2	Particulate Sampling Theory	
	Introduction . . . . .	2-1
	Sources of Variation and Sampling Errors . . . . .	2-2
	Application of Gy's Theory to U.S. EPA Soil and Waste Sampling . . . . .	2-11
3	Some Statistical Concepts that Pertain to Soil Sampling	
	Precision and Accuracy . . . . .	3-1
	Bias . . . . .	3-2
	Subsampling . . . . .	3-3
	Double Sampling . . . . .	3-4
	Composite Sampling . . . . .	3-5
	Homogenization . . . . .	3-7
	Random Sampling . . . . .	3-7
	Stratified Sampling . . . . .	3-8
	Geostatistics . . . . .	3-8
4	Review of Background Data	
	Historical Data . . . . .	4-2
	Geological Data . . . . .	4-4
	Soils Information . . . . .	4-5
	Environmental Studies . . . . .	4-5
	Legal Cases . . . . .	4-6
	Remote Sensing . . . . .	4-6
	Conceptual Model of the Site . . . . .	4-7
5	Methods for Reducing Various Sources of Sampling Error	
	Sampling Tools . . . . .	5-1
	Sample Selection . . . . .	5-6
	Sample Preparation . . . . .	5-7

Table of Contents (Continued)

<u>Section Title</u>	<u>Page Number</u>
6	Sampling Designs
	Sampling Phases . . . . . 6-1
	Suggested Preliminary Study Design . . . . . 6-1
	Volumetric and Area Sampling . . . . . 6-3
	Determining Number of Samples . . . . . 6-5
	Simple Random Sampling . . . . . 6-11
	Stratified Random Sampling . . . . . 6-12
	Systematic Sampling . . . . . 6-14
	Judgemental Sampling . . . . . 6-16
	Control or Background Areas . . . . . 6-16
7	Sample Collection
	Surface Soil Sampling . . . . . 7-1
	Shallow Subsurface Sampling . . . . . 7-4
	Sampling for Underground Plumes . . . . . 7-6
	Compositing . . . . . 7-10
	Record Keeping . . . . . 7-11
	Field Decontamination . . . . . 7-11
	Quality Assurance and Safety . . . . . 7-12
8	Other Types of Sampling of Soil Materials
	Quantity of Materials . . . . . 8-1
	Remediation Sampling . . . . . 8-3
	Safety . . . . . 8-4
9	Data Interpretation
	Other Data Evaluation Techniques . . . . . 9-2
	Components of Variance . . . . . 9-5
	Use of Statistical Tests in Remediation . . . . . 9-5
References	Ref-1
Appendices	
A.	Application of Particulate Sampling Theory to Soil Sampling.
B.	Determining Sample Weights Using Sampling Diagrams.
C.	Percentiles of the t Distribution.
D.	Bibliography
E.	Examples

## LIST OF TABLES

4-1	Sources of Remote Sensing Imagery . . . . .	4-7
6-1	Factors That Can Be Used to Stratify Soils . . . . .	6-13

## LIST OF FIGURES

1-1	Example of Soil Particle Size for Example 2 . . . . .	1-5
2-1	Sources of Estimation Error . . . . .	2-5
5-1	Schematic Diagram of Sampling Design . . . . .	5-3
5-2	Schematic for Sampling for Percentages . . . . .	5-5
5-3	Incremental Sampling Process for Cores . . . . .	5-9
5-4	Example of Splitting Process with Riffle Splitter . . . . .	5-10
5-5	Correct Incremental Delimitation . . . . .	5-11
6-1	Nested Design for Determining Components of Variance . . . . .	6-4
7-1	Example of Trench Sampling Using Soil Punch . . . . .	7-7
9-1	Effects of Structures on Sampling Arrangement and Estimation of Parameters . . . . .	9-4

## LIST OF EXAMPLES

1. NPL Site where battery cases comprise a major portion of the sample.  
(Actual case). . . . . 1-4
2. PCB concentrations in a sandy, clay loam where coarse gravels and  
cobble are present. (Hypothetical case). . . . . 1-4
3. Chemical concentration in various soil size fractions at an Askerel spill  
site. (Actual case). . . . . 1-4
4. Sampling of a lacustrine clay with a core sampler.  
(Hypothetical case). . . . . 2-9
5. Components of variance for an Aroclor 1260 spill. (Actual case). . . . . 2-10
6. Subsampling of a one kilogram soil. (Hypothetical case).. . . . . 3-3
7. Determination of pollution pathway from historical SCS report.  
(Actual case). . . . . 4-4
8. The number of samples required for a trichloroethane spill.  
(Hypothetical case). . . . . 6-6
9. Number of samples required for a PCB spill cleanup based upon the  
budget of the sampling study. (Hypothetical case using actual  
sample data). . . . . 6-10



# **PREPARATION OF SOIL SAMPLING PROTOCOLS: SAMPLING TECHNIQUES AND STRATEGIES**

## **SECTION 1**

### **INTRODUCTION**

#### **BACKGROUND OF REPORT**

This report is a guide for assisting Remedial Project Managers (RPM's) and others involved with site assessments and remediation in the development of soil sampling protocols. The document updates a guide published in 1983 (Mason, 1983). Since that time considerable work has been done in the areas of geostatistics, quality assurance, particulate sampling theory, field analysis, and sample handling.

Kriging, one of the geostatistical tools mentioned in the 1983 report has now become an accepted tool for use in soil (and soil-borne waste) sampling. The purpose of this tool is to provide an estimate of the concentration in a sampling unit or a specific volume of soil and to estimate the variance associated with the concentration estimate. Kriging, combined with the semi-variogram, is very useful in designing and conducting soil and waste sampling efforts.

At the time of the earlier report kriging could only be done on a mainframe computer. Today there are a number of PC-based programs that assist the user in evaluating soil sampling data (Englund and Sparks, 1988; Grundy and Miesch, 1987). The U.S. EPA Environmental Monitoring Systems Laboratory in Las Vegas, Nevada (EMSL-LV), has carried out several major environmental studies in which geostatistical evaluation was used as one of the main guides for designing the monitoring approach and evaluating the collected data (Starks, Sparks, and Brown, 1989; Starks, Brown, and Fisher, 1986; Flatman, 1984; U. S. EPA, 1984a, 1984b).

At the time of the 1983 protocol document, volatile organic chemicals (VOC's) were difficult to sample in the soil environment due to the loss of the chemical during sampling and analysis. That situation still exists and is being addressed in a major research effort conducted by the EMSL-LV. Progress is being made, but an acceptable sampling technology has not been recommended by the agency.

Soil gas sampling methods are being used to aid in identifying the location of plumes generated by volatile pollutants. Field gas chromatographs are also available and are being used to provide rapid, inexpensive data for refining sampling and remedial strategies. These field analytical procedures are most appropriate in the exploratory stage and in the cleanup of sites.

The U.S. EPA has developed the use of data quality objectives (DQO's) as a guiding policy for all environmental sampling (U. S. EPA, 1986, 1987a, 1987b). The DQO process is intended to provide the decision maker with data that meet a predetermined level of precision, accuracy, representativeness, completeness, and comparability.

In addition to identifying the above data characteristics, the DQO's should also specify the detection level needed, the probabilities of false positive (Type I) and false negative (Type II) errors allowable, and the minimum detectable relative difference between data sets that will be required. This later item becomes important when pollutant levels approach a regulatory threshold. Barth et al. (1989) have addressed the quality assurance aspects of soil sampling in a companion document.

Until quite recently, QA/QC efforts within the Agency have been directed primarily at the quality of the laboratory results generated. Field audits (U.S. EPA, 1985) have been done on occasion when requested by RPM's. The National Acidic Precipitation Assessment Program (NAPAP) has developed a system of field audit samples that, when properly utilized, provides an independent assessment of the sources of variation found in the sampling process. Van Ee et al. (1990) has expanded on the guidance developed for the NAPAP and recommends a series of samples interjected into the sample chain that will provide information on the components of variance encapsulated within the data generated by a sampling effort.

Proper application of a components of variance procedure such as a nested sampling scheme (Barth et al., 1989) can greatly aid in determining the sources of variation seen in the results obtained by a sampling program. In order to carry out the components of variance test it is necessary to identify the factors in the sampling process that are introducing the variation in the data. Pitard (1989a, 1989b) identifies seven sources of sampling error and makes suggestions for controlling or estimating the size of these errors. These errors can be used as a guide in selecting the components of variance to be determined by a sampling effort.

Laboratory methodology has reached a point where analytical error contributes only a very small portion of the total variance seen in the data. Examination of the results of a components of variance analysis performed on soils data from an NPL site sampled for PCBs (Barth et al., 1989) indicated that 92% of the total variation came from the location of the sample, while only 8% was introduced after the sample was taken. Less than 1% of the total could be attributed to the analytical process itself. This points out the need for a reallocation of sampling resources -- money, lab capacity, and personnel. Discussion in later chapters shows how such a reallocation can be made in order to make the most economical use of the samples. Van Ee et al. (1990) also makes suggestions for such a reallocation.

Starks (1986) has outlined the concept of support as it applies to soil sampling. For the soil scientist, the support is somewhat analogous to the concept of a pedon used in soil classification work (Soil Survey Staff, 1975). The specific size, shape, orientation, and spatial arrangement of the samples constitutes the support (Davis, 1986). Risk and exposure assess-

ment data can be used to assist in defining an “action support” (Barth et al., 1989) or the application of an action level over a particular support and location relative to the surface. The size of the support may change depending upon the purpose of the sampling effort.

The support concept becomes important when one is using geostatistics to determine the concentration/volume relationships of a block of ore or soil that are used in block kriging. The blocks of soil used for block kriging are estimation units that are closely related to the “remedial management unit” (Bryan, 1989) and the “exposure unit” (Neptune et al., 1990). It is necessary to make sure that the support used to determine the concentration of the unit of soil meets the data reliability called for in the Data Quality Objectives (DQO) for the study.

The amount of material required to make up the support can be determined by using the concepts developed in particulate sampling theory (Gy, 1982; Ingamells, 1974; Pitard, 1989a; Visman, 1969). The unifying theory was developed by Dr. Pierre Gy of the Paris School of Mines. Gy’s theories are in part based on work by a number of sampling specialists extending back to D. W. Brunton in 1894 and 1895 (Brunton, 1895a, 1895b, 1909). Brunton, without help of modern statistical tools, demonstrated that a relationship exists between a particle size and the weight of sample that must be used to provide a reliable estimate of the concentration of precious metals in an ore body.

Particulate sampling theory (Pitard, 1989a) has now developed to the point that it can be applied to soil and soil-borne waste sampling. The theory formalizes much of what has been done empirically for a number of years. The theory merges with the theory of regionalized variables that is the basis of geostatistics. Geostatistics provides guidance on the location and number of samples needed to determine concentration patterns with a chosen degree of reliability. Particulate sampling theory provides the basis for actually extracting the sample from the materials and aids in defining the size of the support that is needed to characterize a unit of material such as soil or waste.

Once the size of the geostatistical support (Starks, 1986; Barth et al., 1989) is identified, particulate sampling theory also provides guidance on taking subsamples from the support to provide a laboratory sample and on taking aliquots from the laboratory sample. Particulate sampling theory as developed by Dr. Pierre Gy is outlined in considerable detail in a book by Francis Pitard (Pitard, 1989a).

The theory links the size of particles in the material directly to the size of sample that is taken from a unit, batch or lot of soil or ore that is being evaluated. The controlling particle size is the largest particle. Thus samples that have been screened prior to analysis can be greatly biased. Fortunately, however, most soils fall into a range of particle sizes wherein there is little effect upon contaminant concentrations. However, in those cases where the soil is a fine textured soil combined with cobbles, gravels or coarse sands this may not be the case. Also, in cases where non-liquid wastes such as rubble, construction debris, or battery cases, etc. are present in the soil, the validity of the concentration data may be

questionable. Two examples will aid in showing the nature of the problem. A third example is taken from data collected at an actual PCB spill site and shows the results of analysis of various fractions of the soil.

**Example 1:** An NPL site contains an area where the soil profile is comprised of a mixture of crushed battery cases and a small amount of soil-like material. The soil-like materials in the profile were collected and analyzed for lead. The results showed Pb concentrations ranging upwards to 10% by weight. Examination of the materials indicated that the soil fraction constituted less than 0.1% of the total mass of material in the support. Although containing materials of high concentration, this support **actually** contains a concentration of 135 ppm of Pb lead and not the 10% reported for this area.

**Example 2:** A sandy, clay loam soil with 55% coarse gravels and cobbles in it it can be used as an example to show how the inclusion of the non-soil material can influence the actual concentration of PCB in the support. Figure 1 shows the character and particle size analysis for the soil. For purposes of this example, an assumption was made that the PCB coated each particle at a uniform thickness of 1 Angstrom. Concentrations were calculated for each size fraction. Assuming everything but the sand, silt and clay fractions were screened out gave a concentration of 27.3 ppm PCB. Including all fractions in the sample gave a concentration of 17.4 ppm. Should a 25 ppm cleanup level be chosen, this support would be cleaned often in fact it should not be cleaned.

**Example 3:** An Askerel-filled transformer was spilled onto a soil that was formed on glacial outwash material. The soils were alternately stratified with fine sands and sandy, gravelly clay. The PCB and associated trichlorobenzene was found predominantly in the gravelly layers. Concentrations ranged upwards to 32,000 ppm Aroclor 1260. A sample of this material was collected for analysis. Prior to analysis, it was screened through a 1 mm screen and through a 5 mm screen. The fraction that was larger than 5 mm was further divided to separate out particles larger than 12 mm. Samples of each fraction of the material were analyzed. The results are shown below along with the weight percentages of each fraction. Four other samples of the mixed wastes were analyzed according to the normal laboratory procedure. The larger rocks were screened out and discarded. These four samples contained 52.1±6.9 ppm.

Fraction	Weight (gm)	Weight%	PCB (ppm)
<1 mm	53.87	37.89	85.8
> 1-5 mm	23.80	16.74	13.3
>5-12 mm	31.80	22.37	6.5
> 12 mm	32.70	23.00	5.3

The weighted average concentration of this sample was approximately 37.4 ppm. Screening with a 5 mm screen would remove approximately 45% of the material from the analytical process, thus introducing a rather large bias in the analytical results reported.

**Figure 1-1 Example of Soil Particle Size for Example 2**

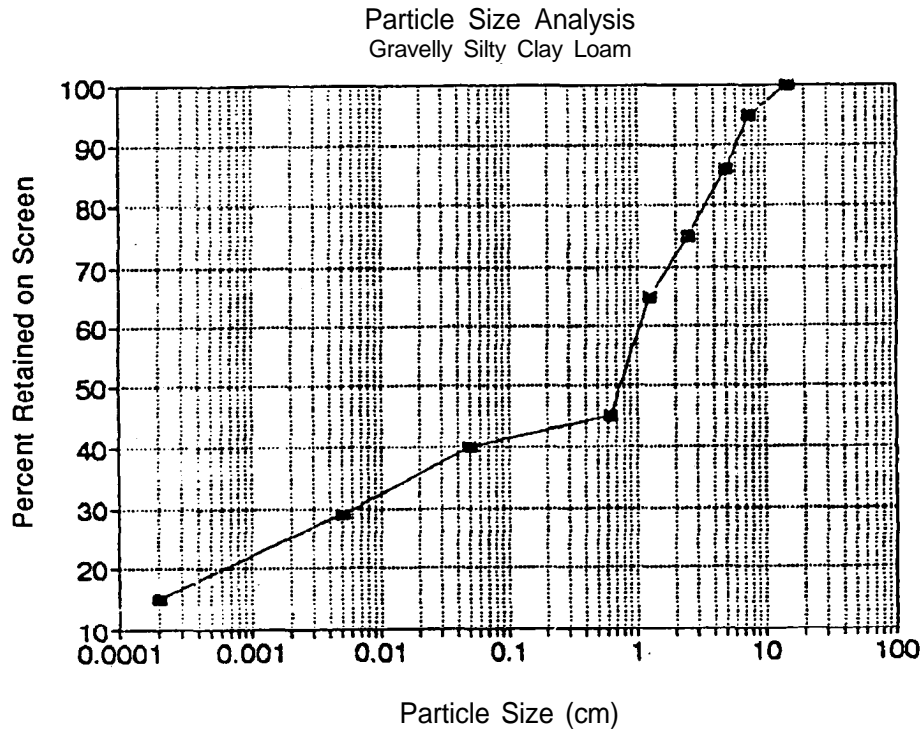

**Appearance**



The sampling effort must be designed so that any non-soil fractions are accounted for either by sampling design or sample extraction and preparation. A conceptual model of how the pollutant is potentially distributed on the site and the exposure pathways that are important for regulating the site can be used to design the soil component of the sampling study (CDM Federal Programs Corp, 1987). In those cases where the non-soil fraction adds materially to the exposure or impacts the remedy at the site these materials must be considered. The following sections provide some guidance for addressing these materials; but, the investigator will have to address the particular circumstances being studied.

## **THE SOIL SYSTEM**

The Soil Scientist identifies soil as “the unconsolidated mineral material on the immediate surface of the earth that has been subjected to and influenced by a genetic and environmental factors...” (Soil Science Society of America, 1965). The engineer, on the other hand, identifies soil as the mass (surface and subsurface) of unconsolidated mantle of weathered rock and loose material lying above solid rock. This is called the regolith (Soil Science Society of America, 1965). The true soil component can also be defined as all mineral and naturally occurring organic materials with a particle size less than 2 mm (Barth et al., 1989). For purposes of this report the definition of soil more closely follows the engineering terminology.

The above definitions, however, do not address the situations normally encountered by the environmental investigator when working on hazardous waste sites. The so called “soils” of the hazardous waste site comprise a mixture of materials ranging from true soil to buried tree trunks, carpets, scrap wood, scrap metal, auto fluff, battery cases, old automobiles, buried drums, etc. At one site studied by the author, more than 100 different materials were identified in the “soil layer”. Often these nonsoil materials can have a marked effect on pollutant concentrations and on the migration of the pollutants through the soil. They must be addressed by any soil sampling effort. Suggestions for addressing these materials are discussed later in this report.

The physical and chemical characteristics of the soil system influence the transformation, retention, and movement of pollutants through the soil. Clay content, organic matter content, texture, permeability, pH, Eh, and cation exchange capacity (CEC) will influence the rate of migration and form of the chemical found in leachate migrating from the waste. These factors must be considered by the investigator when designing a soil sampling effort. This is different from the priorities of the agricultural soil specialist. The agricultural worker considers these factors but does not focus the sampling design on them because a farmer is interested in how much lime or fertilizer to apply to a field and not in the avenues of movement of that fertilizer through the soil system.

Little attention is usually given to the spatial variability of an agricultural field. Occasionally a farmer may fertilize two different soil types at different rates if the yield gains and the

fertilizer cost savings can justify the time and effort required. In such a case the soil scientist sampling the farmer's fields may take separate samples of each soil type. The environmental scientist, on the other hand, is usually interested in a number of possible types of pollution and routes of migration. These cannot be addressed with a single sample or a single composite sample. Therefore, some form of statistical sampling design must be used to evaluate the pollution in a soil system.

This report presents several options for sampling soils that are available for evaluating pollution migration. Barth et al. (1989) present a number of statistical techniques that are germane and should be considered in formulating any soil sampling protocol.

One of the key characteristics of the soil system is its extreme variability. Cline (1944) made note of the variability seen in soil sampling and cautioned the researcher about failing to consider this when dealing with any study of the soils system. Since the author's 1983 report (Mason, 1983), there has been considerable interest in identifying and measuring the spatial variability of physical and chemical properties of the soil system.

Research in this area has been carried out by Nielsen and his associates (Nielsen et al., 1973; Nielsen and Bouma, 1985; Warrick et al., 1977; Vieira et al., 1981) along with others (Jury, 1984; Wierenga, 1985; Bresler, and Dagan, 1988) who have continued to increase our understanding of the variation of soil properties that influence the movement of water and pollutants through the soil. As an indication of the importance of variability, more than 200 scientists representing 16 countries met in Las Vegas, Nevada (Nielsen and Bouma, 1985) in 1984 to discuss soil spatial variability. Also, in the last few years almost every issue of the Soil Science Society of America Journal contained at least one article dealing with spatial variability of some soil property.

Geostatistics attempts to identify and understand the sources of the variation seen in the soil matrix. Gutjahr (1985) states "This approach views variation as part of an overall problem which can convey vital information about the phenomena studied." Wilding (1985) is even more pointed in his assessment of variability when he writes:

"Spatial variability of soil is not an academic question. It is a real landscape attribute; our unwillingness or inability to identify it in no way decreases its magnitude or existence. . . . As scientists we must document the magnitude and form of soil variability; accommodate its existence in models of soils; and transmit accurately the expected pattern and implication of spatial changes to users of soil resources. Soils are not material specific; many soil properties are not single valued, many are transient, and many are not randomly distributed but rather systematically time and spatially dependent. The dilemma is that soils are not isotropic media but rather they are strongly anisotropic laterally and vertically."

Wierenga and his students (1985) have investigated the influence of spatial variability of soil water properties upon the movement of chemicals through the unsaturated zone of the soil. This and similar work is important to the issues of pollutant migration in that the variability seen in Wierenga's field studies provides insight into the influence of the variability upon how the pollutant will behave in the soil environment and how it will migrate. Sampling of the soils media must take these concepts into consideration.

This information is not new. Campbell (1979) makes note of the fact that in 1915 J. A. Harris discussed the effects of soil variability on the results of his experiments. Campbell used this knowledge in evaluating approaches to delineating soil mapping units (Campbell, 1977, 1978, 1979, 1981). Rao et al. (1979) reviewed other work where spatial variability was considered.

Petersen and Calvin (1965) also note: "Soil properties vary not only from one location to another but also among the horizons of a given profile. The horizon boundaries may be more distinct than are the surface boundaries of a soil classification unit. Here, also, however, zones of transition are found between adjacent horizons". The magnitude of sampling errors between layers of soil tends to be less than the magnitude of sampling errors in a horizontal direction. Disturbed soils, such as those found in many NPL sites, are reported to be more variable than virgin soils in most cases (Chapman and Pratt, 1961).

One measure of variation is the coefficient of variation (CV). Coefficients of variation for soil parameters have been reported ranging from as low as 1 to 2% upward to approximately 1000%. White and Hakonson (1979), for example, noted that the CV for plutonium in the soils of a number of test sites ranged from 62% to 840%. Mathur and Sanderson (1978) reported coefficients for natural soil constituents (i.e., part of the soil itself) varying from 5.6% to 75.2%. Harrison (1979) evaluated four phosphorus properties of soil and reported CV values ranging from 11% to 144%, with the highest values being for available P. Hindin et al. (1966) reported a CV of 156% for insecticide residues in a square block of soil that was 30 inches on a side.

Mausbach et al. (1980) reported on a study conducted by the Soil Conservation Service (SCS) laboratory in Lincoln, Nebraska. Matched pairs of samples were collected from areas within a soil series. The samples were stratified by a number of factors in order to reduce the variability. The samples were selected from the modal phases of the series and were collected at distances that ranged from 2 to 32 km from the other member of the pair.

The authors note that the literature indicates that up to half of the variability between similar soils may occur within a distance of one meter. (Studies are underway at Lincoln to determine variability within this one meter distance.) Mausbach et al. (1980) reported that in their study of the variability within a soil type, the CV's for physical properties

---

\*  $CV = \pm (\text{Standard deviation} / \text{Mean}) \times 100$



ranged from 9% to 40% for loess, 23% to 35% for glacial drift, 33% to 47% for alluvium and residuum, 18% to 32% for the A and B horizons, and 33% to 51% for the C horizons. The CV's for the chemical properties tended to be higher ranging from 12% to 50% for Alfisols, 4% to 71% for Aridisols, 6% to 61% for Entisols, 10% to 63% for Inceptisols, 9% to 46% for Mollisols, 16% to 132% for Spodosols, 10% to 1005% for Ultisols, and 8% to 46% for Vertisols.

The variation that seems to be inherent in data collected from any soil sampling study must be taken into consideration during the design of a soil sampling plan. Techniques designed to take the variation into account must be employed in any soil sampling plan. This includes the sampling design, the collection procedures, the analytical procedures and the data analysis. An interactive approach must be used in order to balance the data quality needs and resources with designs that will either control the variation, stratify to reduce the effects of the variation or reduce its influence upon the decision process.

Often it is not economical to reduce the effects of variation on the data. In those cases the data quality objectives may have to be modified to allow the study to continue. The variation must be measured by the statistical design used. Without this information it is not possible to arrive at an unbiased, realistic conclusion about the waste being evaluated. Buffington (1978) quotes Congressman George E. Brown, Jr., as saying "no number is significant, and subsequently worthy of being recorded, without an estimate of its uncertainty." This is one of the drives behind the emphasis on data quality and the DQO process that has evolved over the past several years. Barth et al. (1989) have addressed the application of the DQO process to soil sampling and provide guidance on proper generation and handling of soils data.

When a conceptual model of the site indicates that the soil component is one of the key factors in exposure of some population or environmental component it is necessary to determine the portion of the soil that is of concern and to determine the likely pattern of contamination. Questions such as "Is the contaminant likely to be on the surface or at depth?" "Is it distributed over the entire area or is it only in 'hot spots'?" "Are there obstructions that will hinder the sampling effort?" must be answered. The response to these questions will determine the type and distribution of samples to be taken.

The investigator will have to determine if gravel, cobbles, and other non-soil fractions will have to be sampled and how these are to be handled if they are sampled. Particulate sampling theory can aid in determining if this is important. In cases where litigation is likely to occur this theory may be necessary to provide the reliability in the data that is needed to stand up to the scrutiny of the legal system. It may also be important in those cases where remediation sampling is being done. The section that follows provides a general outline of particulate sampling. Appendix A and B provide a more detailed review of this theory.

## SECTION 2

### PARTICULATE SAMPLING THEORY

#### INTRODUCTION

**NOTE:** The following discussion on particulate sampling theory is given as a means of providing a very general overview of the theory. It is not intended to provide the necessary understanding required to apply all of the aspects of the theory to site investigations. As far as the author knows, the theory has only been used in limited situations with site remediation sampling. The reader is encouraged to review Appendices A and B and Pitard's text (1989a) prior to making a decision if this is needed for a particular investigation.

Particulate sampling theory is new to most environmental investigators even though the techniques used to apply the theory to soil sampling are familiar. Dr. Pierre Gy (Gy, 1982), along with others (Ingamells and Switzer, 1973; Ingamells, 1974; Ingamells and Pitard, 1986; Pitard, 1989a; and Visman, 1969), have developed the theory for sampling particulate materials in the mining industry. Pitard (1989a) has provided a presentation in English that gives a good overview of the theory that should be consulted prior to planning soil sampling and other environmental studies. Information found in this section is based upon the text and also on an introductory course taught by Pitard (1989a, 1989b).

The theory is based upon the relationship that exists between the variability of the material, the particle sizes in the material, the distribution of the component of interest (pollutant), and the size of sample taken. The variability found in particulate material is based upon the number of particles included in the sample. Thus, the smaller the particle the lower the variability in a fixed weight of sample submitted for analysis. Comminution or reduction of particle size to attain this relationship may not be practical in environmental sampling because of safety, costs, and the handling requirements that are required to apply the theory. Much of the theory cannot be used in the case of VOCs because of the grinding, mixing, and subsampling that is required to obtain a correct sample.

With uniform soil materials such as silts or clays the theory does not greatly alter procedures used in the past but, with coarse gravels or with mixed wastes, the theory shows a major problem. One is immediately confronted with dealing with a large volume of material and with reducing the large particles in size. There is a tendency to reject the theory as being impractical. This does not have to be the case, however. There are sampling, analytical, and sample handling procedures that can overcome the problems that are inherent in applying the theory. Some of these are discussed in Appendix A.

When geostatistics were first introduced into soil sampling, a number of investigators were concerned about the large number of samples that were required to make effective use of the techniques. Rather than discard the technique, most investigators have adapted their sampling

approaches to overcome the problems of large sample numbers. A similar developmental pattern can be expected to occur with particulate sampling theory. Fortunately, many of the sampling approaches currently used do not violate the basic theory; however, some do. Those that violate the theory will have to be amended or addressed through different sampling techniques. As with many field sampling efforts, economics is likely to be the driving factor.

Dr. Gy's theory integrates into geostatistics and the concepts of the "action support" outlined by Barth et al. (1989) the concept of a "remedial management unit" (Bryan, 1989) and the "exposure unit" (Neptune et al., 1990). The techniques are designed to extract an unbiased sample from a volume (called a lot by Gy) of soil. Ingamells (1974) has shown how the work of Visman (1969) and Gy's early work influenced his work on the laboratory sampling constant. Pitard (1989a) and Gy (1982) have incorporated this information into the basic theory of particulate sampling.

There are two models that must be considered in order to provide a complete evaluation of pollutant concentrations and distribution. Pitard (1989a) outlines these as follows:

- A continuous model taking into account the continuous nature of the space or time variability of its characteristics. This is where the notions introduced by the regionalized variables (variography) are going to be very important.
- A discrete model taking into account the discrete nature of the population of fragments submitted to the sampling operation, described by the fundamental notions of constitution and distribution heterogeneities.

Pitard (1989a, 1989b) gives an interesting outline of the history of particulate sampling theory, and notes how this fits into the theories of regionalized variables that provide the foundations of geostatistics and kriging. Both regionalized variable theory and particulate sampling theory were developed in the 1'Ecole Nationale Superieure des Mine de Paris (often referred to as The Paris School of Mines) in Fountainbleau, France.

## **SOURCES OF VARIATION AND SAMPLING ERRORS**

Figure 2-1 and the definitions that follow were taken from Pitard (1989a). They outline the relationship between the various sources of heterogeneity and the associated errors or components of variance that are introduced into a sample result. The errors are usually expressed as the relative variance which is equivalent to  $CV^2$ . The relative error or variance is used because variances are additive and because relative variances can be compared between sampling events in much the same way that components of variation (CV) can be used to compare sample sets.

Sampling theory uses two models for assessing errors associated with any set of samples collected from a body of material such as soil, waste, rock, ore, etc. These two models are called the discrete model and the continuous model (or continuous selection model). The mathematics associated with these two models are complex. Pitard (1989a) and the references given by him should be consulted if the reader is interested in the details of these two models.

The discrete model addresses the material itself and encompasses all of the individual particles in the lot to be sampled or it may encompass all groups of particles of some finite size found in the lot. The population being sampled is the total number of particles or groups of particles that make up the lot of the soil or waste being investigated. This model addresses the “fine details” of the material.

The continuous model is like looking at a lot with a wide angle lens (Pitard, 1989a) without paying attention to the details of the material. This model addresses fluctuations within time and space and is most often used in addressing fluctuations in materials flowing along a conveyor belt, a pipe line, or a stream. This model is also the underlying basis for much of geostatistics.

The two models are related to each other and the phenomena identified in the models all contribute to the total sampling error (TE) and the overall estimation error (OE).

The arrows shown in Figure 2-1 show how the various individual errors combine into the next hierarchy of error. For example, the fundamental error (FE), which results from constituent heterogeneity (CH), combines with the segregation and grouping error (GE), which results from distribution heterogeneity (DH), to form the short range heterogeneity fluctuation error ( $CE_1$ ). The short range heterogeneity fluctuation error combines with the long range heterogeneity fluctuation error ( $CE_2$ ) and the periodic heterogeneity fluctuation error ( $CE_3$ ) to form the continuous selection error (CE) of the continuous model. The continuous selection error combines with the incremental materialization error (ME) (comprised of DE and EE) to form the sampling error (SE) for a particular stage of sampling.

The arrows also symbolize the mathematics of the sampling process as is shown in Equations 2-1 and 2-2.

The total sampling error (TE) is a combination of the preparation errors (PE) and the sampling or selection errors (SE) for each stage in the sampling process. The sampling or selection error (SE) is a combination of six basic error components: (1) the fundamental error (FE); (2) the grouping and segregation error (GE); (3) the long-range fluctuation error ( $CQ_2$ ); (4) the periodic fluctuation error ( $CE_3$ ); (5) the increment delimitation error (DE); and (6) the increment extraction error (EE). Each error shown in Figure 2-1 has an average value ( $m$ ) and a variance ( $s^2$ ). This is different from classical statistics where usually a single variance term is estimated for a material being sampled.

## Sample Correctness

Gy's theory makes use of the concept of sample correctness which is a primary structural property. A primary structural property is a property that is intrinsic to the material itself and to the equipment used to extract the sample, and is independent of the sampling problem itself. A sample is correct when all particles in a randomly chosen sampling unit have the same probability of being selected for inclusion in the sample. Antithesis to this, all particles that do not belong to the material to be sampled should have a zero probability of selection if the sample is to be correct. "Grab samples" or judgmental samples lack the component of correctness; therefore, they are biased. The so-called grab sample is not really a sample but a specimen of the material that may or may not be representative of the sampling unit. Great care must be exercised when interpreting the meaning of these samples.

Sampling bias is always introduced when one fails to use correct sampling. The importance of the bias that is introduced may be quite small in materials that are relatively uniform in composition and particle sizes. Mixed materials such as a cobbly, clay loam may show a large bias if the cobbles and gravel particles are excluded from the sample. These coarse materials may need to be addressed by use of some form of double sampling technique so that they can be included into risk assessments or into remedial goals for a site. Bias that is measured by standard additions in the laboratory is an analytical bias and only reflects the analytical error and not the sampling error (SE).

**Figure 2-1 Sources of Estimation Error**

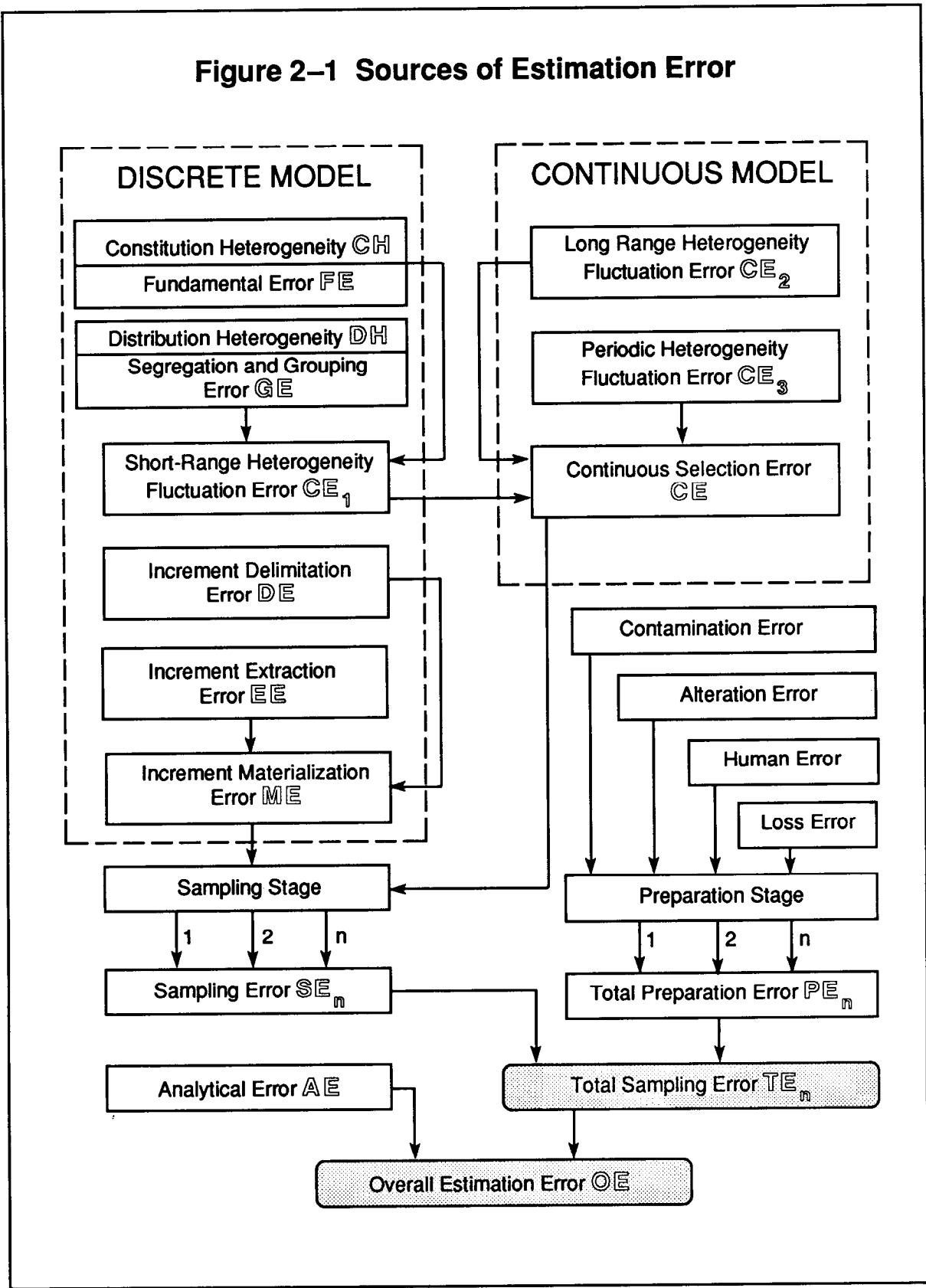

5313EAD92-2

### **Constitution Heterogeneity (CH)/Fundamental Error (FE)**

The constitution or composition heterogeneity of a material is the variability inherent in the composition of each particle making up the lot (L); a lot being a batch, volume of soil, or sampling unit. Constitution or composition heterogeneity leads to the fundamental error (FE) for the soil or waste. This error cannot be canceled out. It is the underlying variability of the soil or waste and cannot be eliminated. This would be the error that was left after perfectly carrying out all sampling and analytical processes in an error-free manner (i.e., perfection which is also an unattainable limit). The variance of this error can be reduced by grinding the material to a fine particle size (see Appendix A for guidance on carrying this out).

### **Distribution Heterogeneity (DH)/Grouping and Segregation Error (GE)**

The distribution heterogeneity derives from the manner in which separate and distinct particles or units are scattered or distributed within the material being sampled. The grouping and segregation error (GE) results from the distribution heterogeneity of the soil or waste material. This error can become quite large for trace constituents such as one might encounter with pollutants. The variance in GE is related to the constitution heterogeneity (CH), a grouping factor, and a segregation factor.

The grouping factor reflects the probability of a particular particle being included in an increment of a sample and increases as the number of particles in an increment increases. The grouping factor is zero when each increment of a sample is made up of only one particle. The segregation factor is a multiplier or correction factor. This factor is used to adjust the distribution heterogeneity so that it lies between zero when a sample is homogeneous and approaches a maximum equal to the constitution heterogeneity; The size of this factor depends upon the degree of heterogeneity within the material.

### **Short-Range Heterogeneity Fluctuation Error (CE<sub>1</sub>)**

The errors resulting from constitution and distribution heterogeneity combine in the short-range fluctuation error (CE<sub>1</sub>). This error is the error occurring within the sampling support. The short-range heterogeneity (h<sub>1</sub>) is essentially a random, discontinuous function.

### **Long-Range Heterogeneity Fluctuation Error (CE<sub>2</sub>)**

This error is generated by the heterogeneity (h<sub>2</sub>) created by local trends and is essentially a non-random, continuous function. This heterogeneity is the underlying basis for much of geostatistics and kriging. The variograms generated by line transects result in part from this component of error or variance.

### **Periodic Heterogeneity Fluctuation Error (CE<sub>1</sub>)**

This error is a continuous term generated by handling of the material to be sampled, processing, reclaiming, disposal, and environmental parameters. The error is non-random and cyclic. Perhaps one of the most common factors likely to be encountered in soil sampling results from seasonal rainfall patterns. Frequently pollutants will move out of the disposal area during the rainy season then migrate some distance from the source before the next rainy season begins. This can give a cyclic pattern to the concentrations found in the vadose zone.

### **Continuous Selection Error (CE)**

The continuous selection error is comprised of the errors resulting from short-range, long-range, and cyclic heterogeneity.

$$CE = CE_1 + CE_2 + CE_3 \qquad \qquad \qquad \textbf{Equation 2-1}$$

or expanded

$$CE = (FE + GE) + CE_2 + CE_3$$

These sources of sampling error are the point where regionalized variables (geostatistics) and particulate sampling theory merge.

### **Increment Delimitation Error (DE)**

One of the major sources of sampling bias is the increment delimitation error. This results from incorrectly defining the shape of the volume of material that is to be extracted. An increment is a group of fragments. In the case of a core sample, an increment would be a cross section of the core taken between two parallel planes passing completely through the core. Delimitation is based upon the number of dimensions of the waste or soil deposit. The model delimitation for each dimensional waste is:

- A zero-dimensional waste is one in which an entire lot such as a forensics specimen is submitted for analysis to the laboratory. The sample is analyzed *in toto*. Delimitation is not a problem when the entire lot is analyzed.
- A one-dimensional waste is one defined by a thin, elongated stream such as one might encounter with a conveyor belt or an elongated pile of waste. The sample is delimited by cutting across the waste with two parallel planes. All material within the delimited sample must be included in the sample sent to the laboratory or in the sample that will be reduced to a



subsample for analysis. An individual core sample can be considered one-dimensional.

- A two-dimensional waste is defined as a mass with a definite upper and lower boundary such as a soil horizon or a layer within a horizon. To properly sample this type of material, it is necessary to define a cylinder passing through the entire waste or soil layer. To be correct, the cylinder must have a constant cross section. An example of such a cylinder would be the path that would be cut by a Shelby tube or a split spoon sampler.
- A three-dimensional waste would be a very large pile of material, the entire soil system below a site, or a mountain. The delimitation model for this type of waste is a sphere. With the exception of liquids or very fine slurry material, it is not possible to collect a spherical sample. Geostatistics addresses this situation and must be used to properly sample these large waste deposits. Correct delimitation is neither practical nor economically feasible with three-dimensional wastes because tools do not exist for extracting such a sample.

### **Increment Extraction Error (EE)**

The increment extraction error results from incorrect extraction of the defined increment and can be an important source of sampling bias. Pitard (1989a) states that “extraction is said to be correct if, and only if, the rule of the center of gravity is respected; all particles with their center of gravity inside the boundaries of the correctly delimited increment belong to the increment.” Pitard (1989a) gives some guidelines for selecting the types of coring tools that are correct and identifies the types that are not correct.

Basically, the correct tools include materials that should be a part of the sample and exclude those that should not be a part of the sample. Diamond drilling in consolidated rock is likely to be correct. On the other hand, split spoon sampling of a gravelly clay can have major errors created by the presence of rocks that block the tube and result in poor recovery.

Soils can be considered to be two-dimensional wastes if the layers are sampled separately with some form of coring device. The extraction process must cut through the entire deposit of waste or layer within the deposit. Example 4 may help to see why failure to observe this requirement can produce biased results.

**Example 4:** A site located on lacustrine clay has an eight-inch fine, sandy layer located at 16-24 inches. An unsuspecting investigator has designed a sampling plan that will take every other 18" long split spoon sample. A randomly selected cross section out of the core becomes the analytical sample sent to the laboratory. The selection of a random section out of the core is not incorrect in itself unless there are distinct layers in the soil. Each layer should be sampled as a discrete unit. The core collected from 0-18 inches only cuts the top of the sandy layer. Experience has shown that these layers often contain pollutants. For pollutants that are heavier than water, the concentration is often higher on the bottom of the layer than the top. The sample is biased by the fact that the polluted layer is discriminated against by the sample plan being used. Most of the 16-24 inch fine, sandy layer is missed because the protocol does not sample the 18-36 inch zone in the soil. Extraction of separate samples from each layer within the spoon is acceptable because the split spoon sampler cuts through the entire layer.

### **Preparation Error (PE)**

Each preparation stage has an error associated with it. These errors result from variation introduced during grinding, screening, sifting, storage, etc. The major sources, such as cross-contamination, alteration in the form of the pollutant (volatilization, etc.), human error, loss of material (deposition onto sample containers), etc. have been identified in Figure 2-1. Others, such as fraud or willfully altering the sample, could also be included in the preparation error. This error is not the same as the sampling or sample selection error (SE) and should not be confused with it.

### **Sampling or Selection Error (SE)**

This is the relative sampling error that occurs as the result of estimating the actual content of a waste or soil lot. It is composed of the six errors occurring in the sampling chain. In the remainder of this report, this error is referred to as the sampling error and is designated SE. It is comprised of the variance or error from each of the other steps in the sampling chain.

$$SE = CE + ME \qquad \qquad \qquad \text{Equation 2-2}$$

or expanded

$$SE = FE + GE + DE + EE + CE_2 + CE_3$$

Any discussion of this error would include the discussion given above for each of the components; therefore, no further discussion is given about this error.

## Total Sampling Error (TE)

One should keep in mind that the total sampling error, TE, is not the sum of a single set of sampling and preparation errors but may be comprised of a number of sets of these errors. There will be a set of errors for each stage in a multistage sampling plan. For example, a sample taken in the field may be screened and split into components in the field. Each component then is handled as a separate material. The sample is sent to the laboratory where it is ground and split several times into smaller and smaller samples. Each stage in the splitting process has its associated errors. These added together yield the total error for the sample. This is a true chain of events and is only as strong as the so-called "weakest link." The stage with the largest variance will control the total variance (Pitard, 1989a).

## Analytical Error (AE)

The analytical error is only one component of the total sampling chain that leads to a final result with its associated overall error (OE). Currently, most quality control efforts address the endpoint of the chain of events leading to the estimate of pollutant concentration in the soil or waste materials. Generally, when the subsampling error is greater than three times the analytical error, the analytical error is of no consequence (Youden, 1967). This requires that studies be carried out on the material from a particular site in order to determine the sampling error. Frequently the analytical errors amount to less than two percent of the total variation seen in the sample data. Example 5 was developed by the author at an NPL site in U.S. EPA Region 4.

**Example 5:** Aroclor 1260 was spilled onto the soil at a site in an industrial area. The soils at the site were primarily fill material comprised of crushed limestone rock and peat. Samples were taken from an area of known contamination located in the center of PCB dumping. Duplicate samples were taken from the faces of a soil pit at two depths within the pit. Each sample was then split in the field and sent to the laboratory. The quality control officer then had the laboratory personnel split the samples again. Each split sample was submitted to the analytical staff who took two samples for extraction. Each of these was extracted then analyzed twice. The ANOVA for the components of variance test were:

Source of Variation	dof	Mean Squares	% Sampling Error
Depth	1	54.0800	
Duplicates/depth	2	24.2425	89.32
Slit/duplicate	4	1.2638	9.50
Extract/split	8	0.0412	0.11
Analysis	16	0.0344	1.07
Total	31		

## **APPLICATION OF GY'S THEORY TO U. S. EPA SOIL AND WASTE SAMPLING**

Most soil scientists are unfamiliar with Gy's particulate sampling theory. In cases where Gy's published works are encountered, they are difficult to understand even if one is able to translate from French into English. Pitard (1989a, 1989b) has provided an interpretive tool that can help understand the theory. The terminology is new and often there are no direct links to similar terms used in environmental science. Appendix A and B attempt to help the potential user adapt the theory to soil sampling. For those cases where litigation is likely, the theory should be considered and a statistician or other investigator familiar with the theory should be consulted prior to finalizing the protocol. Pitard's text (1989a) can be of considerable assistance in applying Gy's theory.

The fact that application of the theory appears to be difficult does not negate the validity of the theory and its application to environmental science. Future soil sampling efforts will be adapted to incorporate the theory as more scientists become aware of its usefulness. In A Rationale for the Assessment of Errors in the Sampling of Soils, Van Ee et al. (1990) note, "Measurement error consists of three major components, i.e., sample collection, preparation, and analysis." This reference outlines a procedure for addressing these sources of error. Figure 2-1 shows the same components of the overall estimation error (OE) in the sampling error (SE), the total preparation error (PE), and the analytical error (AE). Gy's theory can fit into the rationale set forth by Van Ee et al. (1990).

An example of how Gy's theory can provide assistance to the soil sampling effort is seen in the QA area of representativeness. Currently, QA guidance for soil sampling (Barth et al., 1989; Van Ee et al., 1990; and CDM Federal Programs Corporation, 1987) give a qualitative definition for representativeness. Gy's theory provides a means of quantifying the sampling effort. The theory does not invalidate the qualitative definitions currently in use; it just strengthens what is currently being done.

Sample correctness determines the accuracy of the estimation process. An incorrect sample is a biased sample (Pitard, 1989a). Analytical bias is only a small part of the bias that can be introduced into the final result reported to the user. Correct delimitation and extraction of a soil sample is necessary to avoid introducing bias into the sampling effort. Gy's theory indicates that a cylinder is the correct delimitation of the sample to be taken from a two-dimensional waste such as a soil layer. Shelby tubes or some form of channel sampling should be used to provide a correct sample of material from the layers of a soil. Suggestions for correct sampling of these materials are, presented in later sections.

One of the key concepts of Gy's theory is that the variance of the sampling data is a function of the maximum particle size. By reducing the particle size of the material by grinding or some other form of size reduction, the investigator can reduce the variance to some predetermined variance specified in the DQO document. Pitard (1989a, 1989b) outlines procedures for

determining the particle size classes that are required to reduce the sample to an analytical subsample. The protocol of arriving at this particle size can be determined from a sampling nomograph similar to that shown in Appendix A and the sampling diagram shown in Appendix B.

Where the sample weight would be too large for shippers or the laboratory to handle, it will be necessary to grind the sample to a size that will allow the analytical subsample to be reduced to a weight that is acceptable for shipping or analysis. Most soils do not require the grinding process unless gravels or other large components are present.

In those cases where grinding is not acceptable because of volatility, etc., it will be necessary to collect a number of small increments to be included in an analytical composite sample or else each increment can be analyzed separately. The coarse materials should be screened out, weighed, and documented prior to submission to the laboratory.

## SECTION 3

### SOME STATISTICAL CONCEPTS THAT PERTAIN TO SOIL SAMPLING

Barth et al. (1989) have outlined many of the statistical concepts that are important to soil sampling. This section will only give an overview of the key concepts that are necessary to understand materials that are given in later sections.

The reader is encouraged to review classical statistical texts and the Soil Sampling Quality Assurance User's Guide (Barth et al., 1989) for more detailed information. A Statistical Manual for Chemists (Bauer, 1971) is also very useful in sampling and quality assurance work.

#### PRECISION AND ACCURACY

Precision and accuracy are occasionally used interchangeably (Bauer, 1971). Precision is a measure of the reproducibility of measurements of a particular soil condition or constituent. The statistical techniques encountered in soil sampling are designed to measure precision and not accuracy.

Accuracy is the correctness of the measurement; however, it is an unknown. If the investigator knew the absolute amount of a pollutant in the sample, there would be no need to sample. Accuracy cannot be measured; it can only be surmised from secondary measures that reflect the likelihood that an analytical method is accurate. Standards, spiked samples, referee, and audit samples are all used as an attempt to evaluate the accuracy of an analytical method. These samples are actually used to estimate the bias (see below) (Barth et al., 1989) and not the accuracy of the sample or of the sampling process. The Quality Assurance Management Staff (QAMS) (1991) has developed a glossary of QA terms that are recommended for use by the U.S. EPA. Regarding the term accuracy, QAMS states "EPA recommends that this term not be used and that precision and bias be used to convey the information usually associated with accuracy.

Pitard (1989a, 1989b) makes a statement about accuracy that should be kept in mind when discussing precision and accuracy. This is:

The definition of accuracy is often controversial and it is incorrect to include the notion of precision with the notion of accuracy; consequently, definitions given by most current dictionaries are misleading, confusing, and incorrect. . . . As far as sampling is concerned, a sample is said to be accurate when the absolute value of the bias,  $|m_{SE}|$ , is smaller than a certain standard of accuracy,  $m_{oSE}$ , which is regarded as acceptable for a given purpose. Accuracy is a property of the mean of a given error exclusively. It is very important to

make a distinction between an accurate and an unbiased sample. An unbiased sample implies that the mean of the selection error,  $m_{SE}$ , is equal to zero. . . . The bias is never strictly zero. . . . It is a limit case never encountered in practice.

Usually the term “precision” is used to describe the reproducibility of estimates. An estimate is precise or reproducible when the variance of the selection error (this is also called the sampling error),  $s_{SE}^2$ , is not larger than a certain standard of precision,  $s_{OSE}^2$ , regarded as acceptable for a given purpose. Precision is a property of the variance of a given error exclusively.

The precision that is used for a particular study should not be the precision attainable in the laboratory but should be the precision attainable by the entire sampling and analysis scheme. Precision is controlled by the step in the sampling chain with the largest error. This step is seldom the laboratory. Van Ee et al. (1990) have developed a rationale for addressing the precision and bias of the entire measurement process that closely follows the concepts outlined in Pitard’s text (1989a).

When the difference between background and some action level is small, it will be necessary to meet precision standards that are quite rigorous. The precision of samples that have been subjected to the comminution process outlined in Appendix A should have a potential for less bias than samples that have not been handled in this detail. VOA samples can be expected to be less precise than would a metals sample that had been dried, ground, and properly split.

## **BIAS**

Bias is most often used in U.S. EPA sampling efforts to reflect the accuracy of the analytical method and, therefore, only looks at one very small component of the total sample bias. It is usually determined by evaluating spiked samples and referee samples. These samples do not measure sampling bias. An unbiased sample is an unattainable limit (Pitard, 1989a) except under conditions where all particles are exactly alike or when the entire lot is submitted for analysis. (A forensics specimen may be completely digested and analyzed in order to determine its composition. There is no sampling bias in this case.)

Bias cannot be measured because the true concentration of a pollutant in a sample is unknown. The tools that are used to extract a sample and the preparation of the sample, as well as the analysis, can introduce bias into the measurement results. The use of spiked samples is often used to attempt to determine if bias is present in the analysis. Van Ee et al. (1990) outline a procedure or rationale that attempts to identify if bias is present in the measurement process. This reference should be considered when designing the sampling protocol and appropriate field evaluation samples interjected into the sampling chain.

## SUBSAMPLING

Cochran (1963) outlines the statistical concepts of subsampling, or two-stage sampling as he calls it. When a sample of any population such as soil is collected, it usually is necessary to reduce it to some smaller portion of material for chemical analysis (i.e., a subsample). An example will help to understand the statistical concepts involved.

**Example 6:** Approximately one kilogram of soil is taken from the wells of a sampling pit by creating a series of steps that are the thickness of a stratigraphic unit (layer of soil). The samples are collected with a coring device and traverse the entire layer; thus, the sample is correct for a two-dimensional waste. In a preliminary study, the contaminant was shown to be moving only through a fine, sandy layer of soil located from 0.9-1.0 meters below the surface. The analytical laboratory makes use of only ten-gram samples. There would be approximately 100 ten-gram subsamples in the material sent to the laboratory. This must be split into a single subsample.

Variability in samples taken for assessing chemicals that do not change with the sampling procedure (such as metals or nonvolatile organics) can be further reduced by making the analytical subsample from a number of increments of smaller subsamples.

Cochran (1963) notes that “the principal advantage of two-stage sampling is that it is more flexible than one-stage sampling.” He further notes that a balance between precision and cost must be weighed in determining which approach is to be taken.

Barth et al. (1989) defines an “action support” for a block of soil. Sampling from such a block is in reality a form of sub-sampling. The block that has been identified for sampling becomes the population or lot (L) that is to be sampled. Some form of systematic or probabilistic sampling must be used to extract the material that will be sent to the laboratory. Depending upon the approach and philosophy of the sampler, this may be the sample or it can be considered as a subsample of the support. The analytical sample then becomes either a subsample or a sub-subsample. The latter is a three-stage sampling process.

The components of variance procedure discussed briefly in Section 2 makes use of multi-staged sampling in order to be able to identify where the variance is being introduced into the sample.

Liggett et al. (1984) define a subsampling procedure as: “...a sequence of steps by which one extracts from a sample of a bulk material a subsample of suitable size for chemical analysis.” They also note that the procedure used can have a marked influence upon the results obtained. There are three steps involved in arriving at the average concentration of a bulk material such as soil -- sampling, subsampling, and analysis. The procedures for sampling the lot must account for the variation found in the material itself. Persons interested in obtaining a detailed statistical understanding of the influence of the sampling procedures



upon the results obtained should consult the works of Liggett (Liggett et al., 1984) and his co-workers.

Procedures outlined in Section 2 provide a guide for subsampling a larger sample of soil. One of the key elements of Pierre Gy's particulate sampling theory is the identification of the size or weight of sample that must be taken in order to insure a particular level of reliability. The protocol developed as a result of using the sampling nomograph (Appendix A) provides one means of developing an appropriate sub-sample.

This procedure is by no means the only approach that can be used. Other approaches can be used when the chemicals are volatile or for some reason cannot be handled in the manner outlined. For example, when volatile chemicals are being assessed, it may be necessary to take a number of small incremental samples and analyze each of them. The average concentration then becomes the mean of these subsamples.

Rogers et al. (1988) describe a field method for determining the amount of soil to extract from a core in order to subsample the core. Procedures outlined in Section 2 and described by Pitard (1989a) can be used with this method. Essentially, the method takes randomly located increments of the core to make up the subsample. As long as sample correctness is insured, this would provide an unbiased sample. The number of increments should be increased if experience indicates that the variability within the soil core is large. This can be determined during Phase 1 or the pilot study.

## **DOUBLE SAMPLING**

The term double sampling should not be confused with two-staged sampling. The latter is really subsampling. Double sampling makes use of sampling an area in phases. Estimates of the mean and variance obtained in Phase 1 of a study are used to develop the design used in Phase 2. The phases of the study may occur within a day or two of each other or there may be several months between the phases. The lag time is dependent upon analytical time and the time for review of the Phase 2 sampling plan.

Barth et al. (1989) recommend that double or multi-phased sampling be used when there is little or no information about the site. This provides the data needed to develop a more focused sampling plan. Cochran (1963) notes that double sampling is often used when stratification is deemed necessary to control some of the sources of variation within the data.

The efficiency of geostatistical tools can often be enhanced by stratifying the site according to levels of contamination. This is especially true when a plume of pollutant has developed over time. The orientation of the sampling grid along the axis of the plume provides a means of identifying the trend of the data and controlling this in the analysis of the developed variograms and in kriging the data.

A second type of double sampling is noted by Cochran (1963) and used by Geist and Hazard (1975), who made use of this technique to develop a rapid method for screening a large number of soils on a national forest in northeastern Oregon. A large set of samples was collected and analyzed by an inexpensive, rapid analytical method. A second smaller set of samples was collected and analyzed by a more expensive, lengthy, and difficult method of analysis. A regression equation was developed from the two sets of data. These data were then used to determine the optimum number of samples and analyses to be taken for each type of analytical procedure. These authors also noted that a level of precision can be used as the deciding factor rather than cost. An example using actual PCB data is presented in Appendix E.

## **COMPOSITE SAMPLING**

The standard deviation around a mean estimate obtained from a series of samples taken from a block or batch of soil material is often quite large. This is especially true with wastes that have been deposited on the soil. A well homogenized sample made up of a number of increments of material or from several samples collected from the block of soil will normally exhibit a smaller variance. This sample is called a composite sample.

The use of composite samples is often recommended as a means of reducing the cost of sampling at a particular site. One often encounters sampling plans that composite samples of soil taken over the entire depth of the sampled profile. This can be useful in some cases but should be used only after considerable thought. Properly used, compositing can provide a means of quickly assessing if an area needs further sampling, but it must be used with caution.

The author was asked to review a protocol for a site located in the Midwest where compositing was not appropriate. The study was attempting to determine if soils over a large site were contaminated. A one-foot segment of soil core was taken every five feet down to a depth of approximately fifty feet. These segments were then combined into one sample, homogenized, then subsampled. This approach was intended to show if contamination was present anywhere in the profile. Needless to say, the effort found nothing except in some very high concentration hot-spots. Additional sampling carried out at a later date showed that the pollutant was located in a very narrow zone that fell outside of the sampling intervals chosen for this study.

Pitard (1989) recommends developing a sample by taking a large number of small increments and combining them into a single sample submitted to the laboratory. This sample is then reduced to an analytical subsample by splitting or some other method of volume reduction. This approach provides the benefits of the composite sample and yet avoids the problems of homogenization, etc., that one encounters with large volumes of soil. Appendix A outlines procedures that make use of Gy's sampling theory to carry out the

reduction of sample size. Pitard's text (1989a) outlines several other methods and discusses the potential for bias associated with each.

Skalski and Thomas (1984) outline a procedure for using Bayesian statistics and compositing of samples as a means of identifying the size of a spill zone. Bayes statistics allows the investigator to make use of prior information to guide in the design of the next phase of sampling. These authors go through a procedure for evaluating composite samples. This is discussed in an example given in Appendix E.

One of the problems with compositing samples is the loss of information and the loss of sensitivity because of dilution of the samples such as was noted for the Midwest site example given above. Skalski and Thomas (1984) suggest that the effects of contaminant dilution can be reduced by specifying the minimum detection limit (MDL) for the analytical procedure and what could be called the action level (AL) or action support (Barth et al., 1989) for the site. Using this information, the maximum number of samples or increments that can be composited is given by:

$$n \leq AL/MDL$$

**Equation 3-1**

The use of this equation for screening samples allows the investigator to reduce the number of samples and still detect a single composite at the AL when mixed with (n-1) samples containing no pollutant. Skalski and Thomas (1984) provide test statistics for determining if any sample within the group of samples combined into the composite were above the AL. Those groups that fail the test are then analyzed as individuals to determine which support fails the AL criterion.

Holding times can create a problem for designs in which the composite is analyzed followed by a re-analysis of those samples that failed the screening test. This is especially true when the analytical cycle covers several weeks. For most metals this may not be a problem, but with organic chemicals this may preclude the use of this approach.

In situations where a field method is available to use as a rapid screening tool and where the field method has a low detection limit, such a method can be very useful. Only those samples likely to be close to the AL need be analyzed in detail. Those that fail the field screening test can then be analyzed individually. Samples that are well above or below the AL need not be sent to the laboratory. Only those that are close to the AL need to be sent to the laboratory for detailed analysis.

Brumelle et al. (1984) indicate that composite sampling often is recommended for situations in which the cost of analysis is high in comparison with sampling costs. Efficiency of the sampling plan with the smallest variance is used as a means of identifying the most desirable plan.

## **HOMOGENIZATION**

Homogenization is not a statistical concept; however, it is used to control the variance within a sample. Pitard (1989a) points out that homogeneity is really a limit case that is rarely ever encountered. Bulk materials observed on a macro-scale may appear to be homogeneous but on a micro-scale are quite heterogeneous. Liquids may be homogeneous, but soils seldom are.

Mixing of the samples tends to reduce the distribution and segregation error (DH) provided segregation of fractions does not reoccur. Gravity induces this segregation which cannot be prevented during shipping and storage. Thus, the benefits of homogenization are temporary and unless carried out immediately prior to analysis, may not be beneficial. The constitution heterogeneity is a limit below which the benefits of mixing cannot pass. Homogenization can't improve the situation below this limit since it only impacts the segregation and grouping error.

Cameron (1986) evaluated soil homogenization from the point of view of the analytical laboratory and should be consulted for information on the techniques that are useful in the laboratory setting. He outlines the benefits of various homogenization techniques. When evaluating the information presented in Cameron's report, one should keep in mind the work of Pitard (1989a) and others that have developed particulate sampling theory. Proper incremental sampling produces the same benefit as homogenization and overcomes problems that can occur during shipment and storage of the samples.

## **RANDOM SAMPLING**

The basis of most sampling plans in environmental sampling is the concept of random or probabilistic selection of the sample to be collected and the subsample that is to be analyzed. In random sampling of a site, each sample point within the site must have an equal probability of being selected. The same can be said for the selection of particles within a sample. As was noted in Section 2, each and every particle within the sample must have an equal chance of being selected. Each particle that is not in the sample should have a zero probability of being selected.

Properly designed sampling plans based upon the laws of probability provide a means of making decisions that have a sound basis and are not likely to be biased. So-called "grab samples" or judgmental sampling are often used to do a "quick and dirty" evaluation of a site. In the legal arena, these samples often lead to problems. There is no basis for evaluating the validity of the sample, nor is there any means for using these samples in arriving at a sound decision with regards to the site. The potential for bias introduced by the person taking the sample is great and unknown. These samples, if treated properly, can provide insight into what chemicals may be present on a site, where particular activities have occurred, and the potential source of the pollutant.

These deterministic samples are nonrandom samples collected for a particular reason. Pitard (1989a) also calls these samples “purposive samples” in that they are based solely on the collector’s choice of which units are to be collected or analyzed. They are not samples but are, in reality, only specimens. Any specimen that is submitted to the laboratory should be identified in the field records as such. This prevents the sample from being treated in the same manner as those samples that are collected by some probabilistic method.

## **STRATIFIED SAMPLING**

One of the tools of sampling that can be used to reduce the variability of the sample is stratified sampling. Strata are identified as regions of the site that are expected to be uniform in character, The variance within the strata should be smaller than the variance between strata. Sampling points within the strata are selected systematically or by some random process.

Systematic sampling can be considered a form of stratified sampling, although it is not usually considered as such.

In the soil environment, strata are often associated with soil types or as areas of known pollution versus areas where pollutants are not expected to be present. Stratification is often used in Phase 2 of a sampling plan and is based upon data collected during Phase 1 or by use of field screening techniques such as XRF (Ramsey, 1989) and soil gas surveys (Devitt et al., 1987)

## **GEOSTATISTICS**

The use of geostatistics and geostatistical concepts was mentioned only briefly in the first edition of this sampling document. The techniques have been greatly improved and made available to the investigator since that time. A number of commercial organizations within the United States as well as several Federal agencies have become quite proficient in the use of these techniques as a means of providing estimates of pollutant concentrations at sites within the U.S.

Geostatistical techniques are discussed in depth in Davis (1986), David (1982) and Henley (1981). Starks, Sparks, and Brown (1989) present data on the Palmerton NPL Site in Pennsylvania where geostatistics was used to design the sampling plan as well as analyze the data generated by the sampling effort. A number of other studies have been conducted where geostatistics have been used to provide guidance on environmental remediation (U.S. EPA, 1984a, 1984b, and Florida Power and Light Co., 1986).

Kriging and the other geostatistical techniques are perhaps one of the major advances in soil mapping, isopleth development, and evaluation of the spatial distribution of soil and waste

properties. The primary purpose for the use of kriging is interpolation within the system of samples. It should not be used to extrapolate outside of the boundaries of the sampling area (Barth et al., 1989). Burgess and Webster (1980b) also point out that the results of kriging "...depend to some extent upon the tools and methods that happen to be convenient for sampling." These two factors should be borne in mind when using geostatistics.

Two types of kriging are commonly used:

- Punctual kriging where the estimates are made for points on the surface being modeled (Burgess and Webster, 1980a).
- Block kriging where the estimates are made for points lying within the block (Burgess and Webster, 1980b). It tends to produce a smoother estimate of concentrations and has a smaller estimation variance than punctual kriging.

Block kriging is perhaps the most useful approach for pollutant studies. The term block had its origin in mining where a block of ore or rock was the unit of interest. The investigator or RPM at a site desires to know not the concentration at a particular point in space but the average concentration over a block of soil that represents either an actual or potential risk to a human population or the environment. The support for a block of soil becomes the volume of material extracted from that block (Starks, 1986; David, 1982; and Davis, 1986).

Starks (1986) suggests that the geometric shape of the support for a sampling unit must be compatible with the sampling unit to be kriged. Samples should be taken from a number of locations within the block. These can be composited into a single sample. During the pilot or Phase 1 study, the investigator should plan to incorporate some form of components of variance study so that the within-block variance can be determined. This will require that several composites be prepared from samples of soil taken from the block.

Bryan (1989) indicates that the unit of soil used in block kriging can be the remediation management unit (RMU) (a block or volume of soil that must be treated). This concept offers a means for merging sampling, risk assessment, remedial activities, and cost for a unit of soil located on a site. The mechanism for creating this merger has not been formalized within the U.S. EPA. The Environmental Response Team at Edison, New Jersey, held a workshop on Data Manipulation and Interpretation in the Spring of 1990. At this workshop, there was considerable discussion, indicating that there is interest in using such a procedure. The soil sampling procedures outlined below provide a means for implementing a sampling plan that can be incorporated into a system of sampling designed to address specific volumes of soil material within a site.

## SECTION 4

### REVIEW OF BACKGROUND DATA

There are essentially five major types of sampling situations that the environmental investigator is likely to encounter. These are:

- Large area studies where the pollution is in the surface or shallow layers, e.g., in support of an ambient monitoring effort (Office of Pesticide Programs, 1976).
- Large area studies where pollution has moved down into the soil profile, e.g., assessing the impact from a major industrial complex. (Flatman, 1984; U.S. EPA, 1984a, 1984b; Starks et al., 1989).
- Localized area studies where pollution is in the surface layers, e.g., sampling around a recent hazardous chemical spill or capacitor rupture (Boomer et al., 1985; Kelso et al., 1986).
- Localized plume studies where the major source of contamination is below the surface at some depth, e.g., sampling near a leaking hazardous waste disposal site (U.S. EPA, 1982).
- Special research studies conducted for litigation, scientific understanding, method development, or source identification (Mason and Carlile, 1986; Switzer et al., 1983).

Using data acquired from the local area and from studies carried out by others, the investigator should attempt to determine which of these situations is present at the site to be investigated. The investigator should use this as the basis of a conceptual model of the situation that exists at the site. At each step of the investigation, the model is tested and refined as new data becomes available.

This determination is important because any monitoring effort requires a familiarity with the area under investigation. Too little time is usually spent in preliminary data collection, evaluation, and planning. It is difficult, if not impossible, to undertake a reliable soils study without reviewing existing data and developing a conceptual model of the pollutant behavior at the site. The data sources presented below should be evaluated and studied prior to finalizing a preliminary model and developing a plan to acquire samples to test that model.

The areas outlined below are presented to draw the investigator's focus onto those types of data that will reveal the potential location of pollutants and help evaluate their migration throughout the environment. Combined with site visits and interviews with local citizens, a good grasp of the situation can be gained by this preliminary background data collection.

Libraries, museums, governmental agencies, public agencies, data bases, and researchers are all sources of information that can be accumulated prior to finalizing the study plan. Often local citizens can provide information that is not available in any of the normal research channels. The environmental scientist working on abandoned hazardous waste sites will find that often the private citizen is one of the most useful resources of unpublished data. They have often lived in the area and are familiar with the operation of the site and may even provide insight into the types of chemicals and the methods of disposal.

The scientist working in these cases must become a detective. Any piece of information that will help determine how and where the pollutants may migrate is useful in planning the soil sampling study. Each piece of information must be sifted, sorted, and evaluated in an attempt to determine how the soil system responds to such factors as flooding, movement, and use.

The following listing of information is not exhaustive but is given only as a guide into the types of information that are available. Each researcher should be able to use this listing as a starting point from which to develop the needed data.

## **HISTORICAL DATA**

The investigator should attempt to collect all available documents dealing with the study area including newspaper accounts, if time permits. The more informed the investigator is, the better his grasp of the situation. The result should be a knowledgeable study that addresses the pollutant problem in the context of the soil system in the study area. Historical data can help answer questions about the sources of pollution, routes of migration, uses of the area, or any data that will aid in designing a study that will acquire the necessary data. The kinds of information will vary with the site but, in general, they deal with the history of use of the area, historical drainage patterns, groundwater flow and use, and environmental and health problems associated with the study area.

Sanborn Map Company in Pellam, NY, produced city maps from approximately 1870 until the 1950's. Archives of these old maps exist around the U.S. Sanborn maintains an archive of the old maps and will sell copies of these to the investigator. These maps show old structures, holding tanks, utility lines, transportation routes, water bodies, canals, and ponds. These maps have proven to be invaluable in parts of the U.S. where industrial activity extends back into that period. City atlases can provide much of the same information for the period after 1950.

Wildlife biologists and other conservation workers familiar with the natural environment in the study area, along with hunters, conservation groups, and scouting groups, can prove to be valuable sources of information about the wildlife and vegetation changes that can reflect the impacts of pollution in an area.



Stream gauging station operators, boating clubs and sportsmen are valuable sources of information about the possible routes of migration for groundwater and pollution. Often they have noted changes in color, sediment loading, algal blooms, etc., that indicate chemicals are entering the streams in the area. This becomes especially important when abandoned hazardous waste sites are the source of pollution.

Local authorities such as fire, police, health, engineering, highway and maintenance departments, tax departments, forestry and conservation workers can all provide valuable information on prior land use. Where spills have occurred, the local fire departments are often able to provide information on the movement of the spilled materials. This is especially important if they have used any particular countermeasures on unusually toxic chemicals.

Spill response teams can provide valuable information for planning further studies at a spill site. They should have information on what chemicals were used to counteract the spill, what techniques were used to contain the materials, where the materials were transported, how they were loaded, and what was done that may have spread the pollution either vertically or horizontally. The reader may ask, "Why is this item important if a response team was on site?" Experience has shown that often the spill response activities solve an immediate problem only to create a long-term problem. Information gleaned from the records of the emergency response team or from members of the cleanup crew can provide insight into where the pollutant may have moved.

The U.S. Soil Conservation Service (SCS), along with the Cooperative Extension Service and the Agricultural Stabilization and Conservation Service (ASCS), have frequent contact with the local community and are often in the rural areas. They are interested in the soil system and are usually qualified to assist in obtaining the kinds of information that are needed about not only the history of the area but also the presence and effects of pollution. The staff of all three of these groups can usually identify the local historians in the community. SCS and ASCS both maintain files of aerial photographs of the area. These files often go back for a number of years and can give information on the uses of the area along with changes in soil character with time. Example 7 shows how this information was valuable in determining the migration of pollution at a leaking underground storage tank site.

Basically, the environmental investigator is attempting to reconstruct the situation over a period of time that may extend from weeks to several decades. An attempt must be made to determine where the pollution came from, how long it has been present, where it has gone in the past, and what effects it may have had on the environment. Any information that will aid in answering these types of questions will assist in developing a meaningful study plan.'

**Example 7:** A Leaking underground storage tank located in New Jersey impacted a home located on the property adjacent to it. The insurance company was interested in determining why leaking gasoline only impacted one home located near a service station owned by their customer and did not affect other homes in the area. The 1938 Soil Conservation Service's Soil 1 Survey Map covered this area. At that time the area was open fields and farms. By 1982-83 the area was heavily urbanized. Much of the area had been leveled and old surface drains filled. The SCS map showed that a surface drainage had run from the location of the service station through the homeowner's property. Monitoring well boring logs indicated that the subsoil showed a textural change pattern that followed the trace of the old drainage channel. Closer sampling of the soil indicated that the highest concentrations of gasoline followed this old channel also. This information played a major role in resolving the case.

## GEOLOGICAL DATA

The geological character of the area is important not only for determining the routes of migration of soil pollutants but also as a factor in any attempt to stratify the area into homogeneous soil types. Parent materials and bedrock can often play an important part in determining how the pollutants will react in the soil.

The U.S. Geological Survey (USGS), the Corps of Engineers, and the Bureau of Reclamation all maintain information on stream conditions and stream flow. These agencies are valuable sources of data about the history of the stream channels, about dredging of channels in the streams, and about flooding. These factors may play an important part in determining the rate and route of pollution migration. Groups such as the Tennessee Valley Authority, the Colorado River Commission, and the Great Lakes Basin Commission have environmental scientists on their staffs that are often able to provide insight into the environmental setting of the streams and lakes in the area.

The USGS has produced many reports on the geology of parts of the U.S. Their staffs are knowledgeable on rock formations, drainage, ground-water flow and quality, and can provide maps and remote sensing data in many cases. The USGS field geologists often work closely with the various state agencies that cover areas such as mining, groundwater, construction, and environmental geology. These scientists are usually familiar-with the settings where studies are to be conducted; in fact, they have often been the first persons contacted when a problem with ground water has occurred.

Any information that will tell the investigator about the nature of the bedrock, the ground-water elevations, the direction of ground-water flow, and the sources of recharge to the aquifer should be acquired prior to developing the final study plan.

## **SOILS INFORMATION**

As was mentioned above, the SCS, the ASCS, and the Cooperative Extension Service (County Agent) are three of the best sources of information on soils in an area and should be the first point of contact before any other soils data searches are undertaken. The state and local offices of the SCS maintain information on the status of the agricultural system in the areas under their responsibility. The SCS soils reports are a good place to develop a familiarity with the soil types in the study area.

Most states maintain an agricultural school that is closely aligned with the U.S. Department of Agriculture's various offices. The Soils Department and/or Agronomy Department, if not separate departments, of the Land Grant Universities are in close contact with the SCS and are often directly involved in agricultural soils analysis work. Their files often contain valuable information on the nature of the soils in an area, and they often know of problems that have surfaced in the past. Some of the universities have maintained samples of soils from past studies. These can, on occasion, provide a valuable insight into past pollution levels if the samples have been properly maintained.

Any data that will assist in determining soil properties, chemical composition, amount of organic matter, rates of percolation into the soil, crop history, type and amounts of clay, presence of hardpans (i.e., fragipans or durapans), drainage patterns within the soil, and spatial variability in the study area can be a valuable asset when the time comes to interpret the results of the study as well as during the planning phases of the study.

Currently site investigations go through several cycles of study. More than one soil sampling effort may occur at a site. The results of these studies must be included in the planning for the current study. The quality assurance data (co-located samples, replicates, and splits) must be used to determine the number of samples and the protocol for comminution. Maps of the pollution location can be used to guide the placement of sampling points.

## **ENVIRONMENTAL STUDIES**

Other scientists often are interested in the same areas where the environmental investigator is attempting to determine the levels of soil pollution. These studies often provide valuable insight into the pollution problem even though they may not have been designed to address pollution per se. Frequently the geologist working on a ground-water problem will have information on pollutant migration and soil properties that can prove to be valuable. The well driller's log books kept when exploratory borings are made for construction of highways, water wells' or mining exploration can be used to augment the data collected by the soils investigator.

Universities in the area frequently have accumulated data as part of thesis projects and other research studies that can be used to increase the understanding of the soil system.

Where the U.S. EPA or one of its state counterparts has been investigating a particular pollution incident, the data accumulated by them along with any analyses should be consulted prior to undertaking the study. This search for data at the state level should include both the environmental agencies and the health agencies. Each state has a slightly different organizational structure; therefore, where the data is archived will depend upon the state involved.

Environmental impact statements (EIS) are a gold mine of information that can save considerable time for the field investigator. Studies where highways and canals, etc., have been the subject of an EIS can greatly increase the information available for planning with little cost involved on the part of the investigating agency.

The investigator is attempting to find information on the pollutants, routes of migration, and effects of that migration. Therefore, any environmental study that has been undertaken in the past can provide the keys to preparing a viable study plan.

## **LEGAL CASES**

Where legal action is pending at a particular location, data often is available through the various enforcement channels. This type of information is sensitive and often difficult to use due to chain-of-custody and confidentiality. Frequently government agencies will share data with each other under normal conditions, but when court action is involved or possible, data is difficult to obtain and even more difficult to use in an open forum.

Attorneys often will place restrictions on discussing a pending case with anyone that is not involved with the case. This can create problems for the field investigator who is attempting to plan a study and needs assistance from a technical expert to obtain background data or information. The attorney may not want the expert knowing about the study for fear that this information will get back to the other parties in a case. The restrictions depend upon the agency, the purpose of the case, and the particular attorney that is directing the case.

When a case is closed or has already gone to court, considerable data may be available in the various enforcement offices and in the court proceedings. This is available and can usually be obtained if the need exists. The time involved can be extensive, but the data may well be worth the effort if the soils study being planned has the potential for creating controversy or is being used in litigation.

## **REMOTE SENSING**

Imagery obtained from either aircraft or satellite can prove to be valuable in determining the impacts of pollutants and in identifying routes and effects of migration. Old landfill sites can often be identified from archived aerial photography which is perhaps one of the best

historical records available. The U.S. EPA's Environmental Monitoring Support Laboratory in Las Vegas, Nevada (EMSL-LV), is the best resource available for pollution-oriented imagery. They are knowledgeable about sources of existing imagery and also can assist in obtaining new imagery for Agency cases. Photographs taken in conjunction with accidents or chemical spills are valuable resources for determining the areas where samples should be taken.

The sources listed in Table 4-1 can often provide available imagery.

Table 4-1. Sources of Remote Sensing Imagery.

Agricultural Stabilization and Conservation Service
Bonneville Power Administration
Bureau of Reclamation
Colorado River Commission
EROS Data Center in Sioux Falls, SD
Great Lakes Resin Commission
National Aeronautics and Space Administration
National Archives and Record Service
National Oceanic and Atmospheric Administration
Rations1 Park Service
Tennessee Valley Authority
U.S. Air Force
U.S. Army Corps of Engineers
U.S. Army Map Service
U.S. Bureau of Land Management
U.S. Coast and Geodetic Survey
U.S. Forest Service
U.S. Geological Survey
U.S. Soil Conservation Service
U.S. Canadian Boundary Commission

## CONCEPTUAL MODEL OF THE SITE

A tool that has proven to be useful for designing a sampling plan is the formulation of a conceptual model of how the pollution is distributed over the site and how it might impact the environment or the public. The data that is accumulated through a search of existing information can play a vital role in correctly defining how the pollutant is distributed in the soil.

Data collected can then be used to test the model and thus provide a timely and effective evaluation of the hazards created by the presence of pollutants in the soil. If the model does not fit the data, then it can be modified to better reflect the conditions as they are discovered through sampling of the soils. The model should only be considered as a tool for focusing the sampling designs and for reducing the sampling errors inherent in soils and solid waste materials.

## SECTION 5

### METHODS FOR REDUCING VARIOUS SOURCES OF SAMPLING ERROR

The various sources of sampling error outlined in Section 2 all add together to produce the total sampling error. There are statistical and sampling procedures that can be used to control or reduce the effects of these errors. These procedures are discussed below and should be included in any sampling design.

There is a tendency on the part of many investigators who sample soil to believe that grab, purposive, biased, or judgmental sampling is all that is needed to arrive at a decision about a particular site that is under investigation. Without the input of some form of statistical control, there is no means of determining the reliability of the data or of making a valid decision about the action needed at the site. The controls discussed below are suggestions for aiding in providing the necessary statistical input into the data quality objectives for a site. Barth et al. (1989), provide guidance for developing statistical designs; however, a statistician familiar with environmental sampling should be consulted prior to finalizing the protocol document.

#### SAMPLING TOOLS

Correct sampling (see Section 2 for definition) requires that the proper tool be used. Pitard points out in his class that “the technology of correct samplers remains to be developed” (Pitard, 1989b). Soils are usually treated as two- or three-dimensional materials (Pitard, 1989a, 1989b). The selection of which model to use depends upon the data needs of the agency. Keeping in mind that two- and three-dimensional soil materials are very difficult to sample correctly, the following suggestions are made. These suggestions are modifications of those made in the original protocol document (Mason, 1983).

Soils are usually stratified into layers known as soil horizons. The Soil Science Society of America defines a soil horizon as follows:

A layer of soil or soil material approximately parallel to the land surface and differing from adjacent genetically-related layers in physical, chemical, and biological properties or characteristics such as color, structure, texture, consistency, kinds and numbers of organisms present, degree of acidity or alkalinity, etc. (SSSA, 1965).

In addition to the strata that are used for soil classification, there are also strata that are due to deposition of the original materials and that may fall outside the layers that the soil scientist normally considers. The type of layers one would place in this latter category are

the strata found within the C horizon or the “parent material.” Glacial outwash materials, for example, may contain many layers of interbedded gravels, sands, and clay laid down at different times in the glacial cycle. Lacustrine clays are another example of bedded materials that form distinct layers in the so-called parent material.

These strata become the units of sampling that should be considered because liquid pollutants frequently accumulate in the coarser layers of the soil. The Shelby tube sampler (with or without liners), split spoon samplers, and other core sampling devices are useful for sampling soil strata. Augers may be used, but the investigators should keep in mind that identification of the exact location of the sample and control of cross contamination are difficult to implement with these devices.

No matter which tool is used, it is necessary to insure that the tool traverses the entire strata or portion of the strata that is considered to be the layer of the soil. Once the core is extracted, it can be subsampled by taking segments across the entire core and combining a number of these increments into the sample to be submitted to the laboratory. Pitard (1989a) recommends that the sample be made up of thirty or more increments. This is done in order to reduce the effects of segregation or aggregation -of the pollutant within the soil.

A classical approach for sampling soils is to use a spoon, shovel, scoop, or other scraping tool. Pitard (1989a) points out that these tools do not extract an unbiased sample of the material. These tools can be used to attempt to approximate the proper model of the sample that should be extracted from the soil. For example, Drees and Wilding (1973) present a sampling design that can approach sample correctness.

Figure 5-1 shows the sampling approach used by Drees and Wilding (1973). This approach is called channel sampling by Pitard (1989a). This is a schematic showing a soil sampling pit with six channels cut into the sides of the pit. The letters A-C represent the strata or soil horizons and the numbers 1-6 represent channels or columns of soil taken from the pit. The depth of the channel (the dimension perpendicular to the face of the pit) should be as uniform as possible and the main axis should be perpendicular to the plane of the strata in the pit. It is necessary to clean the face of the pit so that a uniform depth can be extracted. This may be difficult in cases where there is debris and large rocks present in the cut. It may be necessary to work around large rocks, etc. The depth of cut should be from the plane of the cut face and not from a part of a rock or a piece of debris protruding into the pit.

**Figure 5-1 Schematic Diagram of Sampling Design**  
(After Drees and Wilding, 1973)

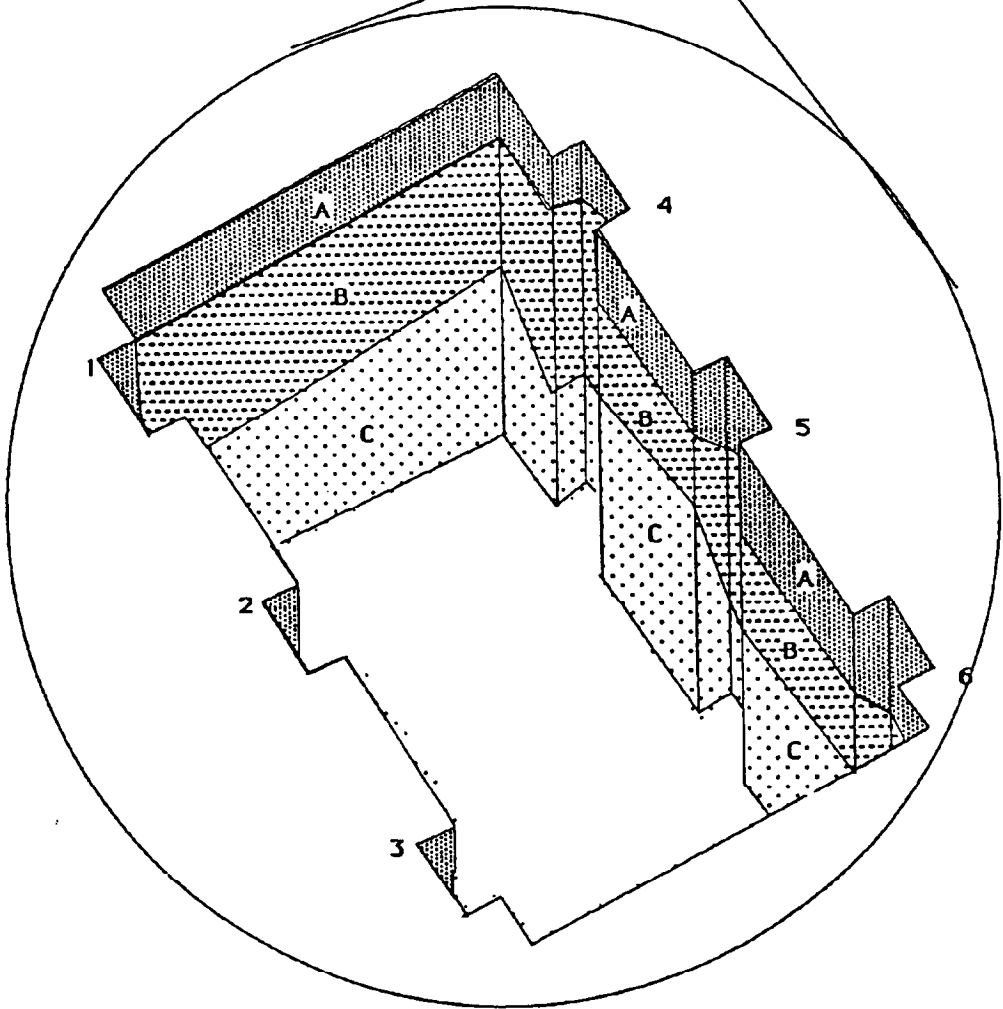
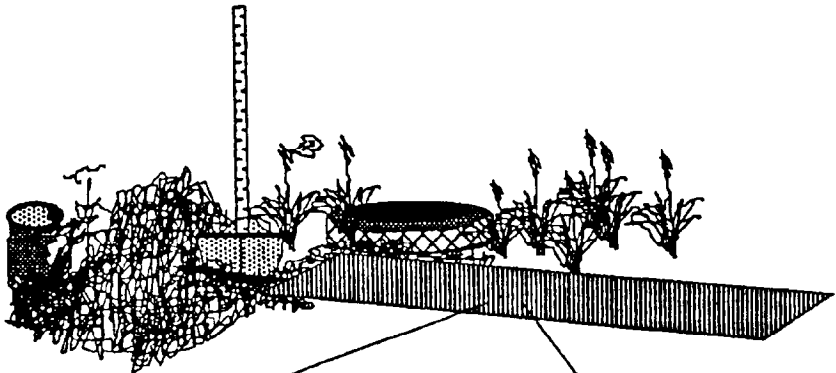



Depending upon the amount of material needed for the analysis and the purpose of the sampling effort, increments can be randomly taken from each horizon or layer in each of the cuts. These are combined into a single sample representing the layer at the pit location. The location of the increments can be determined by randomly locating (use some form of random process and not judgement to select the point) a number of segments along the axis of the channel in each horizon or depth zone. The thickness and the number of increments would depend upon the volume or weight of material that is needed to make up the sample.

Although this design is not theoretically correct from the purist's point of view, it does provide a means for approximating sample correctness in situations where rock, scrap metal, logs, tires, etc., are present in the profile if the sampling is carried out correctly. This design also provides a mechanism for estimating the percentages of these materials at a sample point.

An example is shown in Figure 5-2 of how the volumetric percentage of various materials can be estimated. A cloth or metal measuring tape is hung in the sampling cut. The specific location of the tape should be chosen by a random number or some other unbiased process. A tally of the number of inches intersected by the tape is recorded for each material. For example, rubber is transected about 2.1 to 2.3 inches and 5.4 to 6.0 inches. Thus 0.8 inches would be assigned to rubber. Wood is only intersected from about 4.1 to 4.95; therefore, 0.85 inches would be assigned to wood. Rocks would be assigned 4.15 inches. Assuming that the total transect length would be 14 inches (15.5" - 1.5"), the following percentages would be assigned to the materials found in this transect.

Soil	59.6%
Rock	29.6%
Wood	6.1%
Rubber	5.7%

A procedure obtaining a weight percentage of mixed materials was used in a study at an NPL site that contained auto fluff (Rupp, 1989). A shovel was used to extract a fixed volume of material from the sampling location. The material was then sorted by material type, weighed, and subsampled. The percentages were then calculated on the basis of the weights of each material type.

Coring devices provide the most appropriate choice of tool in order to be theoretically correct for layered materials such as soils. Often core samples are taken as part of other geotechnical exploration such as well drilling, etc. Cores are difficult to take when rock or other obstructions are present in the soil profile that is to be sampled; however, if a diamond drill is being used to collect rock cores, it may be possible to collect samples of the hard, non-soil materials in the soil layer. This is often difficult because of the unconsolidated nature of the soil/waste combination.

**Figure 5-2 Schematic for Sampling for Percentages**

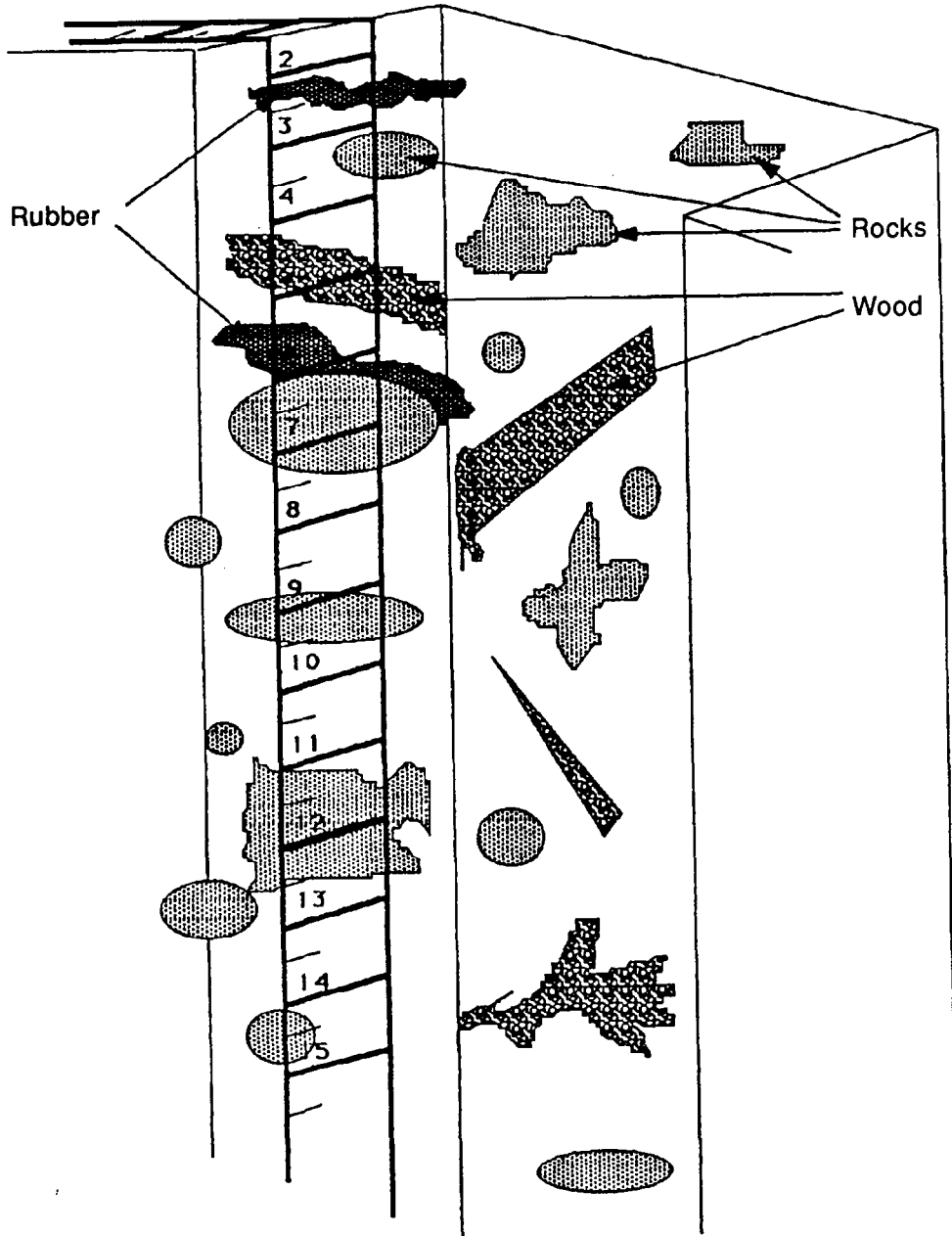

5313EAD92-4

In cases where core samples cannot be taken, pit sampling may be the only choice. A pit sampling approach similar to that used by Drees and Wilding (1973) offers several advantages. First, the entire profile is exposed so that potential pathways and channels can be seen. Second, the percentages of non-soil materials can be estimated, and third, soil samples can be obtained in situations that often cannot be sampled using any other method.

No matter which sampling method is used, it is necessary to insure that delimitation of the portion of the soil to collect is correct and that extraction of this portion is also done correctly. Keep in mind that sampling is correct when the probability of collection of all fractions of the soil is constant. If any fraction is excluded or favored, sampling is not correct and therefore, the results will be biased.

The importance of this bias may be minimal. Samples are often screened in the field to remove debris and rocks larger than approximately  $\frac{1}{4}$  inch or 2 mm. This biases the sample; however, this may not be significant to the study. A sampling study could be done as part of the pilot study to determine the significance of screening to the results.

The author recommends that double sampling similar to that outlined by Geist and Hazard (1975) and shown in Appendix E be used. A set of sample pairs taken over a range of concentrations would be used to evaluate the effects of non-soil materials on the results. One member of the pair would be screened and the second would be comminuted and sampled according to the methods shown in Appendices A and B.

This process would allow the investigator to make an informed decision about including the non-soil fraction or excluding it from the sample. If a decision was made to exclude this fraction, the investigator would be able to support a claim that this exclusion had limited effect upon the results of the investigation and would be able to indicate the size of any effect.

## **SAMPLE SELECTION**

The location for collecting a soil sample, the position of the sample pit, and the location of the cores should all be chosen by some random selection process. When the judgment of the investigator is the major criterion for selection of the samples, these samples are automatically biased. The materials submitted to the laboratory are not true samples but merely specimens of soil. Their use in litigation, in regulation, and for scientific discovery should be very much in question. There are situations where judgmental samplings can be justified. They can provide assistance in helping to develop a conceptual model of how the pollutant is distributed or migrating, but they should not be used in characterization of the site.

Sampling that is to be used in the various phases of the regulatory process can be greatly enhanced by the use of the statistical approaches outlined by Barth et al. (1989), Rogers et

al. (1988), and Van Ee et al. (1990). The entire risk assessment process is based upon probability of a particular outcome; therefore, the sampling that is to be a part of a risk model should also generate the quality of data that provides proper input for the assessment.

Most decision techniques also make use of various probability functions to aid in choosing an appropriate course of action. The DQO procedures developed by the agency are founded on the use of statistical reliability of the data required for the RPM's and the Regional Administrators (RA's) to arrive at a decision about a particular site. A recent article by Neptune et al. (1990), outlines the development of DQO's for a site. This article also defines an exposure unit (EU) that is similar to the remediation management unit (RMU) of Bryan (1989).

Geostatistics has created an emphasis upon the use of systematic sampling with grids, radial transects, or some similar approach to sampling. Grids are in reality nothing more than a form of stratified sampling with the strata based upon spatial location of the sampling unit. The starting point of the grid should be chosen by a random process.

Occasionally, the orientation of the grid is also chosen by the use of a random selection process. Where a plume is suspected and the orientation of the plume can be estimated, it is desirable to orient the grid so that the long axis of the grid is parallel to the suspected plume center line. This is not necessary, however. Griffiths and Ondrick (1970) indicate that a square or rectangular grid is the most useful for reconnaissance. By use of statistical comparisons between rows and columns in the grid and the appropriate interaction terms in the statistical analysis, it is possible to determine: (1) if there is any structure to the pollutant; and (2) identify the approximate orientation of the pollutant (i.e., the plume direction). The latter is accomplished by mathematically rotating the grid orientation until the interaction term is no longer significant.

## **SAMPLE PREPARATION**

The procedures outlined below are an attempt to incorporate some of Gy's theory into soil sampling at hazardous waste sites. These procedures are examples only and are not intended to represent a standard method that should be used in all cases. Each investigator should use the suggestions given below as a starting point for developing appropriate sampling methods.

### **Reducing Sample Volume for Submission to the Laboratory**

Earlier when the choice of a sampling tool was discussed, a suggestion was made that cores or channel samples be used as a means of collecting a correct sample. Frequently the procedure for collecting the sample is to remove the soil from the channel or split spoon, place it in some container, such as a disposable aluminum roasting or turkey pan, mix the

material as best one can in the field, then take a portion of the material by systematically or randomly taking a number of increments and placing them in the sample bottle. This procedure is very common, but it is incorrect sampling as it is usually practiced.

The analytical laboratory requires only a portion of the total material extracted. The field team must have a method for reducing the volume of material down to an appropriate subsample. Coning or quartering is occasionally used to reduce the volume of material down to a manageable volume. Pitard (1989a) notes that this is also prone to bias.

Pitard (1989a) recommends the use of riffle splitters, alternate shoveling, or incremental sampling. With the exception of incremental sampling, these methods will not work with VOC samples. Riffle splitters are usually used in analytical laboratories and only work with freely flowing materials such as dry, screened soil. Alternate shoveling offers a method that can be used in the field if the material is not cohesive, such as wet clay. The material is placed on a flat surface, such as a plastic sheet. One shovel or scoop full of material is placed in a discard pile and the next placed in the sample material. This process is continued until all of the material is divided. This can be repeated if it is necessary to reduce the material further. Incremental sampling involves extraction of one or more distinct increments of material for inclusion in the sample.

The core or channel sample offers a means of reducing the volume of material at the time of collection. A number of random, narrow segments of the channel or the core are taken by cutting across the material at each subsampling point. This is placed in a sample container. The core or channel is then cut at the top of the next sample increment and the waste discarded. This process is continued until the amount of material needed for shipment to the laboratory is obtained.

If the sample is still too large, as might be the case when the sample reaches the laboratory, a flattened elongated pile of the material is formed. Increments of this are selected by cutting completely through the pile and including these in the sample. Figures 5-3, 5-4, and 5-5 (based on Pitard, 1989a) show two approaches for carrying this out -- incremental sampling and splitting. The incremental sampling process is broken into four basic and independent steps. These are:

- 1) Sample point selection: all points along a one-dimensional lot are submitted to either a random or a stratified random selection process. The appropriate number of points are selected.
- 2) Increment delimitation: the size and orientation of the increment is chosen so that the increment crosses the entire sample and takes all material in that increment. This is a mental process, the sample is not handled. A light line might be drawn across the material with a spatula blade.

**Figure 5-3 Incremental Sampling Process for Cores**

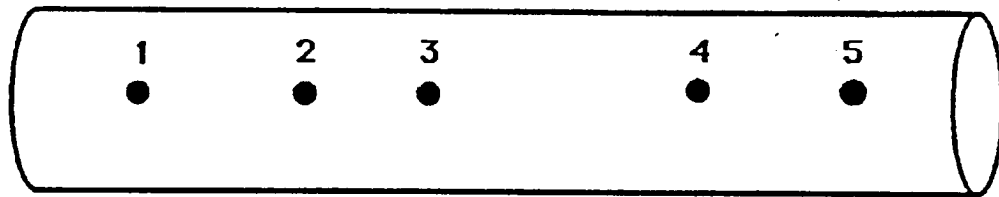

Selection of Increments

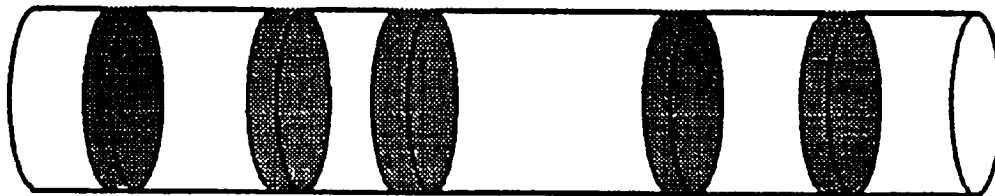

Delimitation of Extended Increments

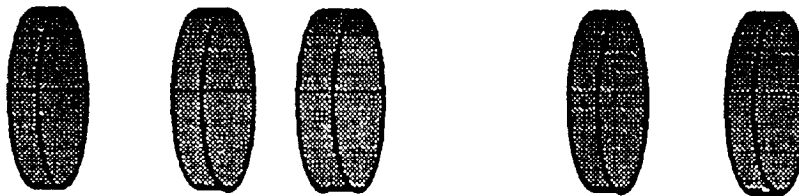

Extraction of Increments

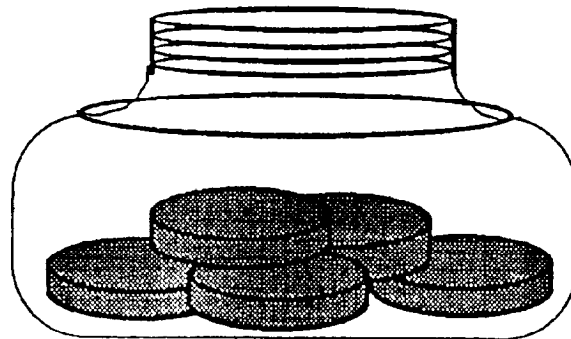

Reunion of Increments into Subsample

**Figure 5-4 Example of Splitting Process with Riffle Splitter**

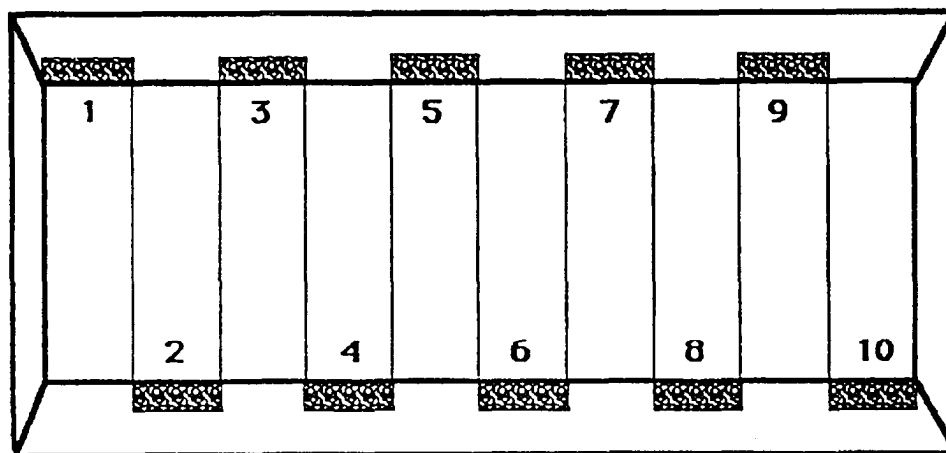
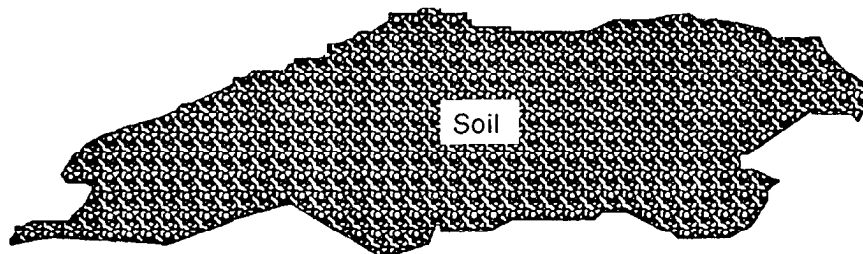

Separation of Fractions

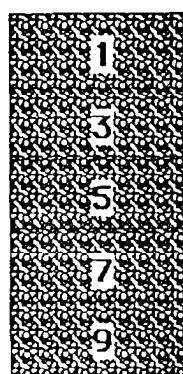

Discard Fractions

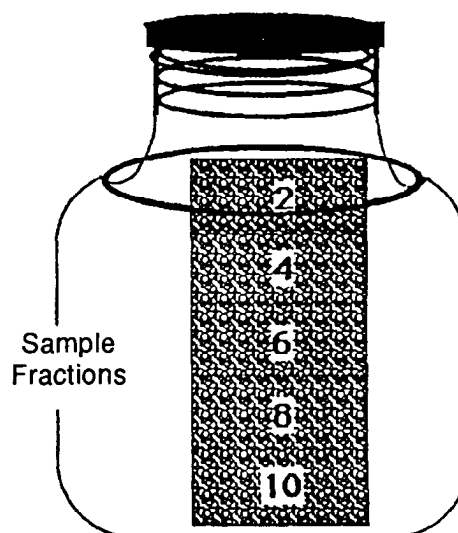

Sample Fractions

**Figure 5-5 Correct Incremental Delimitation**

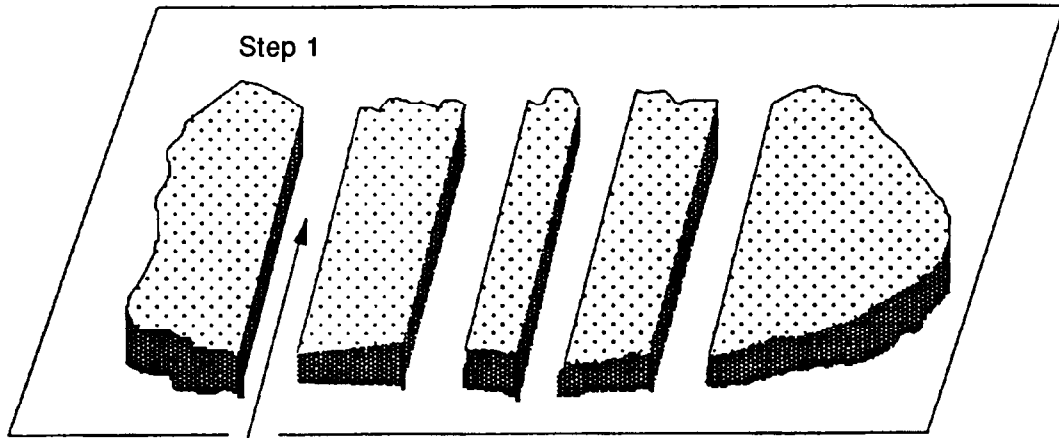

Spatula trajectory

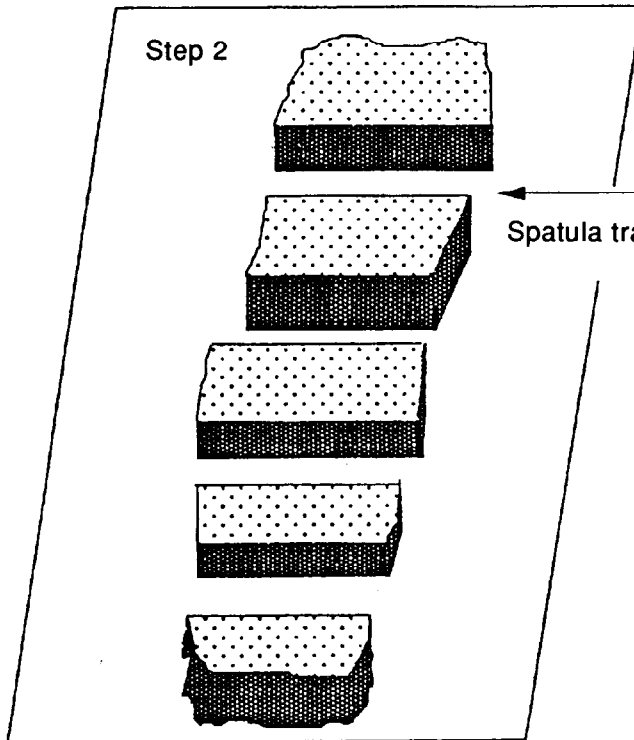

Spatula trajectory

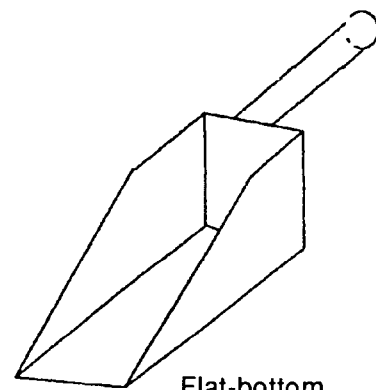



- 3) Increment extraction: the increment is removed from the mass of the material. The tool used must remove all of the material lying within the delimited increment.
- 4) Increment reunion: the increments selected are then recombined into a single sample to be submitted to the laboratory.

This process is most often used for sampling flowing streams or cores. These samples are considered to be punctual or point samples when in reality they are an extended sample of this point. Figure 5-3 shows this process for a soil core taken from a split spoon sampler. Figure 5-5 shows incremental sampling of loose material. The selection of the increment is made prior to extracting the material for the subsample.

An appropriate number of random locations or points are chosen along the length of the core. These points are then expanded into a segment across the core (this is a mental process; no soil is moved at this point). After the segments are visually delimited, they are extracted from the core by use of a stainless steel spatula or knife. The segments are then placed in a mixing pan, a shipping bottle, or some similar container. If the laboratory is known to use an appropriate subsampling procedure, it is not necessary to mix the increments. However, if the laboratory is unknown, it is advisable to mix the increments prior to shipment to the lab.

Although similar to incremental sampling, splitting divides the material into a number of equal segments that are selected after the material is divided. Pitard (1989a) breaks the splitting process into four independent steps. These are:

- 1) Fraction delimitation: the subsampling tool delimits the boundaries of the fractions of the material to be subsampled. The cells of a riffle splitter delimit the material into equal segment or fractions.
- 2) Separation of the fractions: the fractions are split or separated from each other.
- 3) Reunion of fractions: the fractions are regrouped by some systematic scheme.
- 4) Sample selection: the actual material to be submitted is selected by some probabilistic sampling procedure.

Examination of Figure 5-4 shows that the major difference between incremental sampling and splitting is in the selection point. Incremental sampling selects the sample material before delimitation and extraction. Splitting makes the selection after the extraction is complete. When cores are used, or in the case of VOC sampling, only the incremental sampling is appropriate, although splitting can be used with a core. Once the sample is

collected, it may be necessary to further reduce the volume of material at the laboratory. Either approach can be used for the final sample volume reduction.

Figure 5-5 shows how incremental sampling can be carried out in either the field or the laboratory (Pitard, 1989a). A flattened elongated pile is formed from the material. One set of incremental samples is collected, then the pile is reformatted along another axis. A second set of increments is then collected. The final sample should contain approximately 25-30 small increments. This procedure provides a correct sample provided the spatula is flat bottomed and collects all material in the delineated increment. Figure 5-5 exhibits a schematic of a flat-bottomed spatula that can be purchased or manufactured by a sheet metal shop.

When particle size is too coarse to permit the reduction of volume by incremental sampling or splitting, it will be necessary to screen the sample or else follow procedures similar to those outlined in Appendix A where the particle sizes are reduced by grinding or crushing. These procedures can be used for metals and most semi-volatile chemicals but not with volatile organic analysis. Care must be exercised in order to avoid cross contamination. If non-soil materials, such as gravels, can be shown not to contribute to the pollution, they can be screened out of the sample and weighed. The remaining material can then be subjected to incremental sampling or splitting.

Pitard (1989a, 1989b) makes several suggestions for reducing the various factors that lead to the segregation and grouping error (GE). These suggestions are:

- The effects of the constitution heterogeneity (CH) can be reduced by optimizing the sample weight (the smallest weight that will give the desired fundamental error). This is done by use of the techniques discussed in Appendix A.
- Reduce the effects of grouping within the material by taking as many increments of the material as possible. At least 30 increments are recommended (this number of increments is based upon the results of numerous sampling experiments (Pitard, 1989a)).
- The effects of segregation can be reduced by homogenization if this is feasible. The laboratory can carry out these processes, but they are very difficult to do in the field. Also keep in mind that homogenization is not stable over any extended periods of time because of settling, etc.

## VOC Sampling

Sampling for analysis of volatile organic compounds presents a problem for the investigator. Lewis et al. (1991), Siegrist and Jenssen (1990), and Urban et al. (1989) have outlined new approaches for handling VOC samples. These are still under investigation and have not been officially adopted by the U.S. EPA. At the present, the only thing that can be said when VOCs are found in the sample is to note that VOCs are present. With the exception of the methanol preservation method, there is no way of quantitatively determining the concentrations of VOCs. Shipping, storage, homogenizing, sample weighing, or any of the other steps that normally precede analysis provide a point where pollutants can be lost from the sample. Samples are much easier to handle and blend when they are dry. Drying is totally out of the question when VOCs are present.

In discussions with Francis Pitard\*, he noted that the only way to insure that the VOC sampling is correct is to use incremental sampling and to take as many increments of soil as possible. Where small cores can be taken (i.e., fine grained soils), it would be better to submit the entire core segment for analysis if the laboratory can handle these samples. This is seldom possible because many site soils contain some larger coarse-grained materials.

The guiding principle to keep in mind with VOC sampling is to maintain the sample in an intact form from the time of collection to analysis if at all possible. When this cannot be done, every effort should be made to expose the sample to the air for as short an amount of time as possible and use preservation methods similar to the methanol method outlined by Siegrist and Jenssen (1990) and Urban et al. (1989).

Procedures for handling these materials are being considered by several organizations. Lewis et al. (1991) reviewed a number of methods that can be used for handling VOCs in soils. One suggestion is to preserve the sample in methanol. This procedure was reported by Siegrist and Jenssen (1990), Slater et al. (1983), and Urban et al. (1989). All of these authors indicate that the methanol preserved samples exhibited concentrations that were up to an order of magnitude higher than the standard method of sampling for VOCs.

The variability in the sample results was further reduced by Urban et al. (1989) who used a 200-gram sample in a 500 ml glass wide-mouth bottle with a Teflon-lined lid. This was contrasted with the standard 4 grams in a 40 ml VOA vial. The cost of the larger container was approximately one dollar per sample more than the presently used 40 ml VOA vial. The larger, methanol preserved samples had a concentration that was approximately an order of magnitude higher than that obtained by the currently used method.

They also suggest that it is practical to use a 100-pound sample in 25 gallons of methanol for characterizing materials from a landfill. These larger samples provide a better estimate of the

---

\* Personal communication, June 1990.

of the concentration and have a smaller variance due to the larger weight of sample. Because of the lower variance, fewer samples would be required to characterize a site. (See Section 6 and Barth et al., [1989] for the procedure for determining the number of samples needed). A representative sample of coarse materials could be attained without grinding or crushing. There are difficulties in handling the large volumes of solvent, but it is feasible to use such a procedure if it is justified by the conditions of the site.

The American Society for the Testing of Materials has a draft procedure in preparation titled "*Standard Practice for Sampling Waste and Soils for Volatile Organics Analysis*" that may be available shortly. This procedure will make use of methanol preservation.

### **Rocks and Large Fragments**

Perhaps one of the most difficult problems to overcome for the environmental investigator is the problem of the presence in samples of rock and other large debris items such as logs, glass, demolition rubble, scrap steel, etc. The procedures outlined by Pitard (1989a) come out of the mining industry where crushing, screening, and similar techniques are a common practice. In the laboratory they are occasionally used, but the practices are not normally encountered. Cameron (1986) outlines some procedures and equipment that can be used in the laboratory for grinding and mixing samples.

When laboratory sample sizes are greater than ten grams, only the highest analyte concentrations and very heterogeneous materials create a major problem for the analyst if the particles are less than a quarter inch in diameter (see the nomograph in Appendix A). Particles of this diameter are classed as fine gravel (Soil Survey Staff, 1975).

For soil materials that are close to cleanup levels used in most remediation work at Superfund NPL sites, high concentrations do not cause a problem because these areas are subject to remediation no matter which sampling methods are used. Only those areas that are close to a lower remediation limit are likely to be missed if there is a bias in the sampling effort. Heterogeneity is more of a problem under these lower limit cases because it takes more samples to determine if an area is above or below the limit.

If the model for risk assessment can be adapted to take into consideration the presence of the larger materials, and if some means can be determined for estimating the amount of pollutant that is associated with the larger rocks, these can be screened out of the sample and handled mathematically rather than analytically. A rationale for this would be the fact that the pollutant is normally associated with the fine soil materials such as the silts, clays, and organic matter. The fine materials normally contain a larger percentage of the pollutant than the coarse materials. The data in Example 3 show this effect where the PCB concentration in smaller particle sizes was approximately an order of magnitude higher than the concentration in the large particles.

Two possible approaches for handling materials where there are larger sized particles would be to:

- Screen out the larger materials, weigh them, and then put them through a crushing and splitting process. These would then be analyzed as a separate sample. The results of this process would then be added back into the final result reported for the soil materials taken from the site. Double sampling and regression analysis should be used to determine if the analysis of the fine materials can be used to predict the concentration in all of the materials in the block. When the results of the regression analysis indicate that this technique can in fact be done, this becomes an effective estimation tool for that site.
- The second approach would be applicable for those situations where there are materials present other than geological materials (i.e., wood, metal, glass, etc.). A procedure similar to that presented in Figure 5-2 or one reported by Rupp (1989) could be used to determine the percentages of the various materials. Samples of these would be taken and submitted for weighing and analysis. The percentages would then be used to arrive at the final concentration for a block of soil.

These approaches are field expedients and should not be relied upon for determining if a block of soil that is close to a standard or action support should be remediated or not. That should only be done with correct sampling of the RMU.

## SECTION 6

### SAMPLING DESIGNS

The selection of a sampling design depends upon the purpose for which the sampling is being carried out. A research project that is attempting to identify the source of a particular pollutant may be able to make use of a specimen taken from a known contamination source. On the other hand, a soil sampling program for a large community complex such as the lead smelters in the Dallas Lead Study (U.S. EPA, 1984b), Love Canal (U.S. EPA, 1982), or the zinc smelters in Palmerton, PA (Starks et al., 1989) requires an entirely different sampling design. The procedures outlined below provide guidance for the selection of a sampling plan. Barth et al. (1989) and Van Ee et al. (1990) provide additional guidance for developing a sampling plan.

### SAMPLING PHASES

Experience has shown that sampling is most effective when it can be carried out in two or more phases (Barth et al., 1989). The first phase is an exploratory phase, preliminary study, or pilot study designed to determine the components of variance for a particular material, to develop estimates of the variability found in the soil/waste combination, and to work out the necessary subsampling protocol. Further phases are developed from the results obtained during the preliminary study.

A preliminary study that is statistically correct can provide information that can be used during the development of DQO's and in making decisions about the sampling that is needed to meet the data requirements of the RPM.

The results of the preliminary study provide the basis for refining the conceptual model used to describe the site, its associated pollutants and possible exposure to the community or a particular portion of the ecosystem.

### SUGGESTED PRELIMINARY STUDY DESIGN

Barth et al. (1989) suggest that a study should be done in phases with a preliminary phase being used to identify the parameters in the study and to obtain information about the behavior of the pollutant at the site. The importance of an exploratory or preliminary phase in designing a study is discussed by Barth and Mason (1984).

Pitard (1989b) has suggested a design that can provide the necessary information for formulating a plan for a major sampling study. A minimum of 18 sample locations are required to carry out this preliminary study. The selection of sampling depths and the layers

that are to be sampled should be based upon a preliminary conceptual model of the pollutants distribution at the site. Samples should be taken in fairly thin layers close to the surface if there is any reason to suspect that the materials may be located primarily on the surface. Deeper samples can represent thicker strata unless there is reason to suspect zones of accumulation at depths such as one might encounter at the depth of maximum rainfall penetration in desert areas.

The site or boundaries of possible contamination should be divided into nine or more grid cells of approximately equal surface area. Each grid cell is then divided into approximately 100 subcells. Choose two subcells at random from the 100 subcells. Take a sample of weight  $w_1$  from one of these subcells and a sample of weight  $w_2$  from the other randomly selected subcell such that  $w_2 \geq 10 w_1$ .

Reduce the weight of the samples to the appropriate analytical sample size according to the procedures outlined in Section 5. Analyze each sample for the pollutants of interest. Calculate the mean and variance for each sample size. Use the results to develop a sampling diagram following the procedure shown in Appendix B. Also analyze the data by comparing the grid directions against each other and by statistically testing the interaction term. This will give an indication if there is orientation to the pattern of deposition or if a surface plume is present at the site.

If the variance of the small sample ( $w_1$ ) is approximately equal to that of the large sample ( $w_2$ ) and these are both large, then there is a strong indication that the sample weight is really not the major factor in evaluating the variability of this material. Use geostatistical methods to identify and quantify the trends and/or cycles that are creating the variability within the data.

If both variances are small, then the smaller of the two sample weights can be used to arrive at the necessary analytical results. Pitard (1989a, 1989b) notes that this is an unusual case. Experience with the variance seen in soil materials would confirm Pitard's statements about this type of situation.

Pitard (1989a) notes that in cases where the variance of the small samples is greater than the variance of the large samples, an effort must be made to optimize the sample weight by using techniques outlined in Appendix A. This is the most common case encountered in environmental work.

When the opposite situation occurs (i.e., the variance of the large sample is larger than that of the small sample) the investigator should be concerned. Pitard (1989a) points out that this is most likely due to the presence of clusters of material with high concentration scattered in a homogeneous background matrix of low concentration. The small samples are most likely orders of magnitude too small. The study should be repeated with a third set of samples such that  $w_3 \geq 10 w_2$ . Another clue to the presence of clustering would be the fact that the averages calculated by  $w_1$  and  $w_2$  would be quite different with  $a_1 < a_2$ .

Ingamells (1974) notes that, in cases where there is considerable segregation of the material of interest (pollutant is present in pockets of high concentration within a low concentration matrix), it may be advisable to take a third series of samples even if the conditions discussed in the above paragraph are not a problem. This would be especially important if clean up costs are expected to be quite high or the reliability must be high for some other reason.

A nested design similar to that discussed in Barth et al. (1989) can be used to obtain information on the components of variance for a sampling program. The design shown in Figure 6-1 requires a minimum of 27 samples and 81 analyses. The components of variance for this design are location, field replicates, splits, and analysis. If there is reason to believe that the instrumental portion of an analysis is creating problems, the laboratory can be asked to analyze each extract three times and report all three results. This allows a fifth component of variance to be evaluated. (This suggestion is seldom necessary with the sophisticated instrumentation used in current laboratory practices.)

As was discussed in Section 1, the laboratory is not the main component of interest in most cases. The nested design shown above can be modified to evaluate other components of variance. The analytical and the sample preparation components can probably be grouped into a laboratory component and the gain in samples added to other parts of the design or else another field sampling component can be added. Statisticians can help adjust the design so that a partial design can be used. This provides a means for adding more elements or for increasing the degrees of freedom for components such as location or soil type.

Van Ee et al. (1990) has proposed a set of audit samples that will provide estimates of a number of components of variance. This system is somewhat unique in that the audit samples are double blind samples that are interjected into the sampling chain at different points. By careful evaluation of these samples, it is possible to determine where errors are being introduced into the sample results. Field audit samples can be prepared from soil from the actual site. These look like the materials being submitted to the laboratory and should provide an estimate of the bias in the sample results.

## **VOLUMETRIC AND AREA SAMPLING**

There are cases where an area or volume of soil is the unit of measure desired rather than a concentration measure. Normally, the investigator will call for a method that uses an increment of surface area as the sampling unit. The sampling units can be any geometric shape with a fixed area. Normally squares, circles, or rectangles are excavated to a designated depth. An example would be the collection of surface soil samples for determining the deposition of radioactive fallout. Deposition velocity and exposure were the parameters of interest in radiation monitoring of soils. The results of this type of sampling are reported as mass per unit area ( $\text{mg}/\text{m}^2$ ) or mass per unit volume ( $\text{mg}/\text{m}^3$ ).



**Figure 6-1 Nested Design for Determining Components of Variance**

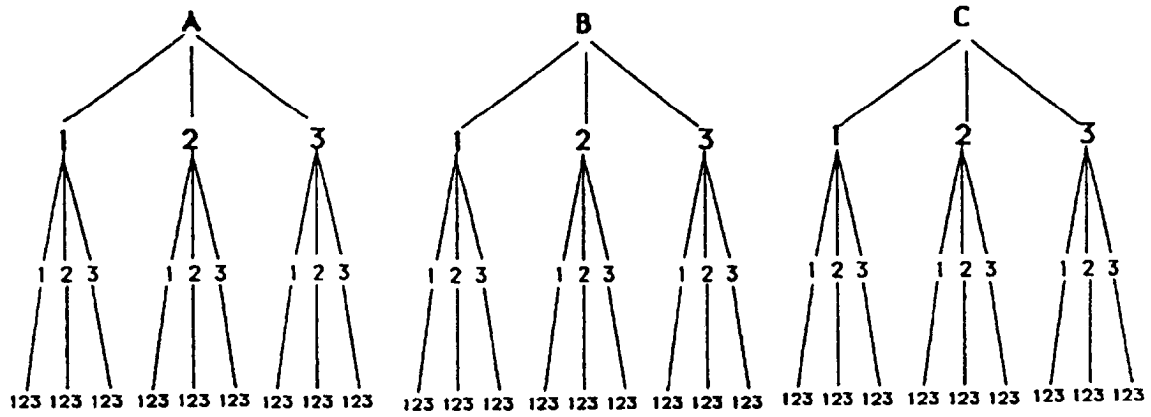

5313EAD92-8

Glenn (1983) notes that volumetric sampling carried out as part of a study in Maine indicated that the results can lead to major errors. The variation seen was traced to differences in aggregation of particles within a particular volume of soil. In a dialogue between Baveye (1983) and Hawley et al. (1983), there is a disagreement over the effects of size of the volumetric unit of soil. Baveye (1983) suggests that the volume and weight should have little effect on the results obtained if geostatistical tools are used. Hawley et al. (1983), on the other hand, suggest that there is a definite difference between large samples and small samples on a volumetric basis. This agrees with Pitard (1989a).

Review of this discussion leads one to the conclusion that, should one desire to determine pollutant loadings on a volume basis rather than a unit weight basis, an effort must be made to determine the unit density of the material. This allows the data user to equate the volumetric data to weight data and avoids the problems outlined in the notes by Baveye (1983) and Hawley et al. (1983).

Laboratories report all results on the basis of concentration per unit mass of soil (i.e., ppm or mg/kg). If the area or volume of soil that is represented by this number is important, it may be desirable to take a number of bulk or unit density measurements of the soil materials at the site. This will allow conversion to other units of measure. If the entire sample excavated is weighed prior to extracting the laboratory subsample, a conversion can also be made from this data. This latter approach is recommended in cases where materials at the site have a wide range of density such as one might encounter with a dense clay layer and an organic muck layer.

Starks' (1986) support concepts permit the investigator to relate the concentration units reported by the laboratory back to a volume or block of soil through the support for that block of soil.

## **DETERMINING THE NUMBER OF SAMPLES**

### **Number of Samples**

The number of samples required to achieve the precision and accuracy specified in the DQO's can be estimated by the use of one of the following equations:

$$n \geq [(Z_a + Z_b) / D]^2 + 0.5 Z_a^2 \quad \text{Equation 6-1}$$

for a one-sided, one sample t-test, and

$$n > 2 [(Z_a + Z_b) / D]^2 + 0.25 Z_a^2 \quad \text{Equation 6-2}$$

for a one-sided, two sample t-test (Barth et al., 1989).

- where:
- n = number of samples
  - $Z_a$  = the percentile of the standard normal distribution such that  $P(Z \geq Z_a) = \text{infinity}$ .
  - $Z_b$  = the percentile of the standard normal distribution such that  $P(Z \geq Z_b) = \text{infinity}$ .
  - a = probability of a Type I error
  - b = probability of a Type II error
  - D = minimum relative detectable difference/CV
  - CV = coefficient of variation.

For a two-tailed test, the terms for a and b would be divided by two.

**Example 8:** A site where trichlorobenzene has been detected was sampled during a preliminary study. The CV for the study was 25%. The DQO calls for a confidence level of 85% and a power of 95%. The minimum relative difference that was considered to be required to make the remedial decisions was 20%. Appendix C can be used to obtain the values for  $Z_a$  and  $Z_b$  (last line in table).  $Z_a$  is 1.062 (obtained by interpolation between .842 and 1.282), and  $Z_b$  is 1.645. D is calculated to be 0.8. Equation 6-1 is used to estimate the number of samples.

$$n \geq [(1.062 + 1.645)/0.8]^2 + 0.5(1.062)^2$$
$$n \geq 11.450 + .564 = 12.013$$

This would be rounded off to 13 samples (the next highest whole number).

### Determination of Field Sample Size

Pitard (1989a, 1989b) presents a method for determining the optimum sample weight that provides the most information about the material being sampled for the least cost. The equations used were based on work by Visman (1969) and Ingamells and Switzer (1973).

Visman (1969) identifies two sampling constants "A" and "B". The constant "A" is the homogeneity constant. The constant "B" is the segregation constant and includes the variance components for segregation, grouping, long-range fluctuations, and periodic fluctuations.

In order to make use of the sampling constants, it is necessary to take two sets of samples from the site as was discussed under the subsection on the Preliminary Study. The site should be divided into nine or more approximately equal rectangular or square cells. Take a series of small random samples of weight  $w_1$  from each cell. Follow this by taking a second series of random samples of weight  $w_2$  from the same cells. The weight of the large sample should be 10 or more times the weight of the small sample.

These two sets of samples are then reduced according to the procedures outlined in Section 5 and submitted to the laboratory for analysis. Calculate the mean ( $m$ ) and the variance ( $s^2$ ) for each set of samples (subscripts identify each individual sample); then, calculate A and B according to the following equations.

$$A = (w_1 * w_2 * (s_1^2 - s_2^2)) / (w_2 - w_1) \quad \text{Equation 6-3}$$

$$B = s_1^2 - (A / w_1) = s_2^2 - (A / w_2) \quad \text{Equation 6-4}$$

The optimum sample weight has been reported in several references (Ingamells and Switzer, 1973; Ingamells, 1974; Ingamells and Pitard, 1986; Pitard, 1989b) to be:

$$w_{opt} = A / B \quad \text{Equation 6-5}$$

The equation was originally developed as a means of obtaining the most information for the lowest cost. With most environmental sampling, the weight of the sample should be at least six times the minimum weight ( $W_{min}$ ) which is:

$$w_{min} = A / (\bar{X} - BG)^2 \quad \text{Equation 6-6}$$

where  $\bar{X}$  is the average concentration in the small samples and BG is the background concentration.

The total variance for the soil material ( $s_T^2$ ) can be estimated by the following relationship:

$$s_T^2 = A/(N*w) + B/N \quad \text{Equation 6-7}$$

where: N = number of samples  
w = weight of small samples  
N\*w = total weight (W) of material from small samples.

This estimate for the total variance is comparable to the sum of the within block variance and the between block variance shown by Krige (Pitard, 1989b).

An interesting observation can be made from use of the above equations. Equation 6-5 was derived from Equation 6-12. When the derivative of the cost equation is solved for the

minimum sample weight, Equation 6-5 results. Substituting Equation 6-5 in Equation 6-7 gives the following:

$$s_T^2 = 2B/N \quad \text{Equation 6-8}$$

This indicates that any estimate of concentration in a support or soil will be followed by an uncertainty that is equal to  $\pm(2B/N)^{.5}$ . In order to further reduce the uncertainty by  $\frac{1}{2}$ , it would take four times the number of samples. An order of magnitude reduction would take a 100-fold increase in the number of samples. This equation allows the RPM to determine if it is desirable to increase the number of samples in a study. In those cases where there is little gained by the increased cost, it may not be desirable to add additional samples to the effort.

### Cost of Sampling and Analysis

Determination of the number of samples in the section above is based upon the coefficient of variation of the sample population. There are many cases where the number of samples required by this method is not acceptable because of the cost of the sample collection, the cost of analysis or limitations imposed by the lack of available laboratory capacity to handle the analyses. The following paragraph outlines a means for integrating the costs with the precision of the estimates obtained by the sampling program.

Petersen and Calvin (1965) and Gilbert and Doctor (1985) give procedures for linking the cost and precision of analysis and the precision with the number of samples that are collected during a sampling operation. Petersen and Calvin (1965) give Equation 6-9 for estimating the number of samples that will meet the budget of a particular operation. (NOTE: Pitard (1989a) cautions against using cost alone as the criterion for defining a sampling plan.)

$$C = C_o + nC_s + nC_a \quad \text{Equation 6-9}$$

where:

n	= number of samples
C	= total costs
C <sub>o</sub>	= overhead or fixed costs
C <sub>s</sub>	= cost of sampling
C <sub>a</sub>	= cost of analysis

Rearranging this gives equation 6-10.

$$n = (C - C_o) / (C_s + C_a) \quad \text{Equation 6-10}$$

This equation, along with Equations 6-1 and 6-2, can be used to arrive at the number of samples that will satisfy the budget and still have an identified precision. Example 9 below shows the use of this procedure.

The procedures outlined by Gilbert and Doctor (1985) are based upon a fixed cost per sample. The emphasis of their paper is on the size of aliquot that the laboratory should take in order to insure a level of precision. By adjusting the aliquot size and the number of aliquots taken, the desired precision can be attained. (Dr. Gilbert and the group at Battelle Pacific Northwest Laboratories have done much to further the science of soil and environmental sampling over the past several decades. Dr. Gilbert has collected this experience together in a book entitled Statistical Methods for Environmental Pollution Monitoring (Gilbert, 1987). This book should be reviewed by anyone developing plans for soil sampling as well as other environmental monitoring efforts.)

Ingamells and Pitard (1986) link the work of Gy and Visman with cost estimating procedures. The starting equation was that shown in Equation 6-11. Equation 6-12 gives the equation for determining the minimum cost for taking samples of an optimum weight calculated according to Equation 6-5.

$$C = PNw + QN + F \qquad \text{Equation 6-11}$$

$$C_{\min} = (AP/s^2) + (BQ/s^2) + F + [(2/s^2) \cdot (AQ/BP) \cdot W^5] \qquad \text{Equation 6-12}$$

where:

- A & B = Visman constants calculated as given in Equations 6-3 and 6-4.
- Q = cost per sample for analysis.
- P = cost per gram of material sampled.
- F = fixed costs and overhead.
- S<sup>2</sup> = the desired variance.
- N = total number of samples
- W = weight of a sample

**Example 9:** A PCB spill site has been sampled during a preliminary study. The data from this phase of the study indicated that the mean concentration for a set of replicated samples was 33.5 and the standard deviation was  $\pm 11.2$ . The coefficient of variation was  $\pm 33.6\%$ . The cost of mobilization and other similar fixed costs was \$18,975. The cost of sampling was \$285 per sample and the cost of analysis was \$20 per sample. The RPM desires to determine the concentrations within  $\pm 10\%$  at a 95% confidence level. The power of the test should be 90% (Barth et al., 1989). The budget for sampling and analysis is \$45,000.

Equation 6-1 was used to determine the number of samples that would be needed to identify cleanup areas. This gave the following:

$$n > [(Z_a + Z_b) / D]^2 + 0.5 Z_a^2$$

$$n = [(1.645 + 1.282) / (.10 / .336)]^2 + (.5 * (1.645^2))$$

$$n = 98.1 \text{ samples (this is rounded to 99)}$$

The budgetary constraints indicate that the following number of samples can be taken (use Equation 6-10).

$$n = (C - C_o) / (C_s + C_a)$$

$$n = (\$45,000 - \$18,975) / (\$285 + \$200)$$

$$n = 53.6 \text{ or } 54 \text{ samples}$$

This indicates that there must be some adjustment made in either the budget of the reliability or the estimates generated by the study. Assuming that the budget cannot be increased, the reliability of the results must be reduced or the detection difference must be increased. For the purposes of this example, the probability of a Type I error will be increased. (The RPM wants to be sure that the probability of removing all of the contaminated material is high at the expense of taking some clean soil off of the site.) Using the 54 samples that the budget will allow, the following calculations are made using Equation 6-1.

$$54 = [(Z_a + 1.282) / (.1 / .336)]^2 + (.5 * Z_a^2)$$

$$Z_a = 0.9028$$

Interpolating from Appendix C gives a Confidence Level of 88.6% for this hypothetical sampling effort. The RPM may choose to work with this probability of committing a Type I error. If for some reason this is not acceptable, the RPM will have to obtain additional funding for the sampling effort.

Equation 6-12 can be used by following the procedures listed below.

1. Determine the optimum weight of sample by using Equation 6-5.
2. Determine the fixed costs (F) for the sampling operation.
3. Determine the sampling costs per gram of material collected (P).  $P = (\text{Sampling costs/sample}) / (w_{opt})$
4. Determine the analytical costs per sample (Q).

5. Solve Equation 6-11 for the number of samples that the budget can provide.
6. If this number is not the same or is less than that determined by Equation 6-1 or 6-2 then enter the number of samples determined by Equation 6-11 and back calculate using either equation 6-1 or 6-2 to determine the probability of a Type I or Type II error that this number of samples will provide. (See Example 9 for details of the back calculation procedure.)

## **SIMPLE RANDOM SAMPLING**

For those situations where there is inadequate information for developing a conceptual model for a site or for stratifying the site, it may be necessary to use a random sampling design. A random sample is any sample in which the probabilities of selection are known. Random samples are selected by some method that uses chance as the determining factor for selection. The chance mechanism used may range from a simple “toss of the coin” to the use of a random number table. The choice can be one of convenience as long as chance is the basis for sample selection. The chance of selection of any individual in the population can be calculated using the laws of probability. The random sample by definition is free of selection bias.

Simple random sampling is a limiting case of random sampling. In simple random sampling of soils, the chances of selection of any particular segment of the soil system must be the same; in other words, each member of the soil population must have an equal probability for selection. If a two-inch core sampler is used to sample the soil, the total number of possible samples is determined by dividing the total area of the study boundaries by the cross sectional area of the soil core. For example, a one-square-mile area would contain approximately 1,278,000,000 individual soil samples  $((640 \times 43,560 \times 144) / (1 \times 1 \times \pi))$ . There should be an equal opportunity for any core to be selected.

Simple random sampling is the basis for all probability sampling techniques used in soil sampling and serves as a reference point from which modifications to increase the efficiency of sampling are evaluated. Simple random sampling in itself may not give the desired precision because of the large statistical variations encountered in soil sampling; therefore, one of the other designs may prove to be more useful.

Where there is a lack of information about the area to be studied or about the pollution distribution, the simple random sampling design is the only design other than the systematic grid that can be used. The simple random sampling design is seldom used in hazardous waste site work because it does not provide the information needed for making the evaluations of pollution pattern that is often required by the RPM's. Geostatistical tools offer the best approach for determining spatial distribution.



## **Location of Sampling Points**

Once the number of samples is determined, their location can be planned. A map of the study area is overlain with a grid of an appropriate scale. The starting point of the grid should be randomly selected rather than located for convenience. This can be accomplished by selecting four random numbers from a random number table. The first two numbers locate a specific grid square on the overlay. The second two identify a point within that grid square. This point is fixed on the map and the entire grid shifted so that a node on the grid coincides with the point selected. This procedure is simple and fast. Using this technique avoids the questions that are often raised about biased sample locations.

A second alternative is to select two map coordinates at random. This becomes the starting point for the grid used in sampling. All lines are then laid out on the map overlay starting at this point and the grid lines renumbered for convenience. When the pattern of pollution cannot be identified from records, etc., the investigator may desire to also select a direction for the orientation of the grid by some random process.

Grids prepared in this fashion become the basis for the selection of the sample locations. Using the number of samples ( $n$ ) determined by Equation 6-1, 6-2 and the cost equations (6-4, 6-11, and 6-12),  $n$  pairs of two digit random numbers are selected from a random number table or a computerized random number generator. (Many hand calculators can be used in this process.) These pairs of numbers become the X and the Y coordinates of the sample locations. The first digit is the square and the second a point within the square.

This procedure is the basis for locating sampling points in all of the methods where random samples are collected. In situations similar to Love Canal (U.S. EPA, 1982), a house lot may be the sampling unit. In this case, either the grid intersections can be used to locate the houses to sample or a listing of the houses can be prepared and the addresses chosen by a random number process.

## **STRATIFIED RANDOM SAMPLING**

Prior knowledge of the sampling area and information obtained from the background data can be combined with information on pollutant behavior to reduce the number of samples necessary to attain a specified precision. The statistical technique used to produce this savings is called stratification. Basically, it operates on the fact that environmental factors play a major role in leaching and concentrating pollutants in certain locations. For example, a pesticide that is attached to clay particles may accumulate in stream valleys because of soil erosion from surrounding agricultural lands. The agricultural land may have lost most of the pesticide because of the same erosion. Stratification in this case might be along soil types; along elevation or slope changes; or according to ridge tops, side slopes, and valley floors. Soil types are frequently used as a means of stratification, especially if they are quite different in physical and chemical properties. Sampling of soil horizons is actually a form

of stratification. Table 6-1 gives some examples that have been used for stratification of soil materials.

TABLE 6-1: Factors that can be used to stratify soils

Soil Type	- Properties of the soil are often different. For example: Comus silt loam and Baile silt loam are closely associated with each other. Comus contains mica that is known to bind a number of pollutants, whereas Baile does not contain mica.
Texture	- Sandy Loam vs clay loam
Drainage	- Streams bottoms, valley slopes and ridge tops are appropriate strata.
Uses	- Cropland, forest areas, pasture, industrial areas, house lots, factories, etc.
Practices	- No till cropland vs plowed land; areas of stockpiled drums vs areas of loose scattered material; abandoned sludge pits vs drum storage areas.
Horizons	- A horizon, B horizon, and C horizon (surface (A) usually has more organic matter in the soil).

The whole purpose of stratification is to increase the precision of the estimates and control the sources of variation in the data. The stratified random sampling plan should lead to this increased precision if the strata are selected in such a manner that the units within each strata are more homogeneous than the total population. Stratification must remove some of the variation from the sampling error or else there is no benefit from the effort (other than perhaps a better geographic spread of sample points).

In general, the more stratification, the greater the increase in precision. Petersen and Calvin (1963) have pointed out that the benefit of stratification has a limit where the law of diminishing returns takes over and no further gain in precision is encountered.

At least two samples must be taken from each stratum in order to obtain an estimate of the sampling error. The larger the number of samples in each stratum, the better the estimate will be. The number of sampling units is usually allocated according to a proportion based on the land area covered by each stratum (i.e., if the area of soil in one stratum is 25% of the total study area, then 25% of the samples would be taken from that stratum.)

Proportional allocation is used in soil sampling work primarily because the variance within a general area tends to be constant over a number of soil types. A pilot study would allow the investigator to determine if this is in fact the case. If the variances are materially different, the allocation must be on the basis of some optimum allocation system.

Sample locations within a stratum are determined according to the procedures outlined in the section on Simple Random Sampling. Each stratum is handled as a separate simple random sampling effort.

Grid or systematic sampling patterns are nothing more than a stratification by geographic area rather than some soil or pollutant property.

## SYSTEMATIC SAMPLING

The systematic sampling plan is an attempt to provide better coverage of the soil study area than could be provided with the simple random sample or the stratified random sampling plan. The exploratory study discussed earlier in this section is an example of the use of some form of grid pattern. The systematic sampling design is in reality a stratification based upon spatial distribution over the site.

Systematic sampling collects samples in a regular pattern (usually a grid or line transect) over the areas under investigation. The starting point is located by some random process similar to those discussed above in the section on locating sampling points. The samples are collected at regular intervals in one or more directions. The orientation of the grid lines should also be randomly selected unless there is a suspected plume, in which case, the orientation of one axis of the grid should lie parallel to the plume axis. This is especially important if geostatistics are being used to aid in interpreting the data.

The spacing on the grid also becomes important if regionalized variable theory (this is the basis of kriging) is used to design the study. The theory is based upon the spacing of data points along the grid lines. The samples must be close enough to provide a measure of the continuity of the location-to-location variation within a soil sampling unit.

Sampling for remediation purposes should be arranged in such a manner that the cells of the grid match the size of the remediation management unit (RMU) (Bryan, 1989). Neptune et al. (1990) make use of a block of soil referred to as an exposure unit (EU). Either of these approaches lend themselves to some form of grid sampling.

The systematic sampling plan is also ideal when a map is the final product of the investigation. This provides a uniform coverage of the area and also allows the scientist to have points to use in developing the map. (Most mapping algorithms use a grid to generate the points for plotting isopleths of concentrations, etc.)

The location of the grids should follow a procedure similar to that discussed above. When punctual (point) kriging is to be used, samples are usually collected at each grid node. It is desirable to collect duplicate samples at some of the locations in order to provide a measure of the sampling error. This will increase the precision of the concentration estimate and also allow the researcher to check sampling reliability at the same time.

Block kriging attempts to estimate the average concentration in a particular block of soil. Sampling from a grid can support this procedure. The grid cells become the surface representation of the block. Samples are collected in some randomized manner within the

block. Starks (1986) outlines the procedure for determining the support of the sampling at each block. In Starks' procedure, a number of samples are taken within each block and composited into one analytical sample.

The compositing procedures outlined by Skalski and Thomas (1984) can be used in this situation. Skalski and Thomas (1984) split each sample into two segments. One segment from each sample is stored and the others are composited. The composited sample is analyzed. If the results exceed a minimum action level, then the other parts of the cores making up the composite are analyzed. This allows the investigator to determine where in the block the contamination is located if this becomes necessary.

Barth et al.'s (1989) concept of the "action support" may preclude the requirement for the detailed procedure outlined by Skalski and Thomas (1984). If the block used in block kriging, the remedial management unit (RMU) and the exposure unit (EU) are synonymous, it may not be necessary to split the samples. At a number of locations replicate samples should be taken to determine the within block variance. The procedure suggested by Skalski and Thomas (1984) is very useful in a laboratory for reducing the sample load. Only second splits from those cores that make up a composite that exceeds some action level are analyzed.

There are two problems that may limit the use of this design. First, the estimation of the sampling error is difficult to obtain from the sample itself unless replicate samples are used at a number of sites. The variance cannot be calculated unless some method such as the mean successive difference test is used to evaluate the data. The second problem concerns the presence of trends and periodicity in the data. As was noted by Pitard (1989a), identification of trends and periodicity may be one of the most important products of the sampling effort and may be one of the major sources of variation in the data. Soil sampling seldom encounters cyclic patterns to a degree that a major problem is created.

However, trends are common in soil pollution work. That is the whole purpose for sampling in many cases. There is a whole array of methods available for handling the analysis of data from sequential sampling. An excellent reference for soil scientists working in this area is a book by John C. Davis (1986) entitled Statistics and Data Analysis in Geology. Davis spends considerable time discussing the analysis of sequences of data. Techniques such as least squares analysis, regression, filtering or time-trend analysis, autocorrelation, cross correlation, Fourier transformations, map analysis, nearest neighbor analysis, cluster analysis, contouring, trend surface analysis, double Fourier series, and moving averages are presented. Kriging and multivariate analysis are also discussed. A valuable addition to this text is a series of computer programs available with the book. Additional programs are available from a software publisher.

Cochran (1946), Yates (1948), and Quenouille (1949) present excellent reviews of the use of systematic sampling from a statistical point of view. References listed that were produced at EMSL-LV (Barth et al., 1989; U.S. EPA, 1984a; U.S. EPA, 1984b; U.S. EPA, 1986; U.S.

EPA, 1986; Starks et al., 1986; Starks et al., 1989; Flatman, 1984) also outline the use of this procedure in considerable detail and provide excellent examples of the use of systematic sampling.

Griffiths (1971) gives a procedure for identifying the structure of the minerals or pollutants observed in geological materials. The orientation of the grid cells is used to develop information about trends, patterns, and variability in the concentration of the material of interest.

## **JUDGEMENTAL SAMPLING**

This technique is often used with one of the other methods in unusual pollution situations or where effects have been seen in the past. The problem with the approach is that it tends to lead to sloppy science and wrong conclusions. The scientist's own bias is built into the sampling effort and the data, therefore, is often suspect.

Where the data has a potential for litigation or where there is a likelihood of emotional reactions to the results, this system should be absolutely avoided. A simple random design with known precision can be developed that will allow the investigator to determine the presence of pollutants without the risk of creating problems that are difficult to handle. The grid design discussed under the section on preliminary studies also offers a better means of evaluating a site. If it is necessary to use judgmental sampling, a number of co-located samples should be taken to have some measure of the precision of the sample data.

Judgmental sampling can also be used to verify the findings of some other form of pollutant identification such as the XRF, soil gas analysis, magnetometry or other similar methods. In this case, the samples are placed in locations where the field methods indicate the presence of a pollutant. Again, replicate samples should be taken to provide some indication of reliability. These verification samples should also meet the requirements of correctness outlined above. Where the areas of interest are large, it is more advisable to develop a detailed sampling plan and conduct a study over the entire areas that are believed to contain pollutants rather than using only judgmental sampling.

## **CONTROL OR BACKGROUND AREAS**

Control or background areas are used quite often in major soils studies especially if the study is attempting to determine the extent and presence of local pollution. Sites for controls must be as representative of the study area as possible. A careful survey of the area should be made prior to the final selection of a background area. In most cases, it is desirable to spend as much time searching out historical data on the control area as on the study area. The purpose of the control area is to serve as a base line against which the results of the soil sampling study can be evaluated.

Background sampling should be done in such a manner that the variability within the background area is measured. This means that several sites should be chosen and they should each be sampled.

Soil type will probably be the main factor used in selecting the control, but factors such as depth to ground water, location in relation to pollution sources, land use, and vegetation type should all be considered in making the selection. Land use patterns can play a major role in how the data is evaluated. Where pollution sources are being studied, the ideal background or control area would be a location that only differs from the study area by the absence of the pollution source. This is seldom possible, but every attempt should be made to reduce the factors that are different between the control and the study area.

Pitard (1989a) and Ingamells (1974) outline procedures for evaluating data collected over a wide area in order to identify the background levels. A very simplistic approach for estimating the background levels is to examine data from a large set of soil samples from the area under investigation. The lowest value or lowest class of values observed is most likely close to the actual background level.

## SECTION 7

### SAMPLE COLLECTION

There are two portions of the soil that are important to the environmental investigator. The surface layer (0-6 in) reflects the deposition of airborne pollutants, especially recently deposited pollutants and also pollutants that do not move downward because of attachment to soil particles. On the other hand, pollutants that have been deposited by liquid spills, by long-term deposition of water soluble materials, or by burial may be found at considerable depth. The methods of sampling each of these are slightly different, but all make use of one of two basic techniques. Samples can either be collected with some form of core sampling or auger device, or they may be collected by use of excavations or trenches. In the latter case, the samples are cut from the soil mass with spades or short punches.

The American Society for Testing and Materials (ASTM) has developed a number of methods that have direct application to soil sampling. These methods often need to be modified slightly to meet the needs of the environmental scientist that requires samples for chemical analyses since the ASTM methods are designed primarily for engineering tests. The techniques that are utilized should be closely coordinated with the laboratory in order to meet the specific requirements of the analytical methods used.

The methods outlined below are primarily for the collection of soil samples alone. At times, it is desirable to collect samples of soil water or soil vapor. In these cases, use can be made of some form of suction collector. In those cases where suction devices are used, the sampling media is water or gas and not soil even though the soil samples are often a good reflection of soluble chemicals that may be moving through the soil matrix. The statistical designs would be the same no matter which media is being sampled. These water and gas sampling methods are not discussed in this report.

Devitt et al. (1987) have presented an effective outline of the techniques that are available for monitoring soil vapors. These may be either active monitors linked to field GC/MS units or passive monitors such as adsorption tubes. This technology is rapidly changing as more investigators move into the field. The reader is encouraged to discuss the technology with investigators that are actively working in this field.

X-ray fluorescence (XRF) is now being used on a number of sites (Ramsey, 1989). The technology allows samples to be analyzed on site for a number of metals. It has the potential for being an effective site screening tool and thus providing data that can be used to reduce the number of analytical samples taken.

### SURFACE SOIL SAMPLING

Surface soil sampling can be divided into two categories -- the upper 6 inches and the upper three feet. Very shallow pollution, such as that found downwind from a new source or at

sites of recent spills or older sites with relatively insoluble chemicals, can be sampled by use of one of the methods listed below. The deeper pollutants found in the top meter are the more soluble, recent pollutants, or those that were deposited on the surface a number of years ago or covered with fill or by soil slumping. These latter situations exhibit migration downward into the deeper soil layers. One of the methods in the section on shallow subsurface sampling should be used in those situations.

Pitard (1989a, 1989b) points out that there are few correct samplers for the environmental arena. This is an area where development work can be of great benefit to the environmental monitoring field. Core samplers are correct for two-dimensional wastes or layers of soil, but they are not correct for sampling massive waste piles or other three-dimensional materials.

### **Sampling With the Soil Punch**

A number of studies of surface soils have made use of a 6 to 8 inch long punch or thin walled steel tube to extract short cores from the soil. The U.S. Army Corps of Engineers surface soil sampler is an example of this type of sampler. The tube is either pushed or driven into the soil with a wooden or rubber mallet. The core and the tube are extracted, and the soil is extruded out of the tube into a stainless steel mixing bowl or disposable aluminum pan and composited with other cores.

Two alternatives to this are the short King-tube samplers or the tube-type density samplers used by the Corps of Engineers. (These devices can be supplied by most field equipment companies or by agricultural equipment companies.)

The soil punch is fast and can be adapted to a number of analytical schemes provided precautions are taken to avoid contamination during shipping and in the laboratory. This is one of the few samplers that is truly correct according to the definitions given in Section 2 based upon Dr. Pierre Gy's particulate sampling theory. The soil material is considered to occupy a finite thickness. The punch must pass through the entire depth and be cut off on the lower end at the exact depth to be sampled.

The punch can also be adapted to use in other types of situations as long as the orientation is maintained in the vertical direction. Horizontal sampling with the punch violates sampling correctness as defined earlier.

Another adaptation of the soil punch is its use to collect samples for VOC analysis. The tubes can be sealed with Teflon caps and wrapped with Teflon tape, then coated with a vapor sealant such as paraffin or, better yet, some nonreactive sealant. These tubes could then be decontaminated on the outside and shipped to the laboratory for analysis.

Another use for this technique is found in soil microbiology work. Samples are extracted from deeper depths with core drills fitted with sterile plastic liners. The samples are capped and quickly taken to a field laboratory. The tube is then cleaned with a disinfectant and cut



with a pipe cutter and sterilized knife. A plastic syringe with the tip cut off is used as a punch. The punch is inserted into the center of the freshly cut section, and a small core of soil removed, placed in a sterile bag, and sealed. Work done by Dr. William Ghiorse at Cornell University indicates that the technique is effective in insuring that the sample does not become contaminated with foreign organisms (Ghiorse et al., 1990).

### **Ring Sampler**

Soil engineers use a tool that can be purchased from any engineering equipment supply house that can be used to collect larger surface samples. A seamless steel ring, approximately 6 to 12 inches in diameter, is driven into the soil to a depth of 6 to 8 inches. The ring is extracted as a soil-ring unit and the soil is removed for analysis.

These large cores should be used where the results are to be expressed on a per unit area basis. This allows a constant area of soil to be collected each time and they are correct samplers. Removal of these cores is often difficult in very loose sandy soil and in very tight clayey soils. The loose soil will not stay in the ring and the clayey soil is often difficult to break loose from the underlying soil layers; thus the ring must be removed with a shovel.

It will be necessary to reduce the volume of these large samples to an appropriate laboratory subsample unless the soil is collected for some of the engineering tests. The techniques outlined in Section 2 should be used for this. One approach that can be used is a variation of the quartering procedure used in the mining industry. A cutter should be made that has four or more equal segments. The cutter must pass completely through the material, taking care to insure that all four segments are equal in size. One of the quarters is then chosen by a random process. This can be further reduced by incremental sampling or by splitting as long as the increments or splits are taken at random. Pitard (1989a) indicates that alternate shoveling is a better means of splitting these samples if it can be used. Tight cohesive clays may prove to be difficult to split by any means other than quartering. Alternate shoveling has an advantage in that it is fast, produces a number of small increments that are included in the final sample, and is easy to carry out in the field.

### **Scoop or Shovel Sampling**

Perhaps the most undesirable sample collection device is the shovel or scoop. It is often used in soil sampling, but it is not a correct sampler because of its shape and its propensity for misuse. This technique is often used in agricultural sampling but, where samples are being taken for chemical pollutant analysis, the inconsistencies are too great. Samples can be collected using a shovel, scoop, or trowel if area and/or volume are not critical. Usually the shovel is used to mark out a boundary of soil to be sampled. The soil investigator attempts to take a constant depth of soil, but the reproducibility of sample sizes is poor. Thus, the variation is often considerably greater than with one of the methods listed above.

In many cases where mixed materials are present, the shovel may be the only tool that can be used. Shovels or scoops can also be used for Pitard's (1989a) "alternate shoveling

technique” that is used to reduce the volume of loose material. The scoop or shovel may also be used as a means of extracting materials during channel sampling (Drees and Wilding, 1973; Pitard, 1989a).

## **SHALLOW SUBSURFACE SAMPLING**

Precipitation may move surface pollutants into the lower soil horizons or move them away from the point of deposition by surface runoff. Sampling pollutants that have moved into the lower soil horizons requires the use of a device that will extract a longer core than can be obtained with the short probes or punches. Three basic methods are used for sampling these deeper soils:

- Soil probes or soil augers
- Power driven corers
- Trenching

The soil probe collects 12 or 18 inches of soil in intact, relatively undisturbed soil cores, whereas the auger collects a “disturbed sample” in approximately the same increments as the probe. (The auger is not recommended because of cross contamination problems and also because of limitations on knowing the exact depth from which the materials are being taken.) Power augers can use split spoons or Shelby tube samplers to extract cores up to 60 cm long. With special attachments, longer cores can be obtained with augers fitted with a core barrel sampler. This avoids the problems normally encountered when using auger sampling alone.

The requirement for detail often desired in research studies or in cases where the movement of the pollutants is suspected to be through very narrow layers cannot be met effectively with the augers. In these cases, some form of core sampling or trenching should be used.

### **Soil Probes and Hand Augers**

Two standard tools used in soil sampling are the soil probe (often called a King-tube sampler) and the soil auger. These tools are standard agricultural soil samplers and occasionally are used in pollutant and waste sampling. These tools are designed to acquire samples from the upper two meters of the soil profile. The soil probe is nothing more than a stainless steel or brass tube that is sharpened on one end and fitted with a long, T-shaped handle. These tubes are usually approximately one inch inside diameter although larger tubes can be obtained. The cores collected by the tube sampler or soil probe are considered to be “undisturbed” samples, although in reality this is probably not the case. The tube is pushed into the soil in approximately 20 to 30 cm increments. The soil core is then removed from the probe and placed in either the sample container, a mixing bowl, or disposable pan for field compositing.

The hand auger is not considered to be a correct sampler, although it can approach this if it is used properly and one is careful. For purposes of pollutant sampling, where depth is of interest, the auger is not recommended.

Decontamination can be a major problem with the probe samplers unless some form of cleaning facility is available. A field expedient is to push the probe into the soil at the new site several times prior to taking the sample. Also, when there is some information on the site, sampling with the probe should proceed from background to high level sampling. This prevents cross contamination. Soils that are not rocky or do not contain large pieces of debris can be sampled with thin walled tubes outfitted with a metal nose piece.

A caution is appropriate when considering using the hand probes. Many older soil scientists have major back problems from attempting to extract a stuck probe or auger. If the length of soil taken in each increment is short, this is not a major problem. Long cores taken from tight, clayey soils are hard to extract after the first segment or two. The foot jack attachment made for these samplers is recommended because it allows the tube to be removed from the soil without using the back.

### **Power Augers and Core Samplers**

These truck or tripod mounted tools are recommended for collecting samples to depths greater than approximately 12 inches. Standard ASTM (ASTM 1587) methods are available for directing the use of these tools. These are discussed below in the section on plume sampling.

### **Trench Sampling**

This method of soil sampling is used to carefully remove sections of soil during studies where detailed examination of pollutant pathways or detailed soil structure are required as part of the investigation. Trench sampling is also the only way to sample situations where there is considerable rubble, wood, rock, scrap metal, or other obstructions present in the soil. In the past, the cost of sampling by this method was greater than, drilling. The availability of backhoes is such that the method is no longer considered to be too expensive. It is a viable alternative to power augers, etc.

A trench approximately three feet wide is dug to a depth below the desired sampling depth. This extra space allows cuttings, etc., to be deposited in the pit without interfering with the sampling. The maximum depth with a standard backhoe should not be over about two meters without taking special precautions with shoring of the pit. If deeper depths are required using this method, it may be better to use a coring rig if at all possible.

The trench samples are extracted from the sides of the soil pit using either a soil punch in a step sampling pattern (see Figure 7-1) or by following channel sampling as outlined in Figure 5-1. Where the soil punch can be used, a number of incremental samples can be taken for incorporation into a composite sample for the pit.

The steps are sequentially sampled from the surface downward. The surface is cleaned and a sample taken through the first layer or increment of soil. This layer is cut back with a shovel or trowel, making sure to remove all material from the layer above. The second layer is sampled, then cut back. This procedure is continued until the entire depth is sampled. Remember that sample correctness requires that the sampling tool must traverse completely through the layer to be sampled. The excess material would be cut from the bottom of the core or punch and discarded.

The reader should be cautioned about the use of the trench method. OSHA requires that any excavation where personnel are going to be working in the excavation must be shored or properly sloped before persons can enter the pit. Where metal scrap is in the pit, there is a hazard to puncturing of the protective suits and gloves. Disposal of the excavated material must be considered. A normal procedure is to replace the material in the hole after the sampling is completed. This may create a potential avenue for migration of chemicals and should be considered.

## **SAMPLING FOR UNDERGROUND PLUMES**

This type of sampling is perhaps the most difficult of all of the soil sampling methods. Often it is conducted along with ground-water and hydrological sampling. The equipment required usually consists of large, vehicle-mounted units that use hollow stem augers and coring devices, although there are some small tripod or trailer mounted coring units available. All of these units make use of hollow stem augers with core barrels for extracting the samples. Split spoon samplers are inserted through the center of the auger, driven into the soil in the bottom of the auger, then the samples extracted. The top of the sample must be discarded because it contains material from the earlier layers and may be contaminated by material falling into the hole from above.

### **Typical Procedure for Underground Plume Sampling**

There are two major techniques for plume sampling. Split spoon or Shelby tube samplers can be used where the plume is within the first six to twelve feet of the surface. Most plume studies will be carried out at greater depths, however. This will require the use of hollow stem augers combined with the split spoon sampler or one of the other samplers adapted for use with the auger.

**Figure 7-1 Example of Trench Sampling Using Soil Punch**

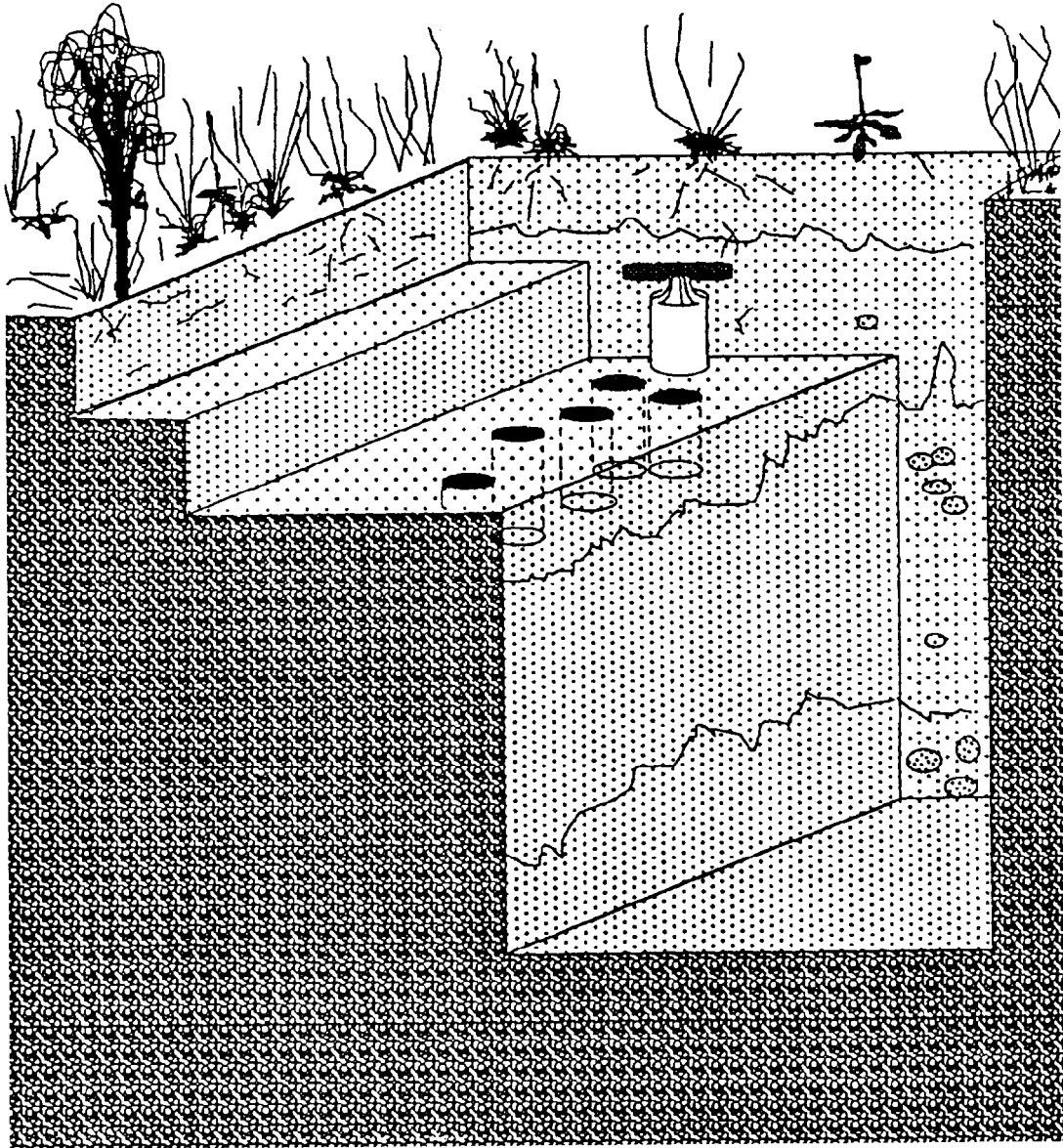

5313EAD92-9

The procedure closely follows ASTM Method D1586. The object of the sampling is to take a series of 1-inch or 24-inch undisturbed cores with a split spoon sampler. (Longer cores can be obtained but are not recommended.) Normally, a 6-inch auger is used to drill down to the desired depth for sampling. (Larger augers are available and can be used when it is necessary to take larger diameter cores.) The split spoon is then lowered to the depth of sampling, driven through the bottom of the augered hole, and the sampler extracted.

The ASTM method calls for the use of a 140 lb. hammer to drive the split spoon. The hammer is allowed to free fall 30 inches for each blow to the drive head. The number of blows required to drive the spoon 6 inches is counted and recorded. The blow counts are a reflection of the density of the soil and can be used to obtain some information on the soil structure below the surface. Unless this density information is needed for interpretive purposes, it may not be necessary to record the blow counts. In soft soils, the split spoon can often be forced into the soil by the hydraulic drawdown on the drill rig. This is often faster than the hammer method and does not require the record keeping necessary to record the blow counts, even though this information is often found on most well log sheets. Rigs are available from local contractors that can be used as long as there is supervision from the field investigator.

Samples should be collected from each 1.5-foot segment or from each distinct stratum. Additional samples should be collected where sand lenses or thin silt and sand layers appear in the profile. This sampling is particularly important when information on pollution migration is critical. Soluble or liquid pollutants are likely to move through permeable layers, such as these sand lenses. This appears to be especially important in tight clay layers where the main avenue of water movement is through cracks and the porous sandy layers. The author has observed pollutants moving through soil layers in bands as narrow as two inches wide. The reasons were not apparent in the visible structure of the soil materials.

Detailed core logs should be prepared by the investigator present at the site during the sampling operation. These logs should note the depth of sample, the length of the core and the depth of any features of the soil such as changes in physical properties, color changes, the presence of roots, rodent channels, etc. If chemical odors are noted or unusual color patterns detected, these should be noted also. (Intentionally smelling the sample is not an acceptable practice because of safety reasons.) Blow counts from the hammer should be recorded on the log along with the data mentioned above. Care should be made to make note of anything that could prove to be important in interpreting the results obtained. Some pollutants leave a telltale staining pattern. If this is seen, it should be recorded.

The procedure using samples collected every 18 inches is most effective in relatively homogeneous soils. A variation in the method that is preferred by soil scientists is to collect samples of every distinct layer in the soil profile. Large layers, such as the C horizon, may be sampled in several increments in the horizon. A disadvantage of this approach is the cost for the analyses of the additional samples acquired at a more frequent interval.

The soil horizons or other strata may be avenues through which chemical pollutants are likely to migrate. Some are more permeable than others and are thus more likely to contain traces of the chemicals if they are moving through the soil. Generally speaking, sands and gravels are more prone to contamination than are clays because of increased permeability, although this may not hold in all cases. Cemented gravels often are quite impermeable and expansive clays that shrink and swell during seasonal weather patterns may be quite permeable on a large scale because of cracking and churning.

Low levels of pollutant found in permeable layers may provide a warning of the presence of the leading edge of the plume. This is especially true when the pollutants first begin to migrate from the point of deposition. They will tend to migrate through the fractures, the sand lenses, and other channels such as old root channels, rodent burrows, or the bedding around electrical cables and utility lines. Low levels found in these areas may provide a warning of a potential problem at a later date.

Decontamination of the large equipment required for plume sampling is difficult, but not impossible. Drillers do not appreciate the detail required to clean up their rigs, and they do not like having to use dry coupling instead of grease. Precleaned split spoons or polycarbonate liners can help prevent contamination of the sample and save valuable field time. The augers can be cleaned with pressure hoses and steam cleaners.

There is a public relations problem with the use of these large rigs. They can have a major impact on yards, cropland, and other areas where the public can observe their impact. Special care must be taken to protect yards, shrubs, fences, and crops. The yards must be repaired, all holes backfilled, and all waste removed if the operations are not in areas that have restricted access. Plastic sheeting should be used under all soil handling operations such as subsampling, compositing, and mixing.

### **Variations in Plume Sampling Procedures**

There are several variations for core sampling. Samples collected from soils below the water table, from flowing sands, and from materials that are not cohesive require special sampling tools. Some sands can be sampled by inserting baskets or other retainers in the shoe of the split spoon. Where this will not retain the materials, other sampling devices are required.

The Waterloo sampler has proven to be very effective in sampling flowing sands, muds, and other similar materials. The Denison sampler is used to sample from difficult sampling situations. The Piston sampler is used to collect samples of sands and clays and has provided samples that retain very fine detail in the soil materials extracted.

Larger diameter split spoon samplers are available and may be required when rock or other hard materials are likely to prevent the small diameter spoons from penetrating the soil.

## COMPOSITING

Many sample plans call for compositing of the soils collected at a sampling location. This creates a problem for the soil scientist and the statistician. The key to any statistical sampling plan is the use of the variation within the sample set to test hypotheses about the population and to determine the precision or reliability of the data set. The composite provides an excellent estimate of the mean, but it does not give any information about the variation within the sampling area.

Without duplication within the sampling location, it is difficult to carry out many statistical techniques. Each subsample is combined into the composite; therefore, the data that is contained in the subsample is an average of all the increments making up the subsample. Starks (1986) uses this technique to obtain the support for a block of soil. If this block is a remedial management unit or an exposure unit, this may not create a major problem because geostatistical tools are designed to handle this situation.

Multiple samples taken at each location would avoid this problem, but costs usually preclude this option. A compromise is possible by only analyzing duplicates or triplicates at a percentage of the locations. The exact location is chosen by use of a random number table. Selection should be made before the study begins. Replicates should not be subsamples taken from the same composite, but should be made up of a completely separate set of subsamples.

Large cores can be split lengthwise, one half placed in one composite, and the other half placed in the second composite. Incremental sampling is recommended to reduce the amount of material that is included in the composite (see Section 5). Mixing is carried out using stainless steel tools and pans. Disposable aluminum basting pans have been found to be useful for this procedure. Mixing is often not complete with heavy or wet soils.

The volume of material included in the sample sent to the laboratory can be reduced by using an alternate scoop technique or one of the methods discussed in Section 5. With the alternate scoop technique, the entire sample is divided by scooping one unit into a discard pile and placing the next unit in the sample container. This is continued until the entire batch of material is reduced to the sample that will go to the laboratory.

Small sets of samples containing chemicals with very low volatility, such as metals, can be better composited in the laboratory. Field labs are becoming quite popular for use at remedial sites. The samples can be air dried, screened, and split. Appropriate splits can be combined into the composite sample and blended with V-blenders or some similar device. Grinding or crushing can also be carried out, if necessary.



## **RECORD KEEPING**

A number of records should be maintained at the study site. Core logs are appropriate for drilling or coring operations. Each team should maintain a detailed log of all activities, observations, and site-related operations. This log book should make note of photographs taken, the reason for taking them, and information the photograph was intended to convey. The log should also record detailed information about the cores or excavations as they are being carried out. Any information on pollutant pathways, unusual staining, or other information should be noted in the log book.

Barth et al. (1989) has a chapter on this important area. The reader is encouraged to read this reference and its included references.

## **FIELD DECONTAMINATION**

Sample collection tools must be cleaned prior to use. The following is a suggested procedure that has been used effectively at a number of field sites. Other procedures have also been used.

1. Wash and scrub the tools with tap water using a pressure hose or pressurized stainless steel, fruit tree sprayer. It may be necessary to use a steel brush or other brush to remove adhered soil (this is especially important with sticky clays). A steam cleaner has also proven to be very effective at this step in the cleaning operation.
2. If organics are present, rinse with the waste solvents from the steps outlined below. Discard contaminated solvent by pouring into a waste container for later disposal.
3. Air dry the equipment or dry with acetone.
4. Double rinse with distilled water.
5. Where organic pollutants are of concern, rinse with spectrographic grade acetone saving the solvent for use in step 3 above.
6. Rinse twice in spectrographic grade hexane, saving the solvent for use in step 3.
7. Air dry the equipment.
8. Package in plastic bags and/or precleaned aluminum foil.

9. Decontamination blanks should be taken from a number of the sampling devices to provide insurance that the tools were properly cleaned.

The distilled water and solvents are poured over the surfaces of all of the tools, bowls, etc. The solvent should be collected in some container for disposal. One technique that has proven to be quite effective is to use a large glass or stainless steel funnel as the collector below the tools during washing. The waste then flows into the old used solvent bottles for later disposal. A mixing bowl can also be used as a collection vessel. It is then the last item cleaned in the sequence of operations. Glass or Nalgene wash bottles can be used in the field to spray the solvents onto the tools.

Where field laboratories are available, decontamination of smaller tools is more effective than with field decontamination, and the tools can be packaged to prevent contamination prior to sampling.

Solvents are not readily available. Planning is necessary to insure an adequate supply. The waste rinse solvent can be used to remove organics from the tools. Acetone is often used as a drying agent prior to the use of hexane or other hydrophobic solvent. Methanol can be used if proper safety precautions are taken.

Steam cleaning might prove effective for much of the cleaning outlined above, but steam alone will not provide assurance of decontamination. The solvents still have to be used.

During remediation, the primary purpose of the sampling is to determine which portions of the soil must be removed or treated and which ones can be left in place. Decontamination of the tools between sample collection locations is very important when one approaches the boundary between "clean" and "not clean" soil. In those areas where contamination is well above the clean up standard being used at the site, steam cleaning of the tools is all that is needed. On the other hand, when sampling is being done in areas where the concentration is close to the clean up standard, a more detailed decontamination protocol must be followed.

## **QUALITY ASSURANCE AND SAFETY**

At the time of the 1983 sampling report, quality assurance and safety procedures were not developed to the extent that they are today. These sections are not included in this new edition of the report because Barth et al. (1989) have prepared an excellent guide on quality assurance in soil sampling programs.

Safety procedures have been carefully spelled out by OSHA and are rigidly followed on most sites. Drilling crews in the past have had a tendency to ignore safety practices because of the discomfort and awkwardness encountered when in safety equipment. They should not be allowed to operate on the site without proper safety equipment. OSHA training is required for all crews operating on hazardous waste sites.

## SECTION 8

### OTHER TYPES OF SAMPLING OF SOIL MATERIALS

The development of a number of remediation technologies has created areas where soil materials must be sampled for quality assurance, for remedial compliance, and for estimating the quantities of material that must be handled. Several of these technologies use similar materials handling equipment. Therefore, the concepts outlined below have application in each of these and any other similar operation. The discussions are not exhaustive, but reflect some of the types of situations that the soil investigator may encounter and be asked to provide assistance.

#### QUANTITY OF MATERIALS

Soil washing and stabilization/solidification are two of the current “hot items” for remediating hazardous waste sites. Both require excavating and handling soil materials and replacing the processed material on site or at some other secure facility.

Hazardous waste sites often contain a mixture of materials along with the soil. Some of these can be handled along with the soil provided that the size is reduced so that it can be handled by the processing equipment. The amount of the total waste at a site that can be processed must be determined in order to estimate the costs of the operation. Unit density of the *in situ* materials must be estimated by some field technique. The standard techniques used by engineers are not designed to handle these types of materials.

#### Unit Density Estimates

One approach for determining in situ unit density is to use several dump trucks. The beds of the dump trucks can be measured reasonably well. Material is excavated from a rectangular hole to a constant depth. The size of the hole should be surveyed so that the volume can be estimated. The trucks should be weighed prior to loading. The truck is filled to the top of the bed and struck off with the bottom of the loader bucket taking care not to compact the material. Reweigh the truck. This gives a weight of the truck plus all waste material. Subtracting the weight of the truck gives the weight of the material in the hole. The weight divided by the volume of the hole gives an estimate for the in situ unit density. The weight of material divided by the volume of the truck bed gives an estimate of unit density of the loose excavated material. The ratio of the in place to the excavated density can be used to estimate the bulking factor that can be used in determining the weight and the volumes of materials that are processed.

Material that cannot be handled by the remedial technology such as large pieces of steel, logs, carpets, tires, etc., can be screened out of the excavated material, loaded into a pre-weighed truck, and the weight determined. These weights are subtracted from the total weight of the material excavated. The percent of processable material can then be determined. At least four to five truck loads should be taken from different parts of the site. The averages of these four loads should be used for estimation. The standard deviation can be used to provide some indication of the reliability of the data generated. The large volumes of material placed in the trucks allow the investigator to include a range of the materials that are present and also compensate for the variability in the excavation and in handling the materials.

This may seem expensive and unnecessary, but it is good insurance compared to the problems generated by greatly under- or over-estimating the materials that must be handled.

### **Sampling from Process Conveyor Belts**

A second approach for determining the processable material involves estimating the quantity of material that is passing through the batch plant or through some other step in the soil treatment process. The materials can be treated as a one-dimensional waste. Cross stream samples are taken at periodic intervals while the plant is operating. This may require stopping the conveyor at periodic intervals and taking samples of material. This sampled material can be weighed, its percent moisture determined, and it can also be analyzed for pollutants, if necessary.

Correct sampling of these materials requires that all of the materials in a segment of the process flow be taken by cutting across the path of the flow with a tool that takes a segment of material having parallel sides in the direction perpendicular to the flow of materials. This detail prevents sample bias.

Sample results from this type of material lend themselves to the use of variography. Quality control samples are usually taken at some regular interval such as twice daily or every shift or some similar approach. Variograms can be prepared using time as the independent variable. Examination of the variogram on a regular basis can be used to evaluate the operation of the equipment.

Control charts (Bauer, 1971) can also be prepared for recording the quality of the materials that are being produced by the remedy. Examination of these charts on a daily basis is recommended. This provides vital information on the effectiveness of the treatment process and also on the output of the contractors carrying out the remedy. Sampling can be for some process standard such as permeability, bearing capacity, etc., in the case of solidification/stabilization, or it could be the percent reduction of a regulated chemical in the case of soil washing. The charts provide a visual means of tracking the quality of the remediation process.

## **Sampling Stockpiled Soil Material**

Frequently, the soil scientist will be asked to sample the materials that have been stockpiled awaiting processing. This presents a very difficult problem. Correct sampling of these piles requires that the materials be sampled by taking a number of cuts through the entire pile similar to the lab procedure shown in Figure 5-5. This material must then be reduced in volume by some probabilistic procedure. During remediation this is often not possible.

If a coring rig can operate on top of the pile, and if the pile can be flattened, cores can be taken from a number of places on the pile and used to provide estimates of the composition of the materials in the pile. The cores must penetrate through the entire pile into the underlying soil in order to insure correctness. The cores should be incrementally sampled at different depths in the pile.

The thickness of the pile should be determined at each point sampled. The location of the cores may have to be surveyed so that a map of the pile can be prepared. This information can also be used to provide estimates of the volume of materials in the pile.

If the pile can be moved by use of a conveyor belt, this offers the best means of sampling the material and also provides a means for obtaining information on the variability within the pile. Samples would be taken by cross stream sampling as was discussed above.

Samples are often taken by taking a cut through the pile and sampling from the cut face. This is not the most desirable approach, but it can be used. If enough increments are taken from the face, a reasonable estimate of the average concentration can be made. Compositing the samples for the entire face is not recommended. The face should be divided into a number of zones and the samples within that zone combined in the composite. Safety is often a problem in sampling these cuts unless the material is quite stable.

## **REMEDATION SAMPLING**

During remediation of the site, the soil investigator may be asked to provide quality assurance on the contractor carrying out the cleanup of the site. Grid sampling appears to offer the most advantageous approach in these situations. The size of the remediation management unit will determine the size of grid pattern to use. Samples should be taken on a systematic basis. Random samples can be used as an additional assurance that no major areas are being missed; however, this is seldom necessary. Normal duplicates and triplicates should be taken.

Often these samples will be submitted to a field laboratory for some form of rapid screening. This greatly speeds up the remediation operation. Any very low concentrations seen during remedial investigations are really not critical unless the cleanup standard is

background. For example, PCB cleanups may use standards as high as 10 ppm for the cutoff. There are a number of field instruments that can determine concentrations down to two to three ppm. The areas of high concentration are usually known and are removed before the remedial soil sampling effort begins.

Adequate sample coverage of the area being remediated along with areas outside the immediate treatment zone will be required to insure that the contaminated materials have all been removed. Final verification sampling should provide data that can be used to confirm, with some associated confidence level, that the contractor has carried out the remedy properly and the site is ready to be closed.

Remediation sampling designs will be dictated by the regulatory directives that are being used at a particular site. At some sites, punctual sampling has been used at the grid nodes. If any one of these was above the action level, a detailed sampling procedure was initiated to determine the size of the "hot spot." At other sites, everything to the next "clean" node was excavated and removed or treated. The "action support" proposed by Barth et al. (1989) offers the most appropriate procedure for determining if the RMU must be remediated. This is essentially a composite sample taken from the RMU. If this exceeds the "action support," then the RMU must be remediated.

## **SAFETY**

Safety should be a primary concern at these large treatment facilities. There is ample opportunity for an investigator to come in contact with machinery, falling material, moving vehicles, and other similar hazards. It is preferable to insure that there are at least two people working together to help avoid unnecessary risks. The buddy system is essential in these situations. Loader operators and truck drivers are not expecting to encounter someone working on foot in the areas where they are working. You must look out for them and not expect the operator to look out for you.

## SECTION 9

### DATA INTERPRETATION

The final step in any sampling study is the analysis and interpretation of the data that has been collected. It is not necessary for the field scientist to conduct the data analysis, but his input is necessary if any interpretation of the data is to be made. Impressions and observations obtained during on-site activities are needed to adequately determine the actual behavior of the pollutant.

The person doing the data analysis must keep in mind the purpose for which the samples were collected. These purposes can usually be grouped into one of the following categories:

- Estimate the level and variability of a pollutant in a geographic area.
- Determine if the pollution measured is above some standard or is higher than the ambient levels found in the control area.
- Define the aerial extent and depth of the pollution and map the pattern of the distribution.
- Determine if an area has been cleaned to some cleanup standard identified in consent decrees or by administrative order.

There are statistical tests available for handling data collected by each sampling design discussed in Section 6. Prior to attempting to use any of the designs, a statistician versed in environmental sampling design should be consulted to assure that the appropriate design is being used. This consultation should be done prior to conducting the study and not after the data is collected. Barth et al. (1989) can be used for assistance in designing sampling plans. Classical statistical methods are available for carrying out many of the analyses.

Geostatistical tools are available for use by the investigator with assistance from a statistician or they can be obtained from a number of reputable firms specializing in geostatistics and sampling. Many of the major geotechnical firms have the capability for doing geostatistical analysis on a service basis. If the investigator intends to make use of these firms, he should consult with the firm prior to collecting the data to insure that the proper information is obtained and that the data is submitted in a form that can be used in the firm's particular software.

Two geostatistical packages are available for use on the PC computer. One developed by EMSL-LV called GEO-EAS (Englund and Sparks, 1988) has been extensively reviewed and appears to be simple to use. User friendliness does not mean that the investigator can pick the software off of the shelf and become an instant expert. One must use the software

under the supervision of someone knowledgeable in geostatistics before launching into a full-scale evaluation of data. Like any other geotechnical tool, it can be misused.

Grundy and Miesch (1987) have assembled a package of computer programs that allow one to handle geostatistical data on the PC. This package is not as user friendly as GEO-EAS, but it covers a wider range of statistical data handling. Grundy and Miesch (1987) make the following observation with emphasis:

...there is no cookbook method of analyzing spatial statistics. The user will find it necessary to use different approaches to different problems. Kriging is not automatic.

Assistance from skilled geostatisticians is recommended if the data is to have any validity. Estimation of the variogram from the sample data is a critical step in any geostatistical study. All of the other steps carried out in geostatistical work are based upon the reliability of the variogram; therefore, it is essential that this be done properly. The form of the variogram can change from case to case and may even change as one changes the orientation of the grid used to calculate the variogram.

## **OTHER DATA EVALUATION TECHNIQUES**

### **Cyclic Data Patterns**

There are a number of other data handling techniques that may prove useful to the investigator. The variogram often shows a pattern that indicates that there is a cyclic pattern to the data. Evaluation of these cycles can be done by using Fourier transforms or some similar time series tool to unravel the underlying causes of the pattern.

As an example, patterns may be caused by seasonal rainfall, by irrigation frequency, by tides, by vehicular traffic, by plant operational cycles, or by other similar factors that occur on a regular basis. Plumes frequently show pockets of high concentration separated by zones of lower concentration. This is believed to represent the pulsing caused by rainfall occurring on a seasonal basis.

Disposal ponds often show patterns that reflect the operation of the plant. When operations are altered on some set frequency, there may be a flush of high concentration pollutant followed by long periods of low concentration. These patterns are occasionally observed in monitoring data.



## **Determining Geological Structure**

Griffiths (1971) points out that all classical statistics are based upon the concept of randomness and the normal distribution. Most environmental data is, at best, log normal. He notes that because the theory has not resolved the problems of the lack of randomness, for example, a plume is not a random occurrence. There is pattern to the plume caused by groundwater or gravity flow.

Griffiths (1971) and Griffiths and Ondrick (1970) offer a pragmatic approach for unraveling data so that it can be interpreted and any underlying structure identified. An underlying assumption is made that the geologic media (soil is classified as such) has some as yet unknown structure and that this structure can be determined by the pattern of variation occurring in the media.

Griffiths (1971) notes that grid sampling is “quite efficient” in revealing the underlying geologic structure. One limitation is the need to have replication at each node. This would double the number of samples required. This could be done as part of an exploratory study. Analysis of Variance (ANOVA) is used to compare rows and columns with each other. If the interaction term is significant, then the grid is not aligned with the major axis of the geologic structure or in our case pollutant plume. The grid can be mathematically rotated to give a new grid that is aligned with the plume direction.

Figure 9-1, taken from Griffiths (1971), shows the effect of structure on the variances obtained by sampling three different media. Case I is a homogeneous material. Case II is a material with a layered pattern to it or a material where there are discrete deposits of material as one might encounter where pollutants were dumped along a trail or roadway. Case III might be a mixed media where several pollutant sources were dumped over the site. For a geologic media, these would be called massive, regular bedded, and irregular patchy respectively. With the case of pollutant deposits, these would be widely disseminated (as one would expect from an airborne material), linear deposits (such as one would encounter with filled-in disposal trenches), and random dumping over a property.

Assuming that these materials are surface configurations (the same procedure can work in three dimensions as well), comparisons are made between various components of the data. Looking at the directional component, there is no difference between N-S and E-W no matter which pattern is examined. When one looks at the the traverses one sees differences. The E-W traverses show a large variance for Case II. The variation in the data for both the N-S and the E-W traverses are large in Case III. The within traverse variation is large in all cases except for the E-W traverse in Case II. By examining the components of variance for each of these cases, information can be gained about the deposition of a pollutant, the structure of a geologic material, or the structure of a soil property.

**Figure 9-1 Effects of Structures on Sampling Arrangement and Estimation of Parameters**

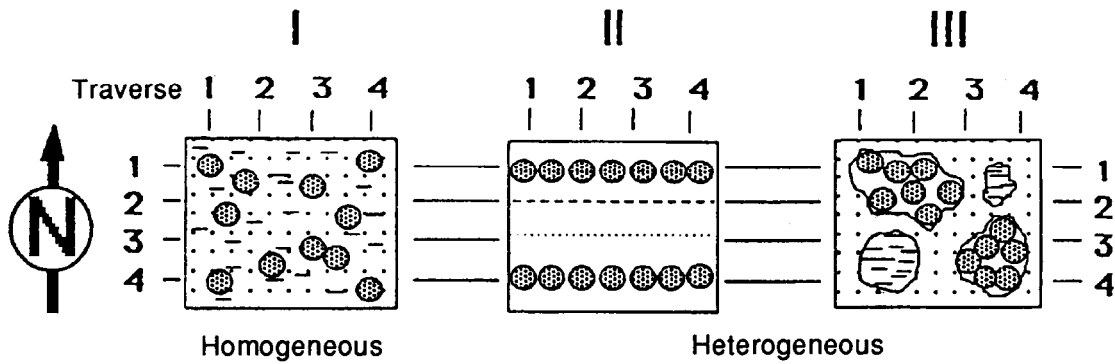

MAGNITUDE OF VARIATION FROM VARIOUS SOURCES						
Source of Variation \ Structure	Massive I		Regular Bedded II		Irregular Patchy III	
		Zero		Zero		Zero
Direction	E-W	N-S	E-W	N-S	E-W	N-S
Traverses	Zero	Zero	Large	Zero	Large	Large
Within Traverses	Large	Large	Zero	Large	Large	Large

This approach can be used with any sampling units ranging in size from microscopic slides to square miles. Comparison of the components of variance seen in each case shown in Figure 9-1 can determine which type of structure is underlying the basic data set. This is a nested type of design and can provide valuable information if enough replication is provided to do the complete ANOVA. The ANOVA can be used to test the differences between directions, between traverses, and within the traverses. A statistician can often assist in revealing more information than can be obtained by using standard ANOVA packages.

Griffith's approach is similar to the approach presented in Pitard (1989b). Pitard noted that when data values representing samples of weight  $w_1$  along one transect direction is composited into several samples of weight  $w_2$ , such that  $w_2 \geq 10w_1$ , Visman's sampling constants can be estimated. These are then used to estimate the standard deviation of sets of samples with different weights ( $s'$ , according to Appendix B). This process is repeated for several different orientations along the suspected plume, across the plume, and diagonal to the plume. The value of  $s'$ , will be large along the plume but much smaller across the plume. The diagonals would lie somewhere in between.

## **COMPONENTS OF VARIANCE**

The components of variance test mentioned above is most often used as a quality assurance tool, but in the litigation arena, this also can provide useful information on the structure of the variation seen in the data. Attorneys frequently like to question a witness about the source of variation in their data. They often attempt to make it appear that the variation is a result of poor sampling or poor analytical procedures when in fact it is a natural phenomenon. When a witness can say, "We measured this and the variation comes from the following steps in the analytical process," the issue is usually dropped.

The system of audit samples proposed by Van Ee et al. (1990) provides a means for determining the components of variance in each study. One should be cautioned about the use of this approach, however. The analysis may show that the sampling was not good and, therefore, the data is unreliable. This is not likely to happen when the procedure is carried out with assistance from a good environmental statistician and the statistician has assisted with the interpretation of the test results.

## **USE OF STATISTICAL TESTS IN REMEDIATION**

Properly designed sampling plans executed during remediation can provide valuable information about the thoroughness of the cleanup. When the statistical error or sampling error (SE) has been determined, confidence intervals around the numbers can be developed. This provides a basis for insuring that remediation has reached the limits of the cleanup that was called for in a consent decree or administrative order. This same data can be used to

provide information that can be used to estimate the probability of there being a hot spot that exceeds the cleanup standard (Zirschky and Gilbert, 1984).

Prior to initiating any remediation sampling plan, a statistician should be involved in reviewing the design and assisting in determining how the data will be used once it is obtained.

## REFERENCES

1. Barth, Delbert S., Benjamin J. Mason, Thomas H. Starks, and Kenneth W. Brown, 1989. *Soil Sampling Quality Assurance User's Guide*. Second Edition. Environmental Monitoring and Support Laboratory. U.S. Environmental Protection Agency. Las Vegas, NV. 89183-3478.
2. Barth, D.S. and B.J. Mason. 1984. The Importance of an Exploratory Study to Soil Sampling Quality Assurance. pp. 97-104 in Schweitzer, Glenn E., and John A. Santolucito. eds. *Environmental Sampling for Hazardous Wastes*. American Chemical Society. Washington, D. C.
3. Bauer, Edward L. 1971. *A Statistical Manual for Chemists*. Academic Press. New York, NY 10003.
4. Baveye, Philippe. 1983. Volume-Accuracy Relationship in Soil Moisture Sampling. *Journal of Irrigation and Drainage Engineering*. Vol. 109(2):287-289.
5. Bresler, E., and G. Dagan. 1988. Variability of Yield of an Irrigated Crop and its Causes: 1. Statement of the Problem and Methodology. *Water Resource Research*. Vol. 24:381-387.
6. Brumelle, S., P. Nemetz, and D. Casey. 1984. Estimating Means and Variances: The Comparative Efficiency of Composite and Grab Samples. *Environmental Monitoring and Assessment*. Vol. 4:8184.
7. Brunton, D.W. 1895a. A New System of Ore-Sampling. *Transactions of the American Institute of Mining Engineers*. Vol. 13:639-645.
8. Brunton, D.W. 1895b. The Theory and Practice of Ore-Sampling. *Transactions of the American Institute of Mining Engineers*. Vol. 25:826-844 (with 2 plates).
9. Brunton, David W. 1909. *Modern Practice of Ore-Sampling*. *Transactions of the American Institute of Mining Engineers*. Vol. 40:567-596.
10. Bryan, Rex. 1989. Honest Abe: Level of Observation and Truthfulness. In: *Proceedings of the Hazardous Materials Conference*. November 1989. Long Beach, California.
11. Buffington, J.P. 1978. Developing Recommendations to Improve Quality Assurance for Federal Monitoring Programs. In: *Proceedings of the National Conference on Quality Assurance of Environmental Measurements*, Denver, CO.

12. Burgess, T.M., and R. Webster. 1980a. Optimal Interpolation and Isarithmic Mapping of Soil Properties: I The Semi-variogram and Punctual Kriging. *The Journal of Soil Science*. Vol. 31(2):315-331.
13. Burgess, T.M., and R. Webster. 1980b. Optimal Interpolation and Isarithmic Mapping of Soil Properties: II Block Kriging. *Journal of Soil Science*. Vol. 31(2):333-341.
14. Cameron, R.E. 1986. Soil Homogenization. Report prepared under Contract 68-03-3249. Environmental Monitoring and Support Laboratory. U.S. Environmental Protection Agency. Las Vegas, NV 89183-3478.
15. Campbell, J.B. 1977. Variation of Selected Properties Across a Soil Boundary. *Soil Science Society of America Journal*. Vol. 41(3):578-582.
16. Campbell, J.B. 1978. Spatial Variation of Sand Content and pH Within Single Contiguous Delineations of Two Soil Mapping Units. *Soil Science Society of America Journal*. Vol. 42(3):460-464.
17. Campbell, J.B. 1979. Spatial Variability of Soils. *Annals of the Association of American Geographers*. Vol. 69(4):544-556.
18. Campbell, J.B. 1981. Spatial Correlation Effects Upon Accuracy of Supervised Classification of Land Cover. *Photometric Engineering and Remote Sensing*. Vol. 47(3):355-363.
19. CDM Federal Program Corporation. 1987. Data Quality Objectives for Remedial Response Activities: Development Process. EPA/540/G-87/003. OSWER Directive 9355.0-7B. U.S. Environmental Protection Agency. Washington, DC 20460.
20. Chapman, H.D., and P.F. Pratt. 1961. *Methods of Analysis of Soils, Plants and Waters*. University of California. Riverside, CA. 309 pp.
21. Cline, M.G. 1944. Principles of Soil Sampling. *Soil Science*. Vol 58:275-288.
22. Cochran, W.G. 1946. Relative Accuracy of Systematic and Stratified Random Samples for a Certain Class of Populations. *The Annals of Mathematical Statistics*. Vol. XVII(2):164-177.
23. Cochran, W.G. 1963. *Sampling Techniques*. John Wiley & Sons. New York, NY.
24. David, M. 1982. *Geostatistical Ore Reserve Estimation*. Elsevier. New York, NY 10017. 364 pp.

25. Davis, John C. 1986. *Statistics and Data Analysis in Geology*. 2nd Edition. John Wiley. New York, NY. 646 pp.
26. Delhomme, J.P. 1978. Kriging in the hydrosociences. *Advances in Water Resources*. Vol. 1(5):251-266.
27. Delhomme, J.P. 1979. Spatial variability and Uncertainty in Groundwater Flow Parameters: A Geostatistical Approach. *Water Resources Research*. Vol. 15(2):269-280.
28. Devitt, Dale A., Roy B. Evans, William A. Jury, Thomas Starks, Bart Eklund, and Alex Gholson. 1987. *Soil Gas Sensing for Detection and Mapping of Volatile Organics*. National Water Well Association. Dublin, OH 43017.
29. Drees, L.R., and L.P. Wilding. 1973. Elemental Variability Within a Sampling Unit. *Soil Science Society of America Proceedings*. Vol. 37:82-87.
30. Englund, Evan, and Allen Sparks. 1988. *GEO-EAS: User's Guide*. EPA-600/4-88-033a. Environmental Monitoring and Support Laboratory. U.S. Environmental Protection Agency. Las Vegas, NV 89183-3478.
31. Flatman, G.T. 1984. Assessing Lead Contamination near Smelters: A Case Study. pp. 43-52. In: Schweitzer, Glenn E., and John A. Santolucito, eds. *Environmental Sampling for Hazardous Wastes*. American Chemical Society. Washington, DC.
32. Flatman, George, T., Kenneth W. Brown, and James W. Mullins. 1985. Probabilistic Spatial Contouring of the Plume Around a Lead Smelter. In: *Proceedings of The 6th National Conference on Management of Uncontrolled Hazardous Waste Sites*. November 4-6, 1985. Hazardous Materials Control Research Institute. Washington, DC.
33. Florida Power and Light Co. 1986. *Remedial Action Work Plan: Pepper's Steel and Alloys NPL Site*. Florida Power and Light Co., Miami, FL.
34. Geist, J. Michael, and John W. Hazard. 1975. Total Nitrogen Using a Sodium Hydroxide Index and Double Sampling Theory. *Soil Science Society of America Proceedings*. Vol. 39:340-343.
35. Ghiorse, W.C., K. Malachowsky, E.L. Madsen, and J.L. Sinclair. 1990. Microbial Degradation of Coal-Tar Derived Organic Compounds at a Town-Gas Site. In Murarka, I.P., and S. Cordle, eds. *Proceedings: Environmental Research Conference on Groundwater Quality and Waste Disposal*. Electric Power Research Institute, Palo Alto, CA 94304.

36. Gilbert, Richard O. 1982. Some Statistical Aspects of Finding Hot Spots and Buried Radioactivity. TRAN-STAT: Statistics for Environmental Studies. PNL-SA-10274. Battelle Memorial Institute. Pacific Northwest Laboratory. Richland, WA. 99352.
37. Gilbert, Richard O. 1987. Statistical Methods for Environmental Pollution Monitoring. Van Nostrand-Reinhold. New York, NY. 320 pp.
38. Gilbert, Richard O., and Pamela G. Doctor. 1985. Determining the Number and Size of Soil Aliquots for Assessing Particulate Contaminant Concentrations. Journal of Environmental Quality. Vol. 14(2):286-292.
39. Glenn, R.C. 1983. Reliability of Volumetric Sampling as Compared to Weighed Samples in Quantitative Soil Test Interpretation, Communications in Soil Science and Plant Analysis. Vol. 14(3):199-207.
40. Griffiths, J. C. 1971. Problems of Sampling in Geoscience. Transactions of the American Institute of Mining and Metallurgy. Vol. 80B: B346-B355.
41. Griffiths, John C., Charles W. Ondrick. 1970. Structure by Sampling in the Geosciences. p. 31-55 in G.P. Patil, ed. Vol. 3, Random Counts in Physical Sciences, Geoscience, and Business. The Pennsylvania State University Press. University Park, PA.
42. Grundy, W.D., and A.T. Miesch. 1987. Brief Description of STATPAC and Related Statistical Programs for the IBM Personal Computer. U.S. Geological Survey. Denver, CO.
43. Gulezian, R.C. 1979. Statistics for Decision Making, W.B. Saunders. Philadelphia, PA. 19105. 665pp.
44. Gutjahr, Allan. 1985. Spatial Variability: Geostatistical Methods. In: Nielsen, D.R, and J. Bouma, eds. Soil Spatial Variability. PUDOC. Wageningen, the Netherlands. pp 9-34.
45. Gy, Pierre. 1982. Sampling of Particulate Materials: Theory and Practice. 2nd. Ed. Elsevier, New York, NY.
46. Harrison, A.F. 1979. Variation of Four Phosphorus Properties in Woodland Soils. Soil Biology and Biochemistry. Vol. 11:393-403.
47. Hawley, Mark E., Richar H. McCuen and Thomas J. Jackson. 1983. Closure on Comments on Volume-Accuracy Relationship in Soil Moisture Sampling. Journal of Irrigation and Drainage Engineering. Vol. 109(2):289-290.
48. Henley, Stephen. 1981. Nonparametric Geostatistics. John Wiley. New York, NY



49. Hindin, E., D.S. May, and G.H. Dunston. 1966. Distribution of Insecticide Sprayed by Airplane on an Irrigated Corn Plot. Chapt. 11 in *Organic Pesticides in the Environment*. A.A. Rosen and H.F. Kraybill (eds.). *Advances in Chemistry Series #60*. American Chemical Society. Washington, D.C. pp, 132-145.
50. Ingamells, C.O. 1974. *New Approaches to Geochemical Analysis and Sampling*. *Talanta*. Vol. 21: 141-155.
51. Ingamells, C.O., and Francis F. Pitard. 1986. *Applied Geochemical Analysis*. Vol. 88. John Wiley. New York, NY.
52. Ingamells, C.O., and P. Switzer. 1973. A Proposed Sampling Constant for Use in Geochemical Analysis. *Talanta*. Vol. 20:547568.
53. Journel, A.G., and Ch.J. Huijbregts. 1978. *Mining Geostatistics*. Academic Press. New York, NY 10003.
54. Jury, W.A. 1985. *Spatial Variability of Soil Physical Parameters in Solute Migration: A Critical Literature Review*. EPRI EA-4228. Electric Power Research Institute. Palo Alto, CA 94304.
55. Lewis, T., A.B. Crockett, R.L. Siegrist, and K. Zarrabi. 1991. *Soil Sampling and Analyses for Volatile Organic Compounds*, EPA540/4-91/001. Environmental Monitoring and Support Laboratory. U.S. Environmental Protection Agency, Las Vegas, NV 89183-3478.
56. Liggett, W.S., K.G.W. Inn, and J.M.R. Hutchinson. 1984. *Statistical Assessment of Subsampling Procedures*. *Environmental International*. Vol. 10: 143-151.
57. Mason, B.J. 1983. *Preparation of Soil Sampling Protocols: Techniques and Strategies*, EPA-600/4-83-020. Environmental Monitoring and Support Laboratory. U.S. Environmental Protection Agency, Las Vegas, NV 89183-3478.
58. Mason, B.J., and D.W. Carlile. 1986. *Round-Robin Evaluation of Regulatory Extraction Methods for Solid Wastes*. EA-4740. Electric Power Research Institute. Palo Alto, CA 94304.
59. Matheron, G. 1963. *Principles of Geostatistics*. *Economic Geology*. Vol. 58: 1246-1266.
60. Matheron, G. 1967. *Kriging, or Polynomial Interpolation Procedures?: A Contribution to Polemics in Mathematical Geology*. *Transactions of the Canadian Institute of Mining*. Vol. 70: 240244.

61. Matheron, G. 1969. *Le Krigeage Universel: Les Cahiers du Centre de Morphologie Mathematique de Fontainebleau. Fascicule 1. 1'Ecole Nationale Superieure des Mines de Paris. Paris. 211 pp.*
62. Matheron, G. 1973. *The Intrinsic Random Functions and their Applications. Advances of Applied Probability. Vol. 5:439-468.*
63. Mathur, S.P., and R.B. Sanderson. 1978. *Relationships Between Copper Contents of Some Histosols in an Area of the Southwestern Quebec in the Summer and the Fall. Canadian Journal of Soil Science. Vol. 58(5):125-134.*
64. Mausbach, J.J., B.R. Brasher, R.D. Yeck, and W.D. Nettleton. 1980. *Variability of Measured Properties in Morphologically Matched Pedons. Soil Science Society of America Journal. Vol. 44(2):358-363.*
65. Neptune, Dean, Eugene P. Brantly, Michael J. Messner, and Daniel I. Michael. 1990. *Hazardous Materials Control. Vol. 3(3):18-27.*
66. Nielsen, D.R., J.W. Biggar, and E.T. Erh. 1973. *Spatial Variability of Field Measured Soil Water Properties. Hilgardia. Vol. 42(7):215-260.*
67. Nielsen, D.R., and J. Bouma (eds.). 1985. *Soil Spatial Variability: Proceedings of a Workshop of the ISSS and the SSSA. Las Vegas, USA. November 30-December 1, 1984. PUDOC. Wageningen, the Netherlands. 243 pp.*
68. Office of Pesticide Programs. 1976. *Sample Collection Manual: Guidelines for Collecting Field Samples. U.S. Environmental Protection Agency. Washington, DC. 39 PP.*
69. Petersen, R.G., and L.D. Calvin. 1965. *Sampling. Chapt. 5 in Methods of Soil Analysis. C.A. Black (ed.). American Society of Agronomy. Madison, WI. pp 54-72.*
70. Pitard, Francis F. 1989a. *Pierre Gy's Sampling Theory and Sampling Practice. CRC Press. Inc., Boca Raton, FL 33431. 461 pp. (2 volumes).*
71. Pitard, Francis F. 1989b. *Class Handouts for a Short Course entitled "Sampling Methodologies for Monitoring the Environment: Theory and Practice." Pierre Gy and Francis Pitard Sampling Consultants. Broomfield, CO 80020.*
72. Quality Assurance Management Staff. 1991. *Quality Assurance Glossary and Acronyms. Officer of Research and Development. U.S. Environmental Protection Agency. Washington, DC 10460.*

73. Quinouille, M.H. 1949. Problems in Plane Sampling. *The Annals of Mathematical Statistics*. Vol.XX:355-375.
74. Ramsey, Charles A. 1989. *The Application of Sampling Theory and Field Analytical Techniques to Environmental Investigation*. Master of Science Thesis submitted at Colorado School of Mines. Golden Colorado. 112 pp.
75. Rao, P.V., P.S.C. Rao, J.M. Davidson, and L.C. Hammond. 1979. Use of Goodness-of-fit Tests for Characterizing the Spatial Variability of Soil Properties. *Soil Science Society of America Journal*. Vol. 43(2):274-278.
76. Rogers, John, Paul Flyer, Adam Chu, Jill Braden, and Ed Bryant. 1988. *Statistical Methods for Evaluating the Attainment of Superfund Cleanup Standards: Volume 1: Soils and Solid Media*. Westat Inc. Rockville, MD 20850.
77. Rupp, Gretchen. 1989. *Bench Scale Fixation of Soils from the Tacoma Tar Pits Superfund Site Final Report*. EPA600/8-89/069. Environmental Monitoring and Support Laboratory. U.S. Environmental Protection Agency. Las Vegas, NV 89183-3478.
78. Skalski, J.R., and J.M. Thomas. 1984. *Improved Field Sampling Designs and Compositing Schemes for Cost Effective Detection of Migration and Spills at Commercial Low-level Radioactive or Chemical Waste Sites*. PNL-4935. Battelle Pacific Northwest Laboratory. Richland, WA 99352.
79. Siegrist, Robert L., and Petter D. Jenssen. 1990. Evaluation of Sampling Method Effects on Volatile Organic Compound Measurements in Contaminated Soils. *Environmental Science and Technology*. Vol. 24(9):1387-1392.
80. Slater, Jill P., Frederick R. McLaren, Del Christenson, and Denis Dineen. 1983. *Sampling and Analysis of Soil for Volatile Organic Compounds: I. Methodology Development*. In Nielsen, David M., and Mary Curl. *Proceedings of the NWWA/U.S. EPA Conference on Characterization and Monitoring of the Vadose (Unsaturated) Zone*. Water Well Publishing Co. Worthington, OH 43085.
81. Soil Science Society of America. 1965. *Glossary of Soil Science Terms*. *Soil Science Society of America Proceedings*. Vol. 29(3):330-351.
82. Soil Survey Staff. 1975. *Soil Taxonomy*. Agricultural Handbook 436. Soil Conservation Service. U.S. Department of Agriculture. U.S. Government Printing Office. Washington, DC. 754pp.
83. Snedecor, G.W., and Cochran, W.G. 1982. *Statistical Methods*. The Iowa State University Press. Amers, Iowa. 507 pp.

84. Starks, Thomas H. 1986. Determination of Support in Soil Sampling. *Mathematical Geology*. Vol. 18(6):529-537.
85. Starks, T.H., K.W. Brown, and N. Fisher. 1986. Preliminary Monitoring Design for Metal Pollution in Palmerton, Pennsylvania. In: Peckert, C. L. ed. *Quality Control in Remedial Site Investigations: Hazardous and Industrial Solid Waste Testing*. 5. ASTM STP 925. American Society for Testing and Materials. Philadelphia, PA. pp. 57-66.
86. Starks, T.H., A.R. Sparks, and K.W. Brown. 1989. Geostatistical Analysis of Palmer-ton Soil Survey Data. *Environmental Monitoring and Assessment*. Vol. 93:239-261.
87. Stout, Douglas. K., Terry A. Ritter, and Steven A. Aulenbach. 1990. Evaluation of Sampling Strategies. Presented at the 22nd Mid-Atlantic Industrial Waste Conference. Drexel University. Philadelphia, PA.
88. Switzer, P., B.P. Eynon, and L.J. Holcombe. 1983. Pilot Study of Time Variability of Elemental Concentrations in Power Plant Ash. EA-2959. Electric power Research Institute. Palo Alto, CA 94304.
89. Switzer, P., J.W. Harden, and R.K. Mark. 1988. A statistical Method for Estimating Rates of Soil Development and Ages of Geologic Deposits: A Design for Soil-Chronosequence Studies. *Mathematical Geology*. Vol. 20(1):49-61.
90. Urban, Michael J., James S. Smith, Elizabeth K. Schultz, and Randall K. Dickinson. 1989. Volatile Organic Analysis for a Soil, Sediment, or Waste Sample. In the *Proceedings of the Fifth Annual Waste Testing and Quality Assurance Symposium*. American Chemical Society. Washington, D.C.
91. U.S. Environmental Protection Agency. 1982. Environmental Monitoring at Love Canal. Volumes I-IV. EPA-600/4-82-030 a-d. U.S. Environmental Protection Agency. Washington, DC. 20460.
92. U.S. Environmental Protection Agency. 1984a. Documentation of EMSL-LV Contribution to the Kellog, Idaho Study. EPA-600/X-84052. Environmental Monitoring and Support Laboratory. U.S. Environmental Protection Agency, Las Vegas, NV 89183-3478.
93. U.S. Environmental Protection Agency. 1984b. Documentation of EMSL-LV Contribution to Dallas Lead Study. EPA-600/4-84-012. Environmental Monitoring and Support Laboratory. U.S. Environmental Protection Agency, Las Vegas, NV 89183-3478.

94. U.S. Environmental Protection Agency. 1985. Standard Operating Procedures for Conducting Sampling and Sample Bank Audits. EPA600/4-85-003. Environmental Monitoring and Support Laboratory. U.S. Environmental Protection Agency, Las Vegas, NV 89183-3478.
95. U.S. Environmental Protection Agency. 1985. Interim Guidance on Preparing Revised Quality Assurance Program Plans. Memo from Stanley Blacker to Deputy Regional Administrators. Dated August 19, 1985.
96. U.S. Environmental Protection Agency. 1986. Field Manual for Grid Sampling of PCB Spill Sites to Verify Cleanup. EPA-560/5-86017. Office of Toxic Substances. U.S. Environmental Protection Agency, Washington, DC 20460.
97. U.S. Environmental Protection Agency. 1987a. Data Quality Objectives for Remedial Response Activities: Development Process. EPA-540/G-87-003. March 1987. U.S. Environmental Protection Agency, Washington, DC 20460.
98. U.S. Environmental Protection Agency. 1987b. Data Quality Objectives for Remedial Response Activities: Example Scenarios. EPA-540/G-87-004. March 1987. U.S. Environmental Protection Agency, Washington, DC 20460.
99. U.S. Environmental Protection Agency. 1989. Documentation of EMSL-LV Contribution to the Palmerton Zinc Study. Environmental Monitoring and Support Laboratory. U.S. Environmental Protection Agency, Las Vegas, NV 89183-3478.
100. Van Ee, J. Jeffrey, Louis J. Blume, and Thomas H. Starks. 1990. A Rationale for the Assessment of Errors in the Sampling of Soils. EPA/600/4-90/013. Environmental Monitoring Systems Laboratory, U.S. Environmental Protection Agency, Las Vegas, NV 89193-3478.
101. Vieira, S.R., D.R. Nielsen, and J.W. Biggar. 1981. Spatial Variability of Field-measured Infiltration Rates. Soil Science Society of America Journal. Vol. 45:1040-1048.
102. Visman, J. 1969. A General Sampling Theory. Materials Research and Standards. MTRSA. Vol. 9(11):8-13.
103. Warrick, A.W., G.J. Mullen, and D.R. Nielsen. 1977. Scaling Field-measured Soil Hydraulic Properties Using Similar Media Concept. Water Resources Research. Vol. 13(2):355-362.
104. Webster, R., and T.M. Burgess. 1980. Optimal Interpolation and Isarithmic Mapping of Soil Properties: III. Changing Drift and Universal Kriging.

105. White, G.C., and T.E. Hakonson. 1979. Statistical Considerations and Survey of Plutonium Concentration Variability in Some Terrestrial Ecosystem Components. *Journal of Environmental Quality*. Vol. 8(2): 176- 182.
106. Wierenga, P.J. 1985. Spatial Variability of Soil-water Properties in Irrigated Soils. In Nielsen, D.R., and J. Bouma, eds. *Soil Spatial Variability*. PUDOC. Wageningen, the Netherlands. pp 112-128.
107. Wilding, L.P. 1985. Spatial Variability: Its Documentation, Accommodation, and Implication to Soil Surveys. In Nielsen, D.R., and J. Bouma, eds. *Soil Spatial Variability*. PUDOC. Wageningen, the Netherlands. pp 166-193.
108. Yates, F. 1949. Systematic Sampling. *Philosophical Transactions of the Royal Society of London: Series A: Mathematical and Physical Sciences*. Vol. 241:345-377.
109. Youden, W.J. 1967. The Role of Statistics in Regulatory Work. *Journal of the American Organization of Analytical Chemists*. Vol.(5):1007-1013.
110. Zirschky, John, and Richard O. Gilbert. 1984. Detecting Hot Spots at Hazardous Waste Sites. *Chemical Engineering*. July 9, 1984. pp. 97-100.

# **APPENDIX A**

**APPLICATION OF PARTICULATE  
SAMPLING THEORY TO SOIL SAMPLING**

## APPENDIX A

### APPLICATION OF PARTICULATE SAMPLING THEORY TO SOIL SAMPLING

#### INTRODUCTION

The concepts from which Gy's sampling theory were developed are established upon the basic concept that the variability in sample results is dependent upon the particle size of the material sampled. The theory shows that the largest particle in the sampling unit controls the variability. Francis Pitard teaches a short course (Pitard, 1989b) designed to train an individual in the use of Gy theory. This course can greatly aid in applying the theory to soil sampling. Pitard has also written a text (Pitard, 1989a) that attempts to translate the basic concepts of the theory into practical application. Pitard's text is essential for understanding the theory and its application to soil and waste sampling. The material that follows is an attempt by the author to apply the theory to soil sampling. Portions of the theory are discussed in Section 2 and must be used to understand the material that follows.

#### Definitions

The following definitions are given to aid in understanding the material in this appendix.

**Components of Variance:** Each sample result is comprised of a series of distinct components. The variation (or variance) in the results is dependent upon the influence of these components. A component of variance test is a standard statistical test that can be carried out with the Analysis of Variance. Section 2 outlines a number of the components that are observed in particulate sampling. These are:

- the fundamental error which is nothing more than the variation within the particles themselves,
- errors due to segregation and grouping of the particles and the pollutant associated with the particles,
- errors due to various types of trends; these can be short range, long range or cyclic,
- errors due to defining the sample space and extracting the sample from that defined area,
- errors due to preparation of the sample,



- errors due to analysis of the sample, and
- errors due to location within the sampling unit or the site.

These errors are discussed in Section 2. Example 5 shown in Section 2 is an example of a Components of Variance test carried out on soil sampling data collected at an NPL site. This test was used to show that the laboratory was not the source of the error seen in the data. Activities in the field, such as where the sample was collected and how it was split, had the major impact on the results.

**Primary Structural Property:** A structural property is an intrinsic property of the material itself and of the equipment used to extract the sample. It is independent of the sampling problem itself; therefore, it is a primary property of the soil or the equipment being used to sample the soil. Both heterogeneity and sampling correctness are primary structural properties.

**Secondary or Circumstantial Property:** A circumstantial property depends upon the sampling problem itself. It is secondary because it depends upon one or more primary properties. Accuracy is a secondary circumstantial property. It depends not only upon the material but also upon how the material was extracted from the sampling unit and how the sample was handled after it was extracted.

**Sample Correctness:** This is a primary structural property depending upon specific sampling conditions over which we have control (sampling tool, sample weight, particle size, model used for dimensions of the waste, etc.), but it is independent of the sampling problem itself. A sample is correct when all particles in the lot or sampling unit have the same probability of being selected. Antithesis to this, all particles that do not belong to the material to be sampled have a zero probability of selection. A biased sample is an incorrect sample because the probability that some fraction of the waste, the pollutant, or the particles themselves is different from the rest of the material.

**Bias:** Sampling bias is the introduction of error into sampling results that is caused by non-probabilistic or non-random factors. These can be intentional influences or accidental influences. They can result from incorrect procedures, from failure to calibrate analytical equipment, from cross contamination, from the investigator attempting to “prove a point,” etc. Sampling bias is always introduced by incorrect sampling (see definition above). Bias is equal to the mean ( $m_{SE}$ ) of the sampling or selection error (SE) when this mean is not equal to zero. It can be either positive or negative. Bias may be very small, but it is never equal to zero. An unbiased sample is an unattainable limit.

**Accuracy:** Based upon the definitions above, one can state that a correct sample is an accurate sample because correctness is a primary property of the material and accuracy reflects that. Mathematically, a sample is accurate when the absolute value of the bias is smaller than some standard identified in the DQO's. It is a property of the mean of an unbiased sample. U.S. EPA (1987a) defines accuracy as the measure of the bias in a measurement system. More recently, the Agency (Quality Assurance Management Staff, 1991) has recommended eliminating the use of the term accuracy and covering the same area with the terms bias and precision because of the problems with determining the "correct standard" to use in determining accuracy.

**Precision:** The reproducibility of estimates of the true content of a pollutant in the soil or waste. An estimate of the true content is precise when the variance ( $s_{SE}^2$ ) of SE does not exceed some standard set by the DQO's. Precision is a property of the variance of SE exclusively. Precision is measured by the standard deviation or the variance of the measurements.

**Representative Sample:** A sample is representative when the mean square,  $r_{SE}^2$ , of SE is not larger than a certain standard of representativeness regarded as acceptable. Representativeness is the sum of the square of the mean of SE ( $m_{SE}$ ), and the variance of SE ( $s_{SE}^2$ ).

$$r_{SE}^2 = m_{SE}^2 + s_{SE}^2 \leq r_{oSE}^2 \quad \text{Equation A-1}$$

This definition is different from that defined in the DQO documents. The Agency document, Data Quality Objectives for Remedial Response Activities: Development Process (U.S. EPA, 1987a) defines representativeness as:

Representativeness expresses the degree to which sample data accurately and precisely represents a characteristic of a population, parameter variations at a sampling point, or an environmental condition. Representativeness is a qualitative parameter which is most concerned with the proper design of the sampling program. The representativeness criterion is best satisfied by making certain that sampling locations are selected properly and a sufficient number of samples are collected. Representativeness is addressed by describing sampling techniques and the rationale used to select sampling locations.

Gy's theory does not contradict the DQO concept of representativeness, but it does provide a quantitative measure of representativeness that could be included in the DQO's.

**Sampling Unit:** A sampling unit of soil, waste, or other particulate matter that is to be sampled. This can be a point or a block such as the RMU or Exposure Unit. Pitard (1989a) refers to this as a “lot” (L). Barth et al. (1989) refer to the volume, shape, and orientation of the soil sampling unit as the “support.”

**Increment:** An increment is a segment, section, or small volume of material extracted from a sample. The most common increments seen in soil sampling are small sections from a core or portions taken from a pile of soil.

## **APPLICATION OF GY’S THEORY TO U.S. EPA SOIL AND WASTE SAMPLING**

One of the key concepts of Gy’s theory is that the investigator can select a particle size range that will reduce the variance of the results obtained to a minimum under the conditions of the sampling study. One can work from the particle sizes available in the raw material to the weight of sample that is required to reduce the variance to some predetermined acceptable standard. This standard should be spelled out in the DQO document. Where the particle sizes are such that the weight would be too large for the laboratory to handle, it will be necessary to reduce the volume by using incremental sampling, splitting, or grinding the sample to a size that will allow reduction of the material to a weight that is acceptable for analyses. Most soils do not require the grinding process unless gravels, cobbles, or other large components are present.

Pitard (1989a, 1989b) outlines procedures for determining the particle size classes that are required to reduce the sample to an analytical subsample. The procedure can be worked in reverse and a determination can be made of the comminution protocol that will be needed to reach an acceptable variance. This is determined by the use of a sampling nomograph discussed below.

In those cases where grinding is not acceptable because of volatility, etc., it will be necessary to collect a number of small increments to be included in the analytical sample or else analyzed as a separate sample. Screening can also be done if the conceptual model used to design the sampling study can show that there is little or no impact from the coarser materials. This decision should be supported by data collected from a portion of the samples.

## **SAMPLING NOMOGRAPH**

The sampling nomograph is used to determine the particle size and sample weights that should be used for a particular material.

## Determination of Particle Size and Sample Weights:

Pitard (1989a, 1989b) outlines a procedure for determining the particle size-sample weight relationship that should be met to insure that an unbiased sample of material is submitted to the laboratory for analysis. Parts of this procedure are applicable to soil sampling, but some aspects of the procedure cannot be carried out especially with volatile organic chemicals. Paramount to this is the requirement for grinding or pulverizing the sample to reduce the particle sizes to a size that maintains a desirable fundamental error (FE). The procedure outlined below is taken from Pitard (1989a), Ingamells (1974), and Visman (1969).

The constitution heterogeneity (CH) of a material which leads to the fundamental error (FE) can only be measured when the number of fragments can be counted. With soils, this is a difficult proposition. Pitard (1989a, 1989b) introduces a term called the constant factor of constitution heterogeneity (IH<sub>L</sub>) IH<sub>L</sub> is more useful for purposes of soil sampling since this constant can be estimated by making some simplifying assumptions.

It is not possible to determine FE directly, but the maximum and minimum variance of this error can be estimated by the following relationship:

$$s^2_{FE} = (1/M_s - 1/M_L) * IH_L \quad \text{Equation A-2}$$

where:

$s^2_{FE}$	= variance of the fundamental error
$M_s$	= weight of sample
$M_L$	= weight of lot or support
$IH_L$	= constant factor of constitution heterogeneity

When the mass of the lot  $M_L$  is large in relation to the sample weight ( $M_s$ ), A-2 simplifies to:

$$s^2_{FE} = IH_L/M_s \quad \text{Equation A-3}$$

$IH_L$  can be estimated by the following relationship:

$$IH_L = clfgd^3 \quad \text{Equation A-4}$$

where:  $c$  = mineralogical factor

$$c = (\lambda_M * (1-a_L)^2/a_L) + (\lambda_L * (1-a_L)) \quad \text{Equation A-5}$$

$a_L$	= average concentration in the lot or support
$\lambda_M$	= density of the pollutant

$\lambda$ , = density of the soil material (2.65 g/cc)  
 $l$  = is called the liberation fraction that lies between 0 and 1 and can be estimated as follows:

very heterogeneous material	= 0.8
heterogeneous material	= 0.4
average material	= 0.2
homogeneous materials	= 0.1
very homogeneous materials	= 0.05

It is also equal to the following:

$$l = (a_{max} - a_L) / (1 - a_L) \quad \text{Equation A-6}$$

$f$	=	shape factor	
		if all particles are cubes	= 1
		most materials	= 0.5
		flakes such as mica, biotite, etc.	= 0.1
		soft solids such as tar	= 0.2
		needle-like mineral material	= >1

This can be estimated by the following:

$$f = M / (p d_a^3 \lambda) \quad \text{Equation A-7}$$

$p$	=	number of fragments collected between two sieves of diameter $d_1$ and $d_2$	
$d_a$	=	average diameter of particles	= $(d_1 + d_2) / 2$
$\lambda$	=	average density of fragments.	
$g$	=	granulometric factor	
	=	1 if material was perfectly calibrated	
	=	0.25 for non-calibrated -material (out of jaw crusher)	
	=	0.55 for calibrated material (material retained between two screens)	
	=	0.75 for materials that are naturally calibrated such as beach sands, uniform gravels, etc.	

Most soils can be estimated using 0.25 for  $g$ .

$d$	=	is the maximum particle size
	=	the opening of a square mesh retaining no more than 5 % oversize (Pitard, 1989a).

The product (clfg) is also known as the sampling constant C. This is used in the nomographs shown below. Equation A-3 can be rewritten using C to give:

$$s_{FE}^2 = Cd^3/M_s$$

**Equation A-8**

To implement this procedure, it is necessary to determine the particle size distribution of the soil or waste. The fragment of interest is the maximum particle size, d. The material in Figure 1-1 would have  $d = 7.5$  cm. This is a very large particle for “soil,” but this is the controlling particle size for ‘sampling this material. The sampling nomograph is used for reducing the sample size down to the amount of material needed for analysis. The procedure for developing and using this nomograph is outlined below.

Determine the average concentration of several sampling units or blocks by taking a number of samples in each block. Attempt to obtain at least one set of samples from a known “hot spot” in order to obtain an estimate of  $a_{max}$

1. Determine the maximum particle size.
2. Determine the weight of the field sample that is to be taken.
3. Determine the density of the pollutant.
4. Calculate 1 using Equation A-6.
5. Calculate  $IH_L$  using Equation A-4.
6. Prepare a nomograph for the particle size ranges encountered at the site or use one of the nomographs given below.
7. Determine the comminution that must occur to arrive at the sample aliquot needed by the laboratory. This is done by:

Plotting the weight of the field sample on the line represented by  $d_{max}$  (see Fig. A-1 point A). The sample would then be reduced in size until the variance of the fundamental error specified in the DQO is reached (point B) (for most environmental work a relative standard deviation (CV) of  $\pm 15\%$  is often used. The variance would be 0.0225 for this CV.

Grind the sample to a smaller maximum particle size, then reduce the sample size (point C) until the line represented by variance chosen in the DQO is reached (point D). With soils, it is often possible to reach the analytical aliquot with only one grinding operation.

Figure A-1 is an example taken from the material shown in Figure 1-1. The  $d_{\max}$  for this material is 3 inches or 75 mm. Assume a two kilogram field sample. A one gram aliquot is needed by the laboratory. Use of the nomograph is started at point A. The sample size would be reduced to 100 grams by splitting, etc. (point B). The particle size would be reduced to 6.35 mm (point C). The sample would then be reduced in weight again by splitting or some other process of sample reduction until point D is reached. The standard deviation of the fundamental error would be  $\pm 3\%$ , considerably less than the  $+15\%$  recommended for environmental sampling (Pitard, 1989a, 1989b).

This procedure is followed using the other nomographs given in this appendix, or else the investigator can prepare nomographs for use in other studies or for situations where the conditions differ. In the examples given in Figures A-2 through A-7, the following parameters were used:

$$f = 0.5$$

$$g = 0.25$$

$\bar{I}$  = calculated using  $a_t$  in a range from 10% to parts per trillion and  $a_{\max}$  in a range from  $1.1 \times a_t$  to 10,000 times.

$c_1$  = inorganic chemical with a density of  $0.5 \text{ g/cm}^3$ .

$c_2$  = inorganic chemical with a density of  $2.5 \text{ g/cm}^3$ .

$c_3$  = inorganic chemical with a density of  $22.4 \text{ g/cm}^3$ .

$c_4$  = organic chemical with a density of  $0.4 \text{ g/cm}^3$ .

$c_5$  = organic chemical with a density of  $1.1 \text{ g/cm}^3$ .

$c_6$  = organic chemical with a density of  $2.75 \text{ g/cm}^3$ .

FIGURE A1: SAMPLING NOMOGRAPH FOR SOILS  
 $C = 0.005$

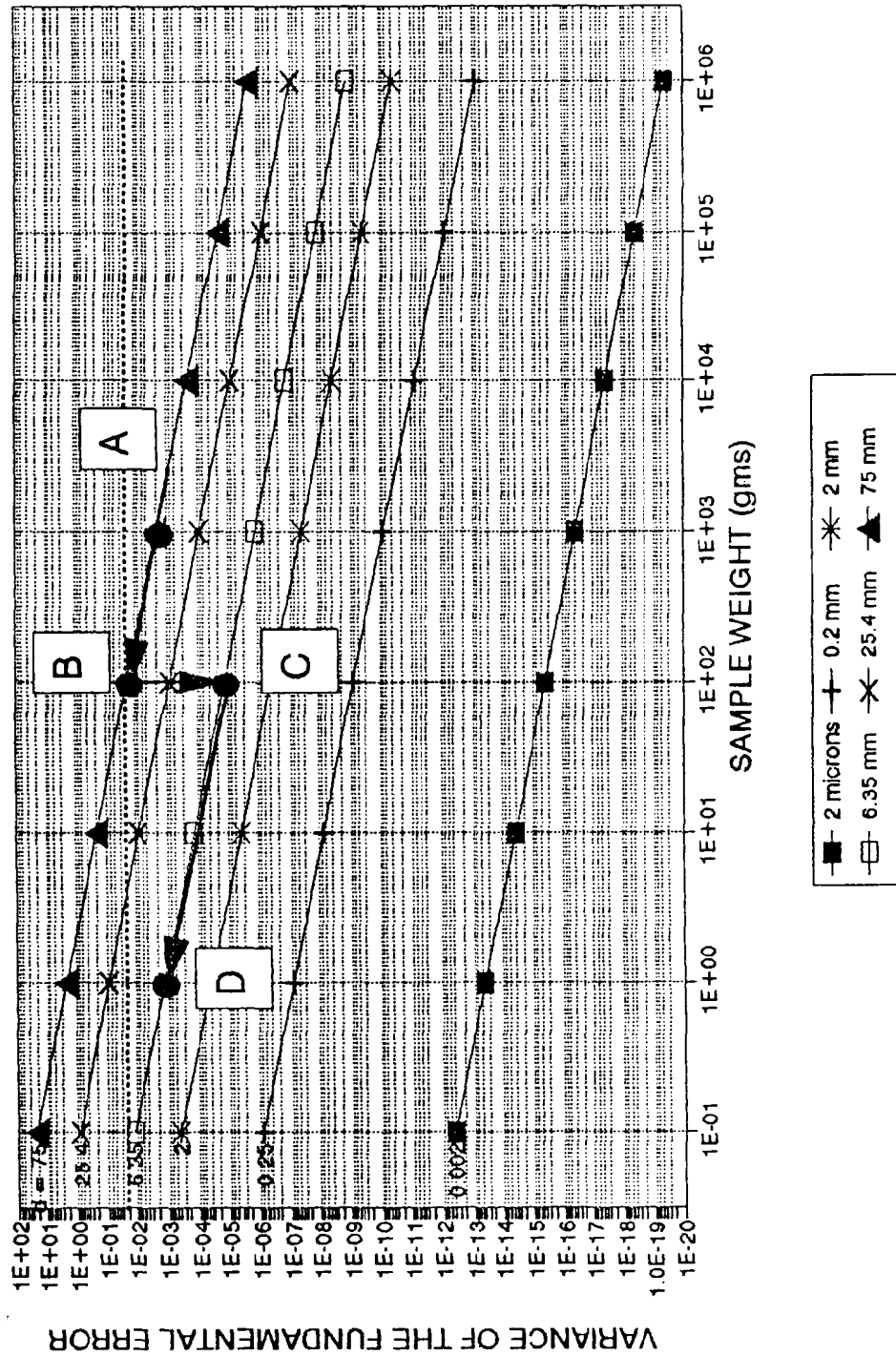



FIGURE A2: SAMPLING NOMOGRAPH FOR SOILS  
 $C = 0.005$

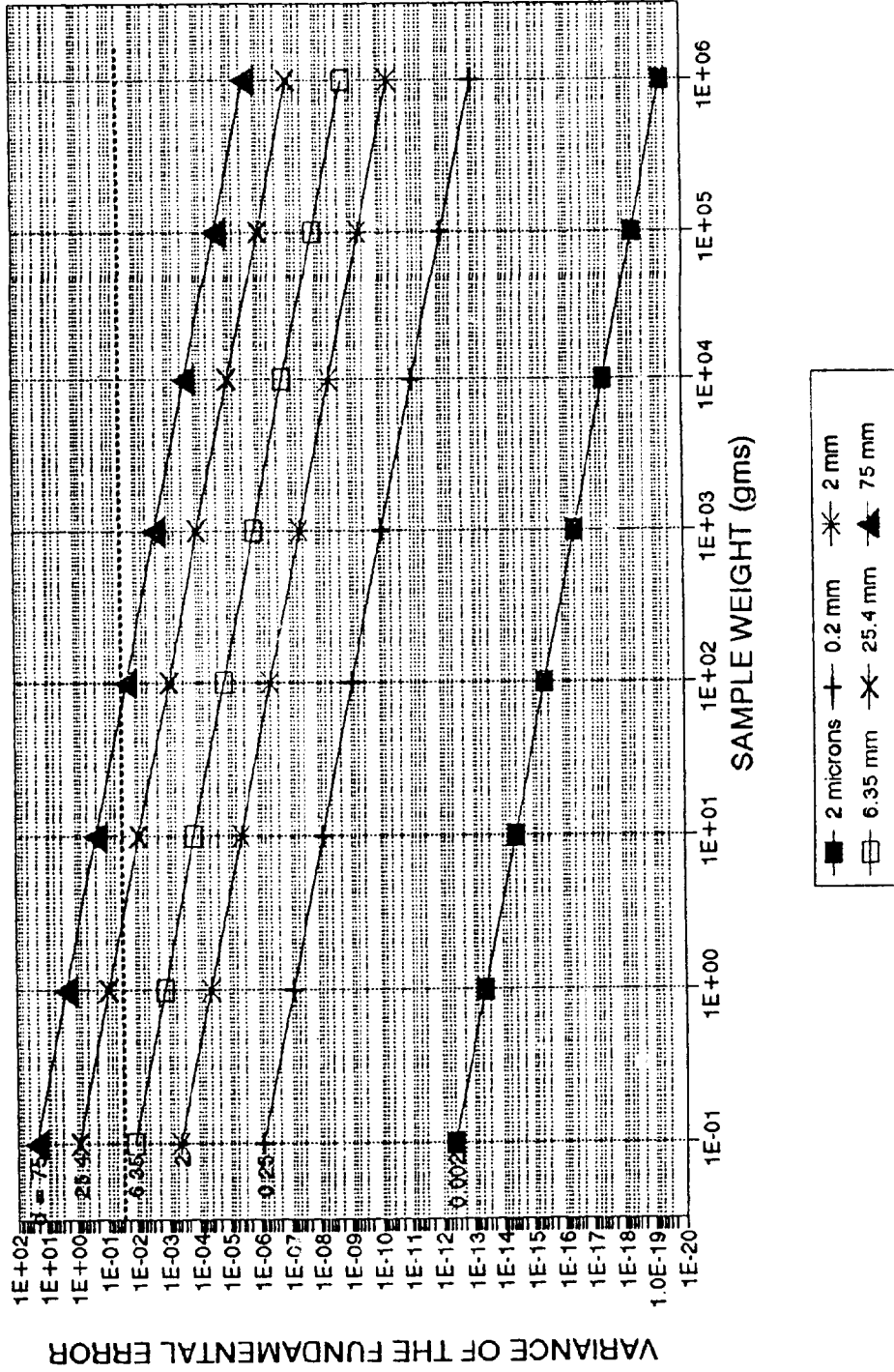

FIGURE A3: SAMPLING NOMOGRAPH FOR SOILS  
 $C = 0.05$

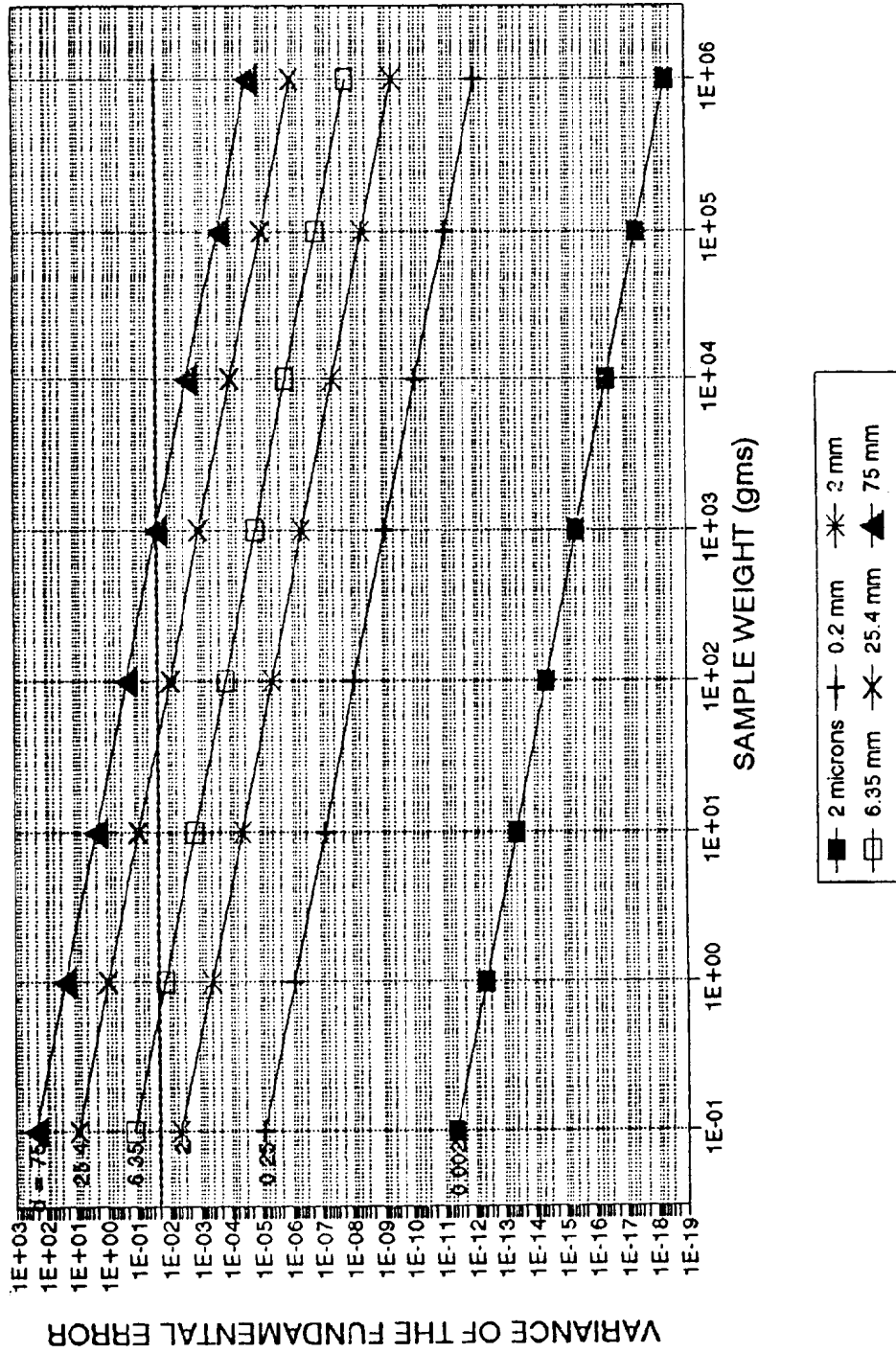

FIGURE A4: SAMPLING NOMOGRAPH FOR SOILS  
 $C = 0.5$

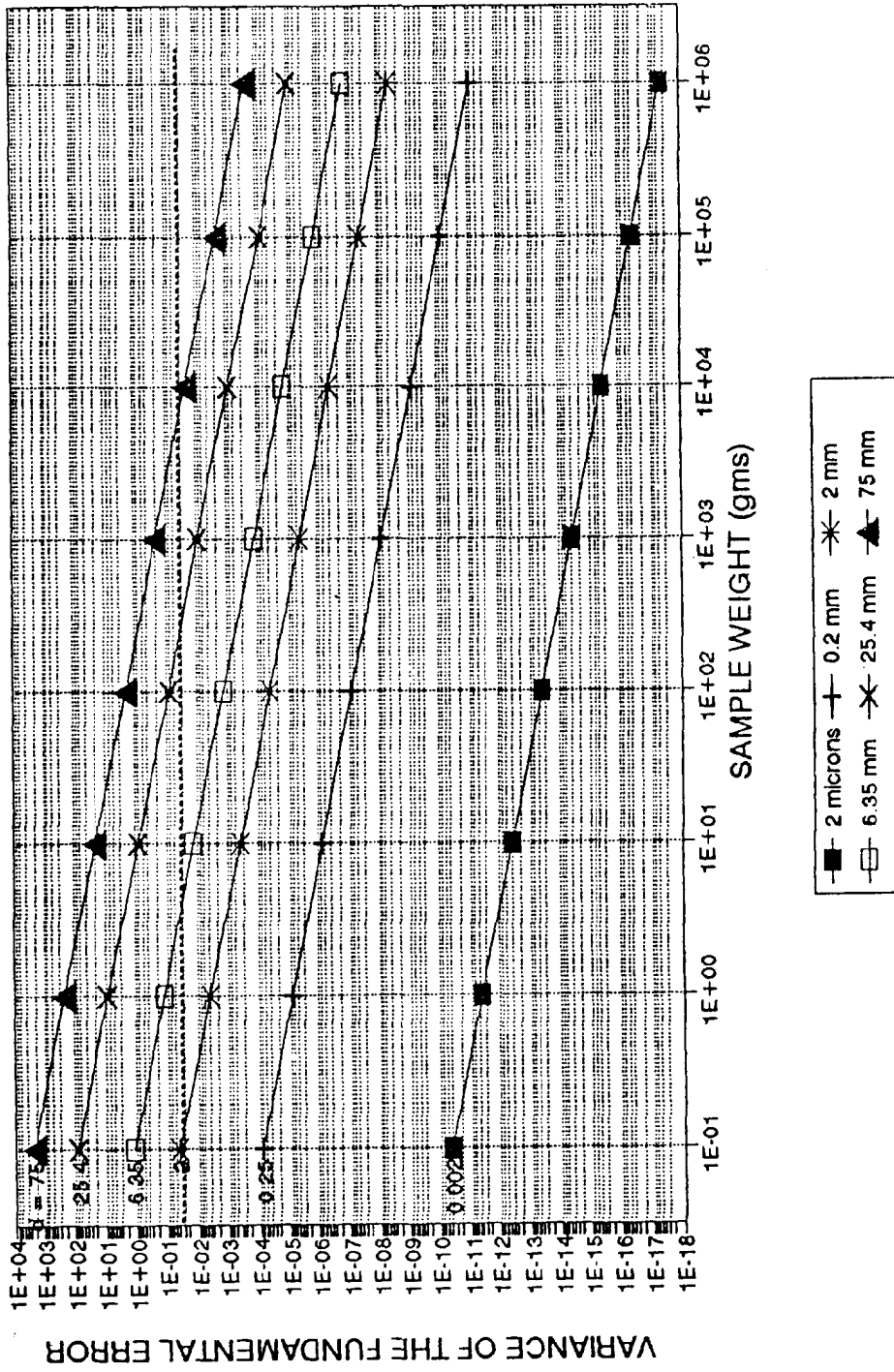

FIGURE A5: SAMPLING NOMOGRAPH FOR SOILS  
 $C = 5.0$

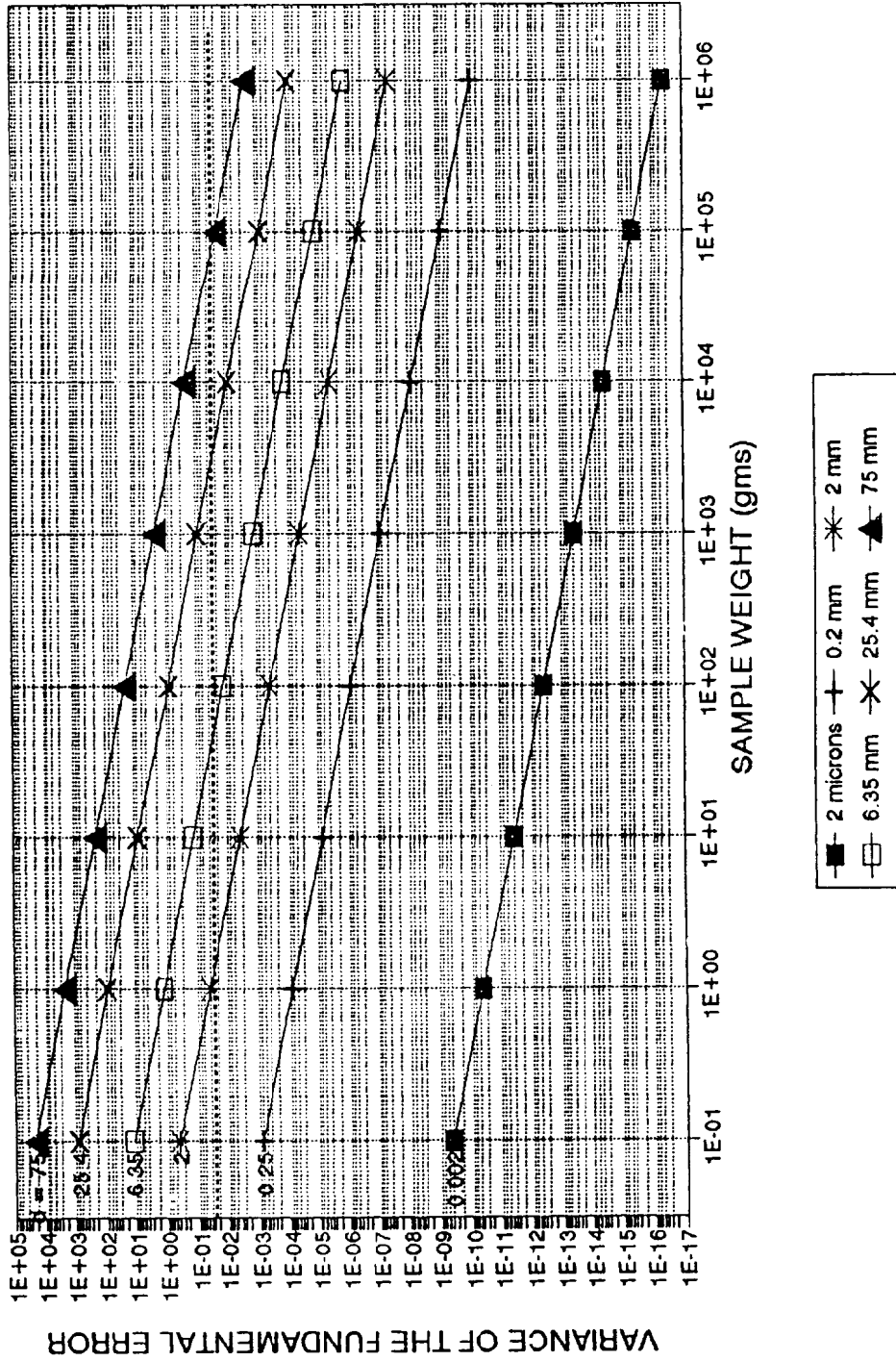

FIGURE A6: SAMPLING NOMOGRAPH FOR SOILS  
 $C = 50.0$

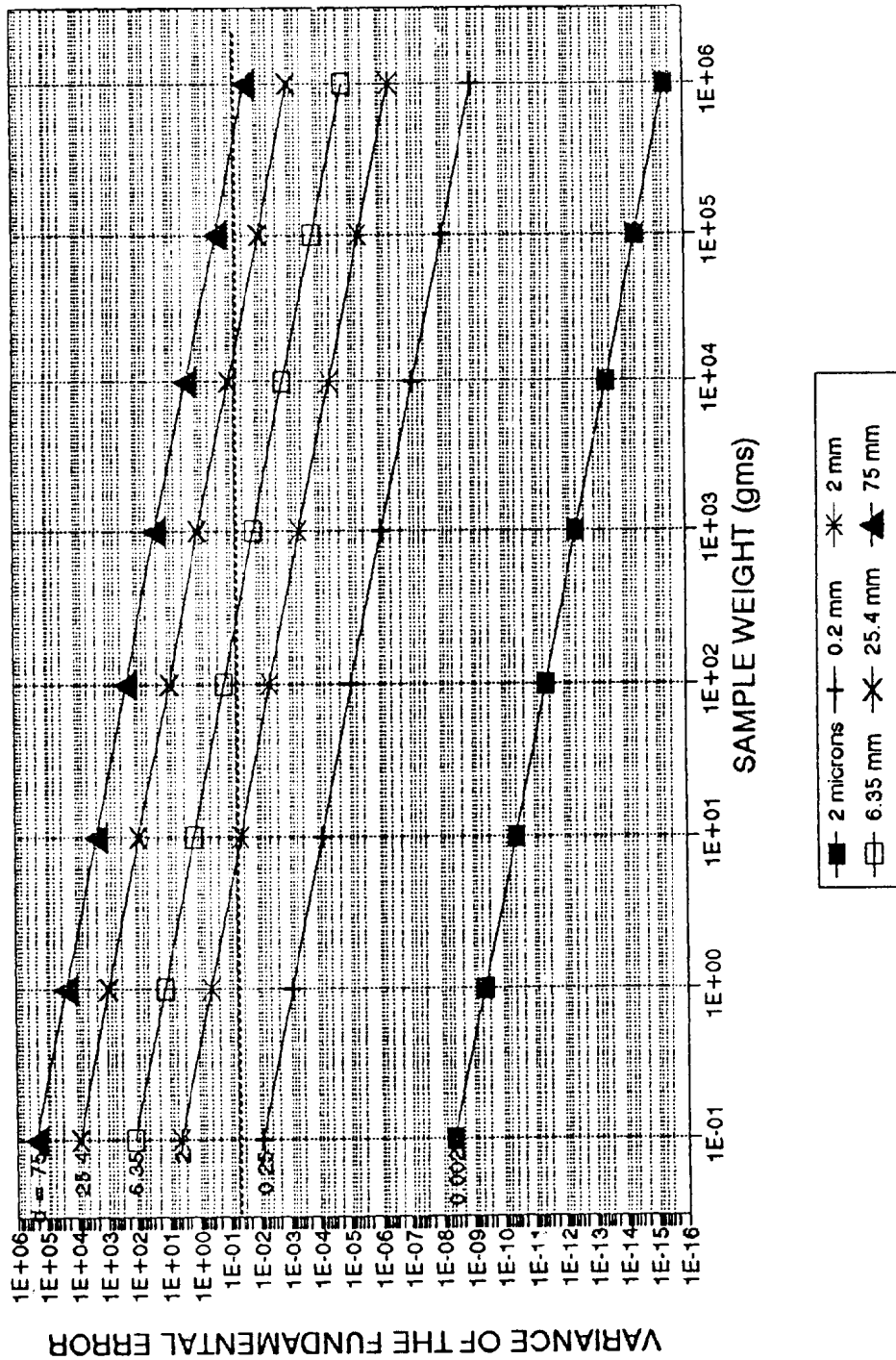
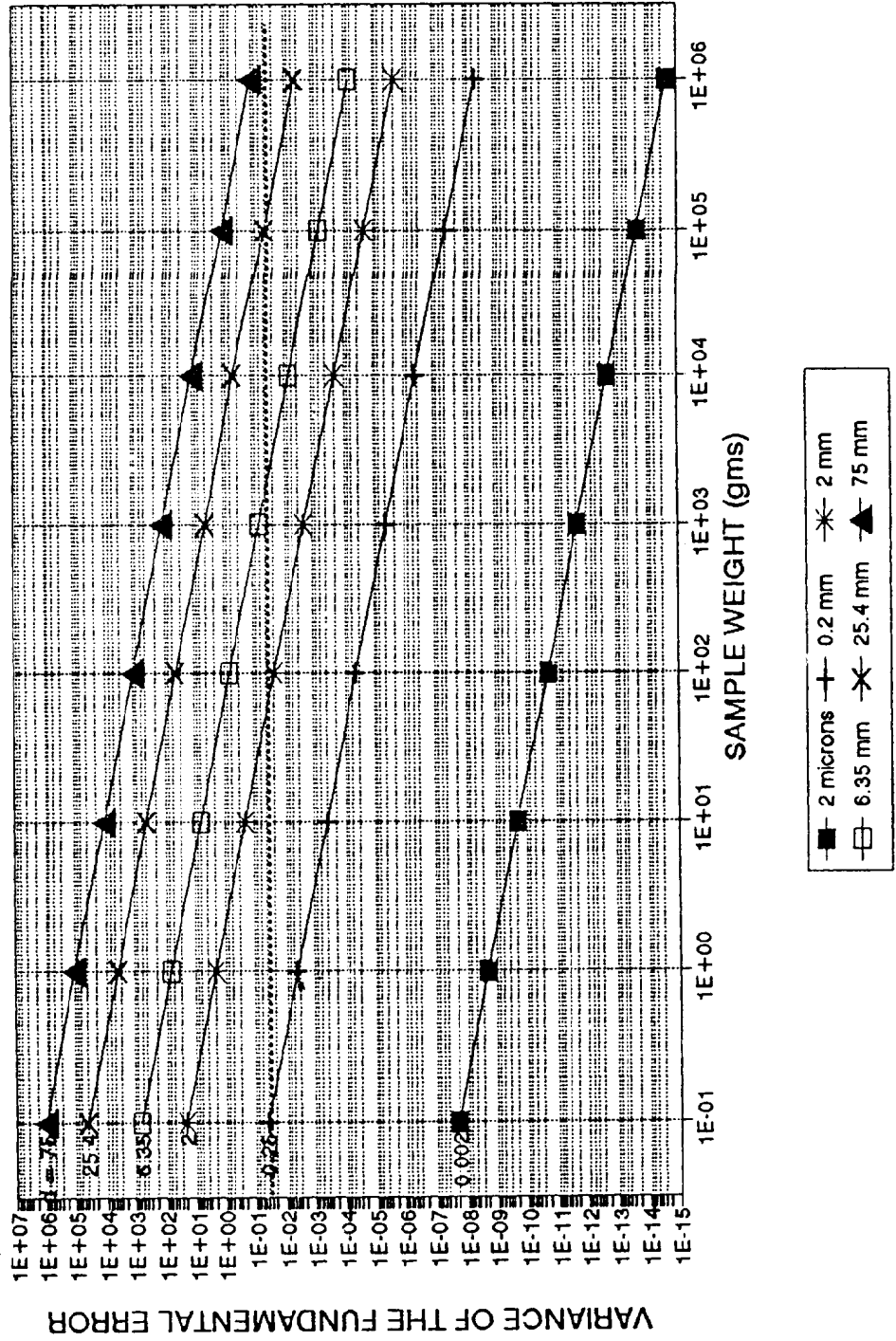

FIGURE A7: SAMPLING NOMOGRAPH FOR SOILS  
 $C = 250$



In developing Figures A-2 to A-7, all possible combinations of the various parameters were used to calculate the points on the curves. The range of each parameter was chosen to match the ranges seen in sampling situations reported in many of the references used in this report. Reviewers of early drafts of this material suggested that the range of variance used in these figures was too large. The author chose to retain this wide range because of his own experience at over 30 Superfund sites. This experience, combined with information obtained in the reviewed literatures, indicates that the range reflects what one is likely to encounter in soil sampling work. Also, one should keep in mind the discussion on soil coefficients of variation given in Section 1. In addition to the natural variability of soils, pollutants are known to have a wider range of variation than the natural components. It is not uncommon to have a CV of 300% to 400% in samples taken at waste sites.

## **DETERMINATION OF FIELD SAMPLE SIZE**

### **Determination of Field Sample Size**

Pitard (1989a, 1989b) presents a method for determining the optimum sample weight that provides the most information about the material being sampled for the least cost. The equations used are based on work by Visman (1969) and Ingamells and Switzer (1973).

Visman (1969) identifies two sampling constants "A" and "B". The constant "A" is the homogeneity constant which is closely related to C or  $IH_L$  of Gy (1986) and Pitard (Pitard, 1989a, 1989b). The constant "B" is the segregation constant and includes the variance components  $GE$ ,  $CE_2$  and  $CE_3$ .

These two sampling constants are used to develop the sampling diagram outlined in Appendix B.

# **APPENDIX B**

## **DETERMINING SAMPLE WEIGHTS USING SAMPLING DIAGRAMS**



## APPENDIX B

### DETERMINING SAMPLE WEIGHTS USING SAMPLING DIAGRAMS

The development of a sampling diagram and the determination of the optimum and minimum sampling weights are discussed in Section 6. The material presented in that section is repeated here for convenience. Appendix B-1 can be used for generating an estimate of the fundamental error for samples of different sizes and also for estimating the optimum sampling weight using Gy's basic theory as discussed by Pitard (1989a). Appendix B-2 is a printout of the spreadsheet that was used to generate Appendix B-1. This is in Lotus 1-2-3 format.

Appendix B-3 is a table for calculating the Visman sampling constants and the optimum sampling weight based upon these constants. (See Visman, 1969; Pitard, 1989a; or Ingamells and Switzer, 1973.) Appendix B-4 is the sampling diagram calculated according to the procedures outlined in Appendix A. The example is discussed in that section and in Section 1 (see Example 2).

### DETERMINING SAMPLING CONSTANTS

Visman's sampling constants are used to determine the size of sample that should be used for collecting samples in the field. The sampling constants are determined upon data collected from two sets of samples from the site. The site should be divided into nine or more approximately equal rectangular or square cells. Take a series of small random samples of weight  $w_1$  from each cell. Follow this by taking a second series of random samples of weight  $w_2$  from the same cells. The weight of the large sample should be 10 or more times the weight of the small sample.

These two sets of samples are then reduced in size according to procedures outlined in Section 5 and Appendix A and submitted to the laboratory for analysis. Calculate the mean ( $m$ ) and the variance ( $s^2$ ) for each set of samples (subscripts identify each individual sample), then calculate A and B according to the following equations.

$$A = (w_1 * w_2 * (s_1^2 - s_2^2)) / (w_2 - w_1) \quad \text{Equation B-1}$$

$$B = s_1^2 - (A / w_1) = s_2^2 - (A / w_2) \quad \text{Equation B-2}$$

The optimum sample weight ( $w_{opt}$ ) has been reported in several references (Ingamells and Switzer, 1973; Ingamells, 1974; Ingamells and Pitard, 1986; Pitard, 1989b;) to be:

$$w_{opt} = A / B \quad \text{Equation B-3}$$

This weight is optimum because it allows the investigator to obtain the most information for the lowest cost. With most environmental sampling, the weight of the sample should be at least six times the minimum weight ( $w_{\min}$ ) which is:

$$w_{\min} = A / (\bar{X} - BG)^2 \quad \text{Equation B-4}$$

where  $\bar{X}$  is the average concentration in the small samples and BG is the background concentration.

The total variance for the soil material ( $s_T^2$ ) can be estimated by the following relationship:

$$s_T^2 = A/(N*w) + B/N \quad \text{Equation B-5}$$

where:            N        = number of samples  
                       W        = weight of small samples  
                       N\*w     = total weight (W) of material from small samples.

This estimate for the total variance is comparable to the sum of the within block variance and the between block variance shown by Krige (Pitard, 1989b).

An interesting observation can be made about the above equations. Equation 6-5 was derived from Equation 6-12. When the derivative of the cost equation is solved for the minimum sample weight, Equation 6-5 results. Substituting Equation 6-5 in Equation 6-7 gives the following:

$$s_T^2 = 2B/N \quad \text{Equation B-6}$$

This indicates that any estimate of concentration in a support or soil sampling unit will be followed by an uncertainty that is equal to  $\pm(2B/N)^{1/2}$ . In order to further reduce the uncertainty by 1/2, it would take four times the number of samples. An order of magnitude reduction would take a 100-fold increase in the number of samples.

A second method for estimating the size of sample ( $M_s$ ) that is needed is based upon the use of Equation A-3. Rearranging Equation A-3 gives:

$$M_s = IH_L / s^2 \quad \text{Equation B-7}$$

The precision specified in the DQO can be squared and substituted in Equation B-7 for  $s^2$ . The sampling constant,  $IH_L$ , can be estimated according to the procedures outlined in Appendix A. An approximation for the precision is  $\pm 15\%$  for most environmental studies

(Pitard, 1989a). The equations presented in this appendix along with Appendix A can be used to determine the size of sample that is needed and a procedure for reducing this down to a laboratory sample.

### SAMPLING DIAGRAM

Another tool that has been suggested by Pitard (1989a, 1989b), Gy (1986), and Ingamells and Switzer (1973) is the sampling diagram. This is a graphic presentation of the information that is derived from the above evaluation of a sampling situation. The mean and standard deviation derived from the two sample sizes discussed above is used to develop a curve of the most probable concentration estimate. Equation B-8 is used to develop points on this curve. The curve can be improved by making use of more than the two sample sizes, although, this is not required.

$$Y = \frac{(2 \bar{X} * (\bar{X} - BG)^2 * w) + (A * BG)}{(2 * (\bar{X} - BG)^2 * w) + A} \quad \text{Equation B-8}$$

The standard deviation curve is then solved for situations when there is no large scale segregation (i.e., B = 0). Equation B-9 is used to estimate the standard deviation (s) for this situation. The estimate of s is then added and subtracted from the average obtained for the large sample size ( $\bar{X}_2$ ). This is then plotted on the sampling diagram. A second standard deviation (s') is based upon Equation B-10 for the variance of individual samples and is plotted on the diagram. This gives an indication of the spread of the sample results likely to be encountered during collection of an individual sample of the soil material. It is the same as the variance of the fundamental error (s<sub>FE</sub>) of the material. A third standard deviation (s<sub>v</sub>) is calculated using Equation B-11 and plotted on the sampling diagram. This is based upon a range of optimum sample weights. (Normally, one calculates the optimum weight then uses multiples of that weight to obtain the points for plotting the curve.) The point where s<sub>v</sub> and s' intersect is the optimum sampling weight for the material. The point where s intersects the background concentration is the minimum sample weight. Appendix B-4 shows the results of this calculation for materials similar to those in Example 5.

$$s = (A / w)^5 \quad \text{Equation B-9}$$

$$s'_v = ((A / w) + B)^5 \quad \text{Equation B-10}$$

$$s_v = (2 * A / w)^5 \quad \text{Equation B-11}$$

APPENDIX B-1  
TABLE FOR ESTIMATING IHL AND SAMPLE WEIGHTS

FACTORS				
Chemical Compound	Pb PbSO <sub>4</sub>			
f	5.000E-01			
g	4.000E-01			
Maximum Concentration	3.760E-02			
Average Concentration	2.500E-04			
Density	6.400E+00			
DQO	1.500E-01			
CALCULATIONS				
e	2.559E+04			
l	3.736E-02			
C	1.912E+02			
Sample Weights (gm)	1	20	100	250
Particle Diameter (cm)	2.540	0.635	0.200	0.020
IHL (gm)	3.134E+03	4.896E+01	1.530E+00	1.530E-03
1 gm s <sup>2</sup>	3.134E+03	4.896E+01	1.530E+00	1.530E-03
+ - s (%)	5597.97%	699.75%	123.69%	3.91%
20 gm s <sup>2</sup>	1.567E+02	2.448E+00	7.649E-02	7.649E-05
+ - s (%)	1251.74%	156.47%	27.66%	0.87%
100 gm s <sup>2</sup>	3.134E+01	4.896E-01	1.530E-02	1.530E-05
+ - s (%)	559.80%	69.97%	12.37%	0.39%
250 gm s <sup>2</sup>	1.253E+01	1.959E-01	6.119E-03	6.119E-06
+ - s (%)	3.540E+00	4.426E-01	7.823E-02	2.474E-03
Optimum Weight (gm)	1.393E+05	2.176E+03	6.799E+01	6.799E-02

APPENDIX B-2: SPREADSHEET FORMULAS FOR APPENDIX B-1

A1: [W23] ^ APPENDIX B-2: SPREADSHEET FORMULAS FOR APPENDIX B-1  
A2: [W23] [F2] ' TABLE FOR ESTIMATING IHL AND SAMPLE WEIGHTS  
B4: [F2] 'FACTORS  
A5: [W23] [F2] ^ Chemical  
C5: [F2] ^ Pb  
A6: [W23] [F2] ^ Compound  
C6: [F2] ^ PbS04  
A7: [W23] [F2] ^ f  
C7: [F2] 0.5  
A8: [W23] [F2] ^g  
C8: [F2] 0.4  
A9: [W23] [F2] ^ Maximum Concentration  
C9: [F2] 0.0376  
A10: [W23] [F2] ^ Average Concentration  
C10: [F2] 0.00025  
A11: [W23] [F2] ^ Density  
C11: [F2] 6.4  
A12: [W23] [F2] ^ DQO  
C12: [F2] 0.15  
B14: [F2] 'CALCULATIONS  
A15: [W23] [F2] ^ c  
C15: [F2] (+\$C\$11\*((1-\$C\$10) ^ 2)/\$C\$10) +(\$C\$11\*(1-\$C\$10))  
A16: [W23] [F2] ^ 1  
C16: [F2] (\$C\$9-\$C\$10)/(1-\$C\$10)  
A17: [W23] [F2] ^ C  
C17: [F2] +\$C\$7\*\$C\$8\*\$C\$15\*\$C\$16  
A18: [W23] [F2] ^ Sample Weights (gm)  
B18: (F0) [F2] 1  
C18: (F0) [F2] 20  
D18: (F0) [F2] 100  
E18: (F0) [F2] 250  
A19: [W23] [F2] ^ Particle Diameter (cm)  
B19: (F3) [F2] 2.54  
C19: (F3) [F2] 2.54/4  
D19: (F3) [F2] 0.2  
E19: (F3) [F2] 0.02  
A20: [W23] [F2] ^ IHL (gm)

B20: (S4) [F2] +\$\$17\*(B\$19 ^ 3)  
 C20: (S4) [F2] +\$\$17\*(C\$19 ^ 3)  
 D20: (S4) [F2] +\$\$17\*(D\$19^3)  
 E20: (S4) [F2] +\$\$17\*(E\$19^ 3)  
 A21: [W23] [F2] ^ 1 gm s ^ 2  
 B21: (S4) [F2] (\$\$17\*(B\$19^3))/B\$18  
 C21: (S4) [F2] (\$\$17\*(C\$19^3))/B\$18  
 D21: (S4) [F2] (\$\$17\*(D\$19^3))/B\$18  
 E21: (S4) [F2] (\$\$17\*(E\$19^3))/B\$18  
 A22: [W23] [F2] ^ +- s (%)  
 B22: (P2) [F2] @SQRT(B21)  
 C22: (P2) [F2] @SQRT(C21)  
 D22: (P2) [F2] @SQRT(D21)  
 E22: (P2) [F2] @SQRT(E21)  
 A23: [W23] [F2] ^ 20 gm s ^ 2  
 B23: (S4) [F2] (\$\$17\*(B\$19^3))/\$\$18  
 C23: (S4) [F2] (\$\$17\*(C\$19^3))/\$\$18  
 D23: (S4) [F2] (\$\$17\*(D\$19^3))/\$\$18  
 E23: (S4) [F2] (\$\$17\*(E\$19^3))/\$\$18  
 A24: [W23] [F2] ^ +- s (%)  
 B24: (P2) [F2] @SQRT(B23)  
 C24: (P2) [F2] @SQRT(C23)  
 D24: (P2) [F2] @SQRT(D23)  
 E24: (P2) [F2] @SQRT(E23)  
 A25: [W23] [F2] ^ 100 gm s ^ 2  
 B25: (S4) [F2] (\$\$17\* (B\$19 ^ 3))/\$D\$18  
 C25: (S4) [F2] (\$\$17\*(C\$19^3))/\$D\$18  
 D25: (S4) [F2] (\$\$17\*(D\$19 ^ 3))/\$D\$18  
 E25: (S4) [F2] (\$\$17\*(E\$19 ^ 3))/\$D\$18  
 A26: [W23] [F2] ^ +-s (%)  
 B26: (P2) [F2] @SQRT(B25)  
 C26: (P2) [F2] @SQRT(C25)  
 D26: (P2) [F2] @SQRT(D25)  
 E26: (P2) [F2] @SQRT(E25)  
 A27: [W23] [F2] ^ 250 gm s ^ 2  
 B27: (S4) [F2] (\$\$17\*(B\$19^ 3))/\$E\$18  
 C27: (S4) [F2] (\$\$17\*(C\$19^ 3))/\$E\$18

D27: (S4) [F2] ( $\$C\$17*(D\$19 \wedge 3)/\$E\$18$ )

E27: (S4) [F2] ( $\$C\$17*(E\$19 \wedge 3)/\$E\$18$ )

A28: [W23] [F2]  $\wedge$  +-s (%)

B28: (S4) [F2] @SQRT(B27)

C28: (S4) [F2] @SQRT(C27)

D28: (S4) [F2] @SQRT(D27)

E28: (S4) [F2] @SQRT(E27)

A29: [W23] [F2]  $\wedge$  Optimum Weight (gm)

B29: (S4) [F2] +B\$20/(\$C\$12  $\wedge$  2)

C29: (S4) [F2] +C\$20/(\$C\$12  $\wedge$  2)

D29: (S4) [F2] +D\$20/(\$C\$12  $\wedge$  2)

E29: (S4) [F2] +E\$20/(\$C\$12  $\wedge$  2)

APPENDIX B-3  
 TABLE FOR ESTIMATING VISMAN CONSTANTS AND OPTIMUM SAMPLE WEIGHTS

SAMPLE NUMBER	SMALL SAMPLE			LARGE SAMPLE		
	LOCATION (XXXXYY)	WEIGHT (gm)	ANALYSIS (g/g)	LOCATION (XXXXYY)	WEIGHT (gm)	ANALYSIS (g/g)
1	153173	2.01	235.7	181114	20.55	285.9
2	166297	2.04	250.0	170271	20.20	245.0
3	130318	2.03	350.0	138353	19.89	225.0
4	219193	1.96	100.0	275140	20.61	210.6
5	231276	2.11	125.9	248203	20.75	225.0
6	261348	2.00	125.8	283311	20.70	235.0
7	305132	1.99	225.9	390196	21.00	275.8
8	354242	1.98	128.6	333256	19.99	267.5
9	327349	2.01	100.9	358340	19.95	276.8
N		9				
Sum		18.13			183.64	
Average		2.01	182.53333333		20.40	249.6
Variance			6679.42			670.00
Relative SD (CV) (%)			44.77%			10.37%
VISMAN'S "A"		13431.689				
VISMAN'S "B"		11.73	11.73			
VISMAN'S						
Sample Variance		742.15753				
Sample Standard Deviation		27.242568				
Relative SD (CV) (%)		14.92%				
Background (g/g)		10				
OPTIMUM WEIGHT		1145.1654				



APPENDIX B-4 SAMPLING DIAGRAM  
PCB SAMPLING STUDY RESULTS

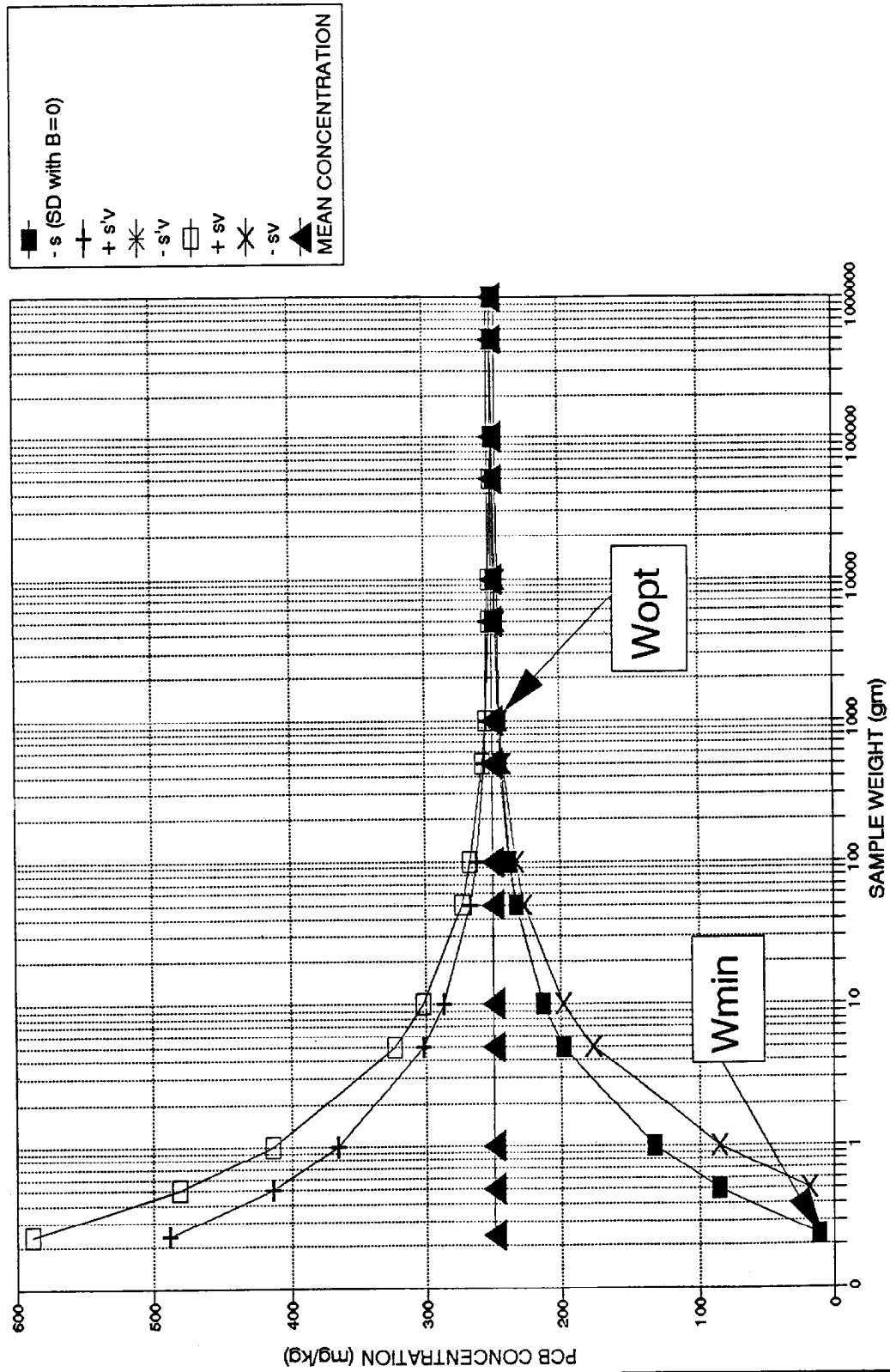

# **APPENDIX C**

## **PERCENTILES OF THE $t$ DISTRIBUTION**

APPENDIX C.

PERCENTILES OF THE t DISTRIBUTION

df	Confidence Level (%): $1-\alpha/2$ for two-tailed test							
	20	40	60	80	90	95	98	99
	Confidence Level (%): $1-\alpha$ for one-tailed test							
	60	70	80	90	95	97.5	99	99.5
1	.325	.727	1.376	3.078	6.314	12.706	31.821	63.657
2	.289	.617	1.061	1.886	2.920	4.303	6.965	9.925
3	.277	.584	.978	1.638	2.353	3.182	4.541	5.641
4	.271	.569	.941	1.533	2.132	2.776	3.747	4.604
5	.267	.559	.920	1.476	2.015	2.571	3.365	4.032
6	.265	.553	.906	1.440	1.943	2.447	3.143	3.707
7	.263	.549	.896	1.415	1.895	2.365	2.998	3.499
8	.262	.546	.889	1.397	1.860	2.306	2.896	3.355
9	.261	.543	.883	1.383	1.833	2.262	2.821	3.250
10	.260	.542	.879	1.372	1.812	2.228	2.764	3.169
11	.260	.540	.876	1.363	1.796	2.201	2.718	3.106
12	.259	.539	.873	1.356	1.782	2.179	2.681	3.055
13	.259	.538	.870	1.350	1.771	2.160	2.650	3.012
14	.258	.537	.868	1.345	1.761	2.145	2.624	2.977
15	.258	.536	.866	1.341	1.753	2.131	2.602	2.947
16	.258	.535	.865	1.337	1.746	2.120	2.583	2.921
17	.257	.534	.863	1.333	1.740	2.110	2.567	2.898
18	.257	.534	.862	1.330	1.734	2.101	2.552	2.878
19	.257	.533	.861	1.328	1.729	2.093	2.539	2.861
20	.257	.533	.860	1.325	1.725	2.386	2.528	2.845
21	.257	.532	.859	1.323	1.721	2.080	2.518	2.831
22	.256	.532	.858	1.321	1.717	2.074	2.508	2.819
23	.256	.532	.858	1.319	1.714	2.069	2.500	2.807
24	.256	.531	.857	1.318	1.711	2.064	2.492	2.797
25	.256	.531	.856	1.316	1.708	2.060	2.485	2.787
26	.256	.531	.856	1.315	1.706	2.056	2.479	2.779
27	.256	.531	.855	1.314	1.703	2.052	2.473	2.771
28	.256	.530	.855	1.313	1.701	2.048	2.467	2.763
29	.256	.530	.854	1.311	1.699	2.045	2.462	2.756
30	.256	.530	.854	1.310	1.697	2.042	2.457	2.750
40	.255	.529	.851	1.303	1.684	2.021	2.423	2.704
60	.254	.527	.848	1.296	1.671	2.000	2.390	2.660
120	.254	.526	.845	1.289	1.658	1.980	2.358	2.617
oc	.253	.524	.842	1.282	1.645	1.960	2.326	2.576

# **APPENDIX D**

## **BIBLIOGRAPHY**

## APPENDIX D

### BIBLIOGRAPHY

This Appendix contains a listing of references that have importance to someone involved with soil sampling, exposure assessment, modeling the soil system, or in general interested in evaluating the presence of pollutants in the soil system. The range of subjects pertaining to soils and particulate sampling is extensive and provides an entry into the literature dealing with sampling the soil environment.

1. Amoozegar, A. 1988. Preparing Soil Cores Collected by a Sampling Probe for Laboratory Analysis of Soil Hydraulic Properties. *Soil Science Society of American Journal*. Vol. 52:1814-1816.
2. Athey, Leslie A., John M. Thomas, William E. Miller and Jack Q. Word. 1989. Evaluation of Bioassays for Designing Sediment Cleanup Strategies at a Wood Treatment Site. *Environmental Toxicology and Chemistry*. Vol. 8:223-230.
3. Ball, D.F., and W.M. Williams. 1971. Further Studies on Variability of Soil Chemical Properties: Efficiency of Sampling Programmes on an Uncultivated Brown Earth. *Journal of Soil Science*. Vol. 22(1):60-67.
4. Barbarick, K.A., B.R. Sabey and A. Klute. 1979. Comparison of Various Methods for Sampling Soil Water for Determining Ionic Salts, Sodium, and Calcium Content in Soil Columns. *Soil Science Society of American Journal*. Vol. 43:1053-1055.
5. Bartlett, M.S. 1975. *The Statistical Analysis of Spatial Pattern*. Monographs on Applied Probability and Statistics. John Wiley. New York, NY. 90 pp.
6. Bashan, Y., and J. Wolowelsky. 1987. Soil Samplers for Quantifying Microorganisms. *Soil Science*. Vol. 143(2): 132-138.
7. Baveye, Philippe. 1983. Volume-Accuracy Relationships in Soil Moisture Sampling. *Journal of Irrigation and Drainage Engineering*. Vol. 109(2):287-290.
8. Bicking, C.A. 1964. Bibliography on Sampling of Raw Materials and Products in Bulk. *Tappi*. Vol. 47(5):147A-170A.
9. Blyth, J.F., and D.A. Macleod. 1978. The Significance of Soil Variability for Forest Soil Studies in North-East Scotland. *Journal of Soil Science*. Vol. 29:419-430.

10. Bock, J.R., and AA. Afifi. 1988. Estimation of Probabilities Using the Logistic Model in Retrospective Studies. *Computer and Biomedical Research*. Vol. 21:449-470.
11. Boomer, B.A., M.D. Erickson, S.E. Swanson, G.L. Kelso, D.C. Cox, and B.D. Schultz. 1985. Verification of PCB Spill Cleanup by Sampling and Analysis. EPA-560/5-85/026. Office of Toxic Substances. U.S. Environmental Protection Agency. Washington, D.C. 20460. 68 pp.
12. Box, George E.P. 1974. Statistics and the Environment. *Journal of the Washington Academy of Sciences*. Vol. 64(2):52-59.
13. Bracewell, J.M., G.W. Robertson and J. Logan. 1979. Variability of Organic Matter and Exchangeable Cations within the A<sub>2</sub> Horizon of an Iron Podzol. *Journal of Soil Science*. Vol. 30:327-332.
14. Bresler, Eshel. 1989. Estimation of Statistical Moments of Spatial Field Averages for Soil Properties and Crop Yields. *Soil Science Society of American Journal*. Vol. 53:1645-1653.
15. Bresler, Eshel, and Asher Laufer. 1988. Statistical Inferences of Soil Properties and Crop Yields as Spatial Random Functions. *Soil Science Society of American Journal*. Vol. 52: 1234-1244.
16. Brooker, P.I. 1983. Semi-Variogram Estimation Using a Simulated Deposit. *Mining Engineering*. January 1983. pp 37-42.
17. Brown, Gary R., and John F. Thilenius. 1976. A Tool and Method for Extracting Plant-Root-Soil Cores on Remote Sites. *Journal of Range Management*. Vol. 30(1):72-74.
18. Brumelle, S., P. Nemetz, and D. Casey. 1984. Estimating Means and Variances: The Comparative Efficiency of Composite and Grab Samples. *Environmental Monitoring and Assessment*. Vol. 4:81-84.
19. Bunting, B.T. and J.A. Campbell. 1975. Improvements in Sampling, Storing and Analysis of Soil Air for Gas Chromatography. *Canadian Journal of Soil Science*. Vol. 55:69-71.
20. Burgess, T.M., and R. Webster. Optimal Sampling Strategies for Mapping Soil Types. II. Risk Functions and Sampling Intervals. *Journal of Soil Science*. Vol. 35:655-665.

21. Burgess, T.M., R. Webster and A.B. McBratney. 1981. Optimal Interpolation and Isarithmic Mapping of Soil Properties. IV. Sampling Strategy. *Journal of Soil Science*. Vol. 32:643-659.
22. Burgess, T.M., and R. Webster. 1984. Optimal Sampling Strategies for Mapping Soil Types. I. Distribution of Boundary Spacings. *Journal of Soil Science*. Vol. 35:641-654.
23. Campbell, John A, John V. Towner, and Rajah Vallurupalli. 1988. Distribution of Heavy Metals in Sewage Sludge: The Effect of Particle Size. pp 93-101. in Lichtenberg, J.J., J.A. Winter, C.I. Weber and L. Franklin. *Chemical and Biological Characterization of Sludges, Sediments, Dredge Spoils and Drilling Muds*. ASTM STP 976. American Society for Testing and Materials. Philadelphia, PA.
24. Cary, J.W., C.S. Simmons and J.F. McBride. 1989. Predicting Oil Infiltration and Redistribution in Unsaturated Soils. *Soil Science Society of American Journal*. Vol. 53:335-342.
25. Cassel, D.K., and Armand Bauer. 1975. Spatial Variability in Soils Below Depth of Tillage: Bulk Density and Fifteen Atmosphere Percentage. *Soil Science Society of America Proceedings*. Vol. 39:247-250.
26. Chirlin, Gary R., and Eric F. Wood. 1982. On the Relationship Between Kriging and State Estimation. *Water Resources Research*. Vol. 18(2):432-438.
27. Christakos, George. 1984. On the Problem of Permissible Covariance and Variogram Models. *Water Resources Research*. Vol. 20(2):251-265.
28. Conquest, Loveday L. 1983. Assessing the Statistical Effectiveness of Ecological Experiments: Utility of the Coefficient of Variation. *International Journal of Environmental Studies*. Vol. 20:299-221.
29. De Camargo, O.A., F. Grohmann, E. Salati and E. Matsu. 1974. A Technique for Sampling the Soil Atmosphere. *Soil Science*. Vol. 117(3):173-174.
30. Deming, W.E. and CA. Bicking. eds. 1951. *Symposium on Bulk Sampling*. ASTM STP 114. American Society for Testing Materials. Philadelphia, PA.
31. Duncan, A.J. 1971. Comments on "A General Theory of Sampling." *Materials Research and Standards*. January 1971. p 25.
32. Efron, Bradley, and Carl Morris. Stein's Paradox in Statistics. *Scientific American*. May 1977. pp 110-118.

33. Elder, Robert S., and H. David Muse. 1982. An Approximate Method for Evaluating Mixed Sampling Plans. *Technometrics*. Vol. 24(3):207-211.
34. Engels, J.C., and C.O. Ingamells. 1970. Effect of Sample In-homogeneity in K-Ar Dating. *Geochemica et Cosmochemica Acta*. Vol. 34:1007-1017.
35. Garner, Forest C., Martin A. Stapanian and Llewellyn R. Williams. Composite Sampling for Environmental Monitoring. Chapt. 25 in *Principles of Environmental Sampling*. American Chemical Society. Washington, D. C.
36. Gibson, A.R., D.J. Giltrap, R.H. Wilde and R. Lee. 1983. Soil Variability in Westmere Silt Loam in Relation to Size of Sampling Area: 2. Morphological Variability. *New Zealand Journal of Science*. Vol. 26: 111-119.
37. Gibson, A.R., D.J. Giltrap, R. Lee and R.H. Wilde. 1983. Soil Variability in Westmere Silt Loam in Relation to Size of Sampling Area: 1. Chemical Variability. *New Zealand Journal of Science*. Vol. 26:99-109.
38. Gilbert, Richard O., and Robert R. Kinnison. 1981. Statistical Methods for Estimating the Mean and Variance from Radionuclide Data Sets Containing Negative Unreported or Less-Than Values. *Health Physics*. Vol. 40:377-390.
39. Gilbert, Richard O. 1979. Censored Data Sets. *TRAN-STAT: Statistics for Environmental Transuranic Studies*. PNL-SA-7585. Battelle Memorial Institute. Pacific Northwest Laboratory. Richland, WA 99352. 40 pp.
40. Gilbert, Richard O. 1982. Some Statistical Aspects of Finding Hot Spots and Buried Radioactivity. *TRAN-STAT: Statistics for Environmental Studies*. PNL-SA-10274. Battelle Memorial Institute. Pacific Northwest Laboratory. Richland, WA 99352. 27 pp.
41. Gilbert, Richard O. 1989. *Statistical Methods for Environmental Pollution Sampling*. Van Nostrand-Reinhold Co. New York, NY 10003.
42. Glenn, R.C. 1983. Reliability of Volumetric Sampling as Compared to Weighed Samples in Quantitative Soil Test Interpretation. *Communications in Soil Science and Plant Analysis*. Vol. 14(3):199-207.
43. Griffiths, John C. 1960. Frequency Distributions in Accessory Mineral Analysis. *The Journal of Geology*. Vol. 68(4):353-365.
44. Gy, Pierre M. 1986. The Analytical and Economic Importance of Correctness in Sampling. *Analytica Chimica Acta*. Vol. 190:13-23.



45. Hammer, R. David, Ralph O'Brien and Russell J. Lewis. 1987. Temporal and Spatial Soil Variability on Three Forested Landtypes on the Mid-Cumberland Plateau. *Soil Science Society of American Journal*. Vol. 51: 1320-1326.
46. Hammond, Luther C., William L. Pritchett, and Victor Chew. 1958. Soil Sampling in Relation to Soil Heterogeneity. *Soil Science Society of American Proceedings*. Vol. 22:548-552.
47. Hansen, Warren G., Thomas L. Johnson, and Karen A. Sahatjian. 1986. Guidelines and Alternatives for PCB Soil-Sampling Programs. in *Proceedings: 1985 EPRI PCB Seminar*. EPRI CS/EA/EL4480. Electric Power Research Institute. Palo Alto, CA.
48. Hartman, M.O., D.W.W.Q. Smith and J.J.N. Lampbrechts. 1973. A Statistical Method for Determining the Field Sampling Intensity Necessary in Soil Survey Work. *Agrochemophysica*. Vol. 5:63-66.
49. Healey, R.W., and A.W. Warrick. 1988. A Generalized Solution to Infiltration from a Surface Point Source. *Soil Science Society of American Journal*. Vol. 52:1245-1251.
50. Hipel, Keith William, Dennis P. Lettenmaier, and A. Ian McLeod. 1978. Assessment of Environmental Impacts. Part One: Intervention Analysis. *Environmental Management*. Vol. 2(6):529-535.
51. Holmgren, George G.S. 1988. The Point Representation of Soil. *Soil Science Society of American Journal*. Vol. 52:712-716.
52. Hornby, W.J., J.D. Zabcik and W. Crawley. 1986. Factors Which Affect Soil-Pore Liquid: A Comparison of Currently Available Samplers with Two New Designs. *Ground Water Monitoring Review*. Spring 1986. pp 61-66.
53. Horowitz, Arthur, and Kent A. Elrick. 1988. Interpretation of Bed Sediment Trace Metal Data: Methods for Dealing with the Grain Size Effect. pp. 114-128. in Lichtenberg, J.J., J.A. Winter, C.I. Weber and L. Franklin. *Chemical and Biological Characterization of Sludges, Sediments, Dredge Spoils and Drilling Muds*. ASTM SIP 976. American Society for Testing and Materials. Philadelphia, PA.
54. Howarth, R.J. 1984. Statistical Applications in Geochemical Prospecting: A Survey of Recent Developments. *Journal of Geochemical Exploration*. Vol. 21:41-61.
55. Ingamells, C.O. 1978. A Further Note on the Sampling Constant Equation. *Talanta*. Vol. 25:731-732.

56. Ingamells, C.O. 1974. Control of Geochemical Error Through Sampling and Subsampling Diagrams. *Geochemical et Cosmochemica Acta*. Vol. 38:1255-1237.
57. Ingamells, C.O. 1976. Derivation of the Sampling Constant Equation. *Talanta*. Vol. 23:263-264.
58. Ingamells, C.O. 1981. Evaluation of Skewed Exploration Data - the Nugget Effect. *Geochemica et Cosmochemica Acta*. Vol. 45:1209-1216.
59. Ivancsics, J. 1980. A New Mechanical Soil Sampling Method. *Communications in Soil Science and Plant Analysis*. Vol. 11(9):881-887.
60. Jackson, Kenneth W., Ian W. Eastwood and Michael S. Wild. 1987. Stratified Sampling Protocol for Monitoring Trace Metal Concentrations in Soil. *Soil Science*. Vol. 143(6):436-443.
61. Journel, A.G. 1973. Geostatistics and Sequential Exploration. *Mining Engineering*. Vol. 25(10):44-48.
62. Journel, A.G. 1984. Indicator Approach to Toxic Chemical Sites. Annual Report on Project No. CR-811235-02-0. EMSL-LV. U.S. Environmental Protection Agency. Las Vegas, NV. 89114.
63. Jowett, G.H. 1955. Least Squares Regression Analysis for Trend--Reduced Time Series. *Journal of the Royal Statistical Society: Series B (Methodological)*. Vol. 17(1):91-104.
64. Karioris, Frank G., and Kenneth S. Mendelson. 1981. Statistics of the Percolation Threshold. *Journal of Physical Chemistry: Solid State Physics*. Vol. 14:321-327.
65. Kastens, Marilyn K. 1981. Composition and Variability of a Willakenzie Map Unit in Yamhill County, Oregon. Master of Science Thesis in Soil Science. Oregon State University. Corvallis, OR.
66. Keith, Lawrence H., Robert A. Libby, Warren Crummett, John K. Taylor, John Deegan, Jr., and George Wentler. 1983. Principles of Environmental Analysis. *Analytical Chemistry*. Vol. 55:2210-2218.
67. Kelso, Gary L., Mitchell D. Erickson, and David C. Cox. 1986. Field Manual for Grid Sampling of PCB Spill Sites to Verify Cleanup. Office of Toxic Substances. U.S. Environmental Protection Agency. Washington, D.C. 20460. 48 pp.

68. Kinniburgh, D.G., and P.H.T. Beckett. 1983. Geochemical Mapping in Oxfordshire: A Comparison of Stream Sediment and Soil Sampling. *Journal of Soil Science*. Vol. 34: 183-203.
69. Kleeman, A.W. 1967. Sampling Error in the Chemical Analysis of Rocks. *Journal of the Geological Society of Australia*. Vol. 14(1):43-47.
70. Lehrsch, G.A., F.D. Whisler and M.J.M. Romkens. 1988. Spatial Variability of Parameters Describing Soil Surface Roughness. *Soil Science Society of American Journal*. Vol. 52:311-319.
71. Lettenmaier, Dermis P., Keith William Hipel, and A. Ian McLeod. 1978. Assessment of Environmental Impacts. Part Two: Data Collection. *Environmental Management*. Vol. 2(6):537-554.
72. Levin, M.J., and D.R. Jackson. 1977. A Comparison of In Situ Extractors for Sampling Soil Water. *Soil Science Society of American Journal*. Vol. 41:535-536.
73. Lin, P.C.L., and Joseph F. Roesler. 1988. A Demonstration of a Universal Kriging Program for Monitoring Sediments in Lakes. pp 59-68. in Lichtenberg, J.J., J.A. Winter, C.I. Weber and L. Franklin. *Chemical and Biological Characterization of Sludges, Sediments, Dredge Spoils and Drilling Muds*. ASTM STP 976. American Society for Testing and Materials. Philadelphia, PA.
74. Loehr, Raymond C., John H. Martin, Jr., and Edward F. Newhauser. 1986. Spatial Variation of Characteristics in the Zone of Incorporation at an Industrial Waste Land Treatment Site. pp 285-297 in Petros, J.K., W.J. Lacy and R.A. Conway. Eds. *Hazardous and Industrial Solid Waste Testing*. Fourth Symposium. ASTM STP 886. American Society for Testing and Materials. Philadelphia, PA.
75. Martin, John H., Jr., and Raymond C. Loehr. 1986. Determination of the Oil Content of Soils. pp 7-14 in Petros, J.K., W.J. Lacy, and R.A. Conway. Eds. *Hazardous and Industrial Solid Waste Testing*. Fourth Symposium. ASTM STP 886. American Society for Testing and Materials. Philadelphia, PA.
76. Matheron, G. 1967. Kriging, or Polynomial Interpolation Procedures? *Canadian Institute of Mining Transactions*. Vol. 70:240-244.
77. McBratney, A.B., and R. Webster. 1986. Choosing Functions for Semi-Variograms of Soil Properties and Fitting Them to Sampling Estimates. *Journal of Soil Science*. Vol. 37:617-639.
78. McIntyre, D.S., and C.B. Tanner. 1959. A Normally Distributed Soil Physical Measurements and Nonparametric Statistics. *Soil Science*. Vol. 88(3): 133-137.

79. McIntyre, D.S., and K.J. Barrow. 1972. An Improved Sampling Method for Small Undisturbed Cores. *Soil Science*. Vol. 114(3):239-241.
80. Meyers, Tommy E. 1986. A Simple Procedure for Acceptance Testing of Freshly Prepared Solidified Waste. pp 263-272 in Petros, J.K., W.J. Lacy and R.A. Conway. Eds. *Hazardous and Industrial Solid Waste Testing*. Fourth Symposium. ASTM STP 886. American Society for Testing and Materials. Philadelphia, PA
81. Miyamoto, S., and I. Cruz. 1986. Spatial Variability and Soil Sampling for Salinity and Sodicity Appraisal in Surface-Irrigated Orchards. *Soil Science Society of American Journal*. Vol. 50: 1020- 1026.
82. Morkoc, F., J.W. Biggar, D.R. Nielsen and D.E. Myers. Kriging with Generalized Covariances. *Soil Science Society of American Journal*. Vol. 51:1126-1131.
83. Murray, D.L., H.F.R. Lagocki, and R.M. Jackson. 1975. Stratified Sampling of Soil Moisture. *New Zealand Journal of Science*. Vol. 18:269-276.
84. Noyes, H.A. 1915. Soil Sampling for Bacteriological Analysis. *Journal of American Society of Agronomy*. Vol. 239-249.
85. Otto, George H. 1938. The Sedimentation Unit and Its Use in Field Sampling. *The Journal of Geology*. Vol. 46(4):569-582.
86. Ovalles, F.A., and M.E. Collins. 1988. Variability of Northwest Soils by Principal Component Analysis. *Soil Science Society of America Journal*. Vol 52: 1430-1435.
87. Parizek, Richard R., and Burkee E. Lane. 1970. Soil-Water Sampling Using Pan and Deep Pressure-Vacuum Lysimeters. *Journal of Hydrology*. Vol. 11:1-21.
88. Parkhurst, David F. 1984. Optimal Sampling Geometry for Hazardous Waste Sites. *Environmental Science and Technology*. Vol. 18(7):521-523.
89. Pedersen, T.F., S.J. Malcolm, and E.R. Sholkovitz. 1985. A Lightweight Gravity Corer for Undisturbed Sampling of Soft Sediments. *Canadian Journal of Earth Science*. Vol. 22: 133-135.
90. Perket, Cary L., and Leo R. Barsotti. 1986. Multilaboratory Analysis of Soil for Leads. pp 121-138 in Petros, J.K., W.J. Lacy, and R.A. Conway, Eds. *Hazardous and Industrial Solid Waste Testing*. Fourth Symposium. ASTM STP 886. American Society for Testing and Materials. Philadelphia, PA.
91. Pilgrim, David H., and Dale D. Huff. 1978. A Field Evaluation of Subsurface and Surface Runoff. *Journal of Hydrology*. Vol. 38:299-341.

92. Pitard, Francis. F. 1987. The Variographic Experiment: An Essential Test for Optimizing Sampling Methodology in Monitoring Streams. p 44-58 in Lichtensberg, J.J., J.A. Winter, C.I. Weber, and L. Fradkin, eds. Chemical and Biological Characterization of Sludges, Sediments, Dredge Spoils, and Drilling Muds. ASTM STP 976. American Society for Testing and Materials. Philadelphia, PA.
93. Quackenbush, F.W., and R.C. Rund. 1967. The Continuing Problem of Sampling. Journal of the Association of Official Analytical Chemists. Vol. 50(5):997-1006.
94. Robertson, G.W., and J.M. Bracewell. 1979. Rapid Representative Sampling of Soil Gases and Their Determination by Mass Spectrometry. Journal of Soil Science. Vol. 30:681-689.
95. Roels, J.M., and P.J. Jonker. 1983. Probability Sampling Techniques for Estimating Soil Erosion. Vol. 47: 1224-1228.
96. Rogowski, A.S. 1972. Watershed Physics: Soil Variability Criteria. Water Resources Research. Vol. 4(4): 1015-1023.
97. Roseberg, R.J., and E.L. McCoy. 1988. Time Series Analysis for Statistical Inferences in Tillage Experiments. Soil Science Society of American Journal. Vol. 52:1771-1776.
98. Russo, David, and Eshel Bresler. 1980. Scaling Soil Hydraulic Properties of a Heterogeneous Field. Soil Science Society of American Journal. Vol. 44:681-684.
99. Russo, David, and Eshel Bresler. 1981. Soil Hydraulic Properties as Stochastic Processes: I. An Analysis of Field Spatial Variability. Soil Science Society of American Journal. Vol. 45:682-687.
100. Russo, David, and Eshel Bresler. 1982. Soil Hydraulic Properties as Stochastic Processes: II. Errors of Estimates in a Heterogeneous Field. Soil Science Society of American Journal. Vol. 46:20-26.
101. Russo, David, and William A. Jury. 1988. Effect of Sampling Network on Estimates of the Covariance Function of Stationary Fields. Soil Science Society of American Journal. Vol. 52: 1228-1234.
102. Russo, David. 1984. Design of Optimal Sampling Network for Estimating the Variogram. Soil Science Society of America Journal. Vol. 48:708-715.
103. Sankar, G.R. Maruthi, M. Velayutham, K.C.K. Reddy and K.D. Singh. A New Method for Better Estimation of Soil and Fertilizer Efficiencies. Indian Journal of Agricultural Science. Vol. 53(5):314-319.

104. Schaeffer, David, Harold W. Kerster, and Konanur G. Janardan. 1982. Monitoring Toxics by Group Testing. *Environmental Management*. Vol. 6(6):467-469.
105. Shaffer, K.A., D.D. Fritton and D.E. Baker. 1979. Drainage Water Sampling in a Wet, Dual-Pore Soil System. *Journal of Environmental Quality*. Vol. 8(2):241-245.
106. South, John B. 1982. Selecting an Acceptance Sampling Plan That Minimizes Expected Error and Sampling Cost. *Quality Progress*. October 1982. pp 18-22.
107. Thomas, J.M., et al. 1984. Field Evaluation of Hazardous Waste Site Bioassessment Protocols. PNL-4614. Battelle Memorial Institute. Pacific Northwest Laboratory. Richland, WA
108. Thomas, John M., and J. F. Cline. 1985. Modification of the Newbauer Technique to Assess Toxicity of Hazardous Chemicals in Soils. *Environmental Toxicology and Chemistry*. Vol. 4:201-207.
109. Thomas, John M., et al. 1986. Characterization of Chemical Waste Site Contamination and Determination of its Extent Using Biosassays. *Environmental Toxicology and Chemistry*. Vol. 5:487-501.
110. Triegel, Elly K. 1988. Sampling Variability in Soils and Solid Wastes. Chap. 17 in *Principles of Environmental Sampling*. American Chemical Society. Washington, D.C.
111. Venter, J.H. 1982. A Model for the Distribution of Concentrations of Trace Analytes in Samples from Particulate Materials. *Technometrics*. Vol. 24( 1): 19-27.
112. Watson, K.K., and S.J. Lees. 1975. A Procedure for the Sampling and Testing of Large Soil Cores. *Soil Science Society of American Journal*. Vol. 39:589-590.
113. Webster, R. 1978. Optimally Partitioning Soil Transects. *Journal of Soil Science*. Vol. 29:388-402.
114. Wicherski, Bruce P. 1980. Analysis of Variability of Some Forest Soils in Southwestern Oregon. Master of Science Thesis in Soil Science. Oregon State University. Corvallis, OR.
115. Wilson, A.D. 1964. The Sampling of Silicate Rock Powders for Chemical Analysis. *Analyst*. Vol. 89:18-30.
116. Wilson, G.V., James M. Alfonsi, and P.M. Jardine. 1989. Spatial Variability of Saturated Hydraulic Conductivity of the Subsoil of Two Forested Watersheds. *Soil Science Society of American Journal*. Vol. 53:679-685.

117. Wires, K.C., and G.C. Topp. 1983. Assessing the Variability of Atterberg Indices within the Dalhousie Soil Association (Brandon Series). *Canadian Journal of Soil Science*. Vol. 63:485-494.
118. Wood, A.L., J.T. Wilson, R.L. Cosby, A.G. Hornsby, and L.B. Baskin. 1981. Apparatus and Procedure for Sampling Soil Profiles for Volatile Organic Compounds. *Soil Science Society of American Journal*. Vol. 45:442-444.
119. Yates, S.R., and Marylynn V. Yates. 1988. Disjunctive Kriging as an Approach to Management Decision Making. *Soil Science Society of America Journal*. Vol. 52: 1554-1558.
120. Yost, R.S., G. Uehara and R.L. Fox. 1982. Geostatistical Analysis of Soil Chemical Properties of Large Land Areas. II. Kriging. *Soil Science Society of America Journal*. Vol. 46: 1033-1037.
121. Yost, R.S., G. Uehara, and R.L. Fox. 1982. Geostatistical Analysis of Soil Chemical Properties of Large Land Areas. I: Semi-Variograms. *Soil Science Society of America Journal*. Vol. 46: 1028-1032.
122. Youden, William J. 1949. How Statistics Improves Physical, Chemical and Engineering Measurements. A lecture presented to The Committee on Experimental Design. Agricultural Research Administration. U.S. Department of Agriculture. Washington, D.C. December 14, 1949.

# **APPENDIX E**

## **EXAMPLES**



## **APPENDIX E**

### **EXAMPLES**

The following examples are provided to assist the reader in applying the techniques outlined in this report to situations at hazardous waste sites. The examples are not intended to be all inclusive, but are for illustration purposes only. There are no doubt many other examples that will also provide this type of information.

#### **EXAMPLES OF LARGE AREA STUDIES**

Three examples of large area studies are mentioned in the body of the report. These are:

Love Canal, NY

Palmerton, PA

Dallas Lead, TX

#### **Love Canal**

The Love Canal Study, carried out by the U.S. EPA in 1980, was one of the first large environmental studies ever conducted in the United States. The four volume report (U.S. EPA, 1982) on this major project provides insight into the complexity of conducting a study of this magnitude. The study points out a number of concepts that can be used in other situations and, in retrospect, points out some problem areas that can be used as guides for avoiding similar problems in the future.

The study made use of a stratified random sampling scheme of house lots in the area. Stratification was based upon observations that indicated that there was a potential migration pattern extending out from the canal itself. Homes were selected randomly within concentric rings around the canal. The concept was valid, but the conceived model for migration was not complete. It turned out that one of the major routes of migration was via dump truck. A developer in the area had removed contaminated materials from the cap and used this material as fill at several locations in the outer rings. The random pattern used did not locate these "hot spots" created by this movement.

A second problem area that was uncovered in the Love Canal study was the need for a better control area. The entire area of Niagara and Erie Counties of New York are impacted by heavy chemical production. It is difficult to locate an area that has not had some influence of this activity. The need to link the soils, water, and air studies precluded using some areas that could possibly have been used for soils background areas. Also there

was a problem with obtaining permission to make use of other areas that could provide a reasonable background sample.

The experience gained in this study has proven to be a valuable source of information for designing other large studies. It was a proving ground for the development of much of the early Superfund soil sampling effort.

### **Dallas Lead Study**

The Dallas Lead Study was the first study to make use of kriging and other geostatistical tools in designing and carrying out the soils component of a major environmental study (U.S. EPA, 1984b; Flatman, 1984; Flatman et al., 1985). The study, carried out jointly with federal, state, and local environmental and health authorities, developed concentration and reliability maps of soil lead distribution around two lead smelters located in an urban area. The major objective of the study was to determine the exposure of the population in the study area to lead originating from the two smelters and from automobile emissions.

Homes in the area were stratified by their proximity to the smelters and to major road intersections. Soil, dust, and paint samples were collected from the selected homes. Blood samples were collected from preschool children if these were present in the home.

In addition to the soil samples collected from study homes, a 750' by 750' square grid sampling design was used to collect soil samples within a one-mile radius of the two lead smelters. A similar grid was used in a reference area not subjected to the influence of the smelters. The systematic design was chosen because of the desire to obtain data that could readily be subjected to geostatistics and that would provide adequate coverage of the study area. A total of 177 soil sampling locations were selected from the grids around the two smelters and 89 in the reference area. Approximately 1200 additional locations were selected at specific homes, parks, schools, and playgrounds. At 5 percent of the locations, duplicate or collocated samples were collected.

Composite soil samples were collected at each site, returned to a laboratory located in the county health department, dried, homogenized, then subsampled. The processing of dry samples proved to be a major advantage in obtaining uniformity in the sample material.

### **Palmerton Zinc Smelter Study**

The town of Palmerton, PA, and the surrounding area is included in the Superfund site associated with two zinc smelters. Cadmium and lead distributions around the two smelters were of concern. Starks et al. (1989) and U.S. EPA (1989) provide details of the study. Barth et al. (1989) have made extensive use of this study as an example for describing the design of a major study and for evaluating data generated by the study. (The reader is

encouraged to review this document prior to designing any study where soils data are to be collected. The guidance provided by the document is timely and quite useful.)

At Palmerton, a radial design was used to provide the data needed to develop the variogram of the soil contaminant distribution. The radial design was based upon an overall reference grid that was used throughout the study for collecting data and for evaluating the distribution of the pollutants of concern. The radial transects were oriented to conform to the windrose data obtained from the National Weather Service. Both a preliminary phase and a definitive phase study were used in the evaluation of the site.

The data indicated that the variance for the sampling effort changed with increasing concentration. This required the use of log transformation techniques to stabilize the variance in the data (Barth et al., 1989). An evaluation of the data obtained in the preliminary study indicated that variation coming from short-range variability and sample taking was larger than subsampling errors. This suggested that it was necessary to reduce the error coming from the short-range variation in the data. (This would be comparable to the  $CE_1$  of Gy). By increasing the number of cores in the support, the short range heterogeneity in the data from the definitive study was reduced.

## **DOUBLE SAMPLING**

One of the major problems facing the soils investigator can be traced back to the large variation associated with the soil material itself. Composite sampling can aid in reducing the variability in the data, but considerable information about the pollutant is lost by using this technique. Double sampling can assist in overcoming this problem. Geist and Hazard (1975) outline a procedure for using this technique in soils related work. In their situation, they were measuring nitrogen availability in a forest soil. The example given below is taken from a PCB spill situation.

### **Example:**

A former Nike Missile Command center is being used as a training facility for construction workers. This facility is situated near a small community in the Northwest. The soils are formed on layered glacial deposits that are comprised of sands, silts, clays, and gravels.

A large transformer filled with Askerel was left on the site at the time the U.S. Army vacated the property. The training facility needed the space occupied by the transformer and removed it from the vault located adjacent to the electrical building. The oil in the transformer was spilled onto the soil during the removal operations. A cleanup operation was initiated to remove the contaminated soil from the site.

Preliminary sampling at the site indicated that the transformer fluid had moved down through the gravels into the bedding of an old water line and an old fuel line. Migration had also occurred through what appeared to be minute cracks in cemented sand and clay layers. High concentrations occurred in the gravel layers.

The U.S. EPA regional office called for a cleanup level of 10 ppm PCB in the soil at a 95% confidence level. The variability seen in the preliminary data and the distribution of the PCB combined with sampling requirements outlined in the U.S. EPA Office of Toxic Substances Field Manual for Grid Sampling of PCB Spill Sites to Verify Cleanup (U.S. EPA, 1986) called for a large number of samples to be collected. The cost of this sampling required that a less expensive sampling effort be provided that would provide the needed data reliability. Double sampling was used to reduce the costs.

Dexsil Corporation of Hamden, CT, produces an instrument called the L2000 PCB Analyzer. This instrument, combined with a field procedure that extracts organic chlorine compounds from the soil, provides a real time analysis of PCB in the soil. The costs per sample were approximately 1/10 of the laboratory costs. A split of approximately 20% of the samples were sent to one of the laboratories in the U.S. EPA Contract Laboratory Program (CLP) for analysis by one of the U.S. EPA methods.

A number of samples taken over the range of concentrations seen at the site were submitted to the laboratory along with a random selection of samples from the entire area. The laboratory samples were used in a regression analysis to insure that the field method did in fact provide the quality of information needed to carry out the cleanup. Table E-1 presents the data and Figure E-1 shows the regression for these samples.

The field laboratory results showed good agreement with the CLP laboratory. Additional evaluation of the 50 samples submitted to the CLP lab indicated that there was no significant difference between the field results and the lab results. Most of the samples in the additional set of samples were below the detection limits of 1.0 ppm.

FIGURE E-1. Regression Lab and Field  
PCB Soil Analysis.

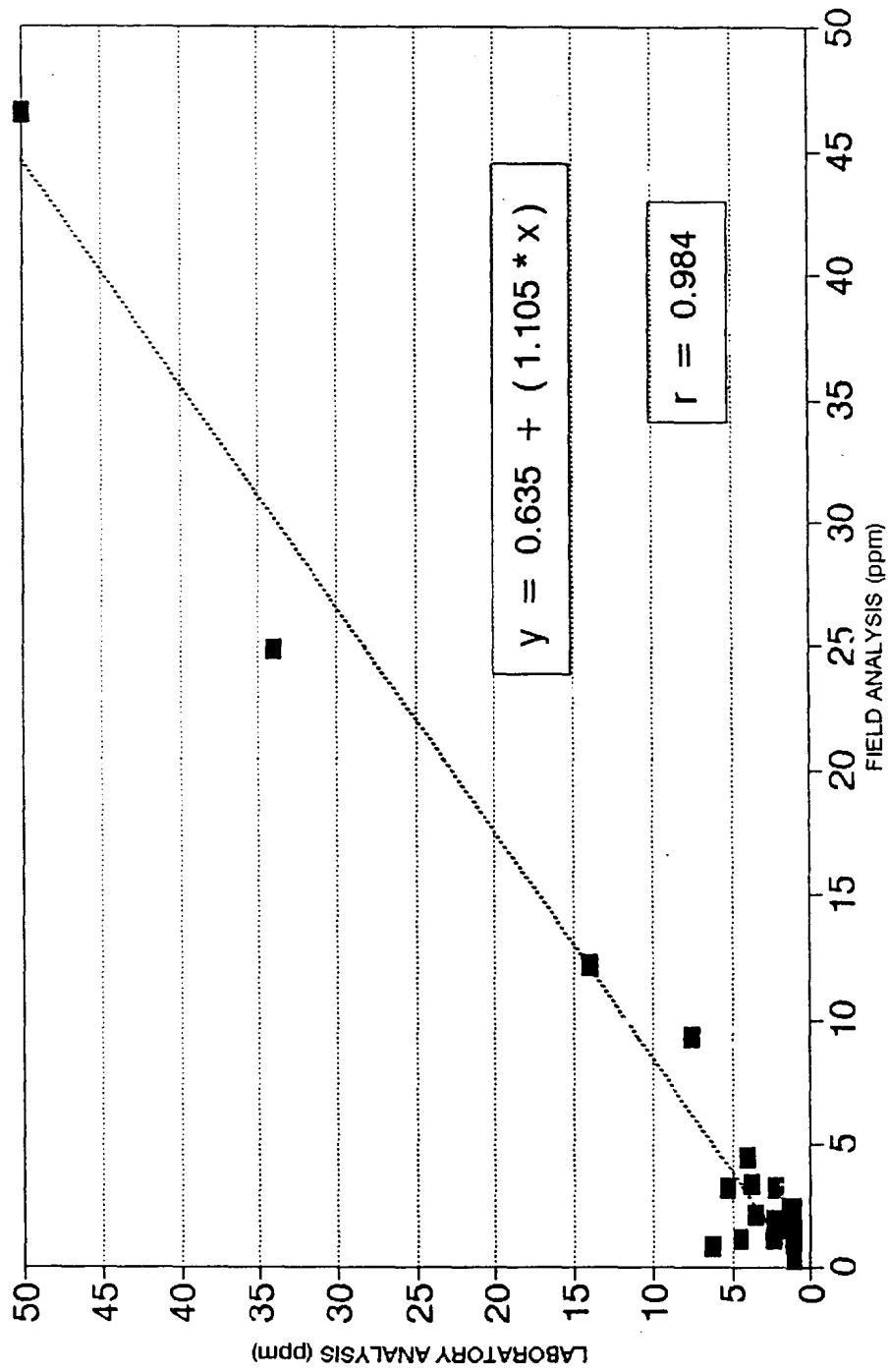

Table E-1. PCB Data Obtained During Remediation of a PCB Spill: Double Sampling.

SAMPLE #	PCB CONCENTRATION (ppm)	
	FIELD	CLP LAB
1-05	1.6	1.3
2-27c	2.4	1.3
3-01	24.9	34.0
4-18	1.2	4.5
4-20	2.0	2.3
4-21	46.6	50.0
4-23	12.2	14.0
4-27	3.3	2.2
4-29	2.2	3.5
4-39	1.1	1.1
8-15	1.2	2.4
9-02	4.5	4.0
9-10	1.9	6.2
9-15	3.3	5.2
9-17	3.4	3.7
REGRESSION ANALYSIS		
a		0.6349
b		1.1049
r		0.9842
n		15
Standard error of Y		2.5816
Standard error of Coeff.		0.0552
F		400.9044 *

\* Significant at the 99.5% confidence level.

## HOT SPOT DETECTION

Zirschky and Gilbert (1984) outline procedures for detecting hot spots at a hazardous waste site. This approach combined with prior information about the variability and distribution of contamination at a site, or at similar sites, can provide a basis for insuring that a hot spot of some designated size will not be left at the site. The example given below is based upon extensive sampling carried out by a Midwestern utility company at sites of old capacitor spills.

The company carried on a program of sampling around old capacitor spill sites as part of its environmental program. Sampling had been done on a five foot grid around each capacitor site identified in the records. Surface soils were sampled at each grid node. A large data base (over 2200 points) had been accumulated over a period of several years that

provided the basis for determining the probability of PCB contamination at different distances from the poles supporting the capacitors.

The utility desired to develop a sampling design that could be used at any additional spill sites and could be used in the future to insure cleanup had occurred. As a starting point for this design process, the distribution of data points in the existing data base was determined. A 10 ppm cleanup level was assumed to be the guideline for any future cleanup. Table E-2 shows the relative cumulative frequency (RCF) of the data points for different distances from the pole.

Table E-2. Relative Cumulative Frequency Distribution of Samples  $\geq$  10ppm PCB.

Distance from Pole (ft)	RCF (%)
5	33.8
10	59.6
15	82.0
20	93.2
25	97.8
30	100.0

This table indicates that for the sites studied, all of the PCB contamination above the clean up level occurred inside of a zone extending out to 30 feet from the pole. This information was used to design the sampling array that was recommended. This was also used in developing the “priors” (Skalski and Thomas, 1984) for use in Bayesian statistics (Gulezian, 1979). Equation E-1 based upon Snedecor and Cochran (1982) was used to determine the probability that a 5’ x 5’ cell would have to be cleaned.

$$p = 1 [ (1-p_1)(1-p_2)(1-p_3)(1-p_4) ] \quad \text{Equation E-1}$$

where:

- $p$  = probability of a cell having to be cleaned.
- $p_n$  = probability of a sample being  $\geq$  10ppm at one of the comers of the cell.
- $n$  = the corner number for a cell = 1, 2, 3, 4.

The average probability for cleanup was calculated for each cell in each five-foot ring around the pole. Figure E-2 shows the zone where the probability of cleanup being required was 95% or better. (The NE skewness is due to prevailing winds during season when capacitors tend to fail.)

This information was used to develop a sampling plan and to assign samples to a particular zone. A twenty-three point triangular grid was recommended. The probability that a hot spot would be found was determined using Equation E-2 (Gilbert, 1982).

$$P(A,B) = P(B@A)P(A) \quad \text{Equation E-2}$$

where:

A = hot spot of size L or larger exists  
 B = a hot spot of size L or larger is hit  
 by taking measurements on the 5' X 5' grid.

$P(B@A)$  =  $P(A,B)/P(A)$   
 = Probability that a hot spot of size L or larger is hit given such a hot spot exists.  
 = 1-beta  
 where beta is the consumers risk or the probability of not finding a hot spot that we are willing to tolerate.

$P(A)$  = Probability a hot spot of size L or larger exists. In the case of a capacitor break this probability = the priors determined from the existing data base.

The probability that a hot spot of size L exists but was not found by a particular grid spacing can be estimated using Equation E-3.

$$P(A@B) = (\beta P(A))/(\beta P(A) + 1 P(A)) \quad \text{Equation E-3}$$



where:

$P(A@B)$  = Probability that a hot spot of size L or larger exists even though our sampling effort did not find it.

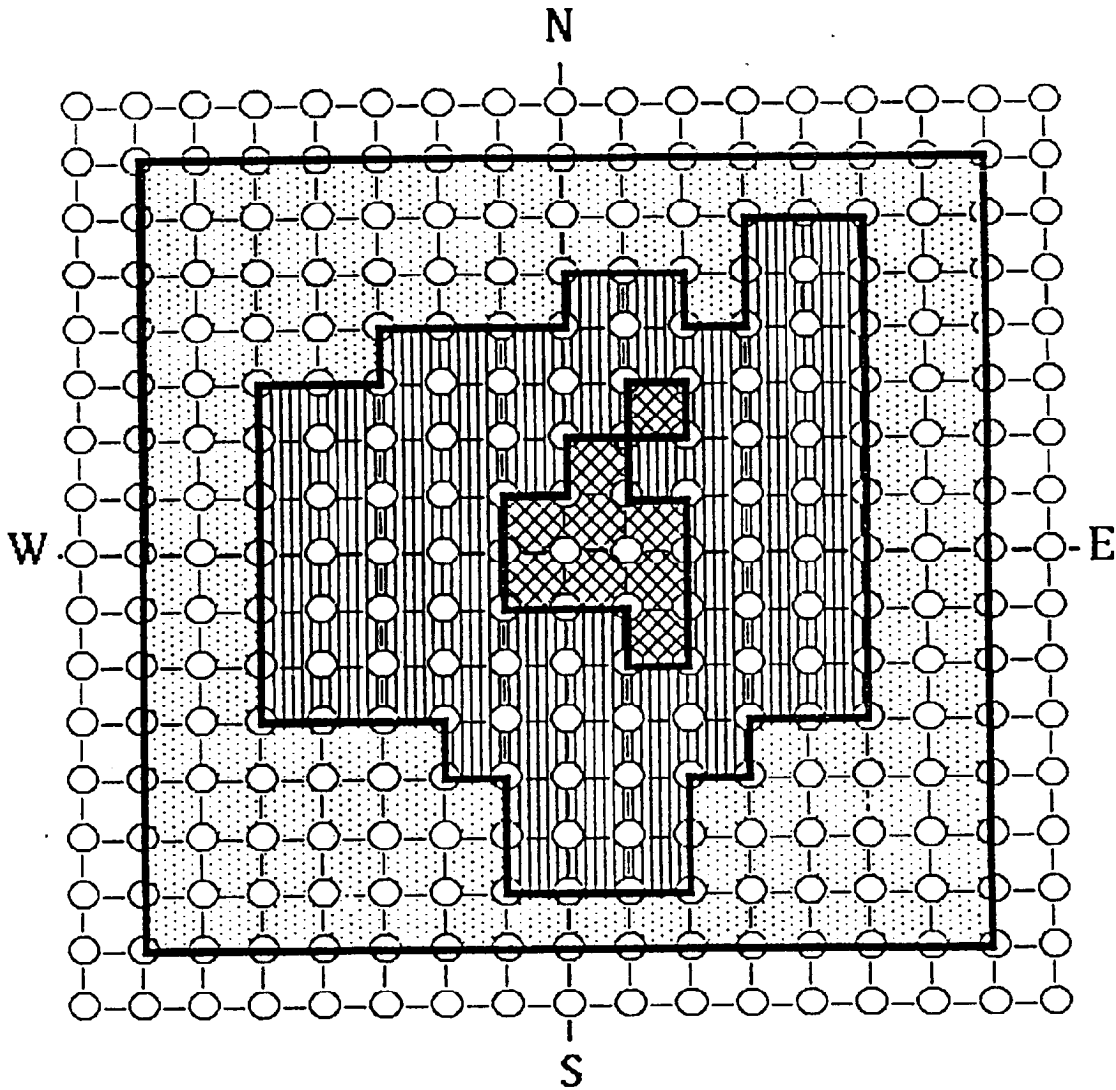

**Figure E-2 Map Showing Probability that a Cell Exceeds  
10 ppm Cleanup Standard**  
(Cells are 5' x 5' located around a power pole)



Legend					
	> = 95% probability		< 95% but > 0% probability		= 0 % probability

For purposes of the study, a beta of 0.05 was chosen. This means that we want to determine with a 95% confidence that we have identified all areas that must be remediated using a particular design.

The cleanup pattern chosen by the company was that they would remediate the four 5' x 5' squares bordering a grid node that was detected to exceed 10 ppm. This means that they desire to locate all hot spots with a radius of 7.07' with a 95% confidence. Using this information and the procedures outlined in Gilbert (1982), it was determined that a twenty-three point triangular grid with a spacing of 12.5' on a side would provide the coverage required.

The use of Bayesian statistics to determine the grid spacing for hot spot analysis is discussed in detail in Gilbert (1982) and in Barth et al. (1989).

## **FIELD BULK DENSITY**

A procedure for determining field bulk density was discussed briefly in Section 8. The following is data obtained in such a study.

A large southern utility was involved in an RI/FS (remedial investigation/feasibility study) at an NPL site. A question arose about the percentages of material that could be processed through a soil remediation process. The site contained large amounts of demolition rubble that consisted of large blocks of concrete, tree stumps, and scrap metal. As part of this, it was necessary to determine the in-place unit density and the excavated unit density.

Based upon preliminary data on the coefficient of variation of samples of these materials, the number of samples for the site was determined to be approximately 6. It was desirous to also obtain information about the variability of the materials over the site. Three locations were randomly chosen. At each location, three holes were excavated. Three truckloads of material were excavated from the holes. The volume of material was determined by survey and by measuring the volumes of the truck beds. Weights were determined at a certified scale located near the site.

ANOVA conducted on these data in Table E-3 indicated that there were no differences among the various locations or within locations at a 95% confidence level.

Table E-3. Determination of Unit Density of Soil.

LOCATION	TRUCK #	WEIGHT OF LOADS	TARE WT	SOIL WT	VOLUME	UNIT DENSITY	
		(tons)	(tons)	(tons)	(cy)	(t/cy)	
1	449	35.02	12.76	23.26	21.00	1.107	
	482	39.08	12.17	26.91	22.16	1.214	
	449	34.77	12.76	22.01	21.00	1.048	
2	482	34.54	12.17	22.37	22.16	1.010	
	412	33.64	12.14	21.50	21.17	1.016	
	117	27.52	10.38	17.14	20.35	0.842	
		412	33.83	12.14	21.69	21.17	1.025
		117	30.40	10.38	20.02	20.35	0.984
		412	36.05	12.14	23.91	21.17	1.129
4	482	36.50	12.17	24.33	22.16	1.098	
5	117	29.98	10.38	19.60	20.35	0.963	
6	449	31.20	12.76	18.44	21.00	0.878	
MEAN				1.026			
STANDARD DEVIATION				0.104			
INPLACE VOLUME		WEIGHT		INPLACE UNIT DENSITY			
(cyd)		(tons)		(t/cy)			
22.03		23.26		1.0558			
18.76		26.91		1.4344			
17.57		22.01		1.2527			
18.10		22.37		1.2359			
19.58		21.50		1.0981			
17.60		17.14		0.9739			
16.96		21.69		1.2789			
14.57		20.02		1.3741			
16.41		23.91		1.4570			
20.71		24.33		1.1748			
19.42		19.60		1.0093			
14.48		18.44		1.2735			
MEAN				1.2182			
STANDARD DEVIATION				0.1602			

## PROCESSING VARIOGRAMS

Processing of soils during remediation often requires that a soil investigator provide assistance in the quality control work carried out at the batch plants treating the soil. The materials presented below were obtained during a solidification/stabilization operation.

Samples were collected from every 500 tons processed through the batch plant. This normally called for two samples per day. During normal operations, samples were collected at 10 am and 2 pm each day. On occasion, additional samples were collected when the plant worked long shifts or when production increased. On days when the plant was down for maintenance, only one sample was collected. Three additional quality assurance samples were collected for unconfined compressive strength (UCS), slump, and unit density on a weekly basis. One UCS sample was tested after 7 days of curing, one after 28 days of curing, and one was archived.

Variograms were prepared from the data collected during the operation of the plant. The data for the 7-day curing is presented in Figure E-3. Figure E-4 shows the variogram for this set of data. Examination of the data in Figure E-3 shows that there appears to be a cyclic pattern to the data. The variogram also suggests this. There appears to be a peak occurring at 1, 7, and 10 days. Discussions with the operators indicated that the plant was adjusted daily and major recalibration of the controllers was done weekly. This is seen in the variogram in the peak at the one day lag and the seven day lag. The reason for the peak occurring at the ten day lag is not known unless it was due to the arrival of new materials.

Similar patterns are often seen in soils data. The variograms should be evaluated to determine if there is a cyclic pattern to the data. In those cases where there is a long range cyclic pattern, this can be taken into consideration in estimating the variation seen in the data.

## **PRELIMINARY STUDY**

The use of a preliminary study can greatly facilitate the final design that is used. If a conceptual model has been developed during the planning stage for the preliminary study, the orientation and spacing of samples can provide valuable information about the site and help to determine if a plume is present. The example below is a hypothetical case that was developed for this report.

### **Example:**

In 1965, a large spill occurred at a site located in the Midwest. The site is under investigation for remediation. Figure E-5 shows the location of the site and identifies the visible boundaries of the spill. The spill occurred on the paved driveway and was washed off the pavement to the west. The site slopes gently to the northwest. Because of the properties of the material, it is believed to be present only in the surface of the soil and not to have penetrated to any depth.

It was decided that a simple grid sampling arrangement would be used for this study. Ten approximately equal grid cells were located over the area as is shown in Figure E-6. The investigator was familiar with particulate sampling theory and decided to make use of the grid arrangement to acquire the needed information for use in the final design that would be used to plan the sampling strategy.

The laboratory informed the investigative party that they would only need 20 gram samples for analysis, but would like additional material for use as archive samples and as a backup in case there are problems with the analytical method. A decision was made to take two samples from each grid cell - a small sample of 100 grams and a large sample of 1000 grams.

Figure E-3  
Unconfined Compressive Strength

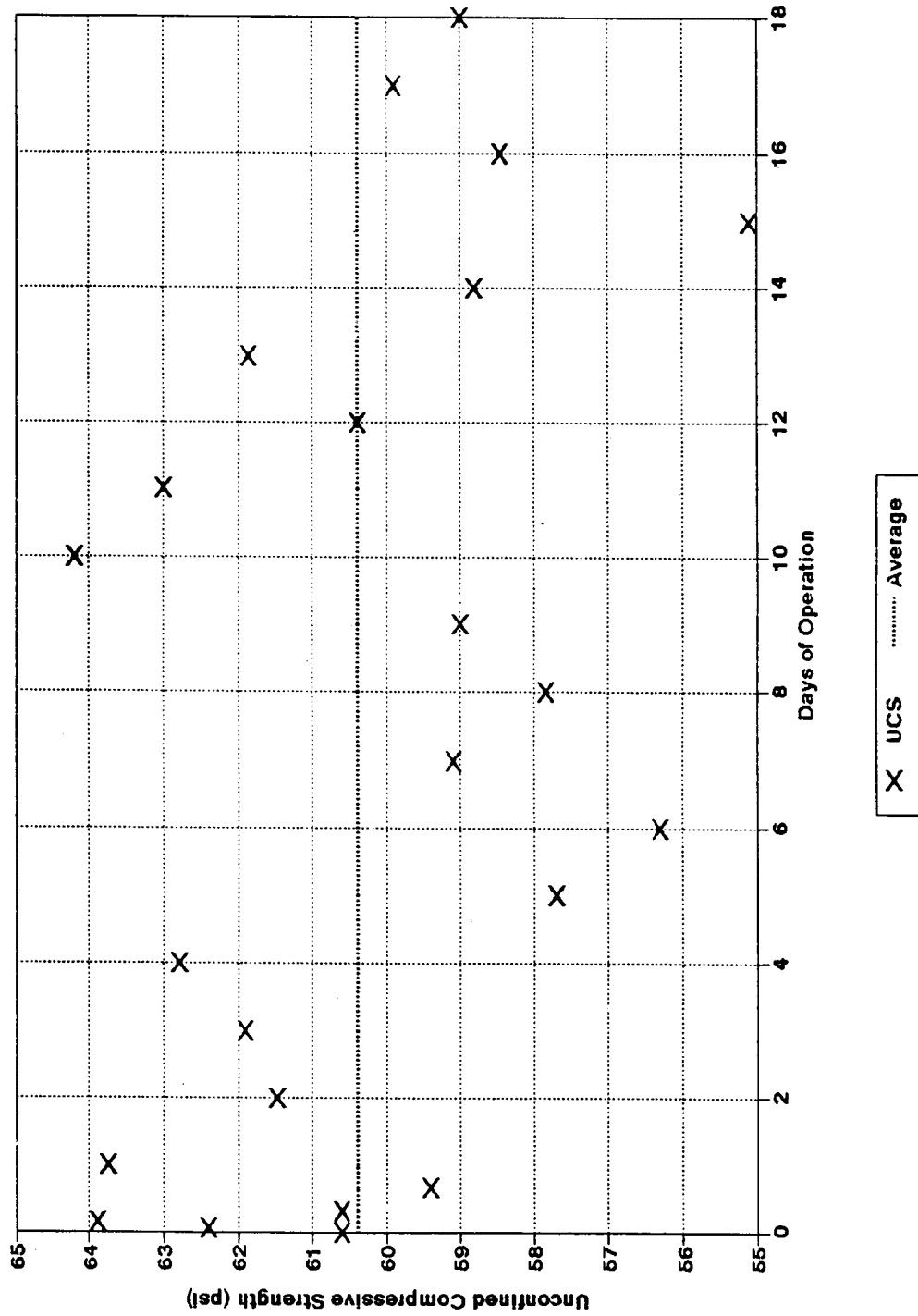
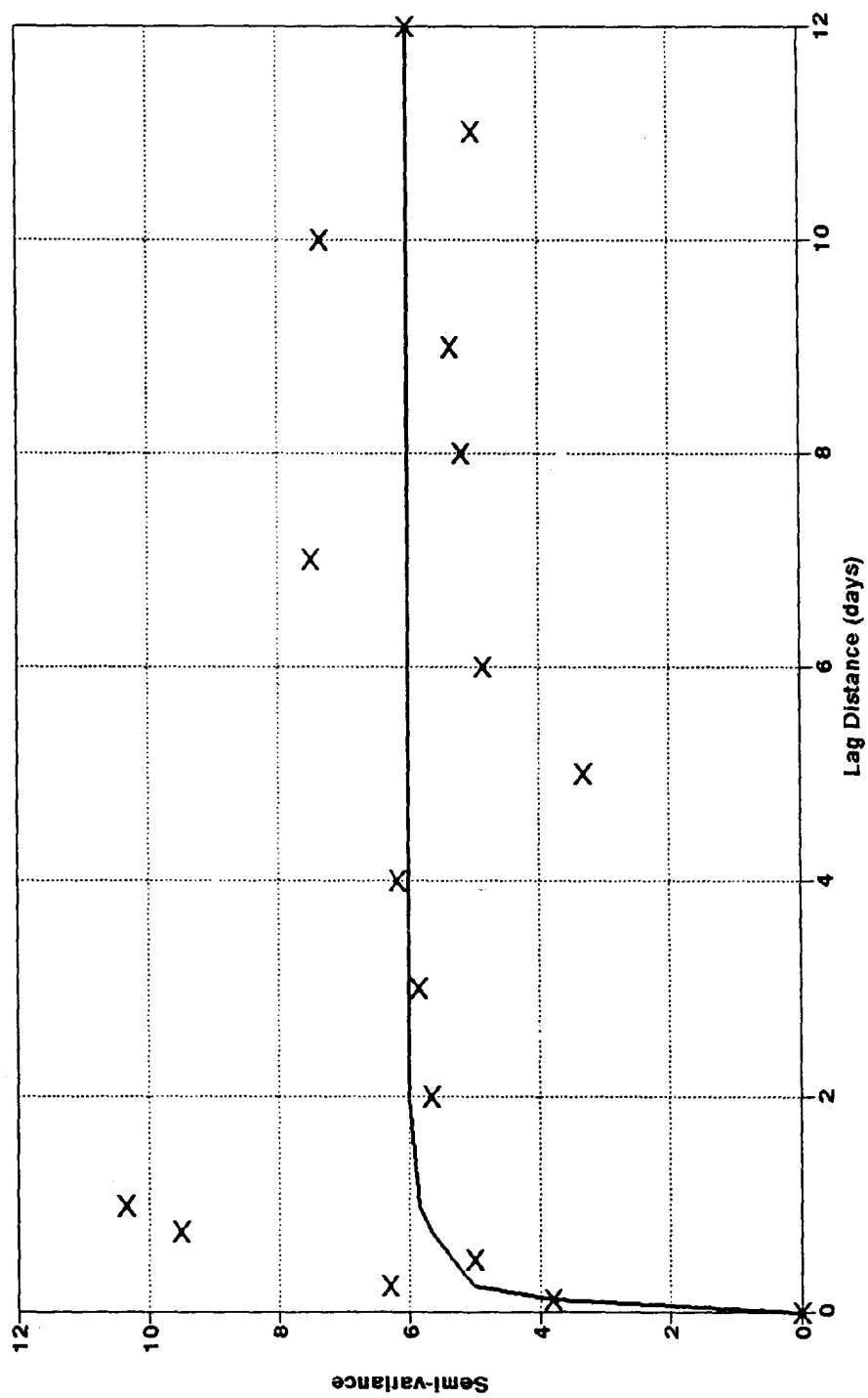

Figure E-4. Variogram for Processing:  
Solidification/Stabilization.



X Semi-variance — Variogram

Figure E-5 Hypothetical Spill Site

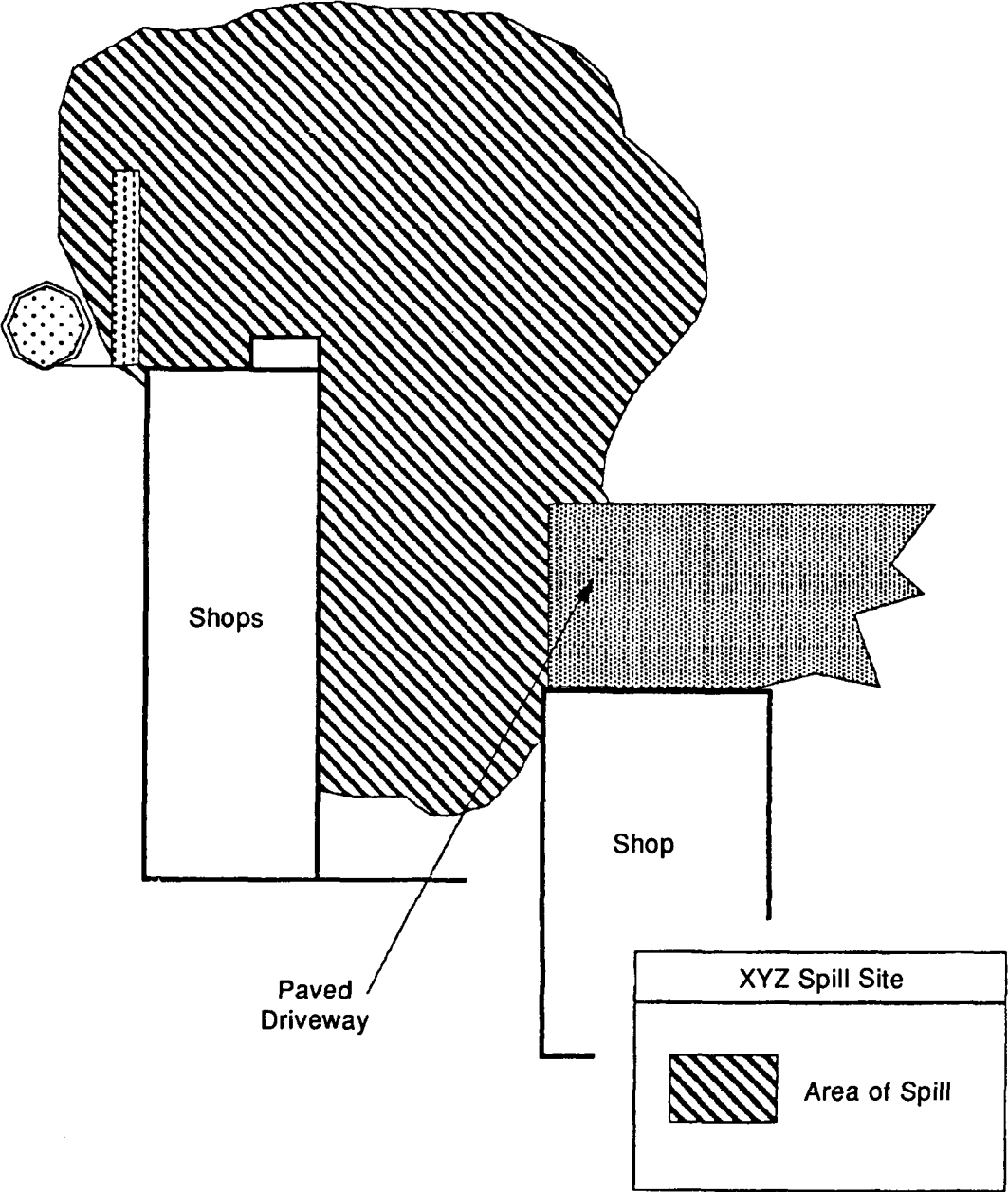
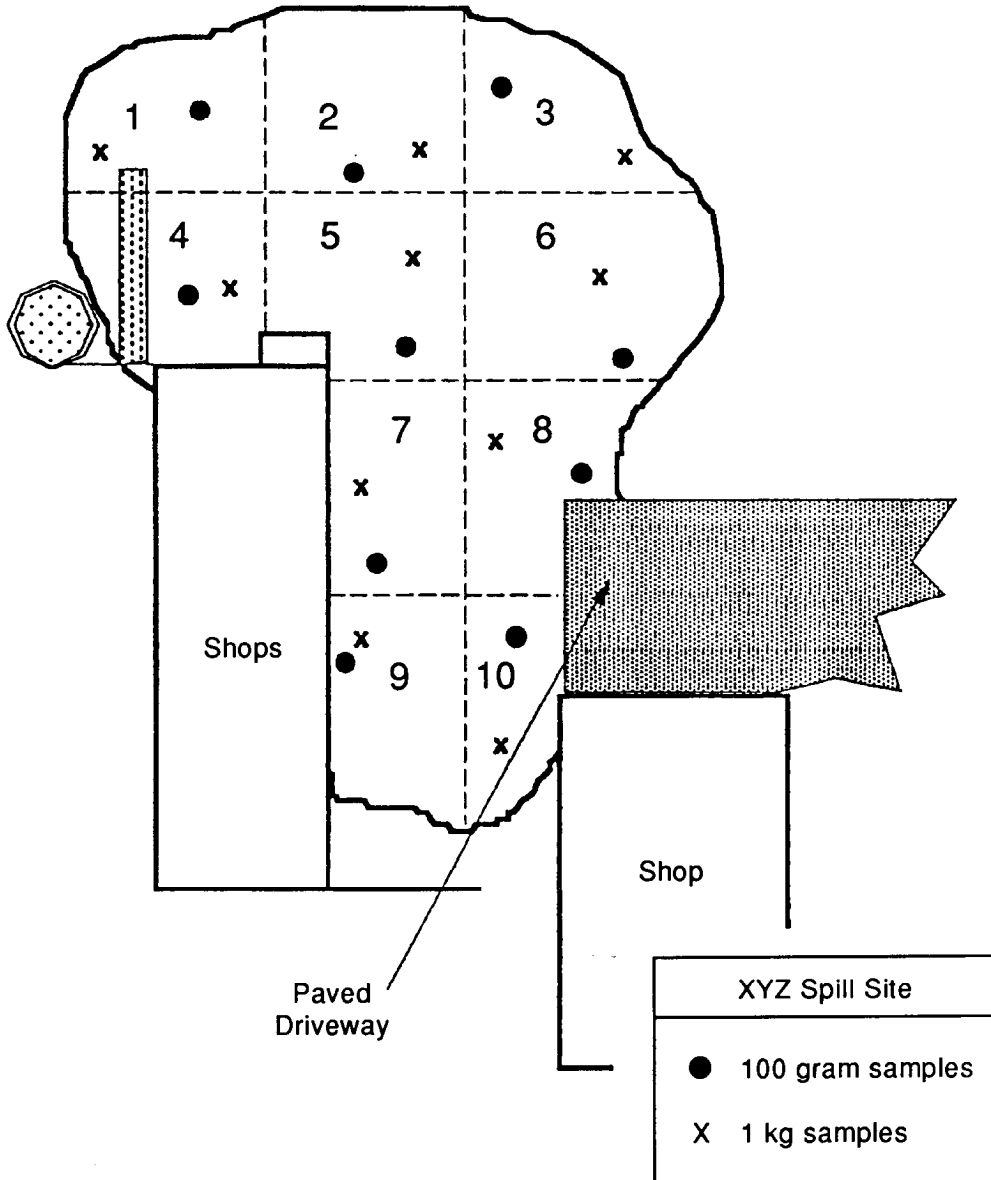

Figure E-6 Sample Locations





The soil is a silty sand and contains little or no gravel. There is grass on the area. The samples were made up of 20 - 30 increments of soil collected from a 2 foot square area using a small punch. The soil was screened to remove grass roots. The samples were stirred with a clean stainless steel spatula prior to subsampling. All samples were reduced to a 100 gram size by using procedures outlined in Section 5. This avoided creating a disposal problem for the laboratory and also insured that the initial subsampling was done according to the procedures outlined in the main body of this report.

Table E-4 shows the data acquired during the preliminary sampling effort. Examination of the data indicates that there is definitely a pattern to the pollution with a northwesterly trend to the deposition. (This is seen in the pattern of the row and column totals.)

The Visman constants indicate that there is a large homogeneity constant, A, (i.e., the waste is not homogeneous) and a relatively small segregation constant, B. The optimum weight of sample would be 466 grams. The minimum weight that should be taken would be 92 grams. For purposes of the main study it was decided to take a 500 gram sample and subsample it by using an incremental sampling technique similar to that shown in Figure E-6.

**TABLE E-4. Data for Preliminary Study**

CELL	SMALL	LARGE	CELL TOTALS
1	45.0	50.0	95.0
2	25.0	55.0	80.0
3	60.0	75.0	135.0
4	99.0	95.0	194.0
5	120.0	96.0	216.0
6	85.0	175.0	260.0
7	65.0	95.0	160.0
8	325.0	250.0	575.0
9	500.0	100.0	600.0
10	125.0	260.0	385.0
SUM	1449.0	1251.0	
AVERAGE	144.9	125.1	
S.D.	142.5	72.6	
C.V.	98.4	58.0	
<b>VISMAN'S CONSTANTS</b>			
A		1.67E+6	
B		3.59E+3	
Optimum Weight		466	
Minimum Weight		92	