

July 2004

Environmental Technology Verification Report

AERODYNE RESEARCH, INC.
QC-TILDAS

Prepared by
Battelle

Battelle
The Business of Innovation

In collaboration with the
U.S. Department of Agriculture

Under a cooperative agreement with

 **EPA** U.S. Environmental Protection Agency

ET ✓

ET ✓

ET ✓

Environmental Technology Verification Report

ETV Advanced Monitoring Systems Center

Aerodyne Research, Inc.
QC-TILDAS

by
Ken Cowen
Ann Louise Sumner
Amy Dindal
Karen Riggs
Zack Willenberg

Battelle
Columbus, Ohio 43201

and
Jerry Hatfield
Richard Pfeiffer
Kenwood Scoggin

USDA National Soil Tilth Laboratory
Ames, Iowa 50011

Notice

The U.S. Environmental Protection Agency (EPA), through its Office of Research and Development, has financially supported and collaborated in the extramural program described here. This document has been peer reviewed by the Agency. Mention of trade names or commercial products does not constitute endorsement or recommendation by the EPA for use.

Foreword

The U.S. Environmental Protection Agency (EPA) is charged by Congress with protecting the nation's air, water, and land resources. Under a mandate of national environmental laws, the Agency strives to formulate and implement actions leading to a compatible balance between human activities and the ability of natural systems to support and nurture life. To meet this mandate, the EPA's Office of Research and Development provides data and science support that can be used to solve environmental problems and to build the scientific knowledge base needed to manage our ecological resources wisely, to understand how pollutants affect our health, and to prevent or reduce environmental risks.

The Environmental Technology Verification (ETV) Program has been established by the EPA to verify the performance characteristics of innovative environmental technology across all media and to report this objective information to permittees, buyers, and users of the technology, thus substantially accelerating the entrance of new environmental technologies into the marketplace. Verification organizations oversee and report verification activities based on testing and quality assurance protocols developed with input from major stakeholders and customer groups associated with the technology area. ETV consists of seven environmental technology centers. Information about each of these centers can be found on the Internet at <http://www.epa.gov/etv/>.

Effective verifications of monitoring technologies are needed to assess environmental quality and to supply cost and performance data to select the most appropriate technology for that assessment. Under a cooperative agreement, Battelle has received EPA funding to plan, coordinate, and conduct such verification tests for "Advanced Monitoring Systems for Air, Water, and Soil" and report the results to the community at large. Information concerning this specific environmental technology area can be found on the Internet at <http://www.epa.gov/etv/centers/center1.html>.

Acknowledgments

The authors wish to acknowledge the support of all those who helped plan and conduct the verification test, analyze the data, and prepare this report. We would like to thank Ernie Bouffard, Connecticut Department of Environmental Protection; Rudy Eden, South Coast Air Quality Management District; Roy Owens, Owens Corning; and Jim Homolya, Bruce Harris, and Linda Sheldon, U.S. Environmental Protection Agency for their careful review of the verification test/QA plan and this verification report. We also thank Amy Morrow and Diane Farris of the U.S. Department of Agriculture National Soil Tilth Laboratory for their assistance in performing the reference sample analysis.

Contents

	Page
Notice	ii
Foreword	iii
Acknowledgments	iv
List of Abbreviations	viii
1 Background	1
2 Technology Description	2
3 Test Design and Procedures	4
3.1 Test Design	4
3.2 Site Descriptions	5
3.2.1 Site Description—Phase I	5
3.2.2 Site Description—Phase II	6
3.3 Test Procedures	6
3.3.1 Accuracy, Linearity, Precision, and Response Time	6
3.3.2 Calibration and Zero Drift	7
3.3.3 Interference Effects	7
3.3.4 Comparability	8
4 Quality Assurance/Quality Control	10
4.1 Equipment Calibrations	10
4.1.1 Reference Method Sampling Equipment	10
4.1.2 Analytical Equipment	10
4.1.3 Meteorological Equipment	11
4.1.4 Ammonia Dilution System	11
4.2 QC Samples	11
4.2.1 Field Blanks	11
4.2.2 Denuder Breakthrough Checks	13
4.2.3 Duplicate Samples	16
4.2.4 Laboratory Blanks	17
4.2.5 Calibration Checks	18
4.2.6 Gas Standard Dilution Checks	18
4.3 Audits	19
4.3.1 Performance Evaluation Audit	19
4.3.2 Technical Systems Audit	20
4.3.3 Audit of Data Quality	20
4.4 QA/QC Reporting	20
4.5 Data Review	21

5	Statistical Methods and Reported Parameters	22
5.1	Relative Accuracy	22
5.2	Linearity	22
5.3	Precision	23
5.4	Response Time	23
5.5	Calibration and Zero Drift	23
5.6	Interference Effects	23
5.7	Comparability	24
6	Test Results	25
6.1	Relative Accuracy	27
6.2	Linearity	31
6.3	Precision	33
6.4	Response Time	34
6.5	Calibration and Zero Drift	36
6.6	Interference Effects	39
6.7	Comparability	39
6.8	Ease of Use	42
6.9	Data Completeness	45
7	Performance Summary	46
8	References	48
	Appendix: QC-TILDAS Checklist	A-1

Figures

Figure 2-1.	QC-TILDAS	2
Figure 3-1.	Phase I Test Site	5
Figure 3-2.	Phase II Test Site	6
Figure 3-3.	Reference Method Sampling Cartridge	8
Figure 4-1.	Denuder Breakthrough During Phase I as a Function of Integrated Ammonia Concentration	14
Figure 4-2.	Denuder Breakthrough During Phase II as a Function of Integrated Ammonia Concentration.	15
Figure 4-3.	Analysis of Diluted Ammonia Standards Using the Denuder Reference Method	19
Figure 6-1.	Phase I Meteorological Conditions and QC-TILDAS Ambient NH ₃ Measurements	25
Figure 6-2.	Phase II Meteorological Conditions and QC-TILDAS Ambient NH ₃ Measurements	26
Figure 6-3a.	Week 1, Phase I Accuracy Results for the QC-TILDAS	28
Figure 6-3b.	Week 4, Phase I Accuracy Results for the QC-TILDAS	28
Figure 6-4.	Phase II Accuracy Results for the QC-TILDAS	29

Figure 6-5a. Results of Linearity Check of the QC-TILDAS During Phase I, Week 1	31
Figure 6-5b. Results of Linearity Check of the QC-TILDAS During Phase I, Week 4	32
Figure 6-6. Results of Linearity Check of the QC-TILDAS During Phase II	32
Figure 6-7. Illustration of Response Time for the QC-TILDAS	36
Figure 6-8. Comparison of Ambient Reference Measurements with Averages from the QC-TILDAS During Phase I	40
Figure 6-9. Comparison of Ambient Reference Measurements with Averages from the QC-TILDAS During Phase II	40
Figure 6-10. Scatter Plot of QC-TILDAS Results versus Ambient Reference Measurements During Phase I	41
Figure 6-11. Scatter Plot of QC-TILDAS Results versus Ambient Reference Measurements During Phase II	41

Tables

Table 4-1. Minimum Detectable Ambient NH ₃ Concentrations During Phase I	12
Table 4-2. Minimum Detectable Ambient NH ₃ Concentrations During Phase II	13
Table 4-3. Denuder Breakthrough Checks During Phase I	15
Table 4-4. Denuder Breakthrough Checks During Phase II	16
Table 4-5. Duplicate Reference Method Samples	17
Table 4-6. Data Recording Process	21
Table 6-1. Relative Accuracy Results During Phase I, Week 1	29
Table 6-2. Relative Accuracy Results During Phase I, Week 4	30
Table 6-3. Relative Accuracy Results During Phase II	30
Table 6-4. Calculated Precision of the QC-TILDAS During Phase I	33
Table 6-5. Calculated Precision of the QC-TILDAS During Phase II	34
Table 6-6. Response Time Determinations During Phase I	35
Table 6-7. Response Time Determinations During Phase II	35
Table 6-8. Calibration and Zero Checks During Phase I	37
Table 6-9. Calibration and Zero Checks During Phase II	38
Table 6-10. Interference Effect Evaluation	39
Table 6-11. Activities Performed During Phase I	43
Table 6-12. Activities Performed During Phase II	44
Table 7-1. QC-TILDAS Performance Summary	47

List of Abbreviations

AFO	animal feeding operation
AMS	Advanced Monitoring Systems
cm	centimeter
CI	confidence interval
DL	detection limit
EPA	U.S. Environmental Protection Agency
ETV	Environmental Technology Verification
FIA	flow injection analysis/analyzer
Hz	Hertz
kg	kilogram
L	liter
Lpm	liter per minute
µg	microgram
µm	micrometer
mg	milligram
mL	milliliter
mm	millimeter
min	minute
NIST	National Institute of Standards and Technology
NH ₃	ammonia
NH ₄ ⁺	ammonium
ppb	part per billion
%D	percent difference
QA	quality assurance
QC	quality control
QC-TILDAS	Quantum Cascade-Tunable Infrared Laser Differential Absorption Spectrometer
QMP	quality management plan
RA	relative accuracy
RPD	relative percent difference
RSD	relative standard deviation
s	second
SD	standard deviation
TSA	technical systems audit
USDA	U.S. Department of Agriculture

Chapter 1

Background

The U.S. Environmental Protection Agency (EPA) supports the Environmental Technology Verification (ETV) Program to facilitate the deployment of innovative environmental technologies through performance verification and dissemination of information. The goal of the ETV Program is to further environmental protection by accelerating the acceptance and use of improved and cost-effective technologies. ETV seeks to achieve this goal by providing high-quality, peer-reviewed data on technology performance to those involved in the design, distribution, financing, permitting, purchase, and use of environmental technologies.

ETV works in partnership with recognized testing organizations; with stakeholder groups consisting of buyers, vendor organizations, and permittees; and with the full participation of individual technology developers. The program evaluates the performance of innovative technologies by developing test plans that are responsive to the needs of stakeholders, conducting field or laboratory tests (as appropriate), collecting and analyzing data, and preparing peer-reviewed reports. All evaluations are conducted in accordance with rigorous quality assurance (QA) protocols to ensure that data of known and adequate quality are generated and that the results are defensible.

The EPA's National Exposure Research Laboratory and its verification organization partner, Battelle, operate the Advanced Monitoring Systems (AMS) Center under ETV. The AMS Center, in collaboration with the U.S. Department of Agriculture's (USDA) National Soil Tilth Laboratory, recently evaluated the performance of the Aerodyne Research, Inc. Quantum Cascade-Tunable Infrared Laser Differential Absorption Spectrometer (QC-TILDAS).

Chapter 2 Technology Description

The objective of the ETV AMS Center is to verify the performance characteristics of environmental monitoring technologies for air, water, and soil. This verification report provides results for the verification testing of the QC-TILDAS. The following is a description of the QC-TILDAS, based on information provided by the vendor. The information provided below was not subjected to verification in this test.

The QC-TILDAS (Figure 2-1) is a tunable infrared laser spectrometer, based on pulsed quantum cascade laser technology. The QC-TILDAS uses an absolute spectroscopic analysis method that is inherently self-calibrating, making calibration gases unnecessary. The QC-TILDAS is optimized for ammonia (NH_3), but it can be used for a variety of gases, depending on laser selection.

Ambient NH_3 is continuously sampled in a multipass (56-meter path length, 0.5-liter volume) cell at reduced pressure (30 to 60 Torr). The glass surfaces are siloxyl-coated to minimize surface losses. The QC-TILDAS uses the unique infrared spectroscopic identification, or fingerprint, of NH_3 to quantify ambient NH_3 levels.

The QC-TILDAS consists of an optical and an electronic subunit, mounted together. The optical system is on a temperature-stabilized 25-centimeter (cm) \times 60 cm optical breadboard and contains a laser, multiple-pass absorption cell, and infrared detectors, coupled with all-reflective optics.

The quantum cascade laser for NH_3 detection at a 10.3-micrometer (μm) wavelength is thermoelectrically cooled in a hermetically sealed housing and operates in the pulsed mode. The astigmatic Herriot multiple pass cell has two mirrors separated by 32 cm. Two infrared detectors,

one for the sample cell and one for a reference cell are contained in one liquid nitrogen-cooled dewar. (Thermoelectrically cooled detector options are available with reduction in sensitivity.)

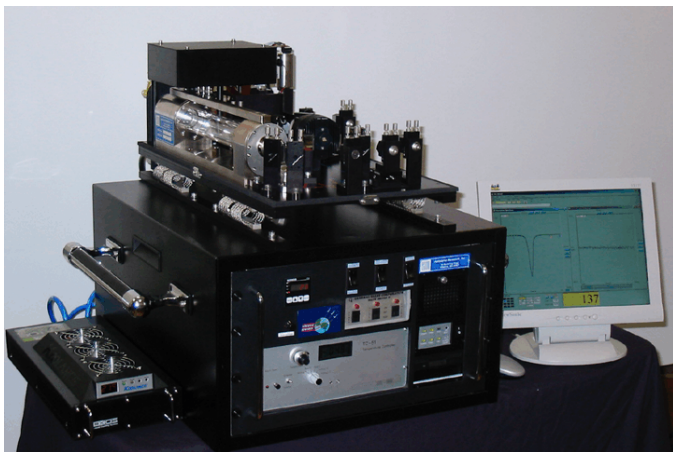

Figure 2-1. QC-TILDAS

The electronics subunit consists of laser temperature and current controllers, pressure and temperature probes, valve driver, and computerized data acquisition. The data acquisition rate is adjustable from 1 Hertz (Hz) to 20 Hz. The electronics are mounted in a standard 48.3-cm rack,

53.3 cm wide by 53.3 cm deep. The total height of QC-TILDAS is 61 cm. The combined weight of the electronics and optical modules is 77.3 kilograms. Several options for removal of particulate matter are available, including the inlet system used in this verification test that utilizes secondary air flow for inertial separation of particulate matter.

A vacuum pump is required for continuous sampling at reduced pressure in the absorption cell. A temperature-controlled, closed-loop circulator provides the coolant for the laser housing and electronics. QC-TILDAS costs \$118,000.

Chapter 3 Test Design and Procedures

3.1 Test Design

Livestock agriculture is thought to be the primary source of atmospheric NH₃ in the United States and accounts for approximately 70% of NH₃ emissions in the United States.⁽¹⁾ As a result, a means to accurately quantify these emissions is needed. The objective of this verification test was to verify the QC-TILDAS performance in measuring gaseous NH₃ in ambient air at animal feeding operations (AFOs).

This verification test was conducted according to procedures specified in the *Test/QA Plan for Verification of Ambient Ammonia Monitors at Animal Feeding Operations*,⁽²⁾ with the exception of six deviations that are addressed later in this report. The verification test was conducted in two phases, each at separate AFOs. The first phase of testing was conducted between September 8 and October 3, 2003, at a swine finishing farm near Ames, Iowa. The second phase was conducted between October 20 and November 14, 2003, at a cattle feedlot in Carroll, Iowa. These sites were selected to provide realistic testing conditions, which were expected to exhibit a wide range of NH₃ concentrations during the test periods.

The verification test was designed to evaluate the following performance parameters:

- Relative accuracy
- Linearity
- Precision
- Response time
- Calibration/zero drift
- Interference effects
- Comparability
- Ease of use
- Data completeness.

During each phase of the verification test, the QC-TILDAS response to a series of NH₃ gas standards of known concentration was used to quantify relative accuracy (RA), linearity, precision (repeatability), and calibration/zero drift. The QC-TILDAS response time, the time to reach 95% of the stable signal, was also assessed during the delivery of the NH₃ standards. During Phase II, interference effects were quantified from the QC-TILDAS response to various chemical species that may be present at AFOs; the potential interferent gases were delivered both in the presence and absence of NH₃. The QC-TILDAS response to ambient air was also evaluated during both

phases as the comparability to simultaneous determinations by an ambient NH₃ reference method (acid-coated denuders). Additionally, the ease of use of the QC-TILDAS was evaluated based on operator observations. Data completeness was determined based on the amount of data collected as a percentage of the amount of data that could have been collected.

3.2 Site Descriptions

The QC-TILDAS was installed at the Phase I and II testing locations by the vendor representatives. Battelle and USDA staff worked with the vendor representatives to establish procedures for operating the QC-TILDAS during this verification test. The vendor representative trained Battelle and USDA staff to check several instrument parameters to verify the operation of the QC-TILDAS and identify signs of malfunction, which was done on a daily basis. A checklist, provided by the vendor representative and included as Appendix A, was completed daily by Battelle and USDA staff. In the event of an instrument malfunction, Battelle and/or USDA staff could contact the vendor representative and conduct minor troubleshooting procedures upon request as necessary, but were not expected to make any major repairs. The vendor representative remained on-site until the installation was complete. All the testing activities were conducted by Battelle and/or USDA staff. The vendor representative returned to the test site after the completion of Phase I to install the QC-TILDAS at the Phase II test site.

3.2.1 Site Description—Phase I

Figure 3-1 shows a schematic diagram of the swine farm during Phase I of the verification test. The AFO included ten animal barns arranged in two parallel rows of five, with each barn housing up to 2,000 swine. The urine and feces from the swine exited the barns through metal gratings in the floor and were deposited in two nutrient lagoons located on the southern end of the AFO. The perimeter of the AFO was lined with trees, with agricultural fields surrounding the AFO perimeter. A temperature-regulated instrument trailer was placed on-site during the test to house the monitoring equipment and to provide a sheltered work space. The QC-TILDAS was installed inside the instrument trailer, and the QC-TILDAS Teflon inlet line was used to sample outside air. The inlet was mounted on a tripod on the west side of the trailer at a height of approximately 2 meters. The platform shown in Figure 3-1 was installed to hold some of the monitoring equipment.

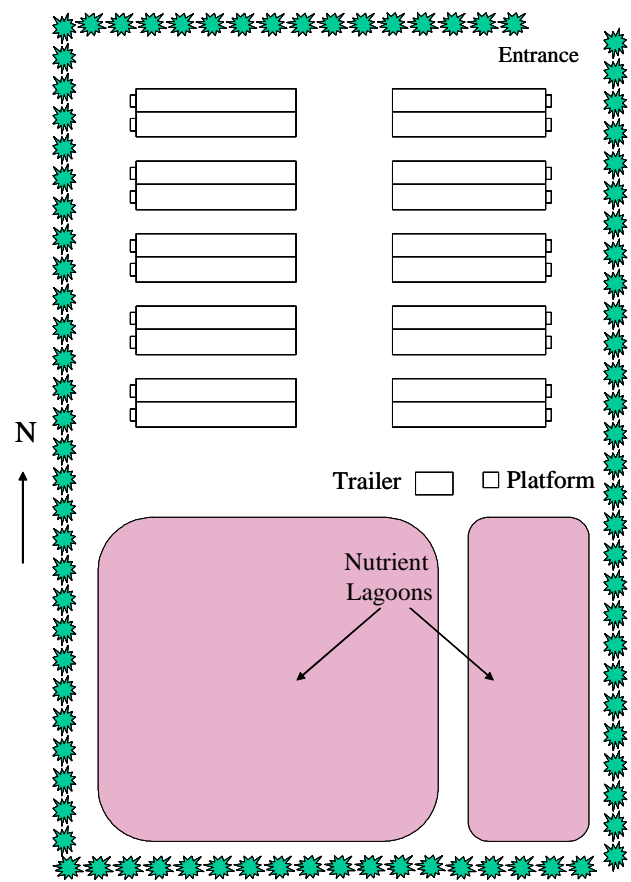

Figure 3-1. Phase I Test Site

3.2.2 Site Description—Phase II

Figure 3-2 shows a schematic diagram of the cattle feedlot during Phase II of the verification test. The instrument trailer used in Phase I of this verification test was also used in Phase II and was in a harvested corn field surrounded on three sides by cow pens. The farm was surrounded on all sides by corn fields, most of which had been harvested. Approximately 2,000 to 3,000 head of cattle were on the farm during the verification test. The QC-TILDAS was installed in the instrument trailer as in Phase I, with an inlet height of approximately 1.5 meters.

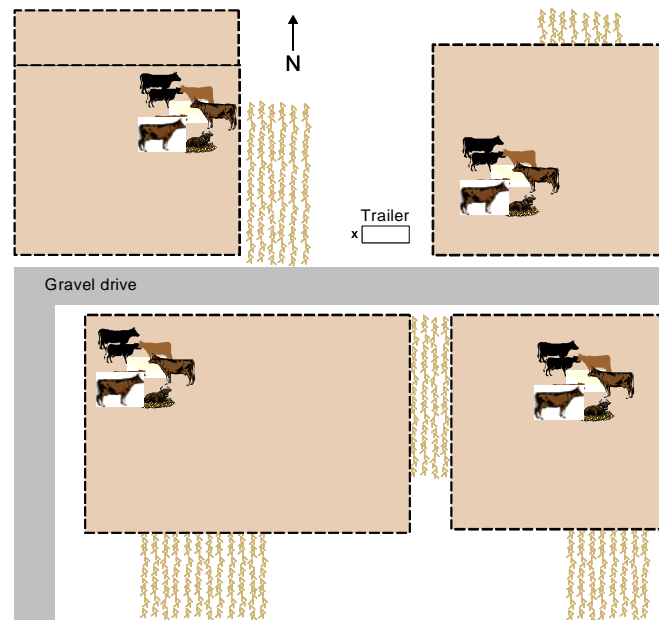

Figure 3-2. Phase II Test Site

3.3 Test Procedures

All tests utilized the continuous NH_3 measurement data record stored by the QC-TILDAS. The QC-TILDAS recorded data at a frequency of 10 Hz (10 data points per second) during this verification test.

3.3.1 Accuracy, Linearity, Precision, and Response Time

During the first week and last (fourth) week of Phase I and the first week of Phase II of testing, the QC-TILDAS was supplied with compressed NH_3 gas standards to achieve NH_3 concentrations over a range from 0 to 3,030 parts per billion (ppb) (Phase I) or 0 to 2,000 ppb (Phase II) to simulate the range expected in ambient air during each phase. The gases delivered to the QC-TILDAS were prepared by diluting higher-concentration NH_3 standard gases (i.e., 100 to 500 parts per million) in zero air using a calibrated dilution system provided by the USDA.

The QC-TILDAS was equipped with a specialized inlet that allowed for automated delivery of zero air to check the baseline drift and used secondary air flow for inertial separation of particulate matter. A vacuum pump drew gas into the inlet at approximately 13 liters per minute (Lpm) and a fraction of the air sample passed into the absorption cell (at 30 to 60 Torr). Since the high inlet

flowrate exceeded the maximum 5 Lpm output of the USDA dilution system, zero air or nitrogen were added at approximately 10 Lpm to the output of the dilution system prior to delivery to the QC-TILDAS (Note that the need for addition of zero air to the output of the dilution system was not a limitation of the QC-TILDAS, but rather was a limitation of the dilution system. In fact, the high flow rate used by the QC-TILDAS allows for a faster response time). Consequently, the NH₃ standards that were delivered to the QC-TILDAS were further diluted by a factor of three; however, during several of the Phase I and Phase II checks, the NH₃ output from the dilution system was not increased correctly to compensate for the change. This did not impact negatively on the quality of the verification of the QC-TILDAS. However, the intended NH₃ concentration range for the Phase I accuracy and linearity checks was 0 to 10,000 ppb NH₃; for these checks, the actual range was 0 to 3,030 ppb in Week 1 and 0 to 2,326 ppb in Week 4 of Phase I.

The NH₃ gas was supplied to the QC-TILDAS for between 1.5 and 20 minutes at each concentration level. Accuracy, linearity, and precision were established based on the continuous digital data set recorded by the QC-TILDAS during the periods when the NH₃ gas was supplied. Data were used for the calculations once the signal had stabilized at a constant concentration (i.e., the signal did not appear to be increasing or decreasing with time). The time required to reach 95% of the change in the stable reading for each concentration was also recorded for the QC-TILDAS. These data were used to assess the response time of the QC-TILDAS.

3.3.2 Calibration and Zero Drift

On Monday, Wednesday, and Friday of the first and last weeks of testing during each phase, the QC-TILDAS was supplied with an NH₃ gas standard and zero air to check the calibration and zero drift of the QC-TILDAS, respectively. The intended NH₃ gas standard concentration for each calibration check was 1,000 ppb. However, for reasons described above, the actual calibration check standards were delivered at NH₃ concentrations between 330 and 1,163 ppb. Zero air and the NH₃ standards were each supplied to the QC-TILDAS for between 5 minutes and one hour, during which time the measured concentrations were recorded by the QC-TILDAS.

3.3.3 Interference Effects

During the Phase II of testing, the QC-TILDAS was independently supplied with a series of potential interference gases (hydrogen sulfide, nitrogen dioxide, 1,3-butadiene, and diethylamine) to assess any impact the gases have on the QC-TILDAS response. The interferent gases were supplied from diffusion tubes (VICI Metronics, Poulsbo, Washington) at concentrations of approximately 100 ppb in zero air and a 500-ppb NH₃ standard as carrier gases.

The process for supplying the interferent gases was as follows: zero air was supplied to the QC-TILDAS until a stable reading was achieved. The interferent gas was added to the zero air flow and supplied to the QC-TILDAS until a stable reading was observed (at least 2 minutes). The QC-TILDAS was flushed for at least 2 minutes with zero air, and the next interferent gas was delivered. This process was repeated for the four interferent gases. A 500-ppb NH₃ standard was then supplied to the QC-TILDAS until a stable reading was achieved. The interferent gas was added to the NH₃ standard for delivery to the QC-TILDAS and the process outlined above was repeated, delivering the 500-ppb NH₃ standard for at least 2 minutes between each interferent gas.

3.3.4 Comparability

The comparability of the QC-TILDAS with a standard reference method was established by comparing the average QC-TILDAS readings with time-integrated NH_3 samples collected using citric-acid-coated denuders. The reference samples were collected based on procedures described in the EPA Compendium Method IO-4.2, *Determination of Reactive Acidic and Basic Gases and Acidity of Fine Particles* ($< 2.5 \mu\text{m}$).⁽³⁾

For this test, NH_3 samples were collected using a ChemComb Model 3500 Speciation Sampling Cartridge (Rupprecht & Patashnick Co., East Greenbush, New York). Figure 3-3 shows a schematic illustration of the ChemComb sampling cartridge. Samples were collected by drawing ambient air through an impactor at a nominal rate of 10 Lpm to remove particulate matter with aerodynamic diameters greater than $2.5 \mu\text{m}$. The air was passed through two or more citric-acid-coated denuders to collect gaseous NH_3 . A single Teflon filter was used to collect the particulate matter that passed through the denuder. For Phase I, air flow was controlled using diaphragm pumps with needle valves. During Phase II, automated Partisol Model 2300 speciation samplers (Rupprecht & Patashnick Co., East Greenbush, New York) were used. The Partisol samplers were equipped with mass-flow controlled sampling systems that were pressure- and temperature-corrected. This improved the accuracy of the sampled air volume and also reduced the overall labor requirements. The samplers had not been available during Phase I.

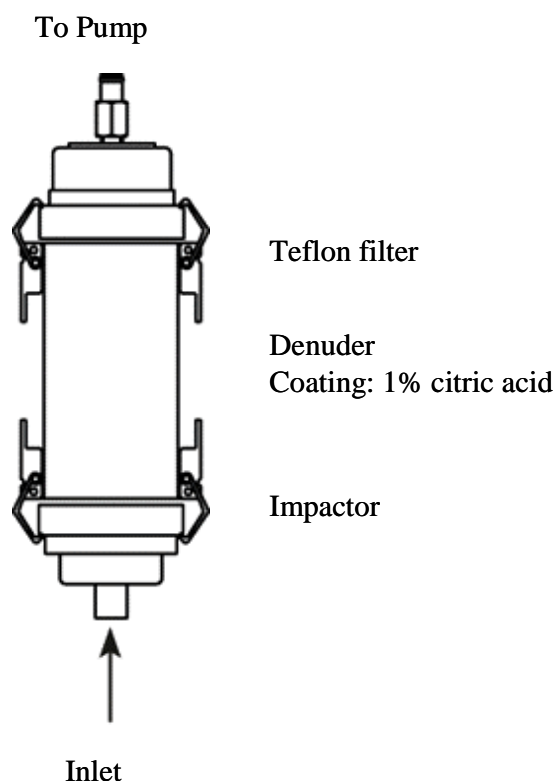

Figure 3-3. Reference Method Sampling Cartridge

The procedures that were used for preparing and coating the denuders were based on the procedures given in the ChemComb Operating Manual⁽⁴⁾ and the test/QA plan.⁽²⁾ The denuders were coated in an NH_3 -free glove box at a USDA National Soil Tilth Laboratory facility in Ames, Iowa, and stored in an NH_3 -free glove box until they were installed in the ChemComb sampling cartridge and transported to the test site. Cartridges were assembled in the laboratory and transported to the test site. All denuders were used within 72 hours of being coated and within 24 hours of being transported to the field.

Reference samples were collected during the second and third weeks of testing during each phase. To capture diurnal variations in NH_3 concentrations, sampling was conducted on approximately the following schedule: 8:00 a.m. to 12:00 p.m., 12:00 p.m. to 2:00 p.m., 2:00 p.m. to 4:00 p.m., 4:00 p.m. to 8:00 p.m., and 8:00 p.m. to 8:00 a.m., so that five sets of samples were collected in each 24-hour period. The short-term (2-hour and 4-hour) sampling captured the midday peaks in NH_3 concentrations, whereas the 12-hour sampling captured overnight, generally low,

concentrations. After sampling, the sampling media were retrieved and transported to the USDA laboratory for extraction and analysis. During Phase I, sampling was conducted at two locations: the instrument trailer near the QC-TILDAS inlet and near the platform shown in Figure 3-1. Duplicate samples were obtained at each location. Sampling was conducted daily, Monday through Friday, during the two-week reference sampling period. During Phase II, the reference sampling for single-point monitors was conducted at one location near the monitor inlets at the instrument trailer. Duplicate samples were also obtained at this site. The sampling schedule for Phase II deviated from the test/QA plan in that sampling was conducted every other day, including weekends, during the two-week sampling period. The schedule allowed sufficient time for sample transportation and processing between sampling days.

Extraction and analysis of the denuders were performed as described in the test/QA plan,⁽²⁾ with one exception. The water volume used to extract the denuders was increased from 10 milliliters (mL), as specified in the test/QA plan, to 20 mL. The volume was increased to accommodate the sample volume requirements of the analysis method described below. A deviation was filed to address this change, which does not impact the quality of the reference data. Samples were extracted in an NH₃-free glove box and stored in acid-washed scintillation vials to prevent contamination. The samples were analyzed by USDA by flow injection analysis (FIA) using a Lachat QuikChem Automated Flow Injection Ion Analyzer (Lachat Company, Loveland, Colorado) according to QuikChem Method No. 10-107-06-2-A. This method involves heating the NH₃ sample with salicylate and hypochlorite in an alkaline phosphate buffer, which produces an emerald green color proportional to the NH₃ concentration. The color was intensified by adding sodium nitroprusside and monitored photometrically.

When possible, samples were analyzed within 24 hours of extraction, as specified in the test/QA plan. When analysis within 24 hours of extraction was not possible, the samples were stored frozen until the analysis could be performed, in accordance with the test/QA plan.

Chapter 4

Quality Assurance/Quality Control

QA/quality control (QC) procedures were performed in accordance with the quality management plan (QMP) for the AMS Center⁽⁵⁾ and the test/QA plan for this verification test.⁽²⁾

Six deviation reports were filed during this test and have been addressed in this report. In summary, a change was made in the reference sampling schedule and equipment for Phase II (Section 3.3.4), the denuder extraction volume was increased (Section 3.3.4), some percent difference values measured for duplicate reference samples exceeded 10% (Section 4.2.3), laboratory blank tolerances were redefined (Section 4.2.4), the order in which laboratory blanks and calibration check standards were submitted for analysis was changed (Section 4.2.4 and 4.2.5), and not all of the test data were reviewed within two weeks of the end of the test phase (Section 4.5). None of these deviations have impacted the quality of this verification test.

4.1 Equipment Calibrations

4.1.1 Reference Method Sampling Equipment

Reference method sampling was conducted based on the procedures described in the EPA method⁽³⁾ and the ChemComb operating manual.⁽⁴⁾ A single-point calibration of the flow rate through each of the sampling systems (i.e., pump, flow controller, filter pack, denuder, impactor) was performed prior to starting each phase using a flow meter with a National Institute of Standards and Technology (NIST)-traceable calibration. The flow rate of each sampler was checked at the beginning and end of each sampling period using an in-line flow meter. The flow rate was readjusted if the flow check was not within $\pm 5\%$ of the nominal flow rate of 10 Lpm (i.e., 9.5 Lpm to 10.5 Lpm). All calibration results were documented for inclusion in the verification test data files. For Phase II, flows were controlled by the pressure- and temperature-corrected mass flow controllers used in the USDA's Partisol samplers. These samplers shut off automatically if the flow deviated by $\pm 5\%$ from the 10 Lpm setpoint for more than 5 minutes, and the data were flagged. Actual sample volumes were recorded by the samplers.

4.1.2 Analytical Equipment

The reference samples were analyzed in the USDA laboratory using FIA. A five-point calibration was measured on the FIA for the reference sample analysis prior to each analytical session by the USDA staff performing the analysis. The calibration was conducted according to the manu-

facturer's recommendations and included concentrations of NH₃ standard solutions throughout the operating range of the FIA. The calibration was acceptable if the coefficient of determination (r^2) of the calibration curve was greater than 0.99. The FIA detection limit (DL) was 0.03 milligrams per liter (mg/L) and was determined as three times the standard deviation of repeated measurements of a low-level NH₃ standard. Any analytical results that fell below the FIA DL were used without any further adjustment.

Calibration check standards were analyzed after every fifteenth sample in the batch. These calibration checks were considered acceptable if the measured concentration agreed within 10% of the standard solution concentration. If a calibration check failed to agree within 10% of the standard concentration, the FIA was recalibrated; all analyses since the last acceptable calibration check were repeated. All calibration results were documented for inclusion in the verification test data files.

4.1.3 Meteorological Equipment

The sensors used for meteorological monitoring had been calibrated by the manufacturer (Met One Instruments, Inc., Grants Pass, Oregon) within one year of their use in this verification test. The calibration results were included in the verification test data files.

4.1.4 Ammonia Dilution System

The USDA NH₃ dilution system (Envionics, Tolland, Connecticut) employs three heated mass flow controllers and valves dedicated for the dilution of compressed NH₃ mixtures. The output flow rates were verified using an independent, NIST-traceable flow meter and agreed to within 10%.

4.2 QC Samples

4.2.1 Field Blanks

At least 10% of all reference samples collected were field blanks. The field blanks were collected by installing the sampling media (i.e., denuder and filters) in the sampling train without drawing any air through the train. The media were recovered and handled as normal samples. Field blanks were collected at each of the sampling locations and during each of the sampling periods (e.g., 8:00 a.m. to 12:00 p.m.). Field blank results were used to detect potential sample contamination (as defined in the test/QA plan as field blank values greater than 5% of any reference samples for that day) and also to determine the reference method DL.

The reference method DL was determined from the field blank results and reported in terms of an NH₃ mass corresponding to three times the standard deviation of the NH₃ mass collected on the field blanks. Reference method DLs were determined for each phase and were more than six times higher than the equivalent FIA DL (0.6 microgram [μg] NH₃ per 20-mL sample).

The reference method DLs, reported as NH₃ masses, were used to determine the minimum detectable NH₃ concentration for each phase. Since the mass of NH₃ collected by the reference method is a function of the sampling time, flow rate, and the ambient NH₃ concentration, the minimum (time-integrated) ambient NH₃ concentration detectable by the reference method varies depending on the sample period duration. (This assumes a constant flow rate.) For example, to collect 100 µg NH₃, the time-integrated ambient NH₃ concentration must be 20 ppb for a 12-hour sample and 120 ppb for a 2-hour sample. Accordingly, the minimum ambient NH₃ concentrations that could be detected from the collection of 2-, 4-, and 12-hour samples at a nominal flow rate of 10 Lpm were calculated from the reference method DL for each phase.

4.2.1.1 Phase I

During Phase I of testing, a total of 11 field blanks were collected (10% of reference samples). The sample cartridges were exposed to ambient air (caps removed) for approximately the time it would take to connect the cartridges to the pump tubing. The caps were then replaced and the cartridges handled in the same way as regular reference samples. The average NH₃ mass collected on the field blanks was 5.3 µg, with a range of 1.5 to 7.0 µg. This range of collected NH₃ corresponded to 0.5% to 6.5% of the NH₃ mass collected on any of the reference samples on the corresponding days during which the field blanks were collected. Two of the Phase I field blanks were above 5% of the minimum reference sample mass for that corresponding day. These field blanks collected 5.6 µg NH₃, which was slightly above the average field blank NH₃ mass during Phase I; however, the field blanks were collected on days that exhibited lower ambient NH₃ levels, resulting in a relatively large percentage of the reference mass (6.5% and 5.9%). These field blanks did not show unusually high levels of contamination, and it does not appear that they had a significant impact on the Phase I reference method results. The standard deviation of the NH₃ collected on field blanks for Phase I was 1.6 µg, and the Phase I reference method DL was 10.1 µg NH₃. The minimum detectable integrated ambient NH₃ concentrations are shown in Table 4-1 for 2-, 4-, and 12-hour samples. During Phase I, all measured NH₃ levels were greater than these minimum NH₃ concentrations, with a minimum measured value of 107 ppb for a 2-hour sample.

Table 4-1. Minimum Detectable Ambient NH₃ Concentrations During Phase I

	2-Hour Sample	4-Hour Sample	12-Hour Sample
Minimum detectable NH ₃ concentration	12.1 ppb	6.0 ppb	2.0 ppb
Number of reference samples collected	46	45	19
Number less than the minimum detectable NH ₃ concentration	0	0	0

4.2.1.2 Phase II

During Phase II of testing, the reference sampling was conducted somewhat differently than in Phase I, in that all the reference sampling cartridges and field blanks were installed in the sampler

prior to the first sampling period on a given day. The reference sample and field blank cartridges were thus exposed to the ambient environment for a period of approximately 24 hours. Nonetheless, the average measured NH₃ mass in the field blanks for Phase II was somewhat lower than in Phase I. A total of 14 field blanks was collected in Phase II. The average NH₃ mass collected on these blanks was 2.5 µg NH₃, and the range was 0.5 to 4.6 µg NH₃. The mass collected on the field blanks ranged from 1.2% to 55.0% of the smallest reference sample mass collected on the same day, with an average of 19.2%. These percentages are not indicative of unusually high levels of contamination, but rather are a result of relatively low ambient NH₃ levels at the AFO. The impact of these blank levels on the results of this verification test may be manifested as a small positive bias of the reference method results relative to the readings of the technologies being verified. This bias would be most pronounced on days with low ambient NH₃ concentrations. The highest field blank percentages were measured on days when the integrated ambient NH₃ levels were as low as 6 ppb, which is approaching the 4.9-ppb minimum detectable ambient NH₃ concentration for a 2-hour sample. Assuming an ambient air sample volume of 1.2 cubic meters, the smallest volume collected during Phase II, the maximum field blank value corresponds to an ambient concentration of 5.5 ppb. Thus, the sample handling may account for up to 5.5 ppb of the measured values.

The standard deviation of the NH₃ collected from field blanks for Phase II was 1.4 µg, which resulted in a 6.6 µg NH₃ Phase II reference method DL. The minimum detectable ambient NH₃ concentrations for 2-, 4-, and 12-hour samples (at a nominal flow rate of 10 Lpm) are shown in Table 4-2. During Phase II, one measured NH₃ concentration in ambient air fell below the minimum detectable NH₃ concentration, as summarized in Table 4-2.

Table 4-2. Minimum Detectable Ambient NH₃ Concentrations During Phase II

	2-Hour Sample	4-Hour Sample	12-Hour Sample
Minimum detectable NH ₃ concentration	7.9 ppb	4.0 ppb	1.3 ppb
Number of reference samples collected	56	56	29
Number less than minimum detectable NH ₃ concentration	2	0	0

4.2.2 Denuder Breakthrough Checks

4.2.2.1 Phase I

Use of backup denuders is called for in the test/QA plan during periods when breakthrough greater than 10% of the front denuder is observed or expected. Owing to the high NH₃ levels observed during Phase I, all reference samples collected during Phase I included at least one backup denuder, and most samples (>70%) included two backup denuders. These backup denuders were used to check the degree of NH₃ breakthrough. The breakthrough checks were conducted at both of the sampling locations and included checks during each of the five sampling periods (i.e.,

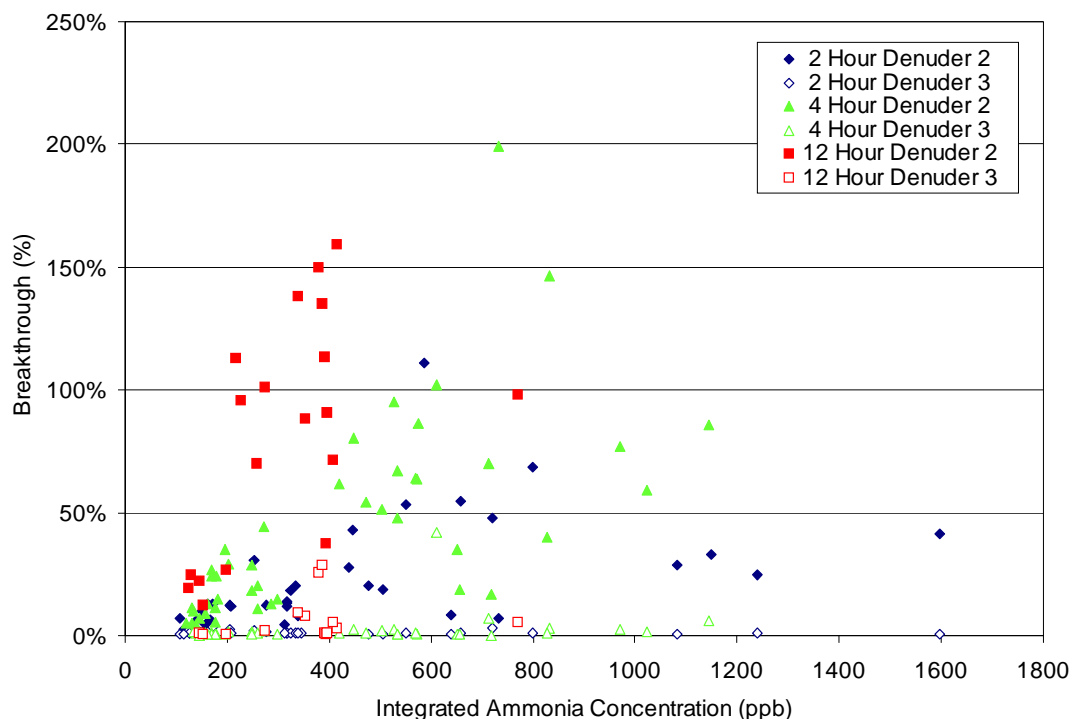

Figure 4-1. Denuder Breakthrough During Phase I as a Function of Integrated Ammonia Concentration

8:00 p.m to 8:00 a.m., 8:00 a.m. to 12:00 p.m., etc.). Figure 4-1 shows the percentage of NH_3 collected on the backup denuders relative to the front denuder (i.e., breakthrough) as a function of the average NH_3 concentration for each of the sampling period lengths (combined data from both sampling locations). The solid symbols in this figure represent the first backup denuder (identified as Denuder 2 in the legend), and the open symbols represent the second backup denuder (identified as Denuder 3 in the legend). This figure illustrates that the first backup denuder captured a significant fraction of NH_3 relative to the front denuder during many of the sampling periods (up to 200% of the front denuder). The second backup denuder captured more than 10% of the NH_3 on the front denuder in only three cases. It is unlikely that NH_3 was lost due to breakthrough of the second backup denuder for these or any of the reference samples. Therefore, these samples were not eliminated from the reference data. The relatively high collection of NH_3 on the first backup denuder may have been caused by displacement by species with a higher affinity for the citric acid coating. Presumably these species would remain on the front denuder, so it is unlikely that NH_3 was lost as a result. Table 4-3 summarizes the results of the breakthrough checks for Phase I.

4.2.2.2 Phase II

The NH_3 levels measured during Phase II were significantly lower than observed during Phase I. Thus, the sampling approach was changed such that all samples still included one backup denuder, but only 19% of the samples collected during Phase II included two backup denuders. Figure 4-2 shows the percentage of NH_3 collected on the backup denuders relative to the front denuder as a function of the average NH_3 concentration during the corresponding sampling period, using the same symbols as in Figure 4-1. Data for all three Phase II sampling locations are included here. In general, breakthrough onto the first backup denuder (Denuder 2 in the figure legend) was low,

Table 4-3. Denuder Breakthrough Checks During Phase I

	2-Hour Samples		4-Hour Samples		12-Hour Samples	
	1 st Backup Denuder (%)	2 nd Backup Denuder (%)	1 st Backup Denuder (%)	2 nd Backup Denuder (%)	1 st Backup Denuder (%)	2 nd Backup Denuder (%)
Percent of reference samples with denuder	100	72	100	80	100	74
Average concentration as % of concentration on front denuder	19.4	1.2	42.4	2.5	82.5	6.5
Maximum concentration as % of concentration on front denuder	111.0	3.6	199.3	41.7	159.2	28.8
Percent of samples with breakthrough greater than 10% of front denuder	57	0	82	3	100	14

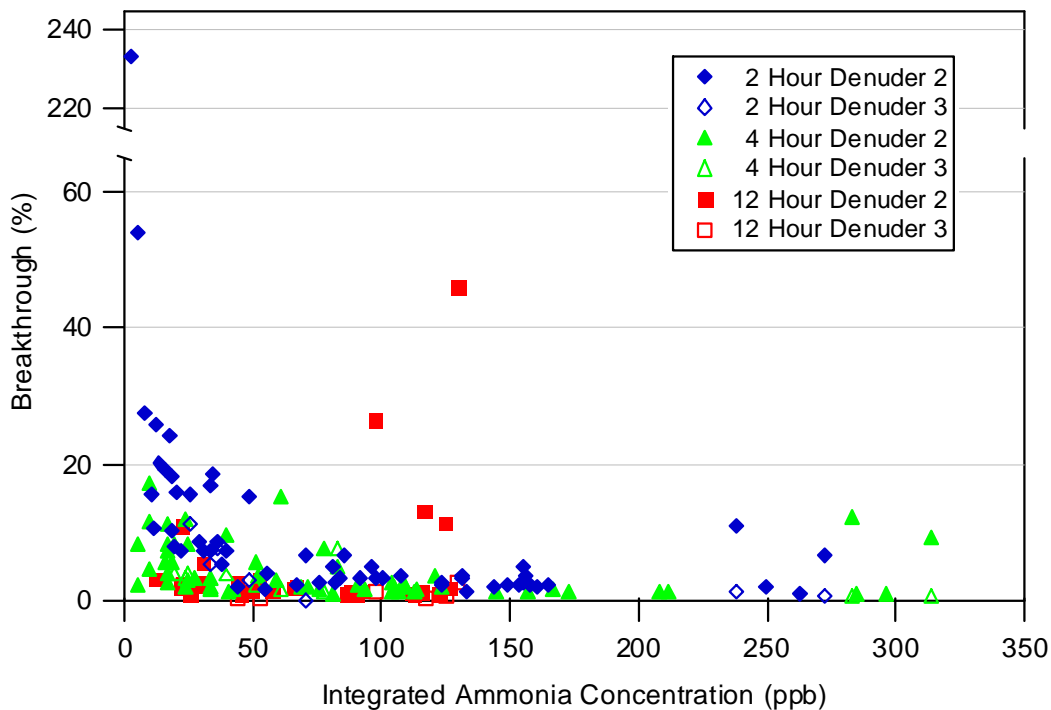

Figure 4-2. Denuder Breakthrough During Phase II as a Function of Integrated Ammonia Concentration

with an average breakthrough of 8.6%. As shown in the figure, many of the high breakthrough values (i.e., greater than 10%) observed on the first backup denuder occurred at very low NH₃ concentrations where the mass of NH₃ collected was similar to that collected for field blanks. The high values do not indicate that breakthrough occurred, but rather that the measurements were near the DL of the overall reference method. High breakthrough of the first backup denuder also occurred at higher NH₃ concentrations and/or long sample durations. Although these high breakthrough values may indicate that breakthrough of the first backup denuder occurred, the second backup denuder (Denuder 3 in the figure legend) was in place to collect any remaining NH₃. With the exception of one sample that occurred at a low ambient NH₃ concentration, breakthrough observed on the second backup denuder was always less than 10% of the amount collected on the front denuder. Thus, it is unlikely that any NH₃ was lost as a result of breakthrough of the first or second backup denuders. Table 4-4 summarizes the results of the breakthrough checks for Phase II.

Table 4-4. Denuder Breakthrough Checks During Phase II

	2-Hour Samples		4-Hour Samples		12-Hour Samples	
	1 st Backup Denuder (%)	2 nd Backup Denuder (%)	1 st Backup Denuder (%)	2 nd Backup Denuder (%)	1 st Backup Denuder (%)	2 nd Backup Denuder (%)
Percent of reference samples with denuder	100	18	100	18	100	24
Average concentration as % of concentration on front denuder	8.6	4.1	4.4	2.8	5.2	1.1
Maximum concentration as % of concentration on front denuder	[233.3] ^(a) 53.8	11.3	17.2	7.5	45.9	2.5
Percent of samples with breakthrough greater than 10% of front denuder	29	10	10.7	0	17.2	0

^(a) Suspect value rejected based on Q-test and not included in other calculations. This value corresponded to an NH₃ concentration that was less than the minimum detectable NH₃ concentration.

4.2.3 Duplicate Samples

For at least 10% of the reference samples, duplicates were collected using a collocated sampling train (within 1 meter). These duplicate samples were collected at both of the sampling locations during Phase I, and only at the trailer location during Phase II, and were collected during each of the sampling periods. The relative percent difference (RPD) between the duplicate samples was calculated by dividing the absolute difference of the sample concentrations by the average of the sample concentrations.

Table 4-5 summarizes the results of the duplicate sampling for both Phases I and II. During Phase I, a total of 18 sets of duplicate samples were collected. Eight of the duplicate samples were

collected at the sampling location next to the trailer, and the other 10 duplicate samples were collected at the sampling location next to the platform. The duplicate samples showed absolute RPD values between 0.6% and 22%. The average RPD for Phase I was 9%. During Phase II, duplicate samples were collected during every sampling period at the sampling location next to the trailer, resulting in a total of 35 duplicate measurements. The absolute RPD varied between 0.7% and 32%, with an average of 7%. Although the average RPD values were comparable in Phases I and II, the absolute differences were significantly smaller during Phase II. For both

Table 4-5. Duplicate Reference Method Samples

	Phase I		Phase II	
	RPD (%)	Absolute Difference (ppb)	RPD (%)	Absolute Difference (ppb)
Average	9	28	7	5
Maximum	22	109	32	18
Minimum	0.6	1	0.7	0.6
Number of duplicate samples		18		35
Number with RPD >10%		6		7

phases combined, the absolute RPD for 13 of the duplicate samples exceeded the QA limit of 10% specified in the test/QA plan. To verify the quality of the reference method, NH₃ gas standards were delivered to the reference method. Repeated delivery of the same concentration standard gave an average RPD of 1.3%. Thus, it is probable that the exceedences were caused by non-uniformity in the air sampled and did not impact the quality of the reference method itself. However, some contributions may result from small variations in sampling flow rates and analytical uncertainties.

4.2.4 Laboratory Blanks

Laboratory blank solutions were prepared for the FIA using distilled, deionized water. In each analytical batch, at least 10% of the number of reference samples analyzed were laboratory blanks, and were submitted to the laboratory as blind samples. The analysis of the laboratory blanks deviated from the test/QA plan in that, rather than submitting the blanks routinely (e.g., every tenth sample), the blanks were interspersed among the other samples and submitted as blind samples.

During Phase I, a total of 31 laboratory blank samples were analyzed. The analytical results from the laboratory blanks indicated no apparent drift in the calibration of the FIA, and none of the blank values were greater than 5% of the lowest measured reference sample on that day. (Note: The test/QA plan indicates that laboratory blanks should not exceed 5% of any concentration measured on that day. As written, this threshold includes field blanks and backup denuder samples. A deviation report has been filed to change this threshold so that it applies only to

composite reference samples and does not include samples that would be expected to have low concentrations, such as field blanks.) During Phase II, a total of 27 laboratory blank samples were analyzed. Similarly, the analytical results from the laboratory blanks indicated no apparent drift in the baseline of the FIA, and none of the blank values was greater than 5% of the lowest measured reference sample on that day.

4.2.5 Calibration Checks

In addition to analyzing every 15th calibration check samples, as described in Section 4.1.2, at least 10% of the samples were submitted to the laboratory as blind calibration check samples. These blind calibration check samples were prepared by diluting NIST-traceable NH_4^+ standard stock solution.

During Phase I, 38 NH_4^+ blind calibration check samples were prepared from 15 different standard solutions, ranging in concentration from 0.4 to 8 mg/L NH_3 . Measured concentrations for 10 of these calibration check samples differed from the delivered standard concentration by more than 10%, and the full set of measured values was on average 1.9% lower than the delivered concentration. It should be noted that the calibration check samples were prepared from NH_4^+ standards that were diluted from a 1,000-mg/L stock solution and that errors may have occurred during the dilution process. For example, nine of the 10 calibration check samples that failed were prepared from four different standard solutions. Of these four standard solutions, a total of 10 samples were submitted to the laboratory for analysis, and 9 of the samples fell outside the 10% acceptance criterion. Of the 28 additional samples submitted to the laboratory from the 11 other prepared standard solutions, only one fell outside the 10% acceptance criterion, and the concentration of that standard solution was near the quantitation limit of the FIA. As such, it is likely that the preparation of the standard solutions contributed to the failure of the calibration check samples, rather than the calibration of the FIA.

During Phase II, 24 calibration check samples were prepared from four different standard solutions. Measured concentrations for six of these calibration check samples differed from the delivered standard concentration by more than 10%, and the full set of measured values was on average 4.4% lower than the delivered concentration. Of the six calibration check samples that failed, five were prepared from two of the four standard solutions. It is possible that the failures may be attributable to inadvertent dilution or degradation of the standard solutions used, since these standards were prepared prior to submission of the first samples and failed consistently only near the end of the analysis period. The sixth calibration check sample that failed may be associated with a transcription error in the submission log.

4.2.6 Gas Standard Dilution Checks

At each of the nominal NH_3 levels to be used for the accuracy and linearity checks, at least one sample of the dilution of the NH_3 gas standard was collected using the reference method. These samples were analyzed as regular samples and used to check the accuracy of the dilution system. Figure 4-3 shows the measured NH_3 captured by the sampling cartridges versus the NH_3 delivered during the dilution checks.

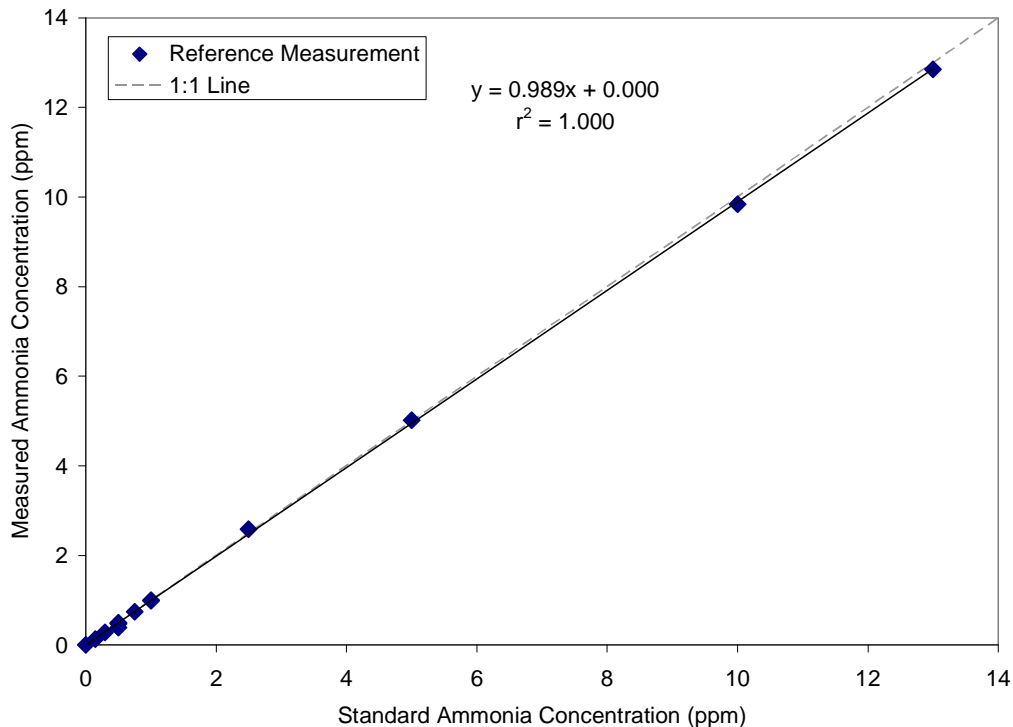

Figure 4-3. Analysis of Diluted Ammonia Standards Using the Denuder Reference Method

A dilution check was conducted before Week 2 of Phase I. However, the sampling line was thought to have not been flushed with the diluted NH_3 sample prior to collecting the check samples, and the measured concentrations did not agree within 10% of the expected concentration. Consequently, the dilution check was repeated prior to Phase II, and the results are shown in Figure 4-3. The average RA of the measured concentrations was 4% and indicates that the NH_3 gas standards as delivered by the dilution system were accurate with respect to the reference method.

4.3 Audits

4.3.1 Performance Evaluation Audit

A performance evaluation audit was conducted to assess the quality of the measurements made in this verification test. This audit addressed only those measurements that factor into the data used for verification, i.e., the sample flow rate and the analytical laboratory measurements. This audit was performed once during the verification test by analyzing a standard or comparing a reading to a reference that was independent of standards used during the testing.

The flow rates of the reference method sampling assemblies were audited once during each phase of testing using a flow meter independent of the meter used to calibrate the flow rate. During Phase I, agreement between the audit flow rate and the nominal flow rate indicated a bias in the calibrated flow rates. The flow rates were recalibrated. The bias was later attributed to a faulty audit flow meter, and the original flow calibrations were verified against a second audit flow meter.

The performance of the FIA was audited by analyzing an NH_4^+ standard independent of those used for the calibration, but were the same as those used for the calibration checks described in Section 4.2.5. These samples were provided as blind audit samples, and the operator of the FIA was not aware of the concentrations of the samples. In several cases, agreement between the measured concentration and the standard concentration was not within $\pm 10\%$ (ranged from -43% to 64%). The cause of the discrepancy was investigated but could not be identified. It is possible that some of the discrepancy is attributable to uncertainties associated with dilution of the stock 1,000 mg/L NH_4^+ standard solution. Multiple solutions were prepared, and only some of those solutions showed discrepancies with the analytical results. The relative agreement between the reference samples collected during the gas standard dilution check (performed between Phases I and II) and their expected values provide additional verification of the accuracy of the FIA.

4.3.2 Technical Systems Audit

Battelle's ETV Quality Manager performed a technical systems audit (TSA) of the performance of this verification test during each phase of the test. The purpose of this TSA was to ensure that the verification test was being performed in accordance with the test/QA plan⁽²⁾ and that all QA/QC procedures were implemented. As part of the audit, Battelle's ETV Quality Manager reviewed the reference sampling and analysis methods used, compared actual test procedures to those specified in the test/QA plan, and reviewed data acquisition and handling procedures. Observations and findings from this audit were documented and submitted to the Battelle Verification Test Coordinator for response. The records concerning the TSA are permanently stored with the Battelle Quality Manager.

4.3.3 Audit of Data Quality

At least 10% of the data acquired during the verification test was audited. Battelle's Quality Manager traced the data from the initial acquisition, through reduction and statistical analysis, to final reporting, to ensure the integrity of the reported results. All calculations performed on the data undergoing the audit were checked during the technical review process.

4.4 QA/QC Reporting

Each audit was documented in accordance with Sections 3.3.4 and 3.3.5 of the QMP for the ETV AMS Center.⁽⁵⁾ Once the audit report was prepared, the Battelle Verification Test Coordinator ensured that a response was provided for each adverse finding or potential problem and implemented any necessary follow-up corrective action. The Battelle Quality Manager ensured that follow-up corrective action was taken. The results of the TSA were sent to the EPA.

4.5 Data Review

Records generated in the verification test were reviewed before these records were used to calculate, evaluate, or report verification results. Table 4-6 summarizes the types of data recorded. The review was performed by a technical staff member involved in the verification test, but not the staff member who originally generated the record. The person performing the his/her initials and the date to a hard copy of the record being reviewed. In some cases, entries in the laboratory record books or on field data sheets were not reviewed within two weeks after completion of each phase. A deviation report was filed to address this.

Table 4-6. Data Recording Process

Data to be Recorded	Responsible Party	Where Recorded	How Often Recorded	Disposition of Data^(a)
Dates, times of test events (site activities, etc.)	USDA/ Battelle staff	Laboratory record books/field data sheet.	Start/end of test, and at each test activity.	Used to organize/check test results; manually incorporated in data spreadsheets as necessary.
Reference method sampling data	USDA/ Battelle staff	Laboratory record books, chain-of-custody forms, or file data sheets as appropriate.	At least at start/end of reference sample, and at each change of a test parameter.	Used to organize/check test results; manually incorporated in data spreadsheets as necessary.
Meteorological conditions	Battelle	Meteorological station data logger.	Continuously.	Used to assess meteorological conditions during testing as necessary.
Ammonia analyzer readings	Vendor or designee	Data acquisition system (data logger, personal computer, laptop, etc.).	Continuously at specified acquisition rate throughout analyzer operation.	Electronically transferred to spreadsheets.
Reference sample analysis and results	USDA/ Battelle staff	Laboratory record books, data sheets, or data acquisition system, as appropriate.	Throughout sample handling and analysis process.	Transferred to spreadsheets.

^(a) All activities subsequent to data recording were carried out by Battelle.

Chapter 5

Statistical Methods and Reported Parameters

The statistical methods presented in this chapter were used to verify the performance parameters listed in Section 3.1. The 10-Hz data set produced by the QC-TILDAS for each phase was averaged over 60-second intervals using IgorPro software, Version 4.09 (Wavemetrics, Lake Oswego, Oregon), to make the data analysis more manageable. (The quantity of data reported by the QC-TILDAS is discussed further in Section 6.8). However, for the analysis of some the testing activities during which gas standards were delivered to the QC-TILDAS for shorter time periods, raw data (10 Hz) were used for the analysis to retain the shorter time-scale features in the data. In general, 10-Hz (raw) data were used for gas delivery less than approximately 15 minutes. Actual data averaging periods used for the analysis each testing activity are specified throughout Chapter 6.

5.1 Relative Accuracy

The percent difference (%D) of the average QC-TILDAS response to each NH_3 gas standard was calculated according to Equation 1:

$$\%D = \frac{x_n - \bar{x}}{x_n} \times 100 \quad (1)$$

where \bar{x} is the average QC-TILDAS response to an NH_3 gas standard of nominal concentration x_n . For each phase of testing, the RA with respect to all of the gas standards (n) delivered to the QC-TILDAS was calculated using Equation 2:

$$\text{RA} = \frac{1}{n} \left(\sum_{i=1}^n |\%D_i| \right) \times 100 \quad (2)$$

5.2 Linearity

Linearity was assessed by a linear regression analysis using the compressed gas standard concentrations as the independent variable and results from the QC-TILDAS as the dependent variable. Linearity was expressed in terms of slope, intercept, and r^2 and was calculated independently for each phase of the verification test. The 95% confidence interval (CI) for the slope and intercept was also calculated.

5.3 Precision

Precision was calculated in terms of the percent relative standard deviation (RSD) of QC-TILDAS measurements of several NH₃ gas standards. The mean and standard deviations of those readings were calculated. The RSD was then determined as:

$$\text{RSD} = \frac{\text{SD}}{\bar{x}} \times 100 \quad (3)$$

where SD is the standard deviation of the QC-TILDAS readings and \bar{x} is the mean of the QC-TILDAS readings. Precision was calculated independently for each phase of testing; the overall precision was calculated by averaging the individual RSD values from the Phase I and Phase II checks.

5.4 Response Time

Response time was assessed in terms of both the rise and fall times of the QC-TILDAS when sampling NH₃ gas standards or zero air. Rise time (i.e., 0% to 95% response time for the change in NH₃ concentration) was determined from the QC-TILDAS response to a rapid increase in the delivered NH₃ concentration. Once a stable response was achieved with the gas standard, the fall time (i.e., the 100% to 5% response time) was determined in a similar way, switching from the NH₃ standard back to zero air or a lower concentration NH₃ gas standard. Rise and fall times were determined for the QC-TILDAS during each phase of testing and are reported in terms of seconds (s). It should be noted that response times include the time associated with equilibration of NH₃ on the tubing and inlet surfaces during delivery of the gas standards.

5.5 Calibration and Zero Drift

Calibration and zero drift were reported in terms of the mean, RSD, and range (maximum and minimum) of the readings obtained from the QC-TILDAS in the repeated sampling of the NH₃ gas standards and of zero air. For zero drift, the SD is reported instead of the RSD since dividing the SD by a value approximately equal to zero is not meaningful. The calibration and zero drift were calculated independently during each phase of testing so that up to six NH₃ standard and zero readings (Monday, Wednesday, and Friday for two weeks) were used for this calculation in each phase. The results of these checks indicate the day-to-day variation in zero and standard readings. Most calibration checks were conducted with 1,000-ppb NH₃ standards. The mean response for each calibration check conducted at a concentration other than 1,000 ppb NH₃ was normalized (i.e., the mean was multiplied by 1,000 and divided the actual nominal NH₃ concentration) to facilitate the comparison of the data.

5.6 Interference Effects

The extent of interference was calculated in terms of the ratio of the response of the QC-TILDAS to the interfering species, relative to the actual concentration of the interfering species. For

example, if 100 ppb of an interfering species resulted in a 1-ppb increase in the NH₃ reading of the QC-TILDAS, the interference effect was reported as 1% (i.e., 1 ppb/100 ppb). The interference effect was reported separately for each interferent, both in the absence and in the presence of NH₃.

5.7 Comparability

The comparability of the QC-TILDAS results and the reference method results with respect to ambient air was assessed by linear regression using the reference method NH₃ concentrations as the independent variable and results from the QC-TILDAS as the dependent variable. The 60-second averaged QC-TILDAS ambient NH₃ measurement data were averaged over 2-, 4-, and 12-hour time intervals corresponding to the reference method sampling schedule. Comparability was expressed in terms of slope, intercept, and r^2 and was calculated independently for each phase of the verification test.

Chapter 6 Test Results

The results of the verification test of the QC-TILDAS are presented in this section. As discussed in Chapter 5, the 10-Hz data recorded by the QC-TILDAS were averaged over 60-second time intervals for use in some of the analyses reported here. Some of the checks required use of higher frequency data to capture short-timescale information or because the gas standard deliveries were short in duration (i.e., 3 to 15 minutes), so only a few averaged data points could be used in each calculation. For these checks, which are specified throughout this section, raw 10-Hz data were used for the analysis, and the number of data points used for each calculation are specified.

Meteorological conditions collected using the meteorological monitoring station during Phase I are presented in Figure 6-1. The ambient data set collected by the QC-TILDAS is shown as 60-second averages in the bottom panel, along with the wind direction, wind speed, and ambient temperature data. The shaded regions indicate the NH_3 reference method sampling periods. The average

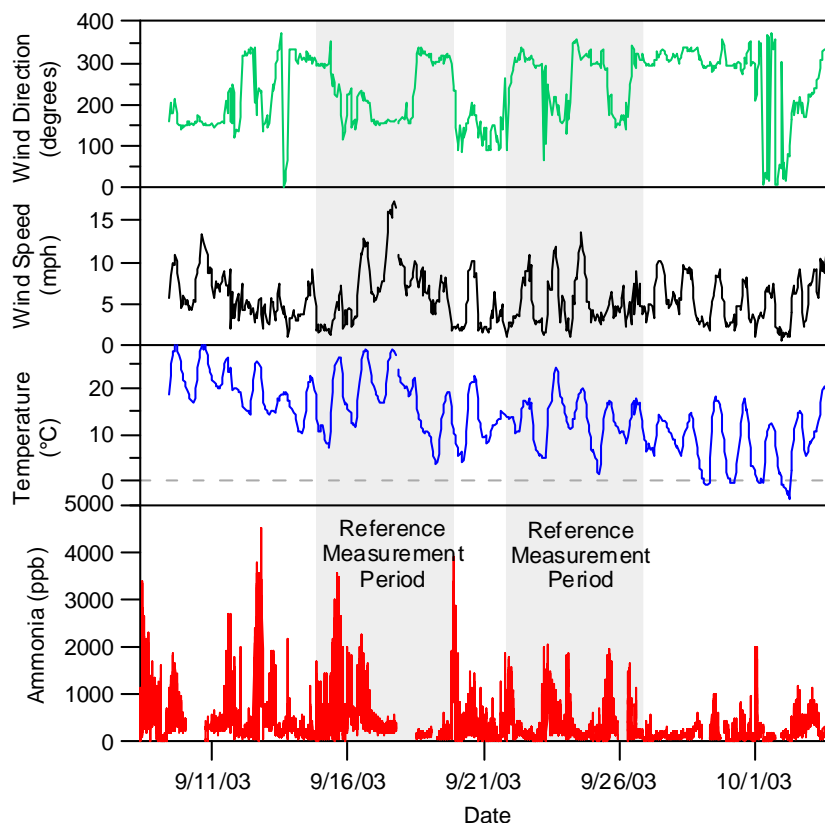

Figure 6-1. Phase I Meteorological Conditions and QC-TILDAS Ambient NH_3 Measurements

ambient NH_3 concentration measured by the QC-TILDAS was 367 ppb, with a range of 1.6 ppb to 4,495 ppb. (These values are reported for 60-second averages.) The gaps in the QC-TILDAS ambient NH_3 data set are discussed in Section 6.8 and were caused by power loss at the test site. Data for periods during which Battelle or USDA staff were performing testing activities on the QC-TILDAS are not shown. The meteorological conditions, which were recorded as 1-hour averages, varied widely over the duration of Phase I. The average ambient temperature during Phase I of the test was 14°C , with a range of -4 to 29°C . The average relative humidity was 66%. Winds were predominantly from the southeast and northwest, with wind speeds up to 17 miles per hour (6 miles per hour average). When winds were observed from the southeast, the monitors were exposed to emissions from the nutrient lagoons, whereas the monitors sampled barn emissions during periods of northerly winds.

Meteorological conditions during Phase II are presented in Figure 6-2. The average ambient temperature was 4.5°C (range: -10 to 29°C), and the average relative humidity was 75%. Winds were predominantly from the northwest and quite variable in speed, averaging 7 miles per hour (30 miles per hour maximum). Figure 6-2 shows the Phase II wind direction, wind speed, and ambient temperature data and the ambient NH_3 data set collected by the QC-TILDAS (bottom panel). The shaded region shows the period during which NH_3 reference measurements were conducted. The reported QC-TILDAS NH_3 measurements ranged from -0.4 ppb to 1,438 ppb during Phase II and averaged 132 ppb (calculated from 60-second averaged data).

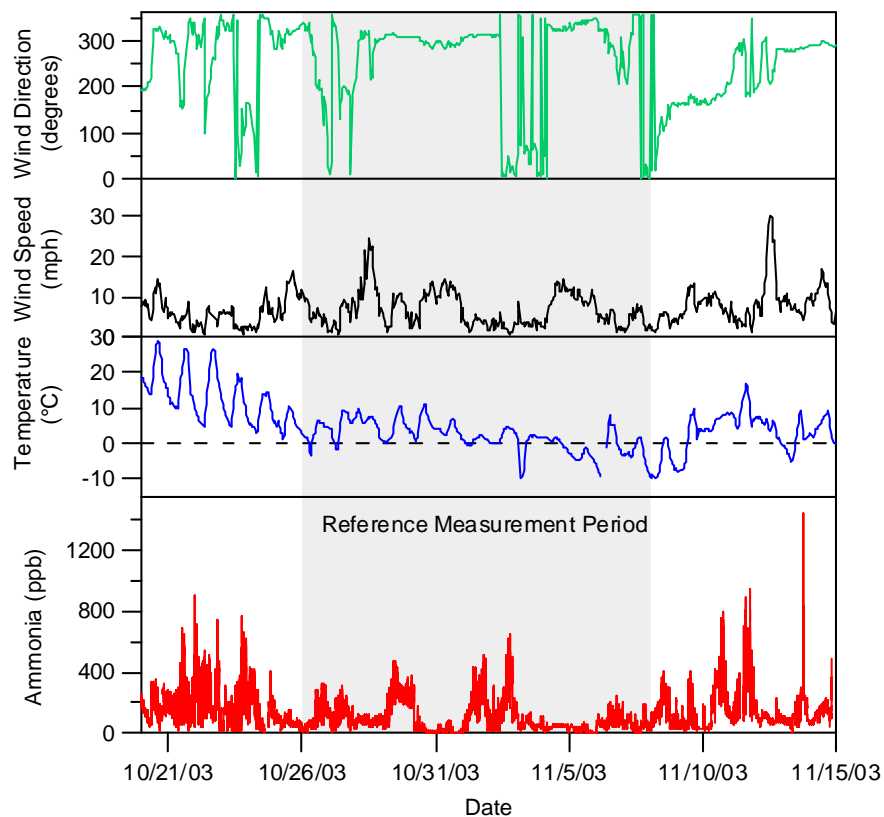

Figure 6-2. Phase II Meteorological Conditions and QC-TILDAS NH_3 Measurements

6.1 Relative Accuracy

During each phase of the verification test, the QC-TILDAS was supplied with compressed NH₃ gas standards at several concentrations. The NH₃ gas standards were diluted in zero air and delivered to the inlet of the QC-TILDAS at a flow rate of approximately 15 Lpm. Relative accuracy checks were conducted once during the first week (Week 1) of Phase I, the last week (Week 4) of Phase I, and during Week 1 of Phase II.

Figures 6-3(a,b) and 6-4 present the NH₃ concentrations recorded by the QC-TILDAS during the RA checks, along with the nominal NH₃ concentration levels supplied to the QC-TILDAS, for Phase I and Phase II, respectively. The averages of the measurements at each nominal NH₃ concentration are presented in Tables 6-1, 6-2, and 6-3 along with the calculated %D, the number of data points used in the calculation, and the average RA for each check. The reported values are based on the average of readings during the RA check when the QC-TILDAS readings had stabilized; thus, the calculations for each check span somewhat different time periods, which ranged from approximately 18 to 3,000 seconds. All calculations were performed on the 10-Hz QC-TILDAS data, without further averaging.

The response of the QC-TILDAS to the 454-ppb NH₃ standard delivered during the Phase I, Week 1 RA check was inconsistent with the response at other concentrations, and the results were not used for any calculations since the response did not reach a stable value, as called for in the test/QA plan.⁽²⁾ As shown in Figure 6-3a, the signal increased to approximately 600 ppb and then fell gradually to a final value of 474 ppb, whereas the QC-TILDAS response to other NH₃ concentrations increased rapidly until reaching the respective stable signals. The RA check was repeated with somewhat shorter (90 second) delivery durations to assess if this inconsistent response was reproducible. The results of the repeated check, also shown in Figure 6-3a, indicate that the initial 454-ppb RA check was not reproducible since, during the second check, the response at 454 ppb was similar to the responses at the other concentrations. The cause of this behavior was not readily apparent. Data from the second check were not included in any calculations because the sampling time was less than the requisite 2 minutes specified in the test/QA plan.

As shown in Tables 6-1 and 6-2, the Phase I %Ds of the QC-TILDAS ranged from -15.0 to 6.5 for the Week 1 RA check (91 to 3,030 ppb). The average RA over all the concentration levels was 6.5% for this check. The QC-TILDAS %Ds ranged from -11.4 to -2.2 for the Week 4 RA check (70 to 2,326 ppb), and the average RA was 4.7%. The overall QC-TILDAS Phase I RA (the average of all the %Ds measured during Phase I) was 6.3. The %Ds (Table 6-3) from the Phase II RA check of the QC-TILDAS (300 to 2,000 ppb) ranged from -12.7 to -8.2. The average RA for Phase II was 10.0%.

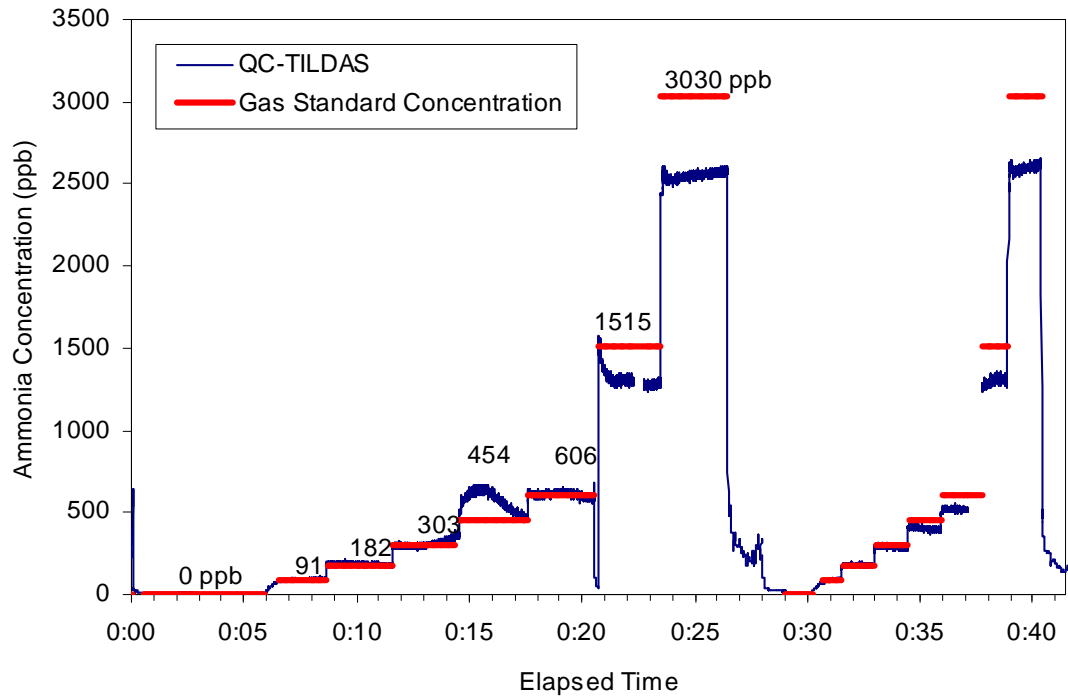

Figure 6-3a. Week 1, Phase I Accuracy Results for the QC-TILDAS

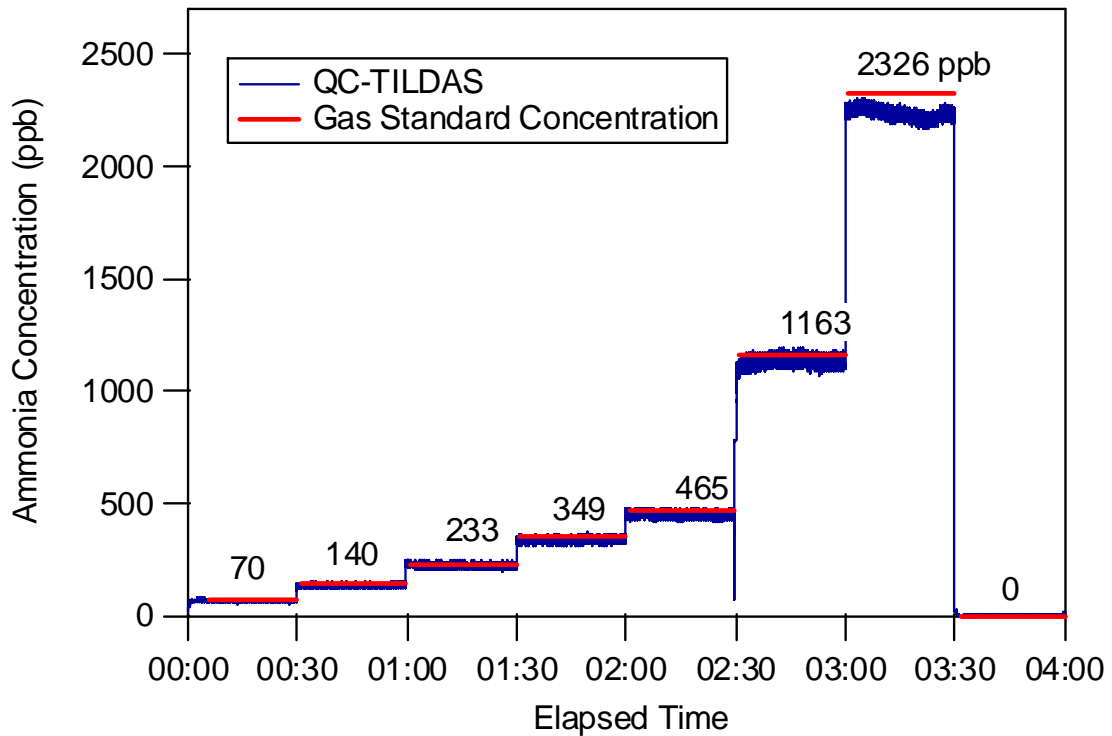

Figure 6-3b. Week 4, Phase I Accuracy Results for the QC-TILDAS

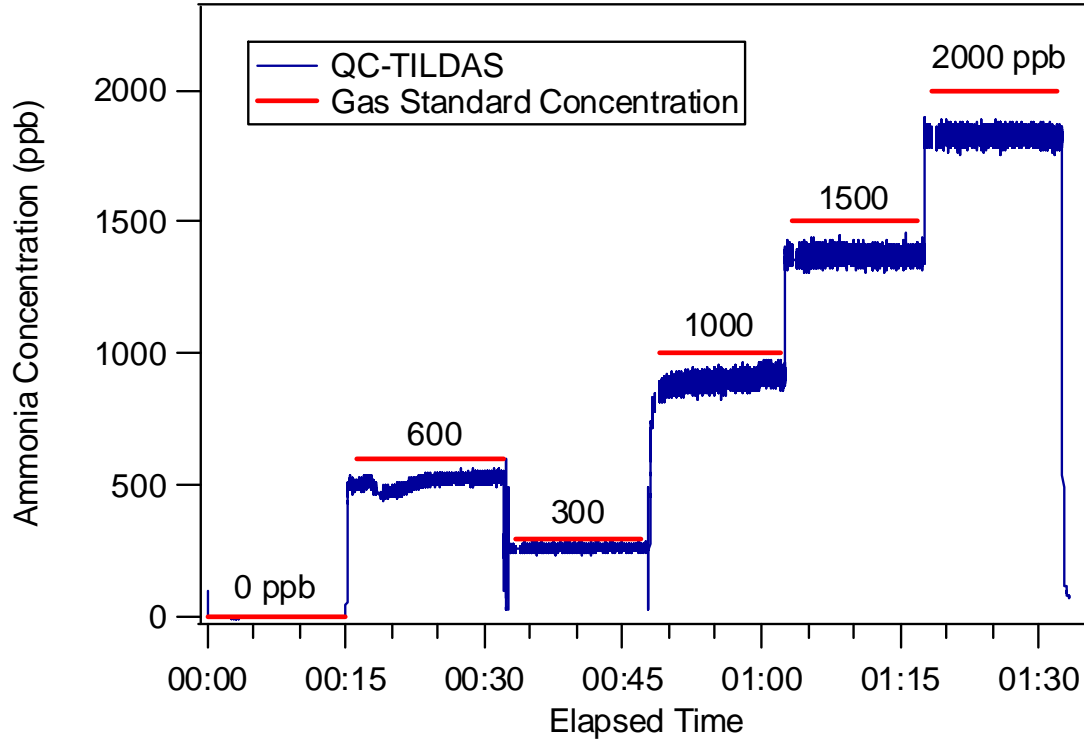

Figure 6-4. Phase II Accuracy Results for the QC-TILDAS

Table 6-1. Relative Accuracy Results During Phase I, Week 1

NH₃ Gas Standard Concentration (ppb)	Average Measured Concentration (ppb)	Number of Data Points^(a)	%D
0	3	403	NA
91	97	436	6.5
182	185	1,668	1.9
303	294	714	-3.1
606	608	1,528	0.3
1,515	1,291	944	-14.8
3,030	2,575	187	-15.0
Average RA			6.5%

NA = not applicable.

^(a) Based on time needed for QC-TILDAS signal to stabilize.

Table 6-2. Relative Accuracy Results During Phase I, Week 4

NH₃ Gas Standard Concentration (ppb)	Average Measured Concentration (ppb)	Number of Data Points^(a)	%D
0	0.5	29,946	NA
70	62	12,730	-11.4
140	134	13,612	-4.2
233	223	14,080	-4.0
349	336	13,725	-3.6
465	449	14,103	-3.5
1,163	1,137	10,667	-2.2
2,326	2,232	14,637	-4.0
Average RA			4.7%

NA = not applicable.

^(a) Based on time needed for QC-TILDAS signal to stabilize.

Table 6-3. Relative Accuracy Results During Phase II

NH₃ Gas Standard Concentration (ppb)	Average Measured Concentration (ppb)	Number of Data Points^(a)	%D (%)
0	0.7	5,538	NA
300	262	8,363	-12.7
600	528	2,627	-11.9
1,000	918	1,619	-8.2
1,500	1,375	7,632	-8.4
2,000	1,828	6,896	-8.6
Average RA			10.0%

NA = not applicable.

^(a) Based on time needed for QC-TILDAS signal to stabilize.

6.2 Linearity

Figures 6-5a and 6-5b show the results of the linearity check for Week 1 and Week 4 of Phase I, respectively. During Week 1 of Phase I, the linear regression of the QC-TILDAS response versus the gas standard concentration, over the range from 0 to 3,030 ppb, showed a slope of 0.840 (± 0.032), an intercept of 35 (± 42) ppb, and an r^2 value of 0.9989, where the numbers in parentheses represent the 95% CI. During Week 4 of Phase I, a linear regression of the QC-TILDAS response versus the gas standard concentrations over the range from 0 to 2,326 ppb showed a slope of 0.962 (± 0.009), an intercept of 1.5 (± 8.9), and an r^2 value of 0.9999. During Phase II (Figure 6-6), the QC-TILDAS showed a linear response, over the range from 0 to 2,000 ppb, with a slope of 0.919 (± 0.016), an intercept of -8.8 ppb (± 18.6), and an r^2 of 0.9998.

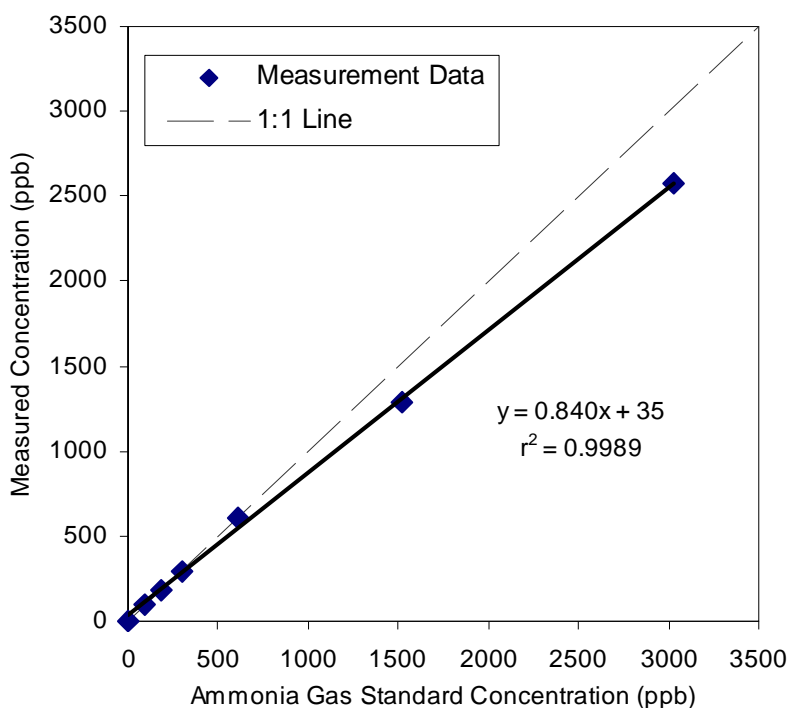

Figure 6-5a. Results of Linearity Check of the QC-TILDAS During Phase I, Week 1

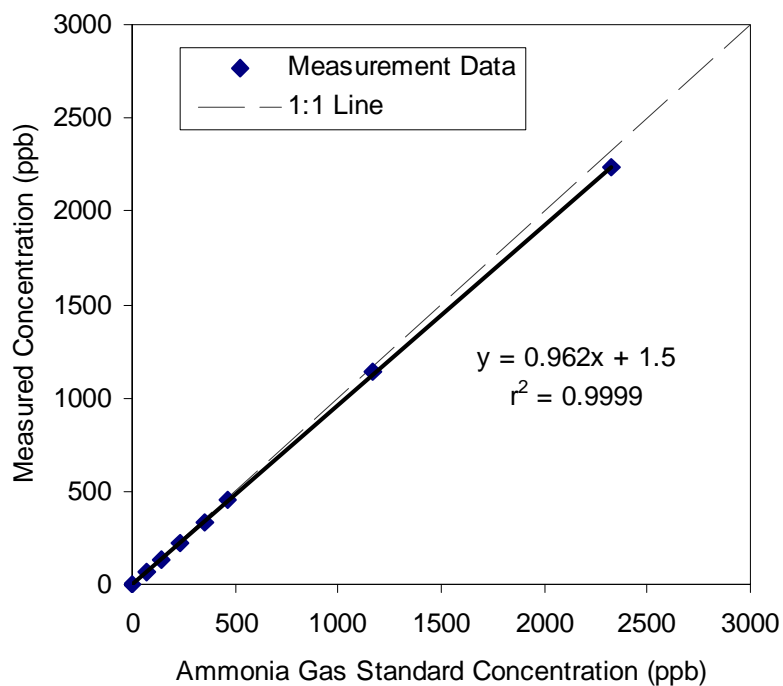

Figure 6-5b. Results of Linearity Check of the QC-TILDAS During Phase I, Week 4

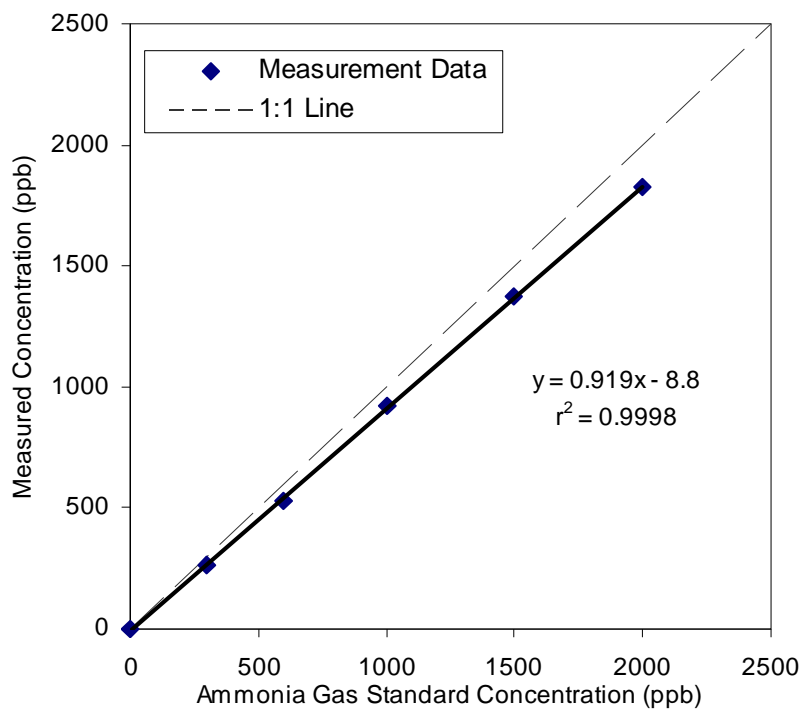

Figure 6-6. Results of Linearity Check of the QC-TILDAS During Phase II

6.3 Precision

Tables 6-4 and 6-5 present the calculated precision of the QC-TILDAS measured during the accuracy and linearity checks for Phases I and II, respectively. During Phase I, the precision of the QC-TILDAS readings varied from 0.5% to 4.1% RSD, with an average precision of 2.4%. During Phase II, the precision of the QC-TILDAS readings ranged from 1.0% to 3.0% RSD over the concentration levels measured in the accuracy/linearity checks, with an average of 1.9%. The number of data points used in each calculation are the same as those shown in Tables 6-1, 6-2, and 6-3. Precision was calculated using the QC-TILDAS 10-Hz data without further averaging.

Table 6-4. Calculated Precision of the QC-TILDAS During Phase I

NH ₃ Gas Standard Concentration (ppb)	Week 1		Week 4	
	Average Measured Concentration (ppb)	RSD (%)	Average Measured Concentration (ppb)	RSD (%)
91	97	3.5	(a)	
182	185	3.7	(a)	
303	294	2.8	(a)	
606	608	2.5	(a)	
1,515	1,291	1.5	(a)	
3,030	2,575	0.5	(a)	
70	(a)		62	4.1
140	(a)		134	3.5
233	(a)		223	2.9
349	(a)		336	2.4
465	(a)		449	2.0
1,163	(a)		1,137	1.4
2,326	(a)		2,232	1.0
Average RSD		2.4		2.5
Overall Average Phase I RSD			2.4	

^(a) Not all nominal NH₃ concentration levels were measured during each RA check.

Table 6-5. Calculated Precision of the QC-TILDAS During Phase II

NH₃ Gas Standard Concentration (ppb)	Average Measured Concentration (ppb)	RSD (%)
300	262	3.0
600	528	2.0
1,000	918	2.0
1,500	1,375	1.4
2,000	1,828	1.0
Average Phase II RSD		1.9

6.4 Response Time

Response time was determined during each phase from the amount of time required for the QC-TILDAS to reach 95% of the change in the stable concentration measured by the QC-TILDAS during the accuracy/linearity checks. All response time calculations utilized the 10-Hz raw data set. Tables 6-6 and 6-7 present summaries of the response time determinations for the QC-TILDAS during Phase I and Phase II, respectively. Phase I rise times ranged from 0.8 to 65.6 s; the measured fall time from 2,326 ppb to 0 ppb was 5.5 s. During Phase II, rise times ranged from 1.1 to 14.9 s. The measured response times include any time required by the dilution system to stabilize at each nominal NH₃ concentration. Furthermore, in each series of rise time measurements, the initial transition from zero air to the first NH₃ concentration exhibited the longest response times in the respective series. This behavior suggests that, in these cases, the response times may have been limited by the equilibration of the NH₃ gas standard on the sampling lines and inlet surfaces. Figure 6-7 shows the 10-Hz data collected during the transition from the delivery of the 233 ppb standard to the delivery of the 349 ppb standard in Week 4 of Phase I. This figure shows the rapid response of the QC-TILDAS to the presence of NH₃.

No fall time for Phase II was calculated because of the inadvertent delivery of zero air between the change from 600 ppb to 300 ppb. This delivery was not apparent until after completion of the verification test, and no additional attempt to measure fall time was made.

Table 6-6. Response Time Determinations During Phase I

Change (ppb)	Week 1		Week 4	
	Rise Time (s)	Fall Time (s)	Rise Time (s)	Fall Time (s)
0 – 91	65.6	—		(a)
91 – 182	3.2	—		(a)
182 – 303	2.2	—		(a)
303 – 455	(b)	—		(a)
455 – 606	(b)	—		(a)
1,515 – 3,030	0.8	—		(a)
0 – 233		(a)	15.0	
70 – 140		(a)	4.0	—
140 – 233		(a)	1.4	—
233 – 349		(a)	2.9	—
349 – 465		(a)	1.4	—
465 – 1,163		(a)	(c)	—
1,163 – 2,326		(a)	1.4	—
2,326 – 0		(a)	—	5.5

^(a) Not all nominal NH₃ concentration levels were measured during both RA checks.

^(b) No response time is reported because of behavior as described in Section 6.1.

^(c) Zero air was inadvertently delivered briefly between the two NH₃ gas standards, consequently no response time is reported.

Table 6-7. Response Time Determinations During Phase II

Change (ppb)	Rise Time (seconds)	Fall Time (seconds)
0 – 600	14.9	—
600 – 300	—	(a)
300 – 1,000	(a)	—
1,000 – 1,500	1.1	—
1,500 – 2,000	1.3	—

^(a) Zero air was inadvertently delivered briefly between the two NH₃ gas standards, consequently no response time is reported.

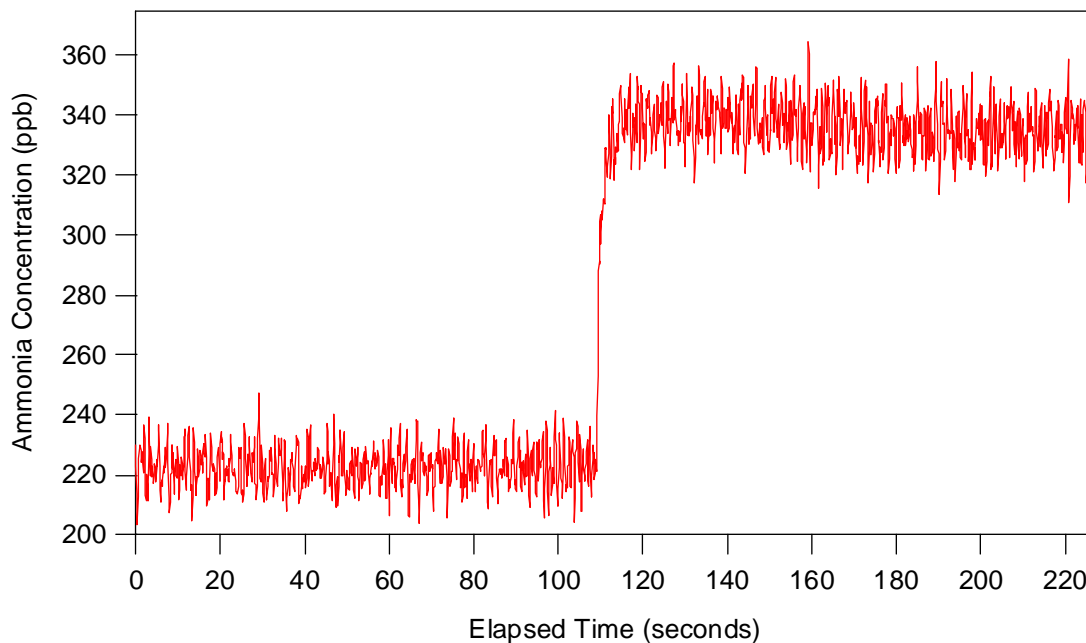

Figure 6-7. Illustration of Response Time for the QC-TILDAS

6.5 Calibration and Zero Drift

The calibration/drift checks were conducted by supplying an NH_3 gas standard and zero air to the QC-TILDAS for a period of at least 2 minutes each on Monday, Wednesday, and Friday during Weeks 1 and 4 of each phase. The values reported in Tables 6-8 and 6-9 are based on the average readings during the calibration and zero checks when the readings of the QC-TILDAS had stabilized; thus, the calculations for each check span somewhat different time periods, which ranged from 3 to 56 minutes. The target NH_3 gas standard concentration for each check was 1,000 ppb; the actual delivered NH_3 concentrations ranged between 333 ppb and 1,163 ppb after dilution to approximately 15 Lpm, as discussed in Section 3.3. For those checks, the equivalent response of the QC-TILDAS to a 1,000-ppb NH_3 standard is also reported. It was discovered that the delivery flow rate of the NH_3 standard and zero air during first two checks was less than the QC-TILDAS inlet flow rate, so the QC-TILDAS also sampled some ambient air during the checks. Therefore, the data from these checks were not analyzed, and drift during Week 1 of Phase I could not be assessed. During Week 4 of Phase I, no drift in the calibration or zero signal was apparent. Similarly, drift in the QC-TILDAS calibration or zero were not apparent during Phase II, although the QC-TILDAS response to the final calibration drift check (840 ppb) was 34 ppb lower than the average of the responses to a 1,000-ppb NH_3 standard (or equivalent) for the other checks (874 ppb).

Table 6-8. Calibration and Zero Checks During Phase I

Zero Check						Calibration Check					
Check Number	Mean (ppb)	SD ^(a) ppb	Minimum (ppb)	Maximum (ppb)	Number of Data Points	Nominal NH ₃ Concentration (ppb)	Mean (ppb)	RSD (%)	Minimum (ppb)	Maximum (ppb)	Number of Data Points
Week 1 Monday			(b)					(b)			
Week 1 Wednesday			(b)					(b)			
Week 1 Friday ^(c)	4.9	1.6	2.1	8.7	2,650	606	608 (1,003) ^(d)	2.4	557	649	1,565
Week 4 Monday ^(e)	-1.1	1.9	-3.7	2.3	14	792	703 (888) ^(d)	1.8	681	734	29
Week 4 Wednesday ^(f)	0.5	1.0	-2.3	1.9	53	1,163	1,133 (975) ^(d)	0.6	1,114	1,144	28
Week 4 Friday ^(f)	1.4	0.8	0	2.6	52	917	799 (872) ^(d)	0.7	793	812	30

^(a) SD reported for zero drift check since the RSD is not meaningful for near-zero values.

^(b) Some ambient air sampled along with the gas standards. Data from this check were not analyzed.

^(c) 10-Hz data used for analysis because of the short gas standard delivery time.

^(d) Equivalent response to a 1,000-ppb NH₃ standard. The NH₃ output concentration of the dilution system was not compensated correctly for the dilution flow rate.

^(e) The vendor representative refitted the spectra (which were saved approximately every 2 minutes) for this check since the peak/reference lock parameters were not set according to vendor instructions.

^(f) 60-second averages used for analysis.

Table 6-9. Calibration and Zero Checks During Phase II

Zero Check						Calibration Check ^(a)				
Check Number	Mean (ppb)	SD ^(b) (ppb)	Minimum (ppb)	Maximum (ppb)	Number of Data Points	Mean (ppb)	RSD (%)	Minimum (ppb)	Maximum (ppb)	Number of Data Points
Week 1 Monday ^(c)	1.0	2.3	-2.7	4.1	1,316	888	2.0	823	961	9,926
Week 1 Wednesday ^(d)	1.5	1.9	-3.9	4.6	56	294 ^(e) (881) ^(f)	1.3	286	302	43
Week 1 Friday ^(d)	-0.8	1.3	-4.7	1.6	79	872	0.3	864	879	48
Week 4 Monday ^(c)	-0.4	2.8	-9.8	6.7	7,843	864	2.1	791	941	5,853
Week 4 Wednesday ^(d)	-1.2	2.1	-4.7	1.2	22	867	0.6	855	879	41
Week 4 Friday ^(c)	-1.9	2.1	-7.9	4.4	2,691	840	1.7	794	898	3,700

^(a) 1,000-ppb NH₃ nominal concentration.

^(b) SD reported for zero drift check since the RSD is not meaningful for near-zero values.

^(c) 10-Hz data used for analysis because of the short gas standard delivery time.

^(d) 60-second averages used for analysis.

^(e) 333-ppb NH₃ nominal concentration. The NH₃ dilution system output was not increased to compensate for the dilution to the 15 Lpm flow rate.

^(f) Equivalent response to a 1,000-ppb NH₃ nominal standard.

6.6 Interference Effects

The effect of potential interferent gases on the response of the QC-TILDAS was assessed by supplying the QC-TILDAS with a series of four gases (hydrogen sulfide, nitrogen dioxide, 1,3-butadiene, diethylamine) in zero air and a 500-ppb NH₃ standard. The response of the QC-TILDAS during the introduction of these gases is summarized in Table 6-10. The interference gas concentrations carry an uncertainty of approximately $\pm 15\%$ (as reported by the manufacturer for uncertified permeation tubes).

The response of the QC-TILDAS to hydrogen sulfide, nitrogen dioxide, and 1,3-butadiene was negligible. The QC-TILDAS showed an increased response of 19% to diethylamine in a zero air matrix; no interference effect was observed in a 500-ppb NH₃ matrix. Since the unique NH₃ spectral signature was observed in the QC-TILDAS data during the delivery of the diethylamine in zero air, the presence of an NH₃ impurity in the diethylamine standard or the release of NH₃ from the sample lines during delivery could not be ruled out.

Table 6-10. Interference Effect Evaluation

Gas	Interferent Gas Concentration (ppb)	Interference Effect (%)	
		Zero-Air Matrix	500-ppb NH ₃ Matrix
Hydrogen sulfide	101	0.5 ^(a)	-2 ^(a)
Nitrogen dioxide	104	3 ^(a)	-2 ^(a)
1,3-Butadiene	102	1 ^(a)	1 ^(a)
Diethylamine	102	19	4 ^(a)

^(a) Signal not significantly different from baseline without interferent gas.

6.7 Comparability

Figures 6-8 and 6-9 show the NH₃ concentrations measured using the reference method, along with the corresponding averages calculated from the readings of the QC-TILDAS (from 60-second averages) for the reference sampling periods during Phase I and Phase II, respectively. In general, the QC-TILDAS data appeared to track changes in NH₃ concentrations measured with the reference method. These data are also presented in Figures 6-10 and 6-11 as scatter plots to illustrate the correlation between the reference and QC-TILDAS data.

A linear regression of the QC-TILDAS responses during the reference sampling periods versus the NH₃ determined from the reference method was calculated for each phase. For Phase I, the linear regression results showed a slope of 1.09 (± 0.05), an intercept of 14.4 ppb (± 22.0), and an r^2 value of 0.9822, where the numbers in parentheses represent the 95% CI. For Phase II, the linear regression results showed a slope of 0.984 (± 0.026), an intercept of -9.52 ppb (± 3.25), and an r^2 value of 0.9943.

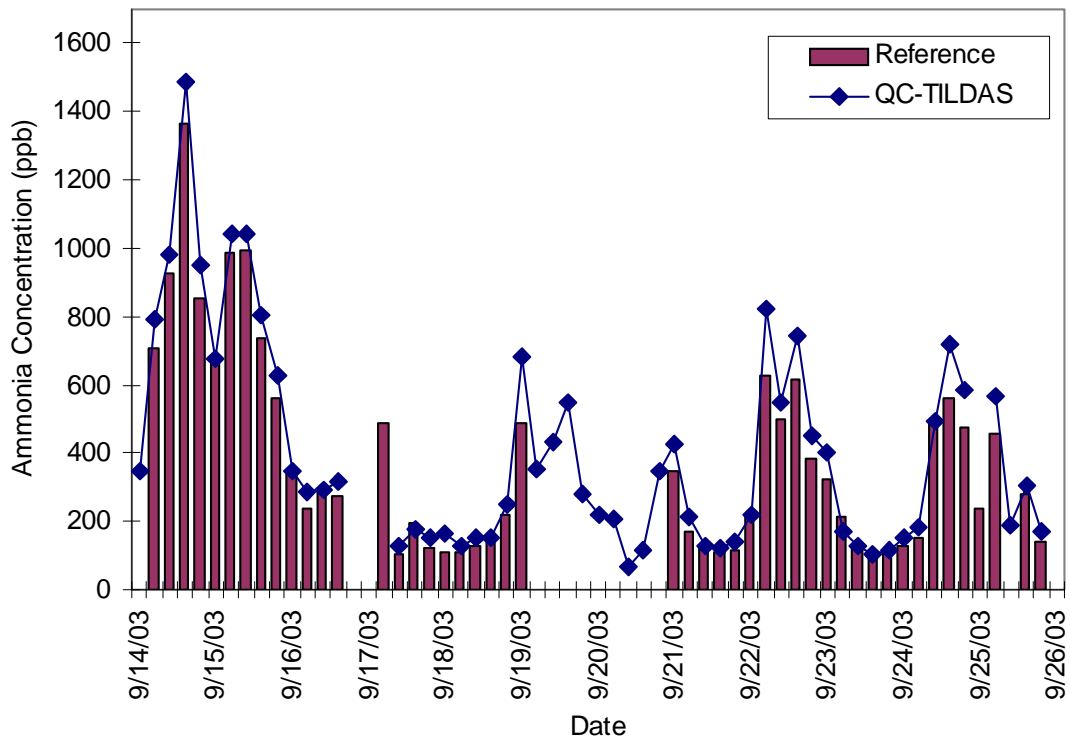

Figure 6-8. Comparison of Ambient Reference Measurements with Averages from the QC-TILDAS During Phase I

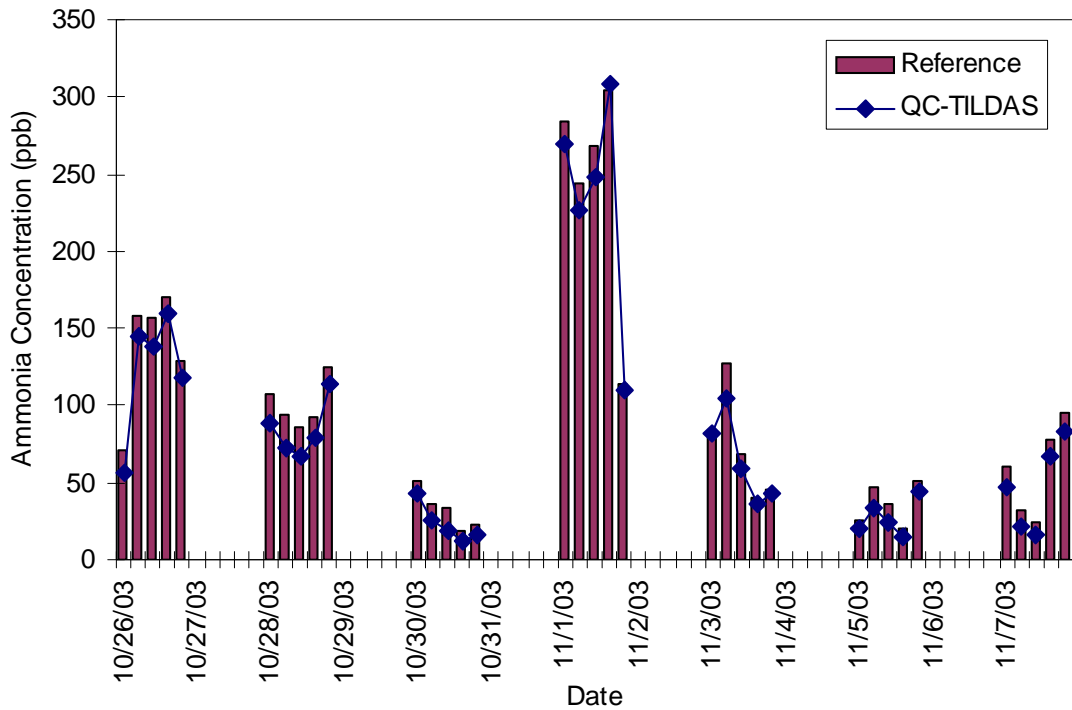

Figure 6-9. Comparison of Ambient Reference Measurements with Averages from the QC-TILDAS During Phase II

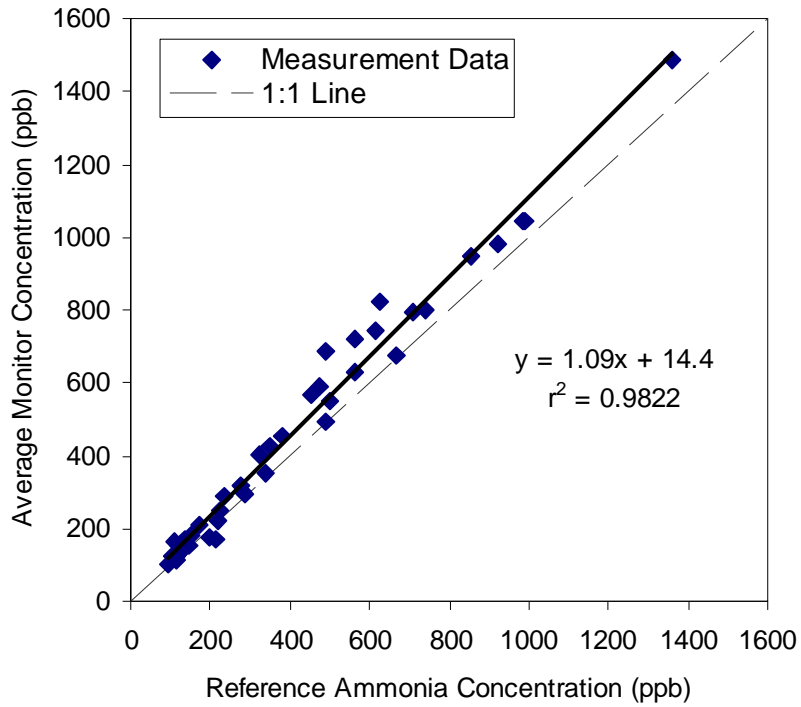

Figure 6-10. Scatter Plot of QC-TILDAS Results versus Ambient Reference Measurements During Phase I

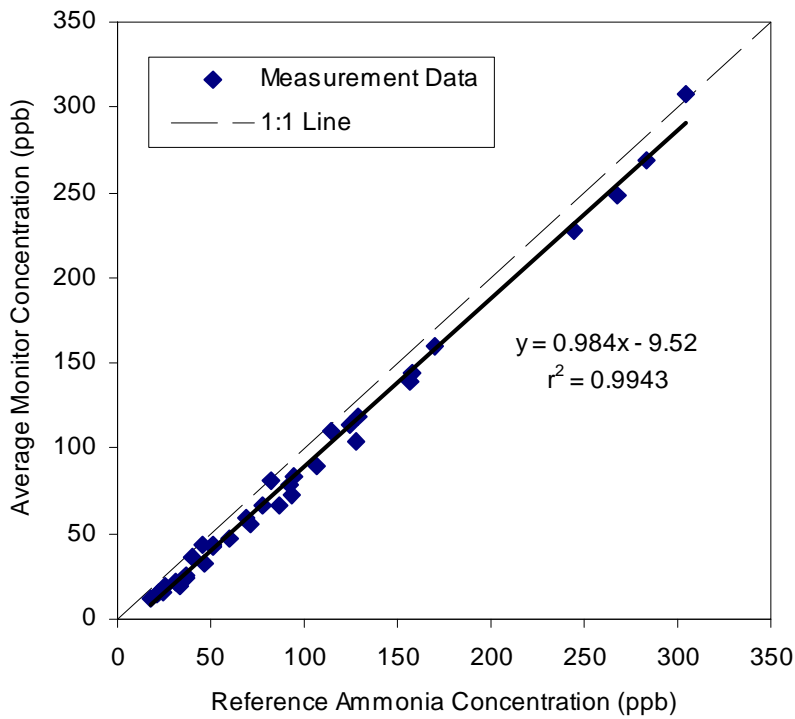

Figure 6-11. Scatter Plot of QC-TILDAS Results versus Ambient Reference Measurements During Phase II

6.8 Ease of Use

The QC-TILDAS was installed at each testing location by the vendor representatives. The initial Phase I installation was performed by three representatives on the first day, after which more minor installation activities were performed by one representative. The installation took approximately three days, which included an on-site software update to improve the automated background checks. The Phase II installation was completed by one vendor representative in approximately one day. The vendor representative trained Battelle and USDA staff to perform daily maintenance activities; the QC-TILDAS detector must be filled with liquid nitrogen approximately every 12 hours, and the folder into which the data are stored on the personal computer should be changed daily. A checklist, shown in Appendix A, was prepared by the vendor representative to establish whether the QC-TILDAS was in proper working order and to document the regular maintenance activities described above. These activities did not require advanced skill, but more experience in instrumentation/spectroscopy and specific training provided by the vendor representative were needed to restart the QC-TILDAS after the loss of power and to conduct some periodic fine-tuning. A summary of these and other activities involving the QC-TILDAS during Phase I and Phase II is presented in Tables 6-11 and 6-12, respectively.

Although the gas standards delivered to the QC-TILDAS during testing required an additional dilution step (described in Section 3.3), the time required to complete the testing activities was quite short. In general, the response of the QC-TILDAS to changes in the NH_3 concentration was immediate, and carry-over from adsorption/desorption of NH_3 from the inlet line or other components was not apparent. For example, an eight-point calibration curve could be measured in a total of approximately 10 minutes, as shown in Figure 6-3a.

The software used to operate the QC-TILDAS and acquire, analyze, and store the QC-TILDAS data was very powerful but not intuitive to operate. Thus, some instruction was required for its use. However, once the QC-TILDAS was running properly, it did not require regular intervention other than the activities described above. The computer software computed the NH_3 concentration from the measured absorbance spectra (and other parameters set by the vendor representative), automatically accounting for the results of the regular (automated) background checks. The measured absorbance spectra were also stored on the QC-TILDAS personal computer. Measurement data were displayed in real time and automatically output into data files containing the timestamp and concentration data. The data output used the timestamp from IGOR Pro (WaveMetrics, Lake Oswego, Oregon), which is provided with the QC-TILDAS. Data were output to a single file until the data acquisition was manually stopped and restarted (usually with a new destination folder selected). For this test, data files each contained approximately 24 hours of 10-Hz data (approximately 800,000 rows) and were approximately 28 megabytes in size, producing a total of approximately 5 gigabytes of data for each phase (including saved spectra, concentration data, instrument parameters, etc.). The size of the data files is dictated by the sampling rate and the sampling duration. These parameters can be varied by the operator depending on the nature of the experiment and the data needs. In both phases, 10-Hz data were collected to demonstrate the rapid response of the QC-TILDAS. This capability of the QC-TILDAS has been identified as being useful for comparison with sonic anemometer data. Additional files saved to the QC-TILDAS hard drive contained absorbance spectra and instrument parameters. During the test, data were downloaded via an external USB drive or local area network connection.

Table 6-11. Activities Performed During Phase I

Date	Time Offline^(a) (minutes)	Down Time^(b) (minutes)	Service Time^(c) (minutes)	Activity
9/8/03		65		No data available, activity performed by vendor representative on the QC-TILDAS
9/8/03	45			Supplied zero air and NH ₃ standard ^(d)
9/9/03		210		No data available, activity performed by vendor representative on the QC-TILDAS
9/10/03		1,115		No data available, power loss overnight
9/10/03			180	Start-up procedures, adjust laser temperature
9/10/03	150			Supplied zero air and NH ₃ standard ^(d)
9/11/03	60			Supplied zero air and NH ₃ standard ^(d)
9/12/03	80			Supplied zero air and NH ₃ standards ^(d)
9/17/03		1,080		No data available, power loss overnight
9/18/03			15	Start-up procedures, adjust laser temperature
9/19/03		(300) ^(e)		No data available, liquid nitrogen filled late
9/25/03		600		Zero air tank ran out
9/26/03			10	Changed zero air tank
9/29/03		40		No data available, power loss
9/29/03			15	Performed start-up procedures
9/29/03		(360) ^(e)		Questionable data, peak lock lost
9/29/03	225			Supplied zero air and NH ₃ standard ^(d)
9/30/03		(15) ^(e)		No data available, liquid nitrogen filled late
10/1/03	525			Supplied zero air and NH ₃ standards ^(d)
10/3/03	150			Supplied zero air and NH ₃ standard ^(d)
9/8 – 10/3/03			130	Fill detector with liquid nitrogen every 12 hours (~5 min per day excluding travel time)
Totals	1,235	3,110 (675)^(e)	350	92% data completeness,^(f) 90% data collected,^(e) and 350-minute (6-hour) service time.

^(a) Time Offline = time that the QC-TILDAS was taken offline for zero or standard gas measurements. The period over which time offline was evaluated began at 8:00 a.m. on 9/8/03 and ended at the conclusion of testing at 5:00 p.m. on 10/03/03. The amount of time was rounded to the nearest 5 minutes.

^(b) Down Time = time that the QC-TILDAS was not operating or was operating but not reporting reliable measurements. The period over which down time was evaluated began at 8:00 a.m. on 9/8/03 and ended at the conclusion of testing at 5:00 p.m. on 10/03/03. The amount of time was rounded to the nearest 5 minutes. Down time that did not result in loss of data is not included in the availability determination.

^(c) Service Time = time spent conducting routine operation and maintenance activities and troubleshooting problems. The period over which service time was evaluated began at 8:00 a.m. on 9/8/03 and ended at the conclusion of testing at 5:00 p.m. on 10/03/03. The amount of time was rounded to the nearest 5 minutes.

^(d) Testing activity performed by Battelle/USDA operator.

^(e) The QC-TILDAS was not operated as intended by the vendor representative during this period, which resulted in additional down time. This should be considered only for purposes of evaluating the ease of use of this technology.

^(f) Data completeness = the ratio of time that the QC-TILDAS was not experiencing down time to the total time available for monitoring ambient NH₃ mixing ratios from the start of testing on 9/8/03 to the end of testing on 10/3/03. The total time that was available for monitoring was 36,540 minutes or 609 hours. This does not include time during which data were not collected as a result of operator error.

Table 6-12. Activities Performed During Phase II

Date	Time Offline ^(a) (minutes)	Down Time ^(b) (minutes)	Service Time ^(c) (minutes)	Activity
10/20/03	35			Supplied zero air and NH ₃ standard ^(d)
10/21/03	90			Supplied zero air and NH ₃ standards ^(d)
10/22/03	120			Supplied zero air and NH ₃ standard ^(d)
10/24/03	180			Supplied zero air and NH ₃ standard ^(d)
10/25/03				70% reduction in signal, perhaps due to particles on cell windows/mirrors. No change in performance observed.
10/25/03		(75) ^(e)		No data available, liquid nitrogen filled late
11/11/03	190			Performed interference test ^(d)
11/12/03	75			Supplied zero air and NH ₃ standard ^(d)
11/13/03			5	Replaced inlet filter, adjusted pump valve
11/14/03	45			Supplied zero air and NH ₃ standard ^(d)
10/20 – 11/14/03			130	Fill detector with liquid nitrogen every 12 hours (~5 min per day excluding travel time)
Totals	735	(75)^(e)	135	100% Data completeness,^(f) 98% data collected,^(e) and 135-minute service time.

^(a) Time Offline = time that the QC-TILDAS was taken offline for zero or standard gas measurements. The period over which time offline was evaluated began at 8:00 a.m. on 10/20/03 and ended at the conclusion of testing at 5:00 p.m. on 11/14/03. The amount of time was rounded to the nearest 5 minutes.

^(b) Down Time = time that the QC-TILDAS was not operating or was operating but not reporting reliable measurements. The period over which down time was evaluated began at 8:00 a.m. on 10/20/03 and ended at the conclusion of testing at 5:00 p.m. on 11/14/03. The amount of time was rounded to the nearest 5 minutes. Down time that did not result in loss of data is not included in the availability determination.

^(c) Service Time = time spent conducting routine operation and maintenance activities and troubleshooting problems. The period over which service time was evaluated began at 8:00 a.m. on 10/20/03 and ended at the conclusion of testing at 5:00 p.m. on 11/14/03. The amount of time was rounded to the nearest 5 minutes.

^(d) Testing activity performed by Battelle/USDA operator.

^(e) The QC-TILDAS was not operated as intended by the vendor representative during this period, which resulted in additional down time. This should be considered only for purposes of evaluating the ease of use of this technology.

^(f) Data completeness = the ratio of time that the QC-TILDAS was not experiencing down time to the total time available for monitoring ambient NH₃ mixing ratios from the start of testing on 10/20/03 to the end of testing on 11/14/03. The total time that was available for monitoring was 36,540 minutes or 609 hours. This does not include time during which data were not collected as a result of operator error.

The data files from each phase were processed by the vendor representative before they were used for the analysis reported here. This generally involved removing spurious data points from the automatic background checks. Some of the processing corrected for parameters that were not set as intended by the vendor representative. The notes provided by the vendor representative that describe the processing steps are included in the test files. Since the QC-TILDAS data files were too large to open using Microsoft Excel, some data averaging was conducted using IGOR Pro software (Version 4.09), and the more manageable averaged data sets were used for the analysis presented in this report.

6.9 Data Completeness

During Phase I, the QC-TILDAS was operating and collecting data for more than 92% of the available time. Loss of data occurred mainly after nighttime power losses at the test site. The QC-TILDAS did not resume measurement once the power was restored without operator intervention. Some parameters on the QC-TILDAS were not reset as intended by the vendor representative after a power loss. Since the vendor representative was able to retrieve and refit the absorbance spectra from these periods, minimal data were lost as a result (less than 2%). Some additional data were lost during Phase I and Phase II because the Battelle/USDA operator was not able to complete some liquid nitrogen fills according to the schedule provided by the vendor representative. During Phase II, the QC-TILDAS was operating and collecting data for 98% of the available time.

Chapter 7

Performance Summary

The performance of the QC-TILDAS was evaluated in two phases in this verification test. Table 7-1 presents a summary of the performance of the QC-TILDAS during this verification test.

Table 7-1. QC-TILDAS Performance Summary

Parameter	Results					
	Phase I			Phase II		
		Week 1	Week 4		Week 1	Week 4
Relative accuracy ^{(a)(b)}	Average RA %D Range	6.5% -15.0% to 6.5%	4.7% -11.4% to -2.2%	Average RA %D Range	10.0% -12.7% to -8.2%	Interference Test Conducted During Week 4
Linearity ^(a)	Range Slope Intercept r ²	0 to 3,030 ppb 0.840 (±0.032) 35 (± 42) 0.9989	0 to 2,326 ppb 0.962 (± 0.009) 1.5 (± 8.9) 0.9999	Range Slope Intercept r ²	0 to 2,000 ppb 0.919 (± 0.016) -8.8 (± 18.6) 0.9998	
Precision ^(a)	Average RSD Range	2.4% 0.5% to 3.7%	2.5% 1.0% to 4.1%	Average RSD Range	1.9% 1.0% to 3.0%	
Response time ^(a) (95%)	Rise Time Fall Time	0.8 to 65.6 s (c)	1.4 to 15.0 s 5.5 s	Rise Time Fall Time	1.1 to 14.9 s (c)	
Calibration/ zero drift	<ul style="list-style-type: none"> No apparent drift in response to zero air during Week 4^(d) No apparent drift in response to NH₃ standards during Week 4^(d) 			<ul style="list-style-type: none"> No apparent drift in response to zero air No apparent drift in response to 1,000 ppb NH₃ during Week 1, a 34-ppb decrease observed for last check of Week 4. 		
Interference effects ^(e)	Interference Test Conducted During Phase II			<ul style="list-style-type: none"> Hydrogen sulfide (101 ppb): No apparent effect Nitrogen dioxide (104 ppb): No apparent effect 1,3-Butadiene (102 ppb): No apparent effect Diethylamine (102 ppb): 19% increase in zero air, no apparent effect in 500 ppb NH₃^(f) 		
Comparability ^(g)	Slope = 1.09 (± 0.05) Intercept = 14.4 (±22.0) r ² = 0.9822			Slope = 0.984 (± 0.026) Intercept = -9.52 (± 3.25) r ² = 0.9943		
Ease of use	<ul style="list-style-type: none"> Required liquid nitrogen fills every 12 hours; other daily checks were straightforward and quick Technician experienced in instrumentation/spectroscopy required to operate; some spectra were refitted by vendor representative during periods when the operational parameters were not set properly Testing activities completed in a short time Operator required to restart after power loss Delivery of gas standards required additional dilution because of 13-Lpm inlet flow rate Vendor representative conducted data processing to remove spurious data points resulting from automated zero air measurement for background subtraction 					
Data completeness	92% data completeness, 90% data collected			100% data completeness, 98% data collected		

^(a) 10-Hz data used for this analysis.

^(b) Relative accuracy is expressed as an average absolute value of the percent difference from NH₃ gas standards.

^(c) Fall time not measured/reported during this check.

^(d) The first two calibration and zero checks during Phase I could not be analyzed because some ambient air was sampled along with the gas standards. Drift could not be assessed during Week 1 of Phase I.

^(e) Calculated as the change in signal divided by the interferent gas concentration, expressed as a percentage.

^(f) The presence of an NH₃ impurity in the diethylamine gas standard or the release of NH₃ from the sample lines during delivery could not be ruled out.

^(g) 60-second averages used for this analysis.

Chapter 8 References

1. *National Air Pollutant Trends, 1900-1998*. EPA-454/R-00-02, U.S. Environmental Protection Agency, Office of Air Quality Planning and Standards, Research Triangle Park, North Carolina, 27711.
2. *Test/QA Plan for Verification of Ambient Ammonia Monitors at Animal Feeding Operations*, Battelle, Columbus, Ohio, September 2003.
3. *Determination of Reactive Acidic and Basic Gases and Acidity of Fine Particles (<2.5 μm)*, Environmental Protection Agency Compendium Method IO-4.2, EPA/625/R-96/010A, U.S. Environmental Protection Agency, Office of Research and Development, Cincinnati, Ohio, 45268.
4. *Operating Manual, ChemComb Model 3500 Speciation Sampling Cartridge*, Revision A, January 2000, Rupprecht & Patashnick Co., Inc. East Greenbush, New York, 12061.
5. *Quality Management Plan (QMP) for the ETV Advanced Monitoring Systems Center*, U.S. EPA Environmental Technology Verification Program, prepared by Battelle, Columbus, Ohio, Version 4.0, December 2002.



Appendix A
QC-TILDAS Checklist

ETV Verification of Ambient Ammonia Monitors
Aerodyne Research QC-TILDAS
Daily Checklist

Vendor Contact Information

- | | | | | |
|----|--|-----------------|--------------------------|---|
| 1. | Liquid Nitrogen | Fill 1 Time | _____am/pm | Fill every
12 hours |
| | | Fill 2 Time | _____am/pm | |
| 2. | Light Levels | Field 1 | _____mV | ~700-900 mV |
| | | Field 2 | _____mV | ~230 mV |
| | | Field 4 | _____mV | ~40 mV |
| 3. | Laser Parameters | Temperature | _____°C | Normally ~ -16.5 °C |
| | | Voltage | _____V | Pulse voltage: 8.8 V |
| 4. | Cell | Pressure | _____Torr | Target = 40-50 Torr (adjust with valve
to blow-by pump if <40 Torr) |
| 5. | Thermocube | Temperature | _____°C | Set point +25 °C |
| | | Level OK? | _____ | Alarm will show if level is low
(additional fluid provided) |
| | | + or - ? | _____ | If “*” shows, unit is not
functioning properly. Press
“Start” |
| 6. | New Data File | | | |
| | <input type="checkbox"/> Turn off WD | | | |
| | <input type="checkbox"/> Change Data Folder | | | |
| | <input type="checkbox"/> New File Name TDLWintel_____ | | | |
| | <input type="checkbox"/> Select New Data Folder | | | |
| | <input type="checkbox"/> Stop and Restart WD and ASS | | | |
| 7. | Toggle Buttons | WD | <input type="checkbox"/> | ASS |
| | | PN | <input type="checkbox"/> | |
| | | Rlk4 | <input type="checkbox"/> | Abg |
| | | DT | <input type="checkbox"/> | (Selected from DT, DS, and DR) |
| 8. | Zero Air Tank | Tank Pressure | _____psi | (Item #8 was inadvertently left off
of the checklist, but this should be
checked daily and the tank replaced as
necessary) |
| | | Supply Pressure | _____psi | |

Signature _____ Date _____

Comments _____

