

Geologic Framework

By J. Michael O'Neill, Karen Lund, Bradley S. Van Gosen, George A. Desborough,
Tracy C. Sole, and Ed H. DeWitt

Chapter D1 of

Integrated Investigations of Environmental Effects of Historical Mining in the Basin and Boulder Mining Districts, Boulder River Watershed, Jefferson County, Montana

Edited by David A. Nimick, Stanley E. Church, and Susan E. Finger

Professional Paper 1652–D1

U.S. Department of the Interior
U.S. Geological Survey

Contents

Abstract.....	53
Introduction	53
Previous Work	53
Setting	55
Regional Tectonic Setting.....	55
Contacts with Adjacent Rocks	57
Mode of Emplacement.....	57
Tertiary Extensional Structures	58
Igneous Rocks.....	58
Upper Cretaceous Elkhorn Mountains Volcanics	58
Lower Member	59
Middle Member.....	59
Upper Member	59
Chemical Composition	59
Metamorphism	60
Ages	63
Late Cretaceous Butte Pluton of the Boulder Batholith.....	63
Medium- to Coarse-Grained Phase	63
Fine-Grained Porphyritic Phase	64
Aplite and Porphyry.....	65
Chemical Composition	65
Ages	66
Relationship Between Late Cretaceous-Age Volcanic and Plutonic Rocks.....	67
Comparison of Geochemical Data	67
Emplacement History	67
Internal Geometry of Butte Pluton	67
Tertiary Volcanic Rocks	67
Eocene Lowland Creek Volcanics.....	68
Eocene-Oligocene Helena Volcanic Rocks.....	68
Miocene-Pliocene Volcanic Rocks.....	68
Sedimentary Rocks.....	69
Lower Tertiary Sedimentary Rocks.....	69
Quaternary Deposits	71
Structural Geology and Tectonics.....	72
Introduction	72
Nondiastrophic Fracture Systems	73
Synemplacement Diastrophic Fracture Systems.....	75
Late Diastrophic Structures.....	78
Lineaments.....	78
Dikes	78
Faults	78
Mineral Deposits.....	78

Late Cretaceous Mineralized Rock.....	79
Controlling Structures.....	79
Polymetallic Quartz Veins.....	79
Alteration Envelopes.....	80
Origin of Mineralizing Fluids.....	81
Comparison to Other Veins in the Butte Pluton.....	81
Age.....	81
Tertiary Mineralization.....	82
Lowland Creek Volcanics Mineralization.....	82
Helena Volcanic Rocks Mineralization.....	82
Pervasive Alteration Systems.....	82
Gold Placer Deposits.....	83
Tin Placer Deposits.....	83
Acid-Neutralizing Potential of Bedrock.....	83
Summary.....	84
References Cited.....	85

Plates

[Plates in this report are on accompanying CD-ROM]

1. Geologic map of the Boulder watershed study area and vicinity, Powell, Jefferson, and Lewis and Clark Counties, Montana
2. Fence diagram showing correlation of Quaternary deposits in Buckeye Meadow, Basin Creek drainage, Jefferson County, Montana

Figures

1. Index map to area described in this report..... 54
2. Tectonic map of the Boulder batholith area showing major plutonic units and faults .. 56
3. Regional cross section showing interpreted relationship of main mass of Butte pluton to faults..... 57
4. Classification diagram of samples of the Elkhorn Mountains Volcanics in the study area based on the R_1R_2 -diagram of De La Roche and others (1980)..... 60
5. Harker variation diagrams showing abundances of major oxides versus SiO_2 for samples of the Elkhorn Mountains Volcanics..... 61
6. Harker variation diagrams showing abundances of major oxides versus SiO_2 for samples of Butte pluton..... 62
7. Ternary diagram showing modes of rocks of Butte pluton in the study area..... 64
8. Classification diagram of Butte pluton samples from the study area based on the R_1R_2 -diagram of De La Roche and others (1980)..... 66
9. Classification diagram of samples of Eocene Lowland Creek Volcanics and of Eocene-Oligocene volcanic rocks from the Helena volcanic field in the study area based on the R_1R_2 -diagram of De La Roche and others (1980)..... 69

10. Harker variation diagrams showing abundances of major oxides versus SiO ₂ for samples of Eocene Lowland Creek Volcanics and of Eocene-Oligocene volcanic rocks from the Helena volcanic field in the study area	70
11. Photograph showing prominent fracture systems in Butte pluton.	72
12. Contour diagram of joints in Butte pluton rocks from west half of the area of plate 1	73
13. Diagrams of joints, dikes, veins, faults, and lineaments in the northern Elkhorn Mountains east of the area of plate 1	74
14. Diagram showing principal stress trajectories and net change in temperature in the model system at 0, 35,000, and 150,000 years after pluton emplacement	75
15. Rose diagrams showing trends of dikes, veins, shear zones, and nonmineralized faults in the east half of the area of plate 1	76
16. Schematic diagram showing relationship of deep-seated fault zones to synemplacement diastrophic fractures in the Butte pluton.....	77
17. Variation diagram showing relationship of selected metal oxides in Butte pluton wallrocks and in alteration zones from two mines near the study area.	80

Tables

1. Acid-neutralizing potential for three samples of plutonic rocks with different calcite concentration and different concentrations of mafic minerals, and total acid-neutralizing potential	84
---	----

Chapter D1

Geologic Framework

By J. Michael O'Neill, Karen Lund, Bradley S. Van Gosen, George A. Desborough, Tracy C. Sole, and Ed H. DeWitt

Abstract

The Boulder River watershed study area is underlain by the Late Cretaceous Butte pluton of the Boulder batholith. The elongate, northeast-trending batholith is interpreted to have been emplaced in a slowly opening pull-apart along strike-slip faults that were active during tectonic development of the Cordilleran overthrust belt. Batholithic emplacement was accompanied by voluminous cogenetic volcanism; these volcanic rocks formed the roof of the intrusive complex and are now preserved as roof pendants within the study area. Subsequent erosion has exposed only the upper few thousand feet of the batholith, which is interpreted to be as much as 10 miles thick. The exposed, upper part of the batholith is cut by two well-developed fracture systems. Fractures that developed during emplacement of the batholith are widely spaced and through-going; they are related to the dynamics of the pull-apart mechanism of pluton emplacement. These syn-emplacement fractures were commonly filled with late-stage magmatic fluids that crystallized to form aplitic to pegmatitic dikes commonly associated with thin polymetallic quartz veins. The second set of fractures appear to be related to cooling of the batholithic mass; they are unmineralized, closely spaced, and restricted to the outer margins of the batholith. The cooling fractures greatly influence near-surface groundwater flow in the study area.

The Butte pluton in the study area contains numerous polymetallic quartz-vein deposits as well as well-developed cooling fracture systems. Inactive mines and prospects in the watershed are located along widely spaced polymetallic quartz veins. Geochemical studies of plutonic rocks that host the polymetallic quartz-vein deposits have shown that iron- or magnesium-bearing minerals, an integral part of the mineralogic composition of the Butte pluton, are capable of neutralizing acidic waters. Prior to mine development, the polymetallic quartz-vein deposits were likely minor point-source acid-producing sites surrounded by rocks with high acid-neutralizing potential. Closely spaced cooling fractures that control the current hydrologic character of the area greatly assist the effectiveness of neutralizing potential of the bedrock. At present, acidic water within the study area is associated with (1) inactive mine adits that have opened and exposed the

quartz-vein deposits and channeled the flow of ground water, or (2) mine dumps and mill tailings that have concentrated mineralized rock waste.

Introduction

The Boulder River watershed study area is located in southwestern Montana approximately midway between Butte and Helena (fig. 1). The study area is in the north-central part of the large Late Cretaceous Boulder batholith and is centered on the Basin and Boulder mining districts north and northeast of the town of Basin. The mining districts comprise numerous base- and precious-metal mines that explored thin polymetallic quartz veins filling fractures and small faults in the basins of Basin, Cataract, and High Ore Creeks, tributaries to the Boulder River (pl. 1). The aim of this report is to characterize the geologic framework and associated mineral deposits in the watershed, to identify and prioritize the major contributors of acid mine drainage and deposit-related trace elements to primary streams and tributaries, and to assess the natural acid-neutralizing capacity of the bedrock that hosts the polymetallic vein deposits.

The Boulder River study area is located in an area that was the focus of an earlier, comprehensive study undertaken by the U.S. Geological Survey in the 1950s and 1960s. The result of that original undertaking was the publication of numerous maps and reports on the geology of the central part of the Boulder batholith (fig. 1). The Boulder River study area was mapped and described in the maps and reports of Ruppel (1963) for the Basin 15-minute quadrangle and Becraft and others (1963) for the adjacent Jefferson City 15-minute quadrangle. This report is in many ways a summary of the previous work as it pertains to the Boulder River watershed study area. The reader is encouraged to refer to the previous reports for amplification of details of the geologic investigations.

Previous Work

Lindgren (1886) made the first study of the igneous rocks in this area. These igneous rocks were soon thereafter named

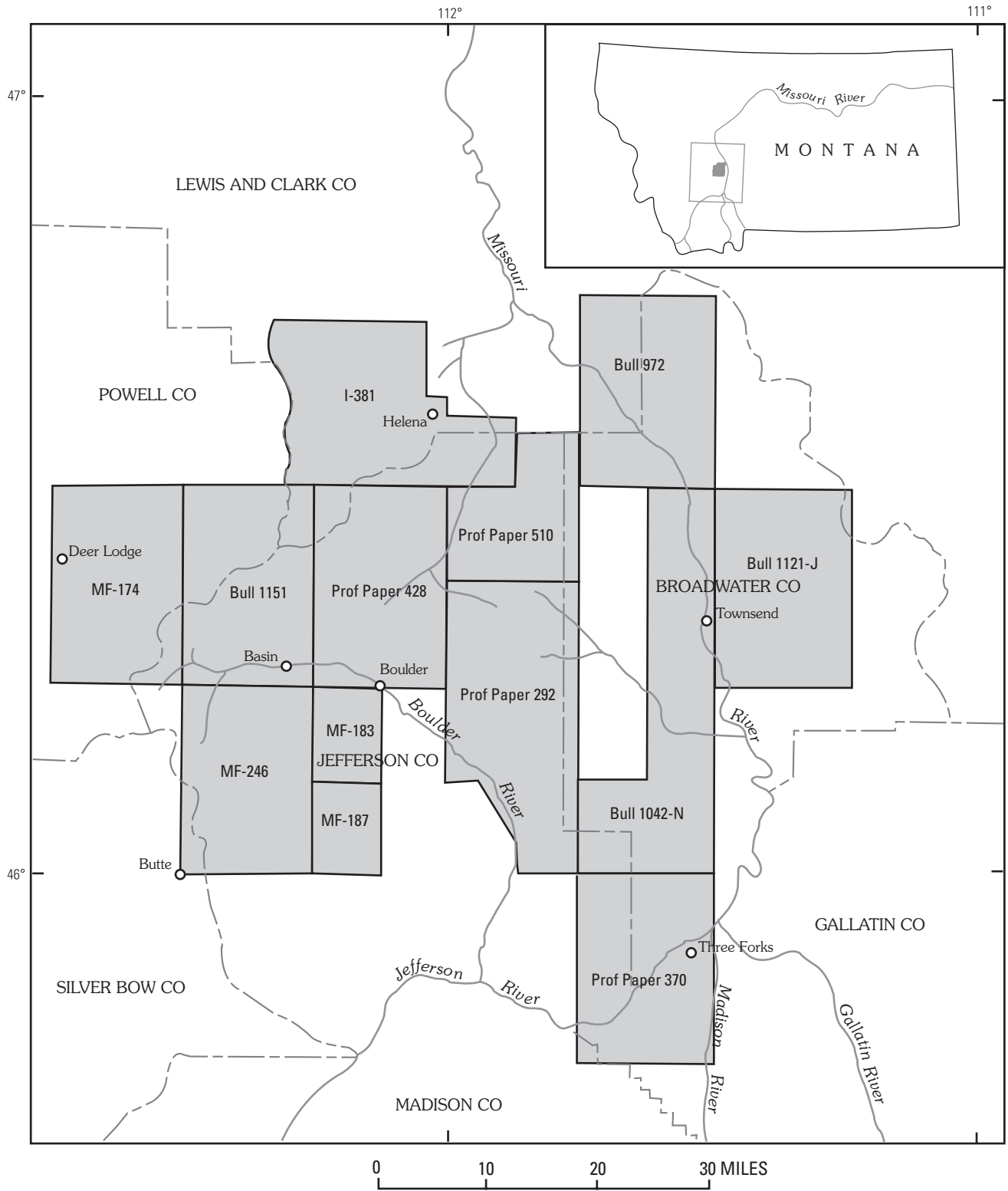

Figure 1. Index map to area described in this report. Labels refer to publications of the U.S. Geological Survey (from Smedes, 1966, fig. 1). Plate 1 covers the area of USGS publications Professional Paper 428 (Becraft and others, 1963) and Bulletin 1151 (Ruppel, 1963).

the Boulder batholith by Weed (1887) in a study of the area around Butte. The Boulder River study area is included in a report by Knopf (1913) on the northern part of the Boulder batholith. During the 1950s and 1960s, the U.S. Geological Survey conducted geologic investigations of 13 quadrangles covering the north-central part of the Boulder batholith (fig. 1). The careful descriptive manner in which the plutonic rocks were described and depicted on these maps allowed us to compile consistent units across the batholith and provided a remarkable view of the geometry of the entire intrusive complex. The closely coordinated individual studies formed the basis for several batholith-wide topical studies, including chemistry (Tilling, 1968, 1973, 1974), timing (Tilling and others, 1968), magmatic evolution (Robinson and others, 1968; Rutland and others, 1989), emplacement models (Hamilton and Myers, 1967; Klepper and others, 1971), and regional tectonic syntheses (Robinson and others, 1968; Schmidt and others, 1990) that have been influential in the studies of magmatic systems and their settings. Mapping studies by Ruppel (1963) and Becraft and others (1963) as part of the Boulder batholith study form the basis of the geologic information used in our analyses and summary.

Setting

Western Montana is underlain by rocks that range in age from Archean to Quaternary. High-grade metamorphic rocks and lesser amounts of felsic plutonic rocks compose most of the Archean lithologic units exposed in cores of mountain ranges in the southwestern part of the State. Archean rocks were deformed in Paleoproterozoic time during the assembly and formation of the North American craton. A major Paleoproterozoic contractional suture zone between Archean cratonic provinces of the northern Rocky Mountains trends northeasterly across east-central Idaho and western Montana, into southern Saskatchewan. In Mesoproterozoic time, the area comprising western Montana and adjacent Idaho was the site of thick accumulations of sediment deposited in what is now known as the Belt basin. The basin trends north and extends from southwest Montana into British Columbia. The Helena embayment, an east-trending arm of the basin, projects eastward into west-central Montana; the embayment is bounded by high-angle faults on the north and south. Phanerozoic miogeoclinal rocks that cover Archean and Proterozoic rocks were complexly deformed in the Cretaceous. Large sheets of allochthonous rocks exposed in the western part of the State were thrust eastward and tectonically interacted with coeval Laramide uplifts of Precambrian basement rocks east of the overthrust belt. Batholithic rocks were also emplaced into these rocks during the Cretaceous; the Boulder batholith, the subject of this report, is one of the larger of these intrusive bodies.

The Boulder batholith is a plutonic complex consisting of a sequence of Cretaceous intrusions that evolved into

more silicic compositions through time (Knopf, 1963). The emplacement sequence of the Boulder batholith is from initial more mafic plutons to a voluminous intermediate-composition main batholithic phase to a final, minor late-stage, alkali-rich felsic pluton. Early mafic plutons are elongate east-west bodies at the northern and southern borders of the Boulder batholith (fig. 2); their emplacement was controlled by reactivated east-trending structures acting primarily as tear structures and lateral ramps during Late Cretaceous thrust faulting. The most voluminous, intermediate plutonic phase of the batholithic complex has historically been called the "Butte Quartz Monzonite." However, by use of more recent plutonic classification systems, the composition of this pluton is not quartz monzonite (see discussion on Butte pluton); thus the name Butte pluton will be adopted, following the usage of Schmidt and others (1990), to prevent confusion. The Butte pluton is about 10 mi wide and 32 mi long and forms the north-northeast elongated heart of the plutonic complex (fig. 2). The shape and location of the Butte pluton were probably controlled by tension related to geometry of interacting structures during Late Cretaceous thrust faulting (Schmidt and others, 1990). Late-stage felsic plutons crosscut the Butte pluton; their location may be controlled by the Butte-Helena fault zone (fig. 2, see discussion on mode of emplacement).

Regional Tectonic Setting

The structural setting of the Boulder batholith region¹ has been dominated by recurrent movement on three sets of steep faults (fig. 2): northwest-trending, northeast-trending, and east-trending sets. The northwest-trending fault set consists of about 30 separate faults spaced 3.5–6 mi apart. Some of these faults are vertical at the surface, but most dip 50°–80° NE. Schmidt and Garihan (1986) concluded that these faults were down to the northeast during Mesoproterozoic time. They were reactivated as left-reverse, oblique-slip faults during east-west shortening of the thrust belt and adjacent Rocky Mountain foreland in the Late Cretaceous (Schmidt and Garihan, 1983). Most of these faults are restricted to the Tobacco Root and Highland Mountains, directly south of the Boulder batholith.

Faults of the northeast-trending set occur over a wide zone (120 mi) spanning both the thrust belt and the basement rocks of the foreland. O'Neill and Lopez (1985) have documented recurrent activity along this fault set, going back to at least Mesoproterozoic time; they named the fault trend the Great Falls tectonic zone (not labeled in fig. 2). McBride and others (1990) extended the zone to include thrusts in the Archean basement rocks of the Rocky Mountain foreland and showed that the thrusts had a component of right-lateral slip

¹The following discussion of the kinematics of emplacement of the Boulder batholith is excerpted from Schmidt, Smedes, and O'Neill (1990). Minor additions to the original article herein are by O'Neill and are based on geologic observations made since that time.

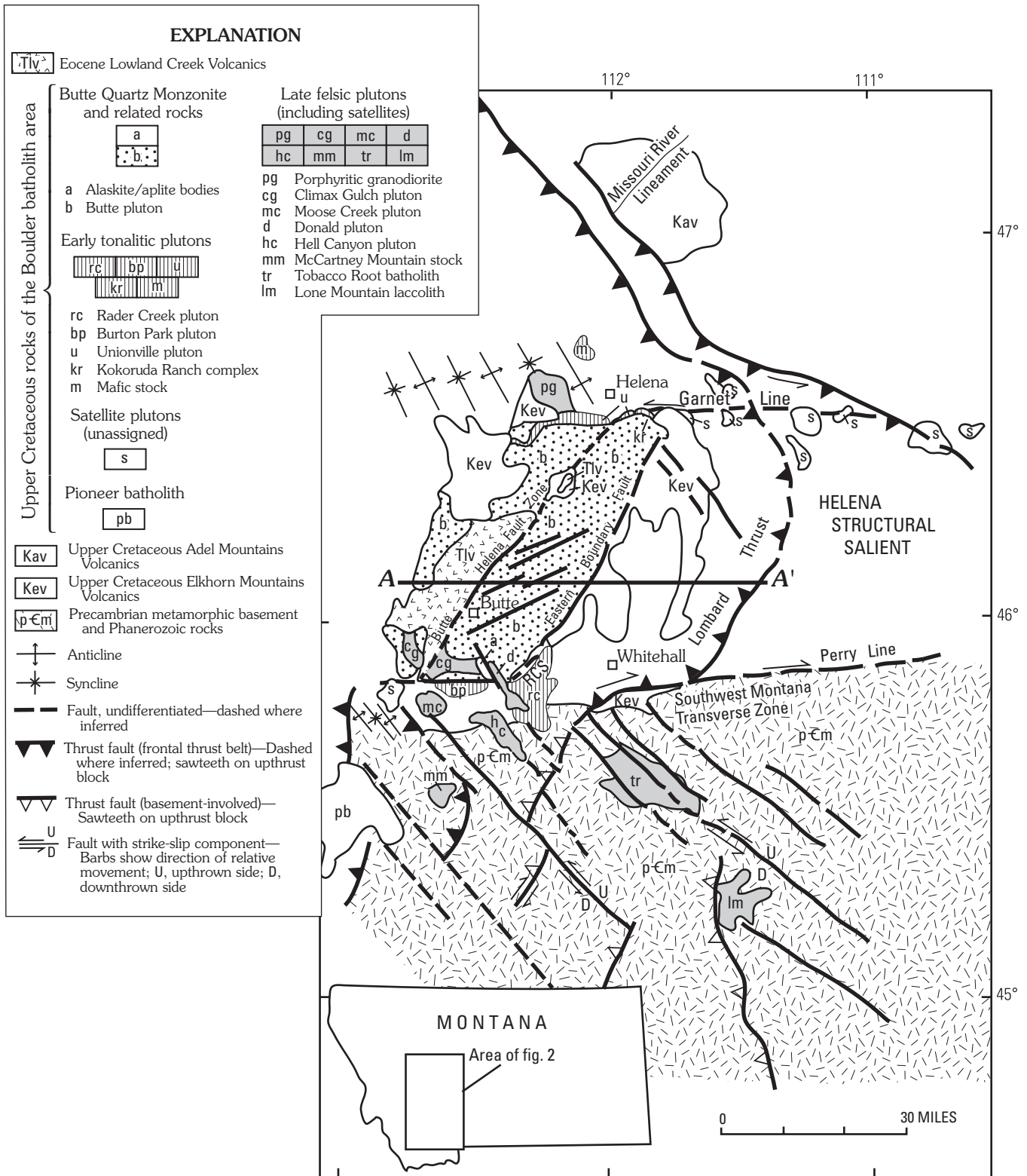

Figure 2. Tectonic map of the Boulder batholith area showing major plutonic units and faults (modified from Schmidt and others, 1990, fig. 1). Inset map shows location. Unlabeled areas are Proterozoic and Phanerozoic rocks. RCS, Rader Creek screen. Cross section A–A' is shown in figure 3.

due to easterly-directed compression during the Late Cretaceous. More recently, O'Neill (1998) has described the architecture of the Great Falls tectonic zone across western Montana; he described the zone as a Paleoproterozoic collisional orogen and continental suture whose axis is now obscured beneath the Boulder batholith.

Major east-trending Mesoproterozoic faults or fault zones are inferred to be either buried or reactivated by thrusts along the southwest Montana transverse zone at the southern margin of the Helena structural salient (fig. 2) (Robinson, 1963; Schmidt and O'Neill, 1983). The zone is likely controlled by a major down-to-the-north normal fault zone, the Perry line of Harris (1957), that marked the southern margin of the Helena embayment of the Belt basin in Mesoproterozoic time. The westward projection of the line closely coincides with the southern margin of the Boulder batholith. Another, though less distinct, east-trending Proterozoic normal fault zone has been identified in the northern Helena salient (Winston, 1986). This fault zone, the Garnet line of Winston (1986), is interpreted to mark the north edge of the Mesoproterozoic Helena embayment. Late Cretaceous sinistral shear along the segment of the Garnet line fault zone that crosses the northern boundary of the Boulder batholith has produced a series of large northwest-trending en echelon folds in the Proterozoic and Phanerozoic rocks in that region.

In summary, the upper crust in the region of the Boulder batholith is crisscrossed by three sets of deeply penetrating faults that have been recurrently active since the Proterozoic.

Contacts with Adjacent Rocks

Fifteen plutons make up the Boulder batholith (fig. 2). Tonalitic plutons are products of the earliest stage of intrusive activity and are preserved dominantly along the north and south margins of the batholith. These plutons are the most mafic bodies in the batholith and occur as northwest-trending

and east-trending dike-like bodies. The intrusion of the earliest plutons appears to have been controlled by the intersection of east-trending faults that bound the Mesoproterozoic Helena embayment of the Belt basin on the north and south with the axial crustal suture zone within the Great Falls tectonic zone.

The Butte pluton, which underlies the entire study area, forms about 73 percent of the outcrop area of the Boulder batholith. It can be divided into eastern and western sectors separated by the Butte-Helena fault zone (fig. 2). In the south, the fault zone is 3 mi wide and separates the batholith from younger Lowland Creek Volcanics. In the north the zone is marked by northeast-trending late-stage plutons, small bodies of alaskite and pegmatite, and abundant late-stage fissure veins. This zone is interpreted to be one of deep-seated faulting associated with the axial suture of the Great Falls tectonic zone.

The eastern boundary of the Butte pluton has long been interpreted as having been emplaced along a preexisting north-east-trending fault that was partly obliterated by stoping. In several places the Elkhorn Mountains Volcanics are intensely sheared and recrystallized along the fault zone (Smedes, 1966; Prostka, 1966). In the north the fault appears to terminate abruptly against the east-trending Garnet line. On the south, it bends gradually westward and merges with the east-trending Perry line that marks the southern boundary of the batholith.

The east-west cross-sectional shape of the pluton is known only from gravity data of Biehler and Bonini (1969) and Burfeind (1967). The pluton is highly asymmetric and can be divided into two parts: (1) a relatively thin wedge-shaped body west of the Butte-Helena fault zone and (2) a thick, steep-sided pluton east of the fault zone (fig. 3).

Mode of Emplacement

Plutonic rocks west of the Butte-Helena fault zone appear to have been intruded as a laccolith that now has an

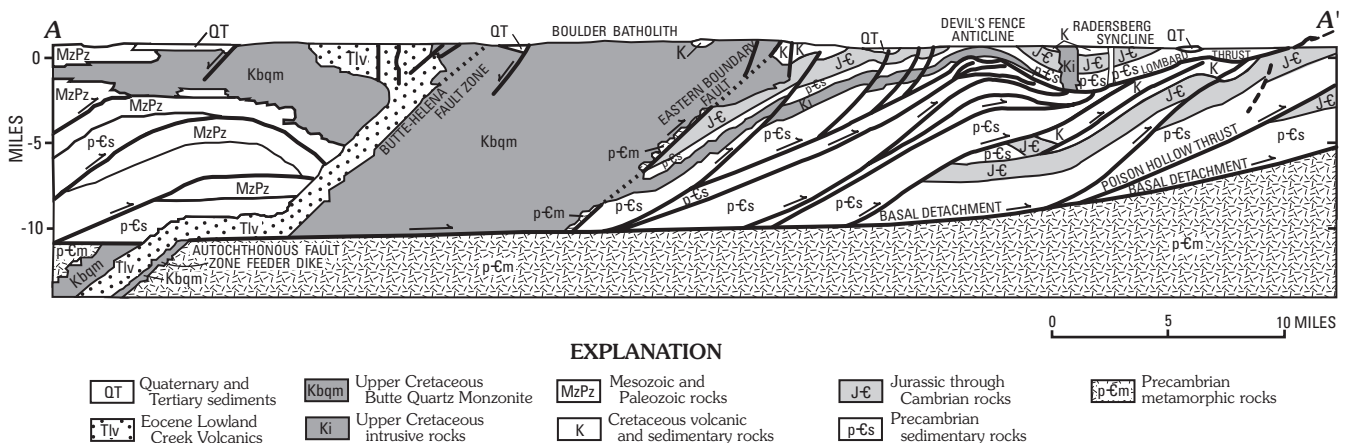

Figure 3. Regional cross section (line A-A' of fig. 2) showing interpreted relationship of main mass of Butte pluton to faults (modified from Schmidt and others, 1990, fig. 3).

extensive gently west dipping updomed roof of Elkhorn Mountains Volcanics and a few large roof pendants of pre-volcanic sedimentary rocks (Smedes and others, 1988). This part of the batholith is clearly thinner than the eastern part and probably thins gradually westward. However, quite a different mode of intrusion seems to be required for the eastern part of the pluton (figs. 2, 3), because (1) this part of the batholith is a parallelogram in map view and is bounded on four sides by faults; (2) the roof apparently never contained any rocks older than the cogenetic Elkhorn Mountains Volcanics; and (3) the floor is interpreted to be a thrust belt decollement. We suggest that a rhombohedral pull-apart opened up within the Helena salient of the thrust belt during active eastward movement of the thrust sheets. Such a cavity may have formed by interaction of the thrust sheet above the basal decollement with the east-trending faults that bound the pluton on the north and south and with the northeast-trending faults that bound the rhombohedral mass on the east and west. Emplacement may have taken place episodically as a series of sheeted dikes.

The pull-apart is centered on the Butte-Helena fault zone that in turn is a Cretaceous manifestation of recurrent faulting above the Paleoproterozoic continental suture zone named the Great Falls tectonic zone. Thin-skinned, east-directed tectonic transport occurred in rocks north and south of the suture zone; however, thick-skinned basement deformation of the Rocky Mountain foreland occurred only southeast of the Great Falls tectonic zone. Thus, east-west crustal shortening southeast of the tectonic zone included both thick- and thin-skinned deformation, whereas to the northwest only thin-skinned deformation is recorded; hence east-directed tectonic transport of the crust was greater to the southeast. The deep-seated fault lines that bound the north and south sides of the Helena embayment of the Belt basin acted as accommodation zones that allowed a pull-apart to form along the crust-penetrating suture of the Paleoproterozoic collisional orogen. A progressively opening rhombohedral pull-apart was thus outlined by northeast- and east-trending faults, and this pull-apart was progressively filled from below by Butte pluton magmas. When pull-apart ceased and the rhomb-shaped part of the Butte pluton achieved its final form, the western, laccolithic part of the Butte pluton developed as the volume of magma exceeded the room available in the pull-apart region.

Tertiary Extensional Structures

In middle Eocene time, regional extension of the crust led to renewed eruption of calc-alkaline magmas along the Butte-Helena fault zone to produce the Lowland Creek Volcanics (Tlv, figs. 2 and 3). In the early Oligocene, bimodal rhyolite-basalt volcanism of the Helena volcanic field was centered in the northwestern part of the batholith.

Igneous Rocks

Names for rock units used in the original reports (Becraft and others, 1963; Ruppel, 1963) are not used in this report in favor of using names that indicate textural and chemical character of the rocks. Because the plutonic rocks are all part of the same pluton and have the same general chemistry throughout the area, map units are defined on the basis of texture. Rock textures highlight cooling features of the pluton and are important for understanding the physical breakdown and chemical weathering of these rocks. Traditional modal data are available for the plutonic rocks, and these data are presented herein for comparison to other commonly used rock classification systems. However, because of the desirability of using the ground-water and surface-water chemistry of both the plutonic and volcanic rocks to relate rock type to other collaborative studies that are part of this project, we have chosen to discuss and compare the volcanic and plutonic rocks of the study area using their major-element chemistry. Thus, the major-element chemistry of the igneous rocks is presented and classification of the volcanic and plutonic rocks is based on systems used by De La Roche and others (1980). Using the same criteria to classify all the igneous rocks provides better comparison among rock types and includes the mafic minerals as part of the classification. Using mafic minerals as part of the classification system is pertinent to this study because mafic minerals are extremely important constituents in contributing to the acid-neutralizing potential of rocks in contact with acid-bearing water that issues both from exposed, unmined but mineralized areas, and from inactive mine workings.

Most of the rock units in the study area are Cretaceous igneous rocks. Previous work has shown that the Elkhorn Mountains Volcanics and the Boulder batholith are part of the same magmatic system (Roberts, 1953; Klepper and others, 1957; Robinson, 1963; Smedes, 1966). In general, the Elkhorn Mountains Volcanics represent magma that reached the surface and erupted, forming a volcanic and volcanogenic layered sequence; the Boulder batholith represents the parent magma that crystallized beneath the Elkhorn Mountains Volcanics (Robinson and others, 1968; Rutland and others, 1989). Only two eruptive units of the Elkhorn Mountains Volcanics are present in the area of plate 1. The Boulder batholith in the area of plate 1 includes three textural phases of the Butte pluton, the largest pluton of the Boulder batholith. Younger, Eocene and Oligocene volcanic rocks and associated dikes are not related to the Boulder batholith but are related to later regionally important igneous events.

Upper Cretaceous Elkhorn Mountains Volcanics

The Elkhorn Mountains Volcanics are from 2.2 to 3.0 mi thick and once covered about 10,000 mi² (Smedes, 1966), making this volcanic field one of the largest known ash-flow volcanic fields (Lipman, 1984). The Elkhorn Mountains Volcanics are folded concordantly with the pre-volcanic rocks

and were thus erupted during and after contractional deformation. They were named and described from the Elkhorn Mountains (Klepper and others, 1957) located about 15 mi east of the study area. The volcanics are informally divided into three members: a lower unit of tuff, lapilli tuff, and tuff breccia; a middle unit mainly of welded tuff; and an upper unit of well-bedded tuffaceous sedimentary rocks. Small bodies of intrusive rocks are included with the Elkhorn Mountains Volcanics because they are thought to be the same age as the volcanics rather than part of the major intrusion of the Butte pluton.

Lower Member

The lower member does not crop out in the study area or in the area of plate 1 but is found to the east in the Elkhorn Mountains (Smedes, 1966). The lower member is andesitic tuff, flow breccias, and volcanoclastic rocks and is as much as 4,900 ft thick. Andesitic ash-flow tuffaceous rocks are massive and commonly flow brecciated; some are slightly welded. Sedimentary rocks derived from these andesitic rocks range from sandstone to pebble and boulder conglomerate.

It is unlikely that the lower member was ever deposited in the study area, given that the batholith was intruded into an ever-opening pull-apart that formed after the lower member was deposited; the lower member is necessarily restricted to areas east and west of the Butte pluton.

Middle Member

The middle member is primarily dacitic welded tuff and also includes lapilli tuff, tuff breccia, and minor volcanic sandstone and conglomerate. The middle member may be as much as 8,200 ft thick (Smedes, 1966) and is the predominant member of the Elkhorn Mountains Volcanics in the study area and across the area of plate 1. Two welded tuff zones of which dacite is the most common rock type make up the middle member. Welded tuffs of the upper zone are light-greenish-gray and medium-gray rocks. Groundmass is fine to very fine grained, and phenocrysts are mostly euhedral plagioclase and hornblende. Plagioclase composition is An_{30-35} (Ruppel, 1963). Plagioclase phenocrysts range from 0.5 to 3 mm long, and the mafic minerals are generally less than 1 mm across.² Welded tuffs of the lower zone are brownish gray or reddish gray. The groundmass is aphanitic to very fine grained. Plagioclase phenocrysts are 1–2 mm long, and biotite grains are found in trace amounts. Small lithic fragments of volcanic rock are common. In the welded tuffs, phenocrysts are commonly aligned parallel to welding features and flattened fragments of pumice and glass. Tuff breccia and lapilli tuff are more common in the lower parts of the middle member and probably represent unwelded or partly welded tuff of the same compositions.

²All microscopic measurements are given in millimeters rather than inches. To convert to inches, multiply by 0.04.

Local interbedded volcanic sandstone and conglomerate contain fragments of welded tuff and probably originated by local erosion of volcanic rocks between major volcanic eruptions.

The middle member crops out as roof pendants on the Butte pluton across the western part of the study area and as a weakly folded inlier on the east side of the study area. Throughout the study area, the base of the middle member has been partly assimilated by the intrusion.

Upper Member

The upper member of the Elkhorn Mountains Volcanics is primarily volcanoclastic material reworked from the lower members; it includes some tuff layers. The upper member is as much as 1,900 ft thick (Smedes, 1966). Dark-gray, thin-bedded to laminated, fine-grained andesitic mudstone to siltstone is the dominant rock type, interbedded with lesser amounts of andesitic sandstone to conglomerate and breccia. Andesitic sandstone contains subrounded to rounded grains that are well sorted. Breccia is probably of landslide or mud-flow origin. Lapilli tuff and crystal tuff, which are interbedded with the fine-grained sedimentary rocks, document on-going volcanism.

Rocks of the upper member are found in and extending out of the southwestern part of the study area above the welded tuff of the middle member, and also along the east side of the study area. The base of the upper member is generally conformable with rocks of the middle member. The overlying Lowland Creek Volcanics lie on top of the upper member of the Elkhorn Mountains Volcanics across an angular unconformity.

Chemical Composition

Becraft and others (1963) reported the chemical analyses of two samples of tuff from the upper member of the Elkhorn Mountains Volcanics and one sample of same-age intrusive porphyry. Their tuff samples are andesite and rhyodacite in composition; the intrusive porphyry is a dacite (fig. 4). Ruppel (1963) reported the analyses of two welded tuffs and a metamorphosed welded tuff, with all three samples from the middle member. The two welded tuff samples are dacites (fig. 4). The metamorphosed welded tuff is compositionally a rhyolite (fig. 4). Ruppel (1963) suggested that the tuff was altered (silicified) after its deposition, perhaps by the intrusion of the Butte pluton. Desborough, Briggs, and Mazza (1998, table 1, p. 6–7) collected four samples of unaltered bedrock of the middle member of the Elkhorn Mountains Volcanics from the study area; these samples range from latite to dacite to rhyodacite in composition (fig. 4). Desborough, Briggs, and Mazza (1998, table 3, p. 11) also sampled silicified volcanic rocks of the Elkhorn Mountains Volcanics at Jack Mountain (fig. 5).

Similar to the rocks of the Butte pluton, samples of Elkhorn Mountains Volcanics show rather consistent and typical

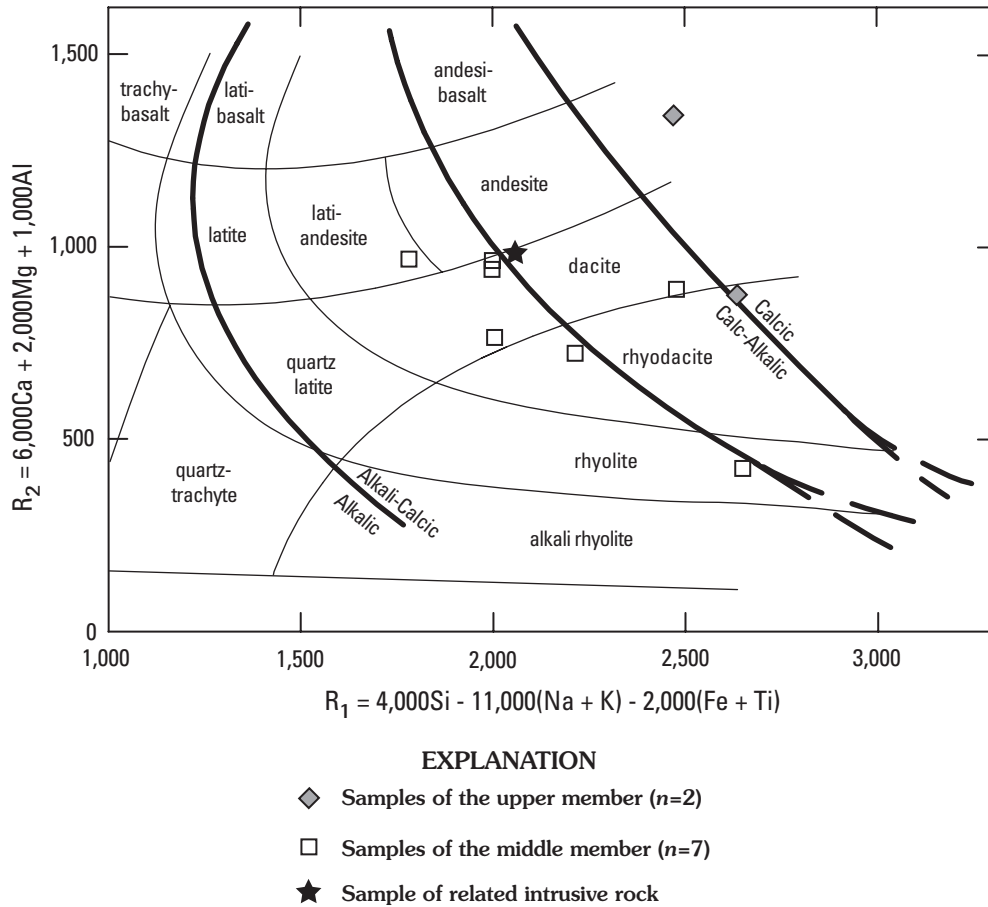

Figure 4. Classification of samples of the Elkhorn Mountains Volcanics in the study area based on the R_1, R_2 -diagram of De La Roche and others (1980). Analytical data from Becraft and others (1963, table 1, p. 7), Ruppel (1963, table 2, p. 16), and Desborough, Briggs, and Mazza (1998, table 1, p. 6–7).

inverse relationships between silica content and concentrations of magnesium, calcium, phosphorus, and titanium (fig. 5); aluminum and manganese also show similar inverse trends. An association of these metals with mafic minerals is likely; therefore, the least silica rich rocks of the Elkhorn Mountains Volcanics likely contain relatively more mafic minerals.

A comparison of figures 5 and 6 shows that the range and magnitude of major-element concentrations are generally similar between the representative samples of the Butte pluton and the Elkhorn Mountains Volcanics. No modal data for the Elkhorn Mountains Volcanics have been published, mainly because the fine-grained nature of these rocks precludes mineral identification and volume estimates in petrographic sections.

Metamorphism

The Butte pluton intruded into the middle and upper members of the Elkhorn Mountains Volcanics, and, near contacts with plutonic rocks, the tuffs are contact metamorphosed to cordierite hornfels facies. The hornfels are very fine grained

rocks in which original textures have been destroyed, resulting in a dense impermeable rock. As for less dramatic metamorphic effects, low-grade contact metamorphism of the tuffs and welded tuffs formed quartz-sericite-alkali feldspar hornfels as much as 65 ft away from the contact. In these hornfels, Becraft and others (1963) and Ruppel (1963) observed that mafic minerals have been mostly destroyed and the remainder of the rock has been converted to sericitized feldspar phenocrysts and a groundmass of fine-grained intergrown sericite, quartz, and alkali feldspar. Pyrite and tourmaline in cavities and along fractures were introduced during or after formation of the hornfels. Wispy textures in these hornfels rocks in the western part of the study area are probably relict welding texture. Chemically, samples of this rock are much more silicic than unmetamorphosed samples (fig. 4), reflecting the importance of the hydrothermal introduction of silica as part of the metamorphism. Both the composition and texture of the hornfels considerably affect the chemical reactions between this rock and ground and surface water and the response of this rock to weathering. See section, "Acid-Neutralizing Potential of Bedrock," p. 83 .

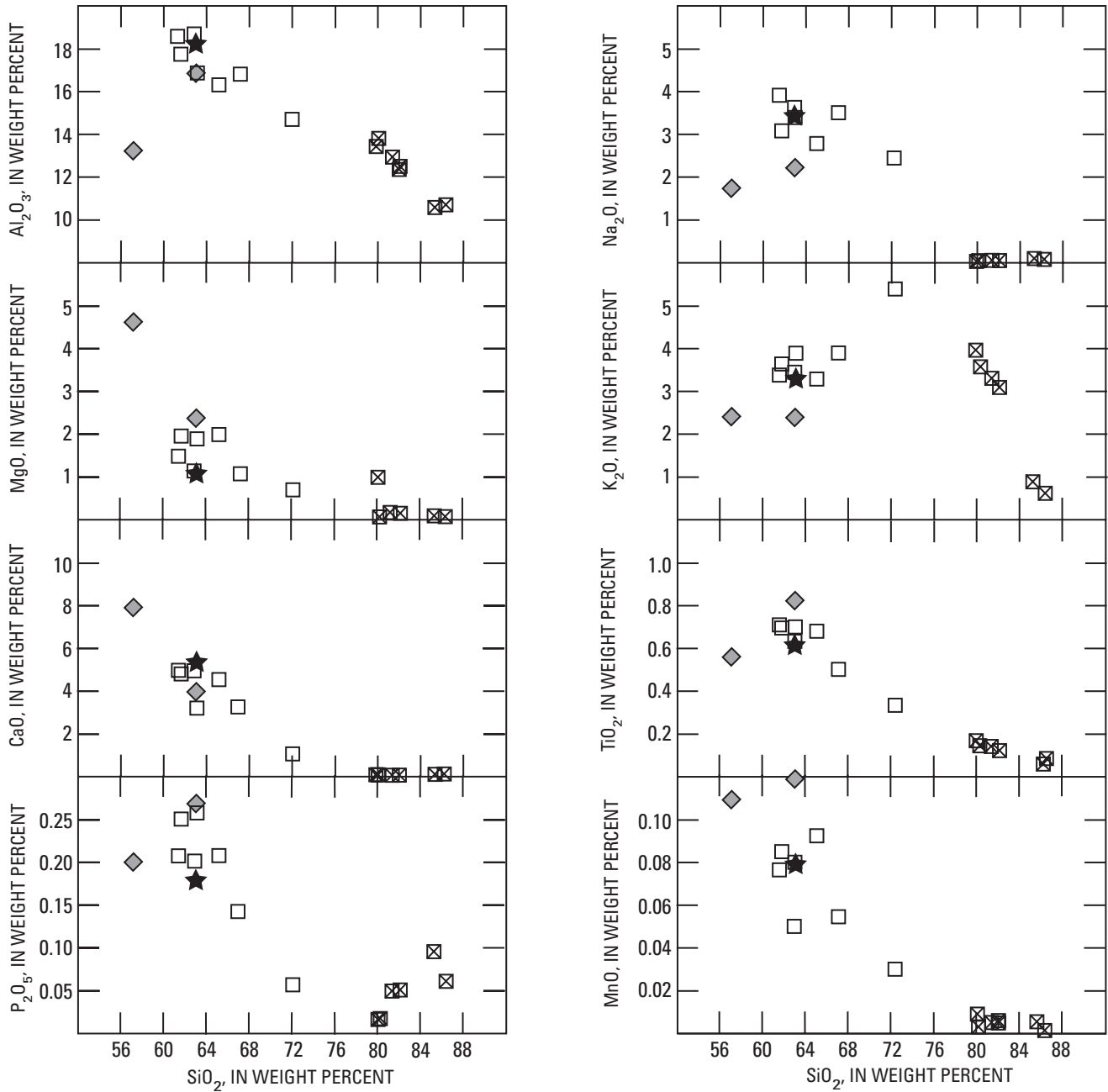

EXPLANATION

- ◆ Samples of the upper member (n=2)
- Samples of the middle member (n=7)
- ★ Sample of related intrusive rock
- ⊠ Samples of silicified volcanic rocks at Jack Mountain (n=7) collected by Desborough, Briggs, and Mazza (1998)

Figure 5. Harker variation diagrams showing abundances of major oxides versus SiO₂ for 17 samples of the Elkhorn Mountains Volcanics from the study area. Analytical data from Becraft and others (1963, table 1, p. 7), Ruppel (1963, table 2, p. 16), and Desborough, Briggs, and Mazza (1998, table 3, p. 11).

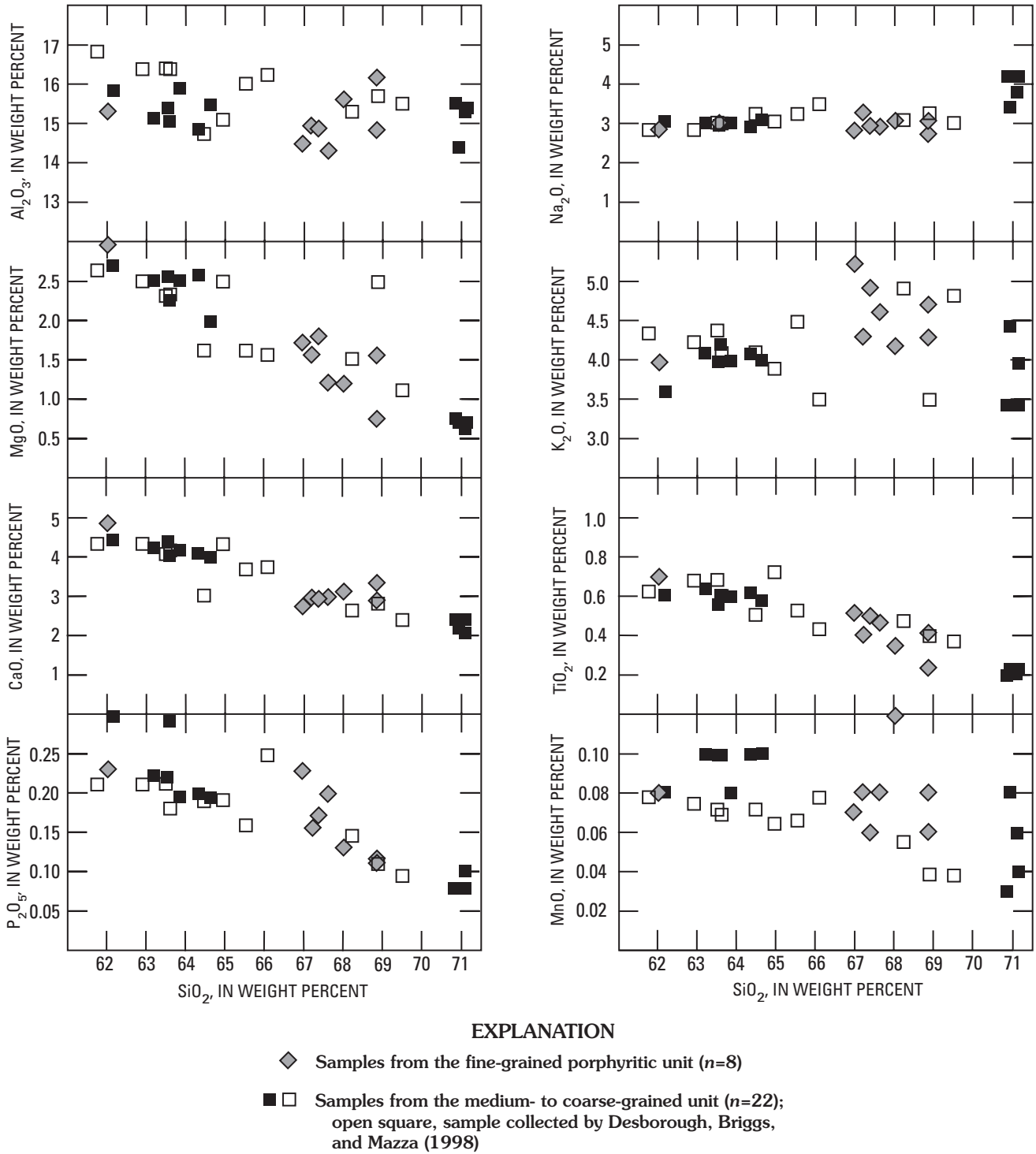

Figure 6. Harker variation diagrams showing abundances of major oxides versus SiO₂ for 30 samples of Butte pluton in the study area. Chemical data from Becraft and others (1963, table 2, p. 10), Ruppel (1963, table 3, p. 26), and Desborough, Briggs, and Mazza (1998, table 1, p. 6–7).

Ages

Age determinations of rocks of the Elkhorn Mountains Volcanics have been obtained elsewhere in the region. Vertebrate and plant fossils found in the Elkhorn Mountains Volcanics are from the Campanian Stage of the Upper Cretaceous (Smedes, 1966). Only a few isotopic ages are reported and, of these, only two have been considered reliable. These are hornblende K-Ar ages, both from the lower member, thus recording the onset of volcanism. A sample of autoclastic breccia from near the base of the lower member from a site southeast of this study area resulted in reported dates of 77.6 ± 2.4 and 78.8 ± 2.4 Ma (Robinson and others, 1968). Another sample from near the top of the lower member west of this study area resulted in a reported date of 77.6 ± 2.4 Ma (Robinson and others, 1968). Fossils from welded tuffs near the top of the upper member are dated at 73 to 75 Ma and record the end of volcanism. Together these data indicate that volcanism occurred for about 5 m.y. from about 78 to 73 Ma (Robinson and others, 1968). More recent dating of Cretaceous fossil zones (Obradovich, 1993) suggests that volcanism, represented as volcanoclastic rocks of the underlying Slim Sam Formation, began about 81 Ma (Tysdal, 2000), thus extending the period of igneous activity.

Late Cretaceous Butte Pluton of the Boulder Batholith

Previous mapping in the study area by Ruppel (1963) and Becraft and others (1963) resulted in complex subdivision of granitic units based on grain size, amount of mafic minerals, outcrop color, and texture. Between the two maps, 19 map units were used to subdivide rocks of the Butte pluton. Units used for the present study are simplified to only three map units (pl. 1) for the following reasons.

Although the units designated by Ruppel and Becraft and others were used consistently where defined, they were not completely carried across both quadrangles. Additionally, gradational boundaries without identified contacts were used in some areas. Thus, distinctions among medium grained, coarse grained, and porphyritic or among the different color varieties were not made everywhere and could not be carried across the present study area without a great deal of additional field mapping.

Significantly, the previous reports make it abundantly clear that such effort is not warranted. Geochemical analyses and modal data for units show unequivocally that some units distinguished by texture or by color index could not be differentiated based on rock chemistry, and further, some units that have identical textures have different chemical signatures and modes. Thus, color was used by earlier workers to distinguish some otherwise chemically and texturally identical rocks (Becraft and others, 1963; Ruppel, 1963). Pink versus gray color in granite is, in some cases, indicative of later alteration of the rock by hydrothermal fluids. Where alteration has not

occurred, the pink color may reflect magmatic conditions, in particular, the oxidation state of iron in the feldspar. The previous authors make it clear that the chemical, modal, and textural data show no indication of separate magma sources or even of separate intrusive phases of the same magma (Becraft and others, 1963; Ruppel, 1963). To avoid confusion of the classification systems in these rocks with similar chemistry and to highlight internal features of the Butte pluton in the study area, map units used on plate 1 are defined mostly on the basis of texture. Thus, the complicated map units used by Becraft and others (1963) and Ruppel (1963) are not used in this study in favor of units that were mapped consistently by previous workers and those presented here that are deemed relevant to the present study.

Based on replotting of modal data of Becraft and others (1963) and Ruppel (1963), samples from the Butte pluton plot in the granite field (fig. 7; Streckeisen, 1976) as it was originally classified (Weed, 1887; Knopf, 1957). Subsequent to the original work, these rocks were typically named quartz monzonite (Butte Quartz Monzonite of Becraft and others, 1963; Ruppel, 1963; and many others) due to a then popular igneous rock classification system (Johannsen, 1939; and see Knopf, 1957). Alternatively, based on major-element chemistry in which all constituents of the rock are considered, samples of the Butte pluton from the study area plot in the granodiorite-tonalite fields (see discussion on "Chemical Composition").

Medium- to Coarse-Grained Phase

The dominant rock type in the study area is the medium- to coarse-grained hornblende-biotite phase of the Butte pluton; this phase (Kbm) underlies as much as 90 percent of the study area but is conspicuously absent in the vicinity of Jack Mountain. Even where not exposed on the surface, this rock is not deeply buried and underlies all other exposed rocks. Thus, the chemistry, grain size, and fracture patterns of the medium- to coarse-grained phase and the presence of hornblende and biotite are the most important factors in the environmental geology of the study area. The chemical and physical characteristics of this rock type dominate all other factors in controlling ground-water flow, ground-water chemistry, and acid-neutralizing potential of bedrock in the study area.

The medium- to coarse-grained phase is light to dark gray in fresh samples; some samples are pinkish gray or brownish gray as well. Modal counts published in Becraft and others (1963) and Ruppel (1963) have been replotted in figure 7 and show a spread of compositions across the part of the granite field (monzogranite) where plagioclase and potassium feldspar are present in subequal amounts. A few samples fall in the granodiorite field owing to a predominance of plagioclase over potassium feldspar. Plagioclase composition is in the range of An_{20} - An_{50} ; plagioclase crystals are commonly rimmed by zoned albite in coarser grained rocks. Quartz makes up 20–30 percent of the medium- to coarse-grained phase and is commonly strained. Mafic minerals are biotite and hornblende and represent from 5 to 14 percent of the rock. Generally,

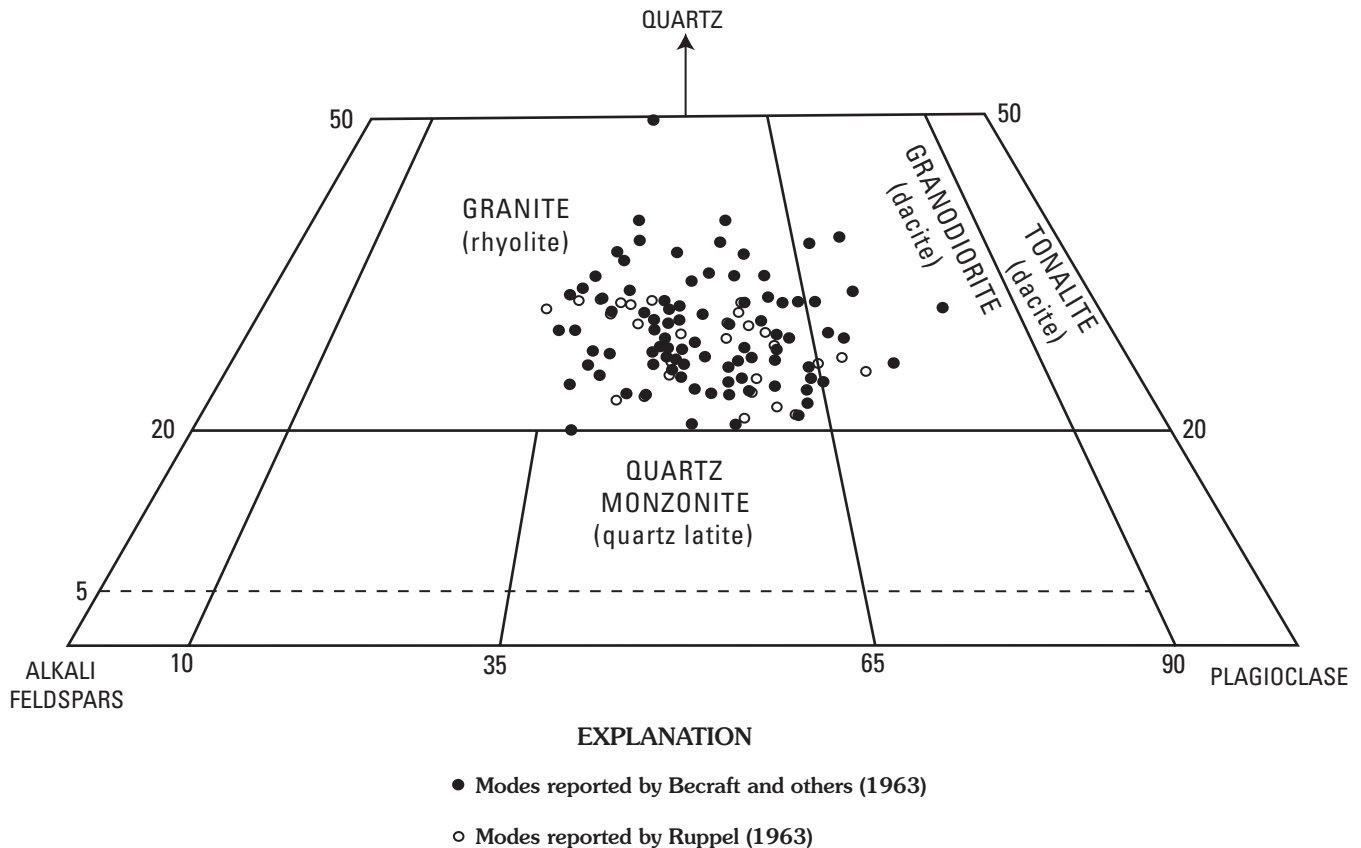

Figure 7. Modes of rocks of Butte pluton in the study area as counted from thin sections by Becraft and others (1963, fig. 3, p. 8) and Ruppel (1963, fig. 3, p. 23). Modes are plotted on modal classification diagram for plutonic rocks constructed by Streckeisen (1976); equivalent volcanic rock names are given in parentheses.

biotite slightly predominates over hornblende; biotite averages 3–7 percent and hornblende averages 1–7 percent. Relict augite is found in most samples. As much as 4 percent tourmaline is present. Sphene, magnetite, zircon, apatite, and allanite are common as trace minerals.

The medium- to coarse-grained phase is commonly equigranular, but minor areas of porphyritic texture with medium- and coarse-grained groundmass are found along the northern edge of the map area of plate 1. Based on mapping of Becraft and others (1963) and Ruppel (1963), the grain size in this unit forms a distinct pattern of coarser at deeper exposures as opposed to medium at higher positions relative to the original roof of the pluton. The porphyritic varieties noted in previous mapping are at the northern contact of the Butte pluton against the older, cogenetic Unionville pluton (Knopf, 1963). This porphyritic texture in the Butte pluton is presumably due to more rapid cooling near the roof and side of the magma body during crystallization.

Pegmatitic to aplitic segregations form knots in the medium- to coarse-grained phase, especially in the upper parts of this unit. The pegmatitic and aplitic segregations are feldspar and quartz intergrowths that can be either coarser or finer than the surrounding rock and also commonly include visible crystals of tourmaline and epidote. Some of these pegmatitic or aplitic knots have crystals terminating inward into poorly

formed miarolitic cavities. Where the knots or cavities are particularly common, the rock has locally been mapped as aplite bodies by the previous workers; in this study, these rocks are interpreted to be textural and compositional phases that formed due to liquid-rich bubbles near the top of the crystallizing magma. Miarolitic cavities indicate moderate to shallow emplacement and cooling of the magma at about 2.5 mi beneath the paleosurface.

Fine-Grained Porphyritic Phase

The fine-grained porphyritic phase includes light- and dark-gray and pinkish-gray varieties and both porphyritic and equigranular varieties; this phase (Kbf) is most abundant in the study area in the vicinity of Jack Mountain. Phenocrysts are most commonly potassium feldspar, but one variety has plagioclase phenocrysts. Plagioclase composition is in the range of An_{30} - An_{50} ; crystals are commonly zoned. Quartz makes up 20–30 percent of the fine-grained phase and is commonly strained. Mafic minerals are biotite and hornblende. Generally, biotite slightly predominates over hornblende; biotite averages 4–7 percent and hornblende averages 2–4 percent. Sphene, magnetite, zircon, apatite, and allanite are common trace minerals.

The porphyritic fine-grained variety is composed dominantly of rocks with groundmass crystals of about 1 mm and phenocrysts as much as 30 mm.³ Some equigranular varieties with grain size of about 1 mm were originally mapped as separate units based on the textural difference. The groundmass in both porphyritic and equigranular varieties is formed of interlocking grains.

Other textural varieties in this unit include granophyre, porphyry, and minor aplite. In the granophyric variety, fine to very fine rosettes of quartz and graphic intergrowths of quartz and feldspar form most of the groundmass. In the porphyry variety, the groundmass is very fine and the appearance of the phenocrysts dominates the rock in hand specimen. Some small zones of aplite, rock having lower mafic mineral content and composed of a mosaic of quartz and feldspar grains, are included in this unit. In all these textural types, aplitic material forms knots and segregations associated with sparse, poorly formed mirolitic cavities. These textures indicate moderately shallow cooling at about 2.5 mi beneath the surface.

The fine-grained porphyritic variety and associated varieties are most commonly found at the highest elevations in the Butte pluton. They are located overwhelmingly near the contact of the Butte pluton with overlying roof rocks. This phase forms a chill margin to the rest of the pluton and, thus, crystallized before the coarser grained phases. In places where this relationship does not hold and the fine-grained phase appears to be surrounded by the coarser grained phases, this chill phase may represent rafts caused by the failure of the roof zone during emplacement of the still mobile coarser magma.

Aplite and Porphyry

The aplite and porphyry unit (Kba) includes rocks originally mapped as alaskite and pegmatite map units. When replotted (fig. 7), modal counts published in Becraft and others (1963) spread across the modal granite field with most samples falling in the part of the granite field (syenogranite) having higher concentration of potassium feldspar than plagioclase feldspar. These rocks have considerably higher silica content than the other phases with quartz composing 31–42 percent of the rock. Potassium feldspar makes up 30–65 percent, and sodic plagioclase makes up most of the rest of the rock. Biotite is the only common mafic mineral, and it is only present in trace amounts of less than 1 percent. Black tourmaline is common locally.

Textures in much of this unit are similar to those in the fine-grained porphyritic phase; the unit is distinguished from it on the basis of the very low mafic content. Although some sugary alaskitic textures do exist in the area, most of this unit has aplitic (fine-grained pegmatitic) or leucocratic porphyritic

textures. Grain size of the aplite and porphyry matrix averages about 1 mm. However, some pegmatite with much coarser quartz and feldspar grains is also included in this unit. Fine-grained to very fine grained rosettes of quartz and graphic intergrowths of quartz and feldspar are common.

The aplite and porphyry units form tabular bodies and dikes throughout the map area. East of the study area, on the east side of the area of plate 1, aplite dikes are common. These have strongly preferred northeast trends, although other orientations are also evident. These aplite dikes formed in steep joints. Aplite is also present as segregations that form knots at different scales: many knots are characteristically small but some are so extensive and intergrown that they were mapped as separate bodies. Many of the tabular aplite bodies throughout the map area are part of the fine-grained, chilled facies that formed near the top of the magma chamber rather than the usual late-stage segregations typical of aplite.

Chemical Composition

As part of this study, Desborough, Briggs, and Mazza (1998) collected 11 samples of unaltered Butte pluton bedrock in the Basin and Cataract Creek basins. The major-element compositions of their samples appear to overlap with those of the Butte pluton samples of Ruppel (1963, p. 26), as well as all but the four most silica rich rocks of Becraft and others (1963, table 2, p. 10), as shown in figures 6 and 8. Harker variation diagrams showing the rock chemistry of Butte pluton samples from all three studies (fig. 6) reveal a fairly consistent trend for a few elements. The concentrations of magnesium, calcium, phosphorus, and titanium show an inverse relationship with silica; that is, as silica content increased in the melt, magnesium, calcium, phosphorus, and titanium decreased. Harker variation diagrams by Tilling (1974, fig. 3, p. 3883), which display more than 250 chemical analyses of Boulder batholith rocks and its satellite plutons, show this same inverse relationship between silica and magnesium, calcium, phosphorus, and titanium.

In major-element composition, no distinct difference is evident between rocks of the fine-grained porphyritic unit and rocks of the medium- to coarse-grained unit (figs. 6 and 8). This similarity provides further evidence that these two units had a common magma source and probably do not represent separate intrusive events. Because of the similar compositions, the two units should have nearly the same acid-neutralizing potential in the study area. (See section, “Acid-Neutralizing Potential of Bedrock.”)

The multi-element chemistry of the 11 Butte pluton bedrock samples collected by Desborough, Briggs, and Mazza (1998, table 1, p. 6–7) was examined with correlation statistics. Although this data set is not large enough to warrant confident statistical conclusions, a few interesting relationships were found. Calcium correlated very strongly with iron and scandium (correlation coefficient (R) of >0.9), strongly with vanadium and titanium (R>0.8), and well with magnesium, phosphorus, and manganese (R>0.7). Iron and titanium

³All microscopic measurements are given in millimeters rather than inches. To convert to inches, multiply by 0.04.

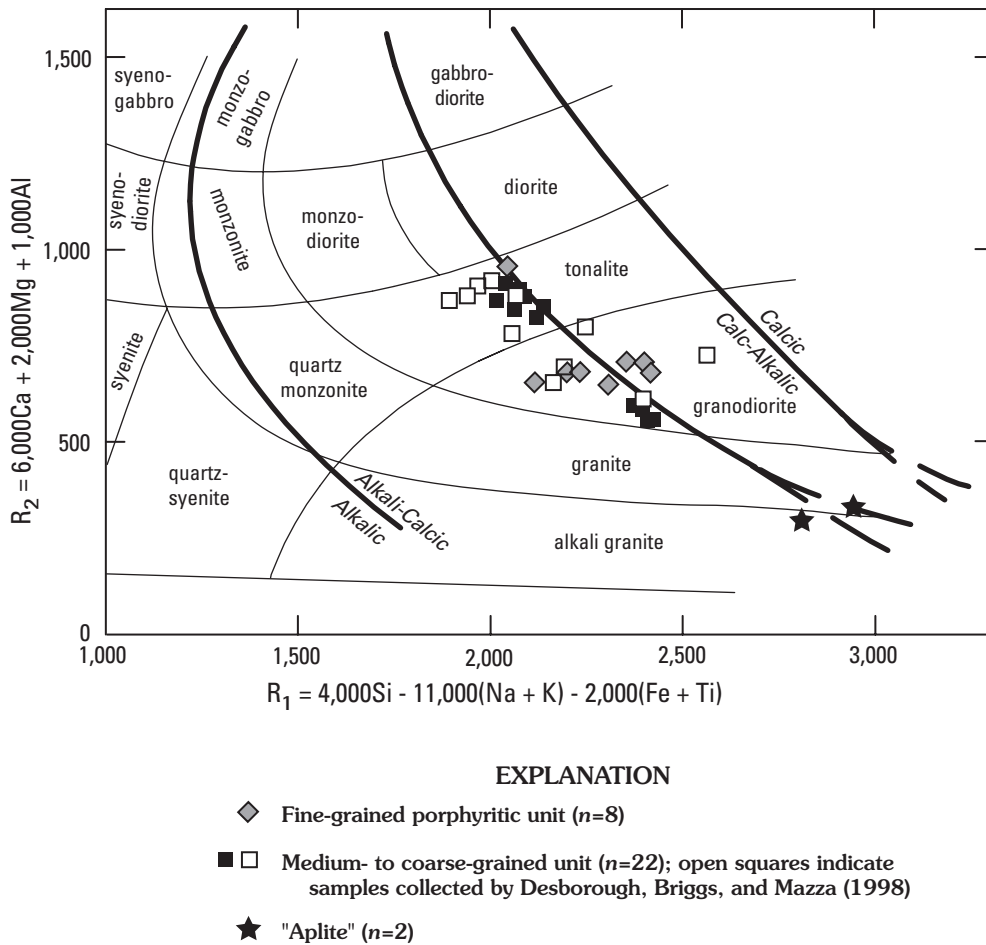

Figure 8. Classification of Butte pluton samples from the study area based on the R_1R_2 -diagram of De La Roche and others (1980). Chemical data from Becraft and others (1963, table 2, p. 10, and table 5, p. 22), Ruppel (1963, table 3, p. 26), and Desborough, Briggs, and Mazza (1998, table 1, p. 6–7).

showed similar correlation matrices. A grouping of Ti-Sc-V-Ca-Fe-Y, and to a lesser extent, manganese, accounted for 30 percent of the variation in the factor analysis. The grouping of Ca-Fe-Ti, associated with magnesium and phosphorus, may be explained by mafic minerals, such as: (1) the amphiboles tremolite [ideal formula $\text{Ca}_2\text{Mg}_5\text{Si}_8\text{O}_{22}(\text{OH})_2$], actinolite [$\text{Ca}_2(\text{Mg}, \text{Fe})_5\text{Si}_8\text{O}_{22}(\text{OH})_2$], and hornblende [$(\text{Ca}, \text{Na})_{2-3}(\text{Mg}, \text{Fe}, \text{Al})_5\text{Si}_6(\text{Si}, \text{Al})_2\text{O}_{22}(\text{OH})_2$]; (2) sphene [$\text{CaTiO}(\text{SiO}_4)$]; (3) biotite [$\text{K}(\text{Mg}, \text{Fe})_3(\text{AlSi}_3\text{O}_{10}(\text{OH})_2)$]; and (4) apatite [$\text{Ca}_5(\text{PO}_4)_3(\text{F}, \text{Cl}, \text{OH})$]. Note again the trends in figure 6, which suggest that as silica content increased in the normal crystallization of this plutonic melt, magnesium, calcium, phosphorus, and titanium concentrations decreased. Thus, silica-rich facies of the Butte pluton should contain relatively fewer mafic minerals, whereas less silica-rich facies should have relatively more mafic minerals.

Project research indicates that the mafic minerals within the Butte pluton contribute significantly to the acid-neutralizing potential of the watershed (Desborough, Briggs, Mazza, and Driscoll, 1998). Butte pluton rocks rich in mafic minerals

are thought to have higher capacity to neutralize acidic waters than plutonic and volcanic facies that are more silicic and have fewer mafic minerals. The relationship between mafic minerals and acid-neutralizing potential is discussed later in this chapter and in McCafferty and others (this volume, Chapter D2).

Ages

Rocks of the Boulder batholith have been dated previously by K-Ar methods (Knopf, 1956; McDowell, 1966; Robinson and others, 1968; Tilling and others, 1968) and preliminary Pb-alpha dating has also been done (Chapman and others, 1955). Previous K-Ar ages for the Boulder batholith are cooling ages that range from 78 to 70 Ma. The Pb-alpha ages obtained by Chapman and others (1955) on the Butte pluton were 71 Ma.

New U-Pb dating using SHRIMP techniques was done in conjunction with this study. The single age, from a sample collected from the central part of the Butte pluton near the trace

of the Butte-Helena fault zone, is 74.5 ± 0.9 Ma. This new age indicates that the span of emplacement for most of the Boulder batholith is from about 82 to 74 Ma (Lund and others, 2002).

Relationship Between Late Cretaceous-Age Volcanic and Plutonic Rocks

Comparison of Geochemical Data

Rock chemistry indicates that most of the magma that formed the Elkhorn Mountains Volcanics was related to the mafic plutons of the Boulder batholith (Tilling, 1974). Significant mafic plutons, of relatively lesser volumetric importance in the Boulder batholith, are the Unionville pluton along the northern margin of the batholith directly north of this study area, the Kokoruda Ranch Complex on the northeast corner of the batholith, and the Burton Park and Rader Creek plutons near the southern margin of the batholith (fig. 2). Thus, rock chemical information suggests that most of the early magma of this volcano-plutonic complex was erupted and relatively little of it crystallized in the crust.

Chemical analyses indicate that only ash flows of the middle member of the Elkhorn Mountains Volcanics were derived from the same magma as the Butte pluton or related silicic intrusive rocks. Chemical compositions of ash flows of the middle member plot in a silicic and potassic extension of the field plotted for the Butte pluton and related silicic plutons (compare figs. 4 and 8). Thus, the middle member of the Elkhorn Mountains Volcanics and the Butte pluton had a common source, and the middle member is probably a differentiate of the magma that formed the Butte pluton and other closely related silicic plutons (Tilling, 1974; Lambe, 1981; Rutland, 1986; Rutland and others, 1989). Further, a volumetrically small part of the volcanic rocks are related to the Butte pluton, which is overwhelmingly the most voluminous part of the Boulder batholith.

Emplacement History

The 78- to 72-Ma volcanic-plutonic episode began with eruption of volcanic ash that was water-worked and became incorporated into Upper Cretaceous volcanogenic sedimentary deposits of the Slim Sam Formation. Early, voluminous volcanism was coeval with injection of the oldest, more mafic magmas into the upper crust along older, deep-seated fault zones. Magma of this generation intruded Paleozoic and Mesozoic prevolcanic country rocks and cooled to form the mafic plutons concentrated along the northern and southern margins of the batholith; most of the magma of this generation erupted to form the lower member of the Elkhorn Mountains Volcanics. During the main stage, more silicic magmas were injected, probably as sheeted dikes, into the progressively forming structural pull-apart in the upper crust, forming the

voluminous Butte pluton. Because the void created by the pull-apart was an ongoing process, apparently less magma was available to be erupted to form the middle member of the Elkhorn Mountains Volcanics. The upper member of the Elkhorn Mountains Volcanics documents the waning stages of volcanism and the return to a sedimentary environment, as much of the material in the upper member is water-worked tuff and coarse volcanogenic sedimentary rocks. The magma that formed the Butte pluton clearly intruded its own cogenetic volcanic cover rocks; that the lower member of the Elkhorn Mountains Volcanics is absent in the study area is consistent with the dynamic opening of a pull-apart and consequent tectonic transport of early, lower member volcanics to the east. Thus, the presence of the contact between the Elkhorn Mountains Volcanics and the Butte pluton in the study area suggests that the exposures of coeval volcanic-plutonic rocks are at or near the structural top of the pluton where it intrudes its volcanic cover.

Internal Geometry of Butte Pluton

Becraft and others (1963) and Ruppel (1963) described, and plate 1 illustrates, a textural pattern of finer grained rocks at the top of the Boulder batholith. The overall pattern is of an original chill zone of fine-grained rock at the roof and more slowly cooled, coarse-grained zones at depth; finer grained rocks near or at the original roof of the pluton are more common in the laccolithic part of the pluton in the west part of the area of plate 1. In some places, the coarser phases are in direct contact with the overlying roof rocks, suggesting an unsolidified, mobile interior of the magma body intruded above the level of its earlier formed chilled border. The large number of aplite dikes in the Butte pluton on the east side of the map area in the main body of the pluton probably represents late water-rich segregations that migrated into joints. Some of the aplite bodies that were mapped as irregular sheets are interpreted to be part of the chilled facies that formed near the roof of the magma chamber. This silicic, water-rich phase either chilled against the roof or was injected into joints as they formed during the contraction related to cooling of the whole pluton. The chilled phases of the roof zone also show evidence of having been stopped (cut loose and rafted in the magma) and of being assimilated by still-mobile magmas, resulting in some irregular outcrop patterns.

Tertiary Volcanic Rocks

Tertiary volcanic and intrusive rocks of the study area were mapped and classified by Becraft and others (1963) and Ruppel (1963) into "quartz latite" and "rhyolite" groups. These workers agreed with Knopf (1913, p. 41) that the "rhyolite" and "quartz latite" seem to represent two distinctly different periods of volcanic activity. Becraft and others (1963) and Ruppel (1963) correlated the "quartz latite" group with a part of the Lowland Creek Volcanics of early Eocene in age, as

defined by Smedes and others (1962) southwest of the study area. "Rhyolite" rocks in the study area have been included in the early Oligocene Helena volcanic field of Chadwick (1978).

Eocene Lowland Creek Volcanics

Smedes (1962) named and described the Lowland Creek Volcanics for a thick sequence of volcanic rocks and associated intrusive dikes and plugs exposed north and west of Butte, Mont. Lowland Creek, the type locality of these rocks, drains into the Boulder River about 7.5 mi upstream from the town of Basin. The original extent of the volcanic field was a northeast-elongate zone of about 125 mi², more or less centered near Lowland Creek. The northeasternmost extent of the volcanic field was just east of the study area at Jefferson City. Radiometric K-Ar age determinations indicate the volcanics are Eocene in age, 50–48 Ma (Smedes and Thomas, 1965). New ⁴⁰Ar/³⁹Ar ages suggest that some of these rocks may be as old as 52 Ma (Ispolatov and others, 1996).

Lowland Creek Volcanics are a complexly intertongued and interlayered volcanic and volcanoclastic sequence nearly 6,100 ft thick. The layered rocks, in general, consist of a basal conglomerate overlain by welded tuff deposits that compose more than half of the volcanic sequence. Lava flows and vitrophyre make up the uppermost part of the sequence.

Lowland Creek Volcanics are present only in the southernmost part of the watershed study area. Tuffaceous rocks underlie Pole Mountain northwest of Basin as well as the nose of a small ridge at the confluence of Cataract and Big Limber Creeks just east of Basin. The remaining Lowland Creek rocks occur as small plugs, phreato-magmatic breccia pipes and diatremes, and abundant northeast-trending dikes best exposed near High Ore Creek. These volcanic rocks rest on partly exhumed Butte pluton rocks as well as on the cogenetic Elkhorn Mountains Volcanics.

Based on normative quartz, potassium feldspar, and plagioclase calculated from chemical analyses, Becraft and others (1963) and Ruppel (1963) classified rocks from this group as quartz latites. Becraft and others (1963, table 7, p. 28) reported the chemical analyses of four samples of intrusive rocks of this group. Ruppel (1963, table 4, p. 49) reported the analyses of two volcanic rocks and one intrusive rock from this group. Use of the R₁R₂-diagram of De La Roche and others (1980) plots three of Becraft's samples in the rhyodacite field and one just into the rhyolite field (fig. 9); Ruppel's analyses of welded tuff and intrusive rock samples plot in the rhyodacite field (fig. 9). Ruppel's lapilli tuff sample plots well to the right of the alkali rhyolite field (fig. 9); the high silica content is probably due to silicification after deposition. In general chemical composition (refer to fig. 10), the rhyodacite welded tuff sample of Ruppel (1963) clusters with the four intrusive rocks of Becraft and others (1963). The rhyodacite intrusive rock of Ruppel (1963) appears to be compositionally intermediate between the rhyodacite of the Lowland Creek Volcanics and rhyolitic rocks of the Helena volcanic field (fig. 10).

Eocene-Oligocene Helena Volcanic Rocks

The Helena volcanic field includes rhyolitic rocks in the northern part of the Boulder batholith, as well as silicic flows west, northwest, and east of Helena at Avon, Mullan Pass, and Lava Mountain, respectively. Rocks from this field have yielded radiometric K-Ar ages between 37.3 and 35.8 Ma (Chadwick, 1978). Rocks in the northern part of the Boulder batholith, near or within the study area, have not been dated.

Rhyolitic rocks of the Helena volcanic field are present along the Continental Divide in the western and northern parts of the watershed study area (pl. 1). The rhyolite consists of volcanic flows and tuffs on the west and forms intrusive centers near the Basin Creek mine in the north. The rock is porphyritic with common sanidine and biotite phenocrysts. The rhyolite was erupted onto an erosion surface of low relief and rests unconformably on plutonic rocks of the Butte pluton, Elkhorn Mountains and Lowland Creek Volcanics, and the Eocene-Oligocene sedimentary rocks of the poorly exposed and unmapped Renova Formation.

On the R₁R₂-diagram of De La Roche and others (1980), the four published analyses for samples of the Eocene-Oligocene rhyolitic rocks of the Helena volcanic field plot in the alkali rhyolite field (fig. 9). These rocks include two samples of flows collected by Ruppel (1963), a sample of silicified rock collected from the southeast flank of Red Mountain directly north of the study area by Becraft and others (1963), and a sample of rhyolite from the top of Red Mountain reported by Clarke (1910, p. 80). In addition to higher silica content than the Eocene Lowland Creek Volcanics, the Eocene-Oligocene alkali rhyolites of the Helena volcanic field have generally lower amounts of aluminum, calcium, magnesium, and titanium, and higher sodium and potassium (fig. 10). A silica-rich sample of the Lowland Creek Volcanics, Ruppel's (1963) lapilli tuff sample (likely silicified), is chemically similar to the Helena volcanic rocks (fig. 10).

Miocene-Pliocene Volcanic Rocks

Although no volcanic rocks younger than the Helena volcanic rocks have been recognized from the central parts of the Boulder batholith, Ruppel (1963) described basalt in the northwestern part of the area of plate 1, and he included these rocks with the Elkhorn Mountains Volcanics. Basaltic flows and flow breccias rest unconformably on the Elkhorn Mountains Volcanics; basaltic intrusive rocks commonly intrude them as well. Ruppel (1963) commented that the basaltic rocks west of the Basin quadrangle are folded and faulted in a style similar to that of the Elkhorn Mountains Volcanics in the Basin quadrangle. Based largely on the structural similarity, Ruppel (1963) provisionally included the extrusive basalts with the Elkhorn Mountains Volcanics.

Basalts are known from the Avon area, directly northwest of the area of plate 1. Trombetta (1987), in his study of Helena rhyolitic rocks exposed near Avon, recognized that the basaltic rocks in this area are the youngest of the extrusive rocks and

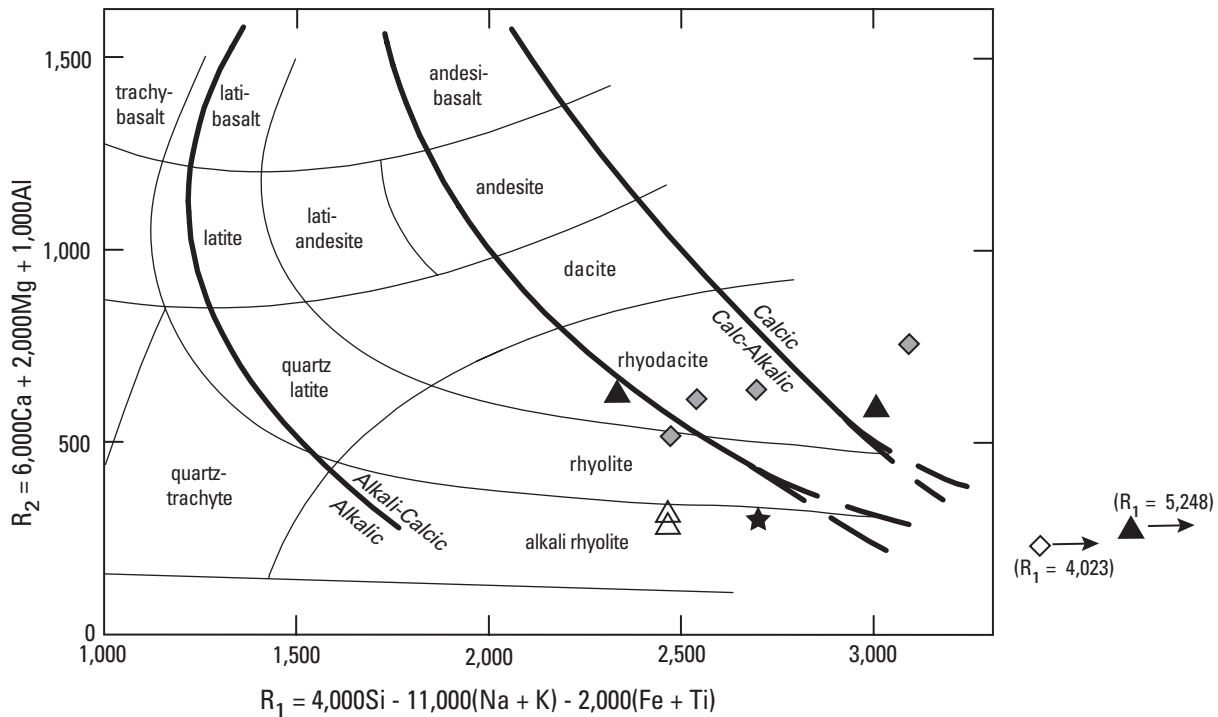

EXPLANATION

- ◆ Intrusive rocks related to Lowland Creek Volcanics, called "quartz latite" ($n=4$) and collected by Becraft and others (1963, table 7, p. 28)
- ▲ Lowland Creek Volcanics: lapilli tuff ($n=1$), welded tuff ($n=1$), and intrusive rock ($n=1$) called the "quartz latite group" and collected by Ruppel (1963, table 4, p. 49)
- △ Helena volcanics flow rocks called the "rhyolite group" ($n=2$) and collected by Ruppel (1963, table 4, p. 49)
- ◇ Altered rhyolite from the Helena volcanics from southeast slope of Red Mountain collected by Becraft and others (1963, table 8, p. 30)
- ★ Rhyolite from the Helena volcanics from top of Red Mountain, as reported by Clarke (1910, p. 80)

Figure 9. Classification of samples of Eocene Lowland Creek Volcanics and of Eocene-Oligocene volcanic rocks from the Helena volcanic field in the study area based on the R_1R_2 -diagram of De La Roche and others (1980).

are not genetically related to underlying rhyolitic rocks. We have no definitive data regarding the age of the basalt flows, flow breccias, and intrusive basaltic rocks in the map area; however, on the basis of crosscutting relations observed directly northwest of the study area (Trombetta, 1987), at least some basaltic rocks are likely late Tertiary in age. No basaltic rocks are present in the study area.

Sedimentary Rocks

Lower Tertiary Sedimentary Rocks

Sedimentary rocks of early Tertiary age were not recognized in the study area by previous workers. Today, due largely

to numerous new roads constructed to accommodate development of the Basin Creek mine in the northern part of the study area and extensive logging operations in the western part, new exposures of bedrock in roadcuts have allowed recognition of previously concealed sedimentary rocks. The newly recognized rocks consist of poorly cemented and layered, light-gray to tan sediment composed of sand and silt derived mainly from erosion of batholithic rocks. The newly discovered sedimentary deposits are preserved only where they are overlain by more resistant Eocene to lower Oligocene rhyolitic rocks of the Helena volcanic field in the western and northern parts of the study area.

The new exposures are extremely limited and of poor quality, and are not shown on plate 1. Along the Elk Gulch tributary of Joe Bowers Creek in the northwestern part of the study area, the upper 3–4 ft of the sedimentary unit has been exposed. The sediments are weakly layered and locally

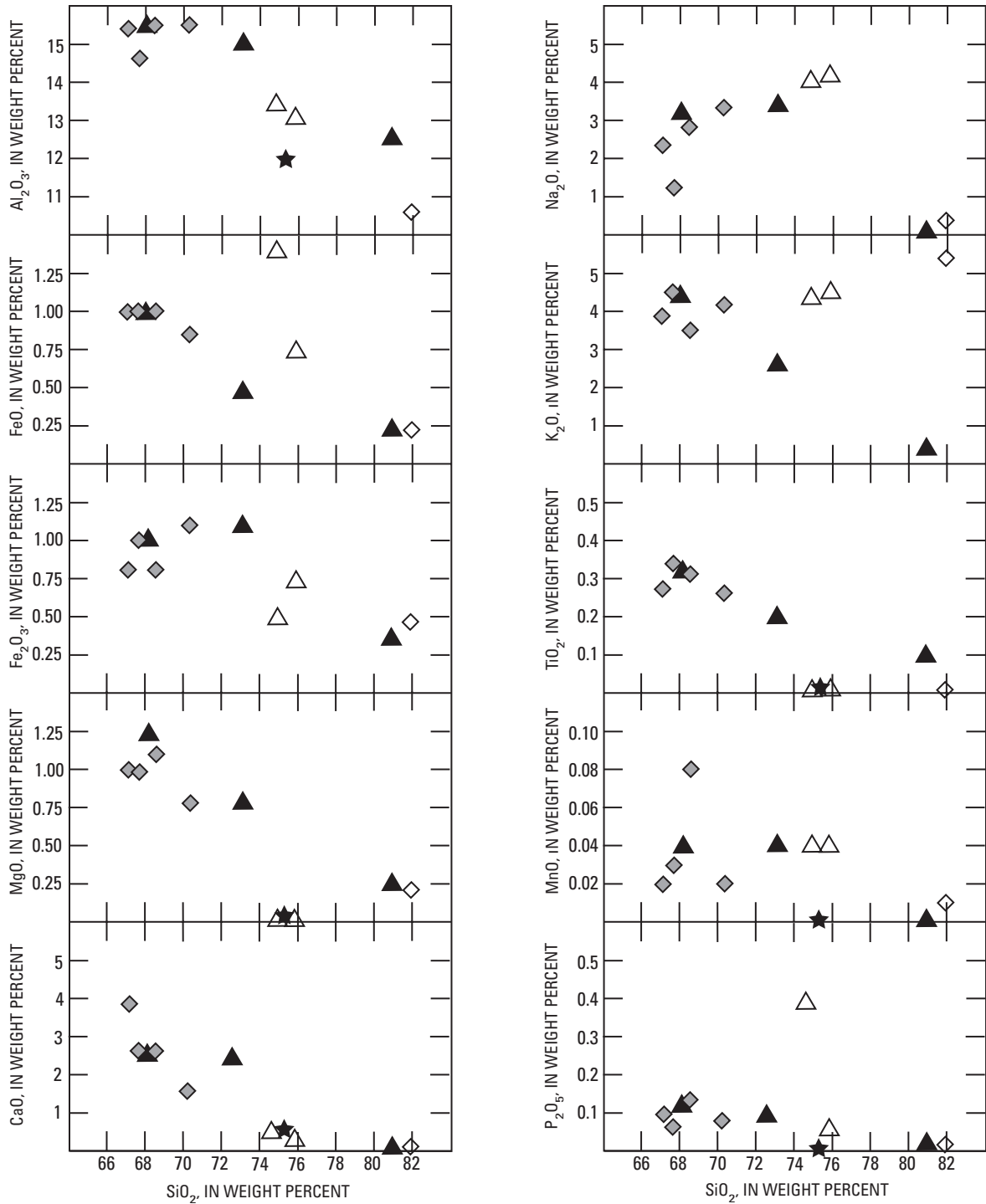

EXPLANATION

- ◆ Intrusive rocks related to Lowland Creek Volcanics, called "quartz latite" (n=4) and collected by Becraft and others (1963, table 7, p. 28)
- ▲ Lowland Creek Volcanics: lapilli tuff (n=1), welded tuff (n=1), and intrusive rock (n=1) called the "quartz latite group" and collected by Ruppel (1963, table 4, p. 49)
- △ Helena volcanics flow rocks called the "rhyolite group" (n=2) and collected by Ruppel (1963, table 4, p. 49)
- ◇ Altered rhyolite from the Helena volcanics from southeast slope of Red Mountain collected by Becraft and others (1963, table 8, p. 30)
- ★ Rhyolite from the Helena volcanics from top of Red Mountain, as reported by Clarke (1910, p. 80)

Figure 10. Harker variation diagrams showing abundances of major oxides versus SiO₂ for 11 samples of Eocene Lowland Creek Volcanics and of Eocene-Oligocene volcanic rocks from the Helena volcanic field in the study area.

contain cut and fill sedimentary structures. Here, the overlying rhyolite has baked the underlying sedimentary rocks, resulting in a 6-in. thick, bright-red zone of oxidation at the contact. An exploratory hole dug at the base of the exposure revealed 2 ft of loosely consolidated arkosic sand; the base of the sand was not reached.

The maximum thickness of the sedimentary rocks is not known; thickness is variable, as the unit is not everywhere present, and probably does not exceed 50 ft. Maximum road-cut thicknesses of about 15 ft are present west of the study area in the Red Rock Creek drainage basin, west of Thunderbolt Mountain and outside the area shown on plate 1. The distribution of the sediment appears to have been controlled by early Tertiary topography in this area. The sedimentary deposits appear to have filled in lower areas, while higher areas remained uncovered.

Although these sedimentary rocks were not previously mapped in the study area below the Helena volcanic rocks, somewhat anomalous geologic conditions present at this geologic horizon can be interpreted to reflect the presence of these deposits. Abundant colluvial deposits, landslides, and unusually moist and wet soil conditions associated with bogs and springs are present in many places along the lower contact of the Helena volcanic rocks. We suggest that the localized mass-wasting deposits and unusual hydrologic conditions reflect the presence of concealed, poorly consolidated, porous, and easily weathered sedimentary units at this contact.

Lower Tertiary sedimentary rocks are common in southwestern Montana but are mostly found only in present-day basins. These basin-fill sediments are part of the Bozeman Group of Robinson (1963) and have been divided into the older Eocene-Oligocene Renova Formation and the younger Miocene-Pliocene Six Mile Creek Formation. The older Renova filled sedimentary basins of unknown extent that formed in the Eocene. The Renova basins were later segmented by late Tertiary-Quaternary basin-range faulting. The Renova is known primarily from sparse outcrops along the margins of these young basins. In only one other uplifted mountain range in this region are lower Tertiary basin-fill sediments known to be preserved—the Gravelly Range south of the study area (O'Neill and Christiansen, 2002; Luikart, 1997). In the Gravelly Range, loosely consolidated sandstone and siltstone containing Eocene-Oligocene vertebrate fossils are preserved beneath resistant volcanic rock.

Quaternary Deposits

The most extensive surficial deposits in the study area are glacial accumulations of Pleistocene age. These deposits comprise mainly morainal debris and outwash. On the east the glacial drift is largely confined to the headwaters area and valley bottom of Cataract Creek. On the west, in the Basin Creek watershed, glacial till is extensive, covering gentle,

east-facing slopes from Pole Mountain to the Continental Divide as well as the broad valley bottoms of Basin and Jack Creeks and their smaller tributaries. Ruppel (1963) and Becraft and others (1963), in their discussion of glaciation, concluded that the glacial deposits represent the older of two major late Pleistocene periods of glaciation in southwest Montana. The older glacial period, now commonly referred to as Bull Lake episode, ended about 120,000 years ago. Bull Lake glaciation was more extensive and reached lower elevations than the younger Pinedale episode, which was restricted to only the highest alpine areas of the region, some 18,000 to 10,000 years ago. The assignment of the glacial deposits to the older, Bull Lake period of glaciation in the study area was based largely on the 6 to 10 ft depth of weathering of the till, the lack of conspicuous, preserved glacial morphology, and the relatively low elevation of the deposits.

The till is composed mainly of locally derived plutonic and volcanic rocks. Because much of the till is deeply weathered, smaller clasts in the original till are poorly preserved and most have disintegrated into unsorted sand- and granule-size grains that now form the interstitial matrix for larger, less weathered boulders.

Glacial outwash is exposed only in the Basin Creek drainage of the study area, at the confluence of Basin and Jack Creeks, and along Basin Creek about 2 mi southeast of the confluence. The deposits consist of pebbles and cobbles inter-layered with fine- to coarse-grained sand lenses. Additional deposits of relatively coarse grained outwash are concealed beneath younger, finer grained stream and bog deposits along the upper reaches of Basin Creek as well. During the course of this study, stream and flood-plain deposits along Basin Creek at Buckeye Meadow were sampled in 10 relatively closely spaced monitoring wells in the vicinity of the Buckeye mine. In this area, coarse braided stream deposits interpreted to represent, in part, glacial outwash are overlain by as much as 10 ft of thin stream sand and gravel lenses interlayered with organic-rich sand, silt, and clay deposited in levees, bogs, and backswamps (pl. 2). One well (site 4a, pl. 2) drilled in these organic-rich sediments intersected the 6,845 year old Mazama ash at 3.6 ft depth.

Less widespread surficial deposits are also present throughout the study area. These deposits include stream alluvium, localized alluvial fan deposits, colluvium, talus deposits, and localized landslides. Solifluction or down-slope creep of many of the finer grained surficial deposits appears to be occurring at the present time. Relatively gentle slopes, extensive exposures of deeply weathered, porous glacial till locally superimposed on weakly consolidated lower Tertiary sedimentary rocks, and relatively thick winter snow pack combine to produce a large area of water-logged, unstable surface conditions that engender down-slope creep of unconsolidated sediment during periods of snow melt and high runoff.

Structural Geology and Tectonics

Introduction

Fracture systems in igneous rocks are a prominent phenomenon recognized and described worldwide. Perhaps the most commonly recognized fractures are primary nondiastrophic cooling and contraction columnar joints characteristic of volcanic flows and intrusive rocks emplaced at shallow depths. Fractures can also reflect diastrophic processes that record structural and tectonic events. The Butte pluton of the Boulder batholith, well known for its locally spectacular fracture systems (fig. 11), appears to contain both nondiastrophic and diastrophic features. Prominent nondiastrophic fracture systems are well exposed because the level of erosion of the pluton is minimal, and only the outer skin of the magma body (1,500 ft or less), where cooling fractures are best developed, is exposed. The Cretaceous Boulder batholith was also intruded during Laramide time into one of the more complexly deformed tectonic regions of the American Cordillera. The Butte pluton can be considered unusual because it appears to contain both primary and secondary diastrophic structures. Primary diastrophic fractures are herein interpreted to represent

structures related to the mechanism of intrusion of the pluton; colinear secondary fractures are postemplacement structures formed throughout the Tertiary and Quaternary in response to reactivation of deep-seated, earlier formed structures. The origin and orientation of the fracture systems in the pluton, including the nondiastrophic cooling features, appear to be intimately tied to the mechanism of emplacement of the igneous body.

The origin of the fracture systems presented here follows years of discussion regarding the origin of vein systems in the Butte pluton. The most recent discussion of their origin was by Woodward (1986), who correctly observed that polymetallic quartz veins developed in an east-west compressional stress field within the Sevier orogenic belt. Woodward (1986) postulated that the northeast and northwest vein systems represented conjugate shears in such a stress field, whereas east-trending fractures, which host the quartz-vein deposits in the study area as well as at Butte, were extensional fractures oriented parallel to the maximum principal stress trajectories. Although this proposal would apply to a static, cooling body intruded into an ongoing contractional environment, we do not believe it to be compatible with the mechanism of emplacement of the batholith described previously, in the section, "Mode of Emplacement."



Figure 11. Prominent fracture systems in Butte pluton. View to north from Interstate 90 about 2 mi east of Homestake Pass south of the area of plate 1.

Nondiastrophic Fracture Systems

Nine major fracture systems are recognized in the Boulder batholith. The primary age of six of these systems is established by the observation that aplite (including pegmatite and alaskite) dikes and quartz veins follow them. Three of the six primary fracture systems, best exposed in the Basin quadrangle, were interpreted by Ruppel (1963), following the terminology of Balk (1948), as nondiastrophic cooling joints: they are cross joints, longitudinal joints, and primary flat-lying joints (fig. 12). In the Boulder batholith, cross joints are steep to nearly vertical east-trending fractures spaced from about 5 to 10 ft. Longitudinal joints trend north and generally dip steeply west; spacing on these fractures is from 1 to 5 ft. These two nearly vertical joint sets have been intruded in various localities by thin dikes of aplite. Primary flat-lying joints, which mainly dip gently south, have locally been intruded by thick sheets of aplite. In coarser grained facies of the batholith, joint spacing of north-trending fractures increases to 15 ft, and east-trending fractures are spaced at intervals as much as 40 ft. Individual joints are rarely longer than about 30 ft; however, where one joint dies out, it is commonly overlapped by a parallel joint that either is entirely separate and less than 1 in. to several inches away, or is connected by a transverse joint or joint set.

Joint sets of identical orientation and character were described by Smedes (1966) from the northern Elkhorn Mountains directly east of the study area (fig. 13). In that area, the north-trending set is the better developed of the two nearly vertical sets.

The three primary, nondiastrophic fracture sets just described appear to be genetically related to the emplacement and cooling history of the batholith. Theoretical,

two-dimensional calculations of the stress field in static, cooling magma bodies in the crust have been presented by Knapp and Norton (1987). Theoretical calculations of such a magma body reveal a radial and concentric stress field in which the maximum principal stress is in the radial position (fig. 14). In such a case, tension fractures related to the cooling, crystallization, and contraction of a magma body will be vertical at the top and rotate to horizontal along the sides of the crystallized, brittle pluton. Nearer to the molten center of the magma, maximum principal thermal stress trajectories are deflected to horizontal and become concentric around the cooling center. Fractures formed directly above the cooling center are flat lying or horizontal.

The east half of the Butte pluton has been interpreted to have been emplaced within an ever-widening, east-directed pull-apart in the Helena embayment that was bounded by steep fault abutments on the north, south, east, and west (figs. 2, 3). Along the roof of the crystallized, yet still cooling pluton, the stress field described by Knapp and Norton (1987) likely applies (fig. 14); that is, the maximum principal stress trajectories are vertical and the least principal stress is horizontal. However, because the inferred pull-apart emplacement mechanism is not static but an ongoing process, maximum stress is unlikely to be radial around the body; the likelihood is that it remains vertical along the sides of this particular, eastward-expanding pluton. Thus, the least principal stress must be horizontal and oriented east-west. In this kinematic scenario the intermediate stress must also be horizontal and directed normal to the confining walls on the north and south. With this configuration of stress trajectories, well-developed north-trending fractures should be a prominent joint set in the pluton. In the likelihood that growth of a pull-apart follows the conventional wisdom of strike-slip fault displacement, the

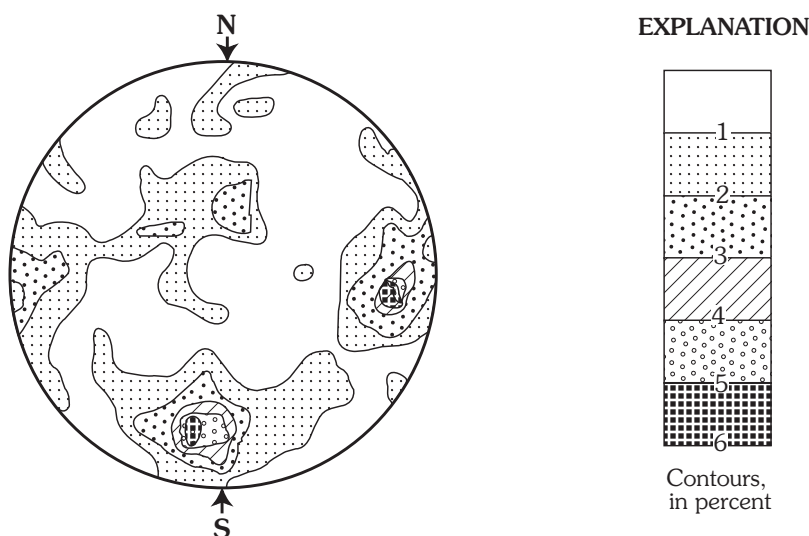

Figure 12. Contour diagram of 493 joints in Butte pluton rocks from west half of the area of plate 1, equal area projection on lower hemisphere (from Ruppel, 1963, pl. 5).

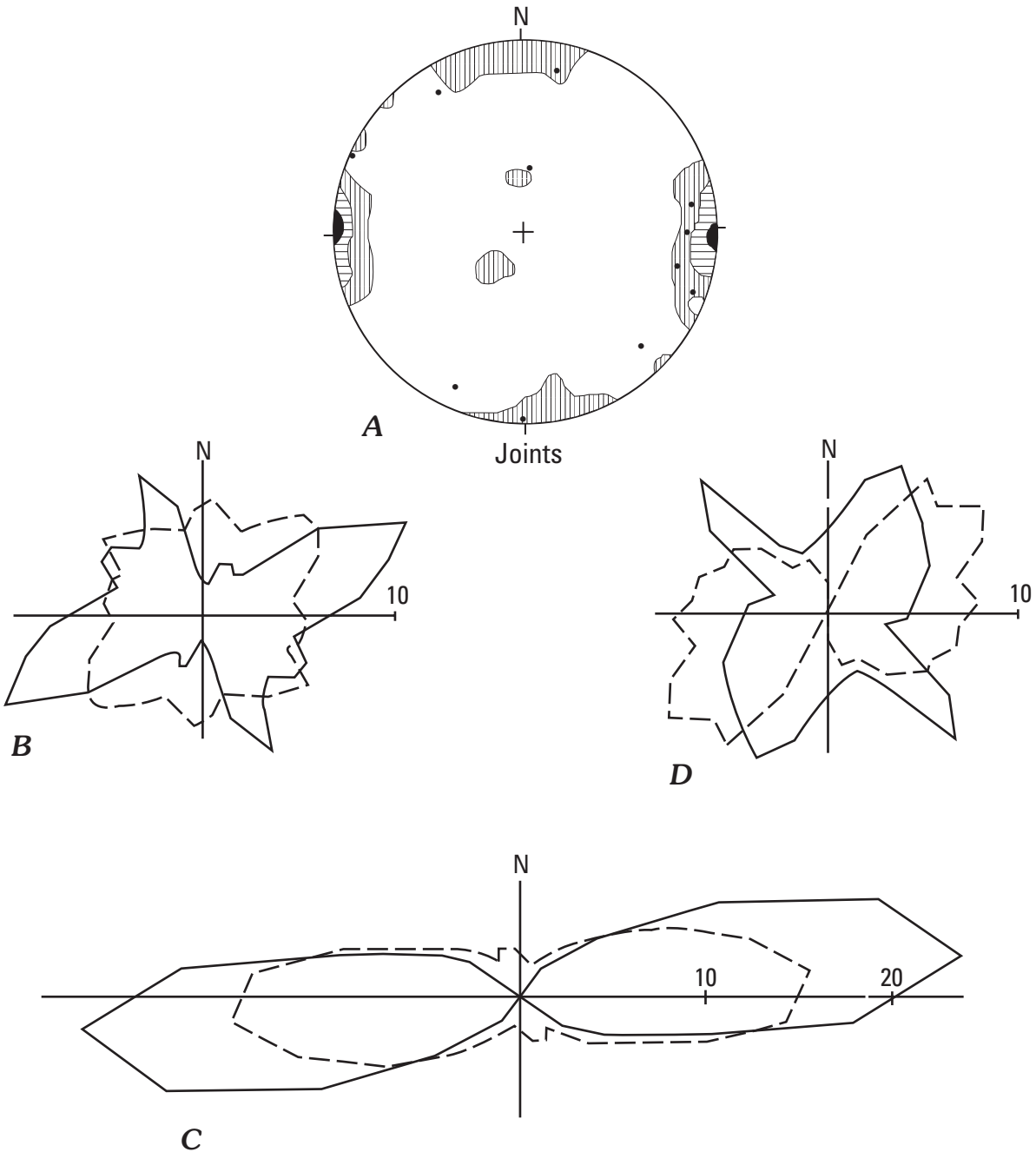

Figure 13. Summary diagrams of *A*, joints; *B*, alaskite, aplite, and pegmatite dikes; *C*, veins; and *D*, faults and lineaments in the northern Elkhorn Mountains east of the area of plate 1 (from Smedes, 1966, fig. 30). *A*, Contour diagram of poles of 283 joints in Butte pluton and point diagram of poles of 11 joints in the Kokoruda Ranch complex. Contours 2-6-10 (11) percent. Equal area projection of lower hemisphere. *B*, *C*, *D*, Each rosette is a statistical summary showing relative abundance (percent) of trends of all high-angle planar structures of a given type and is weighted according to length. *B*, Solid line, dikes in the Butte pluton ($n=685$); dashed line, dikes in the Kokoruda Ranch complex ($n=42$). *C*, Solid line, metalliferous quartz veins ($n=192$); dashed line, chalcedony veins ($n=698$). *D*, Solid line, faults ($n=996$); dashed line, lineaments ($n=1,357$).

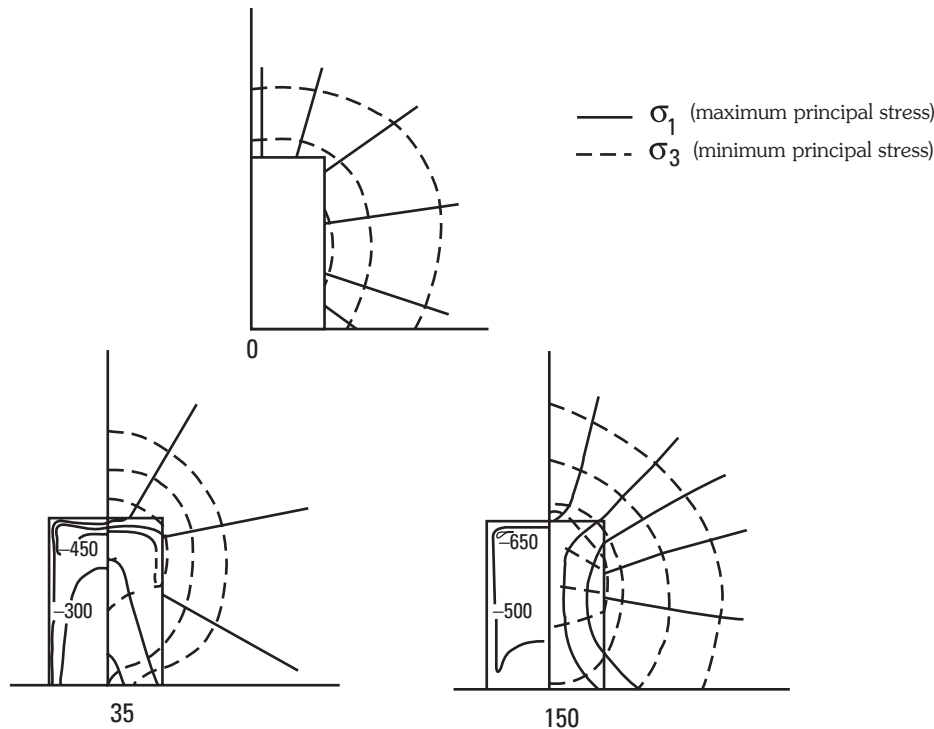

Figure 14. Principal stress trajectories and net change in temperature ($^{\circ}\text{C}$) in the model system at 0, 35,000, and 150,000 years after pluton emplacement (from Knapp and Norton, 1987, fig. 6). Rectangular box represents hypothetical pluton measuring 3 km wide, 4.5 km high, and infinite in the third dimension. Trajectories are radial and tangential around the cooling center located at the top of the pluton at 35,000 years after emplacement.

horizontal intermediate and least principal stresses seem likely to switch positions periodically during magma emplacement. North-south least principal stress orientation should lead to the development of east-trending fractures as well.

Directly above the partly molten cooling center of the pluton, the maximum and least principal stress trajectories are deflected and switch orientations: the maximum principal stress trajectories become horizontal and the least principal stress is vertical (fig. 14). In this stress configuration, prominent horizontal or flat-lying fractures should develop. Because the cooling and crystallization of an igneous body proceeds from the outer rind toward the center, the horizontal fractures are probably the first joint system to form. The common horizontal fractures and joints, often filled with aplite, probably formed earliest, in the elastic, upper parts of the pluton directly above the cooling center where the maximum principal stress was horizontal. Vertical joints, sparsely filled with aplite, formed later in solidified regions farther away from the cooling center of the magma; these joints formed in response to horizontal tensile stresses related to the position of the least principal stress and a nonradial vertical maximum principal stress. As such, the joints formed should be of three orientations: one early-formed horizontal set and two vertical sets trending north and east. As observed by Smedes (1966), the north-trending fractures, which reflect the east-directed pull-apart mechanism, are the prominent tensile fracture in the batholith.

Given the theoretical parameters presented by Knapp and Norton (1987) and the mechanism of emplacement interpreted by Schmidt and others (1990), the orientation of the three observed primary, nondiastrophic joint sets in the Boulder batholith seems to conform with the thermal stress field postulated to occur during magma cooling within a progressively opening, east-directed pull-apart zone.

Synemplacement Diastrophic Fracture Systems

Of the six primary fracture systems in the study area the three remaining systems are diastrophic and appear to be best developed and their included fractures more numerous on the east in the Jefferson City quadrangle. These three fracture systems are best developed farther east in the northern part of the Elkhorn Mountains (figs. 13 and 15). These fracture systems are intruded by large aplite (alaskite) dikes or thin chalcedony veins, or are shear zones that contain quartz veins and polymetallic mineral deposits. That these fracture systems contain late melt fractions from the Butte pluton indicates that they are primary structural features. (See section on "Age," p. 81.)

Large aplite (alaskite) dikes that extend for many hundreds of feet are the most prominent linear features in the area. The preferred orientation of these dikes in the Jefferson City quadrangle and adjacent Elkhorn Mountains is northeast (fig. 15A). Becraft and others (1963) observed a bimodal

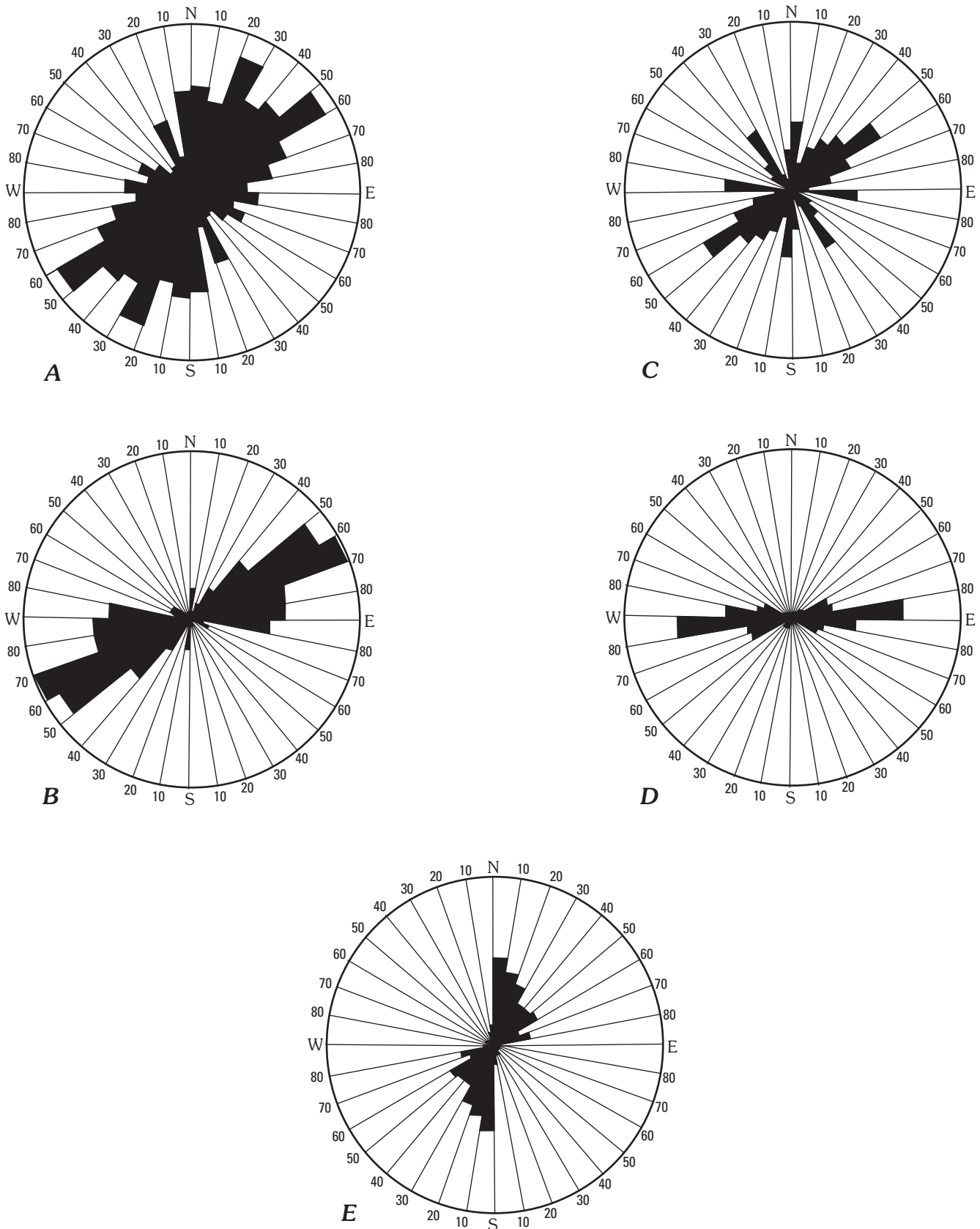

Figure 15. Trends of dikes, veins, shear zones, and nonmineralized faults in the east half of the area of plate 1 (from Becraft and others, 1963, figs. 29, 30, 31, 32, and 33). All data plotted in 10° increments; all data are from Jefferson City quadrangle. *A*, trends of 513 steeply dipping alaskite dikes. *B*, trends of 255 steeply dipping chalcedony vein zones. *C*, trends of 142 nonmineralized faults and topographically expressed lineaments. *D*, trends of 182 shear zones. *E*, trends of 177 Tertiary quartz latite dikes.

northeast trend with two rose diagram maxima at N. 25°E. and N. 55°E. Their rose diagram reveals a small but conspicuous N. 25°W. preferred orientation as well. To the northeast in the Elkhorn Mountains, Smedes (1966) observed and recorded equal numbers of northeast- and northwest-trending aplite (alaskite) dikes (fig. 13). Becraft and others (1963) also examined and described chalcedony veins that are most common in the southern part of the study area. Preferred orientation of chalcedony veins is N. 55°–65°E. (fig. 15B).

The most important fracture system, based on its economic significance, is marked by east-trending shear zones as much as 6 mi long (fig. 15D). The zones are unusual because, although they cut the overlying Elkhorn Mountains Volcanics, offset is not observed along them. Moreover, the shear zones terminate at the east edge of the batholith and do not extend into the adjacent country rock. Also, east-trending faults have not been mapped in the western, laccolithic part of the batholith. Northeast-trending dikes of the middle Eocene Lowland Creek Volcanics cut the shear zone, and they themselves are neither sheared nor altered. The east-trending shear zones have slickensided surfaces that indicate oblique-slip movement; most zones dip steeply north. The major east-trending zones in the study area host the major mineral deposits and sites of the largest mines. The Comet mine on the east in High Ore Creek

and the Morning Glory mine in Cataract Creek are along one of these major east-trending zones; a second major east-trending shear is the locus of the Crystal mine in Uncle Sam Gulch and the Bullion mine along the south fork of Jack Creek (pl. 1). All these mines are point sources for acidic mine and/or metal-rich drainage in the study area (Nimick and Cleasby, this volume, Chapter D5).

These three primary fracture systems parallel the major fault systems that controlled the location and shape of the batholith. Their genesis is interpreted to be related to the emplacement mechanism of the batholith (fig. 16). In our summary of the emplacement history of the batholith, we noted that the structural setting of the batholith is dominated by three sets of deep-seated northeast-, northwest-, and east-trending faults that first formed in Proterozoic time. All three sets were active during emplacement of the batholith and controlled not only its geographic position and its shape, but also early-formed fracture systems in the igneous mass.

Early-formed fractures directly south of the batholith are northwest-trending reverse faults that offset crystalline basement rocks of the Rocky Mountain foreland; these faults accommodated Laramide basement crustal shortening that terminated against the northeast-trending axial suture of the Great Falls tectonic zone beneath the batholith. Displacement

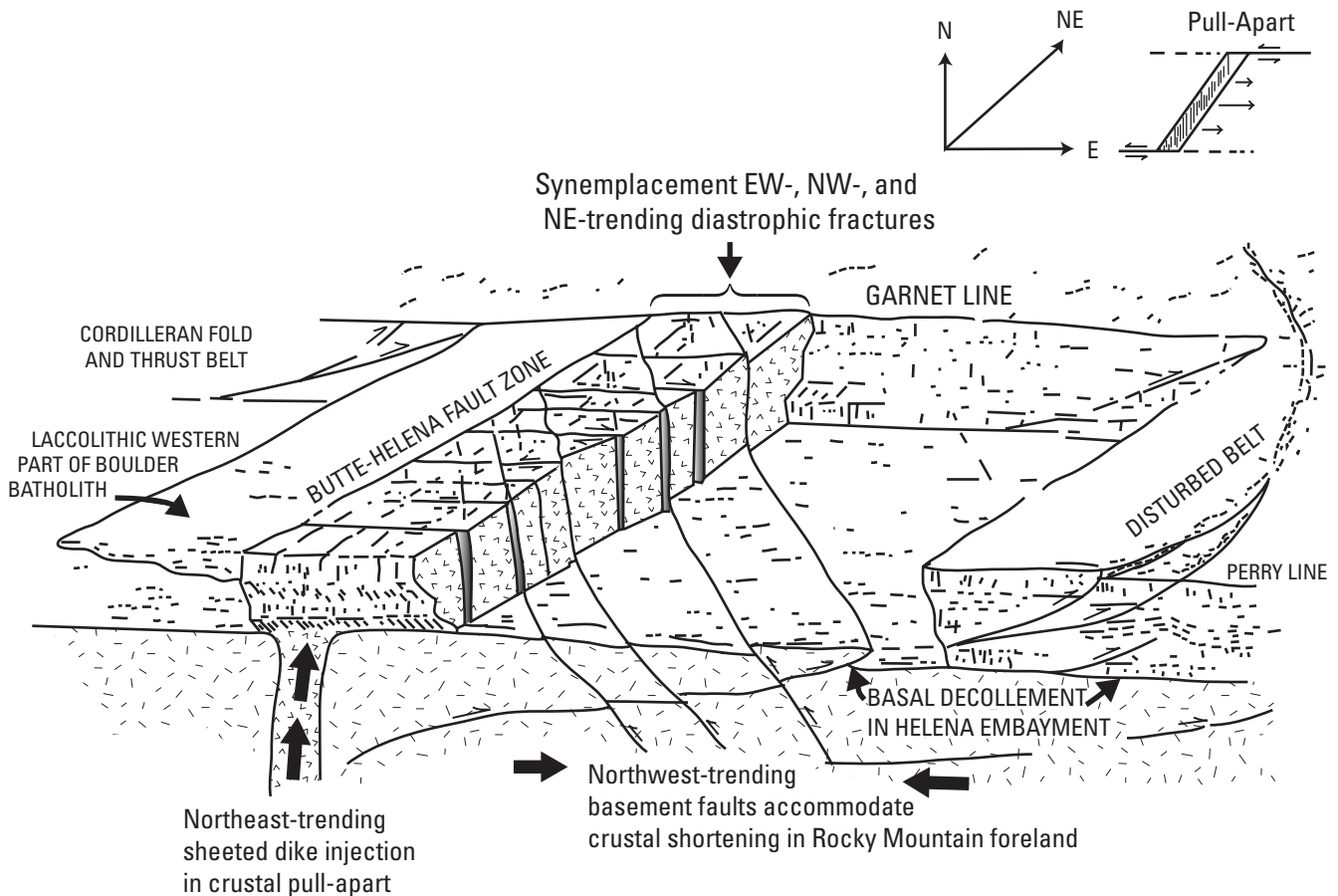

Figure 16. Schematic diagram showing relationship of deep-seated fault zones, which controlled emplacement of the Boulder batholith, to synemplacement diastrophic fractures in the Butte pluton. Butte-Helena fault is directly over central part of Great Falls tectonic zone.

of basement rocks along northwest trends at the floor of the batholith during its emplacement is inferred to have displaced crystallized, brittle batholithic rocks. The cooling, still partly molten core of the batholith would also be affected by fault movement, which would have enhanced leakage of late-stage magmatic melts into newly formed fracture systems. North-east-trending fractures filled with alaskite dikes and chalcidony veins are interpreted to reflect synthetic and antithetic fractures formed subparallel to the Butte-Helena fault zone as the pull-apart expanded eastward.

The east-trending shear zones are subparallel to the bounding faults on the north and south. As the pull-apart widened eastward, it carried with it partly cooled, brittle batholithic rocks. The east-trending shear zones, which host the polymetallic quartz vein deposits and are restricted to the batholith, outline eastward-elongate blocks of Butte pluton rocks carried eastward during tectonism. The east-trending shear zones are interpreted to be accommodation zones within the batholith that allowed coeval, yet slightly disparate, eastward advance of the plutonic rocks during growth of the pull-apart.

Late Diastrophic Structures

Of the nine major fracture systems recognized in the batholith, the last three are secondary systems that owe their origin to reactivation of preexisting structures. Tertiary and Quaternary recurrent movement along preexisting faults and fractures in southwestern Montana has been documented by previous workers (for example, Schmidt and Garrihan, 1983; O'Neill and Lopez, 1985; O'Neill and others, 1986). In middle Eocene time, northeast-trending fracture systems were important in controlling the location of intrusion of numerous dike swarms and igneous plugs and stocks along the Great Falls tectonic zone from east-central Idaho, across southwestern Montana, including the Boulder batholith, and extending into the high plains of north-central Montana. A significant amount of faulting along northwest trends began in the Miocene that marked the initiation of Basin and Range extension in southwestern Montana (Reynolds, 1979). Directly south and southeast of the Boulder batholith, northwest-trending faults that cut the Highland Mountains have been reactivated to form a series of horsts and grabens that trend northwest into the batholith (O'Neill and others, 1986). Faults that controlled the emplacement of the batholith are precisely those that have been reactivated in Cenozoic time. As such, in the study area, primary diastrophic fracture sets that formed in the Cretaceous are colinear with younger, Tertiary and Quaternary nonmineralized fractures and faults, lineaments, and dike swarms within the batholith.

Lineaments

In the Basin and Jefferson City quadrangles, a pronounced rectilinear drainage pattern trends northeast and

northwest. Because the bedrock in these linear drainages is concealed by surficial deposits, the reason for such prominent zones of weakness is not known. Two prominent drainages, the main northwest-trending stem of Basin Creek and north-east-trending Jack Creek, are examples of lineaments in the study area. That the lineaments formed after the emplacement of the Butte pluton is clear because they extend across all phases of the pluton without interruption. Northeast-trending, elongate breccia pipes and northwest-trending shear zones occur along and parallel to the lineaments and are thought to be localized along the structurally weak zones that the lineaments represent.

Dikes

Eocene Lowland Creek dikes in the eastern part of the study area and a younger belt of Oligocene rhyolitic volcanic rocks on the west show a strong northeast trend. The emplacement of these rocks is inferred to have been controlled by structurally weak zones defined by many of the parallel lineaments.

Faults

Quaternary and Tertiary faults are not particularly conspicuous in the study area. The only significant faults are northeast- and northwest-trending structures that parallel topographic lineaments. Two northeast-trending faults are present in the northern part of the study area. The northernmost fault is the larger and parallels the Continental Divide, passing just north of Old Baldy Mountain (pl. 1). This fault cuts all bedrock units and, significantly, displaces glacial deposits, disrupts postglacial drainage patterns, and is marked by prominent scarps as much as 300 ft high. A second fault along the northwest flank of Three Brothers displaces only batholithic rocks; it does not appear to displace swamp and bog deposits along its trace. A large, northeast-trending fault zone is present in the southern part of the study area in Big Limber Gulch and High Ore Creek. This fault zone is marked by pervasive alteration of plutonic and volcanic rocks, giving the rocks an orange-red hue along the trend. The fault drops volcanic rocks of both the Elkhorn Mountains and Lowland Creek Volcanics on the northwest side relative to plutonic rocks on the southeast side. Two northwest-trending shear zones in the vicinity of Pole Mountain are zones of crushed rock bounded by sharp, nearly vertical faults.

Mineral Deposits

The mine wastes of particular interest to this study are related to Late Cretaceous quartz-vein polymetallic sulfide mineralization and alteration systems. Eocene breccia-pipe and Miocene disseminated precious-metal mineralization and associated alteration systems are also present in the study area,

and the resultant metals and areas of altered rock have also contributed to the present-day surficial environment.

Late Cretaceous Mineralized Rock

The Late Cretaceous polymetallic sulfide veins in the study area are in the Basin and Boulder districts. These districts were important primarily for their gold and silver production. Lead and zinc made up the largest volume of the metals recovered, although zinc was not recovered in the early operations because it could not be smelted and had little commercial value. Volumetrically lesser amounts of gold, silver, and copper were recovered, as reported from smelter data, but these were the metals of the most value. All these polymetallic veins have associated pyrite, which generates acid waters in oxidizing, near-surface environments.

Polymetallic deposits in the study area were discovered in the late 1860s, but most of the production probably took place from about 1883 to 1907 (see Church, Nimick, and others, this volume, Chapter B). Sporadic mining activity has been ongoing in the study area in the years following until 1997. Most of the opening up of the veins from the surface rather than by adits has been done since World War II.

Controlling Structures

Narrow brecciated and sheared zones and related joint systems host the polymetallic pyritic quartz-vein mineral deposits that are important to this study. These mineralized shear/breccia zones trend from east-west to about N. 80°E. and are nearly vertical, as discussed in the section, "Structural Geology and Tectonics." The longest zone is the Comet–Gray Eagle zone, which is about 6 mi long; it extends from Cataract Creek to the upper part of the Boulder River valley (pl. 1). Most of these zones are complex features along which different short fault segments anastomose and overlap to form the larger structure.

These mineralized veins are near the top of the Butte pluton. The veins die out upward into the volcanic rocks, perhaps indicating less open fracturing in the volcanic rocks in comparison to the plutonic rocks. Additionally, that the fluids responsible for these mineralized veins were concentrated at the top of the pluton can be inferred from the large number of mines located near or at the top of the plutonic rocks (pl. 1). Mines at the upper contact of the pluton, such as Gray Eagle, Bluebird–Pen Yan, and Boulder Chief mines in or near the southeastern part of the study area, are associated with shear zones; but these deposits are also reportedly somewhat pod-shaped (Becraft and others, 1963). Preferential location of mineralized veins near the roof of the pluton may be a result of the Elkhorn Mountains Volcanics acting as a caprock or impermeable barrier above the pluton.

Many of the polymetallic quartz veins are cut by Eocene dikes related to the Lowland Creek Volcanics. In places, the

dikes follow the trend of the veins, even splitting and complicating the vein exposures. Where parallel to veins, margins of the dikes are sheared in many cases, indicating continued fault movement along some of these shear zones from Late Cretaceous through at least Eocene time.

Polymetallic Quartz Veins

Vein material has intruded fractured and sheared zones; the veins have sharp contacts against the intruded wallrock. Vein systems range from just a few inches across to 50 ft wide. Many of the veins are complexly anastomosing systems of veins and veinlets, even branching off into horsetail structures, rather than being a single simple vein (Becraft and others, 1963). However, in general, they have a tabular geometry. A general appearance of layering is common, reflecting repeated introduction of mineralizing fluids.

Quartz is the dominant mineral in the veins. Most early quartz is milky gray, whereas quartz introduced later in the sequence is commonly white. Few open-space features such as cockscomb structure or crystal terminations are present in the quartz. Absence of these features in deposits of this type is generally considered to indicate mid-level (mesothermal) deposits formed at a depth of 1–2.5 mi (Lindgren, 1933).

Tourmaline, commonly in the form of radiating black needles, is intergrown with quartz and pyrite. Volumetrically, it is the second most important vein mineral; it was a major constituent of the early veins but decreased in prevalence in the later veins.

Pyrite is the most ubiquitous sulfide mineral; fine to medium grains are disseminated in the quartz-vein material and in the nearby wallrocks. Argentiferous galena and sphalerite were the principal ore minerals. Argentiferous galena is also disseminated in veins and wallrock, but the argentiferous sphalerite is confined to the quartz veins. Chalcopyrite is common whereas the abundance of tetrahedrite is highly variable. Arsenopyrite is also disseminated in quartz. Arsenic-rich arsenopyrite was often sorted onto dumps or left in stopes; if present in the ore, it resulted in operators being penalized at the smelters. Stibnite, bornite, cosalite, enargite, chalcocite, ruby silver, boulangerite, bournonite, and albandite also have been reported from these veins (Becraft and others, 1963).

In many deposits, pink-tinged carbonate veinlets, stringers, and networks crosscut the other vein materials and form the youngest phase of the mineralized quartz veins. The carbonate is dominantly dolomite but ranges in composition from calcite to ankerite.

Chalcedony veins and quartz-chalcedony veins are younger than the quartz veins. These are not sulfide bearing but do contain uranium minerals. In places, these veins occupy the same fracture systems as the sulfide-bearing quartz veins, but they are predominantly found on the east side of the area of plate 1, deeper in the Butte pluton, and with strongly dominant northeast trends (Becraft and others, 1963).

Alteration Envelopes

The mineralized veins are accompanied by complex and overlapping alteration zones that range from 2 to 300 ft in width. In the simple veins with well-defined boundaries, alteration zones are distributed symmetrically about the vein. Sericitic, argillic, and chloritic alteration zones are present. Nearest the vein, a narrow (1 to 4 in.) greenish-gray sericite zone developed in the wallrocks. The sericitic alteration zone consists primarily of sericite and quartz. Depending on the amount of quartz in this zone, the contact with the vein itself may be gradational or sharp. Pyrite and lesser argentiferous galena are in places finely disseminated in the sericitic zone (Becraft and others, 1963). Tourmaline is present along with quartz in some localities. Some muscovite is present in addition to sericite; it probably formed as an alteration product of biotite. Original minerals and rock textures are largely destroyed.

The typical argillic zone is dull gray white and clay rich. Original mineral outlines and rock textures are preserved. Plagioclase is altered to montmorillonite with lesser amounts of kaolinite, sericite, quartz, epidote, and calcite. Biotite is altered to montmorillonite and kaolinite with lesser amounts of illite, ilmenite, chlorite, and sericite. Potassium feldspar is only partially altered to kaolinite. The argillic zone as much as 10–15 ft wide and gradational with the sericitic zone over a narrow distance of less than 2 in. (Becraft and others, 1963).

The chloritic zone is typically wider than the sericitic and argillic zones. Original minerals are partially preserved and rock textures remain; the rock is generally nonfriable. Plagioclase is only partly argillized and is altered to sericite along fractures. Biotite and hornblende are altered to chlorite, minor clays, magnetite, ilmenite, epidote, quartz, and calcite. Potassium feldspar is only slightly altered or fresh. The chloritic zone is as much as 4–12 in. wide. It is diffusely gradational with the argillic zone over about 1 ft and is more broadly gradational with fresh rock. The persistent long Comet–Gray Eagle vein system has large alteration envelopes that are in places more than 300 ft wide.

The bulk changes of chemistry resulting from the alteration of country rocks are of particular importance in the study of the capacity of the country rocks to neutralize acid water generated by the exposure of sulfide mineral deposits to weathering and oxidation. Chemical profiles from the data of Becraft and others (1963) for alteration zones at two deposits in the area are shown in figure 17. Whereas the calcium, magnesium, and sodium concentrations are slightly decreased in the chloritic zones, the argillic and sericitic zones show marked decreases in these elements. This change in rock chemistry is due to the loss of mafic minerals during alteration processes. This loss of mafic minerals in the alteration zones affects the ability of the altered rock to neutralize acidic water. (See section, "Acid-Neutralizing Potential of Bedrock.")

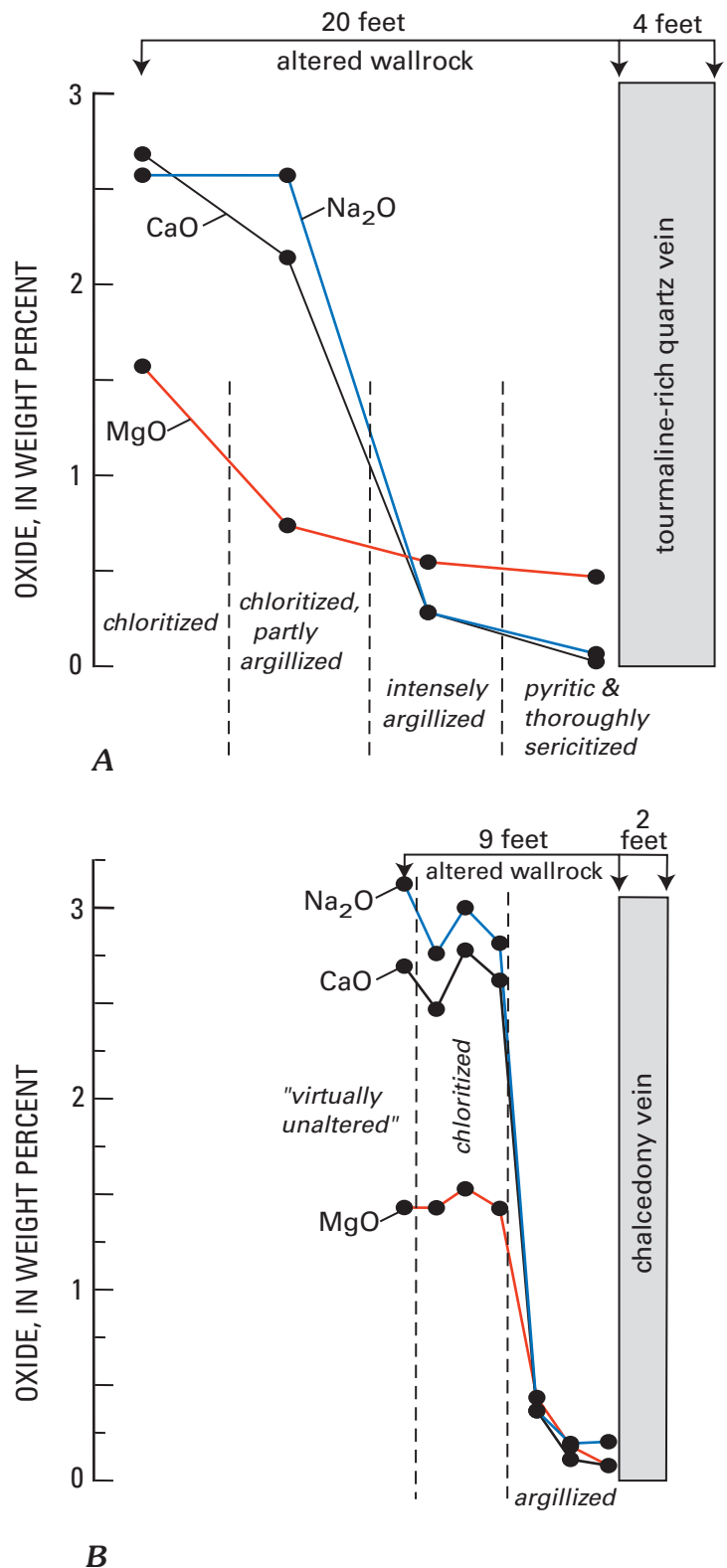

Figure 17. Variation diagram showing relationship of selected metal oxides in Butte pluton wallrocks and in alteration zones from two mines near the study area (data from Becraft and others, 1963, tables 11 and 12, p. 44 and 45). A, Bunker Hill mine; B, G. Washington mine.

Origin of Mineralizing Fluids

Observations at the Bluebird–Pen Yan mine near the eastern border of the study area, the mineralogy of pegmatitic knots and segregations present throughout the study area, the mineralogy of rocks at the roof zone of the pluton, and observations of the silicate mineralogy of the veins all bear on the question of the origin of the mineralizing fluids. At the Bluebird–Pen Yan mine, rosettes of tourmaline intergrown with pyrite are common (Winchell and Winchell, 1912). The character of samples found on the Bluebird–Pen Yan dump is that of a water-saturated, incompatible element-rich, metal-rich fluid that concentrated at the roof of the pluton. Estimates indicate that the deposits extended only about 1,300 ft below the roof of the pluton (Elliott, 1996, p. 36). A simple sulfide-mineral zonation with depth, resulting in relatively fewer precious metals at depth, has been noted (Billingsley and Grimes, 1918). Tourmaline is more prevalent in the deposits that formed at the highest parts of the Butte pluton; it is also common in the pegmatitic/aplitic segregations and knots that also formed in the upper parts of the pluton. Knopf (1913) and Billingsley and Grimes (1918) related the zoning of metals to depth below the roof of the pluton. The presence of tourmaline in all these areas and types of fluid-rich segregations in the Butte pluton suggests that the sulfide mineralizing fluids were similar to late-stage fluids that formed fluid-rich compositional and textural segregations of various sizes in rocks near the roof. This indicates that these mineral deposits are related directly to the Butte pluton and not to a younger igneous event.

Comparison to Other Veins in the Butte Pluton

Polymetallic quartz-vein deposits in the study area (Basin and Boulder mining districts) are similar to those in nearby districts. Vein deposits in mining districts in the drainages north of the study area (Knopf, 1913) are similar to those in the study area in terms of scale and mineralogy and are probably of the same origin. Districts having the most similar characteristics are Rimini to the north and Clancy to the northeast. Some deposits in the Elkhorn Mountains mining district to the east are also similar. Of the districts in the Butte pluton, the quartz-vein deposits in the study area (and at Rimini and Clancy) probably formed closest to the top of the mineralizing system and at the shallowest crustal depths. Deposits farther north, near Helena, had a thicker roof that included Mesozoic sedimentary rocks in addition to Elkhorn Mountains Volcanics. Some of the quartz-vein deposits near Helena are closely related to the emplacement of Eocene porphyritic dikes, and many appear to be more like precious-metal skarn deposits than polymetallic quartz-vein deposits.

Polymetallic precious-metal quartz-vein deposits in and near the study area are clearly simple vein deposits compared to the complex situation in the Butte district to the southwest. Although much excellent work has been done in the Butte district, timing of mineralization and origin of complexly overlapping vein and porphyry deposits have not yet been completely worked out. Current data suggest that products of early vein mineralization at Butte may turn out to have had an origin similar to that of the polymetallic quartz-vein deposits near the study area. The bulk of the mineralized rock at Butte—the porphyry copper and molybdenum deposits—is clearly younger, however; and judging by published age information (Miller, 1973), the deposits are too young to be related to the Boulder batholith. Deposits in the Butte district are distant from roof rocks, indicating a setting in which veins formed deeper within the hosting Butte pluton than veins near the study area to the north.

Tourmaline is an important constituent of the quartz-vein and alteration assemblages in deposits in the districts near Basin (including Rimini and Clancy) and in deposits considered to be the oldest and most closely related to the Butte pluton in the Elkhorn district in the Elkhorn Mountains to the east (Smedes, 1966). These districts containing tourmaline are all proximal to the roof of the Butte pluton. Interestingly, tourmaline is not reported in the vein or porphyry systems at Butte (Sales and Meyer, 1949; Becraft and others, 1963). Geologic information suggests that early vein deposits, now exposed at Butte, may have formed at a greater depth and that porphyry deposits are younger (Meyer and others, 1968; Miller, 1973) than polymetallic quartz-vein deposits in the study area.

Age

No dates are currently available for the polymetallic quartz-vein deposits of the study area. Likewise, no dates are available for the silver-rich vein deposits to the north in the Helena drainages, or for the silver-rich vein deposits that were mined early in the Butte district (prior to discovery of the rich copper-molybdenum porphyry deposits at depth). Relative age relations show that the polymetallic quartz veins are clearly older than chalcedony veins and Lowland Creek Volcanics. The best evidence for the ages of the polymetallic quartz-vein deposits in the study area is that they seem to be related to late-stage crystallization of the Butte pluton and thus probably date from about 74 Ma (Lund and others, 2002). Reported dates for thermal events related to porphyry copper-molybdenum deposits at Butte are between about 65 and 56 Ma (Miller, 1973). Thus, the porphyry systems at Butte are significantly younger than all phases of the Boulder batholith and must be unrelated to the polymetallic quartz-vein deposits that are of interest in this study.

Tertiary Mineralization

Lowland Creek Volcanics Mineralization

Diatreme-related mineral deposits in the study area are in phreato-magmatic units (T1c) associated with Eocene Lowland Creek volcanism. The diatremes crosscut rhyodacite ignimbrite flows of the Lowland Creek Volcanics and Late Cretaceous plutonic and volcanic rocks. Some of the diatremes formed in the same north-northeast fractures as dikes (T1i) that are associated with the Lowland Creek Volcanics, and some are cut by Lowland Creek-related dikes indicating a relation to Eocene volcanism. The diatremes are primarily matrix rich breccia with sand-sized tuffaceous and quartzo-feldspathic matrix and diverse breccia fragments. The angular to sub-rounded breccia fragments include clasts of Lowland Creek Volcanics, Elkhorn Mountains Volcanics, Butte pluton, and carbonized wood (Becraft and others, 1963; Ruppel, 1963; Sillitoe and others, 1985). The composition of fragments and matrix indicate that the diatremes intruded the three rock types. The specimen that contained wood fragments indicates that the diatremes were locally open to the surface as in a maar volcano (Sillitoe and others, 1985). The diatremes are from 300 ft to about 2 mi in length and are known to continue at least 1,000 ft in depth below the present surface (Becraft and others, 1963; Sillitoe and others, 1985).

Mineralized material is in the form of disseminated sulfide minerals in the breccia matrix associated with quartz in vugs and veinlets. In places, most of the matrix itself is sulfide minerals. Multiple episodes of mineralization and brecciation are evident. Sulfide mineralogy is pyrite, sphalerite, galena, minor chalcopyrite, and rare electrum. With the exception of the absence of arsenopyrite, this mineralogy is similar to that of the earlier polymetallic quartz-vein deposits (Sillitoe and others, 1985). Other minerals occurring with the sulfides are quartz, manganocalcite, rhodochrosite, and siderite. Tourmaline is noticeably absent in deposits of this age as compared to the earlier quartz-vein deposits (Sillitoe and others, 1985). Alteration zones include central sericitization with carbonate minerals, minor silicification, and kaolinite formation in plagioclase. A more distal propylitic zone includes chlorite, montmorillonite, and carbonate (Becraft and others, 1963; Ruppel, 1963; Sillitoe and others, 1985). Preliminary $^{40}\text{Ar}/^{39}\text{Ar}$ dating from this study suggests that mineralization took place about 53 Ma (M. Kunk, unpub. data, 2000).

Recent mining of this type of deposit has occurred at the Montana Tunnels mine (Sillitoe and others, 1985) across the drainage divide 2 mi east of the study area. This was an open-pit bulk mining operation that mined lower grade disseminated gold, silver, lead, and zinc. An historical deposit called Montana Tunnels east of the study area and the much smaller Obelisk deposit on the south edge of the study area were both mined by adits for gold and silver in 1900 or before (Becraft and others, 1963).

Helena Volcanic Rocks Mineralization

Oligocene pyroclastic rhyolite tuffs of the Helena volcanic field host disseminated gold deposits at the head of the Basin Creek drainage. The volcanic rocks originated from vents aligned along an east-northeast trend, which are, from west to east, the peak southwest of the Josephine mine, the peak at Carlson mine, Luttrell Peak, and Red Mountain (Smith and others, this volume, Chapter E3). In the volcanic rocks near the vents, the circulation of localized late-stage, ore-bearing hydrothermal fluids was pervasive and resulted in disseminated gold deposits near vents. These deposits are probably about 28 m.y. old, and formed immediately following consolidation of the volcanic rocks (Chadwick, 1978).

The disseminated gold deposits formed in two types of environment. The simplest deposits are in zones of intense alteration in the rhyolite flow layers in this interbedded sequence of flow and pyroclastic layers. The more complex type of deposit is along the contact between the older rocks of the Butte pluton and the young rhyolite where hydrothermal fluids moved along the weathered surface of the older plutonic rocks and up into the base of the volcanic rocks. Some primary mineralized rock is in the weathered rocks of the Butte pluton and in the upper parts of fractures in it (Dan Adams, Pegasus Corporation, oral commun., 1999). Primary gold is in finely disseminated pyrite and possibly locally in arsenopyrite (Ruppel, 1963). Intense low-temperature argillic alteration resulted in destruction of feldspars to form clays, and in silicification in the mineralized zones. Secondary enrichment resulted from oxidation of the primary pyrite during weathering. Gold has been the only metal produced from this type of deposit, making these significantly different from older pluton-related polymetallic quartz-vein deposits in the study area.

The most recent mining of this type of deposit was at the Basin Creek mine, where bulk mining of low-grade mineralized rock was undertaken for gold in three relatively small open pits. This recent mining activity was centered over areas of high-grade gold mineralized rock and in areas of historical mining that explored deposits formed by weathering and secondary enrichment. The historical mines were Venus (Martin, this volume, Chapter D3) and Pauper's Dream and Porphyry Dike (nearby, in Tenmile Creek headwaters).

Pervasive Alteration Systems

Several areas in the study area have undergone pervasive alteration that is unrelated to known mineralized systems as shown previously (Becraft and others, 1963). A large area of hydrothermal alteration, which was not previously shown, is near Big Limber Gulch and Cataract and High Ore Creeks in the southern part of the study area (pl. 1). This alteration resulted in chloritization of biotite and destruction of plagioclase to form clay minerals. The alteration zone seems to be related to north-northeast-trending normal faults and smaller structures that controlled emplacement of late-stage

chalcedony veins as well as Eocene dikes related to the Lowland Creek Volcanics. This zone of pervasive alteration is of a much larger magnitude than the narrow alteration envelopes that formed around the Late Cretaceous polymetallic quartz-vein deposits. Additionally, the setting is quite different from areas of alteration at the top of the Butte pluton directly under the volcanic roof rocks, such as at Jack Mountain and the Occidental Plateau, where alteration is more clearly a direct magmatic process involving water-rich fluids at the top of the magma chamber. These pervasively altered rocks in the southern part of the study area may be related to Eocene Lowland Creek volcanism rather than to the older polymetallic quartz-vein deposits.

Hydrogen and oxygen isotopic study of rocks in the Boulder batholith included rocks of the Butte pluton in the study area (Sheppard and Taylor, 1974; Tilling, 1977). Samples taken by Sheppard and Taylor (1974) near Basin were mostly in the zone of the Eocene Lowland Creek dike swarm and structures that controlled them. Sheppard and Taylor (1974) concluded that most of the alteration in the study area was the result of meteoric water that circulated after solidification of the Butte pluton. They envisioned this process taking place during the Late Cretaceous or early Tertiary. In the absence of dating of the alteration-zone mineralogy, their data and observations would also support an Eocene age for the pervasive alteration event.

The location, size, and chemistry of these pervasive zones of alteration could affect the ability of the country rocks to neutralize acidic water.

Gold Placer Deposits

Placer mining of alluvial and glacial deposits containing gold was the earliest mining in the study area (Church, Nimick, and others, this volume). Some placer mines were also in areas where weathering and oxidation resulted in secondary gold enrichment above lode or disseminated deposits. In these areas gravity separation methods were used to mine as much as 100 ft of the uppermost, strongly weathered rubble. The discovery and mining of placer deposits was an important exploration clue that indicated the presence of gold-bearing lode deposits in the study area.

Tin Placer Deposits

Tin, in the form of cassiterite, is reported in gold-bearing placers along upper reaches of Monitor, Tenmile, and Basin Creeks (pl. 1). The source of the cassiterite is believed to be the Oligocene rhyolite of the Helena volcanic field on the Continental Divide ridge near the Basin Creek mine area (Ruppel, 1963).

Acid-Neutralizing Potential of Bedrock

The acid-neutralizing potential (ANP) of bedrock is an important control on water quality in areas of inactive mines and mill tailings. In areas of polymetallic quartz-vein deposits, such as the Boulder River study area, acidic drainage water is caused chiefly by the oxidation of the common gangue mineral pyrite. Interest in understanding the surficial water-bedrock chemical interactions in the Boulder River study area was prompted by the fact that even though numerous pyrite-bearing mine-waste piles lie in the area (Metesh and others, 1994; Metesh and others, 1995; Desborough and Fey, 1997), only a few, small acidic stream reaches exist (Nimick and Cleasby, this volume, fig. 2). The Boulder River watershed appears to have a natural acid-neutralizing capacity, and that capacity must be controlled by the mineralogy of the bedrock.

Acid-neutralizing potential values reported herein are converted to "calcite equivalent" regardless of whether the acid-neutralizing mineral is calcite or other minerals. Calcite equivalent has become the standard usage for engineering practices and other purposes related to acid-neutralizing potential. For simplicity, consider that 1 g (gram) of calcite will neutralize 10,000 g (10 L (liters)) of acidic water of pH = 3.0. In another context, a cubic foot of rock with 1 weight percent of calcite could neutralize about 8.4 tons (7,660 L) of water of pH = 3.0 if all the calcite were available to react with the acidic water.

Ruppel (1963) studied about 250 thin sections of the Butte pluton and Elkhorn Mountains Volcanics in the west half of the area of plate 1, but he reported no carbonate minerals that might contribute to acid-neutralizing potential. However, large slabs (10×10 cm) of fresh plutonic rocks studied by Desborough, Briggs, and Mazza (1998), using alizarin-red chemical stain, revealed minor amounts of calcite. Calcite concentrations from approximately 0.1 to 1.6 weight percent were determined based on total carbon analyses for 15 bedrock samples. Leaching studies using acidic (pH = 2.90) mine-waste leachate showed that the acid-neutralizing potential of these bedrocks was greater than could be accounted for by the dissolution of these small amounts of calcite. A second quantitative study (Desborough, Briggs, Mazza, and Driscoll, 1998) of three samples of plutonic rocks and their separated mineral fractions, using acidic mine-waste leachate and analysis of total carbon for calculating calcite concentrations, showed that mafic minerals such as biotite, chlorite, and tremolite have significant acid-neutralizing potential. Table 1 summarizes the most significant aspects of mineralogical, chemical, and acidic leaching studies of the three samples of plutonic rocks. These samples had different concentrations of calcite, different concentrations of mafic minerals, and only minor differences in total acid-neutralizing potential. Although sample FMT020

Table 1. Acid-neutralizing potential for three samples of plutonic rocks with different calcite concentration and different concentrations of mafic minerals, and total acid-neutralizing potential.

[Data from Desborough, Briggs, Mazza, and Driscoll (1998)]

Sample No.	FMT020	FMT022	FMT032
Weight percent calcite	1.4	0.4	1.0
ANP of rock due to silicates expressed in wt. percent calcite equivalence	4.7	5.8	7.2
Weight percent mafic minerals	5.2	16.5	16.4
Total calcite equivalent ANP of rock as wt. percent calcite	6.1	6.2	8.2

had only 5.2 weight percent of mafic minerals, it had about 2.6 weight percent of chlorite, whereas the other two samples (FMT022 and FMT032) had no chlorite (table 1) but had higher concentrations of mafic minerals (16.5 and 16.4 percent, respectively). The sample with minor chlorite had significant acid-neutralizing potential because magnesium-rich chlorite (clinoclone) has more acid-neutralizing potential than the other mafic minerals, tremolite and biotite. For this reason, the range in weight percent calcite equivalent acid-neutralizing potential among the three samples studied differed by only 25 percent, whereas the concentration of mafic minerals was tripled in the chlorite-free samples.

The Elkhorn Mountains Volcanics have significant acid-neutralizing potential owing largely to abundant chlorite. Because they lie *above* the polymetallic quartz veins, they could have some impact on acid generated from veins, because water percolating through the volcanics down to mineralized zones would have increased acid-neutralizing capacity.

Rocks that have been altered by hydrothermal solutions, such as those immediately surrounding the small polymetallic quartz veins explored and (or) mined for metallic minerals during the last century, have negligible acid-neutralizing potential because mafic minerals are virtually absent. Although these veins and adjacent altered rock represent less than a few percent of the study area (Ruppel, 1963; Becraft and others, 1963), they are the localities where the mines are situated so their negligible acid-neutralizing potential is significant.

Extensive hydrothermally altered areas that are silicified and highly fractured, such as at Jack Mountain, have insignificant acid-neutralizing potential (Desborough, Briggs, and Mazza, 1998). However, this alteration includes andalusite and pyrophyllite and is thought to be unrelated to the formation of polymetallic quartz-vein deposits.

A study of mineralogy and acid-neutralizing potential of some Butte pluton and Elkhorn Mountains Volcanics was conducted to explore bedrock suitability for mine-waste repositories in the Basin Creek drainage (Desborough and Driscoll, 1998). Four sites were core drilled by the USDA Forest Service in 1998. Two were near the Bullion mine wastes and two were near the Buckeye/Enterprise mine wastes. One site near the Bullion mine-waste piles was drilled into highly silicified and fractured Elkhorn Mountains Volcanics on Jack Ridge east of Jack Mountain; acid-neutralizing potential of samples

was low and equivalent to only 0.4 weight percent calcite. The cored samples in Butte pluton drilled at a site within a few hundred yards of the Bullion waste piles had much larger acid-neutralizing potential, equivalent to 2.0 weight percent calcite. The two sites cored near the Buckeye/Enterprise mine were silicified or silicified+pyrite-bearing altered Elkhorn Mountains Volcanics; their calcite equivalent acid-neutralizing potential was only about 0.5 weight percent and they were intensely fractured—characteristics undesirable for mine-waste repositories.

Cored rocks that had the highest acid-neutralizing potential (for example, near Bullion mine) had abundant magnetite in heavy-mineral concentrates made from these rocks, whereas those with low acid-neutralizing potential contained no magnetite in the heavy-mineral concentrates (Desborough and Driscoll, 1998, table 1). This difference in magnetite concentration is probably due to the destruction of magnetite during hydrothermal alteration. This observation is important because airborne magnetic data for the study area show that the hydrothermally altered areas have a much lower magnetic susceptibility than igneous bedrock unaffected by hydrothermal alteration, and it allows potential discrimination of altered, and thus low ANP, bedrock from airborne geophysical surveys (McCafferty and others, this volume, Chapter D2).

Summary

The description of the geologic framework, the new interpretation of the bedrock geology, and the discussion of the tectonic and structural history of emplacement of the Boulder batholith presented in this report focus on geologic topics that bear greatest relevance to reclamation efforts by Federal land-management agencies entrusted with the remediation of inactive mine sites in the watershed study area. The interpretive geology is portrayed in a consistent, contemporary geologic context designed to tie the geologic conditions to geochemical results for water, sediment, and ultimately to biotic habitat. Discussion of the mineralogic and textural character of the Butte pluton gives insight into the scope of the significant, widespread acid-neutralizing capacity of the bedrock and documents why acidic water is not presently more prevalent within the study area. Additionally,

recognition that the polymetallic quartz-vein deposits are restricted to rocks within 1,000 ft or less of the roof of the Butte pluton suggests that prior to mining, any acid water that may have been generated was quickly neutralized by the subjacent plutonic rocks. Recognition of weakly consolidated Eocene, largely unexposed sediments buried beneath Tertiary volcanic rocks that now underlie the Continental Divide helps explain the hydrology of topographically perched boggy and swampy areas and associated solifluction processes observed within the study area. The mechanism of emplacement of the Boulder batholith is crucial to understanding (1) the nature of the narrow, widely spaced fractures that initially controlled the locus of polymetallic quartz-vein deposits as well as (2) the pervasive, closely spaced cooling fractures that control the current hydrologic character of the plutonic rocks (McDougal and others, this volume, Chapter D9). Closely tied to the understanding of tectonic controls of emplacement of the batholith is the recognition of the propensity for recurrent movement on synemplacement fault or fracture systems and the initiation of younger faults with preferred orientations subparallel to the older structures.

Understanding the bedrock composition and geologic architecture and the characteristics and mode of emplacement of polymetallic quartz-vein deposits is intended to guide the land-management agencies in the selection of suitable repository sites where acid-neutralizing potential is present and where movement of ground water through fractures is minimal. Prior to mine development these polymetallic quartz-vein deposits were likely minor acid-producing sources surrounded by rocks with high acid-neutralizing potential.

References Cited

- Balk, Robert, 1948, Structural behavior of igneous rocks: Ann Arbor, Mich., Edwards Brothers, Inc., 177 p.
- Becraft, G.E., Pinckney, D.M., and Rosenblum, Sam, 1963, Geology and mineral deposits of the Jefferson City quadrangle, Jefferson and Lewis and Clark Counties, Montana: U.S. Geological Survey Professional Paper 428, 101 p., 18 plates.
- Biehler, Shawn, and Bonini, W.E., 1969, A regional gravity study of the Boulder batholith, Montana, *in* Larsen, L., ed., *Igneous and metamorphic geology*: Geological Society of America Memoir 115, p. 401–422.
- Billingsley, Paul, and Grimes, J.A., 1918, Ore deposits of the Boulder batholith of Montana: American Institute of Mining Engineers Transactions, v. 58, p. 284–361.
- Burfeind, W.J., 1967, A gravity investigation of the Tobacco Root Mountains, Jefferson Basin, Boulder batholith, and adjacent areas of southwestern Montana: Bloomington, Ind., Indiana University Ph. D. dissertation, 90 p.
- Chadwick, R.A., 1978, Geochronology of post-Eocene rhyolitic and basaltic volcanism in southwestern Montana: *Isochron/West*, no. 22, p. 25–28.
- Chapman, R.W., Gotfried, D., and Waring, C.L., 1955, Age determinations on some rocks from the Boulder batholith and other batholiths of western Montana: *Geological Society of America Bulletin*, v. 66, p. 607–610.
- Clarke, F.W., 1910, Analyses of rocks and minerals from the laboratory of the United States Geological Survey, 1880 to 1908: U.S. Geological Survey Bulletin 419, p. 80.
- De La Roche, H., Leterrier, J., Grandclaude, P., and Marchal, M., 1980, A classification of volcanic and plutonic rocks using R1R2-diagram and major-element analyses—Its relationships with current nomenclature: *Chemical Geology*, v. 29, p. 183–210.
- Desborough, G.A., Briggs, P.H., and Mazza, Nilah, 1998, Chemical and mineralogical characteristics and acid-neutralizing potential of fresh and altered rocks and soils of the Boulder River headwaters in Basin and Cataract Creeks of northern Jefferson County, Montana: U.S. Geological Survey Open-File Report 98–40, 21 p.
- Desborough, G.A., Briggs, P.H., Mazza, Nilah, and Driscoll, Rhonda, 1998, Acid-neutralizing potential of minerals in intrusive rocks of the Boulder batholith in northern Jefferson County, Montana: U.S. Geological Survey Open-File Report 98–364, 21 p.
- Desborough, G.A., and Driscoll, Rhonda, 1998, Mineralogical characteristics and acid-neutralizing potential of drill core samples from eight sites considered for metal-mine related waste repositories in northern Jefferson, Powell, and Lewis and Clark Counties, Montana: U.S. Geological Survey Open-File Report 98–790, 6 p.
- Desborough, G.A., and Fey, D.L., 1997, Preliminary characterization of acid-generating potential and toxic metal solubility of some abandoned metal-mining related wastes in the Boulder River headwaters, northern Jefferson County, Montana: U.S. Geological Survey Open-File Report 97–478, 21 p.
- Elliott, J.E., 1996, Continental Divide region, *in* Tysdal, R.G., Ludington, Steve, and McCafferty, A.E., Mineral and energy resource assessment of the Helena National Forest, west-central Montana: U.S. Geological Survey Open-File Report 96–683–A, p. F32–F36.
- Hamilton, Warren, and Myers, W.B., 1967, The nature of batholiths: U.S. Geological Survey Professional Paper 554–C, 30 p.
- Harris, S.A., 1957, The tectonics of Montana as related to the Belt series: *Billings Geological Society, 8th Annual Field Conference Guidebook*, p. 22–33.

- Ispolatov, V.O., Dudas, F.O., Snee, L.W., and Harlan, S.S., 1996, Precise dating of the Lowland Creek Volcanics, west-central Montana: Geological Society of America Abstracts with Programs, v. 28, p. 484.
- Johannsen, Albert, 1939, A descriptive petrography of the igneous rocks—Volume I, Introduction, textures, classifications and glossary: Chicago, Ill., University of Chicago Press, 318 p.
- Klepper, M.R., Robinson, G.D., and Smedes, H.W., 1971, On the nature of the Boulder batholith of Montana: Geological Society of America Bulletin, v. 82, p. 1563–1580.
- Klepper, M.R., Weeks, R.A., and Ruppel, E.T., 1957, Geology of the southern Elkhorn Mountains, Jefferson and Broadwater Counties, Montana: U.S. Geological Survey Professional Paper 292, 82 p.
- Knapp, R.B., and Norton, Dennis, 1987, Preliminary numerical analysis of processes related to magma crystallization and stress evolution in cooling pluton environments: American Journal of Science, v. 281, p. 35–68.
- Knopf, Adolph, 1913, Ore deposits of the Helena mining region, Montana: U.S. Geological Survey Bulletin 527, 143 p.
- Knopf, Adolph, 1956, Argon-potassium determination of the age of the Boulder batholith, Montana: American Journal of Science, v. 254, p. 744–745.
- Knopf, Adolph, 1957, The Boulder batholith of Montana: American Journal of Science, v. 255, p. 81–103.
- Knopf, Adolph, 1963, Geology of the northern part of the Boulder batholith and adjacent area, Montana: U.S. Geological Survey Miscellaneous Geologic Investigations I–381, scale 1:48,000.
- Lambe, R.N., 1981, Crystallization and petrogenesis of the southern portion of the Boulder batholith, Montana: Berkeley, Calif., University of California Ph. D. dissertation, 171 p.
- Lindgren, Waldemar, 1886, Relation of the coal of Montana to the older rocks; Appendix B, Eruptive rocks: Tenth Census, v. 15, p. 733–734.
- Lindgren, Waldemar, 1933, Mineral deposits, 4th Edition: New York, McGraw-Hill, 930 p.
- Lipman, P.W., 1984, The roots of ash flow calderas in western North America—Windows into the tops of granitic batholiths: Journal of Geophysical Research, v. 11, p. 8801–8841.
- Luikart, E.J., 1997, Syn- and post-Laramide geology of the south-central Gravelly Range, southwestern Montana: Bozeman, Mont., Montana State University M.S. thesis, 96 p.
- Lund, Karen, Aleinikoff, J.N., Kunk, M.J., Unruh, D.M., Zeihen, G.D., Hodges, W.C., du Bray, E.A., and O'Neill, J.M., 2002, SHRIMP U-Pb and $^{40}\text{Ar}/^{39}\text{Ar}$ age constraints for relating plutonism and mineralization in the Boulder batholith region, Montana: Economic Geology, v. 97, p. 241–267.
- McBride, B.C., Schmidt, C.J., Guthrie, G.E., and Sheedlo, M.K., 1990, Multiple reactivation of a collisional boundary—An example from southwestern Montana, *in* Bartholomew, M.J., Hyndman, D.W., Mogk, D.W., and Mason, Robert, eds., Proceedings of the 8th International Conference on Basement Tectonics: Hingham, Mass., Kluwer Academic Publishers, p. 341–358.
- McDowell, F., 1966, Potassium-argon dating of Cordilleran intrusives: New York, Columbia University Ph. D. dissertation, 246 p.
- Metesh, J.J., Lonn, J.D., Duaine, T.E., and Wintergerst, Robert, 1994, Abandoned-inactive mines program, Deerlodge National Forest—Volume I, Basin Creek drainage: Montana Bureau of Mines and Geology Open-File Report 321, 131 p.
- Metesh, J.J., Lonn, J.D., Duaine, T.E., Marvin, R.K., and Wintergerst, Robert, 1995, Abandoned-inactive mines program, Deerlodge National Forest—Volume II, Cataract Creek drainage: Montana Bureau of Mines and Geology Open-File Report 344, 201 p.
- Meyer, C., Shea, E.P., Goddard, C.C., Jr., Zeihen, L.G., Guilber, J.M., Miller, R.N., McAleer, J.F., Brox, G.B., Ingersoll, R.G., Jr., Burns, G.J., and Wigal, T., 1968, Ore deposits at Butte, Montana, *in* Ridge, J.D., ed., Ore deposits of the United States, 1933–1967, Graton-Sales Volume II: American Institute of Mining, Metallurgical, and Petroleum Engineers, p. 1373–1416.
- Miller, R.N., 1973, Production history of the Butte district and geological function, past and present, *in* Miller, R.N., ed., Guidebook for the Butte field meeting of Society of Economic Geologists, 1973: Butte, Mont., Society of Economic Geologists, p. F1–F10.
- Nimick, D.A., and Cleasby, T.E., 1998, What streams are affected by abandoned mines—Characterization of water quality in the streams of the Boulder River watershed, Montana [abs.] *in* Science for watershed decisions on abandoned mine lands—Review of preliminary results: U.S. Geological Survey Open-File Report 98–0297, p. 9.
- Obradovich, J.D., 1993, A Cretaceous time scale, *in* Caldwell, W.E.G., and Kaufman, E.G., eds., Evolution of the western Interior Basin: Geological Association of Canada Special Paper 39, p. 379–396.

- O'Neill, J.M., 1998, The Great Falls tectonic zone—An Early Proterozoic collisional orogen beneath and south of the Belt basin, *in* Berg, R.B., ed., *Proceedings of Belt Symposium III: Montana Bureau of Mines and Geology Special Publication 111*, p. 227–234.
- O'Neill, J.M., Ferris, D.C., Schmidt, C.J., and Hanneman, D.L., 1986, Recurrent movement along northwest-trending faults at the southern margin of the Belt basin, Highland Mountains, southwestern Montana, *in* Roberts, S.M., ed., *Belt Supergroup: Montana Bureau of Mines and Geology Special Publication 94*, p. 208–216.
- O'Neill, J.M., and Lopez, D.A., 1985, Character and regional significance of the Great Falls tectonic zone, east-central Idaho and west-central Montana: *American Association of Petroleum Geologists Bulletin*, v. 69, p. 437–447.
- Prostka, H.J., 1966, *Igneous geology of the Dry Mountain quadrangle, Jefferson County, Montana: U.S. Geological Survey Bulletin 1221-F*, 21 p.
- Reynolds, M.W., 1979, Character and extent of basin-range faulting, western Montana and east-central Idaho, *in* Newman, G.W., and Goode, H.D., eds., *Basin and range symposium and Great Basin field conference: Rocky Mountain Association of Geologists*, p. 185–193.
- Roberts, W.A., 1953, Notes on the alaskitic rocks in the Boulder batholith near Clancey, western Montana: *Northwest Science*, v. 27, p. 121–124.
- Robinson, G.D., 1963, *Geology of the Three Forks quadrangle, Montana, with descriptions of igneous rocks by H. Frank Barnett: U.S. Geological Survey Bulletin 988-F*, 121–141 p.
- Robinson, G.D., Klepper, M.R., and Obradovich, J.D., 1968, Overlapping plutonism, volcanism, and tectonism in the Boulder batholith region, western Montana *in* Coats, R.R., Hay, R.L., and Anderson, C.A., eds., *Studies in volcanology: Geological Society of America Memoir 116*, p. 557–576.
- Ruppel, E.T., 1963, *Geology of the Basin quadrangle, Jefferson, Lewis and Clark, and Powell Counties, Montana: U.S. Geological Survey Bulletin 1151*, 121 p., 7 plates.
- Rutland, C., 1986, *The geochemistry of the Elkhorn Mountains Volcanics and its relationship to the magma chamber of the Boulder batholith: East Lansing, Mich., Michigan State University Ph. D. dissertation*, 96 p.
- Rutland, C., Smedes, H.W., Tilling, R.I., and Greenwood, W.R., 1989, Volcanism and plutonism at shallow crustal levels—The Elkhorn Mountains Volcanics and the Boulder batholith, southwestern Montana, *in* Hyndman, D.W. ed., *Cordilleran volcanism, plutonism, and magma generation at various crustal levels, Montana and Idaho: 28th International Geological Congress, Field Trip Guidebook T337*, p. 16–31.
- Sales, R.H., and Meyer, C., 1949, Results from preliminary studies of vein formation at Butte, Montana: *Economic Geology*, v. 44, p. 465–484.
- Schmidt, C.J., and Garihan, J.M., 1983, Laramide tectonic development of the Rocky Mountain foreland of southwestern Montana, *in* Lowell, J.D., ed., *Rocky Mountain foreland basins and uplifts: Rocky Mountain Association of Geologists*, p. 271–294.
- Schmidt, C.J., and Garihan, J.M., 1986, Role of recurrent movement of northwest-trending basement faults in the tectonic evolution of southwestern Montana, *in* Aldrich, M.J., and Laughlin, A.W., eds., *Proceedings of the 6th International Conference on Basement Tectonics: International Basement Tectonics Association*, p. 1–15.
- Schmidt, C.J., and O'Neill, J.M., 1983, Structural evolution of the southwest Montana transverse zone, *in* Powers, R.B., ed., *Western overthrust belt—its geology and hydrocarbon potential—from Alaska through Mexico: Rocky Mountain Association of Geologists Special Publication*, p. 193–218.
- Schmidt, C.J., Smedes, H.W., and O'Neill, J.M., 1990, Syncompressional emplacement of the Boulder and Tobacco Root batholith (Montana-U.S.A.) by pull-apart along old fault zones: *Geological Journal*, v. 25, p. 305–318.
- Sheppard, S.M.F., and Taylor, H.P., Jr., 1974, Hydrogen and oxygen isotope evidence for the origins of water in the Boulder batholith and the Butte ore deposits, Montana: *Economic Geology*, v. 69, p. 926–946.
- Sillitoe, R.H., Graubeger, G.L., and Elliott, J.E., 1985, A diatreme-hosted gold deposit at Montana Tunnels, Montana: *Economic Geology*, v. 80, p. 1707–1721.
- Smedes, H.W., 1962, Lowland Creek volcanics, an Oligocene formation near Butte, Montana: *Journal of Geology*, v. 70, p. 255–266.
- Smedes, H.W., 1966, *Geology and igneous petrology of the northern Elkhorn Mountains, Jefferson and Broadwater Counties, Montana: U.S. Geological Survey Professional Paper 510*, 116 p.

- Smedes, H.W., Klepper, M.R., Pinckney, D.M., Becraft, G.E., and Ruppel, E.T., 1962, Preliminary geologic map of the Elk Park quadrangle, Jefferson and Silver Box Counties, Montana: U.S. Geological Survey Mineral Investigations Field Studies Map MF-246, scale 1:48,000.
- Smedes, H.W., Klepper, M.R., and Tilling, R.I., 1988, Preliminary map of plutonic units of the Boulder batholith, southwestern Montana: U.S. Geological Survey Open-File Report 88-283, scale 1: 200,000.
- Smedes, H.W., and Thomas, H.H., 1965, Reassignment of the Lowland Creek volcanics to Eocene age: *Journal of Geology*, v. 73, p. 508-510.
- Streckeisen, A., 1976, To each plutonic rock its proper name: *Earth-Science Reviews*, v. 12, p. 1-33.
- Tilling, R.I., 1968, Zonal distribution of variations in structural state of alkali feldspar within the Rader Creek pluton, Boulder batholith, Montana: *Journal of Petrology*, v. 9, p. 331-357.
- Tilling, R.I., 1973, Boulder batholith, Montana; a product of two contemporaneous but chemically distinct magma series: *Geological Society of America Bulletin*, v. 84, p. 3879-3900.
- Tilling, R.I., 1974, Composition and time relations of plutonic and associated volcanic rocks, Boulder batholith region, Montana: *Geological Society of America Bulletin*, v. 85, p. 1925-1930.
- Tilling, R.I., 1977, Interaction of meteoric waters with magmas of the Boulder batholith, Montana: *Economic Geology*, v. 72, p. 859-864.
- Tilling, R.I., Klepper, M.R., and Obradovich, J.D., 1968, K-Ar ages and time span of emplacement of the Boulder batholith, Montana: *American Journal of Science*, v. 266, p. 671-689.
- Trombetta, J.T., 1987, Evolution of the Eocene Avon volcanic complex, Powell County, Montana: Bozeman, Mont., Montana State University M.S. thesis, 97 p.
- Tysdal, R.G., 1998, Revisions of Cretaceous Slim Sam Formation, western Montana: U.S. Geological Survey Professional Paper 1601-B, 8 p.
- Weed, W.H., 1887, Description of the Butte, Montana special district: U.S. Geological Survey Atlas, Butte special folio 38, 14 p.
- Winchell, H.V., and Winchell, A.N., 1912, Notes on the Blue Bird mine: *Economic Geology*, v. 7, p. 287-294.
- Winston, Don, 1986, Sedimentation and tectonics of the Middle Proterozoic Belt basin and their influence on Phanerozoic compression and extension in western Montana and northern Idaho, *in* Peterson, James, ed., *Paleotectonics and sedimentation: American Association of Petroleum Geologists Memoir 41*, p. 87-118.
- Woodward, L.A., 1986, Tectonic origin of fractures for fissure vein emplacement in the Boulder batholith and adjacent rocks, Montana: *Economic Geology*, v. 81, p. 1387-1395.