

COMPARISON OF SOLAR TERRESTRIAL AND SPACE POWER GENERATION FOR EUROPE

Norbert Geuder⁽¹⁾, Volker Quaschnig⁽²⁾, Peter Viebahn⁽³⁾, Frank Steinsiek⁽⁴⁾, Johann Spies⁽⁴⁾, Chris Hendriks⁽⁵⁾

⁽¹⁾ German Aerospace Center, DLR e.V., Plataforma Solar de Almería, Apartado 39, E-04200 Tabernas, Spain, Phone: +34 950 387908, Fax: +34 950 365313, e-mail: norbert.geuder@psa.es

⁽²⁾ FHTW Berlin, University of Applied Sciences, Marktstr. 9, D-10317 Berlin, Germany, Phone: +49 30 55134-256, Fax: +49 30 55134-199, e-mail: volker@quaschnig.de

⁽³⁾ German Aerospace Center, DLR e.V., Institute of Technical Thermodynamics, Pfaffenwaldring 38-40, D-70569 Stuttgart, Germany, Phone: +49 711 6862 667, Fax: +49 711 6862 783, e-mail: peter.viebahn@dlr.de

⁽⁴⁾ EADS Space Transportation GmbH, Hünefeldstr. 1-5, D-28199 Bremen, Germany, Phone: +49 421 539 4853, Fax: +49 421 539 28 4853, e-mail: frank.steinsiek@space.eads.net

⁽⁵⁾ Ecofys bv, P.O. Box 8408, NL-3503 RK Utrecht, The Netherlands, Phone: +31 30 280 83 93, Fax: +31 30 280 83 01, e-mail: c.hendriks@ecofys.nl

ABSTRACT

Electricity supply from space is one opportunity to ensure a climatic sustainable energy supply. However, generation in space must compete with terrestrial systems like photovoltaic or solar thermal power plants. This paper will compare electricity supply from Solar Power Satellites in space and two terrestrial generation systems for several European load curves: constant base load with 8760 full load hours per year in several power levels from below 1 GW to full supply, as well as remaining load where base load is subtracted from real existing load curves. Additionally, several combined space-terrestrial scenarios have been investigated, optimized for real load curves. Results are leveled electricity costs (LEC) and energy payback time (EPT).

1 INTRODUCTION

A large amount of world energy production is currently based on non-renewable sources such as oil, gas and coal. Global warming and restricted fossil energy sources force a strong demand for another climate compatible energy supply. Beside wind, biomass, water energy, etc., solar energy is a promising solution. However, it suffers alternating supply between day and night, winter and summer and at cloudy skies. To overcome this problem and guarantee a steady power supply, electricity generation in space and transmission to earth has been proposed in the late sixties by [1]. Huge light-weight photovoltaic panels are to be placed in low or geostationary earth orbit and the collected energy transmitted to a receiver on earth via microwave or laser beam. Power can be sent thus directly to where it is needed. Several studies yet have been done to develop realizable concepts [2, 3, 4]. Due to high transportation costs into space and lacking technical maturity, these concepts have not been realized so far. With ongoing technology improvement, this may

change and energy supply from space become of interest in the future.

However, space systems have to compete with the yet existing, established and well known terrestrial solutions as photovoltaics, solar thermal power plants, etc. Checking viability and meaningfulness of Solar Power Satellites in economical and technical aspects has been the aim of a study financed by ESA, concentrating on the electricity supply for Europe [5]. Especially the cases of constant base load and the remaining load have been investigated in detail for several power levels from below 1 GW to full supply. Within a combined space-terrestrial scenario a 24-hour supply with a real load curve has been assumed to get an impression of an optimized realistic situation. The most important results and basic assumptions are presented in this paper.

2 BASIC ASSUMPTIONS

2.1 Scenario situation

Annual irradiation sums in the supply zone (West and Central Europe, zones B-U in Fig. 1) show values from 900 kWh/m² Global Horizontal Irradiation (GHI) in northern Europe to maximal 2000 kWh/m² in southern European countries (or 700 kWh/m² to 2200 kWh/m² Direct Normal Irradiation, DNI). Population density is high there and land widely used. Solar power plants here therefore have to compete with agriculture or forestry, raising the price for renewable energy.

In the so called sun belt in North Africa the irradiation with GHI values from 2000 to 2400 kWh/m² or DNI from 2300 to 3000 kWh/m² is significantly higher. Land there is widely available as huge areas are unused in the Sahara desert (Fig. 2). With the little land available in Europe the whole supply can hardly be generated there, thus the generation zone has been placed to North Africa (zones A1 to A3 in Fig. 1). The energy is transferred to Europe by HV-DC lines (T1-T3 in Fig. 1). Yet there is an increasing interest in projects for

building Solar Power Plants in several northern African countries. Availability of unpopulated land and – depending on the energy transmission technology to ground – also clear skies are a requirement for the ground receiver of space systems, too.

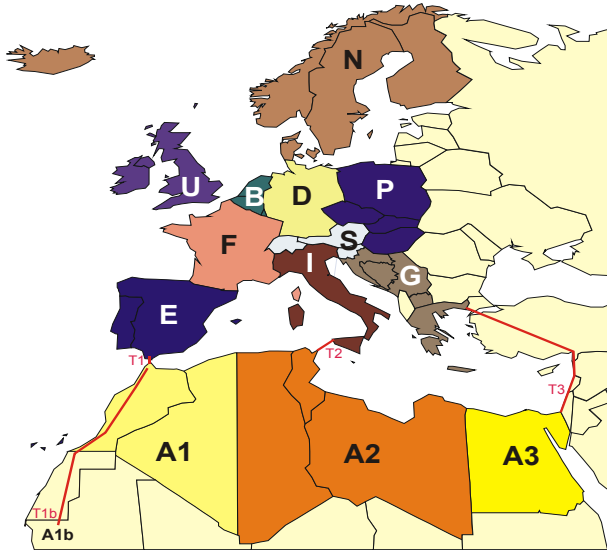

Fig. 1: Definition of supply and generation zones in Europe and North Africa.

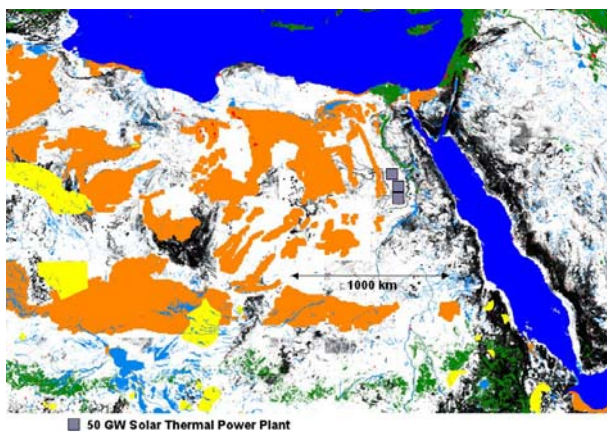

Fig. 2: Availability of land in Northeast Africa: white area is suitable for the construction of solar power plants. Base load full supply (150 GW) of solar thermal needs only a small portion of available land.

The actually necessary power amount for the supply zone has been estimated along interpolated hourly load values from the UCTE [6] and CENTREL [7] net of the year 2000. For the N and U zones with the net operators NORDEL [8] and UKTSOA/TSOI [9] we got only the annual consumption, so the UCTE/CENTREL load curve has been scaled by 136% to cover the whole supply zone. The load curve for the future scenario has been estimated assuming a mean growth rate of 1.5%/a until 2030 [9, 10]. The minimal, average and maximal demand load of the total supply zone B-U of the years 2000 and the assumed for 2030 is presented in Tab. 1.

Tab. 1: Demand loads of supply zones B-U.

Year	Minimum in GW	Average in GW	Maximum in GW	Consumption in TWh/a
2000	196	324	436	2,842
2030	309	512	689	4,489

The minimal load value occurring during one year within this study means base load with 8760 constant full load hours per year. The exceeding power corresponds to remaining load with base load subtracted from the real load curves (as illustrated in Fig. 3).

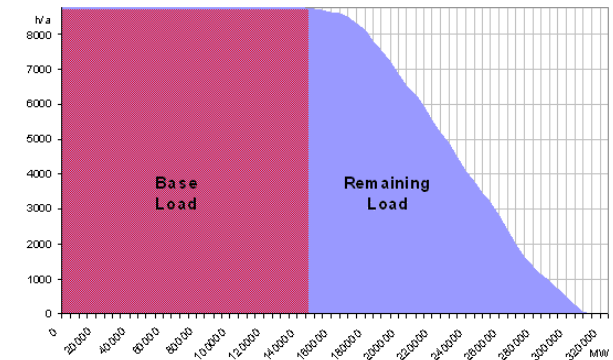

Fig. 3: Definition of base load and remaining load: full load hours in dependence on the demand power.

As 41.8 GW of base load is hydro power which will continue running anyhow, there remain 150 GW base load for 2000. Taking into consideration the development of wind power in the recent 8 years, its installed power has been increasing between 32 and 46% per year to 23 GW in 2002. Continuing with a moderate growth rate of 10 to 15% per year would lead to a complete coverage of the base load demand in 2030. Therefore, scenarios with different power levels from 500 MW over some multi-GW until a full power supply at no more than 150 GW have been examined. The calculation of the terrestrial power generation was done with the simulation tool “greenius” [11] for power plants of 1 GW, using hourly, site-specific irradiation data [12, 13]. The results have been scaled afterwards for the different power levels, respecting storage needs.

2.2 Specifications of technologies

For the *space generation system* the technology presented in Fig. 4 has been chosen: for one SPS unit 110.7 km² of thin film PV cells are placed in geostationary orbit (GEO) with an additionally concentrator of the same size, generating nearly constantly 53 GW of the incoming 275 GW of direct sunlight. The energy is transmitted to ground via laser beam at a receiver of 68.9 km². This receiver consists of PV cells of a similar type as for the terrestrial PV technology (Tab. 3), which finally insert 7.9 GW of electricity (plus additional terrestrial irradiation) into the grid. Together with the terrestrial irradiation this unit delivers 10 GW of constant power assuming that the

daily course of the terrestrial irradiation is buffered by pumped hydroelectricity. Up to three space units are supposed to send the beam to one ground receiver, which then delivers constantly 25 GW. Cloudy locations have to be avoided for the ground receiver as laser light will be extinguished by clouds. The costs of the space unit are listed in Tab. 2.

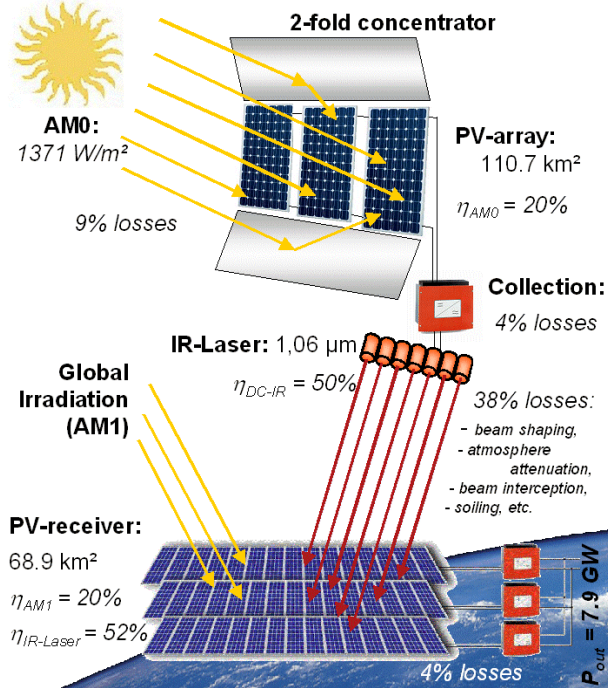

Fig. 4: Technology of the space generation system.

Tab. 2: Costs of the space system.

Space system costs	Initial	Progress rate
PV	4500 €/kW _p	0.8 / 0.92
Conc.&Control	11.5 bill. €/SPS	0.8 / 0.92
Laser	8.8 bill. €/SPS	0.8
Transportation	55.3 bill. €/SPS (530 €/kg)	0.9
Financing		6.7%
Space system lifetime		30 years
Operation&Maintenance costs (of investment)		0.6%

At ground either photovoltaic or solar thermal power plants have been used for electric power generation: The technological data of the PV system is listed in Tab. 3.

Tab. 3: Technology data of the terrestrial PV system.

	2000	2020/2030
PV cell	cryst. Si	3 rd gen. PV
η _{module}	14.2%	15%
η _{inverter}	96%	98%
Losses (soiling, etc.)	10%	7%
Initial costs	4,500 €/kW _p	
Progress ratios	0.82 / 0.92	0.8 / 0.9
Glob. installed capacity / GW _p	2	100
PV system lifetime	25 a	
O&M costs (of investment)	2.2%	2.7%

At the present scenario crystalline silicon PV cells are used. The cost reduction ratio is 0.82 (for now installed 2 GW_p) until half of price is reached and will be 0.92 then, depending on the globally installed power (Fig. 5).

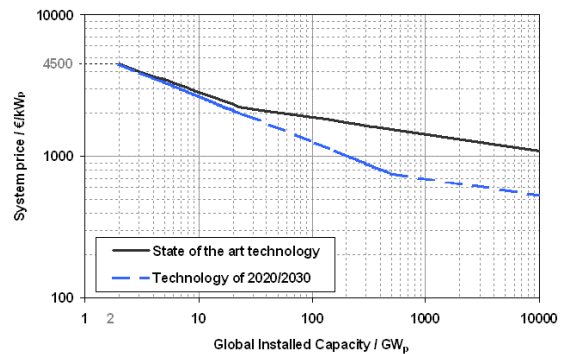

Fig. 5: PV installation costs in dependence on global installed capacity (=initial+2×scenario installation).

The installation within this scenario is assumed to invoke the same amount of additional installation in the world. Until 2020/2030 a technology change will take place to 3rd generation PV cells like e.g. multi junction solar cells with costs as illustrated also in Fig. 5. For a maximal power output with only slight variation throughout the year, PV panel inclination will be changed manually two times per year in spring and autumn for 10° inclination in summer and 60° in winter. The reference Solar Thermal Power Plant consists of a Eurotrough-2 collector, thermal oil as fluid, a Rankine steam turbine cycle and two storage tanks with molten salt (Fig. 6). Further technical data is listed in Tab. 4.

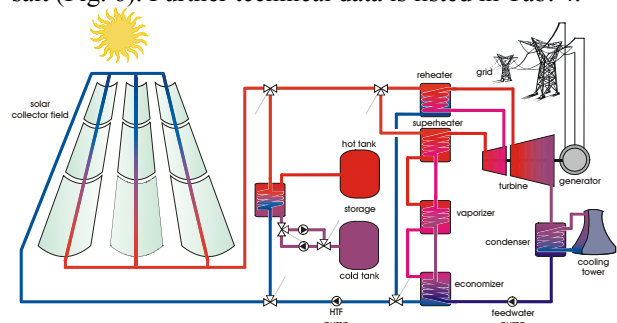

Fig. 6: Solar Thermal Trough Power Plant with storage.

Tab. 4: Technology data of the Solar Thermal system.

	2000	2020/2030
Solar thermal system	Eurotrough-2	Improved ST
η _{collector}	66%	Overall
η _{power block}	39%	efficiency:
Losses (soiling, etc.)	6%	>20%
Initial costs:	Collector:	225 €/m ²
	Power block:	800 €/kW _{el}
	Storage:	30 €/kWh _{th}
Progress ratios	0.88 / 0.96	
Glob. inst. capacity / km ²	2.3	100
ST system lifetime	25 a	
O&M costs (of invest.)	2.9%	

The future Solar Thermal power plant will be an advanced trough system (e.g. direct steam generation) with improved components and efficiencies, or a high-efficiency solar thermal power tower using a combined cycle. Cost depression will change at a global installation of 500 km² from 0.88 to 0.96. In 2020/30 the installation within the scenario will initialize 1.5 times the installation throughout the world.

First simulation runs for the *storage system* showed that there is no need for seasonal storage. As e.g. land in east Egypt beneath the Red Sea is mountainous at high altitude, pumped hydroelectric storage is used [14].

Tab. 5: Technical data of the pumped hydroelectric storage system.

Pumped hydroelectric storage	2000	2020/2030
$\eta_{\text{charge-discharge}}$	75%	85%
Storage power costs / €/kW	700	600
Storage capacity costs / €/kWh	14	12
System lifetime	40 a	
O&M costs / €/kWh	6	4

Produced electricity exceeding the storage capacity is assumed to be sold for a dumping price of 0.02 €/kWh in 2000 or 0.025 €/kWh in the future scenario. As hydrogen storage has low efficiency (see Tab. 6) it has only be considered for comparison purposes in the combined scenario of chap. 3.3.

Tab. 6: Technical data of the hydrogen storage.

Hydrogen storage: pressure vessel storage	
$\eta_{\text{electrolyzer}}$	65%
$\eta_{\text{Fuel cell/CCGT}}$	55%
Electrolyzer investment	500 €/kWh _{H2}
Electrolyzer O&M	1.5%
Pressure vessel costs	1.92 mill. €/vessel
Fuel Cell/CCGT costs	500 €/kWh _{el}
Fuel Cell/CCGT O&M costs	0.01 €/kWh _{el}
System lifetime	30 a

Transmission lines: The generated electricity is transported from the power plant/receiver to the near storage system by High Voltage AC lines and from the storage by one of the paths T1-T3 (see Fig. 1) to the center of the next supply zone via HV DC lines. Among the single supply zones electricity is exchanged via DC lines, within one zone distributed by AC lines. The technical data of the transmission lines is listed in Tab. 7.

Tab. 7: Technical data of the transmission lines.

Transmission lines	2000	2020/2030
HV DC double dipole line	600 kV	800 kV
Capacity / GW	5	6.5
Losses/1000 km	3.3%	2.5%
Losses/station	0.7%	0.5%
Powerline costs	300 million €/1000 km	
Costs of AC/DC-station	350 million €/station	
Progress ratio	0.96	
Start length	10,000 km	
System lifetime	25 a	
O&M costs	1%	

HV AC double lines	1,150 kV
Losses/1000 km	4.4%
Line costs / mill. €/1000 km/GW	200 140
Progress ratio	0.96
Starting point	10,000 km GW
System lifetime	25 a
O&M costs (of investment)	1%

2.3 Financing

The basic economic values are calculated along the following equations 1-3:

Annuity a :

$$a = ir / (1 - (1 + ir)^n) \quad (1)$$

with discount rate ir and system lifetime n .

Present value (PV):

$$PV = c_{Inv} + c_{O\&M} \cdot ((1 + ir)^n - 1) / (ir \cdot (1 + ir))^n \quad (2)$$

with investment costs c_{Inv} and annual operation and maintenance costs $c_{O\&M}$.

Levelised electricity costs (LEC):

$$LEC = PV \cdot a / E_a \quad (3)$$

with the annual demand E_a .

2.4 Energy payback time

The energy payback time (EPT) of a system is the time in which an energy system produces the same amount of energy as consumed for its production, operation and dismantling. The energy needed to produce the system consists of energy needed to produce the materials, transportation energy, energy needed for installation and system set-up. The EPT is calculated along:

$$EPT = CED_c / (E_{net} / g - CED_0) \quad (4)$$

with the cumulated energy demand for construction CED_c , the yearly produced net energy E_{net} , the utilization grade g of primary energy source for electricity generation and the annual energy expense for maintenance CED_0 . The EPT of 2020/2030 has been calculated respecting a probable energy mix and utilization grade g in 2020/2030.

3 RESULTS

From the big variety of data, which define a certain scenario, only the most important are presented here. The leveled electricity costs are determined along the simulation results of the expected annual generation of electricity and at a discount rate for the investors of 6%.

3.1 Base Load

Base load is a constant demand for 8760 hours per year. Tab. 8 and Tab. 9 show the installed capacities of the generation system (PV or Solar Thermal) as well as the necessary capacity and power of the pumped hydroelectric storage system with technology standards of today for several demand power levels.

Tab. 8: Base load scenario of today PV.

Demand	GW	0.5	5	10	100	150
PV cap.	GW _p	3	33	65	653	997
Stor. power	GW _p	2.1	23.7	42.5	425	651
Stor. cap.	GWh	180	820	200	3000	3500
LEC	€/kWh	0.284	0.207	0.180	0.146	0.142
EPT	month	28.7	32.4	31.9	32.0	32.6
LEC-breakdown						
Generation		58%	52%	51%	48%	47%
Storage&Dumping		36%	40%	35%	40%	38%
Transmission		6%	8%	13%	12%	15%

Tab. 9: Base load scenario of today Solar Thermal.

Demand	GW	0.5	5	10	100	150
SoTh cap.	GW _{el}	0.75	7.7	15.5	150	220
Stor. power	GW _p	0.5	5	10	32	47
Stor. cap.	GWh	62	620	680	255	370
LEC	€/kWh	0.136	0.095	0.083	0.060	0.057
EPT	month	8.4	8.9	9.4	9.4	9.2
LEC-breakdown						
Generation		68%	64%	66%	67%	65%
Storage&Dumping		23%	29%	23%	12%	15%
Transmission		10%	7%	11%	21%	20%

As the transmission line T1 in Fig. 1 between Spain and Morocco yet exists, the smaller power levels primarily have been calculated for generation zone A1 respectively A1b. As for power levels over 10 GW new transmission lines have to be build anyhow, electricity generation has been shifted to zone A3 because the annual irradiation sum there is significantly higher and also the daily course of irradiation shows less breakdowns caused by cloudy skies. Shifting to zone A3 explains the unsteadiness in the storage capacity.

Necessary capacities for electricity generation and the storage system are generally significantly higher for photovoltaics than for solar thermal power plants. Solar thermal power plants with its molten salt tanks have an efficient storage system yet integrated and are therefore capable to deliver a constant power level as long as its capacity lasts, whereas photovoltaics is generating electricity only during daytime. Electricity for the night hours has to be produced during daytime and stored by external storage systems.

The comparison on LEC and EPT show the high price and the expensive fabrication process of today's PV cells. Whereas electricity from Solar Thermal Power Plants costs from 14 to 6 Cent per kWh and has an EPT of under 10 month, the LEC of photovoltaics lies between 28 and 14 Cent/kWh with an EPT between 28 and 33 months.

Looking on improved technologies of 2020/2030, also solar power from space has to be considered as it hopefully may be mature and available then. With its nearly constant output it is well suited for base load. Tab. 10 shows the number of SPS units in space and on ground, the installed capacities and the respective LEC and EPT for several power levels.

Tab. 10: Base load provided by the space system.

Demand	GW	10	25	50	100	150
SPS units (space/ground)		1 / 1	3 / 1	6 / 2	12 / 4	18 / 6
Space PV cap.	GW _p	22.1	66.4	133	266	399
Ground PV cap.	GW _p	8.5	8.5	17	33.9	51
Stor. capacity	GWh	200	500	1000	2000	
LEC (530 €/kg)	€/kWh	0.26	0.166	0.137	0.113	0.10
EPT	month	4.2	3.7	3.7	3.7	

The PV capacity here with its continuous generation is around half as high as for the terrestrial PV power plant. The LEC of the space system shows values of 26 Cent per kWh for smaller power levels and goes down to 10 Cent/kWh for 150 GW, further decreasing for even higher power levels (see Fig. 7). These power levels will only be necessary for a worldwide power supply. The EPT of the space system with around 4 month is very short.

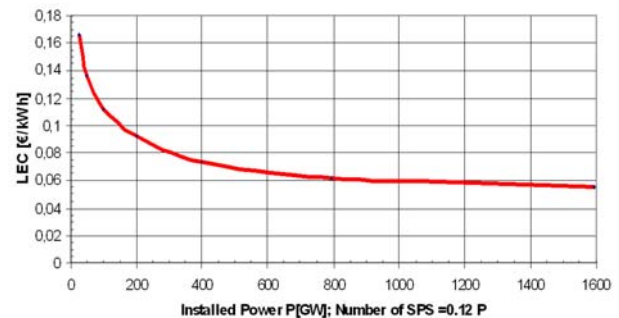

Fig. 7: Leveled Electricity Costs of the space system.

The capacities, storage power levels as well as LEC, its breakdown and EPT of the future terrestrial power plants are listed in Tab. 11 for PV and for Solar Thermal Power Plants in Tab. 12. Compared to the technologies of today, the necessary capacities and/or power levels will slightly decrease. The LEC and EPT values of the PV power plant however show significantly lower values of 12 to 7 Cent/kWh with around 8 months of Energy Payback Time. This is mainly due to the new technology. For the Solar Thermal Power Plants the LEC of the future scenario will be in the range of 5 to 9 Cent/kWh. EPT will be slightly below that of PV between 7 and 8 months.

Regarding the breakdown of LEC for Solar Thermal Power Plants the biggest fraction belongs to the generation of electricity. For the PV power plant storage and dumping is about in the same range as generation because generation only takes place during daytime. The expenses for bringing the electricity to the supply zones is gaining importance with higher power levels.

Tab. 11: Base load of future PV.

Demand	GW	0.5	5	10	100	150
PV cap.	GW _p	3	30	55	553	846
Stor. power	GW _p	2.25	21.9	36.9	369	567
Stor. cap.	GWh	60	700	230	3000	3500
LEC	€/kWh	0.123	0.115	0.087	0.068	0.066
EPT	month	8.2	9.2	8.2	8.3	8.5
LEC-breakdown						
Generation		49%	40%	53%	46%	44%
Storage&Dumping		43%	50%	34%	39%	41%
Transmission		8%	10%	14%	15%	15%

Tab. 12: Base load of future Solar Thermal.

Demand	GW	0.5	5	10	100	150
SoTh cap.	GW _{el}	0.73	7.5	15.1	138	208
Stor. power	GW _p	0.5	5	10	32	48
Stor. cap.	GWh	70	605	530	255	375
LEC	€/kWh	0.095	0.080	0.071	0.051	0.050
EPT	month	6.8	7.4	8.0	7.3	7.4
LEC-breakdown						
Generation		65%	65%	69%	71%	70%
Storage&Dumping		26%	28%	20%	12%	12%
Transmission		9%	7%	12%	18%	18%

3.2 Remaining Load

Remaining load denotes all power exceeding the lowest power level occurring once within a complete year. In contrary to base load its value is permanently changing with high values during the day and the evening and low values during the night. With that permanently change following this load curve with conventional power plants is a harder constraint. Thus the price for remaining load or peak load is usually higher. This is also true for PV power plants (see Tab. 13), where the LEC with 24 to 17 Cent/kWh as well as EPT with 38 to 41 month is about 20% higher for remaining load than for base load. Necessary storage capacity and power are even nearly doubling for high demand loads.

Tab. 13: Remaining load of today PV.

Average Demand	GW	5	10	100	150
PV capacity	GW _p	39	77	876	1243
Storage power	GW _p	29	57	613	920
Storage capacity	GWh	380	890	4000	6000
LEC	€/kWh	0.235	0.219	0.180	0.173
EPT	month	38.2	37.7	40.5	40.5
LEC-breakdown					
Generation		40%	40%	35%	35%
Storage & Dumping		44%	45%	50%	50%
Transmission		15%	15%	15%	15%

Tab. 14: Remaining load of today Solar Thermal.

Average Demand	GW	5	10	100	150
SolarThermal cap.	GW _{el}	11	22	224	336
LEC	€/kWh	0.081	0.070	0.058	0.057
EPT	month	12.3	12.3	12.3	12.3
LEC-breakdown					
Generation		54%	56%	57%	57%
Transmission & Dumping		46%	44%	43%	43%

The EPT of Solar Thermal Power Plants is also increasing about 30% to 12 months whereas contrarily LEC is slightly decreasing for remaining load to about 8 to 6 Cent/kWh (Tab. 14). The different behavior of the Leveled Electricity Costs of PV respectively Solar Thermal originates from the higher storage demand for PV whereas at Solar Thermal Power Plants storage could be done completely within this plant. Additional pumped hydroelectric storage is not necessary.

The step to future scenarios of remaining load shows a very similar characteristic as for base load: The necessary capacities and power levels to be installed can be reduced by around 15 to 20% for PV (Tab. 15) and by about 5 to 10% for Solar Thermal (Tab. 16). The LEC and EPT of PV is going down significantly by a factor 2 for LEC and a factor 4 for EPT due to the technology change and also by notable 25% for LEC as well as EPT of Solar Thermal.

Tab. 15: Remaining load of future PV.

Average Demand	GW	5	10	100	150
PV capacity	GW _p	33	67	704	1056
Storage power	GW _p	25	51	543	814
Storage capacity	GWh	410	665	4000	6000
LEC	€/kWh	0.117	0.108	0.082	0.080
EPT	month	10.1	9.9	10.4	10.5
LEC-breakdown					
Generation		40%	38%	30%	30%
Storage & Dumping		44%	46%	53%	54%
Transmission		16%	16%	17%	17%

Tab. 16: Remaining load of future Solar Thermal.

Average Demand	GW	5	10	100	150
SolarThermal cap.	GW _{el}	11	22	216	324
LEC	€/kWh	0.060	0.056	0.047	0.046
EPT	month	11.9	9.9	10.0	10.0
LEC-breakdown					
Generation		63%	64%	66%	67%
Transmission & Dumping		38%	37%	34%	33%

3.3 Combined Systems

For investigation of a more realistic scenario, the space and terrestrial systems have been combined to cover the power supply of a real load curve. The steady electricity supply of the space system is foreseen to deliver base load whereas the terrestrial system with its daily fluctuation is suited well for covering remaining load. Thus the need for storage is supposed to be minimized. As terrestrial system only photovoltaics has been considered for not mixing different technologies. In reality a further advantage of this solution is that installation of PV can be started yet with an optional add-on of the space system afterwards as illustrated in Phase 2 of Fig. 8.

However, the design of the ground PV will differ depending on its use as a receiver either for a laser beam from a fix position or for capturing the maximal annual amount of global irradiation with the permanently

varying solar angle. Thus spacing and inclination of the PV panels have to be optimized. The following four cases of combined scenarios have been investigated in detail:

- S-1: Ground receiver optimized for laser beam, additional terrestrial PV optimized for solar irradiation, pumped hydroelectric storage,
- S-2: PV as in S-1, hydrogen pressure vessel storage,
- S-3: PV on ground completely optimized for laser beam, pumped hydroelectric storage,
- S-4: PV on ground completely optimized for solar irradiation (for provisional terrestrial set-up acc. to Fig. 8), pumped hydroelectric storage.

For every of the four cases the whole combination range between a complete supply from SPS (without additional terrestrial PV: “SPS only”) and complete supply from terrestrial PV (without SPS) has been calculated. Thereby for a given number of SPS the terrestrial PV capacity as well as storage capacity have been optimized to yield the lowest LEC. The detailed numbers are presented in Tab. 17 to Tab. 20.

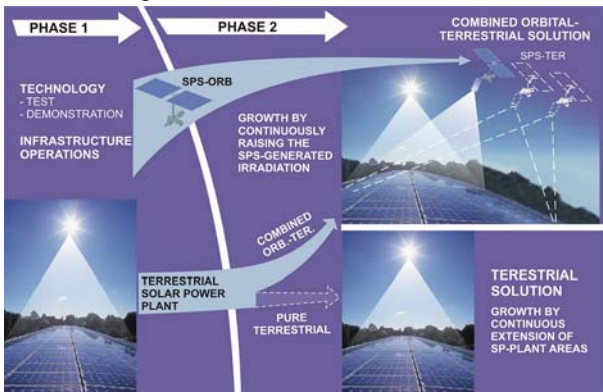

Fig. 8: Set-up of a combined space-terrestrial power plant.

The results for transportation costs of 530 €/kg (ground to GEO) are graphically illustrated in Fig. 9 as the LEC of the four cases in dependence on the combination ratio: SPS only on the left side to terrestrial PV only on the right side.

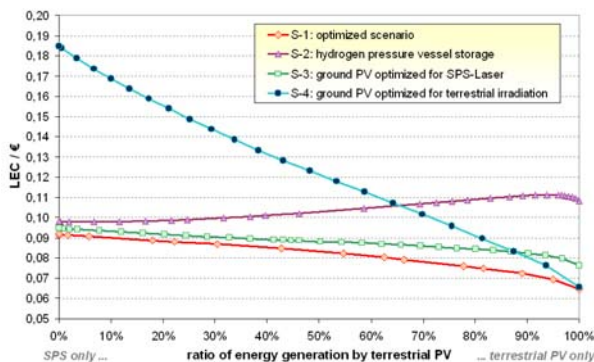

Fig. 9: Levelized electricity costs of the combined space-terrestrial scenarios in dependence on the combination ratio for transportation costs of 530 €/kg.

An expected optimal combination level space and terrestrial systems for the investigated cases cannot be found. Depending on the storage system or the design of the ground PV either pure SPS or pure terrestrial supply is the cheapest solution. The overall lowest electricity costs with 6.5 Cent/kWh are reached within the S-1 scenario for pure terrestrial electricity supply. The LEC is steadily raising with augmenting SPS ratio to 9.2 Cent/kWh for space supply only. A design of the whole ground PV optimized for the laser beam as in S-3 yields slightly higher values especially to higher terrestrial ratios but still resulting pure terrestrial PV as the cheapest solution. The shift to the less efficient and therefore more expensive hydrogen storage (S-2) turns the result to the contrary: the cheapest solution then is the supply by the space system only. However, Levelized electricity costs are 9.8 Cent/kWh increasing to 11.1 Cent/kWh in the 90% and going down again to 10.8 Cent for pure terrestrial supply. For the provisional set-up of the terrestrial system and later add-on of the space system along S-4, a high portion of the laser energy would be wasted due to higher spacing between the single PV module rows. Therefore the LEC is steeply raising to 18.5 Cents/kWh for pure SPS supply. This scenario is not very realistic as the necessary portion of the terrestrial PV would be redesigned as a laser beam receiver.

The costs for the transportation of the Solar Power Satellites from the earth to the geostationary orbit (GEO) have a strong influence on the LEC. This is shown for two levels of transportation costs from ground to GEO for the cases S-1 and S-2 in Tab. 17 and Tab. 18: here for pure space supply the LEC is raising even more steeply to 28 respectively 30 Cents/kWh for five times the transportation costs as assumed so far. So a high reduction of the present transportation costs is strongly necessary to make SPS competitive.

Tab. 17: Results of the combined scenario S-1.

Terrestrial ratio		0%	30%	66%	100%
Number of SPS		77	54	27	0
Space PV cap.	GW _p	1705	1196	598	0
Ground PV cap.	GW _p	221	153	76	0
Terrest. PV cap.	GW _p	0	737	1658	2621
Storage capacity	GWh	7309	9433	11310	12475
LEC (530 €/kg)	€/kWh	0.092	0.087	0.079	0.065
LEC (2650 €/kg)	€/kWh	0.284	0.229	0.158	0.065

Tab. 18: Results of the combined scenario S-2.

Terrestrial ratio		0%	32%	69%	100%
Number of SPS		83	63	36	0
Space PV cap.	GW _p	1838	1395	797	0
Ground PV cap.	GW _p	238	178	102	0
Terrest. PV cap.	GW _p	0	910	2531	4844
Storage capacity	GWh _{H2}	9069	13455	16811	19503
LEC (530 €/kg)	€/kWh	0.098	0.100	0.107	0.108
LEC (2650 €/kg)	€/kWh	0.303	0.262	0.208	0.108

Tab. 19: Results of the combined scenario S-3

Terrestrial ratio		0%	33%	66%	100%
Number of SPS		78	54	30	0
Space PV cap.	GW _p	1727	1196	664	0
Ground PV cap.	GW _p	221	153	85	0
Terrest. PV cap.	GW _p	0	918	2064	3478
Storage capacity	GWh	15434	12649	8807	13549
LEC (530 €/kg)	€/kWh	0.095	0.090	0.086	0.077

Tab. 20: Results of the combined scenario S-4

Terrestrial ratio		0%	34%	64%	100%
Number of SPS		191	108	54	0
Space PV cap.	GW _p	4229	2391	1196	0
Ground PV cap.	GW _p	543	305	153	0
Terrest. PV cap.	GW _p	0	1024	1835	2706
Storage capacity	GWh	7131	9196	10298	12185
LEC (530 €/kg)	€/kWh	0.185	0.139	0.107	0.066

4 CONCLUSIONS

The results of this study show that terrestrial solar systems in North Africa can cover the load curve of West and Central Europe for leveled electricity generation costs between 4 to 6 Cent/kWh at a load higher than 100 GW. Using Solar Power Satellites for electricity supply, a load of more than 1 TW is necessary to reach costs below 6 Cent/kWh. As transportation shows a high contribution to the costs its prize is a key parameter and has to be brought down significantly. With the claim of high power levels and its freedom to change the location of a ground receiver with a changing demand distribution on earth, SPS is merely predestinated for a global use of this generation system. Looking on a combination of SPS and terrestrial systems no benefits has been detected. Generally, electricity generation from solar energy in North Africa will be competitive in 2020/2030 even compared to conventional power generation. Only a small portion of the desert areas will be necessary to cover the European demand – even without taking into account generation from other renewables. The energy payback time of all of the investigated systems with some months is very low.

For terrestrial systems the need for seasonal storage can be minimized if oriented optimal. East-West orientation for solar thermal through power systems and two different tilt angles for photovoltaic systems in winter and summer provide nearly a daily constant power production in North Africa. Therefore, expensive hydrogen storage systems are not needed. Pumped hydroelectric storage systems are sufficient to cover the given load curves. Additionally, the corresponding capacities of storage and generation system can be altered within a broad range as the exact dimensioning has nearly no impact on the costs. Transmission losses from North Africa to Europe are between 14 and 18%. Costs for terrestrial power transmission over a distance of 5000 km are in the order of 1 Cent/kWh.

Due to not negligible land needs, the necessity of cloudless skies and a possible impact on living the receiver for solar power from space has also to be placed to desert areas like e.g. the Sahara desert in North Africa. Thus political risks of secure energy supply, dependencies, etc. are mainly comparable for space and terrestrial solutions. The assumptions of the terrestrial systems seem to be rather reasonable as they are based on yet existing technologies with a known history of the technological development in the last years. Nevertheless, the results may deviate by a certain amount as the real future development may differ from the assumptions. The technology for the space system however has to be developed yet, so the taken assumptions are far more insecure. Whereas an installation of the terrestrial systems can take place also in small units, SPS is only worthwhile when installed at high power levels. This requires a high starting investment. A discussion of eventually existing further risks of the energy transmission to earth by laser beam and maybe problems of acceptance by the human population are not object of this paper.

Acknowledgements

This study has been financed by ESA-ESTEC.

- [1] Glaser, P.E. Power from the Sun: Its Future, *Science*, Vol 162, pp. 856-861, 1968.
- [2] Stancati, M.L. et al. Space Solar Power, a Fresh Look Feasibility Study, Phase 1, SAIC-96/1038, NASA Contract NAS3-26565.
- [3] Ruth J., Westphal W., Study on European Aspects of Solar Power Satellites, ESA-CR 3705/78/F/DK(SC), 2 Vols, 1979.
- [4] NASA, The Final Proceedings of the Solar Power Satellite. Program Review, NASA-TM-84183.
- [5] Solar Power from Space – European Strategy in the Light of Sustainable Development, ESA, Noordwijk, June 2004
- [6] UCTE Statistical Yearbook 2000
- [7] IEA Key World Energy Statistics 2002
- [8] NORDEL Annual Report 2000
- [9] US Department of Energy, International Energy Annual 2001
- [10] US Department of Energy, Annual Energy Review 2002
- [11] www.greenius.net
- [12] S@tel-light 2003, <http://www.satellight.com>
- [13] Meteotest, Meteonorm Version 5, <http://www.meteonorm.com>
- [14] B. Lehner, G. Czisch, S. Vassolo, Europe's Hydropower potential Today and in the Future, Kassel World Water Series 5, Center for Environmental Systems Research, University of Kassel, 2001