

August 2000

Environmental Technology Verification Report

ENDRESS + HAUSER
LIQUISYS CUS 31-W
ON-LINE TURBIDIMETER

Prepared by



Battelle

Under a cooperative agreement with

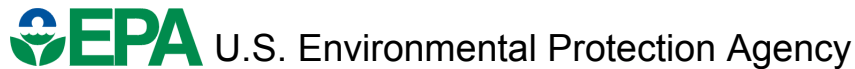

ET ✓ ET ✓ ET ✓

August 2000

Environmental Technology Verification Report

ETV Advanced Monitoring Systems Pilot

ENDRESS + HAUSER LIQUISYS CUS 31-W ON-LINE TURBIDIMETER

By

Kenneth Cowen
Thomas Kelly
Brian Canterbury
Karen Riggs

Battelle
505 King Avenue
Columbus, Ohio 43201-2693

Notice

The U.S. Environmental Protection Agency (EPA), through its Office of Research and Development, has financially supported and collaborated in the extramural program described here. This document has been peer reviewed by the Agency and recommended for public release. Mention of trade names or commercial products does not constitute endorsement or recommendation by the EPA for use.

Foreword

The U.S. Environmental Protection Agency (EPA) is charged by Congress with protecting the Nation's air, water, and land resources. Under a mandate of national environmental laws, the Agency strives to formulate and implement actions leading to a compatible balance between human activities and the ability of natural systems to support and nurture life. To meet this mandate, the EPA's Office of Research and Development (ORD) provides data and science support that can be used to solve environmental problems and to build the scientific knowledge base needed to manage our ecological resources wisely, to understand how pollutants affect our health, and to prevent or reduce environmental risks.

The Environmental Technology Verification (ETV) Program has been established by the EPA to verify the performance characteristics of innovative environmental technology across all media and to report this objective information to permittees, buyers, and users of the technology, thus substantially accelerating the entrance of new environmental technologies into the marketplace. Verification Organizations oversee and report verification activities based on testing and Quality Assurance protocols developed with input from major stakeholders and customer groups associated with the technology area. At present, there are 12 environmental technology areas covered by ETV. Information about each of the environmental technology areas covered by ETV can be found on the Internet at <http://www.epa.gov/etv.htm>.

Effective verifications of monitoring technologies are needed to assess environmental quality and to supply cost and performance data to select the most appropriate technology for that assessment. In 1997, through a competitive cooperative agreement, Battelle was awarded EPA funding and support to plan, coordinate, and conduct such verification tests for "Advanced Monitoring Systems for Air, Water, and Soil" and report the results to the community at large. Information concerning this specific environmental technology area can be found on the Internet at http://www.epa.gov/etv/07/07_main.htm.

Acknowledgments

The authors wish to acknowledge the support of all those who helped plan and conduct the verification test, analyze the data, and prepare this report. In particular we would like to thank the staff at the Dublin Road Water Plant, including Tom Camden and Terry Nichols. We also acknowledge the participation of Dr. Hermann Straub, Dr. Bernd Stenkamp, and Dr. Stefan Vaihinger of Endress + Hauser in this verification test. We would like to thank the Hach Company for supplying the two reference turbidimeters used in this test.

Contents

Notice	ii
Foreword	iii
Acknowledgments	iv
List of Abbreviations	x
1. Background	1
2. Technology Description	2
3. Test Design and Procedures	3
3.1 Introduction	3
3.2 Test Design Considerations	3
3.3 Experimental Apparatus	4
3.4 Reference Instruments	6
3.5 Off-Line Testing	7
3.5.1 Linearity	8
3.5.2 Accuracy and Precision	9
3.5.3 Water Temperature	9
3.5.4 Flow Rate	9
3.5.5 Color	10
3.6 On-Line Testing	10
3.6.1 Accuracy	11
3.6.2 Drift	11
4. Quality Assurance/Quality Control	13
4.1 Data Review and Validation	13
4.2 Deviations from the Test/QA Plan	13
4.3 Calibration	14
4.3.1 Reference Turbidimeters	14
4.3.2 Temperature Sensors	15
4.3.3 Flow Meters	15
4.3.4 pH Meter	15

4.4	Data Collection	16
4.5	Assessments and Audits	16
4.5.1	Technical Systems Audit	16
4.5.2	Performance Evaluation Audit	16
4.5.3	Verification Test Data Audit	17
4.6	Audit Reporting	19
5.	Statistical Methods	20
5.1	Off-Line Testing	20
5.1.1	Linearity	20
5.1.2	Accuracy	20
5.1.3	Precision	21
5.1.4	Water Temperature Effects	21
5.1.5	Flow Rate Sensitivity	21
5.1.6	Color Effects	22
5.2	On-Line Testing	22
5.2.1	Accuracy	22
5.2.2	Drift	22
6.	Test Results	23
6.1	Off-Line Testing	23
6.1.1	Linearity	23
6.1.2	Accuracy	24
6.1.3	Precision	26
6.1.4	Water Temperature Effects	28
6.1.5	Flow Rate	30
6.1.6	Color Effects	31
6.2	On-Line Testing	33
6.2.1	Accuracy	33
6.2.2	Drift	36
6.3	Other Performance Parameters	39
6.3.1	Cost	39
6.3.2	Maintenance/Operational Factors	39

7. Performance Summary	43
8. References	45
Appendix A: Example Data Recording Sheet	A-1
Appendix B: Technical Systems Audit Report	B-1

Figures

Figure 2-1. Liquisys CUS 31-W On-Line Turbidimeter	2
Figure 3-1. Schematic Representation of Recirculation System	6
Figure 4-1a. Control Chart for Performance Evaluation Calibration Checks of the ISO 7027 Reference Turbidimeter	18
Figure 4-1b. Control Chart for Performance Evaluation Calibration Checks of the Method 180.1 Reference Turbidimeter	18
Figure 6-1a. Linearity Plot for Liquisys CUS 31-W Turbidimeter vs. ISO 7027 Reference Turbidimeter	24
Figure 6-1b. Linearity Plot for Liquisys CUS 31-W Turbidimeter vs. Method 180.1 Reference Turbidimeter	25
Figure 6-2a. Effect of Temperature on Liquisys CUS 31-W Turbidity Readings vs. ISO 7027 at Both 0.3 and 5 NTU	29
Figure 6-2b. Effect of Temperature on Liquisys CUS 31-W Turbidity Readings vs. Method 180.1 at Both 0.3 and 5 NTU	29
Figure 6-3. Effect of Sample Flow Rate on Liquisys CUS 31-W Turbidimeter Response	30
Figure 6-4a. Effect of Color on Relative Turbidity with the Liquisys CUS 31-W Turbidimeter vs. ISO 7027 at Both 0.1 and 5 NTU	32
Figure 6-4b. Effect of Color on Relative Turbidity with the Liquisys CUS 31-W Turbidimeter vs. Method 180.1 at Both 0.1 and 5 NTU	32
Figure 6-5. Summary of Stream Turbidity Data from On-Line Testing of Liquisys CUS 31-W	34

Figure 6-6.	Twice-Weekly Calibration Checks During On-Line Testing of the Liquisys CUS 31-W Turbidimeter	36
Figure 6-7a.	Final Linearity Plot for Liquisys CUS 31-W vs. ISO 7027 Reference Turbidimeter	38
Figure 6-7b.	Final Linearity Plot for Liquisys CUS 31-W vs. Method 180.1 Reference Turbidimeter	38
Figure 6-8.	Illustration of Square Wave Signal Caused by Wiper	40
Figure 6-9.	Operation of Liquisys CUS 31-W Turbidimeter with Two Different Controller Units	41

Tables

Table 3-1.	Performance Characteristics Evaluated and Schedule of Verification Tests Conducted on Liquisys CUS 31-W Turbidimeter	3
Table 3-2.	Summary of Measurements for Off-Line Testing	8
Table 3-3.	Summary of Measurements for On-Line Testing	11
Table 4-1.	Results of Linearity Check of Reference Turbidimeters	14
Table 4-2.	Summary of Flow Meter Calibration Check	15
Table 4-3.	Results of Calibration Checks of Thermocouple Used in the Verification Test	17
Table 6-1.	Statistical Results of Initial Linearity Test on Liquisys CUS 31-W Turbidimeter	25
Table 6-2.	Bias of Liquisys CUS 31-W Turbidimeter Relative to Reference Measurements on Prepared Test Solutions	26
Table 6-3.	Adjusted Turbidity Readings for Precision Calculations of the Liquisys CUS 31-W Turbidimeter	27
Table 6-4.	Precision of Liquisys CUS 31-W Turbidimeter	28
Table 6-5.	Statistical Results of Temperature Test on the Liquisys CUS 31-W Turbidimeter	30

Table 6-6.	Statistical Results of Flow Rate Test for the Liquisys CUS 31-W Turbidimeter	31
Table 6-7.	Statistical Results of the Color Test with the Liquisys CUS 31-W Turbidimeter	33
Table 6-8.	On-Line Daily Accuracy Check Results	35
Table 6-9.	Results of Calibration Checks Performed During On-Line Testing	37
Table 6-10.	Statistical Results of Final Linearity Test	39
Table 6-11.	Comparison of Results from Linearity Tests at Beginning and End of the Verification Test	39

List of Abbreviations

AC	alternating current
AMS	Advanced Monitoring Systems
CU	color unit
DC	direct current
DRWP	Dublin Road Water Plant
EPA	U.S. Environmental Protection Agency
ETV	Environmental Technology Verification
gpm	gallons per minute
LOD	limit of detection
NIST	National Institute of Standards and Technology
NPT	normal pipe thread
NTU	nephelometric turbidity unit
OD	outer diameter
QA	quality assurance
QC	quality control
QMP	Quality Management Plan
RSD	relative standard deviation

Chapter 1

Background

The U.S. Environmental Protection Agency (EPA) has created the Environmental Technology Verification (ETV) Program to facilitate the deployment of innovative environmental technologies through performance verification and dissemination of information. The goal of the ETV Program is to further environmental protection by substantially accelerating the acceptance and use of improved and cost-effective technologies. ETV seeks to achieve this goal by providing high quality, peer-reviewed data on technology performance to those involved in the design, distribution, permitting, purchase, and use of environmental technologies.

ETV works in partnership with recognized testing organizations; with stakeholder groups consisting of regulators, buyers and vendor organizations; and with the full participation of individual technology developers. The program evaluates the performance of innovative technologies by developing test plans that are responsive to the needs of stakeholders, conducting field or laboratory tests (as appropriate), collecting and analyzing data, and preparing peer-reviewed reports. All evaluations are conducted in accordance with rigorous quality assurance protocols to ensure that data of known and adequate quality are generated and that the results are defensible.

The EPA's National Exposure Research Laboratory and its verification organization partner, Battelle, operate the Advanced Monitoring Systems (AMS) pilot under ETV. The AMS pilot recently evaluated the performance of on-line turbidimeters for use in water treatment facilities. This verification report presents the procedures and results of the verification test for the Endress + Hauser Conducta Liquisys CUS 31-W on-line turbidimeter.

Chapter 2 Technology Description

The following description of the Endress + Hauser Liquisys CUS 31-W turbidimeter is based on information provided by the vendor.

The basic Liquisys CUS 31-W on-line turbidimeter is a four-wire transmitter that provides measuring and alarm signaling functions in water/waste water applications. The sensor and transmitter are separate devices. The transmitter can be equipped with additional software and hardware modules for specific applications. The Liquisys CUS 31-W sensor uses the 90-degree scattered light method in the near-infrared range to measure turbidity. The sensor wiper has an adjustable cycle time from 1 to 999 seconds, and an adjustable interval time from 1 to 7,200 minutes, as well as an OFF state. The nominal operating temperature range is -5 to +50°C. In addition to turbidity, a temperature measurement signal is detected and transmitted. The Liquisys CUS 31-W turbidity range is 0 to 9999 nephelometric turbidity units (NTU). Selectable units also include ppm, g/L, %, or % SS. The control unit has a two-line display that indicates the measured value and temperature at the same time.



The Liquisys CUS 31-W turbidimeter conforms to the requirements of the ISO 7027 standard for turbidity measurement.⁽¹⁾ The Liquisys CUS 31-W turbidimeter's measuring wave length is 880 nm, and the unit comes in field or panel-mounted housing. The sensor is factory calibrated, and an alarm indicates calibration errors. An on-site recalibration of the zero point based on a reference measurement can also be performed. Cleaning is automatically initiated in case of an alarm or limit violation. Up to four contacts can be used as limit contacts.

Figure 2-1. Liquisys CUS-31-W Turbidimeter

Chapter 3 Test Design and Procedures

3.1 Introduction

The verification test was conducted according to procedures specified in the *Test/QA Plan for Verification of On-Line Turbidimeters*.⁽²⁾ Performance characteristics evaluated in the verification test are listed in Table 3-1, along with the dates that data were collected for these evaluations. The test was conducted at a full-scale municipal water treatment facility in Columbus, Ohio. The verification test described in this report was conducted from September 9 through October 26, 1999, as indicated in Table 3-1.

Table 3-1. Performance Characteristics Evaluated and Schedule of Verification Tests Conducted on the Liquisys CUS 31-W Turbidimeter

Performance Characteristic	Date Data Collected
Off-Line Phase	
Linearity	September 9 to 10; October 20-21
Accuracy	September 9 to 10
Precision	September 9 to 10
Water temperature effects	September 10, 14 to 15
Flow rate sensitivity	September 15 to 16
Color effects	October 25 to 26
On-Line Phase	
Accuracy	September 17 to October 18
Calibration checks	September 23, 24, 27, 30; October 6, 8, 12, 18

3.2 Test Design Considerations

Since turbidity is a measurement of light scattering, a number of factors can influence the measurement of turbidity in a given sample solution. Instrument design, including light source selection and geometric differences, may result in significant differences between the responses of different turbidimeters. Further differences may result from the variable nature of both the size and composition of particles typically found in water streams, relative to those in standard

solutions made with formazin or polymer beads. These issues were addressed in this verification test in two ways: (1) by using different instrumental designs for reference turbidimeters, and (2) by evaluating a variety of samples.

To avoid potential bias associated with a single method of comparison, the verification test used two reference methods for data comparisons: ISO 7027, “Water Quality—Determination of Turbidity”⁽¹⁾ and EPA Method 180.1, “Determination of Turbidity by Nephelometry.”⁽³⁾ Both of these methods measure turbidity using a nephelometric turbidimeter, but they differ in the type of light source and the wavelength used.

ISO 7027 calls for an infrared light source, whereas Method 180.1 calls for a visible light source. The Liquisys CUS 31-W is designed to conform to the requirements of ISO 7027, and thus that method is the appropriate reference for verification of the CUS 31-W’s performance. Verification results presented in this report, and summarized in the Verification Statement, are based on comparisons with the ISO 7027 data. However, secondary comparisons also are shown in this report, based on data from the CUS 31-W and Method 180.1. Those secondary comparisons are of interest because Method 180.1 is widely recognized in the U.S. and is designated as a required method for drinking water compliance measurements. The secondary comparisons are shown only to illustrate the performance capabilities of the CUS 31-W and should not be taken as having equal weight as the comparisons with ISO 7027.

To assess the response of the Liquisys CUS 31-W turbidimeter to both prepared solutions and real-world water samples, verification involved both off-line and on-line phases. The off-line phase challenged the turbidimeter with a series of prepared standards and other test solutions to verify performance under controlled conditions. The on-line phase assessed long-term performance under realistic operating conditions by monitoring a sample stream in a municipal water treatment plant under normal operation. With the cooperation of the City of Columbus Water Division, both off-line and on-line phases were performed at the Dublin Road Water Plant in Columbus, Ohio. The intent of testing was to verify turbidimeter performance in continuous unattended monitoring over a low turbidity range (i.e., approximately 0.1 to 1.0 NTU). No attempt was made to establish the ultimate detection limits of the turbidimeters tested. Other studies have indicated those detection limits can be as low as 0.01 NTU.

3.3 Experimental Apparatus

On-line turbidimeters measure turbidity continuously on flowing sample streams as opposed to the static grab samples analyzed by the bench-top reference turbidimeters. Consequently, great care was taken to ensure that the samples collected for reference analysis were representative of the sample flow measured by the Liquisys CUS 31-W turbidimeter. A cylindrical distribution manifold provided identical sample streams to sample ports spaced equally around the circumference of the manifold. Throughout the verification test, three ports were used for the turbidimeters being verified, and one port provided a stream for the grab samples. A single port centered in the bottom of the manifold introduced the sample stream to the distribution manifold. All the ports were tapped for 1/2" male normal pipe thread (NPT) fittings, and hard plastic compression fittings were used to connect the distribution manifold to the tubing (1/2" OD

polyethylene) used in the recirculation system. Using a consistent tubing size and fitting style enabled rapid switching of the turbidimeters on a scheduled basis among the ports on the distribution manifold. Providing identical samples to each of the manifold ports minimized biases arising from water quality or turbulence issues; rotation of the technologies to each of these ports was used to identify if biases existed.

A schematic representation of this recirculation system is provided in Figure 3-1, where T1 through T3 represent the three on-line turbidimeters undergoing verification testing. T3 represents the Liquisys CUS 31-W turbidimeter. Prepared solutions were supplied to all three turbidimeters simultaneously in a closed-loop recirculation system that used a 40-L reservoir and a centrifugal pump. Stream water from the plant was sampled from a pressurized source in a once-through configuration (i.e., without use of the pump or reservoir). In-line particle filters were inserted into the water flow using appropriate valving when reduction of turbidity levels was needed.

Before verification testing began, a series of five grab samples was collected from each port on the cylindrical manifold while recirculating a formazin solution with a nominal turbidity of 0.5 nephelometric turbidity unit (NTU). These samples were analyzed with the reference turbidimeters and compared to ensure uniformity of the turbidity of the solution. Comparison of the sample analyses indicated agreement in turbidity readings within $\pm 5\%$ among all of the ports.

Before testing began, the on-line turbidimeters verified in this test were installed in the test apparatus at the Dublin Road Water Plant. The Liquisys CUS 31-W turbidimeter was installed by Battelle and inspected by a field representative of Endress + Hauser. Much of the recirculation system, including the flow meters and the distribution manifold, was mounted to a 1/4"-thick aluminum panel installed in the water plant specifically for this verification test. The Liquisys turbidimeter housing was mounted on an "L" shaped Unistrut™ bracket that was bolted to a Unistrut™ beam installed in the water plant. The turbidimeter housing was secured to the bracket with a single bolt, which was screwed into a clamp around the body of the turbidimeter housing. Connections to the flexible plastic tubing on the inlet and outlet line were made with barbed fittings on the tubing in the recirculation system. Manual ball valves were installed upstream and downstream of the turbidimeter to control the flow rate and to maintain a back pressure on the system. A manual needle valve was also installed upstream of the turbidimeter to allow fine adjustment of the sample flow rate. A flow meter was installed downstream of the turbidimeter as illustrated in Figure 3-1.

The control unit (Model CUM 252) for the Liquisys CUS 31-W turbidimeter was installed on the aluminum panel using two of four available bolt holes in the back of the control unit housing. The sensor output was converted from a 4 to 20 mA signal to a direct current (DC) voltage using a precision resistor and was recorded every 10 seconds throughout the test using LabTech Notebook software, which was run on a personal computer at the test site. Throughout this test, the CUS 31-W was operated with a full-scale range of 10 NTU. Lower turbidity ranges can be chosen to improve the resolution of the output signal at the lowest turbidities.

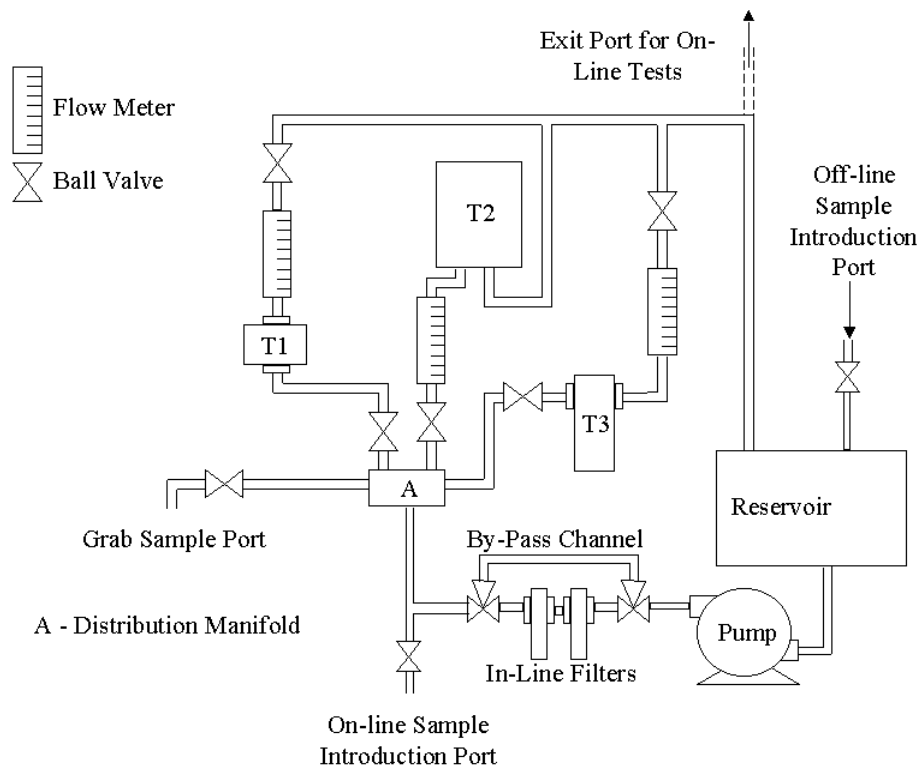

Figure 3-1. Schematic Representation of Recirculation System

As supplied by the vendor for testing, the CUM 252 control unit was wired to operate using 220V alternating current (AC) power. However, no transformer to allow operation on 110V AC was supplied with the instrument. Consequently, a small plug-in transformer with appropriate plug adaptors was purchased from Radio Shack™ with the approval of vendor representatives. During the course of testing, interference arising from the use of this transformer was suspected as the cause of a regular, periodic fluctuation of about 0.07 NTU (peak to peak) in the output of the Liquisys CUS 31-W turbidimeter. On October 18, near the end of the verification tests, a representative of Endress + Hauser performed several instrument checks at the Dublin Road Water Plant in an effort to understand and resolve this anomaly. This effort confirmed that the periodic signal fluctuations were caused by the commercial transformer. The appearance of this noise and its potential impact on the verification results for the CUS 31-W turbidimeter are presented in more detail in Section 6.3.2. The conclusion reached is that the CUS 31-W was not operating under optimal conditions during the verification test and, thus, the verification results must be considered as worst-case results.

3.4 Reference Instruments

Owing to the nature of turbidity measurement and the inherent differences in response arising from different instrumental designs, separate bench-top turbidimeters meeting the design criteria

detailed in ISO 7027⁽¹⁾ and EPA Method 180.1⁽³⁾ were used as reference instruments in this test. Both methods describe procedures to measure the nephelometric light scattering of a formazin solution, albeit with different prescribed instrumental design parameters. The primary difference between these two methods is in the choice of light source. Method 180.1 requires the use of a broadband incandescent tungsten lamp, while ISO 7027 requires the use of a narrowband IR source. Since the CUS 31-W is designed to comply with ISO 7027 requirements, that reference method is the basis for this verification. Comparisons of data with Method 180.1 also are shown because of the widespread recognition and use of that method. However, Method 180.1 comparisons are secondary to the ISO 7027 comparisons used for verification. The bench-top turbidimeters used as the reference methods were the Hach 2100AN IS (Serial Number 950700000173) and the Hach 2100AN (Serial Number 980300001366), which, according to the manufacturer's literature, comply with the design specifications described in ISO 7027⁽¹⁾ and EPA Method 180.1⁽³⁾, respectively. Throughout the test the reference turbidimeters were operated in the non-ratio mode.

3.5 Off-Line Testing

The off-line phase of the verification test involved off-line sample introduction aimed at assessing the linearity, accuracy, and precision of the Liquisys CUS 31-W on-line turbidimeter relative to the reference methods. Additionally, response to various upset conditions was quantified. As a means of testing these parameters, the off-line test phase included the introduction of standard formazin solutions or other samples, and the intentional manipulation of flow and water quality parameters.

Throughout the verification test, continuous turbidity measurements from the Liquisys turbidimeter were recorded at preset intervals using LabTech Notebook software. Grab samples were collected simultaneously with some of these recorded measurements and analyzed using bench-top reference turbidimeters to provide a basis of comparison for the performance evaluations. The collection of grab samples was timed to coincide within 10 seconds with the recording of real-time turbidity measurements from the Liquisys CUS 31-W, and the grab samples were analyzed within three minutes after collection to minimize possible temperature and settling effects.

Additionally, off-line testing included monitoring the instrumental responses of the Liquisys CUS 31-W turbidimeter to variations in water temperature, flow rate, and color. Each of these parameters was varied within a range consistent with conditions encountered under typical plant operation. The following subsections describe the procedures used for the off-line phase of the verification test.

Table 3-2 provides a summary of the parameters tested in the off-line phase, the test solutions used, and the number of readings recorded for each parameter.

Table 3-2. Summary of Measurements for Off-Line Testing

Parameter Tested	Test Solution	Number of Readings
Linearity	Filtered water (< 0.1 NTU)	5
Linearity (accuracy, precision) ^a	0.3 NTU Formazin	5
Linearity (accuracy, precision)	0.5 NTU Formazin	5
Linearity (accuracy, precision)	2 NTU Formazin	5
Linearity (accuracy, precision)	5 NTU Formazin	5
Water Temperature Effect	0.3 NTU Formazin	5 each at 16, 21, 27°C
Water Temperature Effect	5 NTU Formazin	5 each at 16, 21, 27°C
Flow Rate Effect	0.3 NTU Formazin	5
Flow Rate Effect	5 NTU Formazin	5
Color Effect	0.1 NTU	5 each at 5, 15, 30 CU
Color Effect	5 NTU Formazin	5 each at 35, 45, 60 CU

a: () indicates additional parameters analyzed using collected data.

3.5.1 Linearity

Linearity was measured in the range from approximately 0.05 to 5 NTU as an initial check in the off-line phase. The recirculation system was filled with distilled, dionized water, which was then recirculated and filtered in the test apparatus using a 0.2- μ m pleated polypropylene filter for 24 hours. After filtering, the in-line filter was bypassed, and the turbidity of the water in the recirculation system was measured by the reference turbidimeter as approximately 0.05 NTU. A series of five turbidity measurements was taken at that turbidity level with intervals of at least five minutes between successive measurements. A corresponding set of five measurements also was recorded at approximately 0.3, 0.5, 2, and 5 NTU. To reach each turbidity level, a small amount of 4000 NTU StablCal formazin stock solution was diluted in the recirculation system and allowed to flow through the recirculation system unfiltered for at least 15 minutes before turbidity readings were recorded. At each turbidity level, a series of five turbidity readings was recorded with at least a five-minute interval between successive readings. These readings were compared to the reference measurements of grab samples collected simultaneously with each reading; that is, the turbidity of the solutions was determined by measurement with the reference turbidimeters, rather than simply by calculations based on the dilution process. After the prescribed measurements were recorded at each turbidity level, additional formazin stock

solution was added to the recirculation system to increase the turbidity of the solution to the next value in the series.

Before measurements were recorded, the calibration of the reference turbidimeters was checked using a 0.5 NTU StablCal formazin solution purchased from Hach Company, Loveland, Colorado. Pursuant to the requirements of the test/QA plan,⁽²⁾ agreement between the reference measurement and the certified turbidity of the standard was required to be within 10% before recording any series of measurements. After each series of measurements, the calibration of the reference turbidimeters was again checked with the same standard, and the same acceptance limits were applied. In addition to the 0.5 NTU calibration checks, before and after the measurements on the filtered water, a < 0.1 NTU blank standard also was measured to ensure proper calibration of the reference instruments at low levels. The < 0.1 NTU standard also was purchased from Hach Company; agreement between the reference measurement and the turbidity reported on the certificate of analysis was required to be within 0.02 NTU.

3.5.2 Accuracy and Precision

Data obtained from the linearity measurements were used to establish the accuracy and precision of the Liquisys CUS 31-W turbidimeter in measuring formazin solutions. Accuracy was assessed by comparing continuous turbidity measurements with those from the ISO 7027 reference turbidimeter. Precision was assessed from the five replicate results at each turbidity level.

3.5.3 Water Temperature

Variations in the temperature of the water stream were introduced to simulate a range of conditions under which the on-line turbidimeters may typically operate. During off-line testing, the temperature of the recirculating water equilibrated in the range from 27 to 29°C, which was approximately 3 to 6°C above the room temperature at the water plant during testing. To assess the effect of temperature on the turbidimeter performance, the temperature of the recirculating solution was lowered using an immersion type chiller, and replicate turbidity measurements were recorded at approximately 21°C and again at 16°C. In these tests, the solution temperature in the reservoir was held within 2.5 degrees of the nominal 16°C and 21°C targets, while a series of five measurements was recorded at each temperature. To ensure equilibration, the solution was allowed to recirculate for one hour before the turbidity measurements were recorded. For the temperature tests at 16°C and 21°C, the temperature of the sample stream was recorded at the grab sample port within 30 seconds of sample collection, and the temperature of the grab sample was measured within 30 seconds of completion of the reference measurement. To assess temperature effects at different turbidities, this test was conducted with both 0.3 and 5 NTU solutions.

3.5.4 Flow Rate

The flow rate of the sample stream through the Liquisys CUS 31-W turbidimeter was manipulated to assess the response of the turbidimeter to various realistic operational conditions. A manual ball valve upstream and downstream and a manual needle valve upstream of the

Liquisys CUS 31-W turbidimeter were adjusted to vary the flow rate through the turbidimeter while maintaining a back pressure on the line. During normal testing, the flow rate was held in the range from 0.8 to 1.2 gallons per minute (gpm). The flow test was performed at a minimum flow rate of 0.45 gpm and at a maximum flow rate of 1.8 gpm. To assess the effect of flow rate on performance, measurements were made at both the minimum and maximum flow rate at turbidity levels of both 0.3 NTU and 5 NTU.

3.5.5 Color

Changes in water color were introduced by spiking the sample stream with colored solutions prepared from commercial food coloring dye. Stock solution was added to the system reservoir to prepare sample solutions of approximately 5, 15, and 30 color units (CU) successively, and the instrumental response to these color changes was monitored. Five measurements were made for each color level at both low turbidity (~ 0.1 NTU) and higher turbidity (~ 5 NTU).

The color of the recirculated solution was determined by analyzing the grab samples instrumentally using the Hach 2100AN reference turbidimeter with the supplied light filter. This reference turbidimeter was calibrated for color measurements according to the instrument manual. Solutions used in the color calibration of the reference turbidimeter were prepared by dilution of a commercial cobalt-platinum color standard⁽⁴⁾ (Hach Company, Loveland, Colorado).

At ~ 0.1 NTU, the color of the solution before the addition of the dye was approximately 0 CU. However, at the 5 NTU level, light scattering from the presence of formazin introduced an apparent color to the solution of approximately 30 CU. Consequently, for the 0.5 NTU test, dye solution was added to increase the color by 5, 15, and 30 CU; i.e., to bring the absolute color to approximately 35, 45, and 60 CU, respectively.

3.6 On-Line Testing

The on-line test phase focused on assessing the long-term performance of the Liquisys CUS 31-W turbidimeter under realistic unattended operating conditions and assessing its accuracy in monitoring an actual sample stream. Specifically, this phase of testing addressed the calibration and drift characteristics of the turbidimeter over a five-week period of monitoring a sample stream from the water plant. Routine reference measurements were used for comparison with the on-line readings to assess accuracy, and a re-evaluation of the calibration at the end of the test period helped establish drift characteristics. Natural meteorological and demand changes contributed to the variability of water quality in the treatment facility and provided a natural range of turbidity for characterizing performance.

Table 3-3 provides a summary of the parameters tested in the on-line phase, the test solutions used, and the number of readings recorded for each parameter.

Table 3-3. Summary of Measurements for On-Line Testing

Parameter Tested	Test Solution	Number of Readings
Accuracy	Plant Water	2 per weekday for 4 weeks (40 total)
Drift	0.3 NTU Standard	5 for final linearity check
Drift	0.5 NTU Standard	5 each for eight calibration checks and 5 for final linearity check
Drift	2 NTU Standard	5 for final linearity check
Drift	5 NTU Standard	5 for final linearity check

3.6.1 Accuracy

In the on-line testing, the accuracy of the Liquisys CUS 31-W turbidimeter relative to the ISO 7027 reference method was assessed on water samples from the plant stream. A sample stream was drawn from a flocculation settling basin at the Dublin Road Water Plant facility, containing unfiltered water that had been treated with lime, caustic, and alum. The sample stream was directed to the Liquisys turbidimeter through the distribution manifold. Two grab samples of this stream were collected and analyzed by the reference turbidimeters each weekday (Monday through Friday) for the four weeks of testing. The reference measurements of these samples were compared with the simultaneous results from the Liquisys CUS 31-W turbidimeter.

3.6.2 Drift

Drift was determined in two ways: (1) through off-line calibration checks conducted regularly throughout the course of the verification test using formazin solutions, and (2) through a comparison of multi-point linearity checks performed initially during the off-line phase described in Section 3.5.1 and subsequently after the completion of the on-line phase. The Liquisys CUS 31-W turbidimeter was calibrated by the vendor prior to shipment and installation at the water plant. **After that calibration, no further manual calibration or adjustment was performed for the duration of the verification test period.** However, during the course of the on-line testing, the Liquisys CUS 31-W turbidimeter occasionally showed large deviations in turbidity readings relative to the reference measurements. In addition, a small square wave with a period of 4 hours was sometimes observed in the output of the CUS 31-W, associated with the automatic cycle of the wiper on the optical window (see Section 6.3.2 for an illustration). When these behaviors occurred, the Liquisys CUS 31-W turbidimeter was taken off line briefly, and the optics and turbidimeter housing were cleaned.

The Liquisys CUS 31-W turbidimeter was taken off line briefly twice each week for routine calibration checks against a 0.5 NTU formazin solution. These intermediate calibration checks

were performed twice weekly for four consecutive weeks. Freshly prepared 0.5 NTU formazin solutions were used for the standard solution.

Upon completion of the four-week period, calibration and linearity were checked again by comparison with the reference measurements using standard solutions of 0.3, 0.5, 2, and 5 NTU. A linear fit of these data was compared with the initial linearity check performed in the off-line phase to assess the degree of calibration drift.

Chapter 4

Quality Assurance/Quality Control

Quality control (QC) procedures were performed in accordance with the quality management plan (QMP) for the AMS pilot⁽⁵⁾ and the test/QA plan⁽²⁾ for this verification test.

4.1 Data Review and Validation

Test data were reviewed and approved according to the AMS pilot QMP,⁽⁵⁾ the test/QA plan,⁽²⁾ and Battelle's one-over-one policy. The Verification Test Coordinator, or the Verification Test Leader, reviewed the raw data and the data sheets that were generated each day and approved them by adding their signature and the date. Laboratory record notebook entries were also reviewed, signed, and dated.

4.2 Deviations from the Test/QA Plan

During the preparation and performance of the verification test, deviations from the test/QA plan were implemented to better accommodate differences in vendor equipment, and other changes or improvements. Any deviation required the approval signature of Battelle's Verification Testing Leader. A planned deviation form was used for documentation and approval of the following changes:

1. Commercial food coloring dye was used for the color test instead of diluted color standard owing to the strongly acidic nature of the cobalt-platinum standard solution.
2. Calibration of the pH meter was performed only once during the test, and the meter was not readjusted to account for variations in ambient temperature. Recalibration should have been performed under the conditions of the test. However, the pH measurements were used only to assess changes and not for absolute measurements.
3. Only one in-line filter was used in the recirculation system.
4. The schedule of tests was lengthened and the order of testing was changed to better group series of parameter evaluations and to accommodate unexpected experimental anomalies.

These deviations had no significant impact on the test results used to verify the performance of the on-line turbidimeters.

4.3 Calibration

4.3.1 Reference Turbidimeters

The reference turbidimeters were calibrated according to the procedures described in their respective instrument manuals. The calibrations were performed on August 23, 1999. Calibration was performed using a blank, and 20, 200, 2000, and 7500 NTU StablCal calibration standards (Hach Company, Loveland, Colorado). After calibration and before proceeding with the verification test, the calibration of each reference turbidimeter also was checked through a five-point linearity test using solutions with the following turbidities: < 0.1, 0.3, 0.5, 2, and 5 NTU. The < 0.1, 0.3, and 0.5 NTU solutions were purchased and used as is, whereas the 2 and 5 NTU solutions were prepared by diluting a purchased 20 NTU StableCal formazin standard solution. The results of the linearity check are summarized in Table 4-1, indicating that the two reference turbidimeters gave essentially identical results. For each reference turbidimeter, the slope of this linear fit was within the 0.90 and 1.10 limits prescribed in the test/QA plan,⁽²⁾ and each fit had an $r^2 > 0.98$ as called for in the test/QA plan.⁽²⁾

Table 4-1. Results of Linearity Check of Reference Turbidimeters

Parameter	Hach 2100AN IS (ISO 7027)	Hach 2100AN (Method 180.1)
Slope	1.086	1.086
Intercept (NTU)	0.004	0.010
r^2	0.9991	0.9996

The calibration of each reference turbidimeter also was checked both before and after each series of test measurements, using a nominal 0.5 NTU StableCal standard solution. The reference turbidimeters were to be recalibrated if agreement between the turbidity reading and the certified 0.521 NTU turbidity value of this standard solution was not within $\pm 10\%$ (i.e., 0.469 to 0.573 NTU). If this calibration check criterion was met before but not after a series of test measurements, those measurements were to be repeated after recalibration of the reference turbidimeters. Throughout the course of the verification test, neither reference turbidimeter was ever found to be out of calibration, and consequently no recalibration of the reference turbidimeters was performed.

Before the background readings were measured for the detection limit determination, an additional calibration check with < 0.1 NTU standard was also performed on the reference turbidimeters to ensure proper calibration at low levels. These calibration checks were performed on September 9, 1999, for the initial linearity test and October 20, 1999, for the final linearity test. The results showed agreement within 0.02 NTU between the turbidity reading of the < 0.1 NTU standard, and the value as reported on the certificate of analysis.

4.3.2 Temperature Sensors

A Fluke 52 thermocouple (Battelle Asset Number 570080) was used throughout the verification test to determine water temperature and the ambient room temperature. This thermocouple was calibrated on June 30, 1999, against a calibrated temperature standard (Fluke 5500A, Battelle Asset Number SN-714755).

4.3.3 Flow Meters

The flow meter used in the verification test to measure the water flow through the Liquisys CUS 31-W turbidimeter was a panel-mounted, direct-reading meter purchased from Cole-Parmer (Catalog Number P-03248-56), capable of measuring up to 5 gpm. The flow meter was factory calibrated, and was checked once during the verification test by measuring the time required to fill a container of known volume through the meter at settings of 0.5 gpm and 2.5 gpm. Table 4-2 summarizes the results of the flow rate checks.

Table 4-2. Summary of Flow Meter Calibration Check

Flow Meter Setting (gpm)	Volume (gallon)	Time (seconds)	Calculated Rate (gpm)
0.5	2	220	0.54
0.5	3	343	0.52
0.5	4	462	0.52
0.5	5	584	0.51
2.5	5	127	2.4

The flow meter calibration check was performed on August 26, 1999, and indicated agreement within the 10% criterion established in the test/QA plan⁽²⁾ at both the minimum and maximum flow rates.

4.3.4 pH Meter

The pH meter was calibrated once during the verification test, with no further adjustment of the meter. Calibration included standardization at a pH of 7 and a pH of 10 using buffer solutions. Calibration checks performed during the color test indicated a bias of 0.1 to 0.3 pH units. Biases above 0.2 pH units fall outside of the acceptance criterion for the verification test and introduce an uncertainty to the absolute magnitude of the pH readings. However, the pH readings were recorded as a means of assessing if changes in the acidity of the solution occurred as a result of adding the color solution, rather than as an absolute measure of the pH itself. The pH readings recorded during the test indicated no evidence of pH change in the test solution as the result of adding dye to the test solution.

4.4 Data Collection

Electronic data were collected and stored by a PC-based data acquisition system using LabTech Notebook software (Version 8.0.1). Data were collected from the Liquisys CUS 31-W turbidimeter every 10 seconds over much of the course of verification testing. These data were saved in ASCII files along with the time of collection. Data files were stored electronically both on the hard drive of the data collection system and on floppy discs for backup purposes. Data collected manually included turbidity readings of the reference turbidimeters, flow rates, and water and ambient air temperature measurements. An example of the data recording sheet used to record these data is shown in Appendix A.

4.5 Assessments and Audits

4.5.1 Technical Systems Audit

Battelle's Quality Manager performed a technical systems audit once during the verification test. The purpose of this audit was to ensure that the verification test was performed in accordance with the test/QA plan⁽²⁾ and that all QA/QC procedures were implemented. In this audit, the Quality Manager reviewed the calibration standards and reference methods used, compared actual test procedures with those specified in the test/QA plan, and reviewed data acquisition and handling procedures. A report on this audit is provided in Appendix B.

4.5.2 Performance Evaluation Audit

Performance evaluation audits were conducted to assess the quality of the measurements made in the verification test. These audits addressed only those measurements made by Battelle staff in conducting the verification test, i.e., the reference turbidimeter readings and temperature measurements. The audits were conducted by analyzing the standards or comparing them with references that were independent of those used in the verification test. Each audit was made at least once during the verification test.

The audit of the reference turbidimeters was performed by analyzing a reference solution that was independent of the formazin standards used for calibration of the reference turbidimeters during the verification test. The independent reference solution was an AMCO AEPA-1 0.500 NTU standard solution obtained from APS Analytical Standards, Redwood City, California. This audit was conducted once daily throughout the verification test and served as an independent verification of the calibration of the reference turbidimeters. Agreement between the National Institute of Standards and Technology (NIST) traceable turbidity value of the AMCO-AEPA-1 solution and the turbidity readings from each reference turbidimeter was recorded and tracked graphically using a control chart. Furthermore, similar calibration assessments were performed daily using a purchased 0.521 NTU StablCal formazin standard (Hach Company, Loveland, Colorado), as described in Section 4.3.1. The results of these StablCal daily calibration assessments always showed agreement between the turbidity reading from each reference

turbidimeter and the true turbidity within $\pm 10\%$ as required in the test/QA plan.⁽²⁾ The results of the daily calibration assessments are shown in Figures 4-1a and 4-1b, for both the AMCO AEPA-1 standard and the formazin standard on the ISO 7027 and EPA Method 180.1 reference turbidimeters, respectively. (The dashed lines in the upper parts of Figures 4-1a and 4-1b are at intervals of 0.05 NTU, but are for visual reference only and are not exactly the $\pm 10\%$ control limits of the calibration checks. The bottom portion of each figure shows the $\pm 10\%$ control limits.) Throughout the course of the verification test, readings of the AMCO AEPA-1 standard, as measured by the ISO 7027 turbidimeter, ranged from -1.2% to +6.2% relative to the certified turbidity value for that standard, and were on average $\sim 2.7\%$ higher. For the EPA Method 180.1 turbidimeter, the range was -1.2% to +5.4% with an average reading which was 1.7% higher than the certified turbidity value. The daily fluctuations in these measurements resulted in standard deviations of $\sim 1.7\%$ for each reference turbidimeter. Similarly, readings of the formazin standard ranged from -5.2 to +8.4 for the ISO 7027 and from -6.9% to +8.3% for the Method 180.1. The average readings were higher than the certified turbidity value by $\sim 2.2\%$ when measured by the ISO 7027 and by $\sim 1.6\%$ for the Method 180.1 turbidimeter, with standard deviations of 3.5% and 3.7% respectively. Although the average deviations from the true turbidity values for these standards were approximately the same, the scatter in the readings was greater in the formazin readings.

The audit of the thermocouple used during the verification test consisted of a comparison of the temperature readings from the thermocouple with those of an independent temperature sensor. The thermocouple was checked for accuracy by comparison with an American Society for Testing and Materials mercury-in-glass thermometer in the Battelle Instrument Laboratory on October 13, 1999, and again on November 1, 1999. Those comparisons were done at ambient temperature, and the results are shown in Table 4-3.

Table 4-3. Results of Calibration Checks of Thermocouple Used in the Verification Test

	October 13, 1999	November 1, 1999
Fluke 52 Thermocouple	27.2°C	29.5°C
ASTM Mercury-in-Glass Thermometer	27.2°C	29.7°C

Agreement between the thermocouple used in the verification test and the mercury-in-glass thermometer was well within the two-degree specification established in the test/QA plan.⁽²⁾

4.5.3 Verification Test Data Audit

Battelle's Quality Manager audited at least 10% of the verification data acquired during the verification test. The Quality Manager traced the data from initial acquisition, through reduction and statistical comparisons, and to final reporting. All calculations performed on the data undergoing the audit were checked.

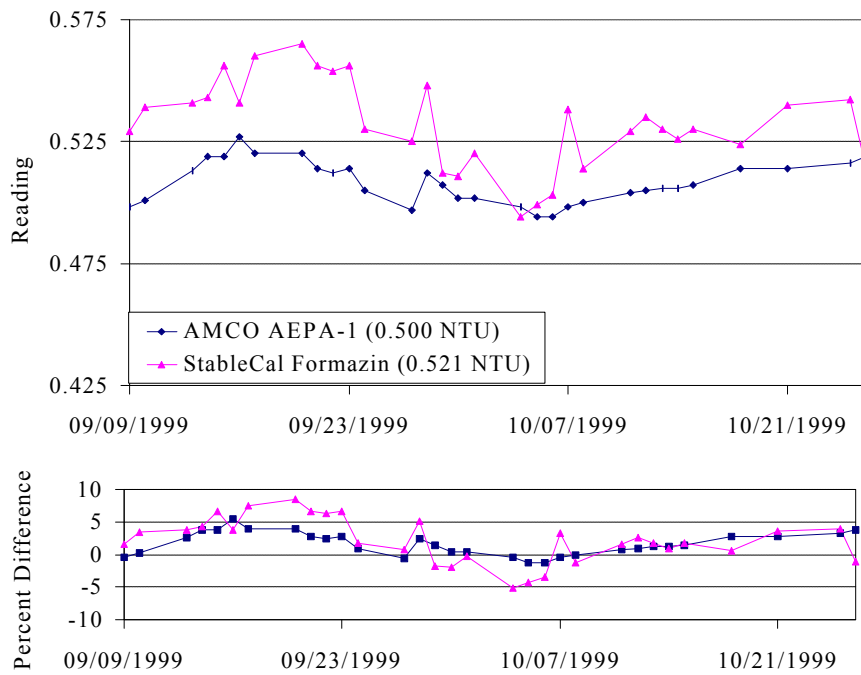

Figure 4-1a. Control Chart for Performance Evaluation Calibration Checks of the ISO 7027 Reference Turbidimeter

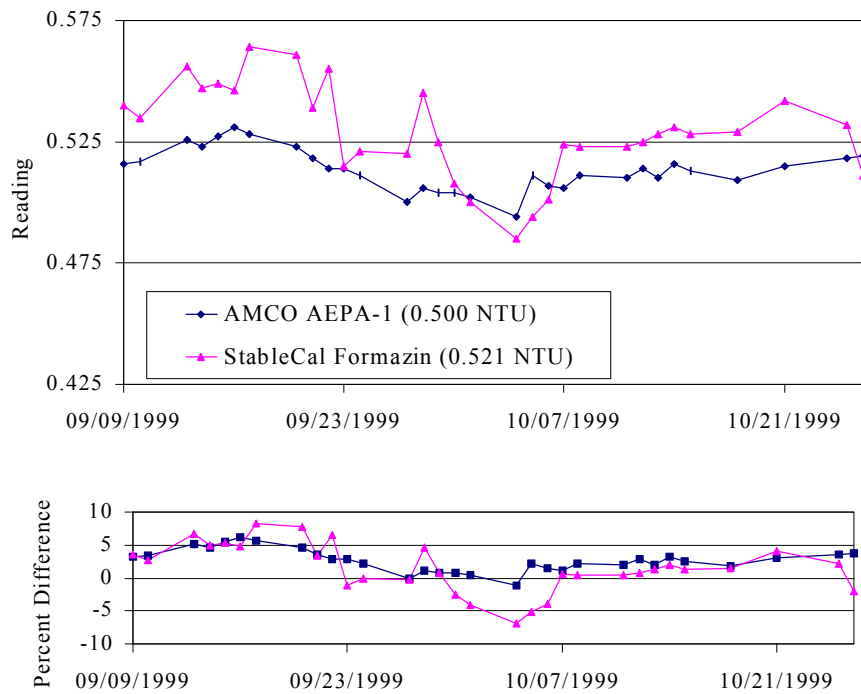

Figure 4-1b. Control Chart for Performance Evaluation Calibration Checks of the Method 180.1 Reference Turbidimeter

4.6 Audit Reporting

Each assessment and audit was documented in accordance with Section 2.9.7 of the Quality Management Plan for the AMS pilot.⁽⁵⁾ Assessment reports included the following:

- Identification of any adverse findings or potential problems
- Response to adverse findings or potential problems
- Possible recommendations for resolving problems
- Citation of any noteworthy practices that may be of use to others
- Confirmation that corrective actions have been implemented and are effective.

A copy of the Technical Systems Audit Report is included in Appendix B of this report.

Chapter 5 Statistical Methods

5.1 Off-Line Testing

The turbidimeter performance characteristics were quantified on the basis of statistical comparisons of the test data. This process began by converting the files that resulted from the data acquisition process into spreadsheet data files suitable for data analysis. The following statistical procedures were used to make the comparisons.

5.1.1 Linearity

Linearity was assessed by linear regression, with the reference turbidity reading (R) as an independent variable and the turbidimeter response (T) as a dependent variable. The regression model was

$$T = \mu_1 \times R + \beta$$

where μ_1 and $\hat{\alpha}$ are the slope and intercept of the response curve, respectively. The turbidimeter performance was assessed in terms of the slope, intercept, and the square of the correlation coefficient of the regression analysis.

5.1.2 Accuracy

The accuracy of the turbidimeter with respect to the reference method was assessed in terms of the average relative bias (B), as follows:

$$B = \left(\frac{\overline{(R - T)}}{R} \right) \times 100$$

where R is the turbidity reading of the reference turbidimeter, and T is the corresponding turbidity reading of the Liquisys CUS 31-W turbidimeter.

Accuracy relative to the reference turbidimeter was assessed both for the prepared solutions and the samples from the plant water stream. The accuracy of the Liquisys CUS 31-W turbidimeter was assessed relative to the ISO 7027 reference method for verification purposes and relative to the 180.1 reference method as an additional illustration of performance.

5.1.3 Precision

Precision was reported in terms of the percent relative standard deviation (RSD) of a group of similar measurements. For a set of turbidity measurements given by T_1, T_2, \dots, T_n , the standard deviation (S) of these measurements is

$$S = \left[\frac{1}{n-1} \sum_{k=1}^n (T_k - \bar{T})^2 \right]^{1/2}$$

where \bar{T} is the average of the turbidity readings. The RSD is calculated as follows:

$$\text{RSD} = \frac{S}{\bar{T}} \times 100$$

and is a measure of the dispersion of the measurement relative to the average value of the measurements. This approach was applied to the groups of replicate measurements on each test solution. In some cases, the turbidity of the prepared solution changed approximately linearly with time, due to loss of particles in the recirculation system. In those cases, a linear regression of the data was performed to assess the slope of the turbidity change as a function of time. This slope was used to adjust the individual turbidity readings to approximately the initial concentration. The precision was then calculated on the adjusted values as described above.

5.1.4 Water Temperature Effects

The effect of water temperature on the response of the Liquisys CUS 31-W at 0.3 NTU and 5 NTU was assessed by trend analysis. The turbidity readings relative to the ISO 7027 reference turbidimeter were analyzed as a function of water temperature to identify trends in the relative turbidity at each of the two levels of turbidity. The calculations were performed using separate linear regression analyses for the data at each turbidity level. A similar calculation was done for illustrative purposes using the 180.1 reference data.

5.1.5 Flow Rate Sensitivity

Analysis of flow rate influence on turbidity readings was similar to that for water temperature effects. The turbidimeter response relative to the ISO 7027 reference turbidimeter was analyzed as a function of flow rate to assess trends in the response of the turbidimeter with changes in sample flow rate. The analyses were performed separately for the 0.3 NTU and 5 NTU data. A similar calculation was done for illustrative purposes using the 180.1 reference data.

5.1.6 Color Effects

The influence of color on turbidity was assessed through a linear regression analysis of the turbidity measured for each color relative to the ISO 7027 reference turbidimeter. Separate analyses were performed for the measurements recorded at 0.1 NTU and those recorded at 5 NTU. A similar calculation was done for illustrative purposes using the 180.1 reference data.

5.2 On-Line Testing

5.2.1 Accuracy

As described in Section 5.1.2, accuracy in the on-line measurements was determined as a bias relative to the ISO 7027 reference turbidimeter. Daily reference measurements of the sample stream from the water plant were used to assess for accuracy. A similar calculation was done for illustrative purposes using the 180.1 reference data.

5.2.2 Drift

Drift was assessed in two ways. The drift in the calibration of the Liquisys CUS 31-W turbidimeter was assessed by comparison of the regression analyses of the multi-point linearity tests performed at the beginning and end of the verification test. This comparison was used to establish any long-term drift in instrumental calibration during the verification test. Also, the reference and on-line turbidity results in monitoring the plant water stream were used to assess drift associated with the operation of the instrument (e.g., fouling of the optics). Trends in the intermediate calibration data toward a positive bias were used to identify when the turbidimeter needed cleaning.

Chapter 6

Test Results

The results of the verification test are presented in this section, based upon the statistical methods of comparison shown in Chapter 5. For all performance characteristics verified, two sets of results are shown. The primary verification results are based on comparisons with the ISO 7027 reference method; a secondary illustration of performance is based on comparisons with the EPA 180.1 reference method. As noted in Section 3.3, and discussed later in Section 6.3.2, concerns about the electrical power supplied to the Liquisys CUS 31-W during verification lead to the recommendation that the verification results be considered worst-case performance results.

6.1 Off-Line Testing

Off-line testing was performed to assess the performance of the Liquisys CUS 31-W turbidimeter when measuring known solutions under controlled conditions. The first of the off-line tests was performed to establish the linearity of the turbidimeter response in the range from < 0.1 to 5 NTU. Data from the linearity test also were used to assess the accuracy and precision of the CUS 31-W in this turbidity range. After the linearity test, the effects of sample temperature, sample flow rate, and sample color were evaluated. The results of each of these tests are described in this section.

6.1.1 Linearity

The verification data from the initial linearity test are shown in Figure 6-1a. A series of at least five data points was recorded at each of the five nominal turbidity levels (approximately 0.05, 0.3, 0.5, 2, and 5 NTU). At the two highest NTU levels, a decrease in turbidity was observed in the readings of both the Liquisys turbidimeter and the reference turbidimeter. This decrease can be seen graphically as a spread in the data along the slope of the linearity plots. Between the first and fifth readings at 2 NTU, the decrease in turbidity represented approximately 4 to 5% of the initial turbidity as measured by the reference turbidimeter. This decrease in turbidity was likely the result of formazin being lost from the solution in the recirculation system. In an attempt to prevent the formazin loss, the solution was stirred magnetically. A second series of five measurements was recorded at the 2 NTU level after magnetic stirring of the formazin solution was introduced. After magnetic stirring was introduced, the decrease in turbidity was still observed, however, to a slightly lesser extent (approximately 2 to 4%).

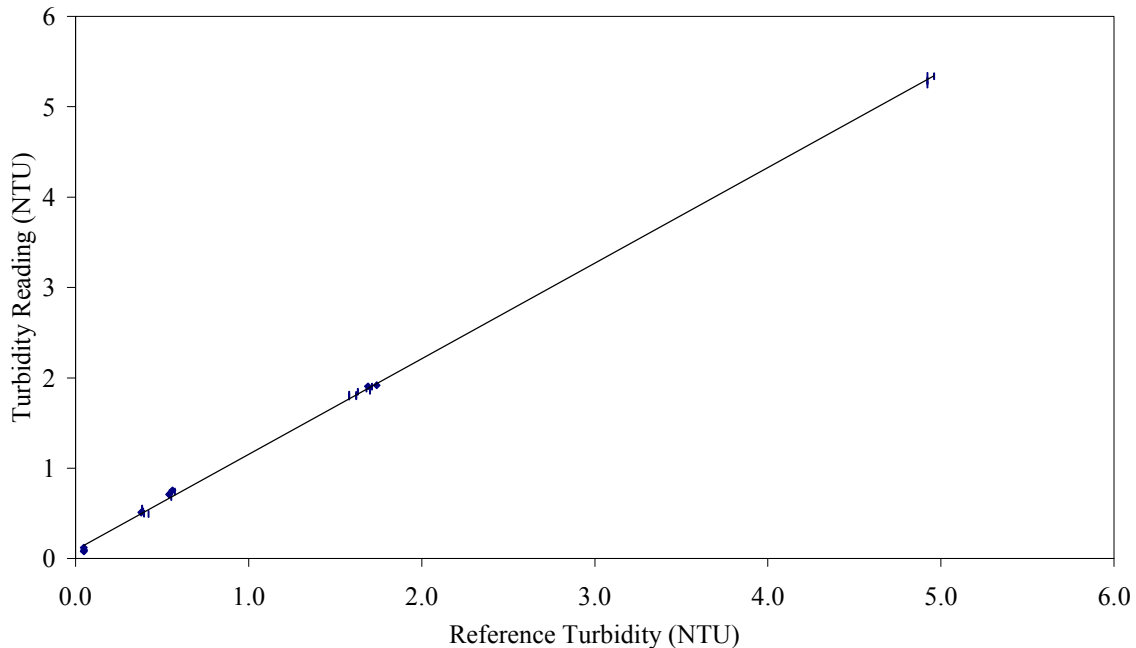

Figure 6-1a. Linearity Plot for Liquisys CUS 31-W Turbidimeter vs. ISO 7027 Reference Turbidimeter

The data from the linearity test were fit using a linear regression as described in Section 5.1.1, and the results of these fits are shown in Table 6-1. The secondary comparison with the Method 180.1 data is shown in Figure 6-1b, with the regression results also shown in Table 6-1.

The verification results of the linear regression indicate that the Liquisys turbidimeter responded linearly to turbidity throughout the range from about 0.05 to 5 NTU. The slope of the response curve was about 6% higher than unity with respect to the ISO 7027 reference turbidimeter, representing a small positive bias in turbidity readings. A small positive intercept of approximately 0.1 NTU was found in the regression. The secondary comparison with the Method 180.1 data (Table 6-1) shows very similar results for linearity.

6.1.2 Accuracy

Data obtained from the initial linearity test were used to assess accuracy for the off-line tests. The results of the accuracy verification are given in Table 6-2 and are presented as the average difference between the Liquisys CUS 31-W turbidimeter and the ISO 7027 reference turbidimeter, as well as the relative bias of the Liquisys CUS 31-W turbidimeter with respect to the reference measurements. Positive values indicate a positive bias in the Liquisys CUS 31-W turbidimeter readings when compared with the reference turbidimeter.

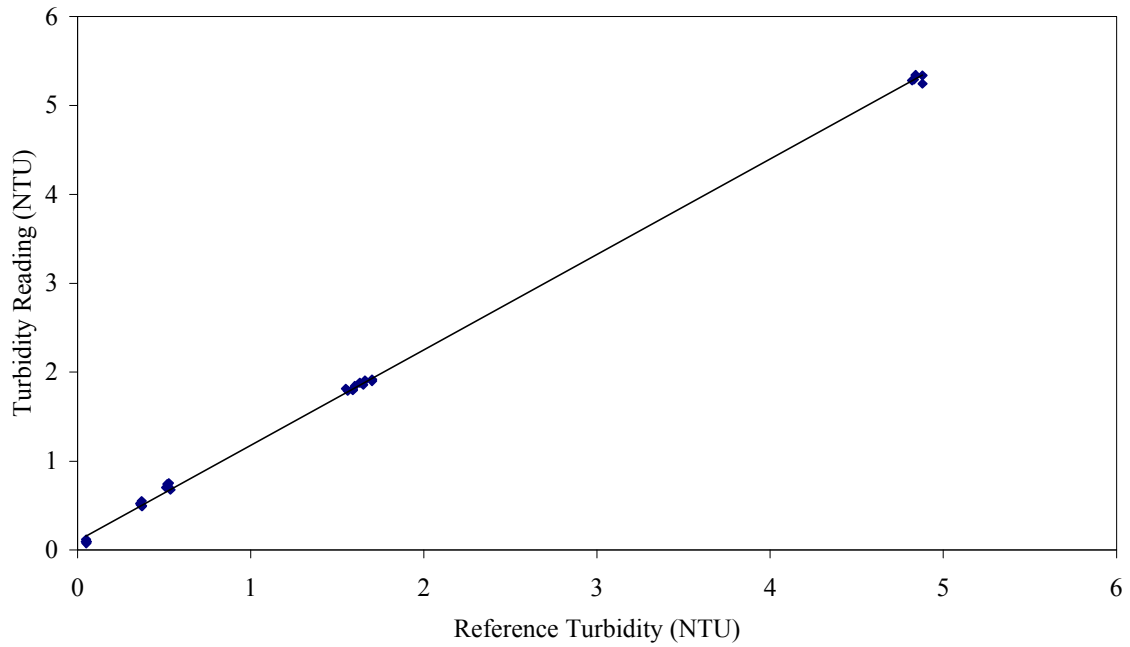

Figure 6-1b. Linearity Plot for Liquisys CUS 31-W Turbidimeter vs. Method 180.1 Reference Turbidimeter

Table 6-1. Statistical Results of Initial Linearity Test on Liquisys CUS 31-W Turbidimeter

Linear Regression Parameter	Verification Results^a	Secondary Comparison^b
Slope (std. error)	1.059 (0.004)	1.073 (0.005)
Intercept (std. error) NTU	0.092 (0.010)	0.106 (0.012)
r^2 (std. error)	0.9996 (0.0379)	0.9993 (0.0461)

^a Comparison with ISO 7027 reference method (2100AN IS reference turbidimeter)

^b Comparison with EPA Method 180.1 (2100AN reference turbidimeter)

Table 6-2. Bias of Liquisys CUS 31-W Turbidimeter Relative to the Reference Measurements on Prepared Test Solutions

Nominal Turbidity (NTU)	Verification Results ^a		Secondary Comparison ^b	
	Average Difference (NTU)	Relative Bias (%)	Average Difference (NTU)	Relative Bias (%)
0.3	0.1205	30.9	0.1461	39.8
0.5	0.1630	29.4	0.1942	37.1
2	0.1974	12.8	0.2294	14.8
5	0.3723	7.6	0.4503	9.3

^a Comparison with ISO 7027 reference method (2100AN IS reference turbidimeter)

^b Comparison with EPA Method 180.1 (2100AN reference turbidimeter)

In general, there is a positive bias in the Liquisys CUS 31-W readings relative to those of the ISO 7027 reference turbidimeter. The absolute magnitude of the difference in readings increases with increasing turbidity, but the relative bias as a percentage of the reference reading decreases with increasing turbidity. At 5 NTU, the bias is 7.6% relative to the reference result. The secondary comparison in Table 6-2 shows similar behavior relative to the Method 180.1 reference method.

6.1.3 Precision

Data from the linearity test were used to calculate precision at 0.3, 0.5, 2, and 5 NTU. At both the 2 NTU and 5 NTU levels, a decrease in turbidity was observed as a function of time during the test procedure. To account for this variability in turbidity, the readings at these two levels were analyzed by linear regression against time and adjusted to approximately the initial turbidity value using correction factors based on the regression results. The adjusted values (T_i') were calculated using the following equation:

$$T_i' = T_i + c(t_i - t_0)$$

where T_i is the i^{th} turbidity reading, t_i is the time at which the i^{th} sample was collected, t_0 is the time of collection for the initial sample in the series, and c is the slope of the line determined from the linear regression results of turbidity versus time at 2 NTU or 5 NTU. The results of these adjustment calculations are given in Table 6-3 for the Liquisys CUS 31-W turbidimeter. Similar corrections were applied to the reference readings since the reference readings showed the same trend of decreasing turbidity with time.

Table 6-3. Adjusted Turbidity Readings for Precision Calculations of the Liquisys CUS 31-W Turbidimeter

Nominal Value (NTU)	Actual Reading (NTU)	Corrected Reading (NTU)	Nominal Value (NTU)	Actual Reading (NTU)	Corrected Reading (NTU)
2	1.9189	1.9189	5	5.3369	5.3369
2	1.9006	1.9156	5	5.2454	5.2514
2	1.9067	1.9366	5	5.3430	5.3550
2	1.8579	1.9023	5	5.2942	5.3122
2	1.8823	1.9412	5	5.2820	5.3060
2	1.8457	1.9196			
2	1.7969	1.8891			
2	1.8091	1.9158			
2	1.8152	1.9364			
2	1.7900	1.9265			

The precision was calculated from the raw data at the 0.3 and 0.5 NTU levels and from the corrected data at the 2 NTU and the 5 NTU levels. The results of these calculations are shown in Table 6-4. For comparison, the calculated precision values for the two reference turbidimeters are also included in that table. The values in Table 6-4 are based on five readings at each level, with the exception of the 2 NTU level, which included ten readings.

The results of these calculations indicate that the Liquisys CUS 31-W turbidimeter readings were comparable in precision to those of the ISO 7027 reference turbidimeter throughout the range of turbidity measured in this verification test. The calculated standard deviations for the Liquisys range from 0.024 at 0.3 NTU (or 4.7% RSD) to 0.0393 at 5 NTU (or 0.74% RSD). In the same range, readings from the ISO 7027 reference turbidimeter had standard deviations ranging from approximately 0.02 NTU (or ~ 4% RSD) to approximately 0.01 NTU (or ~ 0.3% RSD). During the verification test, the Liquisys CUS 31-W turbidimeter output was set at 10 NTU full scale for the 4-20 mA output signal. The output range of the Liquisys CUS 31-W can be set to a smaller turbidity range to improve the resolution of the output signal at low turbidity. Additionally, as discussed in Sections 3.3 and 6.3.2, an increase in the variability of the CUS 31-W readings resulted from the transformer used to provide 220V power to the Liquisys CUS 31-W. Thus, better precision would be expected from the CUS 31-W under optimal conditions.

Table 6-4. Precision of Liquisys CUS 31-W Turbidimeter

Nominal Turbidity	Liquisys CUS 31-W		ISO 7027 (Hach 2100AN IS)		Method 180.1 (Hach 2100AN)	
	SD	RSD (%)	SD	RSD (%)	SD	RSD (%)
0.3 NTU	0.024	4.7	0.0161	4.1	0.0051	1.4
0.5 NTU	0.029	4.1	0.0118	2.1	0.0095	1.8
2 NTU	0.0161	0.84	0.0123	0.71	0.0108	0.64
5 NTU	0.0393	0.74	0.0126	0.26	0.0088	0.18

The secondary comparison shown in Table 6-4 indicates that the precision of the Liquisys CUS 31-W was comparable to that of the ISO 7027 reference turbidimeter, but both gave somewhat poorer precision than did the Method 180.1 reference turbidimeter.

6.1.4 Water Temperature Effects

The verification data obtained for the temperature test are shown in Figure 6-2a. As a result of gradual loss of formazin in the recirculation system during the temperature test, additional formazin solution was added between each set of temperature measurements to maintain turbidity levels at approximately 0.3 NTU and 5 NTU. Consequently, the absolute turbidity readings alone cannot be used as an indication of temperature effects. Therefore, the readings recorded for the Liquisys CUS 31-W turbidimeter were normalized to the corresponding reference readings to get a relative measure of turbidity. These relative values (i.e., ratios of CUS 31-W to ISO 7027 data) are shown in Figure 6-2a and were analyzed by linear regression to assess the effect of water temperature on turbidity reading. The results of the regression analysis are given in Table 6-5. Data used for a secondary comparison with Method 180.1 are shown in Figure 6-2b, and the results are also shown in Table 6-5.

These results indicate a small temperature effect at low turbidity (0.3 NTU), suggesting a slight decrease in relative turbidity readings with increased temperature, i.e., the results indicate a statistically significant change in observed turbidity relative to the reference turbidimeter as a function of temperature. This change represents a relative difference of approximately 1.7% per degree C relative to ISO 7027. At higher turbidity (5 NTU), the data indicate a smaller effect of water temperature on turbidity readings, and the standard error in the calculated slope accounts for about half of the calculated slope. Consequently, there is no strong evidence of a relationship between temperature and turbidity readings at 5 NTU.

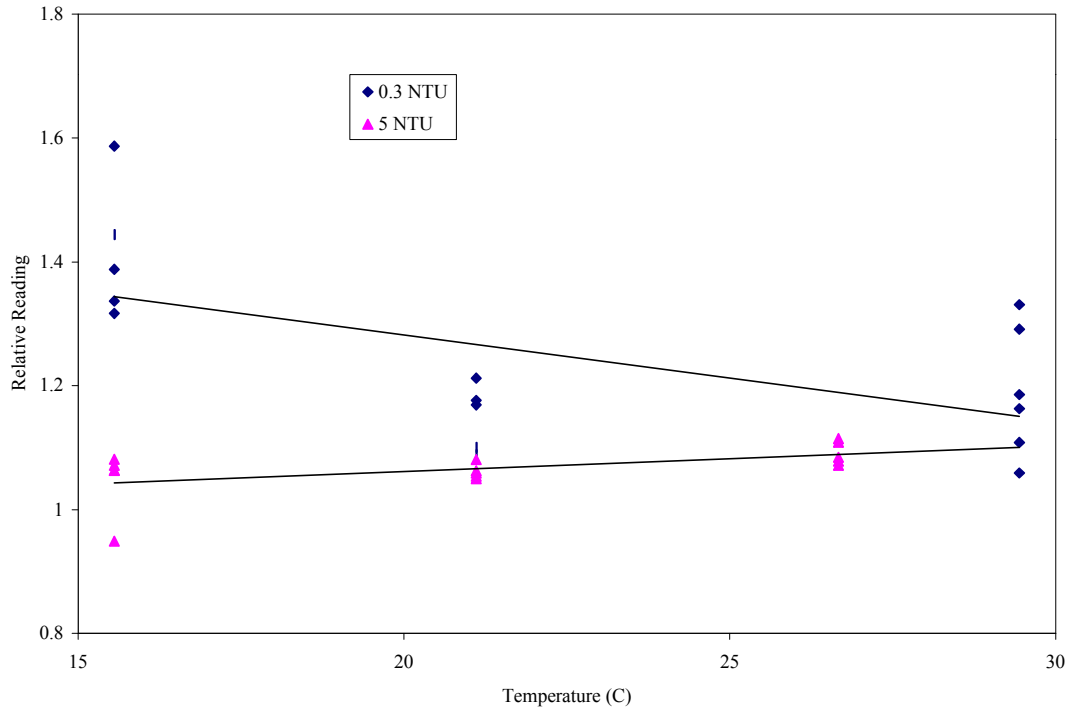

Figure 6-2a. Effect of Temperature on Liquisys CUS 31-W Turbidity Readings vs. ISO 7027 at Both 0.3 and 5 NTU

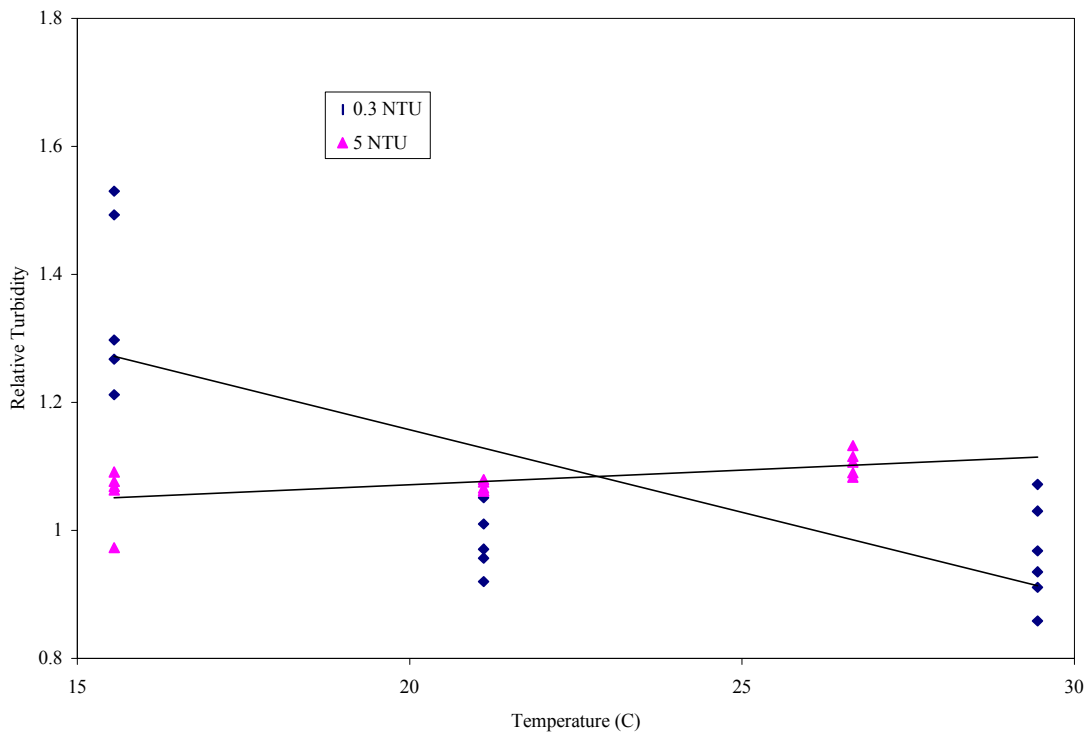

Figure 6-2b. Effect of Temperature on Liquisys CUS 31-W Turbidity Readings vs. Method 180.1 at Both 0.3 and 5 NTU

Table 6-5. Statistical Results of Temperature Test on the Liquisys CUS 31-W Turbidimeter

Linear Regression Parameter	Verification Results ^a		Secondary Comparison ^b	
	0.3 NTU	5 NTU	0.3 NTU	5 NTU
Slope (std. error)	-0.0168 (0.0041)	0.0041 (0.0019)	-0.0237 (0.0046)	0.0046 (0.0017)
Intercept (std. error)	1.612 (0.103)	0.979 (0.041)	1.636 (0.115)	0.979 (0.036)
r ² (std. error)	0.463 (0.112)	0.271 (0.033)	0.579 (0.125)	0.372 (0.029)

^a Comparison with ISO 7027 reference method (2100AN IS reference turbidimeter)

^b Comparison with EPA Method 180.1 (2100AN reference turbidimeter)

The secondary comparison in Table 6-5 shows that similar results were obtained for water temperature effects when comparing with Method 180.1.

6.1.5 Flow Rate

The results of the flow rate test are summarized in Figure 6-3. The data are again presented and analyzed as relative turbidity readings, rather than absolute turbidity readings, to correct for a gradual, slight loss of the formazin during the testing. The results of the statistical analysis of the flow data are presented in Table 6-6.

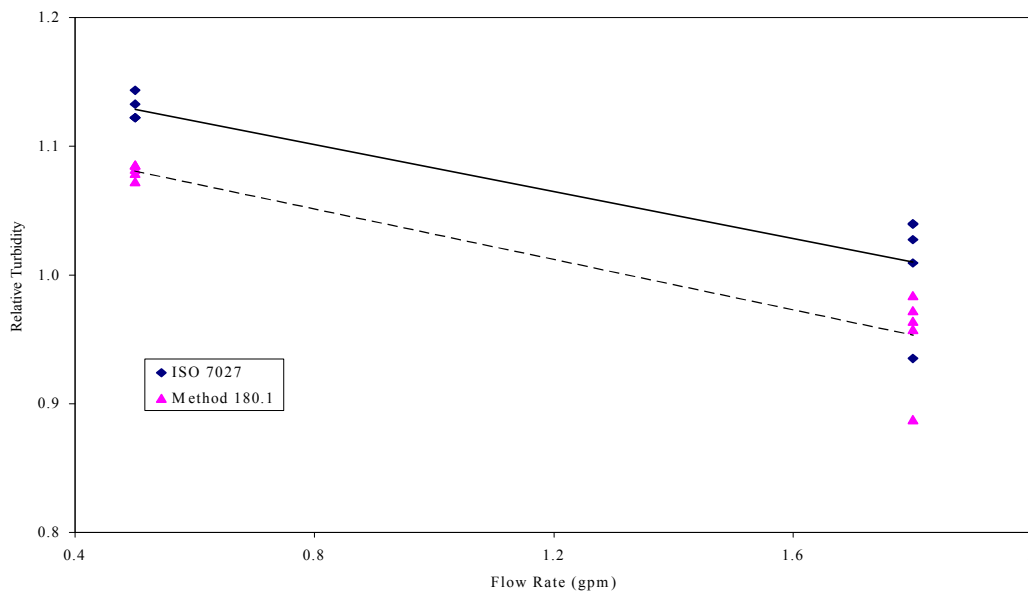

Figure 6-3. Effect of Sample Flow Rate on Liquisys CUS 31-W Turbidimeter Response

Table 6-6. Statistical Results of Flow Rate Test for the Liquisys CUS 31-W Turbidimeter

Parameter	Verification Results^a	Secondary Comparison^b
Slope (std. error)	-0.091 (0.015)	-0.0982 (0.0132)
Intercept (std. error)	1.174 (0.020)	1.130 (0.017)
r ² (std. error)	0.814 (0.032)	0.874 (0.027)

^a Comparison with ISO 7027 reference method (2100AN IS reference turbidimeter)

^b Comparison with EPA Method 180.1 (2100AN reference turbidimeter)

The verification results indicate a significant effect of sample flow rate on the response of the Liquisys CUS 31-W turbidimeter in the range of 0.45 to 1.8 gpm. Relative to ISO 7027, this effect amounts to a decrease in indicated turbidity of 9.1% for a 1 gpm increase in flow rate over the range of flow tested. The secondary comparison in Table 6-6 shows a similar result relative to Method 180.1.

6.1.6 Color Effects

The verification data obtained from the color tests are shown in Figure 6-4a. In this figure, the data at each color level are plotted as relative values with respect to the reference turbidimeter readings, and the statistical analysis of these data involved a linear regression analysis of the relative data as a function of solution color. At 5 NTU, the background color reading of approximately 30 CU was subtracted, and only the effect of color added during the test is shown. The results of the statistical calculations are summarized in Table 6-7. The secondary comparison with Method 180.1 data is shown in Figure 6-4b and summarized in Table 6-7.

The verification results in Table 6-7 show that, at the 5 NTU level, there is no significant effect of color on the response of the Liquisys CUS 31-W turbidimeter. At the 0.1 NTU level, there is an effect of color, which amounts to an increase in turbidity indicated by the Liquisys turbidimeter on the order of 0.5% per CU increase relative to the ISO 7027 reference turbidimeter.

The secondary comparison in Table 6-7 shows similar results relative to Method 180.1 data.

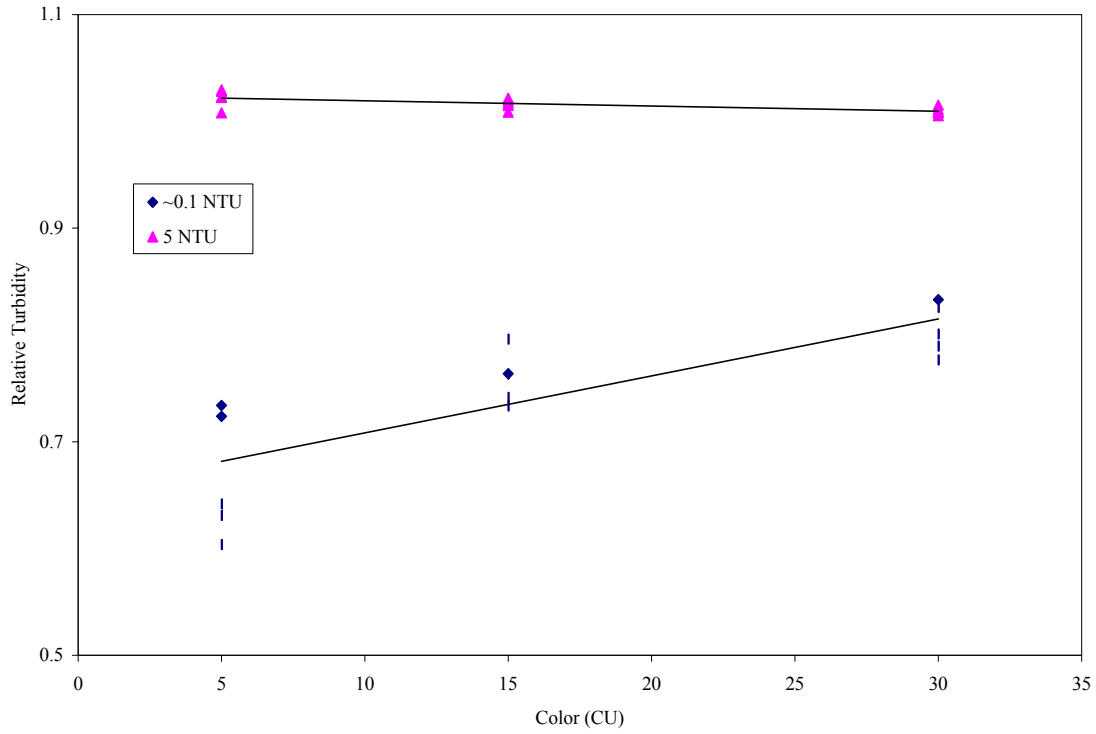

Figure 6-4a. Effect of Color on Relative Turbidity with the Liquisys CUS 31-W Turbidimeter vs. ISO 7027 at Both 0.1 and 5 NTU

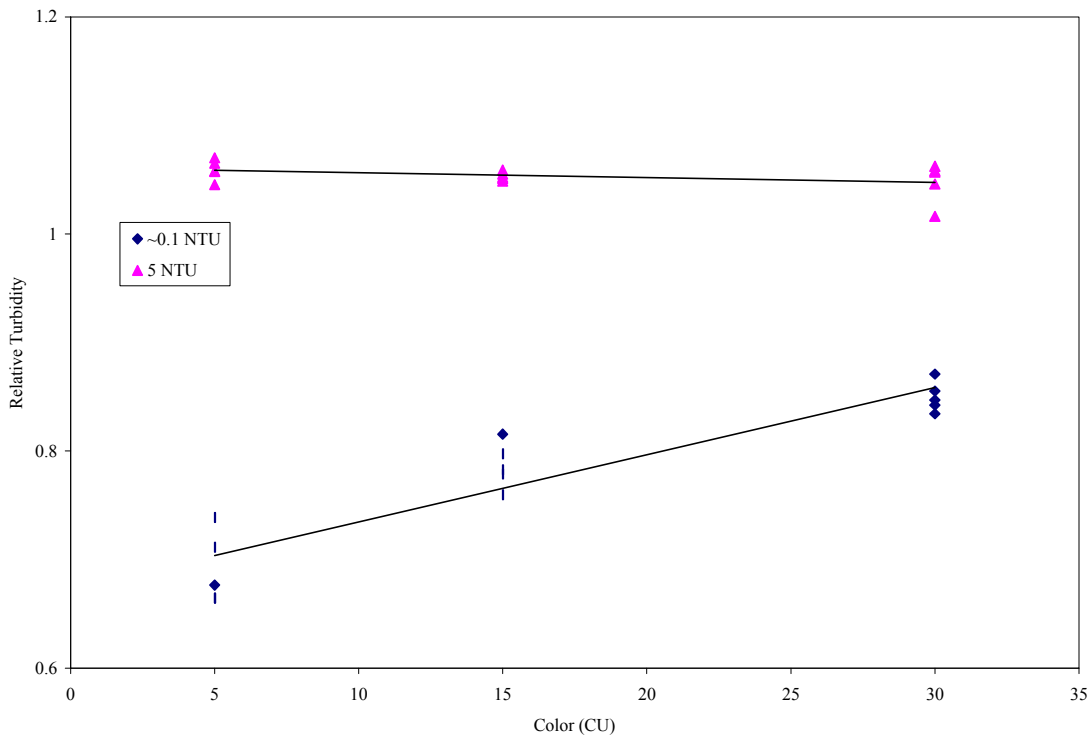

Figure 6-4b. Effect of Color on Relative Turbidity with the Liquisys CUS 31-W Turbidimeter vs. Method 180.1 at Both 0.1 and 5 NTU

Table 6-7. Statistical Results of the Color Test with the Liquisys CUS 31-W Turbidimeter

Parameter	Verification Results ^a		Secondary Comparison ^b	
	0.1 NTU	5 NTU	0.1 NTU	5 NTU
Slope (std. error)	0.0053 (0.0011)	-0.0005 (0.0001)	0.0062 (0.0007)	-0.0004 (0.0003)
Intercept (std. error)	0.655 (0.021)	1.024 (0.003)	0.673 (0.014)	1.061 (0.006)
r ² (std. error)	0.663 (0.042)	0.464 (0.006)	0.855 (0.028)	0.145 (0.012)

^a Comparison with ISO 7027 reference method (2100AN IS reference turbidimeter)

^b Comparison with EPA Method 180.1 (2100AN reference turbidimeter)

6.2 On-Line Testing

Figure 6-5 shows the results from the four weeks of on-line testing. In this figure, data from the Liquisys CUS 31-W and the reference turbidimeters are shown, along with additional data supplied by the Dublin Road Water Plant (DRWP). Data from the DRWP are from a turbidimeter in the plant sampling the same water stream at a different location, for plant operational purposes. These DRWP data are shown to illustrate the trends in turbidity of the water stream sampled for this test. No quantitative comparisons with the DRWP data should be made, since these data were not collected at the same location as samples for this verification test. For convenience, only one data point per hour is shown for the Liquisys CUS 31-W, although data were recorded at intervals of 10 seconds throughout the on-line testing. Breaks in the data from the Liquisys turbidimeter indicate periods during which the turbidimeter was taken off line for calibration checks or cleaning.

In general, Figure 6-5 illustrates correlation and sometimes close quantitative agreement between the Liquisys and the reference measurements. Also, the varying turbidity levels shown by the CUS 31-W indicate a temporal pattern that matches that of the DRWP data.

6.2.1 Accuracy

The results from the daily accuracy checks in the four weeks of on-line testing are given in Table 6-8. The results shown in the table are given as the average of the two simultaneous readings taken each day on samples from the plant water stream with the Liquisys CUS 31-W turbidimeter and the reference turbidimeters. In cases where more than the prescribed two readings were recorded, all the values are included in the reported average. Additionally, the bias in the Liquisys CUS 31-W readings relative to the reference turbidimeters is reported.

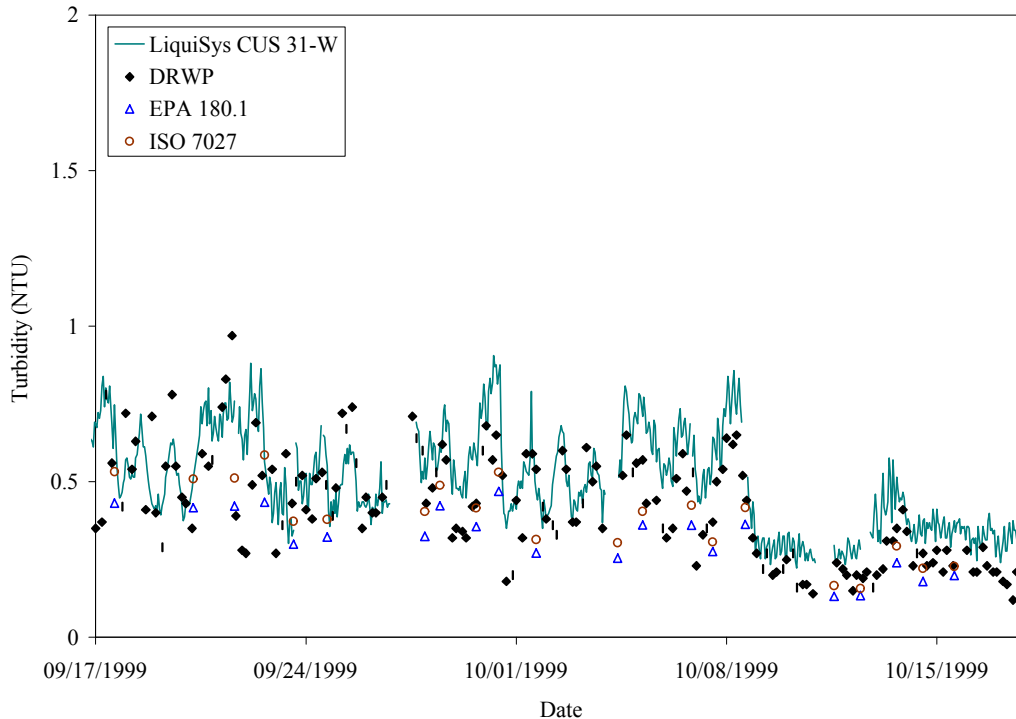

Figure 6-5. Summary of Stream Turbidity Data from On-Line Testing of Liquisys CUS 31-W

The verification results in Table 6-8 show that the Liquisys CUS 31-W generally read about 0.1 to 0.3 NTU higher than the ISO 7027 reference turbidimeter over a reference turbidity range of about 0.16 to 0.6 NTU. Positive biases of about 35 to 65% characterize most of this data range. The CUS 31-W and the reference data exhibited a linear regression of the form $CUS\ 31-W = 1.198 (ISO\ 7027) + 0.113\ NTU$, with $r^2 = 0.757$.

The secondary comparison in Table 6-8 shows somewhat lower accuracy relative to Method 180.1, as expected, but the same degree of correlation ($r^2 = 0.754$).

A similar positive bias was observed for all of the on-line turbidimeters tested in this verification test, suggesting a systematic bias in the reference data. It should be noted that visible granular deposits accumulated in the test apparatus during the on-line testing. Thus, it is possible that a negative bias may have existed in the reference on-line results as a result of large particle settling in the grab sample vial between sample collection and reference analysis.

The optics and housing of the Liquisys CUS 31-W turbidimeter were cleaned after the readings on September 24 and October 18, and before the readings on October 1 and 8. The latter readings recorded directly after the cleanings show some reduction in bias between the Liquisys CUS 31-W and reference readings, when compared with the previous readings. This reduction is most apparent with the October 8 readings, which agree very closely with the reference turbidimeter readings immediately after the cleaning process. These observations suggest that fouling of the CUS 31-W may also have been a factor in the positive bias observed relative to the ISO 7027 data.

Table 6-8. On-Line Daily Accuracy Check Results

Date	Liquisys CUS 31-W, NTU	Verification Results^a (Relative bias %)	Secondary Comparison^b (Relative bias %)
9/17/99	0.7593	0.5320 (42.7)	0.4315 (76.0)
9/20/99	0.7563	0.5090 (48.6)	0.4165 (81.6)
9/21/99	0.7807	0.5115 (52.6)	0.4215 (85.2)
9/22/99	0.7608	0.5855 (29.9)	0.4338 (75.4)
9/23/99	0.5518	0.3725 (48.1)	0.2990 (84.5)
9/24/99	0.6281	0.3790 (65.7)	0.3220 (95.0)
9/27/99	0.6281	0.4040 (55.5)	0.3245 (93.5)
9/28/99	0.5029	0.4885 (2.9)	0.4230 (18.9)
9/29/99	0.5915	0.4155 (42.3)	0.3560 (66.1)
9/30/99	0.8966	0.5310 (68.9)	0.4690 (91.2)
10/1/99	0.4968	0.3140 (58.2)	0.2710 (83.3)
10/4/99	0.5579	0.3040 (83.5)	0.2550 (118.8)
10/5/99	0.5498	0.4043 (36.0)	0.3607 (52.4)
10/6/99	0.6403	0.4240 (51.0)	0.3605 (77.6)
10/7/99	0.6616	0.3065 (115.9)	0.2755 (140.1)
10/8/99	0.4236	0.4173 (1.5)	0.3627 (16.8)
10/11/99	0.2649	0.1660 (59.6)	0.1320 (100.7)
10/12/99	0.2497	0.1570 (59.0)	0.1340 (86.3)
10/13/99	0.4633	0.2930 (58.1)	0.2400 (93.0)
10/14/99	0.3473	0.2215 (56.8)	0.1795 (93.5)
10/15/99	0.3687	0.2280 (61.7)	0.1985 (176.4)
10/18/99	0.3656	0.1900 (92.4)	0.1830 (233.2)

^a Comparison with ISO 7027 reference method (2100AN IS reference turbidimeter)

^b Comparison with EPA Method 180.1 (2100AN reference turbidimeter)

6.2.2 Drift

6.2.2.1 Calibration Checks

The results from the twice weekly calibration checks with formazin standards at 0.5 NTU are shown in Figure 6-6 and summarized in Table 6-9.

The verification results in Table 6-9 show that the Liquisys CUS 31-W read about 12 to 35% higher than the ISO 7027 reference turbidimeter on the twice-weekly calibration solutions, with an average positive bias of 23.8%, and an associated uncertainty of 8.6%. These results show closer agreement on the calibration check samples than on the stream samples (Table 6-8), indicating a difference in performance on these two types of samples.

During the initial linearity check (Section 6.1.2), data from the CUS 31-W showed a positive bias of about 30% relative to the ISO 7027 data at the nominal turbidities of 0.3 to 0.5 NTU. That bias is within the uncertainty of the average bias observed with the twice-weekly calibration checks (Table 6-9), so no significant drift of the CUS 31-W calibration is indicated.

The CUS 31-W housing was cleaned before the calibration checks on September 24 and October 8, and between the calibration checks on October 18 (Table 6-9). In all three cases, bias relative to the ISO 7027 results was substantially reduced after cleaning. These observations indicate that fouling of the CUS 31-W housing may have contributed to the positive biases observed.

The secondary comparison in Table 6-9 shows that similar results were observed relative to the Method 180.1, with slightly higher bias results in all cases.

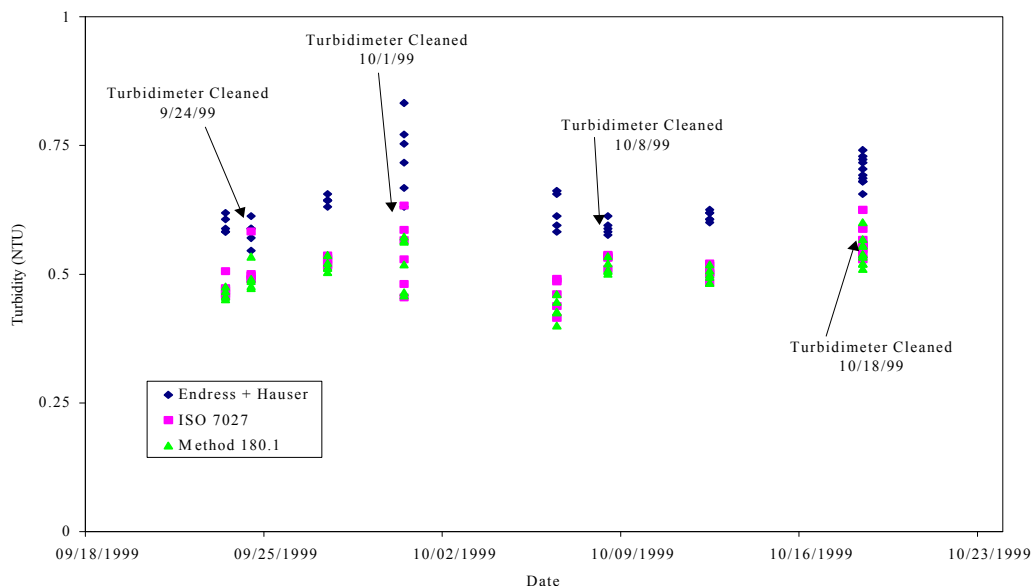

Figure 6-6. Twice-Weekly Calibration Checks During On-Line Testing of the Liquisys CUS 31-W Turbidimeter

Table 6-9. Results of Calibration Checks Performed During On-Line Testing

Date	Liquisys CUS 31-W (NTU)	Verification Results^a (Relative Bias %)	Secondary Comparison^b (Relative Bias %)
09/23/99	0.596	0.473 (25.8)	0.461 (29.1)
09/24/99	0.581	0.512 (13.5)	0.492 (18.0)
09/27/99	0.643	0.526 (22.3)	0.518 (24.3)
09/30/99	0.729	0.542 (34.5)	0.524 (39.1)
10/06/99	0.621	0.458 (35.6)	0.432 (43.8)
10/08/99	0.591	0.530 (11.6)	0.514 (14.9)
10/12/99	0.613	0.505 (21.4)	0.498 (23.1)
10/18/99	0.723	0.556 (30.0)	0.544 (32.8)
10/18/99	0.679	0.569 (19.2)	0.544 (24.7)

^a Comparison with ISO 7027 reference method (2100AN IS reference turbidimeter)

^b Comparison with EPA Method 180.1 (2100AN reference turbidimeter)

6.2.2.2 Final Linearity Check

Verification data from the final linearity check are shown in Figure 6-7a. These data were recorded after completion of the four weeks of on-line testing and after the Liquisys CUS 31-W turbidimeter had been cleaned. As with the data from the initial linearity test, these data were analyzed by linear regression. The results are summarized in Table 6-10. In Table 6-11, the results of the final linearity test are compared with those from the initial linearity check conducted at the start of the verification as part of the off-line phase. Data from the secondary comparison to Method 180.1 are shown in Figure 6-7b and summarized in Tables 6-10 and 6-11.

The verification results of the regression analysis (Table 6-10) show a high degree of linearity, with a slope of about 1.07 with respect to the ISO 7027 reference turbidimeter, and a small negative intercept of approximately 0.1 NTU. Comparison (in Table 6-11) of the regression results from the linearity tests performed at the beginning (Table 6-1) and the end (Table 6-10) of the verification period indicates only a very small difference in the instrument linearity results. This difference is observed primarily as a negative shift (~0.2 NTU) in the intercept of the linearity plot relative to the ISO 7027 data. The observed change in the slope relative to the ISO 7027 data was less than 1%. These results indicate minimal drift in the Liquisys CUS 31-W over the course of the verification.

The secondary comparison data in Tables 6-10 and 6-11 indicate about a 3.7% difference in the regression slopes relative to Method 180.1, with a change in the regression intercept of about -0.2 NTU.

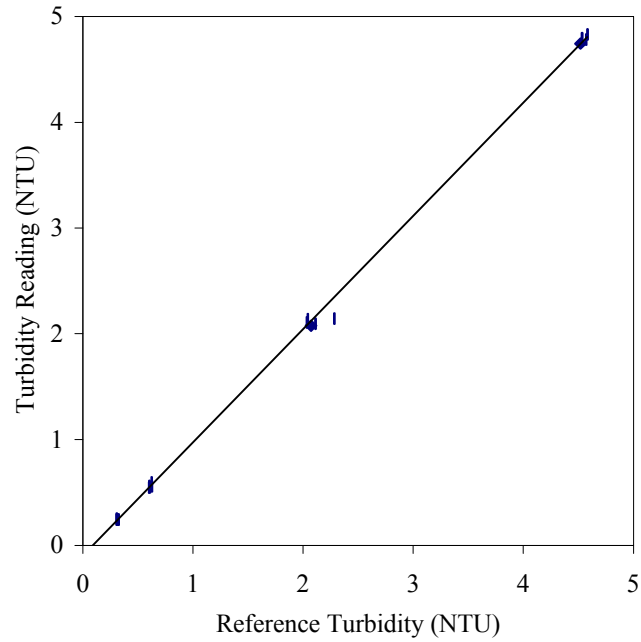

Figure 6-7a. Final Linearity Plot for Liquisys CUS 31-W vs. ISO 7027 Reference Turbidimeter

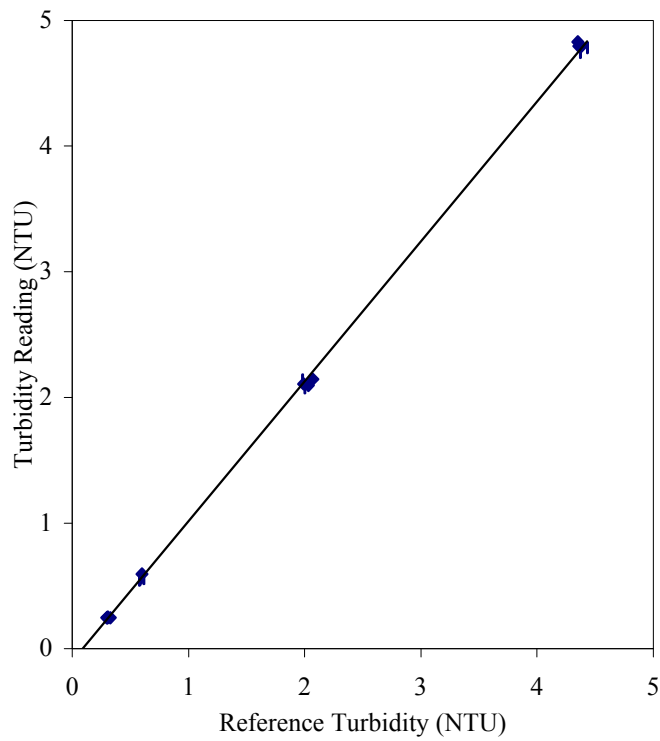

Figure 6-7b. Final Linearity Plot for Liquisys CUS 31-W vs. Method 180.1 Reference Turbidimeter

Table 6-10. Statistical Results of Final Linearity Test

Linear Regression	Verification Results^a	Secondary Comparison^b
Slope (std error)	1.069 (0.006)	1.113 (0.004)
Intercept (std error)	-0.094 (0.014)	-0/099 (0.009)
r^2	0.9993 (0.0499)	0.9997 (0.0343)

^a Comparison with ISO 7027 reference method (2100AN IS reference turbidimeter)

^b Comparison with EPA Method 180.1 (2100AN reference turbidimeter)

Table 6-11. Comparison of Results from Linearity Tests at Beginning and End of the Verification Test

	Verification Results^a		Secondary Comparison^b	
	Slope	Intercept	Slope	Intercept
Initial Linearity Test	1.059	0.092	1.073	0.106
Final Linearity Test	1.069	-0.094	1.113	-0.099
Difference	0.010	-0.186	0.040	-0.205
% Difference	0.94	--	3.7	--

^a Comparison with ISO 7027 reference method (2100AN IS reference turbidimeter)

^b Comparison with EPA Method 180.1 (2100AN reference turbidimeter)

6.3 Other Performance Parameters

6.3.1 Cost

As tested, the cost of the Liquisys CUS 31-W was approximately \$1,500.

6.3.2 Maintenance/Operational Factors

Time requirements for installation were not assessed in this test because temporary installation in the experimental apparatus did not reflect the permanent installation in a water treatment facility. However, the primary time-consuming activities in the installation procedure were securing the Unitstrut™ brackets to support the turbidimeter housing and installing the control unit on the aluminum panel. After installation, Liquisys CUS 31-W turbidimeter required no operator input and provided data continuously throughout the verification test.

The only maintenance of the Liquisys CUS 31-W involved occasional cleaning of the turbidimeter housing, optics, and wiper assembly. The reservoir was cleaned a total of four times during

the on-line testing to remove residues and material deposits that had accumulated. In general, turbidimeter cleaning was initiated when a square wave signal was observed, associated with the two-hour programmed cycle of the wiper. Figure 6-8 illustrates an example of the square wave signal observed in sampling the plant water stream. This square wave generally disappeared after cleaning the turbidimeter housing, optics, and wiper assembly. The square wave resulted from the fact that the wiper assembly made a single pass across the face of the turbidimeter sensor, alternately leaving the wiper on one side of the optics or the other. It is likely that this alternating position slightly changed the amount of reflected light entering the turbidimeter housing, resulting in slightly different signals.

It should be noted that, although this phenomenon was observed with the turbidimeter used in this verification test, Endress + Hauser has addressed the problem and has changed subsequent versions of the Liquisys CUS 31-W to eliminate it. In newer versions, there are always an even number of traverses of the wiper across the optics; i.e., the wiper always returns to its original position.

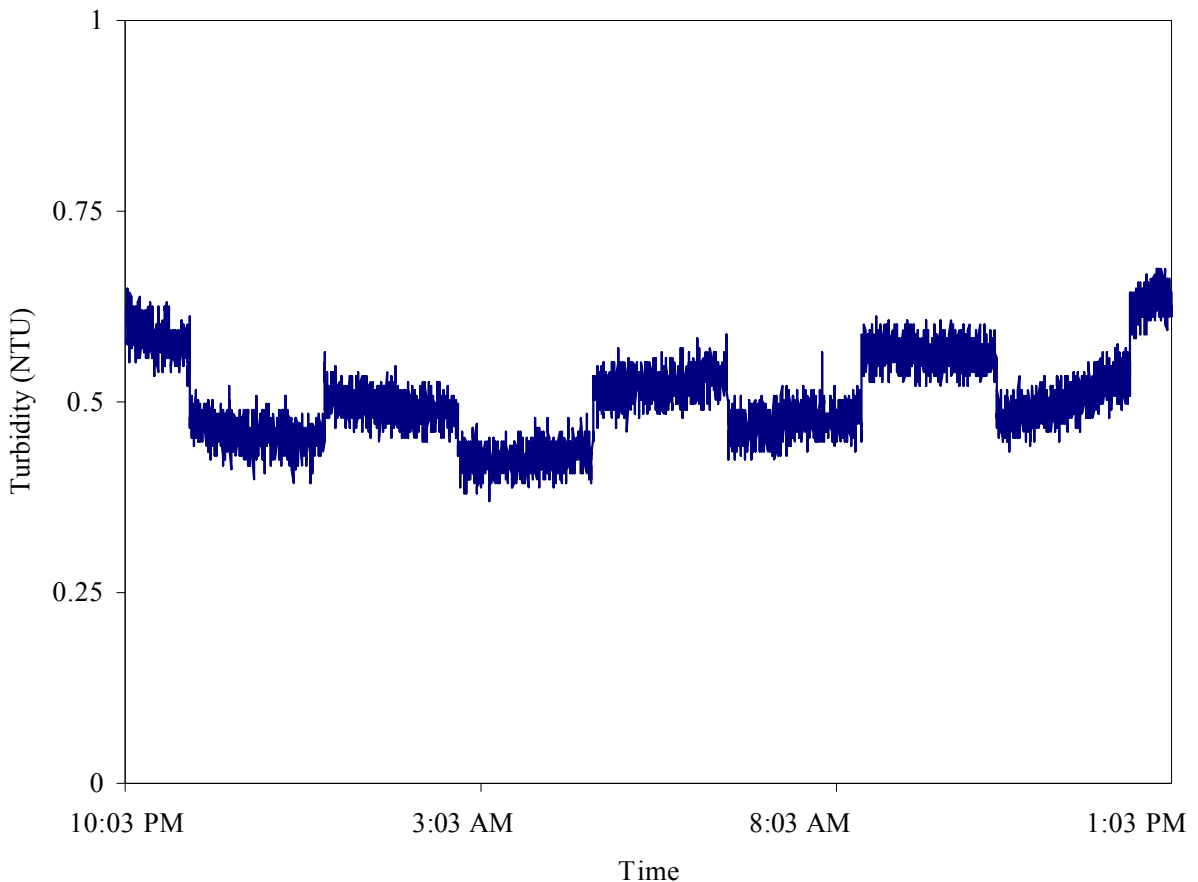

Figure 6-8. Illustration of Square Wave Signal Caused by Wiper

Another phenomenon observed with the Liquisys CUS 31-W turbidimeter was a periodic oscillation in the output signal. An example of this oscillation is shown in the right-hand half of Figure 6-9. This oscillation had a period of approximately 2.5 minutes and a peak-to-peak magnitude of approximately 0.07 NTU, and was observed throughout the verification test.

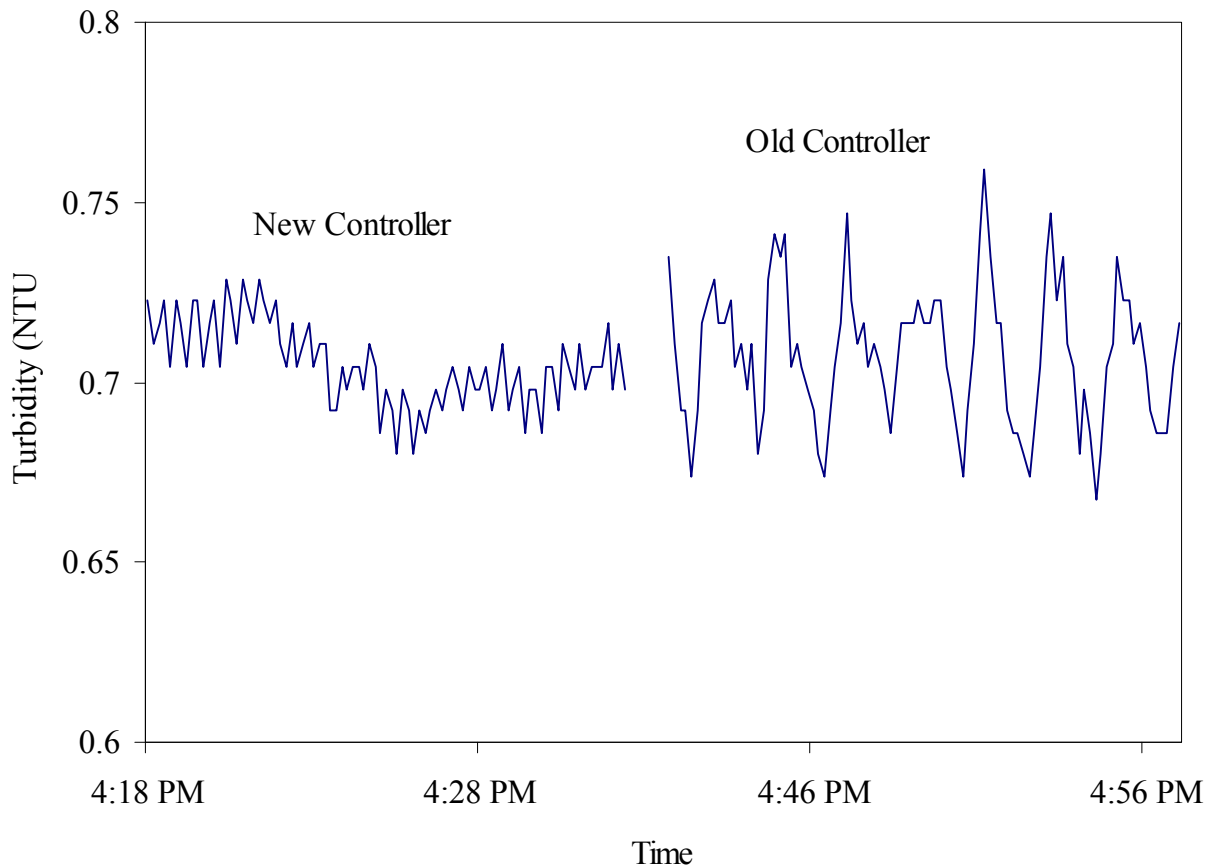

Figure 6-9. Operation of Liquisys CUS 31-W Turbidimeter with Two Different Controller Units

A representative of Endress + Hauser came to the Dublin Road Water Plant on October 18, near the end of the verification test, to isolate the cause of this oscillation and to correct it if possible. As described in Section 3.3, the cause of the oscillation was linked to conversion of the local 110V AC power to 220V for use by the turbidimeter controller. Specifically, the inexpensive transformer purchased at the start of the verification test introduced the periodic oscillation in turbidimeter response. Consequently, a second controller provided by Endress + Hauser was used temporarily to replace the controller used throughout the verification test. The new controller incorporated a design that permitted operation on either 110V or 220V power, based on the position of an internal jumper connection. Figure 6-10 illustrates the operation of the Liquisys CUS 31-W first with the new controller (operating on 220V power without the external transformer) and then with the old controller. Use of the new controller eliminated the large

cyclic oscillation observed with the old controller, reducing typical peak-to-peak noise from about 0.07 NTU to about 0.02 NTU.

During the investigation of this phenomenon, observations also suggested a possible offset in the turbidimeter signal in addition to the oscillation caused by the voltage transformer. However, no quantitative confirmation of this offset could be made because the results of tests were not reproducible.

The implication of these findings is that the Liquisys CUS 31-W turbidimeter was clearly not operated under optimum conditions in this test. As a result, the verification results presented earlier may have been influenced by either the square wave signal associated with the wiper or the oscillation associated with the voltage conversion, or both. Consequently, those verification results should be considered as worst-case performance results for the Liquisys CUS 31-W turbidimeter.

Chapter 7

Performance Summary

The Liquisys CUS 31-W is an on-line turbidimeter designed for continuous, real-time measurement of the turbidity of aqueous solutions. During almost all of this verification test, the Liquisys CUS 31-W turbidimeter was operated with an electrical power source that introduced noise into its output signal. Consequently, the instrument was not tested under conditions optimal for its performance. Also, an additional source of noise was the automatic wiper on the CUS 31-W's optical window, which caused different turbidity readings, depending on its position. The latter problem has been remedied by the vendor, but the result of these factors is that the following verification results should be considered as a worst-case statement of the performance of the CUS 31-W turbidimeter.

The Liquisys CUS 31-W turbidimeter provided linear response over the tested range from 0.3 to 5 NTU. The slope of the response curve for the Liquisys CUS 31-W turbidimeter was 1.06 relative to the ISO 7027 reference turbidimeter at the beginning of this test and 1.07 at the end of the test. The intercepts of the response curves were approximately 0.1 NTU at the beginning of the test and approximately -0.1 NTU at the end. The small change in the intercepts of the curves and the small shift (< 1%) in the slopes from the beginning to the end of the test show that the calibration of the instrument did not drift significantly over the 6-week duration of the test.

The Liquisys turbidimeter showed a positive bias relative to the ISO 7027 reference turbidimeter in measuring standard solutions. This positive bias was approximately 30% at a nominal turbidity of 0.3 NTU. At 5 NTU, the bias was 7.6%. The precision in the measurements of the Liquisys CUS 31-W was comparable to that of the ISO 7027 reference turbidimeter throughout the range of turbidity measured in this test.

Water temperature had a small effect on the response of the Liquisys CUS 31-W turbidimeter at low turbidity (0.3 NTU), but no effect at higher turbidity (5 NTU). The effect at 0.3 NTU resulted in a decrease in indicated turbidity, with increasing temperature, of 1.7% per degree C relative to the ISO 7027 reference turbidimeter. The effect of flow rate on the turbidimeter response amounted to a decrease in indicated turbidity, with increasing flow rate, of 9.1% per gpm over the range of 0.45 to 1.8 gpm. There was no effect of color on readings at high turbidity (5 NTU). At low turbidity (~0.1 NTU), the effect amounted to an increase in the indicated turbidity, with increasing color intensity, of ~0.5% per CU relative to the ISO 7027 reference turbidimeter.

In reading the turbidity of treated, unfiltered water from a municipal drinking water plant, the Liquisys CUS 31-W turbidimeter generally showed a positive bias relative to the ISO 7027 reference turbidimeter. This bias was observed over much of the four weeks of measurement of the water plant sample stream and was typically between 0.1 and 0.3 NTU (amounting to 35 to 65% of the reference turbidimeter readings). Note that a similar positive bias was seen with all the turbidimeters tested, suggesting a possible systematic bias in the reference turbidity readings. Calibration checks of the Liquisys CUS 31-W turbidimeter performed throughout the four weeks of on-line testing also indicated a positive bias with respect to the ISO 7027 reference turbidimeter in reading a 0.5 NTU formazin solution. This bias was typically 12 to 35% of the ISO 7027 reference readings. Thus, the bias was less with prepared formazin standards than with the stream samples.

The Liquisys CUS 31-W turbidimeter is easy to use and provides continuous on-line turbidity readings. The turbidimeter was cleaned during the test to remove residues and material deposits from inside the turbidimeter housing, the turbidimeter optics, and the wiper assembly. Generally, reduced bias was observed immediately following cleaning of the turbidimeter.

Chapter 8 References

1. “Water Quality—Determination of Turbidity,” *International Standard ISO 7027*, Second Edition, International Organization for Standardization, Geneva, 1990.
2. *Test/QA Plan for Verification of On-Line Turbidimeters*, Battelle, Columbus, Ohio, June 3, 1999.
3. “Determination of Turbidity by Nephelometry,” *Methods for the Determination of Inorganic Substances in Environmental Samples*, Method 180.1, EPA/600/R-93/100, U. S. Environmental Protection Agency, Cincinnati, Ohio, August 1993.
4. “Color in Water by Visual Comparison to Standards,” *Standard Methods for the Examination of Water and Wastewater*, 18th Edition, Method 2120-B, American Public Health Association, 1992.
5. *Quality Management Plan (QMP) for the ETV Advanced Monitoring Systems Pilot*, U.S. EPA Environmental Technology Verification Program, Battelle, Columbus, Ohio, September 1998.

Appendix A
Example Data Recording Sheet

Appendix B
Technical Systems Audit Report