

**Arsenic Removal from Drinking Water by Adsorptive Media
U.S. EPA Demonstration Project at Valley Vista, AZ
Six-Month Evaluation Report**

by

**Julia M. Valigore
Lili Wang
Abraham S.C. Chen**

**Battelle
Columbus, OH 43201-2693**

**Contract No. 68-C-00-185
Task Order No. 0019**

for

**Thomas J. Sorg
Task Order Manager**

**Water Supply and Water Resources Division
National Risk Management Research Laboratory
Cincinnati, Ohio 45268**

**National Risk Management Research Laboratory
Office of Research and Development
U.S. Environmental Protection Agency
Cincinnati, Ohio 45268**

DISCLAIMER

The work reported in this document is funded by the United States Environmental Protection Agency (EPA) under Task Order 0019 of Contract 68-C-00-185 to Battelle. It has been subjected to the Agency's peer and administrative reviews and has been approved for publication as an EPA document. Any opinions expressed in this paper are those of the author(s) and do not, necessarily, reflect the official positions and policies of the EPA. Any mention of products or trade names does not constitute recommendation for use by the EPA.

FOREWORD

The U.S. Environmental Protection Agency (EPA) is charged by Congress with protecting the Nation's land, air, and water resources. Under a mandate of national environmental laws, the Agency strives to formulate and implement actions leading to a compatible balance between human activities and the ability of natural systems to support and nurture life. To meet this mandate, EPA's research program is providing data and technical support for solving environmental problems today and building a science knowledge base necessary to manage our ecological resources wisely, understand how pollutants affect our health, and prevent or reduce environmental risks in the future.

The National Risk Management Research Laboratory (NRMRL) is the Agency's center for investigation of technological and management approaches for preventing and reducing risks from pollution that threaten human health and the environment. The focus of the Laboratory's research program is on methods and their cost-effectiveness for prevention and control of pollution to air, land, water, and subsurface resources; protection of water quality in public water systems; remediation of contaminated sites, sediments and ground water; prevention and control of indoor air pollution; and restoration of ecosystems. NRMRL collaborates with both public and private sector partners to foster technologies that reduce the cost of compliance and to anticipate emerging problems. NRMRL's research provides solutions to environmental problems by: developing and promoting technologies that protect and improve the environment; advancing scientific and engineering information to support regulatory and policy decisions; and providing the technical support and information transfer to ensure implementation of environmental regulations and strategies at the national, state, and community levels.

This publication has been produced as part of the Laboratory's strategic long-term research plan. It is published and made available by EPA's Office of Research and Development to assist the user community and to link researchers with their clients.

Sally Gutierrez, Director
National Risk Management Research Laboratory

ABSTRACT

This report documents the activities performed and the results obtained from the first six months of the EPA arsenic removal technology demonstration project at the Arizona Water Company (AWC) facility in Sedona, AZ, commonly referred to as Valley Vista. The main objective of the project is to evaluate the effectiveness of Kinetico's FA-236-AS treatment system using AAFS50 media in order to remove arsenic to meet the new arsenic maximum contaminant level (MCL) of 10 µg/L. Additionally, this project evaluates the reliability of the treatment system for use at small water facilities, the required system operation and maintenance (O&M) and operator skill levels, and the cost-effectiveness of the technology. The project also characterizes water in the distribution system and residuals generated by the treatment process. The types of data collected include system operation, water quality (both across the treatment train and in the distribution system), process residuals, and capital and O&M costs.

The FA-236-AS system consists of two 36-in-diameter, 72-in-tall fiberglass tanks in series (lead/lag), each containing 22 ft³ of AAFS50 media. The media is an iron-modified activated alumina (AA) medium manufactured by Alcan. The system was designed to treat 37 gal/min (gpm) of flow with an empty bed contact time (EBCT) of 4.5 min/tank and 9.0 min for both tanks. For the first of two media runs performed during the first six months of system operation, due in part to the use of an incorrect media density, the vendor inadvertently loaded 16.7 ft³ (i.e., 1,100 lb) of AAFS50 media into each tank, resulting in a shorter EBCT of 3.4 min/tank.

After extensive engineering plan review and approval by the state and county drinking water officials, the treatment system was installed in May 2004 and became operational on June 24, 2004. During the first six months, the treatment system operated for 24 hr/day with less than 1% downtime for repairs and media replacement. The source water contained 34.8 to 47.6 µg/L of total arsenic, with As(V) being the predominating species, averaging 41.8 µg/L. Prechlorination, although not required for oxidation, was performed after a month into the study to inhibit biological growth in the adsorption tanks and to provide residual chlorine in the distribution system.

The raw water pH values, ranging from 7.5 to 8.4 and averaging 7.8, were not adjusted during the first media run. After treating approximately 8,200 and 16,900 bed volumes (BV) of water, the effluent from the lead and lag tanks exceeded the 10-µg/L arsenic breakthrough limit on July 14 and August 4, 2004, respectively. (Note that BV was calculated based on 16.7 ft³ [125 gal] of media in the lead tank.) Based on the breakthrough curves, the arsenic adsorptive capacity of the media without pH adjustment was estimated to be 0.31 mg/g of media at 10-µg/L arsenic breakthrough and 0.6 mg/g of media near exhaustion. An effort to extend the media life by lowering the pH value to 6.8 using H₂SO₄, beginning on September 17, 2004, reduced the arsenic concentrations after both tanks (i.e., 33 to 24 µg/L and 26 to 16 µg/L in the lead and lag tanks, respectively), but not to the desired level of 10 µg/L. Therefore, the spent media in both tanks was replaced on October 25, 2004, and disposed of as non-hazardous waste after passing the Toxicity Characteristic Leaching Procedure (TCLP) tests.

For the second media run, the raw water pH was adjusted to 6.7 to 6.9. As of December 15, 2004, the new AAFS50 media had treated approximately 2,635,000 gal, or 16,000 BV of water, leaving 4.3 µg/L and 0.1 µg/L of total arsenic in the effluent from the lead and lag tanks, respectively. Therefore, pH adjustment significantly increased the media's arsenic adsorptive capacity. Concentrations of iron, manganese, silica, orthophosphate, and other ions in raw water were not high enough to impact arsenic removal by the media.

Comparison of the distribution system sampling results before and after the commencement of the system operation showed a decrease in arsenic concentration, most prominently at one sampling location close to

the treatment plant (from 34.9 to 51.8 $\mu\text{g/L}$ to 0.3 to 23.9 $\mu\text{g/L}$). Arsenic concentrations at the other two locations were much higher than those of the treatment effluent presumably due to the blending of untreated water from other wells supplying the distribution system. The lead and copper concentrations at the three sampling locations did not show a clear pattern of the arsenic treatment system's impact.

Backwash of the filter media was performed monthly based on a set throughput of 1,400,000 gal using treated water at 27 to 36 gpm, or 3.8 to 5.1 gpm/ft². No significant pressure buildup was observed during service runs. Each backwash lasted for 40 min (20 min/tank), producing between 1,060 and 1,400 gal of water. Average soluble arsenic concentrations in the backwash water from the lead and lag treatment tanks were 31.9 and 15.2 $\mu\text{g/L}$, respectively. A backwash recycle loop enabled the system to reclaim nearly 100% of the wastewater produced by blending it with the feed water at a maximum rate of 3.6 gpm.

The capital investment cost of the system was \$228,309 consisting of \$122,544 for equipment, \$50,659 for site engineering, and \$55,106 for installation. Using the system's rated capacity of 37 gpm (or 53,280 gal/day [gpd]), the capital cost was \$6,171/gpm (or \$4.29/gpd). This calculation does not include the cost of the sun shed enclosure which houses the treatment system.

The O&M cost for the treatment system included only incremental cost associated with the FA-236-AS system, such as media replacement and disposal, chemical supply, electricity consumption, and labor. Representing the majority of the O&M cost, the media replacement and disposal cost depended on the number of tanks to be changed out when the arsenic breakthrough following the lag tank reached 10 $\mu\text{g/L}$. Without pH adjustment, it might be more convenient and cost-effective to replace the media in both tanks together to reduce the changeout frequency and minimize the associated scheduling and coordinating effort. The cost for replacing media in both tanks was estimated at \$6,623 (for 33.4 ft³, the total amount of media used during the first media run) or \$3.15/1,000 gal of water treated. With pH adjustment, the media run length was significantly increased so that only the media in the lead tank might be replaced at an estimated cost of \$4,363 for 22 ft³ of media. Adjustment of pH lowered the media replacement cost, but added a chemical cost of \$0.66/1,000 gal of water treated. The total O&M cost and media replacement cost per 1,000 gal of water treated were plotted as a function of the media run length.

CONTENTS

DISCLAIMER	ii
FOREWORD	iii
ABSTRACT	iv
FIGURES	vii
TABLES	vii
ABBREVIATIONS AND ACRONYMS	viii
ACKNOWLEDGMENTS	x
Section 1.0: INTRODUCTION	1
1.1 Background.....	1
1.2 Treatment Technologies for Arsenic Removal.....	1
1.3 Project Objectives	2
Section 2.0: CONCLUSIONS	3
Section 3.0: MATERIALS AND METHODS.....	5
3.1 General Project Approach.....	5
3.2 System O&M and Cost Data Collection.....	6
3.3 Sample Collection Procedures and Schedules	7
3.3.1 Source Water Sample Collection.....	7
3.3.2 Treatment Plant Water Sample Collection.....	7
3.3.3 Backwash Water Sample Collection.....	7
3.3.4 Distribution System Water Sample Collection.....	7
3.3.5 Residual Solid Sample Collection.....	10
3.4 Sampling Logistics	10
3.4.1 Preparation of Arsenic Speciation Kits.....	10
3.4.2 Preparation of Sampling Coolers.....	10
3.4.3 Sample Shipping and Handling	10
3.5 Analytical Procedures.....	11
Section 4.0: RESULTS AND DISCUSSION	12
4.1 Facility Description	12
4.1.1 Source Water Quality.....	12
4.1.2 Distribution System.....	13
4.2 Treatment Process Description	15
4.3 System Installation.....	20
4.3.1 Permitting	20
4.3.2 System Installation, Shakedown, and Startup.....	20
4.3.3 Shed Construction.	20
4.4 System Operation.....	20
4.4.1 Operational Parameters.....	20
4.4.2 pH Adjustment	22
4.4.3 Backwash.....	23
4.4.4 Media Changeout.....	23
4.4.5 Residual Management.....	23
4.4.6 Reliability and Simplicity of Operation.....	24
4.5 System Performance	25
4.5.1 Treatment Plant Sampling.....	25
4.5.2 Backwash Water Sampling	31

4.5.3	Distribution System Water Sampling.....	32
4.5.4	Spent Media Sampling.....	34
4.6	System Cost	35
4.6.1	Capital Cost.....	35
4.6.2	O&M Cost.....	36

Section 5.0	REFERENCES	40
-------------	------------------	----

FIGURES

Figure 3-1.	Process Flow Diagram and Sampling Locations.....	9
Figure 4-1.	Predemonstration Site Conditions.....	12
Figure 4-2.	Existing Chlorine Injection System.....	13
Figure 4-3.	Schematic of Kinetico’s FA-236-AS Treatment System	17
Figure 4-4.	Kinetico’s FA-236-AS Treatment System on Concrete Pad.....	18
Figure 4-5.	Treatment Process Components.....	19
Figure 4-6.	Backwash Process Components.....	19
Figure 4-7.	Sun Shed Structure (Top) and Completed Enclosure (Bottom).....	21
Figure 4-8.	Total Arsenic Concentrations and Treatment pH over Time	28
Figure 4-9.	Alkalinity, Sulfate, and pH Values over Time.....	30
Figure 4-10.	Silica Concentrations over Time.....	31
Figure 4-11.	Media Replacement and O&M Cost without pH Adjustment.....	38
Figure 4-12.	Media Replacement and O&M Cost with pH Adjustment.....	38

TABLES

Table 1-1.	Summary of Round 1 Arsenic Removal Demonstration Technologies and Source Water Quality Parameters.....	2
Table 3-1.	Predemonstration Study Activities and Completion Dates.....	5
Table 3-2.	Evaluation Objectives and Supporting Data Collection Activities	6
Table 3-3.	Sampling Schedule and Analyses	8
Table 4-1.	POE Well No. 2 Water Quality Data	14
Table 4-2.	Distribution System Water Quality Data ^(a)	15
Table 4-3.	Physical and Chemical Properties of Alcan’s Actiguard AAFS50 Media.....	15
Table 4-4.	Design Features for Kinetico’s FA-236-AS Treatment System.....	18
Table 4-5.	Operation of FA-236-AS Treatment System	22
Table 4-6.	Summary of Backwash Events.....	23
Table 4-7.	Summary of Arsenic, Iron, Manganese, and Aluminum Results (06/24/04-12/22/04).....	26
Table 4-8.	Summary of Other Water Quality Parameter Results (06/24/04-12/22/04).....	27
Table 4-9.	Theoretical Calculation of Acid Consumption for pH Adjustment	31
Table 4-10.	Backwash Water Sampling Results	32
Table 4-11.	Distribution System Sampling Results.....	33
Table 4-12.	Spent Media Total Metal Analysis.....	34
Table 4-13.	Summary of Arsenic Removed by AAFS50 Media.....	34
Table 4-14.	TCLP Results of Spent Media.....	35
Table 4-15.	Capital Investment for Kinetico’s Treatment System.....	35
Table 4-16.	O&M Cost during First Media Run (06/24/04 – 08/04/04)	37
Table 4-17.	O&M Cost during Second Media Run (10/25/04 – 12/22/04).....	37

ABBREVIATIONS AND ACRONYMS

Δp	differential pressure
AA	activated alumina
AAL	American Analytical Laboratories
ADEQ	Arizona Department of Environmental Quality
Al	aluminum
AOC	Approval of Construction
APU	arsenic package unit
As	arsenic
ATC	Approval to Construct
AWC	Arizona Water Company
bgs	below ground surface
BV	bed volume(s)
Ca	calcium
CCR	Consumer Confidence Report
Cl	chlorine
CRF	capital recovery factor
Cu	copper
DO	dissolved oxygen
EBCT	empty bed contact time
EPA	U.S. Environmental Protection Agency
F	fluoride
Fe	iron
FRP	fiberglass reinforced plastic
gpm	gallons per minute
H ₂ SO ₄	sulfuric acid
HDPE	high-density polyethylene
ID	identification
IX	ion exchange
kwh	kilowatt-hour(s)
LCR	(EPA) Lead and Copper Rule
LOU	Letter of Understanding
MCL	maximum contaminant level
MDL	method detection limit
MDWCA	Mutual Domestic Water Consumer's Association
Mg	magnesium
μm	micrometer
Mn	manganese

Mo	molybdenum
mph	miles per hour
mV	millivolts
Na	sodium
NA	not applicable
NaOCl	sodium hypochlorite
ND	not detected
NRMRL	National Risk Management Research Lab
NS	not sampled
NSF	NSF International
NTU	nephelometric turbidity units
O&M	operation and maintenance
OIP	operator interface panel
ORD	Office of Research and Development
ORP	oxidation-reduction potential
P&ID	process and instrumentation diagram
Pb	lead
psi	pounds per square inch
PLC	programmable logic controller
PO ₄	orthophosphate
POE	point-of-entry
PVC	polyvinyl chloride
QA	quality assurance
QA/QC	quality assurance/quality control
QAPP	Quality Assurance Project Plan
RPD	relative percent difference
RFQ	Request for Quotation
Sb	antimony
SDWA	Safe Drinking Water Act
SiO ₂	silica
SMCL	secondary maximum contaminant level
SO ₄	sulfate
SOW	scope of work
STMGID	South Truckee Meadows General Improvement District
STS	Severn Trent Services
TCLP	Toxicity Characteristic Leaching Procedure
TDS	total dissolved solids
TO	Task Order
TOC	total organic carbon
TSS	total suspended solids
V	vanadium

ACKNOWLEDGMENTS

The authors wish to extend their sincere appreciation to the staff of the Arizona Water Company (AWC) in Phoenix and Sedona, Arizona. The primary operator, Mr. Paul Blanchard, monitored the treatment system and collected samples from the treatment and distribution systems on a regular schedule throughout this reporting period. This performance evaluation would not have been possible without AWC's support and dedication.

Section 1.0: INTRODUCTION

1.1 Background

The Safe Drinking Water Act (SDWA) mandates that U.S. Environmental Protection Agency (EPA) identify and regulate drinking water contaminants that may have adverse human health effects and that are known or anticipated to occur in public water supply systems. In 1975, under the SDWA, EPA established a maximum contaminant level (MCL) for arsenic at 0.05 mg/L. Amended in 1996, the SDWA required that EPA develop an arsenic research strategy and publish a proposal to revise the arsenic MCL by January 2000. On January 18, 2001, EPA finalized the arsenic MCL at 0.01 mg/L (EPA, 2001). In order to clarify the implementation of the original rule, EPA revised the rule on March 25, 2003, to express the MCL as 0.010 mg/L (10 µg/L) (EPA, 2003). The final rule requires all community and non-transient, non-community water systems to comply with the new standard by January 23, 2006.

In October 2001, EPA announced an initiative for additional research and development of cost-effective technologies to help small community water systems (<10,000 customers) meet the new arsenic standard and to provide technical assistance to operators of small systems in order to reduce compliance costs. As part of this Arsenic Rule Implementation Research Program, EPA's Office of Research and Development (ORD) proposed a project to conduct a series of full-scale, on-site demonstrations of arsenic removal technologies, process modifications, and engineering approaches applicable to small systems. Shortly thereafter, an announcement was published in the *Federal Register* requesting water utilities interested in participating in the first round of this EPA-sponsored demonstration program to provide information on their water systems. In June 2002, EPA selected 17 out of 115 sites to be the host sites for the demonstration studies. The Arizona Water Company (AWC) water system in Sedona, AZ, commonly referred to as Valley Vista, was selected as one of the 17 Round 1 host sites for the demonstration program.

In September 2002, EPA solicited proposals from engineering firms and vendors for cost-effective arsenic removal treatment technologies for the 17 host sites. EPA received 70 technical proposals for the 17 host sites, with each site receiving one to six proposals. In April 2003, an independent technical panel reviewed the proposals and provided its recommendations to EPA on the technologies that it determined were acceptable for the demonstration at each site. Because of funding limitations and other technical reasons, only 12 of the 17 sites were selected for the demonstration project. Using the information provided by the review panel, EPA, in cooperation with the host sites and the drinking water programs of the respective states, selected one technical proposal for each site. Kinetico's adsorptive media process using AAFS50 media was selected for the Valley Vista facility.

1.2 Treatment Technologies for Arsenic Removal

The technologies selected for the 12 Round 1 EPA arsenic removal demonstration host sites include nine adsorptive media systems, one anion exchange system, one coagulation/filtration system, and one process modification with iron addition. Table 1-1 summarizes the locations, technologies, vendors, and key source water quality parameters of the 12 demonstration sites. An overview of the technology selection and system design (Wang et al., 2004) and the associated capital costs for each site (Chen et al., 2004) are provided on the EPA website (<http://www.epa.gov/ORD/NRMRL/arsenic/resource.htm>). As of June 2006, 11 of the 12 systems have been operational, and the performance evaluation of two systems has been completed.

Table 1-1. Summary of Round 1 Arsenic Removal Demonstration Technologies and Source Water Quality Parameters

Demonstration Site	Technology (Media)	Vendor	Design Flowrate (gpm)	Source Water Quality		
				As (µg/L)	Fe (µg/L)	pH
WRWC (Bow), NH	AM (G2)	ADI	70 ^(a)	39	<25	7.7
Rollinsford, NH	AM (E33)	AdEdge	100	36 ^(b)	46	8.2
Queen Anne's County, MD	AM (E33)	STS	300	19 ^(b)	270 ^(c)	7.3
Brown City, MI	AM (E33)	STS	640	14 ^(b)	127 ^(c)	7.3
Climax, MN	C/F (Macrolite)	Kinetico	140	39 ^(b)	546 ^(c)	7.4
Lidgerwood, ND	SM	Kinetico	250	146 ^(b)	1,325 ^(c)	7.2
Desert Sands MDWCA, NM	AM (E33)	STS	320	23 ^(b)	39	7.7
Nambe Pueblo, NM	AM (E33)	AdEdge	145	33	<25	8.5
Rimrock, AZ	AM (E33)	AdEdge	90 ^(d)	50	170	7.2
Valley Vista, AZ	AM (AAFS50)	Kinetico	37	41	<25	7.8
Fruitland, ID	IX (A300E)	Kinetico	250	44	<25	7.4
STMGID, NV	AM (GFH)	USFilter	350	39	<25	7.4

AM = adsorptive media process; C/F = coagulation/filtration process; IX = ion exchange process; SM = system modification; MDWCA = Mutual Domestic Water Consumer's Association; STMGID = South Truckee Meadows General Improvement District; WRWC = White Rock Water Company; STS = Severn Trent Services.

- (a) System reconfigured from parallel to series operation due to a reduced 40-gpm flowrate.
- (b) Arsenic exists mostly as As(III).
- (c) Iron exists mostly as soluble Fe(II).
- (d) System reconfigured from parallel to series operation due to a reduced 30-gpm flowrate.

1.3 Project Objectives

The objective of the Round 1 arsenic demonstration program is to conduct 12 full-scale arsenic treatment technology demonstration studies on the removal of arsenic from drinking water supplies. The specific objectives are to:

- Evaluate the performance of the arsenic removal technologies for use on small systems.
- Determine the required system operation and maintenance (O&M) and operator skill levels.
- Characterize process residuals produced by the technologies.
- Determine the cost-effectiveness of the technologies.

This report summarizes the performance of the Kinetico system at Valley Vista, AZ, during the first six months (from June 24 through December 24, 2004). The types of data collected included system operation, water quality (both across the treatment train and in the distribution system), residuals' characterization, and capital and preliminary O&M costs.

Section 2.0: CONCLUSIONS

The Kinetico treatment system (FA-236-AS) with AAFS50 media was installed and operated at Valley Vista, AZ, since June 24, 2004. Based on the information collected during the first six months of operation, the following preliminary conclusions were made relating to the overall project objectives.

Performance of the arsenic removal technology for use on small systems

- After treating 8,200 and 16,900 bed volumes (BV) (or 1,022,000 and 2,106,000 gal) of water with an average As(V) concentration of 42 µg/L and pH values of 7.5 to 8.4, the effluent from the lead and lag tanks of the FA-236-AS exceeded the 10-µg/L arsenic breakthrough limit on July 14 and August 4, 2004, respectively.
- The arsenic adsorptive capacity of the AAFS50 media without pH adjustment was estimated to be 0.31 mg/g of media at 10-µg/L arsenic breakthrough and 0.6 mg/g of media near exhaustion.
- The spent AAFS50 media was replaced on October 25, 2004, and the second media run began with pH adjustment of raw water at 6.7 to 6.9. As of December 15, 2004, the new media had treated 16,000 BV or 2,635,000 gal of water to 4.3 and 0.1 µg/L of arsenic at the effluent of the lead and lag tanks, respectively. Therefore, pH adjustment significantly increased the media's arsenic adsorptive capacity.
- The presence of low concentrations of iron, manganese, silica, orthophosphate, and other ions in the water did not appear to impact arsenic removal by the AAFS50 media.
- Little or no chlorine was consumed by the AAFS50 media.
- Arsenic concentrations in the distribution system decreased most prominently nearest to the treatment plant (i.e., from 34.9 to 51.8 µg/L to 0.3 to 23.9 µg/L). More distant locations from the treatment plant exhibited higher arsenic than the treatment effluent, which was presumably due to its blending with water from untreated wells in the distribution system.

Required system O&M and operator skill levels

- The daily demand on the operator was typically 20 to 30 min to visually inspect the system and record operational parameters. The FA-236-AS was equipped with semi-automatic controls to initiate backwash and switch tank positions and automatic controls for pH adjustment and backwash recycling.
- During the first media run, operation of the FA-236-AS did not require skills beyond those necessary to operate the existing equipment. During the second media run, however, pretreatment with 37-50% H₂SO₄ added safety precautions, troubleshooting, complexity, and chemical handling and inventory requirements to the system O&M.

- Without pH adjustment, media replacement was required after 41 days of operation (2,106,000 gal of water treated). During the second media run, results indicated that the capacity of the media was greatly extended with pH adjustment, and media handling requirements were thereby reduced. However, pH adjustment increased the complexity of the system and the operator requirements.

Characteristics of process residuals produced by the technology

- The FA-236-AS was backwashed monthly, generating between 1,060 and 1,400 gal of water. Nearly 100% of the wastewater was reclaimed via a backwash recycle system.
- After passing TCLP tests, 2,200 lb of spent media were disposed of in a state-approved landfill as non-hazardous waste.

Technology cost

- The capital investment for the system was \$228,309, including \$122,544 for equipment, \$50,659 for site engineering, and \$55,106 for installation.
- Based on a design capacity of 37 gpm, the capital cost was \$6,171/gpm (or \$4.29/gpd), not including the cost for shed construction.
- Media replacement represented the majority of O&M cost. Changeout for both tanks was estimated at \$6,623 or \$3.15/1,000 gal of water treated for the first media run. For the second media run, acid addition significantly increased the life of the media, but also added \$0.66/1,000 gal of chemical cost to the O&M cost.

Section 3.0: MATERIALS AND METHODS

3.1 General Project Approach

Following the predemonstration activities summarized in Table 3-1, the performance evaluation study of the Kinetico treatment system began on June 24, 2004. Table 3-2 summarizes the types of data collected and/or considered as part of the technology evaluation process. The overall system performance was evaluated based on its ability to consistently remove arsenic to below the target MCL of 10 µg/L through the collection of water samples across the treatment train. The reliability of the system was evaluated by tracking the unscheduled system downtime and frequency and extent of repair and replacement. The unscheduled downtime and repair information were recorded by the plant operator on a Repair and Maintenance Log Sheet.

The O&M requirements were evaluated based on a combination of quantitative data and qualitative considerations, including any pre- and/or post-treatment requirements, level of system automation, operator skill requirements, preventative maintenance activities, frequency of chemical and/or media handling and inventory requirements, and general knowledge needed for safety requirements and chemical processes. The staffing requirements for the system operation were recorded on an Operator Labor Hour Log Sheet.

The quantity of aqueous and solid residuals generated was estimated by tracking the amount of backwash water produced during each backwash cycle and the need to replace the media upon arsenic breakthrough. Backwash water and spent media were sampled and analyzed for chemical characteristics.

Table 3-1. Predemonstration Study Activities and Completion Dates

Activity	Date
Introductory Meeting Held	July 31, 2003
Request for Quotation Issued to Vendor	August 4, 2003
Draft Letter of Understanding Issued	August 13, 2003
Final Letter of Understanding Issued	September 16, 2003
Vendor Quotation Received	September 25, 2003
Purchase Order Completed and Signed	October 16, 2003
Letter Report Issued	October 17, 2003
Draft Study Plan Issued	February 4, 2004
Engineering Package Submitted to ADEQ	February 17, 2004
Final Study Plan Issued	February 24, 2004
Approval to Construct Granted by ADEQ	March 23, 2004
Construction Permit Issued by County	April 12, 2004
FA-236-AS System Shipped	April 23, 2004
System Installation Completed	May 7, 2004
System Shakedown Completed	May 11, 2004
Shed Construction Begun	May 24, 2004
Shed Construction Completed	May 28, 2004
Approval of Construction Granted by ADEQ	June 15, 2004
Performance Evaluation Begun	June 24, 2004

ADEQ = Arizona Department of Environmental Quality

Table 3-2. Evaluation Objectives and Supporting Data Collection Activities

Evaluation Objective	Data Collection
Performance	-Ability to consistently meet 10 µg/L of arsenic in effluent
Reliability	-Unscheduled downtime for system -Frequency and extent of repairs including a description of the problem, labor, and materials' description and cost
System O&M and Operator Skill Requirements	-Pre- and post-treatment requirements -Level of system automation for data collection and system operation -Staffing requirements including number of operators and labor -Task analysis of preventative maintenance including labor and number and complexity of tasks -Chemical handling and inventory requirements -General knowledge needed of safety requirements and chemical processes
Residual Management	-Quantity of residuals generated by the treatment process -Characteristics of the aqueous and solid residuals
Cost-Effectiveness	-Capital cost including equipment, engineering, and installation -O&M cost including media, chemical, and electricity usage and labor

The cost of the system was evaluated based on the capital cost per gpm (or gpd) of design capacity and the O&M cost per 1,000 gal of water treated. This task required tracking the capital cost for the equipment, engineering, and installation, as well as the O&M cost for media replacement and disposal, chemical supply, electricity usage, and labor.

3.2 System O&M and Cost Data Collection

The plant operator performed daily, weekly, and monthly system O&M and data collection according to instructions provided by Kinetico and Battelle. On a daily basis, the plant operator recorded system operational data, such as pressure, flowrate, totalizer, and hour meter readings on a Daily System Operation Log Sheet; checked the sodium hypochlorite (NaOCl) and sulfuric acid (H₂SO₄) drum levels; and conducted visual inspections to ensure normal system operations. If any problems occurred, the plant operator contacted the Battelle Study Lead, who determined if the vendor should be contacted for troubleshooting. The plant operator recorded all relevant information on the Repair and Maintenance Log Sheet. The plant operator measured water quality parameters weekly, including temperature, pH, dissolved oxygen (DO), oxidation-reduction potential (ORP), and residual chlorine and recorded the data on a Weekly On-Site Water Quality Parameters Log Sheet. Monthly backwash data also were recorded on a Backwash Log Sheet.

Capital cost for the arsenic removal system consisted of equipment, site engineering, and system installation. The O&M cost consisted of media replacement and spent media disposal, chemical and electricity consumption, and labor. Consumption of H₂SO₄ and NaOCl was tracked on the Daily System Operation Log Sheet. Electricity consumption was determined from a utility bill. Labor for various activities, such as the routine system O&M, troubleshooting, and repair and demonstration-related work, were tracked using an Operator Labor Hour Log Sheet. The routine O&M included activities such as filling field logs, replenishing chemical solutions, ordering supplies, performing system inspection, and others as recommended by Kinetico. The demonstration-related work included activities such as performing field measurements, collecting and shipping samples, and communicating with the Battelle Study Lead and the vendor. The demonstration-related activities were recorded, but were not used for the cost analysis.

3.3 Sample Collection Procedures and Schedules

To evaluate system performance, samples were collected from the wellhead, treatment plant, distribution system, and adsorptive tank backwash. The sampling schedules and analytes for each sampling event are listed in Table 3-3. In addition, Figure 3-1 presents a flow diagram of the treatment system including analytes and sampling locations. Specific sampling requirements for analytical methods, sample volumes, containers, preservation, and holding times are presented in Table 4-1 of the EPA-endorsed Quality Assurance Project Plan (QAPP) (Battelle, 2003). The procedure for arsenic speciation is described in Appendix A of the QAPP.

3.3.1 Source Water Sample Collection. During the initial visit to the site, source water samples were collected in a 250-mL high-density polyethylene (HDPE) bottle containing nitric acid preservative for metal analyses and in additional HDPE bottles containing appropriate preservatives for water quality analyses (Table 3-3). The source water also was speciated using an arsenic speciation kit (Section 3.4.1). The sample tap was flushed for several minutes before sampling; special care was taken to avoid agitation, which might cause unwanted oxidation.

3.3.2 Treatment Plant Water Sample Collection. The plant operator collected water samples across the treatment train in 250-mL HDPE bottles containing nitric acid preservative for metal analyses and in additional HDPE bottles containing appropriate preservatives for water quality analyses. On-site arsenic speciation was performed using arsenic speciation kits. Samples were collected weekly, on a four-week cycle at three sample taps (i.e., at wellhead location [IN], after Tank A location [TA], and after Tank B location [TB]) for on- and off-site analyses (Figure 3-1). For the first week of each four-week cycle, samples were collected, speciated, and analyzed for the analytes listed in Table 3-3 for monthly treatment plant water. For the next three weeks, samples were collected and analyzed for the analytes listed in Table 3-3 for the weekly treatment plant water. Since November 3, 2004, the speciation sampling was reduced from monthly to bimonthly (effective October 20, 2004) due to the absence of As(III) in the source water. Under this revised schedule, weekly samples were collected for seven consecutive weeks and speciation samples were collected during the eighth week. On-site measurements also were taken after prechlorination location (AC), in addition to IN, TA, and TB, since the system was modified to inject chlorine before adsorption on July 27, 2004.

3.3.3 Backwash Water Sample Collection. Backwash water samples were collected from the sample tap on the backwash water effluent line. For each backwash sampling, an unfiltered sample was collected from each tank in an unpreserved 1-gal wide-mouth HDPE bottle for water quality analyses, and a 60-mL sample filtered on-site with 0.45- μ m filters was collected in a 125-mL HDPE bottle preserved with nitric acid for metal analyses. Analytes for the backwash samples are listed in Table 3-3.

Note that after the first six months of system operation, the backwash water sampling procedure was modified to include collection of composite samples for total suspended solids (TSS) and total metals in addition to pH, total dissolved solids (TDS), and soluble metals. The procedure involves connecting tubing to the tap on the discharge line to collect a portion of the backwash water in a clean, 30-gal container for each tank. Approximately 15-20 gal is collected in the container for the duration of the filter tank backwash. After the backwash completes, the backwash water from each tank is mixed thoroughly and composite samples are collected.

3.3.4 Distribution System Water Sample Collection. Samples were collected from the distribution system to determine the impact of the arsenic treatment system on the water chemistry in the distribution system, specifically the arsenic, lead, and copper levels. From February to March 2004, prior to the startup of the treatment system, four sets of baseline distribution water samples were collected from three locations within the distribution system. Following the system startup, distribution system sampling

continued on a monthly basis at the same three locations. Ideally, the sampling locations selected would have been the historical Lead and Copper Rule (LCR) locations served primarily by the source water well, Point-of-Entry (POE) Well No. 2. However, because the distribution system of Valley Vista was supplied by POE Well No. 2 and other wells, such LCR locations did not exist (Section 4.1.2). As such, two non-LCR residences and one non-residence location served by POE Well No. 2 were used for the distribution system sampling.

Table 3-3. Sampling Schedule and Analyses

Sample Type	Sample Locations ^(a)	No. of Samples	Frequency	Analytes	Collection Date(s)
Source Water	At wellhead	1	Once	As (total, soluble, and particulate), As(III), As(V), total and soluble Fe, Mn, Al, V, Mo, and Sb, Na, Ca, Mg, Cl, F, SO ₄ , SiO ₂ , PO ₄ , TOC, turbidity, pH, and alkalinity	07/31/03
Treatment Plant Water	At wellhead (IN), after Tank A (TA), and after Tank B (TB)	3	Weekly	On-site ^(b) : pH, temperature, DO, ORP, and Cl ₂ (free and total). Off-site: total As, Fe, Mn, and Al, SiO ₂ , PO ₄ , turbidity, and alkalinity	07/07/04, 07/14/04, 07/21/04, 08/04/04, 08/11/04, 08/18/04, 09/01/04, 09/08/04, 09/15/04, 09/29/04, 10/13/04, 10/27/04, 11/03/04, 11/17/04, 12/01/04, 12/08/04
			Monthly ^(c)	Same as weekly sampling (above) plus the following off-site: As (soluble and particulate), As(III), As(V), Fe (soluble), Mn (soluble), Al (soluble), Ca, Mg, F, NO ₃ , and SO ₄	06/30/04, 07/28/04, 08/25/04, 09/22/04, 10/20/04, 12/15/04
Backwash Water	Backwash discharge line	2	Monthly	Soluble As, Fe, Mn, and Al, and pH, TDS, and turbidity	08/16/04, 09/13/04, 10/12/04, 11/22/04, 12/20/04
Distribution Water	Two non-LCR residences and one non-residence serviced by POE Well No. 2 and other wells	3	Monthly ^(d)	Total As, Fe, Mn, Al, Cu, and Pb, pH, and alkalinity	Baseline sampling: 02/10/04, 02/24/04, 03/16/04, 03/30/04 Monthly sampling: 07/28/04, 08/25/04, 09/22/04, 10/20/04, 11/17/04, 12/15/04
Residual Solid	Spent media from Tanks A and B	3 per tank	Once	TCLP metals and total Al, As, Ca, Cd, Cu, Fe, Mg, Mn, Ni, P, Pb, Si, and Zn	10/25/04

(a) Abbreviation corresponds to sample location in Figure 3-1.

(b) On-site measurements of samples collected at AC, in addition to IN, TA, and TB, since prechlorination began on July 27, 2004. Chlorine measurements not performed at IN.

(c) Began bimonthly sampling effective October 20, 2004.

(d) Four baseline sampling events performed during February and March 2004 before system startup.

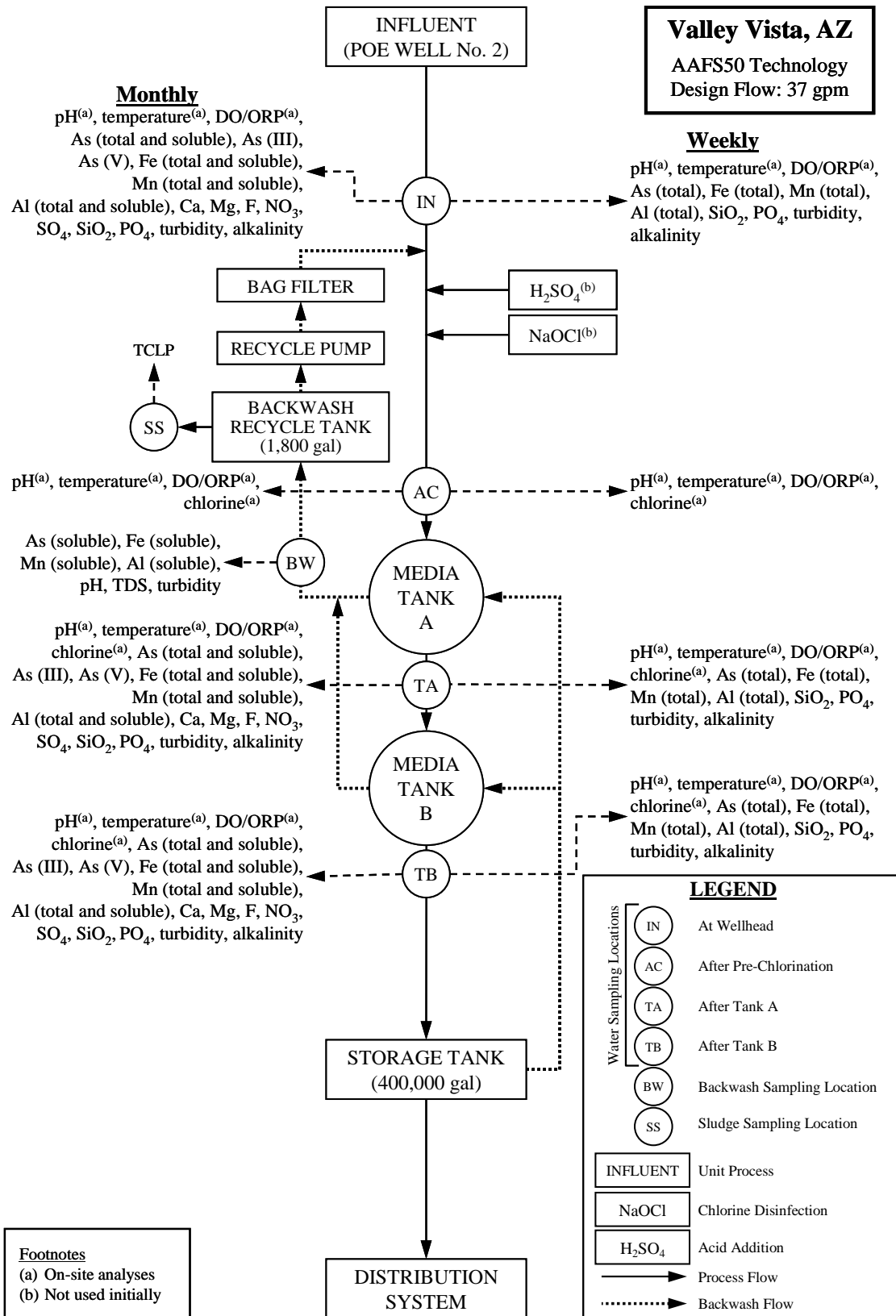

Figure 3-1. Process Flow Diagram and Sampling Locations

For each location, samples were collected in one unpreserved 1-L HDPE wide-mouth bottle for metal analyses (preserved with nitric acid in the lab), and one unpreserved 250-mL HDPE bottle for water quality analyses (Table 3-3). The samples at the two non-LCR locations were taken following an instruction sheet developed according to the *Lead and Copper Monitoring and Reporting Guidance for Public Water Systems* (EPA, 2002). The homeowners recorded the date and time of last water use before sampling and the date and time of sample collection for calculation of the stagnation time. Sampling at the non-residence location was performed by the plant operator with the first sample taken at the first draw and the second sample taken after the sample tap was flushed for several minutes. All samples were collected from a cold-water faucet that had not been used for at least 6 hr to ensure that stagnant water was sampled.

3.3.5 Residual Solid Sample Collection. Residual solids included backwash sludge and spent media samples. Backwash sludge samples were not collected in the initial six months of this demonstration. Three spent media samples were collected from each tank during the first media changeout on October 25, 2004. Spent AAFS50 media was removed from the top, middle, and bottom of each media bed using a 5-gal wet/dry shop vacuum that was thoroughly cleaned out and disinfected. The media from each layer was well-mixed in a clean 5-gal bucket with a small garden spade and sent to Battelle in a 1-gal wide-mouth HDPE bottle. A portion of each sample was submitted to TCCI Laboratories for Toxicity Characteristic Leaching Procedure (TCLP) tests. Another portion of the sample was air dried and acid digested for metal analysis by Battelle ICP-MS Laboratory.

3.4 Sampling Logistics

3.4.1 Preparation of Arsenic Speciation Kits. The arsenic field speciation method uses an anion exchange resin column to separate the soluble arsenic species, As(V) and As(III) (Edwards et al., 1998). Resin columns were prepared in batches at Battelle laboratories according to the procedures detailed in Appendix A of the EPA-endorsed QAPP (Battelle, 2003).

3.4.2 Preparation of Sampling Coolers. For each sampling event, a cooler was prepared with the appropriate number and type of sample bottles, filters, and/or speciation kits. All sample bottles were new and contained appropriate preservatives. Each sample bottle was affixed with a pre-printed, colored-coded label consisting of the sample identification (ID), date and time of sample collection, collector's name, site location, sample destination, analysis required, and preservative. The sample ID consisted of a two-letter code for the specific water facility, the sampling date, a two-letter code for a specific sampling location, and a one-letter code designating the arsenic speciation bottle (if necessary). The sampling locations at the treatment plant were color-coded for easy identification (e.g., red, orange, and yellow designated IN, TA, and TB, respectively). The labeled bottles for each sampling locations were bagged separately and placed in the cooler.

In addition, all sampling- and shipping-related materials, such as disposable gloves, sampling instructions, chain-of-custody forms, prepaid/addressed Federal Express air bills, and bubble wrap, were packed into the coolers. The chain-of-custody forms and Federal Express air bills were complete except for the operator's signature and the sample dates and times. After preparation, sample coolers were sent to the site via Federal Express for the following week's sampling event.

3.4.3 Sample Shipping and Handling. After sample collection, samples for off-site analyses were packed carefully in the original coolers with wet ice and shipped to Battelle. Upon receipt, sample custodians verified that all samples indicated on the chain-of-custody forms were included and intact. Sample IDs were checked against the chain-of-custody forms, and the samples were identified in the laboratory sample receipt log. Discrepancies noted by the sample custodian were addressed with the plant operator by the Battelle Study Lead.

Samples for metal analyses were stored at Battelle's ICP-MS Laboratory. Samples for other water quality analyses were packed in coolers at Battelle and picked up by a courier from Battelle's subcontract laboratories including AAL in Columbus, OH, and TCCI Laboratories in New Lexington, OH. The chain-of-custody forms remained with the samples from the time of preparation through analysis and final disposition. All samples were archived by the appropriate laboratories for the respective duration of the required hold time and disposed of properly thereafter.

3.5 Analytical Procedures

The analytical procedures described in Section 4.0 of the EPA-endorsed QAPP (Battelle, 2003) were followed by Battelle ICP-MS Laboratory, AAL, and TCCI Laboratories. Laboratory quality assurance/quality control (QA/QC) of all methods followed the prescribed guidelines. Data quality in terms of precision, accuracy, method detection limits (MDL), and completeness met the criteria established in the QAPP (i.e., relative percent difference [RPD] of 20%, percent recovery of 80-120%, and completeness of 80%). The quality assurance (QA) data associated with each analyte will be presented and evaluated in a QA/QC Summary Report to be prepared under separate cover and to be shared with the other 11 demonstration sites included in this project.

Field measurements of pH, temperature, DO, and ORP were conducted by the plant operator using a WTW Multi 340i handheld meter, which was calibrated for pH and DO prior to use following the procedures provided in the user's manual. The ORP probe also was checked for accuracy by measuring the ORP of the standard solution and comparing it to the expected value. The plant operator collected a water sample in a clean plastic beaker and placed the WTW probe in the beaker until a stable value was obtained. The plant operator also performed free and total chlorine measurements using Hach chlorine test kits following instructions in the user's manual.

Section 4.0: RESULTS AND DISCUSSION

4.1 Facility Description

Four wells owned by AWC supplied water to a population of 1,520 in Sedona, AZ. POE Well No. 2, located at 315 Deer Pass Drive, with a capacity of 37 gpm, was selected for this demonstration study. Figure 4-1 shows the predemonstration site conditions in late July 2003.

POE Well No. 2, drilled in January 1974, has a 6-in diameter, 585-ft depth, and 565 ft of slotted screen extending from 20 to 585 ft below ground surface (bgs). Prior to installation of the arsenic removal system, treatment consisted of only a chlorine injection system (Figure 4-2) using a 4% NaOCl solution at a feed rate of 0.6 gpd to reach a target chlorine residual of 0.6 mg/L (as Cl₂). The chlorinated water then entered the distribution system and two gravity-fed storage tanks with a total capacity of 400,000 gal. POE Well No. 2 was controlled by level sensors in the storage tanks and operated for approximately 8 hr/day. For the purpose of this demonstration study, the well was operated 24 hr/day.



Figure 4-1. Predemonstration Site Conditions
(Right to Left: Wellhead, Piping, Hydropneumatic Tank, Electrical Panel, and Chlorine Shed)

4.1.1 Source Water Quality. Source water samples were collected from POE Well No. 2 for analysis on July 31, 2003. The results of the source water analyses, along with those provided by the facility to EPA for the demonstration site selection and those independently collected and analyzed by EPA and Kinetico, are presented in Table 4-1.



Figure 4-2. Existing Chlorine Injection System

Based on the July 31, 2003, sampling results, the total arsenic concentration in POE Well No. 2 was 41.0 $\mu\text{g/L}$, with arsenic existing primarily as As(V) (i.e., 93% at 37.8 $\mu\text{g/L}$). A small amount of arsenic also was present as particulate As (i.e., 2.8 $\mu\text{g/L}$) and As(III) (i.e., 0.3 $\mu\text{g/L}$). Because arsenic already existed as As(V), which adsorbs better onto the AAFS50 media, prechlorination upstream of the treatment process was not required.

Raw water pH values ranged from 7.6 to 7.9. Kinetico proposed to adjust the source water pH to 7.2 to improve the media's arsenic adsorptive capacity. Therefore, pH adjustment equipment was installed at the site, but was not used initially in order to evaluate the capacity of the media under the "as is" pH condition.

The adsorptive capacity of AAFS50 media can be impacted by high levels of competing ions such as silica, phosphate, and fluoride. The concentrations of these ions appeared to be low enough as not to affect the media's adsorption of arsenic. The source water also had Fe, Mn, and Al concentrations below detection. These values were comparable to the levels reported by all other parties. Vanadium was measured at 16.2 $\mu\text{g/L}$; however, its adsorption by AAFS50 has not been reported.

4.1.2 Distribution System. The distribution system was supplied by POE Well No. 2 and three other production wells, i.e., Gulf Well, Rancho Rojo Well, and Wild House Mesa Well, with capacities of 262, 118, and 23 gpm, respectively, located within a one-mile radius. After chlorination, water from these wells blended within the distribution system and flowed into two gravity-fed storage tanks (totaling 400,000 gal), located about half a mile downstream of POE Well No. 2. A small area of homes was served predominantly by water produced by POE Well No. 2. Efforts were made to select locations in this area for the distribution system sampling (Section 3.3.4).

Table 4-1. POE Well No. 2 Water Quality Data

Parameter	Units	Facility Data ^(b)	EPA Data	Kinetic Data	Battelle Data	AWC Data ^(d)
<i>Sampling Date</i>		Not specified	10/03/02	12/02	07/31/03	01/94 – 03/02
pH	–	7.6	NS	7.9	7.7	7.6
Total Alkalinity	mg/L ^(a)	162	154	160	154	160
Total Hardness	mg/L ^(a)	149	NS	160	172	149
Chloride	mg/L	11.0	9.7	19.8	11.0	11.3
Fluoride	mg/L	NS	NS	0.1	0.2	<0.1-0.2
Sulfide	mg/L	NS	2.8	NS	NS	NS
Sulfate	mg/L	8.7	8.4	9.0	8.7	9.8
Silica (as SiO ₂)	mg/L	20.8	19.3	21.4	18.5	NS
Orthophosphate	mg/L	<0.065 ^(c)	NS	<0.1	<0.1	NS
TOC	mg/L	<0.5	NS	NS	NA	NS
As (total)	µg/L	40.0	39.0	40.0	41.0	34-47
As (soluble)	µg/L	NS	NS	NS	38.1	NS
As (particulate)	µg/L	NS	NS	NS	2.8	NS
As(III)	µg/L	NS	NS	NS	0.3	NS
As(V)	µg/L	NS	NS	NS	37.8	NS
Fe (total)	µg/L	<10	7.0	<30	<30	<10
Fe (soluble)	µg/L	NS	NS	NS	<30	NS
Al (total)	µg/L	NS	<25	NS	<10	NS
Al (soluble)	µg/L	NS	NS	NS	<10	NS
Mn (total)	µg/L	<50	<0.4	NS	<0.1	<50
Mn (soluble)	µg/L	NS	NS	<10	<0.1	NS
V (total)	µg/L	NS	NS	NS	16.2	NS
V (soluble)	µg/L	NS	NS	NS	15.7	NS
Mo (total)	µg/L	NS	NS	NS	<0.1	NS
Mo (soluble)	µg/L	NS	NS	NS	<0.1	NS
Sb (total)	µg/L	NS	<25	NS	<0.1	<5
Sb (soluble)	µg/L	NS	NS	NS	<0.1	NS
Na (total)	mg/L	11.0	9.9	10.0	11.1	NS
Ca (total)	mg/L	35.0	34.5	35.5	39.3	34.6
Mg (total)	mg/L	15.0	16.2	17.5	18.0	15.2

(a) As CaCO₃.

(b) Provided by AWC to EPA for demonstration site selection.

(c) Provided by EPA.

(d) Samples collected after chlorination.

NS = not sampled.

TOC = total organic carbon.

The distribution piping consisted of 6-in-diameter ductile iron and asbestos cement pipe. Service lines to the homes were primarily copper and polyethylene pipes. Lead joints were found in some homes. Water from the distribution system is sampled periodically for state and federal compliance with the SDWA. Every month, three samples are collected for bacteria analysis. Under the LCR, samples have been collected from customer taps at 14 locations every three years. The monitoring results from AWC's Consumer Confidence Report (CCR) for 2003 are summarized in Table 4-2.

Table 4-2. Distribution System Water Quality Data^(a)

Parameter	Unit	Detected Range
Alpha emitters	pCi/L	0.3 to 6.4
Arsenic	µg/L	33 to 37
Barium	µg/L	120 to 140
Fluoride	mg/L	0.12 to 0.13
Nitrate (as N)	mg/L	0.2 to 0.7
Sodium	mg/L	7.4 to 10
Sulfate ^(b)	mg/L	5.3
Uranium	µg/L	ND to 1.8
Copper ^(c)	mg/L	0.16
Radon ^(b)	pCi/L	170 to 190

Source: AWC, 2004.

(a) All other constituents not detected.

(b) Parameter sampled in 1999.

(c) Parameter sampled in 2002.

ND = not detected.

4.2 Treatment Process Description

Kinetico's FA-236-AS Adsorptive Arsenic Removal System uses standard downflow filtration through two pressure tanks arranged in series. Each tank contains a fixed bed of Alcan's Actiguard AAFS50 media, an iron-modified activated alumina (AA) medium with NSF International (NSF) Standard 61 approval for use in drinking water. This media is engineered with a proprietary additive to enhance its arsenic adsorptive capabilities. Although the media can adsorb both As(III) and As(V), the best performance is observed with As(V). Table 4-3 presents key physical and chemical properties of the media.

Table 4-3. Physical and Chemical Properties of Alcan's Actiguard AAFS50 Media

<i>Physical Properties</i>	
Parameter	Value
Physical form	Dry granular media
Color	Brown
Bulk density (g/cm ³)	1.06 ^(a)
Bulk density (lb/ft ³)	66 ^(a)
BET area (m ² /g)	220
Attrition (%)	0.3
<i>Chemical Analysis</i>	
Constituents	Weight %
Al ₂ O ₃ + proprietary additive	83
Silicon (as SiO ₂)	0.020
Titanium (as TiO ₂)	0.002
Loss on ignition	17

Source: Kinetico, 2004.

(a) Reported as 0.91 g/cm³ (56.8 lb/ft³) on Alcan's Product Data Sheet.

For series operation, the media in the lead tank is generally replaced when it completely exhausts its capacity or when the effluent from the lag tank reaches 10 µg/L of arsenic. The spent media in the lead

tank is removed and can be disposed of as non-hazardous waste after passing EPA's Toxicity Characteristic Leaching Procedure (TCLP) test. After loading the lead tank with new media, it is switched to the lag position, and the lag tank is switched to the lead position. The series operation better utilizes the arsenic removal capacity of the media when compared to parallel system design and operation.

The FA-236-AS system included a chemical feed system for pH adjustment, two pressure tanks arranged in series, a backwash recycle system, and associated instrumentation. The system also featured schedule 80 polyvinyl chloride (PVC) solvent bonded plumbing and PVC pneumatic valves actuated by a 2-hp compressor controlled by a programmable logic controller (PLC). Figure 4-3 is a simplified piping and instrumentation diagram (P&ID) of the treatment system, and Figure 4-4 is a photograph of the system. The system's design features are summarized in Table 4-4. The major processes include:

- **Intake.** Raw water was pumped from POE Well No. 2 at 36 gpm. The system was equipped with a flow-limiting device to prevent filter overrun and ancillary piping to bypass the treatment system (Figure 4-5).
- **pH Adjustment.** The pH control system consisted of a solenoid-driven chemical metering pump, a 2-in in-line static mixer, an acid draw assembly with a low-level float, an in-line pH meter, and a 55-gal drum containing 37% H₂SO₄ to adjust the feed water pH to a desired setpoint (Figure 4-5). For the first media run, the pH of the feed water was not adjusted in order to evaluate the media run length under the "as is" pH condition.
- **Chlorination.** The existing chlorine feed system (Figure 4-2) was used for chlorination. Because As(V) was the predominating species in raw water, preoxidization of the water was not necessary. Initially, NaOCl was applied after the adsorption tanks for disinfection purposes. After approximately one month of system operation, algae growth was observed on the viewglass of the lead tank (Figure 4-5). As a result, the chlorine injection point was relocated to just before the adsorption tanks to prevent biological growth. The chlorine residual was maintained at 0.4 to 0.6 mg/L (as Cl₂) throughout the treatment train with a 4% NaOCl solution.
- **Adsorption.** The system included two 36-in-diameter, 72-in-tall pressure tanks in series configuration, each containing 16.7 ft³ of AAFS50 media. (Note that although the vendor intended to load 22 ft³ of media in each tank, only 16.7 ft³ was loaded for the first media run due, in part, to a discrepancy between the reported and actual bulk density values [Table 4-3]). Each tank had 6-in flanges at the top and the bottom, a diffuser-style upper distributor, a hub and lateral-style lower distributor, and two 4-in side flanges with viewglasses to allow media observation. The adsorption tanks were constructed of fiberglass reinforced plastic (FRP) and rated for a working pressure of 150 pounds per square inch (psi). The tanks were skid mounted and piped to a valve rack mounted on a polyurethane coated, welded steel frame. The system also was equipped with the necessary valves and secondary piping to allow the tank positions to be switched from lead to lag and vice versa at the touch of a button on the touch screen operator interface panel (OIP).
- **Backwash.** Backwashing was recommended by the vendor to remove particulates and/or media fines accumulating in the beds and prevent channeling. Backwash was semi-automatic and was initiated by the operator when a light on

the control panel indicated that a set throughput had been reached. After each adsorptive tank was taken off-line, upflow backwash using treated water was performed at an adjustable flowrate controlled by a diaphragm valve. The resulting backwash water was stored in a 1,800-gal, polyethylene, conical-bottom holding tank (Figure 4-6) equipped with high/low level sensors.

- Backwash Water Recycling.** Recycling capabilities were included to reclaim the backwash water. After solids settled in the storage tank for a preset/adjustable time period, a 1-hp vertical pump pumped the backwash water through a 25- μm bag filter to remove any remaining suspended solids (Figure 4-6). A piping loop reclaimed the filtered wastewater by blending it with the influent at a maximum rate of 10% of the system flowrate.

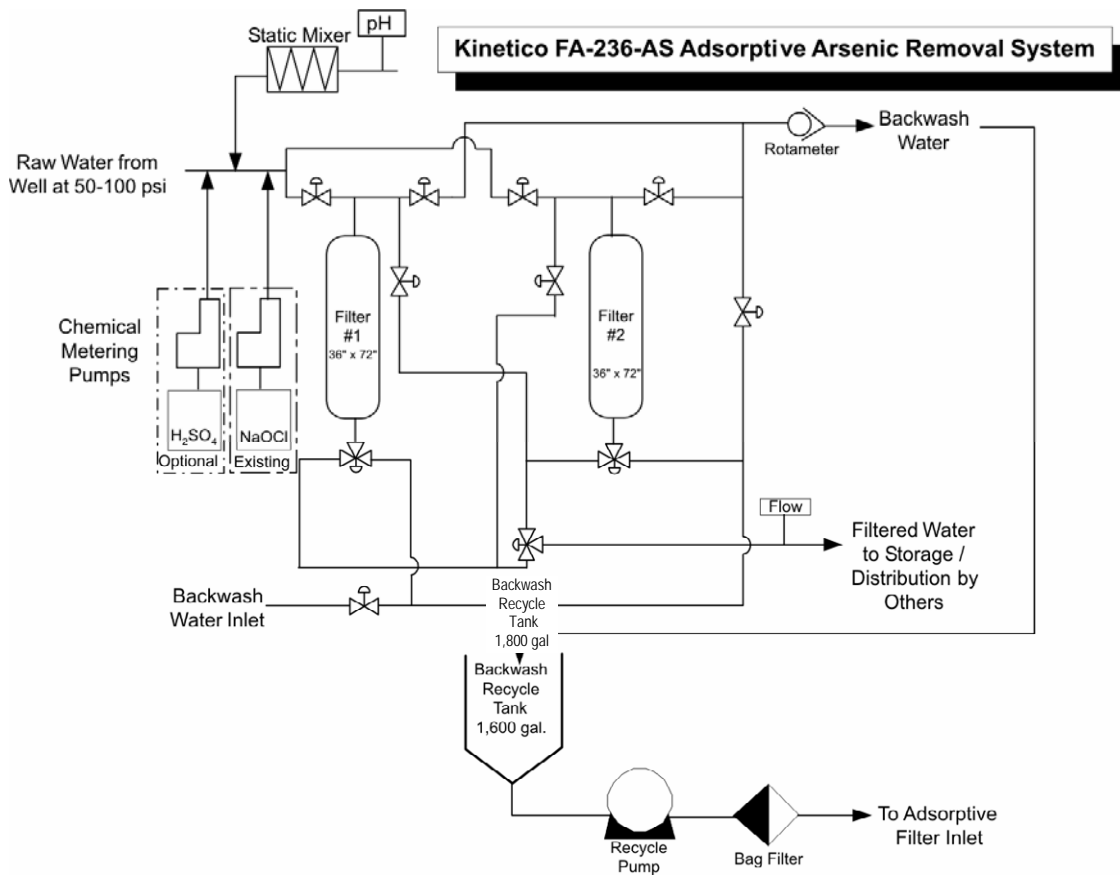

Figure 4-3. Schematic of Kinetico’s FA-236-AS Treatment System



Figure 4-4. Kinetico's FA-236-AS Treatment System on Concrete Pad

Table 4-4. Design Features for Kinetico's FA-236-AS Treatment System

Parameter	Design Value	Remarks
<i>Pretreatment</i>		
37% H ₂ SO ₄ addition (gpd)	5.5	pH setpoint of 7.2; not used initially
Chlorine addition (mg/L)	not required	Added for disinfection
<i>Filtration</i>		
No. of tanks	2	Series configuration
Tank size (in)	36 D × 72 H	7.1 ft ² cross-section
Media type	Alcan AAFS50	-
Media volume (ft ³ /tank)	22	1 BV = 22 ft ³ = 165 gal
Media bed depth (in)	37	-
Peak flowrate (gpm)	37	-
EBCT (min/tank)	4.5	-
Hydraulic utilization (%)	100	24 hr/day operation
Daily use rate (gpd)	53,280	-
Throughput to 10-μg/L of As (gal)	3,074,000	-
Working capacity (BV)	18,680	Based on 10-μg/L As breakthrough from lag tank
Media life (day)	56	Based on capacity and utilization
<i>Backwash</i>		
Frequency (week)	2-3	-
Flowrate (gpm)	55-60	-
Hydraulic loading rate (gpm/ft ²)	8	-
Duration (min/tank)	10-12	-
Wastewater production (gal)	1,100-1,440	-
Recycle flowrate (gpm)	3.7	10% of the system flow

D = diameter; H = height.



Figure 4-5. Treatment Process Components
 (Clockwise from Top: POE Well No. 2 and Treatment System Bypass Piping; Acid Addition Setup; In-Line pH Meter; Adsorption Tanks and Lower Distributor; and Main Control Panel)



Figure 4-6. Backwash Process Components
 (Clockwise from Left: 1,800-gal Holding Tank; Recycle Pump and Bag Filter; and Backwash Flowrate Indicator and Pump Box)

4.3 System Installation

Installation of Kinetico's FA-236-AS system was completed on May 7, 2004, with shakedown and startup activities completed soon after. The system installation and building construction activities were carried out by Fann Environmental in Prescott, AZ, a subcontractor to Kinetico.

4.3.1 Permitting. Engineering plans for the system permit application were prepared by the vendor and its subcontractor. The plans included general arrangement and P&IDs of the FA-236-AS system and drawings of a site plan, treatment plan, and piping plan. The engineering drawings were certified by a Professional Engineer registered in the State of Arizona and submitted to ADEQ for review and approval in mid-February 2004. The Certificate of Approval to Construct (ATC) was received on March 23, 2004, and a construction permit was subsequently applied for and approved by Yavapai County in mid-April 2004. Upon completion of system installation, as-built drawings were submitted to ADEQ and Approval of Construction (AOC) was subsequently issued on June 15, 2004.

4.3.2 System Installation, Shakedown, and Startup. The FA-236-AS treatment system was delivered to the site on April 23, 2004, after a 12 ft × 25 ft concrete pad was poured. The vendor, through its subcontractor, performed the off-loading and installation of the system, including piping connections to the inlet and distribution system. The mechanical installation, hydraulic testing of the unit (without media), and media loading were completed on May 11, 2004. Battelle provided operator training on data and sample collection from May 6-7, 2004.

4.3.3 Shed Construction. After the system was installed, a sun shed structure was built by AWC over the treatment system in late-May (Figure 4-7). The shed structure was 12 ft × 25 ft with a height of 11.5 ft, and was manufactured by Versa-Tube. The shed was constructed with a galvanized steel frame anchored to the concrete pad and sheeted with 29-gauge steel with a specially coated surface. The shed was pre-engineered with loading capacities of 90-mph for wind and 30-lb/ft² for snow. From late-November to mid-December 2004, the sides and ends of the shed structure were enclosed with metal covering, exposed piping was insulated, and heat lamps were installed within the building for added protection from cold weather.

4.4 System Operation

4.4.1 Operational Parameters. The operational parameters for the first six months of the system operation are tabulated and attached as Appendix A. Key parameters of the first and second media runs are summarized in Table 4-5. The first media run (without pH adjustment) began on June 24, 2004, and ended on August 4, 2004, when the arsenic concentration in the effluent of the lag tank exceeded 10 µg/L. Arrangements were then made to lower source water pH values to try to extend the media life (Section 4.4.2). Lowering pH values from September 17 to October 24, 2004, caused the effluent arsenic concentrations to decrease, but not to levels below 10 µg/L. The spent media was subsequently replaced (Section 4.4.4), and the second media run began on October 25, 2004, with pH adjustment.

The system operated for 977 hr during the first media run and 1,387 hr through the second media run, which continued after the end of the first six months of system operation. Operating time was based on 24-hr daily operation of POE Well No. 2 and a replacement hour meter. The operational time represents a utilization rate of 100% over the 27-week period. The faulty hour meter that was existing on-site was replaced on November 4, 2004, to accurately reflect any system downtime due to repairs and maintenance.



Figure 4-7. Sun Shed Structure (Top) and Completed Enclosure (Bottom)

The average flowrate through the system during both media runs was 36 gpm, which was very close to the design flowrate of 37 gpm. Because less media was loaded during the system startup (16.7 instead of 22 ft³/tank) due to the use of an incorrect bulk density value for calculating the required media shipping weight, the average EBCT during the first media run was reduced from the design value of 4.5 min/tank (Table 4-4) to 3.5 min/tank (or from 9.0 to 6.9 min for both tanks). After the media changeout, the average EBCT for the second media run was 4.6 min/tank (or 9.1 min for both tanks), which was very close to the design value.

The pressure differential (ΔP) readings across each tank ranged from 4-6 psi, which were 2-3 psi higher than the baseline ΔP readings measured during the system startup when hydraulic testing was performed on the empty tanks. This extra pressure loss, caused by the media, equates to 0.9-1.3 psi/ft of media. Further, the ΔP readings across each tank between two consecutive backwash events did not increase significantly, indicating that few particulates or media fines were accumulating in the media beds.

The system throughput for the first media run at 10 $\mu\text{g/L}$ of arsenic breakthrough in the effluent of the lag tank without pH adjustment was approximately 2,106,000 gal (or 16,858 BV) based on the treatment system totalizer. By the end of the first six months of system operation, the throughput for the second media run with pH adjustment already surpassed that of the first media run at 3,000,000 gal (or 18,230 BV).

Table 4-5. Operation of FA-236-AS Treatment System

Parameter	First Media Run without pH Adjustment	Second Media Run with pH Adjustment
	06/24/04-08/04/04 ^(a)	10/25/04-12/22/04 ^(b)
<i>Specifications</i>		
Media bed volume (ft ³ /tank)	16.7	22
Media quantity (lb/tank)	1,100	1,450
Media bed depth (in)	28	37
<i>Treatment Operations</i>		
Daily operating time (hr)	24	24
Total operating time (hr)	977	1,387
Acid addition (gpd)	0	3.0-3.4
Average flowrate [range] (gpm)	36 [35-39]	36 [36-37]
Average EBCT [range] (min/tank)	3.5 [3.2-3.6]	4.6 [4.5-4.6]
Pressure differential reading (psi)	4.0-6.0	4.0-5.0
Throughput (gal)	2,106,000	3,000,000
Bed volume (BV)	16,858	18,230
Media life (day)	41	TBD
<i>Backwash Operations</i>		
Frequency (week)	4	4
Flowrate (gpm)	27-35	35-36
Hydraulic loading rate (gpm/ft ²)	4-5	5
Duration (min/tank)	20	20
Wastewater production (gal)	1,060-1,400	1,200-1,350
Recycle flowrate (gpm)	2-3	2

(a) First media run ended on 08/04/04 when lag tank effluent reached 10 µg/L of arsenic. Arrangements made to adjust source water pH values on 09/17/04 as media run continued to 10/24/04.

(b) Second media run continued after 12/22/04.

TBD = to be determined.

4.4.2 pH Adjustment. Due to the 10-µg/L arsenic breakthrough from the lag tank on August 4, 2004, Battelle requested that Kinetico make the necessary preparations for pH adjustment of raw water on August 12, 2004. A 55-gal drum of 37% H₂SO₄ and a chemical transfer pump were delivered to the site during the weeks of August 16 and 23, 2004, respectively. However, the commencement of acid addition had to be postponed due, in part, to problems related to a faulty in-line pH electrode, an incorrect output signal from the pH transmitter, and/or an inoperable acid pump. After Kinetico replaced the in-line pH transmitter and the acid pump and corrected the output setting for the pH transmitter, pH adjustment began on September 17, 2004. During October 13 through 18, 2004, pH adjustment was temporarily interrupted and then resumed on October 19, 2004.

Some discrepancies were observed between the measurements made by the in-line pH meter and the WTW Multi 340i field meter. The in-line pH meter indicated that the raw water pH was adjusted to a setpoint of 7.2; however, the field meter indicated that the average pH value of water samples collected at AC was 6.8.

The system consumed approximately 3.4 gpd of 37% H₂SO₄ until October 1, 2004, and then approximately 3 gpd of 50% H₂SO₄ afterwards. The average acid consumption was 0.06 gal/1,000 gal of water treated, which was equivalent to the theoretical calculation (Section 4.5.1).

4.4.3 Backwash. The FA-236-AS system was backwashed nine times during the first six months of operation. A set throughput was used to alert the operator to manually initiate system backwash. The throughput was initially set at 340,000 gal, increased to 740,000 gal, and then again increased to 1,400,000 gal (Table 4-6), because no significant pressure buildup occurred during system operation. Backwash was then performed about every 28 days except when it was required to adjust the operation of the recycle pump on September 18, 2004, and for media changeout on October 25, 2004.

During system startup, the backwash duration was increased from the design value of 10-12 min/tank to 20 min/tank as the maximum backwash flowrate attainable was 36 gpm or 5 gpm/ft², which was lower than the design value of 55-60 gpm or 8 gpm/ft². With this modification, the volumes of wastewater generated during each event ranged from 1,060 to 1,400 gal, consistent with the target of 1,100 to 1,440 gal. Backwash water handling is discussed in Section 4.4.5. The low ΔP readings indicated that the reduced hydraulic loading rate was adequate to fully backwash the tanks.

Table 4-6. Summary of Backwash Events

Date	Backwash Flowrate	Backwash Duration ^(a)	Wastewater Generated	Backwash Setpoint	Time between Backwash Events
	gpm	min	gal	gal	day
07/02/04	27-29	40	1,112	340,000	8 ^(b)
07/19/04	34-35	40	1,060	740,000	17
08/16/04	34	40	1,362	1,400,000	28
09/13/04	33-34	40	1,354	1,400,000	28
09/18/04	34	40	1,352	1,400,000	5 ^(c)
10/12/04	35	40	1,400	1,400,000	24
10/25/04	35	40	1,200	1,400,000	13 ^(d)
11/22/04	36	40	1,249	1,400,000	28
12/20/04	35	40	1,350	1,400,000	28
Total			11,439		

(a) For both tanks.

(b) First backwash since system startup on 06/24/04.

(c) Backwash initiated to adjust recycle pump operation.

(d) Backwash initiated after media changeout.

4.4.4 Media Changeout. The first media changeout was performed by Fann Environmental on October 25, 2004. Before spent media removal, the heights of the freeboard, as measured from the flange at the top of the tanks to the media surface, were 39.5 in for Tank A and 40.5 in for Tank B. These measurements are comparable to the initial heights of the freeboard measured during shakedown in May 2004 (i.e., 39.3 in for both tanks). The spent media was sampled and removed from each tank as described in Section 3.3.5 after the tanks were drained and pumps and isolation valves were turned off. The tank walls were rinsed and any remaining media was removed from the bottom of the tanks. Each tank was then filled one-third full with water before adding 1,450 lb or 22 ft³ of virgin AAFS50 media, as specified in the original design, by pouring the media through a large funnel from the top of the tank. The tanks were completely filled with water, and the media was allowed to soak for at least 1 hr. After the media was properly backwashed, freeboard measurements were obtained (i.e., 27.3 in for both tanks), and the system was returned to service.

4.4.5 Residual Management. Backwash recycling capabilities (Section 4.2) enabled the system to reclaim nearly 100% of the wastewater produced by blending it with source water at 2-3 gpm. Although it was lower than the design value of 3.7 gpm, the recycle flowrate was not increased as it wasn't critical

to the system performance. The only residual produced by operation of the treatment system was 2,200 lb of spent media. Because the spent media passed TCLP tests (Section 4.5.4), it was disposed of by Waste Management, Inc. at Gray Wolf Landfill in Dewey, AZ.

4.4.6 Reliability and Simplicity of Operation. Relatively rapid arsenic breakthrough during the first media run (Section 4.5.1) and pH adjustment (Section 4.4.2) were the primary sources of concern during this reporting period. Other O&M issues encountered were problems with the chlorine injector, the backwash recycle pump, and a broken inlet bag filter pressure gauge due to unusually cold weather in late November 2005. A minimal amount of unscheduled downtime was necessary to repair system components as discussed above. Scheduled downtime for the first media changeout was 12 hr. The total amount of unscheduled and scheduled downtime was no more than 1%.

Pre- and Post-Treatment Requirements. For disinfection purposes, NaOCl was initially injected downstream of the system to provide a chlorine residual of 0.4 to 0.5 mg/L (as Cl₂) through the distribution system. On July 27, 2004, after biological growth was observed in the lead tank, the chlorine injection point was moved upstream to the system to prevent biological growth and provide disinfection throughout the treatment system.

The demonstration study commenced without raw water pH adjustment to evaluate the media life under the unaltered pH condition. After this condition was evaluated during the first media run, acid addition with a 37-50% H₂SO₄ solution began on September 17, 2004, to improve the performance of the media by adjusting the raw water pH to 7.2.

System Automation. The FA-236-AS was semi-automatically controlled by the PLC in the central control panel. The control panel contained a touch screen OIP that facilitated monitoring of system parameters, changing of system setpoints, and checking the alarm status. Based on the throughput setpoint, the control panel indicated when a backwash or media changeout was needed. The OIP enabled the operator to initiate the automatic backwash sequence and switch tank positions from lead to lag and vice versa. Additional automated features included pH adjustment and backwash water recycling. The acid pump was a paced pump, which was controlled by the pH transmitter based on the pH of the water entering the adsorption tanks. Operation of the backwash recycle pump was controlled using level sensors within the 1,800-gal reclaim tank.

Operator Skill Requirements. Under normal operating conditions, the skill requirements to operate the treatment system were minimal. The daily demand on the operator was typically 20-30 min for visual inspection of the system and recording of operational parameters on the log sheets. In Arizona, operator certifications are classified by grade on a scale of 1 (least complex) to 4 (most complex) according to facility type, size, complexity, and population served (ADEQ, 2005). The primary operator was Water Distribution Grade 4 and Water Treatment Grade 4 certified. After receiving proper training by the vendor during the system startup, the operator understood the PLC, knew how to use the OIP, and was able to work with the vendor to troubleshoot and perform minor on-site repairs.

Preventative Maintenance Activities. Preventative maintenance tasks recommended by the vendor included daily recording of pressures, flows, chemical drum levels, and visually checking for leaks, overheating components, and the manual valves' positions. The vendor also recommended weekly checking for trends in the recorded data which might indicate a decline in system performance, and monthly cleaning and calibrating of the in-line pH probe, initiating backwash, replacing bag filters, and checking the pumps' lubricant levels.

Chemical/Media Handling and Inventory Requirements. The facility coordinated the NaOCl solution supply and refilled the drum on an as-needed basis. H₂SO₄ was supplied in 55-gal drums by Univar's

Phoenix, AZ, facility. Generally, two drums were shipped at a time and replacement drums were ordered once the second drum was opened; each drum typically lasted for 2-3 weeks. Univar did not offer refundable drum deposits for 50% H₂SO₄, so Fann Environmental was contracted by Battelle to neutralize and dispose of empty drums. Although the chemical handling requirement was increased, results through the second media run indicated that the arsenic removal capacity of the media was greatly extended with pH adjustment, and media handling requirements were, thereby, reduced. Without pH adjustment, media replacement was required after 41 days of system operation.

4.5 System Performance

4.5.1 Treatment Plant Sampling. The treatment plant water was sampled on 23 occasions (including two duplicate events) during the first six months, with field speciation performed six times. Table 4-7 summarizes the results of As, Fe, Mn, and Al at IN, TA, and TB. On-site water quality measurements, including pH, temperature, DO, and ORP, were performed at IN, AC, TA, and TB. Chlorine residuals also were measured at AC, TA, and TB since prechlorination began on July 27, 2004. Table 4-8 summarizes the results of the other water quality parameters at IN, AC, TA, and TB during the first six months with alkalinity, pH, and sulfate presented both before and after acid addition began. Appendix B contains a complete set of the analytical results through the first six months of system operation. The results of the water samples collected throughout the treatment plant are discussed below.

Arsenic. Total arsenic concentrations in raw water ranged from 23.5 to 47.6 µg/L and averaged 40.0 µg/L, with As(V) being the predominating species (Table 4-7). Only trace amounts of particulate As and As(III) existed. The arsenic concentrations measured during this period were consistent with those in the raw water sample collected on July 31, 2003 (Table 4-1).

Arsenic results for the Kinetico system are shown in Figure 4-8 with total arsenic concentrations at IN, TA (after the lead tank), and TB (after the lag tank) along with the average pH values measured at TA and TB plotted against the sample collection dates. (Recall that the system was operating at a relatively constant 36-gpm flowrate around the clock.) Without pH adjustment, arsenic concentrations at TA exceeded 10 µg/L (i.e., 13.3 µg/L) at about 8,200 BV, less than three weeks after the system startup. (Note that BV was calculated based on 16.7 ft³ [125 gal] of media in the lead tank.) After another three weeks (on August 4, 2004), arsenic concentrations at TB also exceeded 10 µg/L (i.e., 10.7 µg/L) at about 16,900 BV. It is presumed that the relatively high pH values of the influent to the adsorption tanks (ranging from 7.7 to 7.9; Table 4-8) and the shorter EBCTs (Section 4.4.1) might have contributed to the early arsenic breakthrough.

Based on Figure 4-8, the adsorptive capacity of the AAFS50 media without pH adjustment was estimated to be 0.31 mg of As/g of media at 10-µg/L arsenic breakthrough, which is equivalent to that obtained from a rapid small scale column test conducted on-site by Arizona State University (Westerhoff et al., 2006). After 10-µg/L arsenic breakthrough, arsenic concentrations at TA continued to rise and almost reached the levels of raw water at about 34,000 BV just before the commencement of pH adjustment on September 17, 2004. At this point of near exhaustion, the adsorptive capacity of the AAFS50 media was estimated to be 0.6 mg of As/g of media. The adsorptive capacities were calculated by dividing the arsenic mass represented by the area between the IN and TA curves (i.e., 152 g at 10-µg/L breakthrough and 301 g near exhaustion) by the amount of media in the tank (i.e., 1,100 lb).

On September 17, 2004, pH adjustment of raw water began so that the effect of lowering pH from about 7.8 to 6.8 on arsenic breakthrough and media life might be examined. As shown in Figure 4-8, although it was effective at reducing arsenic concentrations (e.g., from 33.5 to 20.2 µg/L at TA and from 26.0 to 12.3 µg/L at TB on September 29, 2004), the acid addition was not able to bring the effluent to below 10 µg/L. The acid addition was temporarily interrupted during October 13 to 18, 2004, whereupon the

Table 4-7. Summary of Arsenic, Iron, Manganese, and Aluminum Results (06/24/04-12/22/04)

Parameter (Figure, if any)	Sampling Location	Sample Count	Concentration (µg/L)			Standard Deviation
			Minimum	Maximum	Average	
As (total) (Figure 4-8)	IN	25	23.5	47.6	40.0	5.4
	TA	6	NM	NM	NM	NM
	TB	6	NM	NM	NM	NM
As (soluble)	IN	6	39.6	47.4	42.4	3.8
	TA	6	NM	NM	NM	NM
	TB	6	NM	NM	NM	NM
As (particulate)	IN	6	<0.1	0.8	0.2	0.3
	TA	6	NM	NM	NM	NM
	TB	6	NM	NM	NM	NM
As(III)	IN	6	0.4	1.0	0.6	0.2
	TA	6	NM	NM	NM	NM
	TB	6	NM	NM	NM	NM
As(V)	IN	6	38.6	46.7	41.9	3.8
	TA	6	NM	NM	NM	NM
	TB	6	NM	NM	NM	NM
Fe (total)	IN	25	<25	144	18.5	26.4
	TA	25	<25	34.0	14.0	5.2
	TB	25	<25	52.7	16.0	10.1
Fe (soluble)	IN	6	<25	<25	<25	0.0
	TA	6	<25	25.0	14.6	5.1
	TB	6	<25	<25	<25	0.0
Mn (total)	IN	25	<0.1	60.2	2.7	12.0
	TA	25	<0.1	2.4	0.3	0.5
	TB	25	<0.1	19.2	1.2	3.8
Mn (soluble)	IN	6	0.1	0.3	0.2	0.1
	TA	6	<0.1	2.4	0.5	0.9
	TB	6	<0.1	2.8	0.6	1.1
Al (total)	IN	23	<10	22.0	5.7	3.6
	TA	23	<10	29.1	7.3	5.9
	TB	23	<10	23.7	7.7	4.9
Al (soluble)	IN	5	<10	<10	<10	0.0
	TA	5	<10	<10	<10	0.0
	TB	5	<10	13.0	6.6	3.6

NM = not meaningful for data related to breakthrough curves. See Appendix B for analytical results.

One-half of detection limit used for nondetect results for calculations.

Duplicate samples included for calculations.

arsenic concentration at TA returned immediately to that of the raw water. After acid addition resumed on October 19, 2004, the arsenic concentration at TA again decreased. Although less significant, similar observations were made at TB, with arsenic concentrations swinging up and down based on different influent pH values. Lower effluent concentrations at lower influent pH values suggested an increased media capacity for arsenic, thus extending the media life as would be expected.

Table 4-8. Summary of Other Water Quality Parameter Results (06/24/04-12/22/04)

Parameter (Figure, if any)	Sampling Location	Unit	Sample Count	Minimum	Maximum	Average	Standard Deviation
Alkalinity ^(a) (as CaCO ₃) (Figure 4-9)	IN	mg/L	25	138	168	158	6.5
	TA	mg/L	13/11	156/114	169/128	161/122	4.1/3.9
	TB	mg/L	13/11	151/114	167/126	158/122	4.3/3.8
Fluoride	IN	mg/L	6	<0.1	0.1	0.1	0.0
	TA	mg/L	6	<0.1	0.1	0.1	0.0
	TB	mg/L	6	<0.1	0.1	0.1	0.0
Sulfate ^(a) (Figure 4-9)	IN	mg/L	6	6.8	8.4	7.9	0.6
	TA	mg/L	3/3	8.1/31	8.4/50	8.3/39	0.2/9.7
	TB	mg/L	3/3	8.1/31	9.4/45	8.6/37	0.7/7.1
Orthophosphate (as PO ₄)	IN	mg/L	25	<0.06	<0.10	0.0	0.0
	TA	mg/L	25	<0.06	<0.10	0.0	0.0
	TB	mg/L	25	<0.06	<0.10	0.0	0.0
Silica (as SiO ₂) (Figure 4-10)	IN	mg/L	25	18.2	19.5	18.8	0.4
	TA	mg/L	25	NM	NM	NM	NM
	TB	mg/L	25	NM	NM	NM	NM
Nitrate (as N)	IN	mg/L	6	0.8	1.0	0.8	0.1
	TA	mg/L	6	0.7	1.0	0.8	0.1
	TB	mg/L	6	<0.04	0.9	0.7	0.3
Turbidity	IN	NTU	25	0.1	0.6	0.2	0.1
	TA	NTU	25	<0.1	0.5	0.2	0.1
	TB	NTU	25	<0.1	0.7	0.2	0.2
pH ^(a) (Figures 4-8 and 4-9)	IN	S.U.	23	7.5	8.4	7.8	0.2
	AC	S.U.	8/10	7.7/6.7	7.9/6.9	7.8/6.8	0.1/0.1
	TA	S.U.	12/10	7.7/6.7	7.9/6.9	7.7/6.8	0.1/0.1
	TB	S.U.	12/10	7.6/6.7	7.8/6.9	7.7/6.8	0.1/0.1
Temperature	IN	°C	23	18.1	25.0	20.3	1.4
	AC	°C	19	19.0	21.1	20.1	0.6
	TA	°C	23	18.5	22.4	20.2	0.8
	TB	°C	23	18.8	23.3	20.3	0.9
Dissolved Oxygen	IN	mg/L	23	5.3	6.5	6.0	0.3
	AC	mg/L	19	5.1	6.5	5.8	0.3
	TA	mg/L	23	5.1	6.1	5.7	0.3
	TB	mg/L	23	5.2	6.4	5.8	0.3
ORP ^(b)	IN	mV	19	179	248	207	19
	AC	mV	19	560	754	635	63
	TA	mV	19	603	727	657	49
	TB	mV	19	604	751	668	52
Free Chlorine ^(b) (as Cl ₂)	AC	mg/L	19	0.3	0.9	0.5	0.2
	TA	mg/L	19	0.3	0.8	0.4	0.1
	TB	mg/L	19	0.3	0.8	0.4	0.1
Total Chlorine ^(b) (as Cl ₂)	AC	mg/L	19	0.3	0.9	0.5	0.2
	TA	mg/L	18	0.4	0.8	0.5	0.1
	TB	mg/L	19	0.4	0.8	0.5	0.1

Table 4-8. Summary of Other Water Quality Parameter Results (06/24/04-12/22/04) (Continued)

Parameter (Figure, if any)	Sampling Location	Unit	Sample Count	Minimum	Maximum	Average	Standard Deviation
Total Hardness (as CaCO ₃)	IN	mg/L	6	136	181	164	18.1
	TA	mg/L	6	140	178	162	14.7
	TB	mg/L	6	136	180	163	15.6
Ca Hardness (as CaCO ₃)	IN	mg/L	6	66.2	105	88.9	13.6
	TA	mg/L	6	69.6	101	87.2	11.0
	TB	mg/L	6	68.3	101	87.9	11.8
Mg Hardness (as CaCO ₃)	IN	mg/L	6	69.6	86.0	75.5	6.5
	TA	mg/L	6	70.4	88.4	74.8	7.2
	TB	mg/L	6	67.7	85.4	74.6	6.3

(a) Values before (06/24/04-09/16/04)/after (09/17/04-12/22/04) pH adjustment. Data from 10/13/04 not included as pH adjustment was temporarily interrupted.

(b) Measurements since prechlorination began on July 27, 2004.

NM = not meaningful for data related to breakthrough curves. See Appendix B for analytical results.

One-half of detection limit used for nondetect results for calculations.

Duplicate samples included for calculations.

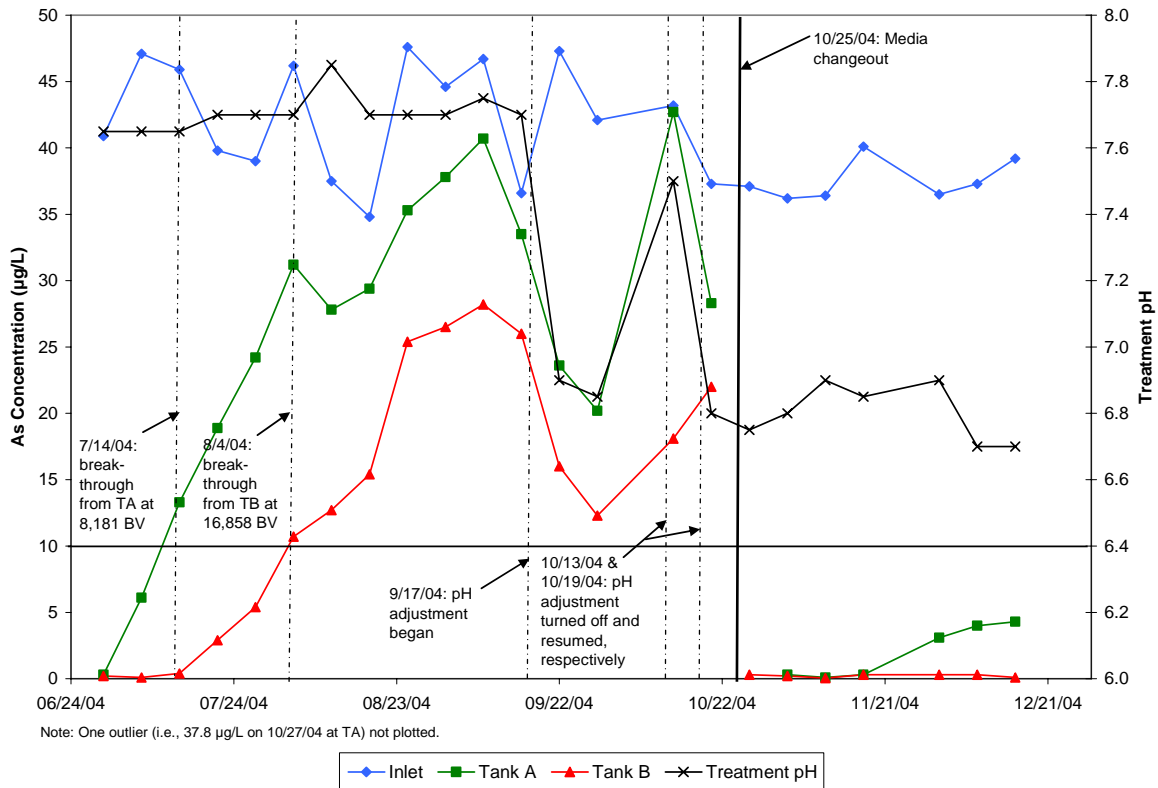

Figure 4-8. Total Arsenic Concentrations and Treatment pH over Time

The second media run with pH adjustment began on October 25, 2004. As of December 15, 2004, the new AAFS50 media, with influent pH values reduced to an average value of 6.8, had treated approximately 16,000 BV (2,635,000 gal) of water, which was 86% of the vendor-estimated working capacity (i.e., 18,680 BV [Table 4-4]). (Note that BV was calculated based on 22 ft³ [165 gal] of media in the lead tank.) Total arsenic concentrations measured at TA and TB were 4.3 and 0.1 µg/L, respectively, as shown in Figure 4-8. The arsenic breakthrough of this media run will be further discussed in the final performance evaluation report.

Iron, Manganese, and Aluminum. Concentrations of total and soluble Fe and Mn were mostly near and/or below the respective detection limits throughout the treatment system except one measurement on September 22, 2004 (i.e., 19.2 µg/L Mn at TB) and two measurements on October 13, 2004 (i.e., 144 µg/L Fe and 60.2 µg/L Mn at IN). Total Al concentrations were mostly <10 µg/L, but were observed up to 22.0, 29.1, and 23.7 µg/L at IN, TA, and TB, respectively. Although this indicates some Al might have leached from the AAFS50 media, all concentrations were below the secondary maximum contaminant level (SMCL) of 0.05 to 0.2 mg/L.

Alkalinity, Sulfate, and pH. Average raw water alkalinity, sulfate, and pH values were 158 mg/L (as CaCO₃), 7.9 mg/L, and 7.8, respectively (Table 4-8). These values remained consistent throughout the treatment train until pH adjustment began on September 17, 2004. Thereafter, 37-50% H₂SO₄, consumed at a rate of approximately 0.06 gal/1,000 gal of water treated, reduced pH values to 6.7-6.9, decreased average alkalinity levels to 122 mg/L (as CaCO₃), and increased average sulfate levels to 39 mg/L at TA (Table 4-8 and Figure 4-9). Concentrations at TA were similar to those measured at TB, indicating that the media had little or no effect on these analytes. It was clear that pH was the single most influential factor affecting the arsenic adsorptive capacity of the media, as evident by the arsenic breakthrough curves with and without pH adjustment shown in Figure 4-8.

The consumption rate of 37-50% H₂SO₄ was equivalent to that derived from a theoretical calculation described by Rubel (2003) (Table 4-9). The actual alkalinity reduction (i.e., 36 mg/L [as CaCO₃]) and sulfate increase (i.e., 31 mg/L) also were similar to the theoretical values of 45 mg/L (as CaCO₃) and 44 mg/L, respectively, as shown in Table 4-9.

Fluoride, Orthophosphate, and Nitrate. Fluoride and orthophosphate concentrations were near and/or below the detection limit for all samples. The nitrate results also remained fairly consistent throughout the treatment train, appearing unaffected by the prechlorination, acid addition, and media during the first six months.

Silica. Silica removal was observed immediately after the initial system startup and media changeout when the media was fresh (Figure 4-10). Within a couple of months, silica levels in the effluent of the adsorption tanks approached influent concentrations. After pH adjustment began on September 17, 2004, silica levels in the treatment tanks' effluent exceeded influent concentrations, presumably because silica was desorbed from the AAFS50 media at lower pH values. The effect of pH on silica removal was observed again at the end of the first media run when acid addition was temporarily interrupted.

DO, ORP, and Chlorine. Raw water from POE Well No. 2 was rather oxidizing as indicated by the DO concentrations ranging from 5.3 to 6.5 mg/L and ORP readings ranging from 179 to 248 millivolts (mV). Thus, it explains why little or no As(III) was present in raw water. As a result of prechlorination, the ORP readings at AC, TA, and TB increased significantly to the range of 560 to 754 mV. The chlorine residuals measured at TA and TB were comparable to those measured at AC, indicating little or no chlorine consumption through the adsorption tanks.

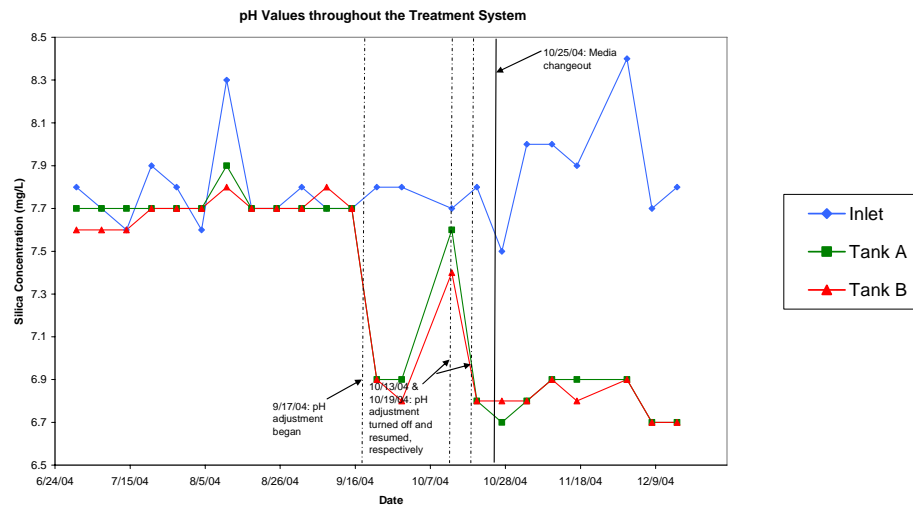
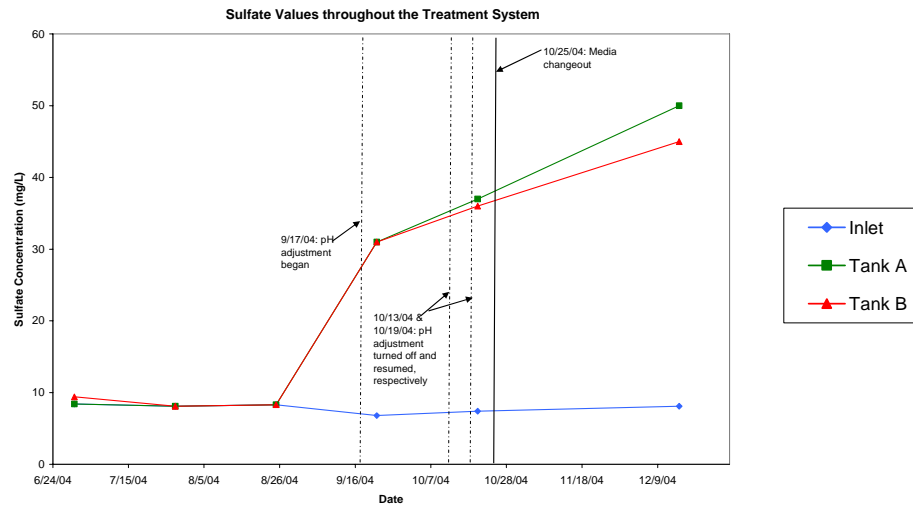
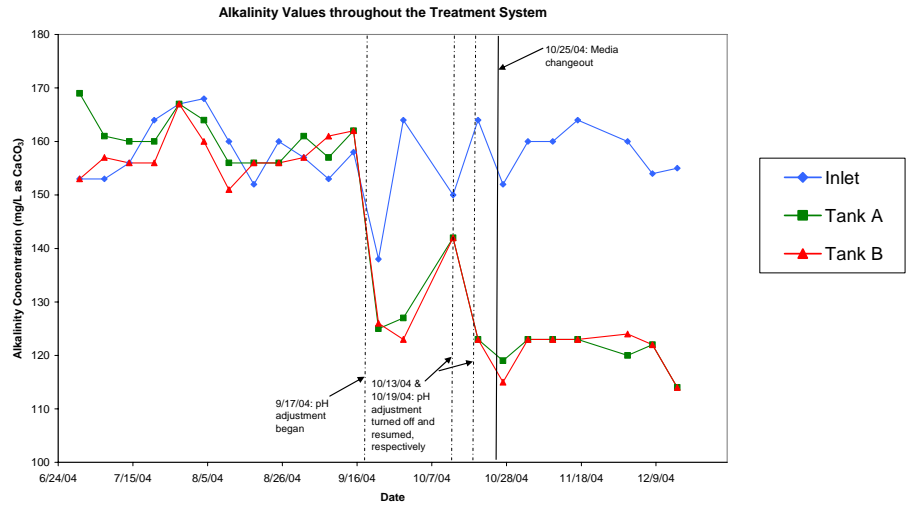

Figure 4-9. Alkalinity, Sulfate, and pH Values over Time

Table 4-9. Theoretical Calculation of Acid Consumption for pH Adjustment

Parameter	Unit	Raw Water Value	pH Adjusted Value
pH	S.U.	7.9	6.8
Alkalinity	mg/L ^(a)	158	113
Free CO ₂	mg/L	4	43
Alkalinity Reduction	mg/L ^(a)	45	
Acid Required	meq/L	0.9	
H ₂ SO ₄ Required	mg/L	44	
50% H ₂ SO ₄ Required	lb/1,000 gal	0.74	
50% H ₂ SO ₄ Required	gal/1,000 gal	0.06	

(a) As CaCO₃.

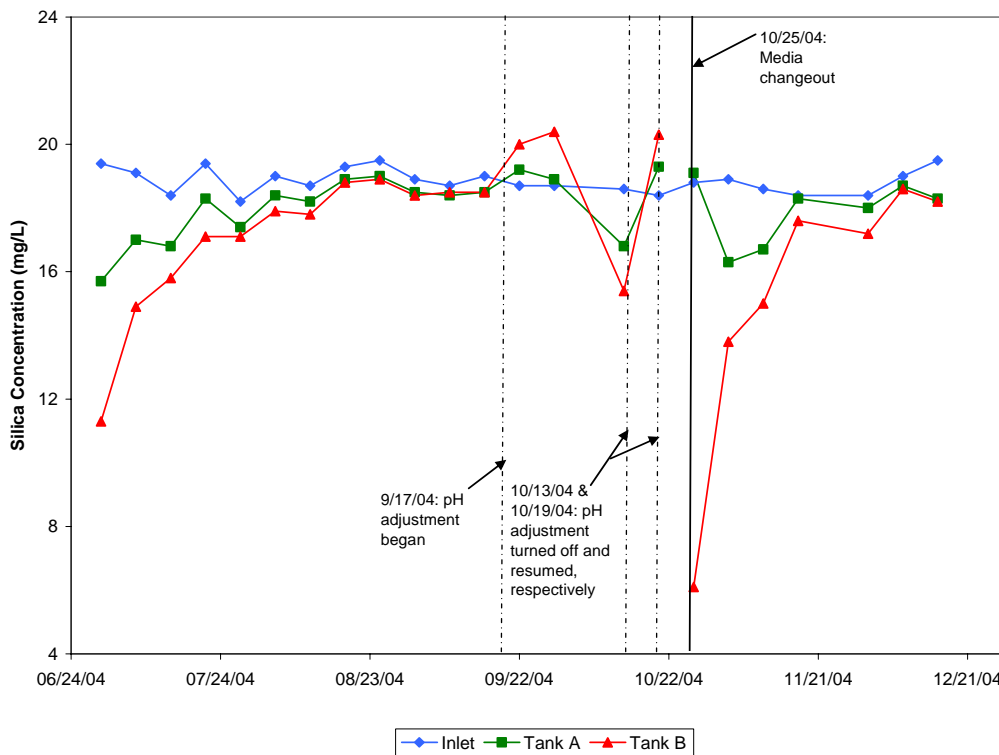

Figure 4-10. Silica Concentrations over Time

Hardness. Total hardness ranged from 136 to 181 mg/L (as CaCO₃) (Table 4-8), consisting of approximately 54% Ca hardness and 46% Mg hardness. Hardness did not appear to be affected by the treatment process or acid addition.

4.5.2 Backwash Water Sampling. The analytical results of the five sets of backwash water samples collected are summarized in Table 4-10. (Note that since the first six months of system operation, the backwash water sampling procedure has been modified [Section 3.3.3].) Because treated water was used for backwash, the pH values of the backwash water were similar to those of the treated water. Since October 12, 2004, the pH values of the backwash water were lower than previous results due to pH adjustment of the raw water beginning on September 17, 2004.

The soluble arsenic concentrations in the backwash water from each tank were higher than those in the treated water used for backwash. Data also show that the backwash water from Tank A contained higher soluble arsenic levels than Tank B. After media changeout on October 25, 2004, soluble arsenic concentrations in the backwash water were significantly less than previous results presumably due to the improved quality of the treated water. The soluble arsenic concentrations in the backwash water were considerably higher than the treated water results possibly due to desorption from the media or blending of the treated water used for backwash in the distribution system with other untreated sources. Turbidity readings of Tank A were higher than those of Tank B, most likely because the lead tank removed the majority of the particulates from raw water. The sampling events did not show significant differences for soluble Fe, Mn, and Al concentrations between the two tanks.

Table 4-10. Backwash Water Sampling Results

Sampling Event		Tank A							Tank B						
		pH	Turbidity	TDS	Soluble As	Soluble Fe	Soluble Mn	Soluble Al	pH	Turbidity	TDS	Soluble As	Soluble Fe	Soluble Mn	Soluble Al
No.	Date	S.U.	NTU	mg/L	µg/L	µg/L	µg/L	µg/L	S.U.	NTU	mg/L	µg/L	µg/L	µg/L	µg/L
1	08/16/04	7.6	22	464	36.5	<25	0.2	13.2	7.7	4.2	822	24.5	<25	<0.1	18.2
2	09/13/04	7.7	30	206	36.5	<25	0.2	<10	7.7	2.6	248	30.9	<25	0.1	11.1
3	10/12/04 ^(a)	7.0	230	224	34.5	<25	0.3	<10	7.2	5.2	216	19.0	<25	<0.1	<10
4	11/22/04 ^(b)	7.2	79	252	27.0	<25	1.0	<10	7.1	18	210	0.3	<25	0.2	11.6
5	12/20/04	6.9	38	292	25.0	<25	0.3	14.2	6.8	6.6	664	1.5	<25	0.2	14.5

(a) pH adjustment began 09/17/04.

(b) Media changeout occurred 10/25/04.

4.5.3 Distribution System Water Sampling. The results of the distribution system sampling are summarized in Table 4-11. The most noticeable change in the distribution samples since the system began operation was a decrease in arsenic concentrations. Baseline arsenic concentrations averaged 41.9, 39.2, and 44.5 µg/L for the first draw samples at DS1, DS2, and DS3, respectively, and 43.0 µg/L for flushed samples at DS3. Since the performance evaluation began and until the first media changeout, arsenic concentrations averaged 31.6, 31.7, and 15.7 µg/L for first draw samples at DS1, DS2, and DS3, respectively, and 16.0 µg/L for flushed samples at DS3. Arsenic levels were reduced most prominently at DS3 where concentrations were 5.5 and 5.4 µg/L for the first event after system startup and 0.3 and 0.2 µg/L for the the two events after media replacement for the first draw and flushed samples, respectively. Throughout the first six months, arsenic concentrations at DS1 and DS2 were higher than those in the system effluent, presumably due to the blending of the treated water (supplied by POE Well No. 2) with untreated water from other wells which also contained arsenic. Arsenic concentrations at DS3 were more representative of those reported at the system effluent due to the location's close proximity to the treatment system.

Lead concentrations ranged from <0.1 to 5.2 µg/L, with no exceedances over the action level of 15 µg/L. Copper concentrations ranged from 0.7 to 435 µg/L, with no samples exceeding the 1,300 µg/L action level. Due to the blending of water from untreated wells at locations DS1 and DS2, it was inconclusive whether the Pb or Cu concentrations in the distribution system had been affected by the arsenic treatment

Table 4-11. Distribution System Sampling Results

Sampling Event	DS1									DS2 ^(a)								DS3 ^(b)																	
	Non-LCR									Non-LCR								Non-Residence																	
	1st Draw									1st Draw								1st Draw							Flushed ^(c)										
	Stagnation Time	pH	Alkalinity ^(d)	As	Fe	Mn	Al	Pb	Cu	Stagnation Time	pH	Alkalinity ^(d)	As	Fe	Mn	Al	Pb	Cu	Stagnation Time	pH	Alkalinity ^(d)	As	Fe	Mn	Al	Pb	Cu	pH	Alkalinity ^(d)	As	Fe	Mn	Al	Pb	Cu
Date	hr	S.U.	mg/L	µg/L	µg/L	µg/L	µg/L	µg/L	hr	S.U.	mg/L	µg/L	µg/L	µg/L	µg/L	µg/L	µg/L	hr	S.U.	mg/L	µg/L	µg/L	µg/L	µg/L	µg/L	µg/L	S.U.	mg/L	µg/L	µg/L	µg/L	µg/L	µg/L	µg/L	
02/10/04 ^(e)	8.5	7.7	157	43.2	71	1.5	<10	0.3	176	8.3	8.2	144	43.7	53	0.5	<10	0.4	216	16.0	7.7	153	46.9	845	6.6	<10	5.2	26.9	NS	NS	NS	NS	NS	NS	NS	
02/24/04 ^(e)	6.8	7.3	160	48.7	<25	0.2	<10	0.1	121	7.9	7.4	143	45.0	<25	0.4	<10	0.2	231	15.8	7.6	160	51.8	<25	1.8	<10	0.5	3.5	7.6	152	50.6	<25	1.6	<10	0.1	0.7
03/16/04 ^(e)	12.5	7.6	150	41.5	<25	<0.1	<10	0.1	140	12.5	7.6	141	38.9	<25	0.4	<10	0.2	278	15.0	7.6	158	44.4	<25	1.4	<10	2.1	23.0	7.5	158	43.8	<25	1.2	<10	0.2	1.5
03/30/04 ^(e)	8.5	7.2	141	34.2	<25	0.5	<10	<0.1	109	99.5	7.6	141	29.1	<25	0.6	<10	0.1	251	14.9	7.6	155	34.9	<25	1.2	<10	0.5	3.0	7.6	157	34.6	<25	1.2	<10	0.1	1.0
07/28/04	9.4	7.8	139	29.5	<25	<0.1	<10	<0.1	53.6	8.5	7.7	139	32.6	<25	<0.1	<10	0.2	186	16.1	7.7	151	5.5	<25	<0.1	<10	0.7	8.6	7.7	159	5.4	<25	<0.1	<10	0.2	1.8
08/25/04	8.5	7.7	146	39.2	<25	0.1	<10	0.2	39.7	8.0	7.7	144	34.5	<25	0.1	<10	0.4	209	19.0	7.7	160	23.9	<25	0.1	<10	1.4	17.4	7.7	148	24.0	<25	0.1	<10	0.2	1.0
09/22/04 ^(f)	8.7	6.8	134	27.5	30.3	3.2	10.5	0.4	147	8.3	7.3	134	28.7	<25	0.6	<10	0.4	163	17.7	7.1	126	13.7	<25	1.0	10.2	0.8	4.5	7.0	126	16.2	<25	<0.1	<10	0.3	3.0
10/20/04	8.5	7.3	144	30.1	<25	0.2	18.7	0.5	141	9.0	7.4	144	31.0	<25	0.6	<10	0.8	207	24.0	7.2	123	19.5	<25	0.3	14.8	0.8	24.6	7.1	131	18.5	65.3	0.6	<10	<0.1	1.0
11/17/04 ^(g)	8.7	7.4	152	19.5	<25	0.3	<10	0.4	285	Homeowner was not available								22.8	7.1	131	0.3	<25	1.9	<10	1.6	11.3	7.0	127	0.2	<25	0.3	<10	0.9	5.5	
12/15/04	9.5	7.4	138	18.2	<25	0.3	<10	0.8	298	8.0	7.4	134	17.5	<25	0.3	<10	1.0	435	13.1	7.1	110	0.3	40.6	0.5	<10	2.5	10.5	7.3	110	0.2	<25	0.4	<10	0.8	4.3

- (a) Samples collected from a neighboring home on 02/10/04.
- (b) Location closest to treatment system; effects from other wells minimized.
- (c) Stagnation times not available for flushed location.
- (d) As CaCO₃.
- (e) Baseline sampling event.
- (f) pH adjustment began 09/17/04.
- (g) Media changeout occurred 10/25/04.

Lead action level = 15 µg/L; copper action level = 1.3 mg/L

NA = data not available.

system. However, Pb and Cu concentrations at DS3 did not appear to be significantly impacted, presumably indicating minimal impacts throughout the distribution system.

Measured pH values were 7.2-8.2 and 6.8-7.4 before and after acid addition began on September 17, 2004, respectively. Alkalinity levels decreased correspondingly from 139-160 to 110-152 mg/L (as CaCO₃). Iron concentrations ranged from <25 to 71 µg/L, except for the first baseline sample at DS3, with concentrations in the majority of the samples at <25 µg/L. The concentrations of Mn in the distribution samples were <7.0 µg/L. Aluminum concentrations were <10 µg/L except for four exceedances slightly over 10 µg/L.

4.5.4 Spent Media Sampling. On October 25, 2004, spent media samples were collected for total metals and TCLP analysis (Section 3.3.5). The results, as presented in Table 4-12, indicate that the AAFS50 media removed As, Zn, Cu, Pb, and P as water passed downward through Tank A, followed by Tank B, as noted by the decreasing concentrations of the metals removed. Average arsenic concentrations throughout Tanks A and B were 0.57 and 0.39 mg/g of media, respectively, which is equivalent to a combined mass of 474 g of As on 2,200 lb of media. Compared to the mass removed from the influent water through October 20, 2004 (i.e., 668 g of As), 71% recovery was achieved (Table 4-13).

The TCLP results indicated that the media was non-hazardous and could be disposed of in a standard landfill (i.e., Gray Wolf Landfill in Dewey, AZ). Only barium was detected at 1.43 and 1.63 mg/L in Tank A and Tank B, respectively (Table 4-14).

Table 4-12. Spent Media Total Metal Analysis

Analyte	Mg	Al	Si	P	Ca	Fe	Mn	Ni	Cu	Zn	As	Cd	Pb
Unit	µg/g	mg/g	µg/g	µg/g	mg/g	mg/g	µg/g	µg/g	µg/g	µg/g	µg/g	µg/g	µg/g
Tank A (Top)	340	111	36.4	563	1.7	16.0	95.8	1.2	4.2	143	638	0.03	1.1
Tank A (Middle)	276	86.4	40.7	498	1.6	14.9	86.2	1.1	4.1	146	531	0.04	0.8
Tank A (Bottom)	265	101	32.3	411	1.6	15.1	77.0	1.1	3.2	121	528	0.04	0.6
Tank B (Top)	251	90.5	29.9	283	1.6	14.3	120.1	1.2	1.7	81.9	410	0.06	0.5
Tank B (Middle)	266	110	35.9	249	1.6	15.4	116.2	1.3	1.5	67.2	396	0.03	0.4
Tank B (Bottom)	261	124	32.5	175	1.7	17.5	123.8	1.4	1.1	52.1	349	0.03	0.5

Note: Average compositions calculated from triplicate analyses.

Table 4-13. Summary of Arsenic Removed by AAFS50 Media

Duration	06/24/04-09/15/04 ^(a)		06/24/04-10/20/04 ^(b)				
Source	Breakthrough Curves (Figure 4-8)		Breakthrough Curves (Figure 4-8)		Spent Media (Table 4-12)		Recovery
Unit	g	mg/g	g	mg/g	g	mg/g	%
Tank A	301	0.60	388	0.78	282	0.57	73
Tank B	193	0.39	280	0.56	192	0.39	69
Combined	494	0.50	668	0.67	474	0.48	71

(a) Without pH adjustment.

(b) pH adjustment began 09/17/04. Spent media collected 10/25/04.

4.6 System Cost

The cost of the system was evaluated based on the capital cost per gpm (or gpd) of design capacity and the O&M cost per 1,000 gal of water treated. This required tracking capital cost for the equipment, site engineering, and installation and the O&M cost for media replacement and disposal, chemical supply, electricity consumption, and labor. The shed construction cost was not included in the capital cost because it was outside of the scope of this demonstration project and was funded separately by AWC.

Table 4-14. TCLP Results of Spent Media

Parameter	Concentration (mg/L)	
	Tank A	Tank B
Arsenic	<0.05	<0.05
Barium	1.43	1.63
Cadmium	<0.05	<0.05
Chrome	<0.05	<0.05
Lead	<0.1	<0.1
Mercury	<0.003	<0.003
Selenium	<0.3	<0.3
Silver	<0.05	<0.05

4.6.1 Capital Cost. The capital investment for the equipment, site engineering, and installation was \$228,309 (Table 4-15). The equipment cost was \$122,544 (or 54% of the total capital investment), which included the cost for two skid-mounted pressure tanks, 44 ft³ (33.4 ft³ actually delivered [Section 4.2]) of AAFS50 media, instrumentation and controls, a backwash recycle system, a chemical injection system, labor (for operator training, technical support, and system shakedown), warranty, and miscellaneous materials and supplies. The AAFS50 media price was quoted at \$85.50/ft³ (or \$1.30/lb) at the beginning of the study, but has since increased to \$98.86/ft³ (or \$1.50/lb).

The engineering cost included preparation of the system layout and footprint, site drawings and piping plans, and equipment cut sheets for the permit application (Section 4.3.1). The engineering cost was \$50,659, which was 22% of the total capital investment.

The installation cost included labor and materials to unload and install the treatment system, perform the piping tie-ins and electrical work, and load and backwash the media (Section 4.3.2). The installation was performed by Kinetico and its subcontractor, Fann Environmental. The installation cost was \$55,106, or 24% of the total capital investment.

The capital cost of \$228,309 was normalized to \$6,171/gpm (\$4.29/gpd) of design capacity using the system's rated capacity of 37 gpm (or 53,280 gpd). The capital cost also was converted to an annualized cost of \$21,550/yr using a capital recovery factor (CRF) of 0.09439 based on a 7% interest rate and a 20-yr return period. Assuming that the system operated 24 hr/day, 7 day/wk at the design flowrate of 37 gpm to produce 19,450,000 gal/yr, the unit capital cost would be \$1.11/1,000 gal. During the first six months, the system operated at approximately 36 gpm, producing 9,350,000 gal of water (Table 4-5), so the unit capital cost increased slightly to \$1.15/1,000 gal.

AWC installed a sun shed structure with a galvanized steel frame, which was later enhanced to completely enclose the treatment system (Section 4.3.3). The 12 ft × 25 ft structure had a height of 11.5 ft and was mounted on a 12 ft × 25 ft concrete pad. The structure was pre-engineered to sustain a 90-mph

Table 4-15. Capital Investment for Kinetico’s Treatment System

Description	Cost	Percent of Capital Investment Cost
<i>Equipment</i>		
Media Skid and Tanks	\$30,134	–
Air Compressor	\$2,602	–
Instrumentation and Controls	\$13,211	–
Backwash Recycle System	\$13,486	–
Media Educator Kit	\$943	–
Chemical Injection	\$11,197	–
Labor	\$39,736	–
Warranty	\$10,610	–
Change Order for Flow Totalizer	\$625	–
Equipment Total	\$122,544	54%
<i>Engineering</i>		
Labor	\$40,021	–
Subcontractor	\$10,638	–
Engineering Total	\$50,659	22%
<i>Installation</i>		
Labor	\$15,213	–
Travel	\$10,319	–
Subcontractor	\$29,574	–
Installation Total	\$55,106	24%
Total Capital Investment	\$228,309	100%

wind load and a 30-lb/ft² snow load. The total cost for the structure was \$22,078 which included \$4,500 for materials and labor for assembly.

4.6.2 O&M Cost. The O&M cost included media replacement and disposal, chemical supply, electricity consumption, and labor. Because the system was under warranty, no additional cost was incurred for repairs. The O&M cost incurred during the first and second media runs are summarized in Tables 4-16 and 4-17, respectively. Although performed free of charge on October 25, 2004, the media replacement of both tanks, based on a vendor quote, would have been \$8,725, including \$4,350 for 44 ft³ of virgin media (or \$98.86/ft³) and \$4,375 for labor, travel, and spent media sampling, testing, and disposal. Using this quote and assuming that the cost for labor, travel, and spent media disposal was proportional to the media quantity, the media replacement cost for one or two tanks with different media quantities could, therefore, be estimated. By averaging each media replacement cost over the life of the media, the cost per 1,000 gal of water treated was plotted as a function of the media run length in BVs and system throughput in gallons, and are shown in Figure 4-11 (for the first media run with 16.7 ft³ of media in each tank) and Figure 4-12 (for the second media run with 22 ft³ of media in each tank).

For the first media run without pH adjustment, the media replacement cost was estimated to be \$3,311 for one tank or \$6,623 for two tanks based on the actual media volume originally loaded in the tanks (i.e., 16.7 ft³ per tank). Arsenic breakthrough to 10 µg/L from the lag tank occurred on August 4, 2004, after treating 2,106,000 gal of water (or about 16,900 BV). If the media in the lead tank was replaced at this time, the unit replacement cost would have been \$1.57/1,000 gal. After the partially exhausted lag tank was switched to the lead position and followed by the newly replaced tank, the run length for the subsequent run would be shorter than the initial run (i.e., less than 16,900 BV), thus resulting in an increased replacement frequency and cost. To reduce the changeout frequency and minimize the associated scheduling and coordinating effort, it might be more convenient and cost-effective in the long

Table 4-16. O&M Cost during First Media Run (06/24/04 – 08/04/04)

Category	Value		Assumptions
Volume Processed (1,000 gal)	2,106		At 10-µg/L As from lag tank
Media Replacement			
No. of Tanks Replaced	1	2	
Media Volume (ft ³)	16.7	33.4	
Media Cost (\$)	1,651	3,302	Media unit price \$98.86/ft ³
Labor Cost (\$)	1,661	3,321	Prorated from vendor quote of \$4,375 for replacing 44 ft ³ of media
Subtotal (\$)	3,311	6,623	
Media Replacement Cost (\$/1,000 gal)	Figure 4-11		
Chemical Usage			
Chemical Cost (\$/1,000 gal)	0		No pH adjustment
Electricity Consumption			
Incremental Electricity Cost (\$/month)	244		Electricity charge \$0.12/kWh
Electricity Cost (\$/1,000 gal)	0.16		
Labor			
Labor (hr/wk)	1.9		20-30 min/day
Labor Cost (\$/1,000 gal)	0.11		Labor rate = \$21/hr
Total O&M Cost (\$/1,000 gal)	Figure 4-11		Media replacement and \$0.27/1,000 gal for electricity and labor

Table 4-17. O&M Cost during Second Media Run (10/25/04 – 12/22/04)

Category	Value		Assumptions
Volume Processed (1,000 gal)	3,000		Second run continuing
Media Replacement			
No. of Tanks Replaced	1	2	
Media Volume (ft ³)	22	44	
Media Cost (\$)	2,175	4,350	Media unit price \$98.86/ft ³
Labor Cost (\$)	2,188	4,375	Prorated based on \$4,375 of labor cost for replacing 44 ft ³ of media
Subtotal (\$)	4,363	8,725	
Media Replacement Cost (\$/1,000 gal)	Figure 4-12		
Chemical Usage			
Acid Unit Price (\$/gal)	10.16		50% H ₂ SO ₄ including shipping
Acid Dosage (gal/1,000 gal)	0.06		50% H ₂ SO ₄
Neutralization and Disposal of 3 Acid Drums (\$)	180		Subcontractor quote
Acid Cost (\$/1,000 gal)	0.66		
Electricity Consumption			
Incremental Electricity Cost (\$/month)	244		Electricity charge \$0.12/kWh
Electricity Cost (\$/1,000 gal)	0.16		
Labor			
Labor (hr/wk)	1.9		20-30 min/day
Labor Cost (\$/1,000 gal)	0.11		Labor rate = \$21/hr
Total O&M Cost (\$/1,000 gal)	Figure 4-12		Media replacement and \$0.93/1,000 gal for acid, electricity, and labor

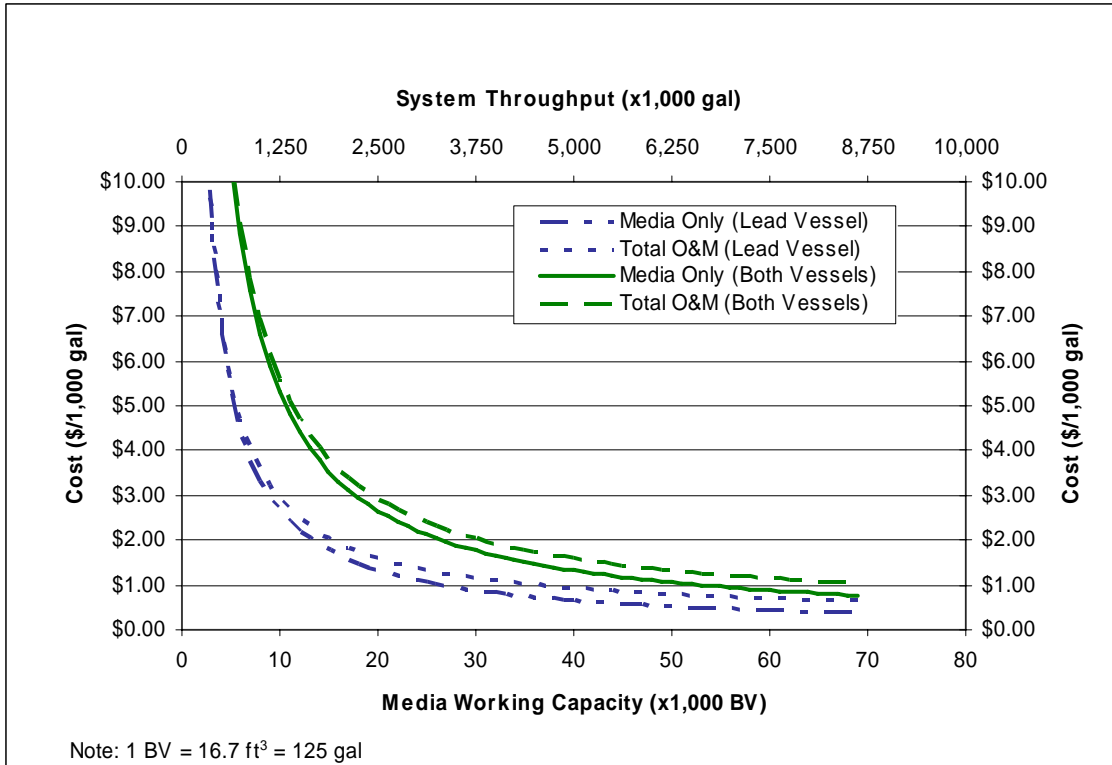

Figure 4-11. Media Replacement and O&M Cost without pH Adjustment

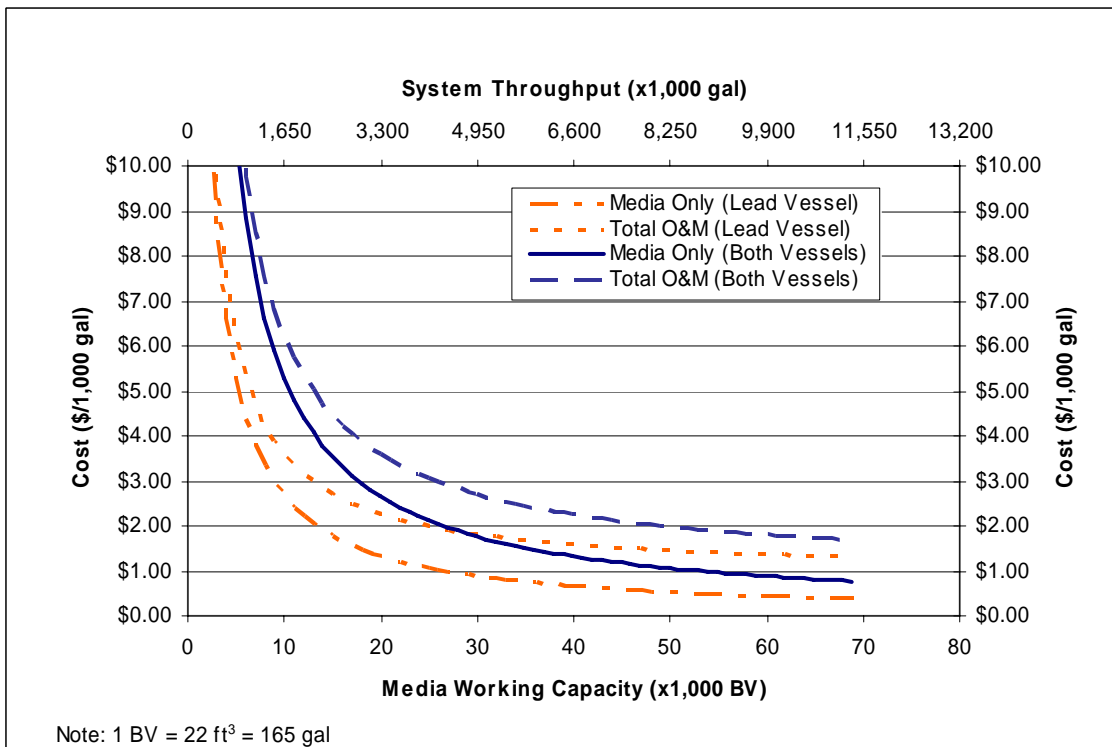

Figure 4-12. Media Replacement and O&M Cost with pH Adjustment

run to replace the media in both tanks altogether. In this case, the replacement cost would increase to \$6,623 or \$3.15/1,000 gal. Less frequent media changeout could save labor, travel, and administrative cost.

For the second media run with pH adjustment, the media run length was increased and media replacement did not occur by the end of this reporting period. The media replacement cost was estimated to be \$4,363 for changing out one tank or \$8,725 for changing out two tanks (Table 4-18) with each tank loaded with 22 ft³. Based on the vendor-projected media run length of 3,074,000 gal (or 18,680 BV) (Table 4-4), the unit replacement cost would be \$1.42/1,000 gal if only the lead vessel is changed out. Because of the extended run length, it is less likely to change out both tanks at the same time. Reducing the pH of raw water incurred \$0.66/1,000 gal of acid cost (Table 4-18). In order to offset the added chemical cost, the run length must be extended to at least 4,772,000 gal (or 29,000 BV) for a lowered unit media replacement cost of \$0.91/1,000 gal, so that the sum of the media replacement and chemical cost is equal to the media replacement cost of \$1.57/1,000 gal without pH adjustment.

The chemical cost was incurred for pH adjustment only. Although NaOCl was used to provide chlorine residuals in the distribution system, the FA-236-AS system did not change its use rate. The system consumed approximately 3.4 gpd of 37% H₂SO₄ from September 17 to October 1, 2004, and then approximately 3 gpd (or 0.06 gal/1,000 gal) of 50% H₂SO₄ afterwards. Including the cost of neutralization and disposal of the empty acid drums, the pH adjustment cost was \$0.66/1,000 gal of water treated. This cost was significantly higher than the vendor-estimated \$0.10/1,000 gal of water treated due to the higher unit price of acid and the neutralization and disposal of the empty acid drums. These costs will be refined in the final report after more data are available.

Electricity consumption was calculated based on the difference between the average monthly cost from electric bills before and after the system startup. The difference in cost was approximately \$244/month or \$0.16/1,000 gal of water treated.

The routine, non-demonstration related labor activities consumed 20-30 min/day (Section 4.4.6). Based on this time commitment and a labor rate of \$21/hr, the labor cost was \$0.11/1,000 gal of water treated.

Section 5.0 REFERENCES

- ADEQ, see Arizona Department of Environmental Quality.
- Arizona Department of Environmental Quality. 2005. *Safe Drinking Water: Operator Certification*. Website: <http://www.azdeq.gov/enviroen/water/dw/opcert.html>.
- Arizona Water Company. 2004. *2003 Annual Water Quality Report for Valley Vista, Arizona PWSID# 13-114*.
- AWC, see Arizona Water Company.
- Battelle. 2003. *Revised Quality Assurance Project Plan for Evaluation of Arsenic Removal Technology*. Prepared under Contract No. 68-C-00-185, Task Order No. 0019, for U.S. EPA NRMRL. November 17.
- Battelle. 2004. *Final System Performance Evaluation Study Plan: U.S. EPA Demonstration of Arsenic Removal Technology at Valley Vista, Arizona*. Prepared under Contract No. 68-C-00-185, Task Order No. 0019 for U.S. EPA NRMRL. February 24.
- Chen, A.S.C., L. Wang, J. Oxenham, and W. Condit. 2004. *Capital Costs of Arsenic Removal Technologies: U.S. EPA Arsenic Removal Technology Demonstration Program Round 1*. EPA/600/R-04/201. U.S. EPA NRMRL, Cincinnati, OH.
- Edwards, M., S. Patel, L. McNeill, H. Chen, M. Frey, A.D. Eaton, R.C. Antweiler, and H.E. Taylor. 1998. "Considerations in As Analysis and Speciation." *J. AWWA* (March): 103-113.
- EPA, see U.S. Environmental Protection Agency.
- Kinetico. 2004. *Operation and Maintenance Manual, FA-236-AS Adsorptive Arsenic Removal System*.
- Rubel, Jr., F. 2003. *Design Manual: Removal of Arsenic from Drinking Water by Adsorptive Media*. EPA/600/R-03/019. U.S. EPA NRMRL, Cincinnati, OH.
- U.S. Environmental Protection Agency. 2003. Minor Clarification of the National Primary Drinking Water Regulation for Arsenic. *Federal Register*, 40 CFR Part 141. March 25.
- U.S. Environmental Protection Agency. 2002. *Lead and Copper Monitoring and Reporting Guidance for Public Water Systems*. Prepared by EPA's Office of Water. EPA/816/R-02/009. February.
- U.S. Environmental Protection Agency. 2001. National Primary Drinking Water Regulations: Arsenic and Clarifications to Compliance and New Source Contaminants Monitoring. *Federal Register*, 66:14:6975. January 22.
- Wang, L., W. Condit, and A. Chen. 2004. *Technology Selection and System Design: U.S. EPA Arsenic Removal Technology Demonstration Program Round 1*. EPA/600/R-05/001. U.S. EPA NRMRL, Cincinnati, OH.
- Westerhoff, P.K., T.M. Benn, L. Wang, and A.S.C. Chen. 2006. *Assessing Arsenic Removal by Metal (Hydr)Oxide Adsorbents Using Rapid Small Scale Column Tests*. Draft in Progress. U.S. EPA NRMRL, Cincinnati, OH.

APPENDIX A
OPERATIONAL DATA

US EPA Arsenic Demonstration Project at Valley Vista, AZ - Daily System Operation Log Sheet

Daily System Operation

Week No.	Date & Time	POE Well #2		Lead/Lag Tank	Treatment System					Pressure			ΔP		In-line pH S.U.	Backwash Water Recycle			Acid Tank Level
		Run Time hr	Master Totalizer ^(a) gal		Flowrate gpm	Totalizer gal	Cumulative Throughput gal	Avg Flowrate gpm	Bed Volume BV	Inlet psig	Between Tanks psig	Outlet psig	Inlet - Between psi	Between - Outlet psi		Bag Filter Inlet Pressure psig	Bag Filter Outlet Pressure psig	Recycle Flow gpm	
1	6/24/04 15:05	NA	15273800	A/B	35	24472	NA	NA	NA	73	70	68	3	2	7.9	77	77	NA	NA
	6/25/04 12:00	16.0	15325100	A/B	36	69934	45462	36.2	364	74	70	68	4	2	7.9	78	78	NA	NA
2	6/28/04 10:30	50.3	15497800	A/B	36	221594	197122	35.9	1578	74	70	68	4	2	7.9	78	78	NA	NA
	6/29/04 12:05	17.1	15560600	A/B	36	276814	252342	36.0	2020	74	70	68	4	2	7.9	78	78	NA	NA
	6/30/04 13:05	16.2	15621700	A/B	35	330598	306126	35.9	2451	74	70	68	4	2	7.9	78	78	NA	NA
	7/1/04 12:20	15.8	15678700	A/B	36	380830	356358	36.0	2853	74	70	68	4	2	7.9	78	77	NA	NA
	7/2/04 13:55	18.4	15741300	A/B	36	436016	411544	36.0	3295	74	70	68	4	2	7.9	77	77	NA	NA
	7/6/04 14:30	65.7	15977300	A/B	39	644385	619913	36.5	4963	76	72	70	4	2	7.9	99	100	2	NA
3	7/7/04 12:55	14.7	16032900	A/B	35	689640	665168	33.6	5325	74	70	68	4	2	7.9	78	78	NA	NA
	7/8/04 13:40	15.8	16093500	A/B	36	742924	718452	35.9	5751	74	70	68	4	2	7.9	78	78	NA	NA
	7/9/04 12:00	13.9	16148100	A/B	35	791020	766548	35.9	6137	74	70	68	4	2	7.9	78	78	NA	NA
4	7/12/04 10:15	45.6	16320000	A/B	36	942199	917727	35.9	7347	74	70	68	4	2	7.9	77	77	NA	NA
	7/13/04 11:35	16.3	16382000	A/B	36	996735	972263	35.9	7783	74	70	68	4	2	7.9	78	78	NA	NA
	7/14/04 10:40	14.9	16438400	A/B	36	46440	1021968	35.9	8181	74	70	69	4	1	7.9	79	79	NA	NA
	7/15/04 13:40	17.2	16504200	A/B	36	104290	1079818	35.7	8644	74	70	69	4	1	7.9	78	78	NA	NA
7/16/04 11:40	14.0	16558200	A/B	36	151771	1127299	36.0	9024	74	70	69	4	1	7.9	78	78	NA	NA	
5	7/19/04 11:15	44.8	16733600	A/B	36	306110	1281638	35.9	10260	74	70	69	4	1	7.9	79	79	NA	NA
	7/20/04 12:55	16.0	16794700	A/B	38	360500	1336028	35.3	10695	76	72	71	4	1	7.9	106	106	3	NA
	7/21/04 9:45	13.1	16846300	A/B	36	405873	1381401	36.3	11059	74	70	69	4	1	7.9	79	79	NA	NA
	7/22/04 14:20	18.2	16916800	A/B	35	467800	1443328	36.1	11554	74	70	69	4	1	7.9	79	79	NA	NA
	7/23/04 14:00	14.9	16974700	A/B	35	518736	1494264	35.9	11962	74	70	69	4	1	7.9	78	78	NA	NA
6	7/26/04 11:30	43.7	17145600	A/B	36	669000	1644528	36.0	13165	74	70	69	4	1	7.9	78	78	NA	NA
	7/27/04 11:00	14.8	17203300	A/B	36	719830	1695358	36.0	13572	74	70	69	4	1	7.9	78	78	NA	NA
	7/28/04 9:30	14.3	17258800	A/B	36	768642	1744170	36.2	13963	74	71	70	3	1	8.0	79	79	NA	NA
	7/29/04 13:30	17.7	17327400	A/B	36	828940	1804468	35.9	14445	74	70	69	4	1	8.0	78	78	NA	NA
	7/30/04 12:30	14.6	17383900	A/B	36	878699	1854227	36.1	14844	74	70	69	4	1	8.0	79	79	NA	NA
7	8/2/04 11:00	44.2	17556400	A/B	36	30800	2006328	36.0	16061	74	71	69	3	2	8.0	78	78	NA	NA
	8/3/04 10:40	14.9	17614800	A/B	36	81830	2057358	35.9	16470	74	71	69	3	2	8.0	78	78	NA	NA
	8/4/04 9:20	14.1	17670000	A/B	36	130350	2105878	35.7	16858	74	71	69	3	2	8.0	78	77	NA	NA
	8/5/04 13:30	17.6	17739400	A/B	36	191400	2166928	36.1	17347	74	72	70	2	2	8.0	79	78	NA	NA
8/6/04 15:05	16.0	17802200	A/B	36	246755	2222283	36.1	17790	76	72	71	4	1	8.0	79	78	NA	NA	
8	8/9/04 13:25	44.6	17974600	A/B	35	398500	2374028	36.0	19005	75	71	70	4	1	8.0	79	78	NA	NA
	8/10/04 16:55	17.7	18041900	A/B	36	457690	2433218	35.9	19479	75	71	70	4	1	8.0	79	78	NA	NA
	8/11/04 11:32	11.8	18087500	A/B	36	497895	2473423	36.0	19801	75	71	70	4	1	8.0	79	78	NA	NA
	8/12/04 13:40	16.9	18151500	A/B	36	554220	2529748	35.9	20252	75	71	70	4	1	8.0	79	78	NA	NA
	8/13/04 13:50	15.4	18210800	A/B	36	606420	2581948	36.0	20669	75	71	70	4	1	8.0	79	78	NA	NA
9	8/16/04 12:15	44.6	18380200	A/B	36	756500	2732028	35.5	21871	74	71	70	3	1	7.9	79	78	NA	NA
	8/17/04 14:07	17.4	18444000	A/B	37	812550	2788078	36.1	22320	76	72	71	4	1	8.0	109	109	2	NA
	8/18/04 9:45	12.8	18492300	A/B	36	855100	2830628	36.1	22660	74	71	70	3	1	8.0	79	78	NA	NA
	8/19/04 11:40	16.8	18556000	A/B	36	911150	2886678	36.0	23109	76	72	71	4	1	8.0	79	79	NA	NA
	8/20/04 12:00	16.1	18616200	A/B	36	964100	2939628	36.3	23533	74	71	70	3	1	8.0	79	78	NA	NA
10	8/23/04 11:38	47.4	18792300	A/B	36	119280	3094808	36.1	24775	74	71	70	3	1	8.0	79	78	NA	NA
	8/24/04 11:55	15.6	18851900	A/B	36	171800	3147328	36.0	25196	75	72	71	3	1	8.0	80	79	NA	NA
	8/25/04 9:30	13.7	18904900	A/B	36	218540	3194068	36.1	25570	74	71	70	3	1	8.0	79	78	NA	NA
	8/26/04 11:40	16.6	18969100	A/B	36	275060	3250588	36.0	26022	74	71	70	3	1	8.0	79	78	NA	NA
8/27/04 14:10	17.3	19034400	A/B	36	332625	3308153	36.2	26483	75	71	70	4	1	8.1	79	79	NA	NA	

US EPA Arsenic Demonstration Project at Valley Vista, AZ - Daily System Operation Log Sheet

Daily System Operation

Week No.	Date & Time	POE Well #2		Lead/Lag Tank A/B	Treatment System					Pressure			ΔP		In-line pH S.U.	Backwash Water Recycle			Acid Tank Level gal
		Run Time hr	Master Totalizer ^(a) gal		Flowrate gpm	Totalizer gal	Cumulative Throughput gal	Avg Flowrate gpm	Bed Volume BV	Inlet psig	Between Tanks psig	Outlet psig	Inlet - Between psi	Outlet - psi		Bag Filter Inlet Pressure psig	Bag Filter Outlet Pressure psig	Recycle Flow gpm	
11	8/30/04 14:15	47.6	19211000	A/B	35	488060	3463588	35.9	27727	75	71	70	4	1	8.0	79	79	NA	NA
	8/31/04 10:15	13.3	19259900	A/B	36	531285	3506813	36.0	28073	75	71	70	4	1	8.0	79	79	NA	NA
	9/1/04 10:07	15.4	19316700	A/B	36	581385	3556913	35.0	28474	74	71	70	3	1	7.3*	78	77	NA	NA
	9/2/04 11:30	17.2	19378400	A/B	36	635700	3611228	35.7	28909	74	71	70	3	1	7.8	79	78	NA	NA
	9/3/04 11:30	16.4	19437200	A/B	36	687530	3663058	36.0	29324	74	71	70	3	1	7.9	79	78	NA	NA
12	9/7/04 11:00	64.3	19671000	A/B	36	893650	3869178	36.0	30974	74	71	70	3	1	7.9	79	78	NA	NA
	9/8/04 10:17	15.5	19728000	A/B	35	943885	3919413	36.0	31376	74	71	70	3	1	7.9	79	78	NA	NA
	9/9/04 13:50	18.5	19795400	A/B	35	3356	3978884	36.0	31852	74	71	70	3	1	7.9	79	78	NA	NA
	9/10/04 14:05	15.6	19854600	A/B	36	55564	4031092	35.9	32270	75	71	70	4	1	7.9	79	78	NA	NA
13	9/13/04 9:40	45.1	20019400	A/B	36	200890	4176418	35.8	33434	75	71	70	4	1	7.9	79	78	NA	NA
	9/14/04 14:05	18.2	20086000	A/B	37	260530	4236058	35.0	33911	75	71	70	4	1	7.9	110	110	2	NA
	9/15/04 10:00	12.8	20135100	A/B	36	303780	4279308	36.2	34257	74	71	70	3	1	7.9	78	78	NA	NA
	9/16/04 17:40	20.8	20212800	A/B	36	372350	4347878	36.1	34806	74	71	70	3	1	7.9	78	78	NA	NA
	9/17/04 12:20	12.0	20258400	A/B	36	412570	4388098	35.9	35128	74	71	70	3	1	7.9	79	78	NA	55
	9/18/04 11:00	NA	NA	A/B	NA	NA	NA	NA	NA	NA	NA	NA	NA	NA	NA	NA	NA	NA	NA
14	9/20/04 13:35	47.0	20436300	A/B	36	569930	4545458	35.8	36388	76	72	71	4	1	7.2	81	80	NA	NA
	9/21/04 11:55	14.6	20491100	A/B	36	618230	4593758	36.0	36775	76	72	71	4	1	7.2	80	79	NA	NA
	9/22/04 9:05	14.0	20542800	A/B	36	663870	4639398	35.9	37140	75	72	71	3	1	7.2	80	78	NA	NA
	9/23/04 13:26	18.8	20610600	A/B	36	724980	4700508	35.9	37629	75	71	70	4	1	7.2	80	79	NA	34
15	9/24/04 13:20	16.0	20699300	A/B	36	776630	4752158	36.0	38043	75	72	71	3	1	7.2	79	79	NA	NA
	9/27/04 13:45	46.0	20846800	A/B	35	933095	4908623	36.0	39295	75	71	70	4	1	7.2	79	79	NA	22
	9/28/04 13:20	14.4	20902100	A/B	36	983890	4959418	35.9	39702	75	72	70	3	2	7.2	79	79	NA	NA
	9/29/04 9:50	12.5	20952400	A/B	36	28230	5003758	36.0	40057	74	71	70	3	1	7.2	79	78	NA	NA
	9/30/04 14:15	17.3	21022100	A/B	36	89593	5065121	36.0	40548	75	72	71	3	1	7.2	80	79	NA	NA
16	10/1/04 13:50	14.4	21077900	A/B	36	140530	5116058	36.0	40956	75	72	71	3	1	7.2	80	79	NA	8
	10/4/04 14:00	46.4	21254200	A/B	36	296207	5271735	36.0	42202	75	72	71	3	1	7.2	80	79	NA	54
	10/5/04 10:45	13.1	21305600	A/B	36	341307	5316835	36.2	42563	75	72	71	3	1	7.2	80	79	NA	52
	10/6/04 9:45	14.7	21361900	A/B	36	391229	5366757	36.2	42963	75	72	70	3	2	7.2	79	78	NA	50
	10/7/04 13:30	17.5	21429800	A/B	36	451156	5426684	36.0	43443	75	72	71	3	1	7.2	79	78	NA	NA
17	10/8/04 17:45	18.3	21499100	A/B	36	512237	5487765	36.0	43932	75	72	71	3	1	7.1	79	78	NA	NA
	10/12/04 13:00	58.3	21719900	A/B	36	707526	5683054	35.7	45495	75	72	71	3	1	7.2	79	78	NA	32
	10/13/04 9:45	13.1	21768200	A/B	36	751266	5726794	35.1	45845	75	72	71	3	1	7.9	79	78	NA	32
	10/14/04 14:15	18.5	21838500	A/B	35	813345	5788873	36.3	46342	75	72	71	3	1	7.9	80	79	NA	NA
	10/15/04 14:30	15.4	21893000	A/B	36	866000	5841528	36.2	46764	75	72	71	3	1	7.9	80	79	NA	NA
18	10/18/04 10:50	43.5	22060700	A/B	36	14290	5989818	36.2	47951	75	72	71	3	1	7.9	80	79	NA	NA
	10/19/04 10:00	14.9	22118200	A/B	36	65148	6040676	36.6	48358	75	72	71	3	1	7.2	80	79	NA	30
	10/20/04 11:50	16.6	22181700	A/B	37	121356	6096884	36.3	48808	76	73	72	3	1	7.1	109	108	4.6	28
	10/21/04 12:25	15.7	22241900	A/B	36	174490	6150018	36.0	49233	75	72	71	3	1	7.1	80	79	NA	26
19	10/22/04 14:55	16.5	22306500	A/B	36	232293	6207821	36.4	49696	76	73	72	3	1	7.1	80	79	NA	22
	10/25/04 15:00	41.2	22467500	A/B	NA	374531	0	NA	0	NA	NA	NA	NA	NA	7.1	NA	NA	NA	NA
	10/26/04 13:30	11.1	22507400	A/B	36	411103	36572	27.1	222	76	73	71	3	2	7.1	81	80	NA	10
	10/27/04 11:40	14.4	22561600	A/B	36	448897	74366	28.4	452	76	73	72	3	1	7.1	81	80	NA	63
	10/28/04 10:50	14.6	22618500	A/B	36	508900	134369	43.2	817	76	73	72	3	1	7.1	81	80	NA	61
20	10/29/04 12:40	16.3	22682400	A/B	36	565237	190706	36.3	1159	76	73	72	3	1	7.1	81	79	NA	58
	11/1/04 10:00	42.5	22849900	A/B	36	713453	338922	35.6	2060	76	73	72	3	1	7.1	82	81	NA	51
	11/2/04 9:45	15.0	22910200	A/B	36	766478	391947	37.2	2382	76	73	72	3	1	7.1	82	79	NA	48
	11/3/04 9:50	15.0	22969400	A/B	36	818612	444081	36.1	2699	76	73	72	3	1	7.1	82	79	NA	45
	11/4/04 14:40	NA	23039700	A/B	36	880599	506068	35.8	3075	76	73	72	3	1	7.2	81	79	NA	41
11/5/04 13:50	22.9	23096000	A/B	36	930338	555807	35.8	3378	76	73	72	3	1	7.1	81	79	NA	39	

US EPA Arsenic Demonstration Project at Valley Vista, AZ - Daily System Operation Log Sheet

Daily System Operation

Week No.	Date & Time	POE Well #2		Lead/Lag Tank	Treatment System					Pressure			ΔP		In-line pH S.U.	Backwash Water Recycle			Acid Tank Level gal
		Run Time hr	Master Totalizer ^(a) gal		Flowrate gpm	Totalizer gal	Cumulative Throughput gal	Avg Flowrate gpm	Bed Volume BV	Inlet psig	Between Tanks psig	Outlet psig	Inlet - Between psi	Between - Outlet psi		Bag Filter Inlet Pressure psig	Bag Filter Outlet Pressure psig	Recycle Flow gpm	
21	11/8/04 13:00	71.3	23270400	A/B	36	83922	709391	36.0	4311	77	74	73	3	1	7.1	81	80	NA	30
	11/9/04 9:30	20.5	23320500	A/B	36	128264	753733	36.1	4580	76	73	72	3	1	7.1	81	80	NA	27
	11/10/04 9:15	23.8	23378900	A/B	36	179798	805267	36.2	4893	76	73	72	3	1	7.2	81	79	NA	24
	11/12/04 11:40	50.5	23502900	A/B	36	289145	914614	36.1	5558	76	73	71	3	2	7.2	81	79	NA	19
22	11/15/04 10:50	71.2	23677800	A/B	36	443389	1068858	36.1	6495	76	73	72	3	1	7.1	81	79	NA	10
	11/16/04 11:25	24.5	23738100	A/B	36	496782	1122251	36.2	6820	76	73	72	3	1	7.1	81	79	NA	63
	11/17/04 11:00	23.5	23796100	A/B	36	547738	1173207	36.0	7129	76	73	72	3	1	7.1	81	79	NA	60
	11/18/04 13:45	26.9	23862200	A/B	36	606003	1231472	36.3	7483	76	72	71	4	1	7.2	81	79	NA	NA
	11/19/04 11:00	21.2	23914400	A/B	36	652019	1277488	36.1	7763	76	73	71	3	2	7.1	81	79	NA	53
23	11/22/04 11:25	70.9	24082600	A/B	36	805679	1431148	35.4	8697	76	72	71	4	1	7.1	80	79	NA	42
	11/23/04 11:00	23.4	24140300	A/B	36	856977	1482446	36.3	9009	76	72	71	4	1	7.1	81	79	NA	40
	11/24/04 11:15	23.5	24197900	A/B	37	907501	1532970	34.7	9316	77	74	72	3	2	7.1	83	80	2	38
24	11/29/04 12:45	121.5	24498500	A/B	36	172782	1798251	36.4	10928	76	73	71	3	2	7.1	101	79	NA	25
	11/30/04 12:00	23.3	24555700	A/B	36	223259	1848728	36.2	11234	76	73	71	3	2	7.2	NA	0	NA	22
	12/1/04 10:15	22.2	24610700	A/B	36	271789	1897258	36.4	11529	76	73	71	3	2	7.1	NA	0	NA	20
	12/2/04 11:00	24.8	24671700	A/B	36	325565	1951034	36.2	11856	76	73	71	3	2	7.1	NA	0	NA	18
	12/3/04 11:30	24.6	24732500	A/B	36	379341	2004810	36.6	12183	76	73	71	3	2	7.2	NA	0	NA	14
25	12/6/04 10:00	70.2	24905700	A/B	36	531705	2157174	36.0	13109	76	73	71	3	2	7.1	NA	0	NA	59
	12/7/04 13:40	27.8	24974400	A/B	36	592582	2218051	36.7	13479	76	73	71	3	2	7.2	NA	0	NA	55
	12/8/04 10:00	20.3	25024600	A/B	36	636518	2261987	36.0	13746	76	73	71	3	2	7.2	NA	0	NA	52
	12/9/04 14:00	28.3	25094500	A/B	36	698174	2323643	36.7	14120	76	73	71	3	2	7.1	NA	0	NA	48
	12/10/04 13:00	22.8	25151100	A/B	36	748362	2373831	36.4	14425	76	73	71	3	2	7.1	NA	0	NA	44
26	12/13/04 9:50	68.8	25321000	A/B	36	NA	NA	NA	NA	76	72	71	4	1	7.2	NA	0	NA	33
	12/14/04 11:25	25.5	25384100	A/B	36	953024	2578493	NA	15669	76	72	71	4	1	7.2	NA	0	NA	29
	12/15/04 13:18	26.0	25448300	A/B	36	9579	2635048	36.4	16013	76	72	71	4	1	7.2	NA	0	NA	24
	12/16/04 11:40	22.3	25503500	A/B	36	58162	2683631	36.2	16308	76	72	71	4	1	7.2	78	80	NA	20
	12/17/04 15:45	28.2	25573300	A/B	36	119385	2744854	36.3	16680	76	72	71	4	1	7.2	80	79	NA	16
27	12/20/04 12:10	68.3	25742100	A/B	36	268249	2893718	36.3	17585	76	72	71	4	1	7.2	82	79	NA	4
	12/21/04 12:25	23.3	25799900	A/B	36	319082	2944551	34.9	17893	76	72	71	4	1	7.1	82	79	NA	56
	12/22/04 13:50	25.4	25862800	A/B	36	374418	2999887	36.3	18230	76	72	71	4	1	7.2	82	79	NA	52

A-3

(a) Throughput based on the Master Totalizer is 12% higher than that based on Treatment System Totalizer due to inherent accuracy errors.

(b) BV calculation based on 16.7 ft³/tank until 10/24/04. BV calculation since 10/26/04 based on 22 ft³/tank.

Highlighted rows indicate backwash; NA = data not available.

APPENDIX B
ANALYTICAL DATA TABLES

Analytical Results from Long-Term Sampling, Valley Vista, AZ

Sampling Date		06/30/04 ^(c)				07/07/04				07/14/04				07/21/04						
Sampling Location	Parameter	Unit	IN	TA	TB	APC	IN	TA	TB	APC	IN	TA	TB	APC	IN	TA	TB	APC		
Bed Volume	-	-	2,451			-	-	5,325			-	-	8,181			-	-	11,059		
Alkalinity	mg/L ^(a)	153	169	153	-	153	161	157	-	156	160	156	-	164	160	156	-			
Fluoride	mg/L	<0.1	<0.1	<0.1	-	-	-	-	-	-	-	-	-	-	-	-	-			
Sulfate	mg/L	8.4	8.4	9.4	-	-	-	-	-	-	-	-	-	-	-	-	-			
Nitrate (as N)	mg/L	1.0	1.0	0.9	-	-	-	-	-	-	-	-	-	-	-	-	-			
Orthophosphate	mg/L ^(b)	<0.1	<0.1	<0.1	-	<0.1	<0.1	<0.1	-	<0.1	<0.1	<0.1	-	<0.1	<0.1	<0.1	-			
Silica (as SiO ₂)	mg/L	19.4	15.7	11.3	-	19.1	17.0	14.9	-	18.4	16.8	15.8	-	19.4	18.3	17.1	-			
Turbidity	NTU	0.5	<0.1	<0.1	-	0.2	0.1	0.2	-	0.6	0.5	0.4	-	0.4	0.2	0.2	-			
pH	-	7.8	7.7	7.6	7.7	7.7	7.7	7.6	7.7	7.6	7.7	7.6	7.7	7.9	7.7	7.7	7.7			
Temperature	°C	21.2	21.4	21.1	22.5	25.0	22.4	23.3	24.5	22.6	21.5	21.9	21.7	20.4	20.3	20.5	21.0			
DO	mg/L	5.7	5.8	6.0	5.4	5.5	5.7	5.4	5.8	5.7	5.1	5.8	5.8	5.8	5.9	6.0	6.2			
ORP	mV	370	430	407	513	189	197	206	226	183	429	381	536	182	186	202	540			
Free Chlorine	mg/L	-	-	-	0.3	-	-	-	0.4	-	-	-	0.4	-	-	-	0.4			
Total Chlorine	mg/L	-	-	-	0.3	-	-	-	0.4	-	-	-	0.4	-	-	-	0.5			
Total Hardness	mg/L ^(a)	152.3	151.8	153.8	-	-	-	-	-	-	-	-	-	-	-	-	-			
Ca Hardness	mg/L ^(a)	81.9	81.0	82.4	-	-	-	-	-	-	-	-	-	-	-	-	-			
Mg Hardness	mg/L ^(a)	70.4	70.8	71.4	-	-	-	-	-	-	-	-	-	-	-	-	-			
As (total)	µg/L	40.9	0.3	0.2	-	47.1	6.1	0.1	-	45.9	13.3	0.4	-	39.8	18.9	2.9	-			
As (soluble)	µg/L	40.2	0.2	0.2	-	-	-	-	-	-	-	-	-	-	-	-	-			
As (particulate)	µg/L	0.7	<0.1	<0.1	-	-	-	-	-	-	-	-	-	-	-	-	-			
As (III)	µg/L	0.4	0.2	0.3	-	-	-	-	-	-	-	-	-	-	-	-	-			
As (V)	µg/L	39.8	0.1	<0.1	-	-	-	-	-	-	-	-	-	-	-	-	-			
Fe (total)	µg/L	<25	<25	39.3	-	<25	<25	<25	-	<25	<25	<25	-	<25	<25	<25	-			
Fe (soluble)	µg/L	<25	25.0	<25	-	-	-	-	-	-	-	-	-	-	-	-	-			
Mn (total)	µg/L	0.2	2.4	2.8	-	0.2	0.9	1.5	-	0.1	0.3	0.6	-	1.1	1.0	1.1	-			
Mn (soluble)	µg/L	0.2	2.4	2.8	-	-	-	-	-	-	-	-	-	-	-	-	-			
Al (total)	µg/L	<10	11.7	18.1	-	<10	<10	<10	-	<10	<10	<10	-	<10	<10	<10	-			
Al (soluble)	µg/L	<10	<10	13.0	-	-	-	-	-	-	-	-	-	-	-	-	-			

(a) As CaCO₃. (b) As PO₄. (c) Temperature, DO, and ORP taken on 07/01/04.
 IN = at inlet; TA = after Tank A; TB = after Tank B; APC = after post-chlorination (field parameters only).

Analytical Results from Long-Term Sampling, Valley Vista, AZ

Sampling Date		07/28/04				08/04/04				08/11/04				08/18/04				
Sampling Location	Parameter	Unit	IN	AC ^(c)	TA	TB	IN	AC	TA	TB	IN	AC	TA	TB	IN	AC	TA	TB
Bed Volume	-	-	-	13,963		-	-	16,858		-	-	19,801		-	-	22,660		
Alkalinity	mg/L ^(a)	167	-	167	167	168	-	164	160	160	-	156	151	152	-	156	156	
Fluoride	mg/L	0.1	-	0.1	0.1	-	-	-	-	-	-	-	-	-	-	-	-	
Sulfate	mg/L	8.1	-	8.1	8.1	-	-	-	-	-	-	-	-	-	-	-	-	
Nitrate (as N)	mg/L	0.8	-	0.8	0.8	-	-	-	-	-	-	-	-	-	-	-	-	
Orthophosphate	mg/L ^(b)	<0.1	-	<0.1	<0.1	<0.1	-	<0.1	<0.1	<0.1	-	<0.1	<0.1	<0.1	-	<0.1	<0.1	
Silica (as SiO ₂)	mg/L	18.2	-	17.4	17.1	19.0	-	18.4	17.9	18.7	-	18.2	17.8	19.3	-	18.9	18.8	
Turbidity	NTU	0.2	-	0.2	0.3	0.2	-	0.3	0.2	0.3	-	0.2	0.1	0.3	-	0.2	0.4	
pH	-	7.8	7.7	7.7	7.7	7.6	7.9	7.7	7.7	8.3	7.9	7.9	7.8	7.7	7.7	7.7	7.7	
Temperature	°C	20.8	20.6	20.3	20.3	20.8	21.1	20.5	20.6	21.0	20.8	20.5	20.6	20.5	20.2	20.4	20.3	
DO	mg/L	6.5	6.5	6.0	5.8	6.0	6.5	6.0	6.4	6.1	5.8	5.7	6.1	6.0	5.9	5.3	6.0	
ORP	mV	196	571	612	621	186	560	608	633	196	570	605	606	179	586	622	635	
Free Chlorine	mg/L	-	0.6	0.6	0.6	-	0.8	0.4	0.4	-	0.4	0.4	0.4	-	0.4	0.5	0.5	
Total Chlorine	mg/L	-	0.6	0.7	0.7	-	0.9	0.4	0.4	-	0.4	0.4	0.4	-	0.5	0.5	0.5	
Total Hardness	mg/L ^(a)	177.6	-	178.2	179.5	-	-	-	-	-	-	-	-	-	-	-	-	
Ca Hardness	mg/L ^(a)	98.1	-	100.6	101.1	-	-	-	-	-	-	-	-	-	-	-	-	
Mg Hardness	mg/L ^(a)	79.5	-	77.6	78.4	-	-	-	-	-	-	-	-	-	-	-	-	
As (total)	µg/L	39.0	-	24.2	5.4	46.2	-	31.2	10.7	37.5	-	27.8	12.7	34.8	-	29.4	15.4	
As (soluble)	µg/L	39.8	-	24.4	5.7	-	-	-	-	-	-	-	-	-	-	-	-	
As (particulate)	µg/L	<0.1	-	<0.1	<0.1	-	-	-	-	-	-	-	-	-	-	-	-	
As (III)	µg/L	0.5	-	0.4	0.4	-	-	-	-	-	-	-	-	-	-	-	-	
As (V)	µg/L	39.3	-	24.0	5.3	-	-	-	-	-	-	-	-	-	-	-	-	
Fe (total)	µg/L	<25	-	<25	<25	<25	-	<25	<25	<25	-	<25	<25	<25	-	28.3	<25	
Fe (soluble)	µg/L	<25	-	<25	<25	-	-	-	-	-	-	-	-	-	-	-	-	
Mn (total)	µg/L	0.1	-	<0.1	<0.1	0.2	-	<0.1	0.1	0.4	-	<0.1	0.4	0.4	-	0.4	0.2	
Mn (soluble)	µg/L	0.1	-	<0.1	<0.1	-	-	-	-	-	-	-	-	-	-	-	-	
Al (total)	µg/L	<10	-	<10	<10	-	-	-	-	<10	-	<10	<10	<10	-	29.1	11.1	
Al (soluble)	µg/L	<10	-	<10	<10	-	-	-	-	-	-	-	-	-	-	-	-	

(a) As CaCO₃. (b) As PO₄. (c) Switched from post-chlorination to prechlorination on 07/27/04.
 IN = at inlet; TA = after Tank A; TB = after Tank B; AC = after prechlorination (field parameters only).

Analytical Results from Long-Term Sampling, Valley Vista, AZ

Sampling Date		08/25/04				09/01/04				09/08/04				09/15/04			
Sampling Location	Parameter	IN	AC	TA	TB	IN	AC	TA	TB	IN	AC	TA	TB	IN	AC	TA	TB
Bed Volume	–	–	–	25,570		–	–	28,474		–	–	31,376		–	–	34,257	
Alkalinity	mg/L ^(a)	160	–	156	156	157	–	161	157	153	–	157	161	158	–	162	162
Fluoride	mg/L	0.1	–	0.1	0.1	–	–	–	–	–	–	–	–	–	–	–	–
Sulfate	mg/L	8.3	–	8.3	8.3	–	–	–	–	–	–	–	–	–	–	–	–
Nitrate (as N)	mg/L	0.8	–	0.8	0.8	–	–	–	–	–	–	–	–	–	–	–	–
Orthophosphate	mg/L ^(b)	<0.1	–	<0.1	<0.1	<0.1	–	<0.1	<0.1	<0.1	–	<0.1	<0.1	<0.06 <0.06	–	<0.06 <0.06	<0.06 <0.06
Silica (as SiO ₂)	mg/L	19.5	–	19.0	18.9	18.9	–	18.5	18.4	18.7	–	18.4	18.5	19.0 18.9	–	18.5 18.8	18.5 18.6
Turbidity	NTU	0.1	–	<0.1	<0.1	0.2	–	0.4	0.4	0.3	–	0.4	0.2	0.4 0.2	–	0.5 0.5	0.7 0.7
pH	–	7.7	7.7	7.7	7.7	7.8	7.8	7.7	7.7	7.7	7.7	7.7	7.8	7.7	7.7	7.7	7.7
Temperature	°C	20.7	20.3	20.3	20.3	20.6	20.3	20.3	20.2	20.7	20.3	20.2	20.3	20.4	20.3	20.3	20.3
DO	mg/L	6.4	5.8	6.1	5.9	6.2	5.5	6.1	5.8	6.2	5.9	5.5	5.8	6.0	5.9	5.8	6.0
ORP	mV	187	572	603	604	194	594	609	618	207	572	605	604	201	585	605	612
Free Chlorine	mg/L	–	0.4	0.4	0.4	–	0.5	0.5	0.5	–	0.5	0.4	0.4	–	0.4	0.4	0.4
Total Chlorine	mg/L	–	0.4	0.5	0.5	–	0.5	0.5	0.5	–	0.5	0.5	0.5	–	0.4	–	0.4
Total Hardness	mg/L ^(a)	135.8	–	140.0	136.0	–	–	–	–	–	–	–	–	–	–	–	–
Ca Hardness	mg/L ^(a)	66.2	–	69.6	68.3	–	–	–	–	–	–	–	–	–	–	–	–
Mg Hardness	mg/L ^(a)	69.6	–	70.4	67.7	–	–	–	–	–	–	–	–	–	–	–	–
As (total)	µg/L	47.6	–	35.3	25.4	44.6	–	37.8	26.5	46.7	–	40.7	28.2	36.6 37.5	–	33.5 34.0	26.0 25.6
As (soluble)	µg/L	47.3	–	34.9	24.7	–	–	–	–	–	–	–	–	–	–	–	–
As (particulate)	µg/L	0.3	–	0.4	0.7	–	–	–	–	–	–	–	–	–	–	–	–
As (III)	µg/L	0.6	–	1.0	1.3	–	–	–	–	–	–	–	–	–	–	–	–
As (V)	µg/L	46.7	–	33.9	23.4	–	–	–	–	–	–	–	–	–	–	–	–
Fe (total)	µg/L	<25	–	<25	<25	<25	–	<25	<25	<25	–	<25	<25	<25 <25	–	<25 <25	<25 <25
Fe (soluble)	µg/L	<25	–	<25	<25	–	–	–	–	–	–	–	–	–	–	–	–
Mn (total)	µg/L	0.4	–	0.7	1.0	0.2	–	<0.1	<0.1	0.2	–	<0.1	<0.1	0.4 0.4	–	0.2 0.5	0.2 0.1
Mn (soluble)	µg/L	0.3	–	0.3	0.6	–	–	–	–	–	–	–	–	–	–	–	–
Al (total)	µg/L	–	–	–	–	<10	–	<10	<10	<10	–	<10	<10	<10 <10	–	<10 <10	10.7 10.2
Al (soluble)	µg/L	–	–	–	–	–	–	–	–	–	–	–	–	–	–	–	–

(a) As CaCO₃. (b) As PO₄.

IN = at inlet; TA = after Tank A; TB = after Tank B; AC = after prechlorination (field parameters only).

Analytical Results from Long-Term Sampling, Valley Vista, AZ

B-4

Sampling Date		09/22/04 ^(c)				09/29/04				10/13/04 ^(d)				10/20/04 ^(e)			
Sampling Location	Parameter	IN	AC	TA	TB	IN	AC	TA	TB	IN	AC	TA	TB	IN	AC	TA	TB
Bed Volume	-	-	-	37,140		-	-	40,057		-	-	45,845		-	-	48,808	
Alkalinity	mg/L ^(a)	138	-	125	126	164	-	127	123	150	-	142	142	164	-	123	123
Fluoride	mg/L	0.1	-	0.1	<0.1	-	-	-	-	-	-	-	-	0.1	-	0.1	<0.1
Sulfate	mg/L	6.8	-	31	31	-	-	-	-	-	-	-	-	7.4	-	37	36
Nitrate (as N)	mg/L	0.8	-	0.8	0.8	-	-	-	-	-	-	-	-	0.8	-	0.8	0.8
Orthophosphate	mg/L ^(b)	<0.06	-	<0.06	<0.06	<0.06	-	<0.06	<0.06	<0.06	-	<0.06	<0.06	<0.06	-	<0.06	<0.06
Silica (as SiO ₂)	mg/L	18.7	-	19.2	20.0	18.7	-	18.9	20.4	18.6	-	16.8	15.4	18.4	-	19.3	20.3
Turbidity	NTU	0.1	-	0.3	0.1	0.2	-	0.2	0.3	0.2	-	0.1	0.1	0.3	-	0.2	0.1
pH	-	7.8	6.9	6.9	6.9	7.8	6.9	6.9	6.8	7.7	7.8	7.6	7.4	7.8	6.9	6.8	6.8
Temperature	°C	20.3	20.2	20.0	20.0	20.4	20.2	20.4	20.3	20.8	20.4	20.2	20.1	19.9	20.1	19.8	19.9
DO	mg/L	6.1	5.8	5.5	5.5	5.9	5.6	5.9	5.9	6.2	6.1	5.6	6.4	5.8	5.3	5.5	5.7
ORP	mV	209	623	652	661	181	671	710	722	213	608	638	653	212	654	672	678
Free Chlorine	mg/L	-	0.4	0.3	0.3	-	0.9	0.8	0.8	-	0.4	0.4	0.4	-	0.3	0.4	0.3
Total Chlorine	mg/L	-	0.5	0.4	0.4	-	0.9	0.8	0.8	-	0.6	0.4	0.4	-	0.3	0.4	0.4
Total Hardness	mg/L ^(a)	160.5	-	158.7	164.0	-	-	-	-	-	-	-	-	178.8	-	175.8	171.7
Ca Hardness	mg/L ^(a)	89.8	-	88.3	92.2	-	-	-	-	-	-	-	-	92.8	-	87.4	86.3
Mg Hardness	mg/L ^(a)	70.7	-	70.4	71.8	-	-	-	-	-	-	-	-	86.0	-	88.4	85.4
As (total)	µg/L	47.3	-	23.6	16.0	42.1	-	20.2	12.3	43.2	-	42.7	18.1	37.3 ^(f)	-	28.3	22.0
As (soluble)	µg/L	47.4	-	23.8	16.1	-	-	-	-	-	-	-	-	39.6 ^(f)	-	24.7	20.1
As (particulate)	µg/L	<0.1	-	<0.1	<0.1	-	-	-	-	-	-	-	-	<0.1	-	3.6	1.9
As (III)	µg/L	0.8	-	0.8	0.9	-	-	-	-	-	-	-	-	1.0	-	1.1	1.3
As (V)	µg/L	46.6	-	23.0	15.2	-	-	-	-	-	-	-	-	38.6	-	23.6	18.8
Fe (total)	µg/L	32	-	34	53	<25	-	<25	<25	144	-	<25	<25	<25	-	<25	<25
Fe (soluble)	µg/L	<25	-	<25	<25	-	-	-	-	-	-	-	-	<25	-	<25	<25
Mn (total)	µg/L	0.4	-	0.5	19.2	0.4	-	0.3	0.2	60.2	-	<0.1	0.5	0.2	-	<0.1	<0.1
Mn (soluble)	µg/L	0.2	-	<0.1	0.1	-	-	-	-	-	-	-	-	0.1	-	<0.1	<0.1
Al (total)	µg/L	<10	-	<10	10.1	<10	-	<10	<10	<10	-	<10	<10	<10	-	<10	<10
Al (soluble)	µg/L	<10	-	<10	<10	-	-	-	-	-	-	-	-	<10	-	<10	<10

(a) As CaCO₃. (b) As PO₄. (c) pH adjustment began on 09/17/04. (d) pH adjustment turned off before sample collection on 10/13/04. (e) pH adjustment resumed on 10/19/04. (f) Data reanalyzed. IN = at inlet; TA = after Tank A; TB = after Tank B; AC = after prechlorination and pH adjustment (field parameters only).

Analytical Results from Long-Term Sampling, Valley Vista, AZ

B-5

Sampling Date		10/27/04 ^(c)				11/03/04				11/10/04				11/17/04			
Sampling Location	Parameter Unit	IN	AC	TA	TB	IN	AC	TA	TB	IN	AC	TA	TB	IN	AC	TA	TB
Bed Volume	-	-	-	452		-	-	2,699		-	-	4,893		-	-	7,129	
Alkalinity	mg/L ^(a)	152	-	119	115	160	-	123	123	160	-	123	123	164	-	123	123
Fluoride	mg/L	-	-	-	-	-	-	-	-	-	-	-	-	-	-	-	-
Sulfate	mg/L	-	-	-	-	-	-	-	-	-	-	-	-	-	-	-	-
Nitrate (as N)	mg/L	-	-	-	-	-	-	-	-	-	-	-	-	-	-	-	-
Orthophosphate	mg/L ^(b)	<0.06	-	<0.06	<0.06	<0.06	-	<0.06	<0.06	<0.06	-	<0.06	<0.06	<0.06	-	<0.06	<0.06
Silica (as SiO ₂)	mg/L	18.8	-	19.1	6.1	18.9	-	16.3	13.8	18.6	-	16.7	15.0	18.4	-	18.3	17.6
Turbidity	NTU	0.2	-	0.1	0.1	0.1	-	0.1	0.2	0.3	-	0.2	0.2	0.3	-	0.3	0.3
pH	-	7.5	6.8	6.7	6.8	8.0	6.8	6.8	6.8	8.0	6.9	6.9	6.9	7.9	6.8	6.9	6.8
Temperature	°C	18.8	19.1	19.3	19.1	19.1	19.4	19.6	19.6	18.9	19.6	19.5	19.7	19.1	19.7	19.8	19.8
DO	mg/L	6.2	5.9	5.6	6.2	6.4	5.7	5.4	5.8	6.4	5.5	5.9	5.9	5.7	5.6	5.3	5.3
ORP	mV	227	635	668	669	217	660	701	704	212	694	707	721	218	699	724	751
Free Chlorine	mg/L	-	0.3	0.3	0.3	-	0.4	0.3	0.3	-	0.4	0.4	0.4	-	0.4	0.4	0.4
Total Chlorine	mg/L	-	0.4	0.4	0.4	-	0.4	0.4	0.4	-	0.4	0.5	0.5	-	0.5	0.5	0.5
Total Hardness	mg/L ^(a)	-	-	-	-	-	-	-	-	-	-	-	-	-	-	-	-
Ca Hardness	mg/L ^(a)	-	-	-	-	-	-	-	-	-	-	-	-	-	-	-	-
Mg Hardness	mg/L ^(a)	-	-	-	-	-	-	-	-	-	-	-	-	-	-	-	-
As (total)	µg/L	37.1	-	37.8 ^(d)	0.3	36.2	-	0.3	0.2	36.4	-	0.1	<0.1	40.1	-	0.3	0.3
As (soluble)	µg/L	-	-	-	-	-	-	-	-	-	-	-	-	-	-	-	-
As (particulate)	µg/L	-	-	-	-	-	-	-	-	-	-	-	-	-	-	-	-
As (III)	µg/L	-	-	-	-	-	-	-	-	-	-	-	-	-	-	-	-
As (V)	µg/L	-	-	-	-	-	-	-	-	-	-	-	-	-	-	-	-
Fe (total)	µg/L	<25	-	<25	32.8	<25	-	<25	<25	<25	-	<25	<25	<25	-	<25	<25
Fe (soluble)	µg/L	-	-	-	-	-	-	-	-	-	-	-	-	-	-	-	-
Mn (total)	µg/L	0.4	-	0.5	1.1	0.3	-	0.1	0.2	0.2	-	<0.1	0.1	<0.1	-	<0.1	<0.1
Mn (soluble)	µg/L	-	-	-	-	-	-	-	-	-	-	-	-	-	-	-	-
Al (total)	µg/L	<10	-	12.5	12.6	<10	-	<10	<10	22.0	-	19.1	23.7	<10	-	<10	<10
Al (soluble)	µg/L	-	-	-	-	-	-	-	-	-	-	-	-	-	-	-	-

(a) As CaCO₃. (b) As PO₄. (c) Media replaced on 10/25/04. (d) Rerun result similar to original result.
 IN = at inlet; TA = after Tank A; TB = after Tank B; AC = after prechlorination and pH adjustment (field parameters only).

Analytical Results from Long-Term Sampling, Valley Vista, AZ

B-6

Sampling Date		12/01/04				12/08/04				12/15/04			
Sampling Location	Parameter	IN	AC	TA	TB	IN	AC	TA	TB	IN	AC	TA	TB
Bed Volume	–	–	–	11,529		–	–	13,746		–	–	16,013	
Alkalinity	mg/L ^(a)	160 156	–	120 128	124 124	154	–	122	122	155	–	114	114
Fluoride	mg/L	–	–	–	–	–	–	–	–	<0.1	–	<0.1	<0.1
Sulfate	mg/L	–	–	–	–	–	–	–	–	8.1	–	50	45
Nitrate (as N)	mg/L	–	–	–	–	–	–	–	–	0.8	–	0.7	<0.04 ^(c)
Orthophosphate	mg/L ^(b)	<0.06 <0.06	–	<0.06 <0.06	<0.06 <0.06	<0.06	–	<0.06	<0.06	<0.06	–	<0.06	<0.06
Silica (as SiO ₂)	mg/L	18.4 18.7	–	18.0 18.0	17.2 17.0	19.0	–	18.7	18.6	19.5	–	18.3	18.2
Turbidity	NTU	0.2 0.1	–	0.2 0.2	0.1 0.2	0.2	–	0.4	0.3	0.1	–	0.2	0.2
pH	–	8.4	6.9	6.9	6.9	7.7	6.7	6.7	6.7	7.8	6.8	6.7	6.7
Temperature	°C	18.5	19.1	18.5	18.8	18.1	19.0	19.0	19.0	19.6	20.4	20.4	20.5
DO	mg/L	5.7	5.1	5.6	5.2	5.5	6.0	5.6	5.5	5.3	5.9	5.5	5.8
ORP	mV	227	746	691	712	248	710	727	744	235	754	727	736
Free Chlorine	mg/L	–	0.5	0.5	0.5	–	0.4	0.4	0.4	–	0.4	0.4	0.4
Total Chlorine	mg/L	–	0.5	0.5	0.5	–	0.5	0.5	0.5	–	0.4	0.4	0.4
Total Hardness	mg/L ^(a)	–	–	–	–	–	–	–	–	181.4	–	167.2	170.3
Ca Hardness	mg/L ^(a)	–	–	–	–	–	–	–	–	104.9	–	95.9	97.3
Mg Hardness	mg/L ^(a)	–	–	–	–	–	–	–	–	76.5	–	71.3	73.0
As (total)	µg/L	36.5 36.5	–	3.1 3.1	0.3 0.2	37.3	–	4.0	0.3	39.2	–	4.3	0.1
As (soluble)	µg/L	–	–	–	–	–	–	–	–	40.4	–	4.3	<0.1
As (particulate)	µg/L	–	–	–	–	–	–	–	–	<0.1	–	<0.1	<0.1
As (III)	µg/L	–	–	–	–	–	–	–	–	0.4	–	0.4	0.3
As (V)	µg/L	–	–	–	–	–	–	–	–	40.0	–	3.9	<0.1
Fe (total)	µg/L	<25 <25	–	<25 <25	<25 <25	<25	–	<25	<25	<25	–	<25	<25
Fe (soluble)	µg/L	–	–	–	–	–	–	–	–	<25	–	<25	<25
Mn (total)	µg/L	0.2 0.2	–	<0.1 <0.1	0.1 0.1	0.3	–	<0.1	<0.1	0.2	–	0.1	<0.1
Mn (soluble)	µg/L	–	–	–	–	–	–	–	–	0.1	–	<0.1	<0.1
Al (total)	µg/L	<10 <10	–	<10 <10	<10 <10	<10	–	<10	<10	<10	–	<10	<10
Al (soluble)	µg/L	–	–	–	–	–	–	–	–	<10	–	<10	<10

(a) As CaCO₃. (b) As PO₄. (c) Data questionable.

IN = at inlet; TA = after Tank A; TB = after Tank B; AC = after prechlorination and pH adjustment (field parameters only).