

Assessment of Vapor Intrusion in Homes Near the Raymark Superfund Site Using Basement and Sub-Slab Air Samples



Assessment of Vapor Intrusion in Homes Near the Raymark Superfund Site Using Basement and Sub-Slab Air Samples

Dominic C. DiGiulio and Cynthia J. Paul
U.S. Environmental Protection Agency
Office of Research and Development
National Risk Management Research Laboratory
Ground Water and Ecosystems Restoration Division
Ada, OK

Raphael Cody and Richard Willey
U.S. Environmental Protection Agency
Region I
Boston, MA

Scott Clifford and Peter Kahn
U.S. Environmental Protection Agency
Region I, New England Regional Laboratory
North Chelmsford, MA

Ronald Mosley
U.S. Environmental Protection Agency
Office of Research and Development
National Risk Management Research Laboratory
Research Triangle Park, NC

Annette Lee and Kaneen Christensen
Xpert Design and Diagnostics, LLC
Stratham, NH

Project Officer
Dominic C. DiGiulio
U.S. Environmental Protection Agency
Office of Research and Development
National Risk Management Research Laboratory
Ground Water and Ecosystems Restoration Division
Ada, OK

U.S. ENVIRONMENTAL PROTECTION AGENCY
OFFICE OF RESEARCH AND DEVELOPMENT
NATIONAL RISK MANAGEMENT RESEARCH LABORATORY
CINCINNATI, OH 45268

Notice

The U.S. Environmental Protection Agency (EPA) through its Office of Research and Development funded and managed the research described here through in-house efforts and under Contract No. 68-C-02-092 to the Dynamac Corporation. It has been subjected to the Agency's peer and administrative reviews and has been approved for publication as an EPA document. Mention of trade names or commercial products does not constitute endorsement or recommendation for use.

All data generated in this report were subjected to an analytical Quality Assurance Plan developed by EPA's New England Regional Laboratory. Also, a Quality Assurance Project Plan was implemented at the Ground Water and Ecosystems Restoration Division. Results of field-based studies and recommendations provided in this document have been subjected to external and internal peer and administrative reviews. This report provides technical recommendations, not policy guidance. It is not issued as an EPA Directive, and the recommendations of this report are not binding on enforcement actions carried out by the EPA or by the individual states of the United States of America. Neither the United States government nor the authors accept any liability or responsibility resulting from the use of this document. Implementation of the recommendations of the document and the interpretation of the results provided through that implementation are the sole responsibility of the user.

Foreword

The U.S. Environmental Protection Agency is charged by Congress with protecting the Nation's land, air, and water resources. Under a mandate of national environmental laws, the Agency strives to formulate and implement actions leading to a compatible balance between human activities and the ability of natural systems to support and nurture life. To meet these mandates, EPA's research program is providing data and technical support for solving environmental problems today and building a science knowledge base necessary to manage our ecological resources wisely, understand how pollutants affect our health, and prevent or reduce environmental risks in the future.

The National Risk Management Research Laboratory is the Agency's center for investigation of technological and management approaches for reducing risks from threats to human health and the environment. The focus of the Laboratory's research program is on methods for the prevention and control of pollution to air, land, water, and subsurface resources; protection of water quality in public water systems; remediation of contaminated sites and ground water; and prevention and control of indoor air pollution. The goal of this research effort is to catalyze development and implementation of innovative, cost-effective environmental technologies; develop scientific and engineering information needed by EPA to support regulatory and policy decisions; and provide technical support and information transfer to ensure effective implementation of environmental regulations and strategies.

This report describes the results of an investigation conducted to assist EPA's New England Regional Office in evaluating vapor intrusion in homes and a commercial building near the Raymark Superfund Site in Stratford, Connecticut. Methods were developed to sample sub-slab air and use basement and sub-slab air measurements to evaluate vapor intrusion on a building-by-building basis. Using the methods described in this report, volatile organic compounds detected in basement air due to vapor intrusion could be separated from numerous other halogenated and non-halogenated (e.g., petroleum hydrocarbons) compounds present in basement air.



Stephen G. Schmelling, Director
Ground Water and Ecosystems Restoration Division
National Risk Management Research Laboratory

Abstract

This report describes the results of an investigation conducted to assist EPA's New England Regional Office in evaluating vapor intrusion at 15 homes and one commercial building near the Raymark Superfund Site in Stratford, Connecticut. Methods were developed to sample sub-slab air and use basement and sub-slab air measurements to evaluate vapor intrusion on a building-by-building basis. A volatile organic compound (VOC) detected in basement air was considered due primarily to vapor intrusion if: (1) the VOC was detected in ground water or soil gas in the vicinity (e.g., 30 meters) of a building, and (2) statistical testing indicated equivalency between basement/sub-slab air concentration ratios of indicator VOCs and VOCs of interest. An indicator VOC was defined as a VOC detected in sub-slab air and known to be only associated with sub-surface contamination. Using this method of evaluation, VOCs detected in basement air due to vapor intrusion could easily be separated from numerous other halogenated and non-halogenated (e.g., petroleum hydrocarbons) VOCs present in basement air. As a matter of necessity, radon was used as an indicator compound at locations where an indicator VOC was not detected in basement air. However, when basement/sub-slab air concentration ratios were compared for radon and indicator VOCs, statistical non-equivalency occurred at three out of the four locations evaluated. Further research is needed to assess the usefulness of radon in assessing vapor intrusion.

Holes for sub-slab probes were drilled in concrete slabs using a rotary hammer drill. Probes were designed to allow for collection of air samples directly beneath a slab and in sub-slab media. Three to five probes were installed in each basement. Placement of a probe in a central location did not ensure detection of the highest VOC concentrations. Schematics illustrating the location of sub-slab probes and other slab penetrations (e.g., suction holes for sub-slab permeability testing) were prepared for each building to document sample locations, interpret sample results, and design corrective measures. Basement and sub-slab air samples were collected and analyzed for VOCs using six-liter SilcoCan canisters and EPA-Method TO-15. Sub-slab air samples were also collected in one-liter Tedlar bags using a peristaltic pump and analyzed on-site for target VOCs. Open-faced charcoal canisters were used to sample radon gas in basement air. Scintillation cells and a peristaltic pump were used to sample radon gas in sub-slab air.

Three methods were used to evaluate infiltration of basement air into sub-slab media during air extraction (purging + sampling). The first method consisted of sequentially collecting five one-liter Tedlar bag samples at a flow rate of 1 standard liter per minute and comparing vapor concentration of four VOCs associated with vapor intrusion as a function of extraction volume. This was performed at three locations with little effect on sample concentration. This testing also indicated the absence of rate-limited mass exchange during air extraction. Replicate canister

samples representing extraction volumes of 5 to 9 and 10 to 14 liters were compared at two locations with similar results. A second method was then employed which utilized a mass balance equation and sub-slab and basement air concentrations. When sensitivity of the method permitted, infiltration was shown to be less than 1% at sampled locations. A third method involved simulating streamlines and travel time in sub-slab media during air extraction. Air permeability testing in sub-slab media was conducted to obtain estimates of radial and vertical air permeability to support air flow simulations. Simulations indicated that less than 10% of air extracted during purging and sampling could have originated as basement air when extracting up to 12 liters of air. Overall, extraction volumes used in this investigation (up to 14 liters) had little or no effect on sample results.

To assess the need for an equilibration period after probe installation, advective air flow modeling with particle tracking was employed to establish radial path lengths for diffusion modeling. Simulations indicated that in sub-slab material beneath homes at the Raymark site (sand and gravel), equilibration likely occurred in less than 2 hours. Sub-slab probes in this investigation were allowed to equilibrate for 1 to 3 days prior to sampling. A mass-balance equation was used to estimate the purging requirement prior to sampling. Simulations indicated that collection of 5 purge volumes would ensure that the exiting vapor concentration was 99% of the entering concentration even if vapor concentration inside the sample system had been reduced to zero concentration prior to sampling.

Table of Contents

Notice	ii
Foreword	iii
Abstract	iv
List of Chemical Abbreviations	viii
List of Figures.....	ix
List of Tables.....	xv
Acknowledgements	xxi
Executive Summary	xxii
1.0 Introduction	1
2.0 Site Description.....	3
3.0 Methods and Materials Used For Basement and Sub-Slab Air Sampling.....	6
3.1 Quality Control Measures for Sampling and Analysis Using EPA Method TO-15	6
3.2 Basement and Outdoor Air Sampling for VOCs	10
3.3 Quality Control Measures and Data Quality for Basement Air Sampling and Analysis for Radon.....	11
3.4 Sub-Slab Probe Assembly and Installation	12
3.5 Sub-Slab Air Sample Collection for VOCs Using EPA Method TO-15.....	17
3.6 Quality Control Measures and Data Quality for Sub-Slab Air Sampling Using Tedlar Bags and On-Site GC Analysis	17
3.7 Quality Control Measures and Data Quality for Sub-Slab Air Sampling for Radon Using Scintillation Cells	19
4.0 Methods and Materials Used for Air Permeability Testing and Sub-Slab Flow Analysis	21
5.0 Discussion of Sampling Issues Associated with Sub-Slab Sampling	25
5.1 Assessment of Infiltration of Basement Air During Air Extraction	25
5.2 Assessment of Extraction Flow Rate	31
5.3 Evaluation of Equilibration Time	32
5.4 Selection of Purge Volume.....	34
5.5 Placement of Sub-Slab Vapor Probes	35
6.0 Use of Basement and Sub-Slab Air Measurement to Assess Vapor Intrusion.....	37
6.1 Method of Vapor Intrusion Evaluation	37
6.2 Summary of Results for Buildings Sampled in July and October 2002.....	39
6.3 Summary of Results for Buildings Sampled in March 2003	62
6.4 Results of Radon Testing to Assess Vapor Intrusion	96
6.5 Summary of Basement/Sub-Slab Concentration Ratios.....	98
7.0 Summary.....	100
References	105

List of Chemical Abbreviations

1,1,1-TCA	1,1,1-trichloroethane
1,1-DCE	1,1-dichloroethylene
TCE	trichloroethylene
c-1,2-DCE	cis-1,2-dichloroethylene
1,1-DCA	1,1-dichloroethane
1,2-DCA	1,2-dichloroethane
PCE	perchloroethylene
CH ₂ Cl ₂	methylene chloride
CHCl ₃	chloroform
CCl ₄	carbon tetrachloride
CCl ₃ F	trichlorofluoromethane (F-11)
CCl ₂ F ₂	dichlorodifluoromethane (F-12)
CHBrCl ₂	bromodichloromethane
CH ₃ CH ₂ Cl	chloroethane
CCl ₃ CF ₃	trichlorotrifluoroethane (F-113)
THF	tetrahydrofuran
MEK	methyl ethyl ketone
MIBK	methyl isobutyl ketone
MTBE	methyl tert-butyl ether
1,2,4-TMB	1,2,4-trimethylbenzene
1,3,5-TMB	1,3,5-trimethylbenzene
CS ₂	carbon disulfide

List of Figures

Figure 1	Direction of ground-water flow (large arrows) and location of the residential area of investigation near the Raymark Superfund Site (modified from Tetra Tech NUS, Inc., 2000).....	3
Figure 2	Location of geologic cross-sections and the residential area of investigation near the Raymark Superfund Site (modified from Tetra Tech NUS, Inc., 2000)	4
Figure 3	Geologic cross-section G – G' (modified from Tetra Tech NUS, Inc., 2000).....	5
Figure 4	Geologic cross-section H – H' (modified from Tetra Tech NUS, Inc., 2000)	5
Figure 5	Collection of a replicate basement air sample.....	7
Figure 6	Replicate precision as a function of mean basement concentration for the July 2002 and March 2003 sampling events	9
Figure 7	Coefficient of variation (COV) as a function of mean basement concentration for July 2002 and March 2003 sampling events	9
Figure 8	Tripod and six-liter evacuated canister used to collect a 24-hour outdoor air sample during the March 2003 sampling event.....	10
Figure 9	Coefficient of variation (COV) as a function of mean basement radon concentration.....	12
Figure 10	General schematic of a sub-slab vapor probe.....	13
Figure 11	Brass materials used for sub-slab probe construction in homes near the Raymark facility	13
Figure 12	Hex bushing used for probe construction when a concrete slab was less than 2.5 cm thick.....	13
Figure 13	A comparison of VOC concentrations in outdoor air and outdoor air passing through brass fittings used for probe construction during the July 2002 sampling event. Dashed lines indicate detection limits.....	14
Figure 14	Stainless-steel materials now used for sub-slab probe assembly	14

List of Figures — continued

Figure 15	Drilling through a concrete slab using a rotary hammer drill.....	15
Figure 16	"Inner" and "outer" holes drilled in a concrete slab	15
Figure 17	Typical schematic illustrating location of sub-slab vapor probes	16
Figure 18	Sample train for sub-slab air collection using EPA Method TO-15	17
Figure 19	Sample train for sub-slab air collection using one-liter Tedlar bags	18
Figure 20	Comparison of EPA Method TO-15 and Tedlar bag sampling with on-site GC analysis for 1,1,1-TCA, 1,1-DCE, TCE, and c-1,2-DCE, n = 91, $r^2 = 0.88$	19
Figure 21	Sample train for sub-slab air collection for radon using scintillation cells.....	20
Figure 22	Regenerative blower used for air permeability testing	21
Figure 23	Variable-area flowmeter used for air permeability testing.....	22
Figure 24	Magnehelic gauges and suction hole used for vacuum measurement.....	22
Figure 25	Best-fit model results for permeability test conducted at House C with four vacuum observation points and a flow rate of 255 SLPM (k_r/k_z constrained between 1 – 2)	24
Figure 26a	Sub-slab vapor concentration as a function of extraction volume at Probe A in House L using Tedlar bag sampling and on-site GC analysis	26
Figure 26b	Sub-slab vapor concentration as a function of extraction volume at Probe B in House M using Tedlar bag sampling and on-site GC analysis	26
Figure 26c	Sub-slab vapor concentration as a function of extraction volume at Probe A in House N using Tedlar bag sampling and on-site GC analysis. Dashed lines denote detection limit.....	27
Figure 27a	Sub-slab vapor concentration as a function of extraction volume at Probe A in House J using EPA Method TO-15	27
Figure 27b	Sub-slab vapor concentration as a function of extraction volume at Probe A in House M using EPA Method TO-15	28
Figure 28	Simulated streamline (solid lines) and travel time (s) (dashed lines) contours in sub-slab media when $k_r = 7.4E-07$ cm ² , $k_r/k_z = 1.5$, $\ell = 3.2E-09$ cm, flow rate = 1 SLPM, and depth to ground water = 500 cm.....	30

List of Figures — continued

Figure 29	Simulated vacuum (Pa) (dashed lines) and pore-air velocity (solid lines) (cm/s) in sub-slab media when $k_r = 7.4E-07 \text{ cm}^2$, $k_r/k_z = 1.5$, $\theta_a = 0.35$, flow rate = 1 SLPM, and depth to ground water = 500 cm.....	31
Figure 30	Time to reach $C(t)/C_\delta = 0.99$ as a function of diffusion path length ' δ ' and θ_w for TCE when $C_0 = 0$, $\eta = 0.4$, $\rho_b = 1.68 \text{ g/cm}^3$, $D_a = 7.4E-02 \text{ cm}^2/\text{s}$, $D_w = 9.3E-06 \text{ cm}^2/\text{s}$, and $H = 0.38$ (no sorption).....	34
Figure 31	Purge volume as a function of C_0/C_{in} and C_{out}/C_{in}	35
Figure 32	Total vapor concentration measured in one-liter Tedlar bags as a function of probe location and house. Dark bars refer to centrally located probes. No VOCs associated with subsurface contamination were detected at Location F. Locations H, K, M, and P did not have a centrally located probe	36
Figure 33	Coefficient of variation (COV) as a function of mean sub-slab concentration (ppbv) and method of analysis for VOCs associated with subsurface contamination	36
Figure 34	Basement/sub-slab concentration ratios using EPA Method TO-15 at House A during the July 2002 sample event. Error bars represent one standard deviation. Arrows indicate greater than or less than values due to non-detection in basement or sub-slab air	42
Figure 35	Comparison of mean sub-slab air concentrations of VOCs collected in one-liter Tedlar bags during the July and October 2002 sample events at House A. Error bars represent one standard deviation	44
Figure 36	Basement/sub-slab air concentration ratios using EPA Method TO-15 at House B during the July 2002 sample event – error bars represent one standard deviation. Arrows indicate greater than or less than values due to non-detection in basement or sub-slab air	47
Figure 37	Comparison of mean sub-slab air concentrations of VOCs collected in one-liter Tedlar bags during the July and October 2002 sample events at House B. Error bars represent one standard deviation	48
Figure 38	Basement/sub-slab concentration ratios using EPA Method TO-15 at House C during the July 2002 sample event. Error bars represent one standard deviation. Arrows indicate greater than or less than values due to non-detection in basement or sub-slab air	51
Figure 39	Comparison of mean sub-slab air concentrations of VOCs collected in one-liter Tedlar bags during the July and October 2002 sample events at House C. Error bars represent one standard deviation	53

List of Figures — continued

Figure 40	Basement/sub-slab concentration ratios using EPA Method TO-15 at House D during the July 2002 sample event. Error bars represent one standard deviation. Arrows indicate greater than or less than values due to non-detection in basement or sub-slab air	56
Figure 41	Comparison of mean sub-slab air concentrations of VOCs collected in one-liter Tedlar bags during the July and October 2002 sample events at House D. Error bars represent one standard deviation	57
Figure 42	Basement/sub-slab concentration ratios using EPA Method TO-15 at House E during the July 2002 sample event. Error bars represent one standard deviation. Arrows indicate greater than or less than values due to non-detection in basement or sub-slab air	60
Figure 43	Comparison of mean sub-slab air concentrations of VOCs collected in one-liter Tedlar bags during the July and October 2002 sample events at House E. Error bars represent one standard deviation	61
Figure 44	Basement/sub-slab concentration ratios using EPA Method TO-15 at House G during the March 2003 sample event. Error bars represent one standard deviation. Arrows indicate greater than or less than values due to non-detection in basement or sub-slab air	67
Figure 45	Basement/sub-slab concentration ratios using EPA Method TO-15 at House H during the March 2003 sample event. Error bars represent one standard deviation. Arrows indicate greater than or less than values due to non-detection in basement or sub-slab air	71
Figure 46	Basement/sub-slab concentration ratios using one-liter Tedlar bags and on-site GC analysis at House I during the March 2003 sample event. Error bars represent one standard deviation.....	73
Figure 47	Basement/sub-slab concentration ratios using one-liter Tedlar bags and on-site GC analysis at House J during the March 2003 sample event. Error bars represent one standard deviation.....	76
Figure 48	Basement/sub-slab concentration ratios using one-liter Tedlar bags and on-site GC analysis at House K during the March 2003 sample event. Error bars represent one standard deviation.....	79
Figure 49	Basement/sub-slab concentration ratios using one-liter Tedlar bags and on-site GC analysis at House L during the March 2003 sample event. Error bars represent one standard deviation.....	82

List of Figures — continued

Figure 50	Basement/sub-slab concentration ratios using one-liter Tedlar bags and on-site GC analysis at House M during the March 2003 sample event. Error bars represent one standard deviation. Arrows indicate less than values due to non-detection in basement air	85
Figure 51	Basement/sub-slab concentration ratios using EPA Method TO-15 at House N during the March 2003 sample event. Error bars represent one standard deviation. Arrows indicate greater than or less than values due to non-detection in basement or sub-slab air	89
Figure 52	Basement/sub-slab concentration ratios using EPA Method TO-15 at House O during the March 2003 sample event. Error bars represent one standard deviation. Arrows indicate greater than or less than values due to non-detection in basement or sub-slab air	92
Figure 53	Basement/sub-slab concentration ratios using EPA Method TO-15 at House P during the March 2003 sample event. Error bars represent one standard deviation. Arrows indicate greater than or less than values due to non-detection in basement or sub-slab air	96
Figure 54	Comparison of basement/sub-slab air concentration ratios for radon and indicator VOCs associated with vapor intrusion. Samples for VOCs collected in one-liter Tedlar bags with on-site GC analysis	97
Figure 55	Coefficient of variation (COV) as a function of location and compound for VOCs detected in basement air as a result of vapor intrusion.....	98
Figure 56	Summary of average basement/sub-slab concentration ratios for VOCs present in basement air due to vapor intrusion using one-liter Tedlar bags and on-site GC analysis. Arrows indicate less than values due to non-detection in basement air	99



List of Tables

Table 1	Computation of maximum percent infiltration of basement air into an evacuated canister during sampling as a function of extraction volume, location, and probe. P[A], P[B], P[C], P[D], and P[E] denote probes evaluated at individual locations29
Table 2	Outdoor air concentrations of VOCs during the July 2002 and March 2003 sample events.....39
Table 3a	Basement and sub-slab concentrations of VOCs at House A using EPA Method TO-15 during the July 2002 sample event.....41
Table 3b	Summary of basement/sub-slab air concentration ratios of VOCs associated with sub-surface contamination in House A using EPA Method TO-15 during the July 2002 sample event43
Table 3c	Summary of basement/sub-slab air concentration ratios of VOCs associated with sub-surface contamination in House A using 1-liter Tedlar bags and on-site GC analysis during the July 2002 sample event43
Table 3d	Sub-slab air concentrations of VOCs associated with sub-surface contamination in House A using 1-liter Tedlar bags and on-site GC analysis during the October 2002 sample event.....43
Table 4a	Basement and sub-slab concentrations of VOCs at House B using EPA Method TO-15 during the July 2002 sample event.....45
Table 4b	Summary of basement/sub-slab air concentration ratios of VOCs associated with sub-surface contamination in House B using EPA Method TO-15 during the July 2002 sample event46
Table 4c	Summary of basement/sub-slab air concentration ratios of VOCs associated with sub-surface contamination in House B using 1-liter Tedlar bags and on-site GC analysis during the July 2002 sample event46
Table 4d	Sub-slab air concentrations of VOCs associated with sub-surface contamination in House B using 1-liter Tedlar bags and on-site GC analysis during the October 2002 sample event.....48

List of Tables — continued

Table 5a	Basement and sub-slab air concentrations of VOCs at House C using EPA Method TO-15 during the July 2002 sample event.....	50
Table 5b	Summary of basement/sub-slab air concentration ratios of VOCs associated with sub-surface contamination in House C using EPA Method TO-15 during the July 2002 sample event	51
Table 5c	Summary of basement/sub-slab air concentration ratios of VOCs associated with sub-surface contamination in House C using 1-liter Tedlar bags and on-site GC analysis during the July 2002 sample event	51
Table 5d	Sub-slab air concentrations of VOCs associated with sub-surface contamination in House C using 1-liter Tedlar bags and on-site GC analysis during the October 2002 sample event.....	52
Table 6a	Basement and sub-slab concentrations of VOCs at House D using EPA Method TO-15 during the July 2002 sample event.....	54
Table 6b	Summary of basement/sub-slab air concentration ratios of VOCs associated with sub-surface contamination in House D using EPA Method TO-15 during the July 2002 sample event	55
Table 6c	Summary of basement/sub-slab air concentration ratios of VOCs associated with sub-surface contamination in House D using 1-liter Tedlar bags and on-site GC analysis during the July 2002 sample event	55
Table 6d	Sub-slab air concentrations of VOCs associated with sub-surface contamination in House D using 1-liter Tedlar bags and on-site GC analysis during the October 2002 sample event.....	56
Table 7a	Basement/sub-slab air concentrations of VOCs at House E using EPA Method TO-15 during the July 2002 sample event.....	58
Table 7b	Summary of basement/sub-slab air concentration ratios of VOCs associated with sub-surface contamination in House E using EPA Method TO-15 during the July 2002 sample event	59
Table 7c	Summary of basement/sub-slab air concentration ratios of VOCs associated with sub-surface contamination in House E using 1-liter Tedlar bags and on-site GC analysis during the July 2002 sample event	59

List of Tables — continued

Table 7d	Sub-slab air concentrations of VOCs associated with sub-surface contamination in House E using 1-liter Tedlar bags and on-site GC analysis during the October 2002 sample event.....	61
Table 8	Basement and sub-slab air concentrations for VOCs at House F using EPA Method TO-15 during the March 2003 sample event	63
Table 9a	Basement and sub-slab air concentration of VOCs at House G using EPA Method TO-15 during the March 2003 sample event	65
Table 9b	Summary of basement/sub-slab air concentration ratios of VOCs associated with sub-surface contamination in House G using EPA Method TO-15 during the March 2003 sample event.....	66
Table 9c	Summary of basement/sub-slab air concentration ratios of VOCs associated with sub-surface contamination in House G using 1-liter Tedlar bags and on-site GC analysis during the March 2003 sample event.....	66
Table 9d	Basement/sub-slab air concentration ratios for radon in House G using 48-hr activated carbon canisters for basement air sampling (3/25-3/27/03) and scintillation cells for sub-slab air sampling during the March 2003 sample event.....	67
Table 10a	Basement and sub-slab air concentrations for VOCs at House H using EPA Method TO-15 during the March 2003 sample event	69
Table 10b	Summary of basement/sub-slab air concentration ratios of VOCs associated with sub-surface contamination in House H using EPA Method TO-15 during the March 2003 sample event.....	70
Table 10c	Summary of basement/sub-slab air concentration ratios of VOCs associated with sub-surface contamination in House H using 1-liter Tedlar bags and on-site GC analysis during the March 2003 sample event.....	70
Table 10d	Basement/sub-slab air concentration ratios for radon in House H using 48-hr activated carbon canisters for basement air sampling (3/21-3/24/03) and scintillation cells for sub-slab air sampling during the March 2003 sample event.....	70
Table 11a	Basement and sub-slab air concentrations for VOCs at House I using EPA Method TO-15 during the March 2003 sample event	72
Table 11b	Summary of basement/sub-slab air concentration ratios of VOCs associated with sub-surface contamination in House H using 1-liter Tedlar bags and on-site GC analysis during the March 2003 sample event.....	73

List of Tables — continued

Table 12a	Basement and sub-slab air concentrations for VOCs at House J using EPA Method TO-15 during the March 2003 sample event	74
Table 12b	Summary of basement/sub-slab air concentration ratios of VOCs associated with sub-surface contamination in House J using 1-liter Tedlar bags and on-site GC analysis during the March 2003 sample event	75
Table 12c	Basement/sub-slab air concentration ratios for radon in House J using 48-hr activated carbon canisters for basement air sampling (3/21-3/24/03) and scintillation cells for sub-slab sampling during the March 2003 sample event.....	75
Table 13a	Basement air concentrations for VOCs at House K using EPA Method TO-15 during the March 2003 sample event	77
Table 13b	Summary of basement/sub-slab air concentration ratios of VOCs associated with sub-surface contamination in House K using 1-liter Tedlar bags and on-site GC analysis during the March 2003 sample event.....	78
Table 13c	Basement and sub-slab air concentration ratios for radon in House K using 48-hr activated carbon canisters for basement air sampling (3/21-3/24/03) and scintillation cells for sub-slab air sampling during the March 2003 sample event.....	78
Table 14a	Basement and sub-slab air concentrations for VOCs at House L using EPA Method TO-15 during the March 2003 sample event	80
Table 14b	Results of sequential sub-slab air sampling using 1-liter Tedlar bags and on-site GC analysis at House L during the March 2003 sample event	81
Table 14c	Summary of basement/sub-slab air concentration ratios of VOCs associated with sub-surface contamination in House L using 1-liter Tedlar bags and on-site GC analysis during the March 2003 sample event	81
Table 14d	Summary of 48-hour indoor air measurements for radon using activated charcoal at House L.....	81
Table 14e	Basement/sub-slab air concentration ratios for radon in House L using 48-hr activated carbon canisters for basement air sampling (3/26-3/28/03) and scintillation cells for sub-slab air sampling during the March 2003 sample event.....	81
Table 15a	Basement and sub-slab air concentrations for VOCs at House M using EPA Method TO-15 during the March 2003 sample event	83

List of Tables — continued

Table 15b	Results of sequential sub-slab air sampling using 1-liter Tedlar bags and on-site GC analysis at House M during the March 2003 sample event	84
Table 15c	Summary of basement/sub-slab air concentration ratios of VOCs associated with sub-surface contamination in House M using 1-liter Tedlar bags and on-site GC analysis during the March 2003 sample event	84
Table 15d	Basement/sub-slab air concentration ratios for radon in House M using 48-hr activated carbon canisters for basement air sampling (3/22-3/24/03) and scintillation cells for sub-slab air sampling during the March 2003 sample event.....	84
Table 16a	Basement and sub-slab air concentrations for VOCs at House N using EPA Method TO-15 during the March 2003 sample event	86
Table 16b	Summary of basement/sub-slab air concentration ratios of VOCs associated with sub-surface contamination in House N using EPA Method TO-15 during the March 2003 sample event.....	87
Table 16c	Results of sequential sub-slab air sampling and on-site GC analysis using 1-liter Tedlar bags at House N during the March 2003 sample event	88
Table 16d	Summary of basement/sub-slab air concentration ratios of VOCs associated with sub-surface contamination in House N using 1-liter Tedlar bags and on-site GC analysis during the March 2003 sample event.....	88
Table 16e	Basement/sub-slab air concentration ratios for radon in House N using 48-hr activated carbon canisters for basement air sampling (3/25-3/27/03) and scintillation cells for sub-slab air sampling during the March 2003 sample event.....	88
Table 17a	Basement and sub-slab concentrations for VOCs at House O using EPA Method TO-15 during the March 2003 sample event	90
Table 17b	Summary of basement/sub-slab air concentration ratios of VOCs associated with sub-surface contamination in House O using EPA Method TO-15 during the March 2003 sample event.....	91
Table 17c	Summary of basement/sub-slab air concentration ratios of VOCs associated with sub-surface contamination in House O using 1-liter Tedlar bags and on-site GC analysis during the March 2003 sample event.....	91
Table 17d	Basement/sub-slab air concentration ratios for radon in House O using 48-hr activated carbon canisters for basement air sampling (3/25-3/27/03) and scintillation cells for sub-slab air sampling during the March 2003 sample event.....	92

List of Tables — continued

Table 18a	Basement and sub-slab air concentrations for VOCs at House P using EPA Method TO-15 during the March 2003 sample event	94
Table 18b	Summary of basement/sub-slab air concentration ratios of VOCs associated with sub-surface contamination in House P using EPA Method TO-15 during the March 2003 sample event.....	95
Table 18c	Summary of basement/sub-slab air concentration ratios of VOCs associated with sub-surface contamination in House P using 1-liter Tedlar bags and on-site GC analysis during the March 2003 sample event.....	95
Table 18d	Basement/sub-slab air concentration ratios for radon in House P using 48-hr activated carbon canisters for basement air sampling (3/26-3/28/03) and scintillation cells for sub-slab air sampling during the March 2003 sample event.....	95

Acknowledgements

The authors would like to thank the following for their help and support in this project: Mike Jasinski, Ron Jennings, Matt Hoagland, Mary Sanderson, and Don Berger of EPA Region I, David Burden of NRMRL, Ada, OK, and William Bell of the Massachusetts Department of Public Health.

The authors would also like to acknowledge the following for their formal review of this manuscript:

Dr. John E. McCray
Colorado School of Mines
Environmental Science and Engineering Division
1500 Illinois Street
Golden, CO 80401

Dr. Blayne Hartman
HP Labs
432 N. Cedros Avenue
Solana Beach, CA 92075

Dr. Brian Schumacher
U.S. EPA
Office of Research and Development
National Exposure Research Laboratory
Environmental Sciences Division
P.O. Box 93478
Las Vegas, NV 89193-3478

Dr. Helen Dawson
U.S. EPA, Region VIII
999 18th Street, Suite 300
Denver, CO 80401

Executive Summary

This report describes the results of an investigation conducted to assist EPA's New England Regional Office in evaluating vapor intrusion at 15 homes and one commercial building near the Raymark Superfund Site in Stratford, Connecticut. Ground water beneath these homes is contaminated with 1,1,1-trichloroethane, 1,1-dichloroethylene, trichloroethylene, cis-1,1-dichloroethylene, and 1,1-dichloroethane. Methods were developed to sample sub-slab air and use basement and sub-slab air measurements to evaluate vapor intrusion on a building-by-building basis. A volatile organic compound (VOC) detected in basement air was considered due primarily to vapor intrusion if: (1) the VOC was detected in ground water or soil gas in the vicinity (e.g., 30 meters) of a building, and (2) the null hypothesis that the basement/sub-slab air concentration ratio of the VOC was equal to the basement/sub-slab air concentration ratio of an indicator VOC could not be rejected using a one-tailed Approximate t-Test at a level of significance less than or equal to 0.05. An indicator VOC was defined as a VOC detected in sub-slab air and known to be associated only with sub-surface contamination (i.e., no outdoor or indoor air sources). The VOCs 1,1-dichloroethylene and 1,1-dichloroethane were considered indicator VOCs in this investigation because they are degradation products of 1,1,1-trichloroethane and not commonly associated with commercial products. The VOC cis-1,2-dichloroethylene was considered an indicator VOC because it is a degradation product of trichloroethylene and also not commonly associated with commercial products. Using this method of evaluation, VOCs detected in basement air due to vapor intrusion could easily be separated from numerous other halogenated and non-halogenated (e.g., petroleum hydrocarbons) VOCs present in basement air. The variance associated with each basement/sub-slab air concentration ratio was calculated using the method of propagation of errors which incorporated the variance associated with both basement and sub-slab air measurement. An average basement/sub-slab air concentration ratio was computed using concentration ratios of all VOCs detected in basement air and associated with vapor intrusion. The method of propagation of errors was then used to calculate the variance associated with the average basement/sub-slab concentration ratio.

As a matter of necessity, radon was used as an indicator compound at locations where an indicator VOC was not detected in basement air. However, when basement/sub-slab air concentration ratios were compared for radon and indicator VOCs, statistical non-equivalency occurred at three out of the four locations evaluated. At these three locations, the null hypothesis that the basement/sub-slab air concentration ratio of radon was equal to the basement/sub-slab air concentration ratio of the indicator VOC, 1,1-DCE, was rejected using a two-tailed Approximate t-Test at a significance level less than or

equal to 0.1. There was a visual dissimilarity between the basement/sub-slab air concentration ratio of radon and VOCs associated with vapor intrusion. This was in contrast to visual and statistical (levels of significance always greater than 0.1) similarity of basement/sub-slab air concentration ratios of indicator VOCs and other VOCs associated with vapor intrusion. These two observations indicate, at least in this investigation, use of indicator VOCs was preferable to radon in assessing vapor intrusion. Further research is needed at other sites containing indicator VOCs to determine the usefulness of radon in assessing vapor intrusion.

Holes for sub-slab probes were drilled in concrete slabs using a rotary hammer drill. Probes were designed to allow for collection of air samples directly beneath a slab and in sub-slab media. Three to five probes were installed in each basement. Fifty-five probes were installed in 16 buildings which, on average, resulted in placement of one probe every 220 ft². Observation of high coefficients of variation in sub-slab air concentrations (greater than 100% at several locations), and the need for statistical analysis in assessing basement/sub-slab air concentration ratios, indicated that placement of multiple probes in sub-slab media was necessary to evaluate vapor intrusion. Generally, one sub-slab vapor probe was centrally located while two or more probes were placed within one or two meters of basement walls in each building. In this investigation, placement of a probe in a central location did not ensure detection of the highest VOC concentrations in sub-slab media. Schematics illustrating the location of sub-slab probes and other slab penetrations (e.g., suction holes for sub-slab permeability testing) were prepared for each building to document sample locations, interpret sample results, and design corrective measures.

Basement and sub-slab air samples were collected and analyzed for VOCs using six-liter SilcoCan canisters and EPA-Method TO-15. Sub-slab air samples were also collected in one-liter Tedlar bags using a peristaltic pump and analyzed on-site for target VOCs by EPA's New England Regional Laboratory within 24 hours of sample collection. Open-faced charcoal canisters were used to sample radon gas in basement air over a 48-hour period. Scintillation cells and a peristaltic pump were used to sample radon gas in sub-slab air. Scintillation cells were analyzed within four hours using a portable radiation monitor to count and amplify light pulses.

Three methods were used to evaluate infiltration of basement air into sub-slab media during air extraction (purging + sampling). The first method consisted of sequentially collecting five one-liter Tedlar bag samples at a flow rate of 1 standard liter per minute and comparing vapor concentration of four VOCs associated with vapor intrusion as a function of extraction volume. This was performed at three locations with little effect on sample concentration. This testing also indicated the absence of rate-limited mass exchange during air extraction. Replicate canister samples representing extraction volumes of 5 to 9 and 10 to 14 liters were compared at two locations with similar results. A second method was then employed which utilized a mass balance equation and sub-slab and basement air concentrations. When sensitivity of the method permitted, infiltration was shown to be less than 1% at sampled locations. A third method involved

simulating streamlines and travel time in sub-slab media during air extraction. Air permeability testing in sub-slab media was conducted to obtain estimates of radial and vertical air permeability to support air flow simulations. Simulations indicated that less than 10% of air extracted during purging and sampling could have originated as basement air when extracting up to 12 liters of air. Overall, extraction volumes used in this investigation (up to 14 liters) had little or no effect on sample results.

To assess the time required after probe installation for sampling (equilibration period), advective air flow modeling with particle tracking was employed to establish radial path lengths for diffusion modeling. Simulations indicated that in sub-slab material beneath homes at the Raymark site (sand and gravel), equilibration likely occurred in less than 2 hours. Sub-slab probes in this investigation were allowed to equilibrate for 1 to 3 days prior to sampling. A mass-balance equation was used to estimate the purging requirement prior to sampling. Simulations indicated that collection of 5 purge volumes would ensure that the exiting vapor concentration was 99% of the entering concentration even if vapor concentration inside the sample system had been reduced to zero concentration prior to sampling. A purge volume for the sample train used in homes near the Raymark site was typically less than 10 cm³.

In summary, this report constitutes an important first step in the development of a technical resource document on sub-slab air sampling and use of indoor and sub-slab air samples to assess vapor intrusion.

1.0 Introduction

In this report, vapor intrusion was defined as the entry of volatile organic or inorganic compounds (elemental mercury) and gases (e.g., methane) into a building due to contaminated subsurface media (ground water, soil, rock), non-aqueous phase liquids (NAPLs), or waste material (e.g., landfills). Vapor intrusion was not defined by the violation of health-based criteria associated with these compounds or gases which vary over time.

One commonly accepted conceptual model of vapor intrusion involves diffusive transport of volatile organic compounds (VOCs) or gases from contaminated ground water and/or soil to sub-slab media. This is followed by advective-diffusive transport in sub-slab media through an overlying concrete slab and basement walls until entry into a building is achieved. Another conceptual model involves VOC and gas transport into a building via preferential pathways (e.g., utility conduits). Entry of methane gas from landfills and gasoline vapors from gas stations into buildings via preferential pathways is well documented. Sub-slab sampling taken alone is likely not an appropriate method for assessing vapor intrusion for this latter conceptual model.

Until recently, potential risk posed by vapor intrusion was not consistently considered during sub-surface

investigations at sites regulated by the Comprehensive Environmental Response and Liability Act (CERCLA) and the Resource Conservation and Recovery Act (RCRA). Also, risk posed by vapor intrusion has not been consistently considered during investigations involving leaking underground storage tank sites or sites where residential or commercial construction is proposed over known areas of soil and/or ground-water contamination (i.e., Brownfields sites). Thus, the number of buildings where vapor intrusion has occurred, or is occurring, is unknown, and the magnitude of the problem remains undefined. Recognition of this exposure pathway necessitates its consideration in regulatory decision making and may require review of past regulatory decisions involving VOC contamination in soil and/or ground water.

To assess this increasingly important regulatory issue, the United States Environmental Protection Agency's (EPA) Office of Solid Waste and Emergency Response developed guidance (USEPA, 2002) to facilitate assessment of vapor intrusion at sites regulated by RCRA and CERCLA - sites where halogenated organic compounds constitute the bulk of risk to human health. EPA does not consider the guidance applicable to underground storage tank sites where petroleum compounds primarily determine risk, and biodegradation in subsurface media may be a dominant

fate process. In the guidance, EPA considers a site as a regulated unit potentially consisting of numerous buildings and subsurface monitoring points. The guidance was not developed to conduct building-to-building investigations. Recommendations provided in this report directly support the guidance but also support subsequent building-to-building investigations. A number of state agencies have or are in the process of developing state-specific guidance or advisories to assess vapor intrusion.

In the guidance, EPA recommends concomitant use of sub-slab air sampling with indoor air sampling to differentiate outdoor and indoor sources of VOCs (e.g., cosmetics, air fresheners, gasoline storage or car parked in garage, cigarette smoke, solvents, paints, furniture polish) from VOCs emanating from contaminated soil or ground water. The agency, however, does not provide detailed recommendations on how to collect sub-slab air samples nor how to use these samples to assess vapor intrusion. Also, little is published in peer-reviewed literature on

sub-slab sample collection and interpretation. Sub-slab sampling offers an opportunity to collect air samples directly beneath the living space of a building and thereby eliminates uncertainty associated with interpolation or extrapolation of soil-gas and/or ground-water concentrations from monitoring points away from a building. Sub-slab sampling also provides an opportunity to evaluate the validity of claims that petroleum hydrocarbons of concern degrade prior to vapor entry into sub-slab material.

The purpose of this report is to provide a method for evaluating vapor intrusion using indoor and sub-slab air samples. This report does not constitute guidance. It is, however, an important first step in the development of a technical resource document on sub-slab air sampling and interpretation. Use of recommendations provided in this report should increase the potential of collecting samples representative of “true” sub-slab air concentration even if the method of data interpretation presented here is not utilized to assess vapor intrusion.

2.0 Site Description

The Raymark Superfund Site consists of 33.4 acres of land previously occupied by the Raybestos-Manhattan Company in Stratford, Connecticut, where the company disposed of solid-waste from settling lagoons during its operation. Between 1919 and 1989, the company produced asbestos and asbestos compounds, metals, phenol-formaldehyde resins, adhesives, gasket material, sheet packing, clutch facings, transmission plates, and brake linings. Between 1993 and 1996, EPA removed fill containing asbestos, lead, and PCBs from a number of residential properties and a middle school. EPA placed the fill back on the facility property and isolated the waste beneath a cap. In 1996 and 1997, EPA demolished the facility buildings and placed a cap over the area previously occupied by the buildings. The property is now occupied by commercial buildings (e.g., Wal-Mart, Home Depot).

As illustrated in **Figure 1**, ground water beneath the residential area of this investigation generally flows southeast from the former facility, underneath a large residential community, and discharges into the Housatonic River which eventually discharges into Long Island Sound. Ground water in the vicinity of the former facility is contaminated with a number of VOCs including 1,1,1-trichloroethane (1,1,1-TCA), trichloroethene (TCE), cis-1,2-dichloroethene

(c-1,2-DCE), 1,1-dichloroethene (1,1-DCE), and 1,1-dichloroethane (1,1-DCA).

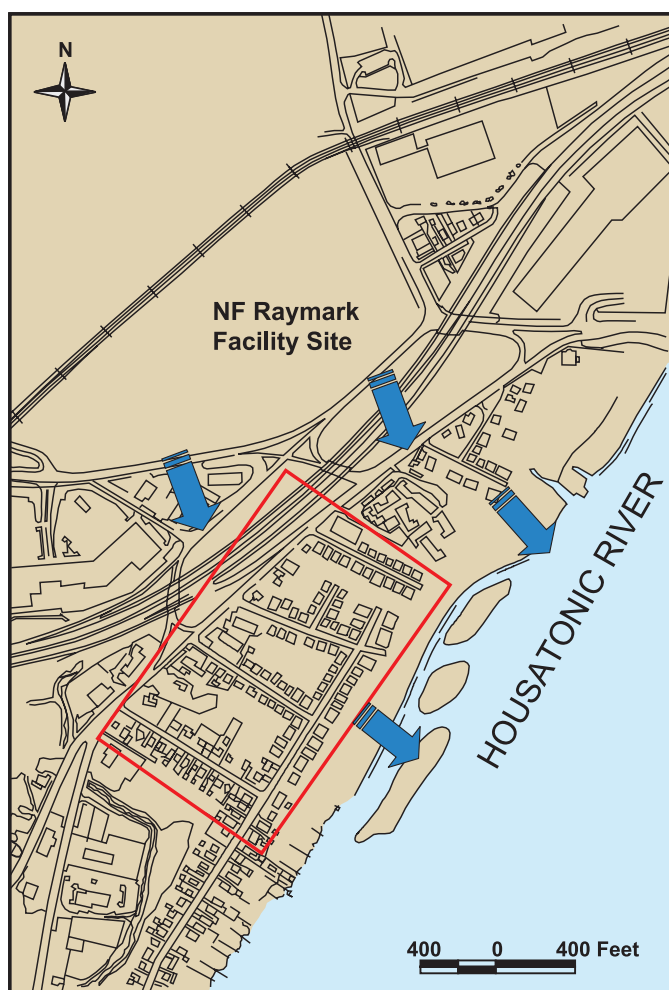

Figure 1. Direction of ground-water flow (large arrows) and location of the residential area of investigation near the Raymark Superfund Site (modified from Tetra Tech NUS, Inc., 2000).

Figures 2, 3, and 4 illustrate glacio-fluvial deposits and fractured granite bedrock valleys in the vicinity of the residential area of investigation. The remedial investigation (TetraTech NUS, 2000) and subsequent studies financed by EPA indicate that ground-water flow is heavily influenced by the location and orientation of bedrock valleys. This results in a fairly complex contaminant distribution profile making interpolation and extrapolation of ground-water contaminant profiles difficult. For instance, TCE was not detected during ground-water sampling at well MW-215, illustrated in **Figure 4**, but was detected in basement air at a home less than 10 meters from this well. As will be discussed, the basement/sub-slab air concentration ratio of TCE observed at this location suggests that the cause of TCE in basement air was vapor intrusion. Non-detection of TCE in well MW-215 was likely caused by a bedrock knoll close to this house where ground-water flow may have been diverted. This assertion is corroborated by significant drawdown during sampling compared to other shallow wells.

Sub-slab and basement air samples were collected in 15 homes and one business near the Raymark Superfund Site in Stratford, Connecticut. The investigation consisted of three separate sample events. In July 2002, basement and sub-slab air was sampled for VOCs at five homes using six-liter SilcoCan canisters and EPA Method TO-15 (USEPA, 1999) analysis. Sub-slab air was also sampled using one-liter Tedlar bags and analyzed on-site using gas chromatography (GC). In October 2002, sub-slab air at these five homes was re-sampled and re-analyzed using one-liter Tedlar bags and on-site GC analysis to assess temporal variability. In March 2003, basement and sub-slab air was sampled for VOCs at an additional ten homes and one commercial building using six-liter

SilcoCan canisters and EPA Method TO-15 analysis. Sub-slab air was also sampled using one-liter Tedlar bags and on-site GC analysis. During this sample event, basement and sub-slab air was sampled for radon gas.



Figure 2. Location of geologic cross-sections and the residential area of investigation near the Raymark Superfund Site (modified from Tetra Tech NUS, Inc., 2000).

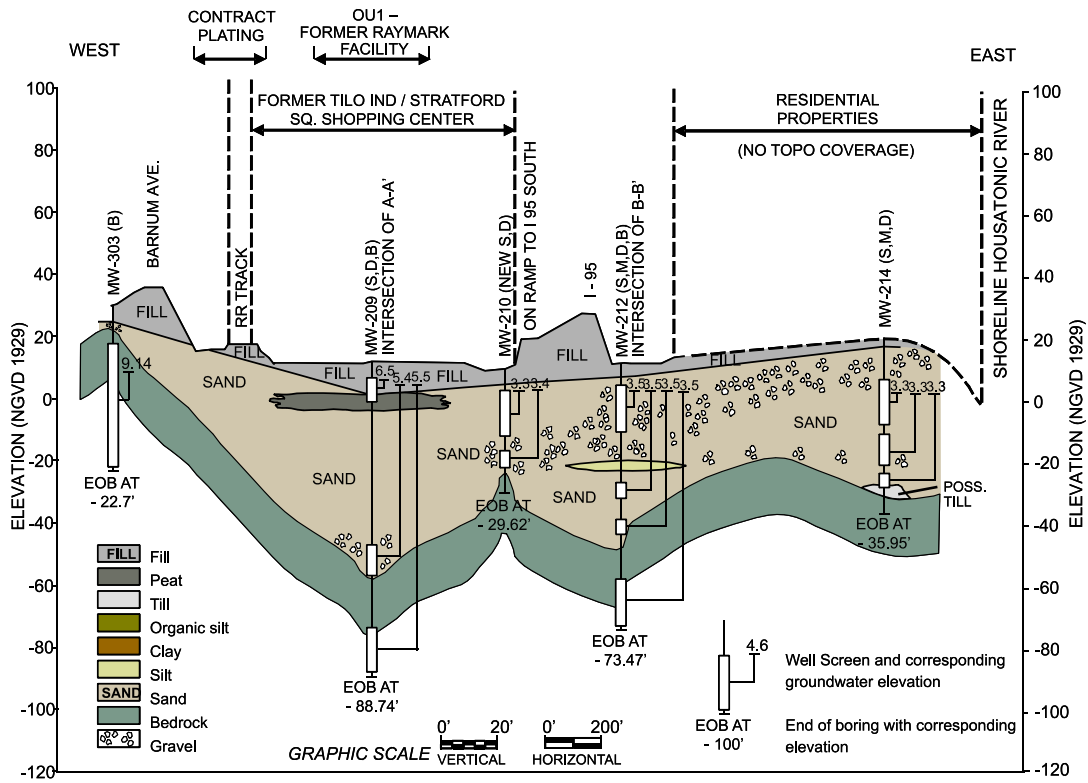

Figure 3. Geologic cross-section G – G' (modified from Tetra Tech NUS, Inc., 2000).

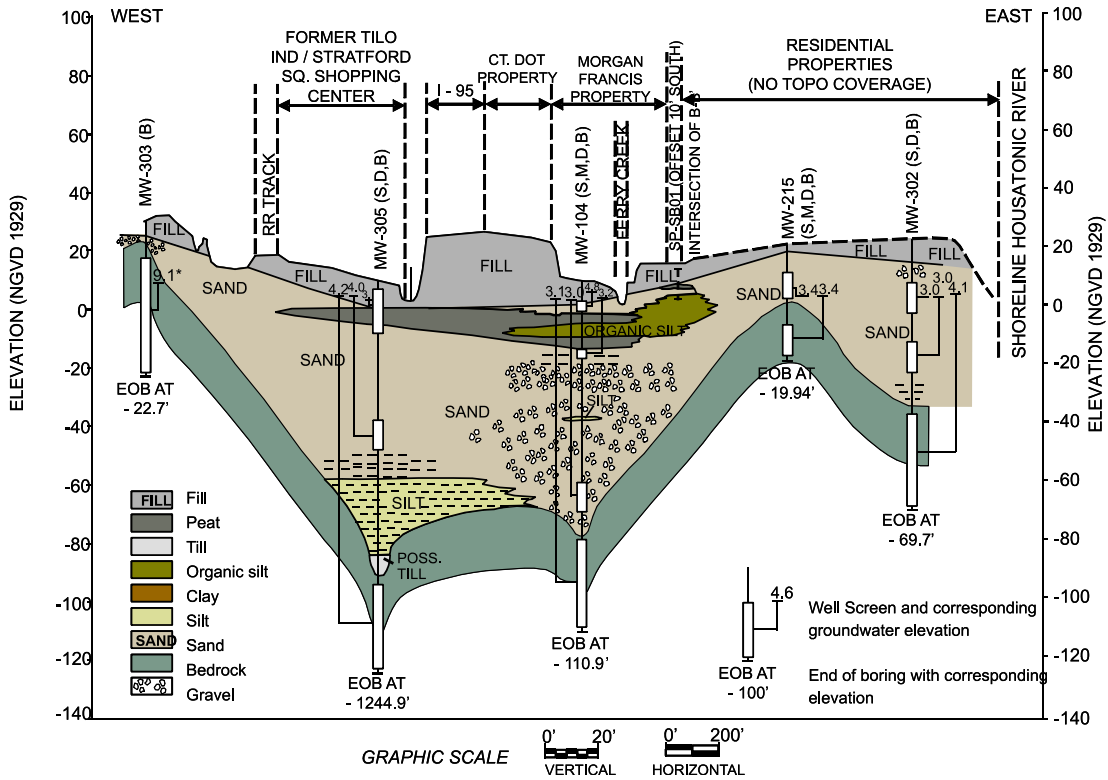

Figure 4. Geologic cross-section H – H' (modified from Tetra Tech NUS, Inc., 2000).

3.0 Methods and Materials Used for Basement and Sub-Slab Air Sampling

3.1 Quality Control Measures and Data Quality for Sampling and Analysis Using EPA Method TO-15

EPA's Compendium of Methods for Determination of Toxic Organic Compounds in Ambient Air (TO Methods) was developed for measurement of 97 VOCs listed in Title III of the Clean Air Act Amendments of 1990. EPA's TO Methods stipulate specific sampling and analytical requirements for determination of VOCs in air. A number of TO Methods are appropriate for indoor and sub-slab air sampling. However, EPA Method TO-15 - Determination of Volatile Organic Compounds (VOCs) in Air Collected in Specially-Prepared Canisters and Analyzed by Gas Chromatography/Mass Spectrometry (GC/MS) (USEPA, 1999) – was used to sample and analyze basement and sub-slab air samples during this investigation.

In EPA Method TO-15, two MS options are available. In the MS-SCAN mode, a GC is coupled to a MS programmed to scan all ions repeatedly over a specified mass range. In the MS-SIM (selected ion monitoring) mode, a GC is coupled to a MS programmed to scan selected ions repeatedly. The MS-SCAN mode allows wide identification of VOCs and detection in tenths of a part per billion volume (ppbv) or hundreds of parts per trillion volume while the MS-SIM mode allows

identification of a few select compounds and detection in the tenths of parts per trillion volume. The MS-SCAN mode was used during this investigation because risk levels for VOCs of concern were generally in the low ppbv range, and VOCs associated with sub-surface contamination were suspected to be present in sub-slab material at concentrations ranging from tens to hundreds ppbv.

EPA Method TO-15 requires that canisters be meticulously cleaned prior to sampling. Six-liter SilcoCan canisters were provided and analyzed by EPA's New England Regional Laboratory. Canisters were cleaned in accordance with EPA's New England Regional Laboratory standard operating procedure (USEPA, 1998). Canister cleaning involved three evacuation/pressurization cycles. Each cycle consisted of evacuation to 0.1 Pascal (Pa), heating to 150°C, and pressurization to 206.7 kPa with humidified nitrogen. Canisters were then evacuated again to 0.1 Pa and vacuum tested with a Pirani sensor for a 24 hour period. Every canister used for basement and sub-slab air sampling was then re-pressurized with humidified, ultra-high purity nitrogen and analyzed for VOCs using the same GC/MS utilized for sample analysis. This process is known as certification. If all canisters are subjected to this process prior to use, as was the case in this investigation, there is 100%

certification. Canisters were considered “clean” if concentrations of target VOCs were less than 0.02 ppbv. Canisters were stored under pressure until the day before sampling and then evacuated once more to 0.1 Pa for sub-atmospheric pressure sampling in accordance with EPA’s New England Regional Laboratory standard operating procedure (USEPA, 1996). A certification level of 100% is generally desirable for indoor air sampling efforts because risk-based concentrations are in the low ppbv range for many compounds. However, a lower level of certification may be suitable for sub-slab sampling because vapor concentrations associated with sub-surface contamination are typically one to three orders of magnitude higher than indoor air.

EPA Method TO-15, EPA requires the use of duplicate, replicate, and audit samples for quality control. Performance is measured by relative percent difference (RPD) defined by:

$$RPD = 100 \frac{|X_1 - X_2|}{\bar{X}}$$

where X_1 and X_2 are values for sample 1 and 2, respectively, and \bar{X} is a sample mean. EPA Method

TO-15 requires duplicate and replicate precision less than or equal to 25%. In Method TO-15, EPA defines duplicate precision as a comparison between two samples taken from the same canister. Duplicate sampling is performed at an analytical laboratory and is used to assess analytical precision. Duplicate sampling was performed at EPA’s New England Regional Laboratory at a sampling frequency of 10%. Relative percent differences did not exceed 30% for any compound in any analysis. In Method TO-15, EPA defines replicate precision as a comparison between two canisters filled from the same air mass over the same period of time. Replicate sampling is performed in the field and can be used to assess precision associated with the entire sample and analytical process. As illustrated in **Figure 5**, replicate sampling consisted of placing two canisters side-by-side. Replicate samples were collected from basement air only. One replicate sample was collected during the July 2002 sample event which included 5 basement air samples and one outdoor air sample. Two replicate samples were collected during the March 2003 sampling event which included 11 basement and two outdoor air samples. Thus, replicate sampling frequency was 3 out of 19 samples, or about 16%.



Figure 5. Collection of replicate basement air sample.

As illustrated in **Figure 6**, RPDs for replicate sampling were generally less than, or near to, 25%. The highest RPDs were for methyl ethyl ketone and trichlorotrifluoroethane analyzed during the July 2002 sample event. An alternative method of assessing replicate precision is to express mean concentration as a function of a coefficient of variability (COV) which is simply the standard deviation divided by the mean times 100. As illustrated in **Figure 7**, the mean COV for the three homes used for replicate sampling during the July 2002 and March 2003 sampling events was only 5.5%. As will be discussed, the COV for replicate basement air sampling was useful for statistical analysis in assessing vapor intrusion.

In EPA Method TO-15, EPA defines audit accuracy as the difference between analyses provided in an audit canister and the nominal value as determined by an audit authority. Audit canisters containing target VOCs were analyzed to assess analytical accuracy. Relative percent differences did not exceed 30% for any compound. As an additional quality control check, ultra-high purity humidified nitrogen was introduced into the analytical instrument inlet line prior to analyzing canisters to serve as laboratory blanks and to demonstrate lack of background contamination in analytical instrumentation. A laboratory blank was analyzed every six canister samples. During the July 2002 sampling event, acetone was detected in 17 of 21 laboratory blanks at concentrations slightly below reporting limits. Acetone concentrations were not high enough though to exceed acceptance criteria (observed concentration in samples less than 5 times the concentration in laboratory blanks). During the March 2003 sampling event, 12 laboratory blanks were analyzed. Acetone was detected in one laboratory blank at 0.11 ppbv. Prior to analyzing each

canister, surrogate compounds 1,2-dichloroethane d4, p-bromofluorobenzene, and toluene d8 were introduced into the analytical instrument inlet line to assess the accuracy of the analytical system. Acceptable recovery (88%-116%) was attained for all surrogate compounds in all samples.

Sub-slab gas sample concentrations were typically much higher than basement air samples. Fifty milliliters (ml) of air were withdrawn from each canister for preliminary analysis to determine if concentrations were within the calibration range. If so, 500 ml were withdrawn from canisters for a second round of analysis. Otherwise, a smaller volume of sample was withdrawn and diluted to ensure analysis within the calibration range. Analytical results were reported in units of $\mu\text{g}/\text{m}^3$ and ppbv. A conversion from ppbv to $\mu\text{g}/\text{m}^3$ can be obtained by use of the Ideal Gas Law:

$$C \left(\frac{\mu\text{g}}{\text{m}^3} \right) = \frac{M_v P}{1000 \mathfrak{R} T} C (\text{ppbv})$$

where M_v = molecular weight of VOC (g/mole), P = pressure (atm), T = temperature ($^{\circ}\text{K}$), and \mathfrak{R} = the ideal gas constant ($8.204\text{E-}05 \text{ atm m}^3/\text{K mole}$). For instance, 10 ppbv benzene ($M_v = 78 \text{ g/mole}$) is equivalent to $32 \mu\text{g}/\text{m}^3$ at a pressure of 1 atmosphere and a temperature of 298°K (25°C).

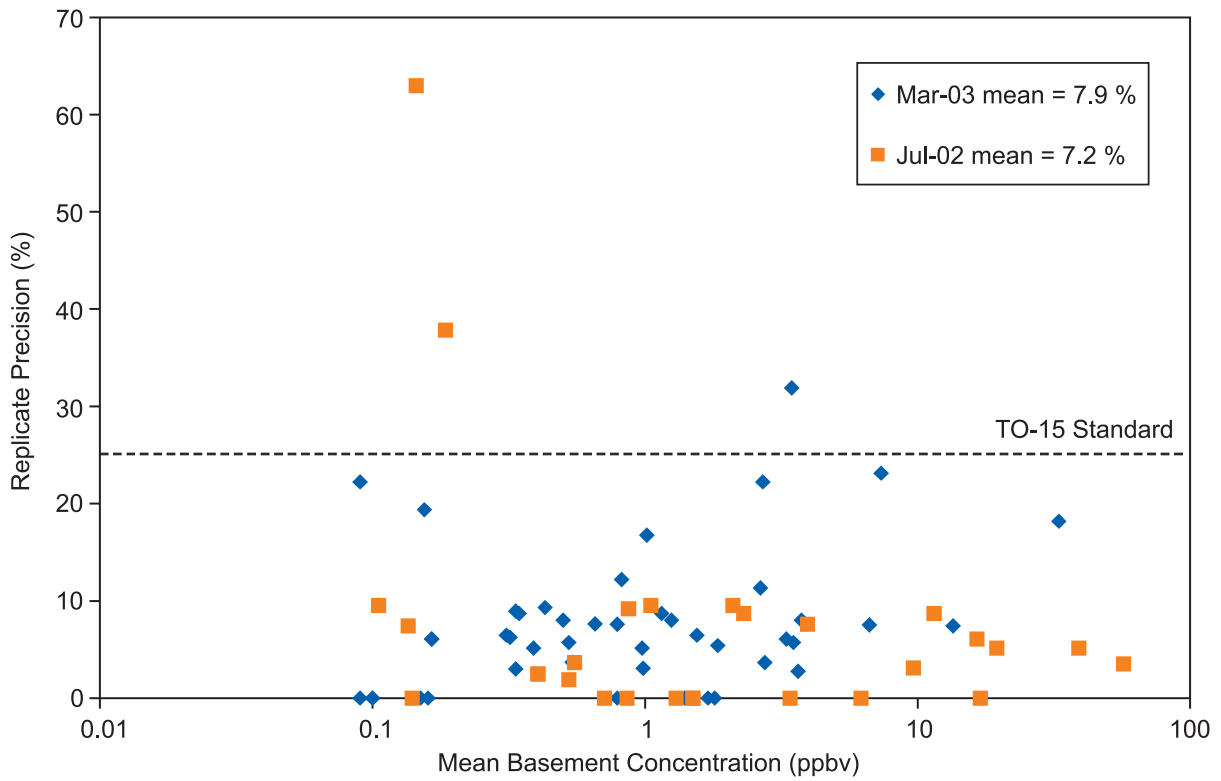

Figure 6. Replicate precision as a function of mean basement concentration for the July 2002 and March 2003 sampling events.

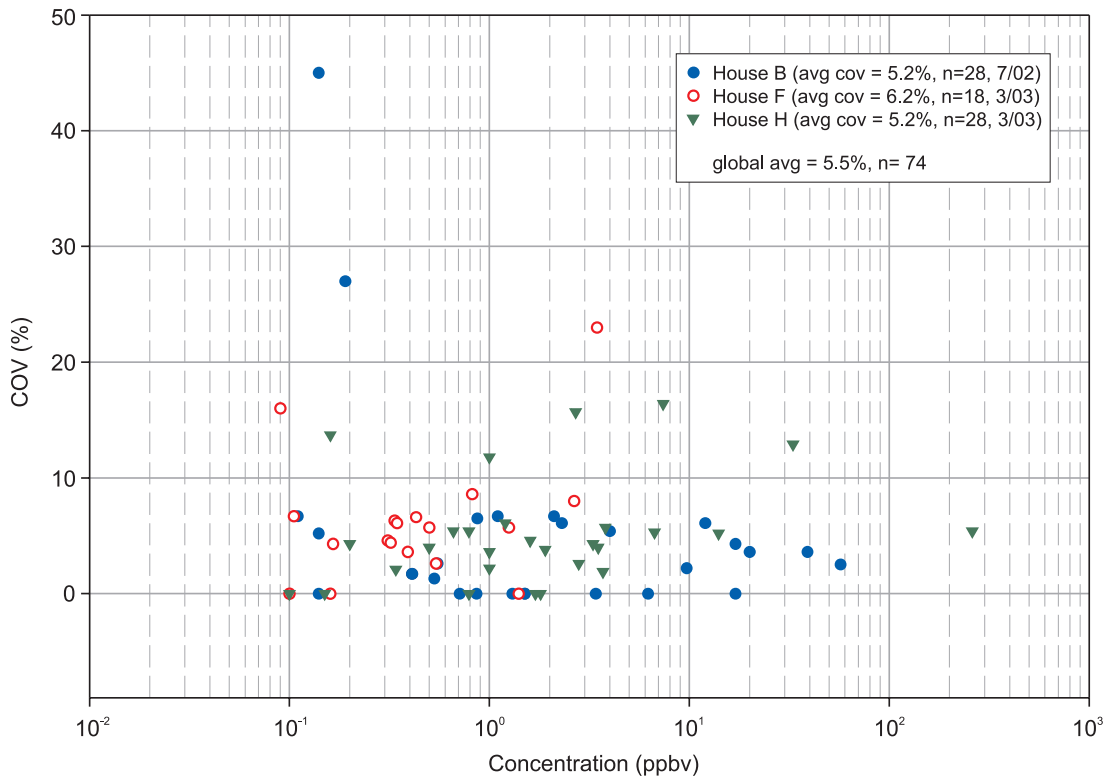

Figure 7. Coefficient of variation (COV) as a function of mean basement concentration for July 2002 and March 2003 sampling events.

3.2 Basement and Outdoor Air Sampling for VOCs

Building surveys were conducted prior to basement and sub-slab sampling. Surveys provide an opportunity to explain the purpose and rudimentary mechanics of indoor air and sub-slab air sampling to homeowners and to check buildings for household solvents which could potentially hinder a vapor intrusion investigation. A survey guide similar to that included in EPA's vapor intrusion guidance (USEPA, 2002) was used for each building.

Basement and outdoor air sampling was conducted prior to sub-slab sampling for VOCs. **Figure 8** illustrates a tripod used to collect a 24-hour outdoor air sample during the March 2003 sampling event.



Figure 8. Tripod and six-liter evacuated canister used to collect a 24-hour outdoor air sample during the March 2003 sampling event.

Each evacuated canister used for basement and outdoor air sampling was equipped with a flow controller and particulate filter. A particulate filter was attached to the high pressure inlet port of a flow controller. The low pressure outlet port of the flow controller was connected to a canister inlet port. Vacuum was measured in each canister prior to sampling. Air in each basement was sampled by placing a six-liter SilcoCan canister approximately 1 to 1.5 meters (3 to 5 feet) above the floor in a centrally located position. With the exception of closing basement doors and windows, no other precautions were taken to reduce air exchange in homes before or during sampling. During the July 2002 sample event, 5 basements were sampled at a flow rate of 73 to 80 ml/min over a 1-hour period. During the March 2003 sample event, 11 basements were sampled at a flow rate of 3.1 to 3.3 ml/min over a 24-hour period.

As illustrated in **Figure 5**, an Aalborg Electronic Mass Flow Meter (Model GFM-1700) was used during sampling of basement air to ensure that flow controllers maintained constant sample flow rates (± 1 ml/min). While not performed in this investigation, flow rate can also be estimated by periodically measuring vacuum in a canister through use of the Ideal Gas Law by:

$$\frac{\Delta V_{\text{STP}}}{\Delta t} = \frac{1}{\Delta t} \left(\frac{P_{\text{can}(2)}}{T_{\text{can}(2)}} - \frac{P_{\text{can}(1)}}{T_{\text{can}(1)}} \right) \frac{T_{\text{STP}} V_{\text{can}}}{P_{\text{STP}}}$$

where: ΔV_{STP} = change in standard volume of air in canister (L), Δt = change in time (min), T_{STP} and P_{STP} = standard temperature (273°K), and pressure (1 atm), V_{can} = volume of canister (L), $P_{\text{can}(1 \text{ or } 2)}$ = pressure (atm) in canister at time 1 or 2, and $T_{\text{can}(1 \text{ or } 2)}$ = temperature (°K) in canister at time 1 or 2. For instance, if absolute pressure in a canister is 0.1 atm and 293°K at time (1) and 0.2 atm and 298°K

at time (2) over a period of 60 minutes, then sample flow rate during this period is estimated at 0.008 standard liters per minute (SLPM) or 8 standard cubic centimeters per minute. At the cessation of sampling, pressure was measured to document the presence of residual vacuum. Mechanical flow controllers have difficulty maintaining constant flow near atmospheric pressure.

3.3 Quality Control Measures and Data Quality for Basement Sampling and Analysis for Radon

Radon was sampled in basement and sub-slab air to evaluate the feasibility of using radon as an indicator compound to assess vapor intrusion. In the absence of significant off-gassing of radon in a water supply or radon precursors in building materials, measurement of radon in sub-slab and indoor air may provide an indoor air/sub-slab air concentration ratio unaffected by source terms outside or inside a building. Radon gas has the potential to be widely utilized as an indicator compound during vapor intrusion investigations because it is present in virtually all sub-surface media, albeit at low concentrations in some areas of the United States.

Open-faced, activated charcoal canisters were used to measure basement radon gas concentrations during the March 2003 sample event in accordance with sampling procedures outlined in EPA 402-R-93-003 (USEPA, 1993). Cylindrical 1.5 cm diameter, 5 cm deep canisters containing Calgon-type 1193-coconut shell charcoal were supplied by AccuStar Labs in Medway, MA. Canisters were placed with the open side up 1.2 to 1.5 meters above a floor in a central location with unimpeded air flow and left undisturbed

for a period of 48 hours. EPA 402-R-93-003 requires placement of canisters a minimum distance of 75 cm from a floor, one meter from an exterior wall, and deployment for a minimum of 48 continuous hours. Property owners were advised to close windows and doors during sampling to minimize ventilation. At the cessation of sampling, canisters were closed with protective covers, resealed, and submitted to AccuStar Labs for analysis.

Compliance with EPA 402-R-93-003 requires attainment of a lower limit of detection (sensitivity) of 0.5 picoCuries per liter (pCi/L) for an exposure period of two to seven days and attainment of five primary quality assurance factors: (1) routine instrument checks, (2) calibration of canisters and equipment utilized to analyze canisters at least once every 12 months, (3) agreement within $\pm 25\%$ between known and measured concentrations at or above 4 pCi/L with a testing frequency of 3 per 100 samples submitted, (4) measurement of background concentration in field blanks with a testing frequency of at least 5% of canisters deployed, and (5) a coefficient of variation (COV) less than 10% for concentrations at or above 4 pCi/L for replicate (comparison of two canisters) analysis with a sampling frequency of at least 10% of samples collected. A detection limit of 0.4 pCi/L was attained in this study. As illustrated in **Figure 9**, the average COV was 10%, but a COV greater than 10% was observed for several samples at concentrations greater than 4 pCi/L.

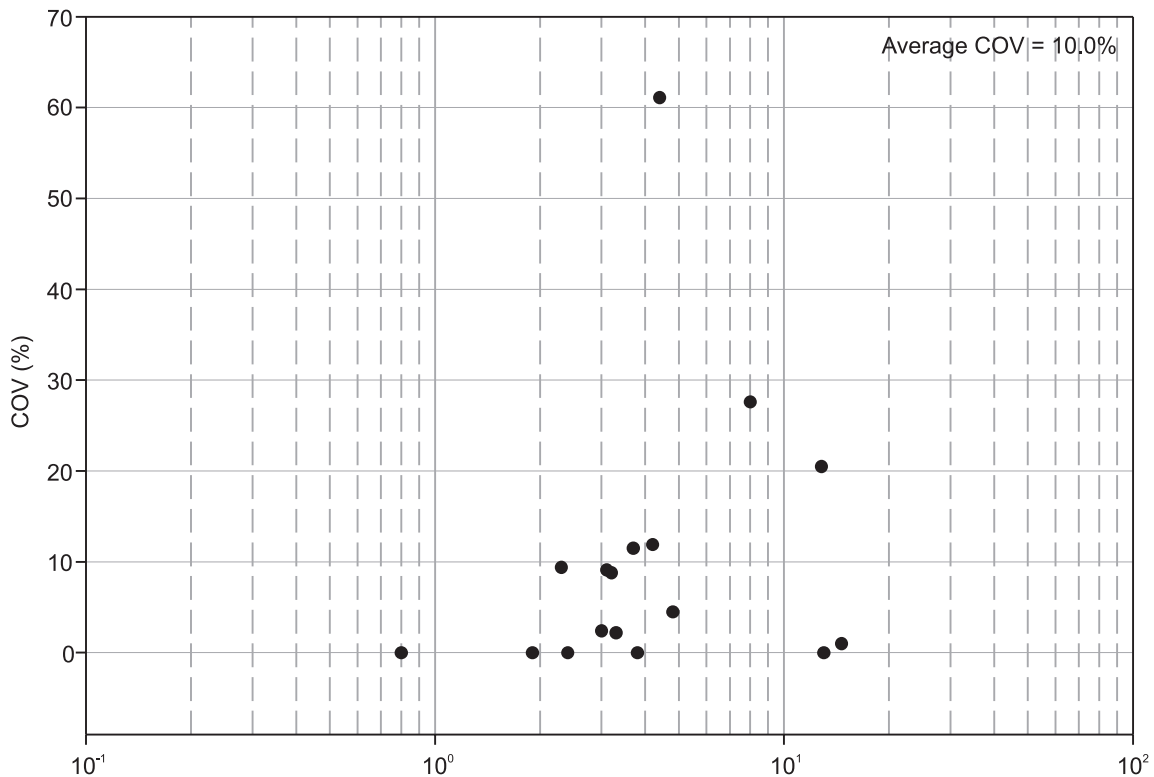

Figure 9. Coefficient of variation (COV) as a function of mean basement radon concentration.

3.4 Sub-Slab Probe Assembly and Installation

To minimize the potential for drilling through utility lines, local utility companies were contacted to mark off entry points of water, gas, electrical, and sewer lines outside each building. Utility companies, however, will not trace utility lines inside a building. During this investigation, it was often possible to see points of entry of gas, water, and sewer lines through basement walls and floors. At most homes, a sewer line entered a basement in a central location and could be traced outside a building by using utility company markings. Tracing utility lines inside a building with a slab on grade would have been considerably more difficult. In this case, a local plumber and electrician would have been contracted to provide recommendations on safe locations to drill.

Sub-slab vapor probes were installed several days prior to sampling. **Figure 10** illustrates general construction details of sub-slab vapor probes installed in concrete slabs. Sub-slab vapor probes were designed to lie flush on the upper surface of a slab to not interfere with daily building use and to “float” in a slab to enable gas sample collection from sub-slab material in direct contact with a slab or from an air pocket directly beneath a slab created by sub-slab material subsidence. Use of a screen was unnecessary because probes were not inserted directly into sub-slab material. Probes were assembled prior to drilling to minimize exposure time of sub-slab soils to an open hole.

As illustrated in **Figure 11**, sub-slab vapor probes were assembled from 5.08 cm (2”) long, 1/8” brass pipe nipples having inner and outer diameters of 0.64 cm (1/4”) and 0.95 cm (3/8”), respectively, and

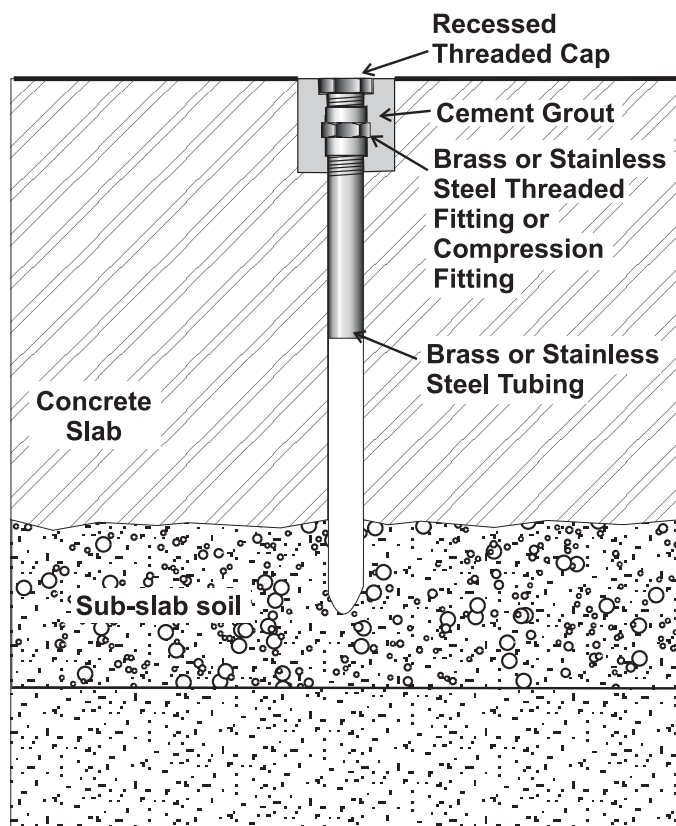

Figure 10. General schematic of a sub-slab vapor probe.

2.5 cm (1") long, 1.3 cm (1/2") outer diameter brass couplings. When slab thickness was less than 2.5 cm (1"), 0.64 cm (1/4") long stainless-steel hex bushings, as illustrated in **Figure 12**, were used in lieu of pipe nipples and couplings. Both probe types were closed by 0.32 cm (1/8") recessed brass socket plugs. To ensure that brass fittings were not a source of VOCs during sampling, one set of brass fittings was immersed in methanol for a 24-hour period. Gas chromatography/mass spectrometry (GC/MS) analysis was then conducted at EPA's ORD Laboratory in Ada, Oklahoma, on the methanol, and a sample of a lime-based cement was used to set the probes. No VOCs were detected in either material. To further assess the potential of brass fittings as a source of VOCs, a sample (grab) of outside air passing through

brass fittings was analyzed by EPA's New England Laboratory using EPA Method TO-15 and compared with a 1-hr time integrated sample of outside air collected the same day. As illustrated in **Figure 13**, VOC concentrations of air exiting the brass fittings were generally equivalent to outside air concentrations indicating again that probe construction materials were not a source of VOCs.



Figure 11. Brass materials used for sub-slab probe construction in homes near the Raymark facility.



Figure 12. Hex bushing used for probe construction when a concrete slab was less than 2.5 cm thick.

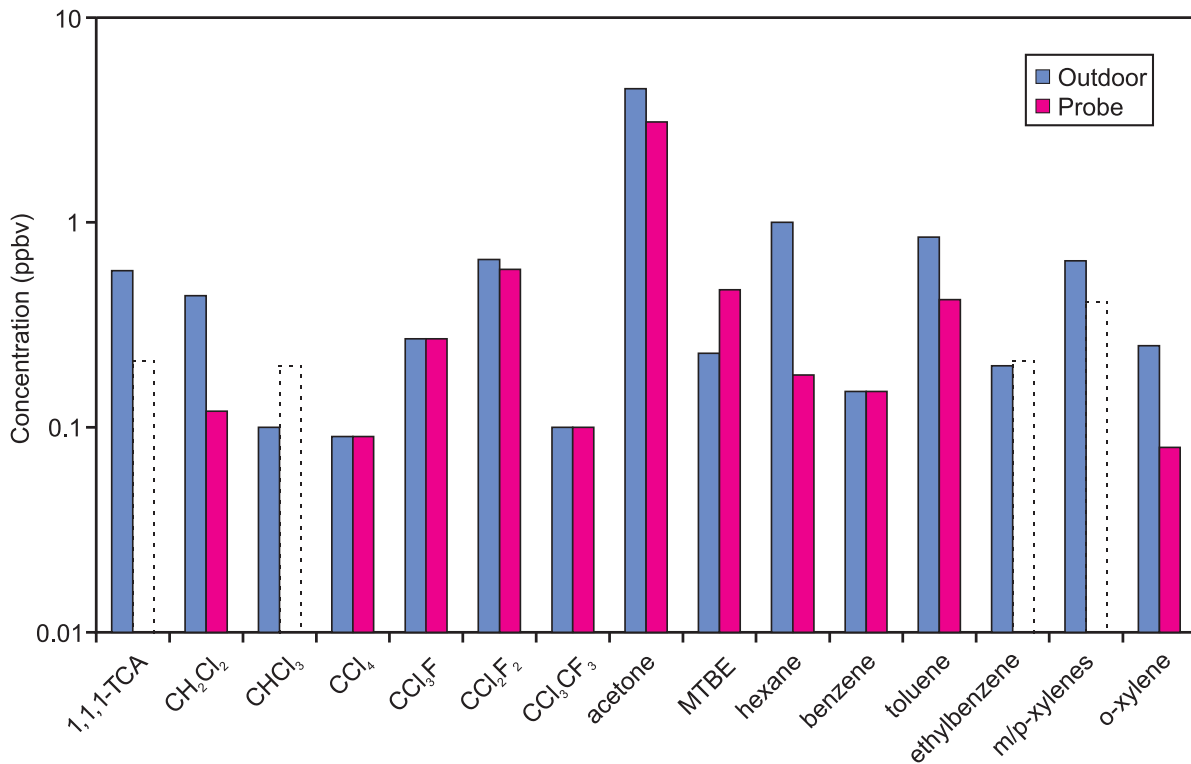

Figure 13. A comparison of VOC concentrations in outdoor air and outdoor air passing through brass fittings used for probe construction during the July 2022 sampling event. Dashed lines indicate detection limits.

Initial probe design emphasized the use of materials readily available at a typical hardware store. However, cutting oils are often used to machine brass nipples and couplings and thus require analytical testing as described here to ensure cleanliness. Sub-slab vapor probes at other sites are now assembled from 2.5 cm (1") long, 0.64 cm (1/4") OD x 0.46 cm (0.18") ID gas chromatography grade 316 stainless-steel tubing and 2.5 cm (1") long, 0.64 cm (1/4") OD x 0.32 cm (1/8") NPT Swagelok stainless-steel compression fittings. Use of gas chromatography grade stainless-steel materials minimizes potential VOC contamination due to probe assembly. The components of this probe design are illustrated in **Figure 14**.

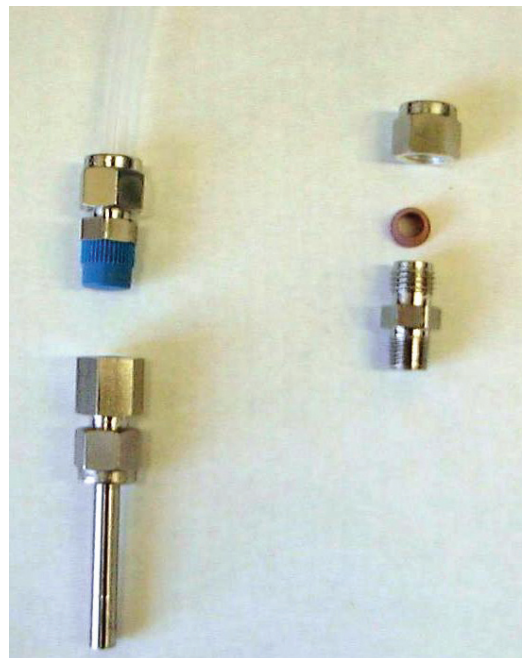

Figure 14. Stainless-steel materials now used for sub-slab probe assembly.

As illustrated in **Figure 15**, a Model 11224E Bosch 1.25-inch rotary hammer drill was used to create a 2.5 cm (1") "outer" diameter hole approximately 2.5 cm (1") into a slab. Initial depth of penetration was equivalent to the length of the brass couplings to ensure that the probes were flush with the upper surface of the slab. The inside of the outer hole was cleaned with a damp towel prior to creating a 0.95 cm (3/8") "inner" diameter hole through the remainder of the concrete. The drill bit was then allowed to penetrate an additional 5 cm (2") into sub-slab material (e.g., sand or sand and gravel) to create an open cavity to prevent potential obstruction of probes during sampling. The outer diameter hole was then cleaned once more with a damp towel to increase the potential of a good seal during cement application. Inner and outer holes are illustrated in **Figure 16**. Probe tubing was then inserted into the inner diameter hole allowing couplings or hex fittings to rest at the base of the outer diameter hole. A quick-drying, lime-based cement which expanded upon drying (to ensure a tight seal) was mixed with tap water to form a slurry and placed into the annular space between the probe and inside of the 2.5 cm (1") diameter hole using a small metal rod. Tap water was not analyzed for VOCs during our investigations. Tap water at these homes was chlorinated and likely contained trihalomethanes but not VOCs of concern in sub-surface media. Nevertheless, it would appear prudent in future investigations to use VOC-free water for cement application. The cement was allowed to cure for at least 24 hours prior to sampling. Using this procedure, 3 probes could be installed in less than 2 hours.



Figure 15. Drilling through a concrete slab using a rotary hammer drill.



Figure 16. "Inner" and "outer" holes drilled in a concrete slab.

Schematics illustrating the location of sub-slab probes and other slab penetrations (e.g., suction holes for sub-slab permeability testing), evacuated canisters for basement air sampling, and other investigative devices (e.g., permeation tubes for air exchange testing) were

prepared for each building. Schematics were used to document sample locations, interpret sub-slab sample results, and design corrective measures. **Figure 17** illustrates a typical schematic developed for each building.

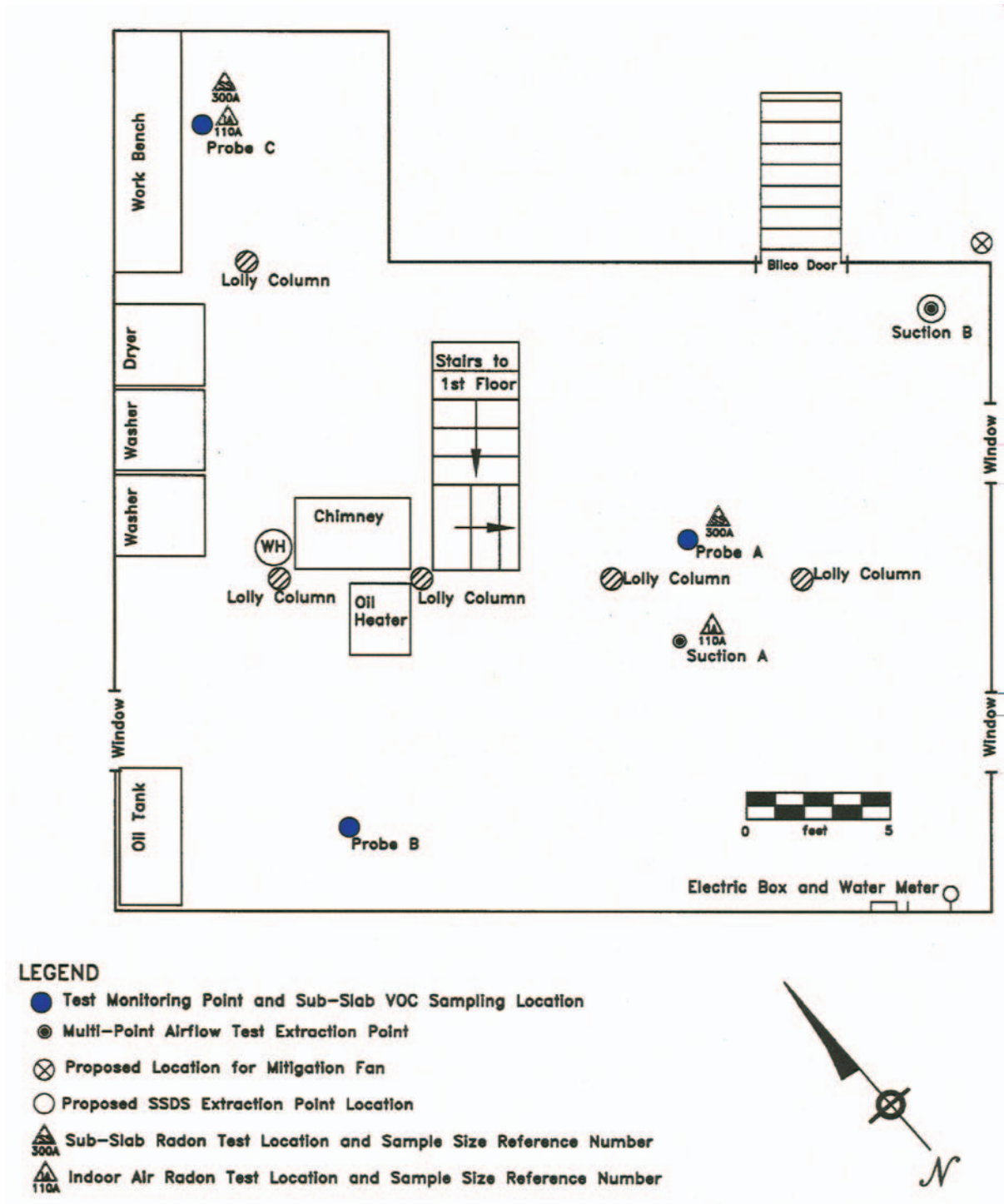

Figure 17. Typical schematic illustrating location of sub-slab vapor probes.

3.5 Sub-Slab Air Sample Collection for VOCs Using EPA Method TO-15

As illustrated in **Figure 18**, a brass NPT to Swagelok union fitting was used to connect vapor probes to a “T” fitting made of a stainless-steel flexible line and an in-line valve. A portable vacuum pump was used to purge vapor probes and sampling lines. Samples were collected by closing the in-line valve on the pump end of the “T” fitting and opening a valve for entry into a six-liter SilcoCan canister. A particulate filter was attached to the inlet port. Samples were collected by opening the canister valve and waiting until canister pressure approached atmospheric pressure (grab sampling). This took approximately two minutes. Time-integrated sub-slab sampling will be evaluated in future investigations.



Figure 18. Sample train for sub-slab air collection using EPA Method TO-15.

3.6 Quality Control Measures and Data Quality for Sub-Slab Air Sampling Using Tedlar Bags and On-Site GC Analysis

In addition to sample collection in evacuated canisters, sub-slab air samples were collected in 1-liter Tedlar bags. Tedlar bags were filled in about one minute resulting in an average flow rate of 1 SLPM. As illustrated in **Figure 19**, sub-slab vapor samples were collected from the vapor probes using a threaded (1/8”) brass or plastic nipple, a peristaltic pump, Tygon, and Masterflex tubing. All tubing was disposed of after sampling at each probe to avoid cross contamination. High purity FEP-lined polyethylene tubing could be used in lieu of Tygon tubing because it offers very low vapor and gas permeability, is non-photo reactive,

and is a low cost alternative to fluoropolymer tubing. Tedlar bags were stored in a cooler without ice to avoid condensation and analyzed for target VOCs (1,1,1-TCE, 1,1-DCE, TCE, c-1,2-DCE) by EPA’s New England Regional Laboratory within 24 hours of sample collection.

Unlike TO Methods, EPA does not have explicit quality assurance guidelines for on-site GC analysis. Thus, a site-specific quality assurance (QA) plan or standard operating procedure (SOP) for on-site GC analysis is critical to collecting defensible data. On-site GC analysis was conducted by EPA’s New England Regional Laboratory using their SOP (USEPA, 2002b). Hartman (2004) discusses the use of QA requirements in EPA Methods 8021 and 8260 (water analysis) for on-site vapor GC analysis.



Figure 19. Sample train for sub-slab air collection using one-liter Tedlar bags.

A brief review of EPA's New England Regional Laboratory SOP for on-site GC analysis is provided to document work here and to aid development of QA plans developed for other sites. Air samples from each Tedlar bag were injected into two portable GCs with results compared for consistency. The first GC was a Shimadzu 14A equipped with a 30 m, 0.53 mm megabore capillary column, a Photoionization Detector (PID), and an Electron Capture Detector (ECD). The second GC was a Photovac 10A10 equipped with a 1.2 m (4 ft), 0.32 cm (1/8") SE-30 column and a PID. A Hamilton 250 μ l steel barrel syringe with a 2 inch, 25-gauge needle was used to directly inject 200 μ l of sample into both GCs. Standards were prepared from readily available commercial methanol stock solutions and diluted in VOC-free water in Class A volumetric glassware to a concentration of 10 μ g/l. Standards were then immediately transferred from the volumetric glassware into 40 ml VOA vials and stored on ice. Prior to air sample analysis, 10 ml of standard was withdrawn from the 40 ml VOA vial to create a headspace above the liquid standard. After a period of equilibrium in an ice bath (0 – 1°C), field GCs were calibrated for target compounds using the

headspace above the 10 μ g/l standard. This proved to be a simple, quick, dependable, and inexpensive method for calibration.

Figure 20 presents a comparison of SilcoCan canister and TO-15 analysis with Tedlar bag sampling with on-site GC analysis for 1,1,1-TCA, 1,1-DCE, TCE, and c-1,2-DCE analysis ($n = 91$, $r^2 = 0.88$). There is no systematic bias in the data set (i.e., Tedlar bag analysis consistently lower or higher than TO-15 analysis). Four out of five of the outliers were associated with sampling one probe during one sample event. The regression coefficient increased to 0.95 when these four points were omitted. In general, there was good agreement between Tedlar bag sampling with on-site GC analysis and EPA Method TO-15.

Tedlar bag sampling and on-site analysis provided near real-time data compared to EPA Method TO-15. However, this method provided analysis for a limited number of compounds with higher detection limits. Detection limits for on-site analysis were 2 – 5 ppbv compared to 0.1 – 0.5 ppbv for EPA Method TO-15.

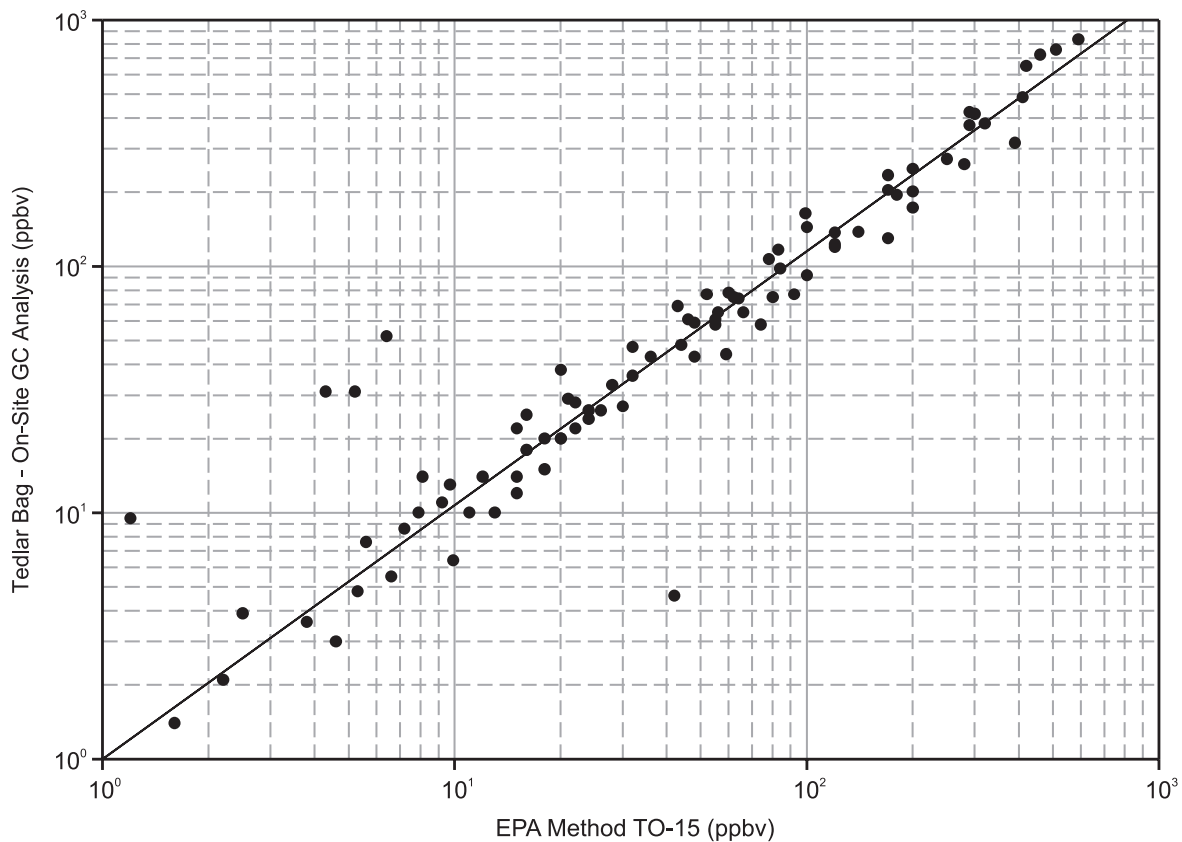

Figure 20. Comparison of EPA Method TO-15 Tedlar bag sampling with on-site GC analysis for 1,1,1-TCA, 1,1-DCE, TCE, and c-1,2-DCE analysis, $n = 91$, $r^2 = 0.88$.

3.7 Quality Control Measures and Data Quality for Sub-Slab Air Sampling for Radon Using Scintillation Cells

Scintillation cells are air-tight metal cylinders lined with activated silver zinc sulfide ZnS(Ag). They have a transparent window at one end for scintillation counting and connectors at the other end for sample intake or flow through. When an alpha particle from the radioactive decay of radon isotopes Rn-222, Rn-220, and Rn-219 strikes the lining of a scintillation cell, the alpha particle becomes a helium atom, and the sulfide de-excites by emitting photons or light pulses. The transparent window and a radiation monitor equipped with a photomultiplier tube are used to amplify and count light pulses.

Scintillation cells used for this investigation were originally purchased from the Pylon Electronic Development Company. Pylon Models 110A and 300A scintillation cells have internal volumes of 151 ± 3 and 270 ± 3 ml, respectively. The larger internal volume of Model 300A allows greater sensitivity compared to Model 110A. The scintillation cells were equipped with two gas-tight Swagelok connectors allowing continuous monitoring (flow through) or grab sampling (vacuum collection or disconnection after a period of flow through or purging).

The sub-slab sampling train is illustrated in **Figure 21**. A threaded (1/8") barbed nipple was used to attach Tygon tubing to a sub-slab probe. Plastic barbed fittings were used to connect Tygon to Masterflex tubing used

by a peristaltic pump to create vacuum in a probe for sample collection. A particulate filter was placed on the inlet side of a scintillation cell. Quick-connect assemblies were used for connection of Tygon tubing to Pylon cells. A flow meter was placed on the outlet side of a scintillation cell to ensure a flow rate of approximately 1 SLPM. The outlet end of the flow meter was vented outside. Purging ceased when 10 cell volumes were exchanged in each cell.



Figure 21. Sample train for sub-slab air collection for radon using scintillation cells.

Samples were analyzed by the MA Department of Public Health (Mr. William Bell) within four hours as recommended in EPA 402-R-93-003. A Pylon AB-5 portable radiation monitor was used to amplify and count light pulses. Counts per minute were determined by recording total counts over six 10 minute measurement intervals and dividing by total counting time. The relationship between the number of light pulses counted per time and the concentration of radon gas in a cell is outlined in EPA 402-R-93-003

$$C_{Rn} = \frac{\text{cpm}(s) - \text{cpm}(bkg)C}{(3)(2.22)(E)(V)(A)}$$

where: C_{Rn} = concentration of radon gas (pCi/l), $\text{cpm}(s)$ = counts per minute for the scintillation cell after sample collection, $\text{cpm}(bkg)$ = counts per minute in the scintillation cell prior to sample collection (background count), C = a correction factor for radon decay during the counting interval provided in EPA (1993), 3 = total number of alpha particle emitters, 2.22 = a conversion factor relating disintegrations per minute (dpm) to pCi,

E = counting efficiency (cpm/dpm), V = volume of the scintillation cell (liters), and A = a correction factor for radon decay between sample collection and start of measurement provided in EPA (1993). Certificates of calibration for counting efficiencies for scintillation cells used in this study were included with analytical results. Knowledge of counting efficiency is necessary because not all alpha particle impacts on the activated zinc sulfide lining result in detection of light pulses.

EPA 402-R-93-003 requires: (1) a lower limit of detection of 1.0 pCi/L or less, (2) collection of replicates at 10% of sample load with attainment of a coefficient of variation of 10% or less at concentrations 4 pCi/L or greater, (3) use of field blanks kept sealed in a low radon (less than 0.2 pCi/L) environment, and analyzed in the same manner as other samples at 5% of sample load, and (4) calibration of cells at least once every 12 months.

4.0 Methods and Materials Used for Air Permeability Testing and Sub-Slab Air Flow Analysis

Air permeability testing was conducted in sub-slab media to support design of corrective action (sub-slab depressurization) and airflow simulations used to evaluate infiltration of basement air into sub-slab media during sampling. A Bosch 1.25-inch capacity hammer drill (Model 11224E) was used to drill a 5.08 cm (2") diameter hole 2.5 cm (1") through a slab for installation of suction points. A 2.5 cm (1") diameter drill bit was then advanced through the remainder of a slab and 7 to 8 cm (3") into sub-slab material to create an open cavity for air extraction. Sub-slab material consisted of coarse sand and gravel similar to native deposits. Suction points were assembled from 5.1 cm (2") long threaded brass pipe having inner and outer diameters of 1.9 cm (3/4") and 2.5 cm (1") respectively and 3.2 cm (1 1/4") outer diameter brass couplings. The length of the threaded pipe used was determined by the thickness of the concrete slab. Couplings were installed without threaded pipe when the slab was less than 7 to 8 cm (3") thick. All suction points were completed flush with the top of the concrete slab with recessed brass plugs so as not interfere with day-to-day use of the basements.

As illustrated in **Figure 22**, a small regenerative blower was used to extract air from sub-slab material. A variable-area flowmeter illustrated in **Figure 23** was used to measure flow rate. As illustrated in **Figure 24**, air pressure was measured with magnehelic gauges. A digital manometer ($\pm 1.0\%$ of range accuracy) was also used for pressure measurement.



Figure 22. Regenerative blower used for air permeability testing.



Figure 23. Variable-area flowmeter used for air permeability testing.



Figure 24. Magnehelic gauges and suction hole used for vacuum measurement.

Radial and vertical air permeability of sub-slab media was estimated using Baehr and Joss's (1995) analytical solution for two-dimensional, axisymmetric, steady-state gas flow in a semi-confined domain.

$$\phi(r, z) = P_{atm}^2 + K \left\{ \sum_{n=1}^{\infty} A_n \cos(q_n[b-z]/b) K_0\left(\frac{q_n r}{ab}\right) \right\}$$

where

$$K = \frac{2abhQ_m\mu_g\mathfrak{R}T}{\pi k_r\omega(l-d)r_w} \quad a = (k_r/k_z)^{1/2} \quad h = \frac{b\ell}{k_z}$$

$$A_n = \frac{\sin(q_n[(b-d)/b]) - \sin(q_n(b-l)/b)}{q_n^2 K_1(q_n r_w/ab)(h + \sin^2 q_n)}$$

and ϕ = pressure squared in sub-slab media (g/cm-s^2)², P_{atm}^2 = pressure squared in air above slab (atmospheric pressure) (g/cm-s^2)², z = depth below bottom of slab (cm), r = radial distance from cavity created in sub-slab media (cm), b = depth below bottom of slab to an impermeable boundary (ground water) (cm), d = distance from bottom of slab and top of cavity in sub-slab media ($d = 0$), l = distance from bottom of slab to bottom of cavity created in sub-slab media (cm), k_z = vertical air permeability of sub-slab media (cm^2), k_r = radial air permeability of sub-slab media (cm^2), μ_g = dynamic viscosity of air (g/cm s), ω = average molecular weight of air (g/mole), Q_m = mass flow of air (g/s), \mathfrak{R} = Ideal Gas Constant ($8.314\text{E}+07 \text{ g-cm}^2/\text{s}^2\text{-mole}^\circ\text{K}$), T = temperature ($^\circ\text{K}$), K_0 = zero-order modified Bessel function of the second kind, K_1 = first-order modified Bessel function of the second kind, and q_n = positive solutions ($n = 1, 2, 3, \dots$) to $\tan(q_n) = h/q_n$. As $h \rightarrow 0$, the roots of the transcendental equation $\tan(q_n) = h/q_n$ become $(2n-1)\pi/2$. Leakance or ℓ is used to represent flux into the simulated domain (sub-slab material) expressed by:

$$k_z \frac{\partial \phi}{\partial z} = \ell (\phi - P_{atm}^2).$$

Baehr and Joss (1995) represent ℓ as the vertical permeability of a semi-confining boundary layer divided by the thickness of the boundary layer. Given the potential of sub-slab material subsidence, ℓ can be taken in this application to represent a term used in describing lateral air flow beneath a slab but above sub-slab material and vertical air flow through cracks in a slab. Air flow through cracks is not explicitly simulated in this model. Also, the vertical permeability of slab material is not estimated in this application.

Parameter estimation involves finding values of k_r , k_z , and ℓ that minimize the difference between observed versus simulated data for pressure or the root mean squared error (RMSE) defined as:

$$RMSE = \sqrt{\frac{\sum_{i=1}^N (P(r_i, z_i) - \hat{P}(r_i, z_i))^2}{n}}$$

where P is observed pressure and \hat{P} is modeled pressure. When there are few pressure measurements (some of which are of minimum usefulness because of near atmospheric pressure response), non-uniqueness in parameter estimation and convergence to a local but not global minimum RMSE can occur. That is, a similar pressure distribution in a domain can be simulated using various parameter inputs. To address this issue, 5000 random initial guesses were applied for k_r , k_z , and ℓ to determine a lowest RMSE. This process was repeated with decreasing intervals of k_r , k_z , and ℓ until the same or similar RMSE values were obtained. A FORTRAN program, MFRLKINV (USEPA, 2001), was used to facilitate computations.

Figure 25 illustrates the best five fits of k_r , k_r/k_z , and ℓ for an air permeability test at House C consisting of four observation points conducted at

a flow rate of 255 SLPM. Estimation of k_r/k_z was constrained between 1 and 2 because sand and gravel typically exhibit k_r/k_z values within this range (USEPA, 2001 - Section 5). Unconstrained estimation of k_r/k_z resulted in greater variation in ℓ to provide comparable fits to the observation points. When pressure measurement of the closest observation point was eliminated from consideration during parameter estimation, estimates of k_r varied from 10^{-10} cm² to 10^{-7} cm². This demonstrates the need to locate one or more pressure monitoring points or sub-slab probes fairly close (e.g., one meter) to the source of vacuum during sub-slab air permeability testing.

Estimates of k_r , k_z , and ℓ were then used for air flow simulations. Radial volumetric specific discharge (q_r) and pore-air velocity (v_r) (cm/s) are defined as:

$$q_r = -\frac{1}{2\sqrt{\phi}} \frac{k_r}{\mu_g} \frac{\partial \phi}{\partial r} \quad v_r = \frac{q_r}{\theta_a}$$

where θ_a = volumetric air content and

$$\frac{\partial \phi}{\partial r} = -\frac{K}{ab} \left\{ \sum_{n=1}^{\infty} q_n A_n \cos [q_n (b-z)/b] K_1 \left(\frac{q_n r}{ab} \right) \right\}.$$

Vertical volumetric specific discharge (q_z) and pore-air velocity v_z (cm/s) are defined as:

$$q_z = -\frac{1}{2\sqrt{\phi}} \frac{k_z}{\mu_g} \frac{\partial \phi}{\partial z} \quad v_z = \frac{q_z}{\theta_a}$$

where

$$\frac{\partial \phi}{\partial z} = \frac{K}{b} \left\{ \sum_{n=1}^{\infty} q_n A_n \sin [q_n (b-z)/b] K_0 \left(\frac{q_n r}{ab} \right) \right\}.$$

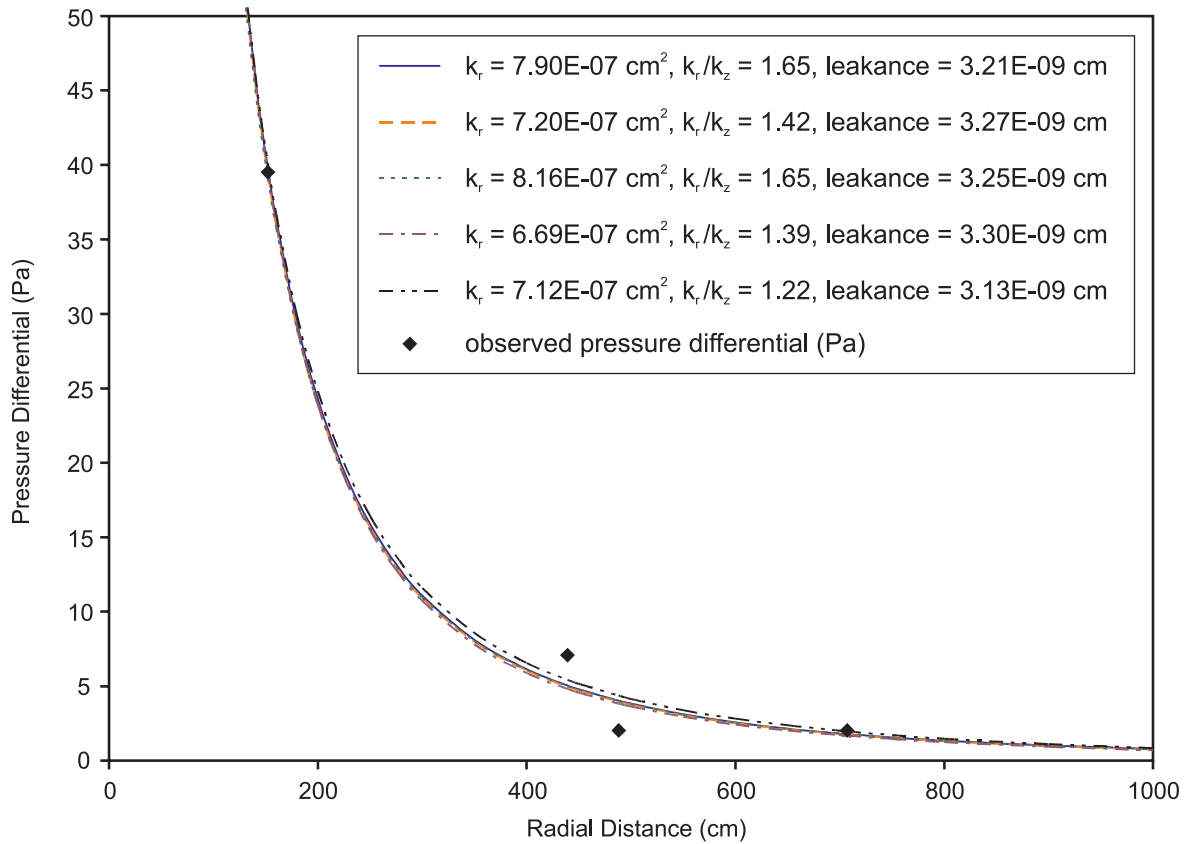

Figure 25. Best fit model results for permeability test conducted at House C with four observation points and a flow rate of 255 SLPM (k_r/k_z constrained between 1 – 2).

For analysis of air flow during sampling, the norm of the radial and vertical pore-air velocity vector (v) (cm/s) is calculated by:

$$v = \sqrt{v_r^2 + v_z^2} .$$

The stream function, $\psi(r,z)$, for axisymmetric flow with anisotropy may be written as:

$$\frac{\partial \psi}{\partial z} = ar \frac{\partial \phi}{\partial r} \quad \frac{\partial \psi}{\partial r} = -\frac{r}{a} \frac{\partial \phi}{\partial z} .$$

Solving for $\psi(r,z)$ yields:

$$\psi(r,z) = Kr \left\{ \sum_{n=1}^{\infty} q_n A_n \sin \left[q_n (b-z)/b \right] K_1 \left(\frac{q_n r}{ab} \right) \right\} .$$

The path of an air particle in a flow field at location (r_0, z_0) at time zero was solved by the following set of ordinary differential equations:

$$\frac{dr}{dt} = v_r = \frac{q_r}{\theta_a} \quad \frac{dz}{dt} = v_z = \frac{q_z}{\theta_a}$$

and the algorithm:

$$r_{i+1}^* = r_i + v_r(r_i, z_i) \Delta t$$

$$z_{i+1}^* = z_i + v_z(r_i, z_i) \Delta t$$

$$r_{i+1} = r_i + \frac{1}{2} \left[v_r(r_i, z_i) + v_r(r_{i+1}^*, z_{i+1}^*) \right] \Delta t$$

$$z_{i+1} = z_i + \frac{1}{2} \left[v_z(r_i, z_i) + v_z(r_{i+1}^*, z_{i+1}^*) \right] \Delta t$$

where $i = 0, 1, \dots, N$. The particle tracking terminates when the particle reaches the probe. Total travel time = $N \Delta t$. The equations were solved numerically using a second-order Runge-Kutta method. A FORTRAN program, SAIRFLOW, (USEPA, 2001) was used to facilitate computation of $P(r,z)$, v_r , v_z , v , $\psi(r,z)$, and travel time to a vapor probe.

5.0 Discussion of Sampling Issues Associated with Sub-Slab Air Sampling

5.1 Assessment of Infiltration of Basement Air During Air Extraction

Generally, sub-slab air samples were collected by first purging two liters of air from probes at a flow rate of 1 SLPM, then collecting a sample into a one liter Tedlar bag at a flow of 1 SLPM, followed by purging one liter again at a flow rate of 1 SLPM, then finally collecting a five-liter sample into a six-liter evacuated canister over a period of approximately one minute.

If during sub-slab sampling, basement or indoor air enters openings in a slab (e.g., cracks, utility entry locations) and is collected into a sampling vessel, then measured sub-slab concentrations should decrease for VOCs having sub-slab concentrations higher than basement air. The opposite effect should occur for VOCs having sub-slab concentrations lower than basement air. One way to directly evaluate infiltration of basement or indoor air into a sampling vessel during air extraction is to collect a series of sequential samples and measure vapor concentration as a function of extraction volume. Constant concentration in sequential samples would indicate the absence of significant infiltration of basement air during the extraction period. A reduction in concentration during air extraction could indicate significant infiltration during extraction or reduced sub-slab air concentration away from the probe (spatial variability). An increase in concentration during air extraction could indicate

increased concentration away from the probe (spatial variability).

Sub-slab samples were collected sequentially in a probe at three homes (L, M, and N) in five 1-liter Tedlar bags at a flow rate of 1 SLPM and analyzed on site by GC analysis. Results of sampling at each location are summarized numerically in **Tables 14b, 15b, and 16c** (see pages 81, 84 and 88) and graphically in **Figures 26a, 26b, and 26c**. At each location, extraction of 5 liters at a flow rate of 1 SLPM had little effect on sample concentration indicating a lack of significant infiltration. Concrete slabs at these three buildings consisted of approximately 2-4" of relatively intact concrete (few cracks). A comparison of replicate canister samples was also used to assess the effect of extraction volume. After Tedlar bag sampling, a canister sample represented an extraction volume of 5 to 9 liters. A replicate canister sample represented an extraction volume of 10 to 14 liters. Results of sampling are summarized numerically in **Tables 12a and 15a** (see pages 74 and 83) and graphically in **Figures 27a and 27b**. Sampling at Probe A in House J indicated little difference in sample results. Sampling at Probe A in House M revealed a slight decrease in vapor concentration as a function of extraction volume for most VOCs. Thus, replicate sampling in canisters indicated little or no effect in sample concentration due to air extraction.

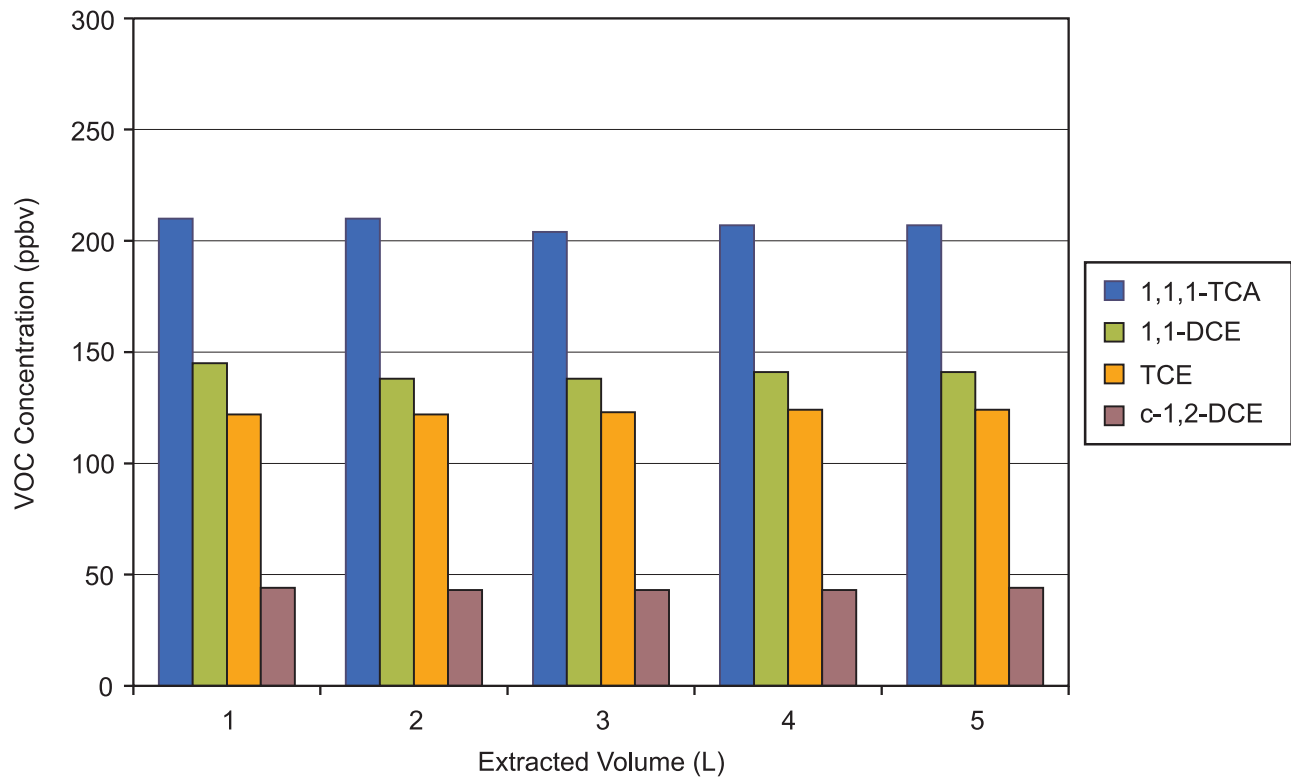

Figure 26a. Sub-slab vapor concentration as a function of extraction volume at Probe A in House L using Tedlar bag sampling and on-site GC analysis.

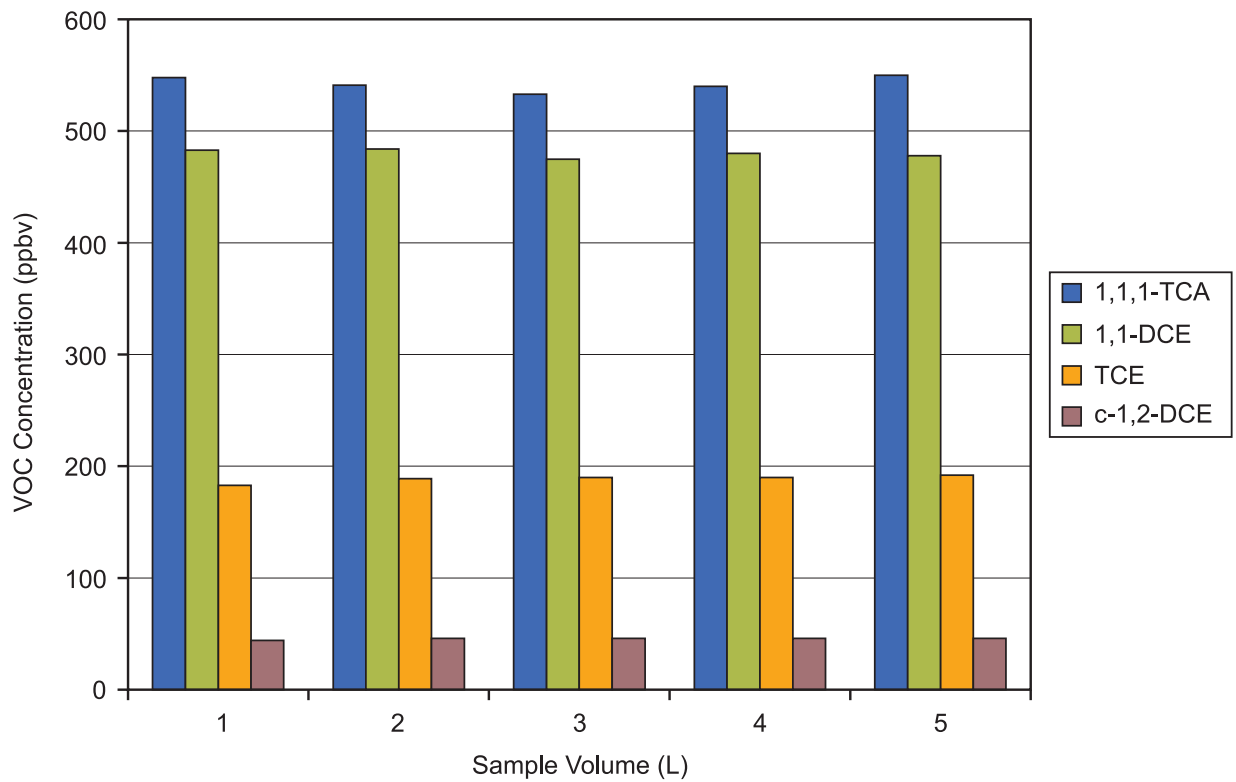

Figure 26b. Sub-slab vapor concentration as a function of extraction volume at Probe B in House M using Tedlar bag sampling and on-site GC analysis.

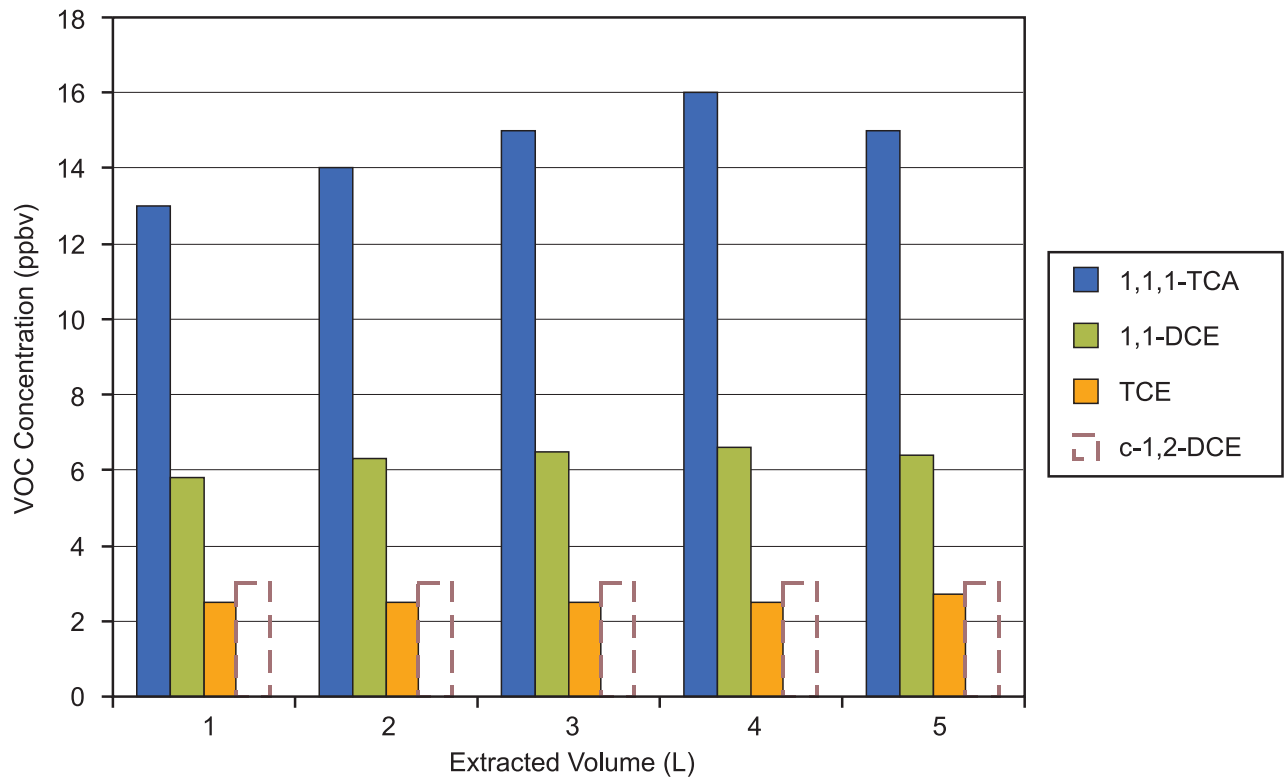

Figure 26c. Sub-slab vapor concentration as a function of extraction volume at Probe A in House N using Tedlar bag sampling and on-site GC analysis. Dashed lines denote detection limit.

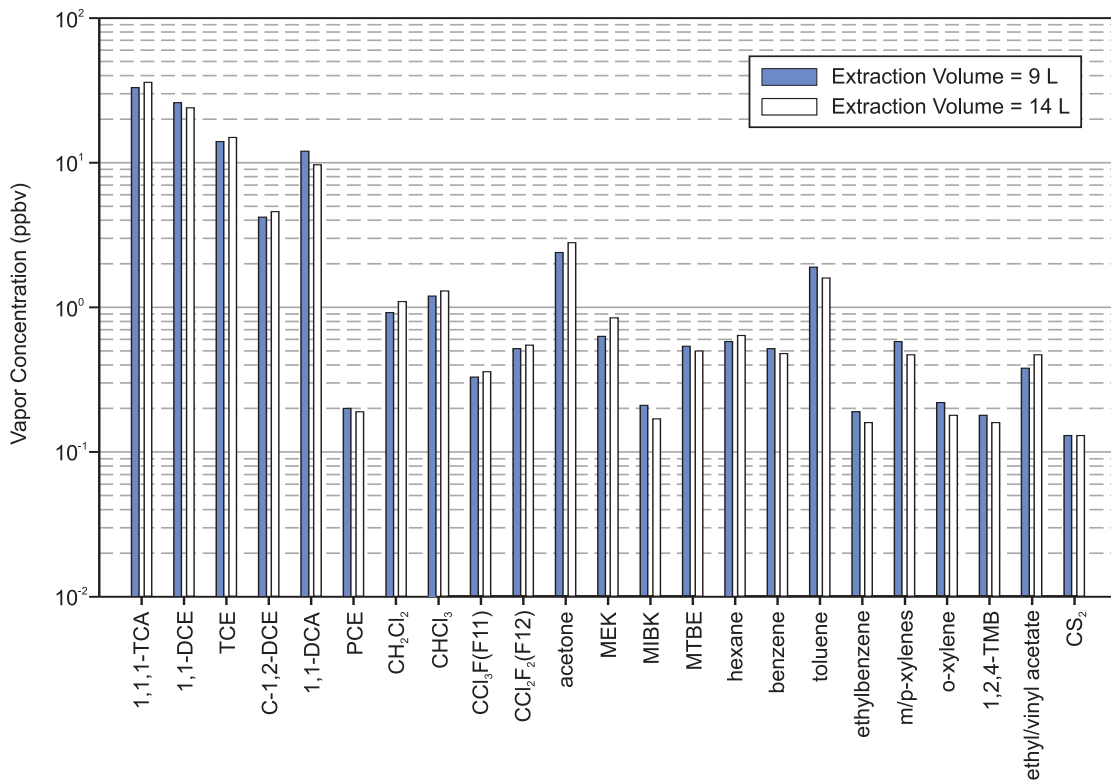

Figure 27a. Sub-slab vapor concentration as a function of extraction volume at Probe A in House J using EPA Method TO-15.

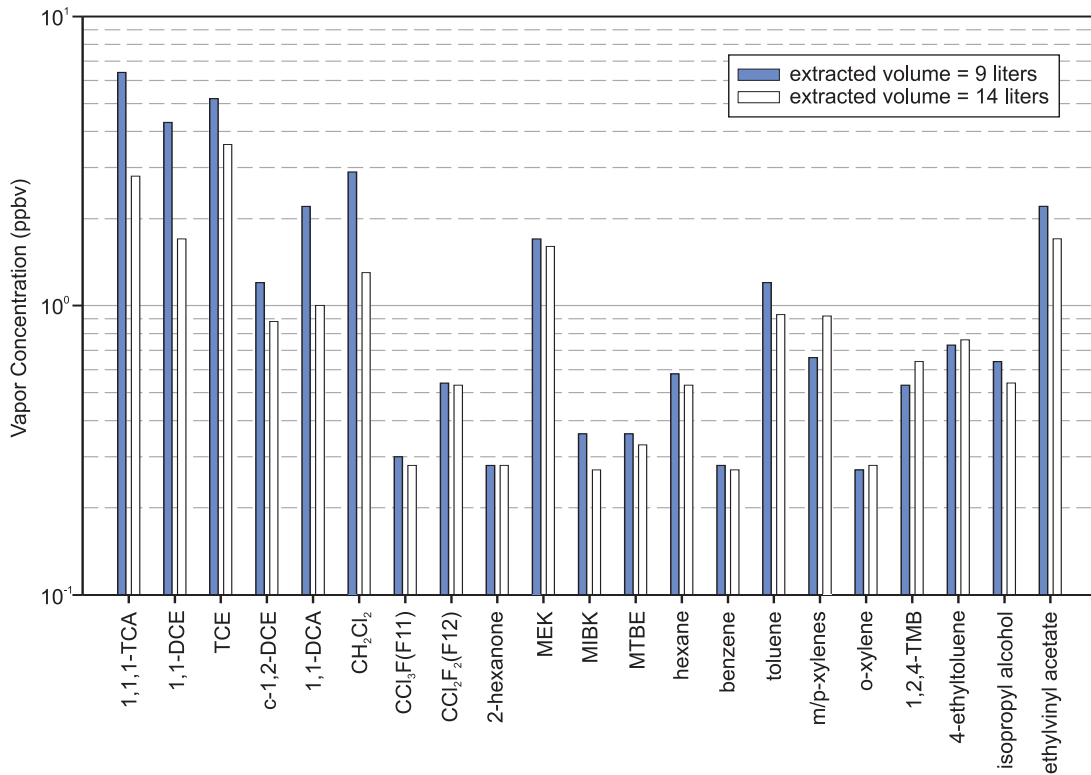

Figure 27b. Sub-slab vapor concentration as a function of extraction volume at Probe A in House M using EPA Method TO-15.

A second direct method to evaluate infiltration of indoor air into sub-slab media during extraction is to compare basement and sub-slab concentrations of VOCs known not to be associated with subsurface contamination. Statistical testing to distinguish VOCs associated with vapor intrusion from other VOCs detected in indoor air is discussed in section 6.0. A simple mass-balance equation:

$$C_{meas} = \frac{C_{ss}Q_{ss} + C_{indoor}Q_{leak}}{Q_{leak} + Q_{ss}}$$

is used to express a measured sub-slab vapor concentration (C_{meas}) as a function of “true” sub-slab concentration (C_{ss}) and indoor air concentration (C_{indoor}) where Q_{leak} = flow rate of air through cracks or other openings in the slab and Q_{ss} = sub-slab air flow to a vapor probe. If infiltration of indoor air into sub-slab

media can be expressed as:

$$I = \frac{Q_{leak}}{Q_{ss} + Q_{leak}}$$

then

$$1 - I = \frac{Q_{ss}}{Q_{ss} + Q_{leak}}$$

and

$$I = \frac{C_{meas} - C_{ss}}{C_{indoor} - C_{ss}}$$

The assumption that C_{meas} is due entirely to infiltration of indoor air into sub-slab media ($C_{ss} = 0$) leads to computation of a maximum value of I for each VOC detected in indoor air and not associated with vapor intrusion. The lowest value of I can then be

selected to represent maximum infiltration during air extraction. For instance, 1,4-dichlorobenzene (not a VOC associated with sub-surface contamination) was detected in basement air at House H at 36 ppbv but was not detected in a sub-slab probe (detection limit 0.086 ppbv). Thus, less than 0.24% of sampled air originated from above the slab. This method provides reasonable results ($I < 100\%$) only if the ratio $C_{\text{indoor}}/C_{\text{meas}}$ is greater than 1. **Table 1** summarizes maximum infiltration of indoor air during air extraction at each probe. When the sensitivity of the test was

Table 1. Computation of Maximum Percent Infiltration of Basement Air into an Evacuated Canister During Sampling as a Function of Extraction Volume, Location, and Probe. P[A], P[B], P[C], P[D], and P[E] Denote Probes Evaluated at Individual Locations

Location	Extraction Volume (L)	P[A] (%)	P[B] (%)	P[C] (%)	P[D] (%)	P[E] (%)
A	9	< 42	< 9.0	IND		
B	9	< 2.1	< 6.7	< 0.35		
C	9	IND	IND	IND	IND	
D	9	< 27	< 27	NA		
E	9	< 12	< 19	< 39		
F	9	< 8.6	NA	< 22	NA	
G	9	< 0.60	NA	< 0.60	NA	NA
H	9	ND	< 0.24	< 0.33	NA	
I	9	< 7.5	NA	NA		
J	14	< 3.0	NA	NA	NA	
K	NA	NA	NA	NA		
L	9	NA	< 2.7	NA		
M	14	< 78	NA	NA		
N	9	NA	< 4.4	< 24		
O	9	< 0.42	NA	< 0.63		
P	9	NA	< 1.3	< 1.4	NA	
NA = not analyzed		IND=indeterminate				

satisfactory (e.g., sensitivity < 1%), infiltration during sampling was evidently very low. Use of this method however, requires detection of elevated levels of VOCs not associated with sub-surface contamination in indoor air and low levels or low detection limits for these compounds in sub-slab air. Sensitivity could be increased by enclosing an area around a probe with a chamber during air extraction and injecting a

tracer over a specified period of time. Infiltration then could be estimated by:

$$I = \frac{C_{\text{meas}}}{C_{\text{tracer}}} \cdot \frac{t_{\text{tracer}}}{t_{\text{sample}}}$$

where C_{tracer} = tracer concentration within the chamber, t_{sample} is total sampling time, and t_{tracer} is time of tracer application. Tracer concentration would have to be held constant during the tracer application period. Also, flow analysis would have to be conducted to estimate the potential area of infiltration during testing. If a pure phase solvent is exposed to air within a chamber surrounding a sub-slab probe and equilibration within the chamber is assumed, C_{tracer} could be estimated in units of $\mu\text{g}/\text{m}^3$ using the solvent's saturated vapor concentration (C_v^{sat})

$$C_v^{\text{sat}} = 10^6 \frac{P_v M_v}{\Re T}$$

or in units of ppbv by

$$C_v^{\text{sat}} = 10^9 \frac{P_v}{P}$$

where P_v = vapor pressure (atm), and M_v , T , P , and \Re are as previously defined. For instance, the saturated vapor concentration of isopropanol, which has a vapor pressure of 0.058 atm at 25°C and a molecular weight of 60.1 g/mole, is $1.43\text{E}+08 \mu\text{g}/\text{m}^3$ or $5.80\text{E}+07$ ppbv at a pressure of 1 atmosphere. If a pure phase solvent is used as a tracer for infiltration testing, it would be prudent to minimize $t_{\text{tracer}}/t_{\text{sample}}$ because detection of a solvent at a high concentration could result in high detection limits for other VOCs of interest. For instance, if $I = 0.01$ or 1%, and $t_{\text{tracer}}/t_{\text{sample}} = 1$, then isopropanol would be present in a sampling canister at a concentration of $1.43\text{E}+06 \mu\text{g}/\text{m}^3$ which would likely preclude detection of other VOCs of

interest. The ratio $t_{\text{tracer}}/t_{\text{sample}}$ would have to be reduced to 0.001 (e.g., sample time of 10,000s, tracer time of 10s) to observe a concentration of $1.43\text{E}+03 \mu\text{g}/\text{m}^3$ in the canister.

A third, but indirect, method of evaluating infiltration of indoor air during air extraction is to simulate streamlines and particle transport during flow. Mean estimated parameters at House C ($k_r = 7.4\text{E}-07 \text{ cm}^2$, $k_r/k_z = 1.5$, $\ell = 3.2\text{E}-09 \text{ cm}$) were used to generate streamlines and travel time contours of air particles in sub-slab material with $\theta_a = 0.35$ at a flow rate of 1 SLPM. Depth to a no flow lower boundary was set at 500 cm. This simulation is illustrated in **Figure 28**. Dashed contour lines for 60 and 300 seconds reflect collection of 1 and 5 liters of sample, respectively, at a flow rate of 1 SLPM. Areas between streamlines reflect fractional flow. As previously stated, air flow through the slab is not simulated because the leakance term represents a combination of lateral flow beneath a slab and sub-slab material and vertical flow through a slab. The solid contour lines for 0.90 and 0.95 streamlines are highlighted. The 0.95 streamline at the top of the figure indicates that approximately 5% of air that had exited a probe at 100 seconds (1.7 liters) originated from above sub-slab material of which some fraction of this 5% could have been from infiltration from basement air. The 0.90 streamline indicates that approximately 10% of air that exited a probe at 700 seconds (11.7 liters) originated from above sub-slab material of which some fraction of this 10%

could have come from infiltration from basement air. Thus, when extracting 12 liters of air, less than 10% of air entering an evacuated canister could have been from infiltration of basement air. The results of sequential sampling and mass balance analysis revealed that less than 1% of air entering evacuated canisters during this investigation were from basement air.

In this investigation, extraction volumes up to 14 liters had little effect on sample results. However, data generated in this investigation cannot be extrapolated to justify the use of large extraction volumes (e.g., 20, 50, or 100 liters) during sampling. Further research is needed in this area.

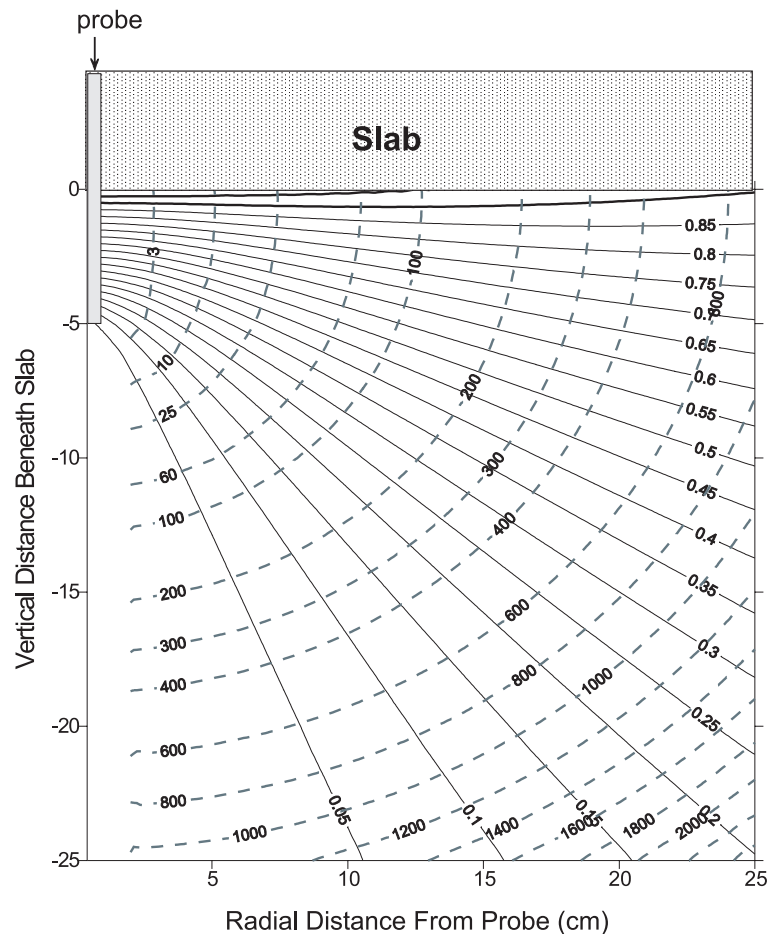

Figure 28. Simulated streamlines (solid lines) and travel time (s) (dashed lines) contours in sub-slab media when $k_r = 7.4\text{E}-07 \text{ cm}^2$, $k_r/k_z = 1.5$, $\ell = 3.2\text{E}-09 \text{ cm}$, flow rate = 1 SLPM, and depth to ground water = 500 cm.

5.2 Assessment of Extraction Flow Rate

Laboratory- and field-scale research conducted on soil venting indicates that rate-limited air-water and/or solid-water mass exchange can occur in sub-surface media during air flow. Rate-limited mass exchange could decrease vapor concentration in a sample container below what would be expected from equilibrium partitioning. EPA (Section 9, 2001) provides a comprehensive summary of mass transfer coefficients for air-water and solids-water exchange determined for several soil types in laboratory column studies. These studies indicate that for sandy, non-oven dried soils typically found directly beneath a slab, solids-water partitioning and hence rate-limited solids-water rate-limited mass exchange should be insignificant. Rate-limited air-water exchange, however, can be significant at high pore-air velocities. In one case, rate-limited air-water exchange was observed at a pore air velocity as low as 0.01 cm/s. In another case, no rate-limited behavior was observed at a pore-air velocity as high as 0.16 cm/s. Rate-limited mass transfer is a function of media-to-media mass transfer coefficients and a characteristic length over which mass transport occurs. The transport length in laboratory column studies is typically on the order of 30 cm. The characteristic length in sub-slab media could be considerably longer (resulting in increased potential of attainment of local equilibrium) depending on the thickness and permeability of sub-slab media as illustrated by streamlines in **Figure 28**.

Figure 29 illustrates pore-air velocity and travel time at a sampling rate of 1 SLPM for sub-slab conditions present at House C. Because of convergent flow to a relatively small probe cross-sectional area (radius = 0.32 cm, length = 5 cm), pore-air velocity likely exceeded 0.01 cm/s throughout most of the domain during sampling (radius \approx 17 cm for 5 liters of air extracted from **Figure 28**). However, constant concentration in sequential samples indicated an absence of rate-limited mass transport during air extraction. This could be due to a long characteristic transport length and low extraction volume relative to the sampled domain. The California Environmental Protection Agency (Cal EPA) in conjunction with the California Department of Toxic Substances and Los Angeles Regional Water Quality Control Board recently published an advisory on soil-gas sampling

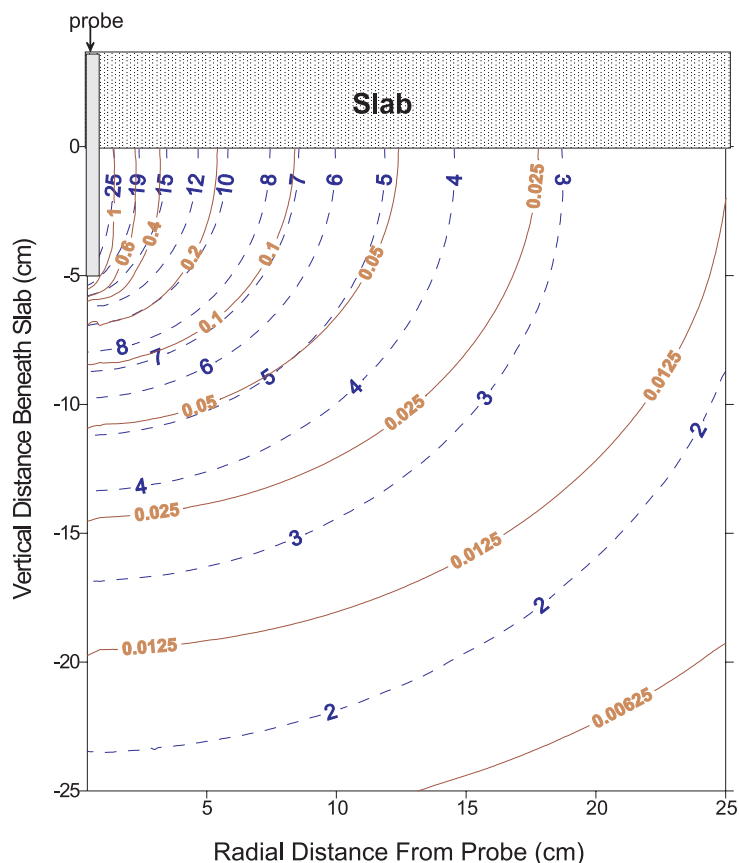

Figure 29. Simulated vacuum (Pa) (dashed lines) and pore-air velocity (cm/s) (solid lines) in sub-slab media when $k_r = 7.4E-07 \text{ cm}^2$, $k_r/k_z = 1.5$, $\theta_a = 0.35$, flow rate = 1 SLPM and depth to ground water = 500 cm.

(Cal EPA, 2003) specifying maximum flow rate during sampling. This advisory is being used for sub-slab sampling. Cal EPA recommends a maximum sampling rate of 0.1 to 0.2 SLPM. Given simulations presented here, this recommendation appears reasonable.

5.3 Evaluation of Equilibration Time

The process of drilling through a concrete slab would be expected to reduce sub-slab vapor concentration in the immediate vicinity of a probe. For strictly diffusive transport, concentration reduction would be a function of chemical properties of a VOC (Henry's constant, organic carbon - water partition coefficient, aqueous diffusion coefficient, air diffusion coefficient), material properties of sub-slab media (water content, porosity, bulk density, and organic carbon content), and temperature. For advective-diffusive transport, additional factors such as air permeability and the pressure differential between basement and sub-slab air are relevant. Concentration reduction would be expected to be greatest in relatively dry permeable material. However, these conditions would also expedite equilibration of the vapor concentration around a sub-slab probe. If sub-slab material consists of silt or clay, equilibration time may not necessarily be significantly longer because the initial vapor concentration perturbation may be reduced by a lower media permeability and lumped diffusion coefficient.

Robust estimation of equilibration time would require knowledge of the extent and magnitude of vapor concentration reduction in sub-slab media and three-dimensional advective-diffusive modeling. The problem can be simplified by using advective air flow modeling

with particle tracking to estimate a maximum radius of perturbation for various sub-slab conditions when clean air flows into an open hole. This radius could then be utilized as a path length in diffusion modeling to calculate a maximum equilibration time when a hole is sealed. For instance, if a maximum pressure differential of 15 Pa (highest pressure differential or most conservative value used in EPA's vapor intrusion guidance) is present between sub-slab media and basement air during probe installation and mean estimated parameters at House C ($k_r = 7.4E-07 \text{ cm}^2$, $k_r/k_z = 1.5$, $\ell = 3.2E-09 \text{ cm}$) with $\theta_a = 0.35$ are used for flow analysis, then this is equivalent to 0.22 SLPM of air flow into a probe. The radius of perturbation then is a function of the time in which the probe is open. In homes near the Raymark facility, holes drilled for probes were open for a maximum period of one hour. Using particle tracking, this results in a radius of perturbation of 27 cm.

Now consider concentration $C(r,t)$ of a VOC at radius 'r' and time 't' in a sphere around a sub-slab probe. If VOC concentration inside the sphere is initially at a uniform initial concentration $C(r,0)$ or C_0 and the surface concentration of the sphere at radius 'δ' is maintained at a constant concentration $C(\delta,t)$ or C_δ , then a normalized concentration at the center of the sphere or at the probe $C(0,t)$ or $C(t)$ can be estimated by (Crank, p.91,1975):

$$\frac{C(t)}{C_\delta} = \left(1 + 2 \sum_{n=1}^{\infty} (-1)^n \exp(-T n^2 \pi^2) \right) \left(1 - \frac{C_0}{C_\delta} \right) + \frac{C_0}{C_\delta}.$$

T is a dimensionless time defined by

$$T = \frac{Dt}{\delta^2}.$$

D is a lumped diffusion coefficient (cm²/s) defined by

$$D = \frac{\tau_a D_a + \tau_w D_w}{H\theta_a + \theta_w + K_d \rho_b}$$

and τ_a = soil-air phase tortuosity, D_a = free air diffusion coefficient (cm²/s), τ_w = soil-water phase tortuosity, D_w = free water diffusion coefficient, H = dimensionless Henry's constant, θ_a = volumetric air phase content, θ_w = volumetric water phase content, K_d = soil - water partition coefficient (cm³/g), and ρ_b = bulk density of soil (g/cm³). Tortuosity factors can be estimated by Millington and Quirk (1961):

$$\tau_a = \frac{\theta_a^{10/3}}{\eta^2}$$

$$\tau_w = \frac{\theta_w^{10/3}}{\eta^2}$$

where η = porosity.

If attainment of $C(t)/C_\delta = 0.99$ is desired and $C_0=0$ (most conservative condition), then T approaches 0.537. The initial concentration would be greater than zero if air exited a probe during installation. The assumption of air entry adds an additional degree of conservativeness. **Figure 30** illustrates time to $C(t)/C_\delta = 0.99$ for trichloroethylene (TCE) as a function of diffusion path length and θ_w when T=0.537 and $\eta = 0.4$, $\rho_b = 1.68$ g/cm³, $D_a = 7.4E-02$ cm²/s, $D_w = 9.3E-06$ cm²/s, H=0.38, and no sorption. This relationship is simply $t = 0.537 \delta^2/D$. At homes near the Raymark site, sub-slab and underlying soils underlying each building consisted of relatively dry sand and gravel. Little or no sorption would be expected in this material and θ_w would be relatively low (e.g., $\theta_w = 0.05$). **Figure 30** indicates that for a diffusion path

length of 27 cm, time to $C(t)/C_\delta = 0.99$ would occur in less than 2 hours. During this investigation, sub-slab probes were allowed to equilibrate for 1 to 3 days. If probes were immediately sampled after installation without regard to grout setting time, approximately 14.4 liters (hemispheric domain with a radius of 27 cm and $\theta_a = 0.35$) of air would have to be extracted to remove sub-slab air potentially affected by probe installation. For sub-slab material consisting of silt or clay with $k_r = k_z = 1.0E-09$ cm² and $\theta_a = 0.10$, the radius of perturbation would be approximately 6 cm over an exposure period of 1 hour requiring an equilibration of time of approximately 10 hours. However, most sub-slab material consists of sand and gravel or sand even for homes built directly on clay. Thus, in most cases, an equilibration time of 2 hours should be sufficient for sampling.

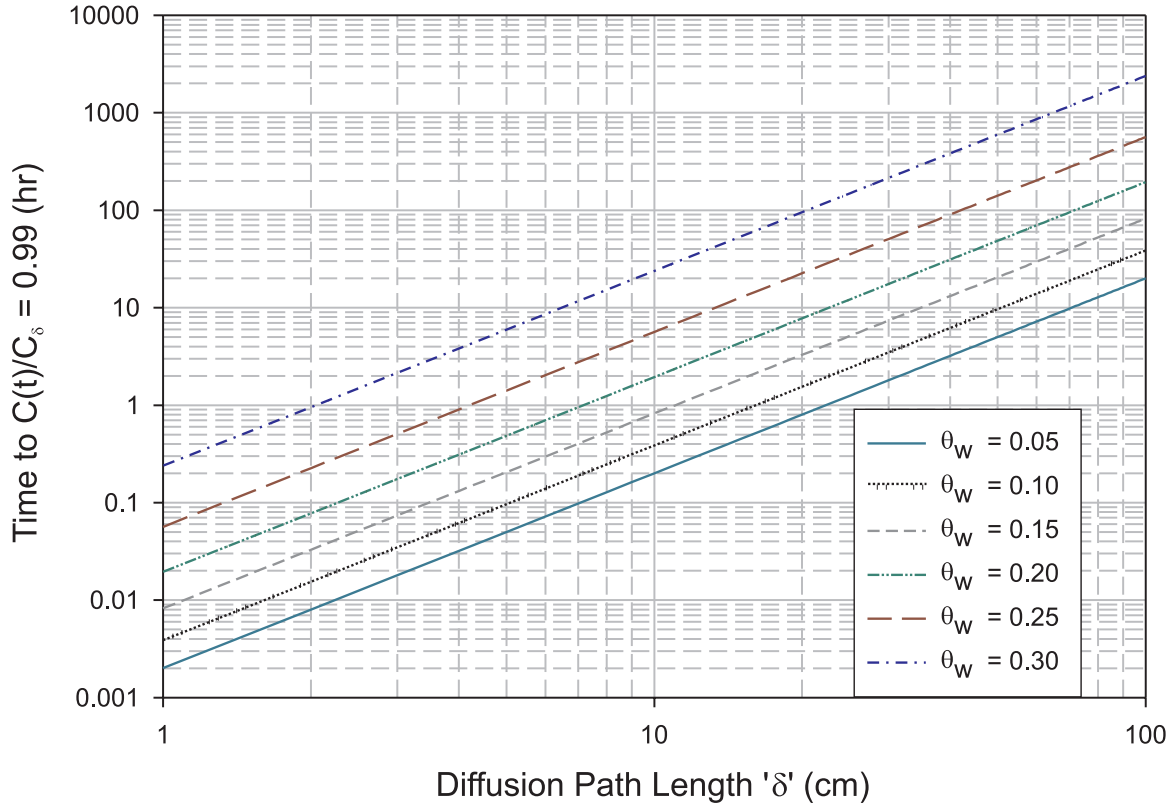

Figure 30. Time to reach $C(t)/C_0 = 0.99$ as a function of diffusion path length ' δ ' and θ_w for TCE when $C_0 = 0$, $\eta = 0.4$, $\rho_b = 1.68 \text{ g/cm}^3$, $D_a = 7.4\text{E-}02 \text{ cm}^2/\text{s}$, $D_w = 9.3\text{E-}06 \text{ cm}^2/\text{s}$, and $H = 0.38$ (no sorption).

5.4 Selection of Purge Volume

Sub-slab vapor probes and associated tubing must be purged prior to sampling because air in a probe and tubing will initially have VOC concentrations reflective of indoor air upon removal of recessed socket plugs. A purge volume consists of the total internal volume of: (1) sample tubing and associated fittings between a probe and sample container, (2) tubing and fittings associated with sub-slab vapor probes, (3) the open hole in slab below a probe, and (4) the cavity created in sub-slab material during drilling. Minimum purge volume prior to sampling can be estimated using a mass balance equation:

$$\frac{dC}{dt} = \frac{Q}{V} (C_{in} - C)$$

where C is a well-mixed vapor concentration within and exiting the sample system, C_{in} = concentration entering the system, C_{out} = concentration exiting system, Q = flow rate entering and exiting sample system, and V = internal volume of sampled system. When subject to an initial condition $C(0)=C_0$, (concentration at time zero), purge volume (tQ/V) can be expressed as a function of C_{in} and C_{out} by:

$$\frac{tQ}{V} = \ln \left| \frac{C_{in} - C_0}{C_{in} - C_{out}} \right|.$$

Figure 31 illustrates a simulation of purge volume as a function of C_0/C_{in} and C_{out}/C_{in} . Collection of 5 purge volumes ensures that the exiting vapor concentration is 99% of the entering concentration even when vapor

concentration inside the sample system has been reduced to zero prior to sampling ($C_0 = 0$). A purge volume for the sample train used in homes near the former Raymark site was typically less than 10 cm³.

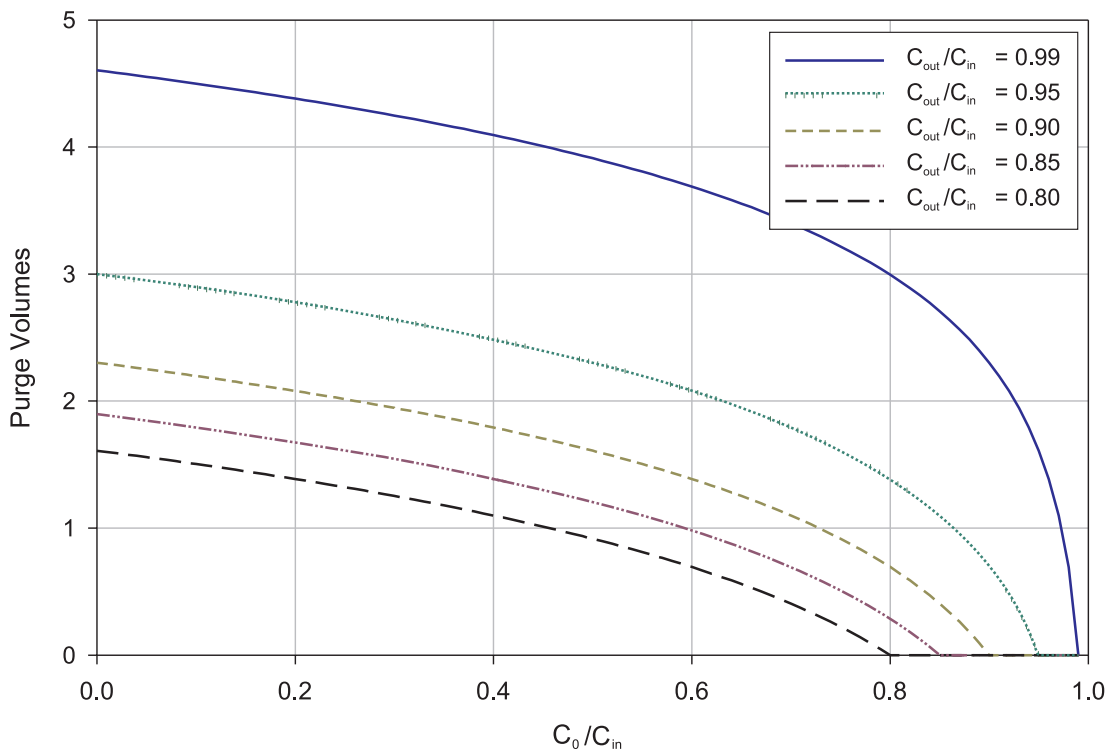

Figure 31. Purge volume as a function of C_0/C_{in} and C_{out}/C_{in} .

5.5 Placement of Sub-Slab Vapor Probes

Generally, during this investigation, one sub-slab vapor probe was centrally located, while two or more probes were placed within one or two meters of basement walls in each building. This was done to ensure detection of vacuum throughout the entire sub-slab during air permeability testing for corrective action. **Figure 32** illustrates total vapor concentration of VOCs detected in Tedlar bags as a function of probe location in each building tested. There appears to be little correlation of probe placement with VOC concentration. That

is, placement of a probe in a central location did not ensure detection of the highest VOC concentrations. **Figure 33** illustrates COVs for VOCs detected in sub-slab air and associated with sub-surface contamination. In many instances, COVs exceeded 100%, indicating substantial spatial variability in sub-slab air concentration and the need for placement of multiple probes during a sub-slab investigation. In this investigation, 55 probes were installed in 16 buildings which on average resulted in the placement of one probe every 20 m² (220 ft²).

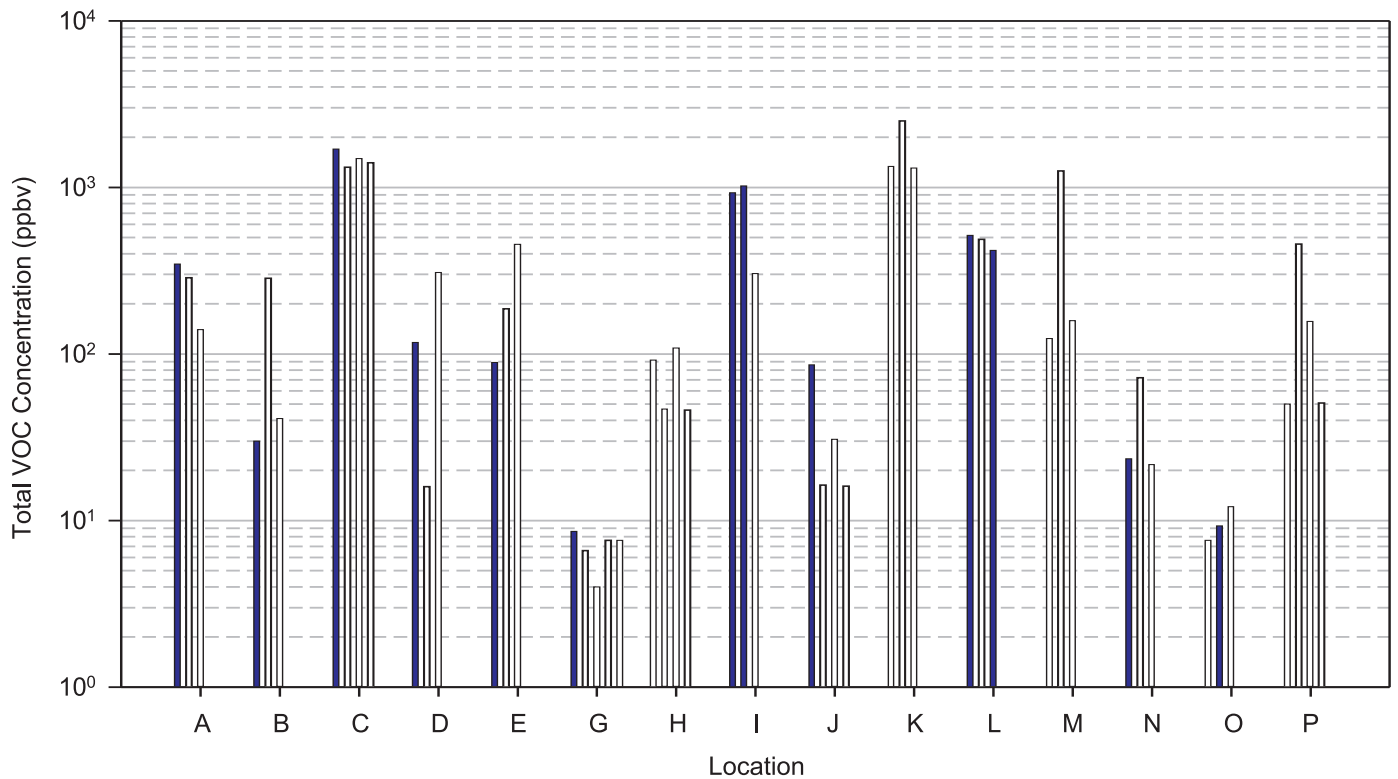

Figure 32. Total vapor concentration measured in one-liter Tedlar bags as a function of probe location and house. Dark bars refer to centrally located probes. No VOCs associated with subsurface contamination were detected at location F. Locations H, K, M, and P did not have a centrally located probe.

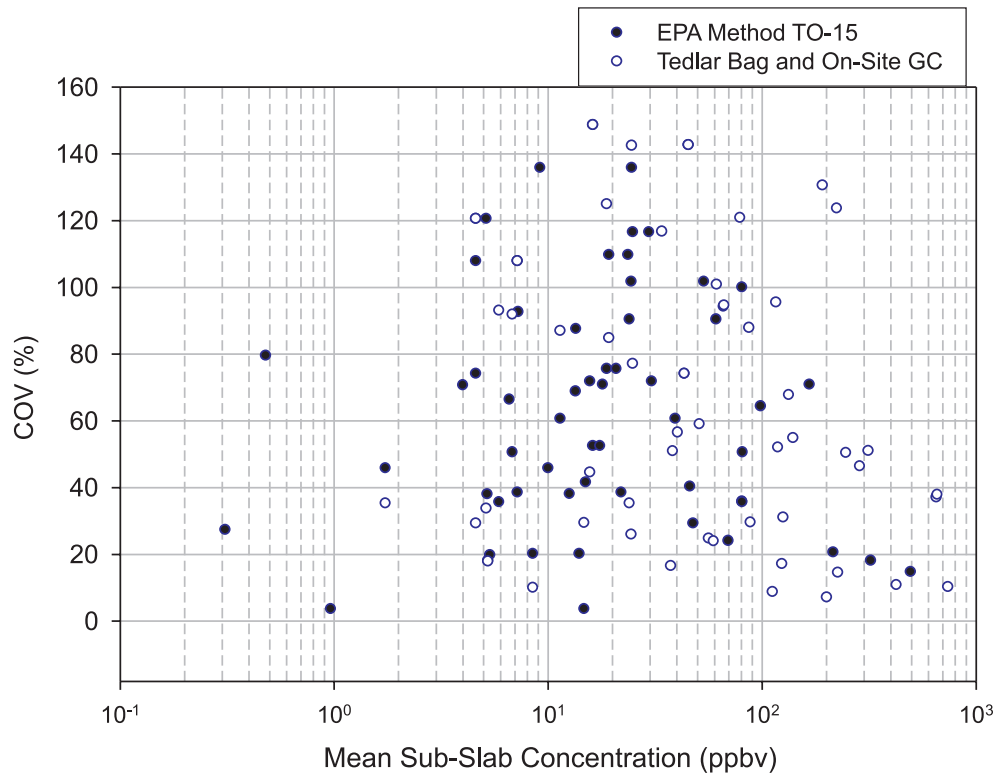

Figure 33. Coefficient of variation (COV) as a function of mean sub-slab concentration (ppbv) and method of analysis for VOCs associated with sub-surface contamination.

6.0 Use of Basement and Sub-Slab Air Measurements to Assess Vapor Intrusion

6.1 Method of Vapor Intrusion Evaluation

A dimensionless basement/sub-slab concentration ratio for a VOC or radon was defined by:

$$\alpha(i) = \frac{\bar{X}_{\text{bsmt}(i)}}{\bar{X}_{\text{ss}(i)}}$$

where $\bar{X}_{\text{bsmt}(i)}$ = mean concentration of a VOC in basement air and $\bar{X}_{\text{ss}(i)}$ = mean concentration of a VOC in sub-slab air. When a VOC was detected in sub-slab air but not basement air, $\alpha(i)$ was reported to be less than the ratio of the detection limit in basement air to sub-slab air. For instance, if $\bar{X}_{\text{ss}(i)}$ for TCE was 48 ppbv but was not detected in basement air at a detection limit of 0.24 ppbv, then $\alpha(i)$ was reported as less than 5.0E-03. When a VOC was not detected in sub-slab air but was detected in basement air, $\alpha(i)$ was reported to be greater than the ratio of basement air concentration to the detection limit of sub-slab air measurement. When a VOC was undetected in all probes tested, $\bar{X}_{\text{ss}(i)}$ was reported as less than the mean of each detection limit. For instance, if the detection limit in probes A, B, and C for m/p-xylenes were 4.3, 3.9, and 3.7 ppbv, respectively, and m/p-xylenes were detected in basement air at 0.89 ppbv, then $\bar{X}_{\text{ss}(i)}$ was reported as less than 4.0 ppbv and $\alpha(i)$ less than 2.2E-01. In some instances, a VOC was detected in two probes but undetected in a third.

In that case, the mean of two measurements was used to estimate $\bar{X}_{\text{ss}(i)}$.

Variance associated with each basement/sub-slab concentration ratio was calculated using the method of propagation of errors:

$$\sigma_{\alpha(i)}^2 = \left(\frac{1}{\bar{X}_{\text{ss}(i)}} \right)^2 \sigma_{\text{bsmt}(i)}^2 + \left(\frac{\bar{X}_{\text{bsmt}(i)}}{(\bar{X}_{\text{ss}(i)})^2} \right)^2 \sigma_{\text{ss}(i)}^2$$

where $\sigma_{\text{bsmt}(i)}^2$ = variance associated with measurement of a VOC in basement air and $\sigma_{\text{ss}(i)}^2$ = variance associated with measurement of a VOC in sub-slab air. With the exception of replicate sampling at one location during the July 2002 sample event and two locations during the March 2003 sampling event, only one air sample was taken in each basement. To estimate $\sigma_{\text{bsmt}(i)}^2$ for locations not having replicate samples, the coefficients of variation (COV) for each VOC in each replicate were calculated. Results of these calculations are illustrated in **Figure 7**. At House B during the July 2002 sample event, the average COV was 5.2%. At Houses F and H during the March 2003 sample event, average COVs were 6.2% and 5.2%, respectively. A global average using all three replicate measurements was 5.5%. A global average of 6% was used to estimate the standard deviation of basement air samples by:

$$\sqrt{\sigma_{\text{bsmt}(i)}^2} \approx 0.06 X_{\text{bsmt}(i)} .$$

An average basement/sub-slab air concentration ratio ($\bar{\alpha}$) was calculated using basement/sub-slab air concentration ratios for all VOCs associated with vapor intrusion by:

$$\bar{\alpha} = \frac{1}{n} \sum_{i=1}^n \alpha(i) .$$

The variance associated with $\bar{\alpha}$ ($\sigma_{\bar{\alpha}}^2$) was calculated by:

$$\sigma_{\bar{\alpha}}^2 = \frac{1}{n^2} \sum_{i=1}^n \sigma^2(i) .$$

Basement/sub-slab air concentration ratios, $\alpha(i)$, and associated standard deviations, $\sqrt{\sigma_{\alpha(i)}^2}$, were computed for every VOC detected in basement or sub-slab air and plotted. A VOC detected in basement air was considered due to vapor intrusion if: (1) the VOC was detected in ground water and/or soil gas in the “vicinity” of the house, and (2) the null hypothesis that basement/sub-slab air concentration ratio of the VOC was equal to the basement/sub-slab air concentration ratio of an indicator VOC could not be rejected using a one-tailed Approximate t-Test at a level of significance or Type I error less than or equal to 0.05. A Type I error is committed when the null hypothesis is rejected when it is true. The alternative hypothesis was that the basement/sub-slab air concentration ratio of the VOC was greater than the basement/sub-slab air concentration ratio of an indicator VOC. An indicator VOC is defined as a VOC detected in sub-slab air and known to be associated only with subsurface contamination. The VOCs, 1,1-dichloroethylene and 1,1-dichloroethane, were considered indicator VOCs

in this investigation because they are degradation products of 1,1,1-trichloroethane and not commonly associated with commercial products. The VOC, cis-1,2-dichloroethylene, was considered an indicator VOC because it is a degradation product of trichloroethylene and not commonly associated with commercial products. Vicinity is a subjective term but generally refers to a number of ground-water or soil-gas measurements within 30 meters of a building. The primary purpose of these two questions was to ascertain whether or not VOCs detected in basement air were due to vapor intrusion. Sources (e.g., indoor, outdoor) of VOCs not associated with vapor intrusion were not investigated. Evaluation of outdoor and indoor air source terms would require additional building-related information or characterization needs (e.g., air exchange rates). The Approximate t-Test for Independent Sample of Unequal Variance was employed for statistical testing where the test statistic t' is defined as:

$$t' = \frac{\alpha(i) - \alpha^*(i)}{\sqrt{\frac{\sigma_{\alpha(i)}^2}{n(i)} + \frac{\sigma_{\alpha^*(i)}^2}{n^*(i)}}$$

where $\sigma_{\alpha^*(i)}^2$ is the variance of the basement/sub-slab air concentration ratio for the indicator VOC, and $n(i)$ and $n^*(i)$ are the number of sub-slab measurements used in determining $\alpha(i)$ and $\alpha^*(i)$, respectively. The degrees of freedom (df) are defined as:

$$df = \frac{(n(i)-1)(n^*(i)-1)}{(n^*(i)-1)c^2 + (1-c)^2(n(i)-1)}$$

where

$$c = \frac{\sigma_{\alpha(i)}^2 / n(i)}{\frac{\sigma_{\alpha(i)}^2}{n(i)} + \frac{\sigma_{\alpha^*(i)}^2}{n^*(i)}} .$$

6.2 Summary of Results for Buildings Sampled in July and October 2002

Basement and sub-slab air samples were collected for VOC analysis in houses A, B, C, D, and E during the July 2002 sample event. Basement (1-hr) and sub-slab (grab) samples were collected in six-liter evacuated canisters using EPA Method TO-15. Sub-slab samples were also collected in one-liter Tedlar bags with on-site GC analyses. An outdoor air sample (1-hr) was collected outside of House B. The results of this sample, as well as two outdoor air samples collected during the March 2003 sample event, are presented in **Table 2**. One of the VOCs associated with sub-surface contamination, 1,1,1-TCA, was detected at 0.58 ppbv during the July 2002 sample event.

Only sub-slab air samples using one-liter Tedlar bags with subsequent on-site GC analysis were collected during the October 2002 sample event. Mean sub-slab air concentrations for 1,1,1-TCA, 1,1-DCE, TCE, and c-1,2-DCE collected in one-liter Tedlar bags were compared for the July 2002 and October 2002 sample events using a two-tailed Approximate t-Test. The null hypothesis was that the mean concentration of a VOC during the July 2002 sample event was equal to the mean concentration of the VOC during the October 2002 sample event. The alternate hypothesis was that the means were not equal. The rejection criteria was a Type I error or level of significance less than or equal to 0.1 (twice the level of significance for one-tailed tests used to assess vapor intrusion). A Type I error is committed when the null hypothesis is rejected when it is true.

Table 2. Outdoor Air Concentrations of VOCs During July 2002 and March 2003 Sample Events

VOC	Outdoor-1hr	Outdoor-24hr	Outdoor-24hr
	07/16/02	03/24/03	03/27/03
	House B	House K	House G
	(ppbv)	(ppbv)	(ppbv)
1,1,1-TCA	0.58	ND(0.09)	ND(0.11)
1,1-DCE	ND(0.25)	ND(0.092)	ND(0.11)
TCE	ND(0.25)	ND(0.092)	ND(0.11)
c-1,2-DCE	ND(0.25)	ND(0.09)	ND(0.11)
1,1-DCA	ND(0.25)	ND(0.092)	ND(0.11)
1,2-DCA	ND(0.25)	ND(0.092)	ND(0.11)
PCE	ND(0.25)	0.12	ND(0.10)
CH ₂ Cl ₂	0.44	0.19	0.70
CHCl ₃	0.10	ND(0.09)	ND(0.11)
CCl ₄	0.09	0.080	ND(0.11)
CCl ₃ F(F-11)	0.27	0.25	0.23
CCl ₂ F ₂ (F-12)	0.66	0.5	0.47
CHBrCl ₂	ND(2.2)	ND(0.084)	ND(0.10)
vinyl chloride	ND(0.25)	ND(0.09)	ND(0.11)
CH ₃ CH ₂ Cl	ND(0.25)	ND(0.95)	0.95
CCl ₃ CF ₃ (F-113)	0.10	ND(0.09)	ND(0.11)
acetone	4.50	2.0	2.0
2-hexanone	ND(0.25)	ND(0.086)	ND(0.10)
THF	ND(2.3)	ND(0.088)	ND(0.10)
MEK	ND(0.46)	0.45	0.51
MIBK	ND(0.21)	0.081	ND(0.096)
MTBE	0.23	0.46	0.61
heptane	ND(0.24)	0.22	0.3
hexane	1.0	0.69	0.62
cyclohexane	ND(0.50)	ND(0.09)	ND(0.11)
benzene	0.15	0.33	0.38
toluene	0.85	0.63	3.5
ethylbenzene	0.20	0.09	0.14
m/p-xylenes	0.65	0.23	0.45
o-xylene	0.25	0.1	0.17
styrene	ND(0.23)	ND(0.084)	ND(0.10)
1,2,4-TMB	ND(0.24)	ND(0.088)	0.16
1,3,5-TMB	ND(0.25)	ND(0.09)	ND(0.11)
1,3-butadiene	ND(0.50)	ND(0.18)	ND(0.21)
1,3-DCB	ND(0.24)	ND(0.09)	ND(0.11)
1,4-DCB	ND(0.24)	ND(0.088)	ND(0.10)
4-ethyltoluene	ND(0.25)	0.09	0.16
isopropyl alcohol	ND(0.25)	0.31	0.93
ethyl/vinyl acetate	ND(0.48)	ND(0.16)	ND(0.19)
CS ₂	ND(0.23)	ND(0.086)	ND(0.10)
ND () = Not detected above (reporting limits)			

The slabs at these houses were located approximately two meters below grade. All buildings tested were in locations of known ground-water and soil-gas contamination from the Raymark Superfund Site. During the October 2002 sample event, basement (48-hr activated charcoal) and sub-slab (scintillation cells) air samples were collected for radon analysis. However, since the results of radon testing in the October 2002 sample event were not used to assess vapor intrusion during the July 2002 sample event, the results of sub-slab air radon testing during the October sample event were not included in this report.

House A

At the time of probe installation, no significant cracks or holes were observed in the concrete slab or in painted cinderblock walls. Concentrations of VOCs detected in basement and/or sub-slab air using EPA Method TO-15 are summarized in **Table 3a**. The only constituent associated with sub-surface contamination detected in basement air was 1,1,1-TCA at a concentration of 0.20 ppbv. The detection limit for other VOCs associated with sub-surface contamination was 0.24 ppbv. Other chlorinated VOCs detected in basement air were methylene chloride, chloroform, and carbon tetrachloride at concentrations of 0.78, 0.14, and 0.13 ppbv, respectively. Freons, F-11, F-12, and F-113 were detected at 0.39, 0.71, and 0.12 ppbv, respectively. Hydrocarbons, hexane, cyclohexane, benzene, toluene, ethylbenzene, m/p-xylenes, o-xylene, styrene, 1,2,4-trimethylbenzene, 1,3,5-trimethylbenzene, and 4-ethyltoluene were detected in basement air at concentrations up to 1.8 ppbv. Acetone, methyl isobutyl ketone, and methyl tertiary-butyl ether were detected in basement air at concentrations of 8.3, 0.11, and 0.49 ppbv, respectively.

Three probes were installed for sub-slab sampling. All three probes were sampled using EPA Method TO-15 and with one-liter Tedlar bags. As indicated in **Table 3a**, when sampling using EPA Method TO-15, 1,1,1-TCA, 1,1-DCE, TCE, c-1,2-DCE, and 1,1-DCA were detected at maximum concentrations of 100, 62, 60, 21, and 13 ppbv, respectively. The only other VOCs detected in sub-slab air using EPA Method TO-15 were acetone and chloroform at maximum concentrations of 3.8 and 1.3 ppbv, respectively. Detection limits of other VOCs varied from 1.8 to 18 ppbv. As indicated in **Table 3c**, when sampling with one-liter Tedlar bags, 1,1,1-TCA, 1,1-DCE, TCE, and c-1,2-DCE were detected at maximum concentrations in Probe A at 164, 75, 78, and 29 ppbv, respectively.

Basement/sub-slab air concentration ratios for VOCs using EPA Method TO-15 are illustrated in **Figure 34**. The basement/sub-slab air concentration ratios for all five VOCs associated with sub-surface contamination were lower than basement/sub-slab air concentration ratios for other VOCs detected in basement air. However, since indicator VOCs, 1,1-DCE, c-1,2-DCE, and 1,1-DCA, were not detected in basement air at the time of sampling, their basement/sub-slab air concentration ratios and associated standard deviations could not be computed. All that can be inferred from available data is that the actual basement/sub-slab air concentration ratios of these indicator VOCs were less than the values indicated. The null hypothesis that the basement/sub-slab air concentration ratio of 1,1,1-TCA was equivalent to the basement/sub-slab air concentration ratios of indicator VOCs, 1,1-DCE, c-1,2-DCE, and 1,1-DCA could not be evaluated. Thus, there was insufficient data to determine whether or not the presence of 1,1,1-TCA in basement air was due to vapor intrusion

Table 3a. Basement and Sub-Slab Air Concentrations for VOCs at House A Using EPA Method TO-15 During the July 2002 Sample Event

VOC	bsmt 1-hr	scaled stdev	P[A] grab	P[B] grab	P[C] grab	sub-slab mean	sub-slab stdev	sub-slab cov	bsmt/ sub-slab ratio	bsmt/ sub-slab stdev
	07/16/02	cov=6%	07/16/02	07/16/02	07/16/02	07/16/02	07/16/02	07/16/02	(-)	(-)
	(ppbv)	(ppbv)	(ppbv)	(ppbv)	(ppbv)	(ppbv)	(ppbv)	(%)		
1,1,1-TCA	0.20	0.01	99	100	43	81	29	36	2.5E-03	9.0E-04
1,1-DCE	ND(0.24)	IND	62	56	20	46	19	40	< 4.3E-03	IND
TCE	ND(0.24)	IND	60	55	28	48	14	29	< 4.2E-03	IND
c-1,2-DCE	ND(0.24)	IND	21	18	6.0	15	6.2	42	< 1.3E-02	IND
1,1-DCA	ND(0.24)	IND	13	13	4.0	10	4.6	46	< 2.0E-02	IND
1,2-DCA	ND(0.24)	IND	ND(2.1)	ND(2.1)	ND(2.1)	ND(<2.1)	IND	IND	IND	IND
PCE	ND(0.25)	IND	ND(2.1)	ND(2.1)	ND(2.1)	ND(<2.1)	IND	IND	IND	IND
CH ₂ Cl ₂	0.78	0.05	ND(2.1)	ND(1.9)	ND(1.8)	ND(<1.9)	IND	IND	> 4.1E-01	IND
CHCl ₃	0.14	0.01	1.0	1.3	0.73	1.0	0.29	28	1.4E-01	4.0E-02
CCl ₄	0.13	0.01	ND(2.1)	ND(1.9)	ND(1.8)	ND(<1.9)	IND	IND	> 6.8E-02	IND
CCl ₃ F(F-11)	0.39	0.02	ND(2.1)	ND(1.9)	ND(1.8)	ND(<1.9)	IND	IND	> 2.1E-01	IND
CCl ₂ F ₂ (F-12)	0.71	0.04	ND(2.1)	ND(1.9)	ND(1.8)	ND(<1.9)	IND	IND	> 3.7E-01	IND
CHBrCl ₂	ND(2.2)	IND	ND(2.1)	ND(2.1)	ND(2.1)	ND(<2.1)	IND	IND	IND	IND
vinyl chloride	ND(0.25)	IND	ND(2.1)	ND(2.1)	ND(2.1)	ND(<2.1)	IND	IND	IND	IND
CH ₃ CH ₂ Cl	ND(2.3)	IND	ND(2.1)	ND(2.1)	ND(2.1)	ND(<2.1)	IND	IND	IND	IND
CCl ₃ CF ₃ (F-113)	0.12	0.01	ND(2.1)	ND(1.9)	ND(1.8)	ND(<1.9)	IND	IND	> 6.3E-02	IND
acetone	8.30	0.50	3.5	3.8	ND(18)	3.7	0.21	IND	2.3E+00	1.9E-01
2-hexanone	ND(2.3)	IND	ND(18)	ND(18)	ND(18)	ND(<18)	IND	IND	IND	IND
THF	ND(2.3)	IND	ND(18)	ND(18)	ND(18)	ND(<18)	IND	IND	IND	IND
MEK	ND(0.26)	IND	ND(1.8)	ND(1.7)	ND(1.6)	ND(<1.7)	IND	IND	IND	IND
MIBK	0.11	0.01	ND(1.8)	ND(1.7)	ND(1.6)	ND(<1.7)	IND	IND	> 6.5E-02	IND
MTBE	0.49	0.03	ND(2.0)	ND(1.8)	ND(1.7)	ND(<2.0)	IND	IND	> 2.5E-01	IND
heptane	ND(0.24)	IND	ND(18)	ND(18)	ND(18)	ND(<18)	IND	IND	IND	IND
hexane	1.2	0.07	ND(2.2)	ND(2.0)	ND(1.9)	ND(<2.0)	IND	IND	> 6.0E-01	IND
cyclohexane	0.19	0.01	ND(4.3)	ND(3.9)	ND(3.7)	ND(<4.0)	IND	IND	> 4.8E-02	IND
benzene	0.25	0.02	ND(2.1)	ND(1.9)	ND(1.8)	ND(<1.9)	IND	IND	> 1.3E-01	IND
toluene	1.8	0.11	ND(2.1)	ND(1.9)	ND(1.8)	ND(<1.9)	IND	IND	> 9.5E-01	IND
ethylbenzene	0.26	0.02	ND(2.1)	ND(1.9)	ND(1.8)	ND(<1.9)	IND	IND	> 1.4E-01	IND
m/p-xylenes	0.89	0.05	ND(4.3)	ND(3.9)	ND(3.7)	ND(<4.0)	IND	IND	> 2.2E-01	IND
o-xylene	0.27	0.02	ND(2.1)	ND(1.9)	ND(1.8)	ND(<1.9)	IND	IND	> 1.4E-01	IND
styrene	0.12	0.01	ND(2.0)	ND(1.8)	ND(1.7)	ND(<1.7)	IND	IND	> 7.1E-02	IND
1,2,4-TMB	0.29	0.02	ND(2.1)	ND(1.9)	ND(1.8)	ND(<1.9)	IND	IND	> 1.5E-01	IND
1,3,5-TMB	0.11	0.01	ND(2.1)	ND(1.9)	ND(1.8)	ND(<1.9)	IND	IND	> 5.8E-02	IND
1,3-butadiene	ND(0.50)	IND	ND(2.1)	ND(1.9)	ND(1.8)	ND(<1.9)	IND	IND	IND	IND
1,3-DCB	ND(0.24)	IND	ND(2.1)	ND(1.9)	ND(1.8)	ND(<1.9)	IND	IND	IND	IND
1,4-DCB	ND(0.24)	IND	ND(2.1)	ND(1.9)	ND(1.8)	ND(<1.9)	IND	IND	IND	IND
4-ethyltoluene	0.19	0.01	ND(2.1)	ND(1.9)	ND(1.8)	ND(<1.9)	IND	IND	IND	IND
isopropyl alcohol	ND(0.25)	IND	ND(2.2)	ND(2.0)	ND(1.9)	ND(<2.0)	IND	IND	IND	IND
ethyl/vinyl acetate	ND(0.48)	IND	ND(2.1)	ND(1.9)	ND(1.8)	ND(<1.9)	IND	IND	IND	IND
CS ₂	ND(0.48)	IND	ND(2.1)	ND(1.9)	ND(1.8)	ND(<1.9)	IND	IND	IND	IND
ND ()=Not detected (reporting limit)				IND = indeterminate						

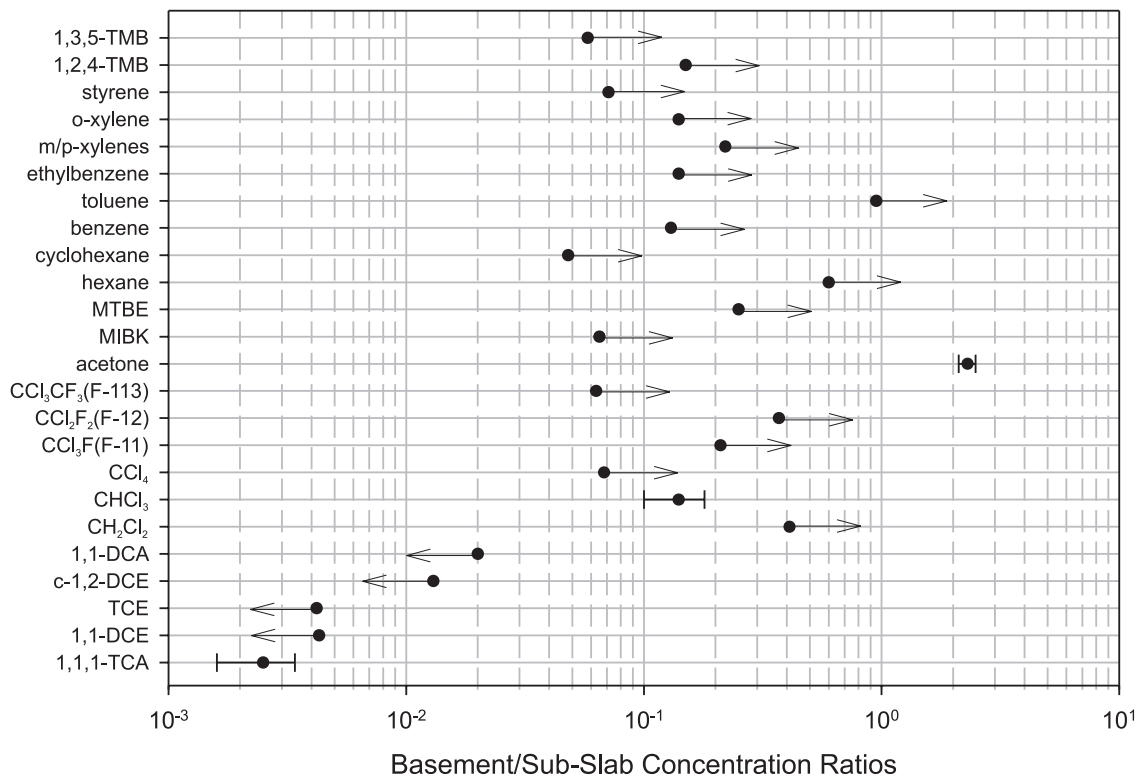

Figure 34. Basement/sub-slab concentration ratios using EPA Method TO-15 at House A during the July 2002 sample event. Error bars represent one standard deviation. Arrows indicate greater than or less than values due to non-detection in basement or sub-slab air.

at the time of sampling. However, it was evident that significant levels of VOCs associated with sub-surface contamination were present in sub-slab air at the time of sampling.

A statistical analysis of VOCs associated with sub-surface contamination and sampled using EPA Method TO-15 is summarized in **Table 3b**. Since the basement/sub-slab air concentration ratios of indicator VOCs, 1,1-DCE, c-1,2-DCE, and 1,1-DCA were less than 4.3E-03, 1.3E-02, and 2.0E-02, respectively, the basement/sub-slab air concentration ratio of VOCs associated with sub-surface contamination was less than 4.3E-03. If the presence of 1,1,1-TCA in basement air was not due to vapor intrusion at the time of sampling, then the basement/sub-slab air concentration ratio of VOCs associated with sub-surface contamination was less

than the basement/sub-slab air concentration ratio of 1,1,1-TCA or 2.5E-03. Coefficients of variation in sub-slab air concentration ranged from 29 to 46%.

A statistical analysis of VOCs associated with sub-surface contamination and sampled using one-liter Tedlar bags is summarized in **Table 3c**. Since the basement/sub-slab air concentration ratio of the indicator VOC, 1,1-DCE, was less than 4.0E-03, the basement/sub-slab air concentration ratio of VOCs associated with sub-surface contamination was less than 4.0E-03. If the presence of 1,1,1-TCA in basement air was not due to vapor intrusion at the time of sampling, then the basement/sub-slab air concentration ratio of VOCs associated with sub-surface contamination was less than the basement/sub-slab air concentration ratio of 1,1,1-TCA or

1.6E-03 for the July 2002 sampling event. Coefficients of variation in sub-slab air concentration ranged from 24 to 31%.

The results of sub-slab sampling using one-liter Tedlar bags during the October 2002 sample are summarized in **Table 3d**. A comparison of mean sub-slab air concentrations of 1,1,1-TCA, 1,1-DCE, TCE, and c-1,2-DCE during the July 2002 and October 2002 sample events is illustrated in **Figure 35**. The null hypothesis

that the mean sub-slab air concentrations of 1,1,1-TCA were equivalent during the July and October 2002 sample events was rejected using a two-tailed Approximate t-Test at a level of significance less than or equal to 0.1 ($p = 0.08$). The null hypotheses that the mean sub-slab concentrations of 1,1-DCE, TCE, and c-1,2-DCE were equivalent during the July and October 2002 sample events were not rejected at significance levels of 0.48, 0.63, and 0.22, respectively.

Table 3b. Summary of Basement/Sub-Slab Air Concentration Ratios of VOCs Associated with Sub-Surface Contamination in House A Using EPA Method TO-15 During the July 2002 Sample Event

VOC	bsmt 1-hr	scaled stdev	P[A] grab	P[B] grab	P[C] grab	sub-slab mean	sub-slab stdev	sub-slab cov	bsmt/ sub-slab ratio	bsmt/ sub-slab stdev
	07/16/02	cov=6%	07/16/02	07/16/02	07/16/02	07/16/02	07/16/02	07/16/02		
	(ppbv)	(ppbv)	(ppbv)	(ppbv)	(ppbv)	(ppbv)	(ppbv)	(%)		
1,1,1-TCA	0.20	0.01	99	100	43	81	29	36	2.5E-03	9.0E-04
1,1-DCE	ND(0.24)	IND	62	56	20	46	19	40	<4.3E-03	IND
TCE	ND(0.24)	IND	60	55	28	48	14	29	<4.2E-03	IND
c-1,2-DCE	ND(0.24)	IND	21	18	6.0	15	6.2	42	<1.3E-02	IND
1,1-DCA	ND(0.24)	IND	13	13	4.0	10	4.6	46	<2.0E-02	IND
mean and standard deviation of basement/sub-slab ratio									<4.3E-03	IND

Table 3c. Summary of Basement/Sub-Slab Air Concentration Ratios of VOCs Associated with Sub-Surface Contamination in House A Using 1-Liter Tedlar Bags and On-Site GC Analysis During the July 2002 Sample Event

VOC	bsmt-1hr #1582	scaled stdev	P[A] grab	P[B] grab	P[C] grab	sub-slab mean	sub-slab stdev	sub-slab cov	bsmt/ sub-slab ratio	bsmt/ sub-slab stdev
	07/16/02	cov=6%	07/16/02	07/16/02	07/16/02	07/16/02	07/16/02	07/16/02		
	(ppbv)	(ppbv)	(ppbv)	(ppbv)	(ppbv)	(ppbv)	(ppbv)	(%)		
1,1,1-TCA	0.20	0.01	164	144	69	126	39	31	1.6E-03	5.0E-04
1,1-DCE	ND(0.24)	IND	75	65	38	59	14	24	<4.0E-03	IND
TCE	ND(0.24)	IND	78	58	33	56	14	25	<4.3E-03	IND
c-1,2-DCE	ND(0.24)	IND	29	20	ND(25)	25	6	26	IND	IND
mean and standard deviation of basement/sub-slab ratio									<4.0E-03	IND

Table 3d. Sub-Slab Air Concentrations of VOCs Associated with Sub-Surface Contamination in House A Using 1-Liter Tedlar Bags and On-Site GC Analysis During the October 2002 Sample Event

VOC	P[A] grab	P[B] grab	P[C] grab	sub-slab mean	sub-slab stdev	sub-slab cov
	10/30/02	10/30/02	10/30/02	10/30/02	10/30/02	10/30/02
	(ppbv)	(ppbv)	(ppbv)	(ppbv)	(ppbv)	(%)
1,1,1-TCA	402	256	197	285	106	37
1,1-DCE	170	102	72	115	50	44
TCE	137	75	47	86	46	53
c-1,2-DCE	48	28	15	30	17	55

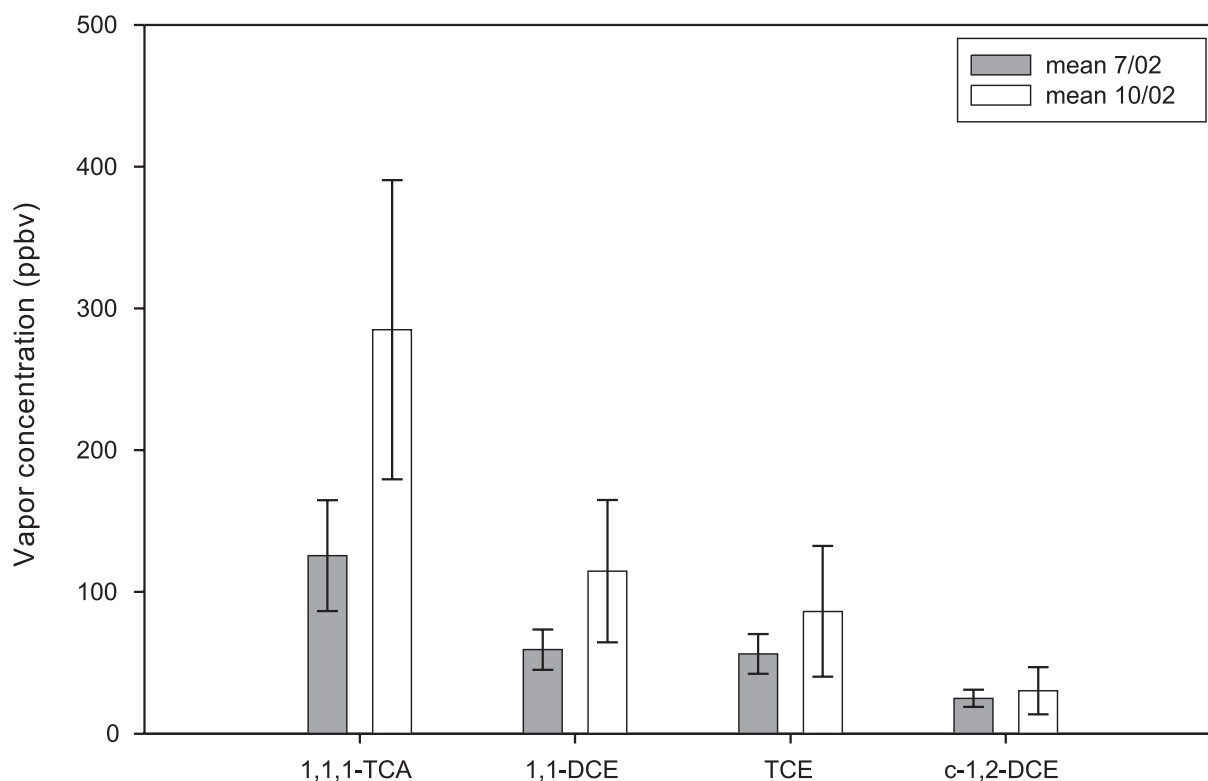

Figure 35. Comparison of mean sub-slab air concentrations of VOCs collected in one-liter Tedlar bags during the July and October 2002 sample events at House A. Error bars represent one standard deviation.

House B

At the time of probe installation, no significant cracks or holes were observed in the visible portion of the concrete slab or in cinderblock walls. Most of the basement was finished with carpeting and paneled walls. Concentrations of all VOCs detected in basement and/or sub-slab air using EPA Method TO-15 are summarized in **Table 4a**. A replicate sample was collected for basement air analysis. VOCs associated with sub-surface contamination, 1,1,1-TCA, 1,1-DCE, and TCE, were detected in basement air at concentrations of 0.41, 0.11, and 0.41 ppbv, respectively. The detection limit for c-1,2-DCE and 1,1-DCA was 0.25 and 0.26 ppbv, respectively. Other chlorinated VOCs detected in basement air were

perchloroethylene, methylene chloride, chloroform, and carbon tetrachloride at concentrations of 0.53, 6.2, 0.91, and 0.14 ppbv, respectively. Freons, F-11, F-12, and F-113, were detected in basement air at concentrations of 0.71, 1.3, and 0.19 ppbv, respectively. Hydrocarbons, heptane, hexane, cyclohexane, benzene, toluene, ethylbenzene, m/p-xylenes, o-xylene, 1,2,4-trimethylbenzene, 1,3,5-trimethylbenzene, 4-ethyltoluene were detected in basement air at concentrations up to 58 ppbv. Acetone, methyl ethyl ketone, methyl isobutyl ketone, and methyl tertiary-butyl ether were detected in basement air at concentrations of 40, 2.4, 0.22, and 9.8 ppbv, respectively. During basement sampling, the homeowner stated that a latex paint had been used on the second floor room two days prior to sampling.

Table 4a. Basement and Sub-Slab Air Concentrations for VOCs at House B Using EPA Method TO-15 During the July 2002 Sample Event

VOC	bsmt 1-hr	bsmt 1-hr	bsmt mean	bsmt stdev	bsmt cov	P[A] grab	P[B] grab	P[C] grab	sub-slab mean	sub-slab stdev	sub-slab cov	bsmt/ sub-slab ratio	bsmt/ sub- slab stdev
	07/16/02	07/16/02	n=2	n=2	n=2	07/16/02	07/16/02	07/16/02	n=3	n=3	n=3		
	(ppbv)	(ppbv)	(ppbv)	(ppbv)	(ppbv)	(ppbv)	(ppbv)	(ppbv)	(ppbv)	(ppbv)	(%)		
1,1,1-TCA	0.40	0.41	0.41	0.01	1.7	7.9	120	8.1	45	65	143	8.9E-03	1.3E-02
1,1-DCE	0.10	0.11	0.11	0.01	6.7	3.7	44	0.94	16	24	149	6.5E-03	9.6E-03
TCE	0.41	0.40	0.41	0.01	1.7	20	80	30	43	32	74	9.3E-03	6.9E-03
c-1,2-DCE	ND(0.25)	ND(0.25)	ND(<0.25)	IND	IND	4.3	16	1.3	7.2	7.8	108	<3.5E-02	IND
1,1-DCA	ND(0.26)	ND(0.26)	ND(<0.26)	IND	IND	1.6	11	1.2	4.6	5.5	121	<5.7E-02	IND
1,2-DCA	ND(0.25)	ND(0.25)	ND(<0.25)	IND	IND	ND(0.23)	ND(1.9)	ND(0.42)	ND(<0.85)	IND	IND	IND	IND
PCE	0.53	0.52	0.53	0.01	1.3	0.37	0.79	0.30	0.49	0.27	54	1.1E+00	5.9E-01
CH ₂ Cl ₂	6.2	6.2	6.2	0.00	0.0	3.6	ND(1.9)	0.15	1.9	2.4	130	3.3E+00	4.3E+00
CHCl ₃	0.91	0.83	0.87	0.06	6.5	4.3	7.2	32	14.5	15	105	6.0E-02	6.3E-02
CCl ₄	0.14	0.14	0.14	0.00	0.0	0.12	ND(1.9)	ND(0.42)	<0.81	IND	IND	>1.7E-01	IND
CCl ₃ F (F-11)	0.71	0.71	0.71	0.00	0.0	0.75	ND(1.9)	0.50	0.63	0.18	28	1.1E+00	3.2E-01
CCl ₂ F ₂ (F-12)	1.3	1.3	1.3	0.00	0.0	34	11	570	205	316	154	6.3E-03	9.8E-03
CHBrCl ₂	ND(2.2)	ND(2.2)	ND(<2.2)	IND	IND	0.13	ND(17)	0.20	0.17	0.05	30	<1.3E+01	IND
vinyl chloride	ND(0.25)	ND(0.25)	ND(<0.25)	IND	IND	ND(0.23)	ND(1.9)	ND(0.42)	ND(<0.85)	IND	IND	IND	IND
CH ₃ CH ₂ Cl	0.86	0.86	0.86	0.00	0.0	ND(0.24)	ND(2.0)	ND(0.44)	ND(<0.9)	IND	IND	>9.6E-01	IND
CCl ₃ CF ₃ (F-113)	0.10	0.19	0.14	0.06	44.5	0.10	ND(1.9)	ND(0.42)	<0.81	IND	IND	>2.3E-01	IND
acetone	38	40	39	1.4	3.6	1.1	ND(18)	1.2	1.2	0.07	6.1	3.4E+01	2.4E+00
2-hexanone	ND(0.25)	ND(0.25)	ND(<0.25)	IND	IND	ND(0.23)	ND(1.9)	ND(0.42)	ND(<0.85)	IND	IND	IND	IND
THF	ND(2.3)	ND(2.3)	ND(<2.3)	IND	IND	ND(18)	ND(18)	ND(18)	ND(<18)	IND	IND	IND	IND
MEK	2.4	2.2	2.3	0.14	6.1	ND(0.43)	ND(3.5)	ND(0.79)	ND(<1.6)	IND	IND	>1.4E+00	IND
MIBK	0.22	0.15	0.19	0.05	26.8	ND(0.20)	ND(1.6)	ND(0.36)	ND(<0.72)	IND	IND	>3.1E-01	IND
MTBE	9.8	9.5	9.7	0.21	2.2	1.8	ND(1.8)	0.16	1.0	1.2	118	9.8E+00	1.2E+01
heptane	3.4	3.4	3.4	0.00	0.0	ND(0.22)	ND(1.9)	ND(0.42)	ND(<0.85)	IND	IND	>4.0E+00	IND
hexane	3.8	4.1	4.0	0.21	5.4	0.44	ND(1.9)	ND(0.43)	<0.92	IND	IND	>4.5E+00	IND
cyclohexane	1.5	1.5	1.5	0.00	0.0	0.53	ND(3.8)	ND(0.86)	<1.7	IND	IND	>8.8E-01	IND
benzene	1.1	1.0	1.1	0.07	6.7	0.26	ND(1.9)	ND(0.42)	<0.86	IND	IND	>1.3E+00	IND
toluene	17	17	17	0.00	0.0	1.6	ND(1.9)	ND(0.42)	<1.3	IND	IND	>1.3E+01	IND
ethylbenzene	17	16	17	0.71	4.3	0.51	ND(1.9)	ND(0.42)	<0.94	IND	IND	>1.8E+01	IND
m/p-xylenes	58	56	57	1.4	2.5	1.2	ND(3.8)	0.20 L	<1.7	IND	IND	>3.4E+01	IND
o-xylene	20	19	20	0.71	3.6	0.55	ND(1.9)	ND(0.42)	<0.96	IND	IND	>2.1E+01	IND
styrene	ND(0.25)	ND(0.25)	ND(<0.25)	IND	IND	ND(0.22)	ND(1.9)	ND(0.42)	ND(<0.85)	IND	IND	IND	IND
1,2,4-TMB	1.5	1.5	1.5	0.00	0.0	ND(0.22)	ND(1.9)	ND(0.42)	ND(<0.85)	IND	IND	>1.8E-01	IND
1,3,5-TMB	0.56	0.54	0.55	0.01	2.6	ND(0.23)	ND(1.9)	ND(0.42)	ND(<0.85)	IND	IND	>6.6E-01	IND
1,3- butadiene	ND(0.25)	ND(0.25)	ND(<0.25)	IND	IND	ND(0.23)	ND(1.9)	ND(0.42)	ND(<0.85)	IND	IND	IND	IND
1,3-DCB	ND(0.25)	ND(0.25)	ND(<0.25)	IND	IND	ND(0.23)	ND(1.9)	ND(0.42)	ND(<0.85)	IND	IND	IND	IND
1,4-DCB	ND(0.25)	ND(0.25)	ND(<0.25)	IND	IND	ND(0.23)	ND(1.9)	ND(0.42)	ND(<0.85)	IND	IND	IND	IND
4-ethyl- toluene	2.2	2.0	2.1	0.14	6.7	ND(0.23)	ND(1.9)	ND(0.43)	ND(<0.84)	IND	IND	>2.6E+00	IND
isopropyl alcohol	ND(0.25)	ND(0.25)	ND(<0.25)	IND	IND	ND(0.23)	ND(1.9)	ND(0.42)	ND(<0.85)	IND	IND	IND	IND
ethyl/vinyl acetate	12	11	12	0.71	6.1	ND(45)	ND(3.7)	ND(0.83)	ND(<17)	IND	IND	>7.1E-01	IND
CS ₂	0.14	0.13	0.14	0.01	5.2	ND(0.21)	ND(1.8)	ND(0.39)	ND(<0.84)	IND	IND	>1.7E-01	IND
ND()=Not detected (reporting limit)				IND = indeterminate			mean and stdev calculated from 2 or more measurements						

Three probes were installed for sub-slab sampling. All three probes were sampled using EPA Method TO-15 and one-liter Tedlar bags. As indicated in **Table 4b**, when sampling using EPA Method TO-15, 1,1,1-TCA, 1,1-DCE, TCE, c-1,2-DCE, and 1,1-DCA were detected at maximum concentrations in Probe B at 120, 44, 80, 16, and 11 ppbv, respectively. Other chlorinated VOCs detected in sub-slab air using EPA Method TO-15 were perchloroethylene, methylene chloride, chloroform, and carbon tetrachloride at maximum concentrations of 0.79, 3.6, 32, and 0.12 ppbv, respectively. Freons, F-11, F-12, and F-113, were detected in sub-slab air at maximum concentrations of 0.75, 570, and 0.10 ppbv, respectively. The high concentration of F-12 at Probe [C] may have been associated with a leak from the central air conditioning system located in the basement. Hydrocarbons, hexane, cyclohexane, benzene, toluene, ethylbenzene, m/p-xylenes, and

o-xylene were detected in sub-slab air at maximum concentrations up to 1.6 ppbv. Acetone and methyl tertiary-butyl ether were detected in sub-slab air at maximum concentrations of 1.2 and 1.8 ppbv, respectively. As indicated in **Table 4c**, when sampling with one-liter Tedlar bags, 1,1,1-TCA, 1,1-DCE, TCE, and c-1,2-DCE were detected at maximum concentrations in Probe B at 137, 48, 75, and 25 ppbv, respectively.

Basement/sub-slab air concentration ratios for VOCs using EPA Method TO-15 are illustrated in **Figure 36**. With the exception of F-12 and chloroform, basement/sub-slab air concentration ratios for all five VOCs associated with sub-surface contamination were lower than other VOCs detected in basement air. The standard deviations of basement/sub-slab air concentration ratios of F-12 and chloroform exceeded

Table 4b. Summary of Basement/Sub-Slab Air Concentration Ratios of VOCs Associated with Sub-Surface Contamination in House B Using EPA Method TO-15 During the July 2002 Sample Event

VOC	bsmt 1-hr	bsmt 1-hr	bsmt mean	bsmt stdev	bsmt cov	P[A]	P[B]	P[C]	sub-slab mean	sub-slab stdev	sub-slab cov	bsmt/ sub-slab ratio	bsmt/ sub-slab stdev
			n=2	n=2	n=2	grab	grab	grab	n=3	n=3	n=3		
	07/16/02	07/16/02	07/16/02	07/16/02	07/16/02	07/16/02	07/16/02	07/16/02	07/16/02	07/16/02	07/16/02		
	(ppbv)	(ppbv)	(ppbv)	(ppbv)	(ppbv)	(ppbv)	(ppbv)	(ppbv)	(ppbv)	(ppbv)	(%)	(-)	(-)
1,1,1-TCA	0.40	0.41	0.41	0.01	1.7	7.9	120	8.1	45	65	143	8.9E-03	1.3E-02
1,1-DCE	0.10	0.11	0.11	0.01	6.7	3.7	44	0.94	16	24	149	6.5E-03	9.6E-03
TCE	0.41	0.40	0.41	0.01	1.7	20	80	30	43	32	74	9.3E-03	6.9E-03
c-1,2-DCE	ND(0.25)	ND(0.25)	ND(<0.25)	IND	IND	4.3	16	1.3	7.2	7.8	108	<3.5E-02	IND
1,1-DCA	ND(0.26)	ND(0.26)	ND(<0.26)	IND	IND	1.6	11	1.2	4.6	5.5	121	<5.7E-02	IND
mean and standard deviation of basement/sub-slab ratio												8.3E-03	5.8E-03

Table 4c. Summary of Basement/Sub-Slab Air Concentration Ratios of VOCs Associated with Sub-Surface Contamination in House B Using 1-Liter Tedlar Bags and On-Site GC Analysis During the July 2002 Sample Event

VOC	bsmt 1-hr	bsmt 1-hr	bsmt mean	bsmt stdev	bsmt cov	P[A]	P[B]	P[C]	sub-slab mean	sub-slab stdev	sub-slab cov	bsmt/ sub-slab ratio	bsmt/ sub-slab stdev
			n=2	n=2	n=2	grab	grab	grab	n=3	n=3	n=3		
	07/16/02	07/16/02	07/16/02	07/16/02	07/16/02	07/16/02	07/16/02	07/16/02	07/16/02	07/16/02	07/16/02		
	(ppbv)	(ppbv)	(ppbv)	(ppbv)	(ppbv)	(ppbv)	(ppbv)	(ppbv)	(ppbv)	(ppbv)	(%)	(-)	(-)
1,1,1-TCA	0.40	0.41	0.41	0.01	1.7	10	137	14	54	72	135	7.5E-03	1.0E-02
1,1-DCE	0.10	0.11	0.11	0.01	6.7	ND(10)	48	ND(10)	<23	IND	IND	>4.8E-03	IND
TCE	0.41	0.40	0.41	0.01	1.7	20	75	27	41	30	74	1.0E-02	7.3E-03
c-1,2-DCE	ND(0.25)	ND(0.25)	ND(<0.25)	IND	IND	ND(25)	25	ND(25)	<25	IND	IND	IND	IND
mean and standard deviation of basement/sub-slab ratio												8.8E-03	6.3E-03

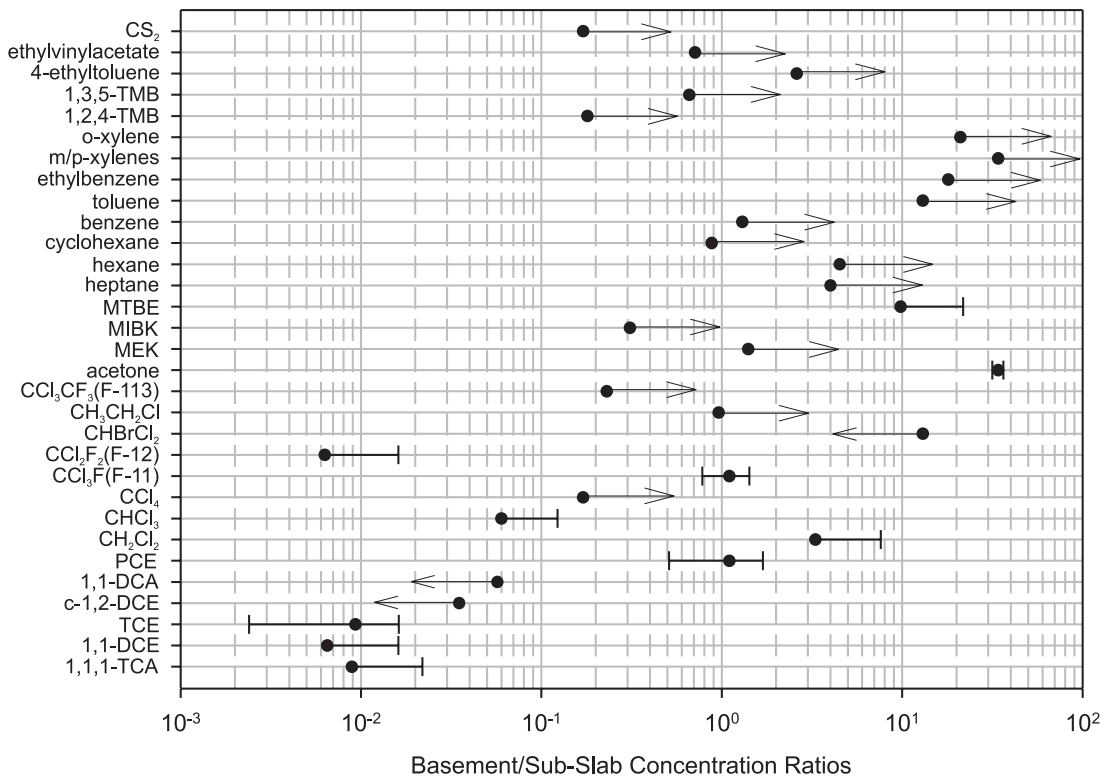

Figure 36. Basement/sub-slab concentration ratios using EPA Method TO-15 at House B during the July 2002 sample event. Error bars represent one standard deviation. Arrows indicate greater than or less than values due to non-detection in basement or sub-slab air.

mean values. F-12 and chloroform were eliminated from consideration of vapor intrusion because these VOCs were not detected in soil gas or ground water in the vicinity of the building. Since the null hypotheses that the basement/sub-slab air concentration ratios of 1,1,1-TCA and TCE were equivalent to the indicator VOC, 1,1-DCE, could not be rejected using a one-tailed Approximate t-Test at a level of significance less than or equal to 0.05 ($p > 0.1$), it was inferred that detection of 1,1,1-TCA, 1,1-DCE, and TCE in basement air was due to vapor intrusion at the time of sampling. 1,1,1-TCA was detected in outside air at 0.58 ppbv during the July 2002 sampling event. Unlike other VOCs such as benzene, toluene, ethylbenzene, and xylenes, 1,1,1-TCA was not detected in outside air during the March 2003 sampling event nor in previous outdoor sampling activities conducted by EPA's New England Laboratory.

Results and statistical analysis of VOCs associated with sub-surface contamination and sampled using EPA Method TO-15 are summarized in **Table 4b**. Use of basement/sub-slab air concentration ratios of 1,1,1-TCA, 1,1-DCE, and TCE resulted in computation of an average basement/sub-slab air ratio of 8.3E-03 for VOCs associated with vapor intrusion. Coefficients of variation in sub-slab air samples ranged from 74 to 149%. Results and statistical analysis of VOCs associated with sub-surface contamination sampled using one-liter Tedlar bags are summarized in **Table 4c**. Use of basement/sub-slab air concentration ratios of 1,1,1-TCA and TCE resulted in computation of an average basement/sub-slab ratio of 8.8E-03 for VOCs associated with vapor intrusion. The coefficients of variation for sub-slab air sampling ranged from 74 to 135%.

The results of sub-slab sampling using one-liter Tedlar bags during the October 2002 sampling event are presented in **Table 4d**. A comparison of mean sub-slab air concentrations for 1,1,1-TCA and TCE for the July 2002 and October 2002 sampling events using one-liter Tedlar bags is illustrated in

Figure 37. The null hypotheses that the mean sub-slab air concentrations of 1,1,1-TCA and TCE were equivalent during the July and October 2002 sample events were not rejected using a two-tailed Approximate t-Test at a level of significance of 0.1 or less.

Table 4d. Sub-Slab Air Concentrations of VOCs Associated with Sub-Surface Contamination in House B Using 1-Liter Tedlar Bags and On-Site GC Analysis During the October 2002 Sample Event

VOC	P[A] grab	P[B] grab	P[C] grab	sub-slab mean n=3	sub-slab stdev n=3	sub-slab cov n=3
	10/30/02	10/30/02	10/30/02	10/30/02	10/30/02	10/30/02
	(ppbv)	(ppbv)	(ppbv)	(ppbv)	(ppbv)	(%)
1,1,1-TCA	101	169	42	104	64	61
1,1-DCE	39	82	18	46	33	70
TCE	50	80	29	53	26	48
c-1,2-DCE	4.6	12	ND(4.1)	8	5.2	63

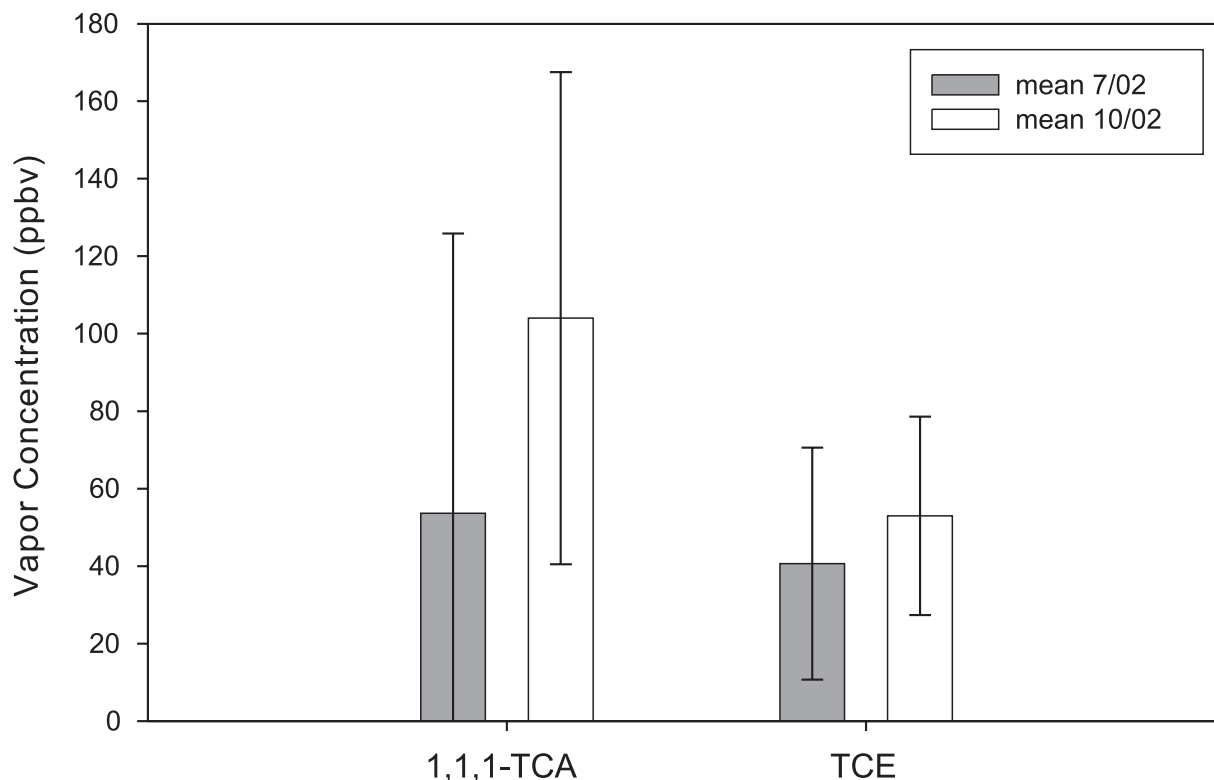

Figure 37. Comparison of mean sub-slab air concentrations of VOCs collected in one-liter Tedlar bags during the July and October 2002 sample events at House B. Error bars represent one standard deviation.

House C

During the home survey, a strong petroleum odor was noticed inside the basement. It was determined that a lawnmower was leaking gasoline from inside a shed attached to the house. The lawnmower was removed from the shed. The shed door was kept open for three days prior to installation of sub-slab probes and basement air sampling. At the time of probe installation, no significant cracks or holes were observed in the concrete slab or in unpainted cinderblock walls. Concentrations of VOCs detected in basement and/or sub-slab air using EPA Method TO-15 are summarized in **Table 5a**. All five VOCs associated with sub-surface contamination were detected in basement air. 1,1,1-TCA, 1,1-DCE, TCE, c-1,2-DCE, and 1,1-DCA were detected at concentrations of 3.8, 2.3, 1.5, 0.57, and 0.52 ppbv, respectively. Other chlorinated VOCs detected in basement air were perchloroethylene, methylene chloride, chloroform, carbon tetrachloride, 1,3-dichlorobenzene, and 1,4-dichlorobenzene at concentrations of 0.17, 3.9, 0.34, 0.23, 0.10, and 0.15 ppbv, respectively. Freons, F-11, F-12, and F-113, were detected at concentrations of 0.82, 1.1, 0.22 ppbv, respectively. Hydrocarbons, heptane, hexane, cyclohexane, benzene, toluene, ethylbenzene, m/p-xylenes, o-xylene, styrene, 1,2,4-trimethylbenzene, 1,3,5-trimethylbenzene, 4-ethyltoluene were detected in basement air at concentrations up to 5.3 ppbv. Acetone, methyl ethyl ketone, and methyl tertiary-butyl ether were detected in basement air at concentrations of 5.3, 1.0, and 8.5 ppbv, respectively. The compound, 1,3-butadiene, was detected at a concentration of 0.35 ppbv.

Four probes were installed for sub-slab sampling. All four probes were sampled using EPA Method

TO-15 and in one-liter Tedlar bags. As indicated in **Table 5b**, when sampling using EPA Method TO-15, 1,1,1-TCA, 1,1-DCE, TCE, c-1,2-DCE, and 1,1-DCA were detected at maximum concentrations in Probe A at 590, 410, 280, 120, and 94 ppbv, respectively. Total VOCs in probes exceeded 1000 ppbv. The only other VOCs detected in sub-slab air were acetone, toluene, and m/p-xylenes at 28, 4.2, and 7.0 ppbv, respectively. Detection limits for other VOCs ranged from 13 to 200 ppbv. As indicated in **Table 5c**, when sampling with one-liter Tedlar bags, 1,1,1-TCA, 1,1-DCE, TCE, and c-1,2-DCE were detected at maximum concentrations in Probe [A] at 833, 486, 260, and 120 ppbv, respectively.

Basement/sub-slab air concentration ratios of VOCs detected in basement air and sampled using EPA Method TO-15 are illustrated in **Figure 38**. With the exception of the bromodichloromethane, which had a basement/sub-slab air concentration ratio at some value greater than $9.2E-04$, basement/sub-slab air concentration ratios for all five VOCs associated with sub-surface contamination were significantly lower than other VOCs detected in basement air. Bromodichloromethane, a trihalomethane, was not present in ground water or soil gas in the vicinity of the house and thus was removed from consideration of vapor intrusion. Since the null hypotheses that basement/sub-slab air concentration ratios of 1,1,1-TCA and TCE were equivalent to indicator VOCs, 1,1-DCE, c-1,2-DCE, and 1,1-DCA, could not be rejected using a one-tailed Approximate t-Test at a level of significance less than or equal to 0.05 ($p > 0.1$), it was inferred that detection of 1,1,1-TCA, 1,1-DCE, TCE, c-1,2-DCE, and 1,1-DCA in basement air was due to vapor intrusion at the time of sampling.

Table 5a. Basement and Sub-Slab Air Concentrations for VOCs at House C Using EPA Method TO-15 During the July 2002 Sample Event

VOC	bsmt 1-hr	scaled stdev	P[A] grab	P[B] grab	P[C] grab	P[D] grab	sub-slab mean n=4	sub-slab stdev n=4	sub-slab cov n=4	bsmt/ sub-slab ratio (-)	bsmt/ sub-slab stdev (-)	
	07/16/02	cov=6%	07/16/02	07/16/02	07/16/02	07/16/02	07/16/02	07/16/02	07/16/02			
	(ppbv)	(ppbv)	(ppbv)	(ppbv)	(ppbv)	(ppbv)	(ppbv)	(ppbv)	(%)			
1,1,1-TCA	3.8	0.23	590	420	510	460	495	73.3	14.8	7.7E-03	1.2E-03	
1,1-DCE	2.3	0.14	410	290	290	300	323	58.5	18.1	7.1E-03	1.4E-03	
TCE	1.5	0.09	280	200	200	180	215	44.3	20.6	7.0E-03	1.5E-03	
c-1,2-DCE	0.57	0.03	120	84	55	64	81	28.8	36	7.1E-03	2.6E-03	
1,1-DCA	0.52	0.03	94	66	57	61	70	17	24	7.5E-03	1.9E-03	
1,2-DCA	ND(0.25)	IND	ND(21)	ND(19)	ND(13)	ND(15)	ND(<17)	IND	IND	IND	IND	
PCE	0.17	0.01	ND(21)	ND(20)	ND(13)	ND(15)	ND(<17)	IND	IND	> 1.0E-02	IND	
CH ₂ Cl ₂	3.9	0.23	ND(21)	ND(20)	ND(13)	ND(15)	ND(<17)	IND	IND	> 2.3E-01	IND	
CHCl ₃	0.34	0.02	ND(21)	ND(19)	ND(13)	ND(15)	ND(<17)	IND	IND	> 2.0E-02	IND	
CCl ₄	0.23	0.01	ND(21)	ND(20)	ND(13)	ND(15)	ND(<17)	IND	IND	> 1.4E-02	IND	
CCl ₃ F(F-11)	0.82	0.05	ND(21)	ND(20)	ND(13)	ND(15)	ND(<17)	IND	IND	> 4.8E-02	IND	
CCl ₂ F ₂ (F-12)	1.1	0.07	ND(21)	ND(19)	ND(13)	ND(15)	ND(<17)	IND	IND	> 6.5E-02	IND	
CHBrCl ₂	0.14	0.01	ND(190)	ND(180)	ND(110)	ND(130)	ND(<152)	IND	IND	> 9.2E-04	IND	
vinyl chloride	ND(0.25)	IND	ND(21)	ND(19)	ND(13)	ND(15)	ND(<17)	IND	IND	IND	IND	
CH ₂ CH ₂ Cl	ND(0.25)	IND	ND(21)	ND(19)	ND(13)	ND(15)	ND(<17)	IND	IND	IND	IND	
CCl ₃ CF ₃ (F-113)	0.22	0.01	ND(21)	ND(20)	ND(13)	ND(15)	ND(<17)	IND	IND	> 1.3E-02	IND	
acetone	5.3	0.32	ND(200)	28	14	20	21	7.0	34	2.5E-01	8.9E-02	
2-hexanone	ND(0.25)	IND	ND(21)	ND(19)	ND(13)	ND(15)	ND(<17)	IND	IND	IND	IND	
THF	ND(2.3)	IND	ND(18)	ND(18)	ND(18)	ND(18)	ND(18)	IND	IND	IND	IND	
MEK	1.0	0.06	ND(39)	ND(36)	ND(24)	ND(28)	ND(<32)	IND	IND	> 3.1E-02	IND	
MIBK	ND(0.22)	IND	ND(18)	ND(17)	ND(11)	ND(13)	ND(<15)	IND	IND	IND	IND	
MTBE	8.5	0.51	ND(20)	ND(18)	ND(12)	ND(14)	ND(<16)	IND	IND	> 5.3E-01	IND	
heptane	0.97	0.06	ND(21)	ND(19)	ND(13)	ND(15)	ND(<17)	IND	IND	> 4.6E-02	IND	
hexane	2.4	0.14	ND(22)	ND(20)	ND(13)	ND(15)	ND(<18)	IND	IND	> 1.3E-01	IND	
cyclohexane	0.57	0.03	ND(43)	ND(40)	ND(26)	ND(90)	ND(<50)	IND	IND	> 1.1E-02	IND	
benzene	0.80	0.05	ND(21)	ND(20)	ND(13)	ND(15)	ND(<17)	IND	IND	> 4.7E-02	IND	
toluene	5.3	0.32	4.2	ND(20)	ND(13)	ND(15)	<13	IND	IND	> 4.1E-01	IND	
ethylbenzene	1.0	0.06	ND(21)	ND(20)	ND(13)	ND(15)	ND(<17)	IND	IND	> 5.9E-02	IND	
m/p-xylenes	3.7	0.22	ND(42)	7.0	ND(26)	ND(30)	<21	IND	IND	> 1.8E-02	IND	
o-xylene	1.5	0.09	ND(21)	ND(20)	ND(13)	ND(15)	ND(<17)	IND	IND	> 8.8E-02	IND	
styrene	0.29	0.02	ND(20)	ND(19)	ND(12)	ND(14)	ND(<16)	IND	IND	> 1.8E-02	IND	
1,2,4-TMB	2.4	0.14	ND(21)	ND(19)	ND(13)	ND(15)	ND(<17)	IND	IND	> 1.4E-01	IND	
1,3,5-TMB	0.77	0.05	ND(21)	ND(20)	ND(13)	ND(15)	ND(<17)	IND	IND	> 4.5E-02	IND	
1,3-butadiene	0.35	0.02	ND(43)	ND(40)	ND(26)	ND(30)	ND(<35)	IND	IND	> 1.0E-02	IND	
1,3-DCB	0.10	0.01	ND(21)	ND(19)	ND(13)	ND(15)	ND(<17)	IND	IND	> 5.9E-03	IND	
1,4-DCB	0.15	0.01	ND(20)	ND(19)	ND(12)	ND(14)	ND(<16)	IND	IND	> 9.4E-03	IND	
4-ethyl-toluene	1.70	0.10	ND(22)	ND(20)	ND(13)	ND(15)	ND(<18)	IND	IND	> 9.4E-02	IND	
isopropyl alcohol	ND(0.25)	IND	ND(22)	ND(20)	ND(13)	ND(15)	ND(<18)	IND	IND	IND	IND	
ethyl/vinyl acetate	1.5	0.09	ND(42)	ND(39)	ND(25)	ND(29)	ND(<34)	IND	IND	> 4.4E-02	IND	
CS ₂	0.18	0.01	ND(20)	ND(18)	ND(12)	ND(14)	ND(<16)	IND	IND	> 1.1E-02	IND	
ND () = Not detected above reporting limits				IND = indeterminate			mean and stdev calculated from 2 or more measurements					

Table 5b. Summary of Basement/Sub-Slab Air Concentration Ratios of VOCs Associated with Sub-Surface Contamination in House C Using EPA Method TO-15 During the July 2002 Sample Event

VOC	bsmt 1-hr	scaled stdev	P[A] grab	P[B] grab	P[C] grab	P[D] grab	sub-slab mean	sub-slab stdev	sub-slab cov	bsmt/sub-slab ratio	bsmt/sub-slab stdev
	07/16/02	cov=6%	07/16/02	07/16/02	07/16/02	07/16/02	n=4	n=4	n=4		
	(ppbv)	(ppbv)	(ppbv)	(ppbv)	(ppbv)	(ppbv)	(ppbv)	(ppbv)	(%)		
1,1,1-TCA	3.8	0.23	590	420	510	460	495	73.3	14.8	7.7E-03	1.2E-03
1,1-DCE	2.3	0.14	410	290	290	300	323	58.5	18.1	7.1E-03	1.4E-03
TCE	1.5	0.09	280	200	200	180	215	44.3	20.6	7.0E-03	1.5E-03
c-1,2-DCE	0.57	0.03	120	84	55	64	81	28.8	36	7.1E-03	2.6E-03
1,1-DCA	0.52	0.03	94	66	57	61	70	17	24	7.5E-03	1.9E-03
mean and standard deviation of basement/sub-slab ratio										7.3E-03	7.9E-04

Table 5c. Summary of Basement/Sub-Slab Air Concentration Ratios of VOCs Associated with Sub-Surface Contamination in House C Using 1-Liter Tedlar Bags and On-Site GC Analysis During the July 2002 Sample Event

VOC	bsmt 1-hr	scaled stdev	P[A] grab	P[B] grab	P[C] grab	P[D] grab	sub-slab mean	sub-slab stdev	sub-slab cov	bsmt/sub-slab ratio	bsmt/sub-slab stdev
	07/16/02	cov=6%	07/16/02	07/16/02	07/16/02	07/16/02	n=4	n=4	n=4		
	(ppbv)	(ppbv)	(ppbv)	(ppbv)	(ppbv)	(ppbv)	(ppbv)	(ppbv)	(%)		
1,1,1-TCA	3.8	0.23	833	650	757	722	741	76.1	10.3	5.1E-03	6.1E-04
1,1-DCE	2.3	0.14	486	374	423	416	425	46.2	10.9	5.4E-03	6.7E-04
TCE	1.5	0.09	260	201	249	195	226	33.0	14.6	6.6E-03	1.0E-03
c-1,2-DCE	0.57	0.03	120	98	61	74	88	26	30	6.5E-03	2.0E-03
mean and standard deviation of basement/sub-slab ratio										5.9E-03	6.0E-04

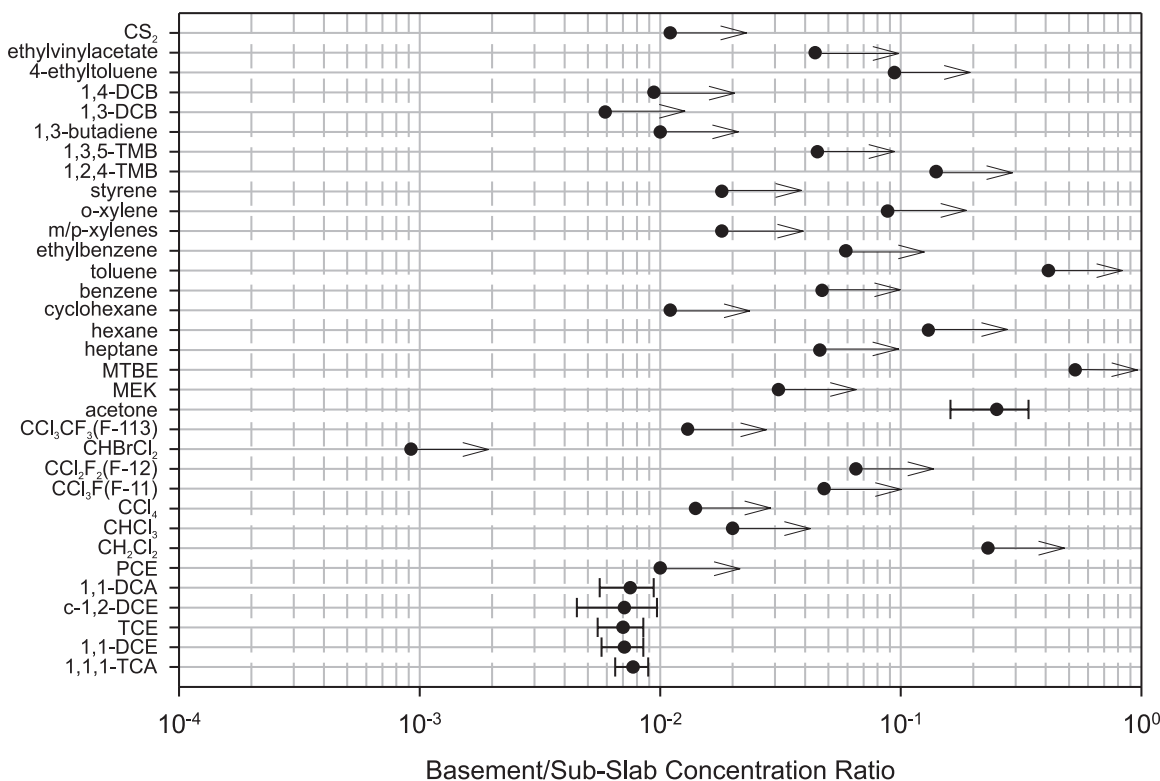

Figure 38. Basement/sub-slab concentration ratios using EPA Method TO-15 at House C during the July 2002 sample event. Error bars represent one standard deviation. Arrows indicate greater than or less than values due to non-detection in basement or sub-slab air.

Results and statistical analysis of VOCs associated with sub-surface contamination and sampled using EPA Method TO-15 are summarized in **Table 5b**. Use of basement/sub-slab air concentration ratios of 1,1,1-TCA, 1,1-DCE, TCE, c-1,2-DCE, and 1,1-DCA resulted in computation of an average basement/sub-slab ratio of 7.3E-03. Coefficients of variation of sub-slab air concentrations varied from 15 to 36%. Results and statistical analysis of VOCs associated with sub-surface contamination and sampled using one-liter Tedlar bags are summarized in **Table 5c**. Use of basement/sub-slab air concentration ratios of 1,1,1-TCA, 1,1-DCE, TCE, and c-1,2-DCE resulted in computation of an average basement/sub-slab air concentration ratio of 5.9E-03. Coefficients of variation of sub-slab air concentrations varied from 10 to 30%.

The results of sub-slab sampling with one-liter Tedlar bags during the October 2002 sample event are summarized in **Table 5d**. A comparison of mean sub-slab air concentrations for 1,1,1-TCA, 1,1-DCE, TCE, and c-1,2-DCE for the July 2002 and October 2002 sampling events using one-liter Tedlar bags is illustrated in **Figure 39**. The null hypotheses that the mean sub-slab air concentrations of 1,1,1-TCA, 1,1-DCE, TCE, and c-1,2-DCE were equivalent during the July and October 2002 sample events was not rejected using a two-tailed Approximate t-Test at significance less than or equal to 0.1.

Table 5d. Sub-Slab Air Concentrations of VOCs Associated with Sub-Surface Contamination in House C Using 1-Liter Tedlar Bags and On-Site GC Analysis During the October 2002 Sample Event

VOC	P[A] grab	P[B] grab	P[C] grab	P[D] grab	sub-slab mean	sub-slab stdev	sub-slab cov
					n=4	n=4	n=4
	10/01/02 (ppbv)	10/01/02 (ppbv)	10/01/02 (ppbv)	10/01/02 (ppbv)	10/01/02 (ppbv)	10/01/02 (ppbv)	10/01/02 (%)
1,1,1-TCA	941	630	623	505	675	187	27.6
1,1-DCE	618	387	323	288	404	148	36.7
TCE	469	276	200	188	283	130	45.8
c-1,2-DCE	167	91	34	57	87	58	67

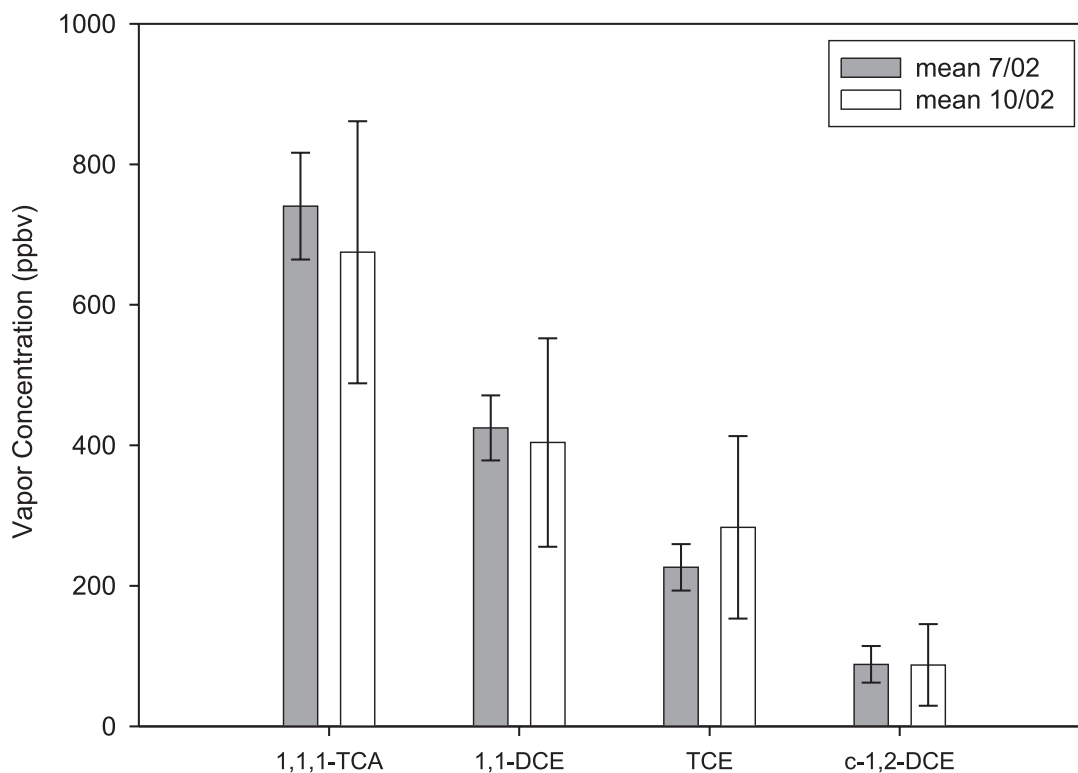

Figure 39. Comparison of mean sub-slab air concentrations of VOCs collected in one-liter Tedlar bags during the July and October 2002 sample events at House C. Error bars represent one standard deviation.

House D

At the time of probe installation, significant cracks and holes were observed in the concrete slab. At some locations, the slab resembled a veneer of plaster-like material. Concentrations of VOCs detected in basement and/or sub-slab air using EPA Method TO-15 are summarized in **Table 6a**. 1,1,1-TCA and 1,1-DCE were detected in basement air at concentrations of 0.48 and 0.13 ppbv, respectively. The detection limit for TCE, c-1,2-DCE, and 1,1-DCA was 0.28 ppbv. Other chlorinated VOCs detected in basement air were methylene chloride, chloroform, and carbon tetrachloride at concentrations of 7.1, 0.11, and 0.11 ppbv, respectively. Freons, F-11, F-12, and F-113 were detected at concentrations of 0.30, 0.61, 0.10 ppbv, respectively. Hydrocarbons, hexane, cyclohexane, benzene, toluene, ethylbenzene, m/p-

xylenes, o-xylene, styrene, 1,2,4-trimethylbenzene, 4-ethyltoluene were detected in basement air at concentrations up to 1.4 ppbv. Acetone, tetrahydrofuran, methyl ethyl ketone, and methyl tertiary-butyl ether were detected at concentrations of 6.9, 3.7, 6.2, and 0.57 ppbv, respectively.

Three probes were installed for sub-slab sampling. All three probes were sampled with Tedlar bags. Only two probes were sampled using EPA Method TO-15 because one probe, Probe P[B], became loose during sampling with a Tedlar bag. As indicated in **Table 6b**, when sampling using EPA Method TO-15, 1,1,1-TCA, 1,1-DCE, TCE, c-1,2-DCE, and 1,1-DCA were detected at maximum concentrations at 110, 110, 28, 6.1, 16 ppbv, respectively. The only other VOCs detected in sub-slab air were acetone and chloroform at 4.5 and 1.4 ppbv, respectively. Detection limits for other

Table 6a. Basement and Sub-Slab Air Concentrations for VOCs at House D Using EPA Method TO-15 During the July 2002 Sample Event

VOC	bsmt 1-hr	scaled stdev	P[A] grab	P[B] grab	sub-slab mean	sub-slab stdev	sub-slab cov	bsmt/ sub-slab ratio	bsmt/ sub-slab stdev
	07/16/02	cov=6%	07/16/02	07/16/02	n=2	n=2	n=2		
	(ppbv)	(ppbv)	(ppbv)	(ppbv)	(ppbv)	(ppbv)	(%)		
								(-)	(-)
1,1,1-TCA	0.48	0.03	52	110	81	41	51	5.9E-03	3.0E-03
1,1-DCE	0.13	0.01	22	110	66	62	94	2.0E-03	1.9E-03
TCE	ND(0.28)	IND	16	28	22	8.5	39	< 1.3E-02	IND
c-1,2-DCE	ND(0.27)	IND	4.6	6.1	5.4	1.1	20	< 5.0E-02	IND
1,1-DCA	ND(0.28)	IND	12	16	14	2.8	20	< 2.0E-02	IND
1,2-DCA	ND(0.28)	IND	ND(1.9)	ND(1.9)	ND(<1.9)	IND	IND	IND	IND
PCE	ND(0.25)	IND	ND(1.9)	ND(1.9)	ND(<1.9)	IND	IND	IND	IND
CH ₂ Cl ₂	7.1	0.43	ND(1.9)	ND(1.9)	ND(<1.9)	IND	IND	> 3.7E+00	IND
CHCl ₃	0.11	0.01	1.4	0.98	1.2	0.30	25	9.2E-02	2.4E-02
CCl ₄	0.11	0.01	ND(1.9)	ND(1.9)	ND(<1.9)	IND	IND	> 5.8E-02	IND
CCl ₃ F (F-11)	0.30	0.02	ND(1.9)	ND(1.9)	ND(<1.9)	IND	IND	> 1.6E-01	IND
CCl ₂ F ₂ (F-12)	0.61	0.04	ND(1.9)	ND(1.9)	ND(<1.9)	IND	IND	> 3.2E-01	IND
CHBrCl ₂	ND(2.2)	IND	ND(1.9)	ND(1.9)	ND(<1.9)	IND	IND	IND	IND
vinyl chloride	ND(0.25)	IND	ND(1.9)	ND(1.9)	ND(<1.9)	IND	IND	IND	IND
CH ₃ CH ₂ Cl	ND(0.25)	IND	ND(1.9)	ND(1.9)	ND(<1.9)	IND	IND	IND	IND
CCl ₃ CF ₃ (F-113)	0.10	0.01	ND(1.9)	ND(1.9)	ND(<1.9)	IND	IND	> 5.3E-02	IND
acetone	6.9	0.41	2.7	4.5	3.6	1.3	35	1.9E+00	6.9E-01
2-hexanone	ND(0.25)	IND	ND(1.9)	ND(1.9)	ND(<1.9)	IND	IND	IND	IND
THF	3.7	0.22	ND(18)	ND(18)	ND(<18)	IND	IND	> 2.1E-01	IND
MEK	6.2	0.37	ND(3.5)	ND(3.6)	ND(<3.6)	IND	IND	> 1.7E+00	IND
MIBK	ND(0.21)	IND	ND(1.9)	ND(1.9)	ND(<1.9)	IND	IND	IND	IND
MTBE	0.57	0.03	ND(1.8)	ND(1.8)	ND(<1.8)	IND	IND	> 3.2E-01	IND
heptane	ND(0.24)	IND	ND(1.8)	ND(1.8)	ND(<1.8)	IND	IND	IND	IND
hexane	1.3	0.08	ND(1.9)	ND(2.0)	ND(<2.0)	IND	IND	> 6.5E-01	IND
cyclohexane	0.21	0.01	ND(3.8)	ND(3.9)	ND(<3.9)	IND	IND	> 5.4E-02	IND
benzene	0.28	0.02	ND(1.9)	ND(1.9)	ND(<1.9)	IND	IND	> 1.5E-01	IND
toluene	1.4	0.08	ND(1.9)	ND(1.9)	ND(<1.9)	IND	IND	> 7.4E-01	IND
ethylbenzene	0.39	0.02	ND(1.9)	ND(1.9)	ND(<1.9)	IND	IND	> 2.1E-01	IND
m/p-xylenes	1.3	0.08	ND(3.8)	ND(3.9)	ND(<3.9)	IND	IND	> 3.3E-01	IND
o-xylene	0.35	0.02	ND(1.9)	ND(1.9)	ND(<1.9)	IND	IND	> 1.8E-01	IND
styrene	0.11	0.01	ND(1.8)	ND(1.8)	ND(<1.8)	IND	IND	> 6.1E-02	IND
1,2,4-TMB	0.71	0.04	ND(1.9)	ND(1.9)	ND(<1.9)	IND	IND	> 3.7E-01	IND
1,3,5-TMB	ND(0.25)	IND	ND(1.9)	ND(1.9)	ND(<1.9)	IND	IND	IND	IND
1,3-butadiene	ND(0.50)	IND	ND(1.9)	ND(1.9)	ND(<1.9)	IND	IND	IND	IND
1,3-DCB	ND(0.24)	IND	ND(1.9)	ND(1.9)	ND(<1.9)	IND	IND	IND	IND
1,4-DCB	ND(0.24)	IND	ND(1.9)	ND(1.9)	ND(<1.9)	IND	IND	IND	IND
4-ethyl-toluene	0.41	0.02	ND(1.9)	ND(2.0)	ND(<2.0)	IND	IND	IND	IND
isopropyl alcohol	ND(0.25)	IND	ND(1.9)	ND(1.9)	ND(<1.9)	IND	IND	> 2.1E-01	IND
ethyl/vinyl acetate	ND(0.48)	IND	ND(1.9)	ND(1.9)	ND(<1.9)	IND	IND	IND	IND
CS ₂	ND(0.23)	IND	ND(1.9)	ND(1.9)	ND(<1.9)	IND	IND	IND	IND
ND()=Not detected (reporting limit)				IND = indeterminate					

compounds ranged from 1.8 to 18 ppbv. As indicated in **Table 6c**, when sampling with one-liter Tedlar bags, maximum concentrations of 1,1,1-TCA, 1,1-DCE, and TCE were 168, 111, and 30 ppbv, respectively. The detection limit for c-1,2-DCE was 25 ppbv.

Basement/sub-slab air concentration ratios of VOCs detected in basement air and sampled using EPA Method TO-15 are illustrated in **Figure 40**. Since the null hypothesis that the basement/sub-slab air concentration ratio of 1,1,1-TCA was equivalent to the indicator VOC, 1,1-DCE, could not be rejected using a one-tailed Approximate t-Test at a significance level less than or equal to 0.05 ($p > 0.1$), it was inferred that detection of 1,1,1-TCA and 1,1-DCE in basement air was due to vapor intrusion at the time of sampling.

Results and statistical analysis of VOCs associated with sub-surface contamination and sampled using EPA Method TO-15 are summarized in **Table 6b**. Use of basement/sub-slab air concentration ratios of 1,1,1-TCA and 1,1-DCE resulted in computation of an average basement/sub-slab air concentration ratio of 3.9E-03. Coefficients of variation of sub-slab air concentrations ranged from 20 to 94%. Results and statistical analysis of VOCs associated with sub-surface contamination and sampled using one-liter Tedlar bags are summarized in **Table 6c**. Use of basement/sub-slab air concentration values of 1,1,1-TCA and 1,1-DCE resulted in computation of an average basement/sub-slab air concentration ratio of 3.7E-03. Coefficients of variation of sub-slab air concentrations ranged from 35 to 95%.

Table 6b. Summary of Basement/Sub-Slab Air Concentration Ratios of VOCs Associated with Sub-Surface Contamination in House D Using EPA Method TO-15 During the July 2002 Sample Event

VOC	bsmt 1-hr	scaled stdev	P[A] grab	P[C] grab	sub-slab mean	sub-slab stdev	sub-slab cov	bsmt/sub-slab ratio	bsmt/sub-slab stdev
					n=2	n=2	n=2		
	07/16/02	cov=6%	07/16/02	07/16/02	07/16/02	07/16/02	07/16/02		
	(ppbv)	(ppbv)	(ppbv)	(ppbv)	(ppbv)	(ppbv)	(%)	(-)	(-)
1,1,1-TCA	0.48	0.03	52	110	81	41	51	5.9E-03	3.0E-03
1,1-DCE	0.13	0.01	22	110	66	62	94	2.0E-03	1.9E-03
TCE	ND(0.28)	IND	16	28	22	8.5	39	<1.3E-02	IND
c-1,2-DCE	ND(0.27)	IND	4.6	6.1	5.4	1.1	20	<5.0E-02	IND
1,1-DCA	ND(0.28)	IND	12	16	14	2.8	20	<2.0E-02	IND
mean and standard deviation of basement/sub-slab ratio								3.9E-03	1.8E-03

Table 6c. Summary of Basement/Sub-Slab Air Concentration Ratios of VOCs Associated with Sub-Surface Contamination in House D Using 1-Liter Tedlar Bags and On-Site GC Analysis During the July 2002 Sample Event

VOC	bsmt 1-hr	scaled stdev	P[A] grab	P[B] grab	P[C] grab	sub-slab mean	sub-slab stdev	sub-slab cov	bsmt/sub-slab Tedlar	bsmt/sub-slab stdev
						n=3	n=3	n=3		
	07/16/02	cov=6%	07/16/02	07/16/02	07/16/02	07/16/02	07/16/02	07/16/02		
	(ppbv)	(ppbv)	(ppbv)	(ppbv)	(ppbv)	(ppbv)	(ppbv)	(%)	(-)	(-)
1,1,1-TCA	0.48	0.03	77	16	168	87	76	87.9	5.5E-03	4.9E-03
1,1-DCE	0.13	0.01	22	ND(10)	111	67	63	95	2.0E-03	1.9E-03
TCE	ND(0.28)	IND	18	ND(6)	30	24	8	35.4	<1.1E-02	IND
c-1,2-DCE	ND(0.27)	IND	ND(25)	ND(25)	ND(25)	<25	IND	IND	IND	IND
mean and standard deviation of basement/sub-slab ratio									3.7E-03	2.6E-03

The results of sub-slab sampling with one-liter Tedlar bags during the October 2002 sample event are summarized in **Table 6d**. A comparison of mean sub-slab sample concentrations for 1,1,1-TCA, 1,1-DCE, and TCE during the July and October sampling events is illustrated in **Figure 41**. The null hypotheses that

the mean sub-slab air concentrations of 1,1,1-TCA, 1,1-DCE, and TCE were equivalent during the July and October 2002 sample events were not rejected using a two-tailed Approximate t-Test at a level of significance less than or equal to 0.1.

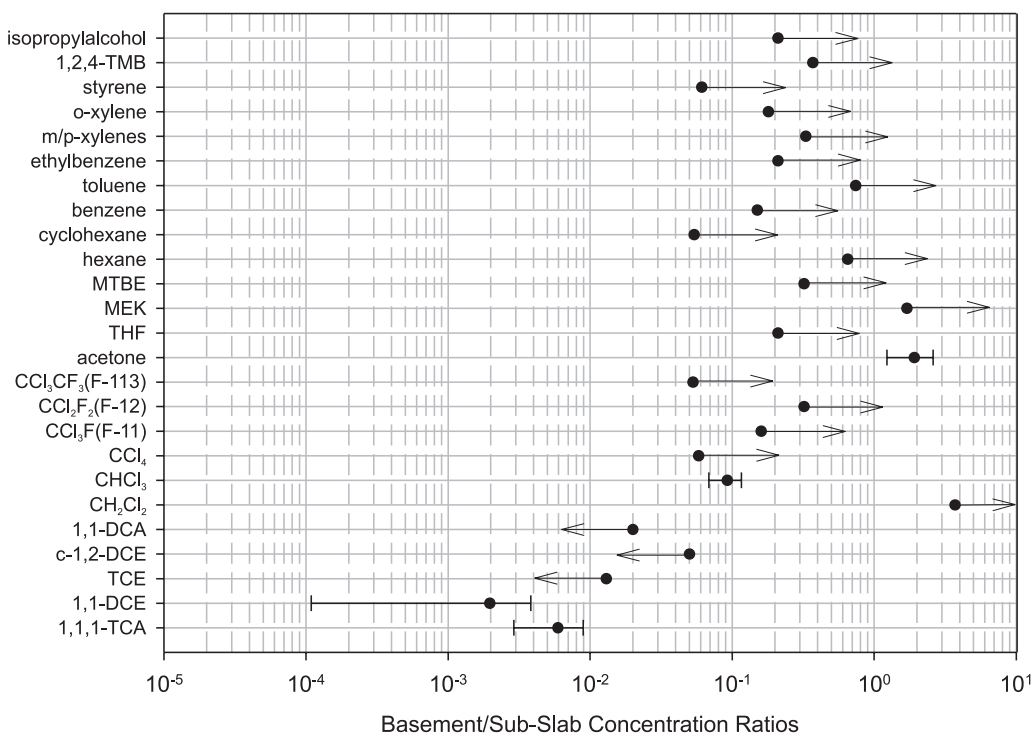

Figure 40. Basement/sub-slab concentration ratios using EPA Method TO-15 at House D during the July 2002 sample event. Error bars represent one standard deviation. Arrows indicate greater than or less than values due to non-detection in basement or sub-slab air.

Table 6d. Sub-Slab Air Concentrations of VOCs Associated with Sub-Surface Contamination in House D Using 1-Liter Tedlar Bags and On-Site GC Analysis During the October 2002 Sample Event

VOC	P[A]	P[C]	sub-slab	sub-slab	sub-slab
	grab	grab	mean	stdev	cov
			n=2	n=2	n=2
	11/01/02	11/01/02	11/01/02	11/01/02	11/01/02
	(ppbv)	(ppbv)	(ppbv)	(ppbv)	(%)
1,1,1-TCA	39	61	50	16	31
1,1-DCE	8.2	52	30	31	103
TCE	7.9	23	15	11	69
c-1,2-DCE	ND(4)	11	11	IND	IND
ND() = Not detected (reporting limit)				IND = indeterminate	

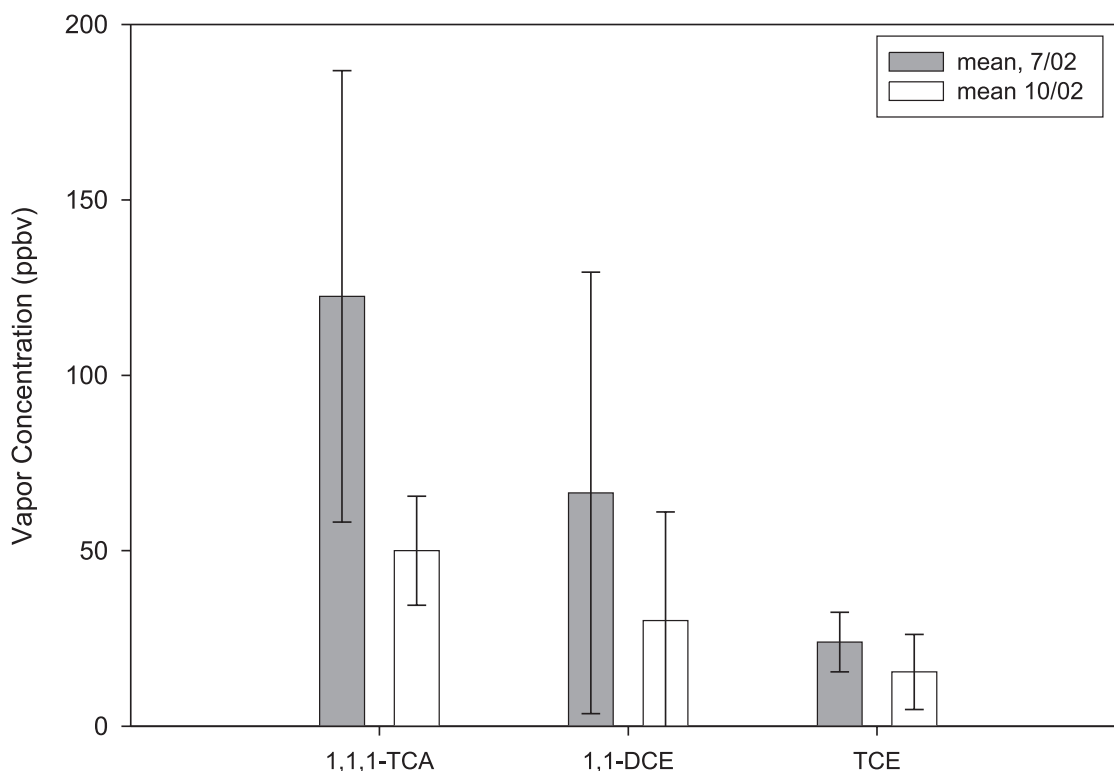

Figure 41. Comparison of mean sub-slab air concentrations of VOCs collected in one-liter Tedlar bags during the July and October 2002 sample events at House D. Error bars represent one standard deviation.

House E

At the time of probe installation, there was a two centimeter separation between the slab and cinderblock walls where underlying sandy soil was exposed. A portion (approximately 30%) of the basement was finished with ceramic tile. Poured concrete walls were painted. An oil furnace was centrally located in the basement. Concentrations of VOCs detected in basement and/or sub-slab air using EPA Method TO-15 are summarized in **Table 7a**. 1,1,1-TCA and 1,1-DCE were detected in basement air at concentrations of 0.57 and 0.12 ppbv, respectively. The detection limits for TCE, c-1,2-DCE, and 1,1-DCA were between 0.26 and 1.1 ppbv. Other chlorinated VOCs detected in basement air were methylene chloride, chloroform,

and carbon tetrachloride at concentrations of 9.5, 0.81, and 0.10 ppbv, respectively. Freons, F-11, F-12, and F-113, were detected at concentrations of 0.44, 0.59, and 0.09 ppbv, respectively. Hydrocarbons, hexane, benzene, toluene, ethylbenzene, m/p-xylenes, o-xylene, 1,2,4-trimethylbenzene were detected in basement air at concentrations up to 1.2 ppbv. Acetone, methyl ethyl ketone, and methyl tertiary-butyl ether were detected at concentrations of 9.6, 1.0, and 0.27 ppbv, respectively.

Three probes were installed for sub-slab sampling. All three probes were sampled using EPA Method TO-15 and one-liter Tedlar bags. As indicated in **Table 7b**, when sampling using EPA Method TO-15, 1,1,1-TCA, 1,1-DCE, TCE, c-1,2-DCE, and 1,1-DCA were

Table 7a. Basement and Sub-Slab Air Concentrations for VOCs at House E Using EPA Method TO-15 During the July 2002 Sample Event

VOC	bsmt 1-hr	scaled stdev	P[A] grab	P[B] grab	P[C] grab	sub-slab mean n=3	sub-slab stdev n=3	sub-slab cov n=3	bsmt/ sub-slab ratio (-)	bsmt/ sub-slab stdev (-)
	07/16/02 (ppbv)	cov=6% (ppbv)	07/16/02 (ppbv)	07/16/02 (ppbv)	07/16/02 (ppbv)	07/16/02 (ppbv)	07/16/02 (ppbv)	07/16/02 (%)		
1,1,1-TCA	0.57	0.03	48	78	170	99	64	64	5.8E-03	3.7E-03
1,1-DCE	0.12	0.01	13	59	170	81	81	100	1.5E-03	1.5E-03
TCE	ND(0.26)	IND	20	32	66	39	24	61	<6.7E-03	IND
c-1,2-DCE	ND(0.26)	IND	2.5	12	26	14	12	88	<1.9E-02	IND
1,1-DCA	ND(1.1)	IND	7.0	15	32	18	13	71	<6.12E-02	IND
1,2-DCA	ND(0.25)	IND	ND(1.1)	ND(1.8)	ND(3.7)	ND(<2.2)	IND	IND	IND	IND
PCE	ND(0.25)	IND	ND(1.1)	ND(1.8)	ND(3.7)	ND(<2.2)	IND	IND	IND	IND
CH ₂ Cl ₂	9.5	0.57	ND(1.1)	ND(1.8)	ND(3.7)	ND(<2.2)	IND	IND	>4.3E+00	IND
CHCl ₃	0.81	0.05	0.73	1.5	1.4	1.2	0.42	35	0.67	2.4E-01
CCl ₄	0.10	0.01	ND(1.1)	ND(1.8)	ND(3.7)	ND(<2.2)	IND	IND	>4.5E-02	IND
CCl ₃ F(F-11)	0.44	0.03	0.47	ND(1.8)	ND(3.7)	<2.0	IND	IND	>2.2E-01	IND
CCl ₂ F ₂ (F-12)	0.59	0.04	0.84	ND(1.8)	ND(3.7)	<2.1	IND	IND	>2.8E-01	IND
CHBrCl ₂	0.15	0.01	ND(9.8)	ND(16)	ND(33)	ND(<20)	IND	IND	>7.3E-03	IND
vinyl chloride	ND(0.25)	IND	ND(1.1)	ND(1.8)	ND(3.7)	ND(<2.2)	IND	IND	IND	IND
CH ₂ CH ₂ Cl	ND(0.25)	IND	ND(1.1)	ND(1.8)	ND(3.7)	ND(<2.2)	IND	IND	IND	IND
CCl ₃ CF ₃ (F-113)	0.09	0.01	ND(1.1)	ND(1.8)	ND(3.7)	ND(<2.2)	IND	IND	>4.12E-02	IND
acetone	9.6	0.58	2.6	5.0	5.7	4.4	1.6	37	2.2E+00	8.2E-01
2-hexanone	ND(0.25)	IND	ND(1.1)	ND(1.8)	ND(3.7)	ND(<2.2)	IND	IND	IND	IND
THF	ND(2.3)	IND	ND(18)	ND(18)	ND(18)	ND(18)	IND	IND	IND	IND
MEK	1.0	0.06	ND(2.0)	ND(3.3)	ND(7.0)	ND(<4.1)	IND	IND	>2.4E-01	IND
MIBK	ND(0.25)	IND	ND(1.1)	ND(1.8)	ND(3.7)	ND(<2.2)	IND	IND	IND	IND
MTBE	0.27	0.02	ND(1.0)	ND(1.7)	ND(3.5)	ND(<2.1)	IND	IND	>1.3E-01	IND
heptane	ND(0.25)	IND	ND(1.1)	ND(1.8)	ND(3.7)	ND(<2.2)	IND	IND	IND	IND
hexane	1.1	0.07	ND(1.1)	ND(1.8)	ND(3.8)	ND(<2.2)	IND	IND	>5.0E-01	IND
cyclohexane	ND(0.50)	IND	ND(1.1)	ND(1.8)	ND(3.7)	ND(<2.2)	IND	IND	IND	IND
benzene	0.22	0.01	ND(1.1)	ND(1.8)	ND(3.7)	ND(<2.2)	IND	IND	>1.0E-01	IND
toluene	1.2	0.07	ND(1.1)	ND(1.8)	ND(3.7)	ND(<2.2)	IND	IND	>5.5E-01	IND
ethylbenzene	0.14	0.01	ND(1.1)	ND(1.8)	ND(3.7)	ND(<2.2)	IND	IND	>6.4E-02	IND
m/p-xylenes	0.37	0.02	ND(2.2)	ND(3.6)	ND(7.5)	ND(<4.4)	IND	IND	>8.4E-02	IND
o-xylene	0.17	0.01	ND(1.1)	ND(1.8)	ND(3.7)	ND(<2.2)	IND	IND	>7.7E-02	IND
styrene	ND(0.23)	IND	ND(1.1)	ND(1.8)	ND(3.7)	ND(<2.2)	IND	IND	IND	IND
1,2,4-TMB	0.19	0.01	ND(1.1)	ND(1.8)	ND(3.7)	ND(<2.2)	IND	IND	>8.6E-02	IND
1,3,5-TMB	ND(0.26)	IND	ND(1.1)	ND(1.8)	ND(3.7)	ND(<2.2)	IND	IND	IND	IND
1,3-butadiene	ND(0.50)	IND	ND(1.1)	ND(1.8)	ND(3.7)	ND(<2.2)	IND	IND	IND	IND
1,3-DCB	ND(0.24)	IND	ND(1.1)	ND(1.8)	ND(3.7)	ND(<2.2)	IND	IND	IND	IND
1,4-DCB	ND(0.24)	IND	ND(1.1)	ND(1.8)	ND(3.7)	ND(<2.2)	IND	IND	IND	IND
4-ethyl-toluene	ND(0.25)	IND	ND(1.1)	ND(1.8)	ND(3.7)	ND(<2.2)	IND	IND	IND	IND
isopropyl alcohol	ND(0.25)	IND	ND(1.1)	ND(1.8)	ND(3.7)	ND(<2.2)	IND	IND	IND	IND
ethyl/vinyl acetate	1.0	0.06	ND(2.2)	ND(3.5)	ND(7.3)	ND(<4.3)	IND	IND	>2.3E-01	IND
CS ₂	ND(0.23)	IND	ND(1.1)	ND(1.8)	ND(3.7)	ND(<2.2)	IND	IND	IND	IND
ND() = Not detected (reporting limit)				IND = indeterminate						

detected at maximum concentrations in Probe C at 170, 170, 66, 26, and 32 ppbv, respectively. The only other VOCs detected in sub-slab air were acetone, chloroform, F-11, and F-12 at maximum concentrations of 5.7, 1.5, 0.47, and 0.84 ppbv, respectively. Detection limits for other compounds ranged from 1.1 to 18 ppbv. As indicated in **Table 7c**, when sampling with one-liter Tedlar bags, 1,1,1-TCA, 1,1-DCE, TCE, and c-1,2-DCE were detected at maximum concentrations at Probe [C] at 234, 130, 65, and 26 ppbv, respectively.

Basement/sub-slab air concentration ratios of VOCs detected in basement air and sampled using EPA Method TO-15 are illustrated in **Figure 42**. Basement/sub-slab air concentration ratios for all five VOCs associated with sub-surface contamination

were significantly lower than other VOCs detected in basement air. The basement/sub-slab air concentration ratio of bromodichloromethane was some value greater than 7.3E-03. This VOC was eliminated from consideration of vapor intrusion because it was not detected in soil gas or ground water in the vicinity of the building. Since the null hypothesis that the basement/sub-slab air concentration ratio of 1,1,1-TCA was equal to the basement/sub-slab air concentration ratio of the indicator VOC, 1,1-DCE, could not be rejected using a one-tailed Approximate t-Test at a level of significance less than or equal to 0.05 ($p = 0.1$), it was inferred that the presence of both 1,1,1-TCA and 1,1-DCE in basement air was due to vapor intrusion at the time of sampling.

Table 7b. Summary of Basement/Sub-Slab Air Concentration Ratios of VOCs Associated with Sub-Surface Contamination in House E Using EPA Method TO-15 During the July 2002 Sample Event

VOC	bsmt 1-hr	scaled stdev	P[A] grab	P[B] grab	P[C] grab	sub-slab mean	sub-slab stdev	sub-slab cov	bsmt/sub-slab ratio	bsmt/sub-slab stdev
	07/16/02	cov=6%	07/16/02	07/16/02	07/16/02	n=3	n=3	n=3		
	(ppbv)	(ppbv)	(ppbv)	(ppbv)	(ppbv)	(ppbv)	(ppbv)	(%)		
1,1,1-TCA	0.57	0.03	48	78	170	99	64	64	5.8E-03	3.7E-03
1,1-DCE	0.12	0.01	13	59	170	81	81	100	1.5E-03	1.5E-03
TCE	ND(0.26)	IND	20	32	66	39	24	61	<6.7E-03	IND
c-1,2-DCE	ND(0.26)	IND	2.5	12	26	14	12	88	<1.9E-02	IND
1,1-DCA	ND(1.1)	IND	7.0	15	32	18	13	71	<6.12E-02	IND
ND() = Not detected (reporting limit)				IND = indeterminate		mean and standard deviation			3.6E-03	2.0E-03

Table 7c. Summary of Basement/Sub-Slab Air Concentration Ratios of VOCs Associated with Sub-Surface Contamination in House E Using 1-Liter Tedlar Bags and On-Site GC Analysis During the July 2002 Sample Event

VOC	bsmt 1-hr	scaled stdev	P[A] grab	P[B] grab	P[C] grab	sub-slab mean	sub-slab stdev	sub-slab cov	bsmt/sub-slab ratio	bsmt/sub-slab stdev
	07/16/02	cov=6%	07/16/02	07/16/02	07/16/02	n=3	n=3	n=3		
	(ppbv)	(ppbv)	(ppbv)	(ppbv)	(ppbv)	(ppbv)	(ppbv)	(%)		
1,1,1-TCA	0.57	0.03	59	107	234	133	90	68	4.3E-03	2.9E-03
1,1-DCE	0.12	0.01	10	44	130	61	62	101	2.0E-03	2.0E-03
TCE	ND(0.26)	IND	20	36	65	40	23	57	<6.4E-03	IND
c-1,2-DCE	ND(0.26)	IND	ND(25)	ND(25)	26.00	<25	IND	IND	IND	IND
ND() = Not detected (reporting limit)				IND = indeterminate		mean and standard deviation			3.1E-03	1.8E-03

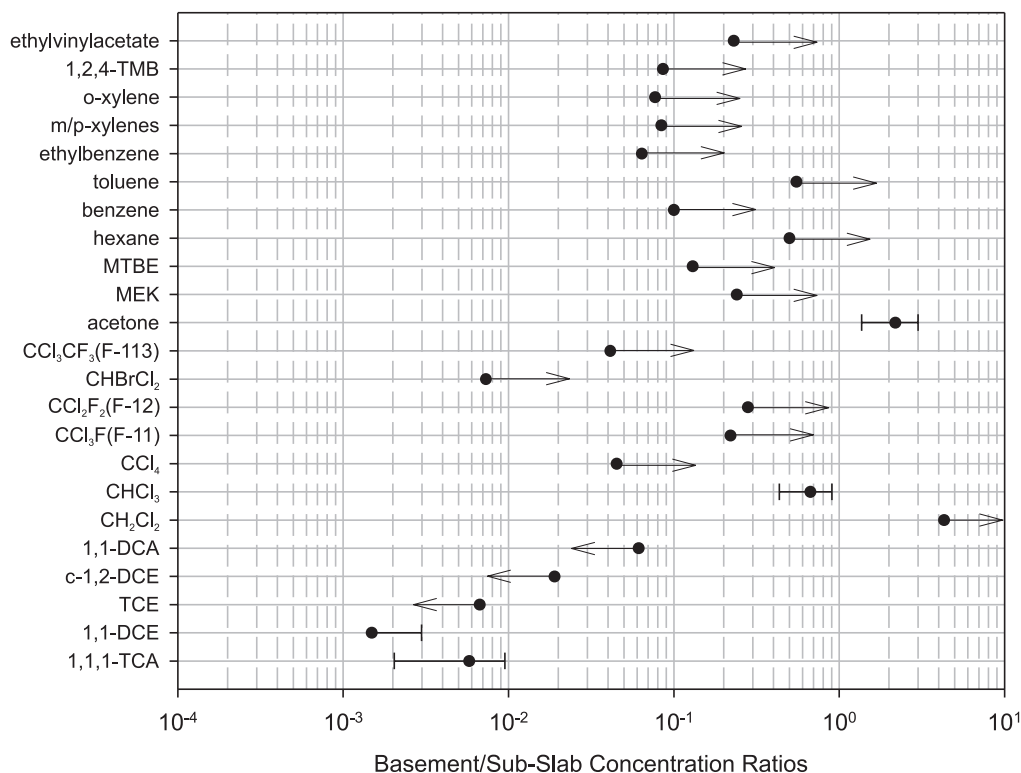

Figure 42. Basement/sub-slab concentration ratios using EPA Method TO-15 at House E during the July 2002 sample event. Error bars represent one standard deviation. Arrows indicate greater than or less than values due to non-detection in basement or sub-slab air.

Results and statistical analysis of VOCs associated with sub-surface contamination and sampled using EPA Method TO-15 are summarized in **Table 7b**. Use of basement/sub-slab air concentration ratios of 1,1,1-TCA and 1,1-DCE resulted in computation of an average basement/sub-slab ratio of 3.6E-03. Coefficients of variation in sub-slab air samples ranged from 61 to 100%. Results and statistical analysis of VOCs associated with sub-surface contamination and sampled using one-liter Tedlar bags are summarized in **Table 7c**. Use of basement/sub-slab air concentration values of 1,1,1-TCA and 1,1-DCE resulted in computation of an average basement/sub-slab ratio of 3.1E-03. Coefficients of variation in sub-slab air samples ranged from 57 to 101%.

The results of sub-slab sampling using one-liter Tedlar bags during the October 2002 sample event are

summarized in **Table 7d**. A comparison of mean sub-slab sample concentrations for 1,1,1-TCA, 1,1-DCE, and TCE during the July and October 2002 sampling events is illustrated in **Figure 43**. The null hypotheses that the mean sub-slab air concentrations of 1,1,1-TCA, 1,1-DCE, and TCE were equivalent during the July and October 2002 sample events were not rejected using a two-tailed Approximate t-Test at a level of significance less than or equal to 0.1.

Hence, a comparison of July and October 2002 sample events indicated that levels of VOCs associated with sub-surface contamination found in sub-slab air were statistically different ($p < 0.10$) in only 1 out of 16 comparisons. This indicated little temporal variability in sub-slab air concentrations between the July 2002 and October 2002 sampling events.

Table 7d. Sub-Slab Air Concentrations of VOCs Associated with Sub-Surface Contamination in House E Using 1-Liter Tedlar Bags and On-Site GC Analysis During the October 2002 Sample Event

VOC	P[A] grab	P[B] grab	P[C] grab	sub-slab mean	sub-slab stdev	sub-slab cov
				n=3	n=3	n=3
	11/01/02 (ppbv)	11/01/02 (ppbv)	11/01/02 (ppbv)	11/01/02 (ppbv)	11/01/02 (ppbv)	11/01/02 (%)
1,1,1-TCA	30	78	370	159	184	115
1,1-DCE	10	37	198	82	102	124
TCE	13	29	152	65	76	118
c-1,2-DCE	6	18	84	36	42	117

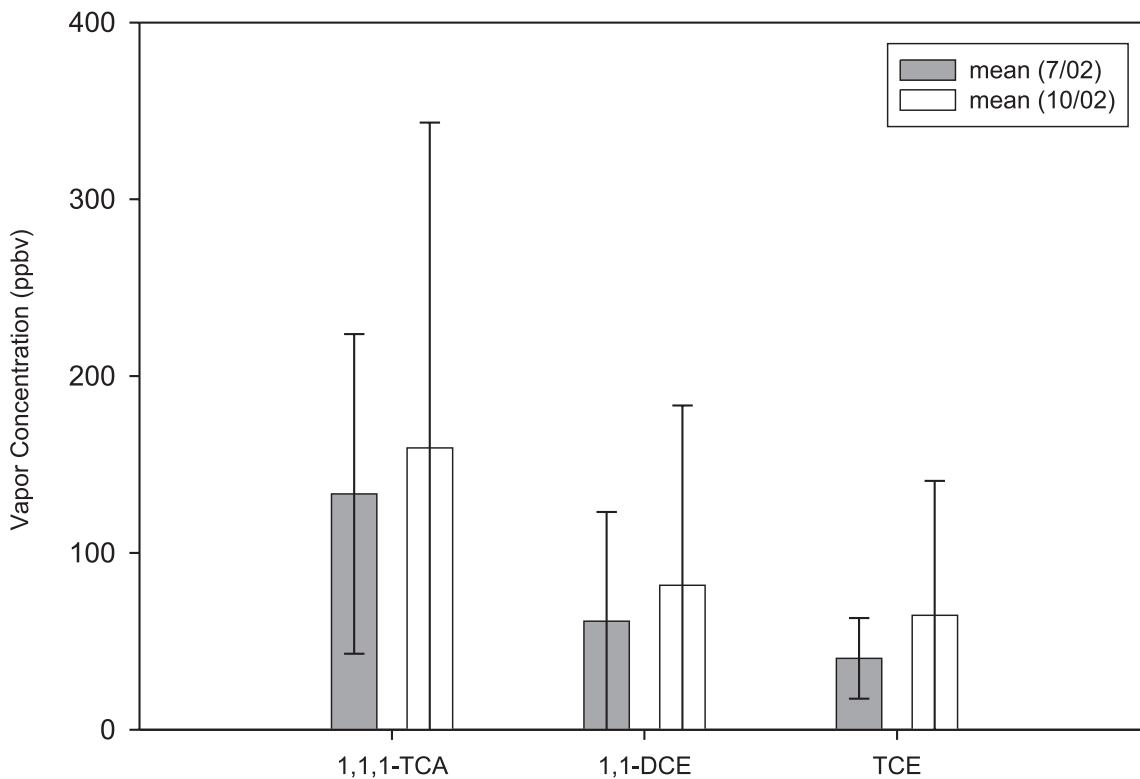

Figure 43. Comparison of mean sub-slab air concentrations of VOCs collected in one-liter Tedlar bags during the July and October 2002 sample events at House E. Error bars represent one standard deviation.

6.3 Summary of Results for Buildings Sampled in March 2003

Basement and sub-slab air samples were collected for VOC analysis in Houses F through P during the March 2003 sample event. Basement (24-hr) and sub-slab (grab) samples were collected in six-liter evacuated canisters. Sub-slab samples were also collected in one-liter Tedlar bags with on-site GC analyses. Two outdoor air samples (24-hr) were collected outside of Houses G and K with results summarized in **Table 2**. (See page 39.)

During the March 2003 sample event, basement (48-hr activated charcoal) and sub-slab (scintillation cells) air samples were collected for radon analysis. When one or more indicator VOCs were present in basement air and more than one probe was sampled for radon, the basement/sub-slab air concentration ratio of radon was compared with the basement/sub-slab air concentration ratio of indicator VOCs using a two-tailed Approximate t-Test. The null hypothesis was that the basement/sub-slab air concentration ratio of radon was equal to the basement/sub-slab air concentration ratio of an indicator VOC. The alternate hypothesis was that the basement/sub-slab concentration ratios were not equal. The rejection criteria was a Type I error or level of significance less than or equal to 0.1 (twice the level of significance for one-tailed tests used to assess vapor intrusion). As a matter of necessity, radon was used as an indicator compound to assess vapor intrusion when indicator VOCs, 1,1-DCE, c-1,2-DCE, and 1,1-DCA, were not detected in basement air. Basement slabs were approximately 1.6 meters below ground surface.

House F

Concentrations of all VOCs detected in basement and/or sub-slab air using EPA Method TO-15 are summarized in **Table 8**. A replicate basement air sample was collected at House F. VOCs associated with sub-surface contamination were not detected in basement air at detection limits ranging from 0.078 to 0.086 ppbv. Thus, assessment of vapor intrusion was not necessary at this location. Other chlorinated VOCs detected in basement air were methylene chloride, carbon tetrachloride, and 1,1-dichlorobenzene at concentrations of 0.87, 0.09, and 0.09 ppbv, respectively. Freons, F-11, F-12, and F-113, were detected at concentrations of 0.40, 1.4, and 0.07 ppbv, respectively. Hydrocarbons, hexane, benzene, toluene, ethylbenzene, m/p-xylenes, o-xylene, styrene, and 1,2,4-trimethylbenzene were detected in basement air at concentrations up to 1.25 ppbv. Acetone, methyl ethyl ketone, and methyl tertiary-butyl ether were detected at concentrations of 2.8, 0.55, and 0.32 ppbv, respectively. The compound, 1,3-butadiene, was detected at a concentration of 0.33 ppbv.

Four probes were installed for sub-slab sampling. Two probes were sampled using EPA Method TO-15. All four probes were sampled using one-liter Tedlar bags. VOCs associated with sub-surface contamination were not detected using EPA Method TO-15. Detection limits ranged from 0.083 to 0.085 ppbv. Other chlorinated VOCs detected in sub-slab air were perchloroethylene, methylene chloride, chloroform, and carbon tetrachloride at maximum concentrations of 0.13, 0.70, 0.09, and 0.09 ppbv, respectively. Freons, F-11 and F-12, were detected at maximum concentrations of 0.42 and 1.7 ppbv,

Table 8. Basement and Sub-Slab Air Concentrations for VOCs at House F Using EPA Method TO-15 During the March 2003 Sample Event

VOC	bsmt 24-hr	bsmt 24-hr	bsmt mean	bsmt stdev	P[A] grab	P[C] grab	sub-slab mean	sub-slab stdev	sub-slab cov	bsmt/ sub-slab ratio	bsmt/ sub-slab stdev
	03/26/03 (ppbv)	03/26/03 (ppbv)	03/26/03 (ppbv)	03/26/03 (ppbv)			n=2	n=2	n=2		
	03/28/03 (ppbv)	03/28/03 (ppbv)	03/28/03 (ppbv)	03/28/03 (ppbv)			03/28/03 (ppbv)	03/28/03 (ppbv)	03/28/03 (%)		
1,1,1-TCA	ND(0.084)	ND(0.082)	ND(<0.083)	IND	ND(0.078)	ND(0.082)	ND(<0.080)	IND	IND	IND	IND
1,1-DCE	ND(0.086)	ND(0.084)	ND(<0.085)	IND	ND(0.08)	ND(0.084)	ND(<0.082)	IND	IND	IND	IND
TCE	ND(0.086)	ND(0.084)	ND(<0.085)	IND	ND(0.08)	ND(0.084)	ND(<0.082)	IND	IND	IND	IND
c-1,2-DCE	ND(0.084)	ND(0.082)	ND(<0.083)	IND	ND(0.078)	ND(0.082)	ND(<0.080)	IND	IND	IND	IND
1,1-DCA	ND(0.086)	ND(0.084)	ND(<0.085)	IND	ND(0.08)	ND(0.084)	ND(<0.082)	IND	IND	IND	IND
1,2-DCA	ND(0.084)	ND(0.082)	ND(<0.083)	IND	ND(0.078)	ND(0.082)	ND(<0.080)	IND	IND	IND	IND
PCE	ND(0.084)	ND(0.082)	ND(<0.083)	IND	ND(0.078)	0.13	<0.10	IND	IND	IND	IND
CH ₂ Cl ₂	0.77	0.87	0.82	0.07	0.49	0.70	0.60	0.15	25	1.4E+00	3.6E-01
CHCl ₃	ND(0.084)	ND(0.082)	ND(<0.083)	IND	ND(0.078)	0.09	<0.084	IND	IND	IND	IND
CCl ₄	ND(0.086)	0.09	<0.088	IND	0.09	0.09	0.09	0.00	0.0	<9.6E-01	IND
CCl ₃ F(F-11)	0.38	0.4	0.39	0.01	0.42	0.36	0.39	0.04	11	1.0E+00	1.1E-01
CCl ₂ F ₂ (F-12)	1.4	1.4	1.4	0.00	1.7	1.4	1.6	0.21	14	9.0E-01	1.2E-01
CHBrCl ₂	ND(0.079)	ND(0.077)	ND(<0.078)	IND	ND(0.073)	ND(0.077)	ND(<0.075)	IND	IND	IND	IND
vinyl chloride	ND(0.086)	ND(0.085)	ND(<0.086)	IND	ND(0.081)	ND(0.085)	ND(<0.083)	IND	IND	IND	IND
CH ₃ CH ₂ Cl	0.5	ND(0.87)	<0.66	IND	ND(0.83)	0.38	<0.61	IND	IND	IND	IND
CCl ₃ CF ₃ (F-113)	0.07	ND(0.082)	<0.076	IND	ND(0.078)	ND(0.082)	ND(<0.080)	IND	IND	IND	IND
acetone	2.8	2.5	2.7	0.21	1.7	2.4	2.1	0.49	24	1.3E+00	3.3E-01
2-hexanone	ND(0.081)	ND(0.079)	ND(<0.080)	IND	0.1	0.12	0.11	0.01	13	<7.4E-01	IND
THF	ND(0.082)	ND(0.08)	ND(<0.081)	IND	ND(0.076)	ND(0.08)	ND(<0.078)	IND	IND	IND	IND
MEK	0.53	0.55	0.54	0.01	0.48	0.66	0.57	0.13	22	9.5E-01	2.1E-01
MIBK	ND(0.076)	ND(0.074)	ND(<0.075)	IND	0.26	0.27	0.265	0.01	2.7	<1.6E-01	IND
MTBE	0.30	0.32	0.31	0.01	0.65	0.69	0.67	0.03	4.2	4.6E-01	2.9E-02
heptane	ND(0.082)	ND(0.08)	ND(<0.081)	IND	ND(0.076)	ND(0.11)	ND(<0.093)	IND	IND	IND	IND
hexane	0.33	0.36	0.35	0.02	0.22	0.25	0.24	0.02	9.0	1.5E+00	1.6E-01
cyclohexane	ND(0.084)	ND(0.082)	ND(<0.083)	IND	0.08	ND(0.082)	ND(<0.081)	IND	IND	IND	IND
benzene	0.41	0.45	0.43	0.03	0.11	0.33	0.22	0.16	71	2.0E+00	1.4E+00
toluene	1.2	1.3	1.25	0.07	0.51	2.2	1.4	1.2	88	9.2E-01	8.2E-01
ethylbenzene	0.16	0.17	0.17	0.01	0.08	0.12	0.1	0.03	28	1.7E+00	4.7E-01
m/p-xylenes	0.48	0.52	0.50	0.03	0.2	0.36	0.28	0.11	40	1.8E+00	7.3E-01
o-xylene	0.16	0.16	0.16	0.00	0.09	0.13	0.11	0.03	26	1.5E+00	3.7E-01
styrene	0.10	0.10	0.10	0.00	ND(0.073)	ND(0.077)	ND(<0.075)	IND	IND	>1.3E+00	IND
1,2,4-TMB	0.080	0.090	0.085	0.01	0.09	0.15	0.12	0.04	35	7.1E-01	2.6E-01
1,3,5-TMB	ND(0.084)	ND(0.082)	ND(<0.083)	IND	ND(0.15)	ND(0.082)	ND(<0.12)	IND	IND	IND	IND
1,3-butadiene	0.31	0.33	0.32	0.01	ND(0.17)	0.31	<0.24	IND	IND	>1.0E+00	IND
1,3-DCB	ND(0.084)	ND(0.082)	ND(<0.083)	IND	ND(0.078)	ND(0.082)	ND(<0.080)	IND	IND	IND	IND
1,4-DCB	0.09	ND(0.08)	<0.09	IND	ND(0.078)	ND(0.08)	ND(<0.079)	IND	IND	IND	IND
4-ethyl-toluene	0.11	0.10	0.11	0.01	ND(0.078)	0.13	<0.10	IND	IND	>8.5E-01	IND
isopropyl alcohol	2.9	4.0	3.5	0.78	0.25	0.64	0.445	0.28	62	7.8E+00	5.1E+00
ethyl/vinyl acetate	0.32	0.35	0.34	0.02	ND(0.14)	ND(0.15)	ND(<0.15)	IND	IND	>2.2E+00	IND
CS ₂	ND(0.081)	ND(0.079)	ND(<0.080)	IND	0.21	0.26	0.24	0.04	15	<3.4E-01	IND
ND() = Not detected (reporting limit)				IND = indeterminate							

respectively. Hydrocarbons, hexane, cyclohexane, benzene, toluene, ethylbenzene, m/p-xylenes, o-xylene, 1,2,4-trimethylbenzene, and 4-ethyltoluene were detected in sub-slab air at concentrations up to 2.2 ppbv. Acetone, methyl ethyl ketone, methyl isobutyl ketone, and methyl tertiary-butyl ether were detected at maximum concentrations of 2.4, 0.66, 0.27, and 0.69 ppbv, respectively. The compound, 1,3-butadiene, was detected at a maximum concentration of 0.33 ppbv. VOCs associated with sub-surface contamination were not detected in one-liter Tedlar bags with detection limits ranging from 2 to 5 ppbv.

Basement/sub-slab ratios of VOCs detected in basement air and sampled using EPA Method TO-15 are summarized in **Table 8**. Basement/sub-slab air concentration ratios for VOCs not associated with sub-surface contamination ranged from less than 1.6E-01 (methyl isobutyl ketone) to 7.8E+00 (isopropyl alcohol). Basement/sub-slab air concentration ratios were less than 1.0E+00 for eight compounds not associated with sub-surface contamination demonstrating that observation of a basement/sub-slab air concentration ratio less than 1.0E+00 does not necessarily indicate vapor intrusion.

House G

There were several visible cracks in the slab and two small diameter holes near an oil tank which serviced an oil furnace. The basement wall consisted of field stone. Concentrations of all VOCs detected in basement and/or sub-slab air using EPA Method TO-15 are summarized in **Table 9a**. The only VOC associated with sub-surface contamination detected in basement air was 1,1,1-TCA at a concentration of 0.28 ppbv. The detection limit of other VOCs

associated with sub-surface contamination was 0.10 ppbv. Other chlorinated VOCs detected in basement air were perchloroethylene and methylene chloride at concentrations of 0.18 and 7.4 ppbv, respectively. Freons, F-11 and F-12, were detected at concentrations of 0.30 and 0.49 ppbv, respectively. Hydrocarbons, hexane, benzene, toluene, ethylbenzene, m/p-xylenes, o-xylene, 1,2,4-trimethylbenzene, 1,3,5-trimethylbenzene, and 4-ethyltoluene were detected in basement air at concentrations up to 42 ppbv. Acetone, methyl ethyl ketone, and methyl tertiary-butyl ether were detected at concentrations of 2.0, 0.81, and 0.54 ppbv, respectively.

Five probes were installed for sub-slab sampling. Two probes were sampled using EPA Method TO-15. All five probes were sampled using one-liter Tedlar bags. As indicated by **Tables 9a** and **9b**, when sampling using EPA Method TO-15, 1,1,1-TCA, 1,1-DCE, TCE, and 1,1-DCA were detected at maximum concentrations of 6.0, 0.75, 0.99, and 0.37 ppbv, respectively. Other chlorinated VOCs perchloroethylene, chloroform, and carbon tetrachloride were detected at maximum concentrations of 0.20, 0.73 and 0.09 ppbv, respectively. Freons, F-11, F-12, and F-113, were detected at maximum concentrations of 0.27, 0.55, and 0.08 ppbv, respectively. Hydrocarbons, hexane and toluene were detected at maximum concentrations of 0.41 and 0.25 ppbv, respectively. Acetone, 2-hexanone, methyl ethyl ketone, methyl isobutyl ketone, and methyl tertiary-butyl ether were detected at maximum concentrations of 2.5, 0.12, 0.80, 0.30, and 0.090 ppbv, respectively. As indicated by **Table 9c**, 1,1,1-TCA and TCE were detected in one-liter Tedlar bag samples at maximum concentrations of 7.5 and 2.4 ppbv, respectively. Detection limits for 1,1-DCE and c-1,2-DCE were 3 to 5 ppbv. Radon was sampled at two probes with

Table 9a. Basement and Sub-Slab Air Concentrations for VOCs Detected at House G Using EPA Method TO-15 During the March 2003 Sample Event

VOC	bsmt 24-hr	scaled stdev	P[A] grab	P[C] grab	sub-slab mean	sub-slab stdev	sub-slab cov	bsmt/ sub-slab ratio	bsmt/ sub-slab stdev
	03/27/03	cov=6%	03/31/03	03/31/03	n=2	n=2	n=2		
	(ppbv)	(ppbv)	(ppbv)	(ppbv)	(ppbv)	(ppbv)	(%)		
1,1,1-TCA	0.28	0.02	6.0	2.0	4.0	2.8	71	7.0E-02	5.0E-02
1,1-DCE	ND(0.10)	IND	0.21	0.75	0.48	0.38	80	<2.1E-01	IND
TCE	ND(0.10)	IND	0.990	0.94	1.0	0.04	3.7	<1.0E-01	IND
c-1,2-DCE	ND(0.10)	IND	ND(0.073)	ND(0.071)	ND(<0.072)	IND	IND	IND	IND
1,1-DCA	ND(0.10)	IND	0.37	0.25	0.31	0.08	27	<3.2E-01	IND
1,2-DCA	ND(0.10)	IND	ND(0.073)	ND(0.071)	ND(<0.072)	IND	IND	IND	IND
PCE	0.18	0.01	0.20	ND(0.071)	<0.14	IND	IND	>1.3E+00	IND
CH ₂ Cl ₂	7.4	0.44	ND(0.074)	ND(0.073)	ND(<0.074)	IND	IND	>1.0E+02	IND
CHCl ₃	ND(0.10)	IND	0.73	0.19	0.46	0.38	83	<2.2E-01	IND
CCl ₄	ND(0.10)	IND	ND(0.074)	0.090	<0.082	IND	IND	IND	IND
CCl ₃ F(F-11)	0.30	0.02	0.25	0.27	0.26	0.01	5.4	1.2E+00	9.3E-02
CCl ₂ F ₂ (F-12)	0.49	0.03	0.55	0.52	0.54	0.02	4.0	9.2E-01	6.6E-02
CHBrCl ₂	ND(0.096)	IND	0.11	ND(0.067)	<0.09	IND	IND	IND	IND
vinyl chloride	ND(0.11)	IND	ND(0.073)	ND(0.074)	ND(<0.074)	IND	IND	IND	IND
CH ₂ CH ₂ Cl	ND(1.1)	IND	ND(0.77)	ND(0.76)	ND(<0.76)	IND	IND	IND	IND
CCl ₃ CF ₃ (F-113)	ND(0.10)	IND	ND(0.073)	0.08	<0.08	IND	IND	IND	IND
acetone	2.0	0.12	2.5	2.1	2.3	0.28	12	8.7E-01	1.2E-01
2-hexanone	ND(0.098)	IND	0.10	0.12	0.11	0.01	13	<8.9E-01	IND
THF	ND(0.10)	IND	ND(0.071)	ND(0.07)	ND(<0.07)	IND	IND	IND	IND
MEK	0.81	0.05	0.80	0.70	0.75	0.07	9.4	1.1E+00	1.2E-01
MIBK	ND(0.092)	IND	0.25	0.30	0.28	0.04	13	<3.3E-01	IND
MTBE	0.54	0.03	0.070	0.090	0.08	0.01	18	6.8E+00	1.3E+00
heptane	ND(0.10)	IND	ND(0.071)	ND(0.07)	ND(<0.07)	IND	IND	IND	IND
hexane	0.70	0.04	0.41	0.17	0.29	0.17	59	2.4E+00	1.4E+00
cyclohexane	0.12	0.01	ND(0.073)	ND(0.071)	ND(<0.072)	IND	IND	>1.6E+00	IND
benzene	0.39	0.02	ND(0.074)	ND(0.073)	ND(<0.074)	IND	IND	>5.3E+00	IND
toluene	42	2.52	0.25	0.25	0.25	0.0	0.0	1.7E+02	1.0E+01
ethylbenzene	0.25	0.02	ND(0.073)	ND(0.071)	ND(<0.072)	IND	IND	>3.4E+00	IND
m/p-xylenes	0.59	0.04	ND(0.15)	ND(0.14)	ND(<0.15)	IND	IND	>3.9E+00	IND
o-xylene	0.35	0.02	ND(0.074)	ND(0.073)	ND(<0.074)	IND	IND	>4.7E+00	IND
styrene	ND(0.096)	IND	ND(0.069)	ND(0.067)	ND(<0.068)	IND	IND	IND	IND
1,2,4-TMB	0.46	0.03	ND(0.071)	ND(0.07)	ND(<0.07)	IND	IND	>6.5E+00	IND
1,3,5-TMB	0.35	0.02	ND(0.073)	ND(0.071)	ND(<0.072)	IND	IND	>4.8E+00	IND
1,3-butadiene	ND(0.20)	IND	ND(0.14)	ND(0.14)	ND(<0.14)	IND	IND	IND	IND
1,3-DCB	ND(0.10)	IND	ND(0.073)	ND(0.071)	ND(<0.072)	IND	IND	IND	IND
1,4-DCB	ND(0.10)	IND	ND(0.071)	ND(0.07)	ND(<0.07)	IND	IND	IND	IND
4-ethyl-toluene	1.4	0.08	ND(0.073)	ND(0.071)	ND(<0.072)	IND	IND	>1.9E+01	IND
isopropyl alcohol	2.1	0.13	0.16	ND(0.13)	<0.15	IND	IND	>1.4E+01	IND
ethyl/vinyl acetate	0.19	0.01	ND(0.13)	ND(0.13)	ND(<0.13)	IND	IND	>1.5E+00	IND
CS ₂	ND(0.098)	IND	ND(0.07)	0.23	<0.15	IND	IND	IND	IND

ND() = Not detected (reporting limit)

IND = indeterminate

concentrations of 916 and 1035 pCi/l and detected in basement air at a mean concentration of 2.3 pCi/l. Results and statistical analysis of sub-slab sampling for radon are summarized in **Table 9d**.

Figure 44 illustrates basement/sub-slab air concentration ratios for VOCs and radon detected in basement air. Radon was used as an indicator compound because indicator VOCs, 1,1-DCE, c-1,2-DCE, and 1,1-DCA, were not detected in basement air. The results of Tedlar bag sampling were used for hypothesis testing because sampling occurred at five sub-slab vapor probes instead of at only two probes for EPA Method TO-15 analysis. Since the null hypothesis that the mean basement/sub-slab air concentration ratio of 1,1,1-TCA was equal to the

mean basement/sub-slab air concentration ratio of radon was rejected using a one-tailed Approximate t-Test at a level of significance less than or equal to 0.05 ($p < 0.005$), it was inferred that the presence of 1,1,1-TCA in basement air was not primarily due to vapor intrusion at the time of sampling.

Tables 9b and **9c** summarize basement/sub-slab air concentration ratios determined using EPA Method TO-15 and Tedlar bag sampling for VOCs associated with sub-surface contamination. For EPA Method TO-15 analysis, the basement/sub-slab air concentration ratio of 1,1,1-TCA was less than 7.0E-02. For Tedlar bag sampling and on-site GC analyses, the basement/sub-slab air concentration ratio of 1,1,1-TCA was less than 5.4E-02.

Table 9b. Summary of Basement/Sub-Slab Air Concentration Ratios of VOCs Associated with Sub-Surface Contamination in House G Using EPA Method TO-15 During the March 2003 Sample Event

VOC	bsmt 24-hr	scaled stdev	P[A] grab	P[C] grab	sub-slab mean	sub-slab stdev	sub-slab cov	bsmt/ sub-slab ratio	bsmt/ sub-slab stdev
	03/27/03	cov=6%	03/31/03	03/31/03	n=2	n=2	n=2		
	(ppbv)	(ppbv)	(ppbv)	(ppbv)	(ppbv)	(ppbv)	(%)		
1,1,1-TCA	0.28	0.02	6.0	2.0	4.0	2.8	71	7.0E-02	5.0E-02
1,1-DCE	ND(0.10)	IND	0.21	0.75	0.48	0.38	80	<2.1E-01	IND
TCE	ND(0.10)	IND	0.990	0.94	1.0	0.04	3.7	<1.0E-01	IND
c-1,2-DCE	ND(0.10)	IND	ND(0.073)	ND(0.071)	ND(<0.072)	IND	IND	IND	IND
1,1-DCA	ND(0.10)	IND	0.37	0.25	0.31	0.08	27	<3.2E-01	IND
ND() = Not detected (reporting limit), IND = indeterminate					mean and standard deviation			<7.0E-02	IND

Table 9c. Summary of Basement/Sub-Slab Air Concentration Ratios of VOCs Associated with Sub-Surface Contamination in House G Using 1-Liter Tedlar Bags and On-Site GC Analysis During the March 2003 Sample Event

VOC	bsmt 24-hr	scaled stdev	P[A] grab	P[B] grab	P[C] grab	P[D] grab	P[E] grab	sub-slab mean	sub-slab stdev	sub-slab cov	bsmt/ sub-slab ratio	bsmt/ sub-slab stdev
	03/27/03	cov=6%	03/31/03	03/31/03	03/31/03	03/31/03	03/31/03	n=5	n=5	n=5		
	(ppbv)	(ppbv)	(ppbv)	(ppbv)	(ppbv)	(ppbv)	(ppbv)	(ppbv)	(ppbv)	(%)		
1,1,1-TCA	0.28	0.02	7.5	5.2	2.6	5.2	5.2	5.1	1.7	34	5.4E-02	1.9E-02
1,1-DCE	ND(0.10)	IND	ND(5.0)	ND(5.0)	ND(5.0)	ND(5.0)	ND(5.0)	ND(<5.0)	IND	IND	IND	IND
TCE	ND(0.10)	IND	1.1	1.4	1.4	2.4	2.4	1.7	0.6	35	<5.9E-02	IND
c-1,2-DCE	ND(0.10)	IND	ND(3.0)	ND(3.0)	ND(3.0)	ND(3.0)	ND(3.0)	ND(<3.0)	IND	IND	IND	IND
ND() = Not detected (reporting limit), IND = indeterminate					mean and standard deviation						<5.9E-02	IND

Table 9d. Basement/Sub-Slab Air Concentration Ratios of Radon in House G Using 48-hr Activated Carbon Canisters for Basement Air Sampling (3/25-3/27/03) and Scintillation Cells for Sub-Slab Air Sampling During the March 2003 Sample Event

bsmt 48-hr	bsmt 48-hr	bsmt-48 hr mean	bsmt-48 hr stdev	bsmt-48 hr cov	P[B] grab	P[C] grab	sub-slab mean	sub-slab stdev	sub-slab cov	bsmt/ sub-slab ratio	bsmt/ sub-slab stdev
		n=2	n=2	n=2	110A	300A	n=2	n=2	n=2		
		3/27/2003	3/27/2003	3/27/2003	3/31/2003	3/31/2003	3/31/2003	3/31/2003	3/31/2003		
(pCi/L)	(pCi/L)	(pCi/L)	(pCi/L)	(%)	(pCi/L)	(pCi/L)	(pCi/L)	(pCi/L)	(%)	(-)	(-)
2.4	2.1	2.3	0.21	9.4	916	1035	976	84.1	8.63	2.31E-03	2.95E-04

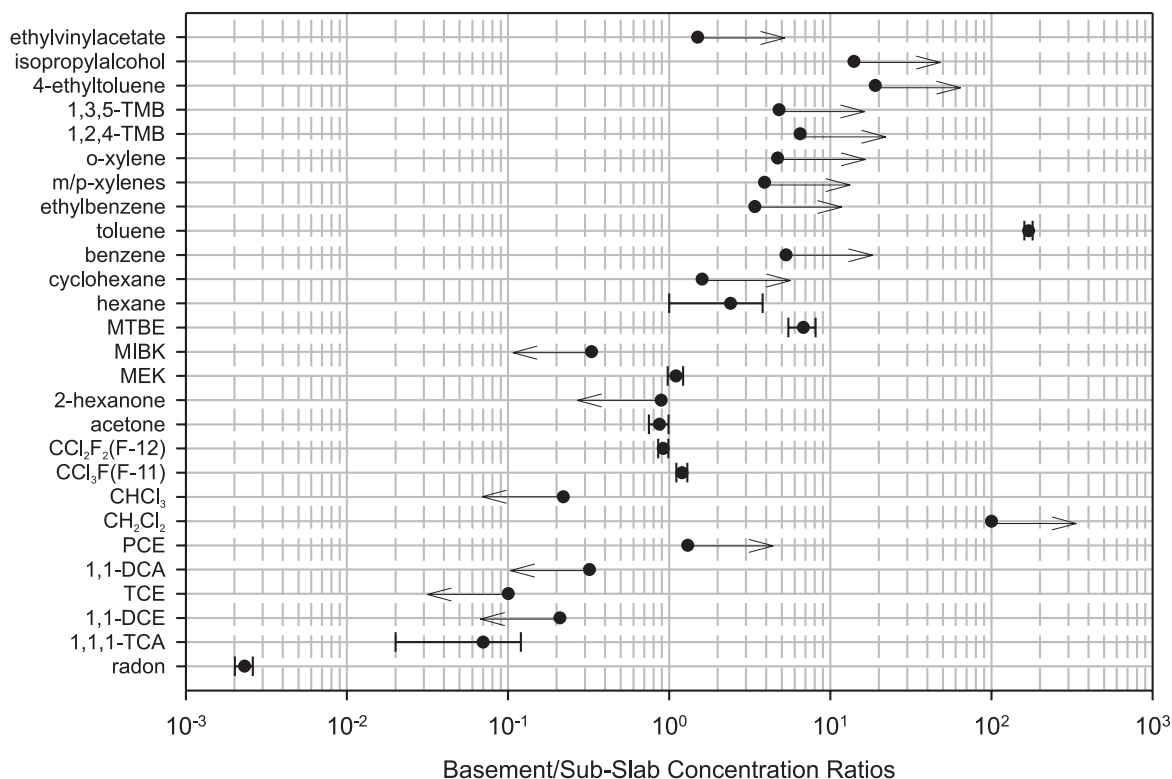

Figure 44. Basement/sub-slab concentration ratios using EPA Method TO-15 at House G during the March 2003 sample event. Error bars represent one standard deviation. Arrows indicate greater than or less than values due to non-detection in basement or sub-slab air.

House H

There were several visible one to two millimeter wide cracks in the slab at House H. Basement walls consisted of poured concrete. Concentrations of all VOCs detected in basement and/or sub-slab air using EPA Method TO-15 are summarized in **Table 10a**. A replicate basement air sample was collected at House H. The only VOC associated with subsurface contamination detected in basement

air was 1,1,1-TCA at a concentration of 3.7 ppbv. The detection limit for other VOCs associated with sub-surface contamination was between 0.079 and 0.082 ppbv. Other chlorinated compounds detected in basement air were perchloroethylene, methylene chloride, chloroform, carbon tetrachloride, and 1,4-dichlorobenzene at concentrations of 0.15, 270, 0.17, 0.090, and 36 ppbv, respectively. Freons, F-11, F-12, and F-113, were detected in basement air at concentrations of 1.8, 0.54, and 0.070 ppbv,

respectively. Hydrocarbons, heptane, hexane, cyclohexane, benzene, toluene, ethylbenzene, m/p-xylenes, o-xylene, styrene, 1,2,4-trimethylbenzene, 1,3,5-trimethylbenzene, and 4-ethyltoluene were detected at concentrations up to 14 ppbv. Acetone, tetrahydrofuran, methyl ethyl ketone, methyl isobutyl ketone, and methyl tertiary-butyl ether were detected at concentrations of 3.0, 0.82, 1.1, 0.17, and 1.0 ppbv, respectively.

Four probes were installed for sub-slab sampling. Two probes were sampled using EPA Method TO-15. All four probes were sampled using one-liter Tedlar bags. As indicated by **Table 10b**, when sampling using EPA Method TO-15, 1,1,1-TCA, 1,1-DCE, TCE, c-1,2-DCE, and 1,1-DCA were detected in sub-slab air at maximum concentrations of 46, 16, 24, 6.6, and 9.7 ppbv, respectively. Other chlorinated VOCs detected in sub-slab air were perchloroethylene, methylene chloride, chloroform, carbon tetrachloride, and 1,3-dichlorobenzene at maximum concentrations of 0.44, 14, 4.5, 0.12, and 0.48 ppbv, respectively. Freons, F-11, F-12, and F-113, were detected at maximum concentrations of 1.1, 0.59, and 0.070 ppbv, respectively. Hydrocarbons, hexane, benzene, toluene, ethylbenzene, m/p-xylenes, o-xylene, 1,2,4-trimethylbenzene, 1,3,5-trimethylbenzene, and 4-ethyltoluene were detected at concentrations up to 0.69 ppbv. Acetone, 2-hexanone, methyl ethyl ketone, methyl isobutyl ketone, and methyl tertiary-butyl ether were detected at concentrations up to 1.8 ppbv. Detection limits for other compounds varied from 0.082 to 0.17 ppbv. As indicated by **Table 10c**, when sampling with one-liter Tedlar bags, 1,1,1-TCA, 1,1-DCE, TCE, and c-1,2-DCE were detected at maximum concentrations of 61, 18, 24, and 6.0 ppbv, respectively. Radon was sampled at two probes with

concentrations of 406 and 343 pCi/l and detected in basement air at a mean concentration of 0.8 pCi/l. Results and statistical analysis of sub-slab sampling for radon are summarized in **Table 10d**.

Figure 45 illustrates basement/sub-slab ratios for VOCs and radon detected in basement air at House H. The results of Tedlar bag sampling were used for hypothesis testing because sampling occurred at four sub-slab vapor probes instead of at only two probes for EPA Method TO-15 analysis. Radon was used as an indicator compound because indicator VOCs, 1,1-DCE, c-1,2-DCE, and 1,1-DCA, were not detected in basement air. Since the null hypothesis that the basement/sub-slab air concentration ratio of 1,1,1-TCA was equal to the basement/sub-slab air concentration ratio of radon could be rejected using a one-tailed Approximate t-Test at a level of significance less than or equal to 0.05 ($p < 0.025$), it was inferred that the presence of 1,1,1-TCA in basement air was not primarily due to vapor intrusion at the time of sampling.

Tables 10b and 10c summarize basement/sub-slab air concentration ratios determined using EPA Method TO-15 and Tedlar bag sampling for VOCs associated with sub-surface contamination. For EPA Method TO-15 analysis, the basement/sub-slab concentration ratio of 1,1-DCE was less than 4.7E-03. For Tedlar bag sampling and on-site GC analyses, the basement/sub-slab air concentration ratio of TCE was less than 5.2E-03.

Table 10a. Basement and Sub-Slab Air Concentrations for VOCs Detected at House H Using EPA Method TO-15 During the March 2003 Sample Event

VOC	bsmt 24-hr	bsmt 24-hr	bsmt mean	bsmt stdev	P[B] grab	P[C] grab	sub-slab mean	sub-slab stdev	sub-slab cov	bsmt/ sub-slab ratio	bsmt/ sub-slab stdev
	03/25/03	03/25/03	03/25/03	03/25/03	03/27/03	03/27/03	03/27/03	03/27/03	03/27/03		
	(ppbv)	(ppbv)	(ppbv)	(ppbv)	(ppbv)	(ppbv)	(ppbv)	(ppbv)	(%)		
1,1,1-TCA	3.7	3.6	3.7	0.07	15	46	31	22	72	1.2E-01	8.6E-02
1,1-DCE	ND(0.082)	ND(0.08)	ND(<0.08)	IND	9.2	16	13	4.8	38	<6.5E-03	IND
TCE	ND(0.082)	ND(0.08)	ND(<0.08)	IND	11	24	18	9.2	53	<4.7E-03	IND
c-1,2-DCE	ND(0.081)	ND(0.079)	ND(<0.08)	IND	3.8	6.6	5.2	2.0	38	<1.6E-02	IND
1,1-DCA	ND(0.082)	ND(0.08)	ND(<0.08)	IND	3.5	9.7	6.6	4.4	66	<1.2E-02	IND
1,2-DCA	ND(0.081)	ND(0.079)	ND(<0.081)	IND	ND(<0.087)	0.070	<0.079	IND	IND	IND	IND
PCE	0.15	0.15	0.15	0.00	0.22	0.44	0.33	0.16	47	4.5E-01	2.1E-01
CH ₂ Cl ₂	270	250	260	14.1	7.7	14	11	4.5	41	2.4E+01	9.9E+00
CHCl ₃	0.16	0.17	0.17	0.01	1.1	4.5	2.8	2.4	86	5.9E-02	5.1E-02
CCl ₄	0.090	0.090	0.090	0.00	ND(0.089)	0.12	<0.10	IND	IND	>8.7E-01	IND
CCl ₃ F(F-11)	1.8	1.8	1.8	0.00	0.63	1.1	0.87	0.33	38	2.1E+00	8.0E-01
CCl ₂ F ₂ (F-12)	0.51	0.54	0.53	0.02	0.54	0.59	0.57	0.04	6.3	9.3E-01	6.9E-02
CHBrCl ₂	ND(0.076)	ND(0.074)	ND(<0.075)	IND	ND(0.082)	0.34	<0.21	IND	IND	IND	IND
vinyl chloride	ND(0.084)	ND(0.082)	ND(<0.083)	IND	ND(0.091)	ND(0.12)	ND(<0.11)	IND	IND	IND	IND
CH ₂ CH ₂ Cl	1.1	1.2	1.2	0.07	ND(0.92)	ND(1.2)	ND(<1.1)	IND	IND	>9.6E-01	IND
CCl ₃ CF ₃ (F-113)	0.070	ND(0.079)	0.07	IND	ND(0.087)	0.070	<0.079	IND	IND	>8.8E-01	IND
acetone	2.4	3.0	2.7	0.42	1.8	2.6	2.2	0.57	26	1.2E+00	3.7E-01
2-hexanone	ND(0.077)	0.090	0.09	IND	0.11	0.13	0.12	0.01	12	7.5E-01	IND
THF	0.76	0.82	0.79	0.04	ND(0.086)	ND(0.11)	ND(<0.10)	IND	IND	>7.2E+00	IND
MEK	0.93	1.1	1.0	0.12	0.58	0.72	0.65	0.10	15	1.6E+00	3.0E-01
MIBK	0.14	0.17	0.16	0.02	0.49	0.19	0.34	0.21	62	4.6E-01	2.9E-01
MTBE	0.97	1.0	1.0	0.02	0.36	0.33	0.35	0.02	6	2.9E+00	1.9E-01
heptane	1.7	1.7	1.7	0.00	ND(0.086)	ND(0.11)	ND(<0.10)	IND	IND	>1.5E+01	IND
hexane	1.6	1.5	1.6	0.07	0.14	0.20	0.17	0.04	25	9.1E+00	2.3E+00
cyclohexane	0.95	1.0	1.0	0.04	ND(0.087)	ND(0.11)	ND(<0.10)	IND	IND	>8.9E+00	IND
benzene	0.63	0.68	0.66	0.04	ND(0.089)	0.14	<0.11	IND	IND	>6.0E+00	IND
toluene	2.7	2.8	2.8	0.07	0.40	0.46	0.43	0.04	10	6.4E+00	6.5E-01
ethylbenzene	0.79	0.79	0.79	0.00	ND(0.087)	0.10	<0.09	IND	IND	>7.2E+00	IND
m/p-xylenes	3.6	3.9	3.8	0.21	0.20	0.18	0.19	0.01	7.4	2.0E+01	1.8E+00
o-xylene	3.4	3.6	3.5	0.14	0.090	0.17	0.13	0.06	44	2.7E+01	1.2E+01
styrene	1.8	1.9	1.9	0.07	ND(0.082)	ND(0.11)	ND(<0.10)	IND	IND	>1.7E+01	IND
1,2,4-TMB	6.4	6.9	6.7	0.35	ND(0.086)	0.69	<0.39	IND	IND	>1.7E+01	IND
1,3,5-TMB	3.2	3.4	3.3	0.14	ND(0.087)	0.25	<0.17	IND	IND	>1.9E+01	IND
1,3-butadiene	ND(0.16)	ND(0.16)	ND(<0.16)	IND	ND(0.17)	0.16	<0.17	IND	IND	IND	IND
1,3-DCB	ND(0.081)	ND(0.079)	ND(<0.080)	IND	ND(0.087)	0.48	<0.28	IND	IND	IND	IND
1,4-DCB	36	30	33	4.24	ND(0.086)	ND(0.11)	ND(<0.10)	IND	IND	>3.0E+02	IND
4-ethyl-toluene	14	13	14	0.71	0.15	0.29	0.22	0.10	45	6.1E+01	2.8E+01
isopropyl alcohol	8.2	6.5	7.4	1.20	0.20	0.33	0.27	0.09	35	2.8E+01	1.1E+01
ethyl/vinyl acetate	0.34	0.33	0.34	0.01	ND(0.16)	0.10	<0.13	IND	IND	>3.0E+00	IND
CS ₂	ND(0.077)	ND(0.075)	ND(<0.076)	IND	ND(0.084)	ND(0.11)	ND(<0.09)	IND	IND	IND	IND

ND () = Not detected (reporting limit)

IND = indeterminate

Table 10b. Summary of Basement/Sub-Slab Air Concentration Ratios of VOCs Associated with Sub-Surface Contamination in House H Using EPA Method TO-15 During the March 2003 Sample Event

VOC	bsmt 24-hr	bsmt 24-hr	bsmt mean	bsmt stdev	P[B] grab	P[C] grab	sub-slab mean	sub-slab stdev	sub-slab cov	bsmt/ sub-slab ratio	bsmt/ sub-slab stdev
			n=2	n=2			n=2	n=2	n=2		
	03/25/03	03/25/03	03/25/03	03/25/03			03/27/03	03/27/03	03/27/03		
	(ppbv)	(ppbv)	(ppbv)	(ppbv)	(ppbv)	(ppbv)	(ppbv)	(ppbv)	(%)	(-)	(-)
1,1,1-TCA	3.7	3.6	3.7	0.07	15	46	31	22	72	1.2E-01	8.6E-02
1,1-DCE	ND(0.082)	ND(0.08)	ND(<0.08)	IND	9.2	16	13	4.8	38	<6.5E-03	IND
TCE	ND(0.082)	ND(0.08)	ND(<0.08)	IND	11	24	18	9.2	53	<4.7E-03	IND
c-1,2-DCE	ND(0.081)	ND(0.079)	ND(<0.080)	IND	3.8	6.6	5.2	2.0	38	<1.6E-02	IND
1,1-DCA	ND(0.082)	ND(0.08)	ND(<0.08)	IND	3.5	9.7	6.6	4.4	66	<1.2E-02	IND
ND() = Not detected (reporting limit), IND = indeterminate							mean and standard deviation		<4.7E-03	IND	

Table 10c. Summary of Basement/Sub-Slab Air Concentration Ratios of VOCs Associated with Sub-Surface Contamination in House H Using 1-Liter Tedlar Bags and On-Site GC Analysis During the March 2003 Sample Event

VOC	bsmt 24-hr	bsmt 24-hr	bsmt mean	bsmt stdev	P[A] grab	P[B] grab	P[C] grab	P[D] grab	sub-slab mean	sub-slab stdev	sub-slab cov	bsmt/ sub-slab ratio	bsmt/ sub-slab stdev
			n=2	n=2					n=4	n=4	n=4		
	03/25/03	03/25/03	03/25/03	03/25/03					03/27/03	03/27/03	03/27/03		
	(ppbv)	(ppbv)	(ppbv)	(ppbv)	(ppbv)	(ppbv)	(ppbv)	(ppbv)	(ppbv)	(%)	(-)	(-)	
1,1,1-TCA	3.7	3.6	3.7	0.07	48	22	61	22	38	20	51	9.7E-02	4.9E-02
1,1-DCE	ND(0.082)	ND(0.08)	ND(<0.08)	IND	19	11	18	11	15	4.3	29	<5.6E-03	IND
TCE	ND(0.082)	ND(0.08)	ND(<0.08)	IND	19	10	24	9.8	16	7.0	45	<5.2E-03	IND
c-1,2-DCE	ND(0.081)	ND(0.079)	ND(<0.08)	IND	6.0	3.6	5.5	3.3	4.6	1.3	29	<1.8E-02	IND
ND() = Not detected (reporting limit), IND = indeterminate							mean and standard deviation		<5.2E-03	IND			

Table 10d. Basement/Sub-Slab Air Concentration Ratios of Radon in House H Using 48-hr Activated Carbon Canisters for Basement Air Sampling (3/21-3/24/03) and Scintillation Cells for Sub-Slab Air Sampling During the March 2003 Sample Event

bsmt 48-hr	bsmt 48-hr	bsmt-48 hr mean	bsmt-48 hr stdev	bsmt-48 hr cov	P[A] grab	P[C] grab	sub-slab mean	sub-slab stdev	sub-slab cov	bsmt/ sub-slab ratio	bsmt/ sub-slab stdev
		n=2	n=2	n=2			n=2	n=2			
		03/24/03	03/24/03	03/24/03			03/27/03	03/27/03			
(pCi/L)	(pCi/L)	(pCi/L)	(pCi/L)	(%)	(pCi/L)	(pCi/L)	(pCi/L)	(pCi/L)	(%)	(-)	(-)
0.8	0.8	0.8	0.0	0.0	406	343	375	44.5	11.9	2.14E-03	2.54E-04

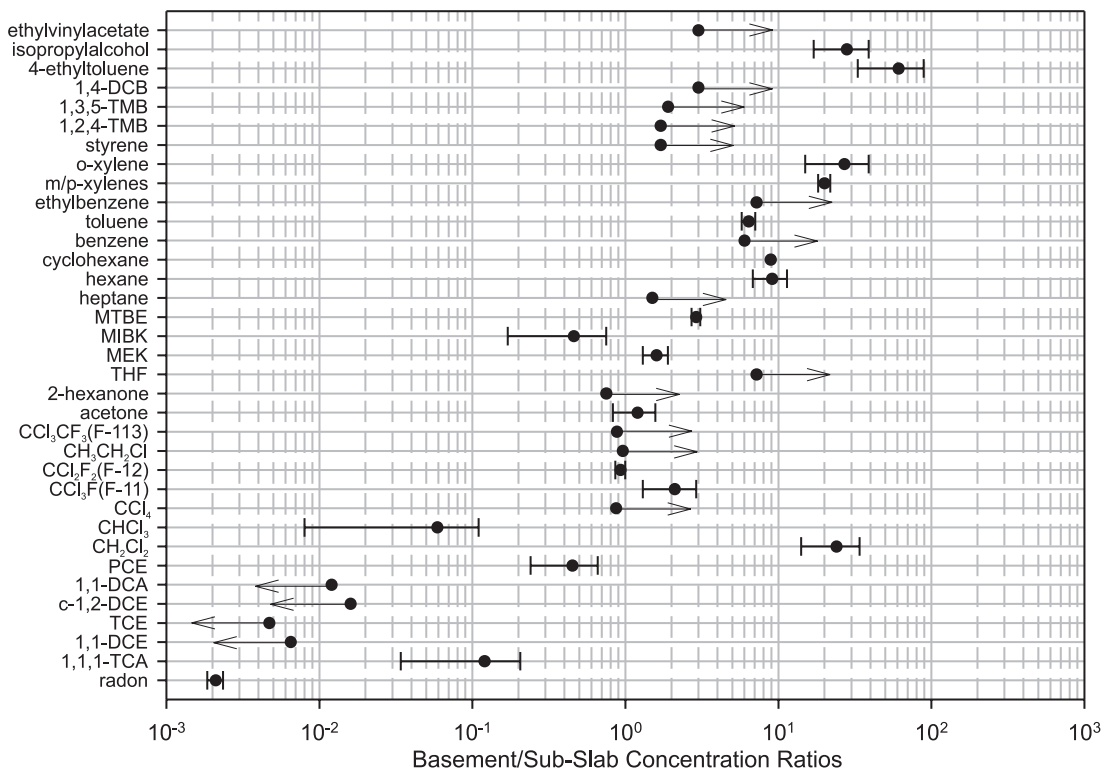

Figure 45. Basement/sub-slab concentration ratios using EPA Method TO-15 at House H during the March 2003 sample event. Error bars represent one standard deviation. Arrows indicate greater than or less than values due to non-detection in basement or sub-slab air.

House I

There were several visible cracks in the slab which varied in thickness between 1 to 2.5 millimeters. Basement walls consisted of poured concrete. Concentrations of all VOCs detected in basement and/or sub-slab air using EPA Method TO-15 are summarized in **Table 11a**. 1,1,1-TCA, 1,1-DCE, TCE, c-1,2-DCE, and 1,1-DCA were detected in basement air at concentrations of 2.8, 2.0, 1.1, 0.54, and 0.46 ppbv, respectively. Other chlorinated compounds detected in basement air were methylene chloride, chloroform, and vinyl chloride at concentrations of 2.5, 0.15, and 0.17 ppbv, respectively. Freons, F-11 and F-12, were detected in basement air at concentrations of 0.42 and 1.0 ppbv, respectively. Hydrocarbons,

hexane, cyclohexane, benzene, toluene, ethylbenzene, m/p-xylenes, o-xylene, 1,2,4-trimethylbenzene, 1,3,5-trimethylbenzene, and 4-ethyltoluene were detected at concentrations up to 3.3 ppbv. Acetone, tetrahydrofuran, methyl ethyl ketone, and methyl tertiary-butyl ether were detected at concentrations of 2.6, 1.1, 1.1, and 3.5 ppbv, respectively.

Three sub-slab probes were installed at House I. Only one probe was sampled using EPA Method TO-15. All three probes were sampled using one-liter Tedlar bags. Using EPA Method TO-15, 1,1,1-TCA, 1,1-DCE, TCE, c-1,2-DCE, and 1,1-DCA were detected at 320, 390, 200, 74, and 73 ppbv, respectively. Other chlorinated compounds detected in sub-slab air were perchloroethylene, methylene chloride, chloroform,

Table 11a. Basement and Sub-Slab Air Concentrations for VOCs Detected at House I Using EPA Method TO-15 During the March 2003 Sample Event

VOC	bsmt 24-hr	scaled stdev	P[A] grab
	03/26/03	cov = 6%	03/28/03
	(ppbv)	(ppbv)	(ppbv)
1,1,1-TCA	2.8	0.17	320
1,1-DCE	2.0	0.12	390
TCE	1.1	0.07	200
c-1,2-DCE	0.54	0.03	74
1,1-DCA	0.46	0.03	73
1,2-DCA	ND(0.12)	IND	ND(0.17)
PCE	ND(0.12)	IND	0.87
CH ₂ Cl ₂	2.5	0.15	0.19
CHCl ₃	0.15	0.01	0.970
CCl ₄	ND(0.12)	IND	ND(0.17)
CCl ₃ F(F-11)	0.42	0.03	0.26
CCl ₂ F ₂ (F-12)	1.0	0.06	0.54
CHBrCl ₂	ND(0.11)	IND	ND(0.16)
vinyl chloride	0.17	0.01	0.27
CH ₃ CH ₂ Cl	1.2	0.07	ND(1.8)
CCl ₃ CF ₃ (F-113)	ND(0.12)	IND	ND(0.17)
acetone	2.6	0.16	2.9
2-hexanone	ND(0.11)	IND	0.14
THF	1.1	0.07	ND(0.16)
MEK	1.1	0.07	0.52
MIBK	ND(0.11)	IND	0.21
MTBE	3.5	0.21	0.26
heptane	ND(0.11)	IND	ND(0.16)
hexane	1.6	0.10	ND(0.17)
cyclohexane	0.87	0.05	ND(0.17)
benzene	0.65	0.04	ND(0.17)
toluene	3.3	0.20	0.3
ethylbenzene	0.71	0.04	ND(0.17)
m/p-xylenes	2.1	0.13	ND(0.33)
o-xylene	0.79	0.05	ND(0.17)
styrene	ND(0.11)	IND	ND(0.16)
1,2,4-TMB	0.65	0.04	ND(0.16)
1,3,5-TMB	0.19	0.01	ND(0.17)
1,3-butadiene	ND(0.23)	IND	ND(0.33)
1,3-DCB	ND(0.12)	IND	ND(0.17)
1,4-DCB	ND(0.11)	IND	ND(0.16)
4-ethyl-toluene	0.62	0.04	ND(0.17)
isopropyl alcohol	ND(0.21)	IND	ND(0.30)
ethyl/vinyl acetate	3.8	0.23	0.36
CS ₂	ND(0.11)	IND	ND(0.16)
ND() = Not detected above reporting limits			IND = indeterminate

and vinyl chloride at concentrations of 0.87, 0.19, 0.97, and 0.27 ppbv, respectively. Freons, F-11 and F-12, were detected in sub-slab air at concentrations of 0.26 and 0.54 ppbv, respectively. The only hydrocarbon detected in sub-slab air using EPA Method TO-15 was toluene at 0.30 ppbv. Acetone, 2-hexanone, methyl ethyl ketone, methyl isobutyl ketone, and methyl tertiary-butyl ether were detected at concentrations of 2.9, 0.14, 0.52, 0.21, and 0.26 ppbv, respectively. As indicated by **Table 11b**, when sampling with one-liter Tedlar bags, 1,1,1-TCA, 1,1-DCE, TCE, and c-1,2-DCE were detected at maximum concentrations in Probe [B] at 430, 320, 194, and 77 ppbv, respectively. Radon was sampled at only one probe with a concentration of 1295 pCi/l and detected in basement air at a mean concentration of 13.0 pCi/l.

Figure 46 illustrates basement/sub-slab air concentration ratios for sub-slab samples collected in 1-liter Tedlar bags and analyzed on site. Since the null hypotheses that the basement/sub-slab air concentration ratios of 1,1,1-TCA and TCE were equal to the basement/sub-slab air concentration ratios of 1,1-DCE and c-1,2-DCE could not be rejected using a one-tailed Approximate t-Test at a level of significance less than or equal to 0.05 ($p > 0.1$), it was inferred that the presence of 1,1,1-TCA, TCE, 1,1-DCE, and c-1,2-DCE in basement air was due to vapor intrusion at the time of sampling.

Table 11b summarizes basement/sub-slab air concentration ratios determined using Tedlar bag sampling for VOCs associated with sub-surface contamination. Use of basement/sub-slab air concentration ratios for 1,1,1-TCA, 1,1-DCE, TCE, and c-1,2-DCE resulted in computation of an average basement/sub-slab air concentration ratio of 8.9E-03. Coefficients of variation in sub-slab air concentration ranged from 50 to 59%.

Table 11b. Summary of Basement/Sub-Slab Concentration Ratios of VOCs Associated with Sub-Surface Contamination in House I Using 1-Liter Tedlar Bags and On-Site GC Analysis During the March 2003 Sample Event

VOC	bsmt 24-hr	scaled stdev	P[A] grab	P[B] grab	P[C] grab	sub-slab mean	sub-slab stdev	sub-slab cov	bsmt/ sub-slab ratio	bsmt/ sub-slab stdev
	03/26/03	cov = 6%	03/28/03	03/28/03	03/28/03	n=3	n=3	n=3		
	(ppbv)	(ppbv)	(ppbv)	(ppbv)	(ppbv)	(ppbv)	(ppbv)	(%)		
1,1,1-TCA	2.8	0.17	380	430	131	314	160	51	8.9E-03	4.6E-03
1,1-DCE	2.0	0.12	317	320	103	247	124	50	8.1E-03	4.1E-03
TCE	1.1	0.07	173	194	52	140	76.6	55	7.9E-03	4.3E-03
c-1,2-DCE	0.54	0.03	58	77	18	51	30	59	1.1E-02	6.3E-03
mean and standard deviation									8.9E-03	2.5E-03

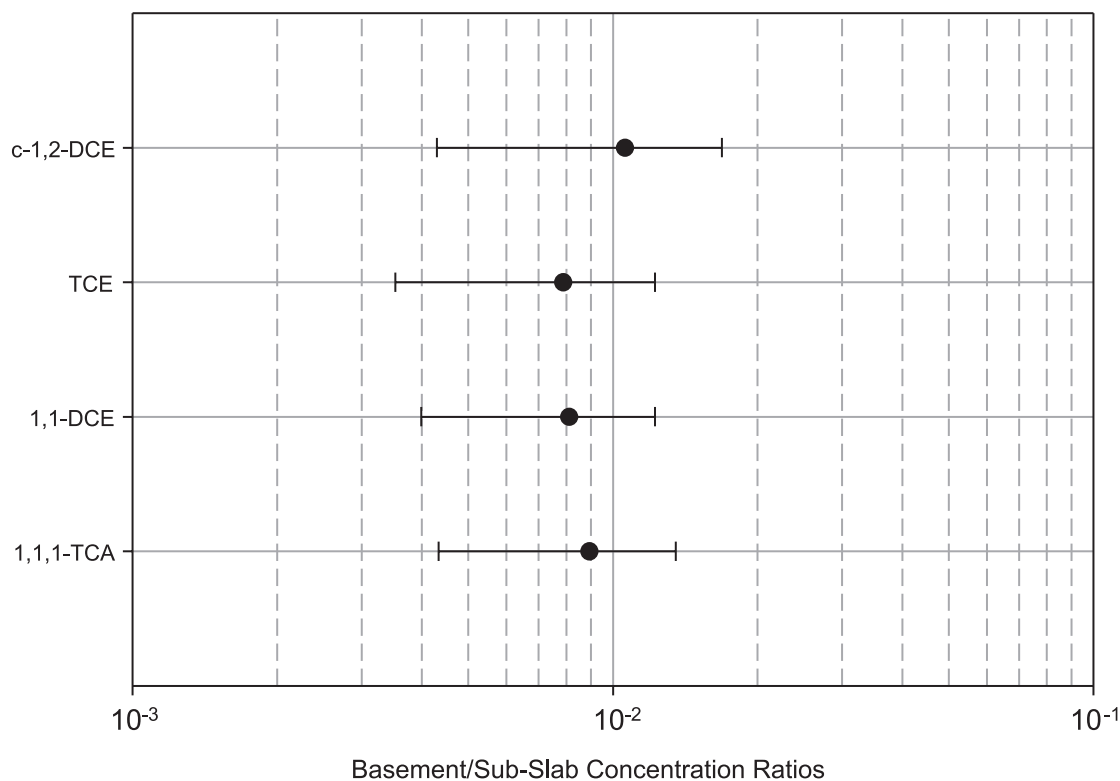

Figure 46. Basement/sub-slab concentration ratios using one-liter Tedlar bags and on-site GC analysis at House I during the March 2003 sample event. Error bars represent one standard deviation.

House J

There were several visible cracks in the concrete slab in the basement of House J. Basement walls consisted of poured concrete but were covered with sheet rock. Concentrations of all VOCs detected in basement and/or sub-slab air using EPA Method TO-15 are summarized in **Table 12a**. 1,1,1-TCA, 1,1-DCE, and TCE were detected in basement air at concentrations of 0.44, 0.20, and 0.18 ppbv, respectively. Other chlorinated compounds detected in basement air were perchloroethylene, methylene chloride, and chloroform at concentrations of 0.10, 15, and 0.18 ppbv, respectively. Freons, F-11 and F-12, were detected in basement air at concentrations of 1.4 and 0.48 ppbv, respectively. Hydrocarbons, heptane, hexane, cyclohexane, benzene, toluene, ethylbenzene, m/p-xylenes, o-xylene, 1,2,4-trimethylbenzene, 1,3,5-trimethylbenzene, and 4-ethyltoluene were detected at concentrations up to 23 ppbv. Acetone, tetrahydrofuran, methyl ethyl ketone, and methyl tertiary-butyl ether were detected at concentrations of 4.2, 2.4, 0.86, and 12 ppbv, respectively. The compound, 1,3 butadiene, was detected at 0.48 ppbv.

Four sub-slab probes were installed at House J. Only one probe was sampled using EPA Method TO-15 (sampled twice). All four probes were sampled using one-liter Tedlar bags. Using EPA Method TO-15, 1,1,1-TCA, 1,1-DCE, TCE, c-1,2-DCE, and 1,1-DCA were found at concentrations of 36, 26, 15, 4.6, 12 ppbv, respectively. Other chlorinated compounds detected in sub-slab air were perchloroethylene, methylene chloride, and chloroform at concentrations of 0.20, 1.1, and 1.3 ppbv, respectively. Freons, F-11, F-12, and F-113, were detected in sub-slab air at concentrations of 0.36, 0.55, and 0.08 ppbv, respectively. Hydrocarbons, hexane, benzene, toluene, ethylbenzene, m/p-xylenes,

o-xylene, 1,2,4-trimethylbenzene, and 4-ethyltoluene were detected at concentrations up to 1.6 ppbv. Acetone, tetrahydrofuran, methyl ethyl ketone, methyl isobutyl ketone, and methyl tertiary-butyl ether were detected at concentrations of 2.8, 0.30, 0.85, 0.21, and 0.54 ppbv, respectively.

Table 12a. Basement and Sub-Slab Air Concentrations of VOCs at House J Using EPA Method TO-15 During the March 2003 Sample Event

VOC	bsmt 24-hr	scaled stdev	P[A] grab	P[A] grab	P[A] mean n=2
	03/24/03 (ppbv)	cov = 6% (ppbv)	03/26/03 (ppbv)	03/26/03 (ppbv)	03/26/03 (ppbv)
1,1,1-TCA	0.44	0.03	33	36	35
1,1-DCE	0.20	0.01	26	24	25
TCE	0.18	0.01	14	15	15
c-1,2-DCE	ND(0.14)	IND	4.2	4.6	4.4
1,1-DCA	ND(0.14)	IND	12	9.7	11
1,2-DCA	ND(0.14)	IND	ND(0.11)	ND(0.11)	ND(0.11)
PCE	0.10	0.01	0.20	0.19	0.20
CH ₂ Cl ₂	15	0.90	0.92	1.1	1.0
CHCl ₃	0.18	0.01	1.2	1.3	1.3
CCl ₄	ND(0.14)	IND	ND(0.12)	ND(0.12)	ND(0.12)
CCl ₃ F(F-11)	1.4	0.08	0.33	0.36	0.35
CCl ₂ F ₂ (F-12)	0.48	0.03	0.52	0.55	0.54
CHBrCl ₂	ND(0.13)	IND	ND(0.11)	ND(0.11)	ND(0.11)
vinyl chloride	ND(0.14)	IND	ND(0.12)	ND(0.12)	ND(0.12)
CH ₃ CH ₂ Cl	ND(1.5)	IND	ND(1.2)	ND(1.2)	ND(1.2)
CCl ₃ CF ₃ (F-113)	ND(0.14)	IND	ND(0.11)	0.08	<0.10
acetone	4.2	0.25	2.4	2.8	2.6
2-hexanone	ND(0.13)	IND	ND(0.11)	ND(0.11)	ND(0.11)
THF	2.4	0.14	0.30	ND(0.11)	<0.21
MEK	0.86	0.05	0.63	0.85	0.74
MIBK	ND(0.13)	IND	0.21	0.17	0.19
MTBE	12	0.72	0.54	0.50	0.52
heptane	3.7	0.22	ND(0.11)	ND(0.11)	ND(0.11)
hexane	6.4	0.38	0.58	0.64	0.61
cyclohexane	1.8	0.11	ND(0.11)	ND(0.11)	ND(0.11)
benzene	3.9	0.23	0.52	0.48	0.50
toluene	23	1.38	1.9	1.6	1.8
ethylbenzene	2.5	0.15	0.19	0.16	0.18
m/p-xylenes	8.6	0.52	0.58	0.47	0.53
o-xylene	2.7	0.16	0.22	0.18	0.20
styrene	ND(0.13)	IND	ND(0.11)	ND(0.11)	ND(0.11)
1,2,4-TMB	1.7	0.10	0.18	0.16	0.17
1,3,5-TMB	0.45	0.03	ND(0.11)	ND(0.11)	ND(0.11)
1,3-butadiene	0.48	0.03	ND(0.22)	ND(0.23)	ND(0.23)
1,3-DCB	ND(0.14)	IND	ND(0.11)	ND(0.11)	ND(0.11)
1,4-DCB	ND(0.14)	IND	ND(0.11)	ND(0.11)	ND(0.11)
4-ethyltoluene	2.0	0.12	ND(0.11)	0.17	<0.14
isopropyl alcohol	0.63	0.04	ND(0.21)	ND(0.21)	ND(0.21)
ethyl/vinyl acetate	3.9	0.23	0.38	0.47	0.43
CS ₂	ND(0.13)	IND	0.13	0.13	0.13

ND = Not detected (reporting limit)

As indicated in **Table 12b**, when sampling with one-liter Tedlar bags, 1,1,1-TCA, 1,1-DCE, TCE, and c-1,2-DCE were found at maximum concentrations in Probe [A] at 43, 26, 14, and 3.0 ppbv, respectively. Radon was sampled at two probes with concentrations

of 1029 and 1253 pCi/l and detected in basement air at a mean concentration of 3.0 pCi/l. Results and statistical analysis of sub-slab sampling for radon are summarized in **Table 12c**.

Table 12b. Summary of Basement/Sub-Slab Air Concentration Ratios of VOCs Associated with Sub-Surface Contamination in House J Using 1-Liter Tedlar Bags and On-Site GC Analysis During the March 2003 Sample Event

VOC	bsmt 24-hr	scaled stdev	P[A] grab	P[B] grab	P[C] grab	P[D] grab	sub-slab mean	sub-slab stdev	sub-slab cov	bsmt/ sub-slab ratio	bsmt/ sub-slab stdev
	03/24/03	cov=6%	03/26/03	03/26/03	03/26/03	03/26/03	n=4	n=4	n=4		
	(ppbv)	(ppbv)	(ppbv)	(ppbv)	(ppbv)	(ppbv)	(ppbv)	(ppbv)	(%)		
1,1,1-TCA	0.44	0.03	43	8.5	17	8.5	19	16	85	2.3E-02	1.9E-02
1,1-DCE	0.20	0.01	26	5.2	9.2	5.2	11	9.9	87	1.8E-02	1.5E-02
TCE	0.18	0.01	14	2.6	4.6	2.4	5.9	5.5	93	3.1E-02	2.8E-02
c-1,2-DCE	ND(0.14)	IND	3.0	ND(3.0)	ND(3.0)	ND(3.0)	<3.0	IND	IND	IND	IND
ND = Not detected (reporting limit), IND = indeterminate							mean and standard deviation			2.4E-02	1.3E-02

Table 12c. Basement/Sub-Slab Air Concentration Ratios for Radon in House J Using 48-hr Activated Carbon Canisters for Basement Air Sampling (3/21-3/24/03) and Scintillation Cells for Sub-Slab Air Sampling During the March 2003 Sample Event

bsmt 48-hr	bsmt 48-hr	bsmt mean	bsmt stdev	bsmt cov	P[A] 110A	P[B] 110A	sub-slab mean	sub-slab stdev	sub-slab cov	bsmt/ sub-slab ratio	bsmt/ sub-slab stdev
		n=2	n=2	n=2	03/26/03	03/26/03	n=2	n=2	n=2		
		(pCi/L)	(pCi/L)	(%)	(pCi/L)	(pCi/L)	(pCi/L)	(pCi/L)	(%)		
2.90	3.00	3.0	0.07	2.4	1029	1253	1141	158.4	13.88	2.59E-03	3.64E-04

Figure 47 illustrates basement/sub-slab air concentration ratios for radon and sub-slab samples collected in one-liter Tedlar bags and analyzed on site. Sub-slab air samples for VOCs from one-liter Tedlar bags were used for statistical testing because only one probe was sampled using EPA Method TO-15. At House J, the basement/sub-slab air concentration ratios for both radon and the indicator VOC, 1,1-DCE, were available. The null hypothesis that the basement/sub-slab air concentration ratio of radon was equal to the basement/sub-slab air concentration ratio of 1,1-DCE could be rejected using a two-tailed Approximate t-Test at a level of significance of 0.1. The null hypotheses that the basement/sub-slab air

concentration ratios for 1,1,1-TCE and TCE were equal to the basement/sub-slab air concentration ratio of 1,1-DCE using a one-tailed Approximate t-Test could not be rejected at a level of significance less than or equal to 0.05 ($p > 0.1$). The null hypotheses that the basement/sub-slab air concentration ratios of 1,1,1-TCA and TCE were equal to the basement/sub-slab air concentration ratio of radon could be rejected using a one-tailed Approximate t-Test at a significance level of 0.1 but not at a significance level of 0.05. Since the rejection criteria for the null hypothesis is a level of significance less than or equal to 0.05, use of both radon and the indicator VOC, 1,1-DCE, led to a consistent finding that the presence of 1,1,1-TCA,

1,1-DCE, and TCE in basement air was due to vapor intrusion at the time of sampling. However, visually and statistically, there was more consistency in the use of 1,1-DCE as an indicator compound compared to radon.

Table 12b summarizes basement/sub-slab air concentration ratios determined using one-liter Tedlar bag sampling for VOCs associated with sub-surface contamination. Use of basement/sub-slab concentration values for 1,1,1-TCA, 1,1-DCE, and TCE

resulted in computation of an average basement/sub-slab ratio of 2.4E-02. The overall basement/sub-slab air concentration ratio for House J appears high relative to other testing locations. However, the basement/sub-slab concentration ratio for 1,1-DCE, a VOC only associated with sub-surface contamination, was 1.8E-02. Also, throughout this investigation, when TCE was detected in basement air, it was always associated with sub-surface contamination. At House J, TCE had a basement/sub-slab air concentration ratio of 3.1E-02 which was similar to 1,1-DCE.

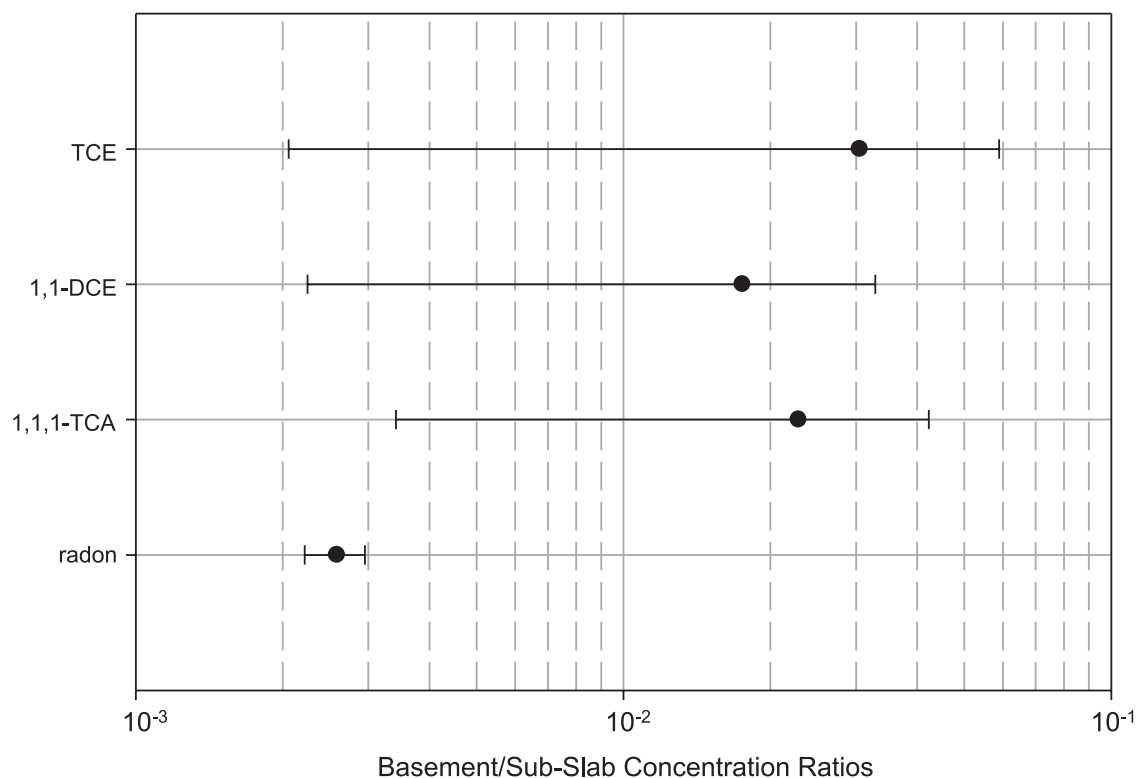

Figure 47. Basement/sub-slab concentration ratios using one-liter Tedlar bags and on-site GC analysis at House J during the March 2003 sample event. Error bars represent one standard deviation.

House K

There were several visible cracks and holes in the concrete slab in the basement of House K. The slab was less than 2.5 centimeters thick. Basement walls consisted of poured concrete. Concentrations of all VOCs detected in basement and/or sub-slab air using EPA Method TO-15 are summarized in **Table 13a**. All VOCs associated with sub-surface contamination were detected in basement air. 1,1,1-TCA, 1,1-DCE, TCE, c-1,2-DCE, and 1,1-DCA were detected in basement air at concentrations of 1.1, 1.3, 0.54, 0.23, and 0.31 ppbv, respectively. Other chlorinated compounds detected in basement air were perchloroethylene, methylene chloride, and 1,4-dichlorobenzene at concentrations of 0.10, 3.3, and 0.19 ppbv, respectively. Freons, F-11 and F-12, were detected in basement air at concentrations of 0.38 and 0.54 ppbv, respectively. Hydrocarbons, heptane, hexane, benzene, toluene, ethylbenzene, m/p-xylenes, o-xylene, 1,2,4-trimethylbenzene, 1,3,5-trimethylbenzene, and 4-ethyltoluene were detected at concentrations up to 3.6 ppbv. Acetone, tetrahydrofuran, methyl ethyl ketone, and methyl tertiary-butyl ether were detected at concentrations of 3.3, 1.6, 2.1, and 0.52 ppbv, respectively.

Three sub-slab probes were installed at House K. Sub-slab air was not sampled using EPA Method TO-15. All three probes were sampled using one-liter Tedlar bags. As indicated in **Table 13b**, maximum concentrations of 1,1,1-TCA, 1,1-DCE, TCE, and c-1,2-DCE were found at Probe B at 947, 933, 440, and 190 ppbv, respectively. Radon was sampled at two probes with concentrations of 142 and 1144 pCi/L and detected in basement air at a mean concentration of 3.2 pCi/L. Results and statistical analysis of sub-slab sampling for radon are summarized in **Table 13c**.

Table 13a. Basement Air Concentrations for VOCs at House K Using EPA Method TO-15 During the March 2003 Sample Event

VOC	bsmt 24-hr	scaled stddev
	03/24/03 (ppbv)	cov = 6% (ppbv)
1,1,1-TCA	1.1	0.07
1,1-DCE	1.3	0.08
TCE	0.54	0.03
c-1,2-DCE	0.23	0.01
1,1-DCA	0.31	0.02
1,2-DCA	ND(0.15)	IND
PCE	0.10	0.01
CH ₂ Cl ₂	3.3	0.20
CHCl ₃	ND(0.15)	IND
CCl ₄	ND(0.15)	IND
CCl ₃ F(F-11)	0.38	0.02
CCl ₂ F ₂ (F-12)	0.54	0.03
CHBrCl ₂	ND(0.14)	IND
vinyl chloride	ND(0.15)	IND
CH ₃ CH ₂ Cl	ND(1.6)	IND
CCl ₃ CF ₃ (F-113)	ND(0.15)	IND
acetone	3.3	0.20
2-hexanone	ND(0.14)	IND
THF	1.6	0.10
MEK	2.1	0.13
MIBK	ND(0.13)	IND
MTBE	0.52	0.03
heptane	0.40	0.02
hexane	0.38	0.02
cyclohexane	ND(0.15)	IND
benzene	0.32	0.02
toluene	3.0	0.18
ethylbenzene	1.4	0.08
m/p-xylenes	3.6	0.22
o-xylene	0.65	0.04
styrene	ND(0.14)	IND
1,2,4-TMB	1.6	0.10
1,3,5-TMB	0.51	0.03
1,3-butadiene	ND(0.29)	IND
1,3-DCB	ND(0.15)	IND
1,4-DCB	0.19	0.01
4-ethyltoluene	1.3	0.08
isopropyl alcohol	0.39	0.02
ethyl/vinyl acetate	6.2	0.37
CS ₂	ND(0.14)	IND

ND () = Not detected (reporting limit)
IND = indeterminate

Table 13b. Summary of Basement/Sub-Slab Air Concentration Ratios of VOCs Associated with Sub-Surface Contamination in House K Using 1-Liter Tedlar Bags and On-Site GC Analysis During the March 2003 Sample Event

VOC	bsmt 24-hr	scaled stdev	P[A] grab	P[B] grab	P[C] grab	sub-slab mean	sub-slab stdev	sub-slab cov	bsmt/ sub-slab ratio	bsmt/ sub-slab stdev
						n=3	n=3	n=3		
	03/24/03 (ppbv)	cov=6% (ppbv)	03/26/03 (ppbv)	03/26/03 (ppbv)	03/26/03 (ppbv)	03/26/03 (ppbv)	03/26/03 (ppbv)	03/26/03 (%)		
1,1,1-TCA	1.1	0.07	530	947	500	659	250	38	1.7E-03	6.4E-04
1,1-DCE	1.3	0.08	513	933	513	653	242	37	2.0E-03	7.5E-04
TCE	0.54	0.03	209	440	210	286	133	46	1.9E-03	8.8E-04
c-1,2-DCE	0.23	0.01	82	190	84	119	62	52	1.9E-03	1.0E-03
ND = Not detected (reporting limit), IND = indeterminate						mean and standard deviation			1.9E-03	4.2E-04

Table 13c. Basement/Sub-Slab Air Concentration Ratios for Radon in House K Using 48-hr Activated Carbon Canisters for Basement Air Sampling (3/21-3/24/03) and Scintillation Cells for Sub-Slab Air Sampling During the March 2003 Sample Event

bsmt 48-hr	bsmt 48-hr	bsmt mean	bsmt stdev	bsmt cov	P[A] 110A	P[B] 110A	sub-slab mean	sub-slab stdev	sub-slab cov	bsmt/ sub-slab ratio	bsmt/ sub-slab stdev
							n=2	n=2	n=2		
		03/24/03 (pCi/L)	03/24/03 (pCi/L)	03/24/03 (%)			03/26/03 (pCi/L)	03/26/03 (pCi/L)	03/26/03 (pCi/L)		
3.0	3.4	3.2	0.28	8.8	142	1144	643	709	110	4.98E-03	5.50E-03

Figure 48 illustrates basement/sub-slab air concentration ratios for radon and VOCs collected in one-liter Tedlar bags and analyzed on site. The null hypotheses that the basement/sub-slab air concentration ratio of radon was equal to the basement/sub-slab concentration ratios of indicator VOCs, 1,1-DCE and c-1,2-DCE, could not be rejected using a two-tailed Approximate t-Test at a level of significance less than 0.1. This finding was in part due to the large standard deviation associated with the basement/sub-slab air concentration ratio of radon (standard deviation larger than mean). The null hypotheses that the basement/sub-slab air concentration ratios of 1,1,1-TCA and TCE were equal to the basement/sub-slab air concentration ratios of indicator VOCs, 1,1-DCE and c-1,2-DCE, could not be rejected using a one-tailed Approximate t-test at a level of significance less than or equal to 0.05 ($p > 0.1$) inferring that the presence of 1,1,1-TCA, TCE, 1,1-DCE, c-1,2-DCE, and 1,1-DCA (indicator VOC) in basement air was

all due to vapor intrusion at the time of sampling. The null hypotheses that the basement/sub-slab air concentration ratios of 1,1,1-TCA and TCE were equal to the basement/sub-slab concentration ratio of radon could not be rejected using a one-tailed Approximate t-Test at a level of significance less than or equal to 0.05 ($p > 0.1$). This provided a consistent finding with indicator VOCs that the presence of 1,1,1-TCA and TCE in basement air was due to vapor intrusion at the time of sampling.

Table 13b summarizes basement/sub-slab air concentration ratios determined using Tedlar bag sampling for VOCs associated with sub-surface contamination. Use of basement/sub-slab concentration values for 1,1,1-TCA, 1,1-DCE, TCE, and 1,2-DCE resulted in computation of an average basement/sub-slab ratio of 1.9E-03. Coefficients of variation in sub-slab air concentration ranged from 38 to 52%.

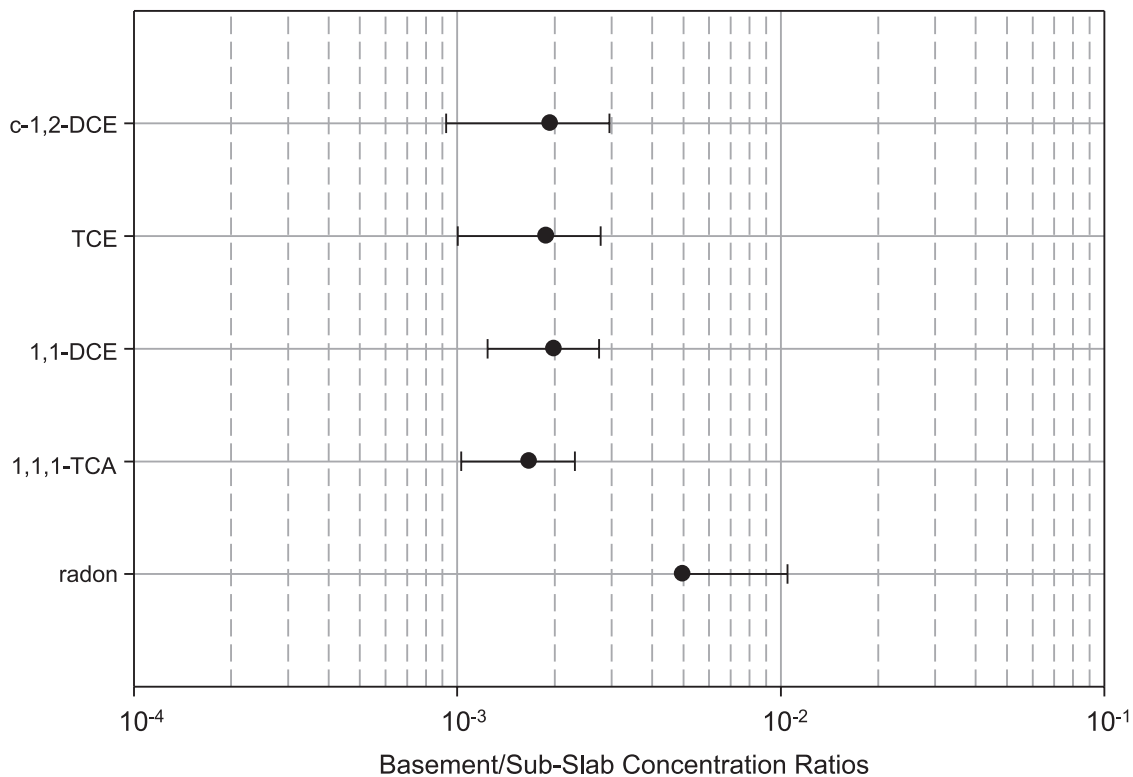

Figure 48. Basement/sub-slab concentration ratios using one-liter Tedlar bags and on-site GC analysis at House K during the March 2003 sample event. Error bars represent one standard deviation.

House L

Basement walls at House L consisted of poured concrete. The basement was partitioned into finished and unfinished areas. Concentrations of all VOCs detected in basement and/or sub-slab air using EPA Method TO-15 are summarized in **Table 14a**. VOCs associated with sub-surface contamination, 1,1,1-TCA, 1,1-DCE, and TCE, were detected in basement air at concentrations of 0.27, 0.24, and 0.20 ppbv, respectively. The only other chlorinated VOC detected in basement air was methylene chloride at a concentration of 1.1 ppbv. Freons, F-11, and F-12, were detected in basement air at concentrations of 0.28 and 0.67 ppbv, respectively. Hydrocarbons, heptane, hexane, benzene, toluene, ethylbenzene, m/p-xylenes, and o-xylene were detected in basement air at concentrations up to 2.0 ppbv. Acetone, tetrahydrofuran, methyl ethyl ketone, methyl isobutyl ketone, and methyl tertiary-butyl ether were detected in

basement air at concentrations of 1.9, 0.38, 1.7, 0.82, and 0.23 ppbv, respectively.

Three sub-slab vapor probes were installed at House L. Sub-slab air was sampled at only one probe using EPA Method TO-15. All probes were sampled using one-liter Tedlar bags. Using EPA Method TO-15, 1,1,1-TCA, 1,1-DCE, TCE, c-1,2-DCE, and 1,1-DCA were detected in sub-slab air at concentrations of 170, 140, 120, 48, and 43 ppbv, respectively. Other chlorinated VOCs detected in sub-slab air using EPA Method TO-15 were perchloroethylene and chloroform detected at 0.44 and 1.1 ppbv, respectively. Freons, F-11 and F-12, were detected at 0.26 and 0.53 ppbv, respectively. Hydrocarbons, hexane and toluene were detected at concentrations of 0.19 and 0.37 ppbv, respectively. Acetone, methyl ethyl ketone, methyl isobutyl ketone, and methyl tertiary-butyl ether were detected at concentrations of 2.8, 0.81, 0.28, and 0.17 ppbv, respectively.

Table 14a. Basement and Sub-Slab Air Concentrations for VOCs at House L Using EPA Method TO-15 During the March 2003 Sample Event

VOC	bsmt 24-hr	scaled stdev	P[B] grab
	03/26/03 (ppbv)	cov = 6% (ppbv)	04/01/03 (ppbv)
1,1,1-TCA	0.27	0.02	170
1,1-DCE	0.24	0.01	140
TCE	0.20	0.01	120
c-1,2-DCE	ND(0.10)	IND	48
1,1-DCA	ND(0.10)	IND	43
1,2-DCA	ND(0.10)	IND	ND(0.17)
PCE	ND(0.10)	IND	0.44
CH ₂ Cl ₂	1.1	0.07	ND(0.18)
CHCl ₃	ND(0.10)	IND	1.1
CCl ₄	ND(0.10)	IND	ND(0.18)
CCl ₃ F(F-11)	0.28	0.02	0.26
CCl ₂ F ₂ (F-12)	0.67	0.04	0.53
CHBrCl ₂	ND(0.096)	IND	ND(0.17)
vinyl chloride	ND(0.11)	IND	ND(0.17)
CH ₃ CH ₂ Cl	ND(1.1)	IND	ND(1.9)
CCl ₃ CF ₃ (F-113)	ND(0.10)	IND	ND(0.18)
acetone	1.9	0.11	2.8
2-hexanone	ND(0.098)	IND	ND(0.17)
THF	0.38	0.02	ND(0.17)
MEK	1.7	0.10	0.81
MIBK	0.82	0.05	0.28
MTBE	0.23	0.01	0.17
heptane	0.75	0.05	ND(0.17)
hexane	0.23	0.01	0.19
cyclohexane	ND(0.10)	IND	ND(0.18)
benzene	0.28	0.02	ND(0.18)
toluene	2.0	0.12	0.37
ethylbenzene	0.19	0.01	ND(0.18)
m/p-xylenes	0.57	0.03	ND(0.35)
o-xylene	0.15	0.01	ND(0.18)
styrene	ND(0.096)	IND	ND(0.17)
1,2,4-TMB	ND(0.10)	IND	ND(0.17)
1,3,5-TMB	ND(0.10)	IND	ND(0.18)
1,3-butadiene	ND(0.20)	IND	ND(0.35)
1,3-DCB	ND(0.10)	IND	ND(0.18)
1,4-DCB	ND(0.10)	IND	ND(0.17)
4-ethyl- toluene	ND(0.10)	IND	ND(0.18)
isopropyl alcohol	0.30	0.02	0.84
ethyl/vinyl acetate	12	0.72	ND(0.32)
CS ₂	ND(0.098)	IND	ND(0.17)
ND () = Not detected (reporting limit)			IND = indeterminate

As indicated in **Table 14b**, Probe A was sampled sequentially five times using one-liter Tedlar bags to assess the impact of extraction volume on sample results. These results were previously discussed. As indicated in **Table 14c**, when sampling with one-liter Tedlar bags, 1,1,1-TCA, 1,1-DCE, TCE, and c-1,2-DCE were found in sub-slab air at maximum concentrations of 210, 141, 123, and 43 ppbv, respectively. Radon was sampled at three probes with concentrations of 695, 567, and 387 pCi/L and detected in basement air at a mean concentration of 2.6 pCi/L. Results and statistical analysis of sub-slab sampling for radon are summarized in **Tables 14d** and **14e**.

Figure 49 illustrates basement/sub-slab air concentration ratios for radon and VOCs collected in one-liter Tedlar bags and analyzed on site. The null hypothesis that the basement/sub-slab air concentration ratio of radon was equal to the basement/sub-slab air concentration ratio of the indicator VOC, 1,1-DCE, could be rejected using a two-tailed Approximate t-Test at a significance level less than or equal to 0.1. The null hypotheses that the basement/sub-slab air concentration ratios of 1,1,1-TCA and TCE were equal to the basement/sub-slab concentration ratio of 1,1-DCE could not be rejected using a one-tailed Approximate t-Test at a significance level less than or equal to 0.05 ($p > 0.1$). This inferred that the presence of 1,1,1-TCA, TCE, and 1,1-DCE in basement air was due to vapor intrusion at the time of sampling. Since the basement/sub-slab air concentration ratio for radon was greater than basement/sub-slab air concentration ratios for 1,1,1-TCA and TCE, use of radon as an indicator compound also inferred that detection of 1,1,1-TCA and TCE in basement air were due to vapor intrusion at the time of sampling. As visually illustrated in **Figure 49**, there was greater consistency in basement/sub-slab air

concentration ratios of VOCs associated with vapor intrusion than between VOCs associated with vapor intrusion and radon.

sampling for VOCs associated with sub-surface contamination. Use of basement/sub-slab air concentration ratios for 1,1,1-TCA, 1,1-DCE, and TCE resulted in computation of an average basement/sub-slab ratio of 1.7E-03.

Table 14c summarizes basement/sub-slab air concentration ratios determined using Tedlar bag

Table 14b. Results of Sequential Sub-Slab Air Sampling Using 1-Liter Tedlar Bags and On-Site GC Analysis at House L During the March 2003 Sample Event

VOC	P[A]-01 grab	P[A]-02 grab	P[A]-03 grab	P[A]-04 grab	P[A]-05 grab	P[A] mean	P[A] stdev	P[A] cov
						n=5	n=5	n=5
	04/01/03	04/01/03	04/01/03	04/01/03	04/01/03	04/01/03	04/01/03	04/01/03
	(ppbv)	(ppbv)	(ppbv)	(ppbv)	(ppbv)	(ppbv)	(ppbv)	(%)
1,1,1-TCA	210	210	204	207	207	207.6	2.51	1.21
1,1-DCE	145	138	138	141	141	140.6	2.88	2.05
TCE	122	122	123	124	124	123	1.00	0.81
c-1,2-DCE	44	43	43	43	44	43.4	0.55	1.26

Table 14c. Summary of Basement/Sub-Slab Air Concentration Ratios of VOCs Associated with Sub-Surface Contamination in House L Using 1-Liter Tedlar Bags and On-Site GC Analysis During the March 2003 Sample Event

VOC	bsmt 24-hr	scaled stdev	P[A] mean grab	P[B] grab	P[C] grab	sub-slab mean	sub-slab stdev	sub-slab cov	bsmt/ sub-slab ratio	bsmt/ sub-slab stdev
						n=3	n=3	n=3		
	03/28/03	cov=6%	04/01/03	04/01/03	04/01/03	04/01/03	04/01/03	04/01/03		
	(ppbv)	(ppbv)	(ppbv)	(ppbv)	(ppbv)	(ppbv)	(ppbv)	(%)	(-)	(-)
1,1,1-TCA	0.27	0.02	208	210	184	201	14	7.2	1.3E-03	1.3E-04
1,1-DCE	0.24	0.01	141	131	100	124	21	17	1.9E-03	3.5E-04
TCE	0.20	0.01	123	109	104	112	10	8.8	1.8E-03	1.9E-04
c-1,2-DCE	ND(0.10)	IND	43	38	31	37	6	17	<2.7E-03	IND
ND = Not detected(reporting limit)			IND = indeterminate			mean and standard deviation			1.7E-03	1.4E-04

Table 14d. Summary of 48-Hour Indoor Air Measurements for Radon Using Activated Charcoal at House L

Location	Start Date	End Date	Conc. (pCi/L)
1st floor	03/26/03	03/28/03	1.1
1st floor	03/26/03	03/28/03	0.9
bsmt	03/26/03	03/28/03	3.2
bsmt	03/26/03	03/28/03	3.3
bsmt-bar	03/26/03	03/29/03	1.9
bsmt-bar	03/26/03	03/29/03	1.9

Table 14e. Basement/Sub-Slab Air Concentration Ratios for Radon in House L Using 48-hr Activated Carbon Canisters for Basement Air Sampling (3/26-3/28/03) and Scintillation Cells for Sub-Slab Air Sampling During the March 2003 Sample Event

bsmt 48-hr mean	bsmt stdev	bsmt cov	P[A] 110A	P[B] 110A	P[C] 110A	sub-slab grab mean	sub-slab grab stdev	sub-slab grab cov	bsmt/ sub-slab ratio	bsmt/ sub-slab stdev
						n=3	n=3	n=3		
	03/29/03	03/29/03	04/01/03	04/01/03	04/01/03	n=3	n=3	n=3		
	(pCi/L)	(%)	(pCi/L)	(pCi/L)	(pCi/L)	(pCi/L)	(pCi/L)	(%)	(-)	(-)
2.6	0.78	30.3	695	567	387	550	155	28.1	4.68E-03	1.94E-03

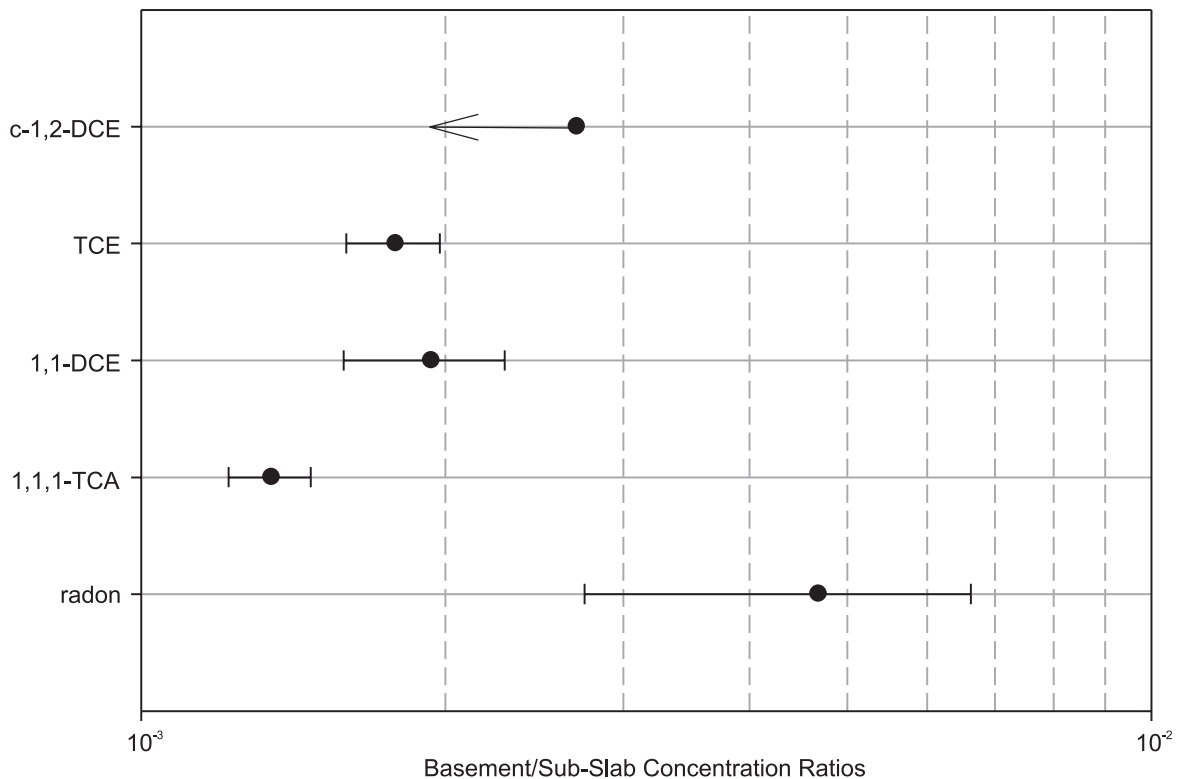

Figure 49. Basement/sub-slab concentration ratios using one-liter Tedlar bags and on-site GC analysis at House L during the March 2003 sample event. Error bars represent one standard deviation. Arrows indicate less than values due to non-detection in basement air.

House M

Basement walls at House M consisted of field stone and were covered with sheet rock and wood framing. Concentrations of all VOCs detected in basement and/or sub-slab air using EPA Method TO-15 are summarized in **Table 15a**. 1,1,1-TCA and 1,1-DCE were detected in basement air at concentrations of 0.14 and 0.12 ppbv, respectively. The only other chlorinated compound detected in basement air was methylene chloride at a concentration of 0.20 ppbv. Freons, F-11 and F-12, were detected in basement air at concentrations of 0.27 and 0.47 ppbv, respectively. Hydrocarbons, heptane, hexane, benzene, toluene, m/p-xylenes, o-xylene, 1,2,4-trimethylbenzene, 1,3,5-trimethylbenzene, and 4-ethyltoluene were detected at concentrations up to 0.66 ppbv. Acetone, methyl ethyl ketone, and methyl tertiary-butyl ether were

detected at concentrations of 2.2, 0.30, and 0.44 ppbv, respectively.

Three sub-slab vapor probes were installed at House M. Sub-slab air was sampled at only one probe using EPA Method TO-15. This probe was sampled twice. All three probes were sampled using one-liter Tedlar bags. Using EPA Method TO-15, 1,1,1-TCA, 1,1-DCE, TCE, c-1,2-DCE, and 1,1-DCA were detected at 6.4, 4.3, 5.2, 1.2, and 2.2 ppbv, respectively. The only other chlorinated compounds detected in sub-slab air were methylene chloride and 1,4-dichlorobenzene at concentrations of 2.9 and 1.2 ppbv, respectively. Freons, F-11 and F-12, were detected in sub-slab air at concentrations of 0.29 and 0.54 ppbv, respectively. Hydrocarbons, hexane, benzene, toluene, m/p-xylenes, o-xylene, 1,2,4-trimethylbenzene, 1,3,5-trimethylbenzene, and 4-ethyltoluene were detected at

concentrations up to 1.2 ppbv. Acetone, 2-hexanone, tetrahydrofuran, methyl ethyl ketone, methyl isobutyl ketone, and methyl tertiary-butyl ether were detected at concentrations of 6.2, 0.28, 0.30, 1.7, and 0.36 ppbv, respectively.

Table 15a. Basement and Sub-Slab Air Concentrations for VOCs at House M Using EPA Method TO-15 During the March 2003 Sample Event

VOC	bsmt 24-hr	scaled stdev	P[A]-01 grab	P[A]-02 grab	P[A] mean n=2
	03/24/03	cov = 6%	03/27/03	03/27/03	03/27/03
	(ppbv)	(ppbv)	(ppbv)	(ppbv)	(ppbv)
1,1,1-TCA	0.14	0.01	6.4	2.8	4.6
1,1-DCE	0.12	0.01	4.3	1.7	3.0
TCE	ND(0.12)	IND	5.2	3.6	4.4
c-1,2-DCE	ND(0.12)	IND	1.2	0.88	1.0
1,1-DCA	ND(0.12)	IND	2.2	1.0	1.6
1,2-DCA	ND(0.12)	IND	ND(0.24)	ND(0.21)	ND(<0.23)
PCE	ND(0.12)	IND	ND(0.24)	ND(0.21)	ND(<0.23)
CH ₂ Cl ₂	0.20	0.01	2.9	1.30	2.1
CHCl ₃	ND(0.12)	IND	ND(0.24)	ND(0.21)	ND(<0.23)
CCl ₄	ND(0.12)	IND	ND(0.24)	ND(0.21)	ND(<0.23)
CCl ₃ F(F-11)	0.27	0.02	0.30	0.28	0.29
CCl ₂ F ₂ (F-12)	0.47	0.03	0.54	0.53	0.54
CHBrCl ₂	ND(0.11)	IND	ND(0.22)	ND(0.20)	ND(<0.21)
vinyl chloride	ND(0.13)	IND	ND(0.25)	ND(0.22)	ND(<0.24)
CH ₃ CH ₂ Cl	ND(1.3)	IND	ND(2.5)	ND(2.2)	ND(<2.4)
CCl ₃ CF ₃ (F-113)	ND(0.12)	IND	ND(0.24)	ND(0.21)	ND(<0.23)
acetone	2.2	0.13	6.20	5.10	5.65
2-hexanone	ND(0.12)	IND	0.28	0.28	0.28
THF	ND(0.12)	IND	0.30	ND(0.21)	<0.23
MEK	0.30	0.02	1.7	1.6	1.65
MIBK	ND(0.11)	IND	0.36	0.27	0.315
MTBE	0.44	0.03	0.36	0.33	0.345
heptane	0.19	0.01	ND(0.23)	ND(0.21)	ND(<0.22)
hexane	0.33	0.02	0.58	0.53	0.555
cyclohexane	ND(0.12)	IND	ND(0.24)	ND(0.21)	ND(<0.23)
benzene	0.32	0.02	0.28	0.27	0.275
toluene	0.66	0.04	1.20	0.93	1.065
ethylbenzene	ND(0.12)	IND	ND(0.24)	ND(0.21)	ND(<0.23)
m/p-xylenes	0.35	0.02	0.66	0.92	0.79
o-xylene	0.15	0.01	0.27	0.28	0.275
styrene	ND(0.11)	IND	ND(0.22)	ND(0.20)	ND(<0.21)
1,2,4-TMB	0.42	0.03	0.53	0.64	0.585
1,3,5-TMB	0.15	0.01	ND(0.24)	0.22	<0.23
1,3-butadiene	ND(0.24)	IND	ND(0.47)	ND(0.42)	ND(<0.45)
1,3-DCB	ND(0.12)	IND	0.83	ND(0.21)	<0.52
1,4-DCB	ND(0.12)	IND	ND(0.23)	1.2	<0.72
4-ethyl-toluene	0.29	0.02	0.73	0.76	0.75
isopropyl alcohol	ND(0.22)	IND	0.64	0.54	0.59
ethyl/vinyl acetate	1.5	0.09	2.2	1.7	2.0
CS ₂	ND(0.12)	IND	ND(0.23)	ND(0.20)	ND(<0.22)
ND = Not detected (reporting limit)			IND = indeterminate		

As indicated in **Table 15b**, Probe B was sampled sequentially five times using one-liter Tedlar bags to assess the impact of extraction volume on sample results. These results were previously discussed. As indicated in **Table 15c**, when sampling with one-liter Tedlar bags, maximum concentrations of 1,1,1-TCA, 1,1-DCE, TCE, and c-1,2-DCE were detected in Probe B at 542, 480, 189, and 46 ppbv, respectively. Radon was sampled at two probes with concentrations of 732 and 766 pCi/L and detected in basement air at a mean concentration of 2.4 pCi/L. Results and statistical analysis of sub-slab sampling for radon are summarized in **Table 15d**.

Figure 50 illustrates basement/sub-slab air concentration ratios for radon and VOCs collected in one-liter Tedlar bags and analyzed on site. The null hypothesis that the basement/sub-slab air concentration ratio of radon was equal to the basement/sub-slab air concentration ratio of the indicator VOC, 1,1-DCE, could be rejected using a two-tailed Approximate t-Test at a significance level less than or equal to 0.1 ($p < 0.025$). The null hypothesis that the basement/sub-slab air concentration ratio of 1,1,1-TCA was equal to the basement/sub-slab air concentration ratio of 1,1-DCE could not be rejected using a one-tailed Approximate t-Test at a significance level less than or equal to 0.05 ($p > 0.1$) inferring that the presence of 1,1,1-TCA and 1,1-DCE in basement air was due to vapor intrusion at the time of sampling. Since the basement/sub-slab air concentration ratio of radon was greater than the basement/sub-slab air concentration ratio of 1,1,1-TCA, use of radon as an indicator compound also inferred that detection of 1,1,1-TCA in basement air was due to vapor intrusion at the time of sampling.

Table 15c summarizes basement/sub-slab air concentration ratios determined using Tedlar bag sampling for VOCs associated with sub-surface contamination. Use of basement/sub-slab air concentration ratios for 1,1,1-TCA and 1,1-DCE resulted in computation of an overall basement/sub-slab ratio of 6.3E-03.

Table 15b. Results of Sequential Sub-Slab Air Sampling Using 1-Liter Tedlar Bags and On-Site GC Analysis at House M During the March 2003 Sample Event

VOC	P[B]-01 grab	P[B]-02 grab	P[B]-03 grab	P[B]-04 grab	P[B]-05 grab	P[B] mean	P[B] stdev	P[B] cov
						n=5	n=5	n=5
	03/27/03	03/27/03	03/27/03	03/27/03	03/27/03	04/01/03	04/01/03	04/01/03
	(ppbv)	(ppbv)	(ppbv)	(ppbv)	(ppbv)	(ppbv)	(ppbv)	(%)
1,1,1-TCA	548	541	533	540	550	542	6.80	1.25
1,1-DCE	483	484	475	480	478	480	3.67	0.77
TCE	183	189	190	190	192	189	3.42	1.81
c-1,2-DCE	44	46	46	46	46	46	0.89	1.96

Table 15c. Summary of Basement/Sub-Slab Air Concentration Ratios of VOCs Associated with Sub-Surface Contamination in House M Using 1-Liter Tedlar Bags and On-Site GC Analysis During the March 2003 Sample Event

VOC	bsmt 24-hr	scaled stdev	P[A] grab	P[B] mean grab	P[C] grab	sub-slab mean	sub-slab stdev	sub-slab cov	bsmt/ sub-slab ratio	bsmt/ sub-slab stdev
		cov = 6%				n=3	n=3	n=3		
	03/24/03		03/27/03	03/27/03	03/27/03	03/27/03	03/27/03	03/27/03		
	(ppbv)	(ppbv)	(ppbv)	(ppbv)	(ppbv)	(ppbv)	(ppbv)	(%)	(-)	(-)
1,1,1-TCA	0.14	0.01	52	542	76	223	276	124	6.3E-04	7.8E-04
1,1-DCE	0.12	0.01	31	480	64	192	250	131	6.3E-04	8.2E-04
TCE	ND(0.12)	IND	31	189	17	79	95	121	<1.5E-03	IND
c-1,2-DCE	ND(0.12)	IND	9.5	46	1.4	19	24	125	<6.4E-03	IND
ND() = Not detected (reporting limit), IND = indeterminate						mean and standard deviation			6.3E-04	5.6E-04

Table 15d. Basement/Sub-Slab Air Concentration Ratios of Radon in House M Using 48-hr Activated Carbon Canisters for Basement Air Sampling (3/22-3/24/03) and Scintillation Cells for Sub-Slab Air Sampling During the March 2003 Sample Event

bsmt 48-hr	bsmt 48-hr	bsmt mean	bsmt stdev	bsmt cov	P[A] pylon	P[C] pylon	sub-slab mean	sub-slab stdev	sub-slab cov	bsmt/ sub-slab ratio	bsmt/ sub-slab stdev
		n=2	n=2		n=2	n=2	n=2				
		03/27/03	03/27/03	03/27/03	03/27/03	03/27/03	03/27/03	03/27/03	03/27/03		
	(pCi/L)	(pCi/L)	(pCi/L)	(%)	(pCi/L)	(pCi/L)	(pCi/L)	(pCi/L)	(%)	(-)	(-)
2.4	2.4	2.4	0.00	0.0	732	766	749	12.0	1.60	3.20E-03	5.14E-05

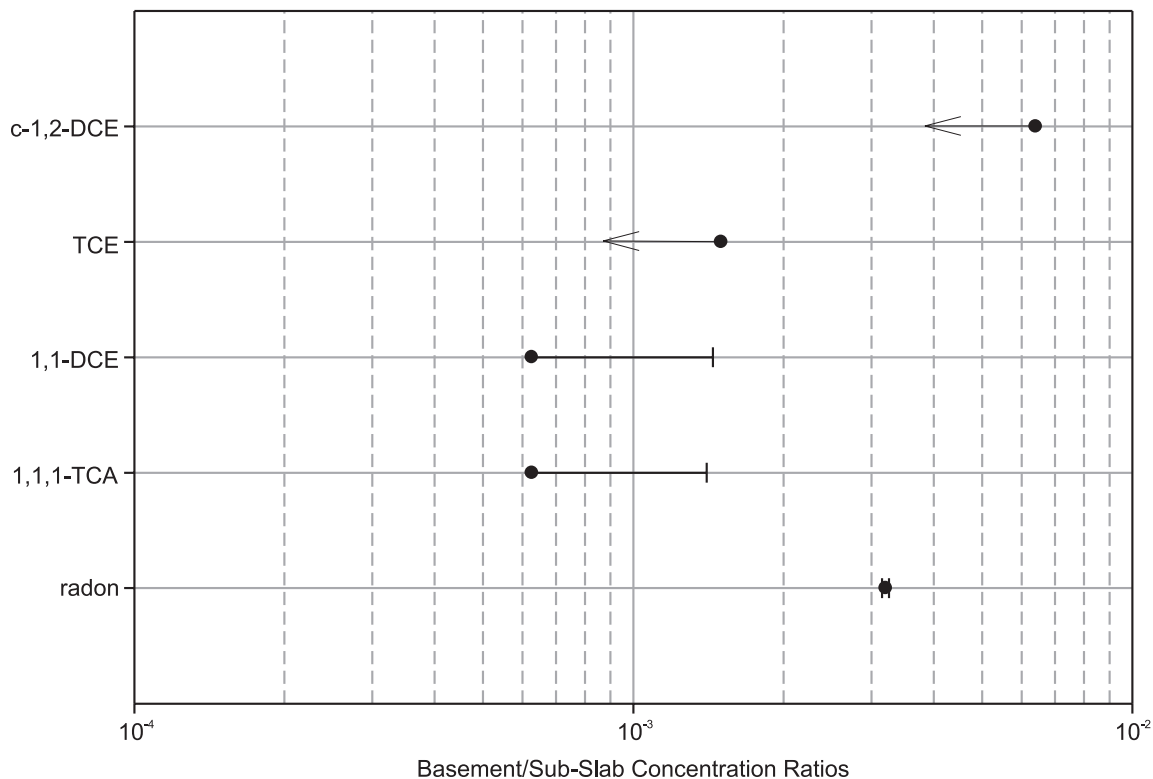

Figure 50. Basement/sub-slab concentration ratios using one-liter Tedlar bags and on-site GC analysis at House M during the March 2003 sample event. Error bars represent one standard deviation. Arrows indicate less than values due to non-detection in basement air.

House N

Basement walls at House N consisted of poured concrete. The basement was equipped with a sub-slab depressurization system which had not been operated for over 3 years. Concentrations of VOCs detected in basement and/or sub-slab air using EPA Method TO-15 are summarized in **Table 16a**. The only VOC associated with subsurface contamination detected in basement air was 1,1,1-TCA at a concentration of 0.10 ppbv. The detection limits of other VOCs associated with subsurface contamination ranged from 0.092 to 0.094 ppbv. Other chlorinated compounds detected in basement air were perchloroethylene, methylene chloride, and chloroform at concentrations of 0.11, 0.54, and 0.11 ppbv, respectively. Freons, F-11 and F-12, were detected in basement air at concentrations

of 0.28 and 0.45 ppbv, respectively. Hydrocarbons, hexane, cyclohexane, benzene, toluene, m/p-xylenes, o-xylene, and 1,3,5-trimethylbenzene were detected at concentrations up to 4.1 ppbv. Acetone, tetrahydrofuran, methyl ethyl ketone, and methyl tertiary-butyl ether were detected at concentrations of 3.3, 0.67, 1.1, and 0.56 ppbv, respectively.

Three sub-slab probes were installed at House N. Two probes were sampled using EPA Method TO-15. All three probes were sampled using one-liter Tedlar bags. As indicated in **Table 16b**, using EPA Method TO-15, 1,1,1-TCA, 1,1-DCE, TCE, c-1,2-DCE, and 1,1-DCA were found at maximum concentrations in Probe B at 32, 42, 12, 9.9, and 20 ppbv, respectively. Other chlorinated compounds detected in sub-slab air were perchloroethylene, methylene chloride, and

Table 16a. Basement and Sub-Slab Air Concentrations for VOCs at House N Using EPA Method TO-15 During the March 2003 Sample Event

VOC	bsmt 24-hr	scaled stdev	P[B] grab	P[C] grab	sub-slab mean	sub-slab stdev	sub-slab cov	bsmt/ sub-slab ratio	bsmt/ sub-slab stdev
	03/28/03	cov=6%	03/28/03	03/28/03	n=2	n=2	n=2		
	(ppbv)		(ppbv)	(ppbv)	(ppbv)	(ppbv)	(ppbv)		
1,1,1-TCA	0.10	0.01	32	9.7	21	16	76	4.8E-03	3.6E-03
1,1-DCE	ND(0.094)	IND	42	5.3	24	26	110	<4.0E-03	IND
TCE	ND(0.094)	IND	12	2.5	7.3	6.7	93	<1.3E-02	IND
c-1,2-DCE	ND(0.092)	IND	9.9	ND(1.0)	<5.5	IND	IND	IND	IND
1,1-DCA	ND(0.094)	IND	20	6.9	13.5	9.3	69	<7.0E-03	IND
1,2-DCA	ND(0.092)	IND	ND(0.098)	ND(1.0)	ND(<0.55)	IND	IND	IND	IND
PCE	0.11	0.01	0.26	ND(1.0)	<0.63	IND	IND	>1.7E-01	IND
CH ₂ Cl ₂	0.54	0.03	0.24	ND(1.0)	<0.62	IND	IND	>8.6E-01	IND
CHCl ₃	0.11	0.01	0.29	1.0	0.6	0.5	78	1.7E-01	1.3E-01
CCl ₄	ND(0.094)	IND	ND(0.10)	ND(1.0)	ND(<0.55)	IND	IND	IND	IND
CCl ₃ F(F-11)	0.28	0.02	0.27	ND(1.0)	<0.64	IND	IND	>4.4E-01	IND
CCl ₂ F ₂ (F-12)	0.45	0.03	0.56	ND(1.0)	<0.78	IND	IND	>5.8E-01	IND
CHBrCl ₂	ND(0.086)	IND	ND(0.092)	ND(0.96)	ND(<0.53)	IND	IND	IND	IND
vinyl chloride	ND(0.095)	IND	ND(0.10)	ND(1.1)	ND(<0.55)	IND	IND	IND	IND
CH ₃ CH ₂ Cl	ND(0.97)	IND	ND(1.0)	ND(11)	ND(<6.0)	IND	IND	IND	IND
CCl ₃ CF ₃ (F-113)	ND(0.092)	IND	ND(0.098)	ND(1.0)	ND(<0.55)	IND	IND	IND	IND
acetone	3.3	0.20	2.2	9.1	5.7	4.9	86	5.8E-01	5.1E-01
2-hexanone	ND(0.088)	IND	0.11	ND(0.98)	<0.56	IND	IND	IND	IND
THF	0.67	0.04	ND(0.096)	ND(1.0)	ND(<0.55)	IND	IND	>1.2E+00	IND
MEK	1.1	0.07	0.73	3.7	2.2	2.1	95	5.0E-01	4.7E-01
MIBK	ND(0.083)	IND	0.16	ND(0.92)	<0.54	IND	IND	IND	IND
MTBE	0.56	0.03	0.50	ND(0.98)	<0.74	IND	IND	>7.6E-01	IND
heptane	ND(0.09)	IND	ND(0.096)	ND(1.0)	ND(<0.55)	IND	IND	IND	IND
hexane	1.4	0.08	0.25	1.9	1.1	1.2	109	1.3E+00	1.4E+00
cyclohexane	0.58	0.03	ND(0.098)	14	<7.0	IND	IND	>8.3E-02	IND
benzene	0.54	0.03	0.14	ND(1.0)	<0.57	IND	IND	>9.5E-01	IND
toluene	4.1	0.25	0.18	ND(1.0)	<0.59	IND	IND	>6.9E+00	IND
ethylbenzene	0.17	0.01	ND(0.098)	ND(1.0)	ND(<0.55)	IND	IND	>3.1E-01	IND
m/p-xylenes	0.54	0.03	ND(0.20)	ND(2.0)	ND(<1.1)	IND	IND	>4.9E-01	IND
o-xylene	0.19	0.01	ND(0.10)	ND(1.0)	ND(<0.55)	IND	IND	>3.5E-01	IND
styrene	ND(0.086)	IND	ND(0.092)	ND(0.96)	ND(<0.53)	IND	IND	IND	IND
1,2,4-TMB	ND(0.09)	IND	ND(0.096)	0.60	<0.35	IND	IND	IND	IND
1,3,5-TMB	0.10	0.01	ND(0.098)	ND(1.0)	ND(<0.55)	IND	IND	>1.8E-01	IND
1,3-butadiene	ND(0.18)	IND	ND(0.19)	ND(2.0)	ND(<1.1)	IND	IND	IND	IND
1,3-DCB	ND(0.092)	IND	ND(0.098)	ND(1.0)	ND(<0.55)	IND	IND	IND	IND
1,4-DCB	ND(0.09)	IND	ND(0.096)	ND(1.0)	ND(<0.55)	IND	IND	IND	IND
4-ethyl-toluene	0.22	0.01	ND(0.098)	ND(1.0)	ND(<0.55)	IND	IND	>4.0E-01	IND
isopropyl alcohol	0.7	0.04	ND(0.18)	ND(1.9)	ND(<1.0)	IND	IND	>7.2E-01	IND
ethyl/vinyl acetate	2.0	0.12	0.31	3.0	1.7	1.9	115	1.2E+00	1.4E+00
CS ₂	ND(0.088)	IND	ND(0.094)	ND(0.98)	ND(<0.54)	IND	IND	IND	IND

ND() = Not detected (reporting limit)

IND = indeterminate

chloroform detected at concentrations of 0.24, 0.24, and 1.0 ppbv, respectively. Freons, F-11 and F-12, were detected in sub-slab air at concentrations of 0.27 and 0.56 ppbv, respectively. Hydrocarbons, hexane, cyclohexane, benzene, and toluene were detected at concentrations of 1.9, 14, 0.14, and 0.18 ppbv, respectively. Acetone, 2-hexanone, methyl ethyl ketone, methyl isobutyl ketone, and methyl tertiary-butyl ether were detected at concentrations of 9.1, 0.11, 3.7, 0.16, and 0.50 ppbv, respectively.

The results of sequential sampling using one-liter Tedlar bags at Probe A at House N to assess the impact of extraction volume on sample results are presented in **Table 16c**. These results were previously discussed.

As indicated in **Table 16d**, when sampling with one-liter Tedlar bags, 1,1,1-TCA, 1,1-DCE, TCE, and c-1,2-DCE were found at maximum concentrations of 47, 6.3, 14, and 6.4 ppbv, respectively. Radon was sampled at two probes with concentrations of 197 and 409 pCi/l and detected in basement air at a mean concentration of 3.1 pCi/L. Results and statistical analysis of sub-slab sampling for radon are summarized in **Table 16e**.

Figure 51 illustrates basement/sub-slab air concentration ratios for VOCs and radon detected in basement air

using EPA Method TO-15 for sub-slab air analysis. The basement/sub-slab air concentration ratio of radon was used to assess vapor intrusion since indicator VOCs, 1,1-DCE, c-1,2-DCE, and 1,1-DCA, were not detected in basement air. A basement/sub-slab air concentration ratio of c-1,2-DCE was not calculated using EPA Method TO-15 analysis because c-1,2-DCE was detected in only one probe. The null hypothesis that the basement/sub-slab air concentration ratio of 1,1,1-TCA was equal to the basement/sub-slab air concentration ratio of radon could not be rejected using a one-tailed Approximate t-Test at a level of significance less than or equal to 0.05 ($p > 0.1$) inferring that the presence of 1,1,1-TCA in basement air was due to vapor intrusion at the time of sampling.

Table 16b summarizes basement/sub-slab air concentration ratios determined using EPA Method TO-15 and Tedlar bag sampling for VOCs associated with sub-surface contamination. For EPA Method TO-15 analysis, the basement/sub-slab air concentration ratio of 1,1,1-TCA was 4.8E-03. **Table 16d** summarizes basement/sub-slab air ratios using Tedlar bags for sampling along with on-site GC analyses. The basement/sub-slab air concentration ratio of 1,1,1-TCA was 4.0E-03.

Table 16b. Summary of Basement/Sub-Slab Air Concentration Ratios of VOCs Associated with Sub-Surface Contamination in House N Using EPA Method TO-15 During the March 2003 Sample Event

VOC	bsmt 24-hr	scaled stdev	P[B] grab	P[C] grab	sub-slab mean	sub-slab stdev	sub-slab cov	bsmt/ sub-slab ratio	bsmt/ sub-slab stdev
	03/28/03	cov = 6%	03/28/03	03/28/03	n=2	n=2	n=2		
	(ppbv)		(ppbv)	(ppbv)	(ppbv)	(ppbv)	(%)		
1,1,1-TCA	0.10	0.01	32	9.7	21	16	76	4.8E-03	3.6E-03
1,1-DCE	ND(0.094)	IND	42	5.3	24	26	110	<4.0E-03	IND
TCE	ND(0.094)	IND	12	2.5	7.3	6.7	93	<1.3E-02	IND
c-1,2-DCE	ND(0.092)	IND	9.9	ND(1.0)	<5.5	IND	IND	IND	IND
1,1-DCA	ND(0.094)	IND	20	6.9	13.5	9.3	69	<7.0E-03	IND
ND() = Not detected (reporting limit), IND = indeterminate					mean and standard deviation			4.8E-03	3.6E-03

Table 16c. Results of Sequential Sub-Slab Air Sampling Using 1-Liter Tedlar Bags and On-Site GC Analysis at House N During the March 2003 Sample Event

VOC	P[A]-01 grab	P[A]-02 grab	P[A]-03 grab	P[A]-04 grab	P[A]-05 grab	P[A] mean	P[A] stdev	P[A] cov
						n=5	n=5	n=5
	03/31/03	03/31/03	03/31/03	03/31/03	03/31/03	03/31/03	03/31/03	03/31/03
	(ppbv)	(ppbv)	(ppbv)	(ppbv)	(ppbv)	(ppbv)	(ppbv)	(%)
1,1,1-TCA	13	14	15	16	15	15	1.14	7.81
1,1-DCE	5.8	6.3	6.5	6.6	6.4	6	0.31	4.93
TCE	2.5	2.5	2.5	2.5	2.7	3	0.09	3.52
c-1,2-DCE	ND(3.0)	ND(3.0)	ND(3.0)	ND(3.0)	ND(3.0)	ND(3.0)	IND	IND

ND = Not detected (reporting limit), IND = indeterminate

Table 16d. Summary of Basement/Sub-Slab Air Concentration Ratios of VOCs Associated with Sub-Surface Contamination in House N Using 1-Liter Tedlar Bags and On-Site GC Analysis During the March 2003 Sample Event

VOC	bsmt 24-hr	scaled stdev	P[A] mean grab	P[B] grab	P[C] grab	sub-slab mean	sub-slab stdev	sub-slab cov	bsmt/ sub-slab ratio	bsmt/ sub-slab stdev
		cov = 6%				n=3	n=3	n=3		
	03/28/03		03/31/03	03/31/03	03/31/03	03/28/03	03/28/03	03/28/03		
	(ppbv)	(ppbv)	(ppbv)	(ppbv)	(ppbv)	(ppbv)	(ppbv)	(%)	(-)	(-)
1,1,1-TCA	0.10	0.01	15	47	13	25	19	77	4.0E-03	3.1E-03
1,1-DCE	ND(0.094)	IND	6.3	4.6	4.8	5.2	0.9	18	<1.8E-02	IND
TCE	ND(0.094)	IND	2.5	14	3.9	6.8	6.3	92	<1.4E-02	IND
c-1,2-DCE	ND(0.092)	IND	ND(3.0)	6.4	ND(3.0)	<4.1	IND	IND	IND	IND

ND() = Not detected (reporting limit), IND = indeterminate

Table 16e. Basement/Sub-Slab Air Concentration Ratios of Radon in House N Using 48-hr Activated Carbon Canisters for Basement Air Sampling (3/25-3/27/03) and Scintillation Cells for Sub-Slab Air Sampling During the March 2003 Sample Event

bsmt 48-hr	bsmt 48-hr	bsmt mean	bsmt stdev	bsmt cov	P[A] 300A	P[B] 330A	sub-slab mean	sub-slab stdev	sub-slab cov	bsmt/ sub-slab ratio	bsmt/ sub-slab stdev
		n=2	n=2	n=2			n=2	n=2	n=2		
		03/27/03	03/27/03	03/27/03	03/31/03	03/27/03	03/31/03	03/31/03	03/31/03		
	(pCi/L)	(pCi/L)	(pCi/L)	(%)	(pCi/L)	(pCi/L)	(pCi/L)	(pCi/L)	(%)	(-)	(-)
3.3	2.9	3.1	0.28	9.1	197	409	303	150	49.5	1.02E-02	5.15E-03

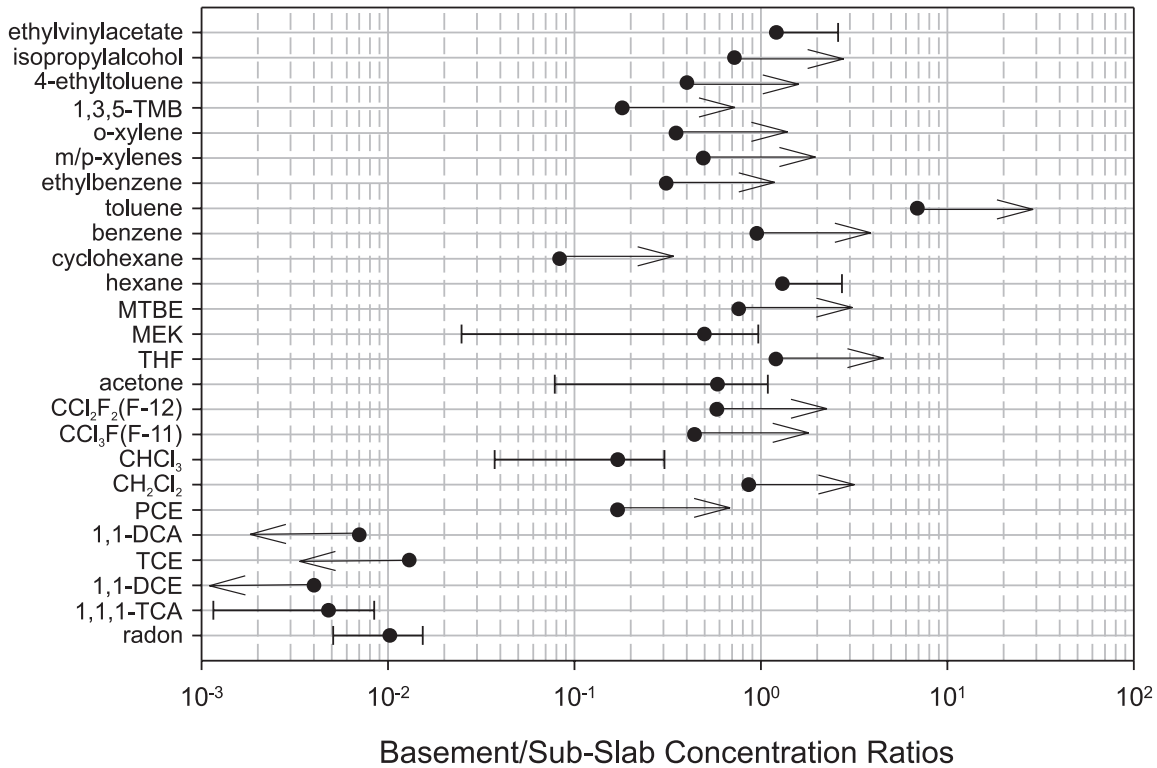

Figure 51. Basement/sub-slab concentration ratios using EPA Method TO-15 at House N during the March 2003 sample event. Error bars represent one standard deviation. Arrows indicate greater than or less than values due to non-detection in basement or sub-slab air.

House O

The slab appeared relatively intact with few cracks. Basement walls consisted of poured concrete. Concentrations of all VOCs detected in basement and/or sub-slab air using EPA Method TO-15 are summarized in **Table 17a**. No VOCs associated with subsurface contamination were detected in basement air. The detection limits of VOCs associated with sub-surface contamination ranged from 0.097 to 0.099 ppbv. Other chlorinated compounds detected in basement air were methylene chloride, chloroform, carbon tetrachloride, and 1,4-dichlorobenzene at concentrations of 1.2, 0.22, 0.17, and 0.16 ppbv, respectively. Freons, F-11 and F-12, were detected in basement air at concentrations of 0.74 and 0.52 ppbv, respectively. Hydrocarbons, heptane, hexane,

cyclohexane, benzene, toluene, ethylbenzene, m/p-xylenes, o-xylene, 1,2,4-trimethylbenzene, 1,3,5-trimethylbenzene, and 4-ethyltoluene were detected at concentrations up to 21 ppbv. Acetone, tetrahydrofuran, methyl ethyl ketone, and methyl tertiary-butyl ether were detected at concentrations of 19, 11, 1.1, and 19 ppbv, respectively. The compound, 1,3-butadiene, was detected in basement air at a concentration of 0.80 ppbv.

Three sub-slab probes were installed at House O. Two probes were sampled using EPA Method TO-15. All three probes were sampled using one-liter Tedlar bags. As indicated by **Table 17b**, 1,1,1-TCA, 1,1-DCE, TCE, c-1,2-DCE, and 1,1-DCA were found at maximum concentrations in Probe C at 7.2, 2.2, 1.6, 0.080, and 1.3 ppbv, respectively. Other

Table 17a. Basement and Sub-Slab Air Concentrations for VOCs at House O Using EPA Method TO-15 During the March 2003 Sample Event

VOC	bsmt 24-hr	scaled stdev	P[A] grab	P[C] grab	sub-slab mean	sub-slab stdev	sub-slab cov	bsmt/ sub-slab ratio	bsmt/ sub-slab stdev
	03/26/03	cov=6%	03/26/03	03/26/03	03/26/03	03/26/03	03/26/03		
	(ppbv)		(ppbv)	(ppbv)	(ppbv)	(ppbv)	(ppbv)		
1,1,1-TCA	ND(0.097)	IND	5.6	7.2	6.4	1.13	18	<1.5E-02	IND
1,1-DCE	ND(0.099)	IND	1.1	2.2	1.7	0.78	47	<5.9E-02	IND
TCE	ND(0.099)	IND	0.56	1.6	1.1	0.74	68	<9.0E-02	IND
c-1,2-DCE	ND(0.097)	IND	ND(0.07)	0.080	<0.08	IND	IND	IND	IND
1,1-DCA	ND(0.099)	IND	0.930	1.3	1.1	0.26	23	<8.7E-02	IND
1,2-DCA	0.080	0.00	ND(0.07)	ND(0.071)	ND(<0.07)	IND	IND	>1.1E+00	IND
PCE	ND(0.092)	IND	0.34	0.33	0.34	0.01	2.1	<2.9E-01	IND
CH ₂ Cl ₂	1.2	0.07	0.10	ND(0.073)	<0.09	IND	IND	>1.3E+00	IND
CHCl ₃	0.22	0.01	0.82	10	5.4	6.49	120	4.1E-02	4.9E-02
CCl ₄	0.17	0.01	ND(0.071)	ND(0.073)	ND(<0.072)	IND	IND	>2.3E+00	IND
CCl ₃ F(F-11)	0.74	0.04	0.30	0.29	0.30	0.01	2.4	2.5E+00	1.6E-01
CCl ₂ F ₂ (F-12)	0.50	0.03	0.57	0.13	0.35	0.31	89	1.4E+00	1.3E+00
CHBrCl ₂	ND(0.092)	IND	ND(0.066)	ND(0.067)	ND(<0.067)	IND	IND	IND	IND
vinyl chloride	ND(0.10)	IND	ND(0.073)	ND(0.074)	ND(<0.074)	IND	IND	IND	IND
CH ₂ CH ₂ Cl	1.5	0.09	ND(0.74)	ND(0.75)	ND(<0.75)	IND	IND	>2.0E+00	IND
CCl ₃ CF ₃ (F-113)	ND(0.097)	IND	0.080	0.090	0.09	0.01	8.3	<1.1E+00	IND
acetone	19	1.14	1.9	2.0	2.0	0.07	3.6	9.7E+00	6.8E-01
2-hexanone	ND(0.094)	IND	0.080	0.10	0.09	0.01	16	<1.1E+00	IND
THF	11	0.66	ND(0.068)	ND(0.07)	ND(<0.07)	IND	IND	>1.6E+02	IND
MEK	1.1	0.07	0.46	0.80	0.63	0.24	38	1.7E+00	6.7E-01
MIBK	ND(0.088)	IND	0.17	0.15	0.16	0.01	8.8	<5.5E-01	IND
MTBE	19	1.14	0.080	0.12	0.10	0.03	28	1.9E+02	5.5E+01
heptane	7.2	0.43	ND(0.068)	ND(0.07)	ND(<0.07)	IND	IND	>1.0E+02	IND
hexane	8.9	0.53	0.11	0.19	0.15	0.06	38	5.9E+01	2.3E+01
cyclohexane	0.94	0.06	ND(0.07)	ND(0.071)	ND(<0.07)	IND	IND	>1.3E+01	IND
benzene	3.4	0.20	ND(0.071)	ND(0.073)	ND(<0.072)	IND	IND	>4.9E+01	IND
toluene	21	1.26	0.17	0.23	0.20	0.04	21	1.1E+02	2.3E+01
ethylbenzene	2.5	0.15	ND(0.07)	ND(0.071)	ND(<0.07)	IND	IND	>3.6E+01	IND
m/p-xylenes	11	0.66	ND(0.14)	ND(0.14)	ND(<0.14)	IND	IND	>7.9E+01	IND
o-xylene	3.6	0.22	ND(0.071)	ND(0.073)	ND(<0.072)	IND	IND	>5.1E+01	IND
styrene	ND(0.092)	IND	ND(0.066)	ND(0.067)	ND(<0.067)	IND	IND	IND	IND
1,2,4-TMB	4.3	0.26	ND(0.068)	ND(0.07)	ND(<0.07)	IND	IND	>6.1E+01	IND
1,3,5-TMB	1.2	0.07	ND(0.07)	ND(0.071)	ND(<0.071)	IND	IND	>1.7E+01	IND
1,3-butadiene	0.80	0.05	ND(0.14)	ND(0.14)	ND(<0.14)	IND	IND	>5.7E+00	IND
1,3-DCB	ND(0.097)	IND	ND(0.07)	ND(0.071)	ND(<0.07)	IND	IND	IND	IND
1,4-DCB	0.16	0.01	ND(0.068)	ND(0.07)	ND(<0.07)	IND	IND	>2.3E+00	IND
4-ethyl-toluene	3.9	0.23	ND(0.07)	ND(0.071)	ND(<0.07)	IND	IND	>5.6E+01	IND
isopropyl alcohol	0.36	0.02	ND(0.13)	ND(0.13)	ND(<0.13)	IND	IND	>2.8E+00	IND
ethyl/vinyl acetate	ND(0.18)	IND	ND(0.13)	ND(0.13)	ND(<0.13)	IND	IND	IND	IND
CS ₂	ND(0.094)	IND	ND(0.067)	ND(0.069)	ND(<0.068)	IND	IND	IND	IND
ND() = Not detected (reporting limit)				IND = indeterminate					

chlorinated compounds detected in sub-slab air were perchloroethylene, methylene chloride, and chloroform at concentrations of 0.34, 0.10, and 10 ppbv, respectively. Freons, F-11 and F-12, were detected in sub-slab air at concentrations of 0.30 and 0.57 ppbv, respectively. Hydrocarbons, hexane and toluene were detected at concentrations of 0.19 and 0.23 ppbv, respectively. Acetone, 2-hexanone, methyl ethyl ketone, methyl isobutyl ketone, and methyl tertiary-butyl ether were detected at concentrations of 2.0, 0.10, 0.80, 0.17, and 0.12 ppbv, respectively. As indicated by **Table 17c**, when sampling with one-liter Tedlar bags, 1,1,1-TCA, 1,1-DCE, and TCE were found at maximum concentrations of 9.3, 2.1, and 1.4 ppbv, respectively. Radon was sampled at two probes with concentrations of 948 and 958 pCi/l and detected in basement air at a mean concentration of 4.8 pCi/L.

Results and statistical analysis of sub-slab sampling for radon are summarized in **Table 17d**.

Figure 52 illustrates basement/sub-slab air concentration ratios for VOCs and radon detected in basement air. **Table 17b** summarizes basement/sub-slab air concentration ratios determined using EPA Method TO-15. Use of the lowest basement/sub-slab air concentration ratio for a VOC associated with sub-surface contamination (1,1,1-TCA) resulted in computation of a basement/sub-slab air concentration ratio of less than 1.5E-02. **Table 17c** summarizes basement/sub-slab air concentration ratios using Tedlar bags for sampling along with on-site GC analyses. Use of a basement/sub-slab concentration value for 1,1,1-TCA resulted in computation of a basement/sub-slab ratio of less than 1.1E-02.

Table 17b. Summary of Basement/Sub-Slab Air Concentration Ratios of VOCs Associated with Sub-Surface Contamination in House O Using EPA Method TO-15 During the March 2003 Sample Event

VOC	bsmt 24-hr	scaled stdev	P[A] grab	P[C] grab	sub-slab mean	sub-slab stdev	sub-slab cov	bsmt/ sub-slab ratio	bsmt/ sub-slab stdev
		cov = 6%			n=2	n=2	n=2		
	03/26/03 (ppbv)		03/26/03 (ppbv)	03/26/03 (ppbv)	03/26/03 (ppbv)	03/26/03 (ppbv)	03/26/03 (%)		
1,1,1-TCA	ND(0.097)	IND	5.6	7.2	6.4	1.13	18	<1.5E-02	IND
1,1-DCE	ND(0.099)	IND	1.1	2.2	1.7	0.78	47	<5.9E-02	IND
TCE	ND(0.099)	IND	0.56	1.6	1.1	0.74	68	<9.0E-02	IND
c-1,2-DCE	ND(0.097)	IND	ND(0.07)	0.080	<0.08	IND	IND	IND	IND
1,1-DCA	ND(0.099)	IND	0.930	1.3	1.1	0.26	23	<8.7E-02	IND
ND() = Not detected (reporting limit), IND = indeterminate					mean and standard deviation			<1.5E-02	IND

Table 17c. Summary of Basement/Sub-Slab Air Concentration Ratios of VOCs Associated with Sub-Surface Contamination in House O Using 1-Liter Tedlar Bags and On-Site GC Analysis During the March 2003 Sample Event

VOC	bsmt 24-hr	scaled stdev	P[A] grab	P[B] grab	P[C] grab	sub-slab mean	sub-slab stdev	sub-slab cov	bsmt/ sub-slab ratio
		cov = 6%				n=3	n=3	n=2	
	03/26/03 (ppbv)		03/31/03 (ppbv)	03/31/03 (ppbv)	03/31/03 (ppbv)	03/31/03 (ppbv)	03/31/03 (ppbv)	03/31/03 (%)	
1,1,1-TCA	ND(0.097)	IND	7.6	9.3	8.6	8.5	0.85	10	<1.1E-02
1,1-DCE	ND(0.099)	IND	ND(5.0)	ND(5.0)	2.1	<4.0	IND	IND	IND
TCE	ND(0.099)	IND	ND(1.2)	ND(1.2)	1.4	<1.3	IND	IND	IND
c-1,2-DCE	ND(0.097)	IND	ND(3.0)	ND(3.0)	ND(3.0)	ND(3.0)	IND	IND	IND
ND() = Not detected (reporting limit), IND = indeterminate						mean and standard deviation			<1.1E-02

Table 17d. Basement/Sub-Slab Air Concentration Ratios for Radon in House O Using 48-hr Activated Carbon Canisters for Basement Air Sampling (3/25-3/27/03) and Scintillation Cells for Sub-Slab Air Sampling During the March 2003 Sample Event

bsmt 48-hr	bsmt 48-hr	bsmt mean	bsmt stdev	bsmt cov	P[B] 300A	P[C] 110A	sub-slab mean	sub-slab stdev	sub-slab cov	bsmt/ sub-slab ratio	bsmt/ sub-slab stdev
		n=2	n=2	n=2			n=2	n=2	n=2		
		03/24/03	03/24/03	03/24/03			03/31/03	3/27/03	3/31/03		
(pCi/L)	(pCi/L)	(pCi/L)	(pCi/L)	(%)	(pCi/L)	(pCi/L)	(pCi/L)	(pCi/L)	(%)	(-)	(-)
4.9	4.6	4.8	0.21	4.5	948	958	953	7.1	0.74	5.0E-03	2.26E-04

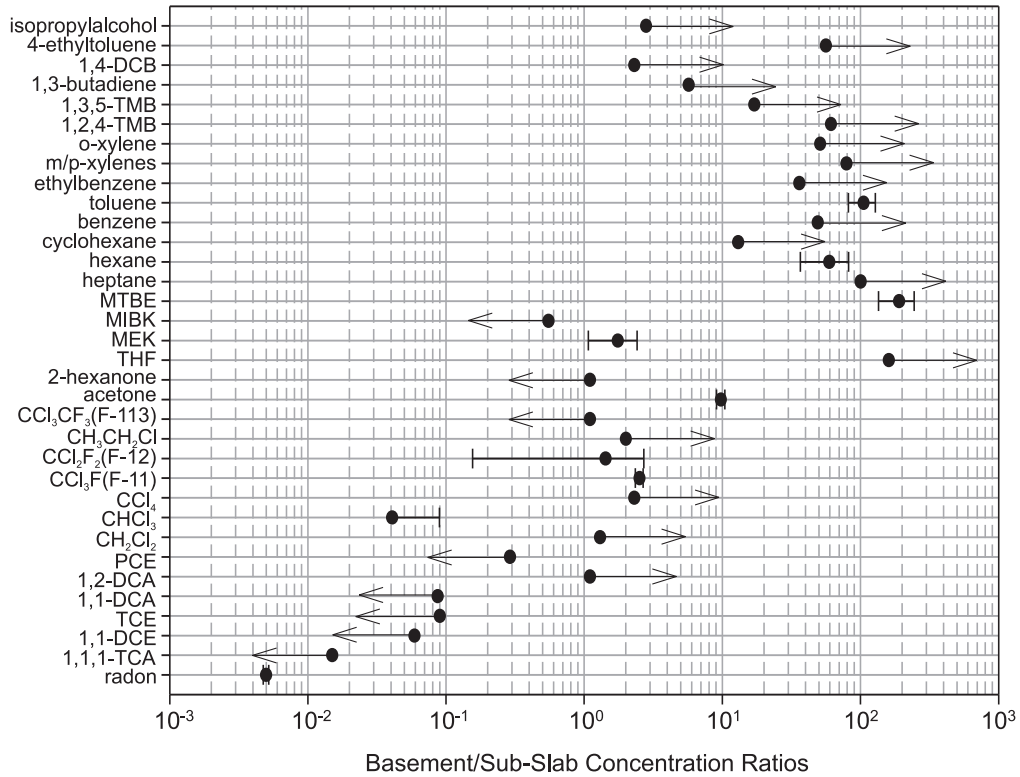

Figure 52. Basement/sub-slab concentration ratios using EPA Method TO-15 at House O during the March 2003 sample event. Error bars represent one standard deviation. Arrows indicate greater than or less than values due to non-detection in basement or sub-slab air.

Location P

Location P is a commercial building. It has a concrete slab approximately 1.6 meters below ground surface. At the time of sub-slab probe installation, the slab appeared relatively intact with few cracks. Basement walls consist of field stone and mortar.

Concentrations of VOCs detected in basement and/or sub-slab air using EPA Method TO-15 for sampling and analysis are summarized in **Table 18a**. The only VOC associated with sub-surface contamination detected in basement air was 1,1,1-TCA at a concentration of 0.12 ppbv. Detection limits for other VOCs associated with sub-surface contamination were 0.09 ppbv. Other chlorinated compounds detected in basement air were methylene chloride, chloroform, carbon tetrachloride, and 1,4-dichlorobenzene at concentrations of 0.55, 0.49, 0.17, and 0.12 ppbv, respectively. Freons, F-11 and F-12, were detected in basement air at concentrations of 0.23 and 0.46 ppbv, respectively. Hydrocarbons, hexane, cyclohexane, benzene, toluene, ethylbenzene, m/p-xylenes, o-xylene, styrene, 1,2,4-trimethylbenzene, 1,3,5-trimethylbenzene, and 4-ethyltoluene were detected at concentrations up to 2.7 ppbv. Acetone, tetrahydrofuran, methyl ethyl ketone, methyl isobutyl ketone, and methyl tertiary-butyl ether were detected at concentrations of 7.7, 11, 33, 3.4, and 0.37 ppbv, respectively.

Four sub-slab probes were installed at location P. Two probes were sampled using EPA Method TO-15. All probes were sampled using one-liter Tedlar bags. As indicated in **Table 18b**, using EPA Method TO-15, 1,1,1-TCA, 1,1-DCE, TCE, c-1,2-DCE, and 1,1-DCA were found at maximum concentrations in Probe [B] at 250, 100, 92, 18, and 54 ppbv, respectively. Other

chlorinated compounds detected in sub-slab air were perchloroethylene and chloroform at concentrations of 2.8 and 1.9 ppbv, respectively. Freons, F-11 and F-12, were detected in sub-slab air at concentrations of 0.37 and 0.52 ppbv, respectively. Hydrocarbons, hexane, toluene, m/p-xylenes, 1,2,4-trimethylbenzene, and 4-ethyltoluene were detected at concentrations of 0.19, 0.19, 0.16, 0.16, and 0.15 ppbv, respectively. Acetone, 2-hexanone, methyl ethyl ketone, and methyl isobutyl ketone were detected at concentrations of 2.6, 0.17, 1.0, and 0.20 ppbv, respectively. As indicated in **Table 18c**, when sampling sub-slab air with one-liter Tedlar bags, 1,1,1-TCA, 1,1-DCE, TCA, and c-1,2-DCE were found at maximum concentrations in Probe [B] at 273, 92, 77, and 15 ppbv, respectively. Radon was sampled at two probes with concentrations of 691 and 1258 pCi/l and detected in basement air at a mean concentration of 3.8 pCi/l. Results and statistical analysis of sub-slab sampling for radon are summarized in **Table 18d**.

Figure 53 illustrates calculated basement/sub-slab ratios for radon and VOCs using EPA Method TO-15 analysis. Since indicator VOCs were not detected in basement air, the basement/sub-slab air concentration ratio of radon was used to assess vapor intrusion. The null hypothesis that the basement/sub-slab air concentration ratio of 1,1,1-TCA was equal to the basement/sub-slab air concentration ratio of radon could not be rejected using a one-tailed Approximate t-Test at a level of significance less than or equal to 0.05 ($p > 0.1$) inferring that the presence of 1,1,1-TCA in basement air was due to vapor intrusion at the time of sampling.

Table 18b summarizes basement/sub-slab air concentration ratios determined using EPA Method

TO-15. Only the upper limit of basement/sub-slab air concentration ratios could be calculated for 1,1-DCE, TCE, c-1,2-DCE, and 1,1-DCA. The basement/sub-slab air concentration ratio of 1,1,1-TCA was 7.2E-04.

Table 18c summarizes basement/sub-slab ratios using Tedlar bag and on-site GC analyses for sub-slab sampling. The basement/sub-slab air concentration ratio of 1,1,1-TCA was 1.0E-03.

Table 18a. Basement and Sub-Slab Air Concentrations for VOCs at House P Using EPA Method TO-15 During the March 2003 Sample Event

VOC	bsmt 24-hr	scaled stdev	P[B] grab	P[C] grab	sub-slab mean	sub-slab stdev	sub-slab cov	bsmt/ sub-slab ratio	bsmt/ sub-slab stdev
	03/26/03 (ppbv)	cov=6% (ppbv)	04/01/03 (ppbv)	04/01/03 (ppbv)	n=2 04/01/03 (ppbv)	n=2 04/01/03 (ppbv)	n=2 04/01/03 (%)		
	(-)		(-)	(-)	(-)	(-)	(-)		
1,1,1-TCA	0.12	0.01	250	83	167	118	71	7.2E-04	5.1E-04
1,1-DCE	ND(0.092)	IND	100	22	61	55	90	<1.5E-03	IND
TCE	ND(0.092)	IND	92	15	54	54	102	<1.7E-03	IND
c-1,2-DCE	ND(0.09)	IND	18	0.36	9.2	12	136	<9.8E-03	IND
1,1-DCA	ND(0.092)	IND	54	5.2	30	35	117	<3.0E-03	IND
1,2-DCA	ND(0.09)	IND	ND(0.14)	ND(0.16)	ND(<0.15)	IND	IND	IND	IND
PCE	ND(0.09)	IND	2.8	1.7	2.3	0.78	35	<4.0E-02	IND
CH ₂ Cl ₂	0.55	0.03	ND(0.14)	ND(0.16)	ND(<0.15)	IND	IND	>3.4E+00	IND
CHCl ₃	0.49	0.03	1.9	0.45	1.2	1.0	87	4.2E-01	3.6E-01
CCl ₄	0.17	0.01	ND(0.14)	ND(0.16)	ND(<0.15)	IND	IND	>1.1E+00	IND
CCl ₃ F(F-11)	0.23	0.01	0.37	0.25	0.31	0.08	27	7.4E-01	2.1E-01
CCl ₂ F ₂ (F-12)	0.46	0.03	0.50	0.52	0.51	0.01	2.8	9.0E-01	6.0E-02
CHBrCl ₂	ND(0.076)	IND	ND(0.082)	0.34	<0.21	IND	IND	IND	IND
vinyl chloride	ND(0.094)	IND	ND(0.14)	ND(0.16)	ND(<0.15)	IND	IND	IND	IND
CH ₃ CH ₂ Cl	ND(0.96)	IND	ND(1.5)	ND(1.6)	ND(<1.6)	IND	IND	IND	IND
CCl ₃ CF ₃ (F-113)	ND(0.09)	IND	ND(0.14)	ND(0.16)	ND(<0.15)	IND	IND	IND	IND
acetone	7.7	0.46	2.6	2.5	2.6	0.07	2.8	3.0E+00	2.0E-01
2-hexanone	ND(0.087)	IND	0.17	ND(0.15)	<0.16	IND	IND	IND	IND
THF	11	0.66	ND(0.14)	ND(0.15)	ND(<0.15)	IND	IND	>6.9E+01	IND
MEK	33	1.98	1.0	0.76	0.88	0.17	19	3.8E+01	7.6E+00
MIBK	3.4	0.20	0.20	0.15	0.18	0.04	20	1.9E+01	4.1E+00
MTBE	0.37	0.02	ND(0.13)	ND(0.15)	ND(<0.14)	IND	IND	>2.3E+00	IND
heptane	ND(0.089)	IND	ND(0.14)	ND(0.15)	ND(<0.15)	IND	IND	IND	IND
hexane	0.33	0.02	0.19	ND(0.16)	<0.18	IND	IND	>1.8E+00	IND
cyclohexane	0.34	0.02	ND(0.14)	ND(0.16)	ND(<0.15)	IND	IND	>2.1E+00	IND
benzene	0.26	0.02	ND(0.14)	ND(0.16)	ND(<0.15)	IND	IND	>1.6E+00	IND
toluene	5.5	0.33	0.19	0.12	0.16	0.05	32	3.5E+01	1.2E+01
ethylbenzene	0.83	0.05	ND(0.14)	ND(0.16)	ND(<0.15)	IND	IND	>5.2E+00	IND
m/p-xylenes	2.7	0.16	0.16	ND(0.31)	<0.24	IND	IND	>1.1E+01	IND
o-xylene	0.57	0.03	ND(0.14)	ND(0.16)	ND(<0.15)	IND	IND	>3.6E+00	IND
styrene	0.13	0.01	ND(0.13)	ND(0.15)	ND(<0.14)	IND	IND	>8.1E-01	IND
1,2,4-TMB	0.85	0.05	0.16	ND(0.15)	<0.16	IND	IND	>5.3E+00	IND
1,3,5-TMB	0.31	0.02	ND(0.14)	ND(0.16)	ND(<0.15)	IND	IND	>1.9E+00	IND
1,3-butadiene	ND(0.18)	IND	ND(0.28)	ND(0.31)	ND(<0.30)	IND	IND	IND	IND
1,3-DCB	ND(0.09)	IND	ND(0.14)	ND(0.16)	ND(<0.15)	IND	IND	IND	IND
1,4-DCB	0.12	0.01	ND(0.14)	ND(0.15)	ND(<0.15)	IND	IND	>7.5E-01	IND
4-ethyltoluene	0.85	0.05	0.15	ND(0.16)	<0.16	IND	IND	>5.3E+00	IND
isopropyl alcohol	4.7	0.28	ND(0.25)	ND(0.28)	ND(<0.27)	IND	IND	>1.7E+01	IND
ethyl/vinyl acetate	6.7	0.40	0.37	0.30	0.34	0.05	IND	2.0E+01	3.2E+00
CS ₂	ND(0.087)	IND	ND(0.13)	ND(0.15)	ND(<0.14)	IND	IND	IND	IND

ND() = Not detected (reporting limit)

IND = indeterminate

Table 18b. Summary of Basement/Sub-Slab Air Concentration Ratios of VOCs Associated with Sub-Surface Contamination in House P Using EPA Method TO-15 During the March 2003 Sample Event

VOC	bsmt 24-hr	scaled stdev	P[B] grab	P[C] grab	sub-slab mean n=2	sub-slab stdev n=2	sub-slab cov n=2	bsmt/ sub-slab ratio	bsmt/ sub-slab stdev
	03/26/03	cov = 6%	04/01/03	04/01/03	04/01/03	04/01/03	04/01/03		
	(ppbv)	(ppbv)	(ppbv)	(ppbv)	(ppbv)	(ppbv)	(%)		
1,1,1-TCA	0.12	0.01	250	83	167	118	71	7.2E-04	5.1E-04
1,1-DCE	ND(0.092)	IND	100	22	61	55	90	<1.5E-03	IND
TCE	ND(0.092)	IND	92	15	54	54	102	<1.7E-03	IND
c-1,2-DCE	ND(0.09)	IND	18	0.36	9.2	12	136	<9.8E-03	IND
1,1-DCA	ND(0.092)	IND	54	5.2	30	35	117	<3.0E-03	IND
ND() = Not detected (reporting limit), IND = indeterminate					mean and standard deviation			7.2E-04	IND

Table 18c. Summary of Basement/Sub-Slab Air Concentration Ratios of VOCs Associated with Sub-Surface Contamination in House P Using 1-Liter Tedlar Bags and On-Site GC Analysis During the March 2003 Sample Event

VOC	bsmt 24-hr	scaled stdev	P[A] grab	P[B] grab	P[C] grab	P[D] grab	sub-slab mean n=4	sub-slab stdev n=4	sub-slab cov n=4	bsmt/ sub-slab ratio	bsmt/ sub-slab stdev
	03/26/03	cov = 6%	04/01/03	04/01/03	04/01/03	04/01/03	04/01/03	04/01/03	04/01/03		
	(ppbv)	(ppbv)	(ppbv)	(ppbv)	(ppbv)	(ppbv)	(ppbv)	(ppbv)	(%)		
1,1,1-TCA	0.12	0.01	37	273	117	38	116	111	95	1.0E-03	9.9E-04
1,1-DCE	ND(0.092)	IND	8.4	92	28	7.8	34	40	117	<2.7E-03	IND
TCE	ND(0.092)	IND	4.6	77	12	4.9	25	35	142	<3.7E-03	IND
c-1,2-DCE	ND(0.09)	IND	ND(3.0)	15	ND(3.0)	ND(3.0)	<6.0	IND	IND	IND	IND
ND() = Not detected (reporting limit), IND = indeterminate							mean and standard deviation		1.0E-03	9.9E-04	

Table 18d. Basement/Sub-Slab Air Concentration Ratios of Radon in House P Using 48-hr Activated Carbon Canisters for Basement Air Sampling (3/26-3/28/03) and Scintillation Cells for Sub-Slab Air Sampling During the March 2003 Sample Event

bsmt 48-hr	bsmt 48-hr	bsmt 48-hr	bsmt mean n=3	bsmt stdev n=2	bsmt cov n=2	P[A] 300A	P[C] 300A	sub-slab mean n=2	sub-slab stdev n=2	sub-slab cov n=2	bsmt/ sub-slab ratio	bsmt/ sub-slab stdev
03/28/03	03/28/03	03/28/03	04/01/03	04/01/03	04/01/03	04/01/03	04/01/03	04/01/03	04/01/03	04/01/03		
(pCi/L)	(pCi/L)	(pCi/L)	(pCi/L)	(pCi/L)	(%)	(pCi/L)	(pCi/L)	(pCi/L)	(pCi/L)	(%)	(-)	(-)
3.8	3.8	1.4	3.0	1.4	46	691	1258	975	401	41.1	3.08E-03	1.90E-03

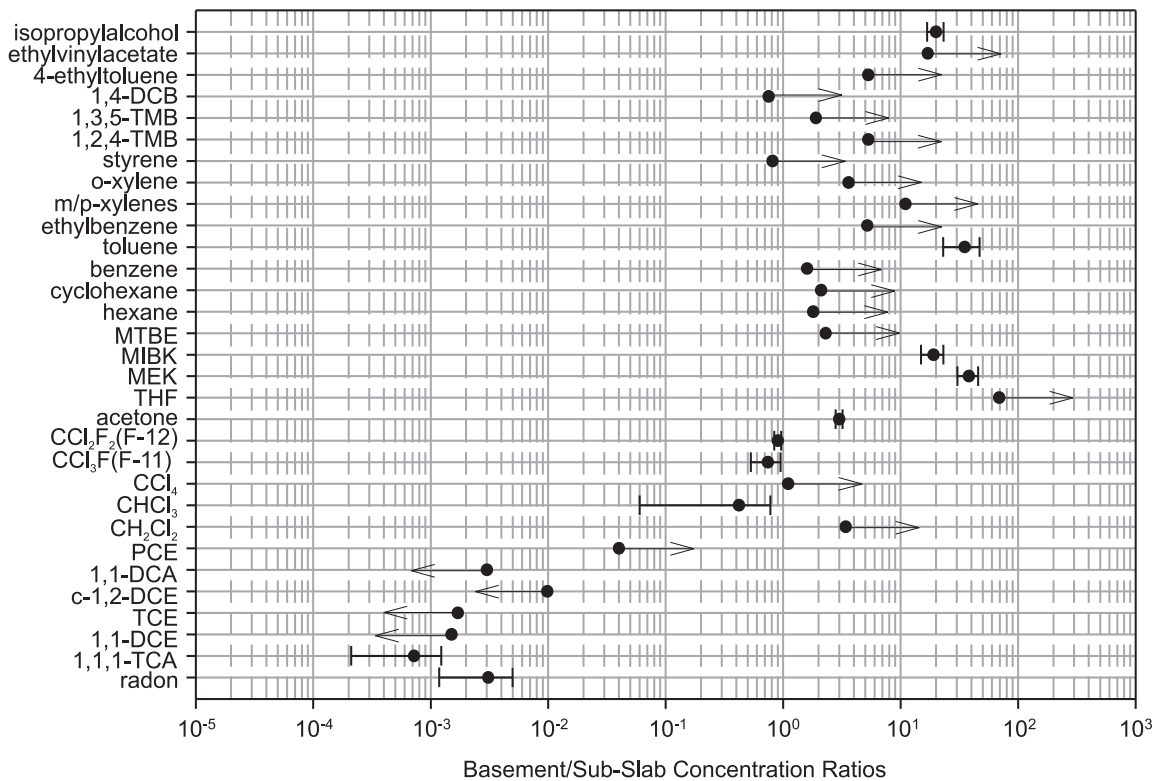

Figure 53. Basement/sub-slab concentration ratios using EPA Method TO-15 at House P during the March 2003 sample event. Error bars represent one standard deviation. Arrows indicate greater than or less than values due to non-detection in basement or sub-slab air.

6.4 Results of Radon Testing to Assess Vapor Intrusion

Figure 54 provides a comparison of basement/sub-slab air concentration ratios for radon and indicator VOCs associated with vapor intrusion. At locations J, L, and M, the null hypothesis that the basement/sub-slab air concentration ratio of radon was equal to the basement/sub-slab air concentration ratio of the indicator VOC, 1,1-DCE, could be rejected using a two-tailed Approximate t-Test at a significance level less than 0.1. At location K, the null hypotheses that the basement/sub-slab air concentration ratio of radon was equal to the basement/sub-slab air concentration ratios of the indicator VOCs, 1,1-DCE and c-1,2-DCE, could not be rejected using a two-tailed Approximate t-Test at a significance level less

than 0.1. As illustrated in **Figures 47, 48, 49, and 50**, for locations J, K, L, and M, respectively, there was a visual dissimilarity between the basement/sub-slab air concentration ratio of radon and VOCs associated with vapor intrusion. This is in contrast to visual and statistical (levels of significance always greater than 0.1) similarity of basement/sub-slab concentration air ratios for indicator VOCs and other VOCs associated with vapor intrusion illustrated in **Figures 36, 38, 46, 47, 48, 49, and 50** at locations B, C, I, J, K, L, and M, respectively. The internal consistency of basement/sub-slab air concentration ratios of 1,1-DCE, c-1,2-DCE, TCE, and 1,1,1-TCA (when associated with vapor intrusion) relative to the basement/sub-slab concentration ratio of radon when compared to VOCs associated with sub-surface contamination, indicates that for this investigation, the use of indicator VOCs

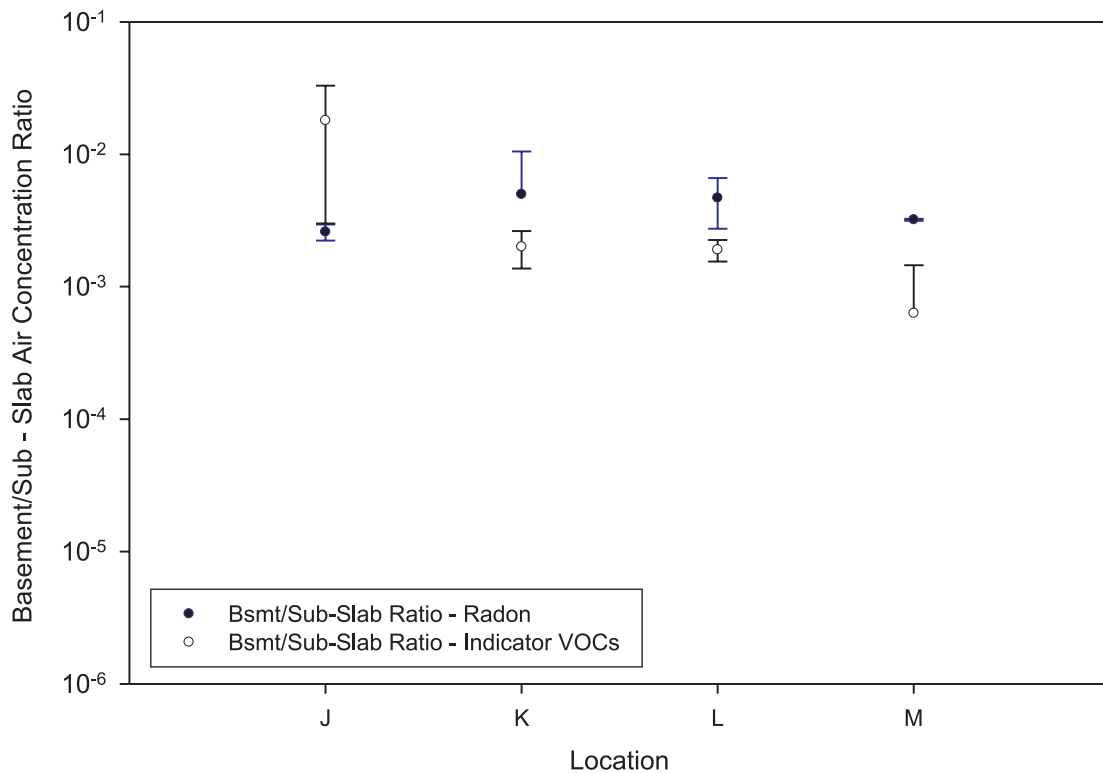

Figure 54. Comparison of basement/sub-slab air concentration ratios for radon and indicator VOCs associated with vapor intrusion. Samples for VOCs collected in one-liter Tedlar bags with on-site GC analysis.

was preferable over the use of radon as an indicator compound to assess vapor intrusion. However, data for comparison of radon with indicator VOCs were available at only four locations. Further research is needed at sites containing conservative VOCs to assess the usefulness of radon as a conservative compound.

Figure 55 illustrates COVs of VOCs associated with vapor intrusion and radon as a function of location.

COVs for VOCs are from Tedlar bag sampling and on-site GC analysis. Sub-slab air concentrations of radon generally do not appear to be more or less variable than VOCs associated with vapor intrusion. Thus, the number of probes used to estimate mean sub-slab air radon concentration should be equivalent to the number of probes used to estimate mean sub-slab air concentrations of VOCs associated with vapor intrusion.

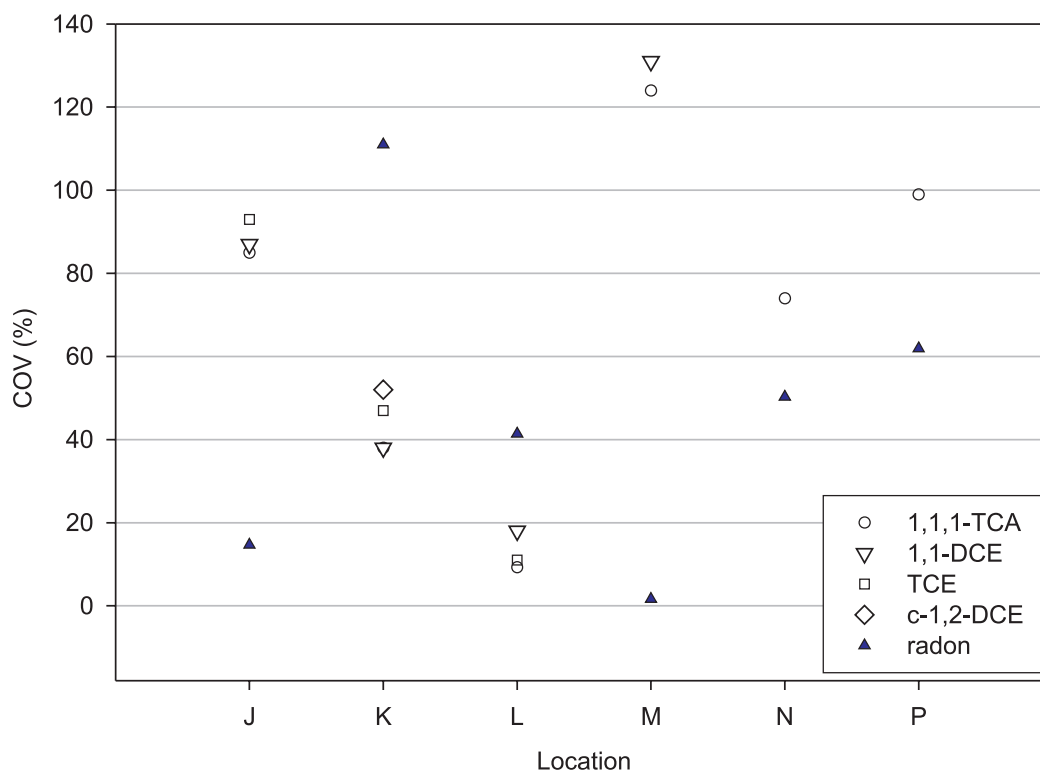

Figure 55. Coefficient of Variation (COV) as a function of location and compound for VOCs detected in basement air as a result of vapor intrusion.

6.5 Summary of Basement/Sub-Slab Concentration Ratios

Figure 56 summarizes the overall basement/sub-slab concentration ratios for VOCs associated with vapor intrusion at each location tested during the July 2002 and March 2003 sample events. Basement/sub-slab concentration ratios of 1,1,1-TCA were removed from consideration of overall basement/sub-slab concentration ratios when statistical testing supported a difference between indicator VOCs and 1,1,1-TCA. While building construction and slab conditions were generally similar, basement/sub-slab concentration ratios varied significantly.

In this investigation, basement/sub-slab concentration ratios were utilized to determine whether or not VOCs

detected in basement air during the time of sampling were due to vapor intrusion. Causative factors for basement/sub-slab concentration ratio variation were not investigated. However, variation in basement/sub-slab concentration ratios in this investigation indicates that it would have been unwise to select a generic basement/sub-slab concentration ratio such as 0.01 or 0.02 and measure only sub-slab air concentrations to assess risk. This approach would not have been conservative at House J where an overall basement/sub-slab concentration ratio of $2.4E-02 \pm 1.3E-02$ was determined for VOCs associated with vapor intrusion. This approach would have been borderline at Houses B and I where basement/sub-slab concentration ratios of $8.3E-03 \pm 5.3E-03$, and $8.9E-03 \pm 2.5E-03$, respectively, were determined for VOCs associated with vapor intrusion. Also,

basement/sub-slab concentration ratios determined during this investigation were specific to the time of sampling. Basement and sub-slab sampling at House B occurred during the summer (July) when air exchange would be expected to be greater than fall or winter months.

Finally, statistical testing sometimes resulted in a finding that the presence of 1,1,1-TCA in basement air

was not due to vapor intrusion despite being found in sub-slab air, soil gas, and ground water in the vicinity of a building. Also, statistical testing sometimes resulted in a finding that the presence of 1,1,1-TCA in basement air was likely due to vapor intrusion despite being found in outdoor air at concentrations comparable to basement air. When 1,1-DCE, TCE, and 1,1-DCA were detected in indoor air, their presence was always due to vapor intrusion.

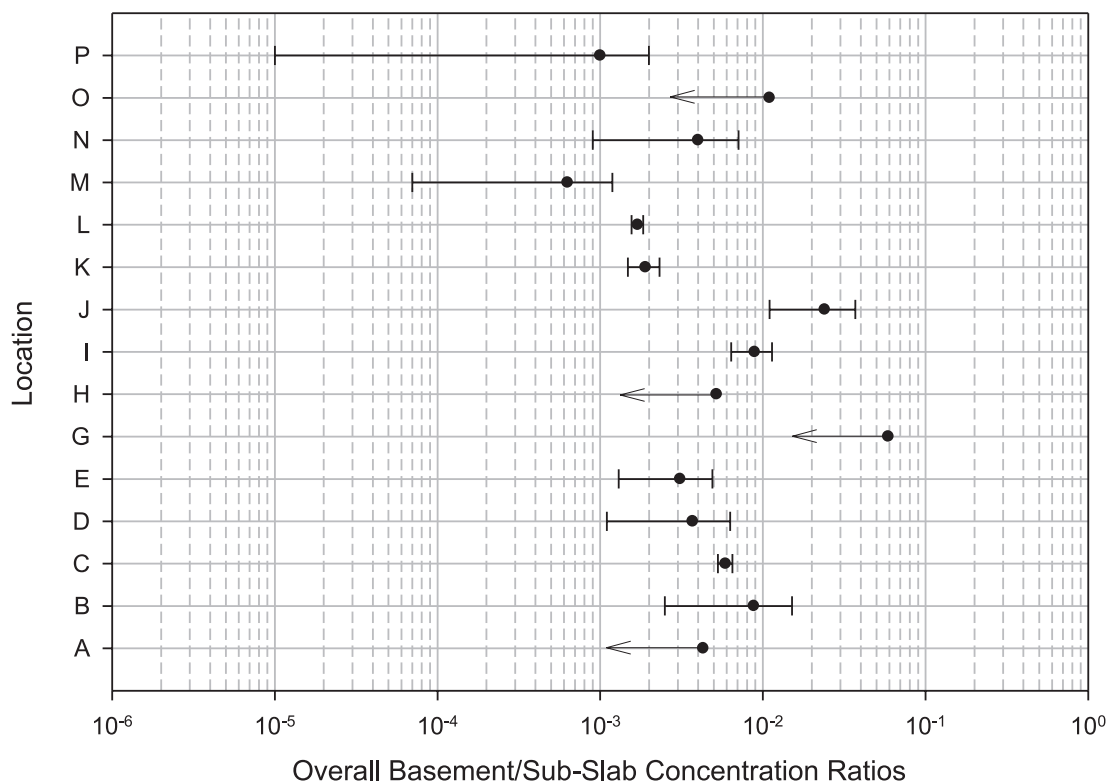

Figure 56. Summary of average basement/sub-slab concentration ratios for VOCs present in basement air due to vapor intrusion using one-liter Tedlar bags and on-site GC analysis. Arrows indicate less than values due to non-detection in basement air.

7.0 Summary

There were three primary objectives in this investigation. The first objective was to develop a method of sub-slab probe installation and sampling. The second objective was to develop a method of assessing vapor intrusion using basement and sub-slab air samples that would be appropriate for building-to-building investigations and sites containing petroleum hydrocarbons. The third objective was to directly assist EPA's New England Regional Office in evaluating vapor intrusion at 15 homes and one business near the Raymark Superfund Site in Stratford, Connecticut. Sub-slab air sampling offers an opportunity to collect samples directly beneath the living space of a building and thereby eliminate uncertainty associated with interpolation or extrapolation of soil-gas and/or groundwater concentrations from monitoring points distant from a building. Sub-slab sampling also provides an opportunity to evaluate the validity of claims that petroleum hydrocarbons degrade prior to vapor entry into sub-slab material.

In this investigation, a VOC detected in basement air was considered due to vapor intrusion if: (1) the VOC of interest was detected in ground water and/or soil-gas in the "vicinity" (e.g., 30 meters) of the house, and (2) the results of statistical testing indicated that the presence of a VOC in indoor air was due to vapor intrusion. Statistical testing consisted of evaluating the null hypothesis that the indoor/sub-slab concentration ratio of a VOC of interest was

equal to the indoor/sub-slab concentration ratio of an "indicator" VOC at the time of sampling. A one-tailed Approximate t-test for Independent Samples of Unequal Variance was used with rejection of the null hypothesis at a level of significance (p) less than or equal to 0.05. An indicator VOC was defined as a VOC detected in sub-slab air and known to be associated only with subsurface contamination. The VOCs 1,1-dichloroethylene and 1,1-dichloroethane were considered indicator VOCs in this investigation because they are degradation products of 1,1,1-trichloroethane and not associated with commercial products. The VOC cis-1,2-dichloroethylene was considered an indicator VOC because it is a degradation product of trichloroethylene and not commonly associated with commercial products. The variance associated with each basement/sub-slab concentration ratio was calculated using the method of propagation of errors which incorporated the variance associated with both basement and sub-slab air measurement. An average or overall basement/sub-slab concentration ratio was computed at each location using concentration ratios of all VOCs associated with vapor intrusion. The method of propagation of errors was then used to calculate the variance associated with the average basement/sub-slab concentration ratio.

Statistical testing sometimes resulted in a finding that the presence of 1,1,1-trichloroethane in basement air was not due to vapor intrusion despite being

found in sub-slab air, soil-gas, and ground water in the vicinity of a building. Also, hypothesis testing sometimes resulted in a finding that the presence of 1,1,1-trichloroethane in basement air was due to vapor intrusion despite being found in outdoor air at a concentration comparable to basement air. When 1,1-dichloroethylene, trichloroethylene, and 1,1-dichloroethane were detected in basement air, their presence was always due to vapor intrusion.

The usefulness of radon as an indicator compound in assessing vapor intrusion was evaluated by statistically comparing basement/sub-slab concentration ratios for radon and indicator VOCs. However, the data set for indicator VOCs versus radon comparison was limited, consisting of testing at only four locations. At three locations, the null hypothesis that the basement/sub-slab air concentration ratio of radon was equal to the basement/sub-slab air concentration ratio of the indicator VOC, 1,1-DCE, was rejected using a two-tailed Approximate t-Test at a significance level less than 0.1. There was a visual dissimilarity between the basement/sub-slab air concentration ratio of radon and VOCs associated with vapor intrusion. This is in contrast to visual and statistical (levels of significance always greater than 0.1) similarity of basement/sub-slab concentration air ratios for indicator VOCs and other VOCs associated with vapor intrusion. The internal consistency of basement/sub-slab air concentration ratios of 1,1-DCE, c-1,2-DCE, TCE, and 1,1,1-TCA (when associated with vapor intrusion) relative to the basement/sub-slab concentration ratio of radon when compared to VOCs associated with sub-surface contamination, indicate that for this investigation, use of indicator VOCs were preferable to use of radon as an indicator compound to assess vapor intrusion. Further research is needed

at sites containing conservative VOCs to assess the usefulness of radon as a conservative compound.

A number of specific recommendations regarding sub-slab probe installation and sampling are provided in this report. A design for a sub-slab vapor probe was presented which allows for multiple use and “floats” in a slab to enable air sample collection from sub-slab material in direct contact with a slab or from an air pocket directly beneath a slab created by subsidence. It was demonstrated that probe materials used in this investigation did not serve as a source of VOCs.

A method of drilling through a concrete slab is presented where a rotary hammer drill was used to create an “inner” and “outer” diameter hole in a concrete slab for probe installation. Initial depth of penetration of the “outer” diameter hole was equivalent to the length of brass couples to ensure that probes were flush with the upper surface of the slab. The “inner” diameter hole fully penetrated the slab and extended into sub-slab material to create an open cavity to prevent potential obstruction of probes during sampling. A quick-drying, lime-based cement which expanded upon drying (to ensure a tight seal) was mixed with tap water to form a slurry and tapped into the annular space between the probe and inside of the “outer” diameter hole using a small metal rod. Using this procedure, 3 probes were typically installed in less than 2 hours. Schematics illustrating the location of sub-slab probes and other slab penetrations (e.g., suction holes for sub-slab permeability testing) were prepared for each building to document sample locations, interpret sample results, and design corrective measures.

Basement air samples were collected in six-liter SilcoCan canisters and analyzed by EPA’s

New England Regional Laboratory using EPA Method TO-15. One-hour samples were collected during the July 2003 sample event while 24-hour samples were collected during the March 2003 sample event. Sub-slab air samples were collected in evacuated six-liter SilcoCan canisters using EPA Method TO-15 and in one-liter Tedlar bags using a peristaltic pump. The canisters were provided and analyzed by EPA's New England Regional Laboratory. Tedlar bags were stored in a cooler without ice (to avoid condensation) and analyzed for target VOCs on-site by EPA's New England Regional Laboratory within 24 hours of sample collection. Canister samples were collected by using a brass NPT to Swagelok union fitting to connect vapor probes to a "T" fitting made of a stainless steel flexible line and an in-line valve. A portable vacuum pump was then used to purge vapor probes and sampling lines. Samples were collected by closing the in-line valve on the pump end of the "T" fitting and opening a valve for entry into a six liter SilcoCan canister. A particulate filter was attached to the inlet port. Samples were collected by simply opening the canister valve and waiting until canister pressure approached atmospheric pressure (grab sampling). This took approximately two minutes. Tedlar bag samples were collected using threaded brass or plastic nipples, a peristaltic pump, and Tygon and Masterflex tubing. All tubing was disposed of after sampling at each probe to avoid cross contamination. Tedlar bags were filled in about one minute resulting in an average flow rate of 1 SLPM.

Open-faced activated charcoal canisters were used to measure indoor radon gas concentrations in accordance with sampling procedures outlined in EPA 402-R-93-004. Canisters were placed with the open side up 1.2 to 1.5 meters above a floor in a central location with unimpeded air flow and left undisturbed for

a period of 48 hours. Sub-slab sampling and analysis using scintillation cells were conducted in accordance with the Grab Radon/Scintillation Cell Method outlined in EPA 402-R-93-003. Tygon tubing was attached to the sub-slab probes using threaded barbed nipples. A peristaltic pump was used to create a vacuum in the probe for sample collection and circulation of sub-slab air through scintillation cells. Barbed fittings were used to connect Tygon to Masterflex tubing used for the peristaltic pump. A flow meter was placed on the outlet side of a scintillation cell to ensure a flow rate of approximately 1 SLPM and to determine when 10 cell volumes were exchanged in each cell. The outlet end of the flow meter was vented outside each house. A particulate filter was placed on the inlet side of the scintillation cell. Quick-connect assemblies were used for connection of Tygon tubing to scintillation cells. Samples were analyzed within four hours as recommended in EPA 402-R-93-003.

Air permeability testing in sub-slab media was conducted to support corrective action (sub-slab depressurization) and air flow simulations used to help assess potential limits to extraction volume and flow rate during sampling and purging. A small regenerative blower was used to extract air from sub-slab material. A variable-area flowmeter was used to measure flow rate. Air pressure was measured with magnehelic gauges and a digital manometer. Radial and vertical air permeability of sub-slab media was estimated using Baehr and Joss's (1995) analytical solution for two-dimensional, axisymmetric, steady-state gas flow in a semi-confined domain. Estimates of radial permeability, vertical permeability, and recharge at the top of sub-slab material along with streamline computation and particle tracking were used to support air flow simulations.

Three methods were used to evaluate infiltration of indoor air flow into a sample container during air extraction (purging + sampling). The first method entailed sequentially collecting five one-liter Tedlar bag samples at a flow rate of 1 SLPM and monitoring vapor concentration as a function of extraction volume. This was carried out in three homes with little effect on sample concentration indicating insignificant infiltration. Concrete slabs at these three buildings consisted of approximately 2-4" of concrete and were relatively intact (few cracks). Similar testing was conducted with evacuated canisters representing extraction volumes of 5 to 9 and 10 to 14 liters at two homes with similar results. A second method was then employed which utilized a simple mass balance equation and sub-slab and basement air concentrations. When the sensitivity of the test permitted assessment, infiltration of basement air into an evacuated canister was less than 1%. However, use of this method to assess infiltration during sampling required detection of fairly high levels of VOCs not associated with subsurface contamination in basement air and low levels or low detection limits for these compounds in sub-slab air. Sensitivity could be increased by enclosing a wide area around a probe with a chamber during air extraction and injecting a compound not present in sub-slab or basement air (tracer) for a specified period of time. However, the tracer concentration would have to be held constant during the application period, and air permeability testing and flow analysis would have to be conducted to estimate the potential area of infiltration during testing. A third method of evaluating infiltration of basement air into a sampling vessel during air extraction involved simulating streamlines and particle transport during air extraction using estimated permeability parameters. Simulations indicated that between 5% and 10% of air extracted

during purging and sampling could have originated as basement air when extracting up to 12 liters of air. However, if there was subsidence of sub-slab material below a concrete slab, most of this airflow would have been lateral flow directly beneath the slab. Overall, the extraction volume used in this investigation had little effect on sample results. However, the impact of large extraction volumes was not evaluated, and results of this investigation do not justify use of large extraction volumes.

The impact of rate-limited mass transport was evaluated during air extraction by comparing sequential sample results with air flow simulations using estimated permeability and recharge parameters. At a sampling rate of 1 SLPM, constant concentration in sequential samples indicated an absence of rate-limited mass transport during air extraction. The California Environmental Protection Agency in conjunction with the California Department of Toxic Substances and the Los Angeles Regional Water Quality Control Board (Cal EPA, 2003) recently published an advisory on soil-gas sampling specifying a maximum flow rate of 0.1 to 0.2 SLPM during sampling. Given simulations presented here, this recommendation appears reasonable.

To evaluate a necessary equilibration time after probe installation for sampling, advective air flow modeling with particle tracking was used to estimate maximum radii of perturbation during probe installation occurring over a period of one hour at a pressure differential of 15 Pa (highest pressure differential or most conservative value used in EPA's vapor intrusion guidance). These radii were then used with a spherical diffusion model to estimate time to reach 99% of a steady-state concentration at a probe given an initial concentration in the modeled domain of zero (most conservative case).

At homes near the former Raymark site, sub-slab and underlying soils underlying each building consisted of relatively dry sand and gravel. Little or no sorption would be expected in this material, and volumetric water content was relatively low. Simulations indicated that under these conditions, equilibration would occur in less than 2 hours. Sub-slab probes in this investigation were allowed to equilibrate for 1 to 3 days. For sub-slab material consisting of silt or clay, simulations indicated that an equilibration time of approximately 10 hours would be necessary. However, most sub-slab material consists of a mixture of sand and gravel or sand even for homes built directly on clay. Thus, an equilibration time of two hours should be conservative for most cases.

A simple mass-balance equation was used to estimate the purging requirement prior to sampling. Simulations indicated that collection of 5 purge volumes should ensure that the exiting vapor concentration is 99% of the entering concentration even when vapor concentration inside the sample system has been reduced to zero prior to sampling (most conservative case). A purge volume for the sample train used in homes near the former Raymark site was typically less than 10 cm³.

Generally, during this investigation, one sub-slab vapor probe was centrally located while two or more probes were placed within one or two meters of basement walls in each building. This was done to ensure detection of vacuum throughout the entire sub-slab during sub-slab depressurization testing. In this investigation, there appeared to be little correlation between probe placement and VOC concentration. That is, placement of a probe in a central location did not ensure detection of the highest VOC concentrations. At several houses,

coefficients of variation in sub-slab air exceeded 100% indicating substantial spatial variability in sub-slab air concentration and the need for placement of multiple probes. In this investigation, 55 probes were installed in 16 buildings which, on average, resulted in placement of one probe every 220 ft².

In conclusion, this work provides an extensive analysis of sub-slab sampling and supporting data-interpretation techniques. It represents an important first step in this area. Further research needs to be conducted to evaluate the use of radon as an indicator compound to assess vapor intrusion.

References

- Baehr, A.L. and C.J. Joss. 1995. An updated model of induced airflow in the unsaturated zone. *Water Resources Research* 31, (2): 417-421.
- California Environmental Protection Agency. 2003. Advisory - Active soil gas investigations. http://www.dtsc.ca.gov/PolicyandProcedures/SiteCleanup/SMBR_ADV_activesoilgasinvst.pdf
- Crank, J. 1975. *The Mathematics of Diffusion*, 2nd Ed., Oxford University Press, New York, NY.
- Hartman, B. 2004. How to collect reliable soil-gas data for risk-based applications - specifically vapor intrusion, Part 3 - Answers to frequently asked questions. LUSTLine Bulletin 48, November, 2004.
- Millington, R.J. and J.P. Quirk. 1961. Permeability of porous solids. *Trans. Faraday Society* 57: 1200-1207.
- Tetra Tech NUS, Inc. 2000. Draft final remedial investigation, Raymark-OU-Groundwater, Stratford, CT, Response action contract (RAC), Region I, EPA contract No. 68-W6-0045, EPA work assignment no. 029-RICO-01H3
- U.S. Environmental Protection Agency. 2002a. Draft guidance for evaluating the vapor intrusion to indoor air pathway from groundwater and soils (subsurface vapor intrusion guidance). <http://www.epa.gov/correctiveaction/eis/vapor.htm>. Office of Solid Waste and Emergency Response, Washington, D.C.
- U.S. Environmental Protection Agency. 2002b. Air sample analysis for volatile organic compounds. Internal report, Feb. 12, 2002. USEPA New England Regional Laboratory, Lexington, MA.
- U.S. Environmental Protection Agency. 2001. Development of recommendations and methods to support assessment of soil venting performance and closure. http://www.epa.gov/ada/download/reports/epa_600_r01_070.pdf. EPA/600/R-01/070. Office of Research and Development, National Risk Management Research Laboratory, Ada, OK.
- U.S. Environmental Protection Agency. 1999. Compendium of methods for determination of toxic organic compounds in ambient air, Determination of volatile organic compounds (VOCs) in air collected in specially-prepared canisters and analyzed by gas chromatography/ mass spectrometry (GC/MS). <http://www.epa.gov/ttn/amtic/files/ambient/airtox/to-15r.pdf>. EPA/625/R-96/010b. Office of Research and Development, National Risk Management Research Laboratory, Cincinnati, OH
- U.S. Environmental Protection Agency. 1998. Pressurized canisters for clean certification, standard operating procedure. EPA-REG1-OEME/CANISTER-PREP-SOP, Revision 2, April 1998. USEPA New England Regional Laboratory, Lexington, MA.
- U.S. Environmental Protection Agency, 1996. Canister evacuation standard operating procedures. EPA-REG1-OEME/CAN-EVACUATION-SOP, May 1996. USEPA New England Regional Laboratory, Lexington, MA.
- U.S. Environmental Protection Agency. 1994. Sampling of trace volatile organic compounds using summa polished stainless steel canisters. EPA-REG1-ESD/CAN-SAM-SOP, Revision 1, March 1994. USEPA New England Regional Laboratory, Lexington, MA
- U.S. Environmental Protection Agency. 1993. Protocols for radon and radon decay product measurements in homes. <http://www.epa.gov/radonpubs/homprot1.html>. EPA 402-R-93-003, June, 1993. Office of Air and Radiation, Washington D.C.



United States
Environmental Protection
Agency

National Risk Management
Research Laboratory
Cincinnati, OH 45268

Official Business
Penalty for Private Use
\$300

EPA/600/R-05/147
March 2006

Please make all necessary changes on the below label,
detach or copy, and return to the address in the upper
left-hand corner.

If you do not wish to receive these reports CHECK HERE ;
detach, or copy this cover, and return to the address in the
upper left-hand corner.

PRESORTED STANDARD
POSTAGE & FEES PAID
EPA
PERMIT No. G-35

