

**U.S. Geological Survey  
Techniques of Water-Resources Investigations**

**Book 9  
Handbooks for Water-Resources Investigations**

**National Field Manual  
for the Collection of  
Water-Quality Data**



**Chapter A4.  
COLLECTION OF  
WATER SAMPLES**

*Revised 2006*



**U.S. DEPARTMENT OF THE INTERIOR**  
**DIRK KEMPTHORNE, *Secretary***

**U.S. GEOLOGICAL SURVEY**  
**Mark D. Myers, *Director***

Any use of trade, product, or firm names is for descriptive purposes only and does not imply endorsement by the U.S. Government.

---

For additional information write to:

Chief, Office of Water Quality  
U.S. Geological Survey  
12201 Sunrise Valley Drive  
Mail Stop 412  
Reston, VA 20192

This report is accessible online at <http://pubs.water.usgs.gov/twri9A/>

---

## Foreword

The mission of the Water Resources Discipline of the U.S. Geological Survey (USGS) is to provide the information and understanding needed for wise management of the Nation's water resources. Inherent in this mission is the responsibility to collect data that accurately describe the physical, chemical, and biological attributes of water systems. These data are used for environmental and resource assessments by the USGS, other government agencies and scientific organizations, and the general public. Reliable and quality-assured data are essential to the credibility and impartiality of the water-resources appraisals carried out by the USGS.

The development and use of a *National Field Manual* is necessary to achieve consistency in the scientific methods and procedures used, to document those methods and procedures, and to maintain technical expertise. USGS field personnel use this manual to ensure that the data collected are of the quality required to fulfill our mission.

Robert M. Hirsch  
Associate Director for Water

# **Techniques of Water-Resources Investigations**

## **Book 9 Handbooks for Water-Resources Investigations**

### **Chapters of Section A, *National Field Manual for the Collection of Water-Quality Data***

#### **A1. Preparations for Water Sampling**

#### **A2. Selection of Equipment for Water Sampling**

#### **A3. Cleaning of Equipment for Water Sampling**

#### **A4. Collection of Water Samples**

#### **A5. Processing of Water Samples**

#### **A6. Field Measurements**

##### **6.0 General Information and Guidelines**

##### **6.1 Temperature**

##### **6.2 Dissolved Oxygen**

##### **6.3 Specific Electrical Conductance**

##### **6.4 pH**

##### **6.5 Reduction-Oxidation Potential (Electrode Method)**

##### **6.6 Alkalinity and Acid Neutralizing Capacity**

##### **6.7 Turbidity**

#### **A7. Biological Indicators**

##### **7.0 Five-Day Biochemical Oxygen Demand**

##### **7.1 Fecal Indicator Bacteria**

##### **7.2 Fecal Indicator Viruses**

##### **7.3 Protozoan Pathogens**

#### **A8. Bottom-Material Samples**

#### **A9. Safety in Field Activities**

Note: Contents are current as of March 2007.

---

**National Field Manual  
for the Collection of  
Water-Quality Data**

**Chapter A4.**

**COLLECTION OF  
WATER SAMPLES**

---

	Page
Abstract .....	7
Introduction .....	8
Purpose and scope .....	8
Requirements and recommendations.....	9
Field manual review and revision.....	10
Acknowledgments.....	10
A4. Collection of Water Samples .....	11
4.0 Responsibilities, field preparations, and preventing sample contamination .....	13
4.0.1 Responsibilities and field preparations .....	14
4.0.2 Preventing sample contamination .....	19
4.1 Surface-water sampling .....	25
4.1.1 Site files.....	26
4.1.1.A NWIS files.....	26
4.1.1.B Field folders.....	28
4.1.2 Selection of surface-water sampling sites .....	30
4.1.2.A Flowing-water sites .....	31
4.1.2.B Still-water sites .....	33

- 4.1.3 Sampling at flowing-water and still-water sites..... 33
  - 4.1.3.A Isokinetic, depth-integrated sampling methods at flowing-water sites..... 37
    - Equal-width-increment method ..... 41
    - Equal-discharge-increment method ..... 50
    - Single vertical at centroid-of-flow method ... 58
  - 4.1.3.B Nonisokinetic (dip, discrete, and pump) sampling methods at flowing-water sites..... 60
  - 4.1.3.C Guidelines for sampling at still-water sites..... 68
- 4.2 Ground-water sampling ..... 73
  - 4.2.1 Site inventory and site files..... 74
  - 4.2.2 Considerations for collecting representative samples at wells..... 86
    - 4.2.2.A Well construction and structural integrity ..... 90
      - Effects of well construction ..... 90
      - Deterioration of the well structure ..... 91
    - 4.2.2.B Well-hydraulic and aquifer characteristics ..... 92
      - Pumping rate ..... 92
      - Low-yield wells..... 93
      - Aquifer media with defined paths of preferential flow ..... 95
    - 4.2.2.C Vulnerability of ground-water samples to contamination ..... 96
      - Standing borehole water..... 97
      - Atmospheric and dissolved gases ..... 97
      - Use of sampling equipment ..... 99
      - Well-bottom detritus..... 101

4.2.3 Well purging.....	103
4.2.3.A Standard purge procedure .....	103
4.2.3.B Exceptions to the standard purge procedure .....	107
4.2.4 Steps for sampling at wells.....	109
4.2.4.A Supply wells.....	115
4.2.4.B Monitor wells.....	123
4.3 Quality control.....	133
4.3.1 Blank samples .....	136
4.3.1.A Pre-field blanks .....	139
4.3.1.B Field blanks .....	140
4.3.2 Replicate samples.....	143
4.3.2.A Concurrent replicates .....	143
4.3.2.B Sequential replicates .....	144
4.3.2.C Split replicates.....	146
4.3.3 Spike samples .....	148
4.3.4 Reference samples.....	150
4.3.5 Blind samples .....	151
Conversion factors, selected terms, and abbreviations .....	153
Selected references and documents .....	159
Appendix A4-A. Transit rate and volume guidelines and filling times for isokinetic samplers .....	APP.A2
1a. Isokinetic transit rates for a 1-liter bottle sampler with a 3/16-inch nozzle .....	APP.A3
1b. Isokinetic transit rates for a 1-liter bottle sampler with a 1/4-inch nozzle .....	APP.A4
1c. Isokinetic transit rates for a 1-liter bottle sampler with a 5/16-inch nozzle .....	APP.A5

- 2a. Isokinetic transit rates for a DH-2 sampler  
(1-liter bag) with a 3/16-inch nozzle..... APP.A6
- 2b. Isokinetic transit rates for a DH-2 sampler  
(1-liter bag) with a 1/4-inch nozzle..... APP.A7
- 2c. Isokinetic transit rates for a DH-2 sampler  
(1-liter bag) with a 5/16-inch nozzle..... APP.A8
- 3a. Isokinetic transit rates for a D-96 sampler  
(3-liter bag) with a 3/16-inch nozzle..... APP.A9
- 3b. Isokinetic transit rates for a D-96 sampler  
(3-liter bag) with a 1/4-inch nozzle..... APP.A11
- 3c. Isokinetic transit rates for a D-96 sampler  
(3-liter bag) with a 5/16-inch nozzle..... APP.A12
- 4a. Isokinetic transit rates for a D-99 sampler  
(6-liter bag) with a 1/4-inch nozzle..... APP.A13
- 4b. Isokinetic transit rates for a D-99 sampler  
(6-liter bag) with a 5/16-inch nozzle..... APP.A15

Tables for sampler filling-time guidelines:

- 5a. Filling times for DH-81 sampler ..... APP.A16
- 5b. Filling times for DH-95 sampler ..... APP.A16
- 5c. Filling times for D-95 sampler ..... APP.A17
- 5d. Filling times for DH-2 sampler ..... APP.A17
- 5e. Filling times for D-96 sampler ..... APP.A18
- 5f. Filling times for D-96 A-1 sampler ..... APP.A18
- 5g. Filling times for D-99 sampler ..... APP.A19

**Appendix A4-B. Instructions related to measuring water levels at wells and a sample USGS ground-water-quality field form ..... APP.B1**

- A4B-1. Establishing a permanent measuring point on wells at which water level will be measured..... APP.B3
- A4B-2. Well-depth measurement..... APP.B5
- A4B-3. Water-level measurement by:
  - (a) Steel tape..... APP.B9
  - (b) Electric tape..... APP.B13
- A4B-4. Water-level measurement by the air-line method ..... APP.B17
- A4B-5. Water-level measurement at flowing wells using low-pressure and high-pressure methods..... APP.B21
- A4B-6. Sample of the U.S. Geological Survey Ground-Water Quality Notes field form ..... APP.B25



<b>Appendix A4-C. Quality-control samples collected by field</b>	
<b>personnel for water-quality studies .....</b>	<b>APP.C1</b>
<b>Blank samples .....</b>	<b>APP.C2</b>
<b>Replicate samples .....</b>	<b>APP.C5</b>
<b>Reference, spike, and blind samples.....</b>	<b>APP.C6</b>
<b>Appendix A4-D. Examples from the National Water-Quality</b>	
<b>Assessment Program related to protocols for collecting</b>	
<b>blank samples at ground-water sampling sites.....</b>	<b>APP.D1</b>
<b>1. Example of procedure to estimate and collect</b>	
<b>field volumes of blank solutions.....</b>	<b>APP.D2</b>
<b>2. Example of procedure to collect blank samples</b>	
<b>with a submersible water-quality pump .....</b>	<b>APP.D3</b>
<b>Illustrations</b>	
<b>4-1. Example of a presampling activities checklist.....</b>	<b>18</b>
<b>4-2. Checklist for contents of a field folder for surface-water</b>	
<b>sampling.....</b>	<b>29</b>
<b>4-3. Relation between intake velocity and sediment</b>	
<b>concentration for isokinetic and nonisokinetic collection</b>	
<b>of water samples that contain particulates greater than</b>	
<b>0.062 millimeters .....</b>	<b>39</b>
<b>4-4. Equal-width-increment method for collection of</b>	
<b>water samples .....</b>	<b>42</b>
<b>4-5. Equal-discharge-increment method for collection of</b>	
<b>water samples .....</b>	<b>51</b>
<b>4-6. Example of discharge-measurement field notes used to</b>	
<b>determine the equal-discharge-increment centroid locations</b>	
<b>based on cumulative discharge and far-midpoint</b>	
<b>stationing .....</b>	<b>54</b>
<b>4-7. Example of a checklist for a well file .....</b>	<b>81</b>
<b>4-8. Checklist for contents of a field folder for ground-water</b>	
<b>sampling .....</b>	<b>83</b>
<b>4-9. Example of (A) site- and well-location maps and</b>	
<b>(B) well-site sketch .....</b>	<b>84</b>
<b>4-10. Example of a manifold used for well purging and</b>	
<b>sample collection .....</b>	<b>102</b>
<b>4-11. Estimation of purge volume and purge time.....</b>	<b>105</b>
<b>4-12. Example of a field log for well purging.....</b>	<b>106</b>

4-13.	Example of checklist of equipment and supplies to prepare for sampling ground water at wells.....	111
4-14.	Example procedure for collecting a field-blank quality-control sample .....	142

#### Tables

4-1.	Example of work-schedule elements .....	17
4-2.	Good field practices for collection of water-quality samples .....	21
4-3.	Clean hands/dirty hands techniques for water-quality sampling .....	22
4-4.	Minimum information required for electronic storage of site and surface-water-quality data in the U.S. Geological Survey National Water Information System .....	27
4-5.	Uses and advantages of equal-width-increment (EWI) and equal-discharge-increment (EDI) sampling methods .....	38
4-6.	Example of ground-water site-inventory activities .....	76
4-7.	Minimum information required for electronic storage of site and ground-water-quality data in the U.S. Geological Survey National Water Information System .....	80
4-8.	Considerations for maintaining the integrity of ground-water samples.....	88
4-9.	Considerations for well selection and well installation.....	89
4-10.	Advantages and disadvantages of collecting water samples from supply wells with permanently installed pumps.....	115
4-11.	Common sources of contamination related to field activities .....	135
4-12.	Common types of blank samples and the questions they address .....	137

#### Note:

The citation for this version of chapter A4 of the *National Field Manual for the Collection of Water-Quality Data* is:

U.S. Geological Survey, September 2006, Collection of Water Samples (ver. 2.0): U.S. Geological Survey Techniques of Water-Resources Investigations, book 9, chap. A4, accessed *\_list the date\_*, from <http://pubs.water.usgs.gov/twri9A>.



---

# Chapter A4. COLLECTION OF WATER SAMPLES

*Revised 2006*  
Franceska D. Wilde, Editor

---

## ABSTRACT

The *National Field Manual for the Collection of Water-Quality Data (National Field Manual)* describes protocols and provides guidelines for U.S. Geological Survey (USGS) personnel who collect data that are used to assess the quality of the Nation's surface-water and ground-water resources. This chapter addresses preparations and appropriate methods for the collection of surface-water, ground-water, and associated quality-control samples. Among the topics covered are considerations and procedures to prevent sample contamination; establishing site files; instructions for collecting depth-integrated isokinetic and nonisokinetic samples at flowing- and still-water sites; and guidelines for collecting formation water from wells having various types of construction and hydraulic and aquifer characteristics.

## INTRODUCTION

As part of its mission, the U.S. Geological Survey (USGS) collects the data needed to assess the quality of our Nation's water resources. The *National Field Manual for the Collection of Water-Quality Data* (*National Field Manual*) describes protocols (requirements and recommendations) and provides guidelines for USGS personnel who collect those data on surface-water and ground-water resources. Chapter A4 provides information about the collection and quality control of water samples for investigations and assessments of environmental water quality. **Formal training and field apprenticeship are necessary in order to implement correctly the procedures described in this chapter.**

The *National Field Manual* is Section A of Book 9 of the USGS publication series "Techniques of Water-Resources Investigations" (TWRI) and consists of individually published chapters designed to be used in conjunction with each other. Chapter numbers are preceded by an "A" to indicate that the report is part of the *National Field Manual*. Other chapters of the *National Field Manual* are referred to in this report by the abbreviation "NFM" and the specific chapter number (or chapter and section number). For example, NFM 6 refers to Chapter A6 on "Field Measurements" and NFM 6.4 refers to the section on field measurement of pH.

The procedures described in this chapter represent protocols that generally are applicable to USGS studies involving the collection of water-quality data. Modification of required and recommended procedures to fulfill study objectives or to enhance data quality must be documented and published with the data and data interpretation.

---

## PURPOSE AND SCOPE

The *National Field Manual* is targeted specifically toward field personnel in order to (1) establish and communicate scientifically sound methods and procedures, (2) provide methods that minimize data bias and, when properly applied, result in data that are reproducible within acceptable limits of variability, (3) encourage consistent use of field methods for the purpose of producing nationally comparable data, and (4) provide citable documentation for USGS water-quality data-collection protocols.

The purpose of this chapter of the *National Field Manual* is to provide field personnel and other interested parties with a description of the requirements, recommendations, and guidelines routinely used in USGS studies involving the collection of water-quality samples from bodies of surface water and ground water. The information provided covers topics fundamental to the collection of water samples that are representative of the ambient environment. The information provided does not attempt to encompass the entire spectrum of data-collection objectives, site characteristics, environmental conditions, and technological advances related to water-quality studies. Also beyond the scope of this chapter is discussion of procedures to collect samples for analysis of suspended or biological materials. Collection of data related to onsite measurements such as pH and alkalinity is addressed in NFM 6, while collection of biochemical and microbiological data is addressed in NFM 7.

---

## REQUIREMENTS AND RECOMMENDATIONS

As used in the *National Field Manual*, the terms **required** and **recommended** have USGS-specific meanings.

**Required** (require, required, or requirements) pertains to USGS protocols and indicates that USGS Office of Water Quality policy has been established on the basis of research and (or) consensus of the technical staff and has been reviewed by water-quality specialists and other professionals who have the appropriate expertise. Technical memorandums or other documents that define the policy pertinent to such requirements are referenced in this chapter. USGS personnel are instructed to use required equipment or procedures as described herein. Departure from or modifications to the stipulated requirements that might be necessary to accomplishing specific data-quality requirements or study objectives must be based on referenced research and good field judgment, and be quality assured and documented.

**Recommended** (recommend, recommended, recommendation) pertains to USGS protocols and indicates that, on the basis of research and (or) consensus, the USGS Office of Water Quality recognizes one or several acceptable alternatives for selecting equipment or procedures. Specific data-quality requirements, study objectives, or other constraints might affect the choice of recommended equipment or procedures. Selection from among the alternatives must be based on referenced research and good field judgment, and reasons for the selection should be documented. Departure from or modifications to recommended procedures must be quality assured and documented.

---

## FIELD MANUAL REVIEW AND REVISION

Chapters of the *National Field Manual* are reviewed, revised, and reissued periodically to correct any errors, incorporate technical advances, and address additional topics. Comments or corrections can be mailed to NFM-QW, USGS, 412 National Center, Reston, VA 20192 (or by e-mail to [nfm-owq@usgs.gov](mailto:nfm-owq@usgs.gov)). Newly published and revised chapters are posted on the USGS Web page "National Field Manual for the Collection of Water-Quality Data." The URL for this page is:

<http://pubs.water.usgs.gov/twri9A/>. The page contains links to an errata page and to the chapters of the *National Field Manual*. Information regarding the status and any errata of this or other chapters can be found near the beginning of the Web page for each chapter. Near the bottom of each chapter's Web page are links to archived versions.

---

## ACKNOWLEDGMENTS

The information included in this chapter of the *National Field Manual* is based on earlier manuals, various reference documents, and a broad spectrum of colleague expertise. Individuals in the USGS—too numerous to mention by name—developed the field and training manuals that provided the foundation for information on the collection and processing of water samples, and others have contributed through peer and editorial reviews to the technical quality of this document. Editorial assistance provided by Iris M. Collies and production assistance from Loretta J. Ulibarri have been indispensable in maintaining and enhancing the quality of this report.

The current editor owes a debt of gratitude to the original team of authors: Dean B. Radtke, Rick T. Iwatsubo, Jacob Gibs, Wayne W. Webb and Roger W. Lee, and to the following scientists who provided technical review, and who contributed significantly to the accuracy, quality, and usability of this report: Andrew Arnsberg, Bruce A. Bernard, William L. Cunningham, Ron G. Fay, Sarah Flanagan, Jacob Gibs, Kathleen K. Fitzgerald, Henry M. Johnson, Michael S. Lico, Jeffrey D. Martin, Timothy D. Oden, Kevin D. Richards, David A. Saad, Terry L. Schertz, Allen M. Shapiro, and Stanley C. Skrobialowski. Special thanks go to Timothy L. Miller for providing the support needed to produce a national field manual for water-quality studies.

Franceska D. Wilde  
Managing Editor

---

# COLLECTION OF WATER SAMPLES A4.

This chapter of the *National Field Manual* (NFM) describes standard USGS methods (sampling strategies, techniques, requirements, and recommendations) for the routine collection of representative water samples. Sample collection forms a continuum with sample processing; therefore, the information in this chapter overlaps with some of the information in NFM 5, *Processing of Water Samples*.

---

**SAMPLING:**  
**The act of collecting a portion of material for analytical purposes that accurately represents the material being sampled with respect to stated objectives.**

Modified from Standard Methods, 1060A  
(APHA and others, 2001)

---

Before sample collection begins, field personnel must take steps to ensure that the samples collected will be representative of the aqueous system being investigated. A representative sample is one that typifies (“represents”) in time and space that part of the aqueous system to be studied, and is delineated by the objectives and scope of the study.

Obtaining representative samples is of primary importance for a relevant description of the environment. In order to collect a representative sample that will yield the information required, (1) study objectives, including data-quality requirements,<sup>1</sup> must be understood in the context of the water system to be sampled, and (2) artifacts of the sampling process must be minimized.<sup>2</sup> Field personnel must be alert to conditions that could compromise the quality of a sample.

- ▶ **Collect a representative sample.** Use appropriate methods and quality-assurance measures to ensure that the field sites selected and the samples collected accurately represent the environment intended for study and can fulfill data-quality objectives.
  
- ▶ **Think contamination!** To ensure the integrity of the sample, be aware of possible sources of contamination. Contamination introduced during each phase of sample collection (and processing) is additive and usually is substantially greater than contamination introduced elsewhere in the sample-handling and -analysis process. **Therefore, collect a sufficient number of quality-control samples, appropriately distributed in time and space, to ensure that data-quality objectives and requirements are met (section 4.3).**

---

<sup>1</sup>As used in this report, data-quality requirements refer to that subset of data-quality objectives pertaining to the analytical detection level for concentrations of target analytes and the variability allowable to fulfill the scientific objectives of the study.

<sup>2</sup>The degree to which a sample can be considered representative of a water body depends on many interrelated factors including, for example, temporal and spatial homogeneity of the water body, sample size, and the method and manner of sample collection.



---

## 4.0 RESPONSIBILITIES, FIELD PREPARATIONS, AND PREVENTING SAMPLE CONTAMINATION

This section of the NFM presents guidelines, requirements, and recommendations for USGS field personnel as they prepare for sample collection at field sites. Collecting comparable data over the duration of the sampling effort and among sampling sites is necessary for a valid analysis and interpretation of the data. This usually requires consistent use of the methods and equipment selected and collection of sufficient quality-control data to verify the quality and comparability of the data collected.

USGS data-collection efforts often take a whole-system approach, meaning that the data-collection methods used are designed so that the entire stream reach or aquifer volume is represented. A modified approach is needed for studies in which samples are representative of a specific portion or aspect of an aqueous system; for example, a study of aquatic ecology may establish nearshore boundaries on the system of study, and an oil-spill study may target only the surface of a water-table aquifer.

- ▶ **What do your data represent?** Data collectors need to know what questions the data being collected are meant to address, and understand the level of accuracy and precision that are needed in the data to answer those questions. The data are no better than the confidence that can be placed in how well the sample represents the aqueous system (Horowitz and others, 1994). Therefore, understand the purpose for which the various types of data will be collected and the aqueous system that each sample should represent.
- ▶ **Are your data of appropriate quality?** Quality-control samples yield information by which confidence brackets can be applied to the environmental data. Field quality control is vital for data interpretation and assessment and yields different information than laboratory-performed quality-control checks.

**Data quality begins before the first sample is collected, by taking care to use proper equipment, being aware of data-quality requirements, and being alert to potential sources of sample contamination.**

## 4.0.1 RESPONSIBILITIES AND FIELD PREPARATIONS

Field personnel are responsible for their safety and for the quality of the work performed.

- ▶ **Never compromise the safety of field personnel.** Be familiar with the safety requirements and recommendations described in NFM 9. Get the appropriate training and certification needed if you will be working at sites designated as hazardous.
- ▶ **Collect data of known quality.** Fundamental to water-quality sampling is the fact that the quality of the analytical results can be no better than the quality of the sample on which the analyses were performed. The sample collector has primary responsibility for the quality and integrity of the sample up to the time that the sample is delivered to the analyzing laboratory or office. Data quality is determined from analysis of quality-control data.
- ▶ **Know what you need to do.** Before departing for field work, review the workplan, and plan for the types of measurements and samples specified.
  - Be thoroughly familiar with your study objectives and requirements. Sampling plans, including quality-assurance and equipment requirements, need to be prepared and reviewed in advance. Some programs require a prescribed format for sampling, quality-assurance, and safety plans. Some projects require chain-of-custody documentation.
  - Review and understand the USGS protocols for collecting and processing your samples before field work begins. Obtain and keep current with training and the laboratory requirements associated with your data-collection activities.

All details of a field trip need to be planned well in advance (fig. 4-1). Adequate time must be scheduled in the workplan to review data requirements and make field-trip preparations; a common mistake is to put off these activities until the last minute (table 4-1).

- ▶ **Make reconnaissance trips** before selecting repeat sampling sites, if possible.
  - Note conditions that could affect sampling operations (such as the seasonal high or low streamflow, flowing or low-flow wells, or site-access peculiarities).
  - Evaluate potential sources of contamination at the site, based on the analytes<sup>3</sup> to be targeted in the sample analysis.
- ▶ **Review site files and field folders** (see sections 4.1.1 and 4.2.1). Check the site location, description, and access. Review any previously collected physical, chemical, and biological data.
- ▶ **When selecting field equipment**, understand the physical and chemical limitations of each piece of equipment, in order to meet data-collection objectives and data-quality requirements (refer to NFM 2). Verify and test, if possible, the operational range of the sampling equipment to be used.

---

<sup>3</sup>"Target analyte" refers to any chemical or biological substance for which concentrations in a sample will be determined. Target analyte does not include field-measured properties such as temperature, specific electrical conductance (conductivity), dissolved-oxygen concentration, pH, Eh, alkalinity, color, or turbidity. The *Concise Chemical and Technical Dictionary*, 4th edition (Bennett, 1986) defines "analyte" as "Substance being determined in an analysis."

- ▶ **Prepare a workplan and checklists.**
  - The workplan delineates study activities and establishes the timeframe in which the activities are to be completed (table 4-1).
  - Checklists help ensure that equipment and supplies will be ordered on time, that data-collection activities will be completed appropriately, and that data-quality requirements will be met (fig. 4-1). Generic checklist items apply to most studies, and the checklist customized for specific study requirements (for example, special equipment or supplies, quantities of equipment and supplies, number of batteries, and types of sample bottles and other equipment).
- ▶ **Data management.** Field personnel also are responsible for providing the necessary information to establish USGS National Water Information System (NWIS) site files for each sampling site and for checking to see that the site file is functional, that the information it contains is correct, and that updates are made promptly. NWIS is the hydrologic data base for the USGS, and includes the following subsystems in which study site files are to be maintained:
  - **Quality-of-Water Data (QWDATA)** – contains field and laboratory data.
  - **Automatic Data Processing System (ADAPS)** – contains time-series information.
  - **Ground-Water Site Inventory (GWSI)** – contains aquifer and ground-water site information.

**PLAN AHEAD! Take adequate time to prepare.**

**Table 4-1.** Example of work-schedule elements

<b>Work-schedule elements</b>	<b>Examples of items or activities in checklists</b>	<b>Completed by</b>
Calendar of planned field trips	Prepare calendars/checklists that include sampling dates, members of field team, vehicle(s) to be used.	
Presampling activities	Prepare checklists (see figs. 4-1 and 4-7). Prepare NWIS site files.	
Postsampling activities	Update field folders and computer files. Log in samples (Analytical Services Request form). Store and dispose of hazardous materials properly. Check that all equipment is clean and properly stored.	
Field equipment and supplies	Prepare lists of equipment/supplies for each field site (see NFM 2). Prepare a list of items to be ordered.	
Equipment/supplies maintenance and testing	Prepare a checklist of maintenance/testing for field-measurement instruments (see NFM 6). Test sample-collection and processing equipment. Charge or replace batteries.	
Sample-collection, -processing, -shipping, and -documentation information and supplies	Prepare headers on forms (such as field, chain-of-custody, and Analytical Services Request forms); prepare bottle labels. Prepare lists of chemical constituents, with respect to: analytical schedules, methods, laboratory codes; bottle type and volume; sample handling, chemical treatment and preservation procedures; sample shipment; quality-control samples.	
Field-folder contents	Prepare a list of logistical information needed for each site, such as permission to access site, keys, maps.	
Safety equipment and information	Keep a copy of NFM 9 for field use and list special considerations for the site, such as personal flotation devices.	

## FIELD-TRIP PREPARATIONS

PROJECT: \_\_\_\_\_

SITES: \_\_\_\_\_ DATE: \_\_\_\_\_

✓	Prefield activity	Comments
	Order supplies	Ordered 3 cases Ultrex for site #2 Completed on _____, by _____.
	Prepare deionized water (in-house system) Check prior laboratory analysis	Last change of cartridges, on _____ Last chemical analysis on _____, by _____, Conductivity checks out, by _____
	Check expiration dates on reagents	Need _____ conductivity standard(s) Need pH _____ buffer(s)
	Clean and test equipment	Completed on _____, by _____ Problems _____
	Collect equipment blanks	Completed on _____, by _____ Results reviewed by _____ (Water-quality specialist or project chief)
	Clean sample bottles	Completed on _____, by _____
	Label sample bottles, prepare field forms	Completed on _____, by _____
	Obtain permission for site access	Completed on _____, by _____
	Check field vehicle for safety equipment and supplies, such as material safety data sheets, flares, and remote communications system (NFM 9)	Completed on _____, by _____
	Charge/replace batteries	Completed by _____
	Update field folder	Completed by _____
	Make travel reservations, arrangements	Completed by _____
	Provide supervisor with field-trip and call-in (check-in) schedule	Provided on _____ to _____
	Vehicle maintenance	Check fluids, battery, tires, lights, cleanliness.
	Other	

**Figure 4-1.** Example of a presampling activities checklist.

---

## PREVENTING SAMPLE CONTAMINATION 4.0.2

The USGS prescribes specific protocols for avoiding contamination of water samples. In addition, collection of quality-control samples (section 4.3) – scaled as appropriate to the objectives of the study and site conditions – is mandated to check for, address, and measure sample contamination and any resulting bias to the data. The most common causes of sample contamination during sample collection include poor sample-handling techniques, input from atmospheric sources, inadequately cleaned equipment, and use of equipment constructed of materials inappropriate for the analytes targeted for study. To prevent or minimize sample contamination from these sources:

- ▶ **Implement good field practices**, summarized on table 4-2.
- ▶ **Use Clean Hands/Dirty Hands sampling techniques**, summarized on table 4-3.

USGS clean-sampling procedures (sometimes called the parts-per-billion or ppb protocol) involve (1) using equipment that is constructed of noncontaminating materials (NFM 2) and that has been cleaned rigorously before field work and between field sites (NFM 3); (2) handling equipment in a manner that minimizes the chance of altering ambient sample composition; (3) handling samples in a manner that prevents contamination; and (4) routinely collecting quality-control (QC) samples. **Good Field Practices and Clean Hands/Dirty Hands (CH/DH) are an integral part of routine USGS water-quality field work.**

The nine major elements that comprise Good Field Practices are listed on table 4-2. Four of the principles are further clarified below.

**Field rinse equipment. Field rinsing of equipment used to collect or process samples should not be confused with the procedures used for equipment cleaning or decontamination;**

directions for field rinsing specific types of surface-water and ground-water equipment are described in sections 4.1.3 and 4.2.2.C, respectively. Collection of equipment blanks and field blanks is necessary to help identify potential sources of sample contamination (section 4.3). The same equipment that is used for collecting and processing environmental samples is used for collecting and processing blanks and other types of quality-control samples; however, equipment-cleaning and -rinsing procedures differ somewhat.

**Follow a prescribed sampling order.** One dictate of Good Field Practices is to follow a prescribed order for collecting samples.

An aspect of this is that cross-contamination between sites can be avoided by planning the order in which field sites will be sampled. Sites should be sampled in the order of least to greatest potential for equipment fouling or contamination, if possible. The cleanest sites are often – although not always – those that are in pristine environments, in areas where concentrations of dissolved solids are low, or upstream or upgradient from known or suspected sources of contamination.

**RULE OF THUMB: Collect samples first at sites having the least contamination or lowest chemical concentrations.**



**Table 4-2.** Good field practices for collection of water-quality samples

[Modified from “Rules for Trace-Metal Sampling” by Howard Taylor, U.S. Geological Survey, written communication, 1992; NFM, *National Field Manual for the Collection of Water-Quality Data*]

- Be aware of and record potential sources of contamination at each field site.
- Wear appropriate disposable, powderless gloves:
  - Change gloves before each new step during sample collection (and processing).
  - Avoid hand contact with contaminating surfaces (such as equipment, coins, food).
  - Gloved as well as ungloved hands must not contact the water sample.
- Use equipment constructed of materials that are relatively inert with respect to the analytes of interest (NFM 2).
- Use only equipment that has been cleaned according to prescribed procedures (NFM 3).
- Field rinse equipment, but only as directed. Some equipment for organic-compound and other analysis should not be field rinsed.
- Use correct sample-handling procedures:
  - Minimize the number of sample-handling steps.
  - Use Clean Hands/Dirty Hands techniques (table 4-3) as required for parts-per-billion trace-element sampling. Adapt Clean Hands/Dirty Hands techniques for other sample types, as appropriate. Obtain training for and practice field techniques under supervision before collecting water samples.
- Collect (and process) samples in enclosed chambers so as to minimize contamination from atmospheric sources.
- Collect a sufficient number of blanks and other types of quality-control samples.
- Follow a prescribed order for collecting samples.

**Table 4-3.** Clean Hands/Dirty Hands techniques for water-quality sampling

- Clean Hands/Dirty Hands techniques require two or more people working together.
- At the field site, one person is designated as Clean Hands (*CH*) and a second person as Dirty Hands (*DH*). Although specific tasks are assigned at the start to *CH* or *DH*, some tasks overlap and can be handled by either, as long as the prescribed care is taken to prevent contaminating the sample.
- *CH* and *DH* wear appropriate disposable, powderless gloves during the entire sampling operation and change gloves frequently, usually with each change in task. (Wearing multiple layers of gloves allows rapid glove changes.) **Gloves must be appropriate to withstand any acid, solvent, or other chemical substance that will be used or contacted.**
- *CH* takes care of all operations involving equipment that contacts the sample; for example, *CH*
  - Handles the surface-water sampler bottle
  - Handles the discharge end of the surface-water or ground-water sample tubing
  - Handles the inner protective bag on the churn splitter
  - Transfers sample to churn or cone splitter
  - Prepares a clean work space (inside vehicle)
  - Sets up processing and preservation chambers
  - Places equipment inside chambers (for example, sample bottles, filtration and preservation equipment)
  - Works exclusively inside chambers during collection/processing and preservation
  - Changes chamber covers, as needed
  - Sets up field-cleaning equipment and cleans equipment
- *DH* takes care of all operations involving contact with potential sources of contamination; for example, *DH*
  - Works exclusively exterior to processing and preservation chambers
  - Prepares and operates sampling equipment, including pumps and discrete samplers, peristaltic pump switch, pump controller, manifold system
  - Operates cranes, tripods, drill rigs, vehicles, or other support equipment
  - Handles the compressor or other power supply for samplers
  - Handles tools such as hammers, wrenches, keys, locks, and sample-flow manifolds
  - Handles single or multiparameter instruments for field measurements
  - Handles the churn carrier, including outer protective bags
  - Handles stream-gaging or water-level equipment
  - Sets up and calibrates field-measurement instruments
  - Measures and records water levels and field measurements

**Use Clean Hands/Dirty Hands (CH/DH) sampling procedures.**

*CH/DH* procedures were developed for collecting (and processing) samples vulnerable to contamination. *CH/DH* procedures separate field-duty chores and dedicate one individual (designated as Clean Hands or *CH*) to tasks related to direct contact with sample-wetted equipment and sample containers (table 4-3). Implementation of this protocol requires hands-on training and field-team coordination.<sup>4</sup>

- ▶ **Requirement:** *CH/DH* procedures are required when collecting samples for analysis of metals and other inorganic trace elements (hereafter referred to collectively as trace elements), as follows:
  - For trace elements with ambient concentrations at or near 1 µg/L.
  - For iron, aluminum, or manganese with ambient concentrations to about 200 µg/L.
  
- ▶ **Recommendation:** *CH/DH* procedures are recommended when collecting samples for analysis of most trace elements with concentrations to about 100 µg/L.
  
- ▶ **Recommendation:** *CH/DH* procedures are recommended when collecting samples for analysis of trace-organic compounds and major inorganic elements, particularly when the target analyte could be subject to contamination from field or laboratory procedures at a level that could exceed data-quality requirements.

---

<sup>4</sup>A detailed description of Clean Hands/Dirty Hands techniques for surface-water sampling can be found in Horowitz and others (1994). Clean Hands/Dirty Hands techniques have been incorporated in the procedures for ground-water sampling (refer to section 4.2), equipment cleaning (NFM 3), and sample processing (NFM 5).

**Minimize atmospheric contamination.** Water bodies that are isolated from the atmosphere or that have dissolved-oxygen concentrations that are substantially less than that of air can be found in surface-water systems (deeper sections of stratified lakes and reservoirs, for example), but are more common in ground-water systems. For such sites, exposure of the sample to the atmosphere can increase dissolved-oxygen concentrations, causing reduced metal ions to oxidize and precipitate as a hydroxide.

Collection of environmental samples from water bodies for which concentrations of dissolved gases differ substantially from atmospheric concentrations might require special field equipment or procedures. Equipment and procedures should be selected that minimize contact with the atmosphere or minimize the effect of pressure changes from the source of the sample to the point of field measurement or sample processing. Sampling methods and equipment for preventing contact of anoxic and suboxic water samples with atmospheric gases are described in section 4.2.2.C.

**TECHNICAL NOTE:** Exposure of anoxic or suboxic samples to atmospheric oxygen can cause reduced metal ions to oxidize and precipitate as a hydroxide (for example, oxidation of iron species from ferrous ( $\text{Fe}^{+2}$ ) to ferric ( $\text{Fe}^{+3}$ ) iron). Precipitation of an iron (or other metal) hydroxide can occur either before or during sample filtration, thereby lowering concentrations of soluble iron and co-precipitating metals in the sample. Examples of nonmetal analytes for which atmospheric exposure can compromise sample integrity include volatile organic compounds (VOCs), pH, alkalinity, sulfide, chlorofluorocarbons (CFCs), and some bacteria species.

---

# SURFACE-WATER SAMPLING 4.1

The methods used to collect surface-water samples depend not only on flow characteristics of the surface-water body but also on the following considerations: safety of field personnel (NFM 9); suitability of the equipment with regard to the analytes of interest as well as that of the anticipated hydraulic conditions (NFM 2); field-measurement profiles (NFM 6); temporal and spatial heterogeneity; physical setting; ecological characteristics; weather conditions; fluvial-sediment transport; point and nonpoint sources of contamination; and study objectives, including data-quality requirements. Each sampling site needs to be selected and sampled in a manner that minimizes bias caused by the collection process and that best represents the intended environmental conditions at the time of sampling.

- ▶ Before beginning field work, USGS study teams should be thoroughly familiar with procedures and requirements described in this *National Field Manual* and in USGS Office of Water Quality Technical Memorandum 99.02.<sup>5</sup> Additional references that provide descriptions of surface-water sampling techniques include: Federal Interagency Sedimentation Project (1986), Ward and Harr (1990), and Edwards and Glysson (1999).
- ▶ Study requirements for collection of equipment blanks, field blanks, concurrent samples, and other relevant QC samples must be prepared for before field work begins (section 4.3). Equipment and supplies must be selected that are appropriate for the use intended.
- ▶ Ensure that the field team is staffed and equipped adequately. For example, additional personnel and equipment are required for collection of concurrently collected samples (concurrent replicate samples, section 4.3). Use of safety equipment and procedures is mandatory (NFM 9).
- ▶ Prior to sample collection, the study team must establish a NWIS site file and field folder for each sampling location (section 4.1.1).

---

<sup>5</sup>The U.S. Geological Survey (USGS) technical and policy memorandums referenced in this manual are available on the Web; see "Selected References and Documents" for numbered memorandum titles, dates, and the Web address.

---

## 4.1.1 SITE FILES

Field personnel are responsible for establishing and maintaining electronic and paper site files and ensuring their accuracy and completeness. The information required for establishing electronic records in NWIS and for creating field folders for surface-water sampling sites is summarized below.

---

### 4.1.1.A NWIS Files

USGS policy requires specific information on surface-water sampling sites to be stored in the site file in NWIS (Hubbard, 1992; USGS Water Resources Policy Memorandum 92.59). Site files should be established as soon as the sampling site has been selected. The minimum information required for establishing electronic files in NWIS for surface water is listed in table 4-4. Individual studies and USGS Water Science Center offices may have additional data-storage requirements.

- ▶ Results of chemical water analyses are stored in the water-quality file (QWDATA) of NWIS (Gellenbeck, 2005).
- ▶ The Automatic Data Processing System (ADAPS) contains continuous records of water levels and water quality (Bartholoma, 2003).

**Once the site location has been established:**

- ▶ Check the NWIS site file before each field trip.
- ▶ Update the files promptly after the field trip.
- ▶ Fill in information that is needed by, or could be useful to, the study in addition to the information shown on table 4-4. For guidance, refer to “Data Elements for Reporting Water Quality Results of: Chemical and Microbiological Analyses” (<http://wi.water.usgs.gov/methods/tools/wqde/>, accessed July 7, 2006).
- ▶ If real-time data are being served on the Web, ensure that current policies and quality-assurance measures are understood and implemented (USGS Water Resources Policy Memorandum No. 99.34, at <http://water.usgs.gov/admin/memo/policy/wrdpolicy99.34.html> (accessed July 7, 2006)).

**Before starting field work:**  
**Make sure that the NWIS file has been established.**  
**After field work:**  
**Input updates to NWIS files promptly and have a second or third party check the input.**

**Table 4-4.** Minimum information required for electronic storage of site and surface-water-quality data in the U.S. Geological Survey (USGS) National Water Information System (NWIS)

[GWSI, Ground-Water Site Inventory; QWDATA, Quality of Water Data]

<b>Required information for creation of a surface-water site in NWIS<sup>1,2</sup></b>		
<b>Data description</b>	<b>Component (C) number for data entry into GWSI</b>	<b>Example (Description of code)</b>
Agency code	C4	USGS
Station Identification Number	C1	11530500
Station Name	C12	Klamath River near Klamath, Calif.
Latitude	C9	413052
Longitude	C10	1235957
USGS Water Science Center /User	C6	06 (California)
State		
County	C7	06 (California)
Agency Use	C8	015 (Del Norte)
Station Type	C803	A (Active)
	C802	SW
<b>Required information for storage of sample analyses in the water-quality file of NWIS (QWDATA)<sup>1</sup></b>		
<b>Data description</b>	<b>Alpha parameter code</b>	<b>Sample data (Description of code)</b>
Agency code	AGNCY	USGS
Station Identification Number	STAID	11530500
Sample Medium	MEDIM	9 (surface water)
Sample Type	STYPE	9 (regular sample)
Hydrologic (“Hydro”) Event	EVENT	9 (routine sample)
Hydrologic (“Hydro”) Condition	HSTAT	9 (stable stage)
Date (year/month/day)	DATES	20070909
Time (standard 24-hour clock time)	TIMES	1530 hrs
Analysis Status	ASTAT	H (initial entry)
Analysis Source	ASRCE	9 (USGS laboratory and field)

<sup>1</sup>Numerous additional data fields are available in NWIS that can be useful for data analysis or mandatory for meeting study objectives; for example, indicating whether a non-USGS agency collected the data.

<sup>2</sup>Modified from Ground-Water Site Inventory Schedule Form 9-1904-A, Revised June 2004, NWIS 4.4.

### **4.1.1.B Field Folders**

Information that is needed for reference while working at a surface-water site is kept in a field folder. The field folder is taken along on each sampling trip. It includes all the information necessary for efficient field operations; for example, directions to and description of the site, safety precautions relevant to the site, and the specifics for sample collection and processing at the site. General contents of the field folder are listed on the field-folder checklist (fig. 4-2), but the folder should be customized according to study needs.



Field-folder checklist: surface-water quality		
✓	Item	Comments
	Station description: <ul style="list-style-type: none"> <li>• Location of gaging station (if one is present).</li> <li>• Location of sample-collection sites: high and low streamflows.</li> <li>• Hydrologic and geologic sections.</li> <li>• Name of landowner, tenant, or other responsible party.</li> <li>• Site access instructions (for example, call owner or site operator before arrival at site, obtain key to unlock security gate).</li> <li>• Photographs to document site conditions.</li> </ul>	
	Maps to site (State and local)	
	Profiles of cross section of stream channel at sampling location(s). <ul style="list-style-type: none"> <li>• Stream-bottom geometry.</li> <li>• Physical and chemical measurements.</li> </ul>	
	Safety information (NFM 9): <ul style="list-style-type: none"> <li>• Nearest emergency facilities.</li> <li>• Phone numbers (home) of study chief or supervisor.</li> <li>• Traffic condition and traffic plan showing where to park, placement of flags and cones.</li> <li>• Location of power lines.</li> <li>• Environmental hazards, such as weather and animals.</li> </ul>	
	Sampling schedule: <ul style="list-style-type: none"> <li>• Laboratory analyses to be requested and associated codes.</li> <li>• When to collect samples (high or low flow).</li> </ul>	
	Bottle types needed for each analytical schedule.	
	Analytical Services Request form(s) and example of a completed form.	
	Sampling instructions: <ul style="list-style-type: none"> <li>• Cumulative-discharge curves at about 10-, 50-, and 90-percent duration.</li> <li>• Velocity cross sections at about 10-, 50-, and 90-percent duration.</li> <li>• Equipment to use at various flows.</li> <li>• Flow-duration curve.</li> <li>• Discharge rating curves and (or) tables.</li> </ul>	
	Shipping instructions: <ul style="list-style-type: none"> <li>• Amount of ice to use.</li> <li>• Mailing labels to and from laboratory.</li> <li>• Location of nearest post office or shipping agent.</li> </ul>	
	Surface-water field form and an example of completed form.	
	A tabulation sheet for each type of bacteria enumerated at the site (include example with date of sample, streamflow, volumes filtered, dilutions, plate counts).	
	Plots of field-measured data (last 5-10 years of record); if there is a good enough relation to show outliers, include: <ul style="list-style-type: none"> <li>• Conductivity versus streamflow.</li> <li>• Conductivity versus alkalinity.</li> <li>• Temperature versus time.</li> </ul>	
	Statistical summary of historical water data: <ul style="list-style-type: none"> <li>• Seasonal, maximum-minimum values.</li> <li>• Discharge-related maximum-minimum values.</li> </ul>	
	Special equipment needed to address site-specific conditions: <ul style="list-style-type: none"> <li>• Sampling.</li> <li>• Safety.</li> </ul>	

**Figure 4-2.** Checklist for contents of a field folder for surface-water sampling.

## 4.1.2 SELECTION OF SURFACE-WATER SAMPLING SITES

The study team is responsible for selecting sampling sites, including the specific point(s) or transect(s) at which samples will be collected. The guiding principle for site selection is that data can be collected that accurately represent the intended conditions (such as time of year and flow rate or stage) of the aqueous system being studied with respect to study objectives. Generic guidelines for selecting flowing-water and still-water sites are described in this section.

- ▶ Each body of flowing and still surface water has a unique set of conditions that needs to be identified and considered in the site-selection process.
- ▶ Field personnel must be trained in the correct and current water-quality data-collection procedures and must exercise judgment gained from field experience to make site selections.
- ▶ Careful and complete documentation of site information and the data collected must be input to electronic and paper files.

In most bodies of flowing or still water, a single sampling site or point is not adequate to describe the physical properties and the distribution and abundance of chemical constituents or biological communities. Location, distribution, and number of sampling sites can affect the quality and applicability of the resulting data.

### **When selecting surface-water sampling sites:**

- ▶ Consider the study objectives, types of data and quality of data needed, equipment needs, and sampling methods.
- ▶ Obtain all available historical information.
- ▶ Consider physical characteristics of the area, such as size and shape, land use, tributary and runoff characteristics, geology, point and nonpoint sources of contamination, hydraulic conditions, climate, water depth, and fluvial-sediment transport characteristics.
- ▶ Consider chemical and biological characteristics of the area (aquatic and terrestrial).
- ▶ Note the types of equipment that will be needed.

---

## 4.1.2.A Flowing-Water Sites

Flowing-water sites can refer to streams (fast or slow, intermittent, ephemeral, or perennial), canals, ditches, and flumes of all sizes and shapes, or to any other surface feature in which water moves unidirectionally. All or parts of reservoirs and estuaries that flow unidirectionally are considered to be flowing water. Determine latitude and longitude from maps or by land-survey techniques. Global-positioning system (GPS) equipment is useful to identify sampling-site location.

### **Flowing-water sampling sites optimally are located:**

- ▶ At or near a streamgaging station, to obtain concurrent surface-water discharge data required for computing constituent-transport loads and to determine discharge/constituent-concentration relations. (Measure discharge at time of sampling if a streamgaging station is not at or near the sampling site or if discharge cannot be rated or estimated with sufficient accuracy.)
- ▶ In straight reaches having uniform flow, and having a uniform and stable bottom contour, and where constituents are well-mixed along the cross section.
- ▶ Far enough above and below confluences of streamflow or point sources of contamination to avoid sampling a cross section where flows are poorly mixed or not unidirectional.
- ▶ In reaches upstream from bridges or other structures, to avoid contamination from the structure or from a road surface.
- ▶ In unidirectional flow that does not include eddies. (If eddies are present within the channel, sample only the unidirectional flow.)
- ▶ At or near a transect in a reach where other data are collected (such as data for suspended sediment, bedload, bottom material, or biological material) and (or) for which historical data are available.
- ▶ At a cross section where samples can be collected at any stage throughout the period of study, if possible.

After a tentative selection of a sampling site, develop a preliminary profile of field measurements<sup>6</sup> at various locations along the cross section (section 4.1.3.A). Final site selection is based on a comparison of field measurements with the data requirements of the study.

**TECHNICAL NOTE:** The preferred sampling method and number of verticals to be sampled within the stream cross section that are needed to obtain a sample that is sufficiently representative depends on stream homogeneity as indicated by the field-measurement profile and stream-discharge or other data, as well as by study objectives. Note that the field-measurement profile is a useful guideline, but might not be representative of chemical homogeneity for the analytes of interest. Also, it might be desirable to move to a sampling site upstream or downstream to adjust for seasonal variation or extreme flow conditions.

The guidelines used for selecting sampling sites on ephemeral and intermittent streams are the same as those for perennial streams. Ephemeral and intermittent stream sites need additional planning and examination to account, for example, for conditions related to rapidly changing stage and discharge that can occur as a result of flash flooding or urban runoff.

**CAUTION: Any stream, including an ephemeral or intermittent stream, can rapidly become too deep and swift to wade safely.**

---

<sup>6</sup>The profile of the cross section usually includes field measurements for specific electrical conductance (conductivity), pH, temperature, dissolved oxygen, and turbidity.

---

## Still-Water Sites 4.1.2.B

Still-water sites refer to all sizes and shapes of lakes, reservoirs, ponds, swamps, marshes, riverine backwaters, or any other body of surface water where water generally does not move unidirectionally. All or parts of reservoirs that do not flow unidirectionally could be considered to be still water.

### When locating still-water sampling sites:

- ▶ Use in situ field measurements to help determine vertical and spatial distribution of sampling locations.
- ▶ Avoid areas near structures such as harbors, boat ramps, piers, fuel docks, and moored houseboats (to avoid point sources of contamination), unless these structures are part of the study.
- ▶ Select sites with a record of historical data, if possible.

---

## SAMPLING AT FLOWING-WATER AND STILL-WATER SITES 4.1.3

**Flowing streamwater is collected using either isokinetic, depth-integrating or nonisokinetic sampling methods.** At flowing-water sites, collection of an isokinetic, depth-integrated, discharge-weighted sample is standard procedure; however, site characteristics, sampling-equipment limitations, or study objectives constrain how a sample is to be collected and could necessitate use of other methods. If the QC plan calls for collection of concurrent samples, then the relevant procedures and equipment needs (section 4.3) must be reviewed before field work begins.

- ▶ Isokinetic, depth-integrating methods (section 4.1.3.A) are designed to produce a discharge-weighted (velocity-weighted) sample; that is, each unit of stream discharge is equally represented in the sample, either by dividing the stream cross section into intervals of equal width (EWI) or equal discharge (EDI) (USGS Office of Water Quality Technical Memorandum 99.02).
  - The analyte concentrations determined in a discharge-weighted sample are multiplied by the stream discharge to obtain the discharge of the analyte.
  - If used correctly and the sample is collected within the limitations of the sampling device being used, the EWI and EDI methods result in samples that have identical constituent concentrations.
- ▶ Nonisokinetic sampling methods (section 4.1.3.B), such as those involving use of an automated point sampler, generally do not result in a discharge-weighted sample unless the stream is completely mixed laterally and vertically. Thus, the analytical results cannot be used to directly compute analyte discharges.

**Still-water samples generally also are collected at multiple locations in the water body and at multiple depths** (section 4.1.3.C). The probability is small that any body of still water (lake, reservoir, pond, lock, storage pool) is relatively homogeneous with regard to any water-quality characteristic. Therefore, a single sampling point generally is not adequate to describe the physical and chemical properties of the water body, or the distribution and abundance of the inhabiting biological community. The number of sampling locations selected and the depths where samples will be collected depend on study objectives and the physical, chemical, and biological characteristics of the water body (Ward and Harr, 1990).

**Document the sampling method used on the appropriate field form for each sample.**

---

## On-site preparations

When arriving at the field site, take the appropriate measures to avoid sample contamination, such as fumes from traffic or other sources and proper handling and care of sampling equipment. The selection and care of equipment employed for isokinetic and nonisokinetic surface-water sampling are described in NFM 2, while standard USGS equipment-cleaning procedures are detailed in NFM 3. Selection, maintenance, and proper cleaning of sampling equipment are of paramount importance in preventing sample contamination and these protocols should be carefully reviewed and consistently implemented. Only clean equipment should be transported to the field.

Once field work has begun, and before samples are collected, the sample-wetted portions of most of the collection and processing equipment require a field rinse with native water. Field rinsing helps to condition, or equilibrate, sampling equipment to the sample environment. Rinsing also serves to ensure that all cleaning-solution residues have been removed.

- ▶ The Clean Hands team member is responsible for field rinsing the equipment whenever *CH/DH* procedures are used.
- ▶ The use and field-rinsing procedures are summarized below for sampling devices and for sample-compositing and sample-splitting equipment. Samples for bacteria analysis are not to be taken from a churn splitter unless it has been sterilized as described in NFM 7.1.1, and has no metal parts in the spigot unit.
  - **Churn splitter:** The 14-L churn can be used to split samples with particle sizes 250  $\mu\text{m}$  and suspended-sediment concentrations 1,000 mg/L; however, splitting accuracy becomes unacceptable for particle sizes >250  $\mu\text{m}$  and suspended-sediment concentrations >1,000 mg/L. Sample volumes less than 4 L or greater than 13 L cannot be split for whole-water subsamples. Churn lid requires a covered opening. To split a sample into subsamples for nonvolatile organic-compound analyses, use a Teflon-coated churn.
  - **Cone splitter:** Used to process samples with suspended-sediment concentrations from 0 to 10,000 mg/L, and to split samples containing sediment particles ranging in size from very fine clay and silt (1 to 10  $\mu\text{m}$ ) to sand-size particles (250  $\mu\text{m}$ ). Samples as small as 250 mL can be split into 10 equal subsamples. A Teflon cone splitter can be used to process samples with volume greater than 13 L and samples to be analyzed for inorganic constituents and nonvolatile organic compounds.

*To field rinse a bottle sampler or bag sampler:*

1. Put on appropriate disposable, powderless gloves (gloves).
2. Partially fill and rinse the sampler with the water to be sampled (rinse water).
  - Avoid getting sand in the rinse water.
  - To avoid suspended sand particles, collect water for rinsing at the edge of the stream in an area of low-flow turbidity.
3. Shake or swirl and then drain the rinse water from the sampler through the nozzle.
4. **For bag samplers** – the bag must be removed from the sampler to properly discard the final rinse water.
  - a. Fill the bottom of the bag with approximately 100 to 200 mL of sample.
  - b. Gently pull the bag into a tube-like shape and loosely fold over the top opening.
  - c. Slosh the sample water back and forth from the bottom to the top of the bag.
  - d. Keeping the bag in a tube-like shape, hold it horizontally and rotate it, making sure that the water flows into all of the folds of the Teflon<sup>®</sup> bag.

*To field rinse a churn splitter:*

1. Put on gloves.
2. Pour 2 to 4 L of rinse water from the sampler into the churn splitter (churn) through the top funnel.
3. Remove the churn from the churn carrier, leaving the outer plastic bag inside the carrier. Move the churn disk up and down several times to ensure that the inside of the churn is thoroughly wetted, then swirl the rinse water vigorously in the churn.
4. Pierce a hole through the inner plastic bag to expose the churn spigot and drain the rinse water through the spigot. **If sand is present**, swirl water vigorously in the churn, open the plastic bag, and partially lift the churn cover to pour the rinse water out of the top of the churn. (Draining the rinse water through the spigot will not adequately remove sand.)
5. After draining the rinse water from the churn, rotate the churn in the plastic bag so that the spigot is not exposed. Place the inner plastic bag holding the churn into an outer plastic bag and place into the churn carrier.



***To field rinse the cone splitter:***

1. Put on gloves.
  2. Uncover the splitter reservoir and pour or pump 2 to 4 L of rinse water into the cone-splitter reservoir, one liter at a time.
  3. Lightly tap the splitter to dislodge adhering water drops. Discard rinse water.
  4. Cover the splitter.
- 

## **Isokinetic, Depth-Integrated Sampling 4.1.3.A Methods at Flowing-Water Sites**

Collection of isokinetic, depth-integrated samples involves using either an equal-width-increment (EWI) or equal-discharge-increment (EDI) sampling method. The EWI or EDI methods usually result in a composite sample that represents the discharge-weighted concentrations of the stream cross section being sampled.

The EWI and EDI methods are used to divide a selected cross section of a stream into increments having a specified width. The term vertical refers to that location within the increment at which the sampler is lowered and raised through the water column.

- ▶ EWI verticals are located at the midpoint of each width increment.
- ▶ EDI verticals are located at the centroid, a point within each increment at which stream discharge is equal on either side of the vertical.

If properly implemented, EDI and EWI methods should yield identical results. The uses and advantages of each method are summarized below and in table 4-5. Isokinetic samplers usually are used to obtain a discharge-weighted sample along the stream cross section. **When using an isokinetic sampler there should be no change in velocity (speed and direction) as the sample enters the intake** (fig. 4-3).

**Table 4-5.** Uses and advantages of equal-width-increment (EWI) and equal-discharge-increment (EDI) sampling methods

EWI method	Advantages of the EWI method
<p>EWI is used when information required to determine locations of sampling verticals for the EDI method is not available, and (or) the stream cross section has relatively uniform depth and velocity.</p> <p><b>Use EWI whenever:</b></p> <ul style="list-style-type: none"> <li>• The location of EDI sampling verticals changes at the same discharge from one sampling time to another. This situation occurs frequently in streams with sand channels.</li> </ul>	<ul style="list-style-type: none"> <li>• EWI method is easily learned and implemented for sampling small streams.</li> <li>• Generally, less time is required onsite if the EWI method can be used and the information required to determine locations of sampling verticals for the EDI method is not available.</li> </ul>
EDI method	Advantages of the EDI method
<p>EDI is used when information required to determine locations of sampling verticals for the EDI method is available.</p> <p><b>Use EDI whenever:</b></p> <ul style="list-style-type: none"> <li>• Small, nonhomogeneous increments need to be sampled separately from the rest of the cross section. The samples from those verticals can be analyzed separately or appropriately composited with the rest of the cross-sectional sample. (Have the sampling scheme approved.)</li> </ul> <p style="text-align: center;"><b>or</b></p> <ul style="list-style-type: none"> <li>• Flow velocities are less than the isokinetic transit-rate range requirement. A discharge-weighted sample can be obtained, but the sample will not always be isokinetic.</li> </ul> <p style="text-align: center;"><b>or</b></p> <ul style="list-style-type: none"> <li>• The EWI sampling method cannot be used. For example, isokinetic samples cannot be collected because stream velocities and depths vary so much that the isokinetic requirements of the sampler are not met at several sampling verticals.</li> </ul> <p style="text-align: center;"><b>or</b></p> <ul style="list-style-type: none"> <li>• Stage is changing rapidly. (EDI requires less sampling time than EWI, provided the locations of the sampling verticals can be determined quickly.)</li> </ul>	<ul style="list-style-type: none"> <li>• Fewer increments are necessary, resulting in a shortened sampling time (provided the locations of sampling verticals can be determined quickly and constituents are adequately mixed in the increment).</li> <li>• Sampling during rapidly changing stages is facilitated by the shorter sampling time.</li> <li>• Subsamples making up a sample set may be analyzed separately or may be proportionally composited with the rest of the cross-sectional sample.</li> <li>• The cross-sectional variation in constituent discharge can be determined if subsample bottles are analyzed individually.</li> <li>• A greater range in velocity and depths can be sampled isokinetically at a cross section.</li> <li>• The total composite volume of the sample is known and can be adjusted before sampling begins.</li> </ul>

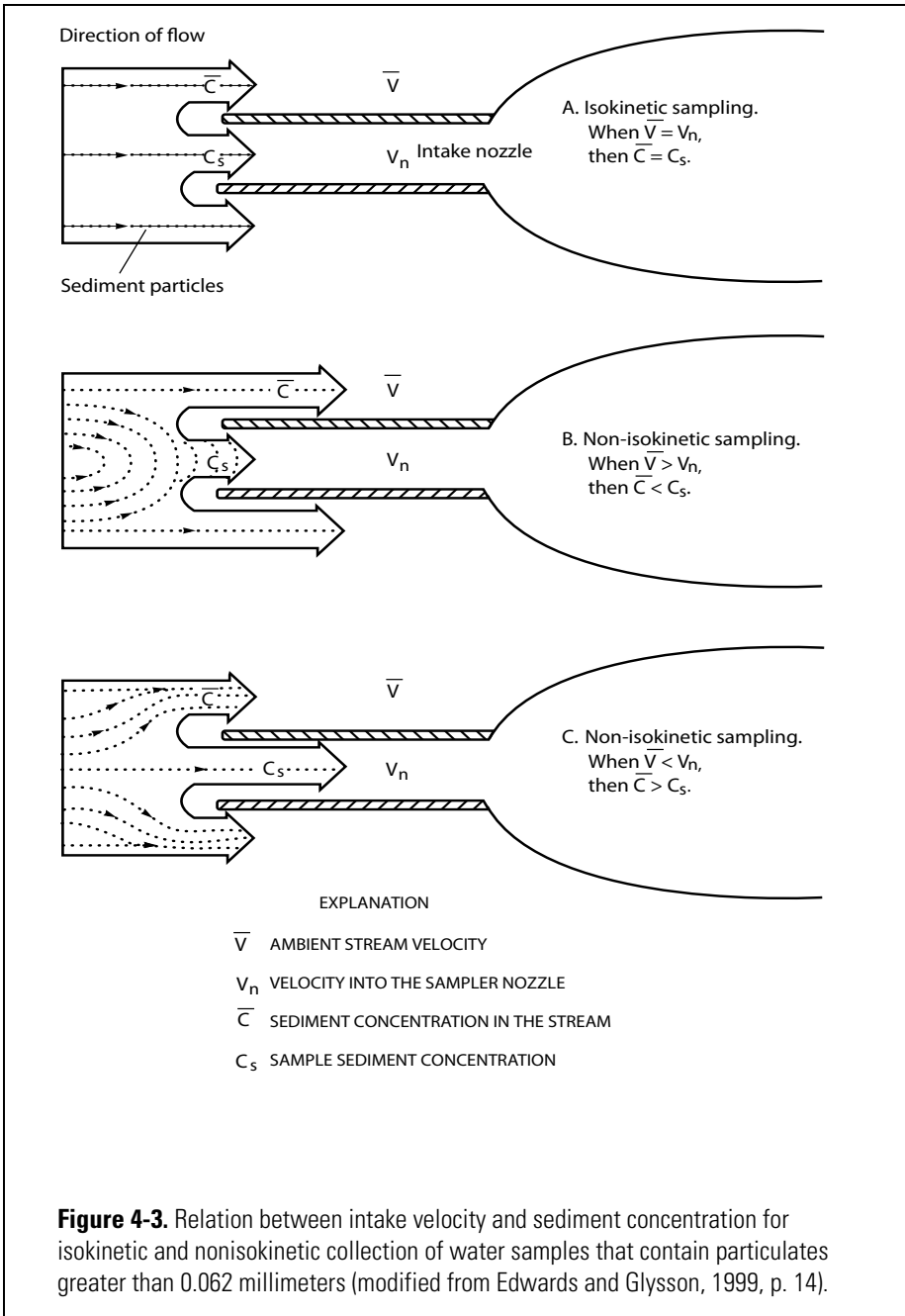

- ▶ Collect isokinetic, depth-integrated samples by using a standard depth- and width-integrating method if analysis of a representative sample from a cross section of flowing water is required for discharge computations. Appendix A4-A and Edwards and Glysson (1999, figures 39–43), provide detailed information about isokinetic, depth-integrating transit rates for collecting samples.
- ▶ For isokinetic sampling, the mean velocity of the vertical that is sampled must exceed the minimum-velocity requirement of an isokinetic sampler—the minimum velocity requirements are 1.5 ft/s for a bottle sampler, 2 ft/s for a 1- or 3-liter bag sampler, or 3 ft/s for a 6-liter bag sampler (Appendix A4-A).
  - The transit rate (the rate at which the sampler is lowered or raised) used to collect an isokinetic, depth-integrated sample is mainly a function of the nozzle diameter of the sampler, volume of the sampler container, stream velocity, and sampling depth (Appendix A4-A). The maximum allowable transit rate for a bag sampler is 0.4 multiplied by the mean stream velocity.
  - An error in concentrations of suspended particulates coarser than 62  $\mu\text{m}$  can be important when the velocity of the sample entering the nozzle and the stream velocity differ significantly. Too fast a transit rate will cause a sampler to undersample sand-sized particulates (Edwards and Glysson, 1999).
  - The transit rate must be kept constant during sampler descent through a vertical and also during sampler ascent through a vertical.

The number of increments needed in order to get a discharge-weighted sample at a site is related primarily to data objectives (for example, the accuracy needed) and how well-mixed or heterogeneous the stream is with respect to the physical, chemical, and biological characteristics of the cross section. The recommended number of increments for EWI and EDI methods are discussed in the sections to follow. Edwards and Glysson (1999) describe a statistical approach for selecting the number of increments to be used, based on sampling error and suspended-sediment characteristics.

## Selecting the number of increments

- ▶ Examine the variation in field-measurement values (such as specific electrical conductance, pH, temperature, and dissolved oxygen) along the cross section (NFM 6).
- ▶ Consider the distribution of streamflow (discharge), suspended-materials concentration and particle-size distribution, and concentrations of other targeted analytes along the cross section. Consider whether the streamflow distribution or analyte concentrations will change during sample collection.
- ▶ Consider the type of sampler that will be used and the volume of sample that will have to be collected for the analysis of the target analytes.
- ▶ Avoid side-channel eddies. EDI and EWI methods cannot be used at locations with upstream eddy flow.

---



---

**👉 RULE OF THUMB: For isokinetic, depth-integrating sampling, do not exceed the designated maximum transit rate.**

---



---

## Equal-width-increment (EWI) method

For the EWI sampling method, the stream cross section is divided into a number of equal-width increments (fig. 4-4). Samples are collected by lowering and raising a sampler through the water column at the center of each increment. (This sampling location is referred to as the vertical.) The combination of the same constant transit rate used to sample at each vertical and the isokinetic property of the sampler results in a discharge-weighted sample that is proportional to total streamflow.

- ▶ **Isokinetic sampling is required for the EWI method.** Use isokinetic, depth-integrating sampling equipment (NFM 2.1.1.A).
  - **Use the same size sampler container (bottle or bag) and nozzle** at each of the sampling verticals (fig. 4-4).
  - **Collect samples using the same transit rate** at each vertical during descent and ascent of the sampler. The transit rate must be constant and within the operational range of the sampler (Appendix A4-A).
- ▶ Composite the subsamples from all verticals in a churn splitter or process subsamples through the cone splitter (NFM 2.2.1 and NFM 5.1.1).

**Do not use EWI when stream velocities are less than the minimum velocity required for the isokinetic sampler selected:  
1.5 ft/s for the bottle sampler.**

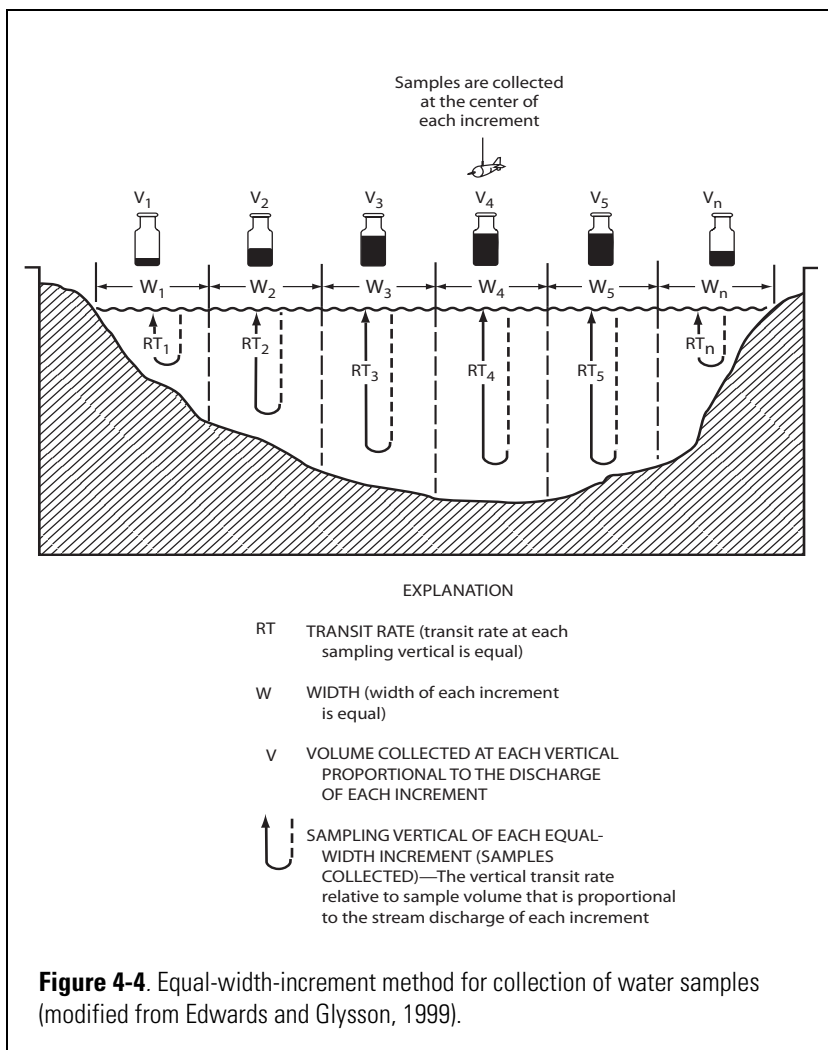

## Steps for the *EWI* sampling method

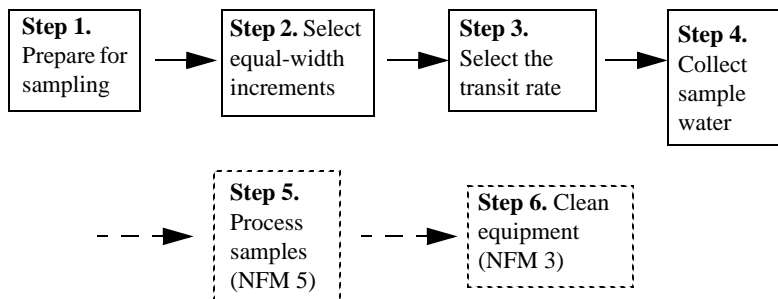

Be sure that the field effort is adequately staffed and equipped. Check QC requirements before departing—QC samples require additional equipment and supplies.

### Step 1. Prepare for sampling<sup>7</sup>

- a. Upon arrival at the field site, set out safety equipment such as traffic cones and signs. Park vehicle in a location and direction so as to prevent sample contamination from vehicle emissions.
- b. Assemble sampling equipment and set up a clean work space.
  - **Organic compounds.** Select equipment with fluorocarbon polymer, glass, or metal components if components will directly contact samples to be analyzed for organic compounds. **Do not use plastics other than fluorocarbon polymers.**
  - **Inorganic constituents.** Select equipment with components made of fluorocarbon polymer or other relatively inert and uncolored plastics or glass if components will directly contact samples to be analyzed for inorganic constituents. **Do not use metal or rubber components for trace-element sampling.**
  - **Microbiological analyses.** Collect samples for microbiological analyses using equipment and techniques described in NFM 7.

<sup>7</sup>Preparations for water sampling are described in NFM 2 and 3. Consult NFM 5 for sample processing, NFM 6 for field measurements, NFM 7 for biological indicators, NFM 8 for bottom-material sampling, and NFM 9 for field safety.

**Step 2. Select the number and width of equal-width increments.**

- a. Visually inspect the stream from bank to bank and longitudinally, observing velocity, width, and depth distribution, and apparent distribution of sediment and aquatic biota along the cross section. Note and document the location of stagnant water, eddies, backwater, reverse flows, areas of faster than normal flow, and piers or other features along the cross section.
- b. Determine stream width from a tagline or from distance markings on a bridge railing or cableway.
- c. At sites with little sampling history, measure and record the cross-sectional variation of field measurements (such as specific electrical conductance, pH, temperature, and dissolved oxygen). Review the magnitude of the variations along the cross section.
- d. Determine the width of the increment. To obtain the number of increments, divide the stream width by the increment width. **The number of increments must be a whole number.** Increment width is based on study objectives, variation in field measurements and flow, and stream-channel characteristics along the cross section.
  - Collect the subsample at the center of each equal-width increment (the vertical).
  - If the subsample does not represent the mean value for that increment, decrease the increment width until the mean value for the increment is represented. This will increase the number of increments sampled.
- e. Locate the first sampling vertical at a distance of one-half of the selected increment width from the edge of the water. Locate all the other verticals at the center of each remaining equal-width increment along the cross section.

**Example:**

- If a stream 56 ft wide has been divided into 14 increments of 4 ft each, the first sampling vertical would be 2 ft from the water's edge and subsequent verticals would be at 6, 10, 14 ft from the water's edge, and so forth.
  - Even if streamflow is divided, as in a braided channel, equal-width increments must be identical from channel to channel, and the same constant transit rate must be used at each vertical.
- f. Make slight adjustments to sampling locations, if necessary, to avoid sampling where the flow is affected by a pier or other obstruction.



**TECHNICAL NOTE:** Sampling near or downstream from large in-stream obstructions such as bridges and piers could result in artificially elevated concentrations of suspended sediments if the sampler is immersed in an eddy that is caused by the obstruction. If it is necessary to include an eddy in the cross section to be sampled, consider treating the eddy as a solid obstruction: subtract the eddy width from that of the total cross section, and determine the width of the increments based on the remaining stream width.

---



---

 **RULE OF THUMB**

**When selecting the number of equal-width increments:**

- Cross-sectional width  $\geq 5$  ft—use a minimum of 10 equal-width increments
- Cross-sectional width  $< 5$  ft—use as many increments as practical, but equally spaced at a minimum of 3 inches apart.

**Equipment limitations also constrain the number of increments selected; for example:**

- When using a 1-L bottle sampler at maximum depth with a 14-L churn splitter, EW samples can be collected at no more than 14 to 17 verticals.
  - If an 8-L churn splitter is used, samples can be collected at no more than 10 verticals.
  - A cone splitter must be used if the total volume collected will exceed the recommended volume for the churn splitter.
- 
- 

**Step 3. Select the transit rate.**

- a. Refer to Appendix A4-A for guidelines for determining the transit rates for collecting isokinetic, depth-integrated samples. Unless the mean velocity is actually determined, use the trial-and-error method to determine the minimum transit rate.
- b. Locate the equal-width increment containing the largest discharge (largest product of depth times velocity) by sounding for depth and either measuring or estimating velocity. At the vertical for this increment, use of the minimum transit rate results in the maximum allowable filling of the sampler bottle or bag during one vertical traverse.

- c. Determine the minimum transit rate at this vertical for the type of sampler (bottle or bag), size of sampler nozzle, and the desired sample volume.
- Approximate the mean velocity of the vertical in feet per second by timing a floating marker (such as a peanut) as it travels a known distance. (A known length of flagging tape tied to the cable where the sampler is attached often is used to measure the distance.) Divide the distance (in feet) by the time (in seconds) and multiply by 0.86.
  - Make sure that the transit rate does not exceed the maximum allowable transit rate to be used at any of the remaining verticals along the cross section. This can be determined by sampling the slowest increment. **If the minimum volume of sample (relative to depth of the vertical) is not collected at this vertical, then the EWI method cannot be used at this cross section to collect a discharge-weighted sample (Appendix A4-A).**
  - Remember that you must keep the transit rate unidirectional, constant, and within the isokinetic transit range of the sampler when collecting isokinetic samples at each centroid.

#### Guidelines for selecting the transit rate for EWI sampling

- The descending and ascending transit rate must be constant in each direction and must be the same for each vertical along the cross section.
- **Do not exceed the maximum allowable transit rate if using EWI.** If the transit rate must exceed the maximum allowable rate, use EDI instead of EWI.
- The transit rate selected must be sufficiently rapid to keep from overfilling the sampler. The sampler is overfilled when the water surface in the sampler container is above the bottom edge of the nozzle when the sampler is held in the sampling position.
- The same size sampler nozzle and container must be used at all verticals along the cross section.
- If the total volume collected will exceed the recommended volume for the churn splitter, then a cone splitter must be used.

#### Step 4. Collect sample water.

The sample-collection procedure is the same whether you are wading or using the reel-and-cable suspension method. When sampling from a bridge, deploy the sampler from the upstream of the bridge, if possible, to avoid bridge-related contamination of the sample. **Use CH/DH techniques, as required (section 4.0.2). Always follow safety procedures (NFM 9).**

- a. Move to the first vertical (midpoint of first EWI near edge of water) and field rinse equipment (section 4.1.3). Collect the rinse water at the edge of the stream in a section of low stream velocity to minimize including suspended sediment.
- b. Record start time and gage height.
- c. Lower field-rinsed sampler at the predetermined constant transit rate until slight contact is made with the streambed. **Do not pause** upon contacting the streambed. Raise the sampler immediately at the same constant transit rate until sampler completes the vertical traverse.
  - Take care not to disturb the streambed by bumping the sampler on it; bed material may enter the nozzle, resulting in erroneous data.
  - Do not overfill the sampler container. Overfilling results in a sample that is not isokinetic and that could be enriched with heavy particulates because of secondary circulation of water through the sampler (from nozzle through air exhaust). This enrichment will result in an artificially increased sediment concentration and will bias particle-size distribution toward heavier and larger particulates.
  - Do not underfill the sampler container (Appendix A4-A). Underfilling will result in a sample that is not isokinetically collected because the maximum transit rate has been exceeded.
  - If the required volume cannot be collected, use the EDI method to obtain discharge-weighted samples.
- d. Inspect each subsample as it is collected, looking for overfilling or underfilling of the sampler container and (or) the presence of anomalously large amounts of particulates that might have been captured because of excessive streambed disturbance during sample collection. **If you note any of these conditions, discard the sample, making sure there are no residual particulates left in the container, and resample.**

- e. Move sampling equipment to the next vertical. Maintain the selected transit rate. The volume of the subsample can vary considerably among verticals. Subsamples can be collected at several verticals before emptying the sampler container, as long as the maximum volume of sample in a bottle or bag sampler has not been exceeded. If the container is overfilled, it is necessary to resample.

**TECHNICAL NOTE:** The tables in Appendix A4-A apply to the first complete round-trip transit, starting with an empty sampler container. These tables cannot be used if the sampler is not emptied between verticals.

- f. Continue to the next vertical until no more samples can be collected without overfilling the sampler container. Empty the subsample into a field-rinsed churn or cone splitter and repeat sample collection in the same manner until subsamples have been collected at all the verticals.

- If the total volume of the subsamples to be collected will exceed the operational capacity of the churn, select from the following options: use a smaller nozzle; or, use a cone splitter; or, use the EDI method, if appropriate.
- To ensure that all particulates are transferred with the sample, swirl the subsample gently to keep particulates suspended and pour the subsample quickly into the churn or cone splitter.
- Sample EWI verticals as many times as necessary to ensure that an adequate sample volume is collected as required for analysis, **but sample at each vertical an equal number of times.** (The composite cross-sectional sample will remain proportional to flow at the time of sampling.)
- If flow is stable during sampling, then multiple samples can be collected at each vertical during a single traverse along the cross section. If flow is changing, however, study objectives should determine whether to collect multiple samples at each vertical during a single traverse or to collect one sample at each vertical during multiple traverses along the cross section. Document on field forms the method used.

- g. Record the following information after all samples have been collected:

- Sampling end time.
- Ending gage height.
- All field observations and any deviations from standard sampling procedures.

**Step 5. Process Samples** → Refer to NFM 5.

**Step 6. Clean Equipment** → Refer to NFM 3.

- If the sampler will not be reused during a field trip, rinse sampler components with deionized water before they dry and place them into a plastic bag for transporting to the office laboratory to be cleaned.
- If the sampler will be reused during the field trip, rinse the components with DIW while still wet from sampling and then field-clean while at the sampling site using the prescribed procedures (NFM 3). Reassemble the sampler.
- Collect a field blank, if required, after sampling equipment has been cleaned at the sampling site.
- Place the cleaned sampler into a plastic bag and seal for transport to the next site.

## Equal-discharge-increment (EDI) method

The objective of the EDI method is to collect a discharge-weighted sample that represents the entire flow passing through the cross section by obtaining a series of samples, each representing equal volumes of stream discharge. The EDI method requires that flow in the cross section be divided into increments of equal discharge. Equal-volume, depth-integrated samples are collected at the centroid of each of the equal-discharge increments along the cross section (fig. 4-5). Centroid is defined as that point in the increment at which discharge is equal on both sides of the point.

### *Steps for the EDI sampling method*

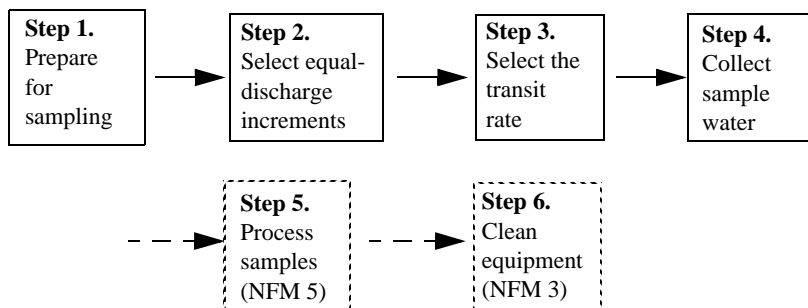

Be sure that the field effort is adequately staffed and equipped. Check QC requirements before departing—QC samples require additional equipment and supplies.

Example: Sampler D95; nozzle size 3/16 inches ID (inside diameter); 1-liter sampler bottle; width, 57 feet; maximum depth, 12 feet; maximum velocity, 6.1 feet per second (ft/s); width of section containing 20 percent of flow is variable, 5 to 22 feet; 20 percent of flow per section will give 5 sampling verticals; transit rate variable, 0.2 to 0.8 ft/s.

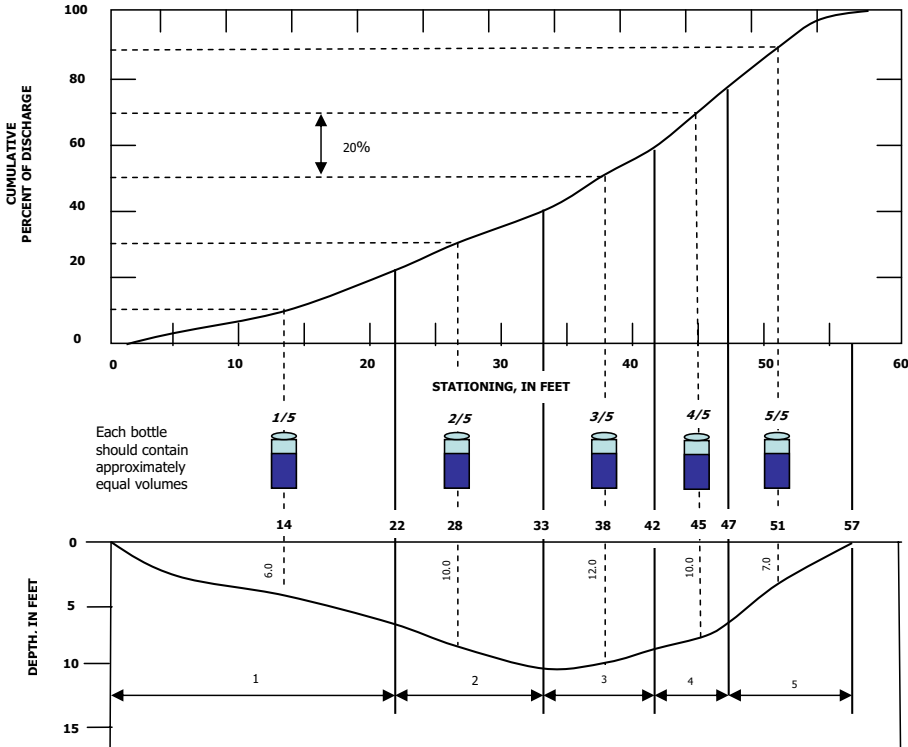

Sampling vertical/ bottle number	Percent discharge	Increment centroid from left edge of water, in feet	Increment depth, in feet	Mean velocity, in feet per second	Transit rate to give 800 milliliters, in feet per second
1/5	20	14	6	2.5	0.2
2/5	20	28	10	3.0	0.4
3/5	20	38	12	3.1	0.5
4/5	20	45	10	6.1	0.8
5/5	20	51	7	4.8	0.5

**Figure 4-5.** Equal-discharge-increment method for collection of water samples (modified from Bruce Ringen, U.S. Geological Survey, written commun., 1978).

**Step 1. Prepare for sampling for inorganic and organic analytes.<sup>8</sup>**

- a. Upon arrival at the field site, set out safety equipment such as traffic cones and signs. Park vehicle in a location and direction so as to prevent sample contamination from vehicle emissions.
- b. Assemble equipment needed and set up a clean work space.
  - **Organic compounds.** Select equipment with fluorocarbon polymer, glass, or metal components if components will directly contact samples to be analyzed for organic compounds. **Do not use plastics other than fluorocarbon polymers.**
  - **Inorganic constituents.** Select equipment with components made of fluorocarbon polymer or other relatively inert and uncolored plastics or glass if components will directly contact samples to be analyzed for inorganic constituents. **Do not use metal or rubber components for trace-element sampling.**
  - **Microbiological analyses.** Collect samples for microbiological analyses using equipment and techniques described in NFM 7.

**Step 2. Select the number and location of equal-discharge increments.**

The number and location of equal-discharge increments should not be determined arbitrarily. Selection of increments for a sampling site is governed by factors described in a, d, and e below.

- a. Visually inspect the stream from bank to bank, observing velocity, width, and depth distribution, as well as apparent distribution of sediment and aquatic biota along the cross section. Document location of stagnant water, eddies, backwater, reverse flows, areas of faster than normal flow, and piers or other obstructions along the cross section.
- b. Determine stream width from a tagline or from distance markings on bridge railings or on a cableway.

---

<sup>8</sup>Preparations for water sampling are described in NFM 2 and 3. Consult NFM 5 for sample processing, NFM 6 for field measurements, NFM 7 for biological indicators, NFM 8 for bottom-material sampling, and NFM 9 for field safety.



- c. At sites with little sampling history—measure, record, and review the cross-sectional variation of field measurements (for example, specific electrical conductance, pH, temperature, and dissolved oxygen).
- d. Measure discharge at the cross section to be sampled or use an existing EDI graph prepared from current or historical discharge measurements (fig. 4-5) (Edwards and Glysson, 1999). An existing EDI graph can be one prepared for the site that shows, for example, cumulative discharge or cumulative percent of discharge versus stationing.
- e. Determine volume of discharge that will be represented in each EDI, based on data objectives for the study, variation in field measurements, flow and stream-channel characteristics along the cross section, and volume of sample required for analyses of target analytes.
- f. Divide the cross section into equal-discharge increments.
  - When determining the number of increments to be sampled, keep in mind that the subsample collected at the centroid of each EDI must represent the mean streamflow measured for that increment. If mean streamflow for the increment is not represented, increase the number of increments by decreasing the volume represented by each discharge increment until the mean streamflow value for the increment is represented.
  - As a guide, a minimum of 4 sampling increments is recommended; the number of increments is usually less than 10.
- g. Determine the location of the centroid of flow within each increment from the discharge measurement by (1) constructing a curve using cumulative discharge or cumulative percentage of discharge (fig. 4-5) plotted against cross-section stationing, or (2) determining EDI locations directly from the discharge measurement sheet (fig. 4-6; an explanation of this method and definition of midpoint are described in Edwards and Glysson, 1999). Centroid-of-flow locations also can be determined from an EDI graph, as described below and in the TECHNICAL NOTE that follows the example below.

Station: *11482500 Redwood Creek at Orick, CA*

Far-Mid Point	Dist. from initial point	Width	Depth	Observation depth	Revolutions	Time in seconds	Velocity		Adjusted for hor. angle or	Area	Discharge	
							At point	Mean in vertical			Q	ΣQ
4	0	4	0	.6	LEW	0			0	0	0	
12	8	8	1.00		30	47	1.41		8.0	11.3	11.3	
20	16	8	1.80		30	44	1.51		14.4	21.7	33.0	
→ 26	24	8	2.00		50	44	2.50		16.0	40.0	73.0	62.2
36	32	8	2.00		60	45	2.92		16.0	46.7	119.7	
44	40	8	2.30		50	48	2.29		18.4	42.1	161.8	
→ 52	50	8	2.25		40	44	2.00		18.0	36.0	197.8	186.6
60	56	8	2.25		40	40	2.20		18.0	39.6	237.4	
68	64	8	2.30		40	40	2.20		18.4	40.5	277.9	
→ 76	72	8	2.30		50	45	2.44		18.4	44.9	322.8	311.0
84	80	8	2.20		40	45	1.96		17.6	34.5	357.3	
92	88	8	2.00		40	43	2.05		16.0	32.8	390.1	
100	96	8	1.90		50	47	2.34		15.2	35.6	425.7	
→ 108	104	8	2.00		40	42	2.10		16.0	33.6	459.3	435.4
116	112	8	2.00		40	40	2.20		16.0	35.2	494.5	
124	120	8	1.90		30	43	1.54		15.2	23.4	517.9	
132	128	8	1.80		40	40	2.20		14.4	31.7	549.6	
→ 140	134	136	8	1.70	50	44	2.50		13.6	34.0	583.6	559.8
148	144	8	1.60		50	44	2.50		12.8	32.0	615.6	
156	152	8	1.00		20	54	.827		8.0	6.6	622.2	
160	160	4	0	.6	REW	0			0	0	622.2	
	160	160							290.4	622.2		

EDI Centroid Location                      EDI Cumulative Discharge

**Figure 4-6.** Example of discharge-measurement field notes used to determine the equal-discharge-increment centroid locations based on cumulative discharge and far-midpoint stationing (from Edwards and Glysson, 1999, p. 45).

**Example:**

In this example, each EDI equals 20 percent of discharge.

- i. If the stream cross section will be divided into five equal-discharge increments, divide stream discharge by five to determine the discharge increment.
- ii. Locate the centroid of the initial EDI where cumulative discharge equals half the discharge increment (10 percent). This is the location of the vertical from which the first subsample is collected.
- iii. Locate each of the remaining centroids (four in this example) by adding the discharge increment (20 percent) to the previous centroid discharge ( $20 + 10 = 30$ ) and determining where that cumulative discharge occurs along the cross section.
- iv. The EDI centroids will correspond to locations of 10, 30, 50, 70, and 90 percent of the cumulative discharge along the cross section. In figure 4-5, these percentages of cumulative discharges correspond to locations at 14, 28, 38, 45, and 51 ft from the left edge of the water, whereas in figure 4-6, the centroid locations of the equal-discharge increments are at 26, 50, 74, 102, and 134 ft.

**TECHNICAL NOTE:** If the stream channel is stable at the cross section to be sampled, graphs of cumulative discharge or percentage cumulative discharge at various stages can be based on historical discharge measurements. Location of EDI centroids can be determined from these EDI graphs so that discharge measurements do not have to be made before each sampling. Linear interpolation based on discharge can be made between curves for different discharges on the EDI graphs. **EDI graphs require periodic verification by being compared to recent discharge measurements.**

**Step 3. Select the transit rate.**

- a. Determine the sampling depth and the mean stream velocity at the centroid of each equal-discharge increment.
- b. Determine the transit rate for each centroid that will yield subsamples with approximately the same volume (within 10 percent) using sampling depth, mean stream velocity, and information in Appendix A4-A. When compositing subsamples, the minimum volume for every equal-discharge increment is the minimum volume for the deepest vertical.

### Guidelines for selecting the transit rate for EDI sampling

- Collect samples of equal volumes at each centroid. This is required for EDI if the sample will be composited (fig. 4-5). Generally, transit rates vary from centroid to centroid in order to collect equal volumes.
- Keep the transit rate unidirectional, constant, and within the isokinetic transit range of the sampler when collecting isokinetic samples at each centroid.
- **Do not exceed the maximum transit rate** (Appendix A4-A). The maximum transit rate will be exceeded if the minimum sample volume associated with stream velocity and the selected nozzle and bottle size is not collected. Exceeding the maximum transit rate will affect the concentration of particulates  $\geq 0.062$  millimeters.

#### Step 4. Collect sample water.

The procedures are the same whether you are wading or using a reel-and-cable suspension method. **Use CH/DH techniques, as required (section 4.0.2), and implement safety procedures (NFM 9).**

- ▶ Collect microbiological samples using equipment and techniques as described in NFM 7.
- ▶ Collect subsamples at EDI centroids as many times as necessary to ensure collection of sufficient sample volume for analysis. If the sample is to be composited, care must be taken to obtain approximately the same total volume ( $\pm 10$  percent) from each EDI centroid so that the composited cross-sectional sample will be proportional to flow at the time of sampling.
- ▶ Stay within the isokinetic transit-rate range of the sampler at each centroid. If flow velocity is less than the isokinetic transit-rate range of the sampler, a discharge-weighted sample still can be obtained by collecting equal volumes at each centroid; however, this sample will not be isokinetic.
  - a. Move sampling and support equipment to the centroid of the first increment to be sampled. Field rinse the sampling equipment (section 4.1.3). Collect the rinse water at the edge of the stream in a section of low stream velocity, to minimize including suspended sediment.
  - b. Read and record the starting gage height. Record sampling start time.

- c. Lower the sampler at the predetermined transit rate until slight contact is made with the streambed.
- **Do not pause upon contacting the streambed.** Raise the sampler immediately at a constant transit rate to complete the vertical traverse. The descending transit rate does not have to equal the ascending transit rate, but each rate must be unidirectional, constant, and within the isokinetic transit range of the sampler.
  - Take care not to disturb the streambed with the sampler. Disturbing the streambed could cause bed material to enter the nozzle, resulting in erroneous data.
  - Ensure that the sampler container has not overfilled. Overfilling will result in enrichment of the sample with heavy particulates due to secondary circulation of water through the sampler (from nozzle through air exhaust). This enrichment will result in an artificially increased sediment concentration and will bias particle-size distribution towards heavier and larger particulates.
- d. Inspect each subsample, looking for overfilling and (or) the presence of anomalously large amounts of particulates that might have been captured because of excessive streambed disturbance during sample collection. If you note either or both of these conditions, discard the sample, making sure there are no residual particulates left in the container, and resample.
- e. Ensure that the sampler container is not underfilled (that the minimum volume indicated in Appendix A4-A has been collected). Underfilling will result in a subsample that is not isokinetically collected—usually because the maximum transit rate has been exceeded.
- f. Depending on study objectives, either process and (or) analyze the subsample collected at the initial centroid as a separate sample, composite this subsample with other subsamples collected along the cross section, or split the subsample for further processing.
- If the total volume of the subsamples that will be collected will exceed the operational capacity of the churn or cone splitter, decrease the number of increments or use a smaller nozzle.
  - Ensure that all particulates in the sampler bottle or bag are transferred with the sample by swirling the sample gently to keep particulates suspended, and quickly pouring the sample into the churn or cone splitter.

- g. Move equipment to the next vertical.
- Determine the transit rate for this vertical. If the subsamples are composited, the total volume collected at each centroid must be equal.
  - Repeat procedures, steps 4 c-f.
  - Repeat this process at the remaining verticals along the cross section.
- h. Record the following information after all samples have been collected:
- Sampling end time.
  - Ending gage height.
  - All field observations and any deviations from standard sampling procedures.

**Step 5. Process samples** → Refer to NFM 5.

**Step 6. Clean equipment** → Refer to NFM 3.

- If the sampler will not be reused during a field trip, rinse the components with deionized water before they dry and place them into a plastic bag for transport to the office laboratory to be cleaned.
- If the sampler will be reused during the field trip, rinse the components with deionized water while still wet from sampling, and then follow the prescribed cleaning procedures while at the sampling site (NFM 3). Reassemble the sampler.
- Collect a field blank, if required, after sampling equipment has been cleaned at the sampling site.
- Place cleaned sampler into a plastic bag and seal for transport to the next site.

---

## **Single vertical at centroid-of-flow (VCF) method**

Samples may be collected at a single vertical at the centroid of streamflow if the section is known to be well mixed laterally and vertically with respect to concentrations of target analytes.

The VCF method for collecting water samples is identical to the EDI method except that there is one centroid of flow for the stream cross section and therefore only one vertical is sampled.

**EDI and EWI methods are preferred for most USGS field applications. Do not use VCF unless you know your stream section to be well mixed with respect to your target analytes.**

*Guidelines for using the VCF method:*

1. Measure discharge along the cross section where sampling is to be done. (This is not necessary if the section is stable and accurate historical discharge measurements are available.)
2. Locate the centroid of flow from the discharge measurement.
  - Either (a) construct an EDI graph using cumulative discharge or cumulative percentage of discharge plotted against cross-section stationing (for example, in fig. 4-5, the centroid location is station 38, which corresponds to 50 percent of cumulative flow), or (b) determine centroid location directly from the discharge measurement sheet (for example, in fig. 4-6, the centroid location is station 74).
  - EDI graphs of cumulative discharge at various stages can be based on historical discharge measurements if the stream channel is stable at the cross section to be sampled. The location of centroids can be determined from these EDI graphs so that discharge measurements do not have to be made before each sampling. **EDI graphs require periodic verification.**
3. Examine the cross section for uniformity of appearance.
4. Measure the cross-sectional variation of field measurements (such as specific electrical conductance, pH, temperature, and dissolved oxygen) at sites with little sampling history. Record and review variations along the cross section.
5. Evaluate data from steps 1–4 to decide if the VCF method is appropriate. Use either the EDI or the EWI sampling method if streamflow, field-measurement, or chemical-analysis data do not confirm that the stream section is well mixed vertically and laterally.
6. If the VCF method is used, follow steps 3 and 4 of the instructions for the EDI method for selecting transit rate and collecting samples.
7. **Process samples** → Refer to NFM 5.
8. **Clean equipment** → Refer to NFM 3, and to the information under Step 6 in either the preceding EDI or EWI methods.

### 4.1.3.B Nonisokinetic (Dip, Discrete, and Pump) Sampling Methods at Flowing-Water Sites

Most nonisokinetic samplers cannot be used to collect representative discharge-weighted samples from streams transporting sand-size or larger particulates. These samplers have important uses for unattended stream sampling and for sampling to determine constituent occurrence and distribution, but they have limited value for collecting samples used to calculate constituent discharge.

#### Guidelines for nonisokinetic sampling methods

##### Use nonisokinetic sampling methods when:

- Velocity of flow is so high that an isokinetic sampler cannot be lowered through the vertical properly and safely.
- Extreme low-flow conditions render use of an isokinetic sampler impractical. For example, when water depth is equal to or less than that of the unsampled zone or when stream velocity is less than the minimum velocity requirement for an isokinetic sampler (1.5 ft/s for bottle samplers, 2 ft/s for bag samplers).
- Automatic pumping samplers are needed for specific situations; for example, time-dependent regulatory monitoring, sampling at remote sites, or sampling of floods or urban runoff when discharge is rapidly changing and a large number of samples are needed from several locations within a relatively short time.
- Periods of extreme cold cause the nozzle or air-exhaust vent to freeze, rendering isokinetic, depth-integrating samplers inoperable.
- Study objectives dictate use of nonisokinetic sampling methods.

Three nonisokinetic sampling methods most commonly used are the dip (weighted-bottle), discrete, and pump methods. Ward and Harr (1990) and Edwards and Glysson (1999) provide detailed information on these sampling methods. General instructions are provided below.



- ▶ **Dip sampling method.** Dip sampling involves either (1) dipping a narrow-mouthed bottle into a water body, or (2) using either the DH-81 or D-95 sampler as described below. To use a DH-81 or D-95 sampler in a stream with velocity less than 1.5 ft/s, remove the nozzle from the sampler and proceed to sample the entire vertical. This is especially useful at a deep-water site. When sampling with a hand-held bottle, stand downstream of the bottle while it is being filled. Dip sampling is not recommended for discharge-weighted sampling when it is possible to obtain a depth-integrated, isokinetic sample. **The error introduced by dip sampling can be substantial if the target analytes are sorbed onto suspended materials that are not uniformly distributed along the cross section.** Care must be taken to avoid collecting particulates that are resuspended as the result of wading or bumping the sampler on the streambed.
  - To collect a dip sample in water that is too shallow to submerge an isokinetic, depth-integrating sampler, wade to where the sample(s) will be collected and immerse a hand-held, narrow-mouth bottle at the centroid of flow or at multiple locations along a cross section.
  - To collect a dip sample where water is too deep to wade and velocity is too great for use of an isokinetic sampler: lower a weighted-bottle sampler at the centroid of flow or at multiple locations along a cross section.
  - Collecting samples for biochemical oxygen demand (BOD) and volatile organic compounds (VOCs) are special cases of dip sampling that require special equipment. Instructions for BOD sampling can be found in NFM 7.0. **Instructions for VOC sampling are described at the end of this section 4.1.3.B under "Instructions for collecting VOC samples at flowing-water sites."**
- ▶ **Discrete sampling method.** Discrete (point) sampling involves either (1) lowering a sampler to a specified depth and collecting a sample by first opening, then closing the sampler, or (2) using a single-stage sampler, which fills when stream stage rises to a predetermined height.
  - Thief-type samplers are the most common point samplers used for collecting water-quality samples (NFM 2.1.1.B). Although these samplers are designed primarily to sample still waters, they can be adapted for slow-flowing water by attaching them to a weighted line. Samples can be collected at the centroid of flow or at multiple verticals and at selected depths along the cross section.

- Isokinetic point samplers (for example, the P-61 and P-63 described in Edwards and Glysson, 1999) are available for collecting samples for suspended-sediment concentration and particle-size determination, and for selected chemical constituents. **The P-61 and P-63 samplers are not suitable for collecting samples for organic-compound or trace inorganic-constituent analyses.**
- Single-stage samplers, such as the U-59 (NFM 2.1.1.B) and U-73 are useful for collecting samples for analysis of sediment and selected chemical constituents at stations located on streams or other locations susceptible to flash floods or where it is otherwise difficult to reach a station to manually collect samples (Edwards and Glysson, 1999). Before single-stage samplers can be installed, some knowledge of the seasonal stage characteristics of the stream is needed so that an appropriate sequence of samples can be obtained for a given storm season. The stream-stage and flow-velocity characteristics not only affect the design with respect to the vertical spacing of the samplers but also the support necessary for the samplers (Inter-Agency Committee on Water Resources, Subcommittee on Sedimentation, 1961, "The Single Stage Sampler for Suspended Sediment," St. Anthony Falls Hydraulic Laboratory Report 13). These samplers have not been certified as appropriate for collection of uncontaminated trace-element or trace-organic samples.
- ▶ **Pump-sampling method.** Pump sampling involves either suction-lift or submersible pump systems designed to collect water-quality samples (NFM 2.1.1.B). Pump systems can be portable or can be permanently installed and automated for sampling (see TECHNICAL NOTE below).
  - Pump samplers generally are not used to collect isokinetic samples because of the difficulty in controlling the sample velocity through the sampler intake relative to the flow rate and direction of suspended particulates in the stream.
  - Portable-pump samplers generally are used to collect a point sample by lowering the pump to a selected depth. A suction pump, such as a peristaltic pump, has a maximum lift of 30 ft or less. Refer to the manufacturer's instructions for the lift capacities of other types of pump samplers.
  - A portable pump also can be used to collect a nonisokinetic, depth-integrated sample by continuous pumping at a constant rate as the intake is being lowered through the vertical.

Collection of useful data, especially with the use of automated pumping samplers, requires intensive planning and quality assurance, including careful site selection, selection of the type and construction material of the sampler, a review of historical hydrologic information, and collection of an adequate number and types of quality-control samples. The physical, chemical, and biological characteristics of the cross section, study objectives, and pump limitations must be considered when determining how and where to collect samples.

**TECHNICAL NOTE:** The selection, deployment, use, and maintenance of automated samplers (auto samplers), such as those manufactured by ISCO, require training and detailed instructions that have not been incorporated into this manual; follow the manufacturer's instructions. Some tips for collecting autosampler samples appear in the steps below.

### *Steps for nonisokinetic sampling methods*

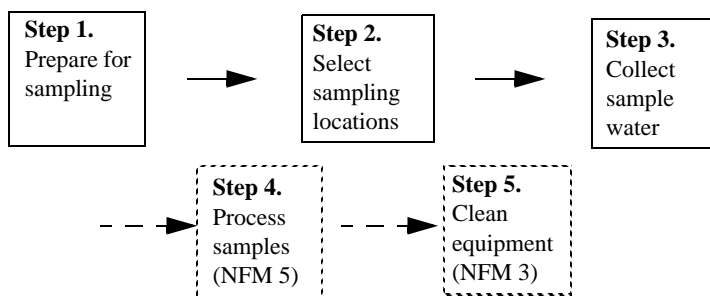

Be sure that the field effort is adequately staffed and equipped. Check QC requirements before departing—QC samples require additional equipment and supplies.

### **Step 1. Prepare for sampling for inorganic and organic analytes.<sup>9</sup>**

- a. Upon arrival at the field site, set out safety equipment such as traffic cones and signs. Park vehicle in a location and direction so as to prevent sample contamination from vehicle emissions.

<sup>9</sup>Preparations for water sampling are described in NFM 2 and 3. Consult NFM 5 for sample processing, NFM 6 for field measurements, NFM 7 for biological indicators, NFM 8 for bottom-material sampling, and NFM 9 for field safety.

- b. Assemble equipment and set up a clean work space.
  - **Organic compounds.** Select equipment with fluorocarbon polymer, glass, or metal components if components will directly contact samples to be analyzed for organic compounds. **Do not use plastics unless they are fluorocarbon polymers.**
  - **Inorganic constituents.** Select equipment with components made of fluorocarbon polymer or other relatively inert and uncolored plastics or glass if components will directly contact samples to be analyzed for inorganic constituents. **Do not use metal or rubber components for trace-element sampling.**
  - Collect samples to be analyzed for sediment concentration and (or) particle-size distribution using a separate set of clean sample bottles. Sediment samples generally are not field composited.
  - Collect samples for microbiological analyses using equipment and techniques described in NFM 7.
  - Calibrate field instruments as described in NFM 6.

## Step 2. Select sampling locations.

Review data objectives to ensure they will be met at the sampling location(s) selected. If discharge-weighted samples are needed and the stream section is well mixed with respect to target analytes, locate multiple sampling points along the cross section using the EDI method.

- a. Measure discharge at the cross section where samples will be collected.
- b. At sites with very little sampling history, measure the variation within each field measurement (specific electrical conductance, pH, temperature, and dissolved oxygen) along the cross section and review these data.
- c. Locate the centroid of flow if distribution of streamflow and the field-measurement data indicate that the section is well mixed (refer to the description of the VCF sampling method at the end of this section (4.1.3.A)).

### Step 3. Collect sample water.

By applying EDI sampling methods and collecting equal-volume samples at the centroid of each equal-discharge increment, a sample can be collected that is discharge-weighted although it is not isokinetic. Using CH/DH techniques, as required (section 4.0.2):

- a. Move sampling and support equipment to the first sampling location. Field rinse equipment (section 4.1.3).
- b. Record starting gage height and sampling start time.
- c. To collect a nonisokinetic sample with a dip or pump sampler:
  - If a discrete sample is to be collected, lower the dip sampler to the desired depth, then sample.
  - If a vertical traverse is made to collect the sample, **do not pause when contact with the streambed occurs**, but raise the dip sampler immediately until the traverse is completed. Take care not to disturb the streambed with the sampler, as bed material entering the sampler results in erroneous data.
  - If a pump is used to collect a sample, lower the pump intake to the desired depth and pump about three sample-tubing volumes to field rinse sample tubing and then collect the sample.
- d. Move to the next vertical (if more than one vertical will be sampled along the cross section).
  - i. Record the time and repeat sample collection as described in step 3c above.
  - ii. Inspect each sample, looking for anomalously large amounts of particulates that might have been captured because of excessive streambed disturbance during sample collection. If such a condition is observed, discard the sample, making sure there are no residual particulates left in the container, and resample.
  - iii. Depending on data objectives, either composite the samples collected or set aside each sample to be independently processed and analyzed.
    - If pumped samples will be composited, pump the samples directly into the churn splitter.
    - If transferring the subsample to a churn or cone splitter, ensure that all particulates in the sampler are transferred with the sample by swirling the sample gently to keep particulates suspended and pouring the sample quickly into a sample splitter.

- e. After all the samples have been collected:
- Record sampling end time and gage height.
  - For automated samplers: record beginning and ending dates and times for the sampling period. Retrieve samples from automated pumping samplers at the earliest possible time to reduce the chance of chemical or biological alteration of the sample. (Automatic samplers with refrigeration are available to help maintain sample integrity.) Samples collected by automatic samplers often are combined as a composite sample.
  - Document all field observations and any deviations from standard sampling procedures.

**Step 4. Process samples** → Refer to NFM 5.

**Step 5. Clean equipment** → Refer to NFM 3.

- If the sampler will not be reused during a field trip, rinse the sampler components with deionized water before they dry and place them in a plastic bag for transport to the office laboratory to be cleaned.
- If the sampler will be reused during the field trip, rinse the components with DIW while still wet from sampling and then field-clean while at the sampling site using the prescribed procedures. Reassemble the sampler.
- Collect a field blank, if required, after sampling equipment has been cleaned at the sampling site.
- Place the cleaned sampler into a plastic bag and seal for transport to the next site.

***Instructions for collecting VOC samples at flowing-water sites:***

Samples for analysis of volatile organic compounds (VOCs) are collected as a single-vertical point sample in a flowing stream. The VOC sampler should be deployed where the stream velocity represents the average flow, which typically is near mid-channel in the cross section. When collecting samples for VOC analyses, special care must be taken to avoid contamination from any oily film and debris floating on the stream surface.

1. VOC samples are collected directly into laboratory-supplied prebaked 40-mL amber-glass vials. If the stream is deep enough, use the VOC sampler described in NFM 2.1.1.B (fig. 2-2). If the sampler will not be used, skip to step 7.
  - a. **Do not clean or field rinse the glass VOC vials – these are supplied by the laboratory ready to use.**
  - b. The VOC sampler must be cleaned after each use and field rinsed before use. **To field rinse the sampler, either submerge it in the stream for several minutes or dowse it three times with native water before inserting the VOC vials.**
2. Change gloves. In an area protected from any direct source of contamination (preferably within a sample-processing chamber), uncap four 40-mL unlabeled VOC vials and place them into the VOC sampler. Secure and lock the sampler top in position. Store the vial caps in a clean, protected area.
3. Lower the sampler into the stream near mid-channel to about one half of the total depth at that vertical. Add weights to the sampler if the stream velocity is great enough to pull the sampler downstream. Use weights made of steel or other noncontaminating material; do not use lead weights.
4. Hold the sampler in one position until the sampler is full. Air bubbles will rise to the surface while the sampler is being filled, but may be difficult to see. This takes about 3 to 4 minutes. The sample will be retained in the vials during the last 15 to 20 seconds of sampling.
5. Remove the sampler when bubbles are no longer present or after about 5 minutes, and return it to the sample-processing chamber or other protected area.
6. Open the sampler carefully. Using metal tongs, slowly lift each vial from the sampler reservoir. Do this carefully to avoid losing the convex meniscus on each vial.

**7. To collect a VOC sample without the sampler:**

Wearing gloves, submerge a capped VOC vial into the stream section; remove the cap underwater, let the vial fill to overflowing, and then firmly recap the vial underwater. Repeat this for each of the VOC vials. Check each vial for bubbles, as described in step 8.

8. Quickly cap the vial, then shake it. Invert, and check carefully for air bubbles. Discard the entire vial if bubbles are present. Three vials from the sampler set are required for one complete sample. Resample if two or more of the vials have air bubbles. If the sample is to be preserved with chemical treatment, refer to the procedure described in NFM 5.

9. Dry and label the sample vials. Place each vial into a foam sleeve, and store on ice for transport to the laboratory.

10. Clean the sampler and store it properly (see 4.0.2, "Preventing sample contamination").

---

### **4.1.3.C Guidelines for Sampling at Still-Water Sites**

In still water, samples generally are collected at multiple sites and at multiple depths. The number of sampling sites and the depths where samples will be collected should be dictated by study objectives and the physical, chemical, and biological characteristics of the water body (Ward and Harr, 1990).

Thief-type samplers usually are used to collect still-water samples; however, pumping samplers also can be used. A disadvantage of collecting a sample by pumping is that if a thin stratum of water is being sampled, water can move radially from unknown depths and distances into the pump.

- ▶ Samples must be collected at a known depth.
- ▶ Sample integrity must be maintained to the degree possible while samples are being brought to the surface for further processing.



### Steps for sampling at still-water sites

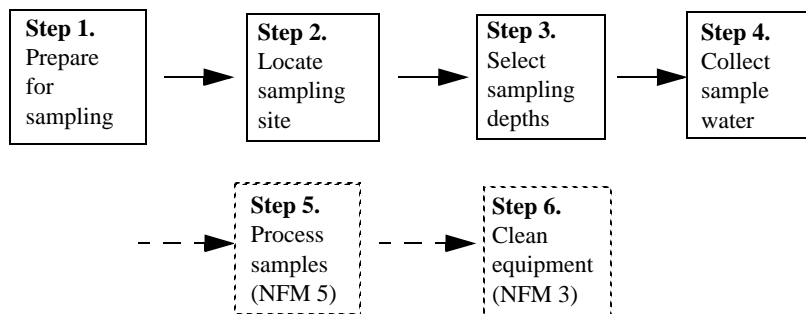

Be sure that the field effort is adequately staffed and equipped. Check QC requirements before departing—QC samples require additional equipment and supplies.

#### Step 1. Prepare for sampling of inorganic and organic analytes.<sup>10</sup>

- a. Upon arrival at the field site, set out safety equipment such as traffic cones and signs. Park vehicle so as to prevent sample contamination from emissions.
- b. Assemble equipment and set up a clean work space.
  - **Organic compounds.** Select equipment with fluorocarbon polymer, glass, or metal components if components will directly contact samples to be analyzed for organic compounds. **Do not use plastics other than fluorocarbon polymers.**
  - **Inorganic constituents.** Select equipment with components made of fluorocarbon polymer or other relatively inert and uncolored plastics or glass if components will directly contact samples to be analyzed for inorganic constituents. **Do not use metal or rubber components for trace-element sampling.**
  - **Microbiological analyses.** Collect microbiological samples using equipment and techniques described in NFM 7.

#### Step 2. Locate sampling site.

- a. Locate the first sampling point and maintain a sampling platform position at the site.
- b. Record depth to bottom.

<sup>10</sup>Preparations for water sampling are described in NFM 2 and 3. Consult NFM 5 for sample processing, NFM 6 for field measurements, NFM 7 for biological indicators, NFM 8 for bottom-material sampling, and NFM 9 for field safety.

### Step 3. Select sampling depths.

- a. Make field measurements (such as specific electrical conductance, pH, temperature, and dissolved oxygen) in situ to obtain a vertical profile of field-measurement variation.
- b. Measure light penetration (if applicable).
- c. Select and record sampling depth(s) based on study objectives and the variation in field measurements for the vertical.

### Step 4. Collect samples.

Field rinse sampling equipment first (section 4.1.3). Collect samples by using the procedures listed below under Step 4A for a thief-type sampler and under Step 4B for a pump sampler.

#### Step 4A. Thief-type sampler.

The instructions listed below are for samplers that operate with an open/close mechanism. If the sampler operates as a point-source bailer, follow steps a and c through g below. Pulling the bailer up will trigger the upper check valve to seal off the sample from the water overlying the targeted depth.

- a. Lower opened sampler to the desired depth while minimizing disturbance of the water column.
- b. Isolate the sample by activating the mechanism that closes the sampler.
- c. Raise the sampler from the water body.
- d. Dispense sample to sample bottle or compositing/splitting device using *CH/DH* techniques.
  - If using a bailer, drain sample through the bottom-emptying device.
  - If sample compositing and (or) splitting is required, ensure that all particulates in the sampler are transferred with the sample by swirling the sample gently to keep particulates suspended and pouring the sample quickly into the churn or cone splitter.
- e. Repeat steps a through d if more sample is needed from the same depth for that vertical section.

- f. Repeat steps a through e for each depth to be sampled in that vertical section. If a second sample from a different depth or vertical section will be composited, either (1) clean and field rinse the splitter after processing the first sample and before collecting the second sample, or (2) use another clean splitter.
- g. Move to the next site if another vertical section will be sampled. Repeat steps a through f.

**Step 4B. Pump sampler.**

- a. Lower the pump or pump-sample tubing (attached to a weighted line) to the desired sampling depth.
- b. Turn on the pump and pump about three sample-tubing volumes to field rinse the pump, tubing, and other sample-collection or -processing equipment. Discard rinse water.
- c. Direct sample flow into collection container(s) until sufficient sample volume has been collected.
- d. Repeat Step 4B, steps a through c, if another depth and (or) vertical section is to be sampled. If a second sample from a different depth or vertical section will be composited, either (1) clean and field rinse the splitter after processing the first sample and before collecting the second sample, or (2) use another clean splitter.

**Step 5. Process samples** → Refer to NFM 5.

**Step 6. Clean equipment** → Refer to NFM 3.

- If the sampler will not be reused during a field trip, rinse the sampler components with deionized water (DIW) before they dry and place them in a plastic bag for transporting back to the office laboratory to be cleaned.
- If the sampler will be reused during the field trip, rinse the components with DIW while still wet from sampling and then field-clean while at the sampling site using the prescribed procedures. Reassemble the sampler.
- Collect a field blank, if required, after sampling equipment has been cleaned at the sampling site.
- Place the cleaned sampler into a plastic bag and seal for transport to the next site.

*Page left blank intentionally.*

---

## GROUND-WATER SAMPLING 4.2

Collecting samples of ground water that accurately represent aquifer conditions requires sampling at appropriate wells and using equipment and methods that maintain the integrity of the sample with respect to the physical, chemical, and biological characteristics of interest. This section provides guidance and protocols for (a) site reconnaissance and establishing site files, (b) avoiding collection of bad data, and (c) ground-water withdrawal up to the point of bottling or processing the sample. USGS procedures for collecting raw or filtered ground-water samples into bottles, sample preservation, and other sample-processing and handling activities are addressed in Chapter A5 (NFM 5), “Processing of Water Samples.” Because ground-water sample collection is a continuous process, the information in this chapter overlaps somewhat with that of NFM 5.

For USGS studies, ground-water samples typically are collected either at monitor wells or at public or domestic water-supply wells.<sup>11</sup>

- ▶ **Monitor wells** are observation wells<sup>12</sup> that are installed principally for the collection of water samples to assess the physical, chemical, and biological characteristics of formation (aquifer) water. Samples from monitor wells are collected either with portable, low-capacity pumps or with other types of sampling devices designed for water-quality work. Sampling devices can be dedicated for use at a given well or can be installed in the well for the duration of the monitoring effort. (The terms “monitor well” and “monitoring well” are used interchangeably in this field manual.)

---

<sup>11</sup>Ground-water samples collected using passive or natural-gradient methods or direct-push or cone penetrometer systems are not addressed in this chapter.

<sup>12</sup>Observation wells are wells or piezometers that are installed (usually without a dedicated pump) for the purpose of collecting hydrologic data. The term generally has been applied to wells installed to observe and determine hydrologic characteristics of an aquifer (Lapham and others, 1997).

- ▶ **Water-supply wells** are wells that are installed primarily for supply of public, domestic, irrigation, commercial, or industrial water and usually are equipped with a dedicated high-capacity pump. Pumps installed in supply wells generally deliver a large volume of water that is subsampled for water quality. (Although the guidance in this manual focuses on sampling at public or domestic supply wells, similar principles and procedures apply when sampling at irrigation, commercial, or industrial wells, with the caveat that additional safety precautions need to be identified and implemented and equipment requirements reviewed.) Note that supply-well construction materials and methods and the pumps installed can have long-lasting effects on the chemistry of water entering the well from the aquifer (Lapham and others, 1997).

---

## 4.2.1 SITE INVENTORY AND SITE FILES

Information about the well and field site is compiled in the office and during site-reconnaissance visits. The information compiled is used by study personnel to help determine site suitability for conducting sampling activities. Site files are then established in the USGS National Water Information System (NWIS) electronic data base<sup>13</sup> and the information compiled is entered into NWIS and is used to create a file for use in the field.

---

<sup>13</sup>NWIS is the public portal to USGS water resources data (Hubbard, 1992; USGS Water Resources policy memorandum 92.59). NWISWeb displays real-time water-level data (<http://waterdata.usgs.gov/nwis/gw>), and real-time water-quality data for selected wells (<http://waterdata.usgs.gov/nwis/qw>) (website accessed June 2, 2006).

**Site inventory** – In an office inventory, the study team identifies existing wells or candidate sites at which to install wells, examines well-construction records, and compiles additional background information and site or well records. The field evaluation, or site reconnaissance, is used to verify well location, select or reject candidate well(s), determine the suitability of the site to meet study objectives, and become aware of equipment or other requirements needed to address specific site conditions (table 4-6). Site-reconnaissance visits also are used to identify areas of ground-water recharge and discharge; test field equipment; test well-purging and sampling procedures; conduct aquifer tests; make preliminary field measurements (see NFM 6); and identify the presence of target analytes, sources of contamination, and potential matrix interferences.

#### **When conducting site inventories:**

- ▶ Be familiar with study objectives and requirements for data collection and quality.
- ▶ Be familiar with the considerations for well selection and (or) installation (table 4-6).
- ▶ Be alert to changes over time that might affect the suitability of the well to meet study needs.
- ▶ Keep in mind the primary criteria for all water-quality studies:
  - The sample must represent the system, in time and space, intended for study.
  - Sample integrity must be maintained.

**Review safety plans and procedures  
before leaving for the field (NFM 9).**

**Table 4-6.** Example of ground-water site-inventory activities

<b>Before the site visit</b>
Review considerations for well selection and installation (section 4.2.2; Lapham and others, 1997).
Review background information collected.
Obtain permission to gain access to the site and to collect samples from the well.
Update well files: record changes in ownership and land use.
Contact utility companies (gas, water, and electric) before digging or drilling.
Determine whether the pump may or may not be removed from the well by field personnel (removal is not recommended, as personal safety could be compromised). The owner's permission is required to remove a pump—you could be liable for damage to pump or well.
Be sure that you get information needed about the site that could interfere with or interrupt sampling. For example, <ul style="list-style-type: none"> <li>• Hours of pump operation and scheduled downtime.</li> <li>• Pumping rate or rates.</li> <li>• Holding tanks or chemical treatments.</li> <li>• Electrical service to the site.</li> <li>• Scheduled maintenance for pumps or related equipment.</li> <li>• Scheduled site maintenance, such as painting, construction, and defoliation.</li> <li>• Seasonal water-level declines that make the well unusable.</li> <li>• Times of denied access; for example, no access while the owner is out of town.</li> <li>• Special site-access needs; for example, clearance with a site owner or site operator, keys to unlock access to the site, animals.</li> <li>• Restrictions on the location.</li> </ul>
<b>Before and during the site visit</b>
Record conditions that could compromise study objectives, including potential point or non-point sources of contamination. For example, <ul style="list-style-type: none"> <li>• Nearby wells that could affect well hydraulics.</li> <li>• Condition of well—for example, rusting or punctured casing, poor surface seal.</li> <li>• Has the well been adequately developed? Could well-development artifacts compromise sample integrity?</li> <li>• Land use and land cover or changes in land use and land cover.</li> <li>• Application of salt on nearby roads during winter, or application or use of herbicides and pesticides.</li> <li>• Landfills or other waste-management facilities.</li> <li>• Industrial, commercial, and agricultural complexes and discharges.</li> </ul>
<b>During the site visit</b>
Measure water level in each well. Record water-level measurements on the appropriate field form(s), and into the Ground-Water Site Inventory (GWSI) and Quality of Water Data (QWDATA) data bases.
Identify potential difficulties with the type of equipment and sample-collection methodology to be used. (Note that sampling plans will have to be modified accordingly.)
Update field folders. <ul style="list-style-type: none"> <li>• Note site conditions that could affect the quality of data collected from that well.</li> <li>• Note change(s) in land use.</li> </ul>
Verify well identification number and make sure that it is clearly and permanently labeled. <ul style="list-style-type: none"> <li>• Check that identification corresponds with what is in the field folder and on site and location maps.</li> <li>• Correct any mistakes or uncertainty about well identification and well location.</li> </ul>



**Table 4-6.** Example of ground-water site-inventory activities—*Continued*

<b>During the site visit—<i>Continued</i></b>
<p>Verify type of pump, well diameter, and use of holding tanks, pressure tanks, chemical treatments.</p> <ul style="list-style-type: none"> <li>• Check whether oil is floating on the water column in a well equipped with an oil-lubricated pump.</li> <li>• Make sure that the downhole treatment system is turned off before collecting water samples.</li> <li>• Determine if the intended sampling device is suitable for use.</li> </ul>
<p>Establish optimum pumping rate(s) for purging and sample collection and decide where to route excess discharge.</p> <ul style="list-style-type: none"> <li>• Adjust pumping rate to ensure adequate purging of the well without entrainment of atmospheric gases due to excessive drawdown.</li> <li>• Route water away from the well to prevent (1) creating muddy and slippery conditions and (2) damage to or defacement of the property to which you were granted access.</li> </ul>
<p>Check that well structure is intact.</p> <ul style="list-style-type: none"> <li>• Wells used for ground-water studies should be "sounded" annually to check whether depth to bottom corresponds with well-construction information or whether the well is filling with loose materials (U.S. Geological Survey, 1980; Lapham and others, 1997). A decrease in depth to bottom could indicate that the well casing is collapsing, or that there is a breach or corrosion of well screen or casing, or that the well is improperly designed to retain aquifer materials.</li> <li>• Borehole caliper and downhole-camera video logs can identify a damaged or broken well casing. A downhole camera can identify a plugged screen or accumulation of sediment in the well.</li> <li>• Aquifer tests, such as slug tests, can be used to check the hydraulic connection between the well and the aquifer. Aquifer tests, however, are generally beyond the scope of site reconnaissance.</li> <li>• The surface seal of a USGS monitoring well should be intact and the well should be capped. Concrete pad should be repaired if cracked or separated from outer casing. A tight-fitting well cap should have a small ventilation hole.</li> </ul>
<p>Check well access for sample-collection points.</p> <ul style="list-style-type: none"> <li>• Sample-collection points need to be near the wellhead, ahead of where water enters pressure tanks, holding tanks, or treatment systems.</li> <li>• At wells where an access point close to the well is not available, it might be possible to install a hose bibb or tap at the wellhead. Because it usually is not possible to control the pumping rate of a supply well, the field person may need to set up a hose-and-valve system to control the rate at which water is sampled and to reduce the likelihood of backflow of water stored in plumbing lines.</li> </ul>
<p>Check well access for water-level measurements. The construction of some supply wells makes water-level measurements difficult or impossible.</p> <ul style="list-style-type: none"> <li>• Although it is often possible to slip a weighted steel or electric well tape below the pump to get a water-level measurement, the pump can be damaged if the weight or tape becomes entangled in the pump. The weight should be attached so that it will snap off of the tape under stress.</li> <li>• Water levels can be estimated through the air line on some wells.</li> <li>• Sometimes field personnel are permitted to remove the pump from the well to get a measurement; however, pump removal can be difficult and time consuming, is potentially unsafe, and could damage the pump.</li> <li>• A note should be made in the well file if there is no access for a depth measurement.</li> </ul>

**NWIS files** – USGS policy requires that specific information collected for each ground-water sampling site and event will be stored in one or more sub-systems of NWIS (USGS Office of Water Quality (OWQ)/Office of Ground Water (OGW) Technical Memorandum 2006.01). In addition, paper documents (such as agreements between the well owner and the USGS for well use, access, or construction), field forms and logs, and any ancillary information that is collected are stored in well files and field folders (USGS Office of Ground Water Technical Memorandum 2003.03). Much of the information needed to set up files for existing wells can be obtained from well owners, drillers, records from state or local jurisdictions, and well-construction logs. Information needed to set up well files for new wells is compiled by field personnel as part of their responsibilities associated with well installation (Lapham and others, 1997).

- ▶ **NWIS** – Within the NWIS system, well information, ground-water levels, and water-quality data are stored in three subsystems: the Ground-Water Site Inventory (GWSI), Quality of Water Data (QWDATA), and the Automatic Data Processing System (ADAPS). Individual studies and USGS Water Science Center offices may have additional data-storage requirements.
  - GWSI primarily contains (1) descriptive information about the site and well, (2) construction information, and (3) noncontinuous water-level data. A GWSI site file (table 4-7) must be established for each well at which water-level and other data are collected (table 4-7) (Hoopes, 2004; USGS OWQ/OGW Technical Memorandum 2006.01). When creating or updating a GWSI site-file record, field personnel should fill in as much information as is available in addition to the required information. For example, the GUNIT (geologic unit) code provides important information for interpretation of ground-water data.
  - QWDATA contains (1) results of field and laboratory water-quality sample analyses and measurements, (2) non-continuous water-level data, and (3) other data related to water-quality samples or sample analyses (Gellenbeck, 2005). A subset of the information entered into GWSI is entered into QWDATA, as appropriate to meet the needs of the study (USGS OWQ/OGW Technical Memorandum 2006.01).
  - ADAPS contains continuous records of water levels and water quality (Bartholoma, 2003).

- ▶ **Field Folder** – The field folder contains information that is necessary or useful to have onsite during the field effort, and includes a well file for the well at which data will be collected (fig. 4-7).
  - A well file is established for each well selected or installed for the study. The well file is the repository of the information compiled for the well, and it should contain documentation for site selection, well inventory, well installation, and sample collection.
  - The field folder (fig. 4-8) is taken along on each site visit and includes site-location maps and a site sketch (fig. 4-9). Files taken to the field should not contain original data records.

*To prepare location maps and site sketches:*

1. Locate the ground-water site in the field on an aerial photograph, or a town plat/lot number map. Transfer the location of the site to a USGS 7.5 minute topographic quadrangle map.
2. Determine the ground-water site latitude and longitude to the nearest second using a USGS 7.5 minute latitude-longitude scale or a digitizer or Global Positioning System (GPS), and record the latitude and longitude accuracy as one second.
3. Prepare a detailed sketch map. Orient the ground-water site on the sketch map relative to north using a compass. The sketch map should contain enough detail so that the site can be found again by a person who has never visited it. All distances should be made in feet from permanent landmarks, such as buildings, bridges, culverts, road centerline, and road intersection.

---



---

 **RULE OF THUMB:**

- **Before starting field work make sure the site file is established in NWIS.**
  - **Keep field files current.**
  - **After field work, update NWIS promptly.**
- 
-

**Table 4-7.** Minimum information required for electronic storage of site and ground-water-quality data in the U.S. Geological Survey National Water Information System

[NWIS, National Water Information System; GWSI, Ground-Water Site Inventory; USGS, U.S. Geological Survey; QWDATA, Quality of Water Data]

<b>Required information for creation of a ground-water site in NWIS<sup>1,2</sup> (GWSI)</b>		
<b>Data description</b>	<b>Component (C) number for data entry into GWSI</b>	<b>Example (Description of code)</b>
Agency code	C4	USGS
Station Identification Number (Latitude/longitude/sequence no.)	C1	394224075340501
Station Name	C12	KE Be 61
Latitude	C9	394224
Longitude	C10	0753405
Country	C41	US
Lat/Long Accuracy	C11	S (seconds)
Lat/Long Method	C35	M (Map)
Lat/Long Datum	C36	NAD83
Time Zone	C813	EST
Daylight Savings Time Flag	C814	Y (Yes)
USGS Water Science Center/User	C6	24 (Maryland)
State	C7	10 (Delaware)
County	C8	003 (Sussex)
Station Type	C802	6 (Well)
Data Reliability	C3	C (Field Checked)
Site Type	C2	W (Well)
Use of site	C23	O (Observation)
<b>Required information for storage of sample analyses in the water-quality subsystem (QWDATA)<sup>1</sup></b>		
<b>Data description</b>	<b>Alpha parameter code</b>	<b>Sample data (Description of code)</b>
Agency code	AGNCY	USGS
Station Identification Number	STAID	394224075340501
Sample Medium	MEDIM	6 (ground water)
Sample Type	STYPE	2 (blank sample)
Hydrologic (“Hydro”) Event	EVENT	9 (routine sample)
Hydrologic (“Hydro”) Condition	HSTAT	A (not determined)
Date (year/month/day)	DATES	20060909
Time (standard 24-hour clock time)	TIMES	1530 hrs
Analysis Status	ASTAT	H (initial entry)
Analysis Source	ASRCE	9 (USGS laboratory and field)

<sup>1</sup>Numerous additional data fields are available in GWSI and QWDATA that can be useful for data analysis or mandatory for meeting study objectives; for example, indicating whether an agency other than the U.S. Geological Survey collected the data.

<sup>2</sup>From GWSI Schedule Form 9-1904-A, revised June 2004, NWIS 4.4.

**WELL-FILE CHECKLIST, Page 1 of 2**

Project name and identification number: \_\_\_\_\_

Latitude-longitude: \_\_\_\_\_ Sequence number: \_\_\_\_\_

Other site or well ID: \_\_\_\_\_ Station name: \_\_\_\_\_

Indicate use of water/site:    Public Supply                      Irrigation  
    Domestic                                      Observation  
    Commercial                                      Monitoring  
    Industrial    Other \_\_\_\_\_

<u>Item in well file</u>	<u>Date item filed</u>
--------------------------	------------------------

Criteria for well selection or installation	_____
---	-------

Station Analysis	_____
------------------	-------

Station Description	_____
---------------------	-------

ADR (Automatic Data Recorder) Manuscript	_____
--	-------

Ground-Water Site Inventory (GWSI) data entered into	_____
--	-------

National Water Information System (NWIS)	_____
--	-------

Paper copy of GWSI form (9-1904-A)	_____
------------------------------------	-------

Copies of agreement to complete activity (drilling, sampling, etc.) _____	_____
--	-------

List agreements _____	_____
-----------------------	-------

Copies of field forms and logs:

Well-drilling record	_____
----------------------	-------

Driller's log	_____
---------------	-------

Lithologic log: Cuttings	_____
Cores	_____

Aquifer tests: (list types) _____	_____
-----------------------------------	-------

_____	_____
-------	-------

Geophysical logs: (list types) _____	_____
--------------------------------------	-------

_____	_____
-------	-------

Well-construction record	_____
--------------------------	-------

Well-development record	_____
-------------------------	-------

Well-maintenance checks: (list types) _____	_____
---	-------

_____	_____
-------	-------

Well-location information:

Latitude-longitude, datum, method of determination, and any changes	_____
---	-------

Well-location map(s)	_____
----------------------	-------

Site-sketch map	_____
-----------------	-------

Written description of location	_____
---------------------------------	-------

Well-casing elevation (elevation, and method and date of determination)	_____
--	-------

Photographs of well and vicinity (with measuring/sampling points identified)	_____
---	-------

Land use/land cover form (Lapham and others, 1997)	_____
--	-------

**Figure 4-7.** Example of a checklist for a well file.

<b>WELL-FILE CHECKLIST, Page 2 of 2</b>	
<u>Item in well file</u>	<u>Date item filed</u>
Water-quality records for each sampling event (for example, purging, field measurements, field forms, sampling history) and copies of laboratory analyses requested	_____ _____ _____ _____ _____
Water-level measurements - current:	_____ _____ _____
Water-level measurements - historical:	_____ _____ _____
Record of well leveling (survey)	_____
Datum corrections	_____
Pumping schedule/history	_____
Type of pump in well and location of intake	_____
Description of measuring point for water levels: _____ _____ _____	
Description of collection point for samples from Supply wells _____ _____ Monitoring wells _____	
Other information (for example, geologic unit, aquifer name): _____ _____ _____ _____	

**Figure 4-7.** Example of a checklist for a well file—*Continued.*

<b>Field-folder checklist: ground-water quality</b>		
<b>✓</b>	<b>Item</b>	<b>Comments</b>
	Forms (new forms and (or) examples of completed forms): <ul style="list-style-type: none"> <li>• Permission forms—must be signed by proper authority.</li> <li>• Analytical Services Request form(s).</li> <li>• Ground-water field form and well-inventory form.</li> </ul>	
	Equipment and supplies checklists.	
	Field-techniques manuals.	
	Safety information: <ul style="list-style-type: none"> <li>• Nearest emergency facilities; home phone number of supervisor.</li> <li>• Diagram of where to park, placement of flags and cones.</li> <li>• Traffic conditions; location of power lines.</li> <li>• Environmental hazards such as weather and animals.</li> </ul>	
	Site location and description: <ul style="list-style-type: none"> <li>• Maps showing location and identification number of well(s).</li> <li>• Name of landowner, tenant, or other responsible party.</li> <li>• Site access instructions (call owner; get keys or tools needed for security gate, well house, well protective casing).</li> <li>• Photographs and land use/land cover form to document site conditions.</li> <li>• Well dimensions and construction logs.</li> </ul>	
	Sampling schedule and instructions: <ul style="list-style-type: none"> <li>• Laboratory analyses, codes, and bottle types.</li> <li>• Preservation requirements, including chilled samples.</li> <li>• Quality-control samples.</li> <li>• Location of sampler intake during sample collection.</li> <li>• Pumping rate for purging and sampling.</li> </ul>	
	Purging instructions: <ul style="list-style-type: none"> <li>• Number of well volumes.</li> <li>• Rate of pumping; containment and discharge of purge water.</li> <li>• Location of sampler intake during purging.</li> <li>• Field measurements and stability protocols.</li> <li>• Previous field-measurement and purge-volume records.</li> <li>• Discharge of purge water.</li> </ul>	
	Water-level measurements: <ul style="list-style-type: none"> <li>• Location of measuring point.</li> <li>• Previous records from well.</li> </ul>	
	Ancillary information: <ul style="list-style-type: none"> <li>• Geologic section(s).</li> <li>• Hydrologic section(s).</li> <li>• Borehole geophysical logs.</li> </ul>	
	Shipping instructions: <ul style="list-style-type: none"> <li>• Mailing labels; location of nearest post office or shipping agent.</li> <li>• Ice and holding time requirements.</li> </ul>	

**Figure 4-8.** Checklist for contents of a field folder for ground-water sampling.

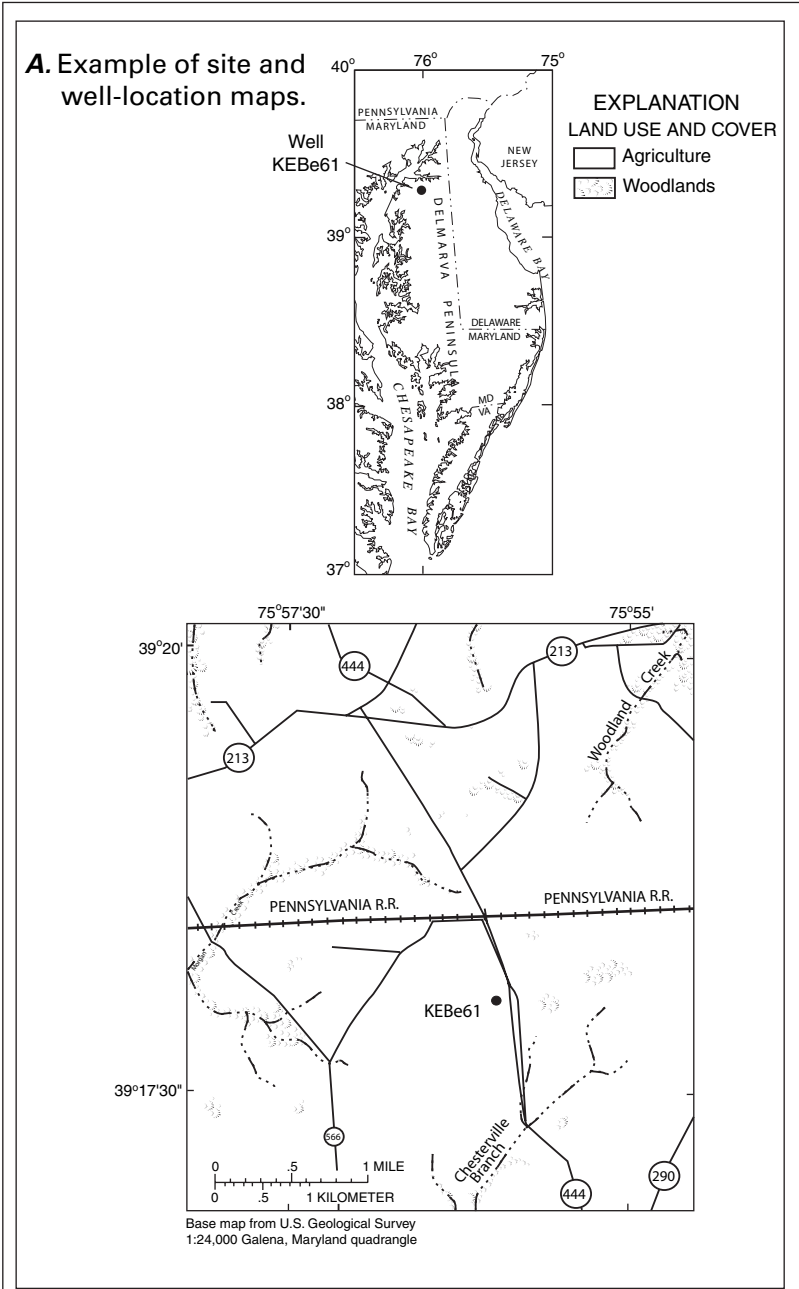

**Figure 4-9.** Example of (A) site- and well-location maps and (B) well-site sketch.

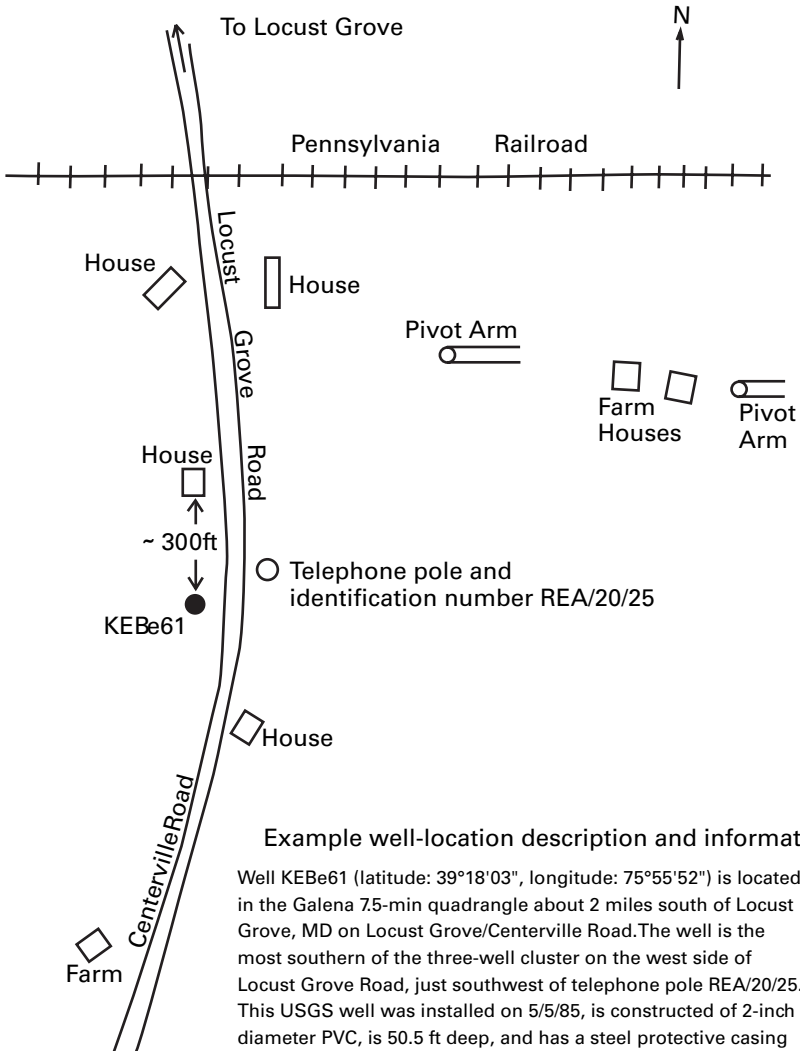

**B. Example of well-site sketch (with well-site information).****Example well-location description and information:**

Well KEB61 (latitude: 39°18'03", longitude: 75°55'52") is located in the Galena 7.5-min quadrangle about 2 miles south of Locust Grove, MD on Locust Grove/Centerville Road. The well is the most southern of the three-well cluster on the west side of Locust Grove Road, just southwest of telephone pole REA/20/25. This USGS well was installed on 5/5/85, is constructed of 2-inch diameter PVC, is 50.5 ft deep, and has a steel protective casing with a USGS lock. Contact property owner at ( )\_ \_-\_\_ one day before sampling.

**Figure 4-9.** Example of (A) site- and well-location maps and (B) well-site sketch—*Continued*.

---

## 4.2.2 CONSIDERATIONS FOR COLLECTING REPRESENTATIVE SAMPLES AT WELLS

The study team must ensure that the wells to be sampled will yield samples that accurately represent the water chemistry of the hydrogeologic system targeted for study. To help prevent data biases that could compromise study objectives, field personnel must be aware of how specific well characteristics and field activities can affect sample chemistry. These considerations are addressed as follows:

- ▶ Table 4-8 summarizes factors that can compromise sample integrity and general strategies for maintaining the integrity of ground-water samples. Table 4-9 lists considerations for selection or installation of wells at which water-quality will be monitored that relate to the quality or representativeness of the samples to be collected.
- ▶ Section 4.2.2.A discusses adverse effects on sample chemistry from introducing air and other fluids into the borehole during well construction, and the importance of monitoring the communication of the well with the aquifer for signs of deterioration.
- ▶ Section 4.2.2.B describes the effect of pumping rates, well yield, and aquifer heterogeneity and anisotropy on the sampling effort and how these factors can limit the types of sample analyses to be performed.
- ▶ Section 4.2.2.C focuses on the vulnerability of ground-water samples to contamination from atmospheric gases, standing fluids and bottom detritus in the borehole, and equipment use.

Some wells might not be suitable for water-quality monitoring. The ultimate decision as to when and if a well should be sampled rests with the study or program personnel and depends on the specific sampling and data-quality requirements of the study. Field personnel need to be alert to the conditions that might cause a change in the suitability of the well over time, whether because of well characteristics, land-use conditions, or other factors. **In general, avoid sampling:**

- ▶ Wells that cannot produce a continuously pumped sample or wells at which water-level recovery takes longer than 24 hours after being pumped.
- ▶ Wells at which purging will stir up bottom detritus that can bias analytical results. This often is the case in wells having 5 ft or less of water. Any reported interpretations of chemical analyses when sampling under such conditions must be clearly qualified and the well conditions documented.
- ▶ Wells at which field measurements have not met stabilization criteria (section 4.2.3), unless the study sampling and (or) quality-assurance plans provide for alternative protocols.
- ▶ Wells in which the water column within the sampling interval is in contact with and mixes with atmospheric gases, unless the analytes of concern will not be affected.
- ▶ Wells at which the water withdrawn must pass through holding tanks or chemical treatments.

**Table 4-8.** Considerations for maintaining the integrity of ground-water samples

<b>Factors that can compromise sample integrity</b>
<ul style="list-style-type: none"> <li>• <b>Time.</b> Chemical and microbial reactions that affect target-analyte concentration can be rapid.</li> <li>• <b>Loss of pressure.</b> Pressure in ground water can be much greater than atmospheric pressure. As the sample is brought to land surface, depressurization of the sample can cause changes in sample chemistry.</li> <li>• <b>Leaching or sorption.</b> Chemical substances can be leached from or sorbed by the equipment that contacts the sample.</li> <li>• <b>Exposure to the atmosphere.</b> Atmospheric gases and particulates that enter the sample can affect the water chemistry.</li> <li>• <b>Temperature.</b> Ground-water temperature is often lower than the atmospheric temperature at land surface. As the sample is brought to land surface, an increase in temperature can increase chemical reaction rates and microbial activity and cause degassing.</li> </ul>
<b>Strategies to maintain sample integrity</b>
<ul style="list-style-type: none"> <li>• <b>Plan sampling at sites in a sequence that avoids contamination.</b> Start with pristine sites or those least contaminated or with lowest concentrations of dissolved solids or target analytes. End at the site with the highest concentrations of target analytes.</li> <li>• <b>Clean equipment.</b> Sample only with decontaminated equipment and quality assure the efficacy of the cleaning procedures (collect equipment blanks).</li> <li>• <b>Purge the well of standing water.</b> Purge the well to reduce artifacts from well installation or sampler deployment. If possible, pump at a rate that does not overly stress the aquifer, creating drawdown and mobilizing particulates. Protocols for purging and pumping rate can depend on well type and study objectives.</li> <li>• <b>Isolate the sample.</b> For example, use packers downhole and processing and preservation chambers at land surface.</li> <li>• <b>Avoid temperature changes.</b> Keep sample tubing as short as possible and shaded from direct sunlight.</li> <li>• <b>Avoid sample aeration.</b> Filter in-line; use thick, nonpermeable sample tubing; completely fill filtration assemblies and sample tubing with sample; fill sample bottles from bottom up to overflowing whenever appropriate; handle anoxic water under an inert gas atmosphere, if necessary (section 4.2.2.C).</li> <li>• <b>Collect quality-control samples.</b> Review the analytical results and adjust field procedures, if necessary, before the next sampling.</li> </ul>

**Table 4-9.** Considerations for well selection and well installation

[Modified from Lapham and others, 1997]

<b>Well location</b>
<ul style="list-style-type: none"> <li>• Location conforms to the study's network design for areal and depth distribution.</li> <li>• Land-use/land-cover characteristics, if relevant, are consistent with study objectives.</li> <li>• Site is accessible for equipment needed for well installation and sample collection.</li> <li>• Well elevation has been determined.</li> </ul>
<b>Hydrogeologic unit(s)</b>
<ul style="list-style-type: none"> <li>• Hydrogeologic unit(s) that contribute water to the well can be identified.</li> <li>• Depth and thickness of targeted hydrogeologic unit(s) are known or can be determined.</li> <li>• Yield of water is adequate for sampling (typically, a minimum of 1 gallon (3.785 liters) per minute).</li> </ul>
<b>Well records, description, design, materials, and structure</b>
<ul style="list-style-type: none"> <li>• Available records (for example, logs of well drilling, completion, and development) have sufficient information to meet the criteria established by the study.</li> <li>• Borehole or casing/screen diameter is adequate for equipment.</li> <li>• Depth to top and bottom of sample-collection (open or screened) interval is known (to determine area contributing water to well); well depth and other well-construction and well-development information is available.</li> <li>• Length of well screen is proportional to the vertical and areal scale of investigation.</li> <li>• Well has only one screened or open interval, if possible. (Packers can be used to isolate the interval of interest, but packers might not completely isolate zones in unconsolidated or highly fractured aquifers. If packers are used, materials of construction must be compatible with analytes to be studied.)</li> <li>• Top of well screen is several feet below mean annual low-water table to reduce chances of well going dry and to avoid sampling from unsaturated intervals.</li> <li>• Filter pack is of a reasonable length (a long interval compared with length of screened or open interval usually results in uncertainty as to location of the source of water to well).</li> <li>• Well-construction materials do not leach or sorb substances that could alter ambient target-analyte concentrations.</li> <li>• Well-structure integrity and communication with the aquifer are sound. (Checks include annual depth-to-bottom measurements, borehole caliper and downhole-camera video logs, and aquifer tests.)</li> </ul>
<b>Pump type, materials, performance, and location of sampler intake</b>
<ul style="list-style-type: none"> <li>• Supply wells have water-lubricated turbine pumps rather than oil-lubricated turbine pumps. (Avoid suction-lift, jet, or gas-contact pumps, especially for analytes affected by pressure changes, exposure to oxygen, or that partition to a gas phase.)</li> <li>• Pump and riser-pipe materials do not affect target-analyte concentrations.</li> <li>• Effects of pumping rate on measurements and analyses have been or will be evaluated.</li> <li>• Sampler intake is ahead of where water enters treatment systems, pressure tanks, or holding tanks.</li> </ul>

---

## 4.2.2.A Well Construction and Structural Integrity

Lapham and others (1997) describe common well-drilling, well-completion, and well-development methods and the importance of checking the structural integrity of the well periodically. Study personnel should be aware of the effects that well installation and the potential failure of the well structure can have on the data being collected.

---

### Effects of well construction

Well-drilling, well-completion, and well-development methods can have long-range effects on sample chemistry (Lapham and others, 1997). Field personnel should review the well-construction methods and materials used, in addition to the length and diameter of the well screen and casing and how the well was completed.

- ▶ Circulation in the borehole of air and fluids such as water, bentonite, and biochemical slurries can infiltrate the aquifer, thereby altering water chemistry or biochemistry. For example, studies indicate that samples collected for chlorofluorocarbon (CFC) and sulfur hexafluoride ( $\text{SF}_6$ ) analyses at monitor wells drilled in fractured-rock aquifers using air-rotary methods can be biased for those analyses 12 months or longer after being drilled (L.N. Plummer, U.S. Geological Survey, written commun., 2006), although a three-well-volume purge protocol is used (section 4.2.3). Well development by air injection also is likely to bias CFC and  $\text{SF}_6$  analyses and produce faulty interpretations with respect to ground-water ages (Shapiro, 2002). High-capacity, high-yielding, or frequently pumped supply wells are less likely to be affected. Claassen (1982) discusses how mud-rotary drilling, grouting, and other well-construction practices also can have a relatively long-lasting effect on major-ion compositions and chemical properties of ground water, and provides methods by which to analyze these effects.
- ▶ Mixing of waters with different quality can occur in wells with long or multiple screens because of well-bore flow. On the other hand, wells with short screens relative to the total thickness of an aquifer might be screened at intervals that miss major zones of interest, such as zones with high transmissivity or contamination.

Selection of the appropriate well design depends on study objectives. For example, if samples withdrawn from an unconfined aquifer will be analyzed for volatile organic compounds, dissolved gases, or trace metals, the top of the screened or open interval should be located far enough below the lowest anticipated position of the water table (3 ft (~1 m) or more) so that the screened interval will not be intersected by the water table during drawdown. The purpose of this design is to avoid gaseous diffusion into the sample from a partially saturated or open interval. On the other hand, the well might be designed specifically to screen across the water table to better assess the thickness of oil or other light non-aqueous phase liquids (LNAPL) floating on the water surface.

---

## Deterioration of the well structure

The integrity of the well's construction can deteriorate or the well can "silt in" over time. The structural integrity of monitor wells and their hydraulic connection with the aquifer should be checked at least annually or as described below. Checking well integrity should be scheduled to occur during a nonsampling site visit, if possible. If the well integrity will be checked during a sampling field trip, do this only after completing sample collection to avoid stirring up particulates that could enter the sample and cause a bias in analysis of trace metals, polychlorobiphenyls (PCBs), or other analytes that tend to associate with particulate matter.

- ▶ Inspect the integrity of the surface casing and seal routinely when visiting the well.
- ▶ Inspect the subsurface casing (this can be done using a borehole televiewer).
- ▶ Note any changes in depth to the bottom of the well; this measurement should be made annually at wells with recurring water-level or water-quality data collection. In addition, the well should be tested for hydraulic connection to the aquifer every 3 to 5 years.
- ▶ Purge well water laden with particulates until turbidity values return to background or near-background levels; that is, the final turbidity value recorded after the well has been properly developed. Typically, the turbidity value measured at a properly constructed and developed well is about 10 turbidity units, although it is common for background turbidity in ground water to be 5 turbidity units (the threshold for visible turbidity). Turbidity values that cannot be improved to less than about 25 units after purging or well redevelopment can indicate failure of the well structure or that the well was improperly constructed. If possible, a different well should be selected or a new well installed.

## 4.2.2.B Well-Hydraulic and Aquifer Characteristics

Hydraulic characteristics of the well and the structural and material properties of the aquifer can impose specific constraints on the sampling effort and achieving results that can be interpreted within a defined measure of quality. These considerations affect the selection of the equipment and sampling methods to be used, and ultimately may result in determining that a well is unsuitable for the intended data-collection effort.

---

### Pumping rate

The pumping-rate capability of a given well-and-pump system is related to well capacity. Compared with pumping rates at supply wells, pumping rates at domestic wells are low. Advantages and disadvantages associated with low- and high-capacity wells are described in Lapham and others (1997). When reviewing study objectives, consider the effect of the proposed pumping rate on the aquifer with respect to what the water quality of the samples to be collected will represent.

- ▶ Pumping a few tens of gallons per minute can induce substantial leakage from confining beds if drawdown is rapid (formation materials are low-yielding). By contrast, pumping at a rate of thousands of gallons per minute from high-yielding materials is not likely to induce such leakage.
- ▶ Pumping at a high rate can cause turbulence and thus turbidity in the water column, resulting in biased data.
- ▶ Pumping at a low rate (for example, 1 to 4 gal/min, or 3.8 to about 15 L/min) in deep wells might result in the sample taking several hours to reach land surface. A long residence time of water within the sample tubing may compromise sample integrity.



- ▶ Be aware that pumping at any rate draws water preferentially from the most transmissive intervals, whether in fractured rock or unconsolidated media. Since the wellbore has a much higher hydraulic conductivity than the formation, the sample collected represents a flux-weighted average of the various inflow locations and the location of the pump intake does not affect this result (A.M. Shapiro, U.S. Geological Survey, written commun., 2006; Gibs and others, 2000; Reilly and LeBlanc, 1998; Gibs and others, 1993; Reilly and Gibs, 1993).
- ▶ The rate of pumping during purging should remain constant and be maintained as the pumping rate for sample withdrawal and collection. Fluctuations in pumping rate affect sample quality (Gibs and others, 2000).

---

## Low-yield wells

A yield of at least 1 gal (3.75 L) per minute without causing drawdown of about 2 ft or more below the top of the open or screened interval is recommended for adequate sampling at monitor wells with a diameter of 2 in. or greater (Lapham and others, 1997). Wells that yield less than 100 mL/min frequently incur substantial drawdown during well purging. **Low-yielding wells, especially those that exhibit slow recovery or are pumped dry, are not recommended for water-quality sampling.** Situations may occur, however, that necessitate use of such wells.

- ▶ Low yield may be a function of poor well construction. Try to improve the well yield by redeveloping the well. Mechanical surging methods commonly produce the best results and avoid introduction of contaminating fluids; however, such methods must be employed in a manner to avoid damage to the structure of the well (Lapham and others, 1997). Pumping or over-pumping methods usually are not as effective for increasing the well yield. It is advisable to consult with an experienced and reputable well driller
- ▶ When drawdown occurs across the open interval, contamination from atmospheric gases or other inputs can affect subsequent water chemistry; for example, VOC loss, contamination of ambient CFC and SF<sub>6</sub> concentrations, and increase in turbidity.

- ▶ Wells must be purged before sampling (see section 4.2.3). After purging, the water level in the well should recover to approximately 90 percent of its starting level before sampling should commence. In low-yield wells this can take several hours or longer, requiring potentially multi-day visits to complete a three-well-volume purge. The longer the recovery time, the lower the confidence that the sample to be collected can be considered representative of ambient aquifer water composition. The actual volume of well water purged needs to be documented if it is less than the standard three-volume protocol.

---

---

 **RULE OF THUMB:**

**Do not sample wells at which recovery of water level after purging to 90 percent exceeds 24 hours.**

---

---

- ▶ Consider whether packers can be used to seal off the interval to be sampled; in this case, only the isolated interval needs to be purged. This assumes that the interval selected is sufficiently transmissive to yield the volume needed of formation water.  
**CAUTION:** installing packers within a well screen can result in drawing in water from above or (and) below the packed-off interval through the filter pack in the annular space.
- ▶ Weigh several factors when selecting the sampler to withdraw water from a low-yield well. If possible use a low-volume submersible pump (for example, a Bennett pump).
  - Bailers may stir up particulate matter and compromise specific analyses of interest.
  - Suction-lift pumps, such as peristaltic pumps, can operate at a very low pumping rate; however, using negative pressure to lift the sample can result in loss of volatile analytes.
  - Operating variable-speed, electrical submersible pumps at low flow rates may result in heating of the sample as it flows around and through the pump; this also can result in sample degassing and VOC loss, in addition to changes in other temperature-sensitive analytes.

---

## Aquifer media with defined paths of preferential flow

In order to make a relevant interpretation of the sample chemistry, it is necessary to take into account the aquifer interval or intervals that yield substantial contributions of water to the well and understand the hydraulic conditions within the well that result from (a) ambient flow in the aquifer to the well, and (b) the conditions induced by sampling (Shapiro, 2002).

- ▶ **Regardless of the pumping rate or location of the pump intake**, water will be withdrawn first from the borehole and only later in time from the aquifer. The heterogeneity and anisotropy within the (consolidated or unconsolidated) aquifer interval being sampled dictates the paths of permeability through which formation water enters the well.
- ▶ **Flow dynamics within the well must be understood to determine if and when the water being withdrawn represents fresh formation water.** Differences in head (from contributing paths of flow within the aquifer) and differences in solution density from these contributing areas of flow will result in flow within the borehole.

---

### 4.2.2.C Vulnerability of Ground-Water Samples to Contamination

Because guidance cannot account for every potential threat to data quality, the responsibility lies with the field personnel to (a) be aware of the factors that can compromise the quality of the ground-water samples collected (table 4-8), and (b) use appropriate techniques and strategies to minimize and account for bias in the resulting data (section 4.3). The most common sources of sample contamination result from improperly cleaned equipment; contact or random particulate input from the atmosphere; and sample-water contact with hands, fumes, or other extraneous matter during sample-handling activities (Horowitz and others, 1994).

- ▶ Implement “good field practices” and collect quality-control samples (section 4.0).
- ▶ Use Clean Hands/Dirty Hands sampling techniques (table 4-3).
- ▶ Use equipment-selection and equipment-cleaning procedures that are described in NFM 2 and NFM 3, respectively.
- ▶ Withdraw sample water in a manner that avoids turbulence, contact with the atmosphere, and changes in temperature and pressure.
- ▶ Avoid sampling at wells that have less than 5 ft of water column, to prevent inclusion of detritus from the bottom of the well.
- ▶ As a rule, collect, process, and preserve samples within clean, enclosed chambers.
- ▶ Review the results of equipment blanks, field blanks, and other quality-control (QC) information well in advance of sampling. Use this information to adjust sampling plans and procedures, or to otherwise prepare for field work.

---

## Standing borehole water

The chemical composition of standing water in a borehole is affected by well-construction practices, as described above, by contact with the initial and overlying air within the borehole, by geochemical and biochemical processes occurring in the borehole water, and by the vertical as well as horizontal borehole flow. Borehole flow is partially a function of hydraulic head differences within zones of preferential flow in the aquifer; consequently, water can move up or down vertically as well as into and out of the aquifer horizontally (Shapiro, 2002).

Formation water that is stored in a filter (gravel) pack within the annular space between the well casing (screen) and aquifer is not necessarily representative of formation-water chemistry, but can take on the mineral signature of gravel materials and can cause a change in pH values. Assuming that the well has been appropriately developed, the well also should be purged of standing water each time before samples are withdrawn (see section 4.2.3).

---

## Atmospheric and dissolved gases

Exposure of anoxic or suboxic samples to the atmosphere can increase dissolved-oxygen (DO) concentrations to a well above ambient concentrations, causing bias not only in the DO data but also in the results of analyses for particulate and dissolved metals, sulfide, VOCs, CFCs, SF<sub>6</sub>, microorganisms, and measurements of pH and alkalinity. Minimize or isolate the sample from atmospheric contact, using the following procedures, as appropriate.

- ▶ If pumping, only use pumps that can deliver a smooth, nonturbulent flow in-line to the sample collection/processing chamber (NFM 2.1.2). The same pumping technique applies for making field-measurement determinations (NFM 6.2), whether pumping while using a multi-parameter instrument for in situ measurements or to deliver the sample to a flowthrough chamber.

- ▶ Avoid sampling at monitor wells in which the sampler intake is drawing in water that has mixed with the overlying air column. If sampling at such wells cannot be avoided, samples should not be collected for analysis of dissolved gases such as VOCs, CFCs, and SF<sub>6</sub>. The accuracy of trace-element data from such samples also may be in question. Check the list of analytes and data-quality requirements to determine if samples of the appropriate quality can be acquired.
- ▶ Use transparent sample-delivery tubing. Avoid entraining bubbles in the tubing by filling it to capacity; if bubbles form, tap the tubing with a blunt object to dislodge them and move them out.
- ▶ Fill sample containers within a processing chamber.
  - An effective bottle-filling method is to insert the discharge end of clean sample tubing to the bottom of the bottle so that the sample fills the container from the bottom up to overflowing. Cap the bottle quickly. This method is not practical for every sample type.
  - Atmospheric oxygen can be completely removed from the processing chamber (or glove box) by filling it with a clean, inert gas, especially one that is heavier than air, such as argon. Alternatively, good results have been documented by passing inert gas over the sample bottle opening while filling the bottle or by filling the bottle (and capsule filter, if used) with the inert gas beforehand.

***To fill a chamber with inert gas:***

1. Insert a desiccant pack in-line between the gas tank and the processing chamber.
2. If using a processing chamber, add a “T” fitting at the top to secure the small-diameter gas delivery hose, which is then inserted through the chamber cover.
3. Seal the chamber cover closed by twisting and tightly clipping it or using some other sealing method.
4. Start the flow of inert gas into the chamber.
5. Cut slits through the top (this is not needed if using a glove box) to allow access with gloved hands. Note that the entry of gas drives air out of the chamber through the slits.

Ground-water samples with ambient concentrations of dissolved gases (for example, methane) should be collected so as to avoid degassing. Degassing can occur from an increase in water temperature as the sample is brought to the surface, or because of leaks in the sampling and pressure system.

- ▶ Effervescent waters or samples collected for dissolved-gas analysis should use a Kemmerer or other sampling device designed to maintain ambient pressure. Collect CFCs and SF<sub>6</sub> samples using the procedures described on the USGS Reston Chlorofluorocarbon website, <http://water.usgs.gov/lab/> (accessed July, 2006).
- ▶ Check that all equipment connections and fittings are airtight.

---

## Use of sampling equipment

The type of equipment used for well purging and sample withdrawal can affect the quality of the sample and how the data are interpreted. Samples of ground water from monitor wells generally are withdrawn using a submersible pump, a peristaltic or valveless metering pump, or a point sampler such as a bailer, thief sampler, or syringe; supply-well pumps generally are permanently installed and should not be removed unless absolutely necessary and with the owner's permission (NFM 2). Equipment to be used for sampling – the materials of construction and the manner of operation – must be checked against the list of target analytes and the characteristics of the well in order to determine whether the equipment is appropriate to meet study requirements. Select and prepare equipment using the guidelines and protocols described in NFM 2, 3, and 6<sup>14</sup> and shown on figure 4-10.

- ▶ The sample-wetted parts of the equipment must be constructed of materials that will not contaminate the sample with respect to target analytes (NFM 2). Collect an equipment blank before field activities begin to test the suitability of the equipment for its intended use.

---

<sup>14</sup>NFM 2, "Equipment selection for water sampling;" NFM 3, "Equipment cleaning for water sampling;" NFM 6, "Field measurements."

- ▶ All sampling equipment must be cleaned and the efficacy of the cleaning or decontamination procedures should be confirmed with analyses from quality-control samples (NFM 3). Document in field notes the cleaning and quality-assurance procedures used, along with the analytical results for equipment-blank samples collected to test cleaning procedures.
- ▶ A flow-splitting manifold (fig. 4-10) constructed of noncontaminating materials is recommended for directing the pumped-sample flow to the point of sample collection (usually a sample-collection or sample-processing chamber).
- ▶ When setting up a pump system that requires a hydrocarbon-fueled generator, take note of the wind direction and locate the generator downwind from the sampling operation.
- ▶ Pump tubing should be kept as short as possible (to avoid changes in sample temperature) and should extend directly into a processing chamber or glove box to avoid sample contamination from the atmosphere. Set up sample chambers before beginning sample collection (a flowthrough chamber, if used for field measurements (NFM 6); and processing and preservation chambers for sample collection and filtration, and preservation, respectively).
- ▶ The sampling device should be conditioned with the well water before being used to collect samples.



***To condition or field rinse a ground-water sampler:***

1. Wearing disposable gloves, gently lower the sampler through the water column in the well to the selected sampling depth interval. Take care to minimize disturbance in the water column and minimize disturbance of sediments at the bottom of the well.
  - If using a pump sampler, field rinsing is accomplished with well purging, provided that the well will be purged with the same equipment to be used for sample withdrawal. Water should be pumped through the sample tubing to achieve the equivalent volume of three equipment rinses.
  - If using a point sampler, fill the sampler partially with the water to be sampled; shake or swirl it to cover all interior parts of the sampler. Drain the rinse water through the nozzle or bottom-emptying device. Repeat this procedure three times.
2. Discard or contain the well-water rinsate (including purge water) as appropriate, to comply with waste-disposal regulations; this is especially critical if the water is known or suspected to contain toxic levels of chemical substances.

---

## **Well-bottom detritus**

Incorporating sediment or other detritus from the bottom of the well into the sample can result in data that do not represent the composition of native aquifer water. To avoid this:

- ▶ Lower the pump or other sampler slowly and smoothly to the desired point of sample intake; that is, without creating turbulence and without stirring up bottom detritus.
- ▶ Keep the sampler intake far enough above the bottom of the well to avoid drawing in bottom detritus.
- ▶ Maintain a pumping rate that is not so high as to draw in bottom detritus.

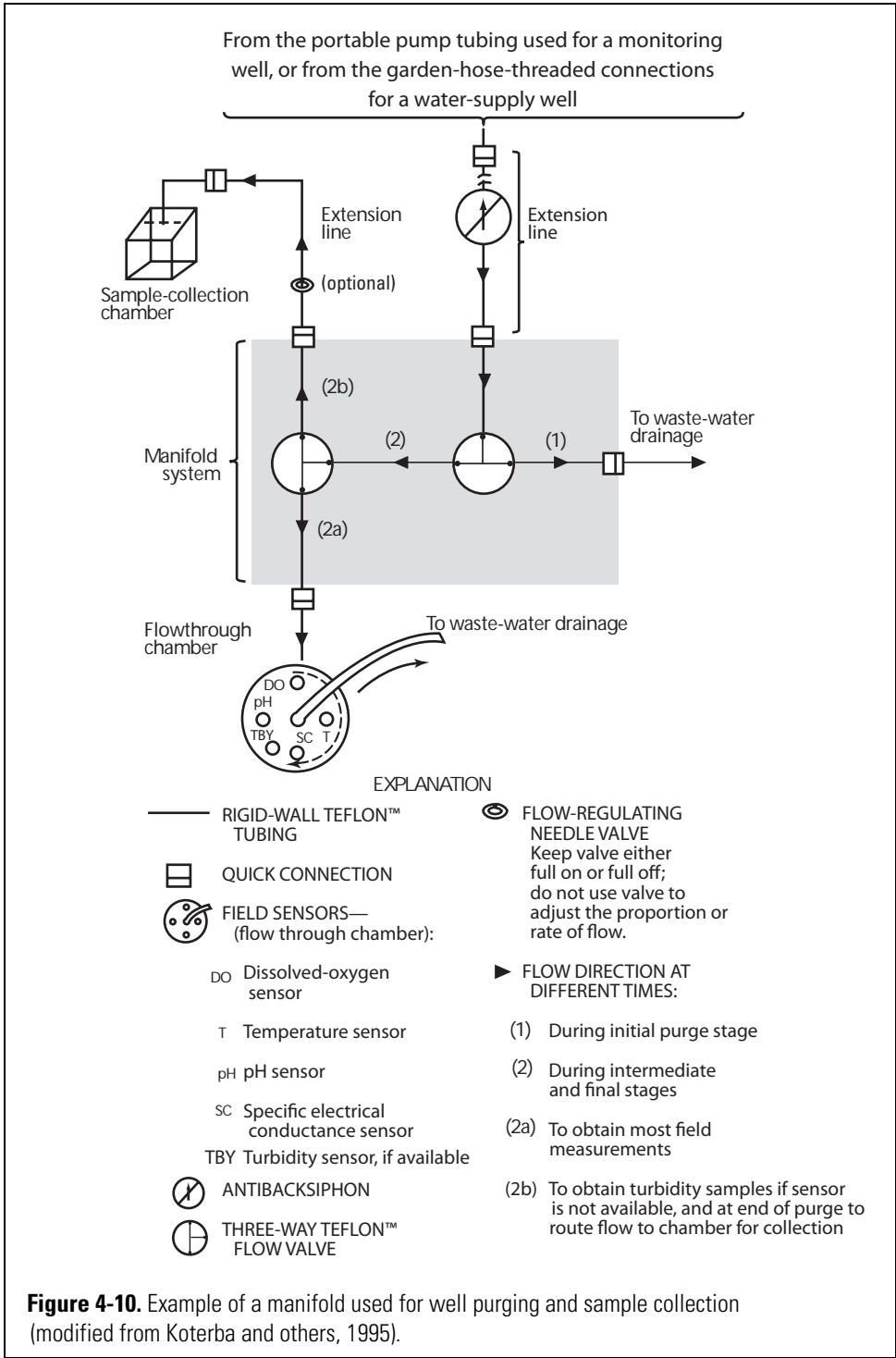

**Figure 4-10.** Example of a manifold used for well purging and sample collection (modified from Koterba and others, 1995).

---

## WELL PURGING 4.2.3

Well purging removes standing water from the borehole. The purpose of purging is to reduce chemical and biochemical artifacts caused by the materials and practices used for well installation, well construction, and well development, and by reactions occurring within an open borehole or annular space between a well casing and borehole wall.<sup>15</sup> Purging also serves to condition the sampling equipment with well water. The purging process forms a continuum with that of sample withdrawal. Sample withdrawal is the process by which sample water is transported for collection and processing, after the well has been purged.

---

### Standard purge procedure 4.2.3.A

**As a rule of thumb, the standard USGS purge procedure removes three or more well volumes of standing water while monitoring the water level and the stabilization of routine field measurements** as a function of time, pumping rate, and the volume of water being removed (figs. 4-11 and 4-12). Routine field measurements include pH, temperature, specific electrical conductance, dissolved oxygen, and turbidity. Inherent in the purge procedure is an assumption that stabilization of field properties indicates that the discharge water represents ambient formation water. Field personnel should examine this assumption for each well, using their knowledge of the well and aquifer hydraulics. Review of the purging history, including physical and chemical data monitored, can save time and help determine how the well should be purged.

---

<sup>15</sup>Passive sampling methods may not require purging of the well prior to sample collection (Vroblesky, 2001; Powell and Puls, 1993; and Ronen and others, 1987).

- ▶ When calculating a purge volume for a cased well:
  - Include an estimate for the volume of water stored in the annular space between the casing and borehole wall, using knowledge of the borehole diameter. It is mandatory to evacuate at least one borehole volume (that is, casing volume plus that of the annular space), whether that space has been backfilled with formation materials or with a gravel pack.
  - Make the calculation of casing volume using the height of the water column to the bottom of the well, instead of the water column height to the top of the screen.
  
- ▶ The number of well volumes to be evacuated relies on confirming the time over which field measurements stabilize, using knowledge of the well and aquifer hydraulics.
  - To the extent practical, field personnel should apply an understanding of the borehole and aquifer hydraulics for the well to determine when the water being withdrawn from the borehole will likely be dominated by formation water (Shapiro, 2002; Claassen, 1982).
  - Values for field properties are recorded sequentially and at regular time intervals. The frequency of these measurements depends on the purging rate, which in turn is a function of well depth and diameter, and aquifer transmissivity. Field-property stabilization should be plotted as a function of a logarithmic time scale rather than a linear time scale, to best determine the point at which the contribution of aquifer water dominates pump discharge (see Shapiro, 2002). Field-measurement procedures are detailed in NFM 6.
  
- ▶ Purging should not cause substantial drawdown in monitor or supply wells when pumping at a rate of at least 1 gal (3.75 L) per minute. Ideally, drawdown will be at a steady state, with the water level remaining above the top of the open or screened interval.
  
- ▶ Use of a borehole packer system or well liner is recommended for wells in fractured or low-yield media, to isolate zones of highest hydraulic conductivity or of particular interest. Transducers should be installed above and below the packers to monitor head differences.

**Well volume =  $V = 0.0408 HD^2 =$  \_\_\_ gallons,**  
where

$V$  is volume of water in the well, in gallons,  
 $D$  is inside diameter of well, in inches, and  
 $H$  is height of water column, in feet

**Purge volume =  $(n)(V) =$  \_\_\_\_\_ gallons,**

where

$n$  is number of well volumes to be removed  
during purging

**$Q =$  estimated pumping rate = \_\_\_\_\_ gallons  
per minute**

**Approximate purge time =  $(\text{purge volume})/Q =$   
\_\_\_\_\_ minutes**

Well casing diameter (D) (in inches)	Gallons per foot of casing
1.0	0.04
1.5	.09
2.0	.16
3.0	.37
4.0	.65
4.5	.83
5.0	1.02
6.0	1.47
8.0	2.61
10.0	4.08
12.0	5.88
24.0	23.50
36.0	52.90

**Explanation:**

Well volume: Volume of water in a borehole or cased well.

Well volumes: For cased wells, the actual number of well volumes should account for evacuation of at least one volume of water stored in the annular space between the casing and borehole wall. This can be estimated from knowledge of the drilled well diameter.

Approximate purge time: Actual purge time depends also on field-measurement stabilization (use fig. 4-12).

**Figure 4-11.** Estimation of purge volume and purge time.

**RECORD OF WELL PURGING**

Date: \_\_\_\_\_ By: \_\_\_\_\_

SITE ID \_\_\_\_\_ STATION NAME \_\_\_\_\_

HEIGHT OF WATER COLUMN \_\_\_\_\_ DEPTH OF WELL \_\_\_\_\_

PUMP INTAKE (ft or m below MP): Start \_\_\_\_\_ End \_\_\_\_\_

WELL-PURGING METHOD AND PUMP TYPE (describe): \_\_\_\_\_

TIME	WATER LEVEL below *MP LS	DRAW-DOWN	TEMPERATURE	CONDUCTIVITY	pH	DISSOLVED OXYGEN	TURBIDITY	APPROX. PUMPING RATE
HR:MIN	*ft or m	*ft or m	°Celsius	µS/cm	standard units	mg/L	**	*gpm or L/min

\*Circle the unit used; MP, measuring point; LS, land surface; HR:MIN, hour and minutes; ft, feet; m, meter; µS/cm, microsiemens per centimeter at 25°C; mg/L, miligrams per liter; gpm, gallons per minute; L/min, liters per minute.

\*\*Select the appropriate turbidity unit from [http://water.usgs.gov/owq/turbidity\\_codes.xls](http://water.usgs.gov/owq/turbidity_codes.xls).

**Well volume** =  $V = 0.0408 HD^2 =$  \_\_\_\_\_ gallons. **Purge volume** =  $(n)(V) =$  \_\_\_\_\_ gallons.

$V$  = volume of water in well, in gallons;  $D$  = inside well diameter, in inches;  $H$  = height of water column, in feet;  $n$  = number of well volumes to purge.

Well volume is 0.16 gallons per foot for a 2-in. casing diameter.

FIELD MEASUREMENT	STABILITY CRITERIA <sup>1</sup>
pH	± 0.1 standard units
Temperature (T) (in degrees Celsius)	± 0.2°C (thermistor thermometer) ± 0.5°C (liquid-in-glass thermometer)
Specific electrical conductance (SC)	± 5%, for SC ≤ 100 µS/cm ± 3%, for SC > 100 µS/cm
Dissolved-oxygen concentration (DO)	± 0.3 mg/L
Turbidity (TBY) <sup>2</sup>	± 10%, for turbidity < 100

<sup>1</sup>Allowable variation between 5 or more sequential field-measurement values.

<sup>2</sup>Select appropriate TBY unit from [http://water.usgs.gov/owq/turbidity\\_codes.xls](http://water.usgs.gov/owq/turbidity_codes.xls)

**Figure 4-12.** Example of a field log for well purging.

---

## Exceptions to the Standard Purge Procedure 4.2.3.B

Site characteristics, well characteristics, or study objectives could require modification of the standard purge procedure by changing the number of well volumes removed or by changing or adding types of field measurements and analyses. **Any modification to the standard well-purging procedure must be documented.** When standard purge volumes cannot be removed, (1) sufficient water must be withdrawn from the well to evacuate at least one borehole volume and to field rinse the sampler and sample tubing—alternatively, flush the pump and tubing system with the equivalent of three tubing volumes of DIW and purge the DIW from the tubing with clean nitrogen gas; and (2) field measurements should be determined before collecting samples, if possible. A lesser purge volume or other procedures may be modified, for example, when:

- ▶ A supply well to be sampled is being pumped continuously or daily at regular intervals and long enough to have removed three casing volumes of water—go directly to monitoring field properties.
- ▶ The sample-collection interval is sealed with packers (the interval to be sampled should be purged of three volumes).
- ▶ Water-level recovery from drawdown to approximately 90 percent of the original volume in the well cannot be achieved within a reasonable timeframe (not to exceed 24 hours; see the previous discussion on low-yield wells).
- ▶ The study will customize the protocol for field-determined properties or constituent analyses to address specific study objectives; however, the routine suite of field-measurement values should be determined.

**TECHNICAL NOTE:** Target or indicator analytes may be added to the purge criteria to address study objectives. The analysis can be performed onsite using portable analytical equipment or a mobile laboratory. The acceptable variability in analyte measurements to define stabilization and minimum number of readings is defined by the study (ASTM International, 2005).

- ▶ One or more field measurement keeps drifting, and sampling at that well cannot be avoided—NFM 6 provides suggestions for poor field-measurement stabilization, including extending the purge time and purge volume. Field personnel must make a decision based on their understanding of study objectives whether to extend purge time. Such decisions should be documented in field notes.
- ▶ Use of low-flow purging techniques is a stipulated study requirement: for a detailed description of the low-flow purge technique, refer to ASTM standard procedure D6452-99 (ASTM International, 2005).

**TECHNICAL NOTE: Low-flow purging** procedures are designed to minimize the volume of purge water and disturbance of the water column and maximize the contribution of formation water from a given interval of interest (Puls and Barcelona, 1996; Unwin and Huis, 1983). Minimizing purge volume is especially useful when regulating authorities mandate containment of purge water.

Low-flow purging is based on the theory that water moving through the well intake is representative of formation water surrounding the intake, and assumes that pumping at a low flow rate isolates the column of standing water so that only formation water is drawn into the intake. The typical flow rates for this method are on the order of 0.1 to 0.5 L/min; however, in formations of coarse-grained materials the flow rate may be as high as 1 L/min (ASTM International, 2005).

**Select a low-flow purge-and-sampling technique with caution and with an understanding of aquifer and well hydraulics.** The assumption should not be made that water withdrawn using a low-flow procedure represents ambient aquifer water at the targeted (intake) interval (Varljen and others, 2006), because the conductivity of well-bore flow within the specified interval is greater than that of the aquifer (Shapiro, 2002). Even where well-bore flow does not occur, aquifer heterogeneity over the length of the specified interval results in water being drawn preferentially through zones of highest permeability.



---

## STEPS FOR SAMPLING AT WELLS 4.2.4

Develop a systematic agenda well in advance of the field effort that follows the sampling plan and quality-assurance protocols. Offsite preparations in addition to the steps needed to carry out onsite activities need to be included in planning for field work. Review the requirements and recommendations for site inventory (reconnaissance) and site file setup (section 4.2.1)

**Field-trip preparations.** Adequate time must be scheduled to plan sampling activities, review data requirements, and make field-trip preparations. Prepare a checklist of equipment and supplies that will be needed, and order what is needed well before the field effort (fig. 4-13). Refer to NFM 2, Section 2.4, for lists of equipment and supplies commonly used for ground-water field activities. Review electronic and paper site files and make sure that they are kept up to date.

Before selecting and implementing purging methods, review table 4-8 to determine how maintaining sample integrity applies to the study and site.

- ▶ Consider whether modifications of standard USGS methods might be needed to address issues specific to the field site or program or study objectives. Document any deviation from the standard protocols.
- ▶ Review the types of quality-control (QC) samples planned for the study. Certain types of blank samples are required for all USGS studies. Review the most recent analyses of blank samples collected through the equipment to be used for sampling before field work begins.
- ▶ Determine if water level and well yield are sufficient to produce a representative sample.
- ▶ Decide how to determine or constrain the interval(s) from which the sample should be collected. Consider whether packers will be used and whether screen lengths are sufficiently short or long to meet the sampling objective. Determine the major sources of flow contribution to the well, if sampling in fractured or anisotropic formation materials.

Before leaving for the field site, review reconnaissance notes from the site inventory (table 4-6), and determine the number and types of environmental and QC samples to be collected (Appendix A4-C).

- ▶ Prepare the field forms that will be needed (for example, water-level, purging, field-measurement, analytical services request, and chain-of-custody forms). Fill out as much information as possible, including the equipment to be used and numbers and types of samples to be collected.
- ▶ Check equipment requirements (NFM 2). When assembling the equipment, test that equipment is in good working condition. Take backup equipment, as appropriate.
  - **Organic-compound samples.** Use fluorocarbon polymer (Teflon), glass, or metal for equipment components that will be in contact with samples to be analyzed for organic compounds. **Exception:** if collecting CFC samples, do not use Teflon sampler components or Teflon tubing (NFM 5).
  - **Inorganic-constituent samples.** Use fluorocarbon polymer or other relatively inert and uncolored plastics or glass for any equipment components that will be in contact with samples to be analyzed for inorganic constituents. Do not use metal or rubber components for trace-element sampling. Stainless-steel sheathed pumps are generally acceptable, but can leach low concentrations of chromium, molybdenum, nickel, and vanadium to the sample. **Collect an equipment blank to be analyzed before sampling begins, to demonstrate the acceptability of the data to be collected.**
- ▶ Set up a clean workspace (usually in the water-quality field vehicle) and the sample-processing and -preservation chambers. Place the filter unit and other necessary supplies for sample collection and processing into the processing chamber. **The generator and gas tanks must not be stored or transported in the water-quality field vehicle.**

**Plan ahead. Take adequate time for site recon, and to prepare sampling plans, order supplies, test equipment, and get the training needed.**

✓	<b>Checklist for ground-water site setup and well-sampling preparations<sup>1</sup></b>
	Antibacksiphon device (one-way or check valve)
	Chemical reagents (for sample preservation and field analyses) and ice
	Deionized water and blank water
	Disposable, powderless, laboratory-grade gloves
	Equipment cleaning, decontamination, and disinfectant supplies
	Field forms (for example, ground-water-quality, water-level, and chain-of-custody forms) - electronic or paper; indelible ballpoint pen (black or blue ink)
	Field manual, sampling and quality-control plan(s)
	Filtration units and supplies
	Flow-regulating valve (needle valve or pinch clamps)
	Flow-splitting valve(s) for manifold system
	Flowthrough cell or chamber and field-measurement instrument(s) (single parameter or multiparameter); standard and buffer solutions; Kimwipes (see NFM 6)
	Keys (for locked facilities)
	Microbiota sampling supplies (see NFM 7)
	Photoionization detector (PID or sniffer)
	Sample processing and preservation chambers in which samples are bottled and treated, respectively, and associated supplies
	Safety equipment
	Sample containers (precleaned)
	Sampling device(s) (precleaned, portable equipment or other, as appropriate) and power supply (if needed); spare batteries
	Sample tubing (precleaned, several lengths)
	Shipping containers and supplies
	Stopwatch and calibrated bucket to measure pumping rate
	Tarp or plastic sheeting to place around well
	Threaded fittings, male/female, such as hose-type connectors (precleaned)
	Tools (such as wrenches to remove well cap)
	Tubing to direct waste discharge offsite or into sample container
	Water-level measurement equipment
<sup>1</sup> See NFM 2.4 for more detailed examples of equipment and supply checklists for sampling.	
<b>Figure 4-13.</b> Example of checklist of equipment and supplies to prepare for sampling ground water at wells.	

**Steps for sampling.** The standard USGS procedure for collecting ground-water samples consists of the following six basic steps and the activities needed to carry them out. The procedures needed for supply wells differ somewhat from those used for monitor wells. Steps 1 through 4 are detailed in this section. Steps 5 and 6 are described in NFM 5 (“Processing of Water Samples”) and NFM 3 (“Cleaning of Equipment for Water Sampling”), respectively.

### **Step 1. Implement safety precautions and site preparations**

Act with common sense. Be aware of existing and impending environmental conditions and hazards. Field personnel must be familiar with the guidance and protocols provided in NFM 9, “Safety in Field Activities.” Organized and orderly procedures for setting up a site for sampling should be routine and helps to prevent mistakes that could compromise personnel safety as well as sample integrity.

### **Step 2. Measure water level**

Procedures for water-level measurement can differ for supply wells and monitor wells. Detailed procedures for various methods of measuring water levels are documented by the U.S. Geological Survey (1980, p. 2-8), and additional information can be obtained from the USGS Office of Ground Water (<http://water.usgs.gov/ogw>). Refer to Appendix A4-B for a summary of water-level-measurement methods.

- ▶ Procedures and equipment for water-level measurement can differ, depending on the type, construction, and design of a well.
- ▶ Clean well tapes after each use at a well as described in NFM 3.3.8. Document in field notes if oil is floating on the water table. Review equipment-cleaning and sample-collection strategies and revise as needed if oil is present, to prevent contamination of samples. A dual-phase sonde can be used to determine the thickness of the oil layer, as well as the depth to water.
- ▶ Record discrete water-level measurements on field forms and in GWSI (USGS Office of Water Quality Technical Memorandum 2006.01).

### Step 3. Purge the well and monitor field measurements

As discussed in Section 4.2.3, purging the well of standing water is generally required to ensure that the sample water will be withdrawn directly from the aquifer. Exceptions to the well-purging protocol may apply more commonly to water-supply wells, although exceptions for some monitor wells also have been described in the previous section. Regardless of the purge procedure followed, enough water must be withdrawn from the well to field rinse sampling equipment and to make measurements of field properties (field measurements). Purging and field-measurement information must be recorded, either on electronic or paper field forms (fig. 4-12). Specific guidance for use of field-measurement instruments is described in detail in NFM 6.

### Step 4. Withdraw the sample

As a rule, pumping is the preferred method for withdrawal of groundwater samples. In this case, purging and sample withdrawal form a continuous process. Field measurements are monitored during purging with sample collection following immediately after final field measurements have been recorded. Equipment is selected that channels flow in-line to a field-measurement chamber and then, without stopping, to a sample collection/processing chamber; the sample is never exposed to the atmosphere during this process (fig. 4-10).

Depending on field conditions and study objectives, samples may be withdrawn using a thief-type sampler. Lower and raise the sampler smoothly at a constant rate, keeping the suspension line clean and off the ground. A bailer or other thief-type sampler generally is not recommended for trace-element or volatile organic compound (VOC) sampling. Bailing can mobilize particulates and, unless designed for VOC sampling, can allow VOCs to escape.

- ▶ Measurements at a monitoring well
  - The standard purging procedure usually is appropriate (section 4.2.3.A). Exceptions to the standard purging procedure are described in section 4.2.3.B.
  - Either a downhole or a flowthrough-chamber system can be used for field measurements (NFM 6). If samples will be collected, use the flowthrough chamber instead of the downhole system in order to avoid bias of chemical analyses from sample contact with downhole instruments.

- ▶ Measurements at a supply well
  - The standard purging procedure may not be appropriate (see section 4.2.3.B).
  - Identify well-construction materials and any equipment permanently installed in the well (such as a pump) that can affect the logistics and quality of the field measurement or sample.
  - Use a flowthrough-chamber type of field-measurement system (NFM 6).
  - Connect the field-measurement system to the wellhead at a point before the sample would pass through holding tanks, backflow pressure tanks, flow meters, or chemical treatment systems.

If more than one well will be sampled during a field trip, each site and (or) a field vehicle must be set up for onsite cleaning of the sampling equipment. Field personnel should design the most efficient field-cleaning system, appropriate for the sites to be sampled and in accordance with the equipment-cleaning guidelines described in NFM 3.

### **Step 5. Process the sample**

Sample processing involves, in part, sample filtration, sample collection into appropriate containers, and sample preservation. Standard USGS procedures for sample processing are described in general and according to analyte type in NFM 5.

### **Step 6. Clean the equipment**

Standard USGS procedures for cleaning (or decontamination) and QC of specific types of equipment used for collecting and processing organic and inorganic analytes are detailed in NFM 3. Field personnel should design the most efficient field-cleaning system, appropriate for the sites to be sampled and in accordance with wastewater disposal regulations.

**Practice safe sampling.**

## Supply Wells 4.2.4.A

Collection of samples from water-supply wells with permanently installed pumps requires specific considerations, preparations, and precautions. Refer to NFM 9 for safety precautions. Field personnel should be aware of the potential sources of contamination to samples withdrawn from supply wells (table 4-10).

- ▶ Do not sample the well if it is not possible to bypass any holding tank or chemical treatment system.
- ▶ Document all field observations and any deviations from standard sampling procedures.
- ▶ Obtain permission for access to and collection of samples and data from the well.

**Table 4-10.** Advantages and disadvantages of collecting water samples from supply wells with permanently installed pumps

Advantages
<ul style="list-style-type: none"> <li>• Cost of well and pump installation is not a factor.</li> <li>• Samples from domestic and municipal wells (for studies of the quality of potable water supplies) are collected directly from the resource being studied.</li> <li>• Pumps are dedicated to the site; therefore,               <ul style="list-style-type: none"> <li>- cross-contamination of other wells from pumping equipment is not a problem, and</li> <li>- field time and effort otherwise expended in operating and cleaning portable pumps can be allocated to other tasks.</li> </ul> </li> <li>• In-service supply wells generally require a minimal amount of purging at the time of sampling.</li> </ul>
Disadvantages
<ul style="list-style-type: none"> <li>• The well and the open or screened intervals might not isolate the aquifer zone where water-quality information is needed.</li> <li>• Materials of well and pump construction may affect concentrations of the analytes targeted for study.</li> <li>• Pumps with high capacities can alter the water chemistry of a sample if the pump is lubricated with oil. The water chemistry of a sample also can be altered by aeration and degassing caused by high-velocity pumping, suction lift, and cavitation.</li> <li>• Access for water-level measurements might be unavailable; or, access might be indirect (through an air line), thus yielding less accurate measurements.</li> </ul>

## Steps for sampling from water-supply wells

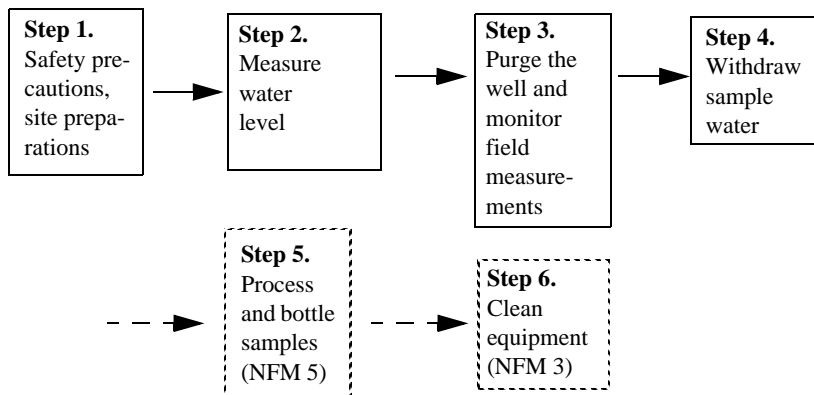

Ensure that the field effort is adequately staffed and equipped. Check QC requirements before departing—QC samples require additional equipment and supplies. Implement good field practices and *CH/DH* techniques, as applicable (duties typically performed by Clean Hands (*CH*) and Dirty Hands (*DH*) are indicated in the steps that follow). Check that you have the correct site and well folders, and a document (preferably signed) granting site access and well sampling and purging permission.

### Step 1. Supply-well sampling: Safety and site preparations.

- a. Upon arrival, set out safety equipment such as traffic cones and signs, as needed. Park vehicle in a position to prevent sample contamination from vehicle and traffic emissions and the prevailing wind.
  - Check the well identification number and compare it with the number in the well file and in field notes (section 4.2.1).
  - Assign *CH/DH* tasks.
- b. Describe well and site conditions in field notes and on field forms, as appropriate (*DH*).
- c. Check site for hazardous conditions (NFM 9) (*DH*).
  - Test for toxic fumes if the well is in an enclosed structure or if there is reason to suspect the presence of organic vapors.
  - Examine the area for evidence of animal infestation and other potential safety hazards.
- d. Prepare an area to be used for field cleaning of equipment (*DH*).



- e. Set up equipment and instruments for field measurements and ground-water withdrawal (*DH*).
  - Calibrate field-measurement instruments (*DH*). Refer to NFM 6 for calibration information and instructions.
  - Wearing disposable gloves, set up the sample-processing and sample-preservation chambers (usually in the water-quality field vehicle). *Change gloves*. Place the filter unit and other supplies that will be needed for the first sample into their respective chambers (*CH*).
- f. Spread clean plastic sheeting (polypropylene tarp, for example) on the ground around the well to keep sampling equipment, the well tape, and sample tubing off of the ground. Prepare area to be used for field cleaning of equipment (*DH*). Take care not to trample on the sheeting.
- g. Determine the location and method of tubing hookup to the well. Connect sample tubing as close as possible to the wellhead (*DH*).
  - i. There must be no water-storage tanks, holding or pressurization tanks, or chemical disinfection or water-softening systems connected in-line between the pump and tap/faucet to which sample tubing will be connected. Obtain written permission to install a tap if it is necessary for bypassing a holding tank or treatment system.
  - ii. Select a faucet without an aerator or obtain written permission to remove the aerator (replace it after sampling). Use connectors and sample tubing that will not contaminate the sample with respect to target analytes.
    - Use only precleaned sample-contacting connectors and tubing.
    - Check that you have the correct size and configuration of connector fittings, as compatibility varies among types of plumbing.
    - At highly contaminated sites, sample-contacting equipment either should be dedicated for that site or should be disposable.
  - iii. Connect a short length of sample tubing (2 to 3 feet) between the tap/faucet fitting and the antibacksiphon valve (*DH*).

- iv. Connect sample tubing from the antibacksiphon valve to the manifold; and from manifold to the flowthrough chamber, the sample-processing chamber, and the waste outlet.
  - Select transparent, nonporous sample tubing and tubing to the flowthrough chamber for field measurements to be able to check for bubbles or sediment entrained in the sample flow. Sample tubing must be clean and of the appropriate material with respect to study objectives; flowthrough-chamber tubing can be of any material if used only in connection with field measurements. Keep the discharge end of the sample tubing sealed until use.
  - Tubing used solely to discharge purge water to waste can be of any material (garden hose, for example), but must be long enough to transport wastewater away from the work area.

### **Step 2. Measure water level (DH).**

Procedures and equipment for water-level measurement depend on well type and construction and the presence of nonaqueous liquid phases. Important considerations and method limitations are described in Appendix A4-B.

- a. Put on gloves if chalking a steel tape. Using a weighted steel or electric tape in a nonpumping well, measure water level to the nearest 0.01 ft (for wells <200 ft to water), starting at the permanent measuring (reference) point. Repeat the measurement until precision is within 0.02 ft (U.S. Geological Survey, 1980). At wells deeper than 200 ft, calculate the compensation factor to account for stretching of the tape.
  - Do not allow the well tape to contact the ground before inserting it into the well.
  - Care must be taken not to entangle the well tape in the pump discharge pipe or intake.
  - Do not use lead weights; use stainless steel or other noncontaminating material. An unweighted tape might be necessary if the weight cannot fit past the pump apparatus.
  - At some supply wells, the water level only can be estimated using the less accurate air-line method. As a last resort if no water-level measurement can be made, use the measurement recorded on the driller's well log in order to calculate an estimated purge volume.

- b. Water-level measurements must be recorded on field form(s) and in GWSI forms. On the field form, note any deviations from standard water-level measuring procedures. It is useful also to record water level in QWDATA (USGS Office of Water Quality Technical Memorandum 2006.01).
- c. Clean the tape after each use to avoid cross-contamination of wells (see NFM 3.3.8).

### Step 3. Purge the well and monitor field measurements (*DH*).

- a. Calculate or estimate the well volume (the depth to the bottom of the well and the inside casing diameter must be known):

$$V = 0.0408 \times HD^2$$

where,

**V** is volume, in gallons

**H** is height of water column

**D<sup>2</sup>** is the inside well diameter squared, in inches.

- b. Begin pumping to purge the well according to study objectives. Discharge the initial well water through the waste line until sediment is cleared from the flow.
  - Supply-well pumps commonly are either on or off, with no variable-speed capability. To regulate the flow, use a manifold with a needle valve, if possible.
  - Open any additional valves or taps/faucets to ensure that the pump will operate continuously and reduce the possibility of backflow stored in ancillary plumbing lines; keep these open throughout purging and sample withdrawal.
  - The pump should produce a smooth, solid stream of water with no air or gas bubbles and without pump cavitation during field measurements and sample withdrawal.
  - **Do not halt or suddenly change the pumping or flow rate during the final phase of purging or while sampling.**
  - Contain and dispose purge waters according to Federal, State, or local regulations. Do not discharge purge water from one well into another without proper authorization. Discharge purge water far enough away from the well or well cluster so as not to enter or affect water quality in the well, and to prevent muddy and slippery work conditions.

**TECHNICAL NOTE:** A supply well that is in regular service and that is pumping continuously or that has been operating long enough to have removed three casing volumes of water within several hours of sample collection does not require removal of three well volumes. Before withdrawing sample in this case, flush sample water through the tubing and monitor measurements.

- Field personnel could request a site operator or homeowner to start pumping the well before personnel arrive onsite.
  - If the pump has been turned off but three well volumes were removed within 24 hours before sampling and samples only will be analyzed for nutrient or major-ion concentrations, additional purging is not necessary.
  - Purging immediately before sampling is recommended if samples for trace elements and volatile organic compounds will be collected.
- c. When the water runs clear, divert flow to the flowthrough chamber for field measurements (unless a downhole instrument is in use). Once the flow is constant (see instructions in step b), begin monitoring field measurements (refer to NFM 6 for detailed instructions); in addition, record the number of well volumes being discharged, the start and end times of purging, the pumping rate, water level, and location of the pump intake (fig. 4-12).
- To control the flow rate from the manifold, use a flow-regulating valve, such as a faucet or needle valve.
  - Keep three-way valves either completely open or closed (partially open three-way valves can create a vacuum or air bubbles, and can draw in contaminating water). **Do not use a two- or three-way valve to regulate the flow.**
  - **Recommended:** To ensure a representative sample, maintain the water level in the well above the screened or open interval.

- d. As the final well volume (commonly the third well volume) is purged, calculate the final pumping rate and record on field forms at least five sets of field measurements determined at regularly spaced intervals while pumping at this rate. Referring to the instructions provided in NFM 6, check the field-measurement data against the measurement-stability criteria (fig. 4-12).
- To record the pumping rate of water flowing through more than one conduit, sum the rate of flow through each conduit.
  - Routine field measurements for USGS studies include water temperature, conductivity, pH, dissolved oxygen, and turbidity.
  - The final pumping rate, used during the final five sets of field measurements, also should be used during sample collection.

#### **Step 4. Withdraw ground water (CH).**

Maintain the same rate of pumping throughout sample withdrawal and collection as the rate used during withdrawal of the final purge volume.

- a. Put on disposable gloves. Check that the sample tubing is properly secured within the sample-processing chamber.
- b. Direct sample flow through the sample tubing to the processing chamber and channel two tubing volumes of the water to waste.
  - **If samples will be collected for organic carbon analysis through equipment and tubing that previously was methanol-rinsed, flush at least five tubing volumes of sample water through the tubing (or collect the organic-carbon sample using a separate, non-methanol-rinsed sampler) before proceeding to Step 5.**
  - Use the needle valve at the manifold to adjust sample flow as appropriate for the target analysis. Depending on the site-specific logistics, a second needle valve can be installed after the outlet end of the manifold and close to the sample-processing chamber. Avoid splashing or pooling water inside the chamber while processing sample and filling sample bottles.

**Flow should be constant and uninterrupted while purging and sampling.**

**Step 5. Collect and process the sample** → Refer to NFM 5, *Processing of Water Samples*, for instructions regarding the field rinse of sample bottles, sample filtration, and the collection and preservation of wholewater and filtered samples.

---

---

**👍 RULE OF THUMB: The rate of flow for filling sample bottles should not exceed**

- 500 mL/min for bottles 250 mL or greater in volume,
  - or
  - 150 mL/min for 40-mL VOC vials.
- 
- 

**Step 6. Clean equipment** → Refer to NFM 3, *Cleaning of Equipment for Water Sampling*. Sampling equipment must be cleaned as instructed in NFM 3 before leaving the field site.

At sites at which the level of contamination is suspected or known to exceed drinking-water standards or health advisories, use sample tubing that is disposable or dedicated to that site in order to minimize the risk of cross contamination between wells. Wear gloves while cleaning and handling sampling equipment.

- Rinse sampling equipment with deionized water before the equipment dries.
- Clean equipment to be used at another well during the same field trip after rinsing it and before moving to the next site.
- Collect field blanks to assess equipment-cleaning procedures directly after the sampling equipment has been cleaned in the field or after moving to the next site and before sampling, as dictated by the data-quality requirements of the study (section 4.3).

---

## Monitor Wells 4.2.4.B

When selecting purging equipment for monitor wells, site conditions need to be considered. In general, a portable, submersible nonaerating pump that also will be used for sampling is recommended. The specific equipment and well-purging method selected, however, can depend on depth to water, length of the open interval, well construction, and site contamination. For example, to reduce the volume and time required for purging, especially in deep wells or in wells for which purge water is contaminated and must be contained, inflatable packers can be used to isolate the aquifer interval of interest.

In addition:

- ▶ When the water table is deeper than 250 ft and (or) a large volume of water must be purged, a dual-pump system can be used: position, in series, a submersible pump downhole and a centrifugal pump at the surface.
  - Water discharging from the slow-pumping submersible pump is used for field measurements and sample collection, whereas the centrifugal pump removes the required volume of purge water at a faster rate. Changes in pumping rate might increase turbidity.
  - Dissolved-oxygen concentration, Eh, or turbidity should not be measured while using a dual-pumping system. Record measurements while operating only the submersible pump.
- ▶ When the water table is less than 25 to 30 ft from land surface, a peristaltic pump can be used for small-diameter wells. A peristaltic pump or other comparable suction device can affect dissolved-oxygen concentrations and Eh measurements unless low gaseous-diffusion tubing such as Tygon® is used (NFM 2).
- ▶ An inflatable packer sometimes is set above and below the screened/open interval, with a pump intake located within the screened/open interval.
  - Packers sometimes fail to form a complete seal between aquifer intervals, and should be used with pressure transducers located directly above and below the isolated interval to indicate whether water is leaking past the packers or short circuiting in the aquifer.
  - The materials of which the packer is made also might affect sample chemistry by leaching or sorbing target analytes.

- ▶ A bailer is not recommended for purging. The plunging action of the bailer can release or stir up particulates that are not ambient in ground-water flow, resulting in biased measurements and analyses.

### *Steps for sampling at monitoring wells*

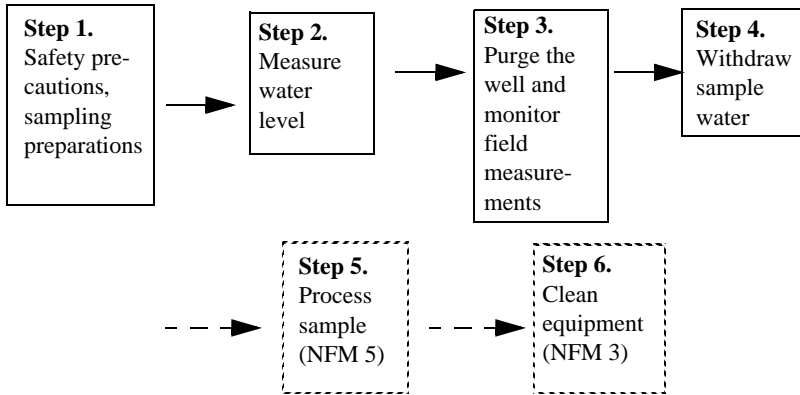

#### **Step 1. Monitor-well sampling: safety and site preparations.**

- Upon arrival, set out safety equipment such as traffic cones and signs, as needed. Park vehicle in a position to prevent sample contamination from vehicle and traffic emissions and prevailing wind.
  - Check well-identification number (this should be indelibly marked on the well casing) and compare it with the well file and field notes (section 4.2.1).
  - Assign *CH/DH* tasks.
  - If a gasoline-powered generator is used, locate it downwind of sample collection or elsewhere to avoid sample contamination from fumes.
  - Prepare an area to be used for field cleaning of equipment (*DH*)
- Describe well and site conditions on field forms, as appropriate (*DH*).
- Check site for hazardous conditions (NFM 9) (*DH*).
  - Test for toxic fumes if the well is in an enclosed structure or if there is reason to suspect the presence of organic vapors.
  - Examine the area for evidence of animal infestation and other potential safety hazards.
- Spread a clean plastic sheeting (polypropylene tarp, for example) on the ground around the well to keep sampling equipment, the well tape, and sample tubing clean (*DH*). Take care not to trample on the sheeting.



- e. Set up equipment and instruments for field measurements and ground-water withdrawal (*DH*). Locate a power supply source, if needed.
- Set up the pump and generator (if needed) in a location to avoid sample contamination from generator fumes.
  - Calibrate field-measurement instruments (*DH*). (Refer to NFM 6 for calibration information and instructions.)
  - Wearing disposable gloves, set up the sample-processing and -preservation chambers (usually in the water-quality field vehicle). Keep sample tubing as short as is practical and shaded from direct sunlight (to minimize changes in the temperature of the sample). *Change gloves*. Place the filter unit and other supplies that will be needed for the first sample into their respective chambers (*CH*).
- f. Remove the well cap. Verify clear access downhole by lowering a section of blank pipe through the depth interval to be sampled and raising it slowly. **Take care not to drop the pipe or otherwise stir up particulates in the process of lowering and raising the pipe (*DH*).**
- i. Connect the antibacksiphon valve in-line between pump and manifold (the antibacksiphon valve is a standard component of some submersible pumps).
  - ii. Use connectors and sample tubing that will not contaminate the sample with respect to target analytes.
    - Use only precleaned sample-contacting connectors and tubing.
    - At contaminated sites, sample-contacting equipment either should be dedicated for that site or should be disposable.
  - iii. From the manifold, connect the appropriate tubing to the flowthrough chamber, the sample-processing chamber, and the waste outlet.
    - Select transparent, nonporous sample tubing and tubing to the flowthrough chamber for field measurements to be able to check for bubbles or sediment entrained in the sample flow.
    - Tubing that transfers sample to the processing chamber must be clean and of noncontaminating material. Keep the discharge end of the sample tubing sealed until use.
    - Flowthrough-chamber tubing can be of any material if used only in connection with field measurements.
    - Tubing used solely to discharge purged water to waste can be of any material (garden hose, for example), but must be long enough to transport wastewater away from the work area.

## Step 2. Measure water level (*DH*).

Procedures and equipment for water-level measurement depend on well type and construction and the presence of nonaqueous liquid phases. Important considerations and method limitations are described in Appendix A4-B-3, 4, and 5. Each well must have a designated measuring point that is indicated permanently on the well (Appendix A4-B-1).

- a. Put on gloves before chalking a steel tape. Using a weighted steel or electric tape in a nonpumping well, record two or more consecutive water-level measurements to the nearest 0.01 ft (for wells of < 200 ft to water), starting at the permanent measuring (reference) point. Repeat the measurement until precision is within 0.02 ft (U.S. Geological Survey, 1980).
  - Do not allow the well tape to contact the ground before inserting it into the well. After measuring the water level, clean the tape (NFM 3.3.8) to avoid cross contaminating the next well.
  - Do not use lead weights, but weight the tape with stainless steel or another relatively noncontaminating material.
  - At wells deeper than 200 ft, calculate the compensation factor to account for stretching of the tape.
- b. Record water-level measurement on field forms and in GWSI (USGS Office of Water Quality Technical Memorandum No. 2006.01). Note any deviations from standard water-level measuring procedures on field forms (fig. 4-12). It is useful also to record water-level data into QWDATA.
- c. Set up a system to measure water levels throughout purging. Electrical tapes or submersible pressure transducers are recommended—repeated measurements with a steel tape can be cumbersome and can generate turbidity in the water column. If a packer system is used, install pressure transducers above and below the packer.
- d. Clean the tape after each use to avoid cross contamination of wells (NFM 3.3.8).

---

---

 **RULE OF THUMB: The initial water-column height should be greater than 4 ft plus the length of the sampling device.**

---

---

### Step 3. Purge the well and monitor field measurements (*DH*).

Purge monitor wells, preferably using a variable-speed pump (see the TECHNICAL NOTES listed at the end of step 6). Operate the pump in a manner that avoids or minimizes turbidity. **Do not use a bailer for purging** unless the well characteristics or other constraints exclude alternatives and the turbidity during and after bailing is at the background level. **Recommendation:** Measure water levels throughout purging to document drawdown and the location of the water level with respect to the screened/open interval and the pump intake.

- ▶ Use the same pumping equipment for purging that will be used to collect samples, if possible.
  - ▶ **Avoid refueling or changing equipment, and do not stop the pump during the final phase of purging and sample collection.** Be aware of study objectives and potential sources of contamination. For example, avoid fueling the generator on the same day that samples are collected for VOC analysis. Do not transport a generator or gas tanks in the water-quality field vehicle.
  - ▶ Adjust the flow rate at the pump if using a variable-speed pump. If a constant-speed pump is used, adjust the flow rate using a needle valve.
    - Pump at a rate that does not substantially lower the water level. Ideally, well yield should be sufficient so that the water level is maintained above the screened or open interval.
    - Flow should not be halted or the flow rate changed suddenly during the final phases of purging and sampling.
- a. Calculate the well volume. For a cased well, the depth to the bottom of the well and the inside casing diameter must be known:

$$V=0.0408 \times HD^2$$

where,

**V** is volume, in gallons

**H** is height of water column

**D**<sup>2</sup> is the inside well diameter squared, in inches

Note that for a cased well, the volume of water stored within the annular space between the well screen and borehole well also should be evacuated at least once.

- b. Lower a submersible pump, followed by a water-level sensor, to the desired location of the pump intake. (The pump position is fixed if the monitoring well has a permanently installed sampling system.) Move the equipment slowly and smoothly through the water column to avoid stirring up particulates. The intake can be either lowered continually while purging to the final depth desired or placed immediately at its final position. **Note that the final pump intake position always is at the point of sample collection.**
- Position the pump intake about 3 ft (about 0.9 m) below static water surface and a minimum distance above the top of the screened/open interval of 7 to 10 times the well diameter (for example, 14 to 20 in. for a 2-in. well diameter), if the sample is to represent the entire screened or open interval of aquifer. The location of the intake might be different if the study objective requires collecting the sample from a point within the screened/open interval or from wells in which packers are installed.
  - Place water-level sensor (electric tapes) a maximum of 1 ft (about 0.3 m) below the water surface.
- c. Position the pump intake.
- **If final intake position is above the screened or open interval, do not exceed 1 ft (about 0.3 m) of drawdown.**
  - **If final intake position is within the screened or open interval, do not exceed 0.5 ft (about 0.15 m) of drawdown.** The final pumping rate should be as slow as necessary to avoid causing turbidity.
- d. Start the pump, channeling initial discharge to waste. Discharge the initial well water through the waste line until sediment is cleared from the flow.
- Gradually increase and (or) adjust the pumping rate to limit drawdown to between 0.5 and 1 ft (about 0.15 to 0.3 m), if possible.
  - **If using a variable-speed pump, adjust the rate of flow at the pump.** If using a constant-speed pump, control the flow rate using a needle valve (fig. 4-10).

- **Do not use a three-way valve or flow-splitting valve to adjust flow rate.** It is necessary to keep the two- or three-way valves either completely open or completely closed (partially open three-way valves can create a vacuum or air bubbles, and can draw in contaminating water).
  - **Contain and dispose of purge waters according to Federal, State, or local regulations.** Do not discharge purge water from one well into another without proper authorization. Discharge purge water far enough away from the well or well cluster so as not to enter or affect water quality in the well, and to prevent muddy and slippery work conditions.
- e. When the water runs clear, divert flow through the manifold to the flowthrough chamber (unless a downhole instrument is being used for field measurements).
- **The flow should be a smooth, solid stream of water with no air or gas bubbles and without pump cavitation** during field measurements and sample withdrawal. Adjust the pumping rate to eliminate air or gas bubbles or cavitation, but do not halt or suddenly change the flow rate.
  - **Record the start time of purging, the pumping rate(s), water level(s), and final location of the pump intake** (fig. 4-12). If water is flowing through more than one conduit (such as valve and manifold lines), calculate the flow rate by summing the flow rate through each conduit.
  - **Begin monitoring field measurements** (refer to NFM 6 for instructions) once flow to field-measurement instruments is constant (see instructions above).
  - **Do not move the pump or change the rate of pumping during field measurements or sample collection after setting the intake at its final depth location.**

- f. **Purge a minimum of three well volumes or the purge volume dictated by study objectives.** (Check exceptions to the three-well-volume procedure described in section 4.2.3.B).
- Record water levels and field measurements at regular time intervals (fig. 4-12; NFM 6). Routine field measurements for USGS studies include water temperature, conductivity, pH, dissolved-oxygen concentration, and turbidity. Check for special instructions regarding field-measurement or field-analysis requirements based on study objectives.
  - As the final well volume (commonly the third well volume) is purged, check the field-measurement data against the measurement-stability criteria (fig. 4-12). Record at least five sets of field measurements determined at regularly spaced intervals, which indicate that measurement values are relatively constant (have "stabilized") or that stabilization cannot be achieved in the given time interval (NFM 6).

#### **Step 4. Withdraw the sample (CH).**

##### **Pumped samples—**

Maintain the same rate of pumping throughout sample collection as the rate used during withdrawal of the final purge volume.

- a. Put on disposable gloves. Check that the sample tubing is properly secured within the sample-processing chamber.
- b. Direct sample flow through the sample tubing to the processing chamber and channel two tubing volumes of the water to waste. Use the needle valve at the manifold (fig. 4-10) to adjust sample flow as appropriate for the target analysis.
  - Depending on the site-specific logistics, a second needle valve can be installed after the outlet end of the manifold and close to the sample-processing chamber.
  - The flow should be smooth and non-turbulent. Avoid splashing or pooling water inside the chamber while processing sample and filling sample bottles.
  - **If samples will be collected for organic carbon analysis through equipment and tubing that previously was methanol-rinsed, flush at least five tubing volumes of sample water through the tubing (or collect the organic-carbon sample using a separate, non-methanol-rinsed sampler) before proceeding to step 5.**

**Remember, flow should be constant and uninterrupted while purging and sampling.**

---



---

**👍 RULE OF THUMB:** When using a pump, the rate of flow for filling sample bottles should not exceed

- 500 mL/min for bottles 250 mL or greater in volume,
  - or
  - 150 mL/min for 40-mL VOC vials.
- 
- 

### Nonpumped samples—

- a. Field rinse the sampler (typically, a bailer) and sampler emptying device (and compositing device, if used) three times before collecting the sample. Deploy the sampler so as to minimize disturbance to the water column and aquifer materials.
  - i. Use a reel to keep sampler line clean and untangled.
  - ii. Lower sampler smoothly, entering water with as little disturbance as possible.
  - iii. Allow sampler to fill, then withdraw sampler smoothly.
  - iv. Shake water in sampler vigorously to rinse all interior surfaces.
  - v. Attach sample-delivery tube or bottom-emptying device to sampler and drain the rinse water through the sampler.
  - vi. Repeat rinse procedure at least twice.
- b. Repeat steps (a) i-iii to withdraw ground water for the sample.

**TECHNICAL NOTE:** When a device is lowered and raised through the water column, the disturbance to the water column can result in outgassing or degassing of ambient dissolved gases and an increase in concentrations of suspended particulates. Repeated movement of the device through the water column exacerbates these effects and can result in substantial modification of the ambient water composition and chemistry.

- c. Set up the bailer in an enclosed or protected space.

**Step 5. Process/collect the sample** → Refer to NFM 5, *Processing of Water Samples*, for instructions regarding the field rinse of sample bottles, sample filtration, and the collection and preservation of whole-water and filtered samples.

**Step 6. Clean equipment** → Refer to NFM 3, *Cleaning of Equipment for Water Sampling*. Sampling equipment must be cleaned as instructed in NFM 3 before leaving the field site.

At contaminated sites, use sample tubing that is disposable or dedicated to that site in order to minimize the risk of cross contamination between wells. Wear gloves while cleaning and handling sampling equipment.

- Rinse sampling equipment with deionized water before the equipment dries.
- Clean equipment to be used at another well during the same field trip after rinsing it and before moving to the next site.
- Collect field blanks to assess equipment-cleaning procedures directly after the sampling equipment has been cleaned in the field or after moving to the next site and before sampling, as dictated by the data-quality requirements of the study (section 4.3).



---

## QUALITY CONTROL 4.3

Collection and analysis of quality-control (QC) samples are mandated components of USGS water-quality field studies. The goal of QC sampling is to identify, quantify, and document bias and variability in data that result from the collection, processing, shipping, and handling of samples. **The bias and variability associated with environmental data must be known for the data to be interpreted properly and be scientifically defensible** (Horowitz and others, 1994; Koterba and others, 1995; Mueller and others, 1997). This section addresses quality control for aqueous samples to be analyzed for inorganic and organic analytes (see NFM 7 for quality control of microbiological sampling and analysis). Quality-assurance terminology in general, and quality-control terminology in particular, can differ within and among organizations; see “*Conversion Factors, Selected Terms, and Abbreviations*” for a glossary of definitions as used in this report.

**Bias:** systematic, directional error measured by the use of blank, spike, or reference-material samples.

**Variability:** random error measured by the use of environmental or QC sample replicates.

The types of QC samples to be collected and their temporal and spatial frequency and distribution depend on study objectives, data-quality requirements, site conditions, and management or regulatory policy. QC sampling is part of an overall strategy for quality assurance of the data collected and generally is described in the Quality Assurance Plan (QAP) or Sampling and Analysis Plan (SAP). QC samples of various types can be used to measure environmental data quality (for example, assign error bars to measurement sets), identify data-quality problems, and locate the sources or causes of data-quality problems. **Field personnel need to understand the purpose for each QC sample type (Appendix A4-C) and how the resulting QC data will be used so they can account for and accommodate QC needs that arise from unforeseen site conditions.**

- ▶ **Basic QC samples** are collected routinely to document the quality of the environmental data and to identify whether data-quality problems exist. They are designed to measure most sources of error that affect environmental samples. Basic QC samples include field blanks, field matrix spikes, and field replicates.
- ▶ **Topical QC samples** address specific QC needs or topics and commonly are designed to (1) help determine when sampling should commence; (2) locate the cause and source of data-quality problems; and (3) assess comparability among field methods. Topical QC samples include all the QC sample types not specifically designated “basic” QC samples.

**Good science requires consideration of measurement errors – such as bias and variability – in data analysis.**

The field team or person collecting samples should be involved in assessing the analytical results of the QC samples collected, because only they have all of the information about the site conditions and procedures that were followed. This knowledge could be crucial in understanding QC sample results. For any water-quality sampling event, USGS field personnel must:

- ▶ Be knowledgeable about and alert to potential sources of contamination (table 4-11). When in doubt, it usually is wisest to collect additional QC samples and decide later whether to have them analyzed.
- ▶ Collect field QC samples at approximately the same time as environmental samples are collected, using the same equipment.
- ▶ Document in the field log as complete a description of the sampling event as possible. Include how, when, where, and why the QC sample was collected, and observations about site or sampling conditions.
- ▶ Implement the prescribed procedures for equipment cleaning and QC sample collection and processing.

- ▶ Use chemical preservatives from the same lot number for a given set of environmental and associated QC samples. Record the preservative lot number on field forms and in field notes.
- ▶ Store QC data in an electronic data base devoted to QC data. For USGS studies, this should be a QC-designated data base within NWIS.

**Use Good Field Practices (table 4-2) and Clean Hands/Dirty Hands techniques (table 4-3) when collecting and processing QC samples.**

**Table 4-11.** Common sources of contamination related to field activities

[SPMDs, semi-permeable membrane devices; DIW, deionized/distilled water of ASTM grade one or better; DEET, N,N-diethyl-meta-toluamide (the active ingredient commonly used in insect repellents)]

Contaminant source type	Examples
Sampling environment	Airborne particulates; precipitation; dust, soil, solid particles; fumes from engine exhaust, chemical preservatives, upwind industrial emissions.
Sample-collection equipment	Pumps, isokinetic samplers, bailers, sample tubing, SPMDs.
Sample-processing equipment	Filtration devices, churn splitter, cone splitter, bottles, water (DIW, tap, blank).
Sample-cleaning processes	Cleaning equipment (basins, brushes); carryover from cleaning solutions or tainted water; methanol carryover; insufficient decontamination or rinsing.
Transport and shipping	Field vehicles; coolers or other shipping containers; improperly closed or protected sample bottles.
Storage	Warehouse; refrigerator; field vehicle; office laboratory; office storage space.
Personnel	Dirty hands; sweat; sunscreen; DEET; nicotine, caffeine, and alcohol (breath); dirty gloves; gloved or ungloved contact with the sample to be analyzed; shedding clothing; hair and dandruff.

**How, when, where, and why a QC sample was collected must be known to understand the sources of error measured.**

---

## 4.3.1 BLANK SAMPLES

The primary purpose of a blank sample (“blank”) is to measure the magnitude of contaminant concentration (for analyte(s) of specific interest) that might have been introduced into the sample as a result of sampling-related activities (table 4-11 and Appendix A4-C). Various types of blanks can be used or customized to identify the source of sample contamination (table 4-12 and Appendix A4-C). Appendix A4-D provides examples for estimating the volume of blank solution needed.

It is necessary to obtain blank water of the quality and type appropriate for the chemical analysis to be performed on the sample. Blank water is strictly defined within the USGS as specially prepared distilled/deionized water (DIW) that is laboratory produced, quality-controlled, and that carries a certificate of analyte concentrations for each grade and lot of water produced. USGS water-quality projects obtain quality-assured blank water through the One-Stop Shopping system of the National Water-Quality Laboratory (NWQL).

- ▶ **Inorganic-grade blank water (IBW)** is required for blanks that will be analyzed for inorganic constituents (major and minor ions including nutrients, trace elements) and suspended sediments.
- ▶ **Pesticide-grade (PBW)** is required for blanks that will be analyzed for pesticide compounds and organic carbon.
- ▶ **VOC/Pesticide-grade (VPBW)** has been purged with nitrogen gas ( $N_2$ ) and is required for blanks that will be analyzed for volatile organic compounds. VPBW is appropriate as a blank sample for analysis of pesticides, organic carbon, and suspended sediments.

Before collecting blank samples, the laboratory certification of concentration for each analyte in the blank water should be compared with the expected concentration in the environmental samples and with the detection limit of the laboratory method to be used for sample analysis.

**The laboratory certificate of analysis for each lot of blank water should be kept on file with project records, and the lot number(s) used for each sample should be recorded on field forms.**

**Wear clean, powderless, disposable gloves  
and conform meticulously to other  
Clean-Hands practices when working  
with blank solutions.**

**Table 4-12.** Common types of blank samples and the questions they address [QC, quality control; IBW, inorganic-grade blank water; PBW, pesticide-grade blank water; VPBW, volatile-organic-compound and pesticide-grade blank water]

Type	Targeted Source(s) of Bias <sup>1</sup>
Field blank	Sample-collection, -processing, -transport process <i>Basic QC sample: Was my sample contaminated as a result of field activities and exposure?</i>
Equipment blank	Sample-collection and processing equipment system <i>Topical QC sample: Does an initial equipment assessment<sup>2</sup> confirm the suitability of the equipment to provide samples within my data-quality requirements?</i> <i>Topical QC sample: Is my equipment-cleaning protocol adequate?</i>
Sampler blank	Sampling device (for example, the D-95 sampler, Fultz pump, or peristaltic-pump tubing) <i>Topical QC sample: Is my sampling device the source of contamination?</i>
Filter blank	Filtration device (for example, the capsule filter, in-line filter holder, aluminum plate filter) <i>Topical QC sample: Is my filtration device the source of contamination?</i>
Ambient blank	Exposure to atmospheric outfall or other conditions <i>Topical QC sample: Was sample exposure to the atmosphere a contaminant source?</i>
Source-solution blank	The blank water used (for example, IBW, PBW, or VPBW) <i>Topical QC sample: Was my blank water tainted with respect to my analyte(s) of interest?</i>

<sup>1</sup>The bias and variability measured includes that from laboratory handling, processing, and analysis of the sample in addition to the targeted source listed.

<sup>2</sup>An equipment blank is required for U.S. Geological Survey investigations to determine the equipment suitability to provide the analyte data needed to meet study objectives.

*To prepare for processing blank samples:*

1. Label the capped, precleaned sample bottle with the site identification number, laboratory sample designation code (NFM 5), date and time, or affix the proper bar-code label to the sample container, as appropriate. Record this information on field forms.
2. Put on gloves. Place each stock container of the blank solution to be used (IBW, PBW, and VPBW) into a clean plastic bag. If pumping blank water from a standpipe, change gloves and then rinse the precleaned standpipe three times using a small volume of blank solution of the type selected. Keep standpipe covered until use.
3. Change gloves. Place precleaned, labeled sample bottle(s) and the stock of blank solutions to be used into processing chamber (or standpipe).
  - IBW blanks—Discard the deionized water that half fills the precleaned polyethylene sample bottle. Rinse the sample bottle with a small quantity of blank solution and discard rinse before filling with IBW.
  - PBW or VPBW blanks—Do not prerinse the sample bottle. Use glass bottles or vials as received precleaned from the laboratory.

**Do not substitute DIW for IBW.**

---

## Pre-Field Blanks 4.3.1.A

The source-solution and initial equipment blanks are common types of blank samples that are collected by the study field team in preparation for environmental sampling. **Collection of an equipment blank is mandated by USGS policy before the sampling phase of the study begins**, to determine if the sample-wetted components of the equipment proposed for use could be a source of contamination by introducing the study's target analytes to a blank or environmental sample. Collection of pre-field equipment blanks is recommended annually, or as appropriate for the sampling schedule of the study.

- ▶ **Source-solution blank.** Collect in a designated clean, draft-free area of the office laboratory, such as under a laminar-flow hood or laminar-flow bench. Do not collect the source-solution blank in a fume hood. Submit the sample for analysis along with or after the equipment blank and field-collected samples, depending on study objectives and the data resulting from other blank samples.
- ▶ **Equipment blank (pre-field).** Collect in a designated clean area of the office laboratory at least 4 weeks before using the equipment in the field to allow enough time for sample analysis and review of the resulting data.

A variety of other types of blank samples that are collected in the controlled office-laboratory environment can be designed to test some aspect of sample handling not related to the field environment. Examples of these types of blanks include the refrigerator blank, the shelf blank, and the preservation blank (Appendix A4-C).

### 4.3.1.B Field Blanks

Field blanks are collected and processed at the field site in the same manner and using the same equipment as the environmental sample(s). Equipment must be cleaned meticulously before field blanks are collected (NFM 3).

- ▶ A single field blank is a “basic” QC sample that represents the entire sampling system. The field blank is collected routinely for basic quality control of the sampling process, rather than identifying the specific source of the contamination. The field blank consists of an aliquot of blank water processed sequentially through each component of the sampling system (fig. 4-14 and Appendix A4-C). The field blank provides a measure of the total contamination (bias) present in the sample.
- ▶ To address topical quality-control questions, blanks can be collected onsite that represent components of the sampling system; for example, the sampler blank (surface water), splitter blank, filter blank, or pump or bailer blank (ground water). Such topical field blanks can be used to trace the specific source of contamination.
- ▶ When collecting field blanks for inorganic and organic analyses after sampling at a site, use the following sequence and the protocols described in NFM 3 and shown in NFM 3, fig. 3-1 for equipment cleaning.
  1. Clean equipment for inorganic-constituent sampling: detergent → tapwater/DIW → acid, if needed → DIW.
  2. Rinse equipment with IBW at least three times.
  3. Collect the IBW blank sample for analysis of inorganic constituents.
  4. Resume equipment cleaning for organic-compound sampling: methanol, if needed → air-dry exposed surfaces → IBW or PBW, as appropriate. Remove methanol from pumps, tubing, and other equipment, as described in NFM 3.
  5. Rinse equipment at least three times with the appropriate organic-grade blank water (VPBW or PBW).
  6. Collect the VPBW (or PBW) blank sample for analysis of organic compounds.



The process of producing a field blank can be designed to collect simultaneously blanks for each component of the sampling system (fig. 4-14). If laboratory analysis of the analytes being quality controlled is not time dependent, the sequential blank samples representing components of the sampling system, as well as any associated source-solution and ambient blanks, normally can be stored for up to 6 months.

- ▶ If the field-blank data indicate constituent concentrations at acceptable levels, then the associated set of sequential blanks can be discarded. (Be sure to use appropriate means for disposing of chemically treated solutions.)
- ▶ If laboratory data indicate greater than acceptable concentrations:
  - Submit the source-solution blank, ambient blank(s), and equipment-component blank(s) (the sampler blank, splitter blank, pump blank, and so forth) to the laboratory for analysis.
  - Use the data from equipment-component blank samples to identify the source(s) of contamination detected in the field blank.
- ▶ Once the source of contamination has been identified, take the measures needed to mitigate or eliminate the contamination for future sampling efforts.

**Prevent contamination of the source-solution and blank sample by capping the respective bottles immediately after decanting the volume of blank solution needed.**

### EXAMPLE OF FIELD-BLANK SAMPLE COLLECTION

A set of blanks can be generated that is associated with the field blank to help determine which equipment component in the system could be a source of contamination. The **field blank** is the final sample that represents all equipment components of the sampling system. After each blank sample is collected, preserve and store sample as required.

- **Surface-water field blank: follow steps 1 through 4.** In this example, the equipment used includes a US D-95 sampler, 8-liter (L) churn splitter, peristaltic pump, and filter assembly.
- **Ground-water field blank: follow steps 1 and 2.** In this example, the equipment used includes a submersible pump and a filter assembly.

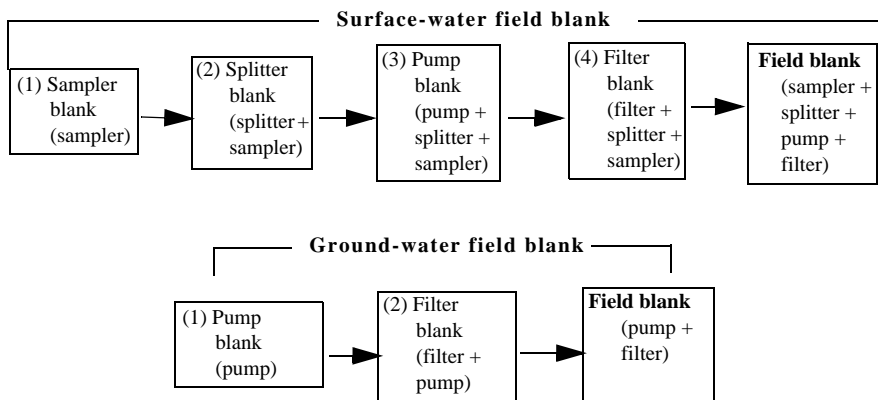

**Sampler Blank.** Using the blank water selected, rinse and then fill the sampler; attach sampler cap and nozzle; pour the required volume through nozzle into sample bottle.

**Splitter Blank.**<sup>1</sup> Rinse churn splitter with blank water. Pour the blank water remaining in the sampler through the sampler nozzle and into the 8-L churn splitter. Refill sampler, repeat until churn contains 3 to 5 L of blank water. Process the required blank-sample volume through the churn spigot into the splitter-blank bottle. (If a cone splitter is used instead of a churn splitter, the blank sample is processed through the exit port tubes.)

**Pump Blank.**<sup>1</sup>

- **Surface-water example:** Using the peristaltic pump, thread the intake end of clean tubing into churn splitter through the funnel, and cap the funnel loosely. Insert the discharge end of the pump tubing into a processing chamber and pump blank water through the tubing for an initial rinse, discharging rinse water to waste. After the rinse, pump the required volume of blank water from the churn splitter into the pump-blank bottle.
- **Ground-water example:** Rinse a precleaned, noncontaminating standpipe with blank water and discard rinse water. Place submersible pump into the standpipe and pour in blank water—keep water level above the pump intake. Insert discharge end of pump tubing into a processing chamber. Circulate blank water through pump and tubing to rinse, discharging rinse water to waste. Pump the required volume of blank water from the standpipe into the pump-blank bottle.

**Field Blank.** The **field blank** in this example is identical to the **filter blank**<sup>1</sup> because the filter assembly is the final component of the equipment system through which the blank is processed. Working in the processing chamber, precondition the filter with blank water (NFM 5).

- **Surface-water example:** Pump the required volume of blank water from the churn splitter through the prerinsed filter assembly into the field-blank bottle.
- **Ground-water example:** Pump the required volume of blank water from the standpipe through the prerinsed filter assembly into the field-blank bottle.

<sup>1</sup>These are special cases of a splitter blank, pump blank, and filter blank, respectively, because the equipment component named is the final component but not the only component contacting the blank sample.

**Figure 4-14.** Example procedure for collecting a field-blank quality-control sample.

---

## REPLICATE SAMPLES 4.3.2

The primary purpose of replicate samples is to identify and (or) quantify the variability in all or part of the sampling and analysis system. Replicates—environmental samples collected in duplicate, triplicate, or greater multiples—are considered identical or nearly identical in composition and are analyzed for the same chemical properties. Common types of replicates are described below and summarized in Appendix A4-C. Field personnel should be careful to keep detailed notes on exactly how the replicate samples were collected and processed, to help distinguish the sources of variability that affected the samples.

**Replicate samples are collected simultaneously or close in time with the associated environmental sample, using identical procedures.**

---

### Concurrent Replicates 4.3.2.A

Concurrent replicates are two or more samples of environmental water that are collected simultaneously or at approximately the same time. Concurrent replicates provide basic QC data for surface-water sampling and incorporate, for example, the total variability introduced from collection, processing, and shipping of the sample; the variability inherent in the aqueous system across a short distance in space and time; and the variability inherent in laboratory handling and analysis of the samples.

Depending on study objectives, duplicate samples can be collected concurrently by using two sampling devices of the same type or by filling separate sample-compositing containers using the same sampling device.

*The following procedure, adapted from Horowitz and others (1994), is used at surface-water sites to fill two or more sample-compositing containers (usually churn splitters):*

1. Complete equipment field-rinsing procedures (surface water, section 4.1.3; ground water, section 4.2.2.C), using two clean churn splitters. Label the sample bottles appropriately. Change gloves.
2. At the first vertical of an EWI or EDI section, collect a sample and pour it into the churn splitter 1 (section 4.1).
3. Using identical technique, resample at the first vertical and pour the sample into churn splitter 2.
4. Move to the second vertical, collect the sample, and pour it into churn splitter 2.
5. Using the identical technique, resample at the second vertical and pour the sample into churn splitter 1.
6. Collect and pour samples into each churn splitter in this manner for each of the remaining verticals, alternating churn splitters as described in steps 2 to 5 above.
7. Using identical technique, process and preserve a sample from churn splitter 1 and then from churn splitter 2.

---

### **4.3.2.B Sequential Replicates**

Sequential replicates are samples of environmental water – commonly ground water – that are collected consecutively (one after the other) from the same sampling site and that are subjected to identical laboratory analysis. The sequential replicate can be collected, for example, as a sample pumped from a well or stream. Sequential replicates are used to assess variability among samples that result from field activities (collection, processing, and shipping procedures). Because sequential replicates are not collected simultaneously, inhomogeneities in the water resource are incorporated into the variability measured. Also included is the variability inherent in laboratory handling and analysis of the samples.

***When collecting sequential replicates for whole-water samples:***

1. Use identical sampling procedures and supplies, collecting the sample for each analysis one after the other.
2. Preserve the replicate-sample set in the same order as the order in which the samples were collected.

***When collecting sequential replicates for filtered samples, use the procedure that best fits study objectives:***

1. Trace-element samples or sample set for inorganic and nutrient analyses that includes trace metals:<sup>16</sup>
  - a. For each replicate prepare a capsule filter unit as described in NFM 3 and NFM 5.2. Two replicates, for example, require two precleaned capsule filters.
  - b. Install “Filter A” and follow filtration procedures and analyte sequence described in NFM 5.2. Trace-element (FA) samples are filtered first, passing no more than 200 mL of sample water through the capsule filter.
  - c. Remove and discard Filter A. Change gloves.
  - d. Install “Filter B.” Use identical procedures and sampling sequence as were used for the “Filter A” sample set.
  - e. Continue with this procedure for each additional replicate. This procedure helps assess the variability in sample chemistry over the time period of sample collection that results from sampling and laboratory procedures, including a potential effect from using different capsule filters. Potential effects from using different filter units is considered insignificant compared to those from particulate loading of the filter (Horowitz and others, 1994; USGS Office of Water Quality Technical Memorandums 92.13 and 93.05).
2. Pesticides and other filtered organic-compound samples:
  - If there is minor or no visible loading of particulate matter on the filter, then replicate samples can be collected one after another without changing filters.
  - If filter loading is observed, using a different filter in the manner described above for trace-element samples is recommended. The decision, however, depends on the data-quality requirements of the study and professional judgment.

<sup>16</sup>This method fulfills the objective to maintain the operational pore-size definition of the filtered-sample for trace-element analysis; one filter unit is designated per trace-element sample set in order to maintain comparable particulate loading on the filter.

### 4.3.2.C Split Replicates

Split replicates are samples obtained by dividing one sample that is designated for a specific laboratory analysis into two or more subsamples (replicates), each of which is submitted to one or more laboratories for identical analysis. Split replicates can be collected for different purposes, depending on the procedures employed and whether the purpose is to determine variability from field plus laboratory processes (the field-replicate split sample) or from laboratory procedures (the lab-replicate split sample).

**When collecting split replicates, sample bottles must be labeled carefully, and the sequence of procedures used must be recorded.**

- ▶ **Lab-replicate split sample.** A sample collected in a single bottle that is split into two or more replicates **after** having been processed and preserved is used to answer the question: “What is the variability associated with laboratory handling and analysis of the sample?” This type of split replicate sample typically is prepared from filtered samples; it is not appropriate, generally, for whole-water samples containing noticeable concentrations of suspended material.

***To collect a lab-replicate split sample (adapted from Horowitz and others, 1994):***

1. Wearing disposable, powderless gloves and working inside a processing chamber, start with a full bottle of sample<sup>17</sup> to which the appropriate chemical treatment has been added. Shake the sample thoroughly to mix.
  - For inorganic samples only, use a bottle rinsed at least twice with IBW and then field rinse the bottle with a small volume of processed sample.
  - Do not prerinse bottles for organic samples.
2. Transfer the entire contents of the first bottle to the second bottle. Cap and shake the second bottle.
3. Uncap the second bottle and pour its entire contents back into the first bottle. Cap and shake.
4. Uncap the bottles and pour one-half of the sample from the first bottle into the second bottle. Cap both bottles tightly.

---

<sup>17</sup>The volume of sample collected and that of the split replicates depends on the volume of sample required by the laboratory for the analysis desired.

► **Field-replicate split sample.** A sample split into subsamples by use of a churn splitter, cone splitter, or T-valve (such as that used on a ground-water manifold device, fig. 4-10), for example, can be used to answer the question, “What is the variability associated with the entire sampling (including any sample collection, processing, preservation, shipping, and laboratory handling and analysis) processes?” Bottles of the replicate samples must be labeled appropriately, and the sequence of procedures used must be recorded. To split concurrent replicate samples that were processed through separate compositing devices (such as churn splitters), follow the procedure shown in steps 1-4 above and label the samples as follows:

*To collect a field-replicate split sample (adapted from Horowitz and others, 1994):*

**Churn splitter 1:** first bottle "Site (X), Sample 1, Split A"  
"Site (X), Sample 1, Split B"

**Churn splitter 2:** first bottle "Site (X), Sample 2, Split A"  
"Site (X), Sample 2, Split B"

---

### 4.3.3 SPIKE SAMPLES

A “spike” sample is an environmental sample to which target compounds (the field-matrix spike mixture) are added after the sample has been processed. Field-spike samples are used to measure bias and answer the question “What loss or gain of target analytes occurred because of degradation and water-matrix characteristics?” Bias determined from spikes is termed “recovery” and reflects the amount of analyte(s) measured expressed as a percentage of the amount spiked.

Spike samples can be customized to address the source of the bias (water matrix, degradation, laboratory method performance) in the data. To address bias from degradation, samples should be spiked in the field as soon as possible after collection. A combination of a laboratory spike, field spike, and field-spike replicate provides the most information, but may not be needed for a given study.

---

---

 **RULE OF THUMB:**

**Spike when target compounds are expected to be low; specifically, when target compounds are at least a factor of two less than the spiking level.**

---

---

The numbers and types of spike samples to be selected depend on study objectives and data-quality requirements. However, **an unspiked environmental sample must accompany each spiked environmental sample to correct the data for background concentrations.**

Training is required before personnel attempt to spike samples. USGS personnel obtain spike solutions, spike kits, and instructions through the NWQL One-Stop Shopping system.

Field-matrix spike mixtures are prepared in a laboratory and commonly are added to environmental samples designated for organic-compound analysis.

- ▶ Short-term use: keep matrix-spike ampoules chilled at all times. Spike compounds are unstable and degrade rapidly at room temperature.
- ▶ Long-term use: store spike mixtures in a freezer.
- ▶ Spike mixtures contain toxic compounds. Dispose of waste materials in accord with current local and State regulations and USGS Science Center guidelines.



*When preparing field-spiked samples for pesticides or VOCs, follow the procedure listed below:*

1. Samples should be processed, spiked, and chilled immediately after collection. If spiking is delayed, keep sample chilled until and after it is spiked. Check that the sample bottles are labeled appropriately:
  - FS = field-spiked sample
  - FSR = field-spiked replicate
  - LS = lab-spiked sample
2. Wearing disposable gloves and working in a preservation chamber, follow the laboratory instructions for spiking the sample. Be sure that the spike mixture is the one intended for the sample, in terms of analytes, volume, and concentration.
3. Chill field-spiked samples to 4°C or below without freezing, and handle in a manner identical to that of the unspiked environmental sample.
4. Record the following information related to the spike sample on field and NWQL Analytical Services Request forms: lot number of spike solution, volume of spike solution, and source of spike solution.

**CAUTION: Spike mixtures can be toxic and might cause cancer or other diseases. Follow the laboratory-prescribed spiking instructions meticulously. Work in a well-ventilated area and avoid inhalation and skin and eye contact.**

---

## 4.3.4 REFERENCE SAMPLES

Standard-reference-water samples (SRS) and reference-material samples that are submitted by field personnel for laboratory analysis can be used to answer questions, such as “What are the bias and variability associated with field-handling, shipping, and laboratory procedures”? Reference samples typically are submitted from the field as blind samples (section 4.3.5) and as split replicate samples (section 4.3.2.C) because the composition is known, thus eliminating guesswork regarding the accuracy of the analytical results.

Reference samples for inorganic analytes in a natural water matrix currently are available to USGS personnel from the USGS Branch of Quality Systems. The National Institute of Standards and Technology and some commercial laboratories also supply reference materials.

*When preparing reference samples, follow the procedure listed below:*

1. **Prepare this sample before leaving for the field site.**
  - a. Relabel the reference-sample bottle with the site identification code and a field date and time. The sample should appear as if it is an environmental sample.
  - b. Process SRS or reference-material samples in a clean environment in the office laboratory, under a laminar-flow hood or other protective chamber, to avoid atmospheric contamination. **Do not process these QC samples under a fume hood.**
  - c. Rinse each sample bottle three times with a small volume of SRS or reference-material sample, fill the bottle with the reference solution, and cap securely.

2. Prepare an Analytical Services Request (ASR) form; record the SRS or reference-material sample identification code (from the original container) in field notes.
3. Pack the sample and the accompanying ASR form to take to the field site.
4. Ship SRS or reference-material samples in the same container with the environmental and other QC samples collected at the field site.

---

### 4.3.5 BLIND SAMPLES

For blind samples, the source and chemical composition of the samples are known to the submitter but typically not known to the analyst; therefore, blanks, SRS, or reference material often are used as blind samples. Blind samples can be designed to answer questions such as “What bias and variability are introduced by procedures used within a single laboratory or among laboratories?” Replicate or spike samples sometimes are used to answer a similar question, but with greater potential for more variability.

*Page left blank intentionally.*

# CONVERSION FACTORS, SELECTED TERMS, AND ABBREVIATIONS

---

## CONVERSION FACTORS

Multiply	By	To obtain
foot (ft)	0.3048	meter
gallon (gal)	3.785	liter
inch (in.)	25.4	millimeter
meter (m)	3.281	foot
micrometer ( $\mu\text{m}$ )	$3.281 \times 10^{-6}$	foot
millimeter (mm)	0.03937	inch
milligram (mg)	$3.527 \times 10^{-5}$	ounce, avoirdupois
microgram ( $\mu\text{g}$ )	$3527 \times 10^{-5}$	ounce
liter (L)	0.2642	gallon
milliliter (mL)	$2.64 \times 10^{-4}$	gallon

**Temperature:** Water and air temperature are given in degrees Celsius ( $^{\circ}\text{C}$ ), which can be converted to degrees Fahrenheit ( $^{\circ}\text{F}$ ) by use of the following equation:

$$^{\circ}\text{F} = 1.8(^{\circ}\text{C}) + 32$$

---

## SELECTED TERMS

**Accuracy:** The degree of agreement of a measured value with the true or expected value (Taylor, 1987).

**Analyte (target analyte):** “Substances being determined in an analysis” (from Bennett, 1986). The term target analyte is used in this report to refer to any chemical or biological substance for which concentrations in a sample will be determined. The definition for target analyte does not include field-measured parameters such as specific electrical conductance, pH, temperature, dissolved oxygen, Eh, alkalinity, color, or turbidity.

**Aquifer:** “A saturated permeable geologic unit that can transmit significant quantities of water under ordinary hydraulic gradients” (Freeze and Cherry, 1979).

**Area-weighted sample:** A sample that contains an equal volume from each unit of area sampled.

**Bias:** Systematic error inherent in a method or caused by some artifact or idiosyncrasy of the measurement, collection, or processing system; systematic directional error measured by the use of blank, spike, and reference-material samples. The error can be positive (indicating contamination) or negative (indicating loss of analyte concentration) (from Taylor, 1987).

**Bag samplers:** Samplers whose containers are bags that instantly transmit the ambient pressure to the interior of the sample container and do not have opening or closing valves.

**Bottle samplers:** A rigid sample container that does not instantly transmit the ambient pressure to the interior of the sample container and has neither pressure compensation nor opening and closing valves. Point samplers described in Edwards and Glysson (1999) use rigid bottles but have pressure compensation and opening and closing valves and are not considered bottle samplers for the purposes of this document. **The tables in Appendix A4-A were not designed for use with point samplers.**

**Centroid** (as used to designate a special case of stream-sampling location for the equal-discharge-increment method): The vertical in the increment at which discharge is equal on both sides of the vertical (G. Douglas Glysson, U.S. Geological Survey, written commun., 1997).

**Contaminant:** Biological, chemical, or physical substances or properties added to the medium of concern through human activity or natural processes and that corrupt its ambient composition.

**Contamination (of water):** Corruption of ambient water composition or attributes by the addition of biological, chemical, or physical substances as a result of human activity or natural processes. Addition of such substances can degrade the quality of the water resource.

**Data-quality requirements:** That subset of data-quality objectives pertaining specifically to the analytical detection level for concentrations of target analytes and the variability allowable without compromising achievement of the scientific objectives of the study.

**Depth-integrated sample:** A sample collected when each vertical portion of the stream depth is represented in the sample in proportion to the desired sampling scheme.

- **Depth integration.** “A method of sampling at every point throughout a given depth (the sampled depth) whereby the water-sediment mixture is collected isokinetically so that the contribution from each point is proportional to the stream velocity at the point. This process yields a sample with properties that are discharge weighted over the sampled depth” (ASTM, 1990).
- **Depth integration for a discharge-weighted sample.** “A discharge-weighted (velocity-weighted) sample of water-sediment mixture collected at one or more verticals in accordance with the technique of depth integration; the discharge of any property of the sample expressible as a concentration can be obtained as the product of the concentration and the water discharge represented by the sample” (ASTM, 1990). For a discharge-weighted sample, the water-sediment mixture is collected isokinetically so that the contribution from each point is proportional to the stream velocity at the point (that is, the sample contains an equal volume from each unit of discharge sampled).

- **Depth integration to collect an area-weighted sample.** The ASTM definition of depth integration does not accommodate the concept of an area-weighted sample. Area weighting is similar in concept to discharge weighting, except that the water-sediment mixture is collected so that the contribution from each point is proportional to the stream area at the point (that is, contains an equal volume from each unit of area sampled). Area-weighted sampling is used to obtain a sample that contains the average concentration of a property that is observed in a cross section. Averaged in situ field measurements of streams are more nearly area weighted than discharge weighted. The product of an area-weighted property concentration and the stream discharge would not yield the discharge of the property unless the stream contained the same property concentration at every point.

**Discharge-weighted sample:** A sample that contains an equal volume from each unit of discharge sampled.

**Equal-width-increment (EWI) and equal-discharge-increment (EDI) sample-collection methods:** Methods specifically designed to result in the collection of discharge-weighted, depth-integrated, isokinetic samples (Edwards and Glysson, 1999). When either method is used properly, the resulting samples contain the same property concentrations.

**Isokinetic sampling:** A sample collected in such a way that the water-sediment mixture moves with no change in velocity as it leaves the ambient flow and enters the sampler intake (ASTM, 1990).

**Precision:** The degree of mutual agreement characteristic of independent measurements as the result of repeated application of the process under specified conditions (Taylor, 1987).

**Purging:** Refers to removal of water standing in a cased well or borehole before water samples are collected for analysis.

**Quality Assessment:** Overall process of assessing the quality of the environmental data by reviewing the application of the quality-assurance elements and the analysis of the quality-control data.

**Quality Assurance (QA):** A system of protocols and procedures implemented to meet expected standards of quality needed to fulfill study objectives and control unmeasurable components of a study, such as sampling at the right place and (or) time using the correct equipment and techniques.

**Quality Control (QC):** A system of activities (such as collection of blank or replicate samples) whose purpose is to assess the quality of environmental data by generating a set of data that will be used to estimate the magnitude of the bias and variability resulting from the procedures used for obtaining the data.

**Raw sample:** A whole-water (unfiltered) sample that has not been processed through a filter or other phase-separation device.

**Transit:** To move the sampler from the stream surface to the streambed or from the streambed to the surface.

**Transit rate:** The rate at which the sampler is passed through the water from the stream surface to the streambed or from the streambed to the surface.

**Unsampled zone:** The unsampled portion of the sampling vertical, usually assumed to be the zone from the streambed to the sampler intake. Generally, sampler intakes are 4 to 7 inches above the streambed, depending on the kind of sampler used.

**Variability:** Random error in independent measurements as the result of repeated application of the process under specific conditions; random error measured by the use of environmental or QC-sample replicates.

**Vertical:** Refers to that location within the increment at which the sampler is lowered and raised through the water column.

**Water Science Center:** An office of the USGS, Water Resources Discipline, located in any of the States or territories of the United States.

**Wholewater sample:** (*see* Raw sample).



---

## ABBREVIATIONS

~	approximately
=	equal to
>	greater than
≥	greater than or equal to
<	less than
≤	less than or equal to
+	plus
±	plus or minus
ft/s	feet per second
gal/min	gallon per minute
L	liter
L/min	liter per minute
µg/L	microgram per liter (equivalent to parts per billion)
µs/cm	microsiemens per centimeter
mg/L	milligram per liter
mL/min	milliliter per minute
ppb	parts per billion (equivalent to micrograms per liter)
ADAPS	Automatic Data Processing System
ASR	Analytical Services Request
ASTM	ASTM, International
BOD	biochemical oxygen demand
CFC	chlorofluorocarbon
<i>CH/DH</i>	Clean Hands/Dirty Hands
DIW	distilled, deionized water
DO	dissolved oxygen
DOC	dissolved organic carbon
EDI	equal-discharge increment
EWI	equal-width increment
FS	field-spiked sample
FSR	field-spiked replicate sample
GPS	global positioning system
GWSI	ground-water site inventory database, a subsystem within the USGS National Water Information System (NWIS)
IBW	inorganic-grade blank water
ID	identification number that is unique to a field site, station, or well

LNAPL	light non-aqueous phase liquid
LS	laboratory-spiked sample
MP	measuring point on a ground-water well
NAWQA	National Water-Quality Assessment Program (USGS)
NFM	<i>National Field Manual for the Collection of Water-Quality Data</i>
NFSS	National (USGS) Field Supplies Service (also referred to as “One-Stop Shopping”)
NIST	National Institute of Standards and Technology
NPDES	National Pollutant Discharge Elimination System
NWIS	National Water Information System of the USGS
NWQL	National Water Quality Laboratory
OGW	Office of Ground Water, USGS
OWQ	Office of Water Quality, USGS
PBW	pesticide-grade blank water
PCB	polychlorobiphenyls
Q	rate of discharge
QA	quality assurance
QADATA	quality-assurance database within NWIS
QAP	Quality Assurance Plan
QC	quality control
SF <sub>6</sub>	sulfur hexafluoride
SAP	Sampling and Analysis Plan
SPMD	semi-permeable membrane device
SRS	Standard reference water sample
TBY	turbidity
TOC	total organic carbon
TU	turbidity unit
URL	Uniform Resource Locator
USGS	U.S. Geological Survey
VPBW	volatile-organic-compound and pesticide-grade blank water, purged with nitrogen gas
VCF	single vertical at centroid of flow
VOC	volatile organic compound

# SELECTED REFERENCES AND DOCUMENTS

## SELECTED REFERENCES FOR COLLECTION OF WATER SAMPLES

- American Public Health Association, American Water Works Association, and Water Environment Federation, 2001, Standard methods for the examination of water and wastewater (20th ed.): Washington, D.C., American Public Health Association, variably paged.
- ASTM International, 1990, Compilation of ASTM standard definitions (7th ed.): Philadelphia, ASTM, 554 p.
- ASTM International, 2005, Standard guide for purging methods for wells used for ground-water quality investigations—Designation D 6452-99 (Reapproved 2005): Subcommittee D18.21, accessed May 30, 2006, at [http://www.astm.org/cgi-bin/SoftCart.exe/DATABASE.CART/REDLINE\\_PAGES/D6452.htm?L+mystore+hynp4105](http://www.astm.org/cgi-bin/SoftCart.exe/DATABASE.CART/REDLINE_PAGES/D6452.htm?L+mystore+hynp4105).
- ASTM International, 1992, ASTM Standards on ground water and vadose zone investigations: Philadelphia, ASTM pub. code 03-418192-38, 166 p.
- Backhus, D.A., Ryan, J.N., Groher, D.M., MacFarlane, J.K., and Gschwend, P.M., 1993, Sampling colloids and colloid-associated contaminants in ground water: *Ground Water*, v. 31, no. 3, p. 466-479.
- Bartholoma, S.D., comp., 2003, User's manual for the National Water Information System of the U.S. Geological Survey (USGS), Automated Data Processing System (ADAPS), Version 4.3: U.S. Geological Survey Open-File Report 03-123, 413 p.
- Bennett, H., ed., 1986, Concise chemical and technical dictionary (4th ed.): New York, Chemical Publishing Co., p. 99.
- Brunett, J.O., Barber, N.L., Burns, A.W., Fogelman, R.P., Gillies, D.C., Lidwin, R.A., Mack, T.J., 1997, A quality-assurance plan for district ground-water activities of the U.S. Geological Survey: U.S. Geological Survey Open-File Report 97-11, 41 p., accessed May 30, 2006, at <http://water.usgs.gov/ogw/pubs/OFR9711/gwqap.pdf>.
- Classen, H.C., 1982, Guidelines and techniques for obtaining water samples that accurately represent the water chemistry of an aquifer: U.S. Geological Survey Open-File Report 82-1024, 49 p., accessed May 30, 2006, at <http://pubs.er.usgs.gov/usgpsubs/ofr/ofr821024>.
- Driscoll, F.G., 1986, Groundwater and wells (2d ed.): St. Paul, Minnesota, Johnson Division, p. 551.
- Edwards, T.K., and Glysson, G.D., 1999, Field methods for measurement of fluvial sediment: U.S. Geological Survey Techniques of Water-Resources Investigations, book 3, chap. C2, 80 p.
- Federal Interagency Sedimentation Project, 1986, Catalog—Instruments and reports for fluvial sediment investigations: Minneapolis, Minnesota, St. Anthony Falls Hydraulics Laboratory, 138 p.
- Freeze, R.A., and Cherry, J.A., 1979, Groundwater: Englewood Cliffs, N.J., Prentice-Hall, 604 p.

- Garber, M.S., and Koopman, F.C., 1968, Methods of measuring water levels in deep wells: U.S. Geological Survey Techniques of Water-Resources Investigations, book 8, chap. A1, Washington, U.S. Government Printing Office, 23 p.
- Gellenbeck, Dorinda, 2005, User's manual for the National Water Information System of the U.S. Geological Survey (USGS), Water-Quality System (QWDATA), Version 4.3: U.S. Geological Survey Open-File Report 2005-1081, 355 p.
- Gibs, Jacob, Brown, G.A., Turner, K.S., MacLeod, C.L., Jelinski, J.C., and Koehnlein, S.A., 1993, Effects of small-scale vertical variations in well-screen inflow rates and concentrations of organic compounds on the collection of representative ground-water-quality samples: *Ground Water*, v. 31, no. 2, p. 201-208.
- Gibs, Jacob, and Imbrigiotta, T.E., 1990, Well-purging criteria for sampling purgeable organic compounds: *Ground Water*, v. 28, no. 1, p. 68-78.
- Gibs, Jacob, Szabo, Zoltan, Ivahnenko, Tamara, and Wilde, F.D., 2000, Change in field turbidity and trace-element concentrations during well purging: *Ground Water*, v. 38, no. 4, p. 577-488.
- Heath, R.C., 1983, Basic ground-water hydrology: U.S. Geological Survey Water Supply Paper 2220, p. 72-73.
- Hoopes, B.C., ed., 2004, User's manual for the National Water Information System of the U.S. Geological Survey (USGS) Ground-Water Site-Inventory System (GWSI), Version 4.3: U.S. Geological Survey Open-File Report 2004-1238, 262 p.
- Horowitz, A.J., Demas, C.R., Fitzgerald, K.K., Miller, T.L., and Rickert, D.A., 1994, U.S. Geological Survey protocol for the collection and processing of surface-water samples for the subsequent determination of inorganic constituents in filtered water: U.S. Geological Survey Open-File Report 94-539, 57 p.
- Horowitz, A., Elrick, K., and Colberg, M., 1992, The effect of membrane filtration artifacts on dissolved trace-element concentrations: *Water Research*, v. 26, p. 753-763.
- Hubbard, E.F., 1992, Policy recommendations for management and retention of hydrologic data of the U.S. Geological Survey: U.S. Geological Survey Open-File Report 92-56, 32 p.
- Inter-Agency Committee on Water Resources, Subcommittee on Sedimentation, 1961, The single-stage sampler for suspended sediment: Minneapolis, Minnesota, St. Anthony Falls Hydraulic Laboratory Report 13, 105 p.
- Ivahnenko, Tamara, Szabo, Zoltan, and Hall, G.S., 1996, Use of an ultra-clean sampling technique with inductively coupled plasma-mass spectrometry to determine trace-element concentrations in water from the Kirkwood-Cohansey aquifer system, coastal plain, New Jersey: U.S. Geological Survey Open-File Report 96-142, 37 p.
- Kearl, P.M., Korte, N.E., and Cronk, T.A., 1992, Suggested modifications to ground water sampling procedures based on observations from the colloidal borescope: *Ground Water Monitoring Review*, v. 12, no. 2, p. 155-160.
- Keith, L.H., 1978, Principles of environmental sampling: Washington, D.C., American Chemical Society ACS Professional Reference Book, 458 p.
- Koterba, M.T., Dysart, J.E., Phillips, S.W., and Zynjuk, L.D., 1994, Use and value of quality-control data in studies in the Chesapeake Bay Region, *in* Proceedings of the National Symposium on Water-Quality, November 5-11, Chicago, Ill., American Water Resources Association, p. 65-74.

- Koterba, M.T., Wilde, F.D., and Lapham, W.W., 1995, Ground-water data-collection protocols and procedures for the National Water-Quality Assessment Program—Collection and documentation of water-quality samples and related data: U.S. Geological Survey Open-File Report 95-399, 113 p.
- Lapham, W.W., Wilde, F.D., and Koterba, M.T., 1995, Ground-water data-collection protocols and procedures for the National Water-Quality Assessment Program—Selection, installation, and documentation of wells, and collection of related data: U.S. Geological Survey Open-File Report 95-398, 69 p.
- Lapham, W.W., Wilde, F.D., and Koterba, M.T., 1997, Guidelines and standard procedures for studies of ground-water quality—Selection and installation of wells, and supporting documentation: U.S. Geological Survey Water-Resources Investigations Report 96-4233, 110 p.
- Loman, S.W., 1953, Measurement of ground-water levels by air-line method: U.S. Geological Survey Water Resources Bulletin, November 1953, Washington, D.C., p. 97-99.
- Martin-Hayden, J.M., 2000, Controlled laboratory investigations of wellbore concentration response to pumping: *Ground Water*, v. 38, no. 1, p. 121-128.
- Martin-Hayden, J.M., 2000, Sample concentration response to laminar wellbore flow—Implications to ground water data variability: *Ground Water*, v. 38, no. 1, p. 12-19.
- Martin-Hayden, J.M., and Wolfe, Natalie, 2000, A novel view of wellbore flow and partial mixing—Digital image analyses: *Ground Water Monitoring & Remediation*, Fall 2000, p. 96-103.
- Miller, James, ed., 2002, Ground water atlas of the United States, accessed May 30, 2006, at <http://capp.water.usgs.gov/gwa/index.html>
- Mueller, D.K., Martin, J.D., and Lopes, T.J., 1997, Quality-control design for surface-water sampling in the National Water-Quality Assessment Program: U.S. Geological Survey Open-File Report 97-223, 17 p.
- New Jersey Department of Environmental Protection, 2005, Field sampling procedures manual, August 2005, accessed October 5, 2005, at <http://www.nj.gov/dep/srp/guidance/fspm/>.
- Nielsen, D.M., ed., 1991, Practical handbook of ground-water monitoring: Chelsea, Mich., Lewis Publishers, 717 p.
- Plumb, R., Jr., 1981, Procedures for handling and chemical analysis of sediment and water samples: Vicksburg, Miss., U.S. Army Engineers Waterways Experiment Station Environmental Laboratory, Technical Report EPA/CE-81-1, p. 3-73 - 3-76.
- Powell, R.M., and Puls, R.W., 1993, Passive sampling of groundwater monitoring wells without purging—Multilevel well chemistry and tracer disappearance: *Journal of Contaminant Hydrology*, v. 12, p. 51-77.
- Puls, R.W., and Barcelona, M.J., 1996, Low-flow (minimal drawdown) ground-water sampling procedures: U.S. Environmental Protection Agency, Ground Water Issue Report, EPA/540/S-95/504.
- Puls, R.W., and Barcelona, M.J., 1989, Ground water sampling for metals analyses: Washington, D.C., U.S. Environmental Protection Agency, Office of Research and Development, EPA Ground Water Issue, EPA/540/4-89/001, 6 p.

- Puls, R.W., and Barcelona, M.J., 1996, Low-flow (minimal drawdown) ground-water sampling procedures: Washington, D.C., U.S. Environmental Protection Agency, Office of Solid Waste and Emergency Response, EPA Ground Water Issue, EPA/540/S-95/504, 12 p.
- Puls, R.W., and Powell, R.M., 1992, Acquisition of representative ground water quality samples for metals: Ground Water Monitoring Review, Summer 1992, v. 12, no. 3, p. 167-176.
- Rantz, S.E., and others, 1982, Measurement and computation of streamflow, volume 1, Measurement of stage and discharge: U.S. Geological Survey Water Supply Paper 2175, 284 p.
- Reilly, T.E., and Gibs, Jacob, 1993, Effects of physical and chemical heterogeneity of water-quality samples obtained from wells: Ground Water, v. 31, no. 5, p. 805-813.
- Reilly, T.E., and LeBlanc, D.R., 1998, Experimental evaluation of factors affecting temporal variability of water samples obtained from long-screened wells: Ground Water, v. 36, no. 4, p. 566-576.
- Ronen, D., Magaritz, M., and Molz, F.J., 1991, Comparison between natural and forced gradient tests to determine the vertical distribution of horizontal transport properties of aquifers: Water Resources Research, v. 27, no. 6, 91WR00332, p. 1309-1314.
- Ronen, Daniel, Magaritz, Mordeckai, and Levy, Itzhak, 1987, An in situ multilevel sampler for preventive monitoring and study of hydrochemical profiles in aquifers: Ground Water Monitoring and Remediation, Fall 1987, p. 69-74.
- Ronen, D., Magaritz, M., Weber, U., and Amiel, A.J., 1992, Characterization of suspended particles collected in groundwater under natural gradient flow conditions: Water Resources Research, no. 91WR02978, p. 1269-1291.
- Sandstrom, M.W., 1990, Sampling requirements for organic contaminants, *in* American Water Works Association Annual Conference: Cincinnati, Ohio, Management Challenges of New Monitoring Requirements for Organic Chemicals, American Water Works Association Seminar Proceedings, p. 71-85.
- Schalla, R., 1996, Purge water minimization at LEHR: Richland, Wash., Pacific Northwest National Laboratory, PNNL-11406, variously paged.
- Shapiro, A.M., 2002, Cautions and suggestions for geochemical sampling in fractured rock: Ground Water Monitoring and Remediation, v. 22, no. 3, p. 151-164.
- Shelton, L.R., 1994, Field guide for collecting and processing stream-water samples for the National Water-Quality Assessment Program: U.S. Geological Survey Open-File Report 94-455, 42 p.
- Solomon, D.K., and Sudicky, E.A., 1992, Correction to "Tritium and helium 3 isotope ratios for direct estimation of spatial variations in groundwater recharge": Water Resources Research, v. 28, no. 4, p. 1197.
- Szabo, Z., Rice, D.E., Plummer, L.N., Busenberg, E., Drenkard, S., and Schlosser, P., 1996, Age dating of shallow groundwater with chlorofluorocarbons, tritium helium 3, and flow path analysis, southern New Jersey coastal plain: Water Resources Research, v. 32, no. 4, p. 1023-1038.
- Taylor, J.K., 1987, Quality assurance of chemical measurements: Chelsea, Mich., Lewis Publishers, 328 p.

- United States, Office of Water Data Coordination, 1977, National handbook of recommended methods for water-data acquisition: Office of Water Data Coordination, Geological Survey, U.S. Department of the Interior, Reston, Va., chap. 2, p. 1-149.
- Unwin, J.P., and Huis, Dennis, 1983, A laboratory investigation of the purging behavior of small-diameter monitoring wells, Proceedings of the Third Annual Symposium on Groundwater Monitoring and Aquifer Restoration: Dublin, Ohio, National Water Well Association, p. 257-262.
- Unwin, J., and Maltby, V., 1988, Investigations of techniques for purging ground water monitoring wells and sampling ground water for volatile organic compounds, *in* Ground-Water Contamination—Field Methods, Philadelphia, American Society for Testing and Materials.
- U.S. Environmental Protection Agency, 1980, Samplers and sampling procedures for hazardous waste stream: Cincinnati, Ohio, Municipal Environmental Research Laboratory, EPA 600/ 2-80-018, 70 p.
- U.S. Environmental Protection Agency, 1982a, Sampling protocols for collecting surface water, bed sediment, bivalves, and fish for priority pollutant analysis: Washington, D.C., Final Draft Report, Office of Water Regulations and Standards Monitoring and Data Support Division.
- U.S. Environmental Protection Agency, 1982b, Handbook for sampling and sample preservation of water and wastewater: Environment Monitoring and Support Laboratory, Cincinnati, Ohio, EPA 600/4-82-029, 402 p.
- U.S. Environmental Protection Agency, 1983, Addendum to handbook for sampling and sample preservation of water and wastewater: Cincinnati, Ohio, Environment Monitoring and Support Laboratory, EPA 600/ 4-83-039, 28 p.
- U.S. Environmental Protection Agency, 1986, RCRA groundwater monitoring technical enforcement guidance document: Washington, D.C., OSWER - 9950.1.
- U.S. Environmental Protection Agency, 1987, A compendium of Superfund field operations methods: Washington, DC., Office of Emergency and Remedial Response, EPA/540-P-87/001, 508 p.
- U.S. Environmental Protection Agency, 1991, Handbook—ground water, v. II, Methodology: Washington, D.C., EPA/625/6-90/016b, 141 p.
- U.S. Environmental Protection Agency, 1992, Consensus method for determining groundwaters under the direct influence of surface water using microscopic particulate analysis (MPA): EPA Region 10.
- U.S. Environmental Protection Agency, 1992, Pocket sampling guide for operations of small water systems: Cincinnati, Ohio, Office of Ground Water and Drinking Water, EPA/814-B-92-001, 94 p.
- U.S. Environmental Protection Agency, 1993, Preparation of a U.S. EPA Region 9 sample plan for EPA-lead superfund projects: San Francisco, Calif., EPA Region 9, Quality Assurance Management Section, August 1993.
- U.S. Geological Survey, 1980, Surface water, chap. 1 *of* National handbook of recommended methods for water-data acquisition: Office of Water Data Coordination, 130 p.
- U.S. Geological Survey, 1980, Ground water, chap. 2 *of* National handbook of recommended methods for water-data acquisition: Office of Water Data Coordination, 130 p.

- U.S. Geological Survey, 1984, Chemical and physical quality of water and sediment, chap. 5 of National handbook of recommended methods for water-data acquisition: Office of Water Data Coordination, p. 5-1 to 5-194.
- U.S. Geological Survey, Variably dated, National field manual for the collection of water-quality data: U.S. Geological Survey Techniques of Water-Resources Investigations, book 9, chaps. A1-A9, available online at <http://pubs.water.usgs.gov/twri9A>.
- U.S. Geological Survey, 1989, Technical procedure HP-61, Yucca Mountain Project, use of hand-held steel tapes in vertical boreholes, p. 2.
- Varljen, M.D., Barcelona, M.J., Obereiner, James, and Kaminski, David, 2006, Numerical simulations to assess the monitoring zone achieved during low-flow purging and sampling: Ground Water Monitoring and Remediation, v. 26, no. 1, p. 44-52.
- Vroblesky, D.A., 2001, User's guide for polyethylene-based passive diffusion bag samplers to obtain volatile organic compound concentrations in wells—Part 1—Deployment, recovery, data interpretation, and quality control and assurance: U.S. Geological Survey Water-Resources Investigations Report 01-4060, 18 p.
- Vroblesky, D.A., ed., 2001, User's guide for polyethylene-based passive diffusion bag samplers to obtain volatile organic compound concentrations in wells—Part 2—Field tests: U.S. Geological Survey Water-Resources Investigations Report 01-4061, variously paged.
- Ward, J.R., and Harr, C.A., eds., 1990, Methods for collection and processing of surface-water and bed-material samples for physical and chemical analyses: U.S. Geological Survey Open-File Report 90-140, 71 p.
- Wilde, F.D., ed., April 2004, Cleaning of equipment for water sampling (ver. 2.0): U.S. Geological Survey Techniques of Water-Resources Investigations, book 9, chap. A3.



# TECHNICAL MEMORANDUMS OF THE U.S. GEOLOGICAL SURVEY, WATER DISCIPLINE

The following U.S. Geological Survey Branch of Quality Systems (formerly Branch of Quality Assurance), Office of Water Quality, National Water Quality Laboratory, and Water Resources Policy Memorandums are available on the World Wide Web at <http://water.usgs.gov/admin/memo/>.

<b>Memo No.</b>	<b>Title</b>	<b>Date</b>
<b>Branch of Quality Systems</b>		
90.03	ADP—Storage of water-quality, quality-assurance data in NWIS	undated
92.01	ADP—Storage of water-quality, quality-assurance data in NWIS	undated
95.01	ADP—Storage of water-quality quality-assurance data in NWIS	October 28, 1994
<b>Office of Ground Water</b>		
03.03	Agreement forms for gaging station and observation well installations and transfers	September 17, 2003
06.01	Storage of water-level data for ground water	February 2, 2006
<b>Office of Water Quality</b>		
92.02	FIELD TECHNIQUES—Field preparation of containers for aqueous samples	December 20, 1991
92.13	Trace element contamination: findings of studies on the cleaning of membrane filters and filtration systems	July 17, 1992
93.05	Programs and Plans—Evaluation of capsule filters	January 21, 1993
94.08	Collection, handling, and analysis of environmental samples in support of regulatory projects	January 14, 1994
94.09	Revision of new Division protocol for collecting and processing surface-water samples for low-level inorganic analyses	January 28, 1994

97.06	Comparison of the suspended-sediment splitting capabilities of the churn and cone splitters	May 5, 1997
99.02	Guidance for collecting discharge-weighted samples in surface water using an isokinetic sampler	October 28, 1998
00.10	Discrete water-quality data in NWISWeb	September 15, 2000
01.02	Guidance for verifying and interpreting field blank determinations that indicate high pesticide or trace-element concentrations or that show large numbers of detections	November 14, 2000
01.03	Collection and use of total suspended-solids data	November 27, 2000
02.11	Policy for storing and reporting significant figures for chemical data	February 14, 2002
02.13	Water-quality field methods/National Field Manual for the Collection of Water-Quality Data	March 15, 2002
06.01	Storage of water-level data for ground water	February 2, 2006

---

#### **National Water Quality Laboratory**

---

02.04	Requirements for the proper shipping of samples to the National Water Quality Laboratory	September 23, 2002
-------	--	--------------------

---

#### **Water Resources Policy Memorandums**

---

90.34	Policy for permission to sample	March 26, 1990
92.59	Policy for management and retention of hydrologic data of the U.S. Geological Survey	undated [1992]
94.008	LEGAL—Agreement forms 9-1482, 9-1482A, and 9-1483	February 18, 1994
99.03	SAFETY—Water Resources Division hazardous waste site operations—Revised safety policy and guidance	November 17, 1998
99.32	SAFETY—Water Resources Division policy for safety associated with measurements, sampling, and related streamgaging	August 17, 1990
99.34	Quality assurance measures for serving real-time water data on the World Wide Web	February 28, 2000

---

# APPENDIXES

---

---

## APPENDIX A4-A

# Transit Rate and Volume Guidelines and Filling Times for Isokinetic Samplers

The tables in Appendix A4-A apply to the first complete round-trip transit starting with an empty sampler container. **These tables are valid only if the sampler is emptied between verticals.**

Tables 1 through 5 show:

1. Isokinetic transit rates and volumes for a 1-liter bottle sampler (US DH-81, US DH-95, US D-95) with a
  - a. 3/16-inch nozzle
  - b. 1/4-inch nozzle
  - c. 5/16-inch nozzle

*The designations in the RATE column of tables 1a, 1b, and 1c are defined as follows:*

**Slowest** The transit rate that fills the sampler to its maximum volume.

**Safe full volume** The transit rate that will result in a volume in a bottle sampler such that, if the sampler nozzle is tipped 10 degrees down from the horizontal, no sample will spill from the nozzle.

**Fastest** The transit rate that is the fastest rate to avoid compression problems in bottle samplers or to not exceed a transit rate that is more than 0.4 times the stream velocity for bag samplers.

2. Isokinetic transit rates and volumes for a US DH-2 sampler (1-liter bag) with a
  - a. 3/16-inch nozzle
  - b. 1/4-inch nozzle
  - c. 5/16-inch nozzle
3. Isokinetic transit rates and volumes for a US D-96 sampler (3-liter bag) with a
  - a. 3/16-inch nozzle
  - b. 1/4-inch nozzle
  - c. 5/16-inch nozzle
4. Isokinetic transit rates and volumes for a US D-99 sampler (6-liter bag) with a
  - a. 1/4-inch nozzle
  - b. 5/16-inch nozzle
5. Filling times, in seconds, for isokinetic samplers
  - a. US DH-81
  - b. US DH-95
  - c. US D-95
  - d. US DH-2
  - e. US D-96
  - f. US D-96 A-1
  - g. US D-99

**APPENDIX A4-A—Table 1a.** Isokinetic transit rates for a 1-liter bottle sampler with a 3/16-inch nozzle.

[Transit rates in feet per second; Depth is (water depth) – (unsampled zone); mL, milliliter; --, not applicable]

Depth (in feet)	Rate	Mean stream velocity in vertical (feet per second)											Volume (mL)	
		1.5	2.0	2.5	3.0	3.5	4.0	4.5	5.0	6.0	7.0	8.0		9.0
1	slowest	0.02	0.02	0.03	0.03	0.04	0.04	0.05	0.05	0.1	0.1	0.1	0.1	1,000
1	safe full volume	0.02	0.03	0.03	0.04	0.05	0.05	0.1	0.1	0.1	0.1	0.1	0.1	800
1	fastest	0.1	0.2	0.2	0.3	0.3	0.3	0.4	0.4	0.5	0.6	0.7	0.7	130
2	slowest	0.03	0.04	0.05	0.1	0.1	0.1	0.1	0.1	0.1	0.1	0.2	0.2	1,000
2	safe full volume	0.04	0.05	0.1	0.1	0.1	0.1	0.1	0.1	0.1	0.2	0.2	0.3	800
2	fastest	0.1	0.2	0.2	0.3	0.3	0.4	0.4	0.5	0.5	0.6	0.7	0.8	240
3	slowest	0.05	0.1	0.1	0.1	0.1	0.1	0.1	0.2	0.2	0.2	0.3	0.3	1,000
3	safe full volume	0.1	0.1	0.1	0.1	0.1	0.2	0.2	0.2	0.3	0.3	0.3	0.4	800
3	fastest	0.1	0.2	0.2	0.3	0.3	0.4	0.4	0.5	0.6	0.7	0.8	0.9	340
4	slowest	0.1	0.1	0.1	0.1	0.1	0.2	0.2	0.2	0.3	0.3	0.3	0.4	1,000
4	safe full volume	0.1	0.1	0.1	0.2	0.2	0.2	0.3	0.3	0.3	0.4	0.4	0.5	800
4	fastest	0.2	0.2	0.3	0.3	0.4	0.4	0.5	0.5	0.6	0.7	0.8	0.9	420
5	slowest	0.1	0.1	0.1	0.2	0.2	0.2	0.2	0.3	0.3	0.4	0.4	0.5	1,000
5	safe full volume	0.1	0.1	0.2	0.2	0.2	0.3	0.3	0.3	0.4	0.5	0.5	0.6	800
5	fastest	0.2	0.2	0.3	0.3	0.4	0.4	0.5	0.6	0.7	0.8	0.9	1.0	500
6	slowest	0.1	0.1	0.2	0.2	0.2	0.3	0.3	0.3	0.4	0.4	0.5	0.6	1,000
6	safe full volume	0.1	0.2	0.2	0.3	0.3	0.3	0.4	0.4	0.5	0.6	0.7	0.7	800
6	fastest	0.2	0.2	0.3	0.4	0.4	0.5	0.5	0.6	0.7	0.8	0.9	1.1	560
7	slowest	0.1	0.1	0.2	0.2	0.3	0.3	0.3	0.4	0.4	0.5	0.6	0.7	1,000
7	safe full volume	0.1	0.2	0.2	0.3	0.3	0.4	0.4	0.5	0.6	0.7	0.8	0.9	800
7	fastest	0.2	0.3	0.3	0.4	0.4	0.5	0.6	0.6	0.7	0.9	1.0	1.1	610
8	slowest	0.1	0.2	0.2	0.3	0.3	0.3	0.4	0.4	0.5	0.6	0.7	0.8	1,000
8	safe full volume	0.2	0.2	0.3	0.3	0.4	0.4	0.5	0.5	0.7	0.8	0.9	1.0	800
8	fastest	0.2	0.3	0.3	0.4	0.5	0.5	0.6	0.7	0.8	0.9	1.0	1.2	670
10	slowest	0.2	0.2	0.3	0.3	0.4	0.4	0.5	0.5	0.6	0.7	0.8	0.9	1,000
10	safe full volume	0.2	0.3	0.3	0.4	0.5	0.5	0.6	0.7	0.8	1.0	1.1	1.2	800
10	fastest	0.2	0.3	0.4	0.4	0.5	0.6	0.7	0.7	0.9	1.0	1.2	1.3	760
12	slowest	0.2	0.3	0.3	0.4	0.4	0.5	0.6	0.6	0.8	0.9	1.0	1.1	1,000
12	safe full volume	--	--	--	--	--	--	--	--	--	--	--	--	--
12	fastest	0.2	0.3	0.4	0.5	0.6	0.6	0.7	0.8	0.9	1.1	1.3	1.4	830
14	slowest	0.2	0.3	0.4	0.4	0.5	0.6	0.7	0.7	0.9	1.0	1.2	1.3	1,000
14	safe full volume	--	--	--	--	--	--	--	--	--	--	--	--	--
14	fastest	0.3	0.3	0.4	0.5	0.6	0.7	0.8	0.9	1.0	1.2	1.4	1.53	900
15	slowest	0.2	0.3	0.4	0.5	0.5	0.6	0.7	0.8	0.9	1.1	1.2	1.4	1,000
15	safe full volume	--	--	--	--	--	--	--	--	--	--	--	--	--
15	fastest	0.3	0.4	0.4	0.5	0.6	0.7	0.8	0.9	1.1	1.2	1.4	1.6	920

**APPENDIX A4-A—Table 1b.** Isokinetic transit rates for a 1-liter bottle sampler with a 1/4-inch nozzle.

[Transit rates in feet per second; Depth is (water depth) – (unsampled zone); mL, milliliter; --, not applicable]

Depth (in feet)	Rate	Mean stream velocity in vertical (feet per second)											Volume (mL)	
		1.5	2.0	2.5	3.0	3.5	4.0	4.5	5.0	6.0	7.0	8.0		9.0
1	slowest	0.03	0.04	0.05	0.1	0.1	0.1	0.1	0.1	0.1	0.1	0.2	0.2	1,000
1	safe full volume	0.04	0.05	0.1	0.1	0.1	0.1	0.1	0.1	0.1	0.2	0.2	0.2	800
1	fastest	0.2	0.3	0.4	0.4	0.5	0.6	0.7	0.7	0.9	1.0	1.2	1.3	130
2	slowest	0.1	0.1	0.1	0.1	0.1	0.2	0.2	0.2	0.2	0.3	0.3	0.3	1,000
2	safe full volume	0.1	0.1	0.1	0.2	0.2	0.2	0.2	0.2	0.3	0.3	0.4	0.4	800
2	fastest	0.2	0.3	0.4	0.5	0.6	0.6	0.7	0.8	1.0	1.1	1.3	1.4	240
3	slowest	0.1	0.1	0.1	0.2	0.2	0.2	0.3	0.3	0.3	0.4	0.4	0.5	1,000
3	safe full volume	0.1	0.2	0.2	0.2	0.3	0.3	0.3	0.4	0.4	0.5	0.6	0.7	800
3	fastest	0.3	0.3	0.4	0.5	0.6	0.7	0.8	0.9	1.0	1.2	1.4	1.5	340
4	slowest	0.1	0.2	0.2	0.2	0.3	0.3	0.3	0.4	0.4	0.5	0.6	0.7	1,000
4	safe full volume	0.2	0.2	0.2	0.3	0.3	0.4	0.4	0.5	0.6	0.7	0.8	0.9	800
4	fastest	0.3	0.4	0.5	0.6	0.6	0.7	0.8	0.9	1.1	1.3	1.5	1.6	420
5	slowest	0.1	0.2	0.2	0.3	0.3	0.4	0.4	0.5	0.6	0.6	0.7	0.8	1,000
5	safe full volume	0.2	0.2	0.3	0.4	0.4	0.5	0.5	0.6	0.7	0.9	1.0	1.1	800
5	fastest	0.3	0.4	0.5	0.6	0.7	0.8	0.9	1.0	1.2	1.4	1.6	1.8	500
6	slowest	0.2	0.2	0.3	0.3	0.4	0.4	0.5	0.6	0.7	0.8	0.9	1.0	1,000
6	safe full volume	0.2	0.3	0.4	0.4	0.5	0.6	0.7	0.7	0.9	1.0	1.2	1.3	800
6	fastest	0.3	0.4	0.5	0.6	0.7	0.8	0.9	1.0	1.2	1.4	1.7	1.9	560
7	slowest	0.2	0.3	0.3	0.4	0.5	0.5	0.6	0.6	0.8	0.9	1.0	1.2	1,000
7	safe full volume	0.3	0.3	0.4	0.5	0.6	0.7	0.8	0.9	1.0	1.2	1.4	1.5	800
7	fastest	0.3	0.4	0.6	0.7	0.8	0.9	1.0	1.1	1.3	1.5	1.7	2.0	620
8	slowest	0.2	0.3	0.4	0.4	0.5	0.6	0.7	0.7	0.9	1.0	1.2	1.3	1,000
8	safe full volume	0.3	0.4	0.5	0.6	0.7	0.8	0.9	1.0	1.2	1.4	1.6	1.7	800
8	fastest	0.3	0.5	0.6	0.7	0.8	0.9	1.0	1.2	1.4	1.6	1.8	2.1	670
10	slowest	0.3	0.4	0.5	0.6	0.6	0.7	0.8	0.9	1.1	1.3	1.5	1.7	1,000
10	safe full volume	0.4	0.5	0.6	0.7	0.9	1.0	1.1	1.2	1.5	1.7	1.9	2.2	800
10	fastest	0.4	0.5	0.6	0.8	0.9	1.0	1.1	1.3	1.5	1.8	2.0	2.3	760
12	slowest	0.3	0.4	0.6	0.7	0.8	0.9	1.0	1.1	1.3	1.6	1.8	2.0	1,000
12	safe full volume	--	--	--	--	--	--	--	--	--	--	--	--	--
12	fastest	0.4	0.6	0.7	0.8	1.0	1.1	1.3	1.4	1.7	1.9	2.2	2.5	840
14	slowest	0.4	0.5	0.6	0.8	0.9	1.0	1.2	1.3	1.6	1.8	2.1	2.3	1,000
14	safe full volume	--	--	--	--	--	--	--	--	--	--	--	--	--
14	fastest	0.5	0.6	0.8	0.9	1.1	1.2	1.4	1.5	1.8	2.1	2.4	2.7	900
15	slowest	0.4	0.6	0.7	0.8	1.0	1.1	1.2	1.4	1.7	1.9	2.2	2.5	1,000
15	safe full volume	--	--	--	--	--	--	--	--	--	--	--	--	--
15	fastest	0.5	0.6	0.8	0.9	1.1	1.3	1.4	1.6	1.9	2.2	2.5	2.8	930

**APPENDIX A4-A—Table 1c.** Isokinetic transit rates for a 1-liter bottle sampler with a 5/16-inch nozzle.

[Transit rates in feet per second; Depth is (water depth) – (unsampled zone); mL, milliliter; --, not applicable]

Depth (in feet)	Rate	Mean stream velocity in vertical (feet per second)											Volume (mL)	
		1.5	2.0	2.5	3.0	3.5	4.0	4.5	5.0	6.0	7.0	8.0		9.0
1	slowest	0.04	0.1	0.1	0.1	0.1	0.1	0.1	0.1	0.1	0.2	0.2	0.2	1,000
1	safe full volume	0.1	0.1	0.1	0.1	0.1	0.2	0.2	0.2	0.2	0.3	0.3	0.3	800
1	fastest	0.3	0.5	0.6	0.7	0.8	0.9	1.0	1.2	1.4	1.6	1.8	2.1	130
2	slowest	0.1	0.1	0.1	0.2	0.2	0.2	0.3	0.3	0.4	0.4	0.5	0.5	1,000
2	safe full volume	0.1	0.2	0.2	0.2	0.3	0.3	0.3	0.4	0.5	0.5	0.6	0.7	800
2	fastest	0.4	0.5	0.6	0.7	0.9	1.0	1.1	1.2	1.5	1.7	2.0	2.2	240
3	slowest	0.1	0.2	0.2	0.3	0.3	0.4	0.4	0.4	0.5	0.6	0.7	0.8	1,000
3	safe full volume	0.2	0.2	0.3	0.3	0.4	0.5	0.5	0.6	0.7	0.8	0.9	1.0	800
3	fastest	0.4	0.5	0.7	0.8	0.9	1.1	1.2	1.3	1.6	1.9	2.1	2.4	340
4	slowest	0.2	0.2	0.3	0.4	0.4	0.5	0.5	0.6	0.7	0.8	0.9	1.0	1,000
4	safe full volume	0.2	0.3	0.4	0.5	0.5	0.6	0.7	0.8	0.9	1.1	1.2	1.4	800
4	fastest	0.4	0.6	0.7	0.9	1.0	1.1	1.3	1.4	1.7	2.0	2.3	2.6	420
5	slowest	0.2	0.3	0.4	0.4	0.5	0.6	0.7	0.7	0.9	1.0	1.2	1.3	1,000
5	safe full volume	0.3	0.4	0.5	0.6	0.7	0.8	0.9	0.9	1.1	1.3	1.5	1.7	800
5	fastest	0.5	0.6	0.8	0.9	1.1	1.2	1.4	1.5	1.8	2.1	2.4	2.7	500
6	slowest	0.3	0.4	0.4	0.5	0.6	0.7	0.8	0.9	1.0	1.2	1.4	1.6	1,000
6	safe full volume	0.3	0.5	0.6	0.7	0.8	0.9	1.0	1.1	1.4	1.6	1.8	2.0	800
6	fastest	0.5	0.6	0.8	1.0	1.1	1.3	1.5	1.6	1.9	2.3	2.6	2.9	560
7	slowest	0.3	0.4	0.5	0.6	0.7	0.8	0.9	1.0	1.2	1.4	1.6	1.8	1,000
7	safe full volume	0.4	0.5	0.7	0.8	0.9	1.1	1.2	1.3	1.6	1.9	2.1	2.4	800
7	fastest	0.5	0.7	0.9	1.0	1.2	1.4	1.5	1.7	2.0	2.4	2.7	3.1	620
8	slowest	0.4	0.5	0.6	0.7	0.8	0.9	1.0	1.2	1.4	1.6	1.8	2.1	1,000
8	safe full volume	0.5	0.6	0.8	0.9	1.1	1.2	1.4	1.5	1.8	2.1	2.4	2.7	800
8	fastest	0.5	0.7	0.9	1.1	1.3	1.4	1.6	1.8	2.2	2.5	2.9	3.2	670
10	slowest	0.4	0.6	0.7	0.9	1.0	1.2	1.3	1.4	1.7	2.0	2.3	2.6	1,000
10	safe full volume	0.6	0.8	0.9	1.1	1.3	1.5	1.7	1.9	2.3	2.6	3.0	3.4	800
10	fastest	0.6	0.8	1.0	1.2	1.4	1.6	1.8	2.0	2.4	2.8	3.2	3.6	760
11	slowest	0.5	0.6	0.8	1.0	1.1	1.3	1.4	1.6	1.9	2.2	2.5	2.9	1,000
11	safe full volume	--	--	--	--	--	--	--	--	--	--	--	--	--
11	fastest	0.6	0.8	1.0	1.2	1.4	1.6	1.8	2.0	2.4	2.8	3.2	3.6	830
12	slowest	0.5	0.7	0.9	1.0	1.2	1.4	1.6	1.7	2.1	2.4	2.8	3.1	1,000
12	safe full volume	--	--	--	--	--	--	--	--	--	--	--	--	--
12	fastest	0.6	0.8	1.0	1.2	1.4	1.6	1.8	2.0	2.4	2.8	3.2	3.6	910
13	slowest	0.6	0.8	0.9	1.1	1.3	1.5	1.7	1.9	2.2	2.6	3.0	3.4	1,000
13	safe full volume	--	--	--	--	--	--	--	--	--	--	--	--	--
13	fastest	0.6	0.8	1.0	1.2	1.4	1.6	1.8	2.0	2.4	2.8	3.2	3.6	980

**APPENDIX A4-A—Table 2a.** Isokinetic transit rates for a DH-2 sampler (1-liter bag) with a 3/16-inch nozzle.

[Transit rates in feet per second; Depth is (water depth) – (unsampled zone); mL, milliliter]

Depth (in feet)	Rate	Mean stream velocity in vertical (feet per second)										Volume (mL)
		2.0	2.5	3.0	3.5	4.0	4.5	5.0	5.5	6.0	6.5	
2	slowest	0.04	0.1	0.1	0.1	0.1	0.1	0.1	0.1	0.1	0.1	1,000
2	fastest	0.8	1.0	1.2	1.4	1.6	1.8	2.0	2.2	2.4	2.6	50
4	slowest	0.1	0.1	0.1	0.2	0.2	0.2	0.2	0.2	0.3	0.3	1,000
4	fastest	0.8	1.0	1.2	1.4	1.6	1.8	2.0	2.2	2.4	2.6	110
6	slowest	0.1	0.2	0.2	0.2	0.3	0.3	0.3	0.4	0.4	0.4	1,000
6	fastest	0.8	1.0	1.2	1.4	1.6	1.8	2.0	2.2	2.4	2.6	160
8	slowest	0.2	0.2	0.3	0.3	0.3	0.4	0.4	0.5	0.5	0.6	1,000
8	fastest	0.8	1.0	1.2	1.4	1.6	1.8	2.0	2.2	2.4	2.6	220
10	slowest	0.2	0.3	0.3	0.4	0.4	0.5	0.5	0.6	0.7	0.7	1,000
10	fastest	0.8	1.0	1.2	1.4	1.6	1.8	2.0	2.2	2.4	2.6	270
12	slowest	0.3	0.3	0.4	0.5	0.5	0.6	0.6	0.7	0.8	0.8	1,000
12	fastest	0.8	1.0	1.2	1.4	1.6	1.8	2.0	2.2	2.4	2.6	330
14	slowest	0.3	0.4	0.5	0.5	0.6	0.7	0.8	0.8	0.9	1.0	1,000
14	fastest	0.8	1.0	1.2	1.4	1.6	1.8	2.0	2.2	2.4	2.6	380
16	slowest	0.3	0.4	0.5	0.6	0.7	0.8	0.9	1.0	1.0	1.1	1,000
16	fastest	0.8	1.0	1.2	1.4	1.6	1.8	2.0	2.2	2.4	2.6	440
18	slowest	0.4	0.5	0.6	0.7	0.8	0.9	1.0	1.1	1.2	1.3	1,000
18	fastest	0.8	1.0	1.2	1.4	1.6	1.8	2.0	2.2	2.4	2.6	490
20	slowest	0.4	0.5	0.7	0.8	0.9	1.0	1.1	1.2	1.3	1.4	1,000
20	fastest	0.8	1.0	1.2	1.4	1.6	1.8	2.0	2.2	2.4	2.6	540
22	slowest	0.5	0.6	0.7	0.8	1.0	1.1	1.2	1.3	1.4	1.6	1,000
22	fastest	0.8	1.0	1.2	1.4	1.6	1.8	2.0	2.2	2.4	2.6	600
24	slowest	0.5	0.7	0.8	0.9	1.0	1.2	1.3	1.4	1.6	1.7	1,000
24	fastest	0.8	1.0	1.2	1.4	1.6	1.8	2.0	2.2	2.4	2.6	650
26	slowest	0.6	0.7	0.8	1.0	1.1	1.3	1.4	1.6	1.7	1.8	1,000
26	fastest	0.8	1.0	1.2	1.4	1.6	1.8	2.0	2.2	2.4	2.6	710
28	slowest	0.6	0.8	0.9	1.1	1.2	1.4	1.5	1.7	1.8	2.0	1,000
28	fastest	0.8	1.0	1.2	1.4	1.6	1.8	2.0	2.2	2.4	2.6	760
30	slowest	0.7	0.8	1.0	1.1	1.3	1.5	1.6	1.8	2.0	2.1	1,000
30	fastest	0.8	1.0	1.2	1.4	1.6	1.8	2.0	2.2	2.4	2.6	820
32	slowest	0.7	0.9	1.0	1.2	1.4	1.6	1.7	1.9	2.1	2.3	1,000
32	fastest	0.8	1.0	1.2	1.4	1.6	1.8	2.0	2.2	2.4	2.6	870
34	slowest	0.7	0.9	1.1	1.3	1.5	1.7	1.8	2.0	2.2	2.4	1,000
34	fastest	0.8	1.0	1.2	1.4	1.6	1.8	2.0	2.2	2.4	2.6	920
36	slowest	0.8	1.0	1.2	1.4	1.6	1.8	1.9	2.2	2.3	2.5	1,000
36	fastest	0.8	1.0	1.2	1.4	1.6	1.8	2.0	2.2	2.4	2.6	980
37	slowest	0.8	1.0	1.2	1.4	1.6	1.8	2.0	2.2	2.4	2.6	1,000
37	fastest	0.8	1.0	1.2	1.4	1.6	1.8	2.0	2.2	2.4	2.6	1,000



**APPENDIX A4-A—Table 2b.** Isokinetic transit rates for a DH-2 sampler (1-liter bag) with a 1/4-inch nozzle.

[Transit rates in feet per second; Depth is (water depth) – (unsampled zone); mL, milliliter]

Depth (in feet)	Rate	Mean stream velocity in vertical (feet per second)										Volume (mL)
		2.0	2.5	3.0	3.5	4.0	4.5	5.0	5.5	6.0	6.5	
2	slowest	0.1	0.1	0.1	0.1	0.2	0.2	0.2	0.2	0.2	0.3	1,000
2	fastest	0.8	1.0	1.2	1.4	1.6	1.8	2.0	2.2	2.4	2.6	100
4	slowest	0.2	0.2	0.2	0.3	0.3	0.3	0.4	0.4	0.5	0.5	1,000
4	fastest	0.8	1.0	1.2	1.4	1.6	1.8	2.0	2.2	2.4	2.6	190
6	slowest	0.2	0.3	0.3	0.4	0.5	0.5	0.6	0.6	0.7	0.8	1,000
6	fastest	0.8	1.0	1.2	1.4	1.6	1.8	2.0	2.2	2.4	2.6	290
8	slowest	0.3	0.4	0.5	0.5	0.6	0.7	0.8	0.8	0.9	1.0	1,000
8	fastest	0.8	1.0	1.2	1.4	1.6	1.8	2.0	2.2	2.4	2.6	390
10	slowest	0.4	0.5	0.6	0.7	0.8	0.9	1.0	1.1	1.2	1.3	1,000
10	fastest	0.8	1.0	1.2	1.4	1.6	1.8	2.0	2.2	2.4	2.6	480
12	slowest	0.5	0.6	0.7	0.8	0.9	1.0	1.1	1.3	1.4	1.5	1,000
12	fastest	0.8	1.0	1.2	1.4	1.6	1.8	2.0	2.2	2.4	2.6	580
14	slowest	0.5	0.7	0.8	0.9	1.1	1.2	1.3	1.5	1.6	1.8	1,000
14	fastest	0.8	1.0	1.2	1.4	1.6	1.8	2.0	2.2	2.4	2.6	680
16	slowest	0.6	0.8	0.9	1.1	1.2	1.4	1.5	1.7	1.9	2.0	1,000
16	fastest	0.8	1.0	1.2	1.4	1.6	1.8	2.0	2.2	2.4	2.6	770
18	slowest	0.7	0.9	1.0	1.2	1.4	1.6	1.7	1.9	2.1	2.3	1,000
18	fastest	0.8	1.0	1.2	1.4	1.6	1.8	2.0	2.2	2.4	2.6	870
20	slowest	0.8	1.0	1.2	1.4	1.5	1.7	1.9	2.1	2.3	2.5	1,000
20	fastest	0.8	1.0	1.2	1.4	1.6	1.8	2.0	2.2	2.4	2.6	970

**APPENDIX A4-A—Table 2c.** Isokinetic transit rates for a DH-2 sampler (1-liter bag) with a 5/16-inch nozzle.

[Transit rates in feet per second; Depth is (water depth) – (unsampled zone); mL, milliliter]

Depth (in feet)	Rate	Mean stream velocity in vertical (feet per second)										Volume (mL)
		2.0	2.5	3.0	3.5	4.0	4.5	5.0	5.5	6.0	6.5	
2	slowest	0.1	0.2	0.2	0.2	0.2	0.3	0.3	0.3	0.4	0.4	1,000
2	fastest	0.8	1.0	1.2	1.4	1.6	1.8	2.0	2.2	2.4	2.6	150
4	slowest	0.2	0.3	0.4	0.4	0.5	0.5	0.6	0.7	0.7	0.8	1,000
4	fastest	0.8	1.0	1.2	1.4	1.6	1.8	2.0	2.2	2.4	2.6	300
6	slowest	0.4	0.5	0.5	0.6	0.7	0.8	0.9	1.0	1.1	1.2	1,000
6	fastest	0.8	1.0	1.2	1.4	1.6	1.8	2.0	2.2	2.4	2.6	450
8	slowest	0.5	0.6	0.7	0.8	1.0	1.1	1.2	1.3	1.4	1.6	1,000
8	fastest	0.8	1.0	1.2	1.4	1.6	1.8	2.0	2.2	2.4	2.6	600
10	slowest	0.6	0.8	0.9	1.1	1.2	1.4	1.5	1.7	1.8	2.0	1,000
10	fastest	0.8	1.0	1.2	1.4	1.6	1.8	2.0	2.2	2.4	2.6	750
12	slowest	0.7	0.9	1.1	1.3	1.4	1.6	1.8	2.0	2.2	2.4	1,000
12	fastest	0.8	1.0	1.2	1.4	1.6	1.8	2.0	2.2	2.4	2.6	900
13	slowest	0.8	1.0	1.2	1.4	1.6	1.8	2.0	2.2	2.4	2.5	1,000
13	fastest	0.8	1.0	1.2	1.4	1.6	1.8	2.0	2.2	2.4	2.6	980

**APPENDIX A4-A–Table 3a.** Isokinetic transit rates for a D-96 sampler (3-liter bag) with a 3/16-inch nozzle.

[Transit rates in feet per second; Depth is (water depth) – (unsampled zone); mL, milliliter]

Depth (in feet)	Rate	Mean stream velocity in vertical (feet per second)																				Volume (mL)	
		2.0	2.5	3.0	3.5	4.0	4.5	5.5	6.0	6.5	7.0	7.5	8.0	8.5	9.0	9.5	10.0	10.5	11.0	11.5	12.0		12.5
2	slowest	0.01	0.02	0.02	0.03	0.03	0.03	0.04	0.04	0.05	0.1	0.1	0.1	0.1	0.1	0.1	0.1	0.1	0.1	0.1	0.1	0.1	3,000
2	fastest	0.8	1.0	1.2	1.4	1.6	1.8	2.2	2.4	2.6	2.8	3.0	3.2	3.4	3.6	3.8	4.0	4.2	4.4	4.6	4.8	5.0	50
4	slowest	0.03	0.04	0.04	0.1	0.1	0.1	0.1	0.1	0.1	0.1	0.1	0.1	0.1	0.1	0.1	0.1	0.2	0.2	0.2	0.2	0.2	3,000
4	fastest	0.8	1.0	1.2	1.4	1.6	1.8	2.2	2.4	2.6	2.8	3.0	3.2	3.4	3.6	3.8	4.0	4.2	4.4	4.6	4.8	5.0	110
6	slowest	0.04	0.1	0.1	0.1	0.1	0.1	0.1	0.1	0.1	0.2	0.2	0.2	0.2	0.2	0.2	0.2	0.2	0.2	0.2	0.3	0.3	3,000
6	fastest	0.8	1.0	1.2	1.4	1.6	1.8	2.2	2.4	2.6	2.8	3.0	3.2	3.4	3.6	3.8	4.0	4.2	4.4	4.6	4.8	5.0	160
8	slowest	0.1	0.1	0.1	0.1	0.1	0.1	0.2	0.2	0.2	0.2	0.2	0.2	0.2	0.3	0.3	0.3	0.3	0.3	0.3	0.3	0.4	3,000
8	fastest	0.8	1.0	1.2	1.4	1.6	1.8	2.2	2.4	2.6	2.8	3.0	3.2	3.4	3.6	3.8	4.0	4.2	4.4	4.6	4.8	5.0	220
10	slowest	0.1	0.1	0.1	0.1	0.1	0.2	0.2	0.2	0.2	0.3	0.3	0.3	0.3	0.3	0.3	0.4	0.4	0.4	0.4	0.4	0.5	3,000
10	fastest	0.8	1.0	1.2	1.4	1.6	1.8	2.2	2.4	2.6	2.8	3.0	3.2	3.4	3.6	3.8	4.0	4.2	4.4	4.6	4.8	5.0	270
12	slowest	0.1	0.1	0.1	0.2	0.2	0.2	0.2	0.3	0.3	0.3	0.3	0.3	0.4	0.4	0.4	0.4	0.5	0.5	0.5	0.5	0.5	3,000
12	fastest	0.8	1.0	1.2	1.4	1.6	1.8	2.2	2.4	2.6	2.8	3.0	3.2	3.4	3.6	3.8	4.0	4.2	4.4	4.6	4.8	5.0	330
14	slowest	0.1	0.1	0.2	0.2	0.2	0.2	0.3	0.3	0.3	0.4	0.4	0.4	0.4	0.5	0.5	0.5	0.5	0.6	0.6	0.6	0.6	3,000
14	fastest	0.8	1.0	1.2	1.4	1.6	1.8	2.2	2.4	2.6	2.8	3.0	3.2	3.4	3.6	3.8	4.0	4.2	4.4	4.6	4.8	5.0	380
16	slowest	0.1	0.1	0.2	0.2	0.2	0.3	0.3	0.3	0.4	0.4	0.4	0.5	0.5	0.5	0.6	0.6	0.6	0.6	0.7	0.7	0.7	3,000
16	fastest	0.8	1.0	1.2	1.4	1.6	1.8	2.2	2.4	2.6	2.8	3.0	3.2	3.4	3.6	3.8	4.0	4.2	4.4	4.6	4.8	5.0	440
18	slowest	0.1	0.2	0.2	0.2	0.3	0.3	0.4	0.4	0.4	0.5	0.5	0.5	0.6	0.6	0.6	0.7	0.7	0.7	0.7	0.8	0.8	3,000
18	fastest	0.8	1.0	1.2	1.4	1.6	1.8	2.2	2.4	2.6	2.8	3.0	3.2	3.4	3.6	3.8	4.0	4.2	4.4	4.6	4.8	5.0	490
20	slowest	0.1	0.2	0.2	0.3	0.3	0.3	0.4	0.4	0.5	0.5	0.5	0.6	0.6	0.7	0.7	0.7	0.8	0.8	0.8	0.9	0.9	3,000
20	fastest	0.8	1.0	1.2	1.4	1.6	1.8	2.2	2.4	2.6	2.8	3.0	3.2	3.4	3.6	3.8	4.0	4.2	4.4	4.6	4.8	5.0	540
24	slowest	0.2	0.2	0.3	0.3	0.3	0.4	0.5	0.5	0.6	0.6	0.7	0.7	0.7	0.8	0.8	0.9	0.9	1.0	1.0	1.0	1.1	3,000
24	fastest	0.8	1.0	1.2	1.4	1.6	1.8	2.2	2.4	2.6	2.8	3.0	3.2	3.4	3.6	3.8	4.0	4.2	4.4	4.6	4.8	5.0	650

**APPENDIX A4-A—Table 3a.** Isokinetic transit rates for a D-96 sampler (3-liter bag) with a 3/16-inch nozzle.—*continued*

[Transit rates in feet per second; Depth is (water depth) – (unsampled zone); mL, milliliter]

26	slowest	0.2	0.2	0.3	0.3	0.4	0.4	0.5	0.6	0.6	0.7	0.7	0.8	0.8	0.8	0.9	0.9	1.0	1.0	1.1	1.1	1.2	3,000
26	fastest	0.8	1.0	1.2	1.4	1.6	1.8	2.2	2.4	2.6	2.8	3.0	3.2	3.4	3.6	3.8	4.0	4.2	4.4	4.6	4.8	5.0	710
28	slowest	0.2	0.3	0.3	0.4	0.4	0.5	0.6	0.6	0.7	0.7	0.8	0.8	0.9	0.9	1.0	1.0	1.1	1.1	1.2	1.2	1.3	3,000
28	fastest	0.8	1.0	1.2	1.4	1.6	1.8	2.2	2.4	2.6	2.8	3.0	3.2	3.4	3.6	3.8	4.0	4.2	4.4	4.6	4.8	5.0	760
30	slowest	0.2	0.3	0.3	0.4	0.4	0.5	0.6	0.7	0.7	0.8	0.8	0.9	0.9	1.0	1.0	1.1	1.1	1.2	1.2	1.3	1.4	3,000
30	fastest	0.8	1.0	1.2	1.4	1.6	1.8	2.2	2.4	2.6	2.8	3.0	3.2	3.4	3.6	3.8	4.0	4.2	4.4	4.6	4.8	5.0	820
35	slowest	0.3	0.3	0.4	0.4	0.5	0.6	0.7	0.8	0.8	0.9	1.0	1.0	1.1	1.1	1.2	1.3	1.3	1.4	1.5	1.5	1.6	3,000
35	fastest	0.8	1.0	1.2	1.4	1.6	1.8	2.2	2.4	2.6	2.8	3.0	3.2	3.4	3.6	3.8	4.0	4.2	4.4	4.6	4.8	5.0	950
40	slowest	0.3	0.4	0.4	0.5	0.6	0.7	0.8	0.9	0.9	1.0	1.1	1.2	1.2	1.3	1.4	1.4	1.5	1.6	1.7	1.7	1.8	3,000
40	fastest	0.8	1.0	1.2	1.4	1.6	1.8	2.2	2.4	2.6	2.8	3.0	3.2	3.4	3.6	3.8	4.0	4.2	4.4	4.6	4.8	5.0	1,090
50	slowest	0.4	0.5	0.5	0.6	0.7	0.8	1.0	1.1	1.2	1.3	1.4	1.4	1.5	1.6	1.7	1.8	1.9	2.0	2.1	2.2	2.3	3,000
50	fastest	0.8	1.0	1.2	1.4	1.6	1.8	2.2	2.4	2.6	2.8	3.0	3.2	3.4	3.6	3.8	4.0	4.2	4.4	4.6	4.8	5.0	1,360
60	slowest	0.4	0.5	0.7	0.8	0.9	1.0	1.2	1.3	1.4	1.5	1.6	1.7	1.8	2.0	2.1	2.2	2.3	2.4	2.5	2.6	2.7	3,000
60	fastest	0.8	1.0	1.2	1.4	1.6	1.8	2.2	2.4	2.6	2.8	3.0	3.2	3.4	3.6	3.8	4.0	4.2	4.4	4.6	4.8	5.0	1,630
70	slowest	0.5	0.6	0.8	0.9	1.0	1.1	1.4	1.5	1.6	1.8	1.9	2.0	2.2	2.3	2.4	2.5	2.7	2.8	2.9	3.0	3.2	3,000
70	fastest	0.8	1.0	1.2	1.4	1.6	1.8	2.2	2.4	2.6	2.8	3.0	3.2	3.4	3.6	3.8	4.0	4.2	4.4	4.6	4.8	5.0	1,900
80	slowest	0.6	0.7	0.9	1.0	1.2	1.3	1.6	1.7	1.9	2.0	2.2	2.3	2.5	2.6	2.8	2.9	3.0	3.2	3.3	3.5	3.6	3,000
80	fastest	0.8	1.0	1.2	1.4	1.6	1.8	2.2	2.4	2.6	2.8	3.0	3.2	3.4	3.6	3.8	4.0	4.2	4.4	4.6	4.8	5.0	2,200
90	slowest	0.7	0.8	1.0	1.1	1.3	1.5	1.8	2.0	2.1	2.3	2.4	2.6	2.8	2.9	3.1	3.3	3.4	3.6	3.7	3.9	4.1	3,000
90	fastest	0.8	1.0	1.2	1.4	1.6	1.8	2.2	2.4	2.6	2.8	3.0	3.2	3.4	3.6	3.8	4.0	4.2	4.4	4.6	4.8	5.0	2,400
100	slowest	0.7	0.9	1.1	1.3	1.4	1.6	2.0	2.2	2.4	2.5	2.7	2.9	3.1	3.3	3.4	3.6	3.8	4.0	4.2	4.3	4.5	3,000
100	fastest	0.8	1.0	1.2	1.4	1.6	1.8	2.2	2.4	2.6	2.8	3.0	3.2	3.4	3.6	3.8	4.0	4.2	4.4	4.6	4.8	5.0	2,700
110	slowest	0.8	1.0	1.2	1.4	1.6	1.8	2.2	2.4	2.6	2.8	3.0	3.2	3.4	3.6	3.8	4.0	4.2	4.4	4.6	4.8	5.0	3,000
110	fastest	0.8	1.0	1.2	1.4	1.6	1.8	2.2	2.4	2.6	2.8	3.0	3.2	3.4	3.6	3.8	4.0	4.2	4.4	4.6	4.8	5.0	3,000

**APPENDIX A4-A–Table 3b.** Isokinetic transit rates for a D-96 sampler (3-liter bag) with a 1/4-inch nozzle.  
 [Transit rates in feet per second; Depth is (water depth) – (unsampled zone); mL, milliliter]

Depth (in feet)	Rate	Mean stream velocity in vertical (feet per second)																				Volume (mL)		
		2.0	2.5	3.0	3.5	4.0	4.5	5.0	5.5	6.0	6.5	7.0	7.5	8.0	8.5	9.0	9.5	10.0	10.5	11.0	11.5		12.0	12.5
2	slowest	0.03	0.03	0.04	0.05	0.1	0.1	0.1	0.1	0.1	0.1	0.1	0.1	0.1	0.1	0.1	0.1	0.1	0.1	0.1	0.2	0.2	3,000	
2	fastest	0.8	1.0	1.2	1.4	1.6	1.8	2.0	2.2	2.4	2.6	2.8	3.0	3.2	3.4	3.6	3.8	4.0	4.2	4.4	4.6	4.8	5.0	100
4	slowest	0.1	0.1	0.1	0.1	0.1	0.1	0.1	0.1	0.2	0.2	0.2	0.2	0.2	0.2	0.2	0.2	0.3	0.3	0.3	0.3	0.3	0.3	3,000
4	fastest	0.8	1.0	1.2	1.4	1.6	1.8	2.0	2.2	2.4	2.6	2.8	3.0	3.2	3.4	3.6	3.8	4.0	4.2	4.4	4.6	4.8	5.0	190
6	slowest	0.1	0.1	0.1	0.1	0.2	0.2	0.2	0.2	0.2	0.3	0.3	0.3	0.3	0.3	0.4	0.4	0.4	0.4	0.4	0.5	0.5	3,000	
6	fastest	0.8	1.0	1.2	1.4	1.6	1.8	2.0	2.2	2.4	2.6	2.8	3.0	3.2	3.4	3.6	3.8	4.0	4.2	4.4	4.6	4.8	5.0	290
8	slowest	0.1	0.1	0.2	0.2	0.2	0.2	0.3	0.3	0.3	0.3	0.4	0.4	0.4	0.4	0.5	0.5	0.5	0.5	0.6	0.6	0.6	0.6	3,000
8	fastest	0.8	1.0	1.2	1.4	1.6	1.8	2.0	2.2	2.4	2.6	2.8	3.0	3.2	3.4	3.6	3.8	4.0	4.2	4.4	4.6	4.8	5.0	390
10	slowest	0.1	0.2	0.2	0.2	0.3	0.3	0.3	0.4	0.4	0.4	0.5	0.5	0.5	0.6	0.6	0.6	0.7	0.7	0.7	0.8	0.8	3,000	
10	fastest	0.8	1.0	1.2	1.4	1.6	1.8	2.0	2.2	2.4	2.6	2.8	3.0	3.2	3.4	3.6	3.8	4.0	4.2	4.4	4.6	4.8	5.0	480
12	slowest	0.2	0.2	0.2	0.3	0.3	0.3	0.3	0.4	0.5	0.5	0.5	0.6	0.6	0.7	0.7	0.7	0.8	0.8	0.8	0.9	0.9	1.0	3,000
12	fastest	0.8	1.0	1.2	1.4	1.6	1.8	2.0	2.2	2.4	2.6	2.8	3.0	3.2	3.4	3.6	3.8	4.0	4.2	4.4	4.6	4.8	5.0	580
14	slowest	0.2	0.2	0.3	0.3	0.4	0.4	0.5	0.5	0.5	0.6	0.6	0.7	0.7	0.8	0.8	0.9	0.9	0.9	1.0	1.0	1.1	1.1	3,000
14	fastest	0.8	1.0	1.2	1.4	1.6	1.8	2.0	2.2	2.4	2.6	2.8	3.0	3.2	3.4	3.6	3.8	4.0	4.2	4.4	4.6	4.8	5.0	680
16	slowest	0.2	0.3	0.3	0.4	0.4	0.5	0.5	0.6	0.6	0.7	0.7	0.8	0.8	0.9	0.9	1.0	1.0	1.1	1.1	1.2	1.2	1.3	3,000
16	fastest	0.8	1.0	1.2	1.4	1.6	1.8	2.0	2.2	2.4	2.6	2.8	3.0	3.2	3.4	3.6	3.8	4.0	4.2	4.4	4.6	4.8	5.0	770
18	slowest	0.2	0.3	0.3	0.4	0.5	0.5	0.6	0.6	0.7	0.8	0.8	0.9	0.9	1.0	1.0	1.1	1.2	1.2	1.3	1.3	1.4	1.4	3,000
18	fastest	0.8	1.0	1.2	1.4	1.6	1.8	2.0	2.2	2.4	2.6	2.8	3.0	3.2	3.4	3.6	3.8	4.0	4.2	4.4	4.6	4.8	5.0	870
20	slowest	0.3	0.3	0.4	0.5	0.5	0.6	0.6	0.7	0.8	0.8	0.9	1.0	1.0	1.1	1.2	1.2	1.3	1.4	1.4	1.5	1.5	1.6	3,000
20	fastest	0.8	1.0	1.2	1.4	1.6	1.8	2.0	2.2	2.4	2.6	2.8	3.0	3.2	3.4	3.6	3.8	4.0	4.2	4.4	4.6	4.8	5.0	970
24	slowest	0.3	0.4	0.5	0.5	0.6	0.7	0.8	0.8	0.9	1.0	1.1	1.2	1.2	1.3	1.4	1.5	1.5	1.6	1.7	1.8	1.9	1.9	3,000
24	fastest	0.8	1.0	1.2	1.4	1.6	1.8	2.0	2.2	2.4	2.6	2.8	3.0	3.2	3.4	3.6	3.8	4.0	4.2	4.4	4.6	4.8	5.0	1,160
26	slowest	0.3	0.4	0.5	0.6	0.7	0.8	0.8	0.9	1.0	1.1	1.2	1.3	1.3	1.4	1.5	1.6	1.7	1.8	1.8	1.9	2.0	2.1	3,000
26	fastest	0.8	1.0	1.2	1.4	1.6	1.8	2.0	2.2	2.4	2.6	2.8	3.0	3.2	3.4	3.6	3.8	4.0	4.2	4.4	4.6	4.8	5.0	1,250
28	slowest	0.4	0.5	0.5	0.6	0.7	0.8	0.9	1.0	1.1	1.2	1.3	1.4	1.4	1.5	1.6	1.7	1.8	1.9	2.0	2.1	2.2	2.3	3,000
28	fastest	0.8	1.0	1.2	1.4	1.6	1.8	2.0	2.2	2.4	2.6	2.8	3.0	3.2	3.4	3.6	3.8	4.0	4.2	4.4	4.6	4.8	5.0	1,350
30	slowest	0.4	0.5	0.6	0.7	0.8	0.9	1.0	1.1	1.2	1.3	1.4	1.4	1.5	1.6	1.7	1.8	1.9	2.0	2.1	2.2	2.3	2.4	3,000
30	fastest	0.8	1.0	1.2	1.4	1.6	1.8	2.0	2.2	2.4	2.6	2.8	3.0	3.2	3.4	3.6	3.8	4.0	4.2	4.4	4.6	4.8	5.0	1,450
35	slowest	0.5	0.6	0.7	0.8	0.9	1.0	1.1	1.2	1.4	1.5	1.6	1.7	1.8	1.9	2.0	2.1	2.3	2.4	2.5	2.6	2.7	2.8	3,000
35	fastest	0.8	1.0	1.2	1.4	1.6	1.8	2.0	2.2	2.4	2.6	2.8	3.0	3.2	3.4	3.6	3.8	4.0	4.2	4.4	4.6	4.8	5.0	1,690
40	slowest	0.5	0.6	0.8	0.9	1.0	1.2	1.3	1.4	1.5	1.7	1.8	1.9	2.1	2.2	2.3	2.4	2.6	2.7	2.8	3.0	3.1	3.2	3,000
40	fastest	0.8	1.0	1.2	1.4	1.6	1.8	2.0	2.2	2.4	2.6	2.8	3.0	3.2	3.4	3.6	3.8	4.0	4.2	4.4	4.6	4.8	5.0	1,930
50	slowest	0.6	0.8	1.0	1.1	1.3	1.4	1.6	1.8	1.9	2.1	2.3	2.4	2.6	2.7	2.9	3.1	3.2	3.4	3.5	3.7	3.9	4.0	3,000
50	fastest	0.8	1.0	1.2	1.4	1.6	1.8	2.0	2.2	2.4	2.6	2.8	3.0	3.2	3.4	3.6	3.8	4.0	4.2	4.4	4.6	4.8	5.0	2,410
60	slowest	0.8	1.0	1.2	1.4	1.5	1.7	1.9	2.1	2.3	2.5	2.7	2.9	3.1	3.3	3.5	3.7	3.9	4.1	4.2	4.4	4.6	4.8	3,000
60	fastest	0.8	1.0	1.2	1.4	1.6	1.8	2.0	2.2	2.4	2.6	2.8	3.0	3.2	3.4	3.6	3.8	4.0	4.2	4.4	4.6	4.8	5.0	2,900

**APPENDIX A4-A—Table 3c.** Isokinetic transit rates for a D-96 sampler (3-liter bag) with a 5/16-inch nozzle.

[Transit rates in feet per second; Depth is (water depth) – (unsampled zone); mL, milliliter]

Depth (in feet)	Rate	Mean stream velocity in vertical (feet per second)																				Volume (mL)		
		2.0	2.5	3.0	3.5	4.0	4.5	5.0	5.5	6.0	6.5	7.0	7.5	8.0	8.5	9.0	9.5	10.0	10.5	11.0	11.5		12.0	12.5
2	slowest	0.04	0.1	0.1	0.1	0.1	0.1	0.1	0.1	0.1	0.1	0.1	0.2	0.2	0.2	0.2	0.2	0.2	0.2	0.2	0.2	0.2	0.3	3,000
2	fastest	0.8	1.0	1.2	1.4	1.6	1.8	2.0	2.2	2.4	2.6	2.8	3.0	3.2	3.4	3.6	3.8	4.0	4.2	4.4	4.6	4.8	5.0	150
4	slowest	0.1	0.1	0.1	0.1	0.2	0.2	0.2	0.2	0.2	0.3	0.3	0.3	0.3	0.3	0.4	0.4	0.4	0.4	0.4	0.5	0.5	0.5	3,000
4	fastest	0.8	1.0	1.2	1.4	1.6	1.8	2.0	2.2	2.4	2.6	2.8	3.0	3.2	3.4	3.6	3.8	4.0	4.2	4.4	4.6	4.8	5.0	300
6	slowest	0.1	0.2	0.2	0.2	0.2	0.3	0.3	0.3	0.4	0.4	0.4	0.5	0.5	0.5	0.5	0.6	0.6	0.6	0.7	0.7	0.7	0.8	3,000
6	fastest	0.8	1.0	1.2	1.4	1.6	1.8	2.0	2.2	2.4	2.6	2.8	3.0	3.2	3.4	3.6	3.8	4.0	4.2	4.4	4.6	4.8	5.0	450
8	slowest	0.2	0.2	0.2	0.3	0.3	0.4	0.4	0.4	0.5	0.5	0.6	0.6	0.6	0.7	0.7	0.8	0.8	0.8	0.9	0.9	1.0	1.0	3,000
8	fastest	0.8	1.0	1.2	1.4	1.6	1.8	2.0	2.2	2.4	2.6	2.8	3.0	3.2	3.4	3.6	3.8	4.0	4.2	4.4	4.6	4.8	5.0	600
10	slowest	0.2	0.3	0.3	0.4	0.4	0.5	0.5	0.6	0.6	0.7	0.7	0.8	0.8	0.9	0.9	1.0	1.0	1.1	1.1	1.2	1.2	1.3	3,000
10	fastest	0.8	1.0	1.2	1.4	1.6	1.8	2.0	2.2	2.4	2.6	2.8	3.0	3.2	3.4	3.6	3.8	4.0	4.2	4.4	4.6	4.8	5.0	750
12	slowest	0.2	0.3	0.4	0.4	0.5	0.5	0.6	0.7	0.7	0.8	0.8	0.9	1.0	1.0	1.1	1.1	1.2	1.3	1.3	1.4	1.4	1.5	3,000
12	fastest	0.8	1.0	1.2	1.4	1.6	1.8	2.0	2.2	2.4	2.6	2.8	3.0	3.2	3.4	3.6	3.8	4.0	4.2	4.4	4.6	4.8	5.0	900
14	slowest	0.3	0.4	0.4	0.5	0.6	0.6	0.7	0.8	0.8	0.9	1.0	1.1	1.1	1.2	1.3	1.3	1.4	1.5	1.5	1.6	1.7	1.8	3,000
14	fastest	0.8	1.0	1.2	1.4	1.6	1.8	2.0	2.2	2.4	2.6	2.8	3.0	3.2	3.4	3.6	3.8	4.0	4.2	4.4	4.6	4.8	5.0	1,060
16	slowest	0.3	0.4	0.5	0.6	0.6	0.7	0.8	0.9	1.0	1.0	1.1	1.2	1.3	1.4	1.4	1.5	1.6	1.7	1.8	1.9	1.9	2.0	3,000
16	fastest	0.8	1.0	1.2	1.4	1.6	1.8	2.0	2.2	2.4	2.6	2.8	3.0	3.2	3.4	3.6	3.8	4.0	4.2	4.4	4.6	4.8	5.0	1,210
18	slowest	0.4	0.5	0.5	0.6	0.7	0.8	0.9	1.0	1.1	1.2	1.3	1.4	1.4	1.5	1.6	1.7	1.8	1.9	2.0	2.1	2.2	2.3	3,000
18	fastest	0.8	1.0	1.2	1.4	1.6	1.8	2.0	2.2	2.4	2.6	2.8	3.0	3.2	3.4	3.6	3.8	4.0	4.2	4.4	4.6	4.8	5.0	1,360
20	slowest	0.4	0.5	0.6	0.7	0.8	0.9	1.0	1.1	1.2	1.3	1.4	1.5	1.6	1.7	1.8	1.9	2.0	2.1	2.2	2.3	2.4	2.5	3,000
20	fastest	0.8	1.0	1.2	1.4	1.6	1.8	2.0	2.2	2.4	2.6	2.8	3.0	3.2	3.4	3.6	3.8	4.0	4.2	4.4	4.6	4.8	5.0	1,510
24	slowest	0.5	0.6	0.7	0.8	1.0	1.1	1.2	1.3	1.4	1.6	1.7	1.8	1.9	2.1	2.2	2.3	2.4	2.5	2.7	2.8	2.9	3.0	3,000
24	fastest	0.8	1.0	1.2	1.4	1.6	1.8	2.0	2.2	2.4	2.6	2.8	3.0	3.2	3.4	3.6	3.8	4.0	4.2	4.4	4.6	4.8	5.0	1,810
26	slowest	0.5	0.7	0.8	0.9	1.0	1.2	1.3	1.4	1.6	1.7	1.8	2.0	2.1	2.2	2.4	2.5	2.6	2.7	2.9	3.0	3.1	3.3	3,000
26	fastest	0.8	1.0	1.2	1.4	1.6	1.8	2.0	2.2	2.4	2.6	2.8	3.0	3.2	3.4	3.6	3.8	4.0	4.2	4.4	4.6	4.8	5.0	1,960
28	slowest	0.6	0.7	0.8	1.0	1.1	1.3	1.4	1.5	1.7	1.8	2.0	2.1	2.3	2.4	2.5	2.7	2.8	3.0	3.1	3.2	3.4	3.5	3,000
28	fastest	0.8	1.0	1.2	1.4	1.6	1.8	2.0	2.2	2.4	2.6	2.8	3.0	3.2	3.4	3.6	3.8	4.0	4.2	4.4	4.6	4.8	5.0	2,110
30	slowest	0.6	0.8	0.9	1.1	1.2	1.4	1.5	1.7	1.8	2.0	2.1	2.3	2.4	2.6	2.7	2.9	3.0	3.2	3.3	3.5	3.6	3.8	3,000
30	fastest	0.8	1.0	1.2	1.4	1.6	1.8	2.0	2.2	2.4	2.6	2.8	3.0	3.2	3.4	3.6	3.8	4.0	4.2	4.4	4.6	4.8	5.0	2,260
35	slowest	0.7	0.9	1.1	1.2	1.4	1.6	1.8	1.9	2.1	2.3	2.5	2.6	2.8	3.0	3.2	3.3	3.5	3.7	3.9	4.0	4.2	4.4	3,000
35	fastest	0.8	1.0	1.2	1.4	1.6	1.8	2.0	2.2	2.4	2.6	2.8	3.0	3.2	3.4	3.6	3.8	4.0	4.2	4.4	4.6	4.8	5.0	2,640
39	slowest	0.8	1.0	1.2	1.4	1.6	1.8	2.0	2.2	2.4	2.5	2.7	2.9	3.1	3.3	3.5	3.7	3.9	4.1	4.3	4.5	4.7	4.9	3,000
39	fastest	0.8	1.0	1.2	1.4	1.6	1.8	2.0	2.2	2.4	2.6	2.8	3.0	3.2	3.4	3.6	3.8	4.0	4.2	4.4	4.6	4.8	5.0	2,940

**APPENDIX A4-A–Table 4a.** Isokinetic transit rates for a D-99 sampler (6-liter bag) with a 1/4-inch nozzle.  
 [Transit rates in feet per second; Depth is (water depth) – (unsampled zone); mL, milliliter]

Depth (in feet)	Rate	Mean stream velocity in vertical (feet per second)																								Volume (mL)	
		3.0	3.5	4.0	4.5	5.0	5.5	6.0	6.5	7.0	7.5	8.0	8.5	9.0	9.5	10.0	10.5	11.0	11.5	12.0	12.5	13.0	13.5	14.0	14.5		15.0
2	slowest	0.02	0.02	0.03	0.03	0.03	0.04	0.04	0.04	0.05	0.05	0.1	0.1	0.1	0.1	0.1	0.1	0.1	0.1	0.1	0.1	0.1	0.1	0.1	0.1	0.1	6,000
2	fastest	1.2	1.4	1.6	1.8	2.0	2.2	2.4	2.6	2.8	3.0	3.2	3.4	3.6	3.8	4.0	4.2	4.4	4.6	4.8	5.0	5.2	5.4	5.6	5.8	6.0	100
4	slowest	0.04	0.05	0.05	0.06	0.06	0.07	0.08	0.08	0.09	0.1	0.1	0.1	0.1	0.1	0.1	0.1	0.1	0.1	0.2	0.2	0.2	0.2	0.2	0.2	0.2	6,000
4	fastest	1.2	1.4	1.6	1.8	2.0	2.2	2.4	2.6	2.8	3.0	3.2	3.4	3.6	3.8	4.0	4.2	4.4	4.6	4.8	5.0	5.2	5.4	5.6	5.8	6.0	200
6	slowest	0.06	0.07	0.08	0.09	0.1	0.1	0.1	0.1	0.1	0.1	0.2	0.2	0.2	0.2	0.2	0.2	0.2	0.2	0.2	0.2	0.2	0.3	0.3	0.3	0.3	6,000
6	fastest	1.2	1.4	1.6	1.8	2.0	2.2	2.4	2.6	2.8	3.0	3.2	3.4	3.6	3.8	4.0	4.2	4.4	4.6	4.8	5.0	5.2	5.4	5.6	5.8	6.0	300
8	slowest	0.08	0.09	0.1	0.1	0.1	0.1	0.2	0.2	0.2	0.2	0.2	0.2	0.2	0.2	0.3	0.3	0.3	0.3	0.3	0.3	0.3	0.3	0.3	0.4	0.4	6,000
8	fastest	1.2	1.4	1.6	1.8	2.0	2.2	2.4	2.6	2.8	3.0	3.2	3.4	3.6	3.8	4.0	4.2	4.4	4.6	4.8	5.0	5.2	5.4	5.6	5.8	6.0	400
10	slowest	0.1	0.1	0.1	0.1	0.2	0.2	0.2	0.2	0.2	0.2	0.3	0.3	0.3	0.3	0.3	0.3	0.4	0.4	0.4	0.4	0.4	0.4	0.5	0.5	0.5	6,000
10	fastest	1.2	1.4	1.6	1.8	2.0	2.2	2.4	2.6	2.8	3.0	3.2	3.4	3.6	3.8	4.0	4.2	4.4	4.6	4.8	5.0	5.2	5.4	5.6	5.8	6.0	500
12	slowest	0.1	0.1	0.2	0.2	0.2	0.2	0.2	0.3	0.3	0.3	0.3	0.3	0.4	0.4	0.4	0.4	0.4	0.5	0.5	0.5	0.5	0.5	0.5	0.6	0.6	6,000
12	fastest	1.2	1.4	1.6	1.8	2.0	2.2	2.4	2.6	2.8	3.0	3.2	3.4	3.6	3.8	4.0	4.2	4.4	4.6	4.8	5.0	5.2	5.4	5.6	5.8	6.0	600
14	slowest	0.1	0.2	0.2	0.2	0.2	0.2	0.3	0.3	0.3	0.3	0.4	0.4	0.4	0.5	0.5	0.5	0.5	0.5	0.6	0.6	0.6	0.6	0.7	0.7	0.7	6,000
14	fastest	1.2	1.4	1.6	1.8	2.0	2.2	2.4	2.6	2.8	3.0	3.2	3.4	3.6	3.8	4.0	4.2	4.4	4.6	4.8	5.0	5.2	5.4	5.6	5.8	6.0	700
16	slowest	0.2	0.2	0.2	0.2	0.3	0.3	0.3	0.3	0.4	0.4	0.4	0.4	0.5	0.5	0.5	0.5	0.6	0.6	0.6	0.6	0.7	0.7	0.7	0.7	0.8	6,000
16	fastest	1.2	1.4	1.6	1.8	2.0	2.2	2.4	2.6	2.8	3.0	3.2	3.4	3.6	3.8	4.0	4.2	4.4	4.6	4.8	5.0	5.2	5.4	5.6	5.8	6.0	800
18	slowest	0.2	0.2	0.2	0.3	0.3	0.3	0.3	0.4	0.4	0.4	0.5	0.5	0.5	0.6	0.6	0.6	0.6	0.7	0.7	0.7	0.8	0.8	0.8	0.8	0.9	6,000
18	fastest	1.2	1.4	1.6	1.8	2.0	2.2	2.4	2.6	2.8	3.0	3.2	3.4	3.6	3.8	4.0	4.2	4.4	4.6	4.8	5.0	5.2	5.4	5.6	5.8	6.0	900
20	slowest	0.2	0.2	0.3	0.3	0.3	0.4	0.4	0.4	0.5	0.5	0.5	0.5	0.6	0.6	0.6	0.7	0.7	0.7	0.8	0.8	0.8	0.9	0.9	0.9	1.0	6,000
20	fastest	1.2	1.4	1.6	1.8	2.0	2.2	2.4	2.6	2.8	3.0	3.2	3.4	3.6	3.8	4.0	4.2	4.4	4.6	4.8	5.0	5.2	5.4	5.6	5.8	6.0	1,000
24	slowest	0.2	0.3	0.3	0.3	0.4	0.4	0.5	0.5	0.5	0.6	0.6	0.7	0.7	0.7	0.8	0.8	0.8	0.9	0.9	1.0	1.0	1.0	1.1	1.1	1.2	6,000
24	fastest	1.2	1.4	1.6	1.8	2.0	2.2	2.4	2.6	2.8	3.0	3.2	3.4	3.6	3.8	4.0	4.2	4.4	4.6	4.8	5.0	5.2	5.4	5.6	5.8	6.0	1,200
26	slowest	0.3	0.3	0.3	0.4	0.4	0.5	0.5	0.5	0.6	0.6	0.7	0.7	0.8	0.8	0.8	0.9	0.9	1.0	1.0	1.0	1.1	1.1	1.2	1.2	1.3	6,000
26	fastest	1.2	1.4	1.6	1.8	2.0	2.2	2.4	2.6	2.8	3.0	3.2	3.4	3.6	3.8	4.0	4.2	4.4	4.6	4.8	5.0	5.2	5.4	5.6	5.8	6.0	1,300

**APPENDIX A4-A—Table 4a.** Isokinetic transit rates for a D-99 sampler (6-liter bag) with a 1/4-inch nozzle.—*continued*  
 [Transit rates in feet per second; Depth is (water depth) – (unsampled zone); mL, milliliter]

28	slowest	0.3	0.3	0.4	0.4	0.5	0.5	0.5	0.6	0.6	0.7	0.7	0.8	0.8	0.9	0.9	0.9	1.0	1.0	1.1	1.1	1.2	1.2	1.3	1.3	1.4	6,000
28	fastest	1.2	1.4	1.6	1.8	2.0	2.2	2.4	2.6	2.8	3.0	3.2	3.4	3.6	3.8	4.0	4.2	4.4	4.6	4.8	5.0	5.2	5.4	5.6	5.8	6.0	1,400
30	slowest	0.3	0.3	0.4	0.4	0.5	0.5	0.6	0.6	0.7	0.7	0.8	0.8	0.9	0.9	1.0	1.0	1.1	1.1	1.2	1.2	1.3	1.3	1.4	1.4	1.4	6,000
30	fastest	1.2	1.4	1.6	1.8	2.0	2.2	2.4	2.6	2.8	3.0	3.2	3.4	3.6	3.8	4.0	4.2	4.4	4.6	4.8	5.0	5.2	5.4	5.6	5.8	6.0	1,500
35	slowest	0.3	0.4	0.5	0.5	0.6	0.6	0.7	0.7	0.8	0.8	0.9	1.0	1.0	1.1	1.1	1.2	1.2	1.3	1.4	1.4	1.5	1.5	1.6	1.6	1.7	6,000
35	fastest	1.2	1.4	1.6	1.8	2.0	2.2	2.4	2.6	2.8	3.0	3.2	3.4	3.6	3.8	4.0	4.2	4.4	4.6	4.8	5.0	5.2	5.4	5.6	5.8	6.0	1,700
40	slowest	0.4	0.5	0.5	0.6	0.6	0.7	0.8	0.8	0.9	1.0	1.0	1.1	1.2	1.2	1.3	1.4	1.4	1.5	1.5	1.6	1.7	1.7	1.8	1.9	1.9	6,000
40	fastest	1.2	1.4	1.6	1.8	2.0	2.2	2.4	2.6	2.8	3.0	3.2	3.4	3.6	3.8	4.0	4.2	4.4	4.6	4.8	5.0	5.2	5.4	5.6	5.8	6.0	1,900
50	slowest	0.5	0.6	0.6	0.7	0.8	0.9	1.0	1.0	1.1	1.2	1.3	1.4	1.4	1.5	1.6	1.7	1.8	1.9	1.9	2.0	2.1	2.2	2.3	2.3	2.4	6,000
50	fastest	1.2	1.4	1.6	1.8	2.0	2.2	2.4	2.6	2.8	3.0	3.2	3.4	3.6	3.8	4.0	4.2	4.4	4.6	4.8	5.0	5.2	5.4	5.6	5.8	6.0	2,400
60	slowest	0.6	0.7	0.8	0.9	1.0	1.1	1.2	1.3	1.4	1.4	1.5	1.6	1.7	1.8	1.9	2.0	2.1	2.2	2.3	2.4	2.5	2.6	2.7	2.8	2.9	6,000
60	fastest	1.2	1.4	1.6	1.8	2.0	2.2	2.4	2.6	2.8	3.0	3.2	3.4	3.6	3.8	4.0	4.2	4.4	4.6	4.8	5.0	5.2	5.4	5.6	5.8	6.0	2,900
70	slowest	0.7	0.8	0.9	1.0	1.1	1.2	1.4	1.5	1.6	1.7	1.8	1.9	2.0	2.1	2.3	2.4	2.5	2.6	2.7	2.8	2.9	3.0	3.2	3.3	3.4	6,000
70	fastest	1.2	1.4	1.6	1.8	2.0	2.2	2.4	2.6	2.8	3.0	3.2	3.4	3.6	3.8	4.0	4.2	4.4	4.6	4.8	5.0	5.2	5.4	5.6	5.8	6.0	3,400
80	slowest	0.8	0.9	1.0	1.2	1.3	1.4	1.5	1.7	1.8	1.9	2.1	2.2	2.3	2.4	2.6	2.7	2.8	3.0	3.1	3.2	3.3	3.5	3.6	3.7	3.9	6,000
80	fastest	1.2	1.4	1.6	1.8	2.0	2.2	2.4	2.6	2.8	3.0	3.2	3.4	3.6	3.8	4.0	4.2	4.4	4.6	4.8	5.0	5.2	5.4	5.6	5.8	6.0	3,900
90	slowest	0.9	1.0	1.2	1.3	1.5	1.6	1.7	1.9	2.0	2.2	2.3	2.5	2.6	2.8	2.9	3.0	3.2	3.3	3.5	3.6	3.8	3.9	4.1	4.2	4.3	6,000
90	fastest	1.2	1.4	1.6	1.8	2.0	2.2	2.4	2.6	2.8	3.0	3.2	3.4	3.6	3.8	4.0	4.2	4.4	4.6	4.8	5.0	5.2	5.4	5.6	5.8	6.0	4,300
100	slowest	1.0	1.1	1.3	1.4	1.6	1.8	1.9	2.1	2.3	2.4	2.6	2.7	2.9	3.1	3.2	3.4	3.5	3.7	3.9	4.0	4.2	4.3	4.5	4.7	4.8	6,000
100	fastest	1.2	1.4	1.6	1.8	2.0	2.2	2.4	2.6	2.8	3.0	3.2	3.4	3.6	3.8	4.0	4.2	4.4	4.6	4.8	5.0	5.2	5.4	5.6	5.8	6.0	4,800
120	slowest	1.2	1.4	1.5	1.7	1.9	2.1	2.3	2.5	2.7	2.9	3.1	3.3	3.5	3.7	3.9	4.1	4.2	4.4	4.6	4.8	5.0	5.2	5.4	5.6	5.8	6,000
120	fastest	1.2	1.4	1.6	1.8	2.0	2.2	2.4	2.6	2.8	3.0	3.2	3.4	3.6	3.8	4.0	4.2	4.4	4.6	4.8	5.0	5.2	5.4	5.6	5.8	6.0	5,800



**APPENDIX A4-A-Table 4b.** Isokinetic transit rates for a D-99 sampler (6-liter bag) with a 5/16-inch nozzle.  
 [Transit rates in feet per second; Depth is (water depth) – (unsampled zone); mL, milliliter]

Depth (in feet)	Rate	Mean stream velocity in vertical (feet per second)																									Volume (mL)
		3.0	3.5	4.0	4.5	5.0	5.5	6.0	6.5	7.0	7.5	8.0	8.5	9.0	9.5	10.0	10.5	11.0	11.5	12.0	12.5	13.0	13.5	14.0	14.5	15.0	
2	slowest	0.03	0.04	0.04	0.05	0.05	0.1	0.1	0.1	0.1	0.1	0.1	0.1	0.1	0.1	0.1	0.1	0.1	0.1	0.1	0.1	0.1	0.1	0.1	0.1	0.2	6,000
2	fastest	1.2	1.4	1.6	1.8	2.0	2.2	2.4	2.6	2.8	3.0	3.2	3.4	3.6	3.8	4.0	4.2	4.4	4.6	4.8	5.0	5.2	5.4	5.6	5.8	6.0	150
4	slowest	0.06	0.07	0.08	0.09	0.1	0.1	0.1	0.1	0.1	0.2	0.2	0.2	0.2	0.2	0.2	0.2	0.2	0.2	0.2	0.3	0.3	0.3	0.3	0.3	0.3	6,000
4	fastest	1.2	1.4	1.6	1.8	2.0	2.2	2.4	2.6	2.8	3.0	3.2	3.4	3.6	3.8	4.0	4.2	4.4	4.6	4.8	5.0	5.2	5.4	5.6	5.8	6.0	300
6	slowest	0.09	0.1	0.1	0.1	0.2	0.2	0.2	0.2	0.2	0.2	0.3	0.3	0.3	0.3	0.3	0.3	0.3	0.4	0.4	0.4	0.4	0.4	0.4	0.4	0.5	6,000
6	fastest	1.2	1.4	1.6	1.8	2.0	2.2	2.4	2.6	2.8	3.0	3.2	3.4	3.6	3.8	4.0	4.2	4.4	4.6	4.8	5.0	5.2	5.4	5.6	5.8	6.0	450
8	slowest	0.1	0.1	0.2	0.2	0.2	0.2	0.2	0.3	0.3	0.3	0.3	0.3	0.4	0.4	0.4	0.4	0.4	0.5	0.5	0.5	0.5	0.5	0.6	0.6	0.6	6,000
8	fastest	1.2	1.4	1.6	1.8	2.0	2.2	2.4	2.6	2.8	3.0	3.2	3.4	3.6	3.8	4.0	4.2	4.4	4.6	4.8	5.0	5.2	5.4	5.6	5.8	6.0	600
10	slowest	0.2	0.2	0.2	0.2	0.3	0.3	0.3	0.3	0.4	0.4	0.4	0.5	0.5	0.5	0.5	0.6	0.6	0.6	0.6	0.6	0.7	0.7	0.7	0.7	0.8	6,000
10	fastest	1.2	1.4	1.6	1.8	2.0	2.2	2.4	2.6	2.8	3.0	3.2	3.4	3.6	3.8	4.0	4.2	4.4	4.6	4.8	5.0	5.2	5.4	5.6	5.8	6.0	750
12	slowest	0.2	0.2	0.2	0.3	0.3	0.3	0.4	0.4	0.4	0.5	0.5	0.5	0.5	0.6	0.6	0.6	0.7	0.7	0.7	0.8	0.8	0.8	0.8	0.9	0.9	6,000
12	fastest	1.2	1.4	1.6	1.8	2.0	2.2	2.4	2.6	2.8	3.0	3.2	3.4	3.6	3.8	4.0	4.2	4.4	4.6	4.8	5.0	5.2	5.4	5.6	5.8	6.0	900
14	slowest	0.2	0.2	0.3	0.3	0.4	0.4	0.4	0.5	0.5	0.5	0.6	0.6	0.6	0.7	0.7	0.7	0.8	0.8	0.8	0.9	0.9	1.0	1.0	1.0	1.1	6,000
14	fastest	1.2	1.4	1.6	1.8	2.0	2.2	2.4	2.6	2.8	3.0	3.2	3.4	3.6	3.8	4.0	4.2	4.4	4.6	4.8	5.0	5.2	5.4	5.6	5.8	6.0	1,100
16	slowest	0.2	0.3	0.3	0.4	0.4	0.4	0.5	0.5	0.6	0.6	0.6	0.7	0.7	0.8	0.8	0.8	0.9	0.9	1.0	1.0	1.0	1.1	1.1	1.1	1.2	6,000
16	fastest	1.2	1.4	1.6	1.8	2.0	2.2	2.4	2.6	2.8	3.0	3.2	3.4	3.6	3.8	4.0	4.2	4.4	4.6	4.8	5.0	5.2	5.4	5.6	5.8	6.0	1,200
18	slowest	0.3	0.3	0.4	0.4	0.5	0.5	0.5	0.6	0.6	0.7	0.7	0.8	0.8	0.9	0.9	1.0	1.0	1.1	1.1	1.1	1.2	1.2	1.3	1.3	1.4	6,000
18	fastest	1.2	1.4	1.6	1.8	2.0	2.2	2.4	2.6	2.8	3.0	3.2	3.4	3.6	3.8	4.0	4.2	4.4	4.6	4.8	5.0	5.2	5.4	5.6	5.8	6.0	1,400
20	slowest	0.3	0.4	0.4	0.5	0.5	0.6	0.6	0.7	0.7	0.8	0.8	0.9	0.9	1.0	1.0	1.1	1.1	1.2	1.2	1.3	1.3	1.4	1.4	1.5	1.5	6,000
20	fastest	1.2	1.4	1.6	1.8	2.0	2.2	2.4	2.6	2.8	3.0	3.2	3.4	3.6	3.8	4.0	4.2	4.4	4.6	4.8	5.0	5.2	5.4	5.6	5.8	6.0	1,500
24	slowest	0.4	0.4	0.5	0.5	0.6	0.7	0.7	0.8	0.8	0.9	1.0	1.0	1.1	1.1	1.2	1.3	1.3	1.4	1.4	1.5	1.6	1.6	1.7	1.7	1.8	6,000
24	fastest	1.2	1.4	1.6	1.8	2.0	2.2	2.4	2.6	2.8	3.0	3.2	3.4	3.6	3.8	4.0	4.2	4.4	4.6	4.8	5.0	5.2	5.4	5.6	5.8	6.0	1,800
26	slowest	0.4	0.5	0.5	0.6	0.7	0.7	0.8	0.8	0.9	1.0	1.0	1.1	1.2	1.2	1.3	1.4	1.4	1.5	1.6	1.6	1.7	1.8	1.8	1.9	2.0	6,000
26	fastest	1.2	1.4	1.6	1.8	2.0	2.2	2.4	2.6	2.8	3.0	3.2	3.4	3.6	3.8	4.0	4.2	4.4	4.6	4.8	5.0	5.2	5.4	5.6	5.8	6.0	2,000
28	slowest	0.4	0.5	0.6	0.6	0.7	0.8	0.8	0.9	1.0	1.1	1.1	1.2	1.3	1.3	1.4	1.5	1.5	1.6	1.7	1.8	1.8	1.9	2.0	2.0	2.1	6,000
28	fastest	1.2	1.4	1.6	1.8	2.0	2.2	2.4	2.6	2.8	3.0	3.2	3.4	3.6	3.8	4.0	4.2	4.4	4.6	4.8	5.0	5.2	5.4	5.6	5.8	6.0	2,100
30	slowest	0.5	0.5	0.6	0.7	0.8	0.8	0.9	1.0	1.1	1.1	1.2	1.3	1.4	1.4	1.5	1.6	1.7	1.7	1.8	1.9	2.0	2.0	2.1	2.2	2.3	6,000
30	fastest	1.2	1.4	1.6	1.8	2.0	2.2	2.4	2.6	2.8	3.0	3.2	3.4	3.6	3.8	4.0	4.2	4.4	4.6	4.8	5.0	5.2	5.4	5.6	5.8	6.0	2,300
35	slowest	0.5	0.6	0.7	0.8	0.9	1.0	1.1	1.1	1.2	1.3	1.4	1.5	1.6	1.7	1.8	1.8	1.9	2.0	2.1	2.2	2.3	2.4	2.5	2.6	2.6	6,000
35	fastest	1.2	1.4	1.6	1.8	2.0	2.2	2.4	2.6	2.8	3.0	3.2	3.4	3.6	3.8	4.0	4.2	4.4	4.6	4.8	5.0	5.2	5.4	5.6	5.8	6.0	2,600
40	slowest	0.6	0.7	0.8	0.9	1.0	1.1	1.2	1.3	1.4	1.5	1.6	1.7	1.8	1.9	2.0	2.1	2.2	2.3	2.4	2.5	2.6	2.7	2.8	2.9	3.0	6,000
40	fastest	1.2	1.4	1.6	1.8	2.0	2.2	2.4	2.6	2.8	3.0	3.2	3.4	3.6	3.8	4.0	4.2	4.4	4.6	4.8	5.0	5.2	5.4	5.6	5.8	6.0	3,000
50	slowest	0.8	0.9	1.0	1.1	1.3	1.4	1.5	1.6	1.8	1.9	2.0	2.1	2.3	2.4	2.5	2.6	2.8	2.9	3.0	3.1	3.3	3.4	3.5	3.6	3.8	6,000
50	fastest	1.2	1.4	1.6	1.8	2.0	2.2	2.4	2.6	2.8	3.0	3.2	3.4	3.6	3.8	4.0	4.2	4.4	4.6	4.8	5.0	5.2	5.4	5.6	5.8	6.0	3,800
60	slowest	0.9	1.1	1.2	1.4	1.5	1.7	1.8	2.0	2.1	2.3	2.4	2.6	2.7	2.9	3.0	3.2	3.3	3.5	3.6	3.8	3.9	4.1	4.2	4.4	4.5	6,000
60	fastest	1.2	1.4	1.6	1.8	2.0	2.2	2.4	2.6	2.8	3.0	3.2	3.4	3.6	3.8	4.0	4.2	4.4	4.6	4.8	5.0	5.2	5.4	5.6	5.8	6.0	4,500
70	slowest	1.1	1.2	1.4	1.6	1.8	1.9	2.1	2.3	2.5	2.6	2.8	3.0	3.2	3.3	3.5	3.7	3.9	4.0	4.2	4.4	4.6	4.8	4.9	5.1	5.3	6,000
70	fastest	1.2	1.4	1.6	1.8	2.0	2.2	2.4	2.6	2.8	3.0	3.2	3.4	3.6	3.8	4.0	4.2	4.4	4.6	4.8	5.0	5.2	5.4	5.6	5.8	6.0	5,300
78	slowest	1.2	1.4	1.6	1.8	2.0	2.2	2.4	2.5	2.7	2.9	3.1	3.3	3.5	3.7	3.9	4.1	4.3	4.5	4.7	4.9	5.1	5.3	5.5	5.7	5.9	6,000
78	fastest	1.2	1.4	1.6	1.8	2.0	2.2	2.4	2.6	2.8	3.0	3.2	3.4	3.6	3.8	4.0	4.2	4.4	4.6	4.8	5.0	5.2	5.4	5.6	5.8	6.0	5,900

**Appendix A4-A–Table 5.** Filling times for isokinetic samplers. [To determine the transit rate, in feet per second, multiply the depth at the sampling vertical by 2 and divide by the sampling time.]

**Appendix A4-A–Table 5a.** Filling times for DH-81 sampler

DH-81 filling times, in seconds, to collect <b>800 milliliters</b>			
stream velocity (ft/sec)	nozzle diameter (in.)		
	3/16	1/4	5/16
1.8		46	
2.0	74	41	27
2.2	67	38	24
2.4	61	35	22
2.6	57	32	20
2.8	53	30	19
3.0	49	28	18
3.2	46	26	17
3.4	43	24	16
3.6	41	23	15
3.8	39	22	14
4.0	37	21	13
4.2	35	20	13
4.4	33	19	12
4.6	32	18	12
4.8	31	17	11
5.0	29	17	11
5.2	28	16	10
5.4	27	15	10
5.6	26	15	9
5.8	25	14	9
6.0	25	14	9
6.2	24	13	9
6.4		13	8
6.6		13	8
6.8		12	8
7.0		12	8
7.2		12	
7.4		11	
7.6		11	

**Appendix A4-A–Table 5b.** Filling times for DH-95 sampler

DH-95 filling times, in seconds, to collect <b>800 milliliters</b>			
stream velocity (ft/sec)	nozzle diameter (in.)		
	3/16	1/4	5/16
1.6	92	52	33
1.8	82	46	29
2.0	74	41	27
2.2	67	38	24
2.4	61	35	22
2.6	57	32	20
2.8	53	30	19
3.0	49	28	18
3.2	46	26	17
3.4	43	24	16
3.6	41	23	15
3.8	39	22	14
4.0	37	21	13
4.2	35	20	13
4.4	33	19	12
4.6	32	18	12
4.8	31	17	11
5.0	29	17	11
5.2	28	16	10
5.4	27	15	10
5.6	26	15	9
5.8	25	14	9
6.0	25	14	9
6.2	24	13	9
6.4	23	13	8
6.6	22	13	8
6.8	22	12	8
7.0	21	12	8
7.2	20	12	7
7.4	20	11	7
7.6	19	11	7

**Appendix A4-A—Table 5c.**  
Filling times for D-95 sampler

D-95 filling times, in seconds, to collect <b>800 milliliters</b>			
stream velocity (ft/sec)	nozzle diameter (in.)		
	3/16	1/4	5/16
1.4	105	59	38
1.6	92	52	33
1.8	82	46	29
2.0	74	41	27
2.2	67	38	24
2.4	61	35	22
2.6	57	32	20
2.8	53	30	19
3.0	49	28	18
3.2	46	26	17
3.4	43	24	16
3.6	41	23	15
3.8	39	22	14
4.0	37	21	13
4.2	35	20	13
4.4	33	19	12
4.6	32	18	12
4.8	31	17	11
5.0	29	17	11
5.2	28	16	10
5.4	27	15	10
5.6	26	15	9
5.8	25	14	9
6.0	25	14	9
6.2	24	13	9
6.4	23	13	8
6.6	22	13	8
6.8	22	12	8
7.0	21	12	8
7.2	20	12	7
7.4	20	11	7
7.6	19	11	7

**Appendix A4-A—Table 5d.**  
Filling times for DH-2 sampler

DH-2 filling times, in seconds, to collect <b>1 liter</b>			
stream velocity (ft/sec)	nozzle diameter (in.)		
	3/16	1/4	5/16
2.0	92	52	33
2.5	74	41	27
3.0	61	35	22
3.5	53	30	19
4.0	46	26	17
4.5	41	23	15
5.0	37	21	13
5.5	33	19	12
6.0	31	17	11

**Appendix A4-A-Table 5e.**  
Filling times for D-96 sampler

D-96 filling times, in seconds, to collect <b>3 liters</b>			
stream velocity (ft/sec)	nozzle diameter (in.)		
	3/16	1/4	5/16
2.0	276	155	99
2.5	221	124	80
3.0	184	104	66
3.5	158	89	57
4.0	138	78	50
4.5	123	69	44
5.0	110	62	40
5.5	100	57	36
6.0	92	52	33
6.5	85	48	31
7.0	79	44	28
7.5	74	41	27
8.0	69	39	25
8.5	65	37	23
9.0	61	35	22
9.5	58	33	21
10.0	55	31	20
10.5	53	30	19
11.0	50	28	18
11.5	48	27	17
12.0	46	26	17
12.5	44	25	16
13.0	42	24	15
13.5	41	23	15
14.0	39	22	14
14.5	38	21	14
15.0	37	21	13

**Appendix A4-A-Table 5f.**  
Filling times for D-96 A-1 sampler

D96 A-1 filling times, in seconds, to collect <b>3 liters</b>			
stream velocity (ft/sec)	nozzle diameter (in.)		
	3/16	1/4	5/16
2.0	277	156	99
2.2	251	141	90
2.4	231	130	83
2.6	213	120	76
2.8	198	111	71
3.0	185	104	66
3.2	173	97	62
3.4	163	91	58
3.6	154	86	55
3.8	146	82	52
4.0	137	77	50
4.2	132	74	47
4.4	126	71	45
4.6	120	68	43
4.8	115	65	41
5.0	111	62	40
5.2	106	60	38
5.4	102	58	37
5.6	99	56	35
5.8	95	54	34
6.0	92	52	33

**Appendix A4-A–Table 5g.**  
Filling times for D-99 sampler

D-99 filling times, in seconds, to collect <b>6 liters</b>			
stream velocity (ft/sec)	nozzle diameter (in.)		
	3/16	1/4	5/16
3.0	368	207	133
3.5	316	178	114
4.0	276	155	99
4.5	245	138	88
5.0	221	124	80
5.5	201	113	72
6.0	184	104	66
6.5	170	96	61
7.0	158	89	57
7.5	147	83	53
8.0	138	78	50
8.5	130	73	47
9.0	123	69	44
9.5	116	65	42
10.0	110	62	40
10.5	105	59	38
11.0	100	57	36
11.5	96	54	35
12.0	92	52	33
12.5	88	50	32
13.0	85	48	31
13.5	82	46	29
14.0	79	44	28
14.5	76	43	27
15.0	74	41	27

*Page left blank intentionally.*

## APPENDIX A4-B

# Instructions Related to Measuring Water Levels at Wells and a Sample USGS Ground-Water-Quality Field Form

All USGS personnel who sample or make water-level or water-quality measurements at wells must comply with requirements and be familiar with the guidelines provided by the USGS Office of Ground Water. Guidelines established by the Office of Ground Water related to measurement of well depth and water level have been adapted for water-quality work and are summarized in this appendix.

	Page
<b>A4-B-1. Establishing a permanent measuring point on wells at which water level will be measured .....</b>	<b>APP.B3</b>
<b>A4-B-2. Well-depth measurement .....</b>	<b>APP.B5</b>
<b>Figure B1. Example of a USGS field form for ground-water-level measurements .....</b>	<b>APP.B7</b>
<b>A4-B-3. Water-level measurement by .....</b>	<b>APP.B8</b>
<b>(a) Steel-tape procedure.....</b>	<b>APP.B9</b>
<b>(b) Electric-tape procedure .....</b>	<b>APP.B13</b>
<b>Figure B2. Example of a water-level measurement using a graduated steel tape .....</b>	<b>APP.B12</b>
<b>A4-B-4. Water-level measurement by the air-line method .....</b>	<b>APP.B17</b>
<b>Figure B3. Typical installation for measuring water level by the air-line method .....</b>	<b>APP.B20</b>
<b>A4-B-5. Water-level measurement at flowing wells using low-pressure and high-pressure methods .....</b>	<b>APP.B21</b>
<b>A4-B-6. Sample of the U.S. Geological Survey Ground-Water Quality Notes field form .....</b>	<b>APP.B25</b>

## Appendix A4-B

<b>Equipment and Supplies</b>	
<b>All sections of appendix A4-B – common supplies</b>	
<b>A4-B-1 – Establishing a permanent measuring point on wells</b>	
<b>A4-B-2 – Well-depth measurement.</b>	
<b>All sections</b>	GWSI site schedule, Form 9-1904-A
	Ground-water-level measurement field form and/or other field forms and/or handheld or field computer for data entry
	Pens, ballpoint with non-erasable blue or black ink, for writing on field forms and in equipment log books
	Field folder and well file
	Two wrenches with adjustable jaws and other tools for removing the well cap
	Clean rag
	Key(s) for opening locks
	Equipment-cleaning supplies (NFM 3). Tape-cleaning supplies: refer to NFM 3.3.8 for soap-and-water wash guidance and disinfection. If disinfecting, use either (a) commercially available hypochlorite wipes; or (b) prepare a dilute chlorine solution adding 1 mL of common household bleach to 900 mL of water (0.005-percent solution)
<b>A4-B-1</b>	<b>Establishing a permanent measuring point (MP)</b>
	Steel tape, graduated in feet, tenths, and hundredths of feet; calibrated for making field measurements
	Reference steel tape, graduated in feet, tenths, and hundredths of feet; designated for calibration of field steel and electric tapes
	Calibration and maintenance log book for each steel tape
	Spray paint (bright color) or casing-notching tool
<b>A4-B-2</b>	<b>Well-depth measurement with steel tape</b>
	Steel tape, graduated in feet, tenths, and hundredths of feet; calibrated for making measurements. A black tape is better than a chromium-plated tape. If a chromium-plated tape has to be used, paint the back of the tape with a flat black paint to make it easier to read the wetted chalk mark
	Reference steel tape, graduated in feet, tenths, and hundredths of feet; designated for calibration of field steel and electric tapes
	Steel-tape calibration and maintenance log book (one for each steel tape)
	Weight (stainless steel, iron, or other noncontaminating material) – not lead
	Strong ring and wire, for attaching weight to end of tape. Wire should be strong enough to hold weight securely, but not as strong as the tape, so that if the weight becomes lodged in the well the tape can still be pulled free
	Carpenters' chalk (blue)



---

## Appendix A4-B-1

### Establishing a permanent measuring point on wells at which water level will be measured<sup>1</sup>

A permanent measuring point (MP) from which all water levels for a given well are measured must be established for each well at which USGS data are collected. The MP should be established when a monitor well is installed or an existing well is inventoried. The accuracy with which the MP is established depends on the accuracy of the water-level measurement being made. **For water level measured in hundredths of a foot, the MP is to be established to an accuracy of 0.01 foot.** This guidance assumes that:

- ▶ All water-level measurements from a given well must be referenced to the same datum to ensure data comparability.
- ▶ Land-surface datum (LSD) at the well was established by the person who made the initial water-level measurement at the well. LSD is an arbitrary plane chosen to be approximately equivalent to the average altitude of the ground around the well. Because LSD around a well may change over time, the distance between the MP and LSD should be checked every 3 to 5 years, or more frequently because of land development or other changes.
- ▶ Measuring points can change from time to time, especially on privately-owned wells. Such changes must be documented and dated in field notes and in the data base(s) into which the water-level data are entered.

#### *To establish a permanent measuring point:*

1. Establish the location of the MP at a specific point within the top of the casing. The MP is measured in reference to LSD. If possible, position the MP at a point on the casing where a leveling rod could be set on it directly over the well and the measuring tape can hang freely when it is in contact with the MP. Locate the MP at the most convenient place from which to measure the water level.

---

<sup>1</sup>From the USGS Office of Ground Water, Ground-Water Procedure Document 3.

2. Clearly mark the MP, either with an arrow sprayed with bright-colored paint or with a notch cut into the top of the casing. The MP must be as permanent as possible and be clearly visible and easily located. Location of the MP must be described in the well file.
3. Measure the height of the MP in feet above or below LSD. For USGS studies, record the following information into GWSI (figure B1):
  - Height and detailed description of the MP. Note that values for measuring point below land surface should be preceded by a minus sign (-).
  - Date the MP was established.
4. For most water-quality studies, the LSD and MP should be surveyed in.
5. Establish at least one clearly displayed reference mark (RM) in a location near the well; for example, a lag bolt set into a nearby telephone pole. The RM is an arbitrary datum established by permanent marks and is used to check the MP or to re-establish an MP should the original MP be destroyed or need to be changed.
6. Clearly locate the MP and RM on a detailed site sketch that goes into the well folder; the sketch commonly is made on the back of the paper GWSI form. If possible, photograph the site, including the RM and MP locations; draw an arrow to the RM and MP on the photograph(s) using an indelible marker, and place the photos in the well file.

---

## Appendix A4-B-2

### Well-depth measurement<sup>2</sup>

This method uses a graduated steel tape to measure the total depth of a well below land-surface datum. Select a graduated steel tape that is accurate to 0.01 foot. The steel tape should be calibrated against a reference steel tape. A reference steel tape is one that is maintained in the office and designated solely for tape calibration.

- If the well casing is angled, instead of vertical, the well depth will have to be corrected.
- When measuring wells of depth greater than 200 feet (deep wells), expansion and stretch of the steel tape must be considered and accounted for (see Garber and Koopman, 1968).
- Use of a steel tape is **not** recommended for measuring the depth of pumping wells.
- A weight usually is attached to the end of a steel tape to allow it to hang plumb. The weight should not be constructed of lead or other material that potentially could contaminate water in the well.
- Well obstructions could cause errors in the measurement if the steel tape cannot hang plumb.

#### *To measure well depth:*

1. Using a clean, calibrated steel tape, measure from the zero point on the tape to the bottom of the weight. Record this number as the length of the weight interval.
2. Lower the weight and tape into the well until the weight reaches the bottom of the well and the tape slackens.
3. Partially withdraw the tape from the well until the weight is standing in a vertical position, but still touching the bottom of the well. A slight jerking motion will be felt as the weight moves from the horizontal to the vertical position.
4. Repeat step 3 several times by lowering and withdrawing the tape to obtain a consistent reading.
5. Record the tape reading held at the measuring point (MP).

---

<sup>2</sup>From the USGS Office of Ground Water, Ground-Water Procedure Document 11.

APP.B6—COLLECTION OF WATER SAMPLES

6. Withdraw the tape from the well 1 to 2 feet, so that the weight will hang freely above the bottom of the well. Repeat steps 2-4 until two consistent depth readings are obtained.
7. Calculate total well depth below land-surface datum (LSD) as follows:
  - a. Tape reading held at the MP      84.3 feet
  - b. Length of the weight interval    + 1.2 feet
  - c. Sum of a + b                            85.5 feet
  - d. MP correction                         - 3.5 feet
  - e. Total well depth below LSD      82.0 feet
8. After completing the well-depth measurement, clean the exposed portion of the tape using the procedures described in NFM 3.3.8. To prevent microbial cross-contamination of other wells, disinfect the tape using commercially available hypochlorite wipes or a dilute (0.005-percent) chlorine solution.
9. Record depth data to the nearest 0.01 foot. USGS well-depth data should be recorded in GWSI and on the Ground-Water Level Notes (fig. B1) and other field forms that are kept in the field folder.



## Appendixes A4-B-3(a) and (b)

### Water-level measurement by (a) steel tape, or (b) electric tape

<b>A4-B-3: Equipment and Supplies</b>	
<b>A4-B-3(a) – Water-level measurement by graduated steel tape</b>	
<b>A4-B-3(b) – Water-level measurement by electric tape</b>	
A4-B-3(a + b) <sup>1</sup>	Steel tape, graduated in feet, tenths, and hundredths of feet; calibrated for making water-level measurements
A4-B-3(a) <sup>1</sup>	Reference steel tape, graduated in feet, tenths, and hundredths of feet. A reference steel tape is one that is maintained in the office and designated solely for tape calibration
A4-B-3(a)	Steel-tape calibration and maintenance log book (one for each steel tape). Field forms, paper and/or electronic; ballpoint pens (blue or black, non-erasable) for recording information in the log book and on paper field forms
A4-B-3(a)	Weight (stainless steel, iron, or other noncontaminating material – do not use lead)
A4-B-3(a)	Strong ring and wire, for attaching weight to end of tape. Wire should be strong enough to hold weight securely, but not as strong as the tape, so that if the weight becomes lodged in the well the tape can still be pulled free
A4-B-3(a)	Carpenters' chalk (blue)
A4-B-3(a + b)	Tape-cleaning supplies: refer to NFM 3.3.8 for soap-and-water wash guidance and disinfection. Disinfect using either commercially available hypochlorite wipes or a dilute (0.005-percent solution) chlorine solution
A4-B-3(b) <sup>2</sup>	An electric tape, double-wired and graduated in feet, tenths, and hundredths of feet, accurate to 0.01 ft. Electric tapes commonly are mounted on a hand-cranked and powered supply reel that contains space for the batteries and some device ("indicator") for signaling when the circuit is closed
A4-B-3(b)	Electric-tape calibration and maintenance log book; manufacturer's instructions. Field forms, paper and/or electronic; ballpoint pens (non-erasable blue or black ink) for recording information in the log book and on paper field forms
A4-B-3(b)	Replacement batteries, charged
A4-B-3(a + b)	Clean rag
A4-B-3(a + b)	Two wrenches with adjustable jaws or other tools for removing the well cap

<sup>1</sup>A black tape is better than a chromium-plated tape. If a chromium-plated tape has to be used, paint the back of the tape with a flat black paint to make it easier to read the wetted chalk mark.

<sup>2</sup>An older model electric tape, also known as an "M-scope", marked at 5-foot intervals with clamped-on metal bands has been replaced by newer, more accurate models.

---

## A4-B-3(a) Steel tape<sup>3</sup>

The graduated steel-tape (wetted-tape) procedure is considered to be the most accurate method for measuring a depth to the water surface at nonflowing wells. A graduated steel tape is commonly accurate to 0.01 foot. When measuring deep water levels, however, tape expansion and stretch is a necessary consideration (Garber and Koopman, 1968). The method is most accurate for water levels less than 200 feet below land surface. This method is **not** recommended for measuring pumping levels in wells.

- ▶ May be impossible to get reliable results if water is dripping into the well or condensing on the well casing.
- ▶ If the well casing is angled, instead of vertical, the depth to water will have to be corrected.
- ▶ The steel tape should be calibrated against a reference steel tape. A reference steel tape is one that is maintained, in the office, for use only for calibrating steel tapes.
- ▶ Check that the well is free of obstructions that can affect the plumbness of the steel tape. An accurate measurement cannot be made if the tape does not hang plumb.

### *Before making a measurement:*

1. Ensure that the steel tape for field use has been calibrated, using a reference steel tape (see the Equipment and Supplies table for Appendix A4-B-3, above). Check the equipment log book for the designated steel tape for calibration information.
2. Maintain the tape in good working condition by periodically checking the tape for rust, breaks, kinks, and possible stretch. Record all calibration and maintenance data associated with the steel tape in its calibration and maintenance log book.
3. If the steel tape is new, be sure that the black sheen on the tape has been dulled so that the tape will retain the chalk.
4. Attach a weight to the tape that is constructed of stainless steel or other noncontaminating material to protect ground-water quality in the event that the weight is lost in the well.
5. Place any previous measured water-level data for the well into the field folder.

---

<sup>3</sup>From the USGS Office of Ground Water, Ground-Water Procedure Document 1.

6. Check that the measuring point (MP) is clearly marked on the well and accurately described in the well file or field folder. If a new measuring point needs to be established, follow the procedures in Appendix A4-B-1 but do not use paint or create casing-material filings until after sampling has been completed for the day.
7. Prepare the Ground-Water Level Notes and Water-Level Data for GWSI field forms (fig. B1). The measurement process will be repeated at least twice and recorded in the respective column (refer to the unshaded portion of the box at the upper right of fig. B1). Record the time of measurement, using the column headed “1<sup>st</sup>” for the initial set of measurements. Water-level data are to be recorded to the appropriate accuracy for the depth being measured.
8. Spread clean plastic sheeting around the well to prevent the well tape from contacting the ground and introducing dirt into the well.

***To measure water level using a steel tape:***

1. Chalk the lower few feet of the tape by pulling the tape across a piece of blue carpenter's chalk (the wetted chalk mark identifies that part of the tape that was submerged).
2. If water level was measured previously at the well, use the previous measurement(s) to estimate the length of tape that should be lowered into the well.
3. Slowly lower the weight and tape into the well until the bottom end of the tape is submerged below the water. Work carefully to avoid splashing. Continue to lower the end of the tape into the well until the next graduation (a whole foot mark) is opposite the MP and record this number on the field form (fig. B1) next to “Hold (for DTW)” as illustrated on fig. B2.
4. Rapidly bring the tape to the surface before the wetted chalk mark dries and becomes difficult to read. Record the number as the “Cut.”
5. Subtract the “Cut” from the “Hold” and record the difference as “DTW from MP” (Depth To Water from MP). The difference between these two readings is the depth to water below the MP.
6. Record the MP correction, subtract it from “DTW from MP,” and record the result as “DTW from LSD” (depth to water from land-surface datum).



- To obtain the depth to water below land surface if the MP is above land surface: the distance between the MP and land surface datum is subtracted from the depth to water from the MP.
  - To obtain the depth to water below land surface if the MP is below land surface: precede the MP correction value with a minus (-) sign and subtract the distance between the MP and land surface datum from the depth to water from the MP.
  - If the water level is above LSD, record the depth to water in feet above land surface as a negative number.
7. Make a check measurement by repeating steps 2 through 6, recording check measurements in the second (“2<sup>nd</sup>”) column (fig. B1).
- The check measurement should be made using a different MP hold value than that used for the original measurement.
  - If the check measurement does not agree with the original measurement within 0.01 or 0.02 of a foot, make a third check measurement, recording this measurement in the third column. Make repeated check measurements until the reason for the lack of agreement is determined or until the results are shown to be reliable.
  - If more than two readings are taken, record the average of all readings.
8. In some pumped wells, a layer of oil may float on the water surface.
- If the oil layer is a foot thick, read the tape at the top of the oil mark and use this data for the water-level measurement instead of the wetted chalk mark. The measurement will differ slightly from the water level that would be measured were the oil not present.
  - If several feet of oil are present in the well, or if it is necessary to know the thickness of the oil layer, a commercially available water-detector paste can be used that will detect the presence of water in the oil. Apply the paste to the lower end of the tape. The top of the oil shows as a wet line, and the top of the water shows as a distinct color change. Since oil density is about three-quarters that of water, the water level can be estimated by adding the thickness of the oil layer times its density to the oil-water interface elevation.
9. Record water-level data to the nearest 0.01 foot. Record USGS water-level data on field forms (kept in the field folder) and in GWSI, using the appropriate method code(s) (fig. B1).

- After completing the water-level measurement, clean the exposed portion of the tape using the procedures described in NFM 3.3.8. To prevent microbial cross-contamination of other wells, disinfect the tape using commercially available hypochlorite wipes or a dilute chlorine solution (1 mL of bleach added to 900 mL water) (NFM 3.3.8). Rinse with DIW and dry the tape after each use. Do not store a steel tape while dirty or wet.

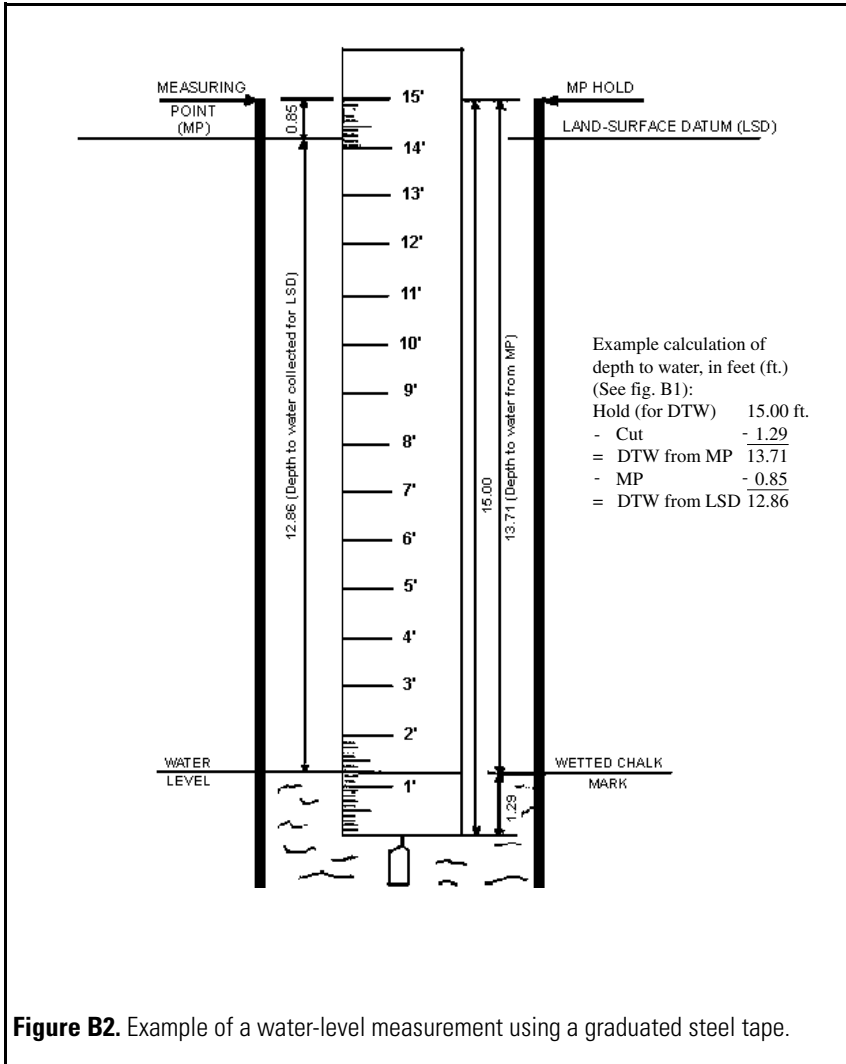

**Figure B2.** Example of a water-level measurement using a graduated steel tape.

## A4-B-3(b) Electric tape<sup>4</sup>

The electric-tape procedure for measuring depth to the water surface in a nonflowing well is especially useful in wells that are being pumped with large-discharge pumps, when making a series of measurements in rapid succession (for example, during purging or aquifer tests), and in wells with condensation or dripping water. Use of an electric tape minimizes the danger of tape entanglement in the pump impellers because the probe signals when the water surface is reached.

The accuracy of electric-tape measurements depends on the type of tape used and whether or not the tape has been stretched out of calibration after use. Tapes that are marked the entire length with feet, tenths, and hundredths of a foot can be considered accurate to  $\pm 0.01$  ft and are most accurate for water levels less than 200 ft below land surface. Electric tapes are harder to keep calibrated than are steel tapes. When measuring deep water levels, tape expansion and stretch is an additional consideration (see Garber and Koopman, 1968). The electric tape should be calibrated against a reference steel tape (see the Equipment and Supplies table above for Appendix A4-B-3).

- ▶ If the water in the well has very low specific conductance, the tape may not give an accurate reading.
- ▶ Material on the water surface, such as oil, may interfere with obtaining consistent readings.
- ▶ If the well casing is angled, instead of vertical, the depth to water will have to be corrected.
- ▶ **The electric tape should be recalibrated annually or more frequently** if it is used often or if the tape has been subjected to abnormal stress that may have caused it to stretch.

### *Before measuring water level with the electric tape:*

1. The electric steel tape requires an initial calibration before using it in the field. Calibrate the electric tape against a reference steel tape as follows:
  - a. Check the distance from the probe's sensor to the nearest foot marker on the tape, to ensure that this distance puts the sensor at the zero foot point for the tape. If it does not, a correction must be applied to all depth-to-water measurements. Record this in the equipment log book and on the field form.

---

<sup>4</sup>From the USGS Office of Ground Water, Ground-Water Procedure Document 4, version 2007.1.

- b. Compare length marks on the electric tape to those on the reference tape with the tapes laid out straight on the ground, or compare the electric tape against the known distance between fixed points on the ground.
    - c. Compare water-level measurements made with the electric tape to those made with the reference steel tape (or one that has recently been calibrated against it) in several wells that span the range of depths to water that are anticipated. For water levels of less than 500 ft below the MP, measurements should agree to within  $\pm 0.01$  ft. For water levels greater than 500 ft below the MP, measurements should agree to within 1 part in 1000. If these accuracies are not met, then a correction factor based on a regression analysis should be developed.
    - d. Record all calibration and maintenance data in the calibration and maintenance log book for the electric tape.
2. Check the circuitry of the electric tape before lowering the probe into the well. To determine proper functioning of the tape mechanism, dip the probe into tap water and observe whether the indicator needle, light, and/or beeper (collectively termed the “indicator” in this document) indicate a closed circuit. For an electric tape with multiple indicators (sound and light, for instance), confirm that the indicators operate simultaneously. If they do not operate simultaneously, determine which is the most accurate and use that one.
3. Inspect the electric tape before using it in the field.
  - a. Check the tape for wear, kinks, frayed electrical connections and possible stretch; the cable jacket tends to be subject to wear and tear.
  - b. Test that the battery and replacement batteries are fully charged.
4. Place any previous measured water-level data for the well into the field folder.
5. After reaching the field site, check that the measuring point (MP) is clearly marked on the well and is accurately described in the well file or field folder. If a new measuring point needs to be established, follow the procedures in Appendix A4-B-1, but do not use paint or create casing-material filings until after sampling has been completed to avoid sample contamination.

6. Prepare the Gound-Water Level Notes and Water-Level Data for GWSI field forms (fig. B1). The measurement process will be repeated at least twice and recorded in the respective column (refer to the unshaded portion of the box at the upper right of fig. B1). Record the time of measurement, using the column headed “1<sup>st</sup>” for the initial set of measurements. Data are to be recorded to the appropriate accuracy for the depth being measured.
7. Prevent the well tape from contacting the ground and introducing dirt into the well by spreading a clean plastic sheet around the well.

***To measure water level using an electric tape:***

1. Lower the electrode probe slowly into the well until the indicator shows that the circuit is closed and contact with the water surface is made. Avoid letting the tape rub across the top of the well casing. Place the tip or nail of the index finger on the insulated wire at the MP and read the depth to water.
  - Record the depth to water measurement in the first data-entry column, as “DTW from MP.”
  - Record the date and time of the measurement.
  - Make all readings using the same deflection point on the indicator scale, light intensity, or sound so that water levels will be consistent between measurements.
  - If the tape has been repaired and spliced go to the section on using a repaired/spliced tape (step 6).
2. Apply the MP correction to get the depth to water in feet below or above LSD. If the MP is below land surface, precede the MP correction value with a minus (-) sign to obtain the MP height. In all cases, subtract the MP height from the water level to obtain the depth to water (DTW from LSD). Referring to the non-shaded section of the Ground-Water Level Notes field form (fig. B1) in the “Depth to Water and Well Depth” table, record this value in the first (1<sup>st</sup>) data-entry column as “DTW from LSD.” If the water level is above LSD, enter the water level as feet above land surface preceded by a minus sign (-).
3. Make a check measurement by repeating steps 1 and 2 and record the measurement in the second data column of fig. B1. If the check measurement does not agree with the original measurement within 0.01 or 0.02 of a foot, make a third check measurement, recording this measurement in the third (3<sup>rd</sup>) column. Make repeated check measurements until the reason for the lack of agreement is determined or until the results are shown to be reliable. If more than two readings are taken, record the average of all readings.

4. Water-level data are recorded to the nearest 0.01 foot. Record USGS water-level data on field forms and in GWSI, using the appropriate method code(s) (fig. B1).
5. After completing the well measurement, wipe down the section of the tape that was submerged in the well water, using the cleaning and/or disinfection method of choice (NFM 3.3.8). If disinfecting the tape, rinse the tape thoroughly with deionized or tap water after disinfection. Dry the tape and rewind it onto the tape reel. Do not rewind or otherwise store a dirty or wet tape.
6. **Using a repaired/spliced tape:** If the tape has been repaired by cutting off a section of tape that was defective and splicing the sensor to the remaining section of the tape, then the depth to water reading at the MP will not be correct. To obtain the correct depth to water, apply the following steps, which is similar to the procedure for using a steel tape and chalk.
  - a. Ensure that the splice is completely insulated from any moisture and that the electrical connection is complete.
  - b. Measure the distance from the sensing point on the probe to the nearest foot marker above the spliced section of tape. Subtract that distance from the nearest foot marker above the spliced section of tape. That point then becomes the “tape correction.” For example, if the nearest foot marker above the splice is 20 feet, and the distance to the probe sensor is 0.85 ft, then the tape correction will be 19.15 feet. Record the tape correction on a field form. Periodically recheck the tape-correction factor by measuring the spliced electric tape with a reference steel tape.
  - c. Lower the electrode probe slowly into the well until the indicator shows that the circuit is closed and contact with the water surface is made. Place the tip or nail of the index finger on the insulated wire at the MP and read the depth to water. Record the depth-to-water measurement and the date and time of the measurement on the field form.
  - d. Subtract the “Tape Correction” value from the “Hold” value and record the result as DTW from LSD (fig. B1).
  - e. Return to Step 2.

## Appendix A4-B-4

### Water-level measurement by the air-line method<sup>5</sup>

The submerged air-line method for measuring a depth to the water surface in a nonflowing well requires installation of the air line and associated equipment. This method is especially useful in pumped wells where water turbulence may preclude using a more precise (steel-tape or electric-tape) method and can be used while the well is being pumped.

The air-line method is less accurate than the graduated steel-tape or the electric-tape method. Bends or spirals in the air line do not influence the accuracy of this method as long as the position of the tubing is not appreciably changed.

- ▶ Water-level measurements using an altitude gage should be accurate to 0.1 foot.
- ▶ Water-level measurements using a pressure gage are approximate and should not be considered accurate to more than the nearest one foot.
- ▶ When measuring deep water levels, corrections for fluid temperatures and vertical differences in air density are additional considerations (see Garber and Koopman, 1968).

<b>Equipment and Supplies</b>	
<b>Appendix A4-B-4 – Air-line method for water-level measurement</b>	
	1/8 or 1/4-inch diameter, seamless copper tubing, brass tubing, or galvanized pipe with a suitable pipe tee for connecting an altitude or pressure gage. (Flexible plastic tubing can be used but is less desirable).
	Altitude or pressure gage, and spare gages
	Tire valve stem and tire pump
	Small open-end wrench
	Wire or electrician's tape
	Steel tape (see Appendix A4-B-3)
	Carpenters' chalk
	Equipment calibration and maintenance log books, for each altitude or pressure gage and steel tape.
	Tape-cleaning supplies (refer to the list for well depth and steel- and electric-tape water-level measurement)

<sup>5</sup>From the USGS Office of Ground Water, Ground-Water Procedure Document 13

*To measure water level using the air-line method:*

1. Install an air-line pipe or tube in the well. Figure B3 shows a typical installation for measuring water levels by the air-line method.
  - The air line can be installed by either lowering it into the annular space between the pump column and casing after the pump has been installed in the well, or by securing it to sections of the pump and pump column with wire or tape as it is lowered into the well.
  - The air line must extend far enough below the water level that the lower end remains submerged during pumping of the well.
2. Attach a pipe tee to the top end of the air line. On the opposite end of the pipe tee, attach a tire valve stem.
3. Using a wrench, connect to the fitting on top of the pipe tee either (a) an altitude gage that reads in feet, or (b) a pressure gage, that reads pressure in pounds per square inch (lb/in<sup>2</sup> or psi).
4. Connect a tire pump to the tire valve stem fitting on the pipe tee.
  - As the water level in the well changes, **h** and **d** (fig. B3) must change in a manner such that their sum remains the same.
  - Their sum is a constant (**k**), which is determined at the same time as a simultaneous wetted-steel tape and air gage measurement is made.
5. To calibrate the air line and gage, make an initial depth to water level (**d**) measurement with a wetted-steel tape, and an initial air gage reading (**h**). Add **d** and **h** to determine the constant value for **k**. Use a tire pump to pump compressed air into the air line until all the water is expelled from the line. Once all water is displaced from the air line, record the maximum gage reading.
  - *Example (a)* – using an altitude gage: given an initial measured depth to the water level, **d**, of 25.86 ft, the initial altitude gage reading, **h**, is 75.5 ft. Then the constant **k** = 25.9 ft + 75.5 ft = 101.4 ft).
  - *Example (b)* – using a pressure gage: given an initial measured depth to the water level, **d**, of 85.85 ft, the initial pressure gage reading, **h**, is 28 psi. Then the constant **k** = 86 ft + (2.3 ft/psi x 28 psi) = 86 ft + 64 ft = 150 ft.
6. Calibrate the air line and gage as described in step 5 above.



7. To measure the water level depth in a well with an air line, subsequent air line readings are subtracted from the constant **k** to determine the depth to the water level below the MP. Use a tire pump to pump compressed air into the air line until all the water is expelled from the line, and record the maximum gage reading.
  - *Example (a)* – depth to the water level in a well using an altitude gage with a constant **k** of 101.4 ft. During a later pumping period, the maximum altitude gage **h** reads 50.0 ft; therefore, the water level, **d** = 101.4 ft - 50.0 ft = 51.4 ft.
  - *Example (b)* – depth to the water level in a well using a pressure gage with a constant **k** of 150 ft. During a later pumping period, the maximum pressure gage **h** reads 18 psi; therefore, the water level, **d** = 150 ft - (2.3 ft/psi x 18 psi) = 150 ft - 41 ft = 109 ft.
8. Measure the water-level depth as described above in step 7.
9. Apply the MP correction to get the depth to water below or above land-surface datum.
10. Record USGS water-level data on a field form and in GWSI, using the appropriate method code(s).

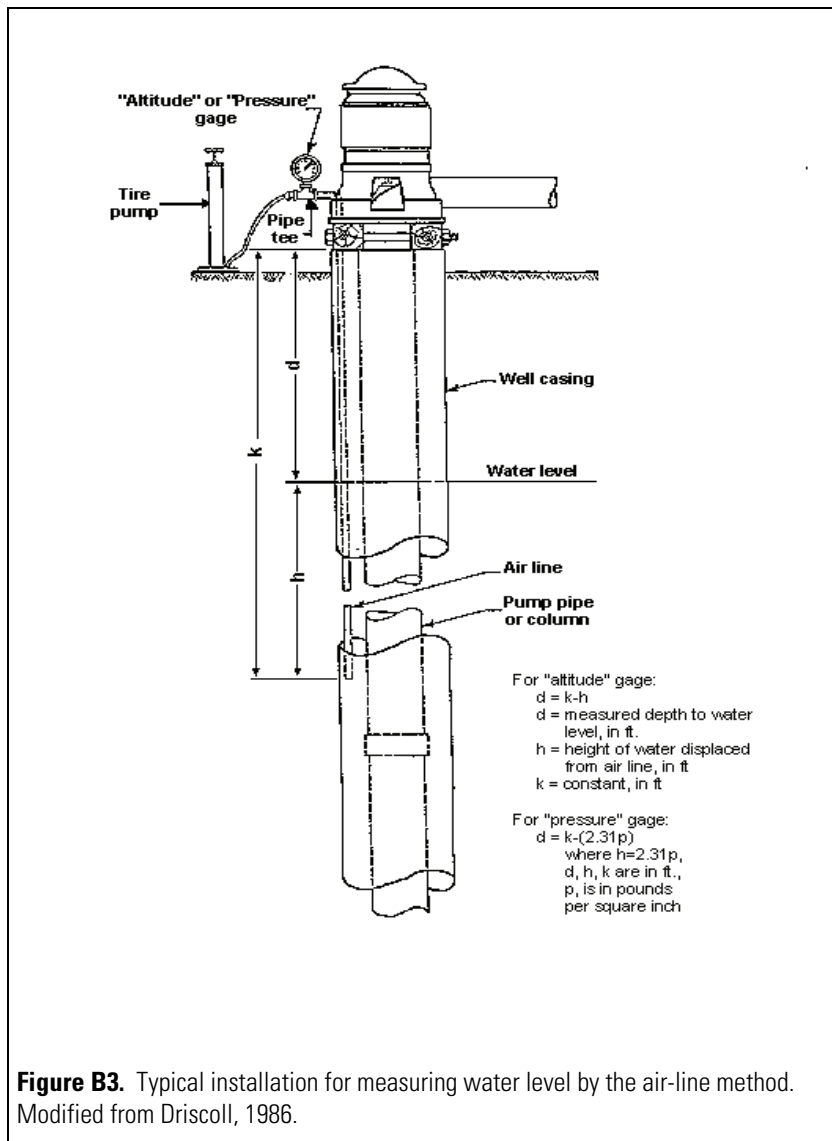

---

## Appendix A4-B-5

### Water-level measurement at flowing wells using low-pressure and high-pressure methods<sup>6</sup>

Head can be measured at flowing wells under low-pressure and high-pressure conditions, but require training and experience to be executed correctly. The low-pressure head-measurement method is more accurate, simpler, faster, and safer than the high-pressure head-measurement method.

- ▶ Use the low-pressure head-measurement method at wells with heads lower than 5 to 6 feet above land surface (the low-pressure method is impractical at wells with heads greater than 5 to 6 feet above land surface).
- ▶ Use the high-pressure method at wells with heads greater than 5 to 6 feet above land surface. Be aware that implementing the high-pressure method is more complex, takes more time, and can be dangerous.
- ▶ The accuracy of the head measurement depends on the method and equipment used, and on the experience and care of the field person:
  - Low-pressure head measurements can be measured to an accuracy of 0.1 foot.
  - High-pressure head measurements using a pressure-gage probably are not accurate to within less than 0.1 foot, although they may be read to 0.01 foot.

---

<sup>6</sup>From the USGS Office of Ground Water, Ground-Water Procedure Document 12.

<b>Equipment and Supplies</b>	
<b>Appendix A4-B-5 – Flowing-well water-level measurements</b>	
Low pressure	Short length of transparent plastic tubing
	Hose clamps
	Measuring scale
High pressure	Flexible hose with a 3-way valve
	Hose clamps
	Altitude or pressure gage, and spare gages
	Small open end wrench
	Altitude or pressure gage calibration and maintenance log book(s)
	Soil-pipe test plug (“sanitary seal”) to fit 2 to 10-inch diameter pipes (available at plumbing supply stores). <sup>1</sup>
<p><sup>1</sup> Soil-pipe test plugs consist of a length of small-diameter pipe, generally 0.75 inch, surrounded by a rubber packer. The packer can be expanded by an attached wingnut to fit tightly against the inside of the well casing or discharge pipe. The small-diameter pipe is threaded so that it can be attached to a valve, hose, or altitude/pressure gage.</p>	

***When preparing for measuring the head at a flowing well:***

- 1. If using the high-pressure method, handle the pressure gage appropriately and with care.** Altitude/pressure gages are delicate, easily broken and subject to erroneous readings if dropped or mistreated.

  - The middle third of the range of the pressure gage provides the most accurate reading.
  - **Never let the well pressure exceed the altitude/pressure gage limits.**
  - Never connect a gage to a well that uses a booster pump in the system – the pump could start automatically and the resulting pressure surge may ruin the gage.
  - Altitude/pressure gages must be calibrated with a dead-weight tester. Record the calibration in the instrument log book for the gage that is being used.
- 2. When a flowing well is closed or opened by a valve or test plug, it should be done gradually.** If pressure is applied or released suddenly, the well could be permanently damaged by the "water-hammer effect" by caving of the aquifer material, breakage of the well casing, or damage to the distribution lines or gages. To reduce the possibility of a "water-hammer effect", install a "pressure-snubber" ahead of the altitude/pressure gage.

3. If possible, shut down all flow from the well so that a static water-level measurement can be made; however, shut down may not be possible because of well owner objections or system leaks. Wells without a shut-down valve, can be shut-in by installing a soil-pipe test plug on the well or discharge line.
4. If a well has to be shut down, the time required to reach static pressure after shut-in may range from hours to days. Since it may be impractical or impossible to reach true static conditions, record the shut-in time for each gage reading. During return visits to a particular well, it is desirable to duplicate the previously used shut-in time before making an altitude/pressure gage reading.
5. Check that the measuring point (MP) is clearly marked on the well and accurately described in the well file or field folder. If a new measuring point needs to be established, follow the procedures in Appendix A4-B-1 but do not use paint or create casing-material filings until after sampling has been completed for the day.

*To measure water level at a flowing well:*

**Low-pressure head-measurement (direct measurement) method:**

1. Connect a short length of transparent plastic tubing tightly to the well with hose clamps.
2. Raise the free end of the tubing until the flow stops.
3. Rest the measuring scale on the measuring point (MP).
4. Read the water level directly, by placing the hose against the measuring scale.
5. Apply the MP correction to get the depth to water above land-surface datum.
6. Repeat steps 2 through 5 for a second check reading.

**High-pressure head-measurement (indirect measurement) method:**

1. Make sure that all well valves are closed except the one to the altitude/pressure gage. This will prevent use of the well during the measurement period and ensure an accurate water-level reading. Record the original position of each valve that is closed (full open, half open, closed, etc.), so that the well can be restored to its original operating condition.

2. Connect a flexible hose with a 3-way valve to the well with hose clamps.
3. Select a gage where the water pressure in the well will fall in the middle third of the gage range. If in doubt, use a pressure gage having a 100-pound per square inch (psi) range to make an initial measurement, then select the gage with the proper range for more accurate measurements.
4. Attach the altitude/pressure gage to one of the two "open" valve positions using a wrench. Never tighten or loosen the gage by twisting the case because the strain will disturb the calibration and give erroneous readings.
5. Bleed air from the hose, using the other "open" valve position.
6. Open the altitude/pressure gage valve slowly to reduce the risk of damage by the "water-hammer effect" to the well, distribution lines and gages. Once the needle stops moving, tap the glass face of the gage lightly with a finger to make sure that the needle is not stuck.
7. Make sure that the well is not being used by checking to see that there are no fluctuations in pressure.
8. Hold the altitude/pressure gage in a vertical position, with the center of the gage at the exact height of the MP. If using an altitude gage, read the gage to the nearest 0.1 foot. For pressure gages with psi units, read the gage to the nearest psi or 0.1 psi and multiply by 2.31 to convert to feet of water.
9. Apply the MP correction to get the depth to water above land-surface datum.
10. Shut off the well pressure and repeat steps e-i for a second check reading.
11. Record the identification number of the altitude/pressure gage with each water-level measurement so that the reading can be back referenced to the calibration record, if necessary.
12. Record USGS water-level data on field forms and in GWSI, using the appropriate method code(s).

**Appendix A4-B-6**  
**Sample of the U.S. Geological Survey**  
**Ground-Water Quality Notes field form<sup>7</sup>**

---

<sup>7</sup>This form was developed for U.S. Geological Survey personnel and is included for informational use only.

APP.B26—COLLECTION OF WATER SAMPLES

February 2006



U. S. GEOLOGICAL SURVEY GROUND-WATER QUALITY NOTES

FIELD ID \_\_\_\_\_

NWIS RECORD NO \_\_\_\_\_

Station No. \_\_\_\_\_ Station Name \_\_\_\_\_ Field ID \_\_\_\_\_  
 Sample Date \_\_\_\_\_ Mean Sample Time (watch) \_\_\_\_\_ Time Datum \_\_\_\_\_ (eg. EST, EDT, UTC)  
 Sample Medium \_\_\_\_\_ Sample Type \_\_\_\_\_ Sample Purpose (71999) \_\_\_\_\_ Purpose of Site Visit (50280) \_\_\_\_\_ QC Samples Collected? Y N  
 Project No. \_\_\_\_\_ Proj Name \_\_\_\_\_ Project No. \_\_\_\_\_ Proj Name \_\_\_\_\_  
 Sampling Team \_\_\_\_\_ Team Lead Signature \_\_\_\_\_ Date \_\_\_\_\_  
 Comments: \_\_\_\_\_

**Sample Set ID** \_\_\_\_\_

**LABORATORY INFORMATION**

Samples Collected: NUTRIENTS \_\_\_\_\_ MAJOR IONS \_\_\_\_\_ TRACE ELEMENTS: filtered \_\_\_\_\_ unfiltered \_\_\_\_\_ MERCURY: filtered \_\_\_\_\_ unfiltered \_\_\_\_\_ MICROBIOLOGY \_\_\_\_\_  
 ORGANICS: filtered \_\_\_\_\_ unfiltered \_\_\_\_\_ PEST \_\_\_\_\_ VOC \_\_\_\_\_ RADIOCHEMICALS: filtered \_\_\_\_\_ unfiltered \_\_\_\_\_ RADON \_\_\_\_\_ (Radon samp coll time: \_\_\_\_\_)  
 ISOTOPEs \_\_\_\_\_ DOC \_\_\_\_\_ TPC \_\_\_\_\_ (vol filtered \_\_\_\_\_ mL) PIC \_\_\_\_\_ (vol filtered \_\_\_\_\_ mL) TPC (QC) \_\_\_\_\_ (vol filtered \_\_\_\_\_ mL) OTHER \_\_\_\_\_  
 Lab Schedule: \_\_\_\_\_  
 Lab Codes: \_\_\_\_\_ ADD/DELETE \_\_\_\_\_ ADD/DELETE \_\_\_\_\_ ADD/DELETE \_\_\_\_\_ ADD/DELETE \_\_\_\_\_ ADD/DELETE \_\_\_\_\_ ADD/DELETE \_\_\_\_\_  
 COMMENTS \_\_\_\_\_ Date Shipped \_\_\_\_\_

**\*\*Notify the NWQL in advance of shipment of potentially hazardous samples—phone 1-866-ASK-NWQL or email LabLogin@usgs.gov**

**FIELD MEASUREMENTS**

Water Level \_\_\_\_\_ Temp, Air (00020) \_\_\_\_\_ °C ANC ( ) \_\_\_\_\_ mg/L  
 ft blw lsd (72019) ft blw mp (61055) Temp, Water (00010) \_\_\_\_\_ °C Alkalinity ( ) \_\_\_\_\_ mg/L  
 ft abv msl (NGVD 1929) (62610) pH (00400) \_\_\_\_\_ units Bicarbonate ( ) \_\_\_\_\_ mg/L  
 ft abv msl (NAVD 1988) (62611) Sp. Cond (00095) \_\_\_\_\_ µS/cm@25 °C Carbonate ( ) \_\_\_\_\_ mg/L  
 Flow Rate (00059) \_\_\_\_\_ gal/min Dis. Oxygen (00300) \_\_\_\_\_ mg/L Hydroxide ( ) \_\_\_\_\_ mg/L  
 Sampling Depth (78890) \_\_\_\_\_ ft blw msl DO sat. (00301) \_\_\_\_\_ % Hydrogen sulfide odor detected? (71875) yes no  
 Sampling Depth (TBD ) \_\_\_\_\_ ft blw lsd Barometric pres. (00025) \_\_\_\_\_ mm Hg Sample acidified beforehand? yes no  
 [see p. 7 for NWIS coding info]  
 Depth to top of sampling interval (72015) \_\_\_\_\_ ft blw lsd Eh (00090) \_\_\_\_\_ mvolts Hyd. sulfide, unfltd, measured ( 99119) \_\_\_\_\_ mg/L  
 Method: Hach Chemetrics Electrode  
 Depth to bottom of sampling interval (72016) \_\_\_\_\_ ft blw lsd Turbidity ( ) \_\_\_\_\_ Method code \_\_\_\_\_ Other: \_\_\_\_\_  
 Units: FNU NTU FNMU FBV

**SAMPLING INFORMATION**

Sampler Type (84164) \_\_\_\_\_ Sampler/Pump Type (make/model) \_\_\_\_\_ Pump/Sampler ID \_\_\_\_\_  
 Sampling Method (82398) \_\_\_\_\_ Sampling Condition (72006) \_\_\_\_\_ Filter Type(s): Capsule Disc 142mm 47mm 25mm GFF Membrane  
 Sampler Material: STAINLESS STEEL PVC TEFLON OTHER \_\_\_\_\_ Tubing Material: TEFLON PLASTIC TYGON COPPER OTHER \_\_\_\_\_  
 Aquifer name \_\_\_\_\_ Depth pump set at: \_\_\_\_\_ ft blw LSD MSL  
 Sampling point description \_\_\_\_\_  
 GW Color \_\_\_\_\_ GW Clarity \_\_\_\_\_ GW Odor \_\_\_\_\_ Sample in contact with: ATMOSPHERE OXYGEN NITROGEN OTHER \_\_\_\_\_  
 Weather: SKY- CLEAR PARTLY CLOUDY CLOUDY **PRECIPITATION-** NONE LIGHT MEDIUM HEAVY SNOW SLEET RAIN MIST \_\_\_\_\_  
**WIND-** CALM LIGHT BREEZE GUSTY WINDY EST. WIND SPEED \_\_\_\_\_ MPH **TEMPERATURE-** VERY COLD COOL WARM HOT  
 OBSERVATIONS: \_\_\_\_\_

COMPILED BY : \_\_\_\_\_ DATE \_\_\_\_\_ CHECKED BY : \_\_\_\_\_ DATE \_\_\_\_\_ LOGGED INTO NWIS BY: \_\_\_\_\_ DATE \_\_\_\_\_



Calibrated by: \_\_\_\_\_  
Date: \_\_\_\_\_ Time: \_\_\_\_\_

STN NO \_\_\_\_\_  
Location: \_\_\_\_\_

**METER CALIBRATIONS/FIELD MEASUREMENTS**

**TEMPERATURE** Meter make/model \_\_\_\_\_ S/N \_\_\_\_\_ Thermister S/N \_\_\_\_\_ Thermometer ID \_\_\_\_\_  
 Calibration criteria: ± 1 percent or ± 0.5 °C for liquid-filled thermometers ± 0.2 °C for thermisters  
 Lab Tested against NIST Thermometer/Thermister? Y N Date: \_\_\_\_\_ ± \_\_\_\_\_ °C  
 Measurement Location : FLOW-THRU CHAMBER SINGLE POINT AT \_\_\_\_\_ ft blw LSD VERTICAL AVG. OF \_\_\_\_\_ POINTS  
**Field Readings** # 1 \_\_\_\_\_ # 2 \_\_\_\_\_ # 3 \_\_\_\_\_ # 4 \_\_\_\_\_ # 5 \_\_\_\_\_ **MEDIAN:** \_\_\_\_\_ °C Remark \_\_\_\_\_ Qualifier \_\_\_\_\_

**pH** Meter make/model \_\_\_\_\_ S/N \_\_\_\_\_ Electrode No. \_\_\_\_\_ Type: GEL LIQUID OTHER \_\_\_\_\_  
 Sample: FILTERED UNFILTERED FLOW-THRU CHAMBER SINGLE POINT AT \_\_\_\_\_ ft blw LSD VERTICAL AVG. OF \_\_\_\_\_ POINTS

pH Buffer	Buffer Temp	Theoretical pH from table	pH Before Adj.	pH After Adj.	Slope	Millivolts
pH 7						
pH 7						
pH 7						
pH ____						
pH ____						
pH ____						
CHECK pH ____						

Temperature correction factors for buffers applied? Y N  
 BUFFER LOT pH 7: \_\_\_\_\_  
 NUMBERS : pH \_\_\_\_\_  
 CHECK pH \_\_\_\_\_  
 BUFFER EXP. pH 7: \_\_\_\_\_  
 DATES: pH \_\_\_\_\_  
 CHECK pH \_\_\_\_\_

Calibration Criteria: ± 0.2 pH units

**Field Readings** # 1 \_\_\_\_\_ # 2 \_\_\_\_\_ # 3 \_\_\_\_\_ # 4 \_\_\_\_\_ # 5 \_\_\_\_\_ **MEDIAN:** \_\_\_\_\_ units Remark \_\_\_\_\_ Qualifier \_\_\_\_\_

**SPECIFIC CONDUCTANCE** Meter make/model \_\_\_\_\_ S/N \_\_\_\_\_ Sensor Type: Dip Flow-thru Other \_\_\_\_\_  
 Sample: Flow-thru chamber Single point at \_\_\_\_\_ ft blw lsd Vertical avg. of \_\_\_\_\_ points

Std Value µS/cm	Std Temp	SC Before Adj.	SC After Adj.	Std Lot No.	Std type (KCl; NaCl)	Std Exp. Date

Calibration Criteria: the greater of 5 µS/cm or 3% of measured value  
 AUTO TEMP COMPENSATED METER \_\_\_\_\_  
 MANUAL TEMP COMPENSATED METER \_\_\_\_\_  
 CORRECTION FACTOR APPLIED? Y N  
 CORRECTION FACTOR= \_\_\_\_\_

**Field Readings** # 1 \_\_\_\_\_ # 2 \_\_\_\_\_ # 3 \_\_\_\_\_ # 4 \_\_\_\_\_ # 5 \_\_\_\_\_ **MEDIAN:** \_\_\_\_\_ µS/cm Remark \_\_\_\_\_ Qualifier \_\_\_\_\_

**DISSOLVED OXYGEN** Meter make/model \_\_\_\_\_ S/N \_\_\_\_\_  
 Sensor Type: Polarographic Luminescent Probe No. \_\_\_\_\_  
 Sample: Flow-thru chamber Single point at \_\_\_\_\_ ft blw lsd Vertical avg. of \_\_\_\_\_ points BOD bottle Stirrer Used? Y N  
 Water-Saturated Air Air-Saturated Water Air Calibration Chamber in Water Air Calibration Chamber in Air Winkler Titration Other \_\_\_\_\_

Calibration Temp °C	Barometric Pressure mm Hg	DO Table Reading mg/L	Salinity Correction Factor	DO Before Adjustment	DO After Adjustment

Zero DO Check \_\_\_\_\_ mg/L Adj. to \_\_\_\_\_ mg/L Date: \_\_\_\_\_  
 Zero DO Solution Date \_\_\_\_\_ Thermister Check? Y N Date \_\_\_\_\_  
 Membrane Changed? N Y N/A Date: \_\_\_\_\_ Time: \_\_\_\_\_  
 Barometer Calibrated? N Y Date: \_\_\_\_\_ Time: \_\_\_\_\_  
 Battery Check: REDLINE \_\_\_\_\_ RANGE \_\_\_\_\_

Calibration Criteria: ± 0.3 mg/L

**Field Readings** # 1 \_\_\_\_\_ # 2 \_\_\_\_\_ # 3 \_\_\_\_\_ # 4 \_\_\_\_\_ # 5 \_\_\_\_\_ **MEDIAN:** \_\_\_\_\_ mg/L Remark \_\_\_\_\_ Qualifier \_\_\_\_\_

STN NO \_\_\_\_\_

**TURBIDITY** Meter make/model \_\_\_\_\_ S/N \_\_\_\_\_ Type: turbidimeter submersible spectrophotometer

Sample: pump discharge line flow-thru chamber single point at \_\_\_\_\_ ft blw LSD MSL MP Sensor ID \_\_\_\_\_

Sample: Collection Time: \_\_\_\_\_ Measurement Time: \_\_\_\_\_ Measurement: In-situ/On-site Vehicle Office lab NWQL Other \_\_\_\_\_

Sample diluted? Y N Vol. of dilution water \_\_\_\_\_ mL Sample volume \_\_\_\_\_ mL

TURBIDITY VALUE =  $A \times (B \times C) / C$   
 where:  
**A**= TURBIDITY VALUE IN DILUTED SAMPLE  
**B**= VOLUME OF DILUTION WATER, mL  
**C**= SAMPLE VOLUME, mL

Calibration Criteria: ± 0.5 TU or ± 5%	Lot Number or Date Prepared	Expiration Date	Concentration (units)	Calibration Temperature °C	Initial instrument reading	Reading after adjustment
Stock Turbidity Standard						
Zero Standard (DIW)						
Standard 1						
Standard 2						
Standard 3						

Comments/Calculations:

Field Readings #1 \_\_\_\_\_ #2 \_\_\_\_\_ #3 \_\_\_\_\_ #4 \_\_\_\_\_ #5 \_\_\_\_\_

MEDIAN \_\_\_\_\_ Parameter Code \_\_\_\_\_ FNU NTRU FNMU FBU METHOD CODE \_\_\_\_\_ Remark Codes(s) \_\_\_\_\_ Qualifier(s) \_\_\_\_\_

**WELL and WATER-LEVEL INFORMATION**

WELL \_\_\_\_\_ SPRING \_\_\_\_\_ MONITOR \_\_\_\_\_ SUPPLY \_\_\_\_\_ OTHER \_\_\_\_\_

SUPPLY WELL PRIMARY USE: DOMESTIC \_\_\_\_\_ PUBLIC SUPPLY \_\_\_\_\_ IRRIGATION \_\_\_\_\_ OTHER \_\_\_\_\_

Casing Material: \_\_\_\_\_ Altitude (land surface) \_\_\_\_\_ ft abv MSL

Measuring Point: \_\_\_\_\_ ft abv blw LSD MSL MP

Well Depth \_\_\_\_\_ ft abv blw LSD MSL MP

Sampling condition (72006) pumping (8) flowing (4) static (n/a)  
(see reference list for additional fixed-value codes)

Water Level: \_\_\_\_\_ ft blw LSD (72019) ft blw MP (61055)  
 \_\_\_\_\_ ft abv MSL (NGVD 29) (62610) ft abv MSL (NAVD 88) (62611)

Comments:

Depth to Water and Well Depth			
	1ST	2ND	3RD (optional)
Time			
Hold (for DTW)			
+ Cut			
= DTW from MP			
- Measuring point (MP)			
= DTW from LSD			
Hold (for well depth)			
+ Length of tape leader			
= Well depth below MP			
- MP			
= Well depth below LSD			

**WATER-LEVEL DATA FOR GWSI**

DATE WATER LEVEL MEASURED (C235) \_\_\_\_\_ " \_\_\_\_\_ " \_\_\_\_\_ " \_\_\_\_\_ TIME (C709) \_\_\_\_\_ WATER LEVEL TYPE CODE (C243) **L M S**  
below land surface below meas. pt. sea level

WATER LEVEL (C237/241/242) \_\_\_\_\_ MP SEQUENCE NO. (C248) \_\_\_\_\_  
 (Mandatory if WL type=M)

WATER LEVEL DATUM (C245) **NGVD 29 NAVD 88** \_\_\_\_\_  
National Geodetic Vertical Datum Of 1929 North American Vertical Datum of 1988 Other (See GWSI manual for codes)

SITE STATUS FOR WATER LEVEL (C238) **A B C D E F G H I J M N O P R S T V W X Z**  
atmos. tide ice dry recently flowing nearby flowing nearby flowing injector site injector site plugged monitor measurement discontinued obstruct-pumping recently pumped recently pumped recently sub-pumped foreign recently sub-pumped well destroyed affected by other surface water

METHOD OF WATER-LEVEL MEASUREMENT (C239) **A B C E F G H L M N O R S T V Z**  
airline analog calibrated airline esti-mated trans-ducer pressure gage pres. gage cal logs geophysi-cal logs manometer non-rec. gage observed reported steel tape electric tape calibrated other elec. tape

WATER LEVEL ACCURACY (C276) **0 1 2 9** SOURCE OF WATER-LEVEL DATA (C244) **A D G L M O R S Z**  
foot tenth hun-dreth nearest foot other gov't driller's log geol-ogist geophysi-cal logs memory owner other reporting agency

PERSON MAKING MEASUREMENT (C246) (WATER-LEVEL PARTY) \_\_\_\_\_ MEASURING AGENCY (C247) (SOURCE) \_\_\_\_\_ RECORD READY FOR WEB (C858) **Y C P L**  
checked; display not checked; display proprietary; no web display only; no web display local use only; no web display





STN NO \_\_\_\_\_

**QUALITY-CONTROL INFORMATION**

**PRESERVATIVE LOT NUMBERS**

7.5N HNO<sub>3</sub> \_\_\_\_\_ 6N HCl \_\_\_\_\_ 4.5N H<sub>2</sub>SO<sub>4</sub> \_\_\_\_\_ Conc. H<sub>2</sub>SO<sub>4</sub> \_\_\_\_\_ NaOH \_\_\_\_\_  
 (METALS&CATIONS) (Hg) (NUTRIENTS&DOC) (COD, PHENOL, O&G) (CYANIDE)

OTHER \_\_\_\_\_ 1:1 HCl \_\_\_\_\_ Number of drops of HCL added to lower pH to ≤ 2 \_\_\_\_\_ (NOTE: Maximum number of drops = 5)  
 (VOC)

**BLANK WATER LOT NUMBERS**

Inorganic (99200) \_\_\_\_\_ 2nd Inorganic (99201) \_\_\_\_\_ Spike vials (99104) \_\_\_\_\_  
 Pesticide (99202) \_\_\_\_\_ 2nd Pesticide (99203) \_\_\_\_\_ Surrogate vials \_\_\_\_\_  
 VOC/Pesticide (99204) \_\_\_\_\_ 2nd VOC/Pesticide (99205) \_\_\_\_\_

**FILTER LOT NUMBERS**

capsule \_\_\_\_\_ pore size \_\_\_\_\_ type \_\_\_\_\_  
 disc \_\_\_\_\_ pore size \_\_\_\_\_ type \_\_\_\_\_  
 142mm GFF \_\_\_\_\_ pore size \_\_\_\_\_ type \_\_\_\_\_  
 (organics)  
 47mm GFF \_\_\_\_\_ pore size \_\_\_\_\_ type \_\_\_\_\_  
 (organics)  
 25mm GFF \_\_\_\_\_ pore size \_\_\_\_\_ type \_\_\_\_\_  
 (organic carbon)  
 142mm membrane \_\_\_\_\_ pore size \_\_\_\_\_ type \_\_\_\_\_  
 (inorganics)  
 other \_\_\_\_\_ pore size \_\_\_\_\_ type \_\_\_\_\_

**QC SAMPLES**

Starting date for set of samples (99109) (YMMDD) \_\_\_\_\_ Ending date for set of samples (99110) (YMMDD) \_\_\_\_\_

Sample Type	NWIS Record No.	Sample Type	NWIS Record No.	Sample Type	NWIS Record No.
Equip Blank _____	_____	Sequential _____	_____	Trip Blank _____	_____
Field Blank _____	_____	Spike _____	_____	Other _____	_____
Split _____	_____	Concurrent _____	_____	Other _____	_____

NWQL Schedules/lab codes (QC Samples) \_\_\_\_\_

COMMENTS \_\_\_\_\_

(Circle appropriate selections)

**99100 Blank-solution type**

- 10 Inorganic grade (distilled/deionized)
- 40 Pesticide grade (OK for organic carbon)
- 50 Volatile-organic grade (OK for inorganic, organic, and organic carbon)
- 80 Universal blank water
- 200 Other

**99101 Source of blank water**

- 10 NWQL
- 40 NIST
- 55 Wisconsin District Mercury Lab
- 200 Other

**99105 Replicate-sample type**

- 10 Concurrent
- 20 Sequential
- 30 Split
- 40 Split-Concurrent
- 50 Split-Sequential
- 200 Other

**99102 Blank-sample type**

- 1 Source Solution
- 30 Trip
- 60 Filter
- 70 Preservation
- 80 Equipment (done in non-field environment)
- 90 Ambient
- 100 Field
- 200 Other

**99111 QC sample associated with this environmental sample**

- 1 No associated QA data
- 10 Blank
- 30 Replicate Sample
- 40 Spike sample
- 100 More than one type of QA sample
- 200 Other

**99108 Spike-solution volume, mL** \_\_\_\_\_

**99106 Spike-sample type**

- 10 Field

**99107 Spike-solution source**

- 10 NWQL

**99112 Purpose, Topical QC data**

- 1 Routine QC (non-topical)
- 10 Topical for high bias (contamination)
- 20 Topical for low bias (recovery)
- 100 Topical for variability (field equip)
- 110 Topical for variability (field collection)
- 120 Topical for variability (field personnel)
- 130 Topical for variability (field processing)
- 140 Topical for variability (shipping&handling)
- 200 Topical for variability (lab)
- 900 Other topical QC purpose

REFERENCE LIST FOR CODES USED ON THIS FORM

<p><b>Sample Medium Codes</b></p> <p>6 Regular Ground water</p> <p>S Quality-control sample (associated environmental sample -6 (GW))</p> <p>For replicates and spikes</p> <p>Q Artificial</p>	<p><b>71999 Sample purpose</b></p> <p>10 Routine</p> <p>15 NAWQA</p> <p>50 GW Network</p> <p>110 Seepage Study</p> <p>120 Irrigation Effects</p> <p>130 Recharge</p> <p>140 Injection</p>	<p><b>A complete set of fixed-value codes can be found online at:</b></p> <p><a href="http://www.wis.er.usgs.gov/currentdocs/index.html">http://www.wis.er.usgs.gov/currentdocs/index.html</a></p>	<p><b>Time Datum Codes</b></p> <table border="1"> <thead> <tr> <th>Time Zone</th> <th>Std Time</th> <th>UTC Offset (hours)</th> <th>Daylight Time Code</th> <th>UTC Offset (hours)</th> </tr> </thead> <tbody> <tr> <td>Hawaii-Aleutian</td> <td>HST</td> <td>-10</td> <td>HDT</td> <td>-9</td> </tr> <tr> <td>Alaska</td> <td>AKST</td> <td>-9</td> <td>AKDT</td> <td>-8</td> </tr> <tr> <td>Pacific</td> <td>PST</td> <td>-8</td> <td>PDT</td> <td>-7</td> </tr> <tr> <td>Mountain</td> <td>MST</td> <td>-7</td> <td>MDT</td> <td>-6</td> </tr> <tr> <td>Central</td> <td>CST</td> <td>-6</td> <td>CDT</td> <td>-5</td> </tr> <tr> <td>Eastern</td> <td>EST</td> <td>-5</td> <td>EDT</td> <td>-4</td> </tr> <tr> <td>Atlantic</td> <td>AST</td> <td>-4</td> <td>ADT</td> <td>-3</td> </tr> </tbody> </table>	Time Zone	Std Time	UTC Offset (hours)	Daylight Time Code	UTC Offset (hours)	Hawaii-Aleutian	HST	-10	HDT	-9	Alaska	AKST	-9	AKDT	-8	Pacific	PST	-8	PDT	-7	Mountain	MST	-7	MDT	-6	Central	CST	-6	CDT	-5	Eastern	EST	-5	EDT	-4	Atlantic	AST	-4	ADT	-3
Time Zone	Std Time	UTC Offset (hours)	Daylight Time Code	UTC Offset (hours)																																							
Hawaii-Aleutian	HST	-10	HDT	-9																																							
Alaska	AKST	-9	AKDT	-8																																							
Pacific	PST	-8	PDT	-7																																							
Mountain	MST	-7	MDT	-6																																							
Central	CST	-6	CDT	-5																																							
Eastern	EST	-5	EDT	-4																																							
Atlantic	AST	-4	ADT	-3																																							
<p><b>Value Qualifiers</b></p> <p>e see field comment</p> <p>f sample field preparation problem</p> <p>k counts outside the acceptable range</p>	<p><b>Sample Type Code</b></p> <p>9 Regular</p> <p>7 Replicate</p> <p>2 Blank</p> <p>1 Spike</p>	<p><b>00003 Sampling depth, ft b/w LSD</b></p> <p><b>00059 Sampling flow rate, GPM</b></p> <p><b>72004 Pump or flow period prior to sampling, minutes</b></p> <p><b>72019 Water level, ft b/w LSD</b></p>	<p><b>84164 Sampler type</b></p> <p>4010 Thief Sampler</p> <p>4020 Open-top Bailer</p> <p>4025 Double-valve Bailer</p> <p>4030 Suction Pump</p> <p>4035 Submersible Centrifugal Pump</p> <p>4040 Submersible Positive-pressure Pump</p> <p>4041 Submersible Helical Rotor Pump</p> <p>4045 Submersible Gear Pump</p> <p>4050 Bladder Pump</p> <p>4060 Gas Reciprocating Pump</p> <p>4070 Gas Lift</p> <p>4075 Submersible Piston Pump</p> <p>4080 Peristaltic Pump</p> <p>4090 Jet pump</p> <p>4095 Line-Shaft Turbine Pump</p> <p>4100 Flowing Well</p> <p>8010 Other</p>																																								
<p><b>Null-value Qualifiers</b></p> <p>e required equipment not functional or available</p> <p>f sample discarded; improper filter used</p> <p>o insufficient amount of water</p>	<p><b>50280 Purpose of site visit</b></p> <p>2001 Primary (primary samples should not exist for a site for more than one date per HIP, and the primary sampling date generally has the highest number of NAWQA analyses)</p> <p>2002 Supplemental (to fill in missing schedules not sampled or lost)</p> <p>2003 Temporal characterization (for previously sampled schedules; includes LIP and seasonal samples)</p> <p>2004 Resample (to verify questionable concentrations in primary sample)</p> <p>2098 Ground-water quality control</p> <p>2099 Other (ground-water related samples with medium code other than "6", such as soil samples or core material)</p>	<p><b>82398 Sampling method</b></p> <p>4010 Thief sampler</p> <p>4020 Open-top bailer</p> <p>4025 Double-valve bailer</p> <p>4030 Suction pump</p> <p>4040 Submersible pump</p> <p>4045 Submersible multiple impeller (turbine) pump</p> <p>4050 Squeeze pump</p> <p>4060 Gas reciprocating pump</p> <p>4070 Gas lift</p> <p>4080 Peristaltic pump</p> <p>4090 Jet pump</p> <p>4100 Flowing well</p> <p>4110 Resin trap collector</p> <p>8010 Other</p>	<p><b>Alkalinity/ANC Parameter Codes</b></p> <p>39086 Alkalinity, water, filtered, incremental titration, mg/L</p> <p>00418 Alkalinity, water, filtered, fixed endpoint, mg/L</p> <p>29802 Alkalinity, water, filtered, Gran titration, mg/L</p> <p>00419 ANC, water, unfiltered, incremental titration</p> <p>00410 ANC, water, unfiltered, fixed endpoint, mg/L</p> <p>29813 ANC, water, unfiltered, Gran titration, mg/L</p> <p>29804 Bicarbonate, water, filtered, fixed endpoint, mg/L</p> <p>63786 Bicarbonate, water, filtered, Gran, mg/L</p> <p>00453 Bicarbonate, water, filtered, incremental, mg/L</p> <p>00440 Bicarbonate, water, unfiltered, fixed endpoint, mg/L</p> <p>00450 Bicarbonate, water, unfiltered, incremental, mg/L</p> <p>29807 Carbonate, water, filtered, fixed endpoint, mg/L</p> <p>63788 Carbonate, water, filtered, Gran, mg/L</p> <p>00452 Carbonate, water, filtered, incremental, mg/L</p> <p>00445 Carbonate, water, unfiltered, fixed endpoint, mg/L</p> <p>00447 Carbonate, water, unfiltered, incremental, mg/L</p> <p>29810 Hydroxide, water, filtered, fixed endpoint, mg/L</p> <p>71834 Hydroxide, water, filtered, incremental, mg/L</p> <p>71830 Hydroxide, water, unfiltered, fixed endpoint, mg/L</p> <p>71832 Hydroxide, water, unfiltered, incremental, mg/L</p>																																								
<p><b>72006 Sampling Condition</b></p> <p>0.01 The site was dry (no water level is recorded)</p> <p>0.02 The site had been flowing recently</p> <p>0.03 The site was flowing, head could not be measured</p> <p>0.04 A nearby site that taps the Aquifer was flowing</p> <p>0.05 Nearby site tapping same Aquifer had been flowing recently</p> <p>0.06 Injector site</p> <p>0.07 Injector site monitor</p> <p>0.08 Measurement discontinued</p> <p>0.09 Obstruction encountered in well above water surface</p> <p>0.10 The site was being pumped</p> <p>0.11 The site had been pumped recently</p> <p>0.12 Nearby site tapping the same Aquifer was being pumped</p> <p>0.13 Nearby site tapping the Same Aquifer was pumped recently</p> <p>0.14 Foreign substance present on the surface of the water</p> <p>0.16 Water level affected by stage in nearby site</p> <p>0.17 Other conditions affecting the measured water level</p> <p>2 Undesignated</p> <p>4 Flowing</p> <p>6 Flowing on gas lift</p> <p>8 Pumping</p> <p>10 Open hole</p> <p>18 Producing</p> <p>19 Circulating</p> <p>22 Lifting</p> <p>23 Flowing to Pit</p> <p>24 Water Flooding</p> <p>25 Jetting</p> <p>30 Seeping</p> <p>31 Nearby well pumping</p> <p>32 Nearby well taking water</p> <p>33 Well taking water</p>	<p><b>71825 Hydrogen Sulfide Odor</b></p> <p>Value none entered (null)</p> <p>Remark Code Method Code</p> <p>M detect U un-acidified sample</p> <p>U non-detect V acidified sample</p>																																										

**APPENDIX A4-C**  
**Quality-control samples collected by field  
personnel for water-quality studies**

	<b>Page</b>
<b>Blank samples .....</b>	<b>APP.C2</b>
<b>Replicate samples.....</b>	<b>APP.C5</b>
<b>Reference, spike, and blind samples .....</b>	<b>APP.C6</b>

**APPENDIX A4-C**—Quality-control samples collected by field personnel for water-quality studies.

[Common types of quality-control (QC) samples are described in this table; the list is not comprehensive. Some terms, descriptions, and purposes for QC samples have been compiled and modified from Sandstrom (1990), Horowitz and others (1994), Koterba and others (1995), Mueller and others (1997), unpublished notes from the USGS course “Quality-Control Sample Design and Interpretation,” and the following USGS Branch of Quality Systems Technical Memorandums: 90.03, 92.01, 95.01; QC, quality control; Blank-water abbreviations<sup>1</sup>: PBW, pesticide-grade (not nitrogen-gas purged) blank water; VPBW, volatile-organic-compound and pesticide-grade, nitrogen-gas-purged blank water; IBW, inorganic-grade blank water]

**BLANK SAMPLES<sup>2</sup>**

Sample type	General description <sup>3</sup>	Purpose <sup>3</sup>
<b>Field blank</b>	<p>Blank water that is passed through the entire sampling equipment system <b>onsite</b> and subjected to identical collection, processing, preservation, transportation, and storage procedures and laboratory handling as for environmental samples.</p> <ul style="list-style-type: none"> <li>The field blank is processed onsite through clean equipment on the same day as, and along with, the environmental samples, either,               <ul style="list-style-type: none"> <li>(a) directly after the equipment has been field cleaned and before leaving for the next site (NFM 3), <i>or</i>,</li> <li>(b) at the next site, just before environmental samples for that site are processed.</li> </ul> </li> <li>A set of blanks can be processed and associated with the field blank (fig. 4-14).</li> </ul>	<p>Determine the concentrations of target analyte(s) present in the environmental sample that could be attributed to field procedures for equipment cleaning and sample handling. Results include effects from laboratory handling.</p> <p>Examples related to (a) and (b) (see “General description”):</p> <ul style="list-style-type: none"> <li>(a) Check the adequacy of field-cleaning procedures (demonstrate that equipment was adequately decontaminated after previous use);</li> <li>(b) Identify contamination of sampling equipment while in transport from office to field site or between field sites, and ambient field conditions at the field site.</li> </ul>
<b>Equipment blank</b>	<p>Blank water that is passed sequentially through each component of the equipment system to be used for collecting and processing environmental samples and resulting in a single final blank sample.</p> <ul style="list-style-type: none"> <li>Differs from a field blank in that the equipment blank is processed under controlled conditions in an office laboratory and before equipment will be used for field work. Standard USGS procedure is to collect an annual equipment blank if the equipment is not in active use.</li> <li>Can result in collecting a series of blank samples sequentially, each sample of which represents a different component or components of the equipment system; for example, sampler-equipment blank, splitter-equipment blank, filter-equipment blank.</li> </ul>	<ul style="list-style-type: none"> <li>Identify effects of the equipment system used to collect and process samples on analyte concentrations.</li> <li>Verify adequacy of equipment-cleaning procedures (NFM 3).</li> <li>Relating to components of the equipment system, assess potential of sample contamination and adequacy of equipment-cleaning procedures associated with each component of the equipment system to be used for field work.</li> <li>Can be used to help identify or eliminate source(s) of contamination.</li> </ul>



**APPENDIX A4-C**—Quality-control samples collected by field personnel for water-quality studies.—*continued*

[Common types of quality-control (QC) samples are described in this table; the list is not comprehensive. Some terms, descriptions, and purposes for QC samples have been compiled and modified from Sandstrom (1990), Horowitz and others (1994), Koterba and others (1995), Mueller and others (1997), unpublished notes from the USGS course “Quality-Control Sample Design and Interpretation,” and the following USGS Branch of Quality Systems Technical Memorandums: 90.03, 92.01, 95.01; QC, quality control; Blank-water abbreviations<sup>1</sup>: PBW, pesticide-grade (not nitrogen-gas purged) blank water; VPBW, volatile-organic-compound and pesticide-grade, nitrogen-gas-purged blank water; IBW, inorganic-grade blank water]

**BLANK SAMPLES<sup>2</sup>**

<b>Sample type</b>	<b>General description<sup>3</sup></b>	<b>Purpose<sup>3</sup></b>
<b>Ambient blank</b>	Blank water that is exposed to the identical collection and processing areas and time period as environmental samples. The blank water is transferred from the stock-solution container to the same type of bottle used for an environmental sample. The specific mode of exposure to the atmosphere is determined by the QC objective. <b>Examples:</b> (a) The blank water is transferred to a sample bottle while in the sample-processing chamber used for environmental samples. (b) Container such as a sample bottle is pre-filled with blank water, opened while in the processing chamber, and exposed to the chamber atmosphere throughout the processing of environmental samples.	Determine analyte concentrations present in the environmental sample that could be attributed to exposure of sample to the ambient atmosphere in which samples are collected, processed, and analyzed.  Referring to the general description: • Example (a) is used to assess concentrations after processing the blank in a manner that mimics collection of the environmental sample. • Example (b) is used to indicate the maximum analyte concentration that would result from prolonged sample exposure to ambient conditions.
<b>Source-solution blank</b>	Stock solution of PBW, VPBW, or IBW that is transferred to a sample bottle in an area of the office laboratory within a controlled atmosphere that is relatively clean and protected with respect to target analytes.	Determine the source of water used for blanks and the degree to which the composition of blank solution could have changed (with respect to target analytes) from time of laboratory certification to time of use.
<b>Sampler blank</b>	Blank water processed through the same sampler used for environmental samples after the sampler has been cleaned. (Blanks processed through pump samplers usually are designated pump blanks).	<ul style="list-style-type: none"> <li>• Identify effects of sampler components on analyte concentrations.</li> <li>• Verify adequacy of cleaning procedures (NFM 3).</li> </ul>
<b>Splitter blank</b>	Blank water processed through the same sample-splitting device used to collect or to process environmental samples (such as a churn splitter, cone splitter, or manifold system), after the splitter has been cleaned.	<ul style="list-style-type: none"> <li>• Identify effects of splitter components on analyte concentrations.</li> <li>• Verify adequacy of cleaning procedures (NFM 3).</li> </ul>

**APPENDIX A4-C**—Quality-control samples collected by field personnel for water-quality studies.—*continued*

[Common types of quality-control (QC) samples are described in this table; the list is not comprehensive. Some terms, descriptions, and purposes for QC control samples have been compiled and modified from Sandstrom (1990), Horowitz and others (1994), Koterba and others (1995), Mueller and others (1997), unpublished notes from the USGS course "Quality-Control Sample Design and Interpretation," and the following USGS Branch of Quality Systems Technical Memorandums: 90.03, 92.01, 95.01; QC, quality control; Blank-water abbreviations<sup>1</sup>: PBW, pesticide-grade (not nitrogen-gas purged) blank water; VPBW, volatile-organic-compound and pesticide-grade, nitrogen-gas-purged blank water; IBW, inorganic-grade blank water]

**BLANK SAMPLES<sup>2</sup>**

<b>Sample type</b>	<b>General description<sup>3</sup></b>	<b>Purpose<sup>3</sup></b>
<b>Pump blank</b>	Blank water processed through the pump-and-tubing system used for environmental samples, after pump and tubing have been cleaned.	<ul style="list-style-type: none"> <li>• Identify effects of pump components and tubing on analyte concentrations.</li> <li>• Verify adequacy of cleaning procedures (NFM 3).</li> </ul>
<b>Filter blank</b>	Blank water processed through the filter assembly used for environmental samples, after the filter unit or assembly has been cleaned.	<ul style="list-style-type: none"> <li>• Identify effects of filtration assembly on analyte concentrations.</li> <li>• Verify adequacy of cleaning procedures, if a plate or cartridge assembly is used—see NFM 3.</li> <li>• If the filter blank is to represent the same filter media, the blank is processed prior to the environmental samples.</li> </ul>
<b>Preservation blank</b>	Blank water that is transferred to a sample bottle and chemically treated with a preservative in an area protected from atmospheric contamination (usually under a clean hood environment in the office laboratory). The preservative used is from the same lot number used for the other QC and environmental samples.	Determine the potential for, and magnitude of, sample contamination from the chemical treatment to be used to preserve the environmental sample.
<b>Shelf blank</b> ("Hold" blank)	Blank water that is transferred into the same type of bottle used for an environmental sample (usually in a protected environment in the office laboratory) and stored adjacent to stored environmental samples for the same length of time.	Determine the potential for and magnitude of sample contamination from sample storage in a designated area for a designated length of time.
<b>Refrigerator blank</b>	Blank water that is transferred to a sample bottle (usually in a protected environment in the office laboratory) and stored adjacent to environmental samples in a refrigerated area for the same length of time.	Determine the potential for, and magnitude of, sample contamination from refrigeration of the sample for a designated length of time.

**APPENDIX A4-C**—Quality-control samples collected by field personnel for water-quality studies.—*continued*

[Common types of quality-control (QC) samples are described in this table; the list is not comprehensive. Some terms, descriptions, and purposes for QC samples have been compiled and modified from Sandstrom (1990), Horowitz and others (1994), Koterba and others (1995), Mueller and others (1997), unpublished notes from the USGS course “Quality-Control Sample Design and Interpretation,” and the following USGS Branch of Quality Systems Technical Memorandums: 90.03, 92.01, 95.01; QC, quality control; Blank-water abbreviations<sup>1</sup>: PBW, pesticide-grade (not nitrogen-gas purged) blank water; VPBW, volatile-organic-compound and pesticide-grade, nitrogen-gas-purged blank water; IBW, inorganic-grade blank water]

Sample type	REPLICATE SAMPLES	
	General description <sup>3</sup>	Purpose <sup>3</sup>
<b>Replicates</b> (duplicates, triplicates, etc. of sequential, split, concurrent, or other type of replicate sample)	A set of samples that is collected close in time and space and in a manner so that the samples are thought to represent virtually the same physical, chemical, and biological properties.	Depending upon its type, a replicate is used to determine variability in some part of the sample collection, processing, and analysis system.
<b>Concurrent replicates</b>	Samples obtained simultaneously using two or more samplers or by using one sampler and alternating collection of samples into two or more compositing containers (Horowitz and others, 1994).	Identify and (or) quantify the variability in the system being sampled.
<b>Sequential replicates</b>	Samples that are collected one after the other and considered virtually identical in composition.	<ul style="list-style-type: none"> <li>Identify and (or) quantify the variability introduced from collection, processing, shipping, and laboratory handling and analysis.</li> <li>Can be designed to indicate temporal variability resulting from consecutive collection of samples.</li> </ul>
<b>Split replicates</b>	<p>Samples obtained by dividing one sample into two or more subsamples either before or after sample processing and preservation. <b>Each of the subsamples is to be analyzed for concentrations of the same constituents or compounds.</b></p> <p>Examples:</p> <p>(a) A processed and treated sample in a sample bottle is split into two or more aliquots and subjected to identical handling and analysis.</p> <p>(b) Environmental water is passed through a splitting device (such as a cone splitter or T-valve) from which subsamples are collected simultaneously and subjected to identical handling and analysis.</p> <p>(c) Environmental water is collected into a compositing device from which subsamples are collected sequentially and subjected to identical handling and analysis.</p>	<ul style="list-style-type: none"> <li>Assess variability for a given sample matrix.</li> <li>Compare differences in analyses obtained from the same or separate laboratories.</li> </ul>

**APPENDIX A4-C**—Quality-control samples collected by field personnel for water-quality studies.—*continued*

[Common types of quality-control (QC) samples are described in this table; the list is not comprehensive. Some terms, descriptions, and purposes for QC samples have been compiled and modified from Sandstrom (1990), Horowitz and others (1994), Koterba and others (1995), Mueller and others (1997), unpublished notes from the USGS course “Quality-Control Sample Design and Interpretation,” and the following USGS Branch of Quality Systems Technical Memorandums: 90.03, 92.01, 95.01; QC, quality control; Blank-water abbreviations<sup>1</sup>: PBW, pesticide-grade (not nitrogen-gas purged) blank water; VPBW, volatile-organic-compound and pesticide-grade, nitrogen-gas-purged blank water; IBW, inorganic-grade blank water]

	<b>REFERENCE, SPIKE, AND BLIND SAMPLES</b>	
<b>Sample type</b>	<b>General description<sup>3</sup></b>	<b>Purpose<sup>3</sup></b>
<b>Reference sample</b>	A laboratory-prepared solution or material whose composition is certified for one or more properties so that it can be used to assess a measurement method or for assigning concentration values of specific analytes.	Tests for bias and variability of the laboratory measurement process.
<b>Spike sample</b>	Environmental (“field-matrix spikes”) or reference-material sample to which a spike solution has been added in known concentrations and in a manner that does not substantially change the original sample matrix. <b>Spike solution</b> is a solution having laboratory-certified concentrations of selected analytes and that are added in known quantities to a sample. <sup>4</sup>	Assess the recovery of target analytes relative to the actual conditions to which samples have been exposed; quantify effects of sample-matrix interferences and analyte degradation on analyte recovery.
<b>Blind sample</b>	A sample (typically, reference material) submitted for laboratory analysis with composition known to the submitter but unknown (blind) to the analyst. Every blind sample analyzed should have an associated reference to the source and preparation procedure.	Test for bias and variability of the laboratory measurement process.

<sup>1</sup>Blank water is a solution that is free of analyte(s) of interest at a specified detection limit and that is used to develop specific types of QC samples. USGS personnel are required to use blank water that has been analyzed and certified to be of a specific grade.

<sup>2</sup>Blank samples (blanks) for trace-element analysis have a unique NWQL schedule of analysis, different from that of the environmental sample.

<sup>3</sup>The description of a QC sample depends to some extent on the purpose for which it is collected. The purpose for the QC sample can govern the mode of its collection, processing, and treatment, and the equipment to which it is exposed. Purposes for a specific type of QC sample are varied. Analysis of all QC samples includes the bias and variability introduced from shipping and laboratory handling and analysis of the sample.

<sup>4</sup>For USGS studies, obtain spike solutions in spike kits for pesticide and volatile organic compound analyses from the USGS National Field Supplies Service (NFSS) through One-Stop Shopping.

**APPENDIX A4-D**  
**Examples from the National Water-Quality**  
**Assessment Program Related to**  
**Protocols for Collecting Blank Samples**  
**at Ground-Water Sampling Sites**

Modified from Koterba and others, 1995

**Table 1. Example of procedure to estimate and collect field volumes of blank solutions.**

**Table 2. Example of procedure to collect blank samples with a submersible water-quality pump.**

**APPENDIX A4-D—Table 1.** Example of procedure to estimate and collect field volumes of blank solutions.

[Modified from Koterba and others, 1995, and based on protocols of the National Water-Quality Assessment Program. DIW, District deionized water with specific electrical conductance less than 1.0 microsiemens per liter; VPBW, volatile-organic-compound and pesticide-grade blank water; PBW, pesticide-grade blank water; IBW, inorganic-grade blank water; DOC, dissolved (filtered) organic carbon; gal, gallons; L, liters; ~, approximately; NWQL, National Water Quality Laboratory]

**Assumptions:** Submersible pump was used to collect the ground-water samples. Equipment just used to collect ground-water samples has been decontaminated, and, except for the pump intake being in a standpipe, is set up on site in the same manner as it was for the collection of ground-water samples.

#### Blank-Solution Types and Estimate of Volumes Required<sup>1</sup>

Field blank(s) desired	Required blank-solution type	Minimum volume in gal (L)	Comments
Major ions and nutrients	IBW	1.0 (~4)	Waste 0.5 gal, then collect field blanks; can use DIW to force last of the IBW needed through the system.
Trace elements	IBW	1.0 (~4)	
Major ions and nutrients and trace elements	IBW	1.5 (~6)	Waste 0.5 gal, then collect field blanks; if necessary, use DIW to force last of the IBW needed through the system.
VOCs and DOC <sup>1</sup>	VPBW	1.5 (~6)	Waste 0.5 gal, then collect field blanks; can use DIW to force last of VPBW (or PBW) through the system.
Pesticides and DOC	PBW <sup>1</sup>	1.5 (~6)	
VOCs, DOC <sup>1</sup> and pesticides	VPBW	2.0 (~8)	Waste 0.5 gal, then collect field blanks; can use DIW to force last of VPBW or PBW through the system.

<sup>1</sup>Use VPBW for VOC field blanks. PBW can not be used. Select VPBW or PBW for DOC field blanks only after reviewing certification forms of the lot numbers available. A solution-blank sample of water from the same lot of NWQL water is poured directly into the DOC 125-mL amber sample bottle and is required for every DOC field blank. Record the lot number of the water used for the solution blank on the ASR form.

**APPENDIX A4-D—Table 2.** Example of procedure to collect blank samples with a submersible water-quality pump.

[Modified from Koterba and others (1995). DIW, deionized water; VPBW, volatile-organic-compound and pesticide-grade blank water; PBW, pesticide-grade blank water; IBW, inorganic-grade blank water; VOC, volatile organic compound; QC, quality control]

### General Field-Blank Collection Procedure<sup>1</sup>

1. Divide field team duties—Three-person team recommended—Two people collect samples in a manner similar to that used to collect ground-water samples; the third person adds blank water to standpipe and controls flow through system, as needed, to facilitate field blank collection.
2. Check flow set-up—From standpipe to sample collection/processing chamber, ensure that adequate volumes of DIW and the required blank water are within easy reach of person stationed at standpipe and arranged in order of collection: IBW first, and PBW or VPBW last.<sup>2</sup>
3. Set low flow rate—Once pumping is initiated, set flow (on basis of measurement at chamber outflow) to about 0.1 gal. (500 mL) per minute or less to avoid wasting excessive amounts of blank water (to avoid air bubbles, 150 mL/min or less is recommended for filling VOC vials).
4. Collect blank solutions in prescribed sequence, collecting the IBW before the equipment is exposed to methanol and PBW or VPBW—As solutions are changed, pump operator should change to clean gloves, empty residual solution from standpipe, rinse pump intake and standpipe, individually, at least three times each, with the next solution.
  - Use an air segment to mark the end of one solution and the beginning of the next; alternatively, determine the change in solutions on the basis of the storage volume in the line divided by the pumping rate to estimate the time it takes for the solution to travel from the standpipe to the collection/processing chamber.
  - Pass about 0.5 gallons (approximately 2 L) of blank solution to waste before collecting the QC sample, regardless of whether air segments or timed flow or both are used to assess when the solution arrives at the collection chamber.
  - Use one type of water to force the last of another type from the sample tubing after all samples that require that blank-water type have been collected, in order to limit the amount of blank water left in the sample tubing.

<sup>1</sup>**Assumptions:** Submersible pump was used to collect the ground-water samples. Organic and inorganic field blanks will be collected. Equipment just used to collect ground-water samples has been cleaned, and, except for the pump intake being in a standpipe instead of a well, is set up on site in the same manner as it was for the collection of ground-water samples. Standpipe has just been cleaned and subsequently rinsed with VPBW. If only inorganic field blanks will be collected, rinse cleaned standpipe with IBW and modify steps 2 to 4 accordingly.

<sup>2</sup>Referring to NFM 3, follow the cleaning sequence shown on fig. 3-1 for the inorganic and organic cleaning procedure.