

Detectable Warnings: Synthesis of U.S. and International Practice

Work performed under contract by:

Billie Louise Bentzen, Ph.D.

Janet M. Barlow, COMS

Lee S. Tabor, architect

Accessible Design for the Blind

P.O. Box 1212

Berlin, Massachusetts 01503 USA

978-838-2307 voice / fax

bbentzen@ma.ultranet.com

12 May 2000



U.S. Access Board • 1331 F Street, NW • Suite 1000 • Washington, DC 20004-1111
(800) 872-2253 (Voice) • (800) 993-2822 (TTY) • (202) 272-5447 (Fax)
info@access-board.gov (E-mail) • <http://www.access-board.gov> (Website)

Acknowledgements

The authors wish to express their appreciation to all who generously contributed their time and efforts in providing information, specifications, and photographs, to those who participated in interviews, and to those who gave permission for us to list their names in this publication as contacts for more information.

The authors are thankful to Lois Thibault of the U.S. Access Board for the provision of difficult to obtain resources, and for her careful editing and suggestions on content organization.

We also wish to acknowledge the dedicated research assistance of Abigail Tabor and Rebekah Barlow.

Illustration Credits

All drawings by Lee Tabor except as noted.

All photos by the authors except as noted.

Photos by Martin Miller: cover, 8-15 through 8-30.

Photos by Lois Thibault: 1-3, 1-4, 2-5, 3-7, 4-4, 4-13, 5-1, 5-2, 5-3, 5-5, 5-11.

Photos by Murray Mountain: 3-5, 4-6, 4-13, 4-14.

Photos by Douglas Barlow: 2-4, 3-6, 5-8.

Photos by Lukas Franck: 5-6, 5-14.

Photos by Ken Zimmerman: 5-7, 6-2.

Photo by Barry Eager: 3-1.

Photo by Robert Laurie: 5-4.

Photos courtesy of Beneficial Designs: 4-5, 4-7.

Photo courtesy of Rick McCarter: 5-10.

Photo courtesy of Maryvonne Dejeammes: 4-10

Photos reproduced, with permission, from König, 1996: unnumbered, p. 64, 4-11, 4-12.

Photo reprinted from Ketola & Chia, 1994: 3-3

Drawing by Joanne Bergen reproduced from Bentzen et al., 1994: 2-6.

Drawing reproduced, with permission, from *Guidance on the use of tactile paving surfaces*, 1998: 3-4.

Drawings reproduced, with permission, from ÖNORM V 2102: 4-1, 4-2.

Drawing reproduced, with modification, by permission, from Sawai et al., 1998: 4-3.

Photos and drawings from manufacturer's brochures: Engineered Plastics, 1-7; Disability

Devices: 1-8; Architectural Tile & Granite: unnumbered, p. 26; Summitville, 5-12;

Carsonite; 5-15; Strongwall Industries: 7-8, 7-9; Increte: 7-10; Cote-L: 7-11, 7-13, 7-14;

Vanguard ADA Products: 7-12.

Contents — Detectable Warnings: Synthesis of US and International Practice

Introduction	Content of synthesis / 11 Purpose of synthesis / 11 Sources of information / 11
---------------------	---

Chapter 1. Background

How people who are blind detect streets	Curbs are a definitive cue / 14 How curbs are detected / 14 Elimination of curbs / 15 The need to rely on multiple clues / 15 The difficulty of finding and using multiple clues / 15
Detecting transit platform edges	Techniques for detecting transit platform edges having a drop-off / 16 Blind people at risk at transit platform edges / 16
Early solutions	Japan / 17 United Kingdom / 17
U.S. research to identify detectable warning surfaces	Extensive research program on detectability / 18 Importance of under foot detectability / 18 Early projects / 19 Surfaces for transit platforms / 19 Surfaces with low detectability / 20
History of U.S. standards	ANSI A117.1-1980—Tactile warnings / 21 Specification of texture / 21 ANSI A117.1-1986—Detectable warnings / 21 Implementation of ANSI A117.1-1980 & 1986 / 22 ADAAG (1991)—Truncated dome detectable warnings / 23 Controversy in the U.S. / 23 ANSI A117.1-1992—Deleted detectable warning specifications / 23 Some ADAAG requirements for detectable warnings suspended / 24 Research on detectable warnings recommended / 24 Rights-of-way guidelines / 24 Local and state guidelines / 25 Variety of recommendations / 25 ICC/ANSI A117.1-1998—Equivalent detectability / 25

Contents — Detectable Warnings: Synthesis, continued

Other textured walking surfaces	Other surfaces / 26 Raised design flooring / 26 Directional tactile paving / 26
--	---

Truncated dome detectable warnings	Focus on truncated dome detectable warnings / 27 ADAAG-compliant detectable warning at curb-ramps / 27
---	---

Chapter 2. Detectable Warnings in ADAAG

Definition & specification	Definition of detectable warnings / 30 Specification for detectable warnings / 30 Visual contrast / 30
---------------------------------------	--

Geometry of detectable warnings	Dome alignment & pattern / 31 Dome profile / 31
--	--

Detectable warnings at transit platform edges	Requirement for transit platform edges (ADAAG 1991) / 32 Why the warning is placed at the platform edge / 32 Why the warning is 24 inches wide / 33 Width & placement decision also based on positive experience / 33
--	--

Detectable warnings at curb-ramps, hazardous vehicular ways & reflecting pools	Requirement at curb-ramps / 34 Requirement at hazardous vehicular ways / 34 Requirement at reflecting pools / 34
---	--

Chapter 3. Recent Research on Detectable Warnings

Effect of curb-ramps on blind pedestrians	Effect on street detection / 36 Effects of slope and placement / 36
--	--

Effects of detectable warnings on blind pedestrians	Detectable warnings are helpful at curb-ramps / 37 Detectable warnings reduce falls at transit platform edges / 37
--	---

Contents — Detectable Warnings: Synthesis, continued

Effects of detectable warnings on people with mobility impairments

Effects on transit platforms / 38
Effects at slopes or curb-ramps / 38
Benefits at curb-ramps / 39
Effects at hazardous vehicular ways / 39

Evaluation of detectable warning materials

Laboratory testing / 40
Field testing / 41

Research on sound on cane-contact differences

A test of difference in sound / 42

Research on visual contrast

Contrast of detectable warnings / 43
Research shows value of safety yellow / 43
Standards for safety yellow / 43

Research on detectability

Many truncated dome surfaces / 44
Many truncated dome surfaces found to be highly detectable / 44
Factors which have little effect on detectability / 44
Factor which decreases detectability / 44

Research on dome dimensions & spacing

Japanese research / 45
Dome height tests / 45
Dome diameter and spacing tests / 45
Optimal dome diameter & spacing combinations / 45

Chapter 4. International Use of Warning Surfaces

Different approaches

Tactile ground surface indicators / 48
TGSIs as a wayfinding system / 48
TGSIs to indicate a variety of features / 48
TGSIs for warnings & directional information / 49
U.S. approach to warning surfaces / 49
U.S. approach to directional surfaces / 49

Contents — Detectable Warnings: Synthesis, continued

Usage by country	Japan / 50
	United Kingdom / 52
	Australia / 55
	New Zealand / 58
	Italy / 60
	France / 62
	Germany / 64
	Austria / 66
Netherlands / 68	

International standardization	International Organization for Standardization (ISO) / 69
	Technical Committee 173 (ISO/TC173) / 69
	ISO draft on TGSIs / 69
	Applications / 70
	Installation of warning surfaces / 70

Chapter 5. U.S. Use of Detectable Warning Surfaces: Case Studies

Locating U.S. installations of detectable warning surfaces	Developing a list of locations / 72
	Mail survey / 72
	Other information sources / 72

Responses to mail survey	Responses to survey / 73
	State & local requirements / 73

Interviews regarding detectable warning installations	Interview / 74
	Locating appropriate persons / 74
	Types of locations for detectable warnings / 74

Interview locations	City interviews / 75
	Transit system interviews / 75
	Other interviews / 75

Interview questions	Interview questions / 76
	Snow removal / 76

Contents — Detectable Warnings: Synthesis, continued

Interview results general	—	Materials / 77 Color of detectable warnings / 77 Installation dates / 77 Installation costs / 77 Installation method / 77
<hr/>		
Interview results installation problems	—	Installation problems or difficulties / 78
<hr/>		
Interview results maintenance	—	General maintenance / 79 Snow & ice removal / 79
<hr/>		
Interview results durability	—	Durability / 80
<hr/>		
Interview results public reaction	—	Public reaction, problems or concerns / 81 No record of any lawsuits / 81 Lawsuits, but no details / 81
<hr/>		
Case studies		Austin, Texas / 82 Metropolitan Atlanta Rapid Transit Authority (MARTA) / 84 Roseville, California / 86 Metro North Railroad / 88 Harrisburg, Pennsylvania / 90 Massachusetts Bay Transportation Authority (MBTA) / 92 Cleveland, Ohio / 94 Baltimore County, Maryland / 96 Bay Area Rapid Transit (BART) / 98 Claremont, California / 100
<hr/>		

Chapter 6. U.S. Use of Detectable Warning Surfaces: Applications

Sources of recommendations	Purpose of this chapter / 102
	ADAAG / 102
	California Title 24 / 102
	Project ACTION panel of experts / 103
	<i>Accessible Rights-of-Way: A Design Guide</i> / 103
	<i>Designing Sidewalks & Trails for Access: Part II. A Best Practices Guidebook</i> / 103
	<i>ACB Street Design Guidelines</i> / 103
	Roseville, CA / 104
	Cambridge, MA / 104
	Austin, TX / 104
	Towson, MD / 104
AER resolutions / 104	
ACB resolutions / 104	
NFB resolutions / 104	
<hr/>	
Recommendations for detectable warnings at curb-ramps	Whole surface of ramp — ADAAG / 105
	Whole surface of ramp — California Title 24 / 106
	Bottom 3 feet — Roseville, CA / 106
	Bottom 2 feet — Multiple sources / 107
	Parallel curb ramp / 108
<hr/>	
Detectable warnings at hazardous vehicular ways	California Title 24 / 109
<hr/>	
Detectable warnings at medians & islands	Cut-through medians / 110
	Cut-through splitter islands / 111
<hr/>	
Detectable warnings at raised crosswalks & raised intersections	Raised crosswalks & raised intersections / 112
	Fitting to a blended curb at a raised intersection / 112
<hr/>	

Chapter 7. U.S. Detectable Warning Products

Spacing of truncated domes	Manufacturing standards / 114
	ADAAG technical specification / 114
	Brick pavers / 114
	Pattern repetition / 115
	Complementary tile pairs / 115
	Working with irregular shapes / 115
<hr/>	
Shape of truncated domes	Truncated dome diameter / 116
	Manufacturers' response / 116
<hr/>	
Types of detectable warning products	Summary / 117
	Use of term “detectable warning” / 117
	Rely on current specifications / 117
	Details should be verified / 117
<hr/>	
Dimensional pavers	Definition / 118
	Natural stone, stone composites, & ceramic tile / 118
	Brick pavers / 118
	Large precast units / 118
<hr/>	
Thin tiles & sheet goods	Definition / 119
	Rigid and flexible composition / 119
	Tile size / 119
	Installation / 119
<hr/>	
On-site fabrication of truncated dome surfaces	Definition / 120
	On-site production of domed surface / 120
	Stamped concrete / 121
	Detectable warnings that are not on grade / 121
	Surface-applied dome products / 122
<hr/>	

Contents — Detectable Warnings: Synthesis, continued

Characteristics of detectable warning products	Slip resistance / 123
	Color / 123
	Contrast / 123
	Sound on cane-contact & resiliency / 124
Durability / 124	

Detectable warning product matrix	Matrix / 125
--	--------------

Photographs of detectable warning products	Sample photography / 126
	16 photographs of product samples / 126

Detectable warning manufacturers	List of manufacturer names and contact information / 132
---	--

Appendix

References and Annotated Bibliography / 136
Glossary / 147
Questionnaire for interviews regarding detectable warning installations / 148

Introduction

Content of synthesis

This synthesis summarizes the state-of-the-art regarding the design, installation and effectiveness of detectable warning surfaces used in the U.S. and abroad.

- The need for a warning surface is documented.
- U.S. and international research on detectable warnings is reviewed.
- U.S. and international standards and guidelines for detectable warnings are presented.
- Use of detectable warnings in the U.S. and abroad is described, with illustrative case studies.
- Information is provided on U.S. detectable warning products and manufacturers.
- Jurisdictional recommendations for the use of truncated dome detectable warnings are summarized and illustrated.

Purpose of synthesis

The synthesis was developed under contract to the U.S. Access Board. It will be helpful to transportation engineers, planners, and other interested persons working to make public rights-of-way more accessible to people who have visual impairments.

Sources of information

Information about detectable warning products and installations comes from these sources:

- Information from the U.S. is based on input from individuals representing public and private agencies or businesses that have installed truncated dome detectable warnings.
 - International information is based on input from individuals who are familiar with the development and regulatory history of warning surfaces in each country.
 - Information on detectable warning products is based on interviews with company representatives and on company literature.
-



FIG. 0-2. CURB RAMP COMPLYING WITH ADAAG 4.7.7
(TEMPORARILY SUSPENDED), CLEVELAND, OH.

Chapter 1

Background

Summary

This chapter includes information on travel clues and cues used by persons with visual impairments at curb-ramps and transit platform edges. Early approaches to providing additional cues in Japan and the United Kingdom are described. The results of U.S. programs of research to identify detectable warning surfaces are summarized, and U.S. standards are discussed.

Chapter contents

This chapter covers the following topics.

Topic	Page
How people who are blind detect streets	14
Detecting transit platform edges	16
Early solutions	17
U.S. research to identify detectable warning surfaces	18
History of U.S. standards	21
Other textured walking surfaces	26
Truncated dome detectable warnings	27

How people who are blind detect streets

Curbs are a definitive cue

The development of sidewalks and streets, with their identifying curbs—the network of vehicular and pedestrian circulation—gave pedestrians who were blind predictable environmental features that could be used to maintain orientation and safety when traveling independently.

Curbs designed to separate pedestrian from vehicular flow and to provide a gutter edge to contain and direct water flow, provided a reliable cue to pedestrians who were blind that they had arrived at an intersecting street. Detection of a down curb unmistakably informed blind pedestrians that they had come to the end of the sidewalk and that their next step would be into the street.

How curbs are detected

Detection techniques depend on the travel aids used by people who are blind, such as long canes or dog guides, and their amount of vision.

- People who are blind and use a long cane for a travel aid detect a curb, or any other drop-off such as stairs or a platform edge, by a change in the angle of the wrist and the failure of the cane to contact the sidewalk at the expected level.
- People who use dog guides are alerted to the presence of a curb or other drop-off when their dogs stop. They then confirm the presence of the drop-off with a foot.
- People who have low vision, and do not use either a long cane or dog guide, rely on differences in color or shading of the walking surface. The sidewalk and street may have visual contrast, or the curb material may contrast with the sidewalk or street.

There are a number of other sources of information about the location of the curb indicating the end of the sidewalk (and the beginning of the street) which may be used by any person having a visual impairment, regardless of their travel aid or amount of low vision. These include traffic sounds, the slope of the sidewalk, the end of a building line, and changes in sun or wind. These are all simply clues to the sidewalk/street boundary. None is a definitive cue.

Continued on next page

How people who are blind detect streets, continued

Elimination of curbs Accessibility requirements that were developed in the 1960s resulted in the disappearance of curbs at many intersections. Curb-ramps, blended curbs and depressed corners became common features.

Recently, raised crosswalks and intersections have been introduced from Europe. Hotel, retail, airport, and other building entrances have been designed without a curb separating them from street grade, for easy access for pedestrians using wheeled luggage or carts, as well as for persons with disabilities.

The need to rely on multiple clues

In the absence of a definitive cue—the curbed sidewalk—at the sidewalk/street boundary, it has become much more difficult for pedestrians who are blind to detect streets. When blind pedestrians do not detect a curb at the end of a block, they must rely on multiple clues which, taken together, indicate the high probability that they have come to a street.

They may detect a change in slope, which could be a curb ramp, a change in terrain, or a broken sidewalk. The end of a building line or grass line may suggest that there is a street directly ahead. Changes in sun and wind are also clues. However, none of these clues, by itself, confirms the presence of an intersecting street.

One of the most reliable clues, when it is present, is the sound of traffic on the intersecting street. But in many locations, and at different times of the day or days of the week, there may be little or no traffic.

The difficulty of finding and using clues

Complex traffic operations, including actuated signals and right turn on red, have made it increasingly difficult to analyze the environment using vehicular sound. Large traffic volume and high ambient sound often mask traffic flow and the sounds of vehicles starting and stopping.

Blind pedestrians have become increasingly at risk in urban environments where traffic flow information is complex, unclear, masked by other sounds, or absent. The trend toward aggressive driving has decreased the likelihood that drivers will stop for pedestrians in crosswalks at unsignalized intersections, and the general decline in pedestrian traffic has made it increasingly difficult for blind travelers to obtain assistance for street crossings where needed.

Continued on next page

Detecting transit platform edges

Techniques for detecting transit platform edges having a drop-off

Detection techniques depend on the travel aids used by people who are blind, and their amount of vision.

- People who are blind and use a long cane for a travel aid detect the edge of a transit platform having a drop-off by a change in the angle of the wrist and the failure of the cane to contact the platform at the expected level. They must normally come to a stop after taking no more than one step following the cane information.
- People who use dog guides are alerted to the presence of the platform edge when their dogs stop. They then confirm the exact location of the platform edge drop-off with a foot.
- People who have low vision, and do not use either a long cane or dog guide, rely on differences in color or shading between the platform and the track bed. Usually the platform is a lighter color than the track bed, although the reverse may also be true. Sometimes people having low vision are able to see a colored safety line defining the end of the safe waiting area, and sometimes illumination patterns may be helpful in determining the location of the platform edge.

There are a number of other sources of information about the general location of the platform edge, such as other riders waiting a safe distance from the drop-off, and changes in air currents.

Blind people at risk at transit platform edges

Falling and fear of falling at high-level transit platform edges have been found to be a major problem and cause of anxiety in blind transit riders (Bentzen, Jackson & Peck, 1981).

In Bay Area Rapid Transit (BART) in San Francisco, during the ten years before the installation of detectable warnings along platform edges, approximately one fourth of all accidents along the edges of raised platforms involved persons who were visually impaired (McGean, 1991).

Early solutions

Japan

Japan was the first country to make up for the information lost by removal of curbs at intersections. Beginning in the 1960s the Japanese installed a warning surface on curb-ramps that was detectable both underfoot and by use of the long cane.

Warning surfaces at curb-ramps and blended curbs are now commonplace throughout Japan. Warning surfaces are also used on nearly all high-level transit platforms.

Surface texture

Most of the early Japanese surfaces intended to be warnings had a surface configuration of domes about 5 mm high, which might be somewhat flattened or truncated on top, arranged in a square pattern, and having domes about 65 mm apart on center.

Placement, size, and material

Warning surfaces typically were placed on the lower end of curb-ramps, or along the former curb line where there were blended curbs. Warning widths varied from about 30 mm to about 900 mm. Materials used included rubber, stainless steel, cast pavers, and tiles. On transit platforms, warning surfaces were commonly 300 mm wide and placed about 900 mm back from platform edges. Warning surfaces were used in conjunction with directional surfaces to form networks of travel paths for persons who are visually impaired.

FIG 1-1. JAPANESE TRANSIT PLATFORM SHOWING DETECTABLE WARNING AT THE TOP OF STAIRS AND PARALLEL TO THE PLATFORM EDGE, AND A TACTILE PATH LEADING FROM THE STAIRS TO THE WAITING AREA ALONG THE PLATFORM.



United Kingdom

In the United Kingdom, a warning surface having a standardized pattern of truncated domes—referred to as modified blister paving—has been recommended for use in specified locations and dimensions since 1983 (Department of Transport, 1991; Gallon, Oxley & Simms, 1991; *Textured pavements to help blind pedestrians*, 1983).

These warnings can now be found throughout the United Kingdom on curb-ramps and blended curbs. Most are cast pavers.

U.S. research to identify detectable warning surfaces

Extensive research program on detectability

An extensive program of research in the United States to identify walking surfaces that could be used to alert people with visual impairments to the presence of hazards such as streets and platform edges began in 1980.

This research has been conducted by a number of researchers and sponsored by

- the Federal Highway Administration,
 - the Urban Mass Transportation Administration (now known as the Federal Transit Administration),
 - the Federal Transit Administration, and
 - the U.S. Architectural and Transportation Barriers Compliance Board (Access Board).
-

Importance of under foot detectability

Many tested surfaces have been found to be non-detectable or minimally detectable; these are not appropriately considered to be detectable warnings.

- It is essential that warnings be highly detectable under foot as well as by use of the long cane.
 - A minority of people who are legally blind regularly use a long cane for obtaining surface information as they travel. Other people who are visually impaired use dog guides or their low vision. To detect changes in walking surfaces, they rely on visual contrast and/or under foot information.
 - Low vision is quite variable; a person who often can see streets, platform edges and stairs may sometimes be unable to see them because of glare, poor illumination, poor visual contrast, or fatigue.
 - Many surfaces that seem likely to be highly detectable are only somewhat detectable, especially under foot. Figure 1-2 shows a number of surfaces that have been found to be minimally detectable.
-

Continued on next page

U.S. research to identify detectable warning surfaces, continued

Early projects

The earliest projects in the U.S. emphasized detection by blind persons who were using a long cane, of a warning surface adjoining brushed concrete.

- A ribbed rubber mat was found highly detectable to blind persons using a long cane because it varied from concrete in texture, resiliency and sound (Aiello & Steinfeld, 1980).
 - A resilient tennis court surface was found to be highly detectable to blind long cane users (Templer & Wineman, 1980).
 - Various steel surfaces were found to be highly detectable on the basis of differences in sound between steel and concrete when contacted by a long cane used in a tapping technique (Templer, Wineman & Zimring, 1982).
-

Surfaces for transit platforms

A warning surface was needed for use on transit platforms, which was highly detectable when it adjoined a variety of surfaces in common use on platforms. The next series of projects addressed this need, and identified two surfaces suitable for transit platform use, which were both highly detectable when used in association with brushed concrete, exposed aggregate concrete, rubber (Pirelli) tile, and heavy wooden decking (Peck & Bentzen, 1987).

- A prototype “corduroy” surface having raised ribs which were dome-shaped in cross section, $\frac{3}{16}$ in high, $\frac{3}{4}$ in wide, and 2 in apart on center
- A resilient rubber tile having a truncated dome pattern (the pattern that was the basis for the technical specification in the *Americans with Disabilities Act Accessibility Guidelines* (ADAAG))

Both of these surfaces were more highly detectable in a noisy environment than a rough textured steel surface or a resilient tennis court surface. Both of these surfaces were highly detectable to blind persons both under foot and with the use of a long cane.

The truncated dome surface was recommended for a standard warning surface because similar surfaces were being used for warnings in Japan and England. Linear surfaces were being used in Japan as directional surfaces.

Surfaces with low detectability

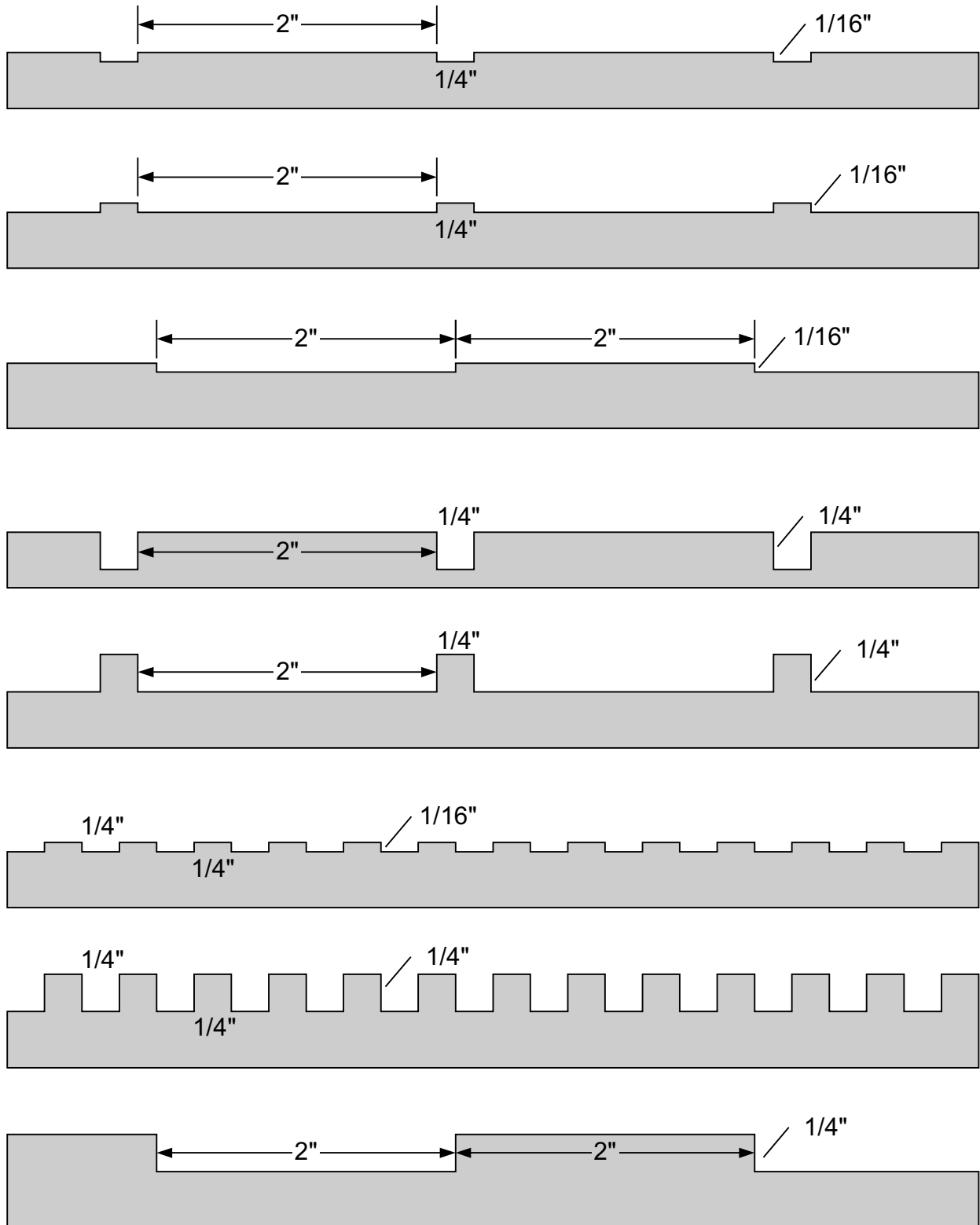

FIG. 1-2. CROSS-SECTIONS OF SURFACES FOUND TO BE LOW IN DETECTABILITY. DRAWN AT FULL SCALE.

History of U.S. standards

ANSI A117.1-1980— In the 1980 ANSI (American National Standards Institute) Standard, *A117.1-1980 American National Standard: Specifications for Making Buildings and Facilities Accessible to and Usable by Physically Handicapped People*, what were then referred to as tactile warnings were specified for the entire walking surface of curb-ramps. A 36 in (915 mm) wide strip was specified along the full edge of blended curbs, and a tactile warning surface was also specified for tops of stair runs except those in dwelling units, in enclosed stair towers, or to the side of the path of travel. Further, tactile warnings were specified for edges of reflecting pools that did not have railings, walls or curbs.

Tactile warnings were to be standardized within a building, facility, site, or complex of buildings.

ANSI standards are voluntary consensus standards. ANSI A117.1-1980 includes specifications for curb-ramps as well as tactile warnings.

Specification of texture

ANSI A117.1-1980 4.29.2

Tactile Warnings on Walking Surfaces. Tactile warning textures on walking surfaces shall consist of exposed aggregate concrete, rubber, or plastic cushioned surfaces, raised strips, or grooves. Textures shall contrast with that of the surrounding surface.... Grooves may be used indoors only.

ANSI A117.1-1986— *ANSI A117.1-1986 American National Standard for Buildings and Facilities—Providing Accessibility and Usability for Physically Handicapped People*, continued to specify the same warning textures, by then called detectable warnings, on the full width and depth of curb-ramps, at uncurbed intersections, at tops of stair runs, and at reflecting pools.

Continued on next page

History of U.S. standards, continued

Implementation of ANSI A117.1-1980 & 1986

Early implementations of the ANSI A117.1-1980 and ANSI A117.1-1986 standard for tactile warnings included a number of surface treatments such as grooved concrete, which were subsequently found not to be highly detectable to pedestrians who are blind. Grooved concrete is still used in some jurisdictions today, and it is sometimes called a detectable warning although it has not been found to be highly detectable and has not been recommended in any U.S. standard for outdoor use.

The photos below illustrate a variety of curb ramp treatments that are not now considered to be detectable warnings because they have not been found to be highly detectable and are not standardized, or because they are easily mistaken for other common features in the pedestrian environment.



FIG. 1-3. A BLENDED CURB IN COLUMBUS, OH, WHICH USES DIFFICULT-TO-DETECT ROWS OF RAISED BRICK.



FIG. 1-4. (LEFT) CURB RAMP WITH A MINIMALLY DETECTABLE GROOVED SURFACE IN PHOENIX. FIG. 1-5 (RIGHT) A CURB RAMP WITH A NARROW BORDER OF DETECTABLE WARNING PAVERS AT THE SIDES AND SMOOTH PAVERS IN THE MIDDLE. BLIND PEDESTRIANS COULD EASILY MISS THE NARROW BORDER OF DETECTABLE WARNING PAVERS.

Continued on next page

History of U.S. standards, continued

ADAAG (1991)— Truncated dome detectable warnings

In 1991, the Architectural and Transportation Barriers Compliance Board (Access Board) published the *Americans with Disabilities Act Accessibility Guidelines* (ADAAG), which included scoping and technical specifications for truncated dome detectable warnings at curb-ramps, hazardous vehicular ways, reflecting pools, and edges of transit platforms having drop-offs. The ADAAG specifications are provided in Chapter 2. The specifications were based on the extensive program of research described above.

Controversy in the U.S.

Both specifications and scoping for detectable warnings quickly became one of the most controversial issues in ADAAG.

- Truncated dome detectable warnings were strongly advocated by some individuals and organizations of blind travelers and the orientation and mobility profession.
 - They were strongly opposed by other individuals and organizations of blind travelers and by some individuals and organizations representing people concerned with safety of persons with mobility impairments.
 - Blind persons opposing detectable warnings at intersections and hazardous vehicular ways claimed that other cues were available and that detectable warnings were an unnecessary and costly feature.
 - Additionally, concerns were expressed regarding the use of truncated dome detectable warnings on sloped curb-ramps and the possibility of trips and falls for sighted pedestrians, particularly women wearing high heels, as well as difficulty for wheelchair users in traversing ramps with additional “bumps.”
-

CABO/ANSI A117.1-1992— Deleted detectable warning specifications

By 1992, some members of the ANSI A117.1 committee were no longer certain that detectable warnings were needed in any location, and all specifications for the texture and for its use in various locations were dropped. There remained only the mention of standardization within a building, facility, site, or complex of buildings.

Continued on next page

History of U.S. standards continued

Some ADAAG requirements for detectable warnings suspended

Since April 1994, ADAAG requirements for truncated dome detectable warnings at curb-ramps, hazardous vehicular ways and reflecting pools have been temporarily suspended while the Access Board has sought additional research on whether detectable warnings are needed at curb-ramps and hazardous vehicular ways, whether detectable warnings help people with visual impairments, and whether detectable warnings have adverse impacts on people with mobility impairments.

The requirement for truncated dome detectable warnings at transit platform edges remains in effect.

Research on detectable warnings recommended

The requirement for detectable warnings at curb-ramps, hazardous vehicular ways, and reflecting pools was suspended pending research to determine

- Whether curb-ramps resulted in problems for pedestrians who are blind,
- Whether detectable warning surfaces helped blind pedestrians, and
- Whether detectable warnings on curb-ramps had adverse impacts on persons with mobility impairments.

See Chapter 3 for a summary of this research.

Rights-of-way guidelines

In 1994 the Access Board proposed rights-of-way guidelines, Section 14, adapting the basic ADAAG 1-10 provisions for application to public rights-of-way. However, Section 14 was not adopted as part of the Department of Justice Standard for Accessible Design.

Accessible Rights of Way: A Design Guide published by the Access Board in 1999, states: “Although no Federal scoping or technical requirements have been established that apply specifically to public rights-of-way, both ADAAG and UFAS [*Uniform Federal Accessibility Standards*] contain technical requirements for the construction of accessible exterior pedestrian routes that may be applied to the construction of public rights-of-way. In the absence of a specific Federal standard, public entities may also satisfy their obligation by complying with any applicable State or local law that establishes accessibility requirements for public rights-of-way that are equivalent to the level of access that would be achieved by complying with ADAAG or UFAS.”

Continued on next page

History of U.S. standards, continued

Local and state guidelines

Many state and local government agencies have adopted standards that include specific recommendations intended to meet pedestrian accessibility requirements. The following pedestrian guidelines were reviewed to determine recommendations regarding the installation of detectable warnings surfaces.

- *Washington Pedestrian Facilities Guidebook*
 - *Portland [Oregon] Pedestrian Design Guide*
 - *Oregon Bicycle and Pedestrian Plan*
 - *Florida Pedestrian Planning and Design Handbook*
 - *Massachusetts Pedestrian Transportation Plan*
 - *California Local Assistance Procedures Manual*
-

Variety of recommendations

All of these guidelines recommended some type of tactile warning surface on curb-ramps. In addition, traffic-engineering professionals from Arizona, Minnesota, Georgia, New Jersey and South Carolina stated, in interviews, that there were state or local recommendations for a surface change on the curb ramp.

- Portland, Oregon, and the States of Oregon, Washington, and Florida guidelines all suggest a texture change on the curb ramp to define the street edge for pedestrians who are visually impaired or blind. However, a truncated dome surface is not required.
 - The *Oregon Bicycle and Pedestrian Plan* recommends that a diamond grid pattern be stamped on curb-ramps, and the *Portland Pedestrian Design Guide* recommends that curb-ramps be finished with heavy brooming parallel to the curb.
 - California requires grooves around the top of the curb ramp, truncated dome detectable warnings on the ramp surface where the slope is lower than 1:15, and a ½ in beveled lip at the curb line.
 - Other guidelines stated that a tactile warning was needed on the curb ramp but gave no guidelines for surface type.
-

ICC/ANSI A117.1-1998—Equivalent detectability

By 1998, based on recommendations of the ADAAG Review Advisory Committee which had recently been submitted to the Access Board for the revision of ADAAG, specifications for truncated dome detectable warnings at platform edges were included in the ANSI A117.1-1998 standard on accessibility. In this edition of ANSI A117.1, the texture and visual contrast specifications were the same as those in ADAAG.

Alternatively, equivalent detectability could be provided by other means (ICC/ANSI A117.1-1998 705.3.2 and 705.3.3).

Other textured walking surfaces

Other surfaces

A number of other textured surfaces are used on curb-ramps, but they have not been demonstrated to be highly detectable to pedestrians who are blind, both under foot and by the use of a long cane.

- Grooved cement has been found to be minimally detectable to people using a long cane as a travel aid, and it is even less detectable under foot.
- Other decorative surfaces that may be assumed to be detectable have not been tested for detectability. Many surfaces that look like they should be highly detectable have been found to be low in detectability.
- Consistency in a warning surface is essential if it is to reliably be understood as a warning by pedestrians with visual impairments.
- The truncated dome texture specified in ADAAG 4.29.2 is the only surface that should be considered a detectable warning.

Raised design flooring

Raised design flooring sold as sheet goods or resilient tile may have a pattern of slightly raised circles. This product, sometimes known as Pirelli tile, is not highly detectable and should not be considered a detectable warning.

Directional tactile paving

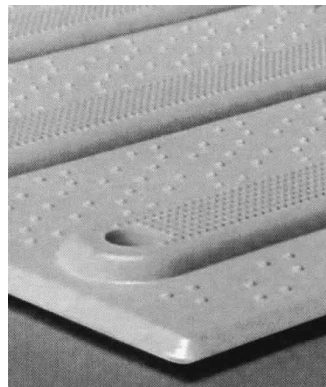
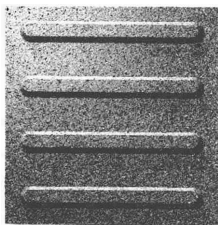

FIG. 1-6. DIRECTIONAL TACTILE TILE (ARMOR-TILE)

FIG. 1-7. DIRECTIONAL TACTILE TILE (DETECTABLE WARNING SYSTEMS)

Some countries have specifications for a raised, directional texture to guide people who are visually impaired. This texture is similar in height and width to truncated domes, but is a linear element. Such a directional texture should not be used as a warning.

Truncated dome detectable warnings

Focus on truncated dome detectable warnings

This publication uses the term “detectable warning” to mean the walking surface consisting of truncated domes as specified in ADAAG.

- The technical specification for detectable warnings in ADAAG is a truncated dome surface.
- Truncated domes are the only texture that has repeatedly been demonstrated to have excellent detectability to pedestrians who are blind, both under foot and through the use of a long cane.
- Therefore, the primary focus of this synthesis is on truncated dome detectable warnings. When the term “detectable warning” is used in this synthesis, it always refers to a truncated dome surface.



FIG. 1-8. CURB-RAMPS WITH TRUNCATED DOME DETECTABLE WARNINGS ON OPPOSITE SIDES OF AN ALLEY, CLEVELAND, OH.

Chapter 2

Detectable Warnings in ADAAG

Summary

This chapter presents specifications for detectable warning surfaces as specified in the *Americans with Disabilities Act Accessibility Guidelines* (ADAAG). It includes information on ADAAG technical provisions for detectable warnings at transit platform edges, on curb-ramps, preceding hazardous vehicular ways, and surrounding reflecting pools.

Chapter contents

This chapter covers the following topics.

Topic	Page
Definition & specification	30
Geometry of detectable warnings	31
Detectable warnings at transit platform edges	32
Detectable warnings at curb-ramps, at hazardous vehicular ways, and reflecting pools	34

Definition & specification

Definition of detectable warnings

A detectable warning is:

A standardized surface feature built in or applied to walking surfaces or other elements to warn visually impaired people of hazards on a circulation path. ADAAG 3.5

Detectable warnings are unique and standardized features, intended to function much like a stop sign. They alert pedestrians who are visually impaired to the presence of hazards in the line of travel, indicating that they should stop and determine the nature of the hazard before proceeding further.

Specification for detectable warnings

ADAAG specifies:

Detectable warnings shall consist of raised truncated domes with a diameter of nominal 0.9 in (23 mm), a height of nominal 0.2 in (5 mm) and a center-to-center spacing of nominal 2.35 in (60 mm) and shall contrast visually with adjoining surfaces, either light-on-dark or dark-on-light.

The material used to provide contrast shall be an integral part of the walking surface. Detectable warnings used on interior surfaces shall differ from adjoining walking surfaces in resiliency or sound-on-cane contact. ADAAG 4.29.2

Visual contrast

The appendix to ADAAG recommends that detectable warnings contrast visually with adjoining surfaces.

The material used to provide contrast should contrast by at least 70%. Contrast in percent is determined by:

$$\text{Contrast} = [(B_1 - B_2)/B_1] \times 100$$

where B_1 = light reflectance value (LRV) of the lighter area and B_2 = light reflectance value (LRV) of the darker area.

Note that in any application both white and black are never absolute: thus, B_1 never equals 100 and B_2 , is always greater than 0. ADAAG A4.29

Geometry of detectable warnings

Dome alignment & pattern

The detectable warning surface consists of truncated domes on a square pattern which are typically arranged in either of two configurations:

- Diagonal alignment
- Parallel alignment

Figure 2-1 illustrates how both configurations can comply with the ADAAG specification for detectable warning.

Depending on which configuration is used, the rows of domes will be aligned with, or at a 45° angle to:

- the curb or platform edge
- the direction of travel

Pedestrians encountering either configuration will find the surface pattern equally detectable.

Another acceptable and plausible arrangement of truncated domes uses an equilateral triangular grid. Only one U.S. manufacturer has ever chosen to produce a detectable warning surface using this pattern.

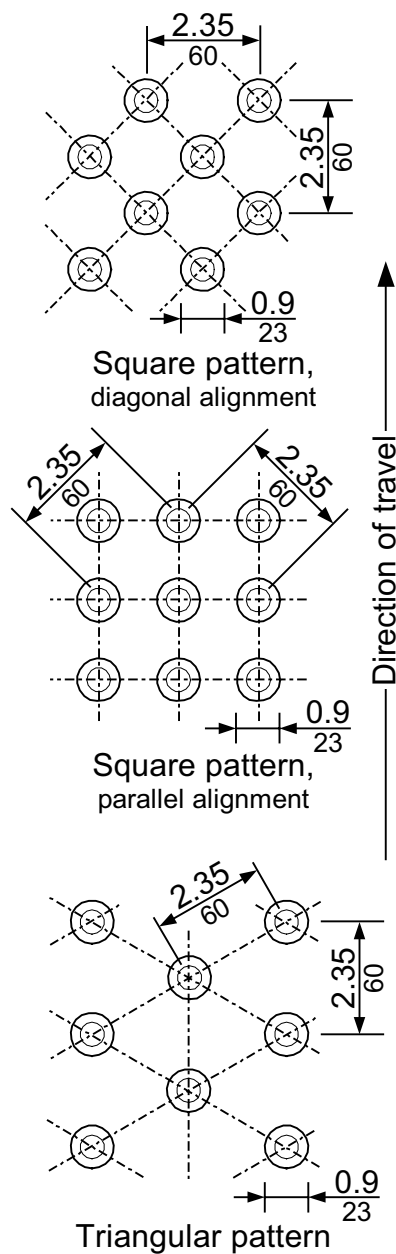
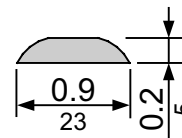

FIG. 2-1. PATTERNS AND ALIGNMENTS OF TRUNCATED DOMES COMPRISING THE ADAAG DETECTABLE WARNING.

Dome profile

FIG. 2-2. HEIGHT AND DIAMETER OF TRUNCATED DOMES USED IN ADAAG DETECTABLE WARNING.



Detectable warnings at transit platform edges

Requirement for transit platform edges (ADAAG 1991)

Platform edges bordering a drop-off and not protected by platform screens or guardrails shall have a detectable warning. Such detectable warnings shall comply with [ADAAG] 4.29.2 and shall be 24 inches wide running the full length of the platform drop-off` ADAAG 10.3.1(8)

This requirement is applicable to new construction, alteration, and in key stations in existing transit facilities.

FIG. 2-3. DETECTABLE WARNING USED AT PLATFORM EDGE BORDERING A DROP-OFF.

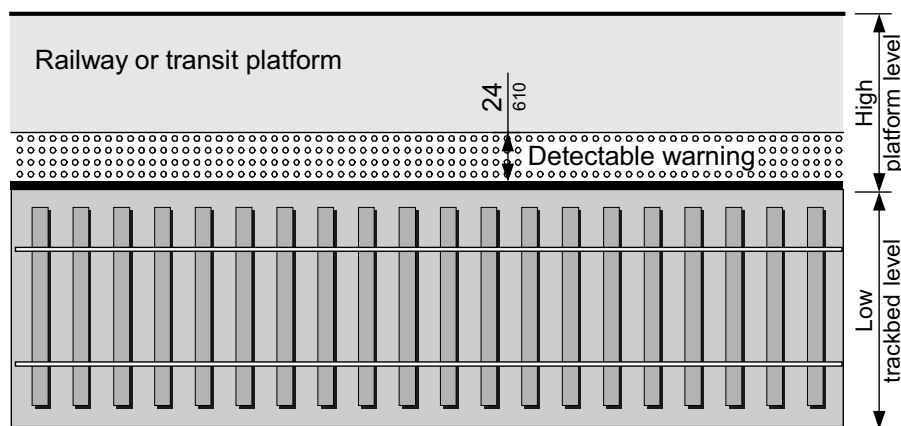

Why the warning is placed at the platform edge

The rationale for placement of detectable warnings as required by ADAAG was as follows.

- Advocates wanted the warning to be at or very near the platform edge so that there would be no possibility that a traveler could interpret a width of platform between the warning and the edge as a safe place to stand.
- Transit managers wanted the warning to be at the edge so that on platforms that were retrofitted with detectable warnings, there would be sufficient platform width on the side away from the edge to accommodate a typical rush hour number of riders without the necessity for riders to stand on the warning due to crowded conditions.

Continued on next page

Detectable warnings at transit platform edges, continued

Why the warning is 24 inches wide

The rationale for the width of detectable warnings required by ADAAG was the following.

- 24 in (610 mm) had been repeatedly demonstrated to be a sufficient width of a surface highly detectable both under foot and by use of a long cane, to enable detection and stopping on that surface by most blind travelers (Peck & Bentzen, 1987; Templer & Wineman, 1980; Templer, Wineman & Zimring, 1982).
- Transit managers wanted the warning to be as narrow as possible. They did not want riders to either stand and wait on the warning, or travel on it while no train was at a platform. Therefore a warning surface needed to:
 - reduce the effective standing capacity of platforms as little as possible;
 - enable blind passengers to stop a safe distance from the platform edge without having to contact the edge to determine where it was; and
 - demarcate the limit of the safe waiting area for all passengers.

Transit managers reasoned that while most passengers would wait behind the warning most of the time, there would nonetheless be a small minority of passengers who would choose to walk along the warning, between the edge and waiting passengers, if the warning was wider than 24 in (R. Weule, BART Safety Manager, personal communication, 1986).

Width & placement decision also based on positive experience



FIG. 2-4. DETECTABLE WARNING SURFACE AT MARTA STATION, ATLANTA, GA.

Also contributing to the rationale for ADAAG specifications regarding both width and placement of detectable warnings on transit platform edges was a decrease in accidents for all riders on BART (McGean, 1991) and Metro Dade (A. Hartkorn, Metro Dade Safety Manager, personal communication, 1994) in the years following installation of 24 in wide detectable warnings at platform edges in those systems.

Detectable warnings at curb-ramps, hazardous vehicular ways and reflecting pools

Requirement at curb-ramps

FIG. 2-5. FLORIDA CURB RAMP COMPLYING WITH ADAAG 4.7.7.

A curb ramp shall have a detectable warning complying with [ADAAG] 4.29.2. The detectable warning shall extend the full width and depth of the curb ramp.



ADAAG 4.7.7.
(Temporarily suspended April 12, 1994, July 29, 1996, and November 23, 1998)

Requirement at hazardous vehicular ways

If a walk crosses or adjoins a vehicular way, and the walking surfaces are not separated by curbs, railings or other elements between the pedestrian areas and vehicular areas, the boundary between the areas shall be defined by a continuous detectable warning which is 36 in (915 mm) wide, complying with 4.29.2

ADAAG 4.29.5 (Temporarily suspended April 12, 1994, July 29, 1996, and November 23, 1998)

FIG. 2-6. EXAMPLE OF DETECTABLE WARNING AT A LEVEL RAIL CROSSING (A TYPE OF HAZARDOUS VEHICULAR WAY).

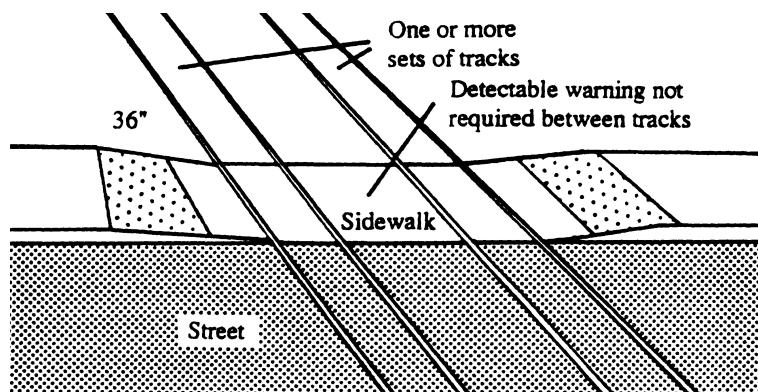

Requirement at reflecting pools

The edges of reflecting pools shall be protected by railings, walls, curbs, or detectable warnings complying with [ADAAG] 4.29.2.

ADAAG 4.29.6 (Temporarily suspended April 12, 1994, July 29, 1996, and November 23, 1998).

Chapter 3

Recent Research on Detectable Warnings

Summary

This chapter summarizes research to answer questions about the need for and effectiveness of detectable warnings for people who are blind or visually impaired and the effects of detectable warnings on pedestrians with mobility impairments. The chapter then describes research on visual contrast and sound contact. It concludes with further research on detectability and discriminability conducted in Japan and the United Kingdom.

Chapter contents

This chapter covers the following topics.

Topic	Page
Effects of curb-ramps on blind pedestrians	36
Effects of detectable warnings on travel by blind pedestrians	37
Effects of detectable warnings on people with mobility impairments	38
Evaluation of detectable warning materials	40
Research on sound on cane-contact differences	42
Research on visual contrast	43
Research on detectability	44
Research on dome dimensions and spacing	45

Effects of curb-ramps on blind pedestrians

Effect on street detection

Two research projects (Barlow & Bentzen, 1994; Bentzen & Barlow, 1995; Hauger, Safewright, Rigby & McAuley, 1994) confirmed that removal of the single reliable cue to the presence of an intersecting street, that is, the down curb, did result in the inability of even skilled, frequent blind travelers to detect some streets.

Barlow and Bentzen found that on 35% of approaches to unfamiliar streets, blind travelers using a long cane failed to detect the presence of an intersecting street before stepping into it. Hauger et al. found failure to detect streets on a somewhat smaller percentage of trials.

Effect of slope & placement

Both projects (Barlow & Bentzen, 1994; Hauger et al., 1994) found that failure to detect streets was highly correlated with slope of the curb ramp. Barlow and Bentzen also found that street detection was correlated with the abruptness of change in angle between the approaching sidewalk and the curb ramp.

Both projects found that street detection was more likely when curb-ramps were at the apex of a corner than when they were in the line of travel. Hauger et al. also found that apex curb-ramps were more likely to lead to unsuccessful street crossings than perpendicular curb-ramps.

FIG. 3-1. WHERE THERE IS NO DIFFERENCE IN SLOPE OR ELEVATION BETWEEN THE SIDEWALK AND STREET, IT IS PARTICULARLY DIFFICULT FOR PEDESTRIANS WHO ARE BLIND TO DETERMINE WHEN THEY HAVE REACHED AN INTERSECTING STREET. BLENDED CURB IN SACRAMENTO, CA.



Effects of detectable warnings on travel by blind pedestrians

Detectable warnings are helpful at curb-ramps

Hauger et al. (1994) obtained subjective data from 70 research participants who were blind or who had low vision, indicating that detectable warnings were judged to be helpful.

In the same project, raters viewing videotapes of the 70 participants as they crossed intersections with and without detectable warnings on curb-ramps, found that a higher proportion of unsuccessful crossings occurred where there were no detectable warnings than where there were detectable warnings.

They also found that the visual contrast of detectable warnings helped participants with low vision establish and maintain a heading toward the opposite corner. Participants using dog guides may also have been aided by the visual contrast that the dog guides appeared to head for.

Hughes (1995) conducted research in which 17 participants who were totally blind or who had low vision traveled up and down laboratory ramps having eight different tactile surfaces, of which five were truncated domes. Ten of the participants then responded to structured interviews including questions about their perception of the tactile surfaces. Nine said use of tactile surfaces on curb-ramps would increase their safety. Six said that use of the tactile surfaces would make them more likely to travel by foot.

Detectable warnings reduce falls at transit platform edges

During the seven years following the installation of detectable warnings on all platform edges in the BART system, platform edge accidents decreased for all riders, but especially for riders having visual impairments (McGean, 1991).

- In San Francisco, riders in stations having different platforms serving both BART and Muni (San Francisco Municipal Railway) were observed to stand at different distances from the platform edge.
 - On BART platforms, which had 24 in detectable warnings along the edges, passengers tended to wait behind the warning, that is, at least two ft from the edge.
 - On MUNI platforms, which did not have detectable warnings, passengers waited closer to the edge (McGean, 1991).
-

Effects of detectable warnings on people with mobility impairments

Effects on transit platforms

Objective and subjective research confirm that truncated dome detectable warnings at transit platform edges do not adversely affect people having a variety of mobility impairments.

- None of the 24 participants in research by Peck and Bentzen (1987) in BART had any difficulty maneuvering across or along truncated domes or turning on truncated domes.
- Participants in this Peck and Bentzen research reported that truncated domes would have minimal effects on their travel in BART. A few people who used canes or crutches said they felt their aids would be less likely to slip as they exited trains onto the truncated dome surface than onto smoother surfaces.

Effects at slopes or curb-ramps

Objective and subjective research confirm that truncated dome detectable warnings on slopes or curb-ramps have minimal adverse effects on people with mobility impairments.

- Bentzen, Nolin, Easton, Desmaris and Mitchell (1993, 1994b) videotaped 40 participants having those mobility impairments which made them most likely to have difficulty on bumpy, sloping surfaces, travel up and down, stopping, starting, and turning on seven ramps (slope 1:12) having nine different truncated dome surfaces and one ramp surfaced with brushed concrete. Video raters observed minimal evidence of increased effort, slipping, loss of stability, or wheel or tip entrapment on this challenging task.
 - Participants in this Bentzen et al. (1993, 1994b) research reported minimal effects of truncated domes relative to the brushed concrete surface.
 - Hughes (1995) had nine people with mobility impairments travel up and down eight ramps with different tactile surfaces. No individuals reported or were observed to have problems with directional control, stability, effort or discomfort that would have altered their ability to travel safely.
-

Effects of detectable warnings on people with mobility impairments, continued

Benefits at curb-ramps

Hauger et al. (1994) had 30 participants with mobility impairments travel up and down curb-ramps with and without truncated domes.

- A majority felt that they were safer, had better traction, and were more stable on ramps having truncated domes than on concrete ramps.
- Forty four percent of participants said it required less effort to negotiate up and down the ramps with detectable warnings than the concrete curb-ramps; 23% said the reverse.
- Some wheelchair users said it was easier to find and steer toward the up-ramp on the opposite corner when it had the contrasting detectable warning surface.



FIG. 3-2. STAMPED CONCRETE DETECTABLE WARNING ON CURB RAMP, AUSTIN, TX.

Effects at hazardous vehicular ways

Hauger et al. (1994) observed pedestrians at three commercial sites where shopping carts were used and where detectable warnings were installed to separate the pedestrian and vehicular ways. In 12 hours of observation, more than 1,500 pedestrians crossed the detectable warnings. No significant incidents or problems were observed for the general public, which included persons with mobility impairments, shopping carts, shopping carts with children, large gurneys, and baby carriages.

Evaluation of detectable warning materials

Laboratory testing

Eighteen truncated dome materials were submitted to laboratory testing under a project sponsored by the Federal Transit Administration (Ketola, N. & Chia, D., 1994). Standard tests were performed for impact resistance, wet and dry slip resistance, wear resistance, high-pressure hot water resistance, and adhesion/bond strength after 55 hours soaking in water.

- Impact tests under room temperature, hot and cold conditions found that, in general, rubber-based and polymer composite materials performed quite well; more rigid products (cementitious or ceramic tile) performed poorly.
- All materials exceeded the minimum value for slip resistance recommended by the Access Board under both wet and dry conditions.
- Wear resistance tested by 30 seconds of sandblasting revealed a wide variety in performance of materials.
- High pressure hot water testing revealed little difference among products.
- Seven materials were found to have poor adhesion/bond strength.

Detailed results of laboratory testing are in Ketola and Chia, 1993.

Continued on next page

Evaluation of detectable warning materials, continued

Field testing

Eight of the surfaces subjected to laboratory testing were field tested in high pedestrian traffic indoor and outdoor areas in stations of three rail transit systems, the MBTA (Boston), GCRTA (Cleveland), and SEPTA (Philadelphia) (Ketola & Chia, 1994). Evaluations included installation and maintenance, wear resistance, maintenance of bond, resistance to cracking and chipping, and maintenance of color.

- Proper installation was found to be crucial to good performance. Factors affecting adequacy of installation included installer skill, ambient conditions, surface preparation, application of material and setting period.
- No transit system reported maintenance problems with any material.
- No transit system reported any difficulty removing snow and ice from any materials using the same tools and chemicals used on the rest of the platform surface.
- Although materials differed in wear resistance, all were estimated to have a relatively long useful life.

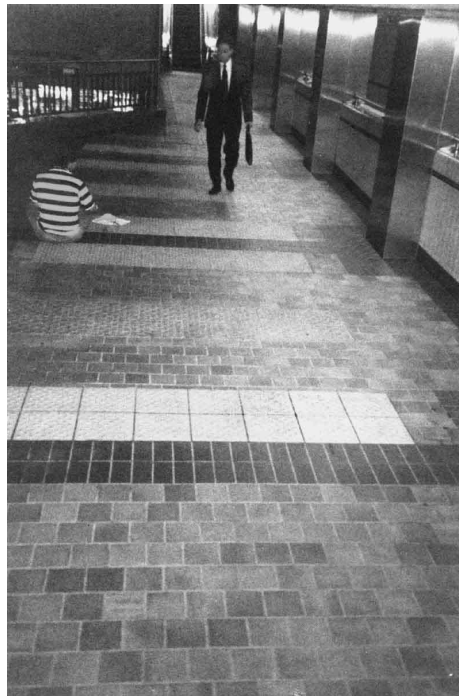

FIG. 3-3. INSTALLATION OF DETECTABLE WARNING TEST SURFACES AT MBTA'S SOUTH STATION, BOSTON, MA.

- Materials differed widely in maintenance of bond; four materials had some bond failure.
- Materials differed greatly in resistance to cracking and chipping; two materials had no instances of cracking and chipping, and two had repeated instances.
- Three materials showed no color change indoors or outdoors; one material showed major color change.

Research on sound on cane-contact differences

A test of difference in sound

Although ADAAG 4.29.2 requires that detectable warning surfaces used indoors differ in sound on cane-contact, there has been no attempt to quantify the amount of difference in sound. Bentzen and Myers (1997) did, however, test four truncated dome products installed on an outdoor light rail platform in Sacramento for differences in sound on cane-contact.

- Surfaces differed from one another in both objective and subjective measures of differences in sound on cane-contact between the adjoining platform of pavers and the detectable warnings.
 - Difference in sound between the warning surface and the adjoining platform surface appears to be related to both the detectable warning material and the way in which it is installed.
 - The detectable warning material installed with a slight gap between the warning and the substrate was most detectable on both objective and subjective measures.
-

Research on visual contrast

Contrast of detectable warnings

ADAAG 4.29.2 requires that detectable warnings contrast visually with adjoining surfaces, either dark on light, or light on dark. A 70% contrast in light reflectance between a detectable warning and an adjoining surface is recommended in the Appendix (A4.29.2).

Research shows value of safety yellow

Recent research indicates that the color safety yellow is so salient—even to persons having very low vision—that it is highly visible even when used in association with surfaces having light reflectance values differing by as little as 40% (new, gray-white concrete) (Bentzen, Nolin, and Easton, 1994a).

- A safety yellow detectable warning surface having a 40% reflectance difference from new concrete was subjectively judged more detectable than a darker warning surface which contrasted with new concrete by 86% (Bentzen et al., 1994a).
 - Hughes (1995) found that yellow or yellow-orange warning surfaces were preferred over black warning surfaces.
-

Standards for safety yellow

Safety yellow is a color that is standardized for use as a warning in the pedestrian/highway environment.

- U.S. —ANSI Z535.1-1991, 6.3
 - Internationally—ISO 3864-1984(E)
-

Research on detectability

Many truncated dome surfaces

Following publication of ADAAG in 1991, numerous manufacturers entered the market. The products differed slightly in execution of the truncated dome dimensions and spacing as well as materials (see Chapter 7).

Truncated dome products soon included resilient sheet material, dimensional pavers, tiles, polymer composites, bricks, pre-cast concrete, stamped concrete and applied surfaces.

Many truncated dome surfaces found to be highly detectable

In 1994 the Federal Transit Administration sponsored laboratory research (Bentzen, Nolin, Easton, Desmarais & Mitchell, 1994) to evaluate the detectability of truncated dome surfaces that differed in material, dome dimensions, and dome spacing.

- 13 surfaces representing the extremes as well as the midpoints of dome dimensions and dome spacing were tested by 24 blind participants for under foot detectability in association with four transit platform surfaces varying in roughness and resiliency.
 - Each detectable warning surface was paired with brushed concrete, coarse exposed aggregate concrete, Pirelli tile, and wooden decking.
 - Detection rate was greater than 95% for all but one warning surface (a prototype that was not offered for sale).
-

Factors which have little effect on detectability

A number of factors were found to have little or no effect on detectability.

- Parallel vs. diagonal alignment of domes
 - Differences in resiliency
 - Additional small elements added to increase slip resistance
 - Irregularities in spacing where domes in adjoining tiles or pavers were somewhat closer together or farther apart than within the tiles or pavers
 - A gradual increase in dome height within the first several inches
-

Factor which decreases detectability

Detectability of truncated dome warning surfaces was less when the warning was installed in association with coarse exposed aggregate concrete.

Research on dome dimensions and spacing

Japanese research Dome (raised dot) height, diameter and spacing were investigated to determine optimal dome dimensions and spacing. (*Report of fundamental research on standardization relating to tactile tiles for guiding the visually impaired*, 1998).

- For testing dome height, 60 participants walked from smooth tiles, across domed tiles of different heights, and were asked to report whether they detected a domed tile under foot.
 - For testing dome diameter and spacing, 60 blind participants walked from smooth tiles, across either domed tiles or directional (bar) tiles having different dimensions, and reported whether tiles had domes or a directional (bar) pattern. (See Fig. 4-3 for the nine diameters and spacings tested.)
 - Participants also rated tiles for ease of identifying them as either dome or directional tiles.
-

Dome height tests Dome heights tested were 0 mm, 2.5 mm, 5.0 mm, 7.5 mm and 10 mm.

- All participants detected tiles having 5.0 mm high domes.
 - 15% of participants could not detect tiles having 2.5 mm high domes.
 - Some participants stumbled when traversing tiles having 10 mm high domes.
 - 5.0 mm high domes were recommended.
-

Dome diameter and spacing tests Dome base diameters tested were (22 mm, 28 mm, and 35 mm), and dome spacings were (42.9 mm, 50 mm, and 60 mm). Top diameter of domes was always 10 mm less than bottom diameter. Dome spacing was measured on centers parallel to one side of a square pattern.

Optimal dome diameter and spacing combinations Three tiles had identification rates greater than 90% and were also rated easy to identify:

- 22 mm base diameter with 50 mm spacing;
 - 22 mm base diameter with 60 mm spacing; and
 - 28 mm base diameter with 60 mm spacing.
-

Illustrations of international tactile ground surface indicators

3-4. WARNING PAVERS AT A RAISED CROSSWALK. UNITED KINGDOM.

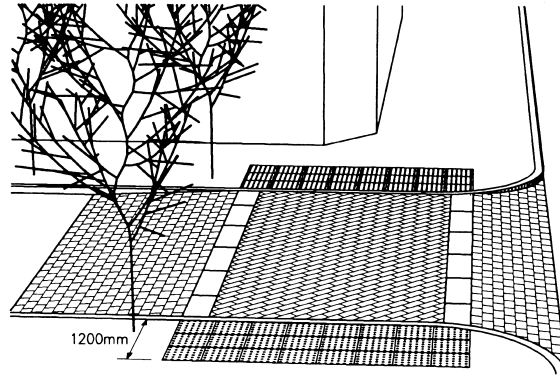

FIG.3-5. DETECTABLE WARNING AT TOP & BOTTOM OF STAIRS, EXTERIOR USE IN AUSTRALIA.



FIG. 3-6. (LEFT) DETECTABLE WARNINGS (BLISTER SURFACE) ON THE THREE CURB-RAMPS AT A SPLITTER ISLAND, IRELAND



FIG. 3-7. (RIGHT) TACTILE GROUND SURFACE INDICATORS LEADING AWAY FROM STAIRS, LOUVAIN, BELGIUM.



Chapter 4

International Use of Warning Surfaces

Summary

This chapter includes information on approaches to use of tactile ground surface indicators, including warning surfaces. Information on selected countries having significant experience in the application of warning surfaces is presented. Each entry includes the history, specifications or guidelines for textures and locations, maintenance and durability, and acceptance.

Chapter contents

This chapter covers the following topics.

Topic	Page
Different approaches	48
Japan	50
United Kingdom	52
Australia	55
New Zealand	58
Italy	60
France	62
Germany	64
Austria	66
Netherlands	68
International standardization	69

Common conversions (inches are rounded figures)

5 mm = 0.2 in	100 mm = 4 in	600 mm = 24 in
25 mm = 1 in	200 mm = 8 in	1200 mm = 47 in
50 mm = 2 in	300 mm = 12 in	1800 mm = 71 in
60 mm = 2.35 in	500 mm = 20 in	2 m = 79 in

Different approaches

Tactile ground surface indicators

Worldwide, a number of ground or floor surfaces have been used to provide different types of information to people who have visual impairments. In the work of the International Organization for Standardization (ISO), these surfaces are referred to as tactile ground/floor surface indicators or TGSIs.

TGSIs as a wayfinding system

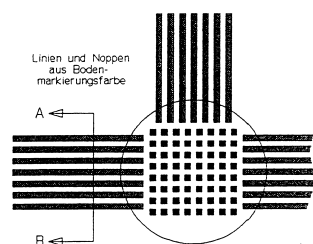
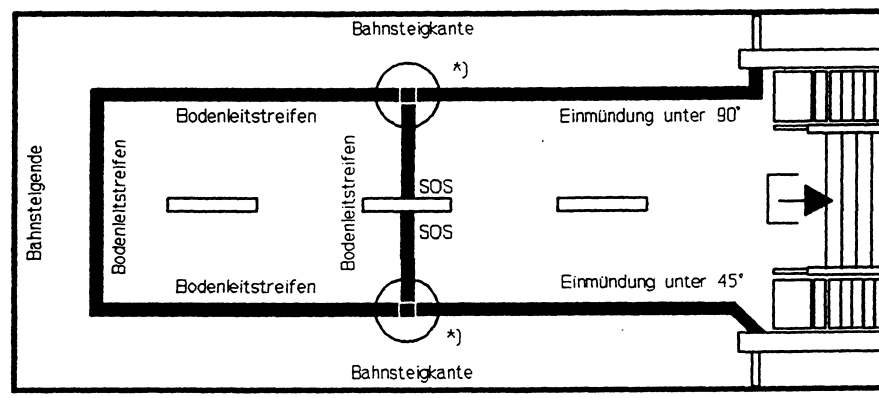

FIG 4-1. "ATTENTION FIELD" SURFACE SHOWN CIRCLED HERE, AND IN FIG. 4-2.

FIG. 4-2. WAYFINDING SYSTEM OF LINEAR SURFACES AND ATTENTION FIELDS IN AUSTRIAN SUBWAY SYSTEM.

In many countries, TGSIs are conceptualized as providing a comprehensive wayfinding system for people with visual impairments. In implementing this approach, extensive use is made of linear surfaces that provide guidance from one place to another such as between the stairs and the platform edge in a transit station.

Surfaces that are similar to the detectable warning surface in the U.S. are designated as "attention fields," and are typically used at path intersections, at curb-ramps (especially mid-block), or at turns, as well as at platform edges and curb-ramps. Japan, Austria, Switzerland, France and Italy take this approach.



TGSIs to indicate a variety of features

In the United Kingdom, seven different tactile ground or floor surfaces are used to help people who are visually impaired recognize different types of features in the environment. Different surfaces are used to indicate crossing points (curb-ramps), hazards (steps, ramps, entrances to transit platforms), indoor transit platform edges, outdoor transit platform edges, segregated shared bicycle/pedestrian surfaces, and amenities such as public telephones and ticket offices. A linear surface is also used as a guidance path.

Continued on next page

Different approaches, continued

TGSIs for warnings & directional information

Some countries, including Australia, New Zealand and Canada use warning surfaces (truncated domes) only where there are vehicular hazards or drop-offs.

They also use linear directional surfaces where directional cues such as grasslines, curbs, hedges, fences, or walls are not present.

U.S. approach to warning surfaces

In the U.S., (although opinions vary), the prevailing attitude as articulated in standards and guidelines, is that warning surfaces are needed

- primarily at highly hazardous locations where there is no definitive cue denoting the boundary between pedestrian and vehicular ways (curb-ramps and hazardous vehicular ways), or
- where there is a drop-off (platform edges, reflecting pools and stairs).

It is recognized that people who are blind are usually able to negotiate these hazards safely, using their normal travel aids-such as long canes or dog guides-especially when they are in familiar areas.

Detectable warnings can provide information about the presence, location and direction of hazards that is useful to blind pedestrians traveling in unfamiliar places. Detectable warnings can also provide confirming cues about the environment for pedestrians who may not have highly developed travel skills.

U.S. approach to directional surfaces

There has been limited use of directional surfaces in the U.S. for such purposes as guidance across wide or skewed intersections, or guidance to a curb ramp. Most of this experience has been in San Francisco, Sacramento and San Diego, CA. No standards or guidelines have ever been established in the U.S. for the use of directional surfaces.

In the U.S. it is not considered necessary to provide a comprehensive tactile wayfinding system for people who have visual impairments. Blind pedestrians are instead taught to extract clues from the environment, using natural guidelines provided by such features as grasslines, fences, hedges, building lines and traffic.

Japan

History of use



Tactile warning and guidance surfaces have been used in Japan since 1967.

- Use began in Okayama Prefecture and is now widespread throughout Japan
 - Used on platforms and top and bottom of stairs in almost 100% of transit station in metropolitan areas
 - Also used at curb-ramps and on sidewalks
 - There is on-going research to determine optimal dimensions for truncated dome warning and linear directional surfaces (Murakami, Aoki, Taniai, & Muranaka, 1982; Murakami, Ohkura, Tauchi, Shimizu, & Ikegami, 1991; *Report of fundamental research on standardization...*, 1998)..
-

Most common texture

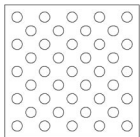

Texture not standardized; dome shape, diameter and spacing varies. This is the most common texture.

- Dome height—5 mm (all warning surfaces)
 - Dome base diameter—35 mm
 - Inter-dome spacing—50 mm with parallel or diagonal alignment
-

Guidelines for location of warning surfaces

From *Guidelines for Installation of Tactile Guide Blocks for the Visually Impaired and Commentary* (1985). These are guidelines only; dimensions are given in only a few instances, but there are numerous illustrations.

- Curb-ramps—600 mm deep, about 300 mm from the street, the full width of the associated crosswalk
 - Islands—on islands wherever a crosswalk contacts an island, 600 mm deep, about 300 mm from the street, the full width of the associated crosswalk
-

Products

Products used for warning surfaces are:

- Stone
 - Concrete
 - Synthetic rubber
 - Plastic resin
 - Vinyl chloride
-

Continued on next page

Japan, continued

Durability and maintenance

Durability and maintenance of warning surfaces are not considered problems in Japan.

- Heavily traveled warning surfaces wear out regardless of the material.
 - Color changes, splitting of tiles, falling off of tiles, and deterioration of domes sometimes occur.
 - Snow and ice area not normally removed.
 - Synthetic rubber and vinyl chloride are very slippery when wet.
-

Acceptance

Warning and guidance surfaces are well accepted in Japan.

- Many Japanese persons with visual impairments depend on warning and guidance surfaces.
 - Persons with mobility impairments accept them.
 - There are few complaints from persons who are elderly.
 - There are few complaints from bicyclists.
-

Information provided by

Masaki Tauchi, Ph.D.
Okayama Prefectural University
111 Kuboki, Soja-shi
Okayama 719-11, Japan
Tel: +81 866-94-2188
Fax: +81 866-94-2206
E-mail: mtauchi@fhw.oka-pu.ac.jp

Japanese research on detectable warnings

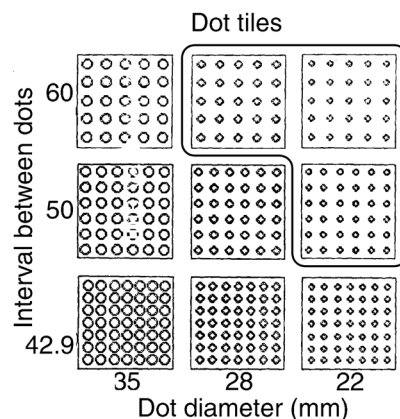

FIG. 4-3. JAPANESE RESEARCH VARIED THE SIZE OF TRUNCATED DOMES (DOT DIAMETER) AND THE SPACING INTERVAL BETWEEN DOMES (DOTS).

OF THE NINE DETECTABLE WARNING TEST SURFACES, THREE (SHOWN ENCLOSED BY THE LINE) WERE IDENTIFIED AS DOT (VERSUS BAR) TILES ON AT LEAST 90% OF TRIALS.

United Kingdom

History of use



Domed warning (blister) surfaces have been used on curb-ramps and at at-grade crossings in the UK since 1986.

- Domed surface for warning changed to truncated dome surface because it was more comfortable, particularly for persons with mobility impairments associated with arthritis
 - Extensive research program conducted on detectability, discriminability and memory for seven different tactile paving surfaces to provide a warning at curb-ramps, at stairs and ramps, at off-street transit platform edges, and at on-street transit platform edges, to provide guidance along a route, to provide information about a segregated cycle/pedestrian way, and to provide information about the location of amenities such as public telephones (Gallon, 1992; Gallon, Oxley & Simms, 1991; Savill, Davies, Fowkes, Gallon & Simms, 1996; Savill, Stone & Whitney, 1998).
-

Texture

Specifications for the blister surface and its use first were adopted in 1986. They were revised in 1991 (*Disability Unit Circular 1/91*).

- Dome height—5 mm ± .5 mm
 - Dome base diameter—25 mm
 - Domes 64-67 mm apart with parallel alignment.
-

Locations of tactile paving surfaces

Extensive guidance on the location and installation of six different tactile paving surfaces is contained in *Guidance on the use of tactile paving surfaces* (1998), which supercedes *Disability Unit Circular 1/91*. Each surface is to be used for a different purpose.

- Pedestrian crossing points where the sidewalk is flush with the street
 - Hazards including stairs, level crossings and the approach to light rapid transit platforms
 - The edge of off-street rail platforms
 - The edge of on-street rail platforms
 - A shared cycle track/footway surface and central delineator strip
 - Guidance along a route where traditional cues such as property lines or curbs are not available
-

Continued on next page

United Kingdom, continued

Warning surface at curb-ramps, medians, and raised crosswalks

“It is vitally important that the removal of any existing kerb upstand at a recognized crossing point, is accompanied by the installation of the blister surface.” Guidance on the Use of Tactile Paving Surfaces (1998)

Guidance on the installation of truncated domes (blister surface) on curb-ramps, medians, and raised crosswalks is as follows.

- Depth of installation varies with nature of crossing, 400-1200 mm across curb ramp, with stem (1200 mm wide) to the building line at signalized crossings
 - On medians >2 m wide, warning surface required for depth of 800 mm at each side
 - On medians <2 m wide, warning surface required for entire depth of median
 - On the sidewalk at both ends of raised crosswalks.
 - Red normally used at signalized crossings
 - Buff (or any color other than red, which contrasts with surrounding pavement) normally used at unsignalized crossings
-

Warning surface at off-street transit platform edges

Specifications for truncated domes and guidance on their installation on off-street transit platform edges are as follows.

- Dome height—5 mm ± 0.5 mm
 - Dome base diameter—22.5 mm
 - Installation—400 mm deep, installed 500-700 mm from platform edge
-

Other warning surfaces

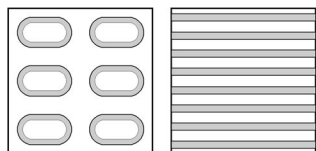

Two additional warning surfaces are recommended for other purposes.

- At on-street platform edges: a surface comprised of small raised lozenge shapes running in the direction of the platform edge is installed at a depth of 400 mm, 500-700 mm from the platform edge.
 - At stairs, level crossings and the approach to light rapid transit platforms: an 800 mm deep “corduroy” surface is required.
-

Products for curb-ramps and transit platforms

The following materials are typically used for warnings at curb-ramps and transit platforms.

- Pre-cast concrete pavers
- Natural stone

Other materials are currently being investigated.

Continued on next page

United Kingdom, continued

Products for other applications

Typical products

- Rubber tile
- Vinyl

Occasionally used for special purposes

- Hardwood
- Aluminum
- Stainless steel
- Brass nails



FIG. 4-4. BRASS NAILS INSTALLED IN PAVEMENT AS DETECTABLE WARNINGS.

Durability

In heavily trafficked areas, modules need occasional replacement to maintain the detectable texture.

Slip Resistance

There is no evidence that surfaces are slippery under any conditions.

Acceptance

Acceptance of truncated dome detectable warnings (blister surfaces) is good.

- They are reported to be helpful to people with visual impairments.
- Some people having mobility impairments report having difficulties, therefore the extent of the surface is limited.
- No adverse impact has been reported for the general public.

Information provided by

Sue Sharp, Disability Policy
Branch, Mobility Unit
Dept. of the Environment,
Transport and the Regions
Floor 1/11, Great Minster House
76 Marsham St.
London SW1P 4DR, England
Phone: +44 (0) 171 890 4917
Fax: +44 (0) 171 890 6102
E-mail:
sue_sharp@detr.gsi.gov.uk

Peter Barker, Manager
Joint Mobility Unit
Royal National Institute
for the Blind
224 Great Portland St.
London W1N 6AA, England
Phone: +44 (0) 171-387 2233
Fax: +44 (0) 171-388 3160
E-mail: Pbarker@rnib.org.uk

Australia

History of use



Truncated dome warning surfaces have been specified since 1988, but not required under the Building Code of Australia until 1999 (*AS 1428.4 Design for access and mobility—Tactile ground surface indicators for the orientation of people with visual impairment*).

- Required at curb-ramps, medians, stairs, ramps, escalators, around overhead obstacles under 2000 mm in height from the floor, and at main entrances to buildings where there is no curb separating the pedestrian from the vehicular way
 - Also becoming common at bus and trolley stops, railway platforms and wharves
-

Specifications: two types

Type A

- Dome height—4 to 5 mm
- Dome base diameter— 23 ± 1 mm
- Dome top diameter— 11.5 ± 1 mm
- Dome spacing— 60 ± 1 mm apart, measured on the diagonal, with diagonal alignment

Type B—recommended for outdoor use

- Dome height—4 to 5 mm
 - Dome base diameter— 35 ± 1 mm
 - Dome top diameter— 25 ± 1 mm
 - Dome spacing— 50 ± 1 mm apart, with parallel alignment
-

Location

Warning surface locations are specified in the Building Code of Australia.

- At curb-ramps: placed 300 mm back from the curb line, 600 mm deep, and the width of the ramp
- At medians and islands: placed 300 mm back from the curb line, 600 mm deep, and the entire width of the curb-ramp or cut-through
- At high use vehicular areas such as parking lots: placed 300 mm back from the driveway, 600 mm deep, and full width of the pathway
- At transit platforms: placed 600 to 900 mm from platform edge, 600 mm deep

List continued on next page

Australia, continued

- Location, continued**
- At bus stops: placed 300 mm back from the edge of the road, 600 mm deep and 1800 mm wide
 - At tops and bottoms of stairways and escalators: one tread width from riser, 300 ± 10 mm deep for enclosed stairways and escalators, and 600 ± 10 mm deep for unenclosed stairways and escalators
-

- Products**
- Concrete—must be 60-70 MPa (8,700-10,000 psi) in strength to maintain luminance contrast in wet weather and to produce strong, durable domes.
 - Vitrified porcelain
 - Synthetic rubber/vinyl
 - Polymer plastic—on trial
 - Layers of reflective paint—on trial

FIG. 4-5. (LEFT)
AUSTRALIAN CURB RAMP
WITH DETECTABLE
WARNING.



FIG. 4.6. (RIGHT)
CURB RAMP LEADING TO
HANDICAPPED PARKING
SPACE, AUSTRALIA.



Continued on next page

Australia, continued

Durability

- Concrete and vitrified porcelain are durable, but domes can be damaged when snowplows are not set carefully.
 - Synthetic rubber/vinyl is subject to damage.
 - Methacrilate resin cracks and chips.
-

Acceptance

- People with visual impairments find them helpful provided they have some instruction in their use.
 - Major organizations of and for people with mobility impairments agree that rises of 5 mm can be negotiated without difficulty.
 - Truncated domes are not used in “Aged Care Residential Facilities” as they could be hazardous to residents who shuffle. Also, residents become familiar with layout of their residences and do not need warnings.
 - The general public experiences no problems.
 - When used to warn of overhead protrusions where there is no barrier, they protect all pedestrians.
-

Information provided by

Murray Mountain
Access Design Solutions
103 New Street
Brighton, Victoria
Australia 3186
Phone: +61 3 9593 3750
Fax: +61 3 9592 9071
Mobile: 0414 589 414
E-mail: mountain@
alphalink.com.au



FIG. 4-7. DETECTABLE WARNING SURFACE ACROSS FULL WIDTH OF SIDEWALK AT AN ALLEYWAY (HAZARDOUS VEHICULAR WAY) IN AUSTRALIA.

New Zealand

History of use



Truncated dome warning surfaces and guidance surfaces have been in use in New Zealand since 1990.

They have been required since 1993 under NZS/AS 1428.4 Design for access and mobility—Tactile ground surface indicators for the orientation of people with visual impairment.

Most local authorities are using warning surfaces at intersections.

Texture of warning surface

Specified by NZS/AS 1428.4 and Land Transport Safety Authority Standards RTS 14 (June 1997)

Type A

- Dome height—4 to 5 mm
- Dome base diameter— 23 ± 1 mm
- Dome top diameter— 11.5 ± 1 mm
- Dome spacing— 60 ± 1 mm apart, measured on the diagonal, with diagonal alignment

Type B—(preferred in New Zealand)

- Dome height—4 to 5 mm
- Dome base diameter— 35 ± 1 mm
- Dome top diameter— 25 ± 1 mm
- Dome spacing— 50 ± 1 mm apart, with parallel alignment

Location

Warning surfaces are required:

- At curb-ramps: placed 300 mm back from the curb line, 600 mm deep, and the width of the ramp
 - At medians and islands: placed 300 mm back from the curb line, 600 mm deep, and the entire width of the curb-ramp or cut-through
 - At high use vehicular areas such as parking lots: placed 300 mm back from the driveway, 600 mm deep, and 600 mm min. wide
-

Products

- Precast concrete
 - Synthetic rubber
 - Cobble stone with truncated domes
-

Continued on next page

New Zealand, continued

Maintenance and durability

- Concrete is extremely durable and maintenance-free.
 - There are some maintenance problems with synthetic rubber.
 - There has been minimal experience with snow removal, but this does not seem to be a problem.
 - Surfaces are not slippery in wet or dry conditions.
-

Acceptance

- Positive feedback from people with visual impairments has been received for 10 years.
 - People with mobility impairments have a strong preference for Type B warnings.
 - No complaints by general public have been received except when tiles are not installed flush with the ground surface.
 - General recognition of tactile tiles at crossing points has increased awareness of general population, making these crossing points safer.
 - People with multiple disabilities consider them helpful.
 - People who are elderly report that they are helpful.
-

FIG. 4-8. DIAGRAM SHOWING REQUIREMENTS FOR GUIDANCE SURFACE AND DETECTABLE WARNING ON CURB-RAMPS IN NEW ZEALAND.

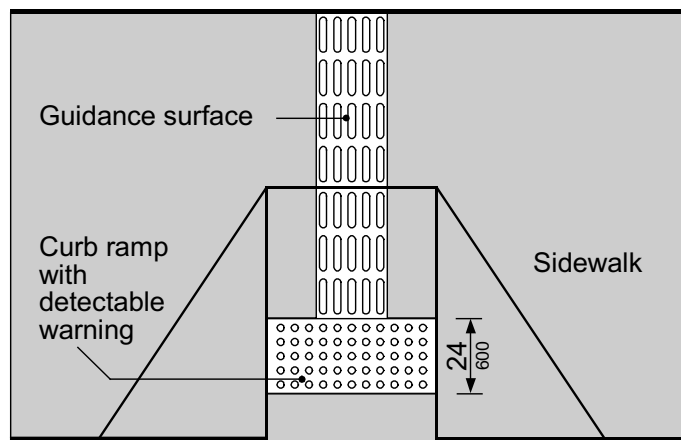

Information provided by

Michael Browne, Mobility Research Centre
P.O. Box 9518
Newmarket
Auckland, New Zealand
Phone: +64 520-4953
Fax: +64 524-4177

Italy

History of use



A tactile warning surface, “Loges,” exhibited in Düsseldorf, Germany was introduced in Italy in 1997.

- Loges is now used in 20 cities.
 - Locations include subway stations, railway stations and post offices.
-

Texture of domes

A handbook describes the texture characteristics (*Orientation and safety guide-strip: Designer’s handbook*).

- Full domes 5 mm high having diagonal alignment are used as a warning.
 - Truncated domes 5 mm high having diagonal alignment are used to signal a danger that can be safely overcome.
 - Dome base diameter—22 mm
 - Dome spacing—55 mm with parallel arrangement
-

Location

Distance of warning surface from the indicated danger varies.

- Placed 300-400 mm back from a danger that can be crossed
 - Placed 500-700 mm back from a danger which cannot be crossed
 - Depth of warning—400 mm
-

Products

Commonly used materials are:

- Concrete (exterior use)
 - Rubber (interior use)
 - Reconstructed stone (areas of artistic or historic significance)
 - Stoneware
-

Maintenance, durability and slip resistance

Maintenance and durability are not considered to be a problem.

- Surfaces are as easy to maintain as other paving or flooring surfaces.
 - Surfaces are as durable as other paving or flooring surfaces.
 - Surfaces do not become slippery.
-

Continued on next page

Italy, continued

Acceptance

Warning surfaces are well accepted in Italy.

- Blind pedestrians find them very helpful.
- Blind pedestrians consider that warning surfaces promote a positive image of pedestrians with visual impairments, as they travel with greater independence and confidence.
- People having mobility impairments do not find them troublesome.

Information provided by

Antonio Quatraro, Counselor in the domain of
the integration of the visually impaired.

Via L. Fibonacci 9

50131 Firenze, Italy

Phone: +39 335 246246

Fax: +39 55 588103

E-mail: a.quatraro@fol.it

France

History of use

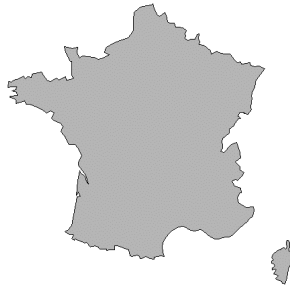

Use of warning surfaces began in France in 1989, along rail transit platforms.

- French standard, *NF P 98-351, 1989, Footways—Provision for disabled persons—Warning for caution—Characteristic and testing of pedotactile warning devices for the blind and partially sighted*, specifies textures, locations and placement of warning surfaces:
 - Along railway platforms,
 - At crosswalks with cut curbs,
 - At raised crosswalks.
 - Warning surfaces have been required since September 1999 on curb-ramps and on sidewalks where they adjoin raised crosswalks.
-

Specified texture

The texture of the domes is:

- Dome height—5 mm
- Dome base diameter—25 mm (domes not truncated)
- Dome spacing—75 mm on center, with diagonal alignment

The dome profile is specified by French standard NF P98-351. Figure 4-9 shows the dimensions of the dome.

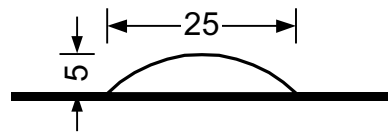

FIG. 4-9. DIMENSIONS OF FRENCH DOME PROFILE (FULL DOME, NOT TRUNCATED)

Placement of warning surfaces

Depth of the warning surface and placement in relation to the street or platform edge are the same for different environments.

- Placed 900 mm back from platform edge or bottom of curb ramp, extending the length of the platform, or width of the curb ramp
 - 420 mm deep
-

Continued on next page

France, continued

Materials

Commonly used materials are:

- Rubber
- Concrete pavers
- Methacrilate resin
- Stainless steel tiles or stainless steel nails

The photograph in Figure 4-10 shows a detectable warning installation with steel nails manufactured by ACCESSIville.

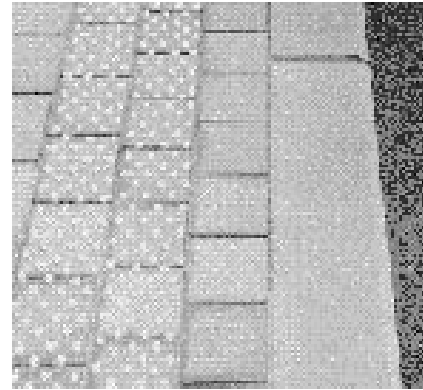

FIG. 4-10. FRENCH
DETECTABLE WARNING NAILS.

Durability

Concrete pavers have performed best in France.

- Rubber is difficult to adhere.
- Methacrilate resin cracks and chips.

Acceptance

Warning surfaces are well accepted in France because of the involvement of persons with disabilities in their design.

- Surfaces were field tested and approved by persons with visual impairments and persons with mobility impairments.
- On rail transit platforms, all passengers tend to wait further from the platform edge, behind the warning.

Information provided by

Maryvonne Dejeammes
CERTU
9 Rue Juliette Recamier
69456 Lyon 06
France
Tel: (33)(0) 4 72 74 5867
Fax: (33)(0) 4 72 74 5930
E-mail: mdejam@certu.fr

Germany

History of use



Tactile ground surface indicators have been used in Germany since 1984.

- Warning and guidance surfaces are now in use in approximately 1000 (17%) of German railway stations, and they are widely used in pedestrian areas in towns and cities.
 - Efforts toward standardization began in 1989.
 - A sinusoidal wavy texture, in various dimensions, is used for guidance and warning.
-

Standard texture

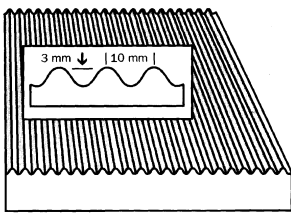

Standards to be published in April 2000 as DIN 32984.

- Texture is comprised of parallel rounded grooves.
 - Grooves—3 mm deep
 - Spacing—10 to 20 mm on center
-

Location

TGSIs are used at curb ramps, medians, top and bottom of stair runs, transit platforms, and bus stops.

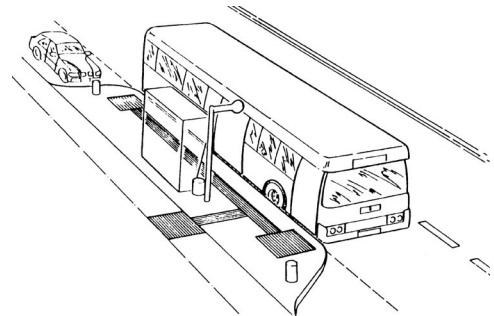

FIG. 4-11. WARNING & GUIDANCE SURFACE AT GERMAN BUS STOP.

Products

The following products are used in Germany.

- Concrete tiles
 - Ceramic tiles
 - Hard rubber tiles
 - Metal plates
-

Maintenance and durability

- Surfaces are easily cleaned using cleaning machines.
 - Surfaces are less slippery than normal concrete surfaces when wet, oily or icy.
 - Surfaces are adequately durable.
-

Continued on next page

Germany, continued

Acceptance

The guidance system is well accepted by all groups.

- Blind pedestrians who use a long cane find the guidance system helpful, but travel somewhat more slowly using the system than when not using it.
- Surfaces are well accepted by people with mobility impairments because they comply with a standard requiring a minimum tremor to wheels when crossing structured surfaces.
- Most rail passengers seem to use the guidance system as an indication of the limit of the safe waiting area on the platform.
- Older persons comment that their feet don't get cold when they stand on rubber guidance tiles at bus stops.



FIG. 4-12. GERMAN TGSi PATH DOWN A SIDEWALK AND TO A CROSSWALK.

Information provided by

Gerhard Kuper
Von-Siemensstr. 6A
D 22880 Wedel, Germany
Phone & Fax: +49 4103-87083
E-mail: Gerhard.Kuper@arcormail.de

Volker Koenig
Wiedetwiete 42
D 22880 Wedel, Germany
Phone: +49 4103 84311
Fax: +49 4103 180438

Austria

History of use

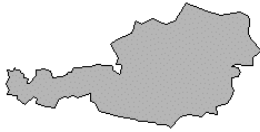

Warning surfaces have been used in Austria since 1992, primarily on transit platforms.

Approximately 80% of metro stations in Vienna have warning surfaces.

Specifications for warning textures (“attention fields”)

ÖNORM V2102, adopted in 1997, specifies the dimensions of tactile indicators for warning (attention) and guidance, and the dimensions and placement for installations on transit platforms and on public rights-of-way. Warnings can be either truncated domes or truncated pyramids.

- Height—5 mm preferred; 4 mm minimum acceptable for exterior use; 3 mm minimum acceptable for interior use
 - Dome diameter—base 30-40 mm; top 20-30 mm
 - Dome spacing—50-70 mm on center
 - Pyramid side—base 30 mm; top 20 mm
 - Pyramid spacing—45-50 mm on center, with parallel alignment
 - Warning and guidance indicators should contrast visually with adjoining surfaces by at least 30%.
-

Placement and dimensions

ÖNORM V2102 also specifies dimensions and placement of warning textures to indicate changing situations and boarding locations on transit platforms and public rights-of-way.

- At changing situations, warning indicators should be 300-400 mm from a change such as a drop-off, stairs or a ramp; they should be 400-1000 mm deep.
 - At boarding locations, warning indicators should be 100-120 cm square.
 - At cut-through islands or medians, a 600 mm deep warning indicator should be placed at each side of the island.
 - At raised crosswalks, warning indicators should be placed on the sidewalk 300-400 mm from the curb line.
-

Continued on next page

Austria, continued

Materials

Materials used for warning indicators are:

- Stone
 - Concrete
 - Road marking paint
-

Maintenance, durability and slip-resistance

Maintenance, durability and slip resistance of warning indicators are not a problem.

- Stone and concrete surfaces have not deteriorated.
 - Road marking paint is in good condition after seven years.
 - Snow and ice removal is not considered a problem.
 - Warning surfaces are sometimes slippery, but only when surrounding surfaces are also slippery.
-

Acceptance

Warning indicators are well accepted.

- Pedestrians with visual impairments find them very helpful.
 - There have been no complaints from persons with mobility impairments.
-

Information provided by

Günther Ertl
Wiener Linien-Vproj
A-1030 Wein
Erdbergstrasse 202
Vienna, Austria

Phone: +43 (0) 1 7909-41300
Fax: +43 (0) 1 7909 41390
E-mail:
guenther.ertl@wienerlinien.co.at

FIG. 4-13. (LEFT) A LINEAR DIRECTIONAL SURFACE LEADS TO AND BEYOND A LEVEL RAIL CROSSING. A DETECTABLE WARNING SURFACE EXTENDS FROM BUILDING TO CURB LINE ON BOTH SIDES OF TRACKS, VIENNA, AUSTRIA.

FIG. 4-14. (RIGHT) A LINEAR DIRECTIONAL SURFACE LEADS TO A DETECTABLE WARNING SURFACE AT A CURB, VIENNA, AUSTRIA.

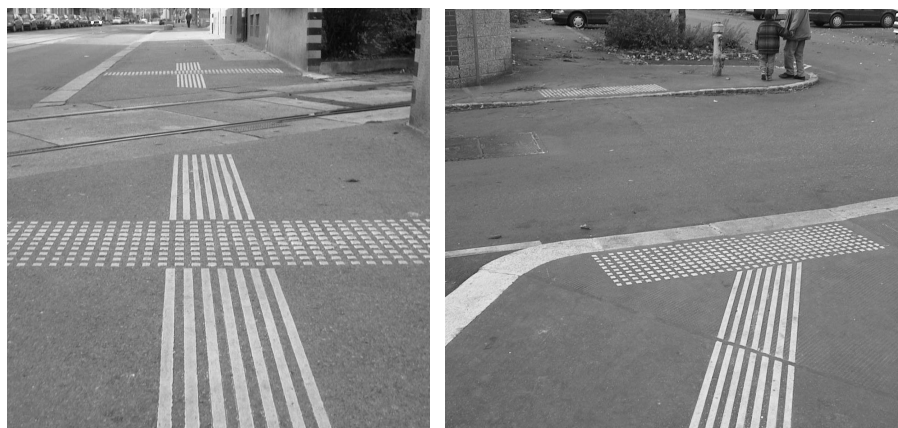

Netherlands

History of use



In the early 1980s a rubber warning surface was introduced in Holland.

- Although detectability seemed good, the surface was not sufficiently durable.
 - Extensive research has been conducted on 40 surfaces. .
-

Recommended texture

A truncated dome (“blister”) surface is now recommended for warning.

- 25 domes in 30 x 30 cm module
-

Location

Warnings should be 60 cm deep, and as wide as the hazard. They are recommended for use in the following types of locations:

- Dangerous crossings
 - All crossing points where there is no level difference between the pedestrian way and the vehicular way
 - Tops and bottoms of stairs
 - Bus stops
 - “Decision points” where tactile guidance surfaces intersect
-

Products

The product currently recommended is a metal plate that has been pre-formed with blisters, glued on 30 x 30 cm concrete, then coated with a gritty white or yellow epoxy layer.



FIG. 4-15. DETECTABLE WARNING PAVERS AT A BLENDED CURB.

Information provided by

Henk Grotendorst
Dutch Federation of the Blind and Partially Sighted
Postbus 2062
3500 GB Utrecht
Phone: +30 299 28 78
E-mail: h.grotendorst@sb-belang.nl

International standardization

International Organization for Standardization (ISO)

ISO is a worldwide federation of national standards bodies.

- International Standards are prepared through the work of ISO technical committees and working groups.
 - International organisations, governmental and non-governmental, in liaison with ISO, participate on technical committees and working groups.
 - Adoption of ISO standards by member countries is voluntary.
-

Technical Committee 173 (ISO/TC173)

ISO/TC173-Technical systems and aids for disabled or handicapped persons-

- Has a number of working groups, including one on tactile ground/floor surface indicators (TGSIs).
 - Working Group 7 completed Committee Draft ISO/CD 11550.2(E), *Technical aids for blind and vision impaired persons—Tactile ground/floor surface indicators (TGSIs)* in November 1999.
-

ISO draft on TGSIs

- Specifies requirements for design and installation of tactile indicators for use on ground or floor surfaces to assist the orientation and mobility of people with visual impairments
- Includes specifications for warning, directional, and shared pedestrian/cycle surface indicators

Warning surface

The warning surface is comprised of truncated domes:

- Dome height— $5 \pm .5$ mm
- Dome top diameter—12-25 mm
- Dome spacing—50-65 mm on

Directional surface

The directional surface is a series of raised elongated bars running in the direction of pedestrian travel:

- Bar height— $5 \pm .5$ mm
 - Bar top width— $30 \pm .5$ mm
 - Bar spacing— $75 \pm .5$ mm on center
-

Continued on next page

International standardization, continued

ISO draft on TGSIs,
continued

Shared pedestrian/bicycle indicator

The shared pedestrian/bicycle indicator is:

- A central delineator strip: trapezoidal profile, 150 ± 1 mm wide
- Trapezoid height: $12-20 \text{ mm} \pm 1 \text{ mm}$
- Top surface: $50 \pm .1 \text{ mm}$

Contrast luminance factor

Recommended minimum of 30% luminance contrast between tactile indicators and surrounding surfaces

Applications

Applications for warning surfaces are:

- Curb-ramps
 - Crossings where there is a raised road surface
 - Vehicle crossovers with high traffic flows
 - Pedestrian refuges/medians
 - Railway platforms and passenger wharves
 - Level railway crossings
 - Stairways and moving stairs
 - Intersections with shared pedestrian/bicycle traffic
 - Shared pedestrian/bicycle paths
-

Installation of warning surfaces

Warning surfaces are to be:

- Installed across the full width of the trafficable surface
 - Installed perpendicular to the path of travel
 - Set back a maximum of 400 mm from the hazard
 - Have a minimum depth of 400 mm (600 mm preferred)
 - Have a base surface level 0-3 mm above the surrounding surface
 - Laid so there is no likelihood of surfaces lifting
 - Have slip resistance in accordance with the standard of the country where the application is laid
-

Chapter 5

U.S. Use of Detectable Warning Surfaces: Case Studies

Summary

This chapter includes information on use of truncated dome detectable warnings in the U.S. The method of obtaining information is described, and a summary of the information is given. The chapter concludes with case studies of selected cities and rail transit systems where truncated dome detectable warnings have been installed. Case studies include history, locations, maintenance and durability, and acceptance of detectable warnings in each location.

Chapter contents

This chapter covers the following topics:

Topic	Page
Locating U.S. installations of detectable warning surfaces	72
Responses to mail survey	73
Interviews regarding detectable warning installations	74
Interview locations	75
Interview questions	76
Interview results — general; installation problems; Maintenance; durability; public reaction	77
Austin, TX	82
Metropolitan Atlanta Rapid Transit Authority (MARTA), Atlanta, GA	84
Roseville, CA	86
Metro North Railroad, greater New York City	88
Harrisburg, PA	90
Massachusetts Bay Transportation Authority (MBTA), Boston, MA	92
Cleveland, OH	94
Baltimore County, MD	96
Bay Area Rapid Transit (BART), San Francisco, CA	98
Claremont, CA	100

Locating U.S. installations of detectable warning surfaces

Developing a list of locations

An E-mail survey was sent to several mailing lists of individuals who might have information regarding locations of detectable warning surfaces in the United States. Manufacturers were also contacted and installation locations were requested. Available pedestrian design guidelines were also reviewed to determine locations that currently require a truncated dome detectable warning surface.

Mail survey

In October 1999, a survey was sent to E-mail listserves whose subscribers might be aware of locations where a texture change is used to provide information to pedestrians who are visually impaired or blind.

- Groups included pedestrian advocates, orientation and mobility specialists, Association for Education and Rehabilitation of the Blind and Visually Impaired (AER), individuals who are blind or visually impaired, and traffic engineers.
 - Survey requested specific locations, types of location (curb ramp, transit platform, edge of street, medians) and the texture (grooves, grid pattern, brick, rubber mat, truncated domes, or other), of any texture change intended to provide information to pedestrians with visual impairments.
 - Survey requested the name of a contact person who might be able to answer questions about experience with truncated dome detectable warning surfaces.
-

Other information sources

Additional information was gathered about installations from:

- Manufacturers of truncated dome detectable warning materials were asked for contacts in locations where their products had been installed
 - Conversations with Access Board staff
 - A review of references in previously published materials
 - Personal contacts of authors
 - American Public Transit Association
-

Responses to mail survey

Responses to survey

The 48 responses included surveys from 28 states, the District of Columbia and Canada

- Many respondents noted two or more locations and types of locations, for example, the name of an entire transit system that had detectable warnings and a list of several intersections in that city with grooves on the curb-ramps.
 - Five respondents replied that they were not aware of any locations where a texture change was used.
 - Thirty-nine reported the use of other surfaces besides, or in addition to, truncated domes, including grooves, grid patterns, standard bricks, exposed aggregate, and “exposed rock.”
-

State and local requirements

Responses from several states indicated that there were state or local requirements for tactile surfaces on curb-ramps.

- For example, a traffic engineer from Minnesota stated that an exposed aggregate was required on all curb-ramps,
- and a response from Phoenix stated that grooves were required on curb-ramps in all new construction.
- California requires grooves at the top of the curb ramp and detectable warnings where the slope is less than 1:15.



FIG. 5-1.
A MINIMALLY DETECT-
ABLE WARNING SURFACE
IN PORTLAND, ME.

Interviews regarding detectable warning installations

Interview

Research assistants made calls to locations identified by the initial survey as having truncated dome detectable warnings.

The detectable warning and its location was confirmed and it was determined that the individual being interviewed had some responsibility related to its installation or use. Names of additional contacts were requested.

Locating appropriate persons

Architects and facilities maintenance supervisors of transit systems, ADA coordinators of transit systems and cities, traffic engineers, city engineers, and various public works officials were queried.

- Phone calls were made to city public works departments, engineering departments, and transit systems in order to locate knowledgeable individuals.
- Some cities have a designated curb ramp manager—many do not.

In several situations, the public official was unaware of the presence of detectable warning within his/her jurisdiction until the researcher identified the specific location.

Types of locations for detectable warnings

The people interviewed reported the following types of locations for detectable warnings:

- Curb-ramps at intersections—18 jurisdictions
 - Curb-ramps throughout the city—2 cities
 - Entrances to public stores, between parking lot and entrance—4 jurisdictions
 - Transit system platforms, or light rail loading areas, usually at numerous locations throughout systems—17 systems
 - Raised intersection crosswalks, along driveways at a school for the blind, and a university—3 reports
-

FIG. 5-2. CURB RAMP EXPOSED AGGREGATE SURFACE IN VIRGINIA. PEDESTRIANS WHO ARE BLIND DO NOT RELIABLY DETECT EXPOSED AGGREGATE CONCRETE.



Interview locations

City interviews

Interviews were conducted for these cities:

- Roseville, CA
 - Sacramento, CA
 - San Diego, CA
 - San Francisco, CA
 - Lakeland, FL
 - Chicago, IL
 - Cambridge, MA
 - Towson, MD
 - Anoka, MN
 - Greensboro, NC
 - Portsmouth, NH
 - Cleveland, OH
 - Harrisburg, PA
 - Austin, TX
-

Transit system Interviews

Interviews were conducted for these transit systems:

- San Diego Trolley, San Diego, CA
 - Bay Area Rapid Transit (BART), San Francisco, CA
 - San Francisco Municipal Railway (MUNI), San Francisco, CA
 - Valley Transportation Authority, San Jose, CA
 - AC Transit, San Pablo, CA
 - Metrolink, Southern California Commuter Rail
 - Sacramento Regional Transit, Sacramento, CA
 - Metro-Dade Transit, Miami, FL
 - Metropolitan Atlanta Rapid Transit Authority (MARTA), Atlanta, GA
 - Chicago Transit Authority, Chicago, IL
 - MTA and Maryland Area Rail Commuter (MARC), Baltimore, MD
 - Massachusetts Bay Transportation Authority, Boston, MA
 - Metro North Railroad, Greater New York City, NY
 - Cleveland Regional Transit Authority, Cleveland, OH
 - Portland TriMet, Portland, OR
 - Virginia Railway Express, Washington DC & VA
-

Other interviews

Interviews were conducted with these individuals and organizations:

- Maintenance supervisor at University of Alaska, Fairbanks, AK
 - Maintenance supervisor at ARCO, Anchorage, AK
 - Blind person in Canada
 - Manager at a TOYS R US store, Roseville, CA
 - Manager of Checkers Drive-In, Lakeland, FL
 - Contractor in Atlanta, GA,
 - Blind person in Towson, MD
 - Consultant in accessibility issues, Ottawa, ON, Canada
 - Employee of Q-Lube, Bonney Lake, WA
 - Maintenance supervisor at the Washington State School for the Blind, Seattle, WA
 - Contractor in Ontario, CA
-

Interview questions

Interview questions

Interview questions were divided into five major categories:

- Location and materials—information about the exact location, type of installation, and type of material including the manufacturer, if known
- Installation—date installed, approximate cost per square foot, installation method, color of detectable warning and problems or difficulties in the installation process
- Maintenance and durability—maintenance problems, cleaning method and products, evidence of wear and tear and extent of the problem, experience with snow and ice removal, and whether any replacements have been needed
- Public Reaction/Problems/Concerns—specific instances where truncated domes have been the cause of pedestrian complaint, or legal action; comments from individuals who are blind, who have mobility impairments, or from the general public
- Additional Information/Contacts—Contacts were asked for names of other knowledgeable individuals, photos of the detectable warning installations, any research on detectable warnings, and about their plans to install more detectable warnings.

See the Appendix for a copy of the interview questionnaire and specific questions asked in each area.

Snow removal

FIG. 5-3. (LEFT)
CURB RAMP IN
ANCHORAGE, AK.



FIG. 5-4. (RIGHT)
CURB RAMP IN
ANCHORAGE, AK
SHOWING SNOW
REMOVAL WITH A
BRUSH.



A

Interview results — general

Materials

A wide range of materials were reported:

- Unit masonry
- Precast concrete units
- Concrete, stamped after pour
- Epoxy polymer composite tile
- Ceramic tile
- Plastic/rubber urethane tile
- Latex-modified mortar

Some of the originally installed products are no longer commercially available and some of the manufacturers are no longer in business. See Chapter 7, U.S. Detectable Warning Manufacturers.

At several locations the original material was unsatisfactory, but replacement detectable warnings from the same or a different manufacturer have been installed and are functioning in a satisfactory manner.

Color of detectable warning

Colors used included safety yellow, light gray, red brick, black and blue.

Installation dates

Dates of installation ranged from 1986 to 1999.

Installation costs

Although cost per square foot information was requested in each interview, it was generally unavailable, or impossible to adequately compare with other installations due to the variations in materials, installation methods (whether installed by manufacturer or a contractor), job size, and dates of installations. Therefore, responses are not reported here.

Installation method

Most panel or sheet type materials were mechanically fastened, as well as glued to the surface material. Some types of panels are specifically manufactured with a flange to be set in wet concrete.

Brick and paver type materials are installed using standard procedures. Stamped concrete requires precise attention to dome height, appropriate pressure in the process, and curing of the concrete.

Detailed specifications and contractor requirements for installation methods and materials have been developed by Roseville, CA; Austin, TX; Cambridge, MA; Towson, MD; and many of the transit systems queried.

Interview results — installation problems

Installation problems or difficulties

Various types of difficulties were reported, many of which were considered minor by the individual reporting them. Each type of material requires a specified procedure.

Transit systems using tiles generally had to grind down a section of the platform edge to retrofit their systems with the detectable warning. Two specifically reported that it was a much easier process than anticipated, since the manufacturer had equipment that handled the requirements.

Many installation difficulties were considered minor by the individuals reporting them

A number of negative reports involved the process of stamping the truncated dome surface in concrete, with very few successful experiences. Stamping the dome texture on sloping concrete and getting an acceptable consistency of surface, dome height, and concrete hardness seemed to be an extremely difficult process, requiring expert contractors. One public works official in Minnesota stated that the dome surface had worn better than he expected, but he would not install it again as stamped concrete because the process was too difficult.

Contractors were generally reported to be familiar with the methods of setting brick pavers, even on a sloped surface. Setting pavers in mortar was suggested by the experience in several locations.

There were a number of negative reports about stamping in concrete.

The problems reported with pavers were related to cutting the pavers to fit curves, and the lack of guidelines for maintaining the distance between domes when materials needed to be cut to fit a curve, such as at the base of a blended curb ramp.

Precast truncated dome units for curb-ramps are manufactured in specific sizes, requiring consistency in the curb ramp type and placement.

Interview results — maintenance

General maintenance

Cleaning method and products were standard. Most curb ramp installations were not cleaned. Many indoor transit locations were pressure washed. One location reported using solvents, as necessary. Frequency of cleaning ranged from “never” to weekly.

Snow & ice removal

Experience, method and comments regarding snow and ice removal were requested. Concerns about snow and ice removal have been one of the barriers to installation of truncated dome surfaces, so questions were specifically asked regarding experience with clearing snow and ice.

<u>Number of cities or transit systems</u>	<u>Experience with snow & ice removal</u>
22	No experience with snow or ice
3	Recent installation and no experience to date
16	Have had experience with snow and ice

Various methods of clearing, including snowplows, brushes or brooms, and chemicals, were reported.

While concerns continue to be expressed about damage to the domes from snowplows, only three people stated that plows removed domes. One said that snowplows removed domes at apex curb-ramps while another stated that it was “no problem because the domes are set in concrete and the blade passes over them”. The same person also stated that truncated domes were “preferred to grooves because they (truncated domes) don’t fill up with snow and dirt.” Clearly, there has been a variety of experience, depending on the equipment and the detectable warning material.

- A report from Anoka, MN stated: “People thought shovels would shear off domes, but they don’t. Brooms work much better ... either do that or flood with salt. Plows break some domes off.”
 - One commented: “Use brooms and sand. Any water will collect below the domes while people step on top.”
 - A plow with a rotary brush was recommended.
 - Two people reported problems with salt degrading the domes on stamped concrete surfaces and another commented “no problems, chemicals don’t seem to hurt.”
 - Chemicals may make some types of detectable warning materials slippery.
-

Interview results — durability

Durability

“We do not take any special precautions during snow removal and it seems to have held up quite well.”

“Yes, it is plowed mainly with a front end loader with a bucket. It scrapes the ground pretty hard so [the detectable warning] takes quite a bit of abuse.”

Ed Foster, Univ. of Alaska Fairbanks Maintenance.

Specific questions were asked about problems with tiles chipping, color fading, domes wearing, tiles peeling, and whether these of problems were considered minor, major or no problem

- More than one transit system facility supervisor stated that although tiles had to be replaced regularly, they considered that a typical maintenance item and did not see it as a problem.
- Numerous problems with peeling and bubbling were reported in early installations of rubber tiles, particularly in outdoor installations. Many of those installations in transit systems have been replaced with a different material. Adhesives alone may not be adequate in outdoor installations and care must be taken to follow manufacturer’s recommendations.
- A detectable warning, thought to be Pathfinder Tile, was installed before 1996 in Fairbanks, AK, and it is still in good condition. It is across a driveway and subject to extreme cold, regular plowing, and some traffic by heavy vehicles. On a similar detectable warning installed in Anchorage, Alaska, snow is regularly removed with the same brush used for sidewalk snow removal (see Fig. 5-4).



FIG. 5-5. DETECTABLE WARNING SURFACE WITH A PARTIAL SNOW COVER BETWEEN THE DOMES, ANCHORAGE, ALASKA.

- Seven of the transit systems and two cities noted color fading. Three indicated that it was major, with two saying that the manufacturer either replaced or re-coated the materials. All others reported the fading as minor.
- Problems with wear on domes were generally reported by cities with curb ramp locations where a “stamped after pour” concrete surface was installed.

Interview results — public reaction

Public reaction, problems or concerns

Pedestrians who are mobility impaired find the truncated domes just “more difficult to manage.” A city ADA coordinator

Public reaction seems to have been most positive in locations where the disability community was involved in the Americans with Disabilities Act (ADA) transition plan and making decisions regarding the use of detectable warnings.

One question asked about specific instances where truncated domes have been the cause of pedestrian complaints or problems. Five locations answered that there was an instance of pedestrian complaint. One was a mobility impaired individual using a cane, who found the truncated domes more difficult to traverse. A city ADA coordinator stated that pedestrians who are mobility impaired find the truncated domes “just more difficult to manage”. Another stated that there were complaints from women in high heels, but no injuries.

There were two instances in which legal action was reported in association with a truncated dome detectable warning. The authors of this report made extensive phone calls to attempt to document the details, as noted below.

No record of any lawsuits

“I think this is one of those urban myths.” A city risk manager.

In one case, the Manager of Construction and Maintenance for a city stated that truncated domes were no longer installed on curb-ramps in that city because there were “too many lawsuits from women in high heels.” However, he said he knew no details and referred us to the Engineering Manager. Phone conversations with the managers and staff of the engineering and traffic operations departments failed to locate any information.

The city’s department of Risk Management was contacted and stated that there was no record of any lawsuits associated with curb-ramps or truncated dome detectable warnings in the past seven years—the detectable warnings were installed six years ago. The Risk Management department Manager stated “I think this is one of those urban myths.”

Lawsuits, but no details

In another situation, the transit system construction manager stated that there had been two lawsuits. He did not know any details and said his only knowledge was that the city had contacted him with general questions regarding the installation of the detectable warning material. Further information could not be located.

Austin, Texas

History



The city of Austin has installed truncated dome detectable warnings at curb-ramps since 1992.

- The disabled community was involved in preparing an ADA compliance transition plan.
- When Austin began putting in curb-ramps, detectable warnings were required. Even though the federal detectable warning requirement was subsequently suspended, the state of Texas continued to require the use of either truncated dome detectable warnings or grooved surfaces at curb-ramps.
- A recent rules change now permits the use of grooved surfaces in residential or industrial areas; however, truncated dome detectable warnings are required within the Central Business District and in the area surrounding the school for the blind.
- Additionally, truncated dome detectable warnings are required at any curb ramp that is constructed using public funds.

Over 1000 ramps in Austin now have truncated dome detectable warnings.

Materials and Installation

- In 1992, the first installations were stamped concrete approximately 4 ft x 6 ft, covering the entire ramped area.
 - This practice was discontinued due to the difficulty associated with stamping the concrete and the poor durability of the painted surface.
 - Dark red brick pavers have been installed since 1995.
 - Pavers are installed in the full width and depth of the ramp, exclusive of the flares, typically an area of 4 ft x 5 ft.
 - There were problems with settling when pavers were installed in sand, but setting in mortar solved that problem.
-

Specifications

FIG. 5-6. MID-BLOCK CROSSING WITH CURB RAMP, AUSTIN.



City of Austin standard specifications and standard details are available on the internet at www.ci.austin.tx.us. From the pull down menu, select Quick Connections > Development Process > Standard Details & Specifications.

Continued on next page

Austin, Texas, continued

Maintenance and Durability

Ken Zimmerman, Project Manager with the ADA Curb Ramp and Sidewalk Program reports no problems with wear, except possibly some fading.

- Pavers are never washed.
- There has been no experience with snow or ice.
- Revising the installation method solved the problem of settling.
- A few individual pavers have been replaced due to settling and damage from trucks.

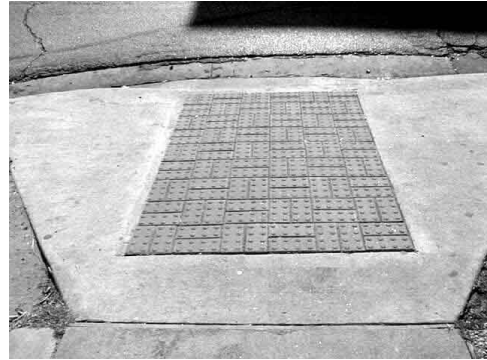

FIG. 5-7. DETECTABLE WARNING BRICK PAVERS, AUSTIN, TEXAS.

Acceptance

The general public is supportive.

- Ken Zimmerman said he thinks wheelchair users would “prefer no bumps”, but there have been no complaints.
- General public is “supportive”.
- Originally detectable warnings were installed across sidewalks at commercial driveways having blended curbs or curb-ramps. Comments from blind individuals led to discontinuing installation of detectable warnings at commercial driveways because blind pedestrians sometimes counted them as streets and thus became disoriented.
- Representatives of the Commission for the Blind, the Texas School for the Blind, and Council of the Blind have attended meetings and hearings and have expressed support for the curb ramp program

Contacts

Dolores Gonzalez
ADA Coordinator
City of Austin
PO Box 1088
Austin, TX 78767-8839
Phone: (512) 499-3256
E-mail:
Dolores.Gonzalez@ci.austin.tx.us

Ken Zimmerman,
Project Manager, ADA Curb
Ramp and Sidewalk Program
Dept. of Public Works & Transportation,
City of Austin PO Box 1088,
Austin, TX 78767-8839
Phone: (512) 499-7138
E-mail:
ken.zimmerman@ci.austin.tx.us

Metropolitan Atlanta Rapid Transit Authority (MARTA)

History



MARTA, the Metropolitan Atlanta Rapid Transit Authority, in Atlanta Georgia, as part of their ADA compliance plan, agreed to install truncated dome detectable warnings at all platform edges in all stations in the system.

- Working with the Elderly and Disabled Access Advisory Committee, MARTA staff evaluated detectable warning materials & installation methods, & determined an installation priority list.
 - Installation of detectable warning began in 12 stations in 1992. All 36 stations now have truncated dome detectable warning along the edge of the platform.
 - Detectable warnings will be installed in all new stations as required by ADAAG.
-

Materials

At this time, the detectable warnings are either Armor-Tile or High-Quality Tile. All are a hard surface, rather than resilient material.

MARTA has a very exacting performance specification and other manufacturers have not been able to meet all their requirements.

In the most recent installations, MARTA has been using a precast Armor-Tile concrete panel that has the warning tile placed on it at the factory. This tile is installed on the concrete slab and “aligns better”.

Installation

Detectable warning is installed 2 ft deep for the length of the platform, with a space underneath to enhance sound on cane-contact difference.

- Tiles are secured with mechanical fasteners and structural adhesive.
 - In the retrofit installations, the detectable warning tiles replaced a two-foot portion of a three-foot granite strip along the edge of the platform, which was originally installed as a tactile warning. A portion of the granite strip was ground down to allow installation of the tiles. This installation was accomplished in stages, with most of the construction done at night when trains were not in service.
 - Tiles are a gray color, preferred by MARTA architects to provide contrast with the original platform colors.
-

Maintenance

The detectable warning is pressure washed and scrubbed approximately bimonthly. MARTA has had very little experience with snow and ice removal. Barry Hodges, MARTA’s Manager of Architecture states that there is not a problem, because the engineering and design of the tile prevents water from pooling or icing on the tile.

Continued on next page

Metropolitan Atlanta Rapid Transit Authority, continued

Durability

- Problems with chipping, cracking and occasional lost screw covers were reported as minor by MARTA staff.
 - The chipping of the detectable warning surface at the platform edge has been determined to be caused by either MARTA's money carts, or escalator equipment carts, which are very heavy and moved from station to station via rail. Replacing the carts' steel wheels with rubber wheels has largely solved this problem. The previous granite edge strip had been cracked and required repair for the same reason, so the chipping of the Armor-Tile is not considered significant.
-

Acceptance

No complaints have been documented.

- The detectable warning installations have been very well received by the patrons. Several blind or visually impaired individuals have expressed appreciation in public hearings regarding the addition of the detectable warnings.
 - MARTA staff has stated that the detectable warnings encourage all patrons to stand back from the edge of the platform.
-

Contact

Barry Hodges, Manager of Architecture
MARTA, 2424 Piedmont Road, Atlanta, GA 30324
Phone: (404) 848-4434
Fax: (404) 848-4329

FIG. 5-8. MARTA STATION SHOWING INSTALLATION OF ARMOR-TILE.



Roseville, California

History



California Title 24 regulations require detectable warnings on curb-ramps that slope less than 1:15 (6.67%). Grooves are required around the top edge of the curb ramp and a 1/2 in beveled lip is required at the curb line.

- The City of Roseville requires that curb-ramps have a maximum 5% slope when street slopes allow this.
- All curb-ramps, regardless of slope and design shall include detectable warnings.
- As curb-ramps are added, detectable warnings are included.
- Detectable warnings are installed at all driveways that include curb radii, such as high volume commercial driveways.
- Detectable warnings are installed at the access and egress points of corner islands.

Currently “several hundred” curb-ramps have detectable warnings.

Materials and installation

- Since August 1997, Roseville’s specifications require a specially manufactured Armor-Tile panel, 3 ft deep x 4 ft wide, installed at the back of the curb.
- This panel is manufactured in safety yellow, with parallel alignment of the rows of truncated domes.
- There is a 1/2 in flange around the detectable warning surface, which is set into wet concrete when the ramp is poured.
- Specifications are available from Rick McCarter (contact information below).

FIGURE 5-9. CURB RAMP DESIGN REQUIRED IN ROSEVILLE, CALIFORNIA.

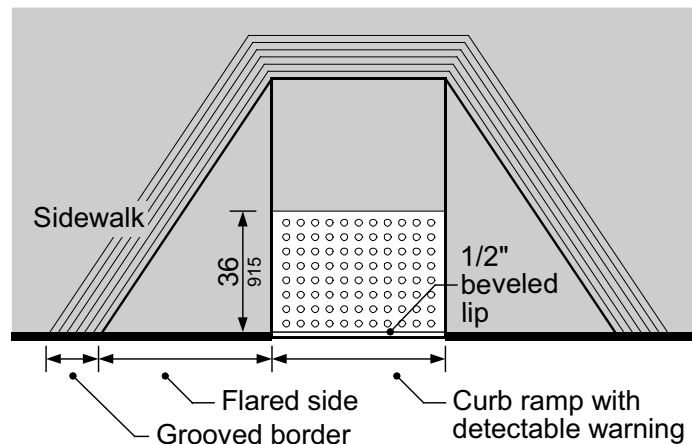

Continued on next page

Roseville, California, continued

Maintenance

- Tiles are not cleaned on a regular basis; rain washes them off
 - There has been no experience with snow or ice.
-

Durability

- No problems with cracking or lifting of panels have been observed, since it is installed in the concrete
 - The color has faded somewhat.
-

Acceptance

There has been good agreement from local disability groups in deciding appropriate placement and solutions. They worked together on requirements and on how to resolve differences.

- Parallel alignment of domes on detectable warning material is helpful to wheelchair users.
 - No complaints have been received.
-

Contact

Rick McCarter, Senior Public Works Inspector
City of Roseville
316 Vernon Street #106, Roseville, CA 95678
Phone: (916) 774-5481
E-mail: rmccarter@roseville.ca.us

FIG. 5-10. PARALLEL
CURB RAMP IN
ROSEVILLE USING
ARMOR-TILE PANEL.



Metro North Railroad

History



Metro North is the second largest commuter railroad in the nation. Metro North's main lines are the Hudson, Harlem, and New Haven runs northward out of Grand Central Terminal into suburban New York and Connecticut. West of the Hudson river, Metro-North's Port Jervis and Pascack Valley lines operate from NJ Transit's Hoboken Terminal. Metro North operates 117 stations.

Metro North Railroad has installed detectable warnings along platform edges in 29 stations, including indoor and outdoor, elevated and non-elevated stations.

- Installations took place from 1995 to 1997.
- Other agencies, vendors, and other systems were contacted in determining appropriate materials and plans for ADA compliance.

Materials and Installation

Detectable warnings are Lanxide (SMC) and Armor-Tile (Engineered Plastics). Most are yellow. Detectable warnings are two feet deep along the length of the platform, set back 4 inches from the platform edge. Setback is to prevent damage from trains to the detectable warning along the platform edge.

- Various installation methods have been tried, including riveting, combining rivets and adhesives/mastics, and setting into wet concrete with overlay type materials. All have some problems and are less than satisfactory.
- Upcoming installation will probably be cast in place as that has been most successful to date. Mr. Ziegler is working on developing the best possible plans, but notes that there are difficulties anytime a cold joint of two dissimilar materials is installed on the platforms and exposed to the elements, particularly in elevated platform situations.
- Some tiles were installed with a cavity between the detectable warning and the base surface for sound difference, but this opens up the concrete base to more possibilities of deterioration. The setback from the platform edge also leaves a joint for water intrusion creating freeze/thaw problems
- Setting in wet concrete was the most successful method of installation in retrofit; however, concrete can puddle and it has to be installed expertly.

Continued on next page

Metro North Railroad, continued

Maintenance

- Detectable warnings are pressure washed on no set schedule.
 - Snow plows and chemical are used to remove snow. Some chipping has resulted from snow plow use. Calcium chloride makes the surface of the detectable warning slippery.
 - Domes are difficult to clean.
-

Durability

Extensive concerns with durability were expressed.

- Cracks in both types of tiles are reported as a major problem. Mr. Ziegler believes it is from freeze/thaw, snow removal, and car washing equipment.
 - The installation procedures for retrofitting tiles required milling up the concrete of the platform, then installing the tiles. No matter how well sealed, this exposed the concrete base to salt and water, which caused it to deteriorate.
 - More problems were reported with the SMC material and ultraviolet, however there is fading in all products.
 - In some instances the riveted overlay material was removed and replaced with tiles set in concrete. This was due to platform deterioration problems.
-

Acceptance

Mr. Ziegler does not strongly favor detectable warnings, feels the “idea was not well thought out” and is concerned by problems he’s had.

- He does not remember any favorable comments about the detectable warning and has observed some slip resistance problems.
 - He stated that there is a tripping hazard, particularly for “drunks who run and trip on the detectable warning”.
-

Contact

Kurt Ziegler
Metro North Railroad
420 Lexington Avenue, 11th Floor
Graybar, Engineering and Design Division
New York, NY 10017
Phone: (212) 499-4417
Fax: (212) 499-4420
E-mail: ziegler@mnr.org

Harrisburg, Pennsylvania

History



Detectable warnings were installed on 300 to 400 curb-ramps in the downtown area of Harrisburg, PA in 1993-1994.

The truncated dome detectable warning surface covers the entire ramped area, exclusive of the flares.

Shortly after project was begun, the requirement for truncated dome detectable warnings was suspended. The experience and results, according to City Engineer Joseph Link, was “less than what was expected”.

Materials and Installation

Units were precast, then installed in the ramp area with concrete poured around them. Most units were brick red, for contrast with surrounding concrete.

A local contractor was used for installation. When he attempted to form the domes by the typical method of pressing the rubber mold into the concrete, the “form stuck to domes and they pulled off”. The contractor developed a process that worked, pouring the concrete into the mold, then installing it in the ramp as a precast unit.

Maintenance

Detectable warnings are not cleaned, except for normal rain washing of the sidewalk.

Snow and ice are removed with salt, which may have degraded the domes. The City Engineer stated that other methods of clearing don’t work with the domes.

Durability

Major wear to the concrete domes is reported. Joseph Link, City Engineer

- Although concrete was rated at 6000 PSI, domes broke off.
 - Major wear is reported. Some settling is also reported.
 - Individual units were replaced in a few instances where cracking occurred. Cracking was thought to be caused by garbage trucks driving over the units.
-

Continued on next page



FIG. 5-11. BRICK
DETECTABLE WARNING
SURFACE CONTRASTS
WITH ADJACENT
CONCRETE,
HARRISBURG, PA.

Acceptance

No comments were received from individuals who are blind. Mr. Link stated that most ramps are 1:12 and there are audible signals at the intersections, so individuals who are blind do not have difficulty recognizing the street.

An individual with a mobility impairment, who uses a cane and cannot lift her feet well, complained. Another individual stated that the bumpiness was bad for those wheelchair users with bladder problems.

Comments from the general public were: “What are those stupid things for?”

Mr. Link was not pleased with the results. He states that he would never do truncated domes again, that the color difference didn't look good and was not important, and that most of the domes are gone anyway. He does not intend to install additional detectable warnings unless mandated.

Contact

Joseph Link, City Engineer
City of Harrisburg
123 Walnut Street, Suite 212
Harrisburg, PA 17101
Phone: (717) 255-3091
Fax: (717) 255-3078
E-mail: jlink@cityofhbg.com

Massachusetts Bay Transportation Authority (MBTA)

History

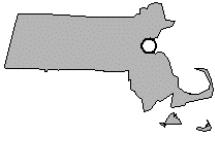

Detectable warnings have been installed at approximately sixty-one stations in the Massachusetts Bay Transportation Authority (MBTA) system, including rapid rail, light rail and commuter rail stations, indoors and outdoors.

- Most have been installed since 1993.
 - Research on detectable warnings was done before, during and after the installation of the detectable warning.
 - A number of different products have been installed in the system.
-

Materials and Installation

Materials vary since the type of detectable warning and manufacturer are subject to the competitive bidding process.

- Installations include detectable warnings of epoxy, plastic and ceramic tiles. The detectable warning materials are adhered with adhesives, fasteners and/or screws directly on the base surface.
 - All detectable warnings are yellow, in accord with the specifications of the Massachusetts Architectural Access Board.
 - The detectable warnings in all stations are 24 in deep by the length of the platform, installed at the edge of the platform.
-

Maintenance

No maintenance issues were reported.

- Detectable warnings are washed on a “non-regular basis”, using a hose and water.
- Snow and ice are removed by shovel, sand and broom.



FIG. 5-12. MBTA STATION WITH DETECTABLE WARNING TILE (SUMMITVILLE).

Continued on next page

Massachusetts Bay Transportation Authority, continued

Durability

- Some tiles are missing, peeled, cracked and chipped and the surface texture of a few detectable warning tiles has degraded somewhat.
 - Detectable warning products have been removed and reinstalled at several stations.
 - The color of a few tiles has degraded with some discoloration.
 - A few tiles have been replaced.
-

Acceptance

No comments or complaints have been received regarding the detectable warnings.

Detectable warnings will be installed throughout the system.

Contact

Michael Festa, Senior Accessibility Specialist for Design
MBTA Design and Construction Department
500 Arborway, Jamaica Plain, MA 02130
phone: (617) 222-1984 TTY
fax: (617) 222-3426
E-mail: mfesta@mbta.com

Cleveland, Ohio

History



Detectable warnings were installed on curb-ramps on the Public Square in the city of Cleveland in 1996.

Materials and Installation

Brick pavers are “the only thing that works in northern climates.”

Detectable warnings are brick units, 4 in x 8 in x 3.5 in, in a red brick color. Full depth bricks are used rather than face bricks for durability.

- The manufacturer’s name is not available. The contractor selects the manufacturer.
- Units were installed in sand with a 4 in concrete base underneath on the entire ramped area, approximately 5 ft x 6 ft.

Randy DeVaul, Commissioner of Engineering, stated that truncated domes are more costly and he prefers ridges that can be sawed.

Mr. McLaughlin stated that brick pavers are the “only thing that works in Northern climates,” and that stamped surfaces of the truncated dome texture were impractical.

Maintenance

No maintenance problems were reported.

- Detectable warnings are swept or hosed down on “no set schedule”.
 - Snow and ice are removed by snow plow, shovel, or salt. Mr. DeVaul expressed concerns about snow removal and snow building up and becoming slippery.
-

Durability

No problems were reported with durability.

A few bricks have broken or become loose from trucks driving over them, but “anything else would be broken up by that.”

Continued on next page

Cleveland, Ohio, continued

Acceptance No problems have been reported.

Contacts

Bill McLaughlin
Consulting Engineer, Division
of Engineering & Construction
City of Cleveland
601 Lakeside Ave.
Cleveland, OH 44114
Phone: (216) 664-4278
Fax: (216) 664-2289

Randy DeVaul
Commissioner of
Engineering & Construction
City of Cleveland
601 Lakeside Ave.
Cleveland, OH 44114
Phone: (216) 664-2371

FIG. 5-13. TRUNCATED
DOME PAVERS CUT AND
FITTED TO THE ENTIRE
SURFACE OF A PERPEN-
DICULAR CURB RAMP,
INCLUDING FLARES,
CLEVELAND, OH.



Baltimore County, Maryland

History



Detectable warnings are used in numerous curb ramp locations in Baltimore County, MD. They have been installed mainly where older commercial areas are being “revitalized”.

At one location a band of detectable warning materials was placed around the perimeter of the ramp, as well as 32” at the base of the ramp. Now, a 32 in deep section of detectable warning material is installed at the base of the ramp.

Materials and Installation

Installation is “the same as any paver.”
Richard Calkins,
Project Manager

Manufacturers vary, since each project is contracted. Specifications call for brick pavers with the truncated dome surface. They are dark red-brown, as are other sidewalk pavers to define the clear path in the concrete sidewalk.

The pavers are set on a concrete substrate. Usually the concrete base is poured, then 1 in of sand, with the brick pavers set into the sand. No problems are reported with installation since installation is “the same as any paver.”

Installation at the Towson roundabout is Endicott Brick, installed in 1997-1998. Where the detectable warnings were laid in a brick field, they are mortared rather than set in sand.

After some informal testing and experimentation, the decision was made to lay the pavers in a layout aligning the domes, so wheelchair wheels can travel between them.

Maintenance and Durability

In traveling in snow and ice, the least of his problems was going over truncated domes.

Maintenance

No problem has been reported.

To date, there has been minimal experience with snow or ice removal. The pavers are dark, so the snow melts quickly. Use of chemicals is planned, as needed. Mr. Calkins stated that in traveling in the snow and ice, the least of his problems was going over the truncated domes.

Durability

Dome wear was reported to be a minor issue.

Continued on next page

Baltimore County, Maryland, continued

Acceptance

No instances of problems have been reported.

Before installation, there were concerns about problems for those wearing high heels; however, it has not been a problem to date.

Comments from individuals who are blind have stated that it's the "only thing detectable".

Contacts

Richard Calkins, Project Manager
Commission on Disability
Baltimore County Department
of Public Works
111 W. Chesapeake Ave.
Towson, MD 21204
Phone: (410) 887-3734
E-mail: rcalkins@co.ba.md.us

Dan Witt
Maryland DOT
Baltimore, MD
Phone: (410) 321-2825

FIG. 5-14. A BAND OF DETECTABLE WARNING PAVERS OUTLINES THE TRIANGULAR SHAPE OF THIS CURB RAMP IN TOWSON, MD.



Bay Area Rapid Transit (BART)

History



Bay Area Rapid Transit (BART) is a 95-mile, automated rapid transit system serving over 3 million people in four counties, including San Francisco County. BART has 12 surface, 13 aerial, and 14 subway stations. Four stations in downtown San Francisco are shared with the San Francisco Municipal Railway.

Research on detectable warning surfaces was conducted in the BART system beginning in 1986 (Peck & Bentzen, 1987).

Since 1987, detectable warnings have been installed throughout the BART system in all of 39 stations.

The BART safety department found that incidence of falls has decreased since installation of the detectable warning tiles.

Materials and Installation

Early installations were Pathfinder Tile, manufactured by Carsonite. The Pathfinder Tile is a resilient material that was glued to the platform surface. Installations since 1997 are Armor-Tile.

All are installations are yellow, with black tiles at door locations.

Armor-Tile installations are attached with adhesives and mechanical fasteners. Two types of Armor-Tile materials have been used. One is flat (1/2 in) tile, attached in a recessed fashion to the platform surface. In a few stations, a 3 in thick Armor-Tile product has been used. This tile replaced the concrete on the platform edge; it was used where there were problems with the concrete of the platform.

Maintenance

Tiles are cleaned on a weekly basis with the stations.

There has been no experience with snow and ice.

Durability

The Pathfinder Tile peeled up over time due to weather, platform vibration and scrubber type cleaning. Many tiles have been replaced by Armor-Tile.

Color degraded in one instance with tile from a different vendor and the contractor replaced the faded tile with Armor-Tile.

Acceptance

Tiles are very well accepted by the public. No problems are reported.

While Armor-Tile is not resilient, Mr. Nnaji reports better sound distinction than with the resilient tiles.

Continued on next page

Bay Area Rapid Transit (BART), continued

Contact

Ike Nnaji, ADA Compliance Officer
BART
800 Madison Street, Oakland, CA 94604
Phone: (510) 464-6173
Fax: (510) 464-6196
E-mail: innaji@bart.dst.ca.us



FIG. 5-15.
DETECTABLE WARNING
SURFACE AT A BART
STATION, CALIFORNIA.

Claremont, California

History



Detectable warnings have been installed on a trial basis at a roundabout in Claremont, CA. The temporary installation is at curb-ramps and median edges and was installed in about October, 1999. Two-foot wide sections were glued down at the ends of the curb-ramps and in the middle of the cut-through area of the splitter island.

Mr. Desatnik states: “In a permanent installation, we would probably try to put the tactile material on both entrances to the cut-through area of the splitter islands.... It is very important for the blind user to know exactly where they are in the splitter island.... With the tactile material at each edge, once they hit the first one, then they know they are in the safe zone, then when they hit the second strip, they know they are at the edge of the travel lane and ready to cross the street.”

Materials and Installation

The detectable warning is a rubber tile product that has been glued down on the surface of the ramp and median areas, on top of the existing pavement. A slight lip of approximately ¼ in is caused by the material thickness.

Maintenance and Durability

- The material is not cleaned.
 - The durability has not really been tested, since the material has been installed recently.
 - There have been no problems with lifting or peeling.
-

Acceptance

Concerns regarding a tripping hazard are “an inflated concern”
Brian Desatnik,
Housing and
Redevelopment
Coordinator

No pedestrian complaints have been received about the detectable warnings. Mr. Desatnik feels that concerns regarding a tripping hazard are “an inflated concern”.

Comments from individuals who are blind are very positive about the detectable warning. These individuals are not happy with the roundabout design, however they have stated that the detectable warning helps them know where the median is. Elderly pedestrians are complaining about the roundabout crossings, but not about the detectable warning.

Contact

Brian Desatnik
Housing & Redevelopment Coord.
City of Claremont
207 Harvard Avenue
Claremont, CA 91711

Phone: (909) 399-5341
Fax: (909) 399-5366
E-mail:
Bdesatnik@ci.claremont.ca.us

Chapter 6

U.S. Use of Detectable Warning Surfaces: Applications

Summary

Recommended locations for use of truncated dome detectable warnings that are currently being considered in the U.S. include curb-ramps, islands and medians, raised crosswalks, and raised intersections.

This chapter summarizes and illustrates recent guidelines and recommendations on the use of detectable warnings in locations other than transit platforms.

None of the recommendations should be construed to represent the opinion of the authors or of the Access Board.

Chapter contents

This chapter covers the following topics.

Topic	Page
Sources of recommendations	102
Recommendations for detectable warnings at curb-ramps	105
Detectable warnings at hazardous vehicular ways	109
Detectable warnings at medians and islands	110
Detectable warnings at raised crosswalks and raised intersections	112

Sources of recommendations

Purpose of this chapter

With the exception of the *Americans with Disabilities Act* requirement (ADAAG 10.3.1(8)) for 24 in deep truncated dome detectable warnings at transit platform edges having drop-offs (see Chapter 2), there is no national requirement in the U.S. for the use of truncated dome detectable warnings in other locations.

- However, a number of publications that followed ADAAG, including local and state standards, resolutions of organizations of and for people who are blind, and a workshop on the topic conducted by Project ACTION provide recommendations or guidance on other uses of truncated dome detectable warnings in locations where pedestrians who are blind do not have a definitive cue to the end of the pedestrian way.
 - These recommendations are summarized and illustrated in this chapter.
 - Readers will note that some of the recommendations are in conflict with one another.
 - **None of the recommendations should be construed to represent the opinion of the authors or of the Access Board.**
-

ADAAG

As published in 1991, ADAAG included scoping and technical provisions for detectable warnings on transit platform edges, curb-ramps, hazardous vehicular ways and at reflecting pools. The specific sections in ADAAG are re-printed in Chapter 2. In this chapter (6), ADAAG requirements for locations other than transit platforms are illustrated for the sake of comparison with other recommendations.

California Title 24

Title 24, California Code of Regulations is the California accessibility code. The 1999 edition requires detectable warnings on curb-ramps having a slope less than 1:15, at hazardous vehicular ways, and on all transit boarding platforms. The specifications for the detectable warning are similar to those in ADAAG 4.29.2, but a little more specific. Detectable warnings at most curb-ramps, at hazardous vehicular ways, and on transit platforms require a more precisely specified surface texture: the dome diameter shall be .9 in, measured at the bottom of the dome, tapering to .45 in at the top. Detectable warnings on curb-ramps for privately funded housing, at hazardous vehicular ways, and on transit platforms shall be safety yellow (Federal color 33538).

Continued on next page

Sources of recommendations, continued

Project ACTION panel of experts

On June 4-5, 1995, Project ACTION, at the request of the Access Board, convened a panel of experts to consider the needs of pedestrians with visual impairments when using intersections. The 22 panel members represented the following constituencies and areas of expertise.

- Two major organizations of people who are blind
- Orientation and mobility specialists
- Civil engineers
- Transportation engineers
- Assistive technology experts
- Experts in human/ergonomic factors

The panel recommended the use of detectable warnings on curb-ramps.

Accessible Rights of Way: A Design Guide

In November 1999, the U.S. Access Board published *Accessible Rights-of-Way: A Design Guide*. This guide contains best practice recommendations for the design, construction, alteration, and retrofit of public pedestrian facilities. Detectable warnings are recommended as one way to make boundaries between sidewalks and streets perceptible at curb-ramps, at raised crosswalks, and at cut-through islands. The guide does not provide recommendations for specific placement and dimensions of the detectable warnings, however.

Designing Sidewalks & Trails for Access: Part II. A Best Practices Guidebook

Designing sidewalks and trails for access: Part II of II: A best practices guidebook (Axelson, Chesney, Galvan, Kirschbaum, Longmuir, Lyons, and Wong) is to be published in late 2000 by the Federal Highway Administration. This detailed, well-illustrated guide to best practices for designing accessible sidewalks and trails contains numerous drawings showing locations for and dimensions of detectable warnings on curb-ramps, at depressed corners, at cut-through and ramped medians and islands, and at level railroad crossings.

ACB Street Design Guidelines

In 1999 the American Council of the Blind (ACB) produced *Street Design Guidelines*, which recommends the placement of 24 in deep detectable warnings at the bottom of curb-ramps and at locations where the pedestrian walkway is level with the street. The guidelines caution against the overuse of detectable warnings, recommending that the truncated dome surface be used only as a warning, never for guidance.

Continued on next page

Sources of recommendations, continued

Roseville, CA	Roseville standard plans require 36 in deep detectable warnings at the bottom of curb-ramps instead of the full surface of the curb ramp as required by California Title 24. Precast detectable warning panels are used.
Cambridge, MA	Cambridge specifications require detectable warnings on sidewalks, at the street edge, at locations with raised crosswalks or raised intersections.
Austin, TX	Austin specifications require detectable warnings on curb-ramps in the central business district. A 4 x 5 ft section of pavers is used on most curb-ramps.
Baltimore County, MD	Baltimore County, MD, specifications call for 32 in deep detectable warnings at the bottom of curb-ramps including the radius of blended curbs.
AER resolutions	The Association for Education and Rehabilitation of the Blind and Visually Impaired (AER) adopted resolutions in 1992, 1994 and 1998 calling for the use of detectable warnings. The 1994 and 1998 resolutions specifically called for a 24 in deep detectable warning at the bottom of curb-ramps.
ACB resolutions	The American Council of the Blind (ACB) adopted resolutions in 1994, 1995, 1996 and 1998, favoring the use of detectable warnings. ACB resolutions in 1995 and 1996 requested the placement of detectable warnings on the bottom 24 in of curb-ramps. A resolution passed in 1994 called for detectable warnings at level track crossings.
NFB resolutions	The National Federation of the Blind (NFB) adopted resolutions in 1992, 1993, 1994 and 1995 opposed to the installation of truncated dome detectable warnings because they were considered to be costly, not necessary, and possibly harmful to the independent mobility of blind pedestrians.

Recommendations for detectable warnings at curb-ramps

Whole surface of ramp— ADAAG

ADAAG originally required detectable warnings on the full surface of curb-ramps. Flares were not required to have detectable warnings.

FIG. 6-1. ADAAG DETECTABLE WARNING DESIGN (TEMPORARILY SUSPENDED).

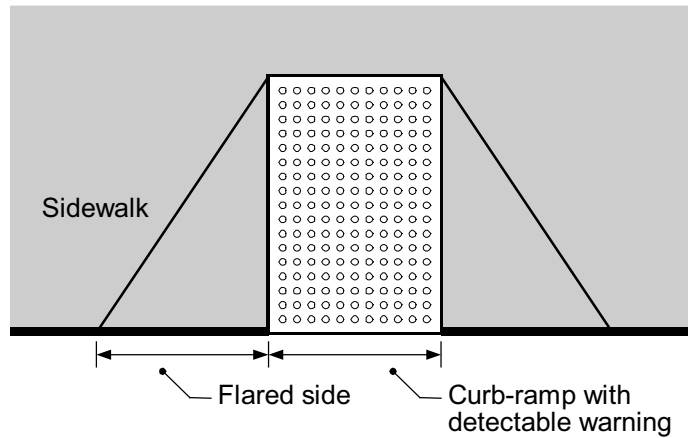

FIG. 6-2. SPLITTER ISLAND WITH DETECTABLE WARNING ON FULL SURFACE OF CURB RAMP, AUSTIN, TX.



Continued on next page

Recommendations for detectable warnings at curb-ramps, continued

Whole surface of ramp— California Title 24

“The only legal action related to detectable warnings in California has been one threatened suit in W. Sacramento. A bicyclist was injured. The city was not considered liable because the domes were required by state law.” Michael Mankin, AIA, CA office of the State Architect.

Since 1994, California Title 24 has required detectable warnings on the full surface of curb-ramps having slopes less than 1:15. The detectable warning on transit platforms must be safety yellow (Federal Color No. 33538).

The California specifications for the detectable warning texture for curb-ramps and transit platforms are more precise than those in ADAAG, specifying that the 0.9 in dome diameter is to be measured at the base of the dome, and the top diameter is to be 0.45 in. The 2.35 in dome spacing is to be measured on the diagonal of a square pattern of domes.

California has also required a ½ in beveled lip at the lower end of each curb ramp since 1982. The requirement for the ½ in beveled lip was the result of extensive consultation involving both pedestrians who are blind and people who use wheelchairs as a mobility aid. The ½ in beveled lip was to indicate to pedestrians who are blind the location of the bottom of the ramp, and the lip was not considered to make curb-ramps inaccessible to people who use wheelchairs.

California Title 24 also requires a grooved border 12 in wide at the level surface of the sidewalk along the top and each side. The grooves are approximately ¾ in on center.

FIG. 6-3. CURB-RAMP DESIGN REQUIRED BY CALIFORNIA TITLE 24.

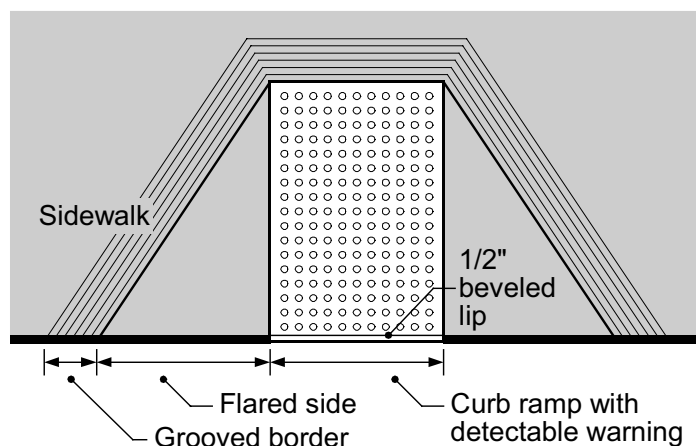

Bottom 3 feet— Roseville, CA

The City of Roseville, CA requires that a 3 ft deep strip of detectable warning surface extend the width of the curb-ramp. See Figure 5-9 in the Roseville Case Study.

Continued on next page

Recommendations for detectable warnings at curb-ramps

Bottom 2 feet— multiple sources

Placing detectable warnings only on the bottom 2 ft of curb-ramps has been recommended in a number of sources.

- The panel of experts convened by Project ACTION at the request of the Access Board, on June 4-5, 1995, recommended that 24 in deep detectable warnings be placed at the bottom of curb-ramps.
- The same recommendation is made in *Designing sidewalks and trails for access: Part II of II: A best practices guidebook* (Axelson, et al., 2000, FHWA).
- Multiple resolutions passed by the AER and by the ACB have also called for 24 in deep detectable warnings at the bottom of curb-ramps.
- All of these sources suggest that parallel alignment of the truncated domes may make it easier for people with mobility impairments, especially those who use wheelchairs, to use curb-ramps having detectable warnings.

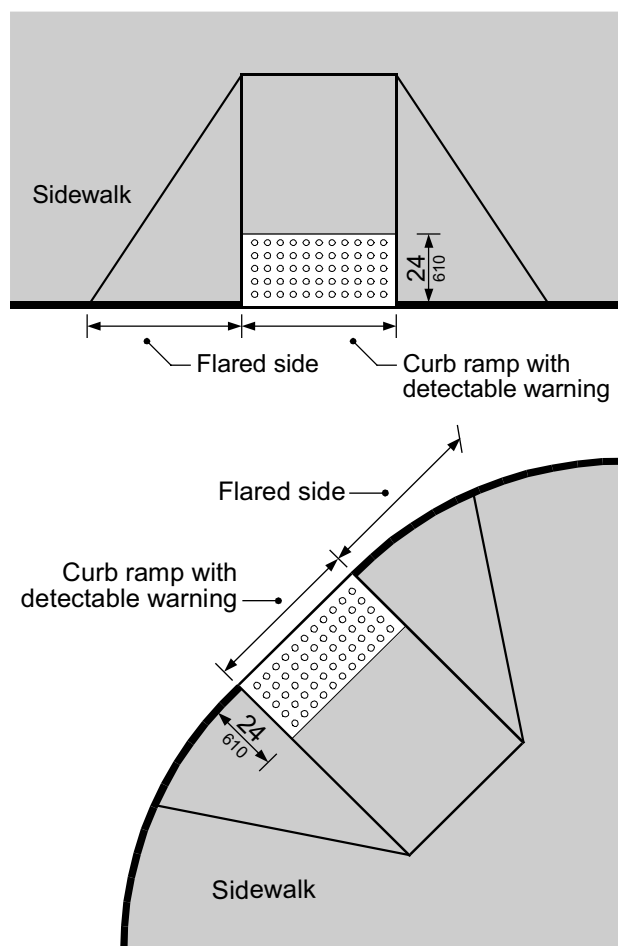

FIG. 6-4. CURB RAMP
DESIGNS SHOWING
24 IN DETECTABLE
WARNING.

Continued on next page

Recommendations for detectable warnings at curb-ramps, continued

Parallel curb-ramp

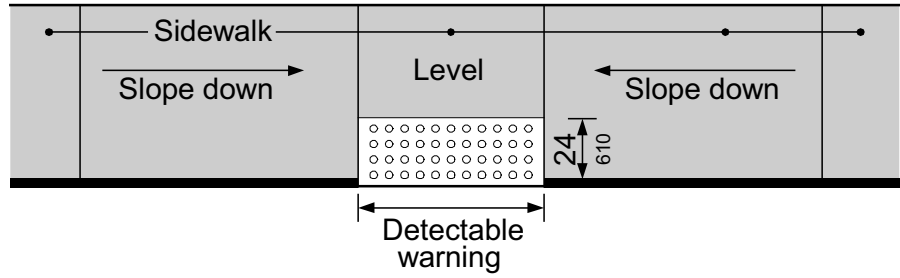

FIG. 6-5. PARALLEL CURB-RAMP DESIGN SHOWING RECOMMENDED 24-INCH DETECTABLE WARNING.

Detectable warnings at hazardous vehicular ways

California Title 24

California Title 24 requires that “If a walk crosses or adjoins a vehicular way, and the walking surfaces are not separated by curbs, railings or other elements between the pedestrian areas and vehicular areas, the boundary between the areas shall be defined by a continuous detectable warning which is 36 inches (914 mm) wide....” It must be safety yellow.

Several types of hazardous vehicular ways are shown below.

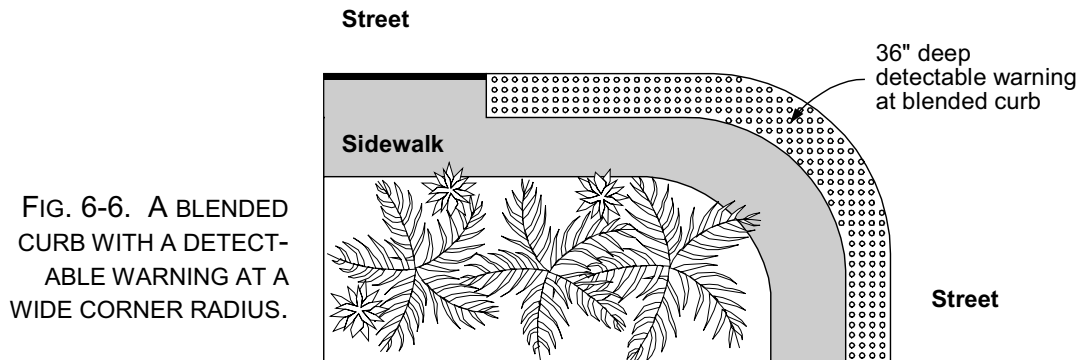

FIG. 6-6. A BLENDED CURB WITH A DETECTABLE WARNING AT A WIDE CORNER RADIUS.

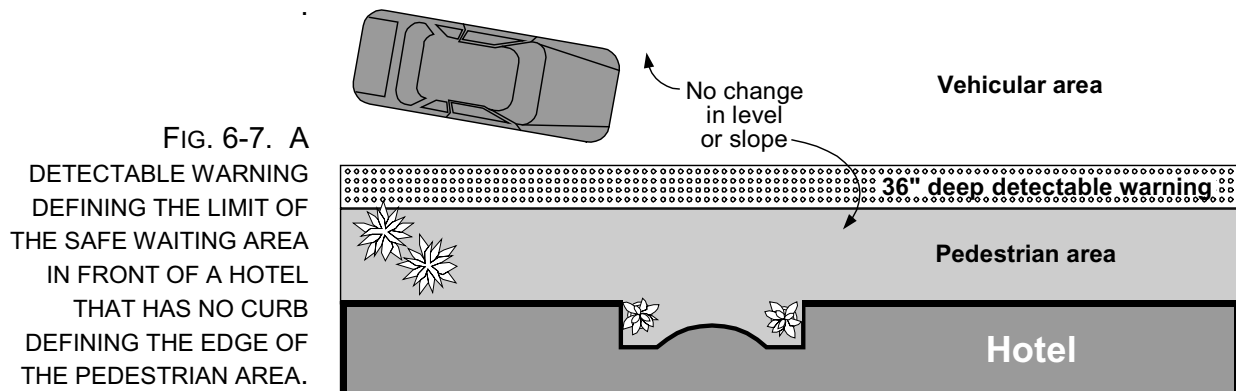

FIG. 6-7. A DETECTABLE WARNING DEFINING THE LIMIT OF THE SAFE WAITING AREA IN FRONT OF A HOTEL THAT HAS NO CURB DEFINING THE EDGE OF THE PEDESTRIAN AREA.

Detectable warnings at medians and islands

Cut-through medians

Placement of detectable warnings on cut-through medians varies with the width of the median.

- *Designing sidewalks and trails for access: Part II of II: A best practices guidebook* (Axelson, et al., 2000, FHWA) recommends a 24 in deep detectable warning at each side of the cut-through walking surface.
- There is no U.S. recommendation that deals with narrow medians, however United Kingdom guidelines (*Guidance on the Use of Tactile Paving Surfaces*, 1998) recommend that on medians no more than 4 ft wide, the detectable warning should cover the entire depth and width of the cut-through.
- Medians that have curb-ramps should have detectable warnings following the guidelines for curb-ramps.

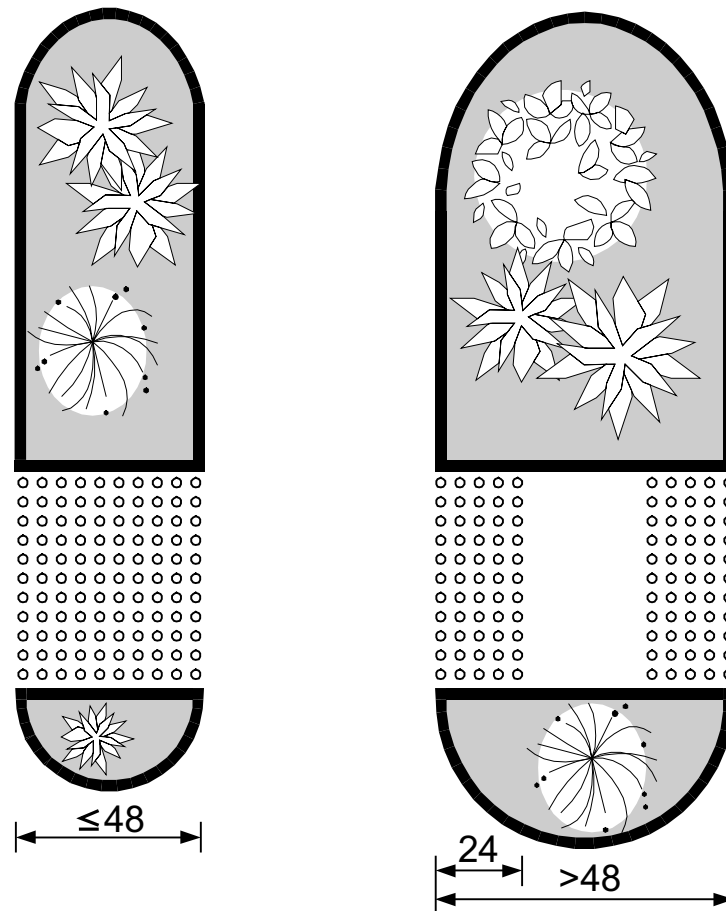

FIG. 6-8. DETECTABLE WARNINGS USED AT CUT-THROUGH MEDIANS.

Continued on next page

Detectable warnings at medians and islands, continued

Cut-through splitter islands

Designing sidewalks and trails for access: Part II of II: A best practices guidebook (Axelson, et al., 2000, FHWA) recommends a 24 in deep detectable warning at each end of all cut-through walking surfaces.

This is also recommended in the United Kingdom publication, *Guidance on the Use of Tactile Paving Surfaces* (1998).

FIG. 6-9. SPLITTER ISLAND: PEDESTRIAN PASSAGE THROUGH THE ISLAND IS AT THE SAME LEVEL AS THE STREET. DETECTABLE WARNING IS SHOWN AT EACH END OF CUT-THROUGH WALKING SURFACES.

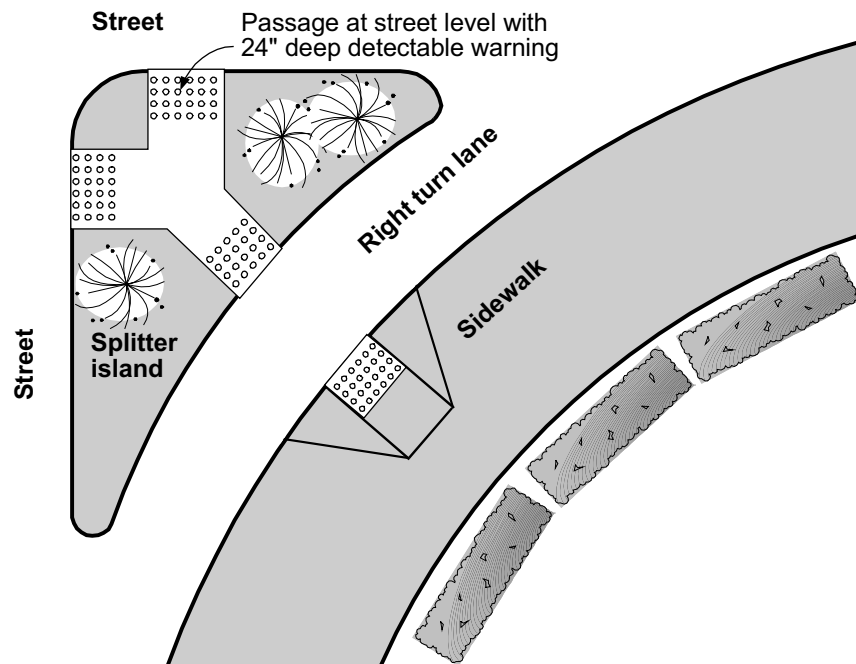

Detectable warnings at raised crosswalks & raised intersections

Raised crosswalks & raised intersections

Designing sidewalks and trails for access: Part II of II: A best practices guidebook (Axelson, et al., 2000, FHWA) recommends a 24 in deep detectable warning on the sidewalk at each end of raised crosswalks.

This design is required by Cambridge, MA specifications.

FIG. 6-10. AT LEFT, A RAISED INTERSECTION. AT RIGHT, A RAISED CROSSWALK SHOWN AT MIDBLOCK

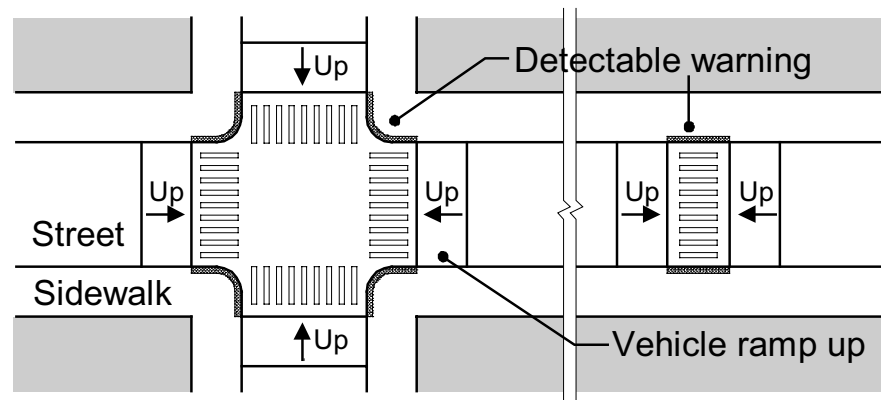

A raised intersection is a traffic calming element that has flat raised areas covering the entire intersection, including adjoining crosswalks, with vehicle ramps on all street approaches. A raised intersection is also known as a raised junction, intersection hump, table, or plateau.

Fitting to a blended curb at a raised intersection

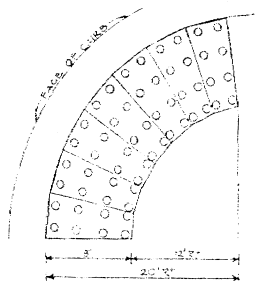

Installing detectable warnings around a corner radius can be accomplished in two ways.

- In Towson, MD, brick pavers are cut into a trapezoidal shape and then fitted together (see Case Study: Baltimore County).
- Alternatively, they can be splayed apart (see Fig. 7-5).
- Either design results in some domes being closer than others are. Small irregularities in dome spacing do not appear to decrease detectability (Bentzen et al., 1993).

FIG. 6-11. DESIGN DRAWING SHOWING CUTTING PATTERN FOR BRICK DETECTABLE WARNING PAVERS AT THE RADIUS CURB LINE OF A RAISED CROSSWALK (TOWSON, MD).

Chapter 7

U.S. Detectable Warning Products

Summary

This chapter includes information on detectable warning products that are produced in the U.S. Information in this chapter is based on research and telephone interviews conducted in late 1999 through April 2000.

Only products and tooling systems generally complying with ADAAG technical provisions for truncated dome detectable warnings are included.

Chapter contents

This chapter covers the following topics:

Topic	Page
Spacing of truncated domes	114
Shape of truncated domes	116
Types of detectable warning products	117
Dimensional pavers	118
Thin tiles and sheet goods	119
On-site fabrication of truncated dome surfaces	120
Characteristics of detectable warning products	123
Detectable warning product matrix	125
Photographs of detectable warning products	126
Detectable warning manufacturers	132

Spacing of truncated domes

Manufacturing standards

In complying with the *Americans with Disabilities Act Accessibility Guidelines* (ADAAG), manufacturers have adopted various dome configurations to accommodate existing industry-standard sizes of paving products

ADAAG technical specification

The ADAAG 4.29.2 (1991) specification for a detectable warning surface is an array of truncated domes. (See the full specification at the beginning of Chapter 2.)

ADAAG includes no illustration of the truncated dome profile or of the dome pattern. It also does not specify where required dimensions are measured.

However, the Access Board issued *Detectable Warnings Bulletin #1* in 1993 to provide additional guidance. A figure in this bulletin shows spacing (2.35 in) measured diagonally. Another figure shows the .9 in dome diameter applied to the base of the domes.

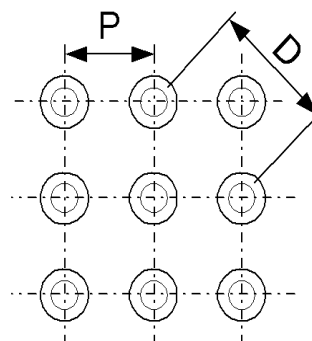

FIG. 7-1. DOME SPACING CAN BE MEASURED EITHER (ADJACENT) PARALLEL (P) OR DIAGONALLY (D).

Brick pavers

Detectable warning brick pavers must conform to the relatively small 4 in x 8 in module to be compatible with the industry standard for flat surface pavers.

Four manufacturers have handled the truncated dome spacing in an identical manner:

- Adjacent spacing = 2.00 in
- Diagonal spacing = 2.82 in

This is a slightly larger dome to dome spacing than is typically found for larger tiles.

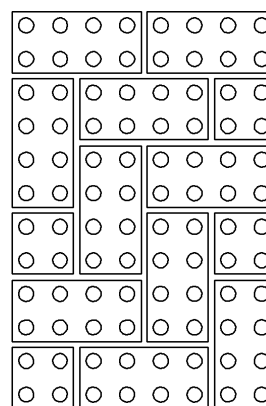

FIG. 7-2. HERRINGBONE BOND WITH DETECTABLE WARNING BRICK PAVERS.

Continued on next page

Spacing of truncated domes, continued

Pattern repetition

Most detectable warning products are configured so that repeating a single unit (tile, paver, or sheet) will result in a continuation of the ADAAG-specified pattern of truncated domes. A gap in pattern between adjacent tiles does not impair detectability (Bentzen et al., 1993).

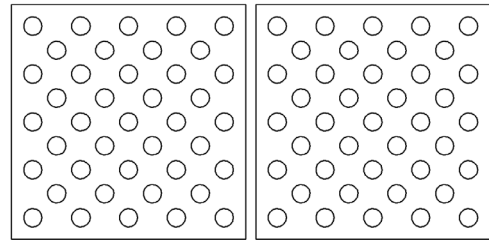

FIG. 7-3. TYPICAL 12"X12" TILES.

Complementary tile pairs

One manufacturer (Crossville Ceramics) produces a detectable warning tile system consisting of two complementary tile pairs:

- Type A tile (rows of 3-2-3-2-3 domes)
- Type B tile (rows of 2-3-2-3-2 domes)

Type A tiles are used in conjunction with Type B tiles to produce an unbroken, repeating pattern.

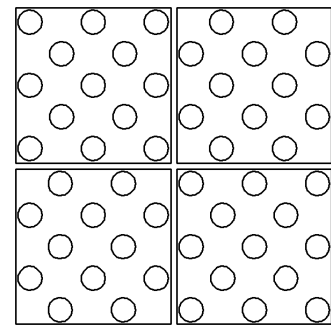

FIG. 7-4. COMBINATION OF 12 AND 13 DOME TILES.

Working with irregular shapes

Fitting square modular pavers within the irregular shape of a radius curb line can be a challenge. Systems with field-applied truncated domes can accommodate to irregular surfaces and to irregular boundaries.

Figure 7-5 shows how detectable warning pavers can be splayed to match the radius of a street boundary.

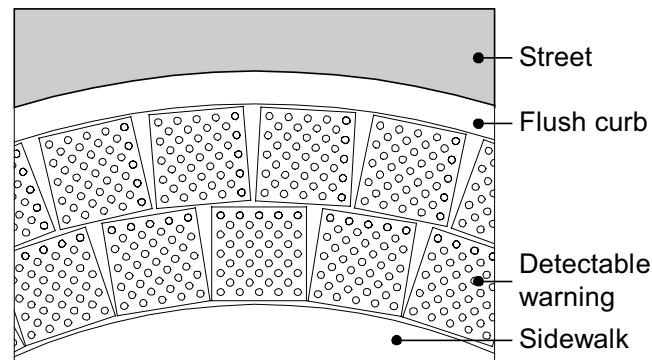

FIG. 7-5. SPLAYED 12 IN TILES ON AN 8 FT TO 10 FT RADIUS.

Shape of truncated domes

Truncated dome diameter

There are two ways to conform to ADAAGs dome size specification: Generally U.S. manufacturers apply the required 0.9 in dimension at the truncated dome base.

Two products conform by applying the dimension to the flattened dome top.

Figure 7-6 illustrates how domes with different base diameters conform to ADAAG. The dome on the right has a base diameter of 1.25 in.



FIG. 7-6. APPLYING DOME DIMENSION GUIDELINES.

Manufacturers' response

The ADAAG specification is open to a number of interpretations. In part, this explains why currently available detectable warning products vary considerably in appearance.

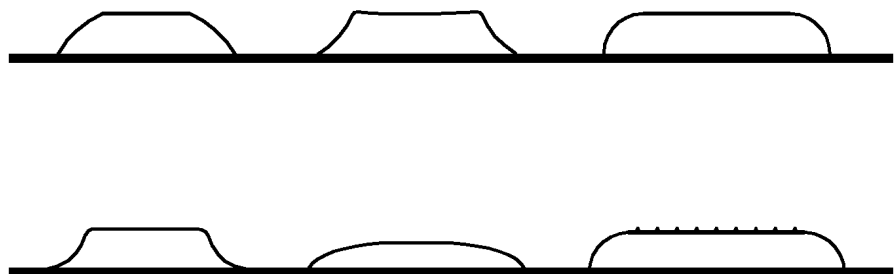

FIG. 7-7. FULL-SCALE CROSS SECTIONS OF TRUNCATED DOMES FROM VARIOUS PRODUCTS.

Types of detectable warning products

Summary

Detectable warning products are produced using a variety of manufacturing processes and materials.

- Natural stone and stone composites
- Brick and concrete
- Rigid polymer and flexible polyurethane sheets and tiles
- Large precast assemblies
- Tools to produce the warning surface in wet concrete
- Surface applied domes used with membrane decking

Each product type is discussed in this chapter. Manufacturers' names are included in parentheses.

Use of term “detectable warning”

This publication uses the term “detectable warning” to mean the walking surface consisting of truncated domes as specified ADAAG.

A number of other textured surfaces are used for flooring and paving. These are not highly detectable and are not comparable in usability to truncated domes.

Rely on current specifications

Persons selecting detectable warning products should rely on current specifications. Manufacturer's product literature may feature products that comply with out-of-date specifications such as ANSI A117.1-1986, which has been superseded by ANSI A117.1-1998.

Details should be verified

This chapter discusses detectable warning products available in the U.S. at the time of writing. The discussion is based on sales/technical literature and product samples, and is an introduction to the wide variety of material types that are offered. Far more options are available than can be suggested in this brief space.

All product specifications should be verified with their respective manufacturers for accuracy and current availability.

Dimensional pavers

Definition

Dimensional pavers as discussed in this section include all products that are sufficiently thick to require that they be recessed into the platform, sidewalk, or curb ramp.

These products vary in thickness from ½ in to 3 or 4 in.

Natural stone, stone composites, & ceramic tile

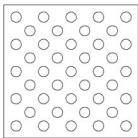

Paving stones manufactured with a truncated dome surface are available in natural granite (Cold Spring Granite) and a similar looking product made of reconstituted granite (Ryowa from Architectural Tile & Granite) which is pressed and fired at high temperature.

Crushed limestone and granite pavers are available (Hanover) as two inch thick pavers in nominal 12 in x 12 in, 24 in x 24 in, and 24 in x 36 in sizes.

Detectable warning products marketed as ceramic tiles and porcelain stone tiles (Summitville and Crossville) are designed to be used in conjunction with a wide range of modularized flooring tile systems.

Brick pavers



Brick and concrete brick pavers that incorporate truncated domes are produced in nominal 4 in x 8 in sizes. This includes pavers measuring an actual 4 in x 8 in, and those that are 3 5/8 in x 7 5/8 in that include a mortar allowance. Thicknesses vary from ½ in to 2¼ in.

Detectable warning brick pavers (and concrete brick pavers) have a uniform spacing of truncated domes that allows the bricks to be laid in a running bond, stack bond, or herringbone pattern (See Fig. 7-2).

Large precast units

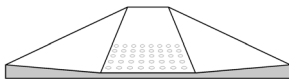

Large precast concrete units are available for detectable warning surfaces. One manufacturer (Steps Plus) makes a 3 ft square sidewalk unit, and a curb ramp unit with ramp and flared sides cast in concrete as a single unit.

Durability of domes has been reported as a problem with some concrete products (see Chapter 5).

One composite stone product (Hanover) mentioned above also markets detectable warning pavers up to 2 ft x 3 ft in dimension.

Thin tiles & sheet goods

Definition

Thin tiles and sheet goods are discussed in this section. This grouping includes those products that are a nominal 1/8 in thick.

These products may be applied to the surface of a new or existing platform, sidewalk, or curb ramp. Often these products are available with a beveled edge to make a smoother transition to adjoining surfaces.

Rigid & flexible product composition

Two manufacturers (ADA Fabricators and Engineered Plastics) supply rigid tiles or panels of polymer composition. The material is described as:

- Glass and carbon reinforced copolymer composite, or
- Vitrified Polymer Composite (VPC).

One supplier (Disability Devices Distributor) offers a flexible tile or mat described as:

- Flexible polyurethane.
-

Tile size

Applied tiles or panels with truncated domes are available in a variety of sizes including: 12 in x 12 in; 24 in x 24 in; 24 in x 36 in; and 24 in x 48 in.

These products are a nominal 1/8 in thickness (exclusive of the height of the truncated domes).

Armor-Tile (Engineered Plastics) also has a second detectable warning product available with truncated domes of 0.9 in top diameter and 1.325 in base diameter. This distinctive product has dome spacing closely resembling that used on the 4 in x 8 in brick pavers.

Installation

Surface applied tiles are secured to the substrate with a structural adhesive system. Two products (Engineered Plastics and Disability Devices Distributor) are available with optional mechanical fasteners that function as anchors into the supporting surface.

In addition, two of these manufacturers offer a thick composite shell product that can be filled with concrete and installed similar to a paving stone.

On-site fabrication of truncated dome surfaces

Definition

Several detectable warning products consist of systems that are fabricated on-site. Three different approaches are used:

- Truncated domes produced by molding or stamping the top surface of freshly poured concrete
- Individual truncated domes transferred from a carrier sheet to new or existing platform, sidewalk, or curb ramp.
- Domes “flowed” onto a surface guided and formed by a fixed or moveable template.

On-site production of domed surface

Individual truncated domes may be applied to an existing surface, often concrete, sometimes metal. Fig. 7-8 shows an example of a truncated dome surface being created on-site.

Domes are produced from a catalyzed carboxylated latex emulsion. The field between domes (if used) is a latex vinyl copolymer applied by roller.

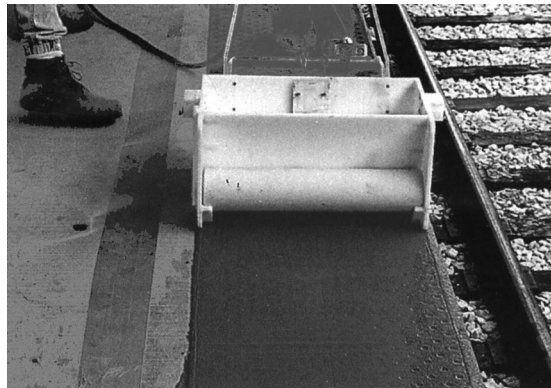

FIG. 7-8. APPLICATOR MACHINE IS PULLED AT STEADY SPEED AS MATERIAL FROM THE HOPPER IS PLACED AS TRUNCATED DOMES ON PLATFORM SURFACE BELOW (STRONGWALL).

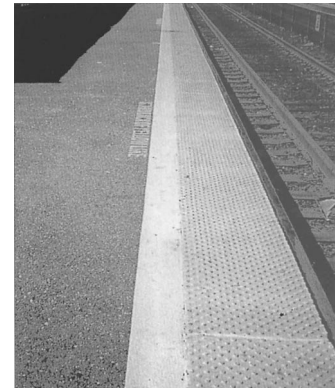

FIG. 7-9. COMPLETED DETECTABLE WARNING APPLICATION AT RAILROAD PLATFORM (STRONGWALL).

Continued on next page

On-site fabrication of truncated dome surfaces, continued

Stamped concrete

Local concrete contractors use stamping tools to produce raised truncated domes on the surface of freshly poured concrete (Cobblecrete and Increte).

A high-quality surface can only be obtained with a skillful installer. See Chapter 5 for case study discussions of problems of casting truncated domes on a sloping surface. Quality control is necessary to prevent premature dome wear.

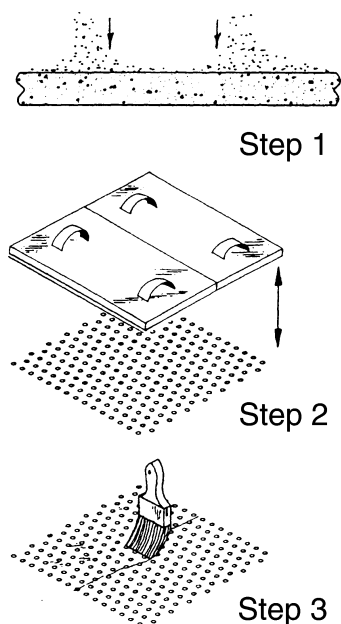

FIG. 7-10.
ONE PROCEDURE
FOR PRODUCING
STAMPED CONCRETE
(INCRETE SYSTEMS).

These on-site procedures for producing truncated domes are an extension of an existing technology which is widely used to impart textures to concrete surfaces to resemble slate, brick, flagstone, and so forth.

Concrete may be integrally colored, or have mineral pigments broadcast over the surface, or both.

The stamping tool may be rigid or flexible, and made of rubber or polyurethane. This tool is pressed into the concrete surface with sufficient force to create the pattern of truncated domes.

After the concrete surface has partially cured, a clear sealer is brushed on.

Detectable warnings that are not on grade

FIG. 7-11. TRUNCATED DOMES APPLIED TO A WOODEN RAILROAD PLATFORM (COTE-L).

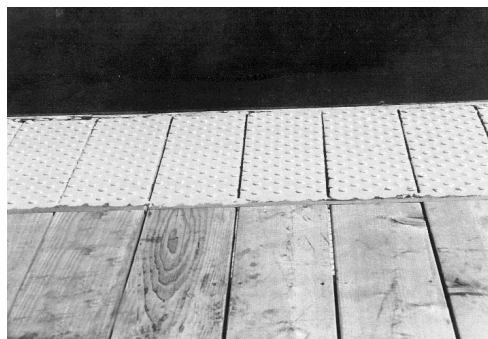

The surface-applied truncated dome products have a special advantage when a detectable warning surface is required on a flexible surface such as a wooden deck above grade.

The applied dome products are usually installed in conjunction with a membrane coating surface. This provides added traction on a surface such as wood that can become slippery when wet.

Continued on next page

On-site fabrication of truncated dome surfaces, continued

Surface-applied dome products

Individual truncated domes may be applied to an existing surface, often concrete or bituminous.

The domes of the Vanguard product (Tilco) may be applied to a surface as shown in Fig. 7-12. The underlying surface is not otherwise coated in this installation. Vanguard also offers a concrete micro-coating system which can be applied to the domes and immediately surrounding surface. This coating provides a high level of visual contrast in white or safety yellow.



FIG. 7-12.
SURFACE-APPLIED
TRUNCATED DOMES
SHOWN CONFORMING TO
IRREGULAR SURFACE
(VANGUARD / TILCO).

In one product application (COTE-L), a polyurethane coating is applied to the underlying surface. The coating includes rubber granules that give increased friction and resilience. Rubber truncated domes, which come attached to a carrier sheet, are pressed on top of the fresh polyurethane coating. The plastic carrier sheet is peeled off, and three additional coats of polyurethane coating are applied.

FIG. 7-13. (LEFT)
TRUNCATED DOMES ARE
ARRAYED ON A CARRIER
SHEET (COTE-L).

FIG. 7-14. (RIGHT)
DOMES SHOWN
ADHERED TO PLATFORM
SURFACE. A SAFETY
YELLOW POLYURE-
THANE COATING IS BEING
APPLIED (COTE-L)



Characteristics of detectable warning products

Slip resistance

Products use several methods to improve traction and reduce potential pedestrian slipping incidents:

- Glass beads embedded in the domes and/or a surface coating
 - Small raised bumps molded onto the field surface and dome surface of rigid polymer products
 - A gritty applied traction coating
 - Raised concentric circles on dome top
-

Color

Manufacturers offer detectable warning products in a wide range of standard and custom colors.

ADAAG requires that detectable warnings contrast with adjacent surfaces, but it does not specify a particular color. Research indicates that standardized safety yellow is especially visible, and it is strongly preferred by many people having low vision (Bentzen et al., 1995; Hughes, 1995). A number of products are available in safety yellow. Some products are available in a more muted yellow or buff color.

A traditional brick red color can be obtained by using traditional brick detectable warning pavers, concrete pavers with integral red color, or stamped concrete with red mineral pigments applied to wet concrete.

Traditional granite colors are available by using actual granite, or composite stone pavers that incorporate granite aggregates. In Atlanta, a polymer detectable warning material was matched to existing granite when this became an architectural requirement (see MARTA case study in Chapter 5).

Color is required by ADAAG to be integral to the product. Some products meet this requirement through the roller application of a heavy coating of pigmented pedestrian decking material. This should not be confused with surface painting.

Contrast

ADAAG (4.29.2) requires that the detectable warning surface contrast visually with adjoining surfaces, and the ADAAG Appendix to that document recommends that the materials should contrast by at least 70%.

Many products come in a wide range of colors from light grays and tans to dark red and blacks. Contrast at curb-ramps helps pedestrians with low vision recognize curb-ramps, and it helps in directing all pedestrians—especially those of short stature—toward the opposite corner.

Characteristics of detectable warning products, continued

Sound on cane-contact & resiliency

Detectable warning surfaces may also differ in resiliency from the adjoining platform, street, or sidewalk surface. This aids detectability under foot and with a long cane. One product (COTE-L) uses rubber domes that are inherently resilient. Another resilient product is flexible polyurethane tile (Disability Devices Distributor).

One product (Armor-Tile) has a series of raised bosses on the lower side of the tile. The purpose of these is to allow the tile to be supported without full adhesive coverage. This in turn produces a “hollow” sound that is detectable by a blind person using a long cane (Bentzen & Myers, 1997).

Durability

The durability of detectable warning products, particularly of the raised truncated domes, is an important concern.

Over the years, a number of jurisdictions have conducted laboratory and field tests of detectable warning products. In Chapter 3, refer to the section titled “Evaluation of detectable warning materials.”

For additional discussion, see the case studies in Chapter 5. Each case study covers durability and maintenance.

Detectable warning product matrix

MANUFACTURER / SUPPLIER	MATERIAL TYPE / COLOR	Natural & pressed stone	Concrete	Brick	Ceramic/porcelain tile	Polymer / polymer conc.	Flexible polyurethane	Rubber & other	Safety yellow	DOME GEOMETRY	Diagonal alignment	Parallel alignment	0.9" dome base diam.	0.2" dome height	Dome spacing	INSTALLATION	Recessed material	Surface applied	
	DIMENSIONAL																		
Cold Spring Granite		•									•	•	•	•	A		•		
Arch. Tile & Granite		•						•			•	•	•	•	A		•		
Hanover Arch. Prods.		•									•		•	•	A		•		
Steps Plus			•								•		•	•	A		•		
Summitville Tiles					•						•		•	•	A		•		
Crossville Ceramics					•						•		•	•	A		•		
Endicott Clay Prods.				•								•	•	•	B		•		
Whitacre-Greer				•								•	•	•	B		•		
Superock Block			•									•	•	•	B		•		
PAVESTONE			•									•	•	•	B		•		
Castek / Transpo						•		•			•		C	•	A		•		
THIN PAVERS																			
ADA Fabrications						•		•			•		•	•	A		•	•	
Engineered Plastics						•		•			•	•	•	•	A		•	•	
Disability Devices							•	•			•		•	•	A			•	
APPLIED DOMES																			
Vanguard-Tilco								•	•		•		D	D	A			•	
COTE-L								•	•		•		•	•	A			•	
Strongwall								•	•		•		•	•	A			•	
STAMPED IN PLACE																			
Cobblecrete			•								•				A		•		
Increte Systems			•								•				A		•		

Notes: Some manufacturers market products in addition to those noted above.

- A.** Adjacent spacing: 1.66" on center
Diagonal spacing: 2.35" on center
- B.** Adjacent spacing: 2.00" on center
Diagonal spacing: 2.82" on center

- C.** 0.90" dome top diameter
- D.** 1.1" dome base diameter;
0.15" dome height.

Photographs of detectable warning products

Sample photography

The photographs in this section are of product samples provided by the manufacturer. All products are shown at the same magnification.

Some manufacturers have more detectable warning products than are illustrated here. Many of the products come in a variety of sizes and thicknesses. The photographs here may not reflect product size; the sample may be cut from a larger paver block or sheet.

Note that the products which require placing truncated domes on an existing walking surface substrate are shown applied to a backing material (plywood or sheet plastic) which is not part of the product.

FIG. 7-15.
**COLD SPRING
GRANITE COMPANY**
R & S TRUNCATED
DOMES FINISH, IN
SIERRA WHITE.

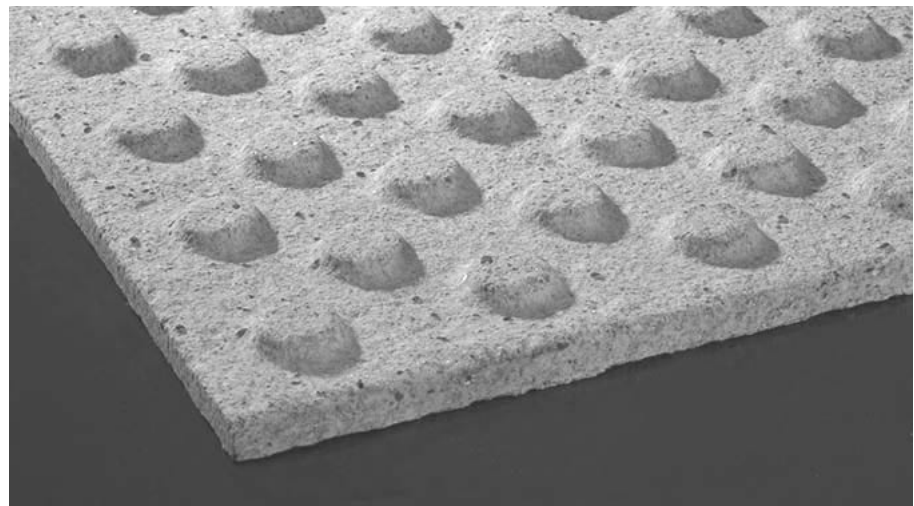
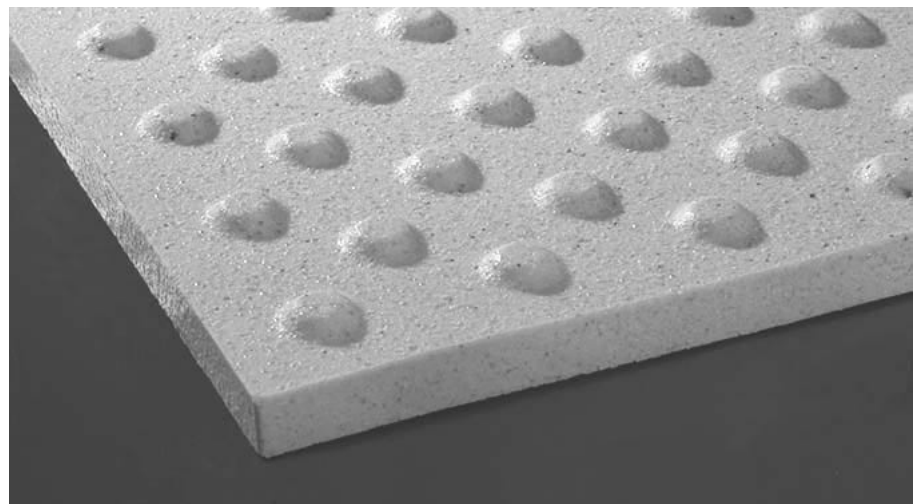

FIG. 7-16.
**ARCHITECTURAL TILE
& GRANITE, INC.**
RYOWA PRESSED STONE
PAVER - BRAILLE
SERIES, DOME TACTILE
TYPE WITH DIAGONAL
ROW.



Photographs of detectable warning products, continued

FIG. 7-17.
**HANOVER
ARCHITECTURAL
PRODUCTS, INC.**
RECONSTITUTED
PRESSED LIMESTONE &
GRANITE DETECTABLE
WARNING PAVER™.

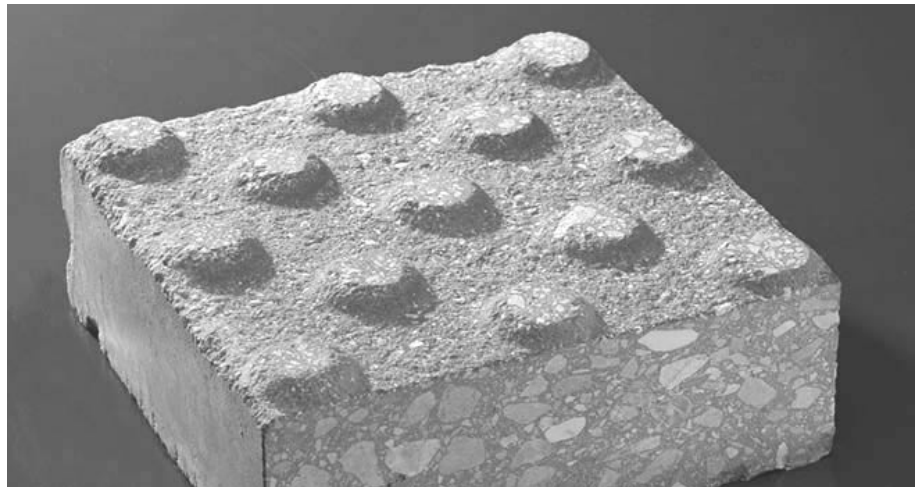

FIG. 7-18.
STEPS PLUS, INC.
PRECAST REINFORCED
CONCRETE.

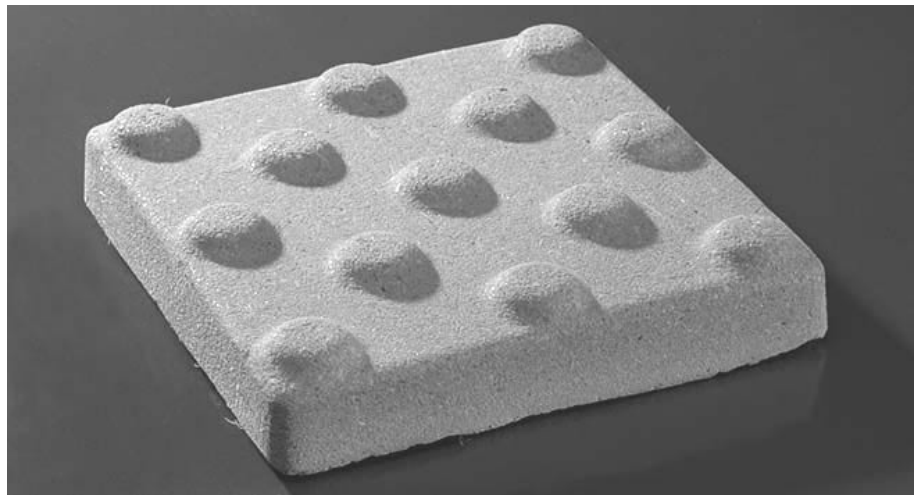

FIG. 7-19.
**SUMMITVILLE
TILES, INC.**
TACTILE-TREAD
CERAMIC TILE.



Photographs of detectable warning products continued

FIG. 7-20.
**CROSSVILLE CERAMICS
COMPANY, L.P.**
A301 TAC TILE.

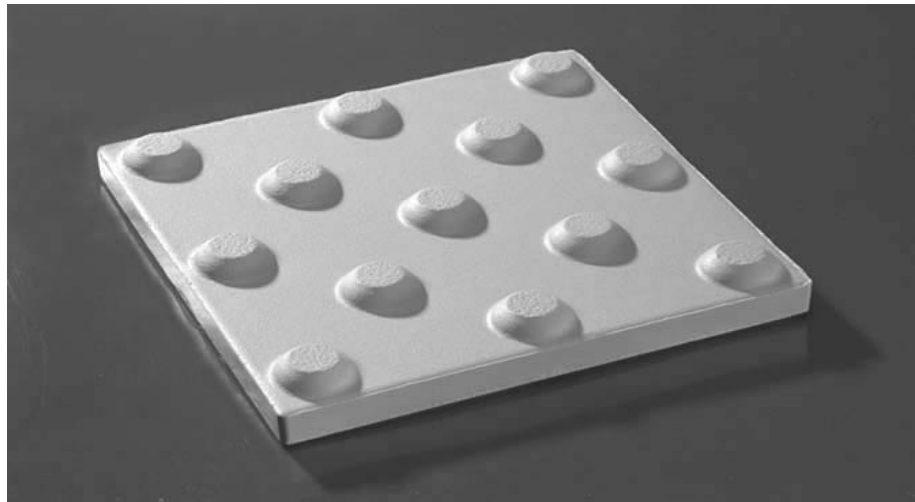
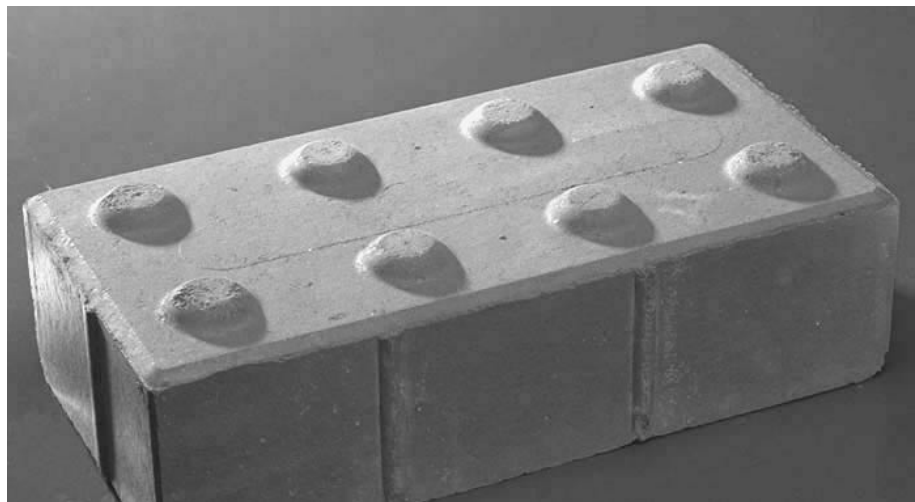

FIG. 7-21.
**ENDICOTT CLAY
PRODUCTS CO.**
HANDICAP DETECTABLE
WARNING PAVER.



FIG. 7-22.
**WHITACRE-GREER
FIREPROOFING CO.**
DETECTABLE WARNING
PAVER.



Photographs of detectable warning products continued

FIG. 7-23.
CASTEK, INC.
PRECAST POLYMER
CONCRETE TILE.

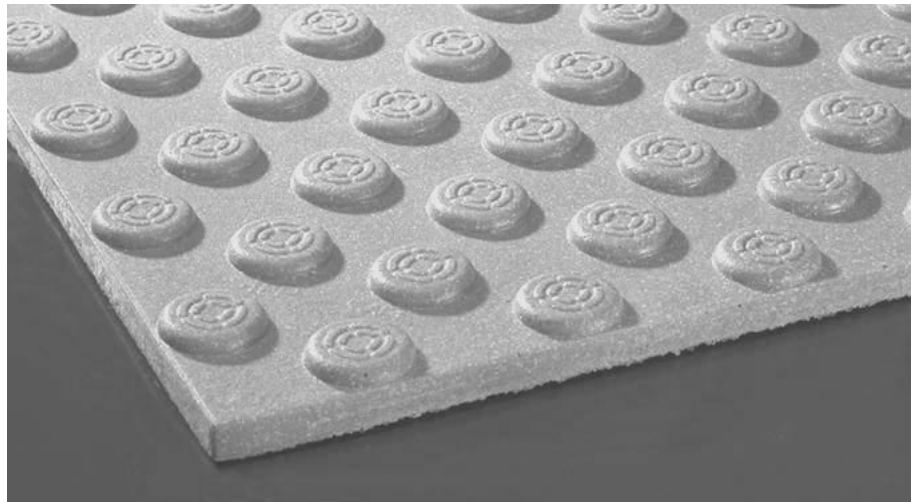

FIG. 7-24.
**ADA
FABRICATORS, INC.**
COPOLYMER COMPOSITE
TILE.

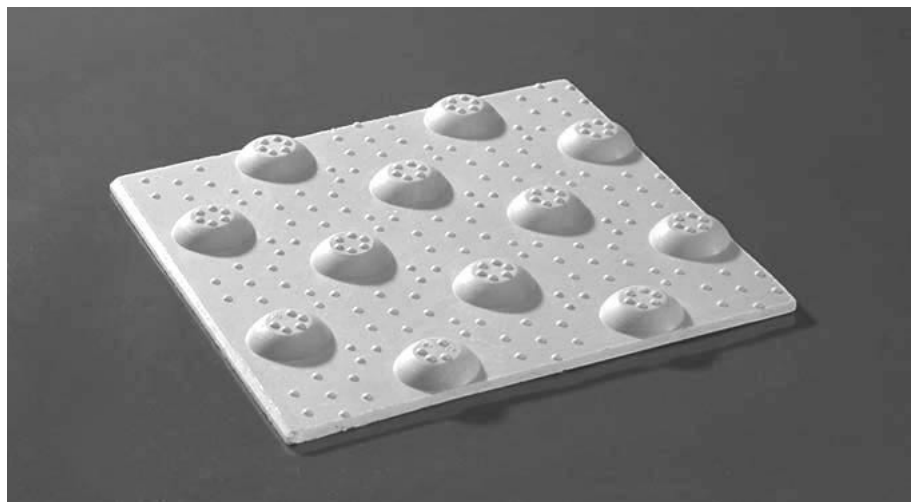
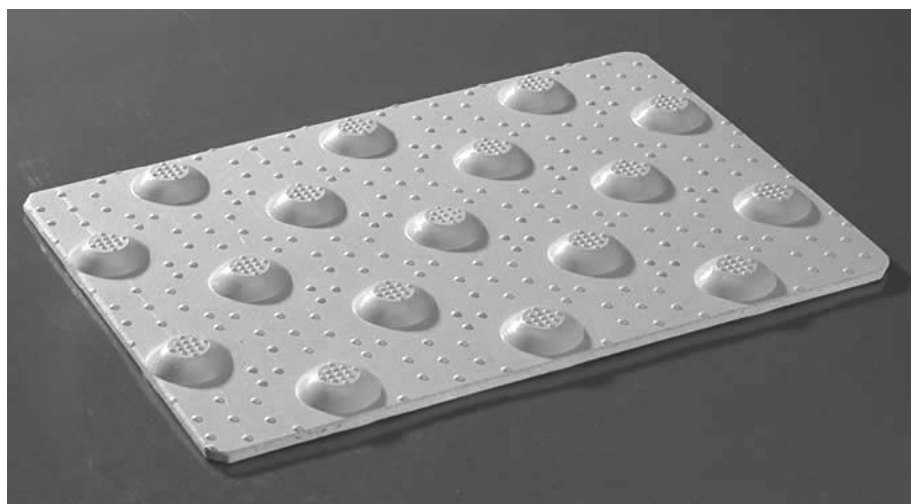

FIG. 7-25.
**ENGINEERED
PLASTICS, INC.**
ARMOR-TILE ADA
EPOXY POLYMER
COMPOSITE TILE.



Photographs of detectable warning products continued

FIG. 7-26.
**ENGINEERED
PLASTICS, INC.**
ARMOR-TILE STANDARD
EPOXY POLYMER
COMPOSITE TILE.

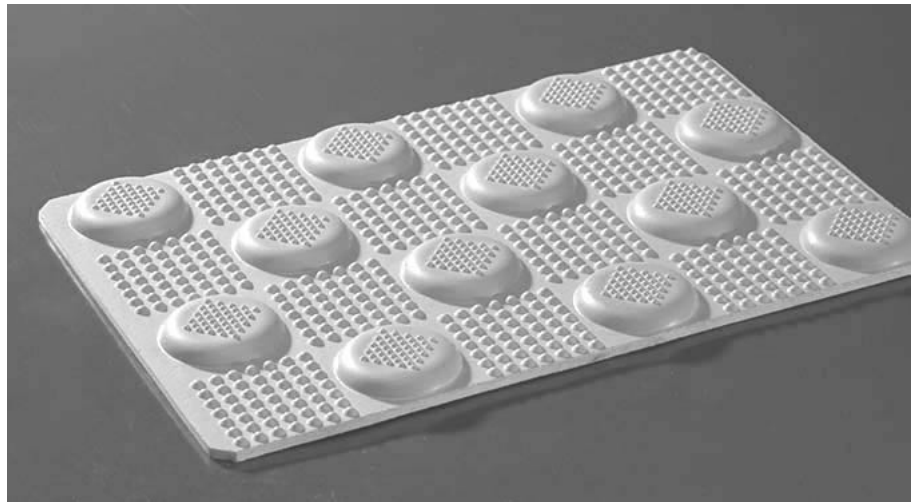

FIG. 7-27.
**DISABILITY DEVICES
DISTRIBUTOR**
POLYURETHANE
DETECTABLE WARNING
MAT™.

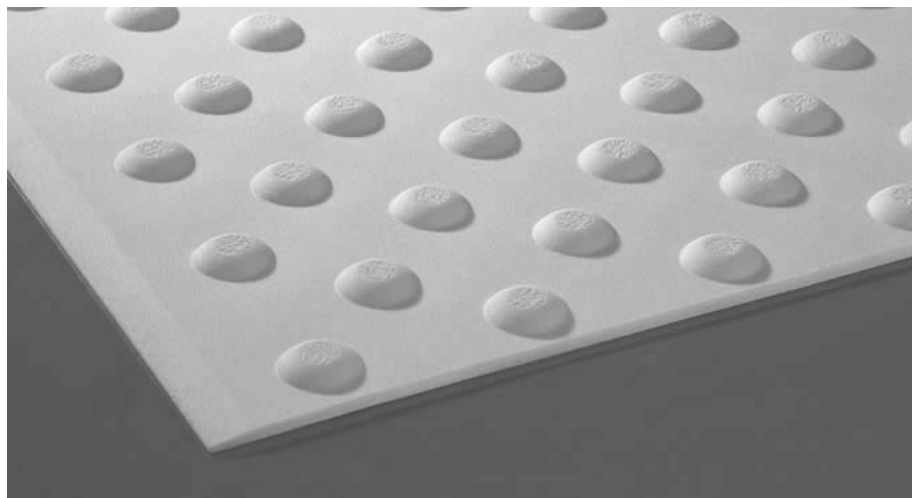

FIG. 7-28.
**VANGUARD ADA
PRODUCTS OF AMERICA,
TILCO, INC.**
APPLIED TRUNCATED
DOMES (SHOWN ON
BLACK SHEET ACRYLIC
BACKING FOR SAMPLE
ONLY).



Photographs of detectable warning products continued

FIG. 7-29.
COTE-L
INDUSTRIES, INC.
SAFTI-TRAX™ APPLIED
RUBBER DOMES &
DURABACK
POLYURETHANE
COATING (SHOWN ON
PLYWOOD BACKING
FOR SAMPLE ONLY).

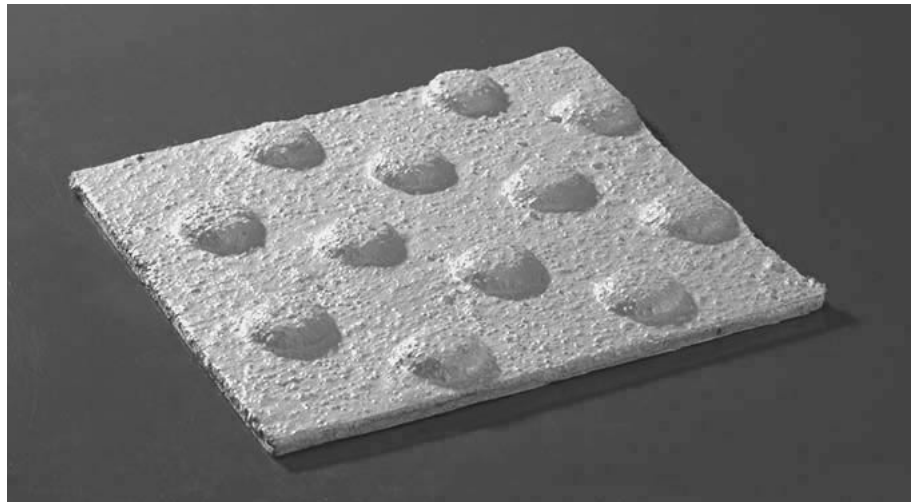

FIG. 7-30.
STRONGWALL
INDUSTRIES, INC.
APPLIED LATEX-
MODIFIED MORTAR
DOMES & TRAFFIC DECK
MEMBRANE SYSTEM
(SHOWN ON PLYWOOD
BACKING FOR
SAMPLE ONLY).



Detectable warning manufacturers

The manufacturers listed below offer truncated dome detectable warning products.

ADA Fabricators, Inc.

P.O. Box 179, N. Billerica, MA 01862
[Copolymer composite tile]
Phone: (978) 262-9900, (800) 372-0519
Fax: (978) 262-1455

Architectural Tile and Granite, Inc.

P.O. Box 3542, Sunriver, OR 97707
[Ryowa Braille Series
reconstituted granite paver]
Phone / Fax: (541) 593-1790

Castek Division, Transpo Industries, Inc.

20 Jones Street, New Rochelle, NY 10801
[Step-Safe® precast polymer concrete tile]
Phone: (800) 321-7870 or (914) 636-1000
Fax: (914) 636-1282

Cobblecrete International, Inc.

485 West 2000 South, Orem, UT 84058
[TurboMat (roller) for on-site texturing]
Phone: (800) 798-5791 or (801) 224-6662
Fax: (801) 225-1690
E-mail: cobble@burgoyne.com
Web: www.cobblecrete.com

COTE-L Industries, Inc.

1542 Jefferson St., Teaneck, NJ 07666
[Safti-Trax™ applied rubber domes
& Duraback polyurethane coating]
Phone: (201) 836-0733
Fax: (201) 836-5220
E-mail: cotel@sprynet.com
Web: www.cotelind.com

Cold Spring Granite Company

202 South 3rd Ave.
Cold Spring, MN 56320
[Granite paver]
Phone: (320) 685-3621, (800) 328-7038
Fax: (320) 685-5490
Web: www.coldspringgranite.com

Crossville Ceramics Co., L.P.

P.O. Box 1168, Crossville, TN 38555
[Porcelain stone tile]
Phone: (931) 484-2110
Fax: (931) 484-8418
E-mail: crossc@crossville.com
Web: www.crossville-ceramics.com

Disability Devices Distributor

17420 Mount Hermon St. #C
Fountain Valley, CA 92708
[Polyurethane Detectable Warning Mat™]
Phone: (714) 437-9237, (800) 747-5651
Fax: (714) 437-9309

Endicott Clay Products Co.

PO Box 17, Fairbury, NE 68352
[Handicap Detectable Warning Paver, brick]
Phone: (402) 729-3315
Fax: (402) 729-5804
E-mail: endicott@endicott.com
Web: www.endicott.com

Engineered Plastics Inc.

Olympic Towers, 300 Pearl Street, Suite 200
Buffalo, NY 14202
[Armor-Tile epoxy polymer composite]
Phone: (800) 682-2525 or (716) 842-6039
Fax: (800) 769-4463
Web: www.engplastics.com

Continued on next page

Detectable warning manufacturers, continued

Hanover Architectural Products, Inc.

240 Bender Rd., Hanover, PA 17331
[Reconstituted pressed limestone &
granite Detectable Warning Paver™]
Phone: (717) 637-0500
Fax: (717) 637-7145
Web: www.hanoverpavers.com

Increte Systems

Inco Chemical Supply Co., Inc.
8509 Sunstate St., Tampa, FL 33634
[Stamping tools for ADA Tactile
Detectable Warning Systems]
Phone: (800) 752-4626, (813) 886-8811
Fax: (813) 886-0188
Web: www.increte.com

Pavestone Company

4835 LBJ Freeway, Suite 700
Dallas, TX 75244
[Concrete detectable warning paver]
Phone: (800) 245-PAVE, (972) 404-0400
Fax (972) 404-9200
E-mail: info@pavestone.com
Web: www.pavestone.com

Steps Plus, Inc.

6375 Thompson Rd., Syracuse, NY 13206
[Precast reinforced concrete
Detectable Warning Units]
Phone: (315) 432-0885
Fax: (315) 432-0612
Web: www.steps-plus.com

Strongwall Industries, Inc.

P.O. Box 201, Ridgewood, NJ 07451
[Applied latex-modified mortar domes
& traffic deck membrane system]
Phone: (800) 535-0668 or (201) 445-4633
Fax: (201) 447-2317
Web: www.strongwall.com

Summitville Tiles, Inc.

P.O. Box 73, Summitville, OH 43962
[Tactile-Tread ceramic tile]
Phone: (330) 223-1511
Fax: (330) 223-1414
Web: www.summitville.com

Superock Block Company Inc.

3301 27th Avenue N, P O Box 5326
Birmingham, AL 35207-0326
[Compressed concrete StoneScape
Detectable Warning Paver]
Phone: (205) 324-8624
Fax: (205) 324-8671
http://ggunn@lehighcement.com

Vanguard ADA Products of America Tilco, Inc.

20628 Broadway Avenue,
Snohomish, WA 98296
[Applied truncated domes]
Phone: (800) 290-5700
Fax: (360) 668-3335
E-mail: tilcovngrd@aol.com
Web: www.vngrd.com

Whitacre-Greer Fireproofing Company

1400 S. Mahoning Avenue,
Alliance, OH 44601
[Detectable warning ADA Brick]
Phone: (800) WGPAPER, (330) 823-1610
Fax: (330) 823-5502
E-mail: Info@wgpaver.com
Web: www.wgpaver.com

The following companies do not currently
offer ADA detectable warning products.
Their names appear on earlier supplier lists:

Advantage Metal	High Quality Tactile
American Olean	Lanxide (SMC)
Bomanite	Rehau, Inc.
Carsonite (Pathfinder)	Roppe Corp.
Daltile Corp.	Specialty Concrete
Goria Enterprises	Synertech Molded
Hastings Pavement	Terra Clay Products

Appendix

Summary

The Appendix includes combined references / annotated bibliography, and a glossary of terms used in the text. A copy of the questionnaire used in interviews regarding detectable warning installations is also included.

Appendix contents

The Appendix has the following sections.

Topic	Page
References and Annotated Bibliography	136
Glossary	147
Questionnaire for interviews regarding detectable warning installations	148

References and Annotated Bibliography

Annotations emphasize only the portions of each publication which are most relevant to this synthesis.

Accessible rights-of-way: A design guide. (1999). Washington, DC: U.S. Architectural and Transportation Barriers Compliance Board.

A comprehensive overview of the Americans with Disabilities Act and its application to public rights-of-way. Contains detailed suggestions for making public rights-of-way accessible. Suggests detectable warnings as a way to make information about pedestrian/vehicular boundaries perceptible to persons who are visually impaired.

Aiello, J. & Steinfeld, E. (1980). *Accessible buildings for people with severe visual impairment.* Washington, DC: US Department of Housing and Urban Development, Office of Policy Research, Report No. HUD-PDR-404.

First U.S. research on warning surfaces. A ribbed rubber mat was found to be highly detectable to eight blind subjects travelling with a long cane, when they approached it from brushed concrete.

American national standard: Accessible and usable buildings and facilities—CABO/ANSI A117.1-1992. (1992). Falls Church, VA: Council of American Building Officials.

The only standard regarding detectable warnings is that they shall be standard within a building, facility, site, or complex of buildings. Contains no technical specification for detectable warnings.

American national standard: Accessible and usable buildings and facilities—ICC/ANSI A117.1-1998. (1998). Falls Church, VA: International Code Council.

Provides standards for truncated dome detectable warnings—similar to ADAAG 4.29.2. Provides use of other surfaces or technology that ensure equivalent detectability.

American national standard: Specifications for making buildings and facilities accessible to and usable by physically handicapped people—ANSI A117.1-1980. (1980). New York: American National Standards Institute, Inc.

The first U.S. standard for tactile warning surfaces on curb ramps, preceding hazardous vehicular ways, preceding stairs, and at reflecting pools. Specifies use of exposed aggregate concrete, rubber, or plastic cushioned surfaces, raised strips, or grooves. Grooves permitted indoors only.

American national standard for buildings and facilities—providing accessibility and usability for physically handicapped people—ANSI A117.1-1986. (1986). New York: American National Standards Institute, Inc.

Similar to ANSI A117.1-1980, except tactile warnings now called detectable warnings.

References and Annotated Bibliography, continued

Americans with Disabilities Act accessibility guidelines (July 26, 1991). Washington, DC: U.S. Architectural and Transportation Barriers Compliance Board. 36 CFR Part 1191.

Contains scoping and technical specifications for achieving accessibility to the built environment for persons with disabilities in accordance with the mandates of the Americans with Disabilities Act. Gives technical specifications for truncated dome detectable warnings and places where they are used.

Axelson, P.W., Chesney, D.A., Galvan, D.V., Kirschbaum, J.B., Longmuir, P.E., Lyons, C., & Wong, K.M. (1999). *Designing sidewalks and trails for access: Part I of II: Review of existing guidelines and practices*. Washington, DC: U.S. Department of Transportation, Federal Highway Administration, Publication No: FHWA-HEPP-00-006.

Reviews ways of providing information to pedestrians who are blind. Describes use of detectable warnings and tactile surfaces for wayfinding.

Axelson, P.W., Chesney, D.A., Galvan, D.V., Kirschbaum, J.B., Longmuir, P.E., Lyons, C., & Wong, K.M. (anticipated 2000). *Designing sidewalks and trails for access: Part II of II: A best practices guidebook*. Washington, DC: U.S. Department of Transportation, Federal Highway Administration.

Provides extensive guidance on making public rights-of-way, including trails, accessible to persons with disabilities including visual impairments. Has numerous examples of the use of detectable warnings to provide information to persons who are visually impaired.

Barlow, J. & Bentzen, B.L. (1994). *Cues blind travelers use to detect streets*. Final report. Cambridge, MA: U.S. Department of Transportation, Federal Transit Administration, Volpe National Transportation Systems Center.

Showed that proficient blind travelers, using a long cane, frequently fail to detect unfamiliar intersecting streets approached via a curb ramp, even in the presence of traffic on the intersecting street. Failure to detect streets found to be associated with ramp slope, abruptness of change in slope between sidewalk and curb ramp, and diagonal vs. perpendicular placement.

Bentzen, B.L. (1997). Environmental accessibility. In B. Blasch, W. Weiner, & R. Welsh (Eds.). *Foundations of orientation and mobility*. 2nd ed. New York: American Foundation for the Blind. 317-356.

Comprehensive review of access problems and solutions for people who are visually impaired, including a section on public rights-of-way.

Bentzen, B.L. & Barlow, J.M. (1995). Impact of curb ramps on safety of persons who are blind. *Journal of Visual Impairment and Blindness*, 89, 319-328.

Journal version of Barlow & Bentzen, 1994.

Bentzen, B.L., Jackson, R.M. & Peck, A.F. (1981). *Techniques for improving communication*

References and Annotated Bibliography, continued

with visually impaired users of rail rapid transit systems. Washington, DC: U.S. Department of Transportation, Urban Mass Transportation Administration. Report No. UMTA-MA-0036-81-3.

Shows that falling or fear of falling from high-level transit platforms is a major cause of anxiety amongst visually impaired transit riders.

Bentzen, B.L., Nolin, T.L. & Easton, R.D. (1994a). *Detectable warning surfaces: Color, contrast and reflectance.* Cambridge, MA: U.S. Department of Transportation, Federal Transit Administration, Volpe National Transportation Systems Center. Report No. VNTSC-DTRS-57-93-P-80546.

Safety yellow detectable warnings having as little as 40% contrast with an adjoining surface are found to be more detectable to persons having low vision than detectable warnings of other colors having up to 86% contrast.

Bentzen, B.L. & Myers, L.A. (1997). Human factors research, Appendix C in *Detectable warnings evaluation services.* Menlo Park, CA: Crain & Associates, Inc.

Objective and subjective testing of four detectable warning materials installed on Sacramento Regional Transit light rail platforms, for detectability under foot and using a long cane or dog guide, differences in sound on cane-contact, and differences in visual contrast.

Bentzen, B.L., Nolin, T.L., Easton, R.D., Desmarais, L. & Mitchell, P.A. (1993). *Detectable warning surfaces: Detectability by individuals with visual impairments, and safety and negotiability for individuals with physical impairments.* Final report VNTSC-DTRS57-92-P-81354 and VNTSC-DTRS57-91-C-0006. Cambridge, MA: U. S. Department of Transportation, Federal Transit Administration, Volpe National Transportation Systems Center, and Project ACTION, National Easter Seal Society.

13 truncated dome surfaces complying approximately with ADAAG specifications but varying in material, were found to be highly detectable to 24 blind travelers under foot and by use of a long cane when used in association with four different transit platform surfaces. Nine truncated dome detectable warning surfaces on 6-ft ramps with 1:12 slope were found to have minimal adverse impact on 40 persons having mobility impairments.

Bentzen, B.L., Nolin, T.L., Easton, R.D., Desmarais, L. & Mitchell, P.A. (1994b). *Detectable warnings: Safety & negotiability on slopes for persons who are physically impaired.* Washington, DC: Federal Transit Administration and Project ACTION of the National Easter Seal Society.

Nine truncated dome detectable warning surfaces on 6-ft ramps with 1:12 slope were found to have minimal adverse impact on 40 persons having mobility impairments.

California Code of Regulations, Title 24. (1999). Sacramento, CA: Division of the State Architect.

The California accessibility code. Requires truncated dome detectable warnings at curb ramps, hazardous vehicular ways, and transit boarding platforms.

References and Annotated Bibliography, continued

California Department of Transportation. (1998). *Local assistance procedures manual: Design standards*. Sacramento, CA: California Department of Transportation.

Includes design standards for curb ramps, including rationale and specifications for placement of truncated dome detectable warnings at curb ramps, islands, and medians.

Collins, B.L., Tibbott, R.L. & Danner, W.F. (1981). *Communication systems for disabled users of buildings*. Washington, D.C., National Bureau of Standards.

Summarizes U.S. research on warning surfaces, and existing standards for warning surfaces as of 1981.

Detectable warnings: Bulletin #1. (1993). Washington, DC: U.S. Architectural and Transportation Barriers Compliance Board.

Provides a figure clarifying the intent of the ADAAG technical specification for truncated dome detectable warnings, and provides background information on the rationale for the use of detectable warnings.

Disability Unit Circular 1/91: *The use of dropped kerbs and tactile surfaces at pedestrian crossing points*. London, England: Department of Transport.

Describes the use of a flat topped dome surface on curb ramps, and extending back to the edge of the sidewalk farthest from the curb line, to help pedestrians who are blind locate crossing points. Detectable warning pavers are aligned in the direction of travel across the crosswalk, regardless of whether this is perpendicular to the curb.

Evaluation of detectable warning surfaces: Final Report. (1997). Menlo Park, CA: Crain & Associates, Inc.

Detectability of four different truncated dome detectable warnings for use on light rail transit platforms in Sacramento, CA. Particular attention to effect of color and sound on cane-contact on detectability. Includes evaluation of maintenance and durability.

Florida pedestrian planning and design handbook. (1999). Tallahassee, FL: Florida Department of Transportation.

Includes guidelines for the installation of curb ramps recommending a tactile surface on curb ramps.

Gallon, C. (1992). *Tactile surfaces in the pedestrian environment: Experiments in Wolverhampton: Contractor report 317*. Crowthorne, England: Transport and Road Research Laboratory.

Evaluation of 5 warning and guidance surfaces installed in one community.

Gallon, C., Oxley, P. & Simms, B. (1991). *Tactile footway surfaces for the blind: Contractor report 257*. Crowthorne: England: Transport and Road Research Laboratory. .

Summary of research on discriminability of tactile surfaces for warning and guidance.

References and Annotated Bibliography, continued

Guidance on the use of tactile paving surfaces. (1998). London, U.K.: Department of the Environment, Transport and the Regions.

Describes the use of seven different tactile surfaces for providing information and/or guidance to persons with visual impairments at crosswalks, hazardous areas, off-street transit platform edges, on-street transit platform edges, shared cycle tracks/footways, guidance paths, and information points.

Hauger, J, Rigby, J, Safewright, M. & McAuley, W. (1996). Detectable warning surfaces at curb ramps. *Journal of Visual Impairments and Blindness* 90:512-525.

Found that curb ramps resulted in inability of blind travelers to detect some streets. Detectable warnings on curb ramps were judged to improve street detection. When negotiating curb ramps with detectable warnings compared with brushed concrete curb ramps, persons with mobility impairments experienced minimal difficulties. Many subjects having mobility impairments judged curb ramps having detectable warnings to be safer, more stable, more slip resistant, and to require less effort than concrete curb ramps.

Hauger, J.S., Safewright, M.P., Rigby, J.C. & McAuley, W.J. (1994). *Detectable warnings project: Report of field tests and observations.* Final Report to U.S. Architectural and Transportation Barriers Compliance Board. Blacksburg, VA: Virginia Polytechnic Institute and State University.

Full version of Hauger, Rigby, Safewright & McAuley (1996).

Hines, S.S. (1990). The impact of fear on blind and visually impaired travelers in rapid rail systems. In M. Uslan, A. Peck, W. Wiener & A. Stern, (Eds.). *Access to mass transit for blind and visually impaired travelers.* New York: American Foundation for the Blind University.

Analysis with anecdotes of consequences of blind persons' fear of falling at transit platforms.

Hughes, R.G. (1995). *A Florida DOT field evaluation of tactile warnings in curb ramps: Mobility considerations for the blind and visually impaired.* Chapel Hill, NC: The University of North Carolina at Chapel Hill, Highway Safety Research Center.

Confirms high detectability of truncated dome detectable warnings. Shows preference of people with low vision for yellow vs. black warning surfaces.

Ibukiyama, S., Fujita, D., Yoshioka, A., & Kinoshita, S. (1985). *Standards for textured guide strips for the visually impaired.* Chiyoda-ku, Tokyo, Japan: The Japan Highway Association, Inc.

Recommended standards for installation of guide strips, including truncated dome detectable warnings.

Inspection and testing of tactile warning strips for Metra [Chicago] railroad platforms, (1993). Northbrook, IL: Wiss, Janney, Elstner Associates, Inc. Project No. 921683.

Laboratory and field evaluation of 11 truncated dome detectable warning surfaces installed on a transit platform. Evaluation included color, installation adequacy, grip and slip resistance, impact performance, and ability to be cleaned.

References and Annotated Bibliography, continued

Kearney, Peter and Planner (1992). *Metro-North Commuter Railroad tactile warning strip: Test methodology, demonstrations results, and rating of the ADA tactile strips test at Peekskill Station, NY*. New York: Metro-North Commuter Railroad, Metropolitan Transportation Authority.

Test of detectability of nine truncated dome detectable warning products. Includes comments on installation, wear and maintenance.

Ketola, N. and Chia, D. (1993). *Results of laboratory testing of detectable warning materials*. Burlington, MA: Technology & Management Systems, Inc. Technical Memo No 65-09-01, November.

Detailed report of laboratory testing of 18 truncated dome detectable warnings.

Ketola, N. and Chia, D. (1994). *Detectable warnings: Testing and performance evaluation at transit stations*. Washington, DC: U.S. Department of Transportation, Federal Transit Administration.

Laboratory testing of 18 truncated dome detectable warnings and subsequent evaluation of 8 of those materials at transit stations in Boston, Cleveland and Philadelphia. Provides performance assessment of the 8 materials after 7 months wear.

König, V. (1996). *Handbuch über die blinden- und sehbehindertengerechte Umwelt- und Verkehrsraumgestaltung*, Bonn: Deutscher Blindenverband e.V. (DBV).

Highly illustrated book showing numerous ways to make the built environment more accessible to people who are blind or who have low vision. Includes chapters on public rights-of-way and transit.

Massachusetts pedestrian transportation plan. (1998). Boston, MA: Massachusetts Department of Transportation.

Includes recommendations for making public rights-of-way accessible to persons with disabilities.

McCulley, R. and Bentzen, B.L. (1987). *Train platform accidents reported by visually impaired travelers: Results of a survey by the Massachusetts Commission for the Blind*. Unpublished report. Boston, MA: Massachusetts Commission for the Blind.

In a 30 day period 24 people who were blind responded to the invitation to call the Massachusetts Commission for the Blind to report that they had fallen from a transit platform edge in the Massachusetts Bay Transportation Authority subway system at some time in the past.

References and Annotated Bibliography, continued

McGean, T.K. (1991). *Innovative solutions for disabled transit accessibility*. Washington, DC: U.S. Department of Transportation, Urban Mass Transportation Administration. Report No. UMTA-OH-06-0056-91-8.

Found that platform edge accidents for all riders decreased following installation of detectable warnings along platform edges in BART. Riders on BART platforms having detectable warnings tended to stand farther from the platform edge while waiting for trains than riders waiting on San Francisco Municipal Railway platforms (not having detectable warnings) in the same station.

Mitchell, M. (1988). *Pathfinder tactile tile demonstration test project*. Miami, FL: Metro-Dade Transit Agency.

Confirmed the high detectability of truncated dome detectable warnings.

Murakami, T., Aoki, S., Taniai, S., & Muranaka, Y. (1982). Braille blocks on roads to assist the blind in orientation and mobility. *Bulletin of the Tokyo Metropolitan Rehabilitation Center for the Physically and Mentally Handicapped*, 11-24.

Describes current (1982) practice in Japan of installing bar tiles and dot tiles (truncated domes) to provide a comprehensive tactile wayfinding system for blind persons.

Murakami, T., Ohkura, M., Tauchi, M., Shimizu, O., & Ikegami, A. (1991). An experimental study on discriminability and detectability of tactile tiles. *Proceedings of the 17th sensory substitution symposium*, 1991/12/3-4 Tokyo.

Research on discriminability of dot (truncated dome) vs. bar (linear surface) tiles. Dot tiles were sometimes misidentified as bar tiles.

National standard for the provision of accessible services to persons with disabilities by Canadian motor coach operators and terminal operators (draft 1993). Ottawa, Canada: National Transportation Agency of Canada.

Calls for detectable warnings at changes in elevation, curb ramps, ramps, staircases, escalators or doors. Does not provide specifications.

O'Leary, A.A., Lockwood, P.B. & Taylor, R.V. (1996). Evaluation of detectable warning surfaces for sidewalk curb ramps. *Transportation Research Record No. 1538*.

Four truncated dome, two exposed aggregate, and one raised linear surface were tested for detectability by people who were visually impaired and maneuverability by people who had mobility impairments. Truncated dome surfaces were more detectable than exposed aggregate surfaces. Exposed aggregate surfaces were minimally detectable by people who were visually impaired, but were preferred by people having mobility impairments. Virginia Department of Transportation standard adopted in 1992 called for exposed aggregate on curb ramps.

References and Annotated Bibliography, continued

Oregon bicycle and pedestrian plan, 2nd ed. (1995). Salem, OR: Oregon Department of Transportation, Pedestrian and Bicycle Program.

Contains facility design standards for public rights-of-way. Includes texturing of curb ramps as an aid to persons having visual impairments.

Pavlos, E., Sanford, J. & Steinfeld, E. (1985). *Detectable tactile surface treatments*. Atlanta, GA: Georgia Institute of Technology.

Test of detectability of a wide variety of existing surfaces. The only material that was sufficiently detectable to be used as a warning was artificial grass. Various grooved textures in concrete were very minimally detectable. Redundancy in differences including texture, resiliency and sound on cane-contact were found to facilitate detection.

Peck, A.F. & Bentzen, B.L. (1987). *Tactile warnings to promote safety in the vicinity of transit platform edges*. Cambridge, MA: U.S. Department of Transportation, Federal Transit Administration, Volpe National Transportation Systems Center. Report No. UMTA-MA-06-0120-87-1.

Three part project to identify a warning surface that was highly detectable both under foot and through use of a long cane, when used in association with four surfaces representing the textural extremes of surfaces currently in use for transit platforms. A truncated dome surface complying with ADAAG 4.29.1 was highly detectable.

Peck, A.F., Tauchi, M., Shimizu, O., Murakami, T., & Okhura, M. (1991). *Tactile tiles for Australia: A performance evaluation of selected tactile tiles under consideration for use by the visually impaired in Australia*. Unpublished manuscript. Association for the Blind, Brighton Beach, Victoria, Australia.

Confirmed the high detectability of truncated dome warning surfaces.

Pedestrian facilities guidebook: Incorporating pedestrians into Washington's transportation system. (1997). Olympia, WA: Washington Department of Transportation.

Includes guidelines for the installation of curb ramps recommending a tactile surface on curb ramps.

Portland pedestrian design study guide. (1998). Portland, OR: City of Portland, Office of Transportation, Engineering and Development, The Pedestrian Transportation Program

Contains detailed guidelines for making sidewalks, street corners, crosswalks, pathways, and stairs accessible to and usable by all pedestrians, including those with disabilities. Includes texturing of curb ramps as an aid to persons with visual impairments.

Ratelle, A., Zabihaylo, C., & Gresset, J. (1998). Detectability of warning tiles by functionally blind persons: Effects of warnings tiles' width and adjoining surfaces' texture. In E. Sifferman, M. Williams, and B. Blasch (Eds.), *Proceedings of the 9th International Mobility Conference*.

References and Annotated Bibliography, continued

Decatur, GA: Veterans Administration, Rehabilitation Research and Development Center.

Thirty inches of detectable warning were required to enable detection and stopping on at least 90% of trials. A rough texture adjacent to a detectable warning decreased the detectability of the warning.

Report of fundamental research on standardization relating to tactile tiles for guiding the visually impaired: Aiming at standardization of patterns. (Study of the relationship between individual patterns and ease of recognition. (1998). Japan: Ministry of International Trade and Industry, National Institute for Technology and Evaluation.

Reports research on detectability and identifiability of nine dot (truncated dome), and nine bar tiles having different height, width or diameter, and spacing.

Samuels, J. (1989). New guidance system aids blind pedestrians. *Civic Public Works*. April, 15-16.

Use of Pathfinder tiles in Canada on transit platforms and public rights-of-way. Snow is easily removed by shovel.

Sanford, J. and Zimring, C. (1985). *Detectable tactile surface treatments*. Atlanta, GA: Georgia Institute of Technology.

There were great differences in detectability of common surface treatments that could be considered for use as warnings. AstroTurf was the most detectable surface tested.

Savill, T., Davies, G., Fowkes, A., Gallon, C. & Simms, B. (1996). *Trials on platform edge tactile surfaces*. Crowthorne, Berkshire, U.K.: Transport Research Laboratory.

Reports research validating the use of tactile warning surfaces at transit platform edges.

Savill, T., Stone, J. & Whitney, G. (1998). *Can older vision impaired people remember the meanings of tactile surfaces used in the United Kingdom?* Crowthorne, Berkshire, U.K.: Transport Research Laboratory.

Reports successful performance of 39 visually impaired persons 66-95 years of age on tasks involving learning and remembering the meanings of six tactile surfaces used for different purposes in the United Kingdom.

Sawai, H., Takato, J., & Tauchi, M. (1998). Quantitative measurements of tactile contrast between dot and bar tiles used to constitute tactile pathway for the blind and visually impaired independent travelers. In E. Sifferman, M. Williams, & B. Blasch (Eds.), *Proceedings of the 9th International Mobility Conference*. Decatur, GA: Veterans Administration, Rehabilitation Research and Development Center.

Research comparing ability to discriminate between dot tiles (dome or truncated dome) and bar tiles showed that tiles having truncated domes spaced closer together were harder to discriminate from bar tiles than dot tiles having full domes or smaller dots, spaced farther apart. Shoe sole also affected ability to discriminate between dot and bar tiles; thinner soled shoes yielded better discrimination.

References and Annotated Bibliography, continued

Shimizu, O., Murakami, T., Ohkura, M., Tanaka, I. and Tauchi, M. (1991). Braille tiles as a guiding system in Japan for blind travelers. *Proceedings, International Mobility Conference 6*, Madrid, Spain.

Reviews history and describes installation of tactile tiles (truncated dome detectable warnings and linear directional surfaces) in Japan. Location and pattern of tactile tiles are not standardized, resulting in confusion. Tactile tiles are considered beneficial to the safety of people who are visually impaired but do not help them establish a direction for crossing streets.

Spiller, D. and Multer, J. (1992). *Assessment of detectable warning devices for specification compliance or equivalent facilitation*. Cambridge, MA: U.S. Department of Transportation, Volpe National Transportation Systems Center.

Evaluates ADAAG specification for detectable warnings. Recommends procedures to establish equivalent facilitation.

Street design guidelines. (1999). Washington, DC: American Council of the Blind.

Provides concise guidance for designing sidewalks and intersections that are accessible to and readily usable by pedestrians who have visual impairments.

Tactile edge warning systems evaluation. (1990). Toronto, Canada: Toronto Transit Commission.

Reports objective and subjective evaluation of 17 potential warning surfaces. A truncated dome surface was recommended for installation. .

Tactile warning panel demonstration installation (1995). Oakland, CA: VBN Architects.

Reports laboratory and field testing of 12 truncated dome detectable warning surfaces.

Tanaka, M. (1991). Making cities safer for the visually impaired. *Wheel Extended* 19:24-32.

Examines use and drawbacks of “guide blocks” in Japan, including truncated domes.

Taraya, E. (1995). *Guidestrips for visually disabled/blind pedestrians: Executive summary*. San Francisco: Department of Public Works, Office of the Disability Access Coordinator.

Tactile strips to provide guidance across geometrically complex or confusing intersections were evaluated for installation requirements, maintenance and durability.

Technical aids for blind and vision impaired persons—Tactile ground/floor surface indicators. (November, 1999). International Organization for Standardization (ISO) TC 173, Working Group 7. Draft.

Proposed international standard for truncated dome warning or attention surfaces and linear guidance surfaces.

References and Annotated Bibliography, continued

Templer, J. A. & Wineman, J.D. (1980). *The feasibility of accommodating elderly and handicapped pedestrians on over-and-undercrossing structures*. Washington, DC: Federal Highway Administration, U.S. Government Printing Office. FHWA-RD-79-146.

A resilient tennis court surfacing material and strips of thermoplastic 6 in wide and spaced 6 in apart were highly detectable to persons who had low vision or who were totally blind.

Templer, J.A., Wineman, J.D., & Zimring, C.M. (1982). *Design guidelines to make crossing structures accessible to the physically handicapped*. Washington, DC: U.S. Department of Transportation, Federal Highway Administration. Final Report #DTF-H61-80-C-00131.

Project to determine the relationship between surface detection and texture (defined as depth, spacing, and width of grooves), impact noise, and resiliency. Steel surfaces and surfaces applied over a plywood surface were most detectable from concrete on the basis of differences in sound.

Textured pavements to help blind pedestrians (1983). Crowthorne, England: Transport and Road Research Laboratory.

Describes first laboratory testing in the United Kingdom to find a distinctive texture by means of which pedestrians who are blind could identify Zebra and Pelican crossings. Criteria for the texture were that the surface had to be simple, detectable, distinctive, comfortable, durable and cheap. The best texture had rounded domes, 25 mm diam., 6 mm high, and 67 mm apart on center. It was acceptable to wheelchair users and detectable by people who were blind.

Tijerina, L., Jackson, J.L. & Tornow, C.E. (1994). *The impact of transit station platform edge warning surfaces on persons with visual impairments and persons with mobility impairments*. Final report. Battelle Contract No. FE-6591/BK to Washington Metropolitan Area Transit Authority.

Four surfaces created by tooling granite were compared with a truncated dome surface for detectability under foot, using a long cane or dog guide, and using low vision, and for maneuverability by people having mobility impairments. The truncated dome surface and a pattern of raised squares were most detectable. No important difficulties in maneuverability occurred with any tested surface.

The use of dropped kerbs and tactile surfaces at pedestrian crossing points. *Disability Unit Circular 1/91* (1992) London, England: Department of Transport.

Guidance on installation of truncated dome surfaces on curb ramps at corners, at mid-block crossings and on islands.

Glossary

Apex curb ramp. A curb ramp occurring at the vertex of the intersection of two streets. Same as diagonal curb ramp or corner-type curb ramp.

Beveled lip. A lip or threshold required in California at the lower end of a curb ramp.

Blended curb. A situation in which there is no perceptible difference in slope or surface level between a sidewalk and the adjoining street.

Cross slope. The slope measured perpendicular to the usual direction of travel.

Curb ramp. A short ramp cutting through a curb or built up to it. Sometimes referred to as curb cut.

Detectable warning. A standardized surface feature built in or applied to walking surfaces or other elements to warn visually impaired people of hazards on a circulation path.

Diagonal curb ramp. See *apex curb ramp*.

Flared side. The triangular transition surface between the main sloped area of a *curb ramp* and the adjacent sidewalk.

Grooved border. A border at the level of the sidewalk required in California at the top and side of a *curb ramp*

Island. A pedestrian refuge within the right-of-way and traffic lanes of a highway or street.

Long cane. A cane individually prescribed to provide safety and orientation information to persons who are blind or visually impaired; typically much longer than a support cane and not intended for support; typically has a white, reflective surface.

Median. See *island*.

Midblock crossing. Crossing point that occurs in the center of a block rather than at an intersection.

Parallel curb ramp. Curb ramp design for a narrow sidewalk, where the sidewalk slopes down on either side of a landing. Also called “dropped landing.”

Pedestrian. People who travel on foot or who use assistive devices, such as wheelchairs, for mobility.

Raised crosswalk. A long raised speed hump with a flat section in the middle and ramps connecting to the street level. Also known as a flat top speed hump, trapezoidal hump, speed platform, speed table, or raised crossing. Often occurs as a *midblock crossing*.

Raised intersection. An intersection with a flat raised area covering the entire intersection, including adjoining crosswalks, and with ramps on all street approaches. Also known as a raised junction, intersection hump, or plateau.

Speed table. See *raised crosswalk* or *raised intersection*.

Tactile. An object that can be perceived using the sense of touch.

Tactile ground/floor surface indicators (TGSIs). Walking surfaces for indoor or outdoor use, intended to provide warning and/or wayfinding information to people who are blind or visually impaired.

TGSI. See tactile ground surface indicators.

Truncated domes. Small domes with flattened tops used as detectable warnings.

Vehicular way. A route intended for vehicular traffic, such as a street, driveway, or parking lot.

Accessible Design for the Blind

Access Solutions • Human Factors Testing • Assistive Technology

Contact Name:

Company:

Phone #/E-mail address:

Date:

Detectable Warning Location A, B, C, D, E (circle 1)

NOTE: On Question # 1, 2 and 3, only one answer should be chosen. If multiple answers apply, a questionnaire should be completed for each location.)

Location Information/Type

Location (street names/station names: _____)

City: _____

State: _____

1. Type of location (choose one, if different types, fill out a different questionnaire as a separate location)

- curb ramp/blended curb
- edge of train or transit platform--indoor
- edge of train or transit platform--outdoor
- median
- edge of street (parallel to walkway/sidewalk)
- other _____

2. Manufacturer's name (choose one, if different types, fill out a different questionnaire as a separate location)

- | | |
|---|--|
| <input type="checkbox"/> Applied Surfaces | <input type="checkbox"/> Increte Systems |
| <input type="checkbox"/> Carsonite | <input type="checkbox"/> Specialty Concrete Products |
| <input type="checkbox"/> Castek/Transpo | <input type="checkbox"/> Steps Plus |
| <input type="checkbox"/> Cobblecrete | <input type="checkbox"/> Strongwall Industries |
| <input type="checkbox"/> Crossville Ceramics | <input type="checkbox"/> Summitville Tiles |
| <input type="checkbox"/> Disability Devices Distributor | <input type="checkbox"/> Tilco/Vanguard |
| <input type="checkbox"/> Engineered Plastics | <input type="checkbox"/> Whitacre-Greer |
| <input type="checkbox"/> Hanover Architectural Products | <input type="checkbox"/> other _____ |

3. Type of material (choose one, if different types, fill out a different questionnaire as a separate location)

- unit masonry (brick, pavers)
- precast concrete units
- concrete, stamped after pour
- fiberglass tile
- epoxy tile
- ceramic tile
- plastic/rubber tile
- other _____

Installation

4. Date installed: _____
5. Approximate cost per square foot : \$ _____
6. Dimensions of the installation? _____ x _____ depth (from edge of platform or street)x width
- a. If curb ramp, where?
- ___ whole ramped area
- ___ centered strip
- ___ strip at bottom/base of ramp
- ___ strip at top
- ___ other
7. Installation method:
- ___ glued/cemented
- ___ screwed
- ___ poured concrete
- ___ other
8. Cavity between DW and base surface (for sound difference)?
- ___ Yes ___ No
9. Color of detectable warning
- ___ yellow ___ black ___ gray ___ other _____
10. Problems or difficulties in the installation process?
- ___ yes ___ no Comments:

Cleaning and Maintenance

- 11 Maintenance problems?
- ___ yes ___ no Comments
12. Cleaning method and products (describe):
- 12a. Cleaning frequency:
- ___ daily ___ weekly ___ monthly ___ annually ___ never ___ no set schedule ___ other _____
- 12b. Any cleaning problems? Describe:
13. Evidence of wear and tear, type of wear, and extent of problem:
- ___ Color degraded: ___ major, ___ minor ___ no problem
- ___ Domes worn: ___ major, ___ minor ___ no problem
- ___ Tiles chipping: ___ major, ___ minor ___ no problem
- ___ Bubbles or lifting: ___ major, ___ minor ___ no problem
- ___ Cracks: ___ major, ___ minor ___ no problem
- ___ Other: ___ major, ___ minor ___ no problem
- Comments:
14. Any experience with snow and ice removal? ___ yes ___ no
- 14a. Method of snow and ice removal:
- ___ Snow plow ___ shovel ___ broom ___ chemical ___ other:
- Comments:
15. Had to replace individual tiles or modules of the surface? ___ yes ___ no
16. Had to remove and reinstall any detectable warning products? ___ yes ___ no
- 16 a. If yes, why?
- 16b. Brand removed and Replacement brand?

Public Reaction/Problems/Concerns

17. There has been concern by some people that truncated domes on slopes like curb ramps could cause trips, slips, falls, or difficulties for pedestrians with mobility impairments, although research has not documented these problems. Do you know of any specific instances where truncated domes have been the cause of pedestrian complaints or problems?

Yes No

17 a. Who made the complaint or had the problem?

Blind pedestrian

Mobility impaired pedestrian using Wheelchair/scooter Cane Crutch Other

General public

Other _____

17 b. What was the nature of the problem?

Trip Slip Fall High heels Stroller Difficulty for mobility impaired pedestrian

Other _____ Comments:

17 c. Has action been taken by your agency in response to the complaint or problem? Yes No

Comment:

17 d. Was any legal action initiated? Yes No

17 e. Would you be willing to discuss legal action? Comment:

18. Have you received any comments from individuals who are blind?

yes no Comments:

19. Have you received any comments from individuals who have mobility impairments?

yes no Comments:

20. Have you received any comments from general public?

yes no Comments:

Additional Information

21. Do you have any photos of installations? If so, could you send copies to us? yes no

22. Has your agency conducted any research on detectable warnings, either before or after installation?

yes no If yes, could we please have three copies of any reports that are available?

23. Do you expect to be installing more detectable warnings?

yes no don't know Comments:

24. Will they be the same type, from the same manufacturer?

yes no don't know Comments:

25. Have you seen/used detectable warnings installed abroad? Comments:

26. Do you know of anyone else in your field/area that we should contact on this subject?

Name:

Title/Company:

E-mail:

Phone:

Address:

27. Can we use your name in our document as a possible contact regarding your experience with detectable warnings?

yes no