

Spatial analysis of hydraulic conductivity measured using disc infiltrometers

B. P. Mohanty,^{1,2} M. D. Ankeny,³ R. Horton,⁴ and R. S. Kanwar¹

Abstract. Spatial variability of surface hydraulic properties and the extrinsic (e.g., traffic, cropping, etc.) and intrinsic (e.g., soil type, pore size distribution, etc.) factors associated with these properties are important for infiltration and runoff processes in agricultural fields. Disc infiltrometers measured infiltration at 296 sites arranged on two parallel transects. To examine and differentiate the factors contributing to spatial structure under different field conditions these measurements were made in the corn rows, no-track interrows, and wheel track interrows of the field using four different soil water tensions Ψ (0, 30, 60, and 150 mm). Unsaturated hydraulic conductivity (K) and saturated hydraulic conductivity (K_s) were maximum in the corn rows and minimum in wheel track inter-rows, with no-track interrows intermediate. Exponents (α parameters) of K_s and K relationships ($K = K_s \exp^{-\alpha\Psi}$) for corn rows and no-track interrows were not significantly different from each other but were significantly different from α for the wheel track interrows at $P = 0.01$ level. Spatial variability of K and K_s values showed some pseudoproportional effect in nugget variance for all three field conditions. No-track interrows clearly showed an inverse trend for semivariogram of K with changing tension (Ψ) values, whereas differences were found for corn rows and wheel traffic interrows. The spatial structure of α for all three field conditions were mostly white noise. Under corn rows, in addition to random variation, a small five-row periodic variation at the $P = 0.20$ level, matching the five-row traffic configuration, was discovered. The spatial structure of α was influenced by soil type for the no-track interrows. Spatial structure was absent in wheel track interrows, indicating the destruction of pore structure due to compaction.

Introduction

Surface conditions of a field influence the infiltration of water into the soil profile. At the beginning and receding periods of a storm event, when the soil is not saturated, unsaturated hydraulic conductivity (K) of the thin surface soil affects the vertical infiltration process. Moreover, saturated hydraulic conductivity (K_s) of the surface layer will influence overland runoff produced relative to the downward infiltration in the subsoil during a storm event. Earlier studies [Edwards *et al.*, 1979, 1988; Dick *et al.*, 1989; Blevins *et al.*, 1990] have shown that infiltration of water into soil is directly related to soil macroporosity. These studies indicated that runoff is much less when soil contains a large number of macropores, compared with soil that has few macropores.

Macropores are important for root growth and solute and water movement [Beven and Germann, 1982]. Studies to quantify macropore flow under rain-fed conditions [Watson

and Luxmoore, 1986; Wilson and Luxmoore, 1988] revealed that more than 70% of water flux can move through the macropores. Meek *et al.* [1989] found 2 to 3 times increase in the infiltration rates over a 3-year period for a field under flood irrigation practice planted to alfalfa. The authors attributed the increase to flow through root channels. Shirmohammadi and Skaggs [1984] conducted experiments to determine the effects of different factors including plant cover on infiltration into columns of fine sand. They found that fescue roots loosened the soil and increased the hydraulic conductivity by an average of 40% over soybeans and 80% over bare soil. Surface soil conditions, resulting from different tillage practices and/or wheel traffic compaction, likely will contribute to spatial variation of the soil macroporosity, thereby altering the hydraulic properties. Disregarding these factors may confound the interpretation of infiltration and runoff results.

Burley [1954] found that the growth of corn roots compacted the soil between the root channels and greatly reduced the permeability, and macropores formed in corn rows as a result of root decomposition increased the permeability. Meek *et al.* [1990] showed that the depth and size of the alfalfa taproot system produced an extensive macropore flow system, resulting in high infiltration rates when the roots decomposed. Warner and Young [1991] concluded that corn roots provided preferential pathways for water movement through the topsoil. Wetting and drying cycles [Akram and Kemper, 1979], freezing and thawing [Akram and Kemper, 1979; Carter, 1988], and earthworm activity [Trojan and Linden, 1992] may also contribute to macropore generation,

¹Agricultural and Biosystems Engineering Department, Iowa State University of Science and Technology, Ames.

²Now at U.S. Salinity Laboratory, Agricultural Research Service, U.S. Department of Agriculture, Riverside, California.

³Daniel B. Stephens and Associates, Incorporated, Albuquerque, New Mexico.

⁴Department of Agronomy, Iowa State University of Science and Technology, Ames.

pore structure manipulation, and increased infiltration rate. Additionally, wheel traffic by agricultural machinery may contribute to changes in infiltration capacity of soil. *Wager and Denton* [1989] found an 86% reduction in K_s in tracked areas compared with that in untracked interrow areas.

On a spatial scale the difference in infiltration between row and interrow areas might be influenced by mutually exclusive intrinsic/extrinsic factors such as soil type, tillage practice, root growth/decay, worm holes, and wheel traffic. *Mohanty et al.* [1994] found the difference in infiltration because of measurement methods used. Under no-till conditions, macropore networks can be well developed (thereby short-circuiting the vertical movement of water) whereas macropores are poorly developed in conventionally tilled soil [Ehlers, 1975; Edwards et al., 1979, 1988; Germann et al., 1984; Zachmann et al., 1987; West et al., 1991]. Edwards et al. [1979, 1988] showed that the number of macropores per unit soil area, as well as the diameter and depth of these pores, greatly influence infiltration and surface runoff. Therefore transport of water in an agricultural field can be viewed as a spatiotemporal process. Identifying changes in the hydraulic conductivity among row, interrow, and wheel traffic conditions on a spatial scale will help unmask some of the intrinsic factors (e.g., pore size distribution and soil type) and extrinsic factors (e.g., root growth and decay and traffic condition) contributing to spatial variability in the infiltration process. Knowledge of these factors will help hydrologists and soil physicists to model infiltration and overland flow processes more accurately.

Although some studies have investigated the effect of traffic and crop rows on infiltration and solute transport properties of soil [Meek et al., 1989, 1990, 1992a, b; Timlin et al., 1992; van Wesenbeeck and Kuchunoski, 1988], to our knowledge no study has been conducted to investigate the effect of these factors (crop row, interrow, and wheel traffic) on spatial variability in soil hydraulic properties (K , K_s , and α). The relation between hydraulic conductivity at different tensions and saturation at a particular site is often described using $K = K_s \exp^{-\alpha\psi}$. Thus in addition to K_s and K the exponent in the relationship, α , is also a site-specific hydraulic parameter of soil and may be subjected to spatial variability [Russo and Bouton, 1992, and references therein].

This study was conducted in a glacial till soil in central Iowa. Natural processes involved in the weathering of a glacial till soil are highly variable and complex [Terzughli and Peck, 1967], but man-made disturbances may make the infiltration capacities of these soils either more or less heterogeneous and/or correlated, spatially. *Wilson and Luxmoore* [1988] suggested that the variability of infiltration rates did not decrease at higher tensions, and they concluded that smaller pores are as variable as larger pores. This result is inconsistent with the conclusions of *Clothier and White* [1981]. Considering these contradictory results, *Ankeny et al.* [1990] pointed out that without knowledge of both measurement variability and site variability, the cause of variability in infiltration rates among pore-size classes cannot be determined. Therefore this study was conducted considering two primary objectives: (1) to compare the hydraulic conductivity measurements (K at different tensions (ψ) and K_s) under crop row, wheel track interrow, and no-track interrow conditions in an agricultural field, and (2) to study the spatial variability in K , K_s , and α and investigate the underlying

(intrinsic) governing factors under these three (extrinsic) surface conditions.

Field Data Collection Procedure

Micropores, mesopores, and macropores are defined in several ways [Luxmoore, 1981]. *Ankeny et al.* [1990] defined macropores as pores that empty at <150 mm of water tension. The capillary-rise equation predicts that pores of 0.2 mm nominal diameter or larger will drain at 150-mm tension. This pore size was chosen as important for root growth [Hackett, 1969; Russell, 1977] and preferential solute transport [Scotter, 1978]. The development of the tension infiltrometer has enabled researchers to quantify the effective macroporosity and equivalent cylindrical diameter macropores [Clothier and White, 1981; Ankeny et al., 1988; Perroux and White, 1988]. Controlling tension at the soil surface by a tension infiltrometer limits the size of pores that are active in conducting water [Clothier and White, 1981]. Sequential increase of tension leads to incremental draining of smaller and smaller pores. Infiltration rate decreases as more water-conducting pores are emptied.

In this study, infiltration rates at selected soil water tensions (0, 30, 60, 150 mm) were measured with automated disc infiltrometers [Ankeny et al., 1988; Ankeny, 1992; Prieksat et al., 1992]. Pondered and tension infiltrometers with a 76.2-mm-diameter base were used. Measurements were made along two parallel transects running in a SE-NW direction at the Agronomy and Agricultural Engineering Research Center near Boone in central Iowa (Figure 1). Corn rows and interrows were measured on two parallel transects 1 m apart (Figures 1 and 2). Figure 2 shows the five-row configuration of tractor and equipment traffic. The distance between consecutive rows and consecutive interrows was 76 cm. Infiltration measurements were made at the center of all corn rows (irrespective of old corn plant locations) and interrows. We chose transects across rows rather than along rows to avoid any localized treatment effects (e.g., traffic, chemical management, soil type with varying bulk density and thus differently compacted by wheel traffic, any misdriven traffic interrow, and compaction because of different weights of tractors and equipments used for different chemical management practices) on K . All the measurements were limited to the no-tillage management practice to avoid any tillage effect on the spatial variability of K , K_s , and α . No-tillage and no-post plant cultivation were practiced for 8 years in this field prior to this experiment. Field plots were established for row crop production with continuous corn during this 8-year period. Soil type in this field is predominantly silt loam that belongs to the Nicollet-Clarion-Webster soil series. Maximum land slope of the area where transects were located was 2%. This study was conducted in May 1990 during the corn planting season. Infiltration measurements at 296 sites were completed in less than a week, minimizing the temporal variability in the data. To accomplish these measurements in such a short period of time, 18 tension infiltrometers and six pondered infiltrometers were used simultaneously. All these disc infiltrometers were calibrated with a reference manometer (as described by *Ankeny* [1992]) and used randomly within two transects.

Disc infiltrometer readings were taken at 160 corn row sites and 136 interrow sites at 0, 30, 60, and 150 mm tensions at each site. At each infiltration measurement site an area

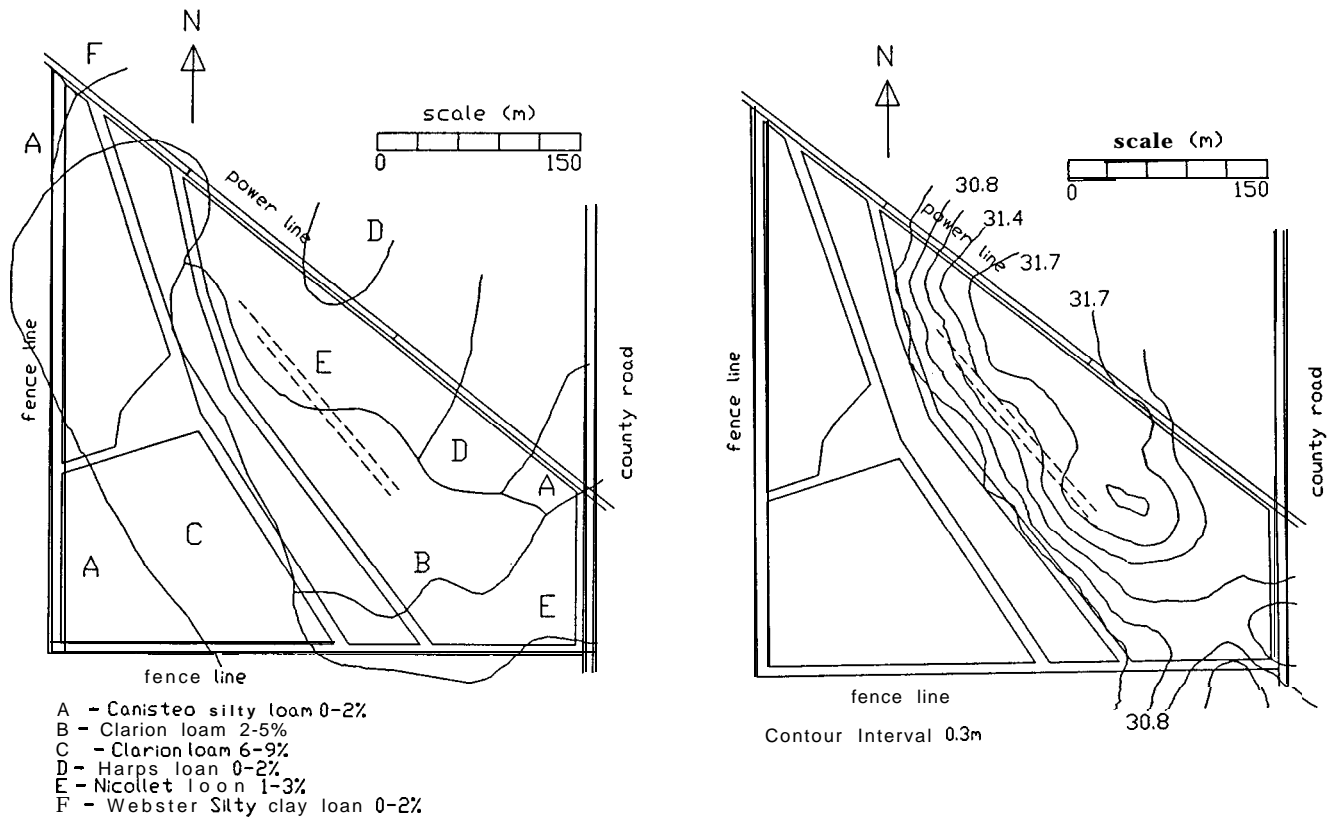

Figure 1. (a) Soil map and (b) topographical map of the experimental site near Boone, Iowa. Sampling transects are shown as two parallel dashed lines across the center of the field running in SE-NW direction. The separation distance between the two transects is 1 m (not to scale).

approximately 25 to 30 cm in diameter was cleared with a hand trowel to a depth of 20 to 30 mm and leveled. This site preparation method minimizes compaction and smearing due to initial dry conditions. Two layers of cheesecloth (of approximately 2 mm pore diameter) were placed on the soil surface before wetting, to minimize slaking of soil into the macropores. A ponded infiltrometer was set, and saturated (0-mm tension) flow measurements were taken followed by tension infiltrometer measurements from low to high tension (30 to 150 mm) on a 7.62-cm-diameter circle on the cleared soil surface. A detailed ponded/tension infiltrometer measurement procedure is outlined by **Ankeny [1992]**. A wet to dry sequence of measurements was followed to reduce the

antecedent water potential effects at low infiltration rates. By conducting saturated measurements first, the wetting front advances as rapidly as possible, and the assumption of a unit gradient below the device is most valid. Unsaturated hydraulic conductivity (K) at different tensions was estimated from the corresponding infiltration rate by using the relationship developed by **Ankeny et al. [1991]**. Then α values for (three) different tensions were calculated from the K_s and K relationships. An average α was computed using α_{30} , α_{60} , and α_{150} . This multiple-tension-based measurement allowed evaluation of treatment effects on different pore sizes. After infiltration measurements were completed for all four tensions at one site, a 7.62-cm soil core was taken from the (infiltration) measurement site and visually examined for root growth and macropores. In corn row locations, 149, 153, 146, and 138 data points could be gathered for analysis at 0-, 30-, 60-, and 150-mm tensions. The reason for missing values are human error and/or instrument failure. Similarly, 54, 72, 72, and 59 data points were available for no-track interrows and 27, 35, 33, and 17 for wheel track interrows.

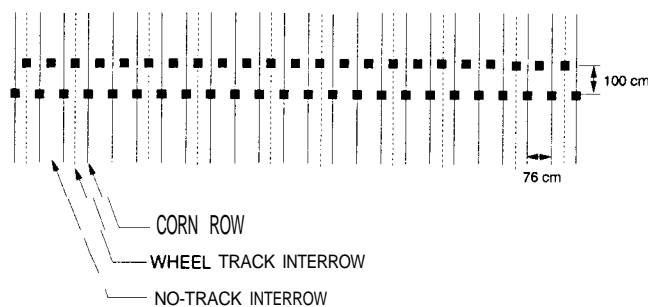

Figure 2. Five-row configuration of equipment traffic at the experimental site near Boone, Iowa. Solid squares indicate the infiltration measurement sites arranged on two parallel transects.

Theory of Spatial Analysis

Geostatistics offer a variety of techniques to fabricate models for transport processes as realizations of space-time random functions. Two basic assumptions used in geostatistics are ergodicity and stationarity of the data. Ergodicity refers to the assumption that the unique realization available behaves in space with the same probability density function

as the ensemble of possible realizations. Stationarity means that any statistical property of the medium does not change with translation thus it is stationary in space, that is, the property is said to be statistically homogenous. Because second-order stationarity [Journal and Huijbregts, 1978, p. 32] has often been violated [Horowitz and Hillel, 1983], a weaker intrinsic hypothesis [Matheron, 1963] is often used to simplify the analysis. Under this assumption the classical semivariogram estimator [Matheron, 1963] is defined as

$$\gamma(h)^* = \frac{1}{2N(h)} \sum_{i=1}^{N(h)} [Z(x_i) - Z(x_i + h)]^2, \quad (1)$$

et al. [1982] considered autocorrelation functions to describe the spatial structure of several soil properties. The autocorrelation function is defined as

$$p(h) = \text{COV} [Z(x_i), Z(x_i + h)] / \sigma^2. \quad (3)$$

Generally, the joint distribution of $Z(x_i)$ and $Z(x_i + h)$ is not known, and $p(h)$ will have to be estimated from the available set of data. In that sample, autocorrelation function $r(k)$ can be estimated by different estimators defined by Davis [1973], Cliff and Ord [1973], and Haan [1977]. Autocorrelation function [Davis, 1973] is a more traditional approach to autocorrelation and defined as

$$r(k) = \frac{\left\{ (n-k) \left[\sum_{i=1}^{n-k} Z(x_i) Z(x_{i+k}) \right] - \sum_{i=1}^{n-k} Z(x_i) \sum_{i=1}^{n-k} Z(x_{i+k}) \right\} / (n-k)(n-k-1)}{\left\{ n \sum_{i=1}^n Z(x_i)^2 - \left[\sum_{i=1}^n Z(x_i) \right]^2 \right\} / n(n-1)}, \quad (4)$$

where

- $r(h)^*$ semivariogram estimator for lag distance class h ;
- $Z(x_i)$ measured sample value at point x_i ;
- $Z(x_i + h)$ measured sample value at point $x_i + h$;
- $N(h)$ total number of sample couples for the interval h .

Different theoretical models such as linear, spherical, and exponential are most commonly used in the field of soil science and hydrology to describe the semivariogram function of regionalized variables. In real-life situations, spatial behavior of soil properties is often so complex that a simple theoretical model could hardly suffice in fitting the data. Mohanty *et al.* [1991] and Oliver and Webster [1986] used nested models ($y(h)$) to represent various kinds of field situations. This structure can be defined as

$$\gamma(h) = \gamma_1(h) + \gamma_2(h) + \gamma_3(h) + \dots + \gamma_n(h), \quad (2)$$

where $\gamma_1(h), \gamma_2(h), \dots, \gamma_n(h)$ are contributions from several semivariogram models. Small-scale variability (e.g., microheterogeneity), large-scale variability (e.g., soil type effect), directional trend (e.g., due to land slope), and periodicity (e.g., due to field traffic configuration) are some of the typical variations found in hydrology and soil science. All of these theoretical models or their tailored combinations, when best fit to the estimated sample semivariogram, reveal the intricacy of spatial pattern of the soil property. Contributing factors of these spatial structures could be investigated by studying the history and geography of the site. Besides revealing spatial structure of a series of observations, a semivariogram is an appropriate tool to estimate unbiased values at unrecorded points using kriging procedures and to account for possible drifts in the property of interest.

In addition to semivariogram, Gajem *et al.* [1981], Sisson and Wierenga [1981], Russo and Bresler [1981], and Vaclin

where $r(k)$ is the value of the autocorrelation function at lag k such that $h = k\Delta x$ for observations spaced at regular intervals Δx along a transect of n observations. $Z(x_i)$ and $Z(x_{i+k})$ are the values of the observations at the i th and $i+k$ th position, respectively. Although it requires an assumption of second-order stationarity, the autocorrelation function has certain advantages over other spatial analysis methods. In particular, its values are normalized to the range $[-1, 1]$, making it easier to interpret the values and to compare several replications. The confidence limits on $p(h)$ at probability level P are then estimated, as defined by Haan [1977]:

$$\text{Lower limit} \quad [-1 - t_{1-P/2}(n-2)^{1/2}] / (n-1) \quad (5)$$

$$\text{Upper limit} \quad [-1 + t_{1-P/2}(n-2)^{1/2}] / (n-1). \quad (6)$$

If the calculated $r(k)$ falls outside these confidence limits, the hypothesis that $p(h)$ is zero ($H_0: p(h) = 0$ versus $H_1: p(h) \neq 0$) is rejected at probability level P .

Webster [1977] and Vaclin *et al.* [1982] used spectral analysis to determine the periodicity in data by considering the spectral density function (Fourier transform of the autocorrelation function) to describe variations along a transect. Spectral density function ($S(f)$) is defined for a discrete spatial series as

$$S(f) = A\Delta x \left[r(0) + 2 \sum_{k=1}^m r(k) \cos(2nkf\Delta x) \right] \quad (7)$$

where m is the maximum number of correlation lags. Values of $S(f)$ should be computed only for frequencies f given by

$$f = \frac{k}{m} f_N, \quad (8)$$

where $f_N (= 1/2\Delta x)$ is the Nyquist frequency. The estimates of $S(f)$, however, need to be smoothed by filtering techniques before extensive interpretation.

Table 1. Analysis of Variance of K at 0-, 30-, 60-, and 150-mm Soil Water Tension and of α

Tension, mm	Between-Treatment Variation		Within-Treatment Variation		Total Variation		Between-Treatment Mean Square	Within-Treatment Mean Square	F**
	Value	d.f.	Value	d.f.	Value	d.f.			
K									
0	200265	2	1893167	227	2093432	229	100132	8340	12.0
30	915	2	4207	257	5122	259	407.7	16.4	24.9
60	124	2	7.54	248	878	250	62	3	20.6
150	11.6	2	97.5	211	109	213	5.8	0.46	12.6
α	0.026	2	0.092	227	0.118	229	0.013	0.0004	32.6

*Degrees of freedom, d.f.

**Significant at $P = 0.01$ level.

In our analysis all the above methods were used in different instances to supplement each other for interpreting the result. Note that all these spatial analyses are preceded by a Hawkins statistics operation in order to remove any existing outlier(s) in any data set. Also, possible drift (first-order increments of Z) was examined by experimentally computing $E[Z(x_i) - Z(x_i + h)]$, as suggested by David [1977], prior to semivariogram and autocorrelation computation.

Results and Discussion

A classical analysis of variance (ANOVA) (Table 1) was made for K at different tensions and α to determine whether there is significant treatment difference between three field conditions: corn row, no-track interrow, and wheel track interrow. In all three cases, results indicate significant between-treatment differences at $P = 0.01$. Following this finding, all further spatial analyses were performed for individual treatments (field conditions) to eliminate any intermixing of within variability and between variability of the treatments.

Various statistical parameters for K at different tensions (Ψ) and field conditions were estimated and compared (Table 2). The greatest coefficient of variation (CV) of K within a field condition occurred at saturation (K_s) (i.e., 0-mm tension) in corn rows and no-track interrows, whereas for wheel track interrows the greatest CV was at 150-mm tension. Moreover, the range of K values was found to be maximum in corn rows, minimum in wheel track interrows, and in between for no-track interrows. When the Shapiro and Wilk test of normality (W statistics) [Shapiro and Wilk, 1965] was used, no K data were found to be normal at the 0.90 level. Data for all four tensions, under the three types of field conditions, fit a lognormal distribution better than a normal distribution. Therefore all the K data were log-transformed before spatial analysis.

Table 3 shows statistics for the α parameter under the three field conditions. Mean values for α for corn row and no-track interrow were not significantly different at the 0.01 probability level, but both were significantly different from the α for the wheel track interrow. CV values, however, were similar for all three field conditions (44% for corn row, 47% for no-track interrow, and 42% for wheel track interrow). The CV of α was found to be much smaller than the CV of K and K_s for all three field conditions. This indicates that α is a more homoscedastic parameter. Furthermore, a

larger range of α was observed for wheel track interrow compared to the other two field conditions. The Shapiro-Wilk normality test for α showed a better fit with the lognormal distribution than the normal distribution. Thus follow-up spatial analyses were conducted for $\log_e(\alpha)$ in corn rows, no-track interrows, and wheel track interrows.

Spatial Analysis of K

Analysis of drift along the transect indicated no significant drift in K at any tension under any field condition. Figure 3 shows sample semivariograms calculated for $\log K$ at four different tensions (0, 30, 60, and 150 mm) under three different field conditions (corn row, no-track interrow, and

Table 2. Summary Statistics of K at Different Soil Water Tension for Corn Row, No-Track Interrow and Wheel Track Interrow

Moments	Tension			
	0mm	30 mm	60 mm	150 mm
	<i>Corn Row</i>			
N^*	149	153	146	138
Mean	110.7	6.9	2.7	1.0
Maximum	723.2	27.6	11.4	4.4
Minimum	2.9	0.8	.2	0.04
Variance	10241.4	22.1	4.0	0.6
Coefficient of variation, %	91.4	67.7	71.3	73.0
W Normal†	0.799‡	0.841‡	0.826‡	0.826‡
	<i>No-Track Interrow</i>			
N^*	54	72	72	59
Mean	66.3	4.2	2.0	0.7
Maximum	317.7	14.6	7.9	2.9
Minimum	2.8	0.1	0.2	0.03
Variance	6922.2	10.9	2.6	0.3
Coefficient of variation, %	125.5	79.7	80.3	76.9
W Normal†	0.706‡	0.881‡	0.848‡	0.866‡
	<i>Wheel-Track Interrow</i>			
N^*	27	35	33	17
Mean	27.3	1.6	0.6	0.2
Maximum	89.7	4.6	1.9	0.8
Minimum	3.9	0.2	0.04	0.002
Variance	451.4	1.0	0.2	0.04
Coefficient of variation, %	76.5	64.3	78.2	120.5
W Normal†	0.864‡	0.938‡	0.849‡	0.710‡

K (hydraulic conductivity) values are in micrometers per second.

*Number of data points.

†Normality test using the Shapiro-Wilk W statistic.

‡Not normally distributed at a confidence level >0.90 .

Table 3. Summary Statistics of α for Corn Row, No-Track Interrow and Wheel Track Interrow

Moments	Corn Row	No-Track	Wheel Track
N	149	54	27
Mean*	0.041	0.040	0.074
Maximum	0.128	0.127	0.177
Minimum	0.018	0.015	0.017
Variance	0.000325	0.000363	0.000978
Coefficient of variation, %	43.870	47.204	42.365
W normal†	0.784‡	0.819‡	0.917‡

*Here $0.074 > 0.041$ and 0.040 at $P = 0.01$ level.

†Normality test using the Shapiro-Wilk W statistics.

‡Not normally distributed at a confidence level >0.90 .

wheel track interrow). The lag distance (Figure 3 and figures hereafter) is intentionally expressed as row/interrow counts (one row/interrow count is 76 cm) to facilitate our site reexamination for possible intrinsic factor(s) contributing to the spatial structure of \mathbf{K} , \mathbf{K}_s , and α . Sample semivariograms of $\log \mathbf{K}$ at all tensions under each field condition were found to be mostly nugget with a certain amount of periodic behavior. These plots indicated pseudoproportional effects in nugget variance for all three field conditions, where proportional effect defines the relative shift in variance with respect to mean. Different trends in the semivariogram of $\log \mathbf{K}$ with respect to tension were found for the three field conditions.

Under no-track interrow the semivariogram estimate for $\log \mathbf{K}$ decreased with tension (i.e., maximum for \mathbf{K}_0 and minimum for \mathbf{K}_{150}). Thus variability in pore sizes decreases too. This behavior might be explained as follows. At 0-mm tension, pores of all sizes (micropores to macropores) conduct water. As the water tension is increased, the conducting pores are those with smaller diameter. At 150-mm tension, for example, pore sizes less than 0.2 mm will conduct water. Because macropores are root- or earthworm-created phenomena, their variability would be larger than that of natural (smaller) pores inherent in the soil. Under no-track interrows this trend of variability of inherited pore structure (of soil) was most prominent because of least external physical disturbance.

For 0-, 30-, and 60-mm tensions, corn rows showed a trend (with respect to tension) similar to no-track interrows. At 150-mm tension, semivariogram estimates were found greater than that for $\log \mathbf{K}$ at 30- and 60-mm tensions. We suspect that this behavior might be the variability in pore size distribution because of the presence or absence of old corn roots. Moreover, our results support *Hamlett et al. [1986]*, *Cressie and Horton [1987]*, *Gotway and Cressie [1990]*, and *Mohanty and Kanwar [1994]*, who have reported that crop rows make some contribution to differing soil hydrologic/chemical properties.

The maximum semivariogram occurred at 30-mm tension in wheel track interrows. The reason for this behavior is not known. We suspect that many of the bigger pores that conduct water at a tension equal to or less than 30 mm were smeared and clogged from wheel traffic, thus reducing the semivariogram of \mathbf{K} at 0-mm tension relative to that of \mathbf{K} at 30-mm tension. Moreover, partial sealing of some macropores to different degrees due to differing compaction (load), which otherwise conduct at saturation, might increase their

ability to conduct at 30-mm tension, causing additional variability in \mathbf{K} at that tension. *Ankeny et al. [1990]* found that larger macropores transported a greater portion of the total water flow in untrafficked soil than in trafficked soil, which reinforces the concept that larger pores are more easily destroyed by wheel traffic than smaller pores. Studies by *Meek et al. [1989, 1992a, b]* found that macropores or biopores allowed water flow to bypass soil compacted by harvest traffic, reducing hydraulic conductivity of the surface layers by 60% compared to no-harvest traffic treatments. From all these findings, including ours, we suggest that compaction destroys a larger percentage of pores which carry water at lower tension (larger pores) than pores which carry water at higher tensions (smaller pores).

Spatial Analysis of α

No apparent drift in α was observed along the transect, when examined for corn row, no-track interrow, and wheel track interrow conditions. Sample semivariogram of α were estimated (Figures 4, 5, and 6) for corn rows, no-track interrows, and wheel track interrows. For all field conditions these semivariograms (up to half of the transect length) showed nugget behavior. Correlograms (autocorrelation function versus lag) up to a quarter of the transect length (Figures 4, 5, and 6) confirmed this finding at the 95% confidence level with few minor deviations.

Some of the salient features or the correlogram under corn row condition are as follows. Except for lag 1, no other $r(\mathbf{k})$

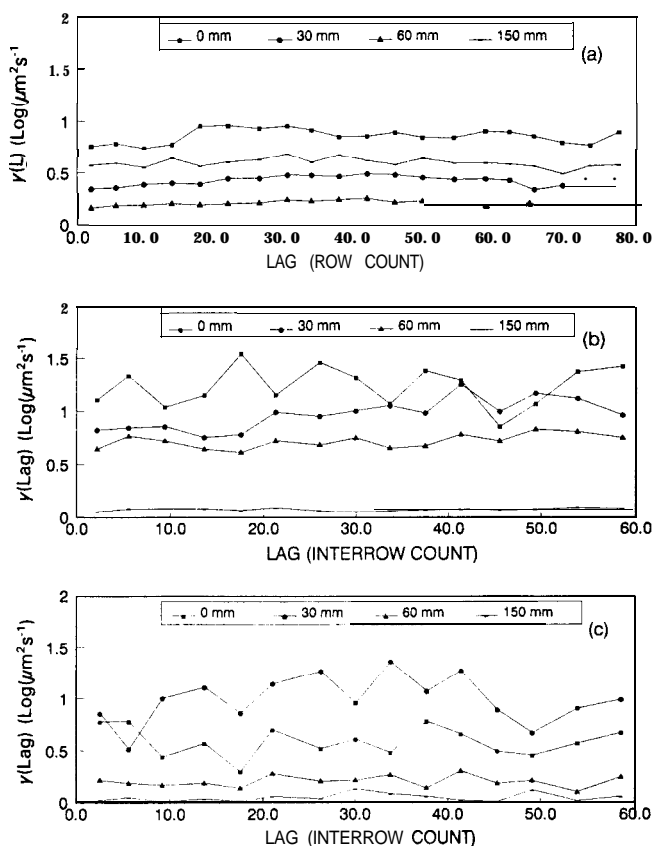

Figure 3. Sample semivariograms of $\log \mathbf{K}$ with outlier(s) removed under (a) corn row, (b) no-track interrow, and (c) wheel track interrow conditions. (One row or interrow count is 76 cm.)

was found significant at the 95% confidence level. A steep initial decay of $r(k)$ followed by a more gradual decay up to lag 5 indicates a large random variation with a small structural variation with a range equal to five row counts. Beyond lag 5, $r(k)$ was found to be somewhat positive periodic up to a lag of 25 row counts. This periodic behavior gradually damped out beyond this lag with some fluctuations around $r(k) = 0$ contained within the 95% confidence limit. To investigate the significance of this periodic variation, several sets of confidence limits around $r(k)$ were computed using (5) and (6). Figure 7a indicates that a periodic variation (of five-row count wavelength) is significant at the 80% confidence level. This periodic variation was reconfirmed by a follow-up spectral analysis (Figure 7b). Spectral density function showed peak concentration of variance at the frequency $f = 0.2$ row count⁻¹, indicating a periodic structure at five (equal to 1/0.2) row counts. The possible reason to induce this periodic behavior that we could suggest is the five-row traffic configuration (in Figure 2). Moreover, to evaluate the contribution of nugget versus the signal (structure) in the total variance of $\log \alpha$ under corn row condition, a first-order autoregressive model plus a white noise was fitted to $r(k)$ at short lag distance (Figure 7). The best fit exponential model is

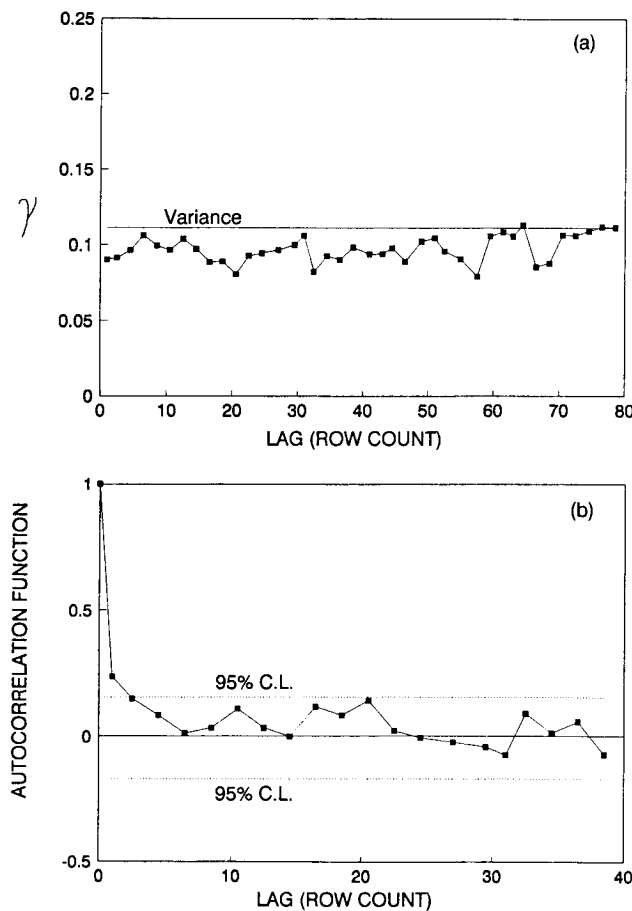

Figure 4. (a) Sample semivariogram and (b) sample correlogram for $\log \alpha$ with outlier(s) removed in corn rows. Dotted lines indicate 95% confidence limits of autocorrelation. (One row count is 76 cm.)

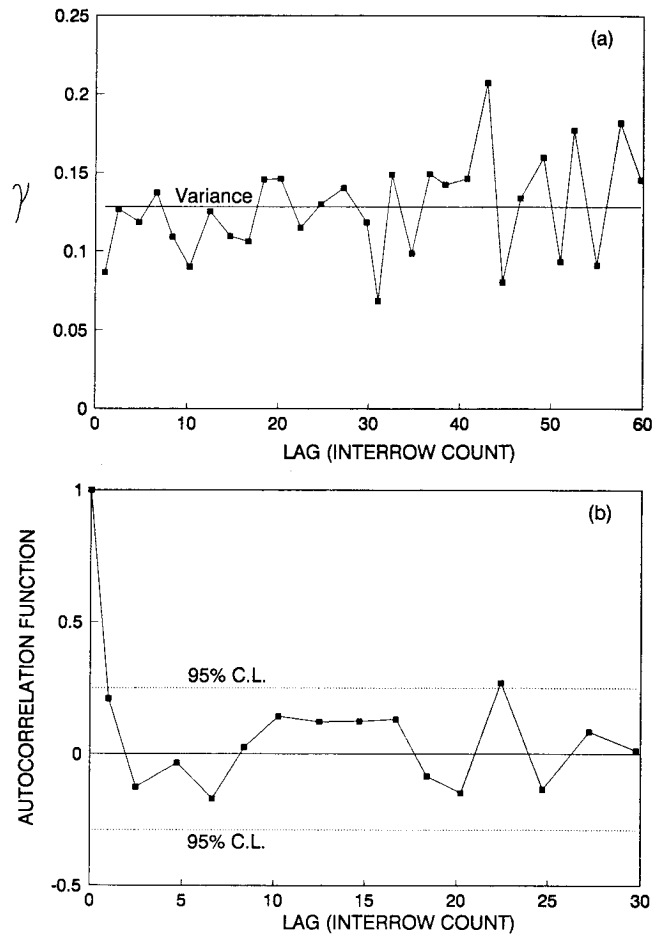

Figure 5. (a) Sample semivariogram and (b) sample correlogram for $\log \alpha$ with outlier(s) removed in no-track interrows. Dotted lines indicate 95% confidence limits of autocorrelation. (One interrow count is 76 cm.)

$$\rho = a \exp \left[-\frac{|h|}{\lambda} \right] \quad r(k) > 0, \quad (9)$$

when $|h|$ is the absolute value of lag distance, equal to $k\Delta x$, $a = 0.33$, and $\lambda = 3$. Thus the signal to white noise ratio calculated by $a/(1 - a) = 0.5$ indicates the dominance of random variation over the structural variation.

For no-track interrow, random variation was observed in the semivariogram and correlogram of $\log \alpha$. However, close examination of the semivariogram and correlogram showed two distinctly different populations (clusters) of sample semivariograms for the lags below 40 and above 40. The white noise became severely erratic beyond lag 40. Researchers usually avoid interpreting this type of unusual phenomena, as it may confound any artifact in the interpretation. However, we wanted to probe the intricacy of this pattern by reexamining the experimental site for possible intrinsic factors causing this behavior. Overlaying the soil map of the site on top of the infiltration measurement sites (transect) map showed that part of the transect lies in Nicollet soil and part lies in Clarion soil (Figure 1). While Clarion soils are well drained in Nicollet-Clarion-Webster series, Nicollet soils are somewhat poorly drained. Studies by Campbell [1978] suggest that soil type may be a possible

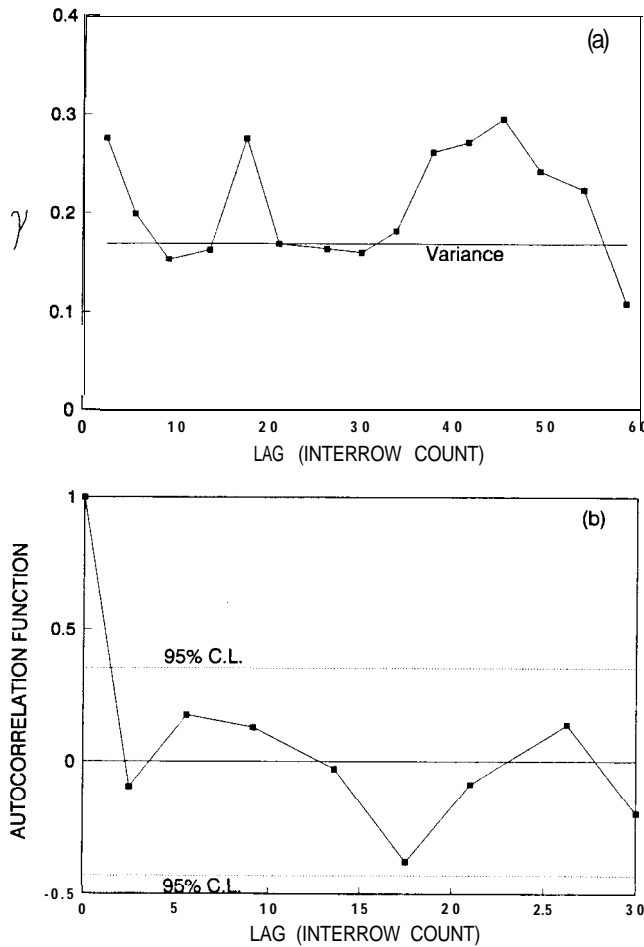

Figure 6. (a) Sample semivariogram and (b) sample correlogram for log α with outlier(s) removed in wheel track interrows. Dotted lines indicate 95% confidence limits of autocorrelation. (One interrow count is 76 cm.)

influential factor for K distribution in the soil profile. To examine any soil type effect on spatial structure of α we divided the transects for Nicollet and Clarion soils. Mean and variance of α for both soils under different field conditions are presented in Table 4. Figure 8 shows the resulting semivariogram of log α for two soils under corn row and no-track interrow conditions. Under wheel track interrow we did not conduct soil type based semivariogram analysis because of too small sample size. Semivariograms for both soils showed random variation under corn row and no-track interrow conditions. Evidently, under corn row condition, semivariograms for two soils merely indicate a small proportional effect. On the other hand, in no-track interrows, Clarion soil showed more sharp peaks and drops in white noise in contrast to smoother variation in Nicollet soil. From this finding we suggest that these two different soil types

Table 4. Statistics of α Under Nicollet and Clarion Soils

Treatment	Statistics	Nicollet	Clarion
Corn Row	mean	0.036	0.045
	variance	0.00012	0.00035
No-track	mean	0.042	0.035
	variance	0.00020	0.00021

contribute to the dual regional behavior of the semivariogram in Figure 5. Unlike corn rows, where the semivariogram shows a periodic effect due to five-row traffic configuration and other unknown intrinsic reasons, the semivariogram for no-track interrows shows tie contribution of soil type (Figure 8). The existence of a soil-type effect in no-track interrows indicates minimum extrinsic factors contributing to the spatial variability, as variography is a soil-inherited phenomenon. Based on this finding one would expect a soil-type effect in the semivariograms for corn rows and wheel track interrows. But, a soil-type effect was diluted or completely removed because of other dominant external factors (e.g., presence of macropores and roots in corn rows and compaction and destruction of pore structure in wheel track interrows).

For the wheel track interrow, no structure was found in the sample semivariogram and correlogram (Figure 6). Moreover, lack of enough pairs at different lags made the sample semivariogram and autocorrelation more unreliable.

Conclusions

A series of infiltration measurements at 0-, 30-, 60-, and 150-mm water tensions was made on the soil surface at 296 sites arranged on two parallel transects in a glacial till soil in

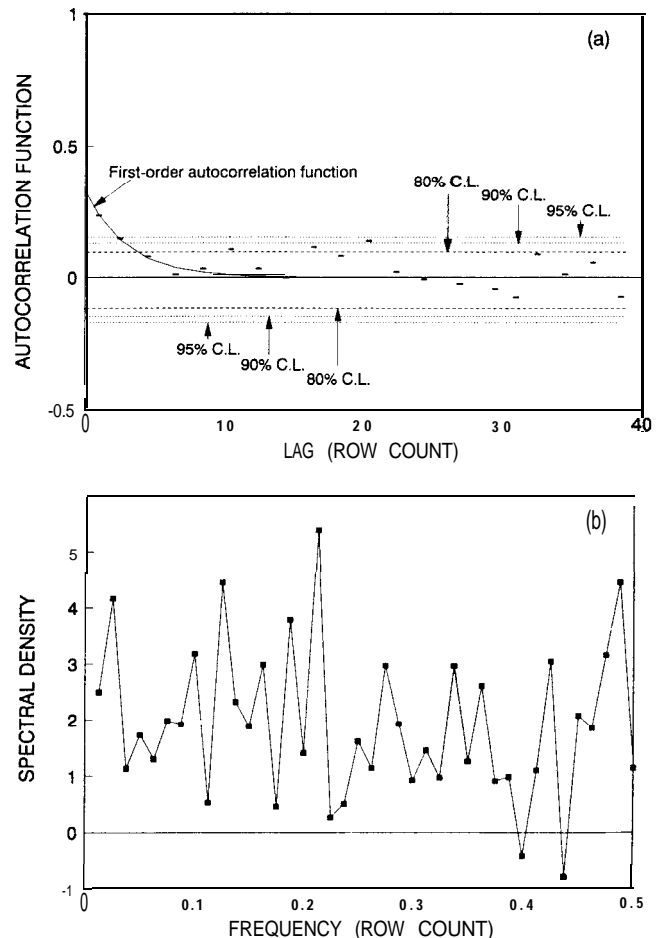

Figure 7. (a) Estimated first-order autocorrelation function for log α under corn row condition. Dotted lines indicate 80, 90, and 95% confidence limits of autocorrelation. (b) Spectral density function for log α under corn row condition.

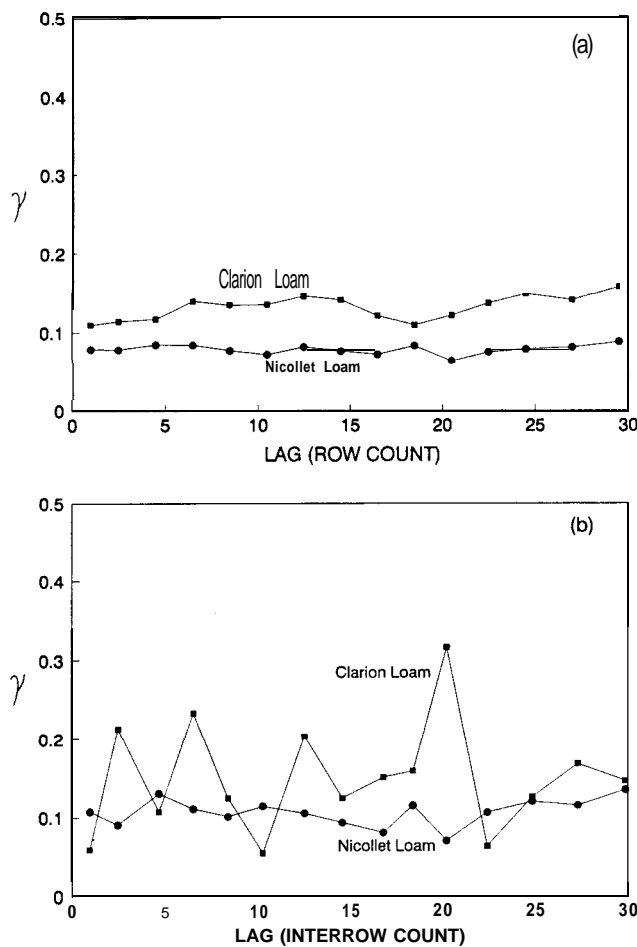

Figure 8. Sample semivariogram for log α in Nicollet loam and Clarion loam soils under (a) corn row and (b) no-track interrow. (One row or interrow count is 76 cm.)

central Iowa to compare the effect of corn row, no-track interrow, and wheel track interrow on the spatial variability of soil hydraulic properties (K , K_s , and α). Hydraulic conductivity, measured at 0-, 30-, 60-, and 150-mm water tensions was compared under the three field conditions. Classical ANOVA showed significant treatment difference ($P = 0.01$) between field conditions. For all four tensions, K was largest in the corn rows and smallest in the wheel track interrows, with no-track interrows intermediate. Sample semivariograms estimated for K and K_s under the three field conditions showed some pseudoproportional effect in nugget variance. A clear negative trend (highest variability at lowest tension and lowest variability at highest tension) was observed for no-track interrows. In corn rows this trend was violated at higher tensions because of root growth and decay (macropore closure and generation) changing the pore structure. In wheel track interrows, on the other hand, compaction and pore structure destruction elevated the variability for pores that conduct water at 30-mm tension. The α parameters for corn rows and no-track interrows were not significantly different but were significantly different from α under wheel track interrows. Spatial analysis of α , for all three field conditions, showed mostly random variation (at $P = 0.05$). Some amount of periodic variation (at $P = 0.20$) contributed to the spatial structure of α under corn rows. Soil types were contributing factors for the change in

semivariogram structure across the soil boundary in no-track interrows. Under wheel track interrows, no structure was found, indicating spatial structure was removed by wheel compaction and pore structure destruction.

Acknowledgments. This project was made possible by grant support from the Iowa Department of Natural Resources and The Management Systems Evaluation Area Project. Journal paper J-15399 of Iowa Agriculture and Home Economics Experiment Station, Iowa State University; project number 2715.

References

- Akram, M., and W. D. Kemper, Infiltration of soils as affected by the pressure and water content at the time of compaction, *Soil Sci. Soc. Am. J.*, 43, 1080-1086, 1979.
- Ankeny, M. D., Methods and theory for unconfined infiltration measurements, in *Advances in Measurement of Soil Physical Properties, Spec. Publ. 30*, edited by G. Clarke, W. D. Reynolds, and R. E. Green, pp. 123-141, Soil Science Society of America, Madison, Wis., 1992.
- Ankeny, M. D., T. C. Kaspar, and R. Horton, Design for an automated tension infiltrometer, *Soil Sci. Soc. Am. J.*, 52, 893-896, 1988.
- Ankeny, M. D., T. C. Kaspar, and R. Horton, Characterization of tillage and traffic effects on unconfined infiltration measurements, *Soil Sci. Soc. Am. J.*, 54, 837-840, 1990.
- Ankeny, M. D., M. Ahmed, T. C. Kaspar, and R. Horton, Simple field method for determining unsaturated hydraulic conductivity, *Soil Sci. Soc. Am. J.*, 55, 467-470, 1991.
- Barley, K. P., Effects of root growth and decay on the permeability of synthetic sandy soil, *Soil Sci.*, 78, 205-210, 1954.
- Beven, K. J., and R. F. Germann, Macropores and water flow in soils, *Water Resour. Res.*, 18, 1311-1325, 1982.
- Blevins, R. L., W. W. Frye, P. L. Baldwin, and S. D. Robertson, Tillage effects on sediment and soluble nutrient losses from a Maury silt loam soil, *J. Environ. Qual.*, 19, 683-686, 1990.
- Campbell, J. B., Spatial variation of sand content pH within single contiguous delineation of two soil mapping units, *Soil Sci. Soc. Am. J.*, 42, 460-464, 1978.
- Carter, M. R., Temporal variability of soil macroporosity in a fine sandy loam under moldboard ploughing and direct drilling, *Soil Tillage Res.*, 12, 37-51, 1988.
- Cliff, A. D., and J. K. Ord, *Spatial Autocorrelation*, 175 pp., Pion, London, 1973.
- Clothier, B. E., and I. White, Measurement of sorptivity and soil water diffusivity in the field, *Soil Sci. Soc. Am. J.*, 45, 241-245, 1981.
- Cressie, N. A. C., and R. Horton, A robust-resistant spatial analysis of soil water infiltration, *Water Resour. Res.*, 23(5), 911-917, 1987.
- David, M., *Geostatistical Ore Reserve Estimation*, 364 pp., Elsevier, New York, 1977.
- Davis, J. C., *Statistics and Data Analysis in Geology*, 550 pp., John Wiley, New York, 1973.
- Dick, W. A., R. J. Rosberg, E. L. McCoy, W. M. Edwards, and F. Haghiri, Surface hydrologic response of soils to no-tillage, *Soil Sci. Soc. Am. J.*, 53, 1520-1526, 1989.
- Edwards, W. M., R. R. van der Ploeg, and W. Ehlers, A numerical study of effects of non-capillary-sized pores upon infiltration, *Soil Sci. Soc. Am. J.*, 43, 851-856, 1979.
- Edwards, W. M., L. D. Norton, and C. E. Redmond, Characterizing macropores that affect infiltration into nontilled soil, *Soil Sci. Soc. Am. J.*, 52, 483-487, 1988.
- Ehlers, W., Observations on earthworm channels and infiltration on tilled and untilled loess soil, *Soil Sci.*, 119, 242-249, 1975.
- Gajem, Y. M., A. W. Warrick, and D. E. Myers, Spatial dependence of physical properties of a typical Torrifiorent soil, *Soil Sci. Soc. Am. J.*, 45, 709-715, 1981.
- Germann, P. F., W. M. Edwards, and L. B. Owens, Profiles of bromide and increased soil moisture after infiltration into soils with macropores, *Soil Sci. Soc. Am. J.*, 48, 237-244, 1984.
- Gotway, C. A., and N. A. C. Cressie, A spatial analysis of variance

- applied to soil-water infiltration, *Water Resour. Res.*, 26(1 1), 2695-2703, 1990.
- Haan, C. T., *Statistical Methods in Hydrology*, 378 pp., Iowa State University Press, Ames, Iowa, 1977.
- Hackett, C., Quantitative aspects of the growth of cereal root systems, in *Root Growth*, edited by W. J. Whittington, pp. 135-145, Butterworths, London, 1969.
- Hamlett, J. M., R. Horton, and N. A. C. Cressie, Resistant and exploratory techniques for use in semivariogram analysis, *Soil Sci. Soc. Am. J.*, 50(4), 868-875, 1986.
- Horowitz, J., and D. Hillel, A critique of some recent attempts to characterize spatial variability, *Soil Sci. Soc. Am. J.*, 47, 614-615, 1983.
- Journel, A. G., and C. J. Huijbregts, *Mining Geostatistics*, 600 pp., Academic, San Diego, Calif., 1978.
- Luxmoore, R. J., Micro-, meso-, macroporosity of soil, *Soil Sci. Soc. Am. J.*, 45, 671-672, 1981.
- Matheron, G., Principles of geostatistics, *Econ. Geol.*, 58, 1246-1266, 1963.
- Meek, B. D., E. A. Rechel, L. M. Carter, and W. R. DeTar, Changes in infiltration under alfalfa as influenced by time and wheel traffic, *Soil Sci. Soc. Am. J.*, 53, 238-241, 1989.
- Meek, B. D., W. R. DeTar, D. Rolph, E. R. Rechel, and L. M. Carter, Infiltration rate as affected by an alfalfa and no till cotton cropping system, *Soil Sci. Soc. Am. J.*, 54, 505-508, 1990.
- Meek, B. D., E. R. Rechel, L. M. Carter, and W. R. DeTar, Bulk density of a sandy loam soil: Effects of traffic, tillage and irrigation method, *Soil Sci. Soc. Am. J.*, 56, 562-565, 1992a.
- Meek, B. D., E. R. Rechel, L. M. Carter, W. R. DeTar, and A. L. Urie, Infiltration rate of a sandy loam soil: Effects of traffic, tillage, and plant roots, *Soil Sci. Soc. Am. J.*, 56, 908-913, 1992b.
- Mohanty, B. P., and R. S. Kanwar, Spatial variability of residual nitrate-nitrogen under two tillage systems in central Iowa: A composite three-dimensional resistant and exploratory approach, *Water Resour. Res.*, 30(2), 237-251, 1994.
- Mohanty, B. P., R. S. Kanwar, and R. Horton, A robust-resistant approach to interpret spatial behavior of saturated hydraulic conductivity of a glacial till soil under no-tillage system, *Water Resour. Res.*, 27(1 1), 2979-2992, 1991.
- Mohanty, B. P., R. S. Kanwar, and C. J. Everts, Comparison of saturated hydraulic conductivity measurement methods for a glacial-till soil, *Soil Sci. Soc. Am. J.*, in press, 1994.
- Oliver, M. A., and R. Webster, Semivariograms for modelling the spatial pattern of land form and soil properties, *Earth Surf. Processes Landforms*, II, 491-504, 1986.
- Perroux, K. M., and I. White, Designs for disk permeameters, *Soil Sci. Soc. Am. J.*, 52, 1205-1215, 1988.
- Prieksat, M. A., M. D. Ankeny, and T. C. Kaspar, Design of an automated self-regulating, single-ring infiltrometer, *Soil Sci. Soc. Am. J.*, 56, 1409-1411, 1992.
- Russell, R. S., *Plant Root Systems*, McGraw-Hill, New York, 1977.
- Russo, D., and M. Bouton, Statistical analysis of spatial variability in unsaturated flow parameters, *Water Resour. Res.*, 28, 1911-1925, 1992.
- Russo, D., and E. Bresler, Soil hydraulic properties as stochastic process, 1, An analysis of field spatial variability, *Soil Sci. Soc. Am. J.*, 45, 682-687, 1981.
- Scotter, D. R., Preferential solute movement through larger soil voids, 1, Some computations using simple theory, *Aust. J. Soil Res.*, 16, 257-267, 1978.
- Shapiro, S. S., and M. B. Wilk, An analysis variance test for normality (complete samples), *Biometrika*, 3, 591-611, 1965.
- Shirmohammadi, A., and R. W. Skaggs, Effect of surface conditions on infiltration for shallow water table soils, *Trans. ASAE*, 27(6), 1780-1787, 1984.
- Sisson, J. B., and P. J. Wierenga, Spatial variability of steady-state infiltration rates as a stochastic process, *Soil Sci. Soc. Am. J.*, 45, 699-704, 1981.
- Terzaghi, K., and R. B. Peck, *Soil Mechanics in Engineering Practice*, 2nd ed., John Wiley, New York, 1967.
- Timlin, D. J., G. C. Heathman, and L. R. Ahuja, Solute leaching in crop row vs. interrow zones, *Soil Sci. Soc. Am. J.* 56, 384-392, 1992.
- Trojan, M. D., and D. R. Linden, Effect of surface microrelief and rainfall intensity on water and solute movement in earthworm burrows, *Soil Sci. Soc. Am. J.*, 56, 727-733, 1992.
- van Wesenbeeck, I. J., and R. G. Kachanoski, Spatial and temporal distribution of soil water in the tilled layer under a corn crop, *Soil Sci. Soc. Am. J.*, 52, 363-368, 1988.
- Vauclin, M., S. R. Vieira, R. Benard, and J. L. Hatfield, Spatial variability of surface temperature along two transects of a bare soil, *Water Resour. Res.*, 18(6), 1677-1686, 1982.
- Wager, M. G., and H. P. Denton, Influence of crop and wheel traffic on soil physical properties in continuous no-till corn, *Soil Sci. Soc. Am. J.*, 53, 1206-1210, 1989.
- Warner, G. S., and R. A. Young, Measurement of preferential flow beneath mature corn, in *Proceedings of the National Symposium on Preferential Flow*, edited by T. J. Gish and A. Shirmohammadi, pp. 150-159, American Society of Agricultural Engineers, St. Joseph, Mich., 1991.
- Watson, K. W., and R. J. Luxmoore, Estimating macroporosity in a forest watershed by use of a tension infiltrometer, *Soil Sci. Soc. Am. J.*, 50, 578-582, 1986.
- Webster, R., Spectral analysis of Gilgai soil, *Aust. J. Soil Res.*, 15, 191-204, 1977.
- West, L. T., W. P. Miller, G. W. Langdale, R. R. Bruce, J. M. Lafren, and A. W. Thomas, Cropping system effects on interrill soil loss in the Georgia Piedmont, *Soil Sci. Soc. Am. J.*, 55, 460-466, 1991.
- Wilson, G. V., and R. J. Luxmoore, Infiltration, macroporosity, and mesoporosity distribution on two forested watersheds, *Soil Sci. Soc. Am. J.*, 52, 329-335, 1988.
- Zachmann, J. E., D. R. Linden, and C. E. Clapp, Macroporous infiltration and redistribution as affected by earthworms, tillage, and residue, *Soil Sci. Soc. Am. J.*, 51, 1580-1586, 1987.

M. D. Ankeny, Daniel B. Stephens and Associates, Incorporated, 6020 Academy NE, Suite 100, Albuquerque, NM 87109.

R. Horton, Department of Agronomy, Iowa State University of Science and Technology, Ames, IA 50011.

R. S. Kanwar, Agricultural and Biosystems Engineering Department, Iowa State University of Science and Technology, Ames, IA 50011.

B. P. Mohanty, U. S. Salinity Laboratory, Agricultural Research Service, U.S. Department of Agriculture, 4500 Glenwood Drive, Riverside, CA 92501.

(Received August 16, 1993; revised April 11, 1994; accepted April 15, 1994.)