

## Chapter 15

# Carbonate and Gypsum

**RICHARD H. LOEPPERT**, *Texas A&M University College Station, Texas*

**DONALD L. SUAREZ**, *USDA-ARS U.S. Salinity Laboratory,  
Riverside, California*

The carbonate minerals and gypsum exert a dominating influence on soils in which they are present because of their relatively high solubility, and in the case of the carbonates, their alkalinity and pH buffering properties. In this chapter, procedures for the determination of quantity, reactivity and equilibrium relations of these minerals will be discussed.

### CARBONATE

Inorganic carbonate in soil occurs predominantly as the sparingly soluble alkaline-earth carbonates, calcite ( $\text{CaCO}_3$ ) and dolomite ( $\text{CaMg}(\text{CO}_3)_2$ ). Calcite is usually the dominant form in active pedogenic environments (Doner & Lynn, 1977; Nelson, 1982). There are only a few reported occurrences of aragonite ( $\text{CaCO}_3$ ) and vaterite ( $\text{CaCO}_3$ ) in soils. Sodium carbonate and magnesium carbonate and hydroxycarbonate are common in evaporates or in regions of high-salt deposition in soil. Concentration of dissolved carbonate is controlled by equilibrium relations of the solid-phase carbonates and gas-phase  $\text{CO}_2$ . Concentration of dissolved carbonate is likely to be higher in systems with high partial pressures of  $\text{CO}_2$ , e.g., in flooded soils or in microenvironments of high microbial activity, or in sodic soils, because of the high solubility of  $\text{Na}_2\text{CO}_3$ . Also, calcite and dolomite usually control the activities of  $\text{Ca}^{2+}(\text{aq})$  and  $\text{Mg}^{2+}(\text{aq})$  in soils containing these minerals.

Calcium carbonate contents of carbonate-influenced soils range from traces to greater than 80%. Calcite exists in a variety of forms, from nodules of 1 cm or greater diameter to submicrometer particles to well-formed rhomboids. The presence of carbonates is usually associated with neutral to alkaline soils, but solid-

phase carbonates in the form of nodules are known to exist in some acid environments.

Soils differ considerably with respect to particle-size distribution of the carbonate phase. Calcite in active pedogenic environments exists predominantly in the fine-silt and coarse-clay particle-size fractions (Bui et al., 1990); alluvial basins in the USA contain calcite predominantly in the silt fraction (Suarez, 1977). Well-formed rhombohedral crystals of calcite are not common in soils with flourishing plant and microbial populations, due to the presence of chemical agents, e.g., phosphate and organic acids, that are readily adsorbed on the calcite surface and can retard or prevent normal crystal growth processes. Calcite is more commonly observed as spheroidal aggregates of microcrystalline particles (Bui et al., 1990). Dolomite is observed predominantly in the silt and fine-sand particle-size fractions. The larger particle size of dolomite, compared to calcite, is attributable to its nonpedogenic origin and its slower rate of dissolution. Soils vary considerably with respect to the relative reactivities of the carbonate component, due to differences in carbonate mineralogy, particle size and morphology. Pedogenic carbonates, due to their aggregated microcrystalline morphology, are usually observed to have relatively high reactivities. Calcite has a considerably higher dissolution rate than dolomite, approximately 100-fold.

The carbonate minerals, due to their relatively high solubility, reactivity and alkaline character, act as pH buffers; the pH values of most calcareous soils are within the range of 7.5 to 8.5. It is because of these properties that carbonates play an important role in pedogenic, chemical and rhizosphere processes in the soil.

#### TOTAL CARBONATE ANALYSIS

Soil carbonate is usually quantified by acid dissolution as summarized in the reactions below (Allison & Moodie, 1965; Nelson, 1982):

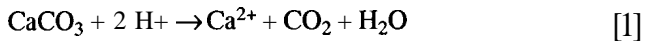

and

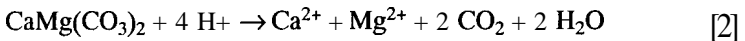

with the determination of either  $\text{H}^+$  consumption or Ca (and Mg) or  $\text{CO}_2$  production. Alternatively, a dry combustion procedure, based on the precombustion of organic matter at 575°C in an  $\text{O}_2$  stream and the subsequent combustion of carbonate at 1000°C and collection of  $\text{CO}_2$  (Rabenhorst, 1988) has been utilized.

Methods involving determination of  $\text{CO}_2$  have usually been preferred, since in the absence of decomposition of organic matter, the measurement of  $\text{CO}_2$  production provides an absolute measure of carbonate; however, it is essential that precautions be taken to ensure that there is no interference from organic matter oxidation. Carbon dioxide released can be measured gravimetrically (Allison, 1960; Allison & Moodie, 1965), titrimetrically (Bundy & Bremner, 1972), manometrically (Martin & Reeve, 1955; Presley, 1975), volumetrically (Dreimanis, 1962), spectrophotometrically by infrared spectroscopy, or by gas chromatogra-

phy. Methods involving  $H^+$  consumption (U.S. Salinity Lab. Staff, 1954; Moore et al., 1987) and Ca (or Mg) production (El Mahi et al., 1987) also have been utilized, but special precautions are required, since neither  $H^+$  consumption nor Ca release are specific for the carbonate dissolution reaction (e.g., the cation exchange complex can be a sink for  $H^+$  and a source of  $Ca^{2+}$ ). The methods of  $H^+$  consumption that involve reaction with a strong acid, such as HCl addition and back titration of the unreacted acid, are usually not suitable due to the problem of consumption of  $H^+$  by other soil components at high  $H^+$  activities; however, methods involving the reaction of a weak acid such as acetic acid (Loeppert et al., 1984; Moore et al., 1987) for the determination of total soil carbonate and of pH 4.0 sodium acetate (Bloom et al., 1985) for the determination of carbonate in the clay-size fraction have been successfully utilized.

Manganese dioxide in the soil can interfere with the acid dissolution procedures due to its influence on oxidation of organic matter (Allison & Moodie, 1965). In HCl solution,  $Cl^-$  reacts with  $MnO_2$  to produce  $Mn^{2+}$  and  $Cl_2$ . The  $Cl_2$  or one of its reaction products,  $HOCl$ , can oxidize organic matter and thus result in the release of  $CO_2$ . Since  $Fe^{2+}$  or  $Sn^{2+}$  are more easily oxidized than  $Cl^-$ , their presence ensures the reduction of  $MnO_2$  without the formation of  $Cl_2$  and  $CO_2$ . The release of  $CO_2$  from organic matter can be minimized by the addition of  $FeCl_2$  or  $FeSO_4$  to the acid (Martin & Reeve, 1955; Allison, 1960; Allison & Moodie, 1965).

Methods have been utilized for the simultaneous quantitative determination of calcite and dolomite based on: (i) the relative rates of calcite and dolomite dissolution upon reaction with HCl (Skinner & Halstead, 1958; Skinner et al., 1959; Dreimanis, 1962; Evangelou et al., 1984); (ii) the selective dissolution of calcite by a citrate buffer and the total carbonate dissolution by HCl (Peterson & Chesters, 1966; Peterson et al., 1966); (iii) the relative intensity ratio of x-ray diffraction (XRD) peaks (Tennant & Berger, 1957; Diebold et al., 1963; Runnells, 1970; Ulas & Sayin, 1984); or (iv) differential thermal analysis (DTA) (Wame & Mitchell, 1979). Each of these methods require the use of finely and uniformly ground soil samples.

Methods which have been utilized for the determination of total carbonate are summarized in Table 15-1. The authors of this chapter prefer the acid dissolution procedure followed by the manometric determination of  $CO_2$ , due to its simplicity, though the other methods presented in the text also will give reliable results. The choice of procedure will depend to a large extent on the equipment available to the researcher. Each of the procedures has several sources of error of which the analyst should be aware (as discussed in the appropriate sections below). In all cases, the soil sample must be finely ground. Also,  $CaCO_3$  or soil standards should be utilized to check that accurate quantitative results are being obtained. Previous reviews by Allison and Moodie (1965) and Nelson (1982) contain additional valuable information. The XRD and DTA methods, utilized by some researchers, have found their greatest utility in the qualitative identification of mineral phases and are not discussed in this chapter. Readers are referred to other sources (Table 15-2) for discussions of these methodologies. Methods for the quantitative determination of calcite and dolomite are summarized in Table 15-2.

Table 15-I. Methods for total carbonate determination of soils.

Principle	Component analyzed	Determination method	References
Acid dissolution	CO <sub>2</sub>	Gravimetric (NaOH absorbent)	Allison, 1960; Allison & Moodie, 1965
		Titrimetric (NaOH absorbent)	Tinsley et al., 1951; Bundy & Brummer, 1972
		Manometric	Martin & Reeve, 195.5; <b>Presley, 1975</b> ; Nelson, 1982; Suarez & Wood, 1984; USDA-SCS, 1984
	HOAc consumed (from HOAc)	Volumetric	Dreimanis, 1962
		Gravimetric (CO <sub>2</sub> loss)	Allison & Moodie, 1965; U.S. Salinity Lab. Staff, 1954
		pH (HOAc/OAc ratio)	Moore et al., 1987; Loepfert et al., 1984
Dry combustion	HOAc consumed (from pH 4 NaOAc)	Titration (difference method)	Bloom et al., 1985
	H <sup>+</sup> consumed (from HCl)	Titration (difference method)	U.S. Salinity Lab. Staff, 1954
	Ca, Mg CO <sub>2</sub>	Atomic absorption Gravimetric (NaOH absorbent)	El Mahi et al., 1987 Rabenhorst, 1988

Table 15-Z. Methods for quantitative determination of calcite and dolomite.

Principle	Component analyzed	Determination method	References
Differential kinetics	CO <sub>2</sub>	Manometric	Skinner et al., 1959; Skinner & Halstead, 1958; Evangelou et al., 1984
		Volumetric	Dreimanis, 1962
Selective dissolution	Ca, Mg	Citrate, HCl (atomic absorption)	Peterson et al., 1966; Peterson & Ches-1966
X-ray diffraction	Mineralogy	XRD†	Tennant & Berger, 1957; Diebold et al., 1963; Runnells, 1970; Ulas & Sayin, 1984
Differential thermal	Mineralogy	DTA†	Wame & Mitchell, 1979

† XRD = x-ray diffraction, DTA = differential thermal analysis.

## Pressure Calcimeter Method

### Principles

The carbonate content of a sample can be determined by reaction with acid, in a closed system, to form CO<sub>2</sub>. At constant temperature, the increase in pressure is linearly related to the quantity of carbonate present in the sample. The slope, *a*, of the equation,

$$\text{CaCO}_3 = a (H) + b \quad [3]$$

where *H* is the pressure and *a* and *b* are empirically determined constants, is less than one, because of the equilibrium relationship between CO<sub>2</sub> partial pressure

and dissolved  $\text{CO}_2$ . That is, as the pressure increases, the quantity of  $\text{CO}_2$  remaining in the liquid phase also increases. Since the equilibrium of  $\text{CO}_2$  between solution phase and gas phase and the pressure of the gas are both dependent on temperature, the temperature of the closed reaction vessel (pressure calcimeter) must be controlled with either a controlled temperature water bath or a constant temperature room. Pressure is measured with either a manometer or a pressure transducer. It is more convenient to run pure calcite standards at the given temperature and barometric pressure and construct a calibration curve, rather than to make specific corrections for temperature and barometric pressure. As with the other acid dissolution methods, ferrous iron, as either  $\text{FeCl}_2$  or  $\text{FeSO}_4$ , can be added to limit the oxidation of organic matter and the subsequent evolution of  $\text{CO}_2$  from this source. The use of an oxidation inhibitor is especially important for any procedure using strong acids that may result in the generation of elevated temperatures within the soil.

Variations of pressure calcimeters, especially with regard to the design of the system for the initial mixing of sample and acid, have been described (Williams, 1949; Martin & Reeve, 1955; Skinner et al., 1959; Evangelou et al., 1984). For example, Evangelou et al. (1984) used a magnet outside the pressure chamber which could be manipulated to dispense the soil sample from a metal cup within the chamber.

A modification of the pressure-calcimeter procedure based on the relative rates of reaction of calcite and dolomite has been used to quantitatively determine calcite and dolomite in mixed-phase systems (Skinner & Halstead, 1958; Skinner et al., 1959; Evangelou et al., 1984). An estimate of the calcite and dolomite contents can be obtained by taking measurements after 1 to 2 min (calcite) and after 1 to 2 h (calcite + dolomite). More accurate determinations of calcite and dolomite require development of time-pressure curves, using either a mercury manometer (Skinner et al., 1959; Turner & Skinner, 1959, 1960) or a pressure transducer (Evangelou et al., 1984). Skinner and Halstead (1958) and Skinner et al. (1959) plotted  $\log (P_\infty - P_t)$  vs. time during reaction of soils with 4 *M* HCl in a pressure calcimeter, took the approximately linear portion of the curve occurring after 1 min and extrapolated this line to time 0 ( $t_0$ ). The intercept value at  $t_0, P_D$ , represents the  $\text{CO}_2$  derived from dolomite, and  $P_\infty - P_D$  represents the  $\text{CO}_2$  derived from calcite. The pressure transducer, such as that described by Evangelou et al. (1984), is more highly suited than the Hg manometer for this purpose due to its more rapid response and higher sensitivity and the ease of obtaining data.

## Method

### Apparatus

1. For use of a Hg manometer:
  - A. Pressure calcimeter, reaction vessel (Fig. 15-1). Use a 90-mL (3-oz) glass bottle (A), approximately 92-mm height and 40-mm diam., with plastic screw cap (B). Drill a 3-mm hole in the plastic cap.
  - B. Hypodermic needle (Et), size 26.

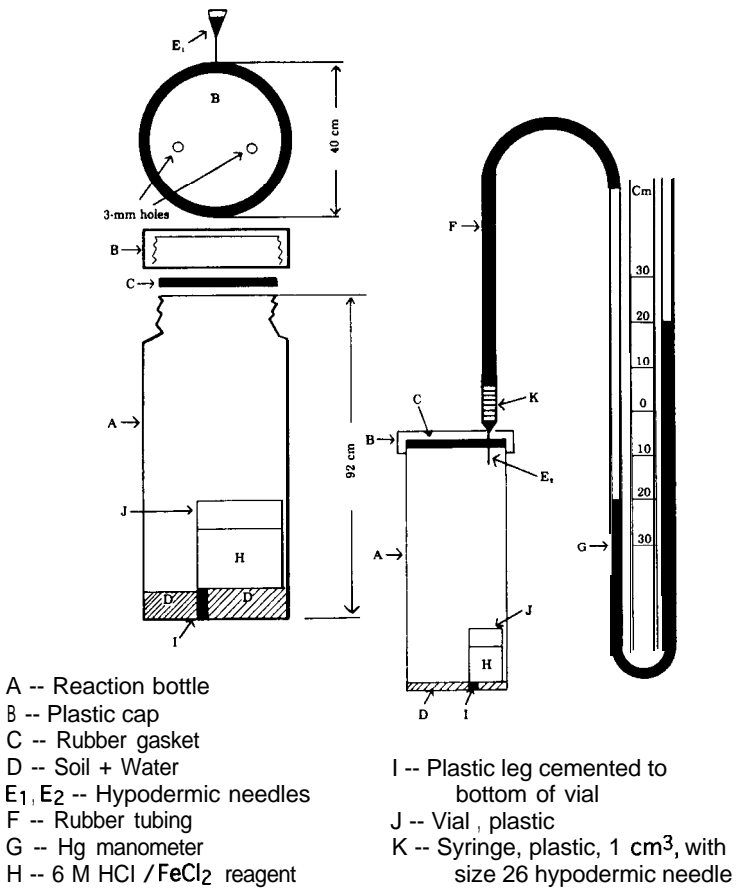

Fig. 15-1. Pressure calcimeter apparatus (Nelson, 1982).

- C. Gasket (C), rubber or plastic. Cut gaskets from rubber sheeting, to fit just inside the plastic screw caps of the pressure calcimeter. The gasket must form a seal with the top of the bottle.
  - D. Vials (J), heavy wall polystyrene or high density polypropylene, 18-mL capacity, 22-mm diam., 46-mm height. Cut vials down to 25-mm height and attach vial to side bottom of the bottle.
  - E. Construct a 90-cm Hg manometer (G) by bending 3- to 4-mm internal diameter (i.d.) glass tubing or by connecting two pieces of glass tubing with Tygon tubing. Attach rubber tubing to one side of the manometer. To the other end of the rubber tubing attach a syringe barrel (K), with the upper lip removed, polypropylene, 1 cm<sup>3</sup>, with hypodermic needle (size 26).
2. For use with pressure transducer:
    - A. Use a 500-mL glass bottle (clean, used reagent bottle) with plastic cap.
    - B. Same as with manometer.

- C. Same as with manometer.
- D. Same as with manometer.
- E. Pressure transducer accurate in the 0 to 20 kPa (above atmospheric) pressure range with a 0 to 1 V, or less, full-scale output.
- F. Strip chart recorder or analog-to-digital board for personal computer.

### Reagents

1. Hydrochloric acid (HCl), 6 M, with 3% (by weight) ferrous chloride ( $\text{FeCl}_2 \cdot 4 \text{H}_2\text{O}$ ): Add 500 mL of concentrated HCl to 400 mL of deionized water, then add 30 g of  $\text{FeCl}_2 \cdot 4 \text{H}_2\text{O}$  and dilute to a total volume of 1 L.
2. Sand, acid-washed and rinsed, and ground to pass a 200 mesh  $\text{in.}^{-1}$  ( $75\mu\text{m}$  nominal pore size) sieve.
3. Calcium carbonate ( $\text{CaCO}_3$ ), reagent grade.
4. Carbon-dioxide ( $\text{CO}_2$ ) free deionized water: Boil deionized water for 10 min, cool rapidly in an ice bath to approximately room temperature, and stopper to prevent contact with atmospheric  $\text{CO}_2$ .

### Procedure

**Calibration.** Prepare 0.5, 1.0, 2.0, 5.0, 7.5, 10, 15 and 20%  $\text{CaCO}_3$  standards by adding dry reagent grade  $\text{CaCO}_3$  to acid-washed and rinsed sand. Transfer 2.000 g of each mixture to the bottom of a dry reaction bottle. Add 5 mL of freshly prepared,  $\text{CO}_2$ -free deionized water gently down the side of the bottle; avoid splattering the standard sample onto the reaction vessel wall. Pipette 5 mL of 6 M HCl- $\text{FeCl}_2$  reagent into the plastic vial and insert, with the aid of tweezers or forceps, onto the platform of the reaction vessel. Wipe the rim of the reaction bottle with glycerol. Insert gasket (C) into the plastic cup (B), and fasten the plastic cap tightly onto the reaction bottle (A).

Insert the hypodermic needle ( $E_1$ ) through the 3-mm hole of the plastic cap (B) and allow 10 s for pressure in the container to equilibrate with atmospheric pressure. Remove the hypodermic needle, then mix the HCl- $\text{FeCl}_2$  reagent with the sample by tilting the vial (J) and bottle (A). After the acid and sample have reacted for 1 min, fully immerse the reaction bottle (A) in water at room temperature to check for leaks. If no leaks are evident, remove bottle (A) from the water bath. After 2 min, tilt and rotate the reaction bottle (A) to mix the acid with soil particles that are on the sides of the bottle. After 1 h, swirl the bottle without splattering solution on the gasket (C).

Insert the hypodermic needle ( $E_2$ ) through the 3-mm opening into the bottle (A). If a manometer is being used, record the difference in height of Hg between the two arms of the manometer. Use the same procedure on two blanks ( $H_b$ ) (reagents only). Subtract the blank ( $H_b$ ) readings from each of the standards to obtain  $H_c$  corrected. Calculate the regression equation using a linear regression procedure

$$\text{CaCO}_3 = a(H_c) + b, \quad [4]$$

where  $a$  and  $b$  are the regression parameters.

If a pressure transducer is being used, read the pressure peaks off the recorder or enter pressure values directly into the personal computer for subsequent processing.

**Samples.** Weigh  $2.00 \pm 0.01$  g of air-dry soil. Transfer the sample to a reaction flask (A) and proceed as described above for the standards. If pressure or manometer readings exceed the value recorded for the highest standard, repeat the sample with an appropriately reduced mass of soil (i.e., 0.5 g of soil).

### Calculations

Calculate the mass of  $\text{CaCO}_3$  (g) in the soil sample using the linear regression between carbonate mass and pressure.

Calculate the calcite equivalent

$$\text{calcite equivalent (mass fraction)} = \frac{\text{g CaCO}_3}{\text{g soil sample}}$$

### Comments

Estimates of  $\text{CaCO}_3$  and  $\text{CaMg}(\text{CO}_3)_2$  (dolomite) contents can be obtained by taking measurements after 2 min (calcite) and after 1 to 2 h (calcite + dolomite). More accurate determinations require development of a time-pressure curve, as described by Turner and Skinner (1959, 1960) for use with a manometer and Evangelou et al. (1984) for use with a pressure transducer.

## Gravimetric Method

### Principles

In this method the inorganic carbonates are decomposed by treating the soil in a reaction flask with 1 M  $\text{H}_2\text{SO}_4$  containing  $\text{FeSO}_4$  as an antioxidant to prevent the release of  $\text{CO}_2$  from organic matter (Allison, 1960; Allison & Moodie, 1965). The  $\text{CO}_2$  released during the dissolution of carbonate is carried by means of a pre-purified  $\text{CO}_2$ -free air or  $\text{N}_2$  stream through a series of traps to remove interfering gases as follows: (i) concentrated  $\text{H}_2\text{SO}_4$  to remove water vapor, (ii) Zn metal to remove traces of  $\text{H}_2\text{SO}_4$ , and (iii)  $\text{Mg}(\text{ClO}_4)_2$  to remove the last traces of water vapor. The gas stream then passes through a Nesbitt bulb which contains NaOH, a  $\text{CO}_2$  absorbent. The  $\text{CO}_2$  originating from the carbonate decomposition reaction is determined by weighing the Nesbitt bulb before and after the absorption of  $\text{CO}_2$ . The chemical reactions involved in the various steps of the process are summarized below:

1. purification of purge gas



2. carbonate decomposition

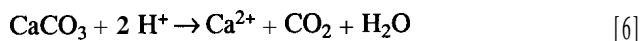



3. removal of water vapor

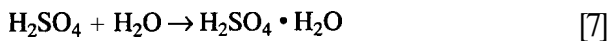

4. removal of traces of  $\text{H}_2\text{SO}_4$

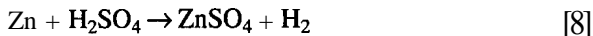

5. removal of traces of water vapor

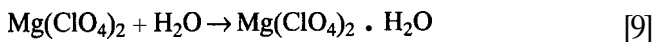

6. absorption of  $\text{CO}_2$

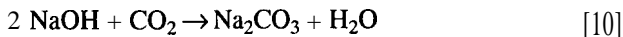

## Method

### Apparatus

A modified version of the apparatus for digestion, trapping of undesirable gases and  $\text{CO}_2$  absorption that was originally described by Allison (1960) is shown in Fig. 15-2. If the same apparatus also is to be used for determination of total organic C, additional traps are needed to remove the N-, S- and halogen-containing gases from the gas stream, as described in Chapter 36 (Sawhney, 1996).

The original apparatus as described by Allison (1960) can be constructed from the following parts (Nelson & Sommers, 1982): (A) Hoke needle valve to control air flow; (B) 25-cm high soda-lime tower; (C) 100-mL Kjeldahl flask to fit a no. 2 stopper; (D) Allihn four-bulb condenser fitted with a no. 2 stopper at the bottom end and a two-hole no. 2 stopper at the top end; (E) 60-mL open-top

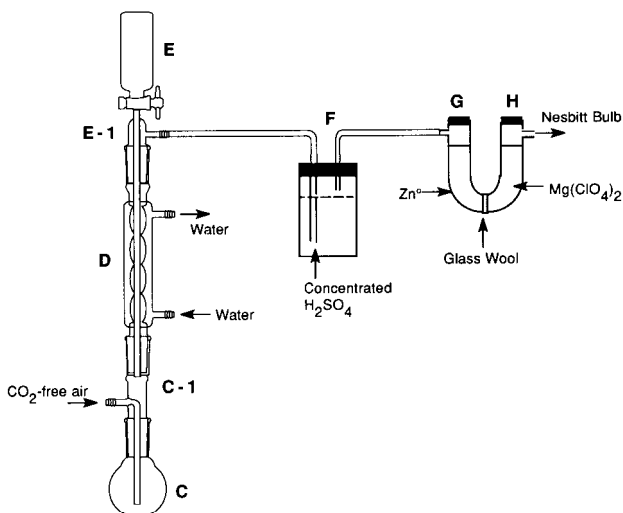

Fig. 1.5-2. Modified Allison apparatus for the gravimetric determination of carbonate (Nelson & Sommers, 1982).

separatory funnel; (F) 25- by 90-mm shell vial with no. 4 stopper; (G and H) 15-cm long U-tube; and (I) Nesbitt absorption bulb. Use neoprene stoppers and gum rubber tubing for all connections, coat all glass-to-rubber tube connections lightly with silicone lubricant.

Items C through **E** (Fig. 15-2) can be replaced with glassware with ground-glass joints (standard-taper 24/40) (Nelson & Sommers, 1982). The following parts are needed: (C) 100-mL round-bottom flask (Corning 4320); (C-I) distilling adapter tube (Coming 9421), which contains an inlet tube for bubbling  $\text{CO}_2$ -free air into the digestion acid mixture; (D) Allihn condenser, with approximately 30-mm jacket length (Coming 2480); (**E-I**) distilling tube with suction side arm (Coming 9420) (side arm is connected to purifying traps); (E) graduated separatory funnel (Coming 6382A).

The carrier gas stream can be supplied by either a laboratory source of compressed air or bottled air or  $\text{N}_2$ . Carbon dioxide in the carrier stream is removed by passing it through the soda-lime tower **B** or other suitable  $\text{CO}_2$  absorbing system. In the original (Allison) apparatus, the outlet of the soda-lime tower is connected to a glass tube of 4-mm outside diameter (o.d.) that extends through the upper stopper of condenser **D**, downward through the condenser and dips about 1 cm below the acid in digestion flask C. The stem of the funnel **E** should extend into condenser **D** to at least 5 cm below the stopper to avoid contact between the acid and the stopper. In the ground-glass apparatus (Fig. 15-2), the stem of the graduated separatory funnel should extend through the entire length of the condenser **D**. The stopcock of the graduated funnel may be lubricated with stopcock grease; however, if the same apparatus is to be used for determination of total organic C by concentrated  $\text{H}_2\text{SO}_4/\text{H}_3\text{PO}_4$  digestion, regular stopcock lubricant should not be used on the stopcock.

The purifying traps are usually mounted on a panel with attached base. The vial for the  $\text{H}_2\text{SO}_4$  trap is fitted with a no. 4 stopper that has approximately 0.6 cm cut off to provide a tight seal with the vial. Fill the trap not more than one-third full with concentrated  $\text{H}_2\text{SO}_4$ . Prepare the inflow tube from the end of a 5-mL pipette with the tip extending not more than 1.3 cm into the acid. The outlet tube from the  $\text{H}_2\text{SO}_4$  trap connects to the U-tube. Place a glass-wool plug in the bottom of the U-tube. Fill the inlet side with 30 mesh  $\text{in.}^{-1}$  (600- $\mu\text{m}$  nominal pore size) granular Zn and the outlet side with anhydrous  $\text{Mg}(\text{ClO}_4)_2$ . Place a loose plug of glass wool in each end of the U-tube and stopper immediately to prevent hydration of the anhydrous  $\text{Mg}(\text{ClO}_4)_2$ .

The Nesbitt bulb should be layered successively with a plug of glass wool, a 3-cm layer of 1.15- to 2.13-mm (8- to 14-mesh)  $\text{in.}^{-1}$   $\text{CO}_2$  absorbent, a 2-cm layer of 0.84- to 1.15-mm (14- to 20- mesh)  $\text{in.}^{-1}$   $\text{CO}_2$  absorbent, a 1-cm layer of anhydrous  $\text{Mg}(\text{ClO}_4)_2$ , and a layer of glass wool.

During the digestion step, heat must be applied to rapidly bring the reaction mixture to a boil. This can be most easily accomplished by use of a Bunsen or Meeker burner (Allison, 1960).

### Reagents

1. Digestion acid for carbonates: Dissolve 56 mL of concentrated sulfuric acid ( $\text{H}_2\text{SO}_4$ ) and 92 g of ferrous sulfate heptahydrate ( $\text{FeSO}_4 \cdot$

7H<sub>2</sub>O) in 600 mL of deionized water. Cool the solution, dilute it to approximately 1 L, and store in a well-stoppered container. This solution is approximately 1 M H<sub>2</sub>SO<sub>4</sub> and contains 5% FeSO<sub>4</sub>, to act as an antioxidant.

2. Calcium oxide, Ascarite II or other suitable CO<sub>2</sub> absorbent for the soda-lime tower.
2. Sulfuric acid, concentrated.
3. Granular zinc, 30 mesh in.<sup>-1</sup>.
4. Magnesium perchlorate [Mg(ClO<sub>4</sub>)<sub>2</sub>], anhydrous.
5. Absorbent for carbon dioxide (CO<sub>2</sub>): Ascarite II or other suitable absorbent, approximately 8- to 14-mesh in.<sup>-1</sup> and 14- to 20-mesh in.<sup>-1</sup>; an indicating absorbent is preferred.

### Procedure

Transfer a soil sample, previously ground to pass a 30 mesh in.<sup>-1</sup> sieve, containing not more than 250 mg of CaCO<sub>3</sub> equivalent into a 100-mL digestion flask, and connect to the condenser (Fig. 15-2). Weigh the Nesbitt bulb, attach it to the system, and open the valve at the top of the bulb. Pour 25 mL of the digestion acid into the burette at the top of the condenser with the stopcock closed. Allow the acid to enter the digestion flask, and immediately close the stopcock to prevent loss of CO<sub>2</sub>. Be sure that the air delivery tube extends at least 5 mm below the acid level in the digestion flask. Turn on the cooling water to the condenser. Adjust the carrier stream to a flow rate of about 2 bubbles s<sup>-1</sup>, and maintain this rate during digestion. Apply heat slowly, and bring the contents of the flask to a boil in about 4 min. Continue gentle boiling for exactly 3 min more. Remove the flame, adjust the carrier stream to 6 to 8 bubbles s<sup>-1</sup>, and continue the aeration for 10 min. Shut off the air stream and disconnect the digestion flask from the condenser. Close the stopcock on the Nesbitt bulb, disconnect the Nesbitt bulb from the system, and weigh it immediately. Make a blank determination using the identical procedure but without a sample. Before determining the carbonate content of soil samples, the procedure should be checked with finely ground CaCO<sub>3</sub> standards to be sure that a quantitative digestion and determination of carbonate is being obtained.

### Calculations

Inorganic carbonate C, mass fraction,  $\frac{\text{g C}}{\text{g soil}}$

$$= \left( \frac{\text{g CO}_2 \text{ from sample} - \text{g CO}_2 \text{ from blank}}{\text{g water-free soil}} \right) \left( \frac{\text{atomic weight of C}}{\text{molecular weight of CO}_2} \right)$$

$$= \left( \frac{\text{g CO}_2 \text{ from sample} - \text{g CO}_2 \text{ from blank}}{\text{g water-free soil}} \right) \cdot (0.2727)$$

Calcium carbonate, %

$$= \left( \frac{\text{g CO}_2 \text{ from sample} - \text{g CO}_2 \text{ from blank}}{\text{g water-free soil}} \right) \cdot \left( \frac{\text{molecular weight of CaCO}_3}{\text{molecular weight of CO}_2} \right) \cdot (100)$$

$$= \left( \frac{\text{g CO}_2 \text{ from sample} - \text{g CO}_2 \text{ from blank}}{\text{g water-free soil}} \right) \cdot (2.274) \cdot (100)$$

### Comments

The  $\text{H}_2\text{SO}_4$  trap should be prepared anew at the beginning of each day's operation, or more often if frothing occurs. One or more reactions with standard  $\text{CaCO}_3$  should be made at the beginning of the day and a single standard determination for at least every 10th sample during the day to determine whether quantitative analyses of  $\text{CaCO}_3$  are being obtained. Low  $\text{CO}_2$  values may indicate incomplete decomposition of carbonate or incomplete purge of  $\text{CO}_2$  (digestion and purge time should be increased by a few minutes; longer reaction times may be needed if samples are known to contain dolomite), leaks in the apparatus (check carefully using an aqueous leak detector), or a depleted  $\text{CO}_2$  absorbent in the Nesbitt bulb (repack the Nesbitt bulb). High  $\text{CO}_2$  values may indicate a depleted soda-lime tower, a depleted water trap [reprepare both the  $\text{H}_2\text{SO}_4$  and  $\text{Mg}(\text{ClO}_4)_2$  traps], or a poorly conditioned apparatus (run 1 or 2 blank samples until system equilibrium is attained).

When the apparatus is idle overnight or for longer periods, the Nesbitt bulb should be detached and stored in a desiccator, and the tubes connecting the  $\text{Mg}(\text{ClO}_4)_2$  trap should be clamped to prevent hydration of the desiccant.

Since strong acids are used in this procedure, essential precautions such as proper eyewear and clothing and protective barriers should be used to shield the operator.

### Simple Titrimetric Procedure

#### Principles

This procedure is based on the dissolution of soil carbonate as described by Eq. [1] and [2] and the subsequent reaction of  $\text{CO}_2$  with aqueous KOH or NaOH by the following reaction

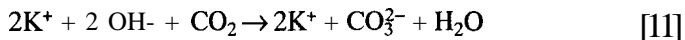

An aliquot of the aqueous KOH or NaOH absorbent is first titrated with standard HCl to the phenolphthalein endpoint, which involves the following reactions,

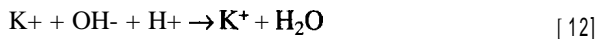

and

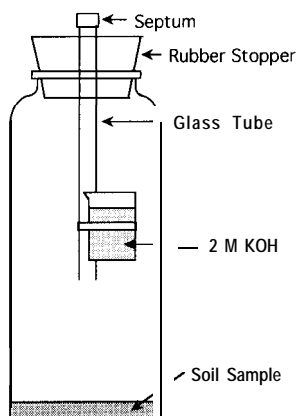
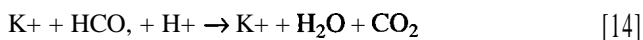

Fig. 15-3. Digestion vessel for the titrimetric determination of carbonate (Bundy & Bremner, 1972).



and then to the bromcresol green endpoint



The inorganic carbonate content is proportional the HCl consumed in this latter reaction.

## Method

### Apparatus

The digestion apparatus should be prepared as illustrated in Fig. 15-3. The digestion chamber is a wide mouth, 8 oz (approximately 240-mL) French square (or similar) bottle. The chamber is fitted with a rubber stopper with a single hole (6-mm diam.) to tightly hold a glass tube (length, 110 mm; i.d., 5 mm). The upper end of the glass tube is sealed with a sleeve-type rubber septum (plug diam., 5 mm; cap diam., 9 mm). A 5-mL beaker (to hold the KOH solution) is attached to the glass rod by means of Epoxy cement or a rubber band, so that the bottom of the beaker is about 5 mm above the lower end of the tube.

### Reagents

1. Potassium hydroxide (KOH), 2 M. Dissolve 112.2 g of reagent grade KOH into  $\text{CO}_2$  free deionized water (which has been boiled to remove dissolved  $\text{CO}_2$ ), and dilute the solution to 1-L total volume. Store in a tightly stoppered polypropylene bottle.
2. Hydrochloric acid (HCl), 2 M. Add 167 mL of concentrated HCl to about 700 mL of deionized water, and dilute the solution to 1-L total volume.

3. Hydrochloric acid (HCl), 1 M. Add 83 mL of concentrated HCl to about 700 mL of deionized water, and dilute the solution to 1-L total volume.
4. Hydrochloric acid (HCl), 0.1 M. Take 100 mL of the 1 M HCl solution and dilute to exactly 1-L total volume. This reagent should be standardized against a standard tris-hydroxyaminomethane (THAM) solution.
5. Phenolphthalein indicator solution. Dissolve 0.05 g of phenolphthalein in 50 mL of 95% ethanol, and add 50 mL of deionized water.
6. Bromocresol green indicator solution: Dissolve 0.1 g of bromocresol green in 250 mL of 0.0006 M NaOH.
7. n-octyl alcohol.

### Procedure

Weigh a sample of finely ground (to pass 100 mesh  $\text{in.}^{-1}$  sieve; 150- $\mu\text{m}$  nominal pore size) soil (not more than 8 g) containing up to 30 mg of inorganic C into an 8-oz (240-mL) square bottle, add 1 drop of n-octyl alcohol, place exactly 5 mL of 2 M KOH in the 5-mL beaker mounted on the stopper assembly, and stopper the bottle tightly. Remove 50 mL of air from the bottle by inserting a 50-mL gas syringe into the septum, then inject 20 mL of 2 M HCl into the bottle with a hypodermic syringe. Swirl the bottle gently for a few seconds to mix the contents, taking care to minimize the splattering of the soil onto the walls of the jar and to prevent the loss of NaOH from the beaker on the stopper assembly. After allowing the bottle to stand at room temperature for 16 to 24 h, gently unstopper the bottle and quantitatively transfer the contents of the beaker on the stopper assembly to a 125-mL Erlenmeyer flask (marked to indicate a volume of 50 mL) with the aid of  $\text{CO}_2$ -free deionized water, to give a final volume of 50 mL. Stopper the Erlenmeyer flask if any time is to elapse before titration.

Add 0.3 mL of phenolphthalein indicator to the flask, titrate with 1 M HCl until the pink color begins to fade, and continue the titration with 0.1 M HCl until the phenolphthalein endpoint (colorless) is reached. Then add 0.8 mL of bromocresol green indicator solution and titrate with standard 0.1 M HCl to the bromocresol green end-point (the color change at the endpoint is from blue to bright yellow). Alternatively, the sample could be titrated to the  $\text{HCO}_3^-$  pH endpoint (approximately 8.2) and then to the  $\text{H}_2\text{CO}_3$  pH endpoint (approximately 4.5).

### Calculations

$$\text{Inorganic carbonate C, mass fraction, } \frac{\text{gC}}{\text{g soil}} = \frac{(\text{mL HCl}_S - \text{mL HCl}_C) (\text{mmol}_c \text{ HCl mL}^{-1}) (0.012 \text{ g C mmol}_c^{-1})}{\text{g soil}}$$

Calcium carbonate, %

$$= \frac{(\text{mL HCl}_S - \text{mL HCl}_C) (\text{mmol}_c \text{ HCl mL}^{-1}) (0.050 \text{ g CaCO}_3 \text{ mmol}_c^{-1})}{\text{g soil}} \quad (100)$$

where,  $\text{mL HCl}_S$  = mL of standard 0.1 M HCl required to titrate the sample from the phenolphthalein endpoint to the bromcresol green endpoint;

$\text{mL HCl}_C$  = mL of standard 0.1 M HCl required for this titration in a blank analysis performed exactly as described for the sample analysis but with no soil sample added to the bottle; and, concentration of the standard HCl is expressed in  $\text{mmol}_C$  HCl  $\text{mL}^{-1}$ .

## Volumetric Calcimeter Method

### Principles

In the volumetric calcimeter method, the carbonates are treated with excess acid, as illustrated by Eqs. [1] and [2], and the  $\text{CO}_2$  is determined volumetrically (Allison & Moodie, 1965). Under conditions of constant pressure and temperature, the increase in volume of the system is a direct measure of mass of  $\text{CO}_2$  evolved and hence of soil carbonate decomposed. The apparatus used to measure the increase in volume is called a volumetric calcimeter. The apparatus described herein is the Chittick apparatus, as utilized by Dreimanis (1962). Since the volume of a given mass of  $\text{CO}_2$  is dependent on both pressure and temperature, corrections must be made to adjust for deviations in  $\text{CO}_2$  volume from those observed at standard temperature and pressure. Also, the solubility of  $\text{CO}_2$  in water or acid is dependent on temperature and  $P_{\text{CO}_2}$ , as well as on the achievement of equilibrium between gaseous phase and solution phase  $\text{CO}_2$ . It is very difficult to make solubility corrections based on physical constants due to the uncertainty of  $\text{CO}_2$  equilibrium. The problem of evaluating  $\text{CO}_2$  equilibrium (or disequilibrium) is usually overcome by calibrating each specific calcimeter apparatus under the exact conditions to be utilized in the analysis.

The Chittick apparatus has been used to determine calcite and dolomite in mixtures, based on the relative rates of reaction of these minerals.

### Method

#### Apparatus

1. Volumetric calcimeter (Dreimanis, 1962). The volumetric calcimeter is shown in Fig. 15-4. The principle components are: (A) 250-mL Florence flask with two-hole rubber stopper, (B) 25-mL addition tube with stopcock, (C) three-way stopcock, (D) manometer, and (E) leveling bulb. Tubing connections can be made with Tygon tubing.
2. Magnetic stirrer.

#### Reagents

1. Hydrochloric acid (HCl), 6 M, with 5% (by weight) ferrous chloride ( $\text{FeCl}_2 \cdot 4\text{H}_2\text{O}$ ): Add 500 mL of concentrated HCl to 400 mL of deionized water, then add 50 g of  $\text{FeCl}_2 \cdot 4\text{H}_2\text{O}$ , and dilute to a total volume of 1 L.
2. n-amyl alcohol.

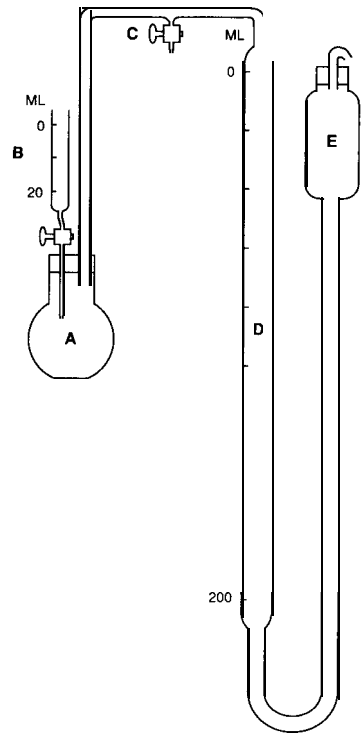

Fig. 15-4. Volumetric calcimeter for the determination of carbonate (Dreimanis, 1962).

### Procedure

#### 1. Calibration of calcimeter:

- A. Weigh dry fine-grained (small enough particle size to pass through a 100 mesh  $\text{in.}^{-1}$  sieve; 150-  $\mu\text{m}$  nominal pore size) reagent-grade  $\text{CaCO}_3$  to the nearest 0.1 mg into separate decomposition flasks. Samples of approximately 10, 20, 30, 50, 75, 100, 150, 200, 300, 400, 600 and 800 mg are recommended.
- B. Place a stirring bar in the flask, and add two drops of amyl alcohol.
- C. Install the sample flask in the system, and fill the graduated funnel (B) to the 25-mL mark with  $\text{HCl-FeCl}_2$  solution.
- D. Open the three-way stopcock (C) to the atmosphere, and adjust the liquid level of the measuring burette (D) to exactly 0mL by adjusting the height of the leveling bulb (E).
- E. Close the system to the atmosphere with the three-way stopcock (C) (180° rotation), and lower the leveling bulb about 2 cm.
- F. Simultaneously begin to add  $\text{HCl-FeCl}_2$  solution from the graduated funnel (B) to the sample and begin lowering the leveling bulb. The leveling bulb liquid level should be kept 1 to 2 cm below the liquid level in the measuring burette (D).
- G. After the sample is moistened, turn on the magnetic stirrer (slow stirring rate).
- H. Close the stopcock of the graduated funnel (B) after 20 mL of acid has been dispensed.



- I. When the level in the gas burette ceases to drop (usually less than 3 min), equalize liquid levels in the leveling bulb (E) and the measuring burette (D), and read and record the volume of  $\text{CO}_2$  that has been evolved. Also record the temperature (T) and barometric pressure (P).
2. Determination of total carbonate in soils:
  - A. Add 0.5 to 5.0 g  $\pm$  1 mg of soil which has been ground to pass a 100 mesh  $\text{in}^{-1}$  sieve (150- $\mu\text{m}$  nominal pore size) to the decomposition flask (A). **The** sample should contain no more than 600 mg  $\text{CaCO}_3$  equivalent.
  - B. Perform steps (b) through (i) as described above. Longer reaction times will be required if the soil contains dolomite.
3. Determination of calcite and dolomite in soils:
  - A. Perform steps (b) through (i) as for the determination of total carbonate; however, in this case, two readings will be taken. The first reading should be taken at 30 s and the second reading at 30 min.
  - B. Exactly 30 s after the addition of acid, equalize liquid levels in the measuring bulb and the measuring burette and read and record the volume of  $\text{CO}_2$  that has been evolved. Also, record the temperature (T) and barometric pressure (P).
  - C. Turn off the magnetic stirrer except for a 15- to 30-s stirring period every 5 to 10 min. Maintain the liquid level in the leveling bulb 1 to 2 cm below that in the measuring burette.
  - D. At 30 min following the addition of acid, repeat the measurements as made at the 30-s reading.

### Calculations

1. Calibration of calcimeter:
  - A. Correct the  $\text{CO}_2$  volume for the standards by subtracting the average  $\text{CO}_2$  volumes for the reagent blanks as follows

$$V_{\text{CO}_2(\text{corr})} = V_{\text{CO}_2(\text{std})} - V_{\text{CO}_2(\text{blank})}$$

- B. Reduce all corrected  $\text{CO}_2$  volumes to those at standard temperature and pressure (STP) using the following equation:

$$V_{\text{CO}_2(\text{STP})} = V_{\text{CO}_2(\text{corr})} \left( \frac{273 \text{ K}}{T \text{ }^\circ\text{K}} \right) \left( \frac{P \text{ mm Hg}}{760 \text{ mm Hg}} \right)$$

- C. Determine the calculated  $\text{CaCO}_3$ ,  $W_{\text{CaCO}_3(\text{cal})}$ , from the  $V_{\text{CO}_2(\text{STP})}$  values using the following equation:

$$W_{\text{CaCO}_3(\text{cal})} = [V_{\text{CO}_2(\text{corr})}] \left( \frac{100 \text{ g CaCO}_3 \text{ mol}^{-1}}{22.414 \text{ L mol}^{-1}} \right) \left( \frac{1 \text{ L}}{1000 \text{ mL}} \right)$$

- D. Plot actual  $\text{CaCO}_3$ ,  $W_{\text{CaCO}_3}$ , on the y-axis vs.  $W_{\text{CaCO}_3(\text{cal})}$  on the x-axis. The plot should be close to a straight line. The slope C is the

correction factor between the actual and calculated  $\text{CaCO}_3$ . The value of C should be less than 1 and is related to the actual quantity of  $\text{CO}_2$  remaining dissolved in the HCl digestion agent under the conditions of analysis.

$$W_{\text{CaCO}_3} = (C) [W_{\text{CaCO}_3(\text{cal})}]$$

2. Determination of carbonate in soils:

- A. The  $V_{\text{CO}_2(\text{STP})}$  is calculated as in (a) and (b) above.  
 B. The weight of  $\text{CaCO}_3$  is calculated as follows

$$W_{\text{CaCO}_3} = (C) [V_{\text{CO}_2(\text{corr})}] \left( \frac{100 \text{ g CaCO}_3 \text{ mol}^{-1}}{22.414 \text{ L mol}^{-1}} \right) \left( \frac{1 \text{ L}}{1000 \text{ mL}} \right)$$

C. Calcium carbonate equivalent is calculated as follows

$$\text{CaCO}_3 \text{ equivalent, \%} = \left( \frac{W_{\text{CaCO}_3 \text{ g}}}{W_{\text{soil g}}} \right) (100).$$

3. Determination of calcite and dolomite:

- A. The  $V_{\text{CO}_2(\text{STP})}$  for the first and second  $\text{CO}_2$  determinations is calculated as in (A) and (B) above.  
 B. The weight of  $\text{CaCO}_3$  is calculated as follows

$$W_{\text{calcite}} = (C) [V_{1-\text{CO}_2(\text{corr})}] \left( \frac{100 \text{ g CaCO}_3 \text{ mol}^{-1}}{22.414 \text{ L mol}^{-1}} \right) \left( \frac{1 \text{ L}}{1000 \text{ mL}} \right)$$

$$W_{\text{dolomite}} = (C) [V_{2-\text{CO}_2(\text{corr})} - V_{1-\text{CO}_2(\text{corr})}]$$

$$\left( \frac{100 \text{ g dolomite mol}^{-1}}{22.414 \text{ L mol}^{-1}} \right) \left( \frac{1 \text{ L}}{1000 \text{ mL}} \right)$$

C. Calcium carbonate equivalent is calculated as follows

$$\text{Calcite, \%} = \left( \frac{W_{\text{calcite g}}}{W_{\text{soil g}}} \right) (100)$$

$$\text{Dolomite, \%} = \left( \frac{W_{\text{dolomite g}}}{W_{\text{soil g}}} \right) (100).$$

### Comments

The major source of error for this procedure results from the degree of degassing of  $\text{CO}_2$  from the digestion mixture. Uniformity of procedure, including volume of acid, agitation of the digestion mixture and time of measurement of  $\text{CO}_2$  volume, is essential.

For the determination of calcite and dolomite, corrections are usually required since not all of the calcite and a portion of the dolomite is dissolved at the 30-s reading. Also, the dolomite may not be totally dissolved at the 30-min reading. Therefore, corrections are utilized to more closely reflect the actual quantities of calcite and dolomite. These constants must usually be calibrated in each laboratory for the specific conditions of analysis, by the use of soils of known calcite and dolomite contents or of reagent grade calcite and dolomite.

## Gravimetric Method for Loss of Carbon Dioxide

### Principles

When carbonates are decomposed with acid as described by Eqs. [1] and [2] in an open system,  $\text{CO}_2$  is released to the atmosphere. The decrease in weight resulting from  $\text{CO}_2$  loss is proportional to the carbonate content of the soil. The method is adopted from U.S. Salinity Lab Staff (1954) and Allison & Moodie (1965).

### Method

#### Reagents

1. Hydrochloric acid (HCl), 3 M. Transfer 250 mL of concentrated HCl to 500 mL of deionized water and dilute to a total volume of 1 L.

### Procedure

Weigh (to the nearest 0.1 mg) a stoppered, 50-mL Erlenmeyer flask containing 10 mL of 3 M HCl. Alternatively, a 70-mL (20-dram) snap-lid polypropylene vial with 2-mm diam. holes in the caps can be utilized. Transfer a 1- to 10-g air-dried soil sample (containing 0.1-0.3 g of  $\text{CaCO}_3$  equivalent) to the container, a little at a time, to prevent excessive frothing. After effervescence has subsided, replace the stopper loosely on the flask and swirl the flask occasionally for about 15 min. At intervals of about 15 min, remove the stopper and swirl the flask for 10 to 20 s to displace any accumulated  $\text{CO}_2$  with air. Replace the stopper, and then weigh the flask and its contents to the nearest 0.1 mg. Repeat the agitation and weighing procedure until the weight of the container does not change by more than 1 to 2 mg. The reaction is usually complete within 1 h.

### Calculations

Weight of  $\text{CO}_2$  = Difference between initial and final weights (flask + stopper + acid + soil)

$$\begin{aligned} \text{CO}_3\text{-C, \%} &= \left( \frac{\text{g CO}_2 \text{ lost}}{\text{g soil}} \right) \left( \frac{\text{g C mol}^{-1}}{\text{g CO}_2 \text{ mol}^{-1}} \right) (100) \\ &= \left( \frac{\text{g CO}_2 \text{ lost}}{\text{g soil}} \right) (0.2727) (100) \end{aligned}$$

$$\begin{aligned} \text{CaCO}_3, \% &= \left( \frac{\text{g CO}_2 \text{ lost}}{\text{g soil}} \right) \left( \frac{\text{g CaCO}_3 \text{ mol}^{-1}}{\text{g CO}_2 \text{ mol}^{-1}} \right) (100) \\ &= \left( \frac{\text{g CO}_2 \text{ lost}}{\text{g soil}} \right) (2.273) (100) \end{aligned}$$

### Comments

The major sources of error with the weight loss procedure are evaporation of water and failure to quantitatively degas  $\text{CO}_2$ . Errors due to decomposition of organic matter can be reduced by the addition of 3%  $\text{FeCl}_2$  to the HCl. Reasonable results can be achieved with proper adherence to uniform experimental procedure; however, precision is usually lower than by the methods involving direct quantification of evolved  $\text{CO}_2$ . This method is not suitable for soils with low  $\text{CaCO}_3$  contents.

### Acetic Acid Dissolution Method

#### Principles

A procedure for the routine determination of soil carbonate which requires only a pH meter is based on the following reaction (Loeppert et al., 1984; Moore et al., 1987)

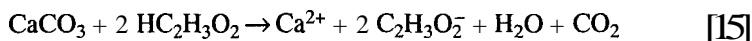

The neutralization of acetic acid in the above reaction is then expressed as

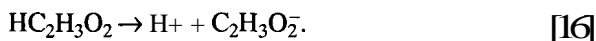

An equilibrium expression for the reaction is

$$\text{pH} = \text{pK} + \log \left( \frac{[\text{C}_2\text{H}_3\text{O}_2^-]}{[\text{HC}_2\text{H}_3\text{O}_2]} \right) \quad [17]$$

which may be written in terms of  $\text{CaCO}_3$  content as

$$\text{pH} = a \log \left( \frac{\text{CaCO}_3}{T - \text{CaCO}_3} \right) + b, \quad [18]$$

in which  $T$  equals the total amount of  $\text{CaCO}_3$  which could be completely neutralized by the quantity of acetic acid added to the system;  $a$  and  $b$  are constants for the empirically determined equation for a series of  $\text{CaCO}_3$  standards.

The experimental procedure involves addition of a known quantity of acetic acid to a given quantity of soil. The pH of the reaction mixture is then determined following the complete dissolution of  $\text{CaCO}_3$ . Calcium carbonate contents are determined from a standard curve of pH vs.  $\log[\text{CaCO}_3/(T - \text{CaCO}_3)]$  for known quantities of  $\text{CaCO}_3$ .

## Method

### Apparatus

1. pH meter, which gives a digital output of 0.01 pH unit or better.

### Reagents

1. Calcium carbonate, fine-grained, reagent-grade.
2. Acetic acid, 0.4 M ( $\text{HC}_2\text{H}_3\text{O}_2$ ); weigh 24.02 g of glacial acetic acid and dilute to 1 L total volume.

### Procedure

To prepare a standard curve, weigh fine-grained reference calcite samples to the nearest 0.1 mg and place in 70-mL (20-dram) snap-lid vials with 1-mm holes in the caps to allow escape of  $\text{CO}_2$  during the dissolution reaction. The 1-mm holes are large enough to allow exchange of  $\text{CO}_2$ , yet small enough to minimize the volatilization of  $\text{HC}_2\text{H}_3\text{O}_2$ . Sample weights of 10, 30, 50, 100, 200, 300 and 400 mg are suggested.

Weigh soil samples (previously ground to pass a 100-mesh  $\text{in.}^{-1}$  sieve; 150- $\mu\text{m}$  nominal pore size) to the nearest 0.001 g and place into 70-mL (20-dram) snap-lid polypropylene vials with 1-mm diam. holes in the caps. Soil weight should be less than 2 g for soils with less than 20%  $\text{CaCO}_3$  equivalent (CCE), 1 g for soils with 20 to 40% CCE and 0.5 g for soils exceeding 40% CCE.

Add 25.0 mL of 0.40 M  $\text{CH}_3\text{COOH}$  to calcite standards and soils in the snap-lid vials. Place the vials on a rotary shaker overnight (approximately 16 h). After overnight equilibration, measure pH of suspensions of standards and soils to the nearest 0.01 pH unit. If the pH exceeds 5.00, the analysis should be repeated with a lower quantity of soil.

### Calculations

Plot a standard curve of pH vs.  $\text{mg CaCO}_3 / (T - \text{mg CaCO}_3)$ , where  $T$  represents the quantity of  $\text{CaCO}_3$  that would react stoichiometrically with the acetic acid added. As described above (with 25 mL of 0.4 M  $\text{CH}_3\text{COOH}$  added),  $T$  is 500 mg. Determine the slope and intercept of the linear equation

$$\text{pH} = a \log \left( \frac{\text{mg CaCO}_3}{T - \text{mg CaCO}_3} \right) + b \quad [19]$$

Calculate CCE from the experimentally determined pH values of the soil suspensions using the following equation

$$\text{CCE, \%} = \frac{100 (T)}{S(1 + 10^{(b - \text{pH})/a})} \quad [20]$$

$$\text{CCE, g kg}^{-1} = 10 (\text{CCE, \%}) \quad [21]$$

where,  $a$  and  $b$  are constants derived empirically from the standard curve, and  $S$  is the oven-dry soil weight in milligrams.

## Comments

This procedure provides a means of obtaining quantitative determinations of soil carbonate with readily available equipment, but it is subject to errors to which the  $\text{CO}_2$  evolution procedures are not subject. Possible sources of error are: (i) consumption of  $\text{H}^+$  by the soil cation-exchange complex, (ii) dissolution of soil components other than  $\text{CaCO}_3$ , (iii) incomplete dissolution of the solid-phase carbonate, (iv) volatilization of acetic acid, and (v) errors in pH determination (Loeppert et al., 1984). Errors due to nonspecific interactions of  $\text{H}^+$  with clay minerals, which are most prevalent at low  $\text{CaCO}_3$  contents (i.e., at the low pH values at high  $\text{HC}_2\text{H}_3\text{O}_2/\text{C}_2\text{H}_3\text{O}_2^-$  ratios), can be reduced by standard additions of Ca (e.g., 0.1 M  $\text{CaCl}_2$ ) to all samples and standards. Errors due to specific interactions of  $\text{H}^+$  with soil organic matter, which are most severe at low carbonate and high organic matter contents, cannot be totally eliminated; for example, at 2% actual  $\text{CaCO}_3$  and 4% organic matter content, the measured  $\text{CaCO}_3$  content was 2.2%, at 20%  $\text{CaCO}_3$  and 4% organic matter the measured  $\text{CaCO}_3$  content was 20.2% (Loeppert et al., 1984). Under the experimental conditions described above, errors due to decomposition of layer-silicate minerals are minimal; however, samples containing readily decomposable minerals, e.g., zeolites, may be subject to errors in carbonate determination. On the other hand, contact time must be sufficient to allow for the complete dissolution of solid-phase carbonate. Longer reaction times may be required for samples containing dolomite, due to the slower reaction rate of this mineral. The precise and reproducible determination of pH is essential for the success of the procedure; therefore, the care and conditioning of the pH electrode is very important.

## CARBONATE REACTIVITY

Particle-size distribution, surface area and reactivity are important properties of soil carbonates which influence soil pedogenic, chemical and rhizosphere processes. Calcium carbonate provides a reactive surface for adsorption and precipitation reactions, for example, of phosphate (Boischof et al., 1950; Talibudeen & Arambarri, 1964; Amer et al., 1985), trace metals and organic acids. Carbonate reactivity can influence the rate of volatilization of ammonia (Ryan et al., 1981). Carbonate reactivity also influences rhizosphere processes, especially those processes in which acidification is an important factor. For example, the Fe-deficiency stress response of dicots involves the exudation of protons and acidification of the rhizosphere; the effectiveness of Fe-deficiency stress response of dicots is therefore negatively influenced by the neutralization of plant-produced acidity, which is influenced by the reactivity of the carbonate phase (Loeppert et al., 1988; Morris et al., 1990).

Several methods have been used to assess either carbonate reactivity or quantity of reactive carbonate. A widely used procedure is the "active" carbonate method (Drouineau, 1942; Boischof and Hebert, 1947), which involves reaction of the soil with ammonium oxalate or oxalic acid for a predetermined time. Other scientists have used quantity of clay-size carbonate as a measure of active carbonate. A radio-tracer technique involving the use of  $^{45}\text{Ca}$  has been proposed to

measure the specific surface area of  $\text{CaCO}_3$  in the soil (Talibudeen & Arambarri, 1964; Abedi & Talibudeen, 1974; Holford & Mattingly, 1975); however, results by this procedure may not be reliable in soils which contain appreciable quantities of layer silicates. Glover (1961) demonstrated the utility of ethylenediaminetetraacetic acid (EDTA) for the evaluation of soil carbonate reactivity.

The evaluation of carbonate reactivity involves the reaction of the soil with either (i) a complexing agent that reacts specifically with the carbonate phase or (ii) a standard acid. In the former case, the rate of depletion of complexing agent from the solution, or the rate of release of Ca (and Mg) is monitored as an index of carbonate reactivity; in the latter case either rate of consumption of  $\text{H}^+$  is monitored with a pH-stat titrator (Moore et al., 1989; Morris et al., 1990; Hartwig & Loeppert, 1991) or rate of production of  $\text{CO}_2$  is monitored with a Hg manometer or a pressure transducer (Suarez & Wood, 1984). The active carbonate and carbonate reactivity procedures are kinetically based methods, and the results are strongly influenced by factors which influence the rate of reaction at the carbonate mineral surface, e.g., sample pretreatment, agitation procedure and temperature. Therefore, for each of these procedures, the experimental methodology must be adhered to carefully to enable comparisons between samples. Table 15-3 provides a summary of the available reactivity methods.

### Carbonate Reactivity by pH Stat

#### Principles

The rate of reaction of  $\text{H}^+$  with  $\text{CaCO}_3$  is directly related to surface area in a well-stirred system, and within the pH range of three to five is approximately first-order with respect to  $\text{H}^+$  activity (Bemer & Morse, 1974). In the pH-state procedure, standard acid is titrated into an aqueous suspension of a calcareous soil at a rate to maintain pH constant at a predetermined value during the carbonate dissolution reaction (Eq. [1]). A plot of cumulative acid addition vs. time is obtained, for which the slope at a given time is equal to the reaction rate at that point in time. Moore et al. (1989) developed a procedure to determine reactive surface area of soil carbonates using pH-stat titrations at pH three and five. This procedure utilizes rate constants for the dissolution of Iceland spar calcite and cumulative soil carbonate dissolution data, which are incorporated into simultaneous multiple linear equations employing the equal diameter-reduction hypoth-

Table 15-3. Methods for evaluation of carbonate particle-size distribution or reactivity.

Principle	Reacting species	Determination method	References
Acid dissolution kinetics	$\text{H}^+$	pH-stat	Morris et al., 1990; Moore et al., 1989; Hartwig & Loeppert, 1991,1992
		$\text{CO}_2$ (manometric)	Suarez & Wood, 1984
Surface complexation	Oxalate	$\text{MKnO}_4$ titration of	Drouineau, 1942; Boisshot & Hebert, 1947
	$^{45}\text{Ca}$	$^{45}\text{Ca}$ analysis	Talibudeen & Arambarri, 1964; Abedi & Talibudeen, 1974
	EDTA	Ca, Mg (atomic absorption)	Glover, 1961

esis (Swartzendruber & Barber, 1965). The particle-size distribution of the soil carbonate is then determined by a least squares technique. The calculated particle-size distribution actually represents the hypothetical particle-size distribution of an equivalent quantity and reactivity of Iceland spar calcite.

The rate of reaction of  $H^+$  with soil carbonate is highly dependent on accessibility of carbonate surface sites to reaction with  $H^+$ ; therefore, sample pretreatment and degree of dispersion of the soil strongly influences the results of the pH-stat titration procedure (Hartwig & Loeppert, 1991). If the researcher's interest is in assessing the relative reactivity of the carbonate particles composing the soil, then the soil aggregates should be totally dispersed by Na saturation and either sonication or vigorous agitation of the sample, prior to pH-stat titration (Hartwig & Loeppert, 1991). If, on the other hand, the interest is in assessing the relative reactivity of the carbonate phase in an aggregated soil, then minimal dispersion of the aggregates is desirable. In this case, the only pretreatment is usually to wet the sample gently with a dilute  $CaCl_2$  solution, to minimize dispersion prior to titration.

## Method

### *Apparatus*

1. Automatic pH-stat titrator with a graphical or digital output of cumulative titrant volume vs. titration time. A stirrer assembly with paddle stirrer rather than a magnetic stirring bar is preferred, to minimize the grinding of soil particles at the bottom of the titration vessel.

### *Reagents*

1. Hydrochloric acid (HCl), 0.5 M: Transfer 41.7 mL of concentrated HCl to 600-mL deionized water and dilute to 1-L total volume. Standardize this reagent against a standard solution of tris-hydroxyaminomethane (THAM).
2. Calcium chloride ( $CaCl_2$ ), 0.01 M: Weigh 1.47 g of reagent grade  $CaCl_2 \cdot 2H_2O$ , dissolve in 600 mL deionized water, and dilute to 1-L total volume.
3. Sodium chloride (NaCl), 1 M: Weigh 58.4 g of reagent grade NaCl, dissolve in 600 mL deionized water, and dilute to 1-L total volume.

### *Procedure--Titration of Dispersed Soils for Determination of Effective Particle-size Distribution*

**Sample Pretreatment.** Place an accurately weighed 0.5000-g air-dried soil sample (previously crushed to pass a 2-mm pore-size sieve) into a 40-mL polypropylene centrifuge tube, and saturate with Na by three successive treatments with 20 mL of 1.0 M NaCl. Following each NaCl treatment, centrifuge the suspension at approximately 3000 x G for 10 min and discard the supernate. Following the final treatment with NaCl, centrifuge the sample at approximately 3000 x G for 10 min, discard the supernate, wash once with 20 mL of deionized water, centrifuge, and discard the supernate. Following each addition of NaCl or water, shake the sample vigorously, sonicate for 30 s with a 0.22-cm diam. probe at a power output of 7 W [a power setting of approximately 5 with



the Branson model 350 sonifer (Heat Systems, Farmingdale, NY)], and shake vigorously again to disperse the sample. If the sample remains dispersed following centrifugation of the final water treatment, then totally disperse the sample by vigorous agitation and transfer quantitatively to a titration vessel. If the sample is not adequately dispersed, then wash with deionized water one more time to ensure adequate dispersion. If a sonicator is not available, then instead, shake the sample vigorously for 10 min during each step of the dispersion and washing process. The sonication treatment is severe enough to promote dispersion of the silicate clays, yet mild enough to prevent appreciable grinding of the carbonate aggregates. The washing step is minimized in order to reduce the dissolution of carbonate and to ensure at least a partial Na saturation of the soil cation-exchange complex.

**Titration.** Transfer the soil sample from step 1, above, quantitatively into an appropriate titration vessel. Adjust the pH stat titrator to the desired titration pH. Allow an air purge of approximately 200 cm<sup>3</sup> min<sup>-1</sup> to pass over the suspension, but avoid the bubbling of air in the suspension. The sample is stirred for exactly 30 s on the titration assembly before initiation of titration. Separate samples should be titrated at pH 3 and 5 for 28 min using 0.5 M HCl. Obtain plots of cumulative volume of acid consumed vs. time at each pH value. Titrations at both pH 3 and 5 are utilized, since the pH 3 titration enables a better evaluation of sand-size particles and the pH 5 titration allows the evaluation of clay-size particles.

**Calculations.** The rate of dissolution of soil carbonate is described by the following equation

$$\frac{dQ}{dt} = 4\pi q_a K \left( r_{a0} - \frac{Kt}{\rho} \right)^2 + 4\pi q_b K \left( r_{b0} - \frac{Kt}{\rho} \right)^2 + \dots + 4\pi q_n K \left( r_{n0} - \frac{Kt}{\rho} \right)^2 \tag{22}$$

where

- $\frac{dQ}{dt}$  = rate of dissolution, milligram/minute, of the soil carbonate, taken directly from the slope of the pH stat titration curve at time  $t$
- $q_a$  to  $q_n$  = number of particles in particle-size fractions  $a$  through  $n$  for the initial particle radii,  $r_{a0}$  to  $r_{n0}$
- $r_{a0}$  to  $r_{n0}$  = initial particle radii; these values represent the various particle-size classes; the recommended initial particle-radii are  $5 \times 10^{-6}$ ,  $2.5 \times 10^{-5}$ ,  $2 \times 10^{-4}$ ,  $10^{-3}$ ,  $5 \times 10^{-3}$  cm to represent the fine-clay, coarse-clay, fine-silt, coarse-silt and sand particle-size fractions, respectively.
- $K$  = dissolution rate constant for Iceland spar calcite, milligrams per minute per centimeter square. The reaction rate constant of calcite can be determined by the titration of crushed and thoroughly washed Iceland spar calcite that has been sieved to obtain nar-

row-ranges of particle size (Hartwig & Loeppert, 1991). Usually in the determination of rate constant, the Iceland spar calcite is pretreated to remove 5% of the crystal mass to ensure that surface adsorbed crystallites have been removed. The reaction rate constant is taken as the initial dissolution rate of the mineral. The surface area for the rate constant determination can be either calculated using assumptions of spherical geometry of the particle-size separates or experimentally determined using a BET  $N_2$ -adsorption adsorption procedure.

$$\rho = \text{density of calcite} = 2.71 \text{ g cm}^{-3}$$

The variables  $q_a$  to  $q_n$  are calculated from the multiple linear regression equations generated using reaction rates,  $dQ/dt$ , at time intervals along the pH-stat titration curves at pH 3 and pH 5. The SAS Institute (1985) General Linear Model (GLM) procedure or other suitable linear regression model would provide a means of solving the multiple linear regression equations.

The  $\text{CaCO}_3$  equivalent weight of the soil is the sum of the  $\text{CaCO}_3$  equivalent weight of the individual particle size classes

$$W_t = W_a + W_b + \dots + W_n = q_a V_{a0} \rho + q_b V_{b0} \rho + \dots + q_n V_{n0} \rho \quad [23]$$

$$W_t = (4/3)\pi q_a r_{a0}^3 \rho + (4/3)\pi q_b r_{b0}^3 \rho + \dots + (4/3)\pi q_n r_{n0}^3 \rho \quad [24]$$

where,  $V_a$ , to  $V_{an}$  are the volumes of the individual particles of the particle-size classes a through n, and  $W_a$  to  $W_n$  are the total weights of particle in the particle-size classes a through n. The proportion of the total carbonate in each effective particle-size class is calculated by dividing the total effective weight of carbonate in that class by the total weight of carbonate in the soil, e.g.,  $W_a/W_t$  for particle class a.

The total effective surface area of the carbonate phase may be calculated as follows

$$SA_t = 4 \pi q_a r_{a0}^2 + 4 \pi q_b r_{b0}^2 + \dots + 4 \pi q_n r_{n0}^2 \quad [25]$$

### *Procedure-Titration of Aggregated Soils for Determination of Relative Carbonate Reactivity*

**Sample Pretreatment.** Place an accurately weighed 0.500-g air-dried soil sample into a 40-mL polypropylene titration vessel. Carefully add 20 mL of 0.01 M  $\text{CaCl}_2$  solution, while being careful not to agitate the soil sample. Gently rotate the vessel at an angle for a few rotations to ensure that the soil aggregates are thoroughly saturated with water, allow the sample to stand for 30 min, and gently rotate the vessel again for a few rotations prior to titration.

**Titration.** Adjust the pH-stat titrator to pH 5.0. Allow an air-purge of approximately  $200 \text{ cm}^3 \text{ min}^{-1}$  to pass over the suspension, but avoid bubbling. Initiate the titration immediately following initiation of agitation of the sample with the paddle stirrer on the titration assembly. Allow the titration to proceed for

20 min, during which time a plot of cumulative volume of acid consumed vs. time is obtained.

**Calculation.** Calcium carbonate reactivity as determined by this procedure is usually expressed as milligram per gram per minute, which is determined as the slope of the linear regression of the dissolution curve over the first 20 min or as the net dissolution rate

$$\begin{aligned} \text{CaCO}_3 \text{ reactivity at pH 5.0} &= \frac{\text{mg CaCO}_3 \text{ dissolved}}{(\text{soil g})(\text{time min})} \\ &= \frac{(\text{HCl mL})(\text{HCl mmol, mL}^{-1}) \left( \frac{50 \text{ mg CaCO}_3}{\text{mmol,}} \right)}{(\text{soil g})(\text{time min})} \end{aligned} \quad [26]$$

### Comments

The pH-stat procedure for carbonate reactivity provides an excellent means of comparing soils with respect to relative carbonate reactivity. The pH-stat titration has most commonly been performed at pH 5, though other pH values (e.g., 4, 6 and 7) have also been utilized. Morris et al. (1990) determined that pH 5 titration was the most effective pH for assessment of the role of carbonate reactivity on a rhizosphere process [Fe-deficiency stress response of soybean (*Glycine max* L.)] that is influenced by the relative reactivity of the carbonate phase. The pH-stat carbonate- reactivity titration is highly dependent on pH and soil pretreatment procedure. The choice of pretreatment and reaction pH is influenced by the objective of the experiment.

## Carbonate Reactivity by a Manometric Procedure

### Principles

In the pressure method, a fixed acid concentration is reacted with an aqueous suspension of a calcareous soil in a closed reaction vessel (Suarez & Wood, 1984). The solution is preferably buffered to maintain constant pH during the measurement time. Addition of acid results in dissolution of  $\text{CaCO}_3$  and release of  $\text{CO}_2$  as shown in Eq. [1]. A pressure transducer and a strip chart recorder allow measurement and display of the pressure vs. time relation. The release of  $\text{CO}_2$  is proportional to the dissolution rate (reactivity) which is proportional to the  $\text{CaCO}_3$  surface area, though results are highly dependent on sample preparation (Suarez & Wood, 1984). As with the pH-stat methods (see Carbonate Reactivity by pH-Stat), the choice of pretreatment procedure depends on whether the results are to be used for evaluation of reactivity in the aggregated soil or reactivity of the dispersed particles. Reactive surface area is calculated from comparison of measured soil rates to measured rates of well crystallized calcite of known surface area.

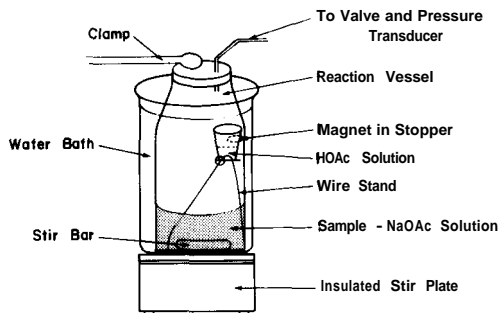

Fig. 15-5. Modified pressure calcimeter for the determination of carbonate reactivity (Suarez & Wood, 1984).

## Method

### Apparatus

1. 500-mL wide-mouth jar (reaction vessel), rubber gasket ring, plastic screw cap and a three-way glass stopcock (Fig. 15-5). Glass stopcock is inserted and sealed into the plastic cap using epoxy glue.
2. Small wire tripod with a plastic table (to fit into the jar as shown in Fig. 15-5).
3. No. 4 polypropylene stopper (cup shaped) attached to the table with a wire loop on one side (stopper is hinged to allow it to tip and empty contents).
4. Small Teflon-coated stir bar wedged near the top of the stopper.
5. Large stir bar.
6. Insulated pressure transducer (e.g., Kistler Model 314D, Kistler Instrument Corp., Amherst, NY) with 0- to 2-kPa sensitivity and 0.1-v output.
7. Water bath and submerged stirrer, or insulated stirring plate and 1 L glass jar with deionized water.
8. 1.5-mm i.d. thick wall polypropylene tubing.
9. 0.1-V full-scale deflection chart recorder.
10. Magnet.

### Reagents

1. Sodium acetate ( $\text{NaC}_2\text{H}_3\text{O}_2$ ), 1.0 M; Weigh 136.08 g of  $\text{NaC}_2\text{H}_3\text{O}_2 \cdot 3\text{H}_2\text{O}$ , dissolve in 600 mL deionized water, and dilute to 1 L total volume.
2. Acetic acid ( $\text{HC}_2\text{H}_3\text{O}_2$ ), 2.0 M, Weigh 120.1 g of glacial acetic acid, dissolve in 600 mL deionized water, and dilute to 1 L total volume.

### Method

The experimental setup is shown in Fig. 15-5. The rubber gasket, plastic screw cap and 3-way glass stopcock are attached to the glass jar. The system should be pressurized to check for leaks.

1. A measured amount of calcite standard or soil (0.1-10.0 g dry weight) is placed into the reaction vessel.
2. Add 100 mL of deionized water and 5.0 mL of 1.0 M Na acetate to the reaction vessel.
3. Add 5.0 mL of 2.0 M acetic acid to the polypropylene stopper.
4. Insert the large stirring bar, wire tripod and polypropylene stopper into the reaction vessel.
5. Cap the jar, and place in the 1 L water bath on top of an insulated stirring plate in a temperature-controlled room.
6. Connect the tubing to the pressure transducer.
7. After 5 min of stirring (300 rpm), close the stopcock from the open-to-air position to the open-to-transducer position.
8. Tip the plastic stopper by manipulating the external magnet near the plastic stopper, and initiate the chart recorder.
9. Stop the reaction after 5 min.
10. Examine pressure vs. time curve and calculate the maximum slope (rate). This will ordinarily be the straight line portion of the curve.
11. Repeat the procedure with standards of known surface area (from 0-0.02 m<sup>2</sup>).
12. Construct a calibration curve by plotting standard surface area against measured reaction rates (Pa s<sup>-1</sup>).
13. Use calibration curve to determine reactive calcite surface area (calcite equivalent).

### Comments

The procedure can be used to determine total carbonate by reacting for 1 h and measuring total pressure. Use of stronger acid is not recommended since reaction rates increase and do not allow sufficient time to ensure that the acid is well mixed when the maximum slope of the pressure-time curve is determined. Surface areas are measured at the low P<sub>CO<sub>2</sub></sub> pressure (0.4-1.6 kPa above atmospheric) and under conditions of buffered pH. As with other procedures, FeSO<sub>4</sub> can be added to samples to prevent oxidation of organic matter and formation of CO<sub>2</sub>, but decomposition of organic matter is ordinarily not a problem due to the use of weak acid and the short reaction times. Surface area of calcite standards should be determined by the BET method using N<sub>2</sub>.

### Active Carbonate

#### Principles

The active carbonate method, originally developed by Drouineau (1942), involves reaction of the soil with 0.1 M ammonium oxalate for 2 h, followed by the determination of unreacted oxalate by titration with 0.1 M KMnO<sub>4</sub>. Boisshot and Hebert (1947) evaluated the procedure and recommended that the pH of the ammonium oxalate extractant be adjusted to 9.0. Some scientists have utilized a pH 7.0 buffered oxalate (Carter, 1981; Ryan et al., 1981), and others have used a 0.2 M ammonium oxalate with no further pH adjustments. The reaction of ammonium oxalate with calcium carbonate can be written as follows

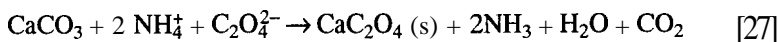

The oxalate also reacts with dissolved and exchangeable Ca to form Ca oxalate; therefore, the procedure should more appropriately be called an active Ca procedure rather than an active carbonate procedure. The reaction of unreacted ammonium oxalate (following acidification with  $\text{H}_2\text{SO}_4$ ) is summarized by the following equation



The active carbonate procedure provides a rapid approximation of the quantity of clay and fine-silt size carbonates in the soil and can be used to obtain a comparative but not an absolute measure of reactive carbonate content of the soil. Results by this procedure have been shown to correlate highly with comparative estimates of soil-carbonate reactivity by the pH-stat procedure (del Campillo et al., 1992). The active oxalate procedure is a kinetically based procedure, the results of which are highly dependent on sample pretreatment and handling. Precautions should be taken to ensure uniformity of sample handling and shaking procedures. Major sources of error include solution and exchangeable Ca and the inability of oxalate to react with Mg in Mg-substituted calcite.

## Method

### Reagents

1. Ammonium oxalate  $[(\text{NH}_4)_2\text{C}_2\text{O}_4]$ , 0.1 M, adjusted to pH 9.0. Place 12.61 g of  $\text{H}_2\text{C}_2\text{O}_4 \cdot 2 \text{H}_2\text{O}$  into a 1000-mL beaker, adjust to pH 9 by addition of 2 M  $\text{NH}_4\text{OH}$ , and make to a 1 L final volume.
2. Potassium permanganate ( $\text{KMnO}_4$ ), 0.02 M. Add 3.16 g of  $\text{KMnO}_4$  to 1 L of deionized water. Keep the solution at a gentle boil for about 1 h, cover, and let stand overnight. Filter through a fine-sintered glass funnel. Store the solution in an amber glass bottle.
3. Sulfuric acid ( $\text{H}_2\text{SO}_4$ ), 3 M. Transfer 167 mL of concentrated  $\text{H}_2\text{SO}_4$  to 600 mL deionized water, and dilute to 1 L total volume.
4. Sulfuric acid ( $\text{H}_2\text{SO}_4$ ), 1 M. Transfer 56 mL of concentrated  $\text{H}_2\text{SO}_4$  to 600 mL deionized water and dilute to 1 L total volume.

### Procedure

1. Standardization of potassium permanganate. Dry about 1.5 g of primary standard ammonium oxalate ( $\text{NaC}_2\text{O}_4$ ) at 110°C for at least 1 h. Cool in a desiccator, weigh three individual 0.2 to 0.3 g samples to the nearest 0.1 mg into 400-mL flasks. Dissolve in 250 mL of 1 M  $\text{H}_2\text{SO}_4$ . Heat to 80 to 90°C and titrate with 0.02 M  $\text{KMnO}_4$  at this temperature. The pink color resulting from addition of an aliquot of titrant should be permitted to disappear before further titrant is introduced. Finely divided  $\text{KMnO}_4$  will be formed along with  $\text{Mn}^{2+}$  if the  $\text{KMnO}_4$  is added too rapidly and will cause the solution to acquire a faint brown discoloration. The first persistent pink color (30 s) should be taken as the endpoint. Determine a blank by titrating an equal volume of 1 M  $\text{H}_2\text{SO}_4$ .

2. Reaction with ammonium oxalate. Weigh 1 g of air-dried soil which has been crushed to pass a 20 mesh  $\text{in}^{-1}$  (850- $\mu\text{m}$  nominal pore size) sieve, and place in a 40-mL snap top polypropylene vial (with a 2-mm diam hole in the top). Add 25 mL of 0.1 M ammonium oxalate, stopper, and shake for exactly 2 h on a rotary shaker set to oscillate at approximately 240 cycles  $\text{min}^{-1}$ . Immediately transfer the suspension to a 40-mL polypropylene centrifuge tube, and centrifuge for 20 min at 3000 x G.

3. Titration with potassium permanganate. Transfer a 10-mL aliquot of the supemate to a 50-mL Erlenmeyer flask, and add 5 mL of 3 M  $\text{H}_2\text{SO}_4$ . Determine the quantity of oxalate remaining in solution by titration with 0.02 M  $\text{KMnO}_4$  as described above.

### Calculations

1. Calculate the concentration of the  $\text{KMnO}_4$  titrant as follows

Concentration of  $\text{KMnO}_4$ , M

$$= (\text{H}_2\text{C}_2\text{O}_4, \text{ g}) \left( \frac{1 \text{ mol H}_2\text{C}_2\text{O}_4}{90.04 \text{ g}} \right) \left( \frac{1}{\text{KMnO}_4 \text{ L}} \right) \cdot \left( \frac{2 \text{ mol MnO}_4^-}{5 \text{ mol H}_2\text{C}_2\text{O}_4} \right) \quad [29]$$

The final concentration of  $\text{KMnO}_4$  is calculated as the average of replicates.

2. Calculate the active carbonate content as follows

Active carbonate content, %

$$= \frac{(V_o - V_s) (C) (\text{dilution factor}) \left( \frac{5 \text{ mol H}_2\text{C}_2\text{O}_4}{2 \text{ mol KMnO}_4} \right) \left( \frac{100 \text{ g CaCO}_3}{\text{mol}} \right)}{\text{soil g}} \quad (100) \quad [30]$$

Active carbonate content, g  $\text{kg}^{-1}$

$$= \frac{(V_o - V_s) (C) (\text{dilution factor}) \left( \frac{5 \text{ mol H}_2\text{C}_2\text{O}_4}{2 \text{ mol KMnO}_4} \right) \left( \frac{100 \text{ g CaCO}_3}{\text{mol}} \right)}{\text{soil kg}} \quad [31]$$

where

$V_o$  = volume (L) of  $\text{KMnO}_4$  required to titrate 10 mL of oxalate extractant.

$V_s$  = volume (L) of  $\text{KMnO}_4$  required to titrate 10 mL of oxalate extractant following treatment with sample

C = concentration of  $\text{KMnO}_4$  in  $\text{mol L}^{-1}$

## Comments

The maximum quantity of active  $\text{CaCO}_3$  that can be dissolved by the above procedure is  $200 \text{ g kg}^{-1}$  soil. If active  $\text{CaCO}_3$  contents greater than about  $150 \text{ g kg}^{-1}$  are obtained, then the analysis should be repeated with a smaller amount of soil and/or a larger volume of ammonium oxalate extractant.

## CARBONATE EQUILIBRIA--SOLID PHASE

### Principles

Carbonate equilibria can be characterized by the reaction of dissolved  $\text{CO}_2$  and the dissociation of the resultant weak acid with carbonate-containing minerals, principally calcite and dolomite. Dissolution of  $\text{CO}_2$  gas into water results in the species  $\text{CO}_{2(\text{aq})}$ . Upon hydration the species  $\text{H}_2\text{CO}_3^\circ$  is formed, (referred to as  $\text{H}_2\text{CO}_3$ ). The weak acid dissociates into  $\text{HCO}_3^-$  and  $\text{CO}_3^{2-}$  with  $\text{p}K_1$  and  $\text{p}K_2$  values of 6.35 and 10.33, respectively, at  $25^\circ\text{C}$ . Typically the terms  $\text{HCO}_3^*$  or  $\text{H}_2\text{CO}_3$  are used to denote the sum of  $\text{CO}_{2(\text{aq})}$  and  $\text{H}_2\text{CO}_3^\circ$ . The solubility of  $\text{CO}_2$  is given by the equation

$$K_{\text{CO}_2} = \frac{\text{H}_2\text{CO}_3^*}{P_{\text{CO}_2}}, \quad [32]$$

where  $K_{\text{CO}_2} = 10^{-1.47}$  at  $25^\circ\text{C}$  when  $P_{\text{CO}_2}$  is expressed in atmospheres. The solubility of  $\text{CO}_2$  increases with decreasing temperature, with a  $K_{\text{CO}_2}$  of  $10^{-1.11}$  at  $0^\circ\text{C}$  and  $10^{-1.64}$  at  $40^\circ\text{C}$ .

The dissociation of carbonic acid is represented by the following equations

$$K_1 = \frac{(\text{H}^+)(\text{HCO}_3^-)}{(\text{H}_2\text{CO}_3)} \quad [33]$$

$$K_2 = \frac{(\text{H}^+)(\text{CO}_3^{2-})}{(\text{HCO}_3^-)} \quad [34]$$

where parentheses represent activities. At  $25^\circ\text{C}$   $K_1 = 10^{-6.35}$  and  $K_2 = 10^{-10.33}$ , while at  $40^\circ\text{C}$ ,  $K_1 = 10^{-6.30}$  and  $K_2 = 10^{-10.22}$ .

The total amount of inorganic C decreases with increasing temperature at fixed  $P_{\text{CO}_2}$ , where total C is defined by  $\Sigma\text{C} = \text{CO}_{2(\text{aq})} + \text{H}_2\text{CO}_3^\circ + \text{HCO}_3^- + \text{CO}^- + \text{CaHCO}_3^+ + \text{CaCO}_3^\circ \dots$ . The solubility of  $\text{CO}_2$  decreases only slightly with increasing ionic strength, while the total dissolved inorganic C content increases substantially (primarily due to decreases in the  $\text{HCO}_3^-$  activity coefficient and ion pair formation of  $\text{HCO}_3^-$  and  $\text{CO}_3^{2-}$  with divalent metals).

Reaction of a carbonate solid phase with a solution free of net alkalinity results in an increase in pH due to dissolution of  $\text{CO}_3^{2-}$  which protonates to  $\text{HCO}_3^-$ . Typically the dissolution of calcite is written as

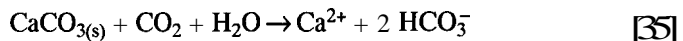



Although this a good overall representation of the major species, it obscures the shift in minor species. Increased concentration or activity of  $\text{HCO}_3^-$  requires that there be a decreased concentration or activity of  $\text{H}^+$ , since  $\text{H}_2\text{CO}_3^0$  is fixed by  $P_{\text{CO}_2}$ . A small but significant component of calcite dissolution results in the reaction



The pH of water in equilibrium with atmospheric  $\text{CO}_2$  is pH = 5.65, while at calcite equilibrium the solution is at pH = 8.4. The reaction shown in Eq. [35] results in approximately  $5 \times 10^{-4}$  moles of calcite dissolved while the reaction represented in Eq. [36] results in  $2 \times 10^{-6}$  moles of dissolved calcite. With increasing  $P_{\text{CO}_2}$ , the pH for calcite-equilibrium is shifted downward; at  $P_{\text{CO}_2} = 100$  kPa (1 atm), pH = 6.01.

Solving speciation problems in the carbonate system requires that one know at least two of the following variables: (i) total dissolved inorganic C, (ii) inorganic C alkalinity, (iii) pH, and (iv) partial pressure of  $\text{CO}_2$ . Typically inorganic C alkalinity and H are determined since they are the easiest to determine experimentally. Use of total dissolved inorganic C may be conceptually preferred since total concentrations are usually measured for other dissolved species, but the measurement is unstable without special precautions, due to the undissociated dissolved  $\text{CO}_2$ . The determination of pH and  $P_{\text{CO}_2}$  are also unstable, but pH can be rapidly measured using electrodes. In contrast to total dissolved C, inorganic carbonate alkalinity is stable in the absence of dissolution or precipitation.

### Reaction Rates

The two important kinetic processes in the carbonate system are equilibration of the gas phase with the dissolved species and equilibration of the dissolved species with the solid phase. Reactions among the dissolved species in the bulk solution are sufficiently fast that reaction rates need not be considered and equilibrium can be assumed. In contrast, disequilibrium between gas and liquid phase must be considered whenever precipitation or dissolution is occurring. This is particularly important at low  $\text{CO}_2$  partial pressures and/or high rate of precipitation of dissolution where the relatively slow rates of diffusion of  $\text{CO}_2$  and conversion to  $\text{H}_2\text{CO}_3^*$  can result in disequilibrium.

It is generally recommended that determinations of equilibria with solid-phase carbonates in the laboratory be done at high  $P_{\text{CO}_2}$ , especially for soils. Disequilibrium between the solid carbonates and liquid phase can almost always be expected for soil-water systems, especially when equilibrium is approached from supersaturation, due to the presence of dissolved organics which inhibit precipitation. An additional problem is the decomposition of organic material which can result in a large increase in total dissolved alkalinity. The combination of these processes make determination of the stability of soil carbonates difficult. The best procedure for determination of  $\text{CaCO}_3$  stability is likely by reaction at high  $\text{CO}_2$  with gentle stirring. Dissolution reaction time for soil calcite in solution may generally be on the order of 0.5 to 3 d, assuming that gas-solution equilibrium is maintained.

In most circumstances, carbonate dissolution is a diffusion controlled process. This is readily demonstrated by the reaction dependence on stirring. Under acidic conditions ( $\text{pH} < 5$ ) in a stirred system, calcite dissolution rate can be represented by the expression  $R = k_1 a_{\text{H}^+}$ . At  $25^\circ\text{C}$  Plummer et al. (1979) list a  $k_1$  of  $0.05 \text{ mmol calcite cm}^2\text{s}^{-1}$  at a stirring rate of 2000 rpm. At pH values above 6, the dissolution reaction rate is related to  $P_{\text{CO}_2}$  when  $P_{\text{CO}_2}$  is greater than 10 kPa, while the rate is constant when the  $P_{\text{CO}_2}$  is below 10 kPa (at constant pH).

### Extraction of Soil Water for Carbonate Equilibrium Determinations

The calcite saturation status of a soil water system depends on the soil  $P_{\text{CO}_2}$  as well as on the water composition. Because of the dependence on the gas phase composition, the saturation status is best determined in the field by extraction of the soil water and immediate determination of pH and subsequent preservation of the sample for further laboratory analysis. Extraction of the water phase requires either application of a vacuum, use of a squeezing technique (press) or immiscible displacement with an organic solvent. Installation of vacuum extractors is recommended for ongoing monitoring of a site.

Use of conventional vacuum extractors will result in  $\text{CO}_2$  degassing and an upward shift in pH (Suarez, 1987). Use of a multichambered extractor described by Suarez (1986) minimizes the air phase in the sample and allows for flushing of the sample chamber. This extractor design reduces the pH error to below 0.05 pH units, when the extractor is operated at the minimum vacuum level required to obtain the sample. Upon obtaining the sample the pH must be immediately measured in the field with a meter calibrated with pH standards at the temperature of the sample. After measurement of the pH, the sample should be tightly capped and placed in an ice chest or refrigerator until determination of alkalinity, preferably within a few hours. Subsequently, the sample is filtered/diluted for analysis of the other major ion components, typically Ca, Mg, Na, K,  $\text{SO}_4$ , Cl and  $\text{NO}_3$ . The chemical speciation program should have temperature dependent expressions for calculation of ionic activity coefficients and activities.

## GYPSUM

Gypsum ( $\text{CaSO}_4 \cdot 2\text{H}_2\text{O}$ ) is almost always the calcium sulfate mineral in soils (Nettleton et al., 1982). Anhydrite ( $\text{CaSO}_4$ ) is rarely found, as is bassanite ( $\text{CaSO}_4 \cdot 0.5\text{H}_2\text{O}$ ), except under surface soil conditions of high temperature and very low humidity or at very high salinity. In microcrystalline size, these minerals will transform into gypsum upon rewetting the soil.

In the subsurface (rock formations) anhydrite is somewhat more common than in soils, existing in association with marine evaporates. Gypsum in arid land soils is usually pedogenic, as most surface waters are undersaturated with respect to gypsum, and it dissolves relatively easily and is rarely transported in fluvial processes. Gypsum may occur as white surface crusts in arid environments, but also readily produces silt-sized crystals to several centimeters in length.

## Method

### Principles

Determination of gypsum has generally been done by dissolution and measurement of Ca and/or  $\text{SO}_4^{2-}$  in a dilute extract. In order to use the procedure in a quantitative manner, correction must be made for dissolved sulfates. In addition, some estimate of soil gypsum is desired in order to select the appropriate soil/water ratio for extraction. This is required to ensure both complete dissolution of the gypsum and yet have sufficient sulfate for analysis. The previously recommended method (Nelson, 1982) involved an initial semiquantitative determination of gypsum by measuring weight loss due to dehydration. This was done by subtracting the weight loss of soil under  $\text{P}_2\text{O}_5$  from the weight loss after being placed in an oven overnight at  $105^\circ\text{C}$ . After this calculation, the appropriate soil/water ratio is determined and the total sulfate is analyzed.

A soil often contains gypsum if the Ca and  $\text{SO}_4$  concentrations of the saturation extract exceed  $20 \text{ mmol L}^{-1}$  (Nelson, 1982). A quick test for the likely presence of gypsum can be made by preparing a dilute water extract (1:2 or 1:5), and separating and treating the supernatant with an equal volume of acetone. The formation of a white precipitate indicates gypsum (U.S. Salinity Laboratory Staff, 1954).

Alternative methods include the infrared dehydration method (El Prince & Turjoman, 1983) the resin method (Frenkel et al., 1986) and XRD (Khan & Webster, 1986).

### Multiple Dilution Procedure

Prepare a saturation extract with 25 g of soil as described in Thomas (1995, see Chapter 16), and extract the water. Grind 50 g of air-dry soil until it passes an 80 mesh  $\text{in}^{-1}$  (180- $\mu\text{m}$  nominal pore size) sieve. Split and weigh 25-g portions into 100-mL and 1-L flasks. Add 100 mL and 1 L of deionized water to the 100-mL and 1-L flasks, respectively. Mix the suspensions overnight on a reciprocating shaker.

Filter each of the suspensions through Whatman no. 42 filter paper, and collect the filtrate. Determine sulfate as recommended in Sawhney (1996, see Chapter 36) on these two extractions and on the saturation extract.

### Calculations

$$\text{SO}_4, \text{ mmol} = \left( \frac{\text{SO}_4 \text{ mmol}}{\text{L}} \right) \left( \frac{\text{L}}{1000 \text{ mL}} \right) (\text{mL deionized water}) \quad [37]$$

$$\text{SO}_4(\text{g}) = \text{SO}_4(\text{DE}) - \text{SO}_4(\text{SE}) \quad [38]$$

where

$\text{SO}_4(\text{g})$  = sulfate from gypsum, mmol

$\text{SO}_4(\text{DE})$  = sulfate in dilute extract, mmol

$\text{SO}_4(\text{SE})$  = sulfate in saturation extract, mmol

$$\frac{\text{g gypsum}}{\text{g soil}} = (\text{SO}_4(\text{g}), \text{mmol}) \left( \frac{0.172 \text{ g CaSO}_4 \cdot 2\text{H}_2\text{O}}{\text{mmol}} \right) \left( \frac{1}{25 \text{ g soil}} \right) \quad [39]$$

## Comments

Heating the soil at 105°C overnight before grinding converts gypsum to bassanite (Rivera et al., 1982) which is more soluble and dissolves faster than gypsum, and ensures a more complete dissolution reaction.

## REFERENCES

- Abedi, M.J., and O. Talibudeen. 1974. The calcareous soil of Azerbaijan. I. Catena development related to the distribution and surface properties of soil. *J. Soil Sci.* 25:357-372.
- Allison, L.E. 1960. Wet combustion apparatus and procedure for organic and inorganic carbon in soil. *Soil Sci. Soc. Am. Proc.* 24:36-40.
- Allison, L.E., and C.D. Moodie. 1965. Carbonate. p. 1379-1400. In C.A. Black et al. (ed.) *Methods of soil analysis*. Part 2. 2nd ed. Agron. Monogr. 9. ASA, CSSA, and SSSA, Madison, WI.
- Amer, EA., A. Mahmoud, and V Sabel. 1985. Zeta potential and surface area of calcium carbonate as related to phosphate sorption. *Soil Sci. Soc Am. J.* 49:1137-1142.
- Bemer, R.A., and J.W. Morse. 1974. Dissolution kinetics of calcium carbonate in seawater. IV Theory of calcite dissolution. *Am. J. Sci.* 274:108-134.
- Bloom, P.R., K. Meter, and J.R. Crum. 1985. Titration method for determination of clay-sized carbonates. *Soil Sci. Soc. Am. J.* 49:1070-1073.
- Boisshot, P., M. Coppenet, and J. Hebert. 1950. Fixation de l'acide phosphorique sur le calcaire des sols. *Plant Soil* 2:311-322.
- Boisshot, P., and J. Hebert. 1947. Determination of available calcium in soil by the ammonium oxalate method and its use to determine the readily assimilable calcium of liming materials. *Ann. Agron.* 17:521-525.
- Bui, E.N., R.H. Loeppert, and L.P. Wilding. 1990. Carbonate phases in calcareous soils of the western United States. *Soil Sci. Soc. Am. J.* 54:39-45.
- Bundy, L.C., and J.M. Bremner. 1972. A simple titrimetric method for determination of inorganic carbon in soils. *Soil Sci. Soc. Am. Proc.* 36:273-275.
- Carter, M.R. 1981. Association of total CaCO<sub>3</sub> and active CaCO<sub>3</sub> with growth of five tree species on chemozemc soils. *Can. J. Soil Sci.* 61:173-175.
- del Campillo, M.C., J. Torrent, and R.H. Loeppert. 1992. The reactivity of carbonates in selected soils of southern Spain. *Geoderma* 52:149-160.
- Diebold, EA., J. Lemish, and C.L. Hiltrop. 1963. Determination of calcite, dolomite, quartz and clay content of carbonate rocks. *J. Sediment. Petrol.* 33:124-139.
- Doner, H.E., and W.C. Lynn. 1977. Carbonate, halide, sulfate and sulfide minerals. p. 279-330. In J.B. Dixon and S.B. Weed (ed.) *Minerals in the soil environment*. SSSA, Book Ser. 1. SSSA, Madison, WI.
- Dreimanis, A. 1962. Quantitative gasometric determination of calcite and dolomite by using Chittick apparatus. *J. Sediment. Petrol.* 32:520-529.
- Drouineau, G. 1942. Dosage rapide du calcaire actif de sols. *Ann. Agron.* Vol. 12.
- El Mahi, H.E., I.S. Ibrahim, M. Abdel, H.M. Magid, and A.M.A. Eltilib. 1987. A simple method for the estimation of calcium and magnesium carbonates in soils. *Soil Sci. Soc. Am. J.* 51:1152-1155.
- El Prince, A.M., and A.M. Turjoman. 1983. Infrared dehydration method for determining gypsum content of soils. *Soil Sci. Soc. Am. J.* 47:1089-1091.
- Evangelou, VP., L.D. Whittig, and K.K. Tanji. 1984. An automated manometric method for quantitative determination of calcite and dolomite. *Soil Sci. Soc. Am. J.* 48:1236-1239.
- Frenkel, H., Z. Gerstel, and J.V. Renger. 1986. Determination of gypsum and cation exchange capacity in arid soils by resin method. *Geoderma* 39:67-77.
- Glover, E.D. 1961. Method of solution of calcareous material using the complexing agent, EDTA. *J. Sediment. Petrol.* 31:622-626.
- Hartwig, R.C., and R.H. Loeppert. 1991. Pretreatment effect on dispersion of carbonates in calcareous soils. *Soil Sci. Soc. Am. J.* 55:19-25.

- Hartwig, R.C., and R.H. Loeppert. 1992. A pH-stat procedure for evaluating reactivity of agricultural limestone. *Soil Sci. Soc. Am. J.* 56:302-308.
- Holford, I.C.R., and G.E.G. Mattingly. 1975. Surface areas of calcium carbonate in soils. *Geoderma* 13:247-255.
- Khan, S.U., and G.R. Webster. 1986. Determination of gypsum in solonchic soils by an x-ray technique. *Analyst* 93:400-402.
- Loeppert, R.H., S.C. Geiger, R.C. Hartwig, and D.E. Morris. 1988. A comparison of indigenous soil factors influencing the Fe-deficiency chlorosis of sorghum and soybean in the calcareous soils. *J. Plant Nutr.* 11:1481-1482.
- Loeppert, R.H., C.T. Hallmark, and M.M. Koshy. 1984. Routine procedure for rapid determination of soil carbonates. *Soil Sci. Soc. Am. J.* 48:1030-1033.
- Martin, S.E., and R. Reeve. 1955. A rapid manometric method for determining soil carbonate. *Soil Sci.* 79:187-197.
- Moore, J.J., R.H. Loeppert, L.T. West, and C.T. Hallmark. 1987. A routine method for calcium carbonate equivalent of soils. *Commun. Soil Sci. Plant Anal.* 18:265-277.
- Moore, T.J., R.H. Loeppert, and R.C. Hartwig. 1989. Steady state procedure for studying the effective particle size distribution of soil carbonates. *Soil Sci. Soc. Am. J.* 54:55-59.
- Morris, D.R., R.H. Loeppert, and T.J. Moore. 1990. Indigenous soil factors influencing Fe chlorosis of soybean in calcareous soils. *Soil Sci. Soc. Am. J.* 15:1329-1336.
- Nelson, D.W., and L.E. Sommers. 1982. Total carbon, organic carbon and organic matter. p. 539-579. In A.L. Page (ed.) *Methods of soil analysis. Part 2.* 2nd ed. Agron. Monogr. 9. ASA and SSSA, Madison, WI.
- Nelson, R.E. 1982. Carbonate and gypsum. p. 181-197. In A.L. Page (ed.) *Methods of soil analysis. Part 2.* 2nd ed. Agron. Monogr. 9. ASA and SSSA, Madison, WI.
- Nettleton, W.D., R.E. Nelson, B.R. Brasker and P.S. Derr. 1982. Gypsiferous soils in the western United States. p. 147-168. In J.A. Kittrick (ed.) *Acid sulfate weathering.* SSSA Spec. Publ. 10. SSSA, Madison, WI.
- Peterson, G.W., and G. Chester. 1966. Quantitative determination of calcite and dolomite in pure carbonates and limestones. *J. Soil Sci.* 17:317-327.
- Peterson, G.W., G. Chesters, and G.B. Lee. 1966. Quantitative determination of calcite and dolomite in soils. *J. Soil Sci.* 17:328-338.
- Plummer, L.N., D.L. Parkhurst, and T.M.L. Wigley. 1979. Critical review of the kinetics of calcite dissolution and precipitation chemical modeling-speciation, sorption, solubility, and kinetics. p. 537-573. In E.A. Jenne (ed.) *Chemical modeling in aqueous systems.* ACS, Washington, DC.
- Presley, B.J. 1975. A simple method for determining calcium carbonate in sediment samples. *J. Sediment. Petrol.* 45:745-746.
- Rabenhorst, H.C. 1988. Determination of organic and carbonate carbon in calcareous soils using dry combustion. *Soil Sci. Soc. Am. J.* 52:965-969.
- Rivera, E.D., C.T. Hallmark, L.T. West and L.R. Drees. 1982. A technique for rapid removal of gypsum from soil samples. *Soil Sci. Soc. Am. J.* 46:1338-1340.
- Runnells, D.D. 1970. Errors in x-ray analysis of carbonates due to solid-solution variation in composition of component minerals. *J. Sediment. Petrol.* 40:1158-1166.
- Ryan, J., D. Curtin, and I. Safi. 1981. Ammonia volatilization as influenced by calcium carbonate particle size and iron oxides. *Soil Sci. Soc. Am. J.* 45:338-341.
- SAS Institute. 1985. *SAS user's guide: Statistics.* Version 5 ed. SAS Inst., Inc., Cary, NC.
- Sawhney, B.L. 1996. Extraction of organic chemicals. p. 1071-1084. In D.L. Sparks et al. (ed.) *Methods of soil analysis. Part 3. Chemical methods.* SSSA Book Ser. 5. SSSA and ASA, Madison, WI.
- Skinner, S.I.M., and R.L. Halstead. 1958. Note on rapid method of determination of carbonates in soils. *Can. J. Soil Sci.* 38:187-188.
- Skinner, S.I.M., R.L. Halstead, and J.E. Brydon. 1959. Quantitative manometric determination of calcite and dolomite in soils and limestones. *Can. J. Soil Sci.* 39:197-204.
- Suarez, D.L. 1977. Ion activity products of calcium carbonate in waters below the root zone. *Soil Sci. Soc. Am. J.* 41:310-315.
- Suarez, D.L. 1986. A soil water extractor that minimizes CO<sub>2</sub> degassing and pH errors. *Water Resour. Res.* 22:876-880.
- Suarez, D.L. 1987. Prediction of pH errors in soil water extractors due to degassing. *Soil Sci. Soc. Am. J.* 51:64-67.
- Suarez, D.L., and J.D. Wood. 1984. Simultaneous determination of calcite surface area and content in soils. *Soil Sci. Soc. Am. J.* 48:1232-1236.

- Swartzendruber, D., and S.A. Barber. 1965. Dissolution of limestone particles in soil. *Soil Sci.* 100:287-291.
- Talibudeen, O., and P Arambarri. 1964. The influence of the amount and the origin of calcium carbonates on the isotopically-exchangeable phosphate in calcareous soils. *J. Agric. Sci.* 62:93-97.
- Tennant, C.B., and R.W. Berger. 1957. X-ray determination of dolomite-calcite ratio of a carbonate rock. *Am. Miner.* 42:23-29.
- Thomas, G.W. 1996. Soil pH and soil acidity. p. 475-490. In D.L. Sparks et al. (ed.) *Methods of soil analysis. Part 3. Chemical methods.* SSSA Book Ser. 5. SSSA and ASA, Madison, WI.
- Turner, R.C., and S.I.M. Skinner. 1959. An investigation of the intercept method for determining the proportion of dolomite and calcite in mixtures of the two. II. Experimental rate of solution of dolomite and calcite in samples consisting of a number of crystals. *Can. J. Soil Sci.* 40:232-242.
- Turner, R.C., and S.I.M. Skinner. 1960. An investigation of the intercept method for determining the proportion of dolomite and calcite in mixtures of the two: II. Experimental rates of solution of dolomite and calcite in samples consisting of crystals. *Can. J. Soil Sci.* 40:232-241.
- Ulas, M., and M. Sayin. 1984. Quantitative determination of calcite and dolomite in soils by x-ray diffraction. *J. Soil Sci.* 35:685-691.
- U.S. Department of Agriculture-Soil Conservation Service. 1984. Procedures for collecting soil samples and methods of analysis for soil survey. *Soil Surv. Invest. Rep. 1. (Rev.)* U.S. Gov. Print. Office, Washington, DC.
- U.S. Salinity Laboratory Staff. 1954. *Diagnosis and improvement of saline and alkali soils.* USDA Handb. 60. U.S. Gov. Print. Office, Washington, DC.
- Wame, S.S.J., and B.D. Mitchell. 1979. Variable atmosphere DTA in identification and determination of anhydrous carbonate minerals in soils. *J. Soil Sci.* 30:111-116.
- Williams, D.E. 1949. A rapid manometric method for the determination of carbonate in soil. *Soil Sci. Soc. Am. Proc.* 13:127-129.