

Nuclear Criticality Safety Evaluation for Contact-Handled Transuranic Waste at the Waste Isolation Pilot Plant

OFFICIAL USE ONLY

May be exempt from public release under the Freedom of Information Act (5 U.S.C. 552) exemption number and category: **Category: Exemption 2 – Circumvention of Statute** Department of Energy review required before public release

Name/Org: _____/WIPP Project Date 05/2008

Guidance (if applicable): _____

Washington TRU Solutions

contributed to the preparation of this document and should not be considered an eligible contractor for its review.

This document revision was prepared by Washington TRU Solutions under contract and subject to the warranty and other obligations of that contract.

Release to and Use by Third Parties. As it pertains to releases of this document to third parties, and the use of or reference to this document by such third parties in whole or in part, neither Washington TRU Solutions, nor its officers, directors, employees, agents, consultants or personal services contractors (i) make any warranty, expressed or implied, (ii) assume any legal liability or responsibility for the accuracy, completeness, or usefulness, of any information, apparatus, product or process disclosed herein or (iii) represent that use of the same will not infringe privately owned rights. Reference herein to any specific commercial product, process, or service by trademark, name, manufacture or otherwise, does not necessarily constitute or imply endorsement, recommendation, or favoring of the same by either Washington TRU Solutions, or its officers, directors, employees, agents, consultants or personal services contractors.

Nuclear Criticality Safety Evaluation for Contact-Handled Transuranic Waste at the Waste Isolation Pilot Plant

Date Issued—May 2008

Prepared for the
U.S. Department of Energy
Waste Isolation Pilot Plant

Washington TRU Solutions
managing the
Waste Isolation Pilot Plant
Carlsbad, NM
under contract DE-AC29-01AL66444
for the
U.S. DEPARTMENT OF ENERGY

This page intentionally left blank.

This document was developed under Master Task Order 506082, Task 1, as modified
January 2008.

Analyst
Senior NCS Engineer

S. L. Larson

Date

Peer Reviewer
Senior NCS Engineer

S. M. Painter

Date

Approver
WIPP Nuclear Safety

A.E. Strait

Date

This page intentionally left blank.

Revision/Date/Summary of Changes	Analyst	Peer Review
Revision 0, May 2008	S.L. Larson	S.M. Painter

This page intentionally left blank.

Executive Summary

This nuclear criticality safety evaluation (NSCE) of the Waste Isolation Pilot Plant (WIPP) facility contact-handled transuranic waste handling, storage, and disposal process provides a comprehensive analysis of waste forms, container types, and container stacking configurations at the WIPP. This NCSE addresses the disposal configuration during active waste emplacement up to when the filled panel is removed from active ventilation with a closure or isolation barrier.

Transuranic waste is currently shipped to the WIPP from the U.S. Department of Energy generator sites in the Transuranic Package Transporter Model II (TRUPACT-II) or Half-package Transporter (HALFPACT) transportation packages. The CH waste containers currently approved for disposal at WIPP include seven packs of 55-gallon drums, four packs of 85-gallon drums, or three packs of 100-gallon drums, standard waste boxes, ten drum overpacks, and pipe configurations overpacked in 55-gallon drums.

This NCSE also considers three containers not yet approved for shipment to WIPP for purposes of providing scoping calculations. The standard large box 2 will be shipped in a TRUPACT-III pending U.S. Nuclear Regulatory Commission approval of the shipping package. This NCSE also considers a shielded container, which is a lead-lined 55-gallon drum, emplaced in the contact-handled disposal array in three-packs. The shielded container is proposed as an alternative to disposal of remote-handled waste in canisters. The shielded container will be shipped in a HALFPACT and transported to the underground as two three-packs on a facility pallet. The ARROW-PAK™ is also considered in this evaluation and consists of a single 55-gallon drum in a high density polyethylene outer container. The standard large box 2, the shielded container, and the ARROW-PAK™ are not currently approved waste containers; however, this analysis establishes the fissile limits applicable to those containers for safe handling, storage, and disposal at WIPP.

This NSCE considers the normal WIPP waste handling, storage, and disposal configurations of these waste containers and evaluates interactions between the different waste forms in the various waste containers types. The primary criticality control for WIPP is the fissile mass and special moderator/reflector mass limits established by this NCSE for each container type and presented in Section 9.0. The fissile and special moderator/reflector mass limits for each waste container type are verified at generator sites through a waste certification process. While the transportation packages have specified fissile limits based on the associated analyses required to transport transuranic waste, the fissile limits modeled in this NCSE apply the transportation limit to each waste assembly and in some models, double the transportation package limit for each waste assembly. This was done to establish the maximum fissile and special moderator/reflector loading for each waste container type to be disposed of in the underground at WIPP while still remaining safety subcritical. This is conservative with respect to the fissile limits authorized for shipment.

The NSCE includes a double-contingency evaluation for credible upset scenarios during waste handling, disposal, and storage at WIPP. The evaluation concludes that no credible criticality accident scenarios exist for the contact-handled transuranic waste storage, handling, and disposal process at the WIPP. Because the evaluation also demonstrates that a criticality at the WIPP is not credible, criticality alarm and detection systems are not required.

Section 9.0 also identifies the acceptable configurations for waste storage and disposal at WIPP.

Table of Contents

1.0	INTRODUCTION	1
2.0	DESCRIPTIONS	1
2.1	FACILITY AND PROCESS DESCRIPTION.....	1
2.2	DESCRIPTION OF WASTE CONTAINERS.....	11
3.0	REQUIREMENTS DOCUMENTATION	18
4.0	METHODOLOGY	19
4.1	EVALUATION METHOD.....	19
4.2	MONTE CARLO COMPUTATIONAL METHOD.....	20
5.0	PROCESS ANALYSIS	21
5.1	GEOMETRY.....	21
5.1.1	Direct-loaded 55-gallon Drums Containing Less Than or Equal to 1 Weight Percent Special Reflectors.....	21
5.1.2	Direct-loaded Shielded Containers with Less Than or Equal to 1 Weight Percent Special Reflectors.....	22
5.1.3	Direct-loaded SWB Containing Less Than or Equal to 1 Weight Percent Special Reflectors	22
5.1.4	Direct-loaded SLB2 Containing Less Than or Equal to 1 Weight Percent Special Reflectors	23
5.1.5	Direct-loaded ARROW-PAK™ Containers Containing Less Than or Equal to 1 Weight Percent Special Reflectors.....	23
5.1.6	Direct-loaded 55-gallon Drums Containing Greater Than 1 Weight Percent Special Reflectors	24
5.1.7	Fully Compacted Waste in 100-gallon Drums.....	24
5.1.8	Partially Compacted Waste in 100-gallon Drums	25
5.1.9	Fully Compacted Waste Direct Loaded in a Standard Waste Box	25
5.1.10	Fully Compacted Waste in 100-gallon Drum Overpacked in a Standard Waste Box.....	25
5.1.11	Fully Compacted Waste in Shielded Containers	26
5.1.12	Pipe Overpacks in 55-gallon Drums containing Less Than or Equal to 1 Weight Percent Special Reflectors	26
5.1.13	Pipe Overpacks in 55-gallon Drums Containing Greater Than 1 Weight Percent Special Reflectors.....	26
5.1.14	Infinite Array Model Details.....	26
5.1.15	Two-Container Model Details	27

5.2	MATERIAL COMPOSITIONS.....	27
5.2.1	Fissile Waste Mixture.....	27
5.2.2	Reflector Material in Waste Container.....	29
5.2.3	Container Materials of Construction.....	30
5.2.4	Reflector Compositions.....	31
5.3	CONTAINER ARRAY RESULTS.....	32
5.3.1	Baseline Disposal Array Calculations.....	32
5.3.2	Conservatisms in Baseline Disposal Array Calculations.....	35
5.4	TWO-CONTAINER MODEL RESULTS.....	37
6.0	PARAMETERS.....	40
6.1	MASS.....	41
6.2	GEOMETRY.....	41
6.3	MODERATION.....	41
6.4	INTERACTION.....	41
6.5	NEUTRON ABSORPTION.....	42
6.6	REFLECTION.....	42
6.6.1	Internal Container Reflection.....	42
6.6.2	External Container Reflection.....	43
6.7	VOLUME.....	43
6.8	ENRICHMENT.....	43
6.9	CONCENTRATION.....	43
7.0	CONTINGENCY EVALUATION.....	43
7.1	LOSS OF CONFINEMENT OF FISSILE MATERIAL.....	44
7.2	EXCEEDING DISPOSAL ARRAY VERTICAL STACKING LIMIT.....	44
7.2.1	Exceeding Array Vertical Stacking Limit in the Underground Repository.....	44
7.2.2	Exceeding Interim Drum Storage Array Stacking Limit.....	46
7.3	LOSS OF GEOMETRY FROM UNDERGROUND ROOF FALL.....	46
7.4	EXCEEDING MASS LIMITS.....	47
7.4.1	Exceeding the Fissile Mass Limit for a Container.....	47
7.4.2	Exceeding the Beryllium Mass Limit for a Container.....	49
7.5	SPRINKLER ACTIVATION IN THE WASTE HANDLING BUILDING.....	50
7.6	EXCESS LIQUID IN WASTE CONTAINERS.....	51
7.7	FORKLIFT ACCIDENT CRUSHES CONTAINERS.....	52
7.8	CONTINGENCY ANALYSIS CONCLUSION.....	55

8.0	BEYOND DESIGN BASIS EVENTS.....	56
9.0	DESIGN FEATURES AND ADMINISTRATIVELY CONTROLLED LIMITS AND REQUIREMENTS.....	57
9.1	DESIGN FEATURES.....	57
9.2	ADMINISTRATIVE LIMITS AND REQUIREMENTS.....	57
10.0	CONCLUSIONS.....	59
11.0	REFERENCES.....	59

List of Appendices

A	Direct-Loaded Waste Containing Less Than or Equal to 1 Weight Percent Special Reflectors.....	A-i
B	Direct-Loaded Waste Containing Greater Than 1 Weight Percent Special Reflectors.....	B-i
C	Machine-Compacted Waste.....	C-i
D	55-gallon Drums Containing Pipe Overpacks.....	D-i
E	Two-Container Combinations.....	E-i
F	Hazard Evaluation Tables.....	F-i

List of Tables

Table 2-1, Modeled 55-gallon Drum Dimensions.....	11
Table 2-2, Modeled 100-gallon Drum Dimensions.....	13
Table 2-3, Modeled SWB Dimensions.....	15
Table 2-4, Modeled Standard Large Box 2 Dimensions.....	17
Table 2-5, Modeled ARROW-PAK™ Dimensions.....	17
Table 2-6, Modeled Shielded Container Dimensions.....	18
Table 5-1, Mixture Parameters for Fully Compacted Waste Versus Hydrogen/Plutonium Ratio.....	28

Table 5-2, Mixture Parameters for Partially Compacted Waste Versus Hydrogen/Plutonium Ratio	29
Table 5-3, Mixture Parameters for Direct-loaded, Non-compacted Waste Versus Hydrogen/Plutonium Ratio	29
Table 5-4, Material Composition for ASTM A 569 Low Carbon Steel	30
Table 5-5, Material Composition for Lead	31
Table 5-6, Material Composition for Concrete.....	32
Table 5-7, Summary of Underground Array Calculation Results	34
Table 5-8, Comparison of Baseline Array and Realistic Array Results for Machine- Compacted Waste	37
Table 5-9, Summary of Two-Container Calculation Results.....	40
Table 7-1, Evaluation of Stacking Containers Four-tiers High in the Underground Repository	45
Table 7-2, Evaluation of Compaction caused by Roof Fall in the Underground Repository	47
Table 7-3, Fissile Gram Equivalent Overbatching Contingency Results	49
Table 7-4, Beryllium Overbatching Contingency Results	50
Table 7-5, Excess Liquid Contingency Results	52
Table 9-1, Summary of Limits Imposed on Contact-Handled Waste.....	58

List of Figures

Figure 2-1, Seven Packs on a Facility Pallet.....	4
Figure 2-2, Layout of the WIPP Underground	5
Figure 2-3, Drum Assemblies on the Transporter and Emplaced in the Disposal Array	7
Figure 2-4, Typical Emplacement Pattern in the Underground Repository	8
Figure 2-5, Standard Large Box 2 Emplacement in the Underground Repository.....	9
Figure 2-6, Shielded Container Emplacement in Underground Repository	10
Figure 2-7, Typical 55-gallon Drum.....	12
Figure 2-8, Typical 100-gallon Drum.....	14
Figure 2-9, 100-gallon Drum Showing Machine-compacted Waste	15
Figure 2-10, Standard Waste Box.....	16
Figure 2-11, Shielded Container	18
Figure 5-1, Sample Array Model Layout.....	33
Figure 5-2, Drum Array with Shielded Containers, X-Y Plane.....	35
Figure 5-3, Sample Two-Container Model Layout.....	39
Figure 7-1, Example Array Model for ²³⁹ Pu Overbatching in 100-gallon Drum Event	48
Figure 7-2, Results of Interstitial Water Between Drums.....	51
Figure 7-3, Top View of Model for the 41-ton Forklift Impact with an Array of 55-Gallon Drums Seven-packs	54
Figure 7-4, System Reactivity Resulting from a 41-ton Forklift Impact with 55-Gallon Drums Seven-packs	55

This page intentionally left blank.

List of Acronyms

AEOF	average energy of fission
ASTM	American Society for Testing and Materials
$C_6H_{10}O_5$	cellulose
CH	contact-handled
DOE	U.S. Department of Energy
DOT	U.S. Department of Transportation
EHMW-HDPE	extra-high molecular weight, high-density polyethylene
FGE	fissile gram equivalent
H/D	height-to-diameter
H/Pu	hydrogen/plutonium
HALFPACT	half-package transporter
MCNP	Monte Carlo N-Particle transport code
MgO	magnesium oxide
NCSE	nuclear criticality safety evaluation
NaCl	sodium chloride
NDA	non-destructive analysis
NRC	U.S. Nuclear Regulatory Commission
RH	remote-handled
SAR	Safety Analysis Report
SLB2	standard large box 2
SWB	standard waste box
TDOP	ten-drum overpack

TRAMPAC	TRUPACT-II Authorized Methods for Payload Control
TRU	transuranic
TRUPACT-II	TRU Package Transporter Model II
TRUPACT-III	TRU Package Transporter Model III
USL	upper subcritical limit
WHB	Waste Handling Building
WIPP	Waste Isolation Pilot Plant
WIPP WAC	<i>Transuranic Waste Acceptance Criteria for the Waste Isolation Pilot Plant</i>
wt%	weight percent
WTS	Washington TRU Solutions LLC

1.0 Introduction

This nuclear criticality safety evaluation (NCSE) of the Waste Isolation Pilot Plant (WIPP) facility contact-handled (CH) transuranic (TRU) waste handling, storage, and disposal process provides a comprehensive analysis of waste forms at the WIPP. This NCSE addresses the disposal configuration during active waste emplacement up to when the filled panel is removed from active ventilation with a closure or isolation barrier.

Transuranic waste is currently shipped to the WIPP from the U.S. Department of Energy (DOE) generator sites in either the TRU Package Transporter Model II (TRUPACT-II) or Half-package Transporter (HALFPACT) transportation packages. The waste containers currently approved for disposal at WIPP include seven packs of 55-gallon drums, four packs of 85-gallon drums, or three packs of 100-gallon drums, standard waste boxes, ten drum overpacks, and pipe configurations overpacked in 55-gallon drums.

This NCSE also considers three containers not yet approved for shipment to WIPP. The standard large box 2 (SLB2) will be shipped in a TRUPACT-III pending U.S. Nuclear Regulatory Commission (NRC) approval of the shipping package. This NCSE also considers a shielded container, which is a lead-lined 55-gallon drum, emplaced in the CH disposal array in three-packs. The shielded container is proposed as an alternative to disposal of remote-handled (RH) waste in canisters. The container will be shipped in a HALFPACT and transported to the underground as two three-packs on a facility pallet. The ARROW-PAK™ is also considered in this evaluation and consists of a single 55-gallon drum in a high density polyethylene outer container. The SLB2, the shielded container, and the ARROW-PAK™ are not currently approved waste containers for shipment to WIPP and subsequent disposal; however, this analysis establishes the fissile limits applicable to those containers for safe disposal at WIPP.

The NCSE includes a double-contingency evaluation for credible upset scenarios and identifies the appropriate controls. The evaluation concludes that no credible criticality accident scenarios exist for the CH TRU waste storage, handling, and disposal process at the WIPP. Because the evaluation also demonstrates that a criticality at the WIPP is not credible, criticality alarm and detection systems are not required. The controls that ensure a criticality accident remain not credible at the WIPP are presented in Section .

2.0 Descriptions

2.1 Facility and Process Description

The WIPP is located in southeastern New Mexico, 26 miles east of Carlsbad. This site is owned by the DOE and operated by the Washington TRU Solutions LLC (WTS). The purpose of the WIPP facility is to serve as a final repository for TRU waste generated at other DOE sites and to demonstrate the feasibility of safe disposal of radioactive wastes in deep underground salt formations. The majority of waste to be disposed of at the WIPP is TRU waste with plutonium as the primary TRU isotope.

Two categories of waste, CH and RH, are approved for disposal at the WIPP. Contact-handled waste containers have surface radiation levels not exceeding 200 mrem/hr and are handled directly by human operators. Remote-handled waste containers have surface radiation levels up to 1,000 rem/hr. This NCSE evaluates CH waste only. The CH waste approved for disposal at the WIPP must meet the requirements of the *Waste Isolation Pilot Plant Hazardous Waste Facility Permit* (NMED 2007) and the requirements of this NSCE.

Contact-handled TRU waste is currently received at the WIPP in various types of NRC-certified containers: 55-gallon drums, 85-gallon drums, 100-gallon drums, standard waste boxes (SWBs), and ten-drum overpacks (TDOPs). The SLB2 and ARROW-PAK™, and shielded container have been proposed for disposal at WIPP and are considered in this analysis. Waste may fill a drum or be contained in a pipe for which the drum is an overpack (i.e., a pipe overpack). The TDOP is currently used to isolate containers that have surface contamination in excess of permissible limits or degraded physical integrity and can contain up to ten 55-gallon drums or one SWB. The waste containers are configured as assemblies of seven-packs of 55-gallon drums, four-packs of 85-gallon drums, or three-packs of 100-gallon drums or ARROW-PAKs™ when transported in the TRUPACT-II. The shorter HALFPACT is used for one drum assembly or SWB. The fissile isotope loading is restricted by the *TRUPACT-II Safety Analysis Report* (SAR) (DOE-CBFO 2005a) and the *HALFPACT-II Safety Analysis Report* (DOE-CBFO 2005b). The SLB2 is designed for shipment in the TRUPACT-III and its loading is restricted by the TRUPACT-III SAR, which is pending approval by the NRC.

Transporters carrying TRU waste arrive at the WIPP and are parked on the south side of the Waste Handling Building (WHB). After the CH TRU shipping package is inspected for contamination, the loaded shipping package is moved into the WHB. The WHB has two TRUDOCKs and four overhead cranes for opening and unloading the TRUPACT-II and HALFPACT shipping packages. Each TRUDOCK is designed to handle up to two TRUPACT-IIs. The CH bay provides space for transferring loaded facility pallets to the waste hoist via forklifts, a shielded holding area, a waste handling equipment battery recharge area, and temporary storage areas for waste containers.

Once at the TRUDOCKs, the shipping packages are opened, surveyed for radiation and contamination levels, and the waste containers removed and placed on a facility pallet. Figure 2-1 shows how seven-packs are loaded onto a facility pallet for transport in the underground. This figure also illustrates the use of slipsheets between layers of seven packs.

The same concept is used for the other waste containers. The 0.15-inch thick polyethylene slipsheet is used to provide a mechanism for sliding the waste container(s) off the pallet and into a disposal location. Alternatives (cardboard) to the polyethylene slipsheets are utilized with SWBs. The reinforcement flat shown in Figure 2-1 is a second polyethylene sheet. A pallet can hold up to four drum assemblies or four SWBs, or two TDOPs or ARROW-PAK™ assemblies, or combinations where the waste is stacked no more than two drum assemblies or SWBs high on the pallet. The TDOP and ARROW-PAK™ assemblies occupy the footprint of a seven-pack, but are as tall as two seven-pack assemblies. The pallet is either transferred to the conveyance

loading car, which is moved into the hoist cage for transfer to the underground repository for permanent disposal, or is temporarily stored in the WHB in a designated area for future transfer to the repository. The SLB2 waste handling equipment and process are still under development, but it is anticipated that only one SLB2 will be on a facility pallet for storage in the WHB and during transport to the disposal room.

The WIPP underground disposal repository consists of eight panels and two panel equivalents mined from the Salado formation, a 2,000-foot-thick series of salt beds [approximately 95% sodium chloride (NaCl)]. Figure 2-2 shows a plan view of the WIPP underground disposal repository. The disposal level lies 2,150 feet below the surface, a little below the middle of the Salado formation. A typical underground panel contains seven rooms, each of which is 300 feet long, 33 feet wide and 13 feet high. The access drifts connect the rooms in a panel and provide an additional length of 33 feet on each side of the room for drum storage. The emplacement of seven-packs is illustrated in Figure 2-3. A magnesium oxide (MgO) backfill is used in the WIPP to reduce actinide solubility in the unlikely event the facility is flooded. A “supersack” of MgO is placed on top of the waste container stack. Figure 2-4 shows a typical waste emplacement pattern with different waste containers. This pattern is designed so that seven-packs of 55-gallon drums, four-packs of 85-gallon drums, three-packs of 100-gallon drums or ARROW-PAK™ containers, a TDOP, and an SWB all occupy the same “footprint.” A closely-packed hexagonal lattice is achieved for a seven-pack or ten drums in a TDOP. There can be spacing between these units, but it is typically less than 2 inches and is currently not controlled. Figure 2-5 shows the proposed emplacement of SLB2s. Because the SLB2 is rectangular, additional void space exists between it and other assemblies in the disposal array.

This NCSE also considers a shielded container, which is a lead-lined 55-gallon drum, emplaced in the CH disposal array in three-packs. The shielded container is proposed as an alternative to disposal of RH waste in canisters. The shielded container will be shipped in a HALFPACT and transported to the underground as two three-packs on a facility pallet. Figure 2-6 depicts a proposed disposal configuration. Alternatively, a single three-pack can be placed on the top of other waste assemblies as the third tier.

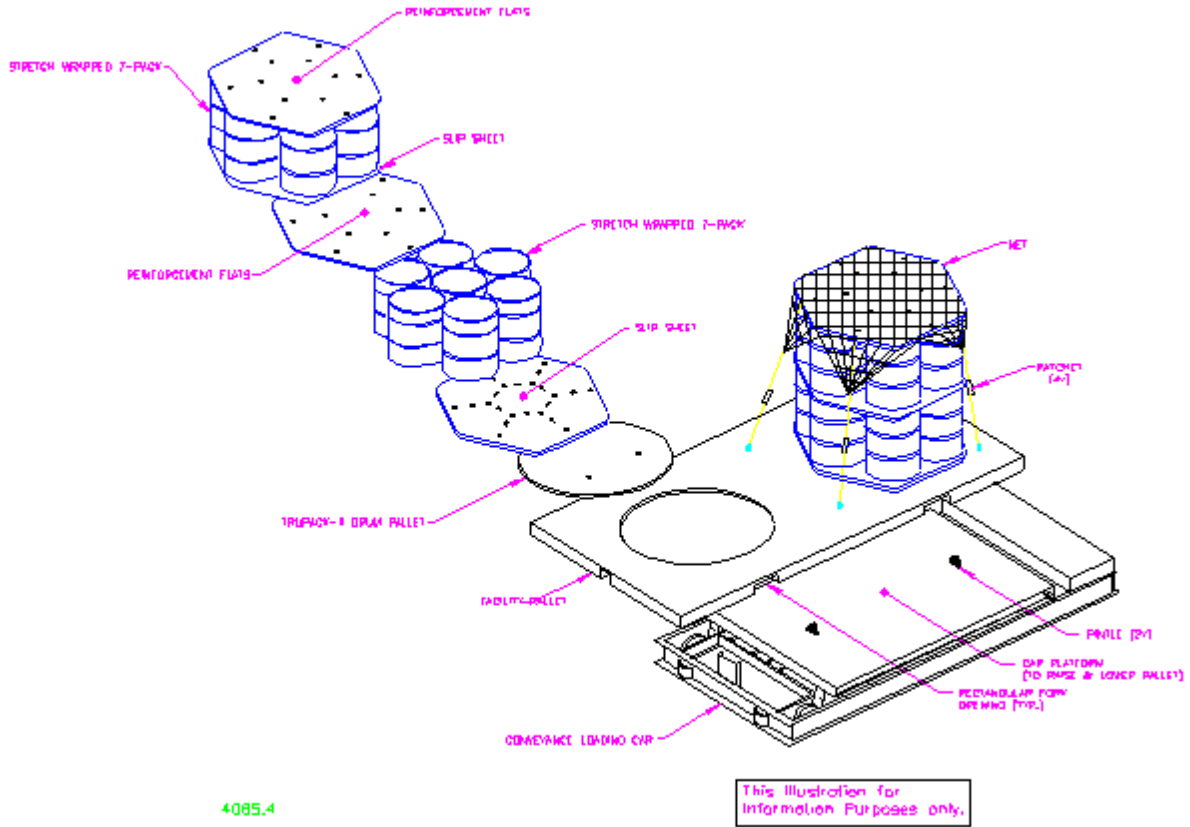
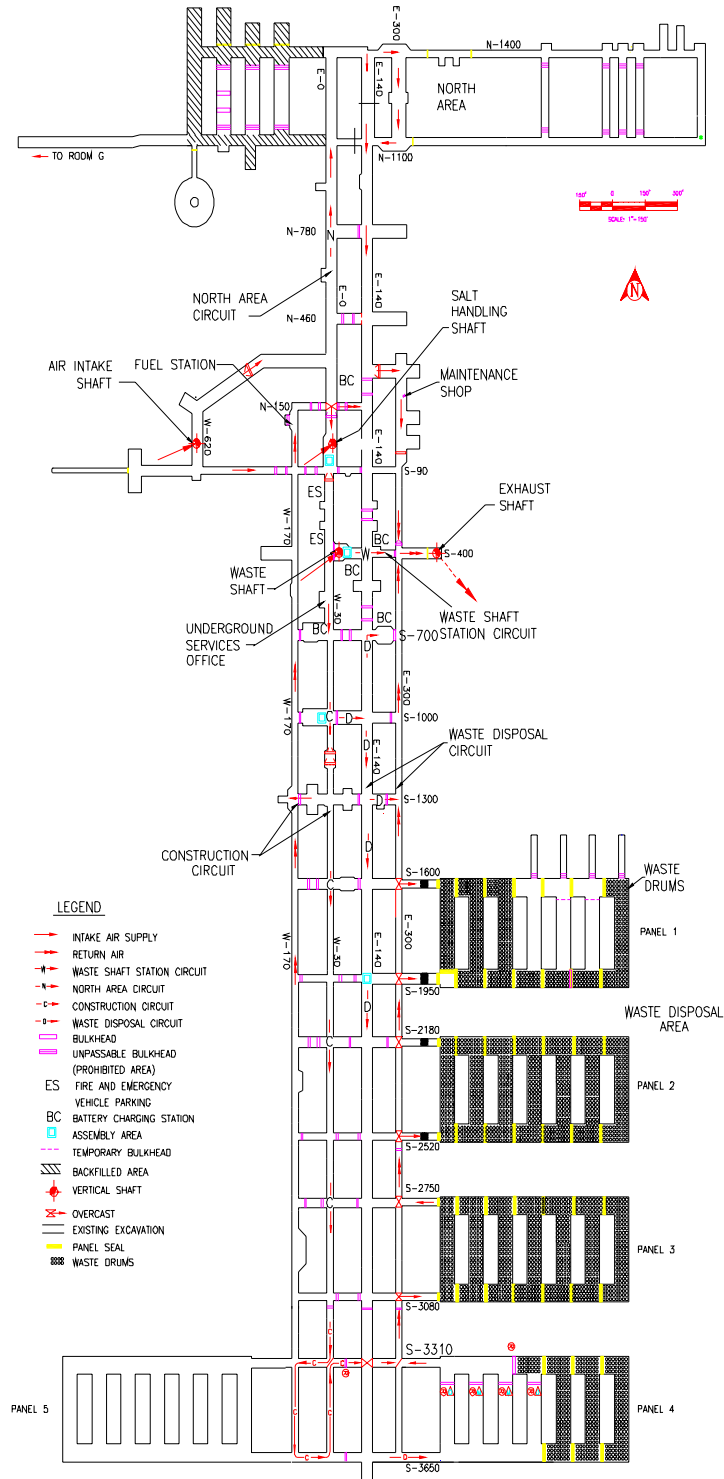

Figure -, Seven Packs on a Facility Pallet



This illustration for Information Purposes only.

4024.14

Figure -, Layout of the WIPP Underground

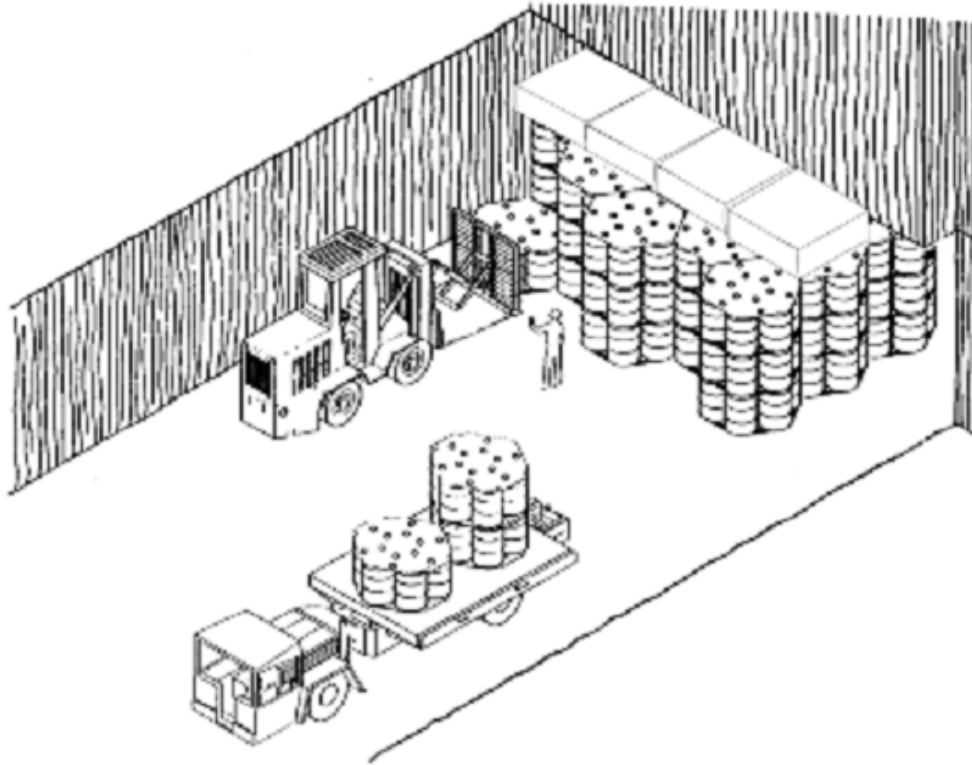

Figure - , Drum Assemblies on the Transporter and Emplaced in the Disposal Array
(Note: "Supersacks" of magnesium oxide on top of the waste stack).

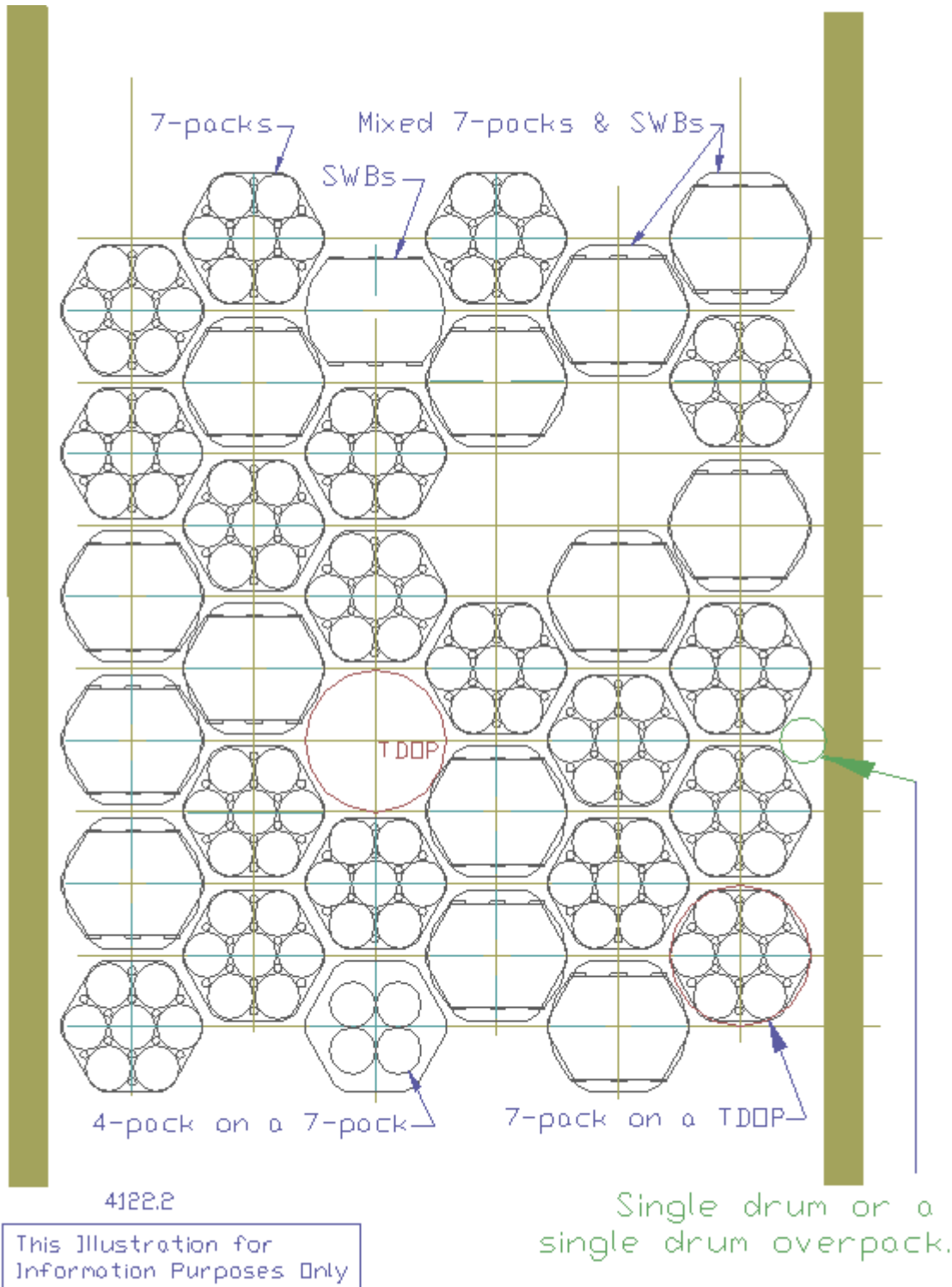

Figure -, Typical Emplacement Pattern in the Underground Repository

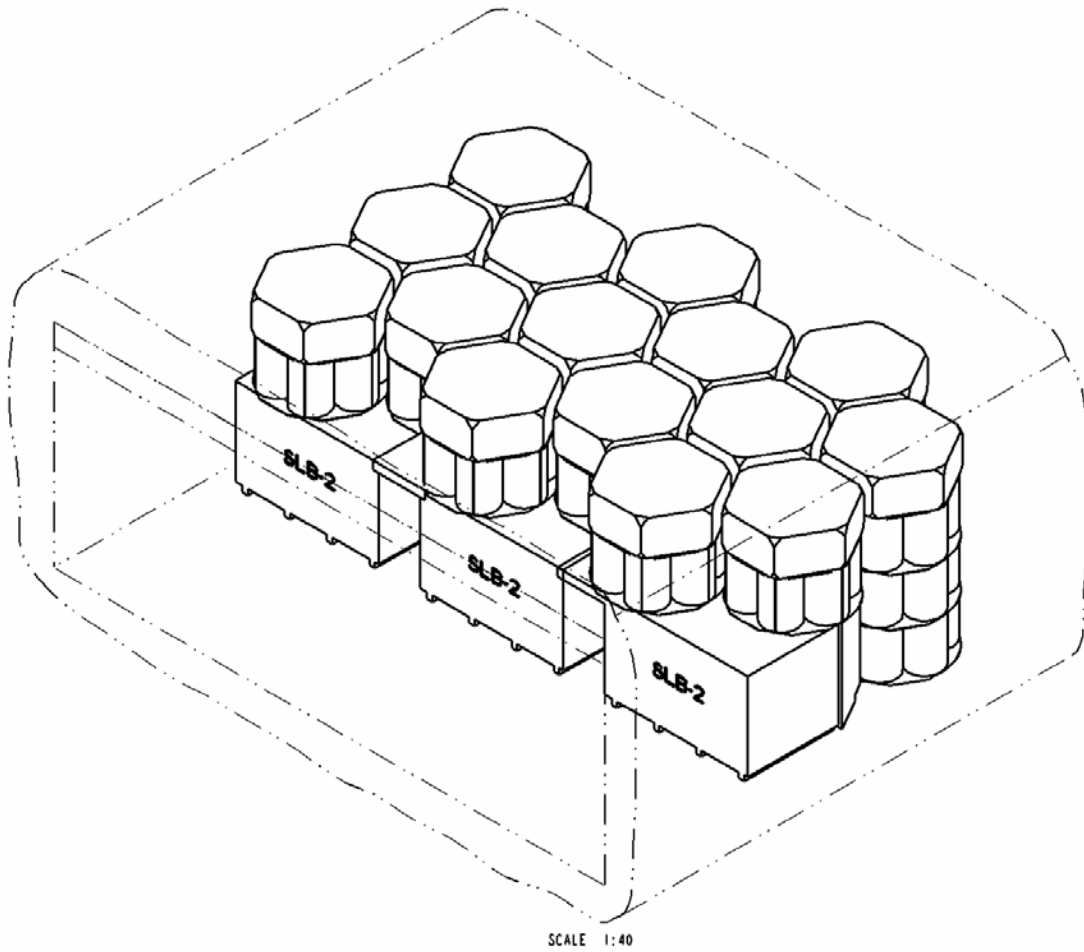

Figure -, Standard Large Box 2 Emplacement in the Underground Repository

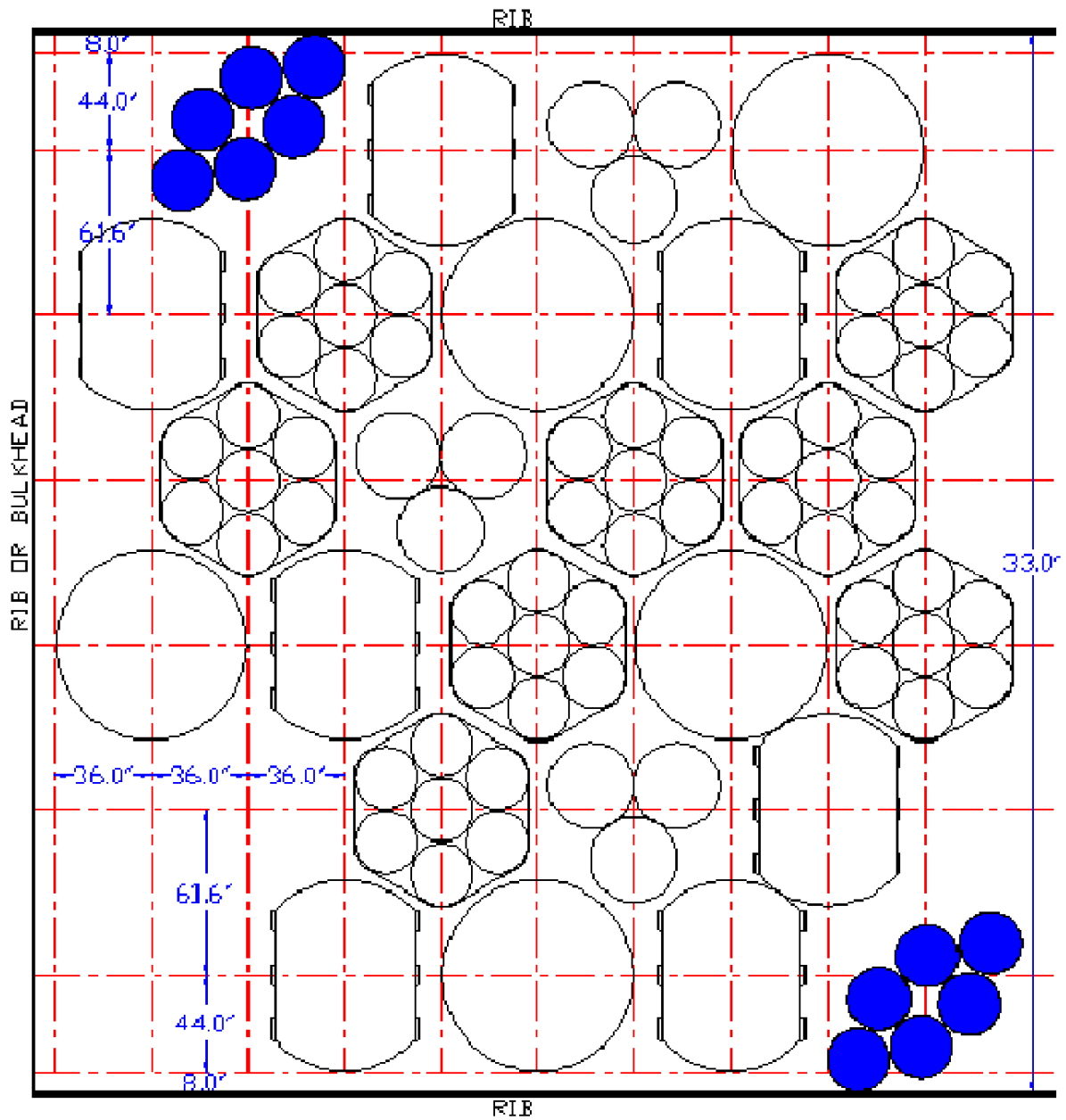

Figure -, Shielded Container Emplacement in Underground Repository

2.2 Description of Waste Containers

Five different container types are currently approved for disposal of CH waste at the WIPP and include 55-gallon drums, 85-gallon drums, 100-gallon drums, SWBs, and TDOPs. The SLB2s ARROW-PAK™ containers are proposed for future CH waste shipments and are considered in this analysis. Additionally, a lead-lined 55-gallon drum is proposed for future RH shipments, referred to as the shielded container, and is considered in this analysis since the disposal configuration will include these containers in the CH array. Waste containers disposed of at the WIPP must meet the requirements of U.S. Department of Transportation (DOT) Type 7A.

The 55-gallon drums used in this NCSE is based on the dimensions given in Section 2.9.1 of the *Contact-Handled Transuranic Waste Authorized Methods for Payload Control (CH-TRAMPAC)* (DOE-CBFO 2005c), which is based on the DOT 17H drum. The drum is constructed with an 18-gauge (0.0478 inch nominal) wall, and does not require a liner or plastic bagging. The drum has an inner diameter of 22.5 inches, an interior height of 33.25 inches, a diameter across the rolling hoops of 24 inches, and an exterior height of 35 inches. The drum is authorized for a total gross weight of 900 or 1,000 pounds, depending on material form. Table 2-1 summarizes the geometric characteristics of the DOT 17-H drum and Figure 2-7 depicts a generic illustration of the drum.

Table -, Modeled 55-gallon Drum Dimensions

Dimension	Modeled Value (in.)	Modeled Value (cm)
Inner Radius	11.25	28.575
Outer Radius*	11.2978	28.69641
Inner Height	33.25	84.455
Outer Height*	33.3456	84.69782
Wall Thickness	0.0478	0.12141

* The Monte Carlo N-Particle transport code drum model uses inner dimensions plus the wall thickness.

**Figure - ,
 55-
 Drum**

In order
 for

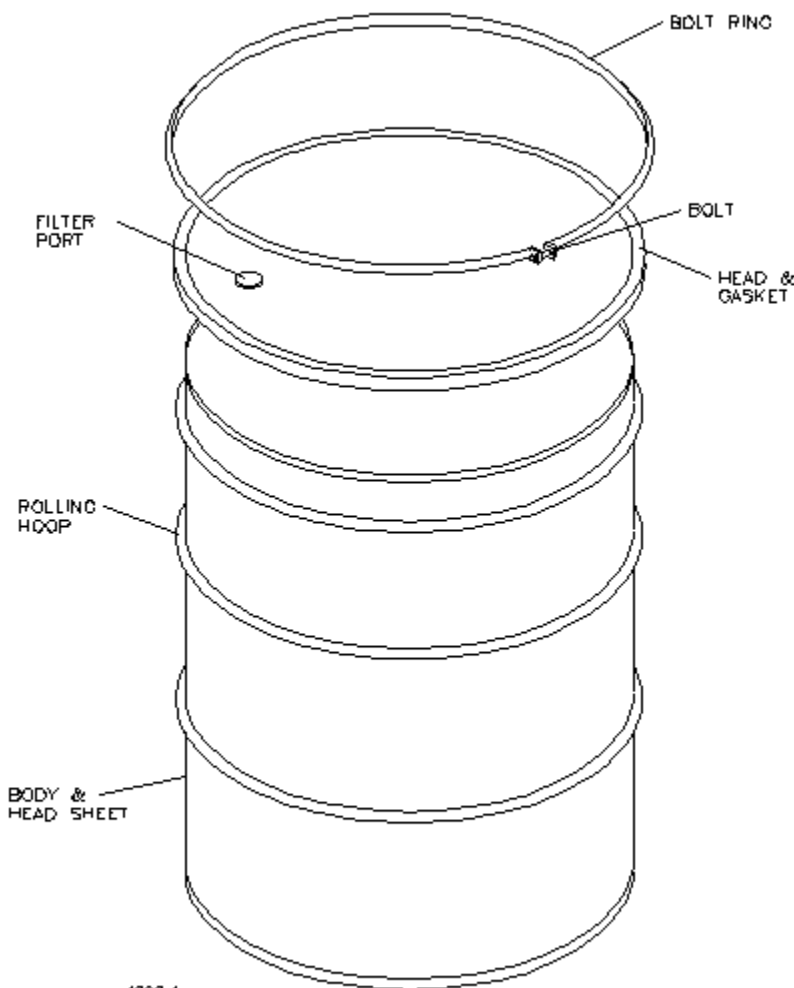

**Typical
 gallon**

to allow

4090.4
 This illustration for
 information purposes only

OVERALL HEIGHT = 34.9 in (886 mm)
 OVERALL DIAMETER = 23.9 in (603 mm)
 ANSI MH2 91

increased fissile content in a single shipment and to allow for certain wastes to be CH, pipe overpack configurations for the 55-gallon drum have been approved. These configurations consist of an inner cylindrical container either approximately 6 or 12 inches in diameter surrounded by shock-absorbing dunnage. The waste is contained within the cylindrical containers and additional shielding can be provided with inserts either in the containers or as part of the surrounding dunnage. The dunnage around the pipe consists of cane fiberboard packing in accordance with *Standard Specification for Cellulosic Fiber Insulating Board* [ASTM C208-95(2001)] and 1/2- or 1/4-inch plywood. In the case of the shielded 6-inch pipe component, a large portion of the dunnage is replaced by water extended polyester/ polyethylene composite or equivalent neutron shielding material. Sections 2.9.2 through 2.9.5 of the CH-TRAMPAC (DOE-CBFO 2005c) describe the various configurations. The pipe components are constructed of 304 stainless steel. Further details of the pipe overpack actual and modeled dimensions are given in of this NCSE.

In addition to the 55-gallon drums, 85- and 100-gallon drums are also authorized for disposal at the WIPP. These drums may be direct loaded but are typically used as an overpack. The 85-gallon drums are bounded by the analysis of arrays of smaller 55-gallon drums and larger 100-gallon drums. The 85-gallon drums will be emplaced into the repository in four-packs versus the seven-pack emplacement pattern for 55-gallon drums and three-pack pattern for 100-gallon drum arrays. The two-container configurations for 85-gallon drums are bounded by the two-container model with 100-gallon drums presented in Section 5.0 as both drum types have 16-gauge walls (per *DOE UN Container Packaging Specifications DOT 7A, Type A Cross Reference* [DOE-RL 2000]) and *General Arrangement & Details 100-Gallon Puck Drum* [Drawing 53-9840 [BNFL 2001]).

Figure 2-8 and Figure 2-9 illustrate a typical 100-gallon drum. This drum is constructed with a 16-gauge (0.0598 inch nominal) wall and is an authorized container for machine-compacted waste. The compacted wastes typically placed in the 100-gallon drum include 55-gallon drums that have been mechanically compressed into a puck, with up to 5 pucks placed in the 100-gallon drum. These drums are received at the WIPP facility and placed into the disposal array as a three-pack that occupies the area defined by a seven-pack of 55-gallon drums. The drum has an inner diameter of 30 inches, an interior height of 33.875 inches, a diameter across the rolling hoops of 31 inches, and an exterior height of 35 inches as shown in Drawing 53-9840 (BNFL 2001). Table 2-2 shows the modeled dimensions for the 100-gallon drum. The drum is authorized for a total gross weight of 1,000 pounds per Section 2.9.7 of the CH-TRAMPAC (DOE-CBFO 2005c).

Table -, Modeled 100-gallon Drum Dimensions

Dimension	Modeled Value (in.)	Modeled Value (cm)
Inner Radius	15	38.1
Outer Radius*	15.0598	38.25189
Inner Height	33.875	86.0425
Outer Height*	33.9946	86.34628
Wall Thickness	0.0598	0.15189

* The Monte Carlo N-Particle transport code drum model uses inner dimensions plus the wall thickness.

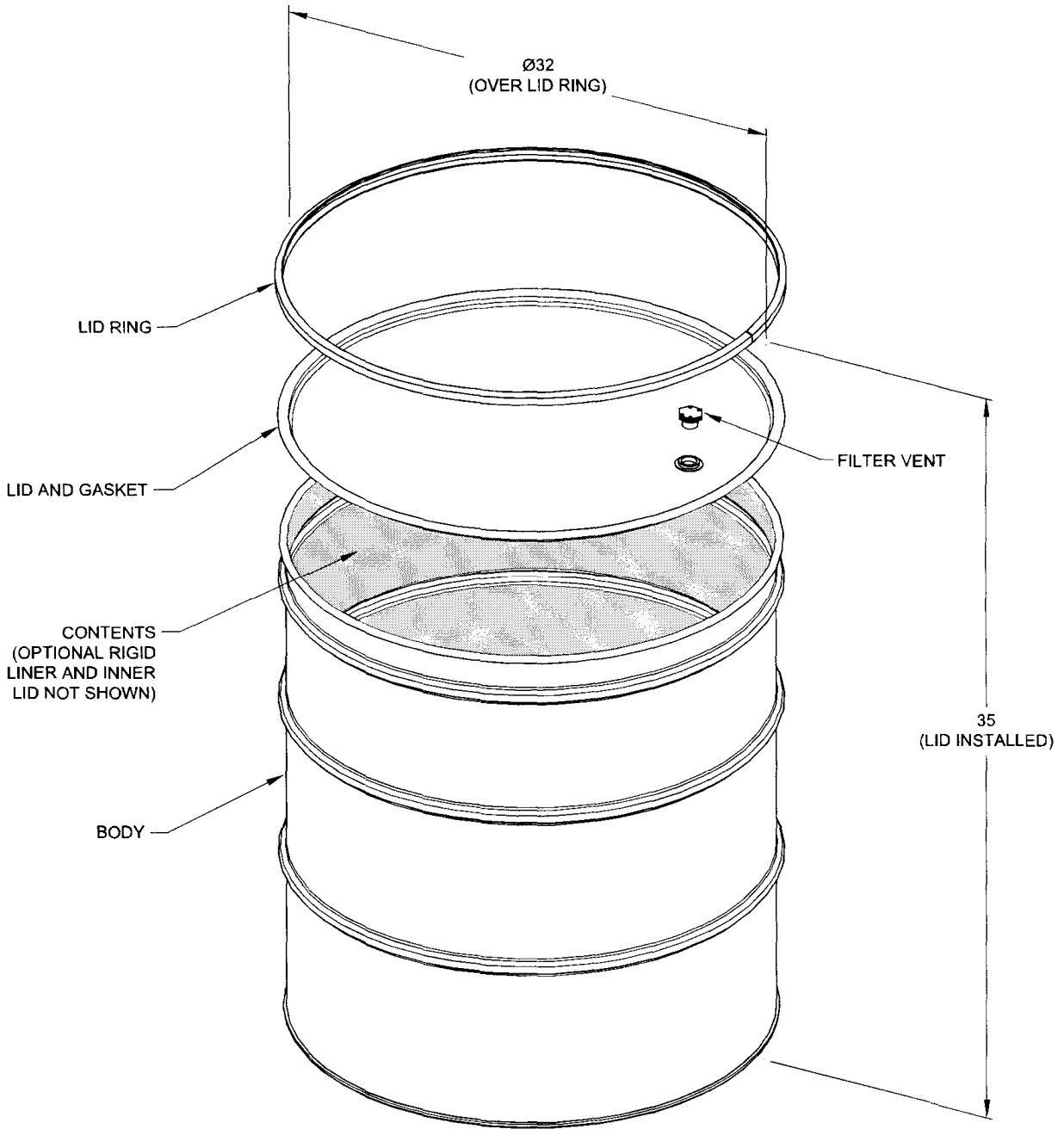

Figure -, Typical 100-gallon Drum

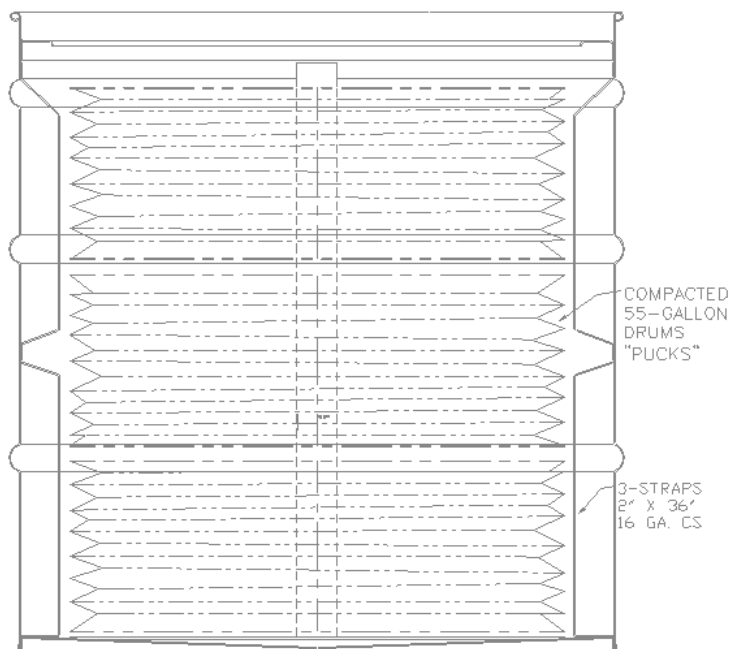

Figure -, 100-gallon Drum Showing Machine-compacted Waste

The SWB is illustrated in Figure 2-10. Sides, walls, and bottom are constructed of 10-gauge carbon steel (*Standard Specification for Steel, Carbon (0.15 Maximum, Percent), Hot-Rolled Sheet and Strip Commercial* [ASTM A 569]). The ends of the box are rounded and the 1/8-inch-thick top lip is attached to the body for positive closure by screws located along the periphery of the box. The SWB dimensions modeled in Monte Carlo N-Particle transport code (MCNP) are given in Table 2-3, which result in an active volume of $1.92 \times 10^6 \text{ cm}^3$. In addition to solids payloads, the SWB is authorized for transportation and disposal of four 55-gallon drums in an overpack arrangement. The SWB has a maximum gross weight of 4,000 pounds per Section 2.9.8 of the CH-TRAMPAC (DOE-CBFO 2005c).

Table -, Modeled SWB Dimensions

Dimension	Modeled Value (in.)	Modeled Value (cm)
Radius	34.375	87.3125
Inner Length	68.75	174.625
Inner Width	51.875	131.7625
Inner Height	36.75	93.345
Wall Thickness	0.125	0.3175

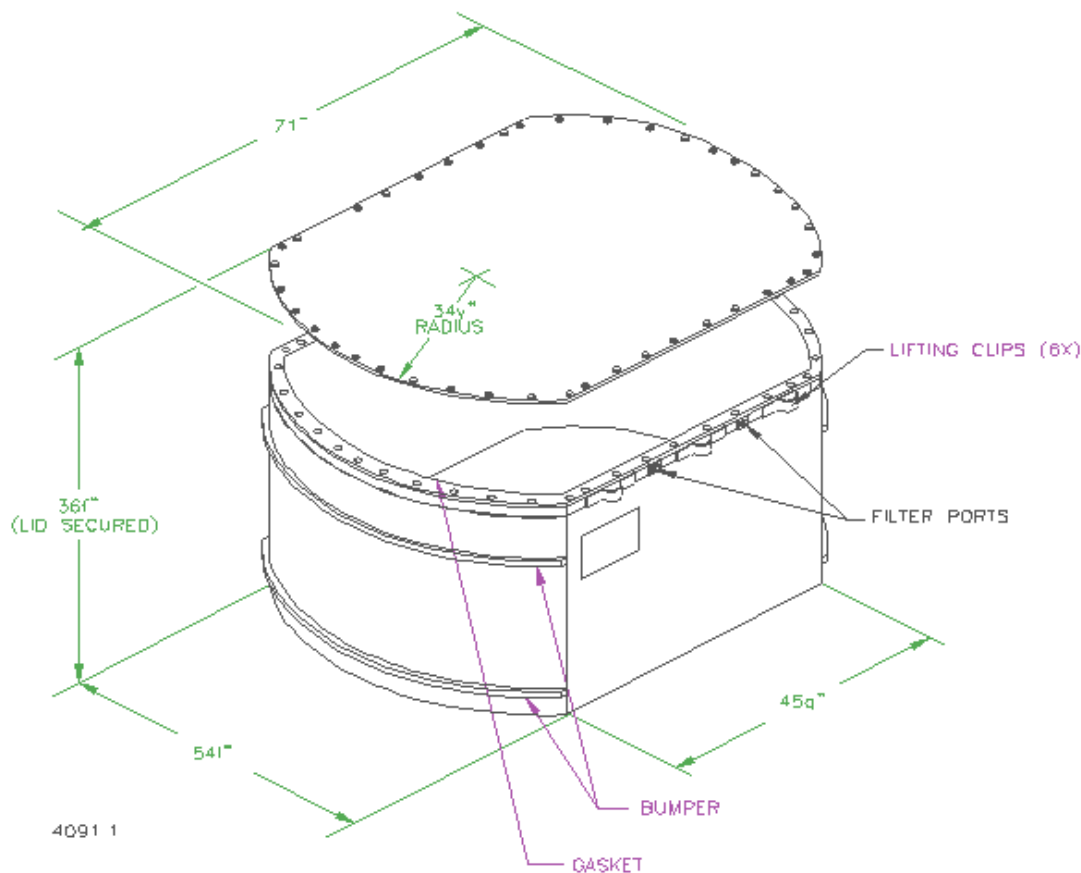

Figure -, Standard Waste Box

The TDOP container is used to overpack up to ten containers that have some form of physical deterioration (e.g., rust or damage) or surface contamination and may contain up to ten 55-gallon drums or one SWB. The TDOP occupies the same footprint as a seven-pack of 55-gallon drums or an SWB, but is two tiers high. These containers are also not specifically assessed in this NCSE, since TDOPs are bounded by the SWB analysis. The TDOP total fissile mass is restricted to the same as that of a SWB and the maximum reflector packing fraction of 25% in both cases is the same. This results in a smaller areal density of fissile material than what may be contained within two SWBs, thus, the TDOPs are less reactive in the arrays than the SWB. In the two-container models of machine-compacted waste, the SWB also bounds TDOP because the fissile material in the SWB is fully reflected by the high-density polyethylene. Consequently, the additional non-fissile material in the TDOP will have little effect. The TDOP has a maximum gross weight of 6,700 pounds per Section 2.9.9 of the CH-TRAMPAC (DOE-CBFO 2005c).

The SLB2 is a large box designed for transport in the TRUPACT-III shipping container. The nominal inner dimensions of the SLB2 are 102 inches by 63 inches by 66 inches tall and the nominal outer dimensions are 106 inches by 69 inches by 73 inches tall as given in

Drawing 165-F-016-W1 (WTS 2007a). The dimensions modeled, as shown in Table 2-4, maximize the inner volume while maintaining the outer dimensions below the nominal values.

Table -, Modeled Standard Large Box 2 Dimensions

Dimension	Modeled Value (in.)	Modeled Value (cm)
Inner Length	104.5	265.43
Inner Width	65.31	165.89
Inner Height	66.31	168.43
Wall Thickness	0.1875	0.48

The ARROW-PAK™ payload containers are constructed of a nominal 30-inch outside diameter, extra-high molecular weight, high-density polyethylene (EHMW-HDPE) cylindrical pipe with a minimum 1.765-inch-thick wall. The EHMW-HDPE density is provided by the material cell classification per *Standard Test Method for Density of Plastics by the Density-Gradient Technique* (ASTM D 1505) as 0.940 to 0.947 g/cm³. The ends of the container are torispherical in shape with minimum thicknesses of 1.765 inches on the sides and 2.5 inches on the bottom. The overall height of the ARROW-PAK™ is nominally 70.5 inches and was used throughout the modeling. The nominal empty weight of an ARROW-PAK™ is 525 pounds, and the maximum payload weight (i.e., one loaded 55-gallon drum) within an ARROW-PAK™ payload container is 1,375 pounds, corresponding to a maximum loaded ARROW-PAK™ weight of 1,900 pounds. A comprehensive description of the ARROW-PAK™ payload container is provided in Drawing 163-004, *ARROW-PAK Drawing* (PTI 2005). The ends of the ARROW-PAK™ are modeled as flat circular plates with a nominal thickness of 2.91 inches (7.3914 centimeters) to maximize the reflection provided by the container at the bottom. Table 2-5 tabulates the ARROW-PAK™ modeled dimensions.

Table -, Modeled ARROW-PAK™ Dimensions

Dimension	Modeled Value (in.)	Modeled Value (cm)
Outer Height	70.50	179.07
Outer Radius	15.00	38.100
Side Wall Thickness	1.765	4.4831
End Wall Thickness	2.910	7.3914

The proposed shielded container has approximately the same exterior dimensions as a standard 55-gallon drum and is designed to hold a 30-gallon drum. The cylindrical sidewall of the shielded container has 1-inch-thick lead shielding sandwiched between a double-walled steel shell as shown in Figure 2-11. The external wall is 1/8 inch thick, and the internal wall 3/16 inch thick. The lid and the bottom of the container are made of carbon steel and are approximately 3 inches thick. The empty weight of the containers is approximately 1,700 pounds. The shielded container and the inner 30-gallon drum will be vented. The container has been tested to DOT

Type 7A specifications, which will ensure that the container is safe for transport and handling and will contain the waste under the most severe accident conditions. The shielded container modeled dimensions, as summarized in Table 2-6, are taken from Drawing 165-F-026-W1, *Shielded Container Assembly* (WTS 2007b) to maximize the lead shielding thickness.

Table -, Modeled Shielded Container Dimensions

Dimension	Modeled Value (in.)	Modeled Value (cm)
Inner Height	29.75	75.565
Inner Diameter	20.375 (min)	51.7525
Inner Steel Wall Thickness	0.179 (min)	0.4547
Lead Wall Thickness	1.013 (max)	2.574
Outer Steel Wall Thickness	0.12 (min)	0.3048
Lid/Bottom Thickness	2.75 (min)	6.985

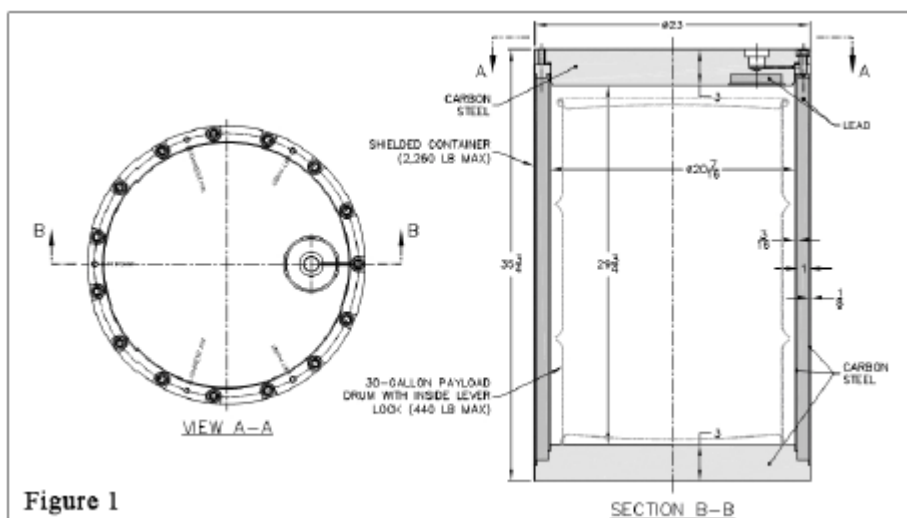

**Figure -,
Shielded
Container**

3.0 Requirements Documentation

The WIPP facility is subject to the requirements of DOE O 240.1B, *Facility Safety*, Chapter III, “Nuclear Criticality Safety” (DOE 2005). Compliance with the double contingency requirements of DOE Order 420.1B is demonstrated for CH waste in this analysis. This NCSE is written to meet the content requirements of the *Guidelines for Preparing Criticality Safety Evaluations at Department of Energy Nonreactor Nuclear Facilities* (DOE 2007).

4.0 Methodology

4.1 Evaluation Method

The methodology used in this NCSE assumes control of both ^{239}Pu and special reflector materials in each waste container. Mass limits for plutonium and beryllium are the primary criticality safety control for storage, handling, and disposal of waste at the WIPP facility. After defining and evaluating the different container geometries, loading configurations and payloads in Sections and , the overall bounding configurations for handling, storage and disposal are identified and narrowed to two bounding configurations. The two bounding configurations were evaluated using MCNP5 (*MCNP — A General Monte Carlo N-Particle Transport Code, Version 5* [LANL 2005]) to determine the appropriate fissile mass limits.

The first configuration modeled is an infinite array of waste containers in the underground repository. The containers are stacked three tiers high and a hexagon placed close around the stack that is infinitely reflected to model a tight-packed, infinite array. The MgO supersack is modeled on top of the stack and salt reflection modeled above the MgO and below the containers. The array results are summarized in Section .

The second configuration, termed the two-container model, evaluates two containers stacked on top of one another with the fissile masses closely located. The fissile mass in the lower container is positioned up against the container lid and the fissile mass in the upper container is concentrated on the bottom of the container directly above the mass in the lower container. The two containers are then infinitely reflected on all sides with concrete, MgO, or salt to represent the various reflector materials available above ground and in the underground repository. This configuration represents the worst-case fissile material interaction and reflection. The two-container results are summarized in Section .

Section contains the parameter evaluation. In this section, the controlled parameters are identified as well as the contingent conditions to be evaluated in the event control of the parameter is lost. The hazard evaluation documented in also provides a basis for the contingencies. Section evaluates various contingent conditions related to waste operations at WIPP. The array model is used as the basis for these upset conditions.

The above configurations are evaluated for each waste type in detail in the appendices. Non-compacted, direct loaded waste is evaluated in with less than or equal to 1 weight percent (wt%) special reflector materials and in with higher special reflector material contents. Machine-compacted waste is evaluated in . Pipe overpack drum assemblies containing non-compacted waste are evaluated separately in and two-container configurations pairing up two different container types or loadings are evaluated in .

4.2 Monte Carlo Computational Method

Monte Carlo calculations were performed to evaluate the reactivity state of various container type/package contents combinations and configurations when machine-compacted waste is present. Calculations in this evaluation were performed using MCNP5 (LANL 2005) on a personal computer. The MCNP5 computer code was run under the allowed Microsoft® platforms and validated in accordance to established guidelines (*Verification of MCNP5 on SAIC Computers* [Larson 2004]). Only the precompiled version of MCNP5 supplied by the vendor (Los Alamos National Laboratory) was used and the Evaluated Neutron Data File VI library was used for all cases.

Per *MCNP5 Bias Validation for the WIPP* (Hayes 2004) and *Determination of Calculational Bias for Criticality Calculations at the WIPP using MCNP* (Rhoden 2003a), the upper subcritical limit (USL) for MCNP at the WIPP for non-graphite bearing waste is 0.97. This USL includes an administrative margin associated with using salt or MgO as a reflector. The USL was found to initially be 0.975 although the large presence of salt (NaCl) as a reflector was not considered to be adequately addressed in the benchmarks resulting in the addition of an administrative margin of 0.005. The basis for this offset value was that a USL of 0.975 gave a 5% probability that 1 in 10,000 critical systems would be modeled as having a reactivity of ≤ 0.975 . Therefore, to account for salt or MgO reflection, a 1 in 100,000 USL was chosen that equated to 0.97. Hayes (2004) also considered steel containers in the development of the bias. The USL is also applicable to beryllium-bearing waste as justified in *Waste Isolation Plant Nuclear Criticality Safety Evaluation for Contact Handled Transuranic Waste Storage* (Rhoden 2003b). The USL determination does include a number of benchmarks with beryllium. However, these were systems with Average Energy Fission Group well above the thermal range. The Falstaff experiments detailed in U233-SOL-INTER-001 of the *International Handbook of Evaluated Criticality Safety Benchmark Experiments* (NEA 2007) were used in the reference to help further validate the use of MCNP for problems that involve beryllium at other than fast energies. These experiments consist of a steel spherical shell that contains a solution of uranium fluoride and water. The steel shell is reflected by different combinations of beryllium metal and polyethylene.

A supplemental validation document (*MCNP5 Bias Validation For Lead And Low Enriched Uranium At The Waste Isolation Pilot Plant* [Newell and Larson, 2007]) was written to evaluate lead reflection and is applicable to the lead-lined drum calculations. The document evaluated 82 low enriched uranium benchmarks, 8 of which contained significant quantities of lead. The supplemental validation concluded that the lead benchmarks result in a higher USL when included in the evaluated benchmark set, as compared to when the benchmarks are removed. Thus, the USL determined in Hayes (2004) for plutonium systems is applicable for lead as modeled in the lead-lined drums.

In addition, the bias analysis states that if the average energy of fission (AEOF) is greater than 2.5 eV, then an additional 0.005 bias in k_{eff} should be utilized, which would further reduce the USL if the AEOF is not shown to be below 2.5 eV. Note that the AEOF values used were calculated based on the average neutron lethargy causing fission due to its basis from the

KENO V.a runs taken from the Office of Environmental Compliance and Documentation benchmarks in Rhoden (2003b). This value was verified to be met based on the value of the “energy corresponding to the average neutron lethargy causing fission” in the MCNP output files, thus the USL was set at 0.97.

The 0.97 USL value was initially used in the development in NCSEs for CH waste. An additional 0.01 administrative margin has been applied in this NCSE to address concerns regarding administrative margin resulting in a final USL of 0.96. Some calculations originally done in earlier WIPP NCSEs have been revised to meet the final USL. Calculations performed under both USL values are referred to in this document and the modeling assumptions required to meet the final USL are discussed as applicable. The resulting modeled scenarios are shown to be compliant with the final USL of 0.96.

5.0 Process Analysis

Because of the different container types, package contents, and disposal configurations at the WIPP facility, waste storage, handling, and disposal involve numerous criticality computations to evaluate the many combinations of container configurations that are possible. In this section, bounding configurations for the receipt, temporary storage in the WHB (above ground), transfer to the underground in the conveyance, and permanent disposal of machine compacted CH waste in the underground repository are evaluated. To simplify the analyses and to ensure a conservative bound is placed on the multitude of waste container storage, handling, and disposal configurations, this NCSE considers two bounding geometric configurations: infinite array configurations with reflection conditions representative of the salt repository and two-container models where the fissile masses are close to one another and the containers are infinitely reflected. These configurations were modeled in MCNP5. The geometry of the waste containers, underground array and two-container models are described in Section , the material compositions used in the models are given in Section and the container array and two-container model results are summarized in Sections and , respectively.

5.1 Geometry

The contents of the various allowed loadings are summarized below with respect to the container type as modeled in MCNP. Further details are given in the appendices for the specific waste type being analyzed.

5.1.1 Direct-loaded 55-gallon Drums Containing Less Than or Equal to 1 Weight Percent Special Reflectors

The direct loaded 55-gallon drums are modeled with 200 grams of ^{239}Pu mixed with a polyethylene-water moderator, which is 25% by volume polyethylene and 75% by volume water. A mixture of polyethylene and special reflector material fills the remainder of the drum reflecting the fissile mass. The special reflector material is modeled as beryllium based on the evaluation in *Reactivity Effects of Moderator and Reflector Materials on a Finite Plutonium*

System (Neeley et al. 2004), which found beryllium to be the most reactive reflector material at infinite thickness for a polyethylene-water moderated ^{239}Pu system. Polyethylene is modeled at a maximum packing fraction of 25% as determined to bound the packing fraction of direct loaded (non-machine compacted) waste in the TRUPACT-II SAR (DOE-CBFO 2005a). The amount of beryllium is based on 1 wt% of the maximum gross container loading limit of 1,000 pounds (DOE-CBFO 2005c) or 4.55 kilograms, which is rounded up to 5 kilograms of beryllium per 55-gallon drum. The beryllium is modeled as homogeneously mixed throughout the polyethylene reflector. The beryllium density varies slightly with the hydrogen/plutonium (H/Pu) ratio as the fuel volume changes but is approximately 0.024 g/cm^3 in the 55-gallon drum. Note that beryllium is slightly more reactive modeled in the reflector than in the moderator as discussed in Section 6.4.3.2.2 of the TRUPACT-II SAR (DOE-CBFO 2005a).

The 55-gallon drum dimensions given in Table 2-1 are used in the MCNP5 models. The drum walls are carbon steel (ASTM A 569), which is modeled with the composition given in Table 5-4. The theoretical density of carbon steel is 7.86 g/cm^3 , but is modeled at 50% of this value, or 3.93 g/cm^3 , to allow for fabrication tolerances, localized wall thinning or other degradation. Section 2.1.2 of the CH-TRAMPAC (DOE-CBFO 2005c) requires that the integrity of the container be visually inspected prior to transport to ensure there is no significant rusting such that the 50% value is conservative.

5.1.2 Direct-loaded Shielded Containers with Less Than or Equal to 1 Weight Percent Special Reflectors

The shielded containers are modeled with the same waste loading as discussed above for the 55-gallon drums, namely 200 fissile gram equivalents (FGE) in the 25% polyethylene and 75% water moderator with 5 kilograms of beryllium in polyethylene at a maximum packing fraction of 25% filling the remainder of the drum. The shielded container dimensions given in Table 2-6 are used in the MCNP5 models. The shielded container walls are carbon steel (ASTM A 569), modeled with the composition given in Table 5-4, lining a lead wall, modeled per Table 5-5. The container has a nominal 3-inch-thick steel lid and bottom modeled at the minimum thickness of 2.75 inches. The carbon steel is modeled at its theoretical density of 7.86 g/cm^3 as degradation of such thick steel piece will not be a significant fraction of the modeled thickness.

5.1.3 Direct-loaded SWB Containing Less Than or Equal to 1 Weight Percent Special Reflectors

The direct-loaded SWB is modeled with 325 grams of ^{239}Pu mixed with a polyethylene-water moderator, which is 25% by volume polyethylene and 75% by volume water. A mixture of beryllium and polyethylene fills the remainder of the SWB reflecting the fissile mass. Polyethylene is modeled at a maximum packing fraction of 25% as determined to bound the packing fraction of direct-loaded (non-machine compacted) waste in the TRUPACT-II SAR (DOE-CBFO 2005a). The amount of beryllium is based on 1 wt% of the maximum container gross weight of 4,000 pounds, which equates to 18.14 kilograms of beryllium per SWB. The beryllium is modeled as homogeneously mixed throughout the polyethylene reflector. The

beryllium density varies slightly with the H/Pu ratio as the fuel volume changes but is approximately 0.0095 g/cm^3 . Note that beryllium is slightly more reactive modeled in the reflector than in the moderator as discussed in Section 6.4.3.2.2 of the TRUPACT-II SAR (DOE-CBFO 2005a).

The SWB dimensions given in Table 2-3 are used in the MCNP5 model. The carbon steel (ASTM A 569) container wall is modeled at full thickness, but the carbon steel is only modeled at 50% of the theoretical density, or 3.93 g/cm^3 , to allow for fabrication tolerances, localized wall thinning or other degradation, etc. The composition of carbon steel used in the models is given later in Table 5-4.

5.1.4 Direct-loaded SLB2 Containing Less Than or Equal to 1 Weight Percent Special Reflectors

The SLB2 is a large box designed for transport in the TRUPACT-III shipping container. The inner dimensions of the SLB2 are approximately 102 inches by 63 inches by 66 inches tall and the outer dimensions are 106 inches by 69 inches by 73 inches tall as given in Drawing 165-F-016-W1 (WTS 2007a). The SLB2 is modeled with slightly smaller inner dimensions as given in Table 2-4 to account for the tolerances given on the drawing. The maximum gross weight of an SLB2 is 1,050 pounds where the beryllium mass at the 1 wt% limit is 47.6 kilograms. The FGE limits from the TRUPACT-II SAR (DOE-CBFO 2005a), namely 500 grams of ^{239}Pu with no ^{240}Pu credited, 515 grams of ^{239}Pu with 5 grams of ^{240}Pu , 535 grams of ^{239}Pu with 15 grams of ^{240}Pu , and 555 grams of ^{239}Pu with 25 grams of ^{240}Pu , were used in this NCSE to evaluate the effect of the SLB2 on waste handling, storage, and disposal configurations at WIPP.

5.1.5 Direct-loaded ARROW-PAK™ Containers Containing Less Than or Equal to 1 Weight Percent Special Reflectors

The ARROW-PAK™ payload containers are constructed of a nominal 30-inch outside diameter, EHMW-HDPE cylindrical pipe with a minimum 1.765-inch-thick wall. The EHMW-HDPE density is provided by the material cell classification per ASTM D 1505 as 0.940 to 0.947 g/cm^3 . The ends of the container are torispherical in shape with minimum thicknesses of 1.765 inches on the sides and 2.5 inches on the bottom. The overall height of the ARROW-PAK™ is nominally 70.5 inches and was used throughout the modeling. The nominal empty weight of an ARROW-PAK™ is 525 pounds, and the maximum payload weight (i.e., one loaded 55-gallon drum) within an ARROW-PAK™ payload container is 1,375 pounds, corresponding to a maximum loaded ARROW-PAK™ weight of 1,900 pounds. The ARROW-PAK™ dimensions and payload are provided in Drawing 163-004 (PTI 2005).

The ARROW-PAK™ geometry is conservatively modeled as a right-circular cylinder of 70.5 inches overall height with an outside diameter of nominally 30 inches (76.20 centimeters) and a minimum sidewall thickness of 1.765 inches. The ends of the ARROW-PAK™ are

modeled as flat circular plates with a nominal thickness of 2.91 inches (7.3914 centimeters) to maximize the reflection provided by the container at the bottom.

The payload container within the ARROW-PAK™ is a standard 55-gallon drum waste container with geometric characteristics identical to those discussed in Section . For conservatism, the 55-gallon drum steel walls are neglected. The beryllium in the ARROW-PAK™ is modeled only in the volume of the drum. This increases the beryllium concentration and its interaction with the fissile mass centered within the drum compared to homogenizing the beryllium over the entire ARROW-PAK™ volume. The beryllium mass is 6.25 kilograms/payload container, or 1 wt% of the payload container maximum weight of 1,375 pounds. Each ARROW-PAK™ is modeled containing 325 grams of ²³⁹Pu in the payload container, again mixed with a 25% by volume polyethylene and 75% by volume water moderator.

5.1.6 Direct-loaded 55-gallon Drums Containing Greater Than 1 Weight Percent Special Reflectors

The special reflector material is modeled as beryllium, which has been shown to result in the highest reactivity when reflecting a plutonium system in unlimited quantity in *Nuclear Criticality Safety Evaluation for Storage of Machine Compacted Transuranic Waste Products at the Waste Isolation Pilot Plant* (Neeley 2005). For these drums, the beryllium may be in large metal pieces or may be present in particulate form, thus the beryllium is modeled as either a moderator or a reflector. When modeled as a reflector, the beryllium is conservatively modeled at 70% of its theoretical density. Reflection by 100% dense beryllium, although bounding, is not possible in these waste drums per *Review of Special Reflectors in the TRU Waste Inventory* (Taggart and Moon 2004). Because the beryllium consists of molds, shapes, chunks, coarse particles, and fines randomly filling the waste container instead of being specifically constructed to surround the fissile material and fill the container with no void, beryllium at 70% of theoretical density or 1.295 g/cm³ is used given that the maximum theoretical density for randomly packed uniform spheres is 70% (“Recursive packing of dense particle mixtures” [Elliot et al. 2002] and “Is random packing of spheres well defined?” [Torquato et al. 2007]). The high beryllium content is only modeled in 55-gallon drums.

5.1.7 Fully Compacted Waste in 100-gallon Drums

This configuration assumes the contents are fully compacted and the non-fissile material in the drum, modeled as polyethylene, reaches theoretical density. Thus, the fissile mass is moderated with 100% dense polyethylene. The drums are modeled with two fissile limits. The first limit of 170 grams of ²³⁹Pu does not credit any difference in the internal and external dimension when the drums are stacked. The second higher fissile mass is 200 grams of ²³⁹Pu and only applies when the design of the container lid and bottom that provides inherent spacing between the internal contents of two stacked drums is credited. With both limits, the fissile mass is reflected by a 100% dense mixture of beryllium and polyethylene. The beryllium content in the reflector mixture is 5 kilograms, which slightly exceeds 1percent by weight of the rated 1,000 pounds weight capacity of the drum (DOE-CBFO 2005c). The reflector configuration used for

compacted drums concentrates the beryllium near the fissile mass. In essence the reflector is broken up into two halves with the reflector half surrounding the fissile mass containing the beryllium-polyethylene mixture, and the remaining half containing only polyethylene. Although unlikely, this configuration represents a credible bound by assuming that the beryllium is concentrated in one or two pucks. The 100-gallon drum is modeled with the dimensions given in Table 2-1 and the steel drum wall is modeled with the composition given in Table 5-4 at 50% density to allow for degradation.

5.1.8 Partially Compacted Waste in 100-gallon Drums

Because 100% compaction may be overly conservative with regard to the compaction that can physically be achieved, limits are also determined based on 70% compaction. This scenario is also evaluated in the TRUPACT-II SAR (DOE-CBFO 2005a) and will require the waste generator to control the compaction process. The fissile mass in this model consists of 200 grams of ^{239}Pu moderated with a polyethylene-water mixture, which is 70% by volume polyethylene and 30% by volume water. This fissile mixture is consistent with the approved TRUPACT-II contents model used in the criticality safety analysis for partially compacted waste. Reflection of the fissile mass with a 70% dense mixture of 5 kilograms of beryllium and polyethylene is modeled. This reflector composition bounds controlled machine compaction operations. As with the fully compacted case, the reflector mass configuration concentrates the beryllium near the fissile mass. Again the reflector is broken up into two halves with the reflector half surrounding the fissile mass containing the beryllium-polyethylene mixture, and the remaining half containing only polyethylene. The 100-gallon drum is modeled with the dimensions given in Table 2-1 and the steel drum wall is modeled with the composition given in Table 5-4 at 50% density to allow for degradation.

5.1.9 Fully Compacted Waste Direct Loaded in a Standard Waste Box

In an SWB, only full compaction is considered. Thus, moderation of the fissile mass is modeled with 100% dense polyethylene and the fissile mass is reflected with a 100% dense mixture of beryllium and polyethylene. The fissile mass consists of 185 grams of ^{239}Pu . The beryllium content in the reflector mixture is 18.14 kilograms, which represents 1% by weight of the rated weight capacity of the SWB, and is consistent with the TRUPACT-II SAR contents model for fully compacted waste. The 18.14 kilograms of beryllium is homogeneously distributed throughout the polyethylene filling the container. The SWB is modeled with the dimensions given in Table 2-3 and the SWB wall is modeled at 50% density to allow for degradation with the composition given in Table 5-4.

5.1.10 Fully Compacted Waste in 100-gallon Drum Overpacked in a Standard Waste Box

A 100-gallon drum of machine-compacted waste may also be overpacked in an SWB. This drum would typically be overpacked in the SWB due to exterior contamination, but the SWB also provides additional spacing and structural steel where the FGE limit in the 100-gallon drum can

be increased. The fissile mass is 250 grams of ^{239}Pu moderated with 100% dense polyethylene. The entire 18.14 kilograms of beryllium, 1 wt% of the SWB-rated weight capacity, is modeled in the 100-gallon drum and the remainder of the SWB is voided to allow for interaction between containers. The 100-gallon drum is modeled with the dimensions given in Table 2-1 and the SWB is modeled with the dimensions given in Table 2-3. Both container walls are modeled with the composition given in Table 5-4 at 50% density to allow for degradation.

5.1.11 Fully Compacted Waste in Shielded Containers

The shielded containers of compacted waste are modeled with 200 FGE moderated by 100% dense polyethylene with 5 kilograms of beryllium in 100% dense polyethylene filling the remainder of the container. The container geometry and materials are modeled as described in Section .

5.1.12 Pipe Overpacks in 55-gallon Drums containing Less Than or Equal to 1 Weight Percent Special Reflectors

The unshielded 12-inch pipe overpack assembly is modeled to bound all pipe overpack configurations. Because the unshielded 12-inch pipe overpack assembly design allows for less dunnage and, therefore, greater interaction between drums, this simplifying assumption is considered conservative. Furthermore, the larger pipe diameter allows for a more favorable fissile material geometry over that of the smaller 6-inch pipe overpack. The cane fiberboard used in the pipe overpack assemblies as shock absorbing dunnage is represented by cellulose ($\text{C}_6\text{H}_{10}\text{O}_5$) at a density of 0.2248 g/cm^3 .

5.1.13 Pipe Overpacks in 55-gallon Drums Containing Greater Than 1 Weight Percent Special Reflectors

The same 12-inch pipe overpack modeled described in Section is also used for the pipe overpacks containing high quantities of special reflectors. The special reflector material is again modeled as beryllium. The beryllium mass is unlimited and it fills the pipe volume around the fissile material.

5.1.14 Infinite Array Model Details

The underground repository array is modeled as a stack of containers in a hexagonal arrangement that is infinitely reflected on the six vertical faces to simulate a tight-packed, infinite array in x and y. The bottom of the stack is reflected with nominally 10 feet of salt modeled at 300 centimeters and the top of the stack is reflected by nominally 2 feet modeled at 62.23 centimeters of MgO backed by 300 centimeters of salt. The MgO represents the supersack placed on top of each stack and the salt thickness provides infinite reflection. The stack represents three tiers of drum assemblies or SWBs. The larger height of the ARROW-PAKs™ and SLB2s only allows for one tier to be stacked on top, thus these array models include only two tiers. Waste container configurations are emplaced on a hexagonal lattice unit with pitch characteristics typical

of a seven-pack of DOT 17-H 55-gallon drums. The disposal configuration is based on typical disposal area dimensions that accommodate the stacked waste and required airflow within an active waste emplacement room.

Fissile masses are located in the center of the container in the infinite array model. In this centralized configuration, the fissile units are equal distance to all other fissile units in the array and; therefore, represent a bounding reactive state with respect to interaction between containers in the array. Assuming random placement of the fissile unit in each container, the average center-to-center separation in either the horizontal or vertical direction will be statistically the same as that of the array with all fissile masses centered in the containers.

5.1.15 Two-Container Model Details

The two-container models used in this evaluation consider the different container types and approved loadings that could be stacked on top of one another in a bounding configuration. Whereas the fissile material is centered in each container in the array model, the two-container model considers worst-case fissile placement for maximum interaction between the two containers. The fissile mass in the lower container is located at the top of the container, while the fissile mass in the upper container is located at the bottom of the container. The fissile mass units form a cylinder with an optimum height-to-diameter (H/D) ratio of 1 and a total mass of 2 times that allowed per container.

Worst-case reflection conditions that may occur during storage, handling, and disposal are also considered in the two-container model. The stack of two containers is tightly reflected by 300 centimeters of either concrete, MgO, or salt to provide infinite reflection. The concrete is modeled to represent above-ground handling and storage in concrete buildings; the MgO represents close reflection by the MgO supersacks in the underground repository and the salt represents the salt walls. The intent of the two-container analyses is to provide a worst-case, conservative model to ensure that a criticality accident at the WIPP due to the storage, handling, and disposal of CH waste is not credible.

5.2 Material Compositions

The material compositions used in the MCNP5 models are summarized in this section.

5.2.1 Fissile Waste Mixture

The majority of the fissile material to be disposed of at the WIPP is ^{239}Pu and is the only fissile component considered in the analysis. Other fissile isotopes are allowed at the WIPP, but all are reported as equivalent grams of ^{239}Pu known as FGE. The ^{239}Pu density used in determining source mixtures is 19.848 g/cm^3 (*Handbook of Chemistry and Physics* [CRC 1991-1992] and *Standard Composition Library* [Petrie et al. 2000]) for alpha-phase plutonium metal with a molecular weight of 239.05 (*Nuclides and Isotopes* [GE 1989] and Petrie et al. 2000).

The moderator component of the fissile mixture used in the criticality analyses is dependent on waste category. In summary, the moderating material in fully compacted waste streams consists of pure polyethylene at its theoretical density of 0.923 g/cm³ or 0.93 g/cm³ (both values for 100% dense polyethylene given in Petrie et al. 2000). For partially compacted waste, the moderator was modeled as a polyethylene-water mixture, which is 70% by volume polyethylene and 30% by volume water. For all other non-compacted waste streams, the moderator was modeled as a mixture of polyethylene and water, which is 25% by volume polyethylene and 75% by volume water. Table 5-1 through Table 5-3 tabulate the fissile mass mixture compositions as a function of H/Pu ratio over the optimum range for the compacted and direct-loaded (non-compacted) waste categories used in this NCSE.

Table -, Mixture Parameters for Fully Compacted Waste Versus Hydrogen/Plutonium Ratio

H/Pu	²³⁹ Pu Conc. (g/l)	Mixture Density (g/cm ³)	Wt.% H	Wt.% C	Wt.% Pu
²³⁹Pu Mixed with 100% Dense Polyethylene					
700	44.8428	0.9658	13.7045	81.6522	4.6433
750	41.8596	0.9629	13.7471	81.9057	4.3472
800	39.2485	0.9604	13.7845	82.1289	4.0866
850	36.9441	0.9582	13.8178	82.3268	3.8555
900	34.8953	0.9563	13.8474	82.5035	3.6491
950	33.0617	0.9545	13.8741	82.6623	3.4637
1000	31.4112	0.9529	13.8981	82.8057	3.2962
1050	29.9177	0.9515	13.9200	82.9358	3.1442
1100	28.5598	0.9502	13.9399	83.0545	3.0056

Table -, Mixture Parameters for Partially Compacted Waste Versus Hydrogen/Plutonium Ratio

H/Pu	²³⁹ Pu Conc. (g/l)	Mixture Density (g/cm ³)	Wt.% H	Wt.% O	Wt.% C	Wt.% Pu
²³⁹Pu Mixed with 70% By Volume Polyethylene and 30% By Volume H₂O						
700	42.6933	0.9855	12.7868	26.8608	56.0201	4.3323
750	39.8528	0.9827	12.8239	26.9386	56.1824	4.0552
800	37.3667	0.9804	12.8564	27.0070	56.3251	3.8114
850	35.1726	0.9783	12.8853	27.0677	56.4517	3.5953
900	33.2218	0.9764	12.9111	27.1219	56.5647	3.4024
950	31.4761	0.9748	12.9343	27.1705	56.6661	3.2291
1000	29.9046	0.9733	12.9552	27.2145	56.7578	3.0726
1050	28.4826	0.9719	12.9742	27.2543	56.8409	2.9306
1100	27.1898	0.9707	12.9915	27.2907	56.9168	2.8011

Table -, Mixture Parameters for Direct-loaded, Non-compacted Waste Versus Hydrogen/Plutonium Ratio

H/Pu	²³⁹ Pu Conc. (g/l)	Mixture Density (g/cm ³)	Wt.% H	Wt.% O	Wt.% C	Wt.% Pu
²³⁹Pu Mixed with 25% By Volume Polyethylene and 75% By Volume H₂O						
700	39.548	1.0170	11.4771	65.2466	19.3876	3.8887
800	34.614	1.0123	11.5331	65.5653	19.4823	3.4193
900	30.774	1.0087	11.5771	65.8153	19.5566	3.0509
1000	27.699	1.0057	11.6125	66.0167	19.6165	2.7542
1100	25.184	1.0033	11.6417	66.1824	19.6657	2.5101
1200	23.088	1.0013	11.6661	66.3212	19.7070	2.3058

5.2.2 Reflector Material in Waste Container

The reflector material around the fissile mixture used in the criticality analyses was varied to maximize reactivity of the two-container model or the array model. The reflector compositions modeled to meet this objective are discussed in the applicable appendix for the waste type analyzed. For waste types limited to less than 1 wt% of special reflector materials, beryllium at 1% of the maximum weight loading of the container is spread through the reflector region.

5.2.3 Container Materials of Construction

U.S. Department of Transportation 17C and 17H specifications require only that the drums be constructed of low carbon or stainless steel (304L), while the 100-gallon drum and the SWB are constructed of ASTM A 569 low carbon steel. Scoping studies have shown that differences between modeling the wall as 304L versus ASTM A 569 does not have a statistically significant effect on the MCNP result. All drum structural components are modeled with ASTM 569 low carbon steel (CRC 1991-1992) at a density of 50% of nominal. In a few cases, 60% density was used as noted in the case description. Because the WIPP repository is situated in a series of thick salt beds, the environment could cause a degradation of the steel drum wall over long periods of time. If credit is taken for the nominal drum wall thickness (i.e., nominal wall density) in the analyses, the wall thickness becomes a controlled parameter. To avoid imposing controls on the thickness and nature of the drum walls, a reduced density of 50 to 60% of nominal is assumed in all criticality safety calculations. Furthermore, to ensure a conservative bound on the analyses, no credit was taken for the additional steel layers of the compacted waste pucks (see Figure 2-9) as the thickness of the steel in the compacted puck is uncontrolled and difficult to quantify. The specification for ASTM A 569 low carbon steel modeled is given in Table 5-4.

Table 5-4, Material Composition for ASTM A 569 Low Carbon Steel

Element/ Isotope	MCNP Library Specification	Wt. Fraction	Element/ Isotope	MCNP Library Specification	Wt. Fraction
Density – 7.86 g/cm³					
C	6000.60c	0.0015	⁵⁴ Fe	26054.60c	0.058513
Mn	25055.60c	0.006	⁵⁶ Fe	26056.60c	0.90963
P	15031.60c	0.00035	⁵⁷ Fe	26057.60c	0.020827
S	16000.60c	0.0004	⁵⁸ Fe	26058.60c	0.0027769

The lead in the shielded containers is modeled at its theoretical density of 11.3437 g/cm³. Lead consists of four naturally occurring isotopes: ²⁰⁴Pb, ²⁰⁶Pb, ²⁰⁷Pb, and ²⁰⁸Pb, at the abundances given in Table 5-5. Lead-204, which represents 1.4 atom% of natural lead, is not in the ENDF-VI MCNP library; therefore, the abundance of the other isotopes was normalized to 1 to account for the lack of this cross-section.

Table -, Material Composition for Lead

Element/ Isotope	MCNP Library Specification	Natural Atom%	Atom% Normalized for lack of ²⁰⁴ Pb Cross-section
Density 11.3437 g/cm³			
²⁰⁴ Pb	None	1.4	Not modeled
²⁰⁶ Pb	82206	24.1	24.442
²⁰⁷ Pb	82207	22.1	22.414
²⁰⁸ Pb	82207	52.4	53.144

5.2.4 Reflector Compositions

To simulate the waste storage, handling, and disposal configurations at WIPP, three different reflectors are used to bound the waste container configurations: concrete, MgO, and salt. Ordinary concrete, at a density of 2.35 g/cm³ (*Handbook of Health Physics and Radiological Health* [Shleien et al. 1998]), is used as one of the reflecting materials for the two-container models to bound above-ground temporary storage. The composition of the concrete (Shleien et al. 1998) used in this NCSE is summarized in Table 5-6.

Salt is used as a reflector for the underground array models. Salt is taken as NaCl with a density of 2.165 g/cm³ with the atomic weights of sodium and chloride being 22.9898 and 35.4527, respectively (CRC 1991-1992). The MgO backfill is modeled at a density of 1.45 g/cm³. The density is based on information provided in Chapter 2 of the *Waste Isolation Pilot Plant Contact Handled (CH) Waste Documented Safety Analysis* (DOE-CBFO 2006a). This information states that the supersack containing the MgO is a hexagon nominally 155 centimeters across the flats and 62.2 centimeters high. A single supersack holds nominally 1,859 ± 22.7 kilograms MgO (modeled as 1,881.7 kilograms). In addition, columns of MgO supersacks may also be placed in the disposal array in the underground. Thus, full reflection of the two-container models by salt and MgO is considered. The amount of MgO modeled in this NCSE will bound any future reduction in MgO.

Table -, Material Composition for Concrete

Element/ Isotope	MCNP Library Specification	Wt. Fraction	Element/ Isotope	MCNP Library Specification	Wt. Fraction
Density – 2.35 g/cm³					
H	1001.60c	0.0056	K	19000.60c	0.0192
O	8016.60c	0.4981	Ca	20000.60c	0.0829
Na	11023.60c	0.0171	⁵⁴ Fe	26054.60c	0.000725
Mg	12000.60c	0.0026	⁵⁶ Fe	26056.60c	0.011377
Al	13027.60c	0.0456	⁵⁷ Fe	26057.60c	0.000263
Si	14000.60c	0.3151	⁵⁸ Fe	26058.60c	0.000035
S	16000.60c	0.0013	–	–	–

5.3 Container Array Results

5.3.1 Baseline Disposal Array Calculations

Calculations were performed to determine the reactivity effect due to the interaction of multiple containers in the underground repository as described in Section . A sample array model is represented in Figure 5-1 for illustration. The array calculations for each container type are discussed in more detail in the appendices of this NSCE.

The baseline array reactivity results, as summarized in Table 5-7, show that the array reactivity is quite low. The evaluation of non-compacted waste in seven-packs of 55-gallon drums bounds four-packs of 85-gallon drums and three-packs of 100-gallon drums as these smaller packs have increased spacing between them and adjacent containers in the array. The 100-gallon drum three-pack was explicitly modeled containing machine-compacted waste and the array reactivity was slightly lower than the seven-pack array of 55-gallon drums containing the same waste type. The three-packs were modeled in a tight-packed lattice, which is conservative compared to the layout that would occur with other waste containers present that have a larger footprint as shown in Figure 2-4. Also, the larger diameter of the 100-gallon drum allows more internal reflection of the fissile material from the compacted waste, which has a smaller effect for non-compacted waste as the array is most reactive without the internal reflector region of the drum voided. Disposal of machine-compacted waste in 85-gallon drums is bounded by the evaluations of smaller 55-gallon drums and larger 100-gallon drums, which account for both the tighter packing of the array and the larger internal reflector volume in the drum. The taller TDOP containers are bounded by the SWB analysis, as the SWBs stack three high, whereas a single TDOP is approximately the height of two SWBs but has the same FGE limit. Although the shielded

containers will be emplaced in three-packs, a seven-pack array was modeled as it is conservative and does not adversely affect the FGE loading limit. Consequently, this model accounts for areas where two three-packs of shielded containers could be placed next to one another as shown in Figure 2-6.

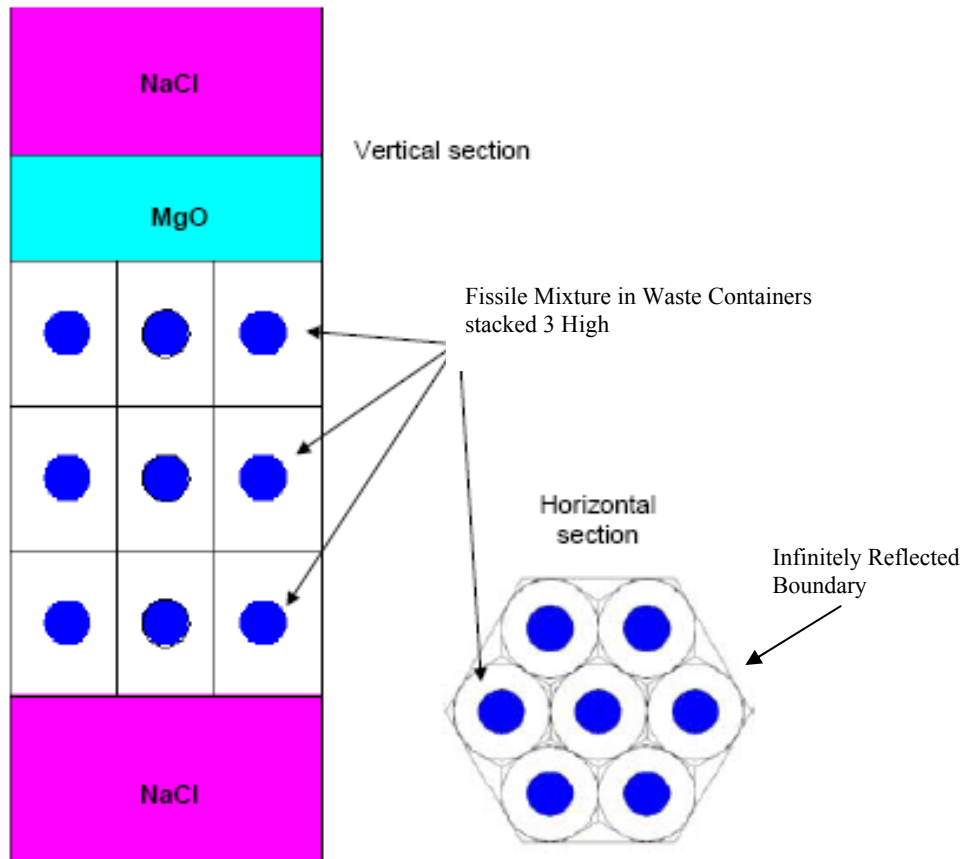

Figure -, Sample Array Model Layout

Table -, Summary of Underground Array Calculation Results

Container Type	Applicable Appendix Section	Container FGE Limit	Pack FGE Limit ^(a)	Maximum $k_{eff} + 2\sigma$
Direct-loaded Waste Containing ≤ 1 wt% Special Reflectors				
55-gallon drums (which bound 85- and 100-gallon drums)	A2.1	200	650	0.90096
Shielded containers	A2.5	200	600	0.91842
Pipe overpacks in 55-gallon drums	D2.1	200	1,400	0.82536
ARROW-PAKs™	A2.4	325	975	0.84935
SWBs (which bound TDOPs)	A2.2	325	N/A	0.84260
SLB2s	A2.3	500 with 0 g ²⁴⁰ Pu 515 with 5 g ²⁴⁰ Pu 535 with 15 g ²⁴⁰ Pu 555 with 25 g ²⁴⁰ Pu	N/A	0.94746
Direct-loaded Waste Containing > 1 wt% Special Reflectors				
55-gallon drums	B2.1	100 + 100 kg Be	700	0.89169
Shielded containers	C2.3	100 + 100 kg Be	700	0.79135
Pipe overpacks in 55-gallon drums	D2.1	140	980	0.89843
Machine-compacted Waste Containing ≤ 1 wt% Special Reflectors				
100-gallon drums ^(b)	C2.1	200	600	0.86925
55-gallon drums ^(b)	C2.2	200	600	0.87079
Shielded containers	C2.3	200	600	0.87039
SWBs	C2.5	185	185	0.84618

(a) Pack is defined as a seven-pack of 55-gallon drums, a four-pack of 85-gallon drums, a three-pack of 100-gallon drums, ARROW-PAKs™ or shielded containers, or a single SWB, TDOP or SLB2

(b) Note that in the array model, compacted waste drums are subcritical at 200 FGE/drum without requirements on compaction density or design spacing.

Although waste with greater than 1 wt% special reflector materials was not specifically modeled in the shielded containers, 55-gallon drum limits can be extrapolated to apply to the shielded container. For both direct-loaded and machine-compacted waste with less than or equal to 1 wt% special reflectors, the shielded container array has a comparable reactivity to the 55-gallon drum array. The lead shielding is expected to have less effect around a waste form with high beryllium content, as the beryllium also provides more neutron reflection than a waste form with little beryllium. This is confirmed by looking at the compacted waste results where the full density

polyethylene provides significant reflection. For this waste, the shielded container array is slightly less reactive than the 55-gallon drum array.

To determine the effect of lead reflection from the shielded containers on other non-shielded waste containers in a mixed array, an array with shielded containers around 55-gallon drums was also modeled as shown in Figure 5-2. The outer hexagonal surface around the shielded containers is infinitely reflected to model an infinite array. As before, the fissile mass is modeled as a cylinder located in the center of each drum or container and the containers are stacked three tiers high with MgO and salt reflection. As discussed in Section A2.6 (non-compacted waste) and Section C2.4 (compacted waste), the presence of shielded containers in the array slightly reduces reactivity from the 55-gallon drum array as the lead reduces interaction between containers. An additional model was evaluated in Section A2.6 that included a stack two 55-gallon drum assemblies surrounded by shielded containers on the sides and on the third tier. The reactivity of this configuration was again slightly lower than the array of 55-gallon drums by themselves. Thus, intermixing shielded and non-shielded containers is not a criticality safety concern.

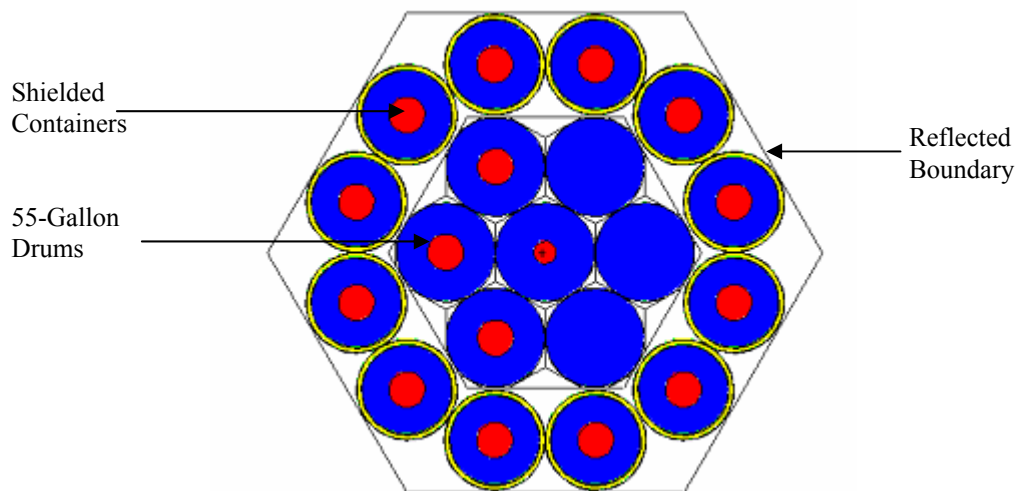

Figure -, Drum Array with Shielded Containers, X-Y Plane

5.3.2 Conservatism in Baseline Disposal Array Calculations

Conservatism in this NCSE include not only modeling the base array at greater than or equal to the transportation package fissile limit for each waste assembly in the array, but also include:

- taking no credit for slipsheets between waste assemblies;
- taking credit for only part of the metal (which acts as a poison) in the waste containers;

- configuring the fissile material as ^{239}Pu in a concentrated, optimally moderated geometry as opposed to being distributed through the waste container;
- modeling beryllium at higher densities than what would be considered realistic in debris waste suitable for compaction.

Additional calculations were performed for machine-compacted waste to study a revised base-case condition in the underground repository array using more realistic modeling assumptions. The details of these calculations are documented in Neeley (2005) and are summarized below.

Machine-compacted waste drums are analyzed at two compaction densities: 100% compaction and 70% dense compaction (see Appendix C). These densities were chosen to correspond to the polyethylene densities assumed in the criticality analyses for shipment of compacted waste in a TRUPACT-II or HALFPACT shipping container. Neeley (2005) determined a limit of 170 FGE per drum of fully compacted waste and 200 FGE per drum for 70% dense compacted waste. These limits were based on analysis that assumed the fissile material was contained in optimized cylinders for the two-container model and spheres for the array models. This modeling assumption, while bounding, can be viewed as unnecessarily conservative. The fissile content of waste proposed for compaction, in general, is low and in the form of contamination, dust, metal oxide, etc., such that it has low density. The underground repository array was found to be significantly less reactive than the two-drum model such that there are no density restrictions on polyethylene for compacted waste in the array case, and the three-pack or seven-pack assembly limit is 600 FGE. In reality, each drum assembly is limited to a maximum of 325 FGE, which is the FGE limit in the HALFPACT and TRUPACT-II shipping containers used to transport waste to the WIPP. This further reduces the reactivity in the storage or disposal configurations at WIPP, as shown in the following sections. A comparison of the baseline array results and the more realistic model results is given in Table 5-8.

The more realistic models were considered in supplemental calculations. In one set of calculations, the geometric arrangement of the mass within the drums remains consistent with the array model discussed in Section (i.e., fissile material is concentrated in a fissile cylinder at optimum H/Pu ratio), but the fissile mass of the three-pack of 100-gallon drums was reduced to TRUPACT-II limit of 325 FGE. The mass in each drum was varied keeping the three-pack at less than or equal to 325 FGE and the maximum reactivity calculated was 0.8352.

Variations on the geometric configuration of the fissile mass were also evaluated to study the reactivity reduction if the ^{239}Pu is homogeneously distributed throughout the drums in two manners: (1) mixed homogeneously with beryllium and polyethylene and spread uniformly throughout the volume of the drum, or (2) configured as more realistic compacted pucks with the plutonium, beryllium, and polyethylene uniformly distributed in a single compacted puck drum. Other conservatisms are also removed from the base array model where 100% of the steel wall is modeled, the slipsheets between layers of containers are added, the design separation provided by the rolling hoops on drums is credited and the exterior height of the drum is increased to include the band clamp, the 3 wt% ^{240}Pu is modeled with the ^{239}Pu . The system eigenvalue is

significantly reduced as shown in Table 5-8. Overbatched cases were also modeled in this configuration by modeling an extra 200 FGE 100-gallon drum in the middle tier. For 55-gallon drums, the middle tier contains extra 200 FGE and 125 FGE drums for a total seven-pack mass of 650 FGE. Even with these significant overbatches, the array reactivity remains below 0.4.

The largest reduction in k_{eff} comes from homogenizing the fissile material throughout the drum. A homogeneous distribution of the fissile material is ordinarily not a conservative assumption, but may be a more reasonable base-case assumption for debris TRU waste. While localized hot spots can occur, it is unlikely that the hot spots will be as severe as the bounding cases presented in Table 5-7. Modeling the fissile material concentrated in a cylinder mixed with the right amount of polyethylene to create optimum moderation is not realistic, but is conservative.

Table -, Comparison of Baseline Array and Realistic Array Results for Machine-Compacted Waste

Case	Maximum Container FGE Limit	Pack FGE Limit ^(a)	Maximum $k_{eff} + 2\sigma$
Baseline Array Results^(a)			
100-gallon drums	200	600	0.86925
55-gallon drums	200	600	0.87079
More Realistic Model Results^(b)			
FGE in 3-packs of 100-gallon drums reduced to TRUPACT-II shipping limit	170	325	0.8352
Fissile material spread throughout drums	200 + 6 g ²⁴⁰ Pu	325 + 9.75 g ²⁴⁰ Pu	100 gal - 0.2885 55 gal - 0.3463
Fissile material spread throughout 100-gallon drums with middle tier overbatched	200 + 6 g ²⁴⁰ Pu	325 + 9.75 g ²⁴⁰ Pu 525 in middle tier	0.3158
Fissile material spread throughout 55-gallon drums with middle tier overbatched	200 + 6 g ²⁴⁰ Pu	325 + 9.75 g ²⁴⁰ Pu 650 in middle tier	0.3828
Fissile material in 1 cylindrical puck representing a machine-compacted drum in the larger drum	200 + 6 g ²⁴⁰ Pu	325 + 9.75 g ²⁴⁰ Pu	100 gal - 0.3736 55 gal - 0.4937

(a) From Table 5-7.

(b) From Neeley (2005).

5.4 Two-Container Model Results

The array model assumes the fissile contents are centered in each waste container to represent the average configuration based on the random nature of the waste. However, although highly unlikely, it is possible that the fissile material could be placed near two adjacent containers. The two-container model, as described in Section , was created to evaluate this possibility. A sample

two-container model with SWBs is represented in Figure 5-3. The two-container calculations for each container type are discussed in more detail in the appendices.

As expected, the two-container results are much higher than the array reactivity results (see Table 5-9). The taller TDOP container is bounded by the SWB analysis, as both containers have the same FGE limit. The ARROW-PAK™ was not analyzed in the two-container configuration as the arrangement maintains the fissile material in a 55-gallon drum in a central location and the ARROW-PAK™ has the same limit as the SWB.

As discussed in the appendices, these cases were originally performed based on a USL of 0.97. Since these calculations were performed, an administrative margin of 0.01 has been included in the USL, which reduces the value to 0.96. Table 5-9 summarizes the results of modeling to determine the spacing between the fissile contents in the two containers that reduces the $k_{\text{eff}} + 2\sigma$ value below 0.96. These calculations are discussed in detail in the appendix for the appropriate container loading and the results are summarized in Table 5-9. The separation needed in all cases is no greater than 1.5 centimeters (0.4 inches). This separation will easily be achieved in reality for the following reasons:

1. The container is not likely to be completely filled to the lid and if it is full when loaded, settling is likely to occur during transportation and handling where some gap will exist.
2. The fissile material is not likely to remain at the top of the container of non-compacted waste due to its high density and gravity effects.
3. In compacted waste drums, all of the fissile mass must be in the uppermost compacted puck drum. The steel of the compacted drum, which has not been included in the model, is likely to provide some spacing and the neutron absorbing steel of the puck drum will also reduce reactivity.
4. The drums provide more spacing inherent in the design of the lid and bottom than has been modeled.
5. Full and even loading to the top of an SWB is highly unlikely due its large volume..

The two-container models with infinitely thick concrete, MgO, or salt reflection bound shielded containers placed around non-shielded containers. The lead in the shielded container wall is approximately 1 inch thick, which is much less than the thickness that would be considered as an infinite reflector. Also, the modeled reflection is tight against the two-containers with no gaps, which contributes significantly to the reactivity of the system. By comparison, the placement of the shielded containers against another container does not result in lead wrapped tightly around the other container. The space between containers allows for more neutron leakage than modeled.

Combinations of two different container types have also been evaluated in the two-container model configuration. The details and results of these MCNP5 calculations are given in . As

expected, placing two different containers together results in an effective “averaging” of the reactivity of the two containers, and has a lower reactivity than the model with the most reactive containers of the same type.

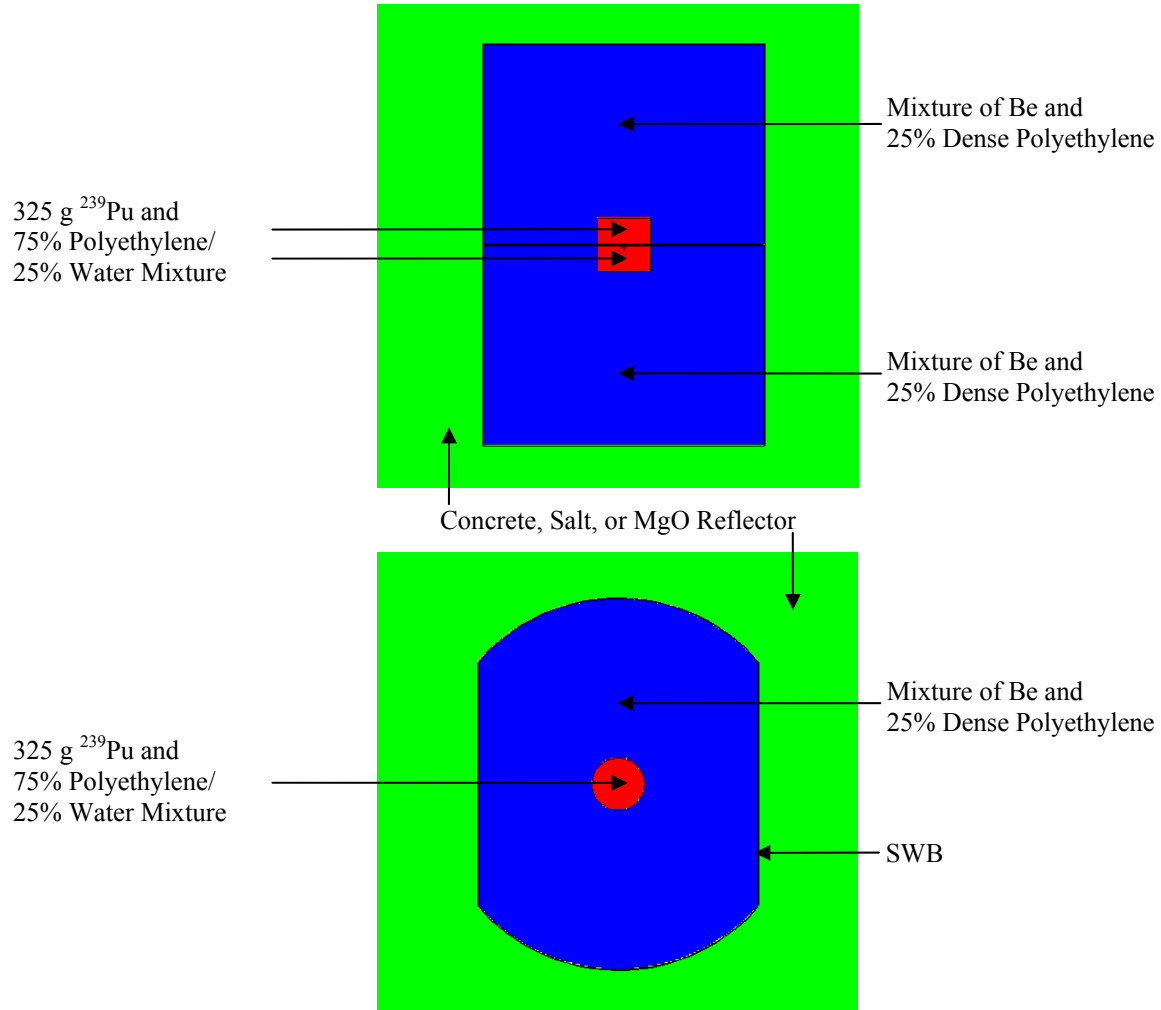

Figure -, Sample Two-Container Model Layout

Table -, Summary of Two-Container Calculation Results

Container Type	Applicable Appendix Section	Container FGE Limit	Maximum $k_{\text{eff}} + 2\sigma$	Non-Credited Separation Included in Model (cm)
Direct-loaded Waste Containing ≤ 1 wt% Special Reflectors				
55-gallon drums (which bound 85- and 100-gallon drums)	A3.1	200	0.88622	0
SWBs (bounds TDOPs) ^(a)	A3.3	325	0.95762	1
SLB2 with an SWB (SLB2s not stacked)	A3.4	500/325	0.95798 ^(b)	0
Shielded containers (analyzed with 100 kg Be such that this case bounds waste with > 1 wt% special reflectors)	A3.2	200 + 100 kg Be	0.91049	0
Pipe overpacks in 55-gallon drums	D2.2	460	0.95609	0
Direct-loaded Waste Containing > 1 wt% Special Reflectors				
55-gallon drums	B3.1	100 + 100 kg Be	0.92707	0
Pipe overpacks in 55-gallon drums	D2.2	260	0.95556	0
Machine-compacted Waste				
100-gallon drums without design spacing	C3.1	170	0.95556	1
100-gallon drums with design spacing	C3.1	200	0.93683	0
Partially compacted 100-gallon drums	C3.2	200	0.95817	0.5
55-gallon drums without design spacing*	C3.3	170	0.95168	1.5
55-gallon drums with design spacing	C3.3	200	0.95284	0.5
Partially compacted 55-gallon drums*	C3.3	200	0.95855	1
Shielded containers	C3.4	200	0.85491	0
Direct-loaded SWBs	C4.1	185	0.95530	1
100-gallon drums overpacked in SWBs	C4.2	250	0.95492	1

(a) These cases model the steel container wall at 60% density.

6.0 Parameters

The following parameters are controlled for criticality safety of CH waste at the WIPP. The contingent events resulting from the loss of each controlled parameter are also given below. The contingent events flow from the hazard evaluation tables given in . These upsets are evaluated in detail in Section .

6.1 Mass

Fissile mass limits are required to maintain the reactivity below the USL, thus mass is controlled. As a contingent condition, an overload of an excess 50% of the mass limit is modeled in one container per stack in the underground array and the stack infinitely reflected.

6.2 Geometry

The geometry of the fissile region is not controlled. The fissile region is modeled as a cylinder at an H/D ratio of 1 to minimize neutron leakage except in the SLB2 contingency models where the fissile mass is modeled in a prism in the corner of the box. This geometry is noted as the most reactive credible configuration per the criticality analysis in the *TRUPACT-III Safety Analysis Report* (DOE-CBFO 2007a), which approves the transportation of the SLB2.

6.3 Moderation

Optimum moderation of the fissile region was modeled by varying the H/Pu ratio to determine the most reactive state. Exterior to the container, interstitial moderation is modeled to represent sprinkler activation or flooding as a contingency event in Section . The interstitial moderation is shown to reduce reactivity, consequently, moderation is not controlled.

6.4 Interaction

Interaction is controlled in that the underground repository array is limited to the three tiers high, where a drum or SWB occupies one tier and an ARROW-PAK™, TDOP, or SLB2 occupies two tiers. The above-ground array is bounded by the underground array and is also limited to three tiers high for criticality safety (although it is restricted to two tiers high for other reasons). Interaction between containers is not controlled as they are modeled in contact with one another.

Interaction is also controlled by the container, which determines the distance between fissile masses. Containers approved for transportation to WIPP in the TRUPACT-II or HALFPACT are evaluated in addition to containers proposed for transportation in these packages and the TRUPACT-III. The 55-, 85-, 100-gallon drums, SWBs, TDOPs, and pipe overpack configurations described in the documented safety analysis are approved for disposal at WIPP. ARROW-PAKs™, SLB2s, and shielded containers, while not currently approved for disposal at WIPP, are also acceptable from a criticality safety perspective. Containers are modeled in contact with one another in an infinite array. Typically, the bottom of one container is placed on top of another with only the thickness of the lid or bottom modeled and any recesses ignored. In some cases, mass limits are also given based on crediting some portion of the inherent vertical spacing between drum contents afforded by the design of the recess in the bottom or lid of a drum or spacers that may be placed within the drum to maintain the credited spacing, such that geometry is controlled. This vertical design spacing was only credited in the two-container model where the worst-case fissile mass locations are modeled by concentrating the fissile material in the top of the lower drum and the bottom of the upper drum to maximize interaction.

The vertical spacing is ignored in the more realistic array model where the upset event has been modeled in the normal condition array and is not further evaluated.

Four loss of interaction control contingencies are evaluated: (1) overstacking the entire array to four tiers high; (2) dropping containers from the waste hoist; (3) underground roof falling resulting in container compaction; and (4) crushing of the containers on the waste array face as a result of impact by the 40-ton forklift.

6.5 Neutron Absorption

The only neutron absorber modeled is the steel of the container. The wall, lid, and bottom of each container type were modeled at full thickness but the steel was modeled at 50% of its theoretical value. Section 2.1.2 of the CH-TRAMPAC (DOE-CBFO 2005c) requires that the integrity of the payload container shall be visually inspected prior to transport to ensure that payload container is in good and unimpaired conditions (e.g., no significant rusting and is of sound structural integrity), where modeling 50% of the steel in the wall is conservative. Thus, neutron absorption is controlled by the TRUPACT-II SAR (DOE-CBFO 2005a) requirement. No credible contingency event was identified that would damage more than 50% of the wall thickness over a significant surface area. Therefore, upsets in this parameter are bounded by the normal condition using only 50% of the steel wall thickness.

6.6 Reflection

6.6.1 Internal Container Reflection

Mass limits on special reflector materials, namely beryllium, within the container are required to maintain system reactivity below the USL. Unless specifically evaluated, special reflector materials are limited to less than 1 wt% of the payload. Mass limits were set for containers with this restriction in . An upset condition of exceeding the beryllium restriction was modeled by placing twice as much beryllium in each drum. A high beryllium content payload with up to 100 kilograms of beryllium in drums was also evaluated in . An upset condition was not evaluated further, as disposing of 100 kilograms of beryllium in a single drum was considered the worst-case credible condition.

Another restriction on internal container reflection occurs in the compacted waste payload. Mass limits were evaluated with 100% polyethylene around the fissile material (100% theoretic packing) and with a maximum of 70% polyethylene, based on a generator site restricting their compaction accordingly. This reduction in compaction was only modeled in the two-container models. The higher mass limit with 100% polyethylene is modeled in the more realistic array model, such that the upset event has been modeled in the normal condition array and is not further evaluated.

6.6.2 External Container Reflection

The external reflection is modeled conservatively compared to actual conditions and is not controlled. In the underground repository, the modeled array is infinite in the x and y directions and reflected by 300-centimeter-thick salt on the top and bottom. The MgO supersack is modeled as a continuous layer of theoretical density MgO directly on top of the container array and the salt modeled directly on top of that. Scoping calculations confirmed that including the MgO has a significant positive effect on reactivity and modeling it as a continuous layer instead of discrete supersacks on top of individual containers provides conservatism. In the two-container model, the reflectors that the containers may come in contact with (concrete, MgO, and salt), are modeled tight fitting around the containers at infinite thickness. This configuration is considerably more reactive than the actual condition where the container may be in a corner of a concrete hot cell or salt panel. This tight fitting reflector around the two container model also simulates interstitial salt or MgO that could be present between waste containers in the event of a roof fall during the operational phase of a disposal room or panel.

6.7 Volume

Volume is not credited in any of the analysis and is not controlled.

6.8 Enrichment

Enrichment is not controlled. All fissile material is modeled as ^{239}Pu . Uranium-235 and ^{233}U can be shipped under these limits using FGE as defined in the CH-TRAMPAC (DOE-CBFO 2005c). The FGE values account for the differences in minimum critical mass between ^{239}Pu and these isotopes.

6.9 Concentration

Concentration is not controlled. The fissile concentration was unrestricted and optimized by varying the H/Pu ratio in the fissile region.

7.0 Contingency Evaluation

Credible abnormal conditions that could occur during waste storage, handling, and disposal of CH waste at the WIPP are assessed in this section. contains a hazard evaluation to identify the conditions that could lead to a loss of the controlled parameters from Section 6.0. Because of the conservatism in the models used, no contingencies are considered for variations in packing fraction, container wall thickness, reflector parameters, or fissile moderation parameters because the analyses in Section along with its subsections determined the worst credible cases for these parameters. The limits and controls needed to render the postulated contingent conditions unlikely are presented in Section .

The contingency evaluation is based on perturbations of the worst-case normal or nominal configuration infinite array models described in Section . The two-container models are

sufficiently conservative to bound any contingency of more realistic or expected conditions involving interaction between small numbers of containers. The array models consider each drum assembly at a fissile loading over 500 FGE, which is greater than the current TRUPACT-II or HALFPACT fissile limit of 325 FGE. The contingencies evaluated in this section are applied to the array models with the fissile material centered in each container. Assuming random placement of the fissile unit in each container, the average center-to-center separation in either the horizontal or vertical direction will be statistically the same as that of the array with all fissile masses centered in the containers.

7.1 Loss of Confinement of Fissile Material

The bounding CH event that results in a loss of confinement is the unlikely failure of the waste hoist such that the CH containers are breached when the load falls down the waste shaft into the waste shaft sump. However, the failure of the waste hoist has been evaluated (case UG3-9 in DOE-CBFO [2006a]) to be beyond extremely unlikely due to the robust design of the waste hoist with redundant brakes and six ropes.

7.2 Exceeding Disposal Array Vertical Stacking Limit

7.2.1 Exceeding Array Vertical Stacking Limit in the Underground Repository

By design, the WIPP panels are mined to a ceiling height that will accommodate up to the nominal height of three 55- or 100-gallon drums or three SWBs. This configuration allows adequate space for the MgO supersack to be placed on top of the waste column and still allow adequate space for the airflow rate required by the Hazardous Waste Facility Permit for WIPP (NMED 2007). Waste handling procedures at WIPP administratively control waste stacks in the disposal array to be stacked no greater than the equivalent of three drum assemblies or three SWBs. However, ground control activities to ensure mine safety have resulted in areas of the disposal rooms being mined to a height greater than 13 feet, such that it is possible to stack greater than three tiers high including the MgO.

To determine the impact on the disposal array reactivity if an overstacking event occurred in the repository, a fourth tier of containers is added to the following arrays:

1. Direct-loaded 55-gallon drums containing less than or equal to 1 wt% special reflectors as described in Section ,
2. Direct-loaded 55-gallon drums containing greater than 1 wt% special reflectors as described in Section
3. 100-gallon drums of fully compacted waste as described in Section , and
4. 12-inch unshielded pipe overpack assemblies as described in Section .

The SLB2 is not analyzed stacked 2 high as the fissile material would be significantly separated in the tall containers plus there is significant spacing between containers provided by the forklift pockets. The results of the base array and the overstacked array are compared in Table 7-1.

A larger reactivity increase over the three-tier array is seen for non-compacted waste than for compacted waste as the higher polyethylene density in the compacted waste acts to isolate the fissile material in the various tiers. The cases with high special reflector content also exhibit a large increase for the four-tier array as the array model considers the plutonium spread through the beryllium at the optimum beryllium/plutonium ratio of 20,000. If the 100 kilograms of beryllium in each drum were modeled purely as a reflector around the fissile material, it would isolate the fissile material in the tiers from one another and little increase would be seen as demonstrated in the compacted waste results. All results are below the USL of 0.96 except for the loading with high beryllium content. That result exceeds 0.96 but is less than 0.97, which is the USL without the administrative margin. Overstacking of the entire array without noticing the error, while at the same time placing the MgO supersack on top of the fourth tier, would require multiple operator errors. Also, although areas of disposal rooms have been mined to a height greater than 13 feet, the entire disposal panel being mined to a height that allows room to create an infinite four-tier array with MgO is unlikely. As such, a four-tier array of drums containing 100 FGE and 100 kilograms of beryllium was modeled without the MgO supersack but with the drums in contact with the salt ceiling. As shown in Table 7-1, the $k_{\text{eff}} + 2\sigma$ value is less than 0.89. The four-tier drum array height is 11.1 feet without the MgO supersack and 13.15 feet with the supersack emplaced on top of the drums. Based on the significant reduction in reactivity without the supersack on top of the array and the small clearance between the worst-case mining height and the four-tier array with MgO, it is not considered credible to create an infinite overstacked array that would result in a critical configuration. In addition, note that each drum in the array is modeled at the FGE limit (whereas the average FGE per drum currently emplaced in the underground is significantly lower than the limit).

Table -, Evaluation of Stacking Containers Four-tiers High in the Underground Repository

Container and Waste Loading	Array Height	$k_{\text{eff}} + 2\sigma$	Filename (Section)
55-gallon drums of direct-loaded waste with ≤ 1 wt% special reflectors	3 tiers	0.90096	dac0026 (A2.1)
	4 tiers	0.94913	dac4h22 (A4.1)
55-gallon drums of direct-loaded waste with > 1 wt% special reflectors	3 tiers	0.89169	a20kb (B2.1)
	4 tiers with MgO	0.96628 ^(a)	a420kb (B4.1)
	4 tiers without MgO	0.88973 ^(b)	a420kbm (B4.1)
100-gallon drums of fully compacted waste	3 tiers	0.86925	aray118 (C2.1)
	4 tiers	0.87247	aray418 (C6.1)
Pipe overpacks in 55-gallon drums with ≤ 1 wt% special reflectors	3 tiers	0.82536	p20024 (D2.1)
	4 tiers	0.83420	p20104 (D3.1)
Pipe overpacks in 55-gallon drums with > 1 wt% special reflectors	3 tiers	0.89843	p14016 (D2.1)
	4 tiers	0.89924	p14096 (D3.1)

(a) An infinite four-tier high array plus MgO is not considered credible.

(b) Modeled with the MgO supersack removed from the infinite four-tier high array.

7.2.2 Exceeding Interim Drum Storage Array Stacking Limit

Waste containers may be stored above ground while awaiting processing and/or transport to the underground facility. Stacking in above-ground storage arrays is administratively limited to the height of 2 containers. Waste containers are required to be stored on facility pallets in the WHB. The load limit of the facility pallet is such that drums/SWBs will not be stacked higher than two containers. Up to four CH drum assemblies or SWBs are stored on a pallet. Only two TDOPs are stored on a pallet. The pallet will accommodate only one SLB2, two three-packs of ARROW PAK™s, and only two three-packs of shielded containers. Overstacking on the surface is unlikely even though forklifts are capable of stacking containers higher. The surface stacking configuration is designed to minimize any additional handling prior to placing waste on the waste shaft conveyance for transfer to the underground. Any overstacking event is bounded by the calculation performed in Section (recall that concrete reflection is comparable to salt and/or MgO reflection).

7.3 Loss of Geometry from Underground Roof Fall

A roof fall during the operational phase of a disposal panel is unlikely due to the historic behavior of the salt repository and WIPP's safe mining practices. If a roof falls, vertical compaction of 15 inches to the bottom tier of drums is postulated in the *Analysis of Roof Fall and Methane Gas Explosions in Closed Rooms and Panels* (PLG 1997). For machine-compacted waste, the result is bounded by the normal condition models since the reflector density considered in these models is already 100% of theoretical. A number of runs were performed to evaluate this scenario for non-compacted waste. The runs modeled direct-loaded drums stacked three high. The first case assumes 650 grams of ^{239}Pu optimally moderated per seven-pack with three 200-gram ^{239}Pu drums and one 50-gram ^{239}Pu drum. The second case assumes 100 grams of ^{239}Pu optimally moderated with 100 kilograms of beryllium per drum. In both cases, runs were performed with and without the 15 inches of compaction of the bottom row. The compaction was modeled by reducing the height of the bottom row of drums by 15 inches and then centering the fissile material in the remainder of the drum. The results with and without compaction are summarized in Table 7-2. The compaction has a small effect on the reactivity of the array and all results remain below the USL of 0.96. In addition to compaction due to roof fall, it is possible that the MgO sacks could break such that MgO would fall between drums in an assembly or between columns of waste assemblies. This condition is bounded by the full MgO reflection evaluated around the two container models as the MgO would provide reflection and act to decouple the fissile masses in the array. Again, a large roof fall is not expected during the operational pre-closure phase of a disposal room or panel.

**Table -, Evaluation of Compaction caused by Roof Fall in the
 Underground Repository**

Container and Waste Loading	Compaction	$k_{eff}+2\sigma$	Filename (Section)
55-gallon drums of direct-loaded waste with ≤ 1 wt% special reflectors	None	0.90096	dac0026 (A2.1)
	15 in. in bottom row	0.92034	daccp24 (A4.4)
55-gallon drums of direct-loaded waste with > 1 wt% special reflectors	None	0.89169	a20kb (B2.1)
	15 in. in bottom row	0.89792	ac420kb (B4.4)

7.4 Exceeding Mass Limits

7.4.1 Exceeding the Fissile Mass Limit for a Container

Exceeding the fissile mass for a container is unlikely as non-destructive analysis (NDA) is performed at the waste generator site and confirmed prior to preparing containers for shipment to WIPP. CH-TRAMPAC requirements (DOE-CBFO 2005c) indicate that the mass estimate must include two times the uncertainty in the NDA measurement. In addition, the underground disposal fissile mass limits are often higher than the limits for transport of the containers in the TRUPACT-II or HALFPACT shipping containers. To simulate a fissile mass overbatching event, it is assumed that one container in a three-tier stack is overbatched by 50% of its nominal value. Thus, one drum out of every nine drums or one SWB or ARROW-PAK™ out of every three drums exceeds the *Transuranic Waste Acceptance Criteria for the Waste Isolation Pilot Plant* (WIPP WAC) (DOE-CBFO 2007b). In addition, since the HALFPACT and TRUPACT-II individual container limits are the same as the WIPP WAC, an overbatch to this magnitude would require more than one out of three shipments to exceed the transportation SAR requirements (DOE-CBFO 2005a and 2005b). Also, all containers around the overbatched container are filled to the underground repository requirements, which would also require exceeding the current total payload mass limits for the transportation package, with the exception of SWBs shipped in the HALFPACT. Thus, exceeding the as modeled condition is not considered credible.

From a modeling perspective, one container in the bottom or middle tier is overbatched and the stack is infinitely reflected on the lateral surfaces as in the base array model described in Section . This is highly conservative as it results in one of twenty one 55-gallon drums, one of nine 100-gallon drums or ARROW-PAKs™, one of three SWBs, or all SLB2s being overbatched. Figure 7-1 illustrates the model configuration used in the fissile mass overbatching event for compacted waste in 100-gallon drums. (Note that in the SLB2 overbatch, the fissile mass is modeled as a prism in the corner of the box instead of in a centralized cylinder. This configuration was determined to be the most reactive-credible configuration in the TRUPACT-III SAR (DOE-CBFO 2007a), which forms the basis of the 500-FGE transportation limit for the SLB2. Further details including a figure are given in Section).

The results of the overbatching contingency are tabulated in Table 7-3. The computational results indicate that the double-contingency requirement for the ²³⁹Pu mass content in the containers is met as multiple overbatching events will not result in the USL being exceeded.

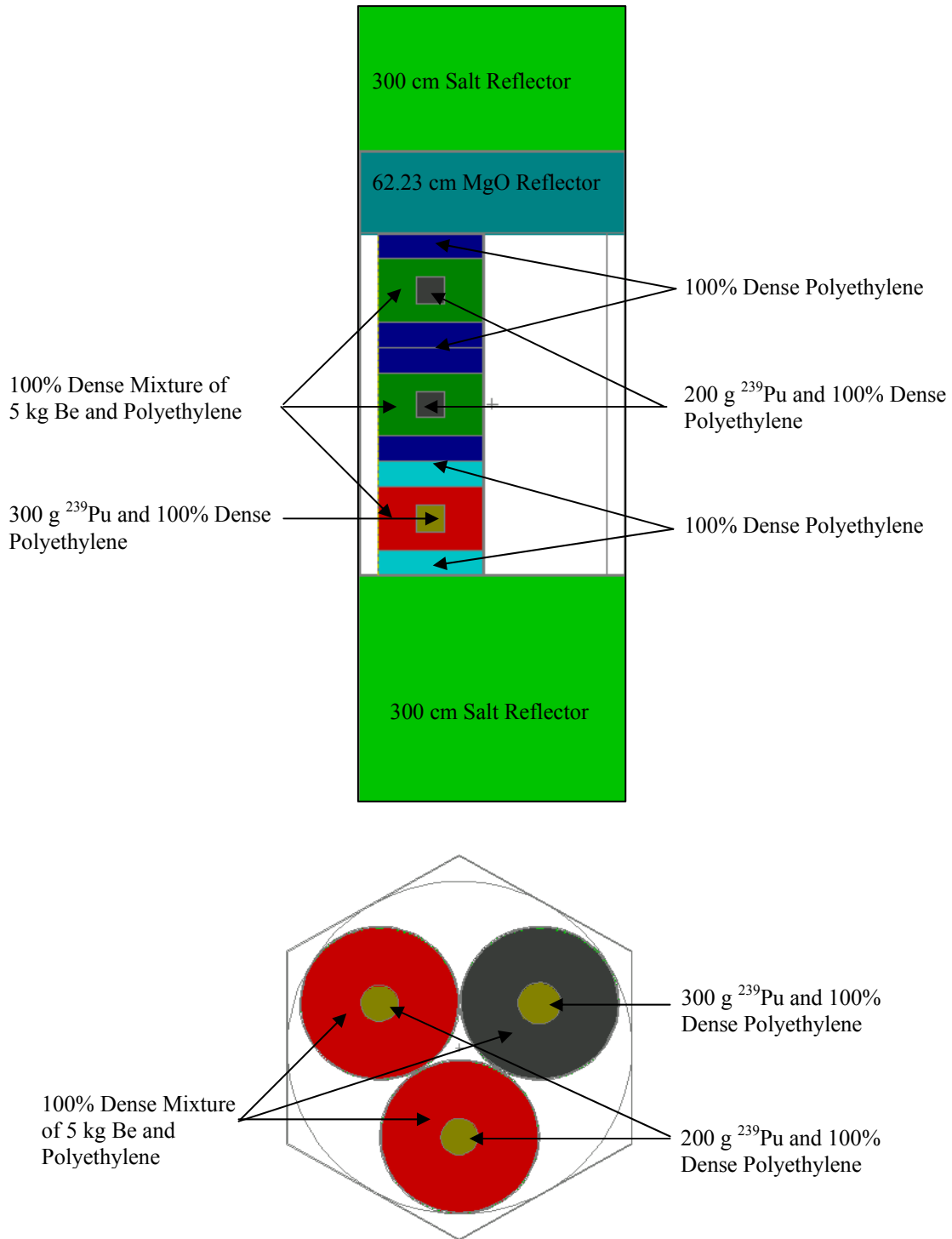

Figure -, Example Array Model for ²³⁹Pu Overbatching in 100-gallon Drum Event

Table -, Fissile Gram Equivalent Overbatching Contingency Results

Container and Waste Loading	Overbatch Scenario	$k_{eff}+2\sigma$	Filename (Section)
55-gallon drums of direct-loaded waste with ≤ 1 wt% special reflectors	None	0.90096	dac0026 (A2.1)
	1 drum at 300 FGE, 7-pack limit of 650 FGE maintained	0.91148	dacdb24 (A4.2)
ARROW-PAKs™ of direct-loaded waste with ≤ 1 wt% special reflectors	None	0.84935	arpa322 (A2.4)
	1 ARROW-PAK™ at 487.5 FGE	0.94282	arpdb20 (A4.2)
Shielded containers of direct-loaded waste with ≤ 1 wt% special reflectors	None	0.91842	pa211a (A2.5)
	1 container at 300 FGE	0.93075	pa310a (A4.2)
SWBs of direct-loaded waste with ≤ 1 wt% special reflectors	None	0.84260	swbar (A2.2)
	1 SWB at 487.5 FGE	0.93907	swbao20 (A4.2)
SLB2s of direct-loaded waste with ≤ 1 wt% special reflectors	None (fissile cylinder)	0.94360	slba100 (A2.3)
	None (fissile prism)	0.80554	slbab26 (A4.2)
	SLB2s at 750 FGE (prism)	0.90444	slbao22 (A4.2)
55-gallon drums of direct-loaded waste with > 1 wt% special reflectors	None	0.89169	a20kb (B2.1)
	1 drum at 150 FGE with 100 kg Be	0.90388	ao15kb (B4.2)
100-gallon drums of fully compacted waste	None	0.86925	aray118 (C2.1)
	1 drum at 300 FGE	0.94963	aray217 (C6.3)
55-gallon drums of fully compacted waste	None	0.87079	ara5519 (C2.2)
	1 drum at 300 FGE	0.95924	ara5558 (C6.2)
SWBs of fully compacted waste	None	0.84618	ar1000 (C2.3)
	1 SWB at 277.5 FGE	0.94033	aro800 (C6.4)
Pipe overpacks in 55-gallon drums with ≤ 1 wt% special reflectors	None	0.82536	p20024 (D2.1)
	All drums at 320 FGE	0.95798	pa32020 (D3.2)
Pipe overpacks in 55-gallon drums with > 1 wt% special reflectors	None	0.89843	pa14016 (D2.1)
	All drums at 180 FGE	0.95269	pa18014 (D3.2)

7.4.2 Exceeding the Beryllium Mass Limit for a Container

The beryllium overbatching contingency is similar to the fissile mass overbatching event in that one drum in the modeled three-tier stack of containers exceeds its mass limit. In this case it is assumed that containers with a 5-kilogram beryllium limit are double batched to 10 kilograms and the high beryllium drums with a 100-kilogram limit are overbatched to 150 kilograms. The results of the overbatching contingency are tabulated in Table 7-4, which shows that the system eigenvalue is well below the USL. As expected, double batching the beryllium has only a minor effect.

Table -, Beryllium Overbatching Contingency Results

Container and Waste Loading	Overbatch Scenario	$k_{\text{eff}}+2\sigma$	Filename (Section)
55-gallon drums of direct-loaded waste with ≤ 1 wt% special reflectors	None	0.90096	dac0026 (A2.1)
	1 drum at 10 kg Be	0.90056	dacbb24 (A4.3)
55-gallon drums of direct-loaded waste with > 1 wt% special reflectors	None	0.89169	a20kb (B2.1)
	1 drum filled with Be (> 300 kg)	0.88842	ae20kb (B4.3)
100-gallon drums of fully compacted waste	None	0.86925	aray118 (C2.1)
	1 drum at 10 kg Be	0.87354	aray319 (C6.5)

7.5 Sprinkler Activation in the Waste Handling Building

The WHB is equipped with a fire sprinkler system. This contingency addresses activation of the sprinkler system resulting in interspersed moderation between the waste containers. Although drums are only stacked two high above ground, a three-tier stack of seven-packs of 55-gallon drums is modeled for conservatism. The ceiling and floor are modeled as 2-foot-thick concrete, while the sides are mirrored for infinite reflection as shown in Figure C-27, in . The cases were evaluated at the optimum H/Pu ratio and mass limits. Thus, per Section , the machine-compacted waste was modeled with 200 FGE in three of the 55-gallon drums in the seven-pack at an H/Pu ratio of 900. The non-compacted waste was modeled with the parameters given in Section of 200 FGE in three drums, 50 FGE in one drum and three drums empty; the fissile material is moderated at an H/Pu ratio of 1,300, which yielded the highest $k_{\text{eff}} + 2\sigma$ value for the base array. Water mist from sprinkler activation is allowed to fill the interstitial spaces between the drums. The water density is varied from 0.05 to 1 g/cm³, and the results are shown in Figure 7-2. Interstitial water reduces the reactivity of direct-loaded waste drums, but has little affect on compacted waste as the high-density polyethylene in the drum isolates the fissile masses in the drums from one another. All results are significantly below the USL. These calculations are summarized from for machine-compacted waste and for direct-loaded waste. Water ingress into the WIPP underground is observed at the shafts and not in the disposal area. The same reactivity trend would occur if water somehow was available in the underground repository, and the k_{eff} would not increase above the analyzed dry condition. These results can be extrapolated to other containers of direct-loaded waste, as all are larger in size such that the interstitial moderation will be further from the fissile material and will exhibit a similar trend in reactivity. Also, the fissile material in containers with large quantities of special reflector materials is already well reflected and the interstitial water will have minimal affect as seen in the compacted waste drum array.

Figure -,
 of

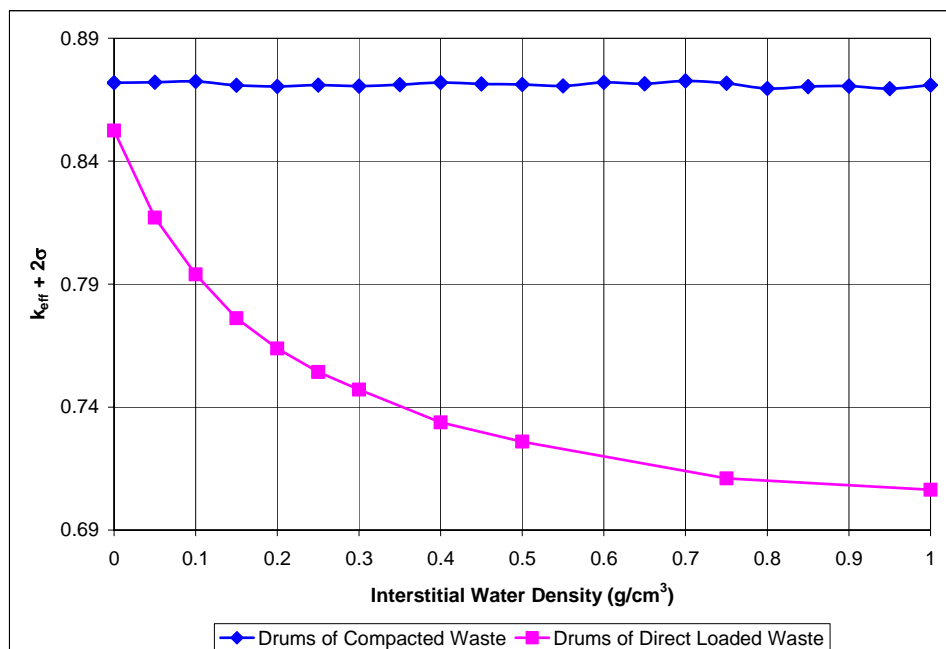

Results

Interstitial Water Between Drums

7.6 Excess Liquid in Waste Containers

This contingency evaluates less than 1% liquid present in the waste container, which could occur from a generator site error or water intrusion into the containers. Although the underground is not subject to flooding, the analysis considers all containers in the underground array containing excess water at various densities up to point where water fills all void space in the container. Only non-machine-compacted waste with loose polyethylene dunnage mixed with 1% special reflector material is considered since waste forms with large quantities of special reflector materials or machine-compacted waste will be less reactive if water is substituted for the special reflector material or the polyethylene. The H/Pu ratio in the fissile material is varied at each water density considered to ensure the optimum condition is modeled.

The calculation results are summarized in Table 7-5 for 55-gallon drums of direct-loaded waste with less than or equal to 1 wt% special reflector materials. These cases are documented in detail in . Additionally, gives the results of similar calculations for direct-loaded waste in shielded container, ARROW-PAK™, SWB, and SLB2 arrays. The results for all container types followed a similar pattern as given in Table 7-5 for 55-gallon drums, with the fully flooded drum at the highest reactivity but well below the USL. The highest eigenvalue was 0.91905 for the ARROW-PAK™ array. (Note that in the SLB2 overbatch, the fissile mass is modeled as a prism in the corner of the box instead of in a centralized cylinder. This configuration was determined to be the most reactive credible configuration in the TRUPACT-III SAR (DOE-CBFO 2007a), which forms the basis of the 500-FGE transportation limit for the SLB2. Further details are given in Section).

Table -, Excess Liquid Contingency Results

Container and Waste Loading	Water Density in 25% Dense Polyethylene Reflector (% of theoretical)	$k_{\text{eff}}+2\sigma$	Filename (Section)
55-gallon drums of direct loaded waste with ≤ 1 wt% special reflectors	0	0.74767	dac2528 (A2.1)
	18.75	0.76707	dacw026 (A4.6)
	37.5	0.78482	dacw062 (A4.6)
	56.25	0.80061	dacw102 (A4.6)
	75	0.81173	dacw142 (A4.6)

7.7 Forklift Accident Crushes Containers

This contingency simulates an accident condition where the 41-ton waste handling forklift impacts an array of seven-packs of 55-gallon drums containing CH waste in the underground repository. The 41-ton forklift is not used to move CH waste, but is used to move the lead shielded facility cask containing RH waste and the shielded, heavy portions of the horizontal emplacement retrieval equipment as described in the *Waste Isolation Pilot Plant Remote Handled (RH) Waste Documented Safety Analysis* (DOE-CBFO 2006b). The 41-ton forklift can also be used to move other large, heavy underground equipment from the waste hoist. The 41-ton forklift cannot travel to areas other than the waste shaft station, the disposal path, and disposal rooms due to its height relative to the height of other bulkheads and airlocks in the underground. Also, the forklift is not normally near the CH waste face because the RH waste is typically emplaced into boreholes in the salt walls before the CH waste is emplaced nearby. The RH horizontal emplacement waste handling equipment is typically placed between the CH waste face and the approaching 41-ton forklift. Consequently, this contingency is unlikely.

The 55-gallon drum of direct-loaded waste was chosen for this contingency because the 55-gallon drum is the smallest CH waste container. The 55-gallon drum will create the tightest array when crushed or when waste types (i.e., as machine-compacted waste or waste with a large amount of special reflectors) contain significant internal reflection, which reduces interaction between the waste containers. To simulate the affects of a high-energy impact on the waste drums, it is assumed that the collision expels some of the air volume from the 55-gallon drums leaving the drums permanently deformed. In particular, it is assumed that the volume of the 55-gallon drums is reduced to 75% of its initial volume. Since some air is expelled, the internal reflector mass around the moderated fissile mass will compress and the density will increase. It is assumed that the polyethylene, which makes up the bulk of the dunnage around the fissile mass, is compressed from a maximum of 25 to 33% of its theoretical density. Furthermore, the model assumes that the geometry of 55-gallon drums is deformed into an elliptical shape with the ratio of the major to minor axes being 2. In this configuration, the elongated fissile mass and internal reflector waste in the 55-gallon drums are moved closer together and become more reactive. In order to minimize the distance between fissile masses in the array, the model uses a rectangular

array since the waste packages and drums are elliptical cylinders. Finally, to maximize the reactivity state of the system and at the same time not restrict the number of seven-packs involved in the accident, mirror boundary conditions are used on three of the four lateral boundaries simulating an infinite array. The fourth boundary uses a reflector made up of 200 centimeters of lead to bound the lead shielding on the RH facility cask and the steel structure of the forklift. In the vertical plane, the upper tier is reflected by an MgO layer (approximately 62 centimeters thick) placed on top of the 55-gallon drums and the whole stack is then reflected by 300 centimeters of salt above and below. Figure 7-3 shows a top view of the model used in the analysis.

Two drum configurations were considered. The first configuration assumes that three 200-FGE drums are impacted by the forklift and the whole seven-pack stack is crushed and displaced into the surrounding seven-packs. The resulting arrangement is a 3-by-3 array with three 200-FGE drums in the first row, one 50-FGE drum in the middle of the second row with one non-fissile bearing drum on either side, and one non-fissile bearing drum in the middle of the last row with one 200-FGE drum on either side. The two 200-FGE drums in the last row originate from the surrounding seven-packs. The boundaries that are not reflected by lead are infinitely reflected to model an infinite array of crushed seven-packs. Figure 7-3 shows the top view of the drums in this configuration. The second configuration is similar to the first except the fissile contents in the drums in the first and last rows are exchanged. Finally, to maximize the interaction effects, a computation was also performed where the polyethylene in the internal reflector was removed and only the beryllium remained in the reflector zone of the “crushed” drums.

Figure 7-4 summarizes the results of the contingency calculation with further details given in Section of . The maximum system eigenvalue was 0.89501 and occurred when the polyethylene was removed from the crushed drums thereby allowing the close fissile masses to interact. This value is below the base 55-gallon drum array $k_{\text{eff}} + 2\sigma$ value of 0.90096 as given in Section A2.1. The reduction in k_{eff} results from the fact that front face of the waste is reflected by lead instead of other fissile waste drums in the base infinite array model. Thus, a criticality accident from a loss of interaction control caused by the impact of a large object, such as a 41-ton forklift, with an array of CH waste packages is not credible.

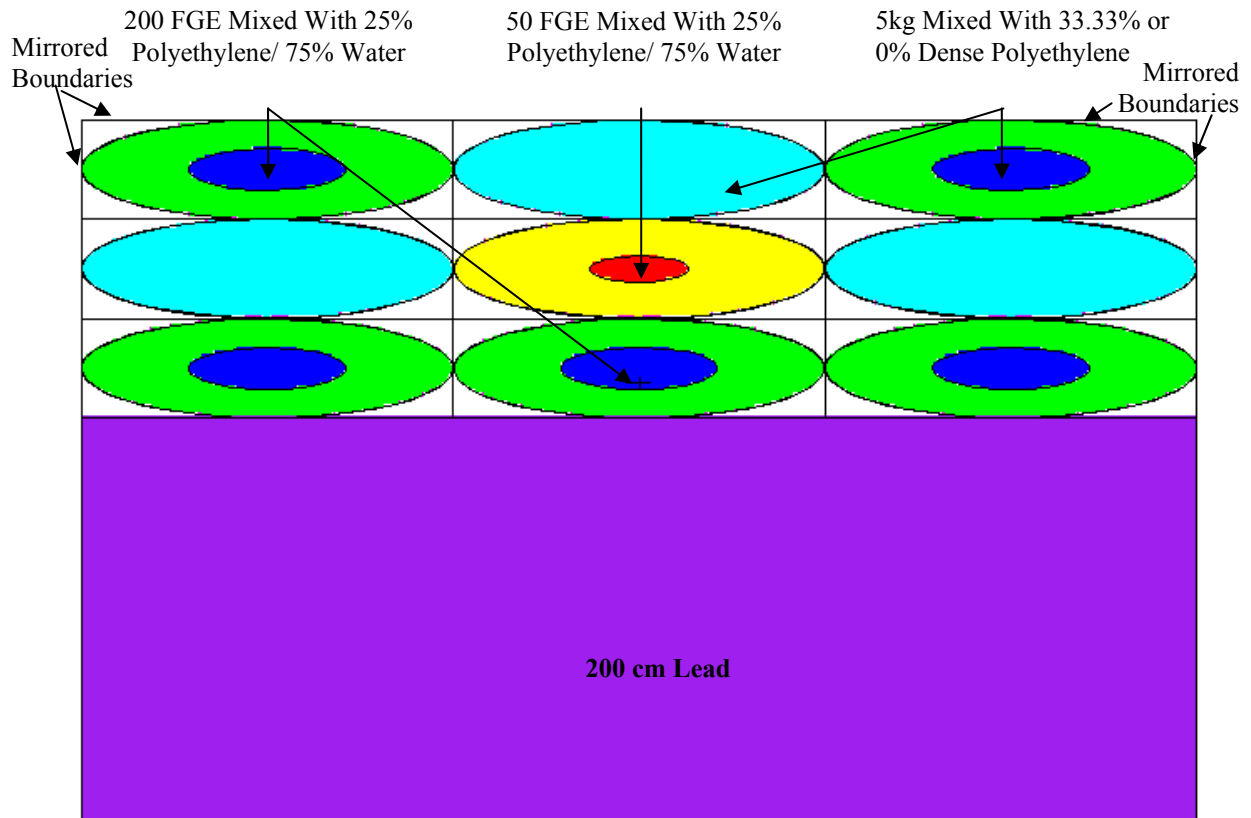

**Figure -, Top View of Model for the 41-ton Forklift Impact with
an Array of 55-Gallon Drums Seven-packs**

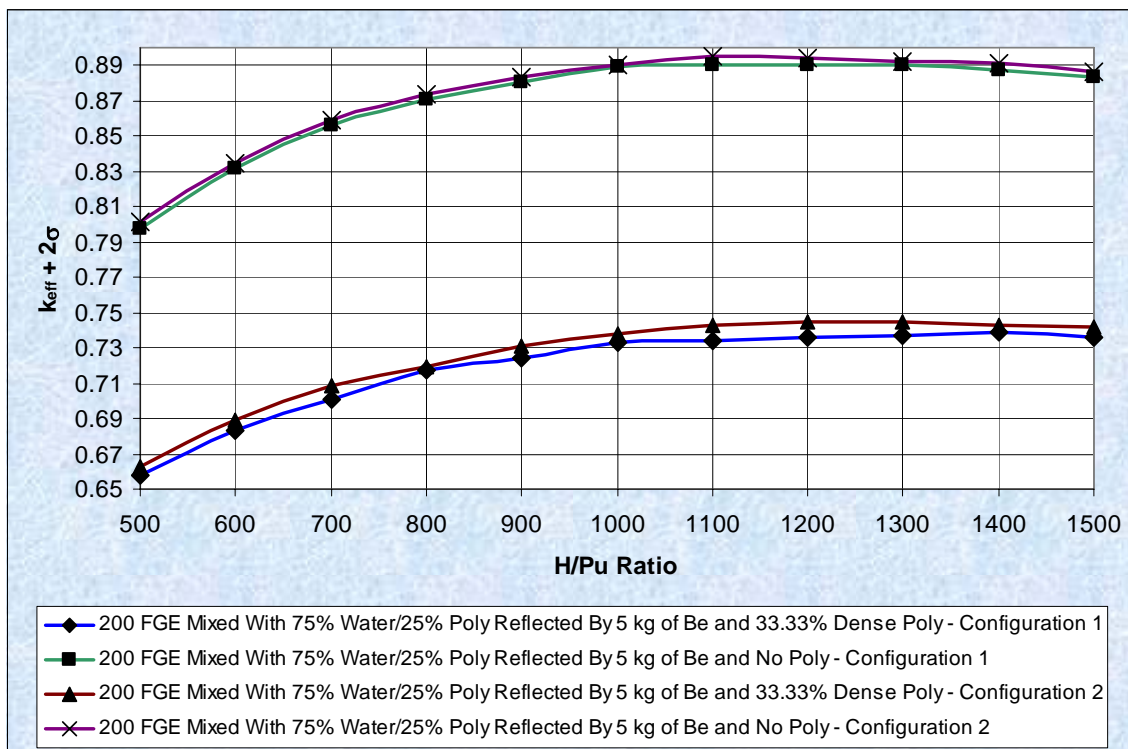

Figure - , System Reactivity Resulting from a 41-ton Forklift Impact with 55-Gallon Drums Seven-packs

7.8 Contingency Analysis Conclusion

The previous subsections have justified that the double contingency principle is met as each contingent condition was shown to remain subcritical. The base cases for the array models in the NCSEs are done such that the fissile content for each drum assembly is nominally twice that allowed by the shipping packages. The contingency upset conditions are evaluated additively to the base cases. However, to demonstrate that a criticality event is not credible, combinations of events must be evaluated. First, note that the load drop in the shaft is shown not to be a credible event, and the sprinkler activation, water intrusion, and forklift crushing contingencies each resulted in a reduction in array reactivity. Thus, none of these events need to be further analyzed. Also, roof fall is extremely unlikely in the active operational phase prior to closure of the panel, which is the scope of the array. The highest risk is judged to result from a container that exceeds the fissile mass limit being placed in a four-tier high array. The over-stacking contingency discussed in Section 7.2 was modeled with each drum assembly at almost twice that allowed in the transportation package and each SWB at the transportation package limit. This configuration is extremely unlikely based on the actual conditions. Further, a mining or waste handling error to this extent to allow a whole panel of containers to be stacked four high with MgO on top is also not credible. In reality, only limited areas would be mined higher than normal to allow a four-tier array. Also, the 55-gallon drum array modeled four high without MgO on top, which is still

conservative compared to the mined height, showed little reactivity change compared to the three-high array. Thus, an overbatched container in a four-tier array will have a comparable reactivity to that given in the over-batching evaluation in Section 7.4 and the array will remain subcritical even with both upset conditions. Thus, a criticality accident at the WIPP is deemed not credible and a criticality detection system is not required.

8.0 Beyond Design Basis Events

Flooding of the underground repository is beyond the design basis of the WIPP facility. Regardless, interstitial moderation between containers is analyzed in Section and flooding of the containers in Section . Both events are shown to not result in an increase in array reactivity above the USL. In addition, all contingent events were analyzed and it was shown that a resulting criticality accident is not credible.

The waste hoist failure is considered not credible based on the probabilistic analysis documented in the *WIPP Waste Hoist Brake System Analysis* (Westinghouse 1996). If the waste hoist failure occurred and the load was dropped, the contents could fall into the sump and become moderated. However, the size of the load is physically restricted to a single SLB2, a three-pack of ARROW-PAKS™, two SWBs or two packs of drums. For a multiple container load, the impact would tend to disperse the containers, such that even if they were breached, it is improbable that the fissile contents would combine into one large mass. In addition, a full array of flooded containers has been shown to remain below the USL such the limited load would remain subcritical if the containers were moderated by the sump water. Overall, the risk of a criticality accident from a load drop from the waste hoist is low; therefore, further analysis is not warranted.

Section evaluates credible overbatch scenarios. The fissile material in one container per stack is overbatched by 50% of the limit or the special reflector material is overbatched by 100% of the limit in one container per stack. All contents of the other containers in the array were modeled at their fissile and special reflector limits. Overbatching by higher amounts was not considered credible, but is discussed here as a beyond design basis event. The fissile material was modeled in an optimally moderated, compact configuration, which is highly conservative because the nature of waste is that the fissile material is dispersed through the waste matrix as pure forms of fissile material would tend to be recovered for use. The multiplication factor of the array drops significantly as the fissile material is dispersed in the container as seen in the study discussed in Section . In addition, the average FGE content in non-compacted drums in the underground repository is less than 50 FGE such that a full array of containers anywhere near the fissile limits is very unlikely. Consequently, further consideration of larger overbatch events is not warranted.

9.0 Design Features and Administratively Controlled Limits and Requirements

A summary of the credited design features and administrative limits and requirements for criticality safety are provided in the following sections.

9.1 Design Features

Washington TRU Solutions maintains configuration control at the WIPP facility. Revision to significant design features requires an unreviewed safety question determination to verify that the change will remain within the approved safety basis. For the purposes of this evaluation, the waste container type is the design feature that provides spacing between the fissile contents of the TRU waste. All containers currently approved for shipment of CH waste to the WIPP in the TRUPACT-II or HALFPACT shipping casks have been evaluated. New containers proposed for disposal at the WIPP have also been evaluated. Changes in container design or the addition of a new container type will need to be evaluated before it can be received, stored, handled, or disposed of at the WIPP.

9.2 Administrative Limits and Requirements

The controls below are required to ensure that a criticality accident is not credible for CH waste at the WIPP.

1. Container arrays are limited to three tiers, where a drum or SWB occupies one tier and an ARROW-PAK™, TDOP, or SLB2 occupies two tiers.
2. Waste approved for shipment to and disposal at WIPP are required to meet the WIPP WAC (DOE-CBFO 2007b). The WAC contains the limits from the transportation analysis and the CH container limits in Table 9-1.

Table -, Summary of Limits Imposed on Contact-Handled Waste

Container Type	Fissile Mass Limit	Container Geometry Requirements	Non-Fissile Material Limits
Direct-loaded Waste Containing ≤ 1 wt% Special Reflectors			
55-, 85-, 100-gallon drums or shielded containers	≤ 200 FGE per drum ≤ 650 FGE per pack ^(a)	Shielded container nominal dimensions per Figure 2-11	Special reflector mass ≤ 5 kg per drum
SWB	≤ 325 FGE	None	Special reflector mass ≤ 18.14 kg per SWB
SLB2	≤ 500 FGE with 0 g 240Pu ≤ 515 FGE with 5 g 240Pu ≤ 535 FGE with 15 g 240Pu ≤ 555 FGE with 25 g 240Pu	Minimum separation between SLB2 contents and the bottom of a container placed on top of the SLB2 is 1.44 in.	Special reflector mass ≤ 47.6 kg per SLB2
ARROW-PAK™	≤ 325 FGE	None	Special reflector mass ≤ 6.25 kg
Pipe overpack assembly	≤ 200 FGE per pipe component	Applies to standard, S100, S200 and S300 pipe overpack assemblies per Appendix 1.3.1 of the TRUPACT SAR ^(b)	Special reflector mass ≤ 5 kg per assembly
Direct-loaded Waste Containing > 1 wt% Special Reflectors			
55-gallon drums or shielded containers	≤ 100 FGE per drum ≤ 700 FGE per pack	Shielded container nominal dimensions per Figure 2-11	Special reflector mass ≤ 100 kg per drum
Pipe overpack assembly	≤ 140 FGE per pipe component	Applies to standard, S100, S200 and S300 pipe overpack assemblies per Appendix 1.3.1 of TRUPACT SAR ^(b)	None
Machine-compacted Waste			
Fully compacted 55-, 85-, 100-gallon drums without design vertical spacing	≤ 170 FGE per drum ≤ 600 FGE per pack ^(a)	None	Special reflector mass ≤ 5 kg per drum
Fully compacted 55-, 85-, or 100-gallon drums with design vertical spacing	≤ 200 FGE per drum ≤ 600 FGE per pack ^(a)	Minimum 0.5-in. spacing ^(c) between drum content and exterior top and bottom must be maintained, even if a smaller drum were placed on top of the drum	Special reflector mass ≤ 5 kg per drum
Partially compacted 55-, 85-, or 100-gallon drums	≤ 200 FGE per drum ≤ 600 FGE per pack ^(a)	None	Packing fraction of drum contents $\leq 70\%$ Special reflector mass ≤ 5 kg per drum
Shielded containers	≤ 200 FGE per drum ≤ 600 FGE per pack ^(a)	Shielded container nominal dimensions per Figure 2-11	Special reflector mass ≤ 5 kg per drum

Table 9-1, Summary of Limits Imposed on Contact-Handled Waste (continued)

Container Type	Fissile Mass Limit	Container Geometry Requirements	Non-Fissile Material Limits
55-, 85-, and 100-gallon drums overpacked in SWB (no loose material in the SWB)	Drum limits given above apply provided all material is contained within a drum	Drum requirements for the applicable container given above apply	Drum limits given above apply provided all material is contained within a drum
Fully compacted 100-gallon drum with design vertical spacing overpacked in an SWB container	≤ 250 FGE per inner drum and per SWB	Minimum 0.75-in. void spacing between drum content and exterior top and minimum 0.5-in. spacing between drum content and exterior bottom ^(c) . Drum must have a 16-gauge drum outer lid and bottom and an inner/recessed 16-gauge steel lid.	Special reflector mass ≤ 18.14 kg per SWB
Fully compacted SWB containers without Inner container	≤ 185 FGE per SWB	None	Special reflector mass ≤ 18.14 kg per SWB

- (a) Pack is defined as a seven-pack of 55-gallon drums, a four-pack of 85-gallon drums, or a three-pack of 100-gallon drums.
- (b) DOE-CBFO (2005a).
- (c) 0.5-in. spacing modeled for 85- and 100-gallon drums whereas only 0.3 in. was modeled for 55-gallon drums. Requirement set at largest value of 0.5 in. for all cases for consistency.

10.0 Conclusions

This NCSE has evaluated the handling, storage, and disposal processes for the various CH waste types in the multiple approved containers allowed at the WIPP. The limits on fissile mass and special reflectors meet or exceed the limits on containers allowed to be transported to the facility in the TRUPACT-II or HALFPACT shipping packages and proposed for transportation in the TRUPACT-III package. The double-contingency principle is met as demonstrated in the contingency analysis of Section . With the controls listed in Section , no credible accidental criticality scenarios exist for the WIPP. Therefore, there is no need for a criticality accident alarm system or a criticality detection system.

11.0 References

ASTM A 569. *Standard Specification for Steel, Carbon (0.15 Maximum, Percent), Hot-Rolled Sheet and Strip Commercial*, American Society for Testing and Materials, West Conshohocken, PA.

ASTM C208-95(2001). *Standard Specification for Cellulosic Fiber Insulating Board*, American Society for Testing and Materials, West Conshohocken, PA.

ASTM D 1505, 2003. *Standard Test Method for Density of Plastics by the Density-Gradient Technique*, November 1, 2003, American Society for Testing and Materials, West Conshohocken, PA.

BNFL, 2001. *General Arrangement & Details 100-Gallon Puck Drum*, BNFL 53-9840, Revision 8, BNFL Inc., Idaho Falls, ID.

CRC, 1991-1992. *Handbook of Chemistry and Physics*, 72nd Edition, 1991-1992, CRC Press, Boca Raton, FL.

DOE, 2005. *Facility Safety*, DOE O 420.1B, Chapter III, Nuclear Criticality Safety, December 22, 2005, U.S. Department of Energy, Washington, DC.

DOE, 2007. *Guidelines for Preparing Criticality Safety Evaluations at Department of Energy Nonreactor Nuclear Facilities*, DOE-STD-3007-2007, February 2007, U.S. Department of Energy, Washington, DC.

DOE-CBFO, 2005a. *TRUPACT-II Safety Analysis Report*, Revision 21, May 2005, U.S. Department of Energy, Carlsbad Field Office, Carlsbad, NM.

DOE-CBFO, 2005b. *HALFPACT-II Safety Analysis Report*, Revision 4, May 2005, U.S. Department of Energy, Carlsbad Field Office, Carlsbad, NM.

DOE-CBFO, 2005c. *Contact-Handled Transuranic Waste Authorized Methods for Payload Control (CH-TRAMPAC)*, Revision 2, May 2005, U.S. Department of Energy, Carlsbad Field Office, Carlsbad, NM.

DOE-CBFO, 2006a. *Waste Isolation Pilot Plant Contact Handled (CH) Waste Documented Safety Analysis*, DOE/WIPP-95-2065, Revision 10, November 2006, U.S. Department of Energy, Carlsbad Field Office, Carlsbad, NM.

DOE-CBFO, 2006b. *Waste Isolation Pilot Plant Remote Handled (RH) Waste Documented Safety Analysis*, DOE/WIPP-06-3174, Revision 0, March 2006, U.S. Department of Energy, Carlsbad Field Office, Carlsbad, NM.

DOE-CBFO, 2007a. *TRUPACT-III Safety Analysis Report*, Revision D, June 2007, U.S. Department of Energy, Carlsbad Field Office, Carlsbad, NM.

DOE-CBFO, 2007b. *Transuranic Waste Acceptance Criteria for the Waste Isolation Pilot Plant*, DOE/WIPP-02-3122, Revision 6.1, October 29, 2007, U.S. Department of Energy, Carlsbad Field Office, Carlsbad, NM.

DOE-RL, 2000. *DOE UN Container Packaging Specifications DOT 7A, Type A Cross Reference*, DOE/RL-96-57, February 2000, U.S. Department of Energy, Richland, Operations Office, Richland, WA.

Elliot J.A., A. Kelly, and A.H. Windle, 2002. "Recursive packing of dense particle mixtures," J. Mat. Sci. Lett. **21**:1249-1251; 2002.

GE, 1989. *Nuclides and Isotopes*, Chart of the Nuclides, 14th Edition, GE Nuclear, San Jose, CA.

Hayes, R., 2004. *MCNP5 Bias Validation for the WIPP*, CS-2004-002, Washington TRU Solutions LLC, Carlsbad, NM.

LANL, 2005. *MCNP — A General Monte Carlo N-Particle Transport Code*, Version 5, LA-UR-03-1987, October 3, 2005, Los Alamos National Laboratory, Los Alamos, NM.

Larson, S.L., 2004. *Verification of MCNP5 on SAIC Computers*, December 1, 2004, Memo to File, Science Applications International Corporation, Oak Ridge, TN.

NEA, 2007. *International Handbook of Evaluated Criticality Safety Benchmark Experiments*, NEA/NCS/DOC(95)03, September 2007 Edition, Nuclear Energy Agency, Organization for Economic Co-Operation and Development, Idaho Falls, ID.

Neeley, G.W., 2005. *Nuclear Criticality Safety Evaluation for Storage of Machine Compacted Transuranic Waste Products at the Waste Isolation Pilot Plant*, Addendum 1 to SAIC-1171-001, June 14, 2005, Science Applications International Corporation, Oak Ridge, TN.

Newell, D.L. and S.L. Larson, 2007. *MCNP5 Bias Validation For Lead And Low Enriched Uranium At The Waste Isolation Pilot Plant*, SAIC-WIPP-VAL-001, October 2007, Science Applications International Corporation, Oak Ridge, TN.

NMED, 2007. *Waste Isolation Pilot Plant Hazardous Waste Facility Permit*, NM4890139088, February 2007, New Mexico Environment Department, Santa Fe, NM.

Petrie, L.M., P.B. Fox, and K. Lucius, 2000, *Standard Composition Library*, ORNL/NUREG/CSD-2/V3/R6, Volume 3, Section M8, March 2000, Oak Ridge National Laboratory, Oak Ridge, TN.

PLG, 1997. *Analysis of Roof Fall and Methane Gas Explosions in Closed Rooms and Panels*, PLG-1167, August 1997, PLG Incorporated, Newport Beach, CA.

PTI, 2005. *ARROW-PAK Drawing*, 163-007, Revision 0, November 2005, Packaging Technology Incorporated, Tacoma, WA.

Rhoden, W.G., 2003a. *Determination of Computational Bias for Criticality Calculations at the WIPP using MCNP*, CS-2002-002, Revision 0, July 2003, Washington TRU Solutions LLC, Carlsbad, NM.

Rhoden, W.G., 2003b. *Waste Isolation Plant Nuclear Criticality Safety Evaluation for Contact Handled Transuranic Waste Storage*, CS-2003-001, July 2003, Washington TRU Solutions LLC, Carlsbad, NM.

Shleien, B., L.A. Slaback, Jr., and B. Birky, 1998, *Handbook of Health Physics and Radiological Health*, 3rd Edition, Scinta Publishing, Silver Spring, MD.

Taggert, D.P. and J.U. Moon, 2004. *Review of Special Reflectors in the TRU Waste Inventory*, LA-UR-04-0857, February 2004, Los Alamos National Laboratory, Los Alamos, NM.

Torquato, S., T.M. Truskett, and P.G. Debenedetti, 2007. "Is random packing of spheres well defined?" *Phys. Rev. Lett.* **84**:2064-2067; 2000.

Westinghouse, 1996. *WIPP Waste Hoist Brake System Analysis*, WIPP/WID-96-2178, Revision 0, July 1996, Westinghouse, Pittsburgh, PA.

WTS, 2007a. *Standard Large Box 2 Assembly (SLB2) Top Loading*, 165-F-016-W1, Revision D, (<http://www.wipp.energy.gov/library/slb/165-F-016.pdf>), Washington TRU Solutions LLC, Carlsbad, NM.

WTS, 2007b. *Shielded Container Assembly*, Drawing 165-F-026-W1, September 2007, Washington TRU Solutions LLC, Carlsbad, NM.

This page intentionally left blank.

Appendix A

Direct-Loaded Waste Containing Less Than or Equal to 1 Weight Percent Special Reflectors

This page intentionally left blank.

Analyst Senior NCS Engineer	_____	
	G. W. Neeley	Date
Analyst NCS Engineer	_____	
	D. L. Newell	Date
Peer Reviewer Senior NCS Engineer	_____	
	S. L. Larson	Date

This page intentionally left blank.

Introduction

This appendix focuses on direct-loaded waste containers containing less than or equal to 1 weight percent (wt%) of special reflector material. Special reflector materials are those that have been shown to increase reactivity above that of a 25% polyethylene/75% water-reflected system and must be limited when mass loading limits are based on this polyethylene/water reflection combination. Containers with no limit on special reflector materials are discussed in . Because 1 wt% is considered a contamination level, the special reflector material is modeled homogeneously distributed throughout the container outside of the fissile region. The material modeled is beryllium, which has been shown to result in the highest reactivity when reflecting a plutonium system (*Reactivity Effects of Moderator and Reflector Materials on a Finite Plutonium System* [Neeley et al. 2004]) and the mass modeled is 1 wt% of the maximum weight of the container. Sample MCNP5 input file listings for the models contained in this appendix are included in Section .

A1.0 Direct-Loaded Waste Configurations

A1.1 55-gallon Drums

The direct-loaded 55-gallon drums are modeled with 200 grams of ^{239}Pu mixed with a polyethylene-water moderator, which is 25% by volume polyethylene and 75% by volume water. A mixture of beryllium and polyethylene fills the remainder of the drum reflecting the fissile mass. Polyethylene is modeled at a packing fraction of 25% as determined to bound the packing fraction of direct-loaded (non-machine compacted) waste in the *TRUPACT-II Safety Analysis Report* [DOE-CBFO 2005a). Consequently, the polyethylene density in the reflector is $0.93 \text{ g/cm}^3 \times 0.25 = 0.23 \text{ g/cm}^3$. The amount of beryllium is based on 1 wt% of the maximum gross container loading limit of 1,000 pounds [*Contact-Handled Transuranic Waste Authorized Methods for Payload Control (CH-TRAMPAC)* [DOE-CBFO 2005b)] or 455 kilograms, which is rounded up to 5 kilograms beryllium per 55-gallon drum. The beryllium is modeled as homogeneously mixed throughout the polyethylene reflector. The beryllium density varies slightly with the H/Pu ratio as the fissile volume changes but is approximately 0.024 g/cm^3 in the 55-gallon drum. Note that beryllium is slightly more reactive modeled in the reflector than in the moderator as discussed in Section 6.4.3.2.2 of the TRUPACT-II SAR.

The 55-gallon drum dimensions given in Table 2-1 are used in the MCNP5 models. The drum walls are carbon steel (*Standard Specification for Steel, Carbon (0.15 Maximum, Percent), Hot-Rolled Sheet and Strip Commercial* [ASTM A 569]), which is modeled with the composition given in Table 5-4. The theoretical density of carbon steel is 7.86 g/cm^3 , but is modeled at 50% of this value, or 3.93 g/cm^3 , to allow for fabrication tolerances, localized wall thinning or other degradation, etc. Section 2.1.2 of the CH-TRAMPAC (DOE-CBFO 2005b) requires that the integrity of the container be visually inspected prior to transport to ensure there is no significant rusting such that the 50% value is conservative.

A1.2 Shielded Containers

Direct-loaded waste may also be loaded into shielded containers. These containers are right circular cylinders made of steel and lead. The base and lid (top) are steel and the walls are lead layered between the inner and outer steel shells. The containers are modeled with the dimensions given in Table 2-6. The steel is modeled with the composition given in Table 5-4. The theoretical density of carbon steel is 7.86 g/cm^3 , and the steel is modeled at full density since the containers will be fabricated new specifically for disposal at the WIPP. The lead is modeled as given in Table 5-5.

A1.3 Standard Waste Box

The direct-loaded SWB is modeled with 325 grams of ^{239}Pu mixed with a polyethylene-water, which is 25% by volume polyethylene and 75% by volume water. A mixture of beryllium and polyethylene fills the remainder of the SWB reflecting the fissile mass. Polyethylene is modeled at a packing fraction of 25% as determined to bound the packing fraction of direct-loaded (non-machine compacted) waste in the TRUPACT-II SAR (DOE-CBFO 2005a). The amount of beryllium is based on 1 wt% of the maximum SWB gross weight of 4,000 pounds (DOE-CBFO 2005b), which equates to 18.14 kilograms of beryllium per SWB. The beryllium is modeled as homogeneously mixed throughout the polyethylene reflector. The beryllium density varies slightly with the H/Pu ratio as the fissile volume changes, but is approximately 0.0095 g/cm^3 . Note that beryllium is slightly more reactive modeled in the reflector than in the moderator as discussed in TRUPACT II SAR.

The SWB dimensions given in Table 2-3 are used in the MCNP5 model. The carbon-steel (ASTM A 569) container wall is modeled at full thickness; however, the carbon steel is only modeled at 50% of the theoretical density, or 3.93 g/cm^3 , to allow for fabrication tolerances, localized wall thinning, or other degradation. The composition of carbon steel used in the models is given in Table 5-4.

A1.4 Standard Large Box 2

The SLB2 is a large box designed for transport in the TRUPACT-III shipping container. The inner dimensions of the SLB2 are 102 by 63 by 66 inches and the outer dimensions are 106 by 69 by 73 inches as given in Drawing 165-F-016-W1, *Standard Large Box 2 Assembly (SLB2) Top Loading* (WTS 2007). The SLB2 FGE limit is 500 grams of ^{239}Pu with no ^{240}Pu credited and higher FGE limits are also given with ^{240}Pu credited. The maximum amount of beryllium allowed in the SLB2 is 1 wt% (47.6 kilograms) of the SLB2 gross weight. The beryllium is modeled as homogeneously mixed throughout the polyethylene reflector. The beryllium density varies slightly with the H/Pu ratio as the fissile volume changes and is slightly more reactive modeled in the reflector than in the moderator.

The SLB2 dimensions given in Table 2-4 are used in the MCNP5 computational model. Following suit with the analyses carried out for the 55-gallon drums and the SWBs, the SLB2 is

modeled with carbon steel (ASTM A 569) container walls at full thickness, but at 50% of the theoretical density to account for fabrication tolerances, localized wall thinning, or other degradation. The composition of carbon steel used in the models is given in Table 5-4.

A1.5 ARROW-PAK™ Containers

The ARROW-PAK™ payload containers are constructed of a nominal 30-inch outside diameter, EHMW-HDPE cylindrical pipe with a minimum 1.765-inch thick wall. The EHMW-HDPE density is provided by the material cell classification per *Standard Test Method for Density of Plastics by the Density-Gradient Technique* (ASTM D 1505) as 0.940 to 0.947 g/cm³. The ends of the container are torispherical in shape with minimum thicknesses of 1.765 inches on the sides and 2.5 inches on the bottom. The overall height of the ARROW-PAK™ is nominally 70.5 inches, which was used in the modeling. The ARROW-PAK™ dimensions and payload are provided in Drawing 163-004, *ARROW-PAK Drawing* (PTI 2005).

The ARROW-PAK™ geometry is conservatively modeled as a right-circular cylinder of 70.5 inches overall height with an outside diameter of nominally 30 inches (76.20 centimeters) and a minimum sidewall thickness of 1.765 inches. The ends of the ARROW-PAK™ are modeled as flat circular plates with a nominal thickness of 2.91 inches to maximize the reflection provided by the container bottom. The walls are modeled as polyethylene with a density of 0.96 g/cm³ to bound the range of EHMW-HDPE densities given above.

The payload container within the ARROW-PAK™ is a standard 55-gallon drum waste container with geometric characteristics identical to those discussed in Section . For conservatism, the 55-gallon drum steel walls are neglected. Each ARROW-PAK™ is modeled containing 325 grams of ²³⁹Pu in the payload container, again mixed with a 25% by volume polyethylene and 75% by volume water moderator. The beryllium in the ARROW-PAK™ is modeled only in the volume of the drum. This increases the beryllium concentration and its interaction with the fissile mass centered within the drum compared to homogenizing the beryllium over the entire ARROW-PAK™ volume. The beryllium mass is 6.25 kilograms/payload container, or 1 wt% of the payload container maximum weight of 1,375 pounds. The inner drum structure is ignored otherwise as the steel wall is not modeled. Also the polyethylene dunnage, with a maximum packing fraction of 25%, as justified in Section , fills the entire ARROW-PAK™.

A2.0 MCNP5 Direct-Loaded Waste Array Models

A2.1 55-gallon Drum Array Model

This section evaluates the disposal array using direct-loaded 55-gallon drums containing particulate beryllium. The particulate beryllium in the drum is considered to be in the form of contamination from compounds such as beryllium oxide or as metal fines or shavings from machining processes. The beryllium material is not in the form of large metal shapes.

The fissile limit on single direct-loaded drums is 200 grams of ^{239}Pu per drum maximum. However, underground array calculations with 200 FGE in each drum are supercritical. A fissile limit is also needed for each seven-pack of drums. A seven-pack limit of 650 FGE, or twice the TRUPACT-II fissile limit of 325 FGE, is analyzed. To determine the effect of the distribution of the fissile material within the seven-pack, six different configurations were examined. The configurations and the resultant $k_{\text{eff}}+2\sigma$ values are displayed in Figure A-1. These calculations include 5 kilograms of beryllium per drum and model the fissile region at an H/Pu ratio of 1,300. The non-fissile bearing drums also contain 5 kilograms of beryllium spread throughout the drum. (The calculations have the same parameters as file dac0026 in Table A-1 as described in the next paragraph.) Per these results, a more concentrated fissile region within the seven-pack yields a higher reactivity. Placing the 200-FGE drums on the outside of the seven-pack is more reactive than placing them in the center as this increases interaction with the adjacent seven-packs in the infinite array. Configuration 4 is the most reactive, although the arrangements where the fissile mass is concentrated into the fewest drums all have very similar reactivity, and will be used in the subsequent calculations.

Next, a computational analysis was performed where the fissile concentration in the drums in configuration 4 was varied. The fissile material is modeled as a cylinder with an H/D ratio of 1 centered in each drum and the H/Pu ratio is varied. The fissile moderator composition is again 25% by volume polyethylene and 75% by volume water, but the polyethylene dunnage (internal reflector material) composition was varied from 0 to 25% of the theoretical density to determine the sensitivity of the seven-pack array reactivity to this parameter, which affects the interaction of the fissile masses in the array. The beryllium content is held constant at 5 kilograms/drum and is spread homogeneously throughout the drum around the fissile cylinder. The beryllium is not modeled as a moderator based on the results in Chapter 6 of the TRUPACT-II SAR (DOE-CBFO 2005a), which indicates that increasing amounts of beryllium moderation reduces the reactivity when the package is limited to 1 wt% special reflectors. The non-fissile drums in the seven-pack are filled with the same polyethylene density as the fissile bearing drums plus 5 kilograms of beryllium spread throughout the drum. Table A-1 and Figure A-2 give the reactivity of the infinite underground array of 55-gallon drums. The results show that the array reactivity drops sharply with the addition of even 5% polyethylene outside of the fissile region and then increases slightly as more polyethylene is added. Thus, the array is most reactive when interaction is maximized, but the maximum $k_{\text{eff}} + 2\sigma$ value is well below the USL of 0.96 at 0.90096. Thus, the fissile limit per seven-pack of 650 FGE with maximum drum contents of 200 FGE and 5 kilograms of beryllium per drum will remain subcritical in the underground storage array.

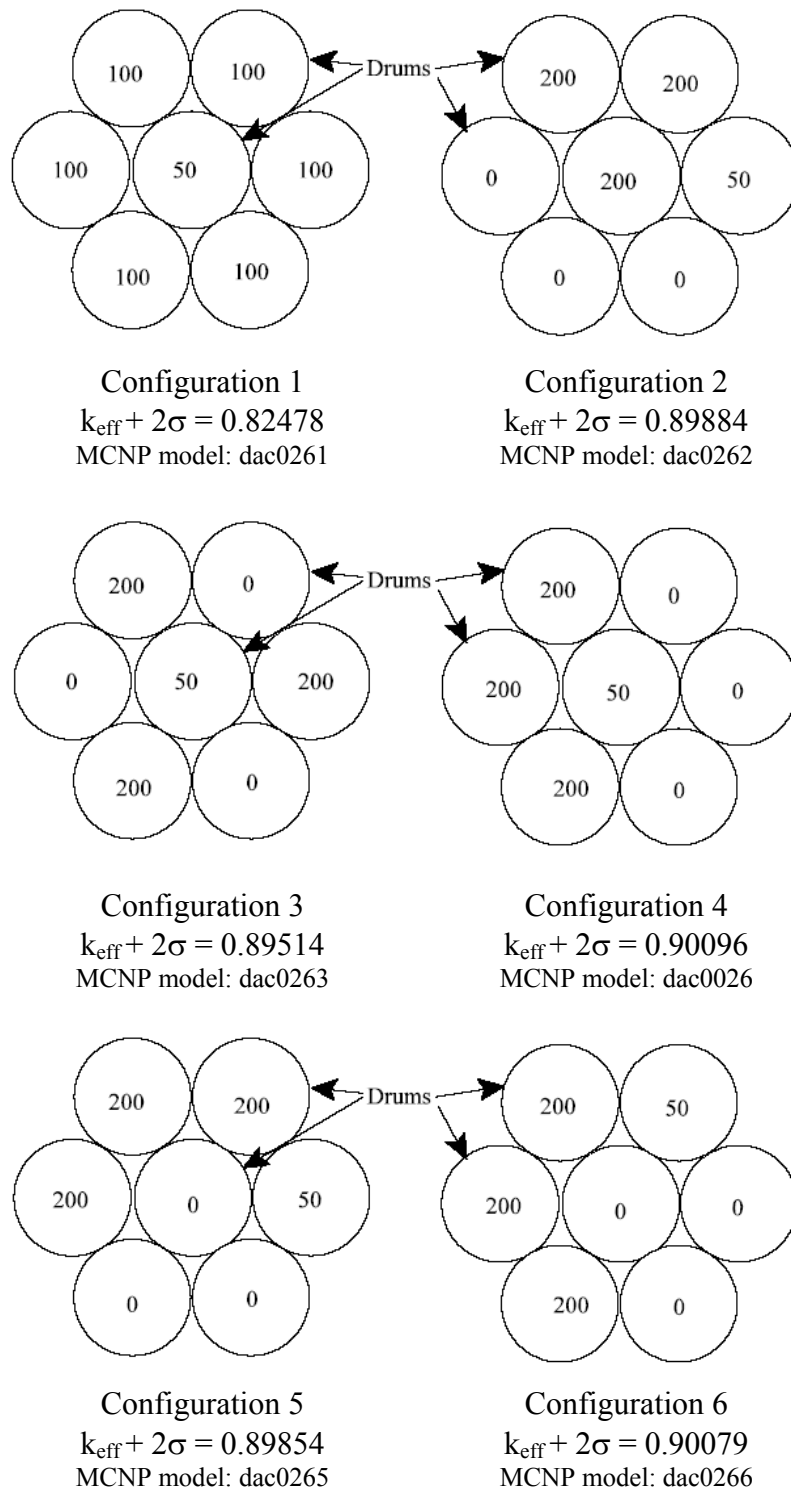

Note: grams ²³⁹Pu modeled shown in each drum. All cases modeled at an H/Pu ratio of 1300 with 5 kg Be.

Figure A-, 650 Fissile Gram Equivalent Seven-pack Distribution Patterns in Array Model of Direct-loaded Drums

**Table A-, MCNP Results for Underground Array of Seven-packs Limited to
 650 Fissile Gram Equivalents per Pack**

H/Pu Ratio	k_{eff}	σ	$k_{eff} + 2\sigma$	File-name	H/Pu Ratio	k_{eff}	σ	$k_{eff} + 2\sigma$	File-name
No Polyethylene					15% Dense Polyethylene				
800	0.87891	0.00078	0.88047	dac0016	800	0.70011	0.00086	0.70183	dac1516
900	0.88979	0.00080	0.89139	dac0018	900	0.71363	0.00084	0.71531	dac1518
1000	0.89600	0.00073	0.89746	dac0020	1000	0.72465	0.00079	0.72623	dac1520
1100	0.89889	0.00077	0.90043	dac0022	1100	0.72932	0.00077	0.73086	dac1522
1200	0.89913	0.00071	0.90055	dac0024	1200	0.73502	0.00075	0.73652	dac1524
1300	0.89966	0.00065	0.90096	dac0026	1300	0.73820	0.00072	0.73964	dac1526
1400	0.89480	0.00065	0.89610	dac0028	1400	0.74110	0.00074	0.74258	dac1528
1500	0.89085	0.00064	0.89213	dac0030	1500	0.73906	0.00074	0.74054	dac1530
1600	0.88760	0.00067	0.88894	dac0032	1600	0.73707	0.00070	0.73847	dac1532
1700	0.88122	0.00059	0.88240	dac0034	1700	0.73613	0.00071	0.73755	dac1534
1800	0.87414	0.00061	0.87536	dac0036	1800	0.73448	0.00065	0.73578	dac1536
5% Dense Polyethylene					20% Dense Polyethylene				
800	0.71580	0.00081	0.71742	dac0516	800	0.70715	0.00084	0.70883	dac2016
900	0.73081	0.00079	0.73239	dac0518	900	0.71957	0.00071	0.72099	dac2018
1000	0.74217	0.00072	0.74361	dac0520	1000	0.72898	0.00081	0.73060	dac2020
1100	0.75102	0.00072	0.75246	dac0522	1100	0.73474	0.00085	0.73644	dac2022
1200	0.75556	0.00075	0.75706	dac0524	1200	0.73652	0.00079	0.73810	dac2024
1300	0.75669	0.00073	0.75815	dac0526	1300	0.74166	0.00074	0.74314	dac2026
1400	0.76108	0.00069	0.76246	dac0528	1400	0.74020	0.00075	0.74170	dac2028
1500	0.76212	0.00071	0.76354	dac0530	1500	0.74078	0.00070	0.74218	dac2030
1600	0.76087	0.00067	0.76221	dac0532	1600	0.73870	0.00076	0.74022	dac2032
1700	0.75957	0.00070	0.76097	dac0534	1700	0.73727	0.00067	0.73861	dac2034
1800	0.75724	0.00065	0.75854	dac0536	1800	0.73360	0.00072	0.73504	dac2036
10% Dense Polyethylene					25% Dense Polyethylene				
800	0.70065	0.00081	0.70227	dac1016	800	0.71594	0.00082	0.71758	dac2516
900	0.71335	0.00079	0.71493	dac1018	900	0.72550	0.00086	0.72722	dac2518
1000	0.72506	0.00082	0.72670	dac1020	1000	0.73576	0.00085	0.73746	dac2520
1100	0.73187	0.00077	0.73341	dac1022	1100	0.74215	0.00080	0.74375	dac2522
1200	0.73779	0.00072	0.73923	dac1024	1200	0.74464	0.00074	0.74612	dac2524
1300	0.74097	0.00077	0.74251	dac1026	1300	0.74625	0.00071	0.74767	dac2526
1400	0.74309	0.00073	0.74455	dac1028	1400	0.74524	0.00065	0.74654	dac2528
1500	0.74256	0.00068	0.74392	dac1030	1500	0.74273	0.00075	0.74423	dac2530
10% Dense Polyethylene					25% Dense Polyethylene				
1600	0.74379	0.00071	0.74521	dac1032	1600	0.74300	0.00065	0.74430	dac2532
1700	0.74103	0.00067	0.74237	dac1034	1700	0.73862	0.00069	0.74000	dac2534
1800	0.74066	0.00064	0.74194	dac1036	1800	0.73505	0.00059	0.73623	dac2536

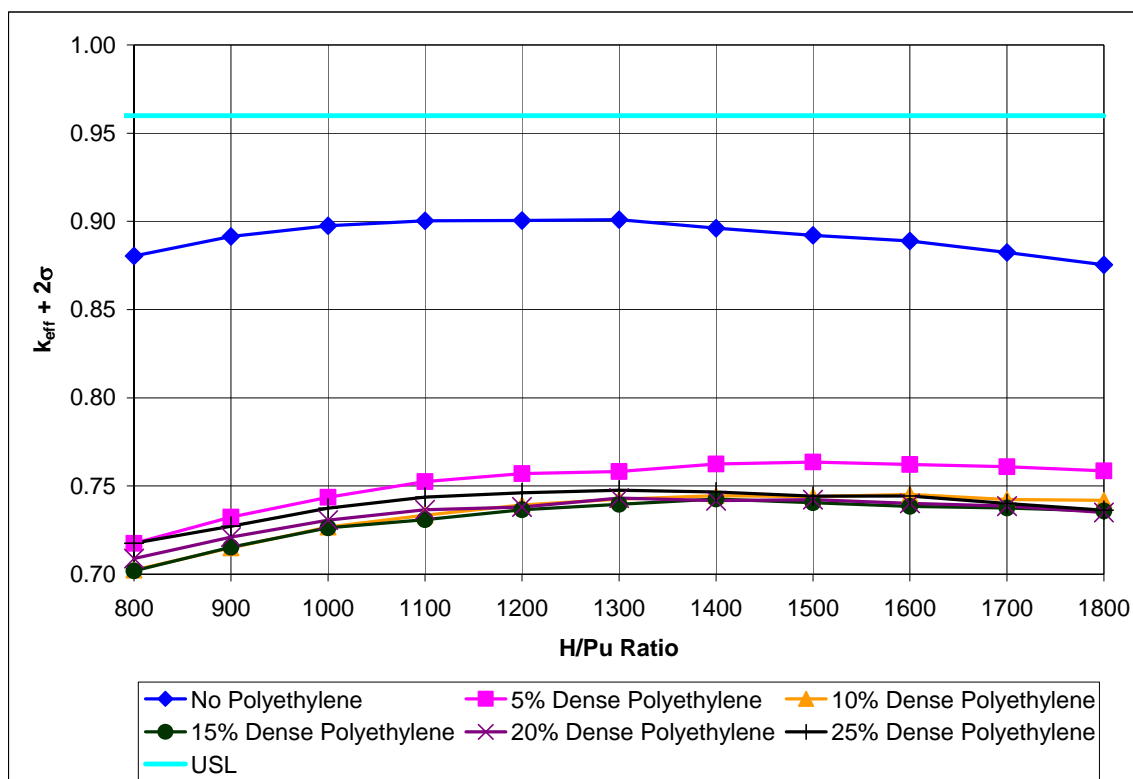

Figure A-1, Underground Array Reactivity for Direct-loaded 55-gallon Drums at 650 Fissile Gram Equivalents per Seven-pack as a Function of Polyethylene Dunnage Density

A2.2 Standard Waste Box Array Model

With respect to the SWB underground array model, the compositions of the fissile mass (plutonium and moderator mixture) and the internal reflector (beryllium-polyethylene) mixture within the containers were consistent with that used in the two-container SWB calculations. However, the geometry and location of the fissile mass within the containers was modified relative to the two-container model in order to simulate the nominal configuration expected in the storage array. Specifically, the fissile masses were modeled as cylindrical units with an H/D ratio of 1, and the mass located in the center of the SWB thereby representing the average reactivity state of the storage array.

The results of the SWB storage array calculations are summarized in Table A-2 and Figure A-3. A maximum reactivity of 0.84260 occurs at an H/Pu ratio of 1,100, which is well below the USL of 0.96.

**Table A-, MCNP Results for Underground Array
 of Standard Waste Box Containers**

H/Pu Ratio	k_{eff}	σ	$k_{eff} + 2\sigma$	Filename
600	0.79337	0.00059	0.79455	swbar12
700	0.81359	0.00057	0.81473	swbar14
800	0.82536	0.00058	0.82652	swbar16
900	0.83411	0.00056	0.83523	swbar18
1000	0.83868	0.00052	0.83972	swbar20
1100	0.84152	0.00054	0.84260	swbar22
1200	0.84090	0.00052	0.84194	swbar24
1300	0.83970	0.00051	0.84072	swbar26
1400	0.83698	0.00053	0.83804	swbar28
1500	0.83443	0.00049	0.83541	swbar30

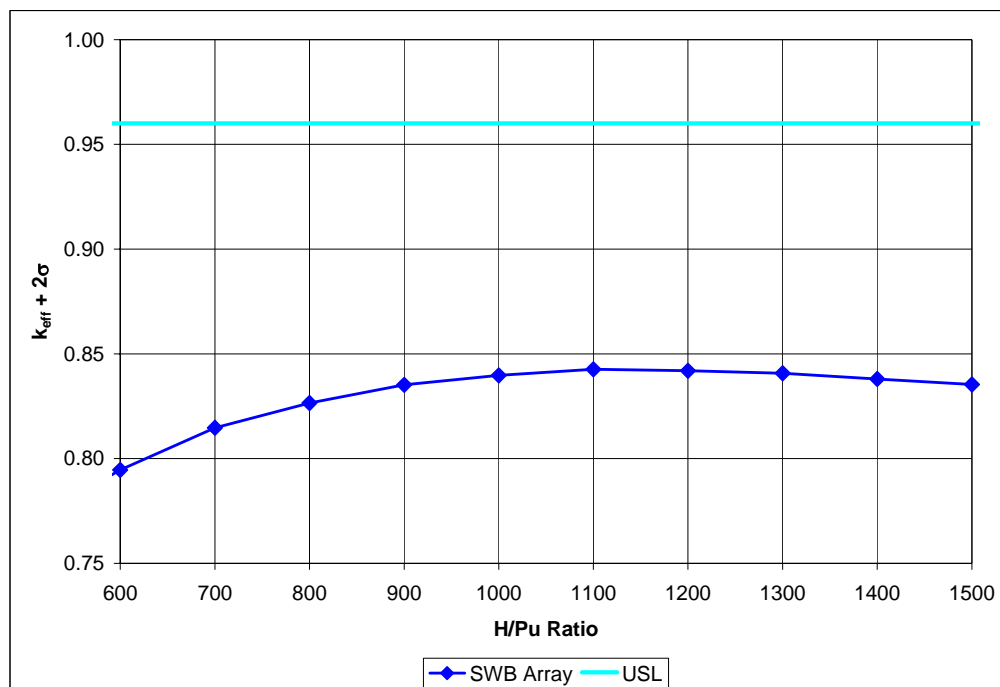

Figure A-, Underground Array Reactivity for Standard Waste Box Containers

A2.3 Standard Large Box 2 Array Model

The SLB2 array model for the underground repository assumes an emplacement configuration where seven-packs of 55-gallon drums at their FGE limit are placed on top of the SLB2s as shown in Figure A-4. The lateral boundaries are mirrored to simulate an infinite array and the

vertical boundaries are reflected with 300 centimeters of salt with an intervening magnesium oxide (MgO) layer between the top of the seven-packs and the upper salt boundary.

The fissile mass in the SLB2 is assumed to be at its FGE limit of 500 grams of ^{239}Pu and modeled as a cylinder with an H/D ratio of 1 centered in the container. The fissile moderator composition is 25% by volume polyethylene and 75% by volume water and the fissile mixture is reflected internally by a mixture of 47.6 kilograms of beryllium mixed homogeneously throughout the container with 25% dense polyethylene. The seven-packs of 55-gallon drums are modeled at their FGE limit of 650 grams of ^{239}Pu with the moderator and internal reflector compositions consistent with that discussed in Section . Furthermore, the drums are arranged geometrically consistently with configuration 4 of Figure A-1. To ensure that all internal reflector states are accounted for, computations are performed with and without the polyethylene content in the dunnage of the SLB2 seven-pack drum configuration, thereby maximizing potential interaction states between container types.

The results of the SLB2 storage array computations with 500 FGE per SLB2 are summarized in Table A-3 and Figure A-5. As indicated by the data, a maximum reactivity of 0.94360 occurs at an H/Pu ratio of 1,000, which is below the USL of 0.96.

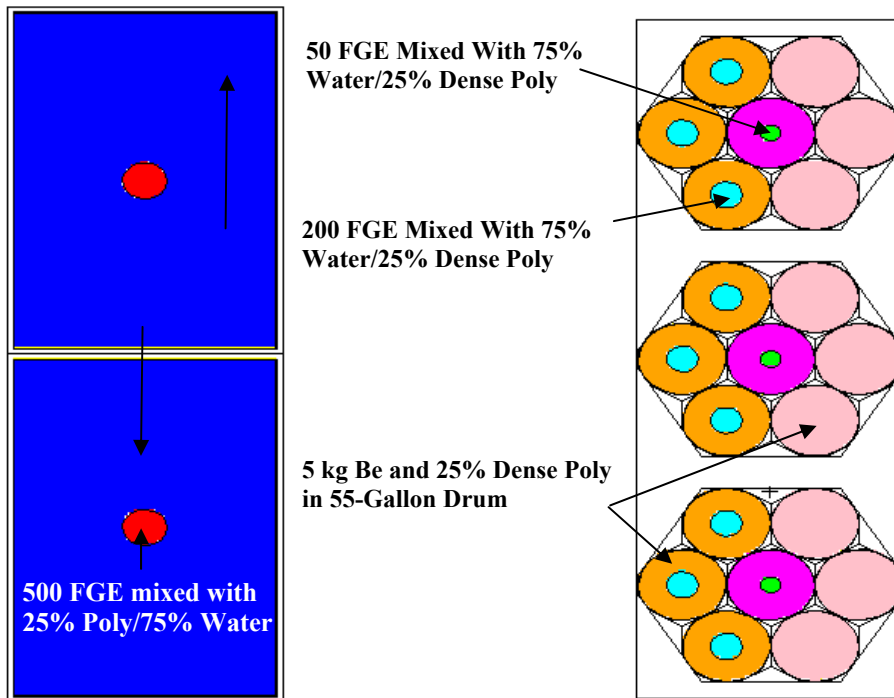
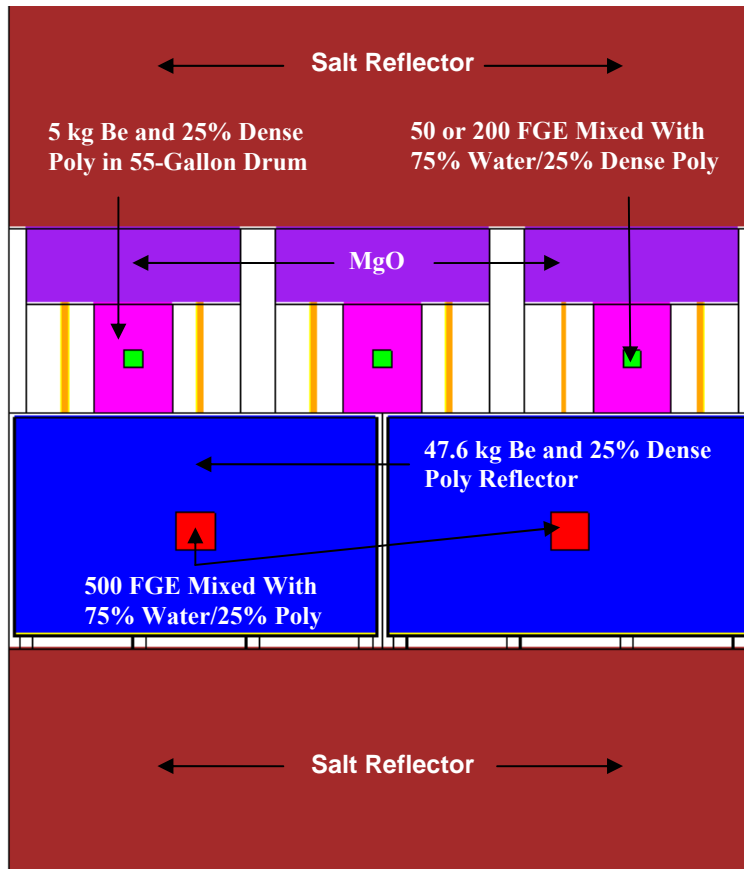

Figure A-, SLB2 Array Model for Seven-pack Drums Stacked on SLB2 Containers

**Table A-, MCNP Results for Underground Array of Seven-pack Drums Stacked
 on Standard Large Box 2 Containers**

H/Pu Ratio	k_{eff}	σ	$k_{\text{eff}} + 2\sigma$	Filename
SLB2 Reflector – Beryllium-Poly Mixture; 7-Pack Drum Reflector – Beryllium-Poly Mixture				
500	0.88586	0.00099	0.88784	slbar10
600	0.91072	0.00081	0.91234	slbar12
700	0.92303	0.00089	0.92481	slbar14
800	0.93368	0.00089	0.93546	slbar16
900	0.94002	0.00086	0.94174	slbar18
1000	0.94146	0.00086	0.94318	slbar20
1100	0.94167	0.00085	0.94337	slbar22
1200	0.93908	0.00080	0.94068	slbar24
1300	0.93714	0.00073	0.93860	slbar26
1400	0.93000	0.00072	0.93144	slbar28
1500	0.92360	0.00074	0.92508	slbar30
SLB2 Reflector – No Poly; 7-Pack Drum Reflector – beryllium-Poly Mixture				
500	0.76566	0.00097	0.76760	slbar50
600	0.79595	0.00091	0.79777	slbar52
700	0.82080	0.00093	0.82266	slbar54
800	0.83351	0.00080	0.83511	slbar56
900	0.84466	0.00089	0.84644	slbar58
1000	0.85079	0.00091	0.85261	slbar60
1100	0.85519	0.00088	0.85695	slbar62
1200	0.85934	0.00081	0.86096	slbar64
1300	0.85612	0.00080	0.85772	slbar66
1400	0.85566	0.00080	0.85726	slbar68
1500	0.85012	0.00085	0.85182	slbar70
SLB2 Reflector – beryllium-Poly Mixture; 7-Pack Drum Reflector – No Poly				
500	0.88361	0.00093	0.88547	slbar90
600	0.90905	0.00094	0.91093	slbar92
700	0.92413	0.00093	0.92599	slbar94
800	0.93635	0.00091	0.93817	slbar96
900	0.93862	0.00081	0.94024	slbar98
1000	0.94174	0.00093	0.94360	slba100
1100	0.94111	0.00080	0.94271	slba102
1200	0.93847	0.00079	0.94005	slba104
1300	0.93408	0.00078	0.93564	slba106
1400	0.93098	0.00075	0.93248	slba108
1500	0.92246	0.00069	0.92384	slba110

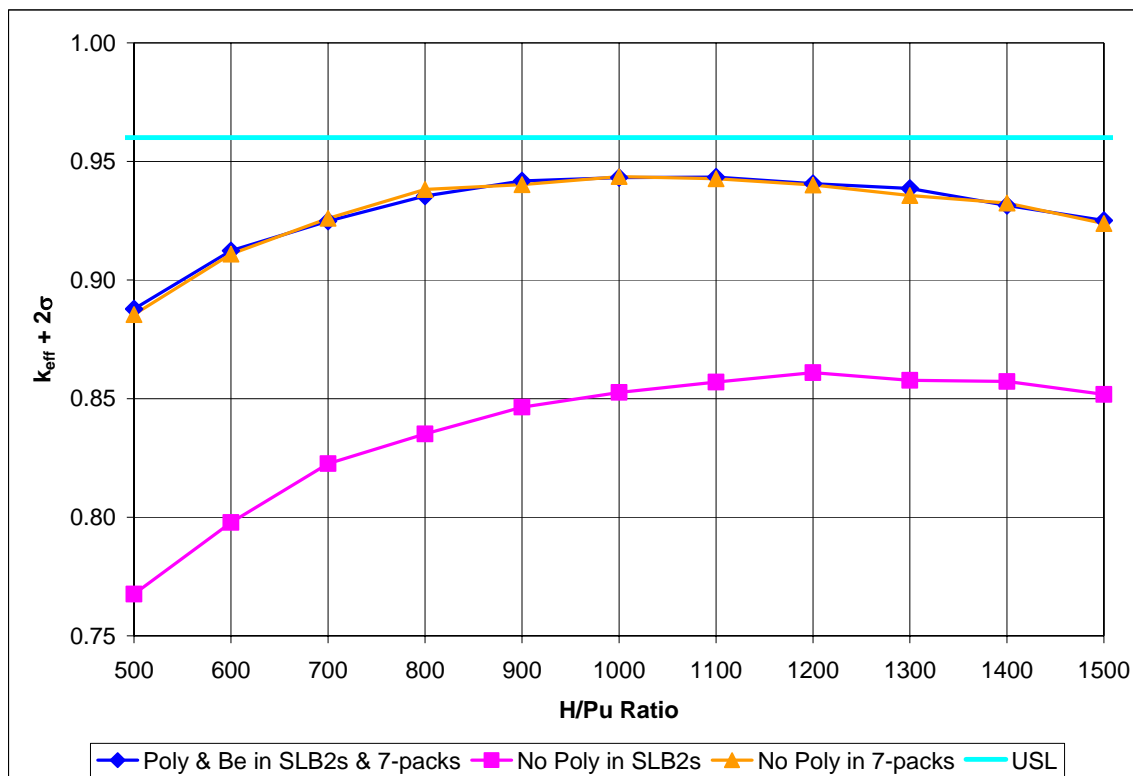

Figure A-, Underground Array Reactivity for Seven-pack Drums Stacked on Standard Large Box 2 Containers

Criticality computations were also performed to address SLB2 waste package arrays that include ^{240}Pu in the fissile mixture. Specifically, three fissile isotope mixtures were considered: 515 grams of ^{239}Pu with 5 grams of ^{240}Pu , 535 grams of ^{239}Pu with 15 grams of ^{240}Pu , and 555 grams of ^{239}Pu with 25 grams of ^{240}Pu . The geometric arrangement and moderator composition in all SLB2 and 55-gallon drums are shown in Figure A-4. In order to maximize the array interaction effects, the most reactive internal reflector composition was selected for the SLB2 and seven-pack stack: 47.6 kilograms of beryllium mixed with 25% dense polyethylene in the SLB2 and no polyethylene reflector in the seven-pack of 55-gallon drums. The results of the calculation are summarized in Table A-4 and Figure A-6. As indicated by the tabulated and graphical data, all cases are below the established USL.

**Table A-, Model Results for Array of Seven-pack Drums Stacked on SLB2
 Containers with $^{239}\text{Pu}/^{240}\text{Pu}$ Mixture**

H/Pu Ratio	k_{eff}	σ	$k_{\text{eff}} + 2\sigma$	Filename
515 g ^{239}Pu with 5 g ^{240}Pu				
500	0.88656	0.00096	0.88848	slbpu10
600	0.90849	0.00096	0.91041	slbpu12
700	0.92593	0.00088	0.92769	slbpu14
800	0.93697	0.00085	0.93867	slbpu16
900	0.94203	0.00088	0.94379	slbpu18
1000	0.94519	0.00085	0.94689	slbpu20
1100	0.94536	0.00079	0.94694	slbpu22
1200	0.94128	0.00082	0.94292	slbpu24
1300	0.93680	0.00079	0.93838	slbpu26
1400	0.93129	0.00074	0.93277	slbpu28
1500	0.92646	0.00073	0.92792	slbpu30
535 g ^{239}Pu with 15 g ^{240}Pu				
500	0.88527	0.00091	0.88709	slbpu50
600	0.91135	0.00089	0.91313	slbpu52
700	0.92712	0.00085	0.92882	slbpu54
800	0.93764	0.00085	0.93934	slbpu56
900	0.94176	0.00082	0.94340	slbpu58
1000	0.94596	0.00075	0.94746	slbpu60
1100	0.94170	0.00076	0.94322	slbpu62
1200	0.94014	0.00078	0.94170	slbpu64
1300	0.93509	0.00072	0.93653	slbpu66
1400	0.93189	0.00072	0.93333	slbpu68
1500	0.92426	0.00070	0.92566	slbpu70
555 g ^{239}Pu with 25 g ^{240}Pu				
500	0.88802	0.00092	0.88986	slbpu90
600	0.91254	0.00097	0.91448	slbpu92
700	0.92922	0.00089	0.93100	slbpu94
800	0.93817	0.00089	0.93995	slbpu96
900	0.94309	0.00083	0.94475	slbpu98
1000	0.94554	0.00078	0.94710	slpu100
1100	0.94481	0.00083	0.94647	slpu102
1200	0.93989	0.00079	0.94147	slpu104
1300	0.93399	0.00073	0.93545	slpu106
1400	0.93089	0.00077	0.93243	slpu108
1500	0.92227	0.00075	0.92377	slpu110

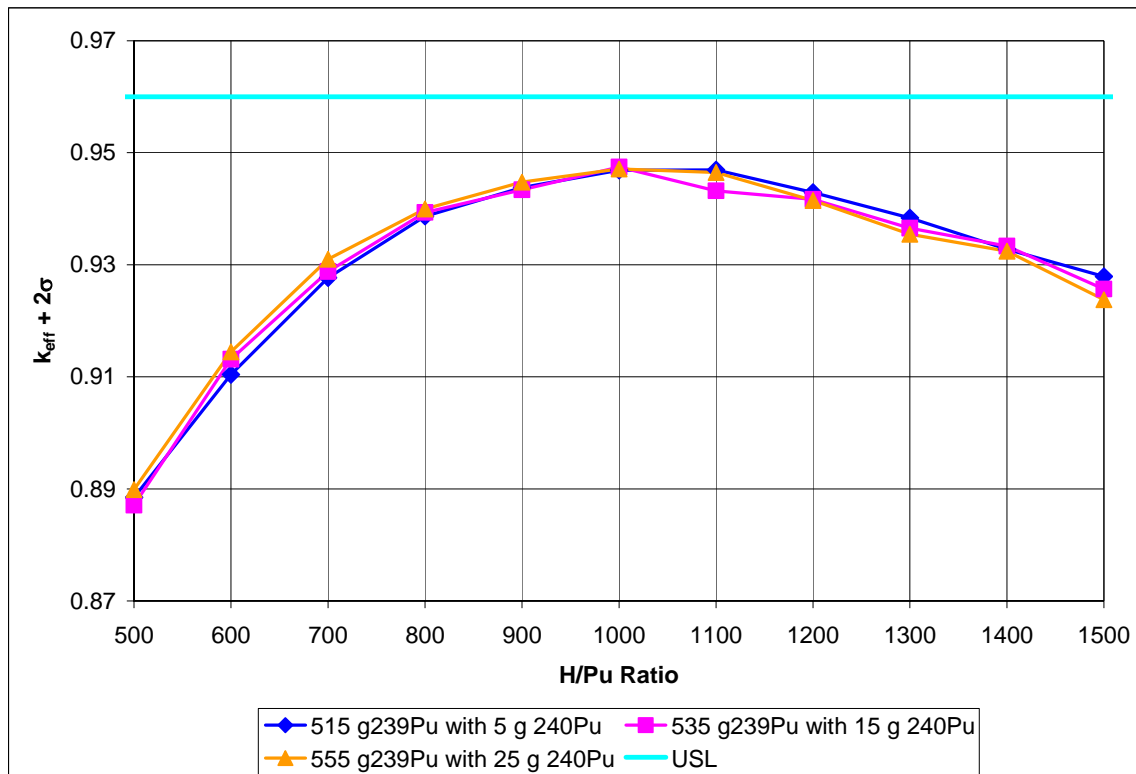

Figure A-, Reactivity for Array of Seven-pack Drums Stacked on SLB2 Containers with ²³⁹Pu/²⁴⁰Pu Mixture

A2.4 ARROW-PAK™ Array Model

The ARROW-PAK™ array model considers a three-packs of ARROW-PAK™ containers on the lower tier and a seven-pack of 55-gallons drums was placed on top of each three-pack such that the two tiers are the equivalent height of three drums. This configuration was then mirrored in the lateral planes creating an infinite storage lattice.

The lower tier of the ARROW-PAK™ array consists of three ARROW-PAK™ containers that are arranged geometrically on a tightly packed triangular pitch. The radial boundaries of the containers touch at three locations. The three-pack is then symmetrically oriented within a hexagonal footprint. The fissile mass within the 55-gallon drum payload containers are modeled as cylinders of 325 grams of ²³⁹Pu with an H/D ratio of 1 centrally located within each payload container. The other model parameters are described in Section . A second configuration with the polyethylene around the fissile mass internal to the drum and also outside the 55-gallon drum is modeled to determine the most reactive configuration; in this case, the 6.25 kilograms of beryllium is still modeled within the payload container.

The upper tier in the ARROW-PAK™ array model consists of a seven-pack of 55-gallon drums. The specific arrangement of the drums with respect to the location and content of the fissile mass is the same as that used in the three-tier, 55-gallon drum array calculations. The two-tier stack

containing an ARROW-PAK™ three-pack in the lower tier and a 55-gallon drum seven-pack in the upper tier is reflected by an MgO layer (approximately 62 centimeters thick) placed on top of the 55-gallon drums and the whole stack is then reflected by 300 centimeters of salt above and below. The two-tier stack is emplaced on a hexagonal footprint whose lateral boundaries were mirrored in order to simulate a storage lattice of infinite extent. Figure A-7 depicts the side view of the configuration and Figure A-8 shows a top view of the ARROW-PAK™ three-pack in the lower tier.

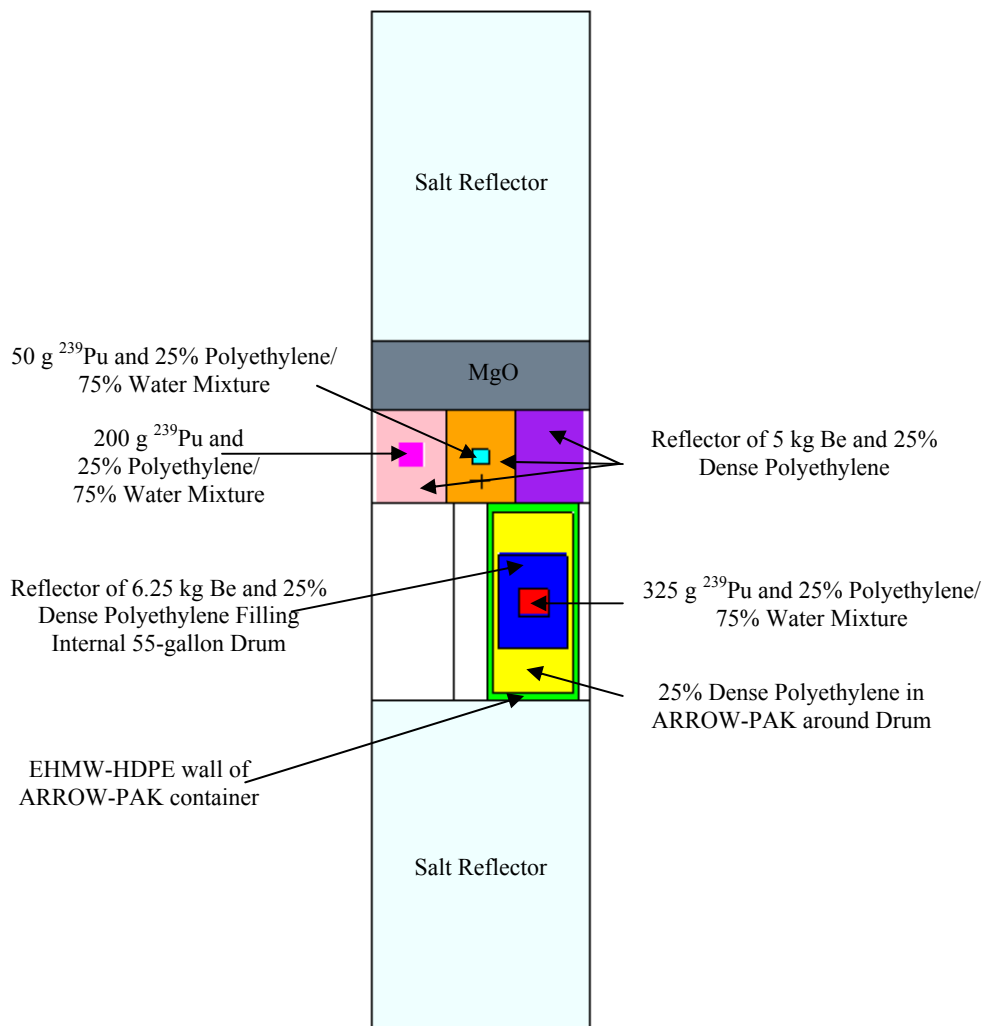

Figure A-, ARROW-PAK Array Geometry in the X-Z Plane

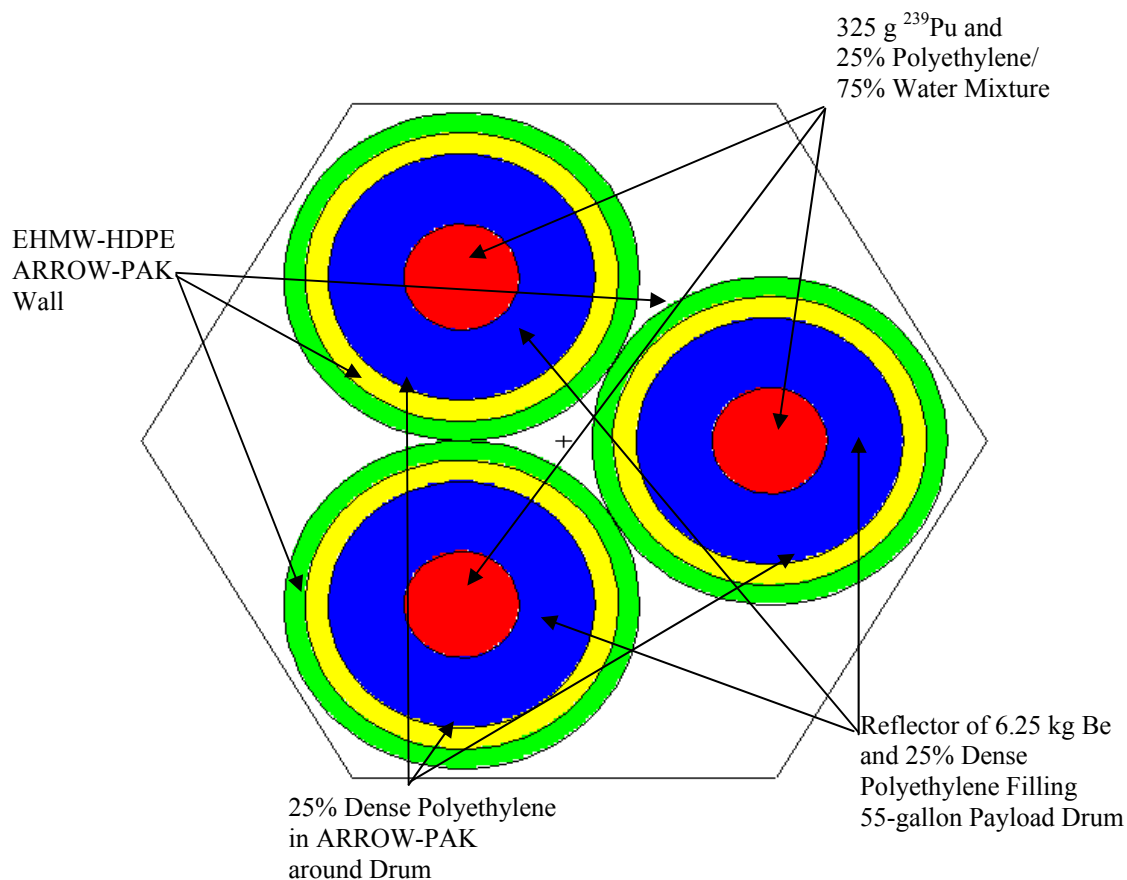

Figure A-, Three-pack Group of ARROW-PAKs™ in the X-Y Plane

The results of the ARROW-PAK™ array computation are summarized in Table A-5 and Figure A-9. The results of the analysis indicate that the maximum reactivity of the array is well below the USL and occurs when the polyethylene dunnage in the drums is at maximum density. This result is different from that obtained for the 55-gallon drum array calculations. These calculations showed that the absence of internal reflection yielded maximal interaction between fissile masses and therefore the largest reactivity state. It is hypothesized that the greater separation between the fissile masses in the ARROW-PAK™ geometry reduces the interaction effect as the polyethylene density is reduced such that the larger system eigenvalue is achieved when the internal reflection is maximized.

**Table A-, MCNP Results for Underground Array Model with
 ARROW-PAK™ Containers**

H/Pu Ratio	k_{eff}	σ	$k_{eff} + 2\sigma$	Filename
25% Dense Polyethylene Reflector in ARROW-PAKs™ and Drums				
500	0.77071	0.00109	0.77289	arpa110
600	0.79923	0.00109	0.80141	arpa112
700	0.81673	0.00107	0.81887	arpa114
800	0.82910	0.00107	0.83124	arpa116
900	0.84064	0.00108	0.84280	arpa118
1000	0.84274	0.00097	0.84468	arpa120
1100	0.84484	0.00096	0.84676	arpa122
1200	0.84475	0.00097	0.84669	arpa124
1300	0.84454	0.00096	0.84646	arpa126
1400	0.84168	0.00093	0.84354	arpa128
1500	0.83774	0.00085	0.83944	arpa130
No Poly Reflector in ARROW-PAKs™ /25% Dense Poly Reflector in Drums				
500	0.66817	0.00107	0.67031	arpa210
600	0.70332	0.00111	0.70554	arpa212
700	0.72557	0.00103	0.72763	arpa214
800	0.74490	0.00098	0.74686	arpa216
900	0.75619	0.00104	0.75827	arpa218
1000	0.76542	0.00101	0.76744	arpa220
1100	0.77108	0.00103	0.77314	arpa222
1200	0.77567	0.00098	0.77763	arpa224
1300	0.77934	0.00099	0.78132	arpa226
1400	0.77849	0.00093	0.78035	arpa228
1500	0.78002	0.00095	0.78192	arpa230
25% Dense Poly Reflector in ARROW-PAKs™ /No Poly Reflector in Drums				
500	0.77164	0.00108	0.77380	arpa310
600	0.79973	0.00103	0.80179	arpa312
700	0.81810	0.00108	0.82026	arpa314
800	0.83091	0.00106	0.83303	arpa316
900	0.83923	0.00105	0.84133	arpa318
1000	0.84298	0.00101	0.84500	arpa320
1100	0.84751	0.00092	0.84935	arpa322
1200	0.84608	0.00095	0.84798	arpa324
1300	0.84506	0.00093	0.84692	arpa326
1400	0.84026	0.00093	0.84212	arpa328
1500	0.83810	0.00088	0.83986	arpa330

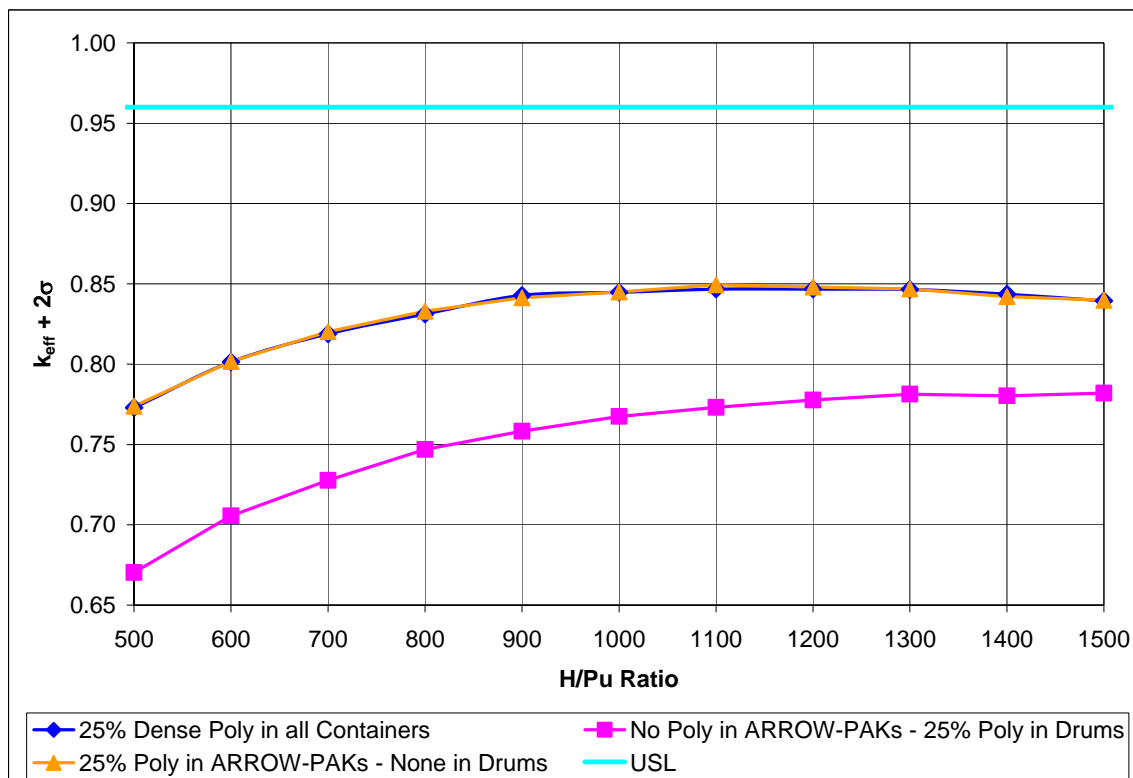

Figure A-1, Underground Array Reactivity for ARROW-PAK™ Containers with Seven-pack of 55-gallon Drums on Top

A2.5 Shielded Container Array Model

An infinite array of shielded containers of non-compacted waste was modeled. Shielded containers are typically placed in a three-pack arrangement because of their weight. Because the shielded container is similar in size to a 55-gallon drum and for conservatism, the seven-pack 55-gallon drum array model discussed in Section was used to evaluate this system. Each shielded container is modeled with 200 grams of ²³⁹Pu and 5 kilograms of beryllium. The fissile mass is modeled as a cylinder located in the center of each container, and the H/D ratio of the cylinder is 1. The beryllium was modeled as a reflector as discussed in Section . The top view of the shielded container array is shown in Figure A-10. To simulate an array of infinite extent, the lateral boundaries of the seven-pack are mirrored and the vertical boundaries reflected by 300 centimeters of salt. The MgO supersack is modeled between the top of the containers on the upper tier of the stack and the upper salt reflection boundary.

The results, as summarized in Table A-6, show that an H/Pu ratio of approximately 1,100 in the fissile mass is most reactive. All cases are below the USL with the highest $k_{eff} + 2\sigma$ value being less than 0.92. Thus, shielded containers with 200 FGE per container and 5 kilograms of beryllium will remain subcritical even in the seven-pack array configuration.

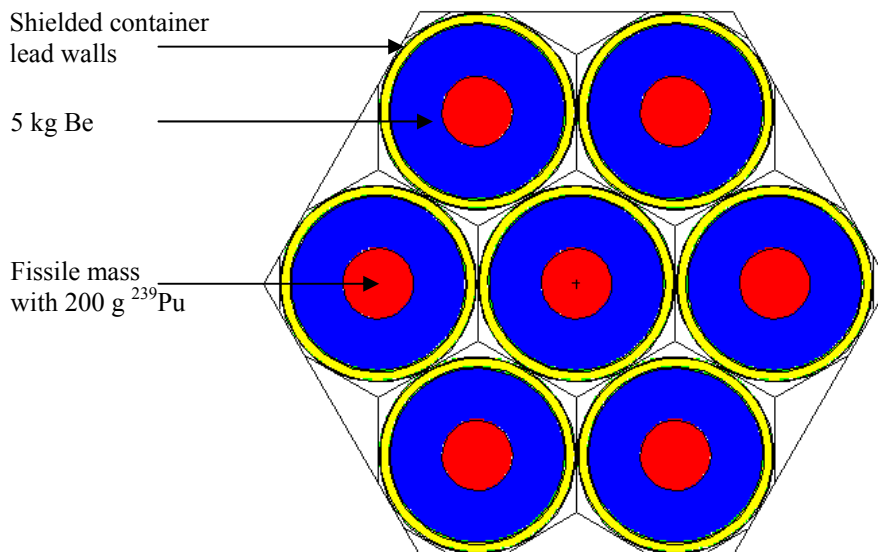

Figure A-, Shielded Containers Seven-pack Array Model, X-Y Plane

Table A-, Results for Shielded Container Seven-pack Array Model with
 200 Fissile Gram Equivalents per Container

H/Pu Ratio	k_{eff}	σ	$k_{eff} + 2\sigma$	Filename
800	0.90687	0.00073	0.90833	pa208a
900	0.91346	0.00072	0.91490	pa209a
1000	0.91505	0.00075	0.91655	pa210a
1100	0.91692	0.00075	0.91842	pa211a
1200	0.91370	0.00065	0.91500	pa212a

A2.6 Array Model of 55-gallon Drums Reflected by Shielded Containers

Shielded containers may be placed adjacent to other waste forms. A model was created with shielded drums around the seven-pack of 55-gallon drums as shown in Figure A-11 to investigate the effect of lead reflection on adjacent non-shielded containers. The outer hexagonal surface around the shielded containers is infinitely reflected to model an infinite array. The fissile mass is modeled as a cylinder located in the center of each container and the containers are stacked three tiers high with MgO and salt reflection.

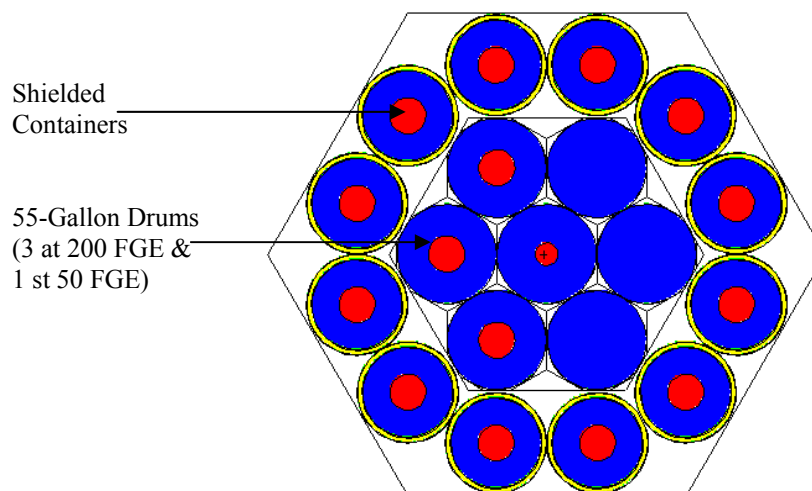

Figure A-, Typical Shielded Container Reflection Model, X-Y Plane

The results in Table A-6 show that an H/Pu ratio of approximately 1,100 is most reactive. All cases are below the USL with the highest $k_{\text{eff}} + 2\sigma$ value being less than 0.92. A further variation of the shielded container reflection model was analyzed with the third tier of 55-gallon drums replaced with a seven-pack of shielded containers. These results given in Table A-7 show that an H/Pu ratio of approximately 1,100 is most reactive. The maximum $k_{\text{eff}} + 2\sigma$ value for this model is less than 0.90. Per Section , the reactivity of the seven-pack array of 55-gallon drums alone is just above 0.90. Thus, the shielded containers have little effect on the reactivity of the non-shielded containers.

Table A-, Results for Intermixed Array of Shielded Containers and 55-gallon Drums

H/Pu Ratio	k_{eff}	σ	$k_{\text{eff}} + 2\sigma$	Filename
Three-tier stack of 55-gallon drums surrounded by shielded containers				
900	0.88728	0.00075	0.88878	pbr509a
1000	0.89387	0.00079	0.89545	pbr510a
1100	0.89404	0.00071	0.89546	pbr511a
1200	0.89289	0.00072	0.89433	pbr512a
1300	0.89046	0.00074	0.89194	pbr513a
1400	0.88510	0.00069	0.88648	pbr514a
Two-tier stack of 55-gallon drums with shielded containers around and on third tier				
900	0.89114	0.00073	0.89260	pbr509p
1000	0.89249	0.00077	0.89403	pbr510p
1100	0.89490	0.00072	0.89634	pbr511p
1200	0.89310	0.00071	0.89452	pbr512p
1300	0.89031	0.00069	0.89169	pbr513p
1400	0.88514	0.00064	0.88642	pbr514p

A3.0 MCNP5 Two-container Direct-loaded Waste Models

The geometry of the two-container model positions the fissile mass at the top of the bottom container and at the bottom of the top container. Consequently, the fissile regions are only separated by the container lid and bottom and any inherent spacing that may be built into the lid or bottom. The fissile mass in each container is modeled as a cylinder with an H/D ratio of 0.5 whereas resulting cylinder in the two containers has an optimum H/D ratio of 1. Figure A-12 shows SWBs in the modeled two-container configuration. The 55-gallon drums and SWBs of direct-loaded waste are evaluated in this configuration. The ARROW-PAK™ is not considered because the configuration of the container keeps the inner 55-gallon drum payload container centered in the ARROW-PAK™.

Three types of materials are analyzed as tight reflectors around the containers: concrete, MgO, and salt. In each case, the material is 300 centimeters thick on all sides of the container stack, effectively creating an infinite reflector. Concrete and salt are analyzed to represent reflection from above-ground facility structures and the underground repository, respectively. MgO is also analyzed because MgO may be placed in columns in the underground disposal array in addition to on top of the three-high container stacks. The material compositions used for these reflector materials are described in Section .

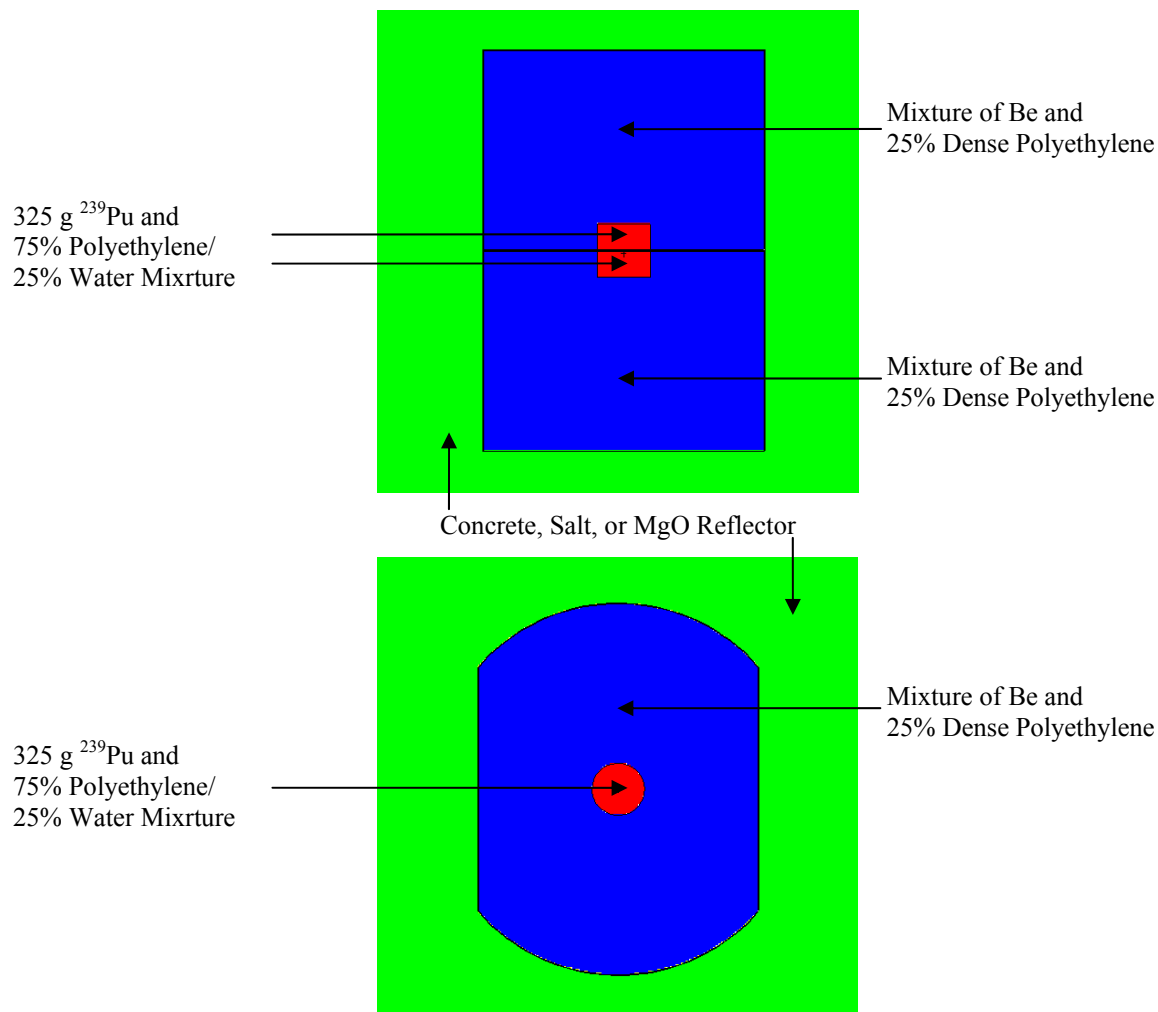

Figure A-, Example Two-Container Model Configuration Showing Two Standard Waste Boxes

A3.1 55-gallon Drum Two-Container Model

The parameters for the fissile material input into MCNP5 are given in Table A-8 for the 55-gallon drum two-container model. The results for the model as a function of H/Pu ratio in the fissile region are given in Table A-9. All cases are well below the USL with the highest $k_{\text{eff}} + 2\sigma$ value being less than 0.89. Thus, 55-gallon drums containing 200 FGE will remain subcritical in the two-container configuration.

Table A-, Parameters for 200 FGE Cylinder in 55-gallon Drum Two-Container Model

H/Pu Ratio	Density (g/cm ³)	Pu (wt. fraction)	H (wt. fraction)	O (wt. fraction)	C (wt. fraction)	Cylinder Height (cm)	Cylinder Radius (cm)
700	1.0170	0.038887	0.114771	0.652466	0.193876	11.71972	11.71972
800	1.0123	0.034193	0.115331	0.655653	0.194823	12.25214	12.25214
900	1.0087	0.030509	0.115771	0.658153	0.195566	12.74192	12.74192
1000	1.0057	0.027542	0.116125	0.660167	0.196165	13.19668	13.19668
1100	1.0033	0.025101	0.116417	0.661824	0.196657	13.62210	13.62210
1200	1.0013	0.023058	0.116661	0.663212	0.197070	14.02248	14.02248

Table A-, Results for 55-gallon Drum Two-Container Model at 200 FGE

H/Pu Ratio	Reflector	k _{eff}	σ	k _{eff} + 2σ	Filename
800	Concrete	0.87265	0.00096	0.87458	c55g800
900	Concrete	0.87910	0.00094	0.88098	c55g900
1000	Concrete	0.88398	0.00095	0.88588	c55g100
1100	Concrete	0.88241	0.00094	0.88429	c55g110
1200	Concrete	0.88183	0.00088	0.88359	c55g120
800	MgO	0.87461	0.00098	0.87657	m55g800
900	MgO	0.88228	0.00096	0.88420	m55g900
1000	MgO	0.88433	0.00094	0.88622	m55g100
1100	MgO	0.88402	0.00094	0.88590	m55g110
1200	MgO	0.88194	0.00087	0.88369	m55g120
800	Salt	0.87256	0.00101	0.87459	s55g800
900	Salt	0.87796	0.00096	0.87988	s55g900
1000	Salt	0.88087	0.00093	0.88272	s55g100
1100	Salt	0.88250	0.00090	0.88431	s55g110
1200	Salt	0.88076	0.00088	0.88251	s55g120

A3.2 Shielded Two-Container Model

A two-container model of the shielded container was used to evaluate a 200 grams of ²³⁹Pu system with 100 kilograms beryllium (although limited to 5 kilograms beryllium for the non-compacted case, 100 kilograms beryllium was modeled to bound the greater than 1 wt% special reflector case). The fissile mass in the top container is located at the bottom and the fissile mass in the bottom container is located in the top, so that the H/D ratio of the two combined cylinders is 1. Concrete, MgO, and salt are modeled as external reflectors (300 centimeters thick).

Figure A-13 shows the configuration. The optimum fissile material moderator of 25% polyethylene and 75% water is modeled. The results for the model as a function of H/Pu ratio in the moderator are given in Table A-10. All cases are well below the USL with the highest $k_{eff} + 2\sigma$ value being 0.91049. Such a low result was expected as the thick steel reflector in the lid and bottom of the shielded container separates and isolates the fissile masses in the two containers.

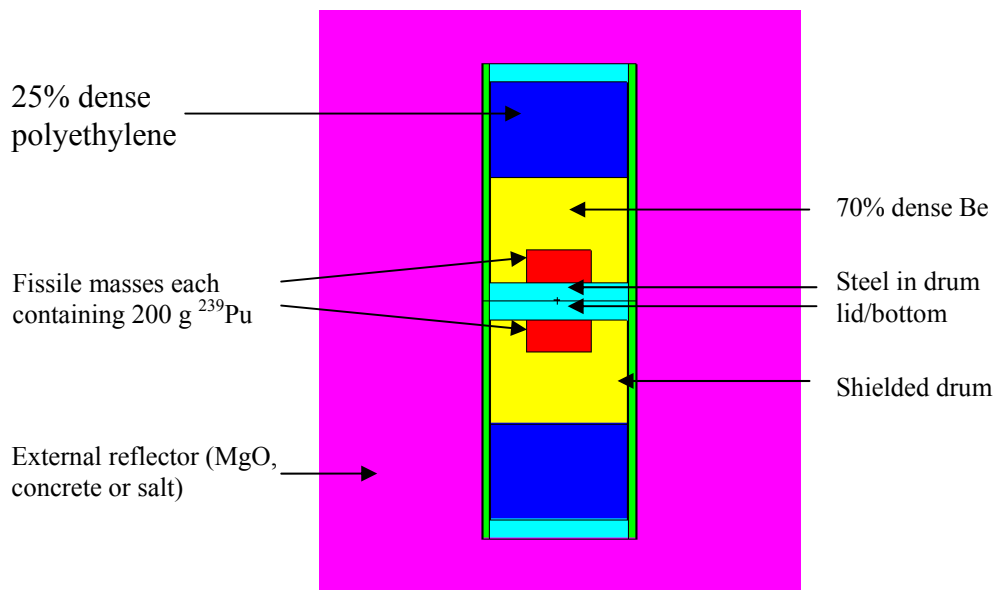

Figure A-, Typical Shielded Container Two-Container Model

Table A-, Results for Shielded Container Two-Container Model at 200 FGE

H/Pu Ratio	Reflector	k_{eff}	σ	$k_{eff} + 2\sigma$	Filename
600	MgO	0.89606	0.00101	0.89808	pb206m
800	MgO	0.90845	0.00102	0.91049	pb208m
1000	MgO	0.90654	0.00096	0.90846	pb210m
600	Concrete	0.88871	0.00107	0.89085	pb206c
800	Concrete	0.90054	0.00105	0.90264	pb208c
1000	Concrete	0.90037	0.00090	0.90217	pb210c
600	Salt	0.88809	0.00105	0.89019	pb206s
800	Salt	0.90110	0.00099	0.90308	pb208s
1000	Salt	0.90013	0.00094	0.90201	pb210s

A3.3 Standard Waste Box Two-Container Model

The parameters for the fissile material input into MCNP5 for the two-container SWB model are given in Table A-11. Table A-12 shows the initial SWB results with a 50% dense wall, where many of the cases exceed the USL of 0.97. Two alternatives can be evaluated to address the cases that are above the USL. First, consider the assumed steel degradation of 50%. If the degradation were slightly less, such as 40%, more steel would be present to reduce the interaction of the two fissile masses. Table A-13 shows that crediting 60% of the steel wall, which still allows for 40% degradation, maintains the reactivity below the USL without administrative margin of 0.97 for all cases.

Second, consider the conservative modeling assumption that the fissile mass in the lower container will be suspended in the SWB tightly against the lid. A parametric study on the separation distance between the fissile masses was performed to determine the sensitivity of the reactivity to this distance. The results given in Table A-14 and plotted in Figure A-14 are for an MgO-reflected two-container model (only MgO was considered as the calculations showed that the various reflectors resulted in statistically identical results.) These results indicate that k_{eff} is reduced significantly with small separation distances. A less than 1 centimeter separation between the fissile mass and the SWB lid is needed to reduce the $k_{\text{eff}} + 2\sigma$ value below the USL of 0.96 and a two-centimeter separation further reduces the value to less than 0.943. It is unlikely that optimally moderated fissile masses in two stacked SWBs would be oriented such that the fissile mass in the lower SWB would be directly opposite a second fissile mass in the upper SWB. Consequently, a mass limit of 325 FGE per SWB is acceptable.

Table A-, Parameters for 325 FGE Cylinder in SWB Two-Container Model

H/Pu Ratio	Density (g/cm ³)	Pu (wt. fraction)	H (wt. fraction)	O (wt. fraction)	C (wt. fraction)	Cylinder Height (cm)	Cylinder Radius (cm)
700	1.0170	0.038887	0.114771	0.652466	0.193876	13.77850	13.77850
800	1.0123	0.034193	0.115331	0.655653	0.194823	14.40444	14.40444
900	1.0087	0.030509	0.115771	0.658153	0.195566	14.98025	14.98025
1000	1.0057	0.027542	0.116125	0.660167	0.196165	15.51491	15.51491
1100	1.0033	0.025101	0.116417	0.661824	0.196657	16.01505	16.01505
1200	1.0013	0.023058	0.116661	0.663212	0.197070	16.48577	16.48577

**Table A-, Results for Two-Container SWB Model at 325 FGE with 50%
 Steel Wall Density Modeled**

H/Pu Ratio	Reflector	k_{eff}	σ	k_{eff} + 2σ	Filename
700	Concrete	0.96278	0.00097	0.96473	cswb700
800	Concrete	0.97092	0.00097	0.97286	cswb800
900	Concrete	0.97115	0.00093	0.97300	cswb900
1000	Concrete	0.96861	0.00094	0.97049	cswb100
1100	Concrete	0.96868	0.00093	0.97053	cswb110
1200	Concrete	0.96268	0.00090	0.96449	cswb120
700	MgO	0.96234	0.00101	0.96437	mswb700
800	MgO	0.96827	0.00095	0.97017	mswb800
900	MgO	0.97189	0.00097	0.97382	mswb900
1000	MgO	0.97183	0.00094	0.97372	mswb100
1100	MgO	0.96878	0.00087	0.97051	mswb110
1200	MgO	0.96289	0.00089	0.96467	mswb120
700	Salt	0.96236	0.00104	0.96444	sswb700
800	Salt	0.96899	0.00096	0.97091	sswb800
900	Salt	0.97318	0.00094	0.97505	sswb900
1000	Salt	0.96911	0.00092	0.97095	sswb100
1100	Salt	0.96755	0.00089	0.96934	sswb110
1200	Salt	0.96231	0.00088	0.96406	sswb120

**Table A-, Results for Two-Container SWB Model at 325 FGE with 60%
 Steel Wall Density Modeled**

H/Pu Ratio	Reflector	k_{eff}	σ	k_{eff} + 2σ	Filename
700	Concrete	0.95809	0.00105	0.96019	cswb706
800	Concrete	0.96746	0.00089	0.96924	cswb806
900	Concrete	0.96816	0.00070	0.96957	cswb906
1000	Concrete	0.96823	0.00068	0.96960	cswb106
1100	Concrete	0.96525	0.00088	0.96701	cswb116
1200	Concrete	0.95944	0.00083	0.96111	cswb126
700	MgO	0.96082	0.00105	0.96291	mswb706
800	MgO	0.96671	0.00100	0.96872	mswb806
900	MgO	0.96774	0.00086	0.96947	mswb906
1000	MgO	0.96905	0.00036	0.96976	mswb106
1100	MgO	0.96501	0.00093	0.96686	mswb116
1200	MgO	0.96166	0.00088	0.96343	mswb126
700	Salt	0.96075	0.00103	0.96281	sswb706
800	Salt	0.96569	0.00098	0.96765	sswb806
900	Salt	0.96785	0.00080	0.96946	sswb906
1000	Salt	0.96750	0.00086	0.96921	sswb106
1100	Salt	0.96487	0.00090	0.96668	sswb116
1200	Salt	0.96114	0.00089	0.96291	sswb126

**Table A-, Parametric Study on Separation Distance in MgO Reflected
 Two-Container SWB Model**

Distance Between Fissile Masses (cm)	Optimum H/Pu Ratio	k_{eff}	σ	$k_{eff} + 2\sigma$	Filename
0	1000	0.96905	0.00036	0.96976	mswb106
0.5	900	0.96305	0.00057	0.96419	swm0518
1.0	1000	0.95656	0.00053	0.95762	swm1020
1.5	900	0.94872	0.00057	0.94986	swm1518
2.0	1000	0.94158	0.00053	0.94264	swm2020

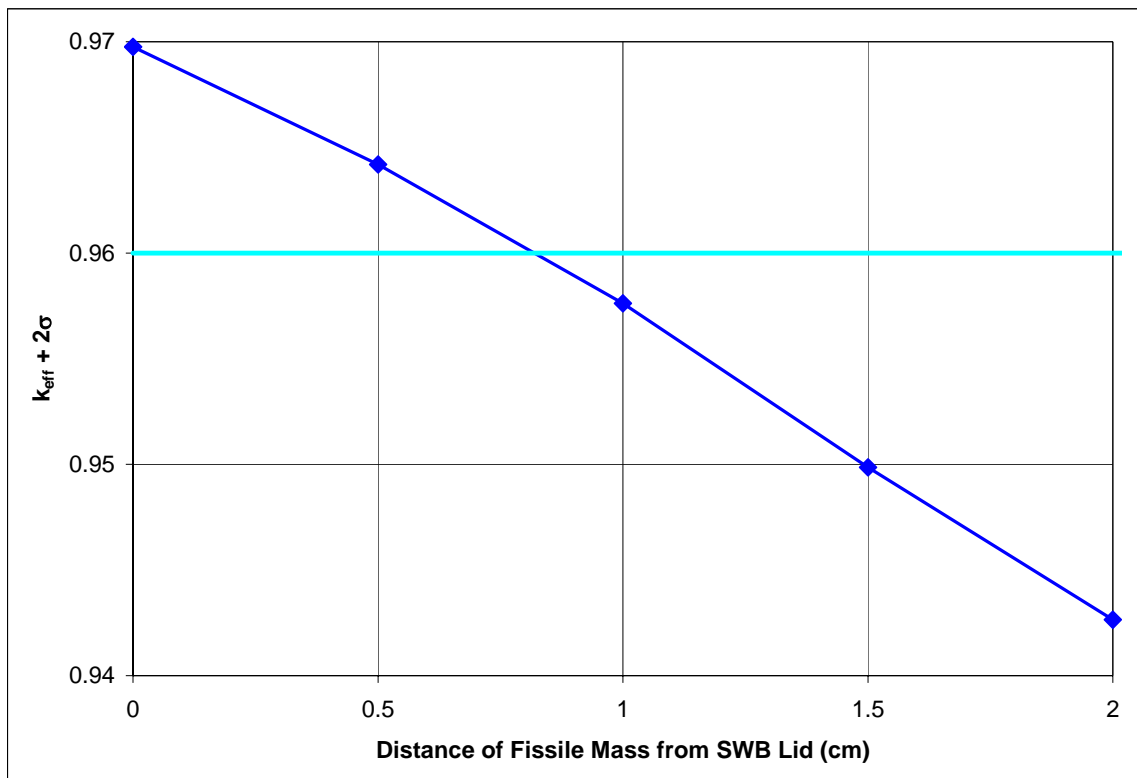

Figure A-, Effect of Separation between Fissile Mass and SWB Lid in Lower SWB in Two-Container Model

A3.4 Standard Large Box 2 Two-Container Model

The SLB2 two-container model assumes that an SWB is stacked on top of an SLB2 as shown in Figure A-15. This two-drum configuration was selected since a two-container SLB2 stack is not feasible at the WIPP due to the height of the SLB2. As indicated by the figure, the fissile masses in each container type are closely positioned, separated by the 0.1875-inch-thick SLB2 steel lid, the 0.125-inch-thick steel SWB bottom, and the inherent design spacing of 1.25 inches provided

by the SLB2 container lid reinforcing steel materials. Only the spacing of these reinforcements is modeled; the total spacing provided by the lid as modeled is 1.4375 inches. The fissile mass in each container type is modeled as a cylinder with an H/D ratio of 0.5 whereas the resulting cylinder in the two containers has an optimum H/D ratio of 1. A 50% dense wall at full thickness is assumed to account for possible wall degradation.

The composition of the fissile units in both containers are assumed to be at their FGE limit (500 grams of ^{239}Pu for the SLB2 and 325 grams of ^{239}Pu for the SWB) moderated by a polyethylene-water mixture that is 75% by volume water and 25% by volume polyethylene. The internal reflector composition for the SLB2 is a mixture of 47.6 kilograms of beryllium mixed with 25% dense polyethylene. A similar composition is used for the SWB internal reflection state, but with a lower beryllium content (18.14 kilograms). Finally, to account for the various external reflection states that could exist during handling and disposal in the underground repository, the two-container configuration was reflected by 300 centimeters of either concrete, MgO, or salt.

The results of the SLB2-SWB two-container computations are summarized in Table A-15 and Figure A-16 for the three reflection states. All cases are below the USL with the highest $k_{\text{eff}} + 2\sigma$ value being 0.95798 with concrete reflection.

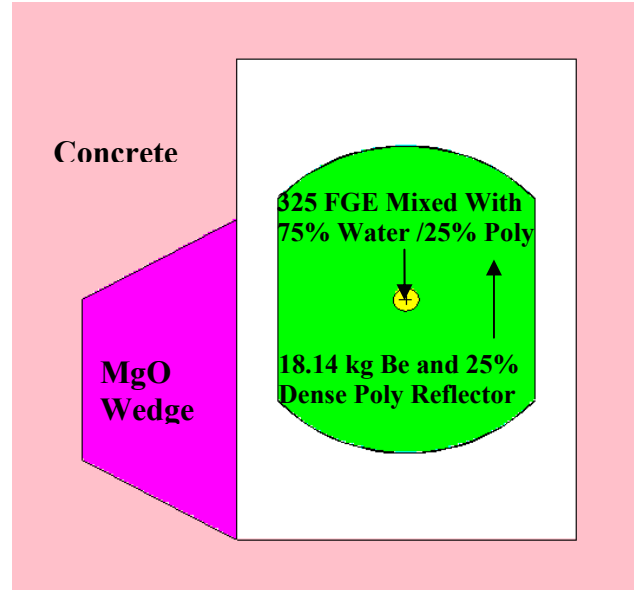
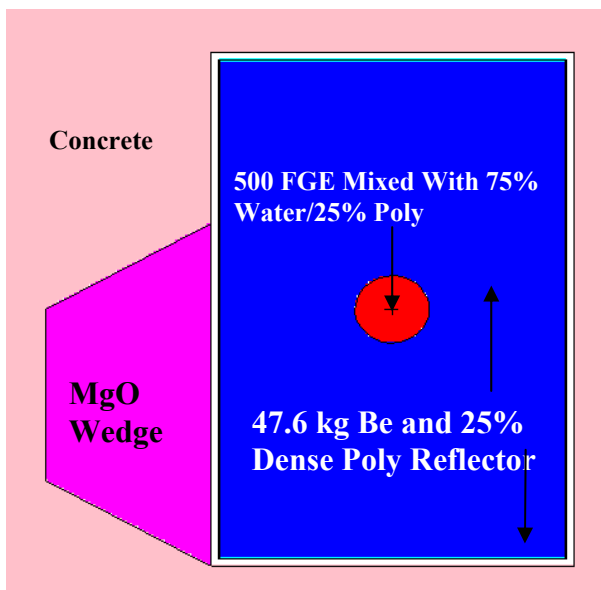
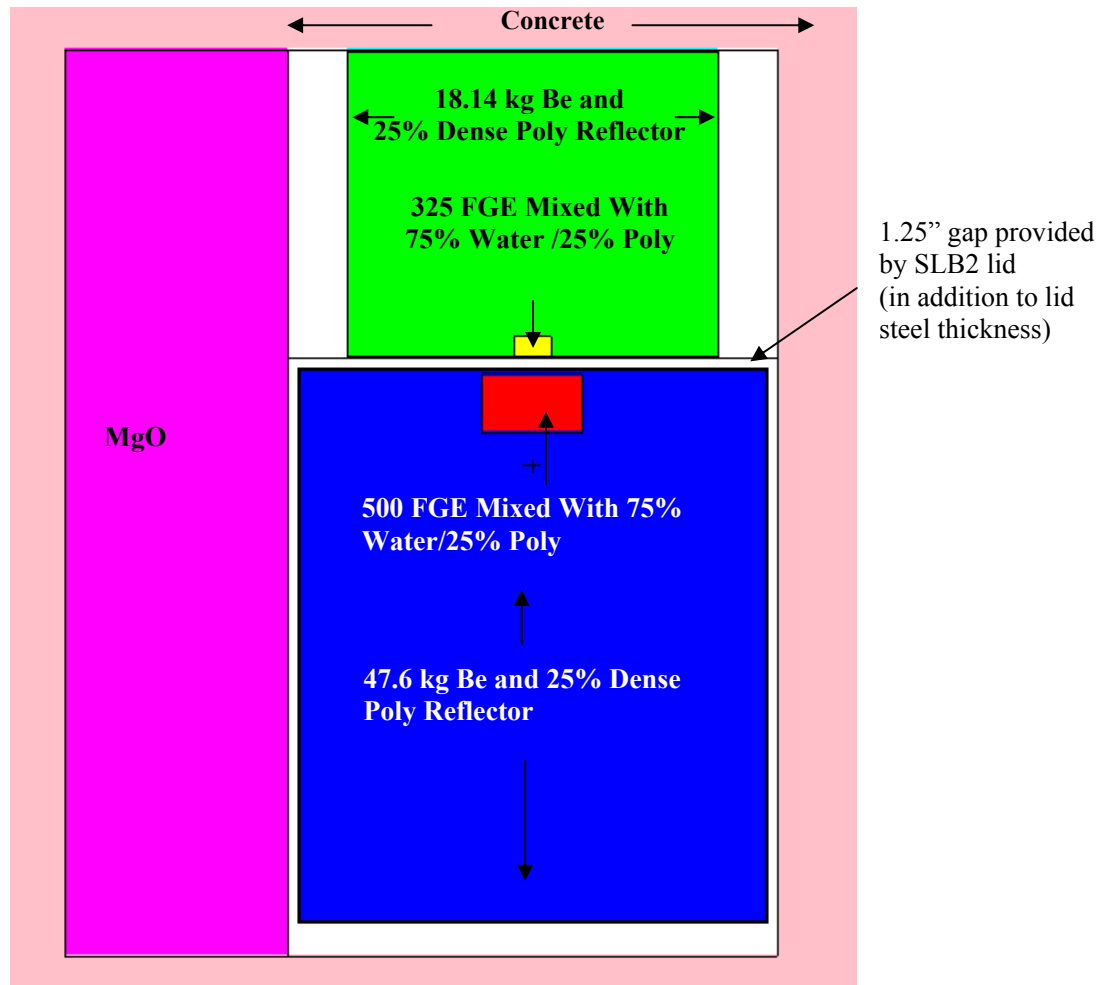

Figure A-, SLB2-SWB Two-container Model

**Table A-, MCNP Results for SLB2-SWB 2 Container Model With
 Different External Reflectors**

H/Pu Ratio	k_{eff}	σ	$k_{eff} + 2\sigma$	Filename
Concrete Reflector				
500	0.90413	0.00102	0.90617	slwtd10
600	0.92570	0.00087	0.92744	slwtd12
700	0.94139	0.00088	0.94315	slwtd14
800	0.94869	0.00079	0.95027	slwtd16
900	0.95430	0.00083	0.95596	slwtd18
1000	0.95624	0.00087	0.95798	slwtd20
1100	0.95387	0.00085	0.95557	slwtd22
1200	0.94954	0.00075	0.95104	slwtd24
1300	0.94621	0.00075	0.94771	slwtd26
1400	0.94000	0.00070	0.94140	slwtd28
1500	0.93299	0.00074	0.93447	slwtd30
Salt Reflector				
500	0.90331	0.00086	0.90503	slwtd50
600	0.92547	0.00087	0.92721	slwtd52
700	0.94057	0.00083	0.94223	slwtd54
800	0.95050	0.00080	0.95210	slwtd56
900	0.95607	0.00081	0.95769	slwtd58
1000	0.95487	0.00085	0.95657	slwtd60
1100	0.95352	0.00086	0.95524	slwtd62
1200	0.94976	0.00083	0.95142	slwtd64
1300	0.94639	0.00073	0.94785	slwtd66
1400	0.93969	0.00077	0.94123	slwtd68
1500	0.93267	0.00071	0.93409	slwtd70
MgO Reflector				
500	0.90131	0.00095	0.90321	slwtd90
600	0.92555	0.0009	0.92735	slwtd92
700	0.94101	0.00094	0.94289	slwtd94
800	0.95271	0.00083	0.95437	slwtd96
900	0.95271	0.00081	0.95433	slwtd98
1000	0.95464	0.00085	0.95634	slwd100
1100	0.95450	0.00078	0.95606	slwd102
1200	0.95075	0.00077	0.95229	slwd104
1300	0.94627	0.00080	0.94787	slwd106
1400	0.94032	0.00068	0.94168	slwd108
1500	0.93257	0.00072	0.93401	slwd110

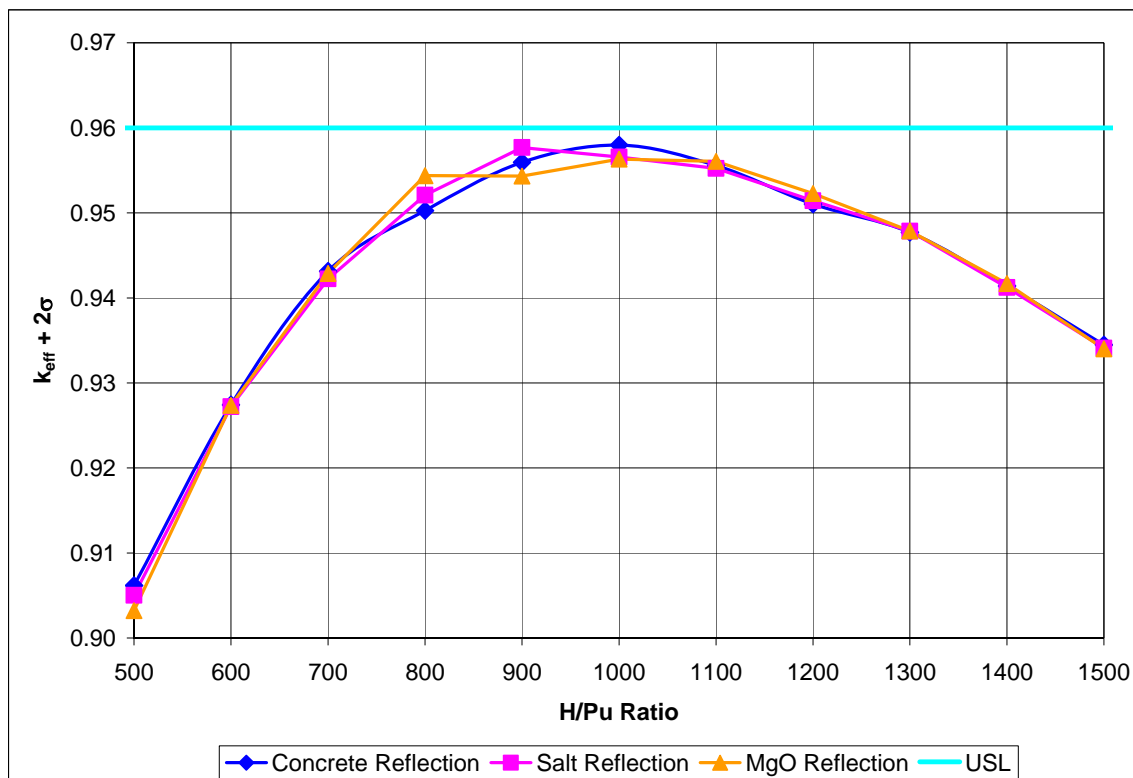

Figure A-, System Reactivity for SLB2-SWB Two-Container Model

A4.0 MCNP5 Direct-loaded Waste Contingency Models

Contingent conditions were also evaluated for the underground storage array of various direct-loaded waste packages containing non-compacted fissile-bearing waste. Since the two-container models are sufficiently conservative to bound any contingency of more realistic or expected conditions related to the interaction between small numbers of containers, only array configurations with centrally located fissile material will be considered.

The contingency states evaluated in this section consisted of overstacking, overbatching, loss of geometry, and sprinkler system activation events. The contingency analyses for the various waste configurations consisted of:

- An overstacking event where the seven-packs were stacked four tiers high;
- An FGE overbatching event where the four fissile-bearing drums in the middle tier of seven-packs contained 50, 100, 200, and 300 FGE;
- An overbatching event where one of the fissile-bearing drums in the middle tier contained 10 kilograms of beryllium;
- An overbatching event where the FGE in one of the ARROW-PAK™ containers was increased by a factor of 1.5 from 325 to 487.5;

- A loss of geometry control resulting from an underground roof falling event performed with and without the 15 inches of compaction of the bottom row; and
- A sprinkler activation event in the WHB used resulting in interstitial moderation between the waste containers.

A4.1 55-gallon Drum Array Overstack Model

Although WIPP panel heights were designed to accommodate three layers of waste containers, ground control safety constraints have resulted in areas of the disposal rooms being mined to a height greater than 13 feet. As a result, it is possible to stack greater than three tiers including the MgO. The computational results for a four-tier stack of seven-packs yielded a system eigenvalue less than 0.96 as summarized in Table A-16.

Table A-, Results for an Array Overstacking Event with 55-Gallon Drum Seven-packs Four Tiers High

H/Pu Ratio	k_{eff}	σ	$k_{eff}+2\sigma$	Filename
800	0.93608	0.00080	0.93768	dac4h16
900	0.94303	0.00073	0.94449	dac4h18
1000	0.94770	0.00070	0.94910	dac4h20
1100	0.94779	0.00067	0.94913	dac4h22
1200	0.94501	0.00072	0.94645	dac4h24
1300	0.94382	0.00069	0.94520	dac4h26

A4.2 Array Overbatch Models

An overbatch event is highly unlikely since waste is required to meet the WAC as part of the approval to ship waste to WIPP. However to ensure a conservative bound on waste storage, handling, and disposal of CH waste packages with less than 1% beryllium, a contingency event was simulated where it was assumed that one container in a three-tier stack is overbatched by 50% of its nominal value. From a modeling perspective, one container in the bottom or middle tier is overbatched and the stack is infinitely reflected on the lateral surfaces as in the base array model. This is conservative as it results in one of twenty one 55-gallon drums or shielded containers, one of nine ARROW-PAKs™, or one in three SWBs being overbatched. In the 55-gallon drum array, the seven-pack limit of 650 FGE was maintained, but in the ARROW-PAK™ and shielded container arrays, the pack limit was ignored and the other containers contained 325 FGE and 200 FGE, respectively. The other SWBs were modeled with 325 FGE per container. All overbatching contingency computations yielded a system eigenvalue under 0.96. Table A-17 through Table A-22 summarize the results of the MCNP5 calculations.

Table A-, Results for an Overbatching Event Where the Four Fissile Drums in the Middle Tier Contained 50, 100, 200, and 300 FGE

H/Pu Ratio	k_{eff}	σ	$k_{eff}+2\sigma$	Filename
800	0.89083	0.00078	0.89239	dacdb16
900	0.90061	0.00079	0.90219	dacdb18
1000	0.90498	0.00079	0.90656	dacdb20
1100	0.90888	0.00078	0.91044	dacdb22
1200	0.90994	0.00077	0.91148	dacdb24
1300	0.90760	0.00069	0.90898	dacdb26
1400	0.90594	0.00065	0.90724	dacdb28
1500	0.90183	0.00064	0.90311	dacdb30

Table A-, Results for an FGE Overbatching Event Where One ARROW-PAK™ contained 487.5 FGE

H/Pu Ratio	k_{eff}	σ	$k_{eff}+2\sigma$	Filename
800	0.93253	0.00105	0.93463	arpdb16
900	0.93946	0.00101	0.94148	arpdb18
1000	0.94082	0.00100	0.94282	arpdb20
1100	0.93917	0.00098	0.94113	arpdb22
1200	0.93683	0.00094	0.93871	arpdb24
1300	0.93531	0.00089	0.93709	arpdb26
1400	0.92721	0.00089	0.92899	arpdb28
1500	0.92170	0.00090	0.92350	arpdb30

Table A-, Results for FGE Overbatching Event with One Shielded Container at 300 FGE

H/Pu Ratio	k_{eff}	σ	$k_{eff}+2\sigma$	Filename
900	0.92573	0.00068	0.92709	pa309a
1000	0.92927	0.00074	0.93075	pa310a
1100	0.92835	0.00066	0.92967	pa311a
1200	0.92607	0.00070	0.92747	pa312a

**Table A-, Results for an FGE Overbatching Event with
 One SWB at 487.5 FGE**

H/Pu Ratio	k_{eff}	σ	$k_{eff}+2\sigma$	Filename
500	0.87914	0.00059	0.88032	swbao10
600	0.90458	0.00059	0.90576	swbao12
700	0.92052	0.00060	0.92172	swbao14
800	0.93013	0.00058	0.93129	swbao16
900	0.93525	0.00056	0.93637	swbao18
1000	0.93801	0.00053	0.93907	swbao20
1100	0.93803	0.00051	0.93905	swbao22
1200	0.93530	0.00054	0.93638	swbao24
1300	0.93197	0.00051	0.93299	swbao26
1400	0.92654	0.00050	0.92754	swbao28
1500	0.91995	0.00049	0.92093	swbao30

An overbatching contingency for an array of SLB2s in the underground disposal configuration was also analyzed. The SLB2 array model for the underground repository was consistent with that used in the nominal baseline analyses in that the emplacement configuration assumed that seven-packs of 55-gallon drums at their FGE limit were placed on top of the SLB2s as shown in Figure A-4. The lateral boundaries are mirrored to simulate an infinite array and the vertical boundaries are reflected with 300 centimeters of salt with an intervening MgO layer between the top of the seven-packs and the upper salt boundary. However, due to the high FGE loading limit in the SLB2, an increase in the fissile content of the SLB2s results in a system reactivity that exceeded the pre-established USL. However, it is not credible that such a large ^{239}Pu fissile mass optimally moderated by a polyethylene-water mixture will be suspended at the center of the large waste box filled with loosely dispersed dunnage at a bulk density of only 25% of its maximum density. Instead, the more realistic configuration used in the *TRUPACT-III Safety Analysis Report* (DOE-CBFO 2007) criticality analysis was adopted where the more dense fissile mass settles in the bottom corner of the SLB2. Figure A-17 illustrates how the overbatched SLB2s are modeled.

A computational analysis simulating an overbatching event where the fissile content in the SLB2s was increased from the mass limit of 500 to 750 FGE was performed with the more realistic model discussed above. To establish a baseline reference for comparative purposes, the system reactivity for the 500-FGE mass limit was also computed with the more realistic model. The results of the computational analysis are summarized in Figure A-18 and Table A-21 and Table A-22. In all cases, the system eigenvalue remained below the USL. Consequently, a criticality event due to overbatching of a storage array of SLB2s in the underground repository is not credible.

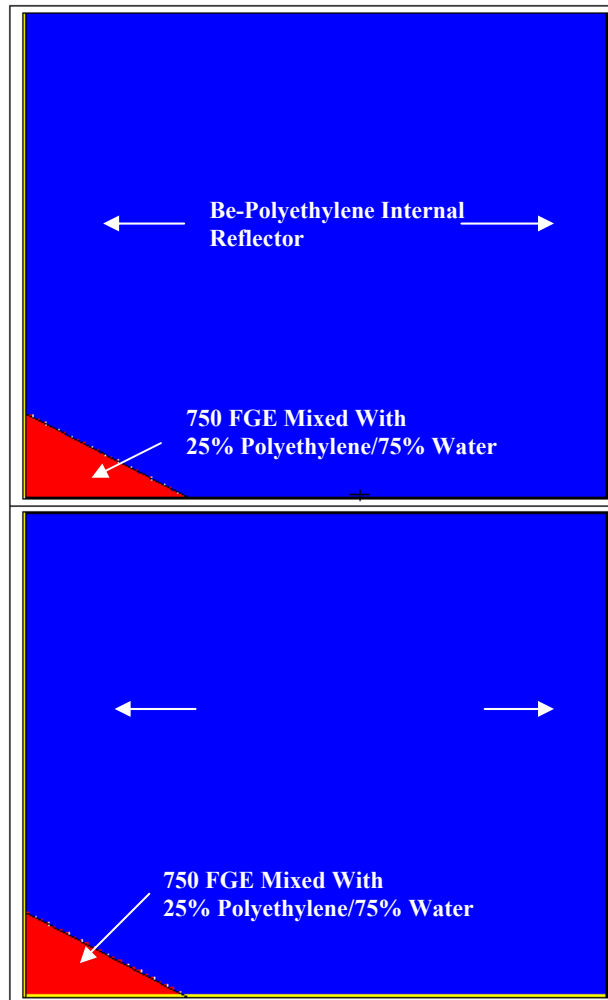

Figure A-, X-Y Planar View Showing Orientation of the Prismatic Fissile Mass in the Corner of the SLB2s

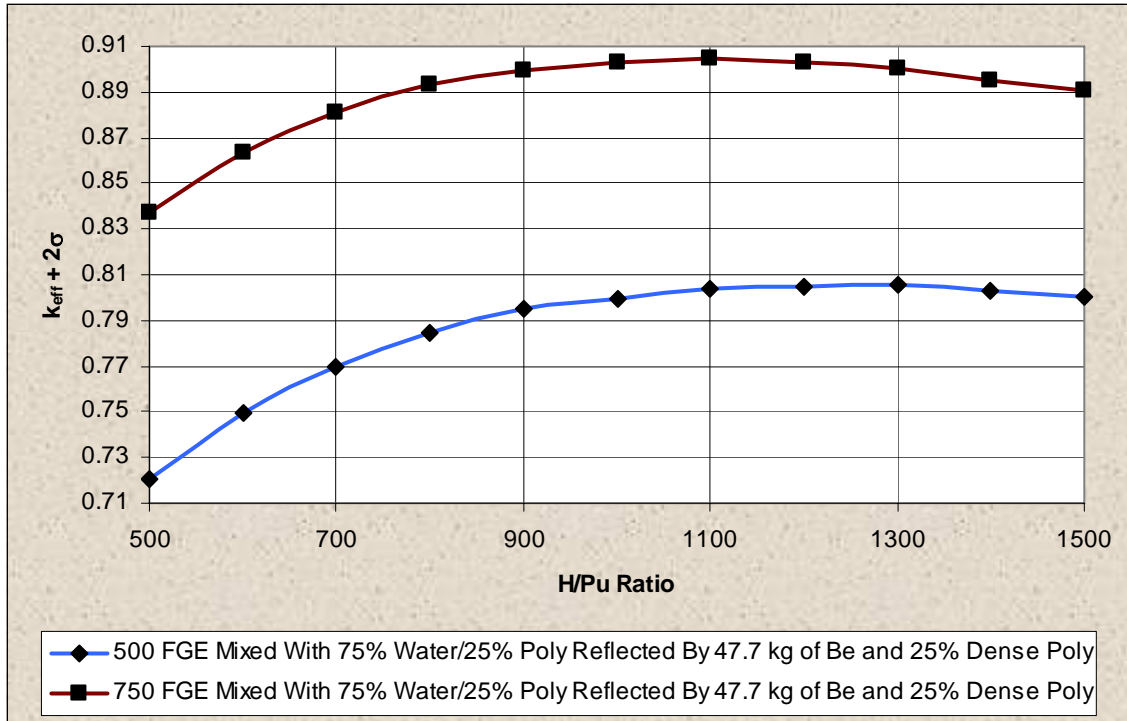

Figure A-, Results for an Underground Array of Overbatched SLB2s with Seven-packs Stacked on Top

**Table A-, Results for an Array of SLB2s with the Fissile Material in a Prism as
 in the TRUPACT-III SAR**

H/Pu Ratio	k_{eff}	σ	$k_{eff}+2\sigma$	Filename
SLB2s at FGE Limit of 500				
500	0.71914	0.00048	0.72010	slbab10
600	0.74814	0.00047	0.74908	slbab12
700	0.76894	0.00046	0.76986	slbab14
800	0.78346	0.00047	0.78440	slbab16
900	0.79390	0.00045	0.79480	slbab18
1000	0.79834	0.00045	0.79924	slbab20
1100	0.80280	0.00043	0.80366	slbab22
1200	0.80414	0.00041	0.80496	slbab24
1300	0.80468	0.00043	0.80554	slbab26
1400	0.80221	0.00042	0.80305	slbab28
1500	0.79973	0.00039	0.80051	slbab30
SLB2s Overbatched to 750 FGE				
500	0.83617	0.00049	0.83715	slbao10
600	0.86226	0.00048	0.86322	slbao12
700	0.87999	0.00049	0.88097	slbao14
800	0.89277	0.00047	0.89371	slbao16
900	0.89866	0.00044	0.89954	slbao18
1000	0.90249	0.00046	0.90341	slbao20
1100	0.90354	0.00045	0.90444	slbao22
1200	0.90181	0.00041	0.90263	slbao24
1300	0.89969	0.00040	0.90049	slbao26
1400	0.89446	0.00040	0.89526	slbao28
1500	0.88997	0.00039	0.89075	slbao30

A4.3 55-gallon Drum Array with Excess Beryllium

In addition to the FGE overbatching contingency, an overbatching event was considered where the beryllium content in one drum in the modeled three-tier stack of containers exceeds its mass limit. Specifically, it was assumed that containers with a 5-kilogram beryllium limit are double batched to 10 kilograms. The results of this overbatching event, which is tabulated in Table A-22, illustrates that double batching the beryllium has only a minor effect.

Table A-, Results for an Overbatching Event with One Fissile Drum in the Middle Tier containing 10 kg of Beryllium

H/Pu Ratio	k_{eff}	σ	$k_{eff}+2\sigma$	Filename
800	0.87837	0.00080	0.87997	dacbb16
900	0.89010	0.00074	0.89158	dacbb18
1000	0.89619	0.00073	0.89765	dacbb20
1100	0.89854	0.00075	0.90004	dacbb22
1200	0.89916	0.00070	0.90056	dacbb24
1300	0.89903	0.00071	0.90045	dacbb26
1400	0.89495	0.00070	0.89635	dacbb28
1500	0.89224	0.00069	0.89362	dacbb30
1600	0.88664	0.00066	0.88796	dacbb32
1700	0.88147	0.00061	0.88269	dacbb34
1800	0.87459	0.00059	0.87577	dacbb36

A4.4 Compaction/Roof Fall Model

The loss of geometry contingency event where it is postulated that the roof fall during the operational phase of the disposal panel, is simulated as a vertical compaction of 15 inches to the bottom tier of drums. Specifically, the compaction was modeled by reducing the height of all drums in the base-case model (i.e., 650 grams of ²³⁹Pu optimally moderated per seven-pack with three 200-gram ²³⁹Pu drums and one 50-gram ²³⁹Pu drum stacked three tiers) by 15 inches and then centering the fissile source in the drum. The results are summarized in Table A-. As indicated by the data, the compaction has a small effect on the reactivity of the array and all results remain below the USL of 0.96.

Table A-, Results for a Roof Fall/Compaction Loss Geometry Event

H/Pu Ratio	k_{eff}	σ	$k_{eff}+2\sigma$	Filename
800	0.82205	0.00079	0.82363	daccp10
900	0.85798	0.00090	0.85978	daccp12
1000	0.88209	0.00076	0.88361	daccp14
1100	0.89644	0.00074	0.89792	daccp16
1200	0.90751	0.00074	0.90899	daccp18
1300	0.91583	0.00079	0.91741	daccp20
1400	0.91693	0.00065	0.91823	daccp22
1500	0.91894	0.00070	0.92034	daccp24
1600	0.91859	0.00069	0.91997	daccp26
1700	0.91467	0.00061	0.91589	daccp28
1800	0.91166	0.00064	0.91294	daccp30

A4.5 Sprinkler Activation Model

The final contingency considered in this section addresses the potential activation of the sprinkler system in the WHB resulting in interstitial moderation between the waste containers. The model employed to simulate this event assumes a bounding a three-tier stack of seven-packs of 55-gallon drums where the ceiling and floor are modeled as 2 feet (60.96 centimeters) thick concrete, while the sides are mirrored for infinite reflection as shown in Figure C-27, of Appendix C. The cases are evaluated at the mass limits at the optimum H/Pu ratio, namely 200 FGE in three drums, 50s FGE in one drum, and three drums empty with the fissile material moderated at an H/Pu ratio of 1,300. Water from sprinkler activation is allowed to fill the spaces between the drums. The water density is varied from 0.05 to 1 g/cm³, and the results are shown in Table A-24. All water densities reduce the reactivity of the direct-loaded waste array. Furthermore, the values are all significantly below the USL.

Table A-, Sprinkler Activation Contingency with Varied Water Density

Water density (g/cm ³)	k _{eff}	σ	k _{eff} + 2σ	Filename
55-gallon Drums of Direct-loaded Waste Containing ≤ 1 wt% Special Reflectors				
0	0.85104	0.00071	0.85246	das0026
0.05	0.81571	0.00066	0.81703	das0526
0.10	0.79249	0.00072	0.79393	das1026
0.15	0.77478	0.00067	0.77612	das1526
0.20	0.76234	0.00074	0.76382	das2026
0.25	0.75280	0.00071	0.75422	das2526
0.30	0.74562	0.00073	0.74708	das3026
0.40	0.73229	0.00071	0.73371	das4026
0.50	0.72438	0.00078	0.72594	das5026
0.75	0.70944	0.00078	0.71100	das7526
1.00	0.70494	0.00072	0.70638	da10026

A4.6 Excess Water/Flooding in a CH Waste Drums/Containers

This contingency condition simulates an abnormal state where the various CH waste drums/containers contain an excess of liquid in the dunnage as a result of a generator site error or water seepage into the container. A water intrusion contingency analysis is performed where it is assumed that various amounts of water mix with the internal polyethylene reflector around the fissile mass. The analysis is parametric in nature in that the amount of water in the beryllium-

polyethylene-water mixture filling the container around the fissile mass varies to represent the range from dry to fully flooded containers. Specifically, the following partially/fully flooded conditions are analyzed:

- Beryllium mixed with 25% by volume polyethylene and 18.75% by volume water,
- Beryllium mixed with 25% by volume polyethylene and 37.5% by volume water,
- Beryllium mixed with 25% by volume polyethylene and 56.25% by volume water,
- Beryllium mixed with 25% by volume polyethylene and 75% by volume water,
- Beryllium mixed with 15% by volume polyethylene and 85% by volume water, and
- Beryllium mixed with 5% by volume polyethylene and 95% by volume water.

Partial and Full Flooding of a 55-Gallon Drum Array in the Underground Repository

The first CH waste configuration evaluated is a disposal array of seven-packs of 55-gallon drums in the underground repository. The model is consistent with that presented in Section with respect to fissile mass content and geometric configuration. The results of the flooding contingency calculation for both partially flooded and fully flooded drums are summarized in Figure A-19 and Figure A-20 and tabulated in Table A-25 and Table A-26. As indicated by the data, the system reactivity increases with the water content in the partial flooding state case and ultimately peaks at above 15% polyethylene and 85% water in the fully flooded state. In all cases, the system eigenvalue remains well below the USL; therefore, a criticality event result from a water intrusion contingency in an array of 55-gallon drums containing CH waste is not credible.

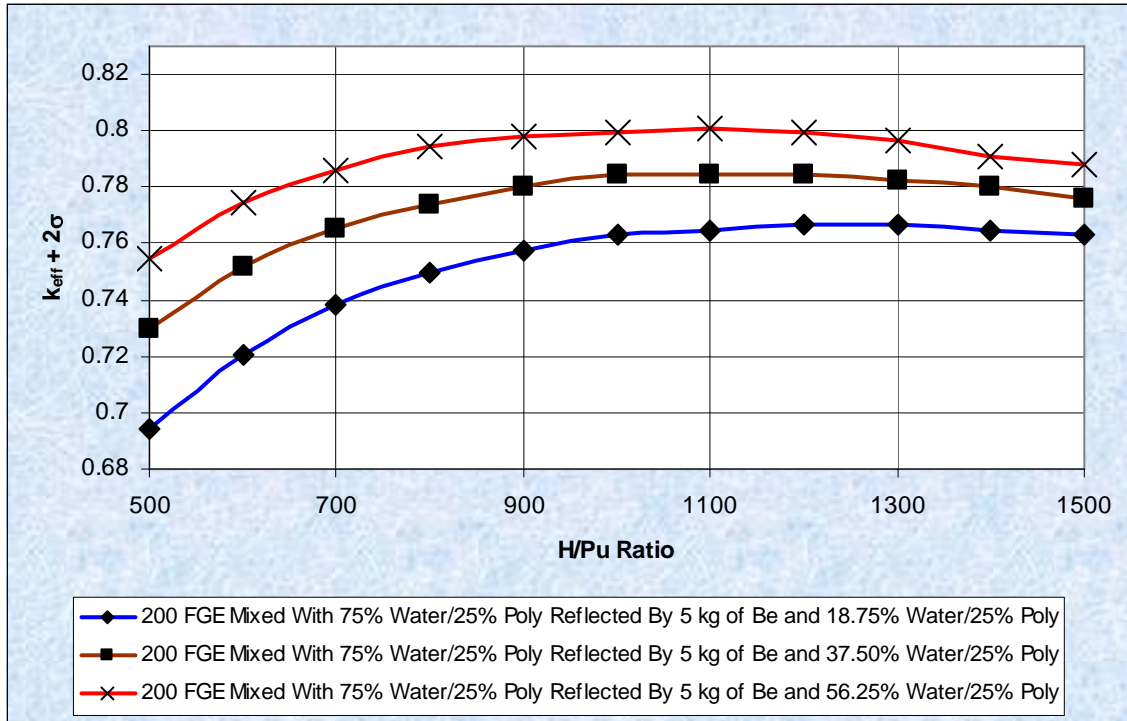

Figure A-, Partial Flooding Results for an Underground Array of Seven-packs of 55-Gallon Drums

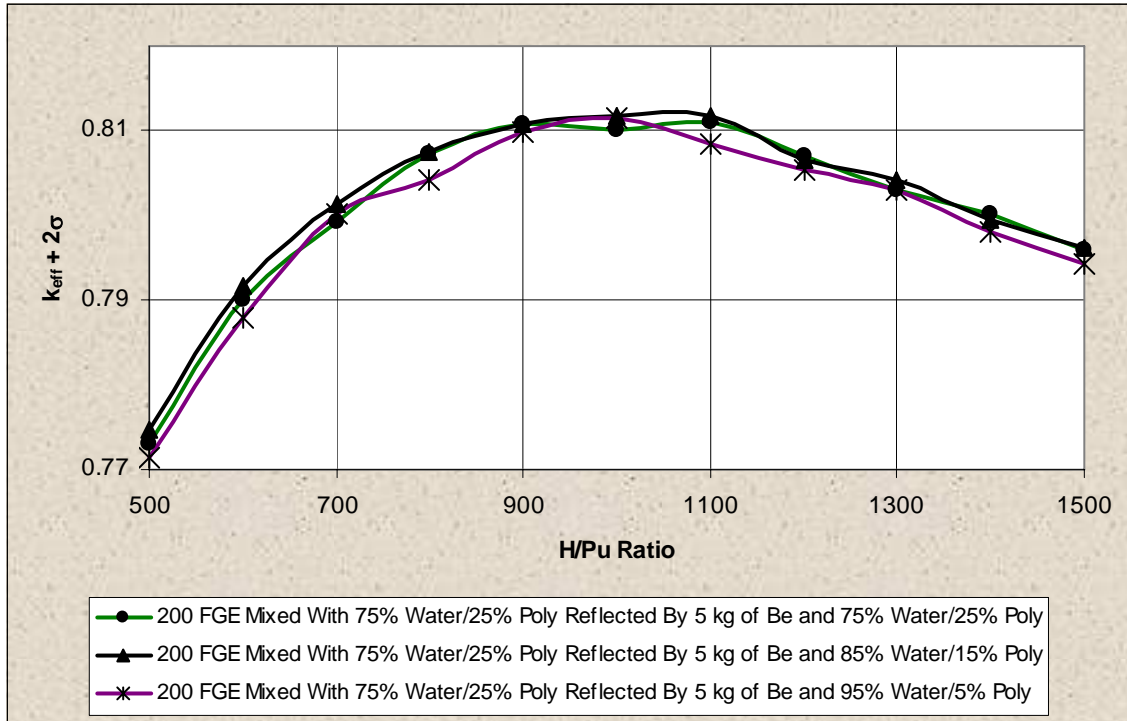

Figure A-, Full Flooding Results for an Underground Array of Seven-packs of 55-Gallon Drums

**Table A-, Partial Flooding Results for an Underground Array of
 Seven-packs of 55-Gallon Drums**

H/Pu Ratio	k_{eff}	σ	$k_{eff} + 2\sigma$	Filename
5 kg beryllium Mixed With 25% By Volume Polyethylene and 18.75% By Volume Water				
500	0.69248	0.00087	0.69422	dacw010
600	0.71931	0.00077	0.72085	dacw012
700	0.73632	0.00087	0.73806	dacw014
800	0.74800	0.00083	0.74966	dacw016
900	0.75565	0.00078	0.75721	dacw018
1000	0.76120	0.00087	0.76294	dacw020
1100	0.76264	0.00085	0.76434	dacw022
1200	0.76493	0.00075	0.76643	dacw024
1300	0.76553	0.00077	0.76707	dacw026
1400	0.76333	0.00078	0.76489	dacw028
1500	0.76149	0.00072	0.76293	dacw030
5 kg beryllium Mixed With 25% By Volume Polyethylene and 37.5% By Volume Water				
500	0.72799	0.00087	0.72973	dacw050
600	0.74966	0.00093	0.75152	dacw052
700	0.76357	0.00085	0.76527	dacw054
800	0.77197	0.00084	0.77365	dacw056
900	0.77887	0.00077	0.78041	dacw058
1000	0.78299	0.00076	0.78451	dacw060
1100	0.78324	0.00079	0.78482	dacw062
1200	0.78267	0.00076	0.78419	dacw064
1300	0.78113	0.00074	0.78261	dacw066
1400	0.77855	0.00073	0.78001	dacw068
1500	0.77463	0.00078	0.77619	dacw070
5 kg beryllium Mixed With 25% By Volume Polyethylene and 56.25% By Volume Water				
500	0.75289	0.00079	0.75447	dacw090
600	0.77298	0.00082	0.77462	dacw092
700	0.78435	0.00083	0.78601	dacw094
800	0.79260	0.00076	0.79412	dacw096
900	0.79668	0.00072	0.79812	dacw098
1000	0.79807	0.00079	0.79965	dacw100
1100	0.79907	0.00077	0.80061	dacw102
1200	0.79783	0.00078	0.79939	dacw104
1300	0.79474	0.00078	0.79630	dacw106
1400	0.78940	0.00076	0.79092	dacw108
1500	0.78696	0.00063	0.78822	dacw110

**Table A-, Full Flooding Results for an Underground Array of
 Seven-packs of 55-Gallon Drums**

H/Pu Ratio	k_{eff}	σ	$k_{eff} + 2\sigma$	Filename
5 kg beryllium Mixed With 25% By Volume Polyethylene and 75% By Volume Water				
500	0.77310	0.00076	0.77462	dacw130
600	0.79004	0.00086	0.79176	dacw132
700	0.79981	0.00081	0.80143	dacw134
800	0.80585	0.00082	0.80749	dacw146
900	0.80933	0.00078	0.81089	dacw138
1000	0.81022	0.00075	0.81172	dacw140
1100	0.81015	0.00079	0.81173	dacw142
1200	0.80514	0.00071	0.80656	dacw144
1300	0.80278	0.00072	0.80422	dacw146
1400	0.79802	0.00075	0.79952	dacw148
1500	0.79476	0.00072	0.79620	dacw150
5 kg beryllium Mixed With 15% By Volume Polyethylene and 85% By Volume Water				
500	0.77143	0.00079	0.77301	dacw170
600	0.78827	0.00085	0.78997	dacw172
700	0.79777	0.00079	0.79935	dacw174
800	0.80575	0.00079	0.80733	dacw176
900	0.80934	0.00076	0.81086	dacw178
1000	0.80849	0.00077	0.81003	dacw180
1100	0.80953	0.00075	0.81103	dacw182
1200	0.80564	0.00074	0.80712	dacw184
1300	0.80165	0.00071	0.80307	dacw186
1400	0.79885	0.00069	0.80023	dacw188
1500	0.79460	0.00064	0.79588	dacw190
5 kg beryllium Mixed With 95% By Volume Polyethylene and 5% By Volume Water				
500	0.76975	0.00089	0.77153	dacw210
600	0.78635	0.00083	0.78801	dacw212
700	0.79866	0.00080	0.80026	dacw214
800	0.80273	0.00076	0.80425	dacw216
900	0.80823	0.00082	0.80987	dacw218
1000	0.80976	0.00083	0.81142	dacw220
1100	0.80685	0.00074	0.80833	dacw222
1200	0.80399	0.00072	0.80543	dacw224
1300	0.80148	0.00074	0.80296	dacw226
1400	0.79664	0.00071	0.79806	dacw228
1500	0.79301	0.00070	0.79441	dacw230

Partial and Full Flooding of an Array of Shielded Containers in the Underground Repository

Partial and full flooding contingency calculations are also performed for an array of shielded containers. The model used is geometrically identical to that used for the analysis of lead-lined containers in Section in that the containers are arranged in an array of seven-packs. The characteristic increase in system reactivity with water content is observed with the fully flooded state being most reactive. In all cases, the system eigenvalue remained below 0.82, which is well below the USL. Therefore a criticality event resulting from a flooding contingency in shielded drums is not credible. Figure A-21, Figure A-22, Table A-27, and Table A-28 summarize the computational results.

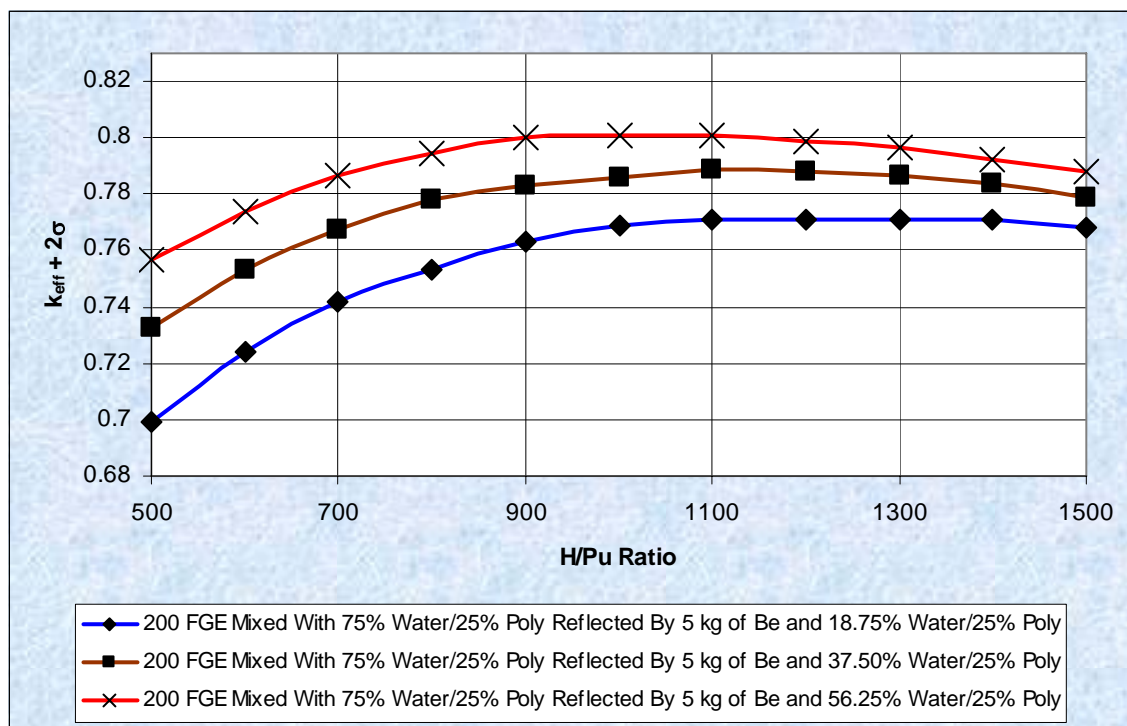

Figure A-, Partial Flooding Results for an Underground Array of Shielded Containers

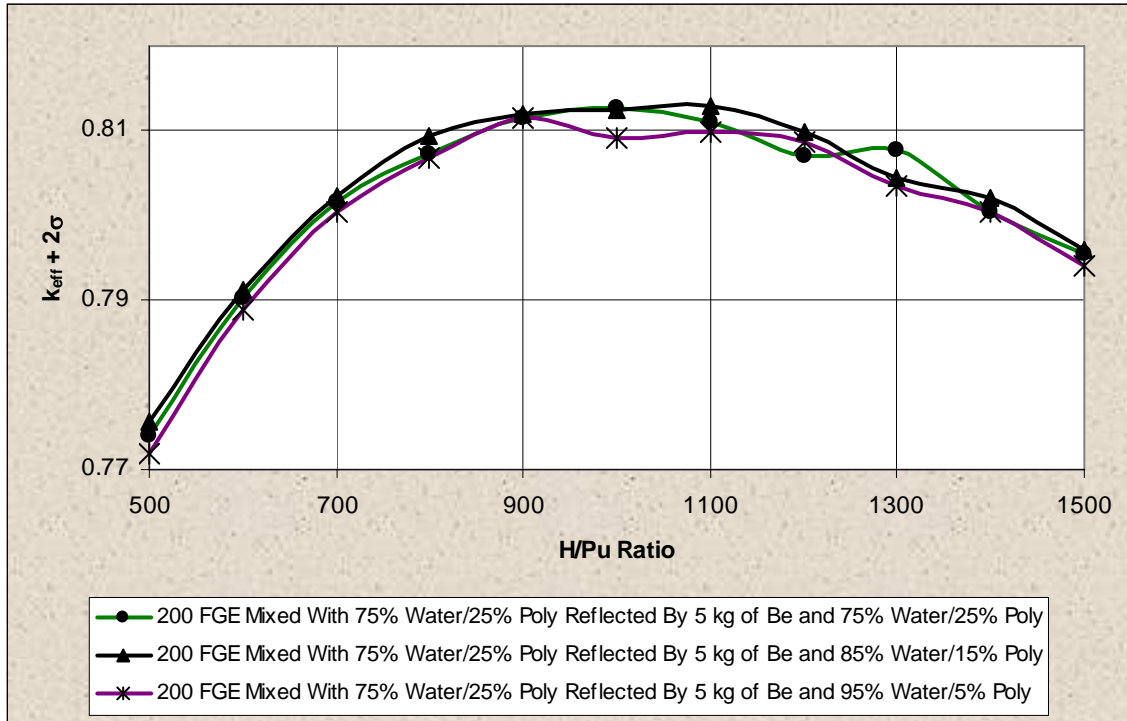

Figure A-, Full Flooding Results for an Underground Array of Shielded Containers

**Table A-, Partial Flooding Results for an Underground Array of
 Seven-packs of Shielded Containers**

H/Pu Ratio	k_{eff}	σ	$k_{eff} + 2\sigma$	Filename
5 kg beryllium Mixed With 25% By Volume Polyethylene and 18.75% By Volume Water				
500	0.69746	0.00095	0.69936	lldw010
600	0.72212	0.00082	0.72376	lldw012
700	0.74063	0.00077	0.74217	lldw014
800	0.75196	0.00079	0.75354	lldw016
900	0.76135	0.00081	0.76297	lldw018
1000	0.76738	0.00082	0.76902	lldw020
1100	0.76933	0.00083	0.77099	lldw022
1200	0.76950	0.00075	0.77100	lldw024
1300	0.76929	0.00075	0.77079	lldw026
1400	0.76979	0.00070	0.77119	lldw028
1500	0.76655	0.00071	0.76797	lldw030
5 kg beryllium Mixed With 25% By Volume Polyethylene and 37.5% By Volume Water				
500	0.73117	0.00084	0.73285	lldw050
600	0.75178	0.00078	0.75334	lldw052
700	0.76610	0.00082	0.76774	lldw054
800	0.77631	0.00078	0.77787	lldw056
900	0.78137	0.00079	0.78295	lldw058
1000	0.78420	0.00083	0.78586	lldw060
1100	0.78708	0.00075	0.78858	lldw062
1200	0.78660	0.00077	0.78814	lldw064
1300	0.78556	0.00068	0.78692	lldw066
1400	0.78192	0.00080	0.78352	lldw068
1500	0.77762	0.00068	0.77898	lldw070
5 kg beryllium Mixed With 25% By Volume Polyethylene and 56.25% By Volume Water				
500	0.75505	0.00085	0.75675	lldw090
600	0.77190	0.00090	0.77370	lldw092
700	0.78530	0.00082	0.78694	lldw094
800	0.79313	0.00076	0.79465	lldw096
900	0.79831	0.00079	0.79989	lldw098
1000	0.79942	0.00071	0.80084	lldw100
1100	0.79942	0.00079	0.80100	Lldw102
1200	0.79719	0.00074	0.79867	Lldw104
1300	0.79526	0.00071	0.79668	Lldw106
1400	0.79135	0.00065	0.79265	Lldw108
1500	0.78641	0.00065	0.78771	Lldw110

**Table A-, Full Flooding Results for an Underground Array of
 Seven-packs of Shielded Containers**

H/Pu Ratio	k_{eff}	σ	$k_{eff} + 2\sigma$	Filename
5 kg beryllium Mixed With 25% By Volume Polyethylene and 75% By Volume Water				
500	0.77403	0.00087	0.77577	lldw130
600	0.78948	0.00085	0.79118	lldw132
700	0.80041	0.00092	0.80225	lldw134
800	0.80792	0.00077	0.80946	lldw136
900	0.81036	0.00081	0.81198	lldw138
1000	0.81097	0.00072	0.81241	lldw140
1100	0.81136	0.00077	0.81290	lldw142
1200	0.80842	0.00073	0.80988	lldw144
1300	0.80318	0.00066	0.80450	lldw146
1400	0.80056	0.00070	0.80196	lldw148
1500	0.79450	0.00069	0.79588	lldw150
5 kg beryllium Mixed With 15% By Volume Polyethylene and 85% By Volume Water				
500	0.77230	0.00085	0.77400	lldw170
600	0.78865	0.00079	0.79023	lldw172
700	0.80012	0.00079	0.80170	lldw174
800	0.80569	0.00081	0.80731	lldw176
900	0.80983	0.00080	0.81143	lldw178
1000	0.81115	0.00075	0.81265	lldw180
1100	0.80965	0.00068	0.81101	lldw182
1200	0.80557	0.00075	0.80707	lldw184
1300	0.80620	0.00071	0.80762	lldw186
1400	0.79898	0.00073	0.80044	lldw188
1500	0.79409	0.00070	0.79549	lldw190
5 kg beryllium Mixed With 95% By Volume Polyethylene and 5% By Volume Water				
500	0.77024	0.00081	0.77186	lldw210
600	0.78732	0.00081	0.78894	lldw212
700	0.79867	0.00083	0.80033	lldw214
800	0.80510	0.00083	0.80676	lldw216
900	0.80992	0.00082	0.81156	lldw218
1000	0.80779	0.00072	0.80923	lldw220
1100	0.80834	0.00078	0.80990	lldw222
1200	0.80712	0.00081	0.80874	lldw224
1300	0.80207	0.00070	0.80347	lldw226
1400	0.79900	0.00076	0.80052	lldw228
1500	0.79250	0.00076	0.79402	lldw230

Partial and Full Flooding of an Array of SWBs in the Underground Repository

A water intrusion event in an array of SWBs in the underground storage repository is simulated. The model used in the computational analysis is consistent with that used in Section with respects to fissile material content, geometry, and array configuration. Figure A-23 and Figure A-24 illustrate the computational results for the partially fully flooded states respectively, whereas Table A-29 and Table A-30 tabulate the associated numerical eigenvalues. Although system reactivity increases with water content and peaks for the fully flooded cases, the results indicate that all cases were below the established USL. Therefore, a criticality event due to water ingress in an array of SWBs containing CH waste is not credible.

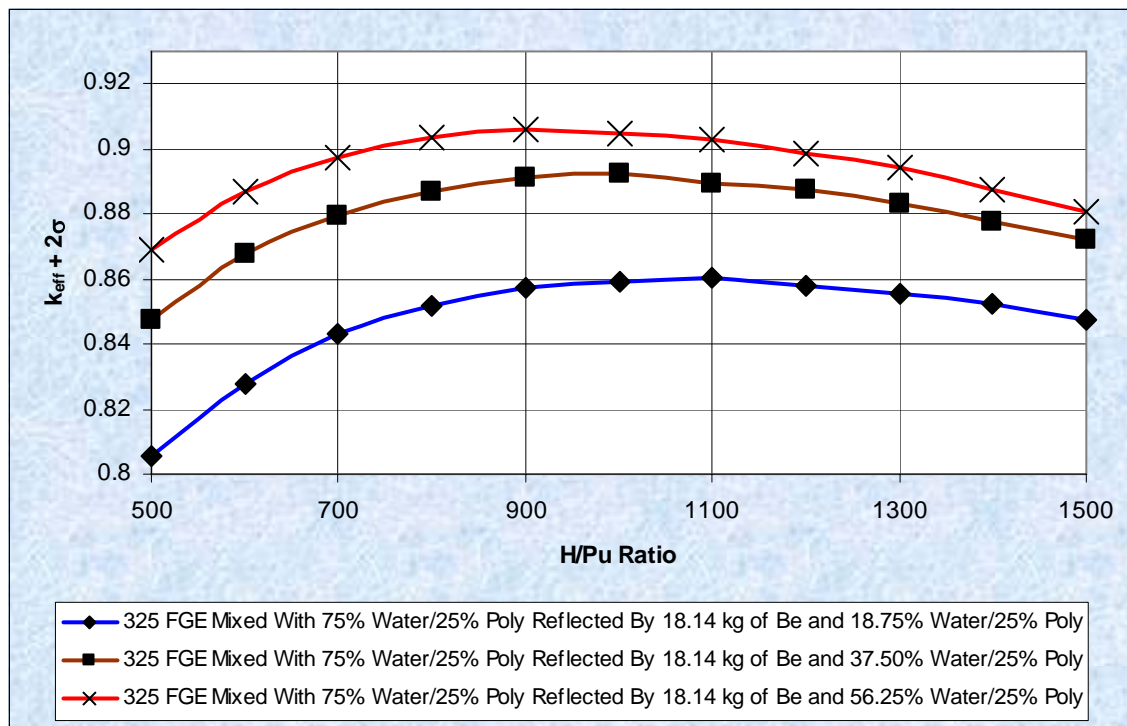

Figure A-, Partial Flooding Results for an Underground Array of SWBs

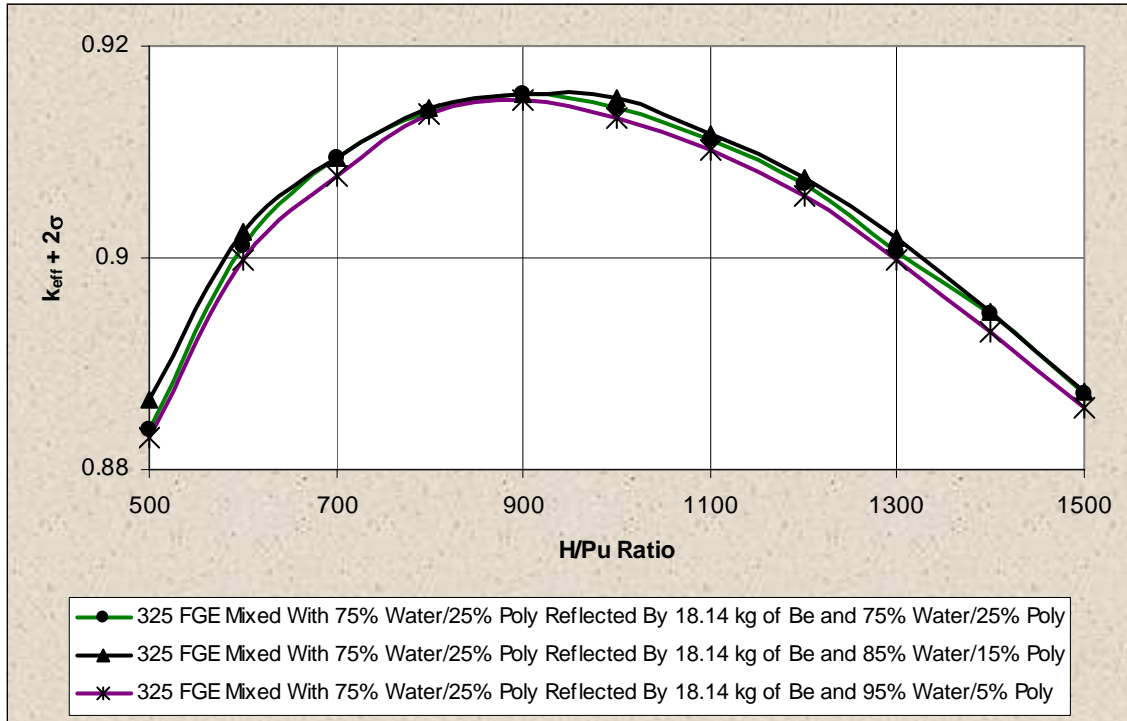

Figure A-, Full Flooding Results for an Underground Array of SWBs

Table A-, Partial Flooding Results for an Underground Array of SWBs

H/Pu Ratio	k_{eff}	σ	$k_{eff} + 2\sigma$	Filename
18.14 kg beryllium Mixed With 25% By Volume Polyethylene and 18.75% By Volume Water				
500	0.80432	0.00060	0.80552	swbw010
600	0.82683	0.00059	0.82801	swbw012
700	0.84205	0.00057	0.84319	swbw014
800	0.85031	0.00057	0.85145	swbw016
900	0.85619	0.00057	0.85733	swbw018
1000	0.85795	0.00057	0.85909	swbw020
1100	0.85958	0.00051	0.86060	swbw022
1200	0.85707	0.00052	0.85811	swbw024
1300	0.85443	0.00051	0.85545	swbw026
1400	0.85120	0.00047	0.85214	swbw028
1500	0.84622	0.00047	0.84716	swbw030
18.14 kg beryllium Mixed With 25% By Volume Polyethylene and 37.5% By Volume Water				
500	0.84651	0.00057	0.84765	swbw050
600	0.86689	0.00056	0.86801	swbw052
700	0.87832	0.00055	0.87942	swbw054
800	0.88567	0.00054	0.88675	swbw056
900	0.89011	0.00055	0.89121	swbw058
1000	0.89118	0.00052	0.89222	swbw060
1100	0.88835	0.00051	0.88937	swbw062
1200	0.88662	0.00051	0.88764	swbw064
1300	0.88223	0.00050	0.88323	swbw066
1400	0.87690	0.00049	0.87788	swbw068
1500	0.87142	0.00047	0.87236	swbw070
18.14 kg beryllium Mixed With 25% By Volume Polyethylene and 56.25% By Volume Water				
500	0.86789	0.00058	0.86905	swbw090
600	0.88582	0.00055	0.88692	swbw092
700	0.89629	0.00054	0.89737	swbw094
800	0.90247	0.00054	0.90355	swbw096
900	0.90496	0.00055	0.90606	swbw098
1000	0.90363	0.00053	0.90469	swbw100
1100	0.90169	0.00053	0.90275	swbw102
1200	0.89751	0.00050	0.89851	swbw104
1300	0.89334	0.00049	0.89432	swbw106
1400	0.88680	0.00045	0.88770	swbw108
1500	0.87980	0.00047	0.88074	swbw110

Table A-, Full Flooding Results for an Underground Array of SWBs

H/Pu Ratio	k_{eff}	σ	$k_{eff} + 2\sigma$	Filename
18.14 kg beryllium Mixed With 25% By Volume Polyethylene and 75% By Volume Water				
500	0.88537	0.00060	0.88657	swbw130
600	0.90131	0.00056	0.90243	swbw132
700	0.90820	0.00057	0.90934	swbw134
800	0.91308	0.00055	0.91418	swbw136
900	0.91450	0.00052	0.91554	swbw138
1000	0.91403	0.00052	0.91507	swbw140
1100	0.91074	0.00051	0.91176	swbw142
1200	0.90647	0.00051	0.90749	swbw144
1300	0.90085	0.00050	0.90185	swbw146
1400	0.89403	0.00048	0.89499	swbw148
1500	0.88628	0.00050	0.88728	swbw150
18.14 kg beryllium Mixed With 15% By Volume Polyethylene and 85% By Volume Water				
500	0.88261	0.00057	0.88375	swbw170
600	0.89993	0.00057	0.90107	swbw172
700	0.90834	0.00057	0.90948	swbw174
800	0.91262	0.00054	0.91370	swbw176
900	0.91444	0.00055	0.91554	swbw178
1000	0.91309	0.00052	0.91413	swbw180
1100	0.91016	0.00053	0.91122	swbw182
1200	0.90599	0.00050	0.90699	swbw184
1300	0.89970	0.00047	0.90064	swbw186
1400	0.89374	0.00049	0.89472	swbw188
1500	0.88615	0.00047	0.88709	swbw190
18.14 kg beryllium Mixed With 95% By Volume Polyethylene and 5% By Volume Water				
500	0.88180	0.00058	0.88296	swbw210
600	0.89866	0.00058	0.89982	swbw212
700	0.90651	0.00057	0.90765	swbw214
800	0.91250	0.00054	0.91358	swbw216
900	0.91389	0.00053	0.91495	swbw218
1000	0.91223	0.00053	0.91329	swbw220
1100	0.90915	0.00050	0.91015	swbw222
1200	0.90494	0.00049	0.90592	swbw224
1300	0.89882	0.00048	0.89978	swbw226
1400	0.89209	0.00047	0.89303	swbw228
1500	0.88489	0.00048	0.88585	swbw230

Partial and Full Flooding of an Array of SLB2s in the Underground Repository

The flooding of an array of SLB2s in the underground disposal configuration was also analyzed. The parametric calculation simulating the water intrusion event at various degrees of flooding was performed in the same manner as done for the other CH waste container types. The SLB2 array model for the underground repository was consistent with that used in the nominal baseline analyses in that the emplacement configuration assumed that seven-packs of 55-gallon drums at their FGE limit are placed on top of the SLB2s as shown in Figure A-4. The lateral boundaries are mirrored to simulate an infinite array and the vertical boundaries are reflected with 300 centimeters of salt with an intervening MgO layer between the top of the seven-packs and the upper salt boundary. The fissile mass in the SLB2 is again modeled in a prism geometry as used in the TRUPACT-III and discussed in Section A4.2. The water content was varied consistently in both the SLB2s and 55-gallon drums on top. The results of the computational analysis are summarized in Figure A-25 and Figure A-26 and tabulated in Table A-31 and Table A-32. In all cases, the system eigenvalue remains below 0.84, which is below the USL. Consequently, a criticality event due to partial or full flooding of SLB2 containers in the underground repository is not credible.

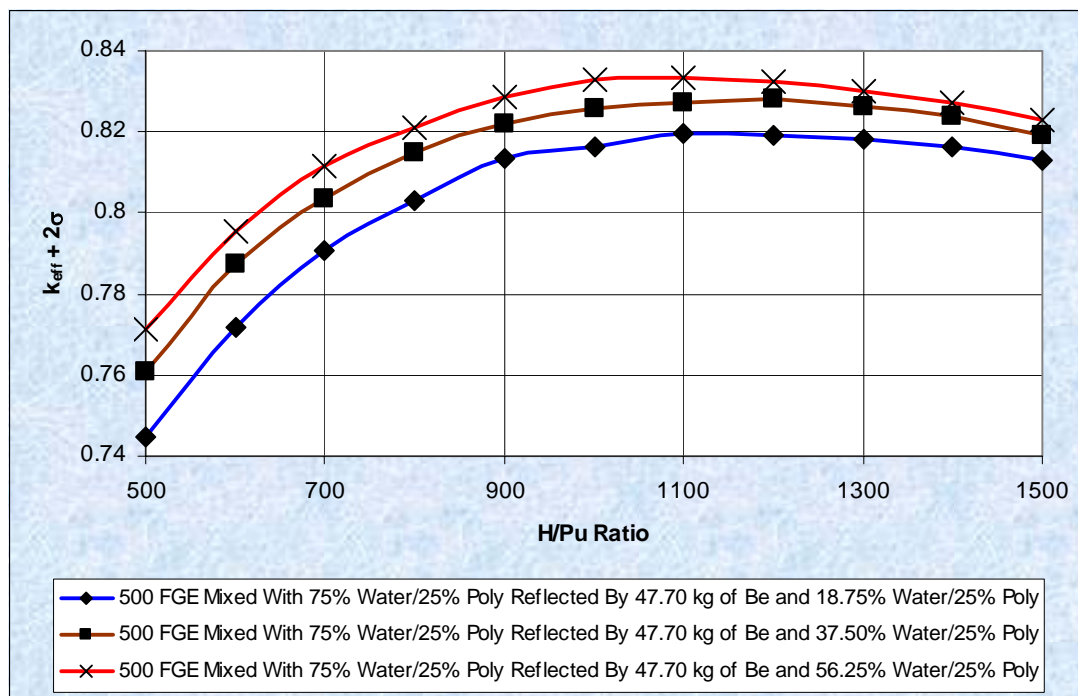
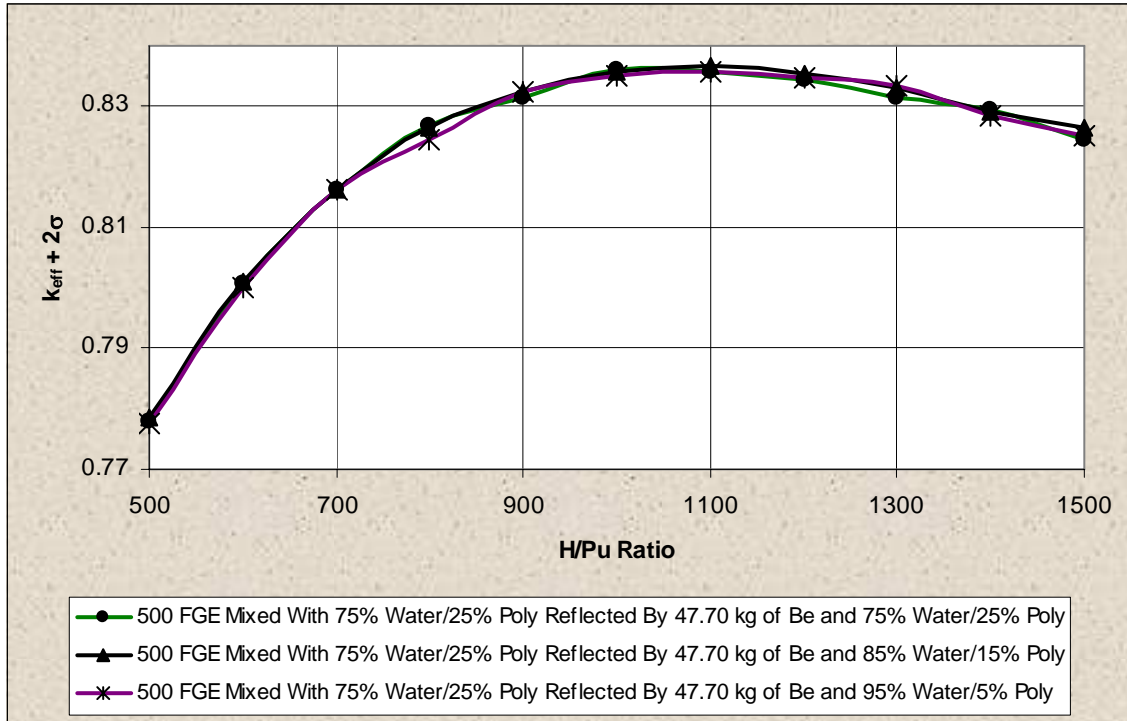

Figure A-, Partial Flooding Results for an Underground Array of SLB2s (with 55-gallon Drums)



**Figure A-, Full Flooding Results for an Underground Array of SLB2s
(with 55-gallon Drums)**

**Table A-, Partial Flooding Results for an Underground Array of SLB2s
 (with 55-gallon Drums)**

H/Pu Ratio	k_{eff}	σ	$k_{eff} + 2\sigma$	Filename
47.7 kg beryllium Mixed With 25% By Volume Polyethylene and 18.75% By Volume Water				
500	0.74381	0.00048	0.74477	slbw010
600	0.77073	0.00048	0.77169	slbw012
700	0.78964	0.00047	0.79058	slbw014
800	0.80227	0.00045	0.80317	slbw016
900	0.81250	0.00044	0.81338	slbw018
1000	0.81558	0.00043	0.81644	slbw020
1100	0.81873	0.00044	0.81961	slbw022
1200	0.81853	0.00041	0.81935	slbw024
1300	0.81757	0.00042	0.81841	slbw026
1400	0.81534	0.00041	0.81616	slbw028
1500	0.81238	0.00040	0.81318	slbw030
47.7 kg beryllium Mixed With 25% By Volume Polyethylene and 37.5% By Volume Water				
500	0.75997	0.00048	0.76093	slbw050
600	0.78642	0.00046	0.78734	slbw052
700	0.80276	0.00046	0.80368	slbw054
800	0.81383	0.00047	0.81477	slbw056
900	0.82096	0.00045	0.82186	slbw058
1000	0.82494	0.00047	0.82588	slbw060
1100	0.82632	0.00041	0.82714	slbw062
1200	0.82733	0.00042	0.82817	slbw064
1300	0.82551	0.00042	0.82635	slbw066
1400	0.82317	0.00039	0.82395	slbw068
1500	0.81809	0.00041	0.81891	slbw070
47.7 kg beryllium Mixed With 25% By Volume Polyethylene and 56.25% By Volume Water				
500	0.77031	0.00049	0.77129	slbw090
600	0.79450	0.00045	0.79540	slbw092
700	0.81061	0.00047	0.81155	slbw094
800	0.82031	0.00046	0.82123	slbw096
900	0.82788	0.00045	0.82878	slbw098
1000	0.83191	0.00045	0.83281	slbw100
1100	0.83269	0.00043	0.83355	slbw102
1200	0.83167	0.00042	0.83251	slbw104
1300	0.82899	0.00044	0.82987	slbw106
1400	0.82632	0.00040	0.82712	slbw108
1500	0.82220	0.00037	0.82294	slbw110

**Table A-, Full Flooding Results for an Underground Array of SLB2s
 (with 55-gallon Drums)**

H/Pu Ratio	k_{eff}	σ	$k_{eff} + 2\sigma$	Filename
47.7 kg beryllium Mixed With 25% By Volume Polyethylene and 75% By Volume Water				
500	0.77750	0.00049	0.77848	slbw130
600	0.80028	0.00046	0.80120	slbw132
700	0.81531	0.00047	0.81625	slbw134
800	0.82547	0.00044	0.82635	slbw136
900	0.83139	0.00047	0.83233	slbw138
1000	0.83480	0.00044	0.83568	slbw140
1100	0.83568	0.00043	0.83654	slbw142
1200	0.83443	0.00043	0.83529	slbw144
1300	0.83241	0.00038	0.83317	slbw146
1400	0.82844	0.00041	0.82926	slbw148
1500	0.82567	0.00038	0.82643	slbw150
47.7 kg beryllium Mixed With 15% By Volume Polyethylene and 85% By Volume Water				
500	0.77687	0.00046	0.77779	slbw170
600	0.79976	0.00049	0.80074	slbw172
700	0.81524	0.00049	0.81622	slbw174
800	0.82575	0.00046	0.82667	slbw176
900	0.83038	0.00047	0.83132	slbw178
1000	0.83499	0.00047	0.83593	slbw180
1100	0.83491	0.00042	0.83575	slbw182
1200	0.83360	0.00042	0.83444	slbw184
1300	0.83076	0.00041	0.83158	slbw186
1400	0.82848	0.00040	0.82928	slbw188
1500	0.82368	0.00040	0.82448	slbw190
47.7 kg beryllium Mixed With 95% By Volume Polyethylene and 5% By Volume Water				
500	0.77656	0.00047	0.77750	slbw210
600	0.79896	0.00048	0.79992	slbw212
700	0.81534	0.00045	0.81624	slbw214
800	0.82370	0.00047	0.82464	slbw216
900	0.83143	0.00044	0.83231	slbw218
1000	0.83431	0.00045	0.83521	slbw220
1100	0.83488	0.00045	0.83578	slbw222
1200	0.83373	0.00043	0.83459	slbw224
1300	0.83267	0.00041	0.83349	slbw226
1400	0.82767	0.00041	0.82849	slbw228
1500	0.82450	0.00040	0.82530	slbw230

Partial and Full Flooding of an ARROW-PAK™ Array in the Underground Repository

The last water intrusion contingency analyzed in this section involves an underground storage array of ARROW-PAKs™. The geometric model used in the partial/full flooding contingency analysis is identical to that described in Section A2.4 where a seven-pack of 55-gallons drums was placed on top of the three-pack ARROW-PAK™ containers. The results of the contingency analysis indicate that the maximum system eigenvalue is below 0.92, which is below the USL. A criticality event due to partial or full flooding of an underground storage array of 55-gallon drums stacked on ARROW-PAK™ containers is not credible. Figure A-27 and Figure A-28 and Table A-33 and Table A-34 provide pictorial and tabulated evidence of this conclusion.

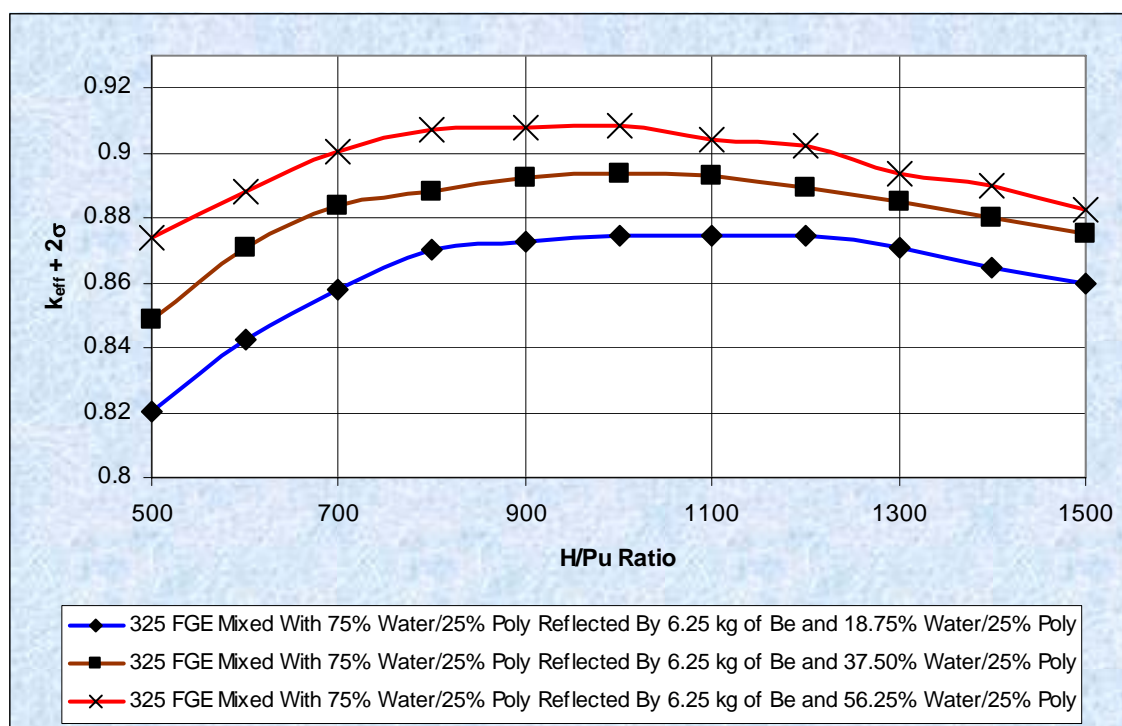
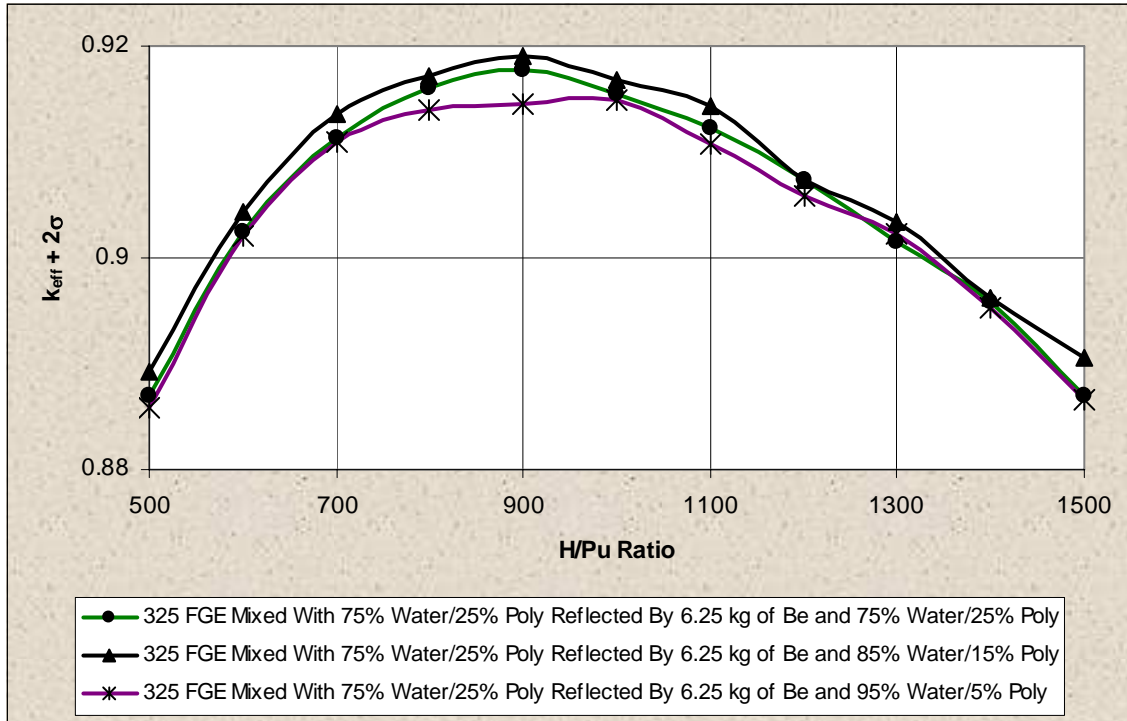

Figure A-, Partial Flooding Results for an Underground Array of ARROW-PAKs (with 55-gallon Drums)



**Figure A-, Full Flooding Results for an Underground Array of ARROW-PAKs
 (with 55-gallon Drums)**

**Table A-, Partial Flooding Results for an Underground Array of
 ARROW-PAKs (with 55-gallon Drums)**

H/Pu Ratio	k_{eff}	σ	$k_{eff} + 2\sigma$	Filename
6.25 kg beryllium Mixed With 25% By Volume Polyethylene and 18.75% By Volume Water				
500	0.81842	0.00106	0.82054	arpw010
600	0.84030	0.00105	0.84240	arpw012
700	0.85600	0.00104	0.85808	arpw014
800	0.86827	0.00101	0.87029	arpw016
900	0.87059	0.00101	0.87261	arpw018
1000	0.87266	0.00097	0.87460	arpw020
1100	0.87253	0.00094	0.87441	arpw022
1200	0.87257	0.00093	0.87443	arpw024
1300	0.86890	0.00101	0.87092	arpw026
1400	0.86294	0.00088	0.86470	arpw028
1500	0.85798	0.00090	0.85978	arpw030
6.25 kg beryllium Mixed With 25% By Volume Polyethylene and 37.5% By Volume Water				
500	0.84653	0.00107	0.84867	arpw050
600	0.86859	0.00102	0.87063	arpw052
700	0.88174	0.00101	0.88376	arpw054
800	0.88582	0.00101	0.88784	arpw056
900	0.89035	0.00099	0.89233	arpw058
1000	0.89196	0.00097	0.89390	arpw060
1100	0.89100	0.00092	0.89284	arpw062
1200	0.88773	0.00089	0.88951	arpw064
1300	0.88319	0.00093	0.88505	arpw066
1400	0.87790	0.00095	0.87980	arpw068
1500	0.87324	0.00087	0.87498	arpw070
6.25 kg beryllium Mixed With 25% By Volume Polyethylene and 56.25% By Volume Water				
500	0.87206	0.00106	0.87418	arpw090
600	0.88619	0.00110	0.88839	arpw092
700	0.89829	0.00103	0.90035	arpw094
800	0.90528	0.00102	0.90732	arpw096
900	0.90580	0.00102	0.90784	arpw098
1000	0.90641	0.00092	0.90825	arpw100
1100	0.90195	0.00095	0.90385	arpw102
1200	0.90060	0.00090	0.90240	arpw104
1300	0.89189	0.00089	0.89367	arpw106
1400	0.88837	0.00089	0.89015	arpw108
1500	0.88069	0.00088	0.88245	arpw110

**Table A-, Full Flooding Results for an Underground Array of
 ARROW-PAKs (with 55-gallon Drums)**

H/Pu Ratio	k_{eff}	σ	$k_{eff} + 2\sigma$	Filename
6.25 kg beryllium Mixed With 25% By Volume Polyethylene and 75% By Volume Water				
500	0.88724	0.00102	0.88928	arpw130
600	0.90219	0.00105	0.90429	arpw132
700	0.91153	0.00104	0.91361	arpw134
800	0.91519	0.00098	0.91715	arpw136
900	0.91705	0.00100	0.91905	arpw138
1000	0.91502	0.00090	0.91682	arpw140
1100	0.91241	0.00095	0.91431	arpw142
1200	0.90555	0.00089	0.90733	arpw144
1300	0.90173	0.00087	0.90347	arpw146
1400	0.89456	0.00085	0.89626	arpw148
1500	0.88890	0.00085	0.89060	arpw150
6.25 kg beryllium Mixed With 15% By Volume Polyethylene and 85% By Volume Water				
500	0.88487	0.00102	0.88691	arpw170
600	0.90049	0.00100	0.90249	arpw172
700	0.90928	0.00098	0.91124	arpw174
800	0.91408	0.00099	0.91606	arpw176
900	0.91574	0.00098	0.91770	arpw178
1000	0.91368	0.00094	0.91556	arpw180
1100	0.91050	0.00092	0.91234	arpw182
1200	0.90557	0.00092	0.90741	arpw184
1300	0.89966	0.00090	0.90146	arpw186
1400	0.89423	0.00081	0.89585	arpw188
1500	0.88535	0.00086	0.88707	arpw190
6.25 kg beryllium Mixed With 95% By Volume Polyethylene and 5% By Volume Water				
500	0.88372	0.00108	0.88588	arpw210
600	0.89998	0.00103	0.90204	arpw212
700	0.90884	0.00104	0.91092	arpw214
800	0.91197	0.00098	0.91393	arpw216
900	0.91258	0.00095	0.91448	arpw218
1000	0.91314	0.00092	0.91498	arpw220
1100	0.90891	0.00090	0.91071	arpw222
1200	0.90414	0.00087	0.90588	arpw224
1300	0.90052	0.00089	0.90230	arpw226
1400	0.89350	0.00089	0.89528	arpw228
1500	0.88504	0.00082	0.88668	arpw230

A4.7 Impact of a 41-Ton Forklift on a Seven-pack Array in the Underground Repository

This contingency simulates an accident condition where the 41-ton waste handling forklift impacts an array of seven-packs of 55-gallon drums containing CH waste in the underground repository. The 41-ton forklift is used to move the lead-shielded facility cask containing remote handled (RH) waste and the shielded, heavy portions of the horizontal emplacement retrieval equipment as described in the *Waste Isolation Pilot Plant Remote Handled (RH) Waste Documented Safety Analysis* (DOE-CBFO 2006). The 41-ton forklift can also be used to move other large, heavy underground equipment from the waste hoist. The 41-ton forklift cannot travel to areas other than the waste shaft station, the disposal path, and disposal rooms due to its height relative to the height of other bulkheads and airlocks in the underground.

To simulate the effects of a high-energy impact on the waste drums, it is assumed that during the collision with the 40-ton forklift, some of the air volume within the 55-gallon drums is expelled, leaving the drums permanently deformed. In particular, it is assumed that the volume of the 55-gallon drums is reduced to 75% of their initial volume. This is a conservative bound on the deformation of the drum considering the maximum credible impact momentum of the forklift, the yield strength of a certified 55-gallon drum, and the way the drums are configured in a seven-pack array. Since some of the air is expelled, the internal reflector mass around the moderated fissile will compress and the density will increase. It is assumed that the polyethylene, which makes up the bulk of the dunnage around the fissile mass, is compressed from a maximum of 25 to 33% of its theoretical density. Furthermore, the model assumes that the geometry of 55-gallon drums is deformed into an elliptical shape with the ratio of the major to minor axes being 2. The elongated fissile mass and internal reflector waste in the 55-gallon drums are moved closer together and become more reactive in this configuration. The model uses a rectangular array (since the waste packages and drums are elliptical cylinders) to minimize the distance between fissile masses in the array. Finally, to maximize the reactivity state of the system and at the same time not restrict the number of seven-packs involved in the accident, mirror boundary conditions are used on three of the four lateral boundaries simulating an infinite array. The fourth boundary uses a reflector made up of 200 centimeters of lead to bound the neutron reflection from the RH canister and the forklift. In the vertical plane, the upper tier is reflected by an MgO layer (approximately 62 centimeters thick) placed on top of the 55-gallon drums and the whole stack is then reflected by 300 centimeters of salt above and below. The contents of the waste package used in the forklift impact contingency analysis are consistent with that presented in Section .

Two configurations were considered in the contingency analysis. The first configuration assumes that three 200-FGE drums are impacted by the forklift and the whole seven-pack stack is crushed and displaced into the surrounding seven-packs. The resulting arrangement is a three-by-three array with three 200-FGE drums in the first row, one 50-FGE drum in the middle of the second row with one non-fissile bearing drum on either side, and one non-fissile bearing drum in the middle of the last row with one 200-FGE drum on either side. The two 200-FGE drums in the last row actually originate from the surrounding seven-packs. The boundaries that are not reflected by lead are infinitely reflected to model an infinite array of crushed seven-packs. The

second configuration is similar to the first except the fissile contents in the drums in the first and last rows are exchanged. Figures A-29a and A-29b illustrate the pertinent model features for the two configurations used in the analysis. Finally, to maximize the interaction effects, a computation was also performed where the polyethylene in the internal reflector was removed and only the beryllium remained in the reflector zone of the “crushed” drums. Figure A-30, Table A-35 and Table A-36 summarize the results of the contingency calculation. As indicated by the data, the maximum system eigenvalue is less than 0.89501 and occurs when the polyethylene was removed from the crushed drums, thereby allowing the closely located fissile masses to interact. Therefore, it is concluded that a criticality event due to the high impact of a large object such as a 41-ton forklift with an array of seven-packs of 55-gallon drums is not credible.

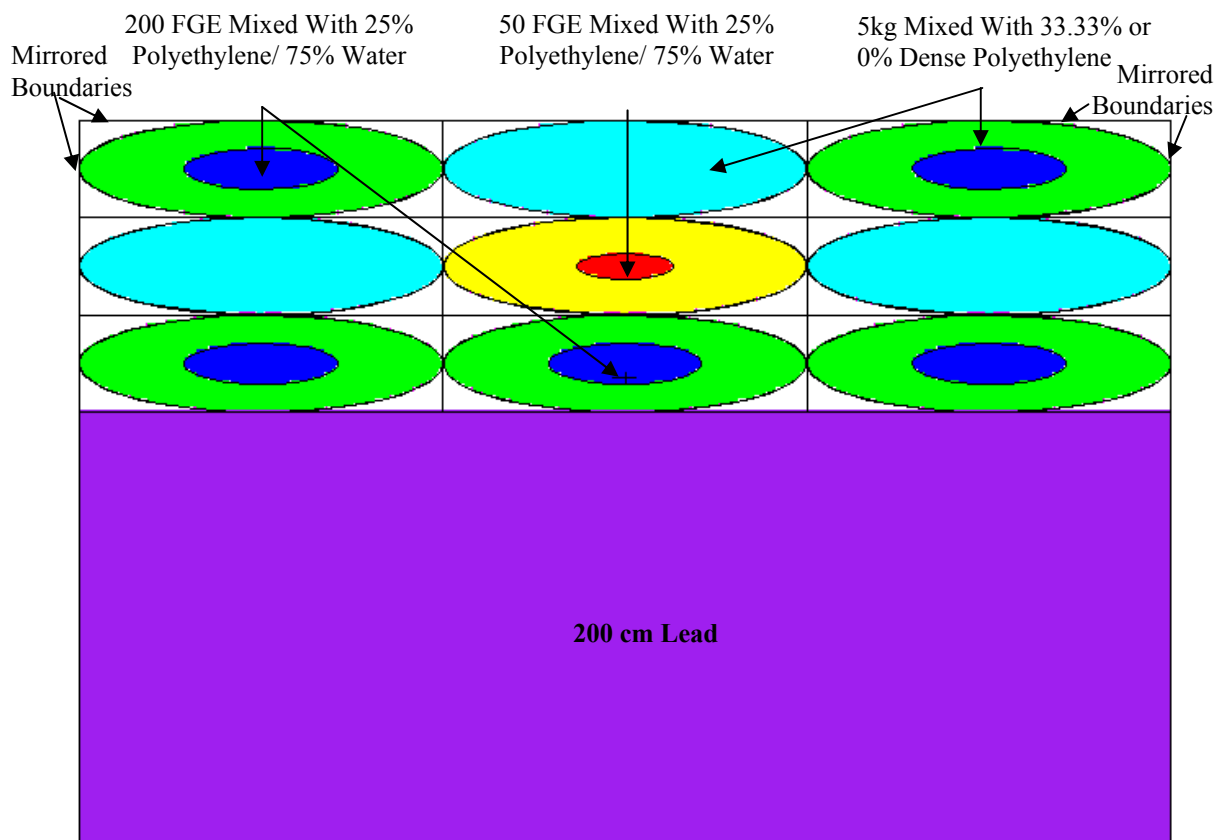

Figure A-a, Top View of Models for the High Energy Impact Contingency Between a 41-ton Forklift and an Array of 55-Gallon Drums Seven-packs

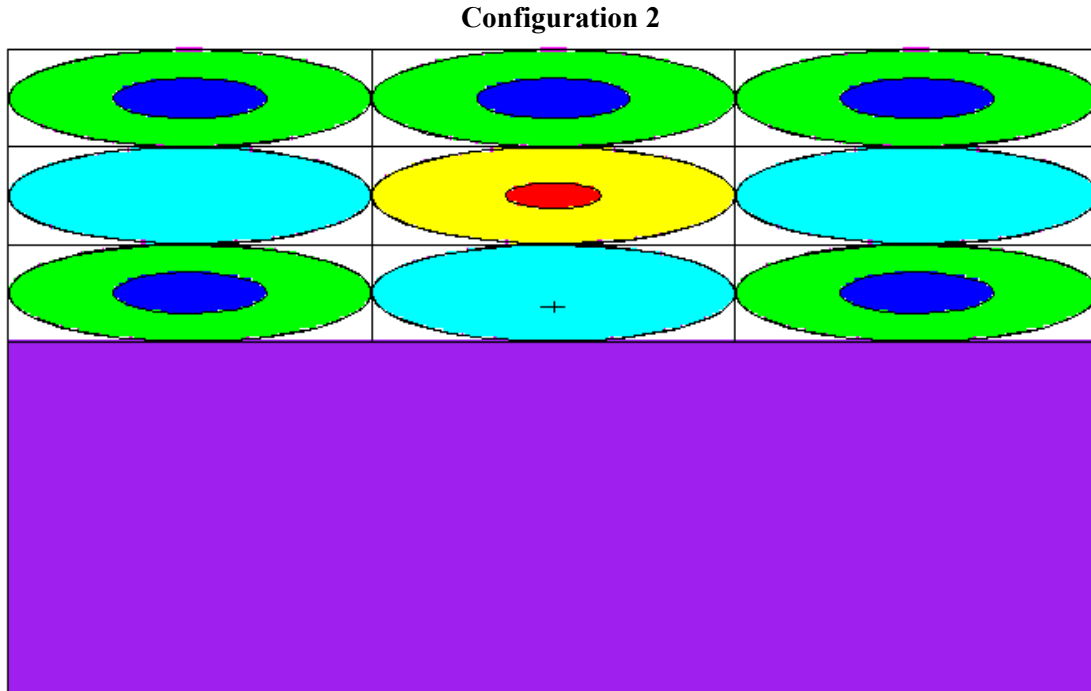

Figure A-29b, Top View of Models for the High Energy Impact Contingency Between a 41-ton Forklift and an Array of 55-Gallon Drums Seven-packs

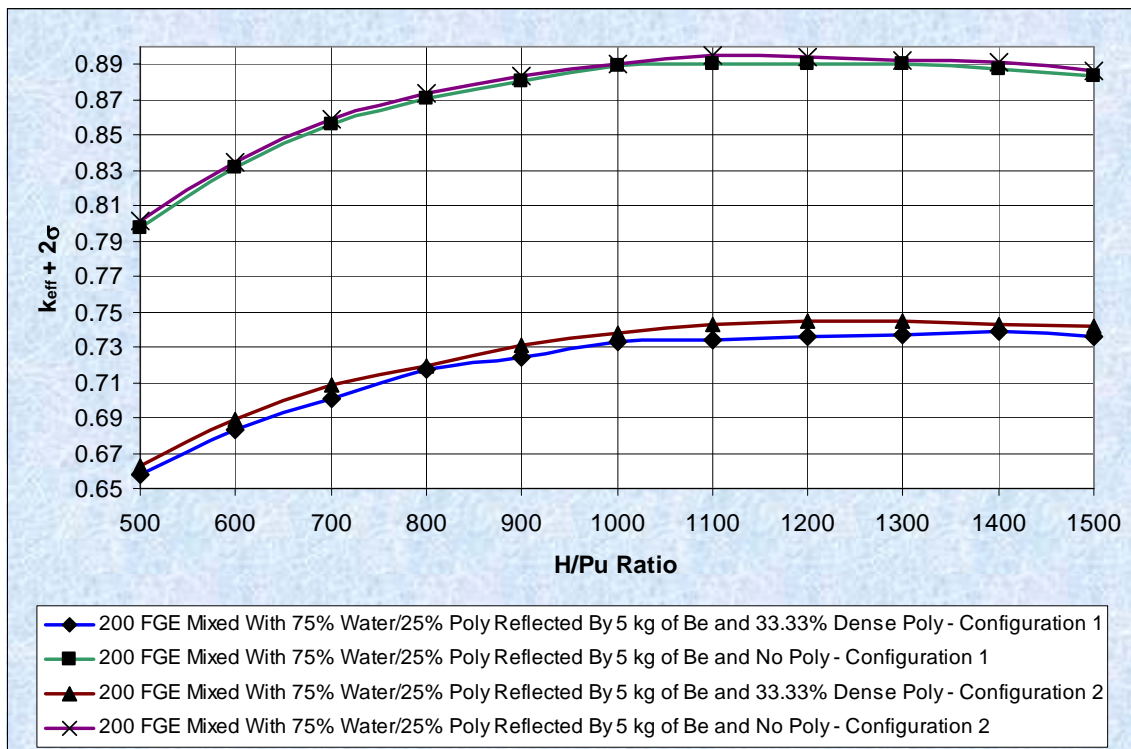

Figure A-, System Reactivity Resulting from a High Energy Impact of a 41-ton Forklift with an Array of 55-Gallon Drums Seven-packs

Table A-, MCNP Results for a High Energy Impact Contingency of a 41-ton Forklift with an Array of 55-Gallon Drums Seven-packs – Configuration 1

H/Pu Ratio	k_{eff}	σ	$k_{eff} + 2\sigma$	Filename
5 kg beryllium Mixed With 33% Dense Polyethylene				
500	0.65619	0.00084	0.65787	dacf010
600	0.68160	0.00082	0.68324	dacf012
700	0.69888	0.00085	0.70058	dacf014
800	0.71556	0.00083	0.71722	dacf016
900	0.72278	0.00080	0.72438	dacf018
1000	0.73164	0.00081	0.73326	dacf020
1100	0.73216	0.00076	0.73368	dacf022
1200	0.73429	0.00079	0.73587	dacf024
1300	0.73495	0.00075	0.73645	dacf026
1400	0.73731	0.00075	0.73881	dacf028
1500	0.73481	0.00068	0.73617	dacf030
5 kg beryllium and No Polyethylene				
500	0.79638	0.00069	0.79776	dacf050
600	0.83041	0.00077	0.83195	dacf052
700	0.85392	0.00085	0.85562	dacf054
800	0.86887	0.00074	0.87035	dacf056
900	0.87896	0.00082	0.88060	dacf058
1000	0.88746	0.00072	0.88890	dacf060
1100	0.88868	0.00074	0.89016	dacf062
1200	0.88905	0.00070	0.89045	dacf064
1300	0.88864	0.00069	0.89002	dacf066
1400	0.88607	0.00063	0.88733	dacf068
1500	0.88222	0.00061	0.88344	dacf070

Table A-, MCNP Results for a High Energy Impact Contingency of a 41-ton Forklift with an Array of 55-Gallon Drums Seven-packs – Configuration 2

H/Pu Ratio	k_{eff}	σ	$k_{eff} + 2\sigma$	Filename
5 kg beryllium Mixed With 33% Dense Polyethylene				
500	0.66135	0.00084	0.66303	dacf090
600	0.68691	0.00084	0.68859	dacf092
700	0.70678	0.00081	0.70840	dacf094
800	0.71824	0.00078	0.71980	dacf096

**Table A-, MCNP Results for a High Energy Impact Contingency of a 41-ton
 Forklift with an Array of 55-Gallon Drums Seven-packs – Configuration 2**

H/Pu Ratio	k_{eff}	σ	$k_{eff} + 2\sigma$	Filename
900	0.72954	0.00076	0.73106	dacf098
1000	0.73684	0.00070	0.73824	dacf100
1100	0.74063	0.00088	0.74239	dacf102
1200	0.74326	0.00078	0.74482	dacf104
1300	0.74343	0.00078	0.74499	dacf106
1400	0.74180	0.00069	0.74318	dacf108
1500	0.74062	0.00072	0.74206	dacf110
5 kg beryllium and No Polyethylene				
500	0.80013	0.00086	0.80185	dacf130
600	0.83314	0.00081	0.83476	dacf132
700	0.85708	0.00084	0.85876	dacf134
800	0.87188	0.00068	0.87324	dacf136
900	0.88215	0.00075	0.88365	dacf138
1000	0.88862	0.00072	0.89006	dacf140
1100	0.89347	0.00077	0.89501	dacf142
1200	0.89318	0.00068	0.89454	dacf144
1300	0.89068	0.00067	0.89202	dacf146
1400	0.88945	0.00068	0.89081	dacf148
1500	0.88481	0.00070	0.88621	dacf150

A5.0 Conclusions

This appendix demonstrates that direct-loaded containers with less than or equal to 1 wt% special reflector materials will remain below the USL in the two-container configuration, as well as in the underground array with the following limits:

- 55-gallon, 85-gallon, 100-gallon drums or shielded containers:
 - Maximum 200 FGE per drum
 - Maximum 5 kilograms particulate beryllium per drum
 - Maximum 650 FGE per pack of drums
- SWB containers
 - Maximum 325 FGE per container
 - Maximum 18.14 kilograms particulate beryllium per SWB
- ARROW-PAK™ containers
 - Maximum 325 FGE per payload container in the ARROW-PAK™ container
 - Maximum 6.25 kilograms particulate beryllium per ARROW-PAK™
- SLB2 containers
 - Maximum 500 FGE with 0 grams of ²⁴⁰Pu, 515 FGE with 5 grams of ²⁴⁰Pu, 535 FGE with 15 grams ²⁴⁰Pu, OR 555 FGE with 25 grams ²⁴⁰Pu per SLB2
 - Maximum 47.6 kilograms particulate beryllium per SLB2.

A6.0 References

ASTM A 569. *Standard Specification for Steel, Carbon (0.15 Maximum, Percent), Hot-Rolled Sheet and Strip Commercial*, American Society for Testing and Materials, West Conshohocken, PA.

ASTM D 1505, 2003. *Standard Test Method for Density of Plastics by the Density-Gradient Technique*, November 1, 2003, American Society for Testing and Materials, West Conshohocken, PA.

DOE-CBFO, 2005a. *TRUPACT-II Safety Analysis Report*, Revision 21, May 2005, U.S. Department of Energy, Carlsbad Field Office, Carlsbad, NM.

DOE-CBFO, 2005b. *Contact-Handled Transuranic Waste Authorized Methods for Payload Control (CH-TRAMPAC)*, Revision 2, May 2005, U.S. Department of Energy, Carlsbad Field Office, Carlsbad, NM.

DOE-CBFO, 2006. *Waste Isolation Pilot Plant Remote Handled (RH) Waste Documented Safety Analysis*, DOE/WIPP-06-3174, Revision 0, March 2006, U.S. Department of Energy, Carlsbad Field Office, Carlsbad, NM.

DOE-CBFO, 2007. *TRUPACT-III Safety Analysis Report*, Revision D, June 2007, U.S. Department of Energy, Carlsbad Field Office, Carlsbad, NM.

Neeley, G.W., D.L. Newell, S.L. Larson, and R.J. Green, 2004. *Reactivity Effects of Moderator and Reflector Materials on a Finite Plutonium System*, SAIC-1322-001, Revision 1, May 2004, Science Applications International Corporation, Oak Ridge, TN.

PTI, 2005. *ARROW-PAK Drawing*, 163-007, Revision 0, November 2005, Packaging Technology Incorporated, Tacoma, WA.

WTS, 2007. *Standard Large Box 2 Assembly (SLB2) Top Loading*, 165-F-016-W1, Revision D, (<http://www.wipp.energy.gov/library/slb/165-F-016.pdf>), Washington TRU Solutions LLC, Carlsbad, NM.

A7.0 Sample MCNP5 Input File Listings for Appendix A

A7.1 MCNP5 Input File Listing for 55-gallon Drum Array Case (Filename dac0026)

```

C ccccccccccccccccccccccccccccccccccccccccccccccccccccccccccccccccccccccccccccc
C
C   INFINITE ARRAY 7-PACK MODEL OF 55-GALLON DRUMS WITH THREE (3) 55-GALLON     $
C   DRUMS CONTAINING 200 GRAMS PU, ONE (1) DRUM CONTAINING 50 GRAMS OF PU,        $
C   AND THE REMAINING DRUMS CONTAIN REFLECTOR MATERIAL. ALL FISSILE BEARING      $
C   DRUMS CONTAIN A H2O-POLY MODERATOR WHICH IS MIXED WITH THE PU. THE H2O-      $
C   POLY MODERATOR IS 25% BY VOLUME POLY AND 75% BY VOLUME WATER. THE FISSILE    $
C   MASSES ARE CENTRALLY LOCATED IN THE FOUR (4) FISSILE BEARING DRUM AND       $
C   ARE CYLINDRICAL IN SHAPE WITH A H/D RATIO OF 1.0. THE FISSILE MASSES        $
C   ARE REFLECTED BY A MIXTURE OF 5 KGS. OF BERYLLIUM AND POLYETHYLENE WHICH    $
C   HAS A DENSITY OF 0% OF THEORETICAL. THE THREE (3) NON-FISSILE BEARING        $
C   ARE FILLED WITH THE SAME REFLECTOR MATERIAL AS THE FISSILE BEARING DRUMS.    $
C   THE DRUM STEEL WALL DENSITY IS 50% TO ACCOUNT FOR DEGRADATION. THE 7-PACKS   $
C   ARE STACKED 3-HIGH WITH A MGO LAYER ON TOP. THE UPPER AND LOWER VERTICAL    $
C   PLANES ARE REFLECTED BY 300 CM OF SALT. THE LATERAL BOUNDARIES ARE          $
C   MIRRORED TO SIMULATE INFINITE REFLECTION IN THE LATERAL PLANE.              $
C                                                                                  $
C ccccccccccccccccccccccccccccccccccccccccccccccccccccccccccccccccccccccccccccc
C
C   CELL CARDS FOR THE 50 FGE DRUMS.                                           $
C                                                                                  $
1   1   -0.99966   -14                                     U=1   IMP:N=1   $
2   3   -0.02333   14  -2 -10  8                           U=1   IMP:N=1   $
3   6   -3.93      (2:10:-8) -4 6 -12                       U=1   IMP:N=1   $
4   0         (4:-6:12)                                     U=1   IMP:N=1   $
C                                                                                  $
C   CELL CARDS FOR THE 200 FGE DRUMS.                                           $
C                                                                                  $
5   2   -0.99966   -34                                     U=2   IMP:N=1   $
6   4   -0.02412   34  -2 -10  8                           U=2   IMP:N=1   $
7   LIKE 3 BUT U=2                                       IMP:N=1   $
8   LIKE 4 BUT U=2                                       IMP:N=1   $
C                                                                                  $
C   CELL CARDS FOR THE BE-POLY DRUMS.                                           $
C                                                                                  $

```

9	5	-0.02308	-2 -10 8		U=3	IMP:N=1	\$
10	LIKE 3	BUT U=3				IMP:N=1	\$
11	LIKE 4	BUT U=3				IMP:N=1	\$
C							\$
C	CELL CARDS FOR THE HEXAGONAL 7-PACK STACK.						\$
C							\$
12	0		-21 20 -22 25 -23 24 -27 26	LAT=2	U=4	IMP:N=1	\$
			FILL=-3:3 -3:3 0:2				\$
			4 16R				\$
			2 3 4 4 4 4				\$
			2 1 3 4 4 4 4				\$
			2 3 4 16R				\$
			4 16R				\$
			2 3 4 4 4 4				\$
			2 1 3 4 4 4 4				\$
			2 3 4 16R				\$
			4 16R				\$
			2 3 4 4 4 4				\$
			2 1 3 4 4 4 4				\$
			2 3 4 16R				\$
13	0		-61 60 -62 65 -63 64 -67 66	FILL=4		IMP:N=1	\$
C							\$
C	CELL CARDS FOR THE MGO AND SALT LAYERS.						\$
C							\$
14	8	-2.165	(53:-66) -61 60 -62 65 -63 64 50 -52			IMP:N=1	\$
15	7	-1.45	-61 60 -62 65 -63 64 67 -53			IMP:N=1	\$
C							\$
C	CELL CARDS FOR THE REST OF THE UNIVERSE.						\$
C							\$
16	0		-50:52:61:-60:62:-65:63:-64			IMP:N=0	\$
C							\$
C	SURFACE CARDS FOR ALL DRUM SURFACES						\$
C							\$
2	CZ	28.575					\$
4	CZ	28.696					\$
6	PZ	0.0					\$
8	PZ	0.121					\$
10	PZ	84.576					\$
12	PZ	84.697					\$
C							\$
C	CELL CARDS FOR THE 50 AND 200 FGE DRUMS.						\$
C							\$
14	RCC	0 0	35.1479 0 0	14.4012	7.2006		\$
34	RCC	0 0	30.9182 0 0	22.8605	11.4303		\$
C							\$
C	SURFACE CARDS FOR THE HEXAGONAL 7-PACK.						\$
C							\$
20	PX	-28.75					\$
21	PX	28.75					\$
22	P	1	1.7321	0	57.5		\$
23	P	-1	1.7321	0	57.5		\$
24	P	-1	1.7321	0	-57.5		\$
25	P	1	1.7321	0	-57.5		\$
26	PZ	0.0					\$
27	PZ	84.697					\$
C							\$
C	SURFACE CARDS FOR THE MGO AND SALT LAYERS.						\$
C							\$
50	PZ	-300.00					\$
52	PZ	616.321					\$
53	PZ	316.321					\$
C							\$
C	SURFACE CARDS FOR THE 7-PACK STACK INFINITE ARRAY.						\$
C							\$
*60	PY	-78.5					\$
*61	PY	78.5					\$
*62	P	1.7321	1	0	157		\$
*63	P	1.7321	-1	0	157		\$
*64	P	1.7321	-1	0	-157		\$
*65	P	1.7321	1	0	-157		\$

66 PZ	0.0				\$
67 PZ	254.091				\$
C					\$
C	DATA CARDS.				\$
C					\$
C	MODE N				\$
C					\$
C	SOURCE CARDS.				\$
C					\$
C	KCODE 5000 1.0 50 250				\$
C	KSRC -58 0 43 -30 -50 43				\$
C	-58 0 128 -30 -50 128				\$
C	-58 0 213 -30 -50 213				\$
C					\$
C	MATERIAL CARDS				\$
C					\$
C					\$
C	PU-H2O-POLY FOR THE FISSILE MASS CONTAINING 50 GRAMS OF PU.				\$
C					\$
M1	94239.60C -0.021322				\$
	1001.60C -0.116868				\$
	8016.60C -0.664390				\$
	6000.60C -0.197420				\$
MT1	LWTR.01T POLY.01T				\$
C					\$
C	PU-H2O-POLY FOR THE FISSILE MASS CONTAINING 200 GRAMS OF PU.				\$
C					\$
M2	94239.60C -0.021322				\$
	1001.60C -0.116868				\$
	8016.60C -0.664390				\$
	6000.60C -0.197420				\$
MT2	LWTR.01T POLY.01T				\$
C					\$
C	BE-POLY REFLECTOR AROUND THE FISSILE MASS CONTAINING 50 GRAMS PU.				\$
C					\$
M3	4009.60C -1.000000				\$
MT3	BE.01T				\$
C					\$
C	BE-POLY REFLECTOR AROUND THE FISSILE MASS CONTAINING 200 GRAMS PU.				\$
C					\$
M4	4009.60C -1.000000				\$
MT4	BE.01T				\$
C					\$
C	BE-POLY REFLECTOR IN THE NON-FISSILE MASS DRUMS.				\$
C					\$
M5	4009.60C -1.000000				\$
MT5	BE.01T				\$
C					\$
C	55-GALLON DRUM STEEL WALLS.				\$
C					\$
M6	6000.60C -0.001500				\$
	25055.60C -0.006000				\$
	15031.60C -0.000350				\$
	16000.60C -0.000400				\$
	26054.60C -0.058513				\$
	26056.60C -0.909630				\$
	26057.60C -0.020827				\$
	26058.60C -0.0027769				\$
C					\$
C	MGO LAYER.				\$
C					\$
M7	12000.60C 0.5				\$
	8016.60C 0.5				\$
C					\$
C	SALT REFLECTOR.				\$
C					\$
M8	11023.60C 0.5				\$
	17000.60C 0.5				\$
C					\$
C	PRINT TABLE 40 FOR MASS FRACTIONS				\$

13	0	-81 80 -82 85 -83 84 -17 16					\$
		#1 #2 #3 #4 #5 #6 #7 #8 #9					\$
		#10 #11 #12			IMP:N=1		\$
C							\$
C		CELL CARDS FOR THE 50 FGE DRUMS.					\$
C							\$
14	5	-1.00334 -34		U=1	IMP:N=1		\$
15	7	-0.02329 34 -20 -30 28		U=1	IMP:N=1		\$
16	10	-3.93 (20:30:-28) -24 26 -32		U=1	IMP:N=1		\$
17	0	(24:-26:32)		U=1	IMP:N=1		\$
C							\$
C		CELL CARDS FOR THE 200 FGE DRUMS.					\$
C							\$
18	6	-1.00334 -54		U=2	IMP:N=1		\$
19	8	-0.02396 54 -20 -30 28		U=2	IMP:N=1		\$
20		LIKE 16 BUT U=2			IMP:N=1		\$
21		LIKE 17 BUT U=2			IMP:N=1		\$
C							\$
C		CELL CARDS FOR THE BE-POLY DRUMS.					\$
C							\$
22	9	-0.02308 -20 -30 28		U=3	IMP:N=1		\$
23		LIKE 16 BUT U=3			IMP:N=1		\$
24		LIKE 17 BUT U=3			IMP:N=1		\$
C							\$
C		CELL CARDS FOR THE HEXAGONAL 7-PACK STACK.					\$
C							\$
25	0	-41 40 -42 45 -43 44 -47 46 LAT=2 U=4			IMP:N=1		\$
		FILL=-3:3 -3:3 0:0					\$
		4 16R					\$
		2 3 4 4 4 4					\$
		2 1 3 4 4 4 4					\$
		2 3 4 16R					\$
26	0	-81 80 -82 85 -83 84 -87 17 FILL=4			IMP:N=1		\$
C							\$
C		CELL CARDS FOR THE MGO AND SALT LAYERS.					\$
C							\$
27	12	-2.165 (73:-16) -81 80 -82 85 -83 84 70 -72			IMP:N=1		\$
28	11	-1.45 -81 80 -82 85 -83 84 87 -73			IMP:N=1		\$
C							\$
C		CELL CARDS FOR THE REST OF THE UNIVERSE.					\$
C							\$
29	0	-70:72:81:-80:82:-85:83:-84			IMP:N=0		\$
C							\$
C		SURFACE CARDS FOR THE ARROWPAKS.					\$
C							\$
1	RCC	0.0000 0 76.8843 0 0 25.4223 12.7112					\$
2	RCC	0 0 47.3075 0 0 84.576 28.575					\$
3	RCC	0 0 7.3914 0 0 164.2873 33.6169					\$
4	RCC	0 0 0 0 0 179.07 38.1					\$
16	PZ	0.0					\$
17	PZ	179.07					\$
C							\$
C		SURFACE CARDS FOR ALL DRUM SURFACES					\$
C							\$
20	CZ	28.575					\$
24	CZ	28.696					\$
26 3	PZ	0.0					\$
28 3	PZ	0.121					\$
30 3	PZ	84.576					\$
32 3	PZ	84.697					\$
C							\$
C		CELL CARDS FOR THE 50 AND 200 FGE DRUMS.					\$
C							\$
34 3	RCC	0 0 35.5375 0 0 13.6221 6.8110					\$
54 3	RCC	0 0 31.5366 0 0 21.6237 10.8119					\$
C							\$
C		SURFACE CARDS FOR THE HEXAGONAL 7-PACK.					\$
C							\$
40	PX	-28.75					\$
41	PX	28.75					\$

42	P	1	1.7321	0	57.5	\$
43	P	-1	1.7321	0	57.5	\$
44	P	-1	1.7321	0	-57.5	\$
45	P	1	1.7321	0	-57.5	\$
46	PZ	179.07				\$
47	PZ	263.767				\$
C						\$
C		SURFACE CARDS FOR THE MGO AND SALT LAYERS.				\$
C						\$
70	PZ	-300.00				\$
72	PZ	625.997				\$
73	PZ	325.997				\$
C						\$
C		SURFACE CARDS FOR THE 7-PACK STACK INFINITE ARRAY.				\$
C						\$
*80	PY	-78.5				\$
*81	PY	78.5				\$
*82	P	1.7321	1	0	157	\$
*83	P	1.7321	-1	0	157	\$
*84	P	1.7321	-1	0	-157	\$
*85	P	1.7321	1	0	-157	\$
86	PZ	0.0				\$
87	PZ	263.767				\$
C		DATA CARDS				\$
C						\$
MODE N						\$
C						\$
C		TRANSFORMATION CARDS				\$
C						\$
TR1		-22.0	38.1	0		\$
TR2		-22.0	-38.1	0		\$
TR3		0.0	0.0	179.07		\$
C						\$
C		MATERIAL CARDS				\$
C						\$
C		PU-H2O-POLY FISSILE MASS.				\$
C						\$
M1		94239.60C		-0.025101		\$
		1001.60C		-0.116417		\$
		8016.60C		-0.661824		\$
		6000.60C		-0.196657		\$
MT1		LWTR.01T	POLY.01T			\$
C						\$
C		BE-POLY REFLECTOR AROUND THE FISSILE MASS.				\$
C						\$
M2		4009.60C		-0.119085		\$
		6000.60C		-0.754229		\$
		1001.60C		-0.126686		\$
MT2		POLY.01T	BE.01T			\$
C						\$
C		POLY REFLECTOR AROUND 55-GALLON DRUM.				\$
C						\$
M3		6000.60C		-0.8561879		\$
		1001.60C		-0.1438121		\$
MT3		POLY.01T				\$
C						\$
C		UHMW HDPE WALL OF ARROWPAK				\$
C						\$
M4		6000.60C		-0.8561879		\$
		1001.60C		-0.1438121		\$
MT4		POLY.01T				\$
C						\$
C		PU-H2O-POLY FOR THE FISSILE MASS CONTAINING 50 GRAMS OF PU.				\$
C						\$
M5		94239.60C		-0.025101		\$
		1001.60C		-0.116417		\$
		8016.60C		-0.661824		\$
		6000.60C		-0.196657		\$
MT5		LWTR.01T	POLY.01T			\$
C						\$

C	PU-H2O-POLY FOR THE FISSILE MASS CONTAINING 200 GRAMS OF PU.				\$
C					\$
M6	94239.60C	-0.025101			\$
	1001.60C	-0.116417			\$
	8016.60C	-0.661824			\$
	6000.60C	-0.196657			\$
MT6	LWTR.01T	POLY.01T			\$
C					\$
C	BE-POLY REFLECTOR AROUND THE FISSILE MASS CONTAINING 50 GRAMS PU.				\$
C					\$
M7	4009.60C	-1.000000			\$
MT7	BE.01T				\$
C					\$
C	BE-POLY REFLECTOR AROUND THE FISSILE MASS CONTAINING 200 GRAMS PU.				\$
C					\$
M8	4009.60C	-1.000000			\$
MT8	BE.01T				\$
C					\$
C	BE-POLY REFLECTOR IN THE NON-FISSILE MASS DRUMS.				\$
C					\$
M9	4009.60C	-1.000000			\$
MT9	BE.01T				\$
C					\$
C	55-GALLON DRUM STEEL WALLS.				\$
C					\$
M10	6000.60C	-0.001500			\$
	25055.60C	-0.006000			\$
	15031.60C	-0.000350			\$
	16000.60C	-0.000400			\$
	26054.60C	-0.058513			\$
	26056.60C	-0.909630			\$
	26057.60C	-0.020827			\$
	26058.60C	-0.0027769			\$
C					\$
C	MGO LAYER.				\$
C					\$
M11	12000.60C	0.5			\$
	8016.60C	0.5			\$
C					\$
C	SALT REFLECTOR.				\$
C					\$
M12	11023.60C	0.5			\$
	17000.60C	0.5			\$
KCODE	1000	1.0	100	800	\$
KSRC	44.0	0	89.535		\$
	-22	38.1	89.535		\$
	-22	-38.1	89.535		\$
	-58	0 222	-30 -50 222		\$
C					\$
C	PRINT TABLE 40 FOR MASS FRACTIONS				\$
C					\$
C	PRINT 40				\$
C					\$
C	PRINT TO MCTAL FILE				\$
C					\$
PRDMP	2j	1			\$

A7.3 MCNP Input File Listing for Shielded Container Array Case (Filename pbr511p)

2-TIER 55-GAL DRUM, 650G/7-PACK; 1-TIER AND REFL PB CONTAINERS, H/PU=1100
 C 650 G PU per 7-PACK OF DRUMS (3=200G/1=50G) AS PER CONFIG. 4 TABLE A-1. \$
 C CONTAINERS: 200G/CONTAINER PU, TOP TIER AND REFLECTOR. \$
 C INFINITE ARRAY 7-PACK MODEL OF 55-GALLON DRUMS REFLECTED BY \$
 C SHIELDED CONTIANERS. ALL FISSILE BEARING DRUMS CONTAIN A \$
 C 75% POLY 25% H2O MODERATOR WHICH IS MIXED WITH THE PU. THE FISSILE \$
 C MASSES ARE CENTRALLY LOCATED IN THE FISSILE BEARING DRUMS AND \$
 C ARE CYLINDRICAL IN SHAPE WITH A H/D RATIO OF 1.0. THE FISSILE MASSES \$

```

C ARE REFLECTED BY BERYLLIUM IN THE REMAINING VOLUME. NON FISSLE DRUMS ARE $
C EMPTY. THE CONTAINER STEEL WALL DENSITY IS 100% AND THE DRUM $
C STEEL WALL DENSITY IS 50% TO ACCOUNT FOR DEGRADATION. THE 7-PACKS $
C ARE STACKED 3-HIGH WITH A MGO LAYER ON TOP. THE UPPER AND LOWER VERTICAL $
C PLANES ARE REFLECTED BY 300 CM OF SALT. THE LATERAL BOUNDARIES ARE $
C MIRRORED TO SIMULATE INFINITE REFLECTION IN THE LATERAL PLANE. 11/12/07 $
C $
C CCCCCCCCCCCCCCCCCCCCCCCCCCCCCCCCCCCCCCCCCCCCCCCCCCCCCCCCCCCCCCCC$
C $
C CELL CARDS FOR THE 200G PU DRUMS. $
C $
1 1 -1.0033 -14 U=1 IMP:N=1 $
2 3 -0.0240 14 -2 -10 8 U=1 IMP:N=1 $
4 6 -3.93 (2:10:-8) -4 6 -12 U=1 IMP:N=1 $
5 0 (4:-6:12) U=1 IMP:N=1 $
C $
C CELL CARDS FOR THE 50G PU DRUMS. $
C $
31 1 -1.0033 -34 U=2 IMP:N=1 $
32 3 -0.0233 34 -2 -10 8 U=2 IMP:N=1 $
34 6 -3.93 (2:10:-8) -4 6 -12 U=2 IMP:N=1 $
35 0 (4:-6:12) U=2 IMP:N=1 $
C $
C CELL CARDS FOR THE 0G PU DRUMS. $
C $
43 3 -0.0231 -2 -10 8 U=3 IMP:N=1 $
44 6 -3.93 (2:10:-8) -4 6 -12 U=3 IMP:N=1 $
45 0 (4:-6:12) U=3 IMP:N=1 $
C $
C CELL CARDS FOR THE HEXAGONAL 7-PACK STACK (2-TIER) $
C $
12 0 -21 20 -22 25 -23 24 -27 26 LAT=2 U=4 IMP:N=1 $
$ FILL=-3:3 -3:3 0:1 $
$ 4 16R $
$ 1 3 4 4 4 4 $
$ 1 2 3 4 4 4 4 $
$ 1 3 4 16R $
$ 4 16R $
$ 1 3 4 4 4 4 $
$ 1 2 3 4 4 4 4 $
$ 1 3 4 16R $
13 0 -61 60 -62 65 -63 64 -67 66 FILL=4 IMP:N=1 $
C $
C CELL CARDS FOR THE SHIELDED CONTAINERS (7-PACK, TOP TIER) $
C $
51 1 -1.0033 -74 U=6 IMP:N=1 $
52 3 -0.0331 74 -132 -140 138 U=6 IMP:N=1 $
54 6 -7.86 (132:140:-138) -134 136 -142 U=6 IMP:N=1 $
55 4 -11.34 134 -146 136 -142 U=6 IMP:N=1 $
56 6 -7.86 146 -147 136 -142 U=6 IMP:N=1 $
57 0 (147:-136:142) U=6 IMP:N=1 $
C $
C CELL CARDS FOR THE HEXAGONAL 7-PACK STACK (TOP TIER) $
C $
38 0 -121 120 -122 125 -123 124 -127 126 LAT=2 U=5 IMP:N=1 $
$ FILL=-3:3 -3:3 0:0 $
$ 5 16R $
$ 6 6 5 5 5 5 $
$ 6 6 6 5 5 5 5 $
$ 6 6 5 16R $
39 0 -261 260 -262 265 -263 264 -267 67 FILL=5 IMP:N=1 $
C $
C CELL CARDS FOR THE MGO AND SALT LAYERS (7-PACK). $
C $
14 8 -2.165 (53:-66) -261 260 -262 265 -263 264 50 -52 IMP:N=1 $
15 7 -1.45 -261 260 -262 265 -263 264 267 -53 IMP:N=1 $
C $
C CELL CARDS FOR THE SHIELDED CONTAINERS (REFLECTORS) $
C $
21 1 -1.0033 -94 U=7 IMP:N=1 $
22 3 -0.0331 94 -102 -110 108 U=7 IMP:N=1 $

```

24	6	-7.86	(102:110:-108)	-104	106	-112	U=7	IMP:N=1	\$			
25	4	-11.34	104	-116		106	-112	U=7	IMP:N=1	\$		
26	6	-7.86	116:-106:112					U=7	IMP:N=1	\$		
C												
101	0		-118				FILL=7	IMP:N=1	\$			
102	LIKE 101	BUT TRCL = (51.37	-29.66	0)				\$			
103	LIKE 101	BUT TRCL = (80.59	-80.28	0)				\$			
104	LIKE 101	BUT TRCL = (80.59	-139.44	0)				\$			
105	LIKE 101	BUT TRCL = (51.37	-190.06	0)				\$			
106	LIKE 101	BUT TRCL = (0	-219.72	0)				\$			
107	LIKE 101	BUT TRCL = (-58.42	-219.72	0)				\$			
108	LIKE 101	BUT TRCL = (-	109.79	-190.06	0)				\$			
109	LIKE 101	BUT TRCL = (-	139.01	-139.44	0)				\$			
110	LIKE 101	BUT TRCL = (-	139.01	-80.28	0)				\$			
111	LIKE 101	BUT TRCL = (-	109.79	-29.66	0)				\$			
112	LIKE 101	BUT TRCL = (-	58.42	0	0)				\$			
C												
201	LIKE 101	BUT TRCL = (0	0	89.535)				\$			
202	LIKE 101	BUT TRCL = (51.37	-29.66	89.535)				\$			
203	LIKE 101	BUT TRCL = (80.59	-80.28	89.535)				\$			
204	LIKE 101	BUT TRCL = (80.59	-139.44	89.535)				\$			
205	LIKE 101	BUT TRCL = (51.37	-190.06	89.535)				\$			
206	LIKE 101	BUT TRCL = (0	-219.72	89.535)				\$			
207	LIKE 101	BUT TRCL = (-	58.42	-219.72	89.535)				\$			
208	LIKE 101	BUT TRCL = (-	109.79	-190.06	89.535)				\$			
209	LIKE 101	BUT TRCL = (-	139.01	-139.44	89.535)				\$			
210	LIKE 101	BUT TRCL = (-	139.01	-80.28	89.535)				\$			
211	LIKE 101	BUT TRCL = (-	109.79	-29.66	89.535)				\$			
212	LIKE 101	BUT TRCL = (-	58.42	0	89.535)				\$			
C												
301	LIKE 101	BUT TRCL = (0	0	179.070)				\$			
302	LIKE 101	BUT TRCL = (51.37	-29.66	179.070)				\$			
303	LIKE 101	BUT TRCL = (80.59	-80.28	179.070)				\$			
304	LIKE 101	BUT TRCL = (80.59	-139.44	179.070)				\$			
305	LIKE 101	BUT TRCL = (51.37	-190.06	179.070)				\$			
306	LIKE 101	BUT TRCL = (0	-219.72	179.070)				\$			
307	LIKE 101	BUT TRCL = (-	58.42	-219.72	179.070)				\$			
308	LIKE 101	BUT TRCL = (-	109.79	-190.06	179.070)				\$			
309	LIKE 101	BUT TRCL = (-	139.01	-139.44	179.070)				\$			
310	LIKE 101	BUT TRCL = (-	139.01	-80.28	179.070)				\$			
311	LIKE 101	BUT TRCL = (-	109.79	-29.66	179.070)				\$			
312	LIKE 101	BUT TRCL = (-	58.42	0	179.070)				\$			
C												
C	CELL CARDS FOR VOID BETWEEN REFLECTION AREA & LOWER 2 TIERS.								\$			
C												
119	0	(61:-60:62:-65:63:-64)	-261	260	-262	265	-263	264	-67	166	IMP:N=1	\$
C												
C	CELL CARDS FOR THE REFLECTION AREA (W/ MGO AND SALT LAYERS).								\$			
C												
120	0	(261:-260:262:-265:263:-264)	-161	160	-162	165	-163	164	-167	166	IMP:N=1	\$
		#101 #102 #103 #104 #105 #106 #107 #108 #109 #110 #111 #112										\$
		#201 #202 #203 #204 #205 #206 #207 #208 #209 #210 #211 #212										\$
		#301 #302 #303 #304 #305 #306 #307 #308 #309 #310 #311 #312										\$
											IMP:N=1	\$
114	8	-2.165	(261:-260:262:-265:263:-264)	(153:-66)							IMP:N=1	\$
			-161	160	-162	165	-163	164	50	-52		\$
115	7	-1.45	(261:-260:262:-265:263:-264)								IMP:N=1	\$
			-161	160	-162	165	-163	164	167	-153		\$
C												
C	CELL CARDS FOR THE REST OF THE UNIVERSE.								\$			
C												
999	0		-50:52:161:-160:162:-165:163:-164								IMP:N=0	\$
C												
C	SURFACE CARDS FOR THE 200 FGE IN THE DRUMS.								\$			
C												
14	RCC 0 0	31.5370	0 0	21.6237	10.8119	\$FGE					\$	
C												
C	SURFACE CARDS FOR THE 50 FGE IN THE DRUMS.								\$			
C												
34	RCC 0 0	35.5379	0 0	13.6221	6.8110	\$FGE					\$	

C										\$
C		SURFACE CARDS FOR THE FISSILE MASS IN THE CONTAINERS (7-PACK).								\$
C										\$
74	2	RCC	0 0	33.9556	0 0	21.6237	10.8119	\$FGE		\$
C										\$
C		SURFACE CARDS FOR THE FISSILE MASS IN THE CONTAINERS (REFLECTOR).								\$
C										\$
94	1	RCC	0 0	33.9556	0 0	21.6237	10.8119	\$FGE		\$
C										\$
C		SURFACE CARDS FOR ALL DRUM SUFFACES								\$
C										\$
2	CZ			28.575						\$
4	CZ			28.696						\$
6	PZ			0.0						\$
8	PZ			0.121						\$
10	PZ			84.576						\$
12	PZ			84.697						\$
C										\$
C		SURFACE CARDS FOR THE INDIVIDUAL HEXAGONS IN THE 7-PACK (DRUMS).								\$
C										\$
20	PX			-28.75						\$
21	PX			28.75						\$
22	P	1	1.7321	0	57.5					\$
23	P	-1	1.7321	0	57.5					\$
24	P	-1	1.7321	0	-57.5					\$
25	P	1	1.7321	0	-57.5					\$
26	PZ			0.0						\$
27	PZ			84.697						\$
C										\$
C		SURFACE CARDS FOR THE MGO AND SALT LAYERS (7-PACK).								\$
C										\$
50	PZ			-300.00						\$
52	PZ			621.159						\$
53	PZ			321.159						\$
C										\$
C		SURFACE CARDS FOR THE 7-PACK STACK ARRAY.								\$
C										\$
60	PY			-78.5						\$
61	PY			78.5						\$
62	P	1	1.7321	1	0	157				\$
63	P	1	1.7321	-1	0	157				\$
64	P	1	1.7321	-1	0	-157				\$
65	P	1	1.7321	1	0	-157				\$
66	PZ			0.0						\$
67	PZ			169.394				\$ TOP OF MIDDLE TIER		\$
C										\$
C		SURFACE CARDS FOR ALL CONTAINER SUFFACES								\$
C										\$
102	1	CZ		25.87625				\$ ir, cavity/interior shell		\$
104	1	CZ		26.33091				\$ or, interior shell		\$
106	1	PZ		0.00000				\$ base, exterior		\$
108	1	PZ		6.98500				\$ base, cavity		\$
110	1	PZ		82.55000				\$ top, cavity		\$
112	1	PZ		89.53500				\$ top, exterior		\$
116	1	CZ		28.90520				\$ ir, exterior shell		\$
117	1	CZ		29.21000				\$ or, exterior shell		\$
118	1	RCC	0 0 0 0	89.535	29.21			\$CONTAINER BOUNDARY		\$
C										\$
C		SURFACE CARDS FOR THE INDIVIDUAL CELLS IN THE CONTAINER HEXAGONAL ARRAY.								\$
C										\$
120	PX			-29.5						\$
121	PX			29.5						\$
122	P	1	1.7321	0	59.0					\$
123	P	-1	1.7321	0	59.0					\$
124	P	-1	1.7321	0	-59.0					\$
125	P	1	1.7321	0	-59.0					\$
126	PZ			169.394						\$
127	PZ			258.929						\$
C										\$
C		SURFACE CARDS FOR CONTAINER SUFFACES (7-PACK)								\$
C										\$

132	CZ	25.87625			\$ ir, cavity/interior shell	\$
134	CZ	26.33091			\$ or, interior shell	\$
136	2 PZ	0.00000			\$ base, exterior	\$
138	2 PZ	6.98500			\$ base, cavity	\$
140	2 PZ	82.55000			\$ top, cavity	\$
142	2 PZ	89.53500			\$ top, exterior	\$
146	CZ	28.90520			\$ ir, exterior shell	\$
147	CZ	29.21000			\$ or, exterior shell	\$
C						\$
C					SURFACE CARDS FOR THE TOP TIER 7-PACK.	\$
C						\$
260	PY	-80.6				\$
261	PY	80.6				\$
262	P	1.7321	1	0	161.2	\$
263	P	1.7321	-1	0	161.2	\$
264	P	1.7321	-1	0	-161.2	\$
265	P	1.7321	1	0	-161.2	\$
267	PZ	258.929				\$
C						\$
C					SURFACE CARDS FOR THE CONTAINER AREA REFLECTING THE 7-PACK STACK ARRAY.	\$
C						\$
*160	PY	-140				\$
*161	PY	140				\$
*162	P	1.7321	1	0	280	\$
*163	P	1.7321	-1	0	280	\$
*164	P	1.7321	-1	0	-280	\$
*165	P	1.7321	1	0	-280	\$
166	PZ	0.0				\$
167	PZ	268.605				\$
153	PZ	330.835			\$ MGO 24.5" thick over containers	\$
C						\$
C					DATA CARDS.	\$
C						\$
TR1		29.21	109.86	0	\$ translation for 1st container in reflector	\$
TR2		0	0	169.394	\$ translation for top tier of containers	\$
C						\$
MODE					N	\$
C						\$
C					SOURCE CARDS.	\$
C						\$
KCODE		5000	1.0	50	250	\$
KSRC		-58	0	43	-30 -50 43	\$
		-58	0	128	-30 -50 128	\$
		-58	0	213	-30 -50 213	\$
C						\$
C					MATERIAL CARDS	\$
C						\$
C						\$
C					PU-POLY-H2O FOR THE FISSILE MASS.	\$
C						\$
M1		94239.60C	-0.025101	1001.60C	-0.116417	\$
		8016.60C	-0.661824	6000.60C	-0.196657	\$
MT1		LWTR.01T	GRPH.01T			\$
C						\$
C					BE REFLECTOR AROUND THE FISSILE MASS (ALL).	\$
C						\$
M3		4009.60C	-1.000000			\$
MT3		BE.01T				\$
C						\$
C					LEAD (density = 11.34 g/cc)	\$
C						\$
M4		82206.60c	24.1	82207.60c	22.1 82208.60c 52.4	\$
C						\$
C					STEEL WALLS.	\$
C						\$
M6		6000.60C	-0.001500			\$
		25055.60C	-0.006000			\$
		15031.60C	-0.000350			\$
		16000.60C	-0.000400			\$
		26054.60C	-0.058513			\$

```

26056.60C      -0.909630
26057.60C      -0.020827
26058.60C      -0.0027769
C
C MGO LAYER.
C
M7  12000.60C      0.5
    8016.60C       0.5
C
C SALT REFLECTOR.
C
M8  11023.60C      0.5
    17000.60C     0.5
C
C PRINT TABLE 40 FOR MASS FRACTIONS
C
PRINT 40
    
```

A7.4 MCNP Input File Listing for 2-Drum Case (Filename m55g100)

```

STACKED 55 GALLON DRUM MODEL. BOTH DRUMS WITH 200G PU, H/PU = 1000
C FGE WITH MIXED WITH A MODERATOR WHICH IS 25% BY VOLUME POLYETHYLENE
C AND 75% BY VOLUME WATER. THE FISSILE MASS IS REFLECTED BY
C A MIXTURE OF 5 KGS. OF BE AND POLYETHYLENE AT 25% PACKING FRACTION.
C THE DRUMS ARE STACKED DIRECTLY ONE ON TOP OF ANOTHER WITH THE FISSILE
C MASS IN THE LOWER DRUM BEING LOCATED AT THE TOP OF THE DRUM AND THE
C FISSILE MASS IN THE UPPER DRUM BEING LOCATED IN THE BOTTOM OF THE DRUM.
C IN THIS CONFIGURATION THE FISSILE MASSES ARE IN CLOSE PROXIMITY.
C BOTH FISSILE MASSES ARE CYLINDRICAL IN SHAPE WITH A H/D RATIO OF 0.5.
C CONTAINER WALL DENSITY (STEEL) IS 50% TO ACCOUNT FOR DEGRADATION.
C THE TWO-DRUM STACK IS SURROUNDED ON ALL SIDES WITH 300 CM OF MgO.
C THE BOUNDARIES ARE MIRRORED TO SIMULATE INFINITE REFLECTION. 1/11/05
C
C CCCCCCCCCCCCCCCCCCCCCCCCCCCCCCCCCCCCCCCCCCCCCCCCCCCCCCCCCCCCCCCCCCCCC
C
C CELL CARDS FOR THE LOWER 55 GALLON DRUM IN THE TWO-DRUM MODEL.
C
1  1  -1.0057  -1  -2  3  IMP:N=1
2  2  -0.2516  -4  -5  6  #1  IMP:N=1
3  6  -3.9300  -7  -8  9  #1 #2  IMP:N=1
C
C CELL CARDS FOR THE UPPER 55 GALLON DRUM IN THE TWO-DRUM MODEL.
C
10  LIKE 1 BUT TRCL=(0 0 13.43950)  IMP:N=1
11  2  -0.2516  -23 -24 25 #10  IMP:N=1
12  6  -3.9300  -26 -27 28 #10 #11  IMP:N=1
C
C CELL CARDS FOR A 300 CM REFLECTOR AROUND THE TWO DRUMS
C
30  7  -1.450  -100 -101 102 #1 #2 #3 #10 #11 #12  IMP:N=1
C
C CELL CARDS FOR EVERYTHING OUTSIDE THE COMPUTATIONAL SPACE.
C
100 0  (100:101:-102)  IMP:N=0
C
C SURFACE CARDS FOR THE LOWER 55 GALLON DRUM IN THE TWO-DRUM MODEL.
C
1  CZ  13.19668
2  PZ  84.57641
3  PZ  71.37973
4  CZ  28.57500
5  PZ  84.57641
6  PZ  0.12141
7  CZ  28.69641
8  PZ  84.69782
9  PZ  0.00000
C
C SURFACE CARDS FOR THE UPPER 55 GALLON DRUM IN THE TWO-DRUM MODEL.
    
```

```

C
23 1 CZ 28.57500
24 1 PZ 84.57641
25 1 PZ 0.12141
26 1 CZ 28.69641
27 1 PZ 84.69782
28 1 PZ 0.00000
C
C SURFACE CARDS FOR A 300 CM REFLECTOR AROUND THE TWO DRUMS
C
*100 CZ 328.69641
*101 PZ 469.39564
*102 PZ -300.00000
C
C MODE CARD.
C
MODE N
C
C TRANSFORMATION CARDS FOR THE TWO-DRUM MODEL.
C
TR1 0.00000 0.00000 84.69782
C
C MATERIAL CARDS
C
C PU-CH2-H2O (55 GALLON DRUM)
C
M1 94239.60C -0.027542 1001.60C -0.116125 &
    8016.60C -0.660167 6000.60C -0.196165
C
C BE-CH2 REFLECTOR (55 GALLON DRUM)
C
M2 4009.60C -0.094875 6000.60C -0.774957 1001.60C -0.130168
C
C CARBON STEEL DRUM.
C
M6 6000.60C -0.001500 25055.60C -0.006000 15031.60C -0.000350 &
    16000.60C -0.000400 26054.60C -0.058513 26056.60C -0.909630 &
    26057.60C -0.020827 26058.60C -0.0027769
C
C MgO
C
M7 8016.60C -0.39700 12000.60C -0.603000
C
C S(ALPHA,BETA)
C
MT1 LWTR.01T GRPH.01T
MT2 POLY.01T GRPH.01T BE.01T
C
C SOURCE CARDS
C
KCODE 1000 1.0 50 800
KSRC 0.00000 0.00000 80.00000
PRINT
C
C PRINT TO MCTAL FILE
C
PRDMP 2j 1
    
```

A7.5 MCNP Input File Listing for Two-Container SWB Case (Filename cswb100)

```

STACKED SWBs MODEL. BOTH SWBs WITH 325G PU, H/PU=1000 1/13/05 $
C FGE MIXED WITH A H2O-POLYETHYLENE MODERATOR WHICH IS 25% BY $
C VOLUME POLYETHYLENE AND 75% BY VOLUME WATER. THE FISSILE MASS IN EACH $
C OF THE SWBs IS REFLECTED BY A MIXTURE OF 18.14 KGS. OF BERYLLIUM AND $
C POLYETHYLENE WITH AN OVERALL PACKING FRACTION OF 25%. $
C ONE SWB IS STACKED DIRECTLY ON TOP OF THE OTHER SWB WITH $
C THE FISSILE MASS IN THE LOWER SWB BEING LOCATED AT THE TOP OF $
C THE SWB CONTAINER AND THE FISSILE MASS IN THE UPPER SWB $
    
```

```

C   LOCATED IN THE BOTTOM. IN THIS CONFIGURATION THE FISSILE           $
C   MASSES ARE IN CLOSE PROXIMITY. BOTH FISSILE MASSES ARE CYLINDRICAL IN $
C   SHAPE WITH A H/D RATIO OF 0.5.                                     $
C   CONTAINER WALL DENSITY (STEEL) IS 50% TO ACCOUNT FOR DEGRADATION. $
C   THE TWO-SWB STACK IS SURROUNDED ON ALL SIDES WITH 300 CM OF CONCRETE. $
C   $
C   CCCCCCCCCCCCCCCCCCCCCCCCCCCCCCCCCCCCCCCCCCCCCCCCCCCCCCCCCCCCCCCCCC $
C   $
C   CELL CARDS FOR THE LOWER SWB.                                     $
C   $
C   1   -1.0057   -1  -2   3                                     IMP:N=1   $
C   2   -0.2391   -7  -8   9  -10  11  #1                       IMP:N=1   $
C   3   -3.9300   -12 -13  14  -15  16                           &         $
C                                     (7:8:-9:10:-11)           IMP:N=1   $
C   $
C   CELL CARDS FOR THE UPPER UPPER SWB.                             $
C   $
C   10  LIKE 1 BUT TRCL=(0 0 16.14991)                             IMP:N=1   $
C   11  -0.2391   -27 -28  29  -30  31  #10                     IMP:N=1   $
C   12  -3.9300   -32 -33  34  -35  36                           &         $
C                                     (27:28:-29:30:-31)           IMP:N=1   $
C   $
C   CELL CARDS FOR A 300 CM REFLECTOR AROUND THE STACKED SWBs     $
C   $
C   30  7   -2.3500   -100 -101 102  #1  #2  #3  #10 #11 #12     IMP:N=1   $
C   $
C   CELL CARDS FOR EVERYTHING OUTSIDE THE COMPUTATIONAL SPACE.     $
C   $
C   100 0           (100:101:-102)                                 IMP:N=0   $
C   $
C   SURFACE CARDS FOR THE LOWER SWB.                                 $
C   $
C   1   CZ   15.51491                                           $
C   2   PZ   93.66250                                           $
C   3   PZ   78.14759                                           $
C   7   CZ   87.31250                                           $
C   8   PZ   93.66250                                           $
C   9   PZ   0.31750                                             $
C   10  PY   65.88125                                           $
C   11  PY  -65.88125                                           $
C   12  CZ   87.63000                                           $
C   13  PZ   93.98000                                           $
C   14  PZ   0.00000                                           $
C   15  PY   66.19875                                           $
C   16  PY  -66.19875                                           $
C   $
C   SURFACE CARDS FOR THE UPPER SWB.                                 $
C   $
C   27  1   CZ   87.31250                                           $
C   28  1   PZ   93.66250                                           $
C   29  1   PZ   0.31750                                           $
C   30  1   PY   65.88125                                           $
C   31  1   PY  -65.88125                                           $
C   32  1   CZ   87.63000                                           $
C   33  1   PZ   93.98000                                           $
C   34  1   PZ   0.00000                                           $
C   35  1   PY   66.19875                                           $
C   36  1   PY  -66.19875                                           $
C   $
C   SURFACE CARDS FOR A 300 CM REFLECTOR AROUND THE STACKED SWBs $
C   $
C   100  CZ   387.63000                                           $
C   101  PZ  487.96000                                           $
C   102  PZ -300.00000                                           $
C   $
C   $
C   MODE CARD.                                                     $
C   $
C   MODE N                                                         $
C   $
    
```

```

C      TRANSFORMATION CARDS FOR THE STACKED SWBs MODEL.
C
C      TR1  0.00000      0.00000      93.98000
C
C      MATERIAL CARDS
C
C      PU-CH2-H2O (SWB)
C
C      M1  94239.60C -0.027542      1001.60C -0.116125      &
C          8016.60C -0.660167      6000.60C -0.196165
C
C      BE-CH2 REFLECTOR (SWB)
C
C      M2  4009.60C -0.039762      6000.60C -0.822144      1001.60C -0.138094
C
C      CARBON STEEL.
C
C      M6  6000.60C -0.001500      25055.60C -0.006000      15031.60C -0.000350      &
C          16000.60C -0.000400      26054.60C -0.058513      26056.60C -0.909630      &
C          26057.60C -0.020827      26058.60C -0.0027769
C
C      CONCRETE
C
C      Composition from Handbook of Health Physics and Radiological Health
C      3rd Edition for Ordinary Concrete.
C
C      M7  1001.60c -0.0056      8016.60c -0.4981      11023.60c -0.0171
C          12000.60c -0.0026      13027.60c -0.0457      14000.60c -0.3151
C          16032.60c -0.0013      19000.60c -0.0192      20000.60c -0.0829
C          26054.60c -0.0007316      26056.60c -0.011373      26057.60c -0.0002604
C          26058.60c -3.472e-005
C
C      S(ALPHA,BETA)
C
C      MT1  LWTR.01T      GRPH.01T
C      MT2  POLY.01T      GRPH.01T      BE.01T
C      MT7  LWTR.01T
C
C      SOURCE CARDS
C
C      KCODE 1000      1.0      50      800
C      KSRC  0.00000      0.00000      80.00000
C      PRINT
C
C      PRINT TO MCTAL FILE
C
C      PRDMP 2j 1
    
```

**A7.6 MCNP Input File Listing for Two-Container SLB2-SWB Case
 (Filename slwtd20)**

```

C CCCCCCCCCCCCCCCCCCCCCCCCCCCCCCCCCCCCCCCCCCCCCCCCCCCCCCCCCCCCCCCCCCCCCCCCC
C
C      ONE SWB STACKED VERTICALLY ABOVE AN SLB2. THE FISSILE MASSES ARE IN
C      CLOSE PROXIMITY. SPECIFICALLY, THE FISSILE MASSES ARE MODEL AS CYLINDERS
C      WITH AN H/D =2. THE FISSILE MASS IN THE SLB2 CONTAINS 500 GM OF PU MIXED
C      WITH A MODERATOR WHICH IS 25% BY VOLUME POLYETHYLENE AND 75% BY VOLUME
C      WATER. THE FISSILE MASS IS REFLECTED BY A MIXTURE OF 47.7 KGS OF BE AND
C      25% DENSE POLYETHYLENE. THE FISSILE MASS IN THE SWB IS COMPOSED OF
C      325 GRAMS OF PU MIXED WITH A H2O-POLY MODERATOR WHICH IS 25% BY VOLUME
C      POLYETHYLENE AND 75% BY VOLUME WATER. THE FISSILE MASS IN THE SWB IS
C      REFLECTED BY A MIXTURE OF 18.14 KGS. OF BE AND POLYETHYLENE WHICH HAS A
C      DENSITY OF 25% OF THEORETICAL. THE FISSILE MASS IN THE LOWER SLB2 IS
C      LOCATED AT THE TOP OF THE SLB2 AND THE FISSILE MASS IN THE UPPER SWB
C      IS LOCATED IN THE BOTTOM OF THE SWB SO THAT THE MASSES ARE IN CLOSE
C      PROXIMITY OF ONE ANOTHER. THE SLB2 AND SWB WALL DENSITY (STEEL) IS 50%
C      TO ACCOUNT FOR DEGRADATION. ALL LATERAL SIDES AND VERTICAL PLANES ARE
C      REFLECTED BY 300 CM OF CONCRETE.
C
C CCCCCCCCCCCCCCCCCCCCCCCCCCCCCCCCCCCCCCCCCCCCCCCCCCCCCCCCCCCCCCCCCCCCCCCCC
    
```

C										\$
C	DATA CARDS									\$
C										\$
MODE N										\$
C										\$
C	TRANSFORMATION CARD									\$
C										\$
TR1	0 0	182.72								\$
TR2	87.235	137.0	182.72							\$
C										\$
C	SOURCE CARDS									\$
C										\$
KCODE	5000	1.0	50	250						\$
KSRC	89.53	133.35	170.1147							\$
	89.53	133.35	188.7200							\$
C										\$
C	MATERIAL CARDS									\$
C										\$
C	PU-H2O-POLY FISSILE MASS (SLB2).									\$
C										\$
M1	94239.60C	-0.027542								\$
	1001.60C	-0.116125								\$
	8016.60C	-0.660167								\$
	6000.60C	-0.196165								\$
MT1	LWTR.01T	POLY.01T								\$
C										\$
C	BE-POLY REFLECTOR AROUND THE FISSILE MASS (SLB2).									\$
C										\$
M2	4009.60C	-0.030303								\$
	6000.60C	-0.830243								\$
	1001.60C	-0.139454								\$
MT2	BE.01T	POLY.01T								\$
C										\$
C	PU-H2O-POLY FISSILE MASS (SWB).									\$
C										\$
M3	94239.60C	-0.027542								\$
	1001.60C	-0.116125								\$
	8016.60C	-0.660167								\$
	6000.60C	-0.196165								\$
MT3	LWTR.01T	POLY.01T								\$
C										\$
C	BE-POLY REFLECTOR AROUND THE FISSILE MASS (SWB).									\$
C										\$
M4	4009.60C	-0.039730								\$
	6000.60C	-0.822171								\$
	1001.60C	-0.138098								\$
MT4	BE.01T	POLY.01T								\$
C										\$
C	STEEL FOR SLB2S.									\$
C										\$
M5	6000.60C	-0.001500								\$
	25055.60C	-0.006000								\$
	15031.60C	-0.000350								\$
	16000.60C	-0.000400								\$
	26054.60C	-0.058513								\$
	26056.60C	-0.909630								\$
	26057.60C	-0.020827								\$
	26058.60C	-0.0027769								\$
C										\$
C	MGO REFLECTOR.									\$
C										\$
M6	12000.60C	0.5								\$
	8016.60C	0.5								\$
C										\$
C	SALT REFLECTOR.									\$
C										\$
M7	11023.60C	0.5								\$
	17000.60C	0.5								\$
C										\$
C	CONCRETE									\$

```
C      Composition from Handbook of Health Physics and Radiological Health      $
C      3rd Edition for Ordinary Concrete.                                     $
C                                                                              $
M8     1001.60c -0.0056      8016.60c -0.4981      11023.60c -0.0171      $
      12000.60c -0.0026     13027.60c -0.0457     14000.60c -0.3151      $
      16032.60c -0.0013     19000.60c -0.0192     20000.60c -0.0829      $
      26054.60c -0.0007316  26056.60c -0.011373   26057.60c -0.000260    $
      26058.60c -3.472e-005                                     $
MT8    LWTR.01T                                               $
C                                             $
C      OUPUT                                                  $
C                                             $
C      PRINT                                                  $
C                                             $
C      PRINT TO MCTAL FILE                                    $
C                                             $
C      PRDMP 2j 1                                           $
```

**A7.7 MCNP Input File Listing for SLB2 Array with Water Ingress
(Filename slbw142)**

```
C CCCCCCCCCCCCCCCCCCCCCCCCCCCCCCCCCCCCCCCCCCCCCCCCCCCCCCCCCCCCCCCCCCCCCC$
C                                                                              $
C      INFINITE ARRAY OF SIDE-BY-SIDE SLB2'S WITH THE FISSILE MASSES ARE      $
C      REPRESENTED AS TRIANGULAR PRISMS LOCATED AT ONE CORNER OF THE SLBS. EACH  $
C      FISSILE MASS IS COMPRISED OF 500 GRAMS OF PU MIXED WITH A POLY-H2O      $
C      MODERATOR WHICH IS 75% BY VOLUME H2O AND 25% BY VOLUME POLYETHYLENE.    $
C      EACH FISSILE MASS IS REFLECTED BY A MIXTURE OF 47.700 KGS OF BE AND    $
C      75% BY VOLUME WATER MIXED WITH 25% BY VOLUME DENSE POLYETHYLENE.      $
C      THREE 7-PACKS ARE STACKED ON TOP OF THE SLB2'S. THREE (3) 55-GALLON    $
C      DRUMS CONTAIN 200 GRAMS PU, ONE (1) DRUM CONTAINING 50 GRAMS OF PU, AND  $
C      THE REMAINING DRUMS CONTAIN REFLECTOR MATERIAL. ALL FISSILE BEARING     $
C      DRUMS CONTAIN A H2O-POLY MODERATOR WHICH IS MIXED WITH THE PU. THE H2O-  $
C      MODERATOR IS 25% BY VOLUME POLYETHYLENE AND 75% BY VOLUME WATER.      $
C      THE FISSILE MASSES ARE CENTRALLY LOCATED IN THE FOUR (4) FISSILE BEAR  $
C      DRUMS AND ARE CYLINDRICAL IN SHAPE WITH A H/D RATIO OF 1.0. THE FISSILE  $
C      MASSES ARE REFLECTED BY A OF 5 KG OF BERYLLIUM AND 75% BY VOLUME WATER  $
C      MIXED WITH 25% BY VOLUME POLYETHYLENE. THE THREE (3) NON-FISSILE BEAR  $
C      ARE FILLED WITH THE SAME REFLECTOR MATERIAL AS THE FISSILE BEARING     $
C      THE SLB2 AND DRUM STEEL WALL DENSITY IS 50% TO ACCOUNT FOR DEGRADATION. $
C      THE 7-PACKS ARE STACKED ON TOP OF THE SLB2'S WITH A MGO LAYER ON TOP OF $
C      THE 7-PACKS. THE UPPER AND LOWER VERTICAL PLANES ARE REFLECTED BY 300 CM $
C      OF SALT. THE LATERAL BOUNDARIES ARE MIRRORED TO SIMULATE INFINITE      $
C      REFLECTION IN THE LATERAL PLANE.                                       $
C                                                                              $
C CCCCCCCCCCCCCCCCCCCCCCCCCCCCCCCCCCCCCCCCCCCCCCCCCCCCCCCCCCCCCCCCCCCCCC$
C      CELL CARDS FOR THE SLB2'S.                                           $
C                                                                              $
1      1      -1.00334      1      2      3      -4           U=1      IMP:N=1      $
2      2      -0.98278      -12 #1           U=1      IMP:N=1      $
3      3      -3.93000      -11 12          U=1      IMP:N=1      $
10     3      -3.93000      -13 14 TRCL=(0 7.79000 0)   U=1      IMP:N=1      $
11     LIKE 10 BUT           TRCL=(0 90.75000 0)   U=1      IMP:N=1      $
12     LIKE 10 BUT           TRCL=(0 173.72000 0)  U=1      IMP:N=1      $
13     LIKE 10 BUT           TRCL=(0 256.70000 0)  U=1      IMP:N=1      $
14     0          -14      TRCL=(0 7.79000 0)   U=1      IMP:N=1      $
15     LIKE 14 BUT           TRCL=(0 90.75000 0)   U=1      IMP:N=1      $
16     LIKE 14 BUT           TRCL=(0 173.72000 0)  U=1      IMP:N=1      $
17     LIKE 14 BUT           TRCL=(0 256.70000 0)  U=1      IMP:N=1      $
20     0      -15 11 #10 #11 #12 #13# 14 #15 #16 #17   U=1      IMP:N=1      $
21     0      15           U=1      IMP:N=1      $
22     0      -15           FILL=1      IMP:N=1      $
23     0      -15 TRCL=(0 274.0000 0)   FILL=1      IMP:N=1      $
C                                                                              $
C      CELL CARDS FOR THE 50 FGE DRUMS.                                     $
C                                                                              $
30     4      -1.00334      -34           U=2      IMP:N=1      $
31     6      -0.99036      34 -20 -30 28           U=2      IMP:N=1      $
32     3      -3.93000      (20:30:-28) -24 26 -32   U=2      IMP:N=1      $
```

33	0	(24:-26:32)		U=2	IMP:N=1	\$
C						\$
C		CELL CARDS FOR THE 200 FGE DRUMS.				\$
C						\$
34	5	-1.00334 -54		U=3	IMP:N=1	\$
35	7	-0.99067 54 -20 -30 28		U=3	IMP:N=1	\$
36		LIKE 32 BUT U=3			IMP:N=1	\$
37		LIKE 33 BUT U=3			IMP:N=1	\$
C						\$
C		CELL CARDS FOR THE BE-POLY DRUMS.				\$
C						\$
38	8	-0.99026 -20 -30 28		U=4	IMP:N=1	\$
39		LIKE 32 BUT U=4			IMP:N=1	\$
40		LIKE 33 BUT U=4			IMP:N=1	\$
C						\$
C		CELL CARDS FOR THE HEXAGONAL 7-PACK STACK.				\$
C						\$
41	0	-40 41 -42 43 -44 45 -46 47 LAT=2 U=5			IMP:N=1	\$
		FILL=-3:3 -3:3 0:0				\$
		5 16R				\$
		3 4 5 5 5 5				\$
		3 2 4 5 5 5 5				\$
		3 4 5 16R				\$
60	0	-200 300 -301		FILL=5	IMP:N=1	\$
61		LIKE 60 BUT TRCL=(0 182.67 0)			IMP:N=1	\$
62		LIKE 60 BUT TRCL=(0 365.34 0)			IMP:N=1	\$
C						\$
C		CELL CARDS FOR A HEXAPRISM MGO UNIT ABOVE THE 7-PACKS.				\$
C						\$
70	9	-1.45 -201 300 -301			IMP:N=1	\$
71		LIKE 70 BUT TRCL=(0 182.67 0)			IMP:N=1	\$
72		LIKE 70 BUT TRCL=(0 365.34 0)			IMP:N=1	\$
C						\$
C		CELL CARDS FOR CONCRETE SALT IN THE UPPER AND LOWER Z PLANE.				\$
C						\$
80	10	-2.165 -306			IMP:N=1	\$
81	10	-2.165 -307			IMP:N=1	\$
C						\$
C		CELL CARDS FOR ARRAY BOUNDARY WITH MIRROR REFLECTION IN THE				\$
C		X & Y PLANE AND 300 CM SALT REFLECTION IN THE UPPER AND LOWER Z PLANE.				\$
C						\$
90	0	300 -301 302 -303 304 -305				\$
		#22 #23 #60 #61 #62 #70 #71 #72 #80 #81			IMP:N=1	\$
100	0	(-300:301:-302:303:-304:305) -400			IMP:N=0	\$
101	0	400			IMP:N=0	\$
C						\$
C		SURFACE CARDS FOR THE SLB2.				\$
C						\$
1	2	PX 0.00000				\$
2	2	PY 0.00000				\$
3	2	PZ 0.00000				\$
4	2	P 0.57735 0.57735 0.57735 28.4362				\$
11	BOX	3.81000 3.81000 10.16000 166.8500 0 0 0 266.3800 0 0 0 169.3900				\$
12	BOX	4.29000 4.29000 10.64000 165.8900 0 0 0 265.4300 0 0 0 168.4300				\$
13	BOX	3.81000 0 0 166.8500 0 0 0 10.1600 0 0 0 10.1600				\$
14	BOX	3.81000 0.32000 0.32000 166.8500 0 0 0 9.5200 0 0 0 9.5200				\$
15	BOX	0 0 0 174.4700 0 0 0 274.0000 0 0 0 182.7200				\$
C						\$
C		SURFACE CARDS FOR ALL DRUM SURFACES IN THE 7-PACK.				\$
C						\$
20	1	CZ 28.57500				\$
24	1	CZ 28.69641				\$
26	1	PZ 0.00000				\$
28	1	PZ 0.12141				\$
30	1	PZ 84.57641				\$
32	1	PZ 84.69782				\$
C						\$
C		SURFACE CARDS FOR THE 50 AND 200 FGE DRUMS IN THE 7-PACK.				\$
C						\$
34	1	RCC 0 0 35.5375 0 0 13.6221 6.8110				\$

54	1	RCC	0	0	31.5366	0	0	21.6237	10.8119		\$
C											
C SURFACE CARDS FOR THE HEXAGONAL 7-PACK.											
C											
40	1	PX			28.69641						\$
41	1	PX			-28.69641						\$
42	1	P	1		1.73205	0		57.39282			\$
43	1	P	1		1.73205	0		-57.39282			\$
44	1	P	-1		1.73205	0		57.39282			\$
45	1	P	-1		1.73205	0		-57.39282			\$
46	1	PZ			84.69782						\$
47	1	PZ			0.00000						\$
C											
C SURFACE CARDS FOR A HEXAPRISM UNIT CONTAINING THE 7-PACK STACK.											
C											
200	1	RHP	0	0		0	0	84.69782	0	78.40005	0
201	1	RHP	0	0	84.69782	0	0	58.97093	0	78.40005	0
C											
C SURFACE CARDS FOR ARRAY BOUNDARY WITH MIRROR REFLECTION IN THE											
C X & Y PLANE AND 300 CM SALT REFLECTION IN THE UPPER AND LOWER Z PLANE.											
C											
300		PX			0.0000						\$
301		PX			174.4700						\$
302		PY			0.0000						\$
303		PY			548.0000						\$
304		PZ			-300.0000						\$
305		PZ			626.3900						\$
306		BOX	0	0	0	174.4700	0	0	0	548.0000	0
307		BOX	0	0	326.39	174.4700	0	0	0	548.0000	0
*400		BOX	-0.001	-0.001	-300.0010	174.4720	0	0	0	548.002	0
C											
C DATA CARDS											
C											
MODE N											
C											
C TRANSFORMATION CARDS											
C											
TR1	87.23	91.33	182.72								\$
TR2	4.30	4.30	10.65								\$
KCODE	5000	1.0	50	800							\$
KSRC	10.00	10.00	15.00	10.00	290.00	15.00					\$
	87.23	91.33	220.07	116.23	140.33	220.07	58.23	140.33	220.07		\$
	87.23	274.00	220.07	116.23	323.33	220.07	58.23	323.33	220.07		\$
	87.23	456.67	220.07	116.23	505.67	220.07	58.23	505.67	220.07		\$
C											
C MATERIAL CARDS											
C											
C PU-H2O-POLY FISSILE MASS.											
C											
M1	94239.60C		-0.025101								\$
	1001.60C		-0.116417								\$
	8016.60C		-0.661824								\$
	6000.60C		-0.196657								\$
MT1	LWTR.01T	POLY.01T									\$
C											
C BE-H2O-POLY REFLECTOR AROUND THE FISSILE MASS.											
C											
M2	4009.60C		-0.007311								\$
	6000.60C		-0.200246								\$
	1001.60C		-0.118541								\$
	8016.60C		-0.673902								\$
MT2	LWTR.01T	BE.01T	POLY.01T								\$
C											
C STEEL FOR SLB2 AND 55-GALLON DRUM WALLS.											
C											
M3	6000.60C		-0.001500								\$
	25055.60C		-0.006000								\$
	15031.60C		-0.000350								\$
	16000.60C		-0.000400								\$
	26054.60C		-0.058513								\$
	26056.60C		-0.909630								\$

	26057.60C	-0.020827		\$
	26058.60C	-0.0027769		\$
C				\$
C	PU-H2O-POLY FOR THE FISSILE MASS CONTAINING 50 GRAMS OF PU.			\$
C				\$
M4	94239.60C	-0.025101		\$
	1001.60C	-0.116417		\$
	8016.60C	-0.661824		\$
	6000.60C	-0.196657		\$
MT4	LWTR.01T	POLY.01T		\$
C				\$
C	PU-H2O-POLY FOR THE FISSILE MASS CONTAINING 200 GRAMS OF PU.			\$
C				\$
M5	94239.60C	-0.025101		\$
	1001.60C	-0.116417		\$
	8016.60C	-0.661824		\$
	6000.60C	-0.196657		\$
MT5	LWTR.01T	POLY.01T		\$
C				\$
C	BE-H2O-POLY REFLECTOR AROUND THE FISSILE MASS CONTAINING 50 GRAMS PU.			\$
C				\$
M6	4009.60C	-0.023519		\$
	6000.60C	-0.196976		\$
	1001.60C	-0.116606		\$
	8016.60C	-0.662898		\$
MT6	LWTR.01T	BE.01T	POLY.01T	\$
C				\$
C	BE-H2O-POLY REFLECTOR AROUND THE FISSILE MASS CONTAINING 200 GRAMS PU.			\$
C				\$
M7	4009.60C	-0.024183		\$
	6000.60C	-0.196843		\$
	1001.60C	-0.116527		\$
	8016.60C	-0.662448		\$
MT7	LWTR.01T	BE.01T	POLY.01T	\$
C				\$
C	BE-H2O-POLY REFLECTOR IN THE NON-FISSILE MASS DRUMS.			\$
C				\$
M8	4009.60C	-0.023306		\$
	6000.60C	-0.197019		\$
	1001.60C	-0.116631		\$
	8016.60C	-0.663043		\$
MT8	LWTR.01T	BE.01T	POLY.01T	\$
C				\$
C	MGO LAYER.			\$
C				\$
M9	12000.60C	0.5		\$
	8016.60C	0.5		\$
C				\$
C	SALT REFLECTOR.			\$
C				\$
M10	11023.60C	0.5		\$
	17000.60C	0.5		\$
C				\$
C	PRINT TABLE 40 FOR MASS FRACTIONS			\$
C				\$
C	PRINT 40			\$
C				\$
C	PRINT TO MCTAL FILE			\$
C				\$
C	PRDMP 2j 1			\$

A7.8 MCNP Input File Listing for Impacted 55-gallon Drum Array (Filename dacf142)

```

CCCCCCCCCCCCCCCCCCCCCCCCCCCCCCCCCCCCCCCCCCCCCCCCCCCCCCCCCCCCCCCCCCCCCCCCCCCCCCCC$
C
C INFINITE ARRAY 7-PACK MODEL OF 55-GALLON DRUMS WITH THREE (3) 55-GALLON
C DRUMS CONTAINING 200 GRAMS PU, ONE (1) DRUM CONTAINING 50 GRAMS OF PU,
C AND THE REMAINING DRUMS CONTAIN REFLECTOR MATERIAL. ALL FISSILE BEARING
C DRUMS CONTAIN A H2O-POLY MODERATOR WHICH IS MIXED WITH THE PU. THE H2O-
    
```

C										\$
C	CELL SURFACE FOR THE 200 FGE DRUM.									\$
C										\$
4	REC	0 0	31.5370	0 0	21.6237	15.2903	0 0	7.6451		\$
5	REC	0 0	0.1214	0 0	84.5764	34.9971	0 0	17.4985		\$
6	REC	0 0	0.0000	0 0	84.6978	35.1185	0 0	17.6199		\$
C										\$
C	SURFACE CARDS FOR THE BE-POLY DRUM.									\$
C										\$
7	REC	0 0	0.1214	0 0	84.5764	34.9971	0 0	17.4985		\$
8	REC	0 0	0.0000	0 0	84.6978	35.1185	0 0	17.6199		\$
C										\$
C	SURFACE CARDS FOR THE RECTANGULAR LATTICE.									\$
C										\$
9	PX		35.1185							\$
10	PX		-35.1185							\$
11	PY		17.6199							\$
12	PY		-17.6199							\$
13	PZ		84.6978							\$
14	PZ		0.0000							\$
*15	PX		105.3554							\$
*16	PX		-105.3554							\$
*17	PY		52.8596							\$
18	PY		-52.8596							\$
19	PZ		254.0933							\$
20	PZ		0.000							\$
C										\$
C	SURFACE CARDS FOR THE MGO AND SALT LAYERS.									\$
C										\$
25	PZ		316.3234							\$
26	PZ		254.0933							\$
27	PZ		616.3234							\$
28	PZ		-300.0000							\$
C										\$
C	SURFACE CARDS FOR THE LEAD SHIELD LAYER.									\$
C										\$
30	PY		-252.8596							\$
C										\$
C	DATA CARDS.									\$
C										\$
MODE	N									\$
C										\$
C	SOURCE CARDS.									\$
C										\$
KCODE	5000 1.0 50 250									\$
KSRC	0 0	40.000								\$
	0 0	125.000								\$
	0 0	205.000								\$
C										\$
C	MATERIAL CARDS									\$
C										\$
C										\$
C	PU-H2O-POLY FOR THE FISSION MASS CONTAINING 50 GRAMS OF PU.									\$
C										\$
M1	94239.60C	-0.025101								\$
	1001.60C	-0.116417								\$
	8016.60C	-0.661824								\$
	6000.60C	-0.196657								\$
MT1	LWTR.01T	POLY.01T								\$
C										\$
C	PU-H2O-POLY FOR THE FISSION MASS CONTAINING 200 GRAMS OF PU.									\$
C										\$
M2	94239.60C	-0.025101								\$
	1001.60C	-0.116417								\$
	8016.60C	-0.661824								\$
	6000.60C	-0.196657								\$
MT2	LWTR.01T	POLY.01T								\$
C										\$
C	BE REFLECTOR AROUND THE FISSION MASS CONTAINING 50 GRAMS PU.									\$
C										\$

M3	4009.60C	-1.000000	\$
MT3	BE.01T		\$
C			\$
C	BE REFLECTOR AROUND THE FISSILE MASS CONTAINING 200 GRAMS PU.		\$
C			\$
M4	4009.60C	-1.000000	\$
MT4	BE.01T		\$
C			\$
C	BE REFLECTOR IN THE NON-FISSILE MASS DRUMS.		\$
C			\$
M5	4009.60C	-1.000000	\$
MT5	BE.01T		\$
C			\$
C	55-GALLON DRUM STEEL WALLS.		\$
C			\$
M6	6000.60C	-0.001500	\$
	25055.60C	-0.006000	\$
	15031.60C	-0.000350	\$
	16000.60C	-0.000400	\$
	26054.60C	-0.058513	\$
	26056.60C	-0.909630	\$
	26057.60C	-0.020827	\$
	26058.60C	-0.0027769	\$
C			\$
C	MGO LAYER.		\$
C			\$
M7	12000.60C	0.5	\$
	8016.60C	0.5	\$
C			\$
C	SALT REFLECTOR.		\$
C			\$
M8	11023.60C	0.5	\$
	17000.60C	0.5	\$
C			\$
C	LEAD REFLECTOR.		\$
C			\$
M9	82206.60c	0.24100000	\$
	82207.60c	0.22100000	\$
	82208.60c	0.52400000	\$
C			\$
C	PRINT TABLE 40 FOR MASS FRACTIONS		\$
C			\$
C	PRINT 40		\$
C			\$
C	PRINT TO MCTAL FILE		\$
C			\$
C	PRDMP 2j 1		\$

This page intentionally left blank.

Appendix B

Direct-Loaded Waste Containing Greater Than 1 Weight Percent Special Reflectors

This page intentionally left blank.

Analyst		
NCS Engineer	<hr/> D. L. Newell	Date
Peer Reviewer		
Senior NCS Engineer	<hr/> S. L. Larson	Date

This page intentionally left blank.

Introduction

This appendix focuses on direct-loaded waste containers containing greater than 1 wt% of special reflector material. Special reflector materials are those that have been shown to increase reactivity above that of a 25% polyethylene/75% water-reflected system and must be limited when mass loading limits are based on this polyethylene/water reflection combination. Containers with limits on special reflector materials are discussed in . Beryllium is modeled as the special reflector material, as it has been shown to result in the highest reactivity when reflecting a plutonium system in *Reactivity Effects of Moderator and Reflector Materials on a Finite Plutonium System* (Neeley et al. 2004). 100 grams of ^{239}Pu and 100 kilograms beryllium per drum is modeled based on minimizing impact to generator site operations. Sample MCNP5 input file listings for the models contained in this appendix are included in Section .

B1.0 Waste Configurations for Direct-Loaded Waste with Greater Than 1 Weight Percent Special Reflector Materials

B1.1 55-gallon Drums

The direct-loaded 55-gallon drums are modeled with 100 grams of ^{239}Pu mixed with a polyethylene-water moderator. The 100 kilograms beryllium is introduced in varying amounts into the moderator and the remainder is modeled as a reflector. Without beryllium, the moderator is 25% by volume polyethylene and 75% by volume water.

The 100 kilograms of beryllium is considered to be in particulate form in compounds such as beryllium oxide (BeO) or as metal waste from machining processes. Beryllium evaluated both as a moderator and as a reflector is consistent with Section 6.4.3.2.2 of the *TRUPACT-II Safety Analysis Report* (DOE-CBFO 2005a) where beryllium is shown slightly more reactive modeled in the reflector than in the moderator. In the moderator, beryllium is modeled at full density for conservatism. However, when modeled as a reflector around ^{239}Pu , beryllium is modeled at 70% density. The use of 100% dense beryllium, although bounding, is not possible in these waste drums per *Review of Special Reflectors in the TRU Waste Inventory* (Taggart and Moon 2004). Because the beryllium consists of molds, shapes, chunks, coarse particles and fines randomly filling the waste container instead of being specifically constructed to surround the fissile material and fill the container with no void, beryllium at 70% of theoretical density or 1.295 g/cm^3 is used given that the maximum theoretical density for randomly packed uniform spheres is 70% (“Recursive packing of dense particle mixtures” [Elliot et al. 2002] and “Is random packing of spheres well defined?” [Torquato et al. 2007]). Both polyethylene and void are evaluated in the remainder of the drum. The polyethylene is modeled at a maximum packing fraction of 25% as determined to bound the packing fraction of direct-loaded (non-machine compacted) waste in the TRUPACT-II SAR.

The 55-gallon drum dimensions given in Table 2-1 are used in the MCNP5 models. The drum walls are carbon steel (*Standard Specification for Steel, Carbon (0.15 Maximum, Percent)*,

Hot-Rolled Sheet and Strip Commercial [ASTM A 569]), which is modeled with the composition given in Table 5-4. The theoretical density of carbon steel is 7.86 g/cm^3 , but is modeled at 50% of this value, or 3.93 g/cm^3 , to allow for fabrication tolerances, localized wall thinning, or other degradation. Section 2.1.2 of the *Contact-Handled Transuranic Waste Authorized Methods for Payload Control (CH-TRAMPAC)* (DOE-CBFO 2005b) requires that the integrity of the container be visually inspected prior to transport to ensure there is no significant rusting whereas the 50% value is conservative.

B1.2 Shielded Containers

As discussed in Section , direct-loaded waste may also be loaded into shielded containers. These containers are right-circular cylinders made of steel and lead. The base and lid (top) are steel and the walls are lead layered between and inner and outer steel shells. The containers are modeled with the dimensions given in Table 2-6; the steel is modeled with the composition given in Table 5-4. The theoretical density of carbon steel is 7.86 g/cm^3 , and the steel is modeled at full density since the containers will be fabricated new specifically for disposal at the WIPP. The lead is modeled as given in Table 5-5.

B2.0 Array Models

B2.1 55-gallon Drum Array Model

The seven-pack 55-gallon drum array model discussed in was used to evaluate the 100-gram ^{239}Pu system with 100 kilograms beryllium per drum. The fissile mass is modeled as a cylinder located in the center of each drum, and the H/D ratio of the cylinder is 1. The beryllium was modeled in varying amounts as a moderator with the amount not used as moderator modeled as a reflector. Figure B-1 and Figure B-2 show a typical configuration. The weight ratios for the fissile material input into MCNP5 are summarized in Table B-1.

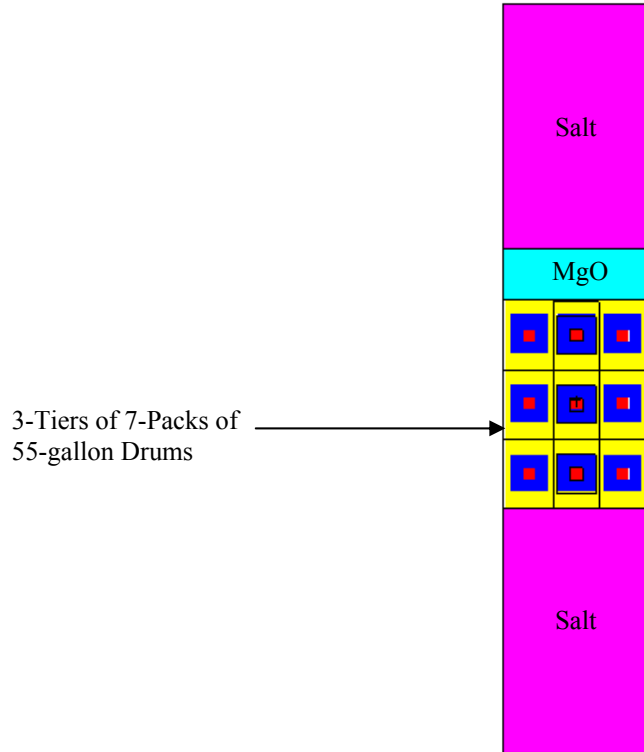

Figure B-, Typical 55-gallon Drum Seven-pack Array Model, X-Z Plane

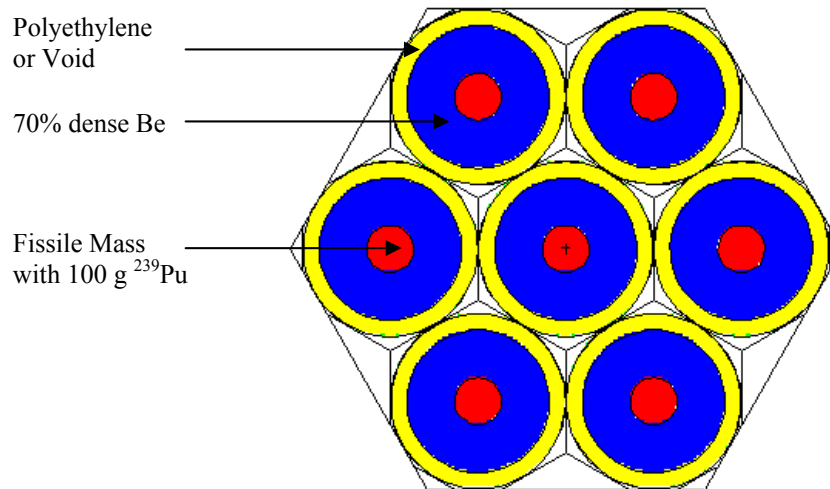

Figure B-, Typical 55-gallon Drum Seven-pack Array Model, X-Y Plane

Table B-, Parameters for 100 FGE Cylinder in 55-gallon Drum Seven-pack Array Model

H/Pu Ratio	Density (g/cm ³)	Pu (wt fraction)	H (wt fraction)	O (wt fraction)	C (wt fraction)	beryllium (wt fraction)	Cylinder Radius (cm)
0% Beryllium, 25% Polyethylene, 75% Water in Moderator							
700	1.0170	0.038887	0.114771	0.652466	0.193876	0.00000	7.3830
800	1.0123	0.034193	0.115331	0.655653	0.194823	0.00000	7.7184
900	1.0087	0.030509	0.115771	0.658153	0.195566	0.00000	8.0269
1000	1.0057	0.027542	0.116125	0.660167	0.196165	0.00000	8.3134
1100	1.0033	0.025101	0.116417	0.661824	0.196657	0.00000	8.5814
1200	1.0013	0.023058	0.116661	0.663212	0.197070	0.00000	8.8336
10% Beryllium, 22.5% Polyethylene, 67.5% Water in Moderator							
800	1.0959	0.028430	0.095893	0.545149	0.161988	0.168500	7.9938
20% Beryllium, 20% Polyethylene, 60% Water in Moderator							
800	1.1796	0.023483	0.079207	0.450286	0.133800	0.313200	8.3134
40% Beryllium, 15% Polyethylene, 45% Water in Moderator							
800	1.3470	0.015428	0.052040	0.295843	0.087908	0.548800	9.1490
60% Beryllium, 10% Polyethylene, 30% Water in Moderator							
800	1.5146	0.009151	0.030866	0.175473	0.052141	0.732400	10.4718
80% Beryllium, 5% Polyethylene, 15% Water in Moderator							
800	1.6822	0.004120	0.013900	0.079020	0.023480	0.879500	13.1921
Be/Pu Ratio	Density (g/cm ³)	Pu (wt fraction)	H (wt fraction)	O (wt fraction)	C (wt fraction)	Be (wt fraction)	Cylinder Radius (cm)
100% Beryllium, 0% Polyethylene, 0% Water in Moderator							
15000	1.8530	0.001765	0.00000	0.00000	0.00000	0.998235	16.9453
20000	1.8522	0.001325	0.00000	0.00000	0.00000	0.998675	18.6505
25000	1.8518	0.001060	0.00000	0.00000	0.00000	0.998940	20.0904

First, a seven-pack with 700 grams of ²³⁹Pu (100 grams of ²³⁹Pu/drum) was modeled with varying amounts of beryllium, water, and polyethylene in the moderator and the remainder of the 100 kilograms of beryllium modeled as a reflector. Figure B-3 shows that the 100 kilograms of beryllium is more reactive as a reflector. Next, the polyethylene was replaced with void. Figure B-3 shows this as a more reactive configuration, and unlike the external polyethylene, the void causes the reactivity to increase with increasing beryllium moderator. The results for these cases are tabulated in Table B-2. To evaluate 100% beryllium moderation (i.e., no polyethylene or water in the moderator), the beryllium/plutonium ratio in the fissile material was optimized as before by varying the amount of beryllium in the moderator with the remainder of the 100 kilograms modeled as a reflector. The beryllium in the moderator is modeled at 100% density while the beryllium in the reflector is at 70% dense. Thus, no assumptions are made on

how the beryllium-plutonium compound was formed. Figure B-4 and Table B-3 show that a beryllium-plutonium ratio of approximately 20,000 is most reactive. With 100 kilograms at this beryllium-plutonium ratio, there are approximately 75 kilograms of beryllium in the moderator and 25 kilograms of beryllium in the reflector. Additional cases with 80 and 90 kilograms of beryllium instead of 100 kilograms are included in Table B-3, which shows that less beryllium is less reactive. All cases are below the USL with the highest $k_{\text{eff}} + 2\sigma$ value being less than 0.90. Thus, 55-gallon drums containing 100 FGE per drum and 100 kilograms of beryllium will remain subcritical in the seven-pack array configuration.

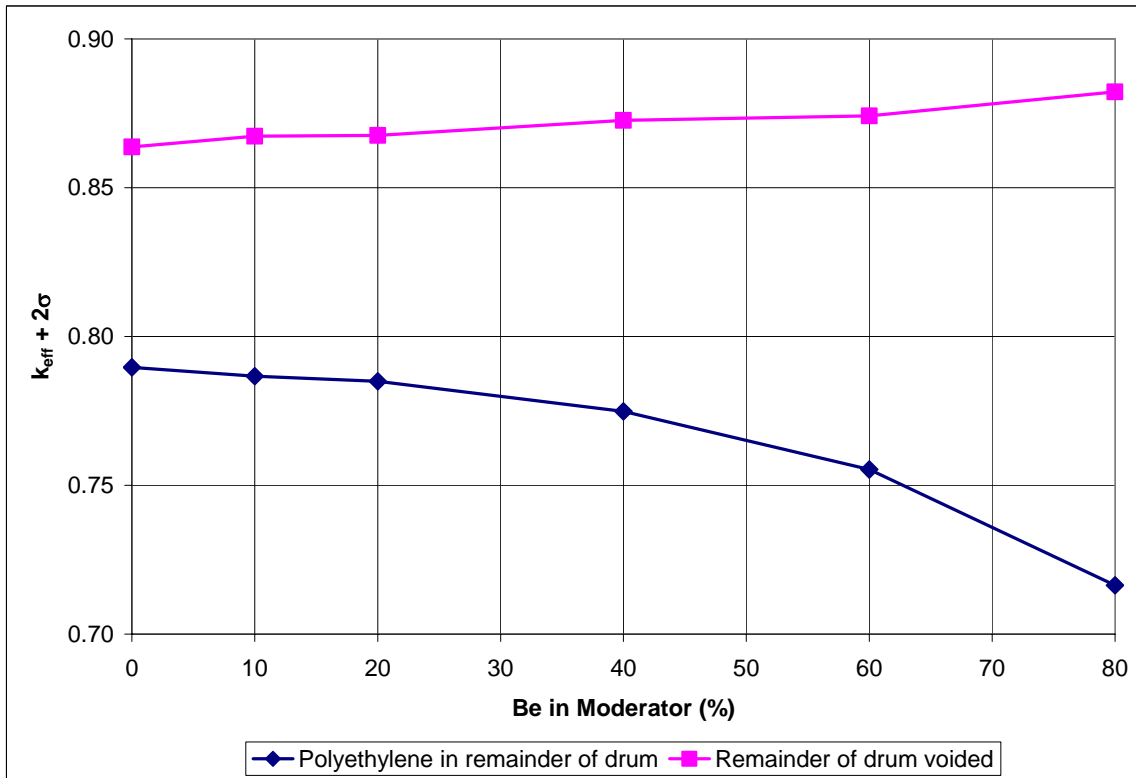

Figure B-, Seven-pack Array Reactivity with 100 g²³⁹Pu/drum as a Function of Beryllium Moderation (H/Pu=800)

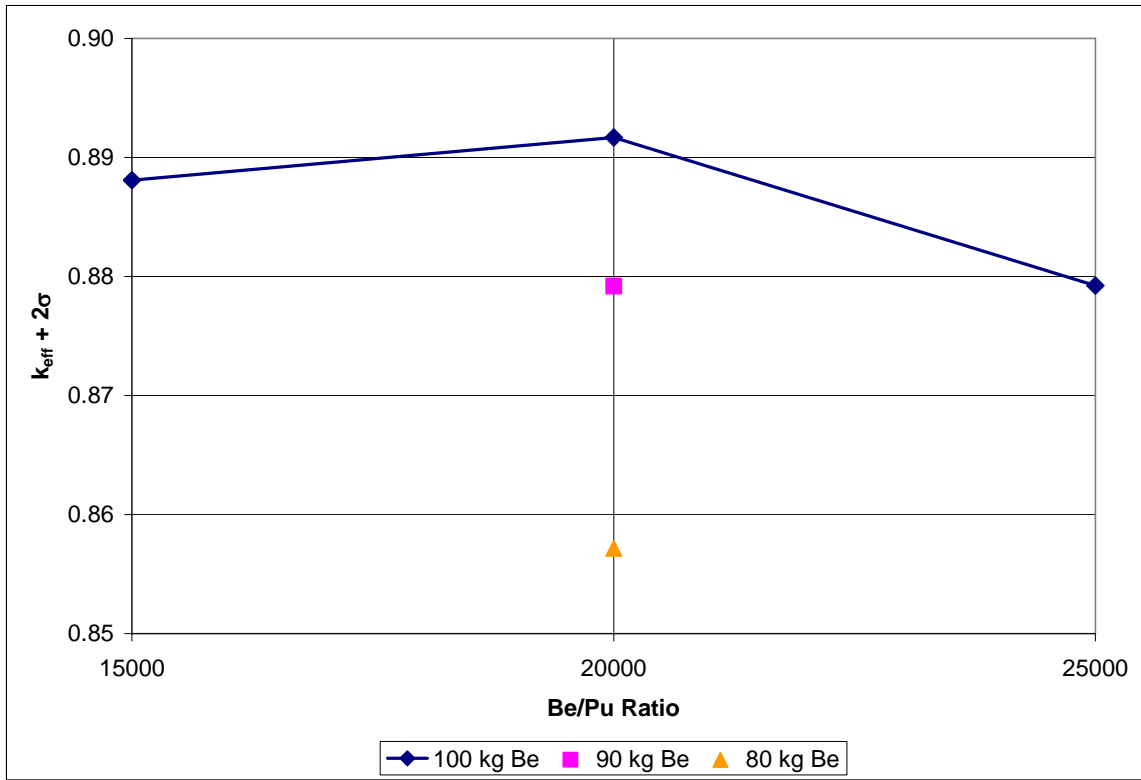

Figure B-, Seven-pack Array Reactivity with 100 g²³⁹Pu/drum as a Function of Beryllium/Pu Ratio

**Table B-, Beryllium Moderator Results for 55-gallon Drum Seven-pack Array
 Model with 100 FGE/drum (H/Pu Ratio = 800)**

% Be in Moderator	Remaining Drum Fill	k_{eff}	σ	$k_{eff} + 2\sigma$	Filename
0	Polyethylene	0.78800	0.00083	0.78966	b700a0
10	Polyethylene	0.78513	0.00078	0.78669	b700a1
20	Polyethylene	0.78347	0.00076	0.78499	b700a2
40	Polyethylene	0.77326	0.00080	0.77486	b700a4
60	Polyethylene	0.75370	0.00081	0.75532	b700a6
80	Polyethylene	0.71489	0.00074	0.71637	b700a8
0	Void	0.86218	0.00077	0.86372	a708v0
10	Void	0.86588	0.00074	0.86736	a708v1
20	Void	0.86608	0.00078	0.86764	a708v2
40	Void	0.87127	0.00068	0.87263	a708v4
60	Void	0.87258	0.00077	0.87412	a708v6
80	Void	0.88078	0.00073	0.88224	a708v8

**Table B-, 100% beryllium Moderator Results for 55-gallon Drum Seven-pack Array
 Model with 100 FGE/drum**

Be/Pu Ratio	Be (kg)	k_{eff}	σ	$k_{eff} + 2\sigma$	Filename
15000	100	0.88673	0.00068	0.88809	a15kb
20000	100	0.89027	0.00071	0.89169	a20kb
25000	100	0.87803	0.00060	0.87923	a25kb
20000	90	0.87782	0.00069	0.87920	a20kb9
20000	80	0.85578	0.00069	0.85716	a20kb8

B2.2 Shielded Container Array Model

Following the model described in Section , a seven-pack of shielded containers with 700 grams of ^{239}Pu (100 grams of ^{239}Pu per drum) was considered with 100 kilograms of beryllium per drum. The beryllium, water, and polyethylene amounts were varied in the moderator with the remainder of the 100 kilograms of beryllium modeled as a reflector. Table B-4 shows that the 100 kilograms of beryllium is most reactive as a reflector with either polyethylene or void in the remainder of the container, and that the voided drum is more reactive. The H/Pu ratio was varied in this most reactive case and the results given in Table B-5 show that an H/Pu ratio of 1,000 is most reactive. All cases are below the USL with the highest $k_{eff} + 2\sigma$ value being less than 0.80. The lead of the shielded container reduces the interaction between the containers, and the reactivity of the shielded container array is less than that of the 55-gallon drum array discussed in

the Section . Thus, shielded containers with 100 FGE and 100 kilograms of beryllium per container will remain subcritical.

Table B-, Beryllium Moderator Results for Shielded Container Seven-pack Array Model with 100 FGE/drum (H/Pu Ratio = 1100)

% Be in Moderator	Remaining Drum Fill	k_{eff}	σ	$k_{eff} + 2\sigma$	Filename
0	Polyethylene	0.77777	0.00074	0.77925	pb111a0
10	Polyethylene	0.77219	0.00072	0.77363	pb111a1
20	Polyethylene	0.76815	0.00081	0.76977	pb111a2
40	Polyethylene	0.75387	0.00078	0.75543	pb111a4
60	Polyethylene	0.72602	0.00077	0.72756	pb111a6
80	Polyethylene	0.66717	0.00066	0.66849	pb111a8
0	Void	0.78892	0.00071	0.79034	pb111v0
10	Void	0.78544	0.00074	0.78692	pb111v1
20	Void	0.78148	0.00079	0.78306	pb111v2
40	Void	0.76947	0.00077	0.77101	pb111v4
60	Void	0.74730	0.00074	0.74878	pb111v6
80	Void	0.69763	0.00072	0.69907	pb111v8

Table B-, 0% Beryllium Moderator Results for Shielded Container Seven-pack Array Model with 100 FGE/Drum

H/Pu Ratio	k_{eff}	σ	$k_{eff} + 2\sigma$	Filename
0 % Be in Moderator, Void in Remainder				
800	0.78293	0.00077	0.78447	pb108v0
900	0.78711	0.00080	0.78871	pb109v0
1000	0.78981	0.00077	0.79135	pb110v0
1100	0.78892	0.00071	0.79034	pb111v0
1200	0.78753	0.00070	0.78893	pb112v0
1300	0.78360	0.00070	0.78500	pb113v0

B3.0 Two-container Models

B3.1 55-gallon Direct-Loaded Two-Drum Model

The two-container 55-gallon drum model discussed in was used to evaluate the 100-gram ^{239}Pu system with 100 kilograms of beryllium. The fissile mass in the top drum is located in the bottom of the drum and the fissile mass in the bottom drum is located in the top; the H/D ratio of the combined cylinders is 1. Magnesium oxide is modeled as the external reflector (300 centimeters thick) in the initial calculations with concrete and salt reflection also considered later in the analysis. The beryllium was modeled in varying amounts in the moderator with the mass not used in the moderator modeled in the reflector region. Figure B-5 shows a typical 55-gallon drum, two-container configuration; the parameters for the fissile material input into MCNP5 are given in Table B-6.

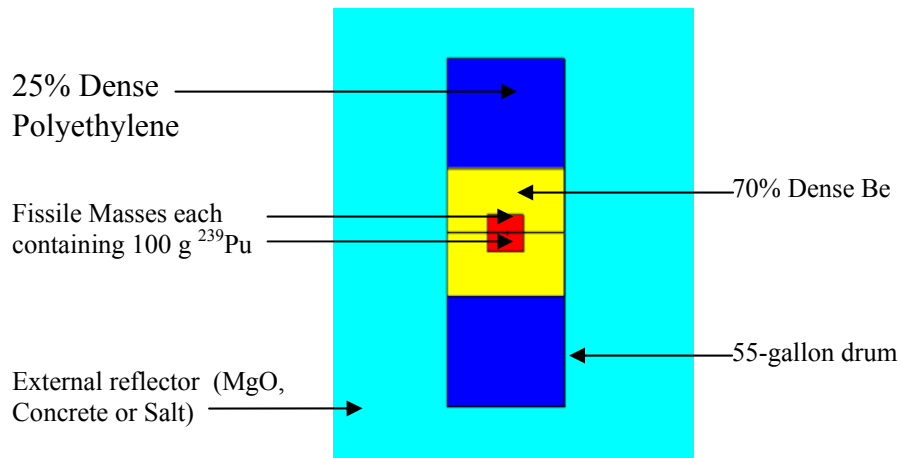

Figure B-, Typical 55-gallon Drum Two-container Model

**Table B-, Parameters for 100 FGE Cylinder in 55-gallon Drum
 Two-Container Model**

H/Pu Ratio	Density (g/cm³)	Pu (wt. fraction)	H (wt. fraction)	O (wt. fraction)	C (wt. fraction)	Be (wt. fraction)	Cylinder Radius (cm)
0% Beryllium, 25% Polyethylene, 75% Water in Moderator							
600	1.0232	0.045076	0.114032	0.648264	0.192628	0.00000	8.83703
700	1.0170	0.038887	0.114771	0.652466	0.193876	0.00000	9.30195
800	1.0123	0.034193	0.115331	0.655653	0.194823	0.00000	9.72453
900	1.0087	0.030509	0.115771	0.658153	0.195566	0.00000	10.11327
1000	1.0057	0.027542	0.116125	0.660167	0.196165	0.00000	10.47421
1100	1.0033	0.025101	0.116417	0.661824	0.196657	0.00000	10.81187
10% Beryllium, 22.5% Polyethylene, 67.5% Water in Moderator							
600	1.1057	0.037551	0.094993	0.540032	0.160467	0.167000	9.15220
700	1.1001	0.032360	0.095505	0.542944	0.161333	0.167900	9.63380
800	1.0959	0.028430	0.095893	0.545149	0.161988	0.168500	10.07154
900	1.0927	0.025351	0.096197	0.546877	0.162501	0.169100	10.47421
1000	1.0901	0.022874	0.096442	0.548267	0.162914	0.169500	10.84810
1100	1.0879	0.020838	0.096643	0.549409	0.163254	0.169900	11.19785
20% Beryllium, 20% Polyethylene, 60% Water in Moderator							
600	1.1883	0.031067	0.078591	0.446789	0.132761	0.310800	9.51793
700	1.1833	0.026748	0.078942	0.448780	0.133352	0.312200	10.01889
800	1.1796	0.023483	0.079207	0.450286	0.133800	0.313200	10.47421
900	1.1767	0.020928	0.079414	0.451464	0.134150	0.314000	10.89306
1000	1.1744	0.018875	0.079580	0.452411	0.134431	0.314700	11.28195
1100	1.1725	0.017188	0.079717	0.453188	0.134662	0.315200	11.64574
40% Beryllium, 15% Polyethylene, 45% Water in Moderator							
600	1.3535	0.020466	0.051773	0.294330	0.087458	0.546000	10.47421
700	1.3498	0.017594	0.051925	0.295193	0.087715	0.547600	11.02575
800	1.3470	0.015428	0.052040	0.295843	0.087908	0.548800	11.52702
900	1.3449	0.013738	0.052129	0.296351	0.088059	0.549700	11.98812
1000	1.3432	0.012381	0.052201	0.296759	0.088180	0.550500	12.41624
1100	1.3417	0.011268	0.052260	0.297093	0.088280	0.551100	12.81671

**Table B-6, Parameters for 100 FGE Cylinder in 55-gallon Drum
 Two-Container Model (continued)**

H/Pu Ratio	Density (g/cm³)	Pu (wt. fraction)	H (wt. fraction)	O (wt. fraction)	C (wt. fraction)	Be (wt. fraction)	Cylinder Radius (cm)
60% Beryllium, 10% Polyethylene, 30% Water in Moderator							
600	1.5188	0.012164	0.030772	0.174939	0.051982	0.730100	11.98812
700	1.5164	0.010445	0.030826	0.175244	0.052073	0.731400	12.61966
800	1.5146	0.009151	0.030866	0.175473	0.052141	0.732400	13.19361
900	1.5131	0.008143	0.030898	0.175652	0.052194	0.733100	13.72155
1000	1.512	0.007334	0.030923	0.175795	0.052236	0.733700	14.21173
1100	1.5111	0.006672	0.030943	0.175912	0.052271	0.734200	14.67023
80% Beryllium, 5% Polyethylene, 15% Water in Moderator							
600	1.6843	0.005487	0.013881	0.078912	0.023448	0.878300	15.10174
700	1.6831	0.004707	0.013892	0.078974	0.023467	0.879000	15.89765
800	1.6822	0.004121	0.013900	0.079020	0.023480	0.879500	16.62097
900	1.6815	0.003665	0.013906	0.079056	0.023491	0.879900	17.28629
1000	1.6810	0.003299	0.013911	0.079085	0.023500	0.880200	17.90398
1100	1.6805	0.003000	0.013915	0.079109	0.023507	0.880500	18.48177

First, beryllium was evaluated as a moderator and as a reflector. Polyethylene was modeled in the remainder of the drum since this increases reflection in the two-container model compared to modeling void. Figure B-6 shows that the 100 kilograms of beryllium is more reactive as a reflector than as a moderator and reflector in the two-container configuration. This is consistent with the results in Section 6.4.3.2.2 of the TRUPACT-II SAR (DOE-CBFO 2005a), which also modeled 100 FGE in a single unit. The array model is more reactive with beryllium moderation because it results in a larger fissile volume at a lower fissile concentration with less beryllium reflector compared to the beryllium-reflected case. In the array model, the larger fissile volume results in more interaction between the containers and increases reactivity; therefore, the thinner beryllium reflector layer also allows for more interaction. In contrast, in the two-container model, the lower fissile concentration reduces the reactivity as the fissile material is more like a fully reflected single unit.

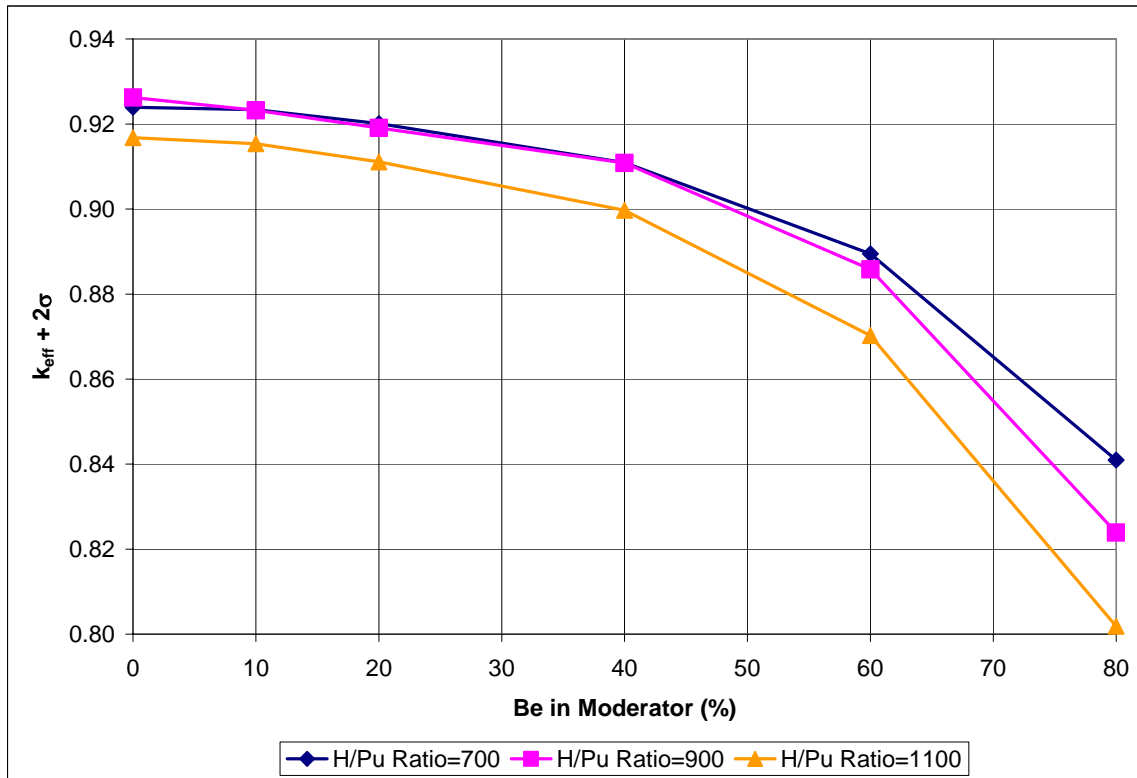

Figure B-, Two-Container Reactivity as a Function of Beryllium Location

Next, the H/Pu ratio in the fissile material was varied to determine the optimum value. Figure B-6 shows that an H/Pu ratio of approximately 800 is most reactive (with a 25% polyethylene, 75% water and 0% beryllium moderator). Additional cases with 10 and 20% beryllium in the moderator are included for illustration and verification that 0% beryllium is most reactive. Table B-7 summarizes the beryllium moderation results from Figure B-6 and Figure B-7.

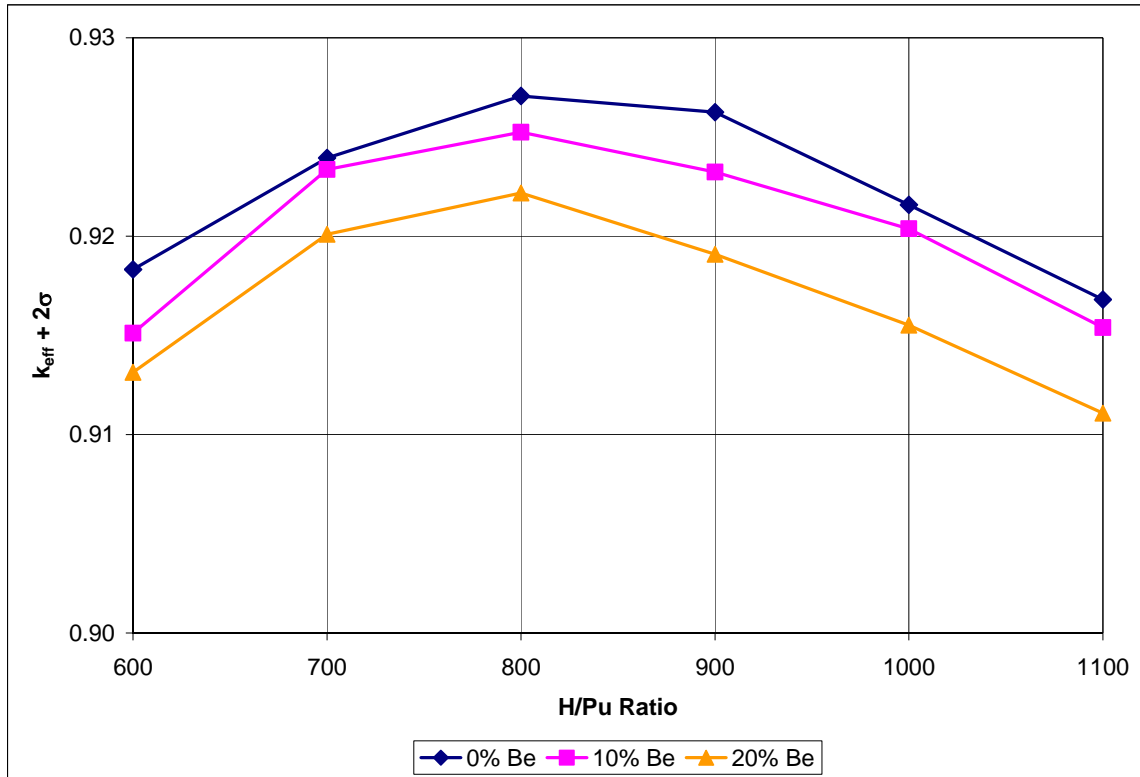

Figure B-, Two-Container Reactivity as a Function of H/Pu Ratio

**Table B-, Beryllium Moderator Results for 55-gallon Drum Two-Container
 Model with 100 FGE/Drum**

H/Pu Ratio	% Be in Moderator	k_{eff}	σ	$k_{eff} + 2\sigma$	Filename
600	0	0.91625	0.00104	0.91833	b0006m
700	0	0.92205	0.00095	0.92395	b0007m
800	0	0.92503	0.00102	0.92707	b0008m
900	0	0.92410	0.00108	0.92626	b0009m
1000	0	0.91968	0.00095	0.92158	b0010m
1100	0	0.91477	0.00102	0.91681	b0011m
600	10	0.91285	0.00113	0.91511	b1006m
700	10	0.92107	0.00115	0.92337	b1007m
800	10	0.92311	0.00107	0.92525	b1008m
900	10	0.92103	0.00110	0.92323	b1009m
1000	10	0.91828	0.00105	0.92038	b1010m
1100	10	0.91342	0.00099	0.91540	b1011m
600	20	0.91086	0.00114	0.91314	b2006m
700	20	0.91790	0.00110	0.92010	b2007m
800	20	0.92000	0.00109	0.92218	b2008m
900	20	0.91687	0.00111	0.91909	b2009m
1000	20	0.91336	0.00108	0.91552	b2010m
1100	20	0.90898	0.00105	0.91108	b2011m
700	40	0.90866	0.00113	0.91092	b4007m
900	40	0.90874	0.00106	0.91086	b4009m
1100	40	0.89768	0.00101	0.89970	b4011m
700	60	0.88725	0.00112	0.88949	b6007m
900	60	0.88374	0.00103	0.88580	b6009m
1100	60	0.86815	0.00104	0.87023	b6011m
700	80	0.83882	0.00106	0.84094	b8007m
900	80	0.82173	0.00109	0.82391	b8009m
1100	80	0.79989	0.00098	0.80185	b8011m

Lastly, the exterior reflector material around the drums was varied to include concrete and salt. The optimum fissile material moderator of 25% polyethylene and 75% water without beryllium, as found in Table B-7, is modeled. The results for the model as a function of H/Pu ratio in the moderator are given in Figure B-8 and Table B-8. Although concrete reflection appears slightly higher for some H/Pu ratios, the difference is statistically insignificant and all cases are well below the USL with the highest $k_{eff} + 2\sigma$ value being less than 0.93. Therefore, 55-gallon drums containing 100 FGE will remain subcritical in the two-container configuration.

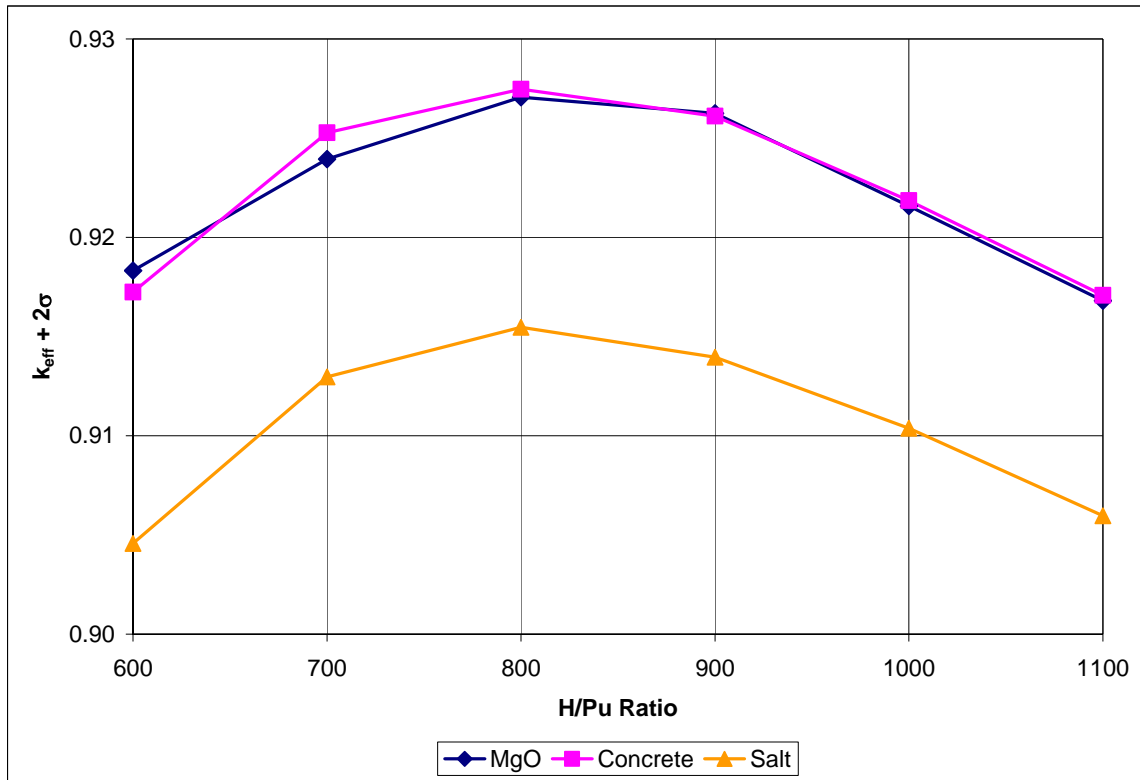

Figure B-, Two-Container Reactivity as a Function of External Reflector

**Table B-, Exterior Reflector Results For 55-Gallon Drum Two-Container
 Model With 100 FGE/Drum**

H/Pu Ratio	Reflector	k_{eff}	σ	$k_{eff} + 2\sigma$	Filename
600	MgO	0.91625	0.00104	0.91833	b0006m
700	MgO	0.92205	0.00095	0.92395	b0007m
800	MgO	0.92503	0.00102	0.92707	b0008m
900	MgO	0.92410	0.00108	0.92626	b0009m
1000	MgO	0.91968	0.00095	0.92158	b0010m
1100	MgO	0.91477	0.00102	0.91681	b0011m
600	Concrete	0.91513	0.00106	0.91725	b0006c
700	Concrete	0.92324	0.00102	0.92528	b0007c
800	Concrete	0.92551	0.00098	0.92747	b0008c
900	Concrete	0.92415	0.00098	0.92611	b0009c
1000	Concrete	0.91994	0.00096	0.92186	b0010c
1100	Concrete	0.91524	0.00092	0.91708	b0011c
600	Salt	0.90249	0.00104	0.90457	b0006s
700	Salt	0.91075	0.00111	0.91297	b0007s
800	Salt	0.91353	0.00097	0.91547	b0008s
900	Salt	0.91200	0.00098	0.91396	b0009s
1000	Salt	0.90858	0.00090	0.91038	b0010s
1100	Salt	0.90395	0.00101	0.90597	b0011s

B3.2 Shielded Container Direct-loaded Two-Container Model

Two shielded containers are modeled in Section using the same model parameters as in Section , except that each container has 200 FGE and 100 kilograms beryllium. Even at this higher FGE mass, the maximum $k_{eff} + 2\sigma$ value was less than 0.92. This low result was expected as the thick steel reflector in the lid and bottom of the shielded container separates and isolates the fissile masses in the two containers.

B4.0 MCNP5 Direct-Loaded Waste Contingency Models

The 55-gallon drum array has a higher reactivity than the shielded container array as shown in Section . Consequently, the contingent events are only modeled in the 55-gallon drum array and these results are bounding of the shielded container array.

B4.1 55-gallon Drum Array Overstack Model

The overstack scenario evaluates an infinitely reflected, four-tier seven-pack array with 100 grams of ²³⁹Pu and 100 grams of beryllium in each 55-gallon drum. The magnesium oxide (MgO) supersacks are modeled on top of the fourth tier and the salt is modeled on the top and bottom of the stack as in the three-tier model. Table B-9 shows that the maximum reactivity again occurs at a beryllium/plutonium ratio of 20,000 and exceeds the USL of 0.96 but is less than 0.97 (the USL without administrative margin). In addition to operator error with regard to stacking, a significant mining error would have to occur to allow enough clearance to stack the drums four tiers throughout the panel with the MgO supersack on top. The optimum case is modeled by replacing the MgO supersack with salt as a more credible condition, as there would not be room for the MgO on top of the fourth tier of drums throughout the array. The reactivity is reduced below the USL to less than 0.89 indicating that this contingent event will remain subcritical.

Table B-, Results for an Array of 55-Gallon Drums Stacked Four Tiers High

Be/Pu Ratio	k _{eff}	σ	k _{eff} + 2σ	Filename
Four Tiers of Drums with MgO Supersack				
15000	0.95533	0.00084	0.95701	a415kb
20000	0.96490	0.00069	0.96628	a420kb
25000	0.95579	0.00068	0.95715	a425kb
Four Tiers of Drums without MgO Supersack				
20000	0.88835	0.00069	0.88973	a420kbm

B4.2 55-gallon Drum Array Overbatch Model

The overbatch scenario evaluates a single 55-gallon drum in the center of a seven-pack array in the middle tier overbatched by 50% to 150 grams of ²³⁹Pu. The other drums contain 100 grams of ²³⁹Pu at the optimum beryllium/plutonium ratio of 20,000. Typically, a 50% overbatch has been evaluated. However, the combination of 150 grams of ²³⁹Pu and 100 kilograms of beryllium, at the optimum beryllium/plutonium ratio of 20,000, is not physically possible. Therefore, two alternative cases were evaluated. First, 150 grams of ²³⁹Pu and 100 kilograms of beryllium were modeled in the overbatched drum at the maximum possible beryllium/plutonium ratio of 17,683.6 and lower. Second, the maximum amount of ²³⁹Pu for a beryllium/plutonium ratio of 20,000 and 100 kilograms of beryllium, which is 132.6273 g, was evaluated. The results in Table B-10 show that all cases are below the USL with the highest k_{eff} + 2σ value remaining below 0.91.

Table B-, Overbatch Case Results for 55-gallon Drum Seven-pack Array Model

Be/Pu Ratio	²³⁹ Pu in Overbatch (g)	²³⁹ Pu in Overbatch (wt. frac)	k _{eff}	σ	k _{eff} + 2σ	Filename
10000	150	0.002646	0.90077	0.00075	0.90227	ao10kb
15000	150	0.001765	0.90248	0.00070	0.90388	ao15kb
17683.6	150	0.001498	0.90142	0.00068	0.90278	ao17kb
20000	132.6	0.001325	0.89684	0.00067	0.89818	ao20kb

B4.3 55-gallon Drum Array Excess Beryllium Model

The excess beryllium scenario evaluates a single drum in the center of the middle tier of a seven-pack array with beryllium filling the drum around the fissile mass. This results in over 300 kilograms of beryllium in the overloaded drum. The results in Table B-11 show that all cases are below the USL with the highest k_{eff} + 2σ value less than 0.89.

Table B-, Excess beryllium Case Results for 55-gallon Drum Seven-pack Array Model with 100 FGE/drum

Be/Pu Ratio	k _{eff}	σ	k _{eff} + 2σ	Filename
15000	0.88197	0.00077	0.88351	ae15kb
20000	0.88708	0.00067	0.88842	ae20kb
25000	0.87759	0.00064	0.87887	ae25kb

B4.4 55-gallon Drum Array Compaction Model

The compaction scenario considers the lower tier of a seven-pack array reduced by 15 inches in height as a result of roof fall in the underground repository. The results in Table B-12 show that all cases are well below the USL as the highest k_{eff} + 2σ value is less than 0.90. In fact, this upset condition has little impact on k_{eff} compared to the maximum normal condition result is 0.89169 per Table B-3.

Table B-, Compaction Case Results for 55-gallon Drum Seven-pack Array Model with 100 FGE/drum

Be/Pu Ratio	k _{eff}	σ	k _{eff} + 2σ	Filename
15000	0.89480	0.00070	0.89620	ac15kb
20000	0.89660	0.00066	0.89792	ac20kb
25000	0.88332	0.00066	0.88464	ac25kb

B5.0 Conclusions

This appendix demonstrates that direct loaded 55-gallon drums or shielded containers with greater than 1 wt% special reflector materials will remain below the USL in the two-container configuration as well in the underground array with the following limits:

- Maximum 100 FGE/drum
- Maximum 100 kilograms of beryllium/drum.

B6.0 References

ASTM A 569. *Standard Specification for Steel, Carbon (0.15 Maximum, Percent), Hot-Rolled Sheet and Strip Commercial*, American Society for Testing and Materials, West Conshohocken, PA.

DOE-CBFO, 2005a. *TRUPACT-II Safety Analysis Report*, Revision 21, May 2005, U.S. Department of Energy, Carlsbad Field Office, Carlsbad, NM.

DOE-CBFO, 2005b. *Contact-Handled Transuranic Waste Authorized Methods for Payload Control (CH-TRAMPAC)*, Revision 2, May 2005, U.S. Department of Energy, Carlsbad Field Office, Carlsbad, NM.

Elliot J.A., A. Kelly, and A.H. Windle, 2002. "Recursive packing of dense particle mixtures," *J. Mat. Sci. Lett.* **21**:1249-1251; 2002.

Neeley, G.W., D.L. Newell, S.L. Larson, and R.J. Green, 2004. *Reactivity Effects of Moderator and Reflector Materials on a Finite Plutonium System*, SAIC-1322-001, Revision 1, May 2004, Science Applications International Corporation, Oak Ridge, TN.

Taggart, D.P. and J.U. Moon, 2004. *Review of Special Reflectors in the TRU Waste Inventory*, LA-UR-04-0857, February 2004, Los Alamos National Laboratory, Los Alamos, NM.

Torquato, S., T.M. Truskett, and P.G. Debenedetti, 2007. "Is random packing of spheres well defined?" *Phys. Rev. Lett.* **84**:2064-2067; 2000.

B7.0 Sample MCNP5 Input File Listings for Appendix B

B7.1 55-gallon Drum Two-Container Model (Filename b0007m)

```

STACKED 55 GAL DRUMS, APPEND B. BOTH DRUMS W/ 100G PU, 0% BE MOD, H/PU = 700 $
C FGE WITH MIXED WITH A BE-POLY-WATER MODERATOR: 0% BE WITH POLY-WATER $
C (25% BY VOLUME POLY AND 75% BY VOLUME WATER). THE FISSILE MASS $
C IS REFLECTED BY THE REMAINING BE (100 KG MINUS BE IN FGE CYLINDER) AT $
C 70% PACKING FRACTION AND POLYETHYLENE AT 25% PACKING FRACTION. $
C THE DRUMS ARE STACKED DIRECTLY ONE ON TOP OF ANOTHER WITH THE FISSILE $
C MASS IN THE LOWER DRUM BEING LOCATED AT THE TOP OF THE DRUM AND THE $
C FISSILE MASS IN THE UPPER DRUM BEING LOCATED IN THE BOTTOM OF THE DRUM. $
    
```



```

C      IN THIS CONFIGURATION THE FISSILE MASSES ARE IN CLOSE PROXIMITY.          $
C      BOTH FISSILE MASSES ARE CYLINDRICAL IN SHAPE WITH A H/D RATIO OF 0.5.    $
C      CONTAINER WALL DENSITY (STEEL) IS 50% TO ACCOUNT FOR DEGRADATION.        $
C      THE TWO-DRUM STACK IS SURROUNDED ON ALL SIDES WITH 300 CM OF MgO.        $
C      THE BOUNDARIES ARE MIRRORED TO SIMULATE INFINITE REFLECTION. 10/12/07     $
C                                                                                    $
C      CCCCCCCCCCCCCCCCCCCCCCCCCCCCCCCCCCCCCCCCCCCCCCCCCCCCCCCCCCCCCCCCCCCCCC  $
C                                                                                    $
C      CELL CARDS FOR THE LOWER 55 GALLON DRUM IN THE TWO-DRUM MODEL.            $
C                                                                                    $
C      1      -1.0170      -1  -2  3                                IMP:N=1          $
C      2      3      -1.2950      -4  -5  10  #1                    IMP:N=1          $
C      3      2      -0.2308      -4  -10  6                        IMP:N=1          $
C      4      6      -3.9300      -7  -8  9  #1 #2 #3                IMP:N=1          $
C                                                                                    $
C      CELL CARDS FOR THE UPPER 55 GALLON DRUM IN THE TWO-DRUM MODEL.            $
C                                                                                    $
C      10     LIKE 1 BUT TRCL=(0 0 9.54477)                                IMP:N=1          $
C      11     3      -1.2950      -23  -22  25  #10                  IMP:N=1          $
C      12     2      -0.2308      -23  -24  22                        IMP:N=1          $
C      13     6      -3.9300      -26  -27  28  #10 #11 #12          IMP:N=1          $
C                                                                                    $
C      CELL CARDS FOR A 300 CM REFLECTOR AROUND THE TWO DRUMS                    $
C                                                                                    $
C      30     7      -1.450      -100 -101 102  #1 #2 #3 #4 #10 #11 #12 #13  IMP:N=1  $
C                                                                                    $
C      CELL CARDS FOR EVERYTHING OUTSIDE THE COMPUTATIONAL SPACE.                $
C                                                                                    $
C      100    0              (100:101:-102)                                IMP:N=0          $
C                                                                                    $
C      SURFACE CARDS FOR THE LOWER 55 GALLON DRUM IN THE TWO-DRUM MODEL.        $
C                                                                                    $
C      1      CZ      9.30195                                          $
C      2      PZ      84.57641                                          $
C      3      PZ      75.27466                                          $
C      4      CZ      28.57500                                          $
C      5      PZ      84.57641                                          $
C      6      PZ      0.12141                                          $
C      7      CZ      28.69641                                          $
C      8      PZ      84.69782                                          $
C      9      PZ      0.00000                                          $
C      10     PZ      53.48783                                          $
C                                                                                    $
C      SURFACE CARDS FOR THE UPPER 55 GALLON DRUM IN THE TWO-DRUM MODEL.        $
C                                                                                    $
C      22     PZ      115.90781                                         $
C      23  1   CZ      28.57500                                         $
C      24  1   PZ      84.57641                                         $
C      25  1   PZ      0.12141                                         $
C      26  1   CZ      28.69641                                         $
C      27  1   PZ      84.69782                                         $
C      28  1   PZ      0.00000                                         $
C                                                                                    $
C      SURFACE CARDS FOR A 300 CM REFLECTOR AROUND THE TWO DRUMS                $
C                                                                                    $
C      *100    CZ      328.69641                                         $
C      *101    PZ      469.39564                                         $
C      *102    PZ      -300.00000                                         $
C                                                                                    $
C      MODE CARD.                                                            $
C      MODE N                                                                $
C      TRANSFORMATION CARDS FOR THE TWO-DRUM MODEL.                          $
C                                                                                    $
C      TR1    0.00000      0.00000      84.69782                        $
C      MATERIAL CARDS
    
```

C PU-BE-CH2-H2O (55 GALLON DRUM) \$
C \$
M1 94239.60C -0.038887 1001.60C -0.114771 & \$
8016.60C -0.652466 6000.60C -0.193876 \$
C \$
C CH2 REFLECTOR (55 GALLON DRUM) \$
C \$
M2 6000.60C -0.856188 1001.60C -0.143812 \$
C \$
C BE REFLECTOR (55 GALLON DRUM) \$
C \$
M3 4009.60C 1 \$
C \$
C CARBON STEEL DRUM. \$
C \$
M6 6000.60C -0.001500 25055.60C -0.006000 15031.60C -0.000350 & \$
16000.60C -0.000400 26054.60C -0.058513 26056.60C -0.909630 & \$
26057.60C -0.020827 26058.60C -0.0027769 \$
C \$
C MgO \$
C \$
M7 8016.60C -0.39700 12000.60C -0.603000 \$
C \$
C S(ALPHA,BETA) \$
C \$
MT1 LWTR.01T GRPH.01T \$
MT2 POLY.01T GRPH.01T \$
MT3 BE.01T \$
C \$
C SOURCE CARDS \$
C \$
KCODE 1000 1.0 50 800 \$
KSRC 0.00000 0.00000 80.00000 \$
PRINT \$

B7.2 55-gallon Drum Array Model (Filename b700a1)

55-gallon Drum Array Case, 700 G TOTAL, 10%BE/22.5%POLY/67.5%H2O MODERATOR
C INFINITE ARRAY 7-PACK MODEL OF 55-GALLON DRUMS WITH 7 55-GALLON \$
C DRUMS CONTAINING 100 GRAMS PU AT H/PU = 800. ALL FISSILE BEARING \$
C DRUMS CONTAIN A H2O-POLY MODERATOR WHICH IS MIXED WITH THE PU. THE H2O- \$
C POLY MODERATOR % IS BY VOLUME. THE FISSILE MASSES ARE CENTRALLY LOCATED \$
C IN THE FISSILE BEARING DRUMS AND ARE CYLINDRICAL WITH A H/D RATIO OF 1.0. \$
C THE FISSILE MASSES ARE REFLECTED BY THE REMAINING BE (100 KG MINUS \$
C BE IN FGE CYLINDER) IN A CYLINDER AT 70% DENSITY WITH H/D=1.0 AND THE \$
C REMAINING VOLUME WITH POLYETHYLENE AT A DENSITY OF 25% OF THEORETICAL. \$
C THE DRUM STEEL WALL DENSITY IS 50% TO ACCOUNT FOR DEGRADATION. THE 7-PACKS \$
C ARE STACKED 3-HIGH WITH A MGO LAYER ON TOP. THE UPPER AND LOWER VERTICAL \$
C PLANES ARE REFLECTED BY 300 CM OF SALT. THE LATERAL BOUNDARIES ARE \$
C MIRRORED TO SIMULATE INFINITE REFLECTION IN THE LATERAL PLANE. 10/21/07 \$
C \$
C CC \$
C \$
C CELL CARDS FOR THE 100 FGE DRUMS. \$
C \$
1 1 -1.0959 -14 U=1 IMP:N=1 \$
2 3 -1.295 14 -11 U=1 IMP:N=1 \$
3 4 -0.2308 11 -2 -10 8 U=1 IMP:N=1 \$
4 6 -3.93 (2:10:-8) -4 6 -12 U=1 IMP:N=1 \$
5 0 (4:-6:12) U=1 IMP:N=1 \$
C \$
C CELL CARDS FOR THE HEXAGONAL 7-PACK STACK. \$
C \$
12 0 -21 20 -22 25 -23 24 -27 26 LAT=2 U=4 IMP:N=1 \$
FILL=-3:3 -3:3 0:2 \$
4 16R \$
1 1 4 4 4 4 \$
1 1 1 4 4 4 4 \$
1 1 4 16R \$

			4 16R						\$
			1 1	4 4 4 4					\$
			1 1 1	4 4 4 4					\$
			1 1	4 16R					\$
			4 16R						\$
			1 1	4 4 4 4					\$
			1 1 1	4 4 4 4					\$
			1 1	4 16R					\$
13	0		-61 60 -62 65 -63 64 -67 66	FILL=4			IMP:N=1		\$
C									\$
C			CELL CARDS FOR THE MGO AND SALT LAYERS.						\$
C									\$
14	8	-2.165	(53:-66)	-61 60 -62 65 -63 64 50 -52			IMP:N=1		\$
15	7	-1.45		-61 60 -62 65 -63 64 67 -53			IMP:N=1		\$
C									\$
C			CELL CARDS FOR THE REST OF THE UNIVERSE.						\$
C									\$
16	0		-50:52:61:-60:62:-65:63:-64				IMP:N=0		\$
C									\$
C			SURFACE CARDS FOR ALL DRUM SURFACES						\$
C									\$
2	CZ	28.575							\$
4	CZ	28.696							\$
6	PZ	0.0							\$
8	PZ	0.121							\$
10	PZ	84.576							\$
12	PZ	84.697							\$
C									\$
C			CELL CARDS FOR THE 100 FGE DRUMS.						\$
C									\$
11	RCC	0 0	19.0008 0 0	46.6963 23.3481		\$BE around 100 FGE			\$
14	RCC	0 0	34.3551 0 0	15.9876 7.9938		\$100 FGE			\$
C									\$
C			SURFACE CARDS FOR THE HEXAGONAL 7-PACK.						\$
C									\$
20	PX	-28.75							\$
21	PX	28.75							\$
22	P	1	1.7321	0 57.5					\$
23	P	-1	1.7321	0 57.5					\$
24	P	-1	1.7321	0 -57.5					\$
25	P	1	1.7321	0 -57.5					\$
26	PZ	0.0							\$
27	PZ	84.697							\$
C									\$
C			SURFACE CARDS FOR THE MGO AND SALT LAYERS.						\$
C									\$
50	PZ	-300.00							\$
52	PZ	616.321							\$
53	PZ	316.321							\$
C									\$
C			SURFACE CARDS FOR THE 7-PACK STACK INFINITE ARRAY.						\$
C									\$
*60	PY	-78.5							\$
*61	PY	78.5							\$
*62	P	1.7321	1	0 157					\$
*63	P	1.7321	-1	0 157					\$
*64	P	1.7321	-1	0 -157					\$
*65	P	1.7321	1	0 -157					\$
66	PZ	0.0							\$
67	PZ	254.091							\$
C									\$
C			DATA CARDS.						\$
C									\$
MODE			N						\$
C									\$
C			SOURCE CARDS.						\$
C									\$
KCODE			5000 1.0 50 250						\$
KSRC			-58 0 43 -30 -50 43						\$

	-58 0 128	-30 -50 128							\$
	-58 0 213	-30 -50 213							\$
C									\$
C	MATERIAL CARDS								
C									\$
C									\$
C	PU-H2O-POLY FOR THE FISSILE MASS CONTAINING 100 GRAMS OF PU.								
C									\$
M1	94239.60C	-0.028430	1001.60C	-0.095893				&	\$
	8016.60C	-0.545149	6000.60C	-0.161988	4009.60C	-0.168500			\$
MT1	LWTR.01T	GRPH.01T	BE.01T						\$
C									\$
C	BE REFLECTOR AROUND THE FISSILE MASS CONTAINING 100 GRAMS PU.								
C									\$
M3	4009.60C	-1.000000							\$
MT3	BE.01T								\$
C									\$
C	CH2 REFLECTOR (55 GALLON DRUM)								
C									\$
M4	6000.60C	-0.856188	1001.60C	-0.143812					\$
MT4	POLY.01T	GRPH.01T							\$
C									\$
C	55-GALLON DRUM STEEL WALLS.								
C									\$
M6	6000.60C	-0.001500							\$
	25055.60C	-0.006000							\$
	15031.60C	-0.000350							\$
	16000.60C	-0.000400							\$
	26054.60C	-0.058513							\$
	26056.60C	-0.909630							\$
	26057.60C	-0.020827							\$
	26058.60C	-0.0027769							\$
C									\$
C	MGO LAYER.								
C									\$
M7	12000.60C	0.5							\$
	8016.60C	0.5							\$
C									\$
C	SALT REFLECTOR.								
C									\$
M8	11023.60C	0.5							\$
	17000.60C	0.5							\$
C									\$
C	PRINT TABLE 40 FOR MASS FRACTIONS								
C									\$
C	PRINT 40								

**B7.3 55-gallon Drum Array Overbatch Model
 (Filename ao15kb)**

55-gallon Drum Array Case, 750 G TOTAL, 100%BE, BE/PU=15000, EXCESS BE, 150 FGE

C INFINITE ARRAY 7-PACK MODEL OF 55-GALLON DRUMS WITH 7 55-GALLON \$
 C DRUMS CONTAINING 100 GRAMS PU AT BE/PU=20000. ALL FISSILE BEARING DRUMS \$
 C CONTAIN A BE MODERATOR WHICH IS MIXED WITH THE PU. THE FISSILE \$
 C MASSES ARE CENTRALLY LOCATED IN THE FISSILE BEARING DRUMS AND \$
 C ARE CYLINDRICAL IN SHAPE WITH A H/D RATIO OF 1.0. THE FISSILE MASSES \$
 C ARE REFLECTED BY A BERYLLIUM CYLINDER (100 KG - BE IN THE FISSILE MASS) \$
 C AT 70% DENSITY WITH H/D=1.0 AND REMAINING VOLUME WITH VOID. \$
 C THE CENTER DRUM IS 150 GRAMS PU FISSILE MASS AT BE/PU AS PER TITLE \$
 C THE DRUM STEEL WALL DENSITY IS 50% TO ACCOUNT FOR DEGRADATION. THE 7-PACKS \$
 C ARE STACKED 3-HIGH WITH A MGO LAYER ON TOP. THE UPPER AND LOWER VERTICAL \$
 C PLANES ARE REFLECTED BY 300 CM OF SALT. THE LATERAL BOUNDARIES ARE \$
 C MIRRORED TO SIMULATE INFINITE REFLECTION IN THE LATERAL PLANE. 11/01/07 \$
 C \$
 C CC \$
 C \$
 C CELL CARDS FOR THE 100 FGE DRUMS. \$
 C \$
 C 1 1 -1.8522 -14 U=1 IMP:N=1 \$
 C 2 3 -1.295 14 -11 U=1 IMP:N=1 \$

3	0		11 -2 -10 8	U=1	IMP:N=1	\$
4	6	-3.93	(2:10:-8) -4 6 -12	U=1	IMP:N=1	\$
5	0		(4:-6:12)	U=1	IMP:N=1	\$
C						\$
C	CELL CARDS FOR THE 150 FGE DRUM					\$
C						\$
101	2	-1.8530	-34	U=2	IMP:N=1	\$
102	3	-1.295	34 -31	U=2	IMP:N=1	\$
103	0		31 -2 -10 8	U=2	IMP:N=1	\$
104	6	-3.93	(2:10:-8) -4 6 -12	U=2	IMP:N=1	\$
105	0		(4:-6:12)	U=2	IMP:N=1	\$
C						\$
C	CELL CARDS FOR THE HEXAGONAL 7-PACK STACK.					\$
C						\$
12	0		-21 20 -22 25 -23 24 -27 26 LAT=2 U=4	IMP:N=1		\$
			FILL=-3:3 -3:3 0:2			\$
			4 16R			\$
			1 1 4 4 4 4			\$
			1 1 1 4 4 4 4			\$
			1 1 4 16R			\$
			4 16R			\$
			1 1 4 4 4 4			\$
			1 2 1 4 4 4 4			\$
			1 1 4 16R			\$
			4 16R			\$
			1 1 4 4 4 4			\$
			1 1 1 4 4 4 4			\$
			1 1 4 16R			\$
13	0		-61 60 -62 65 -63 64 -67 66 FILL=4	IMP:N=1		\$
C						\$
C	CELL CARDS FOR THE MGO AND SALT LAYERS.					\$
C						\$
14	8	-2.165	(53:-66) -61 60 -62 65 -63 64 50 -52	IMP:N=1		\$
15	7	-1.45	-61 60 -62 65 -63 64 67 -53	IMP:N=1		\$
C						\$
C	CELL CARDS FOR THE REST OF THE UNIVERSE.					\$
C						\$
16	0		-50:52:61:-60:62:-65:63:-64	IMP:N=0		\$
C						\$
C	SURFACE CARDS FOR THE 150 FGE DRUM					\$
C						\$
31	RCC	0 0	21.4227 0 0 41.8524 20.9262	\$BE REFLECTOR		\$
34	RCC	0 0	22.9514 0 0 38.7951 19.3975	\$FGE		\$
C						\$
C	SURFACE CARDS FOR ALL DRUM SUFFACES					\$
C						\$
2	CZ	28.575				\$
4	CZ	28.696				\$
6	PZ	0.0				\$
8	PZ	0.121				\$
10	PZ	84.576				\$
12	PZ	84.697				\$
C						\$
C	CELL CARDS FOR THE 100 FGE DRUMS.					\$
C						\$
11	RCC	0 0	21.1618 0 0 42.3743 21.1871	\$BE around 100 FGE		\$
14	RCC	0 0	23.6984 0 0 37.3009 18.6505	\$100 FGE		\$
C						\$
C	SURFACE CARDS FOR THE HEXAGONAL 7-PACK.					\$
C						\$
20	PX	-28.75				\$
21	PX	28.75				\$
22	P	1	1.7321 0 57.5			\$
23	P	-1	1.7321 0 57.5			\$
24	P	-1	1.7321 0 -57.5			\$
25	P	1	1.7321 0 -57.5			\$
26	PZ	0.0				\$
27	PZ	84.697				\$
C						\$
C	SURFACE CARDS FOR THE MGO AND SALT LAYERS.					\$

C							\$
50	PZ	-300.00					\$
52	PZ	616.321					\$
53	PZ	316.321					\$
C							\$
C	SURFACE CARDS FOR THE 7-PACK STACK INFINITE ARRAY.						\$
C							\$
*60	PY	-78.5					\$
*61	PY	78.5					\$
*62	P	1.7321	1	0	157		\$
*63	P	1.7321	-1	0	157		\$
*64	P	1.7321	-1	0	-157		\$
*65	P	1.7321	1	0	-157		\$
66	PZ	0.0					\$
67	PZ	254.091					\$
C							\$
C	DATA CARDS.						\$
C							\$
MODE	N						\$
C							\$
C	SOURCE CARDS.						\$
C							\$
KCODE	5000	1.0	50	250			\$
KSRC	-58	0	43	-30	-50	43	\$
	-58	0	128	-30	-50	128	\$
	-58	0	213	-30	-50	213	\$
C							\$
C	MATERIAL CARDS						\$
C							\$
C	PU-BE FOR THE FISSILE MASS CONTAINING 100 GRAMS OF PU.						\$
C							\$
M1	94239.60C	-0.001325		4009.60C	-0.998675		\$
MT1	BE.01T						\$
C							\$
C	PU-BE FOR THE FISSILE MASS CONTAINING 150 GRAMS OF PU.						\$
C							\$
M2	94239.60C	-0.001765		4009.60C	-0.998235		\$
MT2	BE.01T						\$
C							\$
C	BE REFLECTOR AROUND THE FISSILE MASS						\$
C							\$
M3	4009.60C		-1.000000				\$
MT3	BE.01T						\$
C							\$
C	55-GALLON DRUM STEEL WALLS.						\$
C							\$
M6	6000.60C		-0.001500				\$
	25055.60C		-0.006000				\$
	15031.60C		-0.000350				\$
	16000.60C		-0.000400				\$
	26054.60C		-0.058513				\$
	26056.60C		-0.909630				\$
	26057.60C		-0.020827				\$
	26058.60C		-0.0027769				\$
C							\$
C	MGO LAYER.						\$
C							\$
M7	12000.60C		0.5				\$
	8016.60C		0.5				\$
C							\$
C	SALT REFLECTOR.						\$
C							\$
M8	11023.60C		0.5				\$
	17000.60C		0.5				\$
C							\$
C	PRINT TABLE 40 FOR MASS FRACTIONS						\$
C							\$
PRINT	40						\$

B7.4 55-gallon Drum Array Overstack Model (Filename a420kbn)

```

55-gallon Drum Array Case, 700 G TOTAL, 100%BE, BE/PU=20000, 4-TIER, NO MGO
C INFINITE ARRAY 7-PACK MODEL OF 55-GALLON DRUMS WITH 7 55-GALLON $
C DRUMS CONTAINING 100 GRAMS PU. ALL FISSILE BEARING DRUMS $
C CONTAIN A BE MODERATOR WHICH IS MIXED WITH THE PU. THE FISSILE $
C MASSES ARE CENTRALLY LOCATED IN THE FISSILE BEARING DRUMS AND $
C ARE CYLINDRICAL IN SHAPE WITH A H/D RATIO OF 1.0. THE FISSILE MASSES $
C ARE REFLECTED BY A BERYLLIUM CYLINDER (100 KG - BE IN THE FISSILE MASS) $
C AT 70% DENSITY WITH H/D=1.0 AND REMAINING VOLUME WITH VOID. $
C THE DRUM STEEL WALL DENSITY IS 50% TO ACCOUNT FOR DEGRADATION. THE 7-PACKS$
C ARE STACKED 4-HIGH WITH NO MGO LAYER ON TOP. THE UPPER AND LOWER VERTICAL $
C PLANES ARE REFLECTED BY 300 CM OF SALT. THE LATERAL BOUNDARIES ARE $
C MIRRORED TO SIMULATE INFINITE REFLECTION IN THE LATERAL PLANE. 10/30/07 $
C $
C CCCCCCCCCCCCCCCCCCCCCCCCCCCCCCCCCCCCCCCCCCCCCCCCCCCCCCCCCCCCCCCC$
C $
C CELL CARDS FOR THE 100 FGE DRUMS. $
C $
1 1 -1.8522 -14 U=1 IMP:N=1 $
2 3 -1.295 14 -11 U=1 IMP:N=1 $
3 0 11 -2 -10 8 U=1 IMP:N=1 $
4 6 -3.93 (2:10:-8) -4 6 -12 U=1 IMP:N=1 $
5 0 (4:-6:12) U=1 IMP:N=1 $
C $
C CELL CARDS FOR THE HEXAGONAL 7-PACK STACK. $
C $
12 0 -21 20 -22 25 -23 24 -27 26 LAT=2 U=4 IMP:N=1 $
FILL=-3:3 -3:3 0:3 $
4 16R $
1 1 4 4 4 4 $
1 1 1 4 4 4 4 $
1 1 4 16R $
4 16R $
1 1 4 4 4 4 $
1 1 1 4 4 4 4 $
1 1 4 16R $
4 16R $
1 1 4 4 4 4 $
1 1 1 4 4 4 4 $
1 1 4 16R $
4 16R $
1 1 4 4 4 4 $
1 1 1 4 4 4 4 $
1 1 4 16R $
13 0 -61 60 -62 65 -63 64 -67 66 FILL=4 IMP:N=1 $
C $
C CELL CARDS FOR THE MGO AND SALT LAYERS. $
C $
14 8 -2.165 (53:-66) -61 60 -62 65 -63 64 50 -52 IMP:N=1 $
15 8 -2.165 -61 60 -62 65 -63 64 67 -53 IMP:N=1 $
C 15 7 -1.45 -61 60 -62 65 -63 64 67 -53 IMP:N=1 $
C $
C CELL CARDS FOR THE REST OF THE UNIVERSE. $
C $
16 0 -50:52:61:-60:62:-65:63:-64 IMP:N=0 $
C $
C SURFACE CARDS FOR ALL DRUM SUFFACES $
C $
2 CZ 28.575 $
4 CZ 28.696 $
6 PZ 0.0 $
8 PZ 0.121 $
10 PZ 84.576 $
12 PZ 84.697 $
C $
C CELL CARDS FOR THE 100 FGE DRUMS. $

```

C										\$	
11	RCC	0	0	21.1618	0	0	42.3743	21.1871	\$BE around 100	FGE	\$
14	RCC	0	0	23.6984	0	0	37.3009	18.6505	\$100	FGE	\$
C										\$	
C	SURFACE CARDS FOR THE HEXAGONAL 7-PACK.									\$	
C										\$	
20	PX			-28.75							\$
21	PX			28.75							\$
22	P	1		1.7321	0		57.5				\$
23	P	-1		1.7321	0		57.5				\$
24	P	-1		1.7321	0		-57.5				\$
25	P	1		1.7321	0		-57.5				\$
26	PZ			0.0							\$
27	PZ			84.697							\$
C											\$
C	SURFACE CARDS FOR THE MGO AND SALT LAYERS.									\$	
C											\$
50	PZ			-300.00							\$
c	52	PZ		616.321							\$
c	53	PZ		316.321							\$
52	PZ			701.018							\$
53	PZ			401.018							\$
C											\$
C	SURFACE CARDS FOR THE 7-PACK STACK INFINITE ARRAY.									\$	
C											\$
*60	PY			-78.5							\$
*61	PY			78.5							\$
*62	P	1.7321	1	0	157						\$
*63	P	1.7321	-1	0	157						\$
*64	P	1.7321	-1	0	-157						\$
*65	P	1.7321	1	0	-157						\$
66	PZ			0.0							\$
c	67	PZ		254.091							\$
67	PZ			338.788							\$
C											\$
C	DATA CARDS.									\$	
C											\$
MODE	N									\$	
C											\$
C	SOURCE CARDS.									\$	
C											\$
KCODE	5000	1.0	50	250							\$
KSRC	-58	0	43	-30	-50	43					\$
	-58	0	128	-30	-50	128					\$
	-58	0	213	-30	-50	213					\$
C											\$
C	MATERIAL CARDS									\$	
C											\$
C											\$
C	PU-BE FOR THE FISSILE MASS CONTAINING 100 GRAMS OF PU.									\$	
C											\$
M1	94239.60C			-0.001325			4009.60C			-0.998675	\$
MT1	BE.01T										\$
C											\$
C	BE REFLECTOR AROUND THE FISSILE MASS CONTAINING 100 GRAMS PU.									\$	
C											\$
M3	4009.60C			-1.000000							\$
MT3	BE.01T										\$
C											\$
C	55-GALLON DRUM STEEL WALLS.									\$	
C											\$
M6	6000.60C			-0.001500							\$
	25055.60C			-0.006000							\$
	15031.60C			-0.000350							\$
	16000.60C			-0.000400							\$
	26054.60C			-0.058513							\$
	26056.60C			-0.909630							\$
	26057.60C			-0.020827							\$
	26058.60C			-0.0027769							\$
C											\$

C	MGO LAYER.			\$
C				\$
C	M7	12000.60C	0.5	\$
C		8016.60C	0.5	\$
C				\$
C	SALT REFLECTOR.			\$
C				\$
M8		11023.60C	0.5	\$
		17000.60C	0.5	\$
C				\$
C	PRINT TABLE 40 FOR MASS FRACTIONS			\$
C				\$
PRINT	40			\$

Appendix C

Machine-Compacted Waste

This page intentionally left blank.

Analyst

Senior NCS Engineer

G.W. Neeley

Date

Peer Reviewer

Senior NCS Engineer

S. L. Larson

Date

This page intentionally left blank

Introduction

This appendix focuses on compacted waste in 55-gallon drums, shielded containers, 100-gallon drums and SWBs. Compacting is typically performed mechanically on 55-gallon drums and the resulting machine-compacted drum is called a “puck.” Approximately four pucks are loaded into a 100-gallon drum and sent to the WIPP for disposal. The 100-gallon drum may also be loaded into an SWB. Direct loading of an SWB with pucks is also evaluated. The criticality safety limits are given for the outer container, not the compacted drum. For analysis purposes, the steel of the compacted drum is ignored and the fissile material is assumed to be present in a compact geometry as if all fissile material in the drum was contained in one puck. In reality, the fissile material will likely be spread throughout the pucks and the steel wall of the compacted drum will absorb neutrons. Consequently, the modeled configuration is conservative from a criticality safety perspective. Special reflector materials are limited to less than 1 wt% and are modeled as beryllium consistent with the previous appendices. Both two-container and array configurations are considered. Sample MCNP5 input file listings for the models contained in this appendix are included in Section .

C1.0 Machine-Compacted Waste Configurations

C1.1 Fully Compacted Waste in 100-gallon Drums

This configuration assumes the drum contents are fully compacted and the non-fissile material in the drum, modeled as polyethylene, reaches theoretical density. Thus, the fissile mass is moderated with 100% dense polyethylene. The drums are modeled with two fissile limits. The first limit of 170 grams of ^{239}Pu does not credit any difference in the internal and external dimension when the drums are stacked. The second higher fissile mass is 200 grams of ^{239}Pu and only applies when the design of the container lid and bottom that provides inherent spacing between the internal contents of two stacked drums is credited. With both limits, the fissile mass is reflected by a 100% dense mixture of polyethylene and beryllium. The beryllium content in the reflector mixture is 5 kilograms, which is slightly greater than 1% by weight of the rated 1,000-pound weight capacity of the drum *Contact-Handled Transuranic Waste Authorized Methods for Payload Control (CH-TRAMPAC)* (DOE-CBFO 2005a). The reflector configuration used for compacted drums concentrates the beryllium near the fissile mass. The reflector is modeled in two parts with the reflector part surrounding the fissile mass containing the beryllium-polyethylene mixture, and the remaining part containing only polyethylene. Although unlikely, this configuration represents a credible bound by assuming that the beryllium is concentrated in one or two pucks. The 100-gallon drum is modeled with the dimensions given in Table 2-2 and the steel drum wall is modeled with the composition given in Table 5-4 at 50% density to allow for degradation.

C1.2 Fully Compacted Waste in 55-gallon Drums

Although machine-compacted waste is typically packaged in 100-gallon drums, fully compacted waste in 55-gallon drums is also analyzed to avoid restricting future operations. The model is identical to that described in Section 2.1 except the container dimensions of a 55-gallon drum from Table 2-1 are used.

C1.3 Partially Compacted Waste in 100-gallon Drums

Because 100% compaction may be over conservative with regard to the compaction that can physically be achieved, limits are also determined based on 70% compaction. This scenario is also evaluated in the *TRUPACT-II Safety Analysis Report* (DOE-CBFO 2005b) and will require the waste generator to control the compaction process. The fissile mass in this model consists of 200 grams of ^{239}Pu moderated with a polyethylene-water mixture, which is 70% by volume polyethylene and 30% by volume water. This fissile mixture is consistent with the approved TRUPACT-II contents model used in the criticality safety analysis for partially compacted waste. Reflection of the fissile mass with a 70% dense mixture of 5 kilograms of beryllium and polyethylene is modeled. This reflector composition bounds mechanical machine compaction operations. As with the fully compacted case, the reflector mass configuration concentrates the beryllium near the fissile mass. The reflector is modeled in two parts with one part surrounding the fissile mass containing the beryllium-polyethylene mixture, and the remaining part containing only polyethylene. The 100-gallon drum is modeled with the dimensions given in Table 2-2 and the steel drum wall is modeled with the composition given in Table 5-4 at 50% density to allow for degradation.

C1.4 Fully Compacted Waste in Shielded Containers

Fully compacted waste may also be loaded into shielded containers. These containers are right circular cylinders made of steel and lead. The base and lid (top) are steel and the walls are lead layered between the inner and outer steel shells. The containers are modeled with the dimensions given in Table 2-1; the steel is modeled with the composition given in Table 5-4. The theoretical density of carbon steel is 7.86 g/cm^3 , and the steel is modeled at full density since the containers will be fabricated new specifically for disposal at the WIPP. The lead is modeled as given in Table 5-5.

C1.5 Fully Compacted Waste Direct-Loaded in a Standard Waste Box

Only full compaction is considered for the contents of the SWB. Thus, moderation of the fissile mass is modeled with 100% dense polyethylene and the fissile mass is reflected with a 100% dense mixture of beryllium and polyethylene. The fissile mass consists of 185 grams of ^{239}Pu . The beryllium content in the reflector mixture is 18.14 kilograms, which represents 1% by weight of the rated weight capacity of the SWB. The 18.14 kilograms of beryllium is homogeneously distributed throughout the polyethylene filling the container. The SWB is

modeled with the dimensions given in Table 2-3 and the steel wall is modeled with the composition given in Table 5-4 at 50% density to allow for degradation.

C1.6 Fully Compacted Waste in 100-gallon Drum Overpacked in a Standard Waste Box

A 100-gallon drum of fully compacted waste may also be overpacked in a SWB. This drum would typically be overpacked in the SWB due to exterior contamination. However, the SWB also provides additional spacing and structural steel whereas the FGE limit in the 100-gallon drum can be increased. The fissile mass is 250 grams of ^{239}Pu moderated with 100% dense polyethylene. The entire 18.14 kilograms of beryllium, 1 wt% of the SWB-rated weight capacity, is modeled in the 100-gallon drum and the remainder of the SWB is voided to allow for interaction between containers. The 100-gallon drum is modeled with the dimensions given in Table 2-2 and the SWB is modeled with the dimensions given in Table 2-3. Both container walls are modeled with the composition given in Table 5-4 at 50% density to allow for degradation.

C2.0 Array Models Containing Machine-compacted Waste

An infinite array model simulating the worst-case normal configuration for storage of drums or SWBs containing machine-compacted waste is constructed. Geometrically, the fissile mass mixture is modeled as a cylinder with an H/D ratio of 1. A cylindrical puck with this aspect ratio has the same surface-to-volume ratio as that of a sphere, and the reactivity effect, when reflected, is very close to that of a sphere with equivalent mass and moderation. The fissile cylinder is centrally located in the container. Assuming random placement of the fissile unit in each container, the average center-to-center separation in either the horizontal or vertical direction will be statistically the same as that of the array with all fissile masses centered in the containers. Drum configurations are emplaced on a hexagonal lattice unit with pitch characteristics typical of a seven-pack of 55-gallon drums. The drums or SWBs are stacked three tiers high and all lateral surfaces are mirrored to simulate an infinite array. In the array models, the lower horizontal plane is reflected with 300 centimeters of salt and the upper plane is reflected by 62.23 centimeters of magnesium oxide (MgO) backed by 300 centimeters of salt. This reflector configuration represents a conservative bound on the underground repository reflector conditions with an MgO supersack on top of the storage containers. The array configuration is consistent with the array models discussed in the previous appendices. Figure C-1 summarizes the pertinent features of the baseline array model used in the analysis for 100-gallon drums as an example.

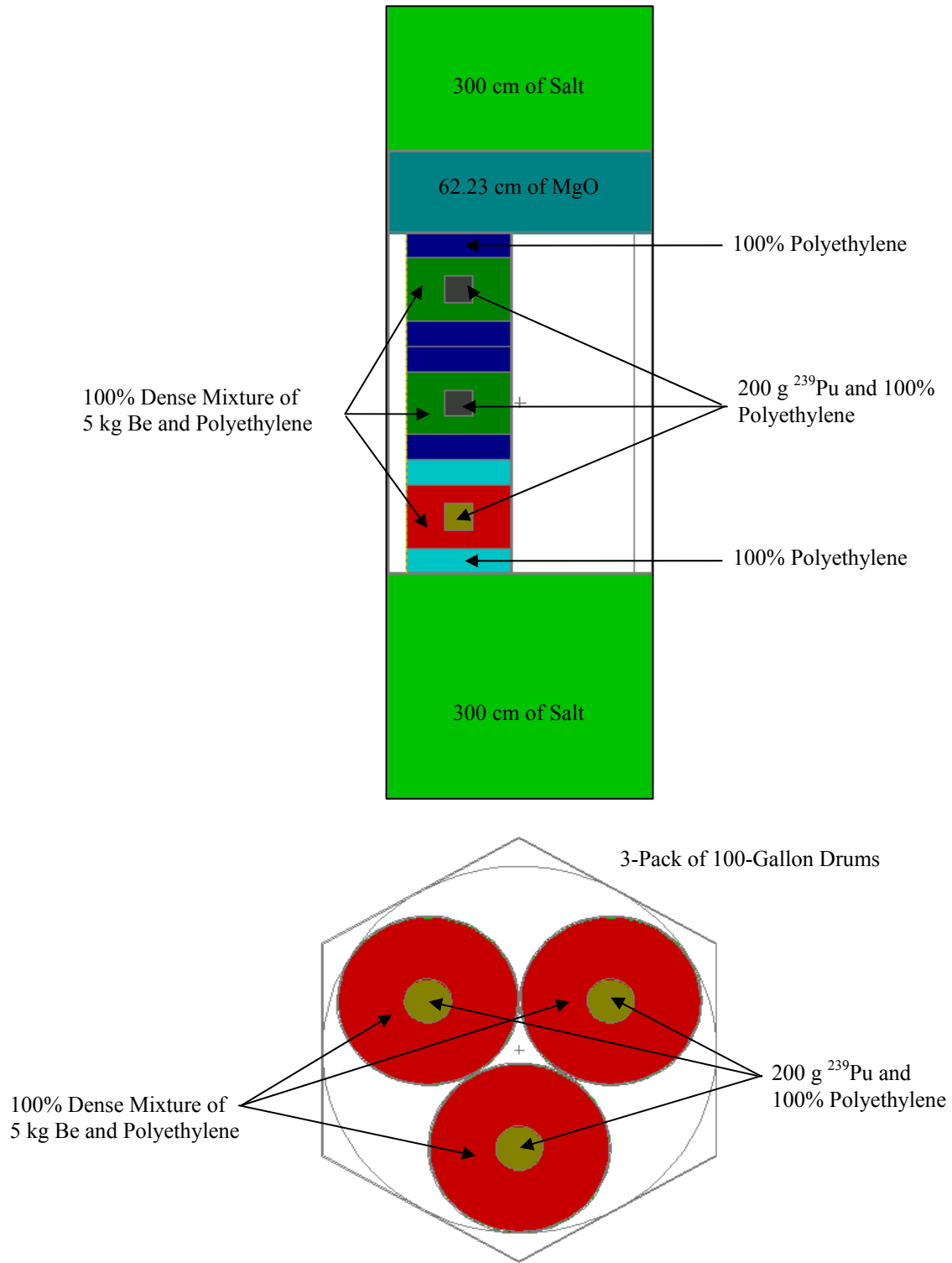

Figure C-, Infinite Array Model for Storage of 100-gallon Drums of

Machine-compacted Waste

C2.1 Infinite Array of 100-gallon Drums of Machine-compacted Waste

An infinite array model that bounds the storage of both fully and partially compacted 100-gallon drums is constructed where the ^{239}Pu mass is 200 grams/drum and 100% compaction is assumed. This model includes the maximum mass combined with the maximum compaction based on the limits given in Section . Any vertical design spacing credited in the two-container models in the Section is ignored and the bottom of the container is placed directly onto the lid of the lower container. This simplifies the modeling while providing a conservative analysis. The three-pack stack of 100-gallon drums is reflected as discussed in Section C2.0.

The H/Pu ratio is varied in all of the drums to find the most reactive state. The results of the 100-gallon drum infinite storage array calculation are summarized in Table C-1 and Figure C-2. The $k_{\text{eff}} + 2\sigma$ value is low at less than 0.87.

Table C-, 100-gallon Drum Infinite Storage Array Computational Results

H/Pu Ratio	k_{eff}	σ	$k_{\text{eff}} + 2\sigma$	Filename
650	0.85570	0.00087	0.85744	aray113
700	0.86085	0.00085	0.86255	aray114
750	0.86241	0.00084	0.86409	aray115
800	0.86544	0.00082	0.86708	aray116
850	0.86604	0.00080	0.86764	aray117
900	0.86761	0.00082	0.86925	aray118
950	0.86735	0.00082	0.86899	aray119
1000	0.86658	0.00080	0.86818	aray120
1050	0.86491	0.00080	0.86651	aray121
1100	0.86503	0.00077	0.86657	aray122
1150	0.86270	0.00078	0.86426	aray123
1200	0.86157	0.00078	0.86313	aray124
1250	0.85913	0.00078	0.86069	aray125

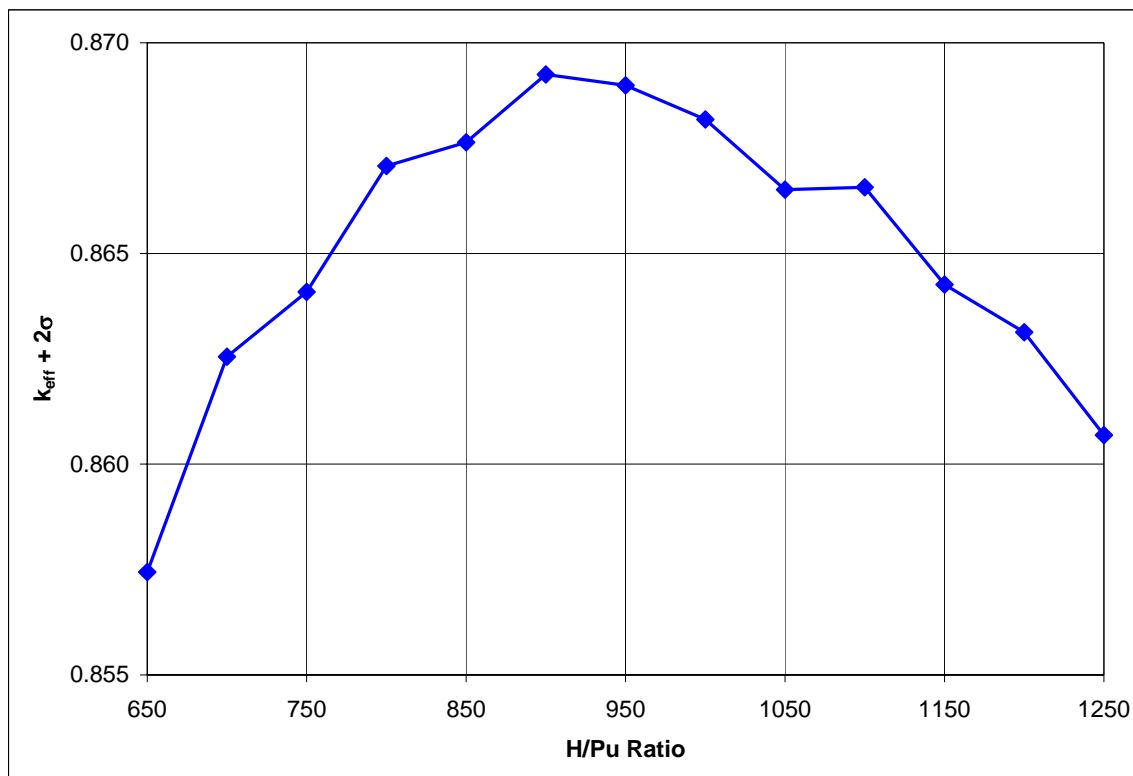

Figure C-, Compacted Waste in 100-gallon Drum Infinite Storage Array

To verify that the 100% dense polyethylene reflector does not reduce k_{eff} by preventing interaction between waste containers, a calculation was performed where the reflector concentration around each fissile mass was reduced to allow for maximum coupling between the fissile units. Although the waste pucks in the 100-gallon drums are compacted, the computation considers a range of reflector conditions ranging from 100% dense compaction to 10% compaction. Table C-2 gives the $k_{eff} + 2\sigma$ value at the optimum H/Pu ratio and Figure C-3 shows the computational results. As indicated by the reduction in reactivity with decreasing polyethylene density, the reflection provided by the polyethylene is more significant than the drum-to-drum interaction.

Table C-, 100-gallon Drum Infinite Storage Array Reactivity at Optimum H/Pu

Optimum H/Pu Ratio	Reflector Density (%)	k_{eff}	σ	$k_{eff} + 2\sigma$	Filename
900	100	0.86761	0.00082	0.86925	aray118
1000	75	0.85207	0.00078	0.85363	arad120
1150	50	0.82482	0.00079	0.82640	arad223
1250	25	0.78525	0.00078	0.78681	arad325
1200	10	0.77248	0.00081	0.77410	arad424

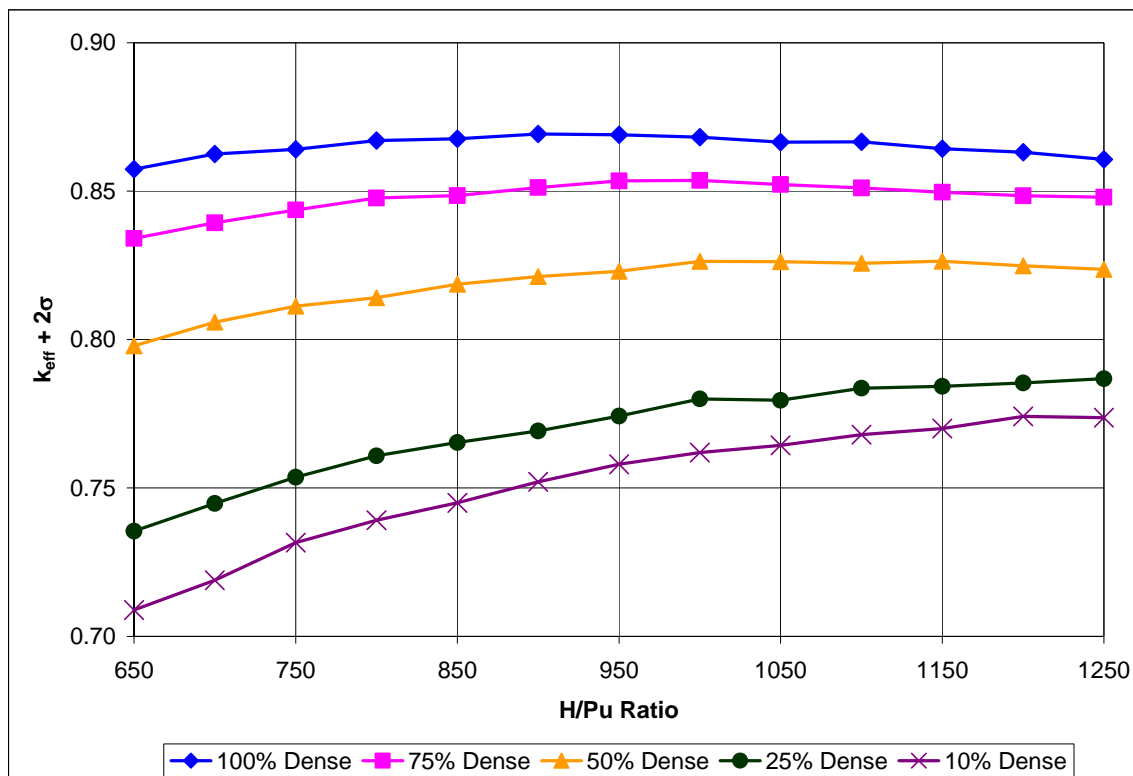

Figure C-, 100-gallon Drum Storage Array Reactivity vs. Polyethylene Reflector Density

C2.2 Infinite Array of 55-gallon Drums of Machine-compacted Waste

An infinite array of 55-gallon drums with machine-compacted waste is also modeled. Although machine-compacted waste is typically packaged in 100-gallon drums, these calculations are performed with the same parameters to avoid restricting future operations. Each drum contains 200 FGE, the fissile mass mixture is modeled as a cylinder with an H/D ratio of one centrally located in the drum, and the vertical spacing provided by the drum is ignored. The FGE in each seven-pack is further limited to 600 FGE. The center drum and two adjacent outer drums of the seven-pack are modeled at 200 FGE surrounded by 5 kilograms of beryllium in 100% polyethylene. The other four drums contain 5 kilograms of beryllium in 100% dense polyethylene with no fissile material. The reflection provided by the polyethylene/beryllium in the non-fissile drums increases the reactivity of the system compared to the configuration where these drums are empty.

The results of the 55-gallon drum infinite storage array calculations are summarized in Figure C-4 and Table C-3. The $k_{eff} + 2\sigma$ value is 0.87079 at an H/Pu ratio of 950 (filename ara5519). Consequently, the 600-FGE limit per seven-pack of machine-compacted waste results in a subcritical system. These 55-gallon drum calculations combined with the 100-gallon-drum evaluation in Section bound machine-compacted waste in 85-gallon drums that are stored in a four-pack arrangement. Thus, the limits of 200 FGE per drum and 600 FGE per pack apply to 55-, 85-, or 100-gallon drums.

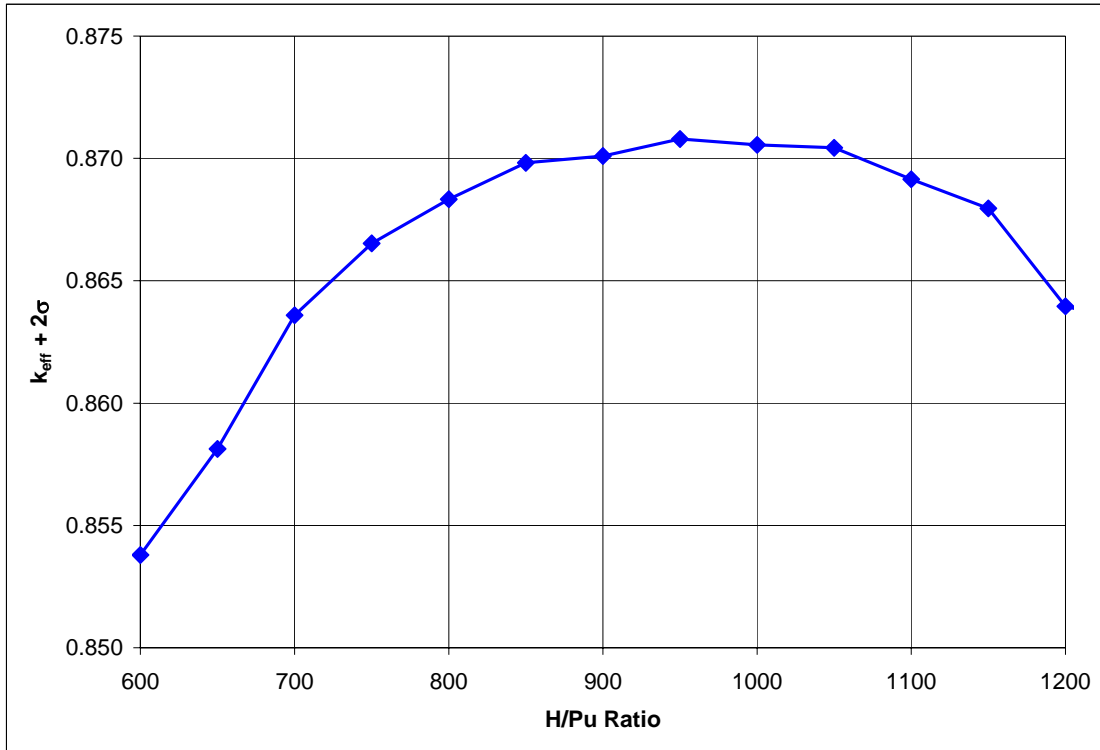

Figure C-, 55-gallon Drum Infinite Storage Array Reactivity as a Function of H/Pu Ratio

Table C-, 55-gallon Drum Infinite Storage Array Computational Results

H/Pu Ratio	k_{eff}	σ	$k_{eff} + 2\sigma$	Filename
600	0.85209	0.00085	0.85379	ara5512
650	0.85641	0.00086	0.85813	ara5513
700	0.86187	0.00086	0.86359	ara5514
750	0.86479	0.00087	0.86653	ara5515
800	0.86663	0.00085	0.86833	ara5516
850	0.86820	0.00081	0.86982	ara5517
900	0.86840	0.00085	0.87010	ara5518
950	0.86917	0.00081	0.87079	ara5519
1000	0.86889	0.00083	0.87055	ara5520
1050	0.86883	0.00080	0.87043	ara5521
1100	0.86759	0.00078	0.86915	ara5522
1150	0.86634	0.00081	0.86796	ara5523
1200	0.86240	0.00078	0.86396	ara5524
1250	0.86172	0.00074	0.86320	ara5525

C2.3 Infinite Array of Shielded Containers of Machine-compacted Waste

An infinite array of shielded containers of machine-compacted waste is modeled. The fissile content of the shielded containers is modeled consistent with drums containing machine-compacted waste. Each container has 200 grams of ^{239}Pu mixed with 100% dense polyethylene and the fissile mixture is modeled as a centrally located cylinder with an H/D ratio of 1. The fissile mass is reflected internally by 5 kilograms of beryllium mixed with 100% polyethylene. Geometrically, the shielded containers are arranged in a seven-pack configuration stacked three tiers high. The seven-pack configuration bounds the actual three-pack configuration used for shielded containers, but does not adversely impact the FGE limits. To simulate an array of infinite extent, the lateral boundaries of the seven-pack were mirrored and the vertical boundaries reflected by 300 centimeters of salt. The MgO supersack is modeled between the top of the containers on the upper tier of the stack and the upper salt reflection boundary.

The results of the shielded container infinite storage array calculations are summarized in Figure C-5 and Table C-4. The maximum $k_{\text{eff}} + 2\sigma$ value is 0.87039 at an H/Pu ratio of 900, which is below the USL of 0.96.

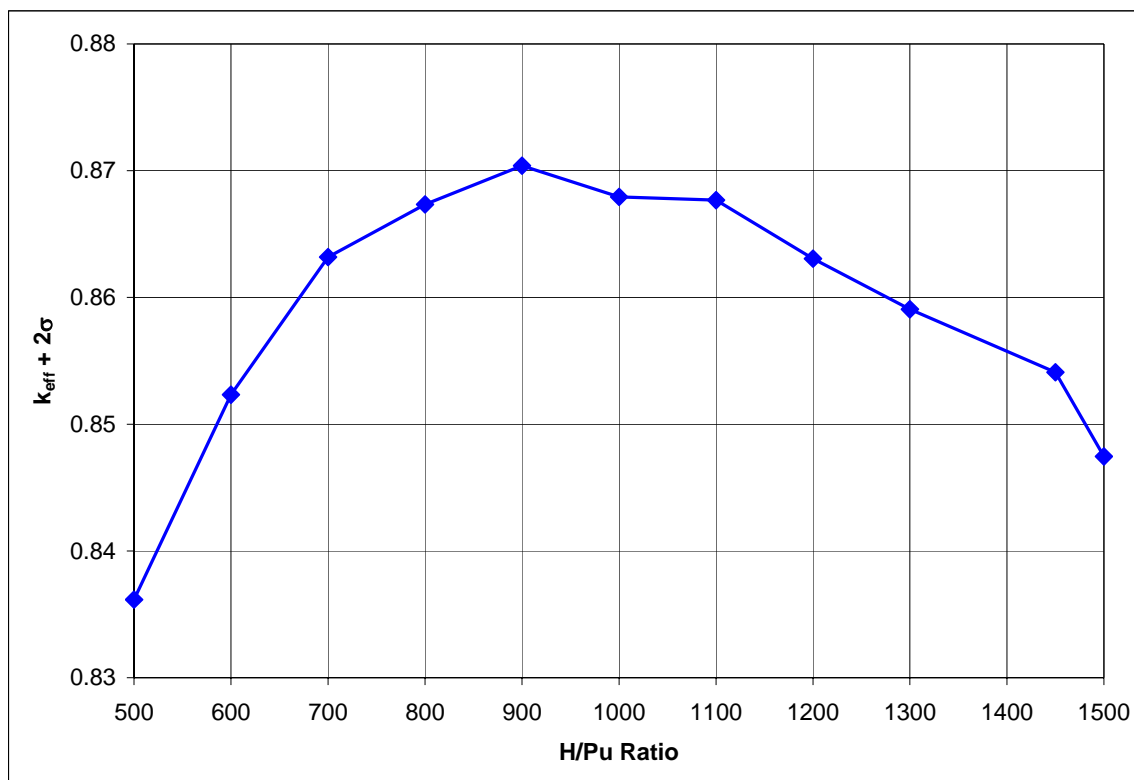

Figure C-, Shielded Container Infinite Storage Array Reactivity as a Function of H/Pu Ratio

Table C-, Shielded Container Infinite Storage Array Computational Results

H/Pu Ratio	k_{eff}	σ	$k_{eff} + 2\sigma$	Filename
500	0.83428	0.00094	0.83616	lldsa10
600	0.85067	0.00083	0.85233	lldsa12
700	0.86147	0.00086	0.86319	lldsa14
800	0.86576	0.00079	0.86734	lldsa16
900	0.86863	0.00088	0.87039	lldsa18
1000	0.86619	0.00087	0.86793	lldsa20
1100	0.86613	0.00077	0.86767	lldsa22
1200	0.86161	0.00072	0.86305	lldsa24
1300	0.85759	0.00074	0.85907	lldsa26
1450	0.85269	0.00070	0.85409	lldsa28
1500	0.84603	0.00071	0.84745	lldsa30

C2.4 Array Model of 55-gallon Drums Reflected by Shielded Containers

Shielded containers may be placed adjacent to other waste forms in the disposal array. A model was created with shielded containers around a seven-pack of 55-gallon drums of compacted waste similar to that shown in Figure A-11. The outer hexagonal surface around the shielded containers is infinitely reflected to model an infinite array. The fissile mass is modeled as a cylinder located in the center of each drum or container and the containers are stacked three tiers high with MgO and salt reflection. However, the seven-pack FGE was increased from the allowable value of 650 FGE per seven-pack of direct-loaded waste to 1,250 FGE per pack. Even with this significant conservatism, the results in Table C-5 show the maximum reactivity is less than 0.90 (the maximum reactivity of the array of 55-gallon drums per Section A2.1). The addition of shielded containers within the array reduces the reactivity.

Table C-, Results for Intermixed Array of Shielded Containers of Compacted Waste and 55-gallon Drums of Non-compacted Waste

H/Pu Ratio	k_{eff}	σ	$k_{eff} + 2\sigma$	Filename
Poly Mixed With beryllium in the 55-Gallon Drum 7-Packs Reflector				
500	0.83559	0.00083	0.83725	lldar10
600	0.85127	0.00082	0.85291	lldar12
700	0.86088	0.00090	0.86268	lldar14
800	0.86586	0.00089	0.86764	lldar16
900	0.86860	0.00075	0.87010	lldar18
1000	0.86817	0.00082	0.86981	lldar20
1100	0.86640	0.00077	0.86794	lldar22
1200	0.86104	0.00074	0.86252	lldar24
1300	0.85679	0.00072	0.85823	lldar26
1400	0.85091	0.00071	0.85233	lldar28
1500	0.84417	0.00076	0.84569	lldar30
No Poly Mixed With beryllium in the 55-Gallon Drum 7-Packs Reflector				
500	0.83465	0.00092	0.83649	lldar50
600	0.85174	0.00077	0.85328	lldar52
700	0.86213	0.00082	0.86377	lldar54
800	0.86637	0.00082	0.86801	lldar56
900	0.86820	0.00081	0.86982	lldar58
1000	0.86777	0.00077	0.86931	lldar60
1100	0.86543	0.00076	0.86695	lldar62
1200	0.86289	0.00077	0.86443	lldar64
1300	0.85813	0.00071	0.85955	lldar66
1400	0.85230	0.00075	0.85380	lldar68
1500	0.84685	0.00071	0.84827	lldar70

The calculations were repeated with the seven-packs of 55-gallon drums containing compacted waste with 200 FGE in three of the drums such that the seven-pack limit of 600 FGE for compacted waste is maintained. From Section , the maximum reactivity of an array of compacted waste in 55-gallon drums is 0.87079. From Table C-, the maximum reactivity of the same array with shielded containers around it is 0.86892. Consequently, the shielded containers do not increase the reactivity of the underground array when intermixed with other compacted waste containers.

Table C-, Results for Intermixed Array of Shielded Containers and 55-gallon Drums both containing Compacted Waste

H/Pu Ratio	k_{eff}	σ	$k_{eff} + 2\sigma$	Filename
500	0.83453	0.00087	0.83627	lldar90
600	0.84920	0.00083	0.85086	lldar92
700	0.86028	0.00085	0.86198	lldar94
800	0.86537	0.00072	0.86681	lldar96
900	0.86736	0.00078	0.86892	lldar98
1000	0.86550	0.00087	0.86724	lldar100
1100	0.86387	0.00079	0.86545	lldar102
1200	0.86152	0.00075	0.86302	lldar104
1300	0.85597	0.00068	0.85733	lldar106
1400	0.85207	0.00077	0.85361	lldar108
1500	0.84477	0.00070	0.84617	lldar110

C2.5 Infinite Array of SWBs of Machine-Compacted Waste

An infinite array simulating the worst-case configuration of SWB containers with machine-compacted waste was modeled with a ^{239}Pu mass of 185 grams per SWB. The compacted reflector dunnage was modeled as a mixture of 18.14 kilograms of beryllium and polyethylene at 100% density. The SWBs are modeled in the hexagonal lattice and stacked three tiers high with no vertical spacing between them. The stack is mirrored on all lateral sides to simulate an infinite array and reflected top and bottom by MgO and salt as discussed in Section .

The results of the SWB infinite storage array calculation are summarized in Figure C-6 and Table C-7 with the maximum k_{eff} of 0.84618 at an optimum H/Pu ratio of 1,000 (filename ar1000). Based on the low reactivity of the array, an array of 100-gallon drums overpacked in SWBs (as analyzed in the two-container configuration in Section C4.2) will also remain subcritical as the additional steel in the drum will further reduce reactivity.

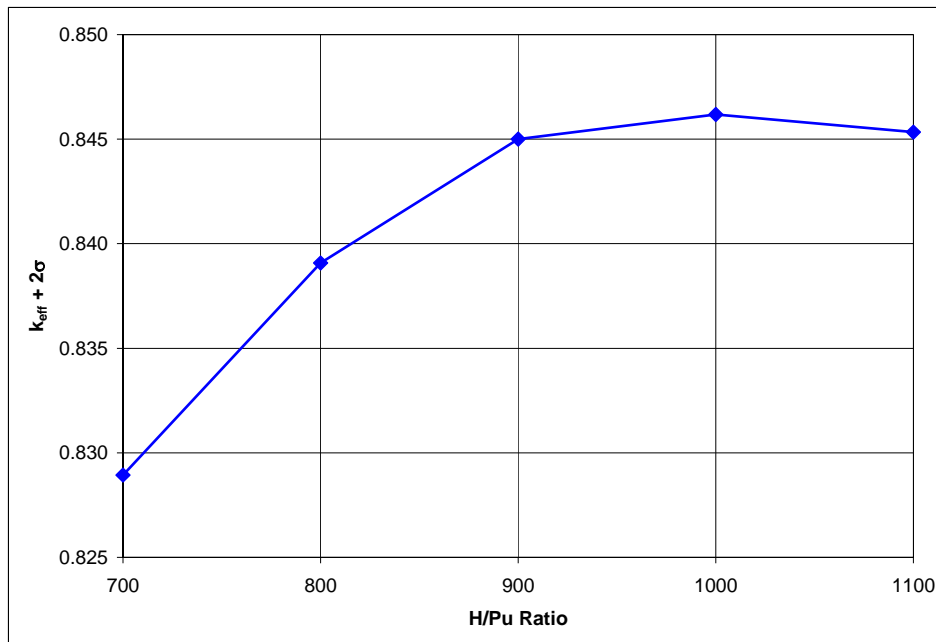

Figure C-, SWB Infinite Storage Array Reactivity as a Function of H/Pu Ratio

Table C-, SWB Infinite Storage Array Computational Results

H/Pu Ratio	k_{eff}	σ	$k_{eff} + 2\sigma$	Filename
700	0.82710	0.00092	0.82894	ar700
800	0.83718	0.00095	0.83908	ar800
900	0.84316	0.00092	0.84500	ar900
1000	0.84432	0.00093	0.84618	ar1000
1100	0.84354	0.00090	0.84534	ar1100

C3.0 MCNP Two-container Models for Machine-compacted Waste

The two-container models used in this evaluation consider the different container types and fissile loadings that could be stacked with a drum or SWB containing machine-compacted CH waste in a bounding configuration. The primary intent of the two-container analyses is to establish an FGE mass limit on machine-compacted waste that is consistent with the TRUPACT-II shipping requirements and yet conservative enough to ensure that a criticality at the WIPP due to the handling and disposal/storage of machine-compacted waste is not credible.

The two containers modeled are surrounded with a 300-centimeter reflector of concrete, MgO, or salt. These reflectors would be present in above-ground handling and storage and repository disposal. Figure C-7 summarizes the geometric characteristics of a 100-gallon two-drum model as an example.

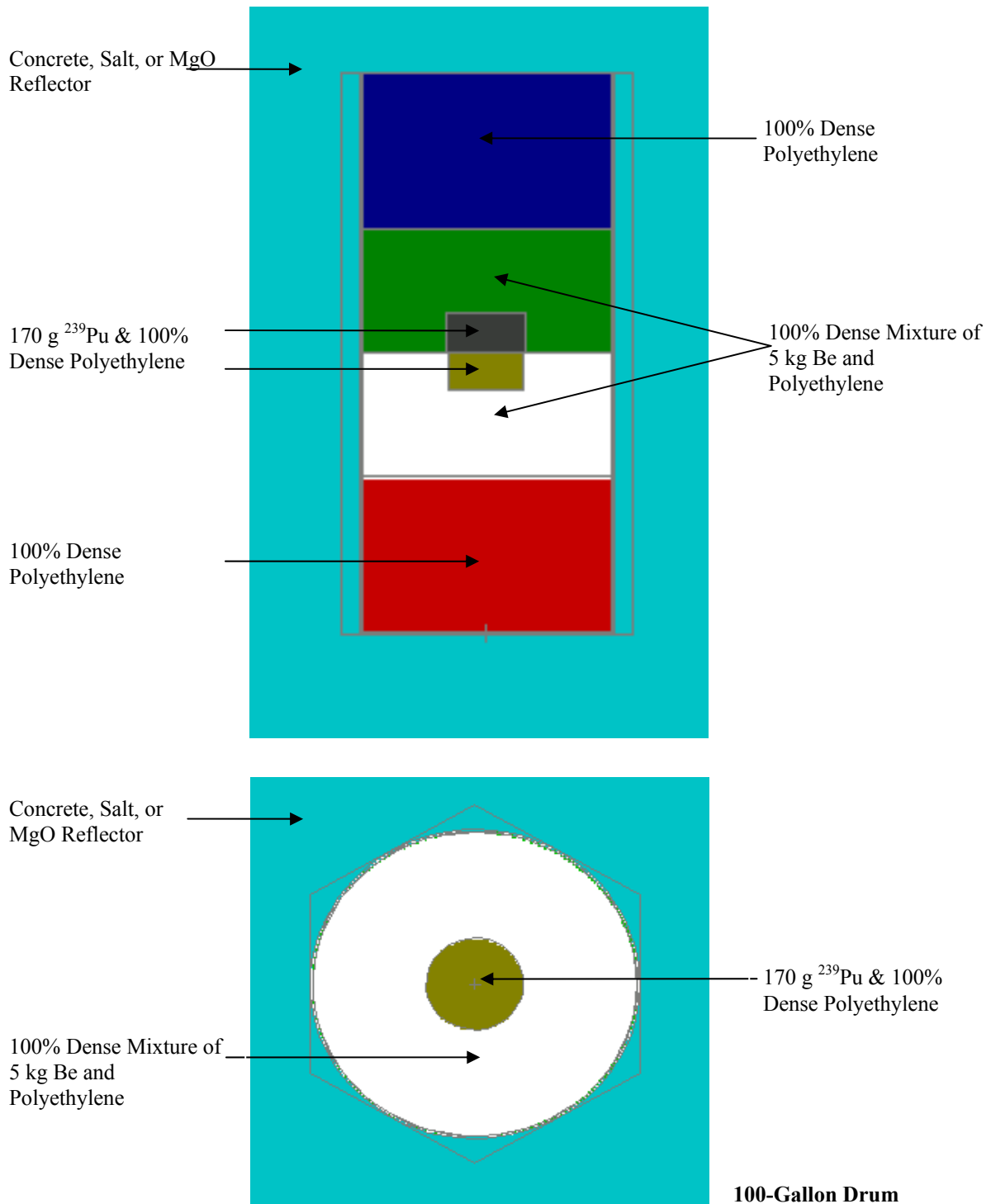

Figure C-, Two-Drum Model for 100-gallon Drums Containing Fully Compacted Waste without Vertical Spacing Between DRUMS

C3.1 100-gallon Drum Two-Container Models with Fully Compacted Waste

The first two-drum model involves two 100-gallon drums containing fully compacted waste. The intent of this calculation is to establish the FGE limit on 100% dense machine-compacted waste for two-drum configurations where no credit is taken for vertical spacing between drums and the spacing between drums inherent in the container design is credited.

In the first two-drum model, the two drums are vertically stacked on top of each other with the fissile masses being separated only by the thickness of the container lid and bottom. In the more realistic model, a 0.5-inch space is modeled between the contents and the exterior bottom of the 100-gallon drum and an additional 0.5-inch separation is modeled between the contents and the drum exterior at the top of the drum to account for the recessed inner lid/lid ring closure mechanism. Drawing BNFL 53-9840 (BNFL 2001) for the 100-gallon drum shows that the space at the bottom of the drum is approximately 0.875 inches thick and the space at the top of the drum from the recessed inner lid is a minimum of 0.873 inches (ignoring the outer lid and ring clamp separation). Thus, the overall distance from the lid top surface to the bottom surface between two vertically adjacent drums is nominally 1.75 inches. The use of 0.5 inches at both the top and bottom is adequate to accommodate variations from the nominal container dimensions and is conservative compared to the actual design. Because there is an outer lid on top of the inner lid in a 100-gallon drum, even if a smaller 55-gallon drum is stacked on top of the 100-gallon drum, the upper spacing will be maintained. Furthermore, the slipsheets or reinforcing plates are not credited in this analysis.

The two-drum models described above were used to determine the FGE mass limit for the 100-gallon drum containing fully compacted waste. With respect to the bounding two-drum model without vertical spacing, a ^{239}Pu mass of 170 FGE is below the original USL of 0.97 as shown in Table C-8. The ^{239}Pu /polyethylene waste mixture concentration in both drums was varied over a full range of H/Pu ratios to ascertain the most reactive state. Table C-8 tabulates maximum k_{eff} and the results over the H/Pu range modeled. As shown in Figure C-9, to allow for the additional 0.01 administrative margin in the USL, the fissile masses in the two containers must be separated by just over 0.5 centimeters (0.2 inches). This separation will easily be achieved in reality as the modeled scenario assumes all of the fissile mass in the 100-gallon drum is located in the uppermost compacted puck drum and the compacted drums completely fill the larger drum whereas no space exists to the lid. Also, 0.5 centimeters is a small fraction of the 0.873-inch design spacing inherent in the recessed lid design of the 100-gallon drum.

Table C-, 100-gallon Drum Two Container Model Reactivity at 170 FGE

Distance between fissile masses (cm)	Optimum H/Pu Ratio	k_{eff}	σ	$k_{eff} + 2\sigma$	Filename
Concrete Reflector					
0	800	0.96464	0.00089	0.96642	ml17016
0.5	800	0.95868	0.00084	0.96036	flc0516
1.0	800	0.95394	0.00081	0.95556	flc1016
1.5	800	0.94362	0.00080	0.94522	flc1516
2.0	800	0.93714	0.00083	0.93880	flc2016
Salt Reflector					
0	800	0.96464	0.00089	0.96642	ms17016
MgO Reflector					
0	800	0.96436	0.00087	0.96610	mm17016

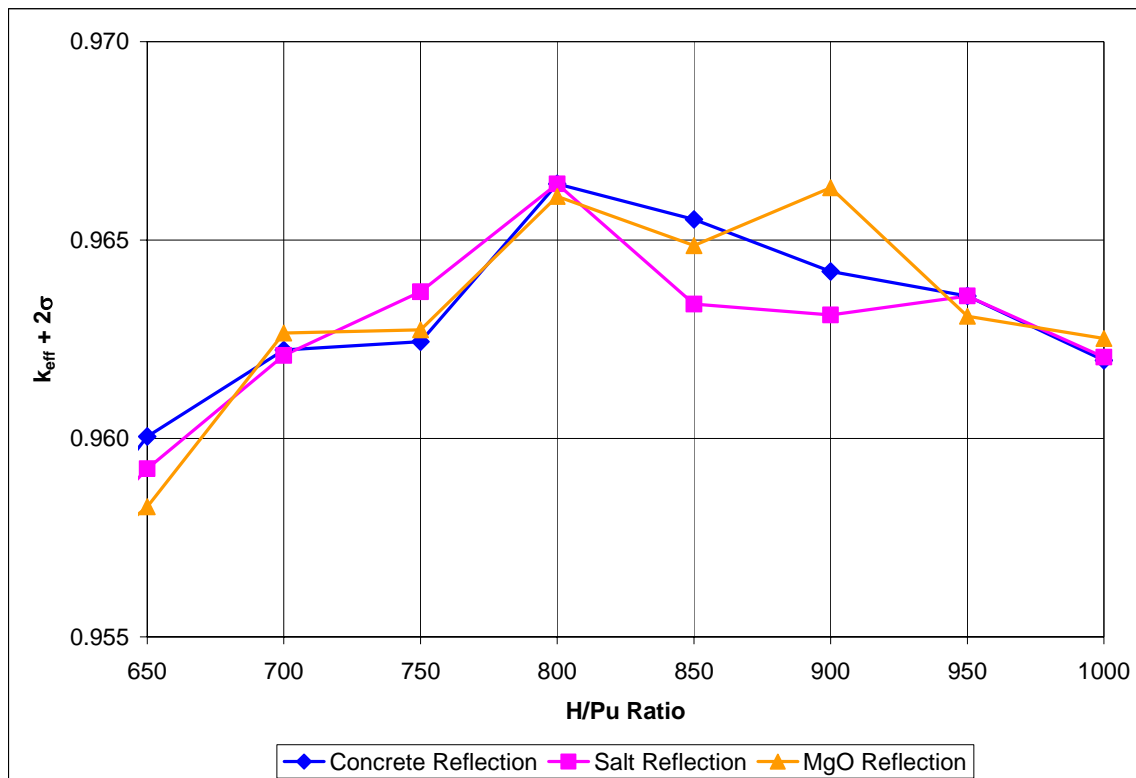

Figure C-, Two-Container Results for 100% Machine-Compacted Waste in 100-gallon Drums at 170 FGE/drum

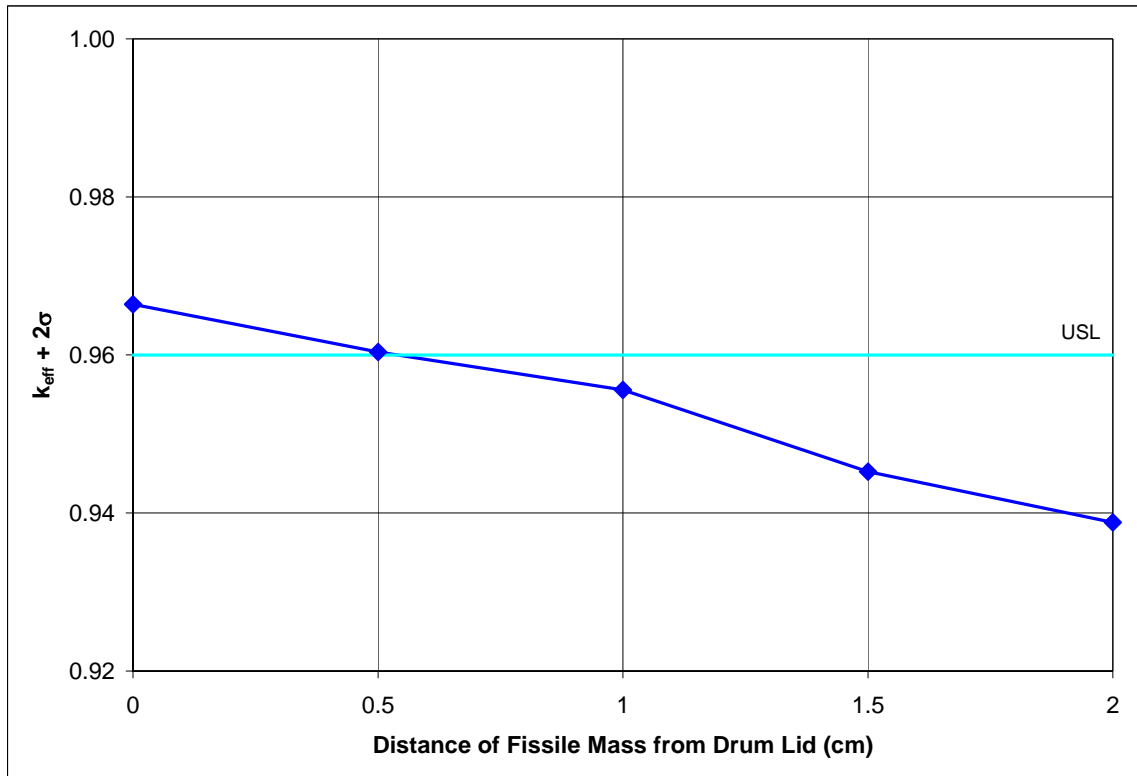
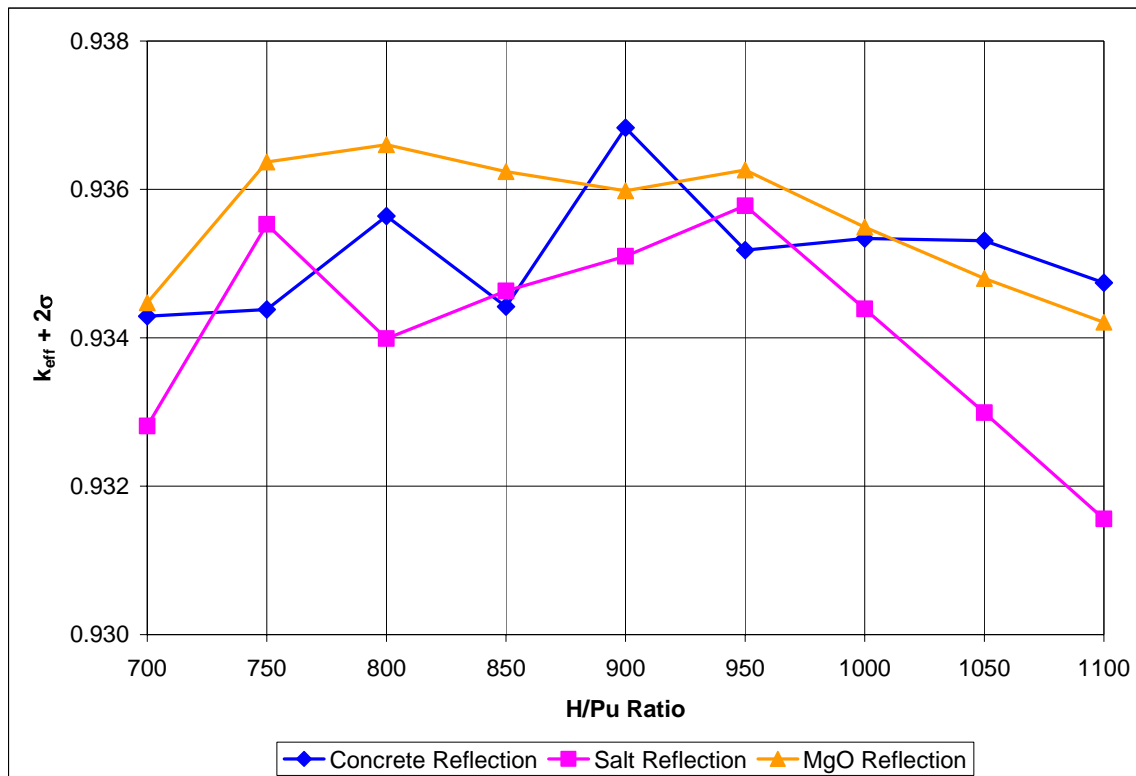

Figure C-, Two-Container Results for 170 FGE in Fully Machine-Compacted Waste in 100-gallon Drums with Additional Separation

In the more realistic or representative two-drum model, the FGE was set at the maximum TRUPACT-II limit allowed (200 grams of ²³⁹Pu) in any given 100-gallon drum. The computational results for this model shown in Table C-9 and Figure C-10 credits 0.5 inch of design spacing in each drum for a 1-inch separation between fissile units. These results indicate that the 200-FGE limit yields a two-drum system eigenvalue below 0.94.

**Table C-, System Reactivity for Two 100-gallon Drums with Vertical Separation
 Containing 200 Grams of ²³⁹Pu in Fully Compacted Waste**

Reflector	Optimum H/Pu Ratio	k _{eff}	σ	k _{eff} + 2σ	Filename
Concrete	900	0.93521	0.00081	0.93683	tdmc258
Salt	950	0.93408	0.00085	0.93578	tdmc859
MgO	800	0.93486	0.00087	0.93660	tdc1456



**Figure C-, Two 100-gallon Drums containing 200 g ²³⁹Pu in Fully
 Compacted Waste with 0.5-inch Drum Design Spacing**

**C3.2 100-gallon Drum Two-Container Models with Partially
 Compacted Waste**

The model for the partially compacted waste assumes that the fissile mass in the partially compacted drum contains 200 grams of ²³⁹Pu moderated with a polyethylene-water mixture, which is 70% by volume polyethylene and 30% by volume water. The fissile mass is reflected by a mixture of 5 kilograms of beryllium and polyethylene, which has an overall bulk density of 70%. Geometrically, no credit is taken for design vertical spacing between axially adjacent drums in the partially compacted models and the only separation is the steel of the drum lid and bottom.

The partially compacted waste drum model is used to evaluate three separate two-drum combinations as follows:

1. A fully compacted/partially compacted combination where no design vertical spacing is assumed (170 grams of ^{239}Pu is modeled in the fully compacted drum);
2. A fully compacted/partially compacted combination where the fully compacted drum provides a 0.5-inch vertical separation between drums (200 grams of ^{239}Pu is modeled in the fully compacted drum); and
3. Two partially compacted drums each containing 200 grams of ^{239}Pu .

For the fully compacted/partially compacted drum combinations, a parametric calculation was performed to ascertain the most reactive H/Pu ratio for the partially compacted drum. This parametric calculation uses a two-drum combination of partially compacted drums and varies the ^{239}Pu /polyethylene waste mixture concentration in the drums over a range of H/Pu ratios to determine the optimal mixture concentration. The results of the parametric calculation indicate that the optimal H/Pu ratio was 900. As a result, the waste mixture concentration in the upper drum (partially compacted waste) was then fixed at an H/Pu ratio of 900 and the bottom drum (fully compacted waste) varied over a range of H/Pu ratio thereby encompassing the most reactive system state. Table C-10 and Figure C-11 through Figure C-13 summarize the computational results for the different two-drum combinations. The results indicate that the 200-FGE mass limit on partially compacted drums provides a sufficient margin to ensure that the reactivity of the two 100-gallon drum system remains below the USL of 0.97, even when considering a partially compacted drum in combination with a fully compacted drum. As with the fully compacted two-drum model without design spacing, the k_{eff} does not meet the final USL of 0.96 with the additional 0.01 administrative margin. A parametric study was performed by varying the distance between the fissile masses. The H/Pu ratio was varied at each distance modeled and the maximum $k_{\text{eff}} + 2\sigma$ values are tabulated in Table C-11 and plotted in Figure C-14. The study found that a less than 0.5-centimeter separation is needed to meet the lower USL. This separation will easily be achieved in reality as the modeled scenario assumes all of the fissile mass in the 100-gallon drum is located in the uppermost compacted puck drum and the compacted drums completely fill the lower drum with no spacing allowed for the lid. The design spacing inherent in the 100-gallon drum recessed lid is 0.873 inches, which exceeds the 0.5-centimeter separation needed to meet the lower USL.

Table C-, 100-gallon Drum Combinations Involving Partially Compacted Drums

Optimum H/Pu Ratio		Reflector	k_{eff}	σ	$k_{\text{eff}} + 2\sigma$	Filename
Bottom Drum	Top Drum					
Fully Compacted/Partially Compacted 2-Drum Combination without Design Spacing						
750	900	Concrete	0.96399	0.00084	0.96567	tdmc615
900	900	Salt	0.96307	0.00083	0.96473	tdc1218
750	900	MgO	0.96388	0.00086	0.96560	tdc1815
Fully Compacted/Partially Compacted 2-Drum Combination with Design Spacing						
850	900	Concrete	0.94846	0.00082	0.95010	tdmc657
750	900	Salt	0.94834	0.00083	0.95000	tdc1255
750	900	MgO	0.94847	0.0008	0.95007	tdc1855
Partially Compacted/Partially Compacted 2-Drum Combination						
800	900	Concrete	0.96318	0.00083	0.96484	tdcw316
950	900	Salt	0.96395	0.00078	0.96551	tdcw619
950	900	MgO	0.96347	0.00081	0.96509	tdcw919

Table C-, Separation Parameter Study for Partially Compacted Two-Drum Combination

Distance between Fissile Masses (cm)	Optimum H/Pu Ratio	k_{eff}	σ	$k_{\text{eff}} + 2\sigma$	Filename
Concrete Reflector					
0	800	0.96318	0.00083	0.96484	tdcw316
0.5	800	0.95645	0.00086	0.95817	p1c0516
1.0	800	0.95115	0.00084	0.95283	p1c1016
1.5	800	0.94376	0.00084	0.94544	p1c1516
2.0	800	0.93588	0.00082	0.93752	p1c2016

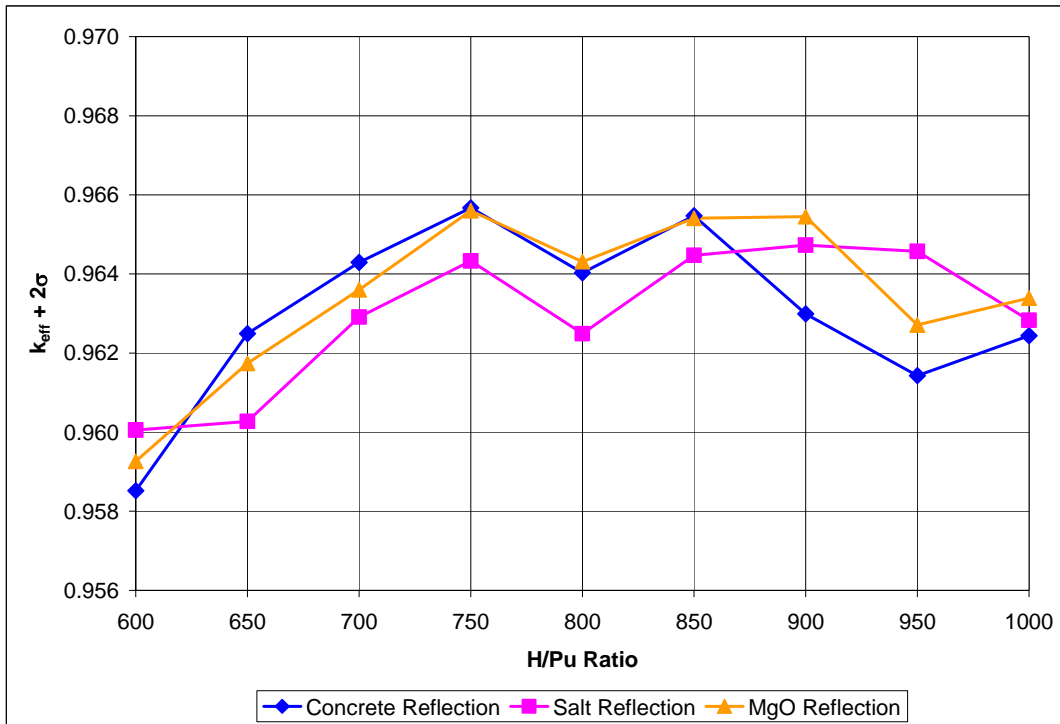

**Figure C-, Partial Compaction/Full Compaction 100-gallon Drum
 Combination without Design Spacing**

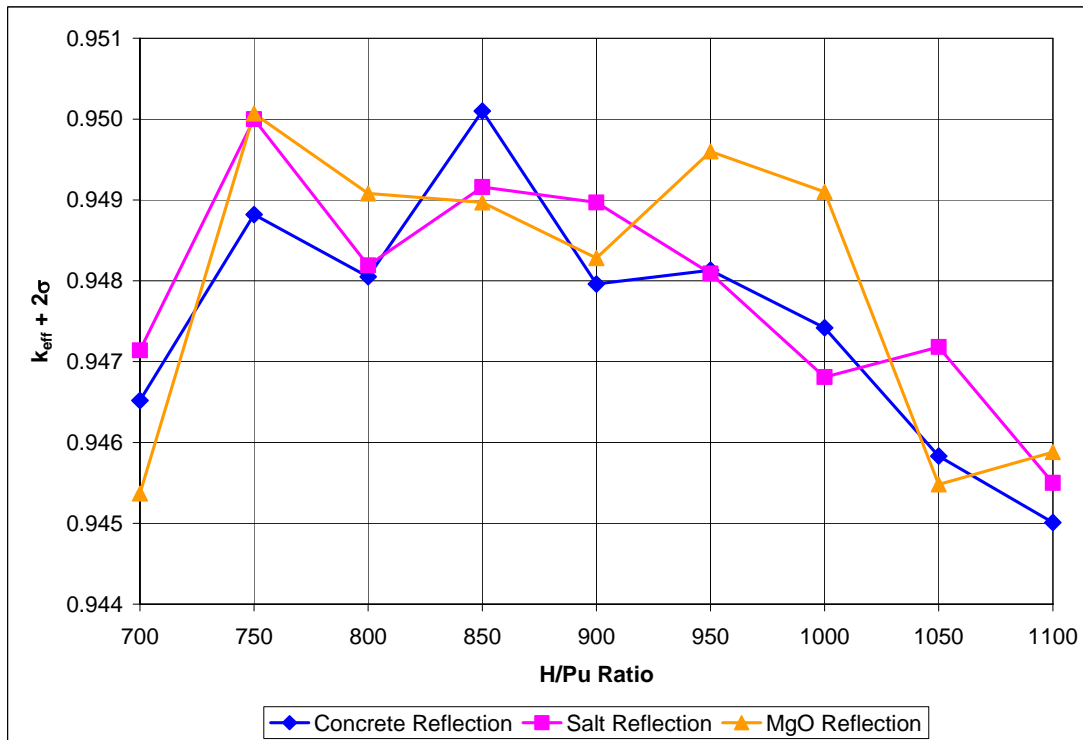

**Figure C-, Partial Compaction/Full Compaction 100-gallon Drum
 Combination with Design Separation**

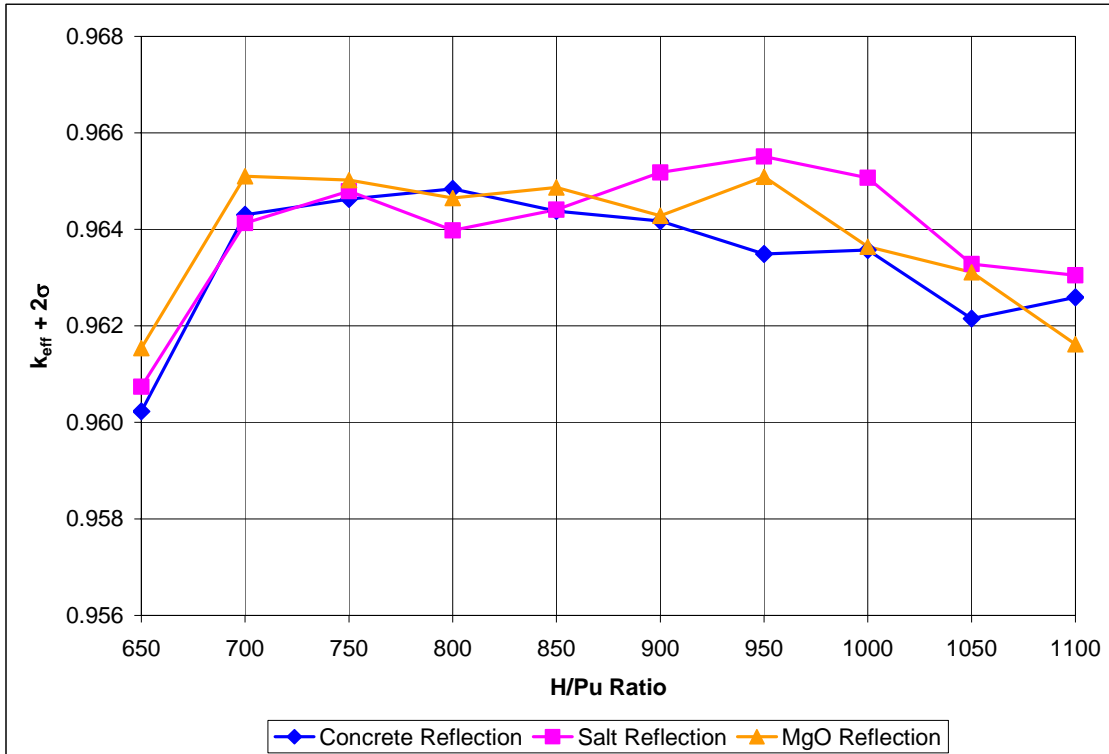

Figure C-, Partial Compaction/Partial Compaction 100-gallon Drum Combination

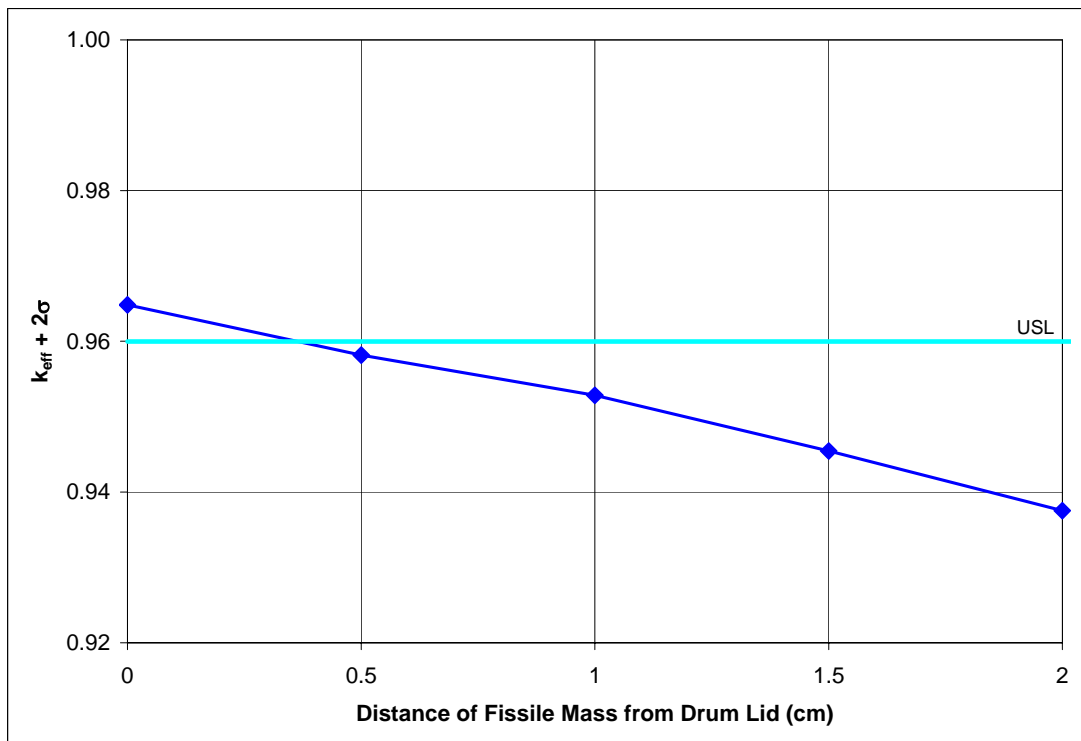

Figure C-, Two-Container Results for Partially Machine-Compacted Waste in 100-gallon Drums at 200 FGE/drum with Additional Separation

C3.3 Two 55-gallon Drum Combinations of Compacted Waste

Although the fully compacted waste is expected to be shipped in 100-gallon drums, the limits for 55-gallon drums are also determined in this evaluation. The 55-gallon drum has a thinner wall than the 100-gallon drum. The 55-gallon drums are analyzed with the corresponding limits for machine-compacted waste in 100-gallon drums with and without design spacing and at 70% compaction. The vertical design spacing modeled in 55-gallon drums is 1.5 centimeters between two drums as was used in *Waste Isolation Plant Nuclear Criticality Safety Evaluation for Contact Handled Transuranic Waste Storage* (Rhoden 2003). This separation distance is conservative as the actual expected separation is 4.445 centimeters (found by subtracting the inner drum height from the outer drum height). Because of the possibility of bowing in the drum and possible slippage/misalignment when stacking drum assemblies, only a fraction of the separation is credited. In reality, slipsheets are used between drum assemblies for ease of handling and also provide separation. The separation provided by slipsheets was not credited in the analysis. The value of 1.5 centimeters is approximately one third of the nominal separation. Other than the size of the drum and the use of the 1.5-centimeter versus 1-inch design separation, the 55-gallon drum models are identical to the 100-gallon drum two-container models.

The results of the two-drum computations are given in Table C-12 and shown in Figure C-15 (fully compacted waste with design separation), Figure C-16 (fully compacted waste without design separation), and Figure C-17 (partially compacted waste without design separation). The cases with design separation remain below the USL with 50% dense steel. The other systems also remain subcritical at the FGE limits determined for 100-gallon drums, but require modeling of 60% of the steel density. This is expected because the 55-gallon drum has a thinner steel wall than the 100-gallon drum. As the use of 50% density was arbitrary, the use of 60% is reasonable as it still allows for significant degradation of the steel wall. However, even with the higher steel density, the k_{eff} does not meet the final USL of 0.96. A parametric study varying the distance between the fissile masses in the drums was performed. The H/Pu ratio was varied at each distance modeled and the maximum $k_{\text{eff}} + 2\sigma$ values are tabulated in Table C-13 and plotted in Figure C-18. The study found that a nominal 1-centimeter separation is sufficient to meet the lower USL. This separation will easily be achieved in reality due to gravitational settling and the thickness of the metal associated with the compacted puck (ignored in the model). The modeled scenario assumes that the entire fissile mass in the 55-gallon drum is located in the uppermost compacted puck drum and the compacted drums completely fill the lower drum such that no space exists to the lid. It is more realistic for the fissile material to be contained in each of the puck drums.

Further container combinations with a compacted 55-gallon drum are not necessary as the machine-compacted 100-gallon drum is modeled with each of the other approved container loadings at the WIPP, as is the machine-compacted SWB. The 100-gallon drum combinations illustrate that machine-compacted waste does not increase reactivity when combined with other waste types.

**Table C-, System Reactivity for 55-gallon Drum Two-Container Models
with Compacted Waste**

Optimum H/Pu Ratio	Reflector	k_{eff}	σ	$k_{eff} + 2\sigma$	Filename
200 g ^{239}Pu in Fully Compacted Waste with Vertical Design Spacing at 50% Steel Density					
850	Concrete	0.96417	0.00083	0.96583	t55c117
800	Salt	0.96381	0.00083	0.96547	t55c216
750	MgO	0.96255	0.00086	0.96427	t55c315
170 g ^{239}Pu in Fully Compacted Waste without Vertical Design Spacing at 60% Steel Density					
800	Concrete	0.96829	0.00083	0.96995	t55c156
800	Salt	0.96808	0.00081	0.96970	t55c256
850	MgO	0.96811	0.00081	0.96973	t55c357
200 g ^{239}Pu in Partially Compacted Waste without Vertical Design Spacing at 60% Steel Density					
850	Concrete	0.96797	0.00082	0.96961	t55w317
800	Salt	0.96826	0.00086	0.96998	t55w616
800	MgO	0.96808	0.00082	0.96972	t55w916

**Table C-, Separation Parameter Study for Compacted Two 55-gallon Drum
Combinations with Concrete Reflector**

Distance between Fissile Masses (cm)	Optimum H/Pu Ratio	k_{eff}	σ	$k_{eff} + 2\sigma$	Filename
200 g ^{239}Pu in Fully Compacted Waste with Vertical Design Spacing					
Des. Spacing 1.5 cm	850	0.96417	0.00083	0.96583	t55c117
Des. Spacing + 0.5 cm	900	0.95122	0.00081	0.95284	f5c2056
170 g ^{239}Pu in Fully Compacted Waste without Vertical Design Spacing					
0	800	0.96829	0.00083	0.96995	t55c156
0.5	700	0.96537	0.00083	0.96703	f5c0514
1.0	800	0.95918	0.00085	0.96088	f5c1016
1.5	800	0.95004	0.00082	0.95168	f5c1516
2.0	800	0.94269	0.00082	0.94433	f5c2016
200 g ^{239}Pu in Partially Compacted Waste without Vertical Design Spacing					
0	850	0.96797	0.00082	0.96961	t55w317
0.5	800	0.96428	0.00085	0.96598	p5c0516
1.0	900	0.95691	0.00082	0.95855	p5c1018
1.5	800	0.94992	0.00084	0.95160	p5c1516
2.0	800	0.94242	0.00085	0.94412	p5c2016

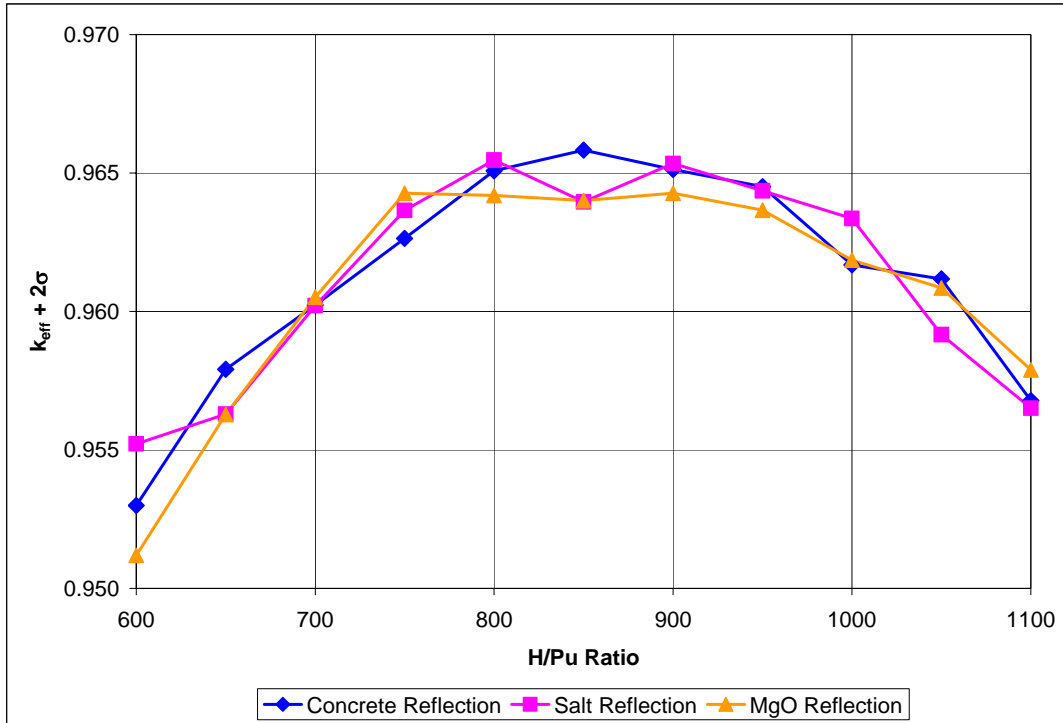

Figure C-, Fully Compacted 55-gallon Drum Combination with Vertical Design Spacing at 50% Steel Density

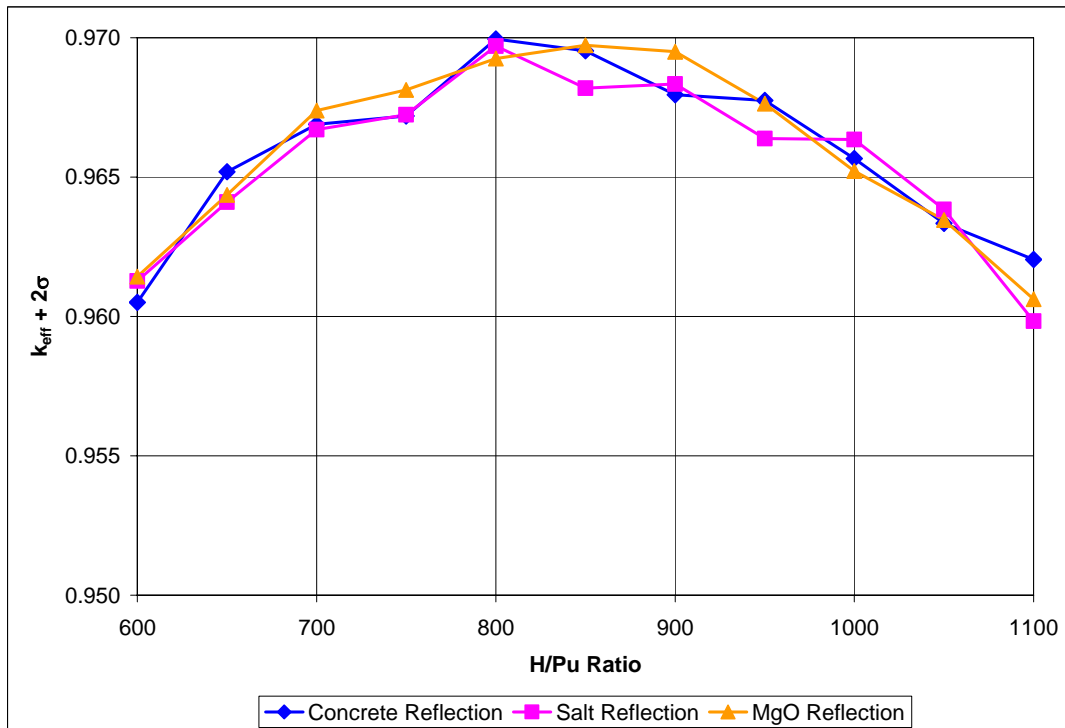

Figure C-, Fully Compacted 55-gallon Drum Combination without Vertical Design Spacing at 60% Steel Density

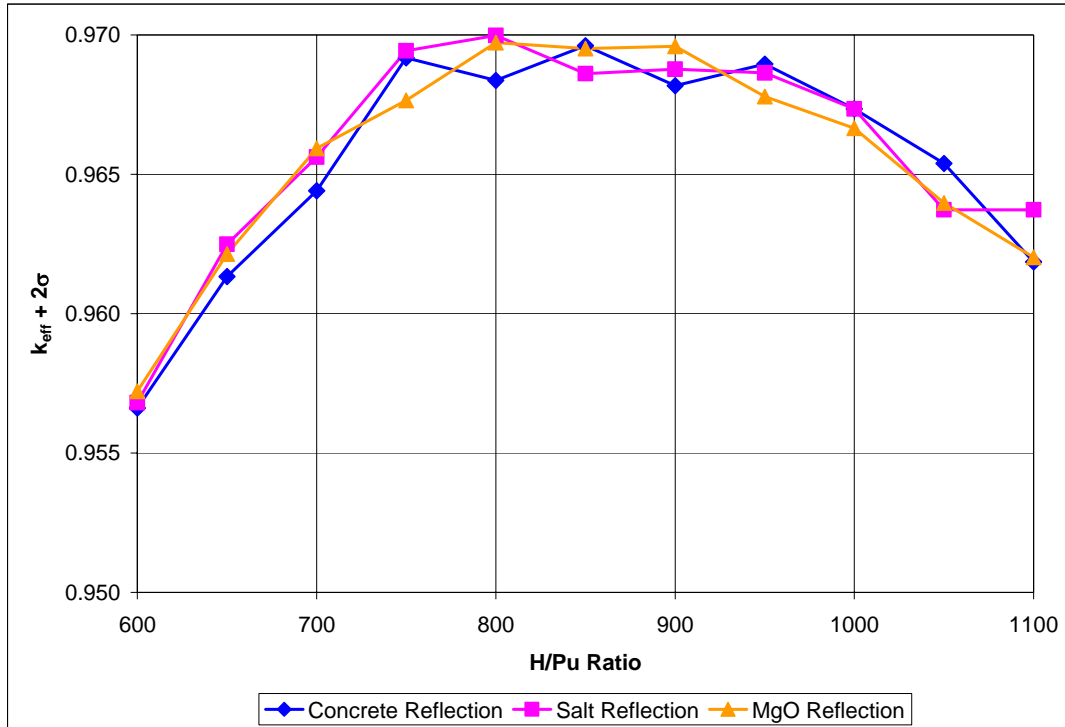

Figure C-, Partially Compacted 55-gallon Drum Combination without Vertical Design Spacing at 60% Steel Density

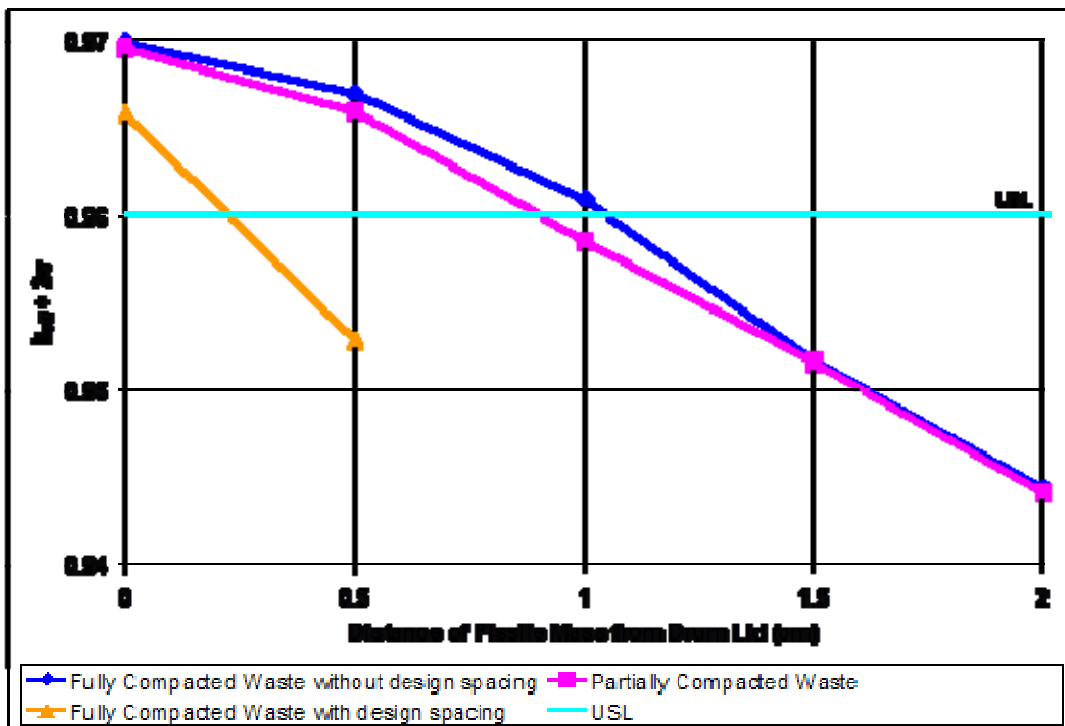

Figure C-, Two-Container Results for Partially Machine-Compacted Waste in 55-gallon Drums with Additional Separation

C3.4 Two Shielded Container Combinations of Fully Compacted Waste

The two-container model for the shielded containers assumes a geometry where the fissile mass in the lower container is positioned at the top of the container and the fissile material in the upper container is located at the bottom on the container. In this configuration, fissile masses in each container are closely positioned, separated by the container lid, bottom, and the inherent design spacing and tolerances that are built into the lid or bottom surface structure. The fissile mass in each container type is modeled as a cylinder with an H/D ratio of 0.5, where the resulting cylinder in the two containers has an optimum H/D ratio of 1. Again, a 50% dense wall at full thickness is assumed to account for possible wall degradation.

The composition of the fissile units in both containers are assumed to be at their FGE limit of 200 grams of ^{239}Pu and moderated by a 100% dense polyethylene. The compacted internal reflector dunnage is assumed to be 5 kilograms of beryllium mixed with 100% dense polyethylene. Furthermore, three types of materials are analyzed as tight reflectors around the containers: concrete, MgO, and salt. These external reflectors account for the various reflection states that may be encountered during storage, handling, and disposal of waste at the WIPP. In each case, the reflector material is 300 centimeters thick on all sides of the container stack, effectively creating an infinite reflector. The material compositions used for these reflector materials are described in Section .

The results of the two-container computations for the shielded containers are summarized in Table C-14 and Figure C-19 the three external reflectors. As expected, all cases are below the USL with the highest $k_{\text{eff}} + 2\sigma$ value being 0.85491 with MgO reflection.

Table C-, Two-Container Model Results for Shielded Containers

H/Pu Ratio	k_{eff}	σ	$k_{eff} + 2\sigma$	Filename
Concrete Reflection				
500	0.81314	0.00110	0.81534	lltdc10
600	0.83283	0.00096	0.83475	lltdc12
700	0.84352	0.00104	0.84560	lltdc14
800	0.84987	0.00104	0.85195	lltdc16
900	0.85224	0.00099	0.85422	lltdc18
1000	0.85215	0.00095	0.85405	lltdc20
1100	0.85149	0.00092	0.85333	lltdc22
1200	0.84874	0.00093	0.85060	lltdc24
1300	0.84364	0.00091	0.84546	lltdc26
1450	0.83806	0.00089	0.83984	lltdc28
1500	0.83434	0.00087	0.83608	lltdc30
Salt Reflection				
500	0.81425	0.00108	0.81641	lltds10
600	0.83350	0.00097	0.83544	lltds12
700	0.84167	0.00107	0.84381	lltds14
800	0.85095	0.00101	0.85297	lltds16
900	0.85201	0.00103	0.85407	lltds18
1000	0.85135	0.00100	0.85335	lltds20
1100	0.85060	0.00092	0.85244	lltds22
1200	0.84791	0.00095	0.84981	lltds24
1300	0.84401	0.00091	0.84583	lltds26
1450	0.83719	0.00087	0.83893	lltds28
1500	0.83452	0.00083	0.83618	lltds30
MgO Reflection				
500	0.81515	0.00107	0.81729	lltdm10
600	0.83313	0.00106	0.83525	lltdm12
700	0.84328	0.00107	0.84542	lltdm14
800	0.84976	0.00099	0.85174	lltdm16
900	0.85263	0.00096	0.85455	lltdm18
1000	0.85299	0.00096	0.85491	lltdm20
1100	0.85185	0.00093	0.85371	lltdm22
1200	0.84744	0.00099	0.84942	lltdm24
1300	0.84562	0.00092	0.84746	lltdm26
1450	0.83916	0.00089	0.84094	lltdm28
1500	0.83203	0.00083	0.83369	lltdm30

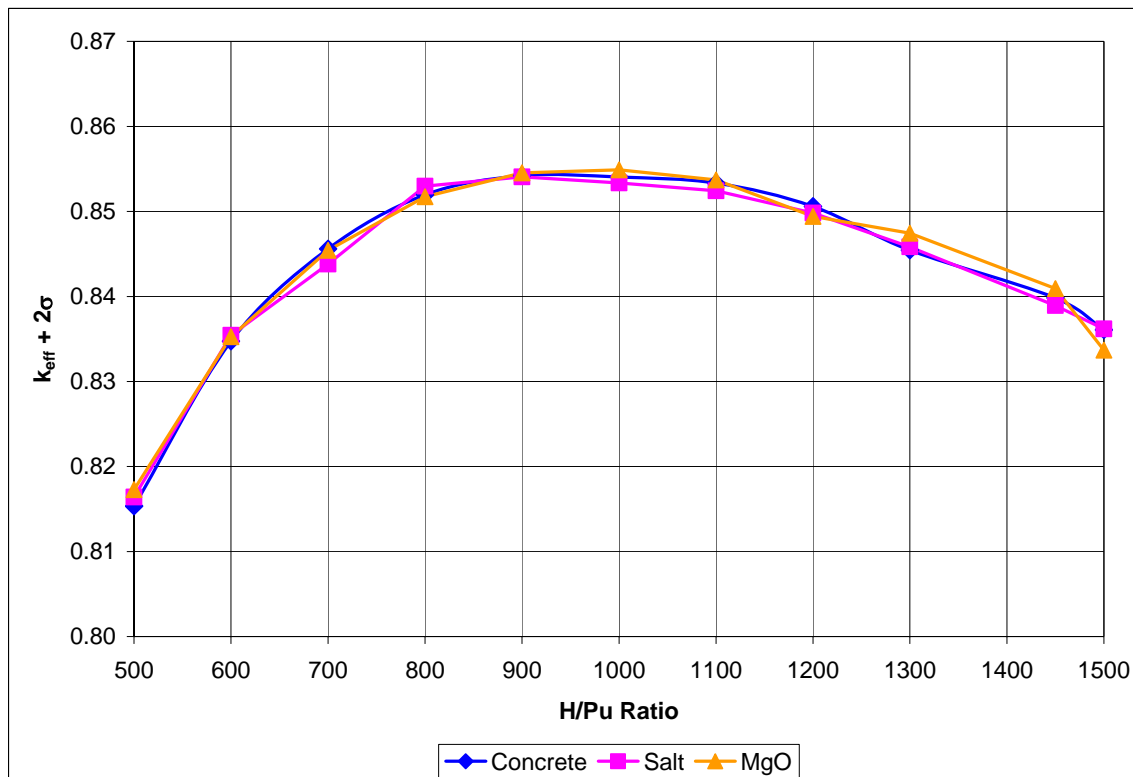

Figure C-, Two-Container Results for a Shielded Containers at 200 FGE/Drum

C4.0 Standard Waste Box Combinations

C4.1 Two-Container SWBs Direct-Loaded with Fully Compacted Waste

The next sequence of calculations evaluates two stacked SWB containers containing fully compacted machine-compactd CH waste to determine the FGE mass limit for this configuration. As discussed in *Nuclear Criticality Safety Evaluation for Storage of Machine Compactd Transuranic Waste Products at the Waste Isolation Pilot Plant* (Neeley 2005), the two-container SWB model was evaluated and the mass limit of 185 grams of ²³⁹Pu was found to maintain the reactivity, as shown in Figure C-20, which is below the USL of 0.97. The results showed that k_{eff} was independent of the reflector material, indicating that the polyethylene in the SWB is infinitely thick and effectively isolates the FGE mass from the external reflector. For verification, a case with no reflector was modeled and was found to produce results identical to the other three cases (concrete, MgO, and salt). Subsequently, an administrative margin of 0.01 was subtracted from the USL lowering it to 0.96. A parametric study was performed by varying the separation of the fissile masses in the two SWBs. The H/Pu ratio was varied at each separation distance modeled and the highest $k_{eff} + 2\sigma$ values are tabulated in Table C-15 and plotted in Figure C-21. The fissile mass must be slightly less than 1 centimeter below the lid to meet the reduced USL. This separation will be easily achieved in reality as the compacted puck drums would be randomly loaded into the SWB during the direct loading process and filling the

SWB exactly to the top is not likely. Also, the probability of all fissile material being in only one puck drum within the large SWB is highly unlikely. The multiple, randomly loaded puck drums would not produce the 100% dense polyethylene reflector modeled around the fissile mass, but would allow multiple streaming paths for neutrons to escape and reduce the reactivity compared to the modeled result.

The 185-FGE limit for SWBs direct loaded with machine-compacted waste is higher than the 170-FGE limit imposed on drums without design spacing. This is due to the increased wall thickness of an SWB (0.3175 centimeters) compared to a 100-gallon (0.15189 centimeters) or a 55-gallon (0.12141 centimeters) drum.

**Table C-, Separation Parameter Study for Direct-Loaded Two-SWB
 Combinations of Fully Compacted Waste**

Distance between Fissile Masses (cm)	Optimum H/Pu Ratio	k_{eff}	σ	$k_{eff} + 2\sigma$	Filename
185 g ²³⁹Pu/SWB with Concrete Reflector					
0	800	0.96753	0.00095	0.96943	c18580p
0.5	800	0.96162	0.00094	0.96350	fsw0516
1.0	800	0.95348	0.00091	0.95530	fsw1016
1.5	800	0.94670	0.00095	0.94860	fsw1516
2.0	800	0.93768	0.00095	0.93958	fsw2016

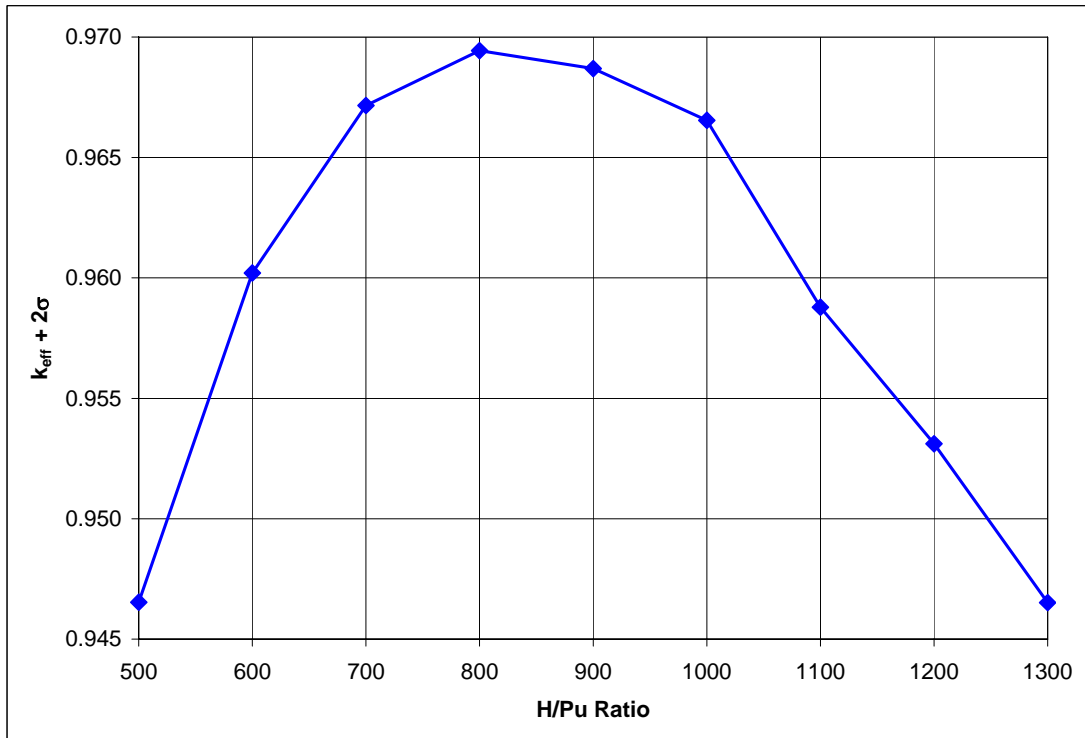

Figure C-, Two-Container Standard Waste Box Model with Fully Compacted Waste filling SWB at 180 FGE/SWB with Concrete, MgO, or Salt Reflection

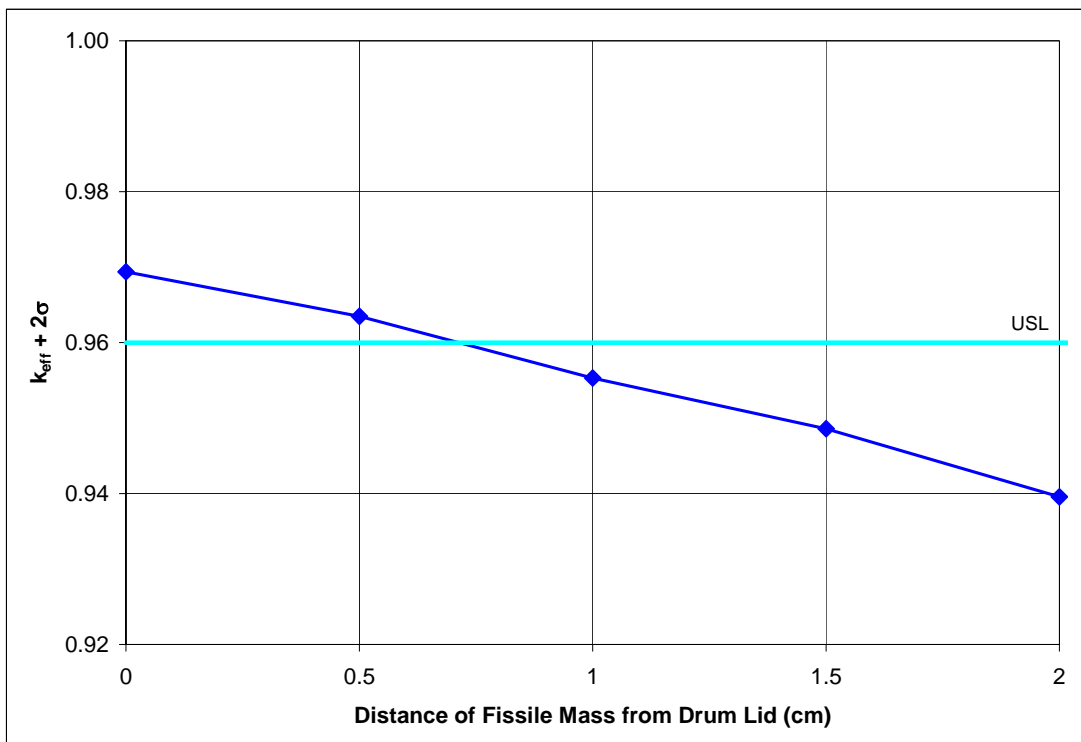

Figure C-, Two-Container Results for Direct-Loaded SWBs with Additional Separation

C4.2 Two-Container Standard Waste Box Model Containing 100-gallon Drums of Fully Compacted Waste

A variation of the fully compacted two-container SWB model is placement of a 100-gallon drum inside each SWB in the two-container stack. The intent of this calculation is to demonstrate that a higher FGE limit is acceptable when credit is taken for the additional steel of the inner lid and vertical spacing between the fissile masses as provided by a 100-gallon drum lid and recessed bottom. The modeled configuration is shown in Figure C-22. The two containers are stacked on with the fissile masses being separated by the:

- Thickness of the SWB container lid and bottom;
- Thickness of the 100-gallon drum recessed lid, outer lid, and bottom; and
- Recesses in the 100-gallon drum top and bottom.

Section describes tail the geometry of the 100-gallon drum and the conservative use of a 0.5-inch gap for the design spacing models. In this model, additional credit is taken for the recessed inner lid, modeled at 100% density, since it is reasonable that the inner lid will not degrade while the outer lid is in place. Furthermore, the gap between the outer lid and the recessed lid is conservatively modeled as 0.75 inches of void (compared to the minimum 0.873 inches present as stated in Section). There is also a bottom gap due to the recessed design of the bottom end of the drum. This gap is modeled as 0.5 inches (compared to 0.875 inches in Section) to be conservative and consistent with the other design spacing models used previously. In addition, the bottom gap is allowed to fill with the reflector material (18.14 kilograms of beryllium mixed with 100% dense polyethylene) since it is inside the SWB.

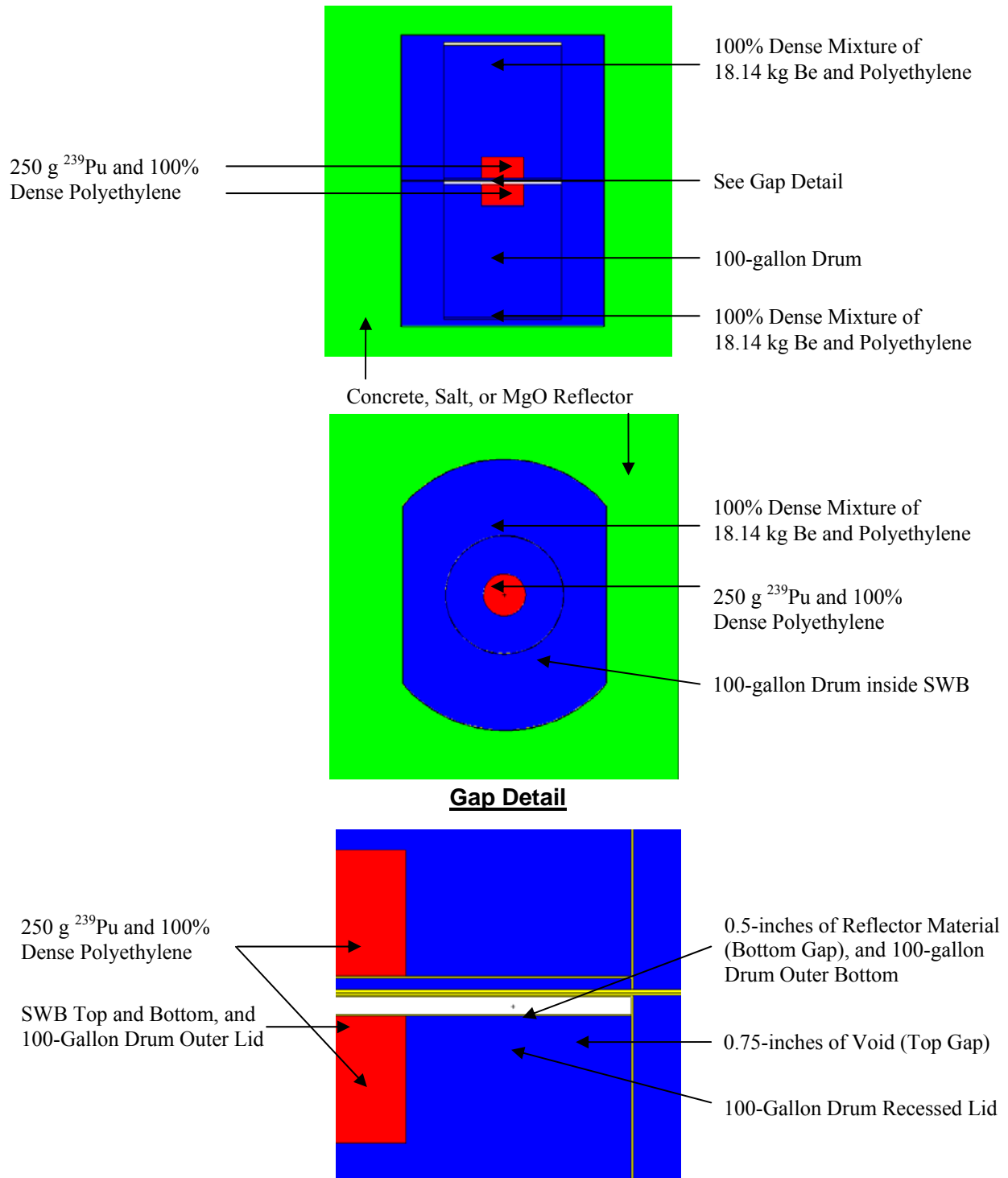

Figure C-, Two-Container Standard Waste Box Model for Fully Compacted Waste in a 100-gallon Drum Overpacked in a Standard Waste Box

Calculations were performed with 250 grams of ^{239}Pu in the drum within each SWB. The results of the two-container computations are summarized in Table C-16 and Figure C-23. A fissile mass limit of 250 grams of ^{239}Pu in a machine-compacted 100-gallon drum overpacked in a compacted SWB is necessary to maintain the two-container system eigenvalue below the original USL of 0.97. As determined in Section , the results show that k_{eff} is independent of the reflector material, indicating that the polyethylene in the SWB was infinitely thick and effectively isolated the fissile mass from the external reflector. As such, this overpack configuration was rerun with the SWB volume outside of the drum voided instead of filled with polyethylene. In this case, all 18.14 kilograms of beryllium is placed inside the 100-gallon drum. The results, also shown in Figure C-23, indicate that removing the polyethylene fill around the drum reduces the reactivity. Note: the fissile material could also be in other drum sizes that have the modeled spacing and a 16-gauge steel recessed lid overpacked within the SWB.

As with the direct-loaded SWBs, a parametric study was performed by varying the separation of the fissile masses in the two SWBs. The H/Pu ratio was varied at each separation distance modeled and the highest $k_{\text{eff}} + 2\sigma$ values are tabulated Table C-17. The fissile mass must be nominally 0.75 centimeters below the lid to meet the reduced USL. This separation will be easily achieved in reality as the compacted puck drums are not likely to completely fill the 100-gallon drum with no space to the lid. Also, the probability of all of the fissile material being in just the uppermost or bottom puck drum with the 100-gallon drum is highly unlikely and achieving the 100% dense polyethylene reflector modeled around the 100-gallon drum is not credible. Instead, the lower density dunnage would allow multiple streaming paths for neutrons to escape and reducing the reactivity compared to the modeled result. Also, the entire gap provided by the 100-gallon drum lid and bottom was not included in the model.

Table C-, System Reactivity for Overpacked 100-gallon Drum in SWBs

Optimum H/Pu Ratio	Reflector	k_{eff}	σ	$k_{\text{eff}} + 2\sigma$	Filename
SWB Filled with Polyethylene around 100-gallon Drum					
800	Concrete, salt, or MgO	0.96503	0.00094	0.96691	sw10016, ssw10016, or msw10016
SWB Voided around 100-gallon Drum					
900	Concrete	0.95856	0.00089	0.96034	c125902
900	Salt	0.96045	0.00086	0.96217	s125902
800	MgO	0.96025	0.00092	0.96209	m125802

**Table C-, Separation Parameter Study for Two-SWB Overpack
 Combinations with 100-gallon Drums**

Distance between Fissile Masses (cm)	Optimum H/Pu Ratio	k_{eff}	σ	$k_{eff} + 2\sigma$	Filename
250 g ^{239}Pu/SWB with Concrete Reflector					
0	800	0.96503	0.00094	0.96691	sw10018
0.5	900	0.95995	0.00092	0.96179	sw10518
1.0	800	0.95310	0.00091	0.95492	sw11016
1.5	800	0.94953	0.00089	0.95131	sw11516
2.0	800	0.94636	0.00092	0.94820	sw12016

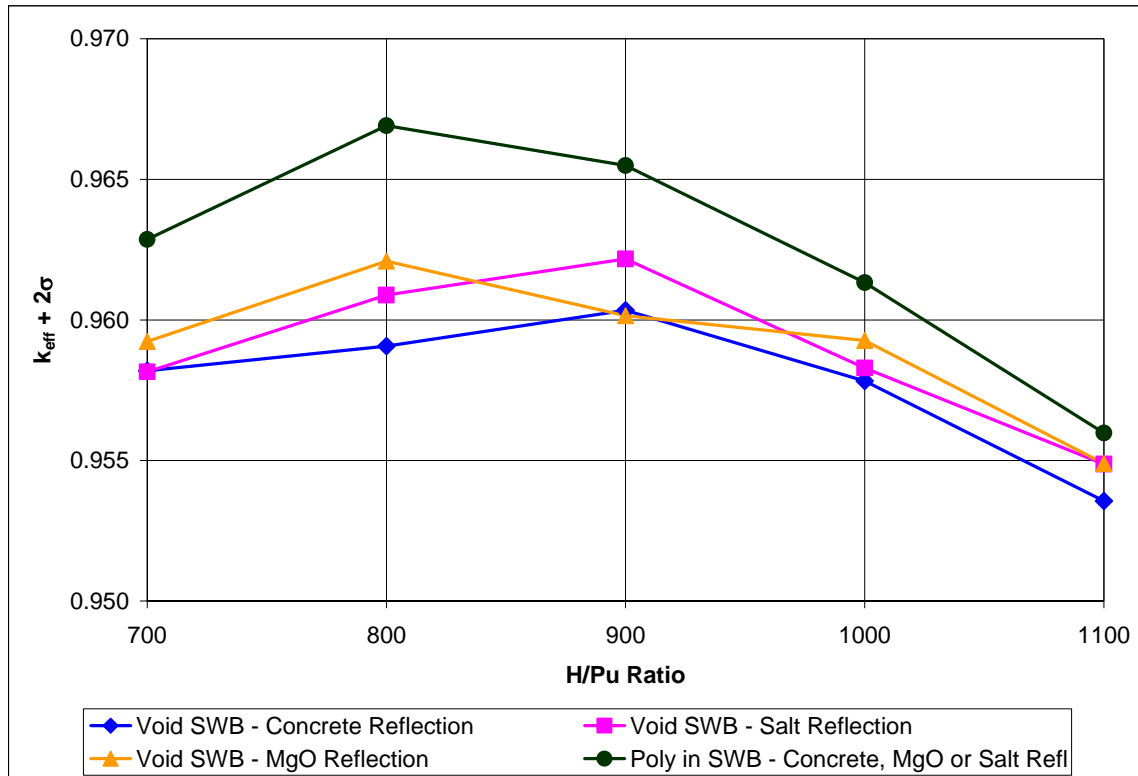

Figure C-, Two-Container Standard Waste Box Model with 100-gallon Drum of Fully Compacted Waste Overpack

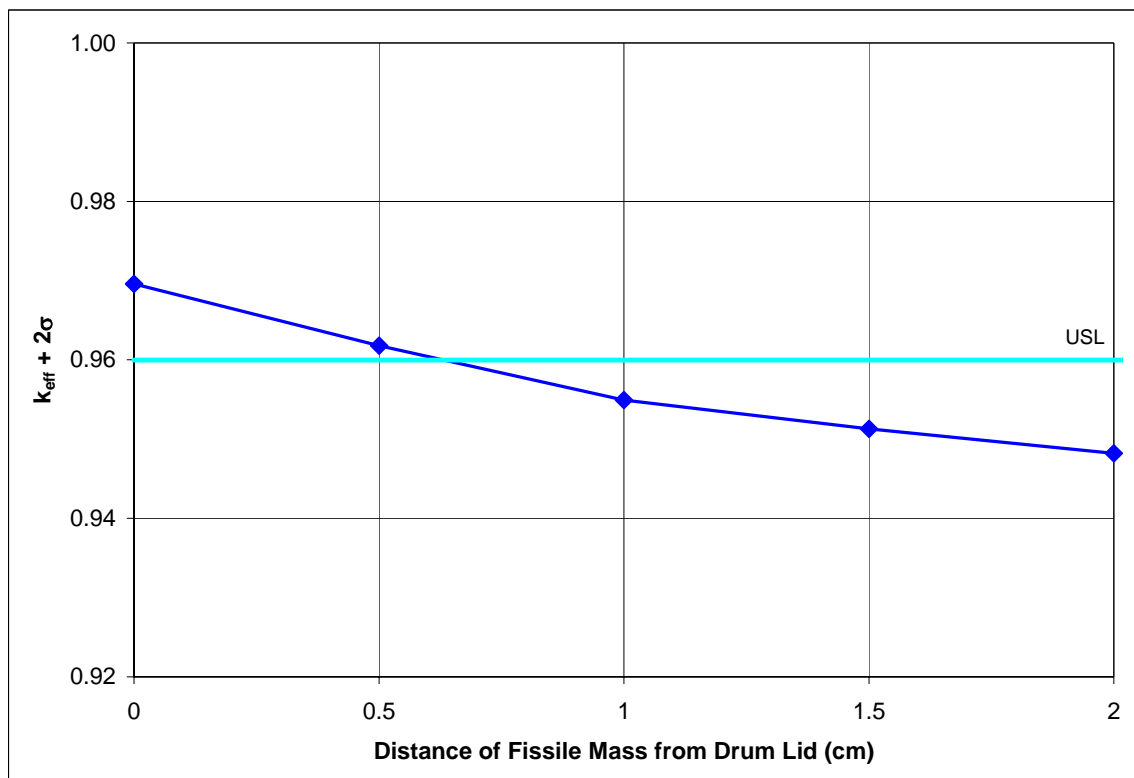

Figure C-, Two-Container Results for 100-gallon Drums in SWBs with Additional Separation

C5.0 Bounding Array Model Including Two-container Configuration

The fissile mass configuration used in the two-configuration model with the tight reflection boundaries modeled is expected to bound any array configuration where a two-container unit is surrounded by other containers in the underground repository. Since a two-container configuration is highly unlikely, then an embedded two-container unit in an infinite storage array (which is mirrored on all lateral sides), will bound any probable geometric arrangement that could be encountered in the repository. Furthermore, this configuration will verify that the FGE mass limit placed on machine-compacted waste is conservative enough to ensure that a criticality accident at the WIPP is not a credible event.

A representative two-container combination of 100-gallon drums containing either fully or partially compacted waste is used in the bounding array model. The bounding array consists of a three-pack stack arranged in a hexagonal lattice. Each three-pack consists of three 100-gallon drums placed inside a cylindrical footprint with the centers of the drums being separated by 120 degrees. The three-packs are stacked three tiers high and the stack is mirrored on all lateral sides to simulate an infinite array. The top and bottom of the stack is reflected as in the array models discussed in Section .

The two-drum arrangement is formed from one drum in the bottom tier and one drum in the middle tier that are vertically adjacent to one another. All other drums contained either fully compacted or partially compacted waste with the fissile material centrally located within the drum volume. Figures C-25a and C-25b illustrate a typical model used in the bounding array calculation.

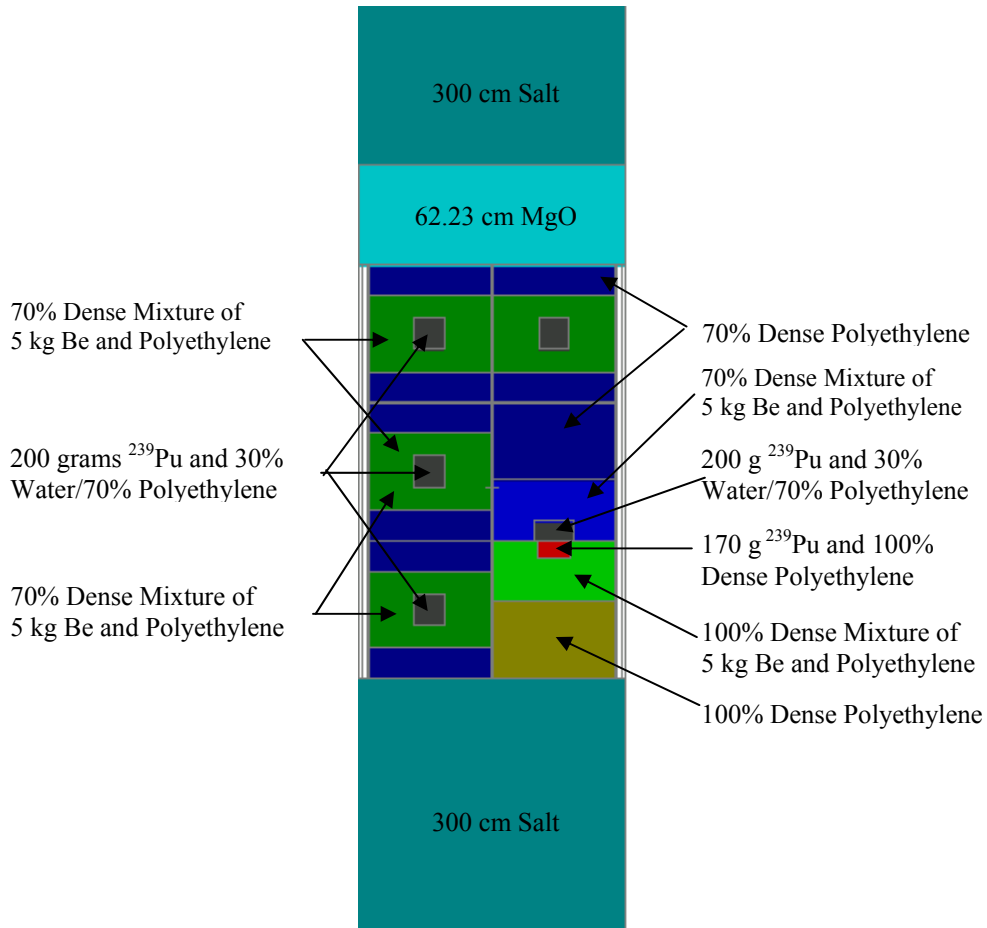

Figure C-a, Bounding Array Model for 100-gallon Drums containing Fully or Partially Compacted Waste

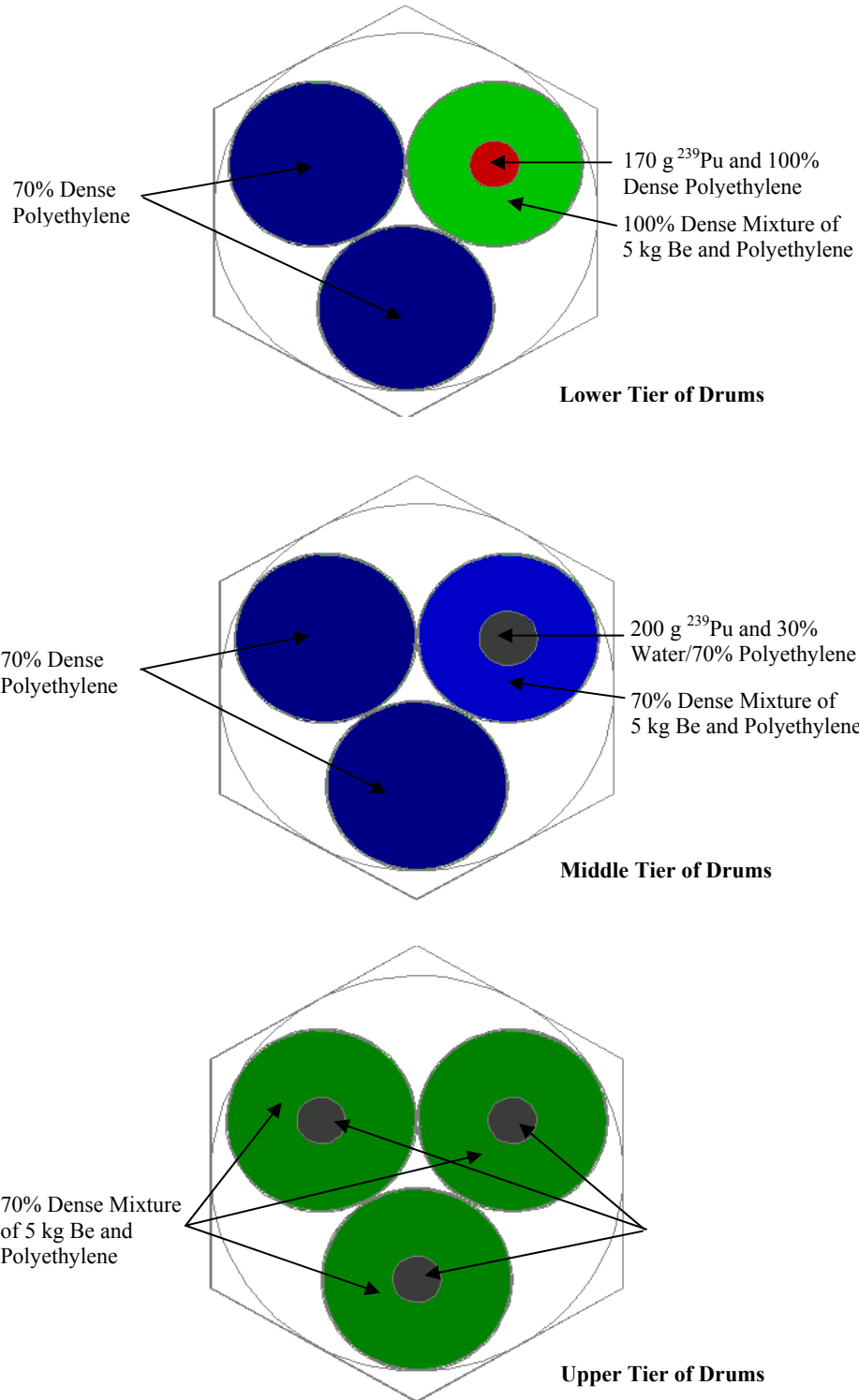

Figure C-25b, Bounding Array Model for 100-gallon Drums containing Fully or Partially Compacted Waste

Again, a parametric calculation was performed to determine the optimal mixture concentration for the two-container system. The optimal H/Pu ratio was determined to be 900. Consequently, the waste mixture concentration in all drums except one are fixed at an H/Pu of 900 and the remaining drum, which is part of the two-drum unit, is varied over a range of H/Pu ratios until an optimal value is obtained. To ensure that the most reactive model was used in the analysis, all fully compacted drums are modeled with 170 grams of ²³⁹Pu and no design spacing between drums as this configuration had a significantly higher two-drum model reactivity as shown in Section C3.1. Table C-18 and Figure C-26 summarize the computational results for the various drum arrangements. The system reactivity is statistically equivalent to the tightly reflected two-drum model results given in Table C-8 and Table C-10. Thus, the two-drum model is shown to bound the worst-case fissile material locations that could occur in the underground repository.

Table C-, Bounding Arrays containing Fully and Partially Compacted Waste

Optimum H/Pu Ratio		Reflector	$k_{eff} + 2\sigma$	Filename
Bottom Drum	All Other Drums			
Array with 100-gallon Drums containing Fully Compacted Waste				
900	900	MgO/Salt	0.9651	arab118
Array with 100-gallon Drums containing Fully and Partially Compacted Waste				
900	900	MgO/Salt	0.9660	arab218

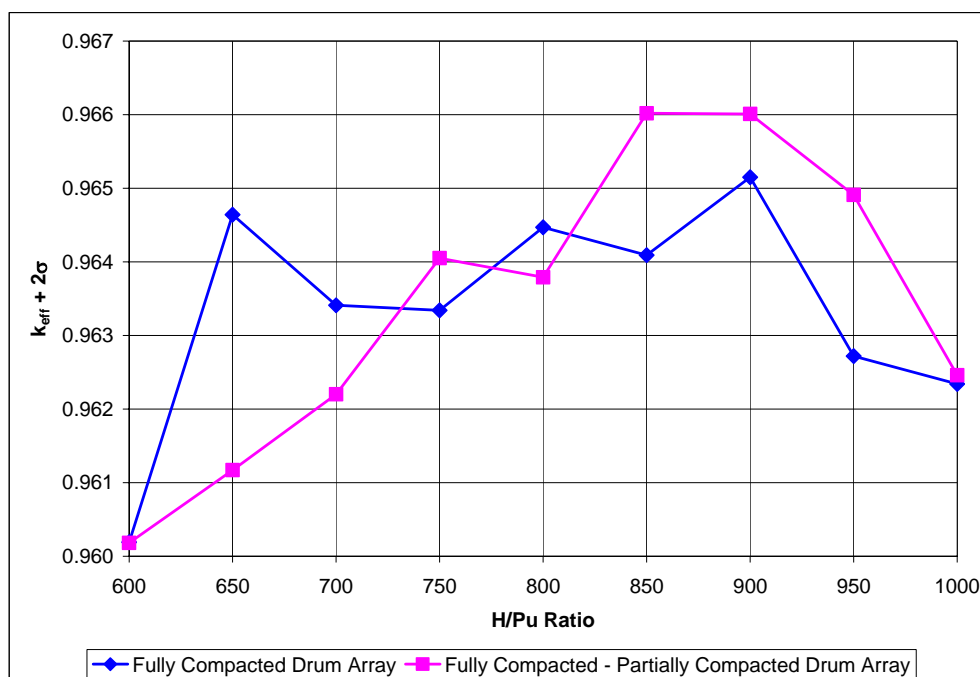

Figure C-, System Reactivity of Bounding Array containing Fully Compacted and Partially Compacted Waste Drum Combinations

C6.0 MCNP5 Machine-compacted Waste Contingency Models

To ensure that the computational analysis of compacted waste packages is bounding for all credible conditions, a few contingency conditions were evaluated for the underground storage array of various waste packages containing compacted, fissile-bearing waste. In this regard, only array configurations with centrally located fissile material were considered since the two-container models are sufficiently conservative to bound any contingency of more realistic or expected conditions related to the interaction between small numbers of containers.

The contingency events evaluated in this section include:

1. An overstacking event where 100-gallon drums in a three-pack configuration containing fully compacted waste were stacked four tiers high;
2. An FGE overbatching event where the four 55-gallon drums containing fissile-bearing compacted waste in the middle tier of seven-packs contained 50, 100, 200, and 300 FGE;
3. An FGE overbatching event where the one 100-gallon fissile-bearing drum in the three-pack contained 300 FGE;
4. An FGE overbatching event where the SWBs in the array contained 277.5 FGE;
5. A beryllium overbatching event where one of the fissile-bearing 100-gallon drums in a three-pack contained 10 kilograms of beryllium; and
6. A sprinkler activation event in the WHB resulting in interstitial moderation between the waste containers containing compacted waste.

C6.1 100-gallon Drum Array Overstack Model

The WIPP disposal room heights in the underground repository are designed to accommodate three tiers of waste containers. In some areas, ground control activities have resulted in areas of the disposal rooms being mined to a height greater than 13 feet such that it is possible to stack greater than three tiers high including the MgO supersack. The computational results for a four-tier stack of three-packs of 100-gallon drums containing compacted waste yields a system eigenvalue well below 0.96 as summarized in Table C-19. In fact, the four-tier array reactivity is not much greater than the three-tier reactivity because the polyethylene filling the drum isolates the fissile mass in adjacent tiers.

Table C-, Results for an Array of 100-Gallon Drum Stacked Four Tiers High

H/Pu Ratio	k_{eff}	σ	$k_{eff} + 2\sigma$	Filename
650	0.85453	0.00127	0.85707	aray413
700	0.85965	0.00122	0.86209	aray414
750	0.86288	0.00119	0.86526	aray415
800	0.86573	0.00118	0.86809	aray416
850	0.86613	0.00117	0.86847	aray417
900	0.87015	0.00116	0.87247	aray418
950	0.86701	0.00112	0.86925	aray419
1000	0.86610	0.00111	0.86832	aray420
1050	0.86378	0.00115	0.86608	aray421
1100	0.86466	0.00111	0.86688	aray422
1150	0.86231	0.00111	0.86453	aray423
1200	0.86112	0.00111	0.86334	aray424
1250	0.85830	0.00111	0.86052	aray425

C6.2 55-gallon Drum Array Overbatch Model

Since rigorous non-destructive quality assurance techniques are employed at the waste generator site to verify compliance to mass loading limits and these limits are confirmed at the WIPP facility on receipt of the waste material, an overbatch event is highly unlikely. However, in compliance with standard nuclear criticality practices and to ensure a potential critical event is not credible, a series of overbatching contingency events for waste packages containing compacted waste were analyzed. Specifically, with respect to a 55-gallon drum containing compacted waste, a scenario was evaluated where it was assumed that one container in a three-tier stack is overbatched by 50% of its nominal value. From a modeling perspective, one container in the bottom or middle tier is overbatched and the stack is infinitely reflected on the lateral surfaces as in the base array model. This is highly conservative as it results in one of twenty one 55-gallon drums being overbatched. The results of these MCNP5 cases, as summarized in Table C-, are below the USL of 0.96.

**Table C-, Results for an Overbatching Event where the Four 55-Gallon Drums
 in the Middle Tier Contained 50, 100, 200, and 300 FGE**

H/Pu Ratio	k_{eff}	σ	$k_{eff} + 2\sigma$	Filename
650	0.94804	0.00089	0.94982	ara5553
700	0.95394	0.00089	0.95572	ara5554
750	0.95517	0.00085	0.95687	ara5555
800	0.95677	0.00086	0.95849	ara5556
850	0.95626	0.00083	0.95792	ara5557
900	0.95762	0.00081	0.95924	ara5558
950	0.95635	0.00077	0.95789	ara5559
1000	0.95401	0.00083	0.95567	ara5560
1050	0.95244	0.00081	0.95406	ara5561
1100	0.95132	0.00077	0.95286	ara5562
1150	0.94814	0.00077	0.94968	ara5563
1200	0.94599	0.00078	0.94755	ara5564
1250	0.94166	0.00080	0.94326	ara5565

C6.3 100-gallon Drum Array Overbatch Model

A model similar to that discussed in Section was created for 100-gallon drums containing compacted waste. One drum in a three-tier stack of three-packs was overbatched by 50% to 300 grams of ²³⁹Pu while the other two drums contained 200 FGE. As shown in Table C-21, the results remain below the USL of 0.96.

**Table C-, Results for an FGE Overbatching Event where One 100-Gallon Drum
 in a three-pack Stack Contained 300 FGE**

H/Pu Ratio	k_{eff}	σ	$k_{eff} + 2\sigma$	Filename
650	0.94212	0.00084	0.94380	aray213
700	0.94478	0.00088	0.94654	aray214
750	0.94685	0.00086	0.94857	aray215
800	0.94709	0.00084	0.94877	aray216
850	0.94795	0.00084	0.94963	aray217
900	0.94745	0.00081	0.94907	aray218
950	0.94703	0.00079	0.94861	aray219
1000	0.94580	0.00081	0.94742	aray220
1050	0.94354	0.00076	0.94506	aray221
1100	0.94028	0.00082	0.94192	aray222
1150	0.93948	0.00080	0.94108	aray223
1200	0.93511	0.00075	0.93661	aray224
1250	0.93349	0.00077	0.93503	aray225

C6.4 Standard Waste Box Array Overbatch Model

The final FGE overbatching scenario evaluated as part of this contingency assumes that the SWBs in the array are overbatched by 50% of the nominal value, or 277.5 FGE. The results of the SWB overbatching contingency are shown in Table C- with the maximum k_{eff} less than 0.95. The computational results indicate that the double contingency requirement for the ^{239}Pu mass content in the SWB is met as multiple overbatching events will not result in the USL being exceeded.

**Table C-, Array Results with One SWB in a Three-pack Stack
 Containing 277.5 FGE**

H/Pu Ratio	k_{eff}	σ	$k_{\text{eff}} + 2\sigma$	Filename
700	0.93021	0.00100	0.93221	aro700
800	0.93845	0.00094	0.94033	aro800
900	0.93789	0.00092	0.93973	aro900
1000	0.93834	0.00096	0.94026	aro1000
1100	0.93639	0.00089	0.93817	aro1100

C6.5 55-gallon Drum Array Excess Beryllium Model

The beryllium overbatching contingency is similar to the fissile mass overbatching event in that one drum in every three three-packs exceeds its mass limit. However, in this case it is assumed that a double-batch event occurs where the beryllium mass content in the overloaded drum is 10 kilograms. The beryllium overbatch analysis with the fissile contents of two of the three three-packs in the stack at their optimum H/Pu state while the composition in the 100-gallon drums in the remaining three-pack, including the excess beryllium drum, was varied over a range of H/Pu ratios. The results of the overbatching contingency are tabulated in Table C-23. As expected, the system eigenvalue is well below the USL.

Table C-, Results for an Beryllium Overbatching Event with One 100-Gallon Drum Three-pack Stack Containing 10 kg of Beryllium

H/Pu Ratio	k_{eff}	σ	$k_{\text{eff}} + 2\sigma$	Filename
650	0.85665	0.00124	0.85913	aray313
700	0.86093	0.00124	0.86341	aray314
750	0.86402	0.00120	0.86642	aray315
800	0.86569	0.00121	0.86811	aray316
850	0.86802	0.00121	0.87044	aray317
900	0.86795	0.00116	0.87027	aray318
950	0.87130	0.00112	0.87354	aray319
1000	0.86730	0.00116	0.86962	aray320
1050	0.86666	0.00117	0.86900	aray321
1100	0.86458	0.00114	0.86686	aray322
1150	0.86612	0.00108	0.86828	aray323
1200	0.86242	0.00110	0.86462	aray324
1250	0.86141	0.00113	0.86367	aray325

C6.6 Array Model with Sprinkler Activation

The final contingency considered in this analysis addresses the potential activation of the sprinkler system in the WHB resulting in interspersed moderation between the waste containers. The model employed to simulate this event includes a bounding three-tier stack of seven-packs of 55-gallon drums containing compacted waste where the ceiling and floor are modeled as 2-foot (60.96-centimeter) thick concrete while the sides are mirrored for infinite reflection as shown in Figure C-27. The cases were evaluated at the mass limits and at the optimum H/Pu ratio where water from a sprinkler activation was allowed to fill the spaces between the drums. The water density is varied from 0.05 to 1 g/cm³, and the results are shown in Table C-24. The computational results show no trend in k_{eff} which suggests that the fissile masses are isolated from one another by the compacted polyethylene in the drums. Sprinkler activation or flooding of the array will not result in a critical configuration.

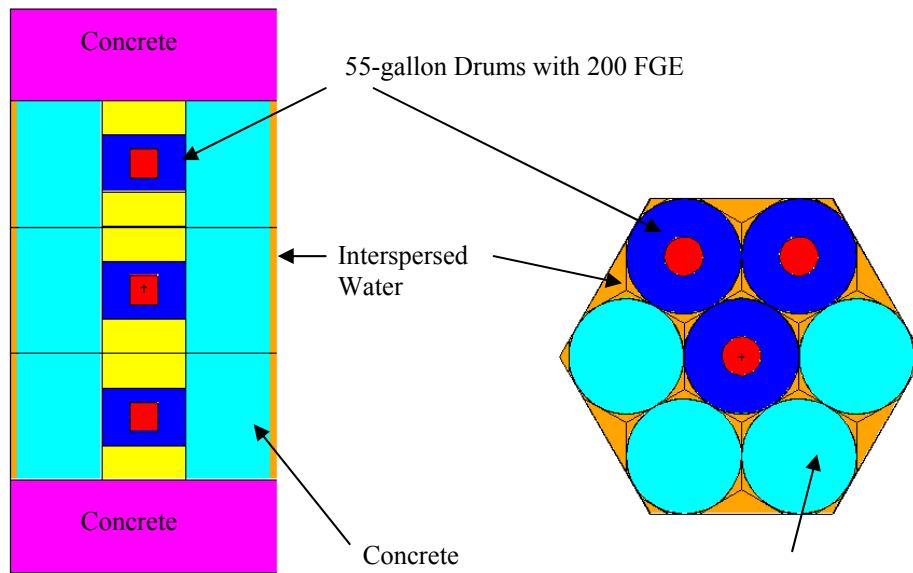

Figure C-, Sprinkler Activation Contingency Model with Interspersed Water

**Table C-, Sprinkler Activation Results for Array of 55-Gallon Drums
Containing Compacted Waste**

Water density (g/cm ³)	k_{eff}	σ	$k_{eff} + 2\sigma$	Filename
0	0.87029	0.0008	0.87189	55arw00
0.05	0.87043	0.00083	0.87209	55arw05
0.10	0.87073	0.00086	0.87245	55arw10
0.15	0.86917	0.00084	0.87085	55arw15
0.20	0.86878	0.00082	0.87042	55arw20
0.25	0.86941	0.00078	0.87097	55arw25
0.30	0.86887	0.00082	0.87051	55arw30
0.35	0.86945	0.00084	0.87113	55arw35
0.40	0.87026	0.00084	0.87194	55arw40
0.45	0.86978	0.00082	0.87142	55arw45
0.50	0.86948	0.00085	0.87118	55arw50
0.55	0.86893	0.00083	0.87059	55arw55
0.60	0.87043	0.00082	0.87207	55arw60
0.65	0.86989	0.00080	0.87149	55arw65
0.70	0.87096	0.00083	0.87262	55arw70
0.75	0.87003	0.00082	0.87167	55arw75
0.80	0.86791	0.00084	0.86959	55arw80
0.85	0.86863	0.00083	0.87029	55arw85
0.90	0.86891	0.00081	0.87053	55arw90
0.95	0.86786	0.00082	0.86950	55arw95
1.00	0.86929	0.00084	0.87097	5arw100

C7.0 Conclusions

This appendix demonstrates that containers of machine-compacted waste containing less than or equal to 1 wt% special reflector materials will remain below the USL in the two-container configuration as well in the underground array with the following limits:

- 55-, 85- or 100- gallon drums of fully compacted waste:
 - Maximum 170 FGE/drum,
 - Maximum 5 kilograms of particulate beryllium/drum, and
 - Maximum 600 FGE per pack of drums
- 55-, 85- or 100- gallon drums of fully compacted waste:
 - Maximum 200 FGE/drum if Minimum 0.5-inch spacing between drum content and exterior top and bottom is maintained, even if a smaller drum were placed on top of the drum,
 - Maximum 5 kilograms of particulate beryllium/drum, and
 - Maximum 600 FGE per pack of drums
- Shielded containers of fully compacted waste:
 - Maximum 200 FGE/drum
 - Maximum 5 kilograms of particulate beryllium/drum, and
 - Maximum 600 FGE per pack of drums
- 55-, 85- or 100- gallon drums of partially (less than or equal to 70%) compacted waste:
 - Maximum 200 g ^{239}Pu /drum,
 - Maximum 5 kilograms of particulate beryllium/drum, and
 - Maximum 600 FGE per pack of drums
- Direct-Loaded SWB containers:
 - Maximum 185 FGE/SWB, and
 - Maximum 18.14 kilograms of particulate beryllium/SWB
- 100-gallon Drum overpacked in SWB containers:
 - Maximum 250 FGE/100-gallon drum in SWB,
 - Minimum 0.75-inch void spacing between drum content and exterior top plus minimum 0.5-inch spacing between drum content and exterior bottom must be maintained,
 - Drum must have a 16-gauge drum outer lid and bottom and an inner/recessed 16-gauge steel lid, and
 - Maximum 18.14 kilograms of particulate beryllium/SWB

90	0		-200 -201 202	#1 #2 #3 #4 #5		&	\$
				#10 #11 #12 #13 #14		&	\$
				#20 #21 #22 #23 #24		&	\$
				#30 #31 #32 #33 #34		&	\$
				#40 #41 #42 #43 #44		&	\$
				#50 #51 #52 #53 #54		&	\$
				#60 #61 #62 #63 #64		&	\$
				#70 #71 #72 #73 #74		&	\$
				#80 #81 #82 #83 #84	U=1	IMP:N=1	\$
91	0		(200:201:-202)		U=1	IMP:N=1	\$
C							\$
C				CELL CARDS FOR A HEXAPRISM LATTICE UNIT CONTAINING THE 3-PACKS.			\$
C							\$
100	0		-300 301 -302 303 -304 305 -306 307			&	\$
				FILL=1		IMP:N=1	\$
C							\$
C				CELL CARDS FOR THE MgO ON THE TOP LAYER OF DRUMS.			\$
C							\$
110	8	-1.4500	-400 401 -402 403 -404 405 -406 407 306			IMP:N=1	\$
C							\$
C				CELL CARDS FOR A HEXAGONAL ARRAY BOUNDARY WITH MIRROR REFLECTION IN THE			\$
C				X & Y PLANE AND 200 CM SALT REFLECTION IN THE UPPER AND LOWER Z PLANE.			\$
C							\$
120	0		-500 501 -502 503 -504 505 -506 507			&	\$
				(400:-401:402:-403:404:-405:406:-307)		IMP:N=1	\$
130	9	-2.165	-500 501 -502 503 -504 505 -600 506			IMP:N=1	\$
140	9	-2.165	-500 501 -502 503 -504 505 -507 601			IMP:N=1	\$
C							\$
C				CELL CARDS FOR EVERYTHING OUTSIDE THE COMPUTATIONAL SPACE.			\$
C							\$
150	0		(500:-501:502:-503:504:-505:600:-601)			IMP:N=0	\$
C							\$
C				SURFACE CARDS FOR THE FIRST 100 GALLON DRUM IN THE LOWER 3-PACK			\$
C				ARRANGMENT. THE FISSILE MASS IS LOCATED IN THE MIDDLE OF THE DRUM.			\$
C							\$
1	1	CZ	9.69828				\$
2	1	PZ	52.87142				\$
3	1	PZ	33.47486				\$
4	1	CZ	38.10000				\$
5	1	PZ	67.07228				\$
6	1	PZ	19.27400				\$
7	1	CZ	38.10000				\$
8	1	PZ	86.19439				\$
9	1	PZ	0.15189				\$
10	1	CZ	38.25189				\$
11	1	PZ	86.34628				\$
12	1	PZ	0.00000				\$
13	1	CZ	38.81095				\$
14	1	PZ	86.34628				\$
15	1	PZ	0.00000				\$
C							\$
C				SURFACE CARDS FOR THE SECOND 100 GALLON DRUM IN THE LOWER 3-PACK			\$
C				ARRANGMENT. THE FISSILE MASS IS LOCATED IN THE MIDDLE OF THE DRUM.			\$
C							\$
20	2	CZ	9.69828				\$
21	2	PZ	52.87142				\$
22	2	PZ	33.47486				\$
23	2	CZ	38.10000				\$
24	2	PZ	67.07228				\$
25	2	PZ	19.27400				\$
26	2	CZ	38.10000				\$
27	2	PZ	86.19439				\$
28	2	PZ	0.15189				\$
29	2	CZ	38.25189				\$
30	2	PZ	86.34628				\$
31	2	PZ	0.00000				\$
32	2	CZ	38.81095				\$
33	2	PZ	86.34628				\$
34	2	PZ	0.00000				\$
C							\$

C			SURFACE CARDS FOR THE THIRD 100 GALLON DRUM IN THE LOWER 3-PACK	\$
C			ARRANGMENT. THE FISSILE MASS IS LOCATED IN THE MIDDLE OF THE DRUM.	\$
C				\$
40	3	CZ	9.69828	\$
41	3	PZ	52.87142	\$
42	3	PZ	33.47486	\$
43	3	CZ	38.10000	\$
44	3	PZ	67.07228	\$
45	3	PZ	19.27400	\$
46	3	CZ	38.10000	\$
47	3	PZ	86.19439	\$
48	3	PZ	0.15189	\$
49	3	CZ	38.25189	\$
50	3	PZ	86.34628	\$
51	3	PZ	0.00000	\$
52	3	CZ	38.81095	\$
53	3	PZ	86.34628	\$
54	3	PZ	0.00000	\$
C				\$
C			SURFACE CARDS FOR THE FIRST 100 GALLON DRUM IN THE MIDDLE 3-PACK	\$
C			ARRANGMENT. THE FISSILE MASS IS LOCATED IN THE MIDDLE OF THE DRUM.	\$
C				\$
60	4	CZ	9.69828	\$
61	4	PZ	52.87142	\$
62	4	PZ	33.47486	\$
63	4	CZ	38.10000	\$
64	4	PZ	67.07228	\$
65	4	PZ	19.27400	\$
66	4	CZ	38.10000	\$
67	4	PZ	86.19439	\$
68	4	PZ	0.15189	\$
69	4	CZ	38.25189	\$
70	4	PZ	86.34628	\$
71	4	PZ	0.00000	\$
72	4	CZ	38.81095	\$
73	4	PZ	86.34628	\$
74	4	PZ	0.00000	\$
C				\$
C			SURFACE CARDS FOR THE SECOND 100 GALLON DRUM IN THE MIDDLE 3-PACK	\$
C			ARRANGMENT. THE FISSILE MASS IS LOCATED IN THE MIDDLE OF THE DRUM.	\$
C				\$
80	5	CZ	9.69828	\$
81	5	PZ	52.87142	\$
82	5	PZ	33.47486	\$
83	5	CZ	38.10000	\$
84	5	PZ	67.07228	\$
85	5	PZ	19.27400	\$
86	5	CZ	38.10000	\$
87	5	PZ	86.19439	\$
88	5	PZ	0.15189	\$
89	5	CZ	38.25189	\$
90	5	PZ	86.34628	\$
91	5	PZ	0.00000	\$
92	5	CZ	38.81095	\$
93	5	PZ	86.34628	\$
94	5	PZ	0.00000	\$
C				\$
C			SURFACE CARDS FOR THE THIRD 100 GALLON DRUM IN THE MIDDLE 3-PACK	\$
C			ARRANGMENT. THE FISSILE MASS IS LOCATED IN THE MIDDLE OF THE DRUM.	\$
C				\$
100	6	CZ	9.69828	\$
101	6	PZ	52.87142	\$
102	6	PZ	33.47486	\$
103	6	CZ	38.10000	\$
104	6	PZ	67.07228	\$
105	6	PZ	19.27400	\$
106	6	CZ	38.10000	\$
107	6	PZ	86.19439	\$
108	6	PZ	0.15189	\$
109	6	CZ	38.25189	\$
110	6	PZ	86.34628	\$

111	6	PZ	0.00000		\$
112	6	CZ	38.81095		\$
113	6	PZ	86.34628		\$
114	6	PZ	0.00000		\$
C					\$
C			SURFACE CARDS FOR THE FIRST 100 GALLON DRUM IN THE UPPER 3-PACK		\$
C			ARRANGMENT. THE FISSILE MASS IS LOCATED IN THE MIDDLE OF THE DRUM.	\$	
C					\$
120	7	CZ	9.69828		\$
121	7	PZ	52.87142		\$
122	7	PZ	33.47486		\$
123	7	CZ	38.10000		\$
124	7	PZ	67.07228		\$
125	7	PZ	19.27400		\$
126	7	CZ	38.10000		\$
127	7	PZ	86.19439		\$
128	7	PZ	0.15189		\$
129	7	CZ	38.25189		\$
130	7	PZ	86.34628		\$
131	7	PZ	0.00000		\$
132	7	CZ	38.81095		\$
133	7	PZ	86.34628		\$
134	7	PZ	0.00000		\$
C					\$
C			SURFACE CARDS FOR THE SECOND 100 GALLON DRUM IN THE UPPER 3-PACK		\$
C			ARRANGMENT. THE FISSILE MASS IS LOCATED IN THE MIDDLE OF THE DRUM.	\$	
C					\$
140	8	CZ	9.69828		\$
141	8	PZ	52.87142		\$
142	8	PZ	33.47486		\$
143	8	CZ	38.10000		\$
144	8	PZ	67.07228		\$
145	8	PZ	19.27400		\$
146	8	CZ	38.10000		\$
147	8	PZ	86.19439		\$
148	8	PZ	0.15189		\$
149	8	CZ	38.25189		\$
150	8	PZ	86.34628		\$
151	8	PZ	0.00000		\$
152	8	CZ	38.81095		\$
153	8	PZ	86.34628		\$
154	8	PZ	0.00000		\$
C					\$
C			SURFACE CARDS FOR THE THIRD 100 GALLON DRUM IN THE UPPER 3-PACK		\$
C			ARRANGMENT. THE FISSILE MASS IS LOCATED IN THE MIDDLE OF THE DRUM.	\$	
C					\$
160	9	CZ	9.69828		\$
161	9	PZ	52.87142		\$
162	9	PZ	33.47486		\$
163	9	CZ	38.10000		\$
164	9	PZ	67.07228		\$
165	9	PZ	19.27400		\$
166	9	CZ	38.10000		\$
167	9	PZ	86.19439		\$
168	9	PZ	0.15189		\$
169	9	CZ	38.25189		\$
170	9	PZ	86.34628		\$
171	9	PZ	0.00000		\$
172	9	CZ	38.81095		\$
173	9	PZ	86.34628		\$
174	9	PZ	0.00000		\$
C					\$
C			SURFACE CARDS FOR A BOUNDARY AROUND THE 3-PACK STACK.	\$	\$
C					\$
200		CZ	83.62598		\$
201		PZ	259.03884		\$
202		PZ	0.00000		\$
C					\$
C			SURFACE CARDS FOR A HEXAPRISM LATTICE UNIT CONTAINING THE 3-PACK STACK.	\$	
C					\$
300		PX	83.62598		\$

301	PX	-83.62598								\$
302	P	1	1.73205	0	167.25196					\$
303	P	1	1.73205	0	-167.25196					\$
304	P	-1	1.73205	0	167.25196					\$
305	P	-1	1.73205	0	-167.25196					\$
306	PZ	259.03884								\$
307	PZ	0.00000								\$
C										\$
C	SURFACE CARDS FOR THE MgO ON THE TOP LAYER OF DRUMS.									\$
C										\$
400	PX	83.62598								\$
401	PX	-83.62598								\$
402	P	1	1.73205	0	167.25196					\$
403	P	1	1.73205	0	-167.25196					\$
404	P	-1	1.73205	0	167.25196					\$
405	P	-1	1.73205	0	-167.25196					\$
406	PZ	321.26884								\$
407	PZ	259.03884								\$
C										\$
C	CELL CARDS FOR A HEXAGONAL ARRAY BOUNDARY WITH MIRROR REFLECTION IN THE									\$
C	X & Y PLANE AND 300 CM SALT REFLECTION IN THE UPPER AND LOWER Z PLANE.									\$
C										\$
*500	PX	83.87598								\$
*501	PX	-83.87598								\$
*502	P	1	1.73205	0	167.75196					\$
*503	P	1	1.73205	0	-167.75196					\$
*504	P	-1	1.73205	0	167.75196					\$
*505	P	-1	1.73205	0	-167.75196					\$
506	PZ	321.51884								\$
507	PZ	-0.25000								\$
600	PZ	621.51884								\$
601	PZ	-300.25000								\$
C										\$
C	MODE CARD.									\$
C										\$
MODE N										\$
C										\$
C	TRANSFORMATION CARDS FOR THE 3-PACK STACK.									\$
C										\$
TR1	38.81095	22.40751	0.00000							\$
TR2	-38.81095	22.40751	0.00000							\$
TR3	0.00000	-44.81503	0.00000							\$
TR4	38.81095	22.40751	86.34628							\$
TR5	-38.81095	22.40751	86.34628							\$
TR6	0.00000	-44.81503	86.34628							\$
TR7	38.81095	22.40751	172.69256							\$
TR8	-38.81095	22.40751	172.69256							\$
TR9	0.00000	-44.81503	172.69256							\$
C										\$
C	MATERIAL CARDS									\$
C										\$
C										\$
C	PU-CH2									\$
C										\$
M1	1001.60C	-0.138474	6000.60C	-0.825035	94239.60C	-0.036491				\$
C										\$
C	BE-CH2 REFLECTOR									\$
C										\$
M2	4009.60C	-0.025201	1001.60C	-0.140097	6000.60C	-0.834702				\$
C										\$
C	CH2 DUNNAGE									\$
C										\$
M3	1001.60C	-0.143720	6000.60C	-0.856280						\$
C										\$
C	CARBON STEEL DRUM.									\$
C										\$
M7	6000.60C	-0.001500	25055.60C	-0.006000	15031.60C	-0.000350	&			\$
	16000.60C	-0.000400	26054.60C	-0.058513	26056.60C	-0.909630	&			\$
	26057.60C	-0.020827	26058.60C	-0.0027769						\$
C										\$

				FILL=1		IMP:N=1	\$
C							\$
C							\$
C							\$
110	10	-1.4500	-400 401 -402 403 -404 405 -406 407 306			IMP:N=1	\$
C							\$
C							\$
C							\$
C							\$
C							\$
120	0		-500 501 -502 503 -504 505 -506 507			&	\$
			(400:-401:402:-403:404:-405:406:-307)			IMP:N=1	\$
130	11	-2.165	-500 501 -502 503 -504 505 -600 506			IMP:N=1	\$
140	11	-2.165	-500 501 -502 503 -504 505 -507 601			IMP:N=1	\$
C							\$
C							\$
C							\$
150	0		(500:-501:502:-503:504:-505:600:-601)			IMP:N=0	\$
C							\$
C							\$
C							\$
C							\$
1	CZ	9.78672					\$
2	PZ	56.77672					\$
3	PZ	37.20328					\$
7	CZ	87.31250					\$
8	PZ	93.66250					\$
9	PZ	0.31750					\$
10	PY	65.88125					\$
11	PY	-65.88125					\$
12	CZ	87.63000					\$
13	PZ	93.98000					\$
14	PZ	0.00000					\$
15	PY	66.19875					\$
16	PY	-66.19875					\$
17	CZ	87.63000					\$
18	PZ	93.98000					\$
19	PZ	-0.25000					\$
C							\$
C							\$
C							\$
C							\$
27	1	CZ	87.31250				\$
28	1	PZ	93.66250				\$
29	1	PZ	0.31750				\$
30	1	PY	65.88125				\$
31	1	PY	-65.88125				\$
37	1	CZ	87.63000				\$
38	1	PZ	93.98000				\$
39	1	PZ	0.00000				\$
C							\$
C							\$
C							\$
C							\$
47	2	CZ	87.31250				\$
48	2	PZ	93.66250				\$
49	2	PZ	0.31750				\$
50	2	PY	65.88125				\$
51	2	PY	-65.88125				\$
57	2	CZ	87.63000				\$
58	2	PZ	93.98000				\$
59	2	PZ	0.00000				\$
C							\$
C							\$
C							\$
C							\$
200		CZ	87.63000				\$
201		PZ	281.94000				\$
202		PZ	-0.25000				\$
C							\$
C							\$
C							\$
C							\$
300		PX	87.63000				\$
301		PX	-87.63000				\$
302		P	1 1.73205 0 175.26000				\$

C									\$
C									\$
C									\$
C									\$
1	1	CZ	11.49993						\$
2	1	PZ	38.10000						\$
3	1	PZ	26.60007						\$
4	1	CZ	38.10000						\$
5	1	PZ	38.10000						\$
6	1	PZ	0.00000						\$
7		CZ	38.10000						\$
8		PZ	86.84311						\$
9		PZ	1.42189						\$
10		CZ	38.10000						\$
11		PZ	86.84311						\$
12		PZ	0.15189						\$
13		CZ	38.25189						\$
14		PZ	86.99500						\$
15		PZ	0.00000						\$
16		CZ	38.81095						\$
17		PZ	88.26500						\$
18		PZ	0.00000						\$
C									\$
C									\$
C									\$
C									\$
20	2	CZ	12.42088						\$
21	2	PZ	12.57277						\$
22	2	PZ	0.15189						\$
23	2	CZ	38.10000						\$
24	2	PZ	38.25189						\$
25	2	PZ	0.15189						\$
26	2	CZ	38.10000						\$
27	2	PZ	86.19439						\$
28	2	PZ	0.15189						\$
29	2	CZ	38.25189						\$
30	2	PZ	86.34628						\$
31	2	PZ	0.00000						\$
32	2	CZ	38.81095						\$
33	2	PZ	86.34628						\$
34	2	PZ	0.00000						\$
C									\$
C									\$
C									\$
C									\$
100		CZ	38.81095						\$
101		PZ	174.61128						\$
102		PZ	0.00000						\$
C									\$
C									\$
C									\$
C									\$
200		PX	38.81095						\$
201		PX	-38.81095						\$
202	P	1	1.73205	0	77.62190				\$
203	P	1	1.73205	0	-77.62190				\$
204	P	-1	1.73205	0	77.62190				\$
205	P	-1	1.73205	0	-77.62190				\$
206		PZ	174.61128						\$
207		PZ	0.00000						\$
C									\$
C									\$
C									\$
C									\$
C									\$
*300		PX	338.81095						\$
*301		PX	-338.81095						\$
*302	P	1	1.73205	0	677.62190				\$
*303	P	1	1.73205	0	-677.62190				\$
*304	P	-1	1.73205	0	677.62190				\$
*305	P	-1	1.73205	0	-677.62190				\$
*306		PZ	474.61128						\$
*307		PZ	-300.00000						\$
C									\$

```

C      MODE CARD.
C
C      MODE N
C
C      TRANSFORMATION CARDS FOR THE TWO-DRUM MODEL.
C
C      TR1  0.00000      0.00000      48.74311
C      TR2  0.00000      0.00000      88.26500
C
C      MATERIAL CARDS
C
C      PU-CH2 (LOWER DRUM)
C
C      M1    1001.60C -0.137471  6000.60C -0.819057  94239.60C -0.043472
C
C      BE-CH2 REFLECTOR (LOWER DRUM)
C
C      M2    4009.60C -0.031553  1001.60C -0.139184  6000.60C -0.829263
C
C      CH2 DUNNAGE (LOWER DRUM)
C
C      M3    1001.60C -0.143720  6000.60C -0.856280
C
C      PU-CH2-H2O (UPPER DRUM)
C
C      M4    1001.60C -0.129111  6000.60C -0.565647  8016.60C -0.271219      &
C      94239.60C -0.034024
C
C      BE-CH2 REFLECTOR (UPPER DRUM)
C
C      M5    4009.60C -0.045404  1001.60C -0.137193  6000.60C -0.817403
C
C      CH2 DUNNAGE (UPPER DRUM)
C
C      M6    1001.60C -0.143720  6000.60C -0.856280
C
C      CARBON STEEL DRUM.
C
C      M7    6000.60C -0.001500  25055.60C -0.006000  15031.60C -0.000350      &
C      16000.60C -0.000400  26054.60C -0.058513  26056.60C -0.909630      &
C      26057.60C -0.020827  26058.60C -0.0027769
C
C      MgO
C
C      M8    8016.60C -0.39700  12000.60C -0.603000
C
C      S(ALPHA,BETA)
C
C      MT1  POLY.01T  GRPH.01T
C      MT2  POLY.01T  GRPH.01T  BE.01T
C      MT3  POLY.01T  GRPH.01T
C      MT4  LWTR.01T  GRPH.01T
C      MT5  POLY.01T  GRPH.01T  BE.01T
C      MT6  POLY.01T  GRPH.01T
C
C      SOURCE CARDS
C
C      KCODE 1000      1.0      50  1000
C      KSRC  0.00000  0.00000  80.00000
C      PRINT
C
C      PRINT TO MCTAL FILE
C
C      PRDMP 2j 1
    
```

C9.4 MCNP Input File for Shielded Container Two-Container Model (Filename Iltm20)

Appendix D

55-gallon Drums Containing Pipe Overpacks

This page intentionally left blank.

Analyst		
Senior NCS Engineer	<hr/> G. W. Neeley	Date
Peer Reviewer		
Senior NCS Engineer	<hr/> S. L. Larson	Date

This page intentionally left blank.

Introduction

In order to allow for increased fissile content in a single shipment and to allow for certain wastes to be CH, a pipe overpack configuration for the 55-gallon drum has been approved. The waste is contained within the cylindrical containers that are constructed of 304 stainless steel. Additional shielding can be provided using inserts either inside the pipes or as part of the surrounding dunnage. Sample MCNP5 input file listings for the models contained in this appendix are included in Section .

D1.0 Pipe Overpack Configurations

The various pipe overpack configuration are described below. Additional details can be found in Sections 2.9.2 through 2.9.5 of the *Contact-Handled Transuranic Waste Authorized Methods for Payload Control (CH-TRAMPAC)* (DOE-CBFO 2005a).

D1.1 Standard Pipe Overpack

The standard pipe overpack consists of a pipe component positioned by fiberboard/plywood dunnage within a 55-gallon drum with a high-density polyethylene rigid liner and lid as shown in Figure D-1. The pipe components are cylindrical containers with the dimensions given in Table D-1. A standard 12-inch pipe component is shown in Figure D-2. The dunnage consists of cane fiberboard packing in accordance with *Standard Specification for Cellulosic Fiber Insulating Board* [ASTM-C208-95(2001)] and 1/2- or 1/4-inch plywood. In the case of the shielded 6-inch pipe component, a large portion of the dunnage is replaced by a water extended polyester/polyethylene composite or equivalent neutron shielding material.

Table D-, Pipe Component Dimensions

Pipe Component Size	Dimension	Measurement (in.)
6-inch	Outer Diameter	6.7 Max
	Overall Height	27.5 Max
12-inch	Outer Diameter	12.8 Max
	Wall Thickness	0.219 Min
	Overall Height	27.5 Max
	Bottom Thickness	0.25 Min

D1.2 S100 Pipe Overpack

As shown in Figure D-3 and Figure D-4, the S100 pipe overpack is based closely on the standard 6-inch pipe component. It differs from the standard pipe component in that most of the cane fiberboard dunnage is replaced with neutron shielding material. In addition, neutron shielding material is placed within the pipe component, above, below, and around the payload. It is intended for the shipment of sealed neutron sources. The S100 pipe overpack uses the 6-inch

diameter pipe component described in Table D-1. The 12-inch diameter pipe component is not used in the S100 pipe overpack.

The neutron shield around the side of the pipe component may be in the form of a casting (such as a commercial neutron shielding casting compound), a solid monolith (such as a molded or machined unit of solid plastic), or fabricated component (such as a tightly wound roll of plastic film or other built-up fabrication). The end plugs and shield sleeve within the pipe component are made of a rigid plastic.

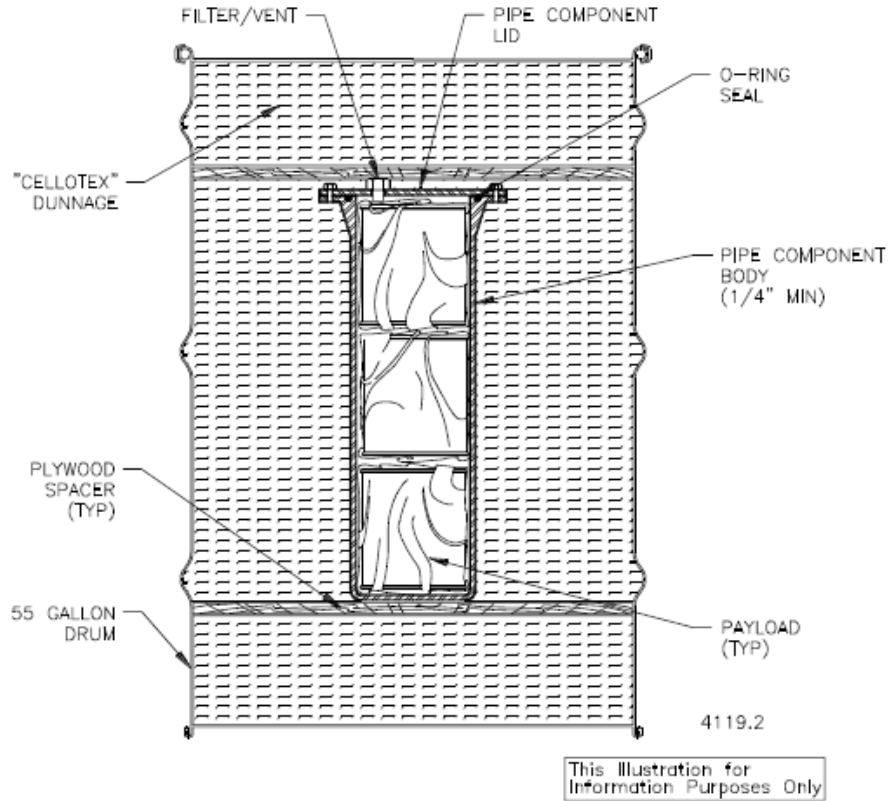

Figure D-, Standard 6-inch Pipe Component in Overpack Assembly

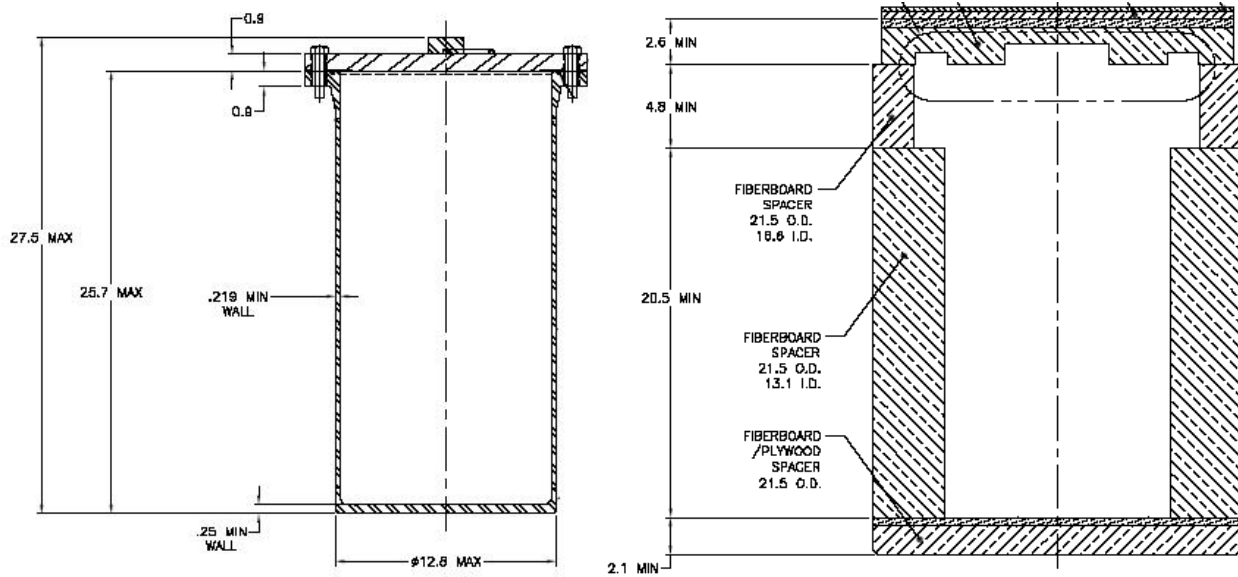

Figure D-, Standard 12-inch Pipe Component and Dunnage

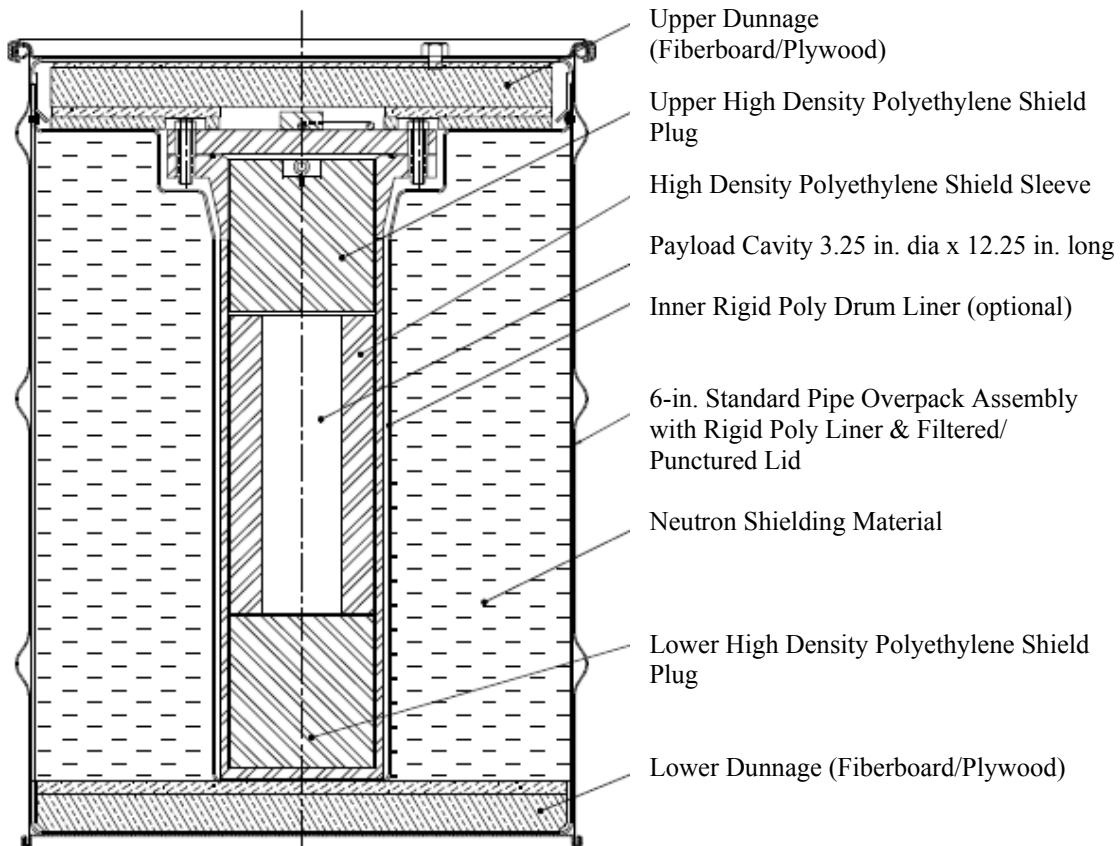

Figure D-, Configuration for the S100 6-inch Shielded Pipe Overpack

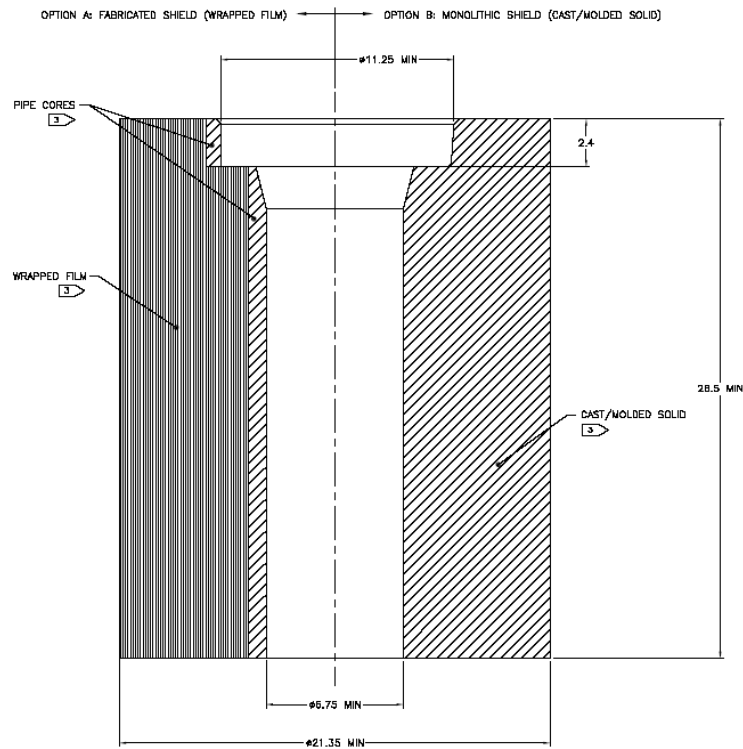

Figure D-, Dunnage and Shielding for the S100 Shielded 6-inch Pipe Component

D1.3 S200 Pipe Overpack

The S200 pipe overpack is a shielded version of the standard pipe overpack. It consists of a gamma shield insert located by rigid polyurethane foam dunnage inside a standard 12-inch pipe component which is, in turn, located by cane fiberboard and plywood dunnage within a standard 55-gallon drum with a rigid polyethylene liner and lid. The 12-inch pipe component, cane fiberboard and plywood dunnage, and 55-gallon drum with rigid polyethylene liner and lid are identical to the standard pipe overpack described in Section . It differs from the standard pipe overpack through the addition of a gamma shield insert inside the pipe component. It is intended for the shipment and storage of TRU waste forms with high gamma energies. Note that the 6-inch pipe component is not used in the S200 pipe overpack.

The gamma shield insert is a two-component lead assembly consisting of a cylindrical body with an integral bottom cap and a detachable lid. The shield insert is available in two sizes: the S200-A shield insert has a nominal thickness of 1.000 inch and the S200-B shield insert has a nominal thickness of 0.600 inch. Both shield inserts have a nominal inner diameter of 8.125 inches, but the S200-B is significantly longer. The inner height of the S200-A insert is 8.125 inches compared to 16.125 inches for the S200-B. The rigid polyurethane foam dunnage fills the bottom and annular space between the shield insert and the 12-inch pipe component to position the insert near the lid of the pipe component. Figure D-5 shows the S200 pipe overpack assembly and Figure D-6 shows the shielded insert options that may be used within the S200 assembly.

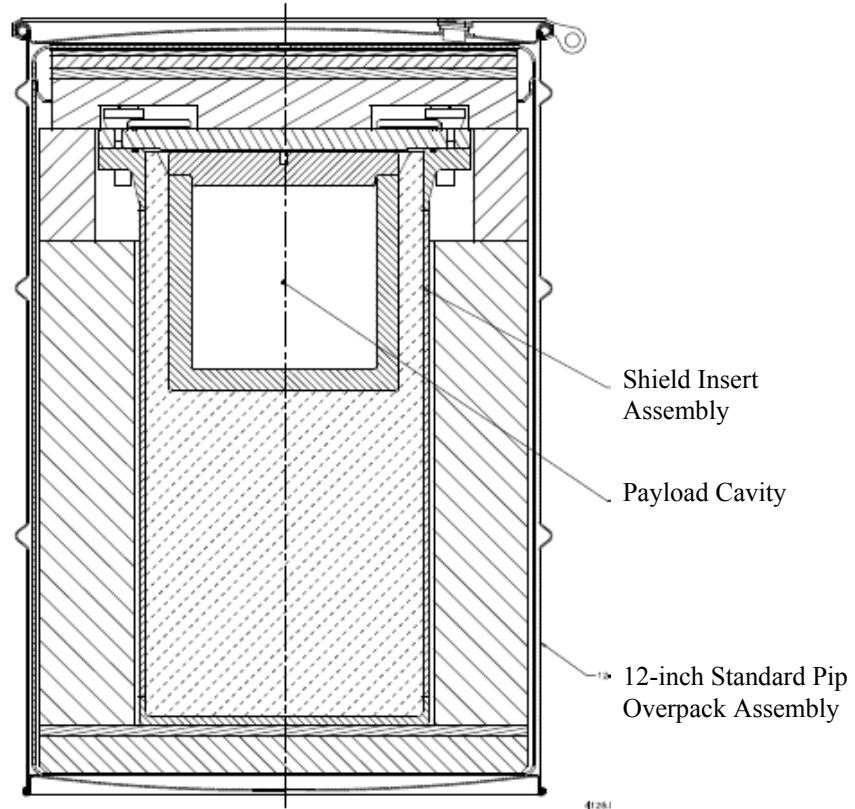

Figure D-, S200 Shielded 12-inch Pipe Component Overpack Assembly

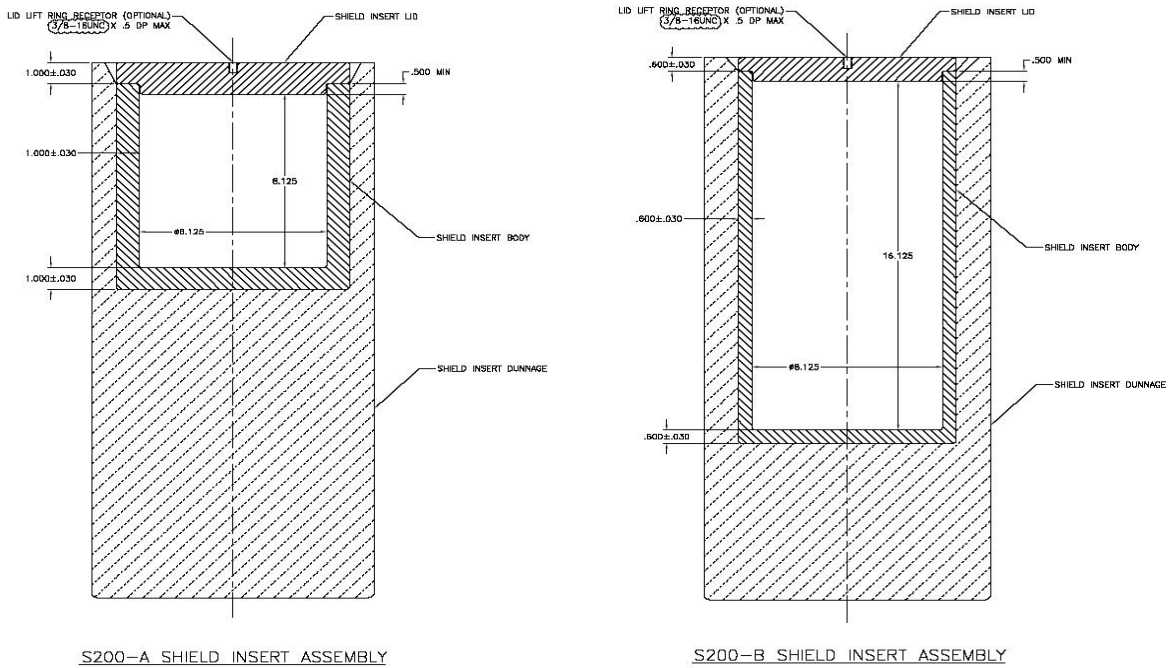

Figure D-, Shielded Insert Options for the S200 12-inch Pipe Components

D1.4 S300 Pipe Overpack

The S300 pipe overpack is based closely on the standard pipe overpack described in Section . It differs from the standard pipe overpack through the addition of neutron shielding within the pipe component. It is intended for the shipment and storage of sealed neutron sources. The S300 pipe overpack consists of a neutron shield insert placed inside a standard 12-inch pipe component which is, in turn, located by cane fiberboard and plywood dunnage within a standard 55-gallon drum with a rigid polyethylene liner and lid. A schematic of the S300 pipe overpack is shown in Figure D-7. All of the components of the S300 pipe overpack, except the neutron shield insert, are identical to the 12-inch version of the standard pipe overpack. Note that the 6-inch pipe component is not used in the S300 pipe overpack.

The neutron shield insert is a two-part assembly consisting of a cylindrical body and stepped lid shown in Figure D-8. With the exception of necessary clearances, the insert fits within and fills the 12-inch pipe component. The insert lid is held in place by the lid of the pipe component. The insert is made from solid, high-density polyethylene, and has a nominal wall thickness of 4.13 inches.

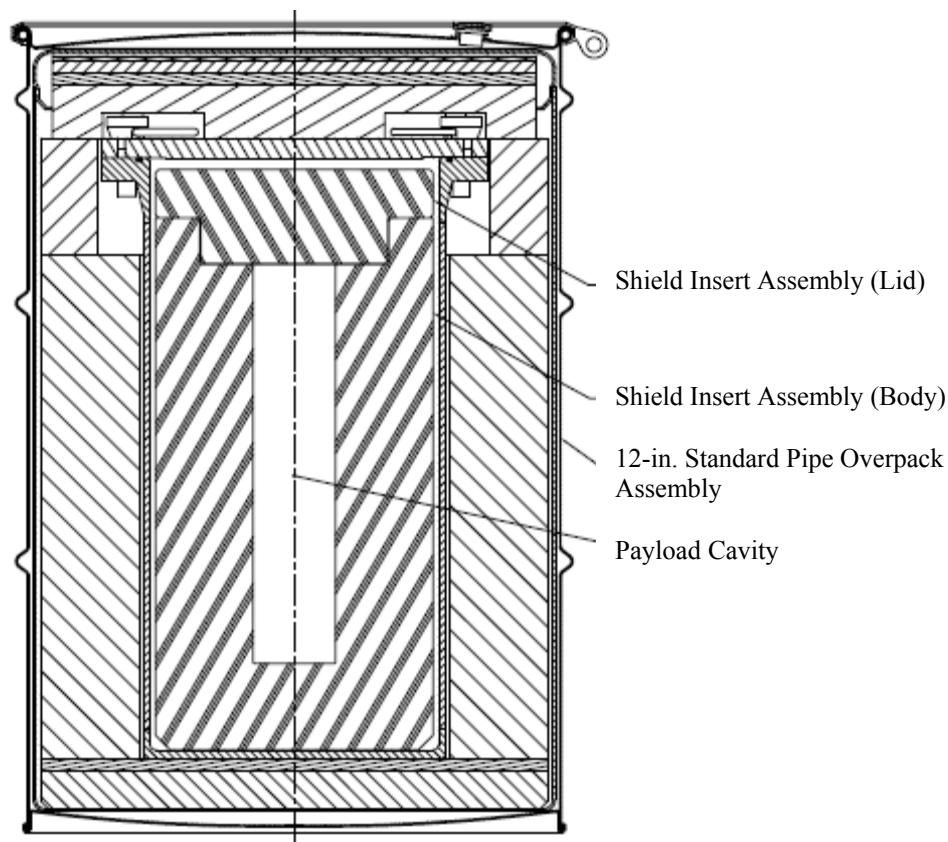

Figure D-, S300 Pipe Overpack Assembly

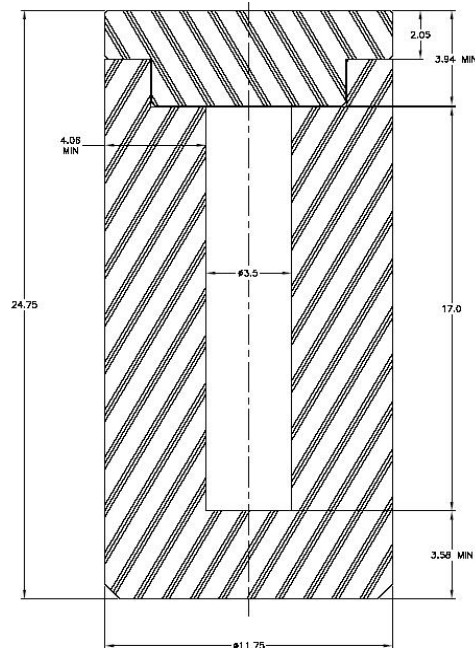

Figure D-, S300 Shield Insert Assembly

D2.0 55-gallon Pipe Overpack MCNP5 Models

The unshielded 12-inch pipe overpack is modeled as the bounding pipe overpack configuration as shown in calculations supporting the *TRUPACT-II Safety Analysis Report* (DOE-CBFO 2005b). In the reference, each pipe overpack configuration was modeled in an array of TRUPACT-II containers with 14 pipe overpack drums per TRUPACT-II and the unshielded 12-inch pipe overpack resulted in the highest reactivity. The unshielded 12-inch pipe overpack assembly design allows for greater interaction between drums compared to the shielded designs and the larger diameter allows for a more optimum fissile material geometry (i.e., larger radius) over that of the smaller 6-inch pipe overpack and the shielded 12-inch designs. The pipe overpack is modeled using the dimensions in Table D-1. The pipe walls and lid are modeled as 304 stainless steel using the composition given in Table D-2. The cane fiberboard used in the pipe overpack assembly as shock-absorbing dunnage is represented by cellulose ($C_6H_{10}O_5$) at a maximum density of 0.2248 g/cm^3 . The drum containing the pipe overpack is modeled using the dimensions given in Table 2-1 with a carbon steel wall at the composition given in Table 5-4 and 50% density to account for possible corrosion. The mixture parameters for non-compacted waste moderated by a 25% polyethylene and 75% water mixture as given in Table 5-3 were used to model the fissile mass.

**Table D-, Material Composition for 304 Stainless Steel for
 Pipe Overpack Structure**

Element	MCNP Library Specification	Wt. Fraction	Element	MCNP Library Specification	Wt. Fraction
Density – 8.02 g/cm³					
C	6000.60c	0.0008	⁵⁴ Fe	26054.60c	0.038259
Mn	25055.60c	0.02	⁵⁶ Fe	26056.60c	0.59476
Si	14000.60c	0.01	⁵⁷ Fe	26057.60c	0.013617
P	15031.60c	0.00045	⁵⁸ Fe	26058.60c	0.0018157
S	16000.60c	0.0003	⁵⁸ Ni	28058.60c	0.081924
⁵⁰ Cr	24050.60c	0.00869	⁶⁰ Ni	28060.60c	0.03132
⁵² Cr	24052.60c	0.16758	⁶¹ Ni	28061.60c	0.001356
⁵³ Cr	24053.60c	0.019	⁶² Ni	28062.60c	0.0043080
⁵⁴ Cr	24054.60c	0.00473	⁶⁴ Ni	28064.60c	0.0010920

D2.1 Array Model

The array models for the pipe overpack configurations are similar to those of the direct loaded drums described in . The difference is that the fissile material is confined within the pipe component and that the shock-absorbing dunnage of the pipe overpack configuration is included in the drum geometry modeled. The models are based on the 12-inch standard pipe overpack and the cane fiberboard in the drum is modeled as C₆H₁₀O₅ at 0.1 g/cm³, which is less than its nominal density, in order to maximize interaction between containers. The limits determined for this configuration will bound other array configurations of pipe overpacks as the reduced interspersed material increases interaction between the individual units in the array. Figure D-9 and Figure D-10 are MCNP5-generated diagrams of the beryllium-reflected models with cylindrical source geometry from pipe overpacks containing less than or equal to 1 wt% beryllium. The 1 wt% beryllium is modeled as 5 kilograms of beryllium split between the top and bottom of the fissile cylinder. In the model for the unlimited beryllium case, the beryllium fills the remainder of the pipe overpack. In both cases, the beryllium is modeled at its theoretical density of 1.85 g/cm³.

The number of FGE per overpack was set at the TRUPACT-II limits of 200 FGE with 5 kilograms of beryllium and 140 FGE with unlimited beryllium (filling the remainder of the pipe). MCNP5 calculations determined that pipe overpacks limited to 320 grams of ²³⁹Pu with a maximum 5 kilograms of beryllium or 180 grams of ²³⁹Pu with no limits on beryllium remained below the USL of 0.96. Table D-3 and Figure D-11 give the results of a parametric study versus H/Pu ratio at these subcritical limits. Calculations were also performed to evaluate different reflector conditions within the pipe overpack in the limited beryllium case. These conditions included spreading the beryllium throughout the reflector region with and without 25% dense

polyethylene and adding 25% dense polyethylene around the solid beryllium reflector. All cases were shown to reduce reactivity as shown in Table D-3 and Figure D-11.

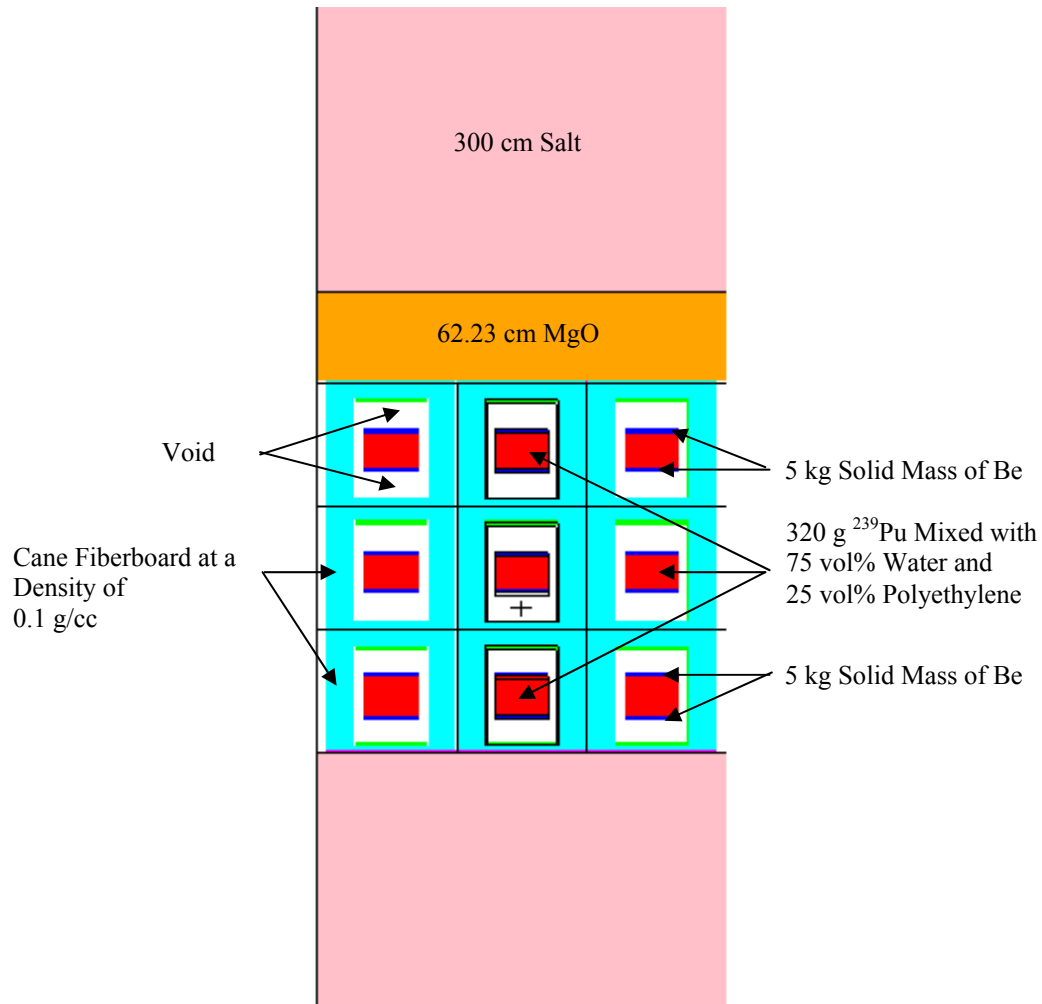

Figure D-, Base Array Geometry for Pipe Overpacks Containing Less Than or Equal to 1 Weight Percent Beryllium

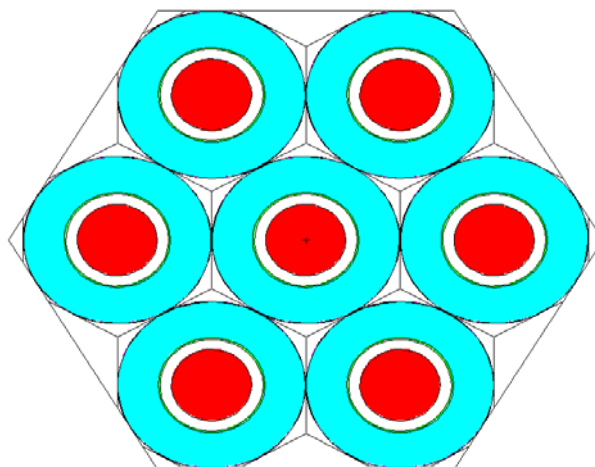

Figure D-, Cross Section of Seven-pack of 12-inch Pipe Overpack Drums Containing Less Than or Equal to 1 Weight Percent Beryllium

Table D-, Pipe Overpack Array Results

H/Pu Ratio	k_{eff}	σ	$k_{eff} + 2\sigma$	Filename
200 FGE and 5 kg beryllium /Pipe Overpack				
500	0.73088	0.00085	0.73258	pa20010
600	0.76157	0.00084	0.76325	pa20012
700	0.78595	0.00085	0.78765	pa20014
800	0.80171	0.00085	0.80341	pa20016
900	0.81043	0.00082	0.81207	pa20018
1000	0.81856	0.00080	0.82016	pa20020
1100	0.82037	0.00078	0.82193	pa20022
1200	0.82380	0.00078	0.82536	pa20024
1300	0.82319	0.00074	0.82467	pa20026
1400	0.82335	0.00072	0.82479	pa20028
1500	0.82041	0.00071	0.82183	pa20030
140 FGE and Unlimited beryllium/Pipe Overpack				
500	0.88091	0.00089	0.88269	pa14010
600	0.88847	0.00089	0.89025	pa14012
700	0.89592	0.00085	0.89762	pa14014
800	0.89677	0.00083	0.89843	pa14016
900	0.89224	0.00082	0.89388	pa14018
1000	0.88642	0.00081	0.88804	pa14020
1100	0.88211	0.00078	0.88367	pa14022

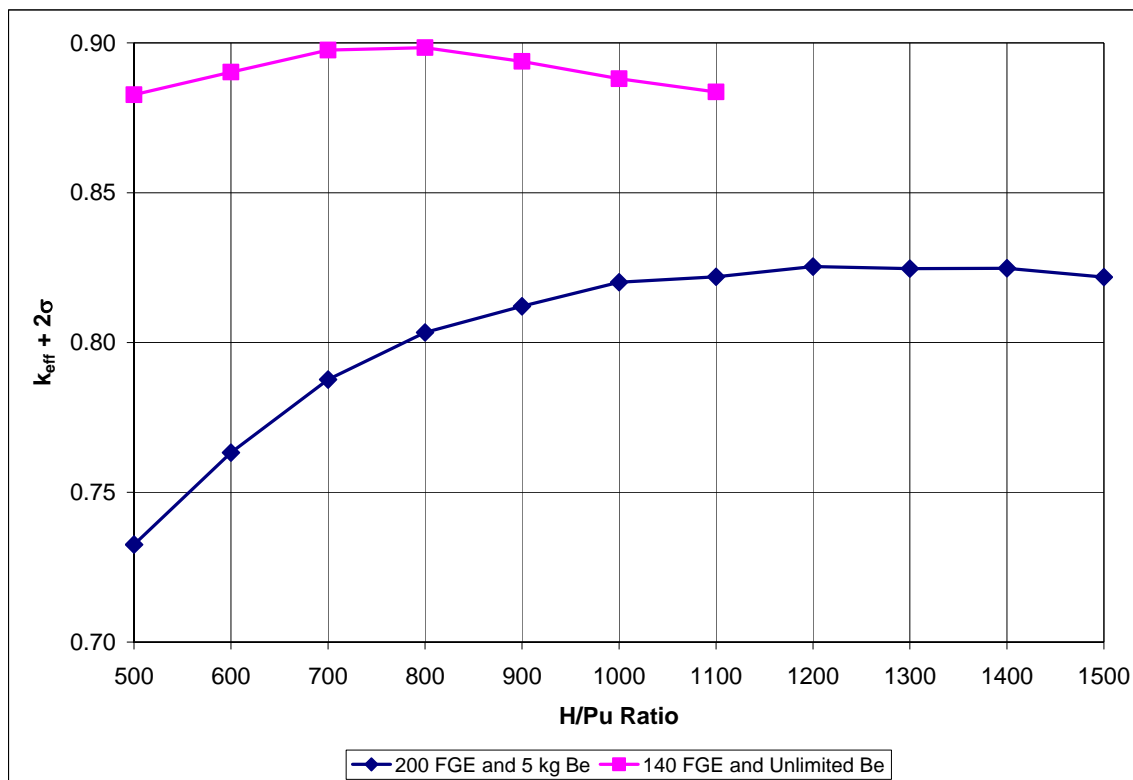

Figure D-, Pipe Overpack Array Reactivity

D2.2 Two-Container Model

A two-container model is developed to evaluate the reactivity of the pipe overpacks. The geometry includes a standard (unshielded) 12-inch pipe component surrounded by cellulose ($C_6H_{10}O_5$) used to represent the cane fiberboard. The fissile source is modeled in a cylindrical geometry with an H/D ratio of 1. The fissile material in the lower overpack is modeled at the top of the pipe component while the fissile material in the upper overpack is modeled at the bottom of the pipe component. The position of the pipe component within the overpack is unchanged because it is fixed by the dunnage. Cellulose is modeled at its nominal density of 0.224 g/cm^3 to provide maximum reflection. Space within the pipe component not occupied by the fissile material is filled with 25% dense polyethylene for the 1 wt% beryllium case or filled with beryllium for the unlimited beryllium case. Figure D-12 shows an MCNP plot of the two-container model with concrete reflector.

The computational analysis determined the limits in the pipe overpacks to be 460 grams of ^{239}Pu if the beryllium is limited to a maximum of 1 wt% or 260 grams of ^{239}Pu if the beryllium content is not restricted to meet the USL of 0.96. The results as a function of H/Pu ratio are tabulated in Table D-4 and shown in Figure D-13. Cases were also run without polyethylene in the pipe component and with the beryllium intermixed with the polyethylene in the pipe component. The results of these cases, as shown in Table D-5, are less than the results in Table D-4, which verifies that the configuration modeled as shown in Figure D-12 is the most reactive.

Contrary to the other container types, the two-drum model yields a higher subcritical limit than the array model. This result is due to the fact that the dunnage maintains the location of the pipe overpack in a central location within the 55-gallon drum. Thus, the fissile material in two adjacent drums is held much further apart than modeled in other two-container models where the location of the fissile material is unrestricted.

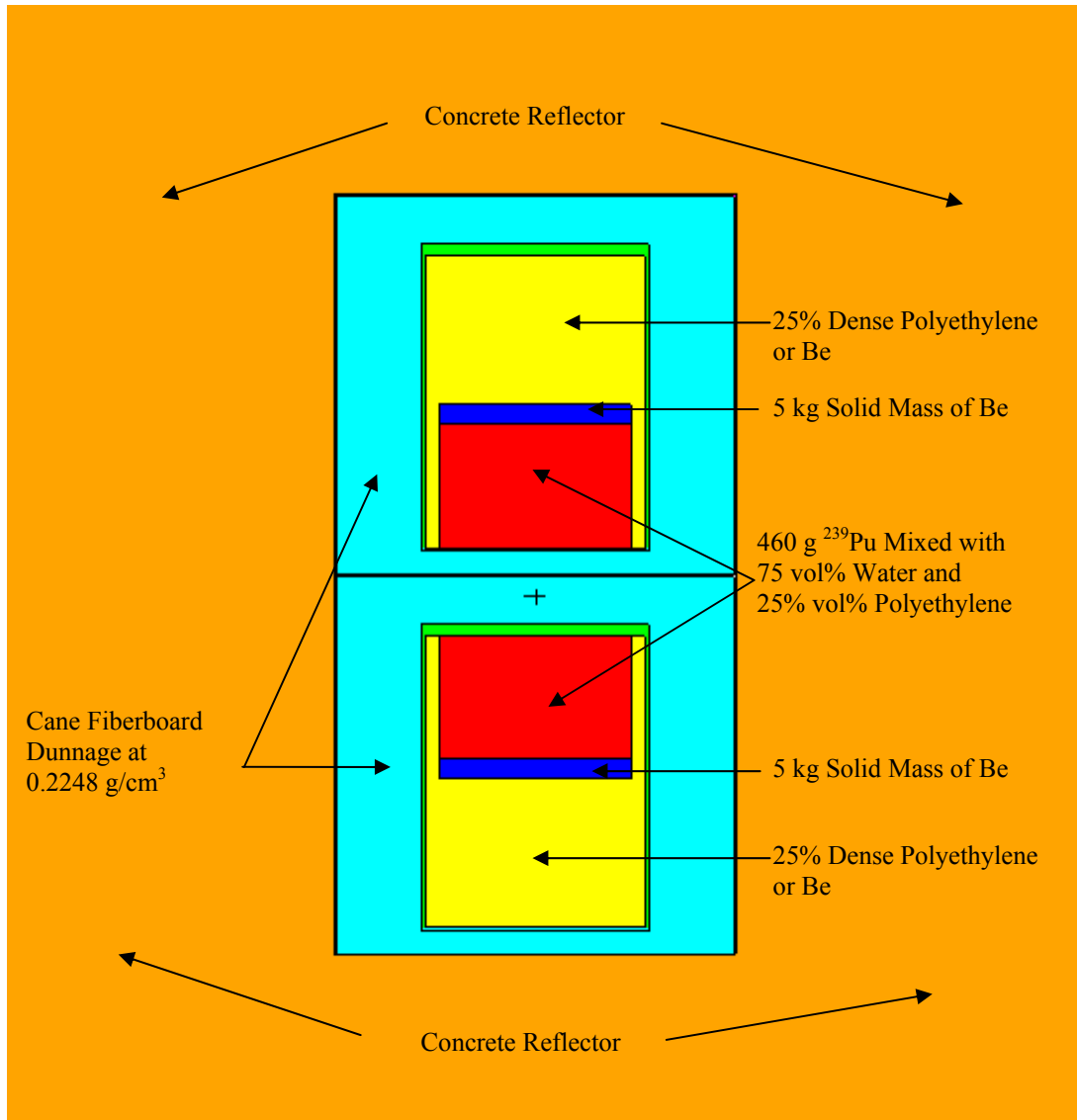

Figure D-, MCNP Plot of 2-Drum 12-inch Standard Pipe Overpack Model with Less Than or Equal to 1 Weight Percent Beryllium and Concrete Reflection

Table D-, MCNP Results for 2 Pipe Overpack Drum Concrete Reflected

H/Pu Ratio	k_{eff}	σ	$k_{eff} + 2\sigma$	Filename
460 g ²³⁹Pu and 5 kg beryllium				
500	0.91077	0.00096	0.91269	pd46010
600	0.93270	0.00094	0.93458	pd46012
700	0.94638	0.00091	0.94820	pd46014
800	0.95242	0.00088	0.95418	pd46016
900	0.95384	0.00087	0.95558	pd46018
1000	0.95439	0.00085	0.95609	pd46020
1100	0.95331	0.00081	0.95493	pd46022
1200	0.94735	0.00080	0.94895	pd46024
1300	0.94200	0.00076	0.94352	pd46026
1400	0.93383	0.00072	0.93527	pd46028
260 g ²³⁹Pu and Unlimited beryllium				
500	0.94638	0.00092	0.94822	pd26010
600	0.95374	0.00091	0.95556	pd26012
700	0.95261	0.00087	0.95435	pd26014
800	0.94938	0.00085	0.95108	pd26016
900	0.94140	0.00084	0.94308	pd26018
1000	0.93418	0.00081	0.93580	pd26020
1100	0.92280	0.00083	0.92446	pd26022

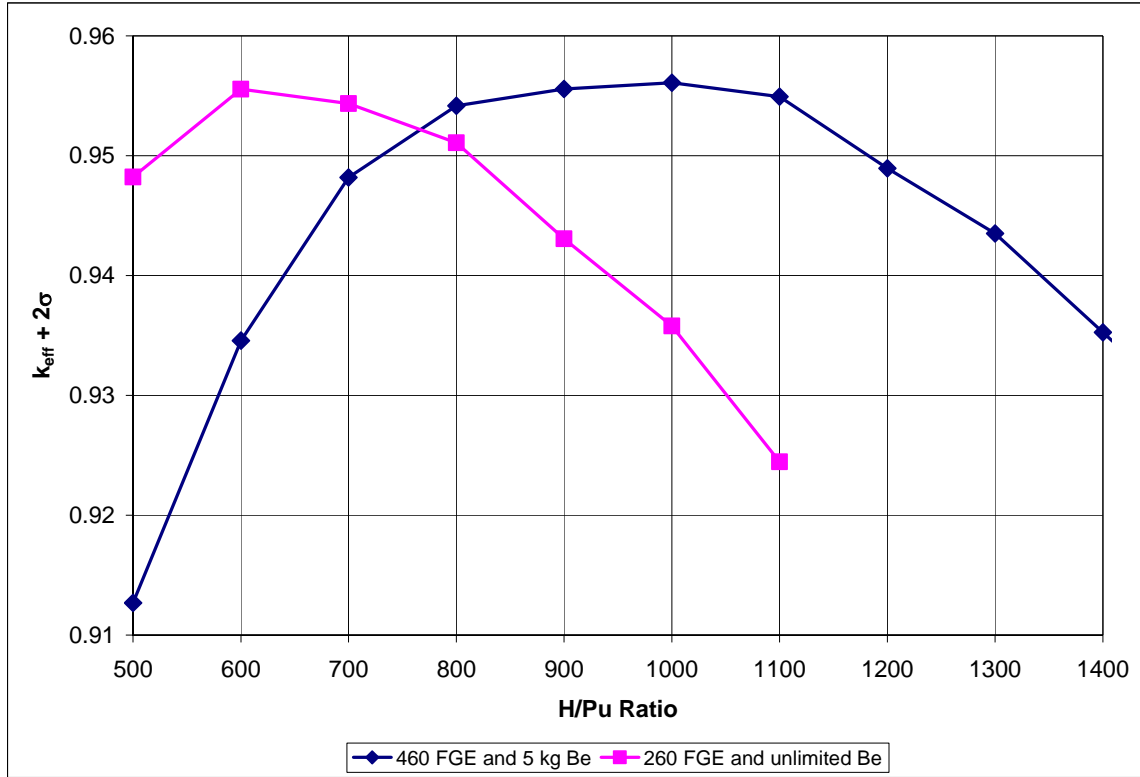

Figure D-, Reactivity of the 55-gallon Pipe Overpack 2-Drum Model with Concrete Reflection

Table D-, Results of Two-Drum Model Variations with 460 g ²³⁹Pu and Less Than or Equal to 1 Weight Percent Beryllium

H/Pu Ratio	k _{eff}	σ	k _{eff} + 2σ	Filename
Without Polyethylene Reflector in Pipe				
600	0.91766	0.00093	0.91952	pd46052
700	0.92992	0.00089	0.93170	pd46054
800	0.94144	0.00088	0.94320	pd46056
900	0.94164	0.00087	0.94338	pd46058
1000	0.94515	0.00083	0.94681	pd46060
1100	0.94199	0.00081	0.94361	pd46062
1200	0.93728	0.00081	0.93890	pd46064
1300	0.93329	0.00077	0.93483	pd46066
Beryllium Dispersed throughout Polyethylene Reflector				
600	0.89981	0.00090	0.90161	pdp0012
700	0.91825	0.00090	0.92005	pdp0014
800	0.92703	0.00090	0.92883	pdp0016
900	0.93621	0.00086	0.93793	pdp0018
1000	0.93769	0.00089	0.93947	pdp0020
1100	0.93765	0.00081	0.93927	pdp0022
1200	0.93573	0.00079	0.93731	pdp0024
1300	0.93331	0.00082	0.93495	pdp0026

D3.0 MCNP5 Machine-compacted Waste Contingency Models

To ensure a conservative bound on the analyses, a few contingency conditions were evaluated for the underground storage array of the 12-inch pipe overpacks. Specifically, an overbatching event and an overstacking event were considered. Since the two-container models are sufficiently conservative to bound any contingency of more realistic or expected conditions related to the interaction between small numbers of containers, only array configurations with centrally located fissile material will be considered.

D3.1 Pipe Overpack Array Overstack Model

Considering the overstacking events, it is important to note that although WIPP panel heights were designed to accommodate three layers of waste containers, ground control safety constraints have resulted in areas of the disposal rooms being mined to a height greater than 13 feet. As a result, it is possible to stack greater than three tiers high including the magnesium oxide (MgO). A contingency calculation was performed for a four-tier-high stack for both less than 1% beryllium and greater than 1% beryllium reflection states. The polyethylene is omitted

in the internal reflector mixture for pipe overpacks containing less than 1% beryllium in order to maximize the interaction between fissile masses in the array. The fissile loadings used in the computational analysis were in compliance to the maximum loading allowed by the TRUPACT-II SAR (DOE-CBFO 2005b): 200 grams of ²³⁹Pu with a maximum 5 kilograms of beryllium or 140 grams of ²³⁹Pu with no limits on beryllium. The lateral boundaries again used reflection symmetry to simulate an infinite array and the vertical boundary were reflected with 300 centimeters of salt with an MgO layer modeled between the upper tier of pipe overpacks and the salt boundary. The computational results for a four-tier-high stack of seven-packs yielded a system eigenvalue less than 0.90, as summarized in Table D-6 and shown in Figure D-14.

Table D-, MCNP Results for an Overstacking Contingency

H/Pu Ratio	k _{eff}	σ	k _{eff} + 2σ	Filename
200 g ²³⁹Pu and 5 kg beryllium Array Stacked Four Tiers High				
500	0.73689	0.00088	0.73865	pa20090
600	0.77027	0.00090	0.77207	pa20092
700	0.79058	0.00087	0.79232	pa20094
800	0.80632	0.00080	0.80792	pa20096
900	0.81888	0.00079	0.82046	pa20098
1000	0.82567	0.00077	0.82721	pa20100
1100	0.82901	0.00076	0.83053	pa20102
1200	0.83272	0.00074	0.83420	pa20104
1300	0.82933	0.00074	0.83081	pa20106
1400	0.82997	0.00072	0.83141	pa20108
1500	0.82618	0.00068	0.82754	pa20110
140 g ²³⁹Pu and Unlimited beryllium Array Stacked Four Tiers High				
500	0.88080	0.00090	0.88260	pa14090
600	0.89269	0.00086	0.89441	pa14092
700	0.89610	0.00085	0.89780	pa14094
800	0.89762	0.00081	0.89924	pa14096
900	0.89313	0.00082	0.89477	pa14098
1000	0.89000	0.00078	0.89156	pa14100
1100	0.88174	0.00076	0.88326	pa14102
1200	0.87580	0.00077	0.87734	pa14104
1300	0.86640	0.00076	0.86792	pa14106
1400	0.85840	0.00074	0.85988	pa14108
1500	0.84759	0.00072	0.84903	pa14110

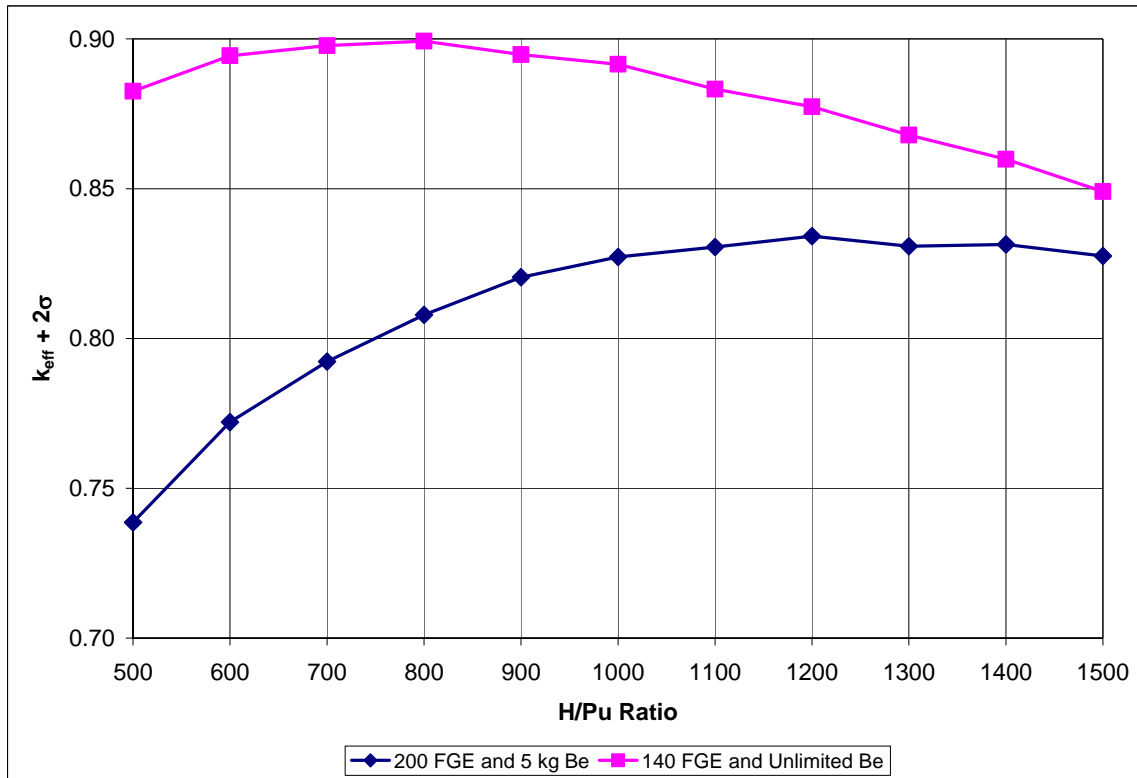

Figure D-, Reactivity of a Four-Tier Array of 12-inch Pipe Overpacks

D3.2 Pipe Overpack Array Overbatch Model

An overbatch scenario in the pipe overpacks was evaluated and the maximum loading per pipe was determined where the array reactivity remained below the USL of 0.96. As shown in Table D-7, MCNP5 calculations determined that pipe overpacks limited to 320 grams of ²³⁹Pu with a maximum of 5 kilograms of beryllium or 180 grams of ²³⁹Pu with no limits on beryllium remained below the USL of 0.96.

Table D-, Overbatched Pipe Overpack Array Results

H/Pu Ratio	k_{eff}	σ	$k_{eff} + 2\sigma$	Filename
320 FGE and 5 kg beryllium/Pipe Overpack				
500	0.88855	0.00090	0.89035	pa32010
600	0.91760	0.00089	0.91938	pa32012
700	0.93424	0.00085	0.93594	pa32014
800	0.94485	0.00083	0.94651	pa32016
900	0.95255	0.00087	0.95429	pa32018
1000	0.95636	0.00081	0.95798	pa32020
1100	0.95608	0.00079	0.95766	pa32022
1200	0.95572	0.00074	0.95720	pa32024
1300	0.95210	0.00071	0.95352	pa32026
1400	0.94570	0.00070	0.94710	pa32028
1500	0.93995	0.00071	0.94137	pa32030
180 FGE and Unlimited Beryllium/Pipe Overpack				
500	0.93967	0.00089	0.94145	pa18010
600	0.94914	0.00085	0.95084	pa18012
700	0.95095	0.00087	0.95269	pa18014
800	0.94950	0.00083	0.95116	pa18016
900	0.94543	0.00085	0.94713	pa18018
1000	0.93752	0.00078	0.93908	pa18020
1100	0.93061	0.00076	0.93213	pa18022

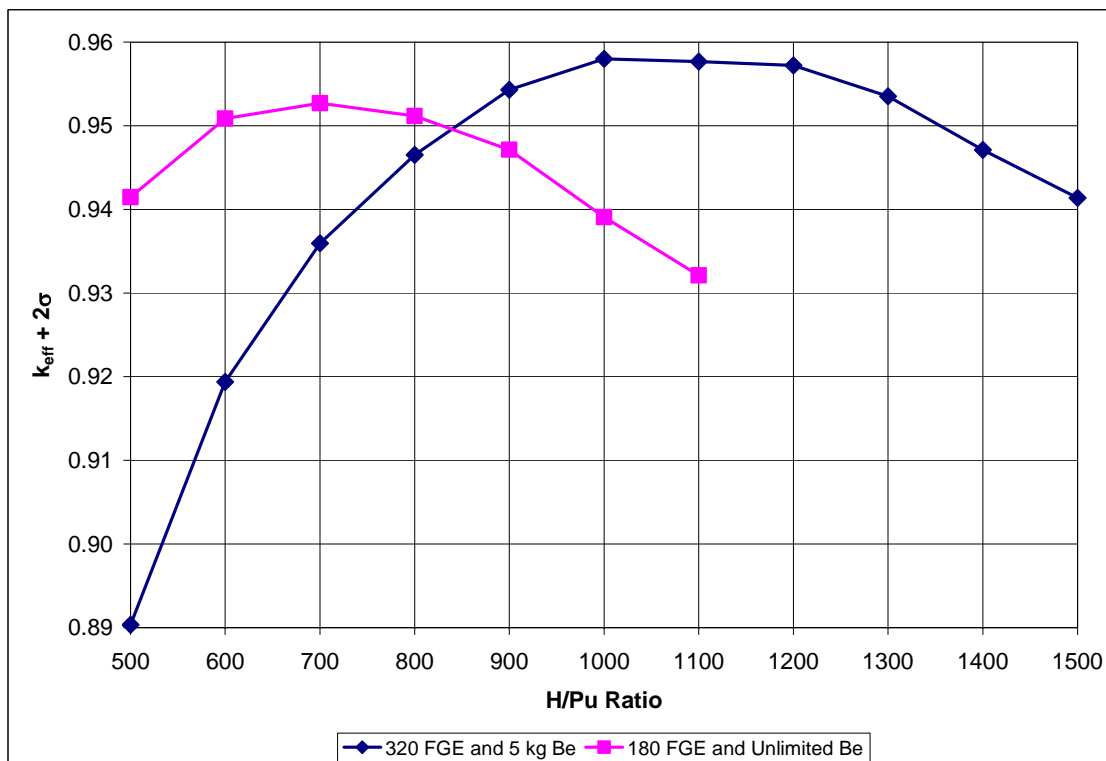

Figure D-, Pipe Overpack Array Reactivity

D4.0 Conclusions

This appendix demonstrates that pipe overpack drums will remain subcritical in the two-container configuration as well in the underground repository array with one of the following maximum limits:

- 200 FGE per pipe component and maximum 5 kilograms of beryllium per drum, or
- 140 FGE per pipe component with unlimited special reflector materials.

D5.0 References

ASTM C208-95(2001). *Standard Specification for Cellulosic Fiber Insulating Board*, American Society for Testing and Materials, West Conshohocken, PA.

DOE-CBFO, 2005a. *Contact-Handled Transuranic Waste Authorized Methods for Payload Control (CH-TRAMPAC)*, Revision 2, May 2005, U.S. Department of Energy, Carlsbad Field Office, Carlsbad, NM.

DOE-CBFO, 2005b. *TRUPACT-II Safety Analysis Report*, Revision 21, May 2005, U.S. Department of Energy, Carlsbad Field Office, Carlsbad, NM.

4	CZ	15.69974					\$
5	PZ	71.38841					\$
6	PZ	6.09041					\$
7	CZ	16.25600					\$
8	PZ	73.65441					\$
9	PZ	5.45541					\$
10	CZ	28.57500					\$
11	PZ	84.57641					\$
12	PZ	0.12141					\$
13	CZ	28.69641					\$
14	PZ	84.69782					\$
15	PZ	0.00000					\$
16	CZ	28.69641					\$
17	PZ	84.69782					\$
18	PZ	0.00000					\$
C							\$
C	SURFACE CARDS FOR THE UPPER 55 GALLON DRUM IN THE TWO-DRUM MODEL.						\$
C							\$
20	1	CZ	9.64468				\$
21	1	PZ	25.37976				\$
22	1	PZ	6.09041				\$
23	1	CZ	15.69974				\$
24	1	PZ	71.36841				\$
25	1	PZ	6.09041				\$
26	1	CZ	16.25600				\$
27	1	PZ	73.65441				\$
28	1	PZ	5.45541				\$
29	1	CZ	28.57500				\$
30	1	PZ	84.57641				\$
31	1	PZ	0.12141				\$
32	1	CZ	28.69641				\$
33	1	PZ	84.69782				\$
34	1	PZ	0.00000				\$
35	1	CZ	28.69641				\$
36	1	PZ	84.69782				\$
37	1	PZ	0.00000				\$
C							\$
C	SURFACE CARDS FOR A BOUNDARY AROUND THE TWO-DRUM MODEL.						\$
C							\$
100		CZ	28.69641				\$
101		PZ	169.39564				\$
102		PZ	0.00000				\$
C							\$
C	SURFACE CARDS FOR A HEXAPRISM LATTICE UNIT CONTAINING THE TWO DRUMS.						\$
C							\$
200		PX	28.69641				\$
201		PX	-28.69641				\$
202		P	1	1.73205	0	57.39282	\$
203		P	1	1.73205	0	-57.39282	\$
204		P	-1	1.73205	0	57.39282	\$
205		P	-1	1.73205	0	-57.39282	\$
206		PZ	169.39564				\$
207		PZ	0.00000				\$
C							\$
C	SURFACE CARDS FOR A 300 CM CONCRETE REFLECTOR AROUND THE TWO DRUMS						\$
C	WITH MIRROR BOUNDARY CONDITIONS ON ALL SIX SIDES, FLOOR AND CEILING.						\$
C							\$
*300		PX	328.69641				\$
*301		PX	-328.69641				\$
*302		P	1	1.73205	0	657.39282	\$
*303		P	1	1.73205	0	-657.39282	\$
*304		P	-1	1.73205	0	657.39282	\$
*305		P	-1	1.73205	0	-657.39282	\$
*306		PZ	469.39564				\$
*307		PZ	-300.00000				\$
C							\$
C	MODE CARD.						\$
C							\$
MODE N							\$
C							\$

```

C     THE 7-PACK STACK HAS A MGO LAYER ON TOP AND IS EMPLACED IN A HEXAPRISM   $
C     LATTICE WITH THE UPPER AND LOWER VERTICAL PLANES ARE REFLECTED BY 300 CM  $
C     OF SALT. THE LATERAL BOUNDARIES ARE MIRRORED TO SIMULATE A LATTICE OF    $
C     INFINITE EXTENT.                                                         $
C                                                                                   $
C     CCCCCCCCCCCCCCCCCCCCCCCCCCCCCCCCCCCCCCCCCCCCCCCCCCCCCCCCCCCCCCCCCCCCCC $
C     CELL CARDS FOR THE 55 GALLON DRUM WITH 12-INCH PIPE OVERPACK.           $
C                                                                                   $
C     1     1     -1.00573     -1     -2     3                                     U=1  IMP:N=1  $
C     2     2     -1.85000     -4     -5     6     (1:2:-3)                       U=1  IMP:N=1  $
C     3     0                                     -7     -8     9     (4:5:-6)         U=1  IMP:N=1  $
C     4     4     -8.02000     -10    -11    12    #1 #2 #3                       U=1  IMP:N=1  $
C     5     5     -0.10000     -13    -14    15    (10:11:-12)                   U=1  IMP:N=1  $
C     6     6     -3.93000     -16    -17    18    (13:14:-15)                   U=1  IMP:N=1  $
C     7     0                                     -19    -20    21    #1 #2 #3 #4 #5 #6   U=1  IMP:N=1  $
C     8     0                                     (19:20:-21)                   U=1  IMP:N=1  $
C                                                                                   $
C     CELL CARDS FOR THE HEXAGONAL 7-PACK STACK.                             $
C                                                                                   $
C     10    0                                     -31 30 -32 35 -33 34 -37 36 LAT=2 U=2  IMP:N=1  $
C           FILL=-3:3 -3:3 0:2                                               $
C           2 16R                                                            $
C             1 1     2 2 2 2                                                $
C             1 1 1   2 2 2 2                                                $
C             1 1     2 16R                                                  $
C           2 16R                                                            $
C             1 1     2 2 2 2                                                $
C             1 1 1   2 2 2 2                                                $
C             1 1     2 16R                                                  $
C           2 16R                                                            $
C             1 1     2 2 2 2                                                $
C             1 1 1   2 2 2 2                                                $
C             1 1     2 16R                                                  $
C     11    0                                     -61 60 -62 65 -63 64 -67 66 FILL=2  IMP:N=1  $
C                                                                                   $
C     CELL CARDS FOR THE MGO AND SALT LAYERS.                                  $
C                                                                                   $
C     12    8     -2.165     (53:-66) -61 60 -62 65 -63 64 50 -52             IMP:N=1  $
C     13    7     -1.45     -61 60 -62 65 -63 64 67 -53                       IMP:N=1  $
C                                                                                   $
C     CELL CARDS FOR THE REST OF THE UNIVERSE.                                $
C                                                                                   $
C     14    0                                     -50:52:61:-60:62:-65:63:-64       IMP:N=0  $
C                                                                                   $
C     SURFACE CARDS FOR THE 55 GALLON DRUM WITH 12-INCH PIPE OVERPACK.       $
C                                                                                   $
C     1     CZ     12.25072                                                    $
C     2     PZ     50.98016                                                    $
C     3     PZ     26.47873                                                    $
C     4     CZ     12.25072                                                    $
C     5     PZ     53.84629                                                    $
C     6     PZ     23.61260                                                    $
C     7     CZ     15.69974                                                    $
C     8     PZ     71.38841                                                    $
C     9     PZ     6.09041                                                      $
C     10    CZ     16.25600                                                    $
C     11    PZ     73.65441                                                    $
C     12    PZ     5.45541                                                      $
C     13    CZ     28.57500                                                    $
C     14    PZ     84.57641                                                    $
C     15    PZ     0.12141                                                      $
C     16    CZ     28.69641                                                    $
C     17    PZ     84.69782                                                    $
C     18    PZ     0.00000                                                      $
C     19    CZ     28.69641                                                    $
C     20    PZ     84.69782                                                    $
C     21    PZ     0.00000                                                      $
C                                                                                   $
C     SURFACE CARDS FOR THE HEXAGONAL 7-PACK.                                $
    
```

M7	12000.60C	0.5	\$
	8016.60C	0.5	\$
C			\$
C	SALT REFLECTOR.		\$
C			\$
M8	11023.60C	0.5	\$
	17000.60C	0.5	\$
C			\$
C	SOURCE CARDS.		\$
C			\$
KCODE	1000 1.0 50 1000		\$
KSRC	-58 0 43 -30 -50 43		\$
	-58 0 128 -30 -50 128		\$
	-58 0 213 -30 -50 213		\$
PRINT			\$
C			\$
C	PRINT TO MCTAL FILE		\$
C			\$
PRDMP	2j 1		\$

This page intentionally left blank.

Appendix E

Two-Container Combinations

This page intentionally left blank.

Analyst		
Senior NCS Engineer	<hr/> G. W. Neeley	Date
Peer Reviewer		
Senior NCS Engineer	<hr/> S. L. Larson	Date

This page intentionally left blank.

Introduction

The two-container model described in the Appendices A, B, C, and D is further evaluated in this appendix. Previously, both containers in the two-container stack were of the same type. This appendix evaluates two different containers or loadings in the two-container stack to determine if a more reactive configuration can occur. The pipe overpack configurations are not considered because the results for the two-container model are higher than those for the array model as discussed in and because the overpack configuration keeps the fissile material centered in the drum. The details of the modeled containers are given in the previous appendices and not fully repeated here. These calculations were originally performed to a USL of 0.97. Subsequently, the USL was further reduced by an administrative margin of 0.01, resulting in a USL of 0.96. The models containing two containers of the same type were re-evaluated to meet the lower USL. Because the objective of these calculations is only to verify that a combination of two different types of containers is less reactive than a model with two of the same container type, these calculations were not revised.

E1.0 Fully Compacted 100-gallon Drum/ Non-Compacted 55-gallon Drum Combination

The first sequence of the two-drum calculations showed a 55-gallon drum containing non-compacted CH waste with 1 weight percent (wt%) beryllium from is stacked on a 100-gallon drum containing fully compacted waste from . Furthermore, two models were employed for the fully compacted 100-gallon drums: a 170-FGE mass without design vertical spacing between drums, and the more representative design, which accounts for design spacing and contains 200 FGE.

A series of parametric computations were performed to ascertain the most reactive H/Pu ratio for the 100-gallon/55-gallon drum combination. A limited range calculation was performed by fixing the H/Pu concentration of the ²³⁹Pu/polyethylene-water waste mixture in the 55-gallon drum and varying the fissile mixture H/Pu ratio in the 100-gallon drum to find the peak value. The H/Pu concentration in the 55-gallon drum was then changed and the calculation repeated until a reactivity map was generated over a limited range. The most reactive state was then selected for the 55-gallon drum and the full spectrum run on the H/Pu range for the 100-gallon drum. The results of the parametric study indicated that the optimal H/Pu ratio for the 55-gallon drum in the two-drum system ranged between 800 and 850. The results of the 2-drum computations are summarized in Table E-1, Figure E-1 and Figure E-2.

Table E-, MCNP Results for 100-gallon Drum (Fully Compacted)/55-gallon Drum (Particulate Beryllium) Combination

Optimum H/Pu Ratio		Reflector	k_{eff}	σ	$k_{eff} + 2\sigma$	Filename
100-gal Drum	55-gal Drum					
100-gal Drum Modeled without Design Separation containing 170 g ^{239}Pu						
900	800	Concrete	0.94928	0.00083	0.95094	tdmp118
900	800	Salt	0.94986	0.00083	0.95152	tdmp718
950	800	MgO	0.94956	0.00086	0.95128	tdp1319
100-gal Drum Modeled with Design Separation containing 200 g ^{239}Pu						
900	800	Concrete	0.93586	0.00081	0.93748	tdmp158
800	800	Salt	0.93505	0.00085	0.93675	tdmp756
900	800	MgO	0.93638	0.00083	0.93804	tdp1358

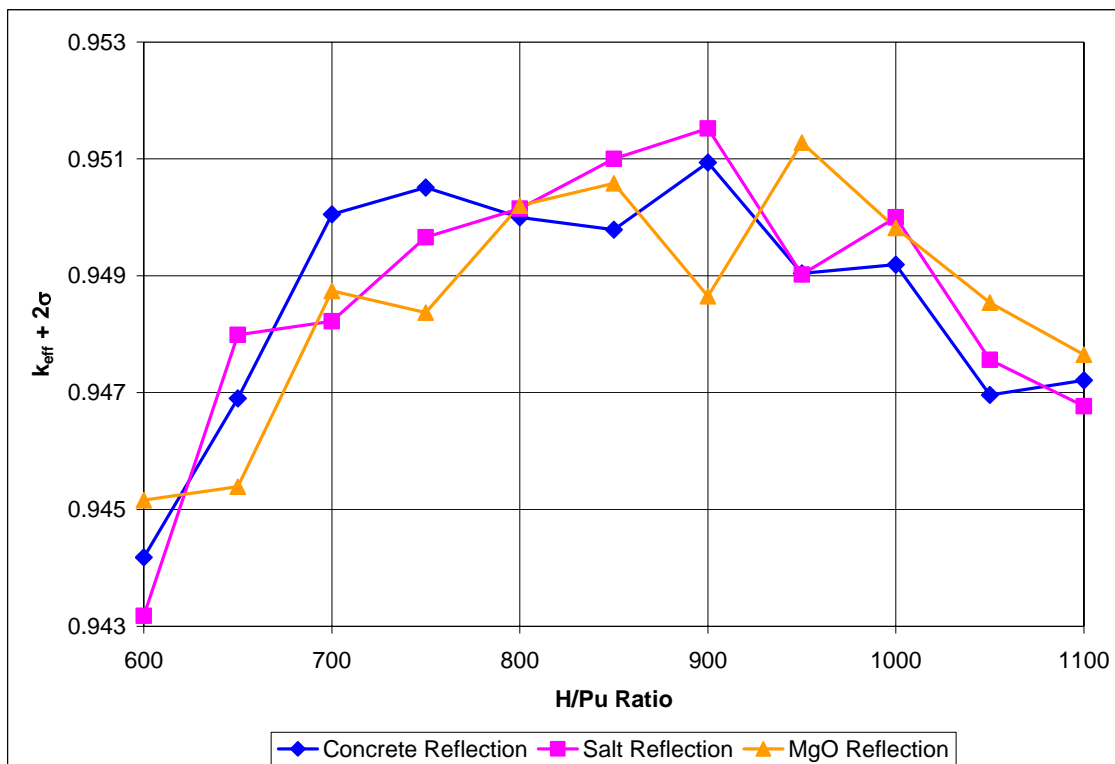

Figure E-, 100-gallon (Fully Compacted)/55-gallon (Particulate Beryllium) Drum Combination without Design Separation

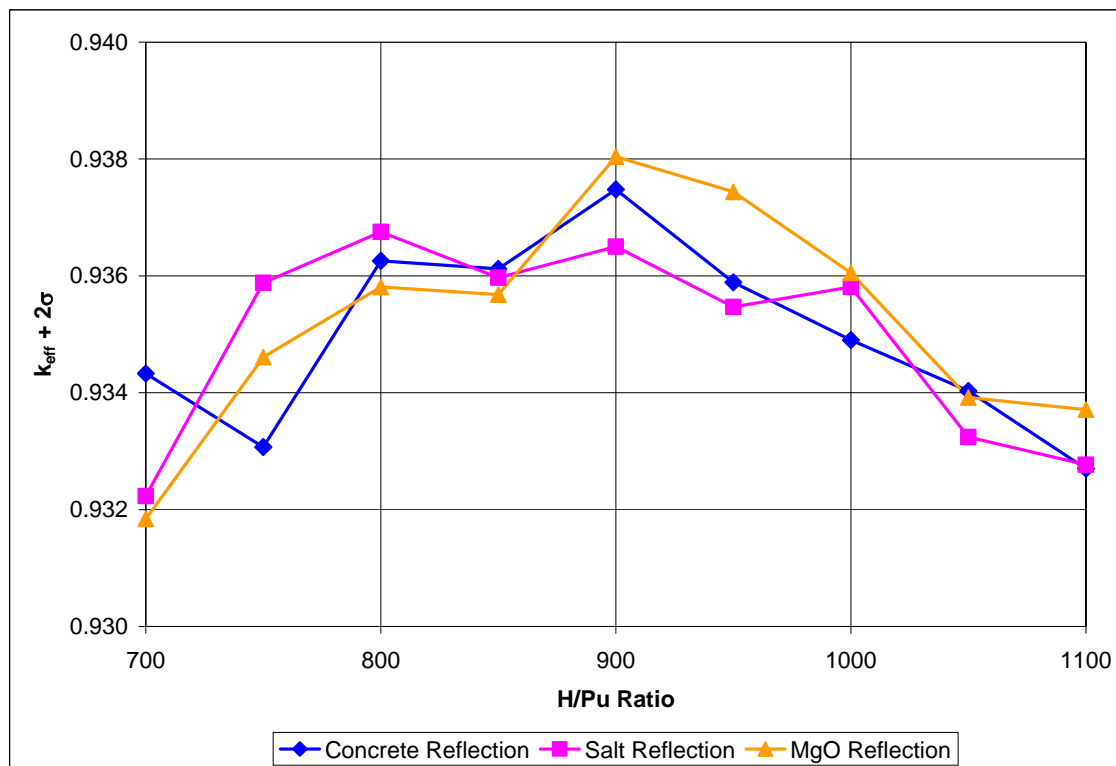

Figure E-, 100-gallon (Fully Compacted)/55-gallon (Particulate Beryllium) Drum Combination with Design Separation

E2.0 Fully Compacted 100-gallon Drum/55-gallon Drum with High Beryllium Combination

In the next two-drum combination, a 55-gallon drum containing non-compacted CH waste with 100 kilograms of beryllium from is stacked on a 100-gallon drum containing fully compacted waste from . No vertical design spacing is modeled in the 55-gallon drum in either configuration. The 55-gallon drum model assumes that 100 kilograms of beryllium surrounds the fissile mass at a bulk density of 70% of theoretical density. The beryllium reflector is backed by 70% dense polyethylene, which fills the remaining volume of the container. This density bounds all non-compacted waste streams since the maximum theoretical density for randomly packed uniform spheres (“Is random packing of spheres well defined?” [Torquato et al. 2007] and “Recursive packing of dense particle mixtures” [Elliot et al. 2002]) is 70%. Furthermore, the assumption that the beryllium will not form a consistent compact reflector around the fissile mass, as modeled in . Such a form would effectively have to be constructed and packaged intentionally to become a tight reflector shell around the optimally moderated fuel volume.

A limited range parametric computation was performed to determine the optimal H/Pu ratio for the 55-gallon drum in the two-drum system. The fissile mixture in the 55-gallon drum is maintained in its most reactive state (in this case, an H/Pu ratio of approximately 800), while the composition in the 100-gallon drum was varied over a full range of H/Pu ratios to ensure that the

most reactive combination state is achieved. Table E-2, Figure E-3, and Figure E-4 summarize the results of the calculation. The results of the calculation indicate that depending on the 100-gallon model employed, either the 170 grams or the 200 grams of ²³⁹Pu mass limit on the fully compacted drum ensures that the eigenvalue of the two-drum system remains at or below the USL.

**Table E-, 100-gallon Drum (Fully Compacted)/55-gallon Drum
 (100 kg Beryllium) Combination**

Optimum H/Pu Ratio		Reflector	k _{eff}	σ	k _{eff} + 2σ	Filename
100-gal Drum	55-gal Drum					
100-gal Drum Modeled without Design Separation containing 170 g ²³⁹Pu						
950	800	Concrete	0.94099	0.00082	0.94263	tdmp419
900	800	Salt	0.93880	0.00086	0.94052	tdp1018
900	800	MgO	0.94018	0.00084	0.94186	tdp1618
100-gal Drum Modeled with Design Separation containing 200 g ²³⁹Pu						
850	800	Concrete	0.93174	0.00083	0.93340	tdmp457
900	800	Salt	0.92848	0.00082	0.93012	tdp1058
950	800	MgO	0.92999	0.00081	0.93161	tdp1659

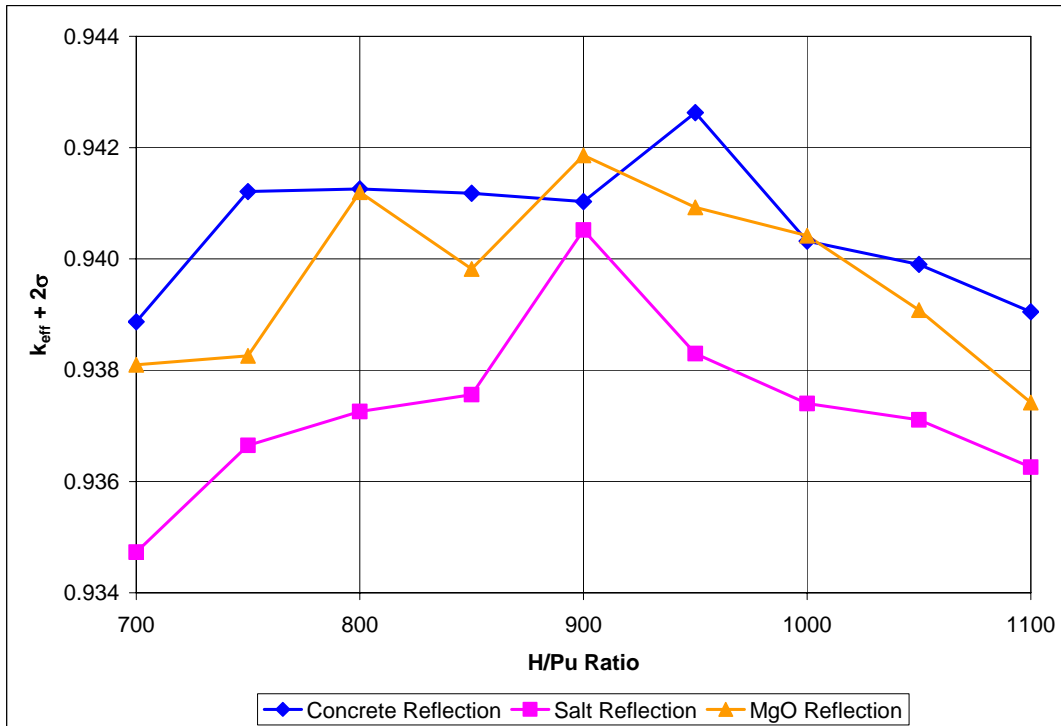

Figure E-, 100-gallon (Fully Compacted)/55-gallon (100 kg Beryllium) Drum Combination without Design Spacing

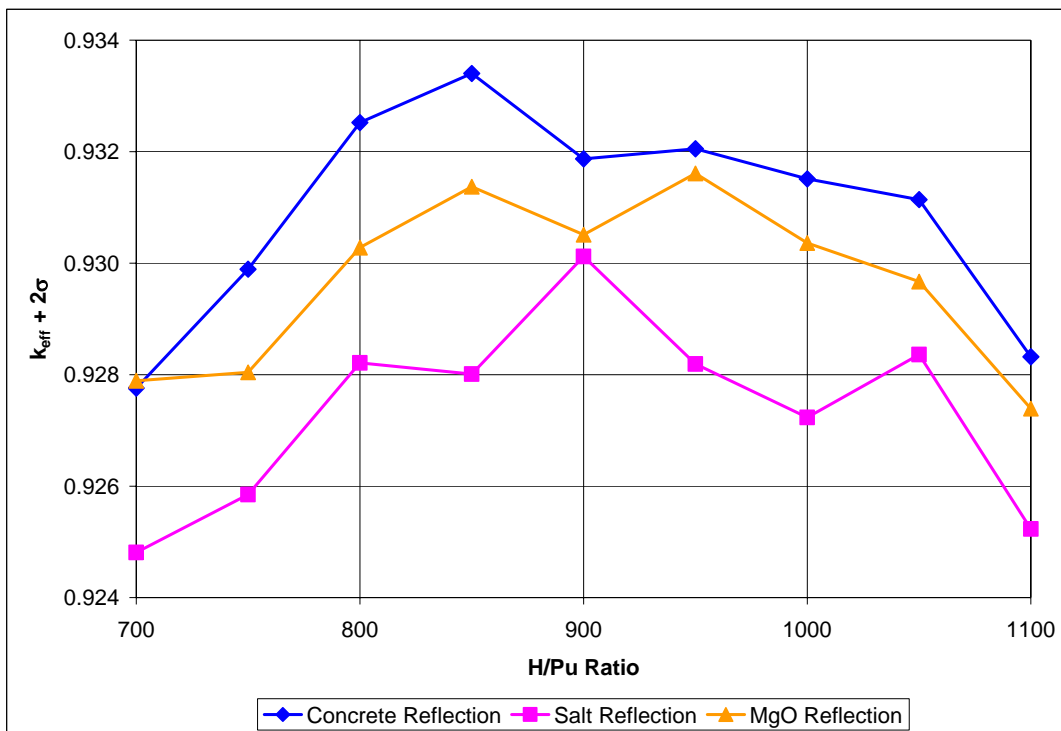

Figure E-, 100-gallon (Fully Compacted)/55-gallon (100 kg Beryllium) Drum Combination with Design Spacing

E3.0 Direct-Loaded Machine-Compacted SWB/ Non-Compacted 55-gallon Drum Combination

In the next sequence of two-container calculations, a 55-gallon drum containing non-compacted CH waste from is stacked on an SWB direct loaded with fully compacted waste from .

Calculations were performed fixing the H/Pu concentration of the ²³⁹Pu-polyethylene-water waste mixture in the 55-gallon drum at the most reactive state as shown in Table E-1 and varying the H/Pu range for the direct-loaded SWB containing fully compacted waste. The results of the two-container computations are summarized in Table E-3 and Figure E-5, indicating that the 200 grams of ²³⁹Pu mass limit on the 55-gallon drum with particulate beryllium ensures the two-container system remains at or below the USL.

**Table E-, SWB (Direct Loaded Fully Compacted)/55-gallon Drum
 (Particulate Beryllium) Combination**

Optimum H/Pu Ratio		Reflector	k _{eff}	σ	k _{eff} + 2σ	Filename
SWB	55-gal Drum					
900	800	Concrete	0.95127	0.00096	0.95319	cs95580
800	800	Salt	0.95189	0.00095	0.95379	ss85580
800	800	MgO	0.95176	0.00092	0.95360	ms85580

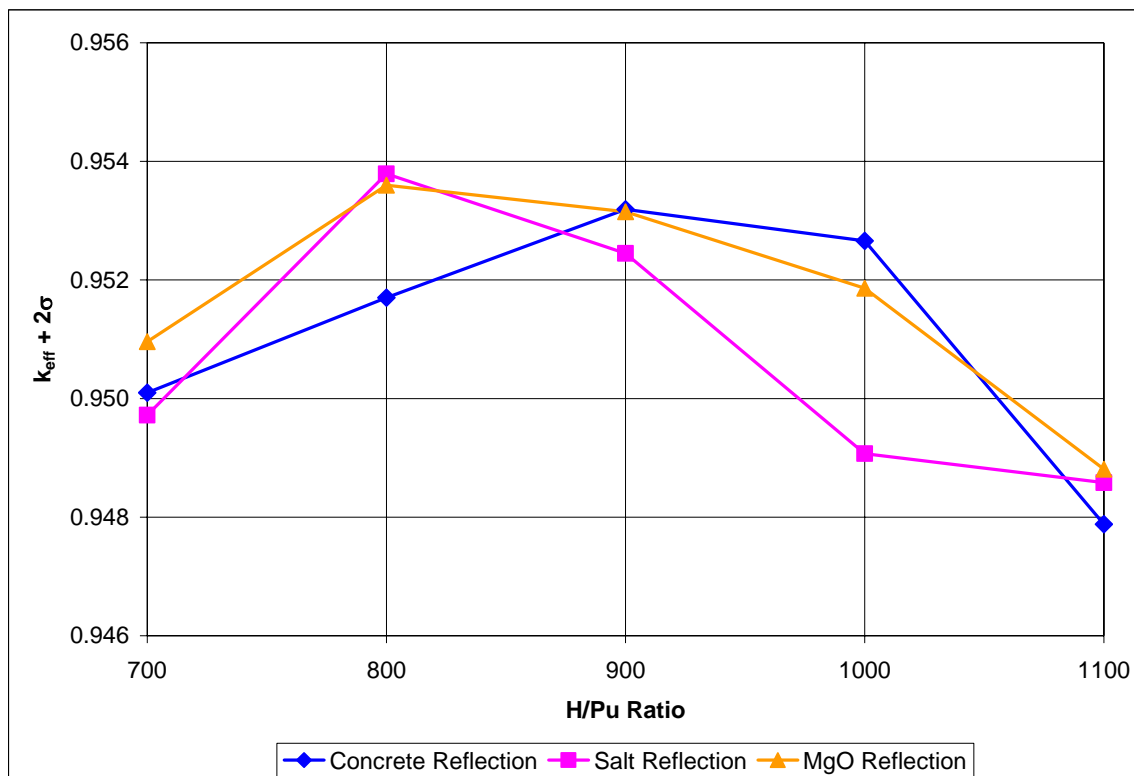

Figure E-, SWB (Direct Loaded Fully Compacted)/55-gallon (Particulate Beryllium) Drum Combination

E4.0 Direct-Loaded Machine-Compacted SWB/55-gallon Drum with High beryllium Combination

The next two-container combination (the 55-gallon drum containing a 100 grams of ^{239}Pu fissile mass reflected by 100 kilograms of beryllium, as described in Section), is stacked on top of an SWB that has been direct loaded with fully compacted waste as described in .

The computation was performed consistently with the previous section. Calculations were performed fixing the H/Pu concentration of the ^{239}Pu -polyethylene-water waste mixture in the 55-gallon drum at 800 and varying the H/Pu range for the fully compacted SWB. The results of the two-container computations are summarized in Table E- and Figure E-. The eigenvalue of the two-container system remains below the USL of 0.96, which includes allowance for administrative margin.

**Table E-, SWB (Direct Loaded Fully Compacted)/55-gallon Drum
 (100 kg Beryllium) Combination**

Optimum H/Pu Ratio		Reflector	k_{eff}	σ	$k_{eff} + 2\sigma$	Filename
SWB	55-gal Drum					
900	800	Concrete	0.94483	0.00092	0.94667	cs9f580
800	800	Salt	0.94200	0.00098	0.94396	ss8f580
800	800	MgO	0.94425	0.00096	0.94617	ms8f580

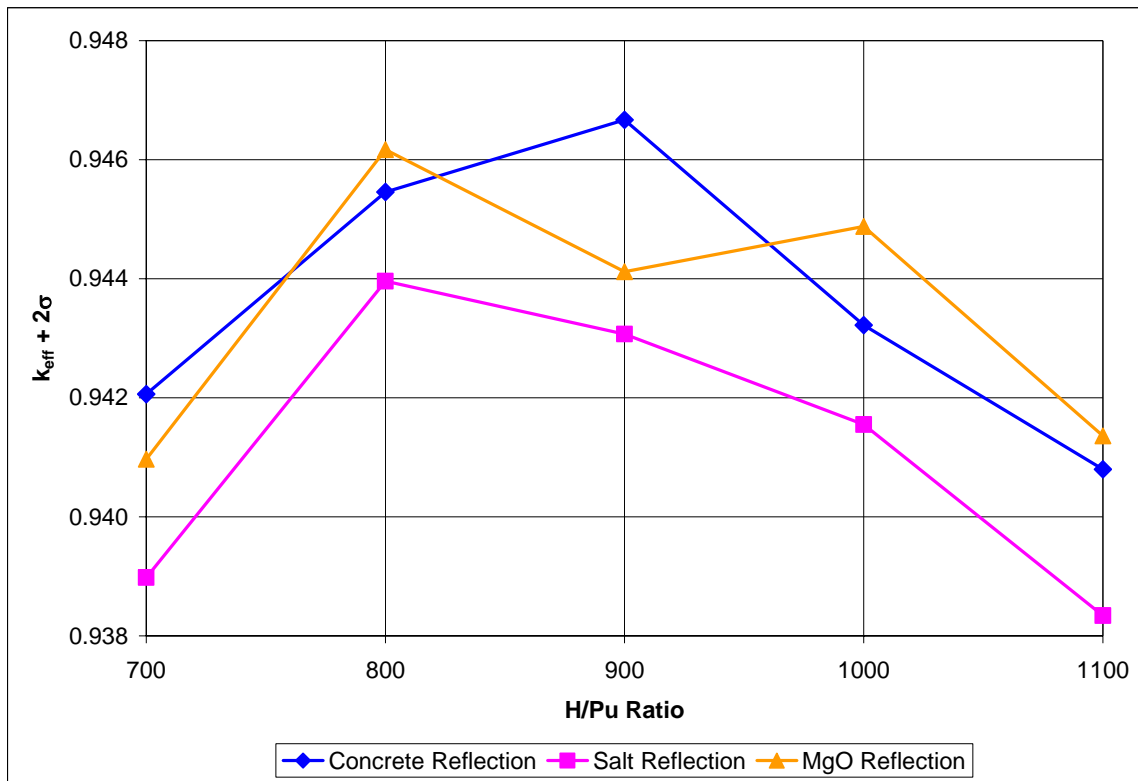

**Figure E-, SWB (Direct Loaded Fully Compacted)/55-gallon
 (100 kg beryllium) Drum Combination**

E5.0 Non-Compacted Direct-Loaded SWB/100-gallon Drum Combination

In this sequence of two-container calculations, a 100-gallon drum of fully compacted waste from is stacked on top of a direct-loaded SWB containing non-compacted waste as described in . The concrete, magnesium oxide (MgO), or salt reflection is conservatively placed as close as possible to each container, even though the reflector would most likely be outside the larger footprint of the SWB.

Calculations in Section A3.2 found that the optimum H/Pu ratio in the non-compacted SWB is 900 to 1,000, thus a value of 950 was used here. (This value was also verified to be the optimum value for this configuration.) The results of the SWB/100-gallon drum calculations are summarized in Table E-5, Figure E-7, and Figure E-8. All results are below the USL of 0.97 and the results are also below the 0.96 USL with allowance for administrative margin when the design separation inherent in the 100-gallon drum is modeled.

Table E-, Direct-loaded Non-compacted SWB/100-gallon Drum (Fully Compacted)

Optimum H/Pu Ratio		Reflector	k_{eff}	σ	$k_{eff} + 2\sigma$	Filename
Bottom SWB	100-gal Drum					
100-gal Drum Modeled without Design Separation containing 170 g ²³⁹Pu						
950	950	Concrete	0.96552	0.00081	0.96714	tdms819
950	750	Salt	0.96443	0.00087	0.96617	tds1715
950	850	MgO	0.96516	0.00086	0.96688	tds2617
100-gal Drum Modeled with Design Separation containing 200 g ²³⁹Pu						
950	900	Concrete	0.95216	0.00086	0.95388	tdms858
950	850	Salt	0.95138	0.00085	0.95308	tds1757
950	800	MgO	0.95085	0.00084	0.95253	tds2656

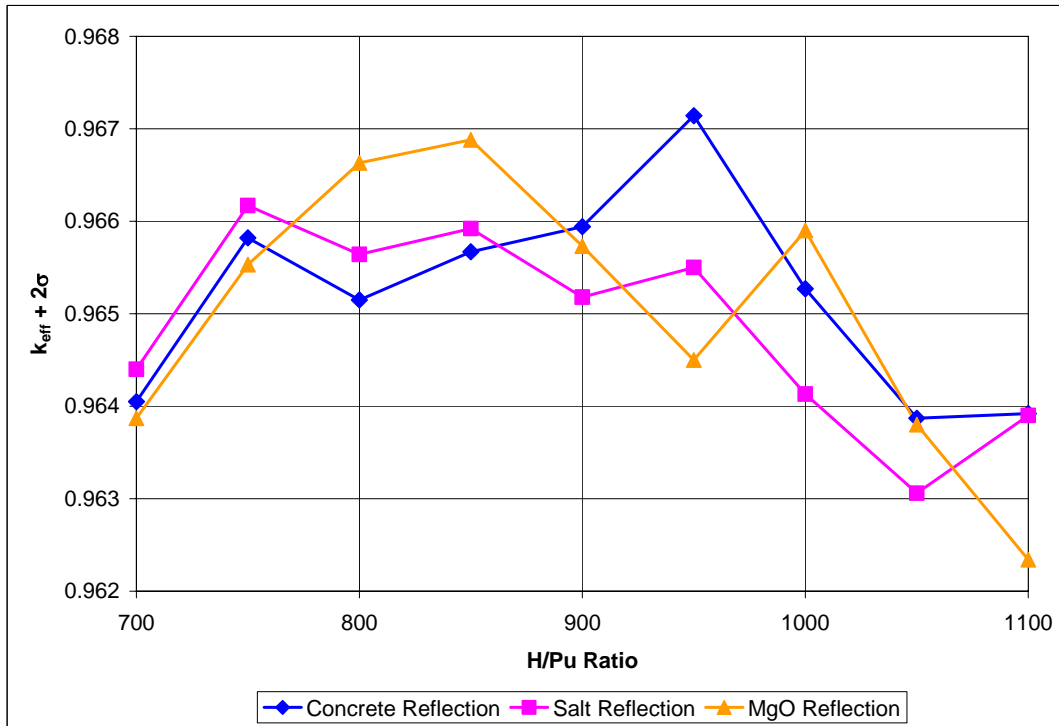

Figure E-, Direct-loaded Non-compacted SWB/100-gallon (Full Compaction) Drum without Design Separation

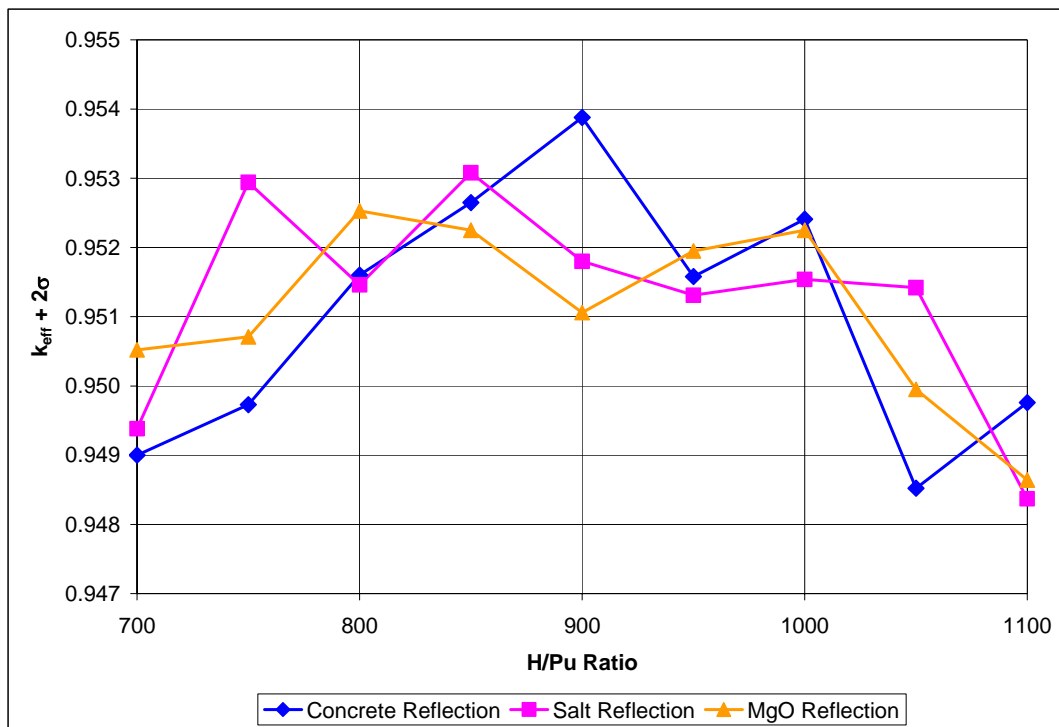

Figure E-, Direct-Loaded Non-compacted SWB/100-gallon (Full Compaction) Drum with Design Separation

E6.0 Direct-Loaded SWB with Compacted Waste/ 100-gallon Drum Combination

Both containers in this combination contain fully compacted waste as described in , where a 100-gallon drum is stacked on a direct-loaded SWB. Again, two models are considered for the 100-gallon drum containing the fully compacted waste: with and without design spacing.

Calculations were performed fixing the H/Pu ratio of the FGE waste mixture in the 100-gallon drum at the most reactive state (800 per Table C-8 for 170 FGE and 900 per Table C-9 for 200 FGE) and varying the H/Pu range for the fully compacted SWB. The results of the compacted SWB/100-gallon drum calculations are summarized in Table E-6, Figure E-9, and Figure E-10. All results are below the original USL of 0.97.

Table E-, Direct-Loaded SWB/100-gallon Drum (Both Fully Compacted)

Optimum H/Pu Ratio		Reflector	k_{eff}	σ	$k_{eff} + 2\sigma$	Filename
Bottom SWB	100-gal Drum					
100-gal Drum Modeled without Design Separation containing 170 g ²³⁹Pu						
800	800	Concrete	0.96719	0.00096	0.96911	cs818
900	800	Salt	0.96697	0.00093	0.96883	ss918
900	800	MgO	0.96748	0.00094	0.96936	ms918
100-gal Drum Modeled with Design Separation containing 200 g ²³⁹Pu						
800	900	Concrete	0.95223	0.00096	0.95415	cs8v19
800	900	Salt	0.95139	0.0009	0.95319	ss8v19
800	900	MgO	0.95188	0.0009	0.95368	ms8v19

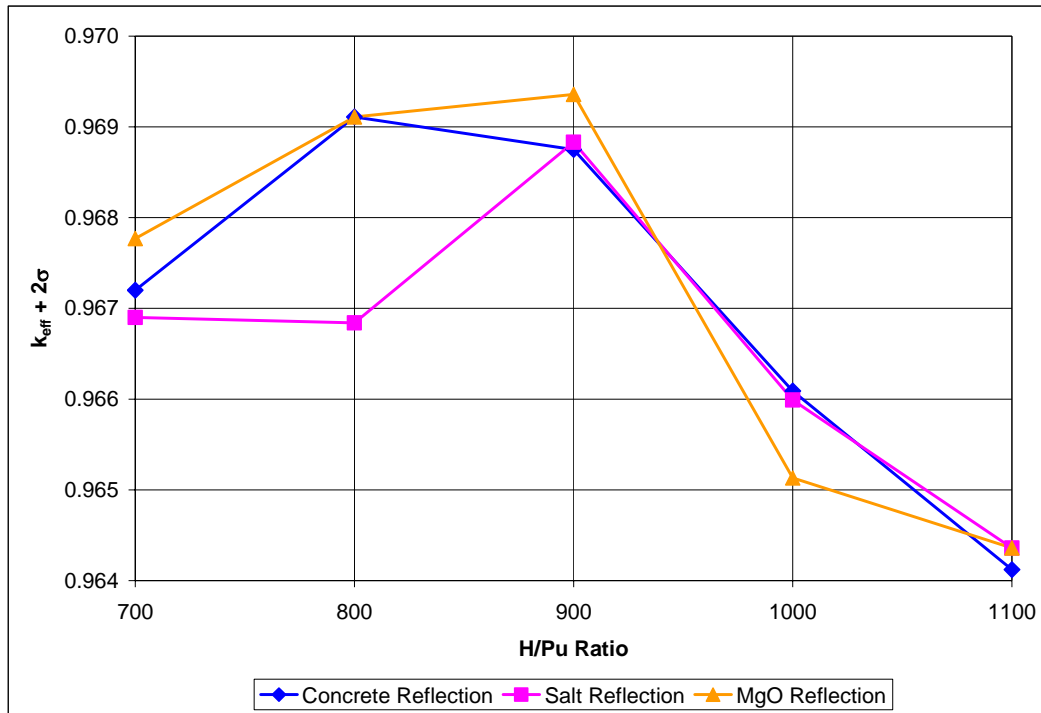

Figure E-, SWB (Direct Loaded Full Compaction) /100-gallon (Full Compaction) Drum without Design Separation

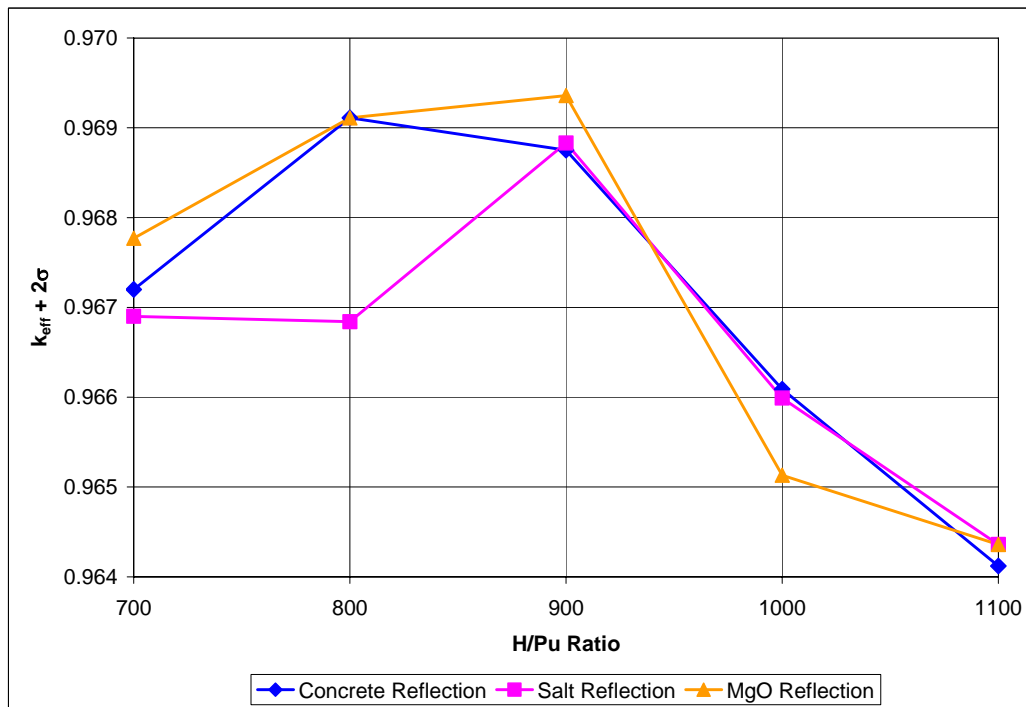

Figure E-, SWB (Direct Laded Full Compaction) /100-gallon (Full Compaction) Drum with Design Separation

E7.0 Conclusions

The maximum reactivity from the various two-container models analyzed is summarized in Table E-7. In studying the results, the models with two different container loadings and/or container types are always less reactive than the more reactive configuration of two of the same container type. As expected, placing two different containers together results in an effective “averaging” of the reactivity of the two containers, and has a lower reactivity than the model with the most reactive containers. Note that the calculations performed for 55- and 100-gallon drums of compacted waste bound the 85-gallon drum. Also, the SWB cases bound the TDOP containers as they have the same footprint but are two tiers high with the same limits as an SWB. The results summary also shows that concrete, MgO, and salt are very comparable as infinite reflectors as each was the reflector resulting in the maximum reactivity in multiple cases. In fact, the results with the various reflectors are often within the statistical uncertainty of the code.

Subsequent to the performance of these calculations, the USL was reduced by an administrative margin of 0.01 resulting in a USL of 0.96. The models containing two containers of the same type were re-evaluated to meet the lower USL as discussed in the previous appendices. Because the objective of these calculations is only to verify that a combination of two different types of containers is less reactive than a model with two of the same container type, these calculations were not revised.

Table E-, Summary of Two-Container Results

Section	Top Container	Bottom Container	Reflector of Max Reactivity	Maximum $k_{eff} + 2\sigma$
	100-gal Drum w/o Design Spacing	100-gal Drum w/o Design Spacing	Salt/ Concrete	0.96642
	Partially Compacted 100-gal Drum	Partially Compacted 100-gal Drum	Salt	0.96551
	55-gal Drum with Particulate beryllium	100-gal Drum w/o Design Spacing	Salt	0.95152
	55-gal Drum with Full Density beryllium	100-gal Drum w/o Design Spacing	Concrete	0.94263
	100-gal Drum w/o Design Spacing	Non-compacted SWB	Concrete	0.96714*
	100-gal Drum w/o Design Spacing	Fully Compacted Direct-Loaded SWB	MgO	0.96936
	100-gal Drum with Design Spacing	100-gal Drum with Design Spacing	Concrete	0.93683
	55-gal Drum with Particulate beryllium	100-gal Drum with Design Spacing	MgO	0.93804
	55-gal Drum with Full Density beryllium	100-gal Drum with Design Spacing	Concrete	0.93340

Table E-7, Summary of Two-Container Results (continued)

Section	Top Container	Bottom Container	Reflector of Max Reactivity	Maximum $k_{\text{eff}} + 2\sigma$
	100-gal Drum with Design Spacing	Non-compacted SWB	Concrete	0.95388 ^(a)
	100-gal Drum with Design Spacing	Fully Compacted Direct-Loaded SWB	Concrete	0.95415
	Fully Compacted Direct-Loaded SWB	Fully Compacted Direct-Loaded SWB	All	0.96943
	100-gal Drum Overpacked in SWB	100-gal Drum Overpacked in SWB	All	0.96691
	55-gal Drum with Particulate beryllium	Fully Compacted Direct-Loaded SWB	Salt	0.95379
	55-gal Drum with Full Density beryllium	Fully Compacted Direct-Loaded SWB	Concrete	0.94667
	55-gal Drum Full Compaction w/o Design Spacing	55-gal Drum Full Compaction w/o Design Spacing	Concrete	0.96995 ^(b)
	55-gal Drum Partial Compaction w/o Design Spacing	55-gal Drum Partial Compaction w/o Design Spacing	Salt	0.96998 ^(b)
	55-gal Drum Full Compaction with Design Spacing	55-gal Drum Full Compaction with Design Spacing	Concrete	0.96583
	55-gal Drum with Particulate beryllium	55-gal Drum with Particulate beryllium	MgO	0.88622
	Non-compacted SWB	Non-compacted SWB	MgO	0.96976 ^(b)
	55-gal Drum with 70% Dense beryllium	55-gal Drum with 70% Dense beryllium	Concrete	0.927072

(a) Per , a model of two non-compacted SWBs stacked on top of one another using the same parameters used here exceeded the 0.97 USL (a 60% dense steel wall was modeled to bring the result below the USL.) The cases modeled here use 50% dense wall on the non-compacted SWB.

(b) These cases model the container steel wall as 60% dense.

E8.0 References

Elliot J.A., A. Kelly, and A.H. Windle, 2002. "Recursive packing of dense particle mixtures," J. Mat. Sci. Lett. **21**:1249-1251; 2002.

Torquato, S., T.M. Truskett, and P.G. Debenedetti, 2007. "Is random packing of spheres well defined?" Phys. Rev. Lett. **84**:2064-2067; 2000.

Appendix F

Hazard Evaluation Tables

This page intentionally left blank.

Analyst		
NCS Engineer	S. L. Larson	Date
Peer Reviewer		
Senior NCS Engineer	S. M. Painter	Date

This page intentionally left blank.

Introduction

The following hazard evaluation tables include potential causes for loss of controlled parameters described in Section of this NCSE. The contingent events flow from the hazard evaluation tables and the associated upset condition are evaluated in Section .

This page intentionally left blank.

Table F-, Waste Handling Building Hazard Evaluation by Control Parameter

Waste Handling Building	Loaded shipping cask is stored in Parking Area on over the road transportation trailer. Loaded shipping cask is moved into the CH bay. Shipping cask is opened and unloaded onto facility pallets using an overhead crane. Facility pallet is transferred to the waste hoist via forklift and onto the conveyance loading car.			
Parameter	Causes	Consequences/Analysis Limits	Barriers/Factors Contributing to Unlikely Failure	Notes
Mass	Generator site error results in excess mass	Fissile mass and beryllium are overbatched beyond the WAC requirements in the contingency analysis. Normal condition and contingency analysis models an optimized fissile mass in terms of moderation and geometry, which is very conservative compared to expected waste configuration. Use of expected configuration would result in higher subcritical mass.	Fissile mass limits established for transportation in HALFPACT, TRUPACT-II or – III shipping casks. Fissile mass and beryllium limits established for CH waste containers in WIPP WAC.	Measurements to satisfy the fissile mass limits must include 2 times the measurement uncertainty.
Geometry	Collision, fires, collision followed by fire, dropped facility pallet causes change in geometry	While geometry could be modified from a fire or other breach of a waste container (such as crane failure), a limited number of containers are handled at one time. Contingency analysis evaluates the bounding condition of the 41 ton RH waste forklift impacting the CH waste face and reducing the crushing the containers.	Waste container design, shipping cask in the CH bay and outside area, crane design, fire suppression system in CH bay, limited material in CH bay available to burn, vehicle control program to prevent non waste handling vehicles in the CH bay during waste handling.	Fissile material conservatively modeled as right cylinders either centralized to the container in the array cases or conservatively placed in two stacked containers such that the fissile material from the two containers is separated only by the metal container and any spacing provided by the outer container. The SLB2 contingency model is the exception where the fissile mass is modeled in a prism in the corner of the box, which is noted as the most reactive credible configuration per the criticality analysis in the TRUPACT-III SAR.

Table F-, Waste Handling Building Hazard Evaluation by Control Parameter

Waste Handling Building	Loaded shipping cask is stored in Parking Area on over the road transportation trailer. Loaded shipping cask is moved into the CH bay. Shipping cask is opened and unloaded onto facility pallets using an overhead crane. Facility pallet is transferred to the waste hoist via forklift and onto the conveyance loading car.			
Parameter	Causes	Consequences/Analysis Limits	Barriers/Factors Contributing to Unlikely Failure	Notes
Moderation	Excess moderation provided by plastic, graphite, beryllium, or water	Analysis modeled fissile mass in compact geometry at optimum moderation level by polyethylene/water mixture with no liquid restriction. beryllium moderation shown to decrease reactivity. Polyethylene density up to 100 volume % assumed in analysis depending on compaction state.	WIPP WAC imposes fissile and beryllium mass limits. WIPP WAC restricts residual liquid content of waste to less than 1% by volume.	The compaction density of polyethylene is typically not controlled such that compacted waste typically meets the lower fissile limits based on 100% compaction.
Interaction	Waste container compaction resulting from collision in the parking area or CH bay of the WHB	Infinite array of containers is modeled and shown to be subcritical such that spacing between containers is not required for criticality safety.	Waste container design and container handling protocol.	None
		Impact of the 41-ton forklift used for moving RH waste in a shielded cask with a CH waste array was evaluated as the bounding contingency event for loss of interaction control.	Vehicle control program to prevent non waste handling vehicles in the CH bay during waste handling.	None
	Overstacking of containers	Four-tier-high array shown to be subcritical.	Containers stacked two tiers high.	None

Table F-, Waste Handling Building Hazard Evaluation by Control Parameter

Waste Handling Building	Loaded shipping cask is stored in Parking Area on over the road transportation trailer. Loaded shipping cask is moved into the CH bay. Shipping cask is opened and unloaded onto facility pallets using an overhead crane. Facility pallet is transferred to the waste hoist via forklift and onto the conveyance loading car.			
Parameter	Causes	Consequences/Analysis Limits	Barriers/Factors Contributing to Unlikely Failure	Notes
Neutron Absorption	Degraded container has rusted steel wall	Analysis models 50%-60% steel density to account for degraded containers.	WAC requires that drums are of good integrity. CH-TRAMPAC also requires that drums are of good integrity prior to shipment to WIPP.	None
Reflection – Internal to Container	Excess reflection provided by excess beryllium, polyethylene, etc., in container	Beryllium mass overbatched beyond the WAC requirements in the contingency analysis. Compacted waste modeled polyethylene at 70%-100% theoretical density to maximize internal reflection. Water filling containers of non-compacted waste also evaluated and system shown to remain subcritical.	WIPP WAC and shipping container SARs impose fissile and special reflector mass limits.	The compaction density of polyethylene is typically not controlled such that compacted waste typically meets the lower fissile limits based on 100% compaction.
Reflection – External to Container	Excess reflection provided by concrete or MgO around the container	Analysis models close fitting, infinite thick, concrete, salt or MgO reflection on all sides of containers in two-container models. Array analysis models MgO supersack plus infinite salt reflection which bounds reflection conditions found above ground.	CH bay is large such that there is no tight fitting concrete reflector.	None

Table F-, Waste Handling Building Hazard Evaluation by Control Parameter

Waste Handling Building	Loaded shipping cask is stored in Parking Area on over the road transportation trailer. Loaded shipping cask is moved into the CH bay. Shipping cask is opened and unloaded onto facility pallets using an overhead crane. Facility pallet is transferred to the waste hoist via forklift and onto the conveyance loading car.			
Parameter	Causes	Consequences/Analysis Limits	Barriers/Factors Contributing to Unlikely Failure	Notes
Volume	Not controlled	Analysis conservatively models fissile masses as cylinders at the optimum H/D ratio of 1 with the remainder of the waste container filled with beryllium, poly/water mixture, or poly only	None	All containers approved to be shipped to WIPP in the HALF-PACT, TRUPACT-II or -III shipping casks are evaluated. The volume provided by the container is treated as geometry and interaction controls only.
Enrichment	Not controlled	Fissile material is modeled as ²³⁹ Pu, ²³⁵ U and ²³³ U can be shipped under these limits using FGE ²³⁹ Pu as defined in the CH-TRAMPAC.	None	WAC imposes fissile limits expressed in FGE ²³⁹ Pu. The FGE value accounts for the difference in minimum critical mass between the isotope and ²³⁹ Pu. Thus, this evaluation assumes 100% enrichment of the fissile isotope as related by the FGE to ²³⁹ Pu.
Concentration	Not controlled	The fissile concentration is unrestricted and optimized by varying the H/Pu ratio in the fissile region.	None	None

Table F-, Underground Hazard Evaluation by Control Parameter

Underground Storage Operations	Waste transported onto conveyance; conveyance moved from waste shaft collar to the waste shaft station; waste moved from waste shaft station to active disposal room using forklift. Waste placed in the CH array stacked three tiers high. MgO supersack placed on top of stack.			
Parameter	Causes	Consequences/Analysis Limits	Barriers/Factors Contributing to Unlikely Failure	Notes
Mass	Generator site error results in excess mass	Fissile mass and beryllium are overbatched beyond the WAC requirements in the contingency analysis. Normal condition and contingency analysis models an optimized fissile mass in terms of moderation and geometry, which is very conservative compared to expected waste configuration. Use of expected configuration would result in higher subcritical mass.	Fissile mass limits established for transportation in HALF-PACT, TRUPACT-II or -III shipping casks. Fissile mass and beryllium limits established for CH waste containers in WIPP WAC.	Measurements to satisfy the fissile mass limits must include 2 times the measurement uncertainty.

Table F-, Underground Hazard Evaluation by Control Parameter

Underground Storage Operations	Waste transported onto conveyance; conveyance moved from waste shaft collar to the waste shaft station; waste moved from waste shaft station to active disposal room using forklift. Waste placed in the CH array stacked three tiers high. MgO supersack placed on top of stack.			
Parameter	Causes	Consequences/Analysis Limits	Barriers/Factors Contributing to Unlikely Failure	Notes
Geometry	Collision, fires, collision followed by fire, dropped facility pallet causes change in geometry (roof collapse addressed in interaction parameter)	While geometry could be modified from a fire or other breach of a waste container (such as crane failure), a limited number of containers are handled at one time. Contingency analysis evaluates the bounding condition of the 41 ton RH waste forklift impacting the CH waste face and crushing the containers..	Waste container design, shipping cask in the CH bay and outside area, crane design, fire suppression system in CH bay, limited material in CH bay available to burn, vehicle control program to prevent non waste handling vehicles in the CH bay during waste handling.	Fissile material conservatively modeled as right cylinders either centralized to the container in the array cases or conservatively placed in two stacked containers such that the fissile material from the two containers is separated only by the metal container and any spacing provided by the outer container. The SLB2 contingency model is the exception where the fissile mass is modeled in a prism in the corner of the box, which is noted as the most reactive credible configuration per the criticality analysis in the TRUPACT-III SAR.

Table F-, Underground Hazard Evaluation by Control Parameter

Underground Storage Operations	Waste transported onto conveyance; conveyance moved from waste shaft collar to the waste shaft station; waste moved from waste shaft station to active disposal room using forklift. Waste placed in the CH array stacked three tiers high. MgO supersack placed on top of stack.			
Parameter	Causes	Consequences/Analysis Limits	Barriers/Factors Contributing to Unlikely Failure	Notes
Moderation	Excess moderation provided by plastic, graphite, beryllium, or water. Water- in waste and as a result of hoist failure such that the load falls into the waste shaft sump	Analysis modeled fissile mass in compact geometry at optimum moderation level by polyethylene/water mixture with no liquid restriction. beryllium moderation shown to decrease reactivity. Polyethylene density up to 100 volume % assumed in analysis depending on compaction state.	WIPP WAC imposes fissile and beryllium mass limits. WIPP WAC restricts residual liquid content of waste to less than 1% by volume.	The compaction density of polyethylene is typically not controlled such that compacted waste typically meets the lower fissile limits based on 100% compaction.

Table F-, Underground Hazard Evaluation by Control Parameter

Underground Storage Operations	Waste transported onto conveyance; conveyance moved from waste shaft collar to the waste shaft station; waste moved from waste shaft station to active disposal room using forklift. Waste placed in the CH array stacked three tiers high. MgO supersack placed on top of stack.			
Parameter	Causes	Consequences/Analysis Limits	Barriers/Factors Contributing to Unlikely Failure	Notes
Interaction	Waste container interaction resulting from waste hoist failure, collision in the underground; roof fall during transport or after disposal	<p>Infinite array of containers is modeled and shown to be subcritical such that spacing between containers is not required for criticality safety.</p> <p>Impact of the 41-ton forklift used for moving RH waste in a shielded cask with a CH waste array was evaluated as the bounding contingency event for loss of interaction control.</p> <p>Four-tier-high array and compacted array resulting from roof fall are shown to be subcritical.</p>	Waste hoist has redundant brakes and ropes. Remote handled waste handling equipment is typically placed between the CH waste face and the approaching 41 ton forklift. Underground array limited to three-tiers high. Mining program limits the mined height such that a four-tier stack is not possible in most areas. Mine engineering provides properly designed roof systems to prevent roof collapse.	None
Neutron Absorption	Degraded container has rusted steel wall	Analysis models 50%-60% steel density to account for degraded containers.	WAC requires that drums are of good integrity. CH-TRAMPAC also requires that drums are of good integrity prior to shipment to WIPP.	None

Table F-, Underground Hazard Evaluation by Control Parameter

Underground Storage Operations Waste transported onto conveyance; conveyance moved from waste shaft collar to the waste shaft station; waste moved from waste shaft station to active disposal room using forklift. Waste placed in the CH array stacked three tiers high. MgO supersack placed on top of stack.				
Parameter	Causes	Consequences/Analysis Limits	Barriers/Factors Contributing to Unlikely Failure	Notes
Reflection – Internal to Container	Excess reflection provided by excess beryllium, polyethylene, etc. in container	Beryllium mass overbatched beyond the WAC requirements in the contingency analysis. Compacted waste modeled polyethylene at 70%-100% theoretical density to maximize internal reflection. Water filling containers of non-compacted waste also evaluated and system shown to remain subcritical.	WIPP WAC and shipping container SARs impose fissile and special reflector mass limits.	The compaction density of polyethylene is typically not controlled such that compacted waste typically meets the lower fissile limits based on 100% compaction.
Reflection – External to Container	Excess reflection provided by salt or MgO around the container	Analysis models close fitting, infinite thick, concrete, salt or MgO reflection on all sides of containers in two-container models. Array analysis models MgO supersack plus infinite salt reflection to represent reflection conditions in underground.	MgO supersack configuration.	None

Table F-, Underground Hazard Evaluation by Control Parameter

Underground Storage Operations				
Waste transported onto conveyance; conveyance moved from waste shaft collar to the waste shaft station; waste moved from waste shaft station to active disposal room using forklift. Waste placed in the CH array stacked three tiers high. MgO supersack placed on top of stack.				
Parameter	Causes	Consequences/Analysis Limits	Barriers/Factors Contributing to Unlikely Failure	Notes
Volume	Not controlled	Analysis conservatively models fissile masses as cylinders at the optimum H/D ratio of 1 with the remainder of the waste container filled with beryllium, poly/water mixture, or poly only	None	All containers approved to be shipped to WIPP in the HALF-PACT, TRUPACT-II or -III shipping casks are evaluated. The volume provided by the container is treated as geometry and interaction controls only.
Enrichment	Not controlled	Fissile material is modeled as ^{239}Pu , ^{235}U and ^{233}U can be shipped under these limits using FGE ^{239}Pu as defined in the CH-TRAMPAC.	None	WAC imposes fissile limits expressed in FGE ^{239}Pu . The FGE value accounts for the difference in minimum critical mass between the isotope and ^{239}Pu . Thus, this evaluation assumes 100% enrichment of the fissile isotope as related by the FGE to ^{239}Pu .
Concentration	Not controlled	The fissile concentration is unrestricted and optimized by varying the H/Pu ratio in the fissile region.	None	None