

Characterization of Mercury-Enriched Coal Combustion Residues from Electric Utilities Using Enhanced Sorbents for Mercury Control



Characterization of Mercury-Enriched Coal Combustion Residues from Electric Utilities Using Enhanced Sorbents for Mercury Control

by

F. Sanchez¹, R. Keeney², D. Kosson¹, and R. Delapp¹

¹Vanderbilt University
Department of Civil and Environmental Engineering
Nashville, TN 37235

²ARCADIS G&M, Inc.
4915 Prospectus Drive, Suite F
Durham, NC 27713

Contract No. EP-C-04-023, Work Assignment 1-31

EPA Project Officer: Ms. Susan Thorneloe
Office of Research and Development (ORD)
National Risk Management Research Laboratory (NRMRL)
Air Pollution Prevention and Control Division (APPCD)
Research Triangle Park, North Carolina.

U.S. Environmental Protection Agency
Office of Research and Development
Washington, DC 20460

Abstract

This report evaluates changes that may occur to coal-fired power plant air pollution control residues from the use of activated carbon and other enhanced sorbents for reducing air emissions of mercury and evaluates the potential for captured pollutants leaching during the disposal or use of these residues. Leaching of mercury, arsenic, and selenium during land disposal or beneficial use of coal combustion residues (CCRs) is the environmental impact pathway evaluated in this report. Coal combustion residues refer collectively to fly ash and other air pollution control solid residues generated during the combustion of coal collected through the associated air pollution control system. This research is part of an on-going effort by U.S. Environmental Protection Agency (EPA) to use a holistic approach to account for the fate of mercury and other metals in coal throughout the life-cycle stages of CCR management.

The specific objectives of the research reported here are to:

1. Evaluate the potential for leaching to groundwater of mercury, arsenic, and selenium removed from coal-fired power plant air emissions by air pollution control technology and, as a result, are contained in CCRs;
2. Provide the foundation for assessing the impact of enhanced mercury and multi-pollutant control technology on leaching of mercury and other constituents of potential concern from CCRs during the lifecycle of CCR management, including storage, beneficial use, and disposal; and
3. Perform these assessments using the most appropriate evaluation methods currently available.

Air pollution control residues were obtained from coal combustion electric utility facilities with a representative range of facility configurations (including air pollution controls) and coal types combusted. Each of the residues sampled has been analyzed for selected physical properties, and for total content and leaching characteristics. Results of laboratory leaching tests were used to develop estimates of constituent release under field management scenarios. Laboratory leaching test results also were compared to field observations of leaching.

This report focuses on facilities that use injected sorbents for mercury control. It includes four facilities with activated carbon injection (ACI) and two facilities using brominated ACI. Fly ash has been obtained from each facility with and without operation of the sorbent injection technology for mercury control. Each fly ash sampled was evaluated in the laboratory for leaching as a function of pH and liquid-to-solid ratio. Mercury, arsenic and selenium were the primary constituents of interest; results for these elements are presented here.

Foreword

The U.S. Environmental Protection Agency (EPA) is charged by Congress with protecting the Nation's land, air, and water resources. Under a mandate of national environmental laws, the Agency strives to formulate and implement actions leading to a compatible balance between human activities and the ability of natural systems to support and nurture life. To meet this mandate, EPA's research program is providing data and technical support for solving environmental problems today and building a science knowledge base necessary to manage our ecological resources wisely, understand how pollutants affect our health, and prevent or reduce environmental risks in the future.

The National Risk Management Research Laboratory (NRMRL) is the Agency's center for investigation of technological and management approaches for preventing and reducing risks from pollution that threaten human health and the environment. The focus of the Laboratory's research program is on methods and their cost-effectiveness for prevention and control of pollution to air, land, water, and subsurface resources; protection of water quality in public water systems; remediation of contaminated sites, sediments and ground water; prevention and control of indoor air pollution; and restoration of ecosystems. NRMRL collaborates with both public and private sector partners to foster technologies that reduce the cost of compliance and to anticipate emerging problems. NRMRL's research provides solutions to environmental problems by: developing and promoting technologies that protect and improve the environment; advancing scientific and engineering information to support regulatory and policy decisions; and providing the technical support and information transfer to ensure implementation of environmental regulations and strategies at the national, state, and community levels.

This publication has been produced as part of the Laboratory's strategic long-term research plan. It is published and made available by EPA's Office of Research and Development to assist the user community and to link researchers with their clients.

Sally Gutierrez, Director
National Risk Management Research Laboratory

EPA Review Notice

The U.S. Environmental Protection Agency through its Office of Research and Development funded and managed the research described here under Contract EP-C-04-023 to ARCADIS Geraghty & Miller, Inc. It has been subjected to Agency review and has been approved for publication as an EPA document. Mention of trade names or commercial products does not constitute endorsement or recommendation for use.

This document is available to the public through the National Technical Information Service, Springfield, Virginia 22161.

Table of Contents

Section	Page
Abstract	ii
Foreword	iii
EPA Review Notice	iv
List of Figures	vii
List of Tables	viii
Glossary of Terms	ix
Acknowledgments	xi
Executive Summary	xii
1 Introduction	1
1.1 Regulatory Context	2
1.1.1 Waste Management	2
1.1.2 Air Pollution Control	3
1.2 Configurations of U.S. Coal Fired Power Plants and Multi-pollutant Control Technologies	3
1.2.1 Current Air Pollution Control Technologies	5
1.2.2 Enhancement of Controls for Mercury Removal: Sorbent Injection	6
1.2.3 Mercury Control by Conventional PAC Injection	8
1.2.4 Mercury Control by Halogenated PAC Injection	8
1.3 Coal Combustion Residues	9
1.4 Residue Management Practices	9
1.4.1 Beneficial Use	10
1.4.2 Land Disposal	11
1.5 Leaching Protocol	11
2 Materials and Methods	15
2.1 CCR Materials for Evaluation	15
2.1.1 Reference Fly Ash	15
2.1.2 Facilities Using Injection of Standard Activated Carbon	15
2.1.2.1 Brayton Point	15
2.1.2.2 Pleasant Prairie	19
2.1.2.3 Salem Harbor	20
2.1.2.4 Facility C	20
2.1.3 Facilities Using Injection of Brominated Activated Carbon	20
2.1.3.1 St. Clair	20
2.1.3.2 Facility L	20
2.2 Leaching Assessment Protocols	21
2.2.1 Alkalinity, Solubility and Release as a Function of pH (SR002.1)	21
2.2.2 Solubility and Release as a Function of LS Ratio (SR003.1)	21
2.3 Analytical Methods	21
2.3.1 Surface Area and Pore Size Distribution	21
2.3.2 pH and Conductivity	22
2.3.3 Moisture Content	22
2.3.4 Carbon Content: Organic Carbon/Elemental Carbon Analyzer	22

Table of Contents (concluded)

Section	Page
2.3.5 Mercury (CVAA, Method 3052, and Method 7473)	22
2.3.6 Other Metals (ICP-MS, Method 3052 and Method 6020)	22
2.3.6.1 ICP-MS Analysis at Vanderbilt	23
2.3.6.2 Severn Trent Laboratories, Inc. (STL)	23
2.3.7 X-Ray Fluorescence (XRF)	23
2.3.8 MDL and ML for Analytical Results	23
2.4 Quality Assurance Validation	24
2.4.1 Homogenization of Individual CCR Samples and Aliquots for Analyses	24
2.4.2 Leaching Test Methods and Analytical QA/QC	24
2.4.3 Laboratory Mass Balance Verification for Leaching Test Methods	24
2.4.4 Improving QA/QC Efficiency	27
2.5 Interpretation and Presentation of Laboratory Leaching Data	27
2.6 Long-Term Release Assessment	29
3 Results and Discussion	35
3.1 Leaching Characteristics from Field Observations of CCR Landfills and Impoundments	35
3.2 Quality Assurance for Laboratory Leaching Tests	39
3.2.1 Mass Balance using EPA Reference Fly Ash	39
3.2.2 Analytical Quality Control/Quality Assurance	39
3.3 Laboratory Test Results	40
3.1.1 Mercury Results	43
3.3.2 Arsenic Results	45
3.3.3 Selenium Results	47
3.4 Long-Term Release Assessment	48
3.3.4 Long-Term Release Estimates for Mercury	49
3.3.4 Long-Term Release Estimates for Arsenic	50
3.3.4 Long-term Release Estimates for Selenium	50
4 Conclusions and Recommendations	55
4.1 Assessment of CCRs Without and With Activated Carbon Injection	55
4.2 Implementation of Leaching Test Methods	56
5 References	57
Appendix A U.S. EPA Science Advisory Board Consultation Summary	59
Appendix B DOE NETL Full-Scale Test Site Flow Diagrams	73
Appendix C Quality Assurance Project Plan	79
Appendix D Brayton Point Fly Ashes	116
Appendix E Pleasant Prairie Fly Ashes	131
Appendix F Salem Harbor Fly Ashes	146

List of Figures

Figure	Page
1 Coal-Fired Boiler with Sorbent Injection and Spray Cooling	7
2 Flow Diagram for Power Plant with a Hot ESP, Carbon Injection, and a COHPAC	7
3 Life-Cycle Evaluation of Coal Combustion Residues	9
4 Uses of CCRs Based on 2003 Industry Statistics	10
5 Mixing Fly Ash Prior to Obtaining Aliquots for Laboratory Analyses	24
6 Flow Diagram for Mass Balance and Quality Control on Laboratory Leaching Procedures	26
7 Example of Extract Concentrations as a Function of pH from SR002.1	28
8 Leachate pH Distribution: Scenario of Disposal in a Combustion Waste Landfill	30
9 LS Ratio Distribution: Scenario of Disposal in a Combustion Waste Landfill	31
10 Example of Variability of Hg Concentrations as a Function of pH from SR002.1	31
11 Example of Regression Fits and Corresponding Equations for Solubility as a Function of pH	32
12 Example of Cumulative Probability Distribution for Release of Selenium from Brayton Point CCR	32
13 Example of Comparison of 100 Yr Cumulative Release Estimates for Arsenic	33
14 Range of pH Observed in Field Leachate at Landfills and Impoundments Used for Disposal of CCRs	36
15 Arsenic Concentrations Observed in Field Leachate at Landfills and Impoundments Used for Disposal of CCRs	37
16 Selenium Concentrations Observed in Field Leachate at Landfills and Impoundments Used or Disposal of CCRs	38
17 STL Versus Vanderbilt Analytical Results for Arsenic and Selenium from Sr002.1	41
18 Example Results from SR002.1	42
19 Example Results from SR002.1 and SR003.1 for Selenium in Fly Ashes from Salem Harbor with Enhanced Hg Control	43
20 Comparison of Total Mercury Content in Baseline Cases and with Sorbent Injection for CCRs from Different Facilities	44
21 Ranges of Laboratory and Field Leachate Mercury Concentrations Compared with the Drinking Water Maximum Contaminant Level	45
22 Comparison of Total Arsenic Content in Baseline Cases and with Sorbent Injection for CCRs from Different Facilities	46
23 Ranges of Laboratory and Field Leachate Arsenic Concentrations Compared with the Drinking Water Maximum Contaminant Level	47
24 Comparison of Total Selenium Content in Baseline Cases and with Sorbent Injection for CCRs from Different Facilities	48
25 Ranges of Laboratory and Field Leachate Selenium Concentrations Compared with the Drinking Water Maximum Contaminant Level	49
26 Example Regression Curves of Experimental Data of Arsenic Solubility as a Function of pH for Brayton Point	49
27 Example 100-Year Arsenic Release Estimates for Brayton Point as a Function of the Cumulative Probability for the Scenario of Disposal in a Combustion Waste Landfill	50
28 Upper Bound of 100 yr Mercury Release Estimates for Landfill Scenario Without and With Activated Carbon Injection	51
29 Upper Bound of 100 yr Arsenic Release Estimates for Landfill Scenario Without and With Activated Carbon Injection	52
30 Upper Bound of 100 yr Selenium Release Estimates for Landfill Scenario Without and With Activated Carbon Injection	53

List of Tables

Table	Page
1 List of CCRs collected to date for evaluation of under this research program	4
2 General Characteristics of Coals Burned in U.S. Power Plants	5
3 Projected Coal-Fired Capacity by APC Configuration	6
4 Beneficial Uses of CCRs	11
5 Characteristics of Coal Combusted and Facilities Sampled and Reported Here	16
6 Fly Ashes from Brayton Point, Pleasant Prairie, Salem Harbor, and Facility C: Elemental Composition (by x-ray fluorescence) and Other Characteristics.	16
7 Fly Ashes from St. Clair and Facility L: Elemental Composition (by x-ray fluorescence) and Other Characteristics	17
8 CCRs from Facilities with Electrostatic Precipitators: Total Content of Mercury, Arsenic, Cadmium, Lead and Selenium.	18
9 Detection Limits and Quality Control Information for ICP-MS Analysis for As, Pb, and Se at Vanderbilt	23
10 Total Content Analysis Results for Reference Fly Ash after Mixing	25
11 Composition of Combustion Waste Landfill Leachate	28
12 Distribution of pH and Concentrations of Arsenic and Selenium from Field CCR Management Facilities from the U.S. EPA Database	35
13 Distribution of pH and Concentrations of Arsenic, Selenium, and Mercury from Field CCR Management Facilities	39
14 Leaching (Method SR002.1) and Mass Balance Results for the EPA-Reference Fly Ash	40

Glossary of Terms

Term	Definition
ACAA	American Coal Ash Association
ACI	activated carbon injection
APC	air pollution control
APPCD	Air Pollution Prevention and Control Division
ASTM	American Society for Testing and Materials
BET	Brunauer, Emmett, and Teller (method for quantification of surface area)
B-PAC	Brominated Powdered Activated Carbon (product name from Sorbent Technologies Corp, Twinsburg, OH)
BPB	Brayton Point baseline
BPT	Brayton Point test (with ACI)
BML	below method limit
CAIR	Clean Air Interstate Rule
CAMR	Clean Air Mercury Rule
CCRs	coal combustion residues
CCV	continuous calibration verification
COHPAC	Compact Hybrid Particulate Collector
CS-ESP	cold-side electrostatic precipitator
CVAA	cold vapor atomic adsorption
DAFs	dilution and attenuation factors
DOE	U.S. Department of Energy
DI	deionized (i.e., deionized water)
DRC	dynamic reaction chamber
EPA	U.S. Environmental Protection Agency
EPRI	Electric Power Research Institute
ESP	electrostatic precipitator
FF	fabric filter (baghouse)
FGD	flue gas desulfurization
FID	flame ionization detector
GAB	Facility C baseline
GAT	Facility C test (with ACI)
HCl	hydrogen chloride
Hg ⁰	elemental mercury
Hg ²⁺	oxidized or ionic mercury
HS-ESP	hot-side electrostatic precipitator
ICP-MS	inductively coupled plasma-mass spectroscopy
ICV	internal calibration verification
JAB	St. Clair facility baseline
JAT	St. Clair facility test (with B-PAC)
k_d	CCR linear partition coefficient

Glossary of Terms (concluded)

Term	Definition
LOI	loss on ignition
LS	liquid-to-solid (LS ratio)
MC	mechanical collector
MCL	maximum concentration limit (for drinking water)
MDL	method detection limit
ML	minimum quantification limit
NETL	National Energy Technology Laboratory
NO _x	nitrogen oxides
NSPS	New Source Performance Standard
OC/EC	organic carbon/elemental carbon
ORD	EPA's Office of Research and Development
OSW	EPA's Office of Solid Waste
PAC	powdered activated carbon
PJFF	pulse jet fabric filter
PM	particulate matter
PPB	Pleasant Prairie baseline
PPT	Pleasant Prairie test (with ACI)
PRB	sub-bituminous coal mined in Wyoming's Powder River Basin
QA/QC	quality assurance/quality control
RCRA	Resource Conservation and Recovery Act
RFA	reference fly ash
PS	particulate scrubber
SAB	EPA's Science Advisory Board
SCA	specific collection area
SCR	selective catalytic reduction
SDA	spray dryer absorber
SGLP	synthetic ground leaching procedure
SHB	Salem Harbor baseline
SHT	Salem Harbor test (with ACI)
SNCR	selective non-catalytic reduction
SO _x	oxides of sulfur
SPLS	synthetic precipitation leaching procedure
S/S	stabilization/solidification
SWDA	Solid Waste Disposal Act
TCLP	toxicity characteristic leaching procedure
TOXECON	toxic emissions control
WS	wet scrubber
XRF	X-ray fluorescence

Acknowledgments

Extensive input on the research program design was provided by G. Helms, U.S. EPA, Office of Solid Waste (Washington, DC). Additional technical support was provided by B. Ghorishi, formerly of ARCADIS, and J. Kilgroe, formerly of U.S. EPA, National Risk Management Research Laboratory.

Laboratory testing described herein was carried out by ARCADIS with technical support from Vanderbilt University. R. Delapp was responsible for the chemical analyses carried out at Vanderbilt University. Technical assistance also was provided by A. Garrabrants and V. Laohom.

K. Ladwig and EPRI are gratefully acknowledged for assistance in obtaining coal combustion residue samples and providing information from the EPRI database on coal combustion residues.

C. Senior also is gratefully acknowledged for her assistance in obtaining coal combustion residue samples and related background information for this project.

Executive Summary

This report evaluates changes that may occur to coal-fired power plant air pollution control residues from the use of activated carbon and other enhanced sorbents for reducing air emissions of mercury and evaluates the potential for captured pollutants leaching during the disposal or use of these residues. Leaching of mercury, arsenic, and selenium during land disposal or beneficial use of coal combustion residues (CCRs) is the environmental impact pathway evaluated in this report. Coal combustion residues refer collectively to fly ash and other air pollution control solid residues generated during the combustion of coal collected through the associated air pollution control system. This research is part of an on-going effort by U.S. Environmental Protection Agency (EPA) to use a holistic approach to account for the fate of mercury and other metals in coal throughout the life-cycle stages of CCR management.

The specific objectives of the research reported here are to:

1. Evaluate the potential for leaching to groundwater of mercury, arsenic, and selenium removed from coal-fired power plant air emissions by air pollution control technology and, as a result, are contained in CCRs;
2. Provide the foundation for assessing the impact of enhanced mercury and multi-pollutant control technology on leaching of mercury and other constituents of potential concern from CCRs during the lifecycle of CCR management, including storage, beneficial use, and disposal; and
3. Perform these assessments using the most appropriate evaluation methods currently available. This involved use of a laboratory leach testing approach developed by Kosson, et al. (2002), which considers the effects of varying environmental conditions on waste constituent leaching. Effective use of this approach required technology transfer to the U.S. EPA National Risk Management Laboratory, and development of a quality assurance/quality control (QA/QC) framework to help evaluate and verify test results.

Air pollution control residues were obtained from coal combustion electric utility facilities with a representative range of facility configurations (including air pollution controls) and coal types combusted. Each of the residues sampled has been analyzed for selected physical properties, and for total content and leaching characteristics. Results of laboratory leaching tests were used to develop estimates of constituent release under field management scenarios. Laboratory leaching test results also were compared to field observations of leaching.

This report focuses on facilities that use injected sorbents for mercury control. It includes four facilities with activated carbon injection (ACI) and two facilities using brominated ACI. Fly ash has been obtained from each facility with and without operation of the sorbent injection technology for mercury control. Each fly ash sampled was evaluated in the laboratory for leaching as a function of pH and liquid-to-solid ratio. Mercury, arsenic and selenium were the primary constituents of interest; results for these elements are presented here.

This testing approach was chosen for use because it evaluates leaching over a range of values for two key variables (pH and liquid:solid ratio) that both vary in the environment and affect the rate of constituent release from waste. The range of values used in the laboratory testing encompasses the range of values expected to be found in the environment for these parameters. Because the effect of these variables on leaching is evaluated in the laboratory, prediction of leaching from the waste in the field is expected to be done with much greater reliability.

Application of this leach testing approach to mercury leaching involved an extensive QA/QC program. This included conducting a mass balance of mercury and other metals using a reference fly ash to ensure that unacceptable losses of mercury in lab equipment or glassware or due to volatilization did not occur. If mercury was not found to be leaching, it was critical to ensure that this result was real and not due to mercury losses during handling or processing of the samples.

In addition, results from laboratory leaching evaluation were compared to field leachate concentrations from CCR management facilities available from a U.S. EPA database and an Electric Power Research Institute (EPRI) database to determine if laboratory testing results reasonably represented field observations.

Constituent release estimates projected to occur over a 100 year period were developed to evaluate the potential cumulative impacts of different CCR management scenarios. Disposal in a combustion waste landfill was examined using Monte Carlo simulation based on reported field conditions and for three hypothetical default landfill scenarios.

Summary of Conclusions

Assessment of CCRs with and without Use of Activated Carbon Injection and Brominated Carbon Injection.

Analysis has been completed for CCRs from four coal combustion facilities using powdered activated carbon injection and from two facilities using brominated powdered activated carbon injection to control mercury emissions. For each facility, the evaluation included assessments of CCRs generated both with and without use of the activated carbon injection. None of these facilities had scrubbers as part of their air pollution control technology. The following conclusions are drawn for this class of facilities:

- Application of activated carbon injection substantially increased the total mercury content in the resulting CCRs for five of the six facilities evaluated. Substantially increased arsenic and selenium content in the CCRs was observed at the one facility that employed compact hybrid particulate collector (COHPAC¹) fabric filter particulate control technology. This may have resulted from additional arsenic and selenium adsorption onto the CCR while retained in the fabric filters. Significant increase in the selenium content of one additional facility was noted.
- Mercury is strongly retained by the CCR and unlikely to be leached at levels of environmental concern. Leaching that did occur did not depend on total mercury content in the CCR, leaching pH, or liquid to solid ratio, and mercury concentrations in laboratory extracts appeared to be controlled by non-linear adsorption equilibrium. Laboratory extract concentrations ranged from less than the minimum detection level (0.01 µg/L) to 0.2 µg/L.
- Arsenic and selenium may be leached at levels of potential concern from CCRs generated at some facilities both with and without enhanced mercury control technology. Further evaluation of leaching of arsenic and selenium from CCRs that considers site specific conditions is warranted.
- Leachate concentrations and the potential release of mercury, arsenic and selenium do not correlate with total content. For many cases, leachate concentrations observed are a function of final pH over the range of field conditions, and the observed leaching behavior implies that solubility in the leachate or aqueous extract controls observed liquid concentration rather than linear adsorption equilibrium. For these cases, use of linear partition coefficients (K_d) in modeling leaching phenomena does not reflect the underlying processes. In addition, for many cases, the amount of mercury, arsenic, and selenium estimated to be released over a 100 year interval is a small fraction (< 0.1% – 5%) of the total content. For selenium, release from less than 5% up to the total content of selenium can be anticipated over the 100 year period.

¹ For the COHPAC air pollution control configuration, combustion gasses pass through an electrostatic precipitator; then activated carbon is injected into the gas stream before it passes through a fabric filter for particulate collection.

Therefore, it is not recommended to base landfill management decisions on total content of constituents in CCRs since total content does not consistently relate to quantity released.

- Results of this assessment also suggest management conditions (e.g., by control of infiltration and pH) that may result in reduction releases of arsenic and selenium by as much as two orders of magnitude in comparison to upper bound estimated releases.
- Use of the leaching framework facilitated understanding the variations in anticipated leaching behavior under the anticipated field landfill disposal conditions, including expected ranges of constituent concentrations in leachate and cumulative release over a defined time interval. In addition, insights into the mechanisms controlling constituent leaching were obtained. This depth of understanding would not have been possible using leaching tests focused on a single extraction condition (e.g., toxicity characteristic leaching procedure, synthetic precipitation leaching procedure, or synthetic groundwater leaching procedure).
- This study provides baseline data which allows using a reduced set of laboratory testing conditions as a screening leaching assessment for CCRs from coal combustion facilities employing similar air pollution control technology. For mercury, extraction only at the material's natural pH at a liquid-to-solid ratio (LS) of 10 is adequate. For arsenic, extraction at four conditions is warranted to define the range of expected leachate concentrations and release: (i) pH 5.5–6.0 at LS=10, (ii) pH 7.5–8.5 at LS=10, (iii) pH 12.0–12.5 at LS=10 and (iv) natural pH at LS=2. For selenium, either the total content or the same conditions as recommended for arsenic can be used. At least duplicate extractions should be used. Results from this more limited testing can be evaluated in comparison with the results presented in this report to determine if more extensive evaluation is warranted.

Implementation of Leaching Test Methods

The leaching assessment approach published by Kosson et al. (2002) and implemented in this report was selected because, after internal EPA review (Office of Research and Development, Office of Solid Waste) and consultation with the Environmental Engineering committee of the EPA Science Advisory Board, it was considered the only available, peer reviewed, and published approach that allowed consideration of the range of potential field management scenarios expected for CCRs and provided a fundamental foundation for extrapolation of laboratory testing to field scenarios. Additional development and validation of the leaching assessment approach through this project provides the following conclusions:

- Laboratory leaching test results were consistent with observations of ranges of field leachate pH and mercury, arsenic, and selenium concentrations. Thus, the leaching test methods employed in this study provide an appropriate basis for evaluating leaching under the range of anticipated field management scenarios.
- Leaching test methods SR002.1 (Solubility and Release as a Function of pH) and SR003.1 (Solubility and Release as a Function of LS ratio) have been successfully implemented at the EPA National Risk Management Research Laboratory. The use of these methods is now considered near routine methodology for the laboratory.
- QA/QC methodology conforming with EPA Category 3 requirements has been developed and demonstrated for the leaching test methods SR002.1 and SR003.1.
- Further efficiency in implementation of the QA/QC methodology may be obtained, based on the results from testing the initial set of CCRs, by reducing the number of replicates and control analyses required under the initial QA/QC plan. These improved project efficiencies are being implemented for evaluation of additional CCRs under this project.
- A mass balance around the laboratory leaching test procedures has been completed for mercury and selected metals of potential concern. These results indicate that recoveries were between 60% and 91% for mercury during the leaching tests and subsequent analytical procedures, which is within the uncertainty resulting from heterogeneity within the CCR. Additional mass balance verification may be warranted if future samples have significantly different characteristics that may result in greater volatility of the constituents of interest than in the reference sample evaluated.

This is the first of a series of reports that will address the potential for leaching of constituents of potential concern from CCRs. Subsequent reports will address:

- CCRs from coal-fired power plants that use SO₂ scrubbers as a part of their air pollution control technology
- CCRs from coal-fired power plants that use air pollution control technologies other than evaluated in earlier reports necessary to span the range of coal-types and air pollution configurations.
- Assessment of leaching for constituents of potential concern under additional management scenarios, including impoundments and beneficial use.
- Broader correlation of CCR leaching characteristics to coal type, combustion facility characteristics and geochemical speciation within CCRs supported by information and analysis on additional trace elements and primary constituents.

1. Introduction

Congress has directed EPA to document that the Clean Air Act regulations are not trading one environmental burden for another. The Air Pollution Prevention and Control Division (APPCD) of EPA's Office of Research and Development (ORD) is conducting the research to help identify any potential leaching with unacceptable impacts resulting from land disposal or beneficial use of mercury-enriched CCRs. The research results presented in this report are part of that effort.

The focus of this report is to present an evaluation of changes to air pollution control residues that may result from the use of sorbent injection as enhanced mercury control technology at coal-fired power plants and to document the potential for transfer of pollutants from the resulting residues to water resources or other environmental systems (e.g., soils, sediments). The residues studied for this report were fly ashes generated using activated carbon and other enhanced sorbents for reducing air emissions of mercury from the power plants and fly ashes from the same power plants without use of sorbent injection. The potential for leaching of mercury and other constituents of potential concern during land disposal or beneficial use of the coal combustion residues (CCRs) is the more narrow focus of this assessment. This research is part of an on-going effort by EPA to use a holistic approach to account for the fate of mercury and other metals in coal throughout the life-cycle stages of CCR management.

CCRs include bottom ash, boiler slag, fly ash, scrubber sludge, and other miscellaneous solids generated during the combustion of coal. The boiler slag and bottom ash are not of interest in this study because enhanced mercury emission controls will not change their composition. Fly ash characteristics are expected to change from implementation of enhanced mercury emission controls. Fly ash includes unburned and inorganic materials in coal that do not burn, such as oxides of silicon, aluminum, iron, and calcium. Fly ash is light enough to be entrained in the flue gas stream and captured in the air pollution control equip-

ment. Scrubber sludge is the by-product of the SO₂ wet scrubbing process resulting from neutralization of acid gases. Air pollution control can concentrate or partition metals to fly ash and scrubber sludge.

When coal is burned in an electric utility boiler, the resulting high combustion temperatures vaporize the Hg in the coal to form gaseous elemental mercury (Hg⁰). Subsequent cooling of the combustion gases and interaction of the gaseous Hg⁰ with other combustion products result in a portion of the Hg being converted to gaseous oxidized forms of mercury (Hg²⁺) and particle-bound mercury. The specific chemical form—known as the speciation—has a strong impact on the capture of mercury and other metals by boiler air pollution control (APC) equipment.

Sorbents, typically finely ground powdered activated carbon, can be used to capture mercury. The sorbent is typically injected upstream of the particulate control device, where both the sorbent and adsorbed mercury are collected. Depending upon the type of sorbent, gas conditioning, and other air pollution control technology in use, there may be changes occurring to the fly ash that may affect the stability and mobility of mercury and other metals in the CCRs.

In response to increasingly stricter requirements to reduce air emissions of mercury and other pollutants from coal-fired power plants, additional advanced air pollution control technology is being introduced. Activated carbon injection (ACI) or brominated powdered activated carbon injection (B-PAC) are two technologies being considered for widespread use. This research is evaluating changes to air pollution control residues as a result of these technologies, and the impacts of land disposal or commercial use of the residues.

The specific objectives of the research reported here are to:

- 1 Evaluate the potential for leaching to groundwater of mercury, arsenic, and selenium removed from coal-

- fired power plant air emissions by air pollution control technology and, as a result, contained in CCRs;
- 2 Provide the foundation for assessing the impact of enhanced mercury and multi-pollutant control technology on leaching of mercury and other constituents of potential concern from CCRs during the lifecycle of CCR management, including storage, beneficial use and disposal; and
 - 3 Perform these assessments using the most appropriate evaluation methods currently available. This has involved use of a laboratory leach testing approach developed by Kosson, et al. (2002), which considers the effects of varying environmental conditions on waste constituent leaching. Effective use of this approach required technology transfer to the U.S. EPA National Risk Management Laboratory and development of a quality assurance/quality control (QA/QC) framework to help evaluate and verify test results.

The approach to satisfying these objectives was to obtain samples of air pollution control residues from a variety of coal-fired power plants, each under operating conditions with and without use of enhanced mercury control technology.

This report focuses on facilities that employ electrostatic precipitators (ESPs) but do not have SO₂ scrubbers for air pollution control. Enhanced mercury control technology consisted of activated carbon injection for four facilities (Brayton Point, Pleasant Prairie, Salem Harbor, and Facility C¹) and injection of brominated activated carbon for two facilities (St. Clair and Facility L¹). This is the first of a series of reports that will address the potential for cross-media transfer of constituents of potential concern from CCRs. Subsequent reports will address:

- CCRs from coal-fired power plants that use scrubbers as a part of their air pollution control technology (report 2);
- CCRs from coal-fired power plants that use air pollution control technologies other than evaluated in earlier reports necessary to span the range of coal-types and air pollution configurations (report 3);
- Assessment of leaching for constituents of potential concern under additional management scenarios, including impoundments and beneficial use on the land (report 4); and,
- Broader correlation of CCR leaching characteristics to coal type, combustion facility characteristics and geochemical speciation within CCRs supported by in-

formation and analysis on additional trace elements and primary constituents (report 4).

Table 1 provides a summary of facilities sampled to date and indicates which of the reports will present an evaluation of which samples.

Sampled CCRs were subjected to multiple leaching conditions according to the designated leaching assessment approach. Leaching conditions included batch equilibrium² extractions at acidic, neutral, and alkaline conditions at a liquid-to-solid ratio (LS) of 10 mL/g, and LS ratio from 0.5 to 10 mL/g using distilled water as the leachant. The results of this testing are being used to evaluate the likely range of leaching characteristics under a variety of CCR management scenarios. Results of the laboratory leaching tests were compared to the range of observed constituent concentrations in field leachates reported in a U.S. EPA database (EPA, 2000) and an Electric Power Research Institute (EPRI) database (EPRI, 2005). A probabilistic assessment approach considered leaching estimates over the observed range of field pH and LS from the U.S. EPA database to develop 100 yr release estimates for constituents of interest from the CCRs tested.

As part of this research program, a QA/QC plan consistent with EPA requirements was developed for the leaching assessment approach. The QA/QC methodology included verification of acceptable mercury retention during laboratory testing through evaluation of a mass balance around testing procedures. Laboratory testing for leaching assessment was carried out at the EPA National Risk Management Laboratory (Research Triangle Park, North Carolina) with technical assistance from Vanderbilt University.

1.1. Regulatory Context

1.1.1. Waste Management

Management of coal combustion residues is subject to the Resource Conservation and Recovery Act (RCRA), which is the federal law regulating both solid and hazardous wastes. Subtitle C under the RCRA pertains to hazardous waste; other solid, non-hazardous wastes fall under Subtitle D. Subtitle C wastes are federally regulated while Subtitle D wastes are regulated primarily at the state level. The

² In the context of leaching tests, the term “equilibrium” is used to indicate that the test method result is a reasonable approximation of chemical equilibrium conditions even though thermodynamic equilibrium may not be approached for all constituents.

¹ These facilities have requested to remain anonymous.

original version of the RCRA did not specify whether CCRs were Subtitle C or D wastes. In 1980, the Solid Waste Disposal Act (SWDA) amendments to RCRA conditionally excluded CCRs from Subtitle C regulation pending completion of a study of CCR hazards. Since that time, CCRs have been regulated at the state level under Subtitle D.

The SWDA amendments to RCRA required EPA to prepare a report to Congress identifying CCR hazards and recommending a regulatory approach for CCRs. In this report (EPA, 1988), EPA recommended that CCRs generated by electric utilities continue to be regulated under Subtitle D (See 58 FR 42466, August 9, 1993).

Other residues generated at coal-fired electric utilities were not included in this 1993 decision. EPA conducted a follow-up study specifically aimed at low-volume, co-managed wastes³ and issued another Report to Congress (EPA, 1999) with a similar recommendation. In April 2000, EPA issued a regulatory determination exempting these wastes from hazardous waste regulations (See 65 FR 32214, May 22, 2000). However, concern was expressed over the use of CCR as backfill for mining operations, and it was decided that this practice be regulated under a federal Subtitle D rule. It was also decided by EPA that federal regulations under Subtitle D are needed for CCR when they are disposed in surface impoundments and landfills. Currently, the Agency is in the process of developing these regulations. The results presented in this report, and subsequent reports, will help provide the information needed to identify the release potential of mercury and other metals that have been removed from stack gases into air pollution control residues, over a range of plausible management options. These data will help identify those conditions that will either reduce or enhance releases to the land so that the effects of different management conditions can be factored into any controls developed under the regulations.

1.1.2. Air Pollution Control

On March 10, 2005, EPA announced the Clean Air Interstate Rule (CAIR; FR 25162, May 2005), which is expected to increase the use of wet scrubbers and selective catalytic reduction (SCR) units to help reduce sulfur dioxide and nitrogen oxides from coal-fired power plants. On March 15, 2005, EPA announced the Clean Air Mercury Rule (CAMR; FR 28606, May 2005) for reducing mercury emissions through the use of a cap and trade program. Power plants are the largest remaining source of anthropogenic

mercury emissions in the county. When fully implemented, a reduction of 70% is projected to occur (from 48 tons to 15 tons annually).

The Clean Air Mercury Rule establishes “standards of performance” that limit mercury emissions from new—through new source performance standards (NSPS)—and existing (through emission guidelines) coal-fired power plants by creating a market-based cap-and-trade program that will reduce mercury emissions in two phases. The first phase caps national annual mercury emissions at 38 tons through co-benefit reductions achieved by controlling sulfur dioxide (SO₂) and nitrogen oxides (NO_x) emissions under CAIR. In the second phase, due in 2018, coal-fired power plants will be subject to a second cap, which will reduce emissions to 15 tons per year upon full implementation.

Congress has directed EPA to document that the Clean Air Act regulations are not trading one environmental burden for another. The Air Pollution Prevention and Control Division (APPCD) of EPA’s Office of Research and Development (ORD) is conducting the current research to help identify any potential pollutant transfers resulting from land disposal or beneficial use of mercury-enriched CCRs. The research results presented in this report are part of that effort.

In response to the evolving implementation of advanced air pollution control technology for coal-fired power plants, this research is directed towards understanding changes in CCR characteristics that may increase environmental burdens from land disposal of CCRs or impact CCR usage in commercial applications.

1.2. Configurations of U.S. Coal Fired Power Plants and Multi-pollutant Control Technologies

The approximately 450 coal-fired electricity generating facilities in the United States uses a range of coals and plant configurations. The coal type burned and facility design characteristics affect the effectiveness of various mercury control methods that are or could be used at these plants. The U.S. coal-fired power plants typically burn one of three types of fuel: (1) bituminous coal (also referred to as “high rank” coal), (2) subbituminous coal, and (3) lignite (subbituminous coal and lignite are referred to as “low rank” coals). Some of the characteristics of interest related to the possible environmental impacts of burning these different coal types are given in Table 2 (EPA, 2005).

³ Co-managed wastes are low-volume wastes that are co-managed with the high-volume CCRs.

Characterization of Coal Combustion Residues

Table 1. List of CCRs collected to date for evaluation of under this research program. [Some facilities are identified by code letter only (e.g., "Facility C") to preserve the confidentiality of the CCR source.]

Facility	Coal Type	APC Configuration	CCR/Ash Type (CCR pH ^a)
Report 1: ACI and B-PAC (this report)			
Brayton Point	low-sulfur bituminous	CS-ESP ^b with and without ACI	Class F (12.2, 9.5)
Salem Harbor	low-sulfur bituminous	CS-ESP with and without ACI; with SNCR ^c /urea	Class F (11.7, 10.3)
Pleasant Prairie	PRB ^d subbituminous	CS-ESP with and without ACI	Class C (11.2, 11.9)
Facility C	low-sulfur bituminous	HS-ESP ^e with and without ACI; with COHPAC ^f	Class F (11.1, 8.4)
St. Clair	PRB subbituminous/ low-sulfur bituminous blend (85:15)	CS-ESP with and without B-PAC	Class C/F (12.1, 12.2)
Facility L ^{g,h}	low-sulfur bituminous	HS-ESP with and without B-PAC; with SOFA ⁱ ports "on" for NO _x ^j control.	Class F (5.8, 6.0)
Report 2: Facilities with scrubbers			
Facility A ^k	low-sulfur bituminous	fabric filter, limestone wet scrubber with and without SNCR/urea	Class F (10.3, 10.5)
Facility B	low-sulfur bituminous	CS-ESP, magnesium-enhanced lime scrubber; with SCR ^l /ammonia	Class F (10.3, 9.5)
Facility H ^m	high-sulfur bituminous	CS-ESP, limestone wet scrubber	Class F (8.5)
Facility I ⁿ	high-sulfur bituminous	CS-ESP, limestone wet scrubber with forced oxidation; SCR not in use when sample taken	Class F (NT ^o)
Facility K ^p	medium-sulfur bituminous	CS-ESP, magnesium-enhanced lime wet scrubber, natural oxidation	Class F (9.2)
Report 3: Miscellaneous configurations			
Facility E (Unit 1)	medium-sulfur bituminous	CS-ESP SCR operating	Class F (4.8)
Facility E (Unit 2)	medium-sulfur bituminous	CS-ESP SCR off	Class F (4.3)
Facility E (Unit 3)	low-sulfur bituminous	CS-ESP SCR operating	Class F (4.8)
Facility E (Unit 4) ^q	low-sulfur bituminous	HS-ESP SCR operating	Class F (NT ^o)
Facility F	low-sulfur bituminous	CS-ESP	Class F (4.2)
Facility G	low-sulfur bituminous	CS-ESP, SNCR operating	Class F (4.3)

^a The pH of the CCR (with and without ACI or B-PAC injection, as applicable) when mixed in distilled water at a ratio of 1g CCR per 10 mL water.

^b CS-ESP = cold-side electrostatic precipitator.

^c SNCR = selective non-catalytic reduction.

^d PRB = Powder River Basin.

^e HS-ESP = hot-side electrostatic precipitator.

^f COHPAC = compact hybrid particulate collector.

continued

Table 1 (concluded). List of CCRs collected to date for evaluation of under this research program. [Some facilities are identified by code letter only (e.g., “Facility C”) to preserve the confidentiality of the CCR source.]

- ^g This facility has HS-ESP for particulate control. The fly ash undergoes pneumatic control. Collected fly ash with and without use of B-PAC.
- ^h Two samples were collected from this facility. The only difference between the two samples (Run #1 and Run #2) was the Run #1 sample was allowed to accumulate in the hopper for 4 hours and the Run #2 sample for 30 minutes prior to collection. Not enough fly ash was collected with 30 minutes of accumulation to evaluate leaching potential. Therefore, the sample that was allowed to accumulate in hopper from HS-ESP for about 4 hours prior to collection was used for leaching evaluation. A concern is that mercury may have partially desorped from fly ash prior to collection because of the high temperature in the collection hopper. Total mercury analyses were used to evaluate the change in mercury content for fly ash with and without brominated carbon injection after being collected over 4 hours and 30 minutes.
- ⁱ SOFA = separated overfire air.
- ^j NO_x = oxides of nitrogen.
- ^k CCR samples obtained when SNCR was in use (during summer months) and not in use.
- ^l SCR = selective catalytic reduction.
- ^m For Facility H, sludge is first collected in the absorber at 12–15% solids, then goes through cyclone to achieve 50% solids, and finally is dewatered using a belt press to >90% solids. While on belt, gypsum is “sprayed” to remove excess soluble salts. For this facility, samples have been obtained of (1) prepared gypsum (which is used for wall board production) and (2) fly ash from the CS-ESP.
- ⁿ Facility I has a 500 MW tangential-fired boiler. Samples from this facility include (1) fly ash when the SCR was operating, (2) fly ash when SCR was not operating, and (3) raw FGD sludge when the SCR was not operating. Scrubber sludge from this facility is used in making gypsum for producing wallboard. The samples from this facility were gypsum and FGD sludge. There was not enough sludge to test for leaching, so the pH was not tested.
- ^o NT = not tested.
- ^p Facility K is an 800 MW facility with two 400 MW units (tangential fired). APC includes CS-ESP, magnesium-enhanced lime wet scrubber with natural oxidation. There is no SCR. Samples received from Facility K, are (1) partially dewatered FGD sludge, (2) fly ash sample, and (3) fly ash stabilized sludge.
- ^q Fly ash found to have low mercury and selenium content and, therefore, was not included in the leaching evaluation.

Table 2. General Characteristics of Coals Burned in U.S. Power Plants (EPA, 2005).

Coal	Mercury ppm (dry)		Chlorine ppm (dry)		Sulfur % (dry)		Ash % (dry)		HHV ^a BTU/lb (dry)	
	Range	Avg	Range	Avg	Range	Avg	Range	Avg	Range	Avg
Bituminous	0.036–0.279	0.113	48–2730	1033	0.55–4.10	1.69	5.4–27.3	11.1	8646–14014	13203
Subbituminous	0.025–0.136	0.017	51–1143	158	0.22–1.16	0.50	4.7–26.7	8.0	8606–13168	12005
Lignite	0.080–0.127	0.107	133–233	188	0.8–1.42	1.30	12.2–24.6	19.4	9487–10702	10028

^a HHV = higher heating value.

1.2.1. Current Air Pollution Control Technologies

The current combined capacity of U.S. coal-fired power plants is just over 300 GW and includes a wide range of combinations of installed air pollution control (APC) devices.

Table 3 shows the current and projected coal-fired capacity by APC configuration. Several of the air pollution control devices described here will remove some mercury (co-benefit control) from stack gases as they perform their main function. Current APC devices are designed primarily to control particulates, oxides of sulfur (SO_x), and NO_x.

Post-combustion particulate matter controls used at coal-fired utility boilers in the United States can include ESPs,

fabric filters (FF), particulate scrubbers (PS), or mechanical collectors (MC). Post-combustion SO₂ controls can consist of a wet scrubber (WS), spray dryer adsorber (SDA), or duct injection. Post-combustion NO_x controls can involve SCR or selective noncatalytic reduction (SNCR).

In response to current and proposed NO_x and SO₂ control requirements, additional NO_x control and flue gas desulfurization (FGD) systems are expected to be installed and more widely used in the future. Over half of the U.S. coal-fired capacity is projected to be equipped with SCR and/or FGD technology by 2020.

The mercury capture efficiency of existing ESPs and FFs appears to heavily depend on the partitioning of mercury between the particulate and vapor phases and the distribu-

Characterization of Coal Combustion Residues

Table 3. Projected Coal-Fired Capacity by APC Configuration (EPA, 2005).

APC Configuration ^a	Current Capacity ^b (MW)	2010 Capacity ^c (MW)	2020 Capacity ^c (MW)
Cold-Side ESP	111,616	75,732	48,915
Cold-Side ESP + Wet Scrubber	41,745	34,570	33,117
Cold-Side ESP + Wet Scrubber + ACI	---	379	379
Cold-Side ESP + Dry Scrubber	2,515	3,161	5,403
Cold-Side ESP + SCR	45,984	35,312	22,528
Cold-Side ESP + SCR + Wet Scrubber	27,775	62,663	98,138
Cold-Side ESP + SCR + Dry Scrubber	---	11,979	13,153
Cold-Side ESP + SNCR	7,019	4,576	2,534
Cold-Side ESP + SNCR + Wet Scrubber	317	2,830	6,088
Fabric Filter	11,969	10,885	7,646
Fabric Filter + Dry Scrubber	8,832	8,037	9,163
Fabric Filter + Wet Scrubber	4,960	4,960	4,960
Fabric Filter + Dry Scrubber +ACI	---	195	195
Fabric Filter + SCR	2,210	2,950	1,330
Fabric Filter + SCR + Dry Scrubber	2,002	2,601	4,422
Fabric Filter + SCR + Wet Scrubber	805	805	2,363
Fabric Filter + SNCR	267	267	345
Fabric Filter + SNCR + Dry Scrubber	559	557	557
Fabric Filter + SNCR + Wet Scrubber	932	932	1,108
Hot-Side ESP	18,929	11,763	10,160
Hot-Side ESP + Wet Scrubber	8,724	10,509	10,398
Hot-Side ESP + Dry Scrubber	---	538	538
Hot-Side ESP + SCR	5,952	3,233	1,847
Hot-Side ESP + SCR + Wet Scrubber	688	6,864	9,912
Hot-Side ESP + SNCR	684	1,490	1,334
Hot-Side ESP + SNCR + Wet Scrubber	474	474	627
Total Existing Units	304,955	298,263	297,161
New Builds of Coal Steam Units			
Fabric Filter + SCR + Wet Scrubber	---	221	17,292
Total All Units	304,955	298,484	314,453

^a Integrated gasification combined cycle units are not included in this list.

^b Current capacity includes some SCR and FGD units projected to be built in 2005 and 2006.

^c 2010 and 2020 is capacity projected for final CAIR rule; Integrated Planning Model projects some coal retirements and some new coal in 2010 and 2020.

tion of mercury species (e.g., elemental or oxidized) in the vapor phase. In general, ESPs and FFs are quite efficient at removing mercury in the particulate phase; however, the overall mercury removal efficiency in these devices may be low if most of the mercury entering the device is in the vapor phase (MTI, 2001). Many factors contribute to this range of performance. Differences in mercury contents of U.S. coals result in a range of mercury concentrations in the flue gas from the boiler. In general, it is easier to achieve higher mercury percent removal with higher mercury inlet

concentrations (MTI, 2001). The addition of NO_x controls may improve the mercury capture efficiency of particulate collection devices for some cases.

1.2.2. Enhancement of Controls for Mercury Removal: Sorbent Injection

Unlike the technologies described earlier, where mercury removal was incidental and achieved as a co-benefit with removal of other pollutants, controls are under development that target mercury removal by injecting sorbent

materials into the gas stream of coal-fired boilers. Injection of dry sorbents, such as powdered activated carbon (PAC), has been used for control of mercury emissions from waste combustors and has been tested at numerous utility units in the United States. However, sorbent injection experience on waste combustors may not be directly transferable to coal-fired electric utility boilers due to differences in facility sizes and mercury content and speciation in the combustion gases.

Figure 1 presents a coal-fired boiler with sorbent injection and spray cooling. Figure 2 presents a power plant with a hot-side ESP (HS-ESP), carbon injection, and a compact hybrid particle collector. Dry sorbent is typically injected into the ductwork upstream of a particulate matter (PM) control device—normally either an ESP or FF. Usually the sorbent is pneumatically injected as a powder, and the injection location is determined by the existing plant configuration. Another approach, designed to segregate col-

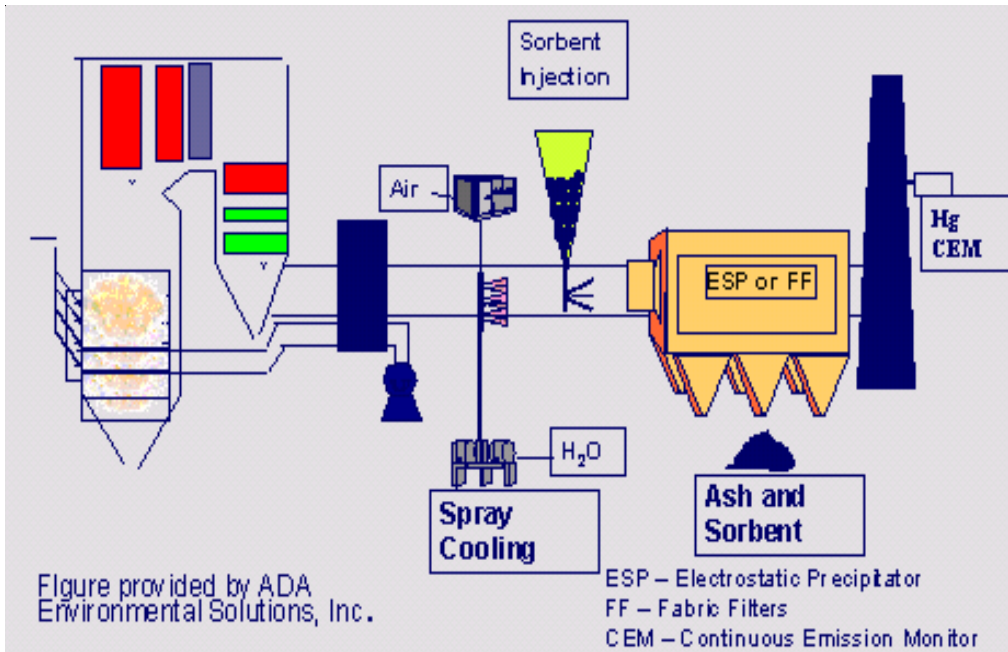

Figure 1. Coal-Fired Boiler with Sorbent Injection and Spray Cooling (Senior et al., 2003a).

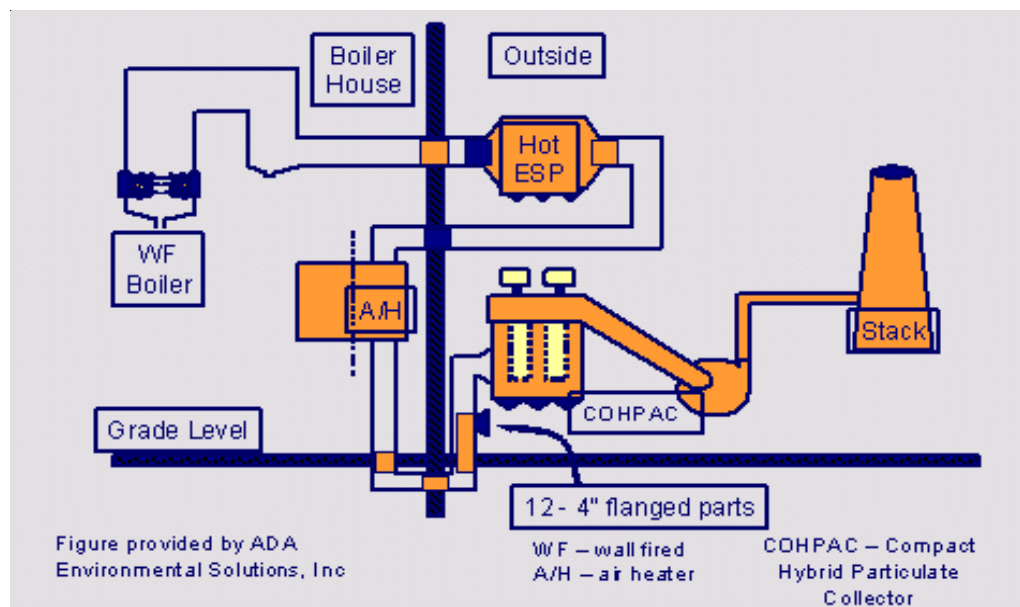

Figure 2. Flow Diagram for Power Plant with a Hot ESP, Carbon Injection, and a COHPAC (Senior et al., 2003a).

lected fly ash from collected sorbent, would be to retrofit a pulse-jet FF (PJFF) downstream of an existing ESP and inject the sorbent between the ESP and the PJFF. This type of particulate removal configuration is called a Compact Hybrid Particle Collector (COHPAC) by its manufacturer and, when combined with sorbent injection, is called Toxic Emission Control (TOXECON). The TOXECON configuration can be useful because it avoids commingling the larger flyash stream with mercury recovered on the injected sorbent. Implementation of sorbent injection for mercury control will likely entail either:

- Injection of powdered sorbent upstream of the existing PM control device (ESP or FF); or
- Injection of powdered sorbent downstream of the existing ESP and upstream of a retrofit PJFF, the TOXECON option; or
- Injection of powdered sorbent between ESP fields (TOXECON-II approach).

In general, factors that affect the performance of sorbent technology for mercury methods include:

- Injection concentration of the sorbent measured in lb/MMacf⁴;
- Flue gas conditions, including temperature and concentrations of hydrogen chloride (HCl) and sulfur trioxide (SO₃);
- The air pollution control configuration;
- The characteristics of the sorbent; and
- The method of injecting the sorbent.

1.2.3. Mercury Control by Conventional PAC Injection

The most widely tested sorbent for mercury control at utility boilers is PAC.

In general, the efficacy of mercury capture using standard PAC increases with the amount of oxidized or ionic mercury (Hg²⁺) in flue gas relative to elemental mercury (Hg⁰),⁵ the number of active sites in the PAC,⁶ and lower tempera-

ture. The amount of Hg²⁺ in flue gas is usually directly influenced by the amount of chlorine present in the flue gas, with higher chlorine content enhancing Hg²⁺ formation. Based on these factors, standard PAC injection appears to be generally effective for mercury capture on low-sulfur bituminous coal applications, but less effective for the following applications:

- Low-rank coals with ESP (current capacity of greater than 150 GW; the capacity with this configuration is not expected to increase significantly in the future). Lower chlorine and higher calcium contents in coal lead to lower levels of chlorine in flue gas, which results in reduced oxidation of mercury and, therefore, lower Hg²⁺ in flue gas;
- Low-rank coals with SDA and FF (current capacity of greater than 10 GW. These number of facilities with this configuration is expected to increase significantly in the future). Similar effect as above, except lime reagent from the SDA scavenges even more chlorine from flue gas;
- High-sulfur coal (current capacity with wet FGD of approximately 100 GW. The number of facilities with this configuration is likely to increase to more than 150 GW capacity by 2015). Relatively high levels of SO₃ compete for active sites on PAC, which reduces the number of sites available for mercury. Generally, plants will use wet FGD and, in many cases, SCR; PAC injection may be needed as a trim application; and
- Hot-side ESPs (current capacity of approximately 30 GW. The number of facilities with this configuration is not likely to increase.). Weak (physical) bonds get ruptured at higher temperatures resulting in lower sorption capacity.

1.2.4. Mercury Control by Halogenated PAC Injection

Some situations, as described above, may not have adequate chlorine present in the flue gas for good mercury capture by standard PAC. Pre-halogenated PAC sorbents have been developed to overcome some of the limitations associated with PAC injection for mercury control in power plant applications (Nelson et al., 2004; Nelson, 2004). Two halogenated PAC sorbents have been tested extensively in the field. They are Sorbent Technologies Corp. brominated-PAC (B-PAC) and Norit America's halogenated PAC (DARCO HG-LH, formerly known as E-3).

⁴ Sorbent injection concentration is expressed in lb/MMacf (i.e., pounds of sorbent used for each million actual cubic feet of gas). For a 500 MW boiler, a sorbent rate of 1.0 lb/MMacf will correspond to approximately 120 lb/hour of sorbent.

⁵ Standard PAC binds mercury via physical (i.e., weak) bonds, which are formed more easily with Hg²⁺. There have been results that show a similar removal for both elemental and oxidized mercury. However, the results do not account for surface catalyzed oxidation of Hg⁰ followed by sorption on the carbon (EPA, 2005).

⁶ These are collection of atoms/radicals such as oxygen, chlorine, and hydroxyls that provide binding sites.

Halogenated PACs offer several potential benefits. Relative to standard PAC, halogenated PAC use:

- may expand the usefulness of sorbent injection to many situations where standard PAC may not be as effective;
- may avoid the need for installation of downstream FF, thereby improving cost-effectiveness of mercury capture;
- would, in general, be at lower injection rates, which potentially will lead to fewer plant impacts and a lower carbon content in the captured fly ash;
- may result in somewhat better performance with low-sulfur (including low-rank) coals because of less competition from SO₃; and,
- may be a relatively inexpensive and attractive control technology option for technology transfer to developing countries as it does not involve the capital intensive FF installation.

Performance of a halogenated sorbent such as B-PAC appears to be relatively consistent regardless of coal type and appears to be mostly determined by whether or not the capture is in-flight—as in upstream of a cold-side ESP (CS-ESP)—or on a fabric filter.

1.3. Coal Combustion Residues

Fossil fuel combustion (burning of coal, natural gas, or oil) is the primary source of energy in the United States—providing approximately 67% of the total demand in 1997. Coal-fired utilities provide more than 50% of all electric power generated using fossil fuels (EPA, 1999). In 1994 there were approximately 1,250 separate coal-fired boilers in operation at 450 different utilities throughout the United States (EPA, 1999). These boilers used approximately 900 million tons of coal and produced approximately 105 million tons of high-volume coal combustion residues—fly ash, bottom ash, boiler slag, and FGD wastes (EPA, 1999). Regulations that require the reduction of mercury air emissions from coal-fired power plants will result in changes to coal combustion residues including increasing the concentration of mercury and other trace metals (Figure 3; EPA, 2002).

CCRs result from unburned carbon and inorganic materials in coal that do not burn, such as oxides of silicon, aluminum, iron, and calcium. Air pollution control can concentrate or partition metals in fly ash and scrubber sludge. Bottom ash and boiler slag are not affected by air pollution control technology, and therefore, these materials are not examined in this report. Bottom ash is the unburned material that is too heavy to be entrained in the flue gas stream

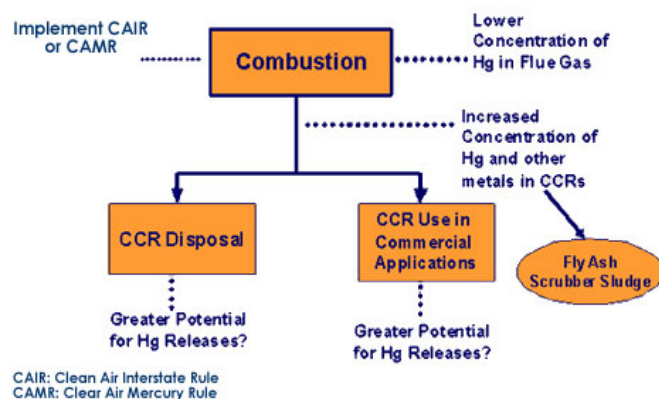

Figure 3. Life-Cycle Evaluation of Coal Combustion Residues (EPA, 2002).

and drops out in the furnace. Boiler slag, unburned carbon or inorganic material in coal that does not burn, falls to the bottom of the furnace and melts.

Fly ash and scrubber sludge are the two types of CCRs of interest in this report. Fly ash is the unburned material from coal combustion that is light enough to be entrained in the flue gas stream, carried out of the process, and collected as a dry material in the air pollution control equipment. Seventy million tons of fly ash were produced in 2003.

FGD wastes (or scrubber sludge) result from a SO₂ wet scrubbing process and generally contain 5% to 10% solids. The quantity of FGD material produced depends on the sulfur content of the coal and the amount of coal being combusted. Thirty million tons of FGD wastes were generated in 2003.

The properties of fly ash and scrubber residues from many facilities are likely to change as a result of enhanced air pollution controls for reducing mercury stack emissions. Changes in CCR properties will include increased content of mercury and other co-collected metals (e.g., arsenic, selenium) and the presence of injected sorbent or other chemical modifiers to improve mercury removal. In several prevalent APC configurations, the sorbent will be commingled with either fly ash or other residue streams, modifying both chemical and physical properties of the CCR.

1.4. Residue Management Practices

CCRs can be disposed in landfills or surface impoundments or used in commercial applications to produce concrete and gypsum wallboard, among other products. The major pathway of concern for release from land disposal and some beneficial use applications is leaching. Research on the impact of CCR disposal on the environment has been conducted by many researchers and has been summarized by

the EPA (1988, 1999). However, most of the existing CCR data are for CCRs prior to implementation of mercury or multi-pollutant controls.

1.4.1. Beneficial Use

In the United States, approximately 31% of all CCRs produced are reused in commercial applications or other beneficial uses. Thirty-two percent of fly ash is used in commercial applications such as making concrete/grout, structural fill, and highway construction (ACAA, 2000; Thorneloe, 2003). Six million tons of the scrubber sludge (or 26%) was used in making wall board (ACAA, 2000; Thorneloe, 2003). In Europe, use of CCRs for commercial applications/beneficial uses is much higher (over 50%). Table 4 ACCA, 2003) and Figure 4 present the primary commercial uses of CCRs, and a breakdown of U.S. production and usage by CCR type. The primary commercial applications or commercial uses of CCRs are shown.

Some of the beneficial uses may have the potential to release mercury from the CCRs, particularly in high-temperature processes. In cement manufacturing, for example, CCRs are inputs to the cement kiln. It is expected that virtually all mercury will be volatilized from CCRs in this application. Even where mercury can be captured by the controls on cement kilns, approximately two-thirds of ce-

ment kiln dust captured by the control devices is reintroduced into the kiln. Therefore, a significant fraction of the mercury in CCRs introduced into cement kilns may be emitted to the air at the cement plant. Some mercury may also be revolatilized when CCRs are used as a filler for asphalt or when FGD material is used in wallboard manufacturing. A separate report will present the results from a study conducted to evaluate the thermal stability of mercury and other metals during application of these high-temperature processes.

The fate of mercury and other metals is a potential concern when CCRs are used on the land (mine reclamation, building highways, soil amendments, agriculture and in making concrete, cement) or to make products that are subsequently disposed (e.g., disposal of wall board in unlined landfill).

For several commercial uses, it appears less likely that mercury in CCRs will be reintroduced into the environment, at least during the lifetime of the product. For example, mercury appears unlikely to be volatilized from confined uses such as concrete, flowable fill, or structural fill. The potential for leaching of mercury in these applications also seems limited, in part due to the relative impermeability of concrete and flowable fill; however, special applications such as those involving continuous immer-

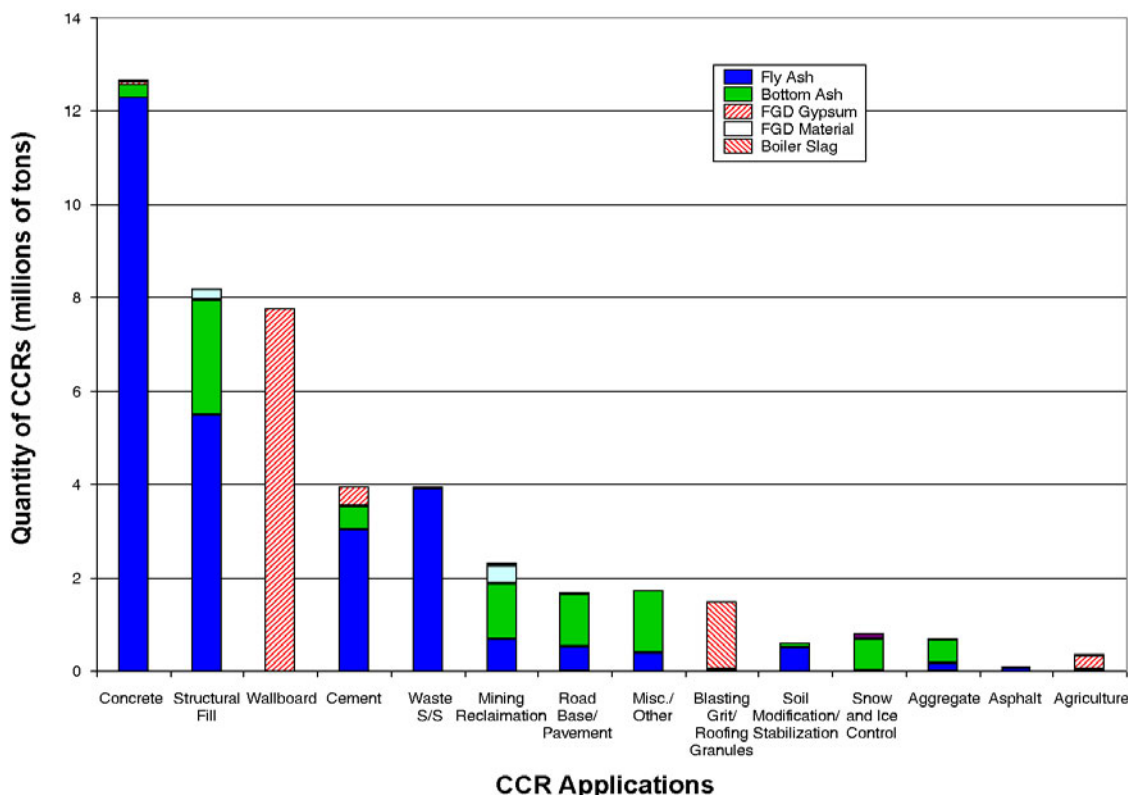

Figure 4. Uses of CCRs Based on 2003 Industry Statistics (ACAA, 2003).

Table 4. Beneficial Uses of CCRs (ACAA, 2003).

CCP ^a Categories	Fly Ash	Bottom Ash	FGD Gypsum	FGD Material Wet Scrubbers	Boiler Slag ^b	FGD Material Dry Scrubbers ^b	FGD Other ^b	FBC Ash ^{b,c}
CCP Production Category Totals ^d	70,150,000	18,100,000	11,900,000	17,350,000	1,836,235	1,444,273	167,345	796,718
CCP Production Total								121,744,571
CCP Use Category Totals ^e	27,136,524	8,247,273	8,299,060	484,412	1,756,004	197,509	0	263,623
All CCP Used Total								46,384,405
CCP Use by Application^f								
Concrete/Concrete Products/Grout	12,265,169	298,181	65,693	0	15,907	34,284	0	0
Cement/Raw Feed for Clinker	3,024,930	493,763	420,043	0	15,766	2,469	0	0
Flowable Fill	136,618	20,327	0	0	0	9,184	0	0
Structural Fills/Embankments	5,496,948	2,443,206	0	224,100	11,074	12,141	0	0
Road Base/Sub-base/Pavement	493,487	1,138,101	0	0	29,800	0	0	0
Soil Modification/Stabilization	515,552	67,998	0	704	0	114	0	188,708
Mineral Filler in Asphalt	52,608	0	0	0	31,402	0	0	0
Snow and Ice Control	1,928	683,556	0	0	102,700	0	0	0
Blasting Grit/Roofing Granules	0	42,604	0	0	1,455,140	0	0	0
Mining Applications	683,925	1,184,927	0	259,608	59,800	130,723	0	11,049
Wallboard	0	0	7,780,906	0	0	0	0	0
Waste Stabilization/Solidification	3,919,898	30,508	0	0	0	0	0	49,217
Agriculture	12,140	3,534	32,518	0	0	2,295	0	0
Aggregate	137,171	512,769	0	0	31,600	6,299	0	0
Miscellaneous/Other	396,150	1,327,797	0	0	2,815	0	0	14,649
CCP Category Use Totals	27,136,524	8,247,273	8,299,060	484,412	1,756,004	197,509	0	263,623
Application Use to Production Rate	38.68%	45.57%	69.74%	2.79%	95.63%	13.68%	0.00%	33.09%
Overall CCP Utilization Rate								38.10%

^a The American Coal Ash Association uses CCP (coal combustion products) to refer to CCRs.

^b As submitted based on 60% coal burn.

^c FBC = fluidized-bed combustion.

^d CCP Production totals for Fly Ash, Bottom Ash, FGD Gypsum, and Wet FGD are extrapolated estimates rounded off to the nearest 50,000 tons.

^e CCP Used totals for Fly Ash, Bottom Ash, FGD Gypsum, and Wet FGD are per extrapolation calculations (not Rounded off).

^f CCP Uses by application for Fly Ash, Bottom Ash, FGD Gypsum, and Wet FGD are calculated per proportioning the CCP Used Category Totals by the same percentage as each of the individual types' raw data contributions to the as-submitted raw data submittal total (not rounded off).

sion in water may produce different results. The impact of advanced mercury emissions control technology (e.g., ACI) on beneficial use applications is uncertain. There is concern that the presence of increased concentrations of mercury, certain other metals, or high carbon content may reduce the suitability of CCRs for use in some applications (e.g., in Portland cement concrete).

1.4.2. Land Disposal

There are approximately 600 land-based CCR waste disposal units (landfills or surface impoundments) being used by the 450 coal-fired power plants in the United States (EPA, 1999). About 70% of the 122 million tons of CCRs generated annually are land disposed. Landfills may be located either on-site or off-site while surface impound-

ments are almost always located on-site with the combustion operations. Although the distribution of units is about equal between landfills and surface impoundments, there is a trend toward increased use of landfills as the primary disposal method.

1.5. Leaching Protocol

One of the major challenges facing this research was identification of an appropriate test protocol for evaluating the leaching potential of CCRs that may have increased levels of several metals, particularly mercury. The goal of this research is to develop the most accurate estimates of likely constituent leaching when CCRs are land disposed. These estimates of leaching need to be appropriate for assessing at a national level the likely impacts through leaching of

pollutants from CCRs that is a consequence of installing enhanced mercury and/or multi-pollutant controls. To achieve this goal requires that U.S. EPA evaluate leaching potential for CCRs as-managed (to the degree this is known) and that the leach testing results can be appropriately extrapolated to a national assessment. A large part of the approach to achieving this has been to identify and evaluate CCR samples collected from the most prevalent combinations of power plant design (with a focus on air pollution control configurations) and coal type used. U.S. EPA and EPRI have also examined and collected data on the actual disposal conditions for CCRs because these conditions will affect leaching and will also vary over time. When disposed, CCRs are typically monofilled or disposed with other CCRs. However, CCR composition can change over time, due to changes in the source of coal or coal type burned or due to installation of additional pollution control equipment, so the conditions of leaching created by the CCRs will also change over time.

Many leaching tests have been developed by regulatory agencies, researchers, or third-party technical standards organizations and are described in the published literature. States and others have expressed concern with the variety of leaching protocols in use, the lack of correlation of test results with field conditions and actual leaching, and lack of comparability of available data because of incomplete reporting of test conditions. There is also limited or no quality assurance (QA) information for many of these tests. Leaching tests such as the toxicity characteristic leaching procedure (TCLP),⁷ which reflects municipal solid waste co-disposal conditions; the synthetic precipitation leaching procedure (SPLP); or any number of deionized-water based tests may be inappropriate or are at least not optimal for evaluating the leaching potential of CCRs as they are

actually managed. These tests either presume a set of prevailing landfill conditions that may or may not exist at CCR disposal sites (e.g., TCLP), try to account for an environmental factor considered to be important in leaching (e.g., SPLP), or presume that the waste tested will define the disposal conditions—such as deionized (DI) water tests. Most existing leaching tests are empirical in that results are presented simply as the contaminant concentrations leached when using the test and presented without measuring or reporting values for factors that may affect waste leaching or that provide insight into the chemistry that is occurring in leaching. Most tests are performed as a single batch test and so do not consider the effect of variations in conditions on waste constituent leaching.⁸

In searching for a leach testing approach that will produce the most reliable results for this waste and that can be used to predict leaching nationally, EPA sought an approach that (1) considers the range of known CCR chemistry and management conditions (including re-use) and (2) permits development of data that are comparable across U.S. coal and CCR types. Because the data resulting from this research will be used to support regulations, careful scrutiny of the data is expected. Therefore, the use of a published, peer-reviewed protocol is also considered to be an essential element of this work.

EPA's Office of Research and Development (ORD) has worked closely with EPA's Office of Solid Waste (OSW) to identify an appropriate leaching protocol for evaluating CCRs. The protocol that has been adopted is the "Integrated Framework for Evaluating Leaching in Waste Management and Utilization of Secondary Materials" (Kosson et al., 2002) and referred to here as the "Leaching Framework," or Framework. The Leaching Framework consists of a tiered approach to leaching assessment. The general approach under the Leaching Framework is to use laboratory testing to measure intrinsic leaching characteristics of a material (i.e., liquid-solid equilibrium partitioning as a function of pH and LS ratio, mass transfer rates) and then use this information in conjunction with mass transfer models to estimate constituent release by leaching under specific management scenarios (e.g., landfilling). Unlike

⁷ TCLP was not included as part of this study for two reasons. First, EPA previously made a waste status determination under RCRA that coal combustion residues are non-hazardous (65 FR 32214, May 22, 2000). Therefore, use of TCLP was not required as indicated under the RCRA toxicity characteristic regulation for determination of whether or not CCRs were hazardous. Second, TCLP was developed to simulate co-disposal of industrial waste with municipal solid waste as a mismanagement scenario and to reflect conditions specific to this scenario. However, the vast majority of CCRs are not being managed through co-disposal with municipal solid waste, and the test conditions for TCLP are different from the actual management practices for most CCRs. In seeking a tailored, "best-estimate" of CCR leaching, the leaching framework provides the flexibility to consider the effects of actual management conditions on these wastes, and so will be more accurate in this case.

⁸ Many factors are known or may reasonably be expected to affect waste constituent leaching. The solubility of many metal salts is well known to vary with pH; adsorption of metals to the waste matrix varies with pH; redox conditions may determine which metal salts are present in wastes; temperature may affect reaction rates; water infiltration can affect the leaching rate and also affect leaching chemistry and equilibrium.

other laboratory leaching tests, under this approach, laboratory testing is not intended to directly simulate or mimic field conditions. Development work to-date on the Framework has focused on assessing metals leaching, and it includes equilibrium batch testing (over a range of pH and LS ratio values), diffusion-controlled mass transfer, and percolation-controlled (column) laboratory test methods in conjunction with mass transfer models to estimate release for specific management scenarios based on testing results from a common set of leaching conditions. EPA's OSW and ORD believe that this approach successfully addresses the concerns identified above because it seeks to consider the effect of key disposal conditions on constituent leaching and to understand the leaching chemistry of wastes tested.

The following attributes of the Leaching Framework were considered as part of the selection process:

- It will permit development of data that are comparable across U.S. coal and CCR types;
- It will permit comparison with existing laboratory and field leaching data on CCRs;
- It was published in the peer-reviewed scientific literature;
- On consultation with EPA's OSW, it was recommended as the appropriate protocol based on review of the range of available test methods and assessment approaches; and
- On consultation with the Environmental Engineering Committee of the Science Advisory Board (June 2003), the Committee considered the Leaching Framework to be responsive to earlier SAB criticisms of EPA's approach to leaching evaluation and to be broadly applicable and appropriate for this study. The complete summary of the SAB consultation is provided as Appendix A.

For this study, the primary leaching tests used from the Leaching Framework were Solubility and Release as a Function of pH (SR002.1) and Solubility and Release as a Function of the Liquid-Solid Ratio (LS) (SR003.1).⁹ These tests represent equilibrium-based leaching characterization.

⁹ LS refers to liquid to solid ratio (mL water/g CCR or L water/kg CCR) occurring during laboratory leaching tests or under field conditions. SR002.1 is carried out at LS=10 with several parallel batch extractions over a range of pH, while SR003.1 is carried out using several parallel batch extractions with deionized water at LS= 0.5, 1, 2, 5 and 10. Under field conditions, LS refers to the cumulative amount of water passing through the total mass of CCR subject to leaching.

The range of pH and LS ratio used in the leaching tests includes the range of conditions (pH and LS ratio) observed for current CCR management practices. Results of these tests provide insights into the physical-chemical mechanisms controlling constituent leaching. When used in conjunction with mass transfer and geochemical speciation modeling, the results can provide conservative but realistic estimates of constituent leaching under a variety of environmental conditions (pH, redox, salinity, carbonation) and management scenarios.

Laboratory testing for leaching assessment was carried out at the U.S. EPA National Risk Management Laboratory (Research Triangle Park, NC) with technical assistance from Vanderbilt University.

2. Materials and Methods

2.1. CCR Materials for Evaluation

The CCR materials tested in this study include a reference fly ash and fly ashes collected by ADA-Environmental Solutions from designated coal combustion facilities under contract for the Department of Energy's National Energy Technology Laboratory (NETL) field evaluation program of sorbent injection upstream of existing particulate control devices. This program represents the first time that PAC has been injected on a large scale for a period of several weeks as enhanced mercury control technology. All six of the facilities evaluated in this report burn either low-sulfur bituminous coal (Brayton Point, Salem Harbor, Facility C, Facility L), sub-bituminous coal (Pleasant Prairie) or a sub-bituminous/low-sulfur bituminous coal blend (St. Clair) and have particulate control devices only (no SO₂ scrubbers). This facility configuration is representative of 75% of the coal-fired utilities in the U.S. The same commercial sorbent (Norit Americas FGD Carbon)¹⁰ was used for all of the tests using ACI. This sorbent has a surface area of approximately 600 m²/g and a mass-mean diameter of 18 μm. The tests using B-PAC used sorbent obtained from Sorbent Technologies Corp., with a surface area of 700 to 1070 m²/g and a mass-mean diameter of 19 μm. Samples of fly ash were collected from each facility under conditions with the enhanced mercury control technology turned off and in use.

The facilities and associated CCRs reported here are described below. Appendix B provides a schematic flow diagram for each facility. Table 5 provides characteristics of the low-sulfur bituminous coal combusted at Brayton Point, Salem Harbor, Facility C and Facility L, the sub-bituminous coal combusted at Pleasant Prairie and the sub-bituminous/low-sulfur bituminous coal blend combusted at St. Clair. Elemental composition by x-ray fluorescence and additional characteristics of the fly ashes from baseline

testing and testing with enhanced mercury control are provided in Table 6 and Table 7. For samples from Salem Harbor, the loss on ignition (LOI) is more than twice the total carbon content because of a relatively high fraction of uncombusted particulate in the CCR. Total content analyses for mercury, arsenic, cadmium, lead and selenium results are provided in Table 8.

2.1.1. Reference Fly Ash

The reference fly ash was obtained from the EPA, National Risk Management Research Laboratory (Research Triangle Park, NC). X-Ray Fluorescence (XRF) analysis shown in Table 6 is typical of a Class F fly ash from an eastern bituminous coal. This fly ash was selected for this program because it was available in large quantities (approximately two 55-gallon drums) and it contained low mercury levels. The large quantity allows for inter-laboratory comparisons at a later date. The low mercury content was important to test the laboratories' ability to close the mercury mass-balance around the leaching and thermal desorption studies in the limit case of very low mercury content.

2.1.2. Facilities Using Injection of Standard Activated Carbon

2.1.2.1. Brayton Point

Brayton Point Station (Somerset, MA) is operated by PG&E National Energy Group. This facility is composed of four fossil fuel fired units designated as Units 1, 2, 3, and 4. The test unit selected, unit 1, has a tangentially fired boiler rated at 245 MW. Brayton Point Unit 1 was chosen for this evaluation because of its combination of firing low-sulfur bituminous coal with a cold-side ESP. This configuration represents a wide range of coal-fired power plants located in the eastern U.S. (Senior et al., 2003a).

The primary particulate control equipment consists of two CS-ESPs in series, with an EPRICON flue gas conditioning system that provides SO₃ for fly ash resistivity control.

¹⁰ DARCO FGD carbon is currently sold under the trade name DARCO-HG.

Characterization of Coal Combustion Residues

Table 5. Characteristics of Coal Combusted and Facilities Sampled and Reported Here (Senior et al., 2003a, Senior et al., 2003b, Senior et al., 2004).

Parameter	Brayton Point	Pleasant Prairie	Salem Harbor	Facility C	St. Clair	Facility L
Coal	Low-sulfur Bituminous (2002) ^a	PRB ^b Sub-bituminous (2002)	Low-sulfur Bituminous (2002)	Low-sulfur Bituminous	PRB Subbituminous/Low-sulfur Bituminous (85:15) Blend	Low-sulfur bituminous
Sulfur, wt%	0.7	0.3	0.67	1.24	NT ^c	NT
Ash, wt%	10.8	5.1	6.48	14.78	NT	NT
Moisture, wt	4.7	30.7	9.05	6.85	NT	NT
HHV ^d , Btu/lb	12,780	8,385	12,420	11,902	NT	NT
Hg, µg/g	0.044	0.109	0.0617	0.136	NT	NT
Cl, µg/g	1475	8.1	64.3	169	NT	NT
As, µg/g	5.68	NT	2.4	NT	NT	NT
Cd, µg/g	0.055	NT	0.14	NT	NT	NT
Pb, µg/g	8.9	NT	3.8	NT	NT	NT
Se, µg/g	3	NT	4.8	NT	NT	NT
Particulate Control Device	2 CS-ESPs in series	CS-ESP	CS-ESP	HS-ESP + COHPAC	CS-ESP	HS-ESP
Sorbent Injection Point	Between the 2 ESPs	Before ESP	Before ESP	Between HS-ESP and COHPAC	Before South Side ESP	Before B-Side ESP
SO _x and NO _x Control	NA ^e	NA	SNCR	NA	NA	Separated Over-fire Air Ports
Sampling Location	Ash Hopper Row C	ESP Hopper 1 and 2 Composite	ESP Hopper A	B-Side Hopper	North and South side Hoppers	A- and B-side Hoppers

^a Year over which coal sampled to obtain average values.

^b PRB = Powder River Basin.

^c NT = not tested.

^d HHV = higher heating value.

^e NA = not applicable.

Table 6. Fly Ashes from Brayton Point, Pleasant Prairie, Salem Harbor, and Facility C: Elemental Composition (by x-ray fluorescence) and Other Characteristics.

Element	Reference Fly (Average%)	Brayton Point (Average%) ^a		Pleasant Prairie (Average%)		Salem Harbor (Average%)		Facility C (Average%)	
		Baseline	with ACI	Baseline	with ACI	Baseline	with ACI	Baseline	with ACI
Al	14.700	13.430	12.400	10.050	10.220	9.523	7.623	12.25	8.96
As	0.010	BML ^b	BML	BML	BML	BML	BML	BML	BML
Ba	0.110	0.010	0.095	0.695	0.647	0.091	0.099	0.206	0.148
Br	BML	0.005	0.065	BML	BML	BML	BML	0.0025	0.0097
Ca	0.860	6.080	2.030	18.430	16.640	1.298	0.803	2.07	1.92
Cl	0.026	0.030	0.440	BML	.0045	0.101	0.203	0.0373	0.0790
Cr	0.017	0.022	0.018	0.016	0.013	0.011	0.012	0.0177	0.0134
Cu	0.018	0.022	0.020	0.022	0.022	0.007	0.008	0.0247	0.0179
Fe	5.110	4.650	2.500	4.310	4.280	4.870	3.630	7.43	5.90
I	BML	BML	0.014	BML	BML	BML	BML	BML	BML
K	2.460	1.853	1.500	0.371	0.455	1.250	0.977	1.84	1.34
Mg	0.637	0.800	0.641	2.810	2.460	1.785	0.420	1.679	0.586
Mn	0.015	0.041	0.020	0.057	0.020	0.045	0.021	0.0196	0.0179

continued

Table 6 (concluded). Fly Ashes from Brayton Point, Pleasant Prairie, Salem Harbor, and Facility C: Elemental Composition (by x-ray fluorescence) and Other Characteristics.

Element	Reference Fly (Average%)	Brayton Point (Average%) ^a		Pleasant Prairie (Average%)		Salem Harbor (Average%)		Facility C (Average%)	
		Baseline	with ACI	Baseline	with ACI	Baseline	with ACI	Baseline	with ACI
Na	0.346	0.511	0.242	1.660	1.310	0.270	0.293	0.374	0.287
Ni	0.011	0.015	0.016	0.006	0.006	0.009	0.009	0.0173	0.0149
Pb	0.008	BML	0.010	BML	BML	0.005	BML	0.0066	0.0037
P _x ^c	0.087	0.161	0.042	0.056	0.508	0.086	0.057	0.303	0.184
Se	BML	0.005	0.020	BML	BML	0.005	0.005	0.0157	0.0487
Si	26.400	23.080	23.240	16.600	16.250	21.898	23.468	17.48	12.92
Sr	0.089	0.124	0.083	0.369	0.341	0.042	0.032	0.143	0.104
S ^d	BML	BML	BML	BML	BML	BML	BML	BML	BML
S _x ^e	0.174	0.351	0.582	0.635	0.971	0.335	0.761	0.544	1.18
Ti	0.897	1.015	0.100	0.964	0.943	0.453	0.407	0.709	0.574
V	0.031	0.043	0.32	0.030	0.033	0.029	0.030	0.0411	0.0322
Zn	0.023	0.021	0.011	0.009	0.010	0.013	0.013	0.0139	0.0105
Zr	0.050	0.031	0.031	0.035	0.035	0.019	0.019	0.0245	0.0202

Physical Parameters

Total Carbon	0.76	2.3	13	0.25	3.6	7.8	11	10.9	24.44
Surface Area ^f (m ² /g)	1.36	6.5	92	1.8	23	28	36	14.10	36.55
LOI (wt%)	0.85	5.5	12	0.60	3.5	21	25	18.0	36.26

^a Unless otherwise noted.

^b BML = below method limit (As<0.009%, I<0.006%, Pb<0.003%, Se<0.003%).

^c P_x = phosphorus in oxidized form such as phosphate.

^d S = sulfur in elemental form.

^e S_x = sulfur in oxidized form such as sulfate.

^f Brunauer, Emmett, and Teller method for quantifying surface area.

Table 7. Fly Ashes from St. Clair and Facility L: Elemental Composition (by x-ray fluorescence) and Other Characteristics.

Element	Reference Fly (Average%)	St. Clair (Average%) ^a		Facility C (Average%)	
		Baseline	with BPAC	Baseline	with BPAC
Al	14.700	10.63	10.16	13.19	13.15
As	0.010	BML ^b	BML	BML	BML
Ba	0.110	1.20	1.01	0.0652	0.0632
Br	BML	BML	0.0962	BML	0.0061
Ca	0.860	12.06	11.35	0.328	0.319
Cl	0.026	0.0156	0.0412	0.0389	0.0339
Cr	0.017	0.0116	0.0109	0.0147	0.0147
Cu	0.018	0.0170	0.0148	0.0100	0.0093
Fe	5.110	5.35	5.52	2.39	2.36
I	BML	BML	0.014	BML	BML
K	2.460	0.794	0.768	2.27	2.22

continued

Characterization of Coal Combustion Residues

Table 7 (concluded). Fly Ashes from St. Clair and Facility L: Elemental Composition (by x-ray fluorescence) and Other Characteristics.

Element	Reference Fly (Average%)	St. Clair (Average%) ^a		Facility C (Average%)	
		Baseline	with BPAC	Baseline	with BPAC
Mg	0.637	3.07	2.92	0.584	0.580
Mn	0.015	0.0350	0.0314	0.0088	0.0085
Na	0.346	4.66	4.09	0.134	0.132
Ni	0.011	0.0074	0.0064	0.0109	0.0109
Pb	0.008	0.0045	0.0040	0.0046	0.0046
P _x ^c	0.087	0.219	0.169	0.0262	0.0240
Se	BML	BML	0.0024	BML	BML
Si	26.400	16.65	17.00	24.75	24.8
Sr	0.089	0.565	0.517	0.0322	0.0322
S ^d	BML	BML	BML	BML	BML
S _x ^e	0.174	1.23	1.03	BML	BML
Ti	0.897	0.759	0.713	0.882	0.878
V	0.031	0.0292	0.0257	0.0232	0.0233
Zn	0.023	0.0104	0.0077	0.0075	0.0065
Zr	0.050	0.0274	0.0283	0.0284	0.0277
Physical Parameters					
Total Carbon	0.76	0.16	2.65	5.56	5.92
Surface Area ^f (m ² /g)	1.36	2.50	24.86	8.23	27.01
LOI (wt%)	0.85	0.41	3.19	12.28	12.38

^a Unless otherwise noted.

^b BML = below method limit (As<0.009%, I<0.006%, Pb<0.003%, Se<0.003%).

^c P_x = phosphorus in oxidized form such as phosphate.

^d S = sulfur in elemental form.

^e S_x = sulfur in oxidized form such as sulfate.

^f Brunauer, Emmett, and Teller method for quantifying surface area.

Table 8. CCRs from Facilities with Electrostatic Precipitators: Total Content of Mercury, Arsenic, Cadmium, Lead and Selenium. [All analyses are according to EPA Method 3052, except for mercury (thermal), which is by EPA Method 7473 (EPA, 1998b)].

Sample ID	Mercury (ng/g)	Mercury (thermal) (ng/g)	Arsenic (µg/g)	Cadmium (µg/g)	Lead (µg/g)	Selenium (µg/g)
Brayton Point Baseline	650.6±6.8	582.2±2.1	80.5±1.9	BML ^a	117.3±4.9	51.4±1.7
Brayton Point with ACI	1529.6±1.1	1414.1±43.7	27.9±2.1	BML	82.9±2.3	151.9±6.2
Pleasant Prairie Baseline	157.7±0.2	146.9±3.9	21.3±0.3	BML	41.6±0.8	BML
Pleasant Prairie with ACI	1180±1.2	1176.8±16.4	24.0±0.8	BML	47.0±0.3	BML
Salem Harbor Baseline	528.5±5.3	573.8±8.7	25.9±0.0	NT ^b	24.9±1.4	41.9±0.1
Salem Harbor with ACI	411.5±12.6	454.0±12.1	26.0±0.0	NT	24.0±0.0	44.0±0.0
Facility C Baseline	15.8±0.9	10.5±0.7	93.6±5.5	NT	55.8±0.7	BML
Facility C with ACI	1150.7±14	1090.1±24.1	506.3±28.7	NT	114.4±5.8	206.3±0.9

continued

Table 8 (concluded). CCRs from Facilities with Electrostatic Precipitators: Total Content of Mercury, Arsenic, Cadmium, Lead, and Selenium. [All analyses are according to EPA Method 3052, except for mercury (thermal), which is by EPA Method 7473 (EPA, 1998b)].

Sample ID	Mercury (ng/g)	Mercury (thermal) (ng/g)	Arsenic (µg/g)	Cadmium (µg/g)	Lead (µg/g)	Selenium (µg/g)
St. Clair Baseline	110.9±5.8	NT	43.4±2.6	1.4±0.1	46.3±17.9	10.7±0.1
St. Clair with B-PAC	1163.0±8.9	NT	40.8±1.1	1.3±0.1	34.9±1.7	12.6±0.9
Facility L (Run 1) Baseline ^c	13.0±0.2	NT	20.0±1.1	0.4±0.0	44.8±0.7	4.1±0.1
Facility L (Run 1) with B-PAC ^c	37.7±1.3	NT	18.7±0.7	0.3±0.0	42.2±0.3	4.3±0.2
Facility L (Run 2) Baseline ^d	20.3±0.14	NT	44.4±1.1	0.6±0.1	60.2±3.8	3.0±0.3
Facility L (Run 2) with B-PAC ^d	71.4±0.03	NT	44.3±1.4	0.9±0.2	63.0±2.8	4.3±0.0
MDL	0.2 ng/g	0.145 ng/g	1.12	1.0	0.18	0.72
Minimum Quantification Limit	0.72 ng/g	1.0 ng/g	4.0	10.0	0.6	4.0

^a BML = below method limit.

^b NT = not tested.

^c Pneumatic controls were turned off for 4 hr to collect fly ash.

^d Pneumatic controls were turned off for 30 min to collect fly ash. Not tested for leaching.

The EPRICON system is not used continuously, but on an as-needed basis. The first ESP (“Old ESP”) in this particular configuration was designed and manufactured by Koppers. The Koppers ESP has a weighted wire design and a specific collection area (SCA) of 156 ft²/1000 acfm. The second ESP (“New ESP”) in the series configuration was designed and manufactured by Research-Cottrell. The second ESP has a rigid electrode design and an SCA of 403 ft²/1000 acfm. Total SCA for the unit is 559 ft²/1000 acfm. The precipitator inlet gas temperature is nominally 280 °F at full load (Senior et al., 2003a).

Hopper ash is combined between both precipitators in the dry ash-pull system. The ash is processed by an on-site Separation Technology Inc. (STI) carbon separation system, to reduce the carbon content. This processed ash is sold as base for concrete and the remainder of the higher carbon ash is land disposed (Senior et al., 2003a).

The injection rate of the PAC was 20 lb of sorbent used for each million actual cubic feet of gas (lb/MMacf) at the time when the CCR with ACI in use was collected from this facility.

The baseline and post-control ashes used for this study were collected as composite samples from the C-row ash hoppers of the new ESP before processing for carbon separation.¹¹ The baseline ash was collected on 6 June 2002. The post-control fly ash was collected on 21 July 2002. Both

fly ashes were stored in covered five gallon buckets in the onsite trailer at ambient temperatures.

2.1.2.2. Pleasant Prairie

Wisconsin Electric Power Company, a subsidiary of Wisconsin Energy, owns and operates Pleasant Prairie Power Plant located near Kenosha, WI. The plant has two 600 MW balanced-draft coal-fired boilers designated Units 1 and 2. Unit 2 is the test unit. This site was of key interest because it was the only plant in the NETL program that burns a variety of Powder River Basin (PRB) low sulfur, sub-bituminous coals. In addition, this facility has the ability to isolate one ESP chamber (1/4 of the unit) (Starns et al., 2002).

The primary particulate control equipment consists of CS-ESPs of weighted wire design with a Wahlco gas conditioning system that provides SO₃ for fly ash resistivity control. The precipitators were designed and built by Research-Cottrell. The design flue gas flow was 2,610,000 acfm. The precipitator inlet gas temperature is nominally 280 °F at full load (Starns et al., 2002).

Precipitator #2 is comprised of four electrostatic precipitators that are arranged piggyback style and designated 2-1, 2-2, 2-3, and 2-4. Each of the four precipitators is two chambers wide and four mechanical fields deep with eight electrical fields in the direction of gas flow. The SCA is 468 ft²/kacfm (Starns et al., 2002).

Hopper ash is combined from all four precipitators in the dry ash-pull system and sold as base for concrete (Starns et al., 2002).

¹¹ Ash for this study was collected before processing for carbon separation because not all facilities do this processing.

The PAC injection rate was 10 lb/MMacf at the time when the CCR with ACI in use was collected from this facility.

The baseline ash was collected as a composite sample from ash hoppers 7-1 and 7-2 of ESP 2-4. The post-control ash was collected as a grab sample from ash hopper 7-2 of ESP 2-4 (see Appendix B for flow diagram). The baseline ash was collected on 11 September 2001, and the post-control fly ash was collected on 13 November 2001. Both fly ashes were stored in covered five gallon buckets in the onsite trailer at ambient temperatures.

2.1.2.3. Salem Harbor

PG&E National Energy Group owns and operates Salem Harbor Station located in Salem, MA. There are four fossil fuel fired units at the facility designated as Units 1, 2, 3, and 4. Units 1–3 fire a low sulfur, bituminous coal and use oil for startup. Unit 4 fires #6 fuel oil. Unit 1, the test unit, is a B&W single-wall-fired unit with twelve DB Riley CCV-90 burners. It is rated at 88 gross MW. Salem Harbor Unit 1 was chosen for this evaluation because of its combination of firing low-sulfur bituminous coal with urea-based SNCR, high LOI, and a CS-ESP. The opportunity to quantify the impact of SNCR on mercury removal and sorbent effectiveness is unique in this program. In addition, test results from prior mercury tests have indicated 87% to 94% mercury removal efficiency on this unit without sorbent injection (Senior et al., 2003a). However, fly ash from this facility has a relatively high percentage of total carbon without carbon injection (7.8%, see Table 6), which likely serves as a sorbent for mercury.

The particulate control equipment consists of a two-chamber CS-ESP (chambers designated 1-1 and 1-2), which provides two separate gas flow paths from the outlet of the tubular air heaters to the ID fan inlets. This Environmental Elements ESP has a rigid electrode design and a SCA of 474 ft²/1000 acfm. The precipitator inlet gas temperature is nominally 255 °F at full load. Typical LOI or carbon content of the Unit 1 ash is about 25%. This ash is landfilled.

The PAC injection rate was 10 lb/MMacf at the time when the CCR with ACI in use was collected from this facility.

The baseline and post-control ashes used for this study were collected as grab samples from the first ash hopper (hopper A) of row 1-1 of the ESP. The baseline ash was collected on 6 June 2002, and the post-control fly ash was collected on 7 July 2002. Both fly ashes were stored in covered five gallon buckets in an onsite trailer at ambient temperatures.

2.1.2.4. Facility C

This plant has four 270 MW balanced draft coal-fired boilers designated as Units 1–4. All of these units fire a variety of low-sulfur, washed, Eastern bituminous coals. Unit #3 was used for the ACI studies.

All of the units at this plant employ HS-ESP as the primary particulate control equipment. The HS-ESP of unit #3 is followed by COHPAC. The COHPAC system is a pulse-jet cleaned baghouse designed to treat flue gas volumes of 1,070,000 acfm at 290 °F. The COHPAC baghouse consist of two sides, with the A-side being the control and the B-side being the side where activated carbon was injected after the HS-ESP but before the COHPAC. An ESP followed by COHPAC and combined with sorbent injection is referred to as the TOXECON configuration.

The injection rate of the PAC was 1.5 lb/MMacf at the time when the CCR with ACI in use was collected from this facility.

2.1.3. Facilities Using Injection of Brominated Activated Carbon

2.1.3.1. St. Clair

Detroit Energy St. Clair Power Plant Unit #1 is a 160 MW boiler that typically burns a 85:15 blend of PRB and bituminous coals.¹² The flue gas from the boiler splits and is directed into two parallel CS-ESPs (designated the “South ESP” and the “North ESP”, each treating half of the flue gas). The flue gas is then recombined before exiting the stack. During testing, B-PAC was injected upstream of the South ESP. The unit has no NO_x or SO₂ controls.

The injection rate of the B-PAC was 5 lb/MMacf at the time when the CCR with B-PAC in use was collected from this facility.

2.1.3.2. Facility L

This facility is configured similarly to St. Clair except that it used one HS-ESP with two compartments rather than two CS-ESPs, and it uses separated overfired air (SO_fA) ports for NO_x control. As a result, the fly ash collection temperature is between 300 and 450 °F. Samples were collected from hoppers which were evacuated under negative

¹² The unit sometimes switches to 100% PRB on the weekends. However, during our flue gas/fly ash sampling, the unit was burning the PRB/bituminous blend.

pressure. The pneumatic hopper controls were turned off to allow enough samples to collect for the leaching evaluation. The controls were off for about 4 hr. There is concern that because of the high temperature within the fly ash collection hoppers, some mercury may have desorbed prior to sampling. Therefore, the samples obtained for evaluation may have a lower metal content. Because of the concern about mercury desorbing from the fly ash, additional fly ash was collected by turning off the pneumatic transfer for 30 min (2 weeks after the original samples were collected). Total metal content determinations were completed for all samples, which includes with and without B-PAC for fly ash collected after accumulation in the hopper for 4 hr (first sampling) and 30 min (second sampling). The leaching evaluation was conducted only on the samples collected over 4 hr intervals since this provided adequate sample size (5 gallons).

2.2. Leaching Assessment Protocols

Laboratory testing for this study focused on leaching as a function of pH and LS ratio as defined by the Leaching Framework. This is considered Tier 2 testing (equilibrium-based) for detailed characterization, which was selected to establish baseline CCR characteristics. Mass transfer rate testing (Tier 3, detailed characterization) may be carried out in the future for specific cases where results from equilibrium-based characterization indicate a need for detailed assessment.

2.2.1. Alkalinity, Solubility and Release as a Function of pH (SR002.1)

Alkalinity, solubility, and release as a function of pH were determined according to method SR002.1 (Kosson et al., 2002). This protocol consists of 11 parallel extractions of particle size reduced material at a liquid-to-solid ratio of 10 mL extractant/g dry sample. Particle size reduction facilitates achieving equilibrium, but minimal size reduction was required for the samples evaluated in this study. Each extraction condition was carried out in triplicate using 40 g of material for each material evaluated. In addition, three method blanks were included, consisting of the deionized water, nitric acid and potassium hydroxide used for extractions. Typical particle size of the tested materials was less than 300 μm . An acid or base addition schedule is formulated based on initial screening for eleven extracts with final solution pH values between 3 and 12, through addition of aliquots of nitric acid or potassium hydroxide as needed. The exact schedule was adjusted based on the nature of the material; however, the range of pH values included the natural pH of the matrix that may extend the pH domain (e.g., for very alkaline or acidic materials). The

final LS ratio is 10 mL extractant/g dry sample, which includes DI water, the added acid or base, and the amount of moisture that is inherent to the waste matrix as determined by moisture content analysis. The eleven extractions were tumbled in an end-over-end fashion at 28 ± 2 rpm for 24 hr followed by filtration separation of the solid phase from the extract using a 0.45 μm polypropylene filter. Each extract then was analyzed for constituents of interest. The acid and base neutralization behavior of the materials was evaluated by plotting the pH of each extract as a function of equivalents of acid or base added per gram of dry solid. Concentration of constituents of interest for each extract was plotted as a function of extract final pH to provide liquid-solid partitioning equilibrium as a function of pH.

2.2.2. Solubility and Release as a Function of LS Ratio (SR003.1)

Solubility and release as a function of LS ratio was determined according to method SR003.1 (Kosson et al., 2002). This protocol consists of five parallel batch extractions over a range of LS ratios (i.e., 10, 5, 2, 1, and 0.5 mL/g dry material), using DI water as the extractant with aliquots of material that has been particle size reduced. Typical particle size of the material tested was less than 300 μm . Between 40 and 200 g of material, based on the desired LS ratio, were used for each extraction. All extractions were conducted at room temperature (20 ± 2 °C) in leak-proof vessels that were tumbled in an end-over-end fashion at 28 ± 2 rpm for 24 hr. Following gross separation of the solid and liquid phases by centrifugation or settling, leachate pH and conductivity measurements were taken, and the phases were separated by pressure filtration using 0.45 μm polypropylene filter membrane. The five leachates were collected and preserved, as appropriate, for chemical analysis. Each extraction condition was carried out in triplicate and a method blank consisting of the DI water used for extraction was included.

2.3. Analytical Methods

2.3.1. Surface Area and Pore Size Distribution

A Quantachrome Autosorb IC-MS was used to perform 5-point Brunauer, Emmett, and Teller (BET) method surface area, pore volume, and pore size distribution analysis on each as-received and size-reduced CCR. A 200 mg sample was degassed under vacuum at 200 °C for at least 1 hr in the sample preparation manifold prior to analysis with N_2 as the analysis gas. Standard materials with known surface area were routinely run as a QC check.

2.3.2. pH and Conductivity

Conductivity and pH were measured for all aqueous extracts using an Accumet 925 pH/ion meter. The pH of the leachates was measured using a combined pH electrode accurate to 0.1 pH units. A 3-point calibration was performed using pH buffer solutions at pH 4.0, 7.0, and 10.0. Conductivity of the leachates was measured using a standard conductivity probe. The conductivity probe was calibrated using appropriate standard conductivity solutions for the conductivity range of concern. Conductivity meters typically are accurate to $\pm 1\%$ and have a precision of $\pm 1\%$.

2.3.3. Moisture Content

Moisture content of the “as received” CCRs, was determined using American Society for Testing and Materials (ASTM) method D 2216-92. This method supercedes the one indicated in the published version of the leaching procedure.

2.3.4. Carbon Content: Organic Carbon/Elemental Carbon Analyzer

Organic carbon (OC) and elemental carbon (EC) content of each CCR tested was measured using a Sunset Lab thermal-optical EC/OC analyzer using NIOSH Method 5040. The sample, collected on quartz fiber filters, was heated under a completely oxygen-free helium atmosphere in a quartz oven in four increasing temperature steps (375, 540, 670, and 870 °C) at 60 s ramp times for the first three temperatures and a 90 s ramp time for the final temperature. This removed all organic carbon on the filter. As the organic compounds were vaporized, they were immediately oxidized to carbon dioxide in an oxidizer oven that followed the sample oven. The flow of helium containing the produced carbon dioxide then went to a quartz methanator oven where the carbon dioxide was reduced to methane, which was then detected by a flame ionization detector (FID). After the sample oven was cooled to 525 °C, the pure helium eluent was switched to an oxygen/helium mixture in the sample oven. At that time, the sample oven temperature was stepped up to 850 °C. During this phase, both the original elemental carbon and the residual carbon produced by the pyrolysis of organic compounds during the first phase were oxidized to carbon dioxide by the presence of oxygen in the eluent. The carbon dioxide was then converted to methane and detected by the FID. After all carbon had been oxidized from the sample, a known volume and concentration of methane was injected into the sample oven, so each sample was calibrated to a known quantity of carbon. This also provided a means of checking the operation of the instrument.

The calibration range for these analyses was from 10 to 200 $\mu\text{g}/\text{cm}^2$ of carbon using a sucrose solution as the standard. The detection limit of this instrument is approximately 100 ng/cm^2 with a linear dynamic range from 100 ng/cm^2 to 1 g/cm^2 .

2.3.5. Mercury (CVAA, Method 3052, and Method 7473)

Liquid samples were preserved for mercury analysis by additions of nitric acid and potassium permanganate and then prepared prior to analysis according to the following method. For each 87 mL of sample, 3 mL of concentrated nitric acid and 5 mL of 5 wt% aqueous potassium permanganate solution were added prior to storage. Immediately before cold vapor atomic absorption (CVAA) analysis, 5 mL of hydroxylamine were added to clear the sample, and the sample was then digested according to ASTM Method D6784-02 (Ontario Hydro) as described for the permanganate fraction. On completion of the digestion, the sample was analyzed for mercury by CVAA. Samples with known additions of mercury for matrix analytical spikes also were digested as described above prior to CVAA analysis.

Sample preparation of the solids and filters was carried out by HF/HNO₃ microwave digestion according to Method 3052 followed by CVAA analysis as indicated above. No additional preservation or digestion was carried out prior to CVAA analysis.

Mercury analysis of each digest, extract, and leachate was carried out by CVAA according to EPA SW846 Method 7470A “Mercury in Liquid Waste (Manual Cold Vapor Technique).” A Perkin Elmer FIMS 100 Flow Injection Mercury System was used for this analysis. The instrument was calibrated with known standards ranging from 0.025 to 1 $\mu\text{g}/\text{L}$ mercury.

Solids also were analyzed by Method 7473 “Mercury in Solids and Solutions by Thermal Decomposition, Amalgamation, and Atomic Absorption Spectrophotometry” (EPA, 1998b). A Nippon MD-1 mercury system was used for this analysis. The instrument was calibrated with known standards ranging from 1 to 20 ng of mercury. The method detection limit for mercury in solids is 0.145 mg/kg.

2.3.6. Other Metals (ICP-MS, Method 3052 and Method 6020)

Inductively coupled plasma-mass spectroscopy (ICP-MS) analyses for other elements of interest were carried out by Vanderbilt and STL laboratories. These two laboratories

were used to provide inter-laboratory comparison for selected analyses.

Liquid samples for ICP-MS analysis were preserved by addition of 3 mL of concentrated nitric acid (trace metal grade) per 97 mL of sample. Solid samples were digested by EPA Method 3052 prior to ICP-MS analysis. Known quantities of arsenic, selenium, cadmium, and lead were also added to sample aliquots for analytical matrix spikes.

2.3.6.1. ICP-MS Analysis at Vanderbilt

ICP-MS analyses carried out at Vanderbilt University (Department of Civil and Environmental Engineering) were completed using a Perkin Elmer model ELAN DRC II in both standard and dynamic reaction chamber (DRC) modes. Standard analysis mode was used for Pb, and DRC mode with 0.6 mL/min of methane as the reaction gas was used for As and Se. Nine-point standard curves were used for an analytical range between approximately 0.1 and 500 µg/L and completed daily. Analytical blanks and analytical check standards at approximately 50 µg/L were run every 10 samples and required to be within 10% of the specified value. Samples for analysis were diluted gravimetrically to within the targeted analytical range using 1% v/v Optima grade nitric acid (Fisher Scientific). Typically, analysis for As, Pb, and Se required 10:1 dilution. Twenty microliters of a 10 mg/L internal standard consisting of indium (In) (for As and Se) and holmium (Ho) (for Pb) was added to 10 mL of sample aliquot prior to analysis. Analytical matrix spikes were completed for As, Pb, and Se on one of each of the three replicate extracts from SR002.1. For each analytical matrix spike, 20 µL of a 10 mg/L standard solution was added to 10 mL of sample aliquot (effective concentration addition of 200 µg/L). Table 9 provides the element analyzed, analytical mode, corresponding internal standard, method detection limit (MDL), and minimum level of quantification (ML).

2.3.6.2. Severn Trent Laboratories, Inc. (STL)

STL (Savannah, GA) was selected as a commercial laboratory to carry out some of the ICP-MS analyses for this project. Analyses for As, Cd, Se, and Pb were performed

on an Agilent ICP-MS with octopole reaction system (ORS). Mixed calibration standards were prepared for each metal at five levels ranging from 0.5 µg/L to 100 µg/L.

2.3.7. X-Ray Fluorescence (XRF)

XRF analysis was performed on each CCR to provide additional information on its total elemental composition. For each CCR, two pellets were prepared as follows. Three grams of material was weighed and mixed with 1.5 mL (100 mg dry solids) of liquid binder to give a 32 mm diameter pellet weighing 3150 mg with a material-to-diluent ratio of 0.05. For high carbon content samples, 3.0 ml (100 mg dry solids) of liquid binder was used to give a 32 mm diameter pellet weighing 3300 mg with a material to diluent ratio of 0.1. XRF intensities were collected on each side of each pellet using Philips SuperQ data collection software and evaluated using Omega Data System’s UniQuant 4 XRF “standardless” data analysis software. The UQ/Flyash calibration was used to analyze the samples. The pellets were evaluated as oxides. Known flyash Standard Reference Materials (SRMs) were also run to assess the accuracy of the analysis. This information is useful in supplementing CVAA and ICP results.

2.3.8. MDL and ML for Analytical Results

The MDL is defined by 40 CFR Part 136, Appendix B, July 1, 1995, Revision 1.11 as “the minimum concentration of a substance that can be measured and reported with 99% confidence that the analyte concentration is greater than zero and is determined from analysis of a sample in a given matrix containing the analyte.”

The MDL was determined statistically from data generated by the analysis of seven or more aliquots of a spiked reagent matrix and verified by the analysis of calibration standards near the calculated MDL according to EPA (2003). The MDL then was determined by multiplying the standard deviation of the replicate measurements by the appropriate Students *t* value for a 99% confidence level (two tailed) and *n*-1 (six) degrees of freedom and also multiplying by the minimum dilution factor required for matrix preservation and analysis.

The ML is defined by 40 CFR Part 136, 1994 as “the lowest level at which the entire analytical system must give a recognizable signal and acceptable calibration point for the analyte.” According to EPA (2003), the ML is intended to be the nearest integer value (i.e., 1, 2 or 5×10*n*, where *n* is an integer) to 10 times the standard deviation observed for determination of the MDL. This value is also multiplied by the minimum dilution factor required for preservation

Table 9. Detection Limits and Quality Control Information for ICP-MS Analysis for As, Pb, and Se at Vanderbilt.

Element	Mode	Internal Standard	MDL (µg/L)	ML (µg/L)
As	DRC	20 µg/L In	0.64	3.0
Pb	Standard	20 µg/L Ho	0.31	1.0
Se	DRC	20 µg/L In	0.52	2.0

and analysis of the sample matrix to obtain the ML reported here.

Mercury, as measured by CVAA, required modification of the calculation of the MDL and ML because very consistent replication resulted in calculation of a MDL lower than the instrument detection limit. For this case, the standard deviation of seven replicate analyses of 0.025 µg/L was 0.00069. Therefore, the MDL was set equal to the instrument detection limit of 0.001 µg/L times the minimum dilution factor from sample preparation (3.59) to result in an MDL of 0.0036 µg/L. The ML was set to 10 times the instrument detection limit and rounded to the nearest integer value as above. The resulting ML was 0.01 µg/L.

2.4. Quality Assurance Validation

2.4.1. Homogenization of Individual CCR Samples and Aliquots for Analyses

To ensure sample homogeneity the fly ashes were mixed using a Morse single can tumbler model 1-305 (Figure 5). This tumbler is designed to provide aggressive corner-over-corner mixing at 23 RPM. Because the sample is tumbled at an angle it yields superior mixing to a conventional tumbler. Briefly, each fly ash was mixed by filling a 5 gal bucket to the half way mark and tumbled for 1 hr. The bucket was then inverted and tumbled for another hour.

At the beginning of this program a series of test were conducted to ensure that the samples were being adequately



Figure 5. Mixing Fly Ash Prior to Obtaining Aliquots for Laboratory Analyses.

mixed. The reference fly ash was mixed as outlined above and 3 sub-samples taken from the top, middle and bottom respectively and XRF pellets prepared. The XRF results showed that the concentrations of 28 elements including calcium and silicon were consistent from sub-sample to sub-sample (Table 10)

2.4.2. Leaching Test Methods and Analytical QA/QC

One of the objectives of this project was to establish a QA/QC framework for the leaching assessment approach developed by Kosson et al. (2002). The developed QA/QC framework incorporates the use of blanks, spiked samples, and replicates, and Appendix C provides the complete Quality Assurance Project Plan. For each designated leaching test condition, triplicate leaching test extractions were obtained (i.e., three separate aliquots of CCR were each extracted at the designated test condition). The three types of method blanks were the deionized water case, the most concentrated nitric acid addition case, and the most concentrated potassium hydroxide addition case. Each method blank was carried through the entire protocol, including tumbling and filtration, except an aliquot of CCR was not added.

During analysis for mercury and elemental species by ICP-MS, analytical spikes for the constituents of interest were carried out for one replicate of each test case to assess analytical recoveries over the complete range of pH and liquid matrix conditions. Using a standard obtained from a source different from the calibration standards, multipoint calibration curves using at least 7 standards and an initial calibration verification (ICV) were completed daily or after every 50 samples, whichever was more frequent. In addition, instrument blanks and continuing calibration verification (CCV) standards were analyzed after every 10 analytical samples and required to be within 10 percent of the expected value. CCV standards and instrument blanks also were run at the end of each batch of samples.

For both ICP-MS and CVAA analyses, each sample was analyzed along with a matrix spike, which is an aliquot of the sample plus a known spike concentration of the element of interest. The “spike recovery” should be within 80–120% of the expected value.

2.4.3. Laboratory Mass Balance Verification for Leaching Test Methods

Mass balance analysis around the SR002.1 Solubility and Release as a Function of pH leaching test procedure was used to demonstrate retention of Hg, As, Se, Cd, and Pb

Table 10. Total Content Analysis Results for Reference Fly Ash after Mixing (mercury analysis by Method 3052 followed by analysis with CVAA).

Element	#1 (%) ^a	#2 (%) ^a	#3 (%) ^a	Mean (%) ^a	Standard Deviation (%) ^a	%RSD
Si	26.41	26.41	26.43	26.4167	0.011547	0.04
Al	14.62	14.64	14.52	14.5933	0.064291	0.44
Fe	5.31	5.29	5.38	5.3267	0.047258	0.89
K	2.43	2.44	2.46	2.4433	0.015275	0.63
Ti	0.871	0.871	0.877	0.8730	0.003464	0.40
Ca	0.834	0.847	0.835	0.8387	0.007234	0.86
Mg	0.638	0.645	0.645	0.6427	0.004041	0.63
Na	0.351	0.352	0.34	0.3477	0.006658	1.92
S _x ^b	0.172	0.164	0.172	0.1693	0.004619	2.73
P _x ^c	0.0834	0.0854	0.0881	0.0856	0.002359	2.75
Ba	0.107	0.106	0.112	0.1083	0.003215	2.97
Sr	0.0846	0.0846	0.085	0.0847	0.000231	0.27
Zr	0.0509	0.0486	0.052	0.0505	0.001735	3.44
V	0.0243	0.0236	0.0234	0.0238	0.000473	1.99
Zn	0.0219	0.0243	0.025	0.0237	0.001626	6.85
Er	0.0224	0.0248	0.024	0.0237	0.001222	5.15
Cu	0.0173	0.0173	0.0205	0.0184	0.001848	10.06
Cr	0.0144	0.0122	0.0122	0.0129	0.00127	9.82
Y	0.0162	0.0153	0.0154	0.0156	0.000493	3.16
Mn	0.0125	0.0099	0.0108	0.0111	0.00132	11.93
Ga	0.0073	0.0073	0.0057	0.0068	0.000924	13.65
As	0.007	0.0072	0.0072	0.0071	0.000115	1.62
Rb	0.008	0.0079	0.0091	0.0083	0.000666	7.99
Co	0.0064	0.0072	0.009	0.0075	0.001332	17.68
Ni	0.0057	0.007	0.008	0.0069	0.001153	16.71
Pb	0.0059	0.0044	0.007	0.0058	0.001305	22.63
Sc	0.0033	0.0028	0.0025	0.0029	0.000404	14.10
Hg	51ng/g	61ng/g	66 ng/g	59.3333 ng/g	7.637626 ng/g	12.87

^a Unless otherwise noted.

^b Sulfur in oxidized form such as sulfate.

^c Phosphorus in oxidized form such as phosphate.

during testing through the analysis of the EPA reference fly ash. Six extraction conditions reflecting six different extraction pHs were completed in triplicate. Figure 6 provides a flow diagram of the approach used to carry out a mass balance analysis. This flow indicates the steps used for completing the necessary analysis of one leaching test condition (pH, LS ratio, and CCR) to assess the mass balance for mercury and other species of interest. The steps indicated in solid lines were already incorporated in the

leaching assessment approach by Kosson et al. (2002). The steps indicated in dotted lines were added during this project to complete mass balance evaluation.

After the samples for each evaluated leaching condition had been tumbled for the appropriate amount of time, they were each filtered and then divided into three fractions: liquid, solid, and filter. In addition, glass containers used in the procedure were rinsed with nitric acid after use, and

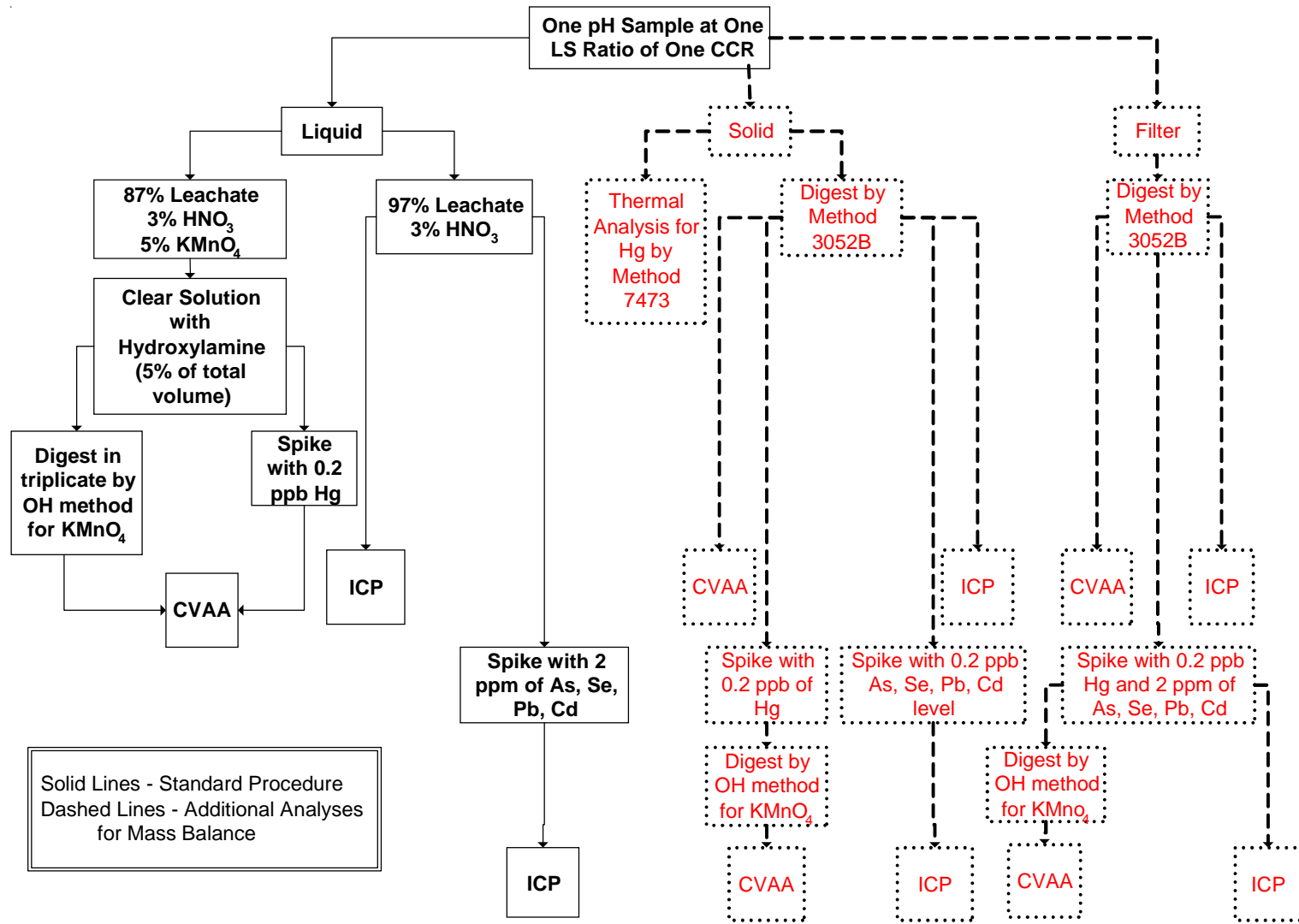

Figure 6. Flow Diagram for Mass Balance and Quality Control on Laboratory Leaching Procedures.

the resulting rinse was analyzed to verify that there were no significant constituent losses to container walls. Each fraction was independently analyzed to evaluate the mass balance. Aliquots of each liquid sample were preserved separately for mercury analysis and for analysis by ICP-MS as described earlier. For the solid, an aliquot was sampled for each case and digested according to EPA Method 3052 (EPA, 1996). For the filter, the entire filter with any retained solids was digested according Method 3052. Each digest and liquid sample was then analyzed in triplicate for mercury using CVAA as described earlier. Each digest and liquid sample also was analyzed in triplicate for As, Se, Cd, and Pb by ICP-MS. In addition to each liquid or digest sample analyzed, matrix spikes were used to determine matrix effects on the analytes of interest (Hg, As, Se, Cd, and Pb). For mercury spikes, the spiked solution then was digested by ASTM method D6784-02 prior to analysis by CVAA.

The mass balance recovery was calculated for each test case according to

$$\%R = \frac{m_L + m_S + m_F}{m_T} \times 100$$

where %R is the percent recovery and m_L , m_S , m_F , and m_T are the masses of the species of interest in the liquid phase, solid phase, filter, and the total content initially in the sample (based on independent analysis of the “as received” EPA reference fly ash), respectively.

2.4.4. Improving QA/QC Efficiency

Throughout the study, the approach to QA/QC was regularly reviewed for opportunities to increase evaluation efficiency without unacceptably degrading precision or accuracy in results. Based on evaluation of results from the first several facilities, the number of replicates for Method SR002.1 (solubility as a function of pH) and Method SR003.1 (solubility as a function of LS ratio) were reduced from three to two. Study results have shown that the precision between duplicate analyses is acceptable and that a triplicate set does not significantly increase the quality of the data set. This finding follows from (i) the data sets generated by Method SR002.1 and SR003.1 must provide both consistency between replicate extractions and analyses and internal consistency between results at different pH and LS ratio and (ii) precision is controlled primarily by the degree of homogeneity of the CCR under evaluation and representative sub-sampling, rather than by the intrinsic variability of the leaching test methods. Reducing the number of replicates has greatly improved laboratory efficiency without compromising data quality.

2.5. Interpretation and Presentation of Laboratory Leaching Data

Complete laboratory leaching results for Brayton Point, Pleasant Prairie, Salem Harbor, Facility C, and St. Clair are presented in Appendices D through H, respectively. For each facility, a common format is used for presenting results. First, a titration curve of pH as a function of milliequivalents of acid or base added is presented, with acid additions considered positive (+) and base additions considered negative (-). The titration figure is then followed by a curve of pH as a function of LS ratio. The pH curves are then followed by a series of figures for each species of interest (i.e., mercury, arsenic, and selenium). The results from Solubility and Release as a Function of pH (SR002.1) are presented first, followed by the results from Solubility and Release as a Function of LS ratio (SR003.1).

For Solubility and Release as a Function of pH (SR002.1), results for the baseline case are presented side by side with the results from the case with enhanced mercury control. Results are presented as extract concentrations as a function of pH. Total content of the species of interest is provided above the first figure for that species. The natural pH¹³ of the system is indicated as a vertical line to the average pH and a horizontal line to the y-axis indicating the corresponding extract concentration. Included with each figure are horizontal lines at the drinking water maximum concentration level (MCL) and ML and MDL analytical limits to provide a frame of reference for the results. Also included with each figure is the 5 and 95 percentile for pH (vertical lines) and for constituent concentration (horizontal lines) from field observations of leachate from landfills for combustion residues (Table 11; EPA, 2000¹⁴; EPRI 2005), forming a rectangular box that encloses the corresponding domain of field leachate observations. An annotated example of the results is provided as Figure 7. Figures with corresponding analytical recoveries are provided below the concentration results.

For Solubility and Release as a Function of LS ratio (SR003.1), results are presented as extract concentrations

¹³ “Natural pH” of a material refers to the equilibrium pH when the material is placed in deionized water at a ratio of 10 g CCR per 100 mL of water.

¹⁴ The EPA data represent six ash landfills for which data were available. These data were not collected as nationally representative although they do portray the range of pH values also found in the EPRI data.

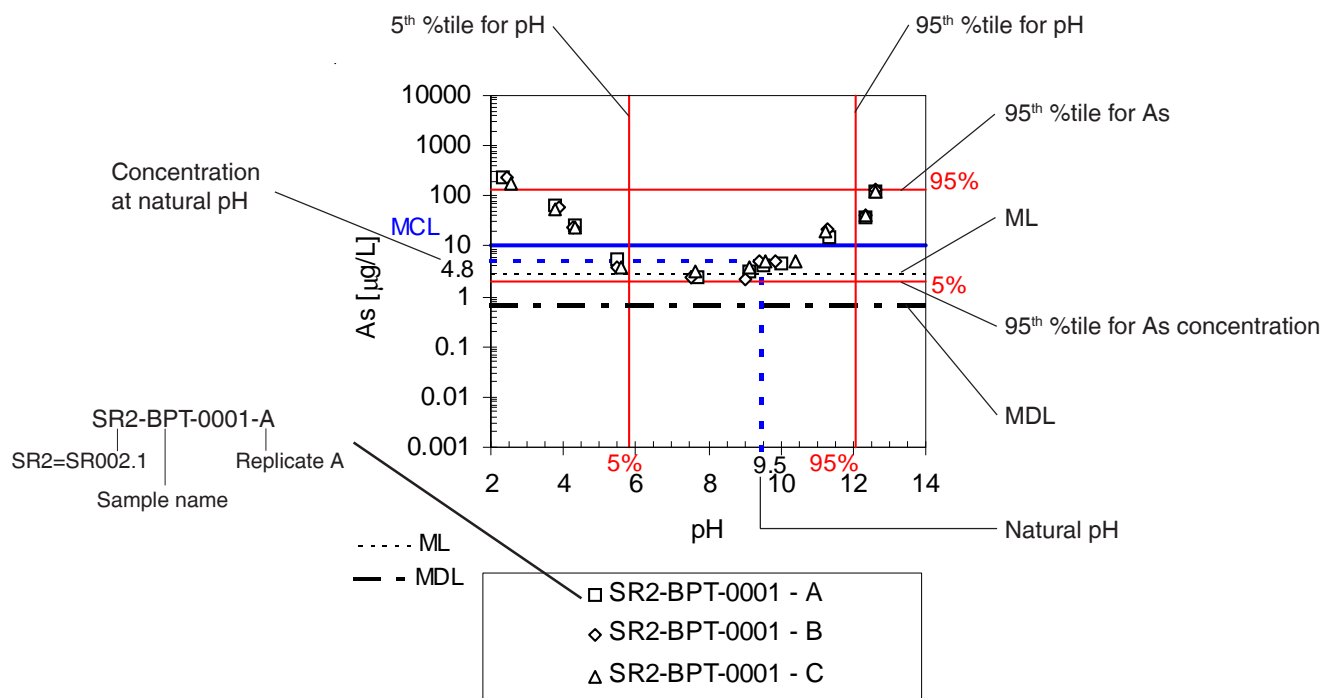

Figure 7. Example of Extract Concentrations as a Function of pH from SR002.1.

Table 11. Composition of Combustion Waste Landfill Leachate—LEACH 2000 database for Arsenic and Selenium (EPA, 2000), EPRI Database for Mercury (EPRI, 2005) and MCL Values.

Parameter	5%	95%	MCLs
pH	5.8	12.09	---
Mercury (µg/L)	0.0021	0.0498	2
Arsenic (µg/L)	2	140	10
Selenium (µg/L)	2.4	170	50

as a function of LS ratio. Also indicated are the relevant MCL, ML, and MDL. A separate figure with analytical recoveries corresponding to the figure with concentration results are provided as an indicator of analytical quality assurance.

Constituent (e.g., mercury, arsenic, and selenium) concentrations observed in laboratory leach test extracts and in field leachate samples may be the result of several mechanisms and factors. The discussion presented here focuses on constituent leaching and source term modeling approaches. Source term is defined here as the flux or amount released from the waste or secondary material (e.g., CCRs). Factors controlling constituent release and transport in and

within the near field of the CCRs are often distinctly different than factors and mechanisms that are important for subsequent vadose zone or groundwater transport outside of the near-field area.

In general, constituents are present in the waste or secondary material (e.g., CCR) either as adsorbed species, co-precipitated as amorphous or crystalline solid phases, or incorporated as trace components in solid phases. If chemical equilibrium conditions are approached (as is the approximate case for the laboratory and field sample conditions discussed in this report), then the functional behavior of the aqueous solution concentration reflects the nature of the constituent species in the waste or secondary material, the presence of any co-constituents in the aqueous phase influencing aqueous solution speciation (e.g., effects of high ionic strength, chelating or complexing constituents), and the presence of species in the solution that may compete for adsorption sites if adsorption is the controlling solid phase mechanism. If the constituent is present in the waste or secondary material as an adsorbed species, many different adsorption/desorption characteristic patterns are possible (Ruthven, 1984; Duong, 1998).

The simplest case is when the constituent of interest is present at very low concentration in the waste or second-

ary material, relatively weakly adsorbed, and the presence of complexing and/or competing species in solution are at a constant concentration. For this case, leaching test results will indicate a constant concentration as a function of pH at a fixed LS ratio and linearly increasing concentration as LS ratio decreases at constant pH. This case is represented mathematically as a linear equilibrium partitioning function, where the critical constant of proportionality is the partitioning coefficient, K_d . Linear partitioning and use of K_d values is a common approach for mathematically modeling contaminant transport at low contaminant concentrations in soils. It is a valid and useful approach when the necessary conditions (discussed above) are fulfilled.¹⁵

For mercury adsorbed on activated carbon, a complex combination of adsorption mechanisms is indicated. During laboratory leaching tests, mercury concentrations in the leaching test extracts are relatively constant over the pH range and LS ratio of interest and independent of total mercury content in the CCR. In addition, the total mercury content in the CCR is very low. These results indicate adsorption phenomena where, in the adsorbed state, interactions between adsorbed mercury species are stronger (thermodynamically) than the interactions between the adsorbed mercury species and carbon surface.¹⁶ This observation has been supported by the observation of mercury dimmer formation during sorption (Munro et al., 2001) and the occurrence of chemisorption as the dominant adsorption mechanism at temperatures above 75 °C (consistent with conditions in air pollution control devices; Vidic, 2002). In other studies, this phenomenon has been observed as the formation of molecular clusters on the adsorbent surface (Ruthven, 1984; Duong, 1998; Rudzinski et al., 1997). For this case, use of a K_d approach would underestimate release because desorption is best represented as a constant aqueous concentration until depletion occurs.

A third case is when the constituent of interest is present in the waste or secondary material (e.g., CCR) as a primary

or trace constituent in either an amorphous or crystalline solid phase and there may be complexing or chelating co-constituents in the aqueous phase. Observed aqueous concentrations are a non-linear function of pH and LS ratio and reflect aqueous saturation with respect to the species of interest under the given conditions (pH, co-constituents). For these cases, an approximation of field conditions can be made empirically based on laboratory testing and observed saturation over the relevant domain (as applied in this report), or geochemical speciation modeling coupled with mass transfer modeling can be used to assess release under specific field scenarios (the subject of a future report). Use of a K_d approach would not be appropriate for these cases because constituent concentrations will remain relatively constant at a given pH until the controlling solid phase is depleted and control is shifted to a new solid phase or mechanism.

2.6. Long-Term Release Assessment

Long-term constituent release estimates were developed to evaluate the potential cumulative impacts of different CCR management scenarios. A scenario of disposal in a combustion waste landfill and three default scenarios were examined. These scenarios were selected to provide upper bounding estimates of release considering:

- the range of field observations (pH and LS ratio¹⁵) for analogous impoundments or landfills of combustion wastes,
- constituent release if occurring at the material's natural pH, and,
- constituent release if occurring at extreme acidic or alkaline pH.

A 100-year time interval was selected as a convenient reference period because it is beyond a lifetime but within a comprehensible period. Cumulative release estimates are provided on the basis of mass of constituent released per

¹⁵ Often specific K_d values are a function of pH because of competition for adsorption sites by hydrogen ions. However, a single K_d or range of K_d values are often used in contaminant fate and transport models without specific relationship between pH and K_d .

¹⁶ For this case, the first mercury molecule is adsorbed more weakly than subsequent mercury molecules because the adsorbed mercury-mercury interaction is stronger than the adsorbed mercury-carbon surface interaction.

¹⁷ For field scenarios, LS is directly a function of time (t), infiltration rate (inf), landfill depth (H_{fill}), and fill density (ρ) according to

$$LS_{site} \left(\frac{L}{kg} \right) = 10 \left(\frac{L}{cm \cdot m} \right) \left[\frac{inf(cm/yr) \cdot t(year)}{\rho(kg/m^3) \cdot H_{fill}(m)} \right].$$

Alternatively, LS can be related to pore volumes of water passing through the CCRs (where A_{fill} is the fill area) according to

$$LS_{site} \left(\frac{L}{kg} \right) = \frac{Pore\ Volume\ e(L)}{\rho(kg/m^3) \cdot H_{fill}(m) \cdot A_{fill}(m^2)}.$$

mass of CCR disposed ($\mu\text{g X/kg CCR}$).¹⁸ These estimates are not intended to be absolute predictions of release, but rather, an initial assessment of whether further evaluation is warranted. These estimates for the monofill disposal scenario assume local equilibrium, which is a conservative assumption (i.e., estimated release is greater than actual expected release). A more refined assessment can be made using results from column leaching tests or diffusion controlled leaching tests that will allow consideration of release kinetics in developing field release estimates. The mass of constituent (e.g., As) that would be released if all of the leachate percolating through the landfill for the given scenario were at the MCL is provided as a reference value. The estimates presented here are only for constituent release from the waste and do not account for any dilution or attenuation that would occur in the vadose zone or groundwater or for the impact of a landfill liner.

For the scenario of disposal in a combustion waste landfill, a historical data set of typical leachate generated from this landfill type was taken from the comprehensive database of landfill leachate characteristics developed by the EPA's Office of Solid Waste (EPA, 2000). Cumulative release estimates were developed according to the methodology developed by Sanchez and Kosson (2005), and values of leachate pH were used to derive the probability distribution function of the field pH. Annual leachate generation quantities observed for industrial co-disposal landfills were used to derive the probability distribution function LS ratio that may be expected to contact the fill over the estimated time period of 100 years. For each data set (field pH and LS ratio), different distribution functions were used to fit the data, and the one providing the best data fit based on the chi-square test was selected. The resulting field pH probability distribution then was truncated and normalized to the pH range of the field data (Figure 8). The distribution for field pH was the result of over 158 sample observations from coal combustion residue disposal facilities at six sites. The probability distribution for the LS ratio was the result of over 41 sample observations from Industrial D landfill facilities at 17 sites. (Figure 9).

For each CCR tested, results from SR002.1 (Alkalinity, Solubility and Release as a Function of pH) were used to develop an empirical functional relationship between solution pH and expected concentration for mercury, arsenic, and selenium. Laboratory results of mercury concentra-

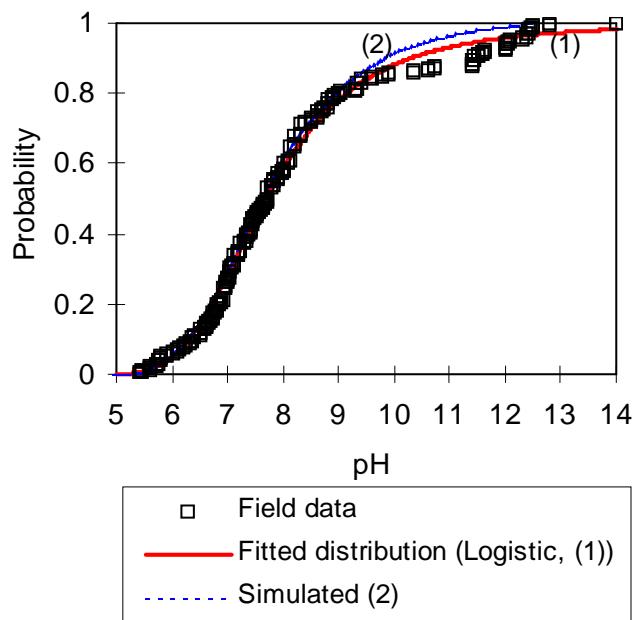

pH	Field data	Fitted distribution	Simulated
pH min	5.40	4.74	4.92
pH - 5%	5.80	6.00	5.97
pH - 50%	7.7	7.69	7.63
pH - 95%	12.09	11.62	10.63
pH max	12.80	+infinity	12.50

Figure 8. Leachate pH Distribution: Scenario of Disposal in a Combustion Waste Landfill.

tions typically showed a high degree of variability between measured and non-detected values in the laboratory leaching test extracts (Figure 10). This was likely due to micro-scale sample heterogeneity with respect to carbon distribution. However, the values of the measured mercury concentrations for a specific CCR typically did not vary significantly as a function of pH. Therefore, as an upper bounding approximation for each specific CCR, the expected mercury concentration over the expected field pH range was set to the maximum observed extract concentration over the anticipated field pH range for that CCR. As a result of this approach, all expected release of mercury should be viewed as less than or equal to the indicated value at the indicated percentile.

For arsenic and selenium, a polynomial function was regressed to the results from SR002.1 (Alkalinity, Solubility and Release as a Function of pH) with each CCR case to provide the expected leachate concentration as a function of solution pH (Figure 11). The regression fits and corresponding equations for solubility as a function of pH are provided in the appendices for each case examined (i.e., for each constituent in each CCR tested).

¹⁸ These release estimates can be converted to the amount released per unit area according to $M_t [\text{mg/m}^2] = M_i [\text{mg/kg}] \cdot \rho [\text{kg/m}^3] \cdot H_{fill} [\text{m}]$.

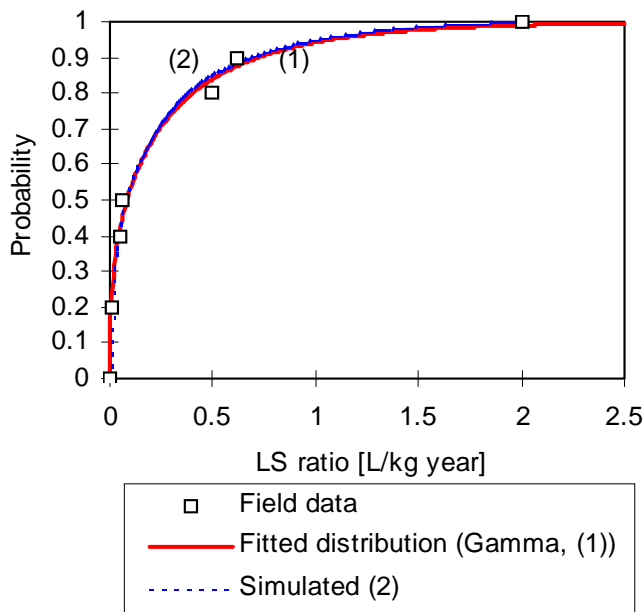

LS 1 year	Field data	Fitted distribution	Simulated
LS min	1.0E-05	3.3E-04	3.3E-04
LS - 5%	5.5E-04	4.9E-04	4.4E-04
LS - 50%	0.06	0.08	0.08
LS - 95%	1.50	1.07	1
LS max	2.50	+infinity	1.99

Figure 9. LS Ratio Distribution: Scenario of Disposal in a Combustion Waste Landfill.

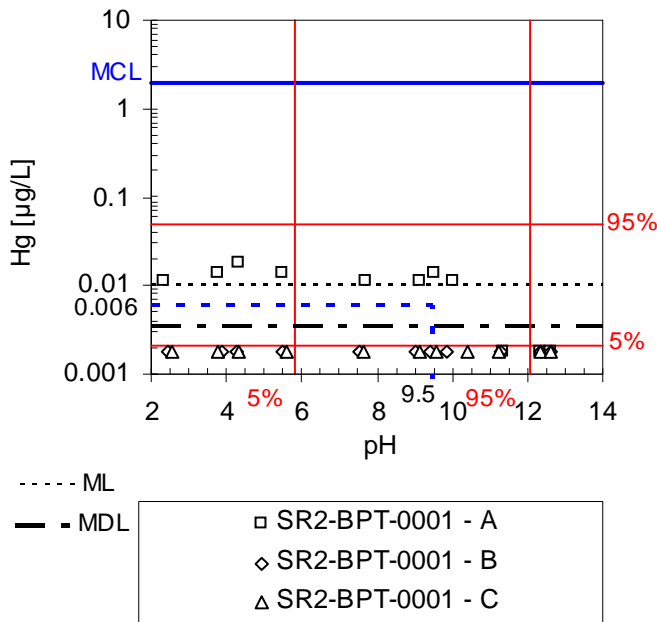
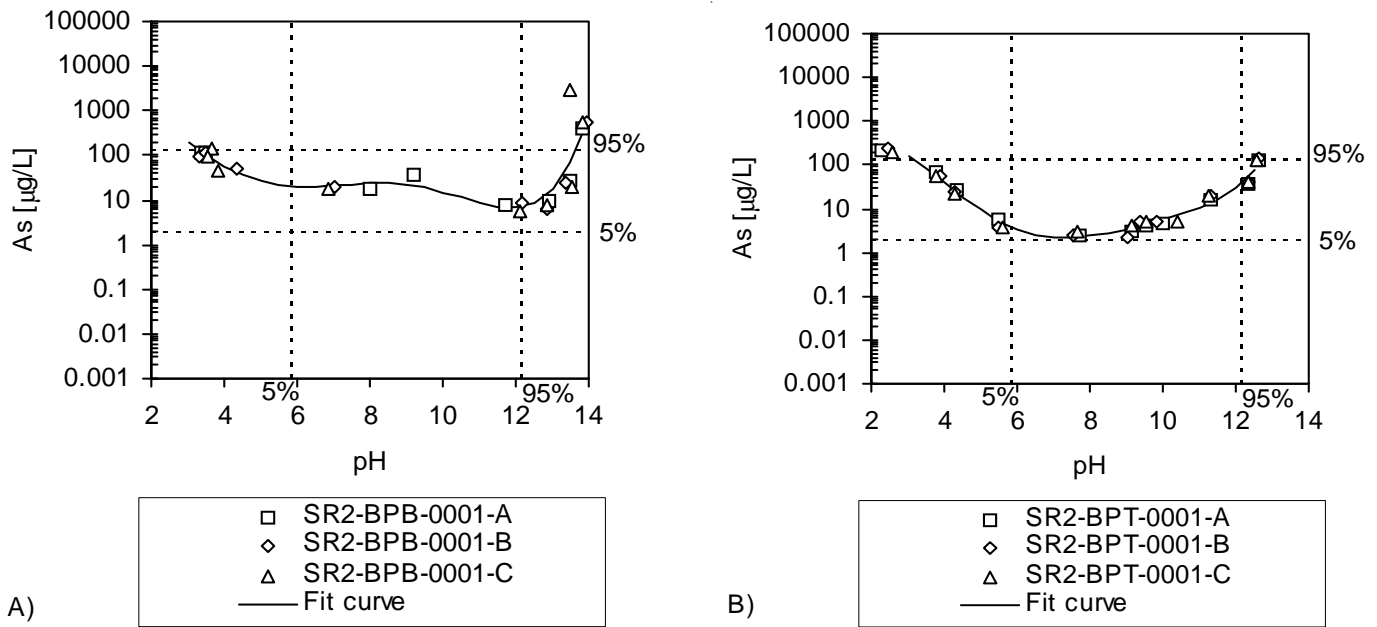

Figure 10. Example of Variability of Hg Concentrations as a Function of pH from SR002.1.

A Monte Carlo simulation was then carried out using randomly selected pH and LS ratio values from the field data set distributions and the expected constituent equilibrium concentration at the designated pH based on laboratory leaching test results as indicated above. Thus, the relative weight of leachate solution concentration at each pH is based on the frequency of that pH occurring in the field observations. Solution concentration values from these equations then were used in conjunction with the randomly selected LS ratio values from the field LS ratio probability distribution as input parameters for the percolation/equilibrium release model. Thus, the final resulting probability distribution for constituent release reflects expected concentration at a given pH from laboratory testing results and weighting from the distributions of field pH, and field LS ratio.

For the three default scenarios, an infiltration rate of 20 cm/yr, a fill depth of 1 m and a fill density of 1.6 g/cm³ were assumed. Three different field pHs were considered: the natural pH of the material (i.e., case of a monofill) and two “extreme” pHs, a pH of 3 and a pH of 12.5. The LS ratio that may be expected to contact the fill over the estimated time period of 100 years was estimated from the assumed geometry, infiltration rate, and time frame. The LS ratio obtained for this scenario was 12.5 L/kg over 100 years. Leachate concentration was assumed to be constant over the release interval at the concentration interpolated from laboratory test results (SR002.1) for the corresponding pH. Assuming constant leachate concentration is considered a first order assumption because, for very soluble constituents, leachate concentration is expected to decrease with increasing LS ratio; but for constituents where solubility increases as pH becomes less alkaline, leachate concentration is expected to increase over time. Using this approach, several of the ash samples would be fully depleted of Se over the 100 year leaching period.

Results of the long-term release estimates, based on the Monte Carlo simulation results accounting for both pH and LS ratio as random variables, are presented as cumulative release probability curves and as a bar chart, comparing total content of the constituent evaluated and cumulative release for each case. Annotated example results figures are provided as Figure 12 and Figure 13.



Material	log As ($\mu\text{g/L}$)			pH range of validity	R^2	Number of points
BPB	0.0004 pH^5	-0.0135 pH^4	0.1634 pH^3	3-14	0.77	27
	-0.8130 pH^2	1.1609 pH	2.7085			
BPT	0.0005 pH^5	-0.0207 pH^4	0.3035 pH^3	3-12.5	0.98	33
	-2.0113 pH^2	5.4552 pH	-2.7126			

Figure 11. Example of Regression Fits and Corresponding Equations for Solubility as a Function of pH.

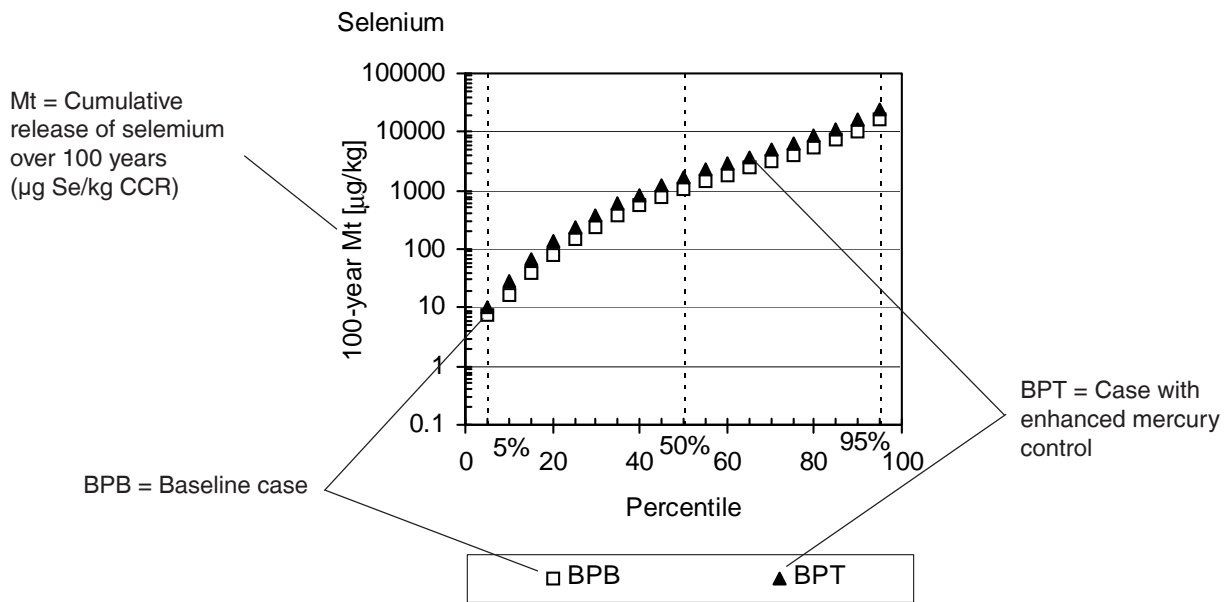

Figure 12. Example of Cumulative Probability Distribution for Release of Selenium from Brayton Point CCR.

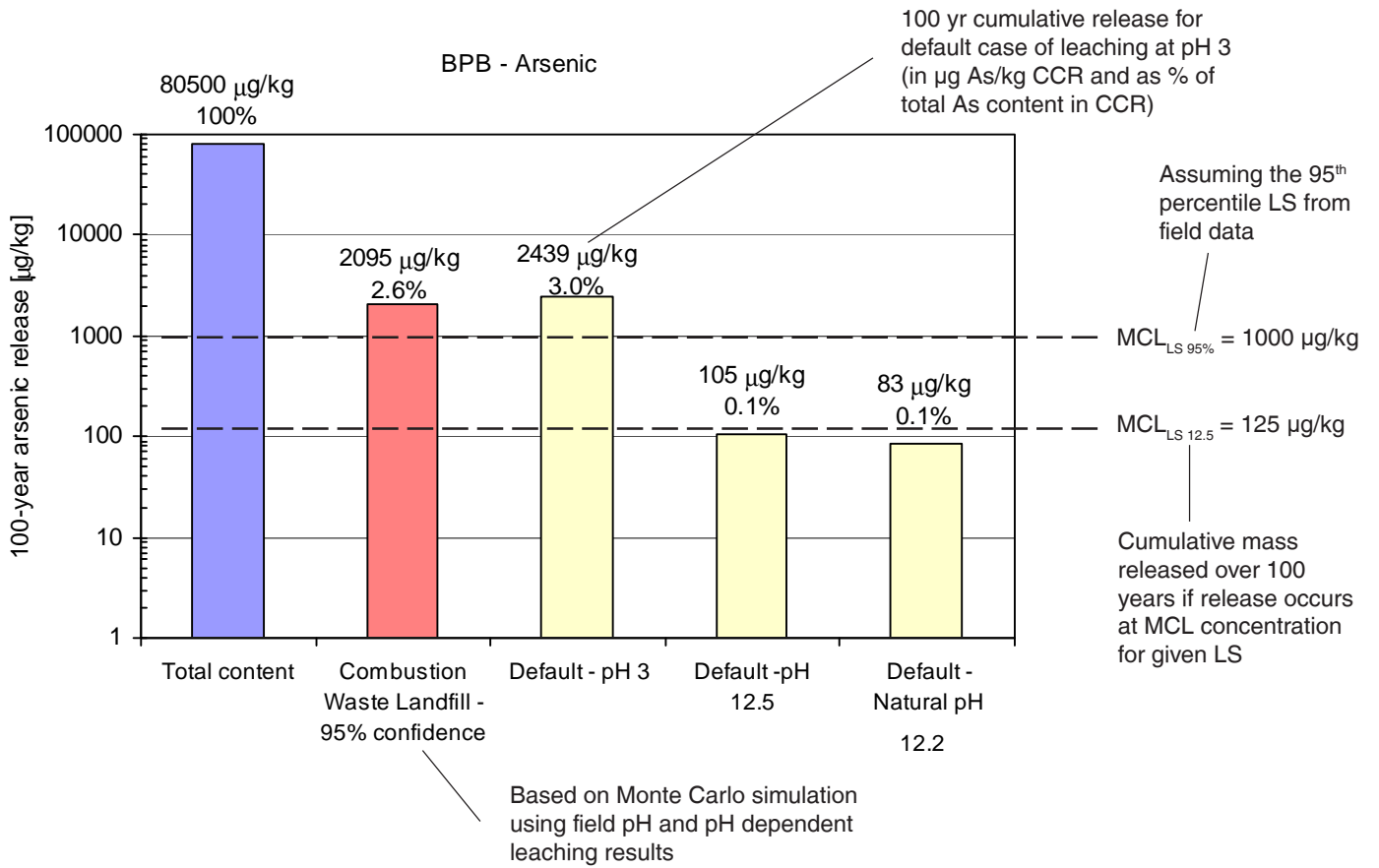

Figure 13. Example of Comparison of 100 yr Cumulative Release Estimates for Arsenic.

3. Results and Discussion

3.1. Leaching Characteristics from Field Observations of CCR Landfills and Impoundments

In response to concerns raised by U.S. EPA Science Advisory Board regarding leaching tests, observations of pH, and concentrations of mercury, arsenic, and selenium from field CCR management facilities were evaluated for comparison with laboratory results. Landfills and impoundments were the types of CCR management facilities considered. Information was available from a U.S. EPA database (EPA, 2000) and an EPRI database (EPRI, 2005).

The U.S. EPA database (EPA, 2000) compiled by OSW included data on six CCR monofills. Data included measurements of pH, mercury, arsenic, selenium and other constituents as self reported by facilities to Office of Solid Waste (OSW).¹⁹ Data in this database was not coded to allow association of different parameters (e.g., pH, mercury, arsenic, selenium) from the same field sample. Therefore, data from this database was evaluated based only on the distribution of measurements for each parameter for the class of CCR monofills (Table 12). Mercury data were carefully reviewed, including re-evaluating the primary

Table 12. Distribution of pH and Concentrations of Arsenic and Selenium from Field CCR Management Facilities from the U.S. EPA Database (EPA, 2000).

Parameter	pH	As ($\mu\text{g/L}$)	Se ($\mu\text{g/L}$)
median	7.7	8.15	19.5
5 th %	5.8	2.0	2.4
95 th %	12.09	140.0	170.0

¹⁹ As noted previously, data from six coal combustion ash landfills were collected based on their availability and are not necessarily representative of all coal combustion ash landfills.

source data, and were not considered to be reliable and, therefore, not included.²⁰

The EPRI database (EPRI, 2005) included measurements of samples obtained from CCR landfills and impoundments. Samples were from leachate collection points, lysimeters, and pore water. For some facilities, multiple observations were obtained from different locations within the facility and over several years. Results from a recent sampling and analysis program were observations from a range of facilities (considered representative of management practices, combustion facility configurations, and coal types) but with only one or two samples per facility. Data included measurements of pH, mercury, arsenic, selenium, and other constituents. Data on selenium were more limited than data on pH and arsenic. Data on mercury were limited to the recent sampling and analysis program from multiple facilities. Data was coded to allow association of different parameters. Only CCR management facilities that receive residues from utilities that do not include scrubbers as part of the air pollution control technology are considered here.

Information on pH from field observations is presented in Figure 14. For landfills, the range of data in the U.S. EPA database (5th–95th percentile) was consistent with the data reported in the EPRI database. In addition, the range of pH reported in the EPRI database for individual facilities with multiple observations was similar to the range reported for multiple facilities with limited numbers of observations. Therefore, it is considered reasonable to use the pH range of 5.8 to 12.09 (5th–95th percentile) reported in the U.S. EPA database as the basis for extrapolating from laboratory leaching test results to field estimates of leaching from landfills.

²⁰ Inconsistent methodologies were used, and most values were either qualified results (e.g., estimated values) or below detection limits (with relatively high corresponding detection limits reported).

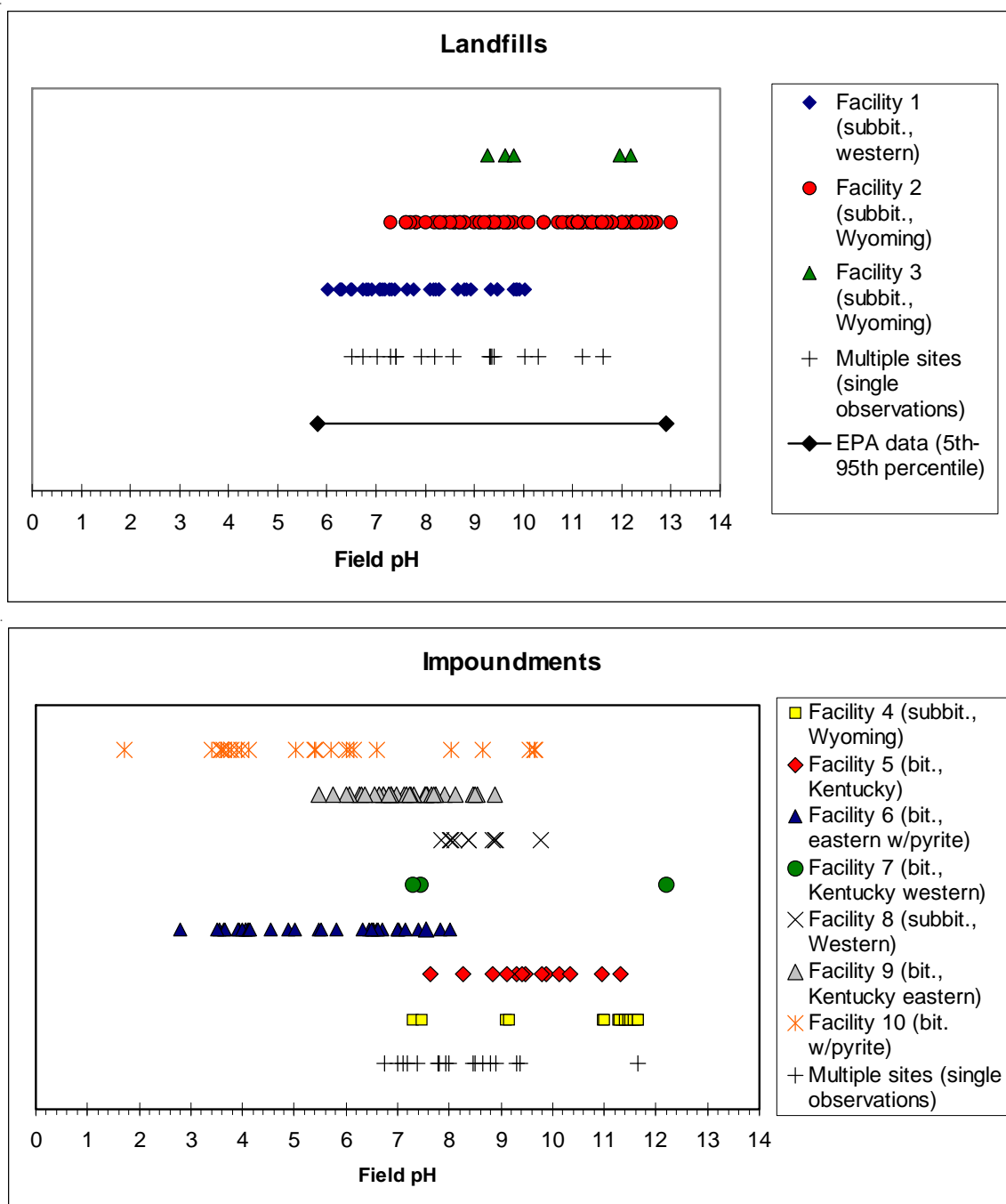

Figure 14. Range of pH Observed in Field Leachate at Landfills and Impoundments Used for Disposal of CCRs—from EPRI Database. Also included is the range (5th–95th percentile) of pH values for CCR landfills reported in the EPA database (EPA, 2000). Facilities 6 and 10 have co-disposal of pyrite from mill rejects with CCRs. Data does not include facilities with scrubbers. Primary data from EPRI (EPRI, 2005).

Information on pH in impoundments from the EPRI database indicates two general groupings of data—impoundments without and with co-disposal of pyrite from coal mill tailings. Facilities without co-disposal of pyrite from coal mill tailings (Figure 14, all except Facilities 6 and 10) fall within the same pH range as the landfill data. Facilities with co-disposal of pyrite (Facilities 6 and 10) include

observations of very acidic pH (pH < 3), presumably as a consequence of acid-forming pyrite oxidation.

Information on arsenic from field observations is presented in Figure 15. For landfills, most of the data from the EPRI database falls within the range (5th–95th percentile) of pH and arsenic concentration reported in the U.S. EPA data-

base. However, the uppermost bound of arsenic concentration in the EPRI database exceeds the U.S. EPA data range illustrated. In addition, the range of arsenic concentrations reported for individual facilities with multiple observations was similar to the range reported for multiple facilities with limited numbers of observations. The greatest arsenic concentrations are reported in the pH range between 7 and 10.

For impoundments, the upper range of arsenic concentrations is substantially greater than reported for landfills. A significant number of reported arsenic concentrations are between 1,000 and 10,000 $\mu\text{g/L}$ for impoundments, whereas all reported concentrations are less than 1,000 $\mu\text{g/L}$ for landfills. Greater observed concentrations may be from leaching of arsenic naturally associated with pyrite in coal mill tailings co-disposed with CCRs rather than from the

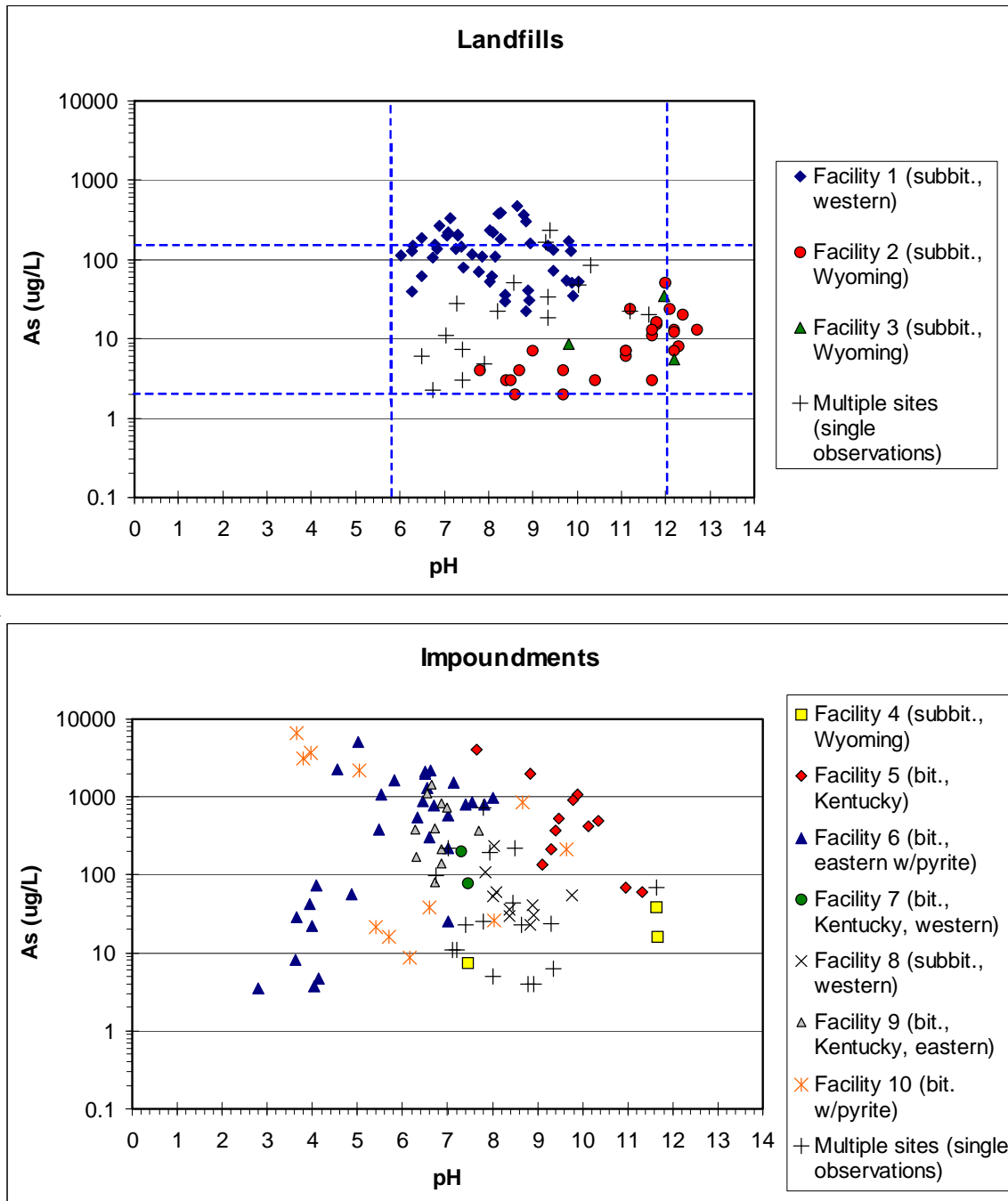

Figure 15. Arsenic Concentrations Observed in Field Leachate at Landfills and Impoundments Used for Disposal of CCRs—from EPRI database. Also indicated by dashed lines is the range (5th–95th percentile) of pH and arsenic values for CCR landfills reported in the EPA database (EPA, 2000). Facilities 6 and 10 have co-disposal of pyrite from mill rejects with CCRs. Data does not include facilities with scrubbers. Primary data from EPRI (EPRI, 2005).

CCRs. Alternatively, the significantly lower pH in the pyrite co-disposal impoundments (Figure 14) may be causing the higher As concentrations (see Figure 13, leaching at pH 3). EPRI has recommended alternative management practices for coal mill tailings containing pyrite, and this practice is diminishing (EPRI, 1999).

Information on selenium from field observations is presented in Figure 16. For landfills, the EPRI database includes a wider range (greater than and less than) of reported concentrations than the U.S. EPA database. For impoundments, the reported range of selenium concentrations is within the same range as reported for landfills. For

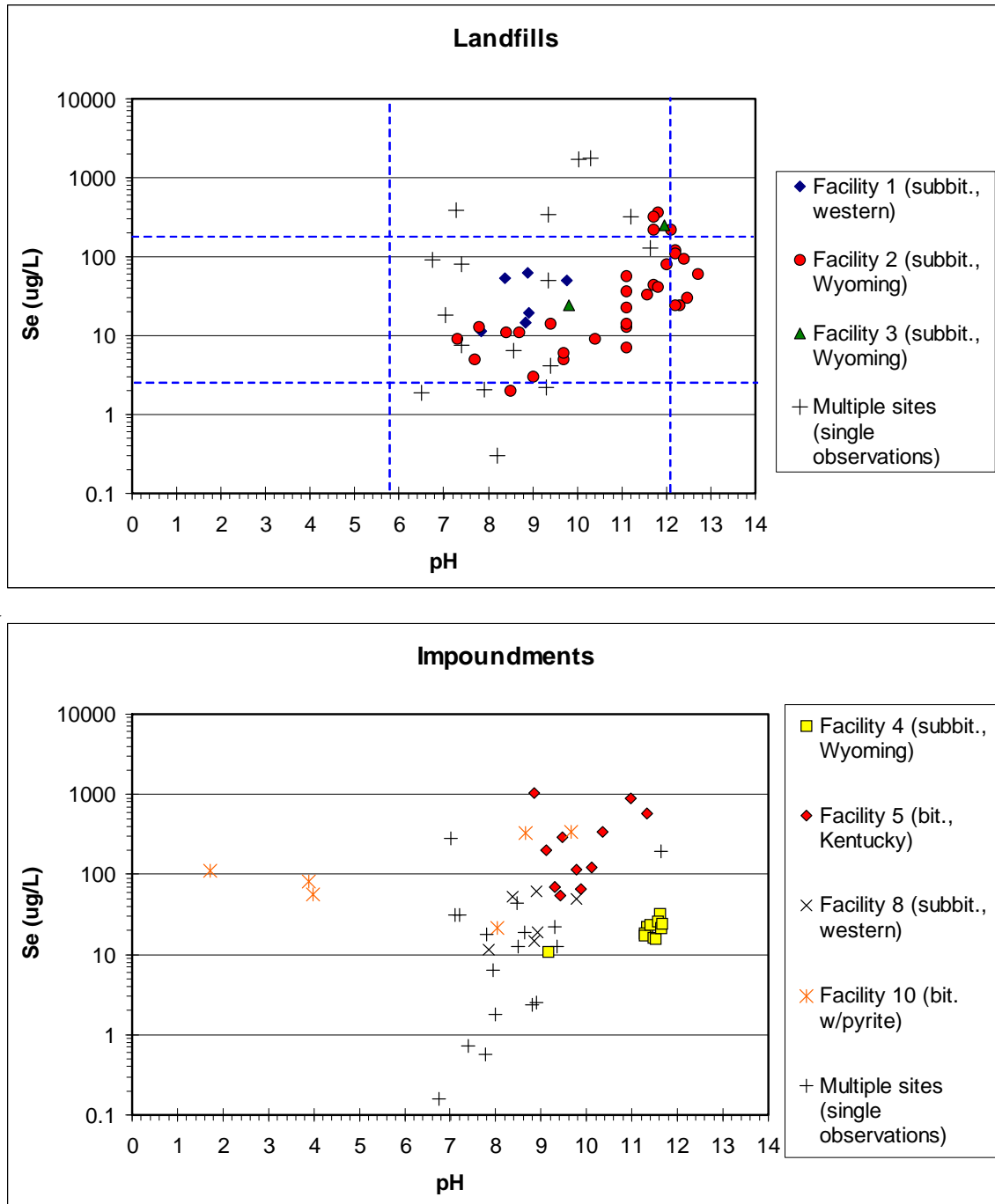

Figure 16. Selenium Concentrations Observed in Field Leachate at Landfills and Impoundments Used for Disposal of CCRs—from EPRI database. Also indicated by dashed lines is the range (5th–95th percentile) of pH and arsenic values for CCR landfills reported in the EPA database (EPA, 2000). Facilities 6 and 10 have co-disposal of pyrite from mill rejects with CCRs. Data does not include facilities with scrubbers. Primary data from EPRI (EPRI, 2005).

both landfills and impoundments, the range of data reported for a single facility (Facility 2) is fairly wide.

To balance the assessment of the EPRI data in comparison with the EPA data and laboratory leaching test results, the following data reduction steps were taken. For the facilities with more than three observations, the mean value of the observations from the individual facility was taken to be representative of that facility. The mean value then was included with the data of single observations from multiple facilities. The MDL was used in the data set when the data were reported as less than the MDL. The resulting data set then was evaluated to obtain distribution statistics for the EPRI data evaluated (Table 13). The median, 5th and 95th percentiles for arsenic, selenium, and mercury then were used to for comparison with the EPA data set and laboratory results, as described later in this report.

3.2. Quality Assurance for Laboratory Leaching Tests

3.2.1. Mass Balance using EPA Reference Fly Ash

The results of the Reference fly ash analysis are provided in Table 14. These results show that the mass balance was closed reasonably well for mercury, arsenic, cadmium, lead, and selenium with a majority of the mass for each analyte remaining in the solid. The mass balance closure is well within the expected range, especially considering the measurement of very small changes in the analyte mass in the solid phase relative to the total content present. These results also indicate that large losses of mercury do not occur as a consequence of the leaching test methods and subsequent analysis. However, additional mass balance verification may be required for implementation when testing

materials with more volatile components or for validation of laboratories newly implementing the procedures.

3.2.2. Analytical Quality Control/Quality Assurance

Implementation of the developed QA/QC plan facilitated analysis of data quality and identification of testing uncertainties. The coefficient of variation for calibration standards and continuing calibration standards and blanks was within 5% for metals analysis by inductively coupled plasma-mass spectroscopy (ICP-MS) (Vanderbilt). Spike recoveries for metals had a mean of 101% with a coefficient of variation within 5%. Typical inter-laboratory comparisons for arsenic and selenium analyses are presented in Figure 17. Good agreement generally was obtained between the two laboratories except for cases of arsenic analyses when the concentration was less than 100 µg/L. For this condition, the Vanderbilt analysis typically resulted in greater values than the commercial laboratory. This result was most likely from the differences in analytical ICP-MS technology, where dynamic reaction chamber (DRC) measurements (Vanderbilt) are considered more sensitive and less susceptible to interferences. For all of these cases, the spike recoveries for Vanderbilt analyses were within ±10% of the expected value, with most cases within ±5% of the expected value. However, the analytical results, including repeating analysis when necessary, demonstrated the importance of including a matrix spike to verify recovery for each test condition. In contrast to the analytical uncertainty, the mean (for different test conditions, i.e., pH values) coefficient of variation for replicate tests on each fly ash type (resulting from variation in the subsamples of the solids tested) varied between 5% and 25%. Thus, the primary source of uncertainty in the leaching test results is a consequence of sampling, homogenization, and inherent heterogeneity of the primary material to be tested.

Table 13. Distribution of pH and Concentrations of Arsenic, Selenium, and Mercury from Field CCR Management Facilities—from the EPRI database (EPRI, 2005) for landfills and impoundments (including impoundments co-disposing mill rejects with CCRs).

Parameter	Landfills			Impoundments		
	As (µg/L)	Se (µg/L)	Hg (µg/L)	As (µg/L)	Se (µg/L)	Hg (µg/L)
Average	48.1	265.9	0.0179	381.4	50.6	0.0019
Median	21.2	57.0	0.0102	55.0	18.5	0.0014
Min	2.2	0.3	0.0021	4.0	0.2	0.0002
5 th %	3.0	1.7	0.0021	4.2	0.6	0.0003
95 th %	179.1	1733.0	0.0498	852.8	278.6	0.0056
Max	238.0	1760.0	0.0606	5223.0	315.0	0.0059

Table 14. Leaching (Method SR002.1) and Mass Balance Results for the EPA-Reference Fly Ash.

Metal	As Received	Leaching at pH of 1.95 (position 1)				Leaching at pH of 2.5 (position 2)			
		Exposed Solid	Leachate solution	Filter	Recovery %	Exposed Solid	Leachate solution	Filter	Recovery %
Hg (ng/g)	59±8	48±2	0.369±0.011	0.279±0.233	76–91	50±11	0.106±0.184	0.155±0.083	76–92
Pb (µg/g)	84±2.5	87±1.8	BD ^a	8±11.2	94–132	93±13.5	BD	2±2.2	84–136
Se (µg/g)	2±0.3	3±0.3	BD	BD	117–194	2±0.2	BD	BD	78–129
Cd (µg/g)	1±0	1±0	BD	BD	100	1±0	BD	BD	100
As (µg/g)	87±2.6	89±1.3	BD	2±0.7	99–110	94±4.1	BD	1±0.6	103–115

Metal	Received	Leaching at pH of 4.0 (position 3)				Leaching at Natural pH (position 4)			
		Exposed Solid	Leachate solution	Filter	Recovery %	Exposed Solid	Leachate solution	Filter	Recovery %
Hg (ng/g)	59±8	39±0.5	0.124±0.215	0.045±0.015	60–75	46±8	0.122±0.212	0.030±0.003	75–81
Pb (µg/g)	84±2.5	89±3.4	BD	0±0.2	99–114	89±6.3	BD	2±1.2	97–121
Se (µg/g)	2±0.3	2±0.1	BD	BD	83–124	3±0.3	BD	BD	117–194
Cd (µg/g)	1±0	1±0	BD	BD	100	1±0	BD	BD	100
As (µg/g)	87±2.6	91±2.6	BD	1±0.1	106–112	90±3.4	BD	2±1.5	97–115

Metal	Received	Leaching at pH of 10.0 (position 5)				Leaching at pH of 12 (position 6)			
		Exposed Solid	Leachate solution	Filter	Recovery %	Exposed Solid	Leachate solution	Filter	Recovery %
Hg (ng/g)	59±8	44±2	0.115±0.199	0.019±0.008	70–82	42±0.4	BD	0.031±0.013	63–82
Pb (µg/g)	84±2.5	87±2.6	BD	20±28	88–169	84±1.5	BD	6±6.6	95–120
Se (µg/g)	2±0.3	2±0.4	BD	BD	70–141	1±0.1	BD	BD	39–59
Cd (µg/g)	1±0	1±0	BD	BD	100	1±0	BD	BD	100
As (µg/g)	87±2.6	92±0.6	BD	4±3.2	103–118	86±0.8	BD	4±1.2	98–121

^a BD = below detection limit.

3.3. Laboratory Test Results

The constituents of interest in this evaluation, based on input from EPA-OSW and EPA-OAQPS, are mercury (Hg), arsenic (As), cadmium (Cd), lead (Pb), and selenium (Se). Initial screening indicated low content and leaching concentrations below levels of concern for lead and cadmium. As a result, although complete data have been developed for lead and cadmium, the results are not provided in this report. Complete data also have been developed for other constituents to facilitate evaluation of geochemical speciation of constituents of concern and to provide more thorough evaluation of leaching under alternative management scenarios in the future, if warranted. Screening of leaching results against drinking water maximum contaminant levels (MCLs) indicates that antimony (Sb) may be a concern for some cases and is being considered for inclusion in future research. Complete results for pH titration, mercury, arsenic and selenium for each CCR reported here are presented in Appendices D through I.

For each CCR evaluated, results of the leaching tests provide the following information:

- Leachate concentrations for the constituents of interest as a function of pH over the range of reported field management conditions (from test method SR002.1; example results provided in Figure 18 and Figure 19A).
- pH titration curves (from test method SR002.1). This information is useful in characterizing the CCR and assessing how it will respond to environmental stresses and material aging (e.g., carbon dioxide uptake, acid precipitation, mixing with other materials).
- Leachate concentrations for the constituents of interest, pH and electrical conductivity as a function of LS ratio when contacted with distilled water (from test method SR003.1; example results are in Figure 19B). This information provides insight into the initial leachate concentrations expected during land disposal and the effects of pH and ionic strength at low LS ratios. Often these concentrations can be either greater

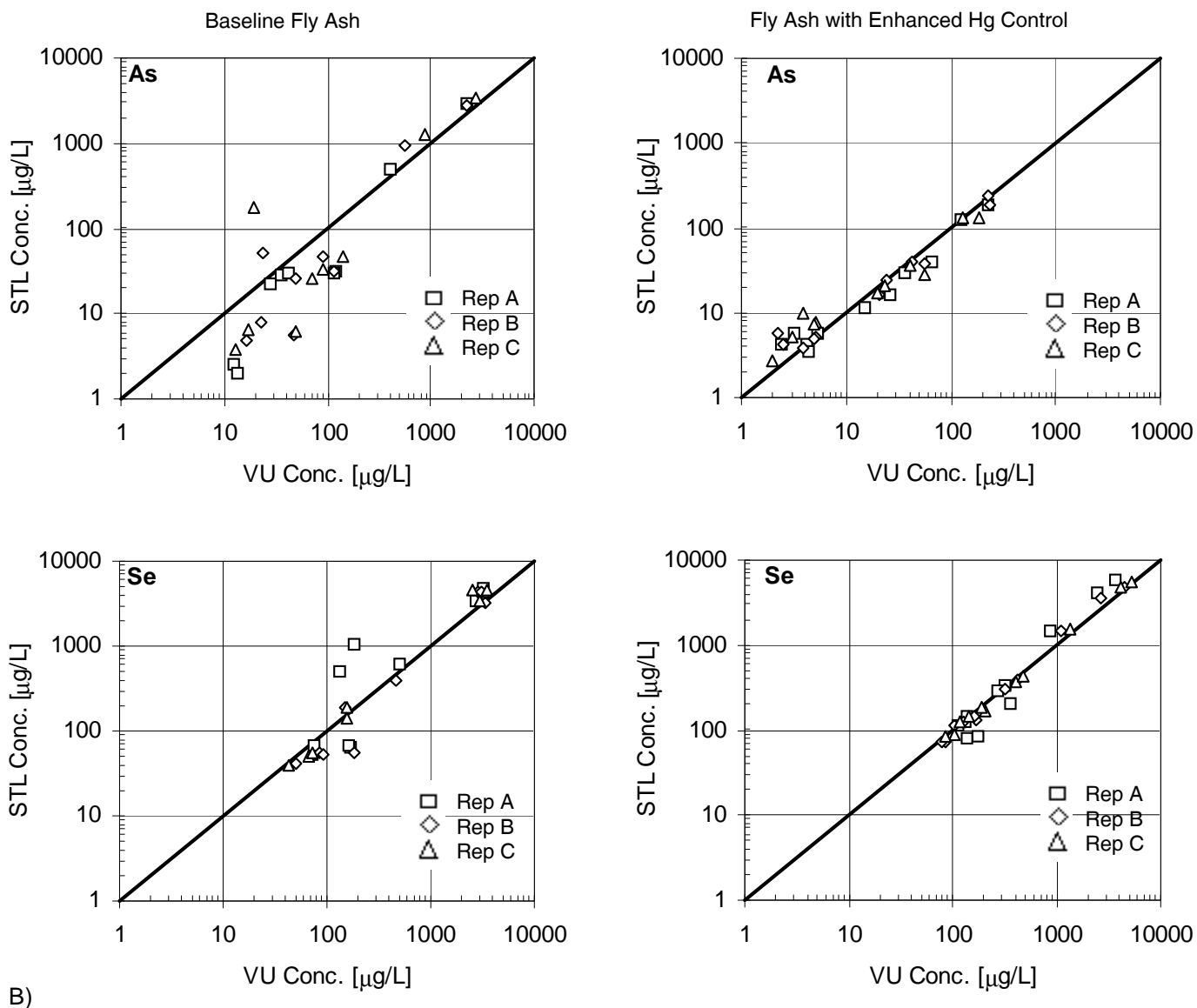

Figure 17. STL Versus Vanderbilt Analytical Results for Arsenic and Selenium from Sr002.1. Baseline Fly Ash and Fly Ash with Enhanced Hg Control from Brayton Point Are Shown.

than or less than concentrations observed at higher LS ratios (i.e., LS=10 mL/g as used in SR002.1) because of ionic strength and co-constituent concentration effects.

The MCL is used as a reference threshold for the constituent of interest. However, releases identified here are estimates of concentrations potentially leaching from landfills. Any assessment of the environmental impact of these releases needs to consider the dilution and attenuation of these constituents in ground water and the plausibility of drinking well-water contamination resulting from the release. Dilution and attenuation factors for metals (DAFs) have been estimated to be potentially as low as 2 to 10 on a national basis or as high as 8,000 at a particular site with

hydrogeology that indicates low transport potential.²¹ Therefore, comparison with thresholds greater than the MCL and developed for specific scenarios may be appropriate. The following comparisons are included for each CCR in Appendices D through I:

- Laboratory leachate concentrations as a function of pH for each CCR are compared to (i) the constituent MCL;

²¹ See 60 FR 66372, Dec. 21, 1995, for a discussion of model parameters leading to low DAFs, particularly the assumption of a continuous source landfill. Implied DAFs for the metals of interest here can be found at 60 FR 66432-66438 in Table C-2. Site specific high-end DAFs are discussed at 65 FR 55703, September 14, 2000.

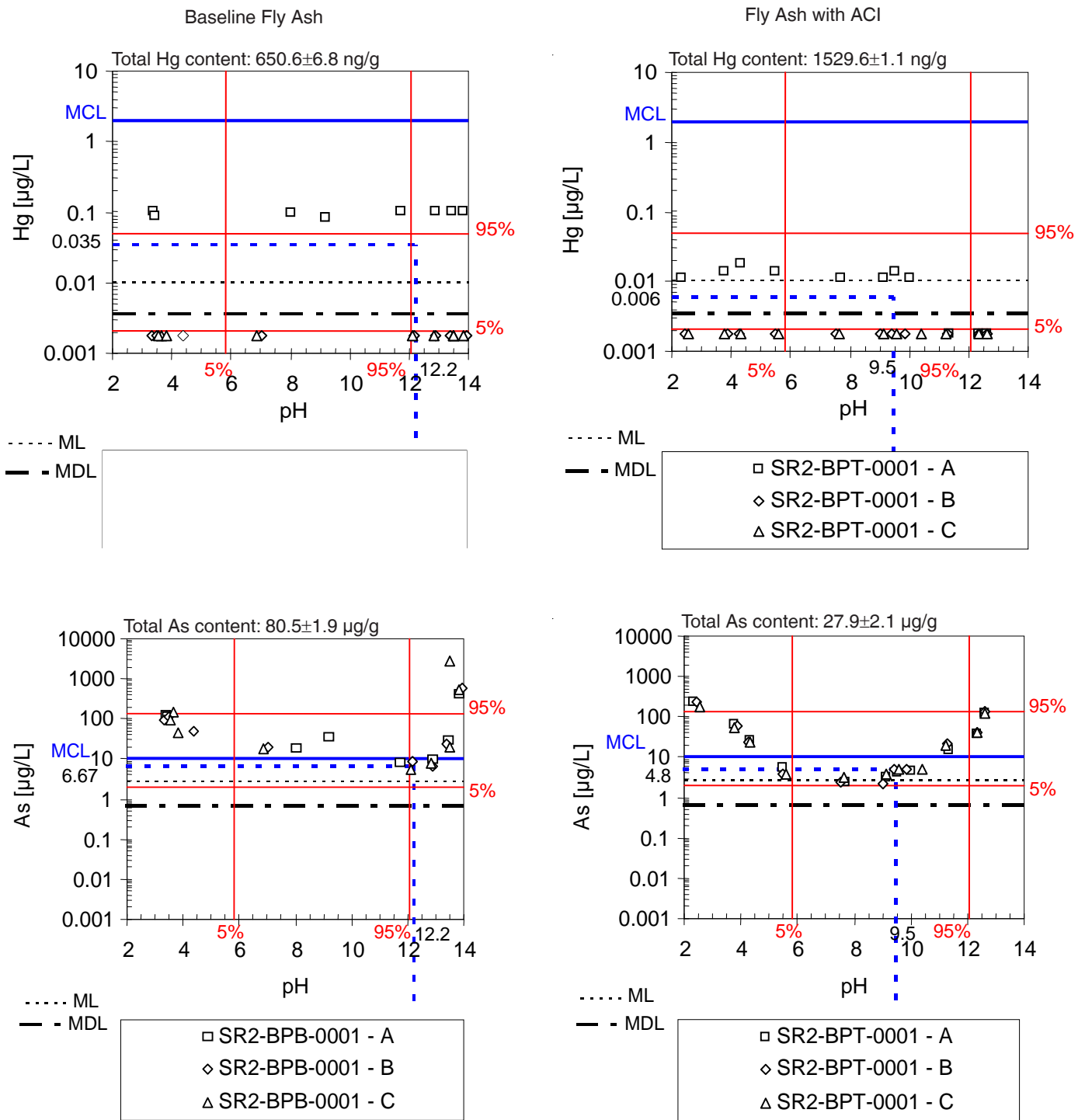
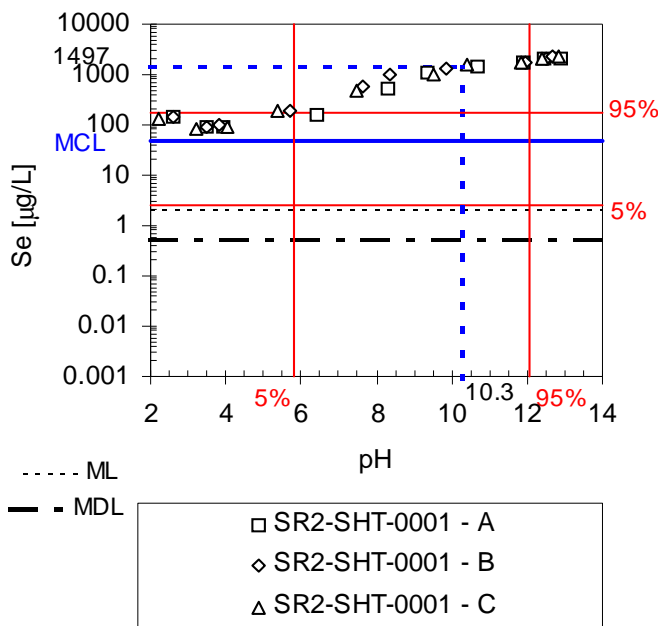
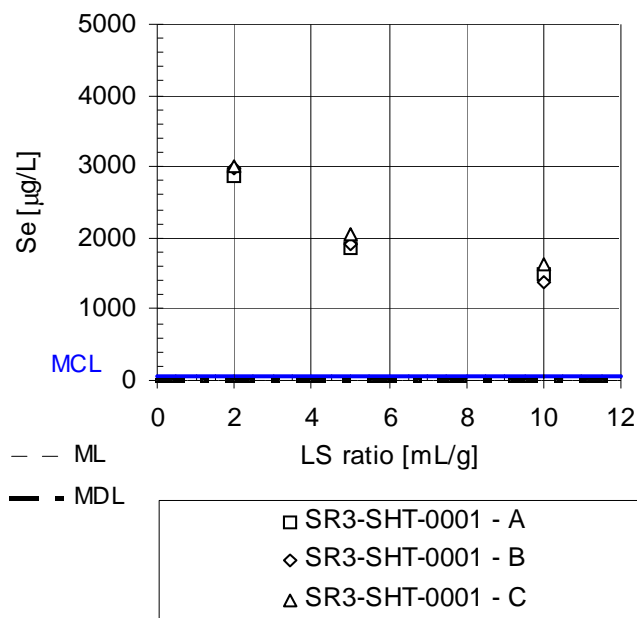

Figure 18. Example Results from SR002.1. Brayton Point fly ashes—mercury (top) and arsenic (bottom) release as a function of pH for the baseline fly ash and the fly ash with enhanced Hg control. 5th and 95th percentiles of mercury and arsenic concentrations observed in typical CCR monofill leachate are shown for comparison. Replicate A for mercury results likely reflects sample heterogeneity (i.e., more activated carbon in sub-sample). ML=method limit (for quantification); MDL=method detection limit; less than MDL reported at ½ MDL.



A. SR002.1



B. SR003.1

Figure 19. Example Results from SR002.1 and SR003.1 for Selenium in Fly Ashes from Salem Harbor with Enhanced Hg Control.

(ii) the observed field leachate concentrations (5th and 95th percentiles of reported concentrations) over the observed pH range for field leachates based on the U.S. EPA database (5th and 95th percentiles of pH), forming a “box” on the results figures (Figure 18); and, (iii) results for CCRs from the same combustion facility with and without the air pollution control technology specifically being evaluated (e.g., with and without activated carbon injection);

- Laboratory leachate concentrations and pH as a function of LS ratio for each CCR are compared to the leachate concentrations as a function of pH at LS=10 to evaluate whether expected initial leachate concentrations under land disposal conditions will be the same, less than, or greater than the concentrations used in comparison to field data and for cumulative release estimates. Figure 19 illustrates a case where initial selenium concentrations in leachate at low LS ratio (Figure 19B, SR003.1) are expected to be greater than indicated by the evaluation of concentration as a function of pH at LS=10 (Figure 19A, SR002.1).

3.3.1. Mercury Results

A comparison of total content and range of laboratory extract mercury concentrations as a function of pH and LS ratio for CCRs from different facilities is provided in Figures 20 and 21, respectively. Total content, especially for mercury, has exhibited considerable variability for reported values from the same facility, most likely resulting from

sample heterogeneity and variations in operating conditions. Values reported here are those measured as part of this study. For each facility, the baseline case and the case with enhanced air pollution control treatment—either activated carbon injection or brominated activated carbon injection (for the St. Clair facility and Facility L)—are compared. Also, note that Facility C uses COHPAC air pollution control configuration. For each case in Figure 21, the range of laboratory extract concentrations was based on the CCR’s natural pH at LS=10 from SR002.1, and the minimum and maximum concentrations observed over $5.8 \leq \text{pH} \leq 12.09$ in results from testing over the range of pH (SR002.1) and LS ratio (SR003.1). For most cases, the minimum value indicated is the MDL (0.004 µg/L). As indicated previously, this pH range is based on the 5th and 95th percentiles of pH in field leachate samples from CCR landfills reported in the EPA database. The MCL is included to provide a reference basis, but consideration must be given to appropriate dilution and attenuation factors when making determinations for specific cases. Also included in Figure 21 are the ranges of mercury concentrations observed in field leachates for landfills from the U.S. EPA database and for landfills and surface impoundments from the EPRI database. For field observations, the symbol with error bars represents the median (50th percentile), 5th and 95th percentiles of applicable observations in the respective database. The full range of values was not included to avoid bias from outlier data points.

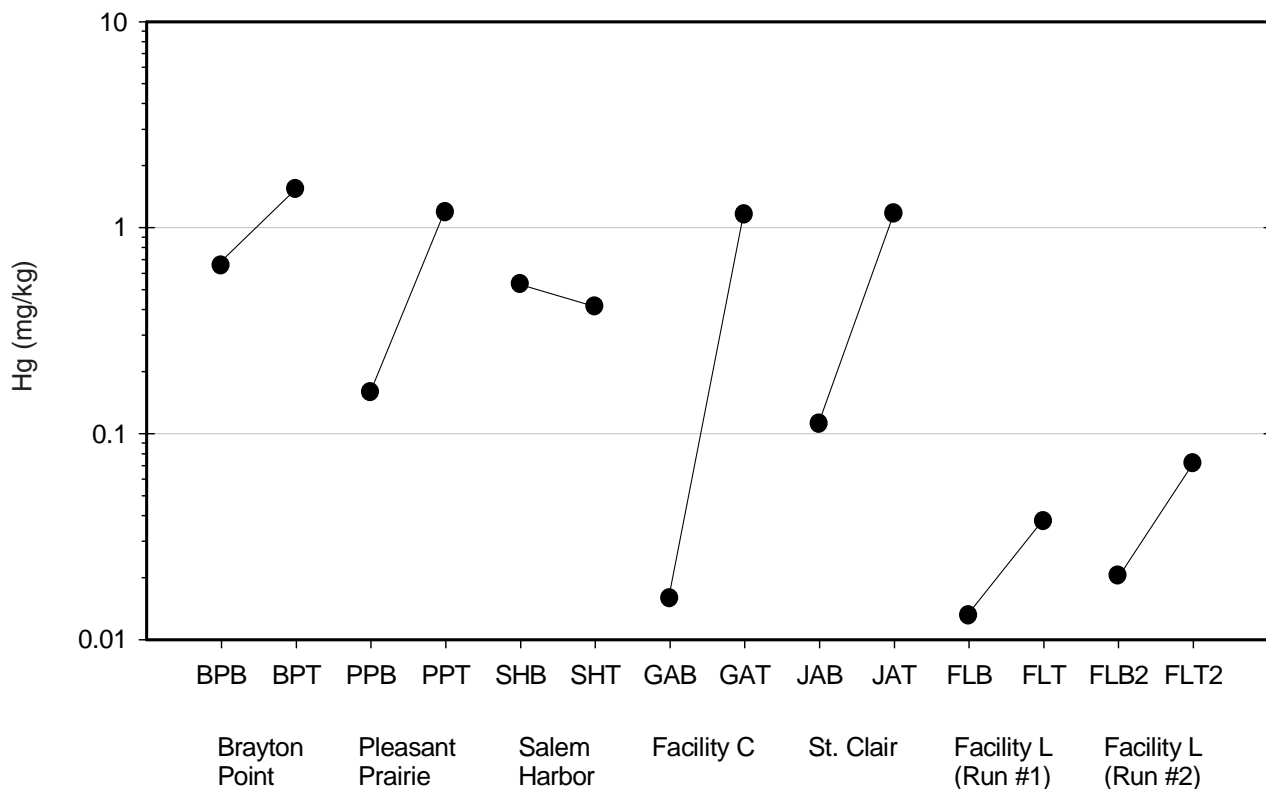

Figure 20. Comparison of Total Mercury Content in Baseline Cases and with Sorbent Injection for CCRs from Different Facilities. (Facility code suffixes B = baseline and T = treated with sorbent injection; for example, PPB = Pleasant Prairie baseline, and PPT = Pleasant Prairie treated)

Considering the results provided in Appendices D through I, and comparisons in Figure 20 and Figure 21, the following observations for mercury are made:

- Use of sorbent injection increased the total mercury content for the fly ash to ca. 1–2 mg/kg except for Salem Harbor. This value may represent the maximum practical capacity for the sorbent entrained with the fly ash. The total content of mercury in fly ash from Salem Harbor may be relatively unchanged or slightly lower because of the high content of uncombusted carbon (LOI = 21 wt%) for the baseline case, which acts a sorbent similar to activated carbon; in this case, injection of activated carbon serves to dilute the total mercury content in the CCR.
- For Facility L, accumulation of the fly ash for sampling for 4 hours (Run #1) resulted in loss of mercury from the fly ash when compared to fly ash accumulated for 30 minutes (Run #2), most likely by volatilization at the elevated temperatures within the accumulation hopper. Fly ash obtained from Run #1 was used for leaching evaluation because of the limited sample quantity available from Run #2.

- Although the use of ACI substantially increases the total mercury content in the CCRs, the range of laboratory leaching extract concentrations in the baseline cases and cases with sorbent injection are either unchanged or the maximum leaching concentration is reduced as a consequence of activated carbon injection. The exceptions are Facility C and Facility L, which have an increased maximum extract concentration for the case with sorbent injection.
- The expected range of mercury leachate concentrations based on these results is from < 0.004 (below MDL) to 0.2 µg/L over the range of pH conditions expected in coal ash landfill leachate.
- The range of mercury concentrations observed from laboratory extracts is consistent with the range reported for field leachates from landfills in the EPRI database. Reliable data on mercury concentrations in leachates from landfills was not available in the EPA database. A lower range of field concentrations is reported for impoundments in the EPRI database, possibly resulting from a combination of dilution or volatilization occurring during management in impoundments.

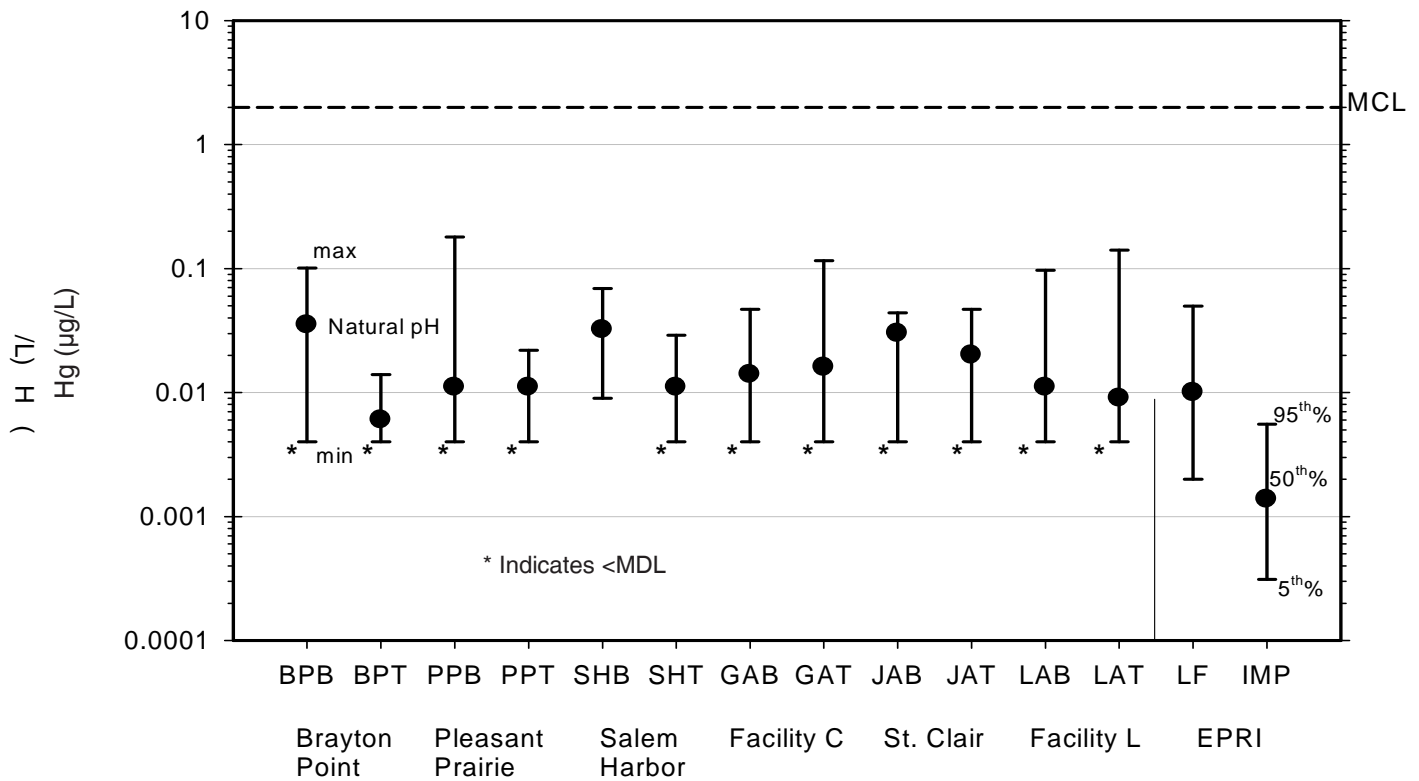

Figure 21. Ranges of Laboratory and Field Leachate Mercury Concentrations Compared with the Drinking Water Maximum Contaminant Level (MCL). [For laboratory data, symbol represents the concentrations at the natural pH of the CCR tested, and the error bars represent the minimum and maximum concentrations within the relevant field pH range of 5.8 to 12.09, inclusive. For field data, symbol and error bars represent the 5th, 50th and 95th percentiles of reported values (LF = landfills from EPRI database; IMP = impoundments from EPRI database). Reliable data for mercury was not available in the EPA database.]

- All concentrations observed in laboratory leach test extracts over $5.8 \leq \text{pH} \leq 12.09$ were at least an order of magnitude less than the MCL.
- For all cases of laboratory extracts, mercury concentrations in extracts were consistent without any significant effect of total mercury content, pH, or LS ratio observed. Mercury leaching appears to be controlled by adsorption from the aqueous phase with strong interaction between adsorbed mercury molecules, indicating that use of a linear partition coefficient (K_d) approach to model source term mercury leaching would not be appropriate. Variability observed in concentrations observed within individual cases is likely the result of sampling and CCR heterogeneity at the particle scale (i.e., resulting from mercury adsorption specifically onto carbon surfaces and relatively more or less carbon particles in a specific subsample used for extraction).

3.3.2. Arsenic Results

A comparison of total content and of the range of laboratory extract arsenic concentrations as a function of pH and LS ratio for CCRs from different facilities is provided in Figures 22 and 23, respectively. The approach used and comparisons made in Figure 23 are the same as for mercury in Figure 21. For the presentation of field leachate concentrations from impoundments, facilities co-disposing CCRs with coal mill rejects containing pyrite are presented along with impoundments not receiving pyrite.

Considering the results provided in Appendices D through H, and comparisons in Figures 22 and 23, the following observations for arsenic are made:

- Use of ACI resulted in a substantial increase in total arsenic content in CCR from Facility C (COHPAC facility), but there was not a corresponding increase in laboratory leaching test extract concentrations.

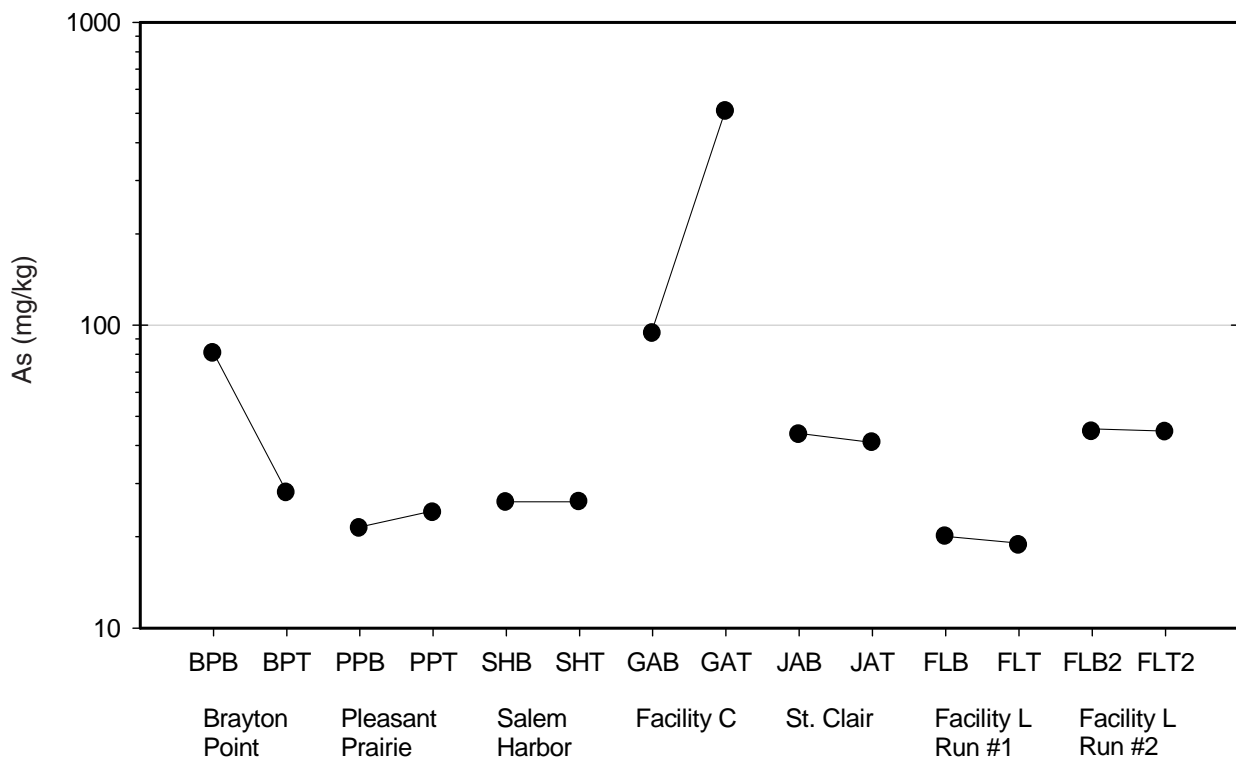

Figure 22. Comparison of Total Arsenic Content in Baseline Cases and with Sorbent Injection for CCRs from Different Facilities. (Facility code suffixes B = baseline and T = treated with sorbent injection; for example, PPB = Pleasant Prairie baseline, and PPT = Pleasant Prairie treated)

- Use of ACI resulted in a substantial decrease in total arsenic content in CCR for Brayton Point.
- There was not a consistent pattern with respect to the effect of ACI on the range of laboratory extract concentrations. For Salem Harbor and slightly for Pleasant Prairie facilities, the cases with ACI had an increase in the upper bound of extract concentrations compared to the same facility without ACI. For Facility C and the Brayton Point and St. Clair facilities, a corresponding decrease was observed.
- Very low extract concentrations were observed for the St. Clair facility without and with B-PAC, even though the total arsenic content was comparable to several of the other cases. Conversely, relatively high extract concentrations were observed for Facility L without and with B-PAC, even though the total arsenic concentration was low compared to the other cases. Thus, the presence of other constituents in the CCRs or the formation conditions appears to have a strong influence on the release of arsenic.
- The range of arsenic concentrations observed in the laboratory extracts is consistent with the range of values reported for field leachates from landfills and im-

poundments. For some cases, both laboratory (Salem Harbor, Facility C, Facility L) and field concentrations exceeded the MCL by more than a factor of 10. The expected range of arsenic concentrations under field conditions is less than 10 µg/L to approximately 1000 µg/L.

- Arsenic leachate concentrations typically are strongly a function of pH over the entire pH range examined and within the pH range observed for field conditions (for example, see Figure 18). For some cases (for example, see St. Clair, Appendix H), measured concentrations of arsenic are strongly a function of LS ratio at the material’s natural pH, with much greater concentrations observed at low LS ratio. Therefore, testing at a single extraction final pH or LS ratio would not provide sufficient information to characterize the range of expected leachate concentrations under field conditions. Furthermore, for some of the CCRs a shift from the CCR’s natural pH within the range of anticipated conditions (e.g., Facility L, Brayton Point with ACI, Salem Harbor baseline, Facility C baseline) can result substantial increases in leachate concentrations. Therefore, co-disposal of these CCRs with other materials should be carefully evaluated.

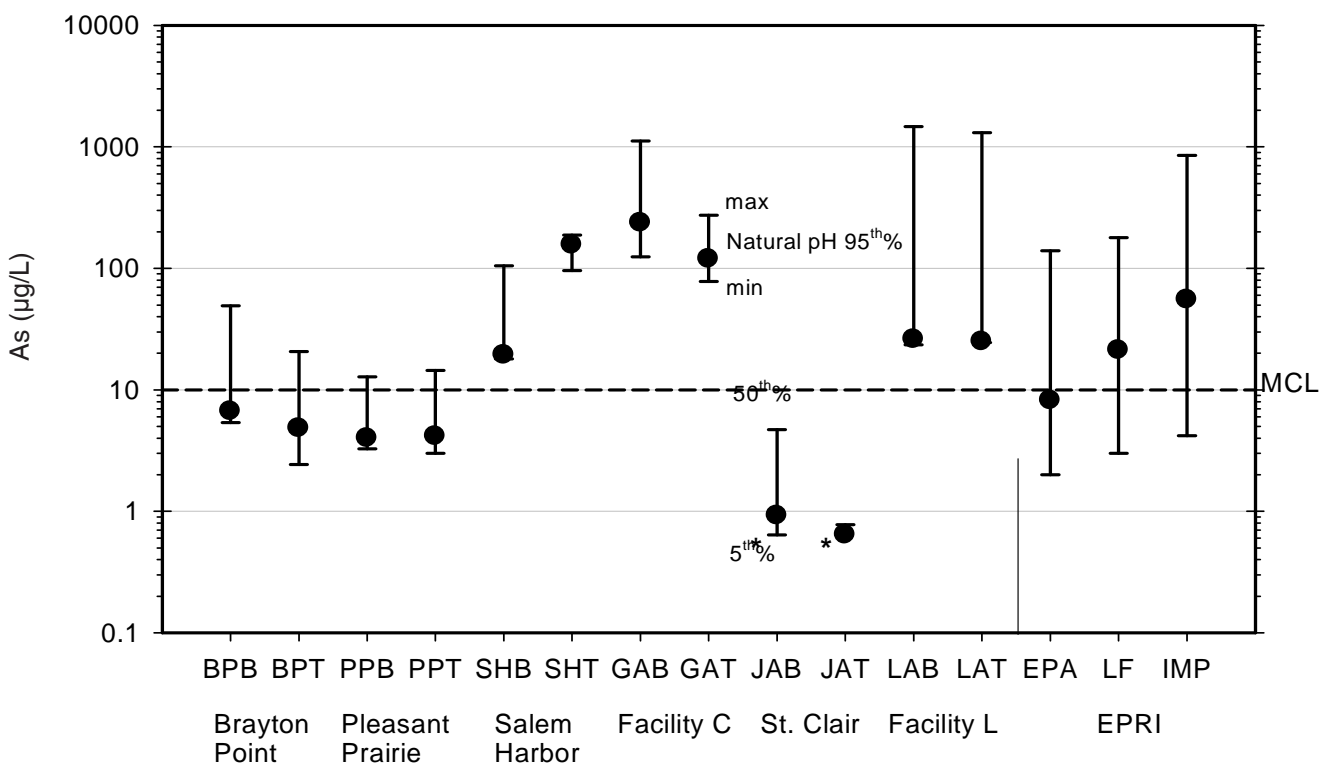

Figure 23. Ranges of Laboratory and Field Leachate Arsenic Concentrations Compared with the Drinking Water Maximum Contaminant Level (MCL). [For laboratory data, symbol represents the concentrations at the natural pH of the CCR tested, and the error bars represent the minimum and maximum concentrations within the relevant field pH range of 5.8 to 12.09, inclusive. For field data, symbol and error bars represent the 5th, 50th and 95th percentiles of reported values (EPA = EPA database; LF = landfills from EPRI database; IMP = impoundments from EPRI database). Reliable data for mercury was not available in the EPA database.]

- For several cases (Brayton Point, Salem Harbor, Facility C without ACI, Facility L), arsenic concentrations in laboratory extracts appear to be controlled by solid phase solubility, whereas adsorption processes appear to play a more important role for other cases (Pleasant Prairie, Facility C with ACI, St. Clair).

3.3.3. Selenium Results

A comparison of total content and of the range of laboratory leach test extract selenium concentrations as a function of pH and LS ratio for CCRs from different facilities is provided in Figures 24 and 25, respectively. The approach used and comparisons made in Figure 25 are the same as for mercury in Figure 21.

Considering the results provided in Appendices D through I, and comparisons in Figures 24 and 25, the following observations for selenium are made:

- For two cases (Brayton Point, Facility C), use of ACI resulted in a substantial increase in the total selenium content of the CCR in comparison to the same case without ACI. For Facility C, this is likely a direct con-

sequence of the COHPAC configuration when ACI is in use. For the other cases, the change in total selenium content resulting from application of ACI or B-PAC was minor but increased in all cases.

- The range of selenium concentration in laboratory leach test extracts is not correlated with total selenium content in the CCRs. For example, Brayton Point with ACI had much greater total selenium content than the other cases except Facility C with ACI, but it had only the fifth highest selenium concentration under the laboratory leaching conditions. Conversely, Facility C baseline had one of the lowest selenium total content (less than MDL), but it had second greatest selenium concentration under the laboratory leaching conditions.
- The range of selenium concentrations observed in laboratory leach test extracts for Facility C are much greater than the concentrations observed for other cases and for field conditions. This is a COHPAC facility, and field leachate composition data for CCRs from this type of facility was not available in the EPA or EPRI databases. For all other facilities, the range of concentrations observed from laboratory testing is consistent with

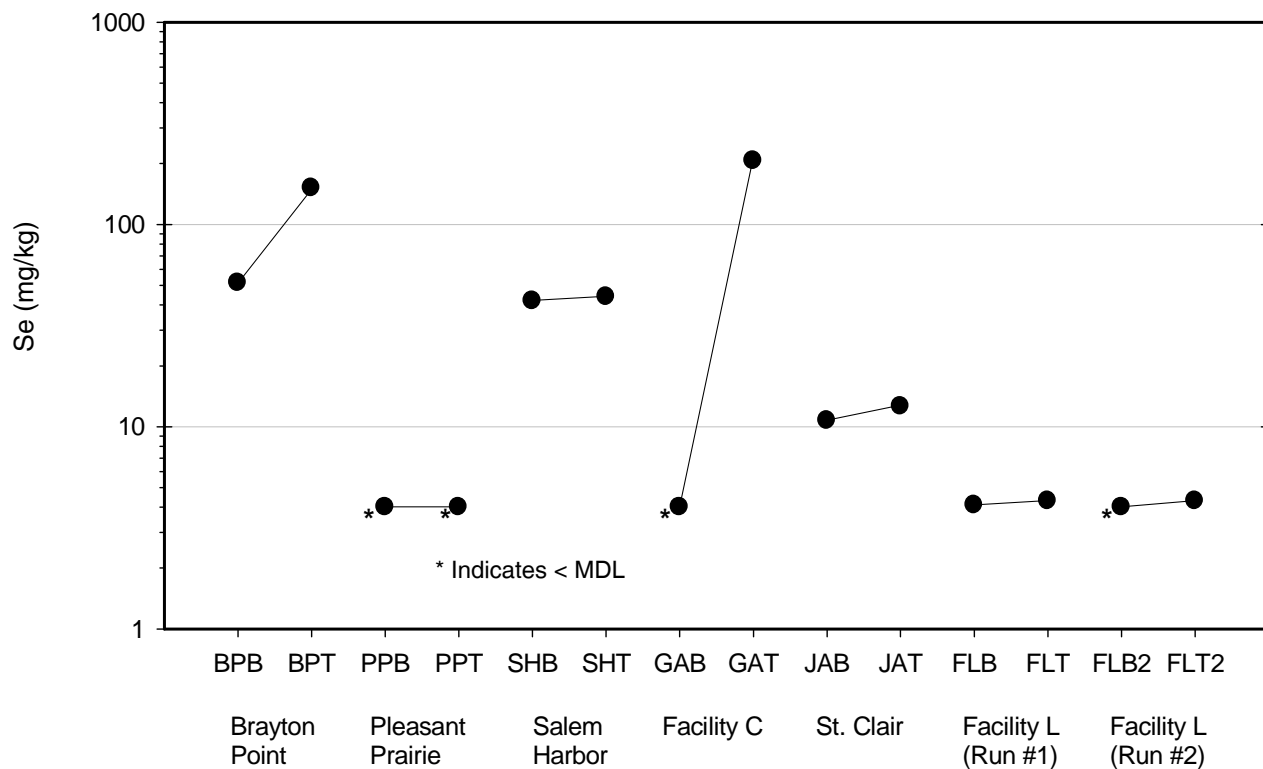

Figure 24. Comparison of Total Selenium Content in Baseline Cases and with Sorbent Injection for CCRs from Different Facilities. (Facility code suffixes B = baseline and T = treated with sorbent injection; for example, PPB = Pleasant Prairie baseline, and PPT = Pleasant Prairie treated)

the range reported in the EPRI database for landfills. The concentration range reported in the EPA database for CCR landfills has a much lower upper bound than reported in the EPRI database.

- The concentration range for laboratory extracts and field observations exceeded the MCL for all cases except Facility L. For 5 out of 12 of the cases used for laboratory evaluation and for some field observations, the MCL is exceeded by more than a factor of 10.
- Selenium concentrations in laboratory leach test extracts typically are strongly a function of pH over the entire pH range examined and within the pH range observed for field conditions (for example, see Brayton Point, Salem Harbor, Facility C). For some cases (for example, see Figure 19 or Brayton Point, Salem Harbor, St. Clair in Appendices D, F, and H, respectively), measured concentrations of selenium are strongly a function of LS ratio at the material’s natural pH, with much greater concentrations observed at low LS ratio. Therefore, testing at a single extraction final pH or LS ratio would not provide sufficient information to characterize the range of expected leachate concentrations under field conditions.

- For several cases (Brayton Point, Salem Harbor, Facility C, Facility L), selenium concentrations in laboratory extracts appears to be controlled by solid phase solubility, whereas adsorption processes appear to play a more important role for other cases (Pleasant Prairie, St. Clair).

3.4. Long-Term Release Assessment

Cumulative release estimates for CCRs from each facility, both for the baseline case and the case with enhanced mercury recovery, are presented in Appendices D through I. One hundred year release estimates of mercury, arsenic and selenium are presented. One example of long-term release assessment results for arsenic and selenium is provided in Figures 26 and 27. For each case, first the polynomial curve fits for solubility as a function of pH are presented along with the corresponding data from laboratory leaching test results (SR002.1) and the 5th and 95th percentile of pH and constituent concentration from the U.S. EPA database. Next, the cumulative probability distribution for cumulative constituent release is provided from the Monte Carlo simulation for both the baseline and test cases. Finally, a bar chart, comparing total content of the constitu-

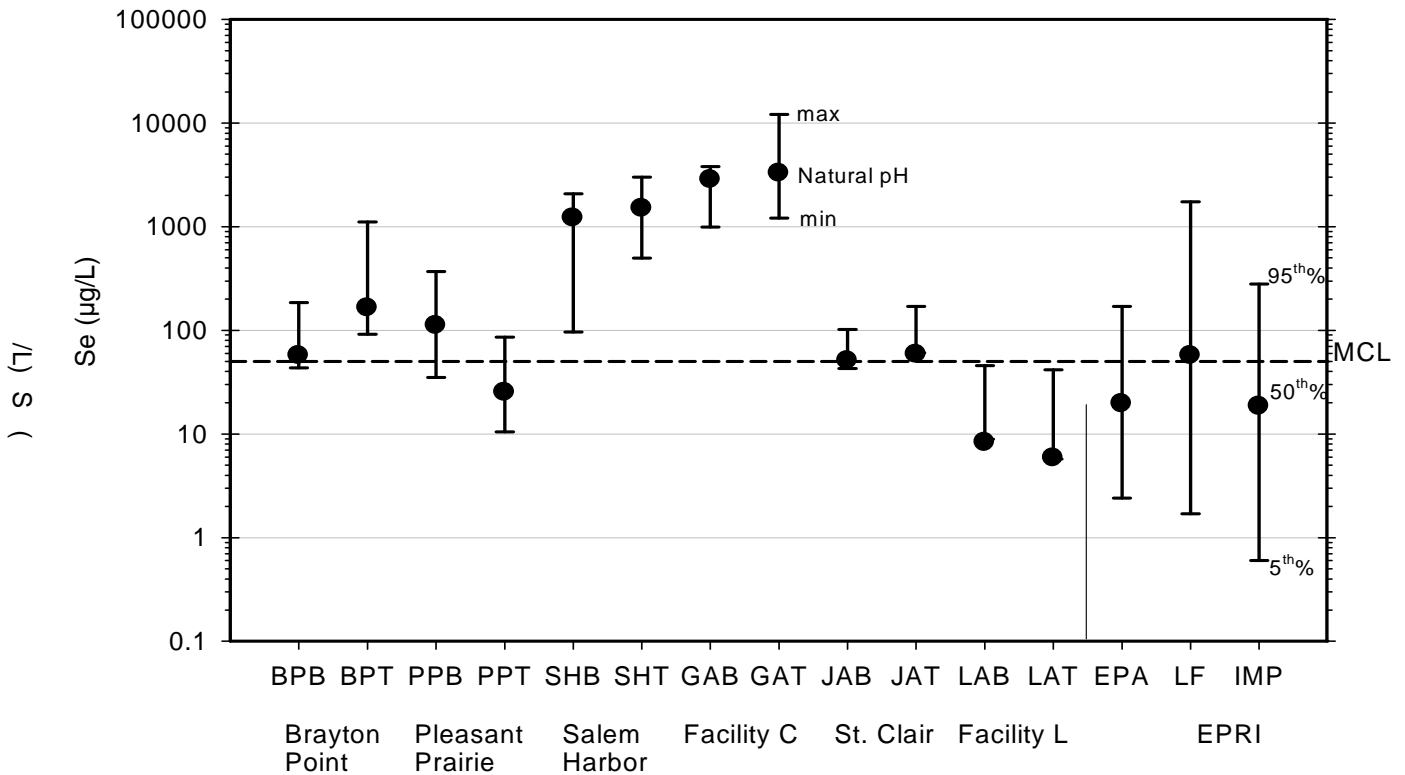

Figure 25. Ranges of Laboratory and Field Leachate Selenium Concentrations Compared with the Drinking Water Maximum Contaminant Level (MCL). [For laboratory data, symbol represents the concentrations at the natural pH of the CCR tested, and the error bars represent the minimum and maximum concentrations within the relevant field pH range of 5.8 to 12.09, inclusive. For field data, symbol and error bars represent the 5th, 50th and 95th percentiles of reported values (EPA = EPA database; LF = landfills from EPRI database; IMP = impoundments from EPRI database). Reliable data for mercury was not available in the EPA database.]

ent evaluated, estimated cumulative release over 100 years, and percent of total content released is provided for the baseline and test cases. Similar results are not provided for mercury because of the simplification used for the assessment based on results and underlying mechanism (see section 2.5.1).

3.4.1. Long-term Release Estimates for Mercury

A comparison of the long-term (100 yr) mercury release estimates from the Monte Carlo simulation for each case is presented in Figure 28A on a mass basis (micrograms of Hg released per kilogram of CCR) and Figure 28B as a percent of total mercury released. Figure 28A also includes the total mercury content for each case.

Considering the results provided in Appendices D through I, and comparisons in Figure 28, the following observations for mercury are made:

- The estimated mass of mercury released over the assessment period does not correlate with the total mer-

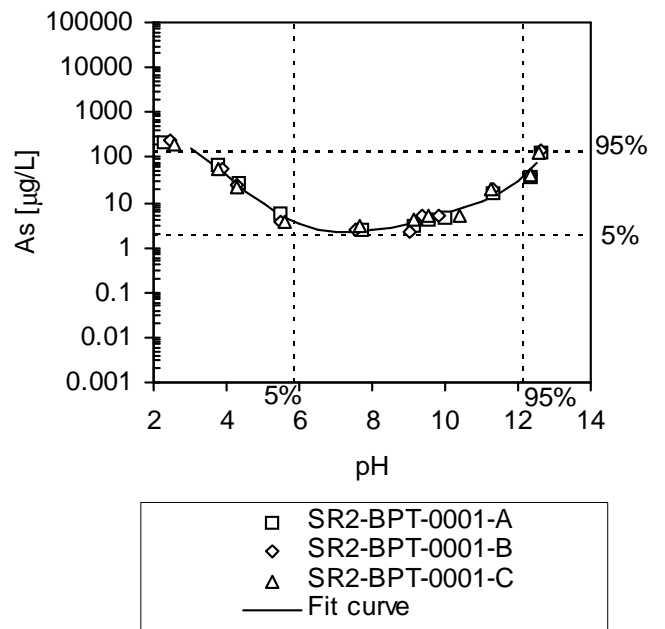
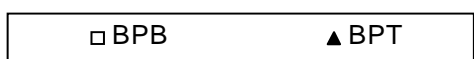
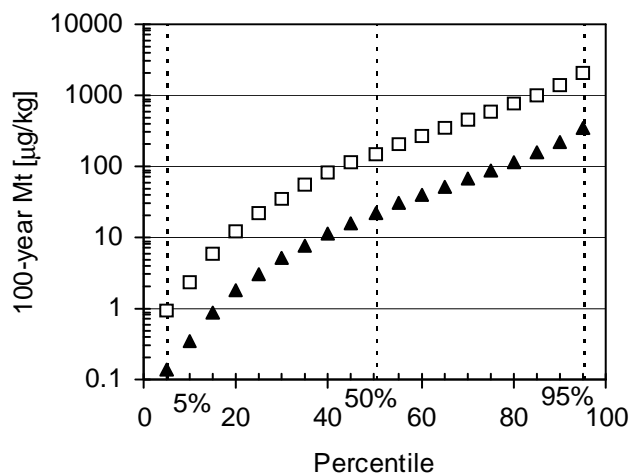

Figure 26. Example Regression Curves of Experimental Data of Arsenic Solubility as a Function of pH for Brayton Point.



	BPB		BPT	
	µg/kg	%	µg/kg	%
Mt min	0.2	0.0003	0.1	0.0003
Mt - 5%	0.9	0.0011	0.1	0.0005
Mt - 50%	152	0.2	22	0.0772
Mt - 95%	2095	2.6	338	1.2
Mean Mt	468	0.6	90	0.3
Mt max	4693	5.8	10157	36.4

Figure 27. Example 100-Year Arsenic Release Estimates for Brayton Point as a Function of the Cumulative Probability for the Scenario of Disposal in a Combustion Waste Landfill. (Mt refers to the cumulative release over the 100-year interval.)

cury content of the CCR. This is a consequence of the relatively constant leaching test extract concentrations independent of the total mercury content in the CCR. For all cases, the median expected release over 100 years is less than or equal to 1 µg/kg, with the 5th and 95th percentiles less than or equal to 0.005 and 15 µg/kg, respectively.

- The percentage of total mercury estimated to be released over 100 years ranges from a very small percentage (less than 0.002%) to less than 5% for most cases. From less than a very small percentage (less than 0.03%) to less than 80% of the total mercury may be released from cases Facility C baseline and Facility L. The higher percentages for these three cases reflects the lower total mercury content present in the CCR.

3.4.2. Long-Term Release Estimates for Arsenic

A comparison of the long-term (100 yr) arsenic release estimates from the Monte Carlo simulation for each case is

presented in Figure 29A on a mass basis (micrograms As released per kilogram CCR) and Figure 29B as a percent of total arsenic released. Figure 29A also includes the total arsenic content for each case and $MCL_{L,S95\%}$ for reference. $MCL_{L,S95\%}$ is the amount of arsenic that would be released (1,000 µg/kg) if the leachate concentration was equal to the MCL for arsenic (10 µg/L) for the entire 100 year period and if the infiltration rate was at the 95th percentile of reference cases for landfills in the U.S. EPA database. For the purposes of this study, values that exceed this threshold may warrant further examination as to whether or not additional management controls should be considered.

Considering the results provided in Appendices D through I, and comparisons in Figure 29, the following observations for arsenic are made:

- The estimated mass of arsenic released over the assessment period does not correlate with the total arsenic content of the CCR. For all cases except Salem Harbor, Facility C, and Facility L, less than 0.1% to 5% of the total arsenic content is anticipated to be released.
- Salem Harbor, Facility C baseline, and Facility L are cases where up to a very high percentage (more than 30%) of the total arsenic content may be released under some management conditions.
- The cases of Salem Harbor, Facility C, and Facility L are examples of where more detailed release evaluation is warranted, considering site specific management practices, infiltration rates, and dilution and attenuation factors.

3.4.3. Long-term Release Estimates for Selenium

A comparison of the long-term (100 yr) selenium release estimates from the Monte Carlo simulation for each case is presented in Figure 30A on a mass basis (micrograms Se released per kilogram CCR) and Figure 30B as a percent of total arsenic released. The presentation in Figure 30 is analogous to the presentation used for arsenic release estimates in Figure 29 and discussed previously.

Considering the results provided in Appendices D through I, and comparisons in Figure 30, the following observations for selenium are made:

- For all cases except Brayton Point, from 40% up to the total content of selenium in the CCR is anticipated to be released at the 95th percentile, with between 3% and 20% for the median case (except Facility C baseline, where the median case is 100% of the total). For Brayton Point, from 1% to 30% of the total con-

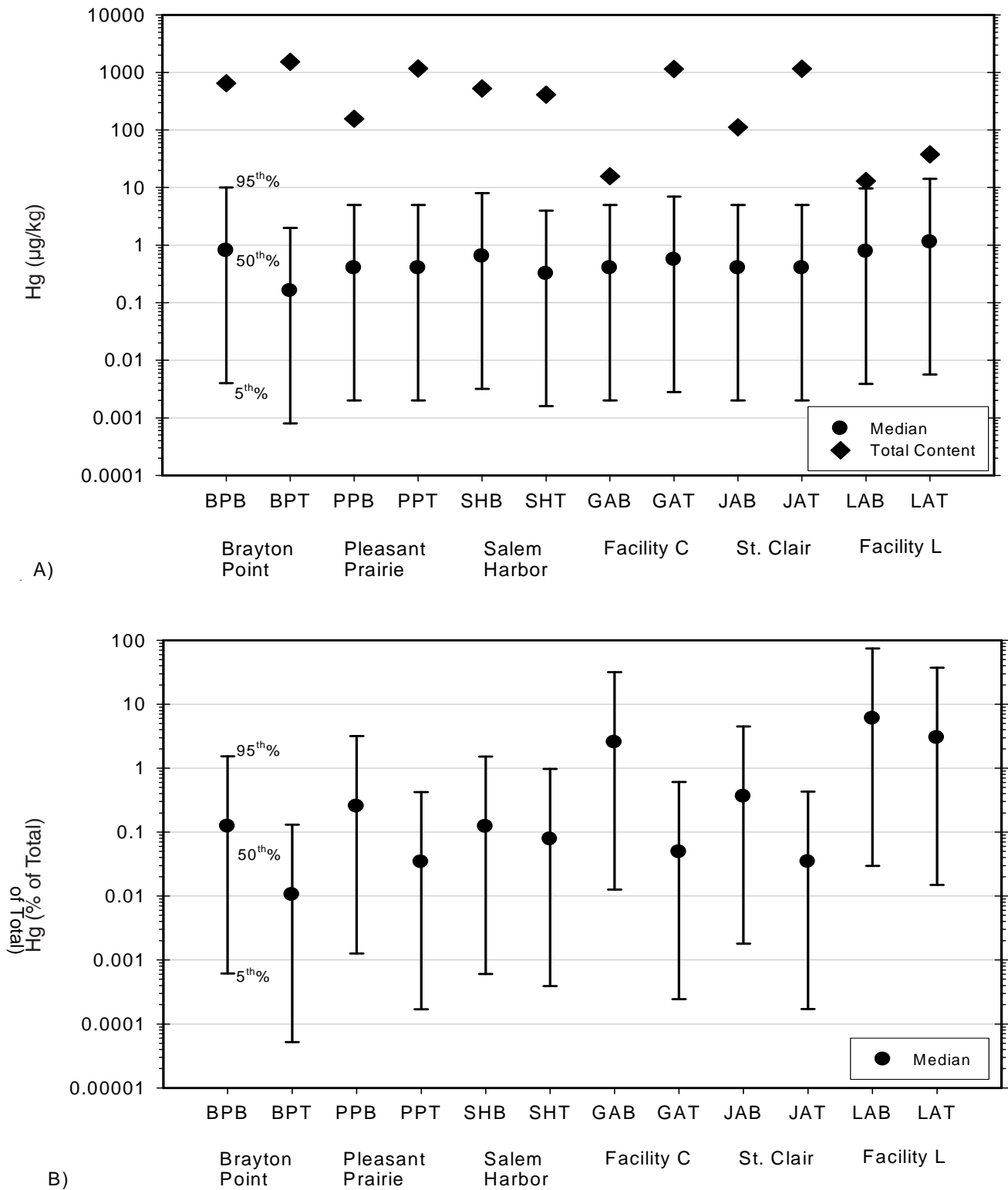

Figure 28. Upper Bound of 100 yr Mercury Release Estimates for Landfill Scenario Without and with Activated Carbon Injection. (A) mass released in µg of mercury released per kg of CCR and total content in µg of mercury per kg of CCR, (B) percent of total mercury content released. Symbol with error bars represents 5th, 50th and 95th percentiles from Monte Carlo simulation. (Facility code suffixes B = baseline and T = treated with sorbent injection; for example, PPB = Pleasant Prairie baseline, and PPT = Pleasant Prairie treated)

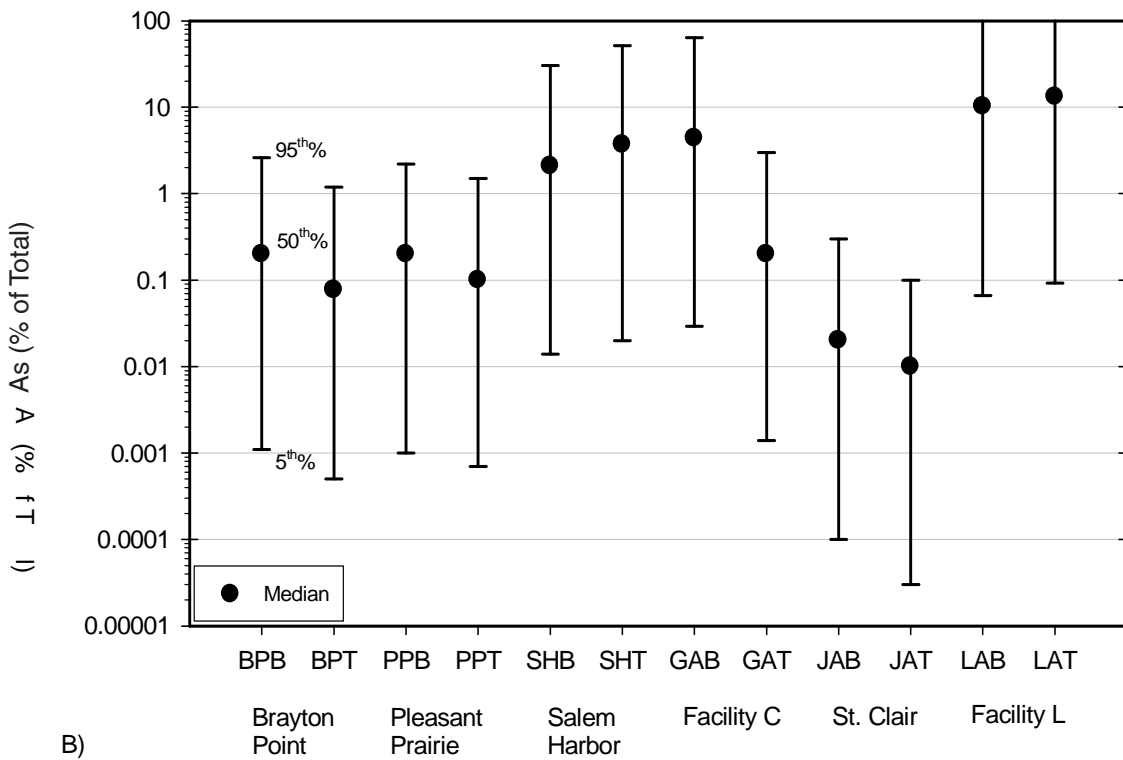
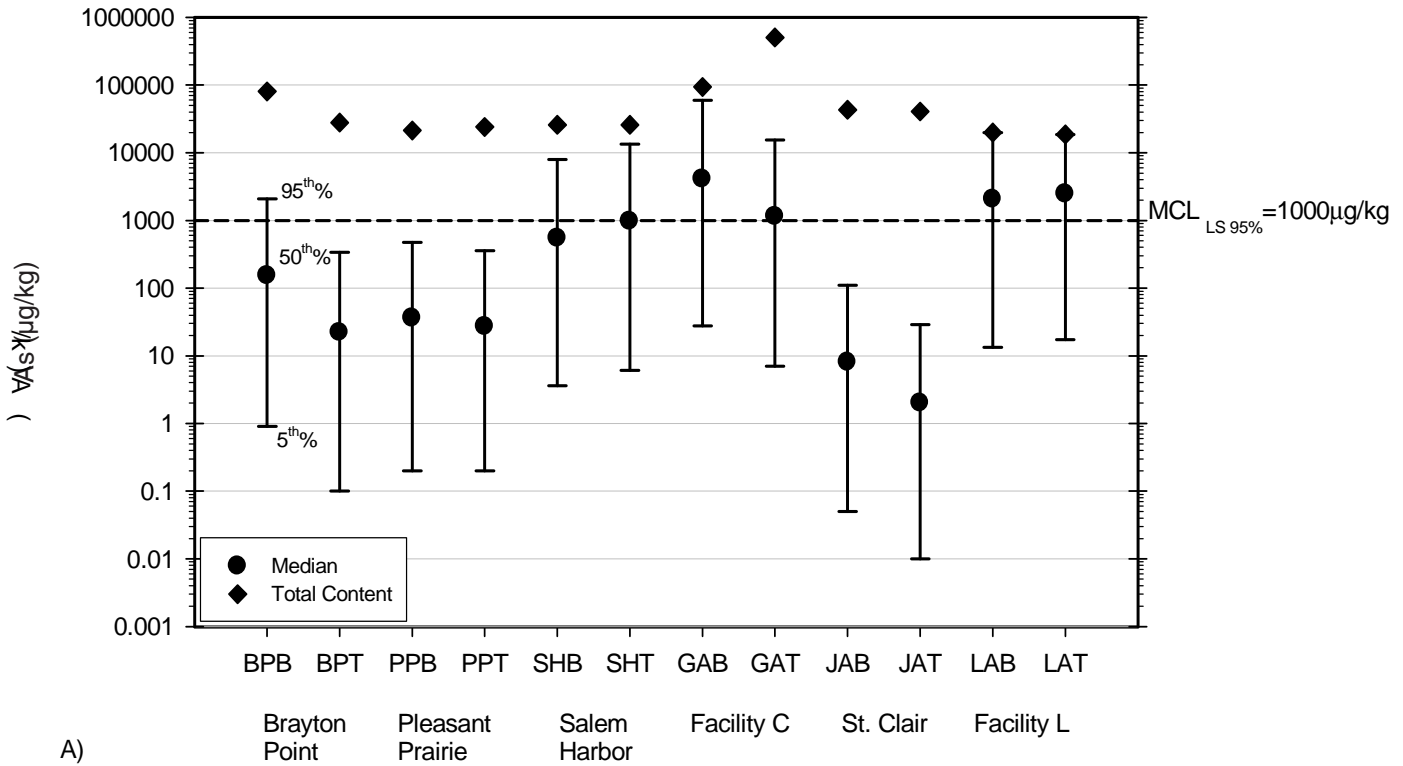
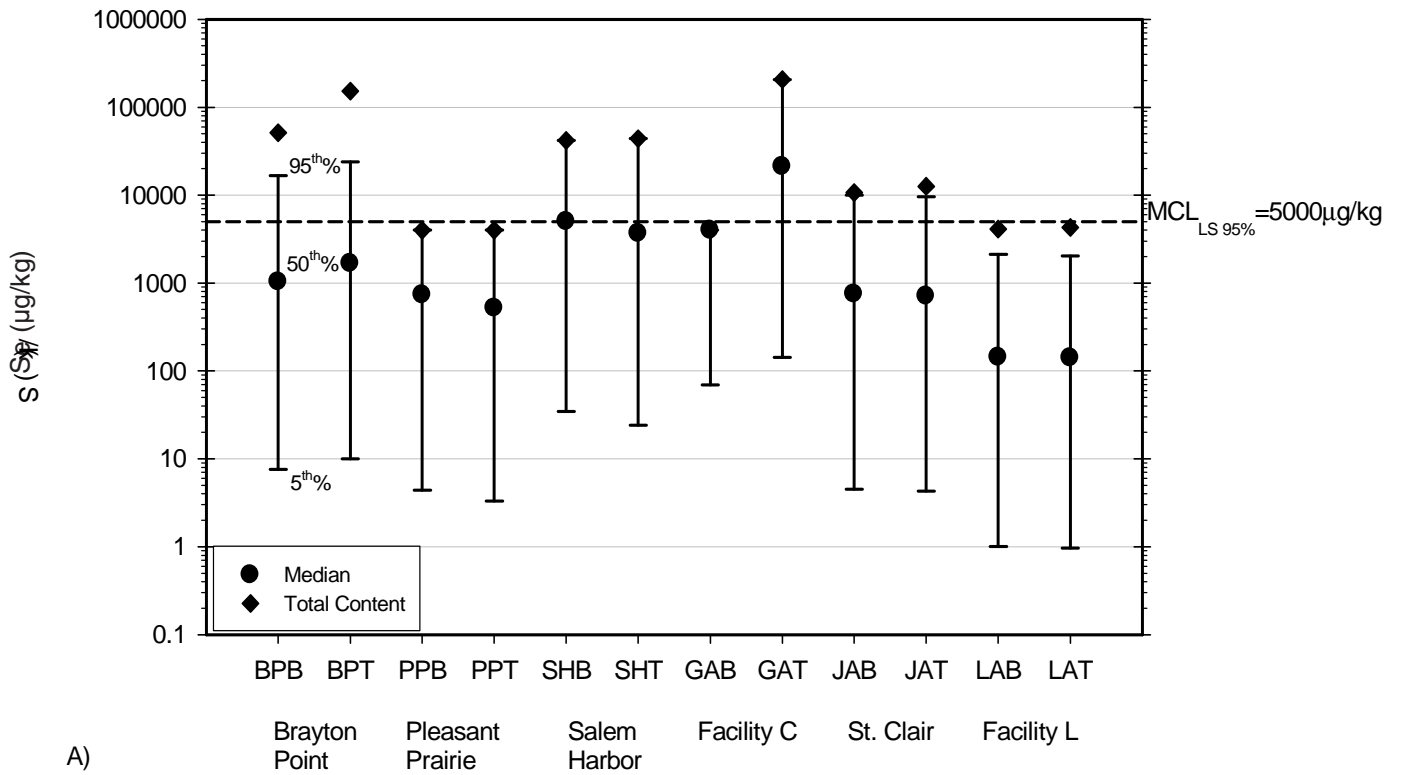
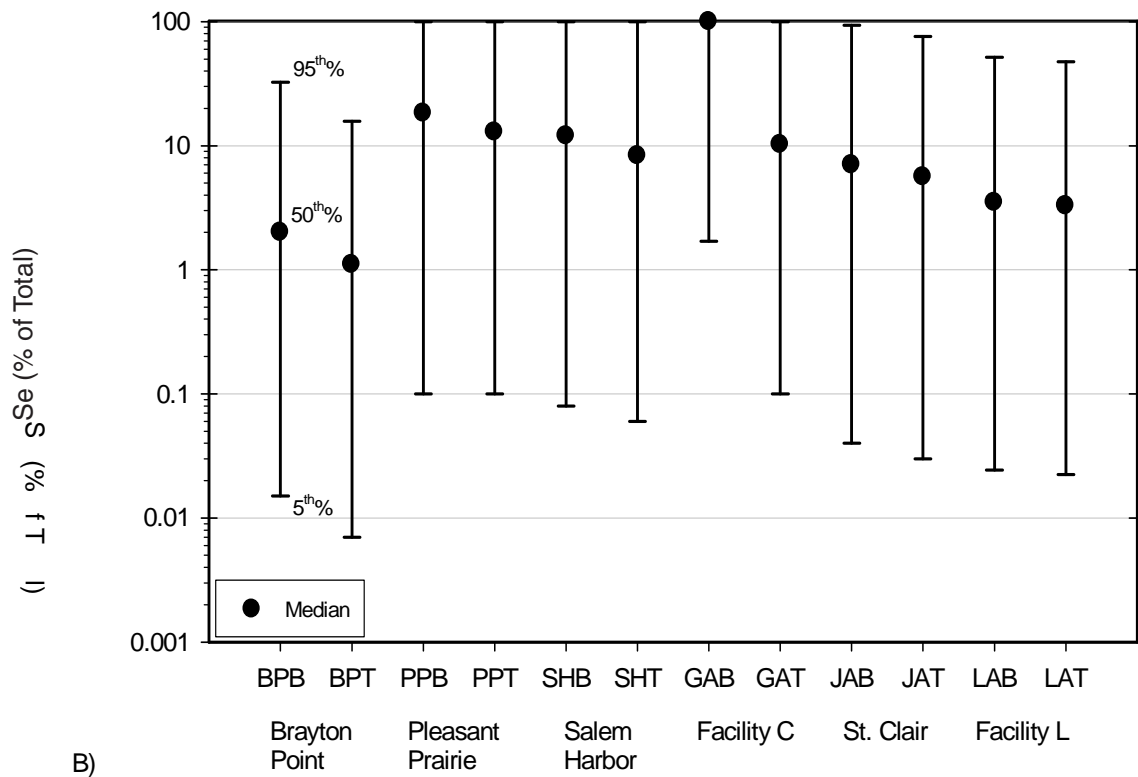

Figure 29. Upper Bound of 100 yr Arsenic Release Estimates for Landfill Scenario Without and with Activated Carbon Injection. (A) mass released in μg of arsenic released per kg of CCR and total content in μg of arsenic per kg of CCR, (B) percent of total arsenic content released. Symbol with error bars represents 5th, 50th and 95th percentiles from Monte Carlo simulation. (Facility code suffixes B = baseline and T = treated with sorbent injection; for example, PPB = Pleasant Prairie baseline, and PPT = Pleasant Prairie treated)



A)



B)

Figure 30. Upper Bound of 100 yr Selenium Release Estimates for Landfill Scenario Without and with Activated Carbon Injection. (A) mass released in μg of selenium released per kg of CCR and total content in μg of selenium per kg of CCR, (B) percent of total selenium content released. Symbol with error bars represents 5th, 50th and 95th percentiles from Monte Carlo simulation. (Facility code suffixes B = baseline and T = treated with sorbent injection; for example, PPB = Pleasant Prairie baseline, and PPT = Pleasant Prairie treated)

Characterization of Coal Combustion Residues

tent is anticipated to be released for more than half of the anticipated conditions.

- Low fractional releases of selenium (less than 0.1%, except for Facility C baseline) at the 5th percentile suggest management scenarios where anticipated release can be substantially reduced for each CCR case, either through control of pH or infiltration.
- All cases are examples of where more detailed release evaluation is warranted, considering site specific management practices, infiltration rates, and dilution and attenuation factors.

4. Conclusions and Recommendations

4.1. Assessment of CCRs Without and With Activated Carbon Injection

Analysis has been completed for CCRs from six coal combustion facilities that control mercury emissions by sorbent injection; four using powdered activated carbon injection and two using brominated powdered activated carbon injection. For each facility, the evaluation included assessments of CCRs generated both with and without use of the activated carbon injection. None of these facilities had scrubbers as part of their air pollution control technology. The following conclusions are drawn for this class of facilities:

- Application of activated carbon injection substantially increased the total mercury content in the resulting CCRs for five of the six facilities evaluated. Substantially increased arsenic and selenium content in the CCRs was observed at the one facility that employed COHPAC fabric filter particulate control technology. This may have resulted from additional arsenic and selenium adsorption onto the CCR while retained in the fabric filters. Significant increase in the selenium content of one additional facility was noted.
- Mercury is strongly retained by the CCR and unlikely to be leached at levels of environmental concern. Leaching that did occur did not depend on total mercury content in the CCR, leaching pH, nor liquid to solid ratio, and mercury concentrations in laboratory extracts appeared to be controlled by non-linear adsorption equilibrium. Laboratory extract concentrations ranged between less than the MDL (0.01 µg/L) and 0.2 µg/L.
- Arsenic and selenium may be leached at levels of potential concern from CCRs generated at some facilities both with and without enhanced mercury control technology. Further evaluation of leaching of arsenic and selenium from CCRs that considers site specific conditions is warranted.
- Leachate concentrations and the potential release of mercury, arsenic and selenium do not correlate with

total content. For many cases, leachate concentrations observed are a function of final pH over the range of field conditions, and the observed leaching behavior implies that solubility in the leachate or aqueous extract controls observed liquid concentration rather than linear adsorption equilibrium. For these cases, use of linear partition coefficients (K_d) in modeling leaching phenomena does not reflect the underlying processes. In addition, for many cases, the amount of mercury, arsenic and/or selenium estimated to be released over a 100 year interval is a small fraction (less than 0.1% to 5%) of the total content. For selenium, release from less than 5% up to the total content of selenium can be anticipated over the 100 year period. Therefore, it is not recommended to base landfill management decisions on total content of constituents in CCRs since total content does not consistently relate to quantity released.

- Results of this assessment also suggest management conditions (e.g., through control of infiltration and pH) that may result in reduction releases of arsenic and selenium by as much as two orders of magnitude in comparison to upper bound estimated releases.
- Use of the Leaching Framework facilitated understanding the variations in anticipated leaching behavior under the anticipated field landfill disposal conditions, including expected ranges of constituent concentrations in leachate and cumulative release over a defined time interval. In addition, insights into the mechanisms controlling constituent leaching were obtained. This depth of understanding would not have been possible using leaching tests focused on a single extraction condition (e.g., TCLP, SPLP, or SGLP).
- This study provides baseline data which allows using a reduced set of laboratory testing conditions as a screening leaching assessment for CCRs from coal combustion facilities employing similar air pollution control technology. For mercury, extraction only at the material's natural pH at LS=10 is adequate. For arsenic, extraction at four conditions is warranted to de-

fine the range of expected leachate concentrations and release: (i) pH 5.5–6.0 at LS=10, (ii) pH 7.5–8.5 at LS=10, (iii) pH 12.0–12.5 at LS=10 and (iv) natural pH at LS=2. For selenium, either the total content or the same conditions as recommended for arsenic can be used. At least duplicate extractions should be used. Results from this more limited testing can be evaluated in comparison with the results presented in this report to determine if more extensive evaluation is warranted.

4.2. Implementation of Leaching Test Methods

The leaching assessment approach published by Kosson et al. (2002) and implemented in this report was selected because after internal EPA review (Office of Research and Development, Office of Solid Waste) and consultation with the Environmental Engineering committee of the EPA Science Advisory Board, it was considered the only available peer reviewed and published approach that allowed consideration of the range of potential field management scenarios expected for CCRs and that provided a fundamental foundation for extrapolation of laboratory testing to field scenarios. Additional development and validation of the leaching assessment approach through this project provides the following conclusions:

- Laboratory leaching test results were consistent with observed ranges of field leachate pH and with mercury, arsenic, and selenium concentrations. Thus, the leaching test methods employed in this study provide

an appropriate basis for evaluating leaching under the range of anticipated field management scenarios.

- Leaching test methods SR002.1 (Solubility and Release as a Function of pH) and SR003.1 (Solubility and Release as a Function of LS ratio) have been successfully implemented at the EPA National Risk Management Research Laboratory. The use of these methods is now considered near routine methodology for the laboratory.
- QA/QC methodology conforming with EPA Tier 3 requirements has been developed and demonstrated for the leaching test methods SR002.1 and SR003.1.
- Further efficiency in implementation of the QA/QC methodology may be obtained, based on the results from testing the initial set of CCRs, by reducing the number of replicates and control analyses required under the initial QA/QC plan. These improved project efficiencies are being implemented for evaluation of additional CCRs under this project.
- A mass balance around the laboratory leaching test procedures has been completed for mercury and selected metals of potential concern. These results indicate that recoveries were between 60% and 91% for mercury during the leaching tests and subsequent analytical procedures, which is within the uncertainty resulting from heterogeneity within the CCR. Additional mass balance verification may be warranted if future samples have significantly different characteristics that may result in greater volatility of the constituents of interest than in the reference sample evaluated.

5. References

- ACAA (American Coal Ash Association), 2000. 1999 Coal Combustion Product (CCP) Production and Use (Short Tons), available at http://www.acaa-usa.org/whatsnew/ccp_surveys.htm (accessed March 2001).
- ACAA (American Coal Ash Association), 2003. 2003 Coal Combustion Product (CCP) Production and Use Survey, ACAA, Alexandria, VA, available at [http://www.acaa-usa.org/PDF/2003_CCP_Survey\(10-1-04\).pdf](http://www.acaa-usa.org/PDF/2003_CCP_Survey(10-1-04).pdf) (accessed January 2006).
- Clean Air Mercury Rule: 70 FR 28606; May 18, 2005.
- Clean Air Interstate Rule: 70 FR 25162; May 12, 2005.
- Duong D. Do., 1998. *Adsorption Analysis: Equilibria and Kinetics*. Imperial College Press, London, 892 p.
- EPA, 1988. Report to Congress—Wastes from the Combustion of Coal by Electric Utility Power Plants. EPA/530/SW-88/002, U.S. EPA, Office of Solid Waste and Emergency Response, Washington, DC.
- EPA, 1996. Method 3052 “Microwave Assisted Acid Digestion of Siliceous and Organically Based Matrices,” Test Methods for Evaluating Solid Waste, Physical/Chemical Methods (SW-846), available at <http://www.epa.gov/sw-846/main.htm> (accessed January 2006).
- EPA, 1998. Method 7473 “Mercury in Solids and Solutions by Thermal Decomposition, Amalgamation, and Atomic Absorption Spectrophotometry,” Test Methods for Evaluating Solid Waste, Physical/Chemical Methods (SW-846), available at <http://www.epa.gov/sw-846/main.htm> (accessed January 2006).
- EPA, 1999. Report to Congress—Wastes from the Combustion of Fossil Fuels: Volume 2-Methods, Findings and Recommendations. EPA/530/R-99/010. U.S. EPA, Office of Solid Waste and Emergency Response, Washington, DC.
- EPA, 2000. Characterization and evaluation of landfill leachate. EPA, Draft Report. 68-W6-0068, September 2000.
- EPA, 2002. Characterization and Management of Residues from Coal-Fired Power Plants, Interim Report. EPA/600/R-02/083, December.
- EPA, 2003. Technical Support Document for the Assessment of Detection and Quantitation Approaches. EPA/821/R-03/005. U.S. EPA, Office of Water, Washington, DC, available at (<http://epa.gov/waterscience/methods/det/index.html>) [Superceded by Revised Assessment of Detection and Quantitation Approaches, EPA/821/B-004/005, available at <http://www.epa.gov/waterscience/methods/det/rad/rad.pdf> (accessed January 2006)].
- EPA, 2005. Control of Mercury Emissions from Coal Fired Electric Utility Boilers: An Update, U.S. EPA, Office of Research and Development, Research Triangle Park, NC, Feb 18, available at http://www.epa.gov/ttn/atw/utility/ord_whtpaper_hgcontroltech_oar-2002-0056-6141.pdf accessed January 2006.
- EPRI, 1999. Guidance for Co-management of Mill Rejects at Coal-Fired Power Plants. Report TR-108994.
- EPRI, 2005. Personal communication of EPRI leaching database (as of June 2005) summary information from K. Ladwig to D. Kosson.

Kosson, D.S., van der Sloot, H.A., Sanchez, F., and Garrabrants, A.C., 2002. An Integrated Framework for Evaluating Leaching in Waste management and Utilization of Secondary Materials, *Environmental Engineering Science* **19**:3, 159–204.

MTI (McDermott Technology, Inc.), 2001. Mercury Emissions Predictions, available at <http://www.mtiresearch.com/aecdp/mercury.html#Coal%20Analyses%20and%20Mercury%20Emissions%20Predictions>, accessed November 2002.

Munro, L.J., Johnson, K.J., and Jordan, K.D., 2001. An Interatomic Potential for Mercury Dimmer, *J. of Chemical Physics*, **114**:13, 5545–5551.

Nelson, S., 2004. “Advanced Utility Sorbent Field Testing Program,” DOE/NETL Mercury Control Technology R&D Program Review, Pittsburgh, PA, July 14–15, 2004.

Nelson, S., Landreth, R., Zhou, Q., Miller, J., 2004. “Accumulated Power-Plant Mercury-Removal Experience with Brominated PAC Injection”, Joint EPRI DOE EPA Combined Utility Air Pollution Control Symposium, The Mega Symposium, Washington, D.C., August 30–September 2.

Rudzinski, W., W.A. Steele, and G. Zgrablich, 1997. *Equilibria and Dynamics of Gas Adsorption on Heterogeneous Solid Surfaces*. Elsevier, Amsterdam.

Ruthven, D.M., 1984. *Principles of Adsorption and Adsorption Processes*. Wiley, New York, 433 p.

SAB (EPA Science Advisory Board, Environmental Engineering Committee), 2003. TCLP Consultation Summary, presented at the SAB Environmental Engineering Committee consultation with EPA, Washington, D.C., June 17–18.

Sanchez, F., Kosson, D.S., 2005. Probabilistic Approach for Estimating the Release of Contaminants under Field Management Scenarios, *Waste Management*, **25**:5, 643–472.

Senior, C, Bustard, C.J., Baldrey, K., Starns, T. Durham, M., 2003a. “Characterization of Fly Ash From Full-Scale Demonstration of Sorbent Injection for Mercury Control on Coal-Fired Power Plants,” presented at the Combined Power Plant Air Pollutant Control Mega Symposium, Washington D.C., May 19–22.

Senior, C., Bustard, C.J., Durham, M., Starns, T., Baldrey, K, 2003b. “Characterization of Fly Ash From Full-Scale Demonstration of Sorbent Injection for Mercury Control on Coal-Fired Power Plants,” presented at the Air Quality IV Conference and Exhibition, Washington D.C, September 22–27.

Senior, C., Bustard, C.J., Durham, M., Baldrey, K., Michaud, D., 2004. Characterization of Fly Ash From Full-Scale Demonstration of Sorbent Injection For Mercury Control on Coal-Fired Power Plants, *Fuel Processing Technology*, **85**:6–7, 601–612.

Starns, T., Bustard, J., Durham, M., Lindsey, C., Martin, C., Schlager, R., Donnelly, B., Sjostrom, S., Harrington, P., Haythornthwaite, S., Johnson, R., Morris, E., Change, R., Renninger, S., 2002. “Full-Scale Test of Mercury Control with Sorbent Injection and an ESP at Wisconsin Electric’s Pleasant Prairie Power Plant,” presented at the Air & Waste Management Association 95th Annual Conference and Exhibition, Baltimore, MD, June 23–27.

Thorneloe, S., 2003. Presentation to EPA Science Advisory Board (Environmental Engineering Committee), Washington, D.C., June 17th.

Vidic, R.D., 2002. Combined Theoretical and Experimental Investigation of Mechanisms and Kinetics of Vapor-Phase Mercury uptake by Carbonaceous Surfaces. Final Report, Grant No. DE-FG26-98FT40119 to U.S. DOE, National Energy Technology Laboratory.

Appendix A

U.S. EPA Science Advisory Board Consultation Summary

This summary was prepared at the close of the June 2003 U.S. EPA OSW and ORD consultation with the Science Advisory Board, Environmental Engineering Committee Review Panel. These comments do not represent formal consensus of the panel, and no consensus recommendations to the U.S. EPA were prepared. These comments do present panel members views, with informal consensus on many points.

TCLP CONSULTATION SUMMARY

Environmental Engineering Committee
Science Advisory Board
U.S. Environmental Protection Agency
Washington, DC

June 18, 2003

FOCUS

- Alternatives to TCLP test for use in waste and site situations where TCLP test is not required by regulation
- Focus Areas: contaminated site remediation; waste material reuse; waste delisting

OVERVIEW

- Five specific consultation issues
- Two general consultation issues
- Key findings and recommendations

SPECIFIC CONSULTATION ISSUE 1

Laboratory testing conditions should, to the degree possible, anticipate the plausible range of field conditions affecting waste leaching in disposal and reuse situations. These conditions will be most realistically represented by a distribution of values for factors affecting leaching, and testing should reflect this range of values to the degree possible

COMMENTS
SPECIFIC CONSULTATION ISSUE 1

- Agree with statement; comments that follow represent consensus of committee
- Statement should be related to some contextual use of leaching test
- Could expand probabilistic approach to include distributions for field property parameters
- Range of conditions considered depends on the intended use of the information; need context
- Need to define what the target problems are. What are we trying to fix? Might be short list.
- EPA needs to define better what the objectives are for the broader leaching framework

COMMENTS
SPECIFIC CONSULTATION ISSUE 1

- Unclear what is the cost of making no change.
- Unclear to what extent overly conservative classification affects beneficial reuse
- Also need to consider waste material properties, e.g., physical form, presence of oil, etc.
- Need to consider organics as well as metals
- Perhaps can group waste materials, consider categories

SPECIFIC CONSULTATION ISSUE 2

Conditions present at the end of a test (rather than initial test conditions) should be the basis for comparison with field conditions.

COMMENTS SPECIFIC CONSULTATION ISSUE 2

- Statement indicates application is to dissolution of solids, and to assessment of max aqueous phase conc of released species for purposes other than waste classification
- To the extent that the test aims to achieve equil conditions, end measurement is appropriate
- Issue motivated by the TCLP test, where final solution pH is not measured.
- Conditions in a reactor at equilibrium or at the end of a fixed period of time are more relevant to the leaching measured in the reactor at the time of sampling than the initial condition.

SPECIFIC CONSULTATION ISSUE 3

For assessing metals leaching, pH is the strongest predictor of leaching potential in most cases. Other important factors include infiltration rate, liquid/solid ratio, redox environment, effect of common ions and ionic strength, effects of external factors (co-disposed waste, biological activity, etc.), and exposure to ambient air. The relative importance of these factors is likely to vary for different wastes.

COMMENTS SPECIFIC CONSULTATION ISSUE 3

- Redox condition (Eh), organic matter, aging-after-disposal are important factors not in current tests
- Microbes important, but not in current tests; biotransformation can render solid phase metals soluble
- Inclusion of microbes difficult for standard tests
- pH important; not clear it is “strongest” predictor
- Depends on constituent; pure metals, organics influenced by different factors
- R&D needed to be able to rank parameters
- Again, need to define objectives better

SPECIFIC CONSULTATION ISSUE 4

The development of multiple leaching tests, or a flexible testing framework is required. Selection of a suitable leaching test should be made based on a number of factors: anticipated use of test results, waste characterization, the range of plausible disposal or reuse conditions, and previously available information on the subject waste or similar wastes. ...

COMMENTS SPECIFIC CONSULTATION ISSUE 4

- Framework of Kosson et al. is flexible tiered approach that encompasses equilibrium and kinetics and includes a suite of tests to address both, and allows for site-specific and generic release estimates using mass transfer modeling
- Framework of Kosson et al. is broad and potentially applicable to broad range of wastes and disposal scenarios
- Framework is open ended; it is a huge step beyond a single leach test; the manner in which it will be implemented by decisionmakers needs to be clarified
- Establishment of the framework for implementation will be resource intensive; EPA needs to justify the value of the information for decisionmaking, as balanced against other waste regulation needs.
- Need systematic approach for applying framework
- Need well-defined objectives for framework in order to develop step-by-step guidance for use

SPECIFIC CONSULTATION ISSUE 5

Modeling may also play an important role in relating laboratory and field conditions to one another, and in using leach test results to assess the leaching potential of waste.

COMMENTS SPECIFIC CONSULTATION ISSUE 5

- Concerned about use of deterministic models for prediction of leaching potential; probabilistic modeling will be more appropriate in some cases, but is resource intensive
- Concern about incorporating modeling into leaching test protocol; connecting model to field difficult
- Modeling of leaching test may be useful for better understanding leach mechanisms, and connection of test with field
- For certain wastes, coupling of leach tests with a model should be considered to predict solubilization over time, especially for organics (Multiple equil. states may exist)
- Usefulness of modeling depends on question to be answered; goals for leach eval. need to be defined

GENERAL CONSULTATION ISSUE 1

EPA requests SAB reaction to current research, and the potential to apply it to improve particular programs, specifically programs that do not now require the use of TCLP.

COMMENTS GENERAL CONSULTATION ISSUE 1

- Capability to address organics, oily wastes, long-term reliability need to be incorporated
- Framework of Kosson et al. is broadly applicable; more development work yet needed (guidance for specific applications, database for field conditions and waste types, data quality criteria, data interpretation/decisionmaking)
- Framework of Kosson et al. is responsive to the 1999 SAB commentary, but to this point is limited to inorganics
- Current research proceeding without clear definition of problem to be addressed by alternatives to TCLP
- EPA should invest in identifying areas where alternative to TCLP is vitally needed

COMMENTS
GENERAL CONSULTATION ISSUE 1

- Leaching-related research inside/outside EPA could be exploited more

COMMENTS
GENERAL CONSULTATION ISSUE 1

- Tiered structure of framework: enables tradeoffs in value of information
- EPA should prioritize R&D efforts based on assessment of the problem most in need of alternatives to the TCLP, e.g.,
 - If going to do evaluation of problems driving TCLP alternatives, try to ascertain value of making a change, i.e., economic analysis of problem
 - Evaluate waste generation and management trends and projections as well as current situation
 - Cost-benefit analysis may be difficult; try to assess opportunity cost of not pursuing alt. to TCLP

GENERAL CONSULTATION ISSUE 2

EPA requests SAB reaction to the direction for long-term research work to further develop fundamental understanding of leaching that would improve the predictive capability of test suites or testing frameworks.

COMMENTS GENERAL CONSULTATION ISSUE 2

- Goals for long-term research not well defined
- Increased fundamental knowledge will yield long-term advancement in assessment of leaching
- Funding priority for leaching research clearly is low.
- Long-term ORD research should be better coordinated with efforts inside/outside EPA, including DOD, FHWA, DOE
- Long-term ORD research is responsive to 1999 SAB commentary in science factors under study, but is focused on inorganics only and will benefit from clearer objectives

COMMENTS
GENERAL CONSULTATION ISSUE 2

- Problem definition has two components
 - determine waste categories and field situations most in need of TCLP alternatives
 - determine research priorities for the most important waste/field situations

COMMENTS
GENERAL CONSULTATION ISSUE 2

- Organics, manufacturing process wastes, end-of-life product wastes need to be considered
- Industry/government/academic research consortium on leaching issues would be useful
- Industry may be willing to co-fund leaching evaluation R&D
- EPA should investigate collaborative efforts with European, Canadian, and Japanese researchers

KEY FINDINGS AND RECOMMENDATIONS

- Alternatives to TCLP for evaluation of leach potential are needed for some waste and site situations
- Not clear if there is large or small number of waste and site situations for which alternative approach is needed
- Framework of Kosson et al. is broadly applicable; more development work yet needed (guidance for specific applications, database for field conditions and waste types, data quality criteria, data interpretation/decisionmaking)
- Framework of Kosson et al. is responsive to the 1999 SAB commentary, but to this point is limited to inorganics

KEY FINDINGS AND RECOMMENDATIONS

- Current research needs clear definition of problem to be addressed by alternative to TCLP
- EPA should invest in identifying areas where alternative to TCLP is vitally needed
- The 1999 SAB commentary focused on science-based issues in leaching: EPA has been responsive within resource limitations.
- Organic waste constituents need to be considered, and a broader framework should include assessment or organic constituent leaching

KEY FINDINGS AND RECOMMENDATIONS

- Research and development should focus on most applicable waste/site situations, and possible beneficial reuse scenarios
- Given limited R&D resources, EPA should prioritize research efforts and leverage DOD, DOE, FHWA interest in leaching through cross-govt coordination, as well as industrial and international collaboration
- EPA intra-agency efforts should be more closely linked

Appendix B
DOE NETL Full-Scale Test Site Flow Diagrams

Brayton Point Unit 1

- Carbon injected upstream of second ESP (Research Cottrell). Only 1/2 of the unit was treated, or carbon was injected into one of the two new ESPs (Research Cottrell ESPs).
- Hopper IDs also shown. Samples from C-row are from the first row of hoppers in the second ESP.

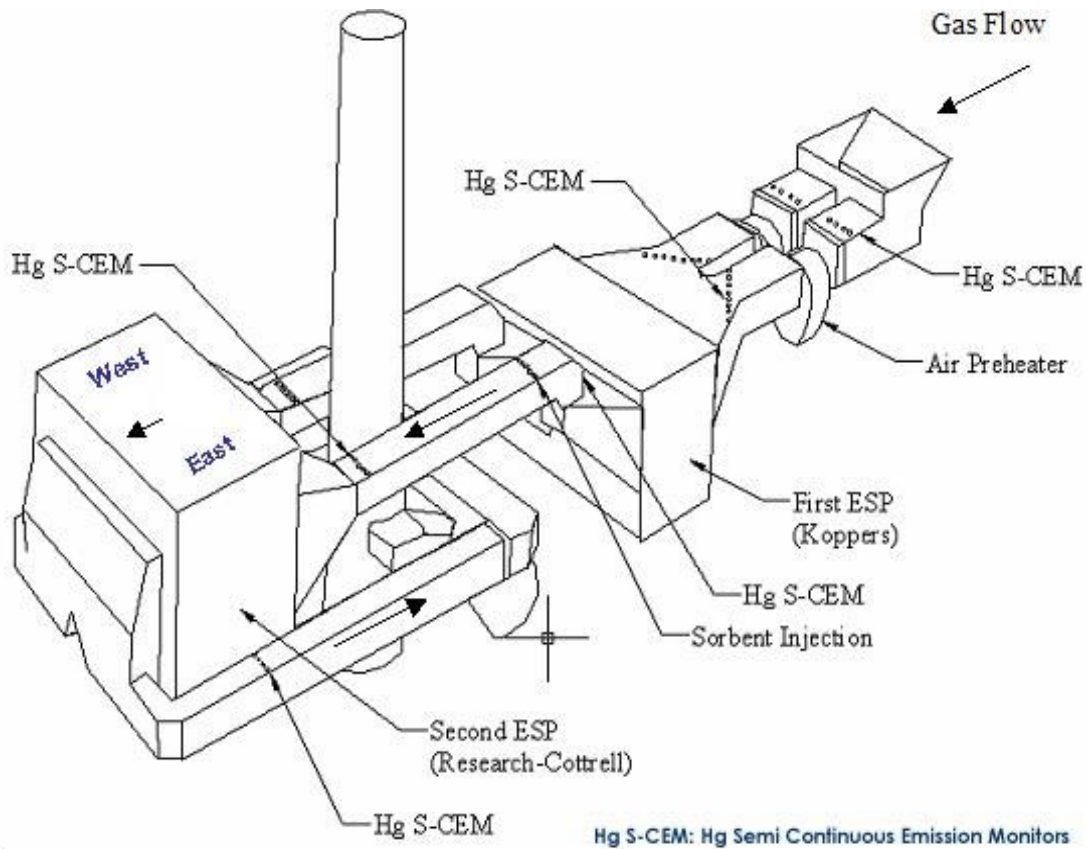

- Bird's eye view of second ESP.
- Samples taken from C-row hoppers.

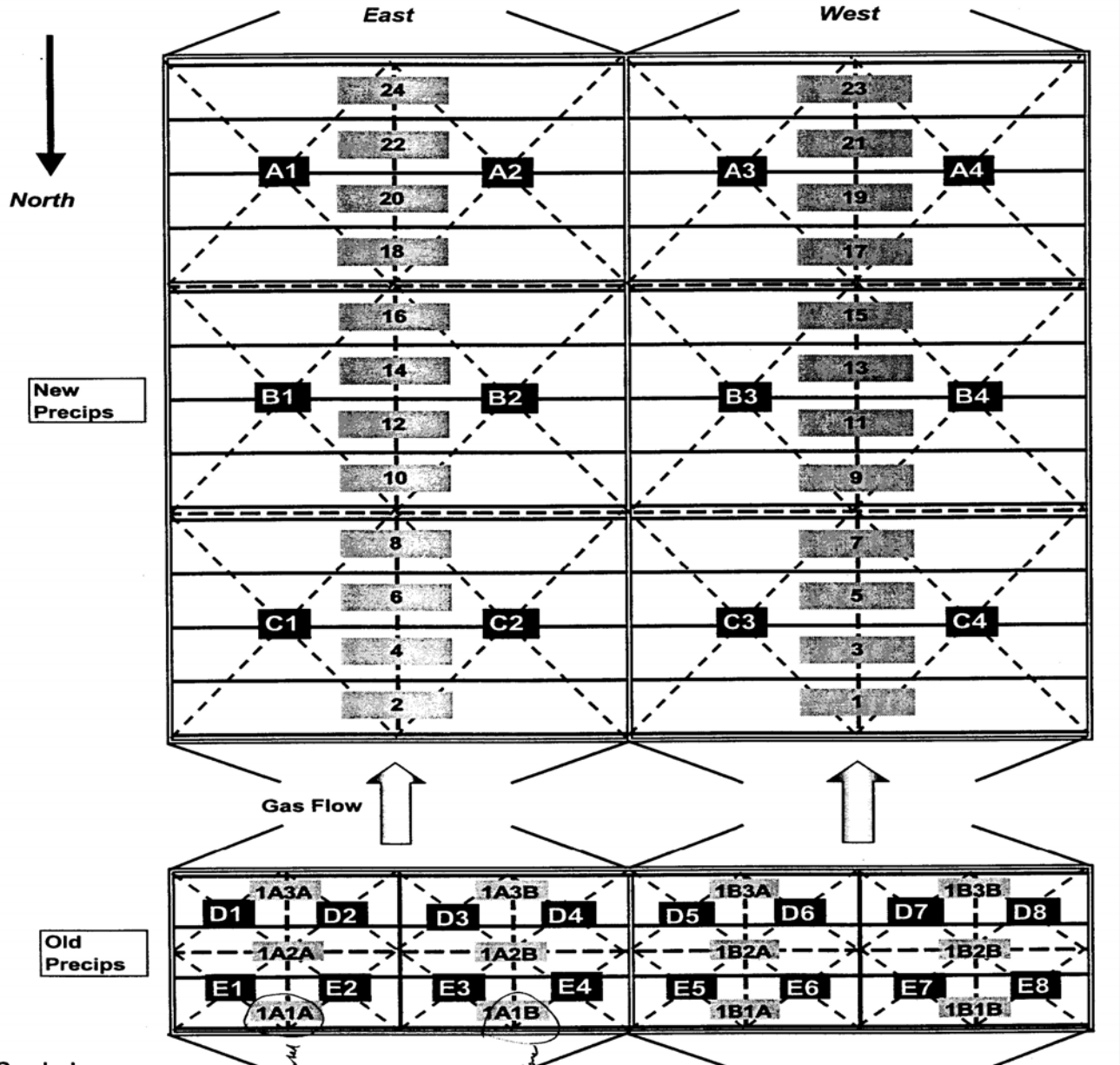

Pleasant Prairie Unit 2

Carbon injected upstream of cold-side ESP. Only ¼ of the unit was treated. Test ESP was ESP 2-4.

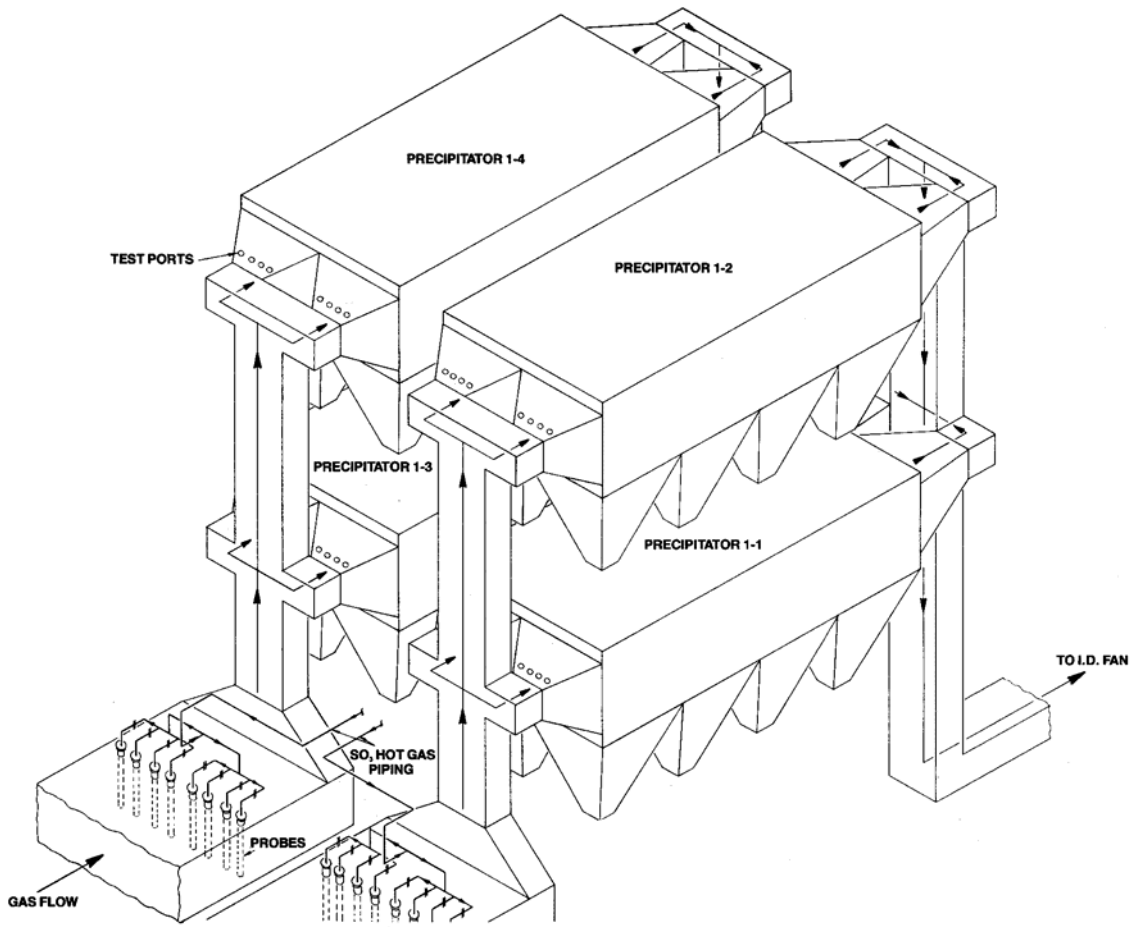

Salem Harbor Unit 1

Carbon injected upstream of cold-side ESP. Row-A hoppers were the front hoppers.

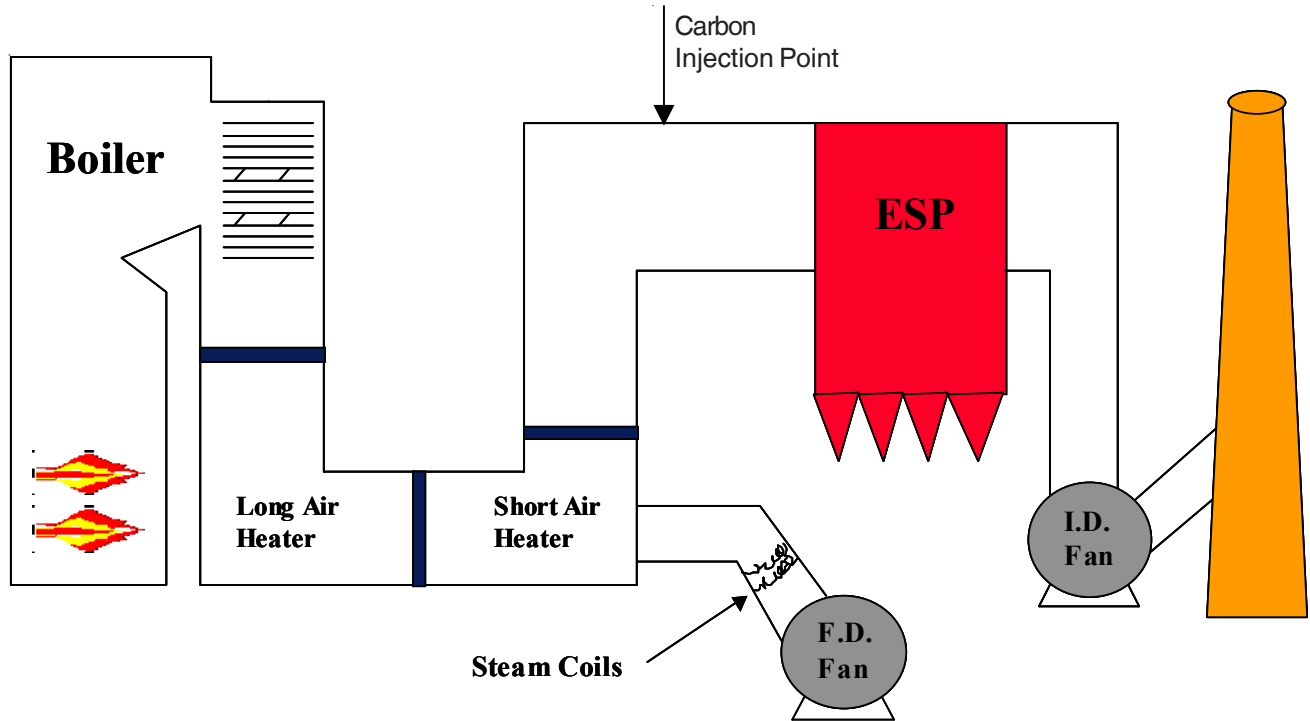

Facility C

Carbon injected upstream of Unit 3B COHPAC baghouse (in between hot-side ESP and baghouse)

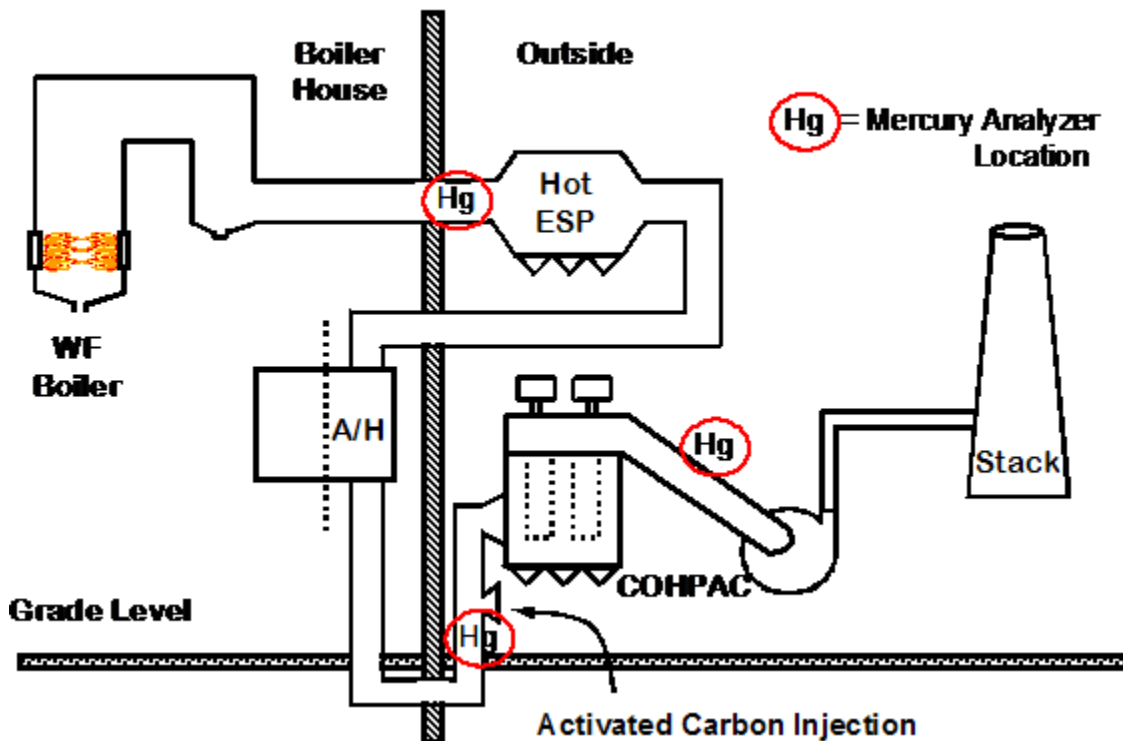

St. Clair

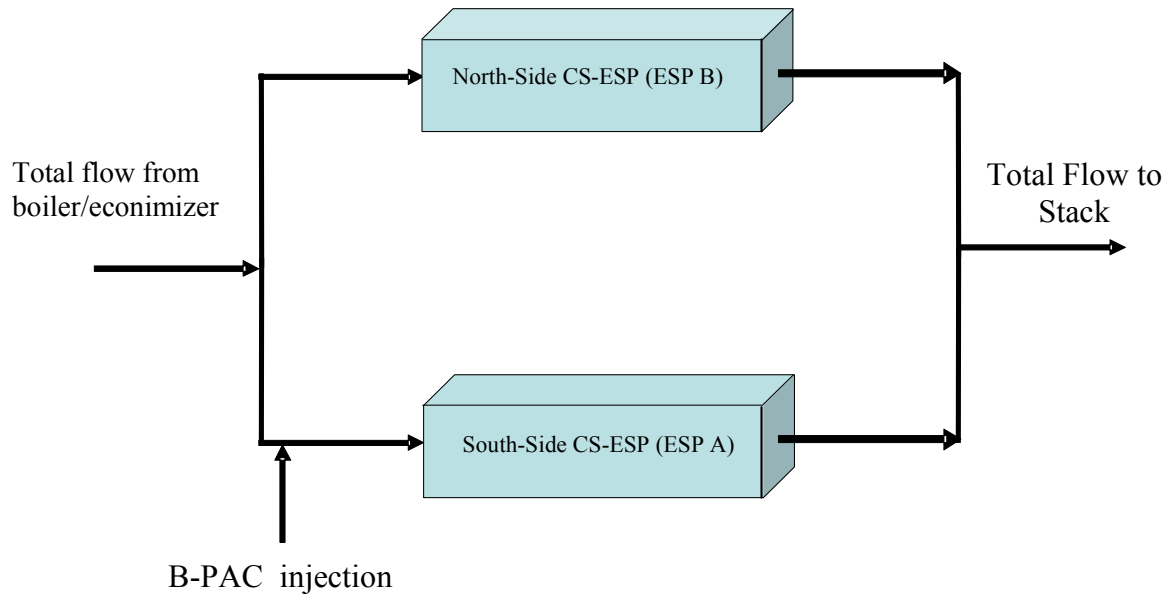

Facility L

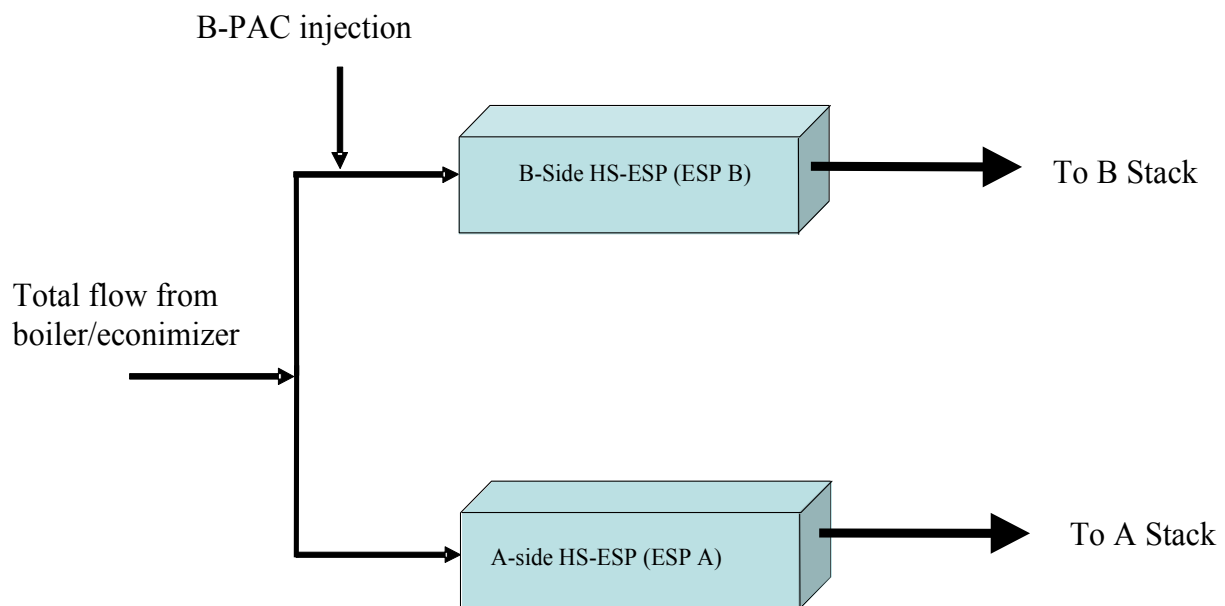

Appendix C
Quality Assurance Project Plan

U.S. EPA/APPCD



**QAPP FOR THE
CHARACTERIZATION
OF COAL COMBUSTION
RESIDUES (WA 4-04)**

**CATEGORY III/APPLIED
RESEARCH**



ARCADIS

Susan Thorneloe
EPA WA Manager

Shirley Wasson
EPA QA Representative

Rob Keeney
ARCADIS WA Leader

Laura Nessley
ARCADIS Designated QA Officer

QAPP for the
Characterization of Coal
Combustion Residues
(WA 4-4)

Category III/Applied
Research

Prepared for:
USEPA/APPCD

Prepared by:
ARCADIS G&M, Inc.
4915 Prospectus Drive
Suite F
Durham
North Carolina 27713
Tel 919 544 4535
Fax 919 544 5690

Our Ref.:
RN9902013.0037

Date:
11 January 2006

1.0 PROJECT DESCRIPTION AND OBJECTIVES

- 1.1 Purpose 1
- 1.2 Project Objectives

2.0 PROJECT ORGANIZATION

3.0 EXPERIMENTAL APPROACH

- 3.1 Task I: Characterization of CCRs
- 3.2 Task II: Chemical Stability of Target Metals
- 3.3 Task III: Thermal Stability of Target Metals
- 3.4 Task IV: Biological Transformation and Volatilization of Organo-Mercury

4.0 SAMPLING PROCEDURES

- 4.1 Sample Custody Procedures
- 4.2 CCR and SRM Samples
 - 4.2.1 Physical and Chemical Characterization Samples
 - 4.2.2 Leaching Study Samples
 - 4.2.3 Fixed-Bed Reactor Samples
- 4.3 Leachate Collection
 - 4.3.1 Tier 1 Screening Tests
 - 4.3.2 Tier 2 Solubility and Release as a Function of pH and LS Ratio
 - 4.3.3 Tier 3 Mass Transfer Rate
- 4.4 Fixed-Bed, TPD Reactor Sampling
 - 4.4.1 Thermal Desorption Test Plan for High Temperature CCR Commercial Processes

5.0 TESTING AND MEASUREMENT PROTOCOLS

ARCADIS

TABLE OF CONTENTS

- 5.1 Physical Characterization
 - 5.1.1 Surface Area and Pore Size Distribution
 - 5.1.2 Density Measurements
 - 5.1.3 pH and Conductivity
 - 5.1.4 Moisture Content
- 5.2 Chemical Characterization
 - 5.2.1 Carbon Content (TGA)
 - 5.2.2 Mercury (CVAA)
 - 5.2.3 Other Metals (ICP)
 - 5.2.4 Anion Analysis by IC
 - 5.2.5 X-Ray Fluorescence (XRF) and Neutron Activation Analysis
- 6.0 QA/QC CHECKS
 - 6.1 Data Quality Indicator Goals
 - 6.2 QC Sample Types
- 7.0 DATA REDUCTION, VALIDATION, AND REPORTING
- 8.0 ASSESSMENTS
- 9.0 REFERENCES

TABLES

Table 3-1 Summary of testing under Task II to be performed on the SRM

Table 3-2 Summary of testing under Task II to be performed for detailed characterization of CCRs

Table 3-3 Summary of testing under Task II to be performed for screening evaluation of CCRs

Table 4-1 SRM certified values

Table 6-1 Data quality indicator goals

Table 8-1 PEA Parameters and ranges

FIGURES

Figure 2-1- Project organizational chart

ARCADIS

QAPP FOR THE
CHARACTERIZATION
OF COAL
COMBUSTION

1.0 PROJECT DESCRIPTION AND OBJECTIVES

Category III

1.1 PURPOSE

In December 2000, EPA determined that regulations are needed to control the risks of mercury (Hg) emissions from coal-fired power plants. A number of Hg control options are currently being evaluated through bench-scale and full-scale demonstrations. For each of the technologies that appear to have commercial application, the resulting residues are to be evaluated to determine any potential cross-media impacts through either waste management of these residues or use in commercial applications. Coal combustion residues (CCRs) include bottom ashes, fly ashes, and scrubber sludges from flue gas desulfurization (FGD) systems. The questions to be addressed through this research include:

- What are the changes to CCRs resulting from application of control technology at coal-fired power plants including changes in pH, metals content, and other parameters that may influence environmental release?
- For CCRs that are land disposed, the questions to be addressed include:
 - Will any of these changes result in an increase in the potential for leaching of Hg and other metals such as As, Se, Pb, and Cd leach from disposal of CCRs in impoundments, monofills, and minefills?
 - What is the fate of Hg and other metals from CCRs that are land disposed?
 - Is there a potential for organo-mercury being formed when anaerobic decomposition conditions exists?
- For CCRs that are used in commercial applications, the questions to be addressed include:
 - Will any of the changes to CCRs, from application of control technologies at coal-fired power plants, impact their use in commercial applications?
 - What is the fate of Hg and other metals in CCRs when used in commercial applications?

ARCADIS

QAPP FOR THE CHARACTERIZATION OF COAL COMBUSTION

Category III

- What is the extent of Hg, As, Pb, Se and Cd release during high temperature manufacturing processes used to produce cement clinkers, asphalt, and wallboard?
- Are Hg and other pollutants such as As, Se, Pb and Cd present in CCRs that are used in commercial applications such as highway construction subject to conditions that would result in their release to the environment?

EPA's Air Pollution Prevention and Control Division (APPCD) through an on-site laboratory support contract with ARCADIS is to conduct a comprehensive study on the fate of mercury (Hg), arsenic (As), selenium (Se), lead (Pb) and cadmium (Cd) in CCRs. This research will be conducted in four tasks. Task I will focus on the characterization of different CCRs and the impact of Hg control technologies on these characteristics. Task II will focus on evaluating the potential for leaching of these toxic metals from CCRs that are generated with and without implementation of Hg control technologies under a range of management scenarios. Task III will focus on the release of these toxic metals during high and low temperature utilization of CCRs in commercial processes. Task IV will study the potential formation and volatilization of organo-mercury and inorganic mercury during simulated anaerobic decomposition processes. The scope of this QAPP covers Task I through Task III. Task IV will be addressed in a separate document.

1.2 PROJECT OBJECTIVES

EPA's Office of Solid Waste (OSW) has been asked to provide general guidance on appropriate testing to evaluate the release potential of Hg and four other metallic contaminants (As, Se, Pb, and Cd) from CCRs via leaching, run-off, and volatilization when disposed in landfills and incorporated into commercial products using high/low temperature commercial processes. This evaluation in projected disposal and reuse situations (different waste management scenarios; see Section 1.1) will both help assess the likely suitability of new or modified wastes for reuse, and ensure that Hg, As, Se, Pb, and Cd removed from stack emissions are not subsequently released to the environment in significant amounts as a result of CCR reuse or disposal practices.

The primary objective of this project is to generate a comprehensive database that will enable EPA/OSW to (1) evaluate changes in CCRs resulting from the implementation of different Hg control technologies (see Section 3.1), and (2) assess environmental releases of these toxic metals during CCR management practices including land

ARCADIS

QAPP FOR THE
CHARACTERIZATION
OF COAL
COMBUSTION

Category III

disposal and commercial applications. OSW will be using the results to determine needs in regard to future policies for managing CCRs whose characteristics are changing as a result of the MACT under development for coal fired power plants. OAR will be using the data to determine the potential for cross-media impacts and potential changes to disposal and reuse practices which impact the economics of potential regulations for coal-fired power plants. The data will also be used to address questions raised by Congress and others regarding establishing the net benefit of potential requirements for reducing emissions from coal-fired power plants.

Data on the chemical stability of these metals (leaching tests) will be generated using the EPA/OSW recommended methods (EPA, 2002b) developed by Dr. David Kosson and Dr. Florence Sanchez of Vanderbilt University titled *An Integrated Framework for Evaluating Leaching in Waste Management and Utilization of Secondary Materials* (Kosson et al., 2002a). The ability of these EPA/OSW methods to assess leaching of the metals of interest will be further demonstrated with the use of a NIST standard reference material (SRM) with certified amounts of trace metals. Data on the thermal stability of these toxic metals during CCRs commercial applications will also be determined by implementing temperature program desorption techniques (see Section 4.4). The time/temperature profiles experienced by CCRs in their commercial applications (highway construction, cement, asphalt, and wallboard manufacturing) as determined based on the study conducted by RTI International and presented in the publication titled *Characterization and management of Residues from Coal-Fired Power Plants/Interim Report*, prepared for APPCD/NRMRL/EPA (EPA, 2002a). Using this comprehensive database, EPA/OSW will determine the feasibility of the application of the above methods to CCRs and they will assess the environmental impacts of different types of CCRs' waste management practices.

A secondary objective of this project is to modify and develop a QA/QC framework for the proposed leaching assessment approach developed by Kosson et al. The reference fly ash may be an appropriate candidate for a method QC sample. These activities will be carried out in cooperation with Drs. Kosson and Sanchez during implementation of the proposed methods (see Task II, Section 3.2).

2.0 PROJECT ORGANIZATION

The organizational chart for this project is shown in Figure 2-1. The roles and responsibilities of the project personnel are discussed in the following paragraphs. In addition, contact information is also provided.

ARCADIS

QAPP FOR THE
CHARACTERIZATION
OF COAL
COMBUSTION

Category III

EPA Work Assignment Manager, Susan Thorneloe: The EPA WA Manager is responsible for communicating the scope of work, data quality objectives and deliverables required for this work assignment. The EPA WA Manager is also responsible for providing ARCADIS with the various types of CCRs to be characterized.

Phone: (919) 541-2709

E-mail: thorneloe.susan@epamail.epa.gov

EPA QA Representative, Shirley Wasson: The EPA QA Representative will be responsible for reviewing and approving this QAPP. This project has been assigned a QA category III and may be audited by EPA QA. Ms. Wasson is responsible for coordinating any EPA audits.

Phone (919) 541-5510

E-mail: wasson.shirley@epamail.epa.gov

ARCADIS Work Assignment Leader, Robert Keeney: The ARCADIS WA Leader is responsible for preparing project deliverables and managing the work assignment. He will ensure the project meets scheduled milestones and stays within budgetary constraints agreed upon by EPA. The WA Leader is also responsible for communicating any delays in scheduling or changes in cost to the EPA WA Manager as soon as possible.

Phone (919) 541-3284

E-mail: rkeeney@arcadis-us.com

ARCADIS Inorganic Laboratory Manager, Robert Keeney. In addition to being the work assignment leader, Robert Keeney is also responsible for the operation of EPA's in-house Inorganic Laboratory. Mr. Keeney will review and validate all analytical data reports and ensure that the leaching studies are performed properly. He will also operate the TGA and surface area analyzers. For the leaching studies and mercury and metals analyses, Mr. Keeney will be supported by one chemist: Gene Gallagher and one technician: John Foley.

ARCADIS

QAPP FOR THE
CHARACTERIZATION
OF COAL
COMBUSTION

Mr. Gallagher will perform HF extractions of solid CCR and SRM samples and also be responsible for mercury analysis of samples by CVAA. John Foley will perform the leaching test. Mr. Keeney and Mr. Gallagher will submit the remaining HF digestates to the subcontract analytical laboratory, STL-Savannah for ICP/MS analysis of the other target metals. Mr. Keeney will also be responsible for assisting Drs. Kosson and Sanchez in the development of appropriate QA/QC procedures for the leaching assessment methods.

Category III

Phone (919) 541-3284

E-mail: rkeeney@arcadis-us.com

STL-Savannah Analytical Manager, Angie Weimerskirk: Ms. Weimerskirk will review and validate the ICP/MS results and report them to Mr. Keeney.

Phone (912) 354-7858

E-mail: aweimerskirk@stl-inc.com

ARCADIS Thermal Desorption Task Manager (Task III), Behrooz Ghorishi: The ARCADIS Thermal Desorption Task Manager is responsible for preparing task III deliverables and managing task III. He will ensure the task meets scheduled milestones. The Thermal Desorption Task Manager is also responsible for communicating any delays in scheduling to the ARCADIS Work Assignment Leader, EPA WA Manager as soon as possible. Dr. Ghorishi will be assisted by Jarek Karwowski. Mr. Karwowski will perform the thermal desorption test and submit the samples to the laboratory.

ARCADIS Designated QA Officer, Laura Nessley: The ARCADIS QA Manager, Laura Nessley, has been assigned QA responsibilities for this work assignment. Ms. Nessley will be responsible for reviewing this QAPP prior to submission to EPA QA for review. Ms. Nessley will also ensure the QAPP is implemented by project personnel by performing internal assessments. All QA/QC related problems will be reported directly to the ARCADIS WAL, Robert Keeney.

Phone: (919) 544-2260 ext. 258

E-mail: lnessley@arcadis-us.com

ARCADIS

QAPP FOR THE
CHARACTERIZATION
OF COAL
COMBUSTION

Category III

Vanderbilt University, Methods Development, Professors David Kosson and Florence Sanchez: Dr. Kosson in cooperation with Dr. Florence Sanchez developed the leachability methods being evaluated on this project. He will be available to consult regarding method optimization and development of QA/QC procedures. Dr. Kosson and Dr. Sanchez will be on-site in the early stages of the project to assist in setting up the procedures. Phones: (615) 322-1064; (615) 322-5135
E-mail: David.Kosson@vanderbilt.edu
Florence.Sanchez@vanderbilt.edu

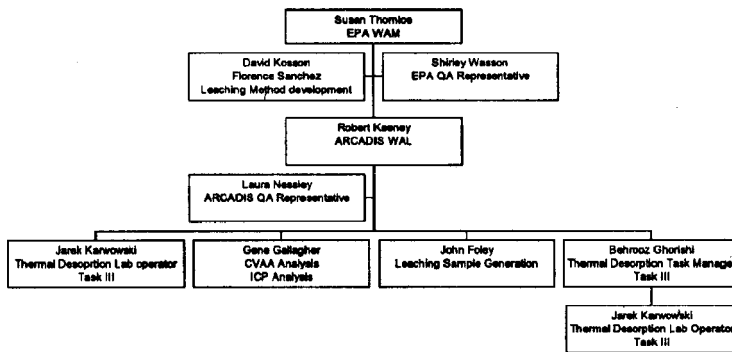

Figure 2-1- Project Organizational Chart

3.0 EXPERIMENTAL APPROACH

3.1 TASK I: CHARACTERIZATION OF CCRs

This task will focus on physical and chemical characterization of as-received CCRs. CCRs from different power plants and various types of control technologies will be selected and provided to ARCADIS by the EPA WA Manager. These CCRs will include fly ashes and scrubber sludges from DOE test facilities. These full-scale facilities are being used to test two different Hg control technologies: activated carbon injection as an adsorbent and addition of agents to wet scrubbers that maintain Hg in an oxidized state to facilitate removal by aqueous scrubbing. Physical characteristics of CCRs to be determined include specific surface area, moisture content and density. Chemical characterization will include total carbon analysis, pH of extract, total

ARCADIS

QAPP FOR THE
CHARACTERIZATION
OF COAL
COMBUSTION

Category III

concentration of target metals (Hg, As, Se, Pb, and Cd) and principal constituents (i.e., Fe, Cl, SO_4^{2-} , CO_3^{2-})¹. The types of analyses and instrumentations used to perform this characterization are further described in Section 5.0. Identical characterizations will be performed on the reference fly ash. Task I results will reveal the effect of implementing the two Hg control technologies on the final characteristics of CCRs. This information will help in decision-making regarding different waste management scenarios.

3.2 TASK II: CHEMICAL STABILITY OF TARGET METALS

This task will investigate the fate of Hg, As, Se, Cd, and Pb during CCR management practice of land disposal. Using the recently proposed test methods developed by Kosson et al in coordination with EPA's Office of Solid Waste, leaching studies will first be conducted on a reference fly ash. The reference fly ash is a high quantity fly ash that has been characterized by ICP/MS and CVAA analyses. The ICP/MS and CVAA analyses will be checked using the NIST SRM 1633b. NIST SRM 1633B is a bituminous coal fly ash that is fully described in Section 4.2.2. The results obtained from the reference fly ash leaching studies will be critical in evaluating the performance of the method. Using a known standard in place of the CCR material, will also allow optimization of the proposed test methods. The quality control procedures regarding the reference fly ash tests are described in section 6.

A summary of testing that will be carried out on the reference fly ash is presented in Table 3-1 along with the number of replicates, the material mass required and the number of extracts that will be generated. Detailed descriptions of the methods listed in Table 3-1 can be found in the document titled An Integrated Framework for Evaluating Leaching in Waste management and Utilization of Secondary materials (Kosson et al., 2002a).

¹ This will provide valuable insights concerning the characteristic behavior of the CCRs.

ARCADIS

QAPP FOR THE
CHARACTERIZATION
OF COAL
COMBUSTION

Category III

TABLE 3-1. SUMMARY OF TESTING UNDER TASK II TO BE PERFORMED ON THE REFERENCE FLY ASH

Sample type	Level of testing	Tests	Material particle size	Number of replicates	Mass material/ aliquot* (g)	Mass material/ test replicate (g)	Total mass of material required (g)	Number of analytical samples
Baseline Fly Ash**	Detailed characterization	pH001.1 (pH Titration Pretest)	< 2 mm	2	8	8	16	NA
		Moisture Content	< 2 mm	3	8	8	24	NA
		AV002.1	< 2 mm	3	8	24	72	3
		Availability at pH 7.5 with EDTA (3 target points)						
		SR002.1	< 2 mm	3	40	440	1320	33
		Alkalinity, Solubility and Release as a Function of pH (11 pHs tested from 2 to 12)						
		SR003.1	< 2 mm	3		430	1290	15
		Solubility and Release as a Function of LS ratio (LS=10, 5, 2, 1, 0.5 mL/g)						
		LS 10 mL/g			40			
		LS 5 mL/g			40			
		LS 2 mL/g			50			
		LS 1 mL/g			100			
		LS 0.5 mL/g			200			
		MT002.1					2500	30
		Mass Transfer Rate in Granular Materials (10 extracts in 30 days)						
		- Optimum moisture content	< 2 mm	2	500	500		
		- Leach test	< 2 mm	3	500	500		
							Total mass material required (g)	5222

* Sample size required for each condition within the test method. For example, one replicate of SR002.1 requires eleven sample aliquots.

** Baseline fly ash is a fly ash that will be used as a reference material. Total elemental content will be determined by NAA/XRF analysis.

After the proposed test methods have been successfully demonstrated on the reference fly ash, leaching studies will be conducted on high priority CCRs that will allow estimating constituent release by leaching for a range of conditions that are likely to occur during management practices. A separate test plan for the leaching experiments under this task is provided by its developers (Drs. Kosson and Sanchez). This test plan, titled "Draft (Revision #2), Sampling and Characterization Plan for Coal Combustion Residues from Facilities with Enhanced Mercury Emissions Reduction Technology" (Kosson et al., 2002b) together with this QAPP will cover all the issues regarding Task II. Two levels of testing will be performed. The first level will provide detailed

ARCADIS

QAPP FOR THE
CHARACTERIZATION
OF COAL
COMBUSTION

Category III

characterization of representative samples of CCRs that reflect each dominant CCR chemistry with respect to mercury release. This will define the behavior of the general class of CCR chemistry. This detailed characterization would establish a baseline for comparison of subsequent test results. A summary of testing that will be carried out on each dominant CCR chemistry is presented in Table 3-2 along with the number of replicates, the material mass required and the number of extracts that will be generated.

The second level will provide screening evaluation of additional samples anticipated to be representative of each dominant CCR chemistry. The second level screening will be used to determine if the CCR being tested exhibits the same leaching behavior as the general class of CCRs, which is assumed to have the same dominant chemistry. If the leaching behavior is found to be significantly different than anticipated, then more complete characterization can be completed. A summary of testing that will be carried out for the screening level is presented in Table 3-3 along with the number of replicates, the material mass required and the number of extracts that will be generated.

Residues collected before and after application of enhanced Hg control technologies will be examined to evaluate the effect of the enhanced systems on the leaching behavior of CCRs.

Estimates of the extent of release of the metals of concern during management scenarios that include percolation through the CCRs or infiltration flow around the CCRs (e.g., when compacted to low permeability or otherwise expected to behave as a monolithic material) will be determined. These data will be used to determine the risk of land disposal of the different CCRs. Mass balances for each metal will be determined using the chemical characterization data obtained in Task I. Utilization of mass balance as a QA/QC tool is described in section 6. Details of this QA/QC procedure are outlined in section 6. In addition to testing of the CCRs as generated, CCRs as used in commercial products will be examined. Only commercial uses for which there is a potential for release of Hg during leaching will be considered. One commercial use of CCRs that may be of concern for Hg leaching is cement-based materials (i.e., concrete/grout, waste stabilization, road base/subbase). A generic cement-based product made from samples representative of the major coal fly ash categories will be examined. A second commercial use of CCRs that may be of concern is incorporation in gypsum board. In this case leaching of Hg after disposal is of concern. This task will consider the potential for Hg leaching after disposal from a representative gypsum board product.

ARCADIS

QAPP FOR THE
CHARACTERIZATION
OF COAL
COMBUSTION

Category III

TABLE 3-2. SUMMARY OF TESTING UNDER TASK II TO BE PERFORMED FOR DETAILED CHARACTERIZATION OF CCRs

Sample type	Level of testing	Tests	Material particle size	Number of replicates	Mass material/ aliquot* (g)	Mass material/ test replicate (g)	Total mass of material required (g)	Number of analytical samples	
Sample reflecting dominant CCR chemistry	Detailed characterization	pH001.1 (pH Titration Pretest)	< 2 mm	2	8	8	16	NA	
		Moisture Content	< 2 mm	3	8	8	24	NA	
		AV002.1**	< 2 mm	2	8	24	48	2	
		Availability at pH 7.5 with EDTA (3 target points)							
		SR002.1	< 2 mm	2	40	440	880	22	
		Alkalinity, Solubility and Release as a Function of pH (11 pHs tested from 2 to 12)							
		SR003.1	< 2 mm	2		430	860	16	
		Solubility and Release as a Function of LS ratio (LS=10, 5, 2, 1, 0.5 mL/g)							
		LS 10 mL/g				40			
		LS 5 mL/g				40			
		LS 2 mL/g				50			
		LS 1 mL/g				100			
LS 0.5 mL/g				200					
MT002.1	< 2 mm	2				2000	20		
Mass Transfer Rate in Granular Materials (10 extracts in 30 days)									
- Optimum moisture content					500				
- Leach test					500				
Total mass material required (g)							3628		

* Sample size required for each condition within the test method. For example, one replicate of SR002.1 requires eleven sample aliquots.
** Optional

ARCADIS

QAPP FOR THE
CHARACTERIZATION
OF COAL
COMBUSTION

TABLE 3-3. SUMMARY OF TESTING UNDER TASK II TO BE PERFORMED FOR SCREENING Category III
EVALUATION OF CCRs

Sample type	Level of testing	Tests	Material particle size	Number of replicates	Mass material/ aliquot* (g)	Mass material/ test replicate (g)	Total mass of material required (g)	Number of analytical samples
Additional samples anticipated to be representative of each dominant CCR chemistry	Screening							
		Moisture Content	< 2 mm	3	8	8	24	NA
		SR002.1 - A (3 pHs @ LS 10mL/g: acidic, neutral, alkali)	< 2 mm	3	40	120	360	3
		SR003.1 - A (LS = 10, 0.5 mL/g)	< 2 mm	3		240	720	6
					LS 10 mL/g 40			
					LS 0.5 mL/g 200			
		MT002.1 - A (4 extractions in 5 days)	< 2 mm				2500	12
		- Optimum moisture content		2	500	500		
		- Leach test		3	500	500		
							Total mass material required (g)	3604

* Sample size required for each condition within the test method. For example, one replicate of SR002.1-A requires three sample aliquots.

3.3 TASK III: THERMAL STABILITY OF TARGET METALS

This task will investigate the potential release of the target metals during their commercial applications such as cement, wallboard and asphalt manufacturing. The potential long-term evaporation of these metals during low temperature applications such as structural fills, highway construction, snow/ice control, and soil amendment will also be determined. Representative samples of CCRs will be tested in an in-house, bench-scale, fixed-bed reactor system called the Thermal Program Desorption (TPD) system. CCRs will be exposed to conditions that are experienced in actual situations. The effluent of the fixed-bed reactor will be sampled and analyzed for inorganic Hg (speciated, elemental and ionic), As, Se, Pb, and Cd using established methods such as EPA Method 29 for metals and Ontario Hydro Method for mercury. Mass balances for the metals will be determined using the chemical characterization data obtained in Task I. The reference fly ash will also be tested in the reactor and the results will be used as a quality control check (see section 6).

ARCADIS

QAPP FOR THE
CHARACTERIZATION
OF COAL
COMBUSTION

Category III

3.4 TASK IV: BIOLOGICAL TRANSFORMATION AND VOLATILIZATION OF ORGANO-MERCURY

This task will investigate the potential formation and release of organo-mercury during anaerobic decompositions. This will be simulated in a bioreactor and the effluent will be sampled for speciated inorganic and organic mercury. The details of these tests will be described in a separate QAPP. Due to the health and safety related concerns regarding organo-mercury compounds, prior to preparation of the QAPP, an extensive literature survey will be performed to select the most appropriate methods for sampling and analysis of these types of compounds.

4.0 SAMPLING PROCEDURES

The following subsections describe the sampling procedures to be used for each task. Whenever possible, standard methods will be followed. In some cases, draft methods may be evaluated and implemented. Each method to be used will be cited and any deviations from the methods will be documented.

4.1 SAMPLE CUSTODY PROCEDURES

The following types of samples will be generated during these tests:

- 1- "As-received" CCR samples before and after application of Hg control technologies, SRM and reference fly ash samples (solid samples) and treated CCR samples as used in commercial applications
- 2- Post-leaching and post-thermal desorption CCR, reference fly ash samples and treated CCR samples (solid samples)
- 3- Leachate samples (liquid samples)
- 4- Method 29 and Ontario Hydro Train samples (liquid samples)

Each sample generated will be analyzed in-house but chain-of-custody procedures will be required. CCRs will be logged as they are received by the ARCADIS WAL, Mr. Robert Keeney. Information regarding where each CCR originated and any other descriptive information available will be recorded in a dedicated laboratory notebook by Mr. Keeney. A 200 g grab sample will be taken from each "as-received" CCR and processed for physical and chemical characterization. All samples will be properly contained and identified with a unique sample ID and sample label. Sample labels at a minimum will contain the sample ID, date sampled, and initials of the analyst

ARCADIS

QAPP FOR THE CHARACTERIZATION OF COAL COMBUSTION

responsible for preparing the sample. Chain-of-custody forms will be generated for all samples prior to transfer for analysis.

Category III

Handling of CCR samples for the leaching tests (Task II) is described in detail by the leaching procedure provided by its developers (Kosson et al., 2002a). For Task III, a 10g grab sample will be taken from each “as received” CCR and will be subjected to the TPD procedures (see section 4.2.3)

4.2 CCR, AND REFERENCE FLY ASH SAMPLES

As mentioned, the focus of this program is to obtain information on the effect of Hg control technologies on the stability of Hg, As, Se, Cd, and Pb in CCRs. Currently, two different Hg control technologies are being tested in full-scale facilities. The focus of the first technology is on powdered activated carbon (PAC) injection upstream of particulate matter control devices. The PAC injection technology affects the properties of fly ashes collected in electrostatic precipitators and baghouses. These facilities are listed in the Vanderbilt test plan “Draft (Revision #2), Sampling and Characterization Plan for Coal Combustion Residues from Facilities with Enhanced Mercury Emissions Reduction Technology” (Kosson et al., 2002b). The second technology focuses on Hg capture by wet scrubbers. Chemical modifications are being implemented in wet scrubbers to enhance the Hg capture. The scrubber sludge from these facilities will be impacted by this control technology. The scrubber sludge samples from these facilities will be included in this test program.

The Hg control testing facilities will be identified and their test reports will be obtained and amended to this QAPP. The test reports will include information on the history/origin of each CCR sample, facility process description, CCR type, sampling location, sampling time and method, coal type, operating condition, and sample storage condition. Section 4.1 describes the sampling custody procedure.

4.2.1 Physical and Chemical Characterization Samples

“As received” CCR will be well mixed prior to taking samples for physical characterization. Mixing of the sub-samples collected at the site will be done using a riffle splitter. To ensure a good homogeneity of the final composite sample that will be used for the study, the first two composite samples exiting the splitter will be reintroduced at the top of the splitter. This procedure should be repeated at least 6 times. At the end, the two resulting homogeneous composite samples will be combined in the same bucket and stored until laboratory testing. A 200 g representative sample

ARCADIS

QAPP FOR THE
CHARACTERIZATION
OF COAL
COMBUSTION

Category III

will be taken from the “as received” CCR and subjected to physical characterization measurements. Samples will also be taken of any CCRs that undergo size-reduction techniques (if size reduction is needed for testing purposes). The reference fly ash samples will be processed in the same manner as the CCRs. They will be tracked by lot number and will not require size-reduction.

4.2.2 Leaching Study Samples

CCRs used for leaching studies may undergo size reduction to acquire an adequate sample for testing. The size reduction method is outlined in the leaching test methods (Kosson et al., 2002a). If “as-received” CCRs are altered in any way prior to leaching studies, a representative sample will be submitted for physical and chemical characterization. SRM samples will not require size reduction. The NIST 1633B SRM is a bituminous coal fly ash that has been sieved through a nominal sieve opening of 90 µm and blended to assure homogeneity. The certified values for the constituent elements are given in Table 4-1. The reference fly ash will also be certified using ICP/MS and CVAA.

4.2.3 Fixed-Bed Reactor Samples

Reactor samples will be essentially the same as the CCR samples used in the leaching studies. Amount of material may be reduced, but physical and chemical characteristics will not be affected.

TABLE 4-1. SRM CERTIFIED VALUES

Element	Concentration (mg/kg)
Arsenic	136.2 ± 2.6
Barium	709 ± 27
Cadmium	0.784 ± 0.006
Chromium	198.2 ± 4.7
Copper	112.8 ± 2.6
Lead	68.2 ± 1.1
Manganese	131.8 ± 1.7
Mercury	0.141 ± 0.019
Nickel	120.6 ± 1.8
Selenium	10.26 ± 0.17

ARCADIS

QAPP FOR THE
CHARACTERIZATION
OF COAL
COMBUSTION

Strontium	1041 ± 14
Thorium	25.7 ± 1.3
Uranium	8.79 ± 0.36
Vanadium	295.7 ± 3.6

Category III

4.3 LEACHATE COLLECTION

The proposed test method described in the publication titled *An Integrated Framework for Evaluating Leaching in Waste Management and Utilization of Secondary Materials* (Kosson, et. al., 2002a) will be used to conduct leaching studies. There are three tiers to this test method:

- Tier 1) Screening based assessment (availability)
- Tier 2) Equilibrium-based assessment over a range of pH and Liquid/solid (LS) ratios
- Tier 3) Mass transfer based assessment

The Tier 1 screening test provides an indication of the maximum potential for release under the limits of anticipated environmental conditions expressed on a mg contaminant leached per kg waste basis. Tier 2 defines the release potential as a function of liquid-to-solid (LS) ratio and pH. Tier 3 uses information on LS equilibrium in conjunction with mass transfer rate information. As mentioned previously, prior to testing CCR, a reference fly ash will be used to demonstrate the effectiveness of the proposed test methods. Procedures for each tier are discussed in the following subsections.

If needed, prior to tier testing, the “as-received” CCR will be size reduced using the procedure **PS001.1 Particle Size Reduction** (Kosson et al., 2002a) to minimize mass transfer rate limitation through larger particles. The pH will be then tested using the method **pH001.0 pH Titration Pretest** (Kosson et al., 2002a).

4.3.1 Tier 1 Screening Tests

Test Method **AV002.1 Availability at pH 7.5 with EDTA** (Kosson et al., 2002a) will be used to perform the screening test. This method measures availability in relation to the release of anions at an endpoint pH of 7.5±0.5 and cations under enhanced liquid-phase solubility due to complexation with the chelating agent. Constituent availability is determined by a single challenge of an aliquot of the reference fly ash or size

ARCADIS

QAPP FOR THE
CHARACTERIZATION
OF COAL
COMBUSTION

Category III

reduced CCR material to dilute acid or base in DI water with the chelating agent, ethylenediamine-tetraacetic acid (EDTA). Extracts are tumbled end-over-end at 28 ± 2 rpm at room temperature for a contact time of 24 hours. At the end of the 24-hour period, the leachate pH value of the extraction is measured. The retained extract is filtered through a $0.45 \mu\text{m}$ polypropylene filtration membrane and the sample is stored at 4°C until analysis.

The results from this test are used to determine the maximum quantity, or the fraction of the total constituent content, of inorganic constituents (Hg, As, Se, Pb, and Cd) in a solid matrix that potentially can be released from the solid material in the presence of a strong chelating agent. The chelated availability, or mobile fraction, can be considered (1) the thermodynamic driving force for mass transport through the solid material, or (2) the potential long-term constituent release. Also, a mass balance based on the total constituent concentration provides the fraction of a constituent that may be chemically bound, or immobile in geologically stable mineral phases.

4.3.2 Tier 2 Solubility and Release as a Function of pH and LS Ratio

Test Method SR002.1 Alkalinity, Solubility and Release as a Function of pH (Kosson et al., 2002a) is the method to be used for Tier 2 pH Screening. The protocol consists of 11 parallel extractions of particle size reduced material at a liquid-to-solid ratio of 10 mL extractant per gram of dry sample. An acid or base addition schedule is formulated for 11 extracts with final solution pH values between 3 and 12, through addition of aliquots of HNO_3 or KOH as needed. The exact pH schedule is adjusted based on the nature of the CCR; however, the range of pH values must include the natural pH of the matrix, which may extend the pH domain. The extraction schedule and the range of tested pHs are outlined in the developers' leaching test plan, "Draft (Revision #2), Sampling and Characterization Plan for Coal Combustion Residues from Facilities with Enhanced Mercury Emissions Reduction Technology" (Kosson et al., 2002b).

If necessary, the material being evaluated is particle size reduced to $<0.3 \text{ mm}$ by sieving to remove any large pebbles present. A mortar and pestle may be used to break up clumps of material. A 40 g dry sample of the reference fly ash or size reduced CCR is used for these tests. Using the schedule, equivalents of acid or base are added to a combination of deionized water and the reference fly ash or particle size reduced CCR. The final liquid-to-solid (LS) ratio is 10 mL extractant per gram of sample, which includes DI water, the added acid or base, and the amount of moisture that is inherent to the waste matrix as determined by moisture content analysis. The 11 extractions are

ARCADIS

QAPP FOR THE
CHARACTERIZATION
OF COAL
COMBUSTION

Category III

tumbled in an end-over-end fashion at 28 rpm for a contact time of 24 hrs. Following gross separation of the solid and liquid phases by settling, leachate pH measurements are recorded and the phases are separated by pressure filtration through 0.45 μm polypropylene filtration membranes. Analytical samples of the leachates are collected and preserved as appropriate for chemical analysis. For metal analysis, leachates are preserved by acidification with HNO_3 to a $\text{pH} < 2$ and stored at 4 $^\circ\text{C}$ until analysis. For anion analysis, leachates are stored at 4 $^\circ\text{C}$ until analysis.

Test method **SR003.1 Solubility and Release as a Function of LS Ratio** (Kosson et al., 2002a) is the method to be used for Tier 2 LS ratio screening. The protocol consist of five parallel batch extractions over a range of LS ratios (0.5, 1, 2, 5, and 10 mL/g dry material) using the particle size reduced CCR and DI water as the extractant. Extractions are conducted at room temperature in leak-proof vessels that are tumbled at 28 ± 2 rpm for 24 hours. Solid and liquid phases are separated by settling and pH and conductivity measurements are taken. The liquid is further separated by pressure filtration using a 0.45 μm polypropylene filter membrane. Leachates are collected for each of the 5 LS ratios and preserved as appropriate for chemical analysis. For metal analysis, leachates are preserved by acidification with HNO_3 to a $\text{pH} < 2$ and stored at 4 $^\circ\text{C}$ until analysis. For anion analysis, leachates are stored at 4 $^\circ\text{C}$ until analysis. The range of tested LS ratios is outlined in the leaching test plan, "Draft (Revision #2), Sampling and Characterization Plan for Coal Combustion Residues from Facilities with Enhanced Mercury Emissions Reduction Technology" (Kosson et al., 2002b).

4.3.3 Tier 3 Mass Transfer Rate

Test method **MT002.1 Mass Transfer Rates in Granular Materials** (Kosson et al., 2002a) is the method to be used for Tier 3 testing. This protocol involves continuous water-saturation of the reference fly ash or CCR material. Compacted granular material is contacted with DI water using a liquid to surface area ratio of 10 mL DI water for every cm^2 of exposed solid surface. Fresh DI water is exchanged with leached material at specific intervals (2, 5 and 8 hours, 1, 2, 4, and 8 days). The pH, and conductivity for each time interval is also recorded. Each leachate sample is prepared for chemical analysis by pressure filtration through a 0.45 μm polypropylene filtration membrane and preserved as appropriate for chemical analysis. For metal analysis, leachates are preserved by acidification with HNO_3 to a $\text{pH} < 2$ and stored at 4 $^\circ\text{C}$ until analysis. For anion analysis, leachates are stored at 4 $^\circ\text{C}$ until analysis. In some cases, this test will be extended up to a cumulative leaching time of *ca.* 30 days to provide more information about long-term material behavior.

ARCADIS

QAPP FOR THE
CHARACTERIZATION
OF COAL
COMBUSTION

Category III

Test method MT001.1 Mass Transfer in Monolithic Materials will be used on the treated CCR samples when applicable instead of the MT002.1 protocol (Kosson et al., 2002a).

4.4 FIXED-BED, TPD REACTOR SAMPLING

Data on the thermal stability of toxic metals on CCRs during their commercial applications will be obtained using simulated conditions in a fixed-bed reactor called the Thermal Program Desorption (TPD) system. The time/temperature profiles experienced by CCRs in their commercial applications, type of other materials that CCRs are mixed with, and the composition of the flue gas that is in contact with CCRs have been determined by a separate study conducted by RTI International (EPA, 2002a). The information from this report has been used to create simulated conditions in our in-house, fixed-bed TPD reactor. This reactor is described in detail in the Mercury Facility Manual. CCRs (mixed with other compounds) will be placed in the fixed bed reactor (about 10 grams). The simulated flue gas will be passed through the fixed-bed that is exposed to a specific time/temperature profile. Detailed description of the simulated flue gas preparation and temperature control of the fixed-bed reactor is also described in the Mercury Facility Manual. This manual also addresses the QA/QC issues regarding the operation of this reactor. The flue gas effluent of the fixed-bed reactor will be sampled for the duration of each test (the time profile) using two standard methods. EPA method 29 (EPA, 1996c) will be used to sample for As, Se, Pb, and Cd. Ontario Hydro Method (ASTM, 2002) will be used to sample for elemental and ionic mercury (inorganic forms of mercury). Since the effluents of the fixed-bed reactor is free of any entrained particulate matter, only the impinger portions of Method 29 and Ontario Hydro will be used (filter box will be eliminated). After each test, the exposed CCR will be recovered and analyzed for Hg, As, Se, Cd, and Pb. The pre- and post-test analysis results of the CCRs together with the Method 29 and Ontario Hydro results will be used to determine mass balances for these five metals. This experiment will also be performed on a sample of the reference fly ash material as a QC check.

4.4.1 Thermal Desorption Test Plan for High Temperature CCR Commercial Processes

A- Cement (Clinker) manufacturing:

In this process, fly ash is used as feed to a cement kiln. Fly ash typically represents a maximum of about 5% (weight) of the typical raw mix to the kiln. Other inputs include

ARCADIS

QAPP FOR THE
CHARACTERIZATION
OF COAL
COMBUSTION

Category III

limestone (90%), iron ore (3%), and sand (2%), but fly ash can displace other components of cement kiln like limestone and iron ore, so its percentage can go higher. Cement kiln residence time is about one hour, temperature is about 1500°C, and the gas environment is natural gas combustion flue gas. The assumption is that all Hg is vaporized. Thus, the focus of this section will be on As, Cd, Se, and Pb. The test plan is as follow:

- 1- Mix 5g fly ash, with 5g CaCO₃ (limestone), 0.2g iron oxide (Fe₂O₃) and 0.5g sand and place the mixture in the fixed-bed reactor.
- 2- Inlet flue gas consists of 14% CO₂, 3% O₂, 5.3% H₂O, and 50 ppm NO_x. The total flow rate will be 400 cc/min.
- 3- Heat the fixed-bed reactor to its maximum temperature (1000°C). With the current system, we will not be able to exceed 1000°C. If no evaporation of these metals is observed at this temperature, we will modify the system to achieve a desorption temperature of 1500°C.
- 4- Attach a mini-impinger, EPA Method 29 to the outlet of the fixed-bed reactor and sample the whole effluent of the fixed-bed reactor for As, Cd, Pb, and Se for one hour (residence time of cement kilns).
- 5- Recover the solid residue and the Method 29 train and submit for metal analysis.
- 6- Close metals' mass balances across all phases (pre-test fixed bed solid, exposed solid, and reactor effluent).

B- Wallboard Manufacturing

This process will be simulated using FGD waste (and not fly ash). Wallboard manufacturing consists of two steps: calcining and drying. FGD waste experiences a higher temperature during calcining, thus only this step will be simulated. The calcining kettle temperature is about 310-370°C; but FGD waste temperature never exceeds 170°C. FGD waste is not mixed with any other compounds, its residence time in the kettle is about 1 hour and it is in contact with natural gas combustion flue gas. The test plan will be as follow:

ARCADIS

QAPP FOR THE
CHARACTERIZATION
OF COAL
COMBUSTION

Category III

- 1- Place 10g of FGD waste in the fixed-bed reactor.
- 2- Inlet flue gas consists of 14% CO₂, 3% O₂, 5.3% H₂O, and 50 ppm NO_x. The total flow rate will be 400 cc/min.
- 3- Heat the fixed bed reactor to 170°C.
- 4- Attach a mini-impinger Method 29 train to the outlet of the fixed-bed reactor and sample for As, Cd, Pb, and Se for one hour (residence time of calcining kettle); recover the solid residue and the Method 29 train and submit for As, Se, Pb, and Cd analysis.
- 5- Repeat steps 1 thru 3 (new batch of sample) and attach a mini-impinger Ontario Hydro train to the outlet of the reactor and sample for one hour. Recover solid residue and the train and submit for Hg analysis. Ontario Hydro sampling will reveal the amount of total Hg, ionic Hg (inorganic Hg), and elemental Hg evolved from the calcining process simulation.
- 6- Close metals' mass balances across all phases (pre-test fixed bed solid, exposed solid, and reactor effluent).

C- Asphalt manufacturing

Asphalt manufacturing consists of two steps: a very short residence time mixing process (about one minute) and a long residence time storage process (several hours). The storage process occurs at temperatures of about 5°C higher than the mixing process. Thus, the most important step (in terms of thermal desorption) is the storage step. Hot mix asphalt (HMA) is 95% stone, sand, or gravel bound together with asphalt cement (crude oil); fly ash makes up approximately 5% of this mixture replacing natural fillers such as hydrated lime or stone. This mixture is in contact with natural gas combustion flue gas. Storage temperatures usually range from 130-150°C for binder grade PG46-28 and 160-170°C for binder grade PG82-22. The test plan for asphalt manufacturing simulation will be as follow:

- 1- Place 1g of fly ash and 9 g sand in the fixed-bed reactor.
- 2- Inlet flue gas consists of 14% CO₂, 3% O₂, 5.3% H₂O, and 50 ppm NO_x. The total flow rate will be 400 cc/min.

ARCADIS

QAPP FOR THE
CHARACTERIZATION
OF COAL
COMBUSTION

Category III

- 3- Heat the fixed bed reactor to 170°C.
- 4- Attach a mini-impinger Method 29 train to the outlet of the fixed-bed reactor and sample for As, Cd, Pb, and Se for three hours (assumed residence time of asphalt storage); recover the solid residue and the Method 29 train and submit for As, Se, Pb, and Cd analysis.
- 5- Repeat steps 1 thru 3 (new batch of sample) and attach a mini-impinger Ontario Hydro train to the outlet of the reactor and sample for three hours. Recover solid residue and the train and submit for Hg analysis. Ontario Hydro sampling will reveal the amount of total Hg, ionic Hg (inorganic Hg), and elemental Hg evolved from the asphalt storage process simulation.
- 6- Close metals' mass balances across all phases (pre-test fixed bed solid, exposed solid, and reactor effluent).

5.0 TESTING AND MEASUREMENT PROTOCOLS

Whenever possible, standard methods will be used to perform required measurements. Standard methods are cited in each applicable section. Where standard methods are not available, operating procedures will be written to describe activities. In situations where method development is ongoing, activities and method changes will be thoroughly documented in dedicated laboratory notebooks.

5.1 PHYSICAL CHARACTERIZATION

5.1.1 Surface Area and Pore Size Distribution

A Micromeritics ASAP 2400 Surface Area Analyzer will be used to perform Brunauer, Emmett, and Teller (BET) method surface area, pore volume, and pore size distribution analysis on each as-received and size reduced CCR. A 200 mg sample is degassed at 200 C for at least one hour in the sample preparation manifold. Samples are then moved to the analysis manifold, which has a known volume. Total gas volume in the analysis manifold and sample tube is calculated from the pressure change after release of an N₂ and He mixed gas from the analysis manifold known volume. Report forms are automatically generated after each completed analysis. The instrument uses successive dosings of N₂ while measuring pressure. The surface area

ARCADIS

QAPP FOR THE
CHARACTERIZATION
OF COAL
COMBUSTION

Category III

analyzer is calibrated annually by a Micromeritics service representative. Standards of known surface area are run with each batch of samples as a QC check. Detailed instructions for the operation of this instrument are included in the Mercury Facility Manual.

5.1.2 Density Measurements

The Micromeritics Accupyc 1330, a helium pycnometer, will be used to determine CCR density. This is a fully automatic gas displacement pycnometer, which measures the volume of solids. Instrument operation is based on the ideal gas law. By measuring the pressure change of He in a calibrated volume, the pycnometer determines sample volume from which density can be derived automatically if sample weight is known. Samples must be free of moisture to obtain true sample weight and to avoid the distorting effect of water vapor on volume measurement. The cell chamber should be kept closed at all times except when actually inserting or removing a sample. The size of the cell and expansion chamber is determined by calibration, which is performed every 10 runs or immediately prior to analysis after two weeks without operation. The density measuring capacity of the Accupyc is calibrated for each run by analyzing two steel balls of known density. Detailed instructions for the operation of this instrument are included in the Mercury Facility Manual.

5.1.3 pH and Conductivity

pH and conductivity will be measured on all aqueous extracts. Conductivity is a measure of the ability of an aqueous solution to carry an electric current. This ability is dependent upon the presence of ions; on their total concentration, mobility, and variance; and on the temperature of the measurement.

pH of the leachates will be measured using a combined pH electrode. A 2-point calibration will be done using pH buffer solutions. The pH meter will be accurate and reproducible to 0.1 pH units with a range of 0 to 14.

Conductivity of the leachates will be measured using a standard conductivity probe. The conductivity probe will be calibrated using appropriate standard conductivity solutions for the conductivity range of concern. Conductivity meters are typically accurate to $\pm 1\%$ and have a precision of $\pm 1\%$. The procedure to measure pH and conductivity will be as follows:

ARCADIS

QAPP FOR THE CHARACTERIZATION OF COAL COMBUSTION

Category III

Following a gross separation of the solid and liquid phases by centrifugation or settling, a minimum volume of the supernatant to measure the solution pH and conductivity will be taken and poured in a test tube. The remaining liquid will be separated by pressure filtration and filtrates will be accordingly preserved and stored for subsequent chemical analysis.

5.1.4 Moisture Content

Moisture content of the “as received” CCR, the reference fly ash and SRM samples will be determined using ASTM D 2216-92 (ASTM, 1992). This procedure supercedes the method indicated in the leaching procedure (Kosson et al., 2002a). This method, however, is not applicable to the materials containing gypsum (calcium sulfate dihydrate or other compounds having significant amounts of hydrated water), since this material slowly dehydrates at the standard drying temperature (110°C). This slow dehydration results in the formation of another compound (calcium sulfate hemihydrate) which is not normally present in natural material. ASTM method C 22-83 will be used to determine the moisture content of materials containing gypsum (ASTM, 1983).

5.2 CHEMICAL CHARACTERIZATION

5.2.1 Carbon Content (TGA)

A Micromeritics Thermogravimetric Analyzer (TGA) is used to determine weight loss due to thermal decomposition. Through knowledge of chemical components in the sample, composition can be determined based on weight loss, decomposition stoichiometry, and decomposition temperature. This method is used to estimate carbon content of the CCR material. Carbon content corresponds to the weight loss in the temperature range of 400-500°C, when TGA is operated in O₂ or air. The TGA requires temperature and weight calibration. Temperature is calibrated using curie point transistors of nickel and iron. Weight is calibrated with a 100 mg standard weight. Values are entered into the TGA whenever configuration is changed or at least annually. Calcium oxalate monohydrate is analyzed to establish accuracy and is run at least every 20 runs.

It should be noted that an alternative method for the analysis of carbon, nitrogen, and sulfur is also available. This method uses a combustion technique followed by mass spectroscopy. The instrument used in this analysis is a Carlo-Erba NA1500 Series II

ARCADIS

QAPP FOR THE
CHARACTERIZATION
OF COAL
COMBUSTION

elemental analyzer. Similar instrumentation is also available from LECO Inc. (www.leco.com).

Category III

5.2.2 Mercury (CVAA)

Mercury analysis of each extract and leachate will be carried out by Cold Vapor Atomic Absorption Spectrometry (CVAA) according to EPA SW846 **Method 7470A Mercury in Liquid Waste (Manual Cold Vapor Technique)** (EPA, 1998). Samples are treated with potassium permanganate to reduce possible sulfide interferences. A Perkin Elmer FIMS 100 Flow Injection Mercury System is the instrument to be used for this analysis. The instrument is calibrated with known standards ranging from 0.25 to 10 µg/L mercury. The detection limit for mercury in aqueous samples is 0.05 µg/L.

5.2.3 Other Metals (ICP)

Analysis for arsenic (As), selenium (Se), cadmium (Cd) and lead (Pb) as well as principal constituents such as iron (Fe), calcium (Ca), phosphorus (P) and sulfur (S) will be performed on a ICP-MS using Method 3052 (EPA, 1996a). Metals and estimated instrument detection limits are listed in the method. The ICP will be profiled and calibrated for the target compounds and specific instrument detection limits will be determined. Mixed calibration standards will be prepared at least 5 levels. Each target compound will also be analyzed separately to determine possible spectral interference or the presence of impurities. Two types of blanks will be run with each batch of samples. A calibration blank is used to establish the analytical curve and the method blank is used to identify possible contamination from varying amounts of the acids used in the sample processing. Additional daily QC checks include an Initial Calibration Verification (ICV) and a Continuing Calibration Verification (CCV). The ICV is prepared by combining target elements from a standard source different than that of the calibration standard and at a concentration within the linear working range of the instrument. The CCV is prepared in the same acid matrix using the same standards used for calibration at a concentration near the mid-point of the calibration curve. A calibration blank and a CCV or ICV are analyzed after every tenth sample and at the end of each batch of samples. The CCV and ICV results must verify that the instrument is within 10% of the initial calibration with an RSD < 5% from replicate integrations. Procedures to incorporate the analysis of a MS/MSD for these CCR samples will be evaluated.

These analyses will be performed at two different ICP-MS facilities. The first facility is Severn Trent Laboratories in Savannah, Ga. This laboratory uses a Agilent ICP-MS

ARCADIS

QAPP FOR THE CHARACTERIZATION OF COAL COMBUSTION

Category III

with octopole reaction system (ORS). The second facility is Vanderbilt University (Department of Civil and Environmental Engineering). This laboratory uses a Perkin Elmer model ELAN DRC II. Standard analysis mode is used for PB and DRC mode is used for analysis of As and Se.

5.2.4 Anions Analysis by IC

Aqueous concentrations of anions (chloride, sulfate, sulfides, carbonate and nitrate) will be determined using ion chromatography (IC). Standard methods (i.e., USEPA guideline SW-846) will be used.

5.2.5 X-Ray Fluorescence (XRF) and Neutron Activation Analysis (NAA)

For the five target metals, XRF analysis will be performed on each CCR to provide additional information on the CCR material. This information will be useful in supplementing and/or validating CVAA and ICP results and calculating mass balances. XRF is capable of detection limits in the μg range. If levels are in the ng range, XRF analysis will not be useful. Considering the high detection limit of the XRF, this method will be used only as a second validation method or a “referee” method. Details of XRF analysis are included in the Mercury Facility Manual.

Neutron activation analysis (NAA) is an established analytical technique with elemental analysis applications. This method will be considered in this test program. NAA is different than AA or inductively coupled plasma mass spectrometry (ICP-MS) because it is based on nuclear instead of electronic properties. Neutron activation analysis is a sensitive multielement analytical method for the accurate and precise determination of elemental concentrations in unknown materials. Sensitivities are sufficient to measure certain elements at the nanogram level and below, although the method is well suited for the determination of major and minor elemental components as well. The method is based on the detection and measurement of characteristic gamma rays emitted from radioactive isotopes produced in the sample upon irradiation with neutrons. Depending on the source of the neutrons, their energies and the treatment of the samples, the technique takes on several differing forms. It is generally referred to as INAA (instrumental neutron activation analysis) for the purely instrumental version of the technique. RNAA (radiochemical neutron activation analysis) is the acronym used if radiochemistry is used to separate the isotope of interest before counting. FNAA (fast neutron activation analysis) is the form of the technique if higher energy neutrons, usually from an accelerator based neutron generator, are used.

ARCADIS

QAPP FOR THE
CHARACTERIZATION
OF COAL
COMBUSTION

Category III

6.0 QA/QC CHECKS

6.1 DATA QUALITY INDICATOR GOALS

Data quality indicator goals for critical measurements in terms of accuracy, precision and completeness are shown in Table 6-1.

TABLE 6-1. DATA QUALITY INDICATOR GOALS

Measurement	Method	Accuracy	Precision	Completeness
As, Se, Pb, Cd, Fe, P, S, and Ca Concentration	ICP/6010B	10%	10%	>90%
Hg Concentration	CVAA/7470A	10%	10%	>90%
Anions, Sulfate, Carbonates, Chlorides	IC/SW-846	10%	10%	>90%
PH	Electrode	2%	2%	100%
Carbon Content	TGA	10%	10%	>90%
Surface Area	BET	5%	5%	>90%
Density	Pycnometer	2%	2%	100%
Moisture	ASTM D2216-92 ASTM C22-83	N/A	10%	N/A

N/A: Not Applicable (see Appendix B)

Accuracy will be determined by calculating the percent bias from a known standard. Precision will be calculated as relative percent difference (RPD) between duplicate values and relative standard deviation (RSD) for parameters that have more than two

ARCADIS

QAPP FOR THE
CHARACTERIZATION
OF COAL
COMBUSTION

replicates. Completeness is defined as the percentage of measurements that meet DQI goals of the total number measurements taken.

Category III

Mass balance calculations will also be used as a data quality indicator. Different mass balance recovery methods will be examined. The reference fly ash sample will be used to develop and validate an appropriate mass balance recovery method. Mass balance will be determined by using the metals concentrations determined by analysis of the "as-received" reference fly ash as the total. Results from successive leaching samples and analysis of any solid residues will be combined to determine recoveries.

One approach that will be considered is the use of either total digestion (Method 3052) or Neutron Activation Analysis (NAA) for the analysis of solid residues.

The mass balance recovery will be only performed on 3 pH points and one low LS ratio. Uncertainty analysis will be considered for each mass balance. The selection of the target pH values will be dependent on the natural pH of the material. If the natural pH is <5, then natural pH, 7 and 9 will be selected as the target pH values. If the natural pH ranges between 5 and 9, then 5, 7 and 9 will be selected as the target pH values, and if the natural pH is >9, then 5, 7 and natural pH will be selected as the target pH values. In addition, an extraction at the natural pH of the material and an LS ratio of 1mL/g will be carried out. At least 4 replicates per extract will be run. In the case where the mass balance will be performed using total digestion or NAA, at least 3 representative samples per residue will be analyzed.

6.2 QC SAMPLE TYPES

Types of QC samples used in this project will include blanks, spiked samples, replicates, and mass balance tests on the reference fly ash and the SRM. For physical characterization testing, duplicate samples of the CCR, reference fly ash and SRM will be processed through each analysis. Duplicates must agree within $\pm 10\%$ to be considered acceptable. For the leaching studies, an objective of this project is to determine the appropriate types of QC samples to incorporate in the proposed leaching methods. This will be accomplished by subjecting the reference fly ash to the leaching procedure and determining the metals' mass balances by analyzing the leaching solution and the post-leachate solids. Initially, mass balances of 70-130% will be considered as an acceptable QC of the leaching procedure. Further statistical analysis on available data will be performed to narrow down the range of acceptable mass balances. This method development will be thoroughly documented in a dedicated laboratory notebook. Leaching of the reference fly ash samples may also be used as

ARCADIS

QAPP FOR THE CHARACTERIZATION OF COAL COMBUSTION

Category III

method controls during testing of CCR samples. For the fixed-bed reactor testing, one in every five tests will be run in duplicate. Duplicate results from the reactor testing are expected to agree within 20% to be considered valid. Identical to the leaching procedure, the use of the reference fly ash as a baseline QC sample will also be implemented during TPD tests (initial mass balances of 70-130%). Required QC samples for metals and mercury sampling trains are detailed in EPA Method 29 (EPA, 1996c) and the Ontario Hydro Methods (ASTM, 2002). QC samples required for ICP, CVAA, IC analysis are detailed in Methods 3052, 7470A, and SW-864 respectively.

7.0 DATA REDUCTION, VALIDATION, AND REPORTING

Chemical (ICP, CVAA, TGA, XRF, IC, NAA) and physical (surface area, pore size distribution and density) characterization data are reduced and reports are generated automatically by the instrument software. The primary analyst will review 100% of the report for completeness and to ensure that quality control checks meet established criteria. If QC checks do not meet acceptance criteria, sample analysis must be repeated. A secondary review will be performed by the Inorganic Laboratory Manager to validate the analytical report. If appropriate, certain chemical characterization data will be compared to the XRF and NAA analyses. In addition, the designated QA Officer will review at least 10% of the raw data for completeness. Analytical data will be summarized in periodic reports to the ARCADIS WAL. The procedure for reduction, validation and reporting of the leaching experiments (Task II) are outlined in Appendix A. ARCADIS WAL is responsible for the implementation of these procedures. Data reduction and interpretation for the TPD experiments (Task III) is included in the Mercury Facility Manual. ARCADIS WAL is responsible for implementing those procedures. ARCADIS WAL is also responsible for ensuring that mass balance criteria have been met. Mass balance for task II will be calculated as:

$$[(\text{metal in leachate} + \text{metal in residue})/\text{metal in "as received" CCR}] * 100$$

Mass balance for Task III will be calculated as:

$$[(\text{metal in off gas} + \text{metal in thermally exposed sample})/\text{metal in "as received" CCR}] * 100$$

Hg control benefit calculation for each metal or other parameters (such as carbon content, surface area, and so on) is:

ARCADIS

QAPP FOR THE
CHARACTERIZATION
OF COAL
COMBUSTION

$$\left[\frac{\text{(content in CCR, leachate, or residue)}_{w \text{ Hg control}}}{\text{(content in CCR, leachate, or residue)}_{w/o \text{ Hg control}}} \right] * 100$$

Category III

Values greater than 100% indicate an increase in that parameter due to implementation of the Hg control technology. In summary, the ARCADIS WAL checks to ensure that the duplicates meet the precision limits and the QC-checks for each run are within documented data quality indicators. Progress of the research conducted under this QAPP is reported in written monthly reports by ARCADIS WAL. Weekly verbal and written progress reports are submitted to the EPA WAM. Efforts will be made to publish and present results. QA/QC activities will be mentioned in any published materials. A data quality report will be provided in the final report of this investigation.

B.0 ASSESSMENTS

Assessments and audits are an integral part of a quality system. This project is assigned a QA Category III and, while desirable, does not require planned technical systems and performance evaluation audits. EPA will determine external or third-party audit activities. Internal assessments will be performed by project personnel to ensure acquired data meets data quality indicator goals established in Section 6. The ARCADIS Designated QA Officer will perform at least one internal technical systems audit (TSA) to ensure that this QAPP is implemented and methods are performed according to the documented procedures. This audit will occur during the early stages of the project to ensure any necessary corrective actions are implemented before large amounts of data are collected.

There are currently not planned performance evaluation audits but Table 8-1 lists the measurement parameters and expected ranges should EPA determine a PEA should be provided.

B-1. PEA PARAMETERS AND RANGES

Analyte or Measurement	Method	Expected Range
As, Se, Pb and Cd	ICP/3052	1-100 ug/mL
Hg	CVAA/7470A	0.25 to 10 ug/L
PH	Electrode	0-14

ARCADIS

QAPP FOR THE
CHARACTERIZATION
OF COAL
COMBUSTION

Category III

In addition to the TSA, the ARCADIS Designated QA Officer will perform an internal data quality audit on at least 10% of the reported data. Reported results will be verified by performing calculations using raw data and information recorded in laboratory notebooks.

9.0 REFERENCES

ASTM, 1983. Method C 22-83, "Standard Specification for Gypsum"

ASTM, 1992. Method D 2216-92, "Standard Test Method for Laboratory Determination of Water (Moisture) Content of Soil and Rock"

ASTM, 2002. Method D 6784-02, "Standard Test Method for Elemental, Oxidized, Particle-Bound, and Total Mercury in Flue Gas Generated from Coal-Fired Stationary Sources (Ontario-Hydro Method)"

EPA, 1996a. Method 3052 "Microwave Assisted Acid Digestion of Siliceous and Organically Based Matrices". Test Methods for Evaluating Solid Waste, Physical/Chemical Methods (SW-846).

EPA, 1996b. Method 6010 "Inductively Coupled Plasma-Atomic Emission Spectrometry". Test Methods for Evaluating Solid Waste, Physical/Chemical Methods (SW-846).

EPA, 1996c. Method 29 "Determination of Metals Emissions from Stationary Sources." *Code of Federal Regulations*, Title 40, Part 60, Appendix A, April 1996.

EPA, 1998. Method 7470A "Mercury in Liquid Waste (Manual Cold-Vapor Technique)". Test Methods for Evaluating Solid Waste, Physical/Chemical Methods (SW-846).

EPA, 2002a. Characterization and Management of Residues from Coal-Fired Power Plants, Interim Report. EPA-600/R-02, 083, December 2002.

EPA, 2002b. Reply to comments on EPA/OSW's Proposed Approach to Environmental Assessment of CCRs. Discussed March 5, 2002.

ARCADIS

QAPP FOR THE CHARACTERIZATION OF COAL COMBUSTION

Kosson, D.S., van der Sloot, H.A., Sanchez, F. and Garrabrants, A.C., 2002a. An Integrated Framework for Evaluating Leaching in Waste management and Utilization of Secondary materials. *Environmental Engineering Science* 19(3):159-204.

Category III

Kosson, D.S., and Sanchez, F., 2002b. Draft (Revision #2), Sampling and Characterization Plan for Coal Combustion Residues from Facilities with Enhanced Mercury Emissions Reduction Technology. May 2002.

Appendix D
Brayton Point Fly Ashes

List of Figures

Figure	Page
D-1 pH Titration Curves for the Baseline Fly Ash and the Fly Ash with Enhanced Hg Control	118
D-2 pH as a Function of LS Ratio for the Baseline Fly Ash and the Fly Ash with Enhanced Hg Control	118
D-3 Mercury Release (top) and Spike Recoveries (bottom) as a Function of pH for the Baseline Fly Ash and the Fly Ash with Enhanced Hg Control	119
D-4 Mercury Release (top) and Spike Recoveries (bottom) as a Function of LS Ratio for the Baseline Fly Ash and the Fly Ash with Enhanced Hg Control	120
D-5 Arsenic Release (top) and Spike Recoveries (bottom) as a Function of pH for the Baseline Fly Ash and the Fly Ash with Enhanced Hg Control	121
D-6 Arsenic Release (top) and Spike Recoveries (bottom) as a Function of LS Ratio for the Baseline Fly Ash and the Fly Ash with Enhanced Hg Control	122
D-7 Selenium Release (top) and Spike Recoveries (bottom) as a Function of pH for the Baseline Fly Ash and the Fly Ash with Enhanced Hg Control	123
D-8 Selenium Release (top) and Spike Recoveries (bottom) as a Function of LS Ratio for the Baseline Fly Ash and the Fly Ash with Enhanced Hg Control	124
D-9 Regression Curves of Experimental Data of Arsenic Solubility as a Function of pH.	125
D-10 Regression Curves of Experimental Data of Selenium Solubility as a Function of pH	126
D-11 100-Year Arsenic Release Estimates as a Function of the Cumulative Probability for the Scenario of Disposal in a Combustion Waste Landfill	127
D-12 100-Year Selenium Release Estimates as a Function of the Cumulative Probability for the Scenario of Disposal in a Combustion Waste Landfill	127
D-13 100-Year Arsenic Release Estimates from A) Baseline Fly Ash and B) Fly Ash with ACI	128
D-14 100-year Selenium Release Estimates from A) Baseline Fly Ash and B) Fly Ash with ACI	129

pH Titration Curves

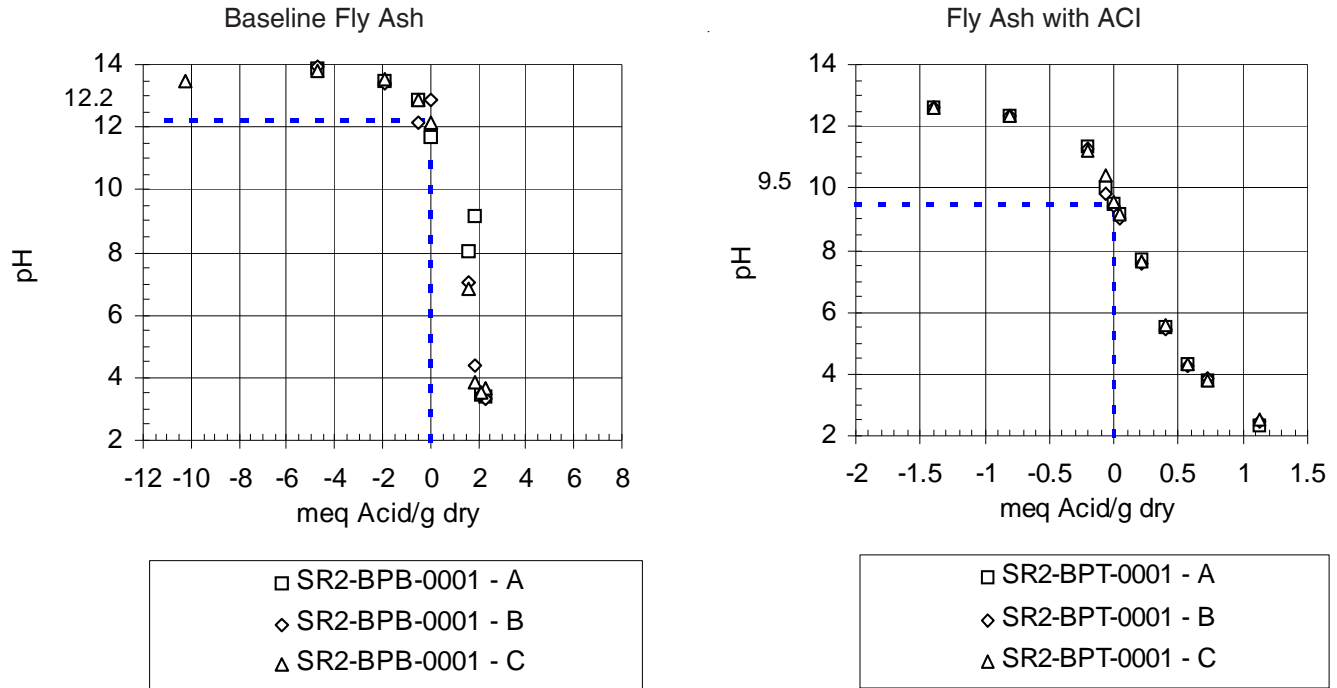

Figure D-1. pH Titration Curves for the Baseline Fly Ash and the Fly Ash with Enhanced Hg Control.

pH as a Function of LS Ratio

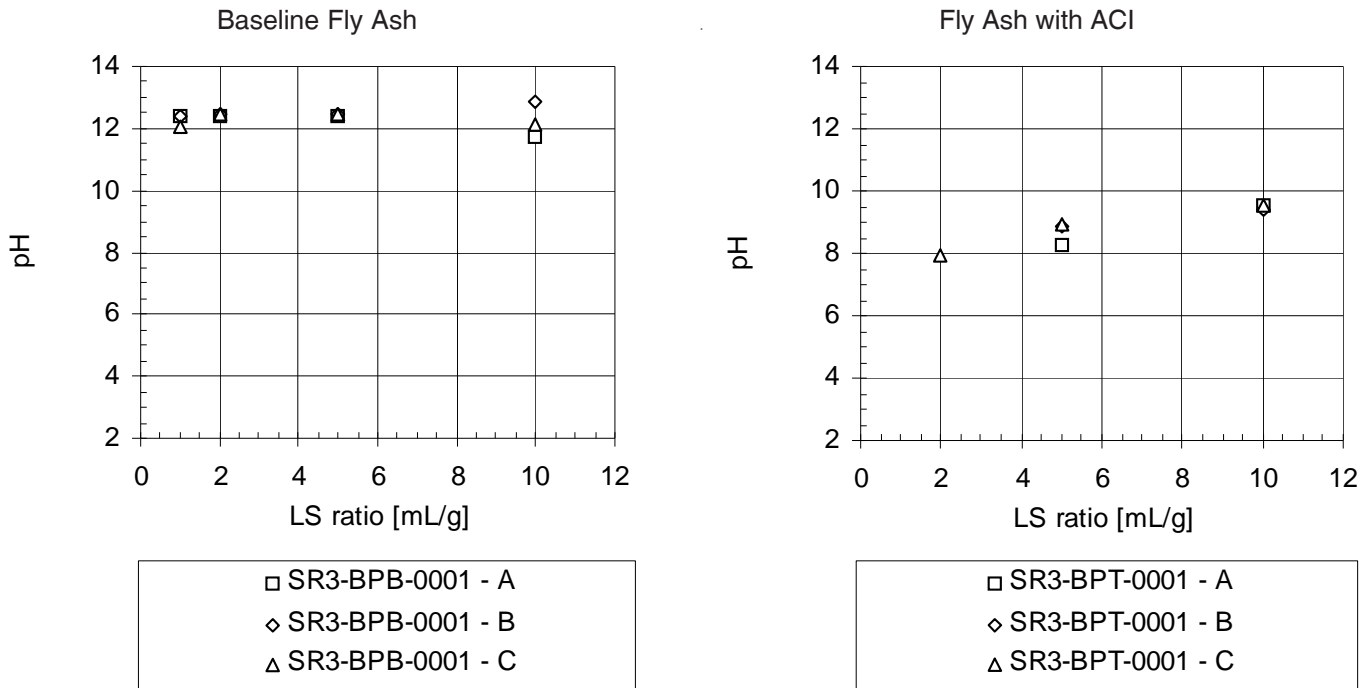
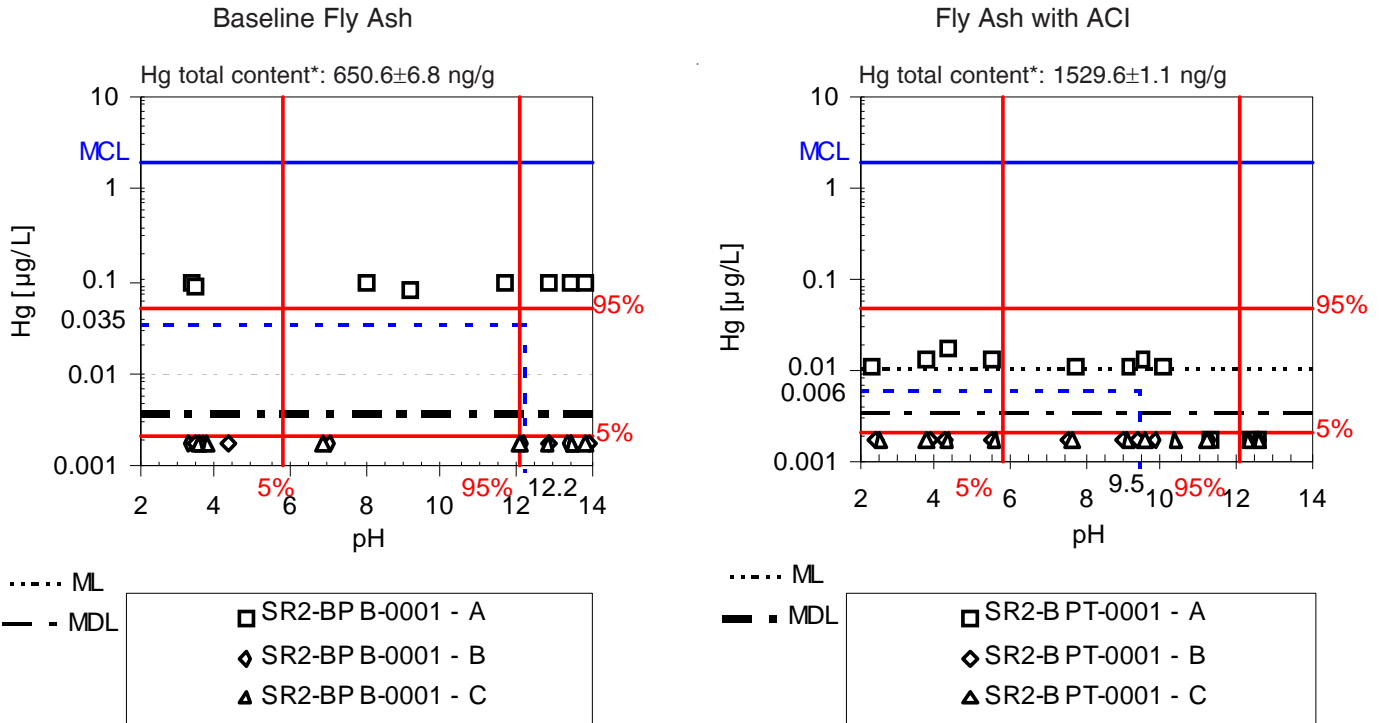

Figure D-2. pH as a Function of LS Ratio for the Baseline Fly Ash and the Fly Ash with Enhanced Hg Control.

Mercury Release as a Function of pH



*Total content as determined by digestion using method 3052.

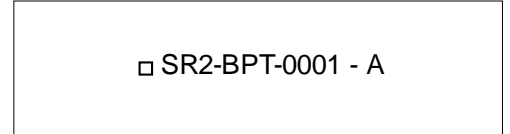
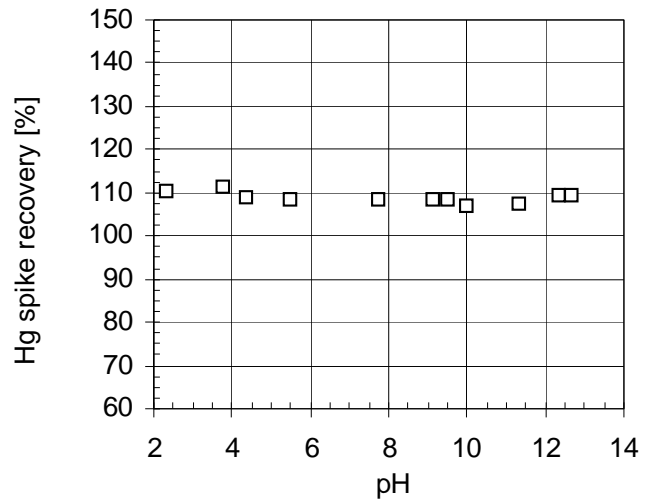
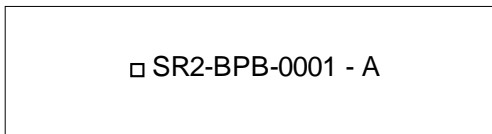
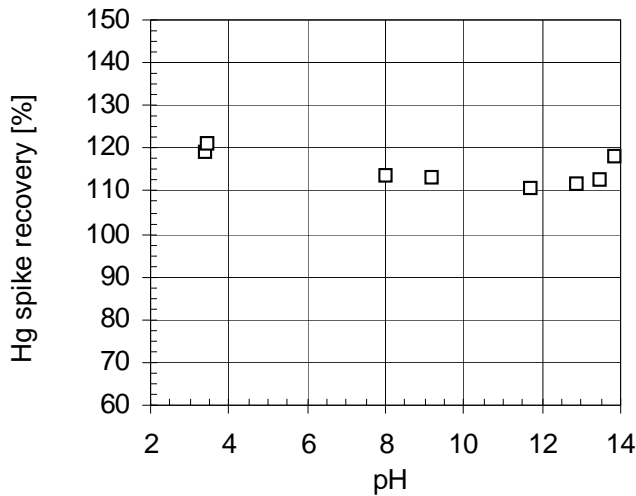

Figure D-3. Mercury Release (top) and Spike Recoveries (bottom) as a Function of pH for the Baseline Fly Ash and the Fly Ash with Enhanced Hg Control. 5th and 95th percentiles of mercury concentrations observed in typical combustion waste landfill leachate are shown for comparison.

Mercury Release as a Function of LS Ratio

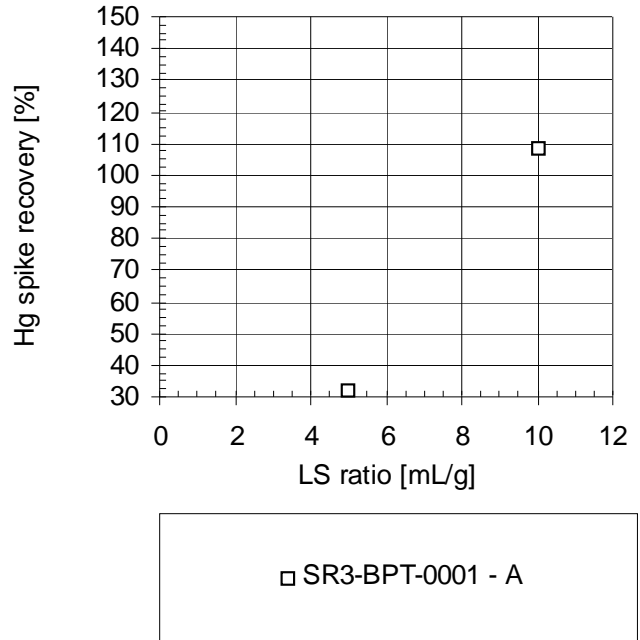
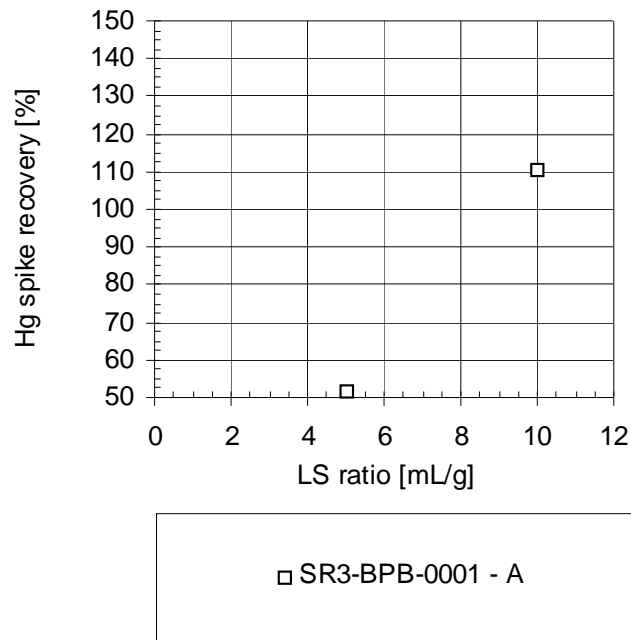
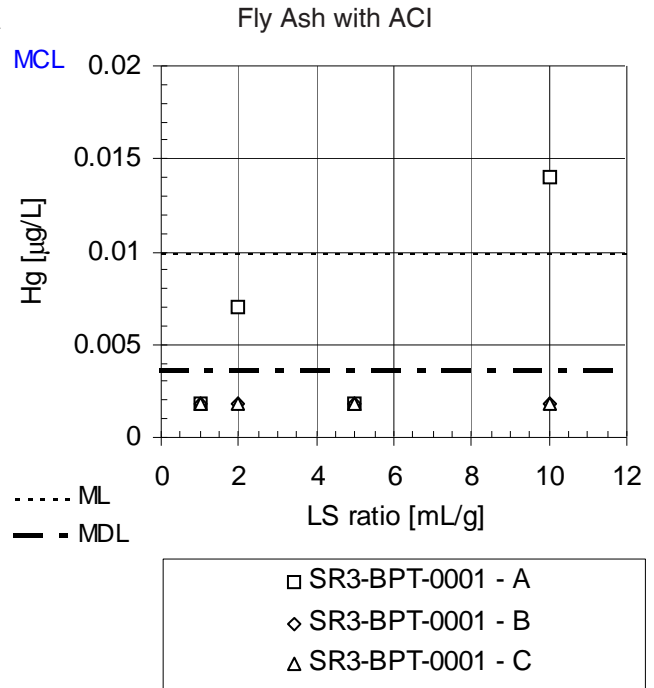
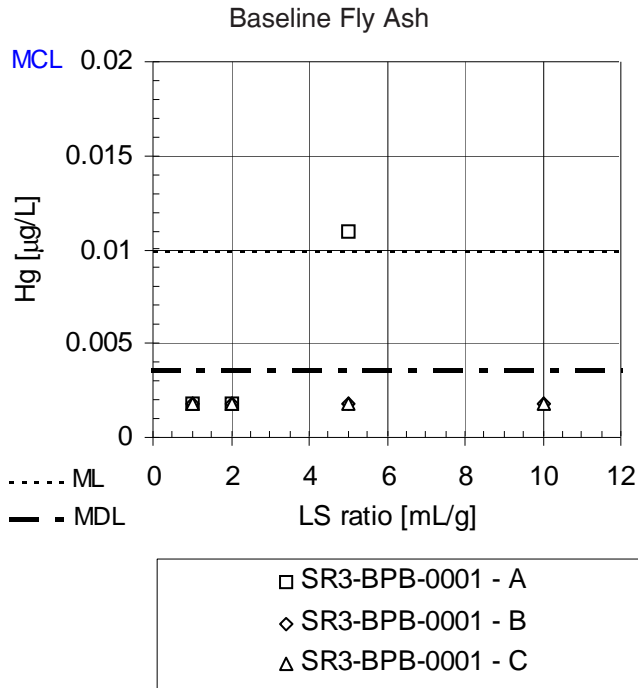
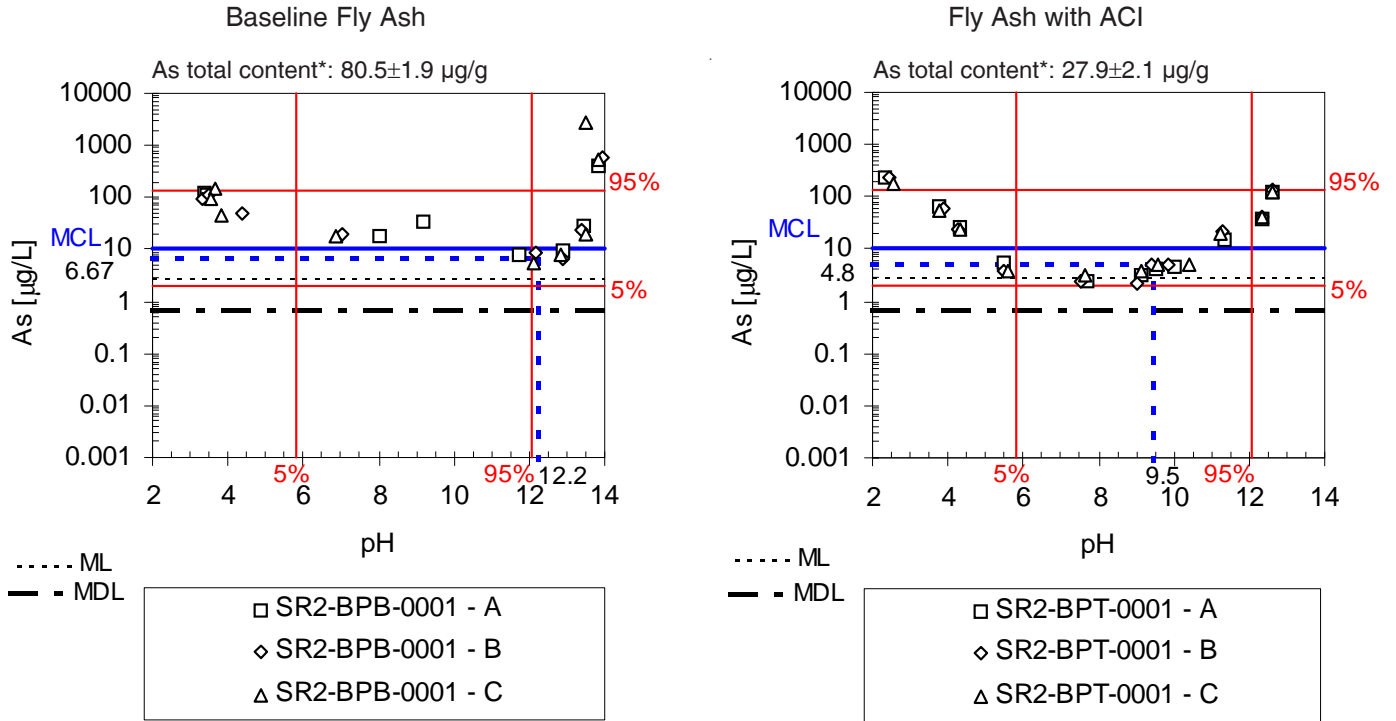

Figure D-4. Mercury Release (top) and Spike Recoveries (bottom) as a Function of LS Ratio for the Baseline Fly Ash and the Fly Ash with Enhanced Hg Control.

Arsenic Release as a Function of pH



*Total content as determined by digestion using method 3052.

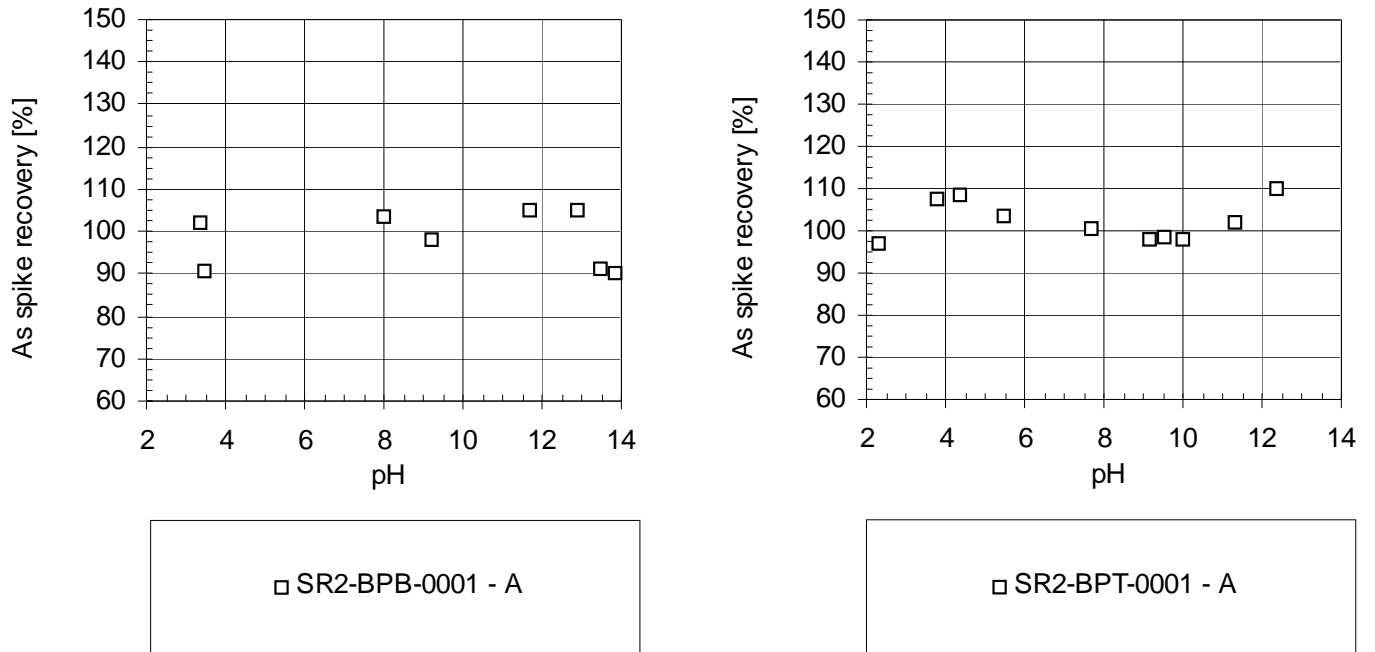

Figure D-5. Arsenic Release (top) and Spike Recoveries (bottom) as a Function of pH for the Baseline Fly Ash and the Fly Ash with Enhanced Hg Control. 5th and 95th percentiles of arsenic concentrations observed in typical combustion waste landfill leachate are shown for comparison.

Arsenic Release as a Function of LS Ratio

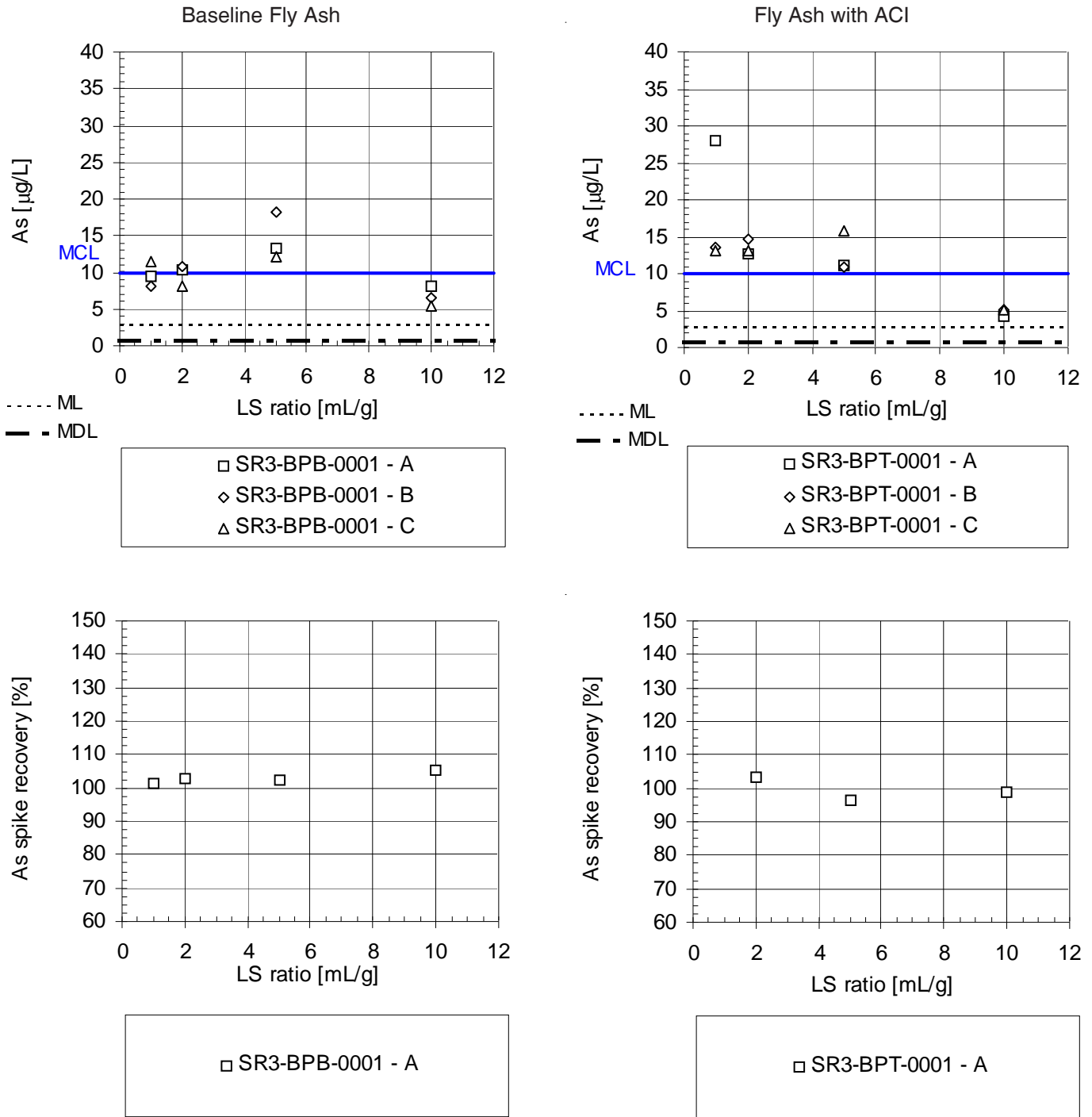
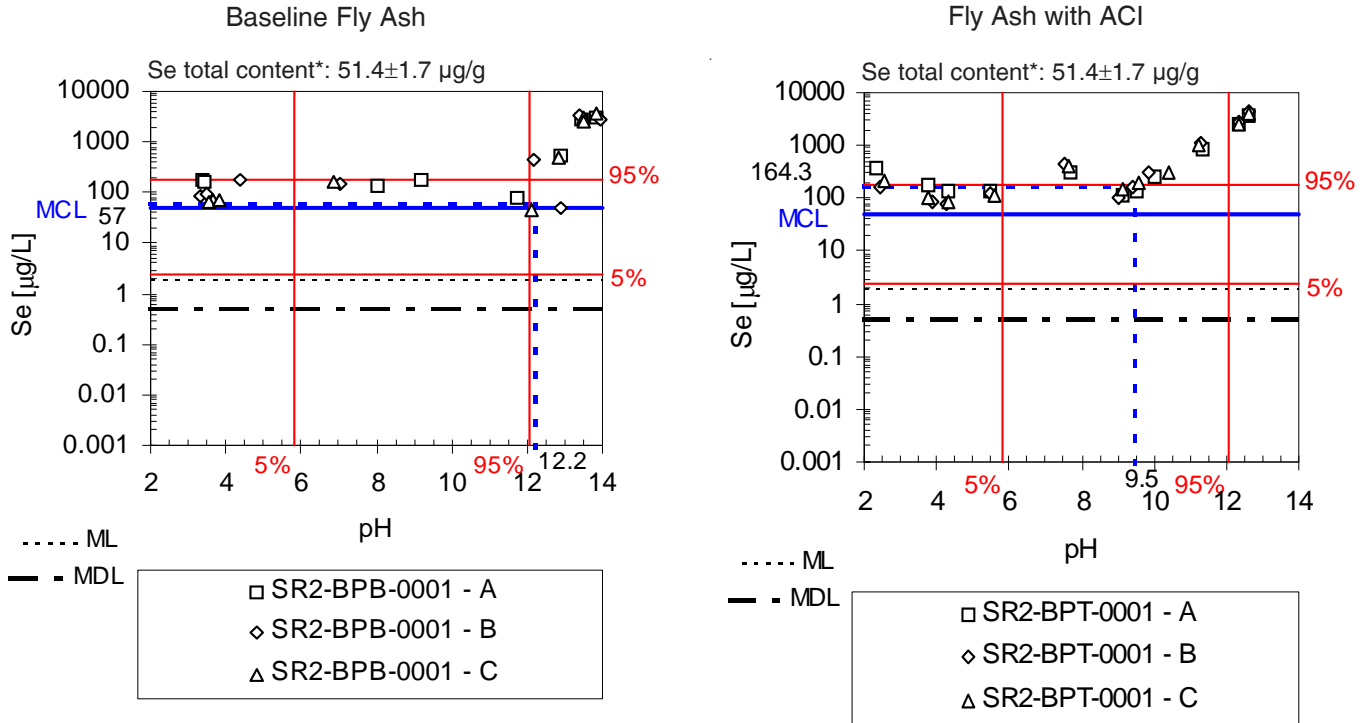

Figure D-6. Arsenic Release (top) and Spike Recoveries (bottom) as a Function of LS Ratio for the Baseline Fly Ash and the Fly Ash with Enhanced Hg Control.

Selenium Release as a Function of pH



*Total content as determined by digestion using method 3052.

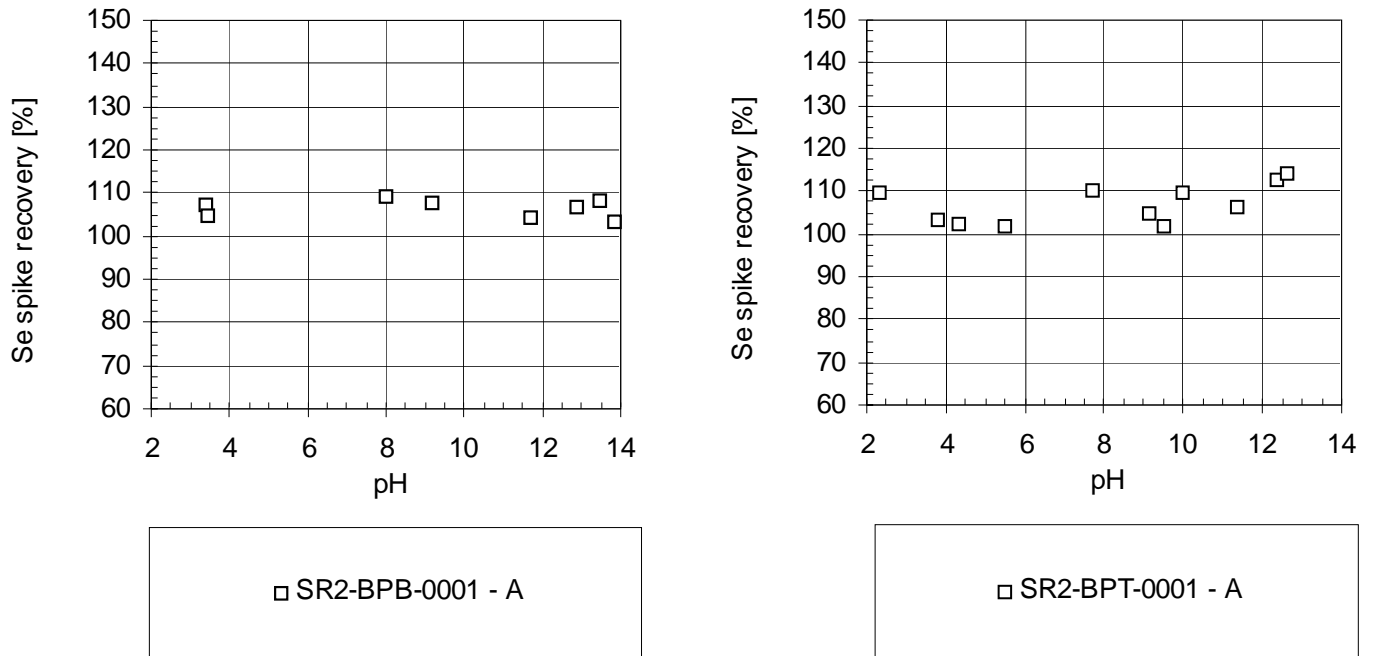

Figure D-7. Selenium Release (top) and Spike Recoveries (bottom) as a Function of pH for the Baseline Fly Ash and the Fly Ash with Enhanced Hg Control. 5th and 95th percentiles of selenium concentrations observed in typical combustion waste landfill leachate are shown for comparison.

Selenium Release as a Function of LS Ratio

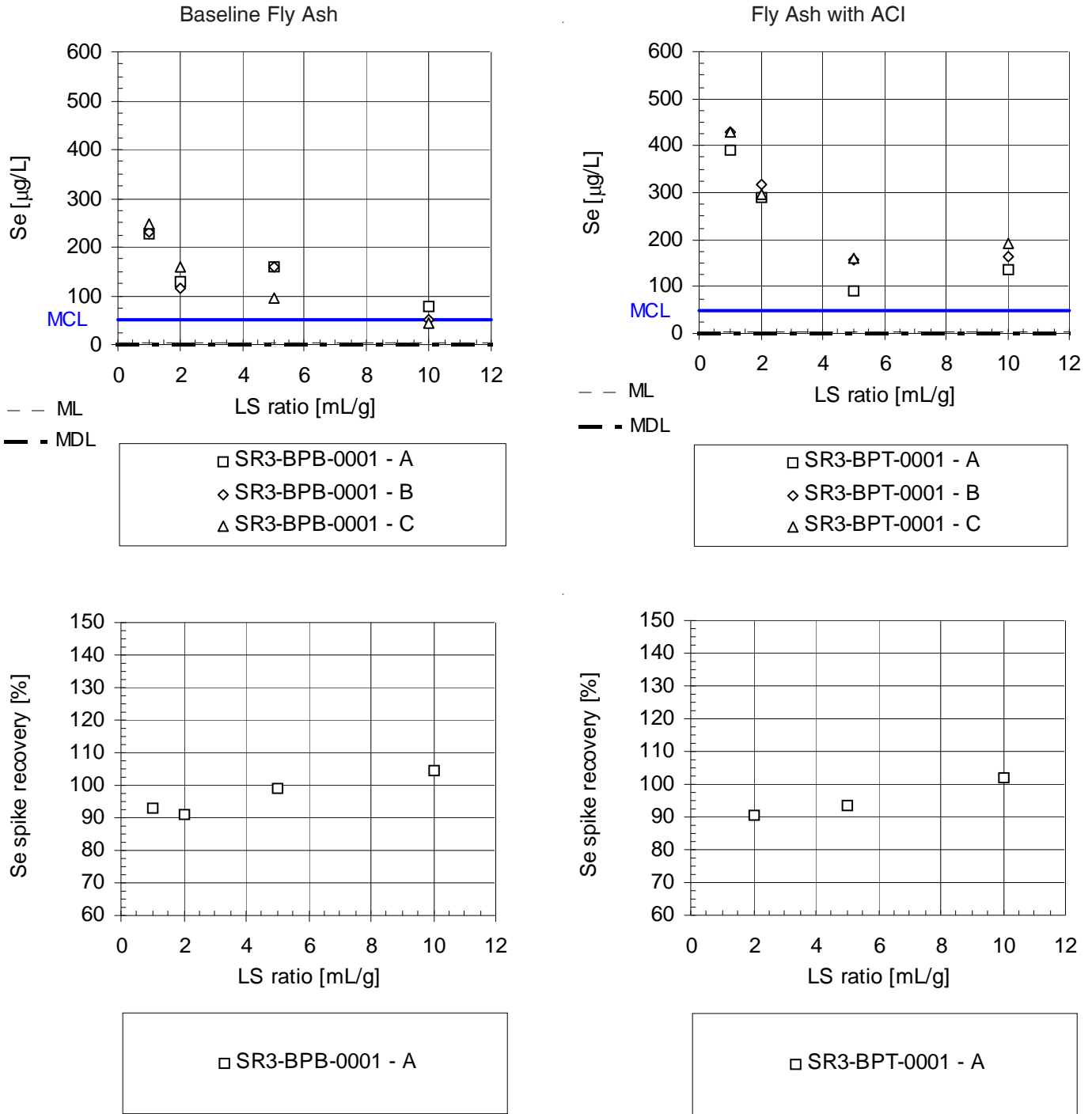
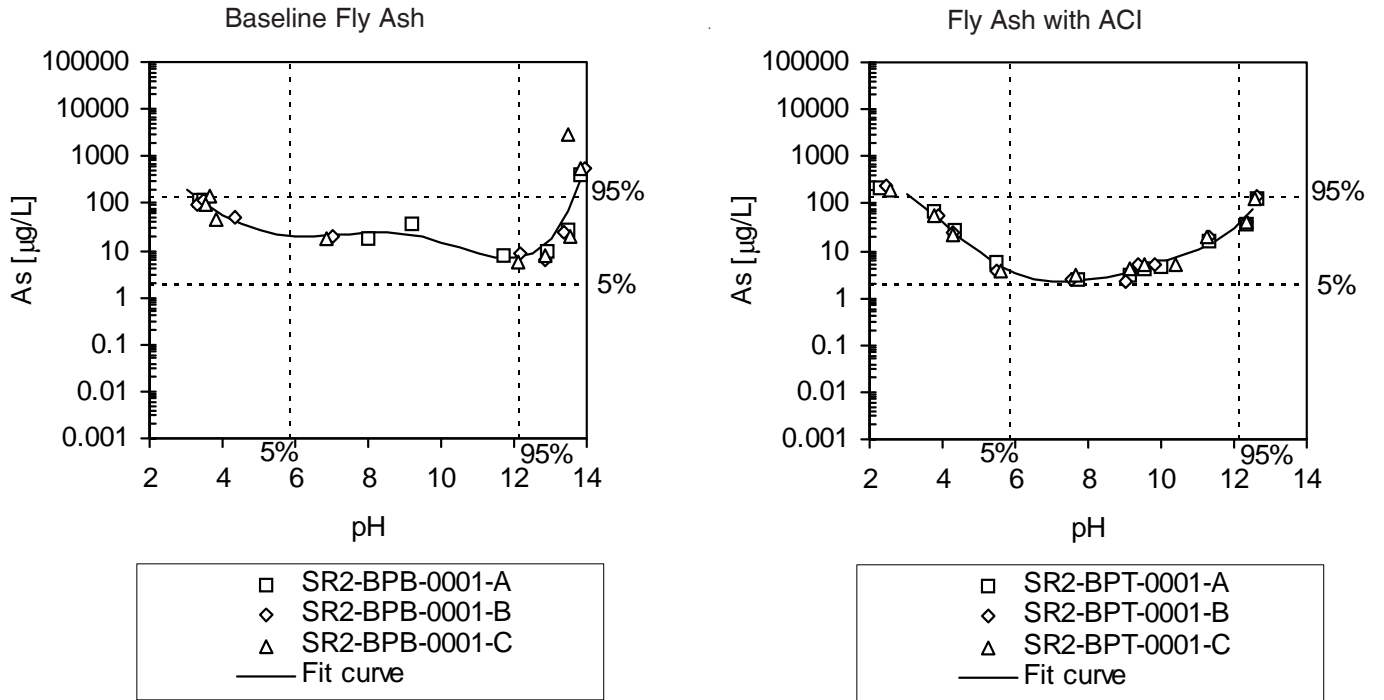

Figure D-8. Selenium Release (top) and Spike Recoveries (bottom) as a Function of LS Ratio for the Baseline Fly Ash and the Fly Ash with Enhanced Hg Control.

Arsenic Solubility



Material	log As (µg/L)			pH range of validity	R ²	Number of points
BPB	0.0004 pH ⁵	-0.0135 pH ⁴	0.1634 pH ³	3-14	0.77	27
	-0.8130 pH ²	1.1609 pH	2.7085			
BPT	0.0005 pH ⁵	-0.0207 pH ⁴	0.3035 pH ³	3-12.5	0.98	33
	-2.0113 pH ²	5.4552 pH	-2.7126			

Figure D-9. Regression Curves of Experimental Data of Arsenic Solubility as a Function of pH.

Selenium Solubility

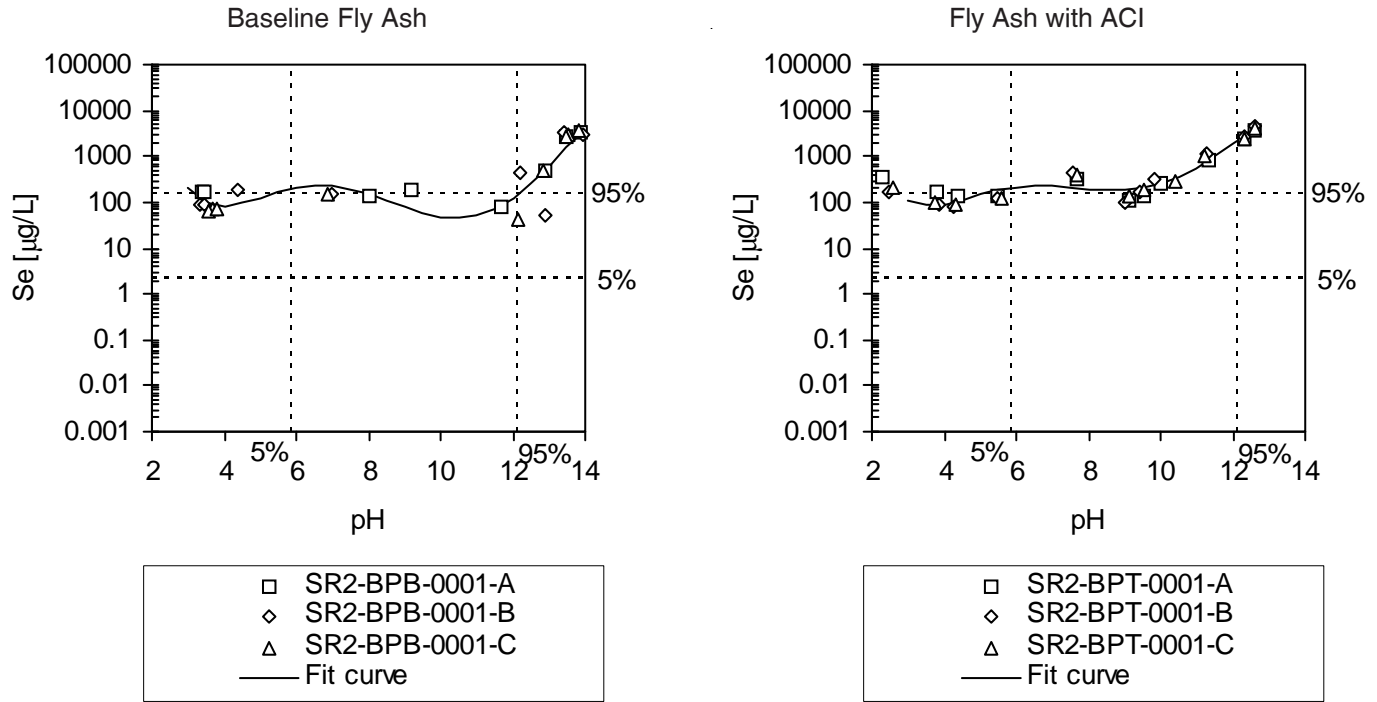

Material	log Se ($\mu\text{g/L}$)			pH range of validity	R^2	Number of points
BPB	-0.0006 pH^5	0.0262 pH^4	-0.4379 pH^3	3-14	0.81	27
	3.3856 pH^2	-12.0291 pH	17.7907			
BPT	-0.0006 pH^5	0.0229 pH^4	-0.3475 pH^3	3-12.5	0.93	33
	2.4521 pH^2	-7.9388 pH	11.4439			

Figure D-10. Regression Curves of Experimental Data of Selenium Solubility as a Function of pH.

100-Year Arsenic Release Estimates

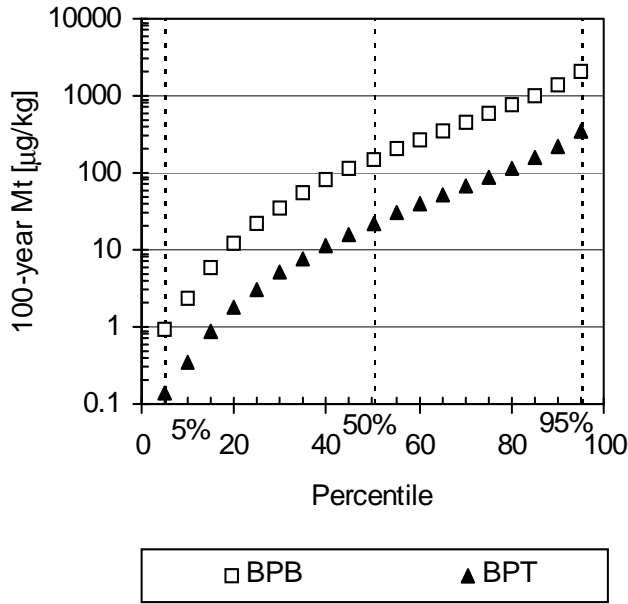

	BPB		BPT	
	µg/kg	%	µg/kg	%
Mt min	0.2	0.0003	0.1	0.0003
Mt - 5%	0.9	0.0011	0.1	0.0005
Mt - 50%	152	0.2	22	0.0772
Mt - 95%	2095	2.6	338	1.2
Mean Mt	468	0.6	90	0.3
Mt max	4693	5.8	10157	36.4

Figure D-11. 100-Year Arsenic Release Estimates as a Function of the Cumulative Probability for the Scenario of Disposal in a Combustion Waste Landfill.

100-Year Selenium Release Estimates

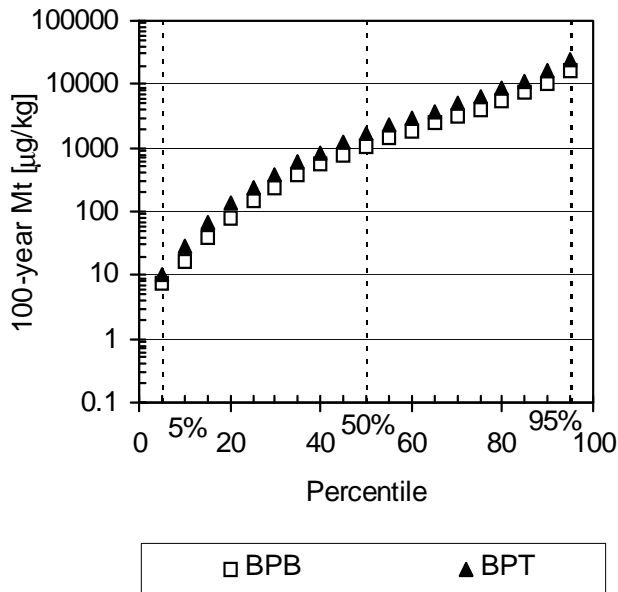

	BPB		BPT	
	µg/kg	%	µg/kg	%
Mt min	1.5	0.003	5.9	0.004
Mt - 5%	7.6	0.015	10.0	0.007
Mt - 50%	1031	2.0	1661	1.1
Mt - 95%	16681	32.5	23931	15.8
Mean Mt	3573	7.0	6038	4.0
Mt max	45169	87.9	151900	100.0

Figure D-12. 100-Year Selenium Release Estimates as a Function of the Cumulative Probability for the Scenario of Disposal in a Combustion Waste Landfill.

100-Year Arsenic Release Estimates

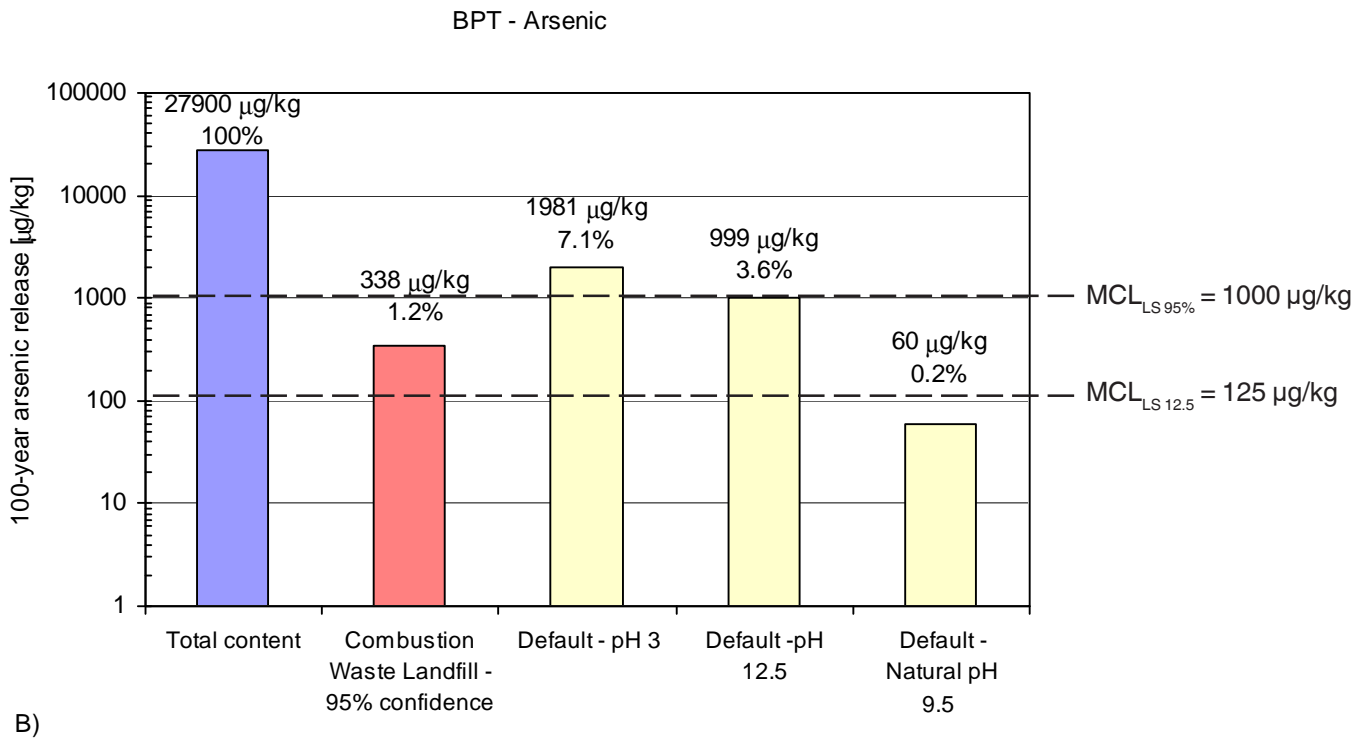
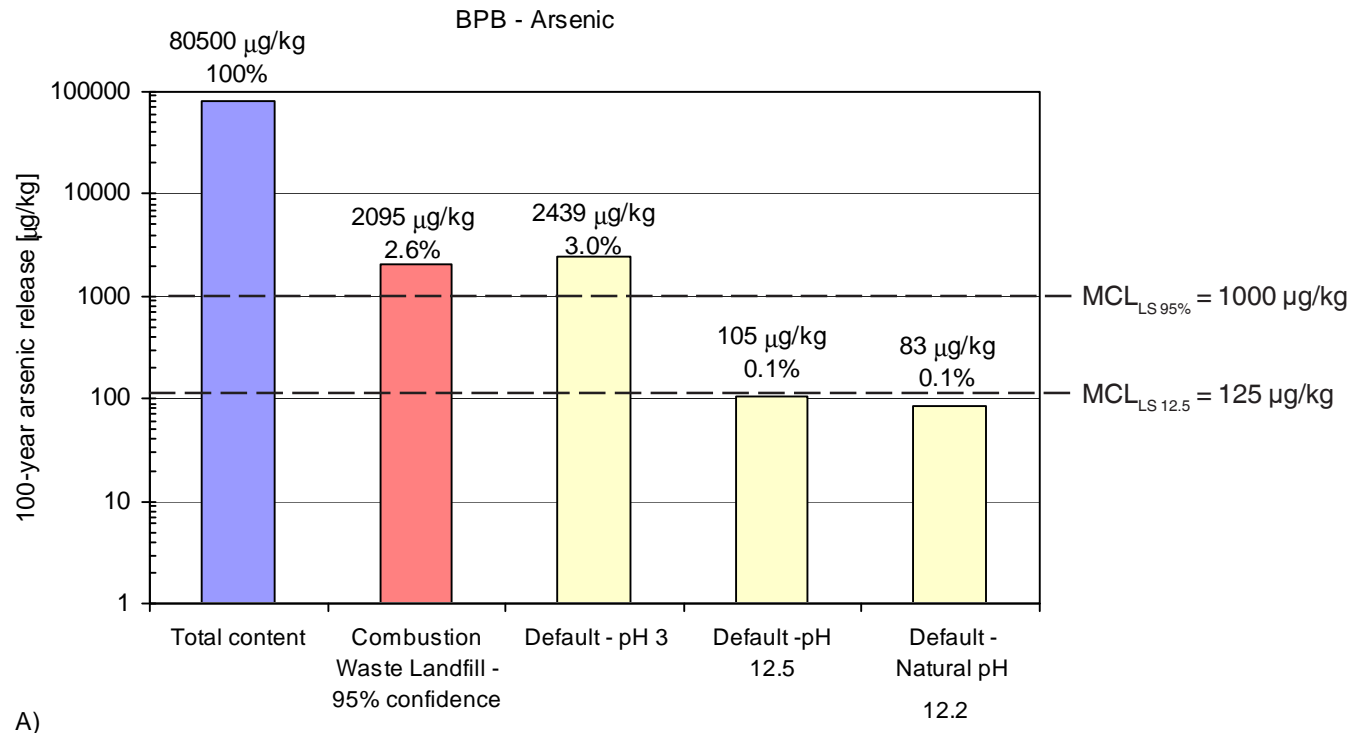

Figure D-13. 100-Year Arsenic Release Estimates from A) Baseline Fly Ash and B) Fly Ash with ACI. Release estimates for percolation controlled scenario are compared to release estimate based on total content. The amount of the arsenic that would be released if the release concentration was at the MCL is also shown for comparison ($LS_{\text{default scenario}} = 12.5 \text{ L/kg}$ and $LS_{95\%} = 100 \text{ L/kg}$).

100-Year Selenium Release Estimates

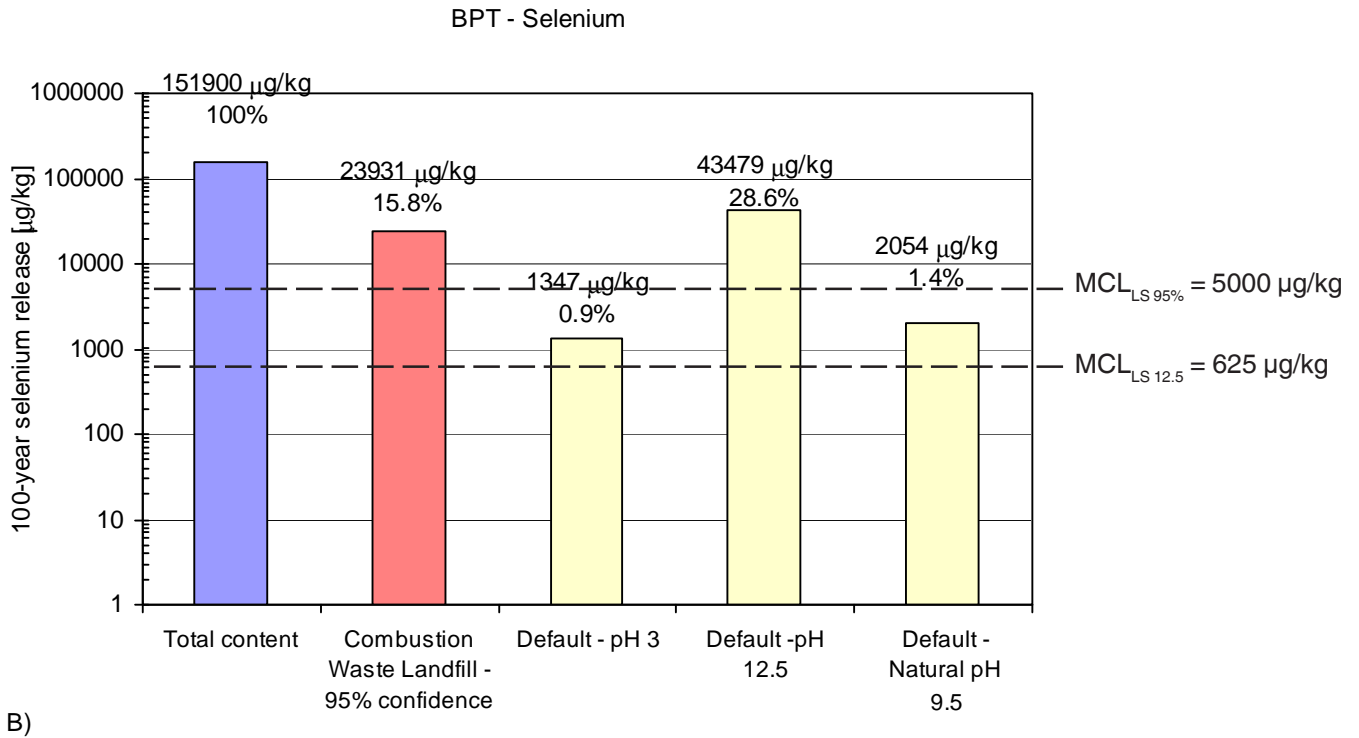
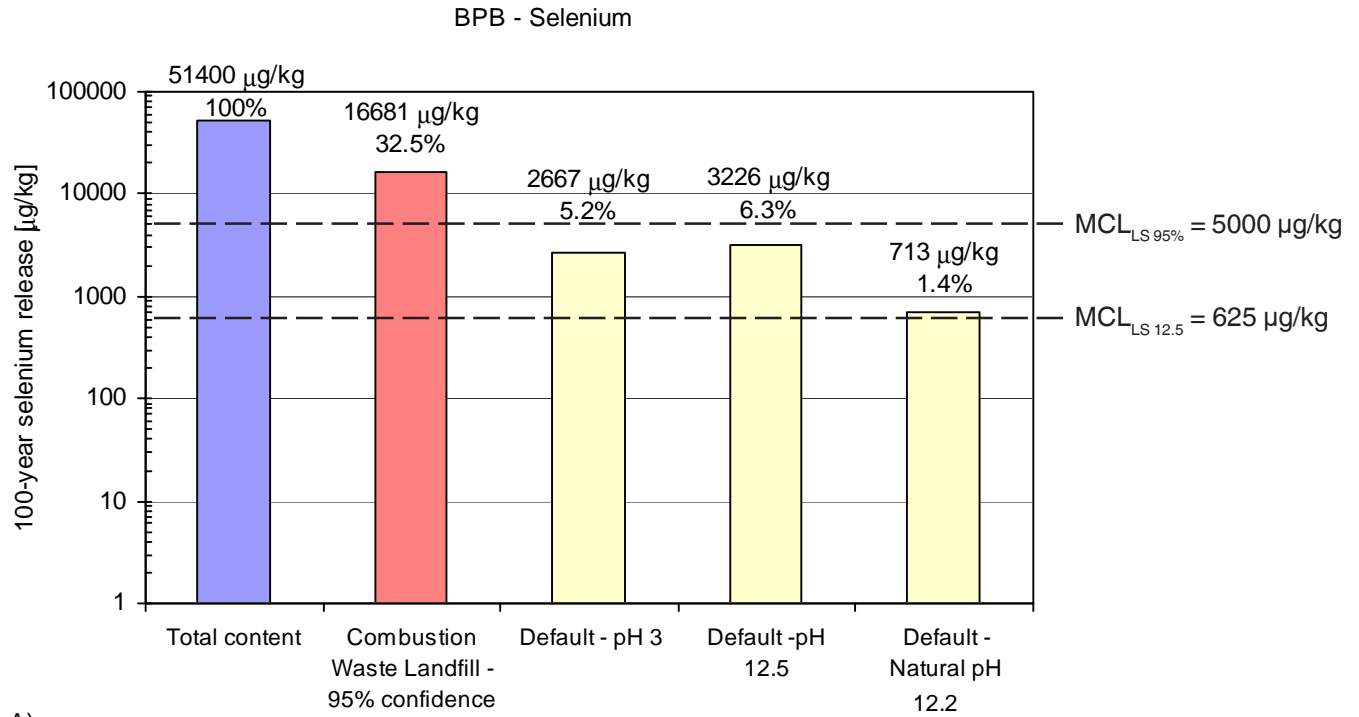

Figure D-14. 100-year Selenium Release Estimates from A) Baseline Fly Ash and B) Fly Ash with ACI. Release estimates for percolation controlled scenario are compared to release estimate based on total content. The amount of the selenium that would be released if the release concentration was at the MCL is also shown for comparison ($LS_{\text{default scenario}} = 12.5 \text{ L/kg}$ and $LS_{95\%} = 100 \text{ L/kg}$).

Comments

Figure D-3:

- The fly ash from the test case had greater total Hg content than the fly ash from the baseline case (by about 2.5 times).
- Hg release is low (but poor replication) for both baseline and test cases.

Figure D-5:

- The fly ash from the test case had lower total As content than the fly ash from the baseline case (by about a factor of 3).
- The laboratory measurements fit within the 5-95% confidence intervals of the field observations.
- As release is most frequently worse in baseline case than test case and exceeds MCL for many possible conditions.

Figure D-7:

- The fly ash from the test case had greater total Se content than the fly ash from the baseline case (by about a factor of 3).
- The laboratory measurements fit within the 5% to 95% confidence intervals of the field observations.
- Se release substantially exceeds MCL for both baseline and test cases and is generally worse for test cases.
- The fly ash from the test case resulted in greater Se concentration at the natural pH of the material than the baseline case (by about 3 times).

Figures D-11. and D-12:

- The fly ash from the test case would result in As release less than expected from the baseline case, with a 95% probability to be less than 338 and 2095 $\mu\text{g}/\text{kg}$, respectively.
- No significant difference in Se release is expected from both baseline and test cases.

Figure D-13:

- For the 95% probability scenario, arsenic release from the baseline case would be greater than the amount

that would be released if the release concentration was at the MCL.

- For the 95% probability scenario, a lower arsenic release would be expected from the test case. However, the fly ash from the test case had lower total As content than the fly ash from the baseline case (by about a factor of 3).
- For the default scenario corresponding to disposal in a monofill (leachate pH controlled by the material being disposed), no significant difference in arsenic release between the baseline and the test cases would be expected. Additionally, arsenic release would be less than the amount that would be released if the release concentration was at the MCL.
- For the default scenario corresponding to the “extreme” pH of 3, arsenic release would be greater than the amount that would be released if the release concentration was at the MCL, for both the baseline and the test cases.
- For the default scenario corresponding to the “extreme” pH of 12.5, arsenic release is expected to be greater for the test case than the baseline case.

Figure D-14:

- For the 95% probability case, selenium release would be greater than the amount that would be released if the release concentration was at the MCL for both the baseline and the test cases.
- For the default scenario corresponding to disposal in a monofill (leachate pH controlled by the material being disposed), a greater selenium release would be expected from the test case.
- For the default scenario corresponding to the “extreme” pH of 12.5, selenium release is expected to be greater for the test case than the baseline case. Selenium release from the test case would be greater than the amount that would be released if the release concentration was at the MCL.

Appendix E

Pleasant Prairie Fly Ashes

List of Figures

Figure	Page
E-1 pH Titration Curves for the Baseline Fly Ash and the Fly Ash with Enhanced Hg Control	133
E-2 pH as a Function of LS Ratio for the Baseline Fly Ash and the Fly Ash with Enhanced Hg Control	133
E-3 Mercury Release (top) and Spike Recoveries (bottom) as a Function of pH for the Baseline Fly Ash and the Fly Ash with Enhanced Hg Control	134
E-4 Mercury Release (top) and Spike Recoveries (bottom) as a Function of LS Ratio for the Baseline Fly Ash and the Fly Ash with Enhanced Hg Control	135
E-5 Arsenic Release (top) and Spike Recoveries (bottom) as a Function of pH for the Baseline Fly Ash and the Fly Ash with Enhanced Hg Control	136
E-6 Arsenic Release (top) and Spike Recoveries (bottom) as a Function of LS Ratio for the Baseline Fly Ash and the Fly Ash with Enhanced Hg Control	137
E-7 Selenium Release (top) and Spike Recoveries (bottom) as a Function of pH for the Baseline Fly Ash and the Fly Ash with Enhanced Hg Control	138
E-8 Selenium Release (top) and Spike Recoveries (bottom) as a Function of LS Ratio for the Baseline Fly Ash and the Fly Ash with Enhanced Hg Control	139
E-9 Regression Curves of Experimental Data of Arsenic Solubility as a Function of pH.	140
E-10 Regression Curves of Experimental Data of Selenium Solubility as a Function of pH	141
E-11 100-Year Arsenic Release Estimates as a Function of the Cumulative Probability for the Scenario of Disposal in a Combustion Waste Landfill	142
E-12 100-Year Selenium Release Estimates as a Function of the Cumulative Probability for the Scenario of Disposal in a Combustion Waste Landfill	142
E-13 100-Year Arsenic Release Estimates from A) Baseline Fly Ash and B) Fly Ash with ACI	143
E-14 100-year Selenium Release Estimates from A) Baseline Fly Ash and B) Fly Ash with ACI	144

pH Titration Curves

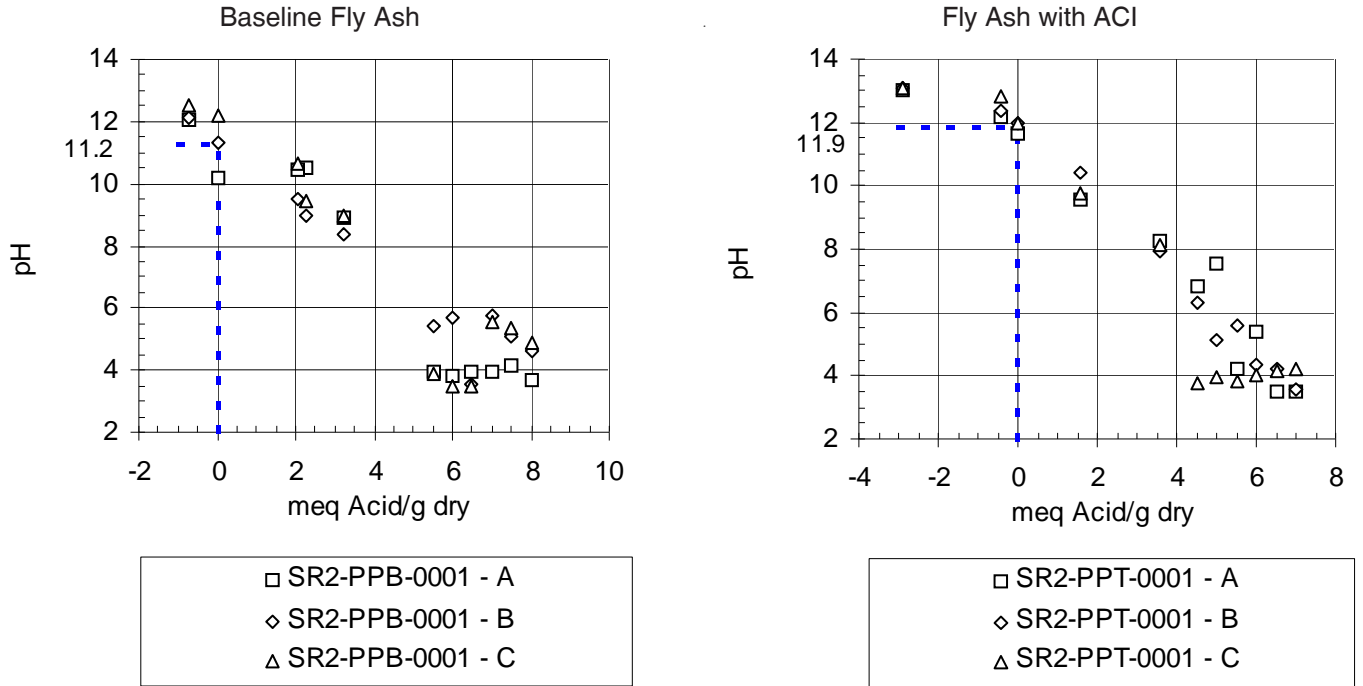

Figure E-1. pH Titration Curves for the Baseline Fly Ash and the Fly Ash with Enhanced Hg Control.

pH as a Function of LS Ratio

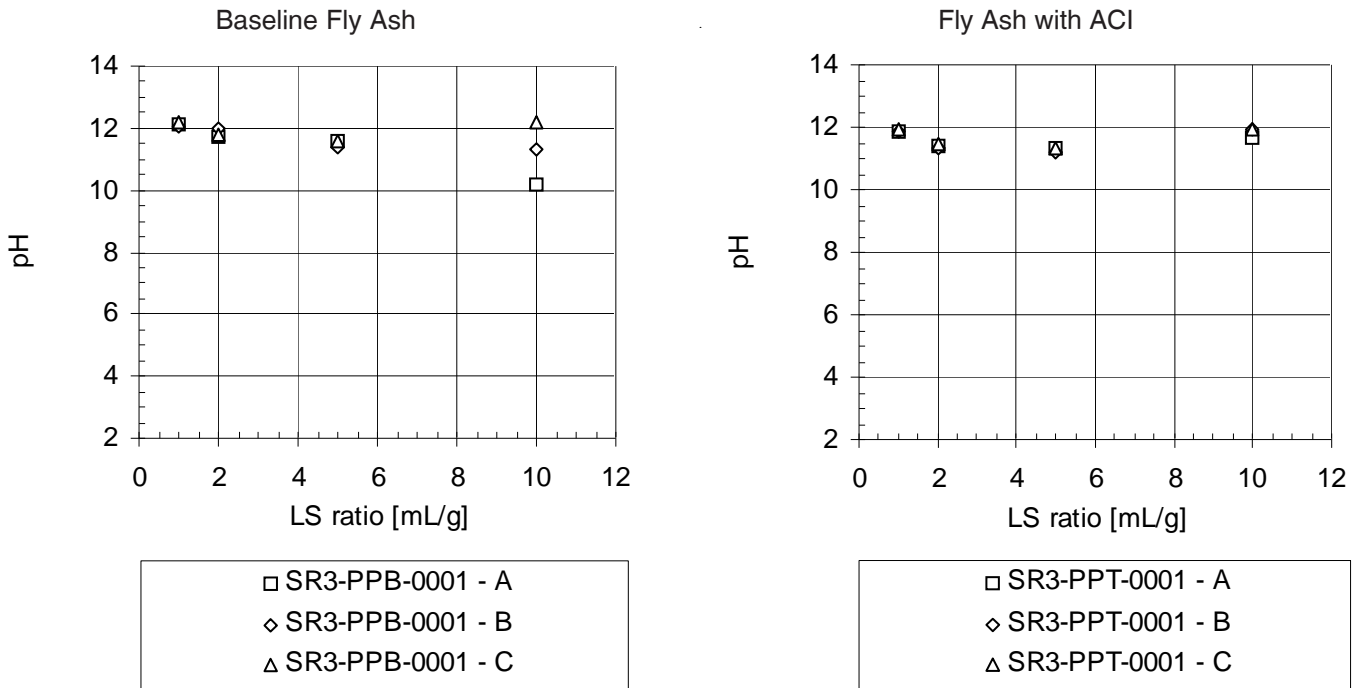
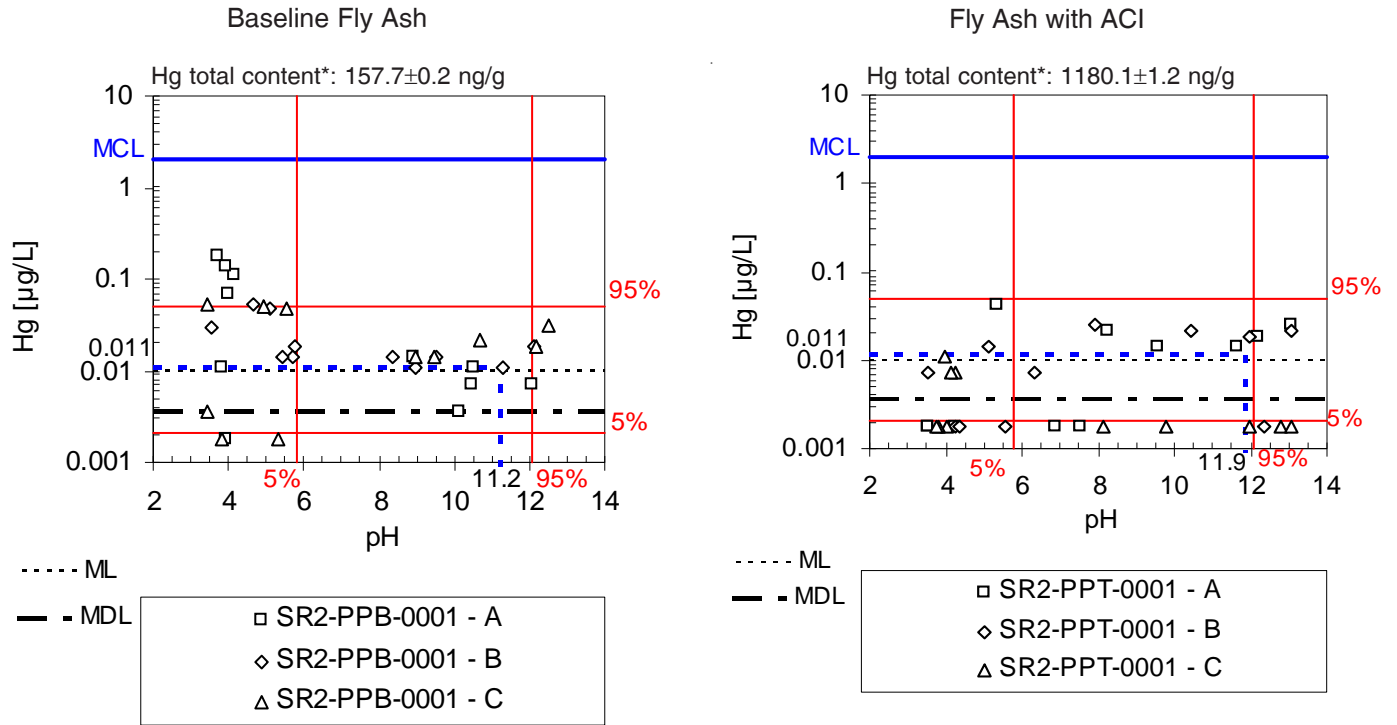

Figure E-2. pH as a Function of LS Ratio for the Baseline Fly Ash and the Fly Ash with Enhanced Hg Control.

Mercury Release as a Function of pH



*Total content as determined by digestion using method 3052.

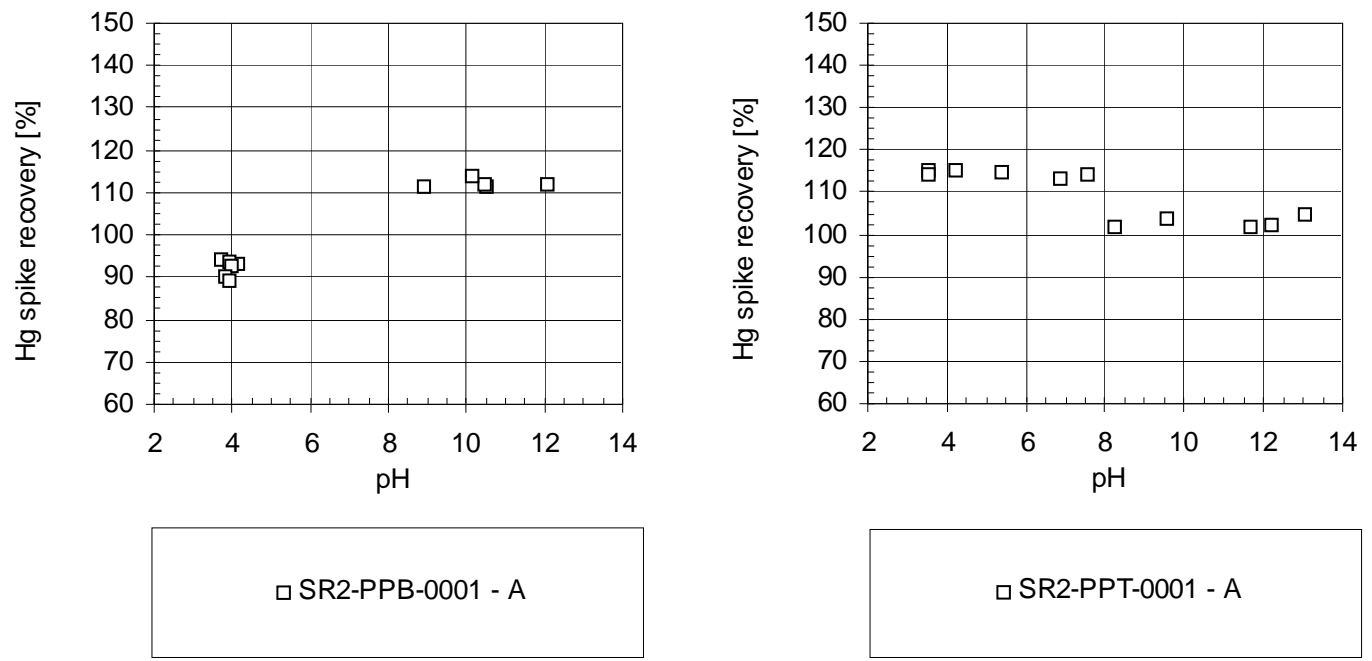

Figure E-3. Mercury Release (top) and Spike Recoveries (bottom) as a Function of pH for the Baseline Fly Ash and the Fly Ash with Enhanced Hg Control. 5th and 95th percentiles of mercury concentrations observed in typical combustion waste landfill leachate are shown for comparison.

Mercury Release as a Function of LS Ratio

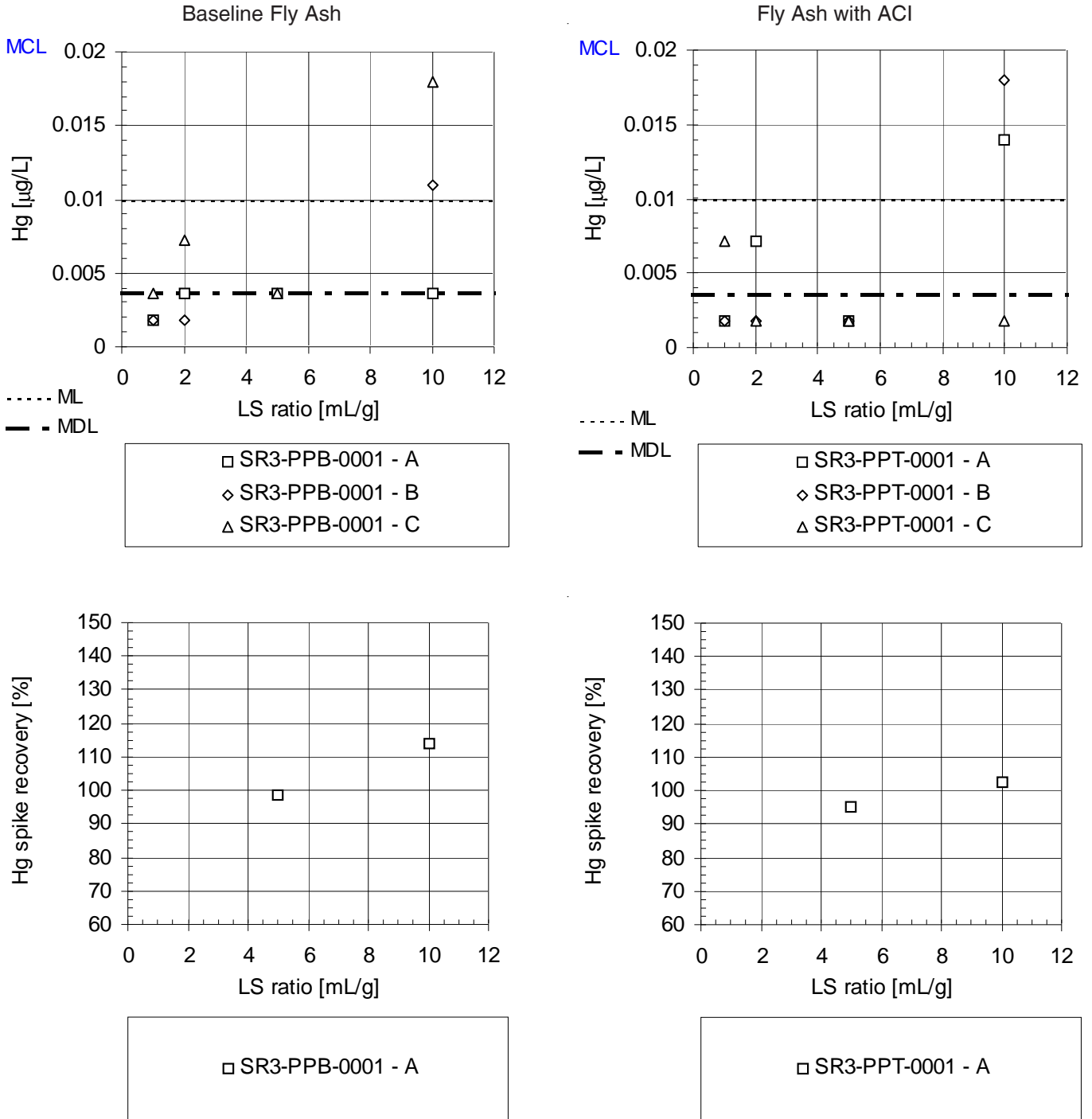
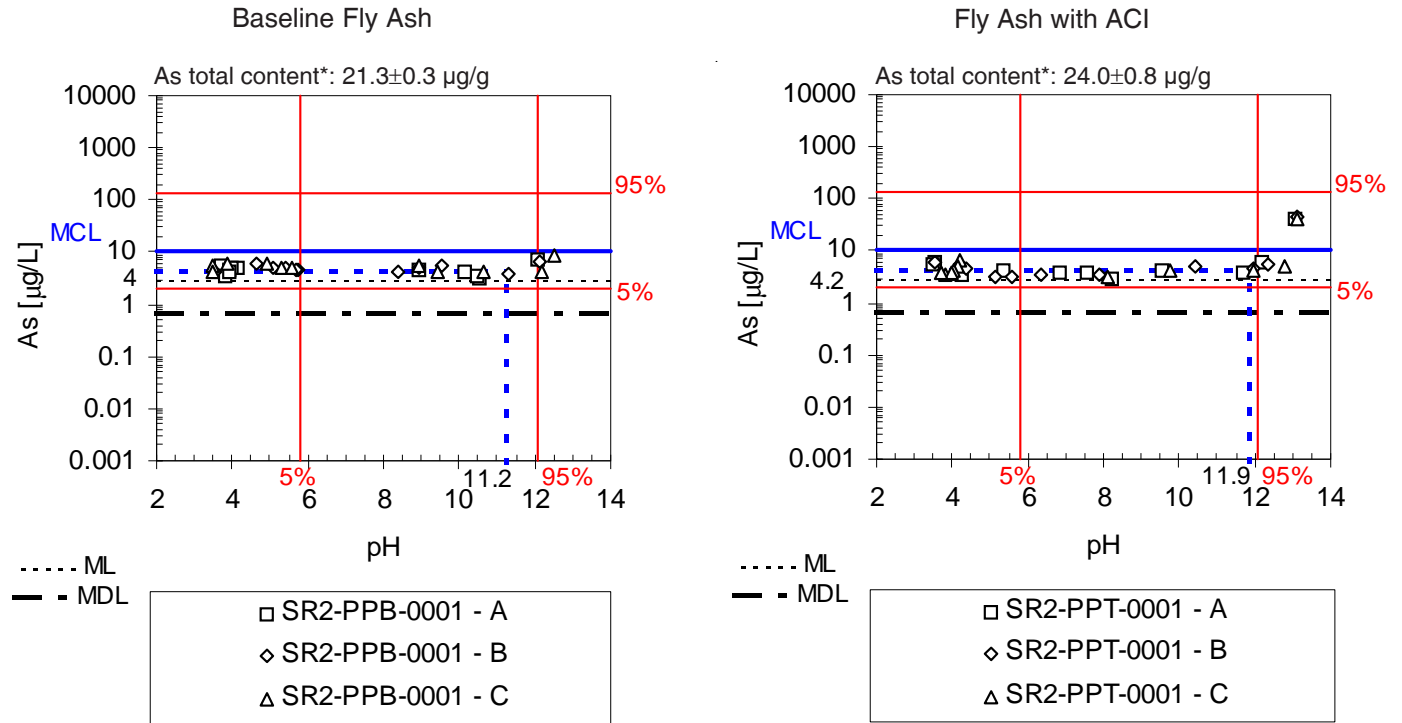

Figure E-4. Mercury Release (top) and Spike Recoveries (bottom) as a Function of LS Ratio for the Baseline Fly Ash and the Fly Ash with Enhanced Hg Control.

Arsenic Release as a Function of pH



*Total content as determined by digestion using method 3052.

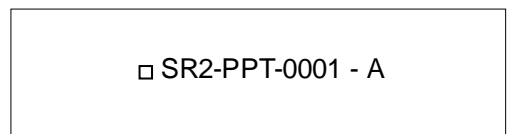
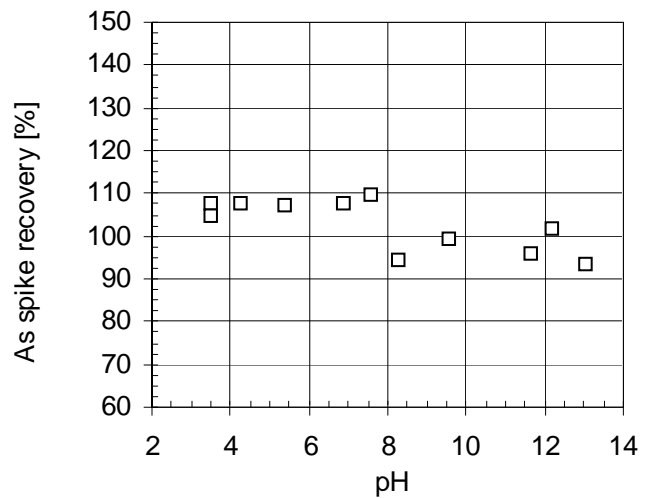
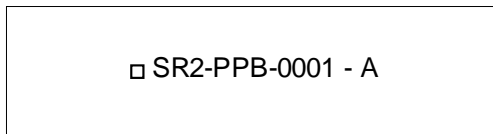
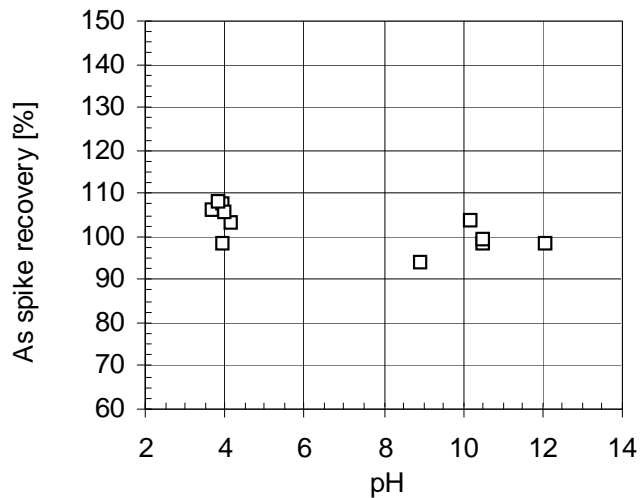

Figure E-5. Arsenic Release (top) and Spike Recoveries (bottom) as a Function of pH for the Baseline Fly Ash and the Fly Ash with Enhanced Hg Control. 5th and 95th percentiles of arsenic concentrations observed in typical combustion waste landfill leachate are shown for comparison.

Arsenic Release as a Function of LS Ratio

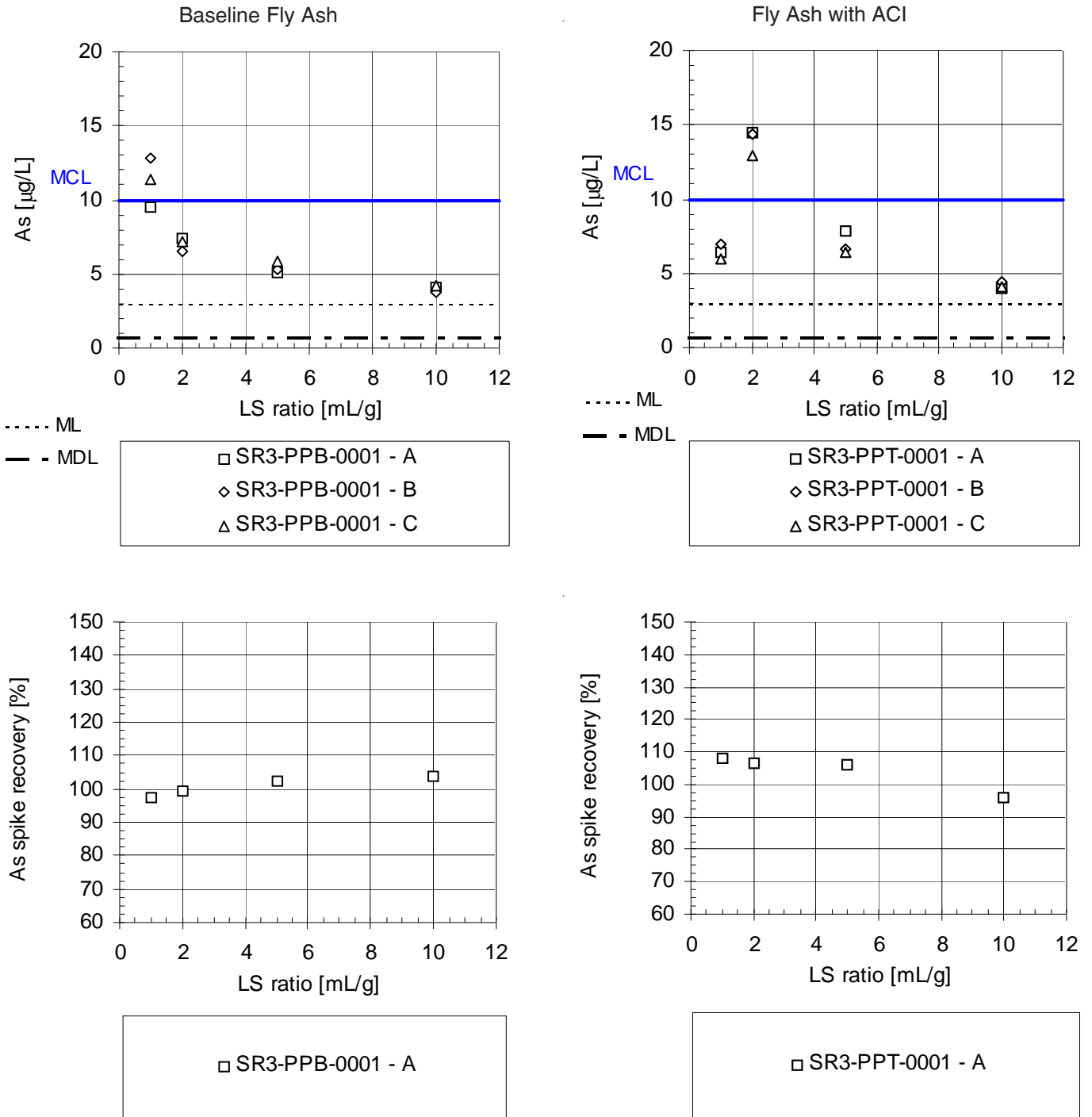
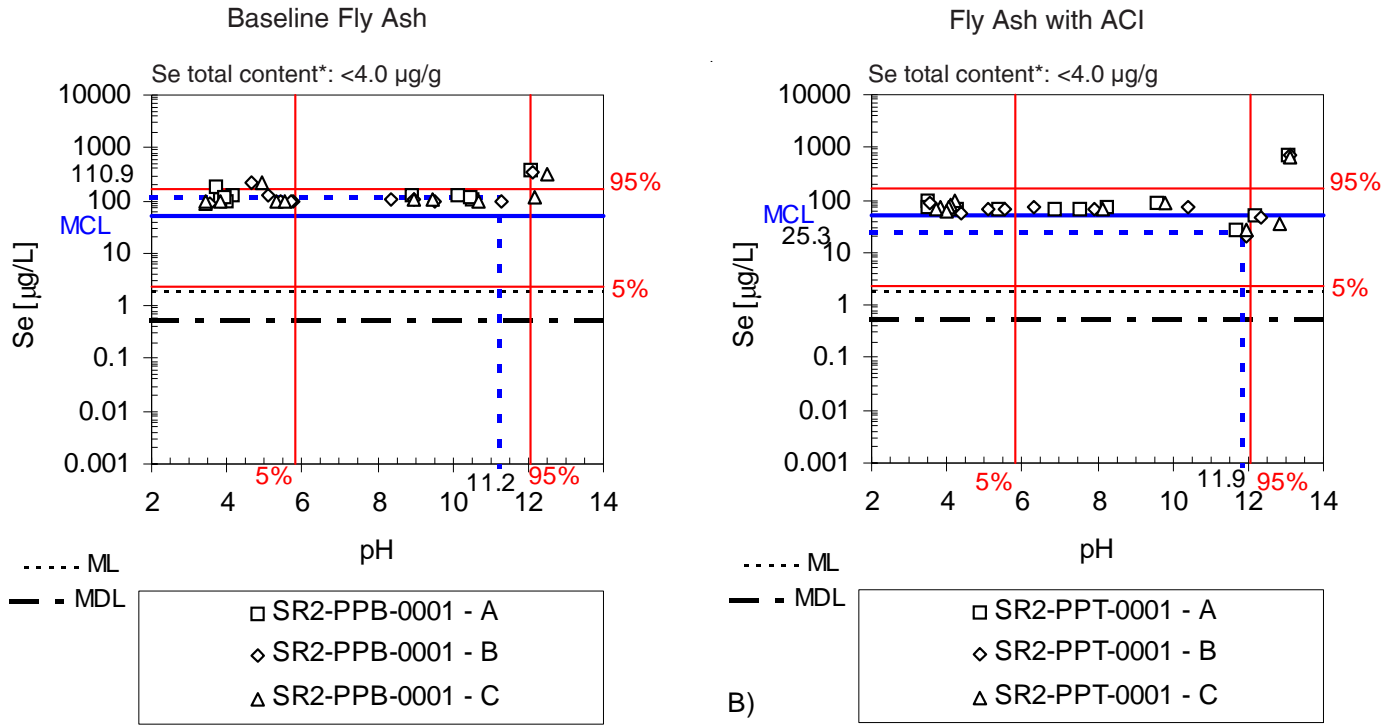

Figure E-6. Arsenic Release (top) and Spike Recoveries (bottom) as a Function of LS Ratio for the Baseline Fly Ash and the Fly Ash with Enhanced Hg Control.

Selenium Release as a Function of pH



*Total content as determined by digestion using method 3052.

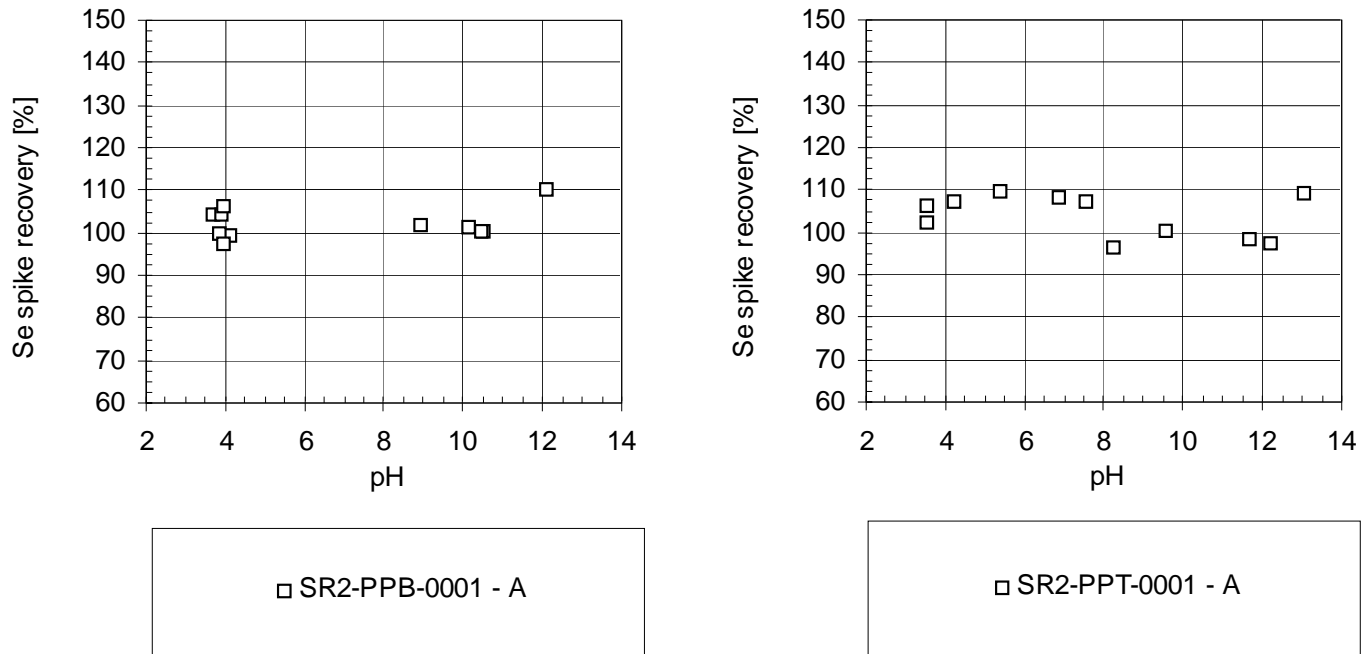

Figure E-7. Selenium Release (top) and Spike Recoveries (bottom) as a Function of pH for the Baseline Fly Ash and the Fly Ash with Enhanced Hg Control. 5th and 95th percentiles of selenium concentrations observed in typical combustion waste landfill leachate are shown for comparison.

Selenium Release as a Function of LS Ratio

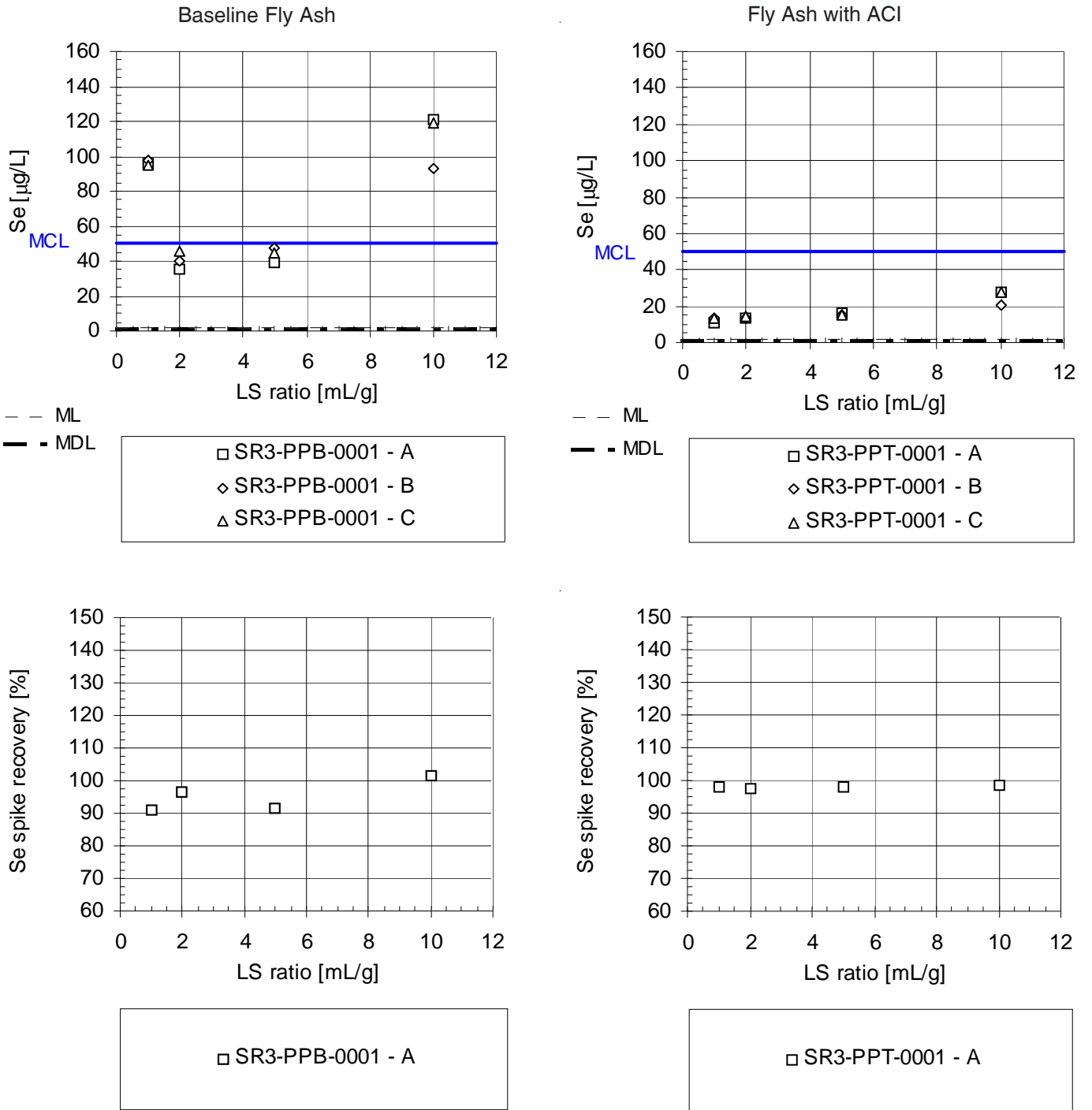
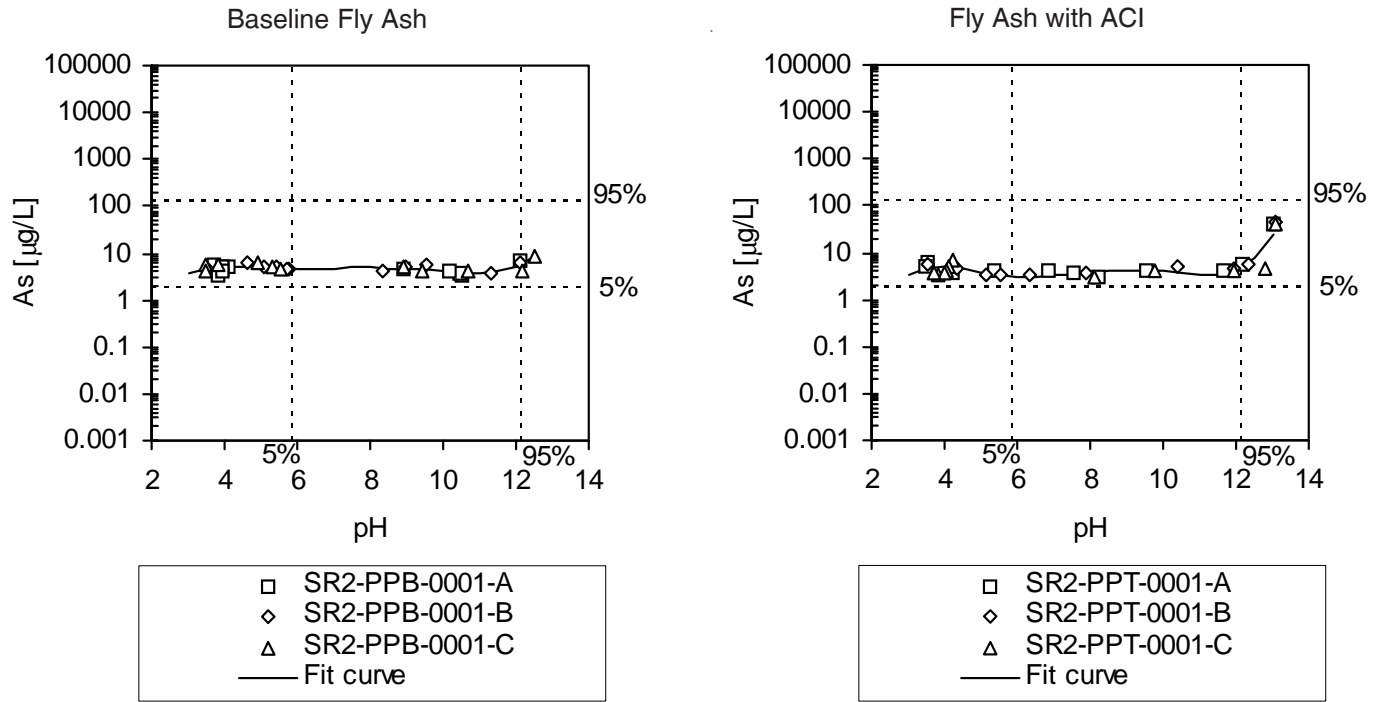

Figure E-8. Selenium Release (top) and Spike Recoveries (bottom) as a Function of LS Ratio for the Baseline Fly Ash and the Fly Ash with Enhanced Hg Control.

Arsenic Solubility



Material	log As ($\mu\text{g/L}$)			pH range of validity	R^2	Number of points
PPB	0.0003 pH^5	-0.0117 pH^4	0.1674 pH^3	3-12.5	0.47	33
	-1.1600 pH^2	3.8716 pH	-4.2743			
PPT	0.0006 pH^5	-0.0238 pH^4	0.3460 pH^3	3-13	0.84	33
	-2.3840 pH^2	7.7036 pH	-8.6786			

Figure E-9. Regression Curves of Experimental Data of Arsenic Solubility as a Function of pH.

Selenium Solubility

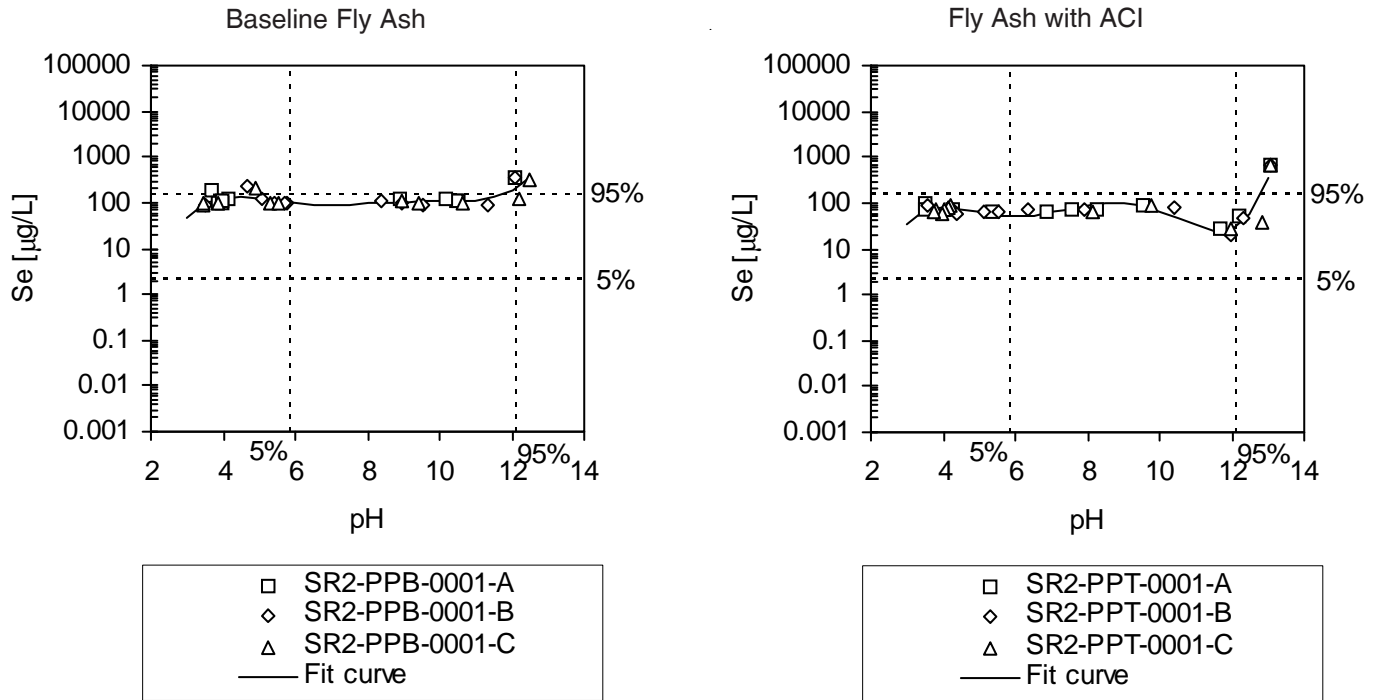

Material	log Se (µg/L)			pH range of validity	R ²	Number of points
PPB	0.0006 pH ⁵	-0.0234 pH ⁴	0.3605 pH ³	3-12.5	0.54	33
	-2.6711 pH ²	9.4536 pH	-10.6432			
PPT	0.0012 pH ⁵	-0.0440 pH ⁴	0.6379 pH ³	3-13	0.81	33
	-4.3855 pH ²	14.2483 pH	-15.6626			

Figure E-10. Regression Curves of Experimental Data of Selenium Solubility as a Function of pH.

100-Year Arsenic Release Estimates

Arsenic

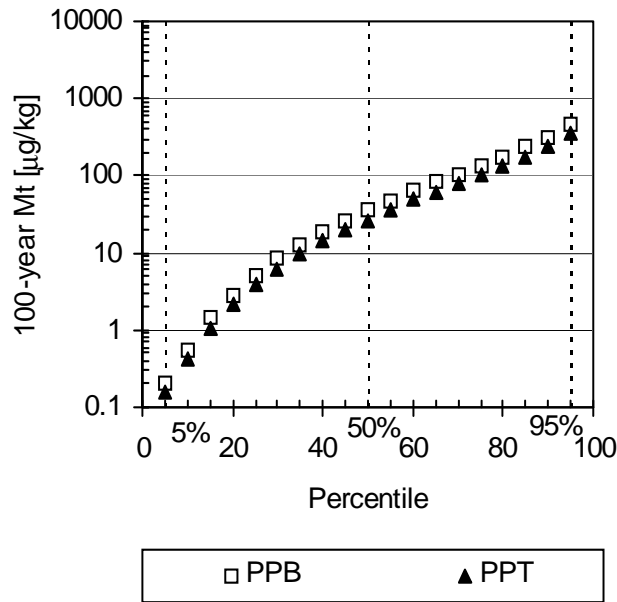

	PPB		PPT	
	µg/kg	%	µg/kg	%
Mt min	0.1	0.0006	0.1	0.0004
Mt - 5%	0.2	0.0010	0.2	0.0007
Mt - 50%	36	0.2	27	0.1
Mt - 95%	473	2.2	358	1.5
Mean Mt	107	0.5	81	0.3
Mt max	1188	5.6	1049	4.4

Figure E-11. 100-Year Arsenic Release Estimates as a Function of the Cumulative Probability for the Scenario of Disposal in a Combustion Waste Landfill.

100-Year Selenium Release Estimates

Selenium

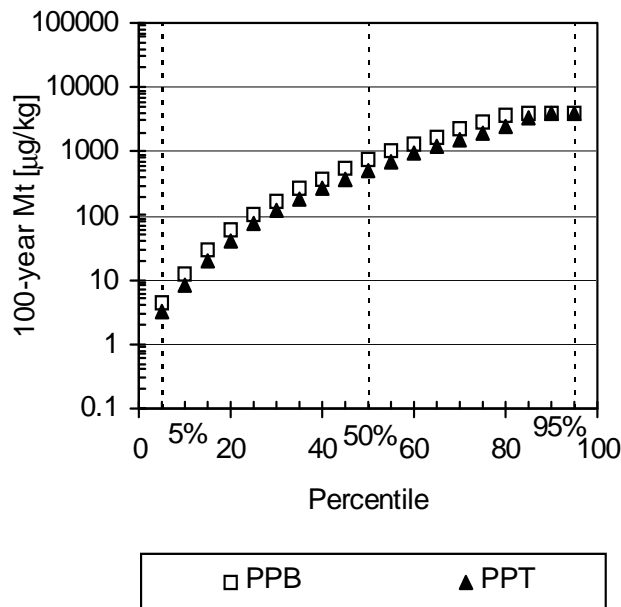

	PPB		PPT	
	µg/kg	%	µg/kg	%
Mt min	3.0	0.1	0.9	0.0
Mt - 5%	4.4	0.1	3.3	0.1
Mt - 50%	733	18.3	516	12.9
Mt - 95%	4000	100.0	4000	100.0
Mean Mt	2254	56.4	1599	40.0
Mt max	4000	100.0	4000	100.0

Figure E-12. 100-Year Selenium Release Estimates as a Function of the Cumulative Probability for the Scenario of Disposal in a Combustion Waste Landfill.

100-Year Arsenic Release Estimates

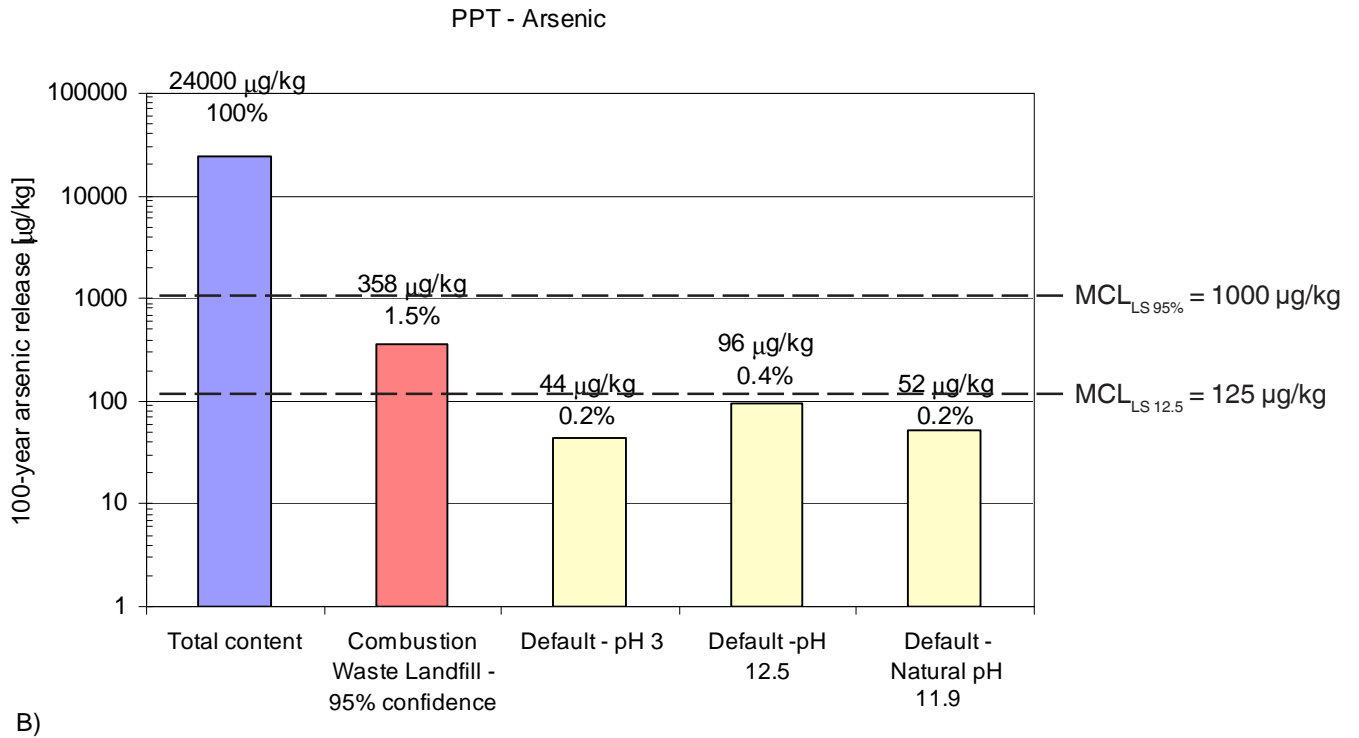
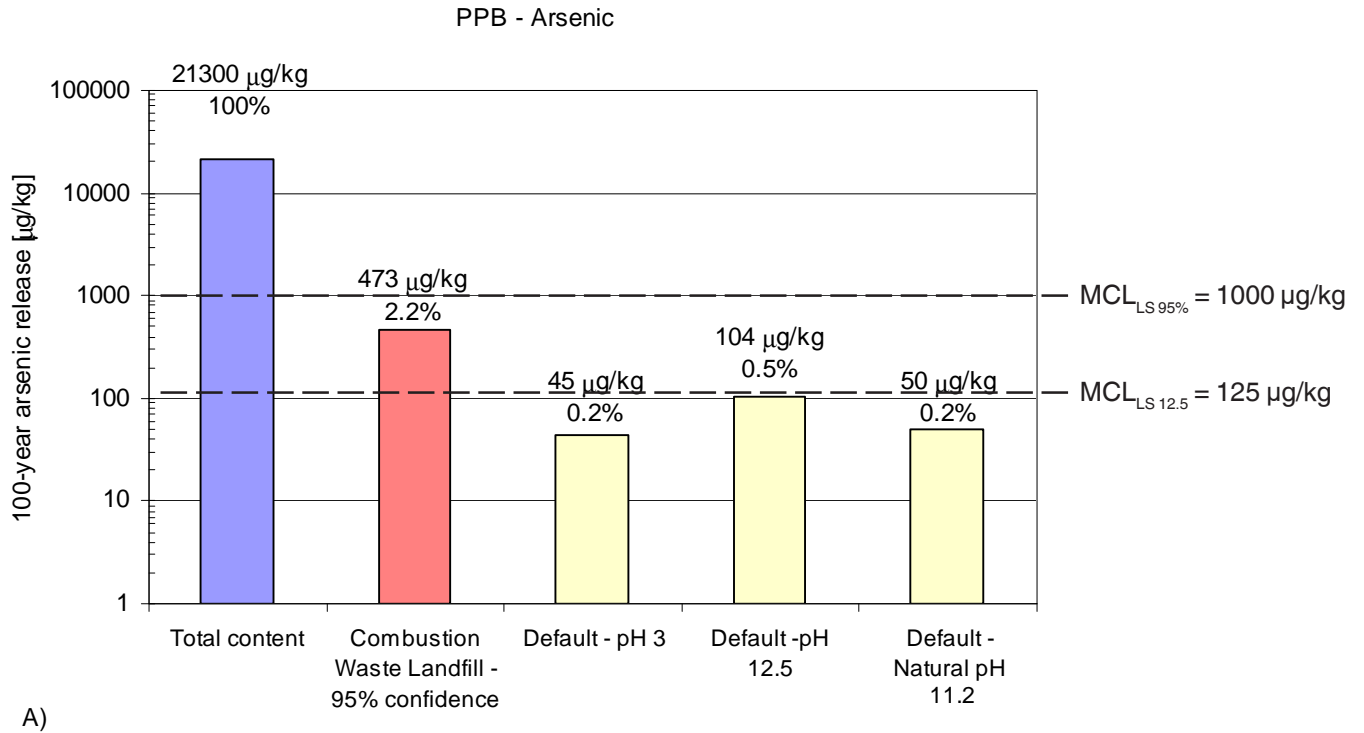

Figure E-13. 100-Year Arsenic Release Estimates from A) Baseline Fly Ash and B) Fly Ash with ACI. Release estimates for percolation controlled scenario are compared to release estimate based on total content. The amount of the arsenic that would be released if the release concentration was at the MCL is also shown for comparison ($LS_{\text{default scenario}} = 12.5 \text{ L/kg}$ and $LS_{95\%} = 100 \text{ L/kg}$).

100-Year Selenium Release Estimates

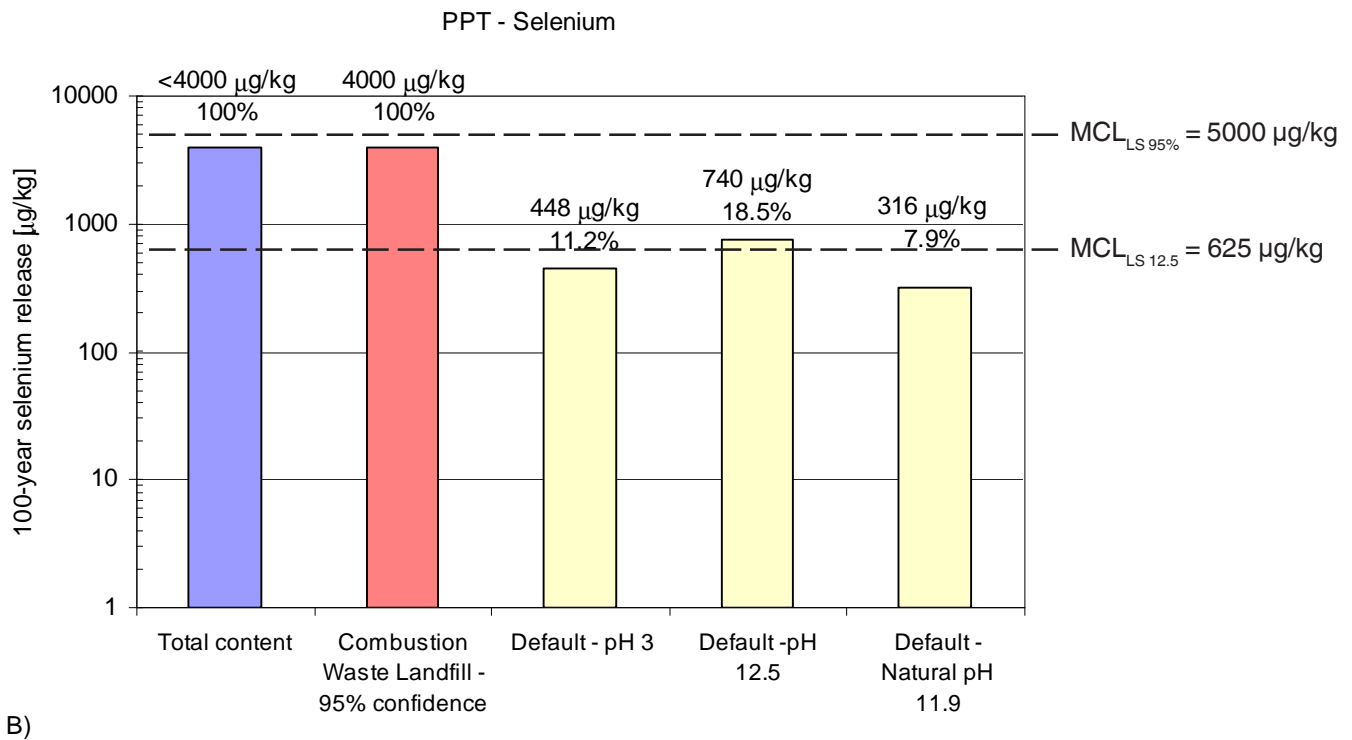
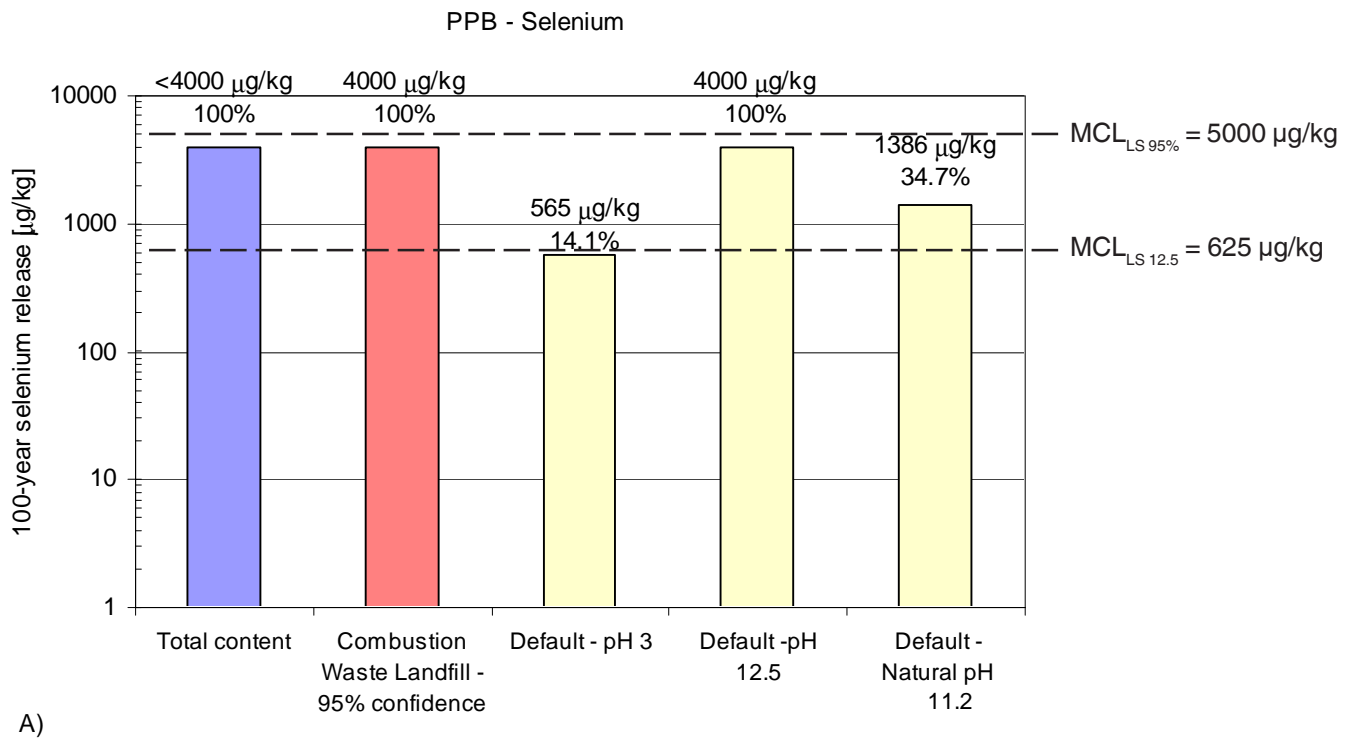

Figure E-14. 100-year Selenium Release Estimates from A) Baseline Fly Ash and B) Fly Ash with ACI. Release estimates for percolation controlled scenario are compared to release estimate based on total content. The amount of the selenium that would be released if the release concentration was at the MCL is also shown for comparison (LS_{default scenario} = 12.5 L/kg and LS_{95%} = 100 L/kg).

Comments

Figure E-3:

- Fly ash from the test case had greater total Hg content than the fly ash from the baseline case (by about 7.5 times).
- Hg release is well below levels of potential concern (but poor replication) for both baseline and test cases.

Figure E-5:

- The fly ash from the test case had similar total As content than that from the baseline case.
- As release was below the MCL for both the baseline and the test cases for most pH conditions.

Figure E-7:

- Total selenium content was below detection limits for Method 3052 for both fly ashes while significant selenium release (ranging from around 30 µg/L to around 1000 µg/L) as a function of pH was observed. This result is a consequence of the dilution effects of the digestion method and analytical requirements.
- Selenium release from both the baseline and the test cases was close to or exceeded the MCL (50 µg/L) for most pH conditions.

Figures E-11 and E-12:

- The fly ash from the test case would result in As release slightly less than expected from the baseline case, with a 95% probability to be less than 358 and 473 µg/kg, respectively.
- The fly ash from the test case would result in Se release less than expected from the baseline case, with a 95% probability to be less than 4000 µg/kg (total con-

tent) in both cases and a 5% possibility that the total content will be released.

Figure E-13:

- For all scenarios examined, no significant difference in arsenic release would be observed between the fly ash from the baseline case and the fly ash from the test case.
- For the 95% probability scenario, arsenic release from both cases would be less than the amount that would be released if the release concentration was at the MCL and the LS ratio was the resultant LS ratio for the 95% case (i.e., about 100 L/kg). However, arsenic release would be greater than the amount that would be released if the release concentration was at the MCL and the LS ratio was the LS ratio of the default scenario considered (i.e., 12.5 L/kg).
- For the three default scenarios considered, arsenic release would most likely be less than the amount that would be released if the release concentration was at the MCL.

Figure E-14:

- For scenarios at alkaline pH, lower Se release would be expected for the test case compared to the baseline case.
- For the 95% probability scenario, selenium release from both cases would be greater than the amount that would be released if the release concentration was at the MCL.
- In conclusion, Se release will most likely be greater than the MCL based on solubility and cumulative release. Without controls appears worse than with controls.

Appendix F
Salem Harbor Fly Ashes

List of Figures

Figure	Page
F-1 pH Titration Curves for the Baseline Fly Ash and the Fly Ash with Enhanced Hg Control	148
F-2 pH as a Function of LS Ratio for the Baseline Fly Ash and the Fly Ash with Enhanced Hg Control	148
F-3 Mercury Release (top) and Spike Recoveries (bottom) as a Function of pH for the Baseline Fly Ash and the Fly Ash with Enhanced Hg Control	149
F-4 Mercury Release (top) and Spike Recoveries (bottom) as a Function of LS Ratio for the Baseline Fly Ash and the Fly Ash with Enhanced Hg Control	150
F-5 Arsenic Release (top) and Spike Recoveries (bottom) as a Function of pH for the Baseline Fly Ash and the Fly Ash with Enhanced Hg Control	151
F-6 Arsenic Release (top) and Spike Recoveries (bottom) as a Function of LS Ratio for the Baseline Fly Ash and the Fly Ash with Enhanced Hg Control	152
F-7 Selenium Release (top) and Spike Recoveries (bottom) as a Function of pH for the Baseline Fly Ash and the Fly Ash with Enhanced Hg Control	153
F-8 Selenium Release (top) and Spike Recoveries (bottom) as a Function of LS Ratio for the Baseline Fly Ash and the Fly Ash with Enhanced Hg Control	154
F-9 Regression Curves of Experimental Data of Arsenic Solubility as a Function of pH.	155
F-10 Regression Curves of Experimental Data of Selenium Solubility as a Function of pH	156
F-11 100-Year Arsenic Release Estimates as a Function of the Cumulative Probability for the Scenario of Disposal in a Combustion Waste Landfill	157
F-12 100-Year Selenium Release Estimates as a Function of the Cumulative Probability for the Scenario of Disposal in a Combustion Waste Landfill	157
F-13 100-Year Arsenic Release Estimates from A) Baseline Fly Ash and B) Fly Ash with ACI	158
F-14 100-year Selenium Release Estimates from A) Baseline Fly Ash and B) Fly Ash with ACI	159

pH Titration Curves

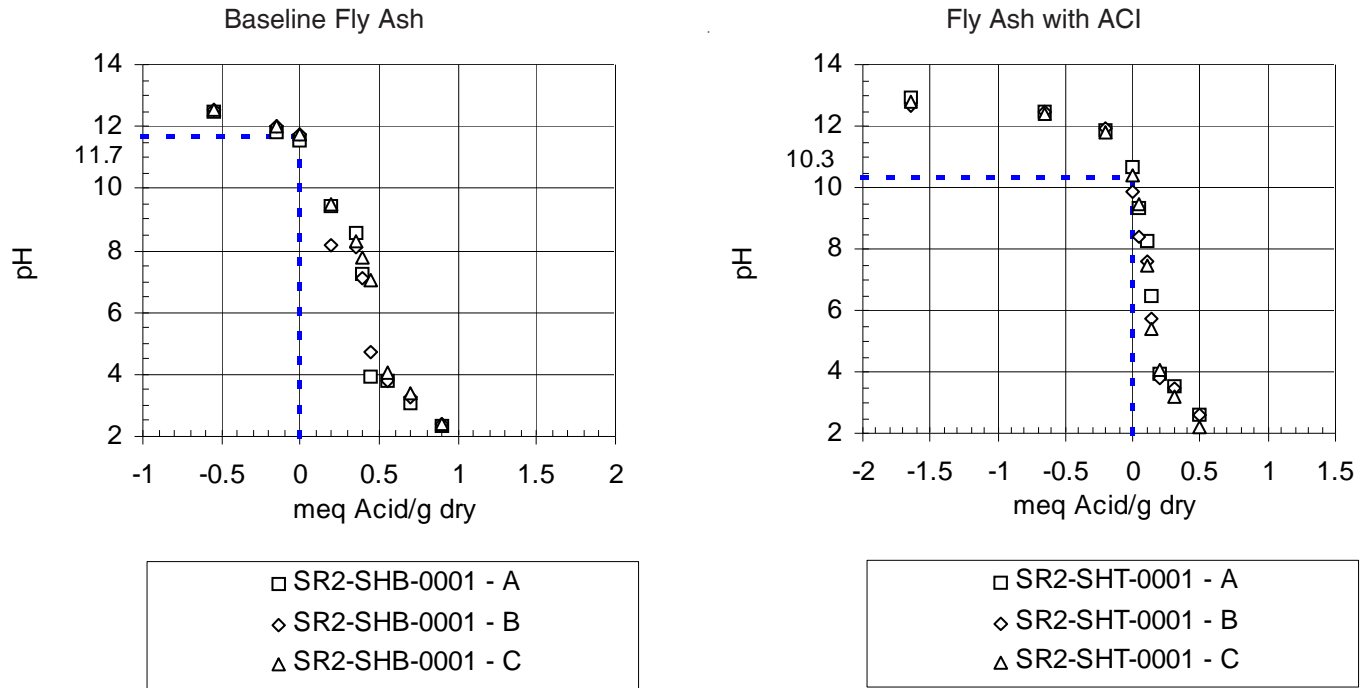

Figure F-1. pH Titration Curves for the Baseline Fly Ash and the Fly Ash with Enhanced Hg Control.

pH as a Function of LS Ratio

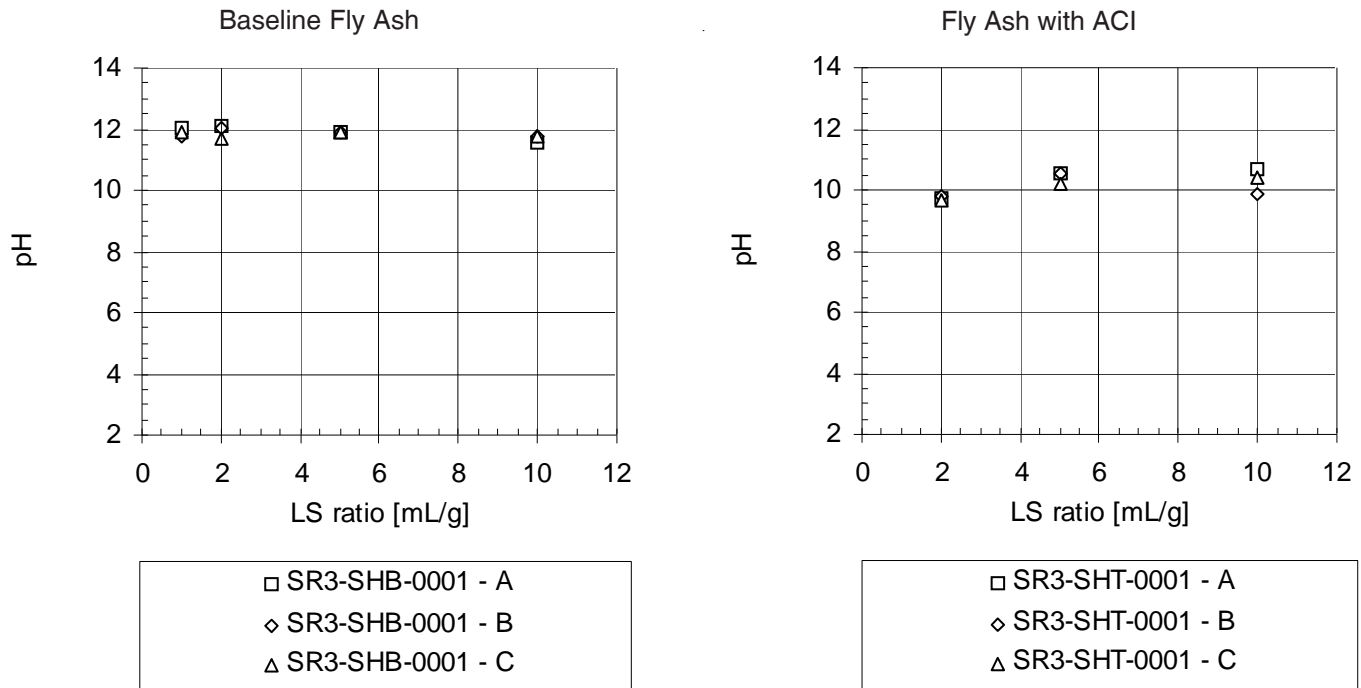
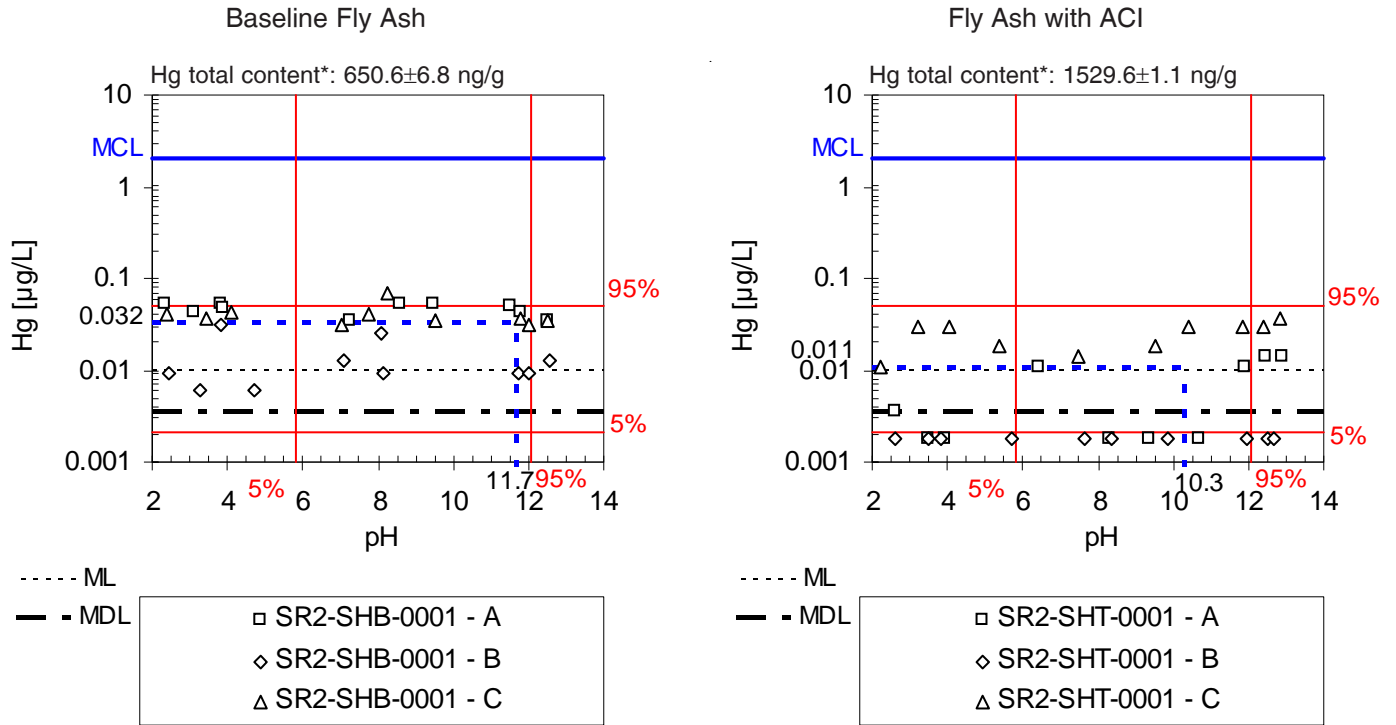

Figure F-2. pH as a Function of LS Ratio for the Baseline Fly Ash and the Fly Ash with Enhanced Hg Control.

Mercury Release as a Function of pH



*Total content as determined by digestion using method 3052.

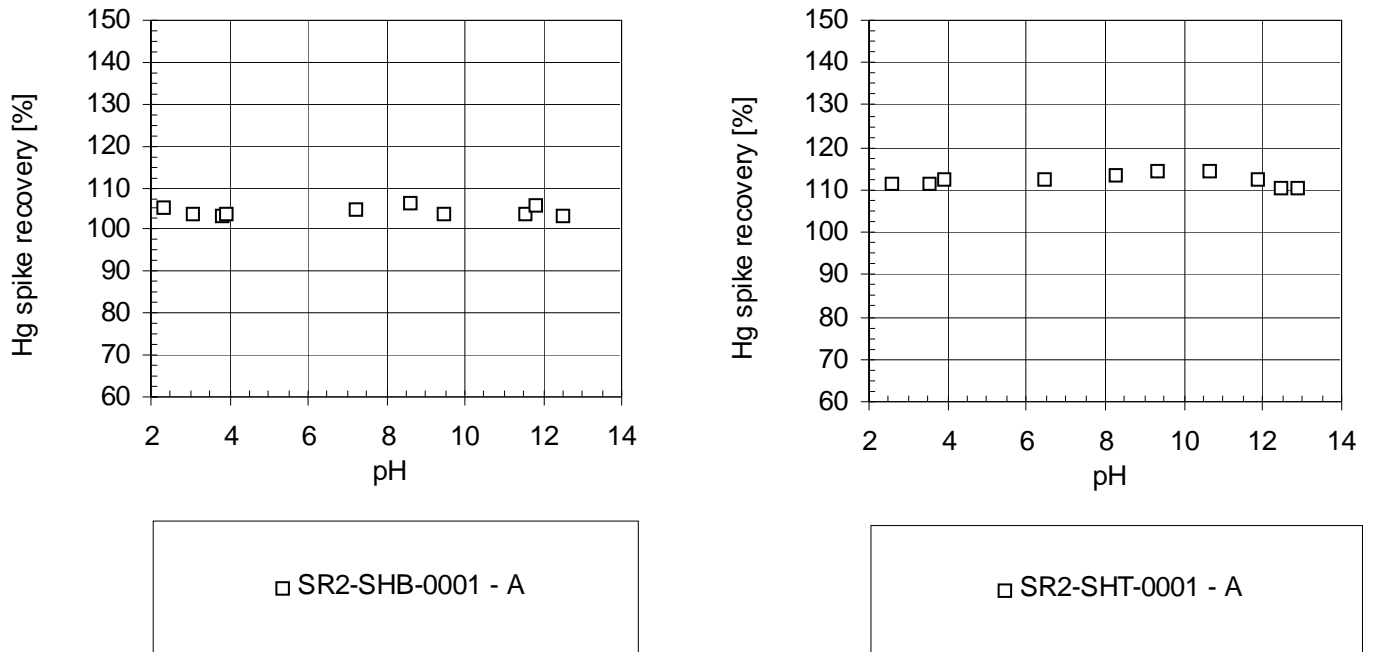

Figure F-3. Mercury Release (top) and Spike Recoveries (bottom) as a Function of pH for the Baseline Fly Ash and the Fly Ash with Enhanced Hg Control. 5th and 95th percentiles of mercury concentrations observed in typical combustion waste landfill leachate are shown for comparison.

Mercury Release as a Function of LS Ratio

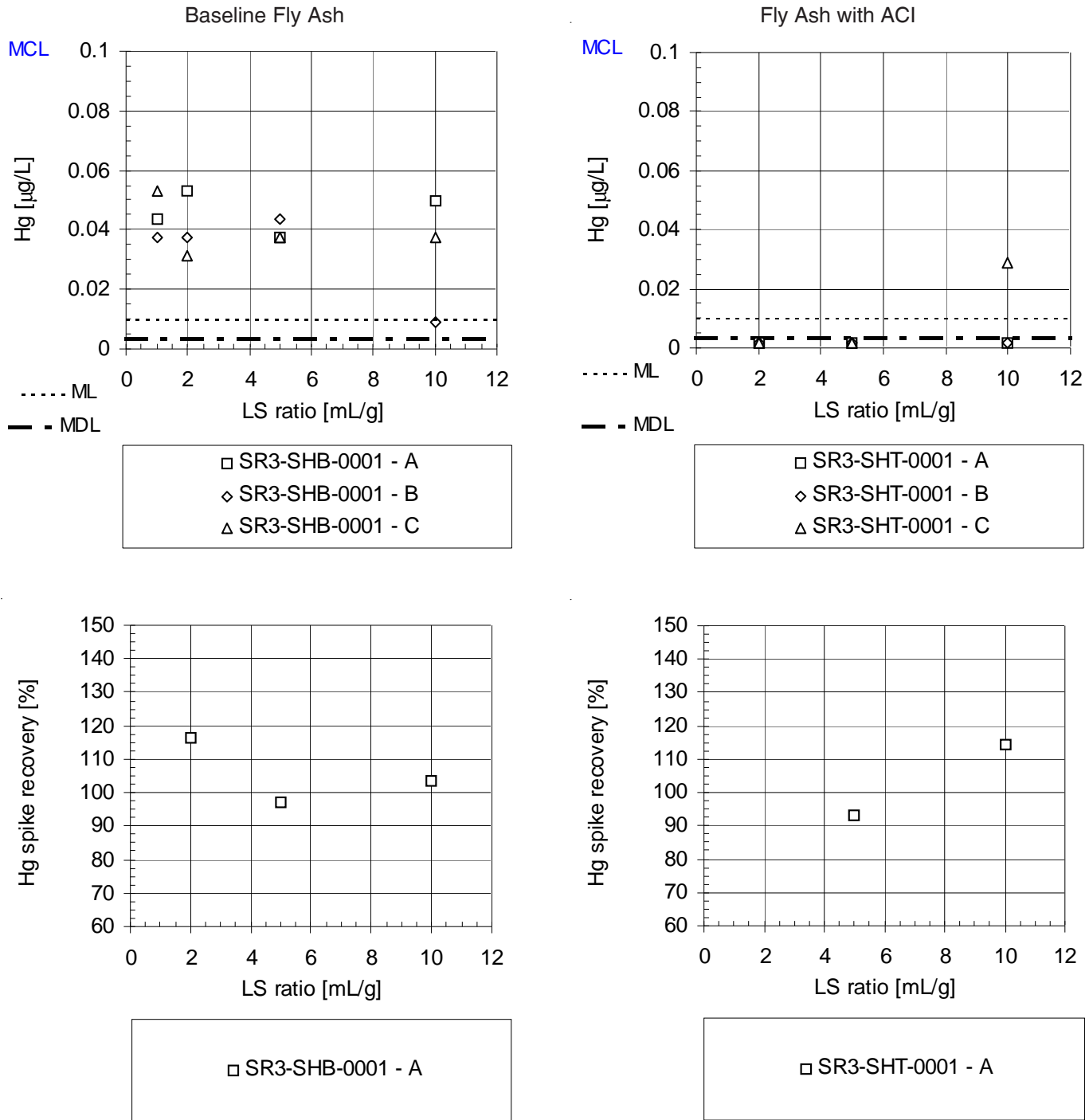
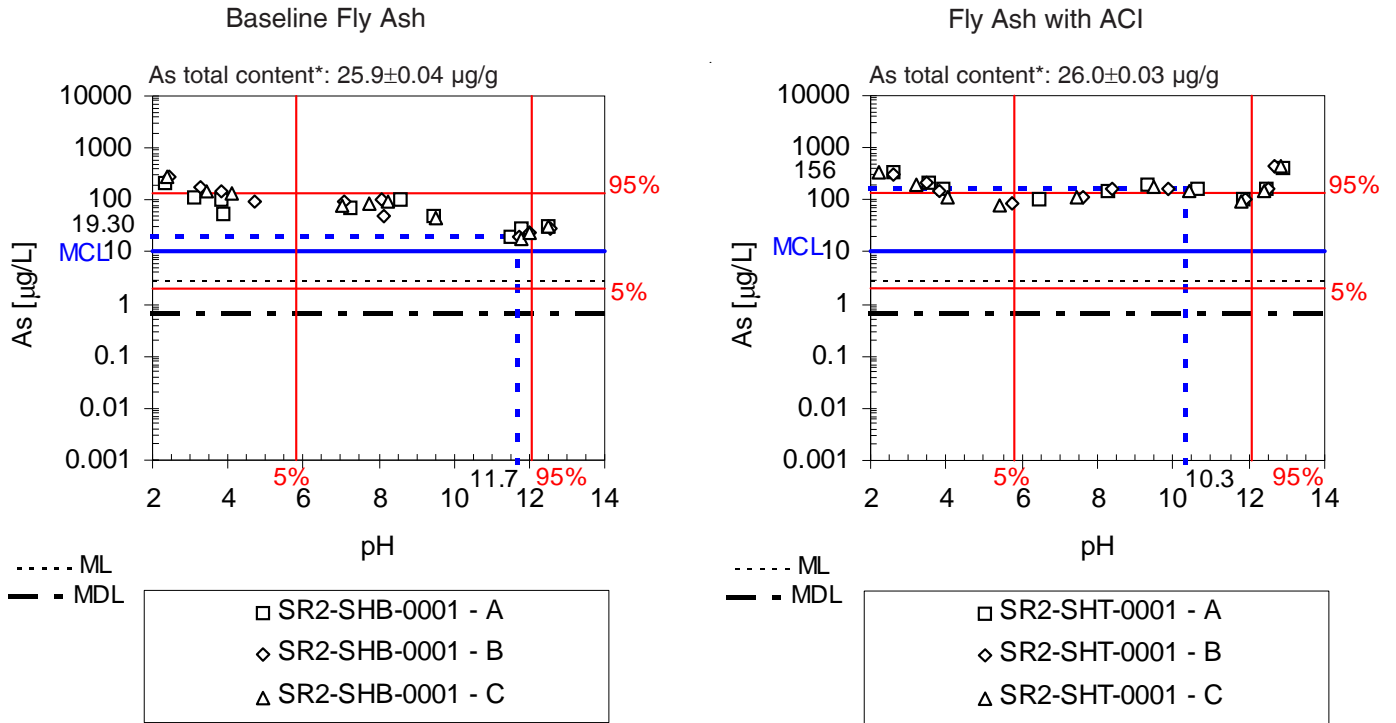

Figure F-4. Mercury Release (top) and Spike Recoveries (bottom) as a Function of LS Ratio for the Baseline Fly Ash and the Fly Ash with Enhanced Hg Control.

Arsenic Release as a Function of pH



*Total content as determined by digestion using method 3052.

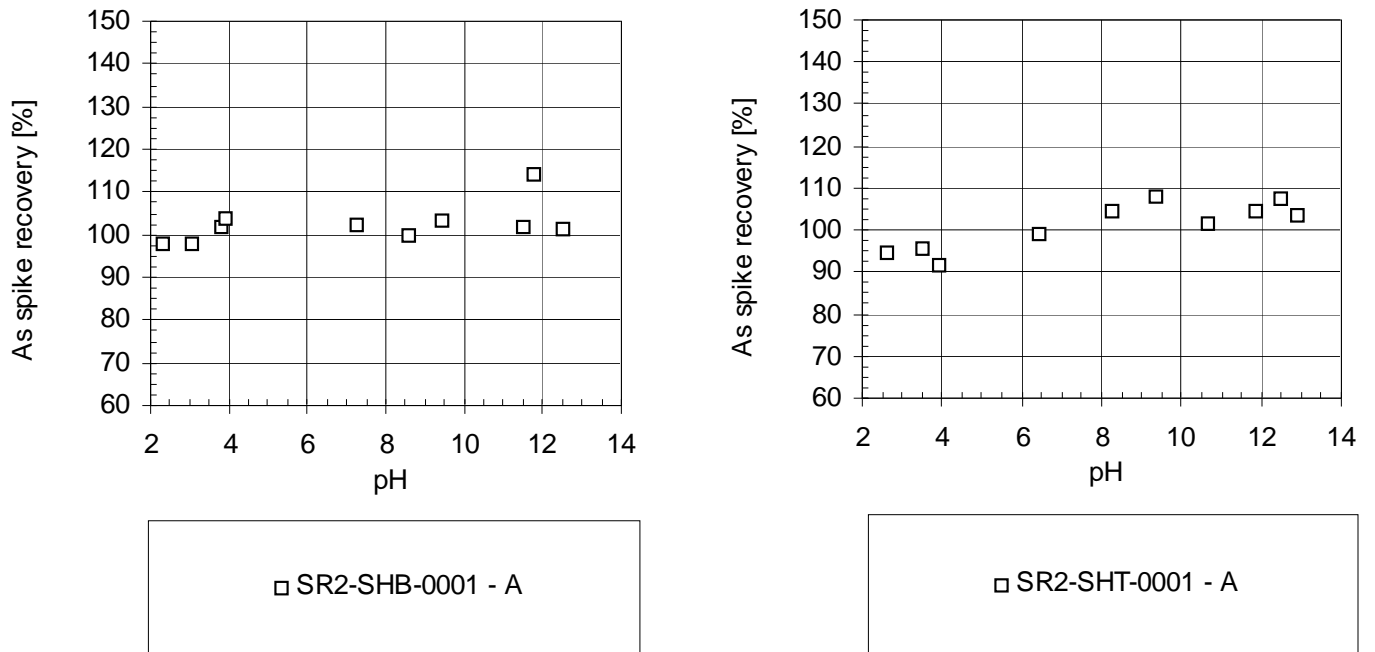

Figure F-5. Arsenic Release (top) and Spike Recoveries (bottom) as a Function of pH for the Baseline Fly Ash and the Fly Ash with Enhanced Hg Control. 5th and 95th percentiles of arsenic concentrations observed in typical combustion waste landfill leachate are shown for comparison.

Arsenic Release as a Function of LS Ratio

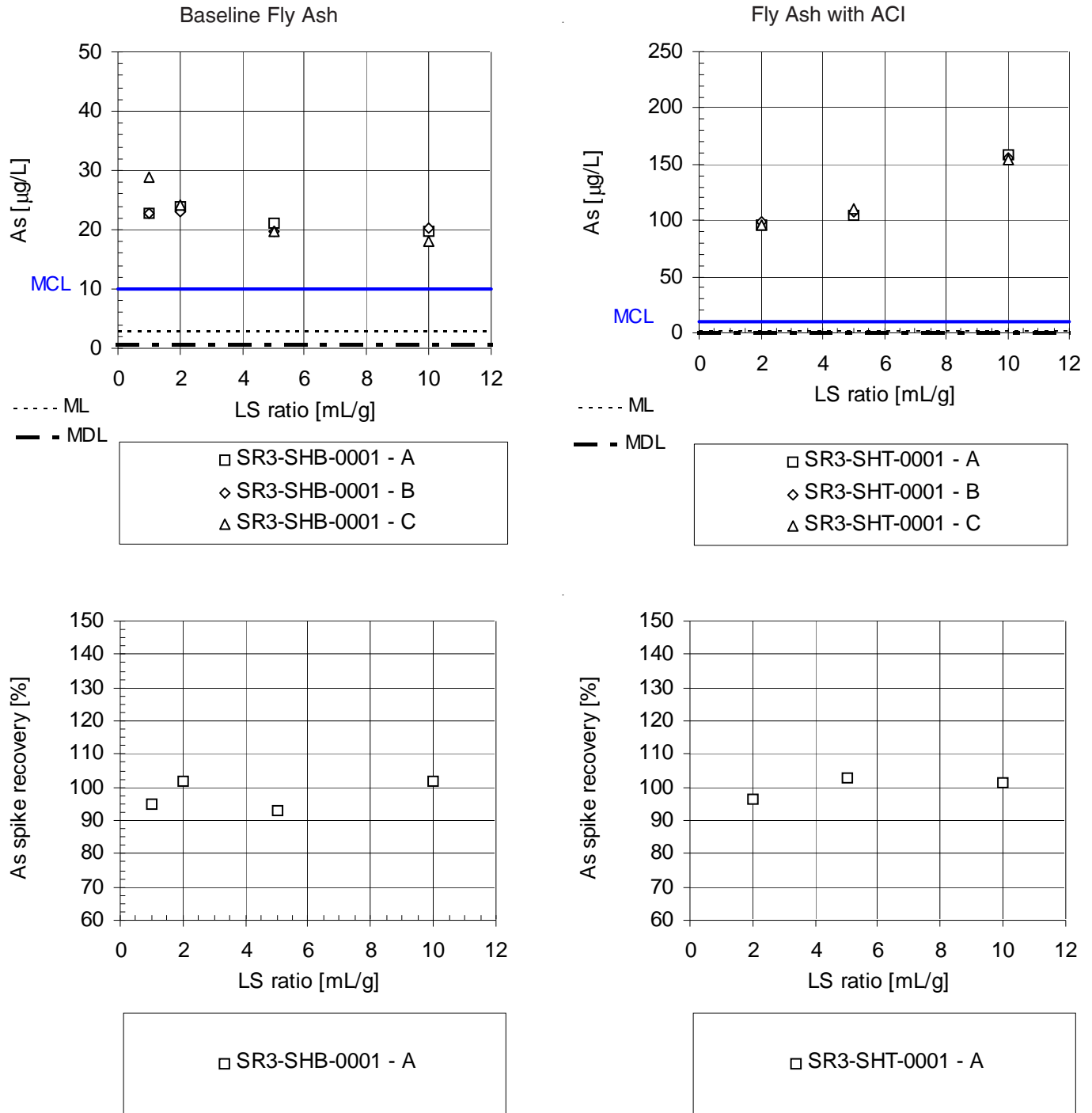
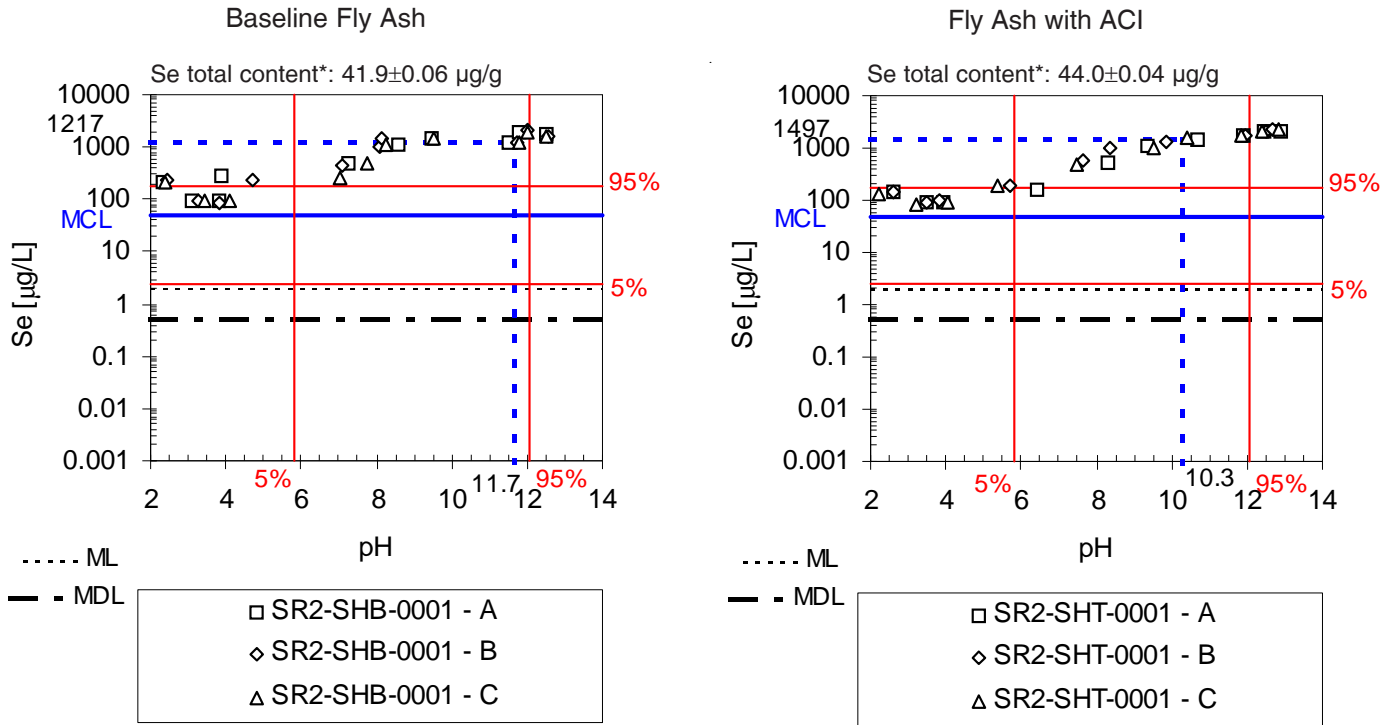

Figure F-6. Arsenic Release (top) and Spike Recoveries (bottom) as a Function of LS Ratio for the Baseline Fly Ash and the Fly Ash with Enhanced Hg Control.

Selenium Release as a Function of pH



*Total content as determined by digestion using method 3052.

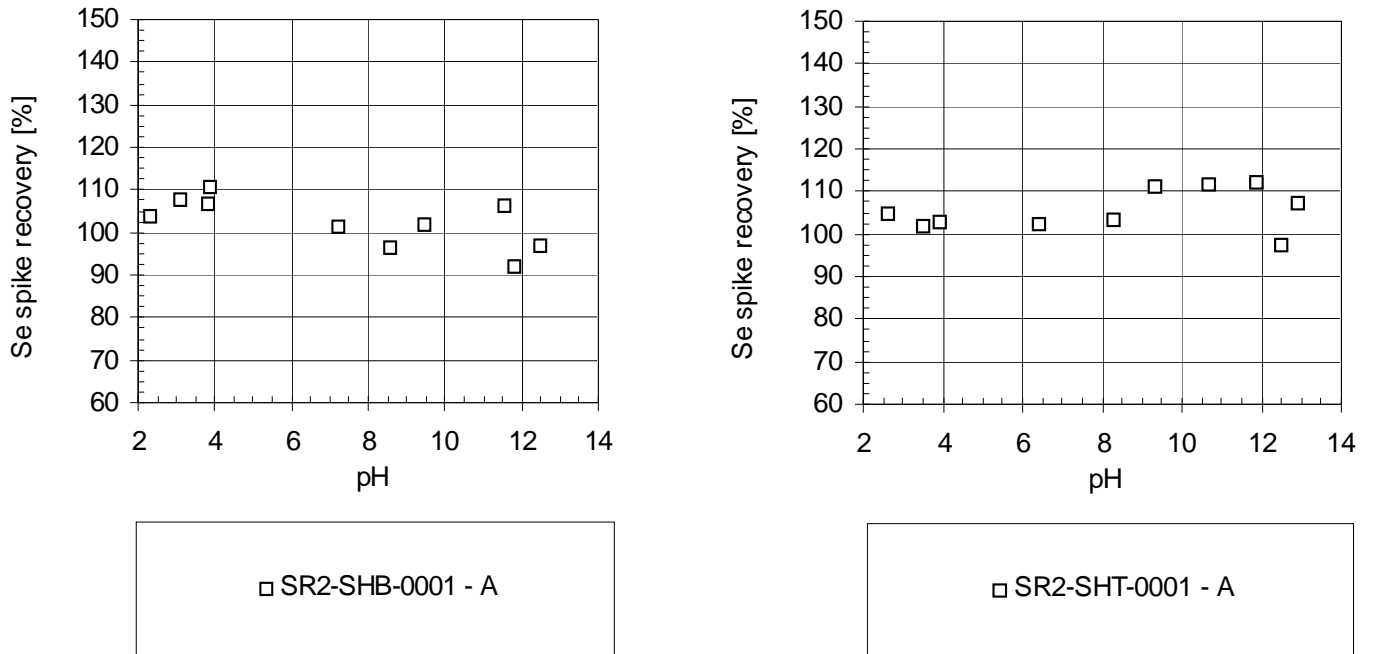

Figure F-7. Selenium Release (top) and Spike Recoveries (bottom) as a Function of pH for the Baseline Fly Ash and the Fly Ash with Enhanced Hg Control. 5th and 95th percentiles of selenium concentrations observed in typical combustion waste landfill leachate are shown for comparison.

Selenium Release as a Function of LS Ratio

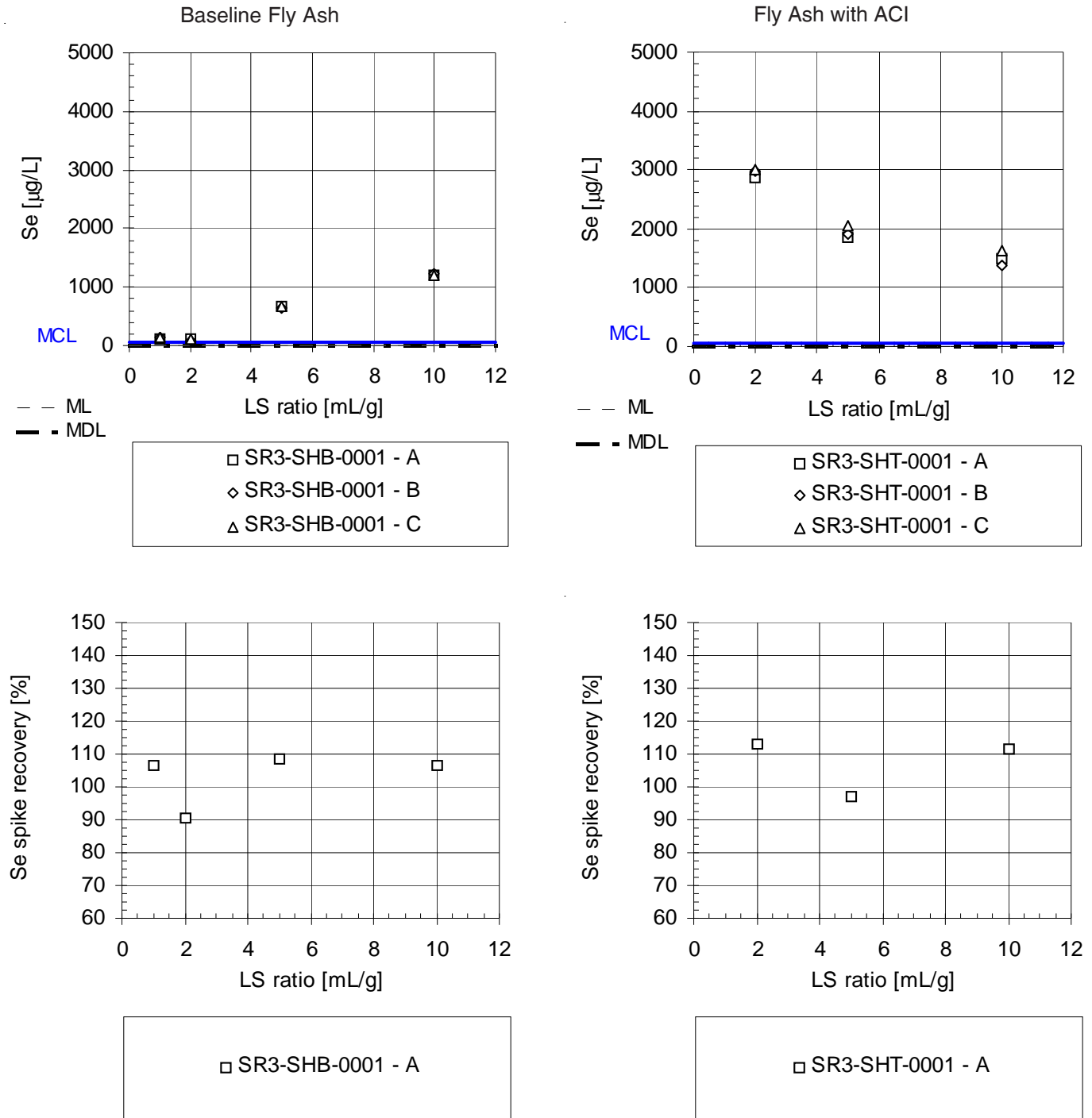
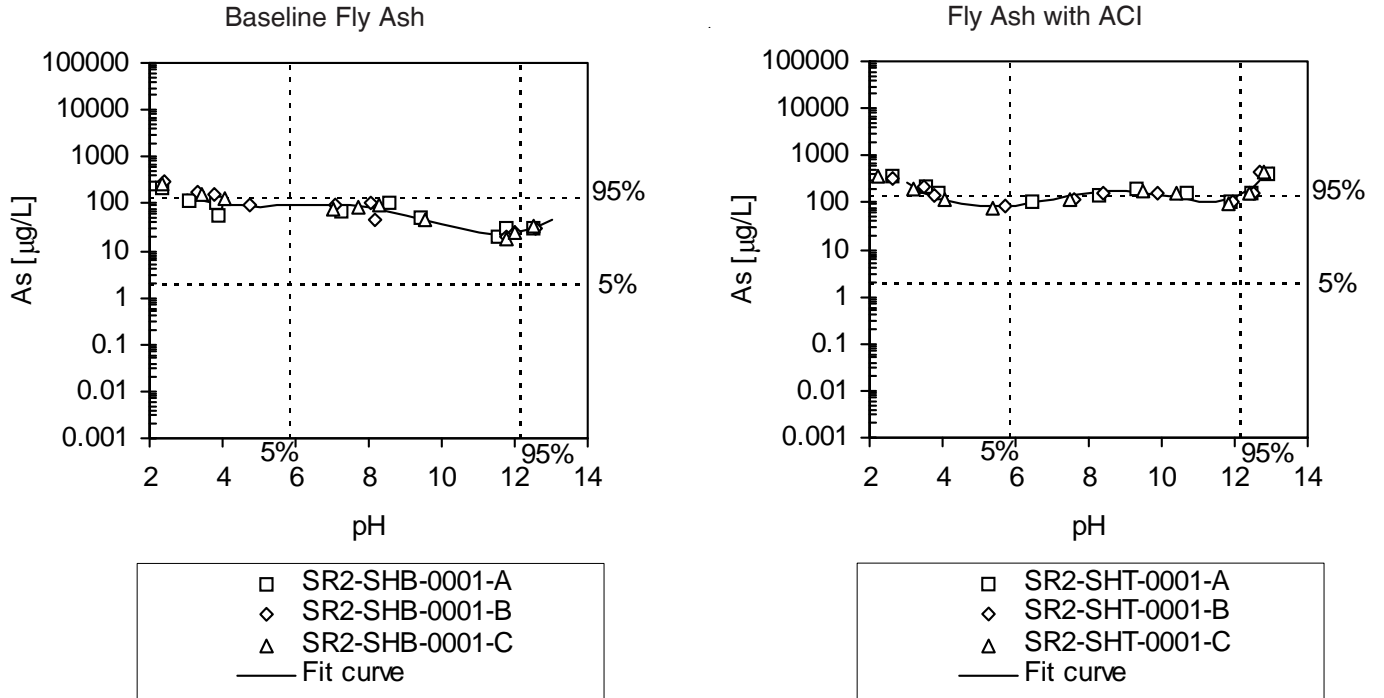

Figure F-8. Selenium Release (top) and Spike Recoveries (bottom) as a Function of LS Ratio for the Baseline Fly Ash and the Fly Ash with Enhanced Hg Control.

Arsenic Solubility



Material	log As ($\mu\text{g/L}$)			pH range of validity	R^2	Number of points
SHB	0.0000 pH^5	0.0011 pH^4	-0.0428 pH^3	3-12.5	0.96	33
	0.4859 pH^2	-2.2393 pH	5.6031			
SHT	0.0003 pH^5	-0.0106 pH^4	0.1194 pH^3	3-13	0.92	33
	-0.5142 pH^2	0.4220 pH	3.3432			

Figure F-9. Regression Curves of Experimental Data of Arsenic Solubility as a Function of pH.

Selenium Solubility

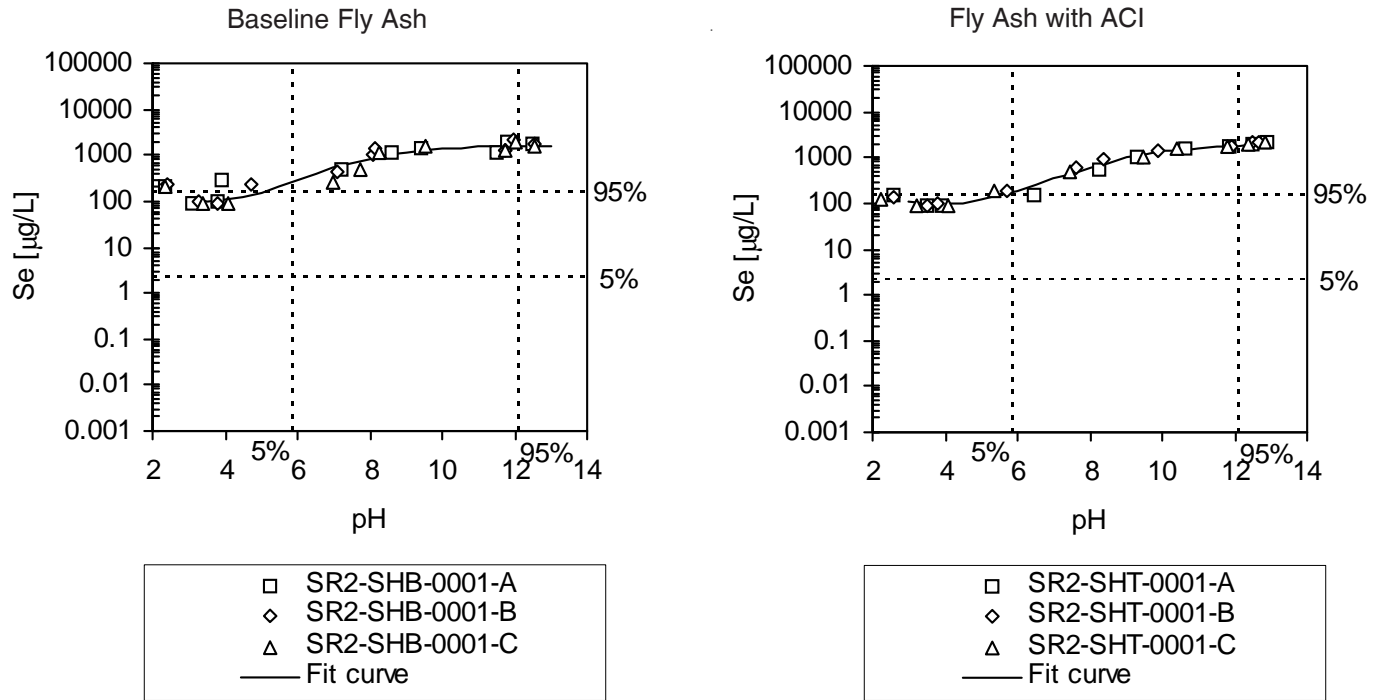

Material	log Se ($\mu\text{g/L}$)			pH range of validity	R^2	Number of points
SHB	-0.0001 pH^5	0.0061 pH^4	-0.1107 pH^3	3-12.5	0.93	33
	0.9490 pH^2	-3.5922 pH	6.8613			
SHT	0.0001 pH^5	-0.0020 pH^4	0.0141 pH^3	3-13	0.98	33
	0.0589 pH^2	-0.6849 pH	3.3216			

Figure F10. Regression Curves of Experimental Data of Selenium Solubility as a Function of pH.

100-Year Arsenic Release Estimates

Arsenic

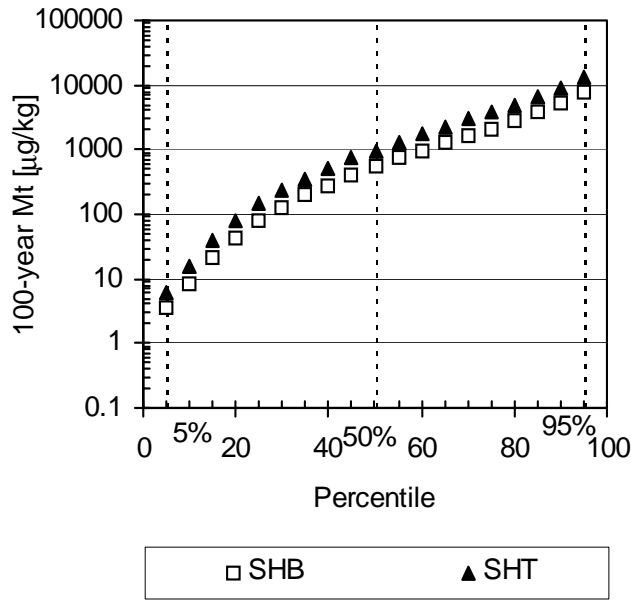

	SHB		SHT	
	µg/kg	%	µg/kg	%
Mt min	0.8	0.003	2.7	0.01
Mt - 5%	3.6	0.014	6.1	0.02
Mt - 50%	546	2.1	968	3.7
Mt - 95%	7922	30.6	13374	51.4
Mean Mt	1749	6.8	3013	11.6
Mt max	18969	73.2	26000	100.0

Figure F-11. 100-Year Arsenic Release Estimates as a Function of the Cumulative Probability for the Scenario of Disposal in a Combustion Waste Landfill.

100-Year Selenium Release Estimates

Selenium

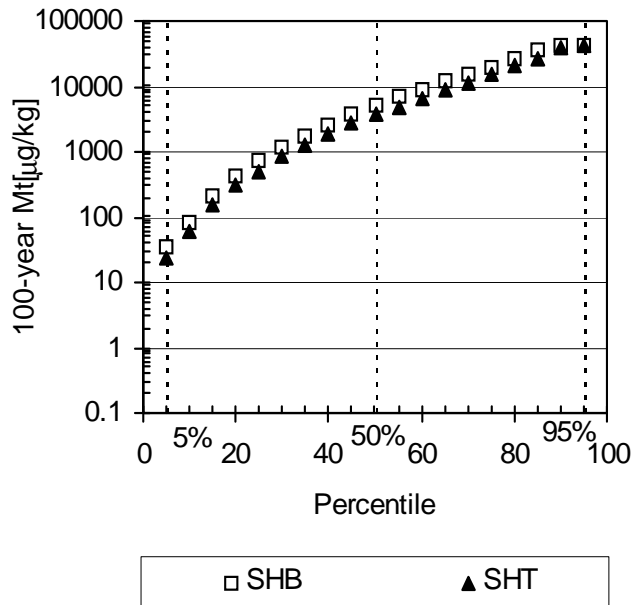

	SHB		SHT	
	µg/kg	%	µg/kg	%
Mt min	6.6	0.02	4.7	0.01
Mt - 5%	34.5	0.08	24.3	0.06
Mt - 50%	5011	12.0	3650	8.3
Mt - 95%	41900	100.0	44000	100.0
Mean Mt	17623	42.1	14240	32.4
Mt max	41900	100.0	44000	100.0

Figure F-12. 100-Year Selenium Release Estimates as a Function of the Cumulative Probability for the Scenario of Disposal in a Combustion Waste Landfill.

100-Year Arsenic Release Estimates

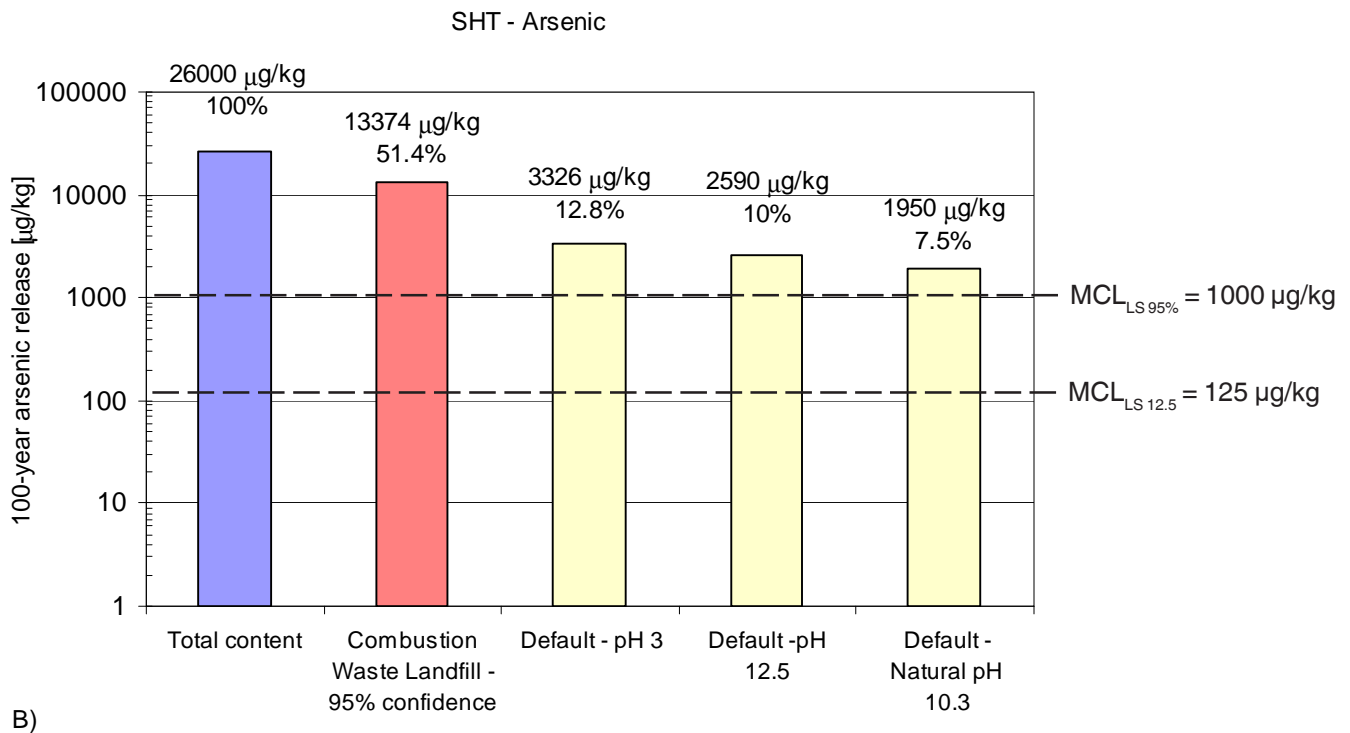
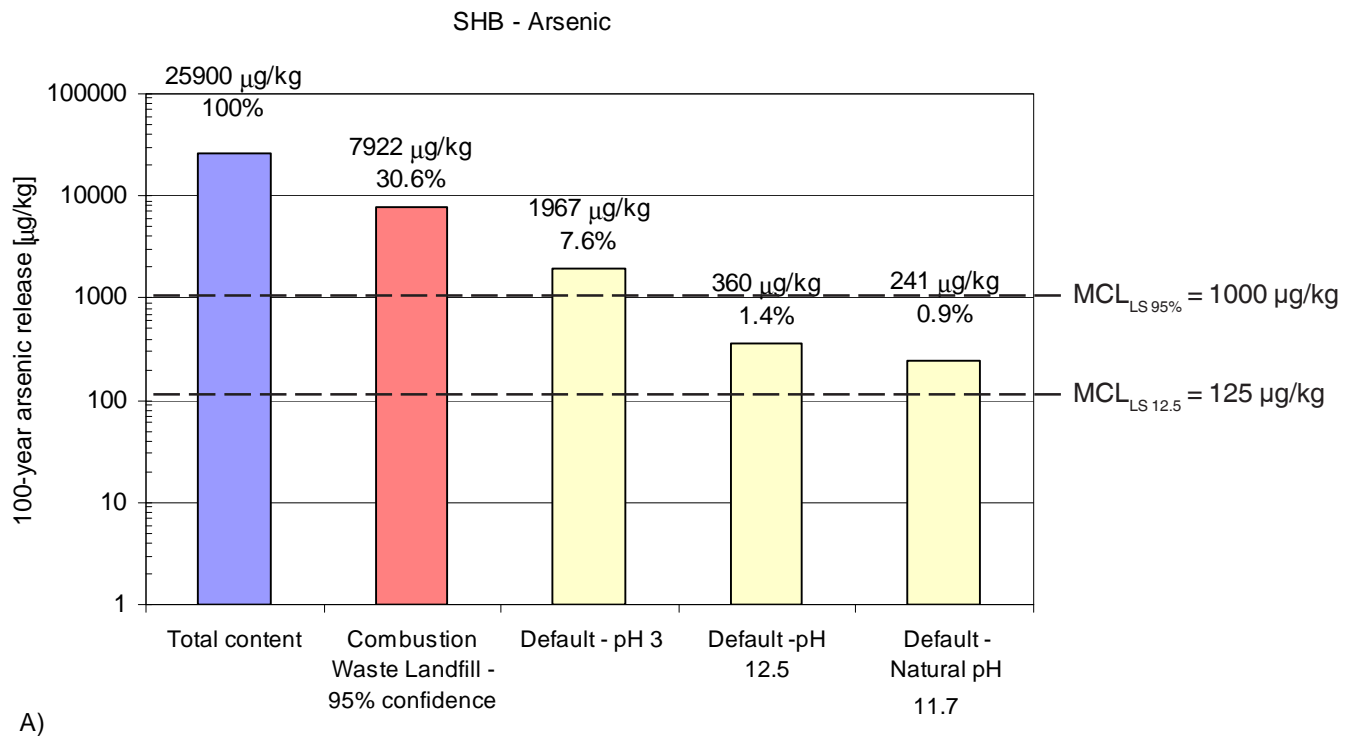

Figure F-13. 100-Year Arsenic Release Estimates from A) Baseline Fly Ash and B) Fly Ash with ACI. Release estimates for percolation controlled scenario are compared to release estimate based on total content. The amount of the arsenic that would be released if the release concentration was at the MCL is also shown for comparison ($LS_{\text{default scenario}} = 12.5 \text{ L/kg}$ and $LS_{95\%} = 100 \text{ L/kg}$).

100-Year Selenium Release Estimates

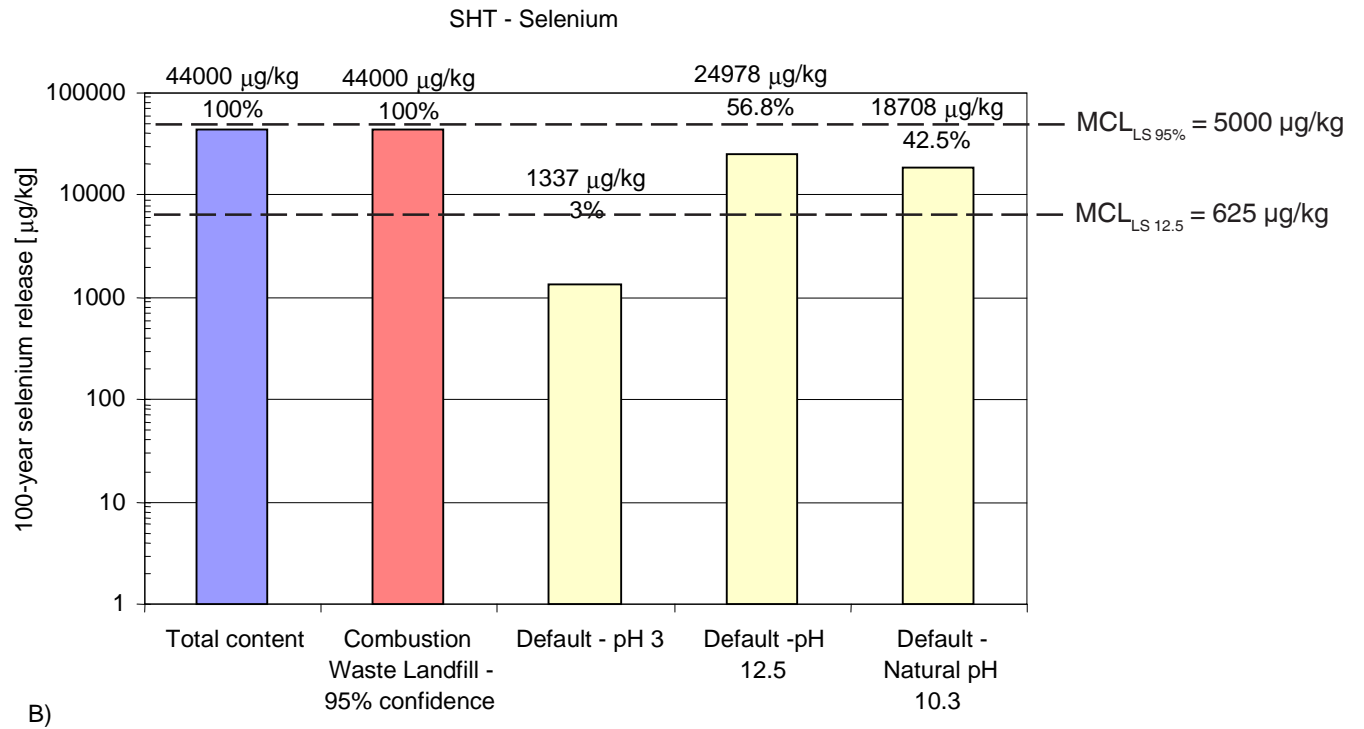
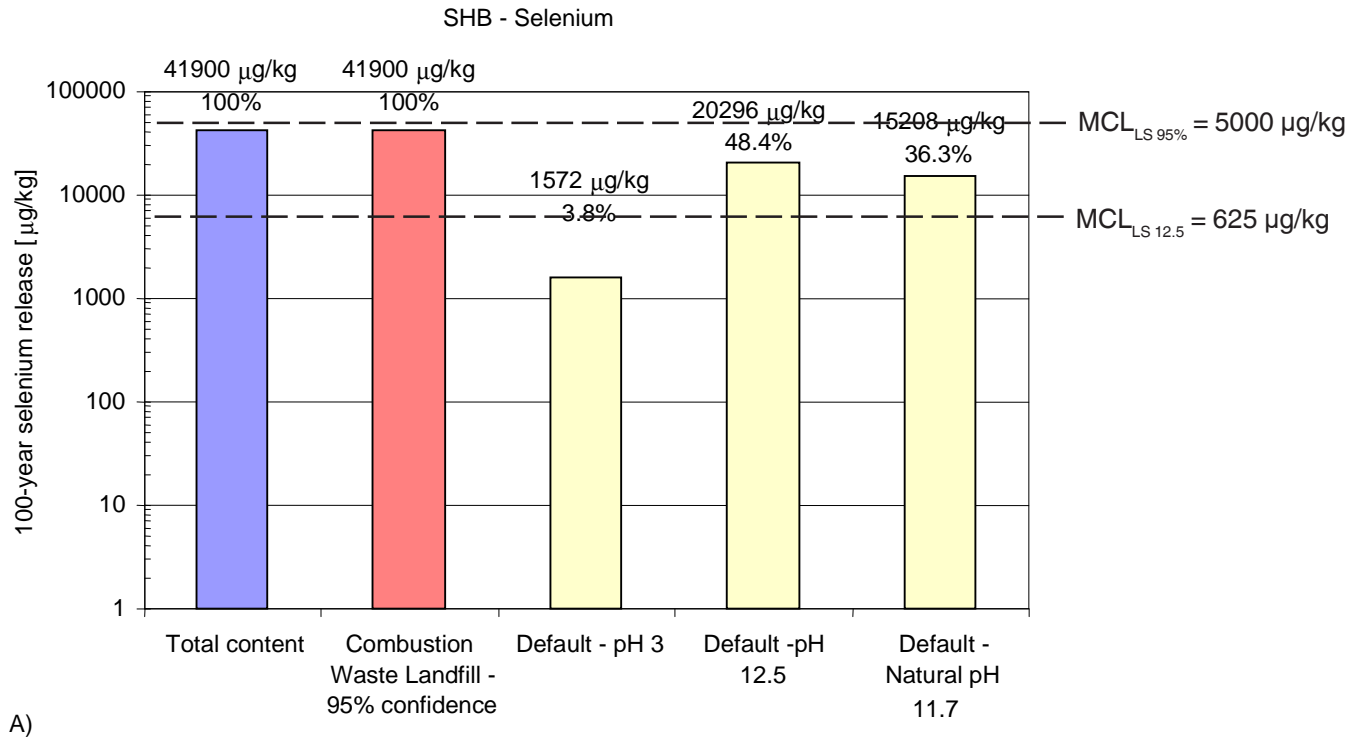

Figure F-14. 100-year Selenium Release Estimates from A) Baseline Fly Ash and B) Fly Ash with ACI. Release estimates for percolation controlled scenario are compared to release estimate based on total content. The amount of the selenium that would be released if the release concentration was at the MCL is also shown for comparison ($LS_{\text{default scenario}} = 12.5 \text{ L/kg}$ and $LS_{95\%} = 100 \text{ L/kg}$).

Comments

Figure F-3:

- The fly ash from the test case had similar total Hg content to that from the baseline case.
- Hg release is greater in baseline than test case, but both were below MCL.

Figure F-5:

- The fly ash from the test case had similar total As content than that from the baseline case.
- The laboratory measurements fit within the 5–95% confidence intervals of the field observations.
- Arsenic release is less in baseline than test case, but both are about 10 times greater than the MCL. Arsenic release at pH higher than 9 is much greater for the test case than the baseline case.

Figure F-6:

- Initial landfill leachate As concentrations will likely be about 20–30 µg/L for the baseline case but at least 100 µg/L for the test case.

Figure F-7:

- The fly ash from the test case had similar total Se content to that from the baseline case.
- Se release is similar in baseline and test cases, but significantly above MCL for both cases. The observed concentrations are greater than reported in the EPA database but consistent with the EPRI database.

Figure F-8:

- Initial landfill leachate Se concentrations are expected to be around 200 µg/L for the baseline case and increasing with increasing LS ratio, but the initial con-

centrations for the test case are expected to be around 3000 µg/L and decreasing with increasing LS ratio.

Figures F-11 and F-12:

- The fly ash from the test case would result in As release greater than expected from the baseline case, with a 95% probability to be less than 13,375 and 7,925 µg/kg, respectively.
- The fly ash from the test case would result in Se release less than expected from the baseline case. At the 95th percentile the total content of Se will be released (41,900 and 44,000 µg/kg, respectively, for the baseline case and the test case).
- 10–100% of the Se can be anticipated to be leached from the fly ash for both cases under the projected landfill conditions.

Figure-13:

- Greater As release would be expected for the test case compared to the baseline case, for all scenarios examined.
- For all scenarios examined, Arsenic release from the test case fly ash would be greater than the amount that would be released if the release concentration was at the MCL.

Figure F-14:

- At the 95th percentile, Se release estimate exceeds total content for both the baseline and the test cases. This is not physically possible. However, this result indicates that there is 5% possibility that 100% of the total Se content would be released.
- For all scenarios examined, Se release would most likely be greater than the amount that would be released if the release concentration was at the MCL.

Appendix G

Facility C Fly Ashes

List of Figures

Figure	Page
G-1 pH Titration Curves for the Baseline Fly Ash and the Fly Ash with Enhanced Hg Control	163
G-2 pH as a Function of LS Ratio for the Baseline Fly Ash and the Fly Ash with Enhanced Hg Control	163
G-3 Mercury Release (top) and Spike Recoveries (bottom) as a Function of pH for the Baseline Fly Ash and the Fly Ash with Enhanced Hg Control	164
G-4 Mercury Release (top) and Spike Recoveries (bottom) as a Function of LS Ratio for the Baseline Fly Ash and the Fly Ash with Enhanced Hg Control	165
G-5 Arsenic Release (top) and Spike Recoveries (bottom) as a Function of pH for the Baseline Fly Ash and the Fly Ash with Enhanced Hg Control	166
G-6 Arsenic Release (top) and Spike Recoveries (bottom) as a Function of LS Ratio for the Baseline Fly Ash and the Fly Ash with Enhanced Hg Control	167
G-7 Selenium Release (top) and Spike Recoveries (bottom) as a Function of pH for the Baseline Fly Ash and the Fly Ash with Enhanced Hg Control	168
G-8 Selenium Release (top) and Spike Recoveries (bottom) as a Function of LS Ratio for the Baseline Fly Ash and the Fly Ash with Enhanced Hg Control	169
G-9 Regression Curves of Experimental Data of Arsenic Solubility as a Function of pH.	170
G-10 Regression Curves of Experimental Data of Selenium Solubility as a Function of pH	171
G-11 100-Year Arsenic Release Estimates as a Function of the Cumulative Probability for the Scenario of Disposal in a Combustion Waste Landfill	172
G-12 100-Year Selenium Release Estimates as a Function of the Cumulative Probability for the Scenario of Disposal in a Combustion Waste Landfill	172
G-13 100-Year Arsenic Release Estimates from A) Baseline Fly Ash and B) Fly Ash with ACI	173
G-14 100-year Selenium Release Estimates from A) Baseline Fly Ash and B) Fly Ash with ACI	174

Mercury Release as a Function of pH

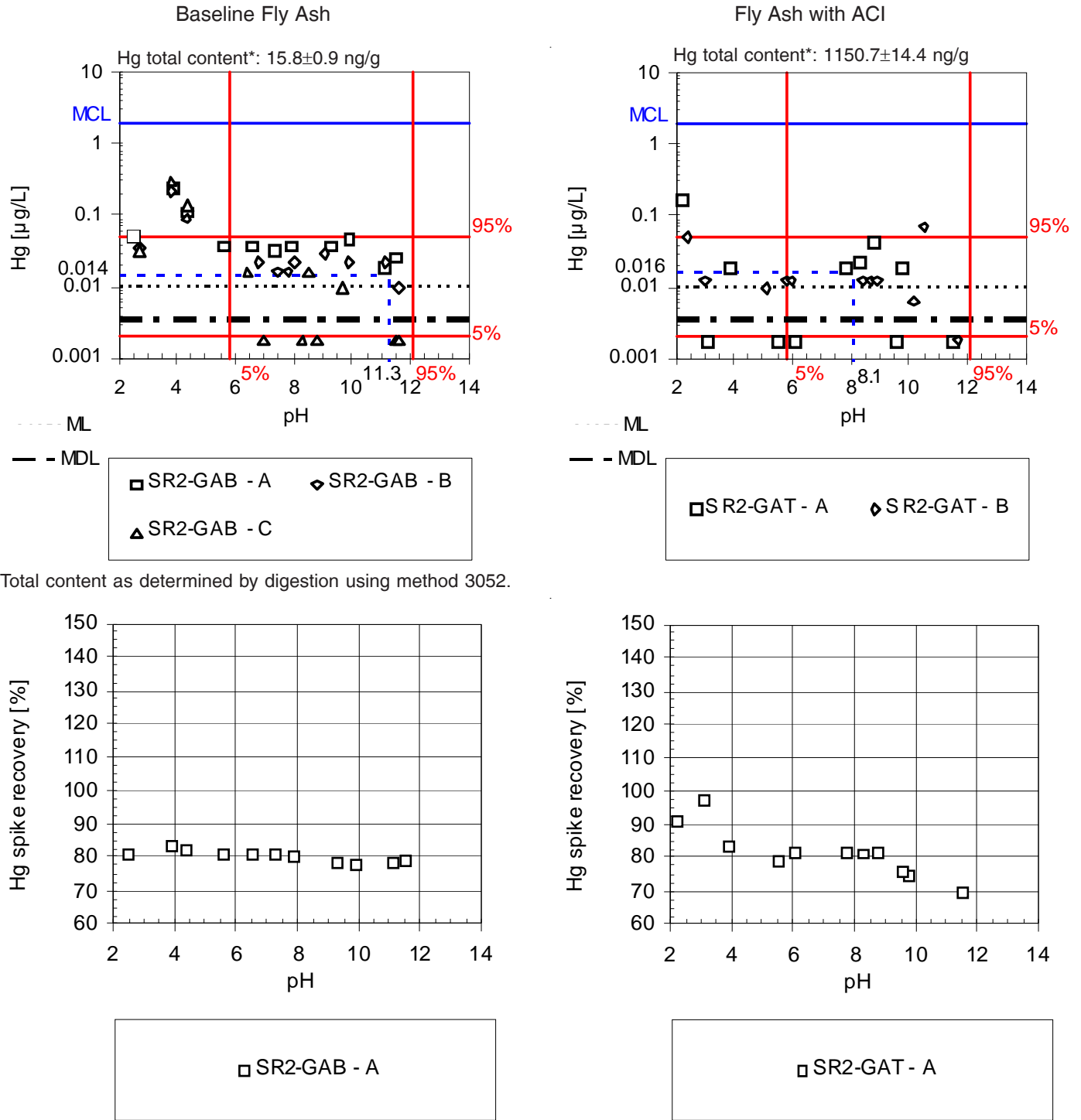

Figure G-3. Mercury Release (top) and Spike Recoveries (bottom) as a Function of pH for the Baseline Fly Ash and the Fly Ash with Enhanced Hg Control. 5th and 95th percentiles of mercury concentrations observed in typical combustion waste landfill leachate are shown for comparison.

Mercury Release as a Function of LS Ratio

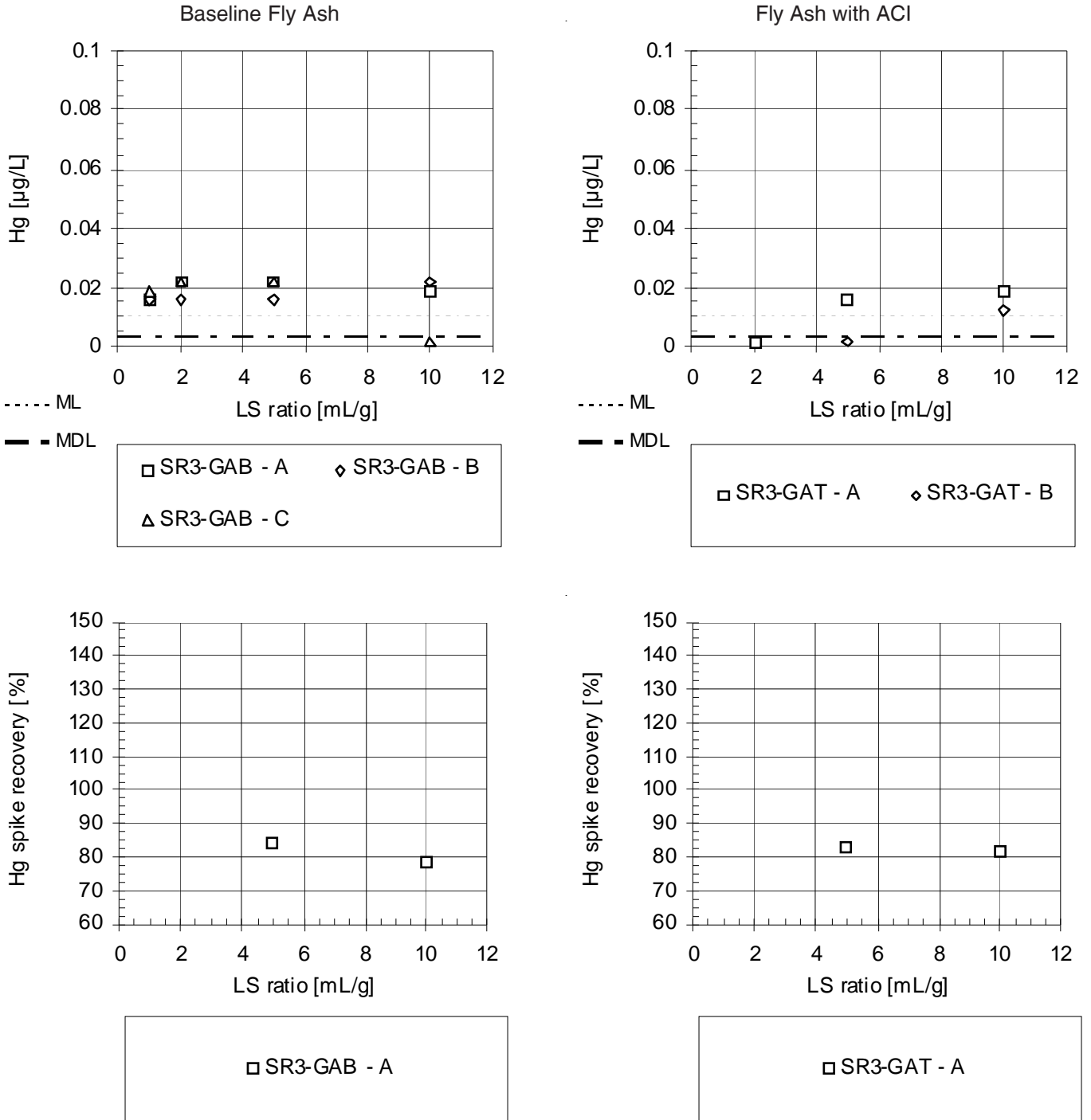
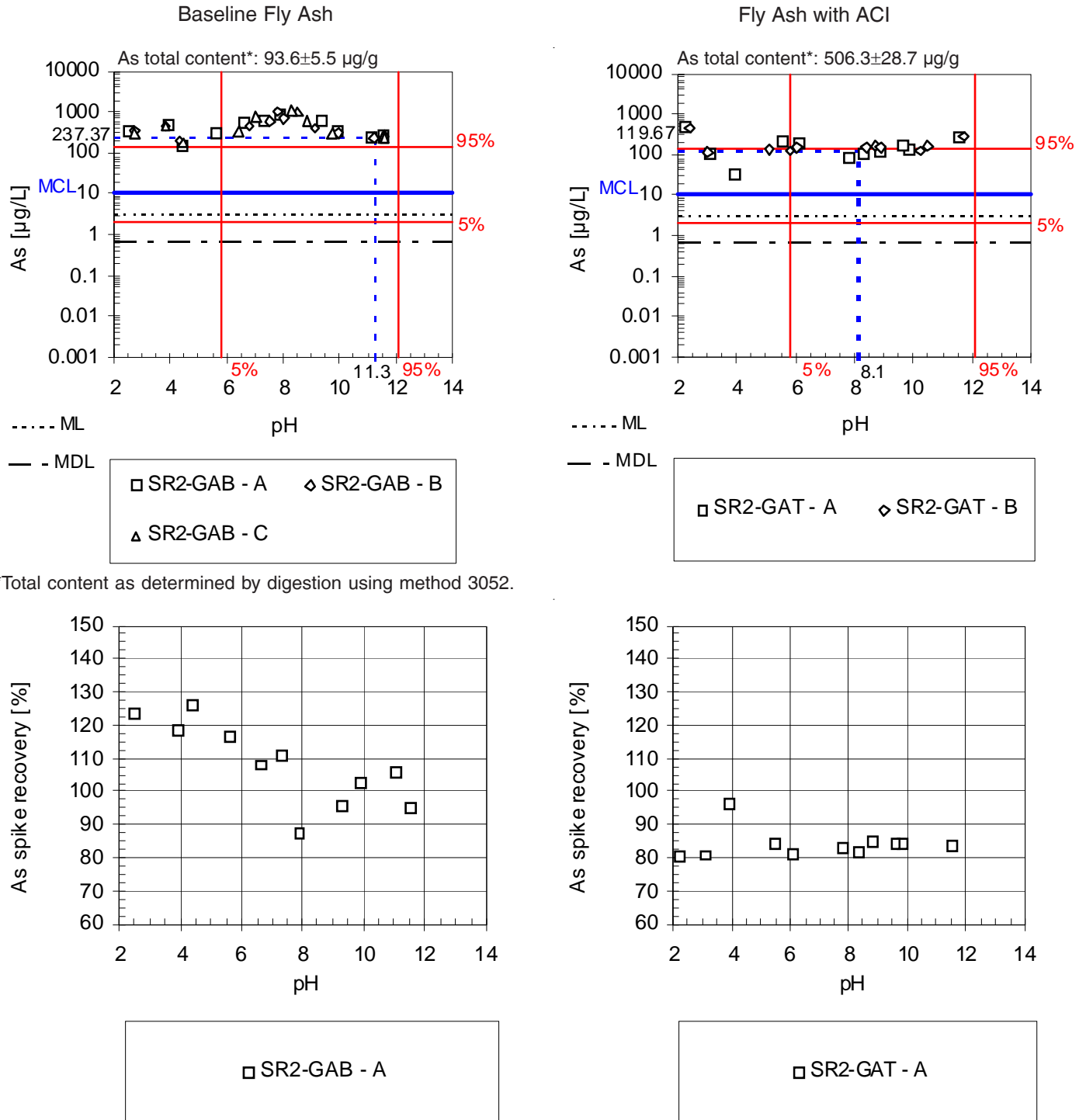

Figure G-4. Mercury Release (top) and Spike Recoveries (bottom) as a Function of LS Ratio for the Baseline Fly Ash and the Fly Ash with Enhanced Hg Control.

Arsenic Release as a Function of pH



*Total content as determined by digestion using method 3052.

Figure G-5. Arsenic Release (top) and Spike Recoveries (bottom) as a Function of pH for the Baseline Fly Ash and the Fly Ash with Enhanced Hg Control. 5th and 95th percentiles of arsenic concentrations observed in typical combustion waste landfill leachate are shown for comparison.

Arsenic Release as a Function of LS Ratio

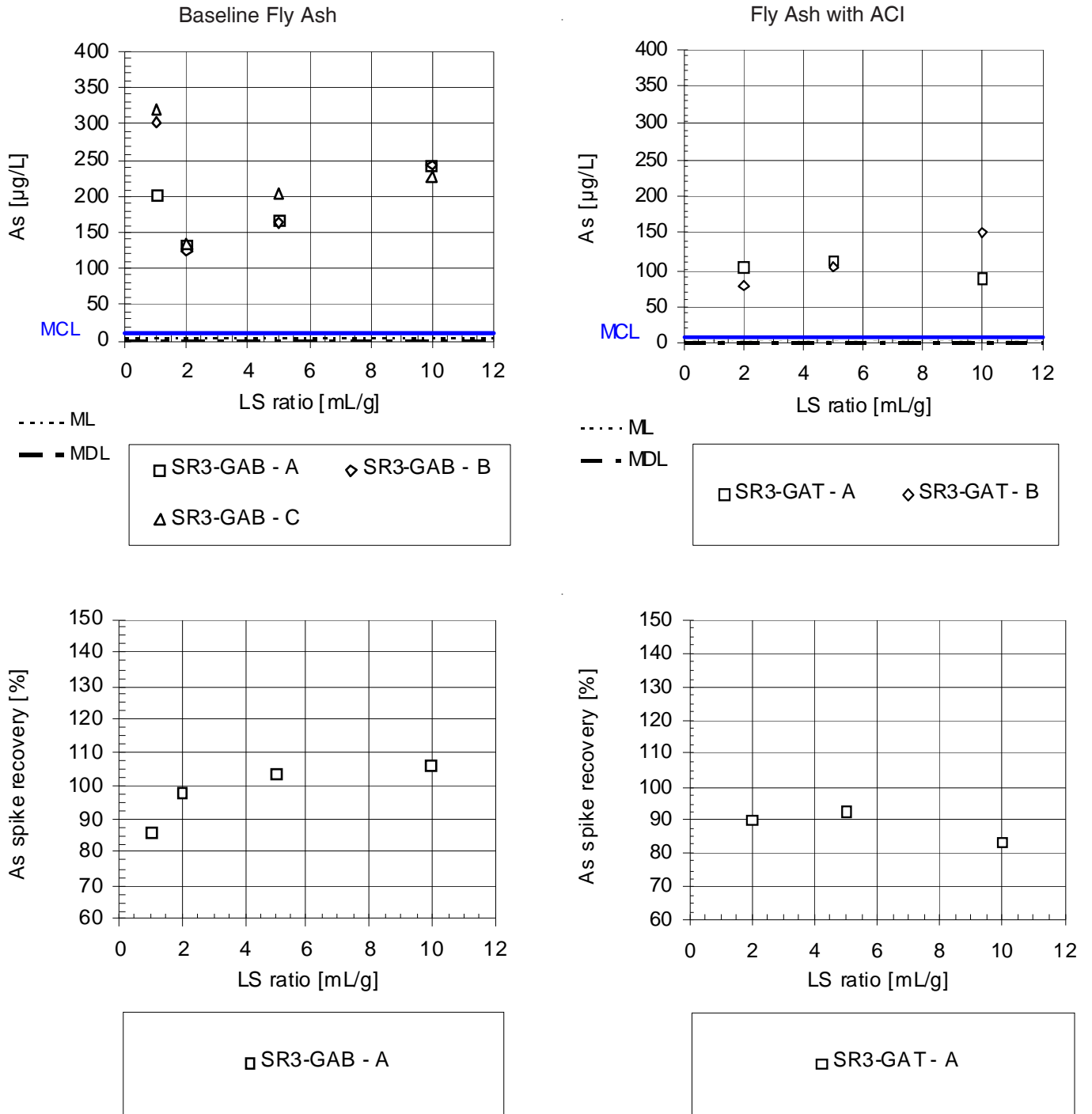
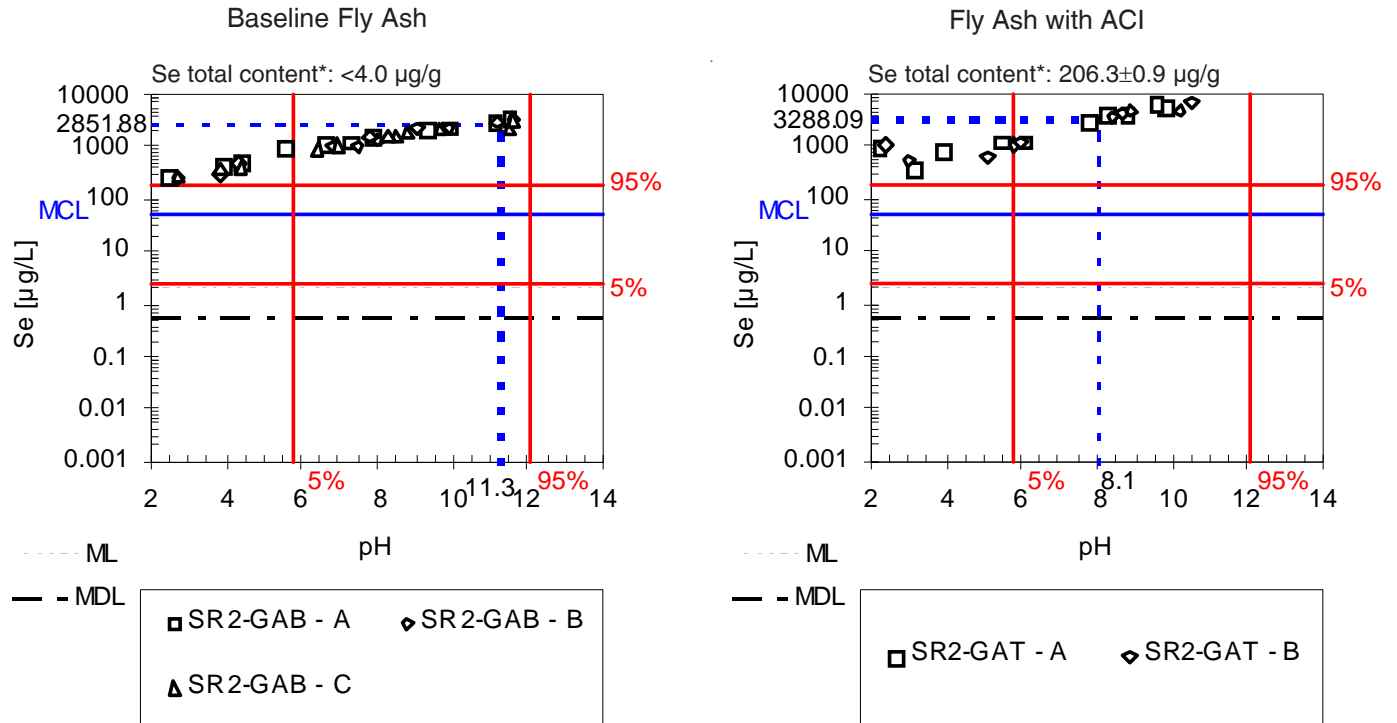

Figure G-6. Arsenic Release (top) and Spike Recoveries (bottom) as a Function of LS Ratio for the Baseline Fly Ash and the Fly Ash with Enhanced Hg Control.

Selenium Release as a Function of pH



*Total content as determined by digestion using method 3052.

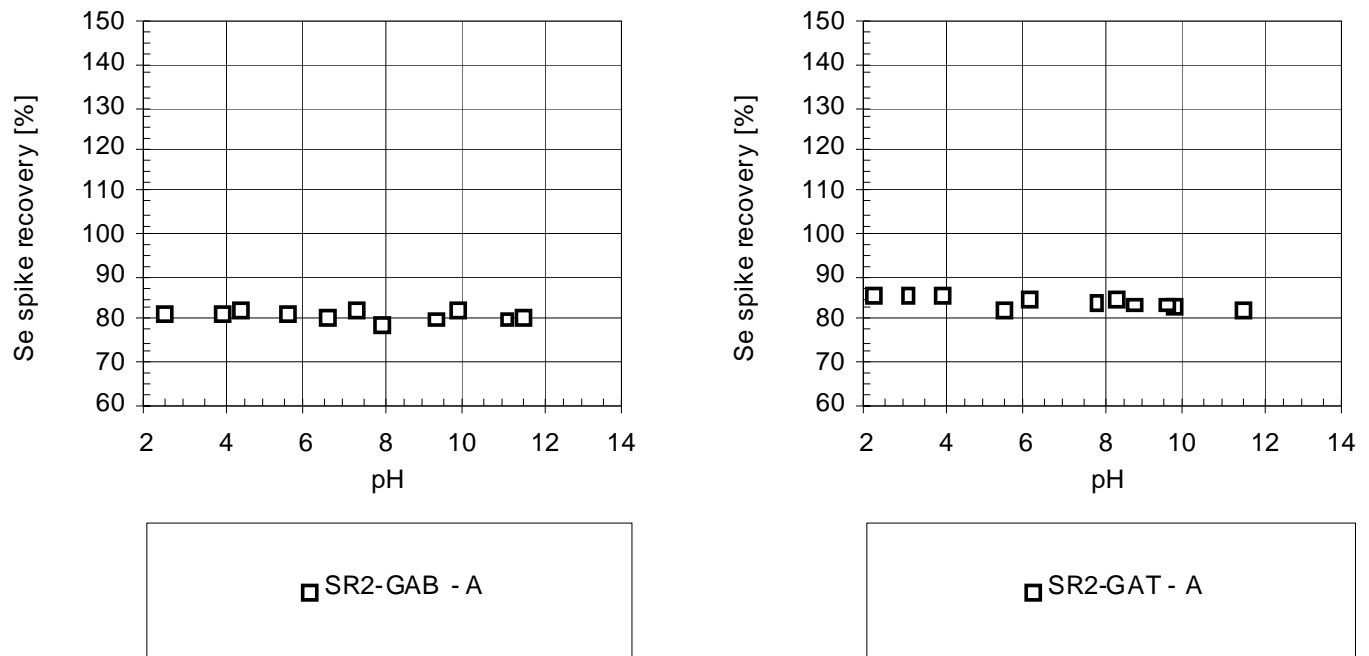

Figure G-7. Selenium Release (top) and Spike Recoveries (bottom) as a Function of pH for the Baseline Fly Ash and the Fly Ash with Enhanced Hg Control. 5th and 95th percentiles of selenium concentrations observed in typical combustion waste landfill leachate are shown for comparison.

Selenium Release as a Function of LS Ratio

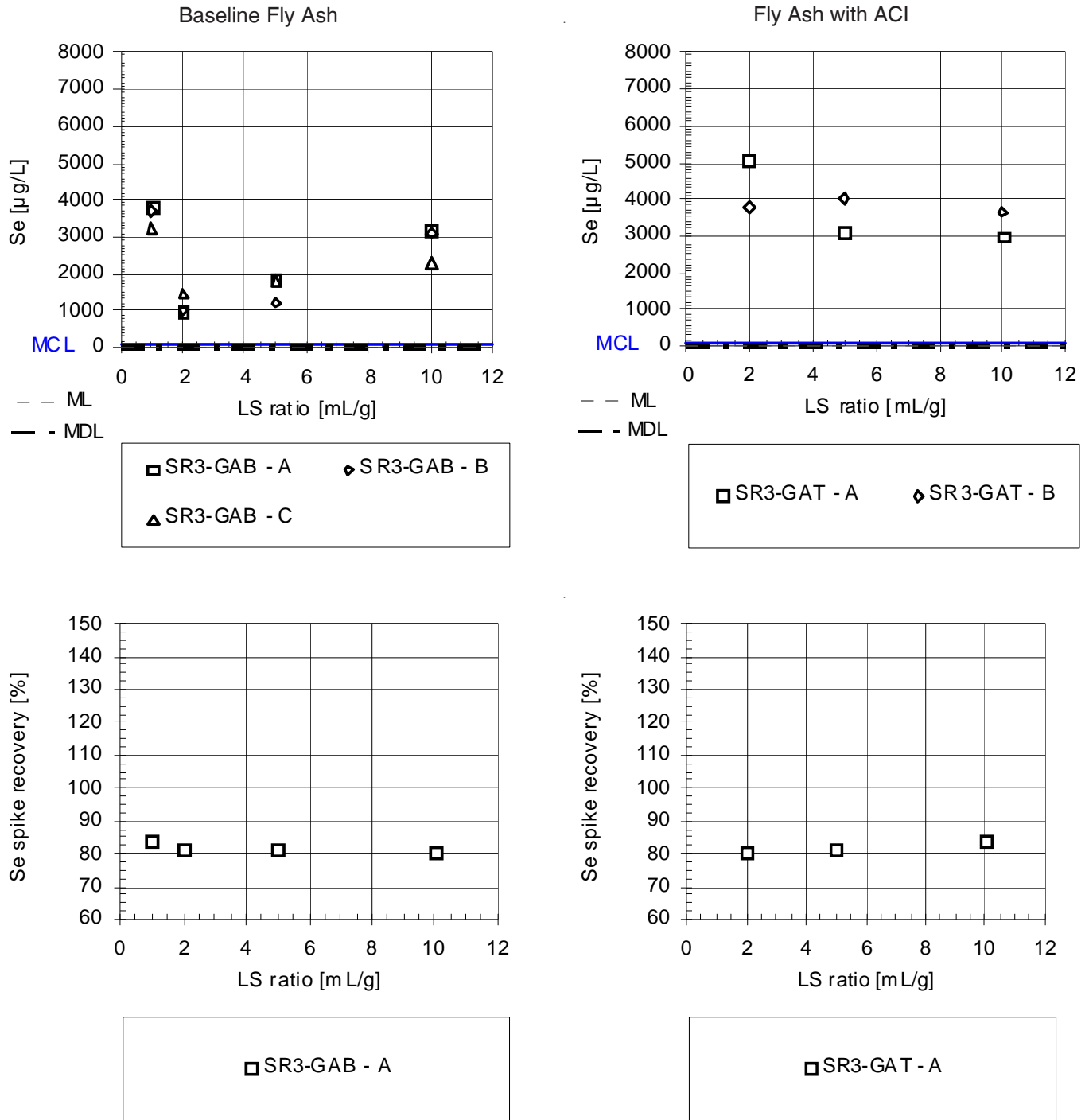
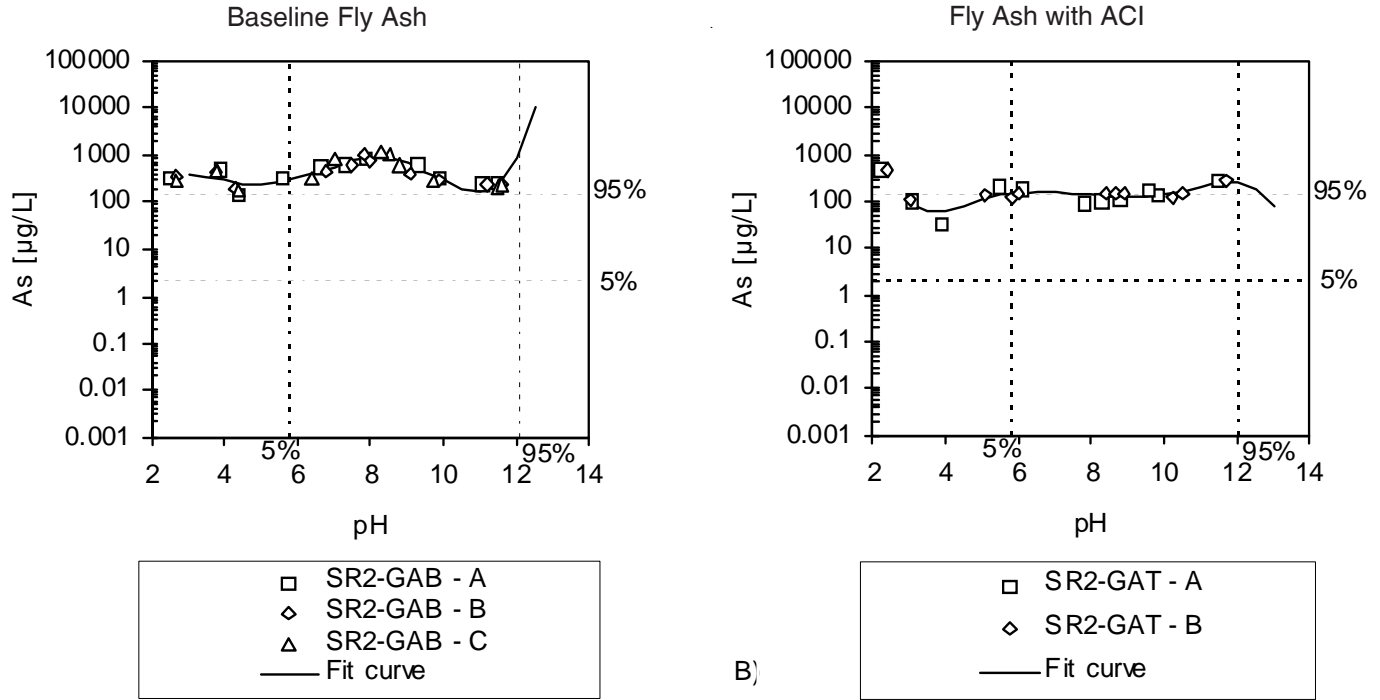

Figure G-8. Selenium Release (top) and Spike Recoveries (bottom) as a Function of LS Ratio for the Baseline Fly Ash and the Fly Ash with Enhanced Hg Control.

Arsenic Solubility



Material	log As (µg/L)			pH range of validity	R ²	Number of points
GAB	0.0012 pH ⁵	-0.0416 pH ⁴	0.5236 pH ³	3-12.5	0.78	33
GAT	-3.0400 pH ²	8.0912 pH	-5.3943	3-12.5	0.75	22
	-0.0008 pH ⁵	0.0304 pH ⁴	-0.4500 pH ³	3-12.5		
	3.1407 pH ²	-10.1848 pH	14.1412			

Figure G-9. Regression Curves of Experimental Data of Arsenic Solubility as a Function of pH.

Selenium Solubility

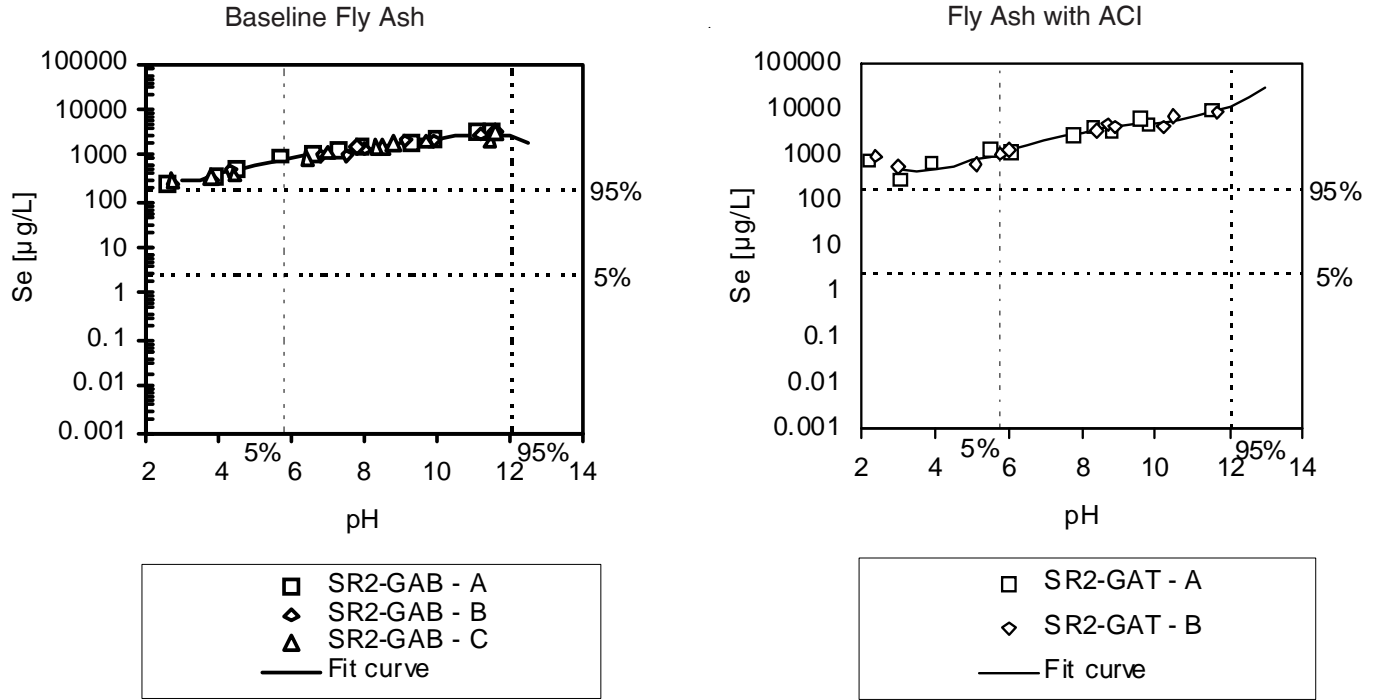

Material	log Se ($\mu\text{g/L}$)			pH range of validity	R^2	Number of points
GAB	-0.0003 pH^5	0.0092 pH^4	-0.1259 pH^3	3-12.5	0.98	33
	0.8035 pH^2	-2.2208 pH	4.5849			
GAT	-0.00002 pH^5	0.0021 pH^4	-0.0530 pH^3	3-12.5	0.96	22
	0.5431 pH^2	-2.2226 pH	5.8084			

Figure G-10. Regression Curves of Experimental Data of Selenium Solubility as a Function of pH.

100-Year Arsenic Release Estimates

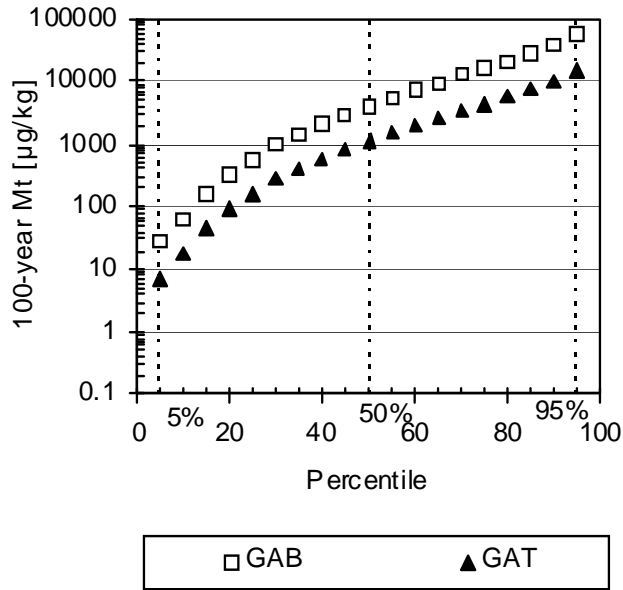

	GAB		GAT	
	µg/kg	%	µg/kg	%
Mt min	5.8	0.0062	4.1	0.0008
Mt - 5%	27.5	0.0294	7.0	0.0014
Mt - 50%	4086	4.4	1142	0.2
Mt - 95%	59706	63.8	15411	3.0
Mean Mt	13789	14.7	3485	0.7
Mt max	93600	100.0	48499	9.6

Figure G-11. 100-Year Arsenic Release Estimates as a Function of the Cumulative Probability for the Scenario of Disposal in a Combustion Waste Landfill.

100-Year Selenium Release Estimates

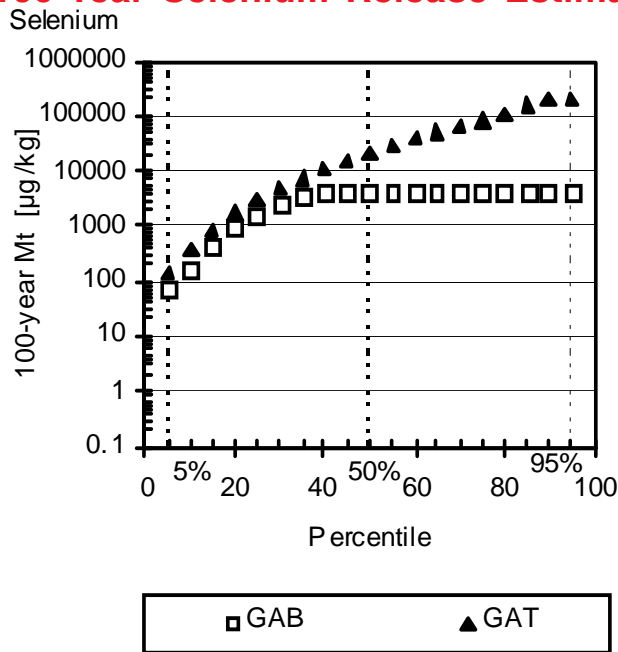

	GAB		GAT	
	µg/kg	%	µg/kg	%
Mt min	24.8	0.6	31.1	0.02
Mt - 5%	69.6	1.7	142.5	0.1
Mt - 50%	4000	100.0	21033	10.2
Mt - 95%	4000	100.0	206300	100.0
Mean Mt	4000	100.0	78816	38.2
Mt max	4000	100.0	206300	100.0

Figure G-12. 100-Year Selenium Release Estimates as a Function of the Cumulative Probability for the Scenario of Disposal in a Combustion Waste Landfill.

100-Year Arsenic Release Estimates

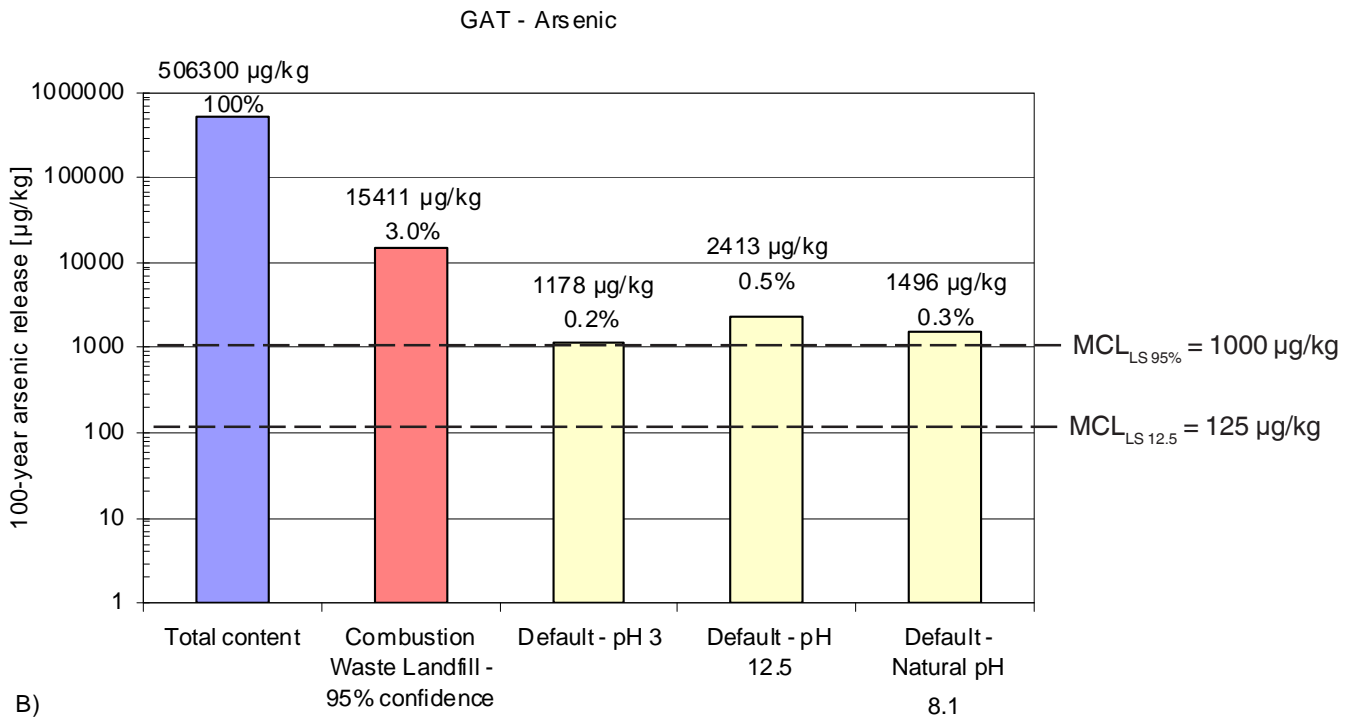
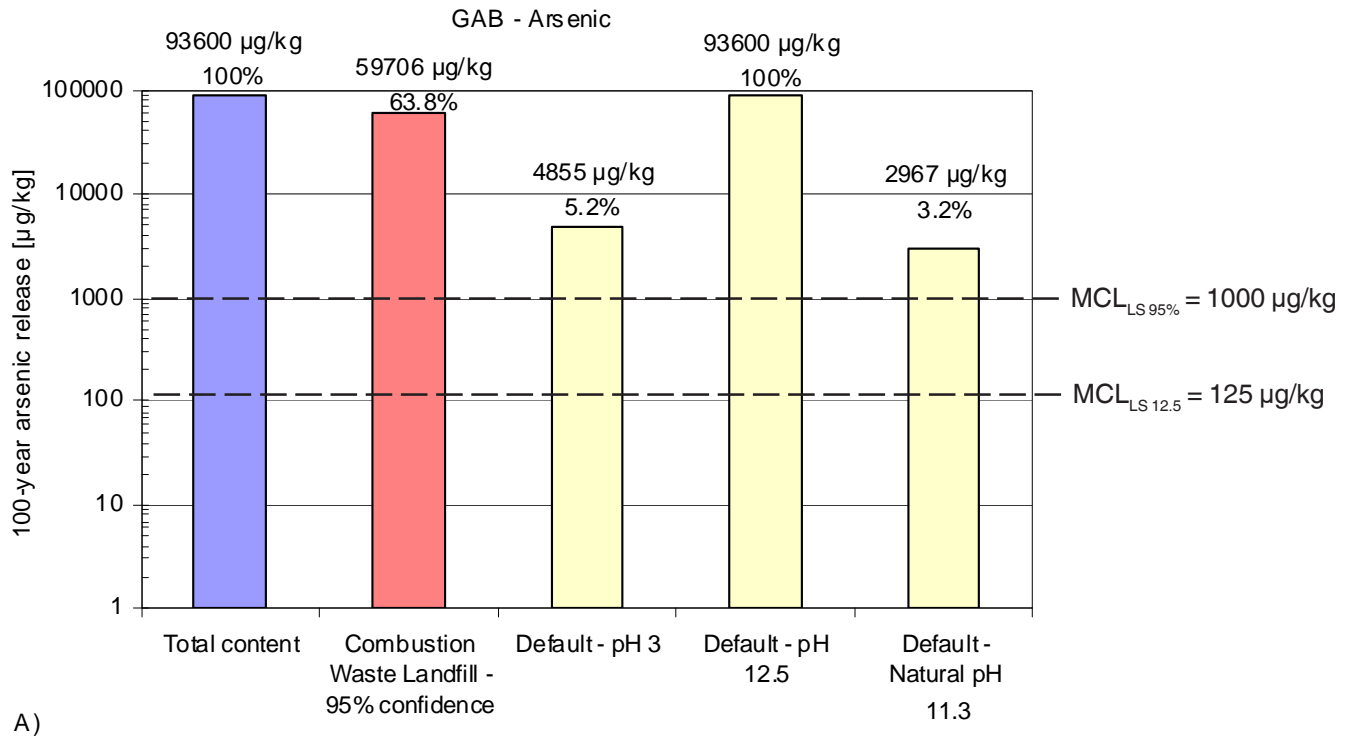

Figure G-13. 100-Year Arsenic Release Estimates from A) Baseline Fly Ash and B) Fly Ash with ACI. Release estimates for percolation controlled scenario are compared to release estimate based on total content. The amount of the arsenic that would be released if the release concentration was at the MCL is also shown for comparison (LS_{default scenario} = 12.5 L/kg and LS_{95%} = 100 L/kg).

100-Year Selenium Release Estimates

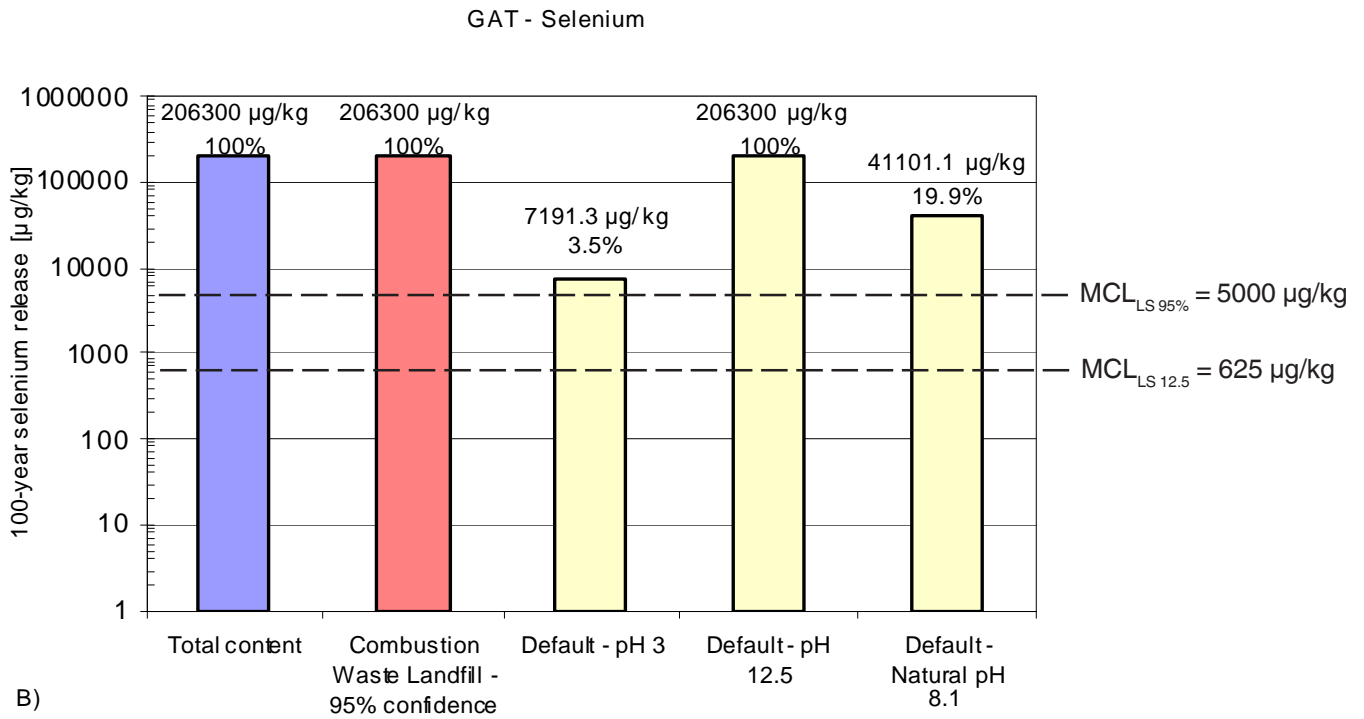
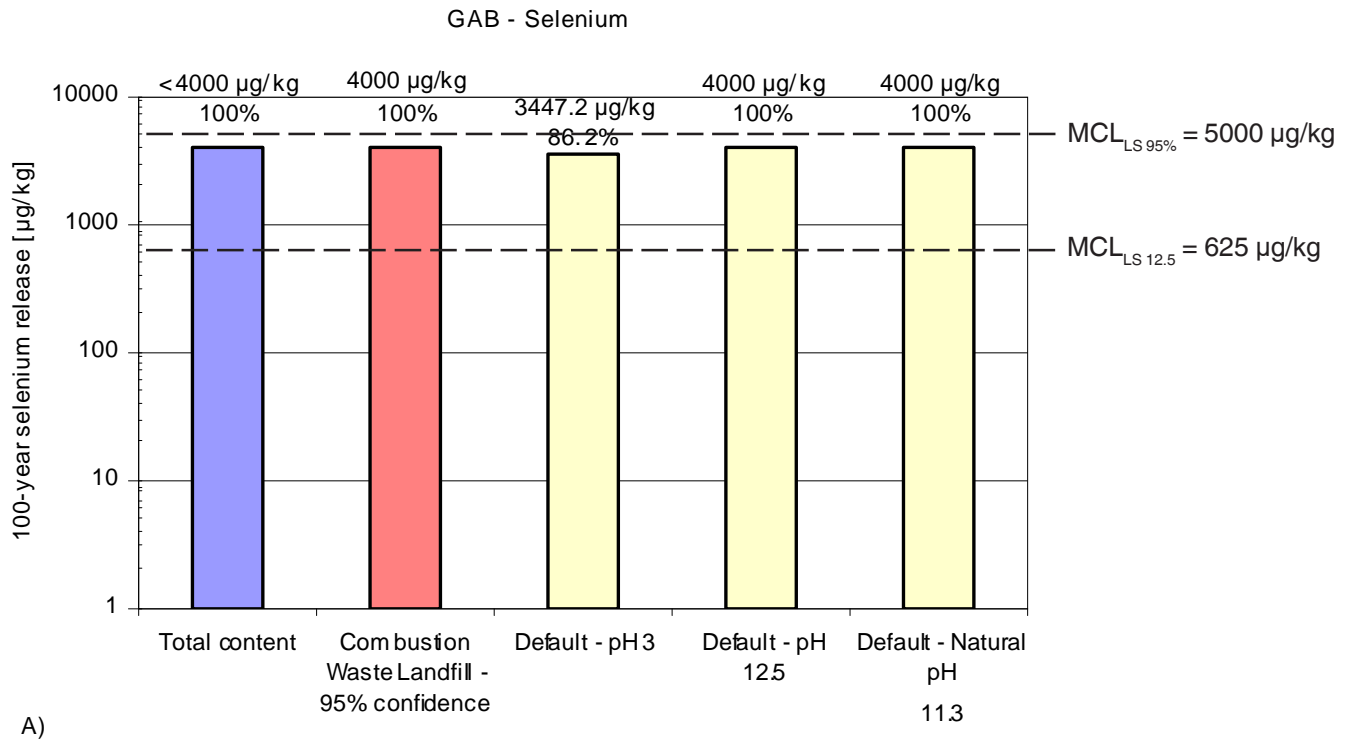

Figure G-14. 100-year Selenium Release Estimates from A) Baseline Fly Ash and B) Fly Ash with ACI. Release estimates for percolation controlled scenario are compared to release estimate based on total content. The amount of the selenium that would be released if the release concentration was at the MCL is also shown for comparison ($LS_{\text{default scenario}} = 12.5 \text{ L/kg}$ and $LS_{95\%} = 100 \text{ L/kg}$).

Comments

Figure G-1:

- All extract Hg concentrations are well below levels of potential concern.

Figure G-5:

- Arsenics extract concentrations for the baseline case peak between pH 7 and 9, with maximum concentrations significantly greater than the range reported for field landfill leachates in the EPA database but consistent with the range of concentrations for field landfill leachates reported in the EPRI database.
- Arsenic extract concentrations for the test case indicate somewhat lower concentrations than for the baseline case over the range of pH examined, even though the test case as around 5 times as much total As as the baseline case. These results also suggest different chemistry controlling the aqueous-solid equilibrium for the two cases.

Figure G-7:

- Se extract concentrations as a function of pH exhibit similar behavior for the baseline and test cases, even

though the test case has greater than 50 times the amount of total As than the baseline case.

Figure G-8:

- Initial leachate concentrations for Se are likely to be ca. 1000–4000 $\mu\text{g/L}$ (at $\text{LS}=2$), which is much greater than reported in the EPA database but consistent with values reported in the EPRI database for landfill leachates.

Figures G-11 and G-12:

- A much greater percentage and quantity of As can be anticipated to be released from the baseline case than for the test case under the scenarios examined.

Figure G13:

- Arsenic release from the base case warrants further examination.

Figure G-14:

- Se release from the test case warrants further examination.

Appendix H
St. Clair Fly Ashes

List of Figures

Figure	Page
H-1 pH Titration Curves for the Baseline Fly Ash and the Fly Ash with Enhanced Hg Control	178
H-2 pH as a Function of LS Ratio for the Baseline Fly Ash and the Fly Ash with Enhanced Hg Control	178
H-3 Mercury Release (top) and Spike Recoveries (bottom) as a Function of pH for the Baseline Fly Ash and the Fly Ash with Enhanced Hg Control	179
H-4 Mercury Release (top) and Spike Recoveries (bottom) as a Function of LS Ratio for the Baseline Fly Ash and the Fly Ash with Enhanced Hg Control	180
H-5 Arsenic Release (top) and Spike Recoveries (bottom) as a Function of pH for the Baseline Fly Ash and the Fly Ash with Enhanced Hg Control	181
H-6 Arsenic Release (top) and Spike Recoveries (bottom) as a Function of LS Ratio for the Baseline Fly Ash and the Fly Ash with Enhanced Hg Control	182
H-7 Selenium Release (top) and Spike Recoveries (bottom) as a Function of pH for the Baseline Fly Ash and the Fly Ash with Enhanced Hg Control	183
H-8 Selenium Release (top) and Spike Recoveries (bottom) as a Function of LS Ratio for the Baseline Fly Ash and the Fly Ash with Enhanced Hg Control	184
H-9 Regression Curves of Experimental Data of Arsenic Solubility as a Function of pH.	185
H-10 Regression Curves of Experimental Data of Selenium Solubility as a Function of pH	186
H-11 100-Year Arsenic Release Estimates as a Function of the Cumulative Probability for the Scenario of Disposal in a Combustion Waste Landfill	187
H-12 100-Year Selenium Release Estimates as a Function of the Cumulative Probability for the Scenario of Disposal in a Combustion Waste Landfill	187
H-13 100-Year Arsenic Release Estimates from A) Baseline Fly Ash and B) Fly Ash with ACI	188
H-14 100-year Selenium Release Estimates from A) Baseline Fly Ash and B) Fly Ash with ACI	189

pH Titration Curves

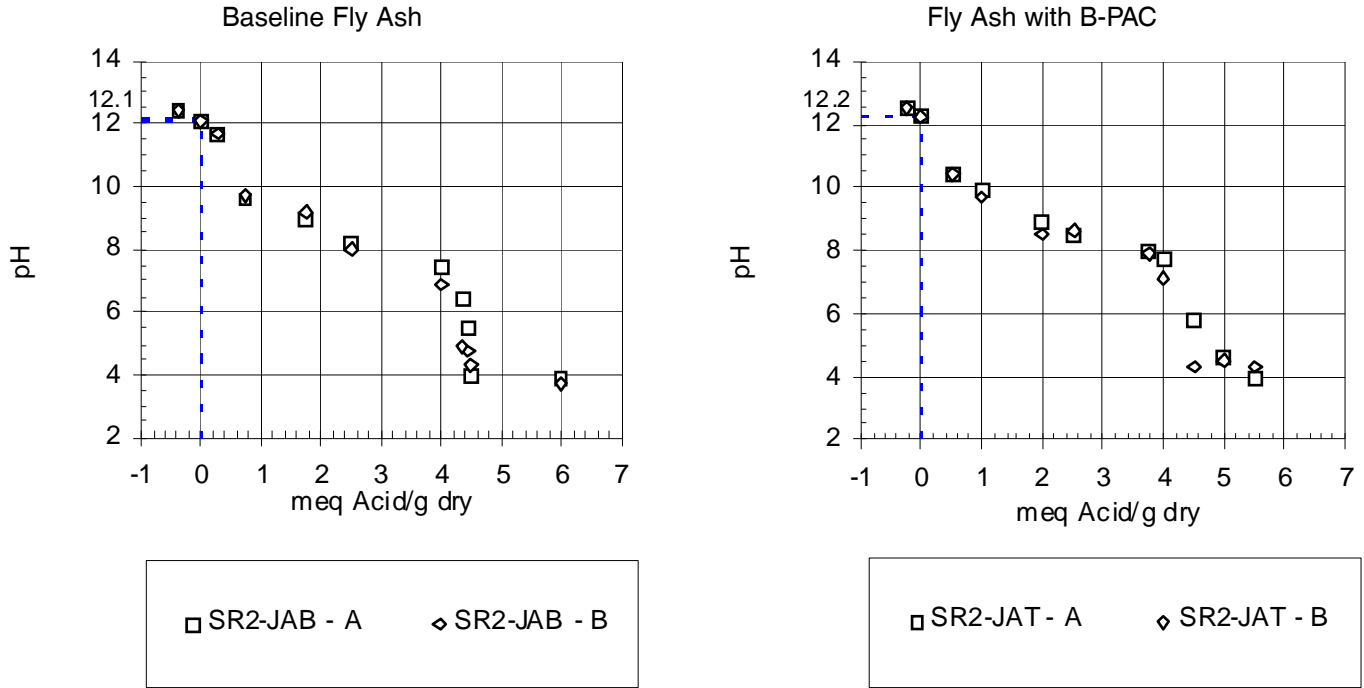

Figure H-1. pH Titration Curves for the Baseline Fly Ash and the Fly Ash with Enhanced Hg Control.

pH as a Function of LS Ratio

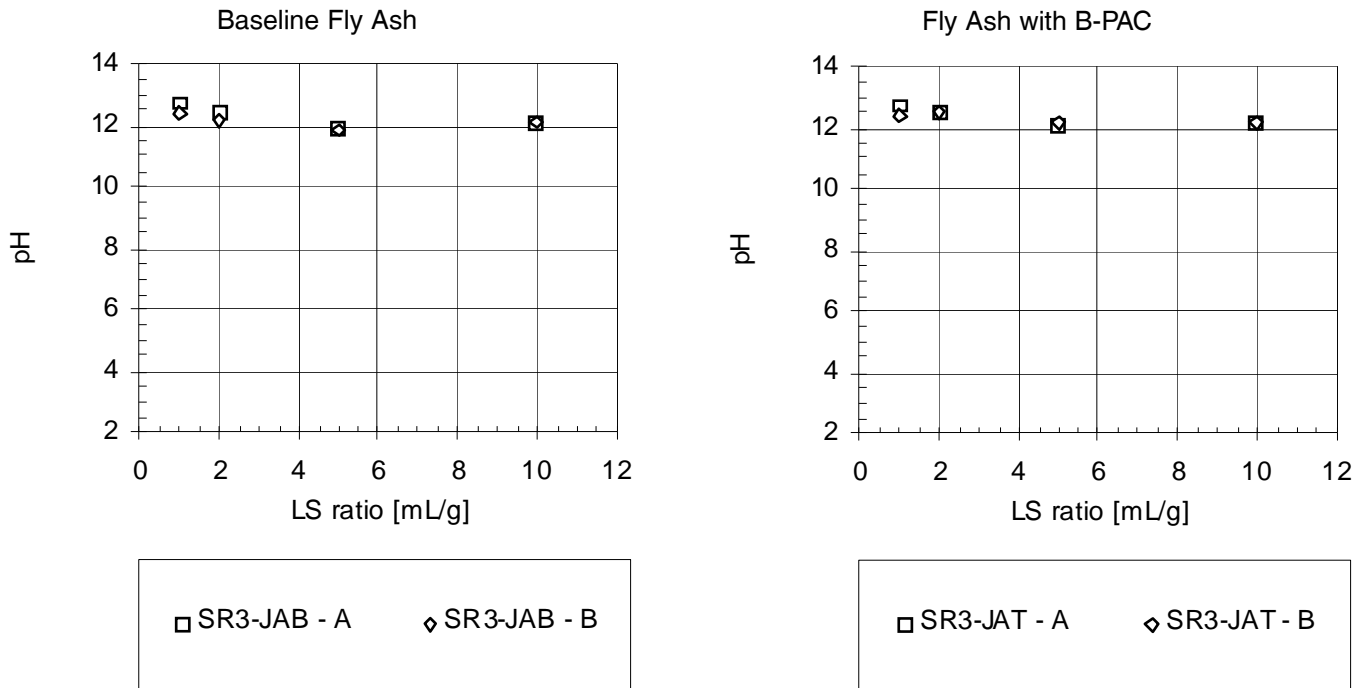
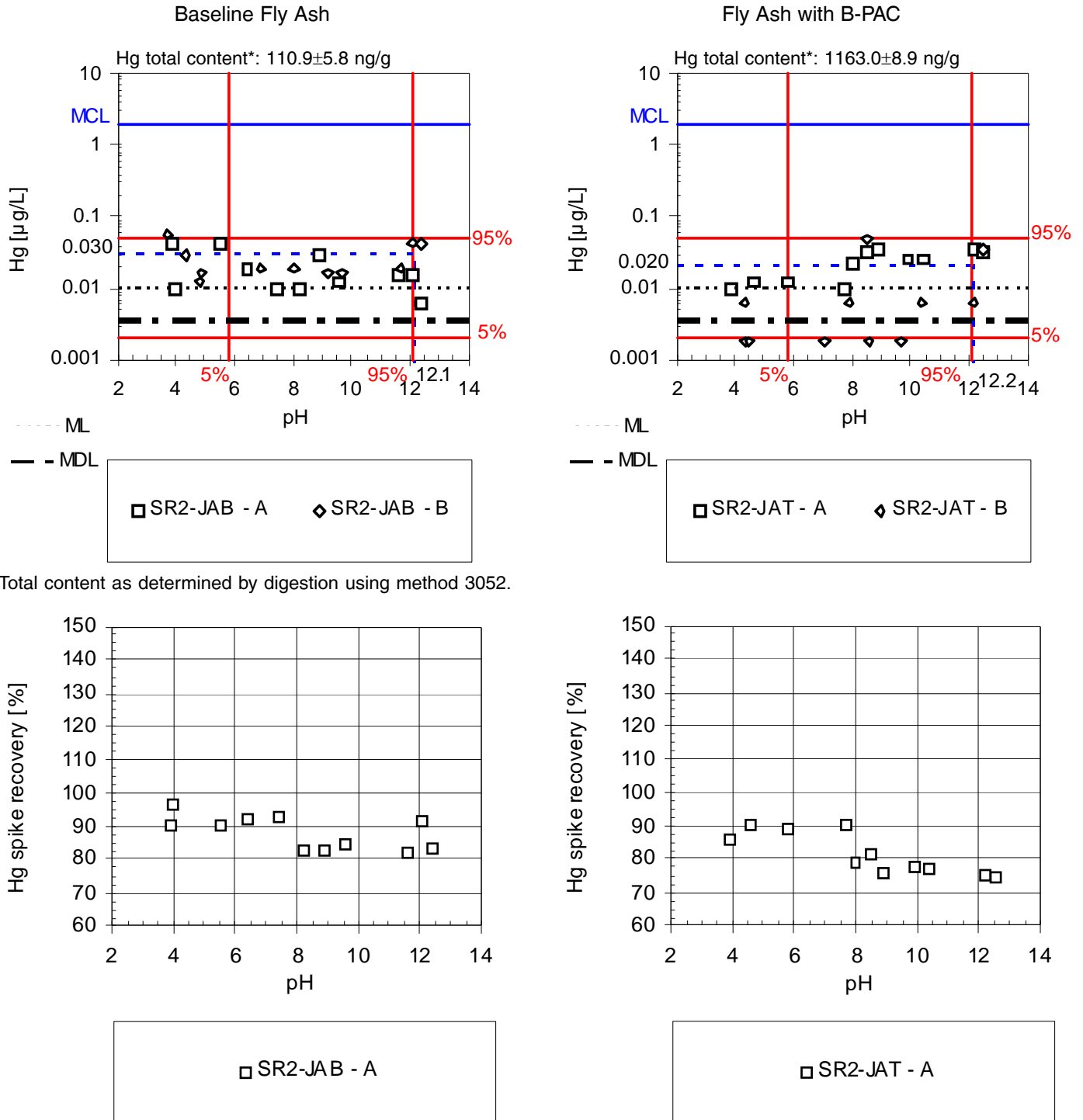

Figure H-2. pH as a Function of LS Ratio for the Baseline Fly Ash and the Fly Ash with Enhanced Hg Control.

Mercury Release as a Function of pH



*Total content as determined by digestion using method 3052.

Figure H-3. Mercury Release (top) and Spike Recoveries (bottom) as a Function of pH for the Baseline Fly Ash and the Fly Ash with Enhanced Hg Control. 5th and 95th percentiles of mercury concentrations observed in typical combustion waste landfill leachate are shown for comparison.

Mercury Release as a Function of LS Ratio

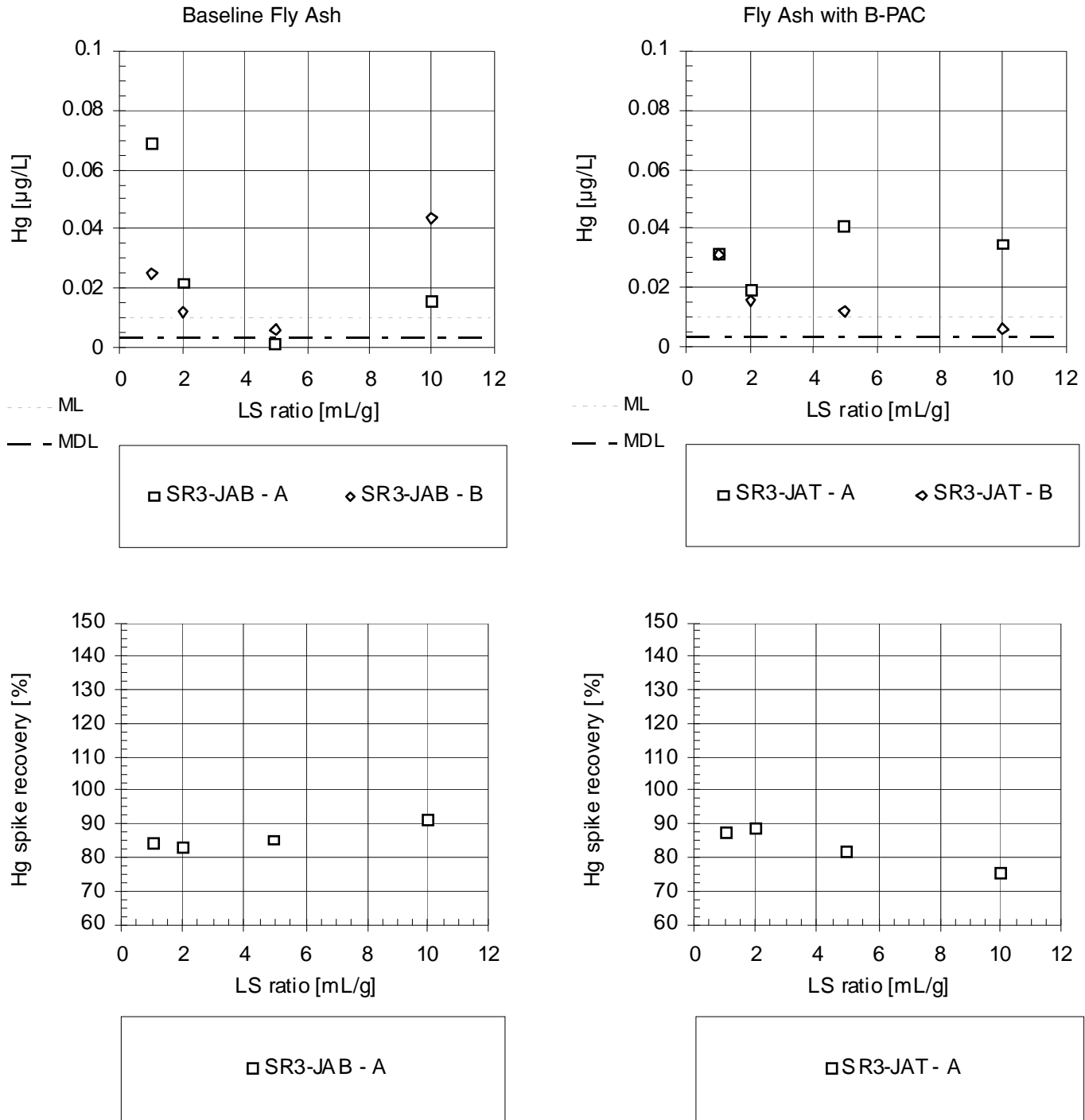

Figure H-4. Mercury Release (top) and Spike Recoveries (bottom) as a Function of LS Ratio for the Baseline Fly Ash and the Fly Ash with Enhanced Hg Control.

Arsenic Release as a Function of pH

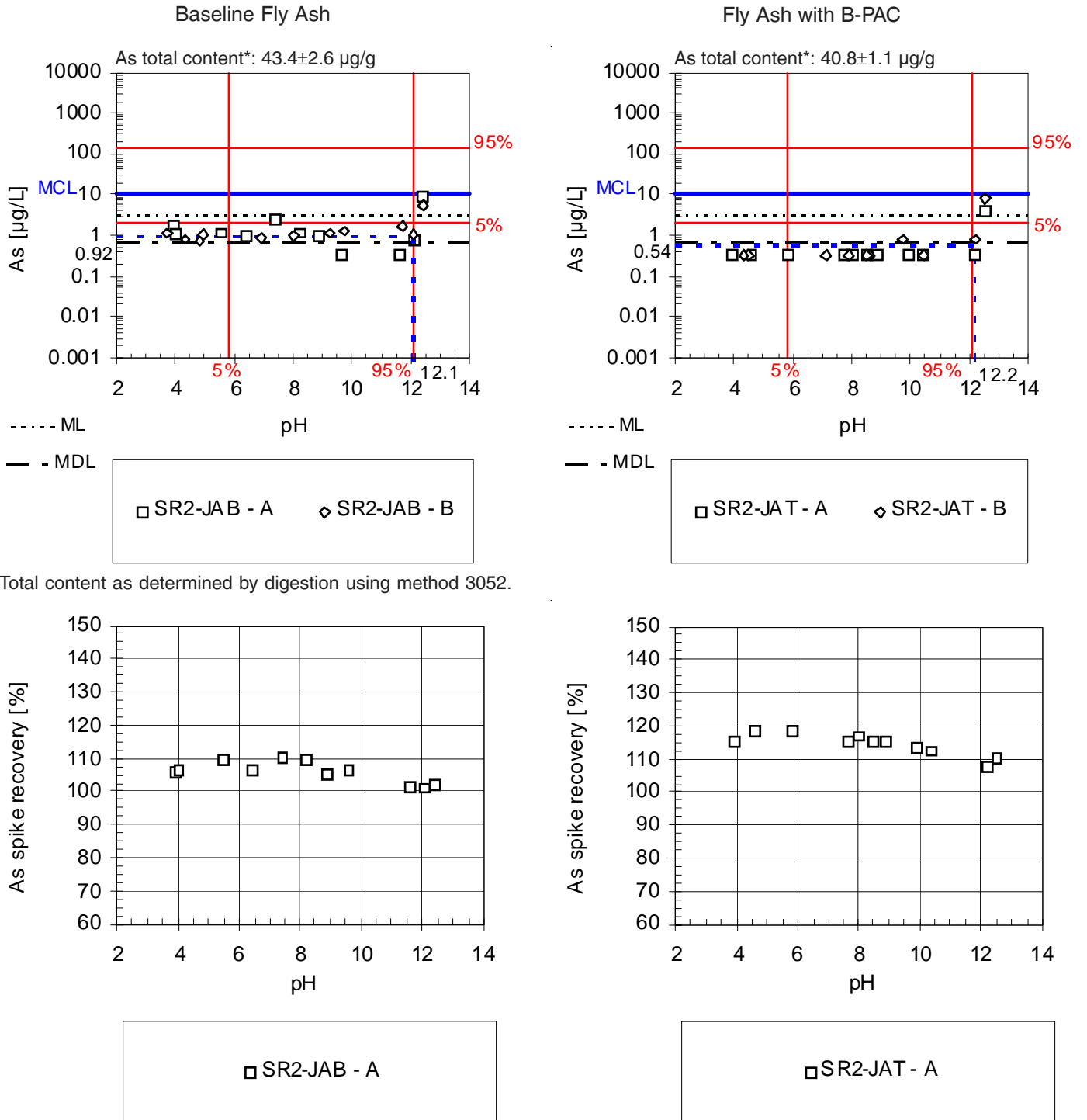

Figure H-5. Arsenic Release (top) and Spike Recoveries (bottom) as a Function of pH for the Baseline Fly Ash and the Fly Ash with Enhanced Hg Control. 5th and 95th percentiles of arsenic concentrations observed in typical combustion waste landfill leachate are shown for comparison.

Arsenic Release as a Function of LS Ratio

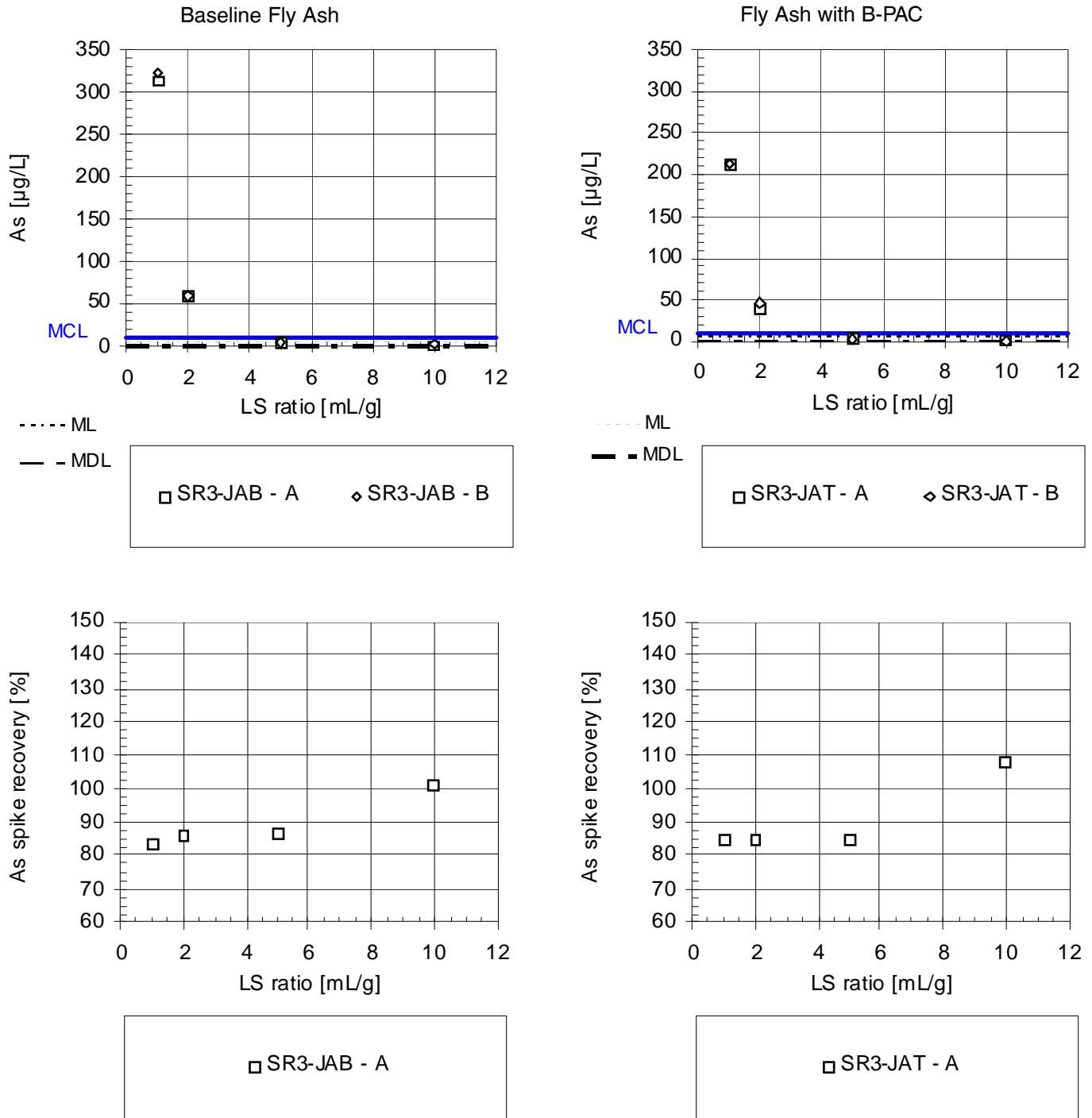
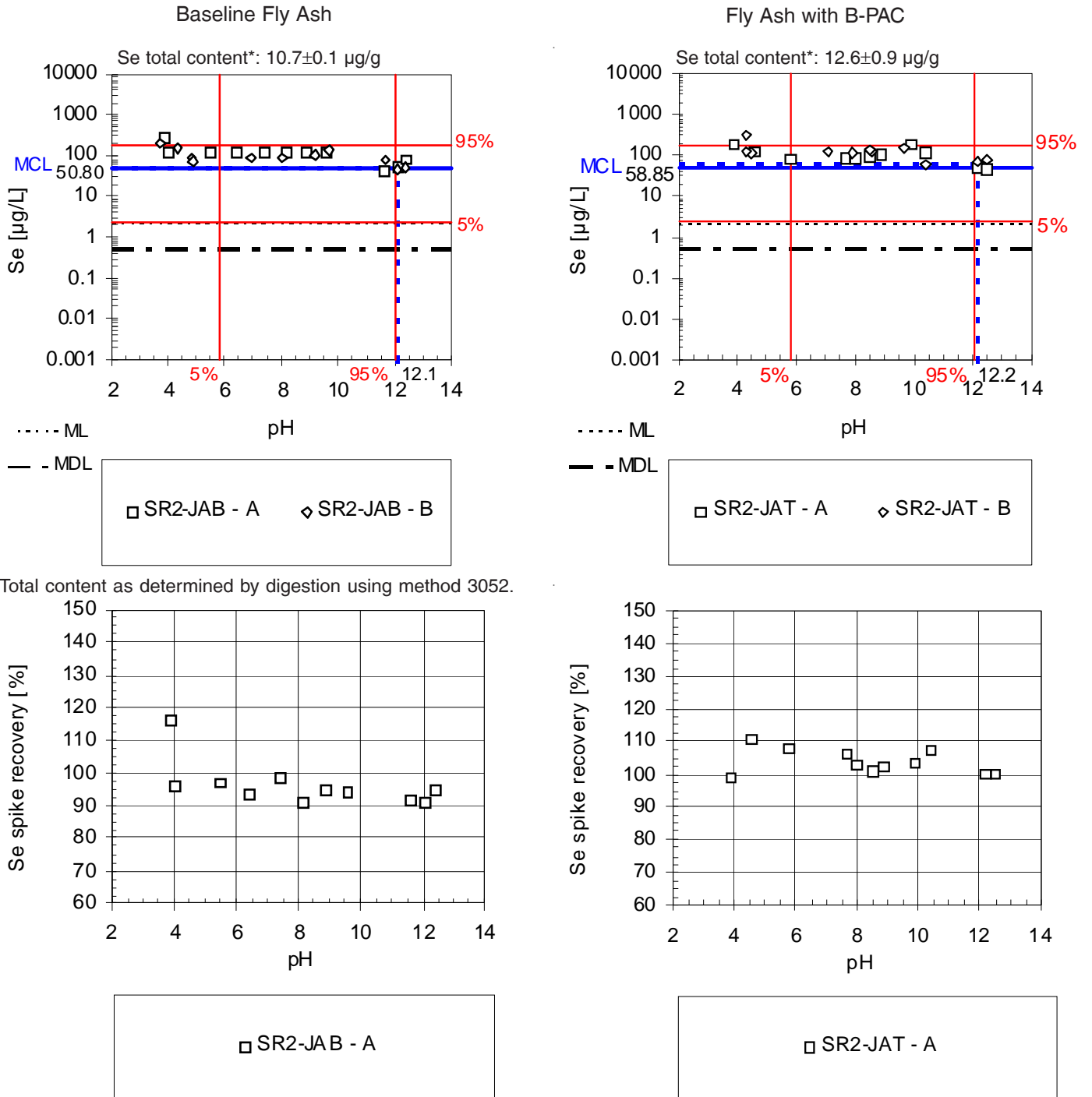

Figure H-6. Arsenic Release (top) and Spike Recoveries (bottom) as a Function of LS Ratio for the Baseline Fly Ash and the Fly Ash with Enhanced Hg Control.

Selenium Release as a Function of pH



*Total content as determined by digestion using method 3052.

Figure H-7. Selenium Release (top) and Spike Recoveries (bottom) as a Function of pH for the Baseline Fly Ash and the Fly Ash with Enhanced Hg Control. 5th and 95th percentiles of selenium concentrations observed in typical combustion waste landfill leachate are shown for comparison.

Selenium Release as a Function of LS Ratio

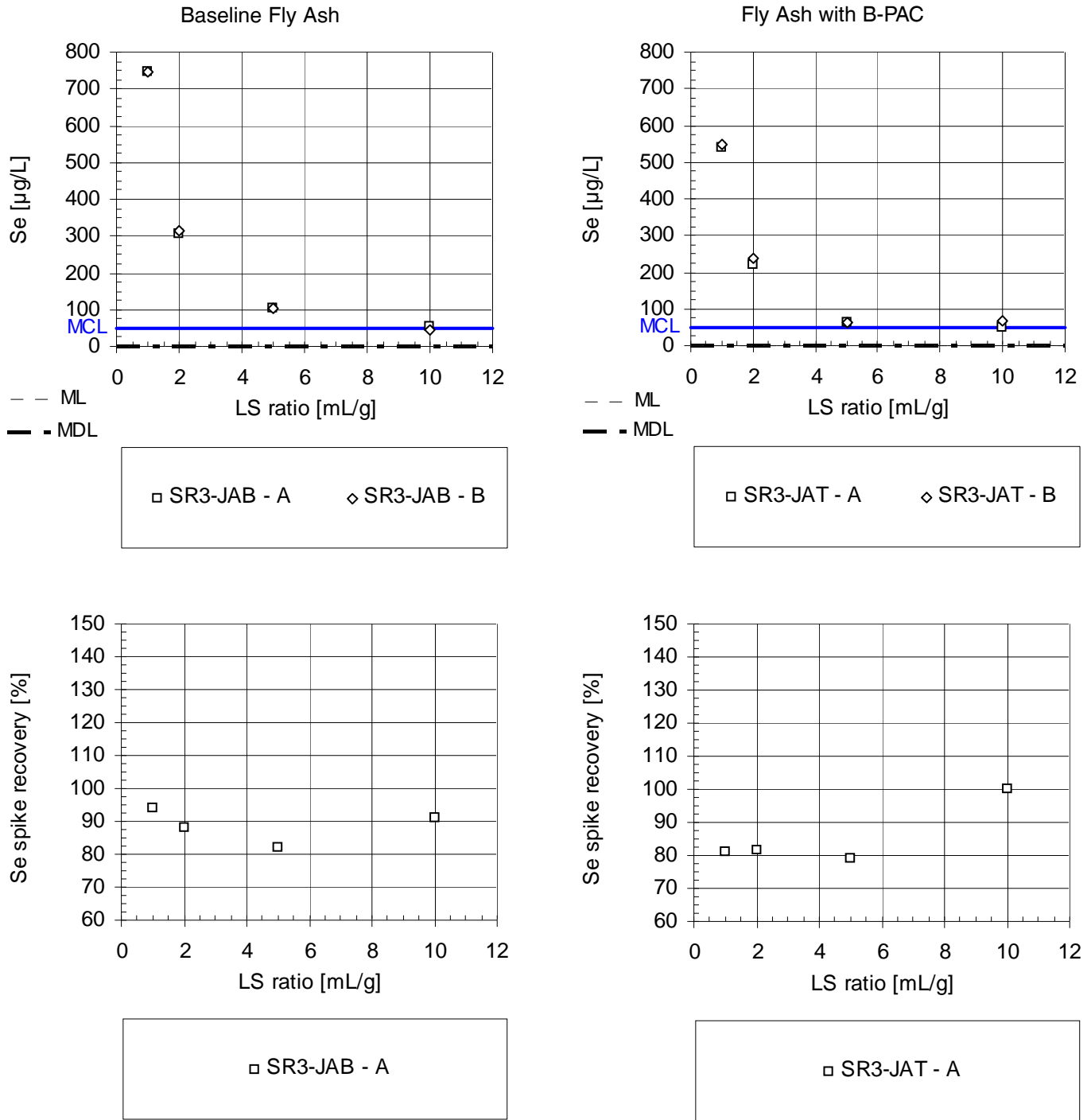
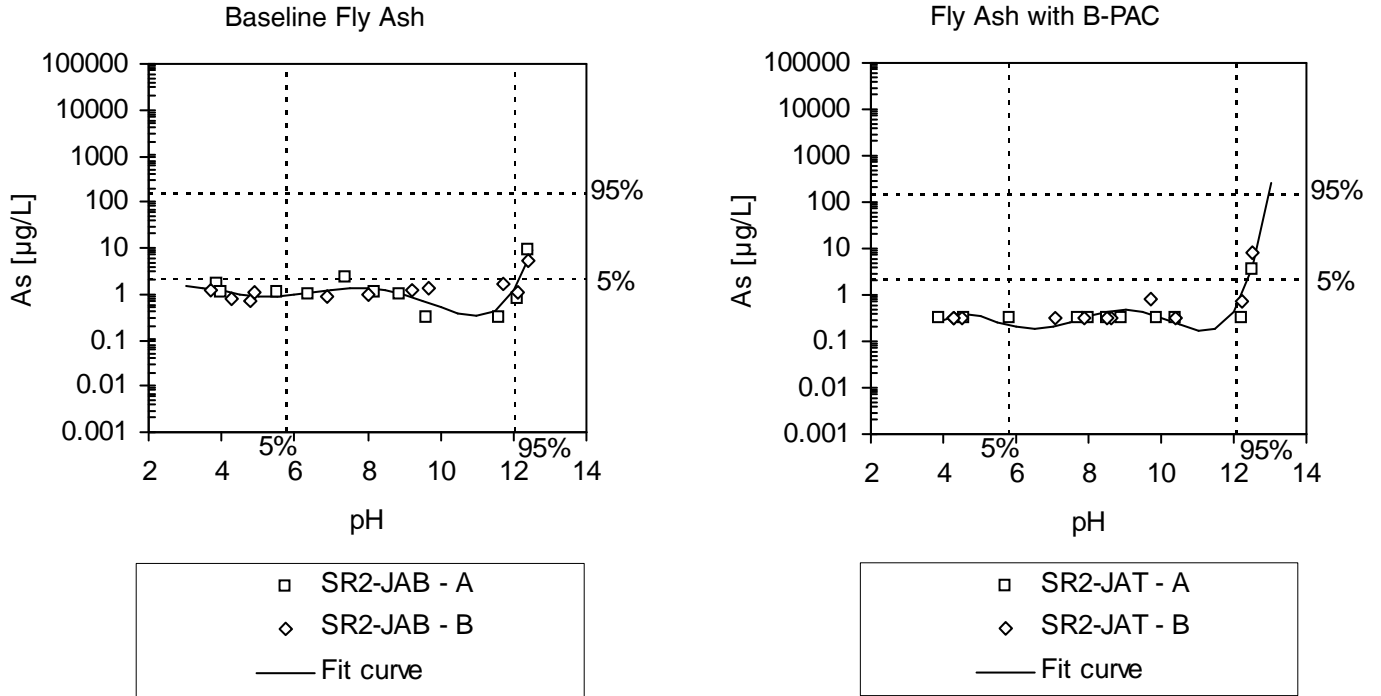

Figure H-8. Selenium Release (top) and Spike Recoveries (bottom) as a Function of LS Ratio for the Baseline Fly Ash and the Fly Ash with Enhanced Hg Control.

Arsenic Solubility



Material	log As (µg/L)			pH range of validity	R ²	Number of points
JAB	0.0010 pH ⁵	-0.0324 pH ⁴	0.4137 pH ³	3-12.5	0.62	22
	-2.4547 pH ²	6.7105 pH	-6.6563			
JAT	0.0025 pH ⁵	-0.0973 pH ⁴	1.4698 pH ³	4-12.5	0.81	22
	-10.6792 pH ²	37.2419 pH	-50.3673			

Figure H-9. Regression Curves of Experimental Data of Arsenic Solubility as a Function of pH.

Selenium Solubility

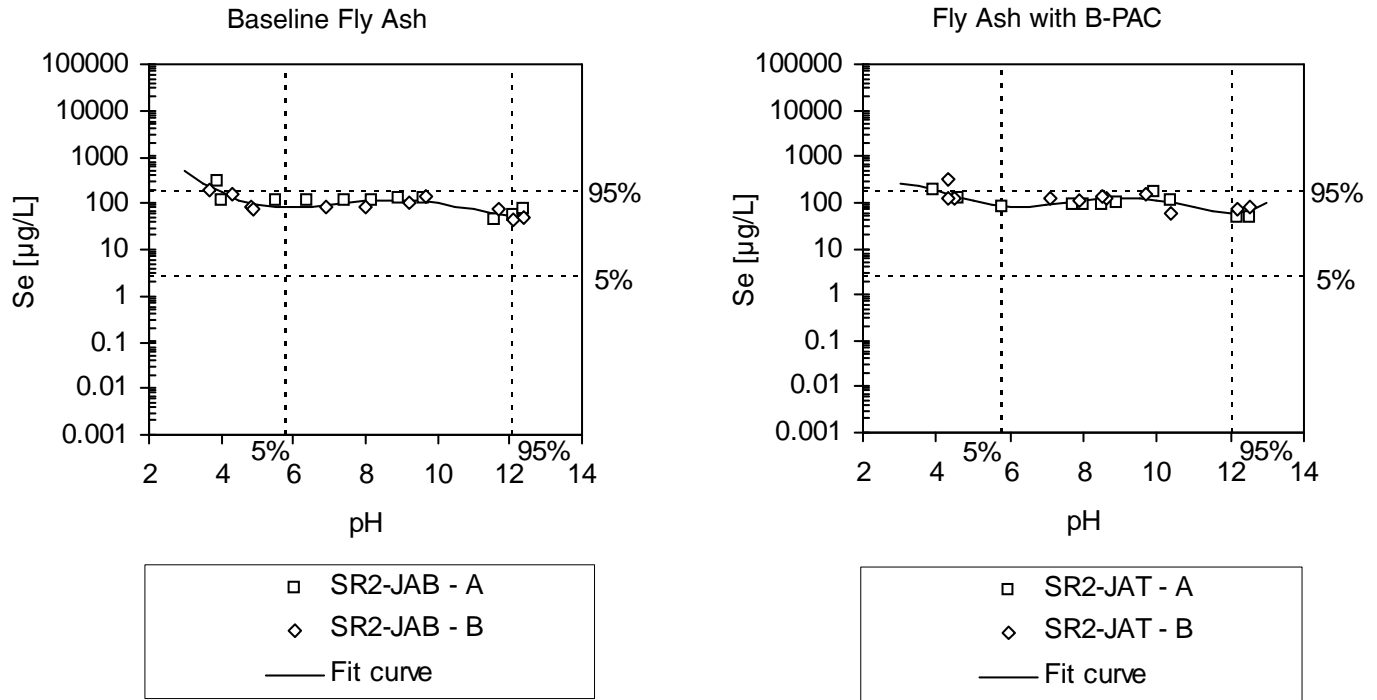

Material	log Se (µg/L)			pH range of validity	R ²	Number of points
JAB	0.0002 pH ⁵	-0.0070 pH ⁴	0.0761 pH ³	3-12.5	0.75	22
	-0.2648 pH ²	-0.3724 pH	4.6460			
JAT	0.0005 pH ⁵	-0.0201 pH ⁴	0.2890 pH ³	3-12.5	0.61	22
	-1.9155 pH ²	5.6877 pH	-3.7128			

Figure H-10. Regression Curves of Experimental Data of Selenium Solubility as a Function of pH.

100-Year Arsenic Release Estimates

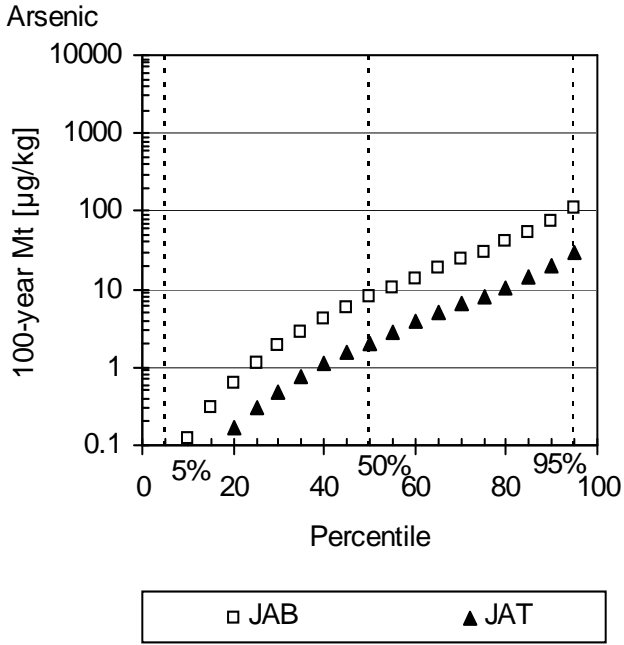

	JAB		JAT	
	µg/kg	%	µg/kg	%
Mt min	0.01	0.00003	0.01	0.00001
Mt - 5%	0.05	0.0001	0.01	0.00003
Mt - 50%	8	0.02	2	0.01
Mt - 95%	110	0.3	29	0.1
Mean Mt	25	0.1	7	0.02
Mt max	836	1.9	346	0.8

Figure H-11. 100-Year Arsenic Release Estimates as a Function of the Cumulative Probability for the Scenario of Disposal in a Combustion Waste Landfill.

100-Year Selenium Release Estimates

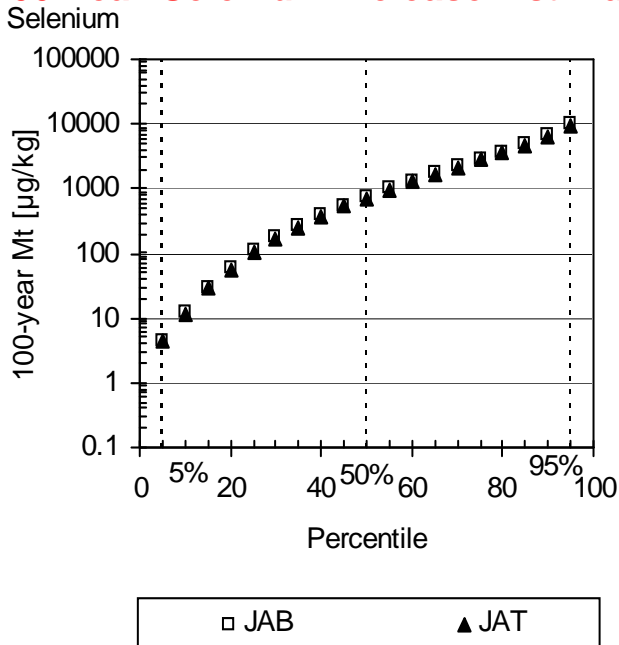

	JAB		JAT	
	µg/kg	%	µg/kg	%
Mt min	1.8	0.02	1.9	0.01
Mt - 5%	4.5	0.04	4.3	0.03
Mt - 50%	748	7.0	710	5.6
Mt - 95%	10028	93.7	9602	76.2
Mean Mt	2270	21.2	2172	17.2
Mt max	10700	100.0	12600	100.0

Figure H-12. 100-Year Selenium Release Estimates as a Function of the Cumulative Probability for the Scenario of Disposal in a Combustion Waste Landfill.

100-Year Arsenic Release Estimates

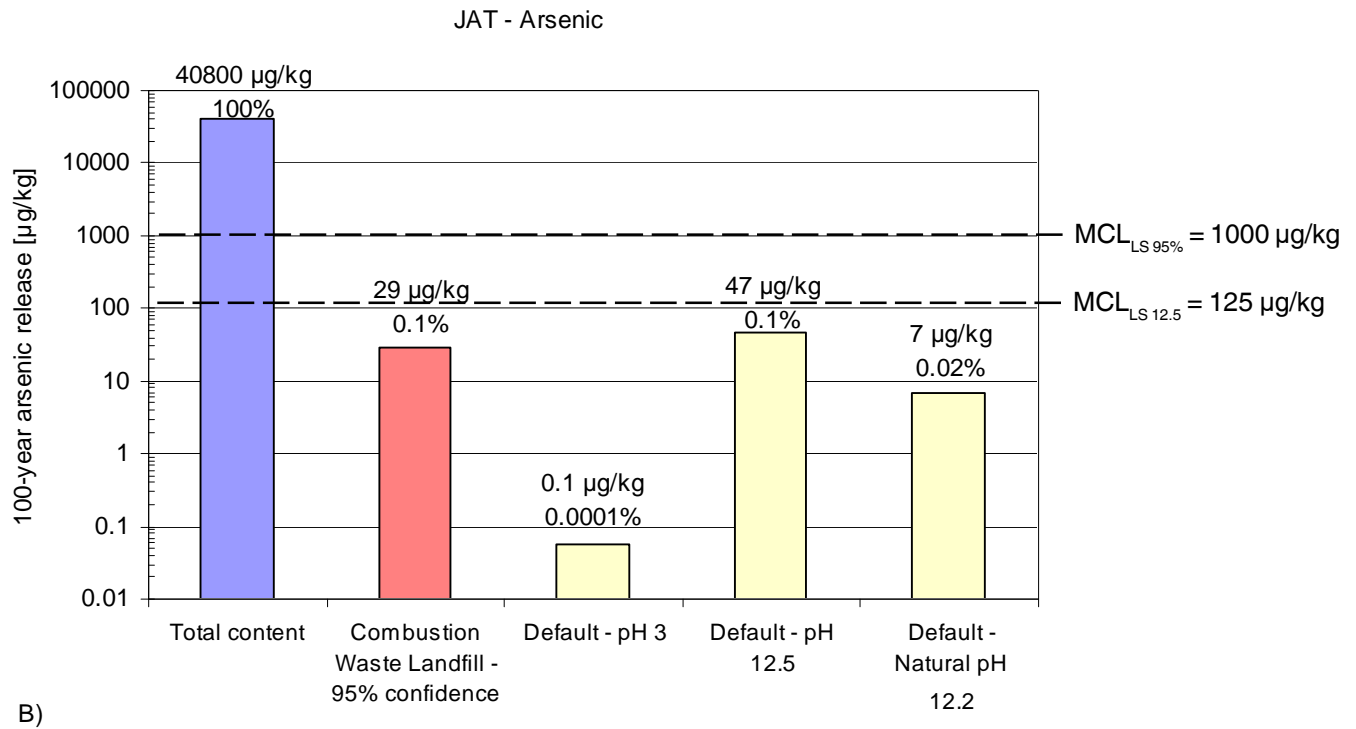
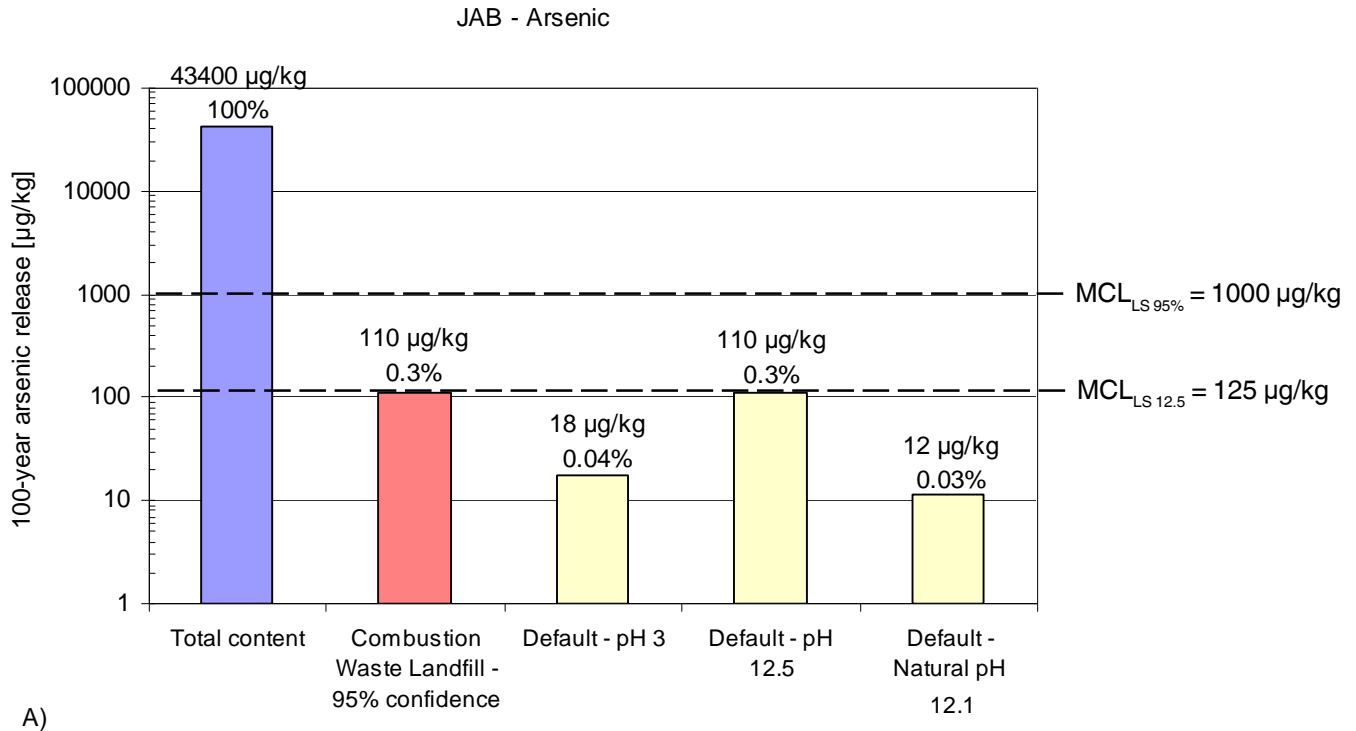

Figure H-13. 100-Year Arsenic Release Estimates from A) Baseline Fly Ash and B) Fly Ash with B-PAC. Release estimates for percolation controlled scenario are compared to release estimate based on total content. The amount of the arsenic that would be released if the release concentration was at the MCL is also shown for comparison ($LS_{\text{default scenario}} = 12.5 \text{ L/kg}$ and $LS_{95\%} = 100 \text{ L/kg}$).

100-Year Selenium Release Estimates

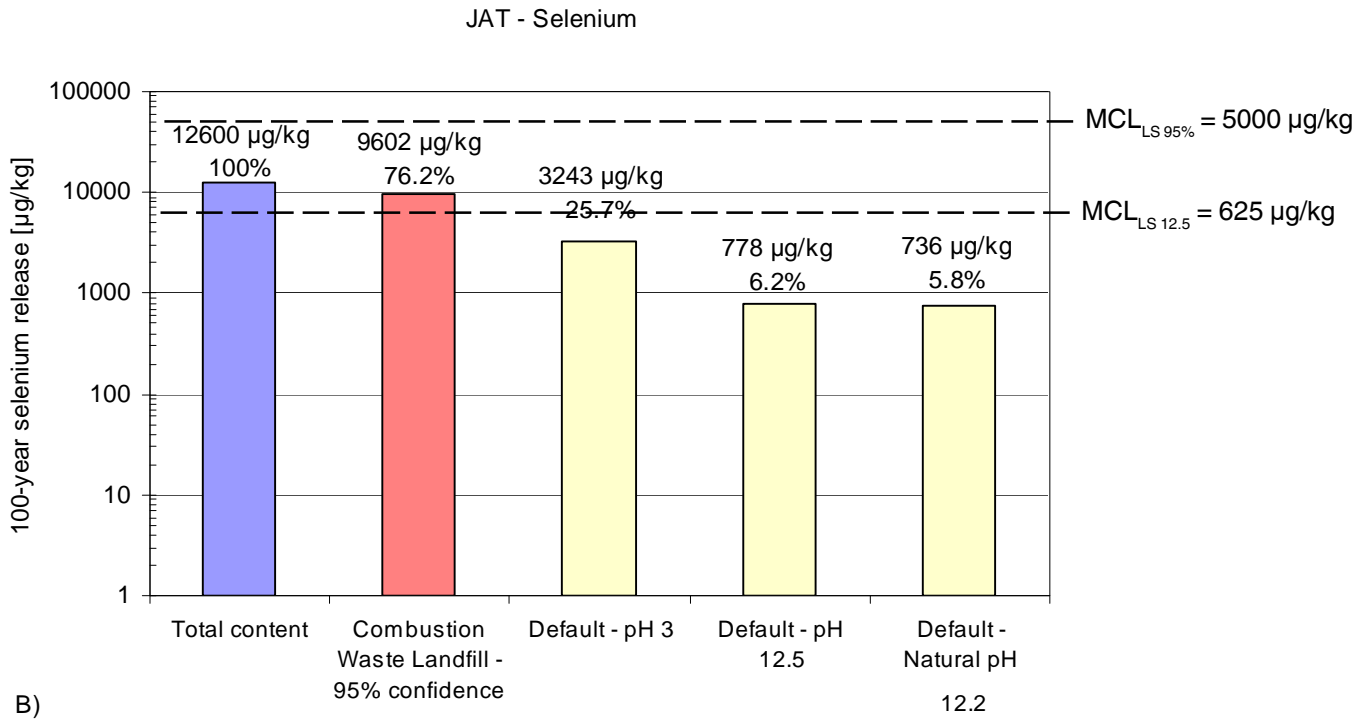
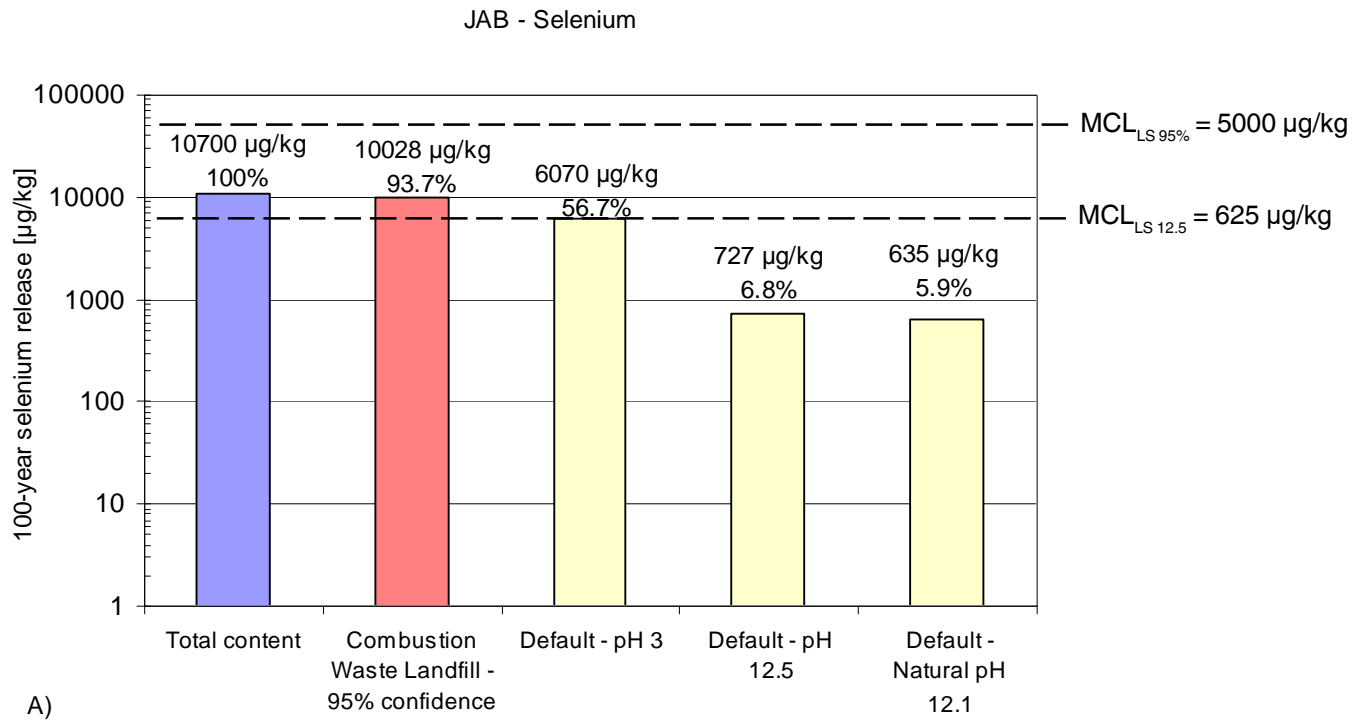

Figure H-14. 100-year Selenium Release Estimates from A) Baseline Fly Ash and B) Fly Ash with B-PAC. Release estimates for percolation controlled scenario are compared to release estimate based on total content. The amount of the selenium that would be released if the release concentration was at the MCL is also shown for comparison (LS_{default scenario} = 12.5 L/kg and LS_{95%} = 100 L/kg).

Comments

Figure H-3:

- All extract concentrations for Hg are well below levels of potential concern.
- Scatter in the extract concentrations for the cases with enhanced Hg control most likely results from the material heterogeneity associated with addition of particulate activated carbon.

Figure H-5:

- All extract concentrations for As are well below levels of potential concern.

Figure H-6:

- Initial As leachate concentrations from landfills are expected to be substantially greater (i.e., equal to 50 µg/L at LS=2) than indicated by SR002 (LS=10) because of other ionic species at higher concentrations present at low LS ratio typical of landfill scenarios. These anticipated concentrations are consistent with landfill leachate concentrations reported in the EPRI database.

Figure H-7:

- Extract concentrations of selenium are greater than the MCL but within the range reported in the EPA and EPRI databases.

Figure H-8:

- Initial Se leachate concentrations from landfills are expected to be substantially greater (i.e., more than 200–300 µg/L at LS=2) than indicated by SR002 (LS=10) because of other ionic species at higher concentrations present at low LS ratio typical of landfill sce-

narios. These anticipated concentrations are consistent with landfill leachate concentrations reported in the EPRI database.

Figures H-11 and H-12:

- A much greater percentage and quantity of As can be anticipated to be released from the baseline case than for the test case under the scenarios examined.

Figure H-13:

- For the three default scenarios considered and the 95% probability scenario, arsenic release would most likely be less than the amount that would be released if the release concentration was at the MCL.

Figure H-14:

- For the 95% probability scenario, selenium release from baseline and test cases would be greater than the amount that would be released if the release concentration was at the MCL.
- For the default scenario corresponding to disposal in a monofill (leachate pH controlled by the material being disposed) and the default scenario corresponding to the “extreme” pH of 12.5, no significant difference in selenium release between the baseline and test cases would be expected.
- For the default scenario corresponding to the “extreme” pH of 3, selenium release is expected to be greater for the baseline case than the test case. In both cases, selenium release would be at or greater than the amount that would be released if the release concentration was at the MCL.
- Se release from the baseline and test cases warrants further examination.

Appendix I
Facility L Fly Ashes

List of Figures

Figure	Page
I-1 pH Titration Curves for the Baseline Fly Ash and the Fly Ash with Enhanced Hg Control	193
I-2 pH as a Function of LS Ratio for the Baseline Fly Ash and the Fly Ash with Enhanced Hg Control	193
I-3 Mercury Release (top) and Spike Recoveries (bottom) as a Function of pH for the Baseline Fly Ash and the Fly Ash with Enhanced Hg Control	194
I-4 Mercury Release (top) and Spike Recoveries (bottom) as a Function of LS Ratio for the Baseline Fly Ash and the Fly Ash with Enhanced Hg Control	195
I-5 Arsenic Release (top) and Spike Recoveries (bottom) as a Function of pH for the Baseline Fly Ash and the Fly Ash with Enhanced Hg Control	196
I-6 Arsenic Release (top) and Spike Recoveries (bottom) as a Function of LS Ratio for the Baseline Fly Ash and the Fly Ash with Enhanced Hg Control	197
I-7 Selenium Release (top) and Spike Recoveries (bottom) as a Function of pH for the Baseline Fly Ash and the Fly Ash with Enhanced Hg Control	198
I-8 Selenium Release (top) and Spike Recoveries (bottom) as a Function of LS Ratio for the Baseline Fly Ash and the Fly Ash with Enhanced Hg Control	199
I-9 Regression Curves of Experimental Data of Arsenic Solubility as a Function of pH.	200
I-10 Regression Curves of Experimental Data of Selenium Solubility as a Function of pH	201
I-11 100-Year Arsenic Release Estimates as a Function of the Cumulative Probability for the Scenario of Disposal in a Combustion Waste Landfill	202
I-12 100-Year Selenium Release Estimates as a Function of the Cumulative Probability for the Scenario of Disposal in a Combustion Waste Landfill	202
I-13 100-Year Arsenic Release Estimates from A) Baseline Fly Ash and B) Fly Ash with ACI	203
I-14 100-year Selenium Release Estimates from A) Baseline Fly Ash and B) Fly Ash with ACI	204

pH Titration Curves

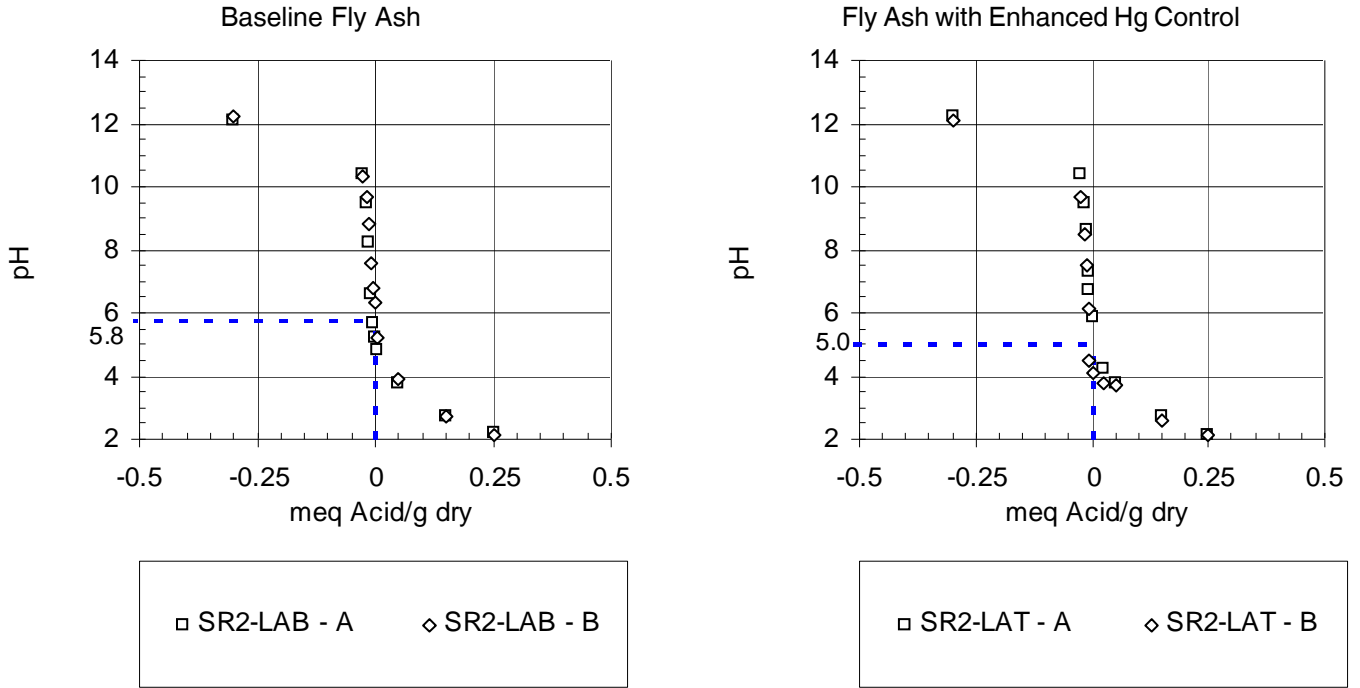

Figure I-1. pH Titration Curves for the Baseline Fly Ash and the Fly Ash with Enhanced Hg Control.

pH as a Function of LS Ratio

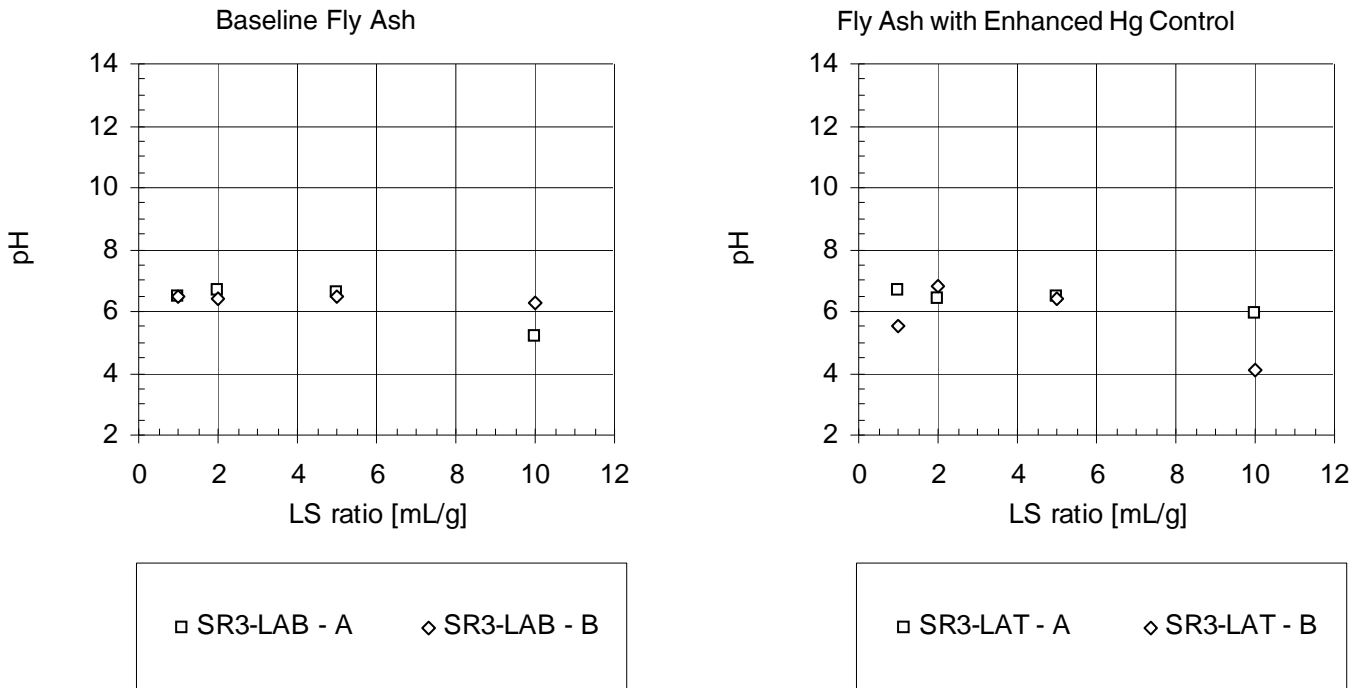
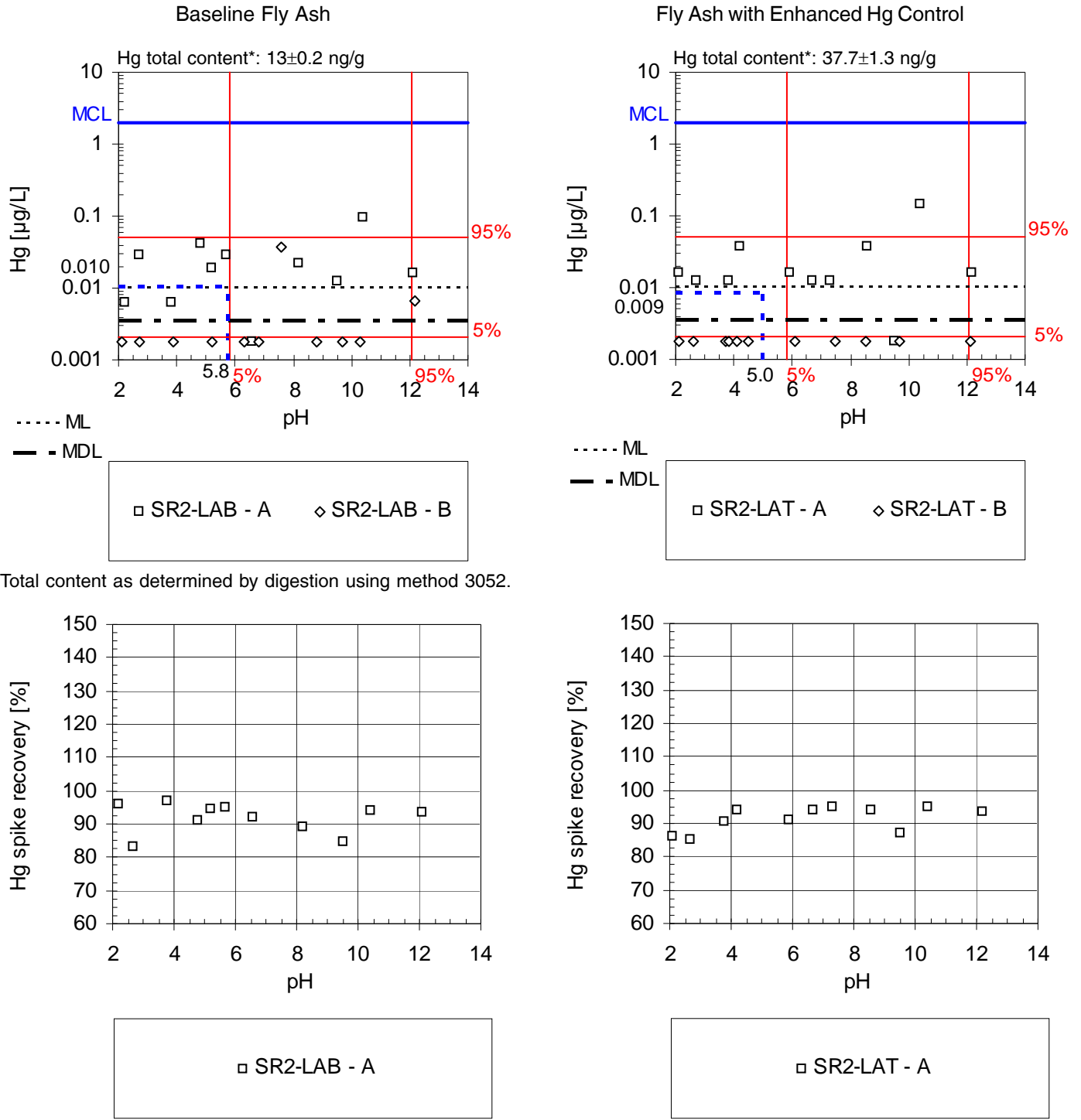

Figure I-2. pH as a Function of LS Ratio for the Baseline Fly Ash and the Fly Ash with Enhanced Hg Control.

Mercury Release as a Function of pH



*Total content as determined by digestion using method 3052.

Figure I-3. Mercury Release (top) and Spike Recoveries (bottom) as a Function of pH for the Baseline Fly Ash and the Fly Ash with Enhanced Hg Control. 5th and 95th percentiles of mercury concentrations observed in typical combustion waste landfill leachate are shown for comparison.

Mercury Release as a Function of LS Ratio

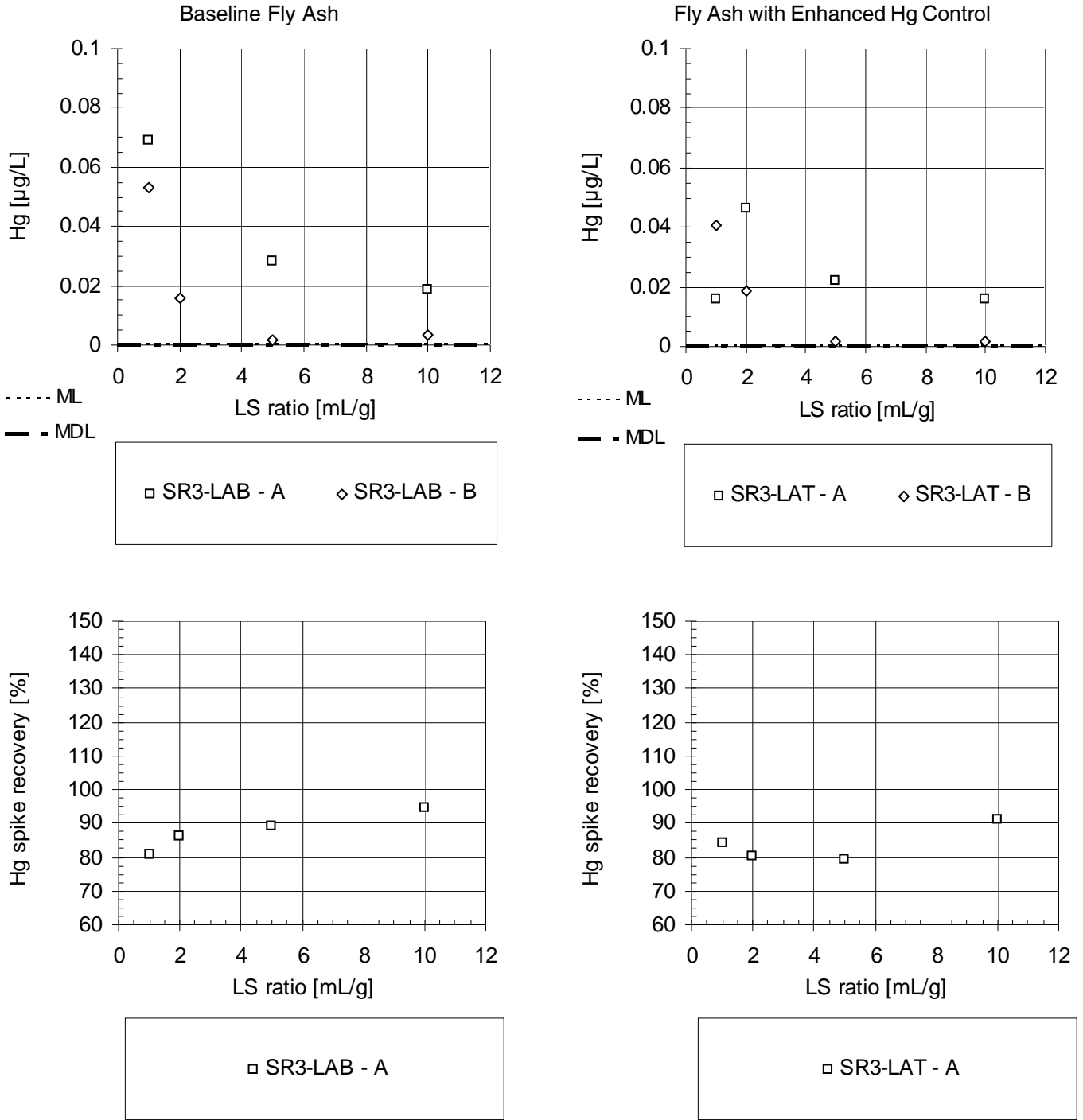
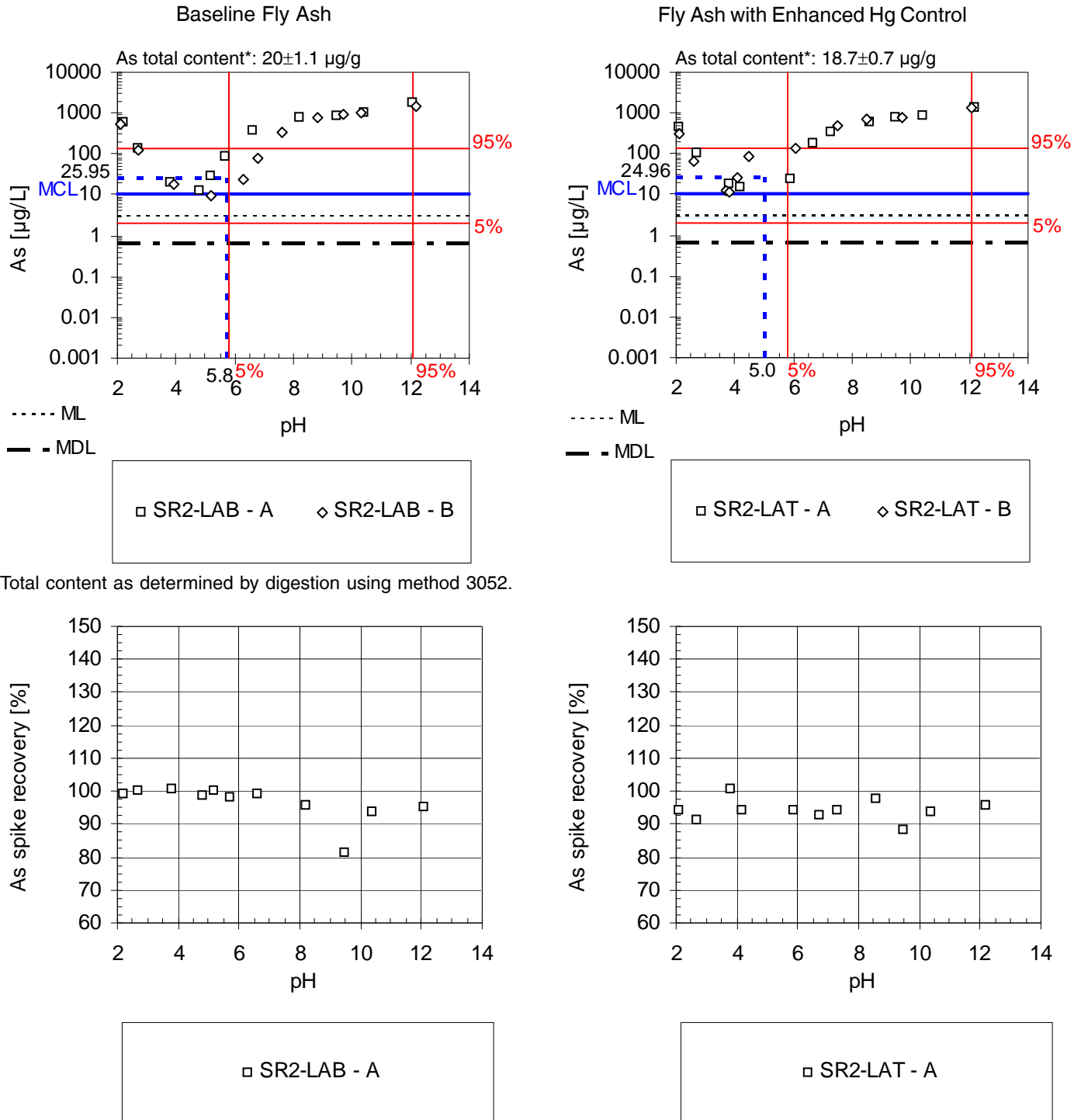

Figure I-4. Mercury Release (top) and Spike Recoveries (bottom) as a Function of LS Ratio for the Baseline Fly Ash and the Fly Ash with Enhanced Hg Control.

Arsenic Release as a Function of pH



*Total content as determined by digestion using method 3052.

Figure I-5. Arsenic Release (top) and Spike Recoveries (bottom) as a Function of pH for the Baseline Fly Ash and the Fly Ash with Enhanced Hg Control. 5th and 95th percentiles of arsenic concentrations observed in typical combustion waste landfill leachate are shown for comparison.

Arsenic Release as a Function of LS Ratio

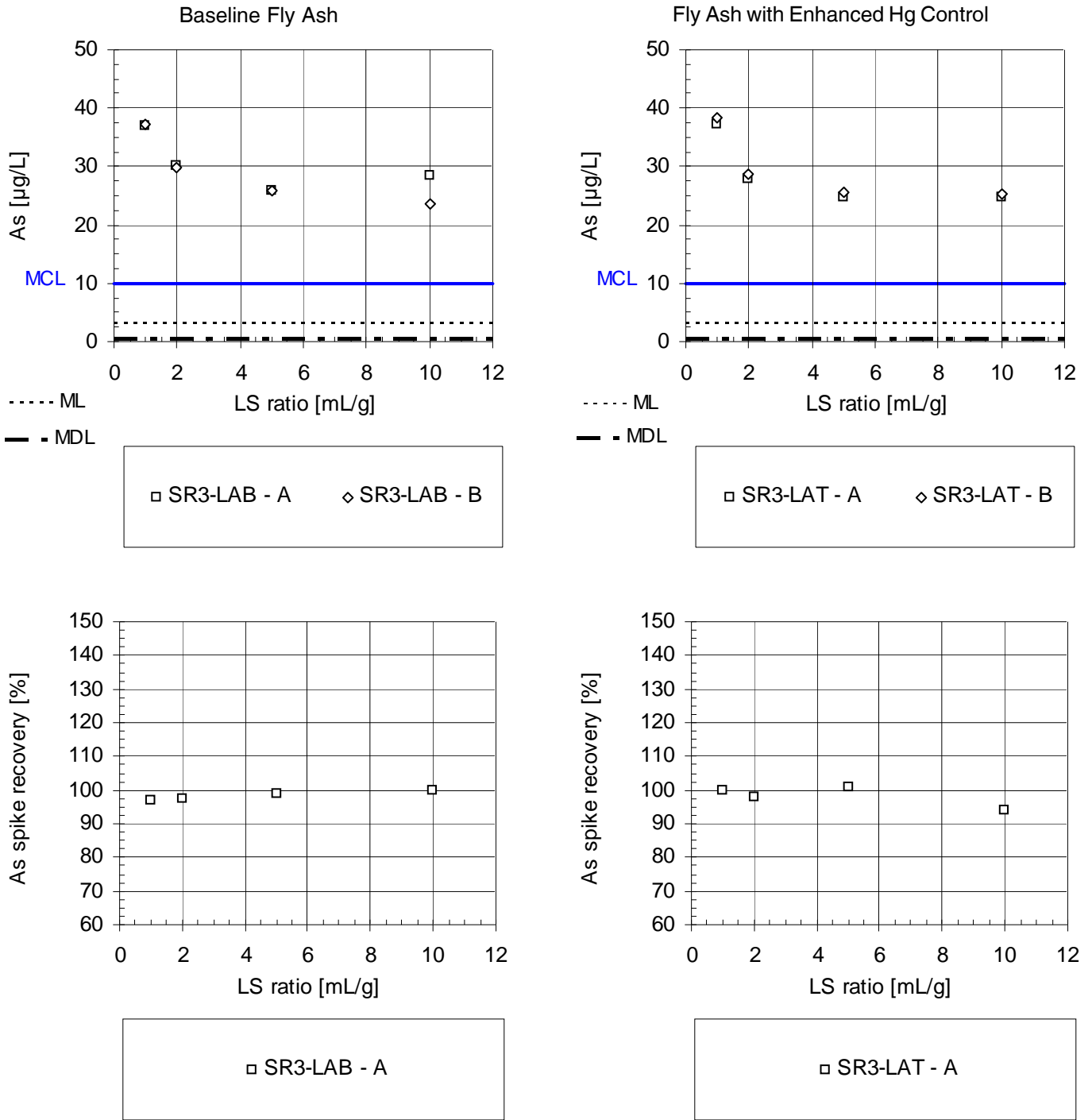
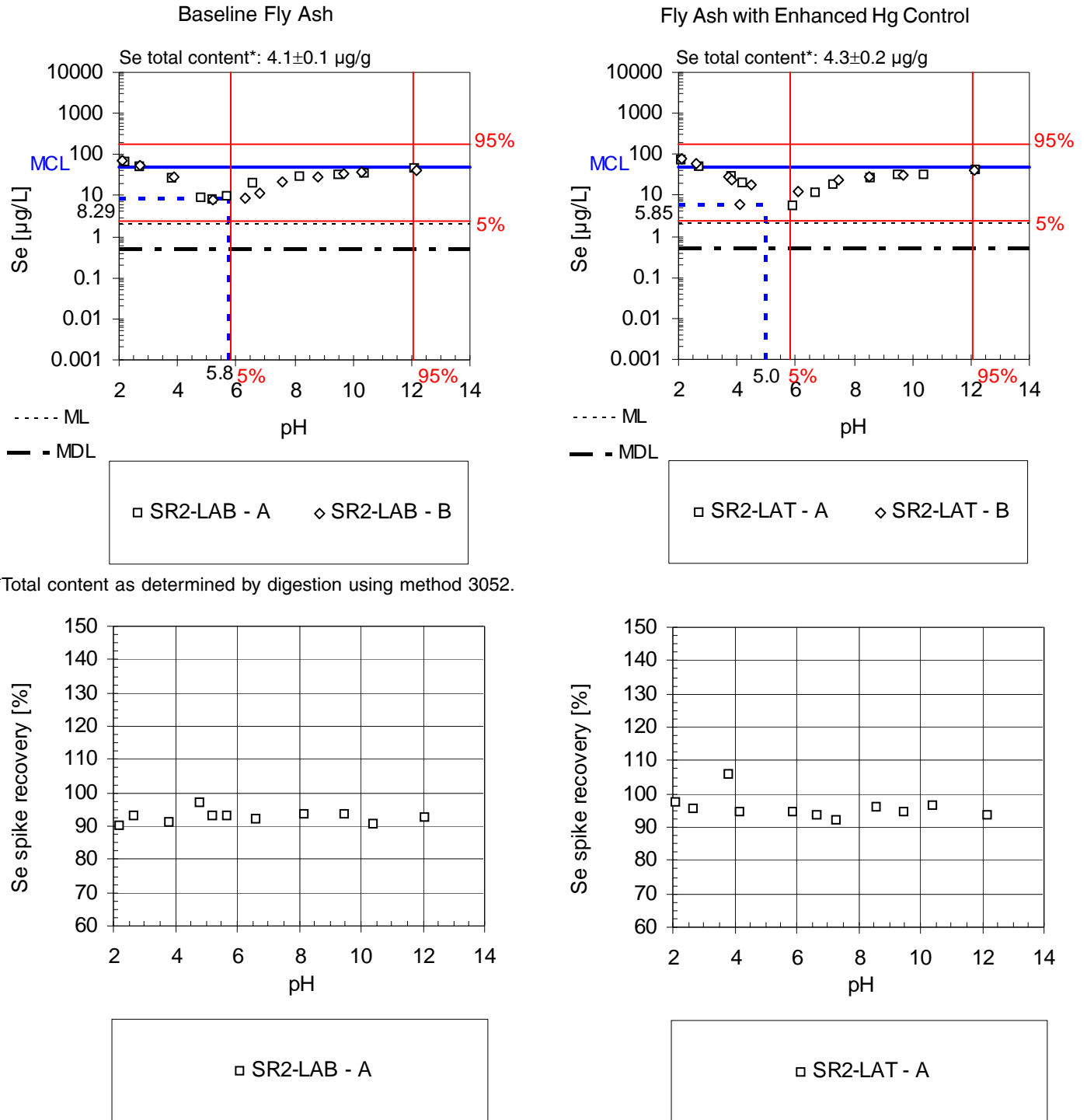

Figure I-6. Arsenic Release (top) and Spike Recoveries (bottom) as a Function of LS Ratio for the Baseline Fly Ash and the Fly Ash with Enhanced Hg Control.

Selenium Release as a Function of pH



*Total content as determined by digestion using method 3052.

Figure I-7. Selenium Release (top) and Spike Recoveries (bottom) as a Function of pH for the Baseline Fly Ash and the Fly Ash with Enhanced Hg Control. 5th and 95th percentiles of selenium concentrations observed in typical combustion waste landfill leachate are shown for comparison.

Selenium Release as a Function of LS Ratio

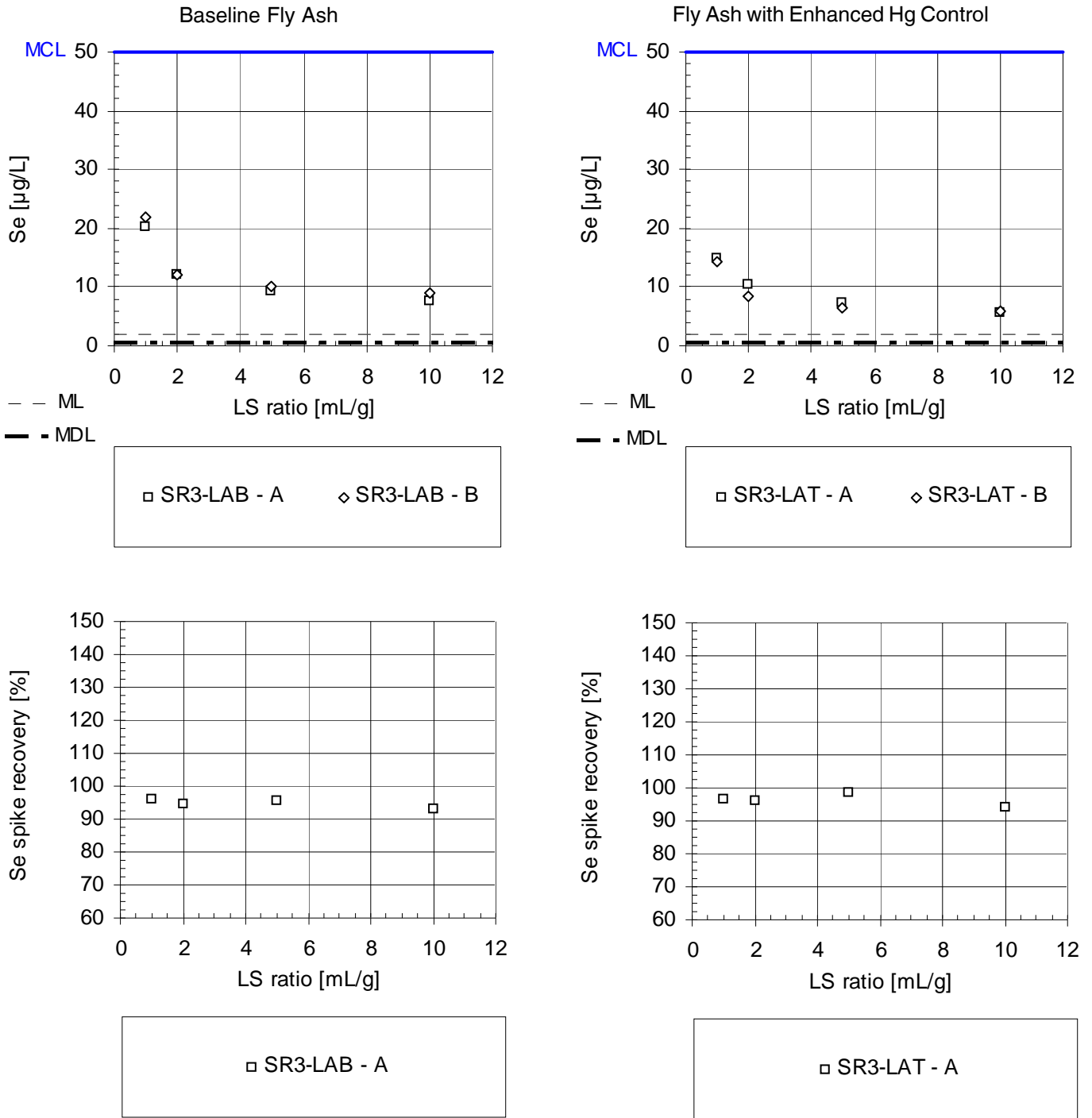
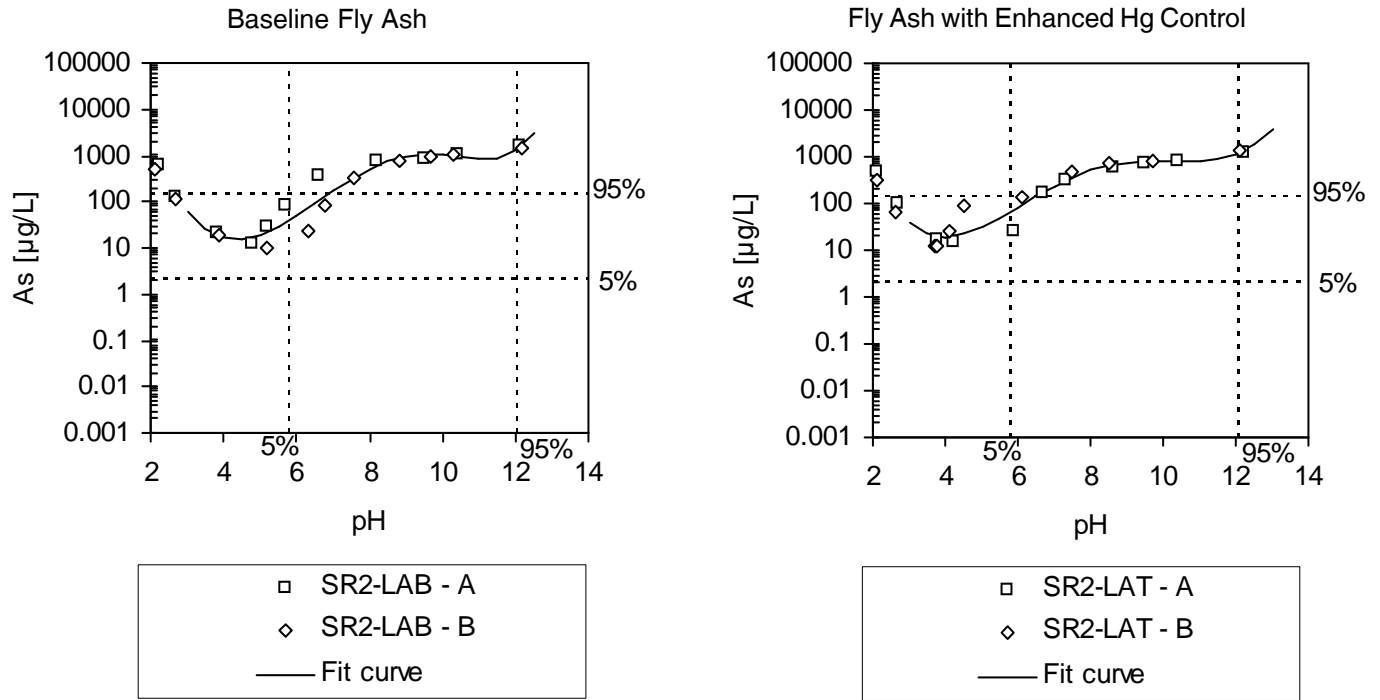

Figure I-8. Selenium Release (top) and Spike Recoveries (bottom) as a Function of LS Ratio for the Baseline Fly Ash and the Fly Ash with Enhanced Hg Control.

Arsenic Solubility



Material	log As ($\mu\text{g/L}$)			pH range of validity	R^2	Number of points
LAB	0.0004 pH^5	-0.0120 pH^4	0.0966 pH^3	3-12.5	0.92	22
	0.0151 pH^2	-2.4406 pH	7.2162			
LAT	0.0000 pH^5	0.0040 pH^4	-0.1157 pH^3	3-12.5	0.92	22
	1.2681 pH^2	-5.5708 pH	9.6784			

Figure I-9. Regression Curves of Experimental Data of Arsenic Solubility as a Function of pH.

Selenium Solubility

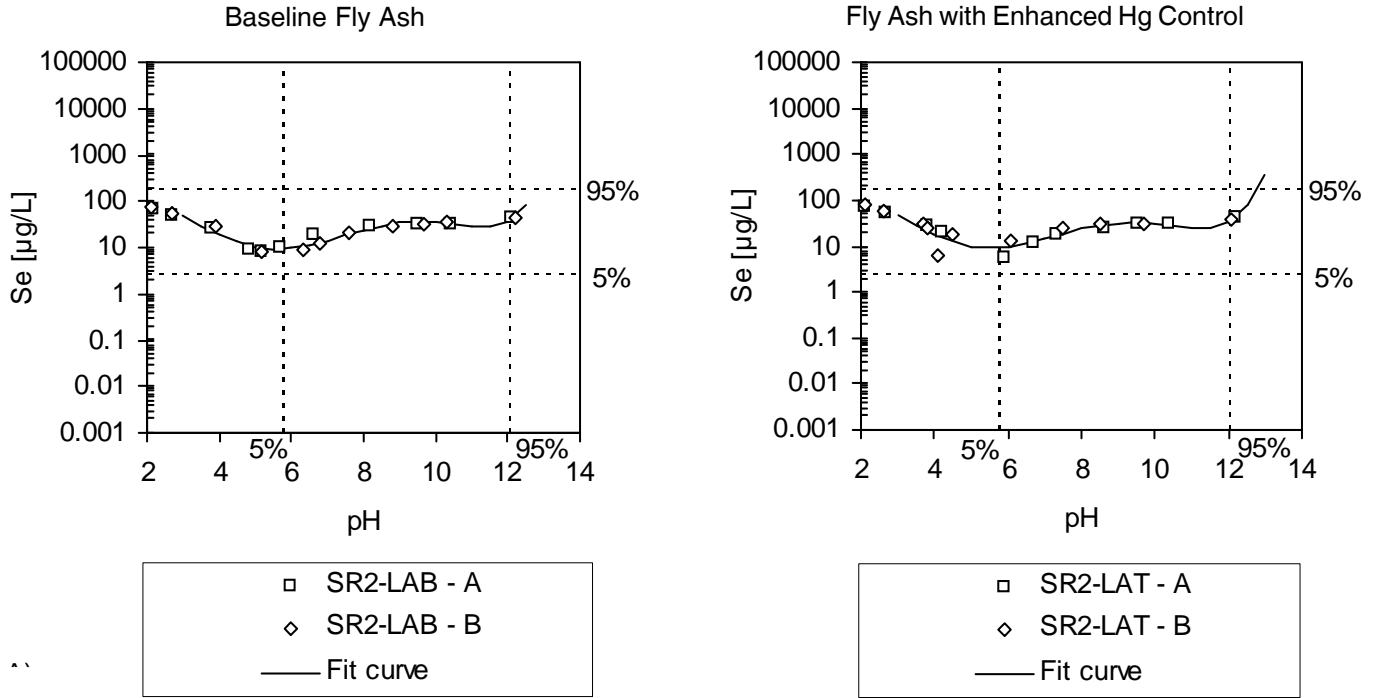

Material	log Se (µg/L)			pH range of validity	R ²	Number of points
LAB	0.0007 pH ⁵	-0.0239 pH ⁴	0.3133 pH ³	3-12.5	0.94	22
	-1.8284 pH ²	4.4667 pH	-1.9621			
LAT	0.0007 pH ⁵	-0.0230 pH ⁴	0.2978 pH ³	3-12.5	0.81	22
	-1.7038 pH ²	4.0275 pH	-1.4335			

Figure I-10. Regression Curves of Experimental Data of Selenium Solubility as a Function of pH.

100-Year Arsenic Release Estimates

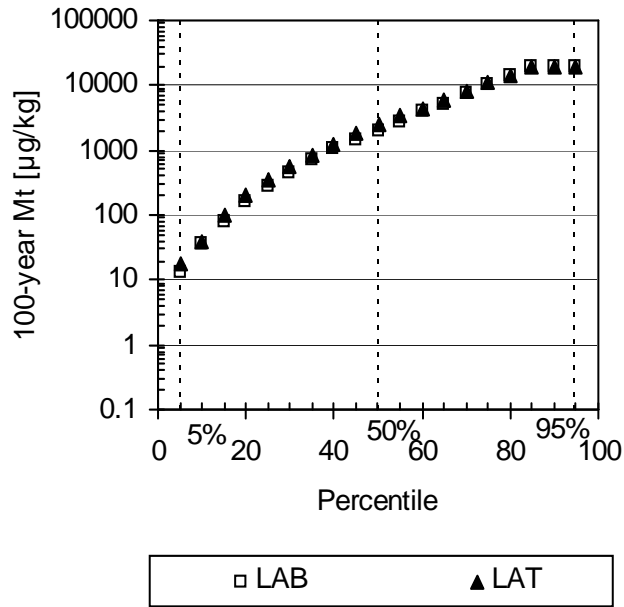

	LAB		LAT	
	µg/kg	%	µg/kg	%
Mt min	0.83	0.00413	1.50	0.00800
Mt - 5%	13.36	0.0668	17.38	0.09296
Mt - 50%	2049	10.25	2471	13.22
Mt - 95%	20000	100.0	18700	100.0
Mean Mt	10541	52.7	10090	53.96
Mt max	20000	100.0	18700	100.0

Figure I-11. 100-Year Arsenic Release Estimates as a Function of the Cumulative Probability for the Scenario of Disposal in a Combustion Waste Landfill.

100-Year Selenium Release Estimates

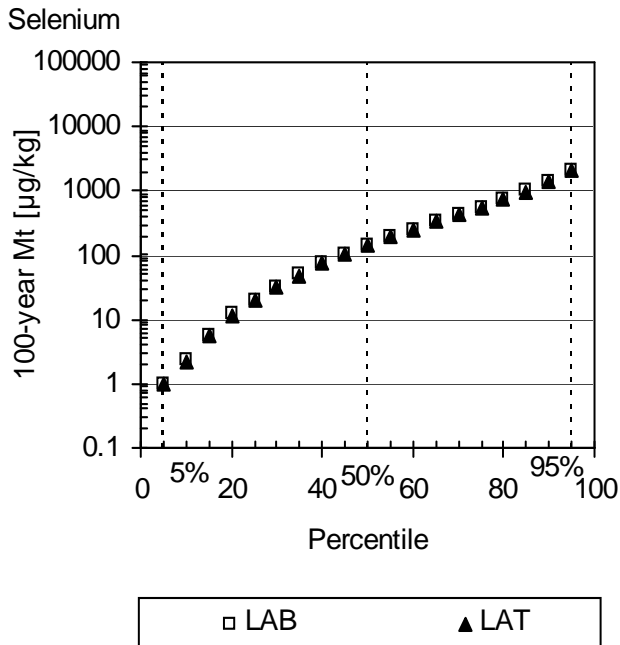

	LAB		LAT	
	µg/kg	%	µg/kg	%
Mt min	0.3	0.01	0.3	0.007
Mt - 5%	1.0	0.02	1.0	0.02
Mt - 50%	143	3.5	141	3.3
Mt - 95%	2113	51.5	2041	47.5
Mean Mt	484	11.8	466	10.8
Mt max	4100	100.0	4300	100.0

Figure I-12. 100-Year Selenium Release Estimates as a Function of the Cumulative Probability for the Scenario of Disposal in a Combustion Waste Landfill.

100-Year Arsenic Release Estimates

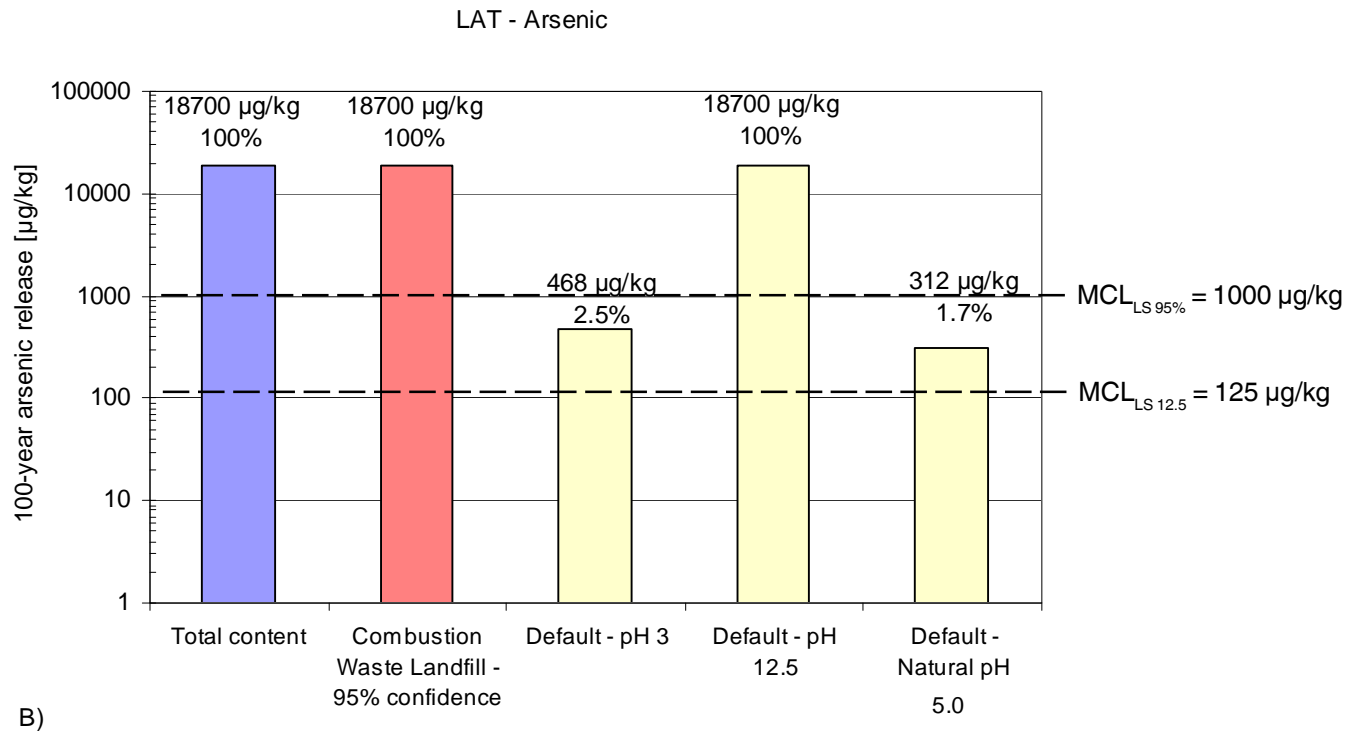
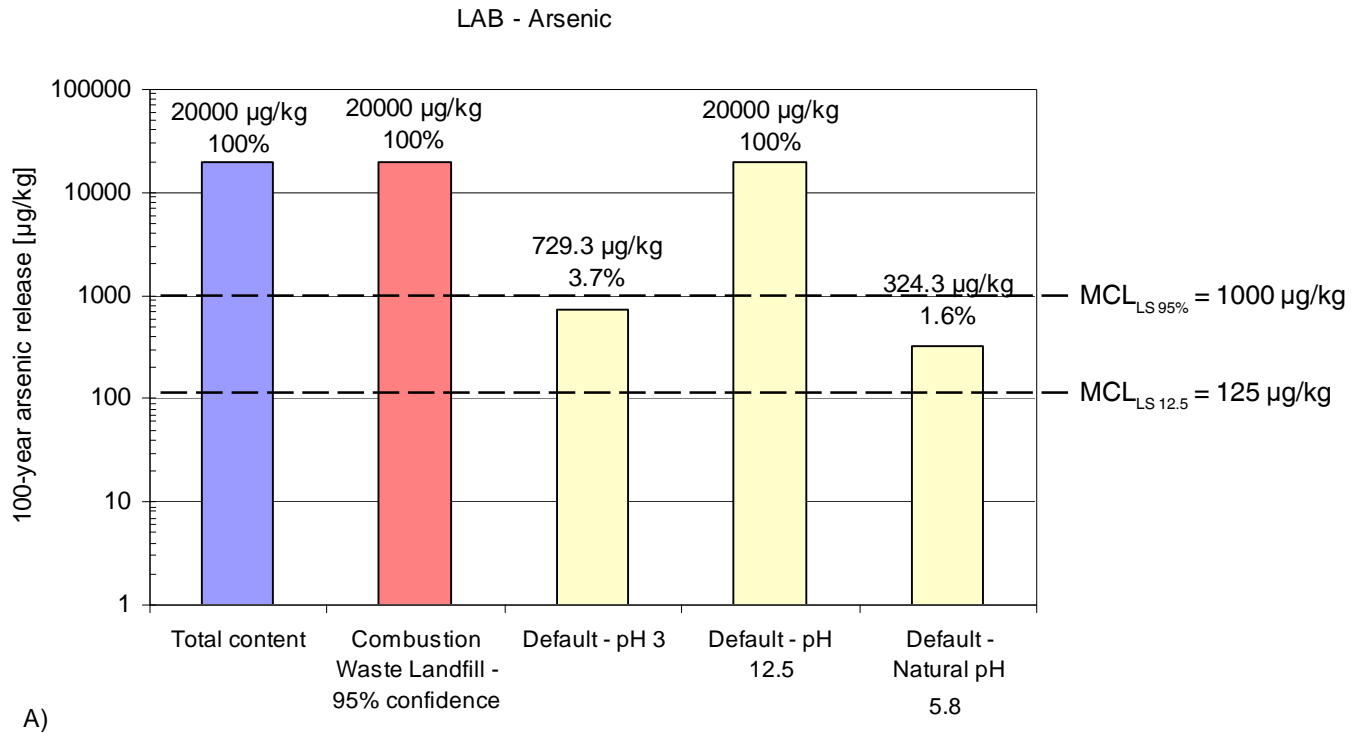

Figure I-13. 100-Year Arsenic Release Estimates from A) Baseline Fly Ash and B) Fly Ash with Enhanced Hg Control. Release estimates for percolation controlled scenario are compared to release estimate based on total content. The amount of the arsenic that would be released if the release concentration was at the MCL is also shown for comparison (LS_{default scenario} = 12.5 L/kg and LS_{95%} = 100 L/kg).

100-Year Selenium Release Estimates

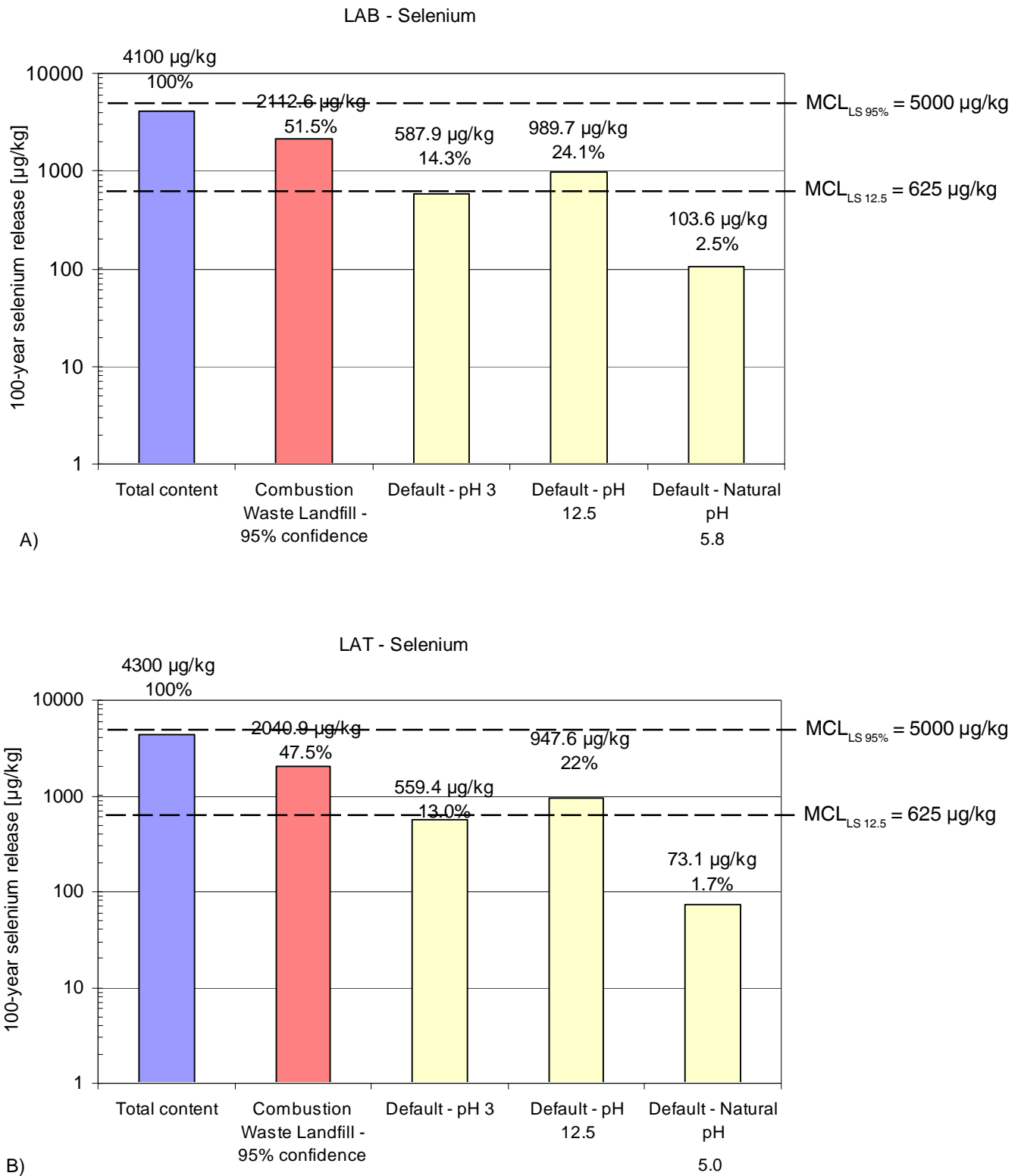

Figure I-14. 100-year Selenium Release Estimates from A) Baseline Fly Ash and B) Fly Ash with Enhanced Hg Control. Release estimates for percolation controlled scenario are compared to release estimate based on total content. The amount of the selenium that would be released if the release concentration was at the MCL is also shown for comparison (LS_{default scenario} = 12.5 L/kg and LS_{95%} = 100 L/kg).

Comments

Figure I-3:

- Fly ash from the test case had greater total Hg content than the fly ash from the baseline case (by about 3 times).
- Hg release is low (but poor replication) for both baseline and test cases.

Figure I-5:

- The fly ash from the test case had lower total As content than that from the baseline case (by about 4.5 times).
- Arsenic release was close to or exceeded the MCL (10 µg/L) for both the baseline and the test cases for all pH conditions.

Figure I-7:

- Fly ash from the test case had greater total Se content than the fly ash from the baseline case (by about 4.5 times).
- Selenium release from both the baseline and the test cases was close to the MCL (50 µg/L) for most pH conditions.

Figures I-11 and I-12:

- The fly ash from the test case would result in similar As release than expected from the baseline case, with a 95% probability to be less than 18700 and 20000 µg/kg, respectively.

- The fly ash from the test case would result in similar Se release than expected from the baseline case, with a 95% probability to be less than 2115 and 2045 µg/kg, respectively.

Figure I-13:

- For the 95% probability scenario, arsenic release from both cases would exceed the amount that would be released if the release concentration was at the MCL.
- For two of the three default scenarios considered (i.e., pH 3 and natural pH), arsenic release would most likely be less than the amount that would be released if the release concentration was at the MCL. However, for the default scenario at pH 12.5, arsenic release would most likely exceed the amount that would be released if the release concentration was at the MCL.

Figure I-14:

- Similar Se release would be expected for the test case compared to the baseline case for all scenarios examined.
- For the 95% probability scenario, selenium release from both cases would be less than the amount that would be released if the release concentration was at the MCL and the LS ratio was the resultant LS ratio for the 95% case (i.e., around 100 L/kg). However, selenium release would be greater than the amount that would be released if the release concentration was at the MCL and the LS ratio was the LS ratio of the default scenario considered (i.e., 12.5 L/kg).