



DVH 0156

DATE OF REGISTRATION/PUBLICATION

Oct. 1, 2003

Month Day Year

DO NOT WRITE ABOVE THIS LINE. IF YOU NEED MORE SPACE, USE A SEPARATE CONTINUATION SHEET. (Form D-VH/CON)

Please give the make and model of the vessel that embodies the design.

Four Winns 170 Horizon

1
TITLE

2 (a) What is the type or style of the design for which registration is sought?
 Fiberglass V-Hull and deck

DESIGN (b) Provide a brief general statement setting forth the salient features of the design.
 Sizing, proportioning and shape that provides aesthetic value along with maximizing functionality per size.

Check here if this is a single design.
 Check here if registering more than one design. Use Form D-VH/CON for additional designs.

(c) If this design is derived from an earlier design, describe how that design has been revised, adapted, or rearranged.

3 Provide the name and address of the designer(s). The name of the employer may be given instead of the designer(s) if: (1) the design was made within the regular scope of employment of the designer(s) and (2) the individual authorship of the design is difficult or impossible to ascribe.

Please check here if those conditions are satisfied and you are providing the employer's name.

Name: Jeremy Sturgeon

Name: Eric Clark

Address: 1811 S. 37 Road
 Cadillac, MI 49601

Address: 220 Winona Pl
 Cadillac, MI 49601

4 If the owner is different from the designer(s) or employer named above, provide the name and address of the owner:

Name: Four Winns Boats, LLC.

Address: 925 Frisbie St.
 Cadillac, MI 49601

OWNER,
 IF NOT
 DESIGNER(S)

5 (a) Was an application for registration of this design identified in an application filed in a foreign country that extends to designs of owners who are citizens of the United States, or to persons filing applications in the United States, similar protection to that afforded in 17 U.S.C. chapter 13?
 Yes No

(b) If yes, identify the country and date of application:
 Country: _____

Date of application: _____

Serial No: _____

Was this design made public before the date of application? Yes No

If yes, on what date? June 1 2003
 Month Day Year

6
DATE MADE
PUBLIC

DO NOT WRITE HERE OFFICE USE ONLY
 APPLICATION RECEIVED SEP 22 2003
 DESIGN COPIES RECEIVED SEP 22 2003
 FUNDS RECEIVED SEP 22 2003

EXAMINED BY JHJ

FORM D-VH

CHECKED BY _____

CORRESPONDENCE

Yes

FOR
COPYRIGHT
OFFICE
USE
ONLY

DO NOT WRITE ABOVE THIS LINE. IF YOU NEED MORE SPACE, USE A SEPARATE CONTINUATION SHEET. (Form D-VH/CON)

Please provide the name and address of the person to whom correspondence regarding this application may be directed:

Name: Tom Wenstadt

Address: 905 Frisbie St.

Cadillac, MI 49601

Email address twensta@fourwinns.com

FAX number 231-779-2342

Daytime phone: (231) 779-2333

Give the name and account number if the registration fee is to be charged to a Deposit Account established in the Copyright Office:

Name of Account: _____

Account number: _____

DECLARATION: The undersigned, as the applicant or the applicant's duly appointed agent or representative, being hereby warned that willful false statements are punishable by fine or imprisonment, or both, under 18 U.S.C. §1001, and that such willful false statements may jeopardize the validity of this application or any resulting registration, hereby declares to the best of his or her knowledge and belief:

- (1) that the design has been fixed in a useful article;
- (2) that the design is original and was created by the designer(s), or employer if applicable, named in the application;
- (3) that those aspects of the design for which registration is sought are not protected by a design patent;
- (4) that the design has not previously been registered on behalf of the applicant or applicant's predecessor in title; and
- (5) that the applicant is the person entitled to protection and to registration under chapter 13 of title 17, United States Code.

Complete if applicable:

The design has been made public with a design notice as prescribed by 17 U.S.C. §1306.

Following is the exact form of the design notice:

PROTECTED DESIGN Four Winns Boats, L.L.C., 2003

Where on the useful article is the design notice located?

Transom

If the undersigned is not the applicant, he or she is properly authorized to execute this application on behalf of the applicant.

Signature

Tom Wenstadt

Print or type name

231-779-2333

Telephone number

231-779-2342

FAX number

7-19-03

Date

Technical Manager

Position or Title

twensta@fourwinns.com

Email address

CERTIFICATION AND SWORN STATEMENTS

CONTACT PERSON

DEPOSIT ACCOUNT

7

8

9

Copyright Office fees are subject to change. For current fees, check the Copyright Office website at www.copyright.gov, write the Copyright Office, or call (202) 707-3000.

Certificate will be mailed in window envelope to this address:

Name ▼	Tom Wenstadt
Number/Street/Apt ▼	905 Frisbie St.
City/State/ZIP ▼	Cadillac, MI 49601

YOU MUST:

- Complete all necessary spaces
- Sign your application in space 9

SEND ALL 3 ELEMENTS IN THE SAME PACKAGE:

1. Application form
2. Nonrefundable filing fee in check or money order payable to Register of Copyrights
3. Design material

MAIL TO:
Dept. D-VH
Vessel Hull Registration
P.O. Box 71380
Washington, D.C. 20024-1380

17 U.S.C. §1327. Penalty for false representation. "Whoever knowingly makes a false representation materially affecting the rights obtainable under this chapter for the purpose of obtaining registration of a design under this chapter shall pay a penalty of not less than \$500 and not more than \$1,000, and any rights or privileges that individual may have in the design under this chapter shall be forfeited."

DVH 0156

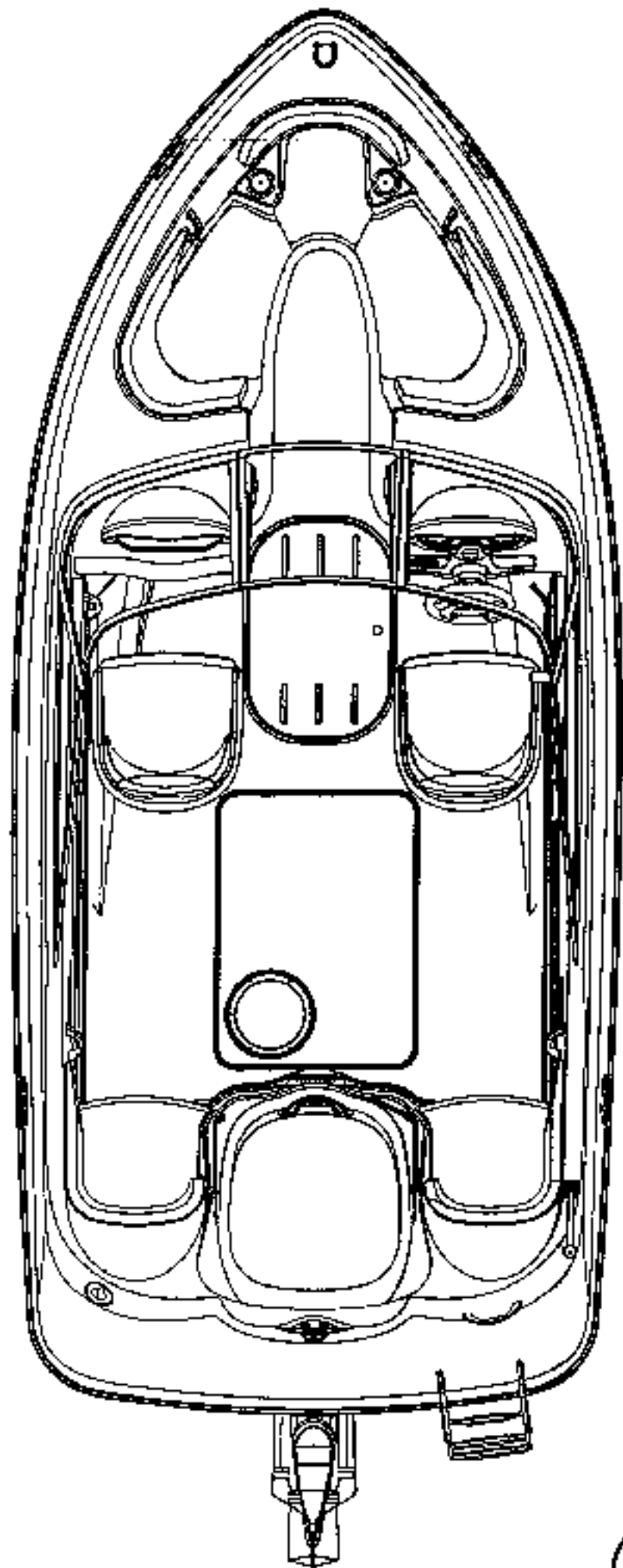

DVH 0156

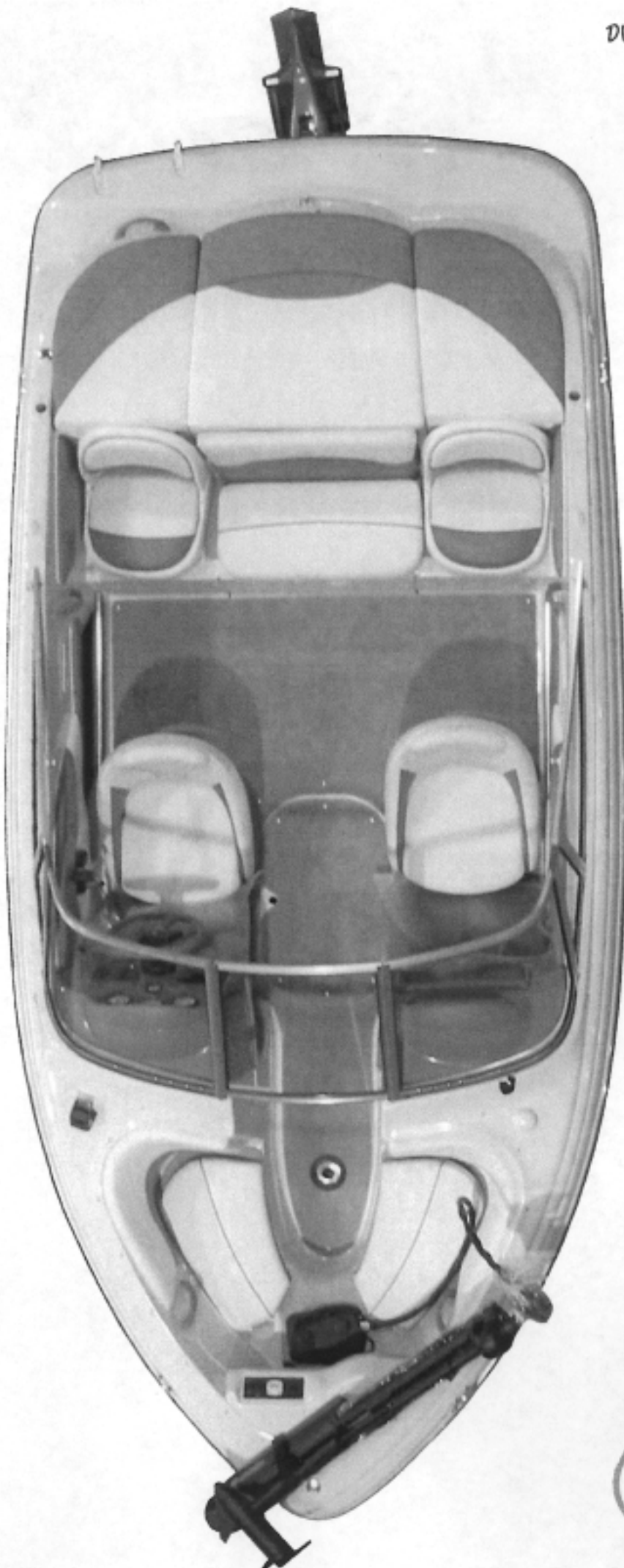

LIBRARY OF CONGRESS
SEP 22 2003 L
COPYRIGHT OFFICE

DVH 0156



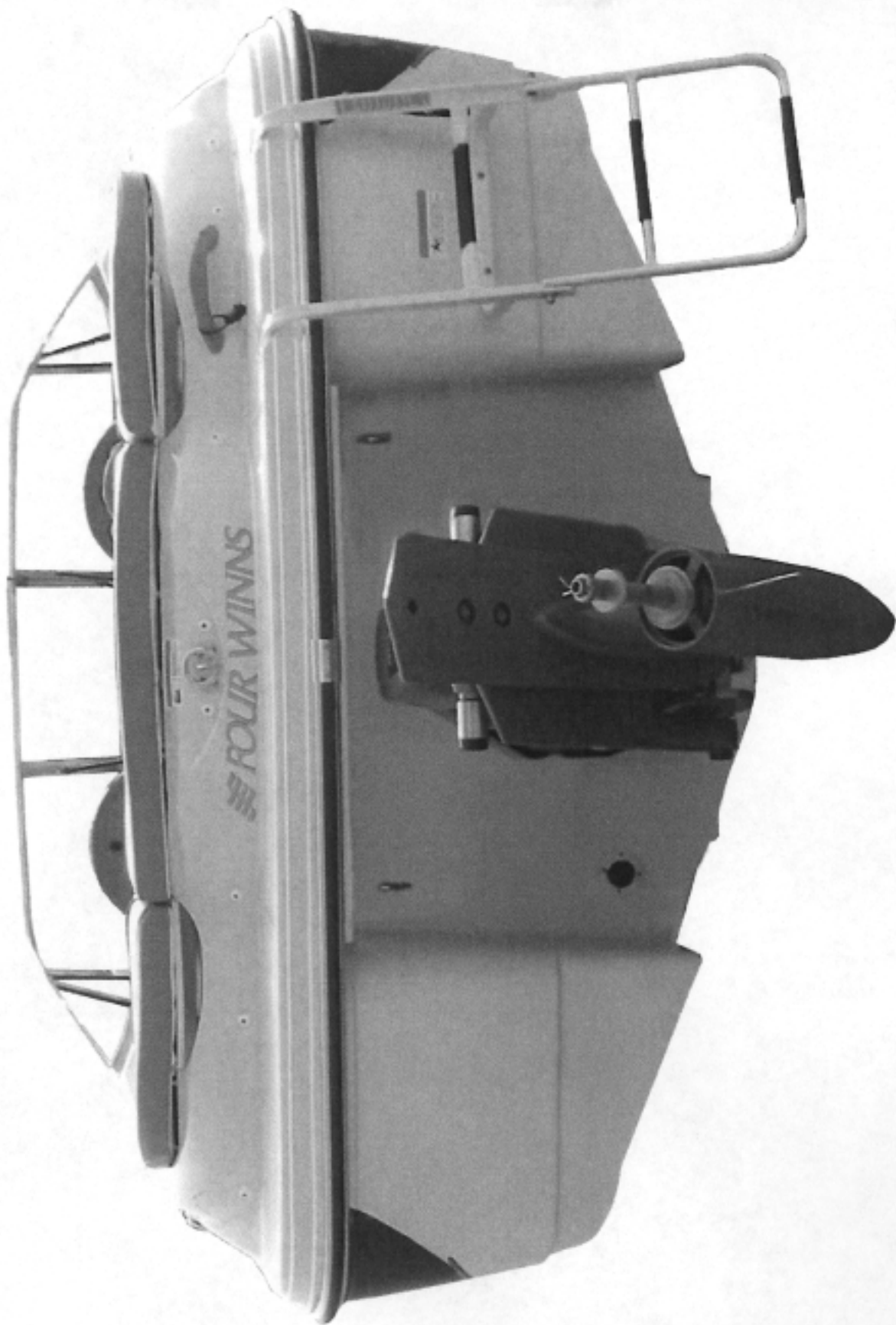

LIBRARY OF CONGRESS
SEP 22 2003 L
COPY _____
COPYRIGHT OFFICE

DVH 0156

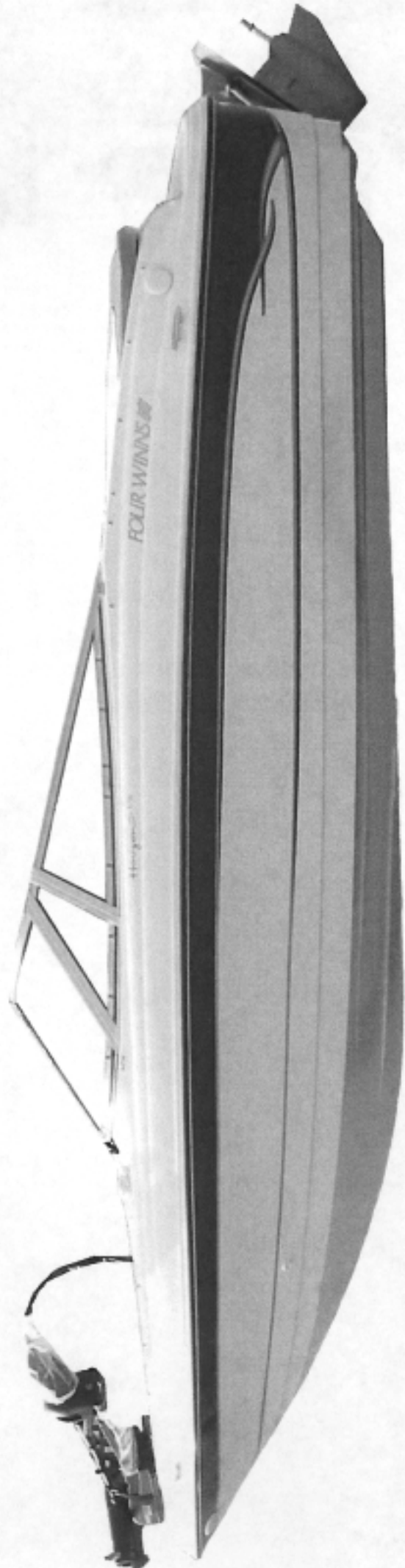

LIBRARY OF CONGRESS
SEP 22 2003 L
COPYRIGHT OFFICE

DVH 0156



LIBRARY OF CONGRESS
SEP 22 2003 L
COPYRIGHT OFFICE

DVH 0156

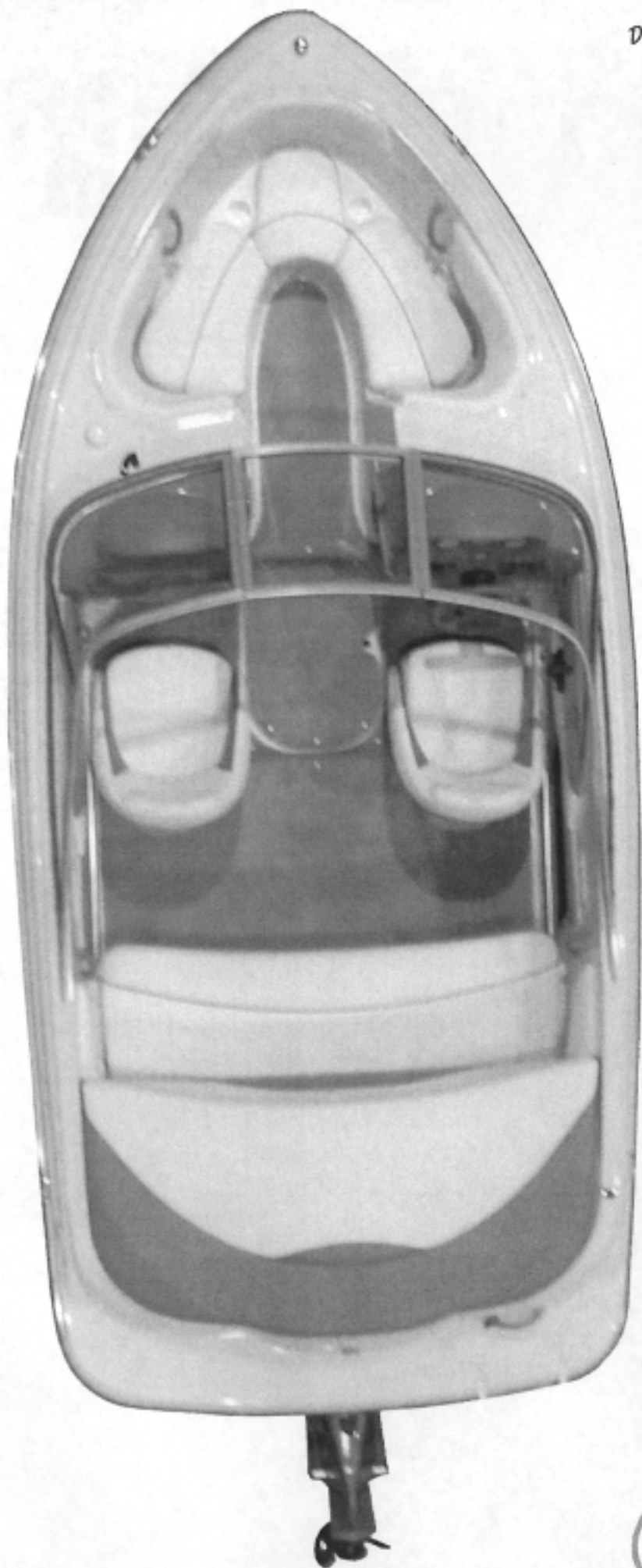

DVH 0156

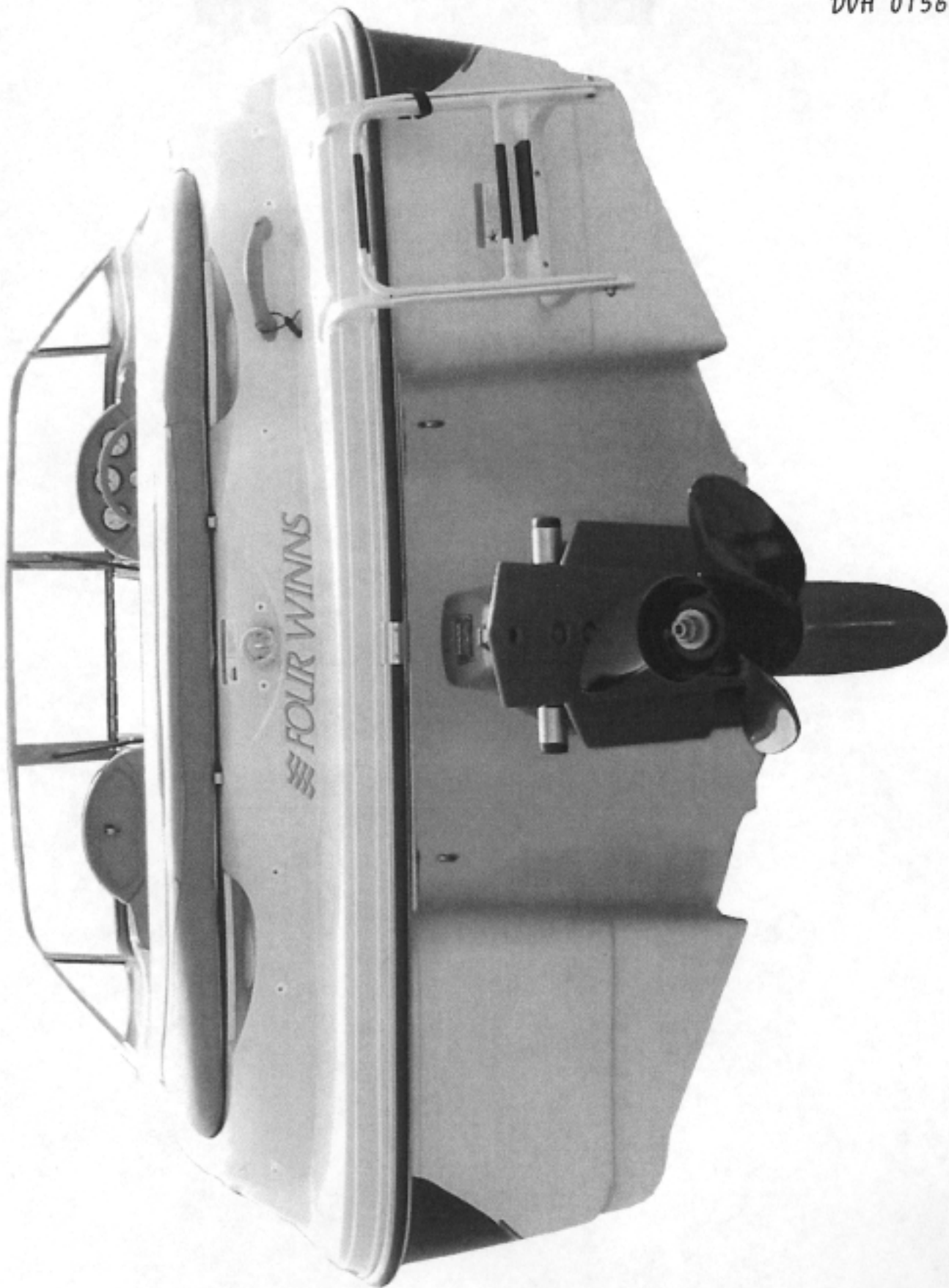

LIBRARY OF CONGRESS
SEP 22 2003 L
COPY _____
COPYRIGHT OFFICE

DVH 0156

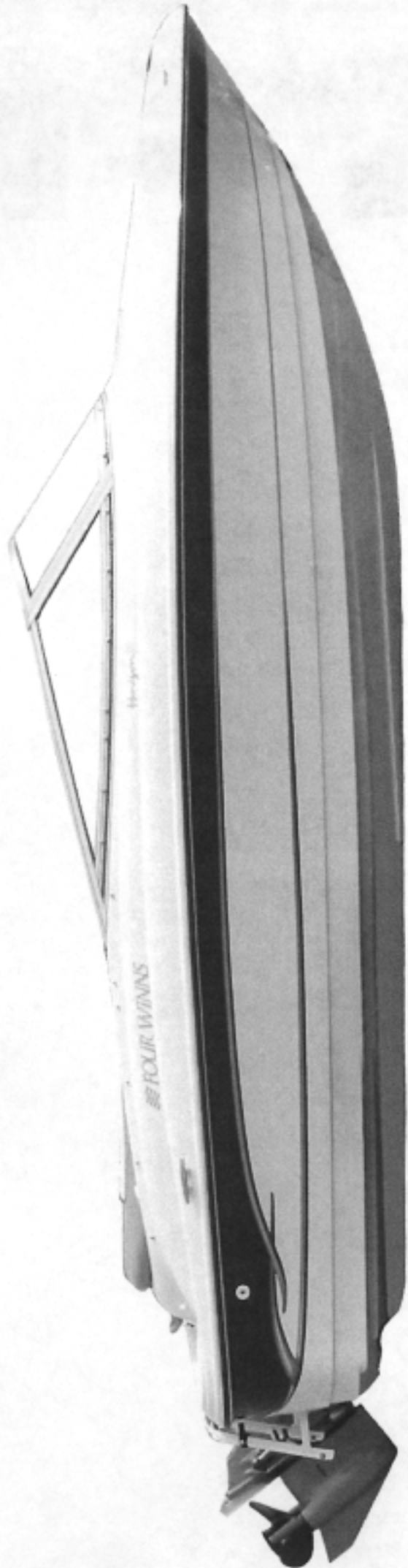

DVH 0156

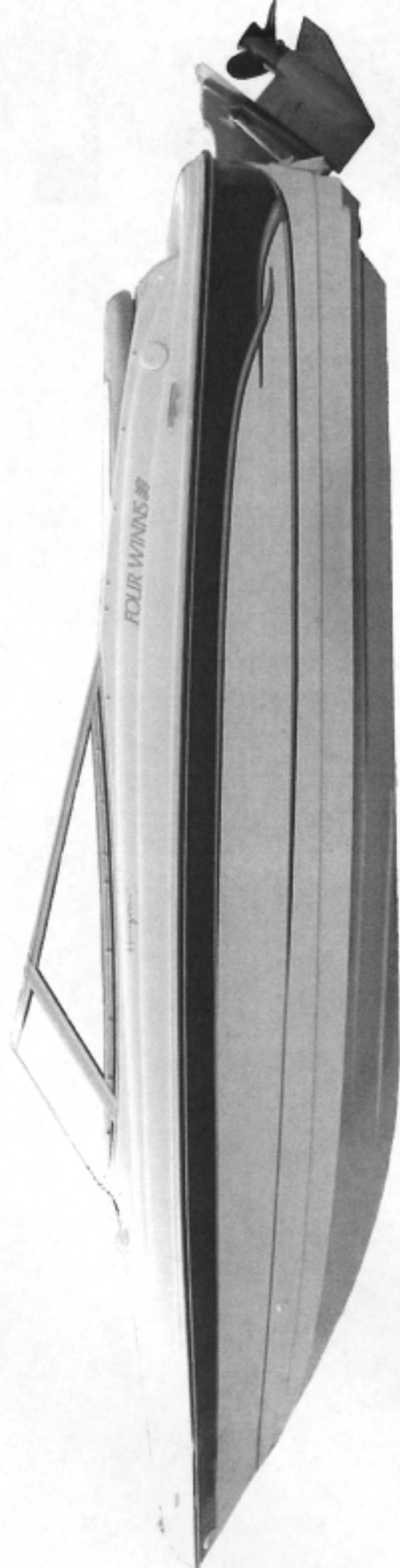

LIBRARY OF CONGRESS
SEP 22 2003
COPY _____
COPYRIGHT OFFICE

DVH 0156

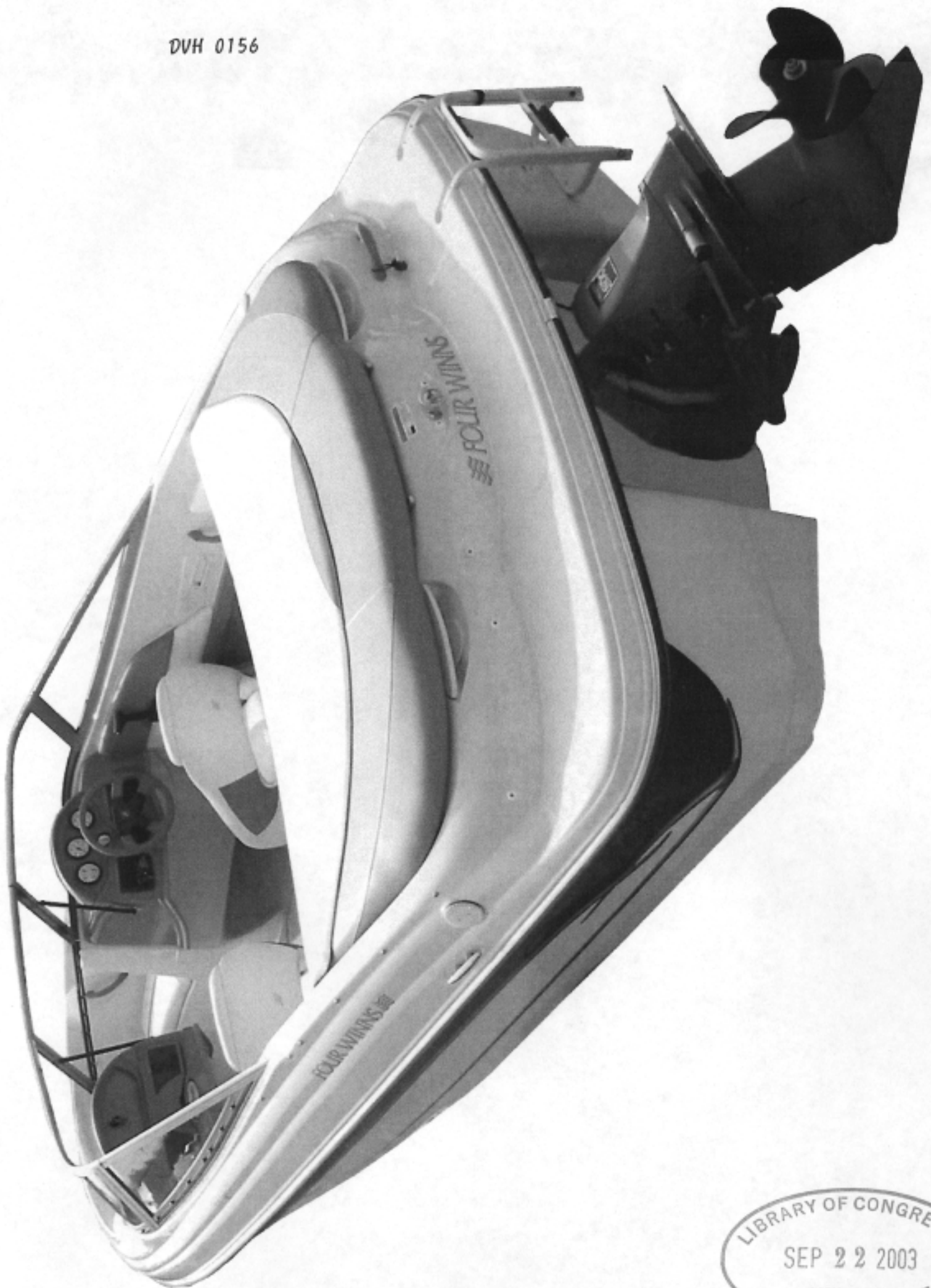

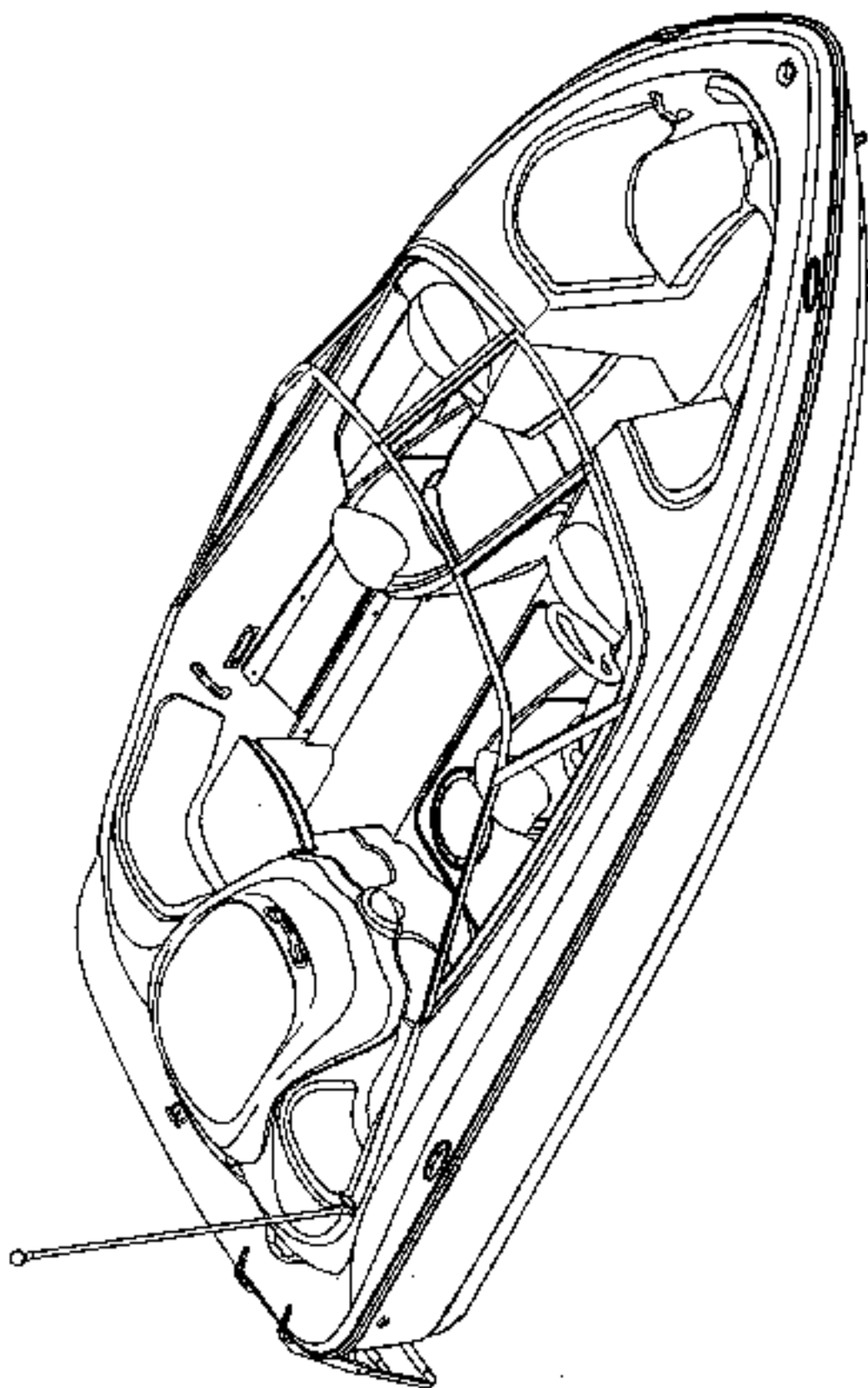

LIBRARY OF CONGRESS
SEP 22 2003
COPYRIGHT OFFICE

DVH 0156

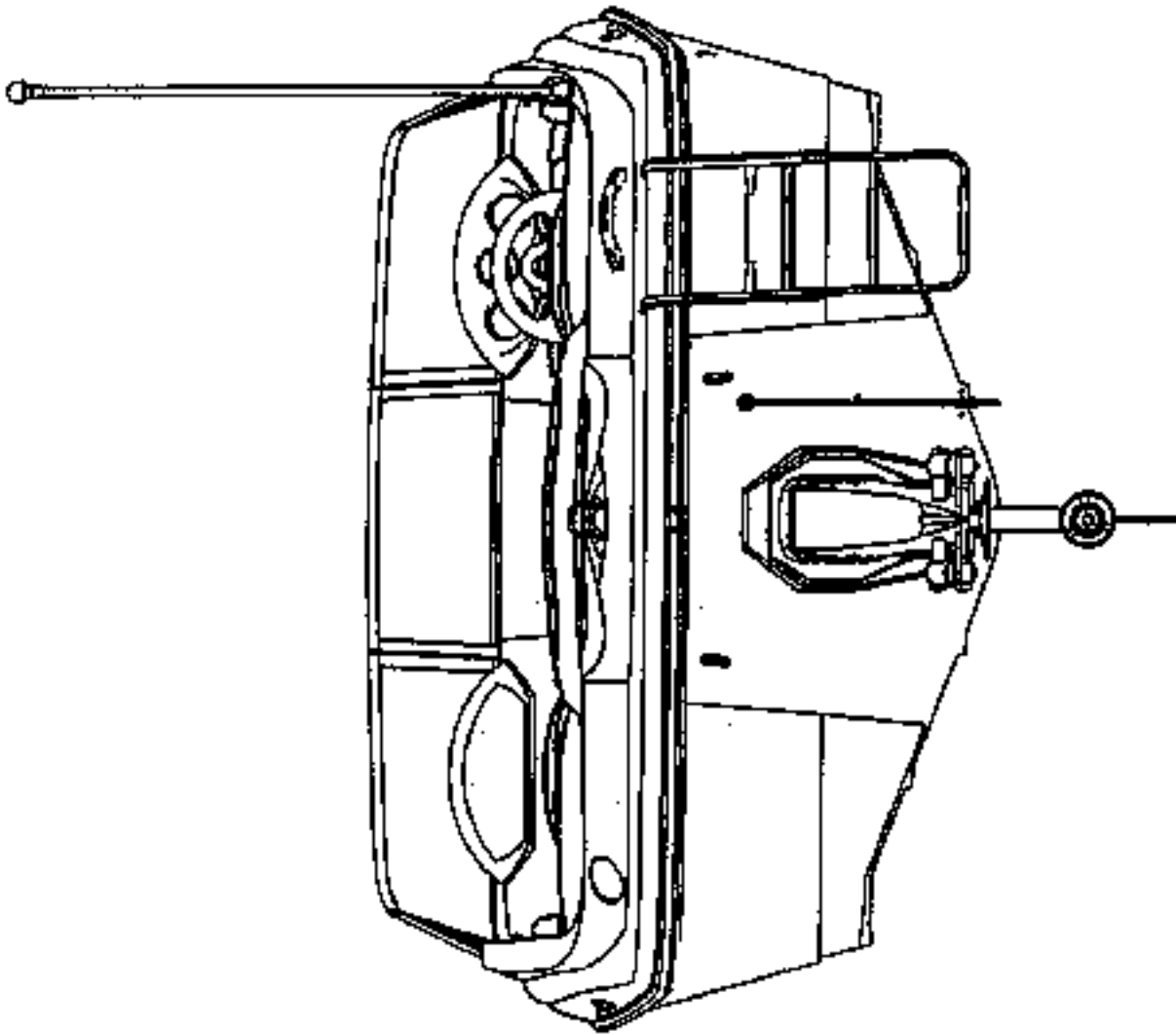

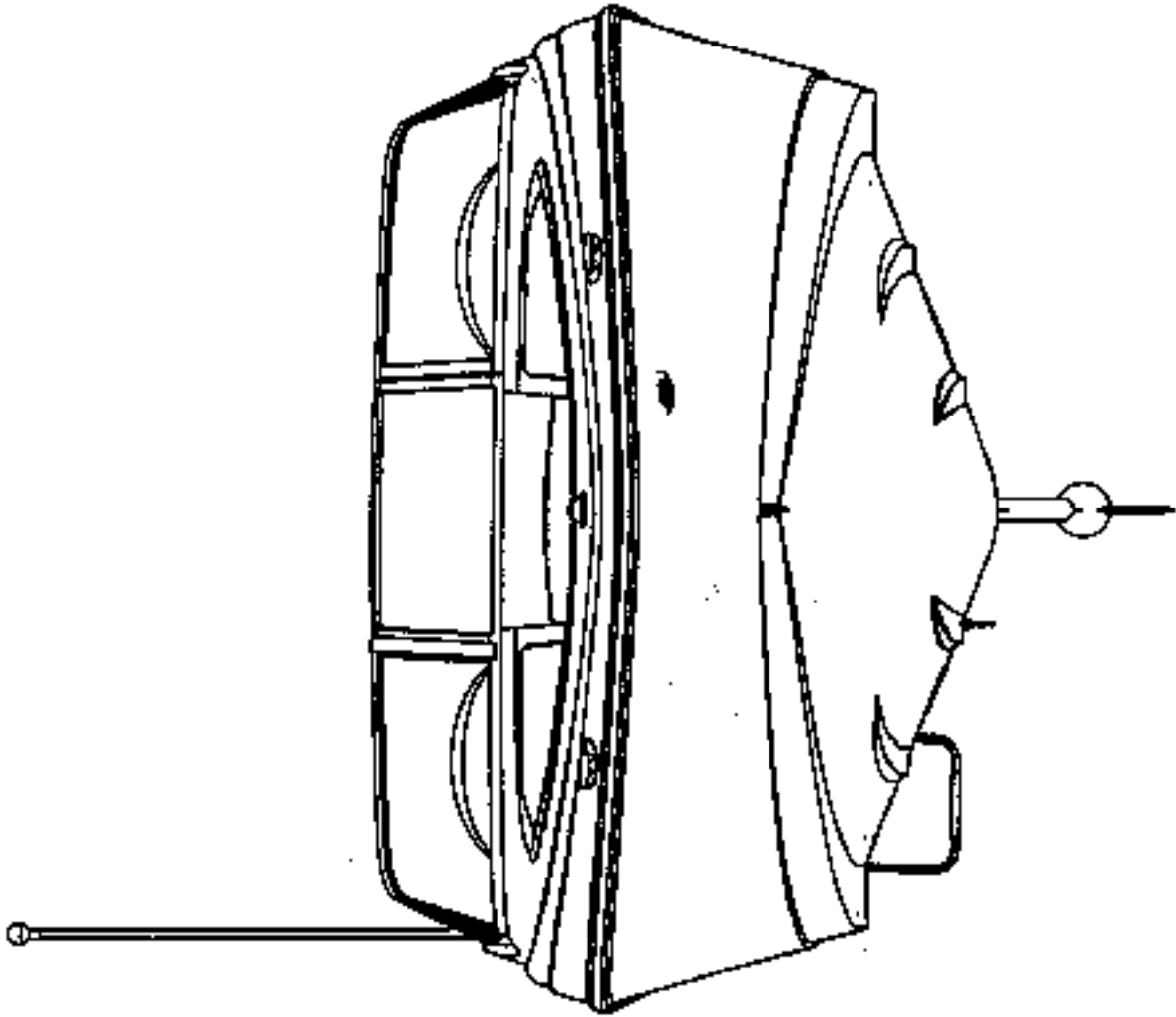

LIBRARY OF CONGRESS
SEP 22 2003 L
COPY _____
COPYRIGHT OFFICE

DVH 0156

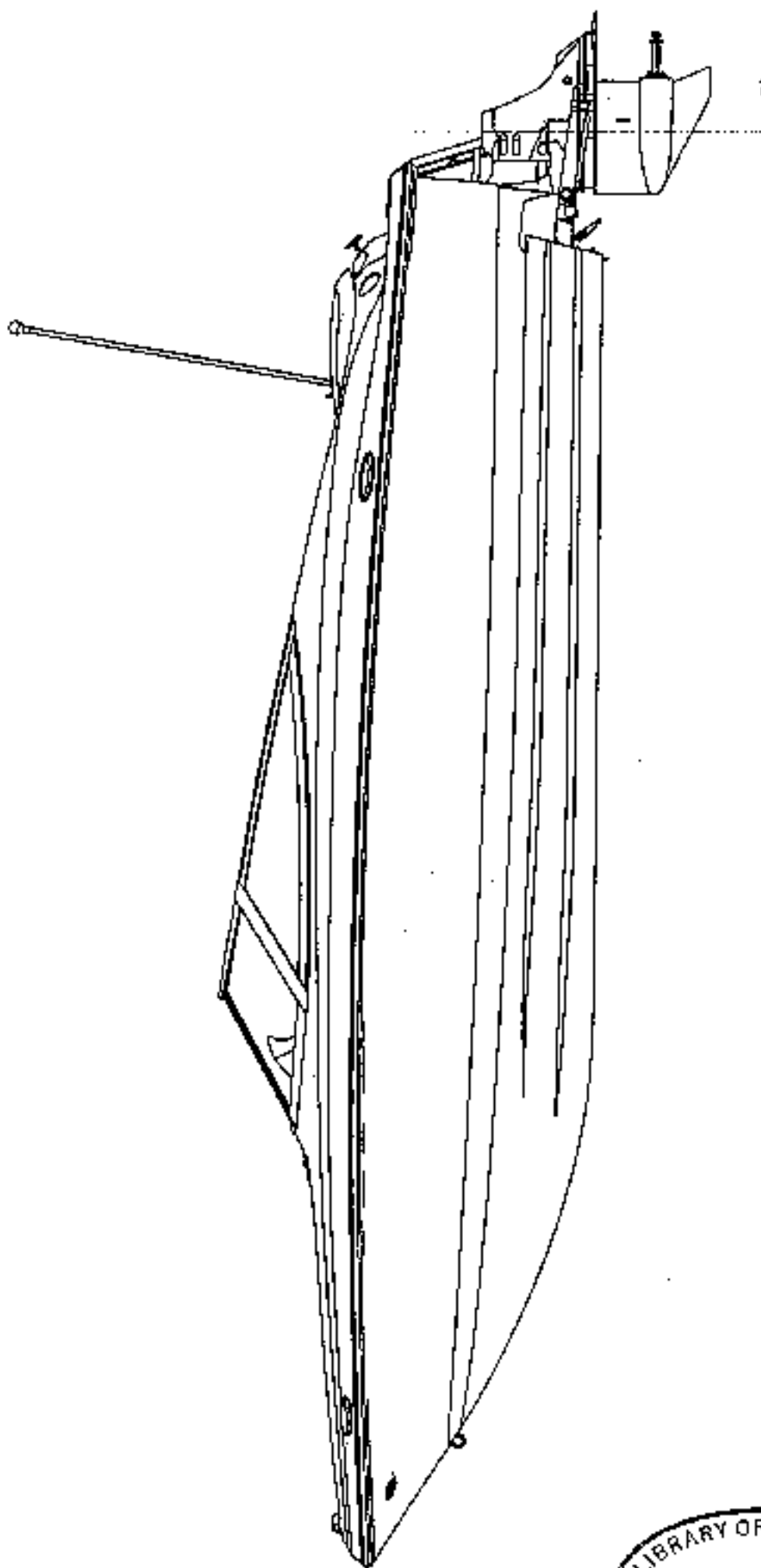

DVH 0156

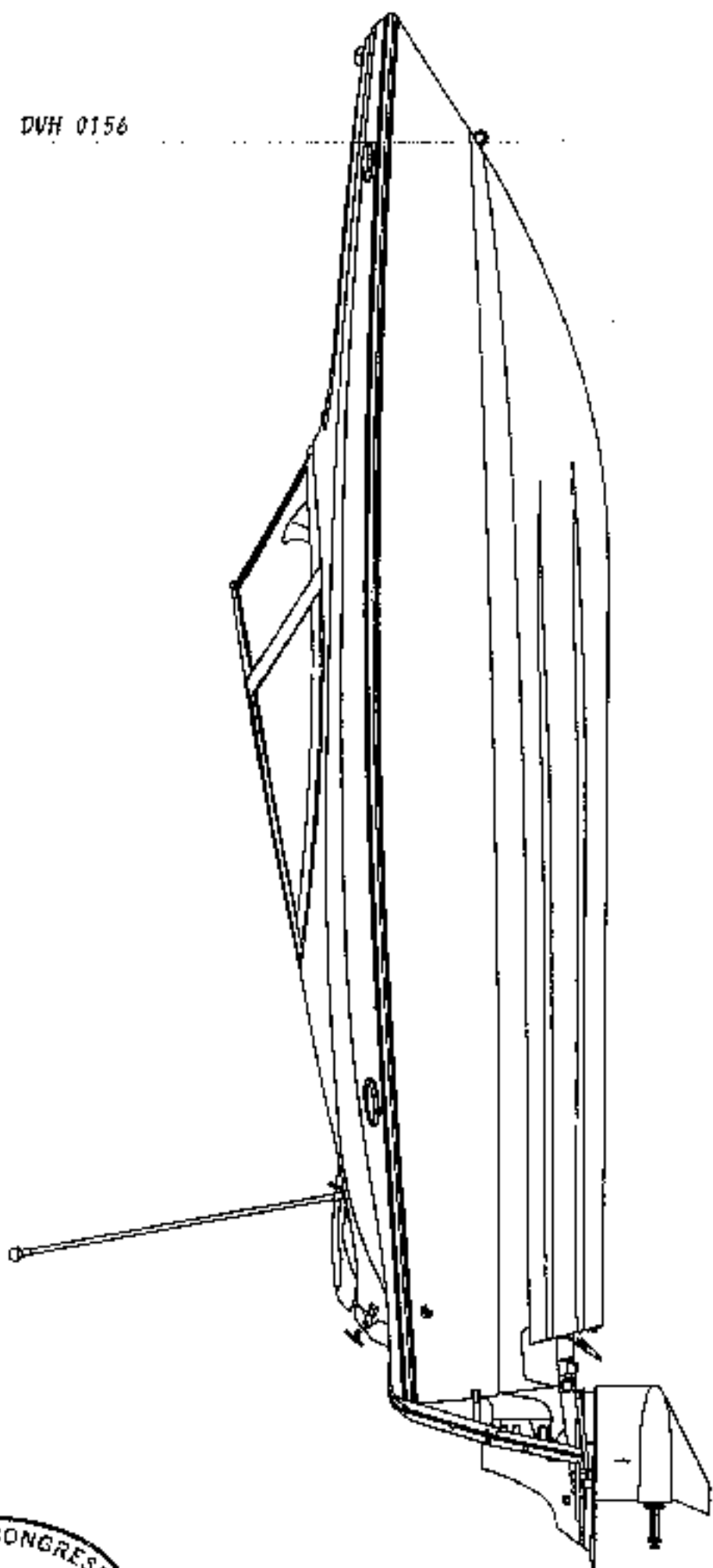

LIBRARY OF CONGRESS
SEP 22 2003
COPYRIGHT OFFICE

DVH 0756

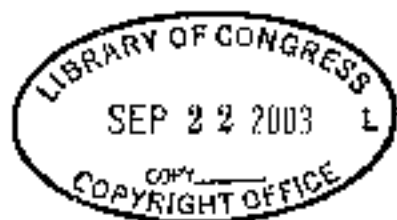
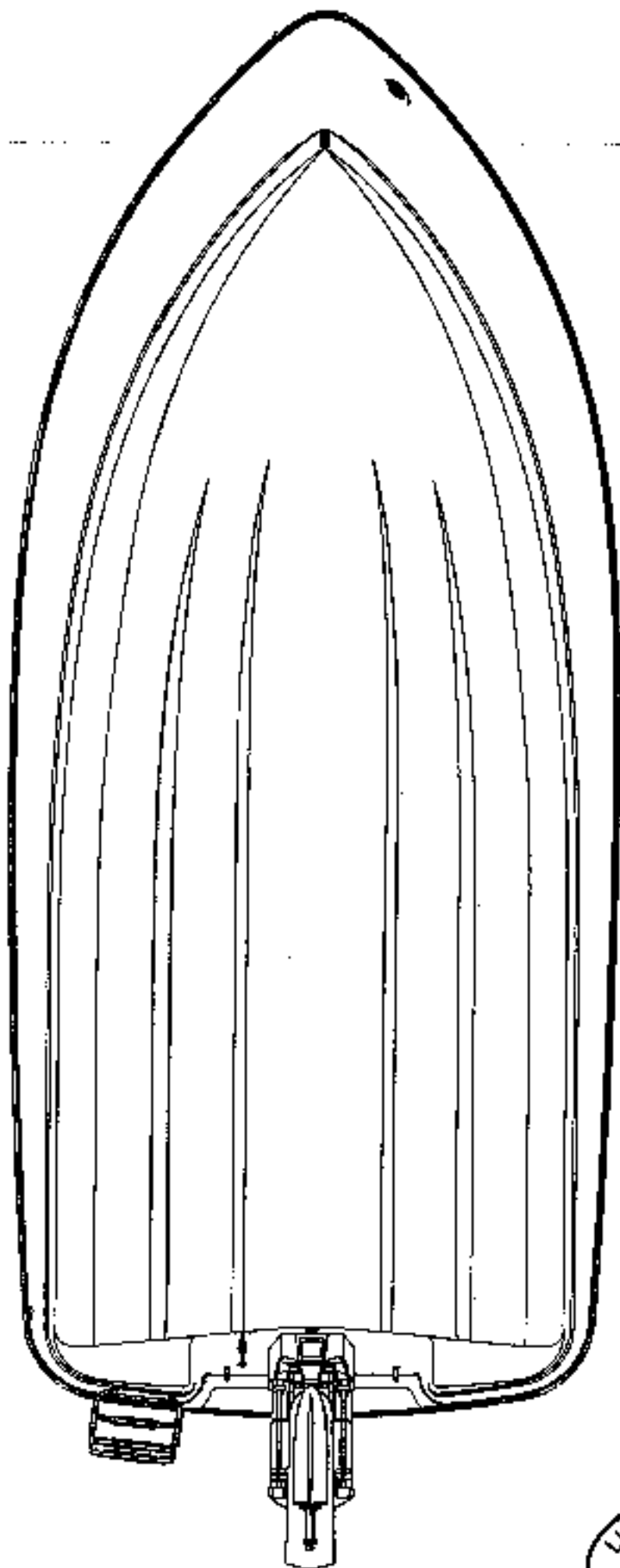

DVH 0156

