

Map MODERNIZATION

Federal Emergency Management Agency



FEMA's Flood Hazard Mapping Program

Guidelines and Specifications *for* Flood Hazard Mapping Partners

*Appendix D: Guidance for Coastal
Flooding Analyses and Mapping*



FEDERAL EMERGENCY MANAGEMENT AGENCY

www.fema.gov/mit/tsd/dl_cgs.htm

FINAL
February 2002

Appendix D

Guidance for Coastal Flooding Analyses and Mapping

D.1 General Guidance

A variety of analytical methodologies may be used to establish Base Flood Elevations (BFEs) and floodplains throughout coastal areas of the United States. These methodologies are too voluminous to be included in these Guidelines. This Appendix itemizes references for the methodologies currently in use by FEMA for specific coastal flood hazards, provides general guidance for documentation of a coastal flood hazard analysis, specifies flood hazard analysis procedures for the Great Lakes coasts, and outlines intermediate data submissions for coastal flood hazard analyses with new storm surge modeling and revised stillwater flood level (SWFL).

[February 2002]

D.1.1 Coastal Flood Hazard Analysis Methodologies

The publications cited below were prepared for, and are available from, FEMA, or they are used to prepare a coastal flood hazard assessment and establish BFEs. The publications prepared for FEMA will be provided to the Mapping Partners responsible for performing coastal flood hazard analyses. The Mapping Partners responsible for final production of Flood Insurance Studies (FISs) for the Atlantic Ocean, Gulf of Mexico and Great Lakes shall obtain copies of the published data used to prepare the coastal flood hazard analyses and establish BFEs, and shall be familiar with the use and application of the information presented in the publications cited below. Mapping Partners responsible for final production of FISs for the Pacific Ocean coastal areas shall consult with the appropriate FEMA Regional Project Officer (RPO) to determine the appropriate methodologies that shall be followed.

Northeaster Flooding

Stone & Webster Engineering Corporation, "Development and Verification of a Synthetic Northeaster Model for Coastal Flood Analysis," 1978.

U.S. Department of the Army, Corps of Engineers, New England Division, Hydraulics and Water Quality Section, "Tidal Flood Profiles, New England Coastline," September 1988.

Hurricane Flooding

U.S. Department of Commerce, National Oceanic and Atmospheric Administration, National Weather Service, *Hurricane Climatology for the Atlantic and Gulf Coasts of the United States (NWS 38)*, April 1987.

Federal Emergency Management Agency, *FEMA Coastal Flooding Storm Surge Model*, Volumes 1, 2, and 3, August 1988.

Pacific Northwest Storm Flooding

CH2M HILL, Inc., “Determination of Flood Levels on the Pacific Northwest Coast for Federal Insurance Studies,” *Journal of Hydraulics Division, ASCE*, D. E. Dorratcague, J. H. Humphrey, and R. D. Black, 1977, Vol. 103, 73–81.

U.S. Department of the Army, Corps of Engineers, Pacific Ocean Division, *Manual for Determining Tsunami Runup on Coastal Area of Hawaii*, August 1978.

U.S. Department of the Army, Corps of Engineers, Waterways Experiment Station, Technical Report H-80-16, *Tsunami-Wave Elevation Predictions for American Samoa*, September 1980.

Tsunami Flooding

U.S. Department of the Army, Corps of Engineers, Waterways Experiment Station, Technical Report H-77-16, *Tsunami-Wave Elevations, Frequency of Occurrence for the Hawaiian Islands*, August 1977.

U.S. Department of the Army, Corps of Engineers, Waterways Experiment Station, Technical Report CERC-87-7, *Tsunami Predictions for the Coast of Alaska, Kodiak Island to Ketchikan*, April 1987.

U.S. Department of the Army, Corps of Engineers, Waterways Experiment Station, Technical Report H-80-16, *Tsunami-Wave Elevation Predictions for American Samoa*, September 1980.

U.S. Department of the Army, Corps of Engineers, Waterways Experiment Station, Technical Report HL-80-18, *Type 19 Flood Insurance Study: Tsunami Predictions for Southern California*, 1980.

U.S. Department of the Army, Corps of Engineers, Pacific Ocean Division, *Manual for Determining Tsunami Runup on Coastal Area of Hawaii*, August 1978.

Great Lakes Mapping of Coastal Flooding Areas

U.S. Department of the Army, Corps of Engineers, *Revised Report on Great Lakes Open-Coast Flood Levels, Phases I and II*, April 1988.

U.S. Department of the Army, Corps of Engineers, *Great Lakes Wave Runup Methodology Study*, June 1989.

Federal Emergency Management Agency, *Guidelines for Great Lakes Wave Runup Computation and Mapping*, June 1991.

Dewberry & Davis, *Basic Analyses of Wave Action and Erosion with Extreme Floods on Great Lakes Shores*, Draft Report, October 1995.

Federal Emergency Management Agency, *Guidelines and Specifications for Wave Elevation Determination and V Zone Mapping – Great Lakes*, Draft Report, August 1996.

Guidelines and Specifications for Flood Hazard Mapping Partners

Mississippi River Delta Flooding

Joseph N. Suhayda, *Attenuation of Storm Waves over Muddy Bottom Sediments*, August 1984.

Wave Height and Runup Analyses

National Academy of Sciences, *Methodology for Calculating Wave Action Effects Associated with Storm Surges*, 1977.

Federal Emergency Management Agency, *Assessment of Current Procedures Used for the Identification of Coastal High Hazard Areas (V Zones)*, September 1986.

Federal Emergency Management Agency, *Basis of Assessment Procedures for Dune Erosion in Coastal Flood Insurance Studies*, January 1989.

U.S. Department of the Army, Corps of Engineers, Waterways Experiment Station, Coastal Engineering Research Center, WIS Report 19, *Hurricane Hindcast Methodology and Wave Statistics for Atlantic and Gulf Hurricanes from 1956-1975*, April 1989.

Federal Emergency Management Agency, *Wave Height Analysis for Flood Insurance Studies (Technical Documentation for WHAFIS Program Version 3.0)*, September 1988, amended with software, July 1989.

Federal Emergency Management Agency, *Wave Runup Model Version 2.0 (RUNUP 2.0)*, 1991.

U.S. Department of the Army, Corps of Engineers, *Shore Protection Manual, Volumes I and II*, 1984.

U.S. Department of the Army, Corps of Engineers, Waterways Experiment Station, *Automated Coastal Engineering System*, Version 1.07, September 1992.

U.S. Department of the Army, Corps of Engineers, Waterways Experiment Station, Coastal Engineering Research Center, WIS Report 20, *Southern California Hindcast Wave Information*, December 1992.

U.S. Department of the Army, Corps of Engineers, Waterways Experiment Station, Coastal Engineering Research Center, WIS Report 30, *Hindcast Wave Information for the U.S. Atlantic Coast*, March 1993.

Evaluation of Coastal Structures

U.S. Department of the Army, Corps of Engineers, *Shore Protection Manual, Volumes I and II*, 1984.

U.S. Department of the Army, Corps of Engineers, *Design of Coastal Revetments, Seawalls and Bulkheads*, April 1985.

Guidelines and Specifications for Flood Hazard Mapping Partners

U.S. Department of the Army, Corps of Engineers, Waterways Experiment Station, Technical Report CERC-89-15, *Criteria for Evaluating Coastal Flood Protection Structures*, December 1989.

Atlantic and Gulf Mapping of Coastal Areas

Federal Emergency Management Agency, *Guidelines and Specifications for Wave Elevation Determination and V Zone Mapping*, Final Draft, March 1995.

[February 2002]

D.1.2 Study Documentation

Mapping Partners responsible for producing coastal FISs must document fully the coastal flood hazard determination for each study. This documentation shall identify the methodology employed as well as the computational approach and the input data used in the calculation of the coastal flood elevations. The technical specifications under which all coastal FISs will be documented are provided in the various internal and public FEMA reports outlining the approved coastal storm surge elevation methodology that are referenced in Subsections D.1.1 and D.1.4. These reports include algorithms, computer codes, guidelines for model use, and examples of model runs.

Although some of these reports provide relatively specific information on both the general procedures to be employed in processing the meteorological and hydrologic data, and the specifics of the hydrodynamic and windfield models to be employed, the reports contain no information on the application of the methodology to a particular coastal site. Therefore, the Mapping Partner responsible for performing a coastal study shall document the specific meteorological and hydrologic data, ocean bathymetry, shoreline characteristics, surface and bottom friction coefficients, and other parameters used in the particular model application. For this purpose, the Mapping Partner shall produce an engineering report for each coastal study.

The purpose of the engineering report is to provide the detailed site-specific data needed by FEMA and the affected coastal communities to reconstruct or defend, on technical grounds, the study results. In general, the documentation shall include the input data; modeling approach; model parameter values; and all assumptions, decisions, and judgments that influence model outputs. The material to be included in the engineering report is summarized in the subsections below. Although the emphasis is on coastal studies incorporating storm surge models, Mapping Partners using other methods shall nonetheless adhere to the appropriate subsections. The Mapping Partner performing a coastal study shall obtain RPO approval for any deviations from the requirements documented in these Guidelines.

[February 2002]

D.1.2.1 Introductory Material

In the first section of the engineering report, the Mapping Partner shall describe the geographic setting of the study site, discuss the local surge-producing climatology of both tropical and

Guidelines and Specifications for Flood Hazard Mapping Partners

extratropical storms, and provide a history of extreme storm surges. The Mapping Partner shall also report on unique aspects of each component of the stillwater flood elevation (SWEL) that was investigated (e.g., inverted barometer setup, wind transport, astronomical tide level, pre-surge anomaly, wave action, and abnormal hydrological conditions). The Mapping Partner also shall include a short discussion of the coastal study results and how they will be used in producing the Flood Insurance Rate Map (FIRM).

[February 2002]

D.1.2.2 Outline of Methodology

In the second section of the engineering report, the Mapping Partner shall provide an outline of the basic technical approach employed in the study. Topics to be covered include identification of the storm (wind) model, the hydrodynamic model, and the statistical procedure used to determine flood frequencies. The purpose of this section is to outline the relationship between the technical material to be covered in the main body of the engineering report and the basic methodological approach used in the study. This outline should be logically organized and sufficiently complete so that the detailed documentation that follows can be easily read and understood.

[February 2002]

D.1.2.3 Storm Climatology and Storm Windfield Methodology

In this section of the engineering report, the Mapping Partner shall:

- Describe the basic climatological storm data used and the windfield methodology employed.
- Map, tabulate, and discuss in terms of local surge impact the storm paths used in the analysis.
- Tabulate and describe in written form the storm parameters (including central pressure deficit, radius to maximum wind, forward speed, shoreline crossing point, and shoreline crossing angle) used in the analysis.
- Identify sources of the basic data used to develop the storm climatology and the method used to sort the data and compare them with the National Weather Service (NWS) *Hurricane Climatology for the Atlantic and Gulf Coasts of the United States (NWS 38)*.
- Describe the technique employed to determine the spatial/temporal distribution of storm occurrences (i.e., storms/nautical mile/year), derivation and discretization of storm intensity parameters, and exceedence probability distributions.
- Provide graphical presentation of the results, including an overlay with orientation of coast to storm path/direction.
- Provide a discussion of storm parameter independence and any unique storm model treatments.

Guidelines and Specifications for Flood Hazard Mapping Partners

- Give the exact equations used to parameterize the model windfield along with any unique values of all the appropriate coefficients and constants used. The windfield used in the analysis is a key component in the determination of the storm surge elevation.
- Include a diagram of the windfield model that gives the surface velocity structure as it changes radially outward from the storm center.
- Provide a comparative graph depiction of measured windfield(s) and modeled windfield, if available.
- Describe the method by which winds are reduced as the storm approaches land and moves inland in detail.
- Report the constants used in windspeed reduction.

[February 2002]

D.1.2.4 Hydrodynamic Storm Surge Model

This section of the engineering report is to address the hydrodynamic storm surge model employed in performing the coastal study. The model used to calculate the surge elevation has been described in detail in various FEMA documents and need only be cited by reference. In this section of the engineering report, the Mapping Partner shall:

- Report the unique model characteristics used for the study, including a discussion of the specific grid system and sub-grid systems employed, the grid used for bottom topography and shoreline, small-scale features such as harbors and barrier islands, and the location and conditions applied for the open boundaries to the grid.
- Describe and document the adjustment to land features to account for erosion.
- Describe and document the method used to determine average ground elevations and water depths within the cells of the grid system. This discussion should be augmented by diagrams that show the grid systems as computer listings of the grid data used in the actual model calculations.
- Describe the method used to relate windspeed and surface drag coefficient is to be described.
- Discuss the Manning's "n" values used in the calculation of bottom and overland friction and provide values in tabular form. This information will include a discussion of any sensitivity tests used to estimate these values in nearshore water. Nearshore bottom and overland friction is an important part of the overall analysis and, therefore, shall be described with care and sufficient detail.
- Provide a graphical depiction of the model cells and grid system as an overlay to the bathymetric charts and topographic maps covering the study area, annotated with the individual cell inputs for the grid system.

Guidelines and Specifications for Flood Hazard Mapping Partners

- Discuss the method by which barriers, inlets, and rivers have been treated.
- Explain the procedures used to determine inland flooding, including parameterization of local features and selection of the friction factors used for the terrain.

[February 2002]

D.1.2.5 Calibration and Verification of Hydrodynamic Storm Surge Model

In this section of the engineering report, the Mapping Partner shall document the calibration and verification of the hydrodynamic surge model. Once the hydrodynamic storm surge model and grid have been set up, calibration and verification are performed. Calibration is done to determine the adjustable "tuning parameters" (e.g., Manning's "n", barrier overflow coefficients) and to validate the chosen grid schematization. Verification is used to validate the model and grid for situations other than the case used to calibrate the model. Sensitivity runs are used to make sure that small changes in the chosen grid and "tuning parameters," will not give rise to unacceptable large changes in the computed flood and tide levels. Calibration and verification computer runs compare computed results with observed water levels. Sensitivity runs compare computed results with other computed results.

When observed (or model simulation) data are employed to calibrate (or compare) hydrodynamic storm surge model results with other available studies, the Mapping Partner shall give a complete description of this calibration procedure (or model comparison), including a listing of measured and simulated tidal data. Calibration (and model comparison) is an important aspect of the model analysis; therefore, the Mapping Partner shall described these activities with sufficient detail and care to allow an independent reviewer to understand the exact procedures employed and the local historical records employed.

[February 2002]

D.1.2.6 Statistical (Joint Probability) Methodology

If the joint probability method was used, the Mapping Partner shall summarize, map, and report the values and combinations used for storm parameters, annual storm density, spacing between storms, and the storm tracks used in the analysis in this section of the engineering report. In this section, the Mapping Partner also shall compare the information above with the probabilities reported in *Hurricane Climatology for the Atlantic and Gulf Coasts of the United States (NWS 38)*. Specifically, the Mapping Partner shall:

- Note the total number of simulations.
- Summarize tidal elevation data, if used, in sufficient detail to remove any doubt as to the values used in the simulations.
- Describe the method by which the tidal elevation data are convoluted with surge data including tidal constants and tidal records.

Guidelines and Specifications for Flood Hazard Mapping Partners

- Describe storm occurrence rate or storm density, the definition of the storm region used to define storm density, and storm kinematics and intensity with respect to their use in the joint probability calculation.
- Report and discuss comparisons to long-term gage statistics.
- Describe and report adjustments to account for the combined probability of coastal and riverine flooding for each area where such an approach was taken.

[February 2002]

D.1.2.7 Unique Computer Programs

Several different computer codes may be used in the wind, hydrodynamic, and joint probability analysis. Several basic computer programs have been listed in numerous FEMA reports. In this section of the engineering report, the Mapping Partner shall list and describe any modifications of these programs and special data inputs used in the study.

[February 2002]

D.1.2.8 Wave Height, Runup, and/or Erosion Analysis

In this section of the engineering report, the Mapping Partner responsible for performing the coastal analysis shall reference the wave height, runup, and/or erosion analysis methodology used for the study. Specifically, the Mapping Partner shall:

- Document fully any deviation or expansion of that approach.
- Describe the selection of input data, including a reference to source data and material.
- Document fully all erosion considerations.
- Include one or more transect location maps as appropriate.
- Include computer printout listings for input and output data as an appendix to the report, keyed to the transect location map(s).

[February 2002]

D.1.2.9 References

In the final section of the engineering report, the Mapping Partner shall provide a complete list of technical references, including computer program references, indicating how to obtain copies of the exact program and the input data sources used in the analysis.

[February 2002]

D.1.3 Great Lakes Wave Runup Computations and Mapping

Mapping Partners performing coastal studies for communities along the Great Lakes shoreline should use the wave runup analysis guidance in Section D.3. Section D.3 provides a wave runup study flow chart, the detailed study procedure steps, sample computations, and mapping policies. An overview of the coastal study procedures is presented below.

[February 2002]

D.1.3.1 Wave Runup Calculation Procedures

The guidelines for Great Lakes wave runup calculations have emerged from methodologies recommended by the Detroit District of the U.S. Army Corps of Engineers (USACE) in the study report entitled *Great Lakes Wave Runup Methodology Study*. The figures and tables in Section D.3 have been drawn from various references cited in this USACE study report. Further guidance on the wave runup approach is included in Section D.3. Although this guidance is subject to change based on new information and methodology improvement, it provides the framework and information on the application of the methodologies.

Three types of shorelines are considered: a natural beach profile and two types of armored shoreline profiles (vertical wall and rock revetment). Therefore, three runup methodologies corresponding to the three shoreline types are employed. The flow of tasks begins with site profile data-gathering, tracks through various intermediate steps, such as the 1-percent-annual-chance flood level determination, and the calculation of the deep water and shallow water wave height, and ends with the wave runup determination for each type of shoreline.

[February 2002]

D.1.3.2 Wave Runup Computation Steps and Sample Calculations

When the site location is identified, the Mapping Partner shall follow the step-by-step study procedures below to determine the maximum wave runup elevations to be used in coastal floodplain boundary delineations.

- Step 1. Profile Data Gathering
- Step 2. 1-percent-annual-chance Flood Level Determination
- Step 3. Offshore (Deep Water) Wave Height Determination
- Step 4. Nearshore (Shallow Water) H_{m0} , H_s , and T_p Computation
- Step 5. Wave Runup Computation
- Step 6. Determination of Maximum Wave Runup Elevation

[February 2002]

D.1.3.3 Delineation and Mapping Policy

Six general policies and 12 specific-case mapping policies accompanied with illustration diagrams may be used in the coastal FIS map delineation for Great Lakes coastal communities. (See Section D.3 for detailed information.) Mapping Partners shall apply the general policies to all cases and the specific-case policy to a certain situation. Three types of shoreline profiles are typical in the Great Lakes region and are used to classify the cases:

- Beach profile with a natural dune system;
- Beach profile with a bluff system; and
- Beach profile with coastal structures.

For each type of shoreline profile, the Mapping Partner shall consider four separate cases, depending on the computed wave height profile, wave runup height, 1-percent-annual-chance stillwater level, and the predicted post-storm erosion profile. For other special cases that cannot be covered by the above policies, the Mapping Partner shall consult with the RPO.

[February 2002]

D.1.4 Intermediate Data Submission for Coastal Flood Studies

Coastal analyses involving storm surge modeling are highly specialized and complex and require a highly specialized review process. Experience has shown that attempting to make changes or corrections to coastal storm surge and wave height analyses after they have been run and mapped is not practical due to the time, cost, and contractual problems involved. Many questions and problems that arise during the review process could be answered or resolved much more readily if these issues were raised early in the study process. Therefore, FEMA has established intermediate data submission requirements to permit review of the Mapping Partner's progress on model development at appropriate milestones. The Mapping Partner performing the study shall submit the data to the reviewing Mapping Partner, as specified by the RPO, in accordance with the sequence discussed below.

The Mapping Partner will receive review comments within 30 days of the receipt of each data submission. The Mapping Partner performing the study shall establish a work plan so that the interim review does not cause any delay in the submission of the FIS Report draft and the maps reflecting the results of the coastal study.

[February 2002]

D.1.4.1 Before Storm-Surge Model Calibration Runs Are Made

The Mapping Partner performing the study shall submit the following to the reviewing Mapping Partner before calibration runs are made:

Guidelines and Specifications for Flood Hazard Mapping Partners

1. A large-scale map of the coastal area which delineates both the coarse grid basin(s) and fine grid basin(s);
2. A schematic of each basin (coarse grid and fine grid) showing sub-grid channel locations, widths, bed elevations, and proposed Manning's "n" values for each channel;
3. Historical evidence establishing the importance of various coastal flooding mechanisms (e.g., tropical and extratropical storms, rainfall and riverine events);
4. Basic data relating to the study area (e.g., documented storm erosion, available design analyses for shore protection or other coastal projects, historical shoreline changes);
5. Aerial photographs, coastal setback maps, and other maps used to determine more accurate topographic-bathymetric values and land cover features in the study area;
6. Table listing astronomical tide events and historical storms selected for use in model calibration and verification, and a plot showing the observed storm surge elevation against the predicted tide elevations;
7. Plots of exceedence probability vs. parameter value for the meteorological storm parameters that vary in the joint probability analysis, as developed for the study area following *NWS 38*, with documentation to include a tabular presentation of all meteorological storm parameter data used in development of the exceedence probability curves; and
8. Table showing storm parameter values and assigned probabilities.

[February 2002]

D.1.4.2 Before Operational Storm Surge Runs Are Made

The Mapping Partner performing the study shall submit the following to the reviewing Mapping Partner before operational storm surge runs are made:

1. A map of each basin (coarse grid and fine grid) showing water depths, ground elevations, and Manning's "n" values for each grid cell;
2. A map of each basin (coarse grid and fine grid) showing barrier locations, barrier heights, barrier widths, barrier Manning's "n" values, location of inlets cutting through barriers, inlet widths, inlet bed elevations, inlet Manning's "n" values and inlet entrance and loss coefficients;
3. A computer printout listing of the water depth, ground elevations, Manning's "n" values, barrier and inlet input, and the sub-grid channel input, and any other input data used in the calibration and verification runs and that will be used in the production runs;
4. Description of sensitivity runs used to optimize model parameters for the study area, for example, in final choices of Manning's "n" values;

Guidelines and Specifications for Flood Hazard Mapping Partners

5. Tide and storm calibration results (including extreme water elevations and time histories) showing computed results and a comparison of these with observations where such observations are available;
6. Grid overlay and work maps used in storm surge analyses for all fine and open-coast grid basins; and
7. Written documentation, including justification, of any modifications made to the standard FEMA storm surge methodology and a listing of the computer source code annotated where the modifications were made.

The work maps listed in No. 6 above should generally be the 7.5-minute series U.S. Geological Survey quadrangle maps and the hydrographic charts that were used to gather topographic, bathymetric, roughness, and other input data for the storm surge calculations. The Mapping Partner performing the study shall draw the grid pattern on the maps or use one or more transparent overlays registered to the work map(s) to indicate where the grid cells fall with respect to various map features. The Mapping Partner also shall indicate the location and extent of each wave transect on the overlays or work maps.

[February 2002]

D.1.4.3 Before Operational Wave Elevation Determination Are Made

The Mapping Partner performing the study shall submit the following to the reviewing Mapping Partner before operational wave elevation determinations are made:

1. Documentation of conclusions on the interaction between storm surge and astronomical tide;
2. Output of PROBS program for all open coast and fine grid basins;
3. Grid showing 10-, 2-, 1-, and 0.2-percent-annual-chance SWFLs for each open coast and fine grid basin; and
4. Location map of proposed transects to be used in the wave elevation determination analyses.

[February 2002]

D.1.4.4 Before Wave Elevation Determinations Are Mapped

The Mapping Partner performing the study shall submit a copy of all wave height and wave runup transect computations, and all modeling assumptions to the reviewing Mapping Partner before wave elevations and resulting BFEs are mapped.

[February 2002]

D.2 Wave Elevation Determination and V Zone Mapping: Gulf of Mexico and Atlantic Ocean

The mapping of V Zones under the NFIP began in the early 1970s. The objective was to identify hazardous coastal areas in a manner consistent with the original regulatory definition of coastal high hazard areas as an “area subject to high velocity waters, including but not limited to hurricane wave wash.” The initial technical guidance for identifying V Zones was provided in a June 1973 report by the USACE, Galveston District entitled *General Guidelines for Identifying Coastal High Hazard Zone, Flood Insurance Study - Texas Gulf Coast Case Study*, prepared by the U.S. Army Corps of Engineers (USACE), Galveston District (1973). The USACE report identified a breaking wave height of 3 feet as critical in terms of causing significant structural damage and illustrated procedures for mapping the limit of this 3-foot wave (V Zone) in two distinct situations along the Texas coast: undeveloped areas and highly developed areas.

In June 1975, the USACE issued a follow-up report entitled *Guidelines for Identifying Coastal High Hazard Zones* which maintained the basic recommendations contained in the 1973 report for identifying V Zones in undeveloped and developed areas; however, the 1975 report also included guidance for determining effective fetch lengths, a technical discussion justifying the 3-foot wave height criterion for V Zones, an abbreviated procedure for V Zone mapping in undeveloped areas, an expanded discussion of V Zone mapping in developed areas, and historical accounts of several severe storms that have impacted developed areas along the Atlantic and Gulf coasts.

Between 1975 and 1980, the Federal Government (U.S. Department of Housing and Urban Development until 1978 and FEMA thereafter) published FIRMs with V Zones for approximately 270 communities along the Atlantic and Gulf coasts using the USACE guidance for V Zone mapping. During this period, the procedures for determining and delineating V Zones in developed areas differed among studies. At that time, the regulatory BFEs, for both insurance and construction purposes, were the 1-percent-annual-chance stillwater elevations (SWELs), which consisted of the astronomical tide and storm surge caused by low atmospheric pressure and high winds. Although V Zones were identified, the increase in water-surface elevation due to wave action was not included. The Federal Government recognized that this practice did not accurately represent the flooding hazard along the open coast, but an adequate method for estimating the effects of wave action, applicable to most coastal communities, was not readily available at the time.

In 1976, the National Academy of Sciences (NAS) was asked to provide recommendations about how calculations of wave height and runup should be incorporated in FISs for Atlantic and Gulf coast communities to provide an estimate of the extent and height of stormwater inundation having specified recurrence intervals. The NAS concluded that the prediction of wave heights should be included in FISs for coastal communities and provided a methodology for the open coast and shores of embayments and estuaries on the Atlantic and Gulf coasts. The 1977 report documenting the NAS findings, *Methodology for Calculating Wave Action Effects Associated with Storm Surges* included means for taking into account varying fetch lengths, barriers to wave transmission, and regeneration of waves likely to occur over flooded land areas. NAS did not

Guidelines and Specifications for Flood Hazard Mapping Partners

address the extent and elevation of wave runup, amount of barrier overtopping, and coastal erosion.

In 1979, FEMA adopted the NAS methodology. In 1980, FEMA issued *Users Manual for Wave Height Analysis*, which was subsequently revised in February 1981. FEMA also introduced a computer program, Wave Height Analyses for Flood Insurance Studies (WHAFIS), in 1980. With WHAFIS, FEMA initiated a large effort to incorporate the effects of wave action on the FIRMs for communities along the Atlantic and Gulf coasts.

Along the New England coast with its very steep shore, the NAS methodology proved to be insufficient. Structures that were shown as being outside of the SFHA on effective FIRMs experienced considerable wave damage from storms, most notably the northeaster of February 1978, a near 1-percent-annual-chance flood event. The need to account for the effects of wave runup was recognized. In 1981 FEMA approved a methodology that determined the height of wave runup landward of the stillwater line. Stone & Webster Engineering Corporation developed the methodology in November 1981. In 1987, FEMA modified its computer model for runup elevations slightly to increase the convenience of preparing input conditions. In 1990, FEMA modified the model again to improve computational procedures and application instructions to conform to the best available guidance on wave runup (Dewberry & Davis, 1990).

Two additions were made to the NAS methodology in 1984 to account for coastal situations involving either marsh grass or muddy bottoms. The NAS methodology did not account for flexible vegetation; in particular, marsh plants. Experts surmised that the motion of submerged marsh plants absorbed wave energy, reducing wave heights. In 1984, a FEMA task force examined this phenomenon in detail and developed a methodology that adjusted the wave height to reflect energy changes resulting from the flexure of various types of marsh plants and the wind, water, and plant interaction (FEMA, 1984). FEMA incorporated the new methodology into WHAFIS.

The muddy bottom situation occurs only at the Mississippi Delta in the United States. The Mississippi River has deposited millions of tons of fine sediments into the Gulf of Mexico to form a soft mud bottom in contrast to the typical sand bottom of most coastal areas. This plastic, viscous bottom deforms under the action of surface waves. This wave-like reaction of the bottom absorbs energy from the surface waves, thus reducing the surface waves. A methodology was developed for FEMA to calculate the wave energy losses due to muddy bottoms (Suhayda, 1984). Waves in the offshore areas are tracked over the mud bottom, resulting in lower incident wave heights at the shoreline. This is a phenomenon unique to the Mississippi Delta, and FEMA has not incorporated the methodology into WHAFIS.

In 1988, FEMA upgraded WHAFIS to incorporate revised wave forecasting methodologies described in the 1984 Edition of the USACE *Shore Protection Manual* (USACE, 1984) and to compute an appropriately gradual increase or decrease of SWELs between two given values (FEMA, September 1988).

In the performance of wave height analyses and the preparation of FISs, erosion considerations were left to the judgment of FEMA contractors. Coastal erosion was to be considered a hazard

Guidelines and Specifications for Flood Hazard Mapping Partners

when there was historical evidence of erosion from previous storms, but prior to 1986, objective procedures for treating erosion were not available. Consequently, some shorefront dunes were designated as stable barriers to flooding and some were not. In 1986, FEMA initiated studies aimed at providing improved erosion assessments in FISs for coastal communities.

In response to criticisms indicating a significant underestimation of the extent of Coastal High Hazard Areas, FEMA undertook an investigation to reevaluate V Zone identification and mapping procedures. The resulting report, entitled *Assessment of Current Procedures Used for the Identification of Coastal High Hazard Areas (V Zones)* presented a number of recommendations to allow for more realistic delineation of V Zones and to better meet the objectives of the NFIP for actuarial soundness and prudent floodplain development (FEMA, 1986). One recommendation was for full consideration of storm-induced erosion and wave runup in determining BFEs and mapping V Zones. As part of its investigation, FEMA performed a study of historical cases of notable dune erosion. In this quantitative analysis, field data for 30 events (later increased to 38 events) yielded a relationship of erosion volume to storm intensity as measured by flood recurrence interval. For the 1-percent-annual-chance storm, FEMA determined that, to prevent dune breaching or removal, an average cross-sectional area of 540 square feet is required above the SWEL and seaward of the dune crest. That standard for dune cross section has a central role in erosion assessment procedures.

The USACE Coastal Engineering Research Center (CERC) performed a study of the available quantitative erosion models for FEMA (Birkemeier, Kraus, Scheffner, & Knowles, 1987). USACE determined that only empirically based models produce reasonable results with a minimum of effort and input data, that each available model for simple dune retreat has certain limitations, and that dune overwash processes are poorly documented and unquantified. After further investigations, FEMA decided to employ a set of extremely simplified procedures for objective erosion assessment (FEMA, November 1988). These procedures have a direct basis in documented effects due to extreme storms and are judged appropriate for treating dune erosion in FISs for coastal communities.

As the official basis for treating flood hazards near coastal sand dunes, FEMA published new rules and definitions in the *Federal Register* that became effective on October 1, 1988. FEMA included the following revised definition in Section 59.1 of the NFIP regulations:

Coastal high hazard area means an area of special flood hazard extending from offshore to the inland limit of a primary frontal dune along an open coast and any other area subject to high velocity wave action from storms or seismic sources.

FEMA also added a clarification of this matter, a definition of primary frontal sand dune, in Section 59.1:

Primary frontal dune means a continuous or nearly continuous mound or ridge of sand with relatively steep seaward and landward slopes immediately landward and adjacent to the beach and subject to erosion and overtopping from high tides and waves during major coastal storms. The inland limit of the primary frontal dune occurs at the point where there is a distinct change from a relatively steep slope to a relatively mild slope.

FEMA also included a new section in Part 65 of the NFIP regulations, identifying a cross-sectional area of 540 square feet as the basic criterion to be used in evaluating whether a primary frontal dune will act as an effective barrier during the 1-percent-annual-chance flood. Another consideration is the documented historical performance of coastal sand dunes in extreme local storms.

In 1989, USACE completed a review for the NFIP regarding coastal structures as protection against the 1-percent-annual-chance flood (Walton, Ahrens, Truitt, & Dean, 1989). Predictions of wave forces, wave overtopping, and wave transmission for commonly occurring structures were among technical topics addressed in the USACE report. The guidelines in this Appendix incorporate procedural criteria recommended by the USACE for evaluating structural stability.

[February 2002]

D.2.1 Organization and Overview

Figure D-1 presents a flowchart of appropriate procedures for defining coastal hazards of the 1-percent-annual-chance flood. Fundamental aspects of the 1-percent-annual-chance flood are addressed in the following sequence:

1. SWEL,
2. Accompanying wave conditions,
3. Stability of coastal structures,
4. Storm-induced erosion,
5. Wave runup and overtopping, and
6. Overland wave heights.

Determination of SWELs usually involves detailed statistical analyses, but added effects due to surface wave action are treated by simplified deterministic methodologies. This strategy avoids any potential complications due to conditional probabilities for simultaneous flooding effects. The sequence for treating these effects is entirely consistent in principle; for example, added wave effects are not resolved within the equations commonly used to simulate coastal storm surges and establish SWEL for the 1-percent-annual-chance flood.

The order indicated in Figure D-1 for activities, assessments, and analyses also outlines the organization of topics treated in these guidelines. Subsection D.2.2 provides general data requirements for conducting a coastal study, including that data needed as input to computer models. Subsection D.2.3 discusses requisite evaluation of coastal structures potentially providing wave and/or flood protection. Subsection D.2.4 considers the erosion assessment needed to project the configuration of the shore profile during the 1-percent-annual-chance flood. Subsection D.2.5 treats wave runup, wave setup, and overtopping occurring at shore barriers in flood conditions. Subsection D.2.6 addresses the analysis of nearshore wave heights

Guidelines and Specifications for Flood Hazard Mapping Partners

and wave crest elevations relevant to a study. Each of these sections provides guidance on the models and procedures for treating individual transects at a study site.

FEMA has established specific models and procedures for the evaluation of shore structures, erosion, wave runup, and wave heights in the determination of coastal flood hazards. For many coastal areas, all four topics must be considered for an adequate treatment; for other coastal areas, application of only one or two of the FEMA methodologies may be required to produce reasonable results. Table D-1 lists some typical shoreline types and the models that should be used for them.

Table D-1. Model Selection for Typical Shorelines

TYPE OF SHORELINE	MODELS TO BE APPLIED		
	EROSION	RUNUP	WHAFIS
Rocky bluffs		x	x
Sandy bluffs, little beach	x	x	x
Sandy beach, small dunes	x		x
Sandy beach, large dunes	x	x	x
Open wetlands			x
Protected by rigid structure		x	x

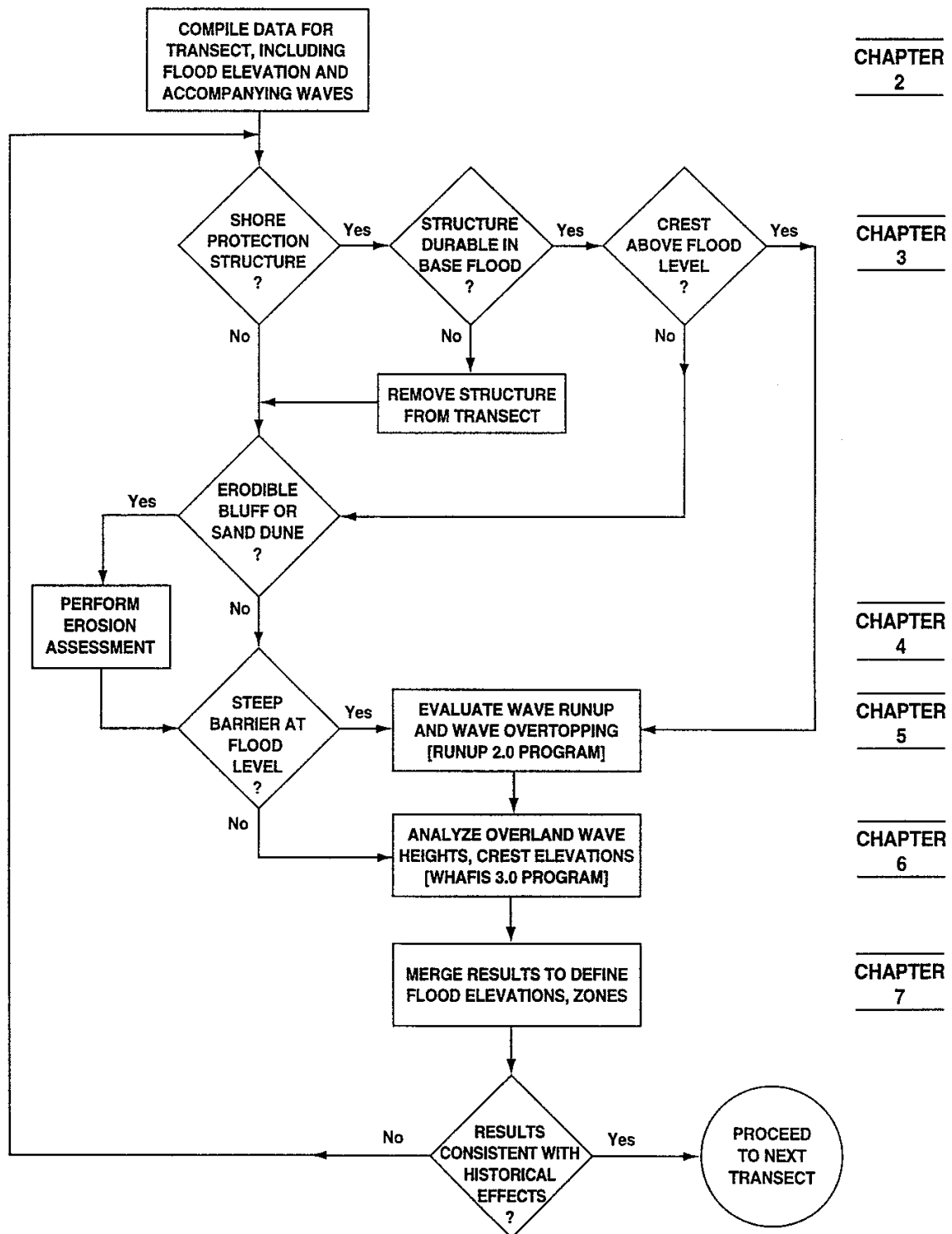

Figure D-1. Procedural Flowchart for Defining Coastal Flood Hazards

The remaining material in these guidelines adopts a more comprehensive view toward completion of an FIS. Subsection D.2.7 addresses the integration of basic results into a coherent map for flood elevations and hazard zones. Subsection D.2.8 defines required documentation of the process, decisions, and data used in determining coastal flood hazards for a community. For consistency with the NFIP and compatibility with FISs, these guidelines use standard English units for all variables.

[February 2002]

D.2.2 Data Requirements for Coastal Flood Hazard Analyses

To conduct a study for a coastal community, the Mapping Partner performing the study shall first collect the wide variety of quantitative data and other site information required in ensuing analyses. This subsection describes how coastal flood elevations and boundaries are determined, including an outline for the storm expected to cause the 1-percent-annual-chance flood, and characteristics of nearshore seabed through upland regions. Some data are directly input to computer models of flood effects, and other data are used to interpret and integrate the calculated results.

Each computer model of a separate flood effect is executed along transects, which are cross sections taken perpendicular to the mean shoreline to represent a segment of coast with similar characteristics. Thus, collected data are compiled primarily for transects, in turn situated on work maps at the final scale of the FIRM. Work maps are used both to locate and develop the transects, and to interpolate and delineate the flood zones and elevations.

Aside from needed quantitative information, the Mapping Partner shall collect descriptions of previous flooding and the community in general to aid in the evaluation of flood hazards and for inclusion in the FIS Report. The Mapping Partner shall start data collection at the community level and proceed with county, state, and Federal agencies. The Mapping Partner also shall contact private firms specializing in topographic mapping and/or aerial photography, following up suggestions provided by government agencies.

[February 2002]

D.2.2.1 Stillwater Elevations

The Mapping Partner shall determine the SWELs in a rational, defensible manner and shall not include contributions from wave action either as a result of the mathematics of the predictive model or of the data used to calibrate the model. Only the 1-percent-annual-chance SWEL is required for the coastal analyses, although 10-, 2-, and 0.2-percent-annual-chance elevations are provided in the FIS Report, and the 0.2-percent-annual-chance floodplain boundary is mapped on the FIRM.

SWELs may be defined by statistical analysis of available tide gage records or by calculation using a storm surge computer model. A minimum of 20 years of recorded tide data is needed if the SWEL is to be based on tide gage records alone. Measured tide levels are preferred over

Guidelines and Specifications for Flood Hazard Mapping Partners

synthetic models provided they have a significant period of continuous record over 20 years and can accurately represent the geographic area of the study. FEMA has available a self-contained hurricane storm surge model that can provide flood elevations (FEMA, August 1988) and a synthetic northeaster model that simulates the wind and pressure fields of an extratropical storm for input to a storm surge computer model (Stone & Webster Engineering Corporation, 1978). The Mapping Partner shall use these computer models for complex shorelines where gage records are limited, nonexistent, or non-representative, and usually indicate appreciable variations in flood elevations within a community. FEMA also has specified procedure and documentation for coastal flood studies using a storm surge model, as presented previously in Subsections D.2.2, D.2.3 and D.2.4. Of particular importance here, the surge model study can provide winds and water levels over time likely with the 1-percent-annual-chance flood.

[February 2002]

D.2.2.2 Selected Transects

The Mapping Partner shall locate transects with careful consideration given to the physical and cultural characteristics of the land so that they will closely represent conditions in their locality. The transects are to be placed closer together in areas of complex topography, dense development, unique flooding, and where computed wave heights and runup may be expected to vary significantly. Wider spacing may be appropriate in areas having more uniform characteristics. For example, a long stretch of undeveloped shoreline with a continuous dune or bluff having a fairly constant height and shape, and similar landward features may require a transect only every 1 to 2 miles, whereas a developed area with various building densities, protective structures, and vegetation cover may require a transect every 1,000 feet.

Good judgment exercised in placing required transects will avoid excessive interpolation of elevations between transects, while also avoiding unnecessary study effort. In areas where runup may be significant, the proper location of transects will be governed by variations in shore slope or gradient. On coasts with sand dunes, the Mapping Partner shall site transects according to major variations in the dune geometry and the upland characteristics. In other areas where dissipation of wave heights may be most significant to the computation of flood hazards, the Mapping Partner shall base transect location on variations in land cover: buildings, vegetation, and other factors. Generally speaking, the Mapping Partner shall site a separate transect at each flood protection structure. However, if areas with similar characteristics are scattered throughout a community and have the same SWEL, the Mapping Partner may apply the results from one transect at various locations within this common area. This should be done only after careful consideration is given to topographic and cultural features to assure the accurate representation of the coastal hazards.

The Mapping Partner shall locate the transects on the work map with the input data compiled on a separate sheet for each transect. The data for the transect are not taken directly along the line on the work map; they are taken from the area, or length of shoreline, to be represented by the transect so that the input data depict average characteristics of the area. Because of this, the Mapping Partner may find it is useful to divide the work map into transect areas for data compilation.

[February 2002]

D.2.2.3 Topography

The topographic data must have a contour interval no greater than 5 feet or 1.5 meters. FEMA does not require more detailed information such as spot elevations or a smaller contour interval, although they can be useful in the definition of the dune or bluff profile and in the delineation of floodplain boundaries. The topographic data, usually in the form of maps, must be recent and reflect current conditions or, at a minimum, conditions at a clearly defined time. Transects need not be specially surveyed unless available topographic data are unsuitable or incomplete. The Mapping Partner shall examine the topographic data to confirm that the information to be used in the analysis and mapping represents the actual planimetric features that might affect identification of the coastal hazards.

If possible, the Mapping Partner shall field-check shore topography to note any changes due to construction, erosion, coastal engineering, and other factors. The Mapping Partner shall document any significant changes with location descriptions, drawings, and/or photographs. The community, county, and state are usually the best sources for topographic data. The Mapping Partner shall examine USGS 7.5-minute series topographic maps. The USGS maps may have a 5-foot contour interval; if not, they are still often useful as reference or base maps.

[February 2002]

D.2.2.4 Land Cover

The land-cover data include information on buildings and vegetation. Stereoscopic aerial photographs can provide the required data on structures and some of the data on vegetation. The Mapping Partner shall ensure that aerial photographs are not more than 5 years old unless they can be updated by surveys. Local, county, or state agencies may have the coastline photographed on a periodic basis, and may provide photographs or permission to obtain them from their source.

Aerial photographs can provide the required data on tree- and bush-type vegetation. However, although they are useful in identifying areas of grass-like vegetation, they cannot identify specific types. National Wetland Inventory maps from the U.S. Fish and Wildlife Service and color infrared aerial photographs can provide some more specific data required for marsh plants. Ground-level photographs are also useful in providing information on plants. State offices of coastal zone management, park and wildlife management, and/or natural resources should be able to provide information. The Mapping Partner also may contact local universities with coastal studies and/or Sea Grant programs. The Mapping Partner may conduct field surveys in lieu of the above sources, but are more cost effective when used only to supplement or verify data obtained from these sources.

[February 2002]

D.2.2.5 Bathymetry

The Mapping Partner may acquire bathymetric data from National Ocean Service nautical charts, although any reliable source may be used. The bathymetry must extend far enough offshore to include the breaker location for the 1-percent-annual-chance flood; although that depth may not be exactly known during the data collection phase, the Mapping Partner may assume that a mean water depth of 40 feet will encompass all typical breaker depths. Bathymetry further offshore also may be useful in interpreting likely differences between nearshore and offshore wave conditions and necessary where offshore waves are more readily specified.

[February 2002]

D.2.2.6 Storm Meteorology

The 1-percent-annual-chance flood elevations represent a statistical summary and likely do not correspond exactly to any particular storm event. However, the meteorology of storms expected to provide approximate realizations of the 1-percent-annual-chance flood can be useful information in deciding recurrence intervals for historical events and in assessing wave characteristics likely associated with the 1-percent-annual-chance flood. An important distinction of the flood source from Delaware to Maine is whether the 1-percent-annual-chance flood is more likely to be caused by a hurricane or by a Northeaster. The Mapping Partner shall establish this distinction in the course of defining the SWELs, because time history of water levels can be radically different in the two possible cases (see Figure D-2).

For a Northeaster, commonly a winter storm occurring between October and March, sustained winds seldom reach much above 60 mph, storm surge has relatively modest magnitude, and surge coincidence with spring high tides is usually required to attain the 1-percent-annual-chance SWEL. Extreme storms that occurred with lower tides can indicate wind and wave conditions also likely to accompany the 1-percent-annual-chance flood. Thus, the Mapping Partner can assemble a fair amount of pertinent historical evidence regarding expected meteorological conditions for the 1-percent-annual-chance flood arising from an extratropical storm. The dominant conditions include speed and duration of sustained winds, along with the storm size controlling fetch along which waves may be generated.

Where hurricanes are of primary importance, the 1-percent-annual-chance flood is likely associated with central pressure deficits having exceedance probabilities between 5 and 10 percent (FEMA, August 1988). That description generally corresponds to a major hurricane, where sustained winds exceed 120 mph. Other meteorological characteristics are likely to be fairly typical for the study area and may be determined using the hurricane climatology documented in *Hurricane Climatology for the Atlantic and Gulf Coasts of the United States* (Ho, Su, Hanevich, Smith, & Richards, 1987). That guidance includes localized probabilities for central pressure deficit, radius to maximum winds, and speed and direction of storm motion.

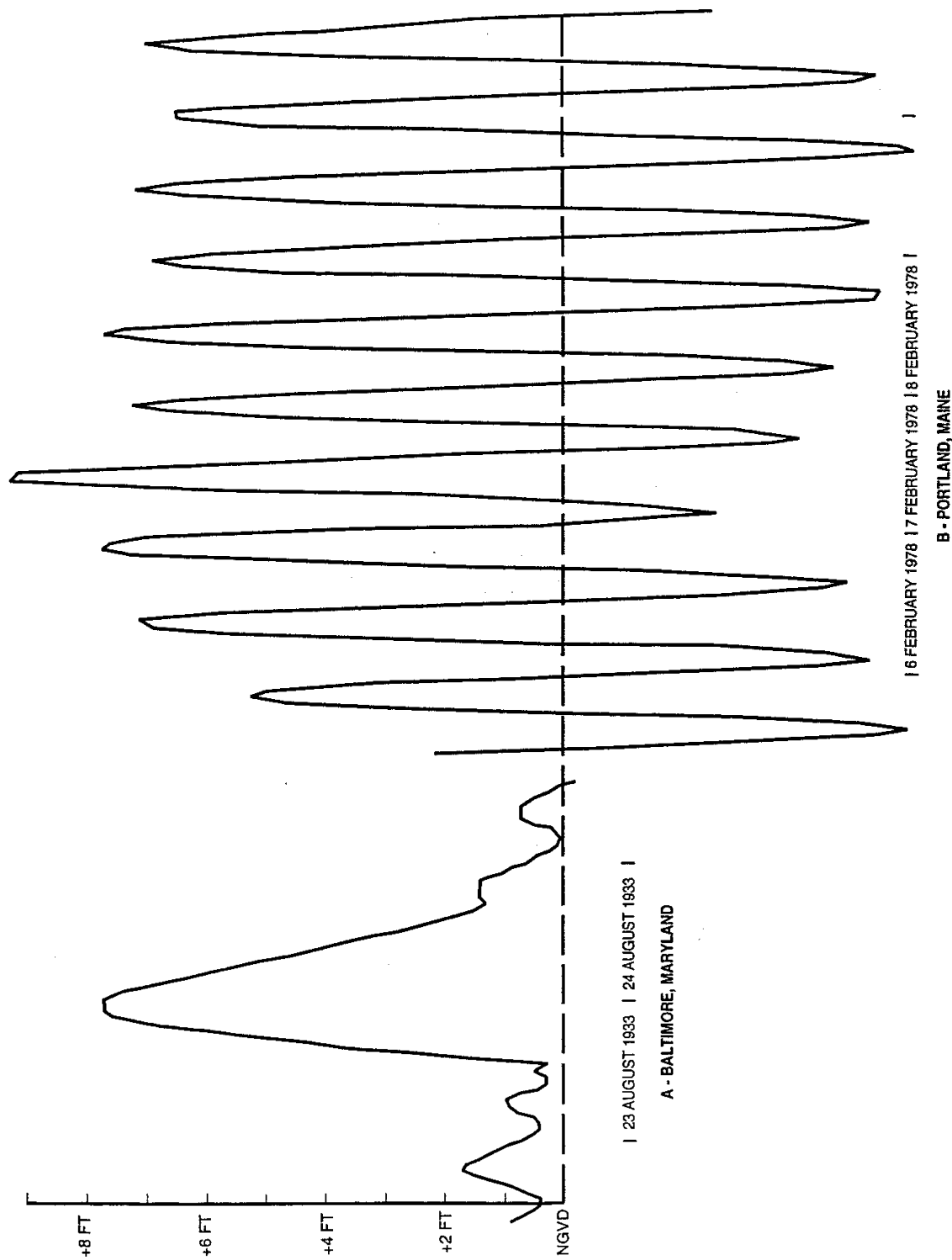

Figure D-2. Gage Records of Floods Peaking near the Local 1-Percent-Annual-Chance SWELs, Caused by, A- a Hurricane; and B- an Extratropical Storm

D.2.2.7 Storm Wave Characteristics

The basic presumption in conducting coastal wave analyses is that wave direction must have some onshore component, so that wave hazards occur coincidentally with the 1-percent-annual-chance flood. That presumption appears generally appropriate for open coasts and along many mainland shores of large bays, where the 1-percent-annual-chance SWEL must include some contribution from direct storm surge and thus requires an onshore wind component. However, an assumption of onshore waves coincident with a flood may require detailed justification along the shores of connecting channels, in complex embayments, near inlets, and behind protective islands. Once it is confirmed that sizable waves likely travel onshore at a site during the 1-percent-annual-chance flood, the storm wave condition must be defined for assessments of coastal structure stability, sand dune erosion, wave runup and overtopping, and overland elevations of wave crests.

It is important to recognize that somewhat different descriptions of storm waves (Table D-2) can be appropriate in assessing each distinct flooding effect. This depends mainly on the formulation of an applicable empirical or analytical treatment for each effect. In FIS models and analyses, the different wave descriptions include the following:

- Various wave statistics (e.g., mean wave condition for runup elevations, but an extreme or controlling height for overland waves);
- Various dominant parameters (e.g., incident wave height for overtopping computation, but incident wave period for overland crest elevations); and
- Various specification sites (e.g., deep water for estimating runup elevations, but waves actually reaching a structure in shallow water for most stability or overtopping considerations).

To proceed with general orientation, the Mapping Partner may develop storm wave conditions from actual wave measurements, from wave hindcasts or numerical computations based on historical effects, and from specific calculations based on assumed storm meteorology. Where possible, the Mapping Partner shall pursue two or all three of these possibilities in estimating wave conditions expected to accompany the 1-percent-annual-chance flood at a study site. Using all available information can improve the level of certainty in estimated storm wave characteristics.

Wave measurements for many sites over various intervals have been reported primarily by the USACE and by the National Data Buoy Center. Available data include records from nearshore gages in relatively shallow water (Thompson, 1977) and from sites further offshore in moderate water depths (Gilhousen, Meindl, Changery, Franks, Burgin, & McKittrick, 1990). The potential sources of storm wave data also include other Federal agencies and some State or university programs.

Table D-2. Some Commonly Used Specifications of Irregular Storm Waves

SYMBOL	NAME	DESCRIPTION
Wave Heights (water depth must be given)		
H_s	Significant	average over highest one-third of waves
H_c	Controlling	defined as (1.6 H_s) in NAS (1977)
\bar{H}	Mean	average over all waves
H_{mo}	zero moment	defined by the variance of water surface, and about equal to H_s in deep water
Wave Periods (basically invariant with water depth)		
T_s	significant	associated with waves at significant height
T_p	peak	represents the maximum in energy spectrum
\bar{T}	mean	average over all waves

The USACE is the primary source for long-term wave hindcasts along open coasts. That information is conveniently summarized as extreme wave conditions expected to recur at various intervals, for Atlantic hurricanes in *Hurricane Hindcast Methodology and Wave Statistics for Atlantic and Gulf Hurricanes from 1956-1975* (Abel, Tracy, Vincent, & Jensen, 1989) and for extratropical storms in *Hindcast Wave Information for the U.S. Atlantic Coast* (Hubertz, Brooks, Brandon, & Tracy, 1993) and *Southern California Hindcast Wave Information* (Jensen, Hubertz, Thompson, Reinhard, Borup, Brandon, Payne, Brooks, & McAneny, 1992), as examples. In some vicinities, other wave hindcasts may be available from the design activities for major coastal engineering projects.

Either measurements or hindcast results pertain to some specific (average) water depth. However, the Mapping Partner may need to convert such wave information into an equivalent condition at some other water depth for appropriate treatment of flood effects. The Mapping Partner shall consult the following publications for guidance regarding transformation of storm waves between offshore and nearshore regions, where processes to be considered include wave refraction, shoaling, and dissipation: the USACE *Shore Protection Manual* (USACE, 1984), *Random Seas and Design of Maritime Structures* (Goda, 1985), and *Automated Coastal Engineering System, Version 1.07* (Leenknecht, Szuwalski, & Sherlock, 1992).

The Mapping Partner may also consider determining local storm wave conditions by developing a specific estimate for storm meteorology taken to correspond to the 1-percent-annual-chance flood. That can be done with relative ease for deep-water waves associated with a hurricane of specified meteorology, using the estimation technique provided in the USACE *Shore Protection Manual* (USACE, 1984). For extratropical storms, the ACES program in *Automated Coastal Engineering System, Version 1.07* (Leenknecht et al., September 1992) executes a modern method of wave estimation for specified water depth, incorporating some basic guidance from the *Shore Protection Manual* (USACE, 1984) and *Random Seas and Design of Maritime Structures* (Goda, 1985). The Mapping Partner may prepare an outline of important considerations to assist in developing a site-specific wave estimate.

Guidelines and Specifications for Flood Hazard Mapping Partners

Major factors in wave generation are windspeed, wind duration, water depth, and fetch length. Fetch length is the over-water distance toward the wind along which waves arise (USACE, 1994). These factors determine flux of momentum and energy from the atmosphere into waves on the water surface. For some cases, fetch length might be estimated as straight-line distance in the wind direction, but the current ACES guidance pertinent to many partially sheltered coastal sites indicates that a more involved analysis of restricted fetches must be performed for water basins of relatively complex geometry. The effective fetch length is derived as a weighted average of over-water distance with angle from the wind direction. With specified geometry for a restricted fetch, the ACES program carries out computations necessary for the desired estimates of representative wave height and wave period (Leenknecht et al., 1992).

The resulting wave field is commonly summarized by the significant wave height and wave period; namely, average height of the highest one-third of waves and the corresponding time for a wave of that height to pass a point. Another useful measure is wave steepness, the ratio of wave height to wavelength: in deep water, the wavelength is 0.16 times the gravitational acceleration, times the wave period squared, that is, $(gT^2/2\pi)$. On larger water bodies and in relatively deep water, typical wave steepness is approximately 0.03 for extreme extratropical storms and 0.04 for major hurricanes. The Mapping Partner may use these values for wave steepness to determine the wave period if only the wave height is known, and the wave height if only the wave period is known.

[February 2002]

D.2.2.8 Coastal Structures

The Mapping Partner shall obtain documentation for each coastal structure possibly providing protection from 1-percent-annual-chance flood. That documentation shall include the following:

- Type and basic layout of structure;
- Dominant site particulars, (e.g., local water depth, structure crest elevation, ice climate);
- Construction materials and present integrity;
- Historical record for structure, including construction date, maintenance plan, responsible party, repairs after storm episodes; and.
- Clear indications of effectiveness or ineffectiveness.

The Mapping Partner shall develop much of this information through office activity, including a careful review of aerial photographs. In some cases of major coastal structures, site inspection would be advisable to confirm preliminary judgments.

[February 2002]

D.2.2.9 Historical Floods

While not required as input to any of the FEMA coastal models, local information regarding previous storms and flooding can be very valuable in developing accurate assessments of coastal flood hazards and validation of storm surge models. General descriptions of flooding are useful in determining what areas are subject to flooding and in obtaining an understanding of flooding patterns. More specific information, such as the location of buildings flooded and damaged by wave action, can be used to verify the results of the coastal analyses. Detailed information on pre- and post-storm beach or dune profiles is valuable in checking the results of the erosion assessment.

When quantitative data are available on historical flooding effects, the Mapping Partner shall make a special effort to acquire all recorded water elevations and wave conditions for the vicinity. That information can be used in estimating recurrence intervals for SWELs and for wave action in the event, assisting an appropriate comparison to the 1-percent-annual-chance flood.

Local, county, and state agencies are usually good sources of historical data, especially more recent events. It is becoming common practice for these agencies to record significant flooding with photographs, maps, and/or surveys. Some Federal agencies (e.g., the USACE, USGS, and National Research Council) prepare post-storm reports for more severe storms. Local libraries and historical societies may also be able to provide useful data.

[February 2002]

D.2.3 Evaluation of Coastal Structures

The purpose of the evaluation is to determine whether each individual coastal structure appears properly designed and maintained in order to provide protection from the 1-percent-annual-chance flood. If a particular structure can be expected to be stable through the 1-percent-annual-chance flood, the structure geometry may figure in all ensuing analyses of wave effects accompanying the flood: coastal erosion, runup and overtopping, and wave crest elevations. Otherwise, the coastal structure is considered to be destroyed during the 1-percent-annual-chance flood and removed from the transect representation before proceeding with analyses of wave effects.

Criteria for Evaluating Coastal Flood-Protection Structures presents a technical review and recommends procedural criteria for evaluating coastal flood protection structures in regard to the 1-percent-annual-chance flood (Walton, Ahrens, Truitt, & Dean, 1989). The FEMA “Memorandum on Criteria for Evaluating Coastal Flood Protection Structures for National Flood Insurance Program Purposes” includes an account of the evaluation process (FEMA, 1990). FEMA has adopted that memorandum as the basis for NFIP accreditation of new or proposed coastal structures in reducing effective flood hazard areas and elevations. Ideally, these evaluation criteria could be applied to existing coastal structures, but available information about older structures typically is not sufficient to complete the detailed evaluation. Where complete information is not available for an existing structure, the Mapping Partner shall make an

Guidelines and Specifications for Flood Hazard Mapping Partners

engineering judgment about its likely stability based on a visual inspection of physical conditions and any historical evidence of storm damage and maintenance.

Criteria for Evaluating Coastal Flood-Protection Structures addressed coastal flood protection structures and identified the four primary types according to a functional standpoint: gravity seawalls, pile-supported seawalls, anchored bulkheads, and dikes or levees. The report recommends as a general policy that "FEMA not consider anchored bulkheads for flood-protection credit because of extensive failures of anchored bulkheads during large storms" (Walton et al., 1989, p. 100).

Flood protection structures can have a significant effect on the flood hazard information shown on a FIRM, perhaps directly justifying the removal of sizable areas from the coastal high hazard area. The focus on flood protection structures in the FEMA memorandum cited above should not divert a recognition that similar considerations are appropriate in crediting the protection provided by structures in categories other than those named in the memorandum, and that such credit can be important. In contrast to flood protection, a breakwater primarily may act to limit wave action and a revetment primarily may control shore erosion, but any stable coastal structure can notably affect results of various hazard analyses for the 1-percent-annual-chance flood, and the Mapping Partner shall take these effects into account. The FEMA memorandum places the responsibility on local interests to certify new structures, but the primary consideration in an FIS must be that the structure evaluation yields a correct judgment based on available evidence. This is necessary for accurate hazard assessments, because a structure might decrease flood effects in one area while increasing erosion and wave hazards at adjacent sites. Of course, the greater the potential effects of a coastal structure, the more detailed should be the evaluation process.

In areas where buildings conforming to V-Zone construction standards are elevated above the wave crest elevation, the Mapping Partner shall model the piles supporting the structure as obstructions in the wave height analysis. The building itself, being elevated, shall not be modeled as an obstruction to wave propagation.

[February 2002]

D.2.4 Erosion Assessment

Coastal sand dunes usually extend above the 1-percent-annual-chance SWEL, but such barriers to flooding may not be durable because of massive shorefront erosion occurring during a 1-percent-annual-chance flood. Storm-induced erosion will remove or significantly modify most frontal dunes on U.S. coasts. This is particularly true on barrier islands known historically to be susceptible to storm overwash. Therefore, the Mapping Partner shall assess coastal erosion before determining wave elevations and mapping V Zones for the 1-percent-annual-chance flood.

Available procedures for computing erosion show limited precision in documented hindcasts of recorded erosion quantities and have questionable pertinence to the entire range of erosion effects possible on U.S. coasts. Therefore, a rather schematic treatment of expected erosion quantities and geometries has been developed as an appropriate approach for treating erosion in

FISs. The overall rationale and level of detail in these erosion assessment procedures closely parallel the simple and effective NAS methodology for calculating wave action effects associated with storm surges (NAS, 1977).

The procedures described here are empirically valid for treating dune erosion during the 1-percent-annual-chance flood. These procedures are meant to give schematic estimates of eroded profile geometry suitable for FEMA flood study purposes. The simplified estimates are suitable erosion approximations for extreme storms at sandy sites with typical open-coast wave and flood climate. The erosion assessment procedures that follow are intended for application to natural sites where there are no coastal structures such as breakwaters, groins, or revetments. Scour in front of certified structures can account for eroded sand quantities and an adjustment of the shore profile.

Quantitative considerations here are based on measured sand erosion accompanying extreme floods from hurricanes or extratropical storms on the U.S. Atlantic and Gulf coasts (FEMA, November 1988). For the study site, the Mapping Partner may use storm meteorology along with associated flood and wave characteristics to assess whether such open-coast effects can be typical of anticipated local erosion for the 1-percent-annual-chance flood. Of course, the Mapping Partner shall examine any local historical evidence on storm erosion in deciding applicability of the procedures below.

[February 2002]

D.2.4.1 Basic Erosion Considerations

The primary factor controlling the basic type of dune erosion is the pre-storm cross section lying above the 1-percent-annual-chance SWEL (frontal dune reservoir). The Mapping Partner shall determine this area to assess the stability of the dune as a barrier. If the elevated dune cross-sectional area is very large, erosion will result in retreat of the seaward duneface with the dune remnant remaining as a surge and wave barrier. On the other hand, if the dune cross-sectional area is relatively small, erosion will remove the pre-storm dune leaving a low, gently sloping profile. Different treatments for erosion are required for these two distinct situations because no available model of dune erosion suffices for the entire range of coastal situations.

Figure D-3 introduces terminology for two representative dune types. A frontal dune is a ridge or mound of unconsolidated sandy soil, extending continuously alongshore landward of the sand beach. The dune is defined by relatively steep slopes abutting markedly flatter and lower regions on each side. For example, a barrier island dune has inland flats on the landward side, and the beach or back beach berm on the seaward side. The dune toe is a crucial feature and can be located as the junction between gentle slope seaward and a slope of 1:10 or steeper marking the front duneface. The rear shoulder, as shown on the mound-type dune in Figure D-3, is defined by the upper limit of the steep slope on the dune's landward side.

The rear shoulder of mound-type dunes corresponds to the peak of ridge-type dunes. Once erosion reaches those points, the remainder of the dune offers greatly lessened resistance and is highly susceptible to rapid and complete removal during a storm. Figure D-3 shows the location of the "frontal dune reservoir," above 1-percent-annual-chance SWEL and seaward of the dune

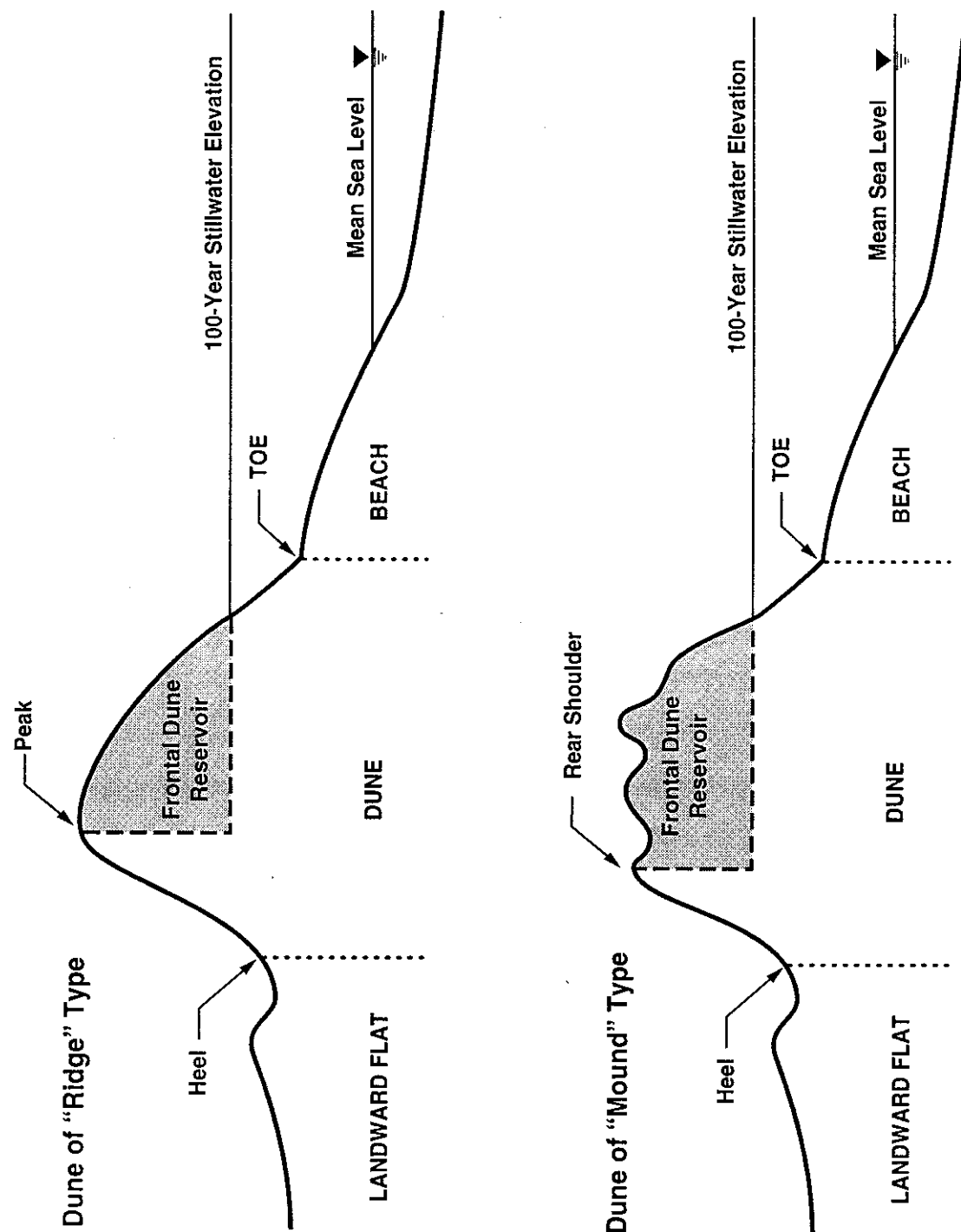

Figure D-3. Dune Features and Present Terminology

Guidelines and Specifications for Flood Hazard Mapping Partners

peak or rear shoulder. The amount of frontal dune reservoir determines dune integrity under storm-induced erosion.

To prevent dune removal during the 1-percent-annual-chance storm, the frontal dune reservoir must typically have a cross-sectional area of at least 540 square feet (or 20 cubic yards volume per foot along the shore) (FEMA, September 1986; FEMA, November 1988). For more massive dunes, erosion will result in duneface retreat, with an escarpment formed on the seaward side of the remaining dune. To compute the eroded profile in such cases, FEMA has adopted a simplified version of the dune retreat model developed by Delft Hydraulics Laboratory of the Netherlands. This treatment is also appropriate in cases with sandy bluffs or headlands extending above the 1-percent-annual-chance SWEL. The simplified treatment of duneface retreat is described in Subsection D.2.4.3.

If a dune has a frontal dune reservoir less than 540 square feet, storm-induced erosion can be expected to obliterate the existing dune with sand transported both landward and seaward. The Mapping Partner shall estimate the eroded profile using procedures presented in Subsection D.2.4.2. Those procedures provide a realistic eroded profile across the original dune, but do not determine detailed sand redistribution by dune erosion, overwash, and breaching.

Quantitative treatment of overwash processes is not feasible at present (Birkemeier, Kraus, Scheffner, & Knowles, June 1987), so the frontal dune is simply removed.

The initial decision in treating erosion as duneface retreat or as dune removal is based entirely on the size of the frontal dune reservoir. For coastal profiles more complicated than those in Figure D-3, the Mapping Partner shall use judgment to separate the sand reservoir expected to be effective in resisting dune removal from the landward portion of the pre-storm dune. The Mapping Partner shall complete the erosion assessment for the shoreline conditions representative of either the summertime shore profile for hurricane effects or the wintertime shore profile for Northeaster storm effects, whichever is the appropriate and predominant source of coastal flooding that has been selected for use in the coastal hydraulic analyses and erosion assessment.

Figure D-4 presents a complete flowchart of necessary erosion considerations, outlining the major alternatives of duneface retreat and dune removal. Figure D-5 provides schematic sketches of the different geometries of dune erosion arising in coastal flood hazard assessments.

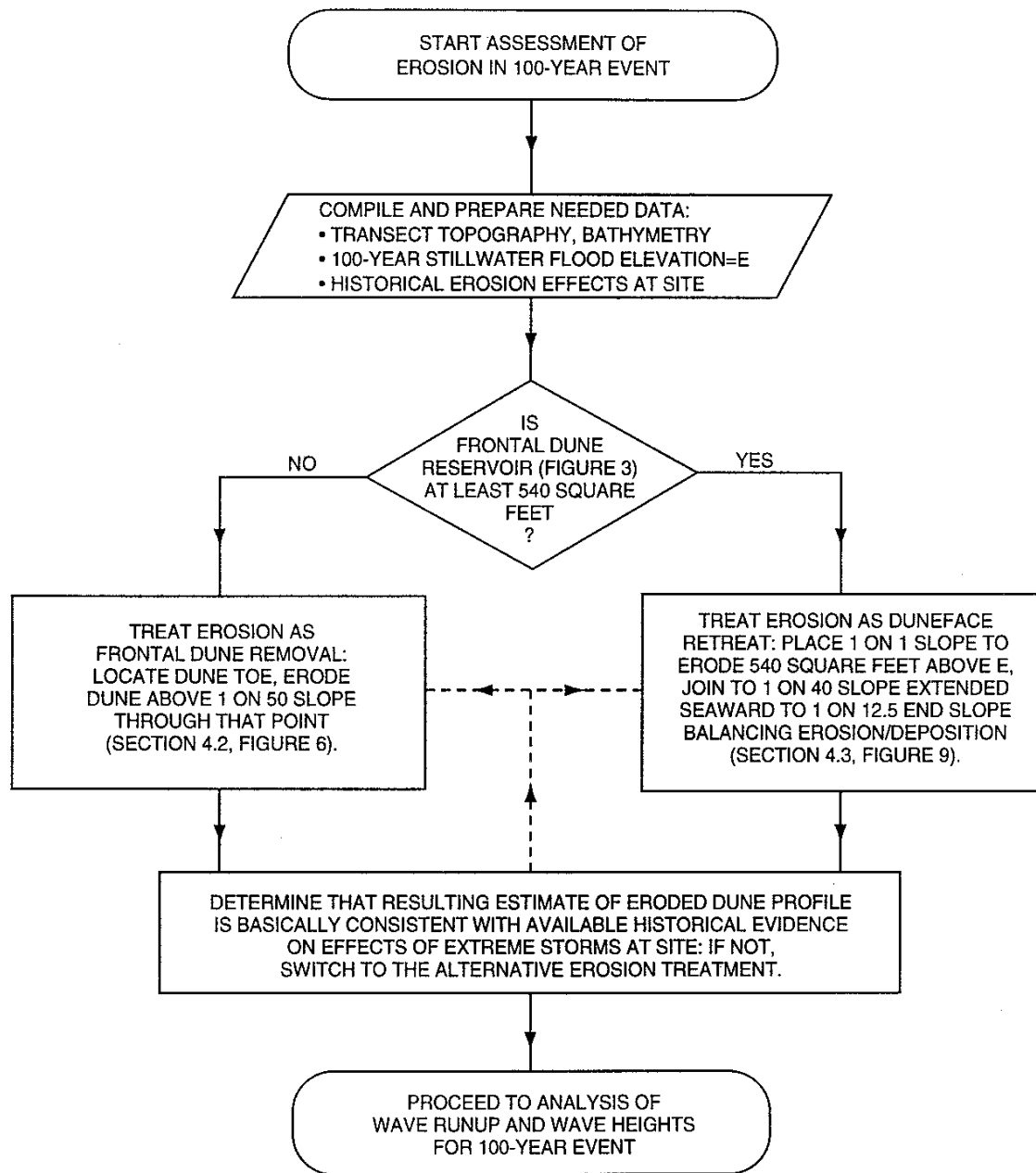

Figure D-4. Flowchart of Erosion Assessment for a Coastal Flood Insurance Study

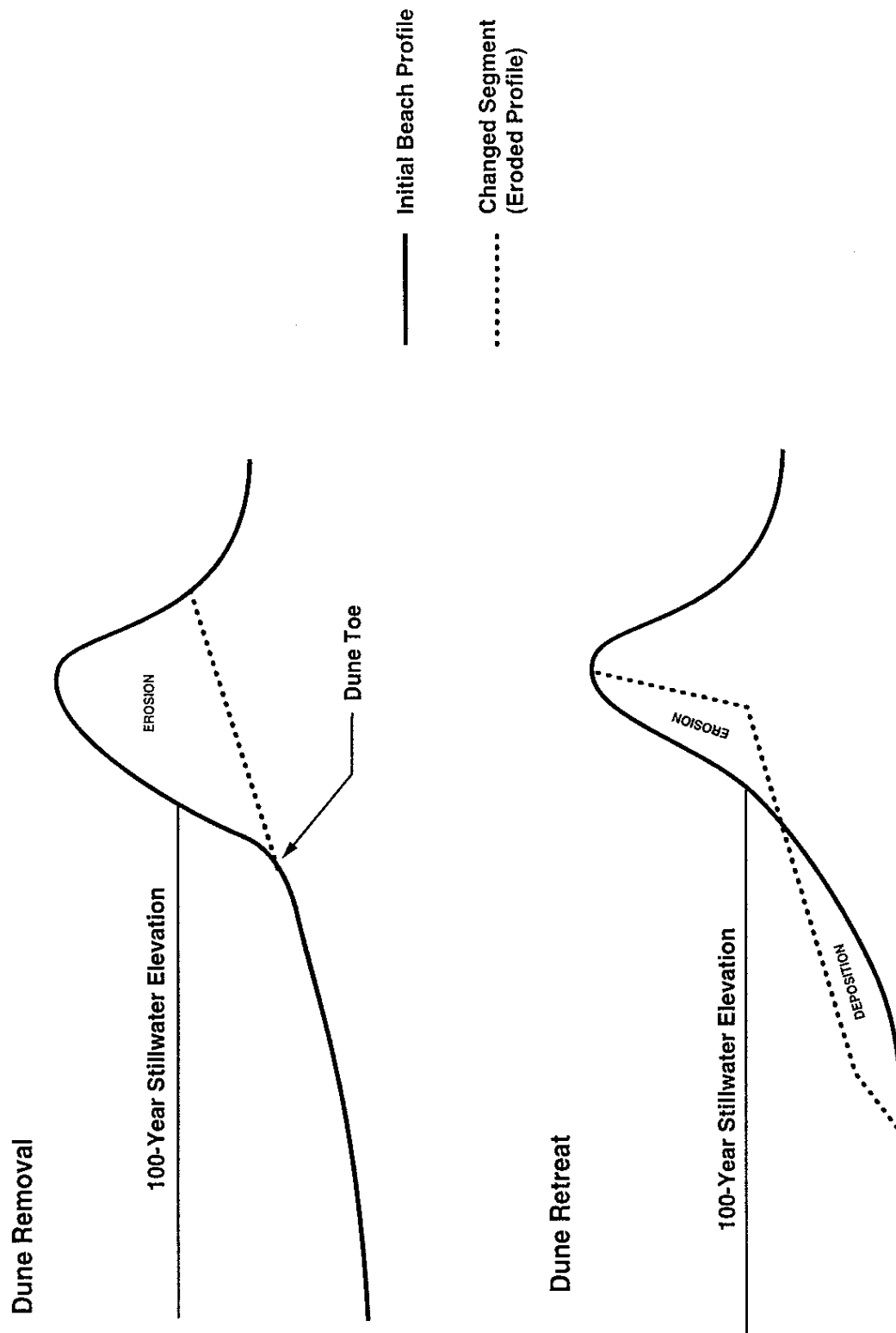

Figure D-5. Schematic Cases of Eroded Dune Geometries with Planar Slopes

One additional factor complicating erosion assessment is the dissipative effect of wide sand beaches that shelter dunes from the full storm impact and retard retreat or removal. If the existing slope between mean level and the 1-percent-annual-chance SWEL is 1:50 or gentler, overestimation of erosion is possible during the 1-percent-annual-chance flood; therefore, the Mapping Partner shall examine this carefully. This effect and other variables, such as sand size, dune vegetation, and actual storm characteristics at a specific site, make thorough comparison of estimated erosion to documented historical effects in extreme storms necessary.

[February 2002]

D.2.4.2 Treatment of Dune Removal

Determining the dune reservoir requires assessing the profile area located above the 1-percent-annual-chance flood level and seaward of the crest of the primary dune (see Figure D-3). Where the frontal dune reservoir is less than 540 square feet, construction of the eroded profile is extremely simple: dune removal is effected by means of a seaward-dipping slope of 1:50 running through the dune toe. The eroded profile is taken to be that slope across the pre-storm dune, simply spliced onto the flanking segments of a given transect. This gives a gentle ramp across the extended storm surf zone adequate as a first approximation to the profile existing at the storm's peak. This treatment simply removes the major vertical projection of the frontal dune from the transect.

Construction of an eroded profile focuses on the usually distinct feature termed the dune toe. The dune toe is taken to be the junction between the relatively steep slope of the front duneface and the notably flatter seaward region of the beach or the backbeach berm (including any minor foredunes). If a clear slope break is not apparent on a given coastal transect, its location should be taken at the typical elevation of definite dune toes on nearby transects within the study region. The alternative is to set the dune toe at the 10-percent-annual-chance SWEL in the vicinity: that appears to be a generally adequate approximation along the Atlantic and Gulf coasts. In every case, the dune toe must be taken at an elevation above that of any beach berms on local shores.

Figures D-6, D-7, and D-8 display examples of this treatment for a removed dune. These simple constructions give appropriate estimates for the limits of high ground removed during the 1-percent-annual-chance flood, but cannot provide accurate representations of eroded profiles because of the complicated processes of dune failure. One example of overly simplified results is that deeper scour appears to occur where the frontal dune reservoir is relatively large.

The present viewpoint is consistent with this basic description of storm-induced erosion: greater erosion occurs where the pre-storm barrier provides more resistance; that is, has a relatively large cross section but still is removed during the 1-percent-annual-chance flood. Net shore erosion appears to be maximum for situations where the dune barrier apparently just failed, and the eroded cross section can be much greater than in cases of duneface retreat. A slight opening to landward flow as an eroded dune becomes an overwash channel can result in much deeper scour than in cases of duneface retreat, where most shore erosion is above the SWEL as duneface sand is continuously deposited in shallow water during the storm.

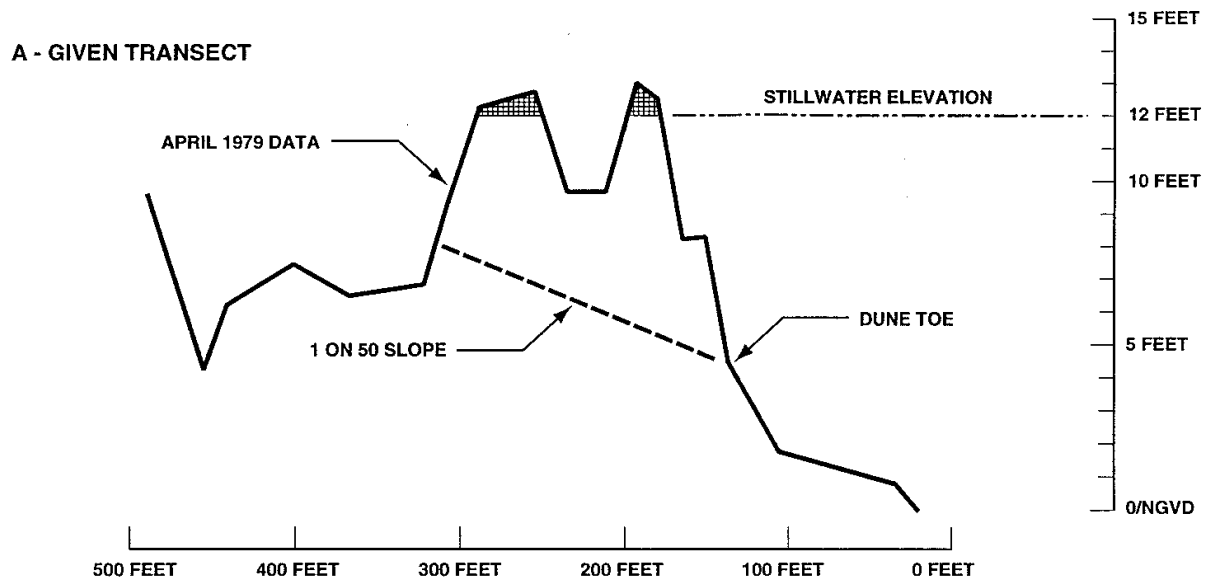

B - ANALYSIS

- 1 - FRONTAL DUNE RESERVOIR ABOVE STILLWATER FLOOD ELEVATION (SHOWN CROSS-HATCHED) TOTALS ABOUT 35 SQUARE FEET, SO DUNE REMOVAL IS EXPECTED IN THIS 100-YEAR EVENT.
- 2 - DUNE TOE IS LOCATED AT JUNCTION BETWEEN 1 ON 3.8 AND 1 ON 11.5 SLOPES ON DUNEFACE.
- 3 - 1 ON 50 SLOPE THROUGH DUNE TOE PROVIDES APPROPRIATE ESTIMATE OF ERODED PROFILE ACROSS REMOVED DUNE.

C - ERODED TRANSECT

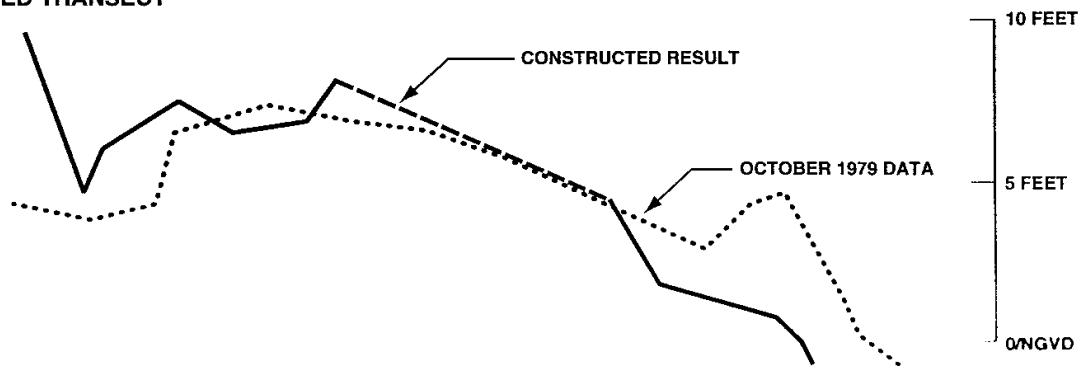

Figure D-6. Quantitative Example of Dune Removal Treatment for Alabama Profile Eroded by 1979 Hurricane Frederic. Situation Is Profile B-35 in Baldwin County, Alabama

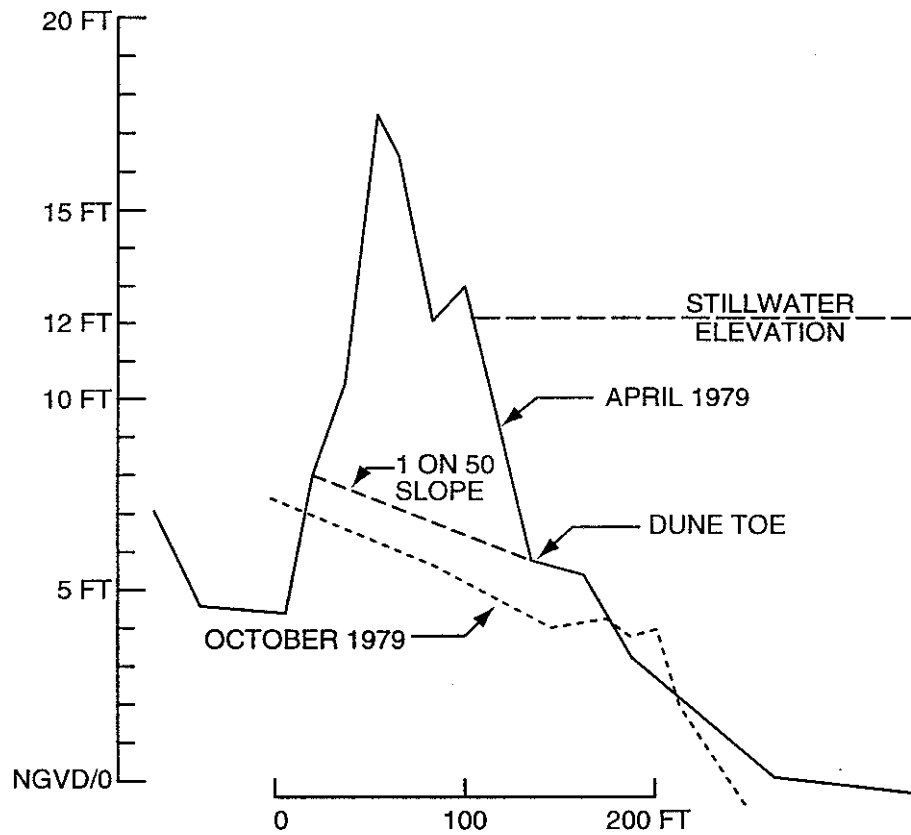

Figure D-7. Case of Relatively Large Dune Removed by 1979 Hurricane Frederic in Baldwin County, Alabama

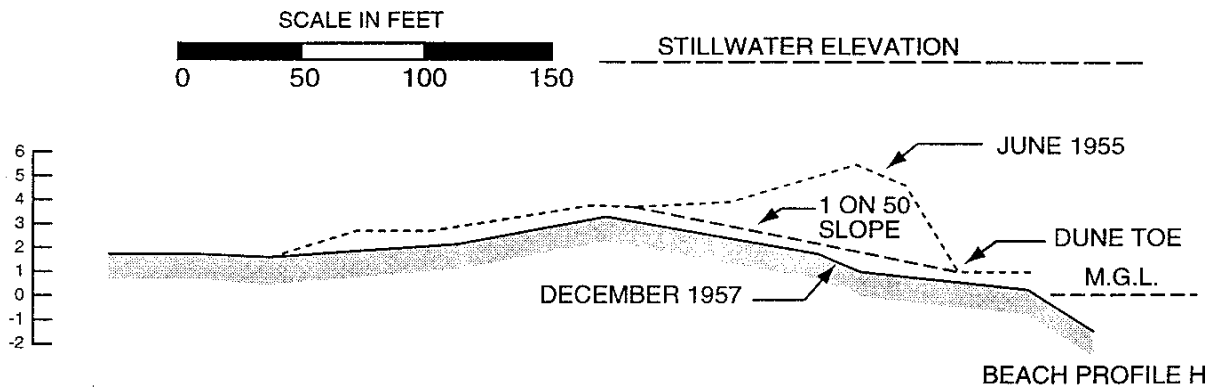

Figure D-8. Erosion of Relatively Low Profile by 1957 Hurricane Audrey in Cameron Parish, Louisiana

[February 2002]

D.2.4.3 Treatment of Duneface Retreat

The procedure described here yields an eroded profile for duneface retreat in the 1-percent-annual-chance flood, for cases where the frontal dune reservoir is at least 540 square feet. During such retreat, the frontal dune barrier remains basically intact and eroded sand is transported in the seaward direction. The post-storm profile provides a balance between sand eroded from the duneface and sand deposited at lower elevations seaward of the dune.

The following procedure for constructing the eroded profile constitutes a simplification of the dune retreat model developed by Delft Hydraulics Laboratory (DHL) of the Netherlands (Vellinga, 1986). Erosion above 1-percent-annual-chance SWEL is fixed at 540 square feet, to guarantee an appropriate amount for the U.S. Atlantic and Gulf coasts (FEMA, 1986 and November 1988). (In the DHL model, erosion is determined as the variable depending on specified storm and site conditions.)

Figure D-9 summarizes the simple procedure adopted to treat cases of duneface retreat. The eroded profile consists of three planar slopes: uppermost is a retreated duneface slope of 1:1, joining an extensive middle slope of 1:40, which is terminated by a brief segment with a slope of 1:12.5 at the limit to storm deposition. Upper dune erosion is specified to be 540 square feet above the 1-percent-annual-chance SWEL and in front of the 1:1 slope. Geometrical construction balances the nearshore deposition with the total dune erosion of somewhat more than 540 square feet by an appropriate seaward extension of the 1:40 slope. The resulting eroded profile is spliced onto the unchanged landward and seaward portions of the pre-storm profile. This procedure gives a complete profile suitable for use with the Wave Runup Model in assessing an appropriate flood elevation on the dune remnant.

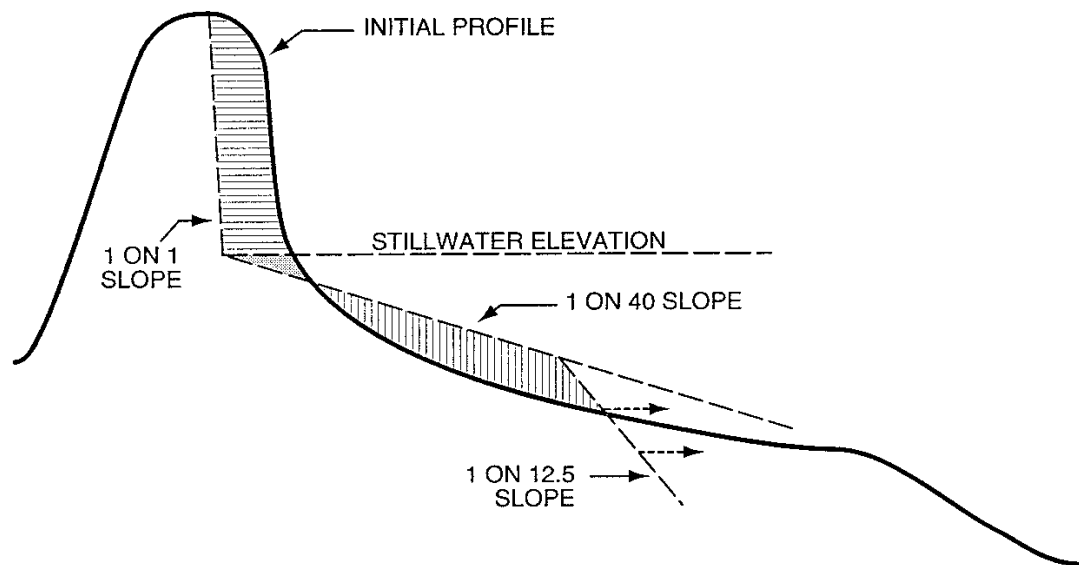

PROCEDURE:



- 1 - CONSTRUCT RETREATED DUNEFACE WITH 540 FT² EROSION [] ABOVE 100-YEAR STILLWATER ELEVATION AND SEAWARD OF 1 ON 1 SLOPE.
- 2 - DETERMINE ADDITIONAL DUNE EROSION QUANTITY, SHOWN DOTTED, IN WEDGE BETWEEN STILLWATER ELEVATION, 1 ON 40 SLOPE, AND INITIAL PROFILE.
- 3 - BALANCE TOTAL DUNE EROSION WITH POSTULATED DEPOSITION [] BY APPROPRIATE PLACEMENT OF 1 ON 12.5 SLOPE AS LIMIT TO DEPOSITION.

Figure D-9. Procedure Giving Eroded Profile in Cases of Duneface Retreat, and Simplification of Dune Retreat Model Developed by Delft Hydraulics Laboratory of the Netherlands)

Figure D-10 presents an example of duneface retreat according to the present procedure. This simple construction of a retreated dune profile gives appropriate eroded slopes important to the wave runoff analysis of the remaining barrier. For this example, estimated erosion and deposition do not match well with those recorded, because there is a net sand loss shown on this profile and the event appears somewhat less extreme than a 1-percent-annual-chance flood (judging from reported characteristics of Hurricane Eloise). Where historical data on duneface retreat are available for comparison, agreement of estimated erosion slopes with those recorded should be considered of primary importance in verifying the present treatment. Actual quantities of dune erosion are subject to large variations in natural situations, and this procedure presumes a generally representative value for 1-percent-annual-chance flood conditions.

The Mapping Partner shall apply the basic procedure illustrated in Figure D-9 in estimating erosion of high open-coast headlands or bluffs of sandy material.

This modification to the DHL model eliminates potential problems associated with computation sensitivity to storm wave height and with uncertain capabilities for situations dissimilar to the Netherlands coast (Birkemeier et al., 1987; FEMA, November 1988). The other modifications of the model and treatment of duneface retreat have been implemented in an attempt to simplify the treatment by ignoring the variation of sand size and approximating the planar slope to the curved segment of the DHL post-storm profile.

In such cases, parallel retreat of the existing face slope should be presumed, rather than using the typical 1:1 slope for the escarpment on an eroded sand dune, because that existing slope reflects actual consolidation properties of the headland or bluff material.

[February 2002]

D.2.4.4 Finalizing Erosion Assessment

Based on measured erosion along the Atlantic and Gulf coasts, the demarcation between duneface retreat and dune removal in a 1-percent-annual-chance flood has been set at a frontal dune reservoir of 540 square feet (FEMA, 1986 and November 1988). This quantitative criterion might appear too precisely stated, in view of potential inaccuracies in available dune topography, possible complications in delineating the effective frontal dune reservoir, and documented variability of dune erosion during extreme storms. In fact, the likelihood of duneface retreat or dune removal cannot be assessed with full certainty, so that validating the present erosion assessment by means of available evidence for a specific site is advisable.

At many sites, some historical evidence may be available regarding the extent of flooding, erosion, and damage in an extreme event comparable to the local 1-percent-annual-chance flood. Then the erosion treatment giving results more consistent with historical records must be selected as appropriate. That choice may be relatively clear-cut, given potential differences in expected erosion and inland flood penetration for duneface retreat versus dune removal. Where available historical evidence is not definitive, the decision between retreat and removal on a given transect should be based solely on size of the frontal dune reservoir. Present procedures for erosion assessment are highly simplified, but provide an unbiased estimation and a level of detail appropriate to coastal FISs.

[February 2002]

D.2.4.5 Wave Overtopping for Cases of Duneface Retreat

Where the erosion assessment indicates duneface retreat, an eroded dune remnant persists as an appreciable barrier to the 1-percent-annual-chance flood. However, storm wave action can result in occasional extreme runups overtopping that barrier, yielding floodwaters running off or ponding landward of the dune. DHL has determined the mean overtopping rate with storm waves incident on a typical duneface retreat geometry determined by the DHL (1983) to be

$$\bar{Q} = 5.26 \exp [-0.253 F] \quad (1)$$

Here the overtopping rate \bar{Q} has units of cubic feet per second per foot alongshore (cfs/ft), and F is maximum height (in feet) of the dune remnant above SWEL.

A - GIVEN TRANSECT

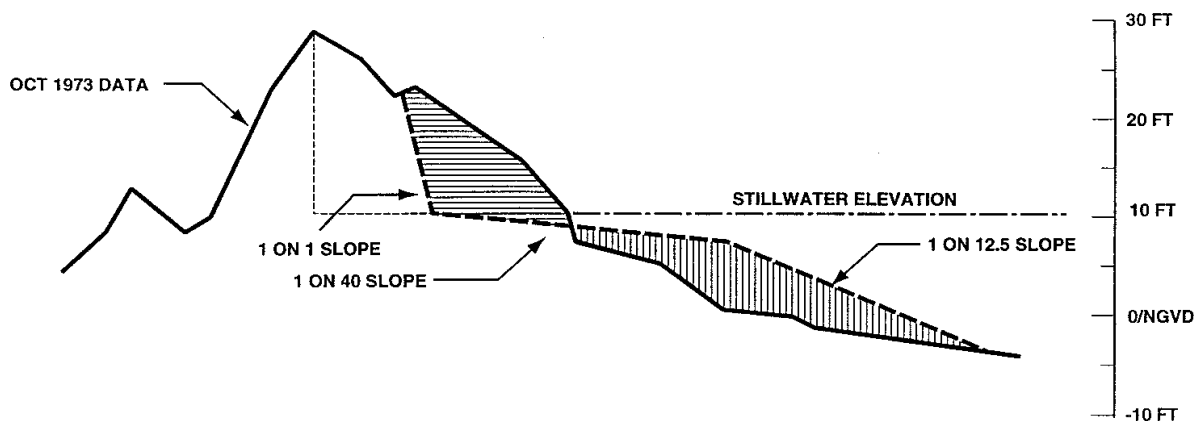

B - ANALYSIS

- 1 - FRONTAL DUNE RESERVOIR, OUTLINED BY--- , GREATLY EXCEEDS 540 FT² SO DUNEFACE WILL RETREAT.
- 2 - SPECIFYING EROSION ABOVE STILLWATER ELEVATION AS 540 FT², TOTAL DUNE EROSION ABOVE TWO UPPERMOST SLOPES IS FOUND TO BE APPROXIMATELY 620 FT².
- 3 - EROSION [|||||] IS MADE TO EQUAL DEPOSITION [|||||] BY EXTENDING MIDDLE (1 ON 40) SLOPE.

C - ERODED TRANSECT

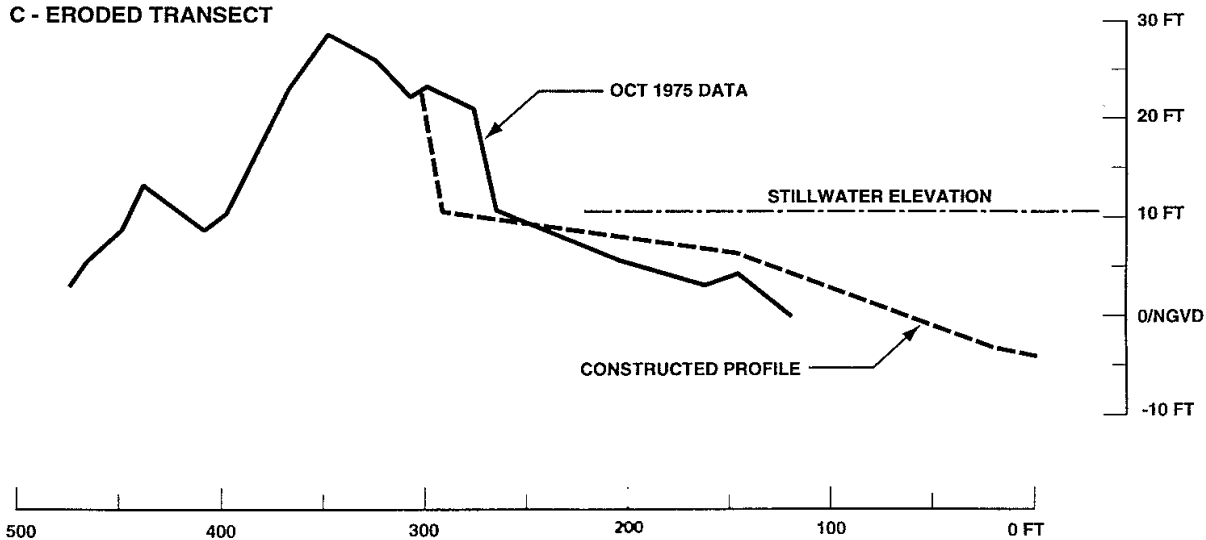

Figure D-10. Example of Duneface Retreat Treated by Simplified version of D.H.L. model, with erosion Above SWEL Fixed at 540 Square Feet. Situation Is Profile R-105 in Walton County, Florida, Surveyed Before and After 1975 Hurricane Eloise

This result was measured in DHL tests scaled to reproduce a specific extratropical storm on the Dutch seacoast, with a significant deep-water wave height of 25 feet and a peak wave period of 12 seconds. Those wave conditions seem roughly representative for the 1-percent-annual-chance flood along U.S. seacoasts, although expected wave characteristics will differ between hurricanes and extratropical storms at various sites. Recorded rates of overtopping can show sizable departures from the expected mean even with steady flood conditions (Goda, 1985; Owen, 1980).

Despite uncertainties about actual overtopping rates for a dune remnant, the equation gives a useful basis for outlining expected effects. The order of magnitude for severe overtopping may be taken as 1 cfs/ft, past allowable thresholds for structural integrity with bare soil behind steep barriers exposed to storm waves (Goda, 1985). From Equation 1, $\bar{Q}2$ of approximately 1 cfs/ft corresponds to F of approximately 7 feet, so retreated remnants with less relief above the 1-percent-annual-chance SWEL certainly require consideration of possible flood hazards landward of the dune. Appropriate treatments for ponding or runoff behind barriers are outlined in Subsection D.2.6.

[February 2002]

D.2.5 Wave Runup, Setup, and Overtopping

Wave runup is the uprush of water from wave action on a shore barrier intercepting stillwater level. The water wedge generally thins and slows during its excursion up the barrier, as residual forward momentum in wave motion near the shore is fully dissipated or reflected. The notable characteristic of this process for present purposes is the wave runup elevation, the vertical height above stillwater level ultimately attained by the extremity of uprushing water. Wave runup at a shore barrier can provide flood hazards above and beyond those from stillwater inundation and incident wave geometry, as illustrated in Figure D-11.

Two additional phenomena, wave setup and wave overtopping, may require explicit consideration for adequate treatment of the coastal flood hazards linked to wave runup. Wave setup generates a mean water surface elevated above the SWFL, caused by accumulation of water against a barrier exposed to wave heights attenuating in shallow water. Wave overtopping consists of any wave-induced flow passing over the barrier crest, so that flood water may exhibit wave, sheet flow, or ponding characteristics over an inland area. These phenomena and their quantitative evaluation will be addressed later in this Appendix.

The extent of runup can vary greatly from wave to wave in storm conditions, so that a wide distribution of wave runup elevations provides the precise description for a specific situation. Current policy for the NFIP is that the mean runup elevation (rather than some occasional extreme) for a situation is appropriate in mapping coastal hazards of the 1-percent-annual-chance flood.

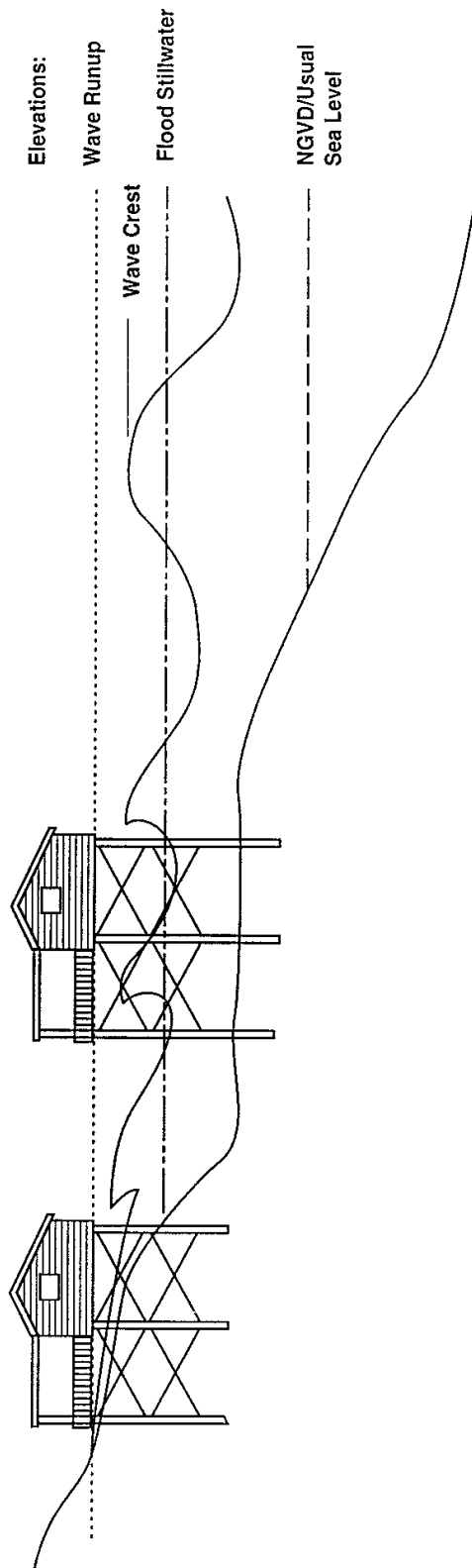

Figure D-11. Schematic Illustration of Wave Effects Extending Above and Landward of Stillwater Intercept on Transect

[February 2002]

D.2.5.1 Wave Runup Model Description

The current version of the FEMA Wave Runup Model, RUNUP 2.0, may be run either on a minicomputer (e.g., DEC VAX 11/750) or on an IBM-compatible personal computer (PC or PC/AT). Given the flood level, shore profile and roughness, and incident wave condition described in deep water, the program computes by iteration a wave runup elevation fully consistent with the most detailed guidance available (Stoa, 1978). This determination includes an analysis separating the profile into an approach segment next to the steeper shore barrier, and interpolation between runup guidance for simple configurations bracketing the specified situation.

Some additional description of the workings of the Wave Runup Model can assist informed preparation of input and interpretation of output. The incorporated guidance gives runup elevation as a function of wave condition and barrier slope, for eight basic shore configurations distinguished by water depth at the barrier toe, along with the approach geometry. Where those basic geometries do not appropriately match the specified profile, reliance is placed on the composite slope method (Saville, 1958); this assumes the input shore profile (composite slope) is equivalent to a hypothetical uniform slope, as shown in Figure D-12. The runup elevations are derived from laboratory measurements in uniform wave action, rather than the irregular storm waves usually accompanying a flood event. Runup guidance for uniform waves, however, also pertains to the mean runup elevation from irregular wave action with identical mean wave height and mean wave period. Figure D-13 presents an overview of the basic computation procedure within RUNUP 2.0.

Basic empirical guidance incorporated within this computer model generally does not extend to vertical or nearly vertical flood barriers. For such configurations, RUNUP 2.0 usually will provide a runup elevation, but the result may be misleading because reliance on the composite-slope method can yield an underestimate of actual wave runup with the abrupt barrier. Where a vertical wall exists on a transect, the Mapping Partner shall develop a runup estimate using specific guidance in Figure D-14, taken from the *Shore Protection Manual* (USACE, 1984). As within RUNUP 2.0, these empirical results for uniform waves should be utilized by specifying mean wave height and mean wave period for entry, and taking the indicated runup as a mean value in storm wave action. Shore configurations with a vertical wall are also addressed separately in Subsection D.2.5.7.

[February 2002]

D.2.5.2 Wave Runup Model Input Preparation

The input to the Wave Runup Model is done by transects. As specified in Subsection D. 2.2, the Mapping Partner shall locate transects along the shoreline. Because the runup results are very sensitive to shore slope or steepness, it is important to have at least one transect for each distinct type of shore geometry. Often, areas with similar shore slopes are located throughout a community, and the results of one transect can be applied to all the areas that are similar. This is

especially typical of New England communities with rocky bluffs. When the Wave Runup Model is being applied to dune remnants where eroded slopes are fairly uniform, transect location is governed by the upland land-cover characteristics, which are major considerations in

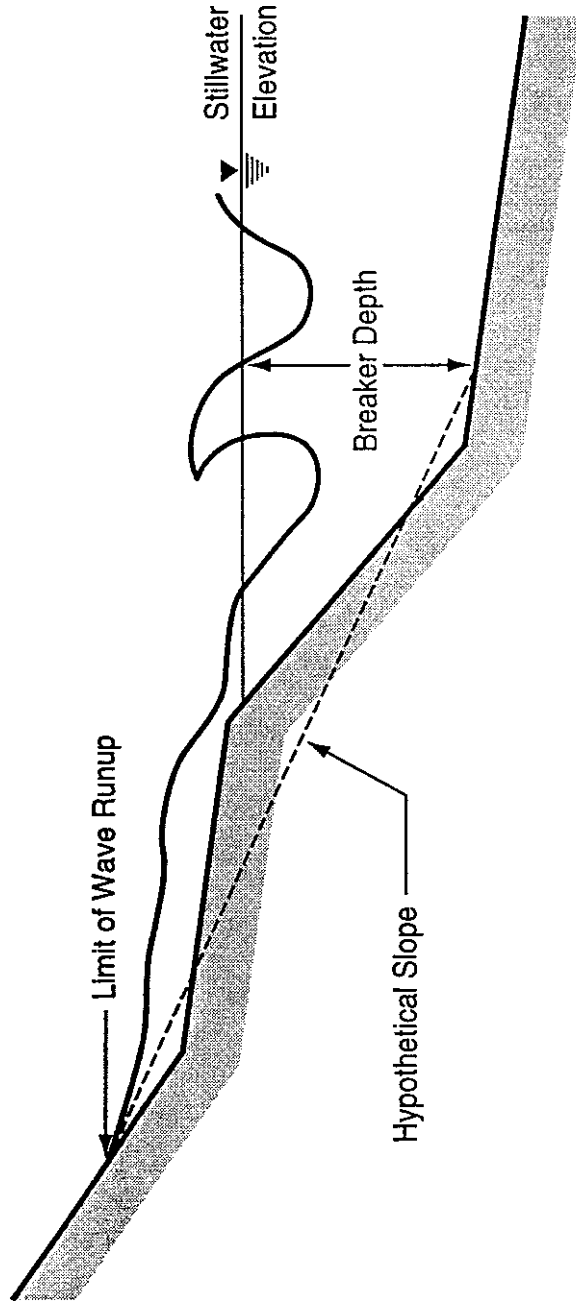

Figure D-12. Hypothetical Slope for Determining Wave Runup on Composite Profiles

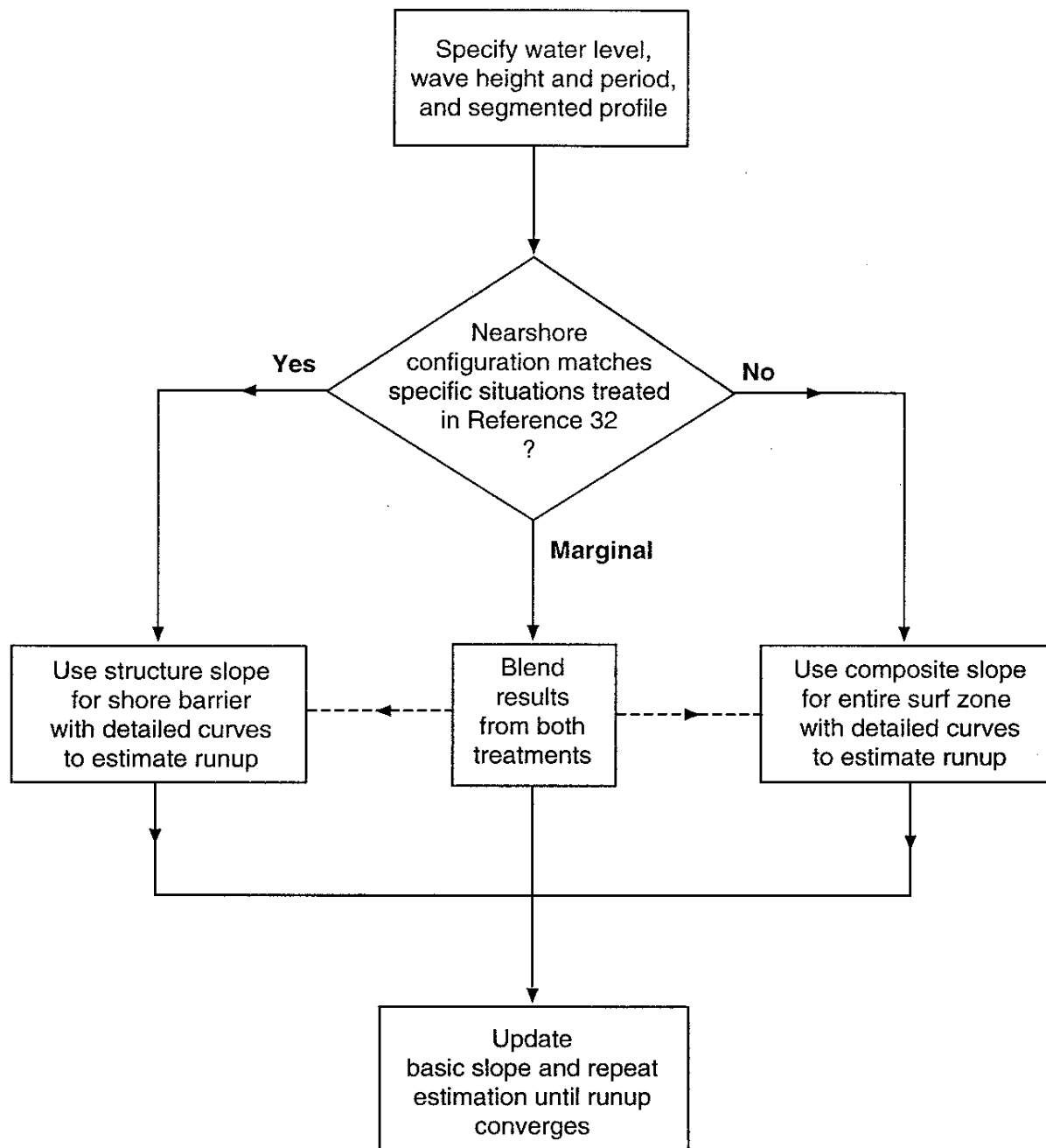

Figure D-13. Overview of Computation Procedure Implemented in Modified FEMA Wave Runup Model

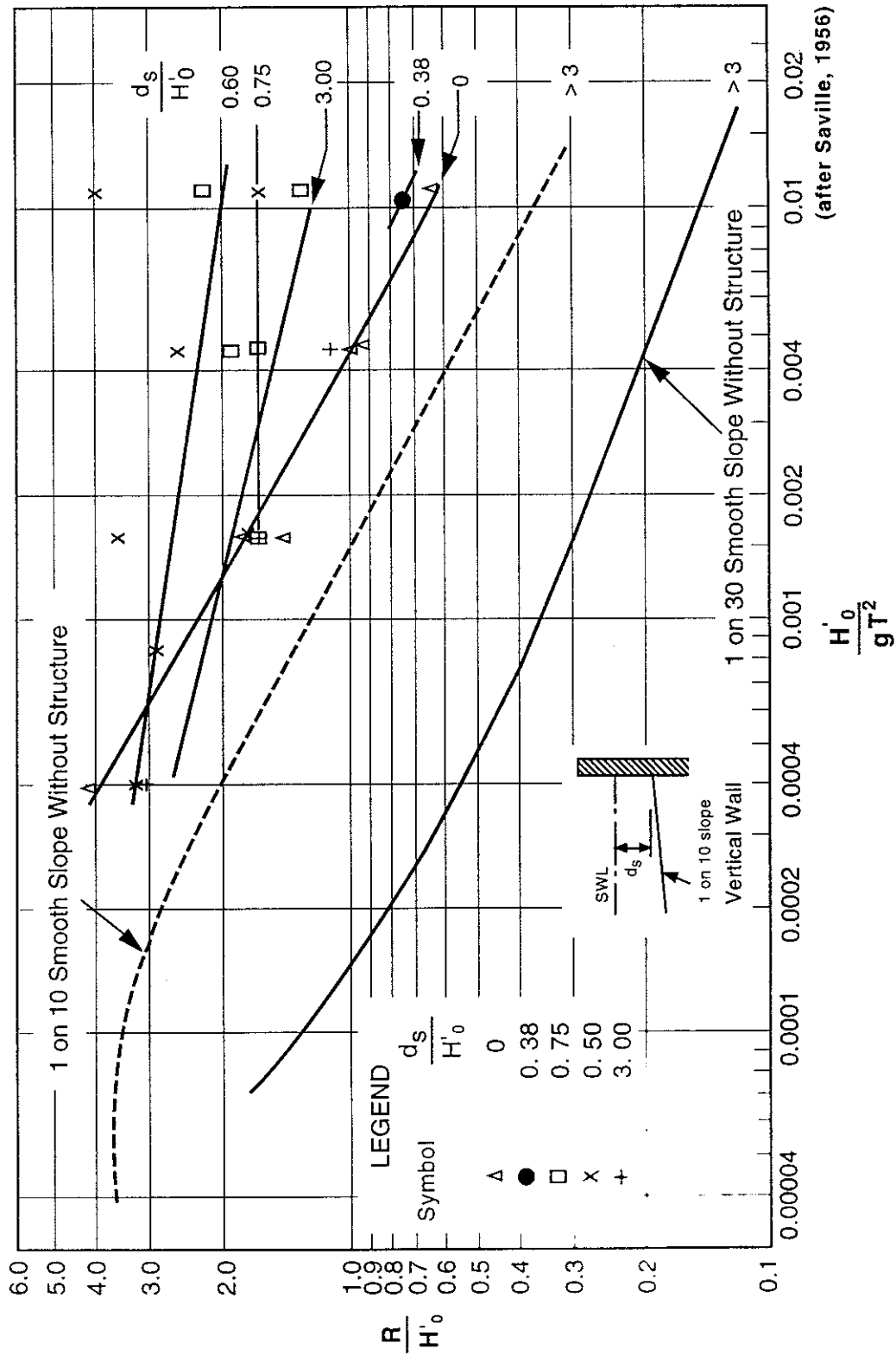

Figure D-14. Wave Runup Guidance from Vertical Wall, From *Shore Protection Manual* (USACE, 1984)

in the WHAFIS model.

The ground profile for the transect is plotted from the topography and bathymetry after the data have been referenced to the National Geodetic Vertical Datum (NGVD). The profile must extend from an elevation below the breaker depth to an elevation above the limit of runup or to the maximum ground elevation. An adequate vertical extent for the transect description will usually be 1.5 times the wave height above and below the SWEL. If the landward profile does not extend above the computed runup (30 feet NGVD is commonly a maximum), it will be assumed that the last positive slope segment continues indefinitely. This is very common with low barriers, so the Mapping Partner shall select the last slope carefully so it is representative. To complete the description, each slope segment of the profile will need a roughness coefficient, with some common values presented in Table D-3. The roughness coefficient must be between zero (maximum roughness) and one (hydraulically smooth), and values for slope segments above the SWFL control the estimated runup. The roughness coefficient (r) is used as a multiplier for runup magnitude (R) defined on a smooth barrier to estimate wave runup with a rough barrier.

Table D-3. Values for Roughness Coefficient in Wave Runup Computations

ROUGHNESS COEFFICIENT	DESCRIPTION OF BARRIER SURFACE
1.00	Sand; smooth rock, concrete, asphalt, wood, fiberglass
0.95	Tightly set paving blocks with little relief
0.90	Turf, closely set stones, slabs, blocks
0.85	Paving blocks with sizable permeability or relief
0.80	Steps; one stone layer over impermeable base; stones set in cement
0.70	Coarse gravel; gabions filled with stone
0.65	Rounded stones, or stones over impermeable base
0.60	Randomly placed stones, two thick on permeable base; common rip-rap installations
0.50	Cast-concrete armor units: cubes, dolos, quadripods, tetrapods, tribars, etc.

Transects are approximated by the minimum adequate number of linear segments, up to a limit of 20. Segments may be horizontal, or higher at the landward end; portions with opposite inclination should be represented as horizontal when developing the transect approximation. Using many linear segments to represent a transect can be wasted effort, because the Wave Runup Model may combine adjacent segments in defining the appropriate approach and barrier extents. With the runup computation procedure, the Mapping Partner shall apply engineering judgment to transect representation to assist in obtaining the most valid estimate of wave runup elevation.

The input transect must reflect wave-induced modifications expected during the 1-percent-annual-chance event, including erosion on sandy shores with dunes. The Mapping Partner shall represent only coastal structures expected to remain intact throughout the 1-percent-annual-chance event on a specific transect. Besides the transect specification, other required input data for the Wave Runup Model are the 1-percent-annual-chance SWEL and the incident mean wave condition described in deep water. The specified SWEL should exclude any contributions from

Guidelines and Specifications for Flood Hazard Mapping Partners

wind-wave effects. If available elevations include wave setup, the Mapping Partner shall remove that component before using this model so that calculated runup elevations do not indicate a doubled wave setup. Basic empirical guidance relates runup at a barrier to the water level in the absence of wave action and thus includes the wave setup component.

The mean wave condition to be specified for valid results with the Wave Runup Model may be derived from other common wave descriptions by simple relationships. Wave heights in deep water generally conform to a Rayleigh probability distribution, so that mean wave height equals 0.626 times either the significant height based on the highest one-third of waves or the zero-moment height derived from the wave energy spectrum. No exact correspondence between period measures exists; but, mean wave period usually can be approximated as 0.85 times the significant wave period or the period of peak energy in the wave spectrum.

Table D-4 lists a series of wave height and period combinations, of which one should be fairly suitable for runup computations at fully exposed coastal sites (depending on the local storm climate). These mean wave conditions have wave steepness values typical of U.S. hurricanes or within 30 percent of a fully arisen sea for extratropical storms. Commonly, the Mapping Partner may have some difficulty in specifying a precise wave condition as accompanying the 1-percent-annual-chance flood. In that case, the Mapping Partner also shall consider wave heights and periods both 5 percent higher and 5 percent lower than that selected (or whatever percentages suit the level of uncertainty) and shall run the model with all nine combinations of those values. The average of computed runup values then provides a suitable estimate for mean runup elevation. A wide range in computed runups signals the need for more detailed analysis of expected wave conditions or for reconsideration of the transect representation.

Table D-4. Appropriate Wave Conditions for Runup Computations Pertaining to 1-Percent-Annual-Chance Event in Coastal Flood Insurance Studies

MEAN WAVE PERIOD (SECONDS)	MEAN DEEP WATER WAVE HEIGHT (FEET)
HURRICANES	
8	12
9	15.5
10	19
11	23
12	27.5
EXTRATROPICAL STORMS	
11	18
12	21.5
13	25
14	29
15	33.5

[February 2002]

D.2.5.3 Wave Runup Model Operation

The input to the FEMA Wave Runup Model consists of several separate lines specifying an individual transect and the hydrodynamic conditions of interest within particular columns. All input information is echoed in an output file, which also includes computed results on wave breaking and wave runup.

The input format is outlined in Table D-5. The first two lines of the input give the Name and Job Description, which must be included for each transect. The next line of input is the Last Slope, which contains the cotangent of the shore profile continuing from the most landward point provided. This is followed by the profile points, which define the nearshore profile in consecutive order from the most seaward point. Each line gives the elevation and station of a profile point and the roughness coefficient for the segment between that point and the following point. The roughness coefficient on the last profile line is for the continuation defined in the Last Slope line. The number of profile points cannot exceed 20. The final input is the series of hydrodynamic conditions of interest. Each line here contains the SWEL along with a mean wave height in deep water and a mean wave period.

Table D-5. Description of Five Types of Input Lines for Wave Runup Model

Name Line

This line is required and must be the first input line.

<u>Columns</u>	<u>Contents</u>
1-2	Blank
3-28	Client's Name
29-60	Blank
61-70	Engineer's Name
71-80	Job Number

Job Description Line

<u>Columns</u>	<u>Contents</u>
1-2	Blank
3-76	Project description or run identification
77-80	Run Number

Last Slope Line

This line is required and defines the slope immediately landward of the profile actually specified in detail.

<u>Columns</u>	<u>Contents</u>
1-4	Slope (horizontal over vertical or cotangent) of profile continuation
5-80	Blank

Profile Lines

These lines must appear in consecutive order from the most seaward point landward. Each line has the elevation and station of a profile point and the roughness coefficient for the section between that point and the following point. The roughness coefficient on the last profile line is for the continuation defined in the Last Slope Line. The Mapping Partner shall ensure that at least one profile point with a ground elevation greater than the SWEL is specified. The number of Profile Lines cannot exceed 20.

<u>Columns</u>	<u>Contents</u>
1	Last point flag. The most landward point on the profile is indicated by a 1. If not the last point, leave blank.

Guidelines and Specifications for Flood Hazard Mapping Partners

2	Blank
3-7	Elevation with respect to NGVD, in feet
8	Blank
9-14	Horizontal distance. It is common to assign the shoreline (elevation 0.0) as Point 0 with seaward distances being negative and landward distances positive.
15	Blank

Table D-5. Description of Five Types of Input Lines for Wave Runup Model (Cont'd).

<u>Columns</u>	<u>Contents</u>
16-20	Roughness coefficient in decimal form between 0.00 (most rough) and 1.00 (smooth).
21-80	Blank

Water Level and Wave Parameter Lines

These lines specify hydrodynamic conditions for runup calculations on each profile. Namely, 1-percent-annual-chance SWEL along with mean wave height and period for deep water. Typically, SWEL remains constant for a given profile, while the selected wave conditions closely bracket that expected to accompany the 1-percent-annual-chance flood. A maximum of 50 of these lines can be input for each profile.

<u>Columns</u>	<u>Contents</u>
1	Last line, new transect flag. A 1 indicates the last line for a given transect and notifies that another transect is following. If not the last line, or if the last line of the last transect, leave blank.
2-6	SWEL with respect to NGVD, in feet.
7	Blank
8-12	Deepwater mean wave height, \bar{H} 3o, in feet, greater than 1 foot
13	Blank
14-18	Mean wave period, \bar{T} 4, in seconds
19-80	Blank

The output as shown in Table D-6 has two parts. The first page is a printout of the transect listed as a numbered set of profile points, cotangents (slopes) of the segments, and the roughness coefficient for each segment. The second page is the output table of computed results for each set of conditions: the values of runup elevation and breaker depth, each with respect to the specified SWEL, along with an identification of the segment numbers giving the seaward limit to wave breaking and the landward limit to mean wave runup.

[February 2002]

D.2.5.4 Wave Runup Model Output Messages

Several output messages alert the user to specific problems encountered in running the program. All but the last three indicate that the program has stopped execution without completing runup calculations.

- "NEGATIVE RUN PARAMETER, PROGRAM STOPS"

Guidelines and Specifications for Flood Hazard Mapping Partners

An input value of wave height or wave period is read as negative or zero. Check that the input has been entered in the correct columns.

- "MORE THAN 20 POINTS IN PROFILE, PROGRAM STOPS"

The program accepts a maximum input of 20 points defining the nearshore profile. This encourages a profile approximation that is not overly detailed, because each transect is to represent an extensive area.

- "***** H_0/L_0 LESS THAN 0.002 *****" or
"***** H_0/L_0 GREATER THAN 0.07 *****"

These limits on wave steepness pertain to the extent of incorporated guidance on breaker location. They should be adequate to include appropriate mean wave conditions for extreme events and also conform to the usual limits in detailed guidance on wave runup elevations.

- "DATA EXCEEDED TABLE"

An entry into subroutine LOOK of the program is not within the parameter bounds of the data table from which a value is sought.

- "SOLUTION DOES NOT CONVERGE"

After 10 iterations, the current and previous estimates of runup elevation continue to differ by more than 0.15 foot, and both values are provided in the output table. The calculation is usually oscillating between these two runup estimates when this occurs.

- "COMPOSITE SLOPE USED BUT WAVE MAY REFLECT, NOT BREAK"

The output runup elevation relies to some extent on a composite-slope treatment, but the overall slope is steep enough that the specified wave may reflect from the nearshore barrier. Thus, the application of a calculated breaker depth in determining overall slope and runup elevation is questionable.

- "WARNING; COMPOSITE SLOPE USED, BUT INPUT PROFILE DOES NOT EXTEND TO BREAKER DEPTH"

If the input profile does not extend seaward of the breaker depth, an incorrect breaker depth may be computed and the associated runup elevation will also be incorrect. The input profile should include bathymetry to 30 or 40 feet in depth.

[February 2002]

D.2.5.5 Wave Runup in Special Situations

To interpret and apply the calculated results properly, the Mapping Partner shall examine the output of the Wave Runup Model carefully for each situation. One important consideration is that a mean runup elevation below the crest of a given barrier does not necessarily imply the barrier will not occasionally be overtopped by floodwaters; the necessary supplementary examination of wave overtopping is addressed in Subsection D.2.5.7. Other cases may yield

CLIENT- FEMA
 PROJECT-Runup calculations on Eroded Transect

 ** WAVE RUNUP-VERSION 2.0 ** ENGINEERED BY DAB
 RUN 1 JOB 1
 PAGE 1

CROSS SECTION PROFILE				
	LENGTH	ELEV.	SLOPE	ROUGHNESS
1	-2670.0	-34.0	97.50	1.00
2	-1500.0	-22.0	76.25	1.00
3	-585.0	-10.0	72.50	1.00
4	-150.0	-4.0	36.43	1.00
5	-99.0	-2.6	42.22	1.00
6	53.0	1.0	24.64	1.00
7	223.0	7.9	39.60	1.00
8	322.0	10.4	.99	1.00
9	335.0	23.5	10.00	1.00
10	350.0	25.0		
	LAST SLOPE	1.00	LAST ROUGHNESS	1.00

Table D-6. Output Example for the FEMA Wave Runup Model

results of more immediate concern, in that the Wave Runup Model may calculate a runup elevation exceeding maximum barrier elevation; this outcome can occur because the program assumes the last positive slope to continue indefinitely. For bluffs or eroded dunes with negative landward slopes, a general rule has been used that limits the wave runup elevation to 3 feet above the maximum ground elevation. When the runup overtops a barrier such as a partially eroded bluff or a structure, the floodwater percolates into the bed and/or runs along the back slope until it reaches another flooding source or a ponding area. The runoff areas are usually designated as Zone AO with a depth of 1, 2, or 3 feet. Ponding areas are designated as Zone AH (depth of 3 feet or less) with a BFE. Standardized procedures for the treatment of sizable runoff and ponding are presented in Appendix E of these Guidelines.

A fairly typical situation on the Atlantic and Gulf coasts is that wave runup exceeds the barrier top and flows to another flooding source such as a bay, river, or backwater. It may not be necessary in this situation to compute overtopping rates and ponding elevations; only the flood hazard from the runoff must be determined. Simplified procedures have been used to determine an approximate depth of flooding in the runoff area (Williams, 1983). These procedures are illustrated in Figure D-15 and discussed below.

When the runup computed on the imaginary extension of the last positive slope is greater than or equal to 3 feet above the maximum ground elevation, the maximum runup shall be 3 feet above the ground crest elevation. This elevation decays to 2 feet above the ground profile at 50 feet behind the crest and continues at this depth until it encounters other flooding. Computed runup is not adjusted if it is less than 3 feet above the ground crest. In the same initial 50 feet, this elevation decays to 1 foot above the ground and continues at this depth until it encounters other flooding. The runoff area from the ground crest to the limit of the other flooding is designated Zone AO with the appropriate depth of flooding.

A distinct type of overflow situation can occur at low bluffs or banks backed by a nearly level plateau, where calculated wave runup may appreciably exceed the top elevation of the steep barrier. A memorandum entitled "Special Computation Procedure Developed for Wave Runup Analysis for Casco Bay, FIS - Maine, 9700-153" provides a simple procedure to determine realistic runup elevations for such situations, as illustrated in Figure D-16 (French, 1982). An extension to the bluff face slope permits computation of a hypothetical runup elevation for the barrier, with the imaginary portion given by the excess height $R' = (R - C)$ between calculated runup and the bluff crest. Using that height R' and the plateau slope m , Figure D-17 defines the inland limit to wave runup, X , corresponding to runup above the bluff crest of (mX) or an adjusted runup elevation of $R_a = (C + mX)$. This procedure is based on a Manning's "n" value of 0.04 with some simplifications in the energy grade line and is meant for application only with positive slopes landward of the bluff crest. A different treatment of wave overflow onto a level plateau, for possible FIS usage, is provided in "Overland Bore Propagation Due to an Overtopping Wave" (Cox & Machemehl, 1986).

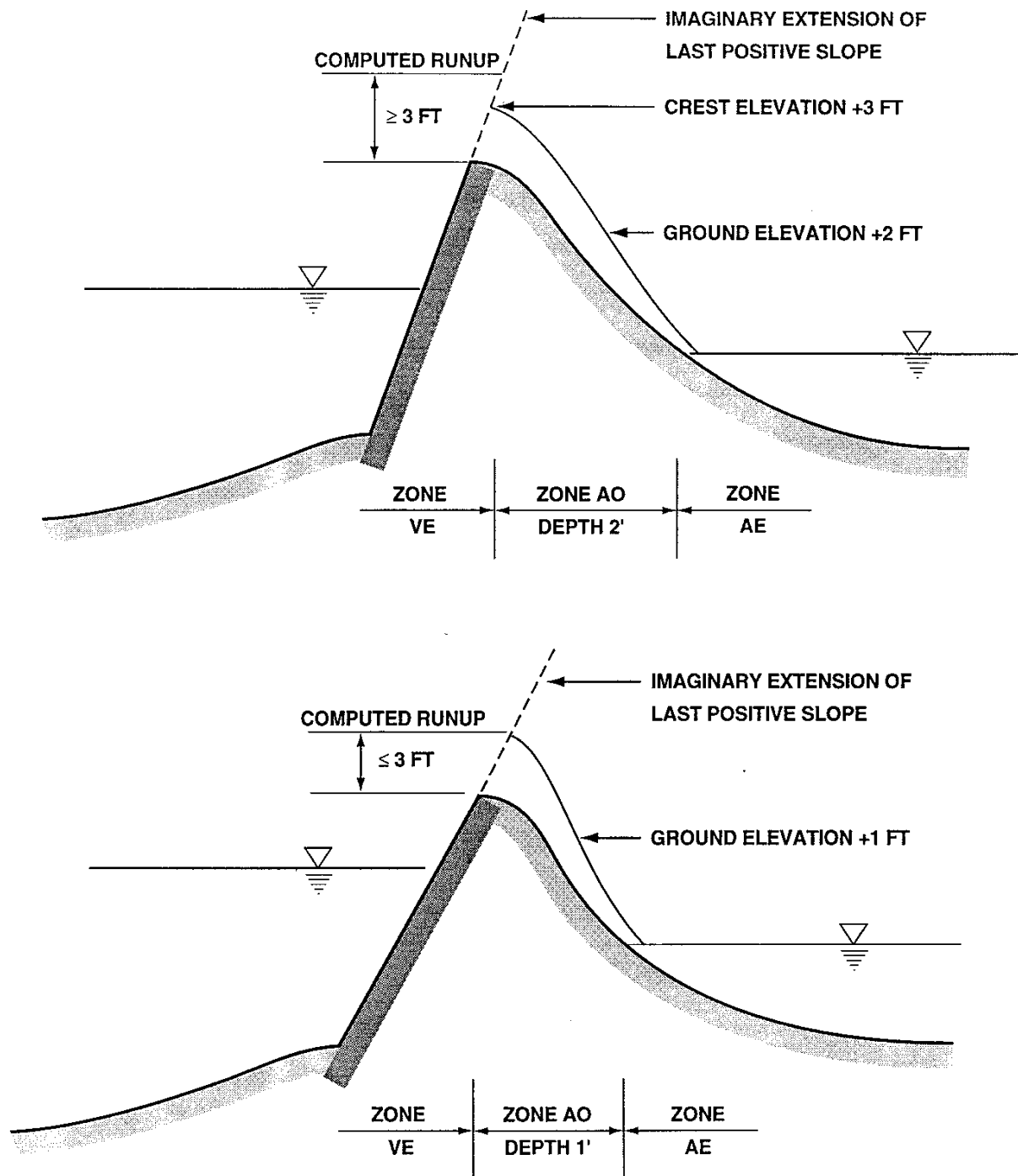

Figure D-15. Simplified Runoff Procedures (Zone AO)

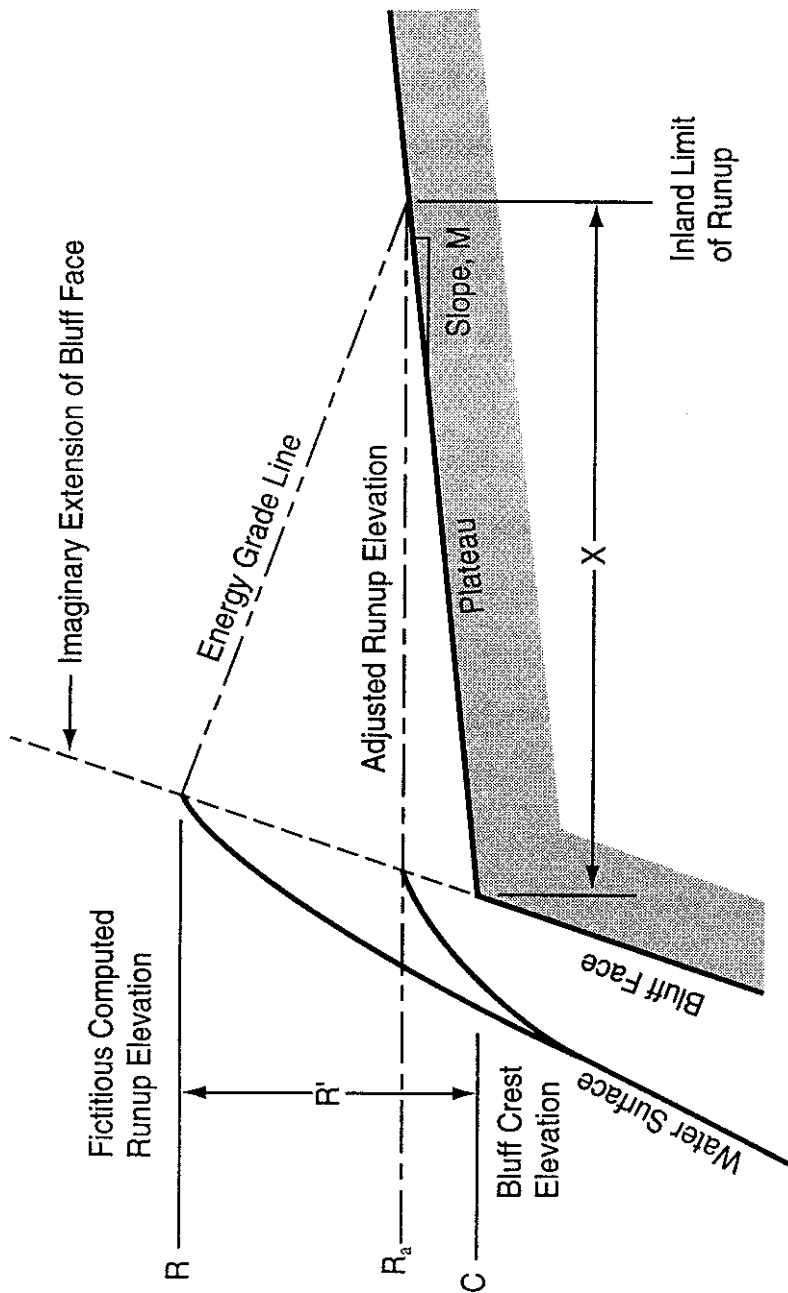

Figure D-16. Treatment of Runup onto Plateau above Low Bluff

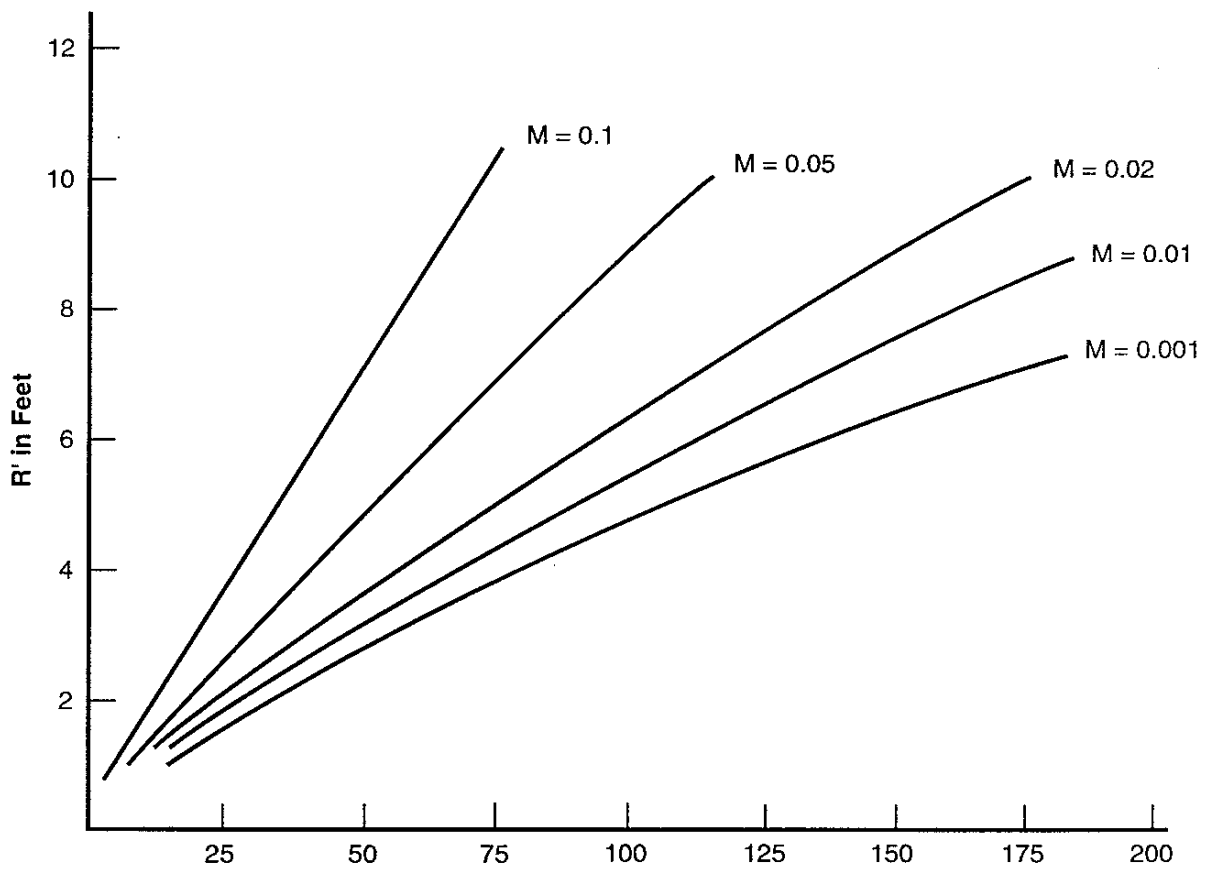

Figure D-17. Curves for Computation of Runup Inland of Low Bluffs

These runup assessment procedures are given for general guidance, but situations may exist where they are not entirely applicable. For example, runup elevations need to be fully consistent with wave setup and wave overtopping assessments described in subsections that follow. In problematic cases, the Mapping Partner shall use good judgment and rely on the historical data to reach a solution about realistic flood hazards associated with a shore barrier. Subsection D.2.7 considers the integration of separately calculated wave effects into coherent hazard zonations for the 1-percent-annual-chance flood. When a unique situation is encountered, the Mapping Partner shall prepare a Special Problem Report and discuss it with the FEMA RPO.

[February 2002]

D.2.5.6 Wave Setup

Nearshore wave action can increase mean water elevation in front of a shore barrier by the phenomenon called wave setup, which is related to wave attenuation by breaking in shallow water. In treating the 1-percent-annual-chance flood, focus may be restricted to the cumulative setup effect in the immediate vicinity of the shore barrier. Laboratory measurements of wave runup generally include the contribution due to wave setup, because runup elevations are defined relative to stillwater level in the absence of wave action.

A separate calculation for wave setup can be appropriate even if a wave runup elevation has already been determined, in part because the changed mean water depth can increase wave heights and crest elevations to be expected near the shore. In addition, empirical guidance within the Wave Runup Model is based on uniform laboratory wave action, so that incorporated setup might pertain to the field situation of swell waves from distant storms; setup effects may be much different in the local storm waves accompanying the 1-percent-annual-chance flood. If storm wave setup is found to exceed the wave runup calculated for a particular situation, the Mapping Partner shall apply the setup estimate as a lower bound for actual wave runup in further analysis of wave effects and 1-percent-annual-chance flood elevations.

The USACE *Shore Protection Manual* provides straightforward empirical guidance on wave setup for various storm wave conditions and plane bottom slopes, as reproduced in Figure D-18 (USACE, 1984). Setup magnitude is given in dimensionless form, as normalized by incident significant wave height. This guidance, given typical significant storm-wave steepness of 0.03 to 0.04, indicates shore setups of 7 to 8 percent of incident wave height. Incident wave conditions are specified in deep water as the significant wave height and the wave steepness, H_{os}/L_p , where $L_p = gT_{op}^2 / 2\pi 5$ is wavelength in deep water. Bottom slope may be taken as an overall average over the breaker zone between $d = 2H_o$ and $d=0$, if the bottom geometry is relatively simple. For other geometries, e.g., with a berm or reef in front of the shore barrier, the wave setup can be larger than given by Figure 18 and a more detailed examination may be required.

Wave setup also appears appreciably larger according to an independent treatment of storm waves on plane slopes, as outlined for a relatively narrow spectrum describing incident wave energy in *Random Seas and Design of Maritime Structures* (Goda, 1985). If historical evidence indicates greater setup increases of mean water depth in extreme floods than Figure D-18 gives

for the study site, the Mapping Partner shall develop a wave setup estimate based on that independent guidance through the ACES computer program provided in *Automated Coastal Engineering System, Version 1.07* (Leenknecht, Szuwalski, & Sherlock, 1992). The program does not permit direct calculation of wave effects at $d=0$; however, the Mapping Partner may linearly extrapolate setup results from about $d=H_o$ to the shallow limit of computations to the stillwater shoreline.

[February 2002]

D.2.5.7 Wave Overtopping

Wave overtopping results when a shore barrier does not contain incident wave action, so that floodwater penetrates to the protected area landward. This process of a partial halt and dissipation to storm waves is more difficult to treat than wave runup or wave setup. Important rates of wave overtopping can vary over several orders of magnitude, and can depend strongly on the detailed geometry of the barrier. That complicates the development of empirical guidance on wave overtopping, but little demand exists for such guidance in coastal engineering practice. According to *Criteria for Evaluating Coastal Flood-Protection Structures*, the design process for a major coastal flood protection structure relies on site-specific model testing, rather than generalized overtopping guidance (Walton, Ahrens, Truitt, & Dean, 1989).

Of course, the assessment of potential wave overtopping for present purposes must rely on readily available empirical guidance, historical effects, and engineering judgment. Except for very heavy overtopping, useful guidance is derived from tests with irregular waves, because the intermittently large overtopping discharges in storm situations could not be reproduced otherwise. Adding to the formal complexity of an adequate treatment for flood hazard assessment, overtopping effects may be cumulative so that the entire course of a flood event could require consideration, not just the peak conditions. However, the Mapping Partner shall estimate only the order of magnitude of overtopping rates because there are clearly documented thresholds below which wave overtopping may be classified as negligible. On the other hand, if a preliminary estimate indicates severe overtopping that threatens the stability of a given structure, that structure might be removed from the transect for analyses of the 1-percent-annual-chance flood, and no further overtopping consideration would be required.

Two publications, *Design of Seawalls Allowing for Wave Overtopping* (Owen, 1980) and *Random Seas and Maritime Structures* (Goda, 1985) appear to provide the most trustworthy and wide-ranging summaries of mean overtopping rates with storm waves. The former publication addresses smooth plane or bermed slopes, and the latter publication considers vertical walls with or without a fronting rubble mound. Before surveying those primary sources of overtopping guidance, however, some introductory considerations can help to determine whether detailed assessment is needed for 1-percent-annual-chance flood conditions at a specific shore barrier.

The initial consideration is an interpretation of mean runup elevation already calculated (\bar{R} 6), in terms of likely extreme elevations according to the Rayleigh probability distribution usually appropriate for wave runups. To parallel the extreme wave height addressed in coastal studies (NAS, 1977), a controlling runup magnitude may be defined as 1.6 times significant runup, or

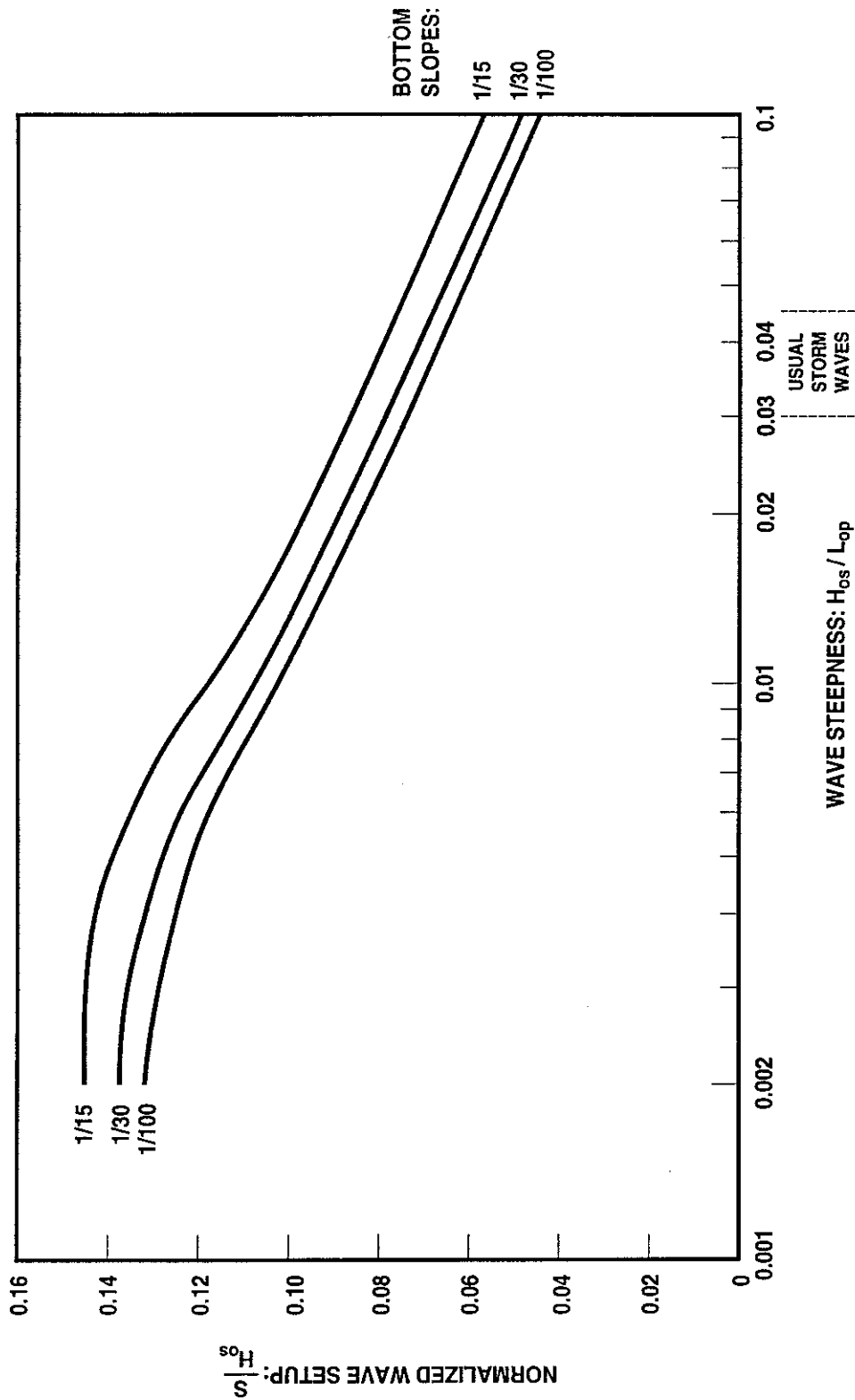

Figure D-18. Guidance on Wave Setup in Irregular Wave Action, From Shore Protection Manual (USACE, 1984)

Guidelines and Specifications for Flood Hazard Mapping Partners

2.5 times mean runup according to the Rayleigh distribution. If elevation of the barrier crest above 1-percent-annual-chance SWEL, or the barrier freeboard F , equals or exceeds $(2.5 \bar{R} 7)$, then the landward area is not subject to wave-induced discharges during the 1-percent-annual-chance flood. That requirement might be supplemented by consideration of F near $(2 \bar{R} 8)$, corresponding to 4.5 percent of the runup reaching the barrier crest according to the Rayleigh distribution. If $F \leq (2 \bar{R} 9)$, wave overtopping can certainly be appreciable during the 1-percent-annual-chance flood, and the Mapping Partner shall assess ponding or runoff behind the barrier. The extreme runups introduced here, $(2 \bar{R} 10)$ and $(2.5 \bar{R} 11)$, bracket the elevation exceeded by the extreme 2 percent of wave runup, a value commonly considered in structure design.

Once the need for quantitative overtopping assessment is established, wave runup considerations become inapplicable because a runup elevation generally cannot be converted to an overtopping estimate. Also, the composite-slope method used in determining wave runup does not appear applicable for overtopping of barriers with composite geometry, because details of the wave transformation on a barrier influence the resultant overtopping rates. Wave overtopping estimates for a specified situation generally must be based on measurements in a similar configuration. Before considering some implications of quantitative guidance for idealized cases, an overview of overtopping magnitudes gives a useful introduction (Goda, 1985; Gadd, Potter, Safaie, & Resio, 1984).

Wave overtopping is specified as a mean discharge: water volume per unit time and per unit alongshore length of the barrier, commonly cfs/ft. By interpreting or visualizing a given overtopping rate, the Mapping Partner may take into account that the actual discharges generally are intermittent and isolated, being confined to some portion of occasional wave crests at scattered locations. Distinct regimes of wave overtopping may be described as spray, splash, runup wedge, and waveform transmission, in order of increasing intensity. Flood discharges corresponding to those regimes naturally depend on the incident wave size, but certain overtopping rates have been associated with various characteristics (Goda, 1985). Among those rates, 0.01 cfs/ft seems to correspond to flooding that generally should be considered appreciable, and 1 cfs/ft appears to define an approximate threshold where structural stability of the shore barrier commonly becomes threatened by severe overtopping.

Once the mean overtopping rate has been estimated for the 1-percent-annual-chance flood, determining resultant flooding may require a representative duration for the interval of overtopping. That duration can vary widely depending on the coastal flood cause, from a fast-moving hurricane to a nearly stationary extratropical storm. A minimum assumption for the duration of flood-peak overtopping would generally be 1 to 2 hours. Durations of 10 hours or more could be appropriate for cumulative effects in an extratropical storm causing flooding over multiple high tides.

Figure D-19 summarizes some empirical overtopping guidance for storm waves, in a schematic form meant to assist deciding the likely significance of flooding behind a coastal structure. Variables describing the basic situation are cotangent of the front slope for a smooth structure with ideally simple geometry, and freeboard of the structure crest above stillwater level, as

Guidelines and Specifications for Flood Hazard Mapping Partners

normalized by incident significant wave height, F/H_s . The mean overtopping rate, \bar{Q} , is provided in dimensionless form as

$$Q^* = \bar{Q} 13 / (gH_s^3)^{0.5} \quad (2)$$

with test results shown for structure slopes of 1:1, 1:2, and 1:4 (Owen, 1980) and for a smooth vertical wall (Goda, 1985). These results pertain to: significant wave steepness of approximately $2\pi H_s / gT^2$

$p = 0.035$, fairly appropriate for extreme extratropical storms or hurricanes; water depth near the structure toe of approximately $d_t = 2H_s$, so that incident waves are not appreciably attenuated; and moderate approach slopes of 1:30 for a vertical wall or 1:20 for other structures. The major feature of interpolated curves is fixed as a maximum in overtopping rate for structure slope of 1:2, corresponding to the gentlest incline producing (at this wave steepness) total reflection rather than breaking, and thus peak waveform elevations (Nagai & Takada, 1972).

These measured results for smooth and simple geometries clearly show severe or "green water" overtopping even at relatively high structures ($F \geq H_s$) for a wide range of common inclinations (cotangents between 0 and 4). Also, for freeboards considered here, a vertical wall (cotangent 0) permits less overtopping than common sloping structures with cotangent less than approximately 3.5. Gentler barriers are uncommon because the construction volume increases with the cotangent squared, so steep coastal flood-protection structures usually face attenuated storm waves and/or have rough surfaces. Basic effects of those differences can be outlined for use in simplified overtopping assessments.

For sloping structures sited within the surf zone ($d_t < 2H_s$), *Design of Seawalls Allowing for Wave Overtopping* indicates that basic overtopping guidance in Figure D-19 can be used with attenuated rather than incoming wave height (Owen, 1980). A simple estimate basically consistent with other analyses of the 1-percent-annual-chance flood is that significant wave height is limited to

$H_s = d_t/2$ at the structure toe. The value of $(2F/d_t)$ describes the effectively increased freeboard in entering Figure D-19, and the indicated Q^* value is then converted to \bar{Q}

using H_s

. The presumed wave attenuation ignores any wave setup as a small effect with the partial barrier, and d_t should always correspond to the scour condition expected in wave action accompanying the 1-percent-annual-chance flood.

Figure D-19 might also be made applicable to rough slopes, using a roughness coefficient (r) from Table D-3 to describe the effectively increased freeboard with greater wave dissipation on the structure. *Design of Seawalls Allowing for Wave Overtopping* proposed formulating effect of structure roughness as F/r , and *Beach and Dune Erosion during Storm Surges* confirmed a similar dependence of overtopping on roughness in measured results for irregular waves (Owen,

Guidelines and Specifications for Flood Hazard Mapping Partners

1980; Vellinga, 1986). The overtopping relation reported as reliable in “Wave Runup and Overtopping on Coastal Structures” is

$$Q^* = 8 \cdot 10^{-5} \exp[3.1(rR^* - F / H_s)] \quad (3)$$

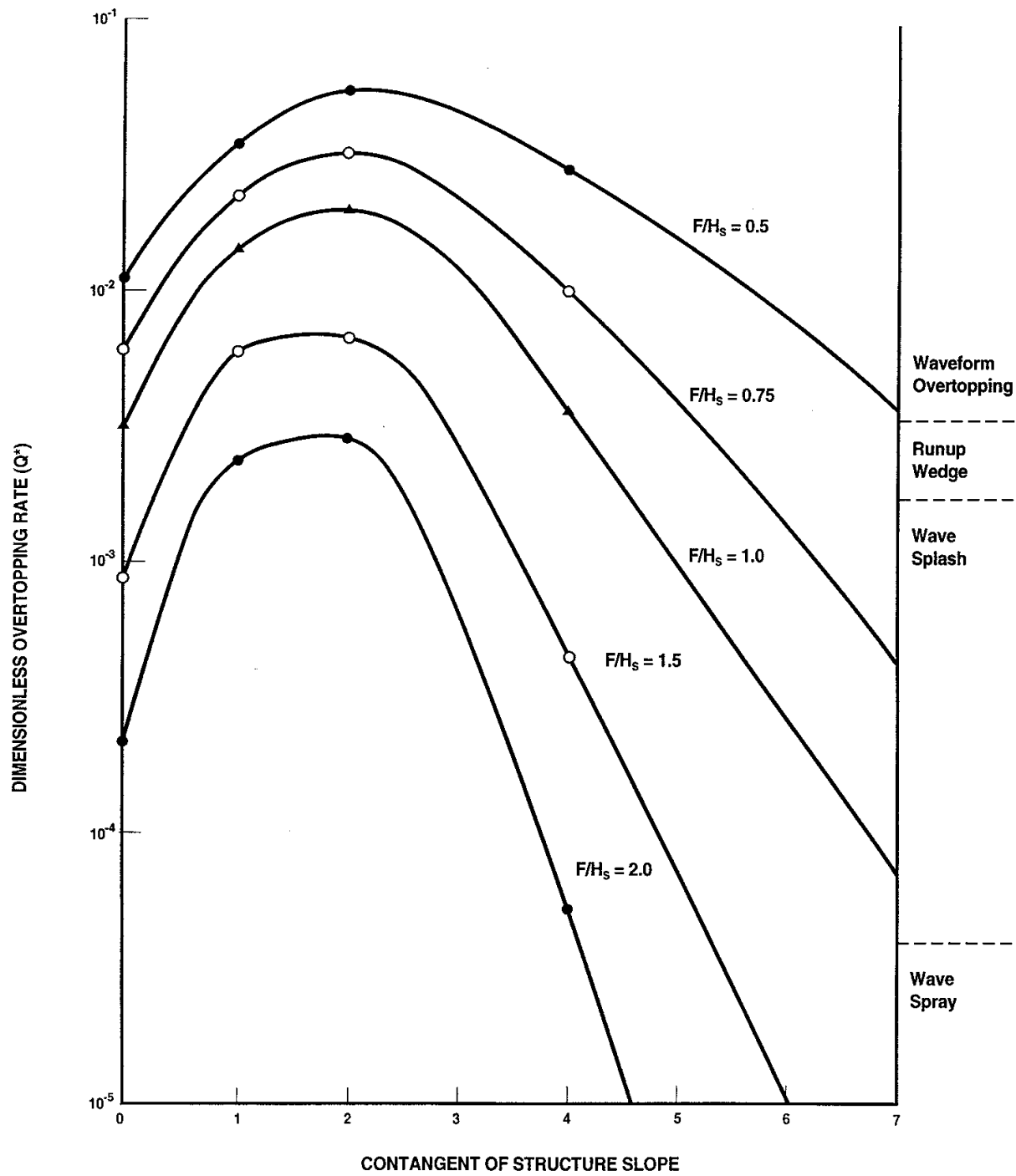

Figure D-19. Schematic Summary of Storm-Wave Overtopping at Structures of Various Slopes and Freeboards, Based on Goda, 1985, and Owen, June 1980.

Guidelines and Specifications for Flood Hazard Mapping Partners

where $R^* = [1.5 m / (H_s / L_{op})^{0.5}]$, up to a maximum value of 3.0, is an estimated extreme runup normalized by H_s , for a barrier slope given as the tangent m (de Waal & van der Meer, 1992). Equation 3 is meant to pertain to very wide ranges of test situations with moderate overtopping, but appears very approximate in comparison with specific results for $r=1$ shown in Figure D-19. It may be advisable to evaluate Equation 3 for both smooth and rough barriers, then to use the ratio to adapt a value from Figure D-19 for the case with roughness. *Design of Seawalls Allowing for Wave Overtopping* (Owen, 1980) and “Wave Runup and Overtopping on Coastal Structures” (de Waal & van der Meer, 1992) provide further overtopping guidance on the effects of composite profiles, oblique waves, and shallow water with sloping structures.

For overtopping of vertical walls, effects of wave attenuation appear relatively complex, but *Random Seas and Design of Maritime Structures* (Goda, 1985) provides extensive empirical guidance on various structure situations with incident waves specified for deep water. Figure D-20 converts basic design diagrams for wave overtopping rate at a vertical wall, to display wall freeboard required for rates of 1 cfs/ft and 0.01 cfs/ft with various incident wave heights. Goda (1985) also provides a convenient summary on the effect of appreciable fronting roughness in storm waves: the required freeboard of a smooth vertical wall for a given overtopping rate is approximately 1.5 times that which is needed when a sizable mound having concrete block armor is installed against the wall. With this information, a specific vertical wall can be categorized as having only modest overtopping ($\bar{Q}_{14} < 0.01$ cfs/ft), intermediate overtopping, or severe overtopping ($\bar{Q}_{15} > 1$ cfs/ft) expected for the 1-percent-annual-chance flood. Likely runoff or ponding behind the wall must then be identified; severe overtopping requires delineation of the landward area susceptible to wave action and velocity hazard. Subsection D.2.7 outlines several common zonations of flood hazards near shore barriers in describing the integration of computed wave effects.

Considering Figure D-20 with respect to common wall and wave heights, wave overtopping dangerous to structural stability appears the usual case during the 1-percent-annual-chance flood.

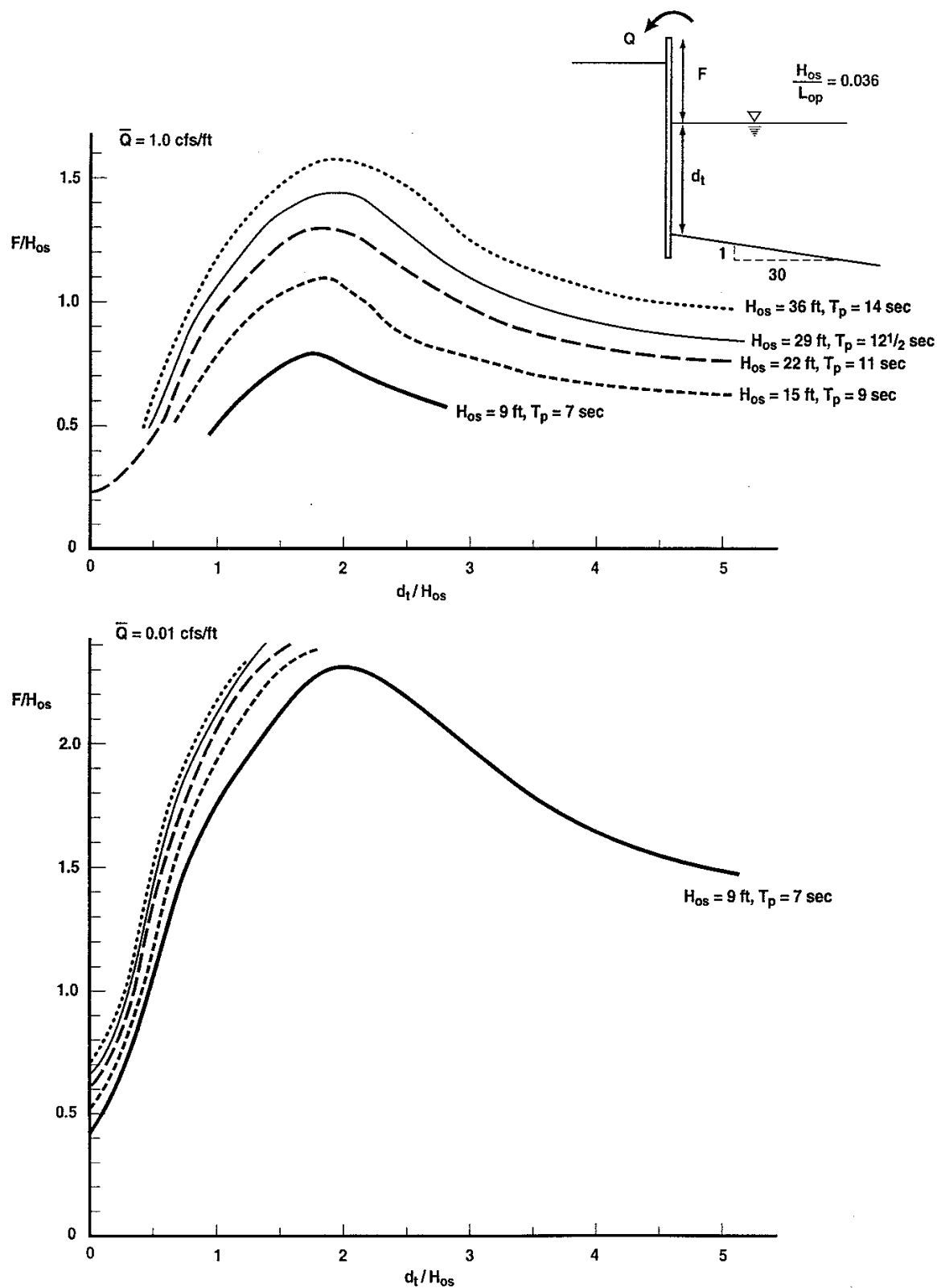

Figure D-20. Required Freeboard of Vertical Wall to Limit Mean Overtopping Rate to Certain Values, Based on Design Curves of *Random Seas and Design of Maritime Structures* (Goda, 1985)

An assessment of failure during the 1-percent-annual-chance flood for typical walls would be fully consistent with one recommendation of *Criteria for Evaluating Coastal Flood-Protection Structures*: that "FEMA not consider anchored bulkheads for flood-protection credit because of extensive failures" (Walton et al., 1989).

Interpretation of estimated overtopping rate in terms of flood hazards is complicated by the projected duration of wave effects, by the increased discharge possible under storm winds, by the varying inland extent of water effects, and by the specific topography and drainage landward of the barrier. However, guidance is provided in Table D-7 as potentially applicable to typical coastal situations.

Table D-7. Suggestions for Interpretation of Mean Wave Overtopping Rates

\bar{Q} 16 ORDER OF MAGNITUDE	FLOOD HAZARD ZONE BEHIND BARRIER
<0.0001 cfs/ft	Zone X
0.0001-0.01 cfs/ft	Zone AO (1 ft depth)
0.01-0.1 cfs/ft	Zone AO (2 ft depth)
0.1-1.0 cfs/ft	Zone AO (3 ft depth)
>1.0 cfs/ft*	30-ft width ⁺ of Zone VE (elevation 3 ft above barrier crest), landward Zone AO (3 ft depth)

*With estimated \bar{Q} 17 much greater than 1 cfs/ft, removal of barrier from transect representation may be appropriate.

⁺Appropriate inland extent of velocity hazards should take into account structure width, incident wave period or wavelength, and other factors.

For each coastal structure experiencing sizable wave runup in the 1-percent-annual-chance flood (for example, \bar{R} 18 > 2 ft), a brief report to the Project Officer should outline overtopping assessments and document conclusions consistent with historical evidence for the site.

[February 2002]

D.2.6 Analysis of Overland Wave Dimensions

As water waves propagate near the shore and over flooded land, they can undergo marked transformations due to local winds, interaction with the bottom, and physical features such as buildings, trees, or marsh grass. Figure D-21 illustrates schematic effects on the wave crest elevations and on the type of flood zone. The fundamental analysis of wave effects for an FIS is provided by the WHAFIS 3.0 computer program, entitled "Wave Height Analysis for Flood Insurance Studies" (FEMA, 1988). This program or model calculates wave heights, wave crest elevations, flood hazard zone designations, and the location of zone boundaries along a transect.

Wave description for NFIP purposes addresses the controlling wave height, equal to 1.6 times the significant wave height common as a representative wave description. Significant wave

height is the average height of the highest one-third of waves, and controlling wave height is approximately the average height of the highest one percent of waves in storm conditions. The original basis for wave treatment under the NFIP was the NAS methodology, which accounted for varying fetch lengths, barriers to wave transmission, and the regeneration of waves over flooded land areas (USACE, 1975). Because of the introduction of the NAS methodology, periodic upgrades have been made to incorporate improved or additional wave considerations.

Technical details of the current WHAFIS model are fully documented (*Technical Documentation for WHAFIS Program Version 3.0*), but a brief overview indicates the level of wave treatment in WHAFIS 3.0 (FEMA, September 1988). A wave action conservation equation governs wave regeneration due to wind and wave dissipation by marsh plants. This equation is supplemented by the conservation of waves equation, which expresses the spatial variation of the wave period at the peak of the wave spectrum. The wave energy (equivalently, wave height) and wave period respond to changes in wind conditions, water depths, and obstructions as a wave propagates. These equations are solved as a function of distance along the transect. A predominant element in this wave treatment remains unchanged from the NAS methodology: controlling wave height is limited to 78 percent of the local mean water depth.

[February 2002]

D.2.6.1 Use of WHAFIS 3.0 Model

Careful preparation and input of required site data are necessary in using WHAFIS. Like the other coastal treatments, the WHAFIS model considers the study area by representative transects. For WHAFIS, transects are selected with consideration given to major topographic, vegetative, and cultural features. The ground profile is defined by elevations referenced to NGVD and usually begins at elevation 0.0 and proceeds landward until either the ground elevation exceeds the meanwater elevation for the 1-percent-annual-chance flood or another flooding source is encountered.

Other fundamental specifications among WHAFIS input include the 1-percent-annual-chance mean water elevation and a description of waves existing at the transect start. In the wave description, provision is made for an overwater fetch length, an initial significant wave height, or an initial period of dominant waves. In most applications, the wave period is the input description, because that parameter is readily available from information about offshore storm waves and the period does not change during most wave transformations. WHAFIS then computes an appropriate depth-limited wave height at the transect start. The only check necessary is to confirm that incident waves likely exceed that height and a wave condition limited by water depth occurs.

Different wave specifications can be appropriate for sites not on an open, straight coast. Where land shelter or wave refraction may result in reduced incident waves, it is appropriate to specify an initial significant wave height for the transect. Also, at sites on restricted water bodies, the overwater fetch length should be specified for likely wind direction at the flood peak. WHAFIS then computes an appropriate incident wave condition for the transect, but such waves are limited and any fetch length exceeding 24 miles yield the same results.

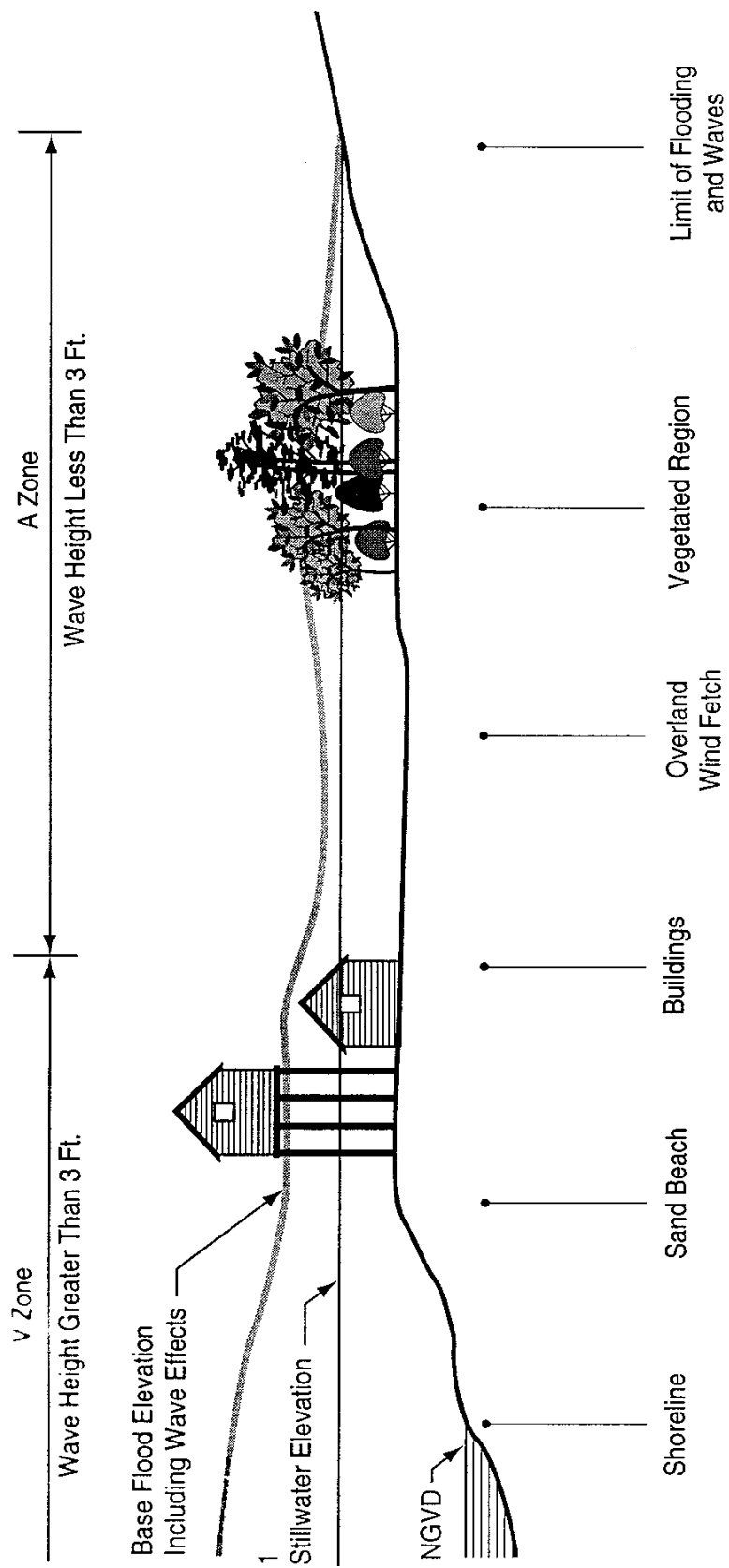

Figure D-21. Schematic Wave Effects on a Transect

Guidelines and Specifications for Flood Hazard Mapping Partners

In preparing WHAFIS input, transects are to be located on the work maps and the transect ground profile is to be plotted from the topographic data, adjusted for erosion. Each transect is to have all the input data identified on the profile plot for ease of input coding. The location, height, and extent of elongated manmade structures is to be identified and shown as part of the ground profile, after the structure's stability under forces of the 1-percent-annual-chance flood is confirmed as discussed in Subsection D.2.3. When locating transects across barrier islands or sand spits, common practice is to continue the transect across the back bay and onto the mainland. If there is a large and/or unusually shaped embayment behind the island, it may be necessary to place additional transects just along the mainland shore. These transects may not parallel the transects from the open coast, and they may cross one another. The Mapping Partner shall keep crossing transects to a minimum; however, where it is not possible to avoid this, the transect determining greatest flood hazards shall control in mapping the flood hazards.

Once representative transects are located, the local 1-percent-annual-chance mean water levels can be defined for WHAFIS input. Wave setup should be included in this water elevation, as a part of the appropriate mean depth controlling wave dimensions (FEMA, September 1988). If wave setup was not calculated separately for the site, 1-percent-annual-chance SWEL is the appropriate specification. WHAFIS also has an input field for a 10-percent-annual-chance SWEL; however, it is only employed to determine Flood Hazard Factors, which FEMA no longer uses. Still, the Mapping Partner shall provide this input if it is readily available, because it could help in distinguishing between transects.

When a transect covers two or more flooding sources, the Mapping Partner shall identify an area of transition between the different SWELs. This is a common situation for barrier islands with ocean elevations on one side and bay elevations on the other side. It is usually assumed that the higher ocean elevations extend inland to the highest point of the reduced ground profile. WHAFIS performs a linear interpolation within a transect segment where elevations differ at the end stations. The interpolated elevations are compared to the ground elevations and adjusted, if necessary, to be above the ground elevations. The Mapping Partner may have to input the SWEL a second time to identify areas of constant elevation and elevation transition.

The proper transect representation of some land features, particularly buildings and vegetation, merits further discussion. Buildings are specified on the transect as rows perpendicular to the transect. Because buildings are not always situated in perfect rows, the Mapping Partner shall exercise judgment to determine which buildings can be represented by a single row. The required input value for each row of buildings is the ratio of open space to total space. This is simply the sum of distances between buildings in a row, divided by the total length of that row. The Mapping Partner shall examine whether the first row or two of buildings along the shoreline should be considered as obstructions. During a 1-percent-annual-chance event, it is sometimes appropriate to assume that these buildings will be destroyed before the peak of the flood occurs if they are not elevated on pilings. If they are elevated, the waves should propagate under the structure with minimal reduction in height. It is useful to contact local officials to obtain typical construction methods and the lowest elevations of structures.

The WHAFIS program has two separate routines for vegetation: one for rigid vegetation that can be represented by an equivalent "stand" of equally spaced circular cylinders (NAS, 1977),

Guidelines and Specifications for Flood Hazard Mapping Partners

and one for marsh vegetation that is flexible and oscillates with wave action (FEMA, 1984). For either type, the Mapping Partner shall exercise considerable care in selecting representative parameters and in ruling out that the vegetation will be intentionally removed or that effects would be markedly reduced during a storm through erosion, uprooting, or breakage.

For the areas of rigid vegetation located on the transect, the required input values are the drag coefficient, C_D ; mean wetted height, h ; mean effective diameter, D ; and mean horizontal spacing, b . The value of C_D should vary between 0.35 and 1.0, with 1.0 being used in most cases of wide vegetated areas. When the vegetation is in a single stand, the Mapping Partner shall use a value of 0.35. The Mapping Partner may obtain representative values for h , D , and b from stereoscopic aerial photographs or by field surveys. Various guides for terrain analysis can provide advice on estimating values from aerial photographs. Table D-8 provides a useful process developed from *Terrain Analysis Procedural Guide for Vegetation* (Messmore, Vogel, & Pearson, 1979).

For marsh vegetation, a more complicated specification is required for completeness. The eight parameters used to describe the dissipational properties of a specific type are explained in Table D-9. However, WHAFIS incorporates considerable basic information on the eight common types of seacoast marsh plants listed in Table D-10 (FEMA, 1984). That information can be used either by specifying the Table D-10 abbreviation or a geographical region as indicated in Figure D-22. Figure D-22 shows the coastal wetland regions of the Atlantic and Gulf coasts, along with the identifying number used in WHAFIS. If the site is near a region border, the likely plant parameters can be interpolated using an input weighting factor. Although the South Texas region has insignificant amounts of marsh grass, it is included for usage in spatial interpolation.

Climate affects the geographic range of each marsh plant type, so that some plant types are not found in all regions. Table D-11 lists the dominant plant type in each region, where the term “dominant” refers to the plant types that cover the largest amount of area in the marshes. Table D-12 shows the significant plant types in each region, where the term “significant” refers to the plant types that occur in large enough patches (at least 10,000 square feet) to significantly affect waves. For marsh plants, simply the coastal wetland region, plant type, and area or percent of coverage may be specified. Given this information, WHAFIS will supply default values for the other marsh plant parameters appropriate to the site (FEMA, 1984).

Following the identification of the marsh plant types present, the area and fraction of coverage, F_{cov} , for each plant type must be calculated. For each transect, the total area of marsh vegetation coverage is determined. The different types of vegetation within this area usually occur in patches. F_{cov} is defined for each plant type as the ratio of the patch area for that type to the total marsh area. Using the above data, a fairly good determination can be made of the plant types present, but an attempt should be made to confirm these plant types. Local, county, or state officials may provide some assistance, and a site visit can be very useful.

Table D-8. Procedures for Vegetation Analysis Using Stereoscopic Aerial Photographs.

1. Using the parallax bar or wedge, determine the height of three representative trees and compute the average height, h .
2. Locate three representative tree crowns, measure the diameters, and compute the average crown diameter, CD .
3. Determine the type of vegetation and calculate the stem diameter, D , using the following formulae:

$$\text{Southern Pines} \quad D \text{ (inches)} = 5 + 0.5 \text{ CD (feet)}$$

Eastern Hardwoods,

$$\text{Northern Pines and Others} \quad D \text{ (inches)} = 0.75 \text{ CD (feet)}$$

4. Based on the scale of the aerial photographs, determine the diameter of a circle containing 0.08 hectares using Table 8a. Place the circle on the photograph, over a representative area of trees, and count the number of trees, n , in the circle. A magnifier may be needed. More than one area can be counted and an average used for n . Calculate the number of trees per hectare, N , using the following formula:

$$N = \frac{n}{0.08}$$

5. Determine the horizontal spacing between trees using the following formula:

$$b \text{ (feet)} = \left(\frac{12732}{N} - \frac{D \text{ (inches)}}{12} \right)$$

**Table D-8. Procedures for Vegetation Analysis Using Stereoscopic
Aerial Photographs (Cont.)**
(800 Square Meters, 8712 Square Feet)





















PHOTO SCALE	.08 HECTARE CIRCLE	CIRCLE DIAMETER	
		INCHES	MILLIMETERS
1:5,000		.253	6.38
1:6,000		.211	5.32
1:7,000		.1805	4.56
1:8,000		.158	3.99
1:9,000		.140	3.55
1:10,000		.126	3.192
1:11,000		.115	2.90
1:12,000		.105	2.66
1:13,000		.092	2.46
1:14,000		.090	2.28
1:15,000		.084	2.13
1:16,000		.079	1.99
1:17,000		.074	1.88
1:18,000		.070	1.77
1:19,000		.067	1.68
1:20,000		.063	1.60
1:21,000		.060	1.52
1:22,000		.057	1.45
1:23,000		.055	1.39
1:24,000		.053	1.33
1:25,000		.051	1.28

Table D-9. Marsh Plant Parameters

PARAMETER	EXPLANATION
C_D	Effective drag coefficient. Includes effects of plant flexure and modification of the flow velocity distribution. Default value is 0.1, usually appropriate for marsh plants without strong evidence to the contrary.
F_{cov}	Fraction of coverage. A default value is calculated by the program so that each plant type in the transect is represented equally, and the sum of the coverage for the plant types is equal to 1.0.
h	Unflexed stem height (feet). The stem height does not include the flowering head of the plant, the inflorescence.
N	Number density. Expressed as plants per square foot. The relationship to the average spacing between plants, b , can be expressed as $N = 1/b^2$.
D_1	Base stem diameter (inches). Default value may be determined from stem height and regression equations built into the program.
D_2	Mid stem diameter (inches). Default value may be determined from plant type and base stem diameter.
D_3	Top stem diameter (inches), at the base of the inflorescence. Default value may be determined from plant type and base stem diameter.
CA_b	Ratio of the total frontal area of the cylindrical portion of the leaves to the frontal area of the stem below the inflorescence. Default value may be determined from the plant type.

Table D-10. Abbreviations of Marsh Plant Types used in WHAFIS

SPECIES OR SUBSPECIES	ABBREVIATION
<i>Cladium jamaicense</i> (saw grass)	CLAD
<i>Distichlis spicata</i> (salt grass)	DIST
<i>Juncus gerardi</i> (black grass)	JUNM
<i>Juncus roemerianus</i> (black needlerush)	JUNR
<i>Spartina alterniflora</i> (medium saltmeadow cordgrass)	SALM
<i>Spartina alterniflora</i> (tall saltmeadow cordgrass)	SALT
<i>Spartina cynosuroides</i> (big cordgrass)	SCYN
<i>Spartina patens</i> (saltmeadow grass)	SPAT

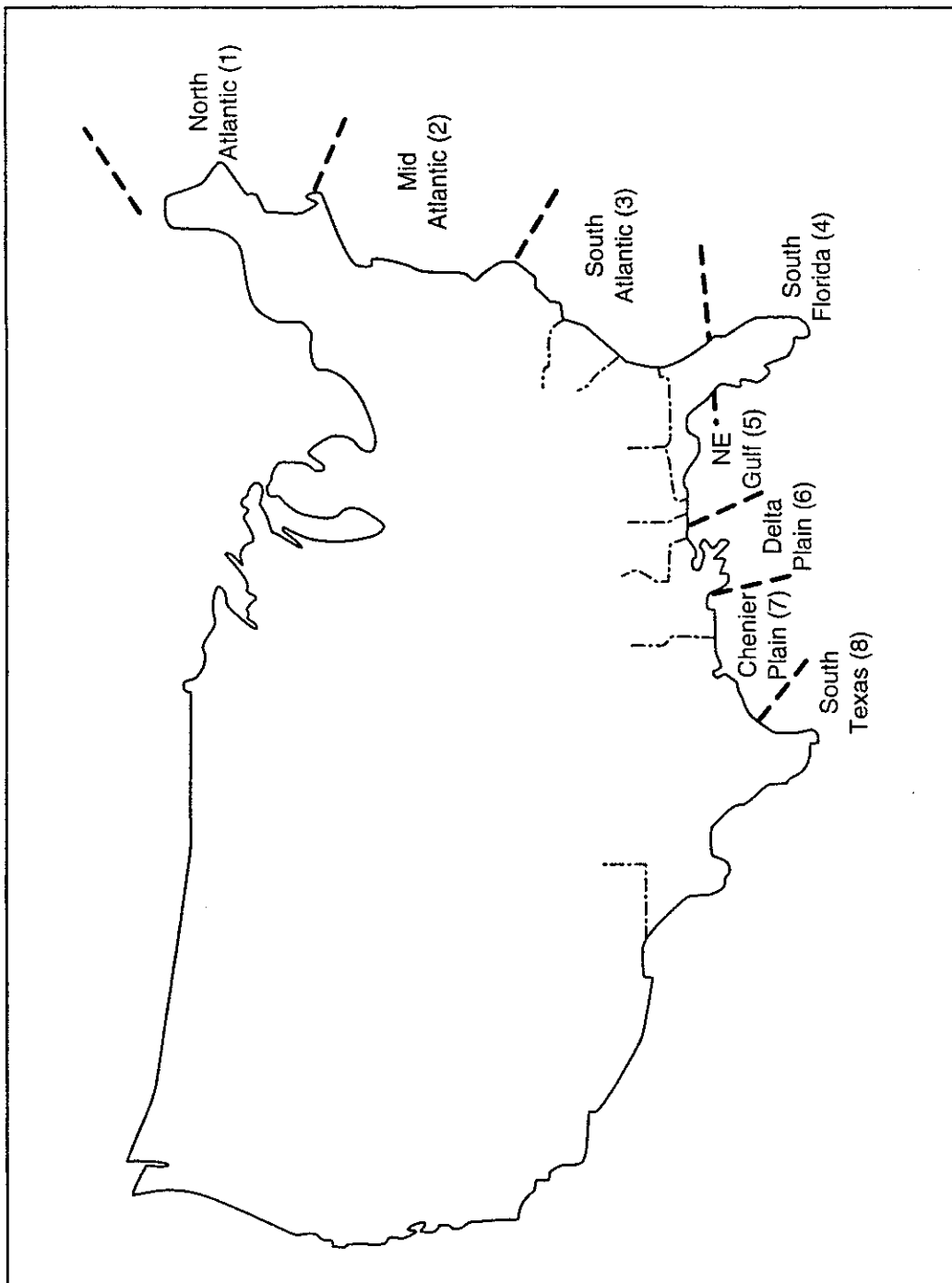

Figure D-22. Coastal wetland regions of Atlantic and Gulf coasts having enough marsh grass to significantly affect wave heights. Region numbers are indicated in parentheses.

Table D-11. Dominant Marsh Plant Types by Region and Habitat

REGION NUMBER	REGION NAME	HABITAT	DOMINANT SPECIES
1	North Atlantic	salt ¹ brackish ²	* <i>S. alterniflora</i> (medium, tall) <i>Spartina patens</i>
2	Mid-Atlantic	salt brackish	<i>S. alterniflora</i> (medium, tall) * <i>Juncus roemerianus</i> / <i>S. patens</i>
3	South Atlantic	salt brackish	* <i>S. alterniflora</i> (medium, tall) <i>J. roemerianus</i>
4	South Florida	salt brackish	<i>S. alterniflora</i> (medium, tall) * <i>C. jamaicense</i>
5	Northeastern Gulf	salt brackish	--- * <i>J. roemerianus</i>
6	Delta Plain	salt brackish	* <i>S. Alterniflora</i> (medium, tall) <i>S. patens</i>
7	Chenier Plain	salt brackish	<i>S. alterniflora</i> (medium, tall) * <i>S. patens</i>
8	South Texas	salt brackish	--- ---

¹Salt concentration is greater than 20 parts per thousand (ppt)

²Salt concentration is between 5 and 20 ppt

*When more than one dominant plant type occurs within the region, the indicated type covers the largest geographic area (acreage)

--- Insignificant amounts of marsh plants within the given habitat in the region

Table D-12. Significant Marsh Plant Types in Each Seacoast Region and WHAFIS Default Regional Plant Parameter Data

REGION NO.	1	2	3	4	5	6	7	8
REGION NAME:	NORTH ATLANTIC	MID-ATLANTIC	SOUTH ATLANTIC	SOUTH FLORIDA	NORTHEASTERN GULF	DELTA PLAIN	CHENIER PLAIN	SOUTH TEXAS
CLAD	---	---	---	7.50(+) 0.0656 6	6.00(2) 0.0260 6	---	---	---
DIST	---	0.78(1) 0.0039 211	1.00(1) 0.038 243	1.00(+) 0.0038 248	---	1.08(4) 0.0035 102	1.08(+) 0.0035 102	---
JUNM	1.23(1) 0.0042 300	1.23(+) 0.0042 300	---	---	---	---	---	---
JUNR	---	2.95(+) 0.0095 147	2.95(+) 0.0095 147	---	2.95(3) 0.0095 147	3.00(4) 0.0106 83	2.95(+) 0.0095 147	---
SALM	1.39(1) 0.0184 45	1.06(1) 0.0103 36	1.63(1) 0.0141 12	1.63(+) 0.0141 12	---	1.67(4) 0.0141 21	2.62(5) 0.0211 16	---
SALT	1.86(1) 0.0175 37	2.21(1) 0.0169 18	3.20(1) 0.0183 10	3.20(+) 0.0183 10	---	3.20(4) 0.0183 10	3.20(+) 0.0183 10	---
SCYN	---	---	8.29(+) 0.0492 6	---	---	4.00(4) 0.0267 7	---	---
SPAT	1.03(1) 0.0025 409	0.85(1) 0.0019 327	1.65(1) 0.0019 236	---	2.58(2) 0.0026 236	1.88(4) 0.0016 333	1.88(+) 0.0019 333	---

Guidelines and Specifications for Flood Hazard Mapping Partners

Data arranged in vertical triplets:

h, stem height below inflorescence, in feet

D, base diameter, in feet

N, number density, in inverse square feet

Parenthetical references indicate data source:

1 = Hardisky and Reimold, 1977

2 = Monte, August 1983

3 = Kruczynski, Subrahmanyam, Drake, 1978

4 = Hopkinson, Gosselink, Parrondo, 1980, Diameters extrapolated

5 = Turner and Gosselink, 1975, Diameters extrapolated

+ = Extrapolated Data

--- = Insignificant amounts of this plant type in the region

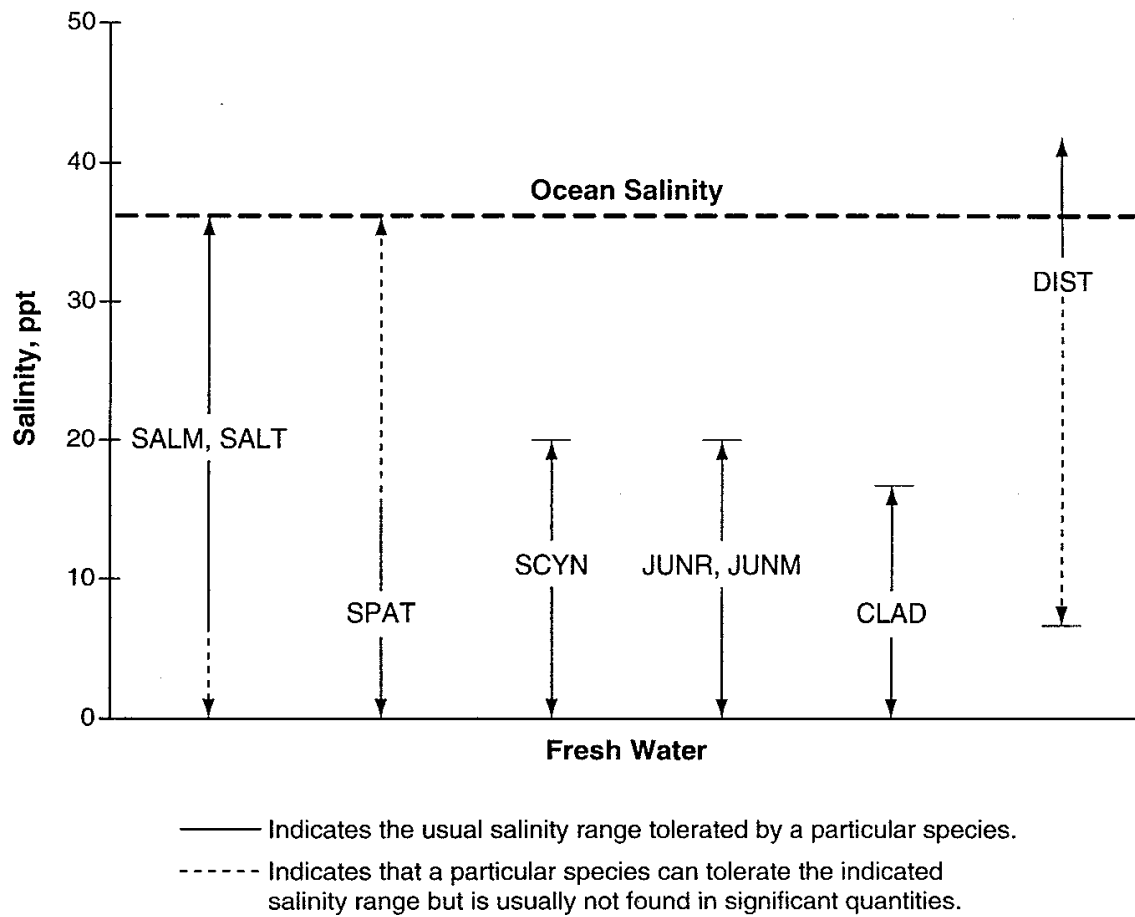

Figure D-23. Salinity Tolerance of Marsh Plants, from Knutson & Woodhouse, 1983

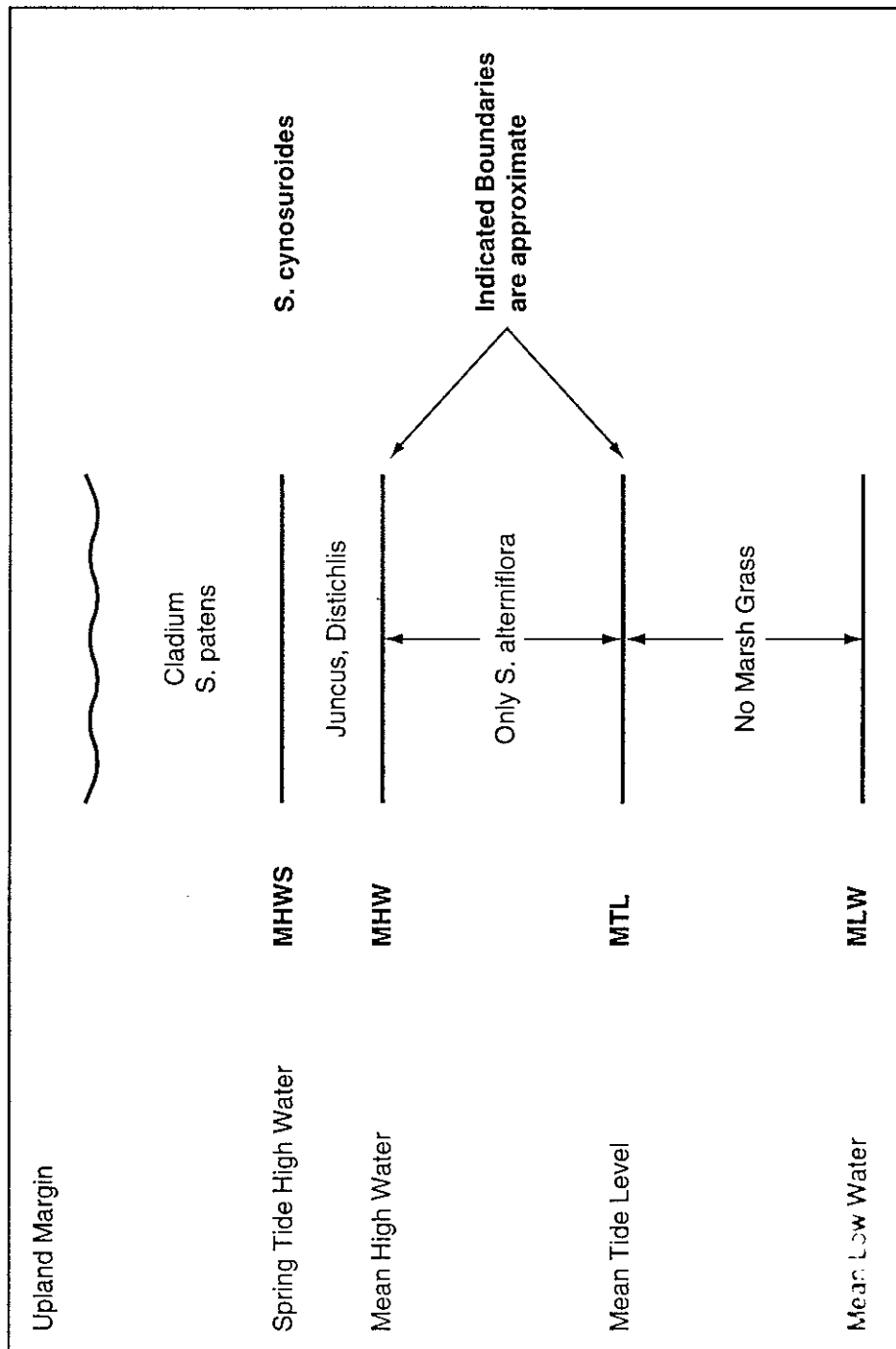

Figure D-24. Tidal Control on Salt Marsh Plant Viability

[February 2002]

D.2.6.2 Input Coding for WHAFIS

After all the necessary input data have been identified on the transect, the Mapping Partner shall divide the transect into contiguous segments, each representing a continuous open fetch or a single obstruction. Fetches are flooded areas with no obstruction, while obstructions include dunes, manmade barriers, buildings, and vegetation. The Mapping Partner shall subdivide the fetches at points where the ground elevation abruptly changes and in the transition area of changing SWELs. The Mapping Partner shall subdivide obstructions into smaller segments at the transect's seaward edge to model the wave dissipation more accurately. Rigid vegetation shall have two to three seaward segments extending 10 to 50 feet, and the first two or three rows of buildings shall have a segment for each row. Marsh vegetation will be subdivided within WHAFIS, so segmented input from the Mapping Partner is not necessary.

The Mapping Partner shall enter the necessary data using 11 line types, including the Title line. The ten remaining lines, each describing a certain type of fetch or obstruction, are listed as follows:

- The IE (Initial Elevation) line describes the initial overwater fetch and the initial SWELs.
- The IF (Inland Fetch) and OF (Overwater Fetch) lines define the endpoint stationing and elevation of inland and overwater fetches, respectively.
- Obstructions are categorized either as buildings (BU line), rigid vegetation (VE line), marsh vegetation (VH and MG lines), dunes and other natural or manmade elongated barriers (DU line), or areas where the ground elevation is greater than the 1-percent-annual-chance SWEL (AS line).
- The ET (End of Transect) line enters no data but indicates the end of the input data.

Each line has an alphanumeric field describing the type of input for that line, followed by ten numeric fields describing the parameters.

To ensure proper modeling, the Mapping Partner shall enter all segments of each transect either as fetches or obstructions, with one input line required for each fetch or obstruction segment. The first two columns of each line identify the type of fetch or obstruction. The remaining 78 columns consist of one field of six columns followed by nine fields of eight columns. The Mapping Partner shall right-justify the numbers in any data field only if no decimal point is used. Decimal points are permitted but not required. The end point of one fetch or obstruction is the beginning of the next. The first two numeric fields of each line are used to read in the stationing (measured in feet from the beginning of transect) and elevation (in feet) of the end point. The last two fields used on each line are for entering new SWELs. An interpolation is performed within a transect segment starting at the closest station with an input SWEL. This interpolation uses the new SWEL input at the end point of the segment and the SWEL input at a previous segment. If these fields are blank or zero, the SWELs remain unchanged.

Guidelines and Specifications for Flood Hazard Mapping Partners

The input data requirements are summarized below for each line type. The Title line must be the first line, followed by the IE line, followed by any combination of the various fetch and obstruction lines. The ET line must be the last card entered for the transect. A blank line must follow to signify the end of the run. If multiple transects are being run, the Title line for the next transect will follow the blank line. All units are in feet unless otherwise specified.

TITLE Line (Title)

This line is required and must be the first input line.

DATA FIELD	COLUMNS	CONTENTS OF DATA FIELDS
0	1-2	Blank
1-10	3-80	Title information centered about column 40

IE Line (Initial Elevations)

This line is required and must be the second input line. This line is used to begin a transect at the shoreline and compute the wave height arising through the overwater fetch.

DATA FIELD	COLUMNS	CONTENTS OF DATA FIELDS
0	1-2	IE
1	3-8	Stationing of end point of initial overwater fetch in feet (zero at beginning of transect)
2	9-16	Ground elevation at end point in feet (usually zero at beginning of transect)
3	17-24	Overwater fetch length (miles), if wave condition is to be calculated. Values of 24 miles or greater yield identical results.
4	25-32	10-percent-annual-chance SWEL in feet
5	33-40	1-percent-annual-chance SWEL in feet
6	41-48	Initial wave height in feet; a blank or zero causes a default to a calculated wave height
7	49-56	Initial wave period (seconds); a blank or zero causes a default to a calculated wave period. The period is usually the most convenient wave specification for open coasts.
8-10	57-80	Not used

AS Line (Above Surge)

This line is used to identify the end point of an area with ground elevation greater than the 1-percent-annual-chance SWEL (such as a high dune or other land mass). This is used when the ground surface temporarily rises above the 1-percent-annual-chance SWEL. The line immediately preceding the AS line must enter the stationing and elevation of the point at which the ground elevation first equals the 1-percent-annual-chance SWEL. SWEL on the inland side may differ from SWEL on the seaward side. The ground elevation entered on the AS line must

Guidelines and Specifications for Flood Hazard Mapping Partners

equal the SWEL that applies to the inland side of the land mass. Computer calculations will be terminated if a ground elevation greater than the 1-percent-annual-chance SWEL is encountered.

DATA FIELD	COLUMNS	CONTENTS OF DATA FIELDS
0	1-2	AS
1	3-8	Stationing at end point in feet of area above 1-percent-annual-chance SWEL
2	9-16	Ground elevation in feet at end point
3	17-24	A blank or zero indicates no change to the 10-percent-annual-chance SWEL; otherwise new 10-percent-annual-chance SWEL
4	25-32	A blank or zero indicates no change to the 1-percent-annual-chance SWEL; otherwise new 1-percent-annual-chance SWEL
5-10	33-80	Not used

BU Line (Buildings)

This line enters information needed to compute wave dissipation at each group of buildings.

DATA FIELD	COLUMNS	CONTENTS OF DATA FIELDS
0	1-2	BU
1	3-8	Stationing of end point in feet of group of buildings
2	9-16	Ground elevation at end point in feet
3	17-24	Ratio of open space between buildings to total transverse width of developed area
4	25-32	Number of rows of buildings
5	33-40	A blank or zero indicates no change to 10-percent-annual-chance SWEL; otherwise new 10-percent-annual-chance SWEL
6	41-48	A blank or zero indicates no change to 1-percent-annual-chance SWEL; otherwise new 1-percent-annual-chance SWEL
7-10	49-80	Not used

DU Line (Dune)

This line enters information necessary to compute wave dissipation over flooded sand dunes and other natural or manmade elongated barriers (e.g., levees and seawalls).

DATA FIELD	COLUMNS	CONTENTS OF DATA FIELDS
0	1-2	DU
1	3-8	Stationing at top of dune or barrier in feet
2	9-16	Elevation at top of dune or barrier in feet
3	17-24	A blank or zero indicates a dune or other natural barrier; any other number indicates a seawall or other manmade barrier
4	25-32	A blank or zero indicates no change to 10-percent-annual-chance SWEL; otherwise new 10-percent-annual-chance SWEL
5	33-40	A blank or zero indicates no change to 1-percent-annual-chance SWEL;

Guidelines and Specifications for Flood Hazard Mapping Partners

DATA FIELD	COLUMNS	CONTENTS OF DATA FIELDS
		otherwise new 1-percent-annual-chance SWEL
6-10	41-80	Not used

IF Line (Inland Fetch)

This line enters the parameters necessary to compute wave regeneration through somewhat sheltered fetches and over shallow inland water bodies. The IF regeneration is computed using a sustained wind speed of 60 mph.

DATA FIELD	COLUMNS	CONTENTS OF DATA FIELDS
0	1-2	IF
1	3-8	Stationing at end point of fetch in feet
2	9-16	Ground elevation at end point in feet
3	17-24	A blank or zero indicates no change to 10-percent-annual-chance SWEL; otherwise new 10-percent-annual-chance SWEL
4	25-32	A blank or zero indicates no change to 1-percent-annual-chance SWEL; otherwise new 1-percent-annual-chance SWEL
5-10	33-80	Not used

OF Line (Overwater Fetch)

This line enters the parameters necessary to compute wave regeneration over large bodies of water (i.e., large lakes, bays) using a sustained wind speed of 80 mph. If an inland body of water is sheltered and has a depth of ten feet or less, the IF line calling for reduced wind speed should be used.

DATA FIELD	COLUMNS	CONTENTS OF DATA FIELDS
0	1-2	OF
1	3-8	Stationing at end point of fetch in feet
2	9-16	Ground elevation at end point in feet
3	17-24	A blank or zero indicates no change to the 10-percent-annual-chance SWEL; otherwise new 10-percent-annual-chance SWEL
4	25-32	A blank or zero indicates no change to 1-percent-annual-chance SWEL; otherwise new 1-percent-annual-chance SWEL
5-10	33-80	Not used

VE Line (Vegetation)

This line enters parameters necessary to compute wave dissipation due to rigid vegetation stands.

DATA FIELD	COLUMNS	CONTENTS OF DATA FIELDS
0	1-2	VE
1	3-8	Stationing at end point of vegetation in feet
2	9-16	Ground elevation at end point in feet
3	17-24	Mean effective diameter of equivalent circular cylinder in feet
4	25-32	Average actual height of vegetation in feet
5	33-40	Average horizontal spacing between plants in feet
6	41-48	Drag coefficient; a blank or zero causes a default to 1.0
7	49-56	A blank or zero indicates no change to 10-percent-annual-chance SWEL; otherwise new 10-percent-annual-chance SWEL
8	57-64	A blank or zero indicates no change to 1-percent-annual-chance SWEL; otherwise new 1-percent-annual-chance SWEL
9-10	65-80	Not used

VH Line (Vegetation Header for Marsh Grass)

Marsh grass is often part of a plant community that may consist of several types. The VH line is used to enter data that apply to all plant types modeled in the transect segment. To enter data for each plant type, MG lines for each plant type must follow the VH line.

DATA FIELD	COLUMNS	CONTENTS OF DATA FIELDS
0	1-2	VH
1	3-8	Stationing at end point of marsh vegetation segment in feet
2	9-16	Ground elevation at end point in feet
3	17-24	Reg _p , number of the primary seacoast region for default plant parameters. See Figure 22.
4	25-32	Wt _p , weighting factor for the primary seacoast region.
5	33-40	Reg _s , number of secondary seacoast region. See Figure D-22.
6	41-48	N _{p1} , number of plant types; range is 1 to 10, inclusive. One MG line is required for each plant type.
7	49-56	A blank or zero indicates no change to the 10-percent-annual-chance SWEL; otherwise new 10-percent-annual-chance SWEL
8	57-64	A blank or zero indicates no change to the 1-percent-annual-chance SWEL; otherwise new 1-percent-annual-chance SWEL
9	65-72	Not used
10	73-80	This field is for overriding the default method of averaging flood hazard factors

Guidelines and Specifications for Flood Hazard Mapping Partners

DATA FIELD	COLUMNS	CONTENTS OF DATA FIELDS
		in A Zones; if 1 in column 80, averaging process begins or ends at end of vegetation segment; otherwise, default averaging method is used

MG Line (Marsh Grass)

This line is used to enter data for a particular plant type. The first MG line must be preceded by a VH line. For the common seacoast marsh grasses listed in Table D-10, some potentially useful default values are supplied in Table D-12, and the program can provide additional default values (FEMA, October 1984). If a plant type not listed in the table is used, then appropriate data must be developed for Fields 2-9.

DATA FIELD	COLUMNS	CONTENTS OF DATA FIELDS
0	1-2	MG
1	5-8	Marsh plant type abbreviation (see Table 10)
2	9-16	C_D , effective drag Coefficient; default value is 0.1
3	17-24	F_{cov} , decimal fraction of vegetated area to be covered by this plant type; a blank or zero causes a default to be calculated so that each plant type is represented equally
4	25-32	h, mean unflexed height of stem (feet); for marsh plants, the inflorescence is not included
5	33-40	N, number of plants per square foot
6	41-48	D_1 , base stem diameter (inches)
7	49-56	D_2 , mid stem diameter (inches)
8	57-64	D_3 , top stem diameter (inches)
9	65-72	CA_b , ratio of the total frontal area of cylindrical part of leaves to frontal area of main stem
10	73-80	Not used

ET Line (End of Transect)

This line is required and must be the last input card because it identifies the end of input for the transect.

DATA FIELD	COLUMNS	CONTENTS OF DATA FIELDS
0	1-2	ET
3-10	3-80	Not used

[February 2002]

D.2.6.3 Error Messages

The error messages that may appear when running the model are described below.

- "AS card ground elevation less than SWEL, should use other type card, job dumped."
Only use AS (above surge) line when the ground elevation is above the SWEL. Can otherwise use IF, OF, BU, DU, VE, or VH.
- "Ground elevation greater than surge elevation encountered, job dumped."

Guidelines and Specifications for Flood Hazard Mapping Partners

If ground elevation is above surge elevation, AS card should be used.

- "Average depth less than or equal to zero, job dumped."

The water depth must be greater than zero or a wave height cannot be computed. Check the SWEL and the ground elevation if point of job dump is not the last point along the transect profile.

- "The above card contains illegal data in the first 2 columns."

Check input data for incorrect values or input within wrong columns. Aside from the title line, the first two columns in each line should contain the card identifiers.

- "Transmitted wave height at last fetch or obstruction = _____ which exceeds 0.5."

Code the transect profile up to the inland limit where ground elevation intersects the SWEL so that wave height should decrease to zero. If the scope of work ends at the corporate limits before the ground elevation meets the SWEL, this message can be ignored.

- "Array dimensions exceeded. Job dumped."

Size of the array is limited and the number of input parameters has exceeded the array. Check the number of input parameters at the location where the job dumped.

- "Invalid data in field 1 of IF card," etc.

Check input data to make sure that data are in correct columns.

- "Wave period less than or equal to zero in subroutine fetch. Abort run."

Either a fetch length or a wave period must be input for the program to run properly. Check input data.

- "Invalid data in field 3 or field 5 of VH card."

Check input data.

- "Invalid data in field 4 of VH card."

Check input data.

- "Invalid data in field 3 of MG card."

Check input data. The fraction of vegetated area covered by the stated plant type should be a decimal number between 0.0 and 1.0.

- "Missing MG card or incorrect data in field 6 of VH card."

A MG card must always follow the VH card. Field 6 of the VH card pertains to the number of plant types, and one MG card is required for each plant type.

- "Invalid input data."

Check input data for invalid characters, such as an O instead of a zero. Check to be sure that all data are in their correct columns.

- "Fcov was found to be negative for plant type = _____."

Check input data to be sure that the decimal fraction of the vegetated area covered by the plant type is not negative.

Guidelines and Specifications for Flood Hazard Mapping Partners

- "Ncov is .LE. zero in Sub.Lookup when it should be .GT. zero. Abort run."

Check input for number of plants covering the area.

- "The first card is not an IE card, this transect is aborted. Continued to next transect."

The first card after the title line must always be an IE card. Check input data.

- "***** The surge elevation at this station (stationing ____), which is ____ card, is less than the ground elevation. The interpolation process is continued. *** Please double check the surge and ground elevations in the vicinity of this station"

The surge elevation should not be below the ground elevation. If the interpolated surge elevation is interpolated below the ground elevation, insert additional cards to specify surge and ground elevations and use an AS card if necessary.

- "Interpolation line cuts off more than two portions of high ground ridge. This transect is aborted, re-assign 1-percent-annual-chance elevations at high ground stations."

When the interpolated value falls below the ground elevation, insert additional cards to better model the area and set the SWEL equal to the ground elevation where appropriate. Insert AS cards as necessary.

- "***** Unreasonable high ground elevation at station ____ which is ____ card. This transect is aborted, continued to next transect. ***** Double check the surge and ground elevations in the vicinity of this station. If the ground elevations are correct, either assign a higher surge elevation or use AS cards."

Add additional input data as necessary to better define the ground elevation and surge elevation in this area.

[February 2002]

D.2.6.4 Output Description

The output of the program provides all the data necessary for plotting the BFEs and flood insurance risk zones along the transect. The output is in six parts:

Part 1 - Input

This is a printout showing all input data lines and the parameters assigned to each line, both manually and by default. This is followed by a more detailed printout with column headings for each input data line. When VH and MG Lines are used, a separate insert will be printed directly beneath the MG Line showing any default values supplied by the computer.

Part 2 - Controlling Wave Heights, Spectral Peak Wave Period, and Wave Crest Elevations

This is a list of the calculated controlling wave heights, spectral wave peak periods, and wave crest elevations at the end point of each fetch and obstruction of the input, and at calculation points generated between the input stations.

Part 3 - Location of Areas Above 1-Percent-Annual-Chance Surge

This is a list of the locations of areas where the ground elevation is greater than the 1-percent-annual-chance stillwater (surge) elevation. Only areas identified by AS lines are listed.

Part 4 - Location of Surge Elevations

This is a list of the 10- and 1-percent-annual-chance stillwater (surge) elevations and the stationing of the points where each set of SWELs first becomes fully effective.

Part 5 - Location of V Zones

This is a list of the locations of the V/A Zone boundary and locations of the V Zone areas relative to these boundaries. The stationing is given for each V/A Zone boundary. The locations of the V Zone areas in relation to these boundaries are given as windward or leeward of the boundary.

Part 6 - Numbered A Zones and V Zones

This is a list of the zone data needed to delineate the flood hazard boundaries on the FIRM. The location of a flood zone boundary and the wave crest elevation at that boundary are given on the left. Between the boundary listings are the zone designations and FHF's. Under FEMA's Map Initiatives Procedure guidelines, all numbered V and A Zones should be changed to VE and AE Zones, respectively (elevations will not change), and the FHF's can be ignored (FEMA, 1991). When the same zone and elevation are repeated in the list, they should be treated as a single zone.

[February 2002]

D.2.7 Mapping of Flood Elevations and Zones

Requirements for reviewing the initial model results and identifying flood insurance risk zones, guidance and examples for determining transects, and guidance for depicting the analysis on the FIRM are presented in this subsection.

[February 2002]

D.2.7.1 Review and Evaluation of Basic Results

Prior to mapping the flood elevations and zones, the Mapping Partner shall review results from the models and assessments from a common-sense viewpoint and compare them to available historical data. When using these models, there is the potential to forget that the transects represent real shorelines of sandy beaches, rocky or cohesive bluffs, wetlands being subjected to extremely high water, waves, and winds. Familiarity and experience with the coastal area being modeled or similar areas should provide an idea of what is a "reasonable" result.

Use of the historical data is also very important in evaluating whether the results are reasonable. It would be very convenient if data from a storm closely approximating the 1-percent-annual-chance event were available, but this is seldom the case. Although most historical flood data are

Guidelines and Specifications for Flood Hazard Mapping Partners

for storms less intense than a 1-percent-annual-chance event, these data will still indicate, at a minimum, what areas should be in flood zones. For instance, if a storm that produced an extreme flood below the 1-percent-annual-chance SWEL generally caused structural damage to houses 100 feet from the shoreline, a "reasonable" Zone VE width must be at least 100 feet. Similarly, houses that collected flood insurance claims for the same storm should be at least in a Zone AE, AH, or AO. If the analyses of the 1-percent-annual-chance flood produce flood zones and elevations indicating lesser hazards than those recorded for a more common storm, the analyses should be reevaluated. One possible explanation can be that a new coastal structure acts to reduce flood hazards locally.

If there are indications that a reevaluation is needed, the Mapping Partner shall determine whether the results of the erosion assessment are appropriate. The Mapping Partner shall attempt to compare the eroded profile to past effects, whether in the form of profiles, photographs, or simply descriptions. A general idea of what happened previously can be sufficient. The Mapping Partner shall use judgment and experience to project previous storm effects to the 1-percent-annual-chance conditions and to ensure that the eroded profile is consistent with previous events.

The Mapping Partner shall examine other data input to the assessments of wave effects. This includes checking that the SWELs, wave heights, wave periods, and fetch lengths were used correctly and are consistent with the historical data. Further consideration might be given to examining if the buildings or structures modeled would be destroyed by the storm or if the buildings are on pilings above the flooding.

The main point to be emphasized here is that the results should not be blindly accepted. There are many uncertainties and variables in coastal processes during an extreme flood and many possible adjustments to methodologies for treating such an event. The validity of any model is demonstrated by its success in reproducing recorded events. Therefore, the model results must be in basic agreement with past flooding patterns, and historical data must be used to evaluate these results.

[February 2002]

D.2.7.2 Identification of Flood Insurance Risk Zones

The Mapping Partner shall identify the flood insurance zones and BFEs including wave heights be identified on each transect plot before delineating the flood insurance zones on the work maps, because of additional wave effects along with the 1988 redefinition of Coastal High Hazard Area to include the primary frontal dune. The existing topography, eroded transect, combination of shore effects in the wave envelope, and other results from wave overtopping assessment are all important to the proper identification of flood insurance risk zones.

Specifically, as discussed in Subsection D.2.1.2, the existing ground profile defines an appropriate extent of the primary frontal dune, as a ridge of sand bounded by relatively steep slopes. As discussed in Subsection D.2.4.5, the eroded transect for cases of duneface retreat may imply that flood hazards due to wave overtopping extend into an area landward of the WHAFIS results. In addition, as discussed in Subsection D.2.5.7, wave overtopping of stable shore barriers can result in flooding to areas above the mean elevation of wave runup. However, the

main consideration for integrated treatment of wave-controlled flood elevations is to define the wave envelope joining height and runup effects.

This wave envelope is a combination of representative wave runup elevation with the controlling wave crest profile determined by WHAFIS. The wave crest profile is plotted on the transect from the data in Part 2 of the WHAFIS output. A horizontal line is extended seaward from the wave runup elevation to its intersection with the wave crest profile to obtain the wave envelope, as shown in Figure D-25. If the runup elevation is greater than the maximum wave crest elevation, the wave envelope will be a horizontal line at the runup elevation. Conversely, if the wave runup is negligible or was not modeled, the wave crest profile becomes the wave envelope.

Flood insurance risk zones are defined basically by the wave envelope along with the general zone descriptions in Table D-13. Those results are supplemented by runup and overtopping considerations, as introduced previously. The following material outlines the process of flood insurance risk zone identification, with specific examples presented in the next section to illustrate some usual results.

Table D-13. Descriptions of Coastal Flood Insurance Risk Zones

Zone VE	Coastal High Hazard Areas where wave action and/or high-velocity water can cause structural damage in the 1-percent-annual-chance flood. These areas are primarily identified by: (1) the area where 3-foot or greater wave height could occur (this is the area where the WHAFIS wave crest profile is 2.1 feet or more above the SWEL), (2) the area where the eroded ground profile is 3 feet or more below the representative runup elevation, and (3) the entire primary frontal dune, by definition. Subdivided into elevation zones with BFEs assigned.
Zone AE	Areas of inundation by the 1-percent-annual-chance flood, including wave heights less than 3 feet and runup elevations less than 3 feet above the ground. These areas are also subdivided into elevation zones with BFEs assigned.
Zone AH	Areas of shallow flooding or ponding, with water depths of 1 to 3 feet. These areas are usually not subdivided, and a BFE is assigned.
Zone AO	Areas of sheet-flow shallow flooding where overtopping water flows into another flooding source. These areas are designated with 1-, 2-, or 3-foot depths of flooding.
Zone X	Areas above 1-percent-annual-chance flood inundation. On the FIRM, shaded Zone X is inundated by the 0.2-percent annual chance flood, unshaded Zone X is above the 0.2-percent annual chance flood.

For a complete listing of flood insurance risk zones, refer to Section 1.4.2.7.1 of Volume 1 of these Guidelines.

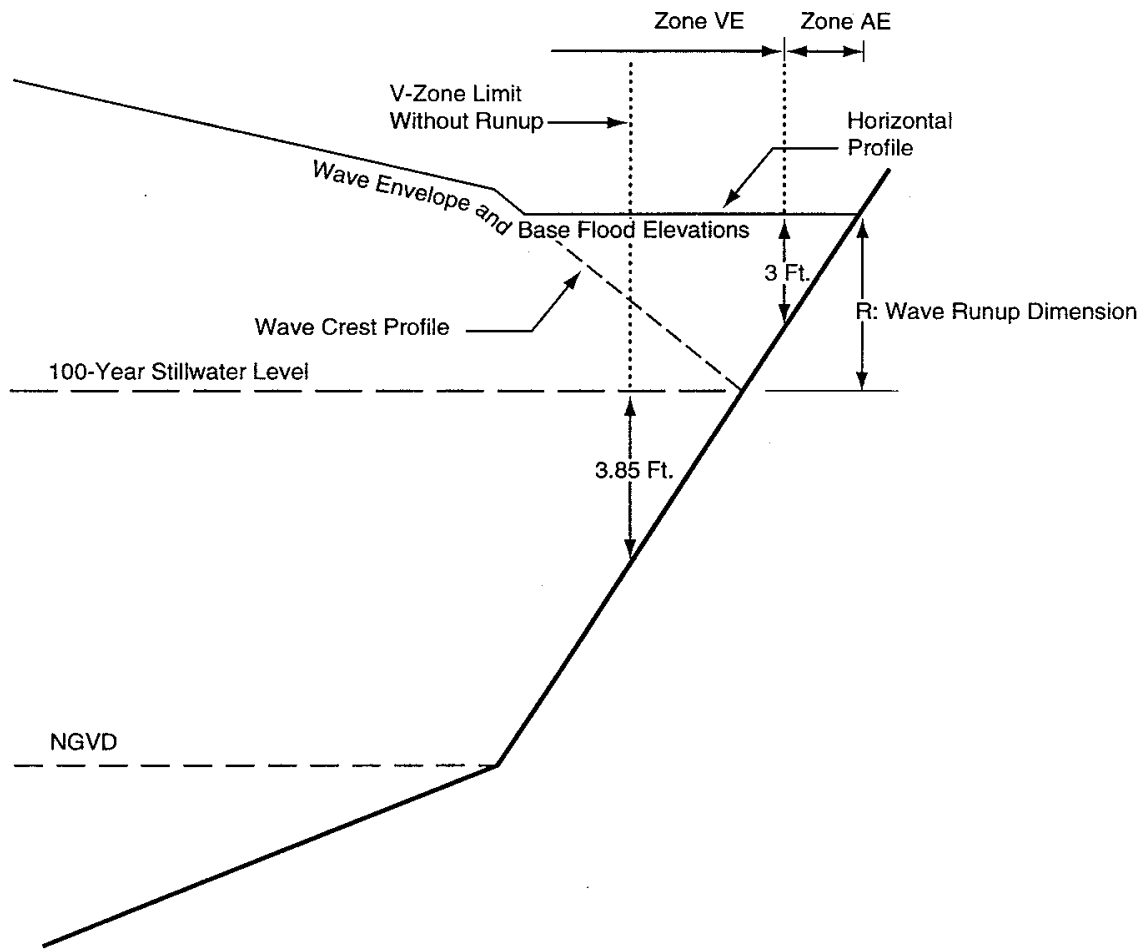

Figure D-25. Wave Envelope Resulting from Combination of Nearshore Crest Elevations and Shore Runup Elevation

Guidelines and Specifications for Flood Hazard Mapping Partners

The first step in identifying the flood insurance risk zones on the transect is locating the inland extent of the VE Zone, also known as the VE/AE boundary. The VE-Zone limit for each of the three criteria is identified, and the VE/AE boundary placed at the one furthest landward, as shown in Figure D-26. The Mapping Partner may need to move that boundary further inland in the vicinity of a wave barrier where severe overtopping is indicated for the 1-percent-annual-chance flood, so high-velocity impacts occur over a limited landward area.

The Mapping Partner shall extend the Zone AE from the VE/AE boundary to the inland limit of 1-percent-annual-chance inundation, which is a ground elevation equal to the representative runup elevation, or the 1-percent-annual-chance SWEL if runup is negligible. The Mapping Partner may designate additional areas of shallow flooding or ponding for the 1-percent-annual-chance event as Zone AH or Zone AO. In cases of severe wave overtopping effects, a VE Zone may abut areas designated as Zone AH or Zone AO. The Mapping Partner shall label all areas above the 1-percent-annual-chance inundation as Zone X.

The Mapping Partner shall then subdivide the Zone AE and VE areas into elevation zones with whole-foot BFEs assigned according to the wave envelope. Ideally, the Mapping Partner would establish an elevation zone for every BFE in the wave envelope; but because these zones are mapped on the FIRM so that buildings or property can be located in a flood insurance risk zone, the Mapping Partner shall use a minimum width for the mapped zone to provide a usable FIRM. For coastal areas, the minimum zone width is 0.2 inch on the FIRM. For identifying elevation zones on the transect, the minimum width is 0.2 times the final FIRM scale; for example, a width of 80 feet for a FIRM at a scale of 1 inch equals 400 feet, or a width of 100 feet for a FIRM at a scale of 1 inch equals 500 feet.

The Mapping Partner shall not subdivide the horizontal runup portion of the wave envelope, if any; the runup elevation, rounded to the nearest whole foot, is the BFE. The Mapping Partner shall subdivide the WHAFIS wave crest profile. Generally, the VE Zone is subdivided first. Initially, the Mapping Partner shall mark the location of all elevation zone boundaries on the transect. Because whole-foot BFEs are being used, these should always be at the location of the half-foot elevation on the wave envelope.

The Mapping Partner shall combine elevation zones that do not meet the minimum width with an adjacent zone or zones to yield an elevation zone wider than the minimum. The BFE for this combined zone is a weighted average of the combined zones. Often, in subdividing VE Zones, the maximum BFE is located just inside the mapped shoreline, and the remainder of the VE Zone is then subdivided into elevation zones of the minimum width.

The Zone AE, if wide enough, shall be subdivided in the same manner. If the total AE Zone is less than the minimum width, the lowest elevation VE Zone is usually assigned to that area. This situation typically occurs for steep or rapidly rising ground profiles, and it is not unreasonable to designate the entire inundated area as a VE Zone. In some cases, however, it may be appropriate for the Mapping Partner to extend the AE Zone slightly into the next zone seaward in order to satisfy the minimum width requirement.

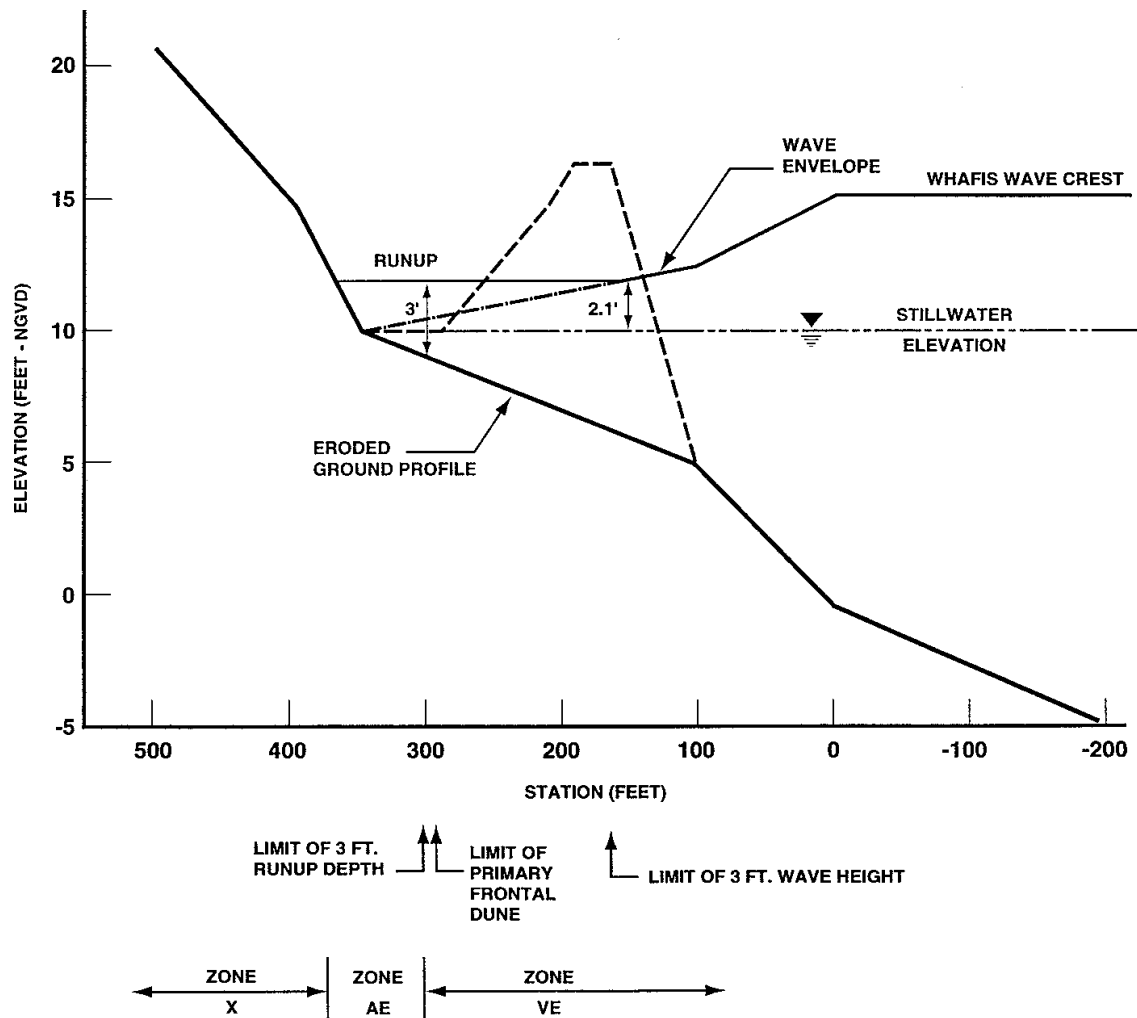

Figure D-26. Possible V-Zone Limits at Eroded Dune

Relatively low areas inland of zones with assigned wave elevations may be subject to shallow flooding or ponding of flood water; the Mapping Partner shall designate these areas as Zone AH or Zone AO. Such designations can be relatively common landward of coastal structures and dunes, where wave overtopping occurs. Identifying appropriate zones and elevations may require particular care for dunes, given that the entire primary frontal dune is defined as Coastal High Hazard Area. Although the analyses may have determined a dune will not completely erode and wave action should stop at the retreated duneface with only overtopping possibly propagating inland, the Mapping Partner shall designate the entire dune as Zone VE. The Mapping Partner shall assign the BFE at the duneface for the remainder of the dune.

It may seem unusual to use a BFE that is lower than the ground elevation, although this is actually fairly common. Most of the BFEs for areas where the dune was assumed to be eroded are also below existing ground elevations. In these cases, it is the VE Zone designation that is most important to the NFIP, under current regulations, structures in VE Zones must be built on pilings and prohibits alterations to the dune.

[February 2002]

D.2.7.3 Transect Examples

Figure D-26 provides a schematic summary for the three criteria potentially defining the landward limit to the Coastal High Hazard Area. The examples discussed below depict idealized transects of typical types to illustrate common flood hazard zonations in a quantitative way. Coastal erosion is a dominant consideration for the first set of examples. The second set of examples addresses some usual effects at stable shore barriers exposed to extreme wave action.

Figure D-27 presents an example of dune removal with appreciable runup occurring on the eroded profile. For this transect, the VE Zones with BFEs of 13, 14, and 15 feet are too narrow to be mapped, so they are averaged to a BFE of 14 feet. The Zone VE, elevation 12 feet, is enlarged slightly to include some of the elevation 13-foot area so that the boundary would be located at the dune toe or 5-foot contour line, a feature easily identified on the work map. The boundary between the Zone VE, elevation 14 feet and the Zone VE, elevation 16 feet is located just landward of the shoreline. The Zone AE, elevation 12 feet, in Figure D-27 is only 70 feet wide, slightly less than the minimum mapping width. In this example, the Mapping Partner would have to examine the work map to determine if this zone might be wider or narrower in the contiguous area. If wider, the Zone AE should be used; if narrower, the designation extended through this area should be Zone VE, elevation 12 feet.

Figure D-28 illustrates an example of a relatively high retreated duneface. A mean runup elevation of 13 feet is calculated for the eroded duneface. This elevation is assigned through the dune, all of which is designated as Zone VE. Because the dune remnant extends more than 7 feet above the SWEL, no flooding landward of the dune is indicated by designating the area as Zone X. Note that the retreated dune profile shifts the 0.0 foot elevation shoreline 65 feet seaward. Because the existing 0.0 foot elevation shoreline is used on the work map, the Zone VE, elevation 16 feet, is located just landward of the existing shoreline.

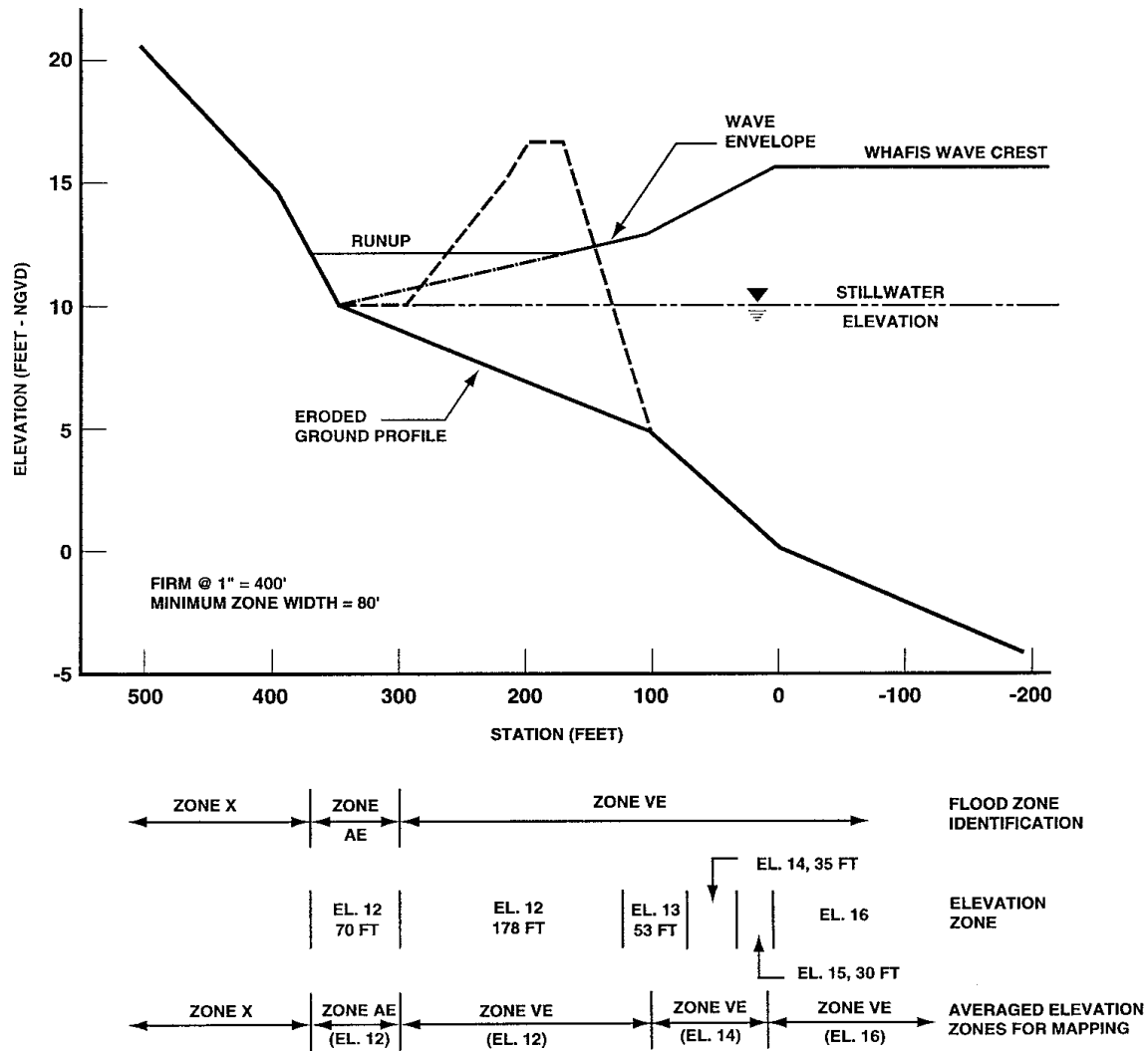

Figure D-27. Identification of Elevation Zones, Example 1: Dune Removal with Wave Runup Landward

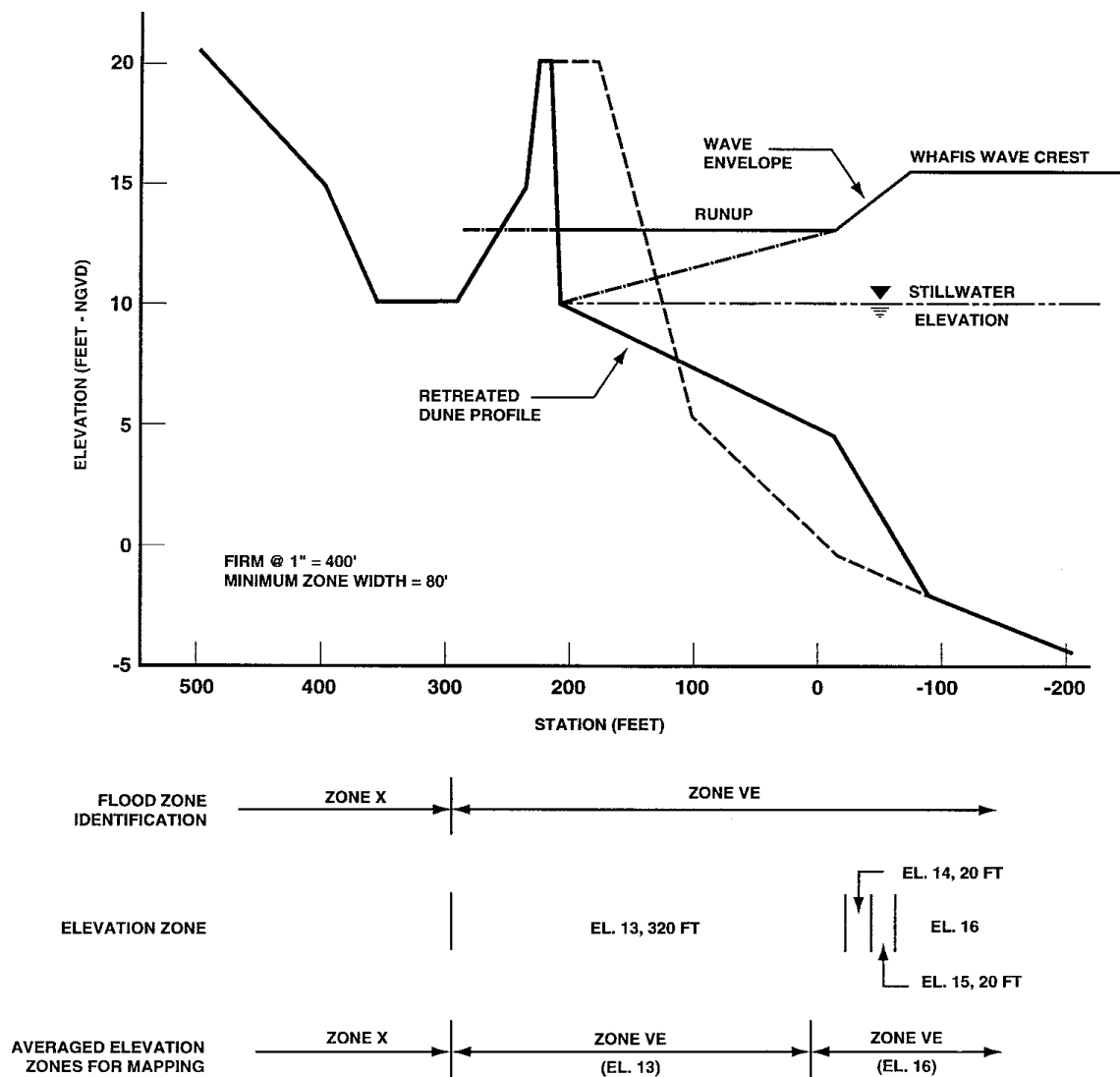

Figure D-28. Identification of Elevation Zones, Example 2: Duneface Retreat with Relatively High Remnant.

Figure D-29 illustrates an example of a retreated duneface with a relatively small remnant having low relief. A mean runup elevation of 12 feet is calculated for the eroded profile, and this flood elevation is assigned through the dune, all of which is designated as Zone VE. The division into separate map zones is similar to the division in Figure D-28. Because the dune remnant extends less than 7 feet above the SWEL, appreciable wave overtopping is expected during the 1-percent-annual-chance flood. An area landward of the dune of about the minimum mapping width is designated as a Zone AO, depth 1 foot.

Figure D-30 illustrates an example of dune removal where there is some runup and overtopping of the remaining stub. As in Figure D-27, the VE Zone with a runup elevation of 11 feet is extended to the dune toe and the Zone VE, elevation 16 feet, is located just landward of the shoreline. Although elevation 14 feet is shown on Figure D-30 for the intermediate VE Zone, elevation 13 feet could also be used; adjacent transects should be examined and a compatible BFE should be selected. Also note that the boundary between the Zone AO, depth 1 foot, and the Zone AE, elevation 7 feet, is at the intersection of the SWEL and ground profile.

An eroded bluff is shown in Figure D-31. The angle of the bluff face remains the same while the seaward extension from the toe is a 1:40 slope. The computed runup elevation slightly exceeds the bluff crest and is higher than the maximum wave crest elevation. The area is designated Zone VE, elevation 18 feet, until the difference between the runup elevation and the ground is less than 3 feet. In this figure, the Zone AE, elevation 18 feet, is slightly narrower than the minimum mapping width. As was recommended for the example in Figure D-27, the neighboring area on the work map should be examined to determine if this zone should be mapped. AE Zones are usually not mapped for bluffs unless computed runup exceeds the bluff crest, as shown in Figure D-31. (Note: Figures D-16 and D-17 outline another flooding treatment of bluffs where computed runup is well above the crest.)

On sandy shores, transects usually are extended across barrier islands, marshes, inland water bodies, etc., such that at least two VE Zones can be identified. Procedures in these cases are the same, with elevation averaging also very common. With a little practice, identification of the flood zones and elevations becomes fairly routine using the wave envelope and transect profile.

With shore structures having steep slopes, runup elevations are relatively high and a wide range of wave hazards can occur, including erosion or scour near the structure. These circumstances may result in a variety of distinct and compact situations, where appreciable engineering judgment can be required for appropriate assessment of flood hazards.

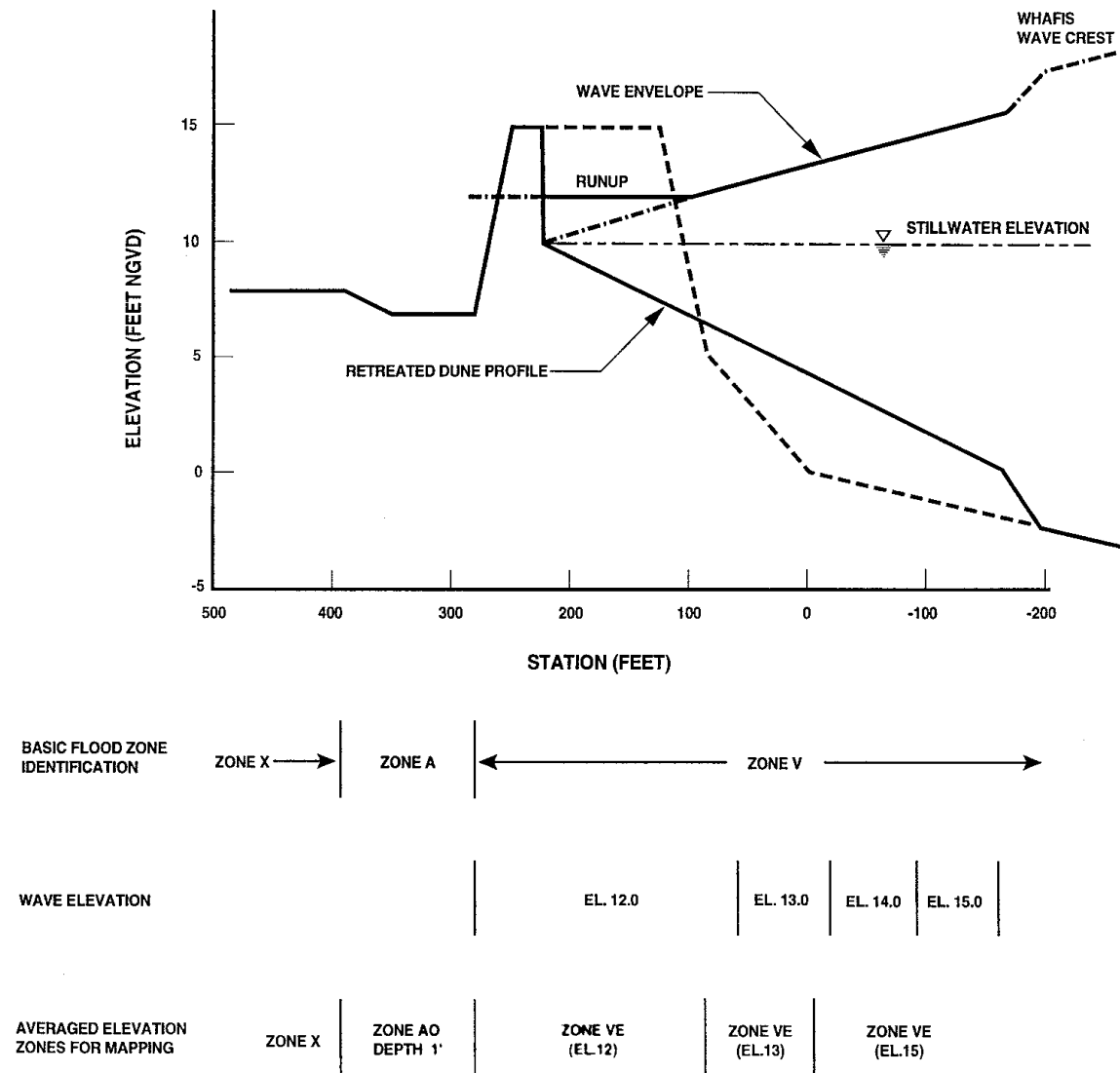

**Figure D-29. Identification of Elevation Zones, Example 3:
Low Retreated Dune with Wave Overtopping.**

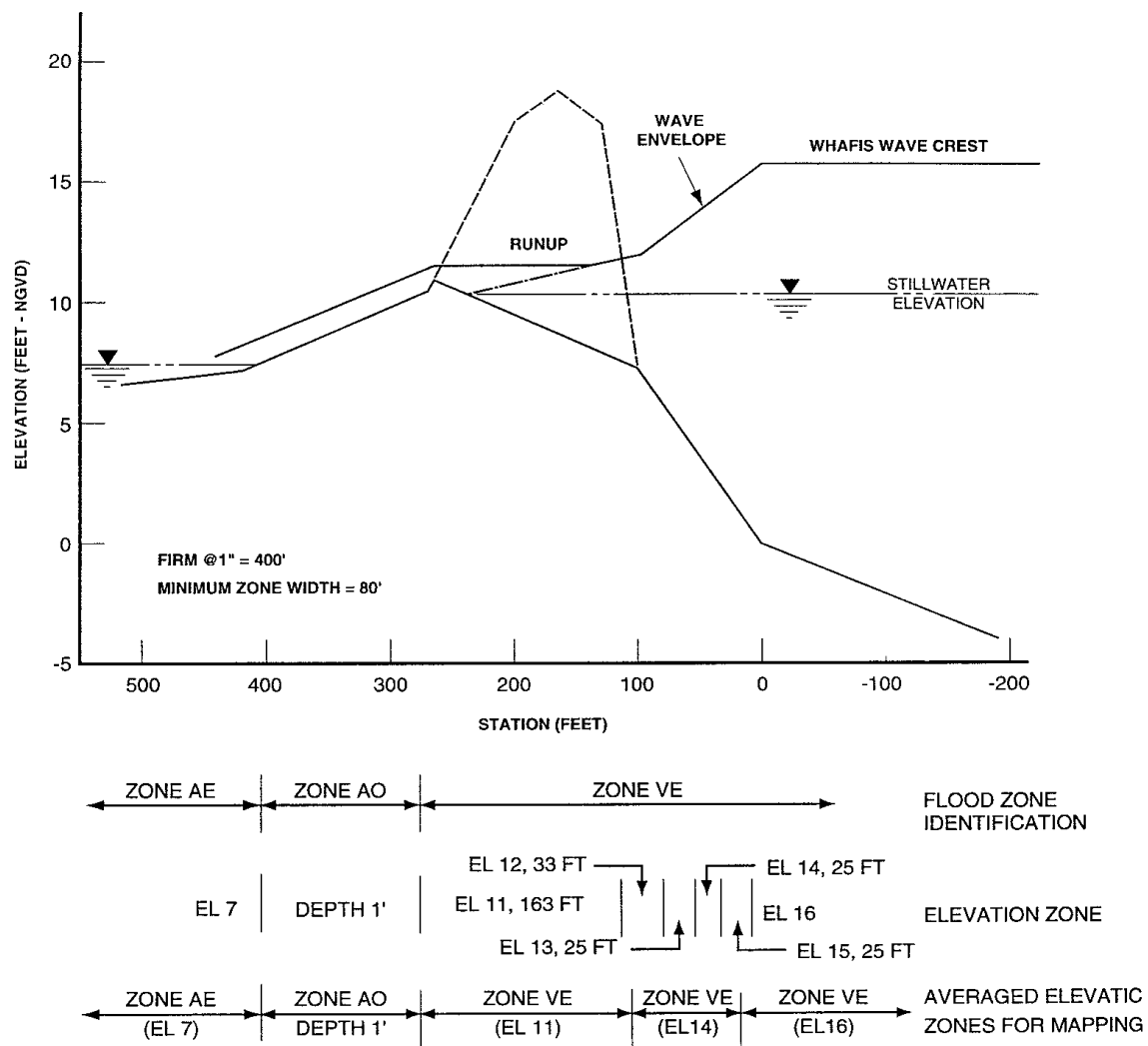

**Figure D-30. Identification of Elevation Zones, Example 4:
Dune Removal with Wave Runup and Runoff**

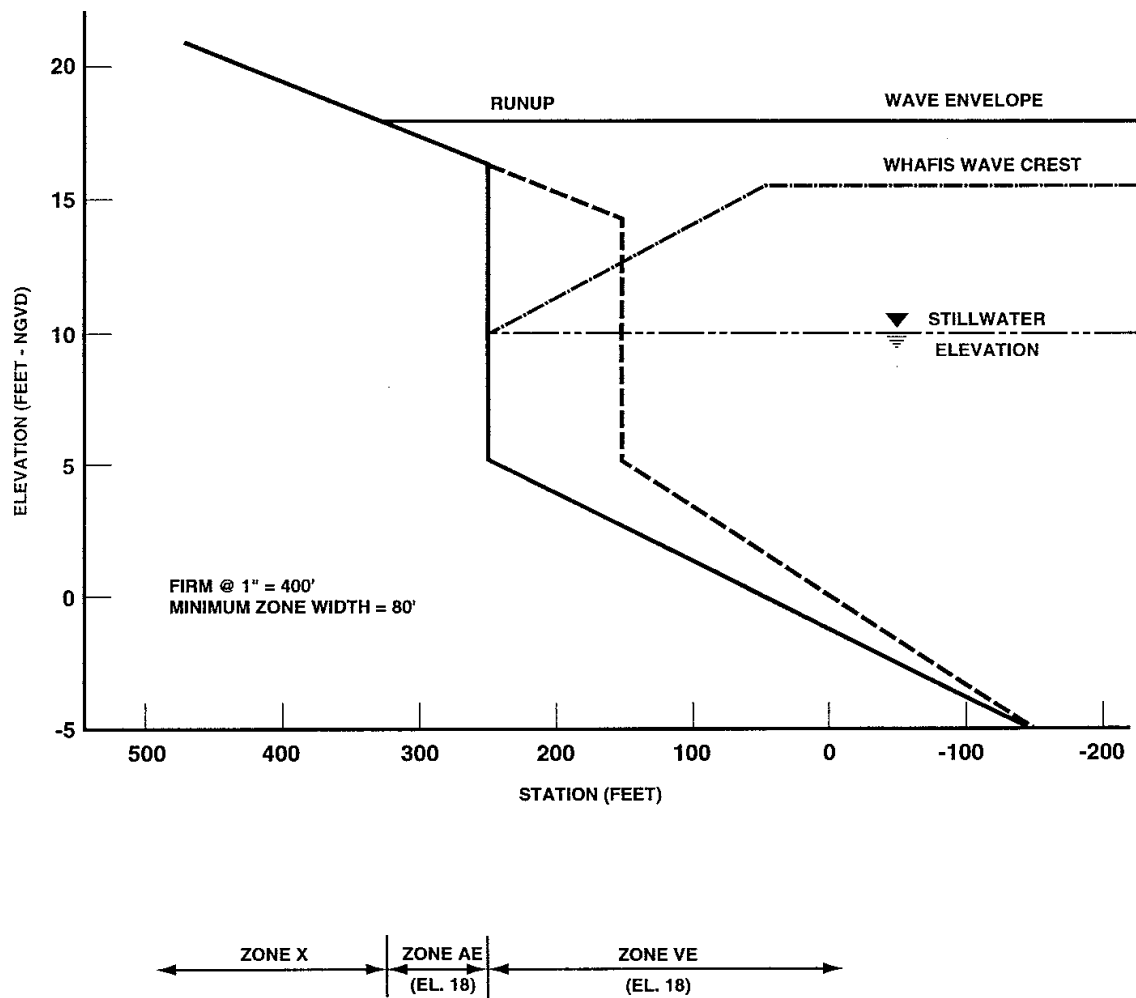

**Figure D-31. Identification of Elevation Zones, Example 5:
Eroded Bluff with Wave Runup**

Guidelines and Specifications for Flood Hazard Mapping Partners

Figures D-32, D-33, and D-34. illustrate schematic effects for a few basic configurations, presuming the structures remain intact through the 1-percent-annual-chance flood and no appreciable shore erosion occurs

Figure D-32 illustrates an example of moderate structure overtopping expected for waves accompanying the 1-percent-annual-chance flood. The structure crest has sufficient freeboard above the 1-percent-annual-chance SWEL to contain a calculated mean runoff of 6 feet, but extreme wave runups are likely to overtop the structure intermittently. The entire extent of shore structure is treated as a unit and designated as a VE Zone, and is assigned the mean runoff elevation of 16 feet. Landward of the structure, an area with at least the minimum mapping width is appropriate for designation as Zone AO, depth 1 foot, with the extent of the zone depending on ground profile.

Figure D-33 illustrates an example of a structure extending above the 1-percent-annual-chance SWEL but heavily overtopped by wave action. The calculated mean runoff elevation is 5 feet above the seaward face, but that is reduced to the maximum excess runoff of 3 feet in assigning a flood elevation of 16 feet for the shorefront VE Zone. That zone extends through the entire structure and over an additional 30 feet landward, because likely wave impact area reaches beyond the structure during the 1-percent-annual-chance flood. Cumulative wave overtopping yields ponding within an additional landward area that is 100 feet wide, which is designated as Zone AO, depth 2 feet.

Figure D-34 illustrates an example of a structure covered by 3 feet of water during the 1-percent-annual-chance flood. Flood depth is not sufficient for waves 3 feet in height to propagate inland of the structure, but the V Zone must extend to 30 feet landward of the structure, in view of likely wave effects through the flood's course. The shore structure is too narrow for multiple V Zones to be delineated, so there is one designation of Zone VE, elevation 13 feet. Landward of that zone, further wave hazards occur in the Zone AE, elevation 11 feet.

In examining Figures D-32, D-33, and D-34, it may seem surprising that relatively high structures can result in higher flood elevations, compared to an inundated structure. However, a structure with more freeboard can deflect incident wave action to greater elevations during the 1-percent-annual-chance flood, so the present zonations are physically appropriate. The hazard zonations landward of coastal structures generally have more importance, and they reflect the greater protection provided by higher but durable structures.

[February 2002]

D.2.7.4 Mapping Procedures

Properly integrated delineation of the results of flooding analyses involves judgment and skill in reading topographic and land cover maps. The time and effort put forth to determine the flood elevations and extents will be negated if the results of these analyses are not properly delineated on the FIRM. The FIRM is usually produced from the work maps described in Subsection D.2.2. Therefore, the Mapping Partner shall transfer the flood zones and elevations identified on the transects to the work maps and interpolate boundaries between transects. The Mapping Partner shall set up the work maps with contour lines, buildings, structures, vegetation, and

transect lines clearly located. Because roads are often the only fixed physical features shown on the FIRM, the

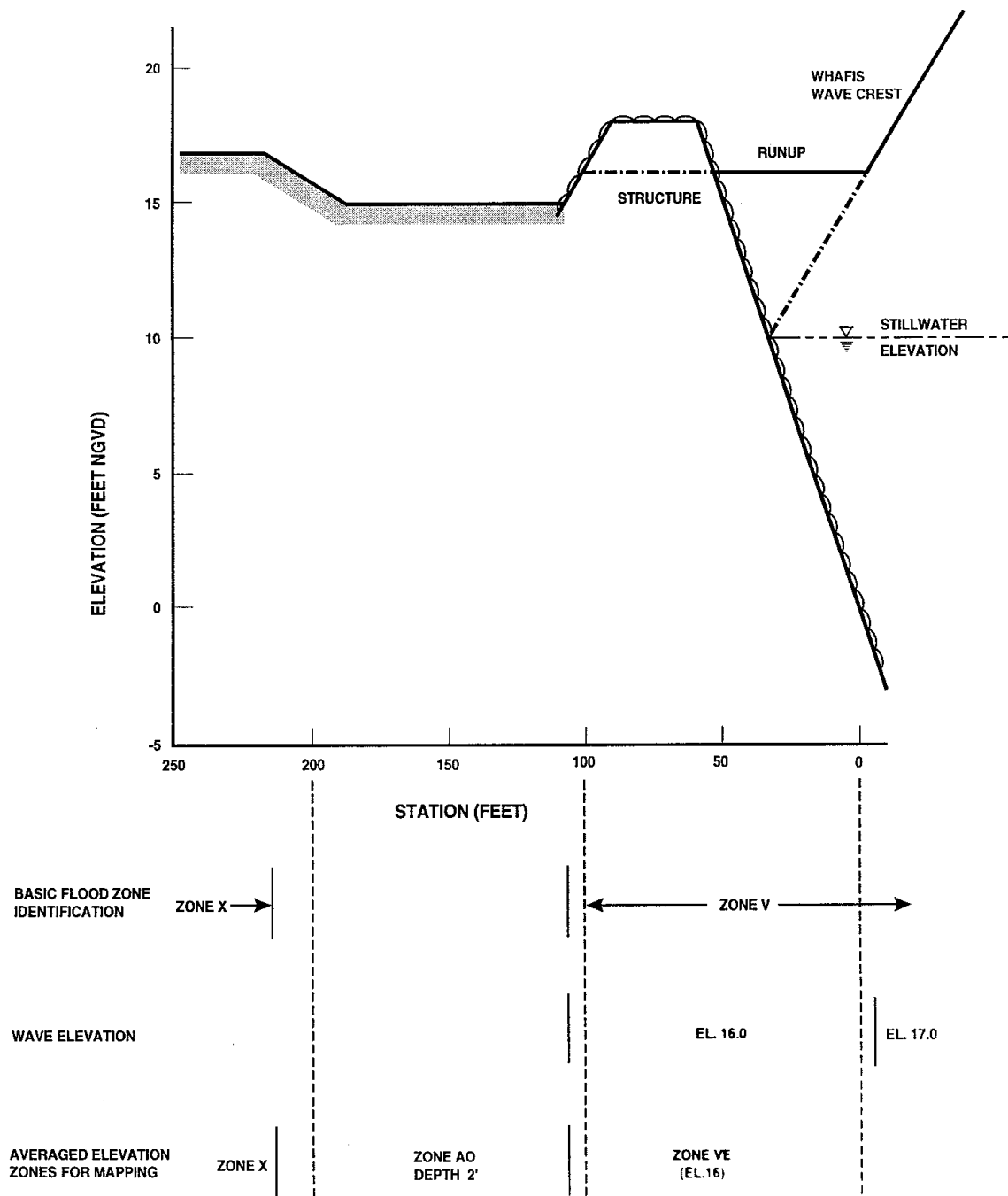

**Figure D-32. Identification of Elevation Zones, Example 6:
Coastal Structure with Moderate Wave Overtopping**

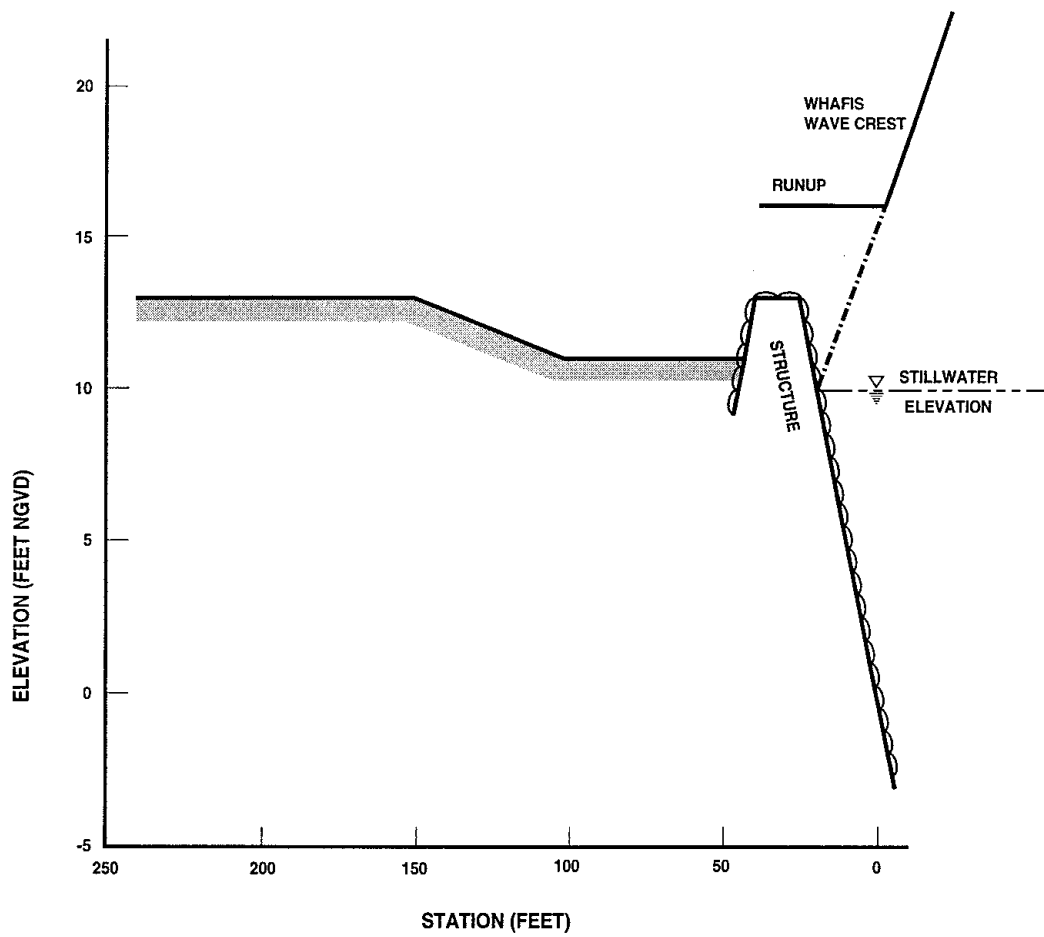

BASE FLOOD ZONE IDENTIFICATION	ZONE X		← ZONE V
WAVE ELEVATION			EL. 16.0 EL. 17.0
AVERAGED ELEVATION ZONES FOR MAPPING	ZONE X	ZONE AO DEPTH 2'	ZONE VE (EL.16)

Figure D-33. Identification of Elevation Zones, Example 7: Coastal Structure with Severe Wave Overtopping

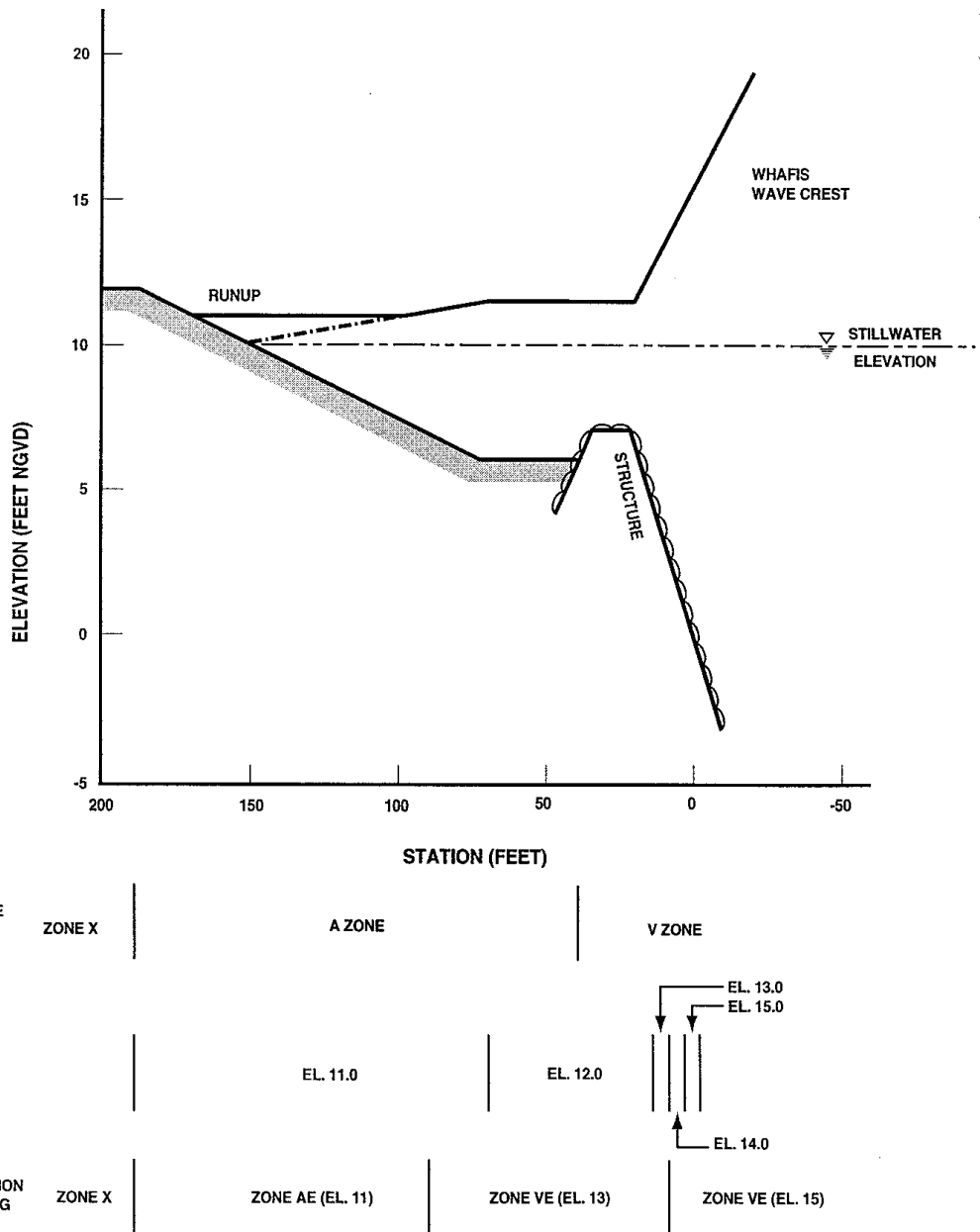

Figure D-34. Identification of Elevation Zones, Example 8: Coastal Structure with Inundation

Guidelines and Specifications for Flood Hazard Mapping Partners

Mapping Partner shall ensure that other features and the flood zone boundaries are properly located on the work maps in relation to the centerline of the roads as they will appear on the FIRM.

For each transect, the Mapping Partner shall transfer the identified elevation zones from the transect to the work maps, marking the location of the boundaries along the transect line so that boundary lines can be interpolated between transects. The Mapping Partner shall ensure that boundaries are marked at the correct location. Because of erosion assumptions, the location of the elevation 0.0 shoreline changes on the transect but not the work maps.

Using the transect profile, the Mapping Partner shall determine the location of the zone change in relation to a physical feature (e.g., ground contour, back side of a row of houses, 50 feet into a vegetated area) and delineate the boundary line for the area represented by that transect along this feature. The Mapping Partner shall measure the widths of the zones carefully; zones that narrow to less than 0.2 inch must be tapered to an end. Likewise, if the zone becomes much wider, it may be possible to break an averaged elevation zone into two mapped elevation zones.

One of the more difficult steps in delineating coastal flood zones and elevations is the transition between transect areas. Good judgment and an understanding of typical flooding patterns are the best tools for this job. Initially, the Mapping Partner shall locate the area of transition (an area not exactly represented by either transect) on the work maps. The Mapping Partner shall then delineate the floodplain boundaries for each transect up to this area. The Mapping Partner shall examine how a transition can be made across this area to connect matching zones and still have the boundaries follow logical physical features. Other transects similar to this area could give an indication of flooding. Sometimes the elevation zones for the two contiguous transects are not the same; in such cases, the Mapping Partner may have to taper the zones to an end or enlarge the zones and subdivide them in the transition area.

Communities with significant flooding hazards from wave runup may have one transect representing more than one area because the areas have similar shore slopes. In this case, the Mapping Partner shall identify the different areas and delineate the results of the typical transect in each area. Transition zones may be necessary between areas with high runup elevations to avoid large differences in BFEs and to smooth the change in flood boundaries. These zones are to be fairly short and cover the shore segment with a slope not exactly typical of either area. The Mapping Partner shall determine the transition elevation using judgment in examining runup transects with similar slopes. The Mapping Partner shall not use transition zones if there is a very abrupt change in topography, such as the end of a structure.

Lastly, Mapping Partner shall map the Zone X areas. The Mapping Partner shall show areas below the 0.2-percent annual chance SWEL that are not covered by any other flood zone as Zone X (shaded) on the FIRM. Often the maximum runup elevation is higher than the 0.2-percent-annual-chance SWEL; in such cases, the Zone X (shaded) designation will be used in that area. All other areas are designated Zone X without shading.

Because flood elevations are rounded to the nearest whole foot, the Mapping Partner does not need to spend hours resolving a minor elevation difference. Also, because structures or proposed structures must be located on the FIRM, the Mapping Partner shall attempt whenever possible to smooth the boundary lines and to follow a fixed feature such as a road. In preparing the FIRM,

the Mapping Partner shall ensure that the mapped results are technically correct and but the FIRM is easy for the local insurance agent, building inspector, or permit officer to use.

[February 2002]

D.2.8 Required Documentation

The Mapping Partner shall fully document the coastal flood hazard determination for each affected community. Because FIS Reports and FIRMs form the basis of Federal, State, and local regulatory and statutory enforcement mechanisms and are subject to administrative appeal and litigation, Mapping Partners shall ensure that all technical processes and decisions are recorded and documented. The FIS Report may not contain all the documentation that would be needed for a response in the event that the study results are questioned. Therefore, the Mapping Partner shall prepare an engineering report for each study. This report will provide detailed data needed by FEMA or the community to reconstruct or defend the study results on technical grounds. The minimum information required for the engineering report is summarized below.

Basic Data.

In this section, the Mapping Partner shall include all contacts made to obtain data for the study. All basic data used must be fully referenced and, if possible, reproduced in the report. All historical flood information must be documented in this section, even if the Mapping Partner did not use the information in quantitative analyses.

Transects

The Mapping Partner shall show all transects on a transect location map. Each transect must be plotted separately and show the erosion assessment, input data for wave models, wave envelope, and zone determination.

Model Input and Output

The Mapping Partner shall provide computer printout listings for input and output data for both the Wave Runup and Wave Height Models for all the transects. These listings must be keyed to the transect location map and transect plots.

Study File

During the course of the study, the Mapping Partner shall maintain a file containing records of all coordination, activities, and decisions. This is especially important where nonstandard approaches were used and engineering judgment played a significant role. The Mapping Partner shall ensure this file meets the requirements for a Technical Support Data Notebook as documented in Appendix M of these Guidelines.

[February 2002]