

# Seismic Event Data Acquisition and Processing: Distribution and Coordination Across PC-Based Networks

*Peter Swanson, Brian Kenner, and Todd Krahenbuhl<sup>1</sup>*

## ABSTRACT

NIOSH has developed an automated PC-based seismic event (induced earthquake) monitoring system for use in mine ground control studies. The distribution and coordination of data acquisition and processing functions across a local area network is a central feature of the system. Mine-wide installations utilize multiple, autonomous seismic networks located both underground and on the surface. Seismic event locations, magnitude estimates, and other processed data are distributed for display and analysis on network nodes both underground and in the offices of mine engineers and managers. This paper describes the system's design philosophy, hardware and software components, examples of installations, and a few observational results.

## BACKGROUND

When development and production mining take place underground, in situ stresses are redistributed in such a fashion that rock mass instabilities can occur. These instabilities, or dynamic releases of stored energy, range from imperceptible microscopic fracturing in the host rock to catastrophic failures that generate seismic events with magnitudes up to 5 and result in total destruction of mine infrastructure. Throughout the world, mines that experience dynamic failures such as rock bursts and coal bumps use seismic monitoring systems in efforts to deal effectively with these ground control problems. Examples of the use of this technology to identify, characterize, and evaluate these hazards and aid in the development of mitigation procedures can be found in the quadrennial series International Symposium on Rockbursts and Seismicity in Mines (e.g., Gibowicz and Lasocki, 1997).

In the United States, mine seismicity studies had largely been conducted by the U.S. Bureau of Mines (USBM). When funding for the USBM was eliminated in 1996, the federal responsibility for health and safety research in mining was transferred to the National Institute for Occupational Safety and Health (NIOSH). Unfortunately, most of the USBM seismic monitoring hardware, software, and expertise was lost in the transition to NIOSH. Therefore, after the transition, a new automated seismic monitoring system was developed for use in several NIOSH studies seeking to reduce hazards from rock mass instabilities such as rock bursts, coal bumps, mine collapse, and roof falls.

---

<sup>1</sup>National Institute for Occupational Safety and Health, Spokane Research Laboratory, Spokane, WA.

## FACTORS GUIDING SYSTEM DESIGN

Besides low cost, reliability, and flexibility were important considerations in system design. The expense and downtime associated with timely repair and/or replacement of custom data acquisition and processing hardware, as experienced with some previous USBM systems, was to be avoided. Mass-produced personal computers (PC's) and commercial multichannel analog-to-digital (A/D) converters minimize capital expenditures and repair costs and provide a high degree of reliability.

Other factors influencing this design effort were distributed processing, automation, low-cost installation, and availability of software.

A distributed network of data collection computers (Figure 1) was selected rather than a single centralized system for several reasons.

(1) A distributed system avoids single-point failures that result in complete loss of monitoring coverage.

(2) Networking several small-scale autonomous seismic networks that share data avoids the installation of an expensive and difficult to maintain network of long cables.

(3) In many, if not most, mining situations, it is extremely difficult to completely surround the area of interest with sensors from accessible underground workings alone. Encircling the area of interest with sensors is a basic requirement for locating seismic events accurately. Drilling boreholes for sensor installation is an expensive and difficult option not generally available to relatively short-term NIOSH research studies and is not practical for high-production mining environments that rapidly sweep through large areas. The use of several smaller autonomous arrays distributed on the surface, underground, in surface boreholes, in neighboring mines, on different underground levels, etc., can surround the area of interest and help provide the needed three-dimensional coverage.

(4) Delivery of summary processed results to mine personnel stationed underground and on the surface was an additional constraint satisfied by a distributed data acquisition and processing scheme.

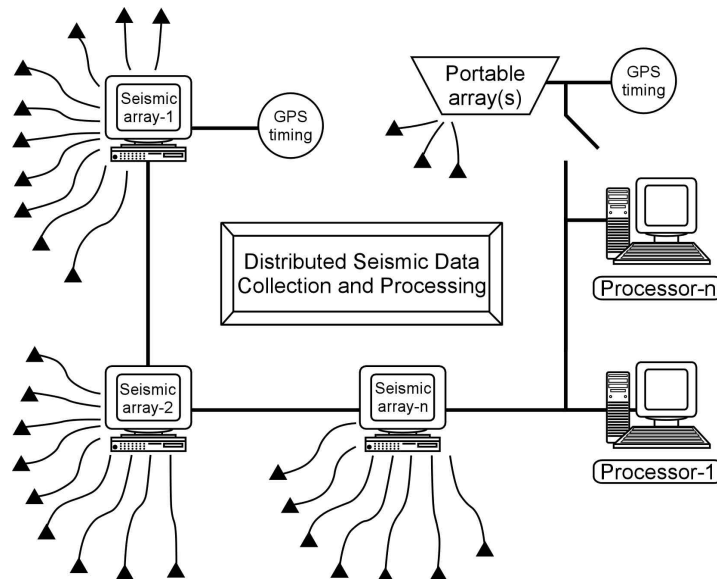

**Figure 1. PC-network-based seismic acquisition and processing system.**

Fully automated operation was another major design goal. A specific requirement was to determine seismic event locations, occurrence times, and magnitudes accurately and rapidly and to superimpose the data on a mine map without human interaction (e.g., manual picking of seismic P-wave arrival times). This led to the decision to use seismic arrays with a modest number of single-axis (e.g., vertical component) sensors instead of arrays with a fewer number of triaxial sensors. While shear- (S) wave arrivals help constrain seismic event location solutions, and triaxial seismic data allow S-wave arrivals to be picked, it is more difficult to achieve a high degree of accuracy in the S-wave arrival pick in software than it is the first-arriving P-wave. Thus, for high-volume, fully automatic seismic data processing, no attempt was made to pick and use S-wave arrival times in the event location process.

It was also important to minimize the difficulty and expense of sensor installation; therefore, most sensors were attached directly to roof and rib surfaces without the use of boreholes. Although sensor placement in boreholes reduces the influence of mine openings and fractured rock surrounding these openings, which is a requirement for more sophisticated, full-waveform inversions and related analyses (e.g., Mendecki, 1990), these influences typically are not significant sources of error in elementary event location solutions (Swanson et al., 1992).

The seismic data acquisition and processing software made available through the International Association of Seismology and Physics of the Earth's Interior (IASPEI) (Lee, 1994) was selected to serve as the initial basic building block for data acquisition in order to take advantage of as much freely available software as possible. A common thread to much of the IASPEI software is the use of the Seismic Unified Data System (SUDS) data format based on C language data structures (Ward, 1989; Banfill, 1996). While providing a starting point for collecting mine-wide seismic data, much of the IASPEI processing software is geared toward larger-scale earthquake networks and is not directly applicable to smaller-scale mining.

## **SYSTEM HARDWARE**

### **Sensors**

Both high-sensitivity accelerometers (40 V/g) and inexpensive 4.5-Hz, moving-coil geophones with variable gain amplifiers are used in the sensor arrays. Sensors are anchored directly to competent roof or rib surfaces or epoxied to the end of tensioned roof bolts. On the surface above a mine, most geophone sensors are pressed into the soil bottom of a shallow hole.

### **Data Acquisition Methods**

Several different types of digitizing systems are used. With the first kind, analog seismic signals are transmitted via cable to a commercial off-the-shelf A/D converter attached to a local data acquisition PC. In the second type, seismic signals are digitized near the sensors, and the data are transmitted digitally to a data acquisition PC on the network. In the third approach, low-power PC104 format computers with A/D converters collect signals and transmit the data over a wireless local area network (LAN). In each approach, data acquisition PC's are dedicated solely to collecting waveform files either continuously or in a triggered event-capture mode.

*(1) Digitizing signals at a centralized network computer.* The PC-based A/D conversion boards used in this part of the development effort are all commercially available (Table 1). Sampling rates are typically between 500 and 2,500 samples per second per channel for systems with 4 to 64 channels.

Table 1 – Commercially available A/D converter hardware

Model	Number of channels	Nominal resolution (bits)	Interface	Operating system	Manufacturer*
Par4ch	4	24	Parallel	Linux,	Symmetric
Par24b	8	24	Parallel	W9x/NT,	Research,
DSPA64	64	16	ISA	DOS	Kirkland, WA
DT2824	16	12	ISA	DOS	Data
DT-EZ	16	11	ISA		Translation,
DT2821	16	12	ISA		Marlboro, MA

The data acquisition software XRTP was developed for Data Translation boards through IASPEI (Lee, 1994) and requires the DOS operating system. The RTPSR (TottCo) software for the Symmetric Research DSPA64 A/D converter is similar. Executable and source codes are provided for Par24b and Par4ch boards so that the user can implement his/her own triggering criteria and make other customizations. In all cases, data files are either output directly in PC-SUDS format or they are immediately converted to this format.

(2) *Remote signal digitizing and wireless data transmission to a network computer.* Low-power, custom-built, three-channel 16-bit A/D converters are used to digitize signals at or near remote sensors. Maximum sampling rate is 1,000 samples per second per channel. Data are continuously sampled and transmitted back to a data acquisition computer via a 115.2 kbaud wireless serial telemetry link. Data are telemetered over line-of-sight distances of several kilometers using pairs of license-free 900-MHz and/or 2.4-GHz frequency-hopping, spread-spectrum radio transceivers. The data are received by a network PC that is equipped with a 16-channel serial port board and running a modified version of IASPEI's XRTPDB software (Lee, 1994).

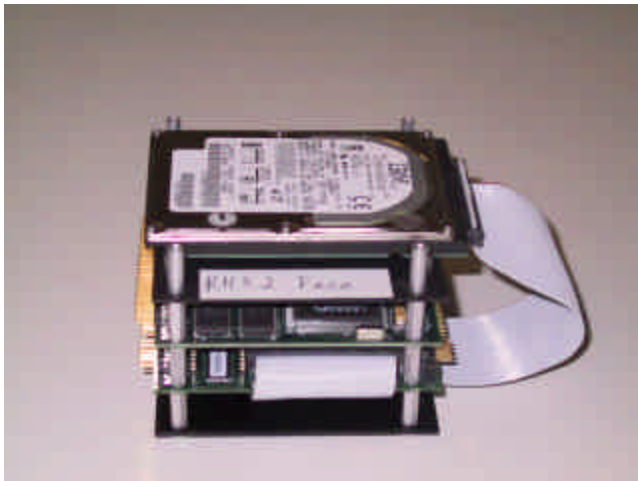

(3) *Low-power remote PC-104 systems with wireless networking.* Current development work focuses on the use of low-power, network-ready, PC-104 format computers (Figure 2) as a basis for stand-alone data acquisition platforms. Four- or eight-channel, 24-bit digitizing units connect to the parallel port and sample the data at 1,000 samples per second or higher. Sensors are deployed in small cabled arrays in specific geographic domains (e.g., mesa top, canyon bottom, etc.). Power is supplied from 12-V dc solar panels

**Figure 2. PC-104 remote, Linux-based, seismic data acquisition computer.**

\* Mention of specific products or manufacturers does not imply endorsement by the National Institute of Occupational Safety and Health.

with battery storage. Seismic data are transferred to data processing workstations on the network via 2.4-GHz, direct-sequence, spread-spectrum wireless transceivers.

While the PC-104 computers can operate the four- and eight-channel A/D boards under Windows95/98/NT, DOS, and Linux, Linux was selected as the operating system of choice because laboratory tests showed that it allows the fastest error-free sampling rates. Samba, an open-source file system server, was used to give Microsoft Windows-based network nodes access to files on the Linux PC-104 units. The 486-100 MHz PC-104 computers are placed at the point of signal digitizing to alleviate a data transmission bottleneck encountered in some applications of method 2.

In method 2, seismic data are continuously sampled and transmitted back to a centralized processing computer on the network, where they are examined for discrete seismic "events." The number of channels that can be recorded at the high sampling rates is limited by the available bandwidth of the spread-spectrum radio network. Adding additional channels reduces the maximum possible sampling rate. To increase the number of stations providing data via radio link without reducing the sampling rates, the distributed PC-104 approach was developed. Continuously sampled seismic data are examined by the embedded processor and discarded, if so desired, when trigger conditions are not met. Data files meeting the trigger criterion are locally saved to disk and/or pulled off the remote node with the wireless network connection. Providing the task load is not too great on the remote computer, additional processing may also be done. Work is currently underway to use the networked PC-104 platforms with inexpensive single-frequency Global Positioning System (GPS) receivers for continuous measurements of subsidence and other factors of importance in mine safety studies (Swanson et al., 2001).

### **Time Base Synchronization**

Each data acquisition system records a common timing signal derived from GPS satellites. Underground data acquisition systems receive these time codes via copper or fiber cables. During the initial part of the data processing cycle, the timing signals are decoded and the time base of each seismic record is adjusted.

## **SOFTWARE**

### **Networking**

Several different types of networking and operating system software were examined during system development. As the initial data acquisition systems were restricted to DOS, peer-to-peer networking to the data processing platforms was achieved using the NetBEUI protocol available in Workgroups Add-On for DOS. TCP/IP protocol is used to connect to Linux-based data acquisition PC's. The main seismic data processing PC's use either Windows9x or NT operating systems.

Use of mining companies' general-purpose LAN's for seismic data acquisition and processing has met with mixed success. If there is no one on site to tend to the monitoring system on a regular basis, a stand-alone, or isolated, LAN is preferred. This avoids problems associated with many diverse users, corporate firewalls, and other security issues. If the corporate system administrator is on site and attuned to the needs of the seismic monitoring system, problems can be minimized. By isolating the data acquisition nodes onto a separate LAN, these problems can be largely limited to periodic temporary disruption of the automated data processing.

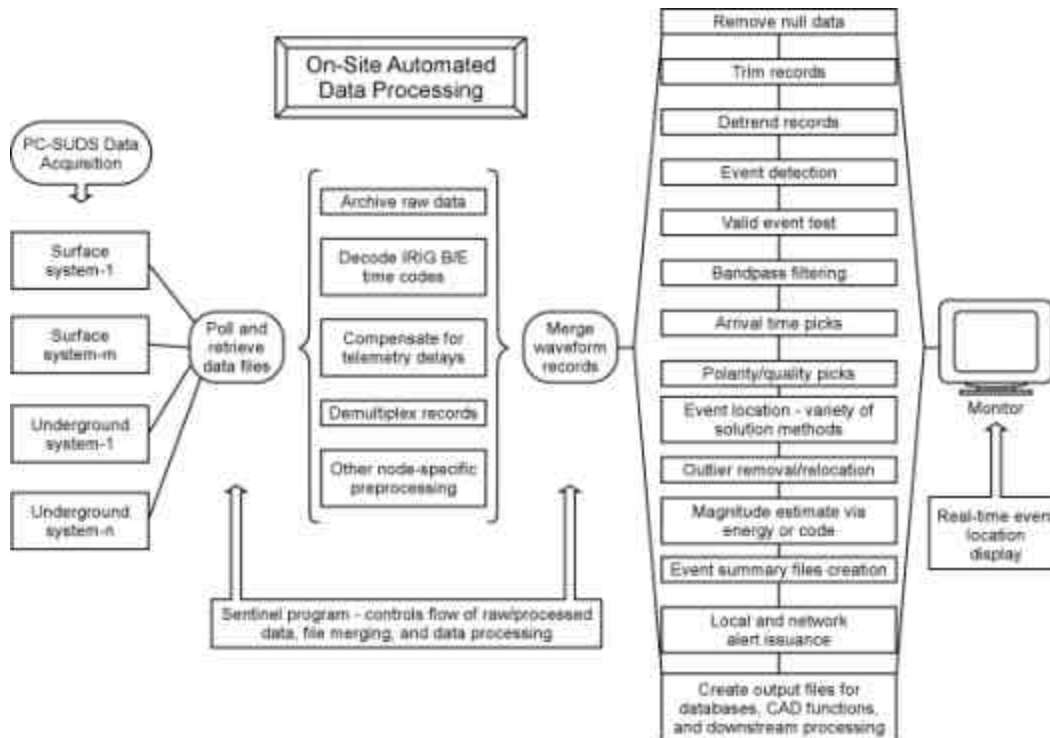

**Figure 3. Flow of data acquisition and processing.**

### **On-Site Automated Data Processing**

Data file collection, network transfer, merging, and processing is coordinated by a “sentinel” program. It watches for the creation of event-triggered and/or continuously recorded data files on the different data acquisition nodes (Figure 3). Any source of seismic data can be utilized providing it resides on the LAN and can be converted to PC-SUDS format. When detected, these data files are retrieved and put through node-specific batch processing. The data are then brought into a buffer that holds time-stamped data from the other data acquisition nodes. Time-correlated data are then merged into a single SUDS file and sent on for further processing. Typical processing options are shown in the flowchart in Figure 3. Seismic event locations are continuously updated on a user-interactive graphical display and exported for additional downstream processing by other user groups. The modular nature of the PC-SUDS utilities and the flexibility inherent in batch processing give significant user control over the data processing.

### **EXAMPLE INSTALLATIONS**

#### **Willow Creek Mine**

A combined surface and underground monitoring system was deployed at the Willow Creek Mine in Helper, Utah (Figure 4) in an investigation into the mechanics of coal bumps in multipanel longwall sequences. Preliminary results from this deployment are presented by Ellenberger et al. (2001). At the level of the mining operation, 12 roof-mounted and two borehole geophones were installed in the mains and bleeders around the first few panels of a longwall district. Signals were fed by cable to a data acquisition PC housed in an underground trailer. A network connection to

the processing workstation in the engineering office was established via fiber-optic cable. Signals from nine surface stations above the longwall panels were sampled continuously with remote digitizers and transmitted to a data acquisition node on the LAN in the engineering office via three 900-MHz, spread-spectrum transceiver pairs. Data from several isolated surface stations were also occasionally merged with data from the main networks in post-collection processing and analysis. A second processing and display workstation node was placed in the shift bosses' meeting room where seismic tomography and longwall shield pressure data were also being archived and analyzed (Westman et al., 2001).

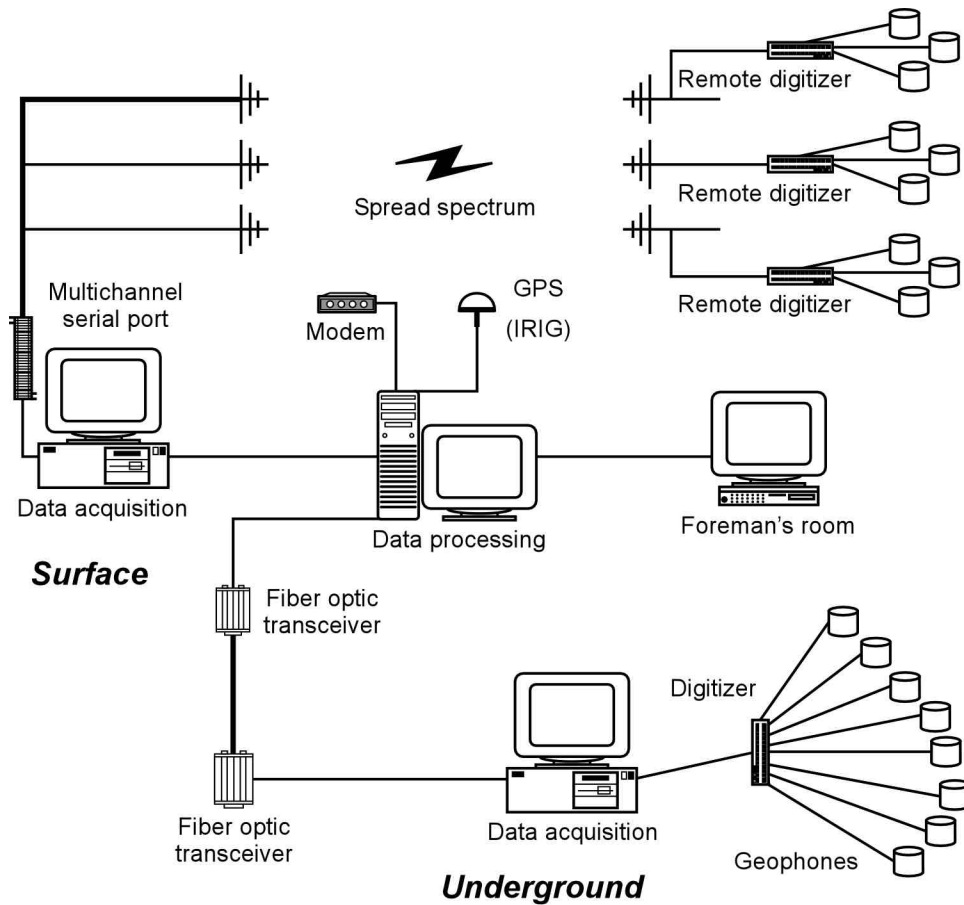

**Figure 4. Willow Creek Mine network.**

### **Bowie No. 2 Mine**

Remote PC-104 data acquisition platforms and a wireless LAN were deployed at the Bowie No. 2 longwall coal mine in western Colorado. The surface above this mine possesses many of the geographical barriers commonly found in western coal mines—steep, rugged terrain and dense vegetation. It is this sort of situation that motivated the development of the distributed network approach to seismic data acquisition. Depth of cover over individual panels varies from 50 m (165 ft) to greater than 500 m (1,600 ft). Three small seismometer arrays were deployed in areas where convenient access through the dense vegetation was possible. Figure 5 shows two arrays deployed

on mountain ridge tops and one in a valley bottom 365 m (1,200 ft) below. Each panel is approximately 250 m (830 ft) wide.

A line-of-sight path between each remote data acquisition node and a data processing site was required for the 2.4-GHz spread-spectrum transceivers employed. Tests of wireless LAN repeaters were also made. The repeaters were found to reduce overall data processing rates to unacceptable levels in certain data acquisition modes. Both continuous and event-triggered seismic data file collection and transmission modes were investigated. Due to the high sampling rates, the data acquisition platforms created an irreversible backlog of data files when a repeater was used between a data acquisition node and the main processing node. Thus, when a repeater was required, it was necessary to collect data in event-triggered mode.

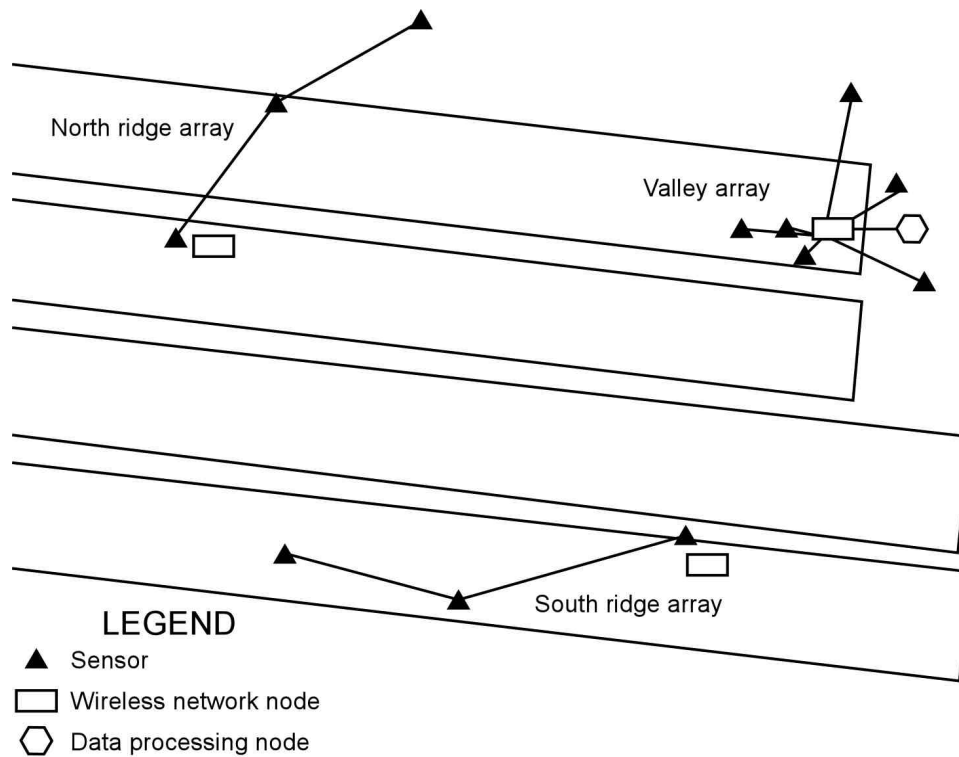

**Figure 5. Bowie No. 2 Mine network.**

### **EXAMPLE SEISMIC MONITORING RESULTS**

Examples of seismic event locations are shown in Figures 6 and 7. Relative seismic event magnitude is indicated by the size of the symbols, with the largest event shown having an approximate magnitude of 2. The processing procedures performed for the event locations were completely software automated without human interaction.

Seismicity associated with 7 m (23 ft) of retreat of the D-2 longwall coal panel at the Willow Creek Mine is shown in Figure 6. The abundant seismic activity is a product of strong, competent



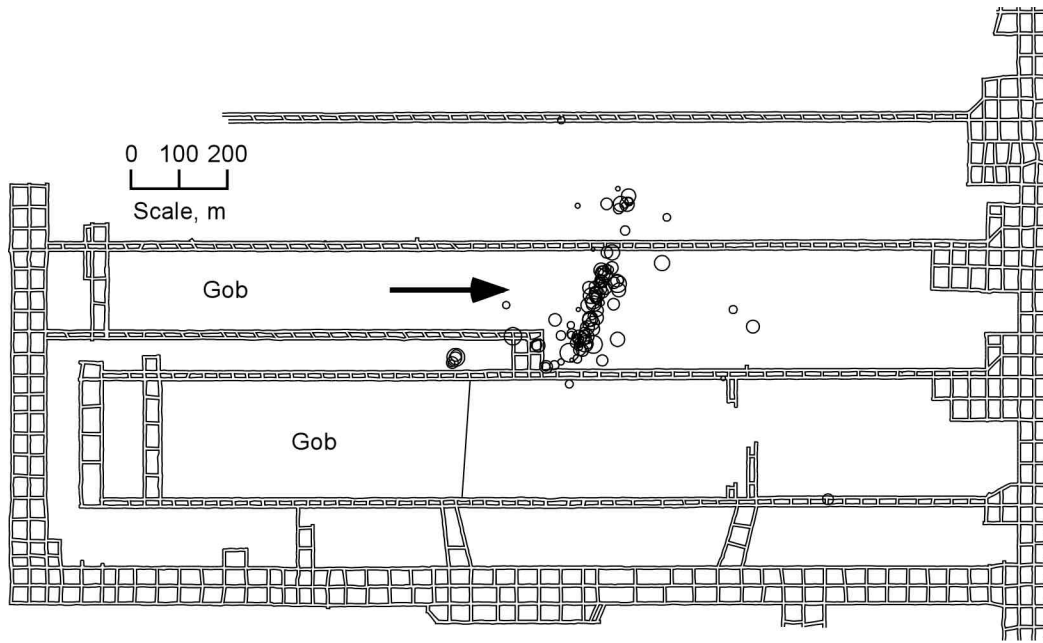

**Figure 6. Seismic events recorded at Willow Creek Mine during 7 m of retreat.**

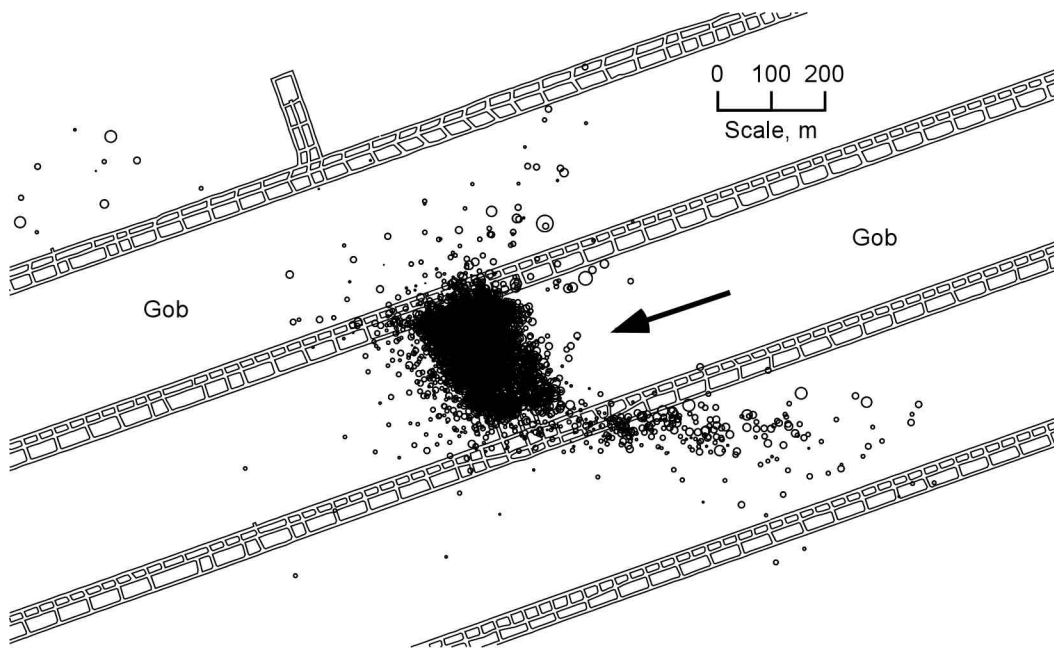

**Figure 7. Seismic activity observed during 188 m of retreat at Foidel Creek Mine.**

strata and deep cover (up to 800 m [2,600 ft]). Despite the rather large 1,100-m (3,600-ft) average source-to-receiver distance in this array, the regularity in seismic activity can be observed. In general, it was found to follow closely the regularity in the fracture and deformation processes accompanying the face.

Data in Figure 7 were acquired with a temporary network of geophones deployed on the surface above a longwall panel at the Foidel Creek Mine near Oak Creek, CO. The 600-m (2,000 ft) diameter array was 365 m (1,200 ft) above the coal seam, yielding an average source-to-receiver distance of 500 m (1,650 ft). Events shown were collected over an 8-day period as the 250-m- (820-ft) wide face advanced 188 m (615-ft) from right to left (Figure 7). As many as 2,000 events per day were detected with this surface array, yielding a detection sensitivity similar to that observed with panel-wide underground networks. The automated processing procedures implemented in the field resulted in 500 to 1,000 well-located events per day. The elongate distribution of seismic activity outside the active panel is a feature that is the subject of additional study. Three-dimensional models of the seismic velocity structure are being constructed to assist in the data processing and interpretation.

## **SUMMARY**

An automated seismic data acquisition and processing system has been developed by NIOSH for use in mine safety studies. Several systems utilizing a distributed PC computing environment have been constructed and deployed in hard-rock, coal, and underground stone mines for testing and applications. System flexibility is derived from its distributed nature, compatibility with multiple A/D converters and operating systems, and user control over the automated processing. These systems are now being applied in studies designed to reduce hazards associated with roof falls, rock bursts, coal bumps, and mine collapse.

## **ACKNOWLEDGMENTS**

This work would not have been possible without the assistance and cooperation of Silver Valley Resources, Twentymile Coal, Plateau Mining, and Bowie Resources. Special recognition is given to Butch Sines, Rocky Thompson, Andy Schissler, John Mercier, and Greg Hunt for their time and assistance. A number of software modules used in the development of this system were authored and/or modified by R. Banfill, F. Boler, D. Dodge, and L. Estey. NIOSH employees K. Heasley, J. Marshall, C. Compton, J. Ellenberger, and P. Jeran made critical contributions in the deployment at the Willow Creek Mine. C. Sunderman developed amplifiers and filter units used in some of the applications. P. Santerre, T. Geiger, and F. Boler provided critical assistance with the measurements at Foidel Creek.

## **REFERENCES**

Banfill, R., 1996, PC-SUDS utilities: A collection of tools for routine processing of seismic data stored in the Seismic Unified Data System for DOS (PC-SUDS), version 2.5.

Ellenberger, J., Heasley, K., Swanson, P., and Mercier, J., 2001, Three-dimensional microseismic monitoring of a Utah longwall. In *Rock Mechanics in the Public Interest. Proceedings of the 38th U.S. Rock Mechanics Symposium, DC Rocks*, ed by D. Elsworth, J.P. Tinnucci, and K.A. Heasley (Washington, D.C., July 7-10, 2001). Balkema, pp. 1321-1326.

Gibowicz, S.J., Lasocki, S., eds. 1997, *Rockbursts and Seismicity in Mines, Proceedings of the 4th International Symposium on Rockbursts and Seismicity in Mines*, ed. by S. J. Gibowicz and S. Lasocki (Kracow, Poland, Aug. 11-14, 1997). Balkema, 437 pp.

Lee, W.H.K., 1989, 1994 (ed.), IASPEI software library, Vol. 1, *Toolbox for Seismic Data Acquisition, Processing, and Analysis*.

Mendecki, A., 1997, Principles of monitoring seismic rockmass response to mining. In *Rockbursts and Seismicity in Mines, Proceedings of the 4th International Symposium on Rockbursts and Seismicity in Mines*, ed. by S. J. Gibowicz and S. Lasocki (Kracow, Poland, Aug. 11-14, 1997). Balkema, pp. 69-80.

Swanson, P., Estey, L., Boler, F., and Billington, S., 1992, Mining-induced microseismic event location errors: accuracy and precision of analog and digital systems. *Pure and Applied Geophysics*, Vol. 139, pp. 375-404.

Swanson, P., Andreatta, V., Meertens, C., Krahenbuhl, T., Kenner, B., 2001, Large-strain monitoring above a longwall coal mine with GPS and seismic measurements. *Transactions of the American Geophysical Union*, Vol. 82, No. 47, p. x.

Ward, P., 1989. SUDS—Seismic Unified Data System. U.S. Geological Survey Open-File Report 89-188, 123 pp.

Westman, E., Heasley, K., Swanson, P., and Peterson, S., 2001, A correlation between seismic tomography, seismic events, and support pressure. In *Rock Mechanics in the Public Interest. Proceedings of the 38th U.S. Rock Mechanics Symposium, DC Rocks*, ed. by D. Elsworth, J.P. Tinucci, and K.A. Heasley (Washington, D.C., July 7-10, 2001). Balkema, pp. 319-326.