

Microwave Deflectors: Normal  
Conducting Crab Cavity for APS  
and Discussion on Microwave  
Undulators

*Valery Dolgashev*  
*SLAC, Stanford, CA*

Talk at Argonne, 17 June 2005

# Microwave Deflector

- Requirements
- Design considerations
- Parameters
- Higher Order Modes

# Microwave Deflector Requirements

Frequency	2.82 GHz
Deflecting Voltage	6 MV
Available power	5 MW or 2.5 MW
Length	<2.4 m

*Michael Borland*

Transverse HOM	<2.5 MOhm/m
Longitudinal HOM	< 0.8 MOhm*GHz

*Geoff Waldschmidt, "Parameters for the  
SCRF Deflecting Cavity," APS/CNM 2005  
Users Meeting, May 6, 2005*

# Design consideration

- Limited available power  $\leq 5$  MW
- Large aperture  $\sim 2$  cm  $\Rightarrow$  Low impedance
- Maximum surface electric fields  $< 100$  MV/m
- Pulsed heating  $< 100$  deg. C  $\Rightarrow$  maximum surface magnetic field  $< 200$  kA/m for  $5 \mu\text{s}$  pulse
- Deflecting mode degeneracy fixed by wall deformation during tuning
- “Smooth” coupler – no field amplification on edges

## Possible approaches

- Resonant ring traveling wave structure
- Standing wave structure

# Regular Cell of Standing Wave Deflector, HFSS Calculations

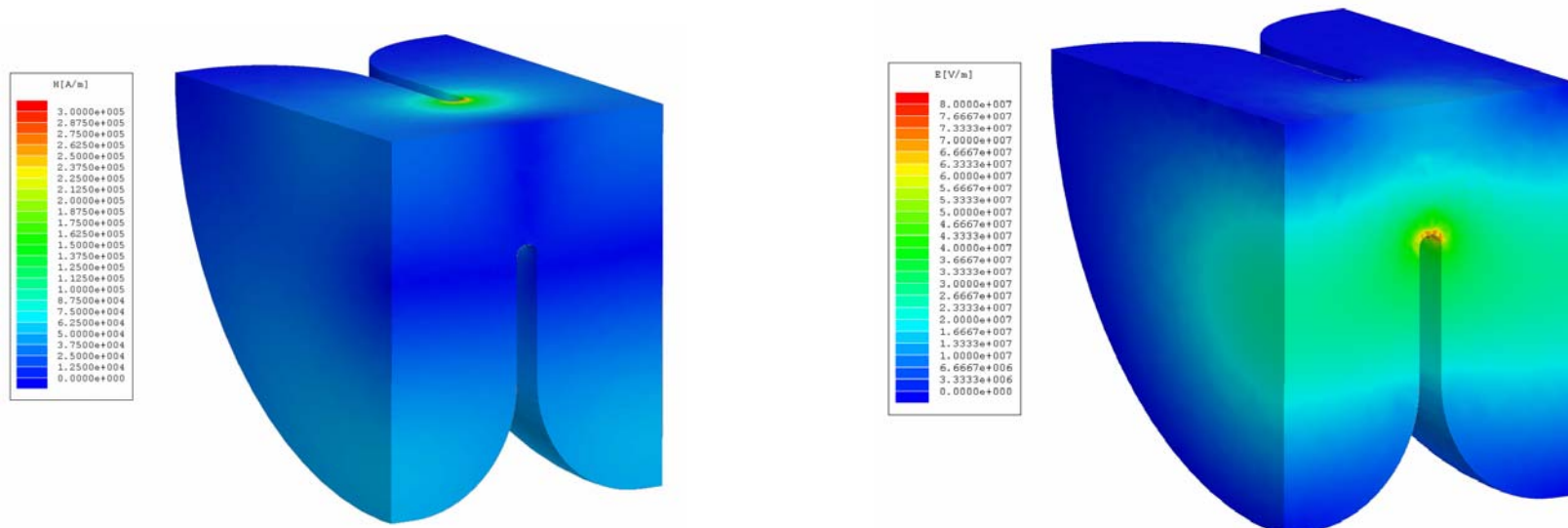

Surface magnetic field for 6/9 MV kick

Surface electric field for 6/9 MV kick

Frequency	2.858 GHz
Q	15750
Beam pipe aperture	2 cm
Phase advance per cell	180 deg.
Transv. impedance	0.44 MOhm
Kick / sqrt(Power)	0.95 MV/sqrt (MW)

# 9 Cell Standing Wave Deflector

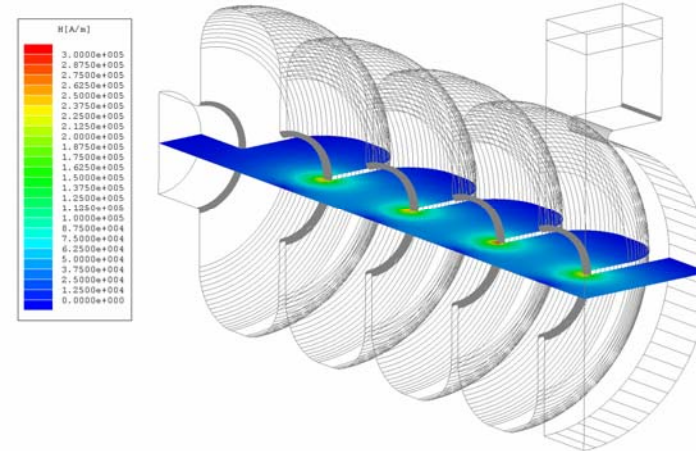
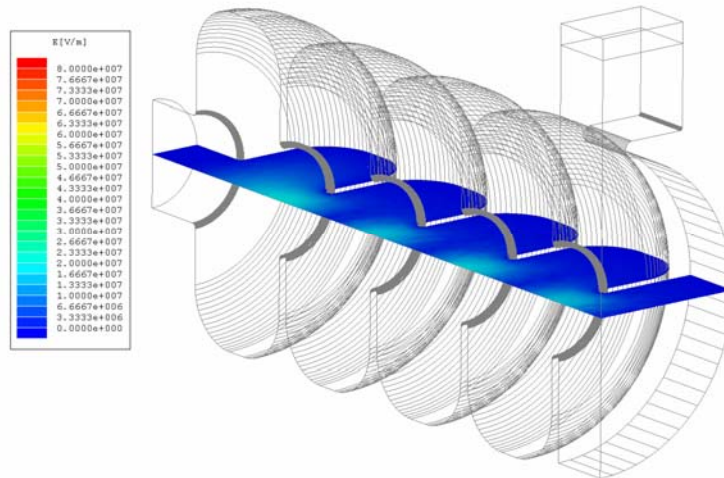
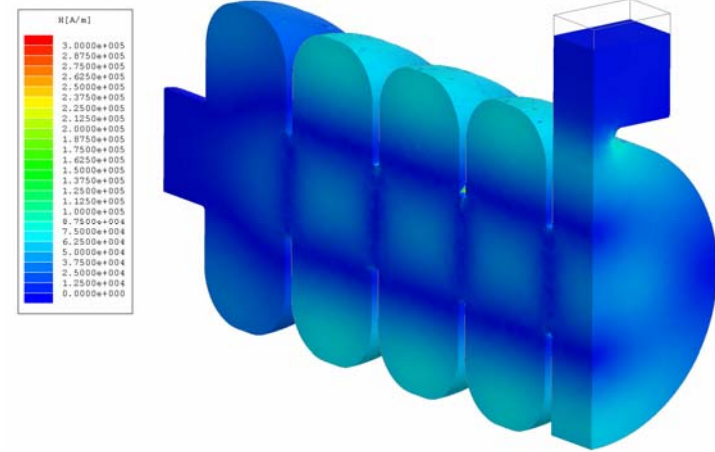
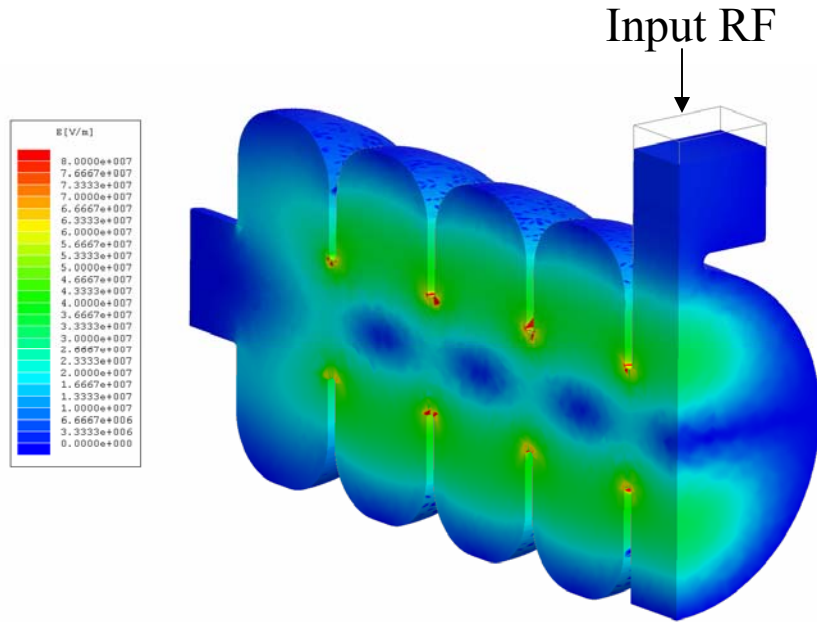

Surface electric field for 5 MW of input power, maximum field  $\sim 70$  MV/m

Surface magnetic field for 5 MW of input power, maximum field  $\sim 30$  kA/m

# 9 Cell Standing Wave Deflector

Reflection vs. frequency, mode separation 1.7 MHz

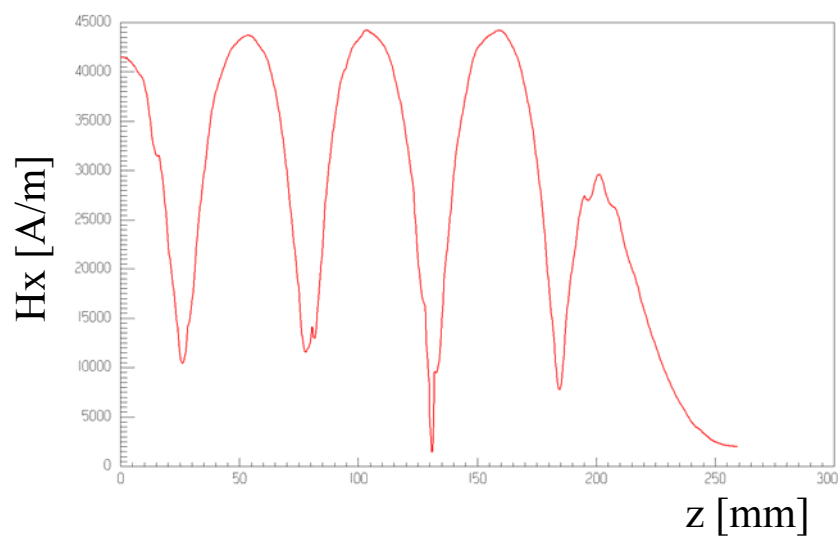
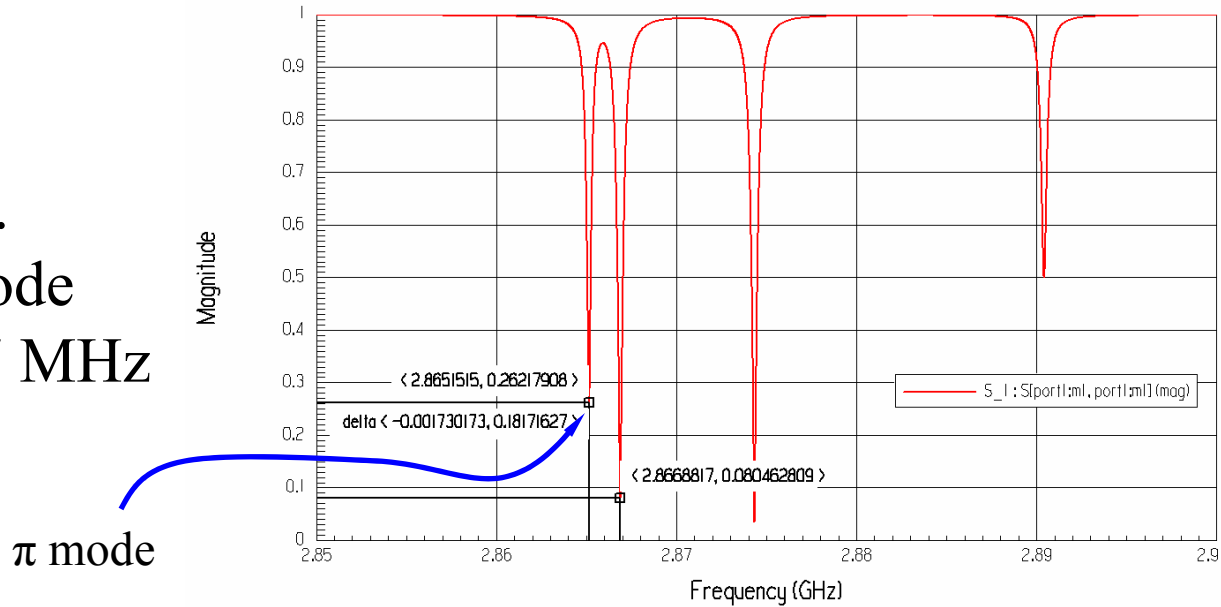

On-axis magnetic field

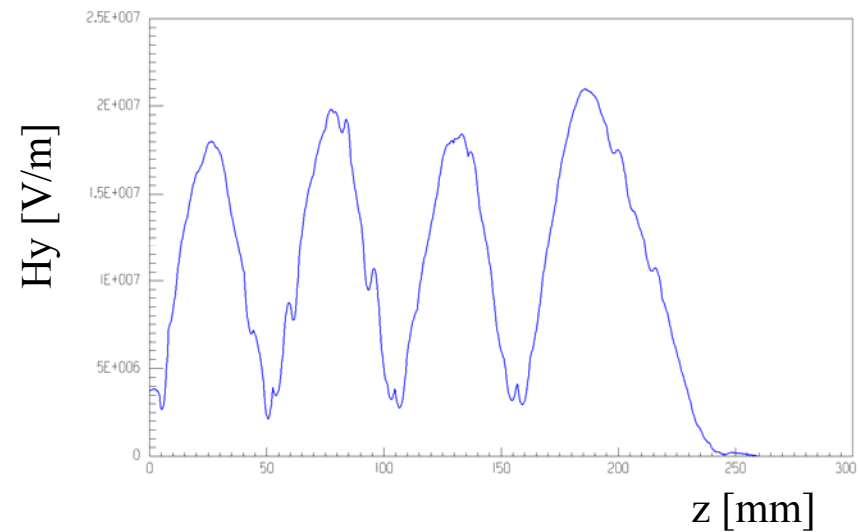

On-axis electric field

Higher Order Modes for **unloaded** structure  
First monopole passband, 2D Finite Element  
calculation (code SLANS)

Must be  $< 0.8 \text{ MOhm} \cdot \text{GHz}$

Frequency [GHz]	Q	Rshunt [MOhm]
1.813	20,000	0.032
1.817	20,000	0.049
1.822	20,000	0.20
1.830	20,000	0.27
1.839	20,000	0.55
1.849	20,000	4.1
1.858	20,000	6.4
1.866	20,000	0.71
1.870	20,000	0.015



# Result

- One 9-cell standing wave structure (0.5 m length) will produce 6 MV kick if powered by a 5 MW klystron. The klystron will need circulator for protection from reflected power.
- Two of these structures will produce 6 MV kick if powered by 2.5 MW. In this case a hybrid will protect klystron – no need for circulator. Two structures will occupy about a meter of beam space.

## Work to do: HOM suppression

- Unloaded Qs of several monopole modes have to be reduced by an order of magnitude to satisfy beam stability requirements. **Chokes in end cavities are possible solution.**
- $\pi$  mode of the “wrong polarization” should be damped. **“Damped” coupler is a possible solution.**

# RF undulators

- With external power
- Beam powered

# Externally powered undulators

## Outline

- Introduction to rf undulators
- Review of the state-of-art in high power Rf generation at X-band.
- Waveguide types suitable for an RF undulator
- RF undulator in an a resonant ring

## Main Contributors:

- Sami Tantawi
- Chistopher Nantista

# Planar Microwave Undulator

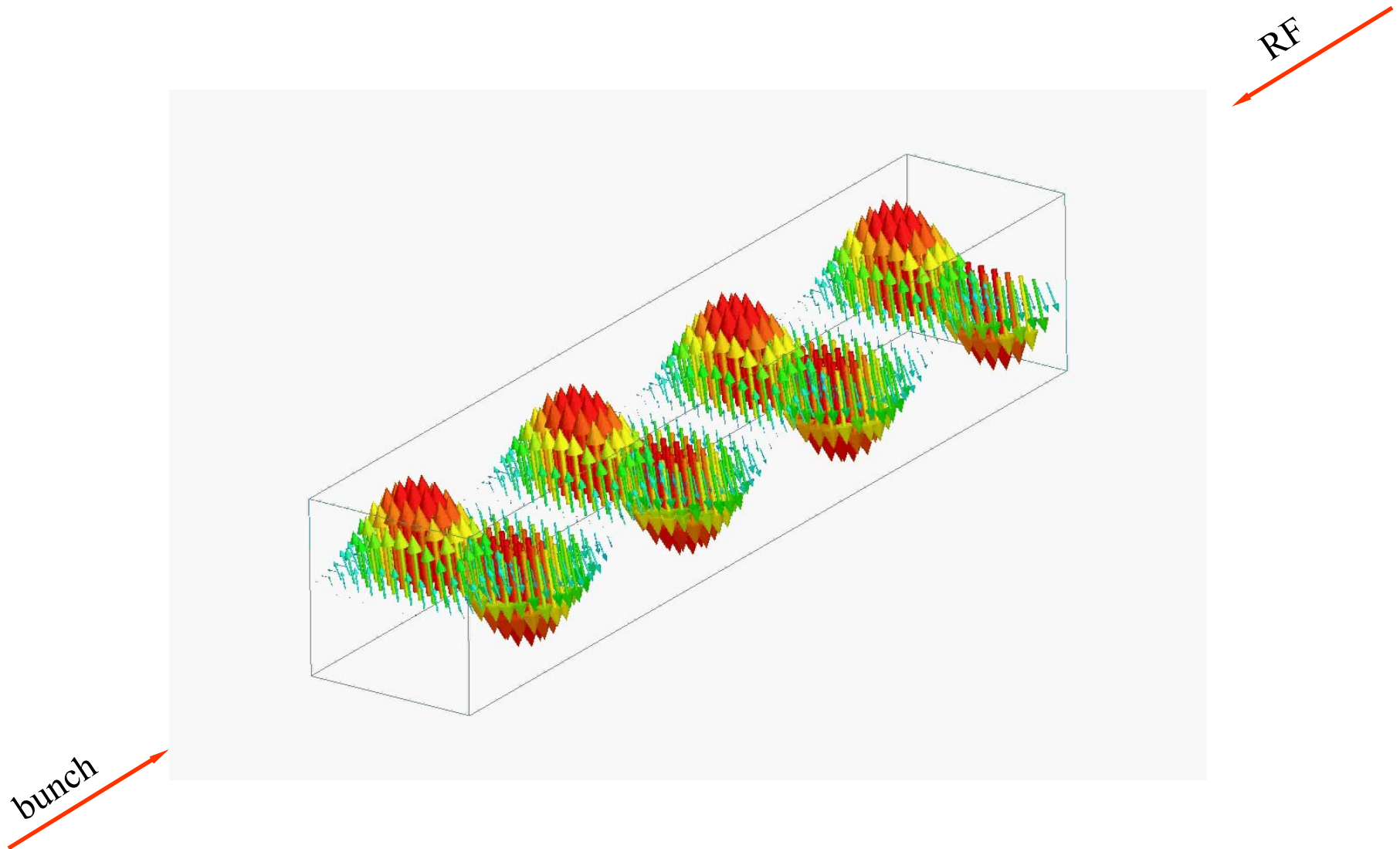

Vector plot of deflecting field in mid-plane of the waveguide

# Helical Microwave Undulator

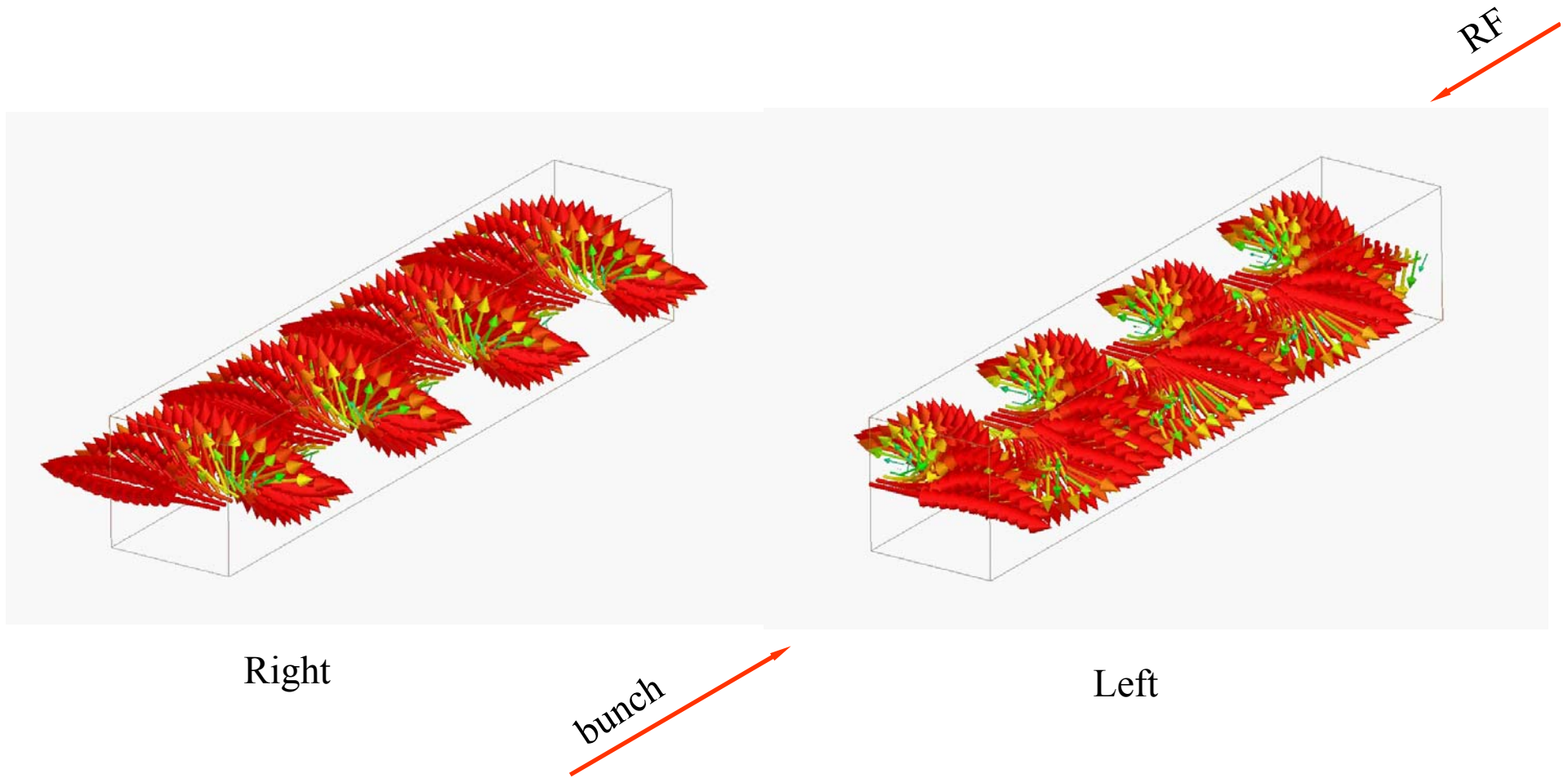

Vector plot of deflecting field in mid-plane of the waveguide

## Development of Microwave Undulator

Tsumoru SHINTAKE, Kazuo HUKU†, Jiro TANAKA†,  
 Isamu SATO† and Isao KUMABE

Department of Nuclear Engineering, Faculty of Engineering,  
 Kyushu University, Fukuoka 812

†Photon Factory, National Laboratory for High-Energy Physics,  
 Oho-machi, Tsukuba-gun, Ibaraki 305

(Received November 17, 1982; accepted for publication February 19, 1983)

A microwave undulator which uses transverse fields of standing microwaves has been operated successfully at the Photon Factory electron linac. The undulator consists of a long rectangular cavity with two ridges. Using a pulsed S-band microwave of 300 kW and a pulsed electron beam, the undulator radiation was observed in the visible region, and the spectral intensities were measured. The equivalent magnetic field and the period are 430 Gauss and 5.5 cm, respectively.

$$f = 2856 \text{ MHz}$$

$$\lambda_u = 5.5 \text{ cm}$$

$$B_u = 0.043 \text{ T}$$

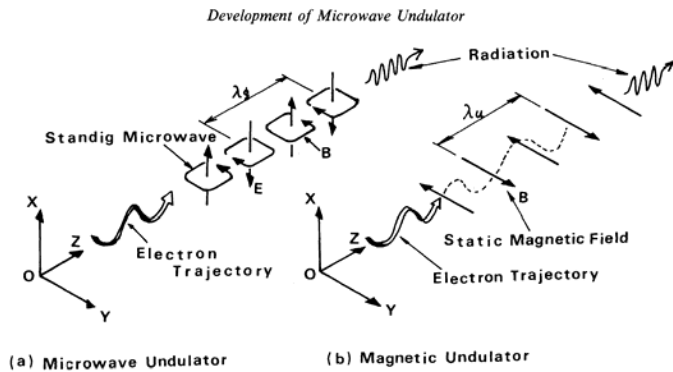

Fig. 1. Coordinates of microwave undulator and magnetic undulator. Electrons undulate in  $xz$ -plane.

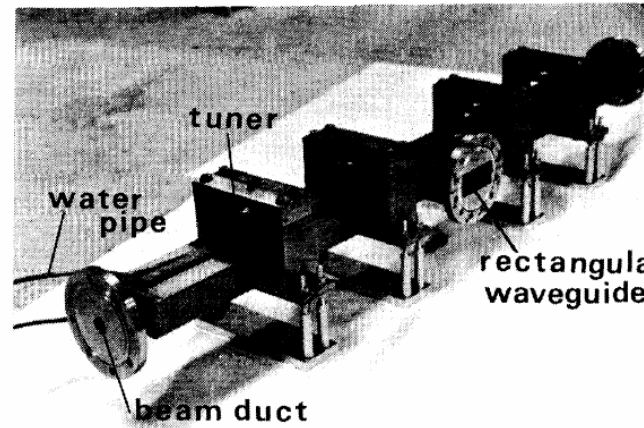
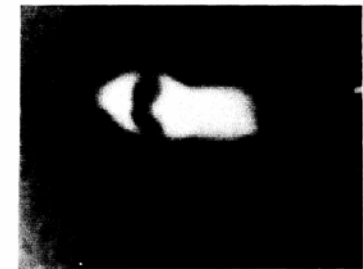

Fig. 5. Photographs of undulator cavity. (a) Completed cavity. (b) Cross-sectional view, before welding beam duct. (c) Coupling hole. Front is rectangular waveguide WRJ-3.



(a)



(b)

Fig. 10. Photographs of normal synchrotron light and undulator light, taken on TV screen. (a) When undulator is switched off; there are two normal synchrotron light spots produced at the two bending magnets. (b) When microwave power is fed into cavity; ring-shaped undulator light emerges.

## A MICROWAVE BEAM WAVEGUIDE UNDULATOR FOR A BRILLIANT ABOVE 100 KEV PHOTON SOURCE\*

Y. Kang, J. Song, and R. Kustom, Argonne National Laboratory, Argonne, IL

$$f = 34 \text{ GHz}$$

$$\lambda_u = 4.5 \text{ mm}$$

$$B_u = 0.25 \text{ T}$$

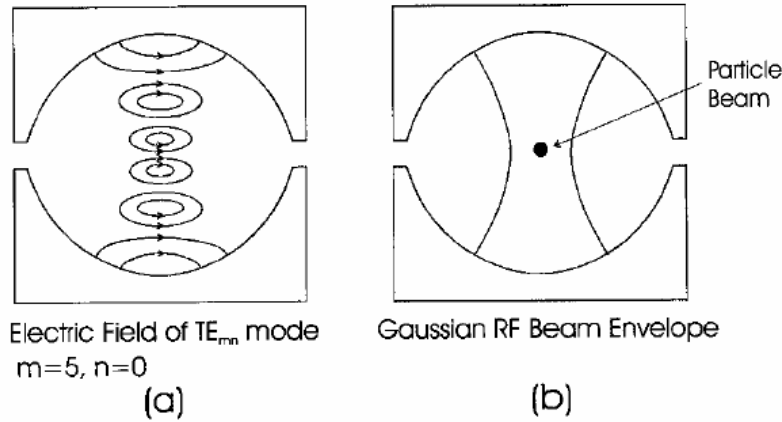

Figure 2: Cross section of a parallel reflector beam waveguide. (a) Electric field of the  $TE_{50}$  mode, (b) particle beam with respect to the microwave beam.

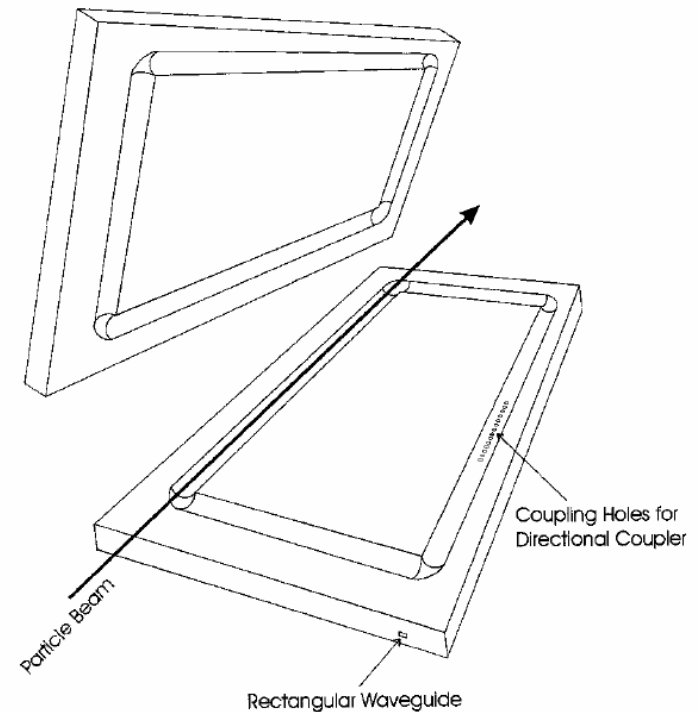

Figure 6: A proposed design of a beam waveguide microwave undulator.

# Why rf for beam deflection?

- RF makes possible small period and large aperture undulators
- Helical undulators are relatively easy with rf
- No magnets to damage by radiation
- Dynamic: **Could change properties from pulse to pulse**, for example flip polarization of helical undulator

## Why such devices are difficult to make?

- High power (100s of MW) rf sources with **precision amplitude and phase** are expensive
- Handling of  $\sim 100$  MW rf power at 10s of GHz is difficult and required expensive R&D efforts

*More information on X-band traveling wave undulator, Claudio Pellegrini, UCLA:  
[http://pbpl.physics.ucla.edu/Literature/\\_library/pellegrini\\_2005\\_624.pdf](http://pbpl.physics.ucla.edu/Literature/_library/pellegrini_2005_624.pdf)*



**8-Pack Phase 1**  
**coherent** power source  
Frequency 11.424 GHz  
Output power 500 MW  
Pulse length 400 ns pulse  
Rep. rate 60 Hz

can power  
**60 m** of rf undulator  
with  
period **~1.6 cm** and  
**K ~0.4**

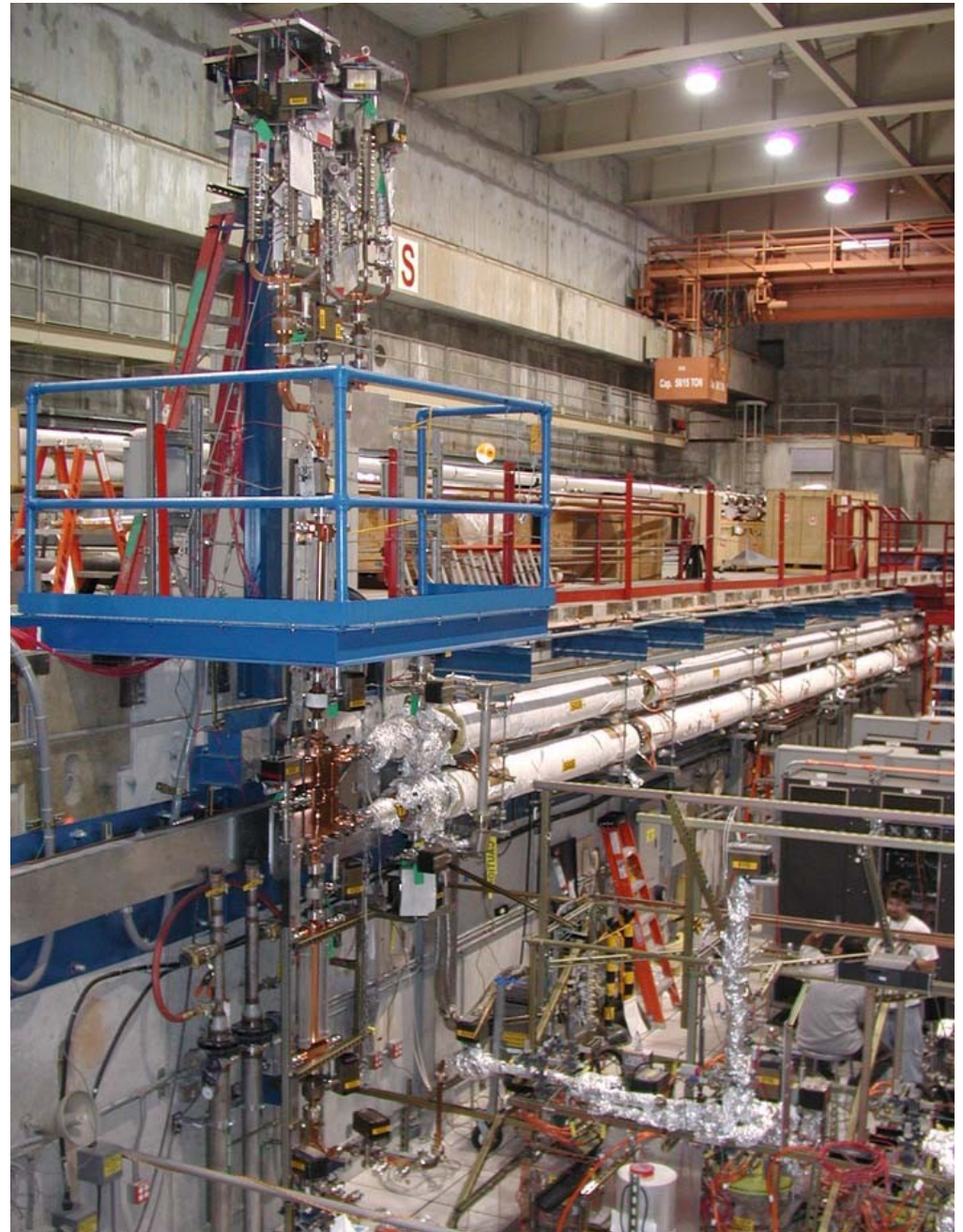

*NLCTA team*

# NLC experimental rf pulse compression system

Output Load Tree

Compressed output > 600 MW 400 ns.

Dual mode waveguide carrying 200 MW

Single mode waveguide input to the pulse compression system; 100 MW/Line for 1.6  $\mu$ s

Dualmode Resonant Delay lines ~30m

RF Input to the 4 50 MW klystrons

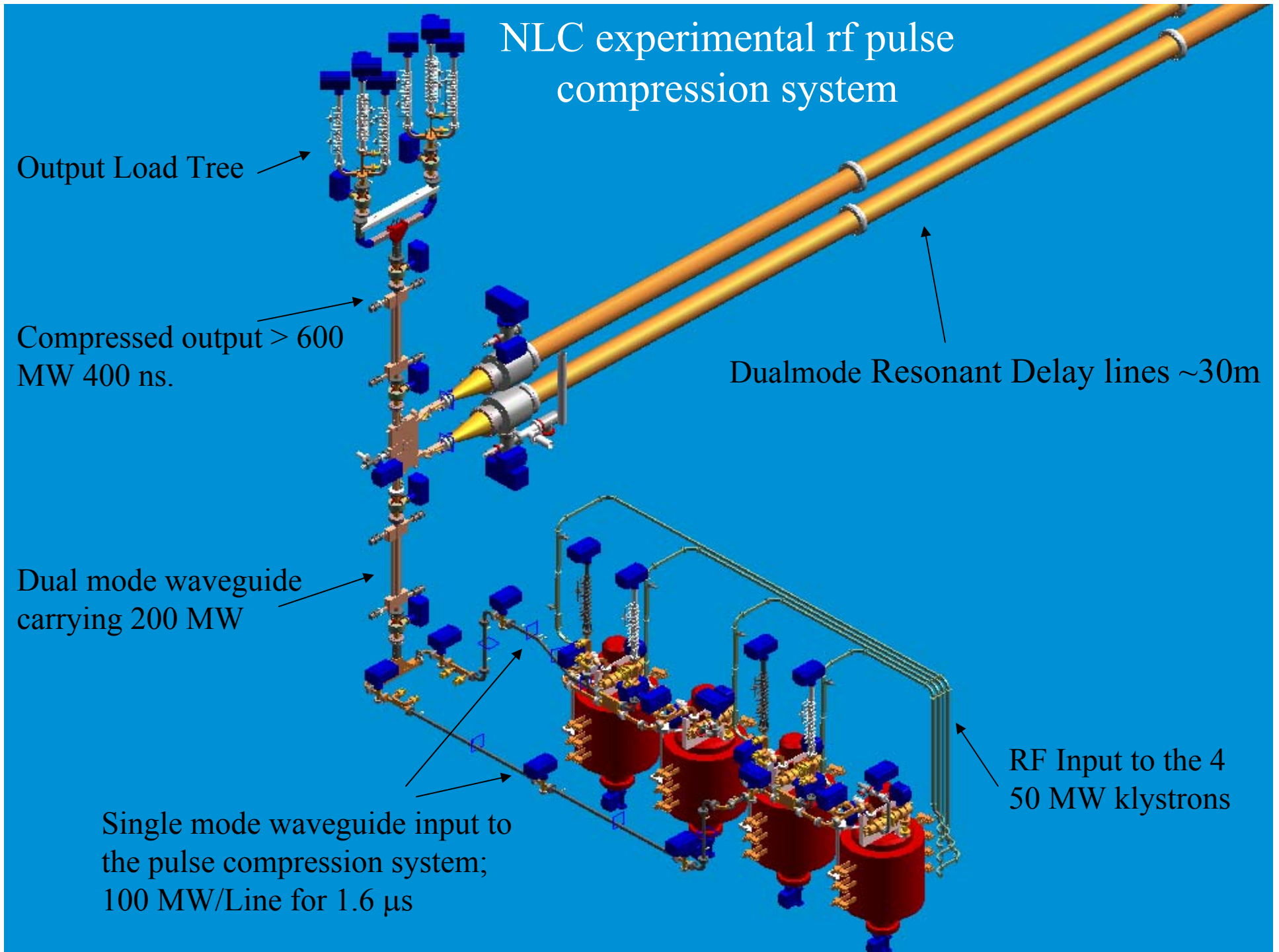

# The Head of the pulse compression system

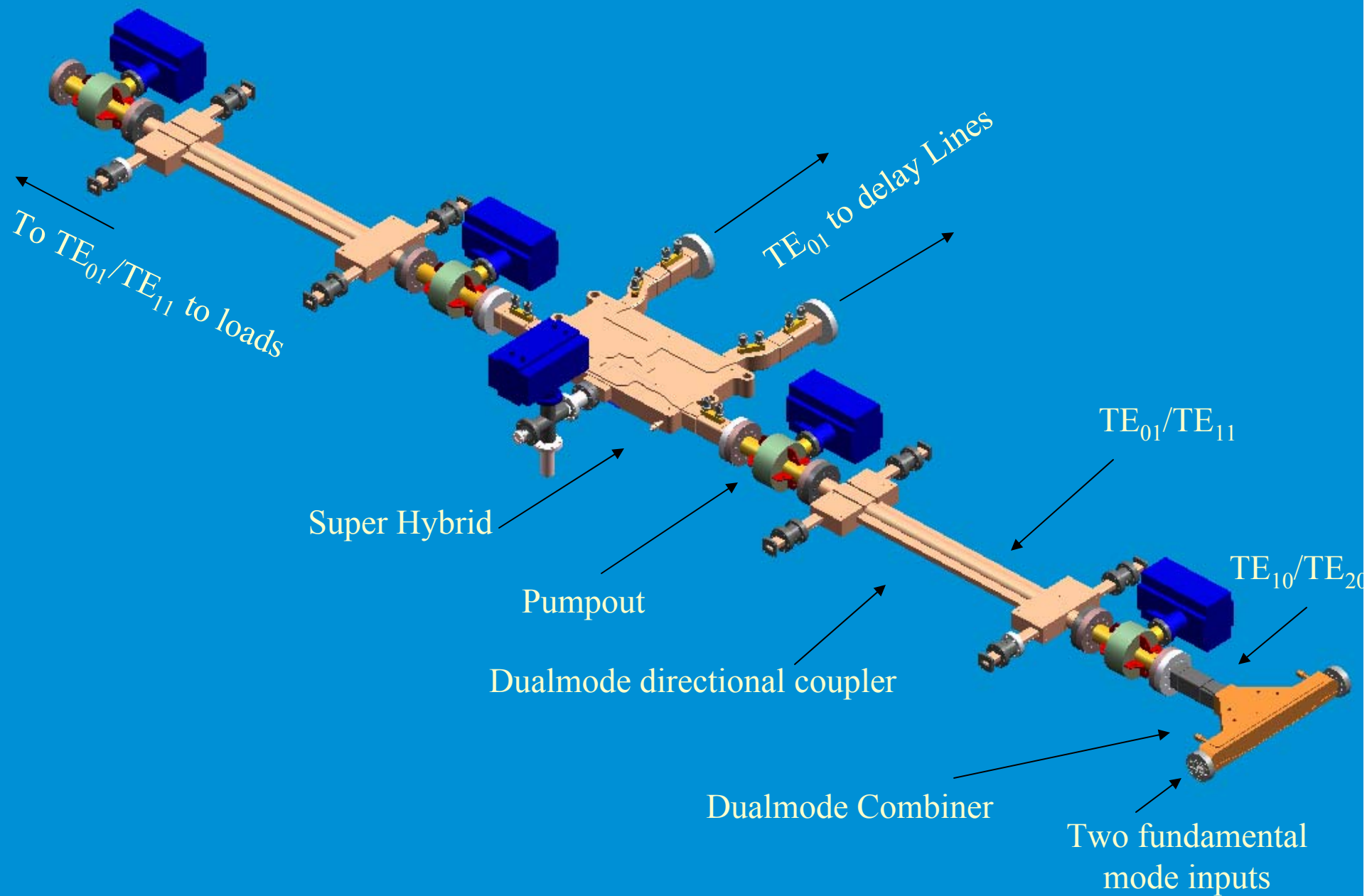

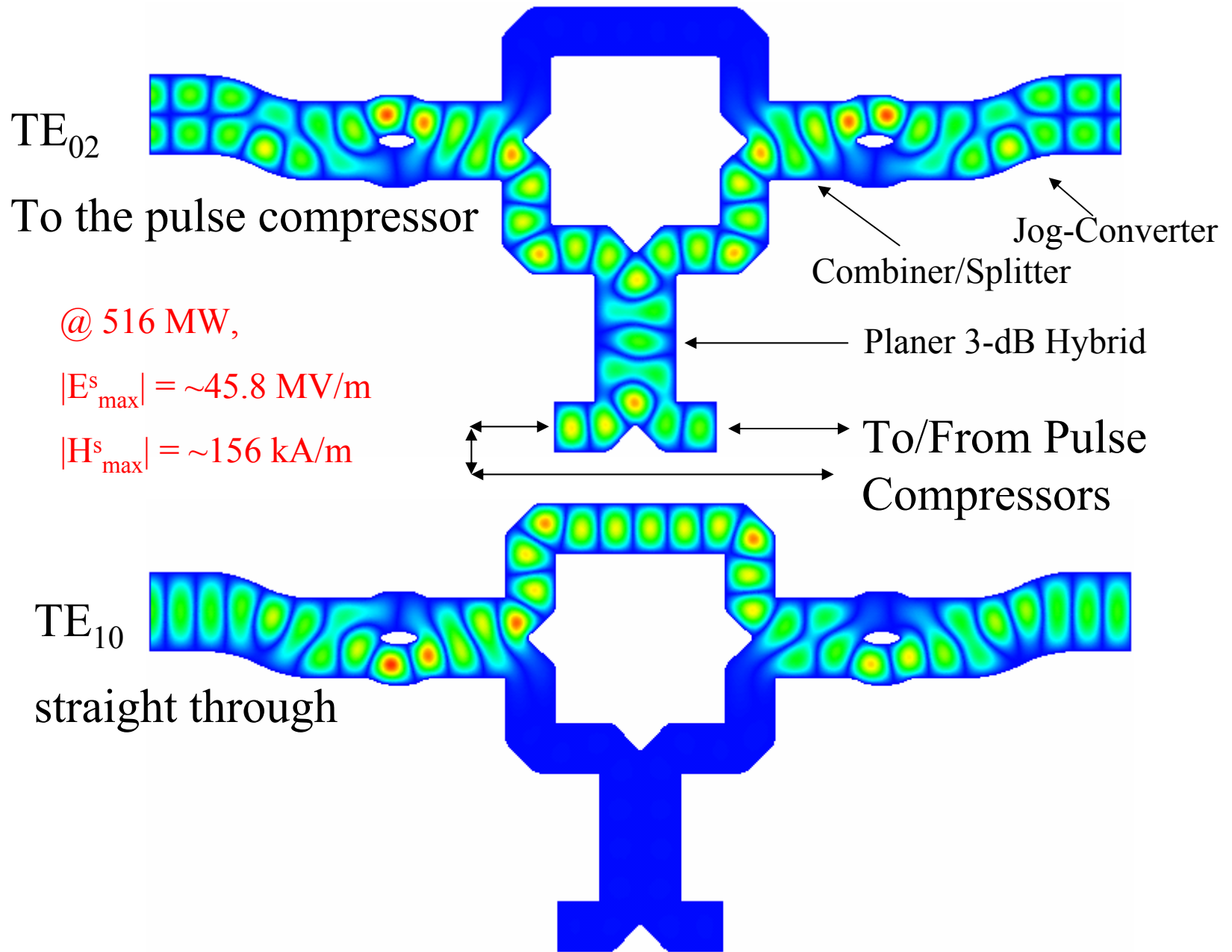

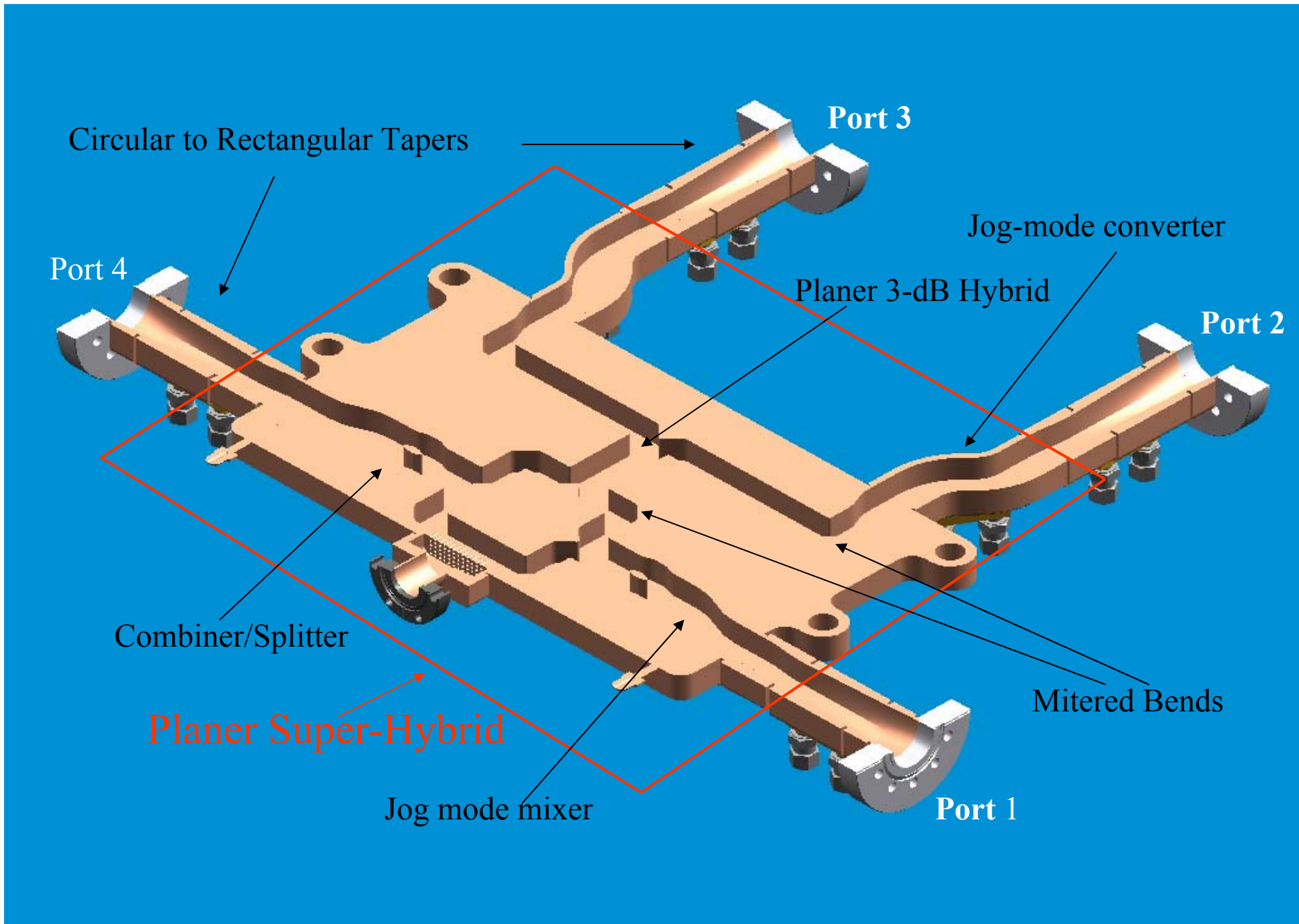

# Dual-Moded Delay Line

Dual-moding the delay lines cuts their required length approximately in half.

$$L = \frac{T}{2} \frac{v_{g1} v_{g2}}{v_{g1} + v_{g2}}$$

Where  $L$  is the required length of the line,  $T$  is the compressed pulse width, and  $v_{g1}$  and  $v_{g2}$  are the group velocities of the two modes used.

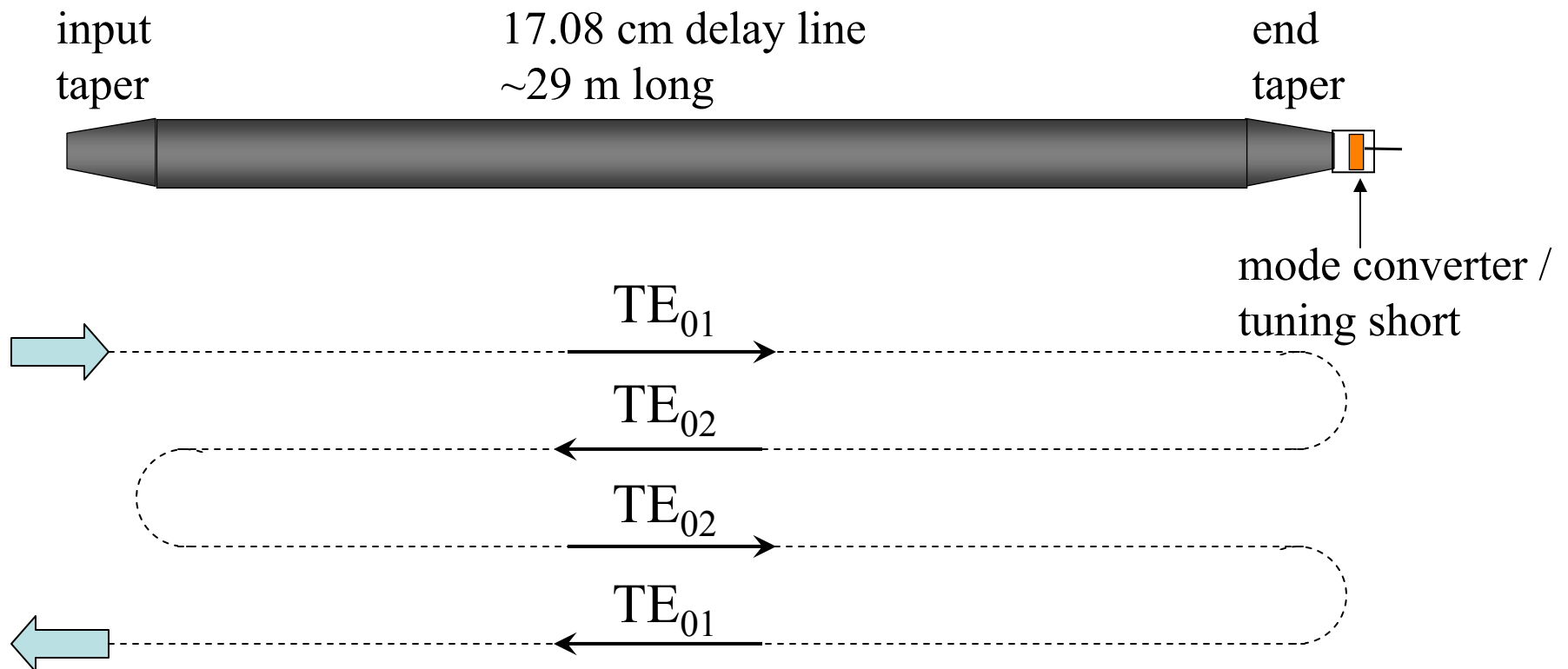



500 113

500 113

500 113

WESTMAN WOODEN MS 1132

WOOD 113

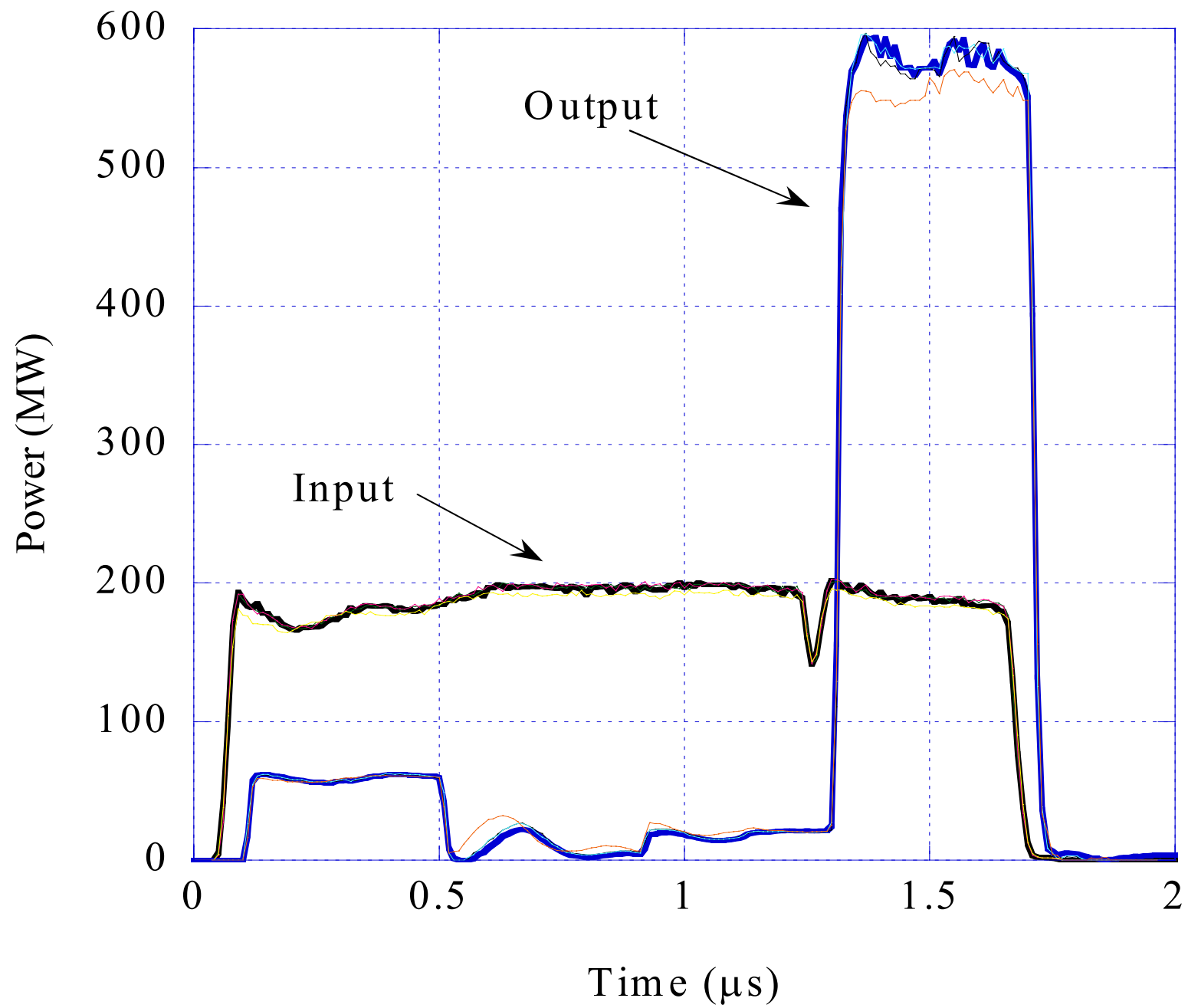



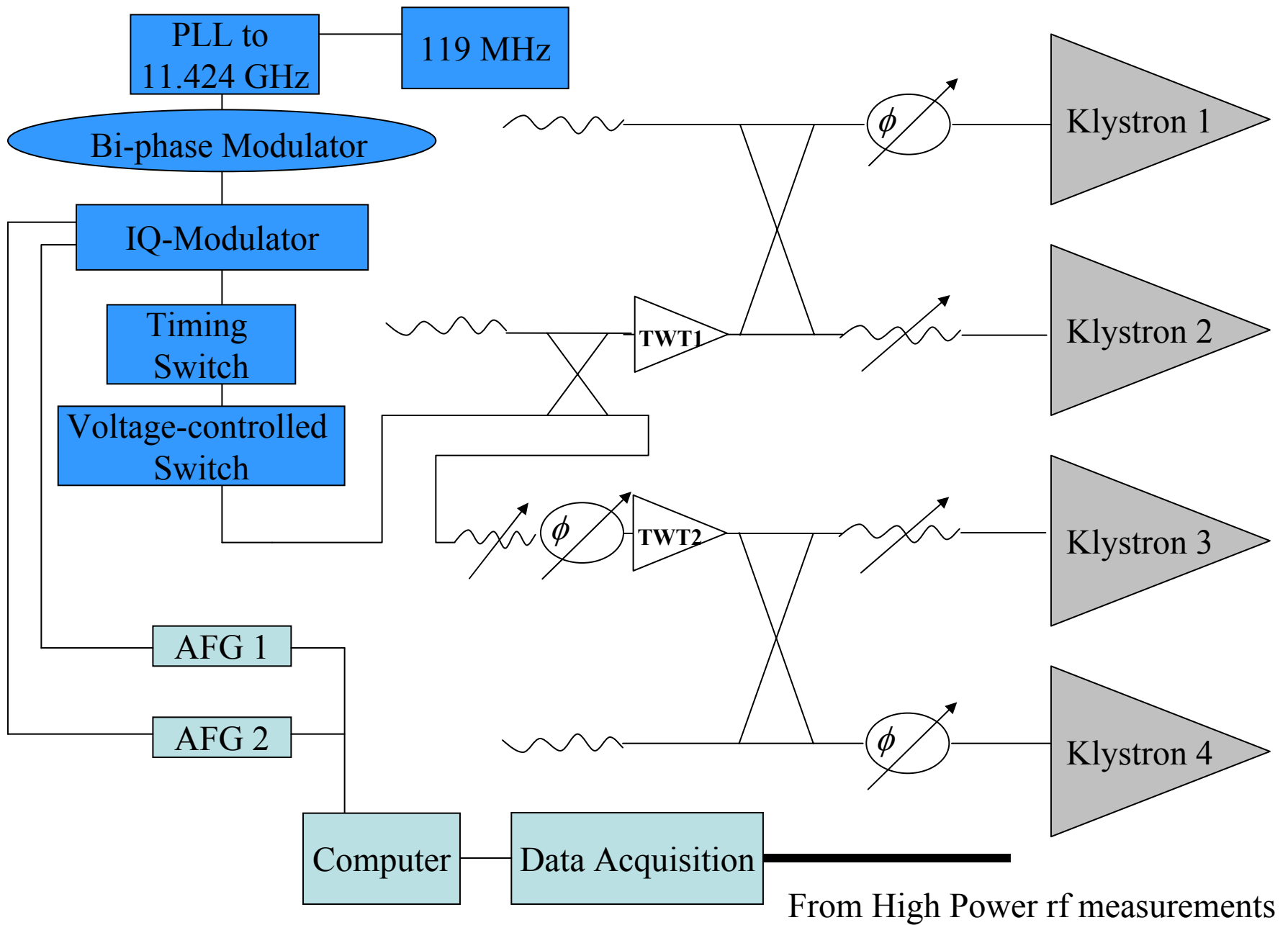

Low-Level RF Architecture

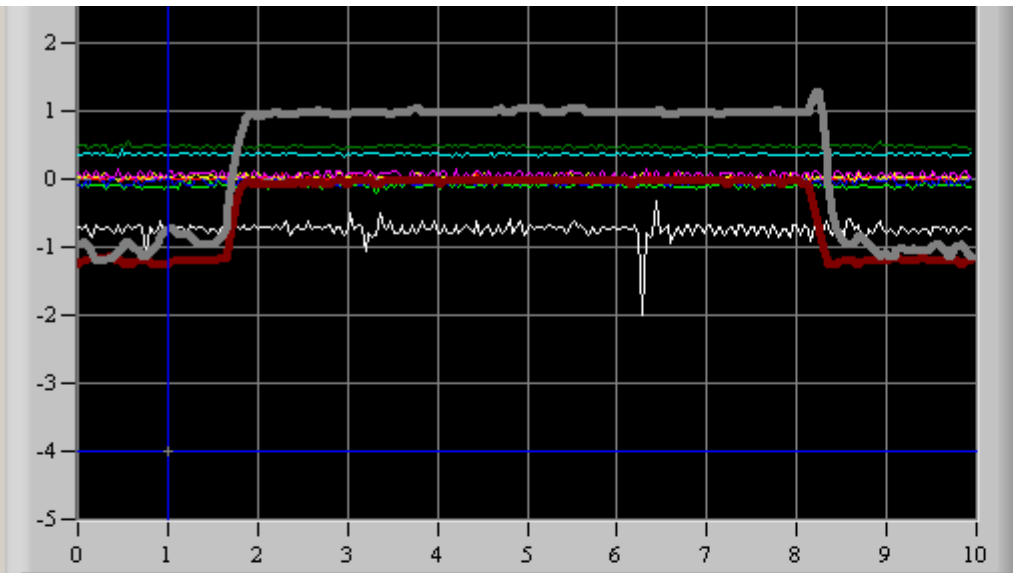

Power



Phase (degrees)

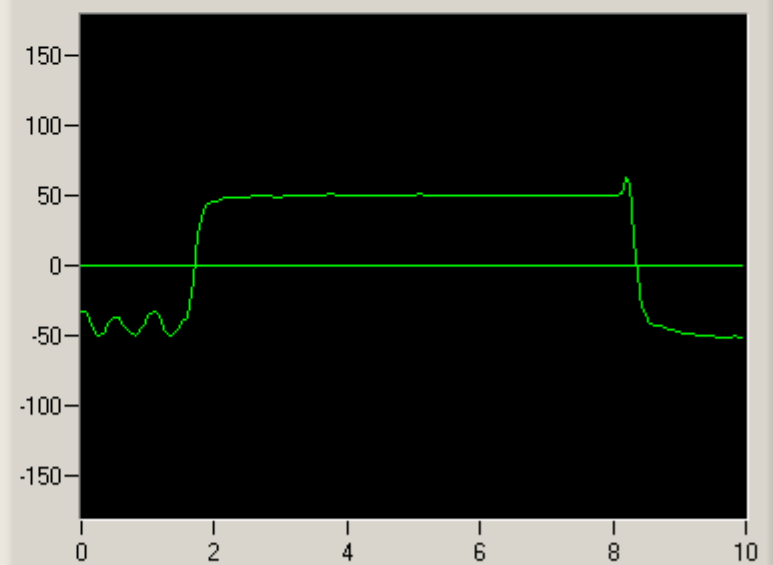

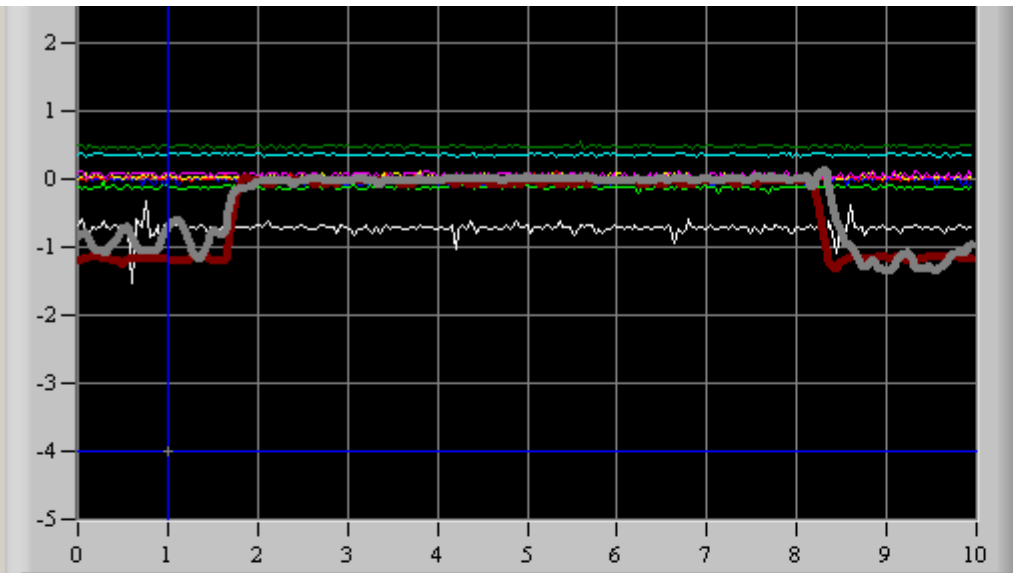

3	0.02	0.000
4	0.2	0.000

Digitizer#2

Time base 0.000 us/div

Ch#	V/div	VOffset, V
1	0.01	0.000
2	0.01	0.000
3	0.2	0.030
4	0.2	0.040
5	1	0.200
6	1	0.000

Saving Data

Power

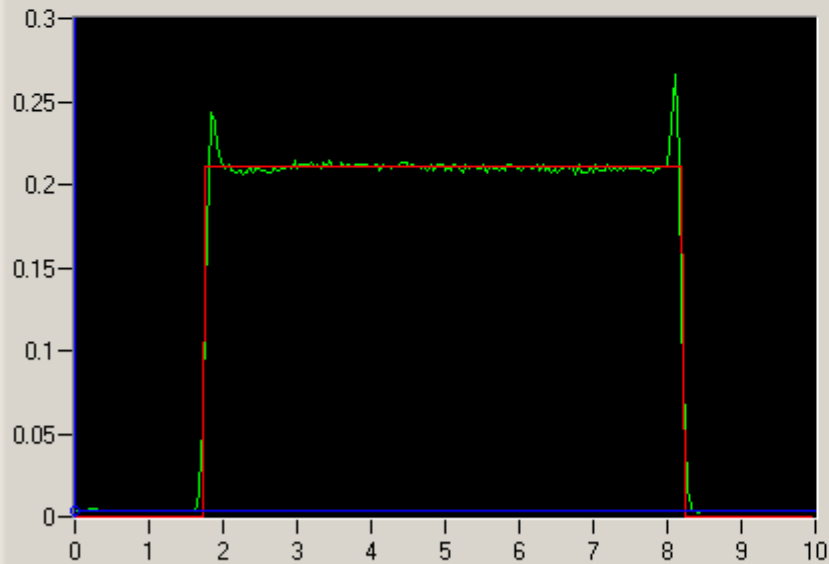

Phase (degrees)

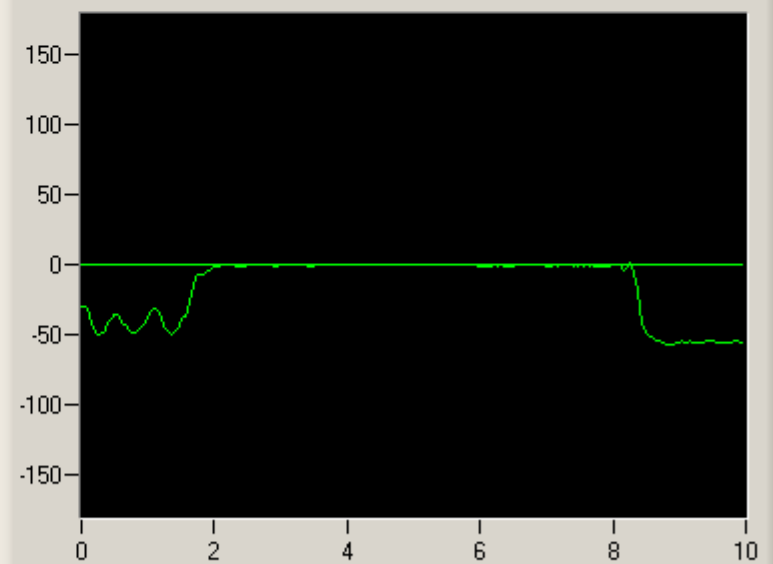

0.00379301656647

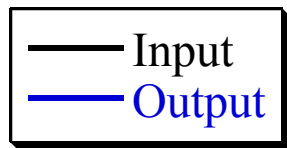

Multimoded SLED-II output with feedback

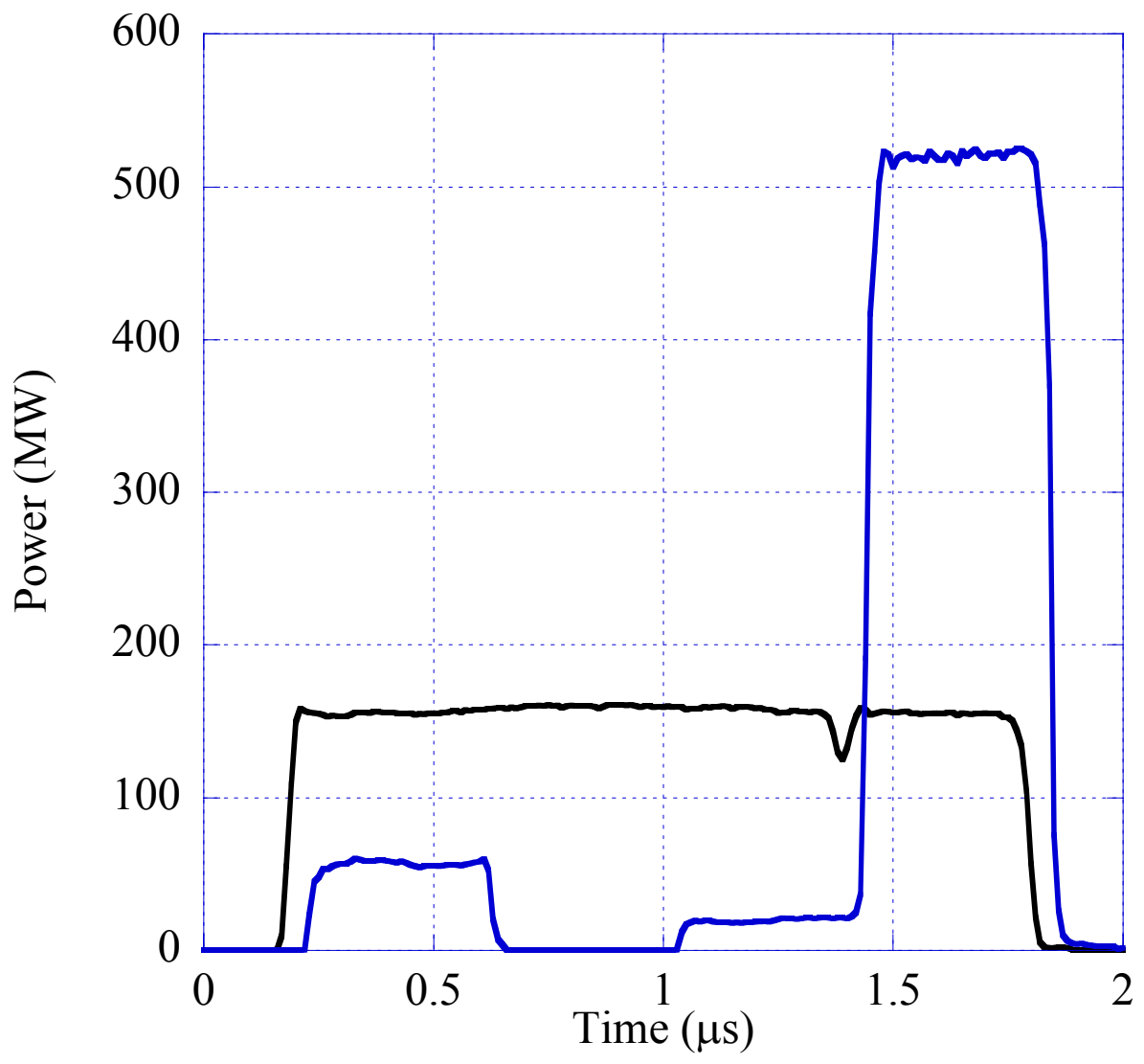

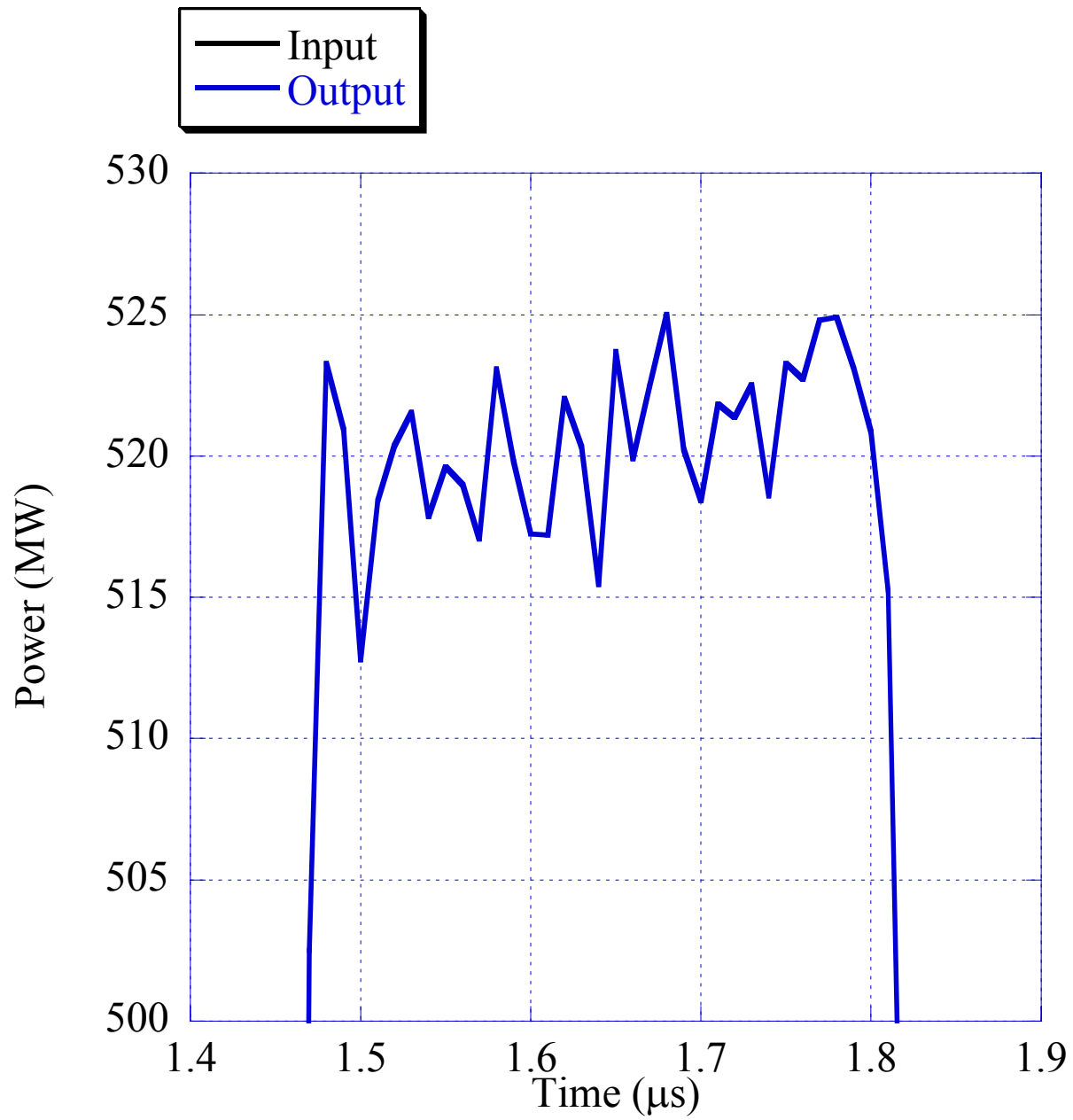

In a “single pass” undulator we have to tailor the rf pulse to compensate for losses and errors in the waveguide

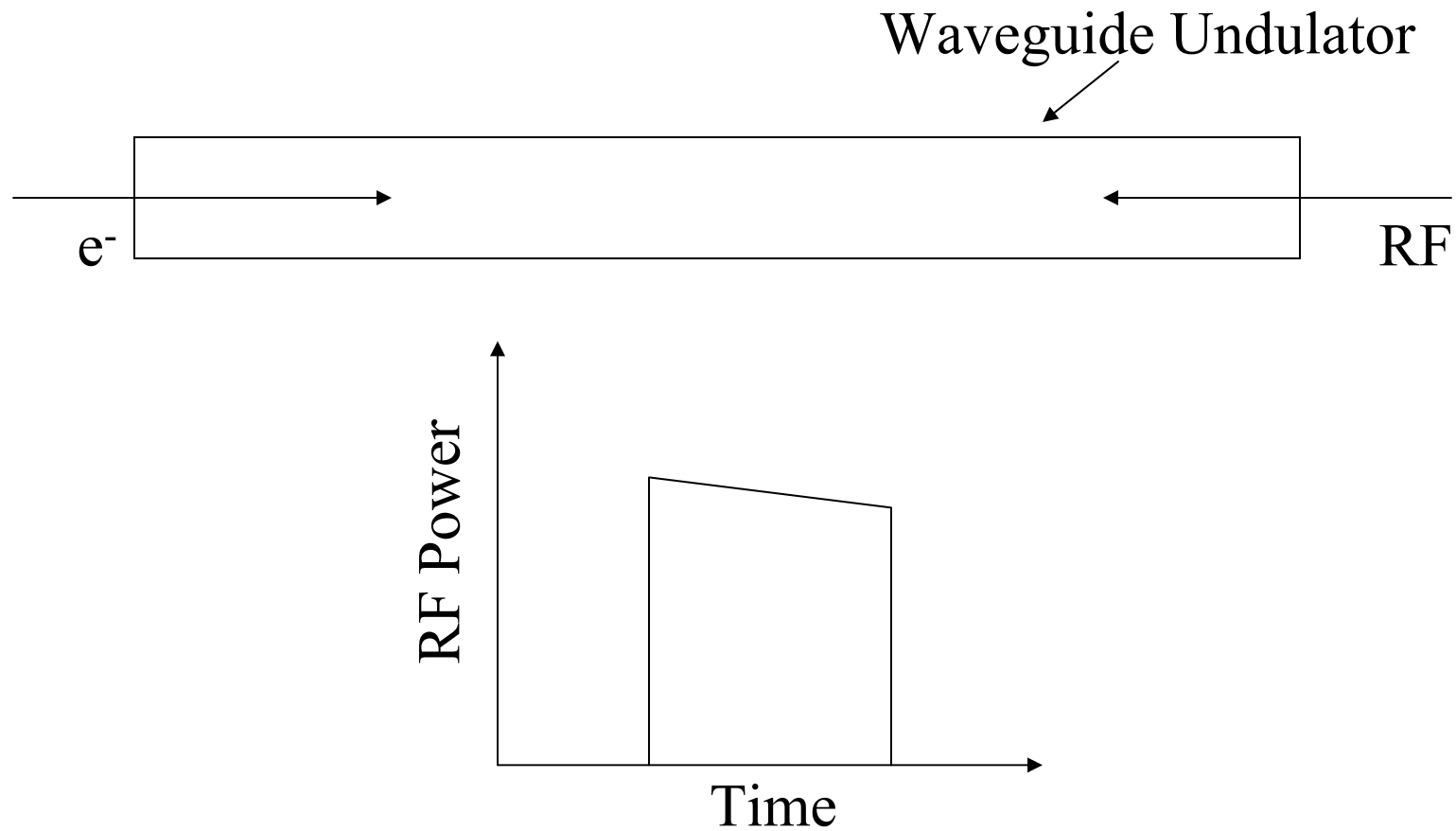

# RF Undulator Realization

- Waveguide need to be precisely machined. Tolerances in the order of 10 microns is desirable.
- High power handling capabilities of the undulator waveguide have to be maximized and losses in the waveguide minimized.

# Possible Waveguide Types

- Rectangular (Square)
  - High Attenuation
- Circular
  - Lower Attenuation
- Open Waveguides
  - Low Attenuation
  - Low transverse impedance

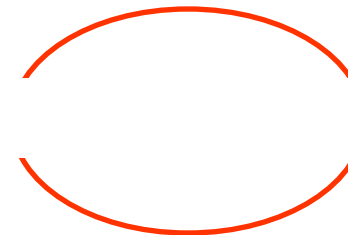
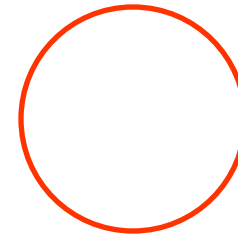



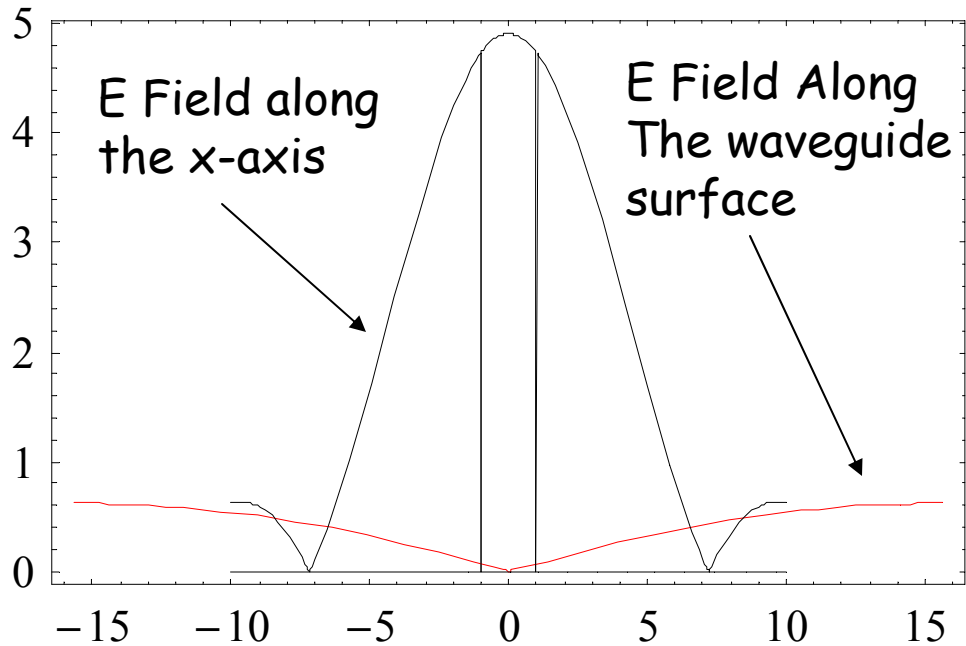
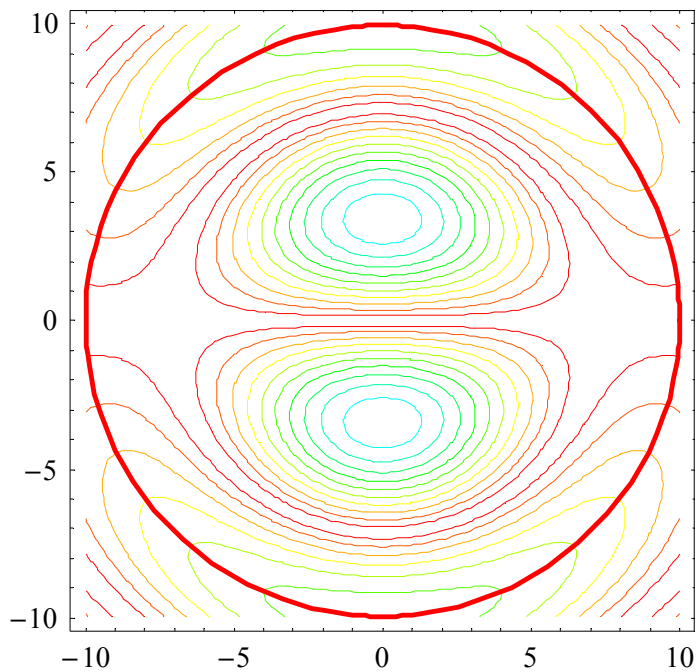

$TE_{12}$  in circular guide (E field Lines)

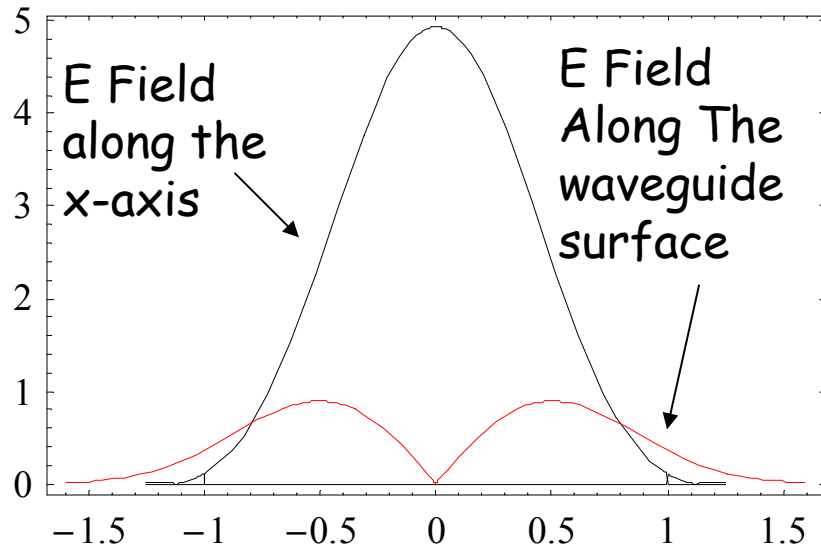
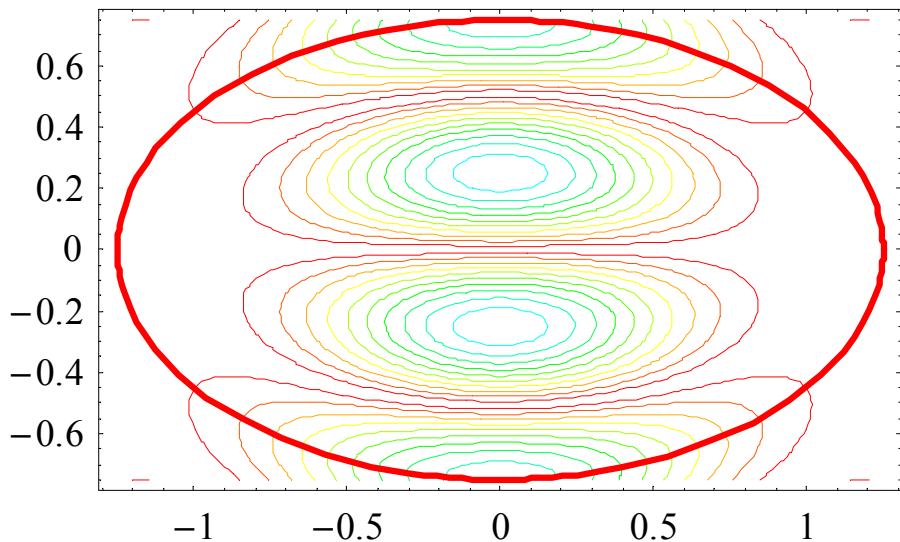

$sTE_{12}$  in elliptical guide (E field Lines)

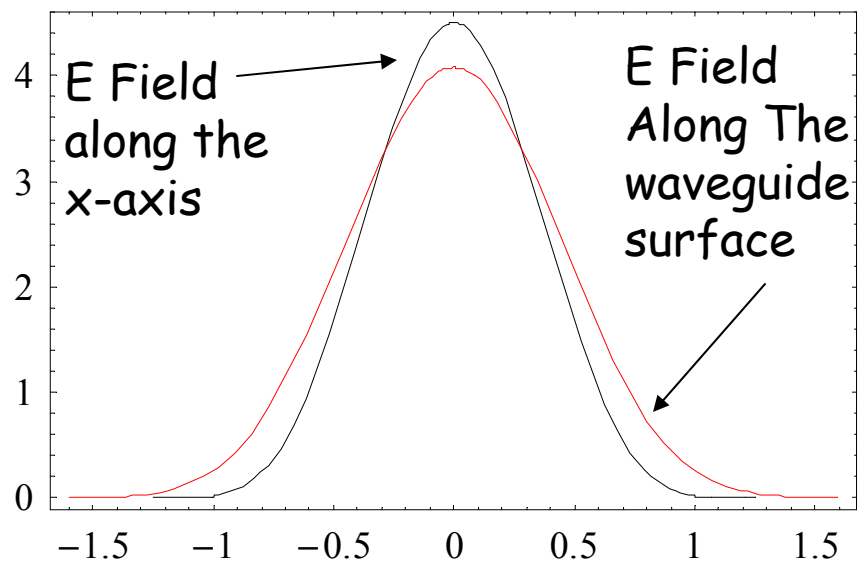
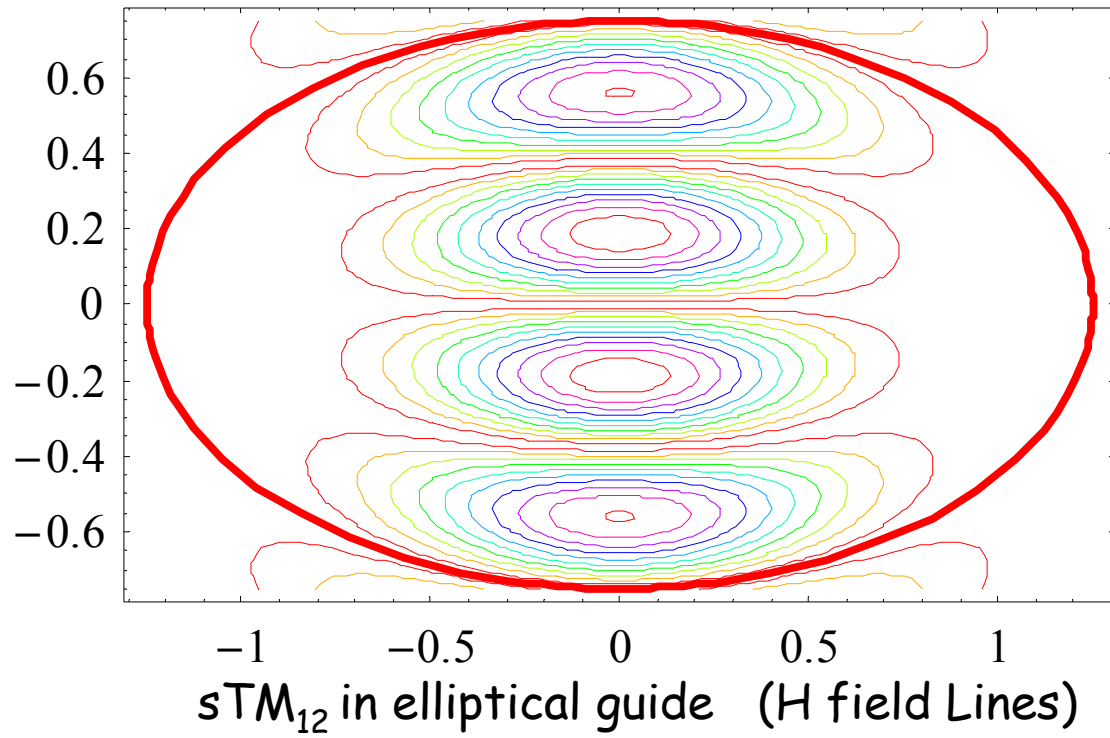

## Open Elliptical Waveguide undulator

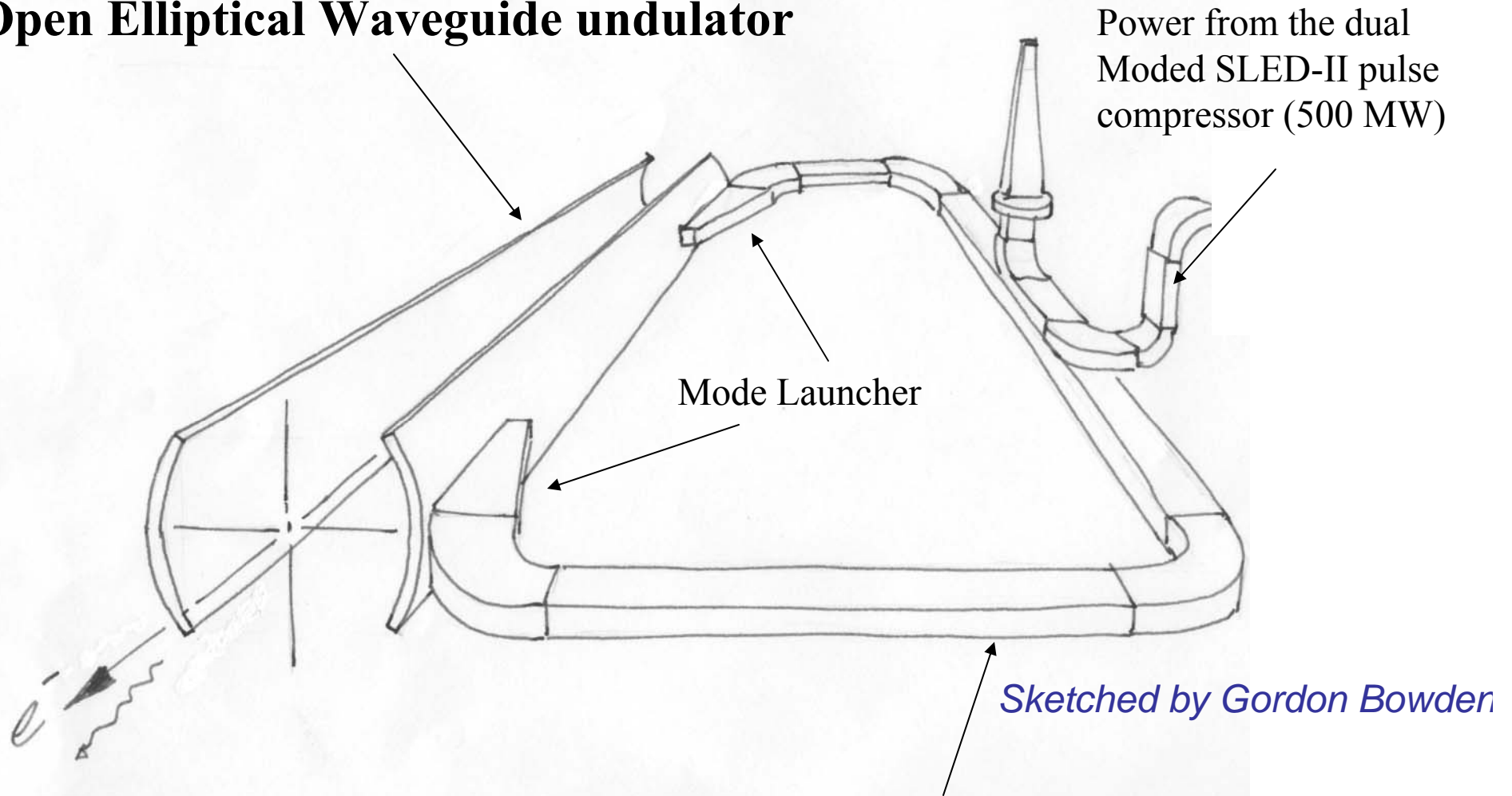

### Low Loss Overmoded waveguide

Because of the integration of RF pulses in a resonant ring the rf pulse in the undulator can be smoothed. Further, the ring can have a multiplication factor of more than 10, resulting in 5 GW of RF power through the undulator waveguide.

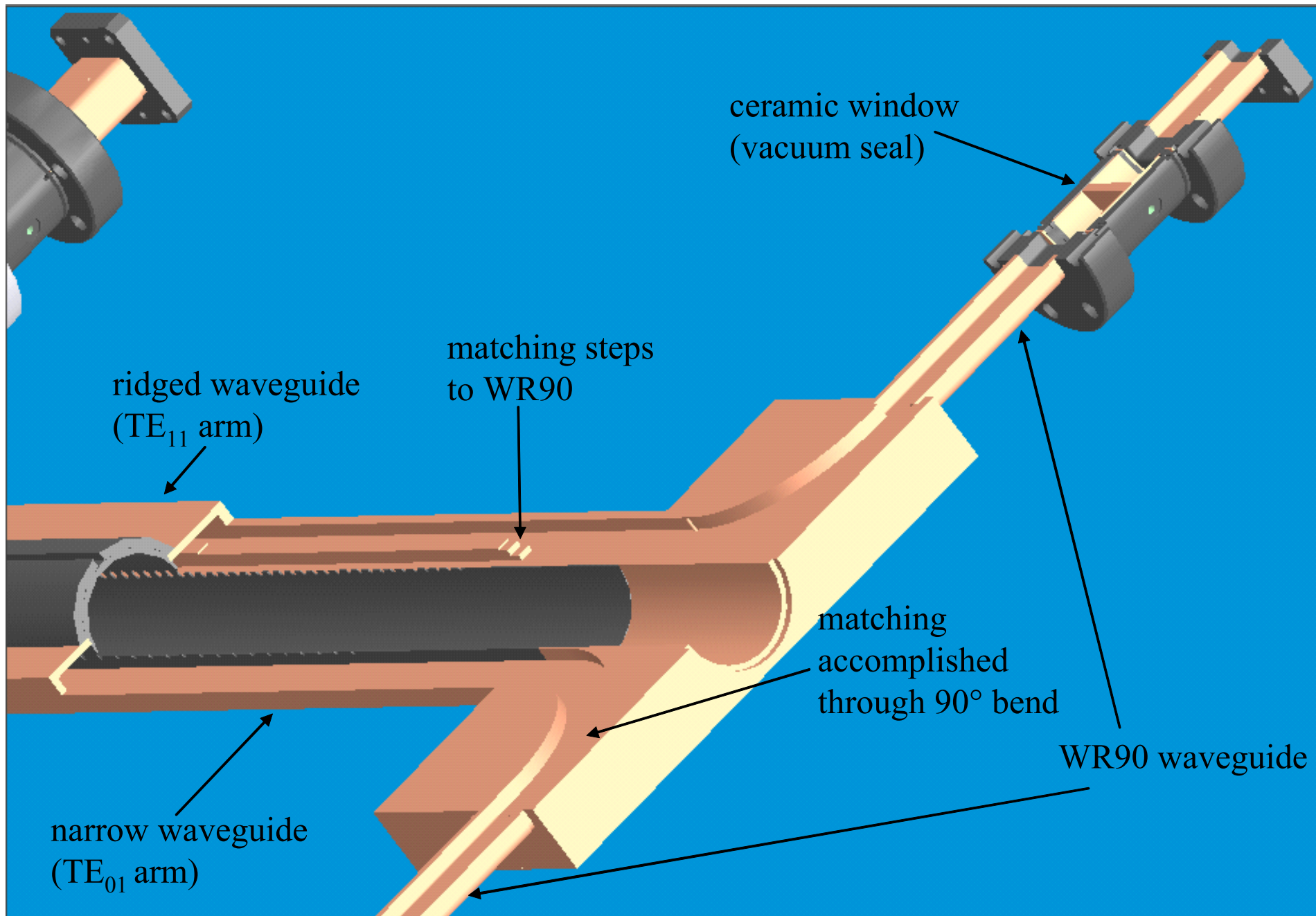

**Inner structure of the dual-mode directional coupler**

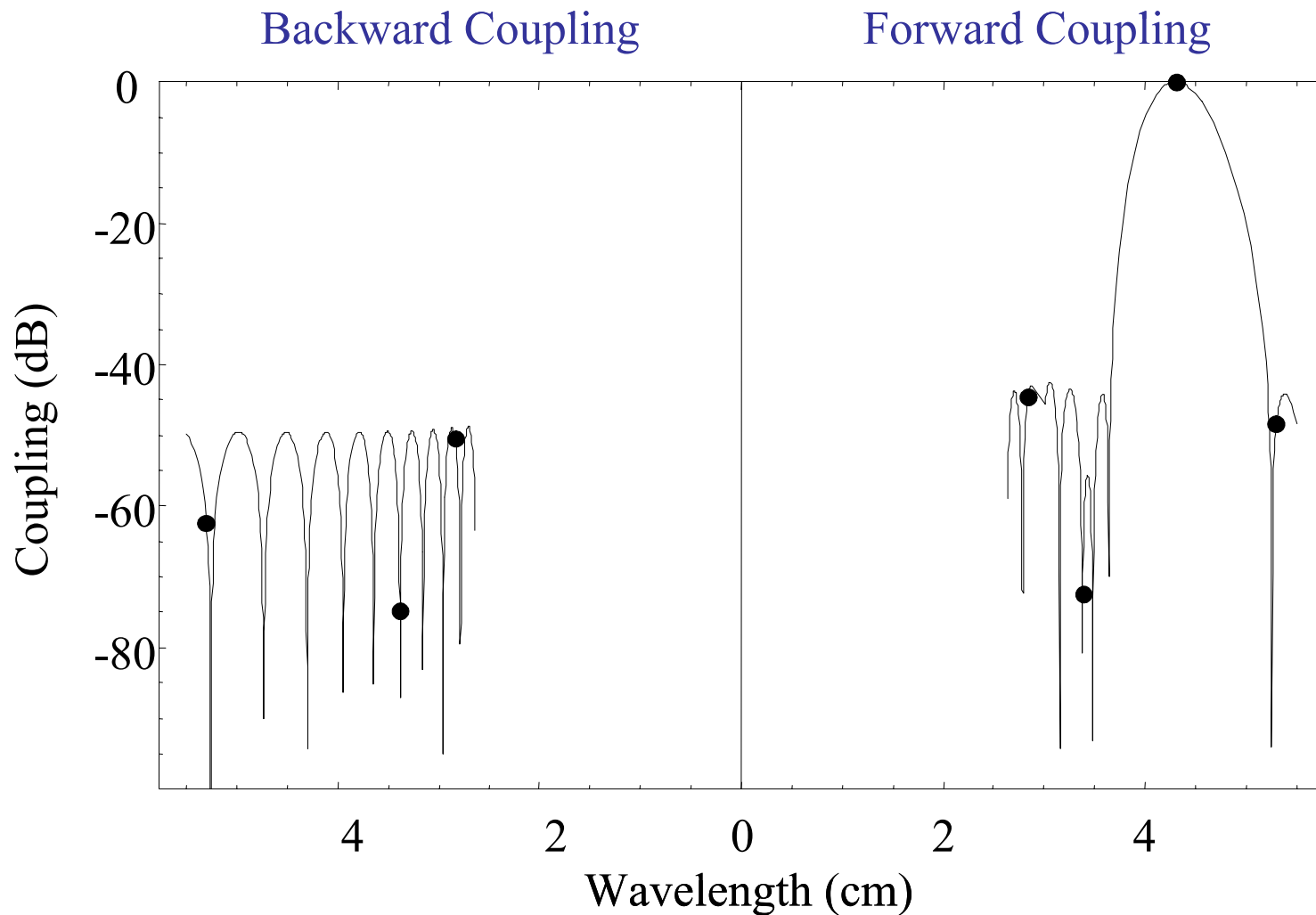

Coupling vs. guided wavelength. TE<sub>01</sub> directional coupler response (normalized to forward coupling of the TE<sub>01</sub> mode). Coupler length = 50.6 cm. Number of coupling holes = 44. Points represent : TE<sub>11</sub>, TE<sub>21</sub>, TE<sub>01</sub>, TE<sub>31</sub>. The TE<sub>01</sub> mode is not shown in the backward coupling because it is theoretically zero because of the choice of coupling holes spacing.

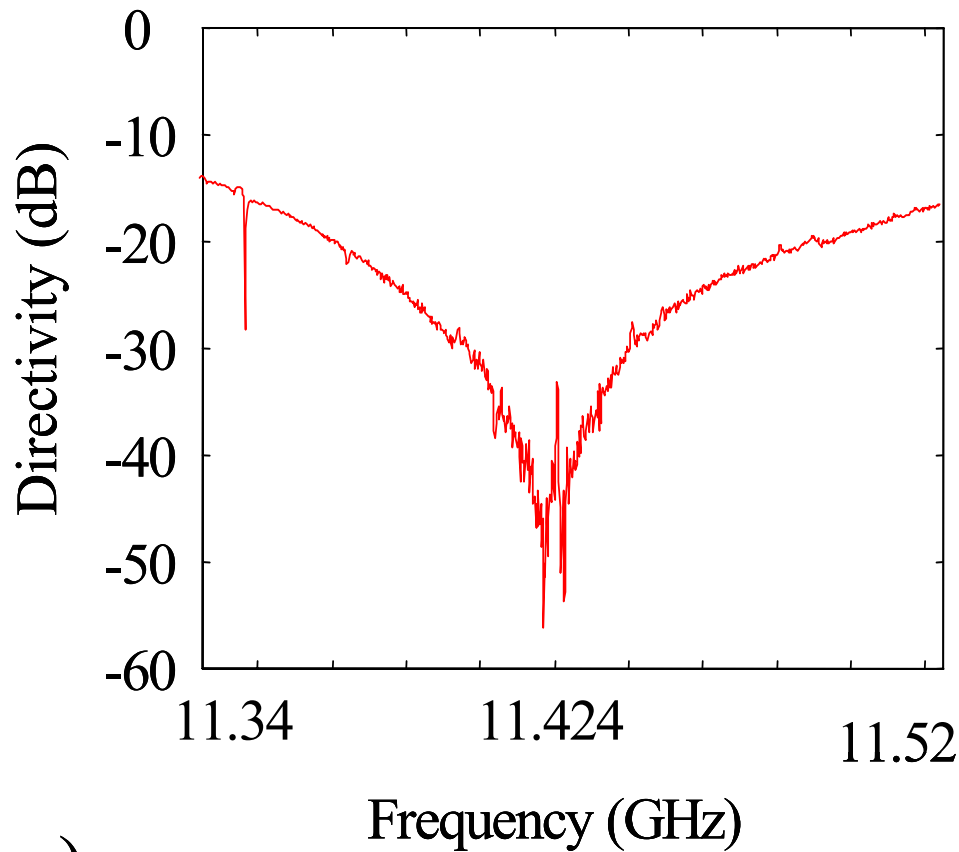

a)

**Directivity**

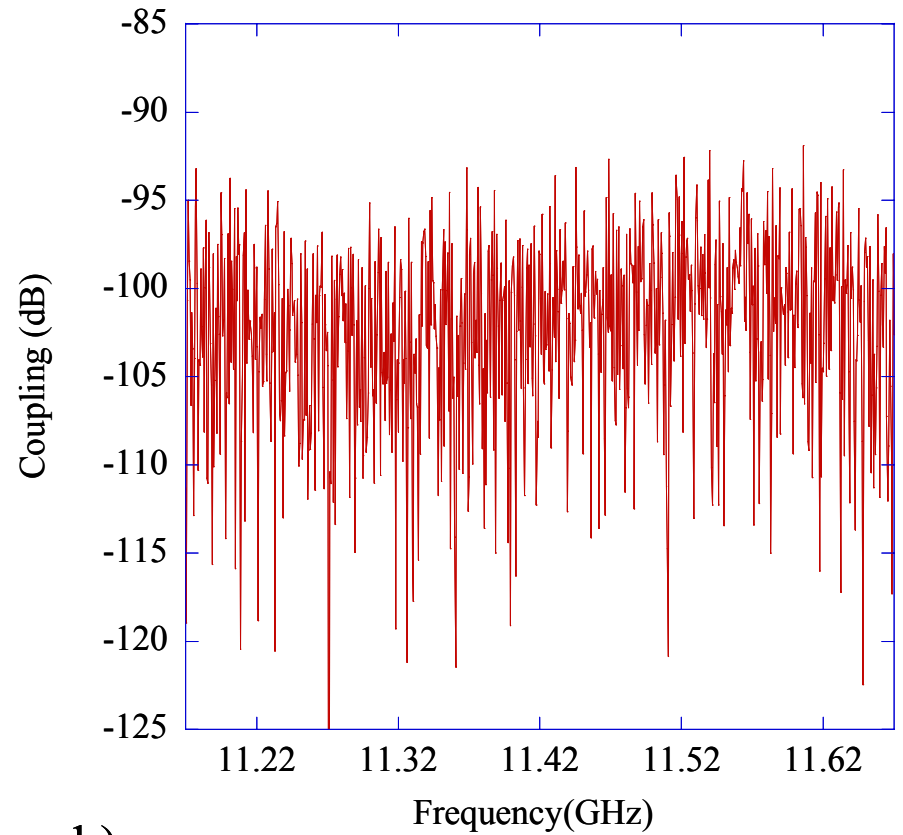

b)

**Coupling between TE<sub>01</sub> and TE<sub>11</sub> mode**

**Measurements Limited by available dynamic range**

# Conclusion on powered rf undulators

- High power microwave technologies developed for NLC make rf undulators practical: **we have a system that reliably manipulates hundreds of MW in highly overmoded waveguide**
- Open elliptical waveguide might provide an attractive design for an rf undulator
- Making the undulator a part of an RF resonant ring will help smooth the RF power and will provide an extra flexibility for the RF system by introducing high compression gain

# Beam-powered rf undulators

## Idea:

Synchrotron radiation sources require **high charge, high current beams**. Small portion of the energy in the beam could be used to generate deflecting fields in rf undulator.

Use of beam power to generate rf allows “**practical**” undulators with  $\sim 1$  cm aperture,  $\sim 1$  mm period, and  $K \sim 0.01$ .

To make such an undulator with an external source one will need  $\sim$ MW, 50-90 GHz, **coherent** power source.



Maximum magnetic field for permanent magnets undulator vs. its period. Undulator gap is 1 cm, and permanent magnet  $B_r = 0.9$  Tesla.

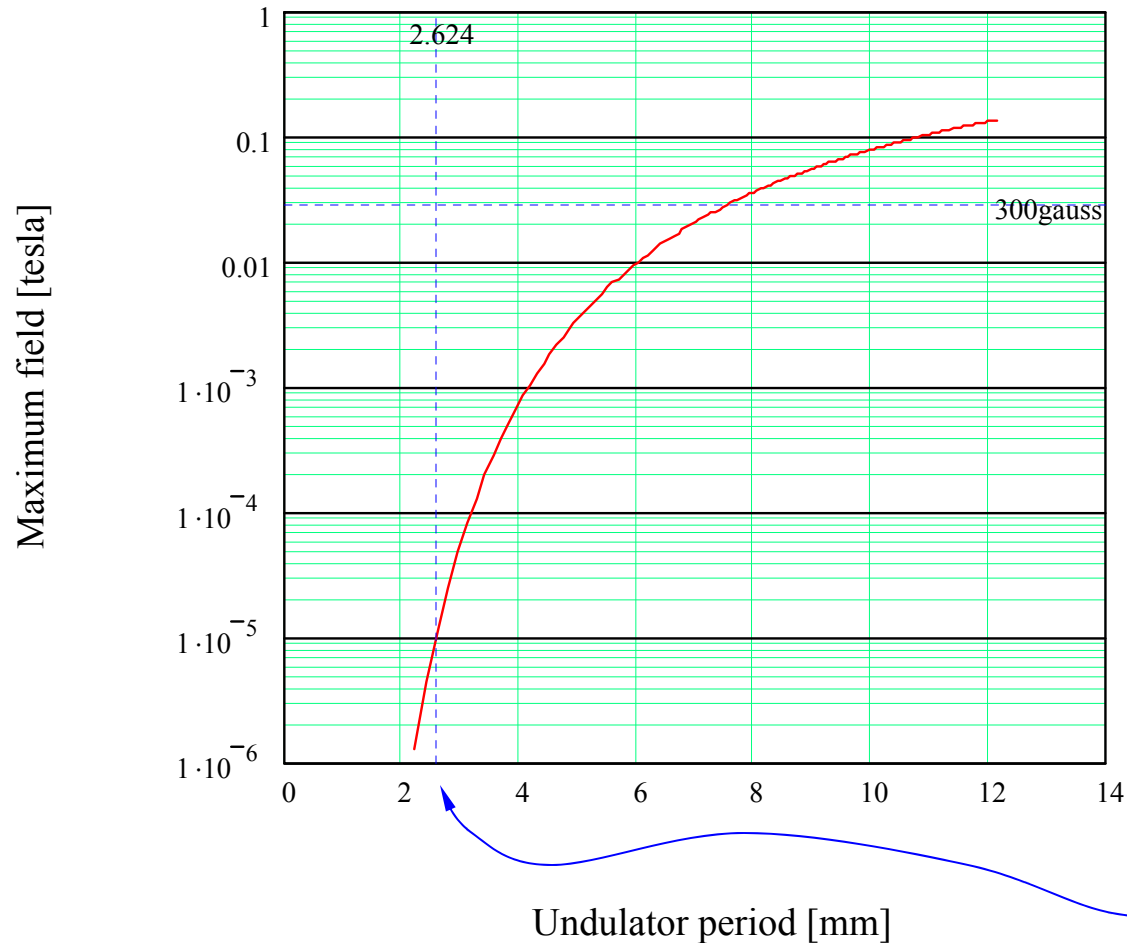

57 GHz  
RF undulator,  
period 2.6 mm,  
 $K = 0.007$

# RF undulator with reflective mode converters

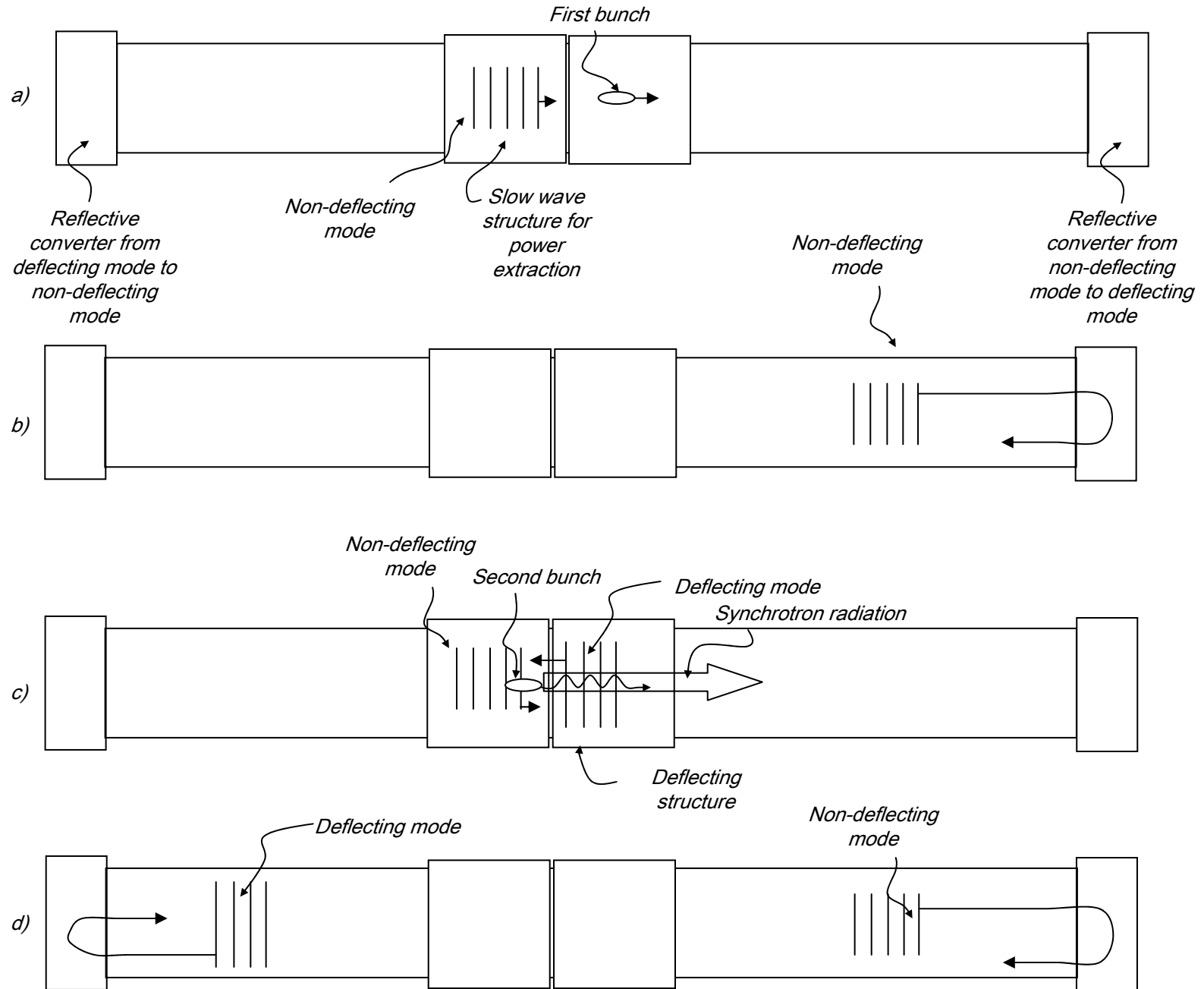

# Inline rf undulator

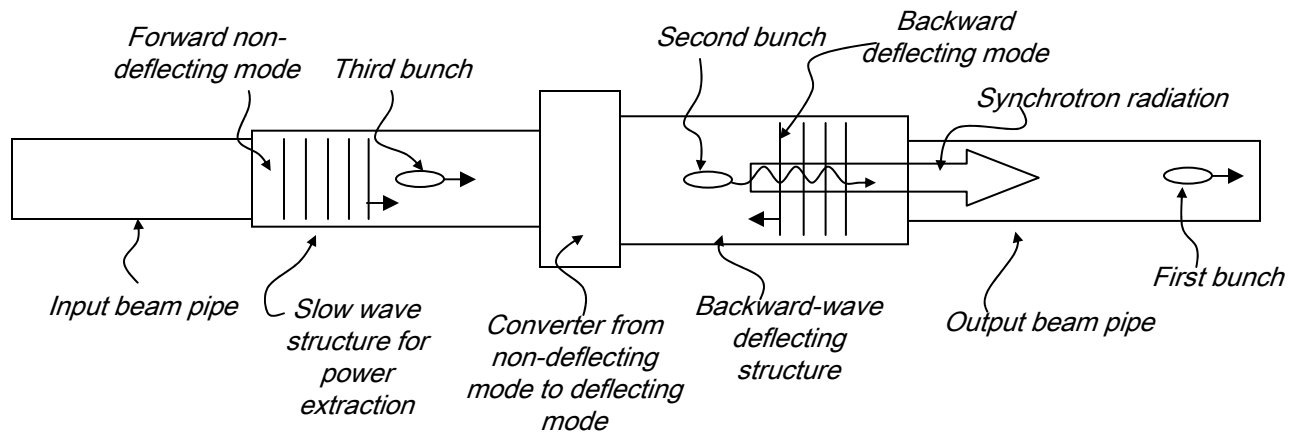

# RF undulator with resonant ring

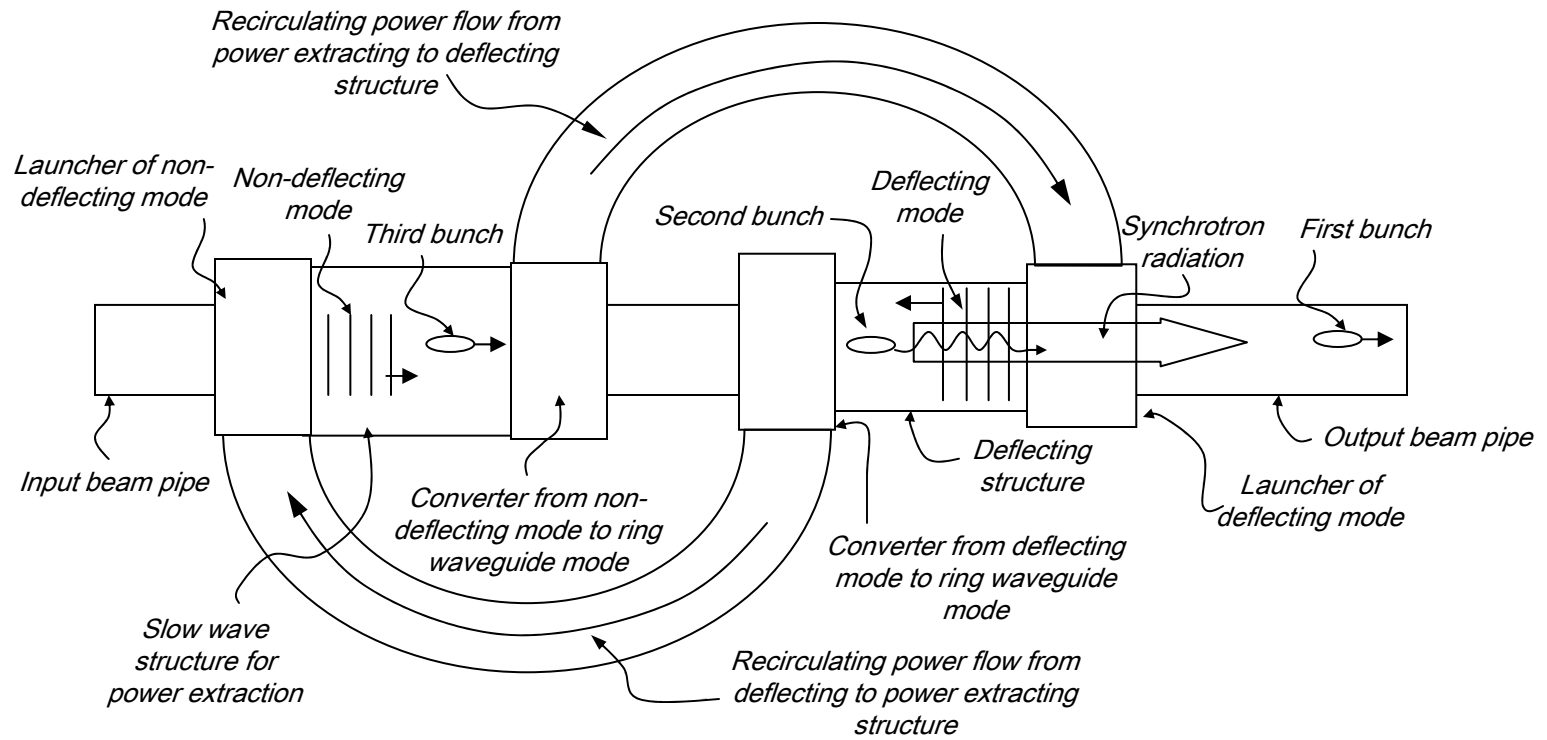

# RF undulator with SLED pulse compressor

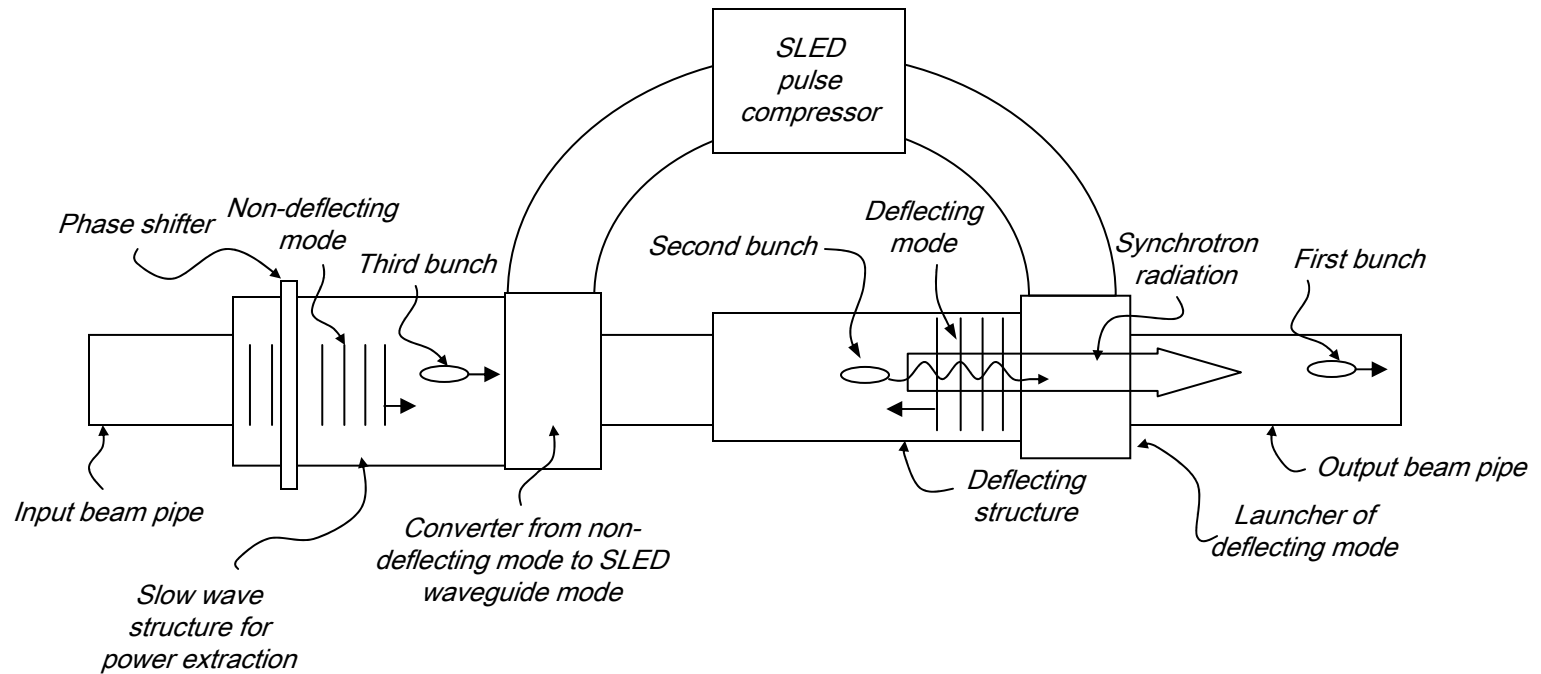

# Example of rf undulator with reflective mode converters

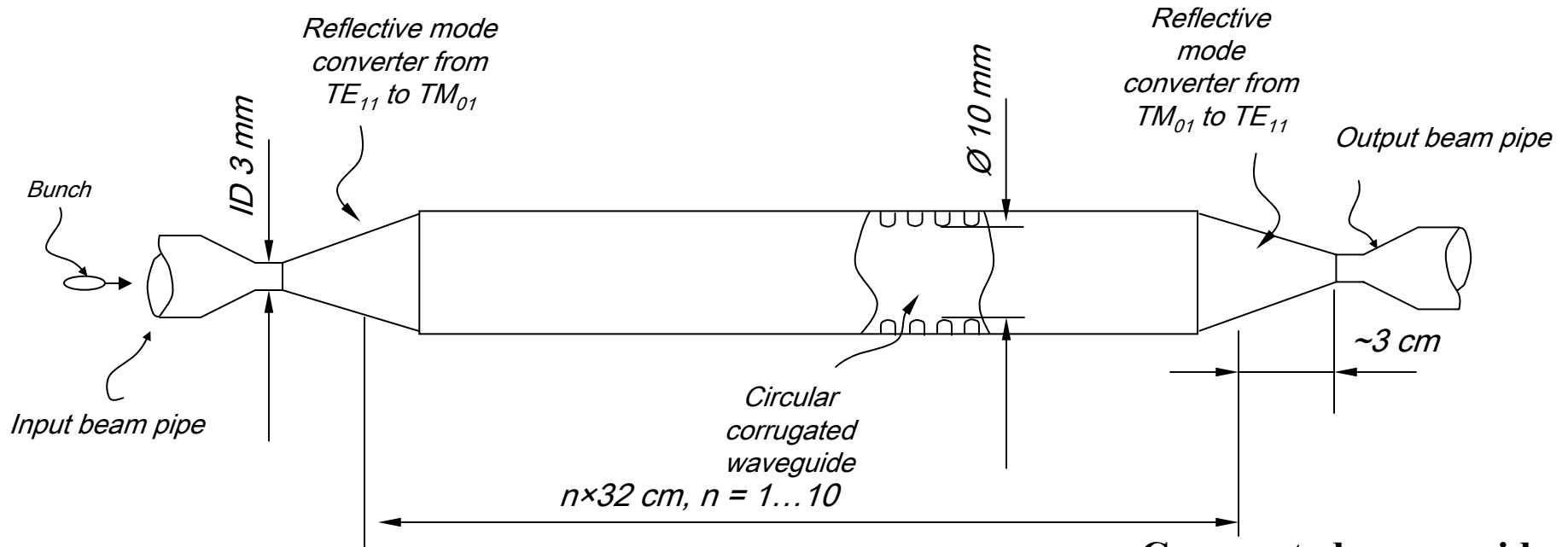

**Properties of rf undulator for  $10^{10}$  electrons in each bunch, and 1.4 ns bunch spacing:**

- Frequency 57 GHz
- Period 2.6 mm
- Equivalent static field 0.028 ... 0.036 T
- $K = 0.0068 \dots 0.0087$
- Length of “deflection”  $2.9 \text{ cm} \times n$

Parameter	Value
Aperture radius ( $a$ )	5 mm
Large radius ( $b$ )	5.6012 mm
Period ( $D$ )	1.7495 mm
Iris thickness ( $t$ )	0.7495 mm
Iris radius ( $r$ )	$t/2$

# Corrugated waveguide, monopole mode

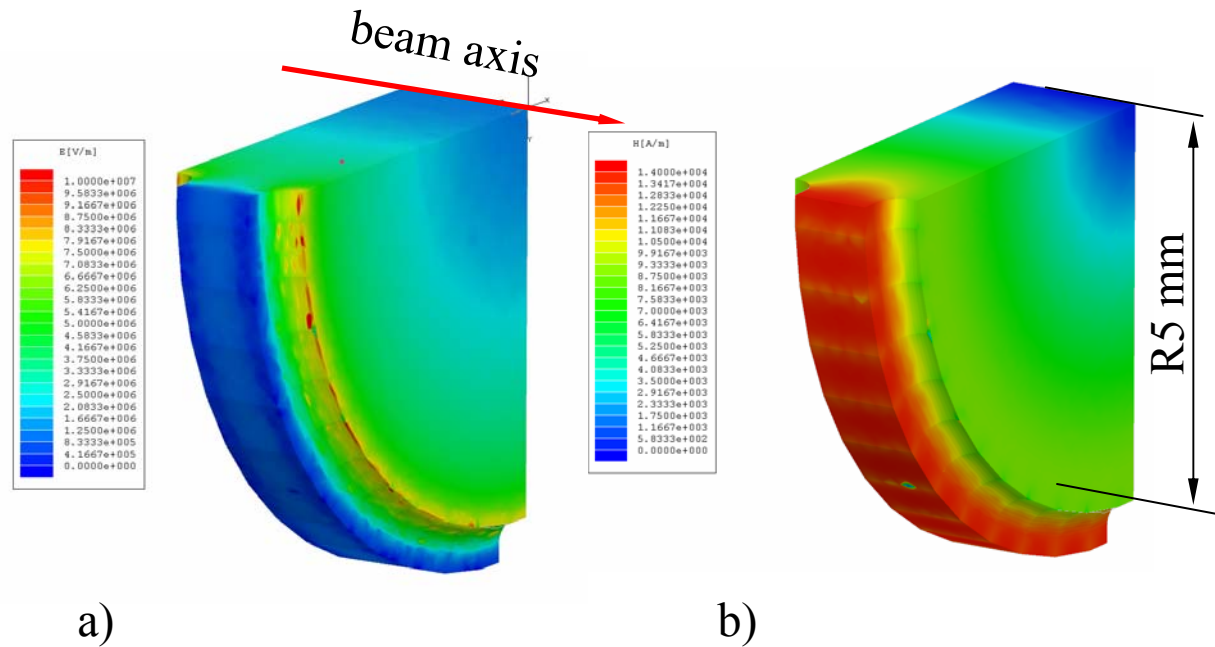

Field amplitudes of first monopole in the corrugated waveguide for 1 MW of transmitted power:

- a) amplitude of electric field
- b) amplitude of magnetic field

Parameter	Value
Frequency	57.12 GHz
Q value	6217
Effective impedance	1.221 kOhm/m
Shunt impedance	7.59180 MOhm/m
Phase advance per cell	120 degrees
Loss factor	461 V/pC/m
Group velocity	.762c
Dissipation length	396 cm

Parameters of corrugated waveguide as power extractor calculated by 2D Finite Element Code SLANS. Here  $c$  is the speed of light.

# Corrugated waveguide, deflecting mode

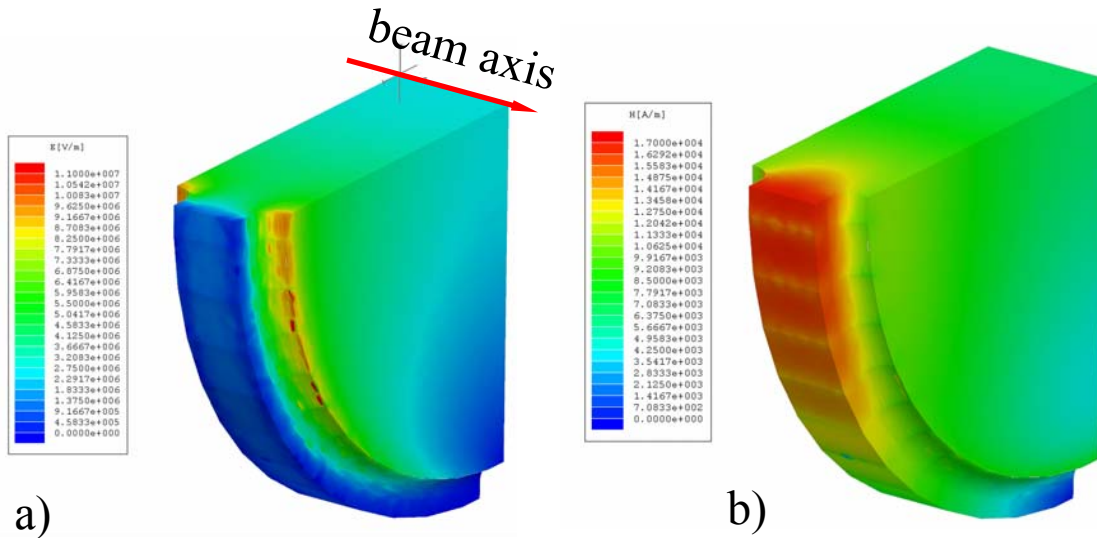

Field amplitudes for the first dipole mode in the corrugated waveguide for 1 MW of transmitted power:

- a) amplitude of electric field;
- b) amplitude of magnetic field

Parameter	Value
Frequency	57.23 GHz
Q value	7724
Maximum deflection	0.02 Tesla/sqrt(MW)
Phase advance per cell	120 degrees
Group velocity	.813c
Dissipation length	524 cm

Parameters of corrugated waveguide as a deflector calculated by 3D Finite Element Code HFSS.



# Example of $TM_{01}$ to $TE_{11}$ mode converter

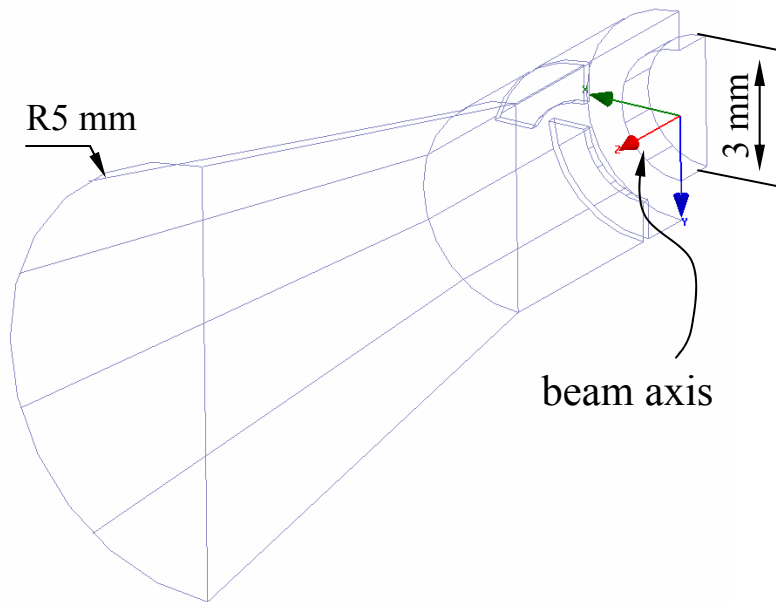

3D model

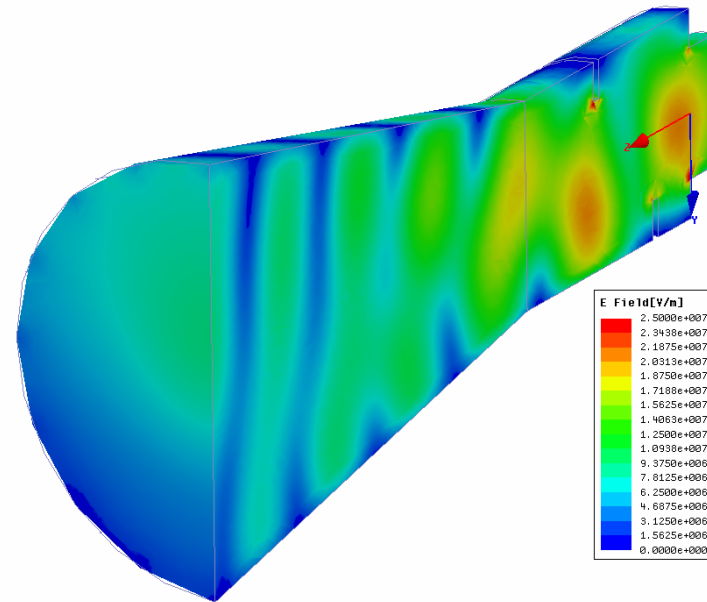

Amplitude of electric field for  
1 MW of incident power in  $TE_{11}$  mode

# S-parameters of $TM_{01}$ to $TE_{11}$ mode converter

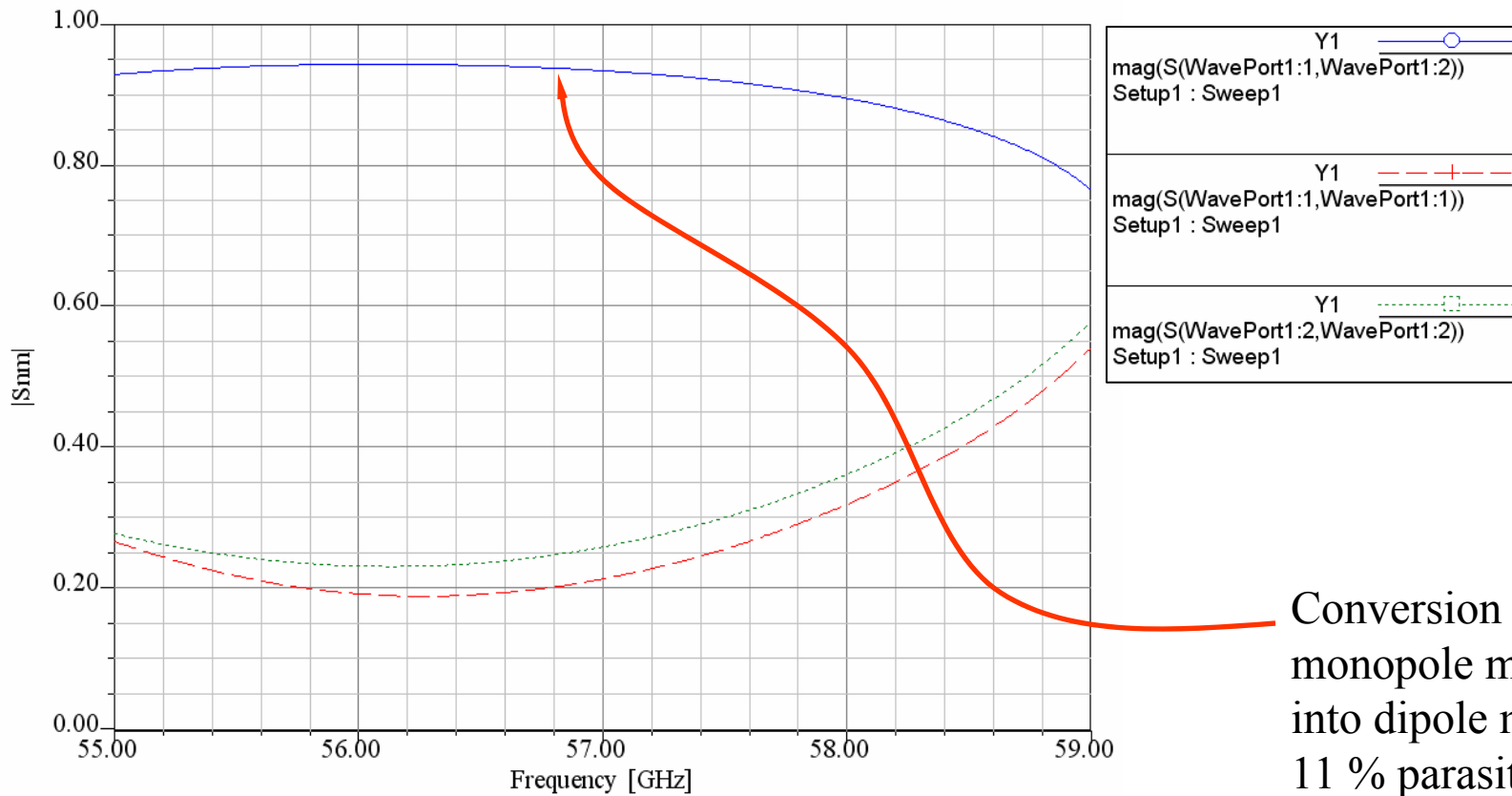

Conversion of the monopole mode into dipole mode, 11 % parasitic mode conversion

# Parameters of 57 GHz rf undulator

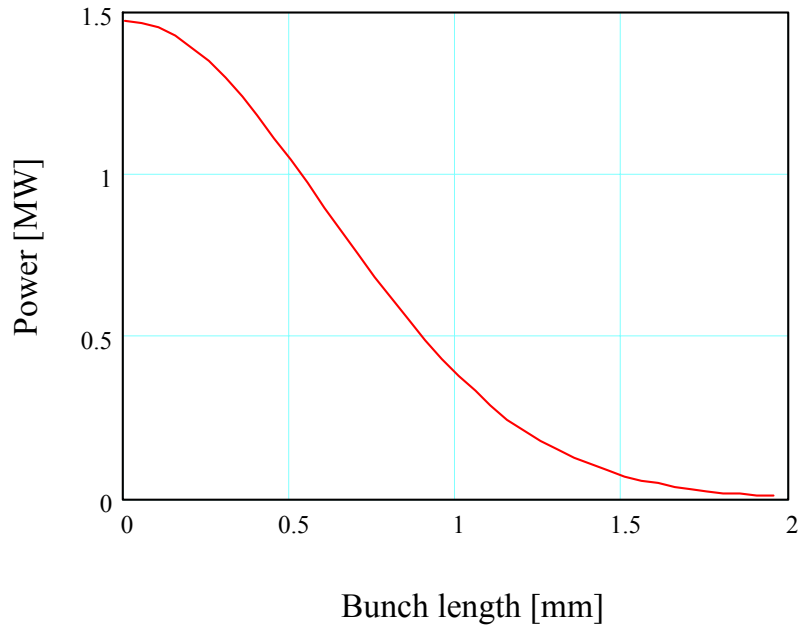

Power generated in the corrugated waveguide by **1.6 nC** bunch *vs.* the bunch length.

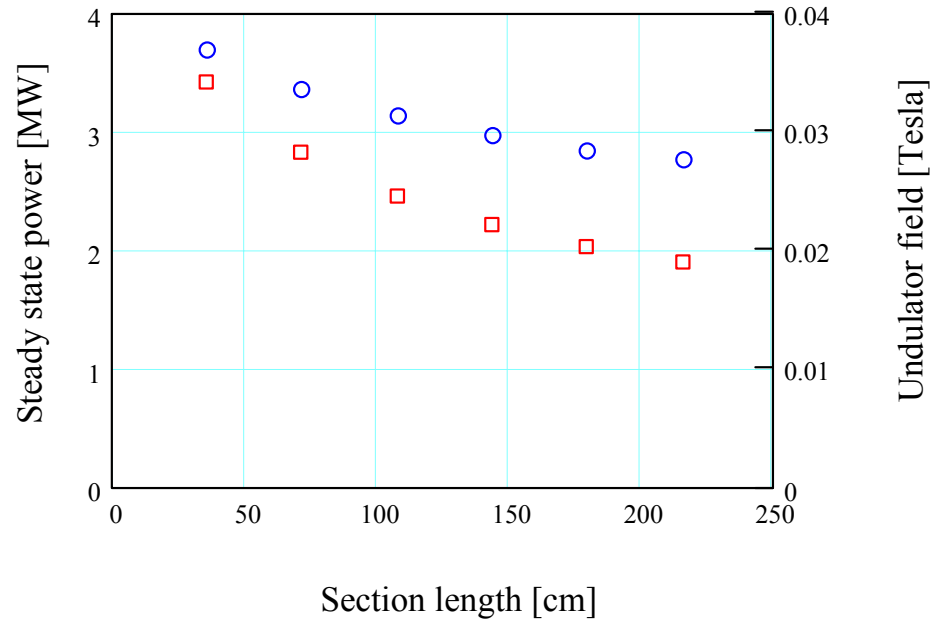

Steady state power (boxes) and undulator magnetic field (circles) *vs.* undulator length. To be resonant with 1.4 ns bunch spacing the undulator length is in multiples of 32 cm. This power is calculated for a bunch length of 0.2 mm, bunch charge 1.6 nC,

# Conclusion on beam-powered rf undulators

- Use of beam power might be a practical solution for  $\sim 1$  cm aperture,  $\sim 1$  mm period undulators.