

June 3, 2005
Tenth Edition



NASA's Implementation Plan for Space Shuttle Return to Flight and Beyond

*A periodically updated document
demonstrating our progress
toward safe return to flight
and implementation of the
Columbia Accident Investigation
Board recommendations*





NASA's Implementation Plan for Space Shuttle Return to Flight and Beyond

A periodically updated document demonstrating our progress toward safe return to flight and implementation of the Columbia Accident Investigation Board recommendations

June 3, 2005
Volume 1, Tenth Edition

An electronic version of this implementation plan is available at www.nasa.gov

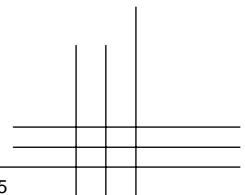

Tenth Edition Summary

June 3, 2005



This edition of NASA's *Implementation Plan for Space Shuttle Return to Flight (RTF) and Beyond* marks significant progress in our efforts to return safely to flight. NASA's focus on safety was reinforced with the decision to delay the planned return to flight launch (STS-114) to the July 2005 launch window when it was determined during the Design Verification Review for Debris that additional analysis was required prior to return to flight. The delay of the launch window will allow adequate time to perform the additional work. NASA's new Administrator, Dr. Michael Griffin, appointed in April 2005, supported the Space Shuttle Program's decision to delay the launch based on sound engineering rationale.

This edition provides updates to all of the *Columbia* Accident Investigation Board (CAIB) Return to Flight Recommendations and Observations that remain open. In this edition, all open Raising the Bar Space Shuttle Program Actions have been updated, and five of the nine open actions were closed. NASA's "Integrated Accepted Risk Approach" has been updated to reflect the steps NASA has taken to respond to the CAIB recommendations, to improve the Space Shuttle system, and to address the resulting impacts on our flight rationale.

The CAIB Recommendations involving the External Tank (3.2-1) and Orbiter Thermal Protection System (6.4-1 and 3.3-2) are key to NASA's return to flight rationale. The updates in this edition reflect the progress made to address the recommendations and the residual risk that NASA will accept when we return the Space Shuttle to flight. NASA's return to flight rationale for these crucial elements involves materials and processes that can only be fully tested and verified in the combined environments of space. As a result, the first two Space Shuttle missions will provide data necessary to support further development and refinement in these areas.

NASA has continued to meet the milestones leading to the STS-114 Space Shuttle return to flight mission including the Space Shuttle Program Design Certification Reviews, Design Verification Review for Debris, Mission Management Team Simulation for a Contingency Shuttle Crew Support decision, rollout of the STS-114 vehicle to the launch pad, tanking test of the External Tank, and Terminal Countdown Demonstration Test with the crew. These milestones and ongoing testing and analysis have helped us to identify some previously unknown issues, including the potential for critical ice debris and two issues identified during the tanking test that need to be resolved to ensure a safe return to flight. The fact that we have identified and responded to these issues by delaying the STS-114 launch date to allow time to resolve them is a demonstration of the improved engineering rigor and decision-making processes that have been implemented since the loss of the *Columbia* and her crew.

NASA continues to work with the Stafford-Covey Return to Flight Task Force toward closure of the remaining CAIB return to flight actions. The next meeting of the Task Force will take place in June 2005, prior to the return to flight mission STS-114.

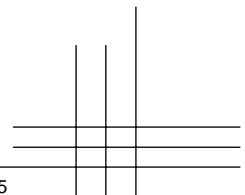

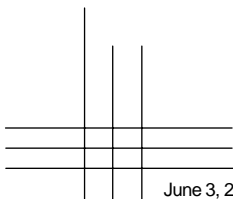

June 3, 2005

NASA's Implementation Plan for Space Shuttle Return to Flight and Beyond

Message From Michael Griffin



NASA is working hard to return the Space Shuttle safely to flight, a vital step in advancing our Nation's Vision for Space Exploration. With this 10th revision of NASA's *Implementation Plan for Space Shuttle Return to Flight and Beyond*, our Shuttle Program team presents the culmination of 27 months of intensive effort to make the Space Shuttle system, and NASA as a whole, stronger and safer. As a result of this work, we are now very close to the time when we can make an informed decision about launching the Space Shuttle *Discovery* on the STS-114 mission, a flight that will test and validate the hardware and procedures developed since the tragic loss of *Columbia* and its valiant crew.

Return to Flight has been a massive effort, focusing the energies of every technical discipline across all the NASA centers and Space Shuttle contractors on a very specific objective. I am proud of this Agency for its hard work, diligence, and professionalism during these difficult times.

As you will see in this update, NASA has made significant progress in improving the Shuttle system. As I stated when I came on board as NASA's Administrator, we will return to flight very deliberately and carefully with the utmost concern for the safety of the brave people we send on missions into space. We will not rush to flight.

Human space exploration is not and will never be without risk. However, I am convinced that this Nation and this Agency can execute the bold exploration agenda set forth by the President as safely as humanly possible.



Michael D. Griffin

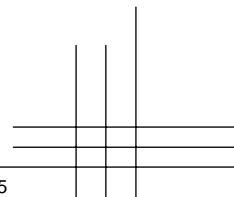

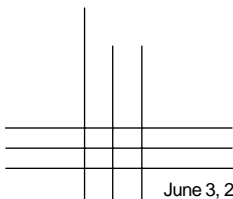

June 3, 2005

NASA's Implementation Plan for Space Shuttle Return to Flight and Beyond

Return to Flight Message from the Space Flight Leadership Council

With this tenth revision to *NASA's Implementation Plan for Return to Flight and Beyond*, NASA continues to make certain that we are as safe as we know how to be before we launch Space Shuttle *Discovery* and its crew on the Return to Flight mission, STS-114.

On April 29, 2005, after several reviews of status and test results, NASA concluded that it was prudent to conduct additional verification and validation of the extensive engineering work to ensure a safe Return to Flight. This decision moved the target launch window for the STS-114 mission to the July 2005 opportunity.

This *Implementation Plan* demonstrates that the NASA approach to returning to flight is based on a rigorous risk reduction approach that has its roots in the system safety engineering hierarchy for hazard abatement employed by NASA since the earliest days of the human space flight program. Through this approach, NASA has taken appropriate and extensive actions to eliminate, reduce, control, and/or mitigate potential hazards and risks in all critical areas of the Space Shuttle system.

Since the release of the *Columbia* Accident Investigation Board Final Report on September 26, 2003, NASA has addressed, and in many cases exceeded, the Board's Return to Flight recommendations. NASA has also conducted a number of related, self-generated "raise the bar" actions with the intent of driving down risks in key Space Shuttle systems. NASA has worked closely with the independent Stafford-Covey Return to Flight Task Group to reach agreement on closure of seven of the Board's fifteen Return to Flight recommendations (R4.2-3, R3.3-1, R4.2-5, R3.4-2, R4.2-1, R10.3-1, and R6.3-2) and conditional closure of Recommendation R3.4-1. Closure packages for the remaining open Return to Flight actions have been provided to the Task Group for review, and updates are scheduled for three of these packages prior to the launch of STS-114.

By its very nature, space flight is a high-risk endeavor. Despite our best efforts, it is not possible to totally eliminate that risk. However, during these past 27 months, we have done everything possible to reduce those risks. We will return to flight because the completion of the International Space Station and taking the first steps in implementing the Vision for Space Exploration depend upon a safe and expeditious launch schedule. But we will not rush to flight, and we will not launch until we are ready.

As NASA prepares to return the Nation to flight, the crew of STS-107—Rick Husband, Willie McCool, David Brown, Kalpana Chawla, Mike Anderson, Laurel Clark, and Ilan Ramon—remains foremost in our hearts and minds. Their legacy will continue to inspire us on the road ahead. For them, and for all the explorers who will follow and for whom we are ultimately responsible, we rededicate ourselves to upholding our core values of Safety, NASA Family, Excellence, and Integrity in all that we do.

Walter H. Cantrell

Walter H. Cantrell
Deputy Chief Engineer
for Independent Technical Authority

William F. Readdy

William F. Readdy
Associate Administrator
for Space Operations

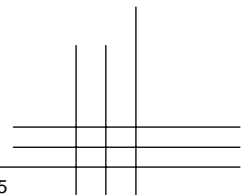

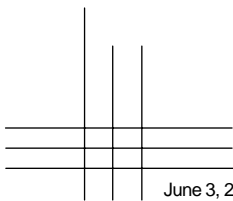

June 3, 2005

NASA's Implementation Plan for Space Shuttle Return to Flight and Beyond



Contents

The Integrated Accepted Risk Approach for Return to Flight	xiii
NASA Space Shuttle Return to Flight Suggestions	xix
CAIB Recommendations Implementation Schedule	xxiii
Return to Flight Cost Summary	xxix
Part 1 – NASA’s Response to the <i>Columbia</i> Accident Investigation Board’s Recommendations	
3.2-1 External Tank Thermal Protection System Modifications [RTF].....	1-1
3.3-2 Orbiter Hardening and Thermal Protection System Impact Tolerance [RTF]	1-15
3.3-1 Reinforced Carbon-Carbon Nondestructive Inspection [RTF]	1-21
6.4-1 Thermal Protection System On-Orbit Inspect and Repair [RTF].....	1-25
3.3-3 Entry with Minor Damage	1-35
3.3-4 Reinforced Carbon-Carbon Database	1-37
3.3-5 Minimizing Zinc Primer Leaching.....	1-39
3.8-1 Reinforced Carbon-Carbon Spares	1-41
3.8-2 Thermal Protection System Impact Damage Computer Modeling	1-43
3.4-1 Ground-Based Imagery [RTF]	1-45
3.4-2 External Tank Separation Imagery [RTF]	1-51
3.4-3 On-Vehicle Ascent Imagery [RTF]	1-53
6.3-2 National Imagery and Mapping Agency Memorandum of Agreement [RTF]	1-57
3.6-1 Update Modular Auxiliary Data Systems	1-59
3.6-2 Modular Auxiliary Data System Redesign.....	1-61



Contents

4.2.2	Enhance Wiring Inspection Capability.....	1-63
4.2-1	Solid Rocket Booster Bolt Catcher [RTF].....	1-67
4.2-3	Closeout Inspection [RTF].....	1-71
4.2-4	Micrometeoroid and Orbital Debris Risk	1-73
4.2-5	Foreign Object Debris Processes [RTF]	1-77
6.2-1	Scheduling [RTF]	1-79
6.3-1	Mission Management Team Improvements [RTF]	1-85
9.1-1	Detailed Plan for Organizational Changes [RTF]	1-89
7.5-1	Independent Technical Engineering Authority	1-89
7.5-2	Safety and Mission Assurance Organization	1-89
7.5-3	Reorganize Space Shuttle Integration Office	1-89
9.2-1	Mid-Life Recertification	1-97
10.3-1	Digitize Closeout Photographs [RTF].....	1-99
10.3-2	Engineering Drawing Update	1-103

Part 2 – Raising the Bar – Other Corrective Actions

2.1 – Space Shuttle Program Actions

SSP-1	Quality Planning and Requirements Document/Government Mandated Inspection Points	2-1
SSP-2	Public Risk of Overflight.....	2-3
SSP-3	Contingency Shuttle Crew Support.....	2-5
SSP-4	Acceptable Risk Hazards.....	2-9
SSP-5	Critical Debris Sources	2-11
SSP-6	Waivers, Deviations, and Exceptions.....	2-13
SSP-7	NASA Accident Investigation Team Working Group Findings.....	2-15
SSP-8	Certification of Flight Readiness Improvements.....	2-17
SSP-9	Failure Mode and Effects Analyses/ Critical Items Lists	2-19

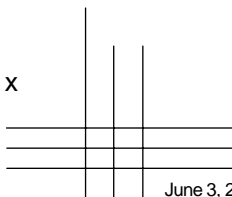



Contents

SSP-10	Contingency Action Plans	2-21
SSP-11	Rudder Speed Brake Actuators	2-23
SSP-12	Radar Coverage Capabilities and Requirements.....	2-25
SSP-13	Hardware Processing and Operations	2-27
SSP-14	Critical Debris Size.....	2-29
SSP-15	Problem Tracking, In-Flight Anomaly Disposition, and Anomaly Resolution.....	2-31
2.2 – CAIB Observations		
O10.1-1	Public Risk Policy.....	2-35
O10.1-2	Public Overflight Risk Mitigation.....	2-41
O10.1-3	Public Risk During Re-Entry.....	2-41
O10.2-1	Crew Survivability.....	2-43
O10.4-1	KSC Quality Planning Requirements Document.....	2-45
O10.4-2	KSC Mission Assurance Office	2-47
O10.4-3	KSC Quality Assurance Personnel Training Programs.....	2-51
O10.4-4	ISO 9000/9001 and the Shuttle.....	2-53
O10.5-1	Review of Work Documents for STS-114.....	2-55
O10.5-2	Orbiter Processing Improvements.....	2-57
O10.5-3	NASA Oversight Process	2-59
O10.6-1	Orbiter Major Maintenance Planning.....	2-61
O10.6-2	Workforce and Infrastructure Requirements.....	2-63
O10.6-3	NASA's Work with the U.S. Air Force.....	2-65
O10.6-4	Orbiter Major Maintenance Intervals	2-67
O10.7-1	Orbiter Corrosion.....	2-69
O10.7-2	Long-Term Corrosion Detection	2-71
O10.7-3	Nondestructive Evaluation Inspections	2-73
O10.7-4	Corrosion Due to Environmental Exposure	2-75
O10.8-1	A-286 Bolts	2-77
O10.8-2	Galvanic Coupling.....	2-79
O10.8-3	Room Temperature Vulcanizing 560 and Koropon	2-81



Contents

O10.8-4	Acceptance and Qualification Procedures	2-83
O10.9-1	Hold-Down Post Cable System Redesign	2-85
O10.10-1	External Tank Attach Ring	2-89
O10.11-1	Shuttle Maintenance Through 2020	2-93
O10.12-1	Agencywide Leadership and Management Training	2-95
 2.3 CAIB Report, Volume II, Appendix D.a		
D.a-1	Review Quality Planning Requirements Document Process	2-99
D.a-2	Responsive System to Update Government Mandatory Inspection Points	2-100
D.a-3	Statistically Driven Sampling of Contractor Operations	2-101
D.a-4	Forecasting and Filling Personnel Vacancies	2-102
D.a-5	Quality Assurance Specialist Job Qualifications	2-104
D.a-6	Review Mandatory Inspection Document Process	2-105
D.a-7	Responsive System to Update Government Mandatory Inspection Points at the Michoud Assembly Facility	2-106
D.a-8	Use of ISO 9000/9001	2-107
D.a-9	Orbiter Corrosion	2-108
D.a-10	Hold-Down Post Cable Anomaly	2-109
D.a-11	Solid Rocket Booster External Tank Attach Ring	2-110
D.a-12	Crew Survivability	2-111
D.a-13	RSRM Segment Shipping Security	2-112
D.a-14	Michoud Assembly Facility Security	2-113

Appendix A – NASA’s Return to Flight Process

Appendix B – Return to Flight Task Group

Appendix C – Return to Flight Summary Overview





The Integrated Accepted Risk Approach for Return to Flight

NASA has come a long way in our journey to reduce the risks of operating the Space Shuttle system. The External Tank bipod Thermal Protection System has been redesigned to eliminate the proximate cause of the *Columbia* accident. In all areas we have applied the collective knowledge and capabilities of our Nation to comply with the *Columbia* Accident Investigation Board recommendations and to raise the bar beyond that. We have taken prudent technical action on potential threats to review and verify the material condition of all critical areas where failure could result in catastrophic loss of the crew and vehicle. We are satisfied that critical systems and elements should operate as intended—safely and reliably. While we will never eliminate all the risks from our human space flight programs, we have eliminated those we can and reduced, controlled, and/or mitigated others. The remaining identified risks will be evaluated for acceptance.

Our approach to launching, operating on orbit, and safely returning the Space Shuttle *Discovery* to flight on the planned STS-114 mission is based on a rigorous process to achieve the capabilities needed to meet our objectives. Greater capabilities may be achievable with more time and resources; however, the current primary Space Shuttle mission is to assemble and support the ongoing operation of the International Space Station. The missions and risks of the International Space Station and Space Shuttle are, for the near term, inseparable. As we look forward to the limited launch window opportunities in 2005, we must ask ourselves if the risks of Space Shuttle flight are acceptable. Although we will never eliminate all the risks from our Space Shuttle missions, we are confident that we have addressed those that constituted the proximate cause of the loss of *Columbia* and have eliminated, reduced, controlled, and/or mitigated other risks, including engineering, operational, and programmatic risks. We acknowledge that there is more that can be done over the long haul to further reduce risk, but the marginal risk return is getting smaller and smaller. With deliberate forethought, we now choose to assess the risk associated with the achievable capabilities consistent with the 2005 launch windows that are available. Before we commit to launching the STS-114 mission, we will assure that the residual risk is at an acceptable level to safely return to flight. If we cannot collectively decide that the risk to the Space Shuttle

is acceptable for a 2005 return to flight, we will continue to work those technical issues until the risk is acceptable. We clearly demonstrated our commitment by our recent decision concerning the risk associated with the potential for ice formation in the forward liquid oxygen bellows. Based on the unanimous position of the Design Verification Review Board, which deemed the risk unacceptable, we now choose to install the bellows heater prior to launch. The only milestone that is irreversible is liftoff; we can choose to stop at any time before T-0.

Our risk reduction approach has its roots in the system safety engineering hierarchy for hazard abatement long employed in aerospace systems engineering. The components of the hierarchy are, in order of precedence, to: design/redesign; eliminate the hazard/risk; reduce the hazard/risk; and control the hazard/risk and/or mitigate the consequence of the remaining hazard/risk through warning devices, special procedures/capabilities, and/or training. This proven approach to risk reduction has been applied to potential hazards and risks in all critical areas of the Space Shuttle and has guided us through the technical challenges, failures, and successes present in return to flight endeavors. This approach, as shown in the figure at the top of the following page, provides the structured deliberation process required to verify and form the foundation for accepting any residual risk across the entire Space Shuttle Program by NASA leadership.

Space flight and operations are endeavors that could not be undertaken without accepting high levels of risk. Throughout history, humans have accepted risk to achieve the great rewards that exploration offers. Many have bravely faced the hazards and dangers of exploration and failed. NASA has had many more successes than failures, but we make every attempt to learn as much as possible from every failure before continuing. We choose to continue space exploration as an endeavor that is worthy of the risks to achieve our mission, to acquire the ultimate rewards, and to expand our knowledge of the universe. Accepting risk is not taken lightly.

Within the Space Shuttle Program, our system safety engineering hierarchy for hazard abatement requires that we understand and document how we deal with identified

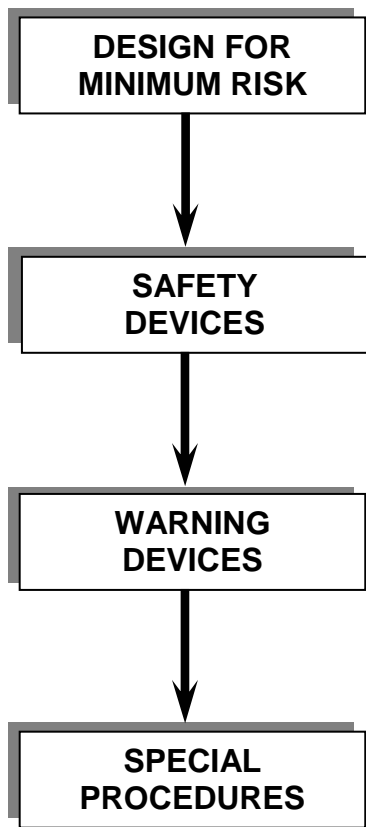

The major goal throughout the design phase shall be to ensure inherent safety through the selection of appropriate design features as fail operational/failure safe combinations and appropriate safety factors. Hazards shall be eliminated by design where possible. Damage control, containment, and isolation of potential hazards shall be included in design considerations.

Known hazards that cannot be eliminated through design selection shall be reduced to an acceptable level through the use of appropriate safety devices as part of the system, subsystem, or equipment.

Where it is not possible to preclude the existence or occurrence of a known hazard, devices shall be employed for the timely detection of the condition and the generation of an adequate warning signal. Warning signals and their application shall be designed to minimize the probability of wrong signals or of improper personnel reaction to the signal.

Where it is not possible to reduce the magnitude of existing or potential hazard through design or the use of safety and warning devices, special procedures shall be developed to counter hazardous conditions for enhancement of ground and flight crew safety. Precautionary notations shall be standardized.

hazards. Hazards that have been eliminated through design by completely removing the hazard causal factors are documented as eliminated. Hazards that cannot be eliminated can be considered controlled when we can demonstrate that the frequency of occurrence or consequence has been reduced to a point that it is unlikely to occur during the life of the program. Where identified hazards cannot be eliminated or where controls of the hazard causes have limitations or uncertainties such that the hazard may occur in the life of the program, program management may, after considering all engineering data and opinions, accept the risk.

Return to Flight Requirements

Our top-level requirement for debris is the same as it was before *Columbia*: “The SSS [Space Shuttle system], including the ground systems, shall be designed to preclude the shedding of ice and/or other debris from the Shuttle elements during prelaunch and flight operations that would jeopardize the flight crew, vehicle, mission success, or would adversely impact turnaround operations.” The *Columbia* Accident Investigation Board deter-

mined that the primary cause of the loss of *Columbia* was the loss of the Thermal Protection System foam from the External Tank bipod that struck the Reinforced Carbon-Carbon panel on *Columbia*'s left wing leading edge. Loss of foam was not an isolated incident. Over the life of the Space Shuttle Program there were seven documented cases of foam loss from the left-hand bipod and loss of foam from other areas of the External Tank on every flight. The Space Shuttle Program has compiled a comprehensive database of historical tile damage to help us understand both the sources of the damage and their effect on the integrity of the Orbiter Thermal Protection System. Since *Columbia*, we have initiated a comprehensive test and analysis program to better characterize the potential for External Tank foam loss, to understand the transport mechanisms that move liberated debris to the Orbiter, and to gain knowledge of the capabilities of the Orbiter Thermal Protection System tile and Reinforced Carbon-Carbon elements to withstand impact. From this effort, requirements for allowable debris for given sources have been established to protect the Orbiter elements from critical impact.

Design for Minimum Risk

The External Tank bipod Thermal Protection System has been redesigned to reduce the potential for loss of foam that led to the *Columbia* accident. Our far-reaching initiative to eliminate or reduce the potential for generation of critical debris has led us to the most comprehensive understanding of the overall Space Shuttle system in the history of the Program. We have identified and examined all debris sources and, where necessary, initiated redesign efforts to reduce the potential for debris formation and liberation. There are four primary areas identified on the External Tank for evaluation and redesign to reduce or eliminate the potential for critical debris generation: the bipod foam, the liquid oxygen feedline bellows ice formation, the liquid hydrogen intertank flange foam close-out, and the protuberance air load foam ramps. All have been addressed with respect to the Orbiter debris damage tolerance capabilities and will be verified for flight. In addition to the External Tank, we have assessed the Solid Rocket Booster separation motor plumes and Thermal Protection System elements, as well as potential Orbiter debris sources such as thruster plumes and butcher paper covers. In the forward portion of the Orbiter, butcher paper was previously used to cover thruster nozzles to prevent rain from entering prior to launch. This butcher paper is being replaced with a less dense material (Tyvec) that will be combined with a release capability to make the material fall off at low speeds and reduce the potential for damage to the windows. Our solid rocket bolt catcher system has been redesigned to eliminate a potential failure point, the housing weld, and has been tested and proven to meet design requirements.

Safety Devices

Although redesigning the External Tank Thermal Protection System to reduce the potential for major foam loss is our primary goal, we have crafted a wide-ranging approach for reducing the overall risk of operating the Space Shuttle system. NASA agrees that *Columbia* clearly demonstrated that the Orbiter Thermal Protection System, including Reinforced Carbon-Carbon panels, is vulnerable to impact damage from the existing debris environment. Through tests and analysis, we have a new appreciation for the potential sources and size of debris that might be present during ascent. We have a new understanding of the capability of the Orbiter Thermal Protection System to withstand debris hits in all flight regimes. Our test program forms the basis for our newly developed debris transport analysis, providing improved knowledge of the multitude of paths debris might travel to impact the Orbiter and forming the basis for a validated computerized model for future near-real-time evaluation.

Our fundamental return to flight rationale is based on the necessary reduction in risk of ascent debris damage to be accomplished primarily through modifications to the External Tank. The allowable debris limits for the External Tank were set, and the External Tank was delivered meeting those limits. The definition of critical debris is derived from the ability of the current Orbiter, not the hardened Orbiter, to withstand impact damage. Therefore, Orbiter hardening provides an additional level of risk mitigation above and beyond our primary control. We have initiated an Orbiter hardening program that will be implemented as feasible—an approach consistent with the *Columbia* Accident Investigation Board recommendation to initiate a program of Orbiter hardening prior to return to flight. The Orbiter hardening options are being implemented in three phases. Four projects were identified as Phase I, based on maturity of design and schedule for implementation, and will be implemented before return to flight. These include: front spar “sneak flow” protection for the most vulnerable and critical wing leading edge panels 5 through 13; main landing gear corner void elimination; forward Reaction Control System carrier panel redesign to eliminate bonded studs; and replacing side windows 1 and 6 with thicker outer thermal panes. We accept the risk associated with not having improved Orbiter hardening capability beyond what has been put in place for return to flight and will reduce this risk over the long haul by continuing to pursue additional hardening measures.

Warning Devices

In the unlikely event the Orbiter experiences a debris hit, we have greatly expanded capabilities to detect debris liberation during ascent, to identify locations on the External Tank where debris may have originated, and to identify impact sites on the Orbiter Thermal Protection System for evaluation. Our ability to identify debris release during the first few minutes of ascent is enhanced through the addition of high-speed cameras, aircraft-mounted cameras, and radar. A camera installed on the External Tank will provide real-time, on-vehicle views during ascent.

Video cameras on the Solid Rocket Boosters will record the condition of the External Tank intertank areas for later review after booster recovery. In addition to the External Tank umbilical film cameras that will be examined after the mission, the images gathered from a digital camera, added in the umbilical area on the Orbiter at the External Tank interface, will be downlinked soon after the Orbiter achieves orbit. The crew will also take images of the External Tank using digital cameras shortly after separation to later downlink.

In the near term, we are committed to daylight launches and External Tank separation in lighted conditions on orbit to improve our ability to identify debris releases during ascent and assess the condition of the External Tank after separation, and to determine that our debris reduction efforts were successful. Requirements for daylight launches and lighted External Tank separation will be re-evaluated after the second mission, STS-121. To further augment impact detection capabilities, we are installing an impact detection sensor system on the interior of the wing leading edge to identify whether the Reinforced Carbon-Carbon panels were struck during ascent. Once on orbit, the crew will use the new Orbiter Boom Sensor System to examine the condition of the wing leading edge and nose cap for signs of critical impact. The Orbiter Boom Sensor System is grappled by the Shuttle Remote Manipulator System, known as the arm, and will have a combination of a camera and a laser depth detection system to characterize the surface of the Reinforced Carbon-Carbon elements. When approaching the International Space Station, the Orbiter will be turned to present its underside to the Expedition crew, who will use digital cameras with telephoto lenses to capture images of the Orbiter's Thermal Protection System.

Individually, each warning device/inspection method listed above will not provide the total information needed to accurately determine the condition of the Orbiter prior to committing to entry. They are not redundant systems per se, in that each provides a different piece of the puzzle, offering overlapping information to improve our knowledge of the Orbiter's condition. We can accept failure of one or more warning devices and have the confidence that we will be able to characterize potential debris liberation and possible damage to the Thermal Protection System tile and Reinforced Carbon-Carbon components. NASA considers the limitations of this approach to be reasonable.

Special Procedures

During Space Shuttle missions, data collected from multiple ground-based, on-vehicle, and space-based sources will be immediately evaluated through an integrated imagery evaluation process. Although we made great strides in reducing the potential for debris generation, a small potential for impacts to Orbiter tile and Reinforced Carbon-Carbon elements remains. Based on our expanded understanding of debris transport mechanisms and the capability of the Orbiter Thermal Protection System, we have established criteria for further on-orbit imagery and evaluation of potential tile damage. Data collected from multiple ground-based, on-vehicle, and space-based sources will be immediately evaluated through an integrated imagery eval-

uation process. Should tile damage exceed our criteria, plans are in place for further evaluation and repair, if necessary. These plans include: a focused inspection using the Orbiter Boom Sensor System, a spacewalk to get close-up images and make a visual evaluation, and/or implementing our limited Thermal Protection System repair capability. In any case, the appropriate risk assessment of each course of action will be conducted and presented to the Mission Management Team for evaluation and an implementation decision. Together with the work of the inspection tiger team, the Shuttle Systems Engineering and Integration Office began development of a Thermal Protection System Readiness Determination Operations Concept document. Most critically, this document will specify the process for collecting, analyzing, and applying the diverse inspection data in a way that ensures effective and timely risk assessment and mission decision-making. This risk assessment process will provide the Mission Management Team with the most comprehensive evaluation of the Orbiter's condition prior to committing to entry in the history of the Program.

We are mindful that our newfound capabilities have both built-in conservatism and limitations in completely identifying all unknowns. In many cases, the determination of debris sources and the resulting definition of potential debris environment during ascent have led to a conservative assessment of the risk. The accuracy of ascent and on-orbit imagery is dependent on the systems working as designed, weather conditions, and lighting. Potential damage to Orbiter Thermal Protection System elements has been closely scrutinized and extensively tested with the expectation that margin is available. Our limited Thermal Protection System repair techniques remain to be demonstrated on orbit, then analyzed and tested upon return to Earth in an effort to provide evidence of capability.

Despite our best efforts, it is not possible to completely reproduce on Earth the integrated environment experienced during a Space Shuttle mission. NASA also recognizes that it is not possible to totally eliminate the possibility of a debris impact like that which doomed *Columbia*; however, the actions taken have reduced to well below any previous Space Shuttle flight the risk of a repeat of that event. Unprecedented mitigation actions for that remote eventuality are in place. In the unlikely event that all of our efforts to reduce risk and safely return the Space Shuttle to flight fail, we have made plans to keep the Space Shuttle crew on the International Space Station and mount a rescue mission. Through the flight readiness review process, we will periodically evaluate the capability of the International Space Station to accommodate the Space Shuttle crew with food, water, and breathable oxygen. This capability, known as the

Contingency Shuttle Crew Support, will only be used in the direst of circumstances and will not be used to justify flying unsafely. The Contingency Shuttle Crew Support and rescue mission requirements will be evaluated after the first two return to flight missions.

Additional Risk Reduction Efforts

In addition to the technical and operational improvements to the Shuttle system, NASA has improved our overall approach to safety and mission success. Early on, we set up the NASA Engineering and Safety Center at Langley Research Center to provide the Agency with a cadre of highly qualified and experienced engineers to deal with tough technical issues and to leverage the best talent our Nation has to offer. Through the implementation of our Agency Independent Technical Authority and the establishment of an independent Safety and Mission Assurance organizational structure, we have invigorated the critical checks and balances needed to provide for safe and reliable operations. Our Space Shuttle System Integration and Engineering Office has broader responsibilities and advanced tools with which to evaluate and define the critical environment in which the Space Shuttle operates in ways never before put into practice. The growth and strength of this office has been instrumental in providing greater understanding and knowledge of the interaction between elements as we prepared for return to safe and reliable Space Shuttle operations. We further defined the roles and responsibilities of the Mission Management Team and provided critical training through courses and mission simulations to assure that team members are ready for the challenges and uncertainty ahead. We have enhanced the integrity of closeout inspections by requiring a minimum of two people at each inspection, improved our digital closeout photography system and processes, and brought our foreign object debris definition processes in line with industry practices.

We are attentive to the fact that we were criticized for focusing on schedule and not heeding the warning signs that we were overtaxing available resources in the system. Our risk management system has been enhanced and strengthened by balancing technical, schedule, and resource risks to successfully achieve safe and reliable

operations. Safe and reliable operations are assured by first focusing on the technical risks and taking the needed time and resources to properly resolve technical issues. Once technical risks are eliminated or reduced to an acceptable level, program managers turn to the management of schedule and resource risks to preserve safety. Schedules are integral parts of program management and provide for the integration and optimization of resource investments across a wide range of connected systems. The Space Shuttle Program must have a visible schedule with clear milestones to effectively achieve its mission. Schedules associated with all activities generate very specific milestones that must be completed for mission success. Nonetheless, schedules of milestone-driven activities will be extended when necessary to ensure safety, as we have demonstrated numerous times during the return to flight process. NASA will not compromise safe and reliable operations in an effort to optimize schedules or costs.

For now, there will be a level of residual risk that will be presented to NASA leadership for acceptance prior to return to flight. Our risk assessment/risk management process does not end with STS-114. We are committed to continuous risk evaluation of our experiences gained through each mission and will continue to factor in ongoing enhancements over time. We understand that the primary Space Shuttle mission is to assemble and support the ongoing operation of the International Space Station. The missions and risks of the International Space Station and Space Shuttles are, for the near term, inseparable.

We have met many challenges during our journey, but we proceed with the full understanding that we have done all that is reasonably achievable; and the result of our efforts offers *Discovery's* crew, led by Commander Eileen Collins, risks that have been reduced and mitigated to the extent possible. We are committed to safely returning to flight and safely flying the Space Shuttle fleet until its retirement. To do less would inappropriately diminish the contributions of the STS-107 crew and our astronauts who will honor that crew's legacy.





NASA Space Shuttle Return to Flight (RTF) Suggestions

As part of NASA's response to the *Columbia* Accident Investigation Board (CAIB) recommendations, the Administrator asked that a process be put in place for NASA employees and the public to provide their ideas to help NASA safely return to flight. With the first public release of NASA's Implementation Plan for Space Shuttle Return to Flight and Beyond on September 8, 2003, NASA created an electronic mailbox to receive RTF suggestions. The e-mail address is "RTFsuggestions@nasa.gov." A link to the e-mail address for RTF suggestions is posted under the return to flight link on the NASA Web page "www.nasa.gov."

The first e-mail suggestion was received on September 8, 2003. Since then, NASA has received a total of 2683 messages, averaging 56 messages per week. NASA has provided a personal reply to each message. When applicable, information was provided as to where the message was forwarded for further review and consideration.

As NASA approaches our planned RTF date, it is critical that we move from development to implementation. As a part of this effort, we are now baselining all critical RTF activities. As a result, although we will continue to maintain the RTFsuggestions@nasa.gov e-mail box, beginning on September 1, 2004, NASA addressees will receive an automated response. NASA will periodically review the suggestions received for future use. We

appreciate all of the interest and thoughtful suggestions received to date and look forward to receiving many more suggestions to both improve the Space Shuttle system and apply to exploration systems.

Many of the messages received are provided for review to a Project or Element Office within the Space Shuttle Program, the International Space Station Program, the Safety and Mission Assurance Office, the Training and Leadership Development Office, the newly established NASA Engineering and Safety Center, or to the NASA Team formed to address the Agencywide implications of the CAIB Report for organization and culture.

NASA organizations receiving suggestions are asked to review the message and use the suggestion as appropriate in their RTF activities. When a suggestion is forwarded, the recipient is encouraged to contact the individual who submitted the suggestion for additional information to assure that the suggestion's intent is clearly understood.

Table 1 provides a summary of the results. The table includes the following information: (1) the categories of suggestions; (2) the number of suggestions received per category; and (3) examples of RTF suggestion content from each category.

Synopsis of Return to Flight Suggestions

Category	No. of Suggestions	Example Suggestion Content
Orbiter	673	(1) Develop a redundant layer of Reinforced Carbon-Carbon panels on the Orbiter wing leading edge (WLE). (2) Cover the WLE with a titanium skin to protect it from debris during ascent.
External Tank	599	(1) Insulate the inside of the External Tank (ET) to eliminate the possibility of foam debris hitting the Orbiter. (2) Shrink wrap the ET to prevent foam from breaking loose.
General Space Shuttle Program	400	(1) Simulate Return to Launch Site scenarios. (2) Orbit a fuel tank to allow the Orbiter to refuel before entry and perform a slower entry. (3) Establish the ability to return the Shuttle without a crew on board.
Imagery/Inspection	183	(1) Use the same infrared imagery technology as the U.S. military to enable monitoring and tracking the Space Shuttle during night launches. (2) Use a remotely controlled robotic free-flyer to provide on-orbit inspection. (3) Bring back the Manned Maneuvering Unit to perform on-orbit inspection of the Orbiter.
Vision for Space Exploration	179	(1) Bring back the Saturn V launch vehicle to support going to the Moon and Mars. (2) Preposition supply/maintenance depots in orbit to reduce the need for frequently returning to Earth. (3) Construct future habitats and vehicles in space to eliminate launching large payloads from Earth.
Aerospace Technology	137	Quickly develop a short-term alternative to the Space Shuttle based on existing technology and past Apollo-type capsule designs.
Crew Rescue/Ops	127	(1) Implement a joint crew escape pod or individual escape pods within the Orbiter cockpit. (2) Have a second Shuttle ready for launch in case problems occur with the first Shuttle on orbit. (3) Have enough spacesuits available for all crewmembers to perform an emergency extravehicular activity.
Systems Integration	126	(1) Mount the Orbiter higher up on the ET to avoid debris hits during launch. (2) Incorporate temporary shielding between the Orbiter and ET that would fall away from the vehicle after lift off.
Public Affairs	85	NASA needs to dramatically increase media coverage to excite the public once again, to better convey the goals and challenges of human space flight, and to create more enthusiasm for a given mission.
NASA Culture	65	(1) Host a monthly employee forum for discussing ideas and concerns that would otherwise not be heard. (2) Senior leaders need to spend more time in the field to keep up with what is actually going on.
NASA Safety and Mission Assurance	47	(1) Learn from the Naval Nuclear Reactors Program. (2) The Government Mandatory Inspection Point review should not be limited to just the Michoud Assembly Facility and Kennedy Space Center elements of the Program.
Space Shuttle Program Safety	27	(1) Develop new Solid Rocket Boosters (SRBs) that can be thrust-controlled to provide a safer, more controllable launch. (2) Use rewards and incentives to promote the benefits of reliability and demonstrate the costs of failure.
International Space Station	20	(1) Adapt an expandable rocket booster to launch Multi-Purpose Logistics Modules to the International Space Station (ISS). (2) Add ion engines to the ISS to give it extra propulsion capability.
Leadership and Management	9	(1) Employees need to be trained while still in their current job to prepare them for increasing positions of responsibility. (2) Institute a rotational policy for senior management, similar to that of the U.S. Armed Forces.

XX

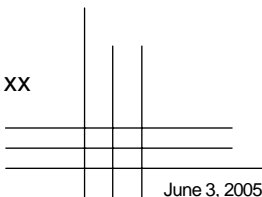

Category	No. of Suggestions	Example Suggestion Content
NASA Engineering and Safety Center	5	(1) Use a group brainstorming approach to aid in identifying how systems might fail. (2) NESC needs to get involved during a project's start as well as during its mission operations.
Solid Rocket Boosters	1	Ensure that the SRB hold-down bolts are properly reevaluated.
Total (As of August 9, 2004)	2683	

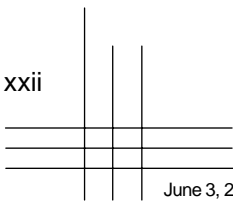

CAIB Recommendations Implementation Schedule

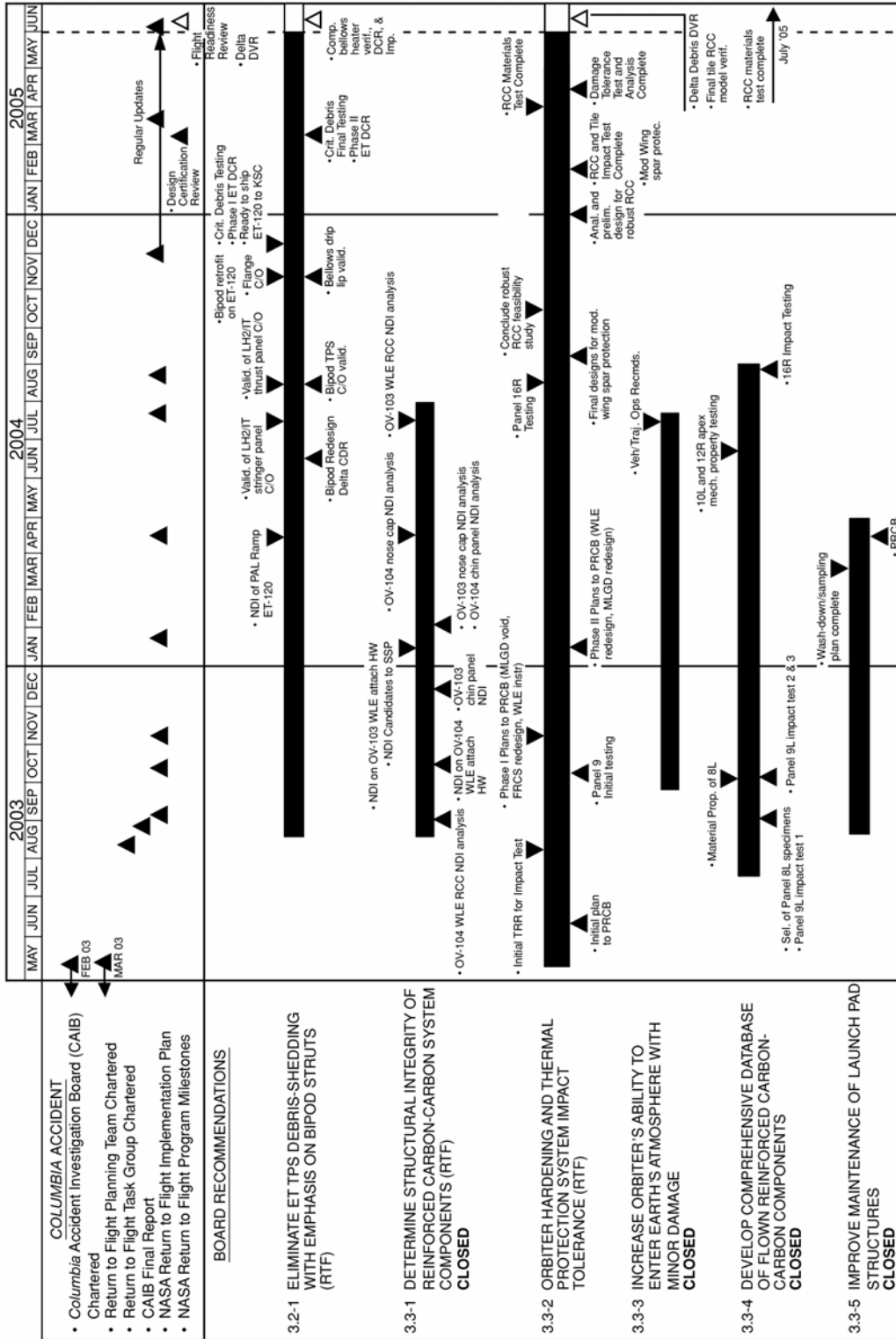

NOTE: See legend on p. xxv for definitions of acronyms

CAIB Recommendations Implementation Schedule

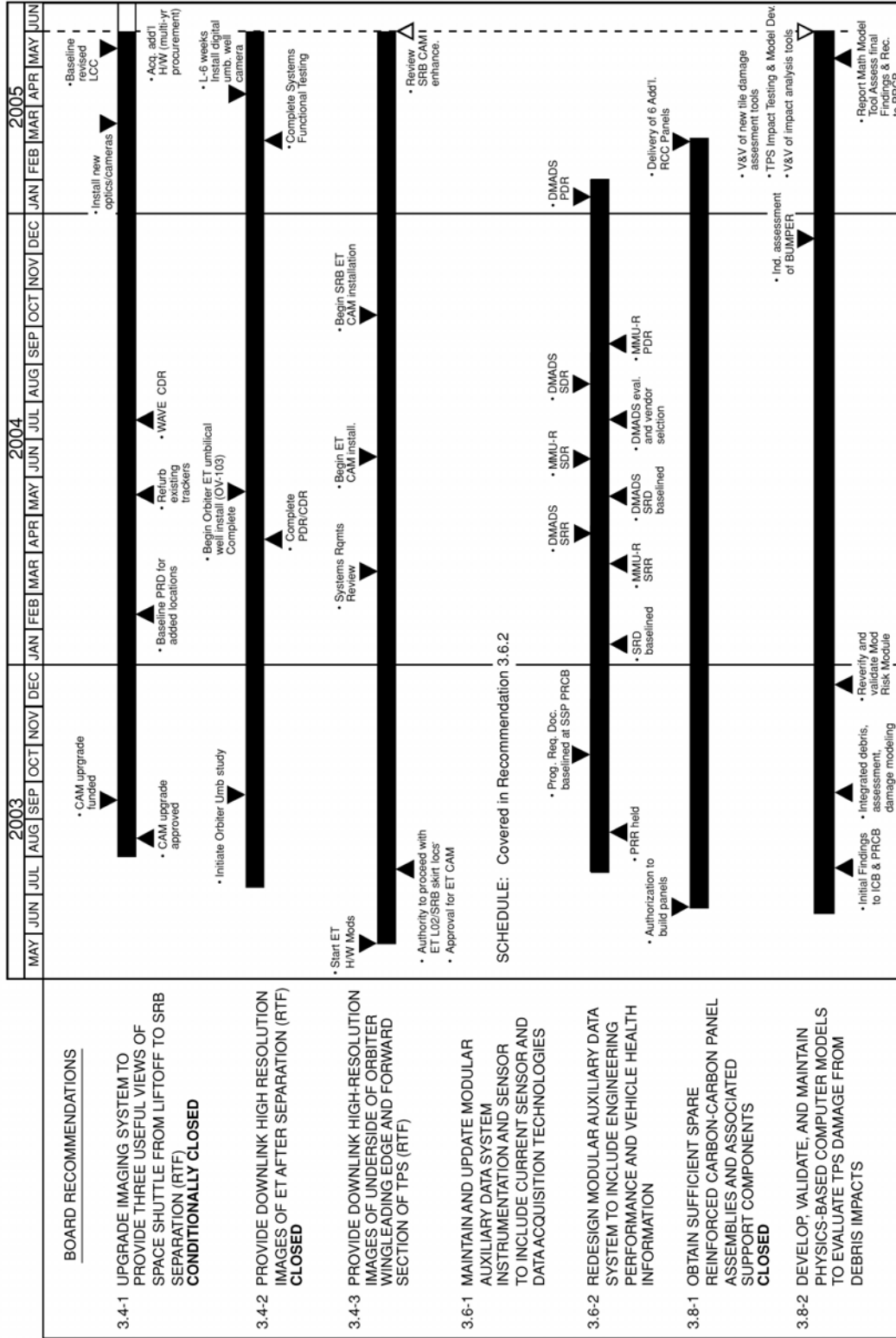

NOTE: See legend on p. xxv for definitions of acronyms

CAIB Recommendations Implementation Schedule

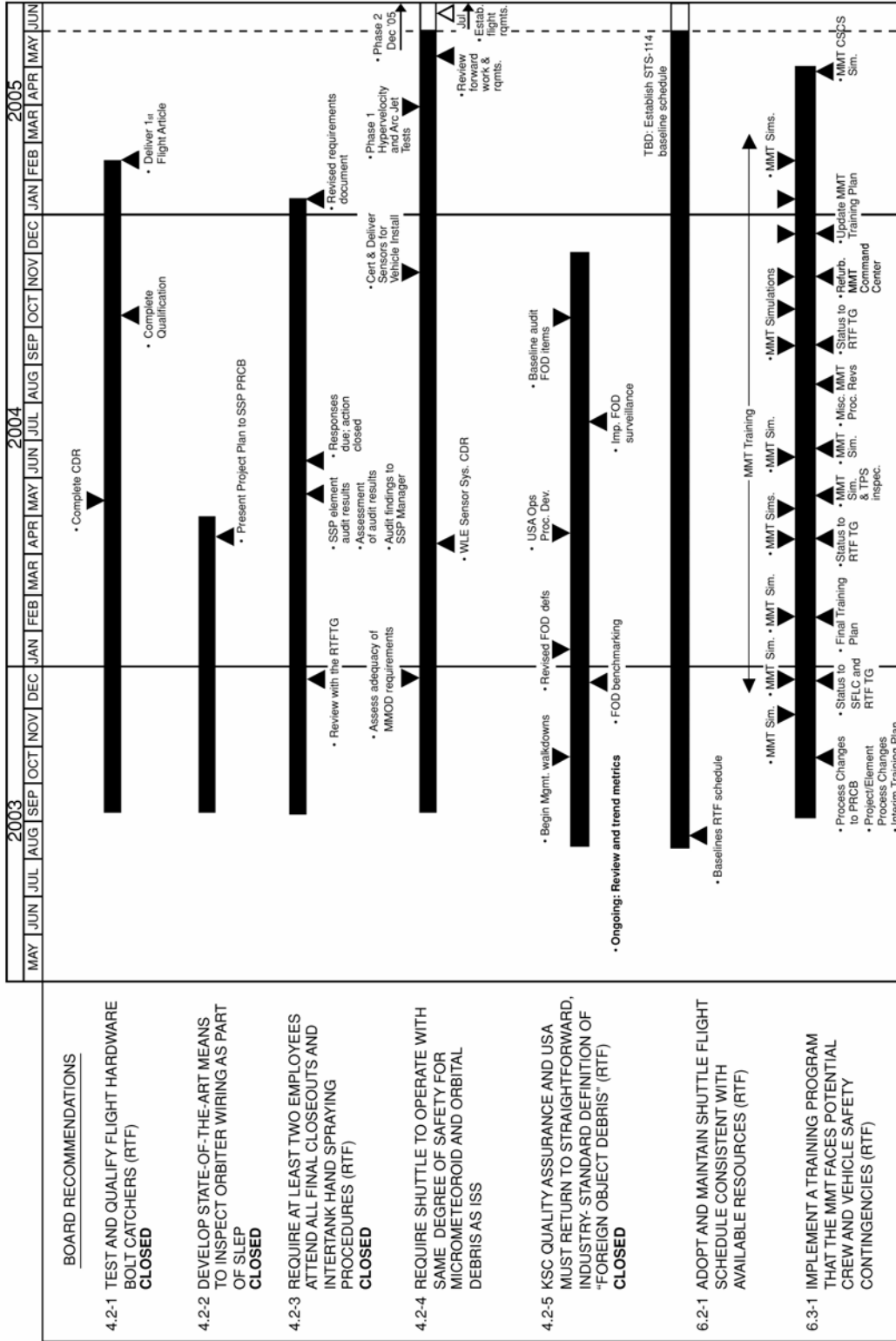

NOTE: See legend on p. xxv for definitions of acronyms

CAIB Recommendations Implementation Schedule

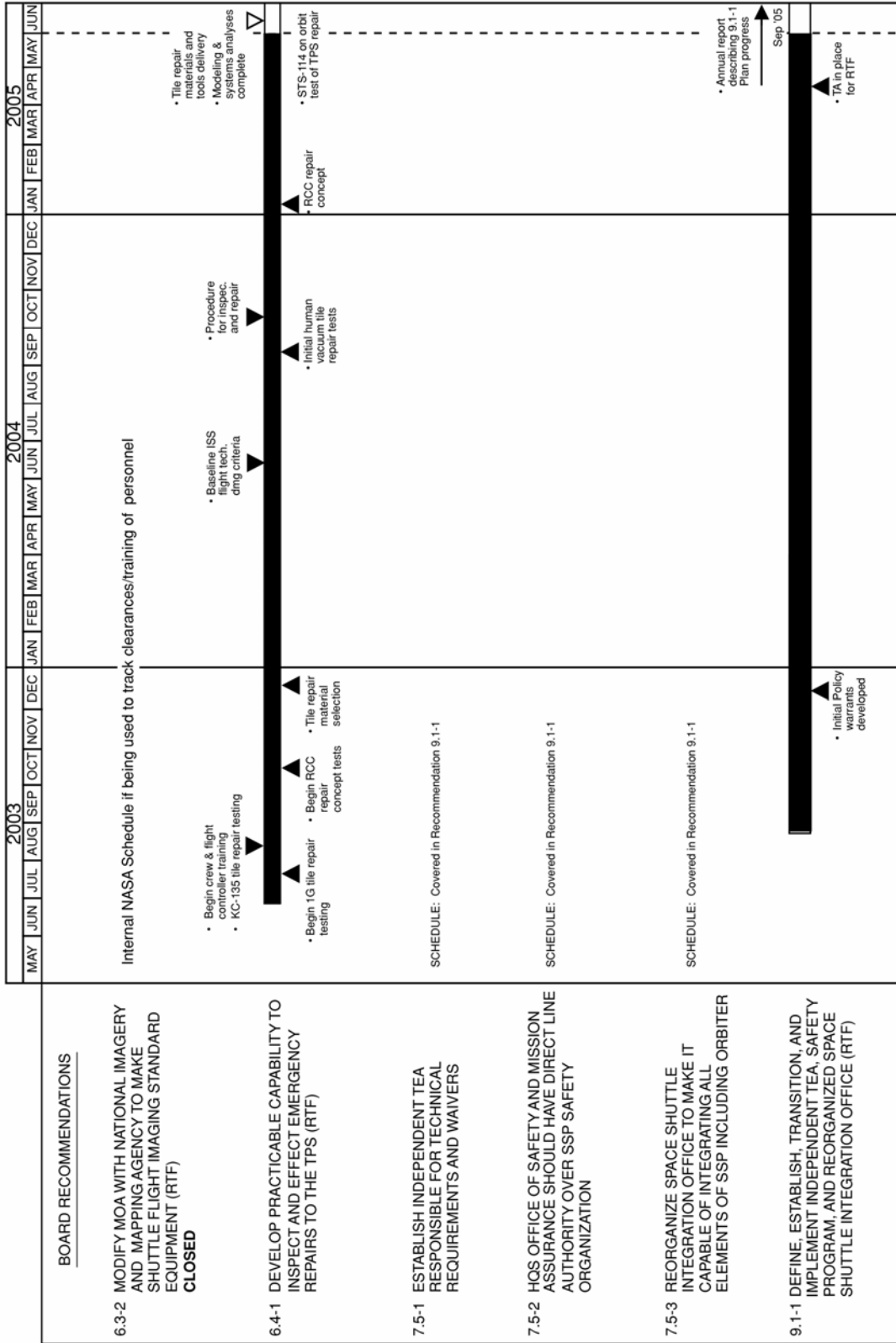

NOTE: See legend on p. xxv for definitions of acronyms

CAIB Recommendations Implementation Schedule

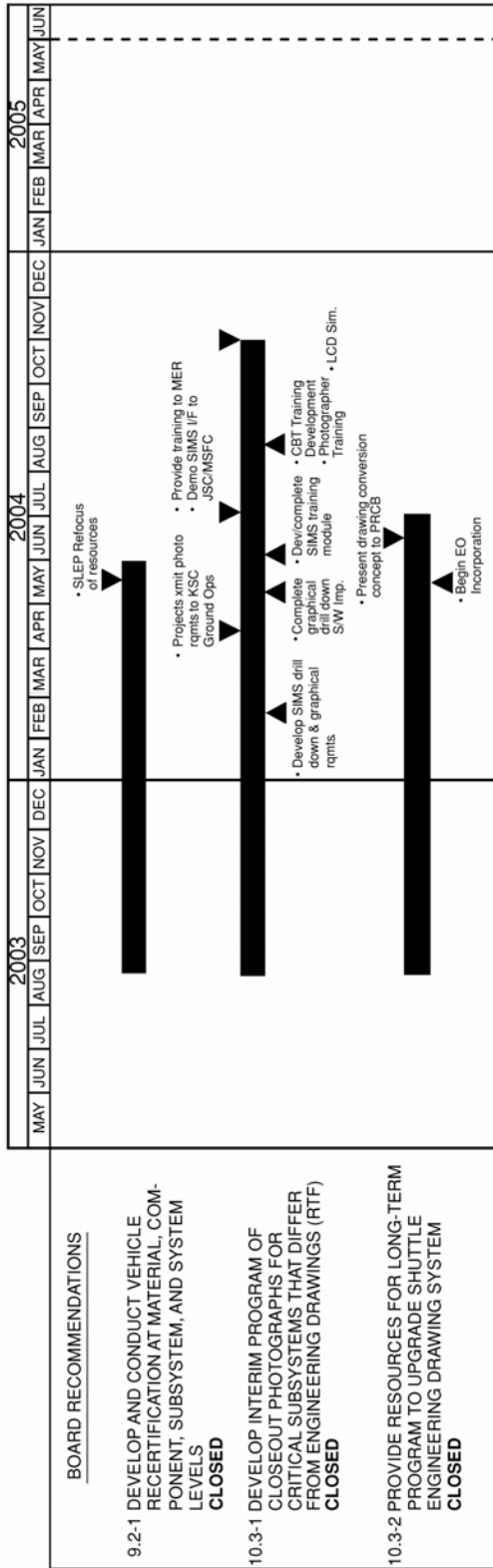

LEGEND

- C/O – Closeout
- CAM – Camera
- CBT – Computer Based Training
- CDR – Critical Design Review
- D/S – Downselect
- DCR – Design Certification Review
- DMADS – Digital Modular Auxiliary Data System
- DVR – Design Verification Review
- EO – Engineering Order
- ET – External Tank
- FOD – Foreign Object Debris
- H/W – Hardware
- ICB – Integration Control Board
- ISS – International Space Station
- IT – Intertank
- JSC – Johnson Space Center
- KSC – Kennedy Space Center
- LCC – Launch Commit Criteria

- LCD – Launch Countdown Demonstration
- LH2 – Liquid Hydrogen
- MER – Mission Evaluation Room
- MLGD – Main Landing Gear Doors
- MMOD – Micrometeoroid/Orbital Debris
- MMT – Mission Management Team
- MMU-R – Mass Memory Unit-Retrofit
- MSFC – Marshall Space Flight Center
- NDI – Nondestructive Inspection
- OV – Orbiter Vehicle
- PAL – Protuberance Airload
- PDR – Preliminary Design Review
- PRD – Program Requirements Document
- PRCB – Program Requirements Control Board
- PRR – Preliminary Requirements Review
- RCC – Reinforced Carbon-Carbon
- RTFTG – Return to Flight Task Group

- S/W – Software
- SDR – Systems Design Review
- SFLC – Space Flight Leadership Council
- SIM – Simulation
- SIMS – Still Imagery Management System
- SLEP – Service Life Extension Program
- SRB – Solid Rocket Booster
- SRD – Systems Requirements Document
- SRR – Systems Requirements Review
- SSP – Space Shuttle Program
- TA – Technical Authority
- TPS – Thermal Protection System
- TRR – Test Readiness Review
- UMB – Umbilical
- USA – United Space Alliance
- V&V – Verification and Validation
- WAVE – WB-57 Ascent Video Experiment
- WLE – Wing Leading Edge





Return to Flight Cost Summary

Proposed Program solutions for all return to flight (RTF) actions are reviewed by the Space Shuttle Program Requirements Control Board (PRCB) before receiving final NASA implementation approval. The PRCB has responsibility to direct studies of identified problems, formulate alternative solutions, select the best solution, and develop overall cost estimates. The membership of the PRCB includes the Space Shuttle Program Manager, Deputy Manager, all Project and Element Managers, Safety and Mission Assurance personnel, and Management Integration and Planning Office. This process applies to solutions to the *Columbia* Accident Investigation Board (CAIB) recommendations as well as to the Space Shuttle Program (SSP) corrective actions.

In the process of down-selecting to two or three “best options,” the projects and elements approve funding to conduct tests, perform analysis, develop prototype hardware and flight techniques, and/or obtain contractor technical expertise that is outside the scope of existing contracts.

The Space Flight Leadership Council (SFLC) is regularly briefed on the overall activities and progress associated with RTF and becomes directly involved when the SSP is ready to recommend a comprehensive solution to a CAIB recommendation or an SSP corrective action. The SFLC receives a technical discussion of the solution as well as an assessment of cost and schedule. With the concurrence of the SFLC, the SSP then receives the authority to proceed. The membership of the SFLC includes the Associate Administrator for the Office of Space Operations, Associate Deputy Administrator for Technical Programs, Deputy Associate Administrator for ISS [International Space Station] and SSP, Associate Administrator for Safety and Mission Assurance, Space Shuttle Program Manager, and the Office of Space Operations Center Directors (at Johnson Space Center, Kennedy Space Center, Marshall Space Flight Center, and Stennis Space Center).

All recommended solutions are further reviewed, for both technical merit and to determine whether the solution responds to the action, by the Return to Flight Task Group (also known as the Stafford-Covey Task Group).

Processes established by NASA to estimate and capture all costs related to RTF have steadily improved the accuracy of Agency budget forecasts. As the technical plan for RTF has matured, so the cost estimates have matured. NASA incurred costs in fiscal year (FY) 2003, valued at \$42M, to initiate RTF actions based on preliminary CAIB recommendations. Since November 2003, additional corrective actions have been initiated, in accordance with the process described above and based on the final CAIB Report recommendations and internal SSP actions.

During FY 2004, RTF activities moved rapidly from planning to execution, with several key option “down-select” decisions being made by the end of the year. The July 2004 RTF cost estimate is considered the first credible Agency projection because it was based on a more mature technical plan. NASA estimated that RTF activities in FY 2004 would cost about \$465M. By the end of the year, the actual costs totaled \$496M. The costs incurred included work carried over from FY 2003 as well as late-year changes in FY 2004 technical content.

The value of RTF activities for FY 2005 is estimated at \$602M, of which \$413M have been approved through the PRCB. Of the remaining \$189M, \$73M represent the estimated value of work review by the control board, but with additional technical effort required before a directive is released, and \$116M is the value of activities that are still in technical definition. As NASA gains actual flight experience, the estimates for FY 2005 and FY 2006 will be adjusted and the changes will be reported to Congress as soon as they are fully assessed.

FY 2006 is planned to be a transition year for the Shuttle Program. RTF technical content that must be sustained for the Program's remaining service life, along with the workforce required to continue safe flight, will be absorbed into the Program's baseline. Therefore, at the end of FY 2006, RTF costs will no longer be budgeted or reported separately.

a complete evaluation of *Columbia* accident impacts across the Program, such as replacement of hardware (e.g., cargo integration, Orbiter pressure tanks). Several solutions to improve NASA's culture and some of the Program's actions detailed in "Raising the Bar – Other Corrective Actions" are integrated into existing processes and do not always require additional funding.

Excluded from the cost estimates provided below are other RTF-related funding requirements resulting from

Table 1. Return to Flight Budget Estimates/Implementation Plan Map for New Estimates Including Threats* As of February 2005

(Cost in Millions)					Recommendation Numbers Map to Implementation Plan																															
(1)		FY 03	FY 04	FY 05	FY 06	CAIB #3.2-1	CAIB #3.3-1	CAIB #3.3-2	CAIB #3.3-3	CAIB #3.3-4	CAIB #3.3-5	CAIB #3.4-1	CAIB #3.4-2	CAIB #3.4-3	CAIB #3.6-1	CAIB #3.6-2	CAIB #3.8-1	CAIB #3.8-2	CAIB #4.2-1	CAIB #4.2-2	CAIB #4.2-3	CAIB #4.2-4	CAIB #4.2-5	CAIB #6.2-1	CAIB #6.3-1	CAIB #6.3-2	CAIB #6.4-1	CAIB #7.5-1	CAIB #7.5-2	CAIB #7.5-3	CAIB #9.1-1	CAIB #9.2-1	CAIB #10.3-1	CAIB #10.3-2	SSP Recommendation	
(1)	Total Initiated SSP RTF Activities	42	496	602	288																															
RE/RP	Orbiter RCC Inspections & Orbiter RCC-2 Shipsets Spares	0	39	41	5	X	X								X												X									
RE/RP	On-orbit TPS Inspection & EVA Tile Repair	20	71	167	49							X														X									X	
	Orbiter Workforce	0	0	38	46															X								X							X	
RE/RP	Orbiter TPS Hardening	0	29	1	0			X																												
	Orbiter/GFE	0	8	4	0																															
RE	Orbiter Contingency	0	8	17	0																															
RE/RP	Orbiter Certification / Verification	0	47	9	0	X	X	X											X		X									X					X	
RE/RP	External Tank Items (Camera, Bipod Ramp, etc.)	10	93	88	14	X						X									X															
RE/RP	SRB Items (Bolt Catcher, ETA Ring Invest., Camera)	1	14	4	0			X				X						X																		X
RE/RP	Ground Camera Ascent Imagery Upgrade	8	40	13	11						X							X	X							X										
	KSC Ground Operations Workforce	0	15	38	42				X									X	X							X										
RE/RP/AC	Other (System Intgr. JBOSC Sys, Full Cost, Additional FTEs, etc.)	4	132	178	121	X	X	X	X																		X	X	X	X					X	
RE/RP	Stafford - Covey Team	0	1	4																																X
	**Other RTF Related	(2)	(3)	(4)	(5)																															
	NASA Engineering and Safety Center (NESC)		45	77	79																							X	X	X						

RE = Reestimated Item; RP = Rephased; AC = Added Content

- (1) This update includes added scope of work and improved estimates. RTF costs are stabilizing as technical solutions reach maturity. The Congress will be kept informed as we refine these requirements and associated cost estimates.
- (2) NASA assumed an estimate of \$94M in budget authority for FY 2003 of which \$52M of FY 2003 planned work and associated cost were carried into FY 2004.
- (3) The FY 2004 RTF cost estimate of \$496M includes \$423M of activities that have been approved for implementation. The remaining \$73M of RTF activities are pending approval. As soon as these additional activities are definitized, they will be shared with Congress.
- (4) The FY 2005 RTF cost estimate of \$602M includes \$413M of activities that have been approved for implementation. Of the remaining \$189M potential, \$73M is in work and \$116M of activities are in technical definition. As soon as these additional activities are definitized, they will be shared with Congress.
- (5) The FY 2006 RTF cost estimate of \$288M includes \$188M of activities that have been approved for implementation. Of the remaining \$100M potential activities, \$26M is in work and \$74M of activities are in technical definition. As soon as these additional activities are definitized, they will be shared with Congress.

*These estimates could change due to improved estimates, additional tasks, and added scope as we better understand the implementation of RTF recommendations.
 **The NASA Engineering and Safety Center (NESC) is funded through NASA's Corporate G&A. The NESC at NASA's Langley Research Center in Hampton, Va., provides comprehensive examination of all NASA programs and projects. The Center thus provides a central location to coordinate and conduct robust engineering and safety assessment across the entire Agency.

Chart 1. February 2005 RTF/CAIB Estimates

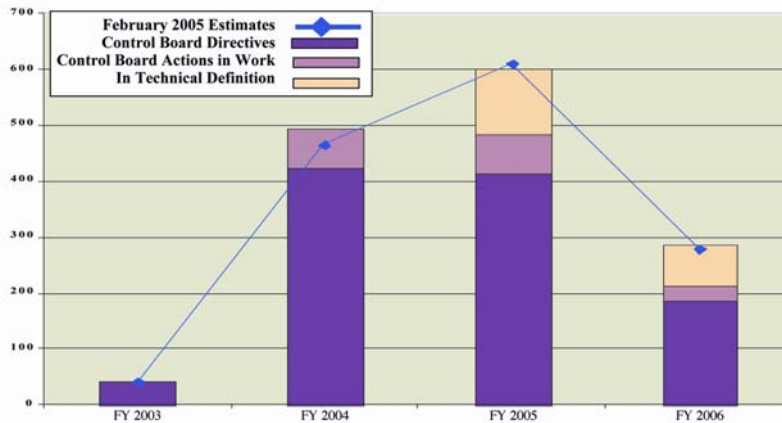

	FY 2003	FY 2004	FY 2005	FY 2006
<i>Estimates Published in July 2004</i>	42	465	643	331
Value of Control Board Directives Issued	42	423	413	188
Estimates for Control Board Actions Work	0	73	73	26
Estimates for Activities Still in Technical Definition	0	0	116	74
Total Board Actions/Pending Board Actions:	42	496	602	288

Table 2. February 2005 RTF Status

	FY 03	FY 04	FY 05	FY 06
TOTAL RTF	42	496	602	288
RTF Activities – Control Board Directive	42	423	413	188
RTF Activities – Been to Control Board/Awaiting	0	73	73	26
RTF Activities – In Review Process	0	0	116	74
<u>RTF Activities – Control Board Directive</u>	<u>42</u>	<u>423</u>	<u>413</u>	<u>188</u>
Orbiter RCC Inspections & Orbiter RCC-2 Shipsets Spares	0	39	22	0
On-Orbit TPS Inspection & EVA Tile Repair	20	71	151	20
Orbiter Workforce	0	0	33	41
Orbiter Hardening	0	29	1	0
Orbiter/GFE	0	7	4	0
Orbiter Contingency	0	8	12	0
Orbiter Certification/Verification	0	47	0	0
External Tank Items (Camera, Bipod Ramp, etc.)	10	42	25	2
SRB Items (Bolt Catcher, Camera)	1	14	4	0
Ground Camera Ascent Imagery Upgrade	8	40	13	11
KSC Ground Operations Workforce	0	15	38	42
Other (System Intrgr., JBOSC Sys., SSME Tech. Assess, Ground Ops Workforce)	4	110	107	71
Stafford-Covey Team	0	1	4	
<u>RTF Activities – Been to Control Board/Awaiting</u>	<u>0</u>	<u>73</u>	<u>73</u>	<u>26</u>
Orbiter RCC Inspections & Orbiter RCC-2 Shipsets Spares	0	0	0	0
On-Orbit TPS Inspection & EVA Tile Repair	0	0	6	8
Orbiter Workforce	0	0	5	5
Orbiter Hardening	0	0	0	0
Orbiter/GFE	0	0	0	0
Orbiter Contingency	0	0	5	0
Orbiter Certification/Verification	0	0	0	0
External Tank Items (Camera, Bipod Ramp, etc.)	0	51	50	9
SRB Items (Bolt Catcher, Camera)	0	0	0	0
Ground Camera Ascent Imagery Upgrade	0	0	0	0
KSC Ground Operations Workforce	0	0	0	0
Other (System Intrgr., JBOSC Sys., SSME Tech. Assess, Ground Ops Workforce)	0	22	7	4

Table 2. February 2005 RTF Status (Continued)

	<u>FY 03</u>	<u>FY 04</u>	<u>FY 05</u>	<u>FY 06</u>
TOTAL RTF	42	496	602	288
<u>RTF Activities – In Review Process</u>	<u>0</u>	<u>0</u>	<u>116</u>	<u>74</u>
Orbiter RCC Inspections & Orbiter RCC-2 Shipsets Spares	0	0	19	5
On-Orbit TPS Inspection & EVA Tile Repair	0	0	10	21
Orbiter Workforce	0	0	0	0
Orbiter Hardening	0	0	0	0
Orbiter/GFE	0	0	0	0
Orbiter Contingency	0	0	0	0
Orbiter Certification/Verification	0	0	9	0
External Tank Items (Camera, Bipod Ramp, etc.)	0	0	14	3
SRB Items (Bolt Catcher, Camera)	0	0	0	0
Ground Camera Ascent Imagery Upgrade	0	0	0	0
KSC Ground Operations Workforce	0	0	0	0
Other (System Integr., JBOSC Sys., SSME Tech. Assess, Ground Ops Workforce)	0	0	64	46



NASA's Response to the *Columbia* Accident Investigation Board's Recommendations

The following section details NASA's response to each CAIB recommendation in the order that it appears in the CAIB Report. NASA will comply with those actions marked "RTF" before we return to flight. This implementation plan is periodically updated to reflect NASA's progress in implementing these recommendations. Program milestones built on the CAIB recommendations will determine when the Space Shuttle will return to safe flight.

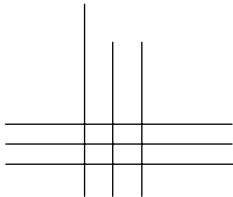



Columbia Accident Investigation Board

Recommendation 3.2-1

Initiate an aggressive program to eliminate all External Tank Thermal Protection System debris-shedding at the source with particular emphasis on the region where the bipod struts attach to the External Tank. [RTF]

BACKGROUND

The External Tank (ET) requires a Thermal Protection System (TPS) to maintain the cryogenic temperature of the propellants, to protect the tank from atmospheric heating, and to prevent ice formation on the exterior of the tank. The majority of the ET TPS is a spray-on foam insulation (SOFI). Foam is the only material that can meet the TPS requirement for a very lightweight, yet highly insulating material. However, foam poses some manufacturing challenges. For example, it is subject to small voids during application, especially around uneven areas such as joints or protrusions. This problem is exacerbated by the fact that foam for complicated areas must be applied manually, rather than with the more consistent

automated process that is used for the smooth areas. Quality assurance of the application process is another major challenge because foam encapsulates air, causing voids in the foam. Using nondestructive inspection (NDI) to find inconsistencies or defects in the foam is an engineering challenge that has eluded a reliable technical solution. NASA has conducted comprehensive searches for NDI techniques in industry and research institutions, and has made repeated attempts to develop a method of inspecting the foam for correct application. We continue these efforts. As an alternative to inspection, NASA is reinvigorating strict process controls of both automated and manual foam applications to reduce the likelihood of voids.

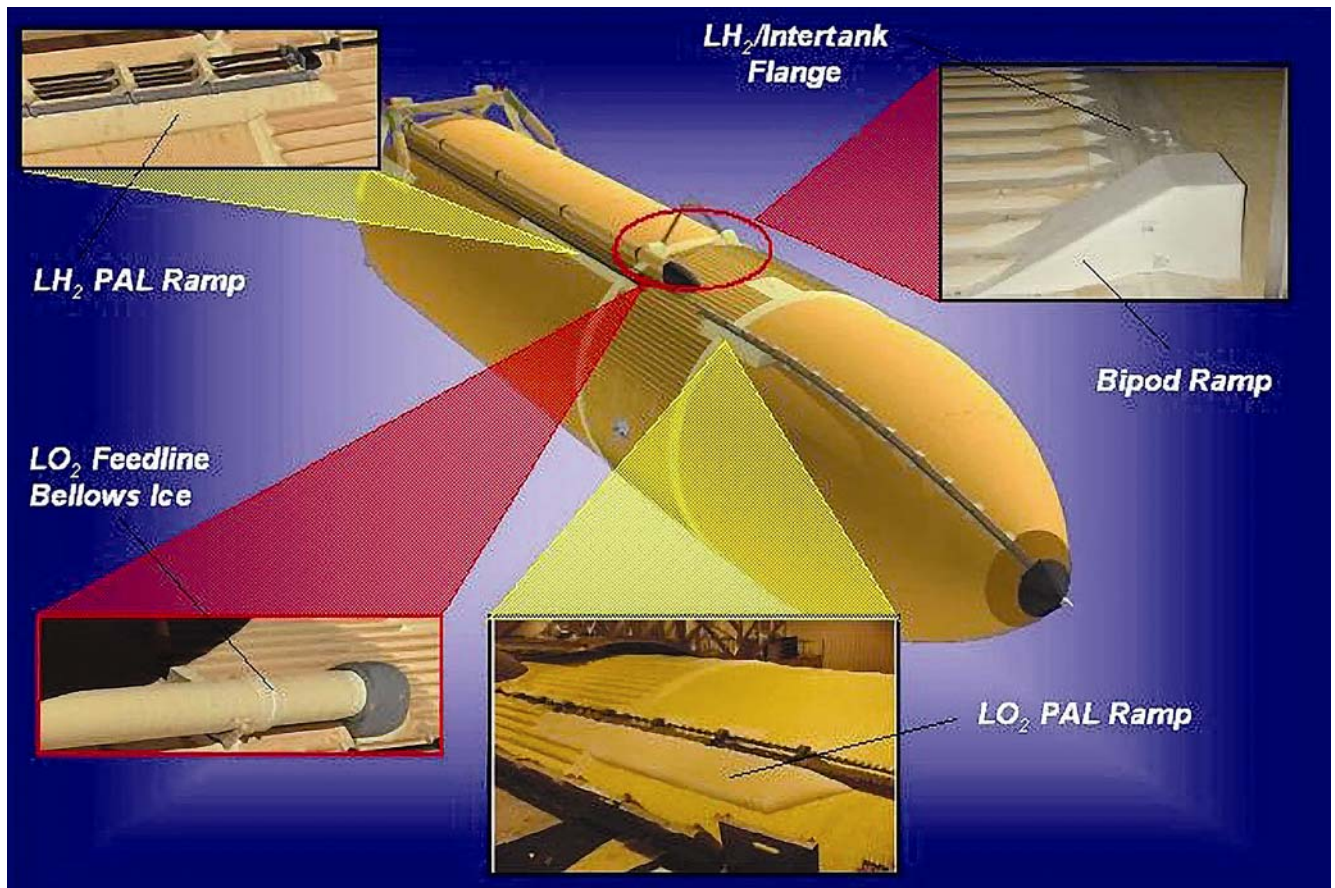
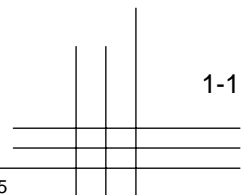

Figure 3.2-1-1. Primary potential ET debris sources being evaluated.



NASA concurs with the *Columbia* Accident Investigation Board (CAIB) findings and recommendations and charged several internal and independent review teams with reviewing the design, manufacturing, process control, and acceptance of the ET. Findings reported by the ET Working Group (ETWG) in June 2003 noted design verification and process validation shortfalls, quality control verification gaps, and a lack of acceptance testing and inspection techniques capable of detecting and rejecting deficient foam applications. Based on the findings of the ETWG, the ET Project concluded that all TPS applications in critical debris zones (those areas of the ET where liberated foam poses a risk of significantly damaging the Orbiter) should be identified for mandatory evaluation.

Figure 3.2-1-1 illustrates the primary areas on the ET being evaluated as potential debris sources for return to flight (RTF).

ET Forward Bipod Background

Before STS-107, several cases of foam loss from the left bipod ramp were documented through photographic evidence. The most significant foam loss events in the early 1990s were attributed to debonds or voids in the “two-tone foam” bond layer configuration on the intertank area forward of the bipod ramp. The intertank foam was thought to have peeled off portions of the bipod ramp when liberated. Corrective action taken after STS-50 included implementation of a two-gun spray technique in the ET bipod ramp area (figure 3.2-1-2) to eliminate the two-tone foam configuration. After the STS-112 foam loss event, the ET Project began developing redesign concepts for the bipod ramp; this activity was still under way at the time of the STS-107 accident. Dissection of bipod ramps conducted for the STS-107 investigation has indicated that defects resulting from a manual foam spray operation over an extremely complex geometry could produce foam loss. Liquid nitrogen (LN₂) ingestion was also identified as an additional potential load environment that, when combined with defects in the TPS, could contribute to large-scale foam loss.

Liquid Oxygen (LO₂) Feedline Bellows Background

The LO₂ feedline is the large external pipe that runs the length of the ET. Bellows are located at three joints along this pipe to accommodate thermal expansion and contraction. The bellows shields (figure 3.2-1-3) are covered with TPS foam, but the ends are exposed. Ice and frost form when moisture in the air contacts the cold surface of the exposed bellows. Although Space Shuttle Program (SSP) requirements include provisions for ice on the feedline supports and adjacent lines, ice in this area presents a potential source of debris in the critical debris zone—the area from which liberated debris could impact the Orbiter.



Figure 3.2-1-2. ET forward bipod ramp (foam).

Protuberance Airload (PAL) Ramps Background

The ET PAL ramps are designed to reduce adverse aerodynamic loading on the ET cable trays and pressurization lines (figure 3.2-1-4). PAL ramp foam loss has been observed on two prior flights, STS-4/ET-4 and STS-7/ET-6. The most likely cause of the losses was repairs and cryo-pumping (air-ingestion) into the Super-Light Ablator panels under and adjacent to the PAL ramps. Configuration changes and repair criteria were revised early in the Program, thereby precluding the recurrence of these failures. However, the PAL ramps are large, thick, manually sprayed foam applications (using a less complex manual spray process than that used on the bipod) that could, if liberated, become the source of large debris. For this reason, NASA placed them at the top of the priority list for TPS verification reassessment and NDI.

ET Liquid Hydrogen (LH₂) Intertank Flange Background

The intertank separates the LO₂ tank from the hydrogen tank. The area where the intertank connects to the pressurized hydrogen tank is called the LH₂/intertank flange (figure 3.2-1-5). ET separation imagery has shown repeated losses of the foam overlying this flange. Foam divots from the LH₂/intertank flange emanate from within the critical debris zone, which is the area of the ET where debris loss could adversely impact the Orbiter or other Shuttle elements.

NASA IMPLEMENTATION

NASA has initiated a three-phase approach to eliminate the potential for debris loss from the ET. Phase 1 includes those activities to be implemented prior to RTF that would control critical debris on tanks already constructed. Phase 2 activities are not required for RTF, but rather focus on continuous improvement. Phase 2 includes debris elimination enhancements that could be incorporated into the ET

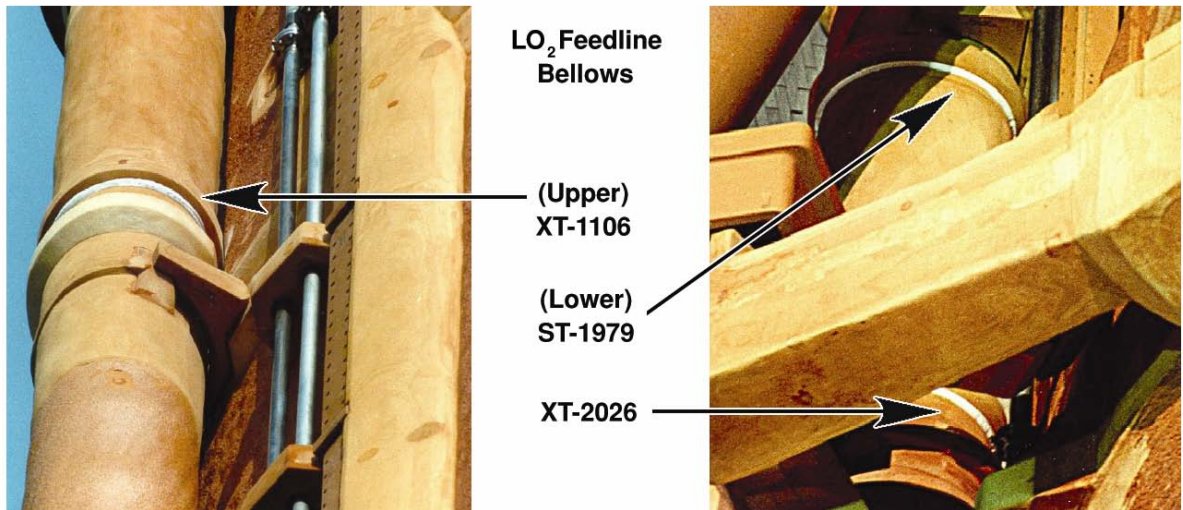
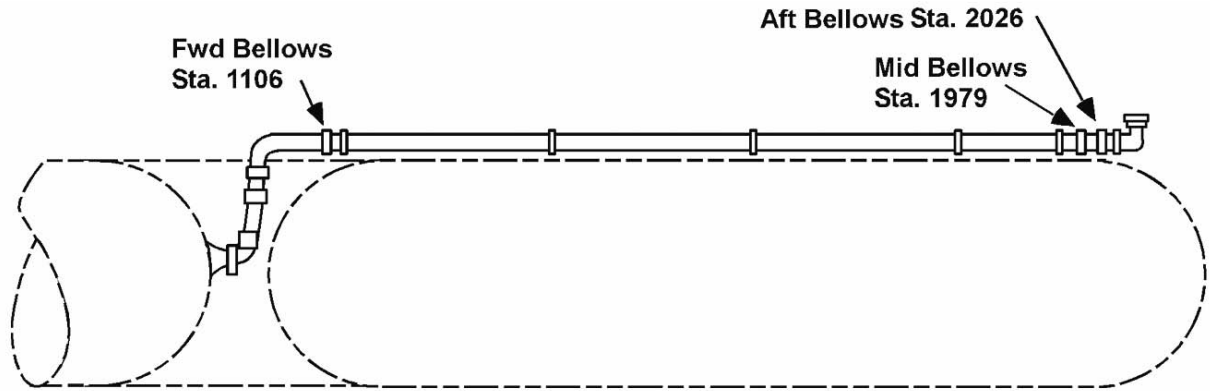

Figure 3.2-1-3. LO₂ feedline bellows.

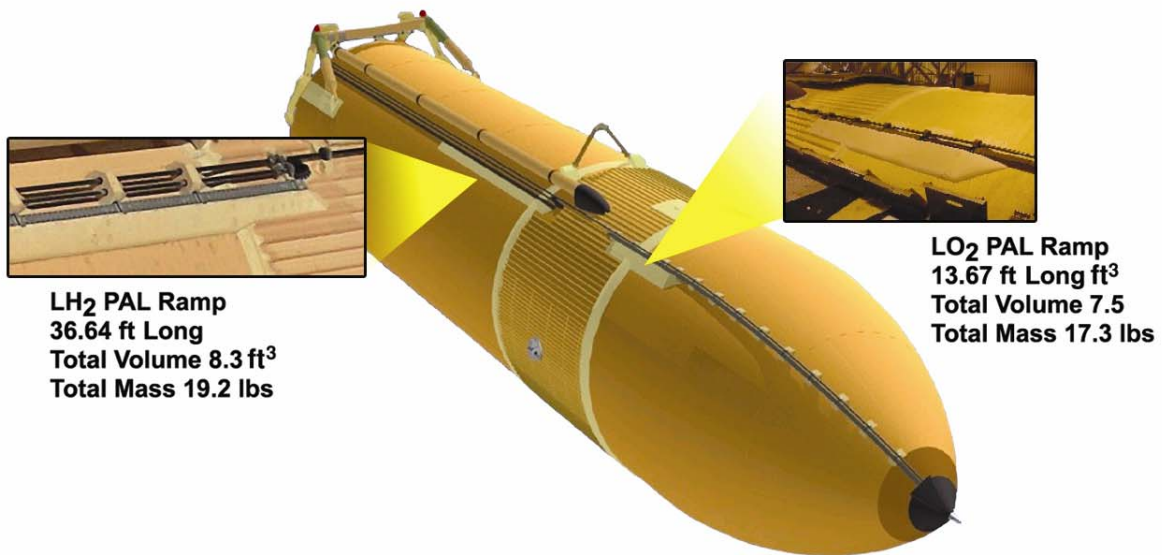

Figure 3.2-1-4. PAL ramp locations.

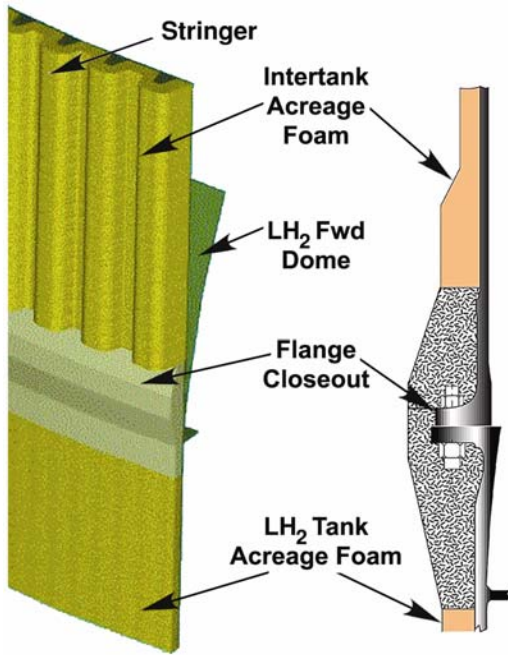

Figure 3.2-1-5. ET LH₂ flange area.

production line as they become available, but are not considered mandatory for RTF. Phase 3 is comprised of long-term development activities that would eliminate TPS foam on the vehicle. However, NASA does not plan to implement the Phase 3 design changes since the Shuttle will be retired at the end of the decade after completion of International Space Station assembly.

Phase 1

A NASA/Lockheed Martin ET Project team conducted the Phase 1 improvements. This team included membership from multiple centers and technical disciplines, including the Marshall Space Flight Center (structures, thermal, materials, and processes), Langley Research Center (structures), Stennis Space Center (safety and mission assurance), and Glenn Research Center (structures). The team identified potential sources of ascent debris, assessed those that could cause critical damage, determined the failure mode and root cause(s) for each potential debris site, proposed corrective design or manufacturing process changes for each site, and selected and implemented the best alternative.

The first step for the ET Project Team was to identify potential sources of ascent debris. They did this by reviewing historical flight data and through engineering analysis. By thoroughly reviewing all ascent and ET separation im-

agery available since the beginning of the SSP, the team identified the areas that historically liberated the most debris. By applying engineering analysis, knowledge of ET design, and engineering judgment, the team identified other areas for additional investigation. These activities were accelerated by the results of inquiries and engineering studies into ascent debris that had been conducted over the life of the Program.

The next step was to assess which sources of debris, if liberated, could cause critical damage to the Space Shuttle. The Space Shuttle Systems Engineering and Integration Office (SEIO) took the lead on this activity (details may be found in SSP-5 and R3.3-2). SEIO performed aerodynamic debris transport modeling for each debris piece at a number of representative ascent flow fields across the vehicle. For those pieces of debris impacting flight hardware, SEIO provided to the hardware projects the impact locations, masses, and velocities. The hardware projects then applied modeling validated by actual impact testing data to determine the extent of damage. If this damage was deemed critical (defined as potentially catastrophic), SEIO added the debris to a database that eventually provided a matrix of debris allowables for the ET. The debris allowables matrix for ET segmented the ET into zones, and each zone was assigned an appropriate maximum allowable mass for debris liberation. The first ET debris allowable matrix for foam was approved by the Program Requirements Control Board in November 2004. A similar ET debris allowable matrix for ice liberation is still in work.

Using the TPS debris allowables matrix, the ET Project identified TPS debris sources that could potentially cause critical damage and therefore required mitigation. For Phase 1, the areas identified were the bipod ramp foam, the hydrogen tank/intertank flange foam, and the PAL foam ramps. The ET Project also recognized the ice formation at the LO₂ feedline bellows as a potentially critical debris source to be addressed during Phase 1. Each of the critical foam debris areas was assigned to a focus team that dissected other ET foam applications and then conducted tests and analysis to understand the root causes of the debris generation. Analysis included inquiries into the basic molecular and cellular structure of foam and the physical failure mechanisms to which ET foam is vulnerable.

Alternative solutions for correcting the failure causes were developed, including both design changes and manufacturing process improvements. The selected improvements are being implemented using the same verification processes applied to all Space Shuttle flight hardware, assuring rigor in configuration management, satisfaction of technical standards and requirements, understanding of any risk to be accepted, and avoidance of unintended consequences.

1-4

In addition to the teams mentioned above, the ET Project assigned a team to survey all foam application processes, both robotic and manual, on the remaining areas of the ET. This was necessary because STS-114 ET TPS was applied prior to the *Columbia* accident. This team reviewed the specific procedures, manufacturing data, and available acceptance testing or inspection techniques for each application. To date, the results of this survey have verified the acceptability of the robotically applied foam that makes up a large percentage of the overall foam acreage. The survey of more than 300 manually applied foam closeouts was reported at the ET Design Certification Review (DCR), Part II, in March 2005. This survey identified the rear attachment longeron manual closeouts as particularly vulnerable to defects. Although there is no significant history of liberation of foam from the longeron area, the ET Project took the conservative path of removing and reapplying this area of foam with an improved process.

As part of the Phase 1 effort, NASA enhanced or redesigned the areas of known critical debris sources (figure 3.2-1-1). This includes redesigning the forward bipod fitting and associated TPS closeout, redesigning the LH₂/intertank flange TPS closeout, and reducing ice from the LO₂ feedline bellows. In addition to these known areas of debris, NASA has reassessed all TPS areas to verify the TPS configuration, including both automated and manual spray applications. Special consideration was given to the LO₂ and LH₂ PAL ramps due to their size and location. This task included assessing the existing verification data, establishing requirements for additional verification data, conducting tests to demonstrate performance against the devoting (cohesive strength failure) failure mode, and evaluating methods to improve process control of the TPS application for re-sprayed hardware.

NASA also pursued a comprehensive testing program to understand the root causes of foam shedding and developed alternative design solutions to reduce the debris loss potential. Additionally, NASA is further developing two NDI techniques, Tetrahertz imaging and backscatter radiography, to conduct ET TPS inspection without damaging the fragile insulating foam. During Phase 1, NDI will be used on the LO₂ and LH₂ PAL ramps as engineering information only; certification of the foam will be achieved primarily through verifying the application and design.

NASA also invited a number of different assessments and reviews of our ET modification efforts. These included a Lockheed Martin independent review team, an independent team of retired contractor and NASA experts, a NASA Engineering and Safety Center review team, and a Quality and Safety Assurance team chartered by the Director of the Marshall Space Flight Center. These teams provided insight

and suggestions that have been incorporated into ET Project corrective measures.

Phase 2

Phase 2 efforts include pursuing the redesign or elimination of the LO₂ and LH₂ PAL ramps and enhancing the NDI technology with the goal of using the technology as an acceptance tool. TPS application processes will be enhanced as appropriate to optimize the application process and incorporate more stringent process controls. Another Phase 2 effort is enhancing the TPS thermal analysis tools to better size and potentially reduce TPS on the vehicle.

Phase 3

The Phase 3 effort, if it were to be implemented, would examine additional means of further reducing ET debris potential. This phase would explore such concepts as rotating the LO₂ tank 180 degrees to relocate all manually applied TPS closeouts outside of the critical debris zone and developing a “smooth” LO₂ tank without external cable trays or pressurization lines. Developing a smooth intertank in which an internal orthogrid eliminates the need for external stringers and implementing a protuberance tunnel in the LH₂ tank could provide a tank with a smooth outer mold line that eliminates the need for complex TPS closeouts and manual sprays.

ET Forward Bipod Implementation Approach

NASA has initiated a redesign of the ET forward bipod fitting (figure 3.2-1-6). The redesign incorporates redundant heaters in the base of the bipod fittings to preclude ice formation formerly prevented by the foam ramps. This redesign addresses the specific proximate cause of the *Columbia* accident. The results of recent wind tunnel tests confirm the acceptability of the increased aero-heating loads that result from this new configuration.

LO₂ Feedline Bellows Implementation Approach

NASA evaluated several concepts to eliminate ice formation on the forward bellows (figure 3.2-1-7). An initial trade study included a heated gaseous nitrogen (GN₂) purge, a flexible boot over the bellows, heaters at the bellows opening, and other concepts. Analysis and testing eliminated the flexible bellows boot as a potential solution since it could not eliminate ice formation within the available volume. Heaters at the bellows opening were analyzed and determined to have a potential impact on adjacent hardware and propellant quality. The heated GN₂ or gaseous helium purge options were eliminated due to implementation issues and debris potential for purge hardware.

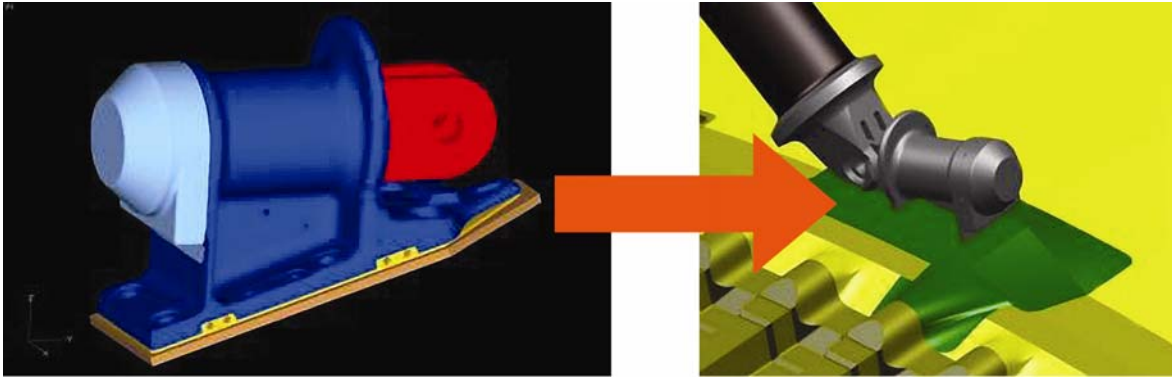
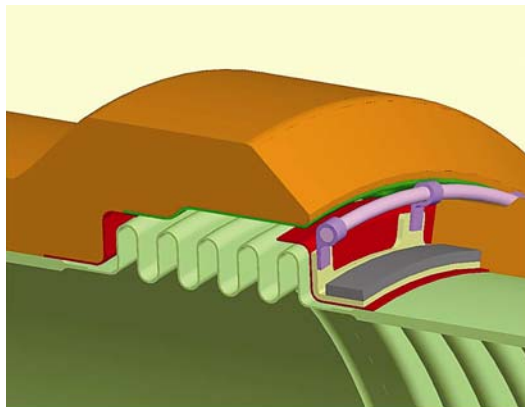
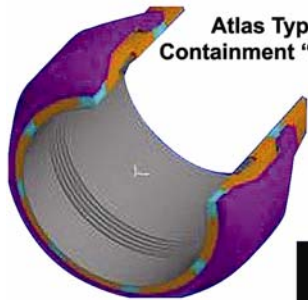

Figure 3.2-1-6. ET forward bipod redesign.



Heated GN₂ Purge

Atlas Type
Containment "Boot"



Condensate drain
"drip lip"

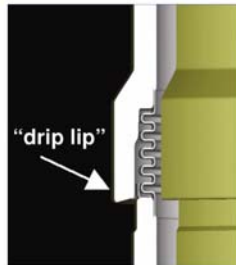

It was during development testing that NASA identified the condensate drain "drip lip" as a solution that could reduce the formation of ice. Since the drip lip alone was not sufficient to completely eliminate the ice, NASA continued to develop alternate mitigations and determined that the most effective solution to eliminate ice at the forward bellows location was an alternate heater system installed inside the bellows cavity.

LH₂/Intertank Flange Closeout Implementation Approach

NASA has conducted tests to determine the cause of foam liberation from the LH₂/intertank flange area. These tests revealed that foam loss from this area was the outcome of a multi-step causal chain: GN₂, used to purge any leaking hydrogen from the intertank, condensed into a liquid upon contact with the cold hydrogen tank dome. The LN₂ then pooled around the perimeter of the dome and seeped through the flange joint, fasteners, vent paths, and other penetrations to the underside of the foam layer. If foam voids were in the seep paths, the LN₂ collected in the voids. During ascent the rapidly decreasing atmospheric pressure and increasing environmental temperature caused the LN₂ to boil into a gas, expand, and blow off a foam divot. NASA's corrective measures interrupt this failure chain. First, seepage of LN₂ was significantly reduced by sealing the flange bolts and injecting all existing foam into the intertank stringers. Second, NASA removed all existing foam from the flange area and replaced it by using an enhanced three-step foam application process to reduce both the volume and quantity of voids.

Figure 3.2-1-7. LO₂ feedline bellows design concepts.

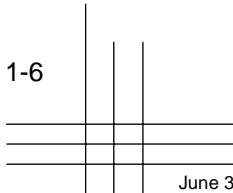

An update to the original Level II debris transport analyses expanded the critical debris zone that must be addressed, and significantly reduced the allowable debris mass in this region. The critical debris zone was expanded from ± 67.5 deg from the top of the ET (the top of the tank directly faces the underside of the Orbiter) to greater than ± 100 deg from the top of the tank. As a result, a new closeout process for the thrust panel of the intertank flange region has been developed and applied to the entire thrust panel, expanding the enhanced closeout region to ± 112 deg from the top of the tank (figure 3.2-1-8). NASA is continuing to refine these analyses.

PAL Ramps Implementation Approach

NASA assessed the verification data for the existing PAL ramps and determined that the existing verification is valid. To increase our confidence in the verification data, NASA dissected similar hardware to determine TPS application process performance. Plans for the redesign or removal of the PAL ramps are continuing as part of Phase 2 of the three-phase approach to eliminate the potential for debris

loss from the ET. Three redesign solutions have been down-selected (figure 3.2-1-9) and will be subjected to wind tunnel testing: eliminating the ramps; reducing the size of the ramps; and redesigning the cable tray with a trailing edge fence. A wind tunnel test has been used to evaluate the potential for aerodynamic instabilities of the basic cable trays and associated hardware due to the proposed redesigns. The test articles are instrumented with pressure transducers, strain gauges, and accelerometers to measure the aero-elastic effect on the test articles.

TPS (Foam) Verification Reassessment Implementation Approach

NASA has performed an assessment for both manual and automated TPS applications in the critical debris zones. This assessment was performed using the same approach applied to the PAL ramps: evaluating existing verification data, performing additional tests and analyses to demonstrate performance against critical failure modes, and reviewing and updating of the process controls applied to re-sprayed TPS applications.

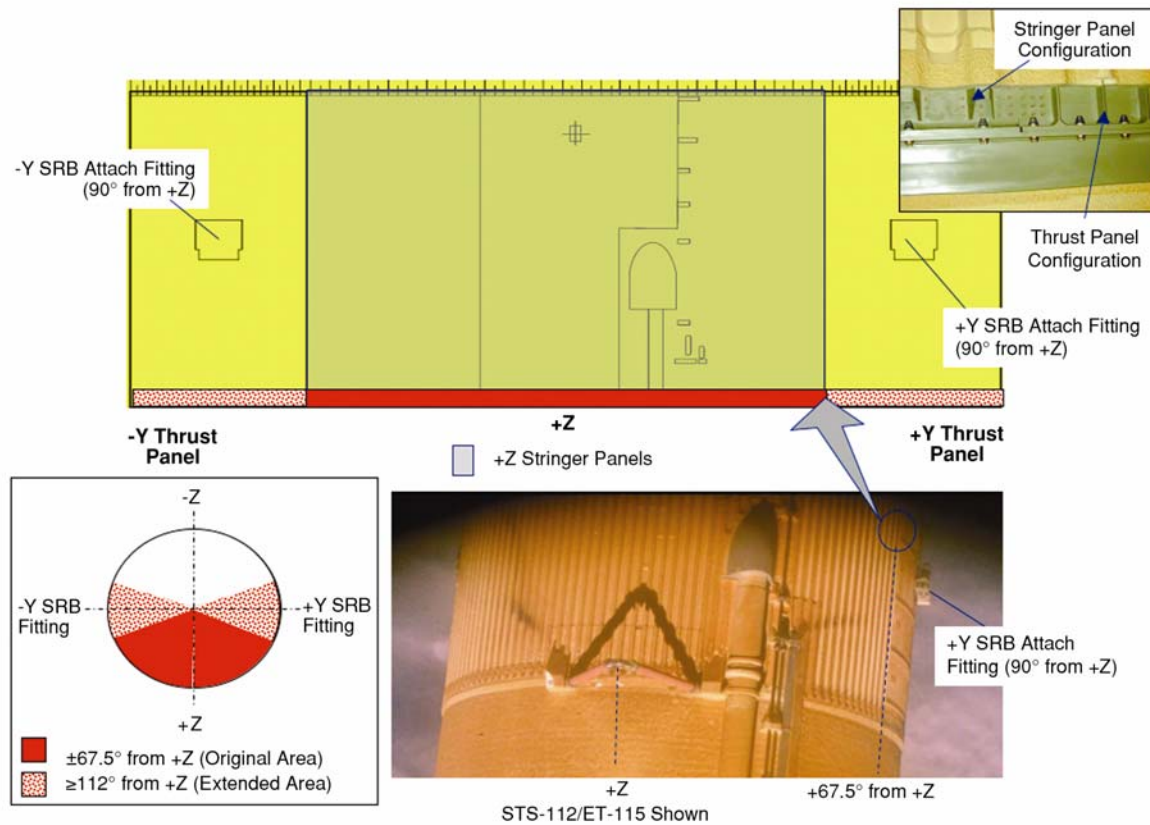

Figure 3.2-1-8. LH₂ intertank flange expanded debris zone.

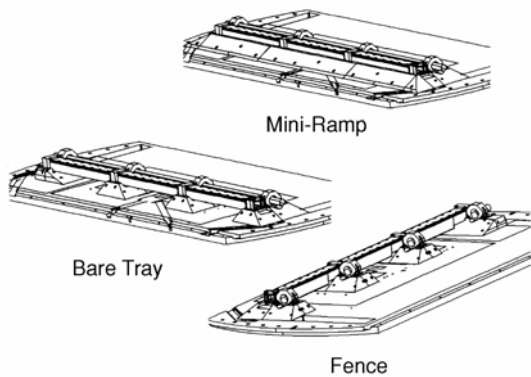

Figure 3.2-1-9. Phase 2 minimal debris ET – PAL ramp redesign solutions.

NASA is enhancing the TPS application process and implementing more stringent process control measures for re-applied TPS hardware and future TPS applications, as appropriate. We will also ensure that at least two certified production operations personnel attend all final closeouts and critical hand-spraying procedures to ensure proper processing and that updates to the process controls are applied to the foam applications (ref. CAIB Recommendation 4.2-3).

NDI of Foam Implementation Approach

During Phase 1, NASA surveyed state-of-the-art technologies, evaluated their capabilities, down-selected options, and began developing a system to detect critical flaws in ET insulation systems. At an initial screening, test articles with known defects, such as voids and delaminations (figure 3.2-1-10), were provided to determine detection limits of the various NDI methods.

TERAHERTZ IMAGING

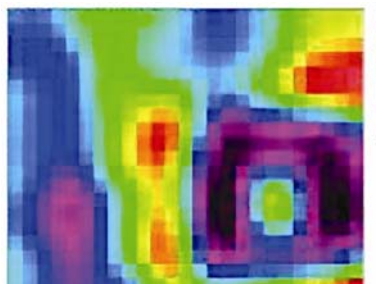
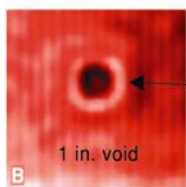
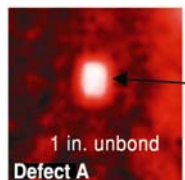
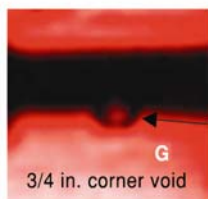
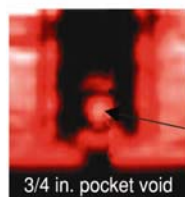

1-in. SOFI to AI delamination imaged with Backscatter Radiography

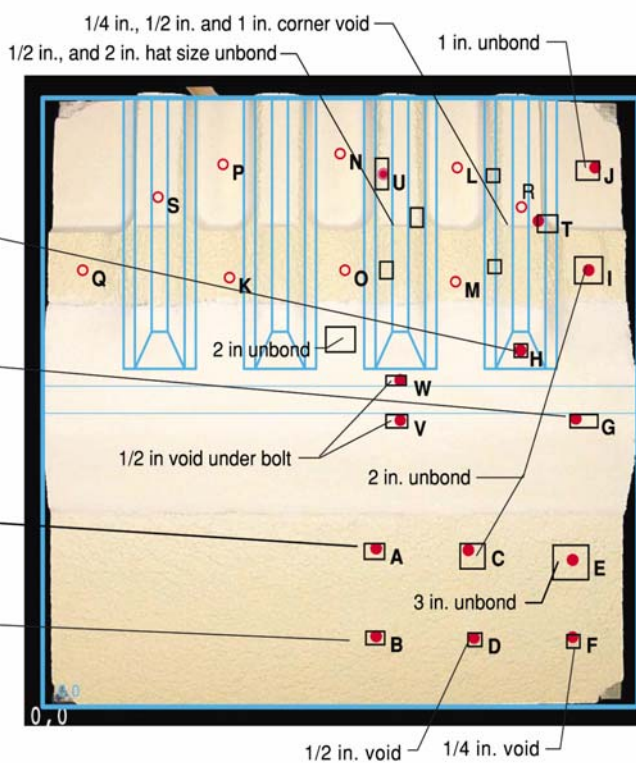

Solid circles = Detected
 Open circles = Weak Indications
 14 Detected
 5 Missed
 0 False calls
 (9 indications below threshold, open circles)

Figure 3.2-1-10. Terahertz images.

NASA is continuing to pursue development of TPS NDI techniques to verify proper application of foam without defects, such as unacceptable volume of voids or poor subsurface adhesion. These NDI techniques are currently being used on the LO₂ and LH₂ PAL ramps. In the future, NASA may mature these techniques for use in verifying the acceptability of the ET. For now, data gathered from the NDI inspections will be used as engineering information only and acceptability of the TPS will be determined primarily through verifying the application and design.

After the initial screening, NASA selected the Tetrahertz and backscatter radiation technologies and conducted more comprehensive probability of detection (POD) tests for those applicable NDI methods. The Phase 2 activities will optimize and fully certify the selected technologies for use on the ET. These new NDI techniques were used for engineering information on the RTF ET PAL ramps. The inspections detected no anomalous conditions above the certification acceptance criteria.

STATUS

ET Forward Bipod Status

NASA successfully completed a Systems Design Review and a Preliminary Design Review. The Critical Design Review (CDR) was held in November 2003, with a Delta CDR in June 2004. The Delta CDR Board approved the bipod redesign. A Production Readiness Review (PRR) was held in June 2004. The PRR Board gave approval for manufacturing operations to proceed with the bipod wedge foam spray on ET-120, which is now complete. The wedge spray is a foam closeout that serves as a transition area for routing of the heater harnesses from the fitting base into the intertank. The wedge is applied prior to fitting installation; after the fitting installation is complete, the final bipod closeout is performed. The final closeout application process has been verified and validated (figure 3.2-1-11).

The bipod fitting design, fitting closeout, and heater system were reviewed during the ET DCR. This hardware, as well as the other ET redesigns, was verified to meet the current SSP performance requirements.

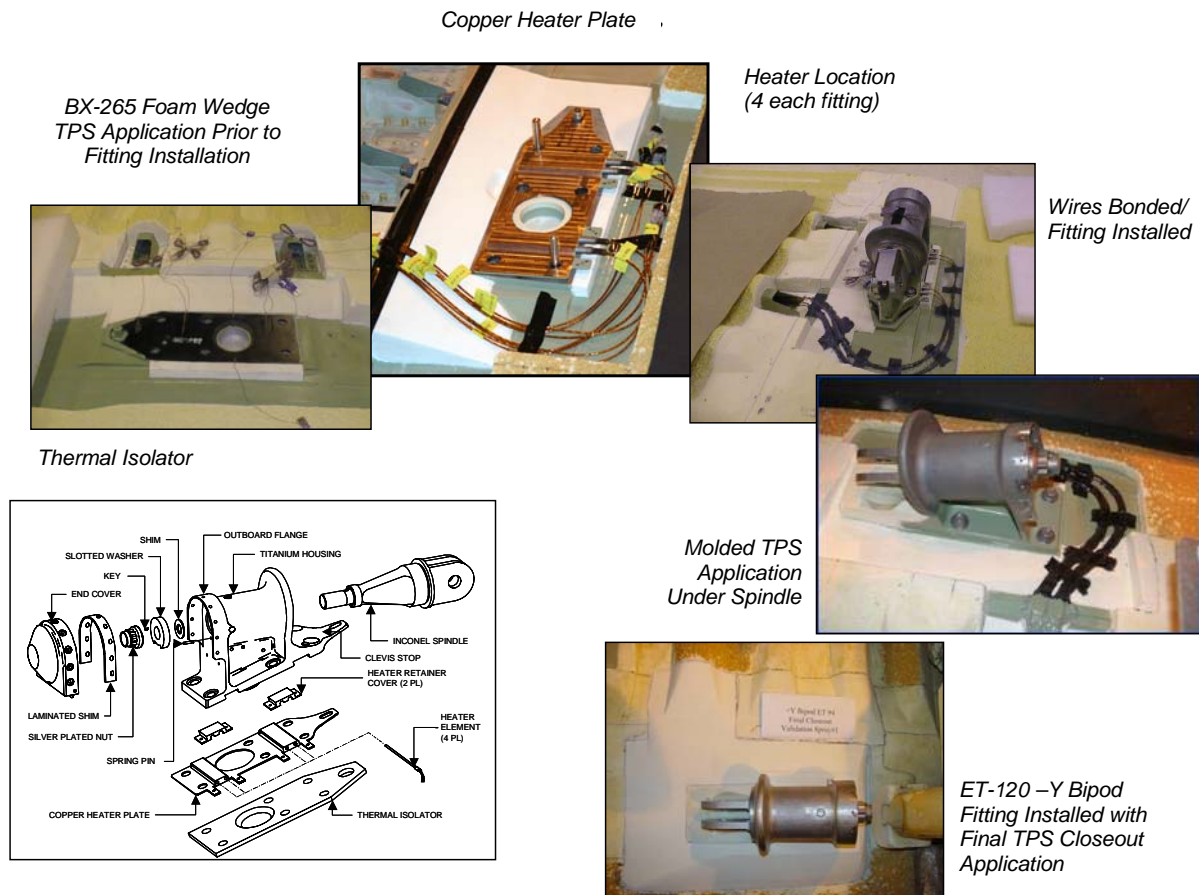

Figure 3.2-1-11. Bipod fitting redesign and TPS closeout.

The bipod fitting redesign verification is complete. The verification included thermal tests to determine the capability of the design to preclude prelaunch ice, with an automated heater control baselined and validated based on bipod web temperature measurements. Structural verification tests have confirmed the performance of the modified fitting in flight environments. Wind tunnel testing has verified the TPS closeout performance when exposed to ascent aerodynamic and thermal environments. The system verification included a full-scale integrated bipod test using hydrogen, the tank fluid, a prototype ground control system to demonstrate system performance, and thermal-vacuum test with combined prelaunch and flight environments to demonstrate TPS performance

LO₂ Feedline Bellows Status

NASA selected the TPS “drip lip” option to reduce ice formation on the three LO₂ feedline bellows. The drip lip diverts condensate from the bellows and significantly reduces ice formation. Since the drip lip alone is not sufficient to

completely eliminate the ice, NASA continued to pursue solutions to complement the TPS drip lip. NASA has conducted tests to characterize the amount and type of residual ice formed during prelaunch and liberated during engine start-up and ascent with the TPS drip lip only. Analysis of the ice formation, estimates of the liberated ice, and transport analyses identified the residual ice at the forward LO₂ feedline bellows location as an unacceptable debris source; therefore, additional reduction of ice at the forward location was required. Through this same analysis, NASA has determined that, if liberated, the ice at the two aft bellows locations would not impact the Orbiter Reinforced Carbon-Carbon; therefore, no additional action is required for those locations (figure 3.2-1-12).

NASA determined that a heater installed in the bellows cavity would reduce ice formation to an acceptable level. The design change includes a redundant heater system with a silicon rubber gasket to join heater elements. The heater is bonded to the bellows rain shield and convolute shield; heater

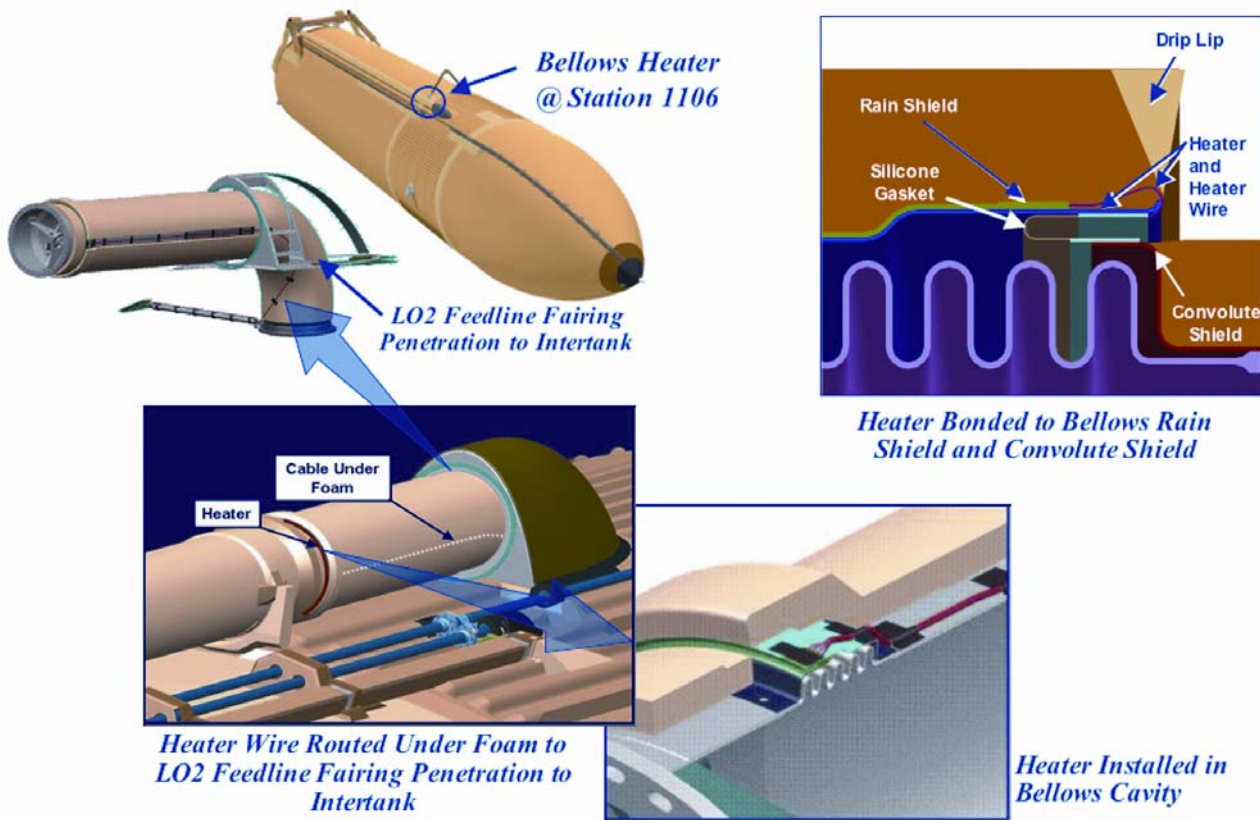

Figure 3.2-1-12. LO₂ feedline bellows condensate drain “drip lip” with heater.

wires are bonded to the external LO₂ feedline substrate. Bonding of the heaters requires removal and replacement of 3-inch width of TPS along the existing drip lip and LO₂ feedline surface. NASA is also continuing to evaluate ice mitigation techniques, such as an infrared projector, that can be implemented at the launch pad, if necessary.

Verification of the design includes testing and analysis to quantify the heater system and ensure that the system does not result in a debris source.

LH₂/Intertank Flange Closeout Status

NASA has successfully determined the primary root cause of foam loss in the intertank/LH₂ tank flange area. LN₂ was formed when the GN₂ used as a safety purge in the intertank came into contact with the extremely cold hydrogen tank dome and condensed into liquid. The LN₂ migrated through intertank joints, fasteners, vent paths, and other penetrations into the foam and then filled voids in the foam caused by unacceptable variability in the manual foam application. During ascent, the LN₂ returned to a gaseous state, pressurizing the voids and causing the foam to detach.

NASA evaluated the foam loss in this region through rigorous testing and analysis. First, a series of 1 ft x 1 ft aluminum substrate panels with induced voids of varying diameters and depths below the foam surface was subjected to the vacuum, heat profiles, and backface cryogenic temperatures experienced during launch. These tests were successful at producing divots in a predictable manner.

Follow-on testing was conducted on panels that simulated the LH₂ intertank flange geometry and TPS closeout configuration to replicate divot formation in a flight-like configuration. Two panel configurations were simulated: (1) a three-stringer configuration and (2) a five-stringer configuration. The panels were subjected to flight-like conditions, including front face heating, backface cryogenics (consisting of a 1.5-hour chill-down, a 5-hour hold, and

an 8-minute heating), ascent pressure profile, and flange deflection. These tests were successful at demonstrating the root cause failure mode for foam loss from the LH₂ tank/intertank flange region.

With this knowledge, NASA evaluated the LH₂/intertank closeout design to minimize foam voids and nitrogen leakage from the intertank into the foam (figure 3.2-1-5). Several design concepts were initially considered to eliminate debris, including incorporating an active helium purge of the intertank crevice to eliminate the formation of LN₂ and developing enhanced foam application procedures.

Testing indicated that a helium purge would not completely eliminate the formation of foam divots since helium, too, could produce enough pressure in the foam voids to cause divot formation. As a result, the purge solution was eliminated from consideration.

NASA also pursued a concept of applying a volume fill or barrier material in the intertank crevice to reduce or eliminate nitrogen condensation migration into the voids. However, analyses and development tests showed that the internal flange seal and volume fill solution may not be totally effective on tanks that had existing foam applications. As a result, this concept was also eliminated from consideration.

The existing intertank closeout is being removed and replaced with the three-step enhanced closeout. NASA is focusing on the enhanced TPS closeout in the LH₂ intertank area to reduce the presence of defects within the foam by using this three-step closeout procedure. This approach greatly reduces or eliminates void formations in the area of the flange joining the LH₂ tank to the intertank. The flange bolts in this area are reversed to put the lower bolt head profile at the lower flange. The LH₂ tank side of flange (shown in figure 3.2-1-13) will provide the foam application technician a much less complex configuration for the foam spray application and subsequently reduce the

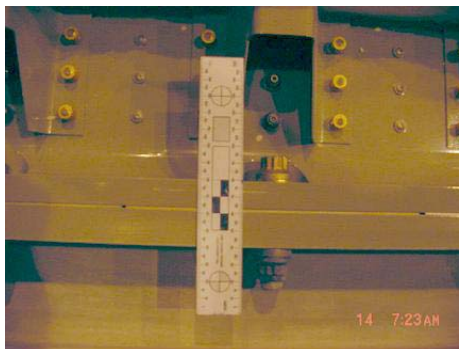

Previous orientation – bolt head forward (top)



New orientation – bolt head aft (bottom)

Figure 3.2-1-13. Flange bolt reversal.

potential for void formation behind the bolt head. The higher profile (nut end) will be encapsulated in the stringer or rib pocket closeout prior to final closeout application. The application process for the intertank stringer panels is shown in figure 3.2-1-14. The stringer panels are the intertank panels ± 67.5 deg from the centerline of the tank directly below the Orbiter.

The areas beyond ± 67.5 deg that remain in the critical debris zone are the intertank thrust panels. The geometry of these panels is simplified by hand-spraying the thrust panel pockets prior to applying the final closeout shown in Steps 2 and 3 of figure 3.2-1-14.

Testing performed on eight panels using the enhanced closeout configuration demonstrated the effectiveness of the closeout; there were no divots formed in any of the tests.

NASA now understands the failure mechanism of the foam and has implemented the appropriate solutions. The baseline flange closeout enhancement (± 112 deg from the +Z, excluding area under LO₂ feedline and cable tray) uses a multi-pronged approach. The baseline includes the external three-step closeout, point fill of the structure, reversal of the flange bolts, and sealant on the threads of the bolts. The external three-step enhanced procedure reduces foam loss to a level within acceptable limits by removing critical voids in the foam. The newly enhanced ET-120 closeout was applied using a verified and validated TPS application process. During production of the ET-120 flange closeout (and all subsequent flange closeouts), a series of high-fidelity production test

articles was used to demonstrate the application on the flight hardware. The acceptability of the closeout is demonstrated through a series of mechanical property tests and dissection of the foam to determine process performance. Defect tolerance of the flange closeout design was demonstrated in a combined environment test.

In addition to hardware redesign, the integration cell access platforms at Kennedy Space Center were modified to provide a more accessible work environment to reduce the potential for TPS damage during ground processing of hardware near the intertank LH₂ tank flange and bipod area.

PAL Ramp Status

Because the PAL ramps have an excellent flight history and have not lost foam since the last configuration change after STS-7, NASA's baseline approach for RTF is to develop sufficient certification data to accept the minimal debris risk of the existing design. Evaluating the available verification data and augmenting them with additional tests, analyses, and/or inspections will accomplish this. This included dissecting several existing PAL ramps to understand the void sizes produced by the existing PAL ramp TPS process.

NASA has obtained sufficient data to proceed to launch with the existing LO₂ and LH₂ PAL ramps. The LH₂ PAL ramp is approximately 38 ft in length. A portion of the LH₂ PAL ramp spans the high-risk LH₂ flange closeout. The forward 10 ft of the LH₂ PAL ramp have been removed to access the underlying intertank/LH₂ tank flange closeout.

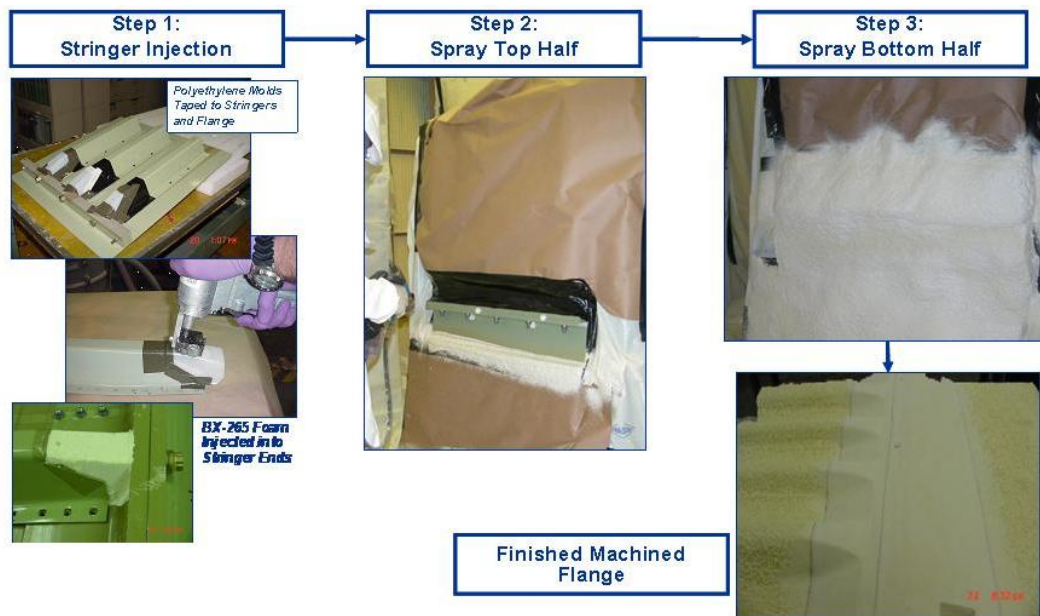

Figure 3.2-1-14. Three-step closeout for LH₂ tank/intertank.

By removing the 10-ft section, an enhanced LH₂/intertank flange closeout can be performed. The removed portion of the LH₂ PAL ramp was replaced with an improved process manual spray application. Inspection of both the LO₂ and LH₂ PAL ramps using engineering development NDI technologies detected no anomalous conditions above the certification acceptance criteria.

As a part of the Phase 2 activities, NASA developed concept designs to eliminate the large PAL ramps. Redesign options included eliminating the PAL ramps altogether, implementing smaller mini-ramps, or incorporating a cable tray aero block fence on either the leading or trailing edge of the tray. NASA performed analysis of the aerodynamic loading on the adjacent cable trays and conducted subscale and full-scale wind tunnel testing of the cable trays to determine the aerodynamic and aero-elastic characteristics of the trays. The tests provided sufficient confidence in the analysis to continue pursuit of ramp elimination. Additionally, NASA has approved the use of flight instrumentation to obtain data to validate the flight environments used in the test and analysis. The instrumentation package, containing accelerometers, is planned to fly on the second ET planned for RTF mission STS-121. These data, in addition to the tests and analysis, will provide the basis to continue pursuing elimination of the LO₂ and LH₂ PAL ramps.

TPS (Foam) Verification Reassessment Status

The SSP established a TPS Certification Plan for the ET RTF efforts. This plan has been applied to each TPS application within the critical debris zone by evaluating the available verification data and augmenting them with additional tests, analyses, and/or inspections. The plan also included dissection of TPS applications within the critical debris zone to understand the void sizes produced by TPS processes that existed when the TPS was applied to the RTF tanks.

The TPS applications underwent visual inspection, verification of the TPS application to specific acceptance criteria, and validation of the acceptance criteria. A series of materials properties tests was performed to provide data for analysis. Acceptance testing, including raw and cured materials at both the supplier and the Michoud Assembly Facility, were used to demonstrate the as-built hardware integrity is consistent with design requirements and test databases. Mechanical property tests, including plug pull, coring, and density, are being performed on the as-built hardware.

NASA also conducted stress analysis of foam performance under flight-like structural loads and environmental conditions, with component strength and fracture tests grounding the assessments. Dissection of equivalent or flight hardware was performed to determine process perform-

ance. TPS defect testing was conducted to determine the critical defect sizes for each application. In addition, various bond adhesion, cryoflex, storage life verification, cryo/load/thermal tests, and acceptance tests were performed to fully certify the TPS application against all failure modes. Finally, a Manual Spray Enhancement Team has been established to provide recommendations for improving the TPS closeout of manual spray applications. Production-like demonstrations are being performed upon completion of all design and development efforts to verify and validate the acceptability of the production parameters of re-designed or re-sprayed TPS applications.

NDI of Foam Status

Activities have been initiated to develop NDI techniques for use on ET TPS. The following prototype systems under development by industry and academia were evaluated:

- Backscatter Radiography: University of Florida
- Microwave/Radar: Marshall Space Flight Center, Pacific Northwest National Labs, University of Missouri, Ohio State
- Shearography: KSC, Laser Technology, Inc.
- Terahertz Imaging: Langley Research Center, Picometrix, Inc., Rensselaer
- Laser Doppler Vibrometry: Marshall Space Flight Center, Honeywell

The Terahertz Imaging and Backscatter Radiography systems were selected for further POD testing based on the results of the initial proof-of-concept tests. The microwave system will still be evaluated during the Phase 2 development activity. This additional POD testing has been completed, but the results are still being analyzed. The preliminary results, however, indicate that these technologies are not yet reliable enough to be used to certify TPS applications over complex geometries, such as the bipod or intertank flange regions. The technologies will continue to be developed to support PAL ramp evaluation and for Phase 2 implementation.

NASA employed a lead tank/trail tank approach for RTF to mitigate risk in the event that the Agency identified any changes required on the lead tank due to the evolving debris analysis. The "trail" or second tank (intended for STS-121 or a launch-on-need rescue mission) was not planned for shipment to the KSC for mating to the Orbiter until after the final ET DCR. The SSP decided to ship the second RTF tank prior to the final ET DCR, which was rescheduled to a date after the required ship date. This decision was based on the ET DCR Pre-board identifying no significant issues, as well as the capability to do certain types of work on the ET at KSC should it be required. Additionally, NASA redefined the trail tank as the third tank (ET-119), once the second

RTF tank (ET-121) was shipped. ET-119 was retrofitted with the required design changes to eliminate critical TPS debris and also eliminate critical ice debris by installing a heater system at the forward LO₂ feedline bellows. Final certification of the heater system and shipment of ET-119 is planned for June 2005.

FORWARD WORK

| Complete bellows heater implementation and certification.

SCHEDULE

Responsibility	Due Date	Activity/Deliverable
SSP	Jun 04 (Completed)	Complete bipod redesign Delta CDR Board
SSP	Apr 04 (Completed)	Perform NDI of PAL ramp on ET-120 (1 st RTF tank)
SSP	Jul 04 (Completed)	Complete validation of LH ₂ /intertank stringer panel closeout
SSP	Aug 04 (Completed)	Complete validation of LH ₂ /intertank thrust panel closeout
SSP	Aug 04 (Completed)	Complete bipod TPS closeout validation
SSP	Nov 04 (Completed)	Complete bellows "drip lip" validation
SSP	Nov 04 (Completed)	Complete bipod retrofit on ET-120
SSP	Nov 04 (Completed)	Complete flange closeout on ET-120
SSP	Dec 04 (Completed)	Critical debris characterization Initial phase testing
SSP	Dec 04 (Completed)	Phase I ET DCR
SSP	Dec 04 (Completed)	Ready to ship ET-120 to KSC
SSP	Mar 05 (Completed)	Phase II ET DCR
SSP	Mar 05 (Completed)	Critical debris characterization final phase testing
SSP	Mar 05 (Completed)	Final External Tank Certification (DCR Board)
SSP	Jun 05	Complete bellows heater verification
SSP	Jun 05	Complete bellows heater DCR
SSP	Jun 05	Complete bellows heater implementation

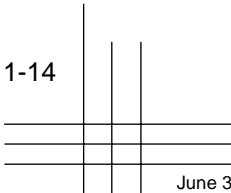



Columbia Accident Investigation Board

Recommendation 3.3-2

Initiate a program designed to increase the Orbiter's ability to sustain minor debris damage by measures such as improved impact-resistant Reinforced Carbon-Carbon and acreage tiles. This program should determine the actual impact resistance of current materials and the effect of likely debris strikes. [RTF]

BACKGROUND

The STS-107 accident clearly demonstrated that the Space Shuttle's Thermal Protection System (TPS) design, including the Reinforced Carbon-Carbon (RCC) panels and acreage tiles, was too vulnerable to impact damage from the existing debris environment. As a result, NASA initiated a broad array of projects to define critical debris (explained in NASA's response to the Columbia Accident Investigation Board (CAIB) Return to Flight (RTF) Recommendations 3.3-1 and 6.4-1), to work aggressively to eliminate debris generation (CAIB Recommendation 3.2-1), and to harden the Orbiter against impacts.

NASA has chosen to address the CAIB requirement by (1) initiating a program of Orbiter hardening and (2) determining the impact resistance of current materials and the effect of likely debris strikes. NASA's Orbiter hardening program is mature and well defined. Four modifications to the Orbiter have been implemented for the STS-114 RTF mission. Impact tolerance testing is also a well-defined effort that has identified impact and damage tolerance data for all portions of the TPS for use by all elements of the Space Shuttle Program (SSP). This effort has provided the SSP with a better understanding of the Orbiter's capability to withstand damage relative to the expected debris environment at RTF. This improved understanding, paired with efforts to reduce the generation of critical debris, allows us to make an informed decision to accept the residual risk posed by ascent debris when we return to flight.

NASA IMPLEMENTATION

Orbiter Hardening

NASA formed an Orbiter Hardening Team to identify options for near-term TPS improvements in critical locations. Initially, the SSP categorized Orbiter hardening into eight candidate design families with 17 design options for further assessment. Each TPS enhancement study was evaluated against the damage history, vulnerability, and criticality potential of the area and the potential safety, operations, and performance benefits of the enhancement. The team focused on those changes that achieve the following goals: increase impact durability for ascent and micro-

meteoroid orbital debris impacts; increase temperature capability limits; reduce potential leak paths; selectively increase entry redundancy; increase contingency trajectory limits; and reduce contingency operations such as on-orbit TPS repair. These candidates were presented to the SSP Program Requirements Control Board (PRCB), which prioritized them. The result was a refined set of 16 Orbiter hardening options in eight different design families.

The 16 selected Orbiter hardening options are being implemented in three phases. Based on maturity of design and schedule for implementation, four projects were identified as Phase I options for implementation before STS-114. These include: front spar "sneak flow" protection for the most vulnerable and critical RCC panels 5 through 13; main landing gear corner void elimination; forward Reaction Control System carrier panel redesign to eliminate bonded studs; and replacing side windows 1 and 6 with thicker outer thermal panes. All four modifications are being implemented on all of the Orbiters. These changes increase the impact resistance of the Orbiter in highly critical areas such as the wing spar, main landing gear door (MLGD), and windows to reduce existing design vulnerabilities.

NASA also selected two Phase II options for implementation after RTF: "sneak flow" front spar protection for the remaining RCC panels 1 through 4 and 14 through 22, and MLGD enhanced thermal barrier redesign. Both of these projects are in the final design phase. Implementation of the Phase II modifications may begin as early as one year after RTF and will be executed during Orbiter Major Modification periods or during extended between-mission flows.

Finally, NASA designated as Phase III the remaining options that were less mature but held promise for increasing the impact resistance of the Orbiter over the longer term. These options will be implemented as feasible, as designs mature, and as implementation opportunities become available. For instance, NASA is actively developing new toughened tiles for the Orbiter TPS. These tiles will be installed as soon as possible around more critical areas such as the landing gear doors. In less critical areas, they will be installed as existing tiles require replacement. Two of the Phase III options have

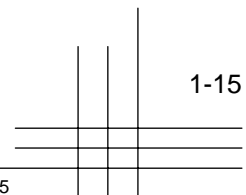

Family	Redesign Proposal	Phase
WLESS	"Sneak Flow" Front Spar Protection (RCC #5 – 13)	I
	"Sneak Flow" Front Spar Protection (RCC # 1 – 4, 14 – 22)	II
	Lower Access Panel Redesign/BRI 20 Tile Implementation	III
	Insulator Redesign	III
	Robust RCC	III
Landing Gear and ET Door Thermal Barriers	Main Landing Gear Door Corner Void	I
	Main Landing Gear Door Enhanced Thermal Barrier Redesign	II
	Nose Landing Gear Door Thermal Barrier Material Change	III
	External Tank Door Thermal Barrier Redesign	III
Vehicle Carrier Panels – Bonded Stud Elimination	Forward RCS Carrier Panel Redesign – Bonded Stud Elimination	I
Tougher Lower Surface Tiles	Tougher Periphery (BRI 20) Tiles around MLGD, NLGD, ETD, Window Frames, Elevon Leading Edge and Wing Trailing Edge	III
	Tougher Acreage (BRI 8) Tiles and Ballistics SIP on Lower Surface	III
Instrumentation	TPS Instrumentation	III
Elevon Cove	Elevon Leading Edge Carrier Panel Redesign	III
Tougher Upper Surface Tiles	Tougher Upper Surface Tiles	III
Vertical Tail	Vertical Tail AFSI High Emittance Coating	III

Table 3.3-2-1. Eight Design Families Targeted for Enhancement.

been approved by the SSP for further development: toughened lower and upper surface tiles and stronger wing leading edge (WLE) RCC.

Impact and Damage Tolerance

Using both test and analysis, the Orbiter Damage Impact Assessment Team (ODIAT) determined the impact and damage tolerance of TPS tile, RCC, and the Orbiter windows to External Tank (ET) foam, ice, and ablator impacts. Impact tolerance is the ability of the TPS materials to withstand impacts before damage occurs. Damage tolerance is defined as the level of damage from a debris strike that can be tolerated while still safely completing the mission; i.e., safe entry. In general, although tile is not very *impact* tolerant (it is damaged easily with very low levels of kinetic energy), both impact tests and flight history show tile to be very *damage* tolerant (even with significant damage, it resists entry heating well). Conversely, RCC is very impact tolerant but is not damage tolerant, since even minor cracks or coating loss can be critical and prevent safe entry.

Preliminary impact tolerance data generated early in the Program were used by SSP project offices to modify hardware as necessary to reduce the risk that critical debris (debris whose impact would preclude safe entry) would be released. These preliminary data were the basis for the ET Project's work to certify the ET for foam releases. Subsequent test and analysis confirmed that the actual damage tolerance of the RCC was less than the ET certification limit. However, further testing and analysis have resulted in a best estimate by the ET Project of a predicted foam loss environment that is significantly less than the ET certification limit as well.

Tile Impact and Damage Tolerance

Tests to determine TPS tile impact tolerance—using foam, ice, and ablator projectiles—are complete. NASA performed impact and damage tolerance testing at several field centers and other test facilities using both acreage and special configuration tiles, and both new and aged tiles. These tests indicated that, although tile is not very resistant to impact,

it tolerates entry heating well even with significant damage. Overall, testing shows tile to be tolerant to moderate levels of impact damage; tile damage tolerance depends on tile thickness, which varies by location. As a result, certain areas of reduced thickness, such as those tiles adjacent to the MLGDs, are more susceptible to critical damage. Based on tests and on flight history, NASA developed zone and cavity definitions for 31 areas of tile with similar structural and thermal characteristics to determine the depth of allowable damage penetration into the tile before critical damage occurs and repair is necessary. These zones take into account aero-heating, impact angle, and tile thickness. NASA also completed thermal analyses that encompass all nominal entry trajectories for each of these areas.

In addition, analysis of the Space Shuttle's flight history indicated that tile damage fell into three impact classes: (1) numerous, shallow impacts primarily on the forward chin and fuselage; (2) fewer, deeper impacts primarily on the lower surface; and (3) umbilical area impacts. The majority of historical damage observed fell into the first category, and was likely caused by foam popcornning rather than large foam divots. ET intertank venting is expected to reduce popcornning masses in the ET foam. At RTF, the risk of significant damage of this nature is categorized as "remote-catastrophic."¹ The second category of damage, with fewer deeper impacts, was most likely the result of ET foam divots and ice from the ET bellows and brackets. This category of damage is the most likely to require repair. Its likelihood has been reduced through redesign and will be categorized as "infrequent-catastrophic" at RTF. Finally, the umbilical area had a mixture of both small and large impacts from a unique subset of sources including ET umbilical ice, baggies, Kapton tape, and ET fire detection paper. Debris transport analysis suggests that most the impacts came from "local" sources rather than from the forward ET. As a result, we expect little change to the damage in this area. At RTF, the risk of damage in this area will be classified as "remote-catastrophic."

RCC Impact and Damage Tolerance

Impact and damage tolerance testing on the RCC was performed at several NASA field centers and other test facilities, using both RCC coupons and full-scale RCC panels. Structural and thermal testing of damaged RCC samples established how much damage will provide the expectation of a safe return for the crew and vehicle. Test-verified models established impact tolerance thresholds for foam and ice against tile and RCC. These impact tolerance

¹ The risk categories referenced in this document refer to the SSP Risk Assessment methodology documented in NSTS 22254, "Methodology for Conduct of Space Shuttle Hazard Analyses," and NSTS 07700 Volume I, Chapter 5, "Risk Management."

thresholds are the levels at which detectable damage begins to occur, and vary depending on RCC panel location or the acreage tile location. These thresholds were provided to the Program for risk assessment of the TPS capability against the expected debris environment.

Testing showed that the RCC cannot tolerate any significant loss of coating from the front surface in areas that experience full heating on entry. This is of concern because impacts can create subsurface delamination of the RCC that is undetectable through imaging scans. Testing indicates that loss of front-side coating in areas that are hot enough to oxidize and/or promote full heating of the damaged substrate can cause unacceptable erosion damage in the delaminated areas. However, for subsurface delamination to be a concern, there needs to be front-side damage that can be detected with the Orbiter Boom Sensor System, thus eliminating the concern of "hidden, undetectable" damage. Further testing and modeling have shown that, although the hottest areas on the WLE (the bottom and apex surfaces) cannot tolerate any significant coating loss, other cooler areas (such as the top surface of the WLE) can tolerate some amount of coating loss and subsurface delamination. Testing and model development work has converged to fully map the damage tolerance capabilities of the WLE RCC depending on panel and location (top, apex, or bottom surface).

Overall, the WLE panels do not have the capability to withstand predicted worst-case foam impacts in the certified (worst-on-worst) ET debris environment. However, the WLE panels' impact resistance is better than the ET's best estimate of the predicted foam debris environment with two exceptions. The ET Project suggests that there is a chance of liquid oxygen (LO₂) flange foam loss of a critical size that, if it impacted the Orbiter, would potentially exceed the WLE panels' damage tolerance. Additionally, NASA testing suggests that the WLE RCC panels cannot withstand ice impacts without violating their damage thresholds. This limitation exists in both the ET certification debris environment and the best-estimate debris environment.

Similarly, the nose cap and chin panel impact and damage tolerance are less than the ET certified environment, but greater than the ET best estimate of the foam debris environment during ascent. Like the WLE, there is one exception to the predicted capability in the best estimate environment: possible LO₂ flange foam loss of a critical size that, if it impacted the nose cap or chin panel, would violate the damage threshold. There are no debris transport cases that would result in ice impacting the nose cap or chin panel.

Window Impact and Damage Tolerance

Testing is complete on window impact from debris, including butcher paper, ablator material, foam, Tyvec, aluminum oxide, and small/fast ogive foam. NASA's debris transport analysis suggests that very small ogive foam has the potential to impact the Orbiter windows, but impact tolerance tests indicate that the windows can withstand these impacts without sustaining critical damage. Testing also indicates that butcher paper causes unacceptable damage to the windows. As a result, NASA is replacing butcher paper covers with Tyvec covers that will not cause critical damage.

Expected Damage

Tile

To build a reasonable picture of expected tile damage, NASA undertook a four-stage analysis. This analysis began with a wide-ranging effort to understand the Space Shuttle's flight history and a significant review of the history of tile damage throughout the SSP. The historical damage was then characterized and a database of historical tile damage was created that will be used to support assessments of any damage sustained on future flights. These data were used to demonstrate the capability of our debris models relative to flight history. Finally, NASA captured the improvements expected in the debris environment based on changes made to the Space Shuttle system. The ET Project provided both possible and likely debris sources, masses, and locations that were used to generate a series of possible debris scenarios. Together, these elements provided the expected foam debris environment at RTF.

The damage generated by foam popcorning is acceptable based on the allowable damage map created with certification rigor (worst-on-worst). However, changes to the ET are expected to significantly reduce the size and quantity of foam debris shed during ascent. These changes include: a redesign of the LH₂ flange closeout—the source of the majority of divots over the history of the SSP; the removal of the bipod foam ramp; significant increase in intertank venting—that will reduce the size of foam popcorning; and a drip lip for the bellows foam that will reduce ice formation.

At RTF, there will still be the potential for foam to cause damage to tile that exceeds safe entry limits, as discussed above, but this potential has been significantly reduced. We will likely see some small foam divots impacting the tile and causing minor, and acceptable, damage. The SSP now has a much greater understanding of the causes, consequences, and likelihood of tile damage, and is treating this as an accepted risk for RTF.

RCC

NASA's tests and analysis demonstrate that, in the worst-case environment, potential impacts to the RCC exceed the RCC's ability to withstand damage, in many cases by a significant margin. However, extensive debris transport analysis and analysis of expected ascent debris indicate that the worst-case environment is very unlikely to occur. In what we believe is the most likely ascent environment, even with some conservative assumptions, the RCC's damage tolerance meets or exceeds the potential debris impacts. Overall, NASA's risk assessment for significant foam damage to the RCC is a remote likelihood and catastrophic consequence. The risk of critical damage is greatest in panels 10 through 12. Based on this assessment, the Program has chosen to accept the remaining risk.

The risk assessment for foam impacts to the nose cap is the same as for the RCC overall, with one exception. Our assessments indicate that there is an increased risk for LO₂ intertank flange foam to impact the nose cap, placing it in the infrequent likelihood category.

STATUS

Orbiter Hardening

NASA has completed implementation of the four Orbiter hardening options that must be completed before RTF. Beyond RTF, NASA will continue to pursue Phase II and III hardening options and will implement those that are feasible at the earliest possible opportunity.

The SSP has reviewed and approved the corrective measures taken in response to this recommendation. The SSP Manager has reviewed the suite of activities summarized above and concluded that, taken as an integrated plan, it fully satisfies the CAIB RTF recommendation to initiate a program to increase the Orbiter's ability to sustain minor debris damage. As NASA's analysis becomes more defined, we will continue to enhance the steps taken to improve the Orbiter's resistance to potential impact damage beyond RTF.

NASA acknowledges that the elimination of all critical debris is not attainable, and has analyzed and formally accepted the remaining risk as a condition for RTF. Improved nondestructive evaluation (NDE) capabilities will provide greater knowledge of the condition of the ET foam in critical areas and the integrity of the Orbiter RCC prior to launch. Although a dramatic improvement, these capabilities use the best available technology to provide a view of what is beneath the surface, but will not allow us to verify the precise condition of foam and RCC. We accept the risk associated with the limitations of our available NDE capabilities.

Impact and Damage Tolerance

NASA conducted two Design Verification Reviews (DVRs) for Debris in March 2005 and April 2005, and will be conducting a third DVR in June 2005. The purpose of the DVR for Debris is to present and document the data used to perform the Systems Engineering and Integration assessment of the debris environment with respect to impact tolerance of Orbiter TPS. Participants of the DVR include members of SSP management, NASA Engineering Safety Center, Independent Technical Authority, and Safety and Mission Assurance.

In preparation for the Delta DVR for Debris in June 2005, NASA has two major objectives to support our rationale for RTF. First, NASA is working to develop an end-to-end estimate of the Orbiter's capability to withstand damage relative to the ascent environment. To do this, we are using the ET Project's best estimate of the foam and/or ice debris that may be liberated, and worst-case assumptions about the potential of that debris to be transported to the Orbiter. Second, for those bounding cases in which the initial assessment indicates that the Orbiter cannot withstand the potential impact, NASA is performing a probabilistic-based risk assessment to determine the acceptability of a critical debris release potential. Currently, NASA plans to assess four foam transport cases and two ice transport cases. These cases represent the worst potential impacts of a general category and so may be used to bound the similar, but less severe, transport cases from the same areas. This analysis will aid NASA in quantifying the risk posed by the debris environment in our formal risk analysis, aid in the determination of the ascent debris risk remaining when we return to flight, and help formulate flight rationale for risk acceptance by NASA Senior Management.

FORWARD WORK

NASA will complete the materials tests to provide insight into the material and physical properties of the TPS. NASA will also validate the analytical models and tools used pre-flight to establish impact and damage tolerance thresholds, as well as to assess any damage seen on orbit.

Impact and Damage Tolerance Verification

The first two Shuttle test flights will enable us to verify the new Space Shuttle ascent debris environment with both imagery and radar and determine the actual size of damage sustained during ascent—rather than the size of the damage after entry heating—through on-orbit inspections. These data will allow us to determine the growth of ascent and on-orbit damage during entry by comparing the on-orbit inspections and postlanding inspections. These data, paired with our test of tile and RCC repair methods, will provide us with a more rigorous understanding of the risk of TPS damage and the Orbiter's damage tolerance.

Additional Monte Carlo analyses will support the flight rationale for the debris sources identified with the largest uncertainty in risk, in particular those risks in the "infrequent" category, including foam from LO₂ ice/frost ramps and ice from the LO₂ feedline bellows and brackets. These data will be presented at a Delta DVR for Debris scheduled for June 2005.

SCHEDULE

Responsibility	Due Date	Activity/Deliverable
SSP	Jun 03 (Completed)	Initial plan reported to PRCB
SSP	Aug 03 (Completed)	Initial Test Readiness Review held for Impact Tests
ODIAT	Oct 03 (Completed)	Initial Panel 9 Testing
SSP	Nov 03 (Completed)	Phase I Implementation Plans to PRCB (MLGD corner void, FRCS carrier panel redesign—bonded stud elimination, and WLE impact detection instrumentation)
SSP	Jan 04 (Completed)	Phase II Implementation Plans to PRCB (WLE front spar protection and horse collar redesign, MLGD redundant thermal barrier redesign)
ODIAT	Aug 04 (Completed)	Panel 16R Testing
SSP	Sep 04 (Completed)	Finalize designs for modified wing spar protection between RCC panels 1–4 and 14–22 on OV-103 and OV-104
SSP	Oct 04 (Completed)	Conclude feasibility study of the Robust RCC option
SSP	Jan 05 (Completed)	Complete analysis and preliminary design phase for robust RCC
SSP	Feb 05 (Completed)	Complete modification of wing spar protection behind RCC panels 5–13 on OV-103
ODIAT	Mar 05 (Completed)	Tile Impact Testing Complete
ODIAT	Mar 05 (Completed)	RCC Impact Testing Complete
SSP	Apr 05 (Completed)	Damage Tolerance Test and Analysis Complete (SSP baseline of models and tools)
SSP	Jun 05	Delta DVR for Debris
ODIAT	Jun 05	Final Tile and RCC Model Verification (Project baselining of models and tools)
ODIAT	Jul 05	RCC Materials Testing Complete



Columbia Accident Investigation Board

Recommendation 3.3-1

Develop and implement a comprehensive inspection plan to determine the structural integrity of all Reinforced Carbon-Carbon system components. This inspection plan should take advantage of advanced non-destructive inspection technology. [RTFF]

Note: The Stafford-Covey Return to Flight Task Group held a plenary session on February 17, 2005, in Houston, Texas. NASA's progress toward answering this recommendation was reviewed and the Task Group agreed that the actions taken were sufficient to change this recommendation from conditionally closed to fully closed.

BACKGROUND

Current on-vehicle inspection techniques are inadequate to assess the structural integrity of Reinforced Carbon-Carbon (RCC) components and attachment hardware. There are two aspects to the problem: (1) how we assess the structural integrity of RCC components and attach hardware throughout their service life, and (2) how we verify that the flight-to-flight RCC mass loss caused by aging does not exceed established criteria. At present, structural integrity is assured by wide design margins; comprehensive nondestructive inspection (NDI) is conducted only at the time of component manufacture. Mass loss is monitored through a destructive test program that periodically sacrifices flown RCC panels to verify by test that the actual material properties of the panels are within the predictions of the mission life model.

The RCC NDI techniques currently certified include X-ray, ultrasound (wet and dry), eddy current, and computer-aided tomography (CAT) scan. Of these, only eddy current can be done without removing components from the vehicle. While eddy current testing is useful for assessing the health of the RCC outer coating and detecting possible localized subsurface oxidation and mass loss, it reveals little about a component's internal structure. Since the other certified NDI techniques require hardware removal, each presents its own risk of unintended damage. Only the vendor is fully equipped and certified to perform RCC X-ray and ultrasound. Shuttle Orbiter RCC components are pictured in figure 3.3-1-1.

NASA IMPLEMENTATION

The Space Shuttle Program (SSP) is pursuing inspection capability improvements using newer technologies to allow comprehensive NDI of the RCC without removing it from the vehicle. A technical interchange meeting held in May 2003 included NDI experts from across the country. This meeting highlighted five techniques with potential for near-term operational deployment: (1) flash thermography, (2) ultrasound (wet and dry), (3) advanced eddy current,

(4) shearography, and (5) radiography. The SSP is assessing the suitability of commercially available equipment and standards for flight hardware. Once an appropriate in-place inspection method is fielded, the SSP will be able to positively verify the structural integrity of RCC hardware without risking damage by removing the hardware from the vehicle. RCC post-flight inspection requirements consist of visual, tactile, and infrared (IR) thermography on the installed (i.e., in-situ) RCC components (wing leading edge (WLE) panels, nose cap, chin panel). Contingency inspections (eddy current, ultrasonic, radiography) will be invoked if there are any suspicions of impact damage to the RCC by virtue of instrumentation, photographic, thermography, or visual post-flight inspection.

NASA has cleared the RCC by certified inspection techniques before return to flight. For the long term, a Shuttle Program Requirements Control Board (PRCB) action was assigned to review inspection criteria and NDI techniques for all Orbiter RCC nose cap, chin panel, and WLE system components. Viable NDI candidates were reported to the PRCB in January 2004, and specific options were chosen.

RCC structural integrity and mass loss estimates were validated by off-vehicle NDI of RCC components and destructive testing of flown WLE panels. All WLE panels, seals, nose caps, and chin panels were removed from Orbiter Vehicle (OV)-103, OV-104, and OV-105 and returned to the vendor's Dallas, Texas, facility for comprehensive NDI. Inspections included a mix of ultrasonic, X-ray, and eddy current techniques. In addition, NASA has introduced off-vehicle flash thermography for all WLE panels and accessible nose cap and chin panel surfaces; any questionable components were subjected to CAT scan for further evaluation. Data collected will be used to support development of future in-place NDI techniques.

The health of RCC attach hardware was assessed using visual inspections and NDI techniques appropriate to the

critical flaw size inherent in these metallic components. This NDI was performed on select components from OV-103 and OV-104. Destructive evaluation of select attach hardware from both vehicles was also undertaken. Additional requirements will be established, if necessary, based on results of inspections.

STATUS

Advanced On-Vehicle NDI: Near-term advanced NDI technologies were presented to the PRCB in January 2004. Thermography, contact ultrasonics, eddy current, and radiography were selected as the most promising techniques to be used for on-vehicle inspection that could be developed in less than 12 months. The PRCB approved the budget for the development of these techniques. IR thermography has been selected as the RCC in-situ NDI method for post-flight inspection.

OV-104: The nose cap, chin panel, and all WLE RCC panel assemblies were removed from the vehicle and shipped to the vendor for complete NDI. The data analysis from this suite of inspections was completed in March 2004. Vendor inspection of all WLE panels and the analysis of the final panel are complete. Eddy current inspections of the nose cap and chin panel were completed before these components were removed, and the results compare favorably to data collected when the components were manufactured, indicating mass loss and coating degradation are within acceptable limits. Off-vehicle IR thermography inspection at KSC was performed to compare with vendor NDI. All findings were cleared on a case-by-case basis through the Material Review Board (MRB) system.

OV-103: As part of the OV-103 Orbiter maintenance down period (OMDP), WLE panels were removed from the vehicle, inspected by visual and tactile means, and then shipped to the vendor for NDI. The analysis of the inspection results was completed in July 2004. X-ray inspection of the RCC nose cap, which was already at the vendor for coating refurbishment, revealed a previously undocumented 0.025 in. \times 6 in. tubular void in the upper left-hand expansion seal area. While this discrepancy does not meet manufacturing criteria, it is located in an area of the panel with substantial design margin (900% at end of panel life) and is acceptable for flight. The suite of inspections performed on the OV-103 nose cap has confirmed the Orbiter's flight worthiness and revealed nothing that might call into question the structural integrity of any other RCC component. Off-vehicle IR thermography inspection at KSC has been performed for

comparison with vendor NDI. All findings were cleared on a case-by-case basis through the KSC MRB system.

OV-105: All OV-105 RCC components (WLE, nose cap, and chin panel) have been removed and inspected during its OMDP, which began in December 2003. Off-vehicle IR thermography inspection at KSC has been performed to compare with vendor NDI. All findings were cleared on a case-by-case basis through the KSC MRB system.

RCC Structural Integrity: Three flown RCC panels with 15, 19, and 27 missions respectively have been destructively tested to determine actual loss of strength due to oxidation. The testing of this flown hardware to date confirms the conservativeness of the RCC material A-Allowables values used for design and projected mission life.

RCC Attach Hardware: The RCC Problem Resolution Team was given approval for a plan to evaluate attach hardware through NDI and destructive testing. Detailed hardware NDI inspection (dye penetrant, eddy current) to address environmental degradation (corrosion and embrittlement) and fatigue damage concerns have been performed on selected OV-103/104 WLE panels in the high heat and fatigue areas. No degradation or fatigue damage concerns were found.

The Stafford-Covey Return to Flight Task Group agreed to conditionally close this recommendation in April 2004. In February 2005, they granted full closure to the recommendation, indicating that NASA had fully complied with the *Columbia* Accident Investigation Board recommendation.

FORWARD WORK

The near-term advanced on-vehicle NDI techniques are in development, as are process and standards for their use. Decisions on long-term NDI techniques (those requiring more than 12 months to develop) will be made after inspection criteria are better established. Data storage, retrieval, and fusion with CATIA CAD models is planned to enable easy access to NDI data for archiving and disposition purposes. The RCC components have been re-baselined according to the Lockheed Martin Mission and Fire Control techniques and the data captured and cataloged for future reference. This catalog of data is unique to each discrete RCC component and serves as the standard for future inspections.

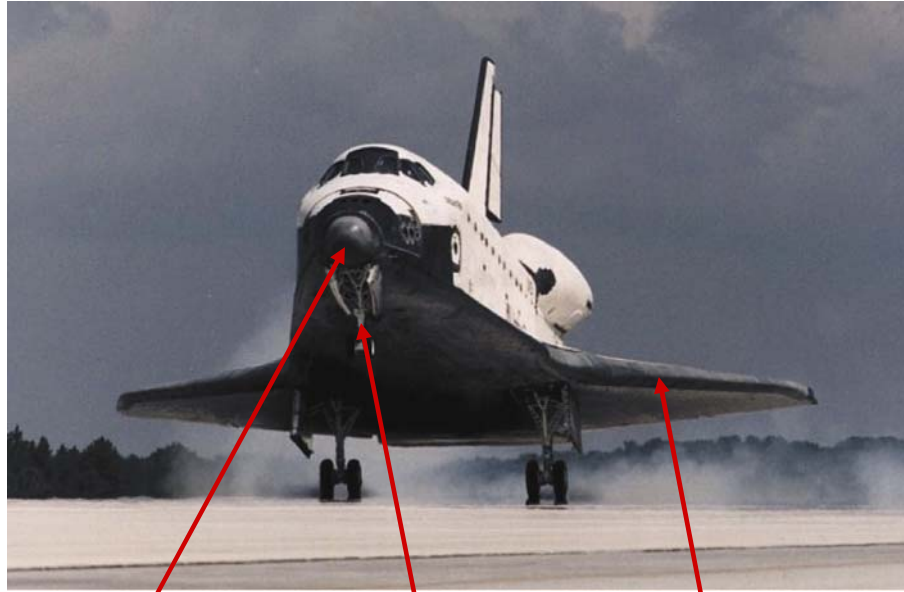

Nose Cap,
Chin Panel,
and Seals

Forward External
Tank Attachment
"Arrowhead" Plate

Wing Leading
Edge Panels
and Seals

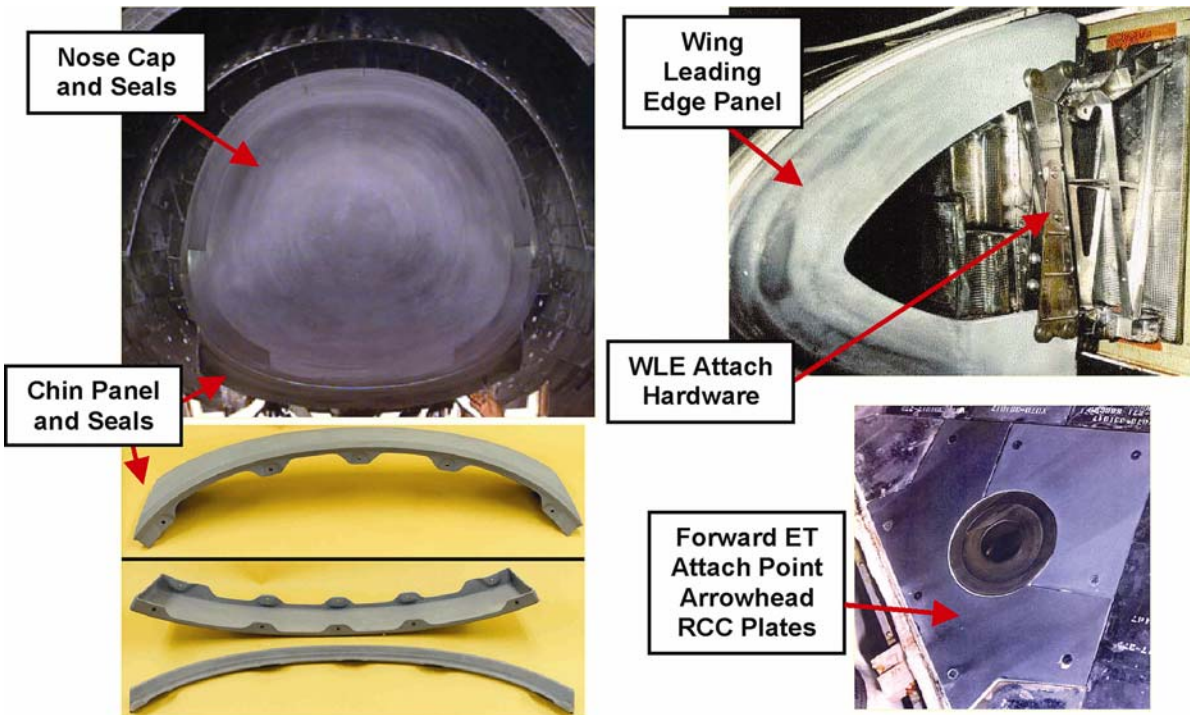

Figure 3.3-1-1. Shuttle Orbiter RCC components.

SCHEDULE

Responsibility	Due Date	Activity/Deliverable
SSP	Sep 03 (Completed)	OV-104 WLE RCC NDI analysis complete
SSP	Oct 03 (Completed)	Completion of NDI on OV-104 WLE attach hardware
SSP	Dec 03 (Completed)	OV-103 chin panel NDI
SSP	Jan 04 (Completed)	Report viable on-vehicle NDI candidates to the SSP
SSP	Jan 04 (Completed)	Completion of NDI on OV-103 WLE attach hardware
SSP	Feb 04 (Completed)	OV-103 nose cap NDI analysis
SSP	Feb 04 (Completed)	OV-104 chin panel NDI analysis
SSP	Apr 04 (Completed)	OV-104 nose cap NDI analysis
SSP	Jul 04 (Completed)	OV-103 WLE RCC NDI analysis



Columbia Accident Investigation Board

Recommendation 6.4-1

For missions to the International Space Station, develop a practicable capability to inspect and effect emergency repairs to the widest possible range of damage to the Thermal Protection System, including both tile and Reinforced Carbon-Carbon, taking advantage of the additional capabilities available when near to or docked at the International Space Station.

For non-Station missions, develop a comprehensive autonomous (independent of Station) inspection and repair capability to cover the widest possible range of damage scenarios.

Accomplish an on-orbit Thermal Protection System inspection, using appropriate assets and capabilities, early in all missions.

The ultimate objective should be a fully autonomous capability for all missions to address the possibility that an International Space Station mission fails to achieve the correct orbit, fails to dock successfully, or is damaged during or after undocking. [RTF]

BACKGROUND

A key element of NASA's rationale for return to flight (RTF) is modification of the Space Shuttle External Tank (ET) to reduce critical debris liberation. NASA will resume Space Shuttle missions only when we have confidence that the ET should not liberate critical debris. Our flight rationale also calls for a capability to inspect the Orbiter to detect critical damage sustained during ascent. This capability will allow us to make informed decisions about steps to preserve the safety of the Orbiter and its crew. NASA is also pursuing a limited Thermal Protection System (TPS) repair capability for RTF, should it be required. Finally, in the extremely unlikely event that the Orbiter sustains critical damage that we are unable to repair or compensate for on entry, we will have the capability to implement an emergency, limited safe haven on the International Space Station (ISS) with the Contingency Shuttle Crew Support (CSCS) capability (CSCS is addressed in SSP-3). In NASA's formal risk hierarchy, TPS repair and CSCS activities are considered special procedures for additional risk mitigation.

There are risks associated with creating and deploying a fully autonomous inspection capability without ISS resources. While all space flight is inherently risky, there are both on-orbit and ground processing requirements that would be unique to an autonomous mission. While similar issues—such as TPS inspection and repair, CSCS, and potentially rescue—exist for missions to the ISS, they can be mitigated more easily, in part due to the increased time available for understanding and responding to an emergency situation at the ISS. For an autonomous mission, the options and available time for dealing with an on-orbit emergency are greatly reduced, posing additional risk to the mission. Therefore, NASA has decided to focus its development of TPS inspection and repair on those capabilities that enhance the Shuttle's suite

of assessment and repair tools, while taking full advantage of resources available while the Space Shuttle is docked to ISS.

The Space Flight Leadership Council has directed the Space Shuttle Program (SSP) to focus its efforts on developing and implementing inspection and repair capability appropriate for the first RTF missions using ISS resources as required. NASA will focus its efforts on mitigating the risk of multiple failures (such as an ISS mission failing to achieve the correct orbit or dock successfully, or the Orbiter being damaged during or after undocking and suffering critical TPS damage) through maximizing the Shuttle's ascent performance margins to achieve ISS orbit, using the docked configuration to maximize inspection and repair capabilities, and flying protective attitudes following undocking from the ISS. However, NASA will continue to analyze the relative merit of different approaches to mitigating the risks identified by the *Columbia* Accident Investigation Board (CAIB).

This approach to avoiding unnecessary risk has also led NASA to recognize that autonomous missions carry a higher risk than ISS missions. A brief summary of the additional risks associated with autonomous missions is described below:

1. *Lack of Significant Safe Haven.* The inability to provide a "safe haven" while inspection, repair, and potential rescue are undertaken creates additional risk in autonomous missions. On missions to the ISS it may be possible to extend time on orbit to mount a well-planned and -equipped rescue mission. NASA is continuing to study this contingency scenario. For autonomous missions, however, the crew would be limited to an additional on-orbit stay of no more than two to four

weeks, depending on how remaining consumables are rationed. The Safe Haven concept is discussed in detail in SSP-3.

2. *Unprecedented Double Workload for Ground Launch and Processing Teams.* Because the rescue window for an autonomous mission is only two to four weeks, NASA would be forced to process two vehicles for launch simultaneously to ensure timely rescue capability. Any processing delays to one vehicle would require a delay in the second vehicle. The launch countdown for the second launch would begin before the actual launch of the first vehicle. This short time period for assessment is a serious concern. It would require two highly complex processes to be carried out simultaneously, and it would not permit thorough assessment by the launch team, the flight control team, and the flight crew.
3. *No Changes to Cargo or Vehicle Feasible.* Because of the very short timeframe between the launch of the first vehicle and the requirement for a rescue flight, no significant changes could reasonably be made to the second vehicle. This means that it would not be feasible to change the cargo on the second Space Shuttle to support a repair to the first Shuttle, add additional rescue hardware, or make vehicle modifications to avoid whatever situation caused the need for a rescue attempt in the first place. Not having sufficient time to make the appropriate changes to the rescue vehicle or the cargo could add significant risk to the rescue flight crew or to crew transfer. The whole process would be under acute schedule pressure and undoubtedly many safety and operations waivers would be required.
4. *Rescue Mission.* Space Shuttles routinely dock with the ISS, and Soyuz evacuation procedures are supported by extensive training, analysis, and documentation. A rescue from the ISS, with multiple hatches, airlocks, and at least one other vehicle available (Soyuz), is much less complex and risky than that required by a stranded Space Shuttle being rescued by a second Space Shuttle. When NASA first evaluated free-space transfer of crew, which would be required to evacuate the Shuttle in an autonomous mission, many safety concerns were identified. This analysis would need to be done again, in greater detail, to identify all of the potential issues and safe solutions.

5. *TPS Repair.* NASA's current planned TPS repair method for an ISS-based repair uses the ISS robotic arm to stabilize an extravehicular activity (EVA) crew person over the worksite. This asset is not available for an autonomous mission, so NASA would have to finish development of an alternate method for stabilizing the crewmember. Such a concept is in development targeting 2006, when it will be needed for ISS-based repairs also. Solving this problem before 2006 represents a challenging undertaking.

NASA IMPLEMENTATION

Note: This section refers to inspection and repair during nominal Shuttle missions to the ISS.

NASA has greatly expanded the capabilities to detect debris liberation during ascent, to identify locations where debris may have originated, and to identify impact sites on the Orbiter TPS for evaluation. The ability to see debris liberated during ascent through the addition of high-speed cameras, aircraft-mounted cameras, and radar, complemented by the impact detection sensor system and suite of on-orbit inspection assets, will aid in providing the data required to ensure an effective inspection and, if necessary, repair of the Orbiter TPS. These capabilities, paired with NASA's improved insight into the impact and damage tolerance of the Orbiter, will allow the Mission Management Team (MMT) to make informed decisions about whether any impacts sustained represent a threat to mission success or the safety of the crew and the vehicle. They will also help to determine whether any repairs that are attempted are successful.

NASA will use a combination of Space Shuttle and ISS assets to image the Shuttle TPS and identify and characterize whether any damage was sustained during ascent. These inspection assets and methods include the Orbiter Boom Sensor System (OBSS), the Shuttle Remote Manipulator System (SRMS), the Space Station Remote Manipulator System (SSRMS), an experimental wing leading edge (WLE) impact sensor detection system, and the R-bar pitch maneuver (RPM). Each inspection method provides a piece of information to improve insight into the conditions of the Orbiter TPS.

Evaluation of the imagery and data collected during ascent and on orbit will determine the need for further, focused inspection. NASA has established criteria for focused on-orbit inspections to evaluate the length, width, and depth of potential critical damage sites. These criteria are based on our expanded understanding of debris transport mechanisms and the capabilities of the Orbiter TPS. Plans are in place for further inspection, evaluation, and repair for tile or Reinforced Carbon-Carbon (RCC) damage that exceeds the

damage criteria. Appropriate risk assessment of each potential damage site that exceeds the damage criteria will be conducted and presented to the MMT for evaluation. NASA will use a TPS assessment process, drawing on the data collected through inspections to make recommendations on whether a repair is required or whether the TPS can be used as is. If a repair is necessary, NASA will use a TPS damage assessment process to determine which repair method is required to enable the Orbiter to withstand the aero-thermal environment of entry and landing. In the event a safe entry is not possible, NASA has also made plans to keep the Space Shuttle crew on the ISS and mount a rescue mission. However, the CSCS capability will not be used to justify flying an otherwise unsafe vehicle and will only be used in the direst of situations.

For the first two flights, NASA's central objective will be to verify the performance of the integrated Shuttle system. As a result, inspection is one of our operational priorities. However, there is limited operational time available to inspect during any mission and conditions during inspection may not always be optimal. Inspections that take place early in the mission will detect damage from ascent debris, but may not find damage sustained while on orbit; for instance, damage from a potential micrometeoroid or orbital debris strike. On STS-114, NASA will actively inspect the entire TPS, including the WLE, nose cap, chin panel, and tile. If necessary, NASA will perform additional focused inspections with the OBSS. Any focused inspections will be guided by the results of ascent imagery that should indicate any areas of potential concern, the initial OBSS scans, and crew camera photos. With the combination of resources available at RTF, NASA will have the capability to inspect for and detect critical damage on 100 percent of the Space Shuttle's TPS tile and RCC.

Detection/Inspection

In February 2004, the SSP established an Inspection Tiger Team to review all inspection capabilities and to develop a plan to integrate these capabilities before RTF. The tiger team succeeded in producing a comprehensive in-flight inspection, imagery analysis, and damage assessment strategy that will be implemented through the existing flight planning process. The best available cameras and laser sensors suitable for detecting critical damage in each TPS zone will be used in conjunction with digital still photographs taken from the ISS during the Orbiter's approach. The tiger team strategy also laid the foundation for a more refined impact sensor and imagery system following the first two successful flights. This plan is being enhanced to clearly establish criteria for transitioning from one suite of inspection capabilities to another and the timeline for these transitions.

Along with the work of the tiger team, the Shuttle Systems Engineering and Integration Office began development of

a TPS Readiness Determination Operations Concept, which is documented in the Operations Integration Plan for TPS Assessment. This document specifies the process for collection, analysis, and integration of inspection data in a way that ensures effective and timely mission decision-making. The TPS assessment process begins with the activities leading up to launch and continues through postlanding. The prelaunch process includes an approved configuration for imagery. Any deviation from this configuration will be presented at the Flight Readiness Review (FRR) and during the subsequent prelaunch MMT reviews. Additionally, the Ice/Debris Inspection Team will perform a series of prelaunch walkdowns of the pad and vehicle for potential debris sources and provide this information to the TPS assessment process.

During the mission, the TPS assessment process is divided into three steps: data collection, data processing, and Orbiter damage assessment. The data collection sources provide information on debris, debris trajectory, impact locations, damage, or depth of damage. During the data processing step, this information is analyzed to determine the health of the TPS. The Manager of Shuttle Systems Engineering and Integration will provide a daily status to the MMT of findings of the data collection and data processing. In addition, the findings are provided to the Orbiter Damage Assessment Team. During the Orbiter damage assessment step, NASA will determine where there is potential TPS damage and develop recommendations to the MMT on whether the damaged TPS is safe to fly as is or whether a repair is needed, as well as which type of repair is required.

Postlanding, the TPS assessment process will continue with a walkdown of the Orbiter by the Ice/Debris Inspection Team, which will document observed TPS defects with photographs. The TPS assessment process concept has been exercised in several simulations.

Damage Threshold

NASA has defined the critical damage threshold for TPS Inspections. This is the ability to detect damage of 1 inch for tile around main landing gear or ET umbilical doors and 3 inches for acreage tile, and to detect cracks 0.020 inch × 2 inches long and 0.020 inch deep for RCC. Through an extensive test program and the application of analytical models developed to predict the capabilities of damaged tile and RCC, NASA has determined that damage smaller than this threshold should not result in increased risk to entry. With the combination of resources available at RTF, NASA will have the capability to detect this damage. However, the damage detection capability itself will not be certified prior to STS-114.

OBSS

The OBSS is an imaging system that consists of sensors on the end of a 50-ft boom structure. The system is installed on the starboard sill of the Orbiter payload bay (figure 6.4-1-1) and is used in conjunction with the SRMS. It is the primary system used to inspect WLE RCC, and to obtain damage depth measurements of Orbiter TPS. The OBSS will carry a laser camera system and a laser dynamic range imager (LDRI) for damage depth detection and will be used in conjunction with the SRMS for inspection. The video from the OBSS is recorded on board the Shuttle and downlinked via the Orbiter communications system. The data will be processed and analyzed on the ground as part of the TPS assessment process. In addition, the OBSS will have the capability to support an EVA crewmember in foot restraints if needed to provide inspection and repair capabilities.

For STS-114, OBSS operations are planned on the second and fourth crew flight day. On the second flight day, prior to docking with the ISS, the crew will use the OBSS to

inspect the nose cap and the underside and apex of the 22 leading edge RCC panels on each wing at a rate of no more than 5 meters per minute. Tests of the OBSS indicate that its sensors will be able to detect critical damage at this scan speed. These data will be fed into the TPS assessment process for Orbiter damage assessment. If potential impacts are indicated by the imagery and/or radar reviews, the OBSS cameras will be used during flight day 4 for focused inspections on areas determined likely to have experienced debris hits. Additional OBSS-based inspections can be performed on a later flight day, if necessary.

ISS Imagery During RPM

The primary method of inspecting the acreage tile across the bottom of the Orbiter will be still photo imagery taken by the ISS crew as the Orbiter approaches for docking. This maneuver, the RPM, has been developed and is being practiced by Shuttle flight crews in the simulator (figure 6.4-1-2). The Orbiter will pause its approach to the ISS when it is 600 ft away and pitch over to present its underside toward

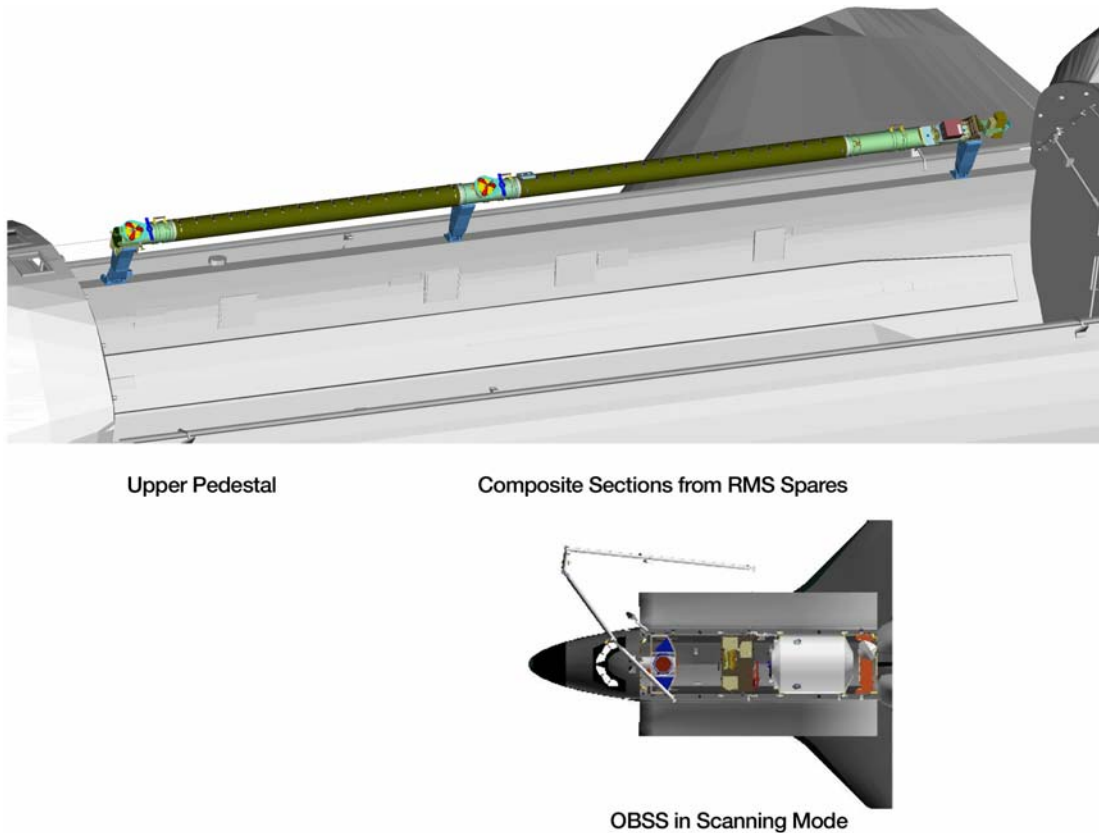
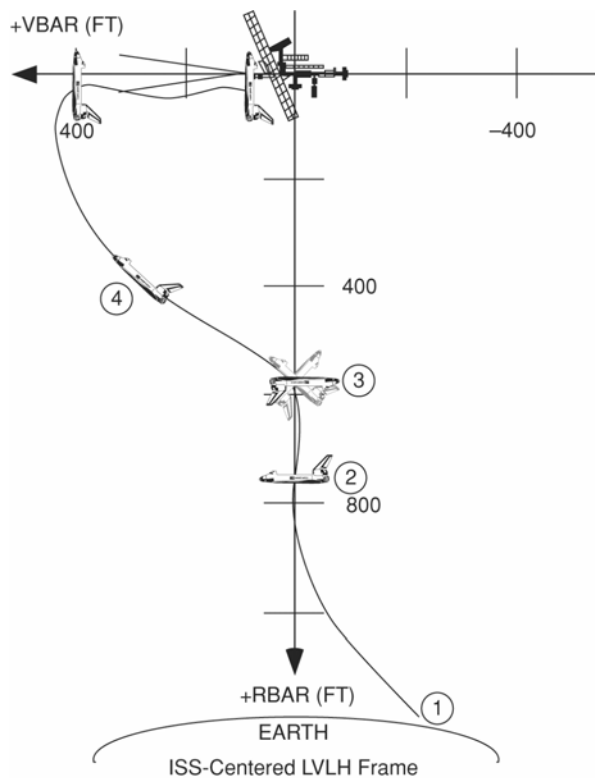

Figure 6.4-1-1. Orbiter Boom Sensor System.



EVENT	
1	1000 FT RANGE RATE GATE (RDOT = -1.3 FPS) TRANSITION TO LOWZ
2	ORBITER ACQUIRES RBAR
3	600 FT (RDOT = -0.1 FPS) BEGIN 1 DEG/SEC POSITIVE PITCH AUTO MNVR: MODE TO FREE DRIFT TO PROTECT ISS FROM ORBITER PLUME LOADS AND CONTAMINATION
	ISS PHOTOGRAPHIC SURVEY OPPORTUNITY FROM U.S. LAB WINDOW
	RESUME ATTITUDE HOLD AS ORBITER RETURNS TO RBAR ATTITUDE AND PILOT BACK TO NOMINAL APPROACH PROFILE
4	TORVA (TWICE ORBITAL RATE RBAR TO VBAR APPROACH)

Figure 6.4-1-2. Orbiter RPM for inspection and approach to ISS.

the ISS. The ISS crew will take overlapping high-resolution digital images of the Orbiter's TPS tile and downlink them to the ground. Areas of concern identified by the RPM photos will be re-inspected for more detail (such as damage depth) while the Orbiter is docked to the ISS.

ISS cameras used to photograph the Orbiter on approach and during the RPM have the capability to detect critical

damage in all areas of the Orbiter TPS tile. NASA's analysis indicates that the 400mm photos have an analytical resolution of 3 inches on normal surfaces; the 800mm photos have a 1-inch analytical resolution.

Other Imagery Assets

Other imagery assets include the SRMS, the SSRMS, and other digital camera assets on board the Shuttle or the ISS. The SRMS and SSRMS can inspect areas of the Orbiter TPS within their operational reach, such as the crew cabin area, forward lower surface, or vertical tail, using their closed circuit television camera systems. Other digital assets include the still cameras available to EVA crewmembers in the event an EVA inspection is required to do focused inspection of the TPS that may have suspected damage. EVA inspections are not planned and will be used as a last resort backup for the other inspection methods.

WLE Impact Detection System

The WLE Impact Detection System was developed from an existing technology that had been previously flown as an experiment on the Shuttle. Initially, NASA hoped to include WLE sensors as a key element of our ability to detect damage. However, this system has not been flight-tested, so its capability is yet to be determined. For STS-114, these sensors will be used primarily as a "pointing" device to cue TPS areas needing further inspection by the OBSS.

The WLE sensor system is composed of accelerometer and temperature sensors located in both of the wing cavities and attached to the wing spar behind the RCC. The WLE sensor system data are collected during ascent and while on orbit and are downlinked to the ground via the Orbiter communications system. These data will help identify possible debris impact areas in the vicinity of the WLE RCC panels. In the event an impact is detected, engineers can determine the location of the sensor(s) that measured the impact and, through the TPS assessment process, recommend a more focused inspection of the suspect area later in the mission. Due to the limited battery life, there is a finite period of time for impact detection using this system. These sensors will be flown on STS-114 and subsequent flights. Long term, the power input will be changed from the current battery system to being powered directly from the on-board fuel cells. This power configuration change will allow the sensor system to provide impact detection throughout the mission.

Repair

Despite comprehensive efforts to develop TPS repair materials and techniques, the state-of-the-art technology in this area has yielded very little technology to support the capability. As a result, continued effort does not hold promise of significant capabilities beyond those in hand.

Complete, vehicle-wide TPS repair capability is not a constraint to RTF. A capability to effect emergency repairs to the widest range of damage practicable will be introduced on STS-114, evolved, and improved for subsequent missions. As a result, the repair capabilities available for STS-114 will include a limited capability to repair minor tile damage and small- to medium-sized RCC damage.

For tile, the repair capability available at RTF will include an emittance wash that can be used to seal tile damage and an experimental, ablative fill material and applicator that can be used to repair larger areas of tile damage, up to 10 inches \times 20 inches, and the depth of the tile. We will also carry an experimental carbon-silicon carbide (C-SiC) tile overlay. For RCC

repair, NASA will have plug and crack repair tools and materials that will potentially allow us to fix holes up to 4 inches in diameter. These materials and techniques will be demonstrated on the first two flights to establish their functionality in the combined environments of space.

NASA has developed a TPS readiness determination operations concept that is documented in the Operation Integration Plan for TPS Assessment. This document specifies the process for collecting, analyzing, and applying the diverse inspection data in a way that ensures effective and timely mission decision-making. This process is used to determine whether damage sustained is safe for entry or requires repair, and whether an attempted repair will render the Orbiter safe for entry. Damage assessment tools used during the mission are the same as those used for preflight inspection criteria validation and include aero-heating environments, cavity heating augmentation factors, damaged tile assessment tools, and structural analysis tools. There are two elements to determine whether damage sustained is safe for entry. The first is a use-as-is assessment to determine whether a repair should be attempted.

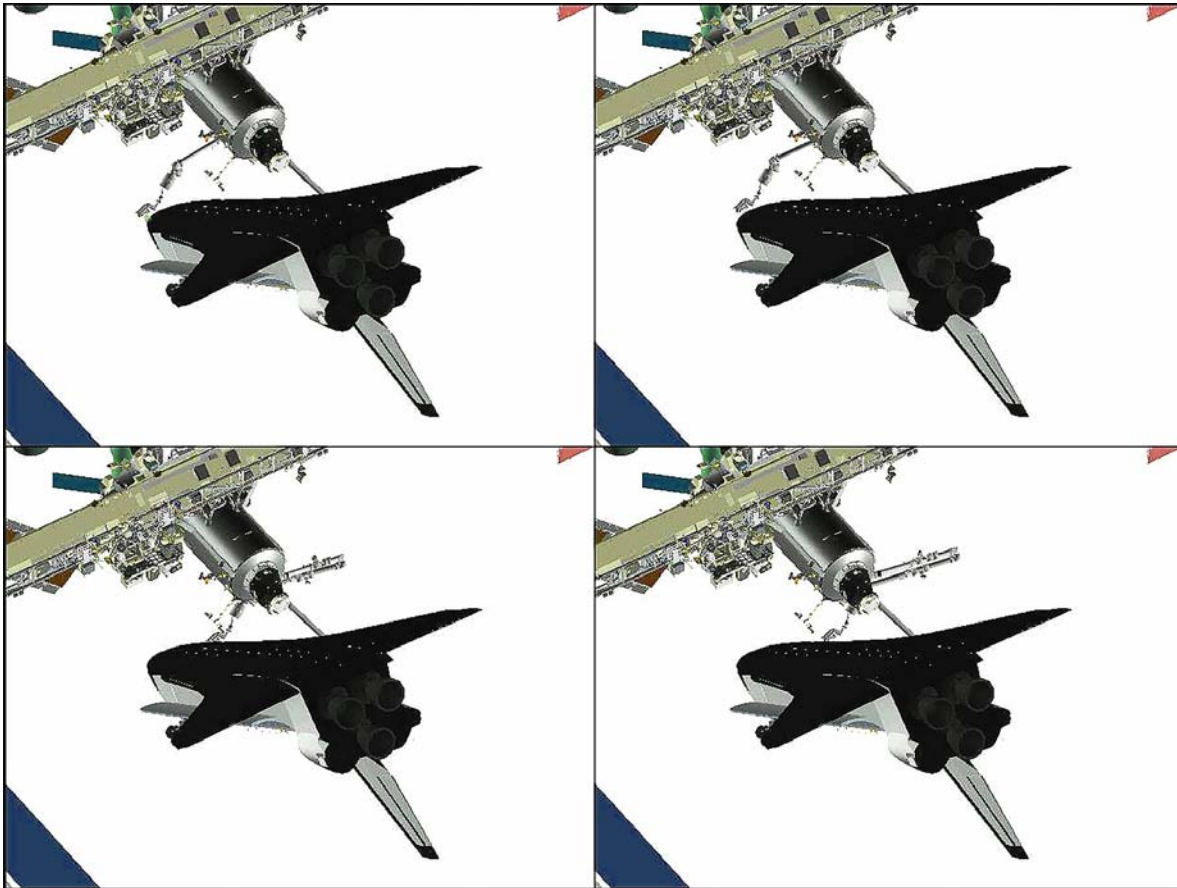

Figure 6.4-1-3. Proposed method for providing EVA access during TPS repair on an ISS flight.

The second is a follow-on assessment to determine whether any repairs attempted have made the Orbiter safe for entry.

The analytical and decision-making processes associated with TPS repair and inspection have been exercised by the MMT through simulations.

TPS Repair Access

The EVA crew will use either the SRMS or the SSRMS to gain access to repair sites on the Orbiter; when necessary, they may also use the OBSS. For repair areas to which the SRMS or SSRMS cannot provide access, NASA has developed a combined SRMS and SSRMS “flip around” operation, called the Orbiter Repair Maneuver (ORM), to allow TPS repairs while the Space Shuttle is docked to the ISS. The ORM involves turning the Shuttle into a belly-up position that provides SSRMS access to the repair site. As depicted in figure 6.4-1-3, the SRMS grapples the ISS while docked. The docking mechanism hooks are then opened, and the SRMS rotates the Orbiter into a position that presents the lower surface to the ISS. The EVA crew then works from the SSRMS, with the SSRMS used to position the crewmember to reach any TPS surface needing repair.

NASA is developing EVA tools and techniques for TPS repair. NASA has already developed prototype specialized tools for applying and curing TPS repair materials. We are also beginning to develop new and innovative EVA techniques for working with the fragile Shuttle TPS system while ensuring that crew safety is maintained. EVAs for TPS repair represent a significant challenge; the experiences gained through the numerous complex ISS construction tasks performed over the past several years are contributing to our ability to meet this challenge.

After the repair, the SRMS maneuvers the Orbiter back into position and reattaches the Orbiter to the docking mechanism. This technique provides access to all TPS surfaces without the need for new equipment. The procedure will work through ISS flight 1J (which will add the Japanese Experiment Module to the ISS on-orbit assembly). After ISS flight 1J, the ISS grapple fixture required to support this technique will be blocked, and new TPS repair access techniques will need to be developed.

RCC Repair

NASA has evaluated RCC repair concepts across six NASA centers, 11 contractors, and the United States Air Force Research Laboratory. The main challenges to repairing RCC are maintaining a bond to the RCC coating during entry heating and meeting very small edge step requirements for repair patches and fills.

NASA is implementing two complementary repair concepts—plug repair and crack repair—that together will enable repair of limited RCC damage. Plug repair consists of a cover plate intended to repair medium-sized holes in the WLE from 1 inch to 4 inches in diameter. Crack repair uses a non-oxide experimental adhesive (NOAX) material application intended to fill cracks and missing coating areas in the WLE. Both concepts are expected to have limitations in terms of damage characteristics, damage location, and testing/analysis.

RCC plug repair requires a hole through the RCC; as a result, some damage types will require drilling to use the plug repair. Currently, RCC plug repair can be successful on 62 percent of the WLE but has not achieved the required step and gap for all RCC surfaces. Additionally, plug repair does not fix damage larger than the plug area. Successful RCC crack repair requires a complex operation. Process controls during EVA in the challenging environment of space will determine the success of repair. The RCC crack repair has been successful in repairing cracks up to 0.065 inch wide in ground tests; these repairs were verified by arc-jet testing. Complementing plug repair, step drills that could penetrate through RCC are being developed for STS-114. The step drills will provide additional capability to repair RCC holes smaller than 1 inch in diameter.

NASA also has initiated a research and development effort to repair medium-sized holes with a flexible patch. The flexible patch would be directly applied over holes and cracks found on RCC panels. The synergy of using the same repair concept for both holes and cracks will greatly reduce the total hardware required for each mission. Schedules for design, development, testing, evaluation, and production of this concept are in work. The flexible patch will not be ready to support STS-114.

A fourth repair concept, RCC rigid overwrap, encountered problems during development and was shown to be infeasible to implement in the near term; as a result, it was deleted from consideration for RTF. NASA is continuing research and development on a long-term, more flexible RCC repair technique for holes greater than 6 inches in diameter.

Tile Repair

A limited tile repair capability will be ready for on-orbit testing at RTF. This capability will include an emittance wash application to repair shallow damage, a cure in place ablator (CIPA) repair material with CIPA applicator to repair larger damage (up to 10 inches by 20 inches and the depth of the tile), and a C-SiC tile repair mechanical overlay designed to repair large tile damage areas and lost tiles.

On STS-114, NASA plans to demonstrate and validate the tile repair emittance wash application during an EVA, fly two CIPA applicators (but will not be demonstrated), and fly the mechanical overlay (but not tested on the first flight). All of these tile repair materials and tools will be verified by ground testing and certified as safe to fly and safe to use on STS-114, if an emergency tile repair is required. The integrated Shuttle Tile Ablator (STA)-54 test will be accomplished on STS-121.

The emittance wash is a silicon carbide (SiC) material mixed with a carrier material. It provides an emissive coating to the damaged tiles, which is used to prevent small gouges in the tile from becoming deeper holes. This keeps the damage shallow and prevents cavity heating effects, preserving the insulating capability of the tile. The emittance wash will also be used to prime and seal CIPA repairs to the tiles.

The CIPA is STA-54, a two-part room temperature vulcanizing-based material. Both the material and the applicator have encountered significant challenges during development. Most significant of these challenges is recurrent bubbling in the material. NASA has been unable to determine the root cause of the bubbling, or to adequately and consistently characterize its severity. Additionally, there remain several areas of uncertainty about the material properties of STA-54, including the material's ability to cure during the thermal cycling of Earth orbit and its adhesion to tile during entry, since tile and STA-54 have different thermal expansion coefficients. As a result, the material and applicator will need to be tested in the combined environments of space to understand their utility for on-orbit repairs. Recent ground tests show that bubbling does not compromise the thermal protection capabilities of the STA-54 material, but testing in the actual on-orbit environment is needed to confirm this finding. A secondary issue concerns the level of toxicity of one of the STA-54 components prior to mixing and dispensing. At this time the Program is pursuing a triple level of containment for STA-54 stowage and is assessing the crew risk during actual EVA use for the STS-121 Detailed Test Objective (DTO) or if needed for tile repair.

The mechanical overlay repair is performed by filling the damaged tile cavity with a Saffil batting insulation, then placing a thin C-SiC cover plate and high-temperature gasket seal over the damaged tile area. SiC-coated ceramic augers (screws) with accompanying SiC-coated ceramic washers are screwed into undamaged tiles to attach the overlay. The 12-inch by 25-inch overlay is capable of covering a 10-square inch by 20-square inch damage area.

TPS Repair Development Test Objective on STS-114

On STS-114 and STS-121, hardware with simulated tile and RCC damage will be flown in the payload bay to enable the crew to practice tile and RCC repair techniques. During STS-114, the following will be demonstrated during an EVA:

- Tile repair emittance wash application
- RCC repair NOAX crack repair material evaluation

Also during STS-114, an intravehicular activity demonstration of the mechanical aspects of the RCC plug repair will be conducted.

STATUS

The following actions have been completed:

- Quantified SRMS, SSRMS, and ISS digital still camera inspection resolution
- Feasibility analyses for docked repair technique using SRMS and SSRMS
- Air-bearing floor test of overall boom to SRMS interface
- OBSS conceptual development, design requirements, and preliminary design review, systems design review, initial OV-103 vehicle integration testing at Kennedy Space Center with both sensors
- Engineering assessment for lower surface radio frequency communication during EVA repair
- Simplified Aid for EVA Rescue technique conceptual development and testing
- Feasibility testing on tile repair material
- Tile repair material transition from concept development to validation tests
- 1-G suited tests on tile repair technique
- Initial KC-135 tile repair technique evaluations
- Vacuum dispense and cure of the tile repair material with key components of the EVA applicator
- Review of all Shuttle systems for compatibility with the docking repair scenario
- Inspection Tiger Team strategy formulated
- Down-selected to two complementary RCC repair techniques for further development (plug repair, crack repair), with the elimination of rigid wrap repair for RTF
- Developed the inspection and repair of the RCC and tile operations concept (figure 6.1-4-4)
- The digital cameras that ISS crew will use to photograph the Shuttle TPS were launched on a Russian Progress vehicle and are now on board the ISS

Transport, impact, and material analyses and tests performed in the past few months have provided a clear enough picture of the WLE and RCC's characteristics to allow NASA to make an informed risk trade for a practicable inspection plan. This inspection plan will be based on potential debris sources and impact likelihood, specific RCC panel capabilities, and LDRI capabilities that have been demonstrated beyond its certified performance.

Individually, each warning device/inspection method described previously will not provide the total information needed to accurately determine the condition of the Orbiter prior to committing to entry. They are not redundant systems, per se, in that each provides a different piece of the puzzle, offering overlapping information to improve our knowledge of the Orbiter's condition. We can accept failure of one or more warning devices and have the confidence that we

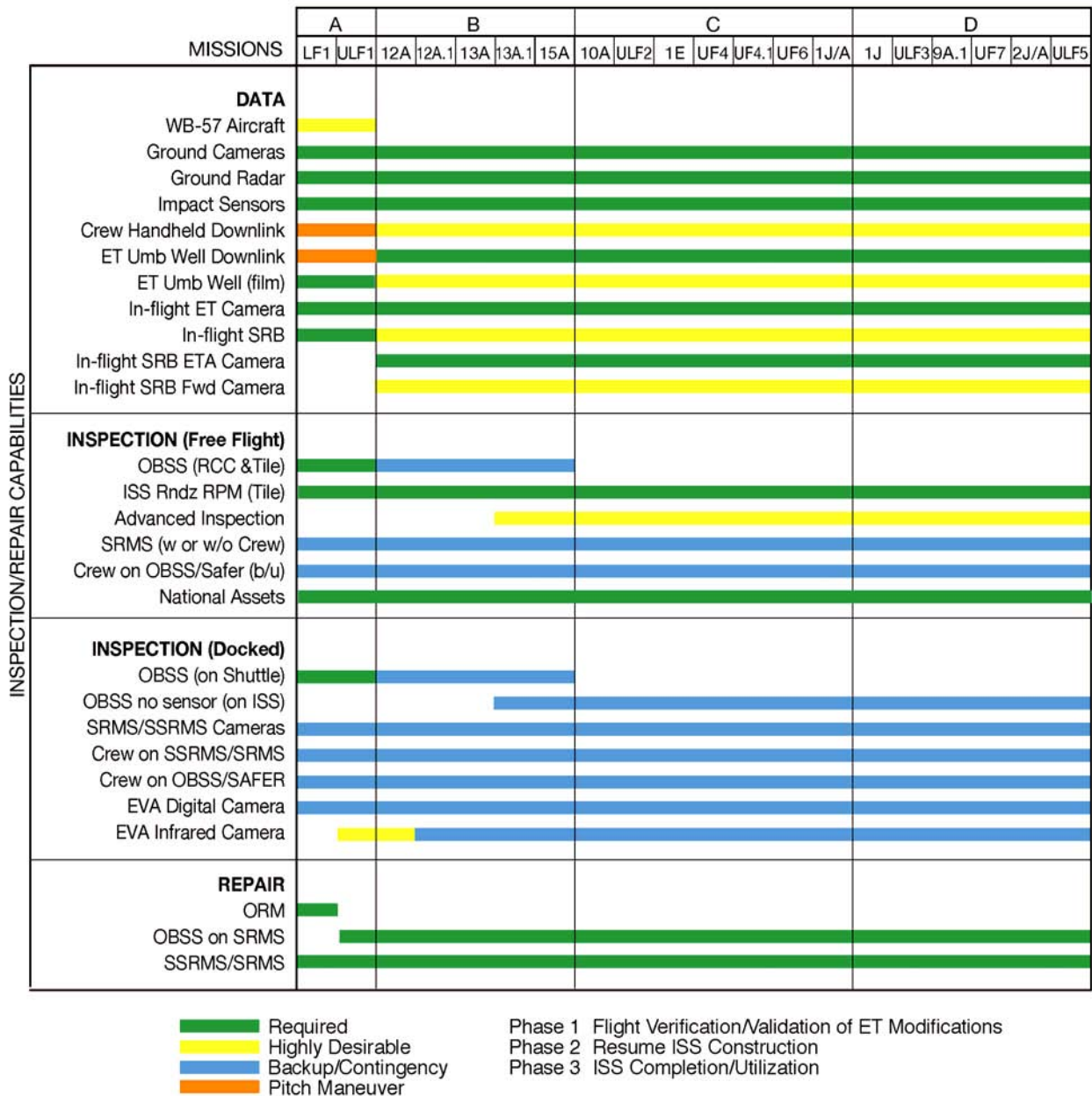

Figure 6.4-1-4. Integrated operations concepts for inspection and repair.

will be able to characterize potential debris liberations and possible damage to the TPS tile and RCC components.

In addition to planned TPS repair capability, a DTO will be performed during STS-114 to further evaluate TPS repair materials, tools, and techniques.

FORWARD WORK

NASA is in the process of verifying the OBSS hardware, finalizing operational procedures, and resolving the technical issue regarding loads and the resulting structural testing and stress analysis. At this point in time, all structural margins are positive for the STS-114 and STS-300 missions. Verification activities are scheduled to be completed prior to the STS-114 FRR in June 2005.

Final detailed analyses are in work to optimize Shuttle attitude control and re-docking methods during repair.

For future flights, we are assessing the development of a second-generation crack repair material that does not require a heater to cure or refrigeration for stowage. However, recent arc-jet testing with uncured NOAX has been successful, so the need for a new material is being reevaluated.

SCHEDULE

Responsibility	Due Date	Activity/Deliverable
SSP	Jul 03 (Completed)	1-G suited and vacuum testing begins on tile repair technique
SSP	Aug 03 (Completed)	Generic crew and flight controller training begins on inspection maneuver during approach to ISS
SSP	Aug 03 (Completed)	KC-135 testing of tile repair technique
SSP	Oct 03 (Completed)	Start of RCC repair concept screening tests
SSP	Dec 03 (Completed)	Tile repair material selection
SSP	Jun 04 (Completed)	Baseline ISS in-flight repair technique requirements and damage criteria
SSP	Sep 04 (Completed)	Initial human thermal-vacuum, end-to-end tile repair tests
JSC/Mission Operations Directorate	Oct 04 (Completed)	Formal procedure development complete for inspection and repair
SSP	Jan 05 (Completed)	RCC repair concept downselect
SSP and ISS Program	Jun 05	All modeling and systems analyses complete for damage assessment and repair techniques
SSP	Jun 05	Tile repair materials and tools delivery
SSP	STS-114, STS-121	On-orbit test of TPS repair tools and process



Columbia Accident Investigation Board

Recommendation 3.3-3

To the extent possible, increase the Orbiter's ability to successfully re-enter Earth's atmosphere with minor leading edge structural sub-system damage.

Note: NASA has closed this recommendation through the formal Program Requirements Control Board process. The following summary details NASA's response to the recommendation and any additional work NASA intends to perform beyond the *Columbia* Accident Investigation Board recommendation.

BACKGROUND

The STS-107 accident demonstrated that the Space Shuttle Leading Edge Structural Subsystem (LESS) is vulnerable, and damage to the LESS can cause the loss of the Orbiter. The Space Shuttle Program (SSP) is developing and implementing a comprehensive test and analysis program to redefine the maximum survivable LESS damage for entry. This information will support the requirements for inspection and ultimately the boundaries within which a Thermal Protection System (TPS) repair can be performed. In addition, the SSP is already pursuing LESS improvements that will increase the Orbiter's capability to enter the Earth's atmosphere with "minor" damage to the LESS. These improvements and NASA's efforts to define minor and critical damage using foam impact tests, arc jet tests, and wind tunnel tests are only mentioned here, since they are covered in recommendations R3.3-1, R3.3-2, R3.3-4, and R6.4-1.

NASA IMPLEMENTATION

The SSP has evaluated operational adjustments in vehicle and trajectory design for reducing thermal effects on the LESS during entry. Possibilities included weight reduction by cargo jettison, cold-soaking the damaged area of the Orbiter by shading it from direct sunlight, lowering the orbit to reduce maximum heat loads during deorbit, and entry trajectory shaping. Additionally, NASA considered expanding the angle-of-attack profile.

STATUS

Evaluations in each of the above areas are complete. These evaluations were conducted within existing certification limits for entry trajectory conditions experienced during Shuttle missions to the International Space Station.

The results showed only minor improvements in the entry thermal environment for Reinforced Carbon-Carbon. These results were presented to the SSP in July 2004. At that time, the SSP directed Mission Operations to conduct further evaluations that were not constrained by existing certification limits. The goal for these evaluations was to discover if major improvements in reducing thermal effects could be attained by exceeding certification limits for entry trajectory and angle of attack and, if so, by how much. The results of these evaluations show potential for more noticeable improvements to the entry thermal environment, however, only with increased risk of guidance, navigation, and control uncertainties.

A clearer understanding of the relationship between entry parameters and risk to the Orbiter has established the framework to consider certified and uncertified options for Flight Rule and procedure changes.

FORWARD WORK

None.

SCHEDULE

Responsibility	Due Date	Activity/Deliverable
SSP	Jul 04 (Completed)	Vehicle/trajectory design operational adjustment recommendation

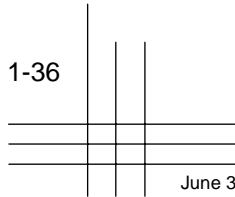



Columbia Accident Investigation Board

Recommendation 3.3-4

In order to understand the true material characteristics of Reinforced Carbon-Carbon components, develop a comprehensive database of flown Reinforced Carbon-Carbon material characteristics by destructive testing and evaluation.

Note: NASA has closed this recommendation through the formal Program Requirements Control Board process. The following summary details NASA's response to the recommendation and any additional work NASA intends to perform beyond the *Columbia* Accident Investigation Board recommendation.

BACKGROUND

The only material property data initially available for flown Reinforced Carbon-Carbon (RCC) components were removed from Orbiter Vehicle (OV)-102 and destructively tested by the Space Shuttle Program (SSP). To obtain these data, material specimens were cut and tested from the lower surface of Panel 10 left (10L) after 19 flights and Panel 12 right (12R) after 15 flights. The results from these tests were compared to the analytical model and indicated that the model was conservative.

NASA IMPLEMENTATION

An RCC material characterization program has been implemented using existing flight assets to obtain additional data on strength, stiffness, stress-strain curves, and fracture properties of RCC for comparison to earlier testing data. The SSP has established a plan to determine the impact resistance of RCC in its current configuration using previously flown Panels 9L and 16R. In addition, tension, compression, in-plane shear, interlaminar shear, and interlaminar tension (coating adherence) properties will be developed. Data on the attachment lug mechanical properties, corner mechanical properties, and coating adherence will also be obtained. NASA will maintain a comprehensive database developed with the information from these evaluations and characterization programs.

Mechanical property specimens excised from the upper surface, apex region, and lower surface of Panel 8L (OV-104 with 26 flights) have been tested, along with additional specimens taken from the apex region of Panels 10L and 12R. The data from these tests are being distributed to the teams performing the material property and impact analysis. As expected, the results so far have shown slightly degraded properties, when compared with new material, but are still well above the conservative design allowables used in the mission life models for RCC. Panel 6L (OV-103 with

30 flights) will be used to perform thermal and mechanical testing to determine material susceptibility to crack propagation during the flight envelope. Panel 9L (OV-103 with 27 flights) was severely cracked during a series of full-scale, damage threshold determination impact tests. Specimens from the damaged region have been excised for damage tolerance assessment in the arc jet facility. In addition, mechanical property specimens adjacent to the damage zone will be used to determine strength properties for use in the impact analysis correlation effort. Panel 16L was also subjected to repeated impacts until notable damage was observed in the RCC (cracking and delamination) to provide additional impact analysis correlation and determination of the damage threshold.

Three new Panel 9Ls will also be subjected to impact testing for further damage model correlation. Mechanical property specimens from Panel 9R (with 30 flights) from OV-103 will be tested in February 2005, using methods similar to those used on Panels 10L and 12R, to compare its material properties to the analytical model and to add to the database.

STATUS

The study of materials and processes will be central to understanding and cataloging the material properties and their relation to the overall health of the wing leading edge subsystem. Materialography and material characteristics (porosity, coating/substrate composition, etc.) for RCC panels are being evaluated with the objective of correlating mechanical property degradation to microstructural/chemical changes and nondestructive inspection results. Once developed, the database will be used to direct design upgrades and mission/life adjustments. The long-term plan will include additional RCC assets, as required to ensure that the database is fully populated (ref. R3.8-1).

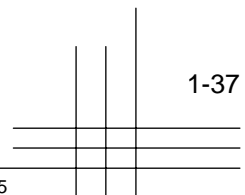

FORWARD WORK

None.

SCHEDULE

Responsibility	Due Date	Activity/Deliverable
SSP	Sep 03 (Completed)	Selection of Panel 8L test specimens for material property testing
SSP	Sep 03 (Completed)	Panel 9L impact test number 1
SSP	Sep/Oct 03 (Completed)	Material property testing of Panel 8L specimens
SSP	Oct 03 (Completed)	Panel 9L impact test number 2 and 3
SSP	Jun 04 (Completed)	Panels 10L and 12R apex mechanical property testing
SSP	Aug 04 (Completed)	Panel 16R impact testing



Columbia Accident Investigation Board

Recommendation 3.3-5

Improve the maintenance of launch pad structures to minimize the leaching of zinc primer onto Reinforced Carbon-Carbon components.

Note: NASA has closed this recommendation through the formal Program Requirements Control Board (PRCB) process. The following summary details NASA's response to the recommendation and any additional work NASA intends to perform beyond the *Columbia* Accident Investigation Board recommendation.

BACKGROUND

Zinc coating is used on launch pad structures to protect against environmental corrosion. "Craze cracks" in the Reinforced Carbon-Carbon (RCC) panels allow rainwater and leached zinc to penetrate the panels and cause pinholes.

NASA IMPLEMENTATION

Before return to flight (RTF), Kennedy Space Center (KSC) will enhance the launch pad structural maintenance program to reduce RCC zinc oxide exposure to prevent zinc-induced pinhole formation in the RCC (figure 3.3-5-1). The enhanced program has four key elements. KSC will enhance the postlaunch inspection and maintenance of the structural coating system, particularly on the rotating service structure. Exposed zinc primer will be recoated to prevent liberation and rainwater transport of zinc-rich compounds. Additionally, postlaunch pad structural wash-downs will be assessed to determine if they can be enhanced to minimize the corrosive effects of acidic residue on the pad structure. This will help prevent corrosion-induced damage to the topcoat and prevent exposure of the zinc primer. NASA will also investigate options to improve the physical protection of Orbiter RCC hardware and implement a sampling program to monitor the effectiveness of efforts to inhibit zinc oxide migration on all areas of the pad structure.

In the long term, the RCC Problem Resolution Team will continue to identify and assess potential mechanisms for

RCC pinhole formation. Options for an enhanced pad wash-down system will be implemented on Pad A in fiscal year (FY) 2005 and on Pad B in FY 2006.

STATUS

NASA is pursuing enhanced inspection, structural maintenance, wash-down, and sampling options to reduce zinc leaching. Changes to applicable work authorization documents are being formulated and will be incorporated before RTF. The options developed were presented to the Space Shuttle PRCB in April 2004 and approved for implementation.

FORWARD WORK

None.

SCHEDULE

Responsibility	Due Date	Activity/Deliverable
Space Shuttle Program (SSP)	Dec 03 (Completed)	Complete enhanced inspection, maintenance, wash-down, and sampling plan
SSP	Apr 04 (Completed)	Present to the PRCB

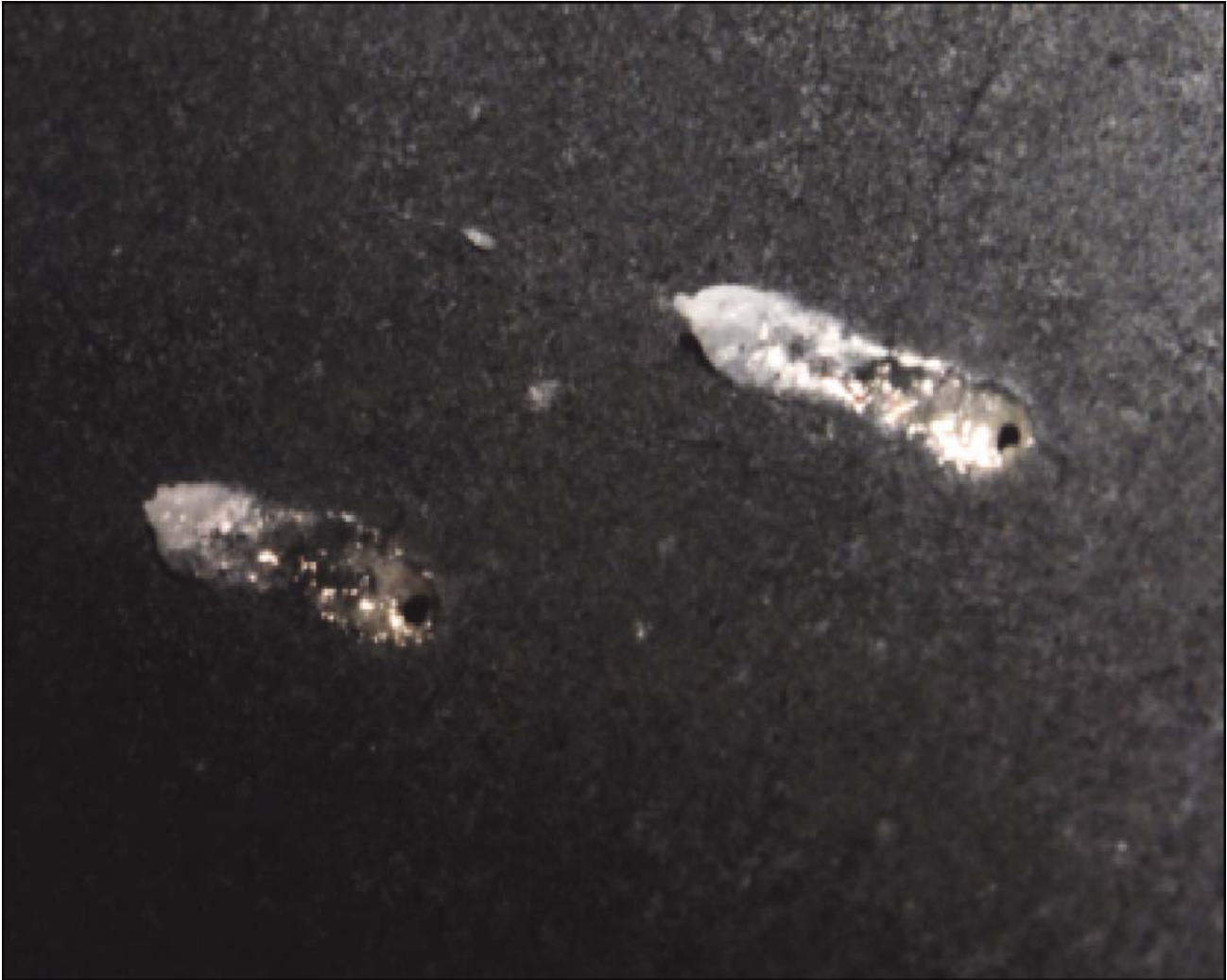

Figure 3.3-5-1. RCC pinholes.



Columbia Accident Investigation Board

Recommendation 3.8-1

Obtain sufficient spare Reinforced Carbon-Carbon panel assemblies and associated support components to ensure that decisions related to Reinforced Carbon-Carbon maintenance are made on the basis of component specifications, free of external pressures relating to schedules, costs, or other considerations.

| Note: NASA has closed this recommendation through the formal Program Requirements Control Board (PRCB) process. The following summary details NASA's response to the recommendation and any additional work NASA intends to perform beyond the *Columbia* Accident Investigation Board recommendation.

BACKGROUND

There are 44 wing leading edge (WLE) panels installed on an Orbiter. All of these components are made of Reinforced Carbon-Carbon (RCC). The panels in the hotter areas, panels 6 through 17, have a useful mission life of 50 flights or more. The panels in the cooler areas, panels 1 through 5 and 18 through 22, have longer lives, as high as 100 flights depending on the specific location. The "hot" panels (6 through 17) are removed from the vehicle every other Orbiter maintenance down period and are shipped to the original equipment manufacturer, Lockheed-Martin, for refurbishment. Because these panels have a long life span, we have determined that a minimum of one spare ship-set is sufficient for flight requirements

Since few panels have required replacement, few new panels have been produced since the delivery of Orbiter Vehicle (OV)-105. Currently, Lockheed-Martin is the only manufacturer of these panels.

NASA IMPLEMENTATION

NASA's goal is to maintain a minimum of one spare ship-set of RCC WLE panel assemblies. To achieve this goal, six additional panel assemblies are required to have a complete spare ship-set. The PRCB has approved procurement of the six panels required to complete the ship-set, which is sufficient for flight requirements. The last of these panels will be available no later than March 2005, prior to return to flight.

STATUS

In addition to the six panels needed to complete one entire ship-set, NASA has procured enough raw materials to build up to four additional ship-sets of RCC panels. The Space Shuttle Program Leading Edge Subsystem Prevention/Resolution Team has developed a prioritized list of additional spare panels over and above the one ship-set of spare panels currently required to support the Program. The prioritization of the list is based on the requirements for the spare ship-set, impact tolerance testing, and development of damage repair techniques.

FORWARD WORK

None.

SCHEDULE

Responsibility	Due Date	Activity/Deliverable
SSP	Jun 03 (Completed)	Authorization to build six panels to complete ship-set
SSP	Mar 05	Delivery of six additional panels

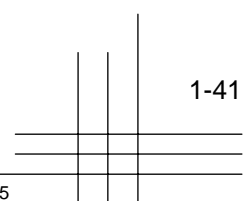

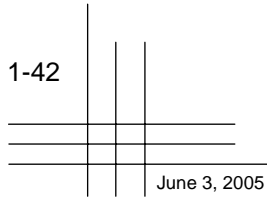



Columbia Accident Investigation Board

Recommendation 3.8-2

Develop, validate, and maintain physics-based computer models to evaluate Thermal Protection System damage from debris impact. These tools should provide realistic and timely estimates of any impact damage from possible debris from any source that may ultimately impact the Orbiter. Establish impact damage thresholds that trigger responsive corrective action, such as on-orbit inspection and repair, when indicated.

BACKGROUND

Foam impact testing, sponsored by the *Columbia* Accident Investigation Board (CAIB), proved that some current engineering analysis capabilities require upgrades and improvement to adequately predict vehicle response during certain events. In particular, the CAIB found that NASA's current impact analysis software tool, Crater, failed to correctly predict the level of damage to the Thermal Protection System (TPS) due to the External Tank foam impact to *Columbia* during STS-107 ascent and contributed to an inadequate debris impact assessment.

NASA IMPLEMENTATION

In addition to improving Crater and other predictive impact models, the Space Shuttle Program (SSP) assigned an action to all Program elements to evaluate the adequacy of all preflight and in-flight engineering analysis tools.

The SSP elements will investigate the adequacy of existing analysis tools to ensure that limitations or constraints in use are defined and documented, and formal configuration management control is maintained. Additionally, tools that are used less frequently, primarily those used to clear mission anomalies, will undergo a more detailed assessment that includes a review of the requirements and verification activities. Results of these element reviews will be briefed in detail at the SSP Integration Control Board (ICB) prior to briefing the specific findings and recommendations to the SSP Manager at the Program Requirements Control Board (PRCB). From these efforts, NASA will have a set of validated physics-based computer models for assessing items such as damage from debris impacts.

STATUS

The SSP is currently working with the Boeing Company, Southwest Research Institute, Glenn Research Center, Langley Research Center, Johnson Space Center Engineering Directorate, and other organizations to develop

and validate potential replacement tools for Crater. Each model offers unique strengths and promises significant improvements beyond the current analytical capability. The existing damage estimation tools, such as Crater, will be removed from use.

An integrated analysis and testing approach is being used to develop the models for Reinforced Carbon-Carbon (RCC) components. The analysis is based on comprehensive dynamic impact modeling. Testing will be performed on RCC coupons, subcomponents, and wing leading edge panels to provide basic inputs to and validation of these models. Testing to characterize various debris materials will be performed as part of model development. An extensive TPS tile impact testing program will be performed to increase this knowledge base.

In parallel with the model development and its supporting testing, an integrated analysis is being developed involving debris source identification, transport, and impact damage, and resulting vehicle temperatures and margins. This integrated analysis will be used to establish impact damage thresholds and to determine whether the Orbiter can safely withstand observed damage without requiring on-orbit repair. Insight from this work will be used to identify Space Shuttle modifications (e.g., TPS hardening, trajectory changes) to eliminate unsafe conditions. In addition, the integrated analytical tools will be used to support real-time assessment of RCC and tile damage detected during the TPS inspection activities. Actual tile damage sites will be assessed against mission-specific entry conditions allowing a risk/benefit trade among return, repair, and rescue. Key integrated analysis tools for damage assessment have undergone review by the NASA Engineering and Safety Center (NESC) prior to the configuration baseline at the Orbiter Configuration Control Board. These tools have been validated against wind tunnel testing at Langley Research Center and arc-jet testing at Ames Research Center and Johnson Space Center. Analytical tools to assess repair with ablator material will be uncorrelated at the time of return to flight.

All SSP elements presented initial findings and plans for completing their assessments to the ICB in July 2003 and have now completed their assessments. Most SSP models and tools have been reviewed for accuracy and completeness. The remaining reviews will be completed before return to flight.

FORWARD WORK

The SSP system engineering and integration technical areas are continuing to evaluate the adequacy of their math models

and tools. The NASA Engineering and Safety Center (NESC) will assess the adequacy of Bumper (ref. R4.2-4) to perform risk management associated with micrometeoroid and orbital debris (MMOD).

Foam impact tests will provide empirical data that will be inserted into the analytical models to define the limits of the models' applicability.

Verification and validation of the analytical models is scheduled to be completed in June 2005.

SCHEDULE

Responsibility	Due Date	Activity/Deliverable
SSP	Jul 03 (Completed)	Report math models and tools assessment initial findings and plans to ICB and PRCB
SSP	Sep 03 (Completed)	Integrated plan for debris transport, impact assessment, and TPS damage modeling
SSP	Dec 03 (Completed)	Reverification/validation of MMOD risk models
NESC	Dec 04 (Completed)	Independent technical assessment of the BUMPER software tool
SSP	May 05 (Completed)	Report math models and tools assessment final findings and recommendations to ICB and PRCB
SSP	Jun 05	TPS impact testing and model development
SSP	Jun 05	Verification/validation of new impact analysis tools
SSP	Jun 05	Verification/validation of new tile damage assessment tools



Columbia Accident Investigation Board

Recommendation 3.4-1

Upgrade the imaging system to be capable of providing a minimum of three useful views of the Space Shuttle from liftoff to at least Solid Rocket Booster separation, along any expected ascent azimuth. The operational status of these assets should be included in the Launch Commit Criteria for future launches. Consider using ships or aircraft to provide additional views of the Shuttle during ascent. [RTF]

Note: The Stafford-Covey Return to Flight Task Group held a plenary session on December 15, 2004, and NASA's progress toward answering this recommendation was reviewed. The Task Group agreed the actions taken were sufficient to conditionally close this recommendation.

BACKGROUND

NASA's evaluation of the STS-107 ascent debris impact was hampered by the lack of high-resolution, high-speed ground cameras. In response to this, tracking camera assets at the Kennedy Space Center (KSC) (figure 3.4-1-1) and on the Air Force Eastern Range will be improved to provide upgraded data during Shuttle ascent.

Multiple views of the Shuttle's ascent from varying angles and ranges provide important data for engineering assessment and discovery of unexpected anomalies. These data are important for validating and improving Shuttle performance, but less useful for pinpointing the exact location of potential damage.

Ground cameras provide visual data suitable for detailed analysis of vehicle performance and configuration from prelaunch through Solid Rocket Booster separation. Images can be used to assess debris shed in flight, including origin, size, and trajectory. In addition to providing information about debris, the images will provide detailed information on the Shuttle systems used for trend analysis that will allow us to further improve the Shuttle. Together, these help us to identify unknown environments or technical anomalies that might pose a risk to the Shuttle.

NASA IMPLEMENTATION

NASA is developing a suite of improved ground- and airborne cameras that fully satisfies this Recommendation. This improved suite of ground cameras will maximize our ability to capture three complementary views of the Shuttle and provide the Space Shuttle Program (SSP) with engineering data to give us a better and continuing understanding of the ascent environment and the performance of the Shuttle hardware elements within this environment. Ground imagery may also allow us to detect ascent debris and identify potential damage to the Orbiter for on-orbit assessment. There are four types of imagery that NASA will acquire from the ground cameras: primary imagery—film images used as the primary analysis tools for launch and ascent operations; fallback imagery—backup imagery for use when the primary imagery is unavailable; quick-look imagery—imagery provided to the Image Analysis labs shortly after launch for initial assessments; and tracker imagery—images used to guide the camera tracking mounts and for analysis when needed. Any anomalous situations identified in the post-ascent “quick-look” assessments will be used to optimize the on-orbit inspections described in Recommendation 6.4-1.



Figure 3.4-1-1. Typical KSC long-range tracker.

NASA has increased the total number of ground cameras and added additional short-, medium-, and long-range camera sites, including nine new quick-look locations. Since all future Shuttle missions are planned to the International Space Station, the locations of the new cameras and trackers are optimized for 51.6-degree-inclination launches. Previously, camera coverage was limited by a generic configuration originally designed for the full range of possible launch inclinations and ascent tracks. NASA has also added High-Definition Television (HDTV) digital cameras and 35mm/16 mm motion picture cameras for quick-look/fallback and primary imagery, respectively. In addition, NASA has taken steps to improve the underlying infrastructure for distributing and analyzing the additional photo imagery obtained from ground cameras.

System Configuration

NASA divides the Shuttle ascent into three overlapping periods with different imaging requirements. These time periods provide for steps in lens focal lengths to improve image resolution as the vehicle moves away from each camera location:

- Short-range images (T-10 seconds through T+57 seconds)
- Medium-range images (T-7 seconds through T+100 seconds)
- Long-range trackers (T-7 or vehicle acquisition through T+165 seconds)

For short-range imaging, NASA has two Photographic Optic Control Systems (POCS), a primary and a backup,

to control the fixed-film cameras at the launch pad, the Shuttle Landing Facility, and the remote areas of KSC where manned cameras are not allowed. There is significant redundancy in this system: each POCS has the capability of controlling up to 512 individual cameras at a rate of 400 frames per second. Currently, there are approximately 75 cameras positioned for launch photography. POCS redundancy is also provided by multiple sets of command and control hardware and by multiple overlapping views, rather than through backup cameras. The POCS are a part of the Expanded Photographic Optic Control Center (EPOCC). EPOCC is the hub for the ground camera system.

The medium- and long-range tracking devices will be on mobile platforms (e.g., Kineto Tracking Mount (KTM)), allowing them to be positioned optimally for each flight. The three trackers on the launch pad will be controlled with the Pad Tracker System (PTS). PTS is a KSC-designed and -built system that provides both film and video imagery. It has multiple sets of command and control hardware to provide system redundancy. Each of the medium- and long-range tracking cameras is independent, assuring that no single failure can disable all of the trackers. Further, each of the film cameras on the trackers uses HDTV as a backup. For each flight, NASA will optimize the camera configuration, evaluating the locations of the cameras to ensure that the images provide the necessary resolution and coverage.

The planned locations at Launch Complex 39-B for short-, medium-, and long-range tracking cameras are as shown in figures 3.4-1-2, 3.4-1-3, and 3.4-1.4, respectively. As studies improve the understanding of vehicle coverage during ascent, these positions may change. Existing cameras

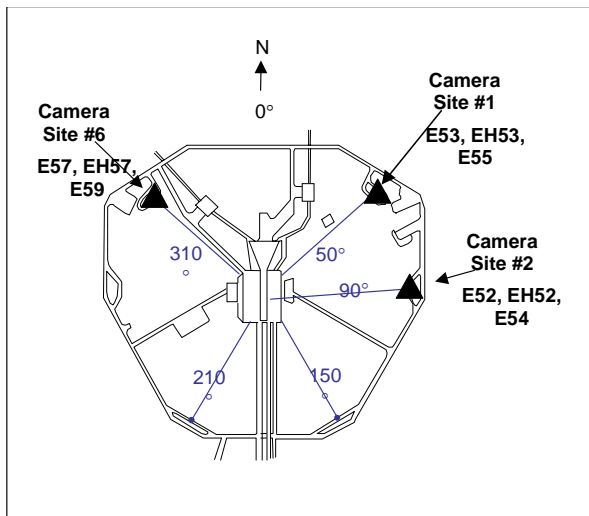

Figure 3.4-1-2. Short-range camera sites.

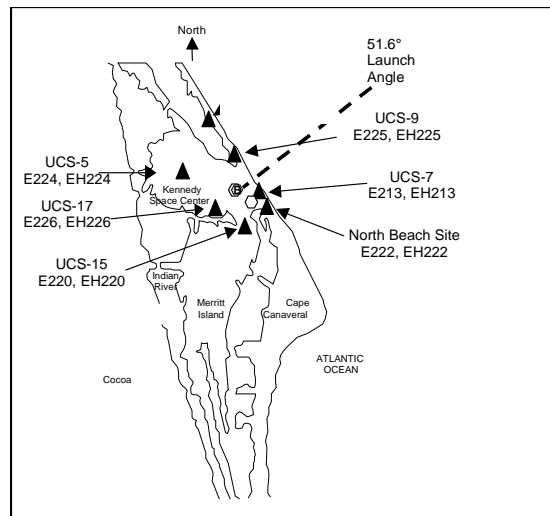

Figure 3.4-1-3. Medium-range tracker sites.

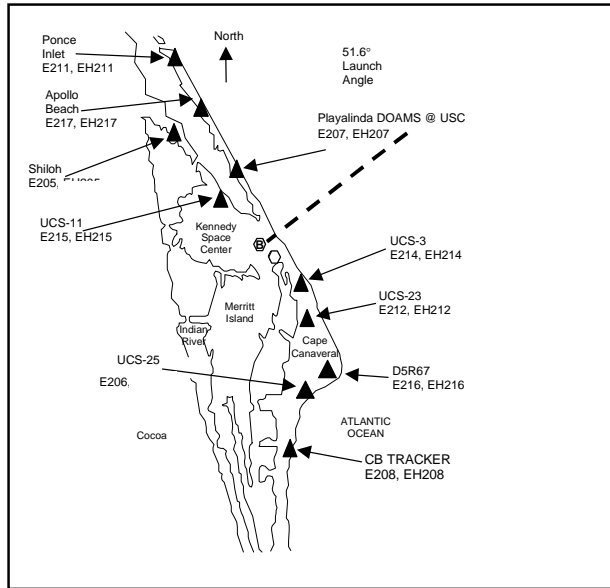

Figure 3.4-1-4. Long-range tracker sites.



Figure 3.4-1-5. WB-57 aircraft.

will be moved, modernized, and augmented to comply with new requirements.

In addition to ground cameras, NASA has approved the development and implementation of an aircraft-based imaging system known as the WB-57 Ascent Video Experiment (WAVE) to provide both ascent and entry imagery. The use of an airborne imaging system will provide opportunities to better observe the vehicle during days of heavier cloud cover and in areas obscured from ground cameras by the exhaust plume following launch.

The primary hardware for the WAVE consists of a 32-in. ball turret system mounted on the nose of two WB-57 aircraft (figure 3.4-1-5). The use of two aircraft flying at an altitude of 60,000 ft will allow a wide range of coverage with each airplane providing imagery over a 400-mi path. The WAVE ball turret houses an optical bench that provides a location for installation of multiple camera systems (HDTV, infrared). The optics consist of a 4.2-m fixed focal length lens with an 11-in. aperture, and the system can be operated in both auto track and manual modes.

WAVE will be used on an experimental basis during the first two Space Shuttle flights following return to flight (RTF). Based on an analysis of the system's performance and quality of the products obtained, following these two flights NASA will make the decision on whether to

continue use of this system on future flights. Critical Design Review for the WAVE was completed on July 1, 2004.

Although the ground cameras provide important engineering data for the Shuttle, they cannot have the resolution and coverage necessary to definitively establish that the Orbiter has suffered no ascent debris damage. No real-time decisions will be based on ground imagery data. Rather, the comprehensive assessments of Orbiter impacts and damage necessary to ensure the safety of the vehicle and crew will be conducted using on-orbit inspection and analysis.

NASA's analysis suggests that this upgraded suite of ground and airborne cameras will significantly improve NASA's ability to obtain three useful views of each Shuttle launch, particularly in conditions of limited cloud cover.

Launch Requirements

NASA is optimizing our launch requirements and procedures to support our ability to capture three useful views of the Shuttle, allowing us to conduct engineering analysis of the ascent environment. Initially, NASA will launch in daylight to maximize our ability to capture the most useful ground ascent imagery. Camera and tracker operability and readiness to support launch will be ensured by an updated set of prelaunch equipment and data system checks that will be

conducted in the days prior to liftoff. These checkouts will be documented in the system setup work documents and reported at the Flight Readiness Review. A final system status is reported to the Launch Director at T-20 minutes. In addition, specific launch commit criteria (LCC) have been added for those critical control systems and data collection nodes for which a power failure would prevent the operation of multiple cameras or disrupt our ability to collect and analyze the data in a timely fashion. The camera LCC will be tracked to the T-9 minute milestone, and the countdown will not be continued if the criteria are not satisfied.

With the additional cameras and trackers that will be available at RTF, NASA has provided sufficient redundancy in the system to allow us to gather ample data and maintain three useful views—even with the loss of an individual camera or tracker. As a result, it is not necessary to track the status of each individual camera and tracker after the final operability checks. This enhances overall Shuttle safety by removing an unnecessary item for status tracking during the critical terminal countdown, allowing the Launch Control Team to concentrate on the many remaining key safety parameters. The LCCs remaining until the T-9 minute milestone protect the critical control systems and data collection nodes whose failure might prevent us from obtaining the engineering data necessary to assess vehicle health and function during the initial moments of ascent. For instance, the LCC will require that at least one POCS be functional at T-9 minutes, and that the overall system be stable and operating.

NASA has also confirmed that the existing LCCs related to weather constraints dictated by Eastern Range Safety satisfy the camera coverage requirements. NASA conducted detailed meteorological studies using Cape weather histories, which concluded that current Shuttle launch weather requirements, coupled with the wide geographic area covered by the ground camera suite and the airborne assets, adequately protect our ability to capture sufficient views of the Shuttle during ascent. The weather LCCs balance launch probability, including the need to avoid potentially dangerous launch aborts, against the need to have adequate camera coverage of ascent. The extensive revitalization of the ground camera system accomplished since the *Columbia* accident provides the redundancy that makes such an approach viable and appropriate.

STATUS

The Program Requirements Control Board (PRCB) approved an integrated suite of imagery assets that will provide the SSP with the engineering data necessary to validate the performance of the External Tank (ET) and

other Shuttle systems, detect ascent debris, and identify and characterize damage to the Orbiter. On August 12, 2004, the PRCB approved funding for the camera suite, to include procurement and sustaining operations. The decision package included the deletion of several long- and medium-range cameras after the first two re-flights, contingent on clearing the ET and understanding the ascent debris environment.

NASA has begun shipping the 14 existing trackers to White Sands Missile Range for refurbishment. This work will be ongoing until refurbishment of all trackers is complete in 2008. Trackers and optics will be borrowed from other ranges to support the first few launches. NASA has also approved funding to procure additional spare mounts, as well as to fund studies on additional capability in the areas of infrared and ultraviolet imagery, adaptive optics, and high-speed digital video, and in the rapid transmission of large data files for engineering analysis. Procurement of new trackers will begin in February 2006. Procurement of optics is in process now.

For RTF, NASA has doubled the total number of camera sites from 10 to 20, each with two or more cameras. At RTF, NASA will have three short-range camera sites around the perimeter of the launch pad; six medium-range camera sites, one at the Shuttle Launch Facility; and 10 long-range camera sites. To accommodate the enhanced imagery, we have installed high-volume data lines for rapid image distribution and improved KSC's image analysis capabilities.

NASA is also procuring additional cameras to provide increased redundancy and refurbishing existing cameras. NASA has ordered 35 camera lenses to supplement the existing inventory and has purchased two KTM Digital Control Chassis to improve KTM reliability and performance. In addition, NASA has procured 36 HDTV cameras to improve our quick-look capabilities.

The U.S. Air Force-owned optics for the Cocoa Beach, Florida, camera (the "fuzzy camera" on STS-107) have been returned to the vendor for repair. We have completed an evaluation on current and additional camera locations, and refined the requirements for camera sites. Additional sites have been picked and are documented in the Launch and Landing Program Requirements Document 2000, sections 2800 and 3120. Additional operator training will be provided to improve tracking, especially in difficult weather conditions.

NASA is on track to implement the WAVE airborne camera systems to provide both ascent and entry imagery for RTF.

NASA's plan for use of ground-based wideband radar and ship-based Doppler radar to track ascent debris is addressed in Part 2 of this document under item SSP-12, Radar Coverage Capabilities and Requirements.

NASA has added redundant power sources to the command and control facility as part of our ground camera upgrade to ensure greater redundancy in the fixed medium/long-range camera system. NASA has also added a third short-range tracker site.

FORWARD WORK

The SSP is addressing hardware upgrades, operator training, and quality assurance of ground-based cameras according to the integrated imagery requirements assessment.

NASA will continue to study improvements to its ground imagery capabilities following RTF. Additional enhancements may include replacing the HDTV and motion picture film cameras with High Speed Digital Video (HSDV) cameras and improving our image distribution and analysis capabilities to accommodate the HSDV content.

SCHEDULE

Responsibility	Due Date	Activity/Deliverable
SSP	Aug 03 (Completed)	Program Approval of Ground Camera Upgrade Plan
SSP	Sep 03 (Completed)	Program Approval of funding for Ground Camera Upgrade Plan
SSP	Feb 04 (Completed)	Baseline Program Requirements Document Requirements for additional camera locations
SSP	May 04 (Completed)	Begin refurbishment of 14 existing trackers. Will be ongoing until all refurbishment of all trackers is complete (expected 2009). Trackers and optics will be borrowed from other ranges to support launch until the assets are delivered
SSP	Jul 04 (Completed)	Critical Design Review for WAVE airborne imaging system
SSP	Mar 05 (Completed)	Install new optics and cameras
SSP	May 05 (Completed)	Baseline revised Launch Commit Criteria
SSP	Multi-year Procurement	Acquire six additional trackers, optics, cameras, and spares for all systems. Trackers will be borrowed from other ranges to support launches until the vendor delivers the new KSC trackers

1-50

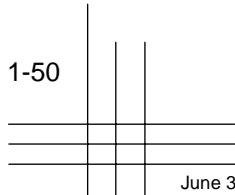

June 3, 2005



Columbia Accident Investigation Board

Recommendation 3.4-2

Provide a capability to obtain and downlink high-resolution images of the External Tank after it separates. [RTF]

Note: The Stafford-Covey Return to Flight Task Group held a plenary session on December 15, 2004, and NASA's progress toward answering this recommendation was reviewed. The Task Group agreed the actions taken were sufficient to fully close this recommendation.

BACKGROUND

NASA agrees that it is critical to verify the performance of the External Tank (ET) modifications to control liberation of ascent debris. Real-time downlink of this information may help in the early identification of some risks to flight. The Space Shuttle currently has two on-board high-resolution cameras that photograph the ET after separation; however, the images from these cameras are available only postflight and are not downlinked to the Mission Control Center during the mission. Therefore, no real-time imaging of the ET is currently available to provide engineering insight into potential debris during the mission.

NASA IMPLEMENTATION

To provide the capability to downlink images of the ET after separation for analysis, NASA is replacing the 35mm film camera in the Orbiter umbilical well with a high-resolution digital camera and equipping the flight crew with a handheld digital still camera with a telephoto lens. Umbilical and handheld camera images will be downlinked after safe orbit operations are established. These images will be used for quick-look analysis by the Mission Management Team to determine if any ET anomalies exist that require additional on-orbit inspections (see Recommendation 6.4-1).

STATUS

The Space Shuttle Program (SSP) Requirements Control Board approved the Orbiter Project plan for installing the new digital camera in the Orbiter umbilical

well for STS-114 (figure 3.4-2-1). NASA has completed test and verification of the performance of the new digital camera for the ET umbilical well and has installed the camera on OV-103 in preparation for STS-114. Orbiter modifications to provide this capability are under way on the other two vehicles.

FORWARD WORK

None.

SCHEDULE

Responsibility	Due Date	Activity/Deliverable
SSP	Sep 03 (Completed)	Initiate Orbiter umbilical well feasibility study
SSP	Mar 05 (OV-103 Completed)	Camera system functional testing completed
SSP	Apr 04 (Completed)	Complete preliminary design review/critical design review on approved hardware
SSP	May 04 (OV-103 Completed)	Begin Orbiter umbilical well camera wiring and support structure installation
SSP	Launch -6 weeks (OV-103 Completed)	Install digital umbilical well camera

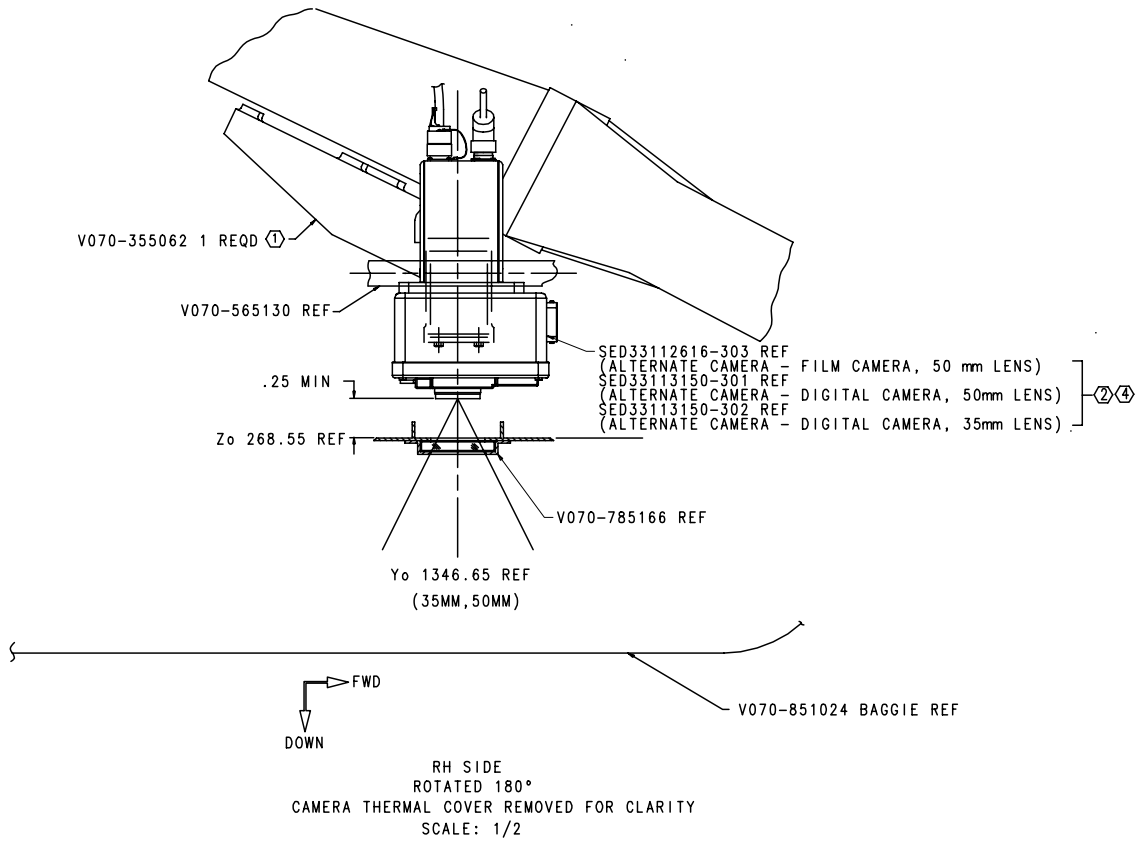

Figure 3.4-2-1. Schematic of umbilical well camera.



Columbia Accident Investigation Board

Recommendation 3.4-3

Provide a capability to obtain and downlink high-resolution images of the underside of the Orbiter wing leading edge and forward section of both wings' Thermal Protection System. [RTF]

BACKGROUND

The damage to the left wing of *Columbia* occurred shortly after liftoff, but went undetected for the entire mission. Although there was ground photographic evidence of debris impact, we were unaware of the extent of the damage. Therefore, NASA is adding on-vehicle cameras and sensors that will help to detect and assess damage.

NASA IMPLEMENTATION

For the first few missions after return to flight, NASA will use primarily on-orbit inspections to meet the requirement to assess the health and status of the Orbiter's Thermal Protection System (TPS). (Details on our on-orbit inspections can be found in Recommendation 6.4-1.) This is because the on-vehicle ascent imagery suite does not provide complete imagery of the underside of the Orbiter or guarantee detection of all potential impacts to the Orbiter. However, on-vehicle ascent imagery will be a valuable source of engineering, performance, and environments data and will be useful for understanding in-flight anomalies. NASA's long-term strategy will include improving on-vehicle ascent imagery.

For STS-114, NASA will have cameras on the External Tank (ET) liquid oxygen (LO₂) feedline fairing and the Solid Rocket Booster (SRB) -forward skirt. The ET LO₂ feedline fairing camera will take images of the ET bipod areas and the underside of the Shuttle fuselage and the right wing from liftoff through the first 15 minutes of flight. The new location of the ET camera will reduce the likelihood that its views will be obscured by the Booster Separation Module plume, a discrepancy observed on STS-112. These images will be transmitted real time to ground stations.

The SRB forward skirt cameras will take images from three seconds to 350 seconds after liftoff. These two cameras will

look sideways at the ET intertank. The images from this location will be stored on the SRBs and available after the SRBs are recovered, approximately three days after launch.

Beginning with STS-115, we will introduce an additional complement of cameras on the SRBs: aft-looking cameras located on the SRB forward skirt and forward-looking cameras located on the SRB External Tank Attachment (ETA) Ring. Together, these additional cameras will provide comprehensive views Orbiter's underside during ascent.

STATUS

The Program Requirements Control Board approved the Level II requirements for the on-vehicle ascent camera system that will be implemented for return to flight.

Because both on-vehicle cameras during ascent and on-orbit inspection will be required to provide a complete picture of the status of the Orbiter's TPS, this recommendation will be considered for closure by the Stafford-Covey Return to Flight Task Group in conjunction with Recommendation 6.4-1, Thermal Protection System On-Orbit Inspection and Repair.

FORWARD WORK

NASA will continue to research options to improve camera resolution, functionality in reduced lighting conditions, and alternate camera mounting configurations. In the meantime, work is proceeding on the new SRB camera designs and implementation of the approved ET and SRB cameras and wing leading edge sensors.

New SRB-mounted cameras located on the ETA ring and forward skirt will be introduced on STS-115.

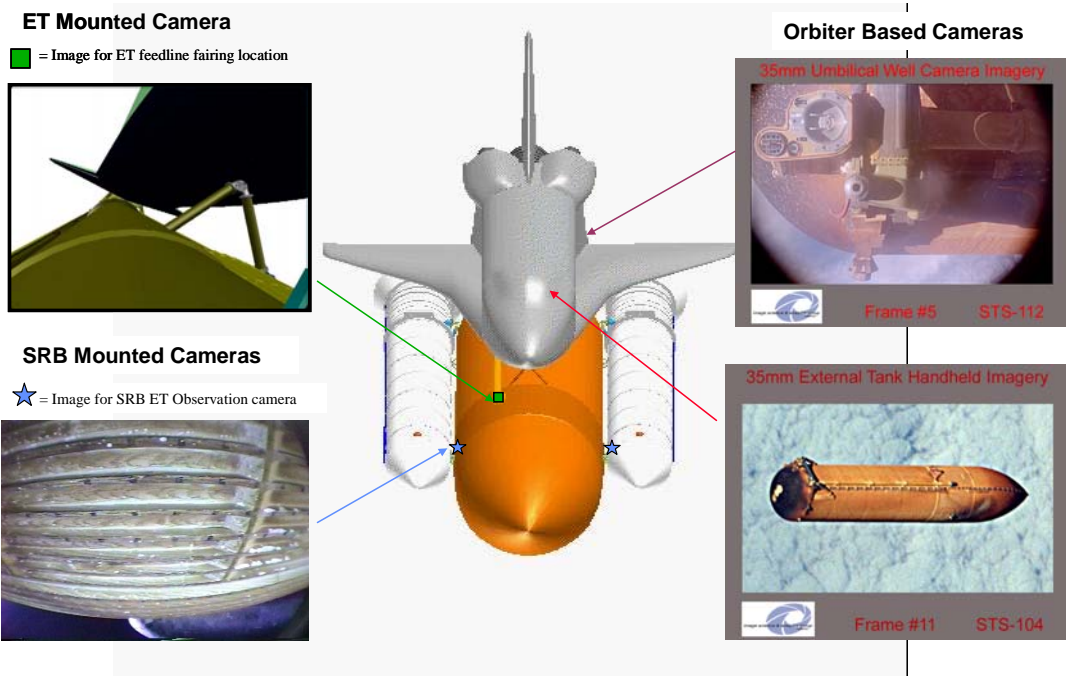

Figure 3.4-3-1. ET flight cameras (STS-114 configuration).

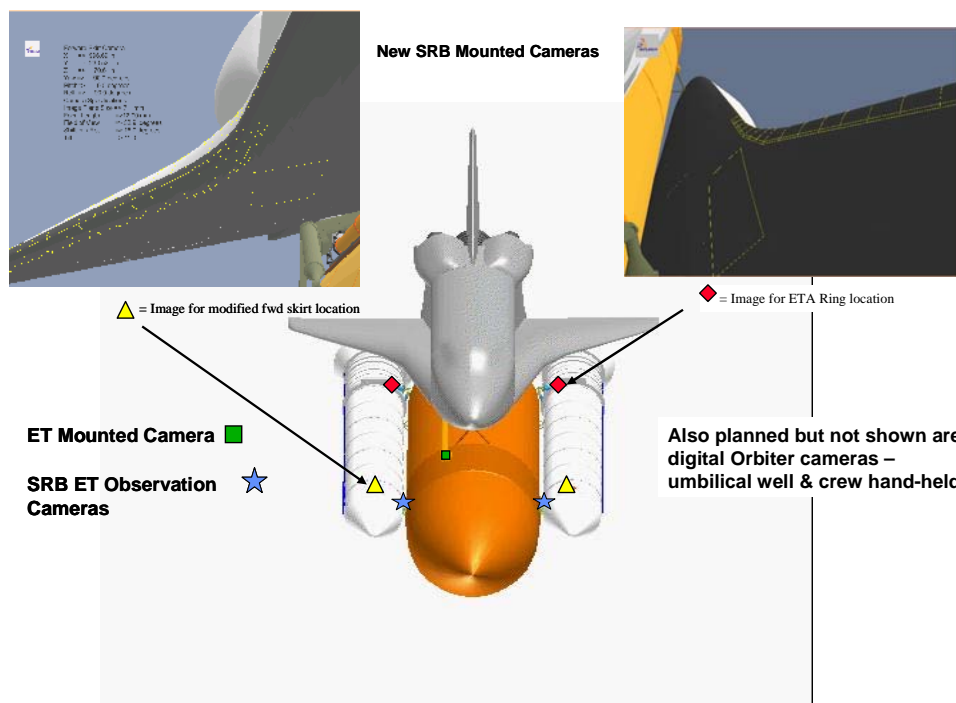
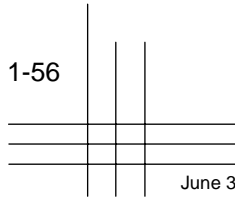

Figure 3.4-3-2. ET flight cameras (TBD configuration).

SCHEDULE

Responsibility	Due Date	Activity/Deliverable
Space Shuttle Program (SSP)	May 03 (Completed)	Start ET hardware modifications
SSP	Jul 03 (Completed)	Authority to proceed with ET LO ₂ feedline and SRB forward skirt locations; implementation approval for ET camera
SSP	Mar 04 (Completed)	Systems Requirements Review
SSP	Jun 04 (Completed)	Begin ET camera installations
SSP	Oct 04 (Completed)	Begin SRB "ET Observation" camera installation
SSP	Jun 05	Review SRB camera enhancements for mission effectivity





Columbia Accident Investigation Board Recommendation 6.3-2

Modify the Memorandum of Agreement with the National Imagery and Mapping Agency (NIMA) to make the imaging of each Shuttle flight while on orbit a standard requirement. [RTF]

Note: The Stafford-Covey Return to Flight Task Group held a plenary session on December 15, 2004, and NASA's progress toward answering this recommendation was reviewed. The Task Group agreed the actions taken were sufficient to fully close this recommendation.

BACKGROUND

The *Columbia* Accident Investigation Board (CAIB) found, and NASA concurs, that the full capabilities of the United States to assess the condition of the *Columbia* during STS-107 should have been used but were not.

NASA IMPLEMENTATION

NASA has already concluded a Memorandum of Agreement with the National Imagery and Mapping Agency (subsequently renamed the National Geospatial-Intelligence Agency [NGA]) that provides for on-orbit assessment of the condition of each Orbiter vehicle as a standard requirement. In addition, NASA has initiated discussions with other agencies to explore the use of appropriate national assets to evaluate the condition of the Orbiter vehicle. Additional agreements have been developed and are in final review. The operational teams have developed standard operating procedures to implement agreements with the appropriate government agencies at the Headquarters level.

NASA has determined which positions/personnel will require access to data obtained from external sources. NASA will ensure that all personnel are familiar with the general capabilities available for on-orbit assessment and that the appropriate personnel are familiar with the means to gain access to that information. Over 70 percent of the

requested clearances have been completed, and the remaining clearances are nearing completion.

Plans to demonstrate and train people per the new processes and procedures have been developed and will be exercised prior to the launch of STS-114. Testing and validation of these new processes and procedures have been accomplished in simulations conducted during the last six months of 2004. Since this action may involve receipt and handling of classified information, the appropriate security safeguards will be observed during its implementation.

In April 2004, the Stafford-Covey Return to Flight Task Group reviewed NASA's progress and agreed to conditionally close this recommendation. The full intent of CAIB Recommendation 6.3-2 has been met and full closure of this recommendation was achieved in December 2004.

FORWARD WORK

None.

SCHEDULE

An internal NASA process is being used to track clearances, training of personnel, and the process validation.

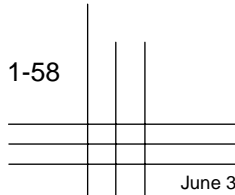



Columbia Accident Investigation Board

Recommendation 3.6-1

The Modular Auxiliary Data System instrumentation and sensor suite on each Orbiter should be maintained and updated to include current sensor and data acquisition technologies.

Note: NASA has closed this recommendation through the formal Program Requirements Control Board process. The following summary details NASA's response to the recommendation and any additional work NASA intends to perform beyond the *Columbia* Accident Investigation Board (CAIB) recommendation.

BACKGROUND

The Modular Auxiliary Data System (MADS), which is also referred to in the CAIB Report as the "OEX recorder," is a platform for collecting engineering performance data. The MADS records data that provide the engineering community with information on the environment experienced by the Orbiter during ascent and entry, and with information on how the structures and systems responded to this environment. The repair and/or upgrade of sensors has not been a formal Space Shuttle Program (SSP) requirement because MADS was intended to be only a supplemental package, not used for flight critical decisions. This lack of formal requirements will be reassessed.

The MADS hardware is 1970's technology and is difficult to maintain. NASA has recognized the problem with its sustainability for some time. The available instrumentation hardware assets can only support the existing sensor suite in each Orbiter. If any additional sensors are required, their associated hardware must be procured.

NASA IMPLEMENTATION

The SSP agrees that MADS needs to be maintained. The SSP approved the incorporation of the MADS subsystem into the Program requirements documentation. The Instrumentation Problem Resolution Team (PRT) will be

reviewing sensor requirements for various Orbiter systems to determine appropriate action for sensors. The PRT will also ensure proper maintenance of the current MADS hardware. NASA has acquired MADS wideband instrumentation tape and certified it for flight. This will extend the operational availability of the MADS recorder. NASA has also extended the recorder maintenance and skills retention contract with the MADS vendor, Sypris.

STATUS

The SSP will maintain the current MADS, including flight hardware and ground support equipment and sensor and data acquisition components for the remainder of the SSP. Space Shuttle retirement is projected to be at the end of the decade.

FORWARD WORK

The PRT and Logistics will continue performing supportability assessments on the MADS subsystem to determine maintenance strategy for continued support through the Space Shuttle's retirement.

SCHEDULE

Complete.

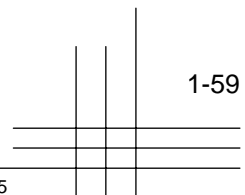

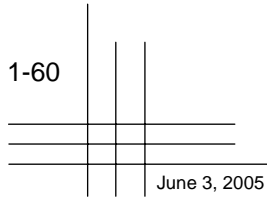



Columbia Accident Investigation Board

Recommendation 3.6-2

The Modular Auxiliary Data System should be redesigned to include engineering performance and vehicle health information and have the ability to be reconfigured during flight in order to allow certain data to be recorded, telemetered, or both, as needs change.

| Note: NASA has closed this recommendation through the formal Program Requirements Control Board (PRCB) process. The following summary details NASA's response to the recommendation and any additional work NASA intends to perform beyond the *Columbia* Accident Investigation Board (CAIB) recommendation.

BACKGROUND

The Modular Auxiliary Data System (MADS)* provides limited engineering performance and vehicle health information postflight. There are two aspects to this recommendation: (1) redesign for additional sensor information, and (2) redesign to provide the ability to select certain data to be recorded and/or telemetered to the ground during the mission. To meet these recommendations, a new system must be developed to replace MADS. The evaluation of this replacement is currently in progress to address system obsolescence issues and also provide additional capability.

The Space Shuttle Program (SSP) has also baselined a requirement to add additional vehicle health monitoring capability. These capabilities will increase the insight into the Orbiter's Thermal Protection System.

NASA IMPLEMENTATION

Initially, NASA planned to address the enhanced requirements for MADS through a new Vehicle Health Maintenance System (VHMS), which was part of the suite of upgrades comprising the Shuttle Service Life Extension Program. In January 2004, the Vision for Space Exploration was announced. The Vision refocused the mission of the SSP on support for and assembly of the International Space Station (ISS), and called for the retirement of the Space Shuttle following ISS assembly complete at the end of the decade. As a result of this program reorientation and the focus on returning safely to flight following the loss of the *Columbia* and her crew, the SSP reevaluated its Program priorities. As a part of this reevaluation, the Shuttle Program reviewed its commitment to the VHMS upgrade and determined that it was not a high-priority investment. VHMS would have expanded the Shuttle's capability to monitor new instrumentation and telemeter the resulting data, but

did not address a specific safety concern. Rather it was designed to improve engineering insight into the Space Shuttle's condition during a mission.

Instead of developing and installing a new VHMS system, the Orbiter will be modified to provide low-rate MADS digital data available for downlink during on-orbit operations. These low-rate data include temperature, strain gauge, and pressure sensors already installed in unique locations specific to each Orbiter. In addition, there are other non-MADS instrumentation systems being proposed that will collect more vehicle health data. For instance, the Wing Leading Edge Sensor System (WLESS) will collect acceleration and temperature data along the Orbiter's right and left leading edge structure. Data from the WLESS will be available for downlink during on-orbit operations.

STATUS

The low-rate MADS digital data modification is installed on OV-104 (STS-121). The engineering and flight hardware has been delivered to Kennedy Space Center and is planned for installation into OV-103 (STS-116) and OV-105 Orbiter Major Modification (OMM) (STS-117). The WLESS is installed on OV-103 (STS-114). The installation is progressing for OV-104 (STS-121) and OV-105 OMM (STS-117).

FORWARD WORK

The SSP will continue to assess the data collection requirements for the integrated vehicle and the Orbiter, and will provide status updates to the PRCB.

*Note that the CAIB Report alternately refers to this as the OEX Recorder.

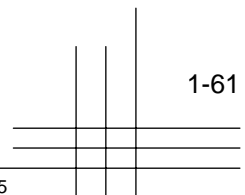

SCHEDULE

Complete.

1-62	



Columbia Accident Investigation Board

Recommendation 4.2-2

As part of the Shuttle Service Life Extension Program and potential 40-year service life, develop a state-of-the-art means to inspect all Orbiter wiring, including that which is inaccessible.

Note: With the establishment of a new national policy for U.S. space exploration in January 2004, the planned service life of the Space Shuttle was shortened. Following its return to flight, the Space Shuttle will be used to complete assembly of the International Space Station, planned for the end of the decade, and then the Shuttle will be retired. Due to the reduced service life, NASA's approach to complying with this recommendation has been appropriately adjusted. These actions were closed through the formal Program Requirements Control Board (PRCB) process. The following summary details NASA's response to the recommendation and any additional work NASA intends to perform beyond the *Columbia* Accident Investigation Board (CAIB) recommendation.

BACKGROUND

A significant amount of Orbiter wiring is insulated with Kapton, a polyimide film used as electrical insulation. Kapton-insulated wire has many advantages; however, over the years several concerns have been identified and addressed by the Space Shuttle Program (SSP) through both remedial and corrective actions.

Arc tracking, one of these ongoing concerns, was highlighted during STS-93 as a result of a short circuit in the wiring powering one of the channels of the Space Shuttle Main Engine controllers. Arc tracking is a known failure mode of Kapton wiring in which the electrical short can propagate along the wire and to adjacent wiring. Following STS-93, NASA initiated an extensive wiring investigation program to identify and repair/replace discrepant wiring. NASA also initiated a program of Critical Wire Separation efforts. This program separated redundant critical function wires that were collocated in a single wire bundle into separate wire bundles to mitigate the risk of an electrical short on one wire arc tracking to an adjacent wire and resulting in the total loss of a system. In areas where complete separation was not possible, inspections are being performed to identify discrepant wire, repair/replace it, and to protect against damage that may lead to arc tracking. In addition, abrasion protection (convoluted tubing or Teflon wrap) is being added to wire bundles that carry circuits of specific concern and/or are routed through areas of known high damage potential.

The STS-93 wiring investigation also led to improvements in the requirements for wiring inspections, wiring inspection techniques, and wire awareness training of personnel working in the vehicle. Wiring was inspected, separated, and protected in the accessible areas during the general flight-to-flight

Operations and Maintenance Requirements Specification Document (OMRSD) process. The wiring that was inaccessible during the OMRSD process was inspected, separated, and protected during the Orbiter Maintenance Down Period.

Currently, visual inspection is the most effective means of detecting wire damage. Technology-assisted techniques such as Hipot, a high-potential dielectric verification test, and time domain reflectometry (TDR), a test that identifies changes in the impedance between conductors, are rarely effective for detecting damage that does not expose the conductor or where a subtle impedance change is present. Neither is an effective method for detecting subtle damage to wiring insulation. However, for some areas, visual inspection is impractical. The Orbiters contain some wire runs, such as those installed beneath the crew module, that are completely inaccessible to inspectors during routine ground processing. Even where wire is installed in accessible areas, not every wire segment is available for inspection due to bundling and routing techniques. However, the results of wire inspections, particularly since STS-93, have shown that the vast majority of wire damage is caused by maintenance workers accessing and working in areas where wire bundles are present. Areas that must be accessed for normal flight-to-flight processing, such as the payload bay or the environmental control systems bay, are particularly vulnerable.

NASA IMPLEMENTATION

NASA initially took a broad approach to mitigating Orbiter wiring concerns by evaluating promising new technologies for nondestructive evaluation (NDE) of wires, benchmarking with the practices of other government agencies, improving its visual wire inspection techniques,

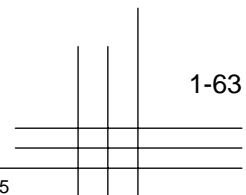

and creating a study group to recommend improvements to wiring issues.

NASA's initial work on NDE involved the Ames Research Center (ARC), where engineers were developing a proposed Hybrid Reflectometer, a TDR derivative, to detect defects in wiring. At the Langley Research Center (LaRC) engineers were developing a wire insulation age-life tester and an ultrasonic crimp joint tool to measure the integrity of wire crimps as they are made. At the Johnson Space Center (JSC) engineers were evaluating a destructive age-life test capability.

Prior to the articulation of the Vision for Space Exploration, NASA was particularly interested in the issue of aging wiring as a part of the Shuttle Service Life Extension Program to the year 2020 and potential 40-year service life of the Orbiters. Military and civilian aircraft are also frequently flown beyond their original design lives. NASA began an effort to benchmark with industry, academia, and other government agencies to find the most effective means to address the aging wiring concerns. Examples are NASA's participation on the Joint Council for Aging Aircraft and its collaboration with the Air Force Research Laboratory.

To improve inspection techniques, the SSP more clearly defined requirements for Category I Inspections (cutting the minimum wire ties needed to perform repair/replacement, opening up bundles, and spreading out and inspecting the additional wires made available) and Category II Inspections (inspecting bundle periphery with 10x magnification, and opening bundles if damage was noted). The Program also planned to update a previous Boeing study that evaluated types of wire insulation other than Kapton, planned to identify and map "inaccessible" wiring, and considered potential wire replacement.

Finally, the SSP assigned an action to the Orbiter Project Office to research, evaluate, and present a comprehensive list of options to address the wiring issue in general and CAIB Recommendation 4.2-2 specifically. An Orbiter Wiring Working Group composed of engineers from SSP, JSC, and Kennedy Space Center (KSC) Engineering, United Space Alliance, and Boeing began this evaluation in 2003.

STATUS

In January 2004, a new national policy for U.S. Space Exploration was established and the planned life of the Space Shuttle was shortened. Following its return to flight, the Space Shuttle will be used to complete assembly of the International Space Station, planned for the end of the decade, and then the Space Shuttle will be retired. Due to

this reduced service life, NASA's approach to complying with CAIB Recommendation 4.2-2 was appropriately adjusted.

On June 17, 2004, the Orbiter Wiring Working Group presented to the PRCB a four-prong, two-phase approach to address wiring issues and respond to CAIB Recommendation 4.2-2. The four prongs or options were: (1) inspect and Protect, by continuing to improve upon current wiring inspections and activities at KSC; (2) invest in the development of NDE, including a wire insulation tester, a wire age life tester, and an ultrasonic wire crimp tool; (3) perform destructive evaluations to determine whether the Orbiter wiring does, in fact, show aging effects that are of concern; and (4) evaluate wire replacement for the Orbiters. The two phases related to NDE were Phase I – Proof of Concept and Phase II – Delivery of a Working Unit.

In light of the reduced service life of the Orbiter, the PRCB approved option 1, inspect and protect, and option 3, perform destructive evaluations. Options (2) and (4) were not approved and, as a consequence, further NDE work at the ARC and LaRC is no longer being funded by the SSP. The investment in NDE in option 2 was felt to offer little return on investment considering the relatively low technology readiness level of wiring NDE techniques. Also, few remaining flights could make use of the new NDE due to the time required to develop, test, and field operational units. In view of the planned retirement of the Space Shuttles in 2010, replacing Orbiter wiring was assessed as not cost effective.

In contrast, the inspect and protect approach continues with wiring damage corrective actions that have been in place since the post-STS-93 wiring efforts, including lessons learned to date. NASA also chartered the Orbiter Wiring Team to evaluate a wiring destructive testing program to better characterize the specific vulnerabilities of Orbiter wiring to aging and damage, and to predict future wiring damage, particularly in inaccessible areas.

To formalize wiring inspection improvements, NASA revised Specification ML0303-0014, "Installation Requirements for Electrical Wire Harnesses and Coaxial Cables," with improved guidelines for wire inspection procedures and protection protocols. A new Avionics Damage Database was implemented to capture statistical data to NASA's ability to analyze and predict wiring damage trends. NASA also initiated an aggressive wire damage awareness program that limits the number of people given access to Orbiter areas where wiring can be damaged. In addition, specific training is now given to personnel who require entry to areas that have a high potential for wiring damage. This training has already helped raise awareness and reduce unintended processing damage.

To improve our understanding of wiring issues for the remaining service life of the Space Shuttle, information and technical exchanges will continue between the SSP, NASA research centers, and other agencies dealing with aging wiring issues, such as the Federal Aviation Administration and the Department of Defense.

FORWARD WORK

In April 2005 the multi-disciplinary Orbiter Wiring Working Group will present its findings to the Orbiter Project Office regarding the need for and feasibility of a destructive age-

life testing capability. The SSP will continue to evaluate the risk of aging/damaged wiring against the other major risk drivers in the Program, within the constraints of current technical capabilities, and given the Shuttle’s planned retirement at the end of the decade.

SCHEDULE

Responsibility	Due Date	Activity/Deliverable
SSP	Apr 04 (Completed)	Present project plan to the PRCB

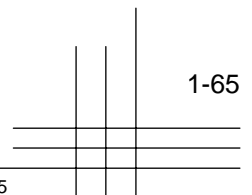

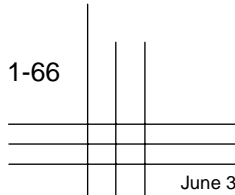



Columbia Accident Investigation Board

Recommendation 4.2-1

Test and qualify the flight hardware bolt catchers. [RTF]

Note: The Stafford-Covey Return to Flight Task Group held a plenary session on December 15, 2004, and NASA's progress toward answering this recommendation was reviewed. The Task Group agreed the actions taken were sufficient to fully close the recommendation.

BACKGROUND

The External Tank (ET) is attached to the Solid Rocket Boosters (SRBs) at the forward skirt thrust fitting by the forward separation bolt. The pyrotechnic bolt is actuated at SRB separation by fracturing the bolt in half at a predetermined groove, releasing the SRBs from the ET thrust fittings. The bolt catcher attached to the ET fitting retains the forward half of the separation bolt. The other half of the separation bolt is retained within a cavity in the forward skirt thrust post (figure 4.2-1-1).

The STS-107 bolt catcher design consisted of an aluminum dome welded to a machined aluminum base bolted to both the left- and right-hand ET fittings. The inside of the bolt catcher was filled with a honeycomb energy absorber to decelerate the ET half of the separation bolt (figure 4.2-1-2).

Static and dynamic testing demonstrated that the manufactured lot of bolt catchers that flew on STS-107 had a factor of safety of approximately 1. The factor of safety for the bolt catcher assembly should be 1.4.

NASA IMPLEMENTATION

NASA determined that the bolt catcher assembly and related hardware needed to be redesigned and qualified by testing as a complete system to demonstrate compliance with factor-of-safety requirements.

NASA completed the redesign of the bolt catcher assembly, the redesign and resizing of the ET attachment bolts and inserts, the testing to characterize the energy absorber material, and the testing to determine the design loads.

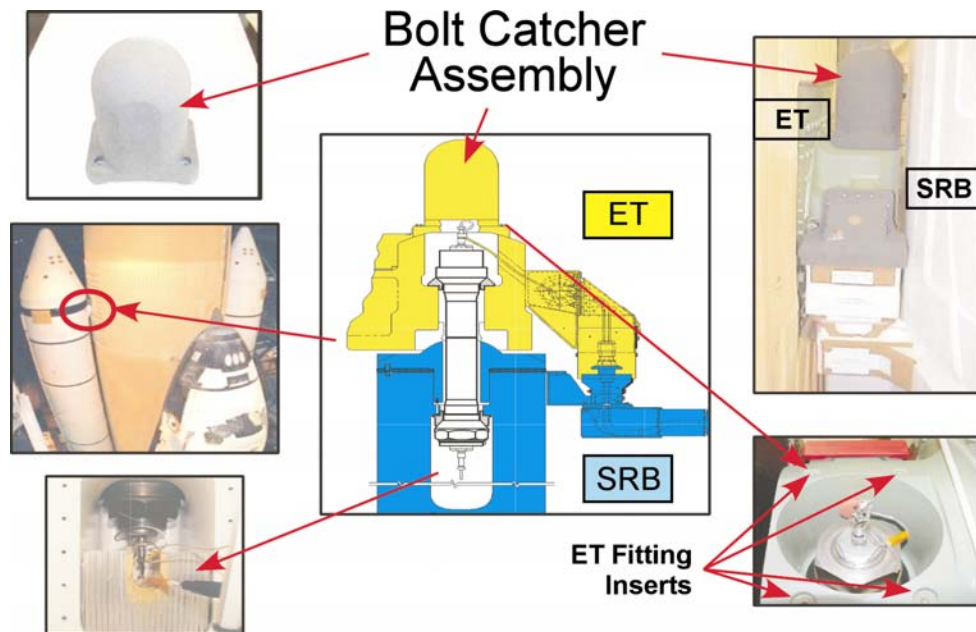
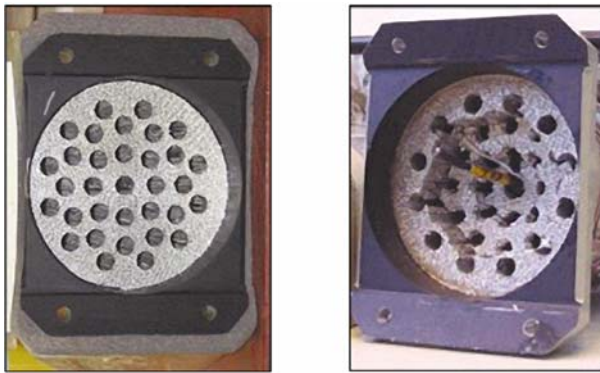

Figure 4.2-1-1. SRB/ET forward attach area.



Bolt catcher energy absorber

Bolt catcher energy absorber after bolt impact

Figure 4.2-1-2. Bolt catcher impact testing.



Figure 4.2-1-3. New one-piece forging design.

The bolt catcher housing will be fabricated from a single piece of aluminum forging (figure 4.2-1-3) that removes the weld from the original design (figure 4.2-1-4). Further, new energy-absorbing material and thermal protection material

have been selected (figure 4.2-1-4), and the ET attachment bolts and inserts (figure 4.2-1-5) have been redesigned and resized.

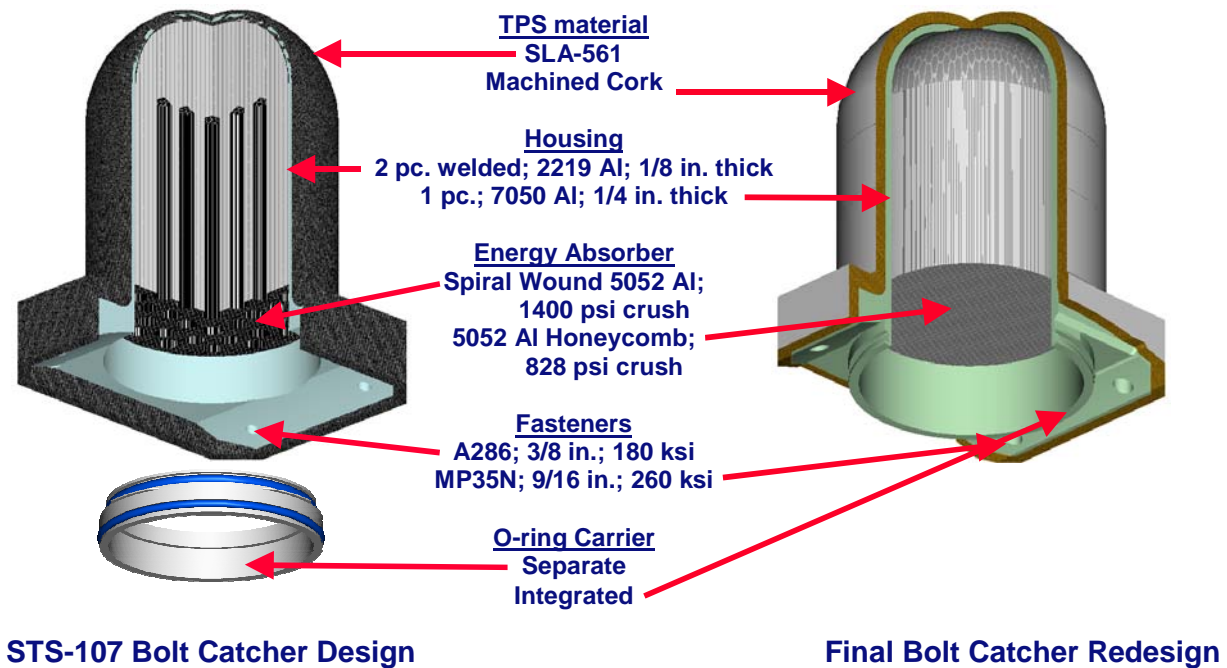

Figure 4.2-1-4. Old and new bolt catcher design comparison.

STATUS

Structural qualification to demonstrate that the assembly complies with the 1.4 factor-of-safety requirement is complete. Cork has been selected as the Thermal Protection System (TPS) material for the bolt catcher. TPS qualification testing is complete including weather exposure followed by combined environment testing, which includes vibration, acoustic, thermal, and pyrotechnic shock testing.

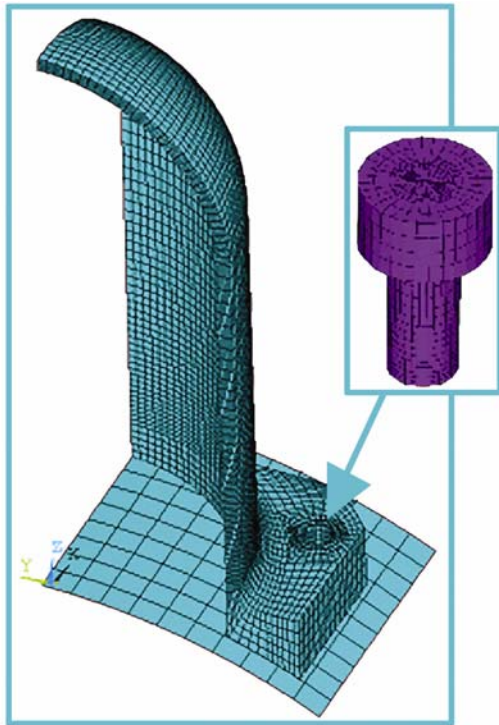

Figure 4.2-1-5. ET bolt/insert finite element model.

FORWARD WORK

None.

SCHEDULE

Responsibility	Due Date	Activity/Deliverable
Space Shuttle Program (SSP)	May 04 (Completed)	Complete Critical Design Review
SSP	Oct 04 (Completed)	Complete Qualification
SSP	Feb 05 (Completed)	First Flight Article Delivered

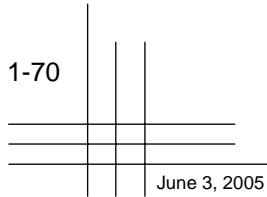



Columbia Accident Investigation Board

Recommendation 4.2-3

Require that at least two employees attend all final closeouts and intertank area hand-spraying procedures. [RTF]

Note: The Stafford-Covey Return to Flight Task Group held a plenary session on December 15, 2004, and NASA's progress toward answering this recommendation was reviewed. The Task Group agreed the actions taken were sufficient to fully close this recommendation.

BACKGROUND

External Tank (ET) final closeouts and intertank area hand-spraying processes typically require more than one person in attendance to execute procedures. Those closeout processes that can currently be performed by a single person did not necessarily specify an independent witness or verification.

NASA IMPLEMENTATION

NASA has established a Thermal Protection System (TPS) verification team to verify, validate, and certify all future foam processes. The verification team will assess and improve the TPS applications and manual spray processes. Included with this assessment is a review and an update of the process controls applied to foam applications, especially the manual spray applications. Spray schedules, acceptance criteria, quality, and data requirements will be established for all processes during verification using a Material Processing Plan (MPP). The plan will define how each specific part closeout is to be processed. Numerous TPS processing parameters and requirements will be enhanced, including additional requirements for observation and documentation of processes. In addition, a review is being conducted to ensure the appropriate quality coverage based on process enhancements and critical application characteristics.

The MPPs will be revised to require, at a minimum, that all ET critical hardware processes, including all final closeouts and intertank area hand-spray procedures, be performed in the presence of two certified Production Operations employees. The MPPs will also include a step to require technicians to stamp the build paper to verify their presence, and to validate the work was performed according to plan. Additionally, quality control personnel will witness and accept each manual spray TPS application. Government oversight of TPS applications will be determined upon completion of the revised designs and the identification of critical process parameters.

In addition to these specific corrective measures taken by the ET Project, in March 2004 the Space Shuttle Program

(SSP) widened the scope of this corrective action in response to a recommendation from the Return to Flight Task Group (RTFTG). The scope was widened to include all flight hardware projects. An audit of all final closeouts will be performed to ensure compliance with the existing guidelines that a minimum of two persons witness final flight hardware closures for flight for both quality assurance and security purposes.

The audits included participation from Project engineers, technicians, and managers. The following were used to complete the audit: comprehensive processing and manufacturing reviews, which included detailed work authorization and manufacturing document appraisals, and on-scene checks.

STATUS

The SSP has approved the revised approach for ET TPS certification, and the Space Flight Leadership Council approved it for RTFTG review. TPS verification activities are under way, and specific applicable ET processing procedures have been changed.

All major flight hardware elements (Orbiter, ET, Solid Rocket Booster, Solid Rocket Motor, extravehicular activity, vehicle processing, and main engine) have concluded their respective audits as directed by the March 2004 SSP initiative. The results of the audits were presented to the Program Manager on May 26, 2004. The two-person closeout guideline was previously well-established in the SSP and largely enforced by multiple overlapping quality assurance and safety requirements. A few projects have identified and are addressing some specific processing or manufacturing steps to extend this guideline beyond current implementation; or where rigorous satisfaction of this guideline can be better documented. Changes to Program-level requirements documents are complete, and will include the requirement for the projects and elements to have a minimum of two people witness final closeouts of major flight hardware elements.

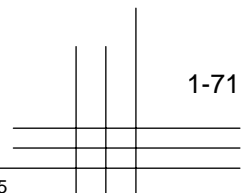

In April 2004, the Stafford-Covey Return to Flight Task Group reviewed NASA's progress and agreed to conditionally close this recommendation. The full intent of CAIB Recommendation 4.2-3 has been met and full closure of this recommendation was achieved in December 2004.

FORWARD WORK

None.

SCHEDULE

Responsibility	Due Date	Activity/Deliverable
ET	Dec 03 (Completed)	Review revised processes with RTFTG
All flight hardware elements	May 04 (Completed)	Audit results of all SSP elements due
ET	May 04 (Completed)	Assessment of Audit Results
SSP	May 04 (Completed)	SSP element audit findings presented to SSP Manager
SSP	Jun 04 (Completed)	Responses due; PRCB action closed
SSP	Jan 05 (Completed)	Revised requirements formally documented

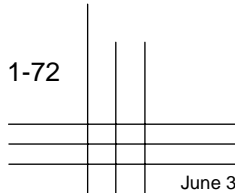



Columbia Accident Investigation Board

Recommendation 4.2-4

Require the Space Shuttle to be operated with the same degree of safety for micrometeoroid and orbital damage as the degree of safety calculated for the International Space Station. Change the micrometeoroid and orbital debris safety criteria from guidelines to requirements.

BACKGROUND

Micrometeoroid and orbital debris (MMOD) is a continuing concern. The current differences between the International Space Station (ISS) and Orbiter MMOD risk allowances for a critical debris impact are based on the original design specifications for each of the vehicles. Specifically, the ISS was designed for long-term MMOD exposure, whereas the Orbiter was designed for short-term MMOD exposure. The debris impact factors that are considered when determining the MMOD risks for a spacecraft are mission duration, attitude(s), altitude, inclination, year, and the on-board payloads.

The current Orbiter impact damage guidelines dictate that there will be no more than a 1 in 200 risk for loss of vehicle for any single mission. This recommendation suggests that the Orbiter meet the same degree of safety that the ISS meets in regards to MMOD risks. The ISS currently has a 0.5 percent catastrophic risk of MMOD debris impact per year. If we assume there will be five Space Shuttle flights per year, this would require that the Orbiter meet an annual average MMOD critical damage risk of 1 in 1000 for any single mission. This risk tolerance may vary from mission to mission, depending on whether the risk profile is determined annually or over the remaining life of the Shuttle Program. NASA continues to evaluate the appropriate means of determining the Shuttle MMOD risk profile.

NASA uses a computer simulation and modeling tool called BUMPER to assess the risk from MMOD impact to the Orbiter during each flight and takes into account the mission duration, attitude variations, altitude, and other factors. BUMPER has been certified for use on both the ISS and the Orbiter. BUMPER has also been examined during numerous technical reviews and deemed to be the world standard for orbital debris risk assessment. Optimized trajectories, vehicle changes, results from trade studies, and more detailed ballistic limit calculations are used to improve the fidelity of the BUMPER results.

NASA IMPLEMENTATION

To comply with the recommendation to operate the Orbiter with the same degree of safety for MMOD as calculated for

ISS, NASA will continue to evaluate the following options for possible implementation in the long term:

- Orbiter vehicle design upgrades to decrease vulnerability to MMOD
- Operational changes during the docked mission phase
- Development of an inspection capability to detect and repair critical damage
- Addition of an on-board impact sensor system to detect critical damage that may occur to the Thermal Protection System (TPS) during ascent or while on orbit.

Once they are fully defined by the Space Shuttle Program (SSP), NASA will change the MMOD safety criteria from guidelines to requirements.

STATUS

The SSP's ability to implement the wide range of mitigations necessary to comply with this recommendation is limited by the time that the Shuttle will continue to operate before retirement after completion of ISS assembly at the end of the decade. Given this limitation, it is unlikely that NASA can achieve the Space Station's level of risk (1 in 1000). NASA's assessments indicate that an alternate operational docked attitude change may decrease the Orbiter's MMOD risk from 1 in 200 to approximately 1 in 485. Currently, NASA is performing hypervelocity impact tests and arc-jet tests on Orbiter wing leading edge (WLE) Reinforced Carbon-Carbon (RCC) coupons to evaluate MMOD damage limits as a function of location on the WLE. Results from these tests will be used to define the failure criteria for the WLE and update the MMOD risk assessment for the Orbiter vehicle. An MMOD risk sensitivity to the RCC WLE failure criteria indicates that a more conservative failure criteria change will limit NASA's ability to achieve the 1 in 485 risk. Appropriate changes will be made over time according to prioritization based on a combination of the efficacy of the change and the relative difficulty of its implementation.

For return to flight (RTF), NASA has approved flying the alternate operational docked attitude of yawing the Shuttle-ISS stack by 180 degrees to reduce critical risk. In the short term also, NASA will continue to consider the following actions to reduce critical risk:

1. Implementing late mission inspection of TPS followed by repair if necessary
2. Installing WLE damage detection sensors and implementing inspection, repair, and/or Contingency Shuttle Crew Support (CSCS) operations, if damage is detected during flight.

A longer-term strategy that shows promise of achieving a reduction in MMOD risk is also under consideration. This strategy includes the following:

1. Continuing the 180-degree yaw strategy post-ISS dock
2. Selective hardening of TPS tiles and WLE to reduce impact hazards from both launch debris and on-orbit MMOD strikes
3. Extending the impact detection sensors to the Orbiter nose cap, wing, and belly TPS areas of the vehicle. If damage is detected, closer inspection of the impacted area will be initiated, followed by repair or resorting to CSCS procedures if necessary.

FORWARD WORK

Investigations will continue on potential vehicle modifications, such as new impact detection sensors, next-generation tiles and toughened strain isolation pad materials, improved RCC, and improved crew module aft bulkhead protection. Hypervelocity impact tests and subsequent arc-jet tests will be performed to evaluate MMOD damage limits as a function of location on the WLE that could result in burn-through during entry. The hypervelocity impact damage limits will be used to update the MMOD risk assessment for the Orbiter vehicle. Testing will be performed in two phases. The first phase is ongoing and limited to available RCC coupons, and results will be used to update the MMOD risk assessment for STS-114. The second phase will be performed to refine failure criteria for WLE by more extensive hypervelocity and arc-jet testing on other RCC coupons to remove any conservatism from the phase one results. Upon completion of the WLE MMOD damage assessment, NASA will update the new RCC loss of vehicle failure criteria for calculating Orbiter MMOD critical damage risk. NASA will also evaluate the cost/benefits for late inspection of RCC and other

TPS for critical MMOD impact damage. Although WLE impact detection hardware has been installed, its capability for detecting MMOD damage is limited due to short-term battery life (sensors will be active 3–5 hours mission elapsed time). An SSP decision to upgrade power has been made, but flight effectivity for the power upgrade is yet to be determined. The benefit for the WLE sensors in reducing loss of communications risk from MMOD impact will be included in the risk assessments after the WLE sensors have been proven in the first two flights and power upgrades have been implemented. Hypervelocity impact tests will continue to be performed, and the BUMPER code will be updated to support the risk reduction effort. To satisfy the second part of the CAIB Recommendation R4.2-4, NASA will continue to work on establishing an MMOD protection requirement for Shuttle. This will be provided in steps based on actions implemented by the SSP to reduce critical risk. For RTF, this will be based on the 180-degree yaw docked attitude for the ISS-Shuttle stack.

SCHEDULE

Responsibility	Due Date	Activity/Deliverable
SSP	Dec 03 (Completed)	Assess adequacy of MMOD requirements
SSP	Apr 04 (Completed)	WLE Sensor System Critical Design Review
SSP	Nov 04 (Completed)	WLE Impact Detection System hardware delivery (OV-103)
SSP	Apr 05 – Phase 1 (Completed) Dec 05 – Phase 2	Assess WLE RCC impact damage tolerance Perform hypervelocity and arc-jet tests
SSP	May 05 (Completed)	Flight-by-flight SSP review of forward work status and MMOD requirements
SSP	Jul 05 – RTF and flight-by- flight basis for subse- quent flights	Establish MMOD Protection Requirement for RTF and subsequent flights

Case 1 - Baseline LVLH TEA Attitude (23° Pitch Bias)

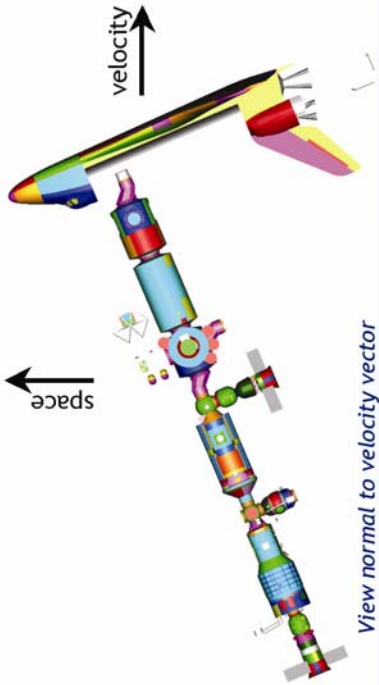

View 45° off velocity vector



Case 2 - ISS/Shuttle 180° Yaw (23° Pitch Bias)

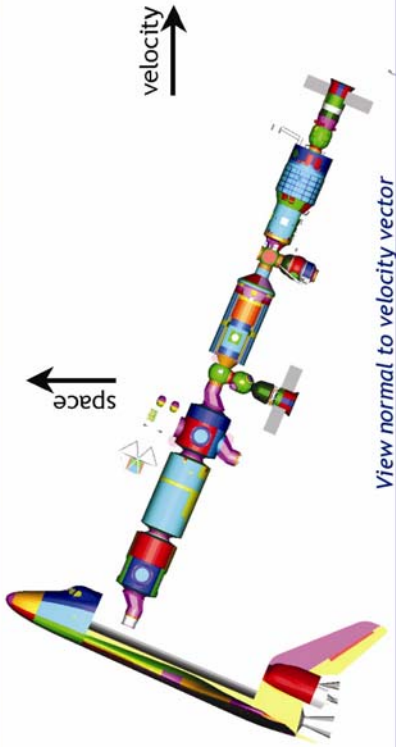

View 45° off velocity vector



Case 3 - Node 2 Nadir (No Pitch Bias)

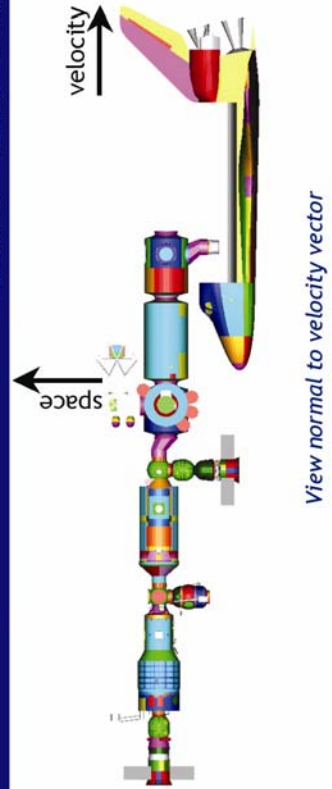

View 45° off velocity vector

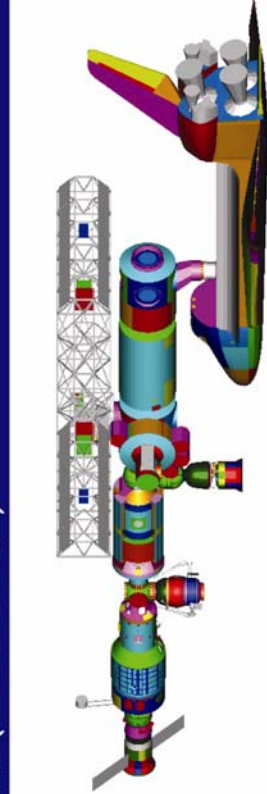

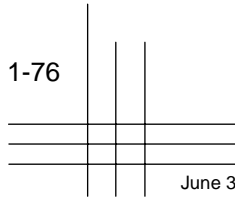



Columbia Accident Investigation Board

Recommendation 4.2-5

Kennedy Space Center Quality Assurance and United Space Alliance must return to the straight-forward, industry-standard definition of “Foreign Object Debris,” and eliminate any alternate or statistically deceptive definitions like “processing debris.” [RTF]

Note: The Stafford-Covey Return to Flight Task Group held a plenary session on December 15, 2004, and NASA’s progress toward answering this recommendation was reviewed. The Task Group agreed the actions taken were sufficient to fully close this recommendation.

BACKGROUND

Beginning in 2001, debris at Kennedy Space Center (KSC) was divided into two categories, “processing debris” and foreign object debris (FOD). FOD was defined as debris found during the final or flight-closeout inspection process. All other debris was labeled processing debris. The categorization and subsequent use of two different definitions of debris led to the perception that processing debris was not a concern.

NASA IMPLEMENTATION

NASA and United Space Alliance (USA) have changed work procedures to consider all debris equally important and preventable. Rigorous definitions of FOD that are the industry standard have been adopted. These new definitions adopted from National Aerospace FOD Prevention, Inc. guidelines and industry standards include Foreign Object Debris (FOD), Foreign Object Damage, and Clean-As-You-Go. FOD is redefined as “a substance, debris or article alien to a vehicle or system which would potentially cause damage.”

KSC chartered a multidiscipline NASA/USA team to respond to this recommendation. Team members were selected for their experience in important FOD-related disciplines including processing, quality, and corrective engineering; process analysis and integration; and operations management. The team began by fact-finding and benchmarking to better understand the industry standards and best practices for FOD prevention. They visited the Northrop Grumman facility at Lake Charles, La.; Boeing Aerospace at Kelly Air Force Base, Texas; Gulfstream Aerospace in Savannah, Ga.; and the Air Force’s Air Logistics Center in Oklahoma City, Okla. At each site, the team studied the FOD prevention processes, documentation programs, and assurance practices.

Armed with this information, the NASA/USA team developed a more robust FOD prevention program that

not only fully answered the *Columbia* Accident Investigation Board (CAIB) recommendation, but also raised the bar by instituting a myriad of additional improvements. The new FOD program is anchored in three fundamental areas of emphasis: First, it eliminates various categories of FOD, including “processing debris,” and treats all FOD as preventable and with equal importance. Second, it reemphasizes the responsibility and authority for FOD prevention at the operations level. FOD prevention and elimination are stressed and the work force is encouraged to report any and all FOD found by entering the data in the FOD database. This activity is performed with the knowledge that finding and reporting FOD is the goal of the Program and employees will not be penalized for their findings. Third, it elevates the importance of comprehensive independent monitoring by both contractors and the Government.

USA has also developed and implemented new work practices and strengthened existing practices. This new rigor will reduce the possibility for temporary worksite items or debris to migrate to an out-of-sight or inaccessible area, and it serves an important psychological purpose in eliminating visible breaches in FOD prevention discipline.

FOD “walkdowns” have been a standard industry and KSC procedure for many years. These are dedicated periods during which all employees execute a prescribed search pattern throughout the work areas, picking up all debris. USA has increased the frequency and participation in walkdowns, and has also increased the number of areas that are regularly subject to them. USA has also improved walkdown effectiveness by segmenting FOD walkdown areas into zones. Red zones are all areas within three feet of flight hardware and all areas inside or immediately above or below flight hardware. Yellow zones are all areas within a designated flight hardware operational processing area. Blue zones are desk space and other administrative areas within designated flight hardware operational processing areas.

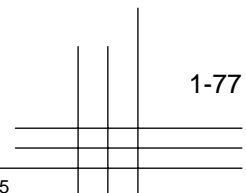

Additionally, both NASA and USA have increased their independent monitoring of the FOD prevention program. The USA Process Assurance Engineering organization randomly audits work areas for compliance with such work rules as removal of potential FOD items before entering work areas and tethering of those items that cannot be removed (e.g., glasses), tool control protocol, parts protection, and Clean-As-You-Go housekeeping procedures. NASA Quality personnel periodically participate in FOD walk-downs to assess their effectiveness and oversee contractor accomplishment of all FOD program requirements.

An important aspect of the FOD prevention program has been the planning and success of its rollout. USA assigned FOD Point of Contact duties to a senior employee who led the development of the training program from the very beginning of plan construction. This program included a rollout briefing followed by mandatory participation in a new FOD Prevention Program Course, distribution of an FOD awareness booklet, and hands-on training on a new FOD tracking database. Annual FOD Prevention training is required for all personnel with permanent access permissions to controlled Shuttle processing facilities at KSC. This is enforced through the KSC Personnel Access Security System. Another important piece of the rollout strategy was the strong support of senior NASA and USA management for the new FOD program and their insistence upon its comprehensive implementation. Managers at all levels will take the FOD courses and periodically participate in FOD walkdowns.

The new FOD program has a meaningful set of metrics to measure effectiveness and to guide improvements. FOD walkdown findings will be tracked in the Integrated Quality Support Database. This database will also track FOD found during closeouts, launch countdowns, postlaunch pad turn-arounds, landing operations, and NASA quality assurance audits. "Stumble-on" FOD findings will also be tracked, as they offer an important metric of program effectiveness independent of planned FOD program activities. For all metrics, the types of FOD and their locations will be recorded and analyzed for trends to identify particular areas for improvement. Monthly metrics reporting to management will highlight the top five FOD types, locations, and observed workforce behaviors, along with the prior months' trends. Continual improvement will be a hallmark of the revitalized FOD program.

STATUS

NASA and USA completed the initial benchmarking exercises, identified best practices, modified operating plans and database procedures, and conducted the rollout

orientation and initial employee training. Official, full-up implementation began on July 1, 2004, although many aspects of the plan existed in the previous FOD prevention program in place at KSC. Assessment audits by NASA and USA were conducted beginning in October 2004. Corrective Action Plans have been established to address the findings and observations identified during the two audits. Schedules for the verification of the actions taken and for verifying the effectiveness of the corrective actions have been established to ensure the ongoing effectiveness of the FOD prevention program. Continual improvement will be vigorously pursued for the remainder of the life of the Shuttle. In July 2004, the Stafford-Covey Return to Flight Task Group reviewed NASA's progress and agreed to conditionally close this recommendation. The full intent of CAIB Recommendation 4.2-5 has been met, and full closure of this recommendation was achieved in December 2004. NASA and USA have gone beyond the recommendation to implement a truly world-class FOD prevention program.

FORWARD WORK

None.

SCHEDULE

Responsibility	Due Date	Activity/Deliverable
Space Shuttle Program (SSP)	Ongoing	Review and trend metrics
SSP	Oct 03 (Completed)	Initiate NASA Management walkdowns
SSP	Dec 03 (Completed)	FOD Control Program benchmarking
SSP	Jan 04 (Completed)	Revised FOD definition
SSP	Apr 04 (Completed)	Draft USA Operating Procedure released for review
SSP	Jul 04 (Completed)	Implement FOD surveillance
SSP	Oct 04 (Completed)	Baseline audit of implementation of FOD definition, training, and surveillance
SSP	Ongoing	Periodic surveillance audit



Columbia Accident Investigation Board

Recommendation 6.2-1

Adopt and maintain a Shuttle flight schedule that is consistent with available resources. Although schedule deadlines are an important management tool, those deadlines must be regularly evaluated to ensure that any additional risk incurred to meet the schedule is recognized, understood, and acceptable. [RTF]

BACKGROUND

NASA has enhanced and strengthened our risk management system that balances technical, schedule, and resource risks to successfully achieve safe and reliable operations. Safe and reliable operations are assured by first focusing on the technical risks and taking the needed time and financial resources to properly resolve technical issues. Once technical risks are eliminated or reduced to an acceptable level, program managers turn to the management of schedule and resource risks to preserve safety. Schedules are integral parts of program management and provide for the integration and optimization of resource investments across a wide range of connected systems. The Space Shuttle Program (SSP) must have a visible schedule with clear milestones to effectively achieve its mission. Schedules associated with all activities generate very specific milestones that must be completed for mission success. Nonetheless, schedules of milestone-driven activities will be extended when necessary to ensure safety. NASA will not compromise safe and reliable operations in our effort to optimize schedules.

NASA IMPLEMENTATION

NASA's priorities will always be operating safely and accomplishing our missions successfully. NASA will adopt and maintain a Shuttle flight schedule that is consistent with available resources. Schedule threats are regularly assessed and unacceptable risk will be mitigated. In support of the Program Operating Plan (POP) process, NASA Shuttle Processing and United Space Alliance (USA) Ground Operations management use the Equivalent Flow Model (EFM) to plan resources that are consistent with the Shuttle flight schedule provided in the POP guidelines. The EFM is a computerized tool that uses a planned manifest and past performance to calculate processing resource requirements. The EFM concept was partnered among USA and NASA Shuttle Processing in fiscal year 2002 and is based on the total flight and ground workforce. The workforce, a primary input to the EFM tool, comprises fixed resources, supporting core daily operations, and variable resources that fluctuate depending on the manifest. Using past mission timelines and actual hours worked, an "equivalent flow" is developed

to establish the required processing hours for a baseline processing flow. The baseline "equivalent flow" content is adjusted to reflect the work content in the planned manifest (i.e., Orbiter Major Modifications, Operations and Maintenance Requirements Specification interval requirements, mini-mods, etc.) to arrive at the total equivalent flows in the year for all vehicles in processing. This in turn drives the resource requirement to process those equivalent flows. The result is a definition of an achievable schedule that is consistent with the available workforce needed to meet the technical requirements. If the achievable schedule exceeds the schedule provided in the POP guidelines, one of three actions is available:

- The workforce needed to meet the requirements is identified as an over-guide threat and is accommodated within the budget,
- The schedule is adjusted to meet the available workforce, or
- The technical requirements are adjusted.

The result is an achievable schedule that is consistent with the available resource for processing the Space Shuttle at the Kennedy Space Center (KSC).

To assess and manage the manifest, NASA has developed a process, called the Manifest Assessment System (MAS), for Space Shuttle launch schedules that incorporates all manifest constraints and influences and allows adequate margin to accommodate a normalized amount of changes. This process entails building in launch margin, cargo and logistics margin, and crew timeline margin while preserving the technical element needed for safe and reliable operations. MAS simulates the Space Shuttle flight production process of all flights in the manifest, considering resource sharing (facilities and equipment) in its multi-flow environment. MAS is a custom software application powered by the Extend™ simulation software package and the Efficiency Quotient, Inc (EQI) Scheduling Engine; data supporting the application software is prepared in Oracle database tables. USA Ground Operations is using MAS to assess the

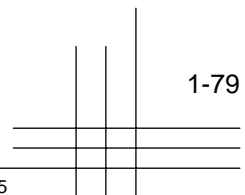

feasibility of proposed technical and manifest changes to determine how changes to facility availability, the schedule, or duration of flight production activities effect the overall manifest schedule. Figure 6.2-1-1 illustrates an example of the Space Shuttle manifest.

The Extend™ simulation engine uses EQI custom model blocks to simulate the flight production process for every flight in the scenario as a multi-flow process. A simulation “item,” representing each payload and each flight, passes through the activities of the template specified for the flight. The process model attempts to adhere to the schedule provided. However, delays may occur along the way due to constraints to launch, including lighting, orbit thermal constraints, Russian launch vehicle constraints, and facility or vehicle availability. The ability to define and analyze the effects of Orbiter Maintenance Down Period (OMDP) variations and facility utilization are also part of the system.

MAS results are presented through graphical depictions and summary reports. Figure 6.2-1-2 illustrates the simulation results overlaid on the display of the Space Shuttle manifest. “Drill-down” features allow the user to investigate why the results are as presented and enable modifications to mitigate conflicts. Subsequent runs can then validate proposed changes to resolve conflicts.

Scenario datasets can be saved and shared among users in different locations to communicate the complex details of different manifest options under assessment. Coordinated results can then be presented to senior management for their consideration.

By sharing information with the Program-level scheduling tools, MAS can provide integrated analysis of current schedules and projected schedules in the same simulation. This capability enables a more useful way to implement realistic, achievable schedules while successfully balancing technical, schedule, and resource risks to maintain safe and reliable operations.

Schedule deadlines and milestones are regularly evaluated so that added technical requirements and workload changes can be adjusted based on the available resources. New requirements technically required to maintain safe and reliable operations become mandatory, and a NASA KSC Shuttle Processing and USA Ground Operations assessment concerning impacts to accomplish this added work is made. The results of this assessment are presented to Program Management, and schedule milestones and launch dates are adjusted when the necessary resources to accomplish the

new requirements are not available. New technical requirements that are highly desirable or can be implemented on an as-available basis are deferred; schedule and resource risks would be incurred. There are numerous forums held as needed (daily/weekly/monthly) in which the SSP management is provided status from each of the Program Elements on current technical requirements, operational requirements, and reasons for necessary adjustments to schedules.

Policies are in place to assure the workforce health in the face of schedule deadlines. The NASA Maximum Work Time Policy, found in KSC Safety Practices Handbook (KHB 1710.2, section 3.4) includes daily, weekly, monthly, yearly, and consecutive hours worked limitations. Deviations require senior management approval up to the KSC Center Director and independent of the Space Shuttle Program. KSC work time safeguards assure that when available resource capacity is approached, the schedule is adjusted to safely accommodate the added work. When possible, launches are planned on Wednesdays or Thursdays to minimize weekend hours and associated costs; repeated launch attempts are delayed to reduce crew and test team fatigue. Overtime hours and safety hazard data are continually monitored by KSC and Space Shuttle Program management for indications of workforce stress, and when management and/or an employee deem it appropriate time-outs are called.

Robust processes are in place to assess and adjust schedules to prevent excessive workload and maintain safe and reliable operations. These processes maintain a Shuttle flight milestone schedule that is consistent with available resources. Evidence of this practice is demonstrated by the SSP’s willingness to judiciously move milestones, such as has been repeatedly done in the return to flight (RTF) effort.

Recent management changes in NASA’s key human space flight programs will contribute to ensuring that Shuttle flight schedules are appropriately maintained and amended to be consistent with available resources. In 2002, the Office of Space Operations established the position of Deputy Associate Administrator for International Space Station and Space Shuttle Programs (DAA for ISS/SSPs) to manage and direct both programs. This transferred the overall program management of the ISS and SSP from Johnson Space Center to Headquarters, as illustrated in figure 6.2-1-3. The DAA for ISS/SSP is accountable for the execution of the ISS and SSP, and the authority to establish requirements, direct program milestones, and assign resources, contract awards, and contract fees.

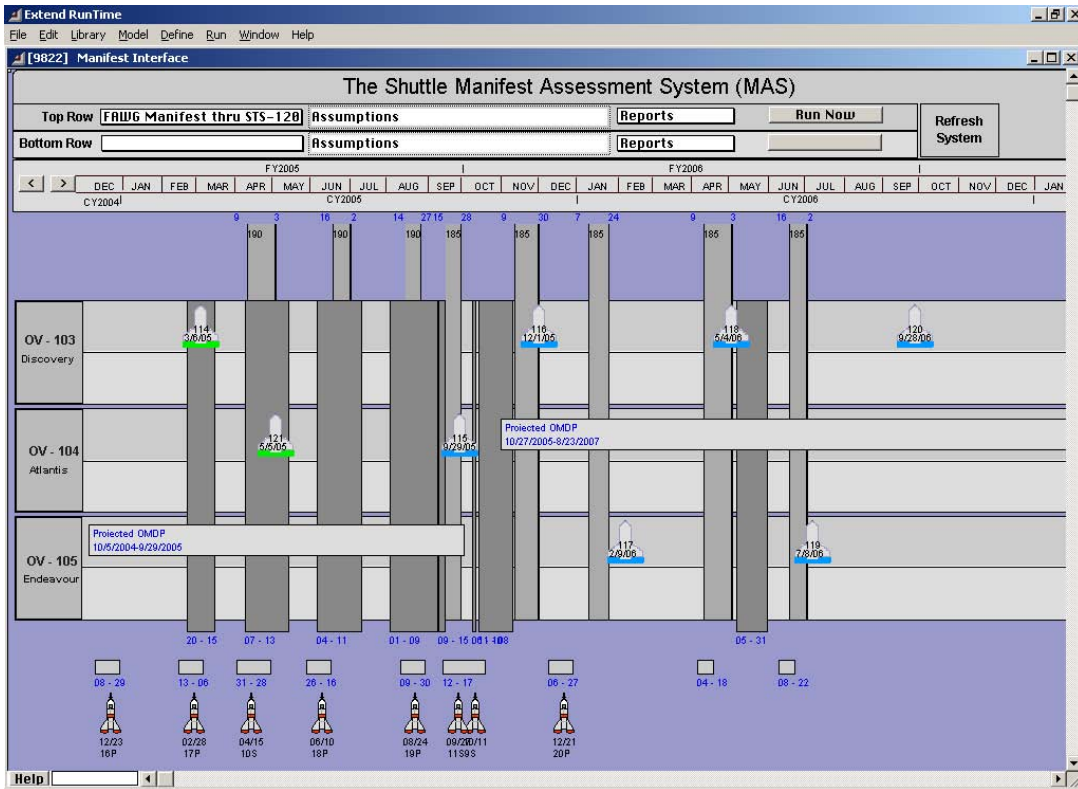

Figure 6.2-1-1. Space Shuttle manifest.

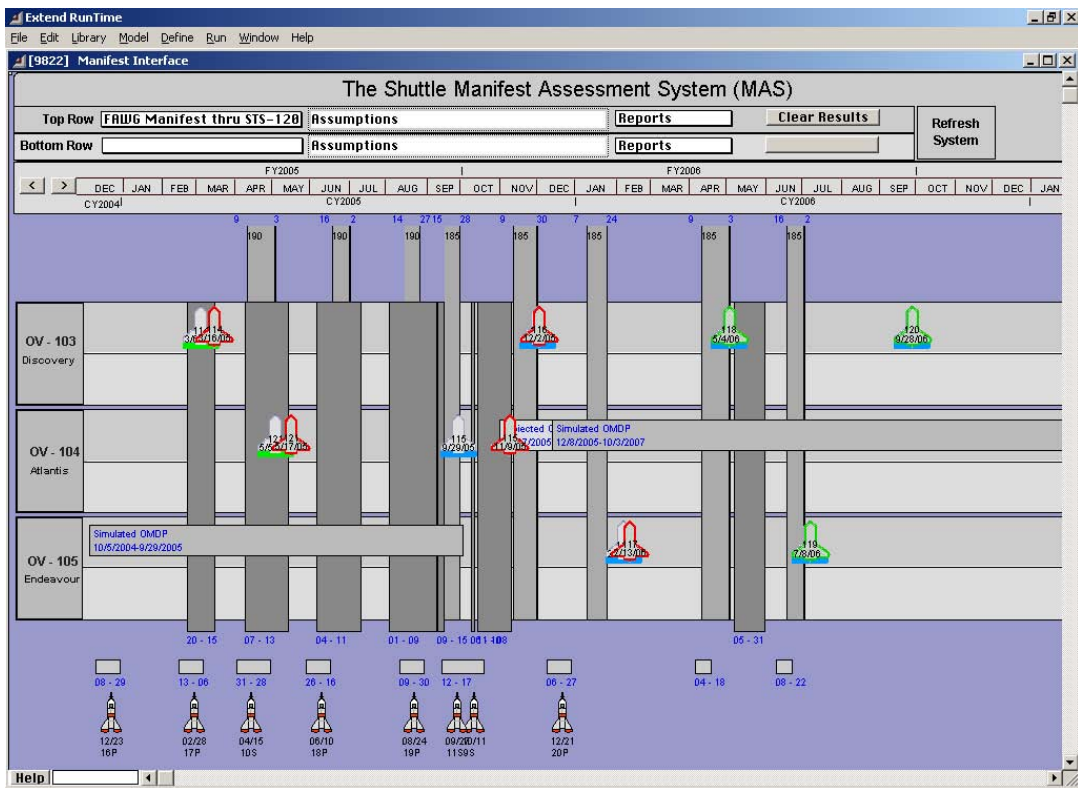

Figure 6.2-1-2. Space Shuttle manifest with simulation results.

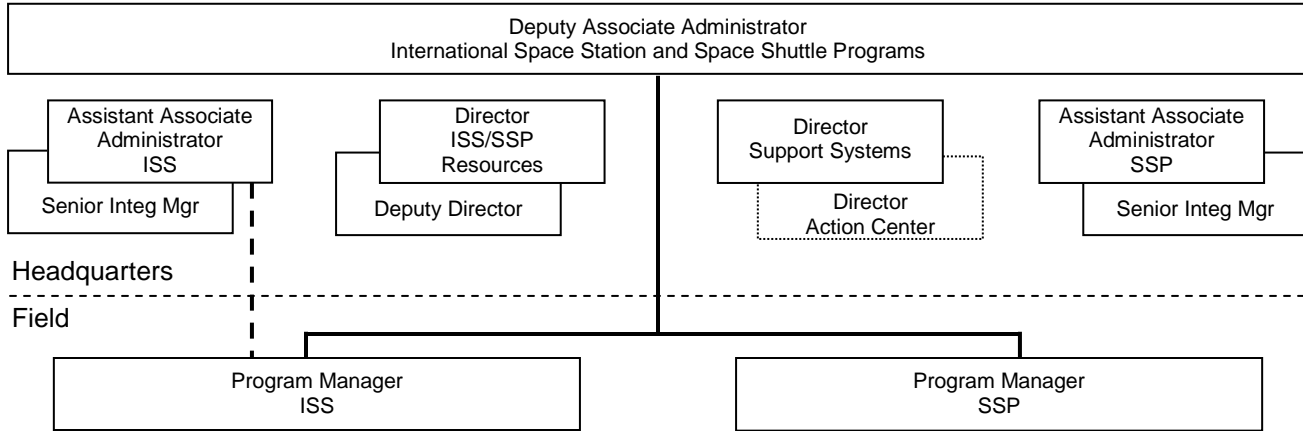

Figure 6.2-1-3. Office of Deputy Associate Administrator for International Space Station and Space Shuttle Programs (Office of Space Operations) is organized to maximize performance oversight.

Illustrated in figure 6.2-1-4, the Office of DAA for ISS/SSP employs an integrated resource evaluation process to ensure the effectiveness of both programs. Initial resource allocations are made through our annual budget formulation process. At any given time, there are three fiscal year budgets in work: the current fiscal year budget, the presentation of the next fiscal year Presidential budget to Congress, and preparation of budget guidelines and evaluation of budget proposals for the follow-on year. This overlapping budget process, illustrated in figure 6.2-1-5, provides the means for reviewing and adjusting resources to accomplish an ongoing schedule of activities with acceptable risk. Quarterly Program Management Reviews have begun in fiscal year 2005 to assess program and project technical, schedule, and cost performance against an established baseline. These reviews will continue as another tool to assure that the SSP is executed within available resources.

Defined mission requirements, policy direction, and resource allocations are provided to the ISS and SSP Managers for execution. The Space Flight Leadership Council provided specific direction during RTF efforts. The Office of DAA for ISS/SSP continually evaluates the execution of both programs as policy and mission requirements are implemented with the assigned resources. Resource and milestone concerns are identified through this evaluation process. Continued safe operation of the ISS and SSP is the primary objective of program execution; technical and safety issues are evaluated by the Headquarters DAA staff in preparation for each ISS and SSP mission and continuously as NASA prepares for RTF. As demonstrated in actions before the *Columbia* accident and continually during

the RTF process, adjustments are made to program milestones, such as launch windows, to assure safe and successful operations. Mission anomalies, as well as overall mission performance, are fed back into each program and adjustments are made to benefit future flights.

The Office of DAA for ISS and SSP staff reviews and assesses the status of both programs daily. The Office of DAA for ISS/SSP staff is evolving evaluation process called the NASA Management Information System (MIS). The One-NASA MIS will eventually provide NASA senior management with access to non-time-critical program data and offers a portal to a significant number of NASA Center and program management information systems and Web sites. Among the extensive information on the One-NASA MIS is the Key Program Performance Indicators (KPPIs). The Office of DAA for ISS/SSP uses the KPPIs to present required information to the Space Operations Mission Directorate Program Management Council and the Agency Program Management Committee on a quarterly basis.

Overall, the Office of DAA for ISS/SSP has implemented a comprehensive process for continually evaluating the effectiveness of the SSP. This process allows the Office of DAA for ISS/SSP staff to recognize and rapidly respond to changes in status and to act transparently to elevate issues such as schedule changes that may require decisions from the appropriate leaderships. NASA, the Space Flight Leadership Council, and the Office of DAA for ISS/SSP have repeatedly demonstrated an understanding of acceptable risk, and have responded by changing milestones to assure continued safe and reliable operations.

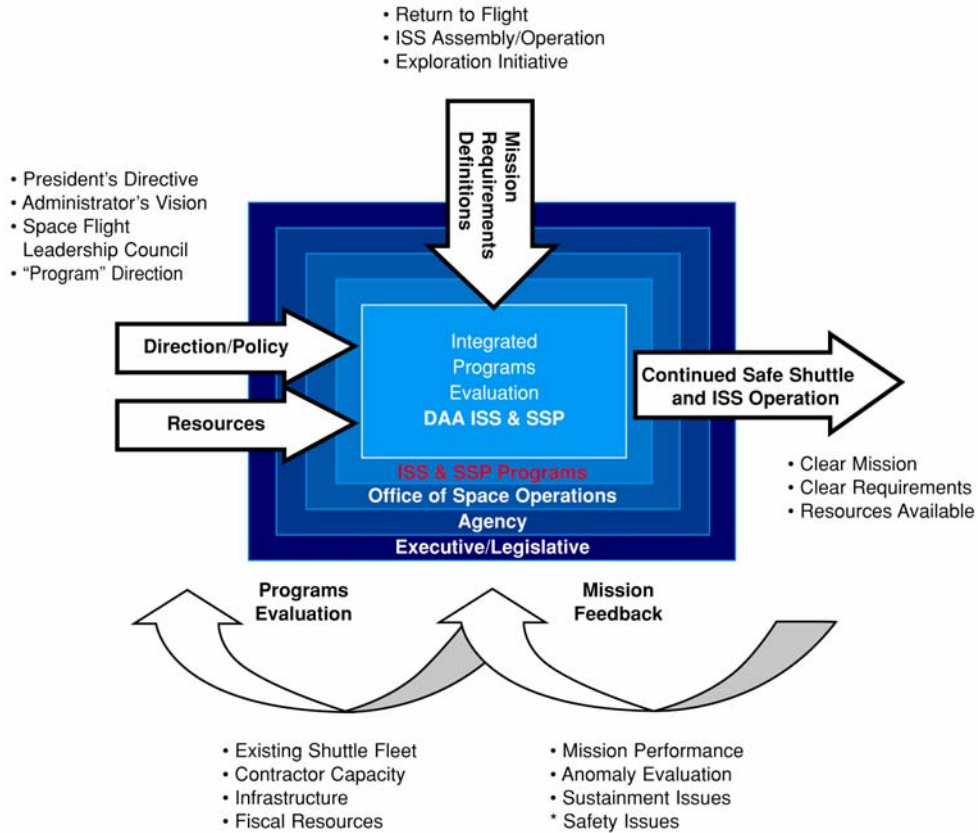

Figure 6.2-1-4. Integrated Resource Evaluation Process is employed by NASA Headquarters, Office of Space Operations.

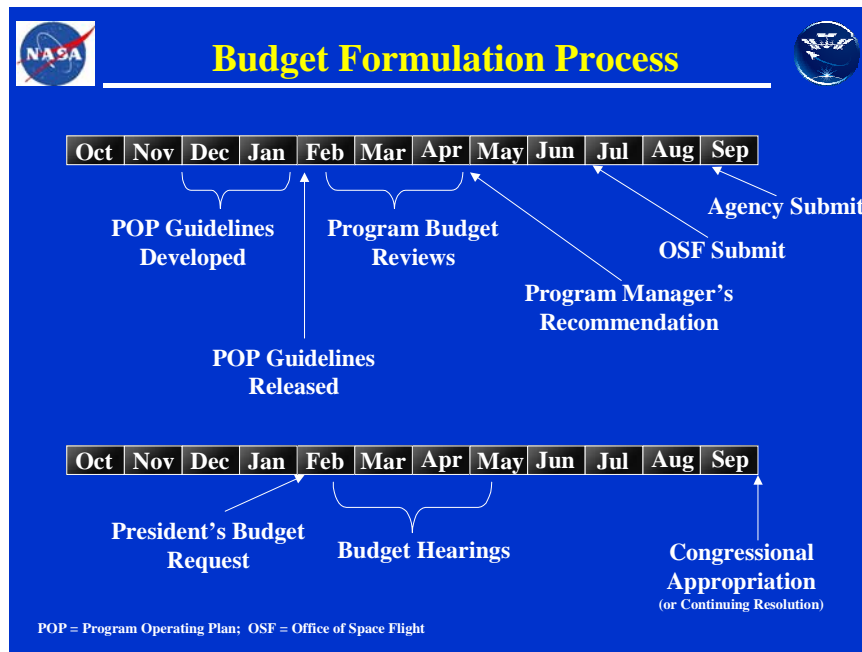

Figure 6.2-1-5. Office of Deputy Associate Administrator for ISS and SSP annual budget formulation process.

STATUS

NASA has repeatedly demonstrated its willingness and ability to make changes in the manifest to account for resource constraints and milestone movement and maintain safe and reliable operations. The *Columbia* accident has resulted in new requirements that must be factored into the manifest. The ISS and SSP are working together to incorporate RTF changes into the ISS assembly sequence. A system review of currently planned flights is constantly being performed. After all of the requirements have been analyzed and identified, a launch schedule and ISS manifest will be established. NASA will continue to add margin that allows some changes while not causing downstream delays in the manifest.

All appropriate manifest owners have initiated work to identify their requirements. SSP now coordinates with the ISS Program to create an RTF integrated schedule. The SSP Systems Engineering and Integration Office reports the RTF Integrated Schedule every week to the SSP Program Requirements Control Board. Summary briefs are also provided at each Space Flight Leadership Council meeting. SSP Flight Operations and Integration has scheduling and manifesting responsibility for the Program, working both the short-term and long-term manifest options. The current proposed manifest launch dates are all “no earlier than” (NET) dates, and are contingent upon the establishment of an RTF date. A computerized manifesting capability, called the MAS, is now being used to more effectively manage the schedule margin, launch constraints, and manifest flexibility. The primary constraints to launch, including lighting, orbit thermal constraints, and Russian Launch Vehicle constraints, have been incorporated into MAS and tested to ensure proper effects on simulation results. The ability

to define and analyze the effects of OMDP variations and facility utilization are also now part of the system. The system will be improved in the future to include increased flexibility in resource loading enhancements.

All of the RTF launch constraints are understood and their schedules have been incorporated into the manifest. The External Tank separation lighting and launch-on-need Shuttle rescue constraints are the primary drivers to the launch window for STS-114, which is July 13 through July 31, 2005.

FORWARD WORK

Development will continue on the computer-aided tools to manage the manifest schedule margin, launch constraints, and manifest flexibility.

NASA is reviewing our progress on the response to this *Columbia* Accident Investigation Board recommendation with the Stafford-Covey Return to Flight Task Group.

SCHEDULE

Responsibility	Due Date	Activity/Deliverable
SSP	Aug 03 (Completed)	Baseline the RTF constraints schedule
SSP	Jun 05	Establish STS-114 base-line schedule



Columbia Accident Investigation Board

Recommendation 6.3-1

Implement an expanded training program in which the Mission Management Team faces potential crew and vehicle safety contingencies beyond launch and ascent. These contingencies should involve potential loss of Shuttle or crew, contain numerous uncertainties and unknowns, and require the Mission Management Team to assemble and interact with support organizations across NASA/Contractor lines and in various locations. [RTF]

BACKGROUND

During Space Shuttle missions, the Shuttle Mission Management Team (MMT) is responsible for oversight of the operations teams during both prelaunch and in-flight activities. The countdown and flight operations are conducted by the operations teams according to rules and procedures approved by Space Shuttle Program (SSP) Management well prior to operations and documented in NSTS 07700. The Mission Operations Team leads all nominal mission operations. The MMT provides guidance to the operations teams for situations that fall outside normal operations; the MMT also redefines programmatic priority when in-flight anomalies or off-nominal conditions result in conflicting priorities.

In the past, the MMT's work was focused on the immediate decision-making required of in-flight operations. In this environment, the concerns of individual engineers, the quality of risk assessments, and the pedigree of engineering assessments were sometimes poorly understood. Training for managers on the MMT reflected this bias and consisted primarily of briefings and simulations that focused on the prelaunch and launch phases, including launch aborts. In retrospect, this approach did not adequately sensitize NASA management in general, and the MMT specifically, to actively seek out potential concerns and issues raised by support teams and working groups. As a result, the MMT training has changed to focus on: clearer communication processes centered on bringing out differing opinions; maintaining awareness of decisions that impact the remainder of the flight; and ensuring an understanding of the roles and responsibilities of team members and supporting working groups and teams, including data-sharing processes and required milestones to support real-time operations. All of these changes will improve the ability of the MMT to identify and address in-flight problems effectively.

The MMT is responsible for making SSP decisions regarding preflight and in-flight activities and operations that exceed the authority of the launch director or the flight director. The MMT's responsibilities for a specific Space Shuttle mission start with the first scheduled meeting two days prior to a scheduled launch (L-2). Kennedy Space Center

(KSC) prelaunch activities continue through launch and terminate at a mission elapsed time of two hours. At that time, MMT activities transfer to the Johnson Space Center (JSC). The flight MMT meets daily during the subsequent on-orbit, entry, landing phases and terminates with crew egress from the vehicle. When the flight MMT is not in session, all MMT members are on-call and required to support emergency MMTs convened because of anomalies or changing flight conditions.

NASA IMPLEMENTATION

NASA's response to this recommendation was implemented in two phases: (1) review and revise MMT processes and procedures; and (2) develop and implement a training program consistent with those process revisions.

Processes and Procedures

NASA contracted with the Behavioral Excellence Strategic Team and several past flight directors, including Gene Kranz and Glynn Lunney, to study the MMT processes and make recommendations to improve communications, decision-making, and operational processes. The result was a demonstrable improvement in critical decision-making efficiency and more open communication among MMT members to resolve critical issues.

NASA established a process for the review and resolution of off-nominal mission events to assure that all such issues are identified to and resolved by the flight MMT. The Space Shuttle Systems Engineering and Integration Office will maintain and provide an integrated anomaly list at each MMT meeting. All anomalies will be assigned a formal office of primary responsibility (OPR) for technical evaluation and will be subject to an independent risk assessment by Safety and Mission Assurance (SMA). The MMT has one SSP SMA core member and three institutional SMA advisory members from JSC, KSC, and Marshall Space Flight Center. In addition, the MMT has added the Space Shuttle System Technical Warrant Holder as a core member; this person represents the NASA Independent Technical Authority (ITA) as a voting member of the MMT.

The MMT secretary will maintain and display an action tracking log to ensure all members are adequately informed of the anomaly's status. Closure of actions associated with the anomaly will require a formal written request. The request must include a description of the issue (observation and potential consequences), technical analysis details (including databases, employed models, and methodologies), recommended actions and associated mission impacts, and flight closure rationale, if applicable. These steps are all designed to eliminate the possibility of critical missteps by the MMT due to incomplete or un-communicated information. These steps also make the process of anomaly resolution more transparent to all stakeholders. NASA has documented these changes in a new Mission Evaluation Room console handbook that includes MMT reporting requirements, a flight MMT reporting process for on-orbit vehicle inspection findings, and MMT meeting support procedures.

Additional improvements were made to MMT internal processes and procedures, including more clearly defining requirements for MMT meeting frequency and the process for requesting an emergency MMT meeting. NASA will now conduct daily MMT meetings beginning with the L-2 day MMT. Membership, organization, and chairmanship of the preflight and in-flight MMT are standardized. The SSP Deputy Manager now chairs both phases of the MMT, preflight and on orbit.

MMT membership has been expanded and augmented with core and/or advisory members from SMA, the ITA, the NASA Engineering and Safety Center, and engineering and program management disciplines. The MMT membership's responsibilities have been clearly defined, and MMT membership and training status for each mission is established by each participating organization in writing at the Flight Readiness Review (FRR). Each MMT member also has clearly defined processes for MMT support and problem reporting.

Procedures for Flight MMT meetings are standardized through the use of predefined templates for agenda formats, presentations, action item assignments, and readiness polls. This ensures that the communication and resolution of issues are performed in a consistent, rigorous manner. Existing SSP meeting support infrastructure and a collaboration tool are used to ensure that critical data are distributed before scheduled meetings and that MMT meeting minutes are quickly distributed following each meeting. In addition, NASA established formal processes for the review of findings from ascent and on-orbit imagery analyses, postlaunch hardware inspections, ascent reconstruction, and all other flight data reviews to ensure timely, effective reviews of key data by the MMT.

Using research on improving communications for critical decision making, NASA refurbished the Mission Control

Center and redesigned the MMT's working space to provide increased seating capacity and communications improvements. Improvements include a video-teleconferencing capability, a multi-user collaboration tool, and a larger room to allow more subject matter experts and MMT members. A large "C"-shaped table now seats all members of the MMT and encourages open communication by eliminating a hierarchical seating arrangement. The MMT Command Center has been operational since the November 2004 MMT simulation to give the Team time to adapt and learn how to use all of the new tools.

Training

All MMT members, except those serving exclusively in an advisory capacity and the Department of Defense Mission Support representative, are required to complete a minimum set of training requirements to attain initial qualification prior to performing MMT responsibilities. MMT members must also participate in an ongoing training program to maintain qualification status, which is renewed annually. Training records are maintained to ensure compliance with the new requirements. NASA has employed independent external consultants, including Behavioral Science Technology, to assist in developing these training activities and to evaluate overall training effectiveness.

In addition, to ensure adequate backups are available, at least two people will be trained to fill each MMT core position prior to return to flight. This will protect the integrity of the integrated MMT process against individuals' inability to perform their role for any reason. Verification of each flight specific team will be presented at the appropriate FRR.

STATUS

The SSP published a formal MMT training plan (NSTS 07700, Volume II, Program Structure and Responsibilities, Book 2 – Space Shuttle Program Directives, Space Shuttle Program Directive 150) that defines the generic training requirements for MMT certification. This plan is comprised of three basic types of training: courses and workshops, MMT simulations, and self-instruction. Courses, workshops, and self-instruction materials were selected to strengthen individual expertise in human factors, critical decision making, and risk management of high-reliability systems. MMT training activities are well under way with several courses/workshops held at various NASA centers and 13 simulations are completed, including an end-to-end contingency simulation and a simulation to address MMT actions related to Contingency Shuttle Crew Support. These simulations brought together the flight crew, flight control team, launch control team, engineering staff, outside agencies, and MMT members to improve communication and teach better problem-recognition

and decision-making skills. By return to flight, all MMT members will have completed the requisite training.

As a result of the significant changes made to the MMT processes and structure, the MMT has changed from an operationally oriented, problem-solving team to a critical decision-making management body. The MMT's technical engineering sub-teams perform the engineering root-cause analysis and technical problem solving, and identify options and make recommendations to the MMT. This paradigm shift has resulted in more focused decision making by the MMT, better using the unique expertise of the MMT membership.

Risk management is now a major consideration at each MMT meeting. Each identified hazard is required to have a clear risk assessment performed and presented to the MMT so the appropriate risk versus risk tradeoffs can be discussed and decided upon. Supporting analyses, assumptions, issues, and ramifications are a part of this discussion.

Communication between the various sub-teams and the MMT and between remote locations and the MMT has improved tremendously, in part due to the physical layout

of the new MMT Command Center and the ability to tie in remote sites through a video-teleconference link. As a result, the MMT and sub-team members are receiving data at the required times, members are more aware of mission timelines, and all stakeholders can view actions in real time since these actions are posted electronically in the MMT Command Center and on the video-teleconference circuits. This improved communication results in an improved state of situational awareness and ability to make informed, appropriate decisions more quickly.

In May 2005, the MMT will complete one final simulation prior to return to flight. This simulation will address MMT actions related to a Contingency Shuttle Crew Support (CSCS) capability decision. (See SSP-3 for details on CSCS.)

FORWARD WORK

Revisions to project and element processes will be established consistent with the new MMT requirements and will follow formal Program approval. Associated project and element activities in development include but are not limited to a flight MMT reporting process for launch imagery analysis and on-orbit vehicle inspection findings.

SCHEDULE

Responsibility	Due Date	Activity/Deliverable
SSP	Oct 03 (Completed)	MMT Interim training plan
SSP	Oct 03 (Completed)	MMT process changes to Program Requirements Change Board
SSP	Oct 03 (Completed)	Project/element process changes
SSP	Nov 03 – Return to Flight (Completed)	MMT training
SSP		MMT Simulation Summary
	Nov 03 (Completed)	MMT On-Orbit simulation
	Dec 03 (Completed)	MMT SSP/International Space Station (ISS) Joint On-Orbit simulation
	Feb 04 (Completed)	MMT On-Orbit simulation
	Apr 04 (Completed)	MMT Prelaunch simulation
	May 04 (Completed)	MMT On-Orbit simulation involving Thermal Protection System (TPS) inspection
	Jun 04 (Completed)	MMT Prelaunch simulation

Responsibility	Due Date	Activity/Deliverable
SSP	Jul 04 (Completed)	MMT On-Orbit simulation
	Sep 04 (Completed)	MMT On-Orbit simulation
	Nov 04 (Completed)	MMT SSP/ISS Joint On-Orbit simulation involving TPS inspection
	Dec 04 (Completed)	MMT Prelaunch simulation
	Jan 05 (Completed)	MMT Prelaunch Contingency simulation
	Feb 05 (Completed)	MMT Prelaunch/On-Orbit/Entry Integrated simulation involving TPS inspection
	May 05 (Completed)	MMT Contingency Crew Survival Capability Sim
SSP	Dec 03 (Completed)	Status to Space Flight Leadership Council and Stafford/Covey Task Group
SSP	Feb 04 (Completed)	MMT final training plan
SSP	Apr 04 (Completed)	Status to Stafford/Covey Task Group
SSP	Aug 04 (Completed)	Miscellaneous MMT process and training revisions to address simulations lessons learned
SSP	Sep 04 (Completed)	Status to Stafford/Covey Return to Flight Task Group
SSP	Nov 04 (Completed)	Complete refurbishment of MMT Command Center
SSP	Feb 05 (Completed)	Update MMT Training Plan



Columbia Accident Investigation Board

Recommendations 9.1-1, 7.5-1, 7.5-2, and 7.5-3

R9.1-1 Prepare a detailed plan for defining, establishing, transitioning, and implementing an independent Technical Engineering Authority, independent safety program, and a reorganized Space Shuttle Integration Office as described in R7.5-1, R7.5-2, and R7.5-3. In addition, NASA should submit annual reports to Congress, as part of the budget review process, on its implementation activities. [RTF]

R7.5-1 Establish an independent Technical Engineering Authority that is responsible for technical requirements and all waivers to them, and will build a disciplined, systematic approach to identifying, analyzing, and controlling hazards throughout the life cycle of the Shuttle System. The independent technical authority does the following as a minimum:

- Develop and maintain technical standards for all Space Shuttle Program projects and elements
- Be the sole waiver-granting authority for all technical standards
- Conduct trend and risk analysis at the sub-system, system, and enterprise levels
- Own the failure mode, effects analysis and hazard reporting systems
- Conduct integrated hazard analysis
- Decide what is and is not an anomalous event
- Independently verify launch readiness
- Approves the provisions of the recertification program called for in Recommendation [R9.2-1]

The Technical Engineering Authority should be funded directly from NASA Headquarters and should have no connection to or responsibility for schedule or program cost.

R7.5-2 NASA Headquarters Office of Safety and Mission Assurance should have direct line authority over the entire Space Shuttle Program safety organization and should be independently resourced.

R7.5-3 Reorganize the Space Shuttle Integration Office to make it capable of integrating all elements of the Space Shuttle Program, including the Orbiter.

INTRODUCTION

NASA, under the leadership of the Office of Safety and Mission Assurance (OSMA) and the Office of the Chief Engineer, is implementing a plan addressing the Agency-wide response to Recommendation 9.1-1 – referred to as the “9.1-1 Plan” and titled “NASA’s Plan for Implementing Safe and Reliable Operations.” Although the *Columbia* Accident Investigation Board (CAIB) only recommended that NASA prepare a detailed plan for 9.1-1 prior to return to flight (RTF), NASA has begun the transformation called for in the three relevant Chapter 7 recommendations.

The CAIB’s independent investigation revealed areas in NASA’s organization and its operations that needed

substantial improvement before returning the Space Shuttle to safe and reliable flight operations. This report addresses three fundamental changes that NASA is making to improve the safety and reliability of its operations:

- Restore specific engineering technical authority, independent of programmatic decision-making.
- Increase the authority, independence, and capability of the Agency Safety and Mission Assurance (SMA) organizations.
- Expand the role of the Space Shuttle Integration Office to address the entire Space Shuttle system.

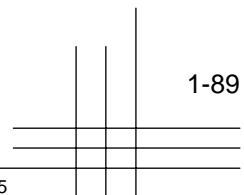

These changes reflect careful and diligent review of the CAIB's investigation as a basis for implementation of their recommendations. Specifically, these changes address CAIB Recommendations R9.1-1 and its accompanying Recommendations R7.5-1, R7.5-2, and R7.5-3.

As a first necessary step to put the CAIB's recommendations regarding independent technical authority into practice, the NASA Administrator designated the Chief Engineer as the NASA Technical Authority (TA). The Chief Safety and Mission Assurance Officer provides leadership, policy direction, functional oversight, assessment, and coordination for the safety and quality assurance disciplines across the Agency. The role of the Shuttle Integration Office (now the Shuttle Systems Engineering and Integration Office) has been strengthened so that it integrates all of the elements of the Space Shuttle Program (SSP). These three organizational changes—an independent technical authority, a separate and distinct independent SMA, and a focused Program management structure—form a foundation for ensuring safe and reliable operations for NASA's Space Shuttle and other missions.

Section I of this report, the first change, was issued in November 2004 to provide NASA's plan to restore specific engineering technical authority, independent of programmatic decision-making, in all of NASA's missions. Section 4.5 provides NASA's progress on implementing technical authority. Section II describes the role of SMA and how the second change increases the authority, capability, and independence of the SMA community. Section III addresses how the third change expands the role of the new Space Shuttle Systems Engineering and Integration Office to address the entire Space Shuttle system. Section 4.3 addresses the relationship of the roles and responsibilities of the ITA and SMA organizations.

NASA IMPLEMENTATION

Independent Technical Authority (R7.5-1)

This plan answers the CAIB Recommendation 7.5-1 by aggressively implementing an independent technical authority at NASA that has the responsibility, authority, and accountability to establish, monitor, and approve technical requirements, processes, products, and policy.

Technical Authority

The NASA Chief Engineer, as the TA, governs and is accountable for technical decisions that affect safe and reliable operations and is using a warrant system to further delegate this technical authority. The TA provides technical decisions for safe and reliable operations in support of mission development activities and programs and projects that

pose minimum reasonable risk to humans; i.e., astronauts, the NASA workforce, and the public. Sound technical requirements necessary for safe and reliable operations will not be compromised by programmatic constraints, including cost and schedule.

As the NASA TA, the NASA Chief Engineer is working to develop a technical conscience throughout the engineering community, that is, the personal responsibility to provide safe technical products coupled with an awareness of the avenues available to raise and resolve technical concerns. Technical authority and technical conscience represent a renewed culture in NASA governing and upholding sound technical decision-making by personnel who are independent of programmatic processes. This change affects how technical requirements are established and maintained as well as how technical decisions are made, safety considerations being first and foremost in technical decision-making.

Five key principles govern the independent technical authority. This authority:

1. Resides in an individual, not an organization;
2. Is clear and unambiguous regarding authority, responsibility, and accountability;
3. Is independent of Program Management;
4. Is executed using credible personnel, technical requirements, and decision-making tools; and
5. Makes and influences technical decisions through prestige, visibility, and the strength of technical requirements and evaluations.

Warrant System

The Chief Engineer has put technical authority into practice through a system of governing warrants issued to individuals. These Technical Warrant Holders (TWHs) are proven subject matter experts with mature judgment who are operating with a technical authority budget that is independent from Program budgets and Program authority. This technical authority budget covers the cost of the TWHs and their agents as they execute their responsibility for establishing and maintaining technical requirements, reviewing technical products, and preparing and administering technical processes and policies for disciplines and systems under their purview.

The warrant system provides a disciplined formal procedure that is standardized across the Agency, and a process that is recognized inside and outside NASA in the execution of independent technical authority.

Technical Conscience

Technical conscience is personal ownership of the technical product by the individual who is responsible for that product. Committee reviews, supervisory initials, etc., do not relieve these individuals of their obligation for a safe and reliable mission operation if their technical requirements are followed. Technical conscience is also the personal principle for individuals to raise concerns regarding situations that do not “sit right” with NASA’s mandate for safe and reliable systems and operations. With adoption of technical authority and the warrant system, technical personnel have the means to address and adjudicate technical concerns according to the requirements of the situation. TA and the TWHs provide the means for independent evaluation and adjudication of any concern raised in exercising technical conscience.

On November 23, 2004, the NASA Administrator issued the policy and requirements to implement technical authority through a technical warrant process. This policy was issued under NPD 1240.4 NASA Technical Authority (draft) and NPR 1240.1 Technical Warrant System (draft), and is in accordance with the plan. In December, NASA Chief Engineer Rex Geveden assigned Walter Hussey as Director of ITA Implementation to focus the Agency’s internal efforts on this cultural transformation. The Chief Engineer has identified and selected TWHs and issued warrants for 26 critical areas, including all major systems for the Space Shuttle. After their selection and training, these newly assigned TWHs are now executing the responsibilities of their warrants. The Space Shuttle TWHs are making the technical decisions necessary for safe and reliable operations and are involved in RTF activities for the Space Shuttle. NASA is selecting additional TWHs to span the full range of technical disciplines and systems needed across the Agency. The Chief Engineer issued several new warrants in March 2005, including one for Systems Safety Engineering who will help revitalize the conduct of safety analyses (failure mode and effects analysis (FMEA), hazards analysis, reliability engineering, etc.) as part of design and engineering, and will continue to issue warrants as required.

Independent Safety (R7.5-2)

This plan answers the CAIB Recommendation 7.5-2 by aggressively addressing the fundamental problems brought out by the CAIB in three categories: authority, independence, and capability.

SMA Authority

To address the authority issue raised by the CAIB, NASA has strengthened OSMA’s traditional policy oversight over NASA programs and Center line organizations with the

explicit authority of the Administrator through the Deputy Administrator/Chief Operating Officer (COO) to enforce those policies. The Chief Safety and Mission Assurance Officer provides leadership, policy direction, functional oversight, assessment, and coordination for the safety, quality, and mission assurance disciplines across the Agency. Operational responsibility for the requirements of these disciplines rests with the Agency’s program and line organizations as an integral part of the NASA mission. To increase OSMA’s “line authority” over field SMA activities, NASA has taken four important steps:

1. The Chief Safety and Mission Assurance Officer now has explicit authority over selection, relief, and performance evaluation of all Center SMA Directors as well as the lead SMA managers for major programs, including Space Shuttle and International Space Station (ISS), as well as the Director of the Independent Verification and Validation (IV&V) Center.
2. The Chief, OSMA will provide a formal “functional performance evaluation” for each Center Director to their Headquarters Center Executive (HCE) each year.
3. “Suspension” authority is delegated to the Center Directors and their SMA Directors. This authority applies to any program, project, or operation conducted at the Center or under that center’s SMA oversight regardless of whether the Center also has programmatic responsibility for that activity.
4. The SMA community, through their institutional chain of command up to the COO, now has the authority to decide the level of SMA support for the project/program.

NASA SMA support for the SSP consists of dedicated Program office staff, technical support from the Centers, and functional oversight from the Headquarters OSMA. A senior SMA professional heads the Program’s SMA Office as the Space Shuttle SMA Manager. The SMA Manager reports directly to the Program Manager and is responsible for execution of the safety and quality assurance requirements within the Program. The Program SMA Office integrates the safety and quality assurance activities performed by all Space Operations Centers for the various projects and Program elements located at those Centers.

The Center SMA Directorates provide technical support to the Program’s SMA Manager. They also provide independent safety and quality assurance functions in the form of independent assessments, safety, and reliability panel reviews. Finally, they provide a cadre of personnel dedicated

to OSMA's Independent Assessment of compliance function.

SMA Independence

The CAIB recommendation requires that the OSMA be independently funded. After the Report of the Presidential Commission on the Space Shuttle *Challenger* Accident, also known as the Rogers Commission Report, NASA created the Office of Safety, Reliability and Quality Assurance, later renamed OSMA, and specifically set up its reporting and funding to be separate from that of the Chief Engineer's office and any of the Program Enterprises. At the time of *Columbia*, all funding for OSMA was in the corporate General and Administrative (G&A) line, separate from all other program, institutional, and mission support and functional support office funding. As for personnel, all permanent OSMA personnel are dedicated to OSMA and, therefore, are independent of program or other mission support and functional support offices. This plan retains that independent reporting and funding approach consistent with the CAIB recommendation.

With respect to Center-based civil servants and their support contractors performing safety, reliability, and quality assurance tasks, this plan calls for significant change. This plan establishes that the institution, not the program, decides SMA resource levels. Under the oversight of the Headquarters HCEs, Centers will set up SMA-"directed" service pools to allow SMA labor to be applied to programs and projects in the areas and at the levels deemed necessary by the SMA Directors and their institutional chain of authority. SMA will pre-coordinate the use of their resources with the programs to foster understanding of how SMA labor will be used. This approach will guarantee both organizational and funding independence from the programs in a way that fully addresses the CAIB's findings. Finally, the Headquarters OSMA will, for the first time, be a voting member of the Institutional Committee wherein institutional (including SMA service pool) budget decisions are made for the Agency. To aid OSMA in its resource oversight and approval responsibilities, each center SMA Directorate will develop an Annual Operating Agreement that calls out all SMA activities at the center, industrial, program support, and independent assessment.

Under NASA's old definition of independence, which focused on organizational independence, the SSP Program and Project Managers had funding approval authority for about 99% (based on fiscal year (FY) 03 estimates) of the total SMA funding level for Shuttle (includes all contractor and Center NASA and support contractor SMA resources). The remaining 1% consisted of Center SMA supervisor time (paid by Center General and Administrative funds) and approximately \$2M per year of Space Shuttle Independent

Assessment (IA) activity (paid for by OSMA). Under NASA's new definition of independence, which now includes the directed service pool, the SSP has funding approval authority for only about 70% of the total SMA funding level. This funding pays for Shuttle prime and subcontractor SMA and for the small civil service SMA Management Office in the Program. The remaining funding approval is accomplished through the directed service pool. This accounts for all Center SMA Civil Service (CS), all SMA support contractors, and OSMA's IV&V and IA that supports Space Shuttle.

SMA Capability

To address SMA capability, all of the Centers have reviewed their SMA skills and resources for adequacy and added positions as required. In particular, the Space Operations Centers have all addressed staffing deficiencies as part of Shuttle RTF, and they have already begun hiring to fill vacancies. Headquarters OSMA has increased significantly its ability to provide functional oversight of all NASA SMA programs. Staffing has been increased in the Headquarters office from 48 to 51 people, partly to accommodate increased liaison needs created by addition of NASA Engineering and Safety Center (NESC), IV&V, and new assurance programs. At the time of *Columbia*, OSMA had a budget of \$6M per year for IA, its primary corporate assurance tool. OSMA will continue to send IA funding to the Space Flight Centers for use by SMA Directorates in performing Center audits and supporting OSMA audits and assessment of resident programs. It also encourages the IA teams to focus more on process and functional audits than they have in the past. This plan shows a substantial increase in OSMA capability by the addition of the responsibility and budgets for the Agency software IV&V services.

The NESC, as a technical resource available to the SMA community, in coordination with the ITA, combined with IV&V and IA capabilities, provides an unprecedented increase in the independent assessment, audit, and review capability and will reinforce the SMA community's role in providing verification and assurance of compliance with technical requirements owned by the ITA, and in technical support for mishap investigations.

The ITA will own all technical requirements, including safety and reliability design and engineering standards and requirements. OSMA will continue to develop and improve generic safety, reliability, and quality (SRQ) process standards, including FMEA, risk, and hazards analysis processes; however, the ITA will specify and approve these analyses and their application in engineering technical products. OSMA's involvement with SRQ process standards will enable the Headquarters office and Center SMA organizations to better oversee compliance with safety, reliability,

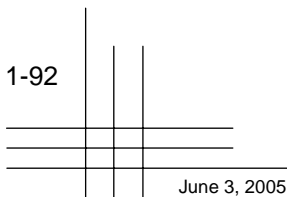

and quality requirements. In addition, OSMA, with the lessons learned in recent U.S. Navy (and other) benchmarking activities, will improve its functional audit capabilities, borrowing techniques used by the Naval Sea Systems Command in submarine certifications. NASA is also improving its trend analysis, problem tracking, and lessons learned systems (ref: F7.4-9, -10, and -11), all in a concerted effort to ensure the TA invokes the correct technical requirements. In order to improve OSMA insight and to reduce confusion cited in F7.4-13, NASA is formalizing its SMA Prelaunch Assessment Review (PAR) process for Shuttle and ISS, and the equivalent processes for expendable launch vehicles and experimental aerospace vehicle flight approvals, called Independent Mission Assurance Reviews (IMARs). Both of these processes will be standardized into a new NASA-wide review process called SMA Readiness Reviews (SMARRs)

In addressing the CAIB concern about the lack of mainstreaming and visibility of the system safety discipline (F7.4-4), OSMA has taken two actions, one long term and the other completed. First, as regards lack of mainstreaming of system safety engineering, the OSMA audit plan will include an assessment of the adequacy of system safety engineering by the audited project and/or line engineering organizations per the new NASA policy directives for Program management and ITA. As for the second concern about the lack of system safety visibility, for some years, the senior system safety expert in the Agency was also the OSMA Requirements Division Chief (now Deputy Chief, OSMA). To respond to the CAIB concern, OSMA has brought on a full-time experienced system safety manager who is the Agency's dedicated senior system safety assurance policy expert. In addition the Chief Engineer will select a Systems Safety Engineering Technical Warrant Holder who will be responsible for establishing systems safety engineering requirements.

The SMA Directorates supporting SSP are staffed with a combination of civil service and support contractors providing system safety, reliability, and quality expertise and services. Their role is predominantly assurance in nature, providing the Program with functional oversight of the compliance of the prime and sub-contractor engineering and operations with requirements. The civil service personnel assigned to work on Shuttle are functionally tied to their Center SMA organizations, and although some are collocated with their project or contractor element, their official supervisors are in the SMA organization.

The System Safety Review Panel (SSRP) process continues to evolve as the relationship between the ITA, SMA, and the SSP is defined and understood. This plan redefines the SSRP as the Engineering Risk Review Panels (ERRP). The ERRP is designed to improve engagement by the engineer-

ing community into the safety process, including the development and maintenance of documentation such as hazard reports.

The organizational structure of the ERRP will consist of Level 2 (Program) and Level 3 (Project/Element) functionality. The ERRP's structure and processes continue to evolve in a phased approach. Until RTF, the ITA Shuttle System TWH will be represented at all ERRP levels through Engineering trusted agents who are assigned to support each ERRP. The trusted agents ensure that the engineering interests of the ITA are represented at all working levels of the ERRP and are reflected in the products resulting from these panels. After RTF, the Shuttle System TWH will reassess his/her role in all Shuttle Program panels and boards that deal with flight safety issues, including the ERRP.

The Level 2 Panel will ensure that the safety integration function remains at the Program level. It will have representation by all program elements as well as the Engineering Directorate, ITA, and SMA. The Lead ERRP Manager will also assure that Level 3 panels operate in accordance with safety program requirements. The Level 2 Panel exists to oversee and resolve integrated hazards, forwarding them to the System Integration Configuration Board (SICB), and finally to the ITA and the Program Manager for approval.

The Level 3 ERRPs will consist of a Johnson Space Center (JSC) Panel (Orbiter/extravehicular activity/government-furnished equipment/integration responsibility), a Marshall Space Flight (MSFC) Center Panel (External Tank/Reusable Solid Rocket Motor/Solid Rocket Booster/Space Shuttle Main Engine responsibility), and a Kennedy Space Center (KSC) Panel (ground servicing equipment/Ground Ops responsibility). As presently defined, the Level 3 Panels will be chaired by the independent SMA Directorates at each Space Operations Center, again with representation by trusted agents at these panels.

The Space Operations Mission Directorate Space Shuttle Certificate of Flight Readiness process is being updated to clearly show the new SMA, Integration, and ITA roles and responsibilities. Part of that will be a requirement for concurrence by the Chief Safety and Mission Assurance Officer on the flight readiness statement as a constraint to mission approval. Also, to clear up another ambiguity present in the system at the time of the *Columbia* accident, the JSC SMA Manager will not have a "third hat" as delegated NASA Headquarters OSMA representative on the Mission Management Team. An OSMA representative (the OSMA Shuttle Point of Contact (POC)) will fill that role in an advisory/functional oversight role.

Integration of the New ITA and SMA (R7.5-1/R7.5-2)

In a practical sense, the people that perform the responsibilities of SMA and the ITA need to be involved within a program or project beginning in the early stages and remain involved for the life of the program or project. R7.5-1 from the CAIB Report defined what activities at the program level must be clearly under formal ITA authority. At the same time, Chapter 7 discussion makes it clear that the SMA organization must be independent of the program and technically capable to provide proper check-and-balance with the program. Finally, the SMA organization must be able to perform its assurance functions in support of but independent of both program and engineering organizations.

In response to R7.5-1, NASA named the Chief Engineer to be the ITA. And that authority is delegated fully to responsible individuals who hold warrants under ITA authority for systems and engineering disciplines. Fundamentally, this concept brings a “balance of power” to program management such that the ITA sets technical requirements, the programs execute to that set of technical requirements, and SMA assures the requirements are satisfied. This means that the ITA owns the technical requirements and will be the waiver-granting authority for them.

The principal effect of the foregoing is the clear assignment of responsibility for execution of design and engineering, including the safety functions (FMEA, hazards analysis, reliability engineering, etc.) to Engineering with the ITA setting requirements and approving the resulting engineering products. In this context, SMA organizations have the responsibility for independently assuring that delivered products comply with requirements.

System Integration (R7.5-3)

The CAIB found several deficiencies in the organizational approach to Program system engineering integration for the Space Shuttle Program. Their recommendation R7.5-3 calls for a reorganization of the Space Shuttle Integration Office to “make it capable of integrating all elements of the Space Shuttle Program, including the Orbiter.” The CAIB concluded, “...deficiencies in communication”...were a foundation for the *Columbia* accident. These deficiencies are byproducts of a cumbersome, bureaucratic, and highly complex Shuttle Program structure and the absence of authority in two key program areas that are responsible for integrating information across all programs and elements in the Shuttle program.”

Integration Definition

NASA defines Integration as a system engineering function that combines the technical efforts of multiple system elements, functions, and disciplines to perform a higher-level system function in a manner that does not compromise the integrity of either the system or the individual elements. The Integration function assesses, defines, and verifies the required characteristics of the interactions that exist between multiple system elements, functions, and disciplines, as these interactions converge to perform a higher-level function.

Restructured Space Shuttle Systems Engineering and Integration Office

NASA has restructured its Shuttle Integration Office into a Space Shuttle Systems Engineering and Integration Office (SEIO) to include the systems engineering and integration of all elements of the Space Shuttle System. This new alignment is consistent with the new ITA where the Space Shuttle Systems TWH has responsibility not only for the Orbiter, but also for the integration of the technical requirements of the entire Space Shuttle system. The SEIO Manager now reports directly to the SSP Manager, thereby placing the SEIO at a level in the Space Shuttle organization that establishes the authority and accountability for integration of all Space Shuttle elements. The new SEIO charter clearly establishes that it is responsible for the systems engineering and integration of flight performance of all Space Shuttle elements. The number of civil service personnel performing analytical and element systems engineering and integration in the SEIO was doubled by acquiring new personnel from the JSC Engineering and Mission Operations Directorates and from outside of NASA. The role of the System Integration Plan (SIP) and the Master Verification Plans (MVPs) for all design changes with multi-element impact has been revitalized. The SEIO is now responsible for all SIPs and MVPs. These tools, along with the new role of the ITA as the owner of technical requirements, have energized SEIO to be a proactive function within the SSP for integration of design changes and verification. SIPs and MVPs have been developing for all major RTF design changes that impact multiple Shuttle elements.

Orbiter Project Office

The Space Shuttle Vehicle Engineering Office is now the Orbiter Project Office, and its charter is amended to clarify that SEIO is now responsible for integrating all flight elements. NASA reorganized and revitalized the Integration Control Board (ICB). The Orbiter Project Office is now a mandatory member of the ICB. The Space Shuttle Flight Software organization was moved from the Orbiter Project

into the SEIO. This reflects the fact that the Shuttle Flight Software Office manages multiple flight element software sources besides the Orbiter.

Integration of Engineering at Centers

All SSP integration functions at MSFC, KSC, and JSC are now coordinated through the SEIO. Those offices receive technical direction from the SSP SEIO. The former MSFC Propulsion Systems Integration office is now called the Propulsion Systems Engineering and Integration (PSE&I) office. The PSE&I is increasing its contractor and civil servant technical strength and its authority within the Program. Agreements between the PSE&I Project Office and the appropriate MSFC Engineering organizations are being expanded to enhance anomaly resolution within the SSP.

Integrated Debris Environments/Certification

The SEIO is also responsible for generation of all natural and induced design environments analyses. Debris is now treated as an integrated induced environment that will result in element design requirements for generation limits and impact tolerance. All flight elements are being reevaluated as potential debris generators. Computations of debris trajectories under a wide variety of conditions will define the induced environment due to debris. The risk associated with the Orbiter Thermal Protection System will be reassessed for this debris environment, as will the systems of all flight elements.

ITA Interface

The SEIO Manager works closely with, supports the responsibilities of, and recognizes the authority over technical requirements of the Space Shuttle Systems TWH and the Discipline TWHs, as defined in NSTS 07700, Volume IV. SEIO will work closely with the TWHs to ensure: the adequacy of technical requirements employed for the Space Shuttle Program; the sufficiency, integrity, and consistency of the systems engineering approach; the robustness and thoroughness of integrated hazard analyses; and the acceptance of engineering analysis approaches and results by the Space Shuttle Systems TWH before technical options or proposed solutions are presented to the Space Shuttle Program Manager.

SMA Interface

The SEIO also works closely with the SMA organization to obtain independent verification that requirements have been met. SEIO will provide requirements, data, and analyses for use by SMA and will be the recipient of the independent verification results for the program. SEIO will factor these results into recommendations for program actions where appropriate. In addition, the conduct of hazard and risk

analyses is coordinated with the SMA, who has the expertise for the government in conduct of these efforts.

Summary

The reorganized SEIO now addresses all elements of the Space Shuttle system including the Orbiter vehicle. The SEIO manager located at JSC has oversight and control of matrix Systems Engineering and Integration support from KSC and MSFC. SEIO works in compliance with ITA requirements and SMA. SEIO has revitalized its systems engineering and integration processes and has integrated the ITA. SEIO will incorporate the ITA in as an approval authority for variances to technical requirements, as documented in NSTS 07700, Volume IV. Additionally, SEIO will conduct integrated hazard analyses with the oversight of the Space Shuttle Systems TWH. The results of these analyses will be accepted or rejected by the Space Shuttle Systems TWH prior to use. The strengthened systems engineering and integration processes and organizational alignment fulfill the CAIB recommendations in supporting the Space Shuttle RTF actions.

Improving Engineering Integration Agency-wide

NASA has a broad range of programs, projects, and research activities with varying scope that are distributed within and between individual NASA Centers. NASA Headquarters, through the Office of the Chief Engineer, has established the policies that govern Program management, which include the policies for system integration functions as related to the project lifecycle. NASA will assess the effectiveness of integration functions for all of its programs and projects. Further, the policies that govern integration will be assessed and strengthened, as appropriate, to apply to all programs and projects.

FORWARD WORK

Technical Authority is operating across the Agency with major programs such as Space Shuttle and ISS having TWHs who are executing their responsibilities. Independent SMA, as described, has been implemented across NASA. Engineering and Safety Standards are being assessed to determine their applicability to the TA. The Space Shuttle reorganization baselined the integration changes within the SSP. Cultural considerations and further improvements will be included in these overall implementations as they are evolved and understood.

NASA will submit an annual update to Congress of the status of the R9.1-1 plan.

SCHEDULE

Responsibility	Due Date	Activity/Deliverable
TA issues policy and warrants	(Completed)	Initial policy/warrants developed
SSP integrated with TA	(Completed)	TA in place and operational prior to RTF
Annual reports to Congress	Sep 05	Annual report describing R9.1-1 Plan progress



Columbia Accident Investigation Board

Recommendation 9.2-1

Prior to operating the Shuttle beyond 2010, develop and conduct a vehicle recertification at the material, component, subsystem, and system levels. Recertification requirements should be included in the Service Life Extension Program.

Note: NASA has closed this recommendation through the formal Program Requirements Control Board process. The following summary details NASA's response to the recommendation and any additional work NASA intends to perform beyond the *Columbia* Accident Investigation Board recommendation.

BACKGROUND

In 2002, NASA initiated the Space Shuttle Service Life Extension Program (SLEP) to extend the vehicle's useful life. When SLEP was initiated, evaluation of the vehicle's mid-life recertification needs was a foundational activity. On January 14, 2004, the Vision for Space Exploration announced plans for the Space Shuttle to retire following completion of the International Space Station assembly, planned for 2010. Thus, recertification for operating the Space Shuttle beginning in 2010 is not necessary. The vision shortens the required service life of the Space Shuttle and, as a result, the scope of vehicle mid-life certification was changed substantially.

NASA IMPLEMENTATION

Despite the reduced time frame for the operation of the Shuttle, NASA continues to place a high priority on maintaining the safety and capability of the Orbiters. A key element of this is timely verification that hardware processing and operations are within qualification and certification limits. These activities will revalidate the operational environments (e.g., loads, vibration, acoustic, and thermal environments) used in the original certification. This action is addressed in SSP-13.

NASA has approved funding for work to identify and prioritize additional analyses, testing, or potential redesign

of the Shuttle to meet recertification requirements. The identification of these requirements puts NASA on track for making appropriate choices for resource investments in the context of the Vision for Space Exploration.

In May 2003, the Space Flight Leadership Council approved the first SLEP package of work, which included funding for Orbiter mid-life certification and complementary activities on the Orbiter Fleet Leader Project, Orbiter Corrosion Control, and an expanded Probabilistic Risk Assessment for the Shuttle. In February 2004, SLEP Summit II revisited some of the critical issues for life extension and began a review of how to appropriately refocus available resources for the greatest benefit to NASA.

STATUS

Through the process of reviewing all Space Shuttle systems in preparation for return to flight, NASA is assessing what is required for the remaining service life of the Space Shuttle. We will continue to invest in safety and sustainability.

FORWARD WORK

None.

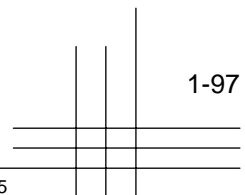

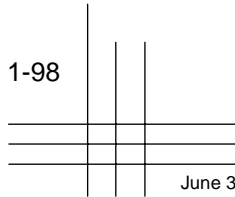



Columbia Accident Investigation Board

Recommendation 10.3-1

Develop an interim program of closeout photographs for all critical sub-systems that differ from engineering drawings. Digitize the closeout photograph system so that images are immediately available for on-orbit troubleshooting. [RTF]

Note: The Stafford-Covey Return to Flight Task Group held a plenary session on December 15, 2004, and NASA's progress toward answering this recommendation was reviewed. The Task Group agreed the actions taken were sufficient to fully close this recommendation.

BACKGROUND

Closeout photography is used, in part, to document differences between actual hardware configuration and the engineering drawing system. The *Columbia* Accident Investigation Board (CAIB) recognized the complexity of the Shuttle drawing system and the inherent potential for error and recommended to upgrade the system (ref. CAIB Recommendation 10.3-2).

Some knowledge of vehicle configuration can be gained by reviewing photographs maintained in the Kennedy Space Center (KSC) Quality Data Center film database or the digital Still Image Management System (SIMS) database. NASA now uses primarily digital photography. Photographs are taken for various reasons, such as to document major modifications, visual discrepancies in flight hardware or flight configuration, and vehicle areas that are closed for flight. NASA employees and support contractors can access SIMS. Prior to SIMS, images were difficult to locate, since they were typically retrieved by cross-referencing the work-authorizing document that specifies them.

NASA IMPLEMENTATION

NASA formed a Photo Closeout Team consisting of members from the engineering, quality, and technical communities to identify and implement necessary upgrades to the processes and equipment involved in vehicle closeout photography. KSC closeout photography includes the Orbiter, Space Shuttle Main Engine, Solid Rocket Boosters, and External Tank based on Element Project requirements. The Photo Closeout Team divided the CAIB action into two main elements: (1) increasing the quantity and quality of closeout photographs, and (2) improving the retrieval process through a user-friendly Web-based graphical interface system (figure 10.3-1-1).

Increasing the Quantity and Quality of Photographs

Led by the Photo Closeout Team, the Space Shuttle Program (SSP) completed an extensive review of existing

closeout photo requirements. This multi-center, multielement, NASA and contractor team systematically identified the deficiencies of the current system and assembled and prioritized improvements for all Program elements. These priorities were distilled into a set of revised requirements that has been incorporated into Program documentation. Newly identified requirements included improved closeout photography of extravehicular activity tool contingency configurations and middeck and payload bay configurations. NASA has also added a formal photography work step for KSC-generated documentation and mandated that photography of all Material Review Board (MRB) reports be archived in the SIMS. These MRB problem reports provide the formal documentation of known subsystem and component discrepancies, such as differences from engineering drawings.

To meet the new requirements and ensure a comprehensive and accurate database of photos, NASA established a baseline for photo equipment and quality standards, initiated a training and certification program to ensure that all operators understand and can meet these requirements, and improved the SIMS. To verify the quality of the photos being taken and archived, NASA has developed an ongoing process that calls for SIMS administrators to continually audit the photos being submitted for archiving in the SIMS. Operators who fail to meet the photo requirements will be decertified pending further training. Additionally, to ensure the robustness of the archive, poor-quality photos will not be archived.

NASA determined that the minimum resolution for closeout photography should be 6.1 megapixels to provide the necessary clarity and detail. KSC has procured 36 Nikon 6.1 megapixel cameras and completed a test program in cooperation with Nikon to ensure that the cameras meet NASA's requirements.

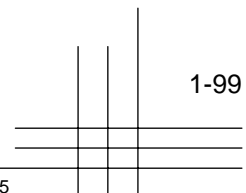

Improving the Photograph Retrieval Process

To improve the accessibility of this rich database of Shuttle closeout images, NASA has enhanced SIMS by developing a Web-based graphical interface. Users will be able to easily view the desired Shuttle elements and systems and quickly drill down to specific components, as well as select photos from specific Orbiters and missions. SIMS will also include hardware reference drawings to help users identify hardware locations by zones. These enhancements will enable the Mission Evaluation Room (MER) and Mission Management Team to quickly and intuitively access relevant photos without lengthy searches, improving their ability to respond to contingencies.

To support these equipment and database improvements, NASA and United Space Alliance (USA) have developed a training program for all operators to ensure consistent photo quality and to provide formal certification for all camera operators. Additional training programs have also been established to train and certify Quality Control

Inspectors and Systems Engineering personnel; to train Johnson Space Center (JSC) SIMS end users, such as staff in the MER; and to provide a general SIMS familiarization course. An independent Web-based SIMS familiarization training course is also in development.

STATUS

NASA has revised the Operation and Maintenance Requirements System (OMRS) to mandate that general closeout photography be performed at the time of the normal closeout inspection process and that digital photographs be archived in SIMS. Overlapping photographs will be taken to capture large areas. NSTS 07700 Volume IV and the KSC MRB Operating Procedure have also been updated to mandate that photography of visible MRB conditions be entered into the SIMS closeout photography database. This requirement ensures that all known critical subsystem configurations that differ from Engineering Drawings are documented and available in SIMS to aid in engineering evaluation and on-orbit troubleshooting.

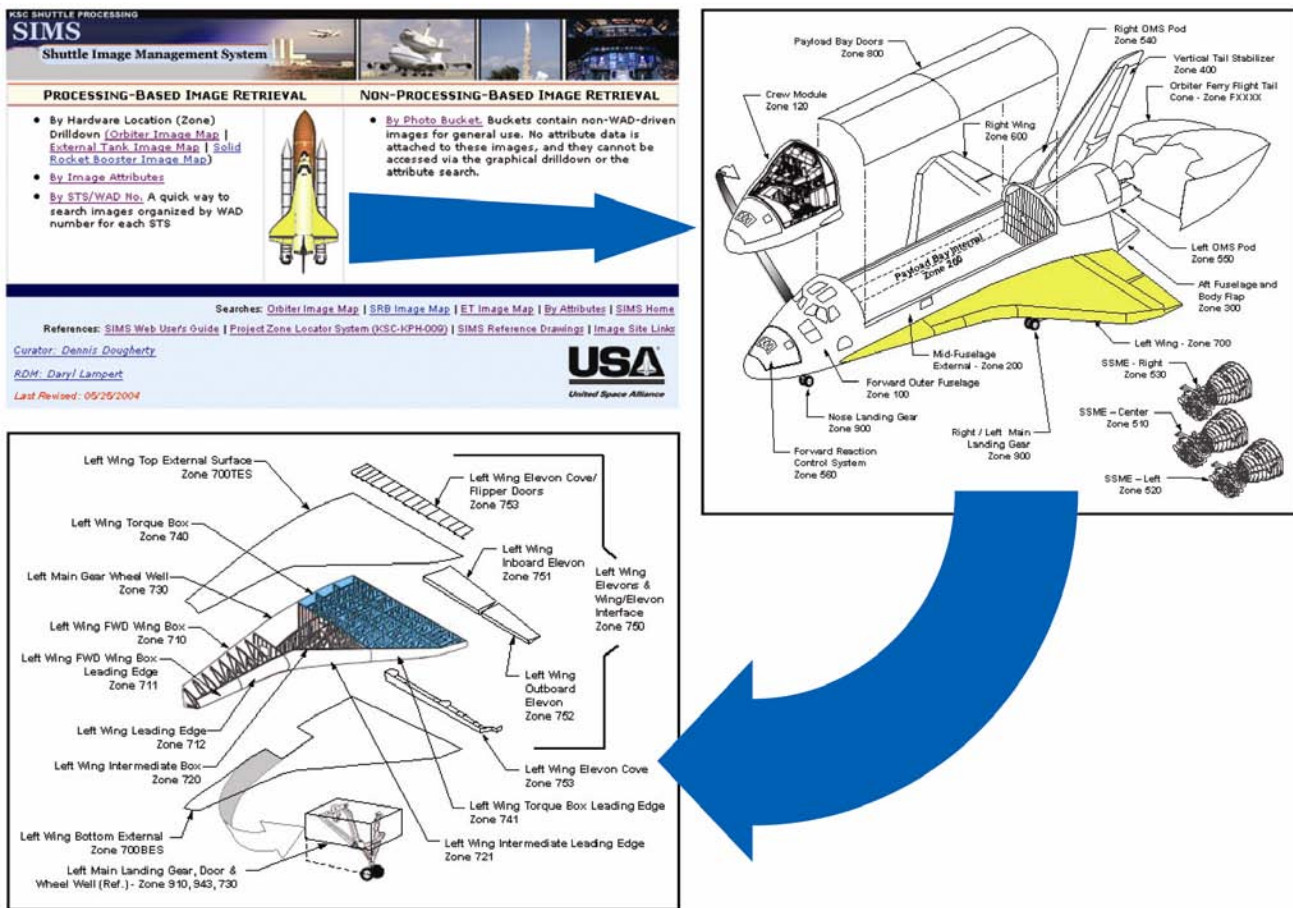

Figure 10.3-1-1. Enhanced SIMS graphic interface.

The revised Shuttle Program closeout photography requirements are documented in RCN KS16347R1 to OMRS File II, Volume I S00GEN.625 and S00GEN.620. Additionally, NASA Quality Planning Requirements Document (QPRD) SFOC-GO0007 Revision L and USA Operation Procedure USA 004644, "Inspection Points and Personnel Traceability Codes," were updated to be consistent with the revised OMRS and QPRD documents. The upgraded SIMS is operational and available for use by all SSP elements. On October 29, 2004, SIMS was successfully used during an inter-center Launch Countdown Simulation with the KSC Launch Team, JSC Flight Control Team, MER, Systems Engineering and Integration Office, and Huntsville Operations Support Center. As a part of the simulation scenario, the SIMS was accessed by participating organizations, and was used to retrieve and view photos to verify the configuration of an Orbital Maneuvering System Pod flight cap installed on the Orbiter.

Training for critical personnel is complete, and will be ongoing to ensure the broadest possible dissemination within the user community. Formal SIMS training has been provided to JSC MER and Marshall Space Flight Center (MSFC) personnel. Photographer training is complete and training classes are held regularly for any new or existing employees needing the certification. SIMS computer-based training (CBT) has been developed and released. Use of SIMS has been successfully demonstrated in a launch countdown simulation at KSC, which included participation from the KSC Launch Team, JSC Flight Control Team, MER, MSFC Huntsville Operations and Support Center (HOSC), and Systems Engineering & Integration (SE&I). Implementation of requirements into KSC operational procedures is continuing.

In July 2004, the Stafford-Covey Return to Flight Task Group reviewed NASA's progress and agreed to conditionally close this recommendation. The full intent of CAIB Recommendation 10.3-1 has been met and full closure of this recommendation was achieved in December 2004.

FORWARD WORK

None.

SCHEDULE

Responsibility	Due Date	Activity/Deliverable
KSC	Feb 04 (Completed)	Develop SIMS drilldown and graphical requirements
SSP	Apr 04 (Completed)	Projects transmit photo requirements to KSC Ground Operations
KSC	May 04 (Completed)	Complete graphical drilldown software implementation
KSC	Jun 04 (Completed)	Develop/complete SIMS training module
KSC	Jul 04 (Completed)	Provide training to MER. Demonstrate SIMS interface to JSC/MSFC
KSC	Aug 04 (Completed)	SIMS CBT course development and deployment. (SIMS familiarization course was provided as needed until CBT was completed)
KSC	Aug 04 (Completed)	Photographer training
SSP	Oct 04 (Completed)	S0044 Launch Countdown Simulation run set for 10/29 with full support from the KSC Launch Team, JSC Flight Control Team, MER, MSFC HOSC, and SE&I

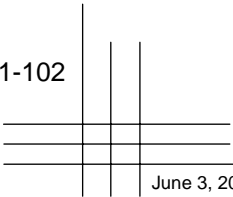



Columbia Accident Investigation Board

Recommendation 10.3-2

Provide adequate resources for a long-term program to upgrade the Shuttle engineering drawing system including

- Reviewing drawings for accuracy
- Converting all drawings to a computer-aided drafting system
- Incorporating engineering changes

Note: NASA has closed this recommendation through the formal Program Requirements Control Board (PRCB) process. The following summary details NASA's response to the recommendation and any additional work NASA intends to perform beyond the *Columbia* Accident Investigation Board (CAIB) recommendation.

BACKGROUND

The CAIB noted deficiencies in NASA's documentation of the Space Shuttle's configuration and therefore recommended a two-step solution. The first was an interim program of closeout photographs for all critical subsystems that differ from engineering drawings (Recommendation 10.3-1). The second is outlined in Recommendation 10.3-2 (above).

NASA IMPLEMENTATION

The Space Shuttle Program (SSP) created a plan for converting Orbiter drawings to computer-aided design (CAD) models and incorporating outstanding engineering orders (EOs). Benefits of the plan include:

- Reducing the EO count to zero on all converted drawings.
- Verifying the accuracy of design data and eliminate dimensional inaccuracies.
- Reconciling many differences between as-designed and as-built configurations.
- Enabling the use of modern engineering and analysis tools.
- Improving safety.
- Recognizing some efficiency improvements.
- Positioning the Shuttle for an evolutionary path.

However, it will take at least three years and \$150M to complete the effort.

STATUS

NASA considered the plan for converting all Orbiter drawings to CAD models and incorporating all outstanding EOs in June 2004. A cost benefit analysis did not support approval of this plan given the shortened life of the SSP. NASA did, however, approve a plan to incorporate some outstanding EOs based on frequency of use and complexity.

Because there is not enough time left in the Program to fully recognize the long-term plan, NASA has redoubled its effort to fully comply with CAIB Recommendation 10.3-1 in implementing an interim program of closeout photographs for all critical subsystems that differ from engineering drawings. This interim program was assessed and conditionally approved by the Stafford Covey Return to Flight Task Group in July 2004.

FORWARD WORK

The SSP will continue to incorporate outstanding EOs into its drawings. Additionally, the SSP will continue to explore options to improve dissemination of its engineering data across the Program.

SCHEDULE

Responsibility	Due Date	Activity/Deliverable
SSP	May 04 (Completed)	Begin EO incorporation
SSP	Jun 04 (Completed)	Present drawing conversion concept to the PRCB



Raising the Bar – Other Corrective Actions

NASA recognizes that it must undertake a fundamental reevaluation of its Agency's culture and processes; this process goes beyond immediate return to flight actions to longer-term work to institutionalize change in the way it transacts business. Much of the work needed for this effort was captured in CAIB observations. Part 1 of this plan addressed the CAIB recommendations. Part 2 addresses other corrective actions, including internally generated actions, the observations contained in Chapter 10 of the CAIB Report, and CAIB Report, Volume II, Appendix D, Recommendations.

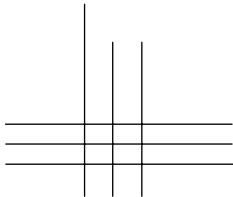



Space Shuttle Program Actions

NASA continues to receive and evaluate inputs from a variety of sources, including those that have been generated from within the Space Shuttle Program. It is systematically assessing all corrective actions and has incorporated many of these actions in this Implementation Plan. This section contains self-imposed actions and directives of the Space Shuttle Program that are being worked in addition to the constraints to flight recommended by the Columbia Accident Investigation Board.

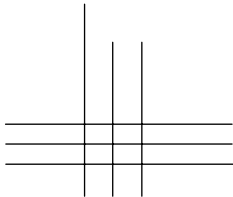



Space Shuttle Program Return to Flight Actions

Space Shuttle Program Action 1

NASA will commission an assessment, independent of the Space Shuttle Program (SSP), of the Quality Planning and Requirements Document (QPRD) to determine the effectiveness of government mandatory inspection point (GMIP) criteria in assuring verification of critical functions before each Shuttle mission. The assessment will determine the adequacy of existing GMIPs to meet the QPRD criteria. Over the long term, NASA will periodically review the effectiveness of the QPRD inspection criteria against ground processing and flight experience to verify that GMIPs are effectively assuring safe flight operations. This action also encompasses an independently led bottom-up review of the Kennedy Space Center Quality Planning Requirements Document (CAIB Observation 10.4-1).

BACKGROUND

The *Columbia* Accident Investigation Board (CAIB) Report highlighted the Kennedy Space Center (KSC) and Michoud Assembly Facility (MAF) Government Mandatory Inspection Point (GMIP) processes as an area of concern. GMIP inspection and verification requirements are driven by the KSC Ground Operations Quality Planning and Requirements Document (QPRD) and the Marshall Space Flight Center (MSFC) Mandatory Inspection Documents.

NASA IMPLEMENTATION

Assuring that NASA maintains appropriate oversight of critical work performed by contractors is key to our overall ability to ensure a safe flight operations environment. As a result, the Space Flight Leadership Council (SFLC) and the Associate Administrator for Safety and Mission Assurance, with concurrence from the Safety and Mission Assurance (SMA) Directors at KSC, Johnson Space Center (JSC), and MSFC, chartered an independent assessment of the Space Shuttle Program (SSP) GMIPs for KSC Orbiter Processing and MAF External Tank manufacturing. The SFLC also approved the establishment of an assessment team consisting of members from various NASA centers, the Federal Aviation Administration, the U.S. Army, and the U.S. Air Force. This Independent Assessment Team (IAT) assessed the KSC QPRD and the MAF Mandatory Inspection Document criteria, their associated quality assurance processes, and the organizations that perform them. The team issued a final report in January 2004, and the report recommendations have become formal SSP actions. The report is also being used as a basis for the SSP to evaluate similar GMIP activity at other Space Shuttle manufacturing and processing locations. The IAT report concluded that the NASA quality assurance programs in place today are relatively good, based on the ground rules that were in effect when the programs were formulated; however, these rules have changed since the programs' formulation. The IAT recommended that

NASA reassess its quality assurance requirements, based on the modified ground rules established as a result of the *Columbia* accident. The modified ground rules for the Space Shuttle include an acknowledgement that the Shuttle is an aging, relatively high-risk development vehicle. As a result, the NASA Safety and Mission Assurance Quality Assurance Program must help ensure both safe hardware and an effective contractor quality program.

The IAT's findings echo the observations and recommendations of the CAIB. The team made the following recommendations:

- Strengthen the Agency-level policy and guidance to specify the key components of a comprehensive Quality Assurance Program that includes the appropriate application of GMIPs.
- Establish a formal process for periodically reviewing QPRD and GMIP requirements at KSC and the Mandatory Inspection Documents and GMIPs at MAF against updates to risk management documentation (hazard analyses, failure modes and effects analyses/critical item list) and other system changes.
- Continue to define and implement formal, flexible processes for changing the QPRD and adding, changing, or deleting GMIPs.
- Document and implement a comprehensive Quality Assurance Program at KSC in support of the SSP activities.
- Develop and implement a well-defined, systematically deployed Quality Assurance Program at MAF.

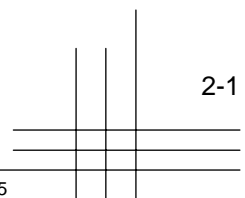

In parallel with the IAT's review, a new process to make changes to GMIP requirements was developed, approved, and baselined at KSC. This process ensures that anyone can submit a proposed GMIP change, and that the initiator who requests a change receives notification of the disposition of the request and the associated rationale. That effort was completed in September 2003. Since then, several change requests have been processed, and the lessons learned from those requests have been captured in a formal revision A of the change process document, KDP-P-1822, Rev. A. This process will use a database for tracking the change proposal, the review team's recommendations, and the Change Board's decisions. The database automatically notifies the requester of the decision, and the process establishes a means to appeal decisions.

STATUS

In response to the CAIB Report, MSFC and KSC Shuttle Processing Safety and Mission Assurance initiated efforts to address the identified Quality Assurance Program shortfalls. The following activities are completed or in progress at KSC:

- A formal process was implemented to revise GMIPs.
- A change review board comprised of the Shuttle Processing Chief Engineer, SMA, and, as applicable, contractor engineering representatives has been designated to disposition proposed changes.
- A new process is under development to document and to implement temporary GMIPs while permanent GMIP changes are pending, or as deemed necessary for one-time or infrequent activities. The new process will also cover supplemental inspection points.
- A pilot project was initiated to trend GMIP accept/reject data to enhance first-time quality determination and identify paths for root cause correction.
- Surveillance has been increased through additional random inspections for hardware and compliance audits for processes.
- Enhanced Quality Inspector training, based on benchmarking similar processes, is under development.
- A QPRD Baseline Review began March 22, 2004. This review will cover all systems and be complete in approximately one year.

In response to the shortfalls identified at MAF, MSFC initiated the following:

- Applying CAIB observations and the IAT recommendations to all MSFC propulsion elements.
- Formalizing and documenting processes that have been in place for Quality Assurance program planning and execution at each manufacturing location.
- Increasing the number of inspection points for External Tank assembly.
- Increasing the level and scope of vendor audits (process, system, and supplier audits).
- Improving training across the entire MSFC SMA community, with concentration on the staff stationed at manufacturer and vendor resident management offices.
- Further strengthening the overall Space Shuttle Quality Assurance Program by establishing a new management position and filling it on the Shuttle SMA Manager's staff with a specific focus on Quality.

SCHEDULE

Responsibility	Due Date	Activity/Deliverable
KSC Shuttle Processing	Sep 03 (Completed)	Develop and implement GMIP change process
Headquarters	Oct 03 (Completed)	Report out from IAT
Headquarters	Jan 04 (Completed)	Publish the IAT report
KSC Shuttle Processing	Apr 04 (Completed)	Develop and implement temporary GMIP process
SSP Program Office	Dec 04 (Completed)	Develop Shuttle Program Quality Assurance Policy for Civil Servants
MAF	Dec 04 (Completed)	Develop Safety and Mission Assurance Plan for Resident Management Office
KSC Shuttle Processing	Feb 05 (Completed)	Develop process for review of QPRD and kick off the baseline review
MAF	Aug 05	Establish a closed-loop GMIP tracking system
KSC Shuttle Processing	Aug 05	Establish metrics for trending and analysis of GMIP activity
KSC Shuttle Processing	Aug 05	Complete baseline review of QPRD



Space Shuttle Program Return to Flight Actions

Space Shuttle Program Action 2

The Space Shuttle Program will evaluate relative risk to the public underlying the entry flight path. This study will encompass all landing opportunities from each inclination to each of the three primary landing sites.

Note: NASA has closed this action through the formal Program Requirements Control Board (PRCB) process. The following summary details NASA's response to the Space Shuttle Program (SSP) action and any additional work NAA intends to perform beyond the SSP action.

BACKGROUND

The *Columbia* accident highlighted the need for NASA to better understand entry public risk. In its report, the *Columbia* Accident Investigation Board (CAIB) observed that NASA should take steps to mitigate the risk to the public from Orbiter entries. NASA now understands and has taken the appropriate steps to mitigate potential risks associated with entry public risk, a topic that is also covered in CAIB Observations 10.1-2 and 10.1-3.

NASA IMPLEMENTATION

NASA's concern for safety addresses public safety, the safety of our employees, and the safety of our critical national assets, such as the Space Shuttle. As a part of our work to improve safety in preparation for return to flight (RTF), we have undertaken a significant assessment of the potential risk posed to the public by Shuttle entry. All of the work to improve the safety of the Space Shuttle has reduced the risk to the public posed by any potential vehicle failures during ascent or entry. Beyond these technical improvements, operational changes are now in place to further reduce public risk. These operational changes include improved insight into the Orbiter's health prior to entry and new landing site selection flight rules that factor in public risk determinations as appropriate.

The entry risk to the public from impacting debris is a function of three fundamental factors: (1) the probability of vehicle loss of control (LOC) and subsequent breakup, (2) quantity and distribution of surviving debris, and (3) the population under the entry flight path. NASA has identified the phases of entry that present a greater probability of LOC based on elements such as increased load factors, aerodynamic pressures, and thermal conditions. The measures undertaken to improve crew safety and vehicle health will result in a lower probability of LOC, thereby improving the public safety during entry. Other factors, such as the effect of population sheltering, are also considered in the assessment.

NASA has completed a study of the public risks associated with entry to its three primary landing sites: Kennedy Space

Center (KSC) in Florida; Edwards Air Force Base (EDW) in California; and White Sands Space Harbor/Northrop (NOR) in New Mexico. We have evaluated the full range of potential ground tracks for each site and conducted sensitivity studies to assess the entry risk to the public for each. NASA also has incorporated entry risk to the public, as well as crew risk considerations, into the entry flight rules that guide the flight control team's selection of landing opportunities.

STATUS

For NASA's risk assessment of the Space Shuttle landing tracks, more than 800 entry trajectories were analyzed covering the three primary landing sites from the Space Shuttle orbit inclination of 51.6° for International Space Station flights. The full range of entry crossrange¹ possibilities to each site was studied in increments of 25 nautical miles for all ascending (south to north) and descending (north to south) approaches. Figure SSP 2-1 displays the ground tracks analyzed for the 51.6° inclination orbit. The results indicate that some landing opportunities have an increased public risk compared to others.

The SSP recommended that the current landing site priorities be maintained, and that KSC remain our primary landing site. NASA will use operational methods and vehicle safety improvements implemented in preparation for RTF to manage the risk to the public posed by vehicle LOC during entry. NASA has developed flight rules to avoid certain opportunities to abate risk to the general public while satisfying other landing site selection priorities for weather, consumables, runway conditions, and entry constraints. Additionally, NASA has developed flight rules that give priority to lower risk opportunities in situations where the Space Shuttle's entry capabilities are compromised.

¹Entry crossrange is defined as the distance between the landing site and the point of closest approach on the orbit ground track. This number is operationally useful to determine whether or not the landing site is within the Shuttle's entry flight capability for a particular orbit.

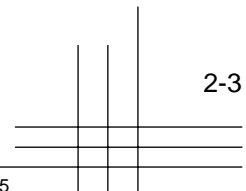

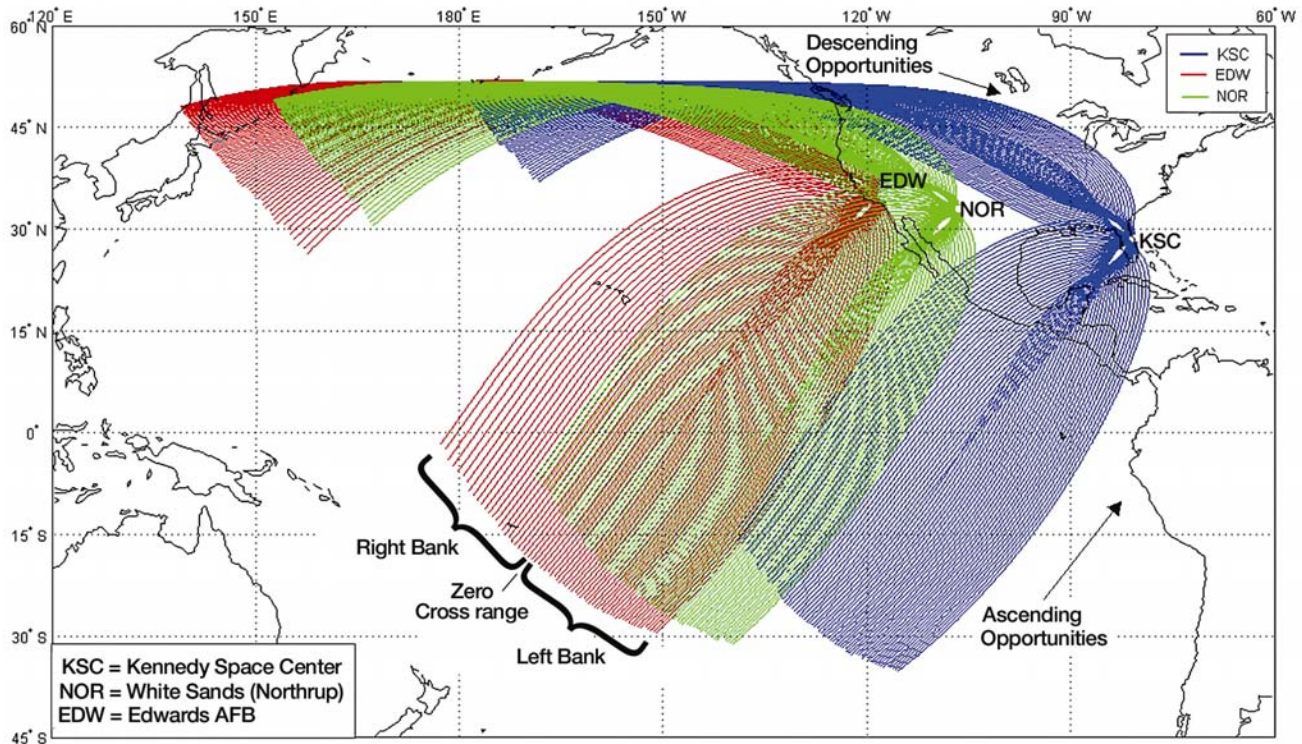

Figure SSP 2-1. Possible entry ground tracks from 51.6° orbit inclination. Blue lines are landing at KSC, green at NOR, red at EDW.

NASA Headquarters (HQ) released a draft policy regarding public safety during all phases of space flight missions into its NASA Online Directives Information System. The policy is currently under review by all stakeholders. See O10.1-1, “Public Risk Policy,” for details regarding this policy.

All RTF actions to evaluate relative risk to the public underlying the entry flight path are now complete.

FORWARD WORK

None.

SCHEDULE

Responsibility	Due Date	Activity/Deliverable
SSP	Jul 03 (Completed)	Preliminary results to RTF Planning Team and SSP PRCB
SSP	Sep 03 (Completed)	Update to RTF Planning Team and SSP PRCB
SSP	Jan 04 (Completed)	Update to RTF Planning Team and SSP PRCB
SSP	Jun 04 (Completed)	Update to SSP PRCB
SSP	Jun 04 (Completed)	Entry risk overview to NASA HQ
SSP	Dec 04 (Completed)	Report to SSP PRCB
NASA HQ	Feb 05 (Completed)	Report to HQ Ops Council



Space Shuttle Program Return to Flight Actions

Space Shuttle Program Action 3

NASA will evaluate the feasibility of providing contingency life support on board the International Space Station (ISS) to stranded Shuttle crewmembers until repair or rescue can be effected.

Note: NASA has closed this action through the formal Program Requirements Control Board process. The following summary details NASA's response to the Space Shuttle Program (SSP) action and any additional work NASA intends to perform beyond the SSP action.

BACKGROUND

It is prudent for NASA to examine options for providing an emergency capability to sustain Shuttle crews on the International Space Station (ISS), should the Orbiter become unfit for entry. This Contingency Shuttle Crew Support (CSCS) capability could, in an emergency, sustain a Shuttle crew on board the ISS for a limited time to enable a repair to the Orbiter or allow the crew to be returned to Earth via a rescue mission. CSCS is not intended to mitigate known but unacceptable risks; rather, it is a contingency plan of last resort with limited capability to sustain the crew on the ISS. However, it is important to have it as an option for at least the first two flights of the Space Shuttle, until we have verified the performance of the Space Shuttle system and the improvements made to reduce the risk of critical ascent debris. CSCS is not a certified capability with redundancy.

NASA IMPLEMENTATION

The fundamental rationale for return to flight is to control the liberation of critical debris from the External Tank (ET) during ascent. NASA will resume Shuttle missions only when we have sufficient confidence in the ET to allow us to fly. While CSCS will offer a viable emergency capability for crew rescue, it will not be used to justify flying a Shuttle that is otherwise deemed unsafe.

After the ET is made safe, CSCS will provide an additional level of mitigation from residual risk. This is particularly desirable during the first few flights when we will be validating the improvements made to the Shuttle system. It is highly unlikely that the combination of failures necessary to lead NASA to invoke the CSCS capability will occur. It is secondary risk control and will be accomplished with zero fault tolerance in areas where ISS resources are taxed by an increased crew size. This approach is consistent with how NASA addresses other emergency measures, such as contingency launch aborts, to reduce residual risk to the crew.

STATUS

At the Space Flight Leadership Council (SFLC) on June 9, 2004, NASA approved the joint SSP/ISS proposal to

pursue CSCS as a contingency capability for STS-114 and STS-121. NASA will revisit the feasibility and need for continued CSCS capability following STS-121. CSCS capability will not be fault tolerant and is built on the presumption that, if necessary, all ISS consumables in addition to all Shuttle reserves will be depleted to support it. In the most extreme CSCS scenarios, it is possible that ISS will be decrewed following Shuttle crew rescue until consumables margins can be reestablished and a favorable safety review is completed. For the first two flights, NASA will ensure that the SSP has the capability to launch a rescue Shuttle mission within the time period that the ISS Program can reasonably predict that the combined Shuttle and ISS crew can be sustained on the ISS while allowing sufficient time to decrew the ISS following Shuttle departure, if decrew is necessary. This time period, which is referred to as the ISS "engineering estimate" of supportable CSCS duration, represents a point between worst- and best-case operational scenarios for the ISS based on engineering judgment and operational experience.

For planning purposes, NASA is assuming that the failures preventing the entry of the stranded Orbiter can be resolved before launching the rescue Shuttle. In an actual CSCS situation, it may not be possible to protect the rescue Shuttle from the hazards that resulted in the damage that precipitated the need for a rescue, and a difficult risk-risk trade analysis will be performed at the Agency level or above before proceeding to launch.

The Mission Management Team (MMT) will conduct a CSCS simulation in early May 2005 in preparation for return to flight.

Contingency Capability for CSCS

CSCS is a contingency capability that will be employed only under the direst emergency situations. In NASA's formal risk management system, CSCS does not improve an otherwise "unacceptable" risk into the "accepted" category. The implementation of risk mitigation efforts such as CSCS

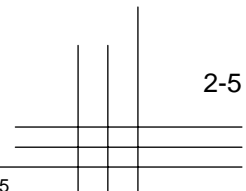

will be accomplished to the greatest degree practicable, but these efforts are not primary controls to the SSP Integrated Hazards of “Degraded Functioning of Orbiter Thermal Protection System” and “Damage to the Windows Caused by the Natural or Induced Debris Environment.” Accordingly, CSCS verification standards are based on risk management decisions by an informed Program management.

The use of CSCS as a contingency capability is analogous to some of our other abort modes. The ability to perform emergency deorbits provides some protection against cabin leaks and multiple system failures. Contingency ascent aborts offer the ability to abort launches to contingency landing sites as protection against two or three Space Shuttle Main Engine failures. In both of these examples, as in many others, the capability is not certified for all, or even most, scenarios. Nevertheless, they do offer mitigation against residual risk and uncertainty. Another analogy can be drawn between CSCS and the ejection seats that were installed in the Orbiter for the first four flights of the Shuttle Program. They offered some crew escape capability during the first part of ascent and the last part of descent and landing, but they by no means represented comprehensive protection. However, they were appropriate and valuable additional risk mitigation options during conduct of the initial test flights that validated the performance of the Shuttle system.

CSCS Requirements

The SSP and ISS Programs have been working to define CSCS requirements using our established Joint Program Requirements Control Board (JPRCB) process. CSCS capability is not premised on the use of any International Partner resources other than those that are an integral part of joint ISS operations, such as common environmental health and monitoring systems. The additional capabilities that could be brought to bear by the International Partners to support CSCS could provide added performance margin.

The ISS Program, working with the Space and Life Sciences Directorate, has analyzed the impacts of maintaining as many as seven additional people on the ISS in the event of CSCS. Their analyses indicate that at current operating levels, CSCS is feasible for long enough to allow the launch of a rescue mission. For a May 2005 launch, the ISS engineering estimate for STS-114 is approximately 45 days. This engineering estimate allows full depletion of the most critical ISS consumables that could require decrewing of the ISS. If any oxygen consumables other than Progress oxygen are consumed prior to launch, the duration will decrease significantly. This uncertainty will lend fluidity to the reported duration as future reporting milestones are reached. The systems status will be updated continually as we approach

a mission that calls for CSCS capability, and the ISS engineering estimate of CSCS duration will be revised accordingly.

The ISS Program is pursuing additional logistics to enable a more robust CSCS capability. NASA is keeping the ISS International Partners informed of the CSCS concept and plan. NASA will evaluate current Shuttle and ISS support capabilities for crew rescue during CSCS and explore ways of using all available resources to extend CSCS to its maximum duration. This will involve making recommendations on operational techniques, such as undocking the Orbiter after depletion of usable consumables and having another Shuttle available for launch to rescue the crew within the projected CSCS duration. These actions are outside of the current flight rules and Orbiter performance capabilities and will need to be fully assessed. Currently NASA is assuming that STS-114 will require no newly developed Shuttle or ISS performance capabilities to enable CSCS. NASA will also evaluate CSCS options to maximize Shuttle/ISS docked capabilities. These options, such as power-downs and resource-saving measures, will be used to extend the time available for contingency operations including Thermal Protection System inspection and repair.

To support the CSCS capability, NASA has evaluated the capability to launch on need to provide crew rescue. Using this capability, NASA could have a second Shuttle, designated STS-300 for STS-114 (LF1) and STS-301 for STS-121 (ULF1.1), ready for launch on short notice during all missions. At the current time, the Space Flight Leadership Council has directed that the ability to launch a rescue mission within the ISS Program engineering estimate will be held as a constraint to launch. The SSP, working with Safety and Mission Assurance and the ISS Program, has developed detailed criteria for the constraint. These criteria have been reported to the JPRCB and documented in an SSP/ISS Program Memorandum of Agreement (MOA). Based on this MOA, both the SSP and the ISS Program are taking the necessary measures to satisfy their respective responsibilities.

NASA’s designated rescue missions will be subject to the same development requirements as any other Shuttle mission; however, they will be processed on an accelerated schedule. Current estimates are that STS-300, the rescue mission for our first flight, can be processed for launch in approximately 45 days following the launch of STS-114. Processing time for STS-301 will be approximately 58 days following STS-121. These assessments assume a work acceleration to three shifts per day, seven days a week, but no deletion of requirements or alteration of protocols.

2-6

Stranded Orbiter Undocking, Separation, and Disposal

The Mission Operations Directorate has developed procedures for undocking a stranded Orbiter from the ISS, separating to a safe distance, then conducting a deorbit burn for disposal into an uninhabited oceanic area. These procedures have been worked in detail at the ISS Safe Haven Joint Operations Panel (JOP), and have been simulated in a joint integrated simulation involving flight controllers and flight crews from both the ISS Program and the SSP. Additional details will be refined, but the requirements and procedures for safely conducting a disposal of a stranded Orbiter are well understood.

Current plans call for the Orbiter crew to conduct a rewiring in-flight maintenance procedure on the day prior to disposal that would “hot wire” the docking system hook motors to an unpowered main electrical bus. Before abandoning the Orbiter and closing the hatches, the crew would set up the cockpit switches to enable all necessary attitude control, orbital maneuvering, and ground uplink control systems. On the day of disposal, after the hatches are closed, Mission Control would uplink a ground command to repower the bus, immediately driving the hooks to the open position. The

rewiring procedure is well understood and within the SSP’s experience base of successful on-orbit maintenance work.

The Orbiter will separate vertically upward and away from the ISS. Orbital mechanics effects will increase the relative opening rate and ensure a safe separation. The Mission Control Center will continue to control the attitude of the Orbiter within safe parameters. Once the Orbiter is farther than 1000 ft from the ISS, the attitude control motors will be used to increase the separation rate and to set up for the disposal burn for steep entry into Earth’s atmosphere. The primary targeted impact zone would be near the western (beginning) end of an extremely long range of remote ocean. Planning a steep entry reduces the debris footprint; targeting the western end protects against eastward footprint migration due to underburn. This disposal plan has been developed with the benefit of lessons learned from the deorbit, ballistic entry, and ocean disposal of the Compton Gamma Ray Observatory in June 2000 and the Russian *Mir* Space Station in 2001.

FORWARD WORK

NASA will pursue the CSCS capability to a contingency level in support of the full joint crew.

SCHEDULE

Responsibility	Due Date	Activity/Deliverable
ISS Program	Aug 03 (Completed)	Status International Partners at Multilateral Mission Control Boards
ISS Program	Nov 03 (Completed)	Assess ISS systems capabilities and spares plan and provide recommendations to ISS and SSP
ISS Program	Jun 04 (Completed)	Develop CSCS Integrated Logistics Plan
ISS Program and SSP	Jun 04 (Completed)	Develop waste management and water balance plans
ISS Program and SSP	Jun 04 (Completed)	Develop ISS Prelaunch Assessment Criteria
ISS Program	Jun 04 (Completed)	Develop food management plan
SSP/ISS Program	Jun 04 (Completed)	Develop crew health and exercise protocols
ISS Program	Jun 04 (Completed)	Assess and report ISS ability to support CSCS
SSP/ISS Program	Dec 04 (Completed)	Safe Haven JOP report to JPRCB on requirements to implement CSCS
MMT	May 05 (Completed)	CSCS MMT Simulation

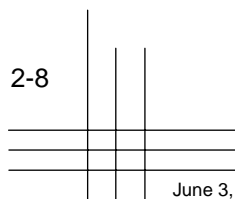



Space Shuttle Program Return to Flight Actions

Space Shuttle Program Action 4

NASA will validate that the controls are appropriate and implemented properly for “accepted risk” hazards and any other hazards, regardless of classification, that warrant review due to working group observations or fault tree analysis.

Note: NASA has closed this action through the formal Program Requirements Control Board (PRCB) process. The following summary details NASA’s response to the Space Shuttle Program (SSP) action and any additional work NASA intends to perform beyond the SSP action.

BACKGROUND

Hazard analysis is the determination of potential sources of danger that could cause loss of life, personnel capability, system, or result in injury to the public. Hazard analysis is accomplished through (1) performing analyses, (2) establishing controls, and (3) establishing a maintenance program to implement the controls. Controls and verifications for the controls are identified for each hazard cause.

Accepted risk hazards are those hazards that, based on analysis, have a critical or catastrophic consequence and the controls of which are such that the likelihood of occurrence is considered higher than improbable and might occur during the life of the Program. Examples include critical single failure points, limited controls or controls that are subject to human error or interpretation, system designs or operations that do not meet industry or Government standards, complex fluid system leaks, inadequate safety detection and suppression devices, and uncontrollable random events that could occur even with established precautions and controls in place.

All hazards, regardless of classification, will be reviewed if working group observations or fault-tree analysis calls into question the classification of the risk or the efficacy of the mitigation controls.

NASA IMPLEMENTATION

Each SSP project performed the following assessment for each accepted risk hazard report and any additional hazard reports indicated by the STS-107 accident investigation findings:

1. Verify proper use of hazard reduction precedence sequence per NSTS 22254, Methodology for Conduct of Space Shuttle Program Hazard Analyses.
2. Review the basis and assumptions used in setting the controls for each hazard, and determine whether they are still valid.

3. Verify each reference to Launch Commit Criteria, Flight Rules, Operation and Maintenance Requirements Specification Document, crew procedures, and work authorization documents as a proper control for the hazard cause.
4. Verify proper application of severity and likelihood per NSTS 22254, Methodology for Conduct of Space Shuttle Program Hazard Analyses, for each hazard cause.
5. Verify proper implementation of hazard controls by confirming existence and proper use of the control in current SSP documentation.
6. Identify any additional feasible controls that can be implemented that were not originally identified and verified.
7. Assure that all causes have been identified and controls documented.

The System Safety Review Panel (SSRP) served as the forum to review the projects’ assessment of the validity and applicability of controls. The SSRP assessed the existence and effectiveness of controls documented in the hazard reports. In accordance with SSP requirements, the SSRP reviewed, processed, and dispositioned updates to baselined hazard reports.

Although the scope of the return to flight (RTF) action encompassed only the accepted risk hazards, the STS-107 accident brought into question the implementation and effectiveness of controls in general. As such, existing controlled hazards were also suspect. The evaluation of all hazards, including the controlled hazards, will be included in the RTF plan if the results of the accepted risk hazards review indicate significant problems, such as a recurring lack of effective controls, insufficient technical rationale, or improper classification.

In summary, the goal of this review is to reconfirm that the likelihood and severity of each accepted risk hazard

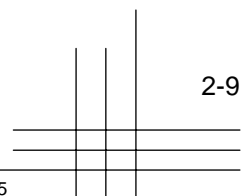

are thoroughly and correctly understood and that mitigation controls are properly implemented.

STATUS

Each project and element is reviewing its accepted risk hazard reports per the PRCB approved schedules. Their results are being presented to the PRCB and accepted by the Program. NASA is identifying and updating all the necessary risk documentation and reestablishing the baseline for future operations of the Space Shuttle.

NASA is undertaking an extensive rewrite of the External Tank (ET) and integration hazards for the Shuttle. As a result of this more rigorous hazard documentation

process, risk will be more fully understood and mitigated before RTF. A special RTF panel of the SSRP is participating in the review and design process of those items requiring redesign or new hardware for flight; this includes ET bipod and Solid Rocket Booster bolt catcher among other items. NASA is committed to continuous, thorough reviews and updates of all hazards for the remaining life of the Shuttle Program.

FORWARD WORK

Analysis results could drive additional hardware or operational changes. As noted previously, review of controlled risks hazards may be necessary after the results of the accepted risk reviews are reported.

SCHEDULE

Responsibility	Due Date	Activity/Deliverable
SSRP	Oct 03 (Completed)	SSRP review element hazards and critical items list review processes Kennedy Space Center – Sep 9, 11 Reusable Solid Rocket Motor – Sep 24, 25 Integration – Oct Solid Rocket Booster – Sep 8 Space Shuttle Main Engine – Oct 7, 8
SSP	(Ongoing)	Identify and review “Accepted Risk” hazard report causes and process impacts
SSP	(Ongoing)	Analyze implementation data
SSP	(Ongoing)	Validate and verify controls and verification methods
SSP	(Ongoing)	Develop, coordinate, and present results and recommendation

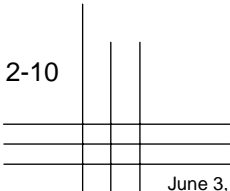



Space Shuttle Program Return to Flight Actions

Space Shuttle Program Action 5

NASA will determine critical debris sources, transport mechanisms, and resulting impact areas. Based on the results of this assessment, we will recommend changes or redesigns that would reduce the debris risk. NASA will also review all Program baseline debris requirements to ensure appropriateness and consistency.

Note: NASA has closed this action through the formal Program Requirements Control Board (PRCB) process. The following summary details NASA's response to the Space Shuttle Program (SSP) action and any additional work NASA intends to perform beyond the SSP action.

BACKGROUND

A review of critical debris potential is necessary to prevent the recurrence of failure similar to that which occurred on STS-107. As a result, NASA is improving the end-to-end process for predicting debris impacts and the resulting damage.

NASA IMPLEMENTATION

NASA analyzed credible debris sources from a wide range of release locations to predict the impact location and conditions. It developed critical debris source zones to provide maximum allowable debris sizes for various locations on the vehicle. A list of credible ascent debris sources was compiled for each SSP hardware element—Solid Rocket Booster, Reusable Solid Rocket Motor, Space Shuttle Main Engine, External Tank (ET), Orbiter, and the pad area around the vehicle at launch. Potential debris sources were identified by their location, size, shape, material properties, and, if applicable, likely time of debris release. These analyses were completed in 2004, and culminated in a comprehensive Space Shuttle Systems Integration Control Board review in December 2004. At this review, all of the Space Shuttle Projects presented their list of all potential debris sources, both expected and unexpected. The Program classified as unexpected those potential debris sources for which design controls are in place to ensure that debris will not be liberated. Those debris sources that fell into the “expected” category—not controlled through design changes—were the focus of the transport analyses performed. The debris transport analyses were used to predict impact location and conditions, such as velocities and relative impact angles. They also supported the SSP's risk assessment by helping to classify the expected debris sources as remote, improbable, or probable.

NASA executed and analyzed between five hundred million and one billion debris transport cases. These included debris type, location, size, and release conditions (freestream Mach number, initial velocity of debris piece, etc.). This work has provided NASA with unprecedented insight into the ascent

debris environment to which the Space Shuttle is subjected, and will aid in the design of future space vehicles.

In some cases, debris sources that could cause significant damage have been redesigned where feasible. Some critical impact locations have been or may be redesigned or have debris protection added (see Recommendation 3.3.2, Orbiter Hardening).

STATUS

All hardware project and element teams have identified known and suspected debris sources originating from the flight hardware. The Flight Crew Operations Directorate requested that NASA review the unexpected debris sources to ensure that they are accurately assessed and validated. This review was completed in May 2005. The debris source tables for all of the propulsive Space Shuttle elements and the pad environment have been formally reviewed and approved by the Program.

The debris transport tools that existed prior to STS-107 have been completely rewritten, and the results have been peer-reviewed. NASA has completed the transport analysis for the initial all planned debris cases; the resulting data were provided to the SSP elements for evaluation and briefed to the wider NASA community in two Design Verification Reviews (DVRs) for Debris in Spring 2005. These data have allowed NASA to develop a comprehensive damage tolerance assessment for the Orbiter Thermal Protection System, and to refine the debris limits for ET foam.

NASA has also been able to validate and refine some of the debris transport model assumptions through testing. These tests included wind tunnel tests and F-15 flight tests to assess foam flight characteristics. NASA also conducted tests on ice, focusing on ice behavior in a flow field. In May 2005, NASA completed its testing on ice debris to determine its flight characteristics. NASA grew ice of various densities and performing vibration/acoustic testing at the NASA

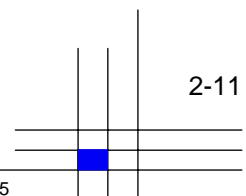

Marshall Space Flight Center to understand how ice on the feedline brackets and bellows might liberate during ascent. NASA's results indicate that, contrary to early assumptions, "soft" ice may pose a greater risk than "hard" ice because of its tendency to release earlier in the flight and to break up into multiple pieces. Hard ice, on the other hand, tends to stay attached longer, breaking off only after the Shuttle has reached a stage in ascent where liberated ice does not pose as large a threat to the Orbiter. Overall, the tests performed have validated the model assumptions, and indicated that, in some cases, the model may be too conservative.

NASA also completed a supersonic wind tunnel test at the NASA Ames Research Center. This test validated the debris transport flow fields in the critical Mach number range. The results showed excellent agreement between wind tunnel results and analytically derived flow field predictions.

Interim results of these analyses helped the SSP to respond to the *Columbia* Accident Investigation Board recommendations, such as those on ET modifications (R3.2-1), Orbiter hardening modification (R3.3-2), and ascent and on-orbit imagery requirements (R3.4-1 and R3.4-3). The most recent results of the transport analyses showed an unacceptable risk of damage to the Orbiter wing leading edge and tile from ET ice. As a result, prior to return to flight (RTF), NASA is installing a heater to the ET forward feedline bellows to mitigate this risk.

In preparation for the next DVR in June 2005, NASA has two major objectives to support our rationale for RTF. First, NASA is working to develop an end-to-end estimate of the Orbiter's capability to withstand damage relative to the ascent environment. To do this, we are using the ET Project's best estimate of the foam and/or ice debris that may be liberated and worst-case assumptions about that debris' potential for transport to the Orbiter. Second, for those cases in which the initial assessment indicates that the Orbiter cannot withstand the potential impact, NASA will perform a probabilistic risk assessment to determine the likelihood of a critical debris impact. Currently, NASA plans to assess four foam transport cases and two ice transport cases. These cases represent the worst potential impacts of a general category, and so may be used to bound the similar, but less severe, transport cases from the same areas. This analysis will aid NASA in quantifying the risk posed by the debris in our formal risk analysis, and aid in the determination of the ascent debris risk remaining when we return to flight.

FORWARD WORK

NASA will continue to refine its analyses with further data from the first two Space Shuttle flights to reduce uncertainties.

SCHEDULE

Responsibility	Due Date	Activity/Deliverable
SSP	Jul 03 (Completed)	Elements provide debris history/sources
SSP	Nov 03 (Completed)	Begin Return to Flight Debris Transport analyses
SSP	Dec 04 (Completed)	Complete second set of Debris Transport analyses
SSP	Mar 05 (Completed)	Complete final round of Debris Transport analyses
SSP	Mar/Apr 05 (Completed)	Summary report/recommendation to PRCB
SSP	May 05 (Completed)	Complete flight characteristic testing on ice debris
SSP	May 05 (Completed)	Validate unexpected debris sources





Space Shuttle Program Return to Flight Actions

Space Shuttle Program Action 6

All waivers, deviations, and exceptions to Space Shuttle Program (SSP) requirements documentation will be reviewed for validity and acceptability before return to flight.

BACKGROUND

Requirements are the fundamental mechanism by which the Space Shuttle Program (SSP) directs the production of hardware, software, and training for ground and flight personnel to meet performance needs. The rationale for waivers, deviations, and exceptions to these requirements must include compelling proof that the associated risks are mitigated through design, redundancy, processing precautions, and operational safeguards. The Program manager, with concurrence by the Independent Technical Authority (ITA), has approval authority for waivers, deviations, and exceptions.

NASA IMPLEMENTATION

Because waivers and deviations to SSP requirements and exceptions to the Operations and Maintenance Requirements and Specifications contain the potential for unintended risk, the Program has directed all elements to review these exemptions to Program requirements to determine whether the exemptions should be retained. Each project and element will be alert for items that require mitigation before return to flight.

The following instructions were provided to each project and element:

1. Any item that has demonstrated periodic, recurrent, or increasingly severe deviation from the original design intention must be technically evaluated and justified. If there is clear engineering rationale for multiple waivers for a Program requirement, it could mean that a revision to the requirement is needed. The potential expansion of documented requirements should be identified for Program consideration.
2. The review should include the engineering basis for each waiver, deviation, or exception to ensure that the technical rationale for acceptance is complete, thorough, and well considered.
3. Each waiver, deviation, or exception should have a complete engineering review to ensure that incremental risk increase has not crept into the process over the Shuttle lifetime and that the level of risk is appropriate.

The projects and elements were encouraged to retire out-of-date waivers, deviations, and exceptions.

In addition to reviewing all SSP waivers, deviations, and exceptions, each element is reviewing all NASA Accident Investigation Team working group observations and findings and Critical Item List (CIL) waivers associated with ascent debris.

Updating the waivers and deviations allows the SSP Management to understand which waivers represent real safety issues and which were merely administrative. This in turn clarifies the level of risk associated with each waiver.

STATUS

Each project and element presented a plan and schedule for completion to the daily Program Requirements Control Board (PRCB) on June 25, 2003. Each project and element is identifying and reviewing the CIL associated with ascent debris generation. The vast majority of waivers, except those in one category, have been reviewed and dispositioned. The remaining waivers, approximately 50% of the original set of over 650, are primarily related to electromagnetic interference (EMI). The Program is in the process of updating EMI requirements, which will make these remaining waivers obsolete.

FORWARD WORK

The SSP continues to review the waivers, deviations, and exceptions at the daily PRCB. These items will be coordinated with the ITA for approval as appropriate.

SCHEDULE

Responsibility	Due Date	Activity/Deliverable
SSP	Jun 05	Review of all waivers, deviations, and exceptions

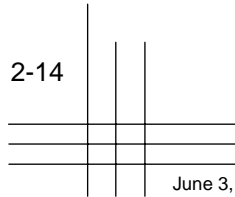



Space Shuttle Program Return to Flight Actions

Space Shuttle Program Action 7

The Space Shuttle Program (SSP) should consider NASA Accident Investigation Team (NAIT) working group findings, observations, and recommendations.

Note: NASA has closed this Space Shuttle Program action through the formal Program Requirements Control Board (PRCB) process. The following summary details NASA's response to the Space Shuttle Program action and any additional work NASA intends to perform beyond the Space Shuttle Program action.

BACKGROUND

As part of their support of the *Columbia* Accident Investigation Board (CAIB), each NASA Accident Investigation Team (NAIT) technical working group compiled assessments and critiques of Program functions. These assessments offer a valuable internal review and will be considered by the Space Shuttle Program (SSP) for conversion into directives for corrective actions.

NASA IMPLEMENTATION

All NAIT technical working groups have an action to present their findings, observations, and recommendations to the Space Shuttle PRCB. Each project and element will disposition recommendations within its project to determine which should be return to flight actions. Actions that require SSP or Agency implementation will be forwarded to the PRCB for disposition.

The following NAIT working groups have reported their findings and recommendations to the SSP at the PRCB: the Space Shuttle Main Engine Project Office, the Reusable Solid Rocket Motor Project Office, the Mishap Investigation Team, the External Tank Project, the Solid Rocket Booster Project Office, and Space Shuttle Systems Integration. The Orbiter Project Office has reported the findings and recommendations of the following working groups to the PRCB: *Columbia* Early Sighting Assessment Team, Certification of Flight Readiness Process Team, Unexplained Anomaly Closure Team, Previous Debris Assessment Team, Hardware Forensics Team, Materials Processes and Failure Analysis Team, Starfire Team, Integrated Entry Environment Team, Image Analysis Team, Palmdale Orbiter Maintenance Down Period Team, Space/Atmospheric Scientist Panel, KSC Processing Team, *Columbia* Accident Investigation Fault Tree Team, *Columbia* Reconstruction Team, and Hazard Controls Analysis Team.

All NAIT working group findings and recommendations were evaluated by the affected SSP projects. Inconsistencies between Working Group recommendations and the projects' disposition were arbitrated by the Systems Engineering and Integration Office (SE&IO), with new actions assigned as warranted. Review of all working group recommendations and final project dispositions was completed in May 2004.

Project and PRCB recommendations currently being implemented include revision of the SSP Contingency Action Plan, modifications to the External Tank, and evaluation of hardware qualification and certification concerns. Numerous changes to Orbiter engineering, vehicle maintenance and inspection processes, and analytical models are also being made as a result of the recommendations of the various accident investigation working groups. In addition, extensive changes are being made to the integrated effort to gather, review, and disposition prelaunch, ascent, on-orbit, and entry imagery of the vehicle, and to evaluate and repair any potential vehicle damage observed. All of this work complements and builds upon the extensive recommendations, findings, and observations contained in the CAIB Report.

STATUS

Following PRCB approval of Working Group recommendations, the responsible project office tracks associated actions and develops implementation schedules with the goal of implementing approved recommendation prior to return to flight. The responsible SSP projects status closure of the working group recommendations as part of the Design Certification Review activity in support of return to flight.

FORWARD WORK

None.

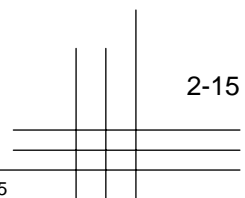

SCHEDULE

Responsibility	Due Date	Activity/Deliverable
SSP SE&IO	May 04 (Completed)	Review Working Group recommendations and SSP Project dispositions

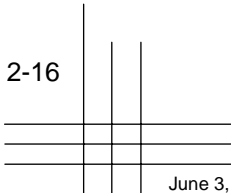



Space Shuttle Program Return to Flight Actions

Space Shuttle Program Action 8

NASA will identify certification of flight readiness (CoFR) process changes, including program milestone reviews, flight readiness review (FRR), and prelaunch Mission Management Team (MMT) processes to improve the system.

Note: NASA has closed this Space Shuttle Program Action through the formal Program Requirements Control Board (PRCB) process. The following summary details NASA's response to the Space Shuttle Program action and any additional work NASA intends to perform beyond the Space Shuttle Program action.

BACKGROUND

The certification of flight readiness (CoFR) is the fundamental process for ensuring compliance with Program requirements and assessing readiness for proceeding to launch. The CoFR process includes multiple reviews at increasing management levels that culminate with the Flight Readiness Review (FRR), chaired by the Associate Administrator for Space Flight, approximately two weeks before launch. After successful completion of the FRR, all responsible parties, both Government and contractor, sign a CoFR.

NASA IMPLEMENTATION

To ensure a thorough review of the CoFR process, the Shuttle PRCB has assigned an action to each organization to review NSTS 08117, Certification of Flight Readiness, to ensure that its internal documentation complies and responsibilities are properly described. This action was assigned to each Space Shuttle Program (SSP) supporting organization that endorses or concurs on the CoFR and to each organization that prepares or presents material in the CoFR review process.

Each organization reviewed the CoFR process in place during STS-112, STS-113, and STS-107 to identify any weaknesses or deficiencies in its organizational plan.

STATUS

NASA has revised NSTS 08117, Certification of Flight Readiness, including providing updates to applicable documents lists as well as the roles and responsibilities within project and Program elements, and has increased the rigor of previous mission data review during the project-level reviews. The revised document was approved by the PRCB in January 2004 and released in February 2004.

FORWARD WORK

None.

SCHEDULE

Responsibility	Due Date	Activity/Deliverable
SSP Element reviews	Aug 03 (Completed)	Report results of CoFR reviews to PRCB
SSP Program Office	Feb 04 (Completed)	Revise NSTS 08117, Certification of Flight Readiness

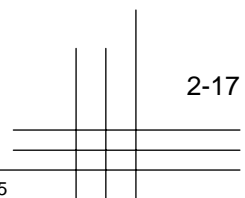

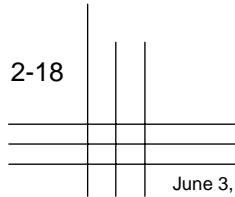



Space Shuttle Program Return to Flight Actions

Space Shuttle Program Action 9

NASA will verify the validity and acceptability of failure mode and effects analyses (FMEAs) and critical items lists (CILs) that warrant review based on fault tree analysis or working group observations.

Note: NASA has closed this Space Shuttle Program (SSP) action through the formal Program Requirements Control Board (PRCB) process. The following summary details NASA's response to the SSP and any additional work NASA intends to perform beyond the SSP action.

BACKGROUND

The purpose of failure mode and effects analyses (FMEAs) and critical items lists (CILs) is to identify potential failure modes of hardware and systems and their causes, and to assess their worst-case effect on flight. A subset of the hardware analyzed in the FMEA becomes classified as critical, based on the risks and identified undesirable effects and the corresponding criticality classification assigned. These critical items, along with supporting acceptance rationale, are documented in a CIL that accepts the design.

The analysis process involves the following phases:

1. Perform the design analysis.
2. For critical items, assess the feasibility of design options to eliminate or further reduce the risk. Consideration is given to enhancing hardware specifications, qualification requirements, manufacturing, and inspection and test planning.
3. Formulate operating and maintenance procedures, launch commit criteria, and flight rules to eliminate or minimize the likelihood of occurrence and the effect associated with each failure mode. Formally document the various controls identified for each failure mode in the retention rationale of the associated CIL, and provide assurance that controls are effectively implemented for all flights.

NASA IMPLEMENTATION

In preparation for return to flight (RTF), NASA will develop a plan to selectively evaluate the effectiveness of the SSP FMEA/CIL process and assess the validity of the documented controls associated with the SSP CIL. Initially, each project and element will participate in this effort by identifying those FMEAs/CILs that warrant revalidation based on their respective criticality and overall contribution to design element risk. In addition, STS-107 investigation findings and working group observations affecting FMEA/CIL documentation and risk mitigation controls will be assessed, properly documented, and submitted for SSP

approval. If the revalidation assessment identifies a concern regarding effective implementation of controls, the scope of the initial review will be expanded to include a broader selection of components.

This plan will vary according to the specific requirements of each project, but all plans will concentrate revalidation efforts on FMEA/CILs that have been called into question by investigation results or that contribute the most significant risks for that Program element. Revalidation efforts include

1. Reviewing existing STS-107 investigation fault trees and working group observations to identify areas inconsistent with or not addressed in existing FMEA/CIL risk documentation.
 - a. Verifying the validity of the associated design information, and assessing the acceptability of the retention rationale to ensure that the associated risks are being effectively mitigated consistent with SSP requirements.
 - b. Establishing or modifying SSP controls as required.
 - c. Developing and revising FMEA/CIL risk documentation accordingly.
 - d. Submitting revised documentation to the SSP for approval as required.
2. Assessing most significant SSP element risk contributors.
 - a. Identifying a statistically significant sample of the most critical CILs from each element project. Including those CILs in which ascent debris generation is a consequence of the failure mode experienced.
 - b. Verifying that criticality assignments are accurate and consistent with current use and environment.
 - c. Validating the SSP controls associated with each item to ensure that the level of risk initially accepted by the SSP has not changed.

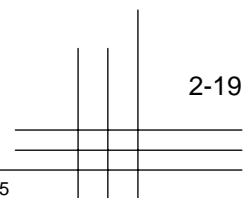

1. Establishing or modifying Program controls as required.
2. Developing and revising FMEA/CIL risk documentation accordingly.
3. Submitting revised documentation to the SSP for approval as required.
- d. Determining if the scope of the initial review should be expanded based on initial results and findings. Reassessing requirements for performance of FMEAs on systems previously exempted from SSP requirements, such as the Thermal Protection System, select pressure and thermal seals, and certain primary structures.

The System Safety Review Panel (SSRP) will serve as the forum to review the project assessment of the validity and applicability of the CIL retention rationale. The SSRP will review any updates to baselined CILs.

STATUS

Each project and element is in the process of reviewing its accepted risk FMEAs/CILs according to the requirements baselined in Program requirements document. The PRCB has approved each element's plan and schedule for these ongoing reviews. Should some of the FMEA/CIL waivers not pass this review, NASA may have to address hardware or process changes.

FORWARD WORK

None.

SCHEDULE

Responsibility	Due Date	Activity/Deliverable
SSP	(Ongoing)	Projects status reports to PRCB
SSP	(Ongoing)	Completion of review



Space Shuttle Program Return to Flight Actions

Space Shuttle Program Action 10

NASA will review Program, project, and element contingency action plans and update them based on *Columbia* mishap lessons learned.

Note: NASA is closing this Space Shuttle Program (SSP) action through the formal Program Requirements Control Board process. The following summary details NASA's response to the SSP action and any additional work NASA intends to perform beyond the SSP action.

BACKGROUND

The SSP Program Requirements Control Board has directed all of its projects and elements to review their internal Contingency Action Plans (CAPs) for ways to improve their emergency response processes.

NASA IMPLEMENTATION

The SSP has updated and approved the Program-level CAP to reflect the lessons learned from the *Columbia* accident. SSP projects and elements are updating their subordinate plans as required to reflect changes to the Program CAP. The Program document has been distributed to all NASA Centers that support human space flight, and orientation training has been conducted across the SSP. A simulation to exercise a realistic contingency situation of the CAP was successfully completed in January 2005.

In implementing changes to the CAP, the SSP incorporated many of the specific lessons learned from the *Columbia* experience while striving to maintain a generic plan that would be useful in a wide range of potential contingency situations. The resulting document is optimized to serve as a rigorous first-response checklist, then to give a menu of possible longer-term response outlines from which to choose based upon the severity of the contingency, its location, and the involvement and responsibilities of other federal, state, and local agencies and foreign governments. Structured responses to Space Shuttle launch contingencies such as trans-oceanic aborts and East Coast abort landings have been retained in the appropriate appendices.

STATUS

Closed.

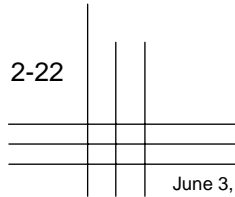



Space Shuttle Program Return to Flight Actions

Space Shuttle Program Action 11

Based on corrosion recently found internal to body flap actuators, NASA will inspect the fleet leader vehicle actuators to determine the condition of similar body flap and rudder speed brake actuators.

Note: NASA has closed this Space Shuttle Program action through the formal Program Requirements Control Board process. The following summary details NASA's response to the Space Shuttle Program action and any additional work NASA intends to perform beyond the Space Shuttle Program action.

BACKGROUND

Internal corrosion was found in Orbiter Vehicle (OV)-104 body flap (BF) actuators in Fall 2002, and subsequently in the OV-103 BF actuators. In addition, corrosion pits were discovered on critical working surfaces of two BF actuators (e.g., planetary gears and housing ring gears), and general surface corrosion was found inside other BF actuators.

Since the rudder speed brake (RSB) actuator design and materials are similar to BF actuators, similar internal corrosion in RSB actuators could adversely affect performance of Criticality 1/1 hardware. Any existing corrosion will continue to degrade the actuators. The loss of RSB functionality due to "freezing up" of the bearing or jamming caused by broken gear teeth would cause Orbiter loss of control during entry. The operational life of the installed RSB actuators is outside of Orbiter and industry experience. The Space Shuttle Program (SSP) and the Space Flight Leadership Council (SFLC) approved removal of all RSB actuators to investigate corrosion, wear, and hardware configuration.

NASA IMPLEMENTATION

The SSP directed the removal and refurbishment of all four OV-103 RSB actuators. The SSP spares inventory included four RSB actuators. All spare RSB actuators were returned to the vendor for acceptance test procedure (ATP) revalidation. All passed ATP and were returned to logistics. The removed (original) OV-103 RSB actuators were disassembled, and one of the actuators, actuator 4, was found to have the planetary gear set installed in reverse. Analysis showed that this condition presented negative margins of safety for the most severe load cases. In addition to the reversed planetary gears and corrosion, fretting and wear were documented on some of the gears from OV-103 RSB actuators. Surface pits resulting from the fretting have led to microcracks in some of the gears.



Figure SSP 11-1. OV-103 RSB actuator.

As a result of the reversed planetary gear set discovery, the spare actuators, installed in OV-103, were X-rayed, and actuator 2 was also found to have the planetary gear set installed in reverse. The RSB actuators were removed from OV-103 and shipped to the vendor, where they were disassembled and inspected. Following repair of spare actuator 2, the spare actuators were reinstalled on OV-103.

RSB actuators from OV-104 and OV-105 were shipped to the vendor for disassembly and inspection. For OV-104, the actuators were assembled from existing OV-105 parts and new parts, all within specification. All actuators for OV-104 will be installed before its next flight. A new ship-set of actuators was procured for OV-105 and will be installed before its next flight.

STATUS

Complete.

FORWARD WORK

None.

SCHEDULE

Responsibility	Due Date	Activity/Deliverable
SSP	Jul 03 (Completed)	Initial plan reported to SFCLC
SSP	Aug 03 (Completed)	ATP Spare RSB actuators at vendor and returned to Logistics
SSP	Sep 03 (Completed)	OV-103 RSB actuators removed and replaced with spares
SSP	Mar 04 (Completed)	RSB findings and analysis completed

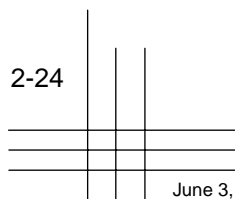



Space Shuttle Program Return to Flight Actions

Space Shuttle Program Action 12

NASA will review flight radar coverage capabilities and requirements for critical flight phases.

Note: NASA has closed this Space Shuttle Program Action through the formal Program Requirements Control Board process. The following summary details NASA's response to the Space Shuttle Program Action and any additional work NASA intends to perform beyond the Space Shuttle Program Action.

BACKGROUND

In addition to Shuttle vehicle ascent imaging by photo and visual means, NASA uses radar systems of the Air Force Eastern Range to monitor Space Shuttle launches. There are several C-Band radars and a Multiple Object Tracking Radar (MOTR) used to monitor the ascent trajectory. Although not specifically designed to track debris, these radars have some limited ability to resolve debris separating from the ascending vehicle, particularly between T+30 to T+250 seconds.

During the STS-107 launch, the MOTR, which is specifically intended for the purpose of tracking several objects simultaneously, was unavailable.

NASA IMPLEMENTATION

The Space Shuttle Systems Engineering and Integration Office commissioned the Ascent Debris Radar Working Group (ADRWG) to characterize the debris environment during a Space Shuttle launch and to identify/define the return signals seen by the radars. Once the capabilities and limitations of the existing radars for debris tracking were understood, this team researched proposed upgrades to the location, characteristics, and post-processing techniques needed to provide improved radar imaging of Shuttle debris.

The specific technical goal of the ADRWG was to improve the radars' ability to resolve, identify, and track potential debris sources. Another goal was to decrease the postlaunch data processing time such that a preliminary radar assessment is available more rapidly, and to more easily correlate the timing of the ascent radar data to optical tracking systems. Successful implementation of a radar debris tracking system will have an advantage over optical systems as it is not constrained by ambient lighting or cloud interference. It further has the potential to maintain insight into the debris shedding environment beyond the effective range of optical tracking systems.

STATUS

The ADRWG was initiated in August 2003. After a review of existing debris documentation and consultation with radar experts within and outside of NASA, a planning presentation outlining the approach and process to be used was provided to the Space Shuttle Program (SSP) office in September 2003. A number of workshops were held at NASA centers and at Wright-Patterson Air Force Base to characterize the debris sources and how they appeared on radar, and to analyze the potential debris threat to the Shuttle represented by the radar data.

The ADRWG constructed a composite list of potential debris sources. This list was coordinated with all of the Shuttle elements and will be the basis for analysis of radar identification capabilities such as radar cross section (RCS) signatures. A series of critical radar system attributes was compiled, and a number of existing radar systems has been evaluated against these criteria. Data analysis included comparisons of radar data with known RCS signatures and ballistic trajectories.

On January 13, 2004, the ADRWG provided its initial findings and draft recommendations to the SSP. The team found that the existing range radars were not well suited to perform the Shuttle debris assessment task because of their siting and configuration. Only a properly sited and configured radar system can be expected to provide the insight needed to assess the debris threat during a Shuttle launch. A candidate architecture, using several elements of the Navy Mobile Instrumentation System (NMIS), formed the basis of the radar system for return to flight (RTF). A long-term, highly capable architecture was also proposed for an on-board debris radar detection capability. Development of this potential capability will continue. However, this capability will not be available for RTF.

Radar field testing included a series of six Booster Separation Motor firings to characterize how the plume contributed to the existing radar data. These tests were completed at the U.S. Navy's China Lake facility in

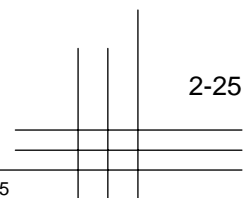

February 2004. A comprehensive set of RCS measurements of candidate Shuttle debris material has been completed at Wright-Patterson Air Force Base and was correlated to dynamic field results at the Naval Air Station at Patuxent River in June 2004.

The final SSP presentation, including field results, prior mission analysis, and final recommendations, was completed in April 2004. To provide adequate threat assessment, a ground-based radar system must include both wideband capabilities to provide the precise position of debris as well as Doppler capabilities for differential motion discrimination. Also necessary are near-real-time data reduction and display in remote facilities, ballistic coefficient traceability, and the highest calibration to meet Range Certification Standard STD 804-01. To meet these requirements, NASA, in cooperation with the U.S. Navy and the U.S. Air Force, is developing a radar plan that involves relocation of the U.S. Navy midcourse radar from Puerto Rico to Cape Canaveral. This radar provides wideband, coherent C-band radar coverage, which will be supplemented with continuous pulse Doppler X-band ship-based radar mounted on the Solid Rocket Booster recovery ships.

A Memorandum of Understanding between NASA and the U.S. Navy is in work for implementation of flight radar coverage. Proof of concept using debris radar was accomplished using the U.S. Navy's NMIS during expendable vehicle launches from the Cape Canaveral Air Force Station.

FORWARD WORK

None.

SCHEDULE

Responsibility	Due Date	Activity/Deliverable
ADRWG	Nov 03 (Completed)	Complete Radar Study
ADRWG	Nov 03 (Completed)	Finalize finding and recommendations
ADRWG	Apr 04 (Completed)	Provide final list of debris sources
SSP	Apr 04 (Completed)	Baseline requirements and initiate implementation – Present to SSP Program Requirements Control Board

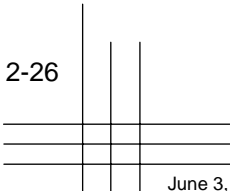



Space Shuttle Program Return to Flight Actions

Space Shuttle Program Action 13

NASA will verify that hardware processing and operations are within the hardware qualification and certification limits.

Note: NASA has closed this Space Shuttle Program Action through the formal Program Requirements Control Board process. The following summary details NASA's response to the Space Shuttle Program Action and any additional work NASA intends to perform beyond the Space Shuttle Program Action.

BACKGROUND

An Orbiter Project Office investigation into several Orbiter hardware failures identified certification environments that were not anticipated or defined during original qualifications. Some examples of these include drag chute door pin failure, main propulsion system flow liner cracks, and environmental control and life support system secondary O₂/N₂ flex hose bellows failure.

Because of these findings by the Orbiter Project Office, all projects and elements are assessing all Space Shuttle hardware operations according to requirements for certification/qualifications. If a finding is determined to be a constraint to flight, the project or element will immediately report the finding to the PRCB for disposition.

NASA IMPLEMENTATION

On December 17, 2002, prior to the *Columbia* accident, the SSP Council levied an action to all SSP projects and elements to review their hardware qualification and verification requirements and to verify that processing and operating conditions are consistent with the original hardware certification (memorandum MA-02-086). At the SSP Council meeting April 10-11, 2003, each Program project and element identified that its plan for validating that hardware operating and processing conditions, along with environments or combined environments, is consistent with the original certification (memorandum MA-03-024). The PRCB has reissued this action as a return to flight action.

Revalidating the qualification and verification of SSP hardware is critical to identifying areas of unrecognized risk in the Space Shuttle system prior to return to flight. Through this process, we have ensured that the Space Shuttle hardware should continue to function within its design specifications for the remainder of the Space Shuttle's service life.

STATUS

Interim status reports from the SSP project and element organizations were presented to the SSP PRCB throughout the year 2004. As a result of this proactive review, NASA identified several areas for additional scrutiny, such as the Solid Rocket Booster Separation Motor debris generation and Orbiter nose wheel steering failure modes. This attitude of critical review, even of systems that have consistently functioned within normal specifications, has significantly improved the safety and reliability of the Shuttles and reduced the risk of future problems.

The SSP projects and elements have completed their assessment of the qualification and verification of all Criticality 1 Space Shuttle hardware. The assessments showed no constraints to the hardware certification limits.

FORWARD WORK

Certification assessments for certain lower criticality hardware will continue through 2006.

SCHEDULE

Responsibility	Due Date	Activity/Deliverable
All SSP project and element organizations	Mar 05 (Completed)	Present certification assessment results to SSP PRCB for return to flight commitments
All SSP project and element organizations	Dec 06	Present certification assessment results to SSP PRCB for any remaining post-return to flight commitments

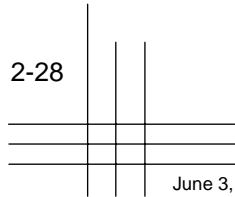



Space Shuttle Program Return to Flight Actions

Space Shuttle Program Action 14

Determine critical Orbiter impact locations and TPS damage size criteria that will require on-orbit inspection and repair. Determine minimum criteria for which repairs are necessary and maximum criteria for which repair is possible.

This Space Shuttle Program Action is addressed by
Columbia Accident Investigation Board Recommendations
3.3-2 and 6.4-1 of this Implementation Plan.

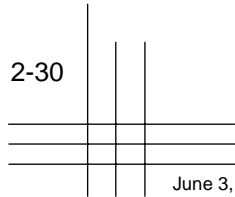



Space Shuttle Program Return to Flight Actions

Space Shuttle Program Action 15

NASA will identify and implement improvements in problem tracking, in-flight anomaly (IFA) disposition, and anomaly resolution process changes.

Note: NASA has closed this Space Shuttle Program action through the formal Program Requirements Control Board process. The following summary details NASA's response to the Space Shuttle Program action and any additional work NASA intends to perform beyond the Space Shuttle Program action.

BACKGROUND

Bipod ramp foam was released during the launch of STS-112 in October 2002. After the mission, the Space Shuttle Program (SSP) considered this anomaly and directed the External Tank Project to conduct the testing and analysis necessary to understand the cause of bipod foam release and present options to the SSP for resolution. The Program did not hold completion of these activities as a constraint to subsequent Shuttle launches because the interim risk was not judged significant. The *Columbia* accident investigation results clearly disclose the errors in that engineering judgment.

NASA IMPLEMENTATION

NASA conducted a full review of its anomaly resolution processes with the goal of ensuring appropriate disposition of precursor events in the future. As a part of the safety and mission assurance changes discussed in NASA's response to *Columbia* Accident Investigation Board Recommendation 9.1-1, NASA has transitioned ownership of the Failure Modes and Effects Analysis/Critical Items List and the determination of what constitutes an in-flight anomaly (IFA) to the newly established Independent Technical Authority (ITA). Johnson Space Center (JSC) ITA members are ex-officio members of the Program forums and advisory members of the Program Mission Management Teams. The JSC ITA will remain cognizant of all in-flight issues. After each flight, the Shuttle Program Requirements Control Board and the International Space Station Mission Evaluation Room Manager will remain responsible for the disposition of their respective IFAs. The ITA Program Lead Engineers may make recommendations to the programs regarding any in-flight issues, whether dispositioned as IFAs or not. This will ensure an independent review of potentially hazardous issues.

However, the primary responsibility for identifying IFAs remains with the SSP. Accordingly, in support of the return to flight activity, the SSP, supported by all projects and elements, identified and implemented improvements to the

problem tracking, IFA disposition, and anomaly resolution processes. A team reviewed SSP and other documentation and processes, as well as audited performance for the past three Shuttle missions. The team concluded that, while *clarification* of the Problem Reporting and Corrective Action (PRACA) System Requirements is needed, the *implementation* of those requirements appears to be the area that has the largest opportunity for improvement. The team identified issues with PRACA implementation that indicate misinterpretations of definitions, resulting in misidentification of problems, and noncompliance with tracking and reporting requirements.

The corrective actions include:

1. Train all SSP elements and support organizations on PRACA requirements and processes. The SSP community is not as aware of the PRACA requirements and processes as they should be to avoid repeating past mistakes.
2. Updated NSTS 08126 to clarify the in-flight anomaly (IFA) definition, delete "program" IFA terminology, and add payload IFAs and Mission Operations Directorate (MOD) anomalies to the scope of the document.
3. Updated the PRACA nonconformance system (Web PCASS) to include flight software, payload IFAs, and MOD anomalies. These changes will be incorporated in a phased approach. The goal is to have a single nonconformance tracking system.

STATUS

NASA and its contractors will provide ongoing training to ensure that all SSP elements and support organizations understand the PRACA system and are trained in entering data into PRACA.

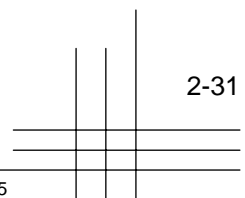

SCHEDULE

Responsibility	Due Date	Activity/Deliverable
JSC	Aug 04 (Completed)	Approve CR to update NSTS 08126, PRACA Systems Requirements



CAIB Observations

The observations contained in Chapter 10 of the CAIB Report expand upon the CAIB recommendations, touching on the critical areas of public safety, crew escape, Orbiter aging and maintenance, quality assurance, test equipment, and the need for a robust training program for NASA managers. NASA is committed to examining these observations and has already made significant progress in determining appropriate corrective measures. Future versions of the Implementation Plan will expand to include additional suggestions from various sources. This will ensure that beyond returning safely to flight, we are institutionalizing sustainable improvements to our culture and programs that will ensure we can meet the challenges of continuing to expand the bounds of human exploration.

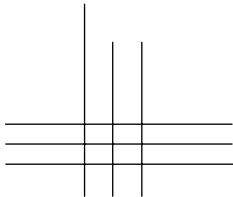



Columbia Accident Investigation Board

Observation 10.1-1

NASA should develop and implement a public risk acceptability policy for launch and re-entry of space vehicles and unmanned aircraft.

BACKGROUND

Space flight is not a risk-free endeavor. All space flight missions, particularly those going to orbit or deeper into space or returning to Earth from space, pose some level of risk to uninvolved people. No matter how small, there is always some potential for failure during flight. If a failure occurs, there will be a possibility of injuring the general public. Overall, NASA's safety approach ensures that any risk to the public associated with space flight is identified and controlled.

People knowingly and unknowingly accept risk throughout their daily lives. Common sources of risk include driving in an automobile, participating in sports, and potential exposure to hazards in the home and the workplace. Our goal is to ensure that a space flight does not add significantly to the public's overall risk of injury. However, a decision to accept greater public risk may be appropriate if the benefits of the mission are great. Such a decision is based on a comprehensive assessment of the risks and a clear understanding of the benefits associated with taking those risks.

As the government agency directing and controlling space flight operations, NASA is legally responsible for public safety during all phases of operation. Throughout its history, NASA has met this responsibility. No NASA space flight has ever caused an injury to any member of the general public.

Historically, NASA has had a general risk management policy designed to protect the public as well as NASA personnel and property, codified in NASA Policy Directive (NPD) 8700.1A. This policy calls for NASA to implement structured risk management processes using qualitative and quantitative risk-assessment techniques to make decisions regarding safety and the likelihood of mission success. The policy requires program managers to implement risk management policies, guidelines, and standards within their programs. Although this Agency-level risk policy does not specifically address range flight operations, individual NASA safety organizations, such as those at Wallops Flight Facility and Dryden Flight Research Center, have well-established

public and workforce risk management requirements and processes at the local level. Also, NASA has always worked closely with the safety organizations at the U.S. Air Force's Eastern and Western Ranges to satisfy public risk requirements during Space Shuttle and other NASA space flight operations.

The *Columbia* Accident Investigation Board (CAIB) suggested that NASA should "develop and implement a public risk acceptability policy." Although the CAIB did not make this a return to flight recommendation, NASA has pursued the development and implementation of this policy as part of its efforts to "raise the bar" and has worked toward the goal of completing this effort for return to flight. The NASA Operations Council has approved the range safety risk policy approach and its implementation for Shuttle return to flight. We have succeeded in completing the draft policy document containing the risk policy and are making every effort to accomplish final approval of the document prior to return to flight, but final approval of the policy document might not be accomplished until June 2005.

NASA IMPLEMENTATION

Policy Overview

NASA has developed a public risk policy that incorporates the Agency's approach for identifying and managing the risk to the general public that is associated with space flight operations, such as launch and entry of space flight vehicles and the operation of crewless aircraft. This new Agency-level policy is documented in Chapter 3 of NASA Procedural Requirement (NPR) 8715.XX, NASA Range Safety Program. NASA intends to implement this policy for the upcoming Space Shuttle return to flight and all future NASA space flight missions.

Development of any Agency policy requires significant coordination among the NASA Centers and programs that will be responsible for its implementation. The NASA Headquarters Office of Safety and Mission Assurance established a risk policy working group with members throughout the Agency and chartered the group to perform the initial development and coordination of the new public

risk policy. The working group coordinated with the interagency range safety community and consulted with experts in applying public and workforce risk assessment to the operation of experimental and developmental vehicles. The CAIB's lead investigator for the issue of public risk participated in many of the working group's activities. This inclusive approach helped to ensure that NASA's new policy fully responds to the related CAIB findings and observations.

The NASA public risk policy incorporates a widely accepted risk management approach that has been used successfully at United States launch sites for addressing the risk to the public associated with space flight operations. The policy includes requirements for risk assessment, risk mitigation, and acceptance/disposition of risk to the public and workforce. The policy incorporates performance standards for assessing risk and contains acceptable risk criteria. Finally, the policy requires review and approval by NASA Senior Management for any proposed operations where the risk to the public or workforce might exceed the public risk criteria. Such approval may be on a case-by-case or programmatic basis.

Public risk policies in general incorporate established risk criteria that a majority of the affected operations are expected to satisfy. Such criteria define a standard level of risk that the approval authority, in this case the NASA Administrator, accepts for normal day-to-day operations. The establishment of public risk criteria at the Agency level helps to facilitate the acceptance of risk in operational environments where it would be impractical for upper management to be involved in making every risk acceptance decision on a case-by-case or programmatic basis.

There are primarily two types of risk criteria that the public risk policy must address. The first type of risk is referred to as "individual risk." The second type of risk is referred to as "collective risk." The NASA public risk policy incorporates criteria for both types of risk. NASA's public risk criteria are consistent with those used throughout the government, the commercial range community, and with other industries whose activities are potentially harmful to the general public.

The measurement for individual risk represents the probability that an individual at a specific location could experience a serious injury for a single event, such as the launch or entry of a Space Shuttle, if a large number of events could be carried out under identical circumstances.

For example, the public individual risk criterion used throughout the space flight operations community and in the new NASA policy is less than or equal to one in a million. In other words, if an individual were to attend one

million identical launches, that person would be expected to experience a serious injury once or less during those million launches (i.e., a relatively low risk). The individual risk criterion is typically enforced by establishing a "keep-out" zone for each launch or entry such that if all individuals remain outside the keep-out zone their individual risk will satisfy the criterion. All NASA launches including Shuttle launches have always, and will continue to employ keep-out zones in the vicinity of each launch site where the risk approaches the one-in-a-million threshold; additionally, NASA will now employ keep-out zones at each landing site. Enforcement of keep-out zones for launches and landings will ensure that the one-in-a-million individual risk criterion is satisfied for all of the public, including visitors to a NASA launch or landing site.

The measurement for collective risk is the average number of serious injuries expected within a defined population for a single event, such as a Space Shuttle launch or entry, if a large number of events could be carried out under identical circumstances. Although the individual risk to members of an exposed population may be very low for a single event, as the number of people within the exposed population increases, the collective risk will increase. The collective risk can be controlled to a reasonable level by controlling the exposed population.

For example, if a group of 100,000 people attends a launch and all of the people are located at the border of the keep-out zone such that each person has an individual risk equal to one in a million, the collective risk for the group would equate to one in a million multiplied by 100,000 or an average of one serious injury within the group in 10 launches. This is an exaggerated example, but it serves to demonstrate how collective risk will continue to increase as the number of people that have any significant individual risk continues to increase. Placing a collective public risk limit on a space flight provides the impetus for the Agency to consider the number of people exposed to a given hazardous condition and place limits on the exposed population.

The criteria for individual and collective risk are established at levels considered acceptable for a majority of the expected operations. Within our space flight community, public risk is assessed to ensure that the risk is understood and is within acceptable limits for day-to-day operations. As with all risk policies, NASA's public risk policy allows for the acceptance of any risk that exceeds the established criteria through a variance or other appropriate process after all reasonable risk-reduction strategies have been employed. NASA Senior Management will make such decisions when warranted on a case-by-case or programmatic basis, with a thorough understanding of any additional risk and the benefits

to be derived from taking the additional risk. Within NASA, the ultimate authority for accepting any risk above the established criteria lies with the NASA Administrator, who may delegate related authority. Authority with regard to the public risk policy is delegated to the Independent Technical Authority and the Center Director or Headquarters-designated manager responsible for the vehicle program with concurrence by the official responsible for the range, launch site, or landing site. Note that NASA's acceptance of the public risk associated with Space Shuttle flights is on a programmatic basis through establishment of the risk policy, which includes a Shuttle-specific provision and requires Senior Management approval of the Shuttle Range Safety Risk Management Plan. NASA does not foresee the need to process any variance to the new risk policy for return to flight or any future Space Shuttle flight.

Space Shuttle Launches

NASA will continue to coordinate fully with the Air Force range safety community to determine the risk to the public associated with each Space Shuttle launch from the Kennedy Space Center (KSC). NASA and the Air Force have worked closely to improve the input data used in the risk assessments to ensure that results are based on the best possible estimate of nominal and off-nominal vehicle behavior. NASA has updated personnel categories and ensured workforce and visitor locations on KSC are accurately modeled. For each Shuttle launch, the Air Force will continue to use its risk analysis tools to provide a best estimate of the risks to the general public, visitors to the launch site, and the workforce. The Air Force, in coordination with NASA, will continue to update these models and to ensure the latest technologies and input data are employed.

All Space Shuttle launches are expected to satisfy the public risk criteria contained in NASA's new policy. Shuttle launches have always satisfied Air Force public risk criteria for individual risk and the Air Force collective risk criteria for the general public outside of KSC. Those criteria are reflected in NASA's new policy. NASA has not previously applied a collective risk criterion to people on KSC during Shuttle launches. Application of a collective public risk criterion to people on KSC represents the primary change affecting launch that will be in place for Shuttle return to flight.

The new NASA policy incorporates an annual public collective risk criterion of one serious injury in a thousand flight years, which is a historical basis for the per-launch public risk criteria used by the federal ranges. Future Space Shuttle launches will satisfy this annual criterion. NASA expects to average five Shuttle launches per year to complete the International Space Station. One-in-a-thousand years

divided by an average of five launches per year yields a per-launch risk criterion of 200 casualties in a million launches. This 200-in-a-million risk can be allocated between on-site and off-site collective public risk. The policy limits collective risk to the public outside KSC to 30 in a million per launch, which remains consistent with the Air Force public launch risk criterion enforced by the Eastern Range. This means that NASA will attempt to apply a limit of 170 in a million to the public on site at KSC during a Shuttle launch. A NASA KSC management review board will evaluate the risk assessment results provided by the Air Force for each Shuttle launch and determine the appropriate risk mitigation options needed to ensure that the risk criteria are satisfied. This will include identifying where people may be located on KSC during a launch and how many will be allowed at each location.

NASA's implementation of the public risk policy will ensure that any risk associated with attending a Shuttle launch at KSC is kept at a reasonable level. Individual risk to the vast majority of the public, those who are not on KSC, will be significantly lower than the one-in-a-million individual risk criterion. Satisfying the collective risk criterion will result in limitations on the numbers of visitors allowed to attend a Shuttle launch at KSC and where these visitors can be located. However, NASA is confident that, through proper establishment of viewing sites and close controls on the numbers of people at each site, KSC will continue to accommodate a reasonable number of visitors for each Shuttle launch, consistent with NASA's mission to inspire the next generation of explorers.

Shuttle Orbiter Entries

Assessment of public risk associated with Orbiter entries is a new requirement for the Space Shuttle Program after the *Columbia* accident. Unlike Shuttle launch, for which the Air Force's risk assessment tools and models were previously well established, the Space Shuttle Program has had to develop the tools and models needed to assess entry public risk. Encouraged by the CAIB Report, this has been a significant effort over the past year and a half for NASA civil servant and contractor personnel.

Because the trajectories, failure modes, and hazard characteristics are very different for entry as compared to launch, new and innovative approaches to risk modeling had to be developed. For example, vehicle breakup during a launch failure is typically modeled as instantaneous (i.e., as in an explosion). The *Columbia* accident demonstrated that a high-altitude structural failure of the Orbiter results in a progressive breakup over a relatively long period of time as pieces separate from the vehicle and then even break into smaller pieces as they fall. Personnel at the NASA Johnson Space Center developed new modeling techniques capable

of accounting for progressive vehicle breakup. The *Columbia* accident represents just one type failure that can occur during an entry. There are other failure modes, such as potential loss of control late in flight at a relatively low altitude. Such a failure would have vehicle breakup characteristics that are very different from a high-altitude failure. NASA has developed risk assessment models that account for the different failure modes and other contributors to public risk associated with Shuttle Orbiter entries. NASA has performed the public risk assessment for Shuttle Orbiter entries as part of the risk management process, and will continue to update the entry risk models and ensure the latest technologies and input data are employed.

All future NASA entries, including Shuttle Orbiter entries, will satisfy the one-in-a-million individual public risk criterion contained in the new NASA policy. The Shuttle entry risk assessments have demonstrated that a person would have to be standing in an area close to the approach end of the runway during an Orbiter landing for that person's individual risk to exceed the criterion. With establishment of appropriate keep-out zones, NASA will ensure that the individual risk criterion is satisfied during each future entry operation.

With regard to the public collective risk criteria associated with entry operations, the new NASA policy takes a two-part approach. The first part of the entry risk policy applies specifically to Shuttle. This provision recognizes Shuttle's established design and operational constraints, which were developed more than 25 years ago without a specific requirement for managing public entry collective risk. Under this provision, KSC will continue as the Shuttle's primary landing site, with Edwards Air Force Base (EAFB) and White Sands Missile Range (WSMR) as backups. The Space Shuttle Program has implemented new flight rules that address the need for public risk abatement in the selection of the landing site for each mission.

The second part of NASA's new entry public collective risk policy contains risk criteria that will apply to future space flight vehicles. These risk criteria were developed in consultation with the national range community and are intended to serve the Nation's space program into the future as new vehicles are developed and entry operations become more common.

NASA has assessed the relative public collective risk associated with all possible Shuttle entry trajectories into the three landing sites from the International Space Station orbit inclination of 51.6 degrees. On average, entry opportunities into KSC are half the public risk level of entries into EAFB. On average, entry opportunities into WSMR are

one-seventh the public risk level of EAFB and one-third the public risk level of KSC. Although entries to WSMR represent a lower average public collective risk, WSMR does not have the infrastructure needed to safely and efficiently support regular Shuttle landings. WSMR and EAFB are best used as backups in conjunction with the Space Shuttle Program's use of flight rules designed to balance all safety concerns in the selection of a landing site.

The risk to the general public during entry has been significantly reduced for Shuttle return to flight as compared to the past. Most of the improvements developed for return to flight either directly or indirectly serve to improve public safety during entry. For example, improvements to the External Tank and thermal protection systems and efforts to reduce critical debris all serve to ensure a successful and, therefore, safe flight for both the crew and the public. Also, we now have an unprecedented capability to inspect and assess the operational status of safety-critical thermal protection systems while on orbit. The flight rules for entry will account for the Orbiter systems' operational status and will balance crew and public safety concerns when selecting among the available entry opportunities and landing sites. NASA is confident that this balanced approach is the wisest. The bottom line is that the Orbiter will normally land at KSC; but if the Orbiter experiences system failures or is considered compromised, the flight rules provide guidelines for further abating risk to the public while carefully considering the overall risk to the crew. In cases that pose a threat to the public, WSMR becomes the preferred landing site.

The criterion for entry collective risk represents the only portion of NASA's new policy that contains a Space Shuttle-specific provision. In addition to this provision, all other aspects of the NASA's public risk policy apply to the Space Shuttle for return to flight.

STATUS

In a series of meetings that culminated on February 15, 2005, the NASA Operations Council approved the range safety risk policy approach and its implementation for Shuttle return to flight. The Council directed that NPR 8715.XX, which contains the detailed policy, be entered into the Agency's formal review and approval process using the NASA Online Directives Information System (NODIS), which occurred on March 15, 2005. NASA anticipates that the final review will be complete by June 2005.

FORWARD WORK

The new NASA policy requires that each program document its safety risk management process in a written Range Safety Risk Management Plan (RSRMP) approved by the

responsible NASA officials. The Space Shuttle Program will complete its RSRMP and obtain the required approvals for return to flight.

SCHEDULE

Schedule Track to process NPR 8715.XX, NASA Range Safety Program

Action	March 2005 NODIS Review Cycle
Published Deadline for Submission to NODIS	Mar 2005 (Completed)
Comments Due	Apr 2005 (Completed)
Signature Package Prepared	May 2005 (Completed)
Final Signature Expected	Jun 2005

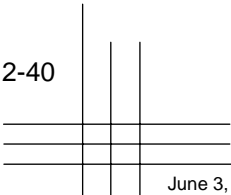



Columbia Accident Investigation Board

Observations 10.1-2 and 10.1-3

O10.1-2 NASA should develop and implement a plan to mitigate the risk that Shuttle flights pose to the general public.

O10.1-3 NASA should study the debris recovered from *Columbia* to facilitate realistic estimates of the risk to the public during Orbiter re-entry.

Note: NASA has closed these observations through the formal Program Requirements Control Board (PRCB) process. The following summary details NASA's response to the observation and any additional work NASA intends to perform beyond the *Columbia* Accident Investigation Board observation.

BACKGROUND

The *Columbia* accident raised important questions about public safety. The recovery and investigation effort found debris from the Orbiter scattered over a ground impact footprint approximately 275 miles long and 30 miles wide. Although there were no injuries to the public due to falling debris, the accident demonstrates that Orbiter breakup during entry may pose a risk to the general public.

NASA IMPLEMENTATION

The Space Shuttle Program (SSP) issued a PRCB directive to the Johnson Space Center Mission Operations Directorate to develop and implement a plan to mitigate the risk to the general public. NASA is currently studying the relative risks to persons and property associated with entry to the three primary Shuttle landing sites, and is developing plans and policies to mitigate the public risk, thus addressing Observation 10.1-2. The results of these analyses will determine if some ground tracks must be removed from consideration as normal, preplanned, end-of-mission landing opportunities. (For a complete discussion of this topic and Observation 10.1-2, see the related actions in Space Shuttle Program Action 2.)

Additionally, a multi-agency effort is being conducted between NASA, the Federal Aviation Administration (FAA), and the U.S. Air Force to study the debris recovered from

Columbia. This study addresses Observation 10.1-3. The multi-agency team has defined requirements for data collection and performed a measurement-taking trial run to define those requirements. Data collection for this study is scheduled for the period December 2004 through June 2006. The refined public risk assessments and mitigation plans will be provided in September 2006. NASA will continue to develop and implement a plan that mitigates the risk that Shuttle flights may pose to the general public prior to return to flight.

STATUS

Subsequent reports of progress and resolution will be consolidated under SSP-2, Space Shuttle Entry Overflight.

SCHEDULE

Responsibility	Due Date	Activity/Deliverable
SSP	May 04 (Completed)	Finalize Responsibilities and Requirements for Data Collection
SSP/FAA	Sep 04 (Completed)	Signed Memorandum of Agreement between NASA and the FAA

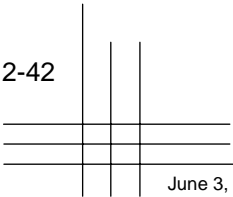



Columbia Accident Investigation Board

Observation 10.2-1

Future crewed-vehicle requirements should incorporate the knowledge gained from the *Challenger* and *Columbia* accidents in assessing the feasibility of vehicles that could ensure crew survival even if the vehicle is destroyed.

| Note: NASA has closed this observation through the formal Program Requirements Control Board (PRCB) process. The following summary details NASA's response to the observation and any additional work NASA intends to perform beyond the *Columbia* Accident Investigation Board observation.

NASA IMPLEMENTATION

In July 2003, NASA published the Human-Rating Requirements and Guidelines for Space Flight Systems policy, NPR 8705.2. This document includes a requirement for flight crew survivability through a combination of abort and crew escape capabilities. The requirements in NASA Procedural Requirement (NPR) 8705.2 are evolving to include NASA lessons learned from the Space Shuttle Program, including the lessons learned from the *Challenger* and *Columbia* accidents, Space Station operations, and other human space flight programs. NPR 8705.2 will be the reference document for the development of the planned Crew Exploration Vehicle (CEV).

On July 21, 2004, the Space Shuttle Upgrades PRCB approved the formation of the Space Craft Survival Integrated Investigation Team (SCSIIT). This multidisciplinary team, comprised of JSC Flight Crew Operations, JSC Mission Operations Directorate, JSC Engineering, Safety and Mission Assurance, the Space Shuttle Program, and Space and Life Sciences Directorate, was tasked to perform a comprehensive analysis of the two Shuttle accidents for crew survival implications. The team's focus is to combine data from both accidents (including debris, video, and Orbiter experiment data) with crew module models and

analyses. After completion of the investigation and analysis, the SCSIIT will issue a formal report documenting lessons learned for enhancing crew survivability in the Space Shuttle and for future human space flight vehicles, such as the CEV. Funding for fiscal year 2005 (FY05) and FY06 has been committed for this team's activities.

In conjunction with Space Shuttle Program activities, the Space and Life Sciences Directorate is sponsoring a contract with the University Space Research Association and the Biodynamics Research Corporation to perform an assessment of biodynamics from *Columbia* evidence. Their project plan is due November 2004.

Future crewed-vehicle spacecraft will use the products of the Space Shuttle Program and Space and Life Sciences Directorate to aid in the developments of crew safety and survivability requirements.

STATUS

Complete.

FORWARD WORK

None.

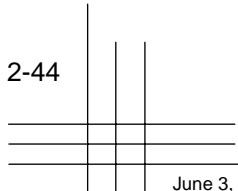



Columbia Accident Investigation Board

Observation 10.4-1

Perform an independently led, bottom-up review of the Kennedy Space Center Quality Planning Requirements Document to address the entire quality assurance program and its administration. This review should include development of a responsive system to add or delete government mandatory inspections.

This Observation is addressed in Section 2.1, Space Shuttle Program Action 1.

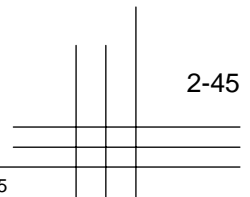

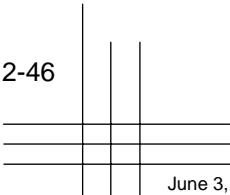



Columbia Accident Investigation Board

Observation 10.4-2

Kennedy Space Center's Quality Assurance programs should be consolidated under one Mission Assurance office, which reports to the Center Director.

Note: NASA has closed this observation through the formal Program Requirements Control Board process. The following summary details NASA's response to the observation and any additional work NASA intends to perform beyond the *Columbia* Accident Investigation Board (CAIB) observation.

BACKGROUND

Prior to the *Challenger* accident, Quality Assurance functions were distributed among the programs at Kennedy Space Center (KSC). In response to the findings of the Rogers Commission Report, KSC consolidated its Safety and Mission Assurance (SMA) functions into a single organizational entity. In May 2000, KSC once again dispersed the SMA function into each program and appropriate operational directorate. This was done to provide direct SMA support to each of the directorates, to ensure that the programs had the resources to be held accountable for safety, and to enhance acceptance of the SMA role. Although this improved the relationships between SMA and the programs, the dependence of SMA personnel on program support limited their ability to effectively perform their role.

NASA IMPLEMENTATION

In close coordination with the effort led by the Associate Administrator for Safety and Mission Assurance (AA for SMA) in responding to CAIB Recommendation 7.5-2, KSC has established a center-level team to assess the KSC SMA organizational structure. This team was chartered in October 2003 to determine plans for implementing a consolidated SMA organization. The team developed several different candidate organizational structures. To maintain the benefits of the existing organization, which had SMA functions distributed to the appropriate programs and operational directorates, and to limit disruption to ongoing processes, the KSC Center Director chose a consolidated structure organized internally by program (see figure 10.4-2-1).

On January 13, 2004, KSC formed a Return to Flight Reorganization Team, which included an SMA Reorganization Team. The first task of this team was to perform a bottom-up review of the entire SMA organization. This bottom-up review revealed the need for additional SMA resources to fully perform the required functions. The proportion of SMA personnel to the total center population was

deliberately decreased from a period shortly before the creation of the Space Flight Operations Contract (SFOC) based on the tasks transitioned to the contractor workforce; however, the bottom-up review demonstrated the need for expansion of the oversight/insight function and the associated collection of SMA data independent of the contractor-derived SMA data. As a result, additional SMA positions (Full-Time Equivalents (FTEs)) are being provided. These additional FTEs will reduce the amount of overtime currently required of the SMA professionals. They will also bring the percentage of SMA personnel to the entire KSC population back to the level that existed prior to the SFOC (see figure 10.4-2-2, chart 1). The additional positions will also decrease the dependence on the contractor for SMA data.

The bottom-up review also revealed unnecessary duplication of independent assessment resources. It was determined that if the entire KSC SMA workforce became centralized and once again independent of the programs, there would be no need for a large independent assessment organization.

When developing the single consolidated SMA organization at KSC, the SMA Reorganization Team identified the need for an Integration Division. Depicted as SA-G in figure 10.4-2-1, this Division will be responsible for ensuring consistency across the programs and for developing and implementing technical training for the SMA disciplines. The Integration Division will include discipline experts in Safety Engineering, Quality Engineering, Quality Assurance, Software Assurance, Reliability, Human Factors, and Risk Management, and it will be responsible for policy creation and review and procurement assurance.

The SMA Reorganization Team also evaluated the work required by the planned Independent Technical Authority (ITA) to incorporate its requirements into the centralized SMA organization. To fulfill these requirements, KSC has requested three FTEs for SMA/ITA within the total 58

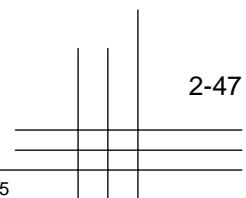

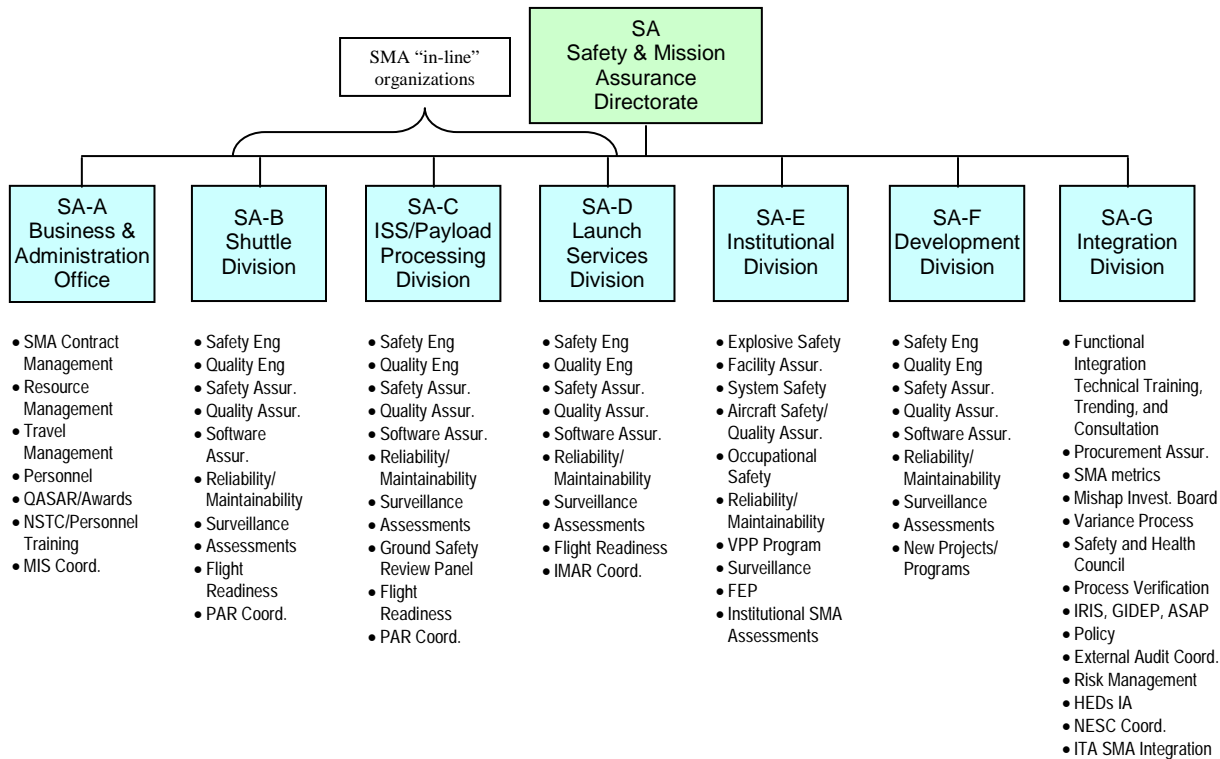

Figure 10.4-2-1. Consolidated SMA.

being requested. These three FTEs will be responsible for SMA trending and integration.

In addition to the managerial independence established by consolidation, the SMA Reorganization Team worked with the KSC financial organization and NASA Headquarters to create a new “directed service pool” funding process. The directed service pool gives the SMA Directorate the authority to determine, in consultation with the programs, the level of support it will provide to each program. The SMA Reorganization Team also developed an avenue to use the Johnson Space Center SMA contract to provide for immediate resource needs while allowing SMA to have an independent contract at the end of this fiscal year.

Finally, KSC has several ongoing initiatives to address the culture within SMA and throughout the center. Specifically, Behavioral Science Technologies Inc. has identified the need for the KSC SMA organization to work on improving its organizational culture. This process will continue after the SMA reorganization is complete.

STATUS

Complete.

FORWARD WORK

None.

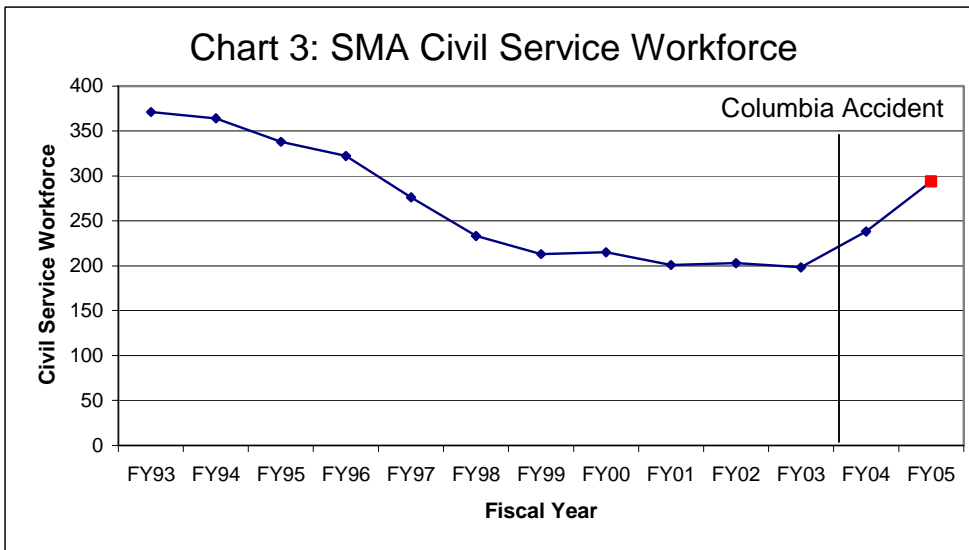
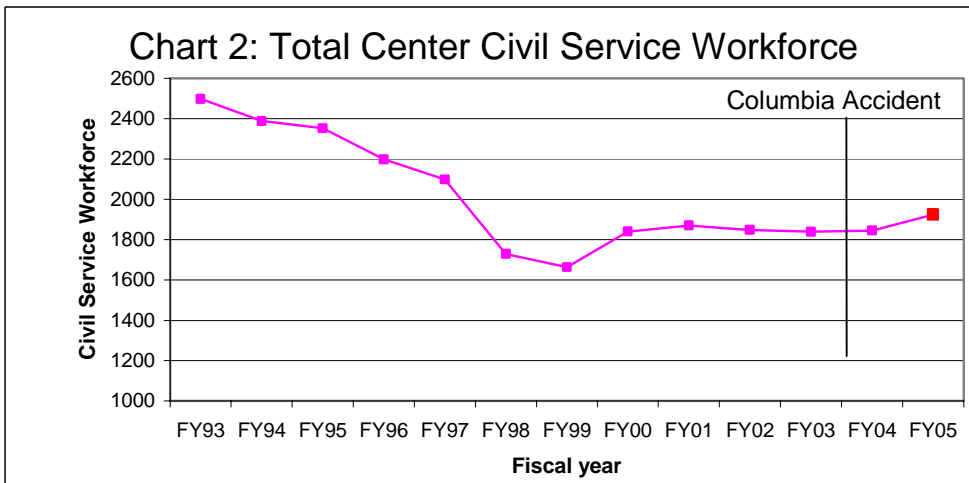
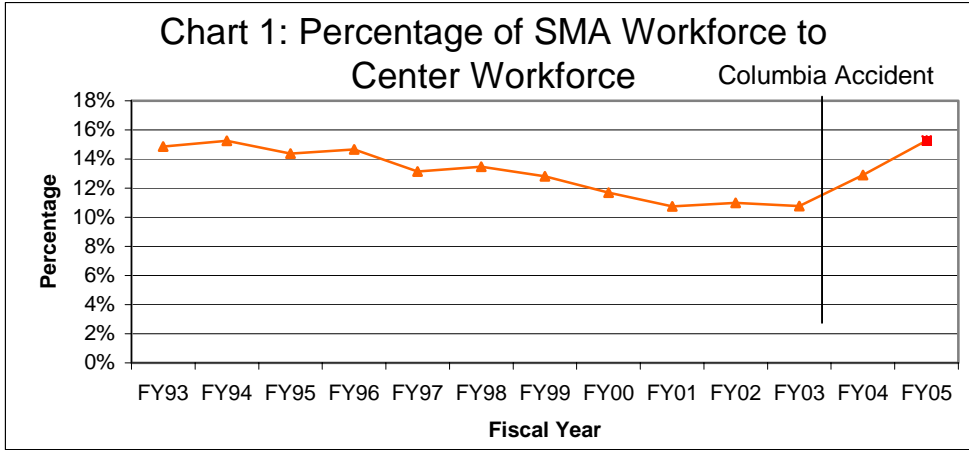

Figure 10.4-2-2. SMA workforce.

SCHEDULE

Responsibility	Due Date	Activity/Deliverable
KSC	Completed	Recommendations to KSC Center Director
KSC	Apr 04 (Completed)	Reorganization definition complete
KSC	May 04 (Completed)	Implementation complete



Columbia Accident Investigation Board

Observation 10.4-3

Kennedy Space Center quality assurance management must work with NASA and perhaps the Department of Defense to develop training programs for its personnel.

Note: NASA has closed this observation through the formal Program Requirements Control Board process. The following summary details NASA's response to the observation and any additional work NASA intends to perform beyond the *Columbia* Accident Investigation Board observation.

BACKGROUND

The *Columbia* Accident Investigation Board reported most of the training for quality engineers, process analysts, and quality assurance specialists was on-the-job training rather than formal training. In general, Kennedy Space Center (KSC) training is extensive for the specific hardware tasks (e.g., crimping, wire bonding, etc.), and includes approximately 160 hours of formal, on-the-job, and safety/area access training for each quality assurance specialist. However, there are deficiencies in basic quality assurance philosophy and skills.

NASA IMPLEMENTATION

NASA's KSC has worked with the Department of Defense (DoD) and Defense Contract Management Agency (DCMA) to benchmark their training programs and to determine how NASA can develop a comparable training program for quality engineers, process analysts, and quality assurance specialists. A team recently completed a DCMA quality assurance skills course and has provided recommendations to management. The KSC Safety and Mission Assurance (SMA) Directorate has documented the training requirements for all SMA positions and the improved training is being implemented.

STATUS

NASA continues to monitor and improve our Quality Assurance programs.

FORWARD WORK

None.

SCHEDULE

Responsibility	Due Date	Activity/Deliverable
KSC	Apr 04 (Completed)	Benchmark DoD and DCMA training programs
KSC	Aug 04 (Completed)	Develop and document improved training requirements

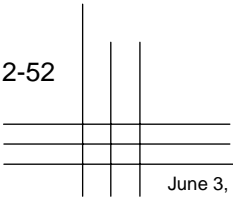



Columbia Accident Investigation Board

Observation 10.4-4

Kennedy Space Center should examine which areas of International Organization for Standardization 9000/9001 truly apply to a 20-year-old research and development system like the Space Shuttle.

BACKGROUND

The *Columbia* Accident Investigation Board Report high-lighted Kennedy Space Center's (KSC's) reliance on the International Organization for Standardization (ISO) 9000/9001 certification. The report stated, "While ISO 9000/9001 expresses strong principles, they are more applicable to manufacturing and repetitive-procedure Industries, such as running a major airline, than to a research-and-development, flight test environment like that of the Space Shuttle. Indeed, many perceive International Standardization as emphasizing process over product." ISO 9000/9001 is currently a contract requirement for United Space Alliance (USA).

NASA IMPLEMENTATION

NASA has assembled a team of Agency and industry experts to examine the ISO 9000/9001 standard and its applicability to the Space Shuttle Program. Specifically, this examination will address the following: 1) ISO 9000/9001 applicability to USA KSC operations; 2) how NASA should use USA's ISO 9000/9001 applicable elements in evaluating USA performance; 3) how NASA currently uses USA's ISO certification in evaluating its performance; and 4) how NASA will use the ISO certification in the future and the resultant changes.

STATUS

The ISO 9000/9001 review team established a methodology to determine the applicability of the ISO standard to USA operations at KSC. The ISO 9000/9001 standard establishes high-level requirements that comprise a quality management system and do not dictate the specifics of implementation for those requirements. Consequently, NASA believes the ISO 9000/9001 certification is applicable to USA KSC operations.

NASA should not and does not rely on third-party ISO 9000/9001 certification for assurance that flight preparations are appropriately and effectively performed. Rather, NASA relies on surveillance of contractor activities and compliance with contractual and USA requirements to assure flight processes and products are accurate, effective, and timely. NASA surveillance requirements to evaluate

contractor performance in processing flight/ground hardware are documented at the Agency, Program, and Center levels for both the Certificate of Flight Readiness and the Award Fee determinations.

NASA encourages ISO 9000/9001 certification because it reflects management commitment to developing and sustaining a robust quality management system. Third-party audits also provide objective looks at the contractor and opportunities for improvement. Although ISO 9000/9001 certification will not be used as a direct measure of performance, the products of a robust quality system will be used, such as measures/metrics and process improvement initiatives.

FORWARD WORK

The closure package for this item is in work. The KSC surveillance plan will be updated after completion of all planned activities.

SCHEDULE

Responsibility	Due Date	Activity/Deliverable
KSC	Jan 05 (Completed)	Identify applicability to USA KSC Operations
KSC	Jan 05 (Completed)	Proper usage of standard in evaluating contractor performance
KSC	Mar 05 (Completed)	Current usage of standard in evaluating contractor performance
KSC	Mar 05 (Completed)	Future usage of standard and changes to surveillance or evaluation of contractor
KSC	Jun 05	Presentation of Review

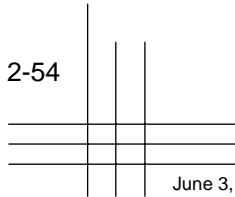



Columbia Accident Investigation Board

Observation 10.5-1

Quality and Engineering review of work documents for STS-114 should be accomplished using statistical sampling to ensure that a representative sample is evaluated and adequate feedback is communicated to resolve documentation problems.

Note: NASA has closed this Columbia Accident Investigation Board (CAIB) Observation through the formal Program Requirements Control Board process. The following summary details NASA's response to the CAIB Observation and any additional work NASA intends to perform beyond the CAIB Observation.

BACKGROUND

The Kennedy Space Center (KSC) Processing Review Team conducted a review of the ground processing activities and work documents from all systems for STS-107 and STS-109, and from some systems for Orbiter Major Modification. This review examined approximately 3.9 million work steps and identified 9672 processing and documentation discrepancies resulting in a work step accuracy rate of 99.75%. While this is comparable to our performance in recent years, our goal is to further reduce processing discrepancies; therefore, we initiated a review of STS-114 documentation.

NASA IMPLEMENTATION

NASA has performed a review and systemic analysis of STS-114 work documents from the time of Orbiter Processing Facility roll-in through system integration test of the flight elements in the Vehicle Assembly Building. Pareto analysis of the discrepancies revealed areas where root cause analysis is required.

STATUS

The STS-114 Processing Review Team systemic analysis revealed six Corrective Action recommendations consistent with the technical observations noted in the STS-107/109 review. Teams were formed to determine the root cause

and long-term corrective actions. These recommendations were assigned Corrective Action Requests that will be used to track the implementation and effectiveness of the corrective actions. In addition to the remedial actions from the previous review, there were nine new system-specific remedial recommendations. These remedial actions primarily addressed documentation errors, and have been implemented. Quality and Engineering will continue to statistically sample and analyze work documents for all future flows.

The root cause analysis results and Corrective Actions were presented to and approved by the Space Shuttle Program in February 2004.

FORWARD WORK

None.

SCHEDULE

Responsibility	Due Date	Activity/Deliverable
KSC	Feb 04 (Completed)	Program Requirements Control Board

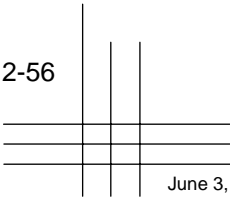



Columbia Accident Investigation Board

Observation 10.5-2

NASA should implement United Space Alliance's suggestions for process improvement, which recommend including a statistical sampling of all future paperwork to identify recurring problems and implement corrective actions.

Note: NASA is closing this recommendation through the formal Program Requirements Control Board process. The following summary details NASA's response to the recommendation and any additional work NASA intends to perform beyond the *Columbia* Accident Investigation Board recommendation.

BACKGROUND

The Kennedy Space Center (KSC) Processing Review Team (PRT) conducted a review of the ground processing activities and work documents from all systems for STS-107 and STS-109 and from some systems for the Orbiter Major Modifications. This review examined approximately 3.9 million work steps and identified 9672 processing and documentation discrepancies resulting in a work step accuracy rate of 99.75%. These results were validated with the review of STS-114 work documents (ref. Observation 10.5-1). Pareto analysis of the discrepancies revealed areas where corrective action is required and where NASA Shuttle Processing surveillance needs augmentation.

NASA IMPLEMENTATION

NASA will refocus the KSC Shuttle Processing Engineering and Safety and Mission Assurance (SMA) surveillance efforts and enhance the communication of surveillance results between the two organizations. KSC Shuttle Processing Engineering will increase surveillance of processing tasks and of the design process for government-supplied equipment and ground systems. This will include expanding the list of contractor products requiring NASA engineering approval. SMA surveillance will be expanded to include sampling of closed paper and hardware surveillance (ref. Observation 10.5-3). The initial focus for sampling of closed paper will be to determine the effectiveness of corrective action taken by the contractor as a result of the PRT's work.

NASA will improve communication between the Engineering Office and SMA through the activation of a Web-based log and the use of a new Quality Planning and Requirements Document change process for government inspection requirements.

FORWARD WORK

NASA will implement periodic reviews of surveillance plans and adjust the tasks as necessary to target problem areas identified by data trends and audits.

Engineering and SMA organizations are evaluating and revising their surveillance plans. Required changes to the Ground Operations Operating Procedures are being identified.

STATUS

NASA will implement periodic reviews of surveillance plans and adjust the tasks as necessary to target problem areas identified by data trends and audits.

SCHEDULE

Responsibility	Due Date	Activity/Deliverable
KSC	Nov 03 (Completed)	Surveillance task identification

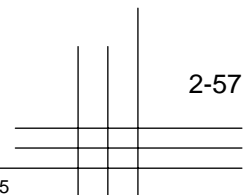

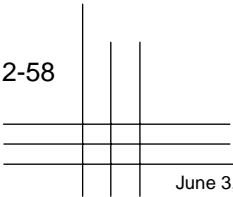



Columbia Accident Investigation Board

Observation 10.5-3

NASA needs an oversight process to statistically sample the work performed and documented by Alliance technicians to ensure process control, compliance, and consistency.

Note: NASA has closed this recommendation through the formal Program Requirements Control Board process. The following summary details NASA's response to the recommendation and any additional work NASA intends to perform beyond the *Columbia Accident Investigation Board (CAIB)* recommendation.

BACKGROUND

The CAIB noted the need for a statistically valid sampling program to evaluate contractor operations. NASA Safety and Mission Assurance identified two distinct processing activities within the observation: (1) work performed and (2) work documented.

NASA IMPLEMENTATION

NASA will assess the implementation, required resources, and potential benefits of developing a statistical sampling program to provide surveillance of the work performed and documented by United Space Alliance (USA) technicians. USA developed and implemented a process (work performed) sampling program in 1998 for Shuttle ground operations. NASA Process Analysts will assess this USA sampling program by collecting additional data to independently evaluate the USA program. NASA has begun development and implementation of an independent statistical sampling program for closed Work Authorized Documents (WADs) (work documented). Together, the two activities will provide additional verification of the quality of USA's work.

NASA and USA have worked together over the past several months to collect process sampling data. Additionally, as an Independent Assessment, NASA engaged a Summer Faculty Fellow to evaluate Shuttle process sampling. The Faculty Fellow study indicated the need for close collaboration between NASA and USA to ensure that there is no undue duplication of effort, that the process sampling effort maintains focus on areas of importance, and that there is the appropriate NASA management of the activity. As a result, the USA process sampling effort has been converted to a program jointly owned by NASA and USA. An initial closed WAD sample schedule has been developed for measuring WAD accuracy of completeness in execution. The plan incorporates unplanned and planned WADs, with unplanned having priority. Problem Reports have been sampled and results communicated to USA. Discrepancy Reports are currently being sampled.

STATUS

Sampling activities will continue, data will be analyzed, and, when necessary, sampling techniques will be refined to provide necessary level quality assurance. NASA will continue improving its ability to assure the quality of USA work.

FORWARD WORK

None.

SCHEDULE

Responsibility	Due Date	Activity/Deliverable
KSC	Nov 03 (Completed)	Provide resource estimate
KSC	Nov 03 (Completed)	Implement in-process sampling program
KSC	Nov 03 (Completed)	Implement Closed WAD sampling program – vehicle problem reports only
KSC	Mar 04 (Completed)	Define/develop in-process metrics
KSC	Apr 04 (Completed)	Closed WAD sampling program – addition of Space Shuttle Main Engine and ground support equipment problem reports
KSC	May 04 (Completed)	Define/develop closed WAD sampling standard metrics
KSC	Oct 04 (Completed)	Develop closed WAD sampling plan and schedule

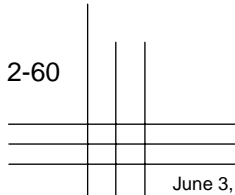



Columbia Accident Investigation Board

Observation 10.6-1

The Space Shuttle Program Office must make every effort to achieve greater stability, consistency, and predictability in Orbiter Major Modification planning, scheduling, and work standards (particularly in the number of modifications). Endless changes create unnecessary turmoil and can adversely impact quality and safety.

Note: NASA has closed this observation through the formal Program Requirements Control Board process. The following summary details NASA's response to the observation and any additional work NASA intends to perform beyond the *Columbia* Accident Investigation Board observation.

BACKGROUND

NASA agrees that greater stability in Orbiter Maintenance Down Period (OMDP) processes will reduce risk.

NASA IMPLEMENTATION AND STATUS

The current OMDP for OV-105 began in December 2003 and is ongoing. In planning for this OMDP, NASA emphasized stability in the work plan by following the practice of approving most or all of the known modifications at the onset of the OMDP/Orbiter Major Modification period.

The Space Shuttle Program (SSP) will continue to assess and periodically review the status of all required modifications. NASA will continue to integrate lessons learned from each OMDP and will emphasize factors that could destabilize plans and schedules. NASA will also conduct delta OMDP Flow Reviews for each Orbiter on an ongoing basis.

STATUS

Complete.

FORWARD WORK

None.

SCHEDULE

Responsibility	Due Date	Activity/Deliverable
SSP	Oct 03 (Completed)	OV-105 OMDP Modification Site Flow Review

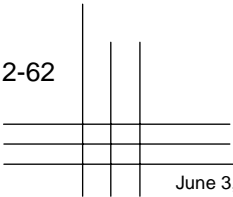



Columbia Accident Investigation Board

Observation 10.6-2

NASA and United Space Alliance managers must understand workforce and infrastructure requirements, match them against capabilities, and take actions to avoid exceeding thresholds.

Note: NASA has closed this observation through the formal Program Requirements Control Board (PRCB) process. The following summary details NASA's response to the observation and any additional work NASA intends to perform beyond the *Columbia* Accident Investigation Board observation.

BACKGROUND

The transfer of Orbiter Maintenance Down Periods (OMDPs) from Palmdale to Kennedy Space Center placed additional demands on the existing infrastructure, ground support equipment, and personnel. NASA made significant efforts to anticipate these demands, to transfer the needed equipment from Palmdale, and to hire additional personnel required to accomplish the OMDP-related tasks independent of normal Orbiter flow processing. Because of the fluctuating demands on the Orbiters supporting the flight manifest, some workers with unique critical skills were frequently shared among the Orbiter in OMDP and the Orbiters being processed for flight. Additional inspection and modification requirements, and unanticipated rework for structural corrosion and Thermal Protection Systems, created demands on limited critical skill sets not previously anticipated.

NASA IMPLEMENTATION

Lessons learned from the third Orbiter Vehicle (OV)-103 OMDP have been incorporated into the current OV-105 OMDP. These lessons have allowed NASA and United Space Alliance managers to better integrate infrastructure, equipment, and personnel from a more complete set of work tasks. Unlike the piecemeal approach used during OV-103's OMDP, the requirements for OV-105's OMDP were approved at the beginning, with the exception of two modifications. The PRCB approved 72 modifications at the Modification Site Requirements Review in early July 2003, and reviewed the overall modification plan again in mid-October 2003 at the Modification Site Flow Review. The Space Shuttle Program (SSP) will follow the practice of approving most or all of the known modifications for incorporation at the beginning of an OV's OMDP, typically at the Modification Site Requirements Review.

Many "out of family" discrepancies identified as the result of scheduled structural and wiring inspections require design center coordination and disposition. The incorporation of new Orbiter modifications also requires close coordination for design issue resolution. Timely design response can reduce the degree of rescheduling and critical skill rebalancing required. During the OV-103 OMDP, design center engineers were available on the floor in the Orbiter Processing Facility where the work was being accomplished to efficiently and effectively disposition discrepancies when identified. The additional emphasis on "on floor" design response, which helped to reduce rescheduling and resource rebalancing during OV-103's third OMDP, is being expanded for OV-105's OMDP.

Lessons learned will be captured for each ensuing OMDP and will be used to improve future OMDP processing.

STATUS

Complete.

FORWARD WORK

None.

SCHEDULE

Responsibility	Due Date	Activity/Deliverable
SSP	Oct 03 (Completed)	Mod Site Flow Review
SSP	Dec 03 (Completed)	Complete OV-103 Lessons Learned

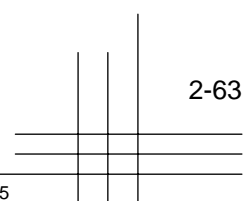

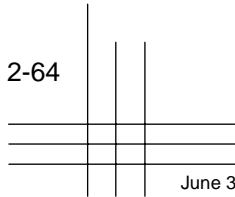



Columbia Accident Investigation Board

Observation 10.6-3

NASA should continue to work with the U.S. Air Force, particularly in areas of program management that deal with aging systems, service life extension, planning and scheduling, workforce management, training, and quality assurance.

Note: NASA has closed this observation through the formal Program Requirements Control Board process. The following summary details NASA's response to the observation and any additional work NASA intends to perform beyond the *Columbia* Accident Investigation Board observation.

BACKGROUND

In June 2003, NASA requested that the U.S. Air Force conduct an assessment of the Orbiter Maintenance Down Period/Orbiter Major Modification (OMDP/OMM) being performed at Kennedy Space Center (KSC). The U.S. Air Force team provided similarities, compared best practices, identified differences between NASA and the U.S. Air Force practices, identified potential deficiencies, and provided recommendations and areas for potential improvements. NASA is using this information to improve our practices and processes in evaluating the Orbiter fleet, and to formulate our approach for continued benchmarking.

NASA also initiated a number of aging vehicle assessment activities as part of the integrated Space Shuttle Service Life Extension Program (SLEP) activities. Each of the Space Shuttle element organizations is pursuing appropriate vehicle assessments to ensure that Shuttle Program operations remain safe and viable throughout the Shuttle's operational life.

NASA IMPLEMENTATION

Personnel from Wright-Patterson Air Force Base have provided direct support to SLEP and have contributed to management decisions on needed investments through membership on SLEP panels. NASA will continue to work with the U.S. Air Force in its development of aging vehicle assessment plans and benefit from its knowledge of operating and maintaining long-life aircraft systems. Planned assessments for the Space Shuttle Orbiters, for example, include expanded fleet leader hardware programs and corrosion control programs.

In addition to working with the U.S. Air Force on these assessments, NASA is actively drawing upon resources external to the Space Shuttle Program that have valuable experience in managing the operations of aging aircraft and defense systems. NASA is identifying contacts across government agencies and within the aerospace and defense industries to bring relevant expertise from outside the Shuttle Program to assist the team. The Orbiter Project has already augmented its aging Orbiter assessment team with systems experts from Boeing Integrated Defense Systems.

In 1999, NASA began a partnership with the U.S. Air Force Research Laboratory, Materials and Manufacturing Directorate, at Wright-Patterson Air Force Base to characterize and investigate wire anomalies. The Joint NASA/Federal Aviation Administration/Department of Defense Conference on Aging Aircraft focused on studies and technology to identify and characterize these aging systems. NASA will continue this partnership with constant communication, research collaboration, and technical interchange.

STATUS

NASA continues to assess vehicle systems for aging effects and will update inspection and maintenance requirements accordingly. Lessons learned from past Orbiter maintenance periods as well as knowledge gained in cooperation with the U.S. Air Force will be applied in the remaining OMDPs/OMMs.

FORWARD WORK

None.

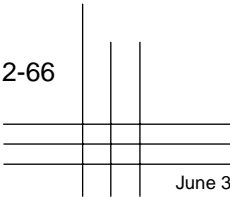



Columbia Accident Investigation Board

Observation 10.6-4

The Space Shuttle Program Office must determine how it will effectively meet the challenge of inspecting and maintaining an aging Orbiter fleet before lengthening Orbiter Major Maintenance intervals.

| Note: NASA has closed this recommendation through the formal Program Requirements Control Board process. The following summary details NASA's response to the recommendation and any additional work NASA intends to perform beyond the *Columbia* Accident Investigation Board recommendation.

BACKGROUND

An aging Orbiter fleet presents inspection and maintenance challenges that must be incorporated in the planning of the Orbiter Maintenance Down Periods (OMDPs). Prior to the *Columbia* accident, the Space Shuttle Program Office had begun an activity to lengthen the interval between OMDPs from the current requirement of every 3 years or 8 flights to a maximum of 6 years or 12 flights. This activity consists of two major areas of assessment, structural inspection and systems maintenance.

The Structures Problem Resolution Team (PRT) was assigned the action to examine all structural inspection requirements for effects to extending the OMDP interval. The Structures PRT examined every requirement dealing with structural inspections in the Orbiter Maintenance Requirements and Specifications Document and compared findings from previous OMDP and in-flow inspections to determine whether new inspection intervals were warranted. The findings from this effort resulted in updated intervals for structures inspections. Structural inspections can support an OMDP interval of 6 years or 12 flights. Part of this new set of inspections is the inclusion of numerous interval inspections that would be conducted between OMDPs. Adverse findings from the sampling inspections could lead to a call for an early OMDP.

In similar fashion, the systems maintenance requirements were to be assessed for interval lengthening by the various responsible PRTs. These assessments were put on hold at the time of the *Columbia* accident and will be reinstated only if NASA determines more consideration should be given to extending OMDP intervals.

NASA IMPLEMENTATION

Orbiter aging vehicle assessments, initiated as part of the Shuttle Service Life Extension Program, will ensure that inspection and maintenance requirements are evaluated for any needed requirements updates to address aging vehicle concerns. An explicit review of all hardware inspection and systems maintenance requirements will be conducted during the Orbiter life certification assessment to determine if aging hardware considerations or certification issues warrant the addition of new inspection/maintenance requirements or modification to existing requirements. Subsequent to completion of the life certification assessment, inspection requirement adequacy will continue to be evaluated through ongoing aging vehicle assessment activities, including the Orbiter fleet leader program and corrosion control program.

STATUS

NASA has initiated an assessment to ensure that Space Shuttle operations remain safe and viable throughout the Shuttle's service life.

FORWARD WORK

None.

SCHEDULE

None.

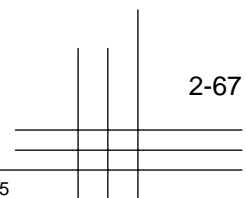

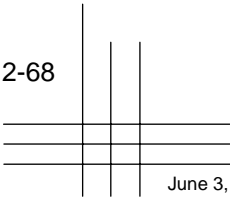



Columbia Accident Investigation Board

Observation 10.7-1

Additional and recurring evaluation of corrosion damage should include non-destructive analysis of the potential impacts on structural integrity.

Note: NASA has closed this observation through the formal Program Requirements Control Board process. The following summary details NASA's response to the observation and any additional work NASA intends to perform beyond the *Columbia* Accident Investigation Board (CAIB) observation.

BACKGROUND

The Space Shuttle Program has initiated an action to assess the CAIB observations related to corrosion damage in the Space Shuttle Orbiters. This action has been assigned to the Orbiter Project Office.

NASA IMPLEMENTATION

The Orbiter element is in full compliance with this observation. Before the disposition of any observed corrosion on Orbiter hardware, a full action plan is coordinated by the responsible subsystem engineering discipline. To resolve specific corrosion issues, evaluation and/or analysis is performed by the appropriate subsystem, stress, and materials engineers. Investigations into hardware conditions and exposure environments are performed to determine root cause of any corrosion, and nondestructive analysis is used to assist in characterization of the depth and breadth of existing corrosion. Destructive analysis is pursued where appropriate.

In all cases, Space Shuttle requirements mandate that positive safety margins must be retained by Orbiter hardware. To do this, where necessary, affected components may be replaced or supplementary load paths/doublers applied. Any course of action (e.g., leave as-is, application of corrosion preventative compounds, re-work, replace, etc.) must be agreed upon by the appropriate technical communities. Cross-disciplinary reviews of significant corrosion-related issues take place on a regular basis. As new or repeat corrosion issues are discovered, the governing Operations and Maintenance Requirements and Specifications Document is reviewed and modified as appropriate. Future inspection schedules are adjusted accordingly to maintain conservative time intervals.

To support Orbiter corrosion issues and concerns, the Orbiter Corrosion Control Review Board (CCRB) provides an independent technical review of ongoing corrosion issues.

The CCRB has representation from both NASA and NASA contractors in materials and processes engineering, subsystem engineering, and safety and mission assurance.

For "minor" corrosion issues, the Orbiter CCRB may be consulted for a recommendation at the discretion of the subsystem engineer. If the corrosion in question cannot be repaired by the Orbiter Standard Repair Procedure (V-ST-0029) or if reapplication of per print corrosion protective finishes cannot be accomplished or is inadequate, a review by the CCRB is required.

On a case-by-case basis, the engineering review team/CCRB may identify other similar hardware, materials, and locations on the flight vehicles as suspect; this determination results in targeted inspections. In areas where nondestructive analysis is not currently feasible (e.g., under the Thermal Protection System, between faying surface joints, etc.), "sampling" inspections are carried out to quantify the scope and magnitude of the corrosion issue. Analysis is completed to determine whether the corrosion is local or systemic.

Additional funding for augmentation of Orbiter corrosion control activities was authorized in May 2004 and extends through early fiscal year 2006. Thereafter, the expanded efforts will be covered within scope as part of the Space Flight Operations Contract extension. This authorization implements proactive corrosion control measures to ensure continued safety and sustainability of Orbiter hardware throughout the planned Shuttle Program Service Life, including identification of improvements to nondestructive evaluation techniques.

STATUS

Complete.

FORWARD WORK

None.

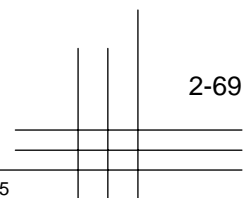

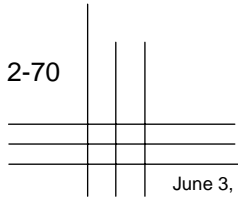



Columbia Accident Investigation Board

Observation 10.7-2

Long-term corrosion detection should be a funding priority.

Note: NASA has closed this observation through the formal Program Requirements Control Board process. The following summary details NASA's response to the observation and any additional work NASA intends to perform beyond the *Columbia* Accident Investigation Board observation.

BACKGROUND

Both Orbiter engineering and management concur that ongoing corrosion of the Space Shuttle fleet should be addressed as a safety issue. As the Orbiters continue to age, NASA must direct the appropriate level of resources to sustain the expanding scope of corrosion and its impact to Orbiter hardware.

NASA IMPLEMENTATION

Following the *Columbia* accident, the Orbiter Corrosion Control Review Board has been strengthened significantly. Additional funding for augmentation of Orbiter corrosion control activities was authorized in May 2004 and extends through early fiscal year 2006. Thereafter, the expanded efforts will be covered within scope as part of the Space Flight Operations Contract extension. This authorization implemented proactive corrosion control measures to ensure safety and sustainability of Orbiter hardware throughout the planned Space Shuttle Program (SSP) service life. Specific activities addressing corrosion prevention and detection include: developing methods to reduce hardware exposure to corrosion causes; identifying and evaluating the environment of corrosion prone areas and environmental control mitigation options; identifying improved nondestructive evaluation (NDE) techniques; and implementing an industry benchmark team for reducing corrosion and improving NDE methods.

NASA, United Space Alliance, and Boeing are developing and implementing the expanded scope of an effective, long-term corrosion control program. This expanded program will attempt to inspect for, detect, evaluate, trend, and predict corrosion on Orbiter hardware throughout the remainder of the SSP.

STATUS

Complete.

FORWARD WORK

None.

SCHEDULE

Responsibility	Due Date	Activity/Deliverable
Orbiter Project Office	Completed	Direct appropriate long-term funding (sustained)
Orbiter Project Office	Jun 04 (Completed)	Develop an advanced Orbiter Corrosion Control Program to detect, trend, analyze, and predict future corrosion issues

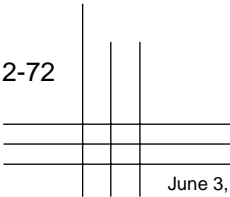



Columbia Accident Investigation Board

Observation 10.7-3

Develop non-destructive evaluation inspections to find hidden corrosion.

Note: NASA has closed this observation through the formal Program Requirements Control Board (PRCB) process. The following summary details NASA's response to the observation and any additional work NASA intends to perform beyond the *Columbia* Accident Investigation Board (CAIB) observation.

BACKGROUND

An integral part of an effective corrosion control program is the continual development and use of nondestructive evaluation (NDE) tools. The development of tools that explore hidden corrosion is a complex problem.

NASA IMPLEMENTATION

NASA is investigating a wide range of advanced NDE techniques, and has several activities ongoing to use NDE to find hidden corrosion. These activities include:

- Chartered by the NASA, the NDE Working Group (NNWG) has representatives from each of the NASA field centers and affiliated contractors. This group meets periodically to address NASA's short- and long-term NDE needs. In the past, the NNWG has executed efforts to develop NDE techniques directly in support of this subject, such as corrosion under tile. In the future, Orbiter engineering will partner with the NNWG on NDE development work as specific achievable needs are identified.
- An Orbiter NDE working group was established to address both immediate and long-term Orbiter needs. This technical team has become an important resource in support of ongoing Orbiter problem resolutions. This team will attempt to address the need for advanced NDE tools and techniques required to address hidden corrosion.
- United Space Alliance has begun to investigate advanced techniques, such as the Honeywell Structural Anomaly Mapping System, to support both structural assessments as well as hidden corrosion. This technology is currently under assessment for potential certification by the Federal Aviation Administration.
- Johnson Space Center and Marshall Space Flight Center have developed a compilation of hidden corrosion test standards. These standards will be used for future evaluation of potential NDE techniques.

In areas where nondestructive analysis is not currently feasible (e.g., under the Thermal Protection System (TPS), between faying surface joints, etc.), "sampling" inspections are carried out to quantify the scope and magnitude of the particular corrosion issue. Analysis is subsequently completed to determine whether the corrosion is local or systemic.

As an example, the CAIB Report referenced corrosion discovered prior to STS-107 on the *Columbia* vehicle in the lower forward fuselage skin panel and stringer areas (inner surfaces). Subsequently, inspections of the TPS bond line (outer surfaces) identified isolated incidents of localized surface corrosion. This raised concerns regarding a potential threat to the TPS bond-line. As a result, a complete history of previous TPS corrosion inspections, bond-line corrosion indications, bond surface preparation processes and controls, and TPS bond operation materials and processes was reviewed. The review was coordinated jointly between the Materials and Processes, TPS, and Structures engineering organizations with a contributing independent assessment by the Corrosion Control Review Board. This activity resulted in a reversal of previous engineering direction; as a result, damaged Koropon primer is now required to be repaired/reconditioned before tiles are bonded, and NASA authorized development of an extensive multi-year sampling program intended to characterize the magnitude and scope of corrosion occurring under tile.

In May 2004, the Shuttle Program authorized \$3.3M of additional funding for augmentation of Orbiter corrosion control activities via PRCB directive S061984R1. This authorization implemented proactive corrosion control measures to ensure continued safety and sustainability of Orbiter hardware throughout the planned Shuttle Program service life, including identification and development of improvements to NDE techniques. Following fiscal year 2006, the expanded Orbiter corrosion control efforts will be covered under the Space Flight Operations Contract extension.

As a part of this expanded program, the current and future Orbiter project needs for NDE will be evaluated for further development. A review of all current activities will be completed and compared with long-term project needs.

FORWARD WORK

None.

STATUS

Complete.

SCHEDULE

Responsibility	Due Date	Activity/Deliverable
Orbiter Project Office	Jun 04 (Completed)	Develop an advanced Orbiter Corrosion Control Program, chartered to detect, trend, analyze, and predict future corrosion issues. Development of NDE techniques for corrosion detection shall be included in the Program.

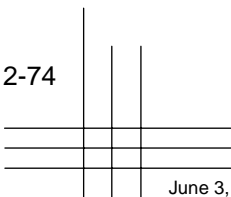



Columbia Accident Investigation Board

Observation 10.7-4

Inspection requirements for corrosion due to environmental exposure should first establish corrosion rates for Orbiter-specific environments, materials, and structural configurations. Consider applying Air Force corrosion prevention programs to the Orbiter.

| Note: NASA has closed this observation through the formal Program Requirements Control Board process. The following summary details NASA's response to the observation and any additional work NASA intends to perform beyond the *Columbia* Accident Investigation Board observation.

BACKGROUND

Historically, inspection intervals for Orbiter corrosion have not been driven by mathematical corrosion rate assessments. In practice, predicting corrosion rates is only effective when the driving mechanism is limited to general surface corrosion in a known environment over a known period of time. To date, general surface corrosion is not an Orbiter problem. Common Orbiter corrosion problems include pitting, crevice, galvanic, and intergranular corrosion attack. These mechanisms are extremely sporadic and inconsistent and present tremendous difficulty in effectively predicting corrosion rates. Environments are complex, including time histories with intermittent exposure to the extreme temperatures and vacuum of space. Also, with a limited data set (three vehicles), it is difficult to develop and use a database with a reasonable standard deviation. Any calculated results would carry great uncertainty.

NASA IMPLEMENTATION

NASA agrees with the importance of understanding when and where corrosion occurs as a first step towards mitigating it. Given the difficulty in establishing trenchant mathematical models of corrosion rates for the multiple Orbiter environments, the NASA/contractor team (through the Orbiter Corrosion Control Review Board (CCRB)) will assess mechanisms, magnitudes, and rates of corrosion occurrence. This can be used to prioritize high corrosion occurrence areas. The CCRB will also target inspections toward low-traffic and/or hard-to-access areas that are not consistently inspected. Furthermore, the CCRB will address predicting the rates of long-term degradation of Orbiter corrosion protection systems (i.e., paints, sealants, adhesives, etc.).

Beyond the original Orbiter design life of 10 years, corrosion inspection intervals have been driven by environment, exposure cycles, time, materials, and configuration without the use of specific corrosion rate predictions.

Although not fool-proof, these inspection intervals have generally been extremely conservative. In the few cases where this has not been conservative enough, the scope of concern has been expanded accordingly and the inspection interval requirements have been changed. Moreover, when corrosion is identified, the standard procedure is to immediately repair it. If the corrosion is widespread in an area or a configuration, specific fixes are incorporated (e.g., between faying surfaces/dissimilar metals, etc.) or refurbishments are implemented (e.g., strip and reapplication of primers, etc.). In the few cases where this is not possible, such as when the rework cannot be completed without major structural disassembly, engineering assessments are completed to characterize the active corrosion rate specific to the area of concern, and inspection intervals are assigned accordingly, until the corrosion can be corrected. Relative to the general aviation industry, NASA's approach to corrosion repair is extremely aggressive.

In the past, NASA has worked closely with the U.S. Air Force to review corrosion prevention programs for potential application to the Orbiter Program. Several successes from Air Force programs have already been implemented, such as the use of water wash-downs and corrosion preventative compounds. In the future, the Orbiter CCRB will continue to partner with both industry and the Department of Defense (DoD) to further develop and optimize the Orbiter corrosion control program. To maintain exposure to the current state-of-the-art in this area, the CCRB will participate annually in the NASA/DoD Aging Aircraft Conference.

Following the *Columbia* accident, the Orbiter CCRB has been strengthened significantly. Additional funding for augmentation of Orbiter corrosion control activities was authorized in May 2004 and NASA, United Space Alliance, and Boeing are working to implement an expanded corrosion control program. This authorization implements proactive corrosion control measures to ensure continued

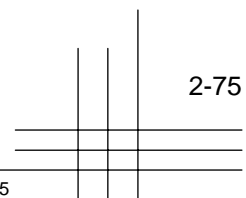

safety and sustainability of Orbiter hardware throughout the planned Shuttle Program service life. This activity will include a review of the current state of the art in corrosion control tools and techniques, followed by consideration for implementation into the future Orbiter corrosion control program. Authorized funding extends through early fiscal year 2006 to expand Orbiter corrosion control. Thereafter, the expanded efforts will be covered within scope as part of the Space Flight Operations Contract extension.

STATUS

Complete.

FORWARD WORK

None.

SCHEDULE

Responsibility	Due Date	Activity/Deliverable
Orbiter Project Office	Completed	Direct appropriate funding to develop a sustained Orbiter Corrosion Control Board.
Orbiter Project Office	Jun 04 (Completed)	Develop an advanced Orbiter Corrosion Control Program to detect, trend, analyze, and predict future corrosion issues.

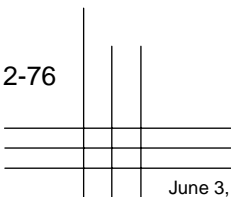



Columbia Accident Investigation Board

Observation 10.8-1

Teflon (material) and Molybdenum Disulfide (lubricant) should not be used in the carrier panel bolt assembly.

Note: NASA has closed this observation through the formal Program Requirements Control Board process. The following summary details NASA's response to the observation and any additional work NASA intends to perform beyond the *Columbia* Accident Investigation Board observation.

BACKGROUND

Concerns regarding the use of these materials were initiated due to the brittle fracture mode observed on some A-286 Stainless Steel Leading Edge Subsystem Carrier Panel bolts. Specifically, it was argued that lubricant materials consisting of Teflon and/or Molybdenum Disulfide should not be used due to their potential to contribute to a stress corrosion cracking fracture mechanism at elevated temperatures. Traces of perfluorinated polyether grease and Molybdenum Disulfide (lubricants) were found on the carrier panel bolt shank and sleeve. However, no Teflon was found during the failure analysis of carrier panel fasteners.

A-286 fasteners in the presence of an electrolyte must also be exposed to elevated temperatures for stress corrosion cracking to be of concern. However, fastener installations are protected from temperature extremes (the maximum temperatures seen, by design, are less than 300°F).

NASA IMPLEMENTATION

NASA conducted interviews with ground technicians at Kennedy Space Center (KSC); these interviews indicated that the use of Braycote grease as a lubricant may have become an accepted practice due to the difficult installation of this assembly. Braycote grease contains perfluorinated polyether oil, Teflon, and Molybdenum Disulfide materials. According to design drawings and assembly procedures, the use of lubricants should not have been allowed in these fastener installations.

As a result of these findings, NASA directed United Space Alliance (USA) to institute appropriate corrections to their fastener installation training and certification program. USA

shall emphasize to its technicians to follow exactly the installation instructions for all Orbiter fastener installations. Any deviation from specific instructions will require disposition from engineering before implementation. USA will further emphasize that lubricants cannot and should not be used in any fastener installation, unless specifically authorized.

In addition, NASA has implemented an engineering review of all discrepancy repairs made on Orbiter hardware at KSC. An engineering review will occur to provide the appropriate checks and balances if a lubricant is required to address a specific fastener installation problem.

STATUS

NASA and USA have implemented corrective actions to ensure that lubricant will not be used in fastener applications unless explicitly approved by engineering.

FORWARD WORK

None.

SCHEDULE

Responsibility	Due Date	Activity/Deliverable
KSC/USA Ground Operations	Mar 04 (Completed)	Update fastener training and certification program for USA technicians; require deviations from instructions to be approved before implementation

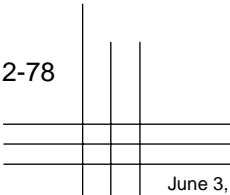



Columbia Accident Investigation Board

Observation 10.8-2

Galvanic coupling between aluminum and steel alloys must be mitigated.

Note: NASA is closing this observation through the formal Program Requirements Control Board (PRCB) process. The following summary details NASA's response to the observation and any additional work NASA intends to perform beyond the *Columbia* Accident Investigation Board observation.

BACKGROUND

Galvanic coupling between dissimilar metals is a well-recognized Orbiter concern. As galvanic couples between aluminum and steel alloys cannot be completely eliminated, the Space Shuttle Program (SSP) must implement appropriate corrosion protection schemes.

The SSP Orbiter element requirements are in full compliance with this observation. Currently, according to the Boeing Orbiter Materials Control Plan, "Metals shall be considered compatible if they are in the same grouping as specified in Military-Standard (MIL-STD)-889 or the difference in solution potential is ≤ 0.25 Volts." Otherwise, mitigation for galvanic corrosion is required. Per NASA requirement Marshall Space Flight Center-Specification (MSFC-SPEC)-250, "...when dissimilar metals are involved... the fasteners shall be coated with primer or approved sealing compounds and installed while still wet or for removable or adjustable fasteners, install with corrosion preventative compound." Where there are exceptions, such as fastener installations that are functionally removable, we depend on scheduled inspections of the fastener hole.

NASA IMPLEMENTATION

Since Orbiter galvanic couples are generally treated with corrosion mitigation schemes, the time-dependent degradation of approved sealing compounds must be addressed. Recent inspections have raised concern in areas where significant galvanic couples exist, even in the presence of sealing materials. This concern has led to the consideration of design changes. Examples of recent design modifications

include electrical ground paths in the Orbiter nose cap and on the metallic fittings of the External Tank doors. In the future, NASA will take action to be more proactive in addressing this vehicle-wide concern.

The SSP Aging Vehicle Assessment Committee has approved a proposal to expand the scope and authority of the Orbiter Corrosion Control Board. This activity included a review of the time-dependent degradation of approved sealing compounds. NASA has developed an advanced Orbiter Corrosion Control Program, including implementation of an aging materials evaluation as applied to galvanic couple seal materials on Orbiter hardware.

STATUS

Complete.

FORWARD WORK

None.

SCHEDULE

Responsibility	Due Date	Activity/Deliverable
SSP	Apr 04 (Completed)	Present to the SSP PRCB for direction and funding.
Kennedy Space Center	Jun 04 (Completed)	Develop an advanced Orbiter Corrosion Control Program.

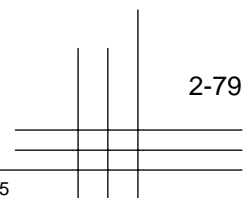

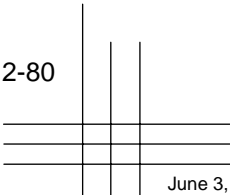



Columbia Accident Investigation Board

Observation 10.8-3

The use of Room Temperature Vulcanizing 560 and Koropon should be reviewed.

Note: NASA has closed this observation through the formal Program Requirements Control Board process. The following summary details NASA's response to the observation and any additional work NASA intends to perform beyond the *Columbia* Accident Investigation Board observation.

BACKGROUND

Concerns regarding the use of Room Temperature Vulcanizing (RTV) 560 and Koropon materials were initiated due to the brittle fracture mode observed on some A-286 Stainless Steel Leading Edge Subsystem Carrier Panel bolts. Specifically, it was argued that trace amounts of contaminants in these materials could, at elevated temperatures, contribute to a Stress Corrosion Cracking (SCC) of the bolts. It was also proposed that these contaminants might accelerate corrosion, particularly in tight crevices.

SCC of A-286 material is only credible at high temperatures. This is not a concern as all fastener installations are protected from such temperature extremes (the maximum temperatures seen, by design, are less than 300°F).

NASA IMPLEMENTATION

NASA completed materials analyses on multiple A-286 bolts that exhibited a brittle-like fracture mode. Failure analysis included fractography, metallography, and chemical analysis. Furthermore, a research program was executed to duplicate and compare the bolt failures experienced on *Columbia*. This proved conclusively that the brittle-looking fracture surfaces were produced during bolt failure at temperatures approaching 2000°F and above. This failure mode is not a concern with the A-286 Stainless Steel Leading Edge Subsystem Carrier Panel bolts, as all fastener installations are protected from such temperature extremes.

In addition to failure analysis, both RTV 560 and Koropon were assessed for the presence of trace contaminants. Inductively Coupled Plasma analyses were completed on samples of both materials. The amount and type of trace contaminants were analyzed and determined to be insignificant.

RTV 560 and Koropon were selected for widespread use in the Shuttle Program because they prevent corrosion. All

corrosion testing and failure analysis performed during the life of the Shuttle Program have not shown deleterious effects from either product. Several non-Shuttle aerospace companies have used Koropon extensively as an anticorrosion primer and sealant. To date, problems with its use in the military and industry have not been identified.

Both of these materials may eventually fail in their ability to protect from corrosion attack, but do not fail by chemically breaking down to assist corrosion mechanisms. Thus, NASA concluded that trace contaminants in Koropon and RTV 560 do not contribute to accelerated corrosion or SCC mechanisms.

In addition to answering this specific observation, NASA is assessing the long-term performance of all nonmetallic materials used on the Orbiter through a vehicle-wide aging materials evaluation. This effort is ongoing and will continue in support of the Orbiter for the remainder of its service life.

STATUS

NASA considers that these materials have been reviewed and present no risk for supporting accelerated corrosion and/or SCC mechanisms. Appropriate long-term additional studies have been initiated.

FORWARD WORK

None.

SCHEDULE

Responsibility	Due Date	Activity/Deliverable
Space Shuttle Program	Mar 04 (Completed)	Review use of RTV 560 and Koropon

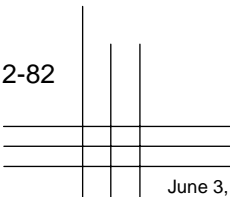



Columbia Accident Investigation Board

Observation 10.8-4

Assuring the continued presence of compressive stresses in A-286 bolts should be part of their acceptance and qualification procedures.

Note: NASA has closed this observation through the formal Program Requirements Control Board process. The following summary details NASA's response to the observations and any additional work NASA intends to perform beyond the *Columbia* Accident Investigation Board observation.

BACKGROUND

Initial concerns regarding the use of these A-286 stainless steel fastener materials were initiated due to the brittle fracture mode observed on some Leading Edge Subsystem Carrier Panel bolts. The concern about residual compressive stresses, and to some extent the concerns about Koropon, Room Temperature Vulcanizing 560, Teflon, and Molybdenum Disulfide, emanated from a conjecture that the brittle fracture of some of the bolts could have been caused by Stress Corrosion Cracking (SCC).

For SCC to occur, each of the following conditions must exist:

- Material of concern must be susceptible to SCC
- Presence of an active electrolyte
- Presence of a sustained tensile stress

Additionally, SCC of A-286 fasteners is a concern only under exposure to high temperatures. All fastener installations are protected from such temperature extremes.

NASA IMPLEMENTATION

To address the concern that sustained tensile stress might have contributed to SCC, NASA completed materials analyses on multiple A-286 bolts that exhibited a brittle-like fracture mode (i.e., minimal ductility, flat fracture). The failure analysis included fractography, metallography, and chemical analysis. Furthermore, a research program was executed to duplicate and compare the bolt failures experienced on *Columbia*. This proved conclusively that the brittle-looking fracture surfaces were produced during bolt failure at temperatures approaching 2000°F and above. The observed

intergranular fracture mechanism is consistent with grain boundary embrittlement at elevated temperatures, along with potential effects from liquid metal embrittlement from vaporized aluminum. The effects of high temperature exposures on A-286 stainless steel materials are not consistent with the SCC concerns.

In addition to this effort, NASA completed residual stress analyses on several A-286 bolts via neutron diffraction at the National Research Council of Canada. In general, residual stresses were determined to be negligible or compressive in the axial bolt direction. The bolts used on the Space Shuttle have a sufficient compressive stress layer, which is governed by appropriate process controls at the manufacturer.

NASA reviewed the manufacturing and material specifications for the A-286 bolts. This review confirmed that only qualified vendors are contracted, manufacturing process controls are sufficient, and Certificates of Compliance are maintained for material traceability. Furthermore, NASA executes material lot testing on all fasteners procured for use in the Shuttle Program to ensure appropriate quality control.

STATUS

NASA has analyzed the requirements and process for A-286 bolts and found that current processes and controls are adequate.

FORWARD WORK

None.

SCHEDULE

None.

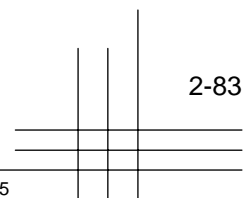

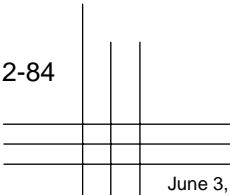



Columbia Accident Investigation Board

Observation 10.9-1

NASA should consider a redesign of the (Hold-Down Post Cable) system, such as adding a cross-strapping cable, or conduct advanced testing for intermittent failure.

Note: NASA has closed this observation through the formal Program Requirements Control Board process. The following summary details NASA's response to the observation and any additional work NASA intends to perform beyond the *Columbia* Accident Investigation Board (CAIB) observation.

This response also addresses Recommendation D.a-10, Hold-Down Post (HDP) Cable Anomaly.

BACKGROUND

Each of the two Solid Rocket Boosters (SRBs) is attached to the Mobile Launch Platform by four hold-down bolts. These bolts are secured by a 5-in. diameter restraint nut. Each restraint nut contains two pyrotechnic initiators designed to sever the nuts when the SRBs ignite, releasing the Space Shuttle stack to lift off the launch platform.

Release is normally accomplished by simultaneously firing two redundant pyrotechnic charges called NASA standard initiators (NSIs) on each of eight SRB. Two independent ground-based pyrotechnic initiation control (PIC) systems, A and B, are used to receive the command and distribute the firing signals to each HDP. On STS-112, the system A Fire 1 command was not received by the ground-based PIC system; however, the redundant system B functioned properly and fired all system B NSIs, separated the frangible nuts, and enabled the release of the four hold-down bolts. As a result, the Shuttle safely separated from the launch platform.

NASA was unable to conclusively isolate the anomaly in any of the failed components. The most probable cause was determined to be an intermittent connection failure at the launch platform-to-Orbiter interface at the tail service mast (TSM). The dynamic vibration environment could have caused this connection failure after main engine start. Several contributing factors were identified, including groundside connector corrosion at the TSM T-0 umbilical, weak connection spring force, potential nonlocked Orbiter connector savers, lack of proper inspections, and a blind (non-visually verified) mate between the ground cable and the Orbiter connector saver.

The STS-112 investigation resulted in the replacement of all T-0 ground cables after every flight, a redesign of the T-0 interface to the PIC rack cable, and replacement of all

Orbiter T-0 connector savers. Also, the pyrotechnic connectors will be prescreened with pin retention tests, and the connector saver mate process will be verified using video-scopes. The CAIB determined that the prelaunch testing procedures for this system may not be adequate to identify intermittent failure. Therefore, the CAIB suggested that NASA consider a redesign of the system or implement advanced testing for intermittent failures.

NASA IMPLEMENTATION

Five options for redesign of this system were presented to the Orbiter Project Configuration Control Board on August 20, 2003. The recommended redesign configuration provides redundancy directly at the T-0 umbilical, which was determined to be a primary contributing cause of the STS-112 anomaly. The selected option results in the least impact to hardware (fewer connectors, less wiring, less weight added), can be implemented in a reasonably short time period, and requires only limited modifications to existing ground support equipment. Orbiter and groundside implementations are not affected as they interface at the same T-0 pins.

Kennedy Space Center (KSC) has implemented a number of processing changes to greatly reduce the possibility of another intermittent condition at the TSM. The ground cables from the Orbiter interface to the TSM bulkhead plate are now replaced after each use, instead of reused after inspection, which was previously allowed. The ground connector springs that maintain the mating force against the Orbiter T-0 umbilical are all removed and tested to verify that the spring constants meet specification between flights. The Orbiter T-0 connector savers are inspected before each flight and are now secured with safety wire before the launch platform cables are connected. New ground cables are thoroughly inspected before mate to the Orbiter. In addition, the connection process was enhanced to provide a bore scope optical verification of proper mate.

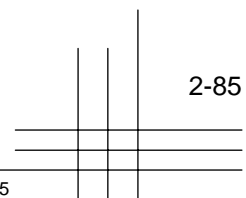

For STS-114 return to flight (RTF), the Space Shuttle Program (SSP) is implementing several design changes and enhancements to further reduce the risk of a similar event. The Orbiter Project is adding redundant command paths for each Arm, Fire 1, Fire 2, and return circuits from the Orbiter through separate connectors on the Orbiter/TSM umbilical. The ground support equipment cables will be modified to extend the signals to the ground PIC rack solid-state switches. This modification adds copper path redundancy through the most dynamic and susceptible environment in the PIC system. Additionally, the KSC Shuttle Processing Project is redesigning and replacing all electrical cables, from the Orbiter T-0 umbilical through the TSMs, to their respective distribution points. The new cables will be factory constructed with more robust insulation and will be better suited for the environment in which they are used. This new cable design also eliminates the old style standard polyimide (“Kapton”) wire insulation that can be damaged by handling and degrades with age.

SSP technical experts investigated laser-initiated ordnance devices and have concluded that there would be no functional improvement in the ground PIC system operation. Although laser-initiated ordnance has good capabilities, no conclusive benefit for use on the Space Shuttle systems has been identified. Additionally, use of laser-initiated ordnance would have changed only the firing command path from the ground PIC rack to each of the ordnance devices. This would not change or have had any impact on master command path failures experienced during the STS-112 launch, since they would still be electrical copper paths.

NASA has been engaged for more than three years with the joint Department of Defense, NASA, Federal Aviation Agency, and industry aging aircraft wiring community to develop, test, and implement fault-detection methods and equipment to find emerging wire anomalies and intermittent failures before they prevent electrical function. Several tools have been developed and tested for that purpose, but no tool is available with a conclusive ability to guarantee total wire function in environments with such dynamic conditions prior to use.

STATUS

A cross-strapping cable was not recommended as part of the redesign options because of concerns that it would introduce a single-point failure that could inhibit both hold-down post pyrotechnic systems. The recommended redesign, plus the previously identified processing and verification modifications, are considered to be sufficient to mitigate the risks identified during the STS-112 anomaly investigation. Actions are in place to investigate additional

methods to verify connector mating and system integrity. Several technical issues associated with the implementation of this redesign are continuing to be evaluated.

Proposed hardware modifications and development activity status:

- The TSM cable preliminary redesign is complete and has been designated an RTF mandatory modification by the Shuttle Processing Project.
- The Orbiter Project is implementing the T-0 redundancy modification in the Orbiter cable system and T-0 connectors. KSC will modify groundside circuits accordingly.
- The SSP is not currently considering laser pyrotechnic firing for the Shuttle Program but may readdress the issue in the future, as the technology matures and the flight vehicle is upgraded.
- NASA is currently supporting two separate strategies to determine wiring integrity. In addition, NASA is engaged with the Department of Defense and the Federal Aviation Agency to encourage further studies and projects.

Additionally, a NASA Headquarters-sponsored Independent Assessment (IA) team was formed to review this anomaly and generically review the T-0 umbilical electrical/data interfaces. While this independent review is not considered a constraint to implementing the redesign, it provides an opportunity to ensure that the original investigation was thorough and provided additional recommendations or improvements that might be implemented.

FORWARD WORK

The evaluation team for laser initiation of pyrotechnics will continue to monitor hardware development for application to Shuttle hardware. The NASA team will continue to engage in development of emerging wire fault detection and fault location tools with the government and industry wiring community. NASA will advocate funding for tool development and implement all new effective methods.

Additionally, SSP Systems Engineering and Integration has led a Program-wide team to address the findings identified by the IA team that reviewed the anomaly and also assess potential common cause failures across the other separation interfaces (both flight and launch interfaces). The recommendations of this team resulted in the implementation of revised assembly and inspection procedures, revised ground cable manufacturing tolerances, and new controls on ground cable assembly and mating.

SCHEDULE

Responsibility	Due Date	Activity/Deliverable
SSP, KSC, USA	Oct 03 (Completed)	Present to SSP Integration Control Board
SSP, KSC, USA	Oct 03 (Completed)	Present to SSP Program Requirements Control Board
SSP, KSC, USA	Nov 03 (Completed)	Design Review
SSP, KSC, USA	Dec 03 (Completed)	Wire Design Engineering
NASA Headquarters IA Team	Jul 04 (Completed)	Independent Assessment Final Report
SSP, KSC, USA	Mar 04 (Completed)	Wire Installation Engineering
Orbiter Project	Apr 04 (Completed)	Provide redundant firing path in the Orbiter for HDP separation
Shuttle Integration	Aug 04 (Completed)	Evaluate cross-strapping for simultaneous NSI detonation
SSP	Mar 05 (Completed)	Respond to IA team findings
SSP	Mar 05 (Completed)	Address potential common-cause failures across the other flight and launch separation interfaces
SSP	Mar 05 (Completed)	Approve new Operations and Maintenance Requirements and Specifications Document requirements for specific ground cable inspections as a condition for mating
Shuttle Processing Project	Mar 05 (Completed)	Modify, install, and certify the ground cabling to protect against damage and degradation and to implement a redundant ground electrical path to match Orbiter commands

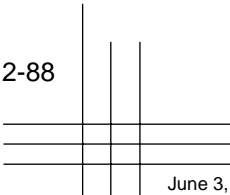



Columbia Accident Investigation Board

Observation 10.10-1

Inspection requirements for corrosion due to environmental exposure should first establish corrosion rates for Orbiter-specific environments, materials, and structural configurations. Consider applying Air Force corrosion prevention programs to the Orbiter.

Note: NASA has closed this observation through the formal Program Requirements Control Board (PRCB) process. The following summary details NASA's response to the observation and any additional work NASA intends to perform beyond the Columbia Accident Investigation Board (CAIB) observation.

This response also addresses Recommendation D.a-11, SRB ETA Ring.

BACKGROUND

The External Tank Attach (ETA) rings are located on the Solid Rocket Boosters (SRBs) on the forward end of the aft motor segment (figure O10.10-1). The rings provide the aft attach points for the SRBs to the External Tank (ET). Approximately two minutes after liftoff, the SRBs separate from the Shuttle vehicle.

In late 2002, Marshall Space Flight Center (MSFC) engineers were performing tensile tests on ETA ring web material prior to the launch of STS-107 and discovered the ETA ring material strengths were lower than the design requirement. The ring material was from a previously flown and subsequently scrapped ETA ring representative of current flight inventory material. A one-time waiver was granted for the STS-107 launch based on an evaluation of the structural strength factor of safety requirement for the ring of

1.4 and adequate fracture mechanics safe-life at launch. The most probable cause for the low strength material was an off-nominal heat treatment process. Following SRB retrieval, the STS-107 rings were inspected as part of the normal postflight inspections, and no issues were identified with flight performance. Subsequent testing revealed lower than expected fracture properties; as a result, the scope of the initial investigation of low material strength was expanded to include a fracture assessment of the ETA ring hardware.

NASA IMPLEMENTATION

NASA used a nonlinear analysis method to determine whether the rings met Program strength requirements for a factor of safety of 1.4 or greater (figure O10.10-1-2). The nonlinear analysis method is a well-established technique employed throughout the aerospace industry that addresses the entire material stress-strain response and more accurately represents the material's ultimate strength capability by allowing load redistribution. The hardware materials characterization used in this analysis include ring web thickness measurements and hardness testing (figure O10.10-1-3) of the splice plates and ring webs. Hardware inspections for the first flight set of ETA rings are complete; there were no reportable problems, and all areas of the rings met factor of safety requirements.

In addition to strength analysis, a fracture mechanics analysis on the ETA ring hardware was performed to determine the minimum mission life for the rings and to define the necessary inspection interval. Serial number 15 and 16 ETA rings exhibited undesirable material variability and are being set aside as the initial candidates for upgrade/replacement. Fracture property testing for the splice plates resulted in

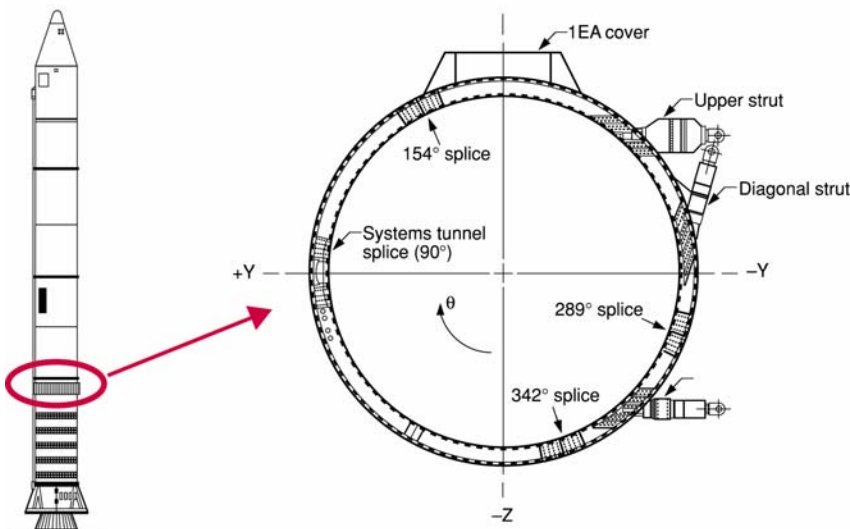

Figure O10.10-1-1. ETA ring location.

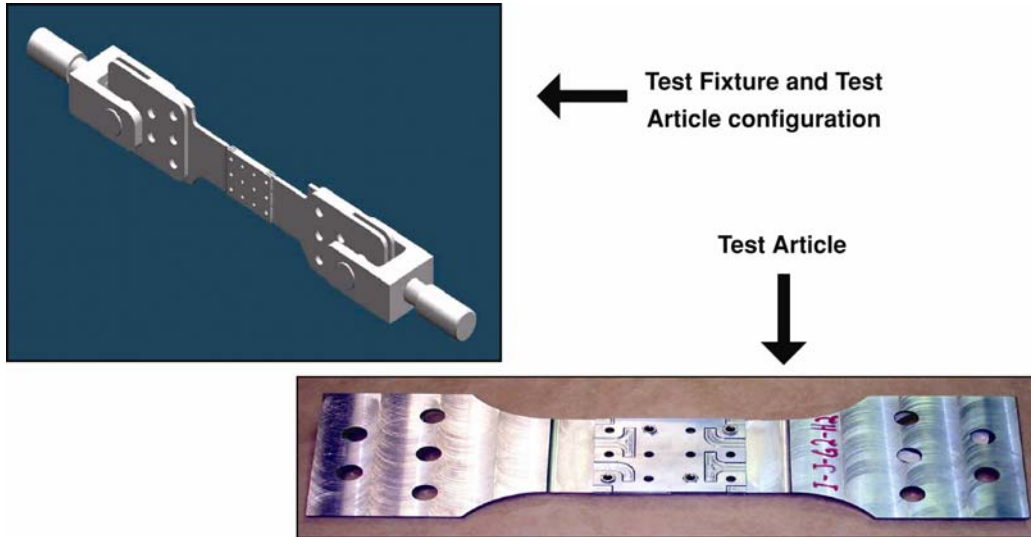

Figure O10.10-1-2. Test articles.

unacceptable material properties. Replacement splice plates are being fabricated under controlled processes and lot acceptance testing. Any other ring hardware that exhibits similarly unacceptable material or high variability in the hardness measurements will also be set aside for upgrade or replacement. Fracture Control Plan requirements compliance will be ensured by performing extensive nondestructive inspections to re-baseline all areas of the ETA ring hardware.

NASA will continue to use testing, inspection, and analyses of flight hardware to fully characterize the material for each of the ETA rings in the Shuttle Program inventory. This will provide added assurance that the flight hardware meets program requirements and continues to have an adequate margin for safety above the 1.4 factor of safety requirement. Hardware inspections for each of the remaining ETA rings in the Space Shuttle Program inventory will continue until replacement hardware becomes available.

STATUS

Complete.

FORWARD WORK

None.

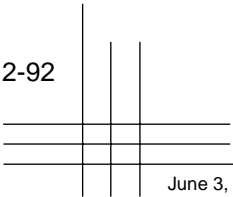

Figure O10.10-1-3. Harness testing.

2-90			

SCHEDULE

Responsibility	Due Date	Activity/Deliverable
SRB Project	Mar 04 (Completed)	New ring procurement funding approved
SRB Project	Jul 04 (Completed)	CAIB observation PRCB action (S064039 MSF-SRB Action 1-1 and 2-1) closure
SRB Project	Aug 04 (Completed)	First flight set ETA rings complete





Columbia Accident Investigation Board

Observation 10.11-1

Assess NASA and contractor equipment to determine if an upgrade will provide the reliability and accuracy needed to maintain the Shuttle through 2020. Plan an aggressive certification program for replaced items so that new equipment can be put into operation as soon as possible.

Note: NASA is closing this observation through the formal Program Requirements Control Board process. The following summary details NASA's response to the observation and any additional work NASA intends to perform beyond the *Columbia* Accident Investigation Board (CAIB) observation.

BACKGROUND

The CAIB review of Shuttle test equipment at NASA and contractor facilities revealed the use of antiquated and obsolete 1970s-era technology such as analog equipment. Current state-of-the-art technology is digital rather than analog. Digital equipment is less costly, easier to maintain, and more reliable and accurate. The CAIB recommended that, with the Shuttle projected to fly through 2020, upgrading the test equipment to digital technology would avoid the high maintenance, lack of parts, and questionable accuracy of the equipment currently in use. Although the new equipment would require certification for its use, the benefit in accuracy, maintainability, and longevity would likely outweigh the drawbacks of certification costs for the Program lasting until 2020.

The Vision for Space Exploration calls for NASA to retire the Shuttle following completion of International Space Station assembly, which is planned for the end of the decade. Because NASA is going to retire the Shuttle approximately ten years earlier than was planned, NASA must reassess whether the benefits of new equipment will outweigh the drawback of certification costs. The Shuttle Program will continue to maintain and upgrade test equipment systems to ensure that we preserve the necessary capacity throughout the life of the Shuttle. Decisions on appropriate investments in new test equipment will be made taking into consideration the projected end of Shuttle service life.

NASA IMPLEMENTATION

Recently, the Space Shuttle Program (SSP) Manager established a Program Strategic Sustainment Office to provide stronger focus and leadership for sustainability issues such as material, hardware, and test equipment obsolescence. The Program Strategic Sustainment Office

conducts reviews of all Program Elements and supporting contractors to identify risks to Program sustainability, with an emphasis on test equipment. The Manager of the Strategic Sustainment Office has hired an Obsolescence Manager whose primary focus is on mitigating risks related to obsolete or near-obsolete test equipment.

In 2003, the logistics board approved \$32M towards equipment modernization or upgrade, such as the Space Shuttle Main Engine controller special test equipment (STE), the Orbiter inertial measurement unit, and the Star Tracker STE. Additionally, the Program Strategic Sustainment Office identified and submitted through the Integrated Space Operations Summit (ISOS) process an additional requirement for sustainability to support similar test equipment and obsolescence issues. Certification costs and schedules and the associated Program risks are required elements of the total project package reviewed by the logistics board prior to authority to proceed.

The Obsolescence Manager will assess all critical Program equipment, through regular reviews, and will determine where upgrades are needed to support the Program for the remainder of the Space Shuttle's service life. Identified upgrades will be submitted through the ISOS process to ensure funding of specific projects.

STATUS

This is an ongoing process. Near-term (<5 year) equipment upgrade requirements are being defined by the Program and validated by the ISOS 2004 Mission Execution Panel. Approximately \$17M in additional test equipment upgrades have been identified and approved through the 2003 Shuttle Life Extension Program summit for fiscal year (FY) 2004.

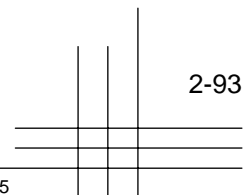

SCHEDULE

Responsibility	Due Date	Activity/Deliverable
SSP	Dec 03 (Completed)	Approve FY04 test equipment upgrades
Service Life Extension Program Sustainability Panel	Feb 04 (Completed)	Define FY05 test equipment upgrades
SSP Development Office	May 04 (Completed)	Provide final Summit II investment recommendations to Space Flight Leadership Council



Columbia Accident Investigation Board

Observation 10.12-1

NASA should implement an agency-wide strategy for leadership and management training that provides a more consistent and integrated approach to career development. This strategy should identify the management and leadership skills, abilities, and experiences required for each level of advancement. NASA should continue to expand its leadership development partnerships with the Department of Defense and other external organizations.

Note: NASA has closed this observation through the formal Program Requirements Control Board process. The following summary details NASA's response to the observation and any additional work NASA intends to perform beyond the Columbia Accident Investigation Board (CAIB) observation.

BACKGROUND

NASA has always considered training and development to be a cornerstone of good management. Even prior to the Columbia accident, the NASA Training and Development Division offered a wide curriculum of leadership development programs to the NASA workforce. The content of internally sponsored programs was developed around the NASA leadership model, which delineates six leadership competencies at four different levels. The four levels are executive leader, senior leader, manager/supervisor, and influence leader. Each level contains distinct core competencies along with a suggested curriculum. NASA also developed leadership skills in the workforce by taking advantage of training and development opportunities at the Office of Personnel Management, Federal Executive Institute, Brookings Institute, Department of Defense, and the Center for Creative Leadership, among many other resources. In addition, the Agency sponsors leadership development opportunities through academic fellowships in executive leadership and management, as well as through the NASA-wide Leadership Development Program. Also, some NASA centers offer locally sponsored leadership development programs for their first-level and/or mid-level managers and supervisors; these programs are unique to the need of each center.

Upon review of this CAIB observation, NASA agrees that the Agency can further improve the training and development programs offered to NASA employees.

NASA IMPLEMENTATION

This CAIB Observation is the inspiration behind the recently announced One NASA Strategy for Leadership and Career Development. The Associate Administrator for Institutions and Management distributed the final

version of the strategy to Officials in Charge and Center Directors in October 2004. NASA's goal for the One NASA Strategy is for the Agency to develop a more integrated process that would identify the management and leadership skills, abilities, and experiences necessary for advancement through various leadership roles. The strategy, informed by data gathered from a process of meetings and benchmarking, presents an overall competency-based framework and approach for leadership development at NASA, outlining leadership roles and core and elective experiences and training.

The underpinnings of the strategy are (1) the NASA Values – safety, the NASA family, excellence, and integrity; and (2) the NASA Leadership Model with its six performance dimensions that define the competencies, knowledge, skills, and abilities necessary for demonstrating excellence in various leadership roles.

The strategy includes a framework that is intended to provide a consistent and integrated approach to leadership and management career development. Each leadership role within the framework contains components that are designed to enable employees to achieve and demonstrate the NASA values along with the identified competencies for that role. Common elements in each role include:

- Core experiences and broadening opportunities including mobility – intellectual as well as geographical.
- Core and optional courses relevant to both achieving mastery in the role as well as preparing for the next step.
- Required role-specific courses on safety and diversity.

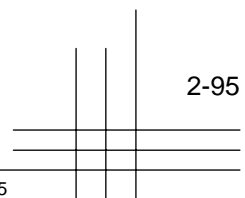

- Assessments – analysis of feedback from subordinates, supervisors, customers, peers, and stakeholders.
- Continuing education.
- Individual Development Plans.
- Coaching and mentoring.

STATUS

The One NASA Strategy for Leadership and Career Development will give NASA employees a framework within which they can plan their NASA careers.

FORWARD WORK

None.

A tiger team will be chartered to develop implementation details in fiscal year 2005.

SCHEDULE

Responsibility	Due Date	Activity/Deliverable
Headquarters (HQ) Office of Human Capital Management	Oct 03 (Completed)	Begin Benchmarking Activities
HQ Office of Human Capital Management	Oct 03 (Completed)	Begin the staff work to form the Agency team
HQ Office of Human Capital Management	Jan 04 (Completed)	Benchmarking data to date compiled
HQ Office of Human Capital Management	Jul 04 (Completed)	Draft strategy reviewed/validated by Enterprises/Senior leadership
HQ Office of Human Capital Management	Sep 04 (Completed)	Strategy developed and presented to the NASA Associate Deputy Administrator for Institutions and Asset Management
HQ Office of Human Capital Management	Oct 04 (Completed)	Strategy distributed to Officials in Charge, Center Directors

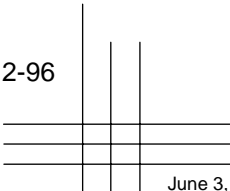



CAIB Report, Volume II, Appendix D.a, “Supplement to the Report”

Volume II, Appendix D.a, also known as the “Deal Appendix,” augments the CAIB Report and its condensed list of recommendations. The Appendix outlines concerns raised by Brigadier General Duane Deal and others that, if addressed, might prevent a future accident. The fourteen recommendations contained in this Appendix expand and emphasize CAIB report discussions of Quality Assurance processes, Orbiter corrosion detection methods, Solid Rocket Booster External Tank Attach Ring factor-of-safety concerns, crew survivability, security concerns relating to the Michoud Assembly Facility, and shipment of Reusable Solid Rocket Motor segments. NASA is addressing each of the recommendations offered in Appendix D.a. Many of the recommendations have been addressed in previous versions of the Space Shuttle RTF Implementation Plan and, therefore, its response to those recommendations refers to the location in the Plan where its previously provided response is found. Although the recommendations are not numbered in Appendix D.a, NASA has assigned a number of each of the fourteen recommendations for tracking purposes.

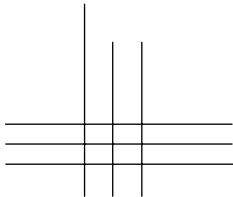



Columbia Accident Investigation Board

Volume II, Appendix D.a, Quality Assurance Section, Recommendation D.a-1 Review Quality Planning Requirements Document Process

Perform an independently led, bottom-up review of the Kennedy Space Center Quality Planning Requirements Document to address the entire quality assurance program and its administration. This review should include development of a responsive system to add or delete government mandatory inspections. Suggested Government Mandatory Inspection Point (GMIP) additions should be treated by higher review levels as justifying why they should not be added, versus making the lower levels justify why they should be added. Any GMIPs suggested for removal need concurrence of those in the chain of approval, including responsible engineers.

BACKGROUND

The *Columbia* Accident Investigation Board noted the need for a responsive system for adding or deleting Government Mandatory Inspection Points (GMIPs) and the need for a periodic review of the Quality Planning Requirements Document (QPRD). The Space Shuttle Program, Shuttle Processing Element located at the Kennedy Space Center is responsible for overseeing the QPRD process and implementation of associated GMIPs.

NASA IMPLEMENTATION, STATUS, FORWARD WORK, AND SCHEDULE

This recommendation is addressed in Section 2.1, Space Shuttle Program Action 1, and Section 2.2, Observation

10.4-1, of this Implementation Plan. Implementation of this recommendation has been in work since the issuance of the *Columbia* Accident Investigation Board Report, Volume I. NASA commissioned an assessment team, independent of the Space Shuttle Program, to review the effectiveness of the QPRD, its companion document at the Michoud Assembly Facility, referred to as the Mandatory Inspection Document, and the associated GMIPs. NASA continues work to improve this process through its defined implementation plan and will demonstrate our progress with this and future updates to the Return to Flight Implementation Plan.

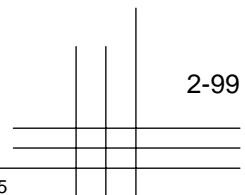



Columbia Accident Investigation Board

Volume II, Appendix D.a, Quality Assurance Section, Recommendation D.a-2 Responsive System to Update Government Mandatory Inspection Points

Kennedy Space Center must develop and institutionalize a responsive bottom-up system to add to or subtract from Government Inspections in the future, starting with an annual Quality Planning Requirements Document review to ensure the program reflects the evolving nature of the Shuttle system and mission flow changes. At a minimum, this process should document and consider equally inputs from engineering, technicians, inspectors, analysts, contractors, and Problem Reporting and Corrective Action to adapt the following year's program.

BACKGROUND

The *Columbia* Accident Investigation Board noted the need for a responsive system for updating Government Mandatory Inspection Points (GMIPs), including the need for a periodic review of the Quality Planning Requirements Document (QPRD). The Space Shuttle Program's Shuttle Processing Element, located at the Kennedy Space Center, is responsible for overseeing the QPRD process and implementation of associated GMIPs.

NASA IMPLEMENTATION, STATUS, FORWARD WORK, AND SCHEDULE

This recommendation is addressed in Section 2.2, Observation 10.4-1, of this Implementation Plan. Implementation of the recommendation has been in work since the release of the *Columbia* Accident Investigation Board Report, Volume I. NASA continues to address this issue through its defined implementation plan and will demonstrate progress with this and future updates to the Return to Flight Implementation Plan.

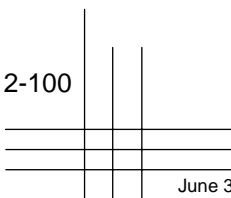



Columbia Accident Investigation Board

Volume II, Appendix D.a, Quality Assurance Section, Recommendation D.a-3 Statistically Driven Sampling of Contractor Operations

NASA Safety and Mission Assurance should establish a process inspection program to provide a valid evaluation of contractor daily operations, while in process, using statistically-driven sampling. Inspections should include all aspects of production, including training records, worker certification, etc., as well as Foreign Object Damage prevention. NASA should also add all process inspection findings to its tracking programs.

BACKGROUND

The *Columbia* Accident Investigation Board (CAIB) noted the need for a statistically valid sampling program to evaluate contractor operations. Kennedy Space Center currently samples contractor operations within the Space Shuttle Main Engine Processing Facility; however, the sample size is not statistically significant and does not represent all processing activities.

NASA IMPLEMENTATION, STATUS, FORWARD WORK, AND SCHEDULE

This recommendation is addressed in Section 2.2, CAIB Observation 10.5-3, of this Implementation Plan. Corrective measures have been in work since the release of the *Columbia* Accident Investigation Board Report, Volume I. NASA continues to address this issue through its defined implementation plan and will demonstrate progress in this and future updates of Observation 10.5-3.



Columbia Accident Investigation Board

Volume II, Appendix D.a, Quality Assurance Section,

Recommendation D.a-4 Forecasting and Filling Personnel Vacancies

The KSC quality program must emphasize forecasting and filling personnel vacancies with qualified candidates to help reduce overtime and allow inspectors to accomplish their position description requirements (i.e., more than the inspectors performing government inspections only, to include expanding into completing surveillance inspections).

Note: The Kennedy Space Center (KSC) Quality Program improvements described here have been implemented by the KSC Director and concurred upon by Space Shuttle Program management. Therefore, this is the final revision to the Return to Flight Implementation Plan regarding Recommendation D.a-4. NASA will continue to monitor and improve our Quality Assurance programs.

BACKGROUND

The *Columbia* Accident Investigation Board expressed concern regarding staffing levels of Quality Assurance Specialists (QASs) at KSC and Michoud Assembly Facility. Specifically, they stated that staffing processes must be sufficient to select qualified candidates in a timely manner. Previously, KSC hired three QASs through a step program; none of them had previous experience in quality assurance. The step program was a human resources sponsored effort to provide training and mobility opportunities to administrative staff. Of the three, only one remains a QAS. In addition to hiring qualified candidates, staffing levels should be sufficient to ensure the QAS function involves more than just inspection. Additional functions performed should include hardware surveillance, procedure evaluations, and assisting in audits.

NASA IMPLEMENTATION

NASA currently uses two methods for selecting and developing qualified QASs. First, NASA can hire a QAS at the GS-7, GS-9, or GS-11 level if the candidate meets a predetermined list of requirements and level of experience. QAS candidates at all levels require additional training. Candidates selected at lower grades require further classroom and on-the-job training before being certified as a QAS. The second method that NASA uses is a cooperative education program that brings in college students as part of their education process. This program is designed to develop QAS or quality control technicians for NASA

and the contractor. The program is an extensive two-year program, including classroom and on-the-job training. If at the end of the cooperative education program the student does not demonstrate the required proficiency, NASA will not hire the individual.

Hiring practices have also improved. NASA can hire temporary or term employees. While permanent hiring is preferred, this practice provides flexibility for short-term staffing issues. Examples include replacements for QAS military reservists who deploy to active duty and instances when permanent hiring authority is not immediately available.

Several QASs are deploying a hardware surveillance program. This program will define the areas in which hardware surveillance will be performed, the checklist of items to be assessed, the number of hardware inspections required, and the data to be collected.

KSC has addressed the hiring issue. Identified training issues are addressed in Section 2.2, Observation O10.4-3.

STATUS

None.

FORWARD WORK

None.

SCHEDULE

Responsibility	Due Date	Activity/Deliverable
KSC	Completed	Develop and implement processes for timely hiring of qualified candidates
KSC	Completed	Develop and implement hardware surveillance program in the Orbiter Processing Facilities
KSC	Completed	Deploy hardware surveillance program to all QAS facilities
KSC	Completed	Develop reporting metric
KSC	Apr 04 (Completed)	Develop and implement procedure evaluation



Columbia Accident Investigation Board

Volume II, Appendix D.a, Quality Assurance Section, Recommendation D.a-5 Quality Assurance Specialist Job Qualifications

Job qualifications for new quality program hires must spell out criteria for applicants, and must be closely screened to ensure the selected applicants have backgrounds that ensure that NASA can conduct the most professional and thorough inspections possible.

Note: NASA is closing this recommendation through the formal Program Requirements Control Board process. The following summary details NASA's response to the recommendation and any additional work NASA intends to perform beyond the *Columbia* Accident Investigation Board (CAIB) recommendation.

BACKGROUND

The CAIB expressed concern regarding staffing qualifications of Quality Assurance Specialists (QASs) at Kennedy Space Center (KSC). Previously, KSC hired three QASs, none of whom had previous experience in quality assurance, through a step program. Of the three, only one remains as a QAS.

NASA IMPLEMENTATION

NASA currently uses two methods for selecting and developing qualified QAS. First, if the candidate meets a predetermined list of requirements and level of experience, NASA can hire a QAS at the GS-7, GS-9, or GS-11 level. QAS candidates at all levels require additional training. Candidates selected at lower grades require further classroom and on-the-job training before being certified as a QAS. The second method NASA uses is a cooperative education program that brings in college students as part of their education process. This program is designed to develop QAS or quality control technicians for NASA and the contractor. The program is an extensive two-year program, including classroom and on-the-job training. If at the end of the cooperative education program the student does not demonstrate the required proficiency, NASA will not hire the individual.

NASA has benchmarked Department of Defense (DoD) and Defense Contract Management Agency (DCMA) training requirements and determined where NASA can use their training as is. A team consisting of engineers and QAS in both the Space Shuttle and International Space Station Programs was formed to develop and document a more robust training program. The team evaluated a course on Quality

Assurance skills and a course on visual inspection. They presented their recommendations on how to improve the overall training program. The KSC Safety and Mission Assurance (S&MA) Directorate, using the recommendations provided, documented the training requirements for all S&MA positions in a formal training records template. Additional information on the training plan is found in Section 2.2, Observation O10.4-3.

STATUS

Current S&MA personnel will have completed or be scheduled for new requirements training by August 2005. NASA will continue to monitor and improve our Quality Assurance programs.

FORWARD WORK

None.

SCHEDULE

Responsibility	Due Date	Activity/Deliverable
KSC	Completed	Develop and implement processes for hiring and developing qualified QAS
KSC	Completed	Benchmark DoD and DCMA training programs (from O10.4-3)
KSC	Apr 04 (Completed)	Develop and document improved training requirements (from O10.4-3)



Columbia Accident Investigation Board

Volume II, Appendix D.a, Quality Assurance Section,

Recommendation D.a-6 Review Mandatory Inspection Document Process

Marshall Space Flight Center should perform an independently-let bottom-up review of the Michoud Quality Planning Requirements Document to address the quality program and its administration. This review should include development of a responsive system to add or delete government mandatory inspections. Suggested Government Mandatory Inspection Point (GMIP) additions should be treated by higher review levels as justifying why they should not be added, versus making the lower levels justify why they should be added. Any GMIPs suggested for removal should need concurrence of those in the chain of approval, including responsible engineers.

BACKGROUND

The *Columbia* Accident Investigation Board noted the need for a responsive system for adding or deleting Government Mandatory Inspection Points (GMIPs), including those at the Michoud Assembly Facility (MAF), and the need for a periodic review of the Quality Planning Requirements Document (QPRD). The Shuttle Propulsion Element at the Marshall Space Flight Center is responsible for overseeing the Mandatory Inspection Document process and implementation of associated GMIPs.

NASA IMPLEMENTATION, STATUS, FORWARD WORK, AND SCHEDULE

This recommendation is addressed in Section 2.1, Space Shuttle Program Action 1, and Section 2.2, Observation 10.4-1, of this Implementation Plan. Efforts to implement this recommendation have been in work since the issuance of the *Columbia* Accident Investigation Board Report, Volume I. NASA commissioned an assessment team, independent of the Space Shuttle Program, to review the effectiveness of the QPRD and its companion document at the MAF, referred to as the Mandatory Inspection Document, and the associated GMIPs. NASA continues efforts to improve this process through its defined implementation plan and will demonstrate its progress with this and future updates to the Return to Flight Implementation Plan.



Columbia Accident Investigation Board

Volume II, Appendix D.a, Quality Assurance Section, Recommendation D.a-7 Responsive System to Update Government Mandatory Inspection Points at the Michoud Assembly Facility

Michoud should develop and institutionalize a responsive bottom-up system to add to or subtract from Government Inspections in the future, starting with an annual Quality Planning Requirements Document review to ensure the program reflects the evolving nature of the Shuttle system and mission flow changes. Defense Contract Management Agency manpower at Michoud should be refined as an outcome of the QPRD review.

BACKGROUND

The *Columbia* Accident Investigation Board noted the need for a responsive system for updating Government Mandatory Inspection Points (GMIPs), including the need for a periodic review of the Quality Planning Requirements Document (QPRD). The Space Shuttle Program, Shuttle Processing Element, located at the Kennedy Space Center is responsible for overseeing the QPRD process and implementation of associated GMIPs.

NASA IMPLEMENTATION, STATUS, FORWARD WORK, AND SCHEDULE

This recommendation is addressed in Section 2.1, Space Shuttle Program Action 1, and Section 2.2, Observation 10.4-1, of this Implementation Plan. Efforts to implement this recommendation have been in work since the issuance of the *Columbia* Accident Investigation Board Report, Volume I. NASA commissioned an assessment team, independent of the Space Shuttle Program, to review the effectiveness of the QPRD, its companion at the Michoud Assembly Facility, referred to as the Mandatory Inspection Document, and the associated GMIPs. NASA continues efforts to improve this process through its defined implementation plan and will demonstrate progress with this and future updates to the Return to Flight Implementation Plan.

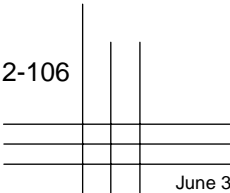



Columbia Accident Investigation Board

Volume II, Appendix D.a, Quality Assurance Section, Recommendation D.a-8 Use of ISO 9000/9001

Kennedy Space Center should examine which areas of ISO 9000/9001 truly apply to a 20-year-old research and development system like the Space Shuttle.

BACKGROUND

The *Columbia* Accident Investigation Board report high-lighted Kennedy Space Center's reliance on the International Organization for Standardization (ISO) 9000/9001 certification. The report stated, "While ISO 9000/9001 expresses strong principles, they are more applicable to manufacturing and repetitive-procedure Industries, such as running a major airline, than to a research-and-development, flight test environment like that of the Space Shuttle. Indeed, many perceive International Standardization as emphasizing process over product." Currently, ISO 9000/9001 certification is a contract requirement for United Space Alliance.

NASA IMPLEMENTATION, STATUS, FORWARD WORK, AND SCHEDULE

This recommendation is addressed in Section 2.2, Observation 10.4-4, of this Implementation Plan. Evaluation of this recommendation has been in work since the release of the *Columbia* Accident Investigation Board Report, Volume I. NASA continues efforts to improve this process through its defined implementation plan and will demonstrate progress with this and future updates to the Return to Flight Implementation Plan.



Columbia Accident Investigation Board

Volume II, Appendix D.a, Quality Assurance Section, Recommendation D.a-9 Orbiter Corrosion

Develop non-destructive evaluation inspections to detect and, as necessary, correct hidden corrosion.

BACKGROUND

The Space Shuttle Program has initiated an action to assess the *Columbia* Accident Investigation Board observations related to corrosion damage in the Orbiters. This action has been assigned to the Orbiter Project Office.

NASA IMPLEMENTATION, STATUS, FORWARD WORK, AND SCHEDULE

This recommendation is addressed in Section 2.2, Observations 10.7-1 through 10.7-4, of this Implementation Plan. Evaluation of this recommendation has been in work since the release of the *Columbia* Accident Investigation Board Report, Volume I. NASA demonstrates progress in the Return to Flight Implementation Plan.

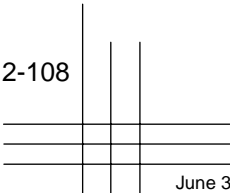



Columbia Accident Investigation Board

Volume II, Appendix D.a, Quality Assurance Section, Recommendation D.a-10 Hold-Down Post Cable Anomaly

NASA should evaluate a redesign of the Hold-Down Post Cable, such as adding a cross-strapping cable or utilizing a laser initiator, and consider advanced testing to prevent intermittent failure.

This recommendation is addressed in Section 2.2, Observation 10.9-1, of this Implementation Plan.



Columbia Accident Investigation Board

Volume II, Appendix D.a, Quality Assurance Section, Recommendation D.a-11 Solid Rocket Booster External Tank Attach Ring

NASA must reinstate a safety factor of 1.4 for the Attach Rings—which invalidates the use of ring serial numbers 15 and 16 in their present state—and replace all deficient material in the Attach Rings.

This recommendation is addressed in Section 2.2, Observation 10.10-1, of this Implementation Plan.

2-110		



Columbia Accident Investigation Board

Volume II, Appendix D.a, Quality Assurance Section, Recommendation D.a-12 Crew Survivability

To enhance the likelihood of crew survivability, NASA must evaluate the feasibility of improvements to protect the crew cabin on existing Orbiters.

Note: NASA is closing this recommendation through the formal Program Requirements Control Board (PRCB) process. The following summary details NASA's response to the recommendation and any additional work NASA intends to perform beyond the *Columbia* Accident Investigation Board (CAIB) recommendation.

BACKGROUND

The CAIB found that, in both the *Challenger* and the *Columbia* accidents, the crew cabin initially survived the disintegration of the Orbiter intact.

NASA IMPLEMENTATION

Implementation of this recommendation has been in work since the release of the *Columbia* Accident Investigation Board Report, Volume I. The Space Shuttle Service Life Extension Program II Crew Survivability Sub-panel recognized the need for the Program to continue funding the vehicle forensic analysis and follow-on thermal and structural hardening analysis. This work plays a part not only as resolution to a CAIB Recommendation but also as a component of furthering the technical understanding of the space/atmosphere-aero interface and conveys knowledge capture for future programs.

On July 21, 2004, the Space Shuttle Upgrades PRCB approved the formation of the Space Craft Survival Integrated Investigation Team (SCSIIT). This multidisciplinary team, comprised of JSC Flight Crew Operations, JSC Mission Operations Directorate, JSC Engineering, Safety and Mission Assurance, the Space Shuttle Program, and Space and Life Sciences Directorate, was tasked to perform a comprehensive analysis of the two Shuttle accidents for crew

survival implications. The team's focus is to combine data (including debris, video, and Orbiter experiment data) from both accidents with crew module models and analyses. After completion of the investigation and analysis, the SCSIIT will issue a formal report documenting lessons learned for enhancing crew survivability in the Space Shuttle and for future human space flight vehicles, such as the Crew Exploration Vehicle.

The SCSIIT expects analysis to be completed within approximately two years. Space Shuttle-critical flight safety issues will be reported to the PRCB for disposition. Future crewed-vehicle spacecraft will use the products of the multidisciplinary team to aid in developing the crew safety and survivability requirements.

STATUS

The SCSIIT anticipates the final report with recommendations will be issued in September 2006. Fiscal year 2005 (FY05) and FY06 funding has been committed for this team's activities.

FORWARD WORK

None.

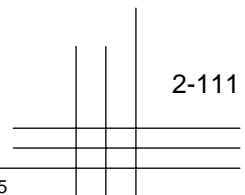



Columbia Accident Investigation Board

Volume II, Appendix D.a, Quality Assurance Section, Recommendation D.a-13 RSRM Segment Shipping Security

NASA and ATK Thiokol perform a thorough security assessment of the RSRM segment security, from manufacturing to delivery to Kennedy Space Center, identifying vulnerabilities and identifying remedies for such vulnerabilities.

Note: NASA considers this recommendation closed, and the following summary details NASA's response.

BACKGROUND

During security program assessments at the ATK Thiokol Reusable Solid Rocket Motor (RSRM) Production Facility, the *Columbia* Accident Investigation Board raised concerns about several elements of the overall security program. Most notable of these concerns was protection of completed segments prior to rail shipment to the Kennedy Space Center (KSC).

NASA IMPLEMENTATION

NASA has conducted a full security program vulnerability assessment of the ATK Thiokol RSRM Production Facility, with the goal of identifying and mitigating security vulnerabilities.

NASA security officials, together with ATK Thiokol Security Program officials, performed an assessment of the RSRM security program from RSRM manufacturing to delivery, inspection, and storage at KSC. The assessment included a review of the ATK Thiokol manufacturing plant to the railhead; participation in the rail shipment activities of RSRM segment(s) to or from KSC; regional and local threats; and rotation, processing, and storage facility security at KSC. Based on this assessment, NASA plans to implement a vulnerability mitigation activity.

STATUS

NASA conducted assessments of several key elements of the ATK Thiokol RSRM operation: December 8–12,

2003, ATK Thiokol RSRM Facilities; January 26–27, 2004, KSC RSRM Facilities; and January 30–February 9, 2004, RSRM Railway Transport Route and Operations.

An RSRM Security Assessment briefing was provided by the assessment team lead to both Marshall Space Flight Center Security and RSRM Project in March 2004. The written report was submitted at a later date. The team's assessment concluded that "threat" and "vulnerability" were low and no critical findings were noted.

A number of recommendations to enhance RSRM security were provided for RSRM Project consideration. These recommendations were grouped into three categories: Corinne Site (where RSRM segments are loaded onto rail cars), rail transport, and general operations. The Project assessed the impact and viability of noted recommendations. Those recommendations that the Project agreed would effectively enhance RSRM security were implemented prior to the shipment of flight hardware to KSC (December 2004).

SCHEDULE

This action is considered closed by the Project.

2-112			



Columbia Accident Investigation Board

Volume II, Appendix D.a, Quality Assurance Section, Recommendation D.a-14 Michoud Assembly Facility Security

NASA and Lockheed-Martin complete an assessment of the Michoud Assembly Facility security, focusing on items to eliminate vulnerabilities in its current stance.

NOTE: NASA has closed this recommendation through the formal Program Requirements Control Board process. The following summary details NASA's response to the recommendation and any additional work NASA intends to perform beyond the *Columbia* Accident Investigation Board (CAIB) recommendation.

BACKGROUND

During security program assessments at the Michoud Assembly Facility (MAF), the CAIB expressed concerns about several elements of the overall security program. Most notable of these concerns is the adequacy of particular security equipment and staffing.

NASA IMPLEMENTATION

NASA conducted a full security program vulnerability assessment of the MAF and External Tank (ET) production activity, with the goal of identifying and mitigating security vulnerabilities.

They assessed the MAF and the ET production security programs from ET manufacturing to delivery, inspection, and storage at Kennedy Space Center (KSC). The assessment included a review of the MAF to the shipping port; shipping activities of the ET to and from KSC; regional and local threats; and Vehicle Assembly Building security at KSC. Based on the assessment, NASA plans to implement a vulnerability mitigation activity.

STATUS

The NASA assessment was conducted from January 26 through January 30, 2004. A comprehensive Report of Findings and a separate Executive Summary, both administratively controlled documents, were prepared by the assessment team and presented to the NASA Office of Security Management and Safeguards and to the Marshall Space Flight Center (MSFC) Security Director.

In June 2004, MSFC Protective Services assigned a Civil Service Security Specialist to the MAF to review and assess the Lockheed Martin-Michoud Operations approach and assure the proposed enhancements are compatible with NASA security standards.

In July 2004, Lockheed Martin submitted a detailed and prioritized security enhancement plan. The priorities were determined based on discussions with MSFC Protective Services, MAF NASA Management, and Lockheed Martin Management.

Lockheed Martin initiated implementation of the improvements that were considered within the scope of the current contract, and they are in the process of addressing staffing needs. NASA has budgeted the appropriate funding. Other improvements have been implemented by authorization of proposals that preceded the security plan. These include an integrated Security Control system that includes closed circuit television, access control, alarm monitoring, and identification management. Additionally, a total modernization of the Security Dispatch Center is under construction.

All elements of the security plan that were not within the scope of contract at the time of the vulnerability assessment have been reviewed by NASA, and budgetary approval was granted in March 2005. A Lockheed Martin proposal to correct the deficiencies is in the process of negotiation, and expected to be on contract by July 2005.

SCHEDULE

The integrated security control system project and the Security Dispatch Center modifications are scheduled for completion by June 2005.

The Lockheed Martin proposal to address all findings in the vulnerability assessment will be on contract by July 2005.

Security staffing levels have been increased and should be at the contracted level by October 2005.

2-114

June 3, 2005



Appendix A: NASA's Return to Flight Process



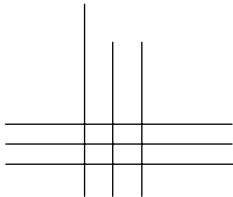

BACKGROUND

The planning for return to flight (RTF) began even before the Agency received the first two *Columbia* Accident Investigation Board (CAIB) preliminary recommendations on April 16, 2003. Informally, activities started in mid-February as the Space Shuttle projects and elements began a systematic fault-tree analysis to determine possible RTF constraints. In a more formal sense, the RTF process had its beginnings in a March 2003 Office of Space Flight (OSF) memorandum.

Mr. William F. Readdy, the Associate Administrator for Space Flight, initiated the Space Shuttle Return to Flight planning process in a letter to Maj. Gen. Michael C. Kostelnik, the Deputy Associate Administrator for International Space Station and Space Shuttle Programs, on March 12, 2003. The letter gave Maj. Gen. Kostelnik the direction and authority “to begin focusing on those activities necessary to expeditiously return the Space Shuttle to flight.”

Maj. Gen. Kostelnik established a Return to Flight Planning Team (RTFPT) under the leadership of astronaut Col. James Halsell. The RTF organization is depicted in figure A-1.

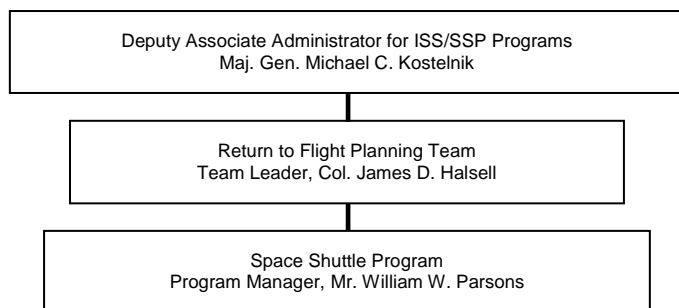

Figure A-1. Original RTFPT organization.

Space Shuttle Program (SSP) Role in Return to Flight

The SSP provided the analyses required to determine the NASA return to flight constraints (RTFCs). SSP project and element fault-tree analyses combined with technical working group documentation and analyses provided the database needed to create a list of potential RTFCs.

For example, the SSP’s Orbiter Project organized first as the Orbiter Vehicle Engineering Working Group (OVEWG) to develop fault-tree analyses, and later as the Orbiter Return-to-Flight Working Group to recommend implementation options for RTFCs. The OVEWG structure and its subgroups are listed in figure A-2.

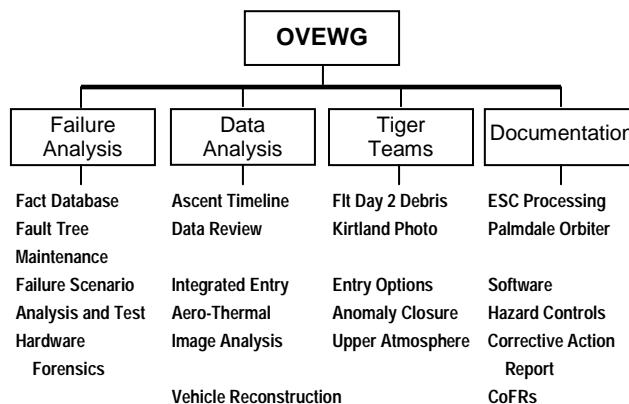

Figure A-2. OVEWG organization.

Once analyses were complete, the working groups briefed the CAIB on their findings and solicited the Space Shuttle Program Requirements Control Board’s (SSPRCB’s) approval of identified corrective actions.

Each SSP project and element formed similar organizations to accomplish thorough fault-tree analysis and closure.

Return to Flight Planning Team

The RTFPT was formed to address those actions needed to comply with formal CAIB recommendations and NASA initiatives (“Raising the Bar”), and to determine the fastest path for a safe RTF. The approximately 30-member team was assembled with representatives from NASA Headquarters and the OSF Field Centers, crossing the Space Shuttle Operations, Flight Crew Operations, and Safety and Mission Assurance disciplines.

Starting in early April 2003, the RTFPT held weekly teleconferences to discuss core team processes and product delivery schedules. Weekly status reports, describing the progress of RTF constraints, were generated for Maj. Gen. Kostelnik and Dr. Michael Greenfield, one of the Space Flight Leadership Council (SFLC) co-chairs. These reports were also posted

on a secure Web site for the RTFPT membership and other senior NASA officials to review. The RTFPT often previewed RTF briefing packages being prepared for SSPRCBs. The leader of the RTFPT, Col. Halsell, became a voting member of the SSPRCB for all RTF issues. The RTFPT also arranged for all recommended SSPRCB RTF issues to be scheduled for SFLC review and approval. These RTFPT tasks were primarily assessment, status, and scheduling activities. The team's most significant contribution has been preparing and maintaining this Implementation Plan, which is a living document chronicling NASA's RTF.

As the Implementation Plan has matured and obtained SFLC approval, NASA has transitioned from planning for RTF to implementing the plan. As intended, the lead role has transitioned from the RTFPT to the Space Shuttle Program, which is now responsible to the SFLC for executing the plan to successful completion. Accordingly, Maj. Gen. Kostelnik decommissioned the RTFPT on June 7, 2004, and transferred all remaining administrative and coordination duties to the Management Integration and Planning Office (MG) of the Space Shuttle Program, under the direction of former astronaut Col. (Ret.) John Casper. The MG office has established a Return to Flight Branch that is responsible for the coordination of RTF constraint closures with the RTF Task Group.

These changes reflect the real progress toward RTF that has been made in the last few months, and NASA's commitment to optimizing our processes and organization as we execute the RTF Plan.

Space Flight Leadership Council

The SFLC was co-chaired by the Associate Administrator for Space Flight (Mr. William F. Readdy) and the Associate Deputy Administrator for Technical Programs (Dr. Michael Greenfield) until August 2004. As NASA moved to an organization of Mission and Support Directorates, the co-chairs became the Associate Administrator for Space Operations (Mr. William Readdy's post-transformation title) and the Deputy Chief Engineer for Independent Technical Authority (Adm. Walt Cantrell). The purpose of the SFLC (figure A-3) remains unchanged and they continue to receive and disposition the joint RTFPT/SSPRCB recommendations on RTF issues. The SFLC is charged with approving RTF items and directing the implementation of specific corrective actions. The SFLC can also direct independent analysis on technical issues related to RTF issues or schedule (e.g., the category of wiring inspection on Orbiter Vehicle (OV)-103/*Discovery*). The membership of the SFLC includes the OSF

Center Directors (Johnson Space Center, Kennedy Space Center, Marshall Space Flight Center, and Stennis Space Center) and the Associate Administrator for Safety and Mission Assurance. SFLC meetings are scheduled as needed.

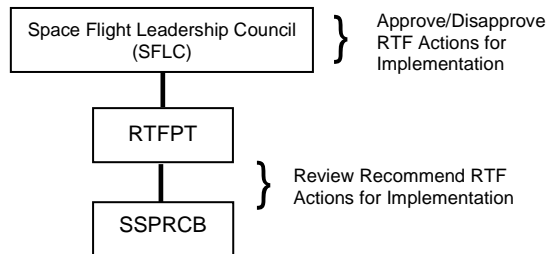

Figure A-3. Space Flight Leadership Council organization for return to flight issue review.

Members of the Return-to-Flight Task Group (RTFTG) are invited to attend the SFLC meetings.

Return to Flight Task Group

Also known as the Stafford Covey Task Group, the RTFTG was established by the NASA Administrator to perform an independent assessment of NASA's actions to implement the CAIB recommendations. The RTFTG was chartered from the existing Stafford International Space Station Operations Readiness Task Force (Stafford Task Force), a Task Force under the auspices of the NASA Advisory Council. The RTFTG is comprised of standing members of the Stafford Task Force, other members selected by the co-chair, and a nonvoting ex-officio member: the Associate Administrator for Safety and Mission Assurance. The RTFTG is organized into three panels: technical, operations, and management. The team held its first meeting, primarily for administrative and orientation purposes, in early August 2003, and has been meeting periodically since. The RTFTG has issued two Interim Reports—one in January 2004, and one in May 2004.

Operational Readiness Review

The SFLC will continue to convene meetings to resolve NASA's internal handling of RTFPT/SSPRCB recommendations and return to flight issues. The first operational readiness review meeting, a Flight Certification Review, was held at the Marshall Space Flight Center on December 11-12, 2003. As the Space Shuttle Program prepares for return to flight, they will conduct element, project, and finally Program Design Certification Reviews (DCRs) in preparation for

the STS-114 Flight Readiness Review. To date, completed project/element DCRs are the Space Shuttle Main Engine (September 2004) and the Reusable Solid Rocket Motor project (October 2004).

RTF Schedule

See figure A-4.

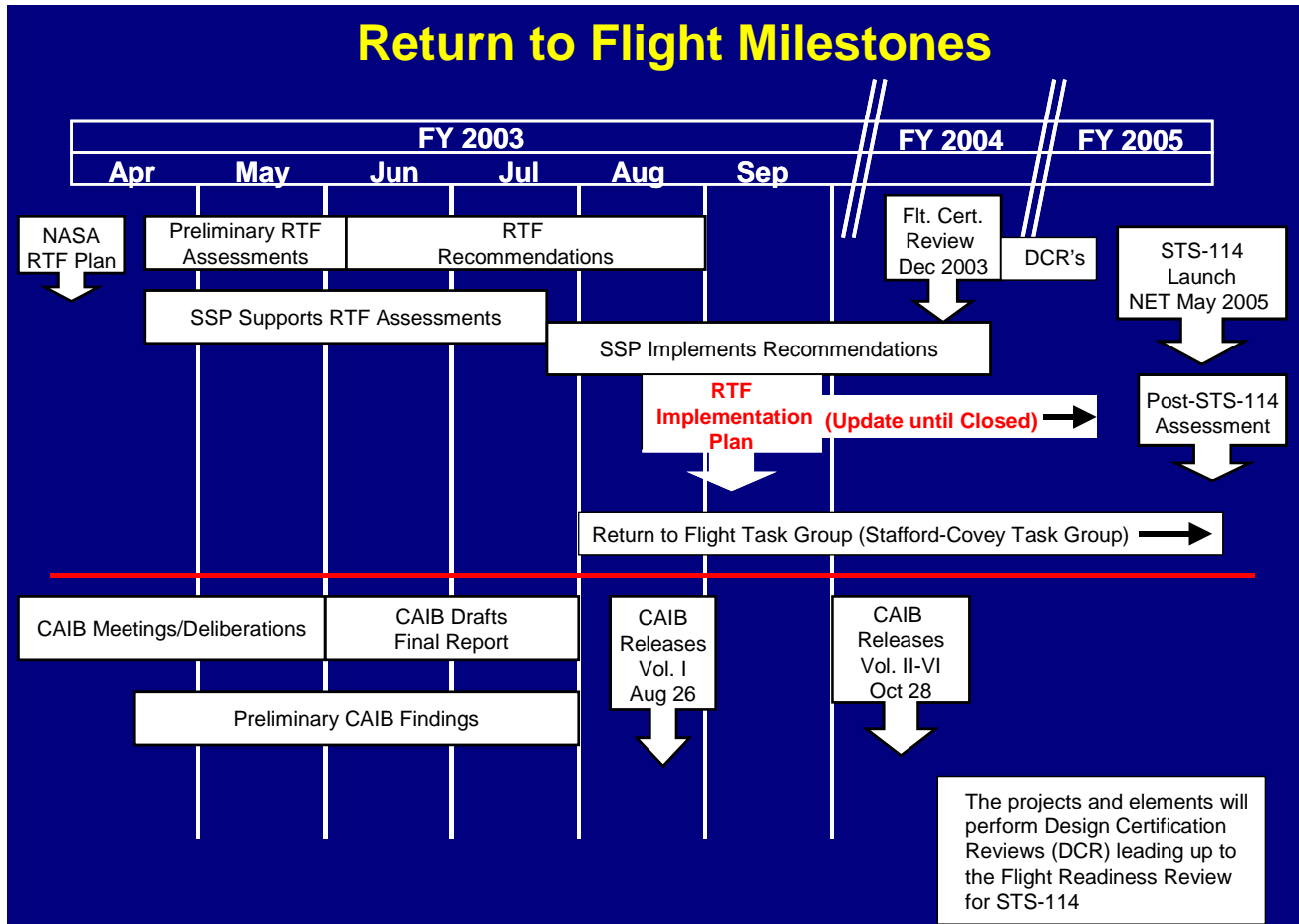
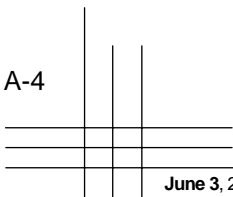

Figure A-4. RTF and RTFTG schedules overlaid with the schedule for release of the CAIB final report.





Appendix B: Return to Flight Task Group



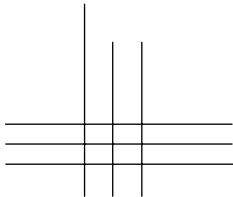

INTRODUCTION

The Return to Flight Task Group, co-chaired by Thomas P. Stafford and Richard O. Covey, was formed to address the Shuttle Program's return to flight effort. The Task Group is chartered to perform an independent assessment of NASA's actions to implement the *Columbia* Accident Investigation Board (CAIB), as they relate to the safety and operational readiness of STS-114.

The Stafford/Covey Task Group will report on the progress of NASA's response to the CAIB report and may also make other observations on safety or operational readiness as it believes appropriate.

The Task Group will formally and publicly report their results to NASA on a continuing basis, and their recommendations will be folded into NASA's formal planning for return to flight. The paragraphs below describe the charter and membership for the Task Group.

RETURN TO FLIGHT TASK GROUP CHARTER ESTABLISHMENT AND AUTHORITY

The NASA Administrator, having determined that it is in the public interest in connection with performance of the Agency duties under the law, and with the concurrence of the General Services Administration, establishes the NASA Return to Flight Task Group ("Task Group"), pursuant to the Federal Advisory Committee Act (FACA), 5 U.S.C. App. §§1 et seq.

PURPOSE AND DUTIES

1. The Task Group will perform an independent assessment of NASA's actions to implement the CAIB recommendations as they relate to the safety and operational readiness of STS-114. As necessary to their activities, the Task Group will consult with former members of the CAIB.
2. While the Task Group will not attempt to assess the adequacy of the CAIB recommendations, it will report on the progress of NASA's response to meet their intent.
3. The Task Group may make other observations on safety or operational readiness as it believes appropriate.
4. The Task Group will draw on the expertise of its members and other sources to provide its assessment to the Administrator. The Task Group will hold meetings and make site visits as necessary to accomplish its

fact finding. The Task Group will be provided information on activities of both the Agency and its contractors as needed to perform its advisory functions.

5. The Task Group will function solely as an advisory body and will comply fully with the provisions of the Federal Advisory Committee Act.

ORGANIZATION

The Task Group is authorized to establish panels in areas related to its work. The panels will report their findings and recommendations to the Task Group.

MEMBERSHIP

1. In order to reflect a balance of views, the Task Group will consist of non-NASA employees and one NASA nonvoting, ex-officio member, the Deputy Associate Administrator for Safety and Mission Assurance. In addition, there may be associate members selected for Task Group panels. The Task Group may also request appointment of consultants to support specific tasks. Members of the Task Group and panels will be chosen from among industry, academia, and Government personnel with recognized knowledge and expertise in fields relevant to safety and space flight.
2. The Task Group members and Cochairs will be appointed by the Administrator. At the request of the Task Group, associate members and consultants will be appointed by the Associate Deputy Administrator (Technical Programs).

ADMINISTRATIVE PROVISIONS

1. The Task Group will formally report its results to NASA on a continuing basis at appropriate intervals, and will provide a final written report.
2. The Task Group will meet as often as required to complete its duties and will conduct at least two public meetings. Meetings will be open to the public, except when the General Counsel and the Agency Committee Management Officer determine that the meeting or a portion of it will be closed pursuant to the Government in the Sunshine Act or that the meeting is not covered by the Federal Advisory Committee Act. Panel meetings will be held as required.
3. The Executive Secretary will be appointed by the Administrator and will serve as the Designated Federal Officer.

4. The Office of Space Flight will provide technical and staff support through the Task Force on International Space Station Operational Readiness. The Office of Space Flight will provide operating funds for the Task Group and panels. The estimated operating costs total approximately \$2M, including 17.5 work-years for staff support.

5. Members of the Task Group are entitled to be compensated for their services at the rate equivalent to a GS 15, step 10. Members of the Task Group will also be allowed per diem and travel expenses as authorized by 5 U.S.C. § 5701 et seq.

DURATION

The Task Group will terminate two years from the date of this charter, unless terminated earlier or renewed by the NASA Administrator.

STAFFORD-COVEY TASK GROUP MEMBERS

**Col. James C. Adamson, U.S. Army (Ret.):
CEO, Monarch Precision, LLC, consulting firm**

Col. Adamson, a former astronaut, has an extensive background in aerodynamics and business management. He received his Bachelor of Science degree in Engineering from the U.S. Military Academy at West Point and his Master's degree in Aerospace Engineering from Princeton University. He returned to West Point as an Assistant Professor of Aerodynamics until he was selected to attend the Navy Test Pilot School at Patuxent River, Md. in 1979. In 1981 he became Aerodynamics Officer for the Space Shuttle Operational Flight Test Program at the Johnson Space Center's Mission Control Center. Col. Adamson became an astronaut in 1984 and flew two missions, the first aboard *Columbia* (STS-28) and the second aboard *Atlantis* (STS-43).

After retiring from NASA in 1992, he created his own consulting firm, Monarch Precision, and was then recruited by Lockheed as President/Chief Executive Officer (CEO) of Lockheed Engineering and Sciences Company. In 1995 he helped create United Space Alliance and became their first Chief Operating Officer, where he remained until 1999. In late 1999, Col. Adamson was again recruited to serve as President/CEO of Allied Signal Technical Services Corporation, which later became Honeywell Technology Solutions, Inc. Retiring from Honeywell in 2001, Col. Adamson resumed part-time consulting with his own company, Monarch Precision, LLC. In addition to corporate board positions, he has served as a member

of the NASA Advisory Council Task Force on Shuttle-Mir Rendezvous and Docking Missions and is currently a member of the NASA Advisory Council Task Force on International Space Station Operational Readiness.

Maj. Gen. Bill Anders, U.S. Air Force Reserve (Ret.):

Maj. Gen. Anders graduated in 1955 as an electrical engineer from the United States Naval Academy and earned his pilot's wings in 1956. He received a graduate degree in nuclear engineering from the U.S. Air Force (USAF) Institute of Technology while concurrently graduating with honors in aeronautical engineering from Ohio State University. In 1963 he was selected for the astronaut corps. He was the Lunar Module Pilot of Apollo 8 and backup Command Module Pilot for Apollo 11. Among other successful public and private endeavors, Maj. Gen. Anders has served as a Presidential appointee to the Aeronautics & Space Council, the Atomic Energy Commission, and the Nuclear Regulatory Commission (where he was the first chairman), and as U.S. Ambassador to Norway.

Subsequent to his public service, he joined the General Dynamics Corporation, as Chairman and CEO (1990–1993), and was awarded the National Security Industrial Association's "CEO of the Year" award.

During his distinguished career, Maj. Gen. Anders was the co-holder of several world flight records and has received numerous awards including the USAF, NASA, and Atomic Energy Commission's Distinguished Service Medals. He is a member of the National Academy of Engineering, the Society of Experimental Test Pilots, and the Experimental Aircraft Association. He is the founder and President of the Heritage Flight Museum.

Dr. Walter Broadnax:

Dr. Broadnax is President of Clark Atlanta University in Atlanta, Ga. Prior to accepting the Presidency at Clark Atlanta University, Broadnax was Dean of the School of Public Affairs at American University in Washington. Previously, he was Professor of Public Policy and Management in the School of Public Affairs at the University of Maryland, College Park, Md., where he also directed The Bureau of Governmental Research. Before joining the University of Maryland faculty, Dr. Broadnax served as Deputy Secretary and Chief Operating Officer of the U.S. Department of Health and Human Services; President, Center for Governmental Research, Inc., in Rochester, N.Y.; President, New York State Civil Service Commission; Lecturer and Director, Innovations

in State and Local Government Programs in the Kennedy School of Government at Harvard University; Senior Staff Member, The Brookings Institution; Principal Deputy Assistant Secretary for Planning and Evaluation, U.S. Department of Health, Education and Welfare; Director, Children, Youth and Adult Services, State of Kansas; and Professor, The Federal Executive Institute, Charlottesville, Va.

He is one of America's leading scholar-practitioners in the field of public policy and management. He has published widely in the field and served in leadership positions in various professional associations: American Political Science Association, American Public Personnel Association, Association of Public Policy and Management, National Association of Schools of Public Affairs and Administration, National Association of State Personnel Executives, and the American Society for Public Administration.

Broadnax received his Ph.D. from the Maxwell School at Syracuse University, his B.A. from Washburn University, and his M.P.A from the University of Kansas. He is a Fellow of the National Academy of Public Administration and a former trustee of the Academy's Board. In March, he was installed as President of the American Society for Public Administration for 2003–2004. He is a member of the Syracuse University Board of Trustees, Harvard University's Taubman Center Advisory Board, and United States Comptroller General Advisory Board. He has also served on several corporate and nonprofit boards of directors including the CNA Corporation, Keycorp Bank, Medecision Inc., Rochester General Hospital, Rochester United Way, and the Ford Foundation/Harvard University Innovations in State and Local Government Program, the Maxwell School Advisory Board, and the National Blue Ribbon Commission on Youth Safety and Juvenile Justice Reform in the District of Columbia.

Dr. Kathryn Clark:

Dr. Clark is the President of Docere, a consulting company that specializes in science and education. She consults for the Jean-Michel Cousteau Society, the Argos Foundation, the National Marine Sanctuaries, and the Sea World Hubbs Institute to enhance the study of oceans and marine wildlife and use the data for education and awareness of the environment of the seas.

She recently completed a job for the Michigan Virtual High School to aid in the development of the Math, Science, and Technology Academy. She worked on the vision and mission of the Academy as well as the development of partners as they increase the scope and reach of the program to a national and international scale. She

recently resigned from her job as NASA's Chief Scientist for the Human Exploration and Development of Space Enterprise (HEDS), a position she accepted in August 2000 after completing a 2-year term as NASA's Chief Scientist for the International Space Station Program. While on leave from the University of Michigan Medical School, she worked in the Chief Scientist position with scientists from all other areas of NASA to communicate research needs and look for possible collaboration among the science programs at NASA. She also assisted with education and outreach activities related to any human space flight endeavors, including the International Space Station, the Shuttle, any expendable launch vehicles intended to further human endeavors in space, and future missions to the Moon and Mars. Her particular interest is in "Human Factors;" all the elements necessary for the health, safety, and efficiency of crews involved in long-duration space flight. These include training, interfacing with machines and robotics, biological countermeasures for the undesirable physical changes associated with space flight, and the psychological issues that may occur in response to the closed, dangerous environments while traveling in space or living on other planets.

She received both her Master's and Doctoral degrees from the University of Michigan and then joined the faculty in the Department of Cell and Developmental Biology in 1993. She also served as the Deputy Director of the NASA Commercial Space Center, The Center for Microgravity Automation Technology (CMAT) from 1996 to 1998. CMAT provides imaging technology for use on the International Space Station. The primary commercial focus of that Center is on using high-fidelity imaging technology for science and education.

Dr. Clark's scientific interests are focused on neuromuscular development and adaptation to altered environments. Her experiments are performed at the tissue level and include immunocytochemistry and in situ hybridization of skeletal muscle and spinal cord grown both in vivo and in vitro. Her experience with NASA began with a neuromuscular development study (NIH.R1) that flew on STS-66 in November 1994. These experiments were repeated and augmented (NIH.R2) on STS-70 in July 1995. She was also involved in the Neurolab project flown on STS-90 in May 1998 and the ladybug experiment that flew on STS-93 with Commander Eileen Collins.

Dr. Clark is the Chair of the Academic Affairs Committee of Board of Control of Michigan Tech University, the Chair of the Board of Visitors of Western Reserve Academy, and serves on the boards of The Space Day Foundation and Orion's Quest, both education oriented not-for-profit organizations.

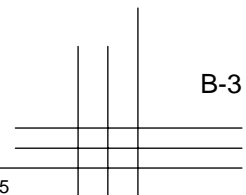

She is a former member of the Board of Directors of Women in Aerospace, is an airplane pilot and member of the 99's (the International Society of Women Pilots), and is an avid cyclist, swimmer, and cross-country skier. She owns a jazz club in Ann Arbor, Michigan. She is married to Dr. Robert Ike, a rheumatologist at the University of Michigan Medical School.

**Mr. Benjamin A. Cosgrove:
Consultant**

Mr. Cosgrove has a long and distinguished career as an engineer and manager associated with most of Boeing jet aircraft programs. His extensive background in aerospace stress and structures includes having served as a stress engineer or structural unit chief on the B-47, B-52, KC-135, 707, 727, 737, and 747 jetliners. He was Chief Engineer of the 767.

Mr. Cosgrove was honored by Aviation Week and Space Technology for his role in converting the Boeing 767 transport design from a three-man to a two-man cockpit configuration and received the Ed Wells Technical Management Award for addressing aging aircraft issues. He received the National Aeronautics Association's prestigious Wright Brothers Memorial Trophy in 1991 for his lifetime contributions to commercial aviation safety and for technical achievement. He is a member of the National Academy of Engineering and a fellow of both the AIAA and England's Royal Aeronautical Society. After retiring from his position as Senior Vice President of the Boeing Commercial Airplane Group in 1993 after 44 years of service, he became a consultant. He holds a Bachelor of Science degree in Aeronautical Engineering and received an honorary Doctorate of Engineering degree from the University of Notre Dame in 1993. Mr. Cosgrove is a member of the NASA Advisory Committee's Task Force on International Space Station Operational Readiness.

**Col. Richard O. Covey, U.S. Air Force (Ret.):
Cochair, Return to Flight Task Group
Vice President, Support Operations, Boeing
Homeland Security and Services**

Col. Covey, a veteran of four Space Shuttle flights, has over 35 years of aerospace experience in both the private and public sectors. He piloted STS-26, the first flight after the *Challenger* accident, and was commander of STS-61, the acclaimed *Endeavour*/Hubble Space Telescope first service and repair mission.

Covey is a highly decorated combat pilot and Outstanding Graduate of the Air Force Test Pilot School, holds a Bachelor of Science degree in Engineering Sciences from the U.S. Air Force Academy, and has a Master of Science

degree in Aeronautics and Astronautics from Purdue University.

He served as the U.S. Air Force Joint Test Force Director for F-15 electronic warfare systems developmental and production verification testing. During his distinguished 16-year career at NASA, he held key management positions in the Astronaut Office and Flight Crew Operations Directorate at Johnson Space Center (JSC). Covey left NASA and retired from the Air Force in 1994.

In his position at Boeing, his organization provides system engineering, facility/system maintenance and operations, and spacecraft operations and launch support to commercial, Department of Defense, and other U.S. Government space and communication programs throughout the world. Prior to his current position, Covey was Vice President of Boeing's Houston Operations.

He has been the recipient of numerous awards such as two Department of Defense Distinguished Service Medals, the Department of Defense Superior Service Medal, the Legion of Merit, five Air Force Distinguished Flying Crosses, 16 Air Medals, the Air Force Meritorious Service Medal, the Air Force Commendation Medal, the National Intelligence Medal of Achievement, the NASA Distinguished Service Medal, the NASA Outstanding Leadership Medal, the NASA Exceptional Service Medal, and the Goddard and Collier Trophies for his role on STS-61.

**Dan L. Crippen, Ph.D.:
Former Director of the Congressional Budget Office**

Dr. Crippen has a strong reputation for objective and insightful analysis. He recently served as the fifth Director of the Congressional Budget Office. His public service positions also include Chief Counsel and Economic Policy Adviser to the Senate Majority Leader (1981–1985); Deputy Assistant to the President for Domestic Policy (1987–1988); and Domestic Policy Advisor and Assistant to the President for Domestic Policy (1988–1989), where he advised the President on all issues relating to domestic policy, including the preparation and presentation of the federal budget. He has provided service to several national commissions, including membership on the National Commission on Financial Institution Reform, Recovery, and Enforcement. He presently serves on the Aerospace Safety Advisory Panel.

Dr. Crippen has substantial experience in the private sector as well. Before joining the Congressional Budget Office, he was a principal with Washington Counsel, a law and consulting firm. He has also served as Executive Director of the Merrill Lynch International Advisory

Council and as a founding partner and Senior Vice President of The Duberstein Group.

He received a Bachelor of Arts degree from the University of South Dakota in 1974, a Master of Arts from Ohio State University in 1976, and a Doctor of Philosophy degree in Public Finance from Ohio State in 1981.

**Mr. Joseph W. Cuzzupoli:
Vice President and K-1 Program Manager, Kistler
Aerospace Corporation**

Mr. Cuzzupoli brings more than 40 years of aerospace engineering and managerial experience to the Task Group. He began his career with General Dynamics as Launch Director (1959–1962), and then became Manager of Manufacturing/Engineering and Director of Test Operations for Rockwell International (1962–1966). Cuzzupoli directed all functions in the building and testing of Apollo 6, Apollo 8, Apollo 9, and Apollo 12 flights as Rockwell's Assistant Program Manager for the Apollo Program; he later was Vice President of Operations. In 1978, he became the Vice President and Program Manager for the Space Shuttle Orbiter Project and was responsible for 5000 employees in the development of the Shuttle.

He left Rockwell in 1980 and consulted on various aerospace projects for NASA centers until 1991, when he joined American Pacific Corporation as Senior Vice President. In his current position at Kistler Aerospace (Vice President and Program Manager, 1996–present) he has primary responsibility for design and production of the K-1 reusable launch vehicle.

He holds a Bachelor of Science degree in Mechanical Engineering from the Maine Maritime Academy, a Bachelor of Science degree in Electrical Engineering from the University of Connecticut, and a Certificate of Management/Business Administration from the University of Southern California.

He was a member of the NASA Advisory Council's Task Force on Shuttle-Mir Rendezvous and Docking Missions and is a current member of the NASA Advisory Council's Task Force on International Space Station Operational Readiness.

**Charles C. Daniel, Ph.D.:
Engineering Consultant**

Dr. Daniel has over 35 years experience as an engineer and manager in the fields of space flight vehicle design, analysis, integration, and testing; and he has been involved in aerospace programs from Saturn V to the International

Space Station. In 1968, he began his career at Marshall Space Flight Center (MSFC) where he supported Saturn Instrument Unit operations for Apollo 11, 12, and 13. In 1971, he performed avionics integration work for the Skylab Program and spent the next decade developing avionics for the Solid Rocket Boosters (SRBs). He was SRB flight operations lead in that activity.

Dr. Daniel worked as part of the original Space Station Skunk Works for definition of the initial U.S. space station concept and developed the master engineering schedule for the station.

Following the *Challenger* accident, he led the evaluation of all hazards analyses associated with Shuttle and coordinated acceptance analyses associated with the modifications to the Solid Rocket Motors (SRMs) and SRBs. During Space Station Freedom development, he was the avionics lead and served as MSFC lead for Level II assembly and configuration development. He was part of the initial group to define the concept for Russian participation in the Space Station Restructure activity and later returned to MSFC as Chief Engineer for Space Station.

Dr. Daniel holds a Doctorate degree in Engineering and has completed postgraduate work at the University of California, Berkeley, and MIT. He was a member of the NASA Advisory Council Task Force on Shuttle-Mir Rendezvous and Docking Operations and is a member of the NASA Advisory Council Task Force, ISS Operational Readiness.

**Amy K. Donahue, Ph.D.:
Assistant Professor of Public Administration at the
University of Connecticut Institute of Public Affairs**

Dr. Amy K. Donahue is Assistant Professor of Public Policy at the University of Connecticut, where she teaches in the Master of Public Administration and Master of Survey Research programs. Her research focuses on the productivity of emergency services organizations and on the nature of citizen demand for public safety services. She is author of published work about the design, management, and finance of fire departments and other public agencies. For the past two years, Dr. Donahue has served as a technical advisor to the Department of Homeland Security's Science and Technology Directorate, helping to develop research and development programs to meet the needs of emergency responders. Dr. Donahue also served as Senior Advisor to the Administrator at NASA from 2002–2004. In this capacity, she worked within NASA to discern opportunities to contribute to homeland security efforts government-wide, including evaluating existing projects and identifying new opportunities for interagency collaboration targeted at

homeland security. Dr. Donahue has 20 years of field experience and training in an array of emergency services-related fields, including managing a 911 communications center and working as a firefighter and emergency medical technician in Fairbanks, Alaska, and upstate New York. In addition, she has served on active duty as an officer in the U.S. Army's Medical Service Corps. In 2003, Dr. Donahue spent three months in the field in Texas managing the Space Shuttle *Columbia* recovery operation. Dr. Donahue holds a Ph.D. in Public Administration, an M.P.A. from the Maxwell School of Citizenship and Public Affairs at Syracuse University, and a B.A. in Geological and Geophysical Sciences from Princeton University.

**Gen. Ron Fogleman, U.S. Air Force (Ret.):
President and Chief Operating Officer of Durango
Aerospace Incorporated**

Gen. Fogleman has vast experience in air and space operations, expertise in long-range programming and strategic planning, and extensive training in fighter and mobility aircraft. He served in the Air Force for 34 years, culminating in his appointment as Chief of Staff, until his retirement in 1997. Fogleman has served as a military advisor to the Secretary of Defense, the National Security Council, and the President of the United States.

Among other advisory boards, he is a member of the National Defense Policy Board, the NASA Advisory Council, the Jet Propulsion Laboratory Advisory Board, the Council on Foreign Relations, and the congressionally directed Commission to Assess United States National Security Space Management and Organization. He recently chaired a National Research Council Committee on Aeronautics Research and Technology for Vision 2050: An Integrated Transportation System.

Gen. Fogleman received a Master's Degree in Military History from the U.S. Air Force Academy, a Master's Degree in Political Science from Duke University, and graduated from the Army War College. He has been awarded several military decorations including: Defense Distinguished Service Medal with two oak leaf clusters; the Air Force Distinguished Service Medal with oak leaf cluster; both the Army and Navy Distinguished Service Medals, Silver Star; Purple Heart; Meritorious Service Medal, and two Distinguished Flying Crosses.

**Ms. Christine H. Fox:
Vice President and Director, Operations Evaluation
Group, Center for Naval Analyses**

Christine H. Fox is President of the Center for Naval Analyses, a federally funded research and development center based in Alexandria, Va. Ms. Fox was the Vice

President and Director, Operations Evaluation Group responsible for approximately 45 field representatives and 45 Washington-based analysts whose analytical focus is on helping operational commanders execute their missions.

Ms. Fox has spent her career as an analyst; assisting complex organizations like the U.S. Navy assess challenges and define practical solutions. She joined the Center for Naval Analysis in 1981 where she has served in a variety of analyst, leadership, and management positions.

Her assignments at the Center include serving as Team Leader, Operational Policy Team; Director, Anti-air Warfare Department; Program Director, Fleet Tactics and Capabilities; Team Leader of Third Fleet Tactical Analysis Team; Field Representative to Tactical Training Group – Pacific; Project Director, Electronic Warfare Project; Field Representative to Fighter Airborne Early Warning Wing–U.S. Pacific Fleet; and Analyst, Air Warfare Division, Operations Evaluation Group.

Before joining the Center, Ms. Fox served as a member of the Computer Group at the Institute for Defense Analysis in Alexandria, where she participated in planning and analyses of evaluations of tactical air survivability during close air support and effectiveness of electronic warfare during close air support.

Ms. Fox received a Bachelor of Science degree in mathematics and a Master of Science degree in applied mathematics from George Mason University.

**Col. Gary S. Geyer, U.S. Air Force (Ret.):
Consultant**

Col. Geyer has 38 years of experience in space engineering and program management, primarily in senior positions in the government and industry that emphasize management and system engineering. He has been responsible for all aspects of systems' success, including schedule, cost, and technical performance.

He served for 26 years with the National Reconnaissance Office (NRO) and was the NRO System Program Office Director for two major programs, which encompassed the design, manufacture, test, launch, and operation of several of our nation's most important reconnaissance satellites. Col. Geyer received the NRO Pioneer Award 2000 for his contributions as one of 46 pioneers of the NRO responsible for our nation's information superiority that significantly contributed to the end of the Cold War.

Following his career at the NRO, Col. Geyer was Vice President for a major classified program at Lockheed Martin and responsible for all aspects of program and mission success. His other assignments have included Chief Engineer for another nationally vital classified program and Deputy for Analysis for the Titan IV Program. Col. Geyer is teaching a Space Design course and a System Engineering/Program Management course at New Mexico State University in Las Cruces, N.M. He has a Bachelor of Science degree in Electrical Engineering from Ohio State University, and a Master's in Electrical Engineering and Aeronautical Engineering from the University of Southern California.

**Col. Susan J. Helms, U.S. Air Force
Chief, Space Control Division, Requirements
Directorate, Air Force Space Command**

Colonel Susan J. Helms is Vice Commander of the 45th Space Wing at Patrick Air Force Base, Fla. She oversees military space launch operations from Cape Canaveral Air Force Station, Fla. (CCAFS), and Eastern Range support for commercial, NASA and military space launches from CCAFS and Kennedy Space Center, Fla., as well as ballistic missile tests at sea.

Colonel Helms is a veteran of five Space Shuttle flights as well as serving aboard the International Space Station as a member of the Expedition 2 crew for a total of 163 days. She received a Bachelor of Science degree in aeronautical engineering from the U.S. Air Force Academy in 1980 and a Master of Science degree in aeronautics/astronautics from Stanford University in 1985.

Col. Helms graduated from the U.S. Air Force Academy in 1980. She received her commission and was assigned to Eglin Air Force Base, Florida, as an F-16 weapons separation engineer with the Air Force Armament Laboratory. In 1982, she became the lead engineer for F-15 weapons separation. In 1984, she was selected to attend graduate school. She received her degree from Stanford University in 1985 and was assigned as an assistant professor of aeronautics at the U.S. Air Force Academy. In 1987, she attended the Air Force Test Pilot School at Edwards Air Force Base, California. After completing one year of training as a flight test engineer, Col. Helms was assigned as a USAF Exchange Officer to the Aerospace Engineering Test Establishment, Canadian Forces Base, Cold Lake, Alberta, Canada, where she worked as a flight test engineer and project officer on the CF-18 aircraft. She was managing the development of a CF-18 Flight Control System Simulation for the Canadian Forces when selected for the astronaut program.

Colonel Helms was selected by NASA in January 1990 and became an astronaut in July 1991. She flew on STS-54 (1993), STS-64 (1994), STS-78 (1996), and STS-101 (2000), and served aboard the International Space Station as a member of the Expedition 2 crew (2001). Colonel Helms has logged 5,064 hours in space, including an extravehicular activity of 8 hours and 56 minutes—a world record.

After a 12-year NASA career that included 211 days in space, Colonel Helms returned to the U.S. Air Force in July 2002 as the Division Chief of the Space Superiority Division of the Requirements Directorate of Air Force Space Command in Colorado Springs, Colorado.

**Mr. Richard Kohrs
Chief Engineer, Kistler Aerospace Corporation**

Richard Kohrs has over 40 years of experience in aerospace systems engineering, stress analysis, and integration. He has held senior management positions in major NASA programs from Apollo to the Space Station.

As a member of the Apollo Spacecraft Program's Systems Engineering and Integration Office, he developed the Spacecraft Operations Data Book system that documented systems and subsystem performance and was the control database for developing flight rules, crew procedures, and overall performance of the Apollo spacecraft.

After Apollo, he became Manager of System Integration for the Space Shuttle Program; Deputy Manager, Space Shuttle Program; and then Deputy Director of the Space Shuttle Program at JSC. As Deputy Director, he was responsible for the daily engineering, processing, and operations activities of the Shuttle Program, and he developed an extensive background in Shuttle systems integration. In 1989, he became the Director of Space Station Freedom, with overall responsibility for its development and operation.

After years of public service, he left NASA to become the Director of the ANSER Center for International Aerospace Cooperation (1994–1997). Mr. Kohrs joined Kistler Aerospace in 1997 as Chief Engineer. His primary responsibilities include vehicle integration, design specifications, design data books, interface control, vehicle weight, performance, and engineering review board matters. He received a Bachelor of Science degree from Washington University, St. Louis, in 1956.

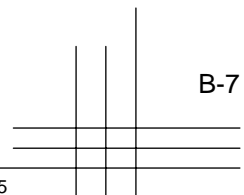

Susan Morrissey Livingstone:

Ms. Livingstone has served her nation for more than 30 years in both government and civic roles. From July 2001 to February 2003, she served as Under Secretary of the Navy, the second highest civilian leadership position in the Department of the Navy. As “COO” to the Secretary of the Navy, she had a broad executive management portfolio (e.g., programming, planning, budgeting, business processes, organizational alignment), but also focused on Naval space, information technology and intelligence/compartimented programs; integration of Navy-Marine Corps capabilities; audit, IG and criminal investigative programs; and civilian personnel programs.

Livingstone is a policy and management consultant. Currently, she is a member of the National Security Studies Board of Advisors (Maxwell School, Syracuse University), a board member of the Procurement Round Table (for the second time), and an appointee to NASA’s Return to Flight Task Group for safe return of Shuttle flight operations.

Prior to serving as Under Secretary of the Navy, Livingstone was CEO of the Association of the United States Army and deputy chairman of its Council of Trustees. She was also a vice president and board member of the Procurement Round Table, and acted as a consultant and panel chairman to the Defense Science Board (on “logistics transformation”).

From 1993 to 1998, Ms. Livingstone served the American Red Cross HQ as Vice President of Health and Safety Services, Acting Senior Vice President for Chapter Services and as a consultant for Armed Forces Emergency Services.

As Assistant Secretary of the Army for Installations, Logistics and Environment from 1989 to 1993, she was responsible for a wide range of programs including military construction, installation management, Army logistics programs, base realignment and closures, energy and environmental issues, domestic disaster relief, and restoration of public infrastructure to the people of Kuwait following operation Desert Storm. She also was decision and acquisition management authority for the DoD chemical warfare materiel destruction program.

From 1981 to 1989, Ms. Livingstone served at the Veterans Administration in a number of positions including Associate Deputy Administrator for Logistics and Associate Deputy Administrator for Management. She was then the VA’s Senior Acquisition Official and also directed and managed the nation’s largest medical

construction program. Prior to her Executive Branch service, she worked for more than nine years in the Legislative branch on the personal staffs of both a Senator and two Congressmen.

Livingstone graduated from the College of William and Mary in 1968 with an A.B. degree and completed an M.A. in political science at the University of Montana in 1972. She also spent two years in postgraduate studies at Tufts University and the Fletcher School of Law and Diplomacy.

Livingstone has received numerous awards for her community and national service, including the highest civilian awards from the National Reconnaissance Office, the VA, and the Departments of the Army and Navy. She is also a recipient of the Secretary of Defense Award for Outstanding Public Service.

**Mr. James D. Lloyd:
Deputy Associate Administrator for Safety and Mission Assurance, NASA**

Ex-Officio Member

Mr. Lloyd has extensive experience in safety engineering and risk management, and has supported a number of Blue Ribbon panels relating to mishaps and safety problems throughout his career. He began his career after an intern training period as a system safety engineer with the U.S. Army Aviation Systems Command in St. Louis.

He transferred to its parent headquarters, the Army Materiel Command (AMC) in 1973 and, after serving several safety engineering roles, was appointed as the Chief of the Program Evaluation Division in the Command’s Safety Office, where he assured the adequacy of safety programs for AMC organizations.

In 1979, he continued his career as a civilian engineer with the AMC Field Safety Activity in Charlestown, IN, where he directed worldwide safety engineering, evaluation, and training support. In 1987, a year after the Shuttle *Challenger* disaster, Lloyd transferred from the U. S. Army to NASA to help the Agency rebuild its safety mission assurance program. He was instrumental in fulfilling several of the recommendations issued by the Rogers’ Commission, which investigated the *Challenger* mishap. After the Shuttle returned to flight with the mission of STS-26, Lloyd moved to the Space Station Freedom Program Office in Reston, Va., where he served in various roles culminating in being appointed as the Program’s Product Assurance Manager.

In 1993, he became Director, Safety and Risk Management Division in the Office of Safety and Mission Assurance, serving as NASA's "Safety Director" and was appointed to his present position in early 2003. He serves also as an ex-officio member of the NASA Advisory Council Task Force on ISS Operational Readiness. Lloyd holds a Bachelor of Science degree in Mechanical Engineering, with honors, from Union College, Schenectady, N.Y., and a Master of Engineering degree in Industrial Engineering from Texas A&M University, College Station.

**Lt. Gen. Forrest S. McCartney, U.S. Air Force (Ret.):
Vice Chairman of the Aerospace Safety Advisory
Panel**

During Lt. Gen. McCartney's distinguished Air Force career he held the position of Program Director for several major satellite programs, was Commander of the Ballistic Missile Organization (responsible for Minuteman and Peacekeeper development), Commander of Air Force Space Division, and Vice Commander, Air Force Space Command.

His military decorations and awards include the Distinguished Service Medal, Legion of Merit with one oak leaf cluster, Meritorious Service Medal, and Air Force Commendation Medal with three oak leaf clusters. He was recipient of the General Thomas D. White Space Trophy in 1984 and the 1987 Military Astronautical Trophy.

Following the *Challenger* accident, in late 1986 Lt. Gen. McCartney was assigned by the Air Force to NASA and served as the Director of Kennedy Space Center until 1992. He received numerous awards, including NASA's Distinguished Service Medal and Presidential Rank Award, the National Space Club Goddard Memorial Trophy, and AIAA Von Braun Award for Excellence in Space Program Management.

After 40 years of military and civil service, he became a consultant to industry, specializing in the evaluation of hardware failure/flight readiness. In 1994, he joined Lockheed Martin as the Astronautics Vice President for Launch Operations. He retired from Lockheed Martin in 2001 and was formerly the Vice Chairman of the NASA Aerospace Safety Advisory Panel.

Lt. Gen. McCartney has a Bachelor's degree in Electrical Engineering from Auburn University, a Master's degree in Nuclear Engineering from the Air Force Institute of Technology, and an honorary doctorate from the Florida Institute of Technology.

Rosemary O'Leary, J.D., Ph.D.:

Dr. Rosemary O'Leary is professor of public administration and political science, and coordinator of the Ph.D. program in public administration at the Maxwell School of Citizenship and Public Affairs at Syracuse University. An elected member of the U.S. National Academy of Public Administration, she was recently a senior Fulbright scholar in Malaysia. Previously Dr. O'Leary was Professor of Public and Environmental Affairs at Indiana University and cofounder and co-director of the Indiana Conflict Resolution Institute. She has served as the director of policy and planning for a state environmental agency and has worked as an environmental attorney.

She has consulted for the U.S. Department of the Interior, the U.S. Environmental Protection Agency, the Indiana Department of Environmental Management, the International City/County Management Association, the National Science Foundation, and the National Academy of Sciences.

Dr. O'Leary is the author/editor of five books and more than 75 articles on environmental management, environmental policy public management, dispute resolution, bureaucratic politics, and law and public policy. She has won seven national research awards, including Best Book in Public and Nonprofit Management for 2000 (given by the Academy of Management), Best Book in Environmental Management and Policy for 1999 (given by the American Society for Public Administration), and the Mosher Award, which she won twice, for best article by an academician published in *Public Administration Review*.

Dr. O'Leary was recently awarded the Syracuse University Chancellor's Citation for Exceptional Academic Achievement, the highest research award at the university. She has won eight teaching awards as well, including the national Excellence in Teaching Award given by the National Association of Schools of Public Affairs and Administration, and she was the recipient of the Distinguished Service Award given by the American Society for Public Administration's Section on Environment and Natural Resources Administration. O'Leary has served as national chair of the Public Administration Section of the American Political Science Association, and as the national chair of the Section on Environment and Natural Resources Administration of the American Society for Public Administration. She is currently a member of the NASA Aerospace Safety Advisory Panel

Dr. Decatur B. Rogers, P.E.:
Dean Tennessee State University College
of Engineering, Technology and Computer Science

Since 1988, Dr. Rogers has served as the Dean, College of Engineering, Technology and Computer Science, and Professor of Mechanical Engineering at Tennessee State University in Nashville. Rogers served in professorship and dean positions at Florida State University, Tallahassee; Prairie View A&M University, Prairie View, Texas, and Federal City College, Washington, D.C.

Dr. Rogers holds a Ph.D. in Mechanical Engineering from Vanderbilt University; Masters' degrees in Engineering Management and Mechanical Engineering from Vanderbilt University; and a Bachelor's in Mechanical Engineering from Tennessee State University.

Mr. Sy Rubenstein:
Aerospace Consultant

Mr. Rubenstein was a major contributor to the design, development, and operation of the Space Shuttle and has been involved in commercial and Government projects for more than 35 years. As an employee of Rockwell International, the prime contractor for the Shuttle, he was the Director of System Engineering, Chief Engineer, Program Manager, and Division President during 20 years of space programs.

He has received the NASA Public Service Medal, the NASA Medal for Exceptional Engineering, and the AIAA Space Systems Award for his contributions to human spacecraft development. Mr. Rubenstein, a leader, innovator, and problem solver, is a fellow of the AIAA and the AAS.

Mr. Robert Sieck:
Aerospace Consultant

Mr. Sieck, the former Director of Shuttle Processing at the Kennedy Space Center (KSC), has an extensive background in Shuttle systems, testing, launch, landing, and processing. He joined NASA in 1964 as a Gemini Spacecraft Systems engineer and then served as an Apollo Spacecraft test team project engineer. He later became the Shuttle Orbiter test team project engineer, and in 1976 was named the Engineering Manager for the Shuttle Approach and Landing Tests at Dryden Flight Research Facility in California. He was the Chief Shuttle Project Engineer for STS-1 through STS-7, and became the first KSC Shuttle Flow Director in 1983. He was appointed Director, Launch and Landing Operations, in 1984, where he served as Shuttle Launch Director for 11 missions.

He served as Deputy Director of Shuttle Operations from 1992 until January 1995 and was responsible for assisting with the management and technical direction of the Shuttle Program at KSC. He also retained his position as Shuttle Launch Director, a responsibility he had held from February 1984 through August 1985, and then from December 1986 to January 1995. He was Launch Director for STS-26R and all subsequent Shuttle missions through STS-63. Mr. Sieck served as Launch Director for 52 Space Shuttle launches.

He earned his Bachelor of Science degree in Electrical Engineering at the University of Virginia in 1960 and obtained additional postgraduate credits in mathematics, physics, meteorology, and management at both Texas A&M and the Florida Institute of Technology. He has received numerous NASA and industry commendations, including the NASA Exceptional Service Medal and the NASA Distinguished Service Medal. Sieck is a former consultant with the Aerospace Safety Advisory Panel.

Lt. Gen. Thomas Stafford, U.S. Air Force (Ret.):
Cochair, Return to Flight Task Group

President, Stafford, Burke and Hecker Inc., technical consulting

Lt. Gen. Stafford, an honors graduate of the U.S. Naval Academy, joined the space program in 1962 and flew four missions during the Gemini and Apollo programs. He piloted Gemini 6 and Gemini 9, and traveled to the Moon as Commander of Apollo 10. He was assigned as head of the astronaut group in June 1969, responsible for the selection of flight crews for projects Apollo and Skylab.

In 1971, Lt. Gen. Stafford was assigned as Deputy Director of Flight Crew Operations at the NASA Manned Spaceflight Center. His last mission, the Apollo-Soyuz Test Project in 1975, achieved the first rendezvous between American and Soviet spacecrafts.

He left NASA in 1975 to head the Air Force Test Flight Center at Edwards Air Force Base and, in 1978, assumed duties as Deputy Chief of Staff, Research Development and Acquisition, U.S. Air Force Headquarters in Washington. He retired from government service in 1979 and became an aerospace consultant.

Lt. Gen. Stafford has served as Defense Advisor to former President Ronald Reagan; and headed The Synthesis Group, which was tasked with plotting the U.S. return to the Moon and eventual journey to Mars.

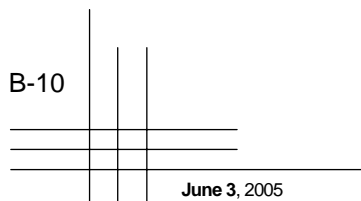

Throughout his careers in the USAF and NASA space program, he has received many awards and medals including the Congressional Space Medal of Honor in 1993. He served on the National Research Council's Aeronautics and Space Engineering Board, the Committee on NASA Scientific and Technological Program Reviews, and the Space Policy Advisory Council.

He was Chairman of the NASA Advisory Council Task Force on Shuttle-Mir Rendezvous and Docking Missions.

He is currently the Chairman of the NASA Advisory Council Task Force on International Space Station Operational Readiness.

Mr. Tom Tate:

Mr. Tate was vice president of legislative affairs for the Aerospace Industries Association (AIA), a trade association representing the nation's manufacturers of commercial, military, and business aircraft, helicopters, aircraft engines, missiles, spacecraft, and related components and equipment. Joining AIA in 1988, Tate directed the activities of the association's Office of Legislative Affairs, which monitors policy issues affecting the industry and prepares testimony that communicates the industry's viewpoint to Congress.

Before joining AIA, Tate served on the staff of the House of Representative's Committee on Science and Technology for 14 years. He joined the staff in 1973 as a technical consultant and counsel to the House Subcommittee on Space Science and Applications. He was then appointed deputy staff director of the House Subcommittee on Energy Research and Development in 1976. In 1978, Tate returned to the space subcommittee as chief counsel; and in 1981, he became special assistant to the chairman of the committee until joining AIA.

Mr. Tate worked for the Space Division of Rockwell International in Downey, Calif., from 1962 to 1973 in various engineering and marketing capacities and was director of space operations when he departed the company in 1973. He worked on numerous programs, including the Gemini Paraglider, Apollo, Apollo/Soyuz, and Shuttle Programs.

He worked for RCA's Missile and Surface Radar Division in Moorestown, N.J. from 1958 to 1962 in the project office of the Ballistic Missile Early Warning System (BMEWS) that was being built for the USAF. From 1957 to 1958, Tate served in the Army as an artillery and guided missile officer at Fort Bliss, Texas.

He received a Bachelor's degree in marketing from the University of Scranton in 1956 and a law degree from Western State University College of Law in Fullerton, Calif., in 1970. In his final year of law school, his fellow students awarded him the Gold Book Award as the most outstanding student. In 1991, he received the Frank J. O'Hara award for distinguished alumni in science and technology from the University of Scranton.

Mr. Tate is a member of numerous aerospace and defense associations including the AIAA, the National Space Club, and the National Space Institute, where he serves as an advisor. He also served as a permanent civilian member of the NASA Senior Executive Service Salary and Performance Review Board.

**Dr. Kathryn C. Thornton:
Faculty, University of Virginia**

Dr. Kathryn Thornton is a Professor at the University of Virginia in the School of Engineering and Applied Science in the Division of Science, Technology and Society, and in the Department of Mechanical and Aerospace Engineering. She is also the Associate Dean for Graduate Programs. Thus, her time is divided between teaching and managing the Graduate Studies Office. Selected as an astronaut in May 1984, Dr. Thornton is a veteran of four Space Shuttle flights between 1989 and 1995, including the first Hubble Space Telescope service mission. She has logged over 975 hours in space, including more than 21 hours of extravehicular activity.

Prior to becoming an astronaut, Dr. Thornton was employed as a physicist at the U.S. Army Foreign Science and Technology Center in Charlottesville, Va. She holds a Bachelor of Science degree in physics from Auburn University and a Master of Science degree and Doctorate of Philosophy degree in physics from the University of Virginia.

**Mr. William Wegner:
Consultant**

Mr. Wegner graduated from the U.S. Naval Academy in 1948. He subsequently received Masters' degrees in Naval Architecture and Marine Engineering from Webb Institute in New York. In 1956 he was selected by Adm. Hyman Rickover to join the Navy's nuclear program and was sent to the Massachusetts Institute of Technology, where he received his Master's degree in Nuclear Engineering. After serving in a number of field positions, including that of Nuclear Power Superintendent at the Puget Sound Naval Shipyard, he returned to Washington. He served as deputy director to Adm. Rickover in the Naval Nuclear Program

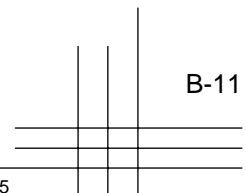

for 16 years and was awarded the DoD Distinguished Service Award and the Atomic Energy Commission's distinguished service award.

In 1979, he retired from Government service and formed Basic Energy Technology Associates with three fellow naval retirees. During its 10 successful years of operation, it provided technical services to over 25 nuclear utilities and other nuclear-related activities. Wegner has served on a number of panels including the National Academy of Sciences that studied the safety of Department of Energy nuclear reactors. From 1989 to 1992, he provided technical assistance to the Secretary of Energy on nuclear-related matters. He has provided technical services to over 50 nuclear facilities. Mr. Wegner served as a Director of the Board of Directors of Detroit Edison from 1990 until retiring in 1999.

**Mr. Vincent D. Watkins:
Executive Secretary, Return to Flight Task Group**

Mr. Vincent Watkins is Executive Secretary to the Return to Flight Task Group (RTFTG), a federal advisory committee appointed to perform an independent assessment of NASA's return to flight actions to implement the recommendations of the *Columbia* Accident Investigation Board.

Prior to joining the RTFTG in May 2004, he was Assistant Chief of the Flight Equipment Division in the Safety and Mission Assurance Directorate at the Johnson Space Center (JSC) in Houston, Texas. His responsibilities included managing Safety and Mission Assurance engineering activities pertaining to the definition, design, development, and operation of JSC government furnished equipment (GFE) and extravehicular

activity equipment and tools. These activities included flight readiness verification, risk assessments, hazard analysis, nonconformance tracking, and product delivery.

His 25-year career at NASA included a six-month tour at NASA Headquarters from April to December 2003. There he served as Executive Officer to the Chief of Staff, providing management oversight and technical expertise to the Office of the NASA Administrator. During this assignment, Mr. Watkins was instrumental in the development and implementation of several key Headquarters initiatives including the *Columbia* Families First Team and the *Columbia* Accident Rapid Reaction Team.

Mr. Watkins joined NASA in 1980 as a Control System Engineer on the Shuttle Training Aircraft in the Flight Crew Operations Directorate at JSC. From 1997 to 2003, he served as Chief of the GFE Assurance Branch in the Flight Equipment Division. He completed a NASA Fellowship with The Anderson School of Management at UCLA on Creativity and Innovation in the Organization in November 2003. He was selected as an inaugural member of the two-year JSC Leadership and Development Program in April 2002.

Mr. Watkins is a graduate of Albany State University with a Bachelor of Science degree in mathematics and a minor in physics and computer science. He received the Mark D. Heath Aircraft Engineering Award in 1987, the NASA Exceptional Service Medal in 1996, and numerous NASA Group Achievement Awards throughout his career at NASA.

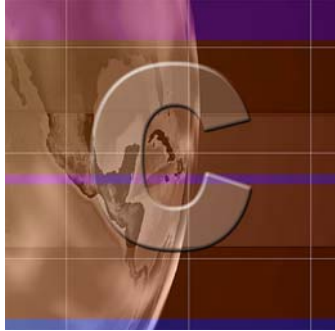

Appendix C: Return to Flight Summary Overview



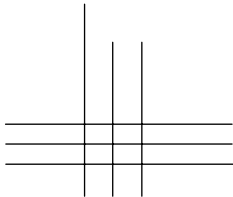

Note: The Return to Flight Summary was originally written in August 2003 (for the first edition of NASA's Implementation Plan for Space Shuttle Return to Flight and Beyond) to reflect NASA's initial approach for responding to the Columbia Accident Investigation Board (CAIB) Recommendations and Observations as well as the Space Shuttle Program's Raising the Bar Actions. It has not been updated since its initial publication; therefore, it may contain outdated information. It is included as Appendix C for historical reference only.

The CAIB Report has provided NASA with the roadmap for moving forward with our return to flight efforts. The CAIB, through its diligent work, has determined the causes of the accident and provided a set of comprehensive recommendations to improve the safety of the Space Shuttle Program. NASA accepts the findings of the CAIB, we will comply with the Board's recommendations, and we embrace the report and all that is included in it. This implementation plan outlines the path that NASA will take to respond to the CAIB recommendations and safely return to flight, while taking into account the Vision for Space Exploration.

At the same time that the CAIB was conducting its assessment, NASA began pursuing an intensive, Agency-wide effort to further improve our human space flight programs. We are taking a fresh look at all aspects of the Space Shuttle Program, from technical requirements to management processes, and have developed a set of internally generated actions that complement the CAIB recommendations.

NASA will also have the benefit of the wisdom and guidance of an independent, advisory Return to Flight Task Group, led by two veteran astronauts, Apollo commander Thomas Stafford and Space Shuttle commander Richard Covey. Members of this Task Group were chosen from among leading industry, academia, and government experts. Their expertise includes knowledge of fields relevant to safety and space flight, as well as experience as leaders and managers of complex systems. The diverse membership of the Task Group will carefully evaluate and publicly report on the progress of our response to implement the CAIB's recommendations.

The space program belongs to the nation as a whole; we are committed to sharing openly our work to reform our culture and processes. As a result, this first installment of the implementation plan is a snapshot of our early efforts and will continue to evolve as our understanding of the action needed to address each issue matures. This implementation plan integrates both the CAIB recommendations and our self-initiated actions. This document will be periodically updated to reflect changes to the plan

and progress toward implementation of the CAIB recommendations, and our return to flight plan.

In addition to providing recommendations, the CAIB has also issued observations. Follow-on appendices may provide additional comments and observations from the Board. In our effort to raise the bar, NASA will thoroughly evaluate and conclusively determine appropriate actions in response to all these observations and any other suggestions we receive from a wide variety of sources, including from within the Agency, Congress, and other external stakeholders.

Through this implementation plan, we are not only fixing the causes of the *Columbia* accident, we are beginning a new chapter in NASA's history. We are recommitting to excellence in all aspects of our work, strengthening our culture and improving our technical capabilities. In doing so, we will ensure that the legacy of *Columbia* guides us as we strive to make human space flight as safe as we can.

Key CAIB findings

The CAIB focused its findings on three key areas:

- Systemic cultural and organizational issues, including decision making, risk management, and communication;
- Requirements for returning safely to flight; and
- Technical excellence.

This summary addresses NASA's key actions in response to these three areas.

Changing the NASA culture

The CAIB found that NASA's history and culture contributed as much to the *Columbia* accident as any technical failure. NASA will pursue an in-depth assessment to identify and define areas where we can improve our culture and take aggressive corrective action. In order to do this, we will

- Create a culture that values effective communication and empowers and encourages employee ownership over work processes.
- Assess the existing safety organization and culture to correct practices detrimental to safety.
- Increase our focus on the human element of change management and organizational development.
- Remove barriers to effective communication and the expression of dissenting views.

- Identify and reinforce elements of the NASA culture that support safety and mission success.
- Ensure that existing procedures are complete, accurate, fully understood, and followed.
- Create a robust system that institutionalizes checks and balances to ensure the maintenance of our technical and safety standards.
- Work within the Agency to ensure that all facets of cultural and organizational change are continually communicated within the NASA team.

To strengthen engineering and safety support, NASA

- Is reassessing its entire safety and mission assurance leadership and structure, with particular focus on checks and balances, line authority, required resources, and funding sources for human space flight safety organizations.
- Is restructuring its engineering organization, with particular focus on independent oversight of technical work, enhanced technical standards, and independent technical authority for approval of flight anomalies.
- Has established a new NASA Engineering and Safety Center to provide augmented, independent technical expertise for engineering, safety, and mission assurance. The function of this new Center and its relationship with NASA's programs will evolve over time as we progress with our implementation of the CAIB recommendations.
- Is returning to a model that provides NASA subsystem engineers with the ability to strengthen government oversight of Space Shuttle contractors.
- Will ensure that Space Shuttle flight schedules are consistent with available resources and acceptable safety risk.

To improve communication and decision making, NASA will

- Ensure that we focus first on safety and then on all other mission objectives.
- Actively encourage people to express dissenting views, even if they do not have the supporting data on hand, and create alternative organizational avenues for the expression of those views.

- Revise the Mission Management Team structure and processes to enhance its ability to assess risk and to improve communication across all levels and organizations.

To strengthen the Space Shuttle Program management organization, NASA has

- Increased the responsibility and authority of the Space Shuttle Systems Integration office in order to ensure effective coordination among the diverse Space Shuttle elements. Staffing for the Office will also be expanded.
- Established a Deputy Space Shuttle Program Manager to provide technical and operational support to the Manager.
- Created a Flight Operations and Integration Office to integrate all customer, payload, and cargo flight requirements.

To continue to manage the Space Shuttle as a developmental vehicle, NASA will

- Be cognizant of the risks of using it in an operational mission, and manage accordingly, by strengthening our focus on anticipating, understanding, and mitigating risk.
- Perform more testing on Space Shuttle hardware rather than relying only on computer-based analysis and extrapolated experience to reduce risk. For example, NASA is conducting extensive foam impact tests on the Space Shuttle wing.
- Address aging issues through the Space Shuttle Service Life Extension Program, including midlife re-certification.

To enhance our benchmarking with other high-risk organizations, NASA is

- Completing a NASA/Navy benchmarking exchange focusing on safety and mission assurance policies, processes, accountability, and control measures to identify practices that can be applied to NASA programs.
- Collaborating with additional high-risk industries such as nuclear power plants, chemical production facilities, military flight test organizations, and oil-drilling operations to identify and incorporate best practices.

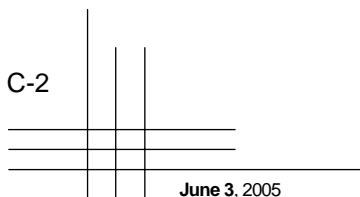

To expand technical and cultural training for Mission Managers, NASA will

- Exercise the Mission Management Team with realistic in-flight crisis simulations. These simulations will bring together the flight crew, flight control team, engineering staff, and Mission Management Team, and other appropriate personnel to improve communication and to teach better problem recognition and reaction skills.
- Engage independent internal and external consultants to assess and make recommendations that will address the management, culture, and communications issues raised in the CAIB Report.
- Provide additional operational and decision-making training for mid- and senior-level program managers. Examples of such training include, Crew Resource Management training, a U.S. Navy course on the *Challenger* launch decision, a NASA decision-making class, and seminars by outside safety, management, communications, and culture consultants.

Returning safely to flight

The physical cause of the *Columbia* accident was insulation foam debris from the External Tank left bipod ramp striking the underside of the leading edge of the left wing, creating a breach that allowed superheated gases to enter and destroy the wing structure during entry. To address this problem, NASA will identify and eliminate critical ascent debris and will implement other significant risk mitigation efforts to enhance safety.

Critical ascent debris

To eliminate critical ascent debris, NASA

- Is redesigning the External Tank bipod assembly to eliminate the large foam ramp and replace it with electric heaters to prevent ice formation.
- Will assess other potential sources of critical ascent debris and eliminate them. NASA is already pursuing a comprehensive testing program to understand the root cause of foam shedding and develop alternative design solutions to reduce the debris loss potential.
- Will conduct tests and analyses to ensure that the Shuttle can withstand potential strikes from noncritical ascent debris.

Additional risk mitigation

Beyond the fundamental task of eliminating critical debris, NASA is looking deeper into the Shuttle system to more fully understand and anticipate other sources of risk to safe flight. Specifically, we are evaluating known potential deficiencies in the aging Shuttle, and are improving our ability to perform on-orbit assessments of the Shuttle's condition and respond to Shuttle damage.

Assessing Space Shuttle condition

NASA uses imagery and other data to identify unexpected debris during launch and to provide general engineering information during missions. A basic premise of test flight is a comprehensive visual record of vehicle performance to detect anomalies. Because of a renewed understanding that the Space Shuttle will always be a developmental vehicle, we will enhance our ability to gather operational data about the Space Shuttle.

To improve our ability to assess vehicle condition and operation, NASA will

- Implement a suite of imagery and inspection capabilities to ensure that any damage to the Shuttle is identified as soon as practicable.
- Use this enhanced imagery to improve our ability to observe, understand, and fix deficiencies in all parts of the Space Shuttle. Imagery may include
 - ground-, aircraft-, and ship-based ascent imagery
 - new cameras on the External Tank and Solid Rocket Boosters
 - improved Orbiter and crew handheld cameras for viewing the separating External Tank
 - cameras and sensors on the International Space Station and Space Shuttle robotic arms
 - International Space Station crew inspection during Orbiter approach and docking
- Establish procedures to obtain data from other appropriate national assets.
- For the time being we will launch the Space Shuttle missions in daylight conditions to maximize imagery capability until we fully understand and can mitigate the risk that ascent debris poses to the Shuttle.

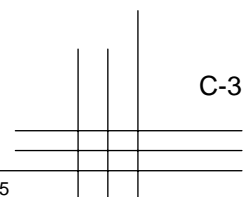

Responding to Orbiter damage

If the extent of the *Columbia* damage had been detected during launch or on orbit, NASA would have done everything possible to rescue the crew. In the future, we will fly with plans, procedures, and equipment in place that will offer a greater range of options for responding to on-orbit problems.

To provide the capability for Thermal Protection System on-orbit repairs, NASA is

- Developing materials and procedures for repairing Thermal Protection System tile and Reinforced Carbon-Carbon panels in flight. Thermal Protection System repair is feasible but technically challenging. The effort to develop these materials and procedures is receiving the full support of the Agency's resources, augmented by experts from industry, academia, and other U.S. Government agencies.

To enhance the safety of our crew, NASA

- Is evaluating a contingency concept for an emergency procedure that will allow stranded Shuttle crew to remain on the International Space Station for extended periods until they can safely return to Earth.
- Will apply the lessons learned from *Columbia* on crew survivability to future human-rated flight vehicles. We will continue to assess the implications of these lessons for possible enhancements to the Space Shuttle.

Enhancing technical excellence

The CAIB and NASA have looked beyond the immediate causes of the *Columbia* tragedy to proactively identify both related and unrelated deficiencies.

To improve the ability of the Shuttle to withstand minor damage, NASA will

- Develop a detailed database of the Shuttle's Thermal Protection System, including Reinforced Carbon-Carbon and tiles, using advanced non-destructive inspection and additional destructive testing and evaluations.
- Enhance our understanding of the Reinforced Carbon-Carbon operational life and aging process.
- Assess potential Thermal Protection System improvements for Orbiter hardening.

To improve our vehicle processing, NASA

- And our contractors are returning to appropriate standards for defining, identifying, and eliminating foreign object debris during vehicle maintenance activities to ensure a thorough and stringent debris prevention program.
- Has begun a review of existing Government Mandatory Inspection Points. The review will include an assessment of potential improvements, including development of a system for adding or deleting Government Mandatory Inspection Points as required in the future.
- Will institute additional quality assurance methods and process controls, such as requiring at least two employees at all final closeouts and at External Tank manual foam applications.
- Will improve our ability to swiftly retrieve closeout photos to verify configurations of all critical subsystems in time-critical mission scenarios.
- Will establish a schedule to incorporate engineering changes that have accumulated since the Space Shuttle's original design into the current engineering drawings. This may be best accomplished by transitioning to a computer-aided drafting system, beginning with critical subsystems.

To safely extend the Space Shuttle's useful life, NASA

- Will develop a plan to recertify the Space Shuttle, as part of the Shuttle Service Life Extension.
- Is revalidating the operational environments (e.g., loads, vibration, acoustic, and thermal environment) used in the original certification.
- Will continue pursuing an aggressive and proactive wiring inspection, modification, and refurbishment program that takes full advantage of state-of-the-art technologies.
- Is establishing a prioritized process for identifying, approving, funding, and implementing technical and infrastructure improvements.

To address the public overflight risk, NASA will

- Evaluate the risk posed by Space Shuttle overflight during entry and landing. Controls such as entry ground track and landing site changes will be considered to balance and manage the risk to persons, property, flight crew, and vehicle.

To improve our risk analysis, NASA

- Is fully complying with the CAIB recommendation to improve our ability to predict damage from debris impacts. We are validating the Crater debris impact analysis model use for a broader range of scenarios. In addition, we are developing improved physics-based models to predict damage. Further, NASA is reviewing and validating all Space Shuttle Program engineering, flight design, and operational models for accuracy and adequate scope.
- Is reviewing its Space Shuttle hazard and failure mode effects analyses to identify unacknowledged risk and overly optimistic risk control assumptions. The result of this review will be a more accurate assessment of the probability and severity of potential failures and a clearer outline of controls required to limit risk to an acceptable level.
- Will improve the tools we use to identify and describe risk trends. As a part of this effort, NASA will improve data mining to identify problems and predict risk across Space Shuttle Program elements.

To improve our Certification of Flight Readiness, NASA is

- Conducting a thorough review of the Certification of Flight Readiness process at all levels to ensure rigorous compliance with all requirements prior to launch.
- Reviewing all standing waivers to Space Shuttle Program requirements to ensure that they are necessary and acceptable. Waivers will be retained only if the controls and engineering analysis associated with the risks are revalidated. This review will be completed prior to return to flight.

Next steps

The CAIB directed that some of its recommendations be implemented before we return to flight. Other actions are ongoing, longer-term efforts to improve our overall human space flight programs. We will continue to refine our plans and, in parallel, we will identify the budget required to implement them. NASA will not be able to determine the full spectrum of recommended return to flight hardware and process changes, and their associated cost, until we have fully assessed the selected options and completed some of the ongoing test activities.

Conclusion

The American people have stood with NASA during this time of loss. From all across the country, volunteers from all walks of life joined our efforts to recover *Columbia*. These individuals gave their time and energy to search an area the size of Rhode Island on foot and from the air. The people of Texas and Louisiana gave us their hospitality and support. We are deeply saddened that some of our searchers also gave their lives. The legacy of the brave Forest Service helicopter crew, Jules F. Mier, Jr., and Charles Krenek, who lost their lives during the search for *Columbia* debris will join that of the *Columbia*'s crew as we try to do justice to their memory and carry on the work for the nation and the world to which they devoted their lives.

All great journeys begin with a single step. With this initial implementation plan, we are beginning a new phase in our return to flight effort. Embracing the CAIB Report and all that it includes, we are already beginning the cultural change necessary to not only comply with the CAIB recommendations, but to go beyond them to anticipate and meet future challenges.

With this and subsequent iterations of the implementation plan, we take our next steps toward return to safe flight. To do this, we are strengthening our commitment to foster an organization and environment that encourages innovation and informed dissent. Above all, we will ensure that when we send humans into space, we understand the risks and provide a flight system that minimizes the risk as much as we can. Our ongoing challenge will be to sustain these cultural changes over time. Only with this sustained commitment, by NASA and by the nation, can we continue to expand human presence in space—not as an end in itself, but as a means to further the goals of exploration, research, and discovery.

The *Columbia* accident was caused by collective failures; by the same token, our return to flight must be a collective endeavor. Every person at NASA shares in the responsibility for creating, maintaining, and implementing the actions detailed in this report. Our ability to rise to the challenge of embracing, implementing, and perpetuating the changes described in our plan will ensure that we can fulfill the NASA mission—to understand and protect our home planet, to explore the Universe and search for life, and to inspire the next generation of explorers.

C-6

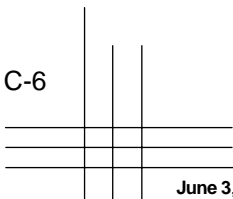

June 3, 2005



NASA: Explore. Discover. Understand.