

CASE HISTORY 58: CHEMICAL PROCESS PLANTS\*  
(OSHA Noise Problem)

Problem Description

Existing chemical process plant noise reduction requires source analysis to determine the method of noise reduction.

Problem Analysis and Control Description

As a result of this study, a list of noise sources is shown in Table 6.58.1, with recommended methods of noise reduction. Some specific examples and results obtained by each noise control method are cited in Figures 6.58.1 through 6.58.4. The attenuation attained is shown in each figure.

---

\*From Judd, S.H. January 11, 1971. Noise abatement in process plants. Chemical Engineering.

Table 6.58.1 Sources of noise and methods of noise reduction.

Equipment	Source of noise	Method of noise reduction
Heaters	Combustion at burners  Inspiration of premix air at burners Draft fans Ducts	Acoustic plenum* (10 Bwg. plate) Seals around control rods and over sight holes Inspiring intake silencer Intake silencer or acoustic plenum Lagging
Motors	TEFC cooling air fan  WP II cooling system Mechanical and electrical	Intake silencer Unidirectional fan Absorbent duct liners Enclosure
Airfin coolers	Fan   Speed changer Motors  Fan shroud	Decrease rpm (increasing pitch) Tip and hub seals Increase number of blades** Decrease static pressure drop** Add more fin tubes** Belts in place of gears Quiet motor Slower motor Streamline airflow Stiffening and damping (reducing vibration)
Compressors	Discharge piping and expansion joint Antisurge bypass   Intake piping and suction drum Air intake Discharge to air Timing gears (axial)  Speed changers	Inline silencer and/or lagging Use quiet valves and enlarge and streamline piping** Lag valves and piping Inline silencers Lagging Silencer Silencer Enclosure (or constrained damping on case) Silencers on discharge and lagging Enclosure (or constrained damping on case)
Engines	Exhaust Air intake Cooling fan	Silencer (muffler) Silencer Enclose intake or discharge or both Use quieter fan
Miscellaneous	Turbine steam discharge Air and steam vents  Eductors Piping  Valves   Pumps	Silencer Silencer Use quiet valve Lagging Limit velocities Avoid abrupt changes in size and direction Lagging Limit pressure drops and velocities Limit mass flow Use constant velocity or other quiet valve Divide pressure drop Size adequately for total flow Size for control range Enclosure
<p>*If oil fired, provide for drainage of oil leaks and inspection. ** Usually limited to replacement or new facilities.</p>		

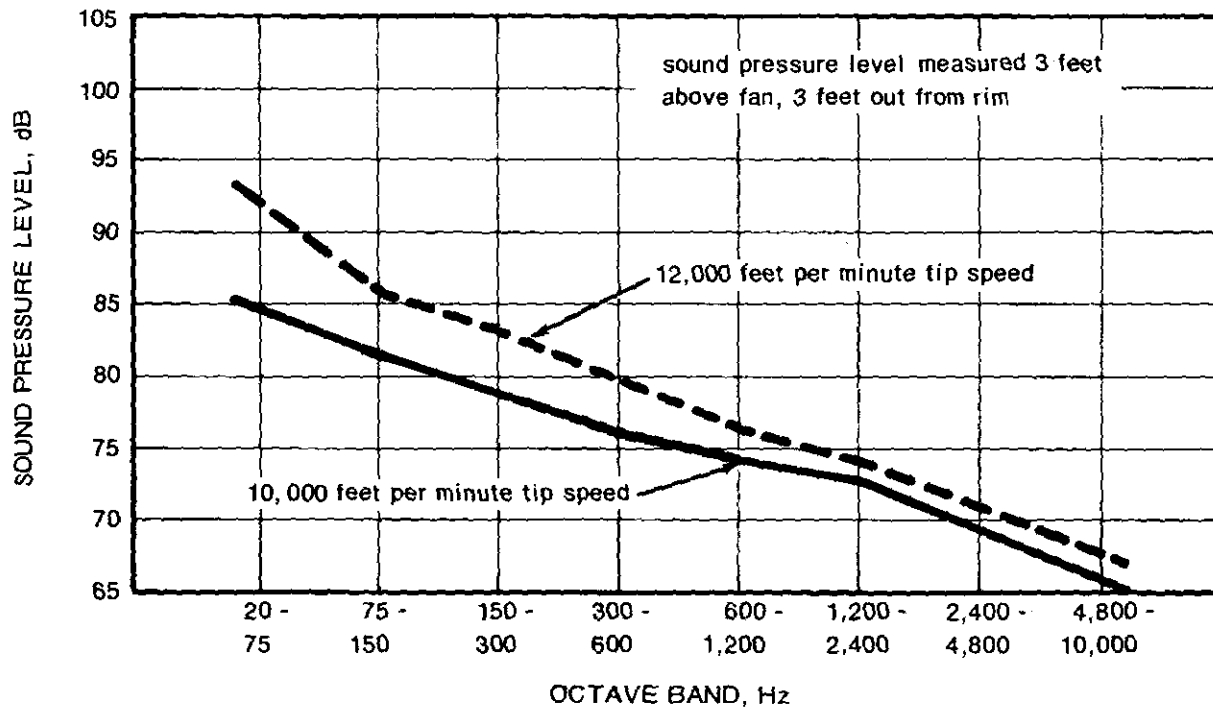

Figure 6.58.1. Noise reduction achieved by reducing fan speed, using increased blade pitch to offset decrease in speed (measured 3 ft above fan, 3 ft out from rim).

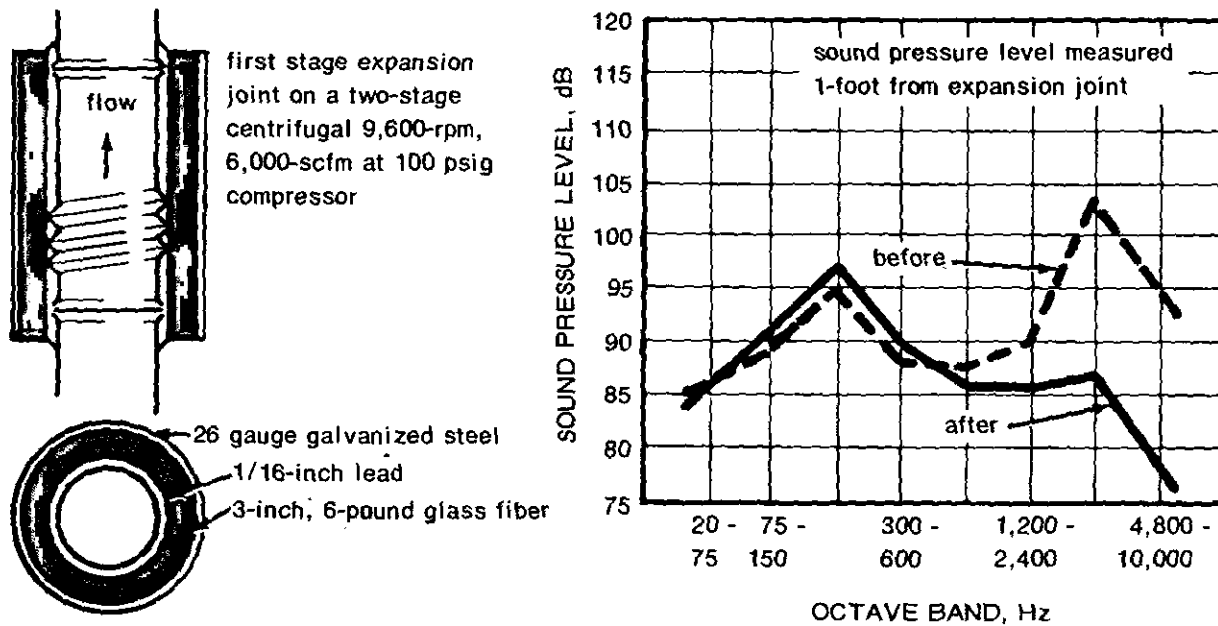
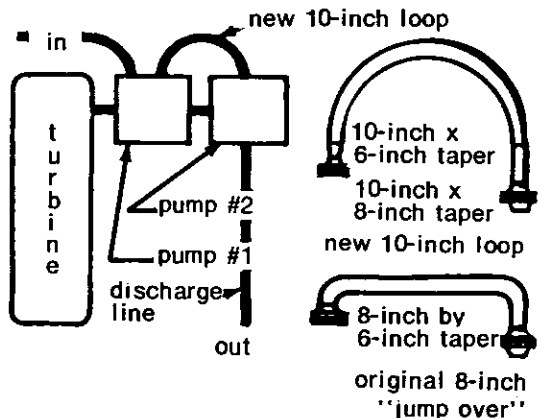

Figure 6.58.2. Compressor discharge noise reduction achieved by lagging expansion joint (measured 1 ft from expansion joint).



	pump #1	pump #2
inlet psi	35	580
outlet psi	580	840
8 volute impellers	4	2
rpm	3,600	3,600
gpm	2,100	2,100

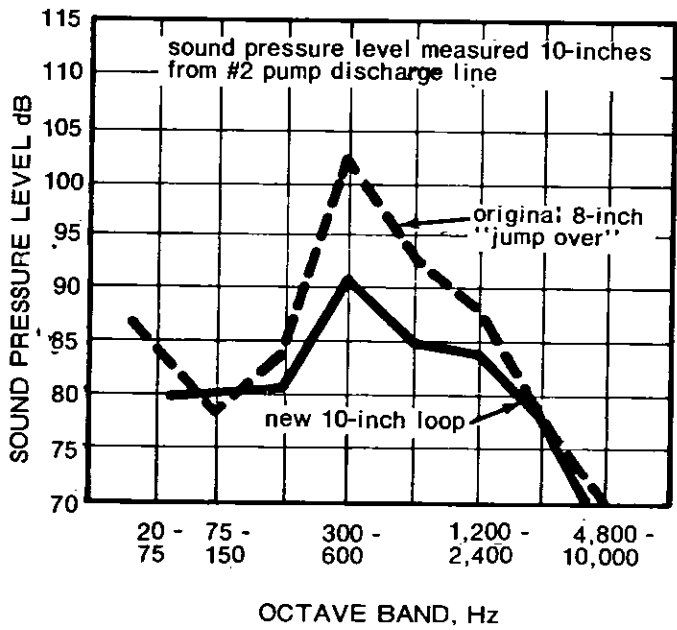

Figure 6.58.3. Noise reduction achieved by redesigning pump bypass loop (measured 10 in. from No. 2 pump discharge line).

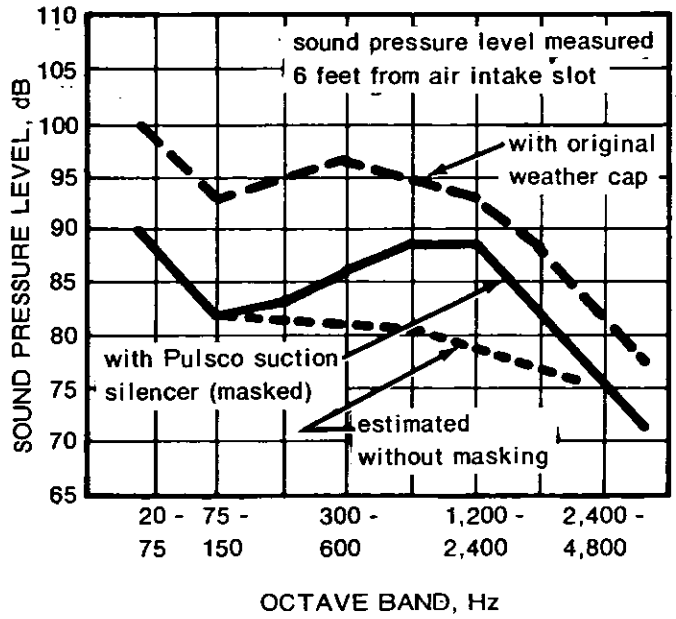
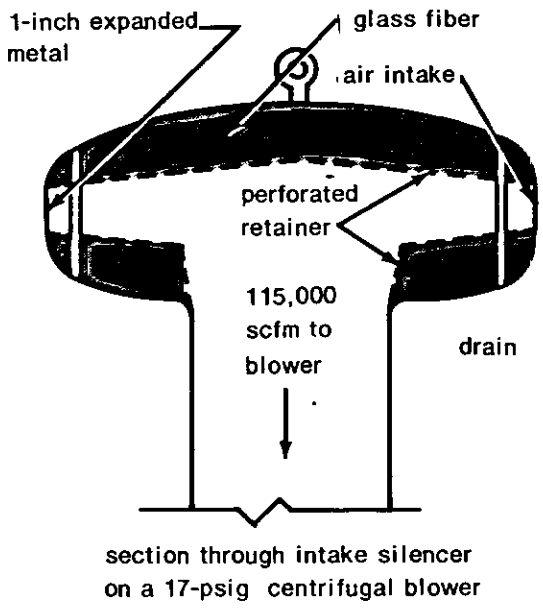

Figure 6.58.4. Noise reduction achieved by adding silencer to air blower intake (measured 6 ft from air intake slot).

CASE HISTORY 59: VIBRATION TABLE  
(Hearing Conservation Noise Problem)

Lars Holmberg  
IFM Akustikbyrån AB  
Warfvinges väg 26  
S-112 51 Stockholm, Sweden  
(08) 131220

#### Problem Description

Product compaction is a necessity in the manufacture of prefabricated concrete building elements. In certain cases, the compaction can be achieved only by external application of vibrations to the molds. This case history concerns vibration tables used in the production of a product called well rings. Sound levels as high as 104 dBA, containing a strong low-frequency tone, were measured at operator stations, approximately 1 m from the approximately 2-m diameter mold, during vibration. Vibration table noise takes place intermittently about 4 hr a day, and operators can also be exposed to noise from several other machines 10 to 40 m away. The operators control the filling of the molds.

#### Problem Analysis

This problem was analyzed by measuring and plotting operator position sound pressure levels during mold vibration on octave-band graph paper that included five curves, each representing maximum recommended daily exposure time in accordance with International Standards Organization guidelines for industrial noise exposure. Results, shown in Figure 6.59.1, indicate the 4 hr of daily exposure are greater than indicated by the penetrated curve on the plot. (Note that our OSHA regulation would allow between 1 and 2 hr/day of exposure to 104-dBA sounds.) A noise reduction of approximately 10 dB is called for in this case.

Although detailed analysis of noise-producing mechanisms would be desirable to identify quantitatively the relative contributions of the table vibrator, table vibrations, and mold vibrations, such data were not obtained. However, some qualitative determinations were made, based on observations.

Low-frequency emissions from the vibrator and broader band emissions from resonances induced in the mold structure and the table were identified as the major noise sources. The rattle of the loose parts of the molds also contributed to the overall noise environment.

Several possibilities exist for reducing noise exposures in this type of process:

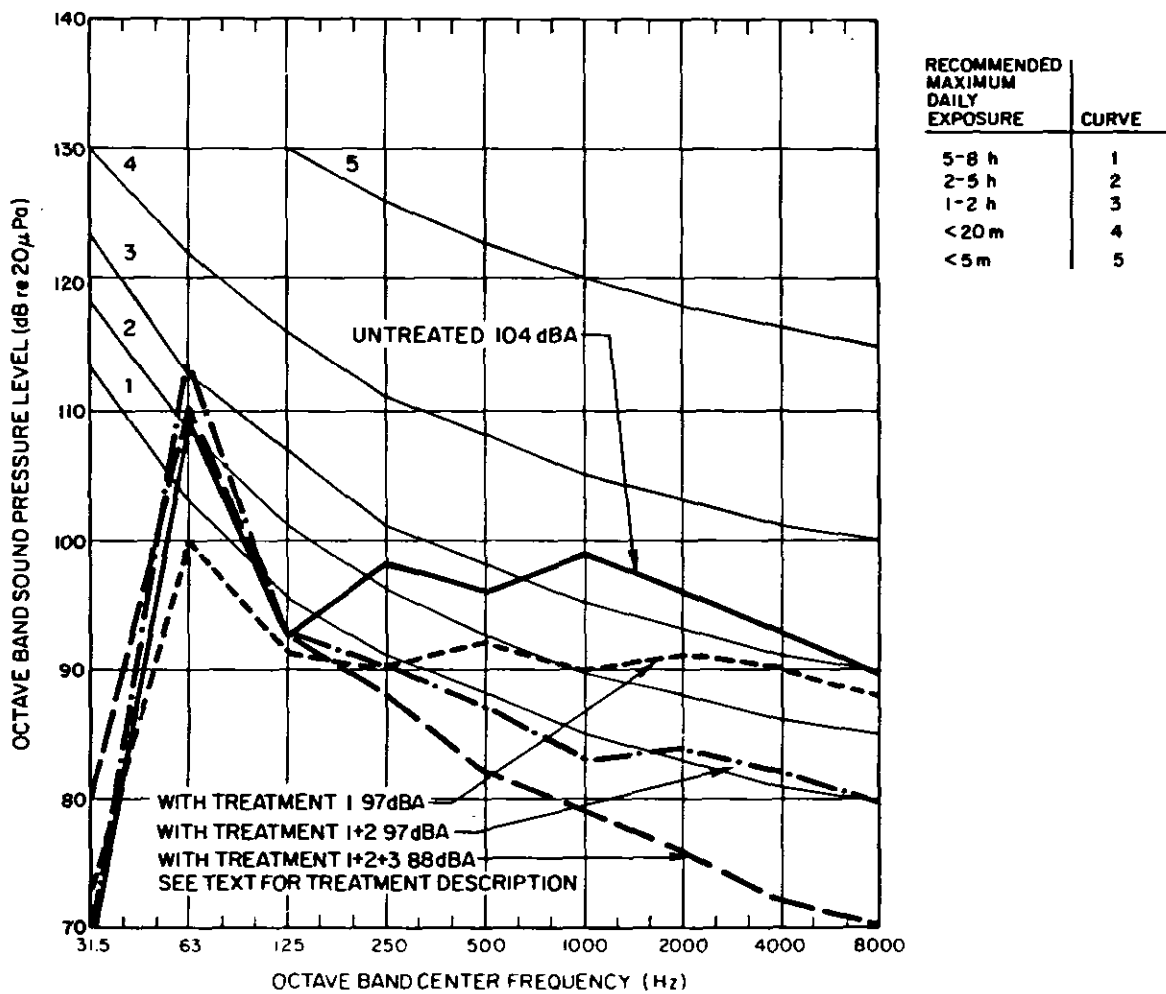

Figure 6.59.1. Results of measurement of operator position sound pressure levels.

- Reducing the vibrated surface area (i.e., by vibration of the bottom of the mold instead of the sides, or damped mold sides);
- Using alternative methods of compaction;
- Optimizing vibration components (frequency, amplitude, time) according to properties of the concrete used (e.g., initiating vibration after the mold is partly filled, adjusting vibration amplitude and/or frequency to obtain maximum compaction for minimal noise emission);
- Eliminating unnecessary impacts between the vibration table and the mold;
- Containing noise emissions by use of shields or enclosure.

Prior studies had revealed that some of these possibilities have yielded good results:

- Elimination of rattles provided between 3 and 10 dB of noise reduction.
- Vibration isolation of the mold from the table had provided up to 20 dB of noise reduction, at the expense of requiring additional vibration time.
- Other methods of compaction are considerably quieter. In particular, internal vibration (using devices that can be held in place inside the mold) produces sound levels in the 85-dBA to 95-dBA range at a distance of 1 m.

Because alternative methods of compaction would be too costly to install and because several of the remaining noise control possibilities require considerable experimentation and study, it was decided, first, to implement vibration isolation of the mold and then, if necessary, containment of the generated sounds.

#### Control Description

A vibration table was quieted with the three-phase program of noise control depicted in Figure 6.59.2.

(1) A rubber ring was mounted on the table below the guide ring.

(2) A rubber ring was mounted between the guide ring and the mold.

(3) A screen was constructed around the mold.

Rings were made of 4-mm rubber. The screen that encloses the 6-ft-diameter mold was constructed of 3-mm steel (outside) and perforated steel plate (inside), sandwiching 100-mm mineral wool. Rubber sheeting completed a seal at floor level.

#### Results

Noise at the vibration table was reduced to 97 dBA after installation of the first two phases of noise control and to 88 dBA when all three phases were completed. Figure 6.59.2 summarizes the reductions obtained.

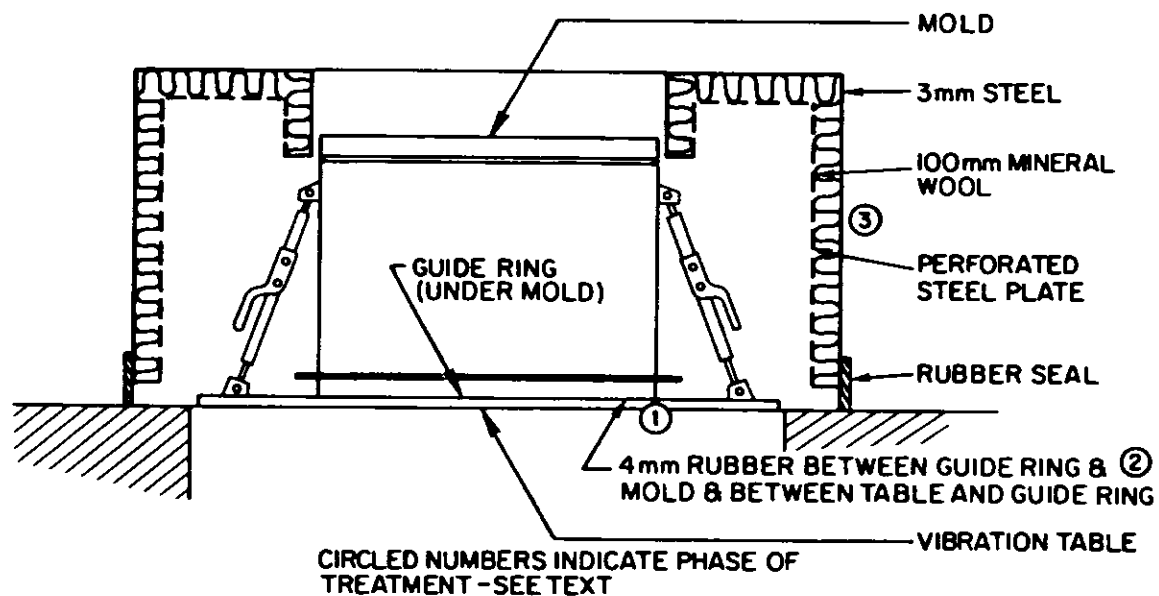

Figure 6.59.2. Three-phase program of noise control used to quiet vibration table.



CASE HISTORY 60: TELETYPE MACHINE  
(Office Noise Problem)

J.B. Moreland  
Westinghouse Electric Corporation  
Research and Development Center  
1310 Beulah Road  
Pittsburgh, Pennsylvania 15235

#### Problem Description

This case history concerns operation of a teletype machine, which disturbed office workers located near the unit. Figure 6.60.1 shows the teletype machine with one of the affected worker locations in the background.

#### Problem Analysis

No detailed noise control solution or design analysis was performed here, as the control was straightforward. A five-sided acoustical booth was chosen to alleviate the problem.

#### Control Description

The booth (Figure 6.60.2) was constructed from 1-in.-thick Micarta-faced compressed fiberboard, lined on the inside with 1-in.-thick compressed glass fiberboard.

#### Results

Figure 6.60.3 compares before-and-after treatment data at the desk portion. The sound pressure levels have been reduced by about 7 dB in the 500-Hz to 8000-Hz octave band, much in agreement with what would be anticipated on the basis of the reduction in sound power afforded to the enclosure (neglecting directional effects, the enclosure "contains" about 4/5 of the sound energy radiated from the teletype;  $10 \log 1/5$  equals -7 dB).

#### Comments

The desk top on which the teletype rests is itself a noise source, since it is drawn into vibration by the teletype. The data given in Figure 6.60.3 were measured with a resilient pad, used as vibration isolation, placed under the machine. The teletype noise spectra with and without the enclosure are also shown in Figures 6.60.4 and 6.60.5, for the condition with and without the resilient pad in place. The latter figures clearly indicate the value of the vibration isolation.

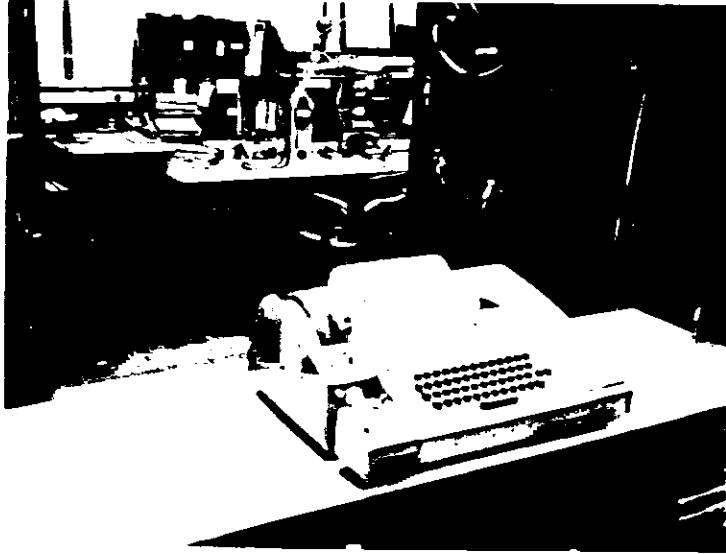

Figure 6.60.1. Teletype and desk where noise reduction was desired.



Figure 6.60.2. Teletype and installed acoustic booth.

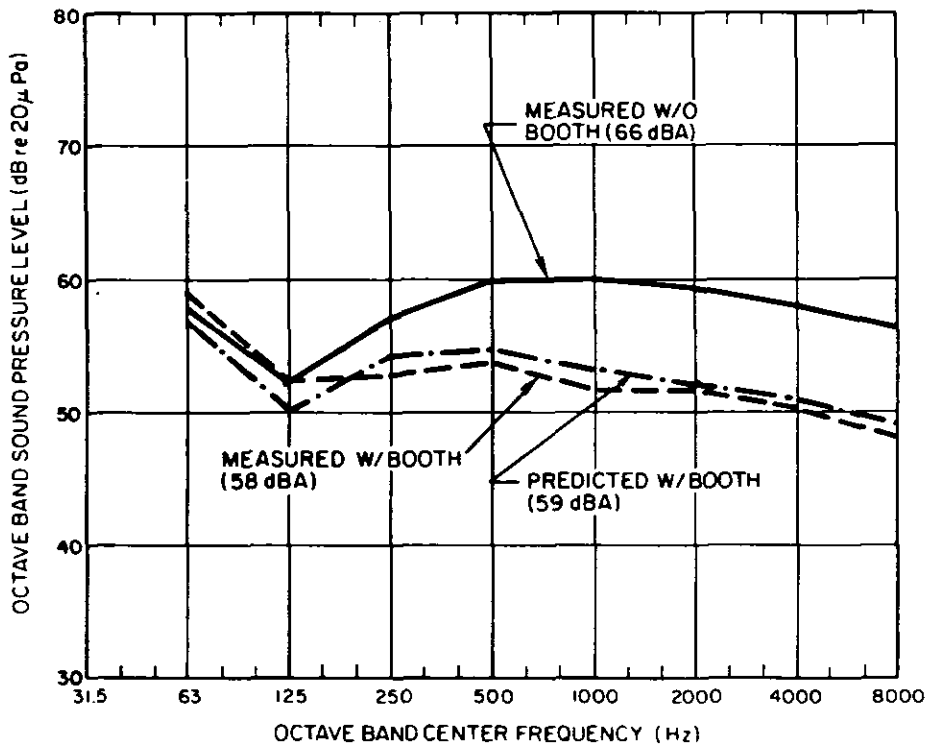

Figure 6.60.3. Before-and-after treatment data at desk.

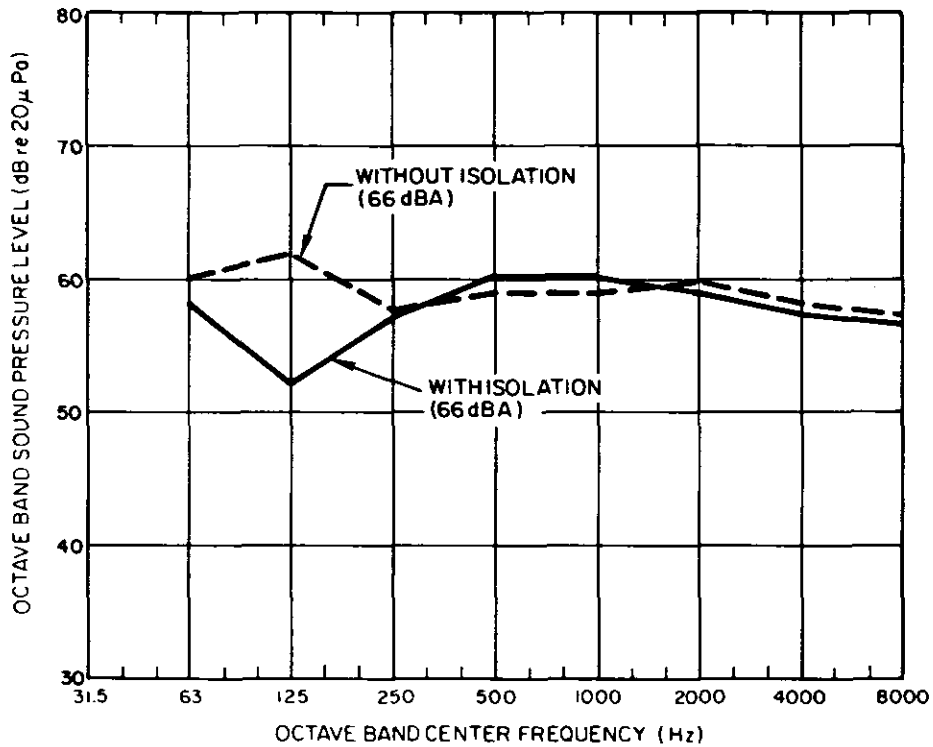

Figure 6.60.4. Unenclosed teletype noise spectra with and without resilient pad in place.

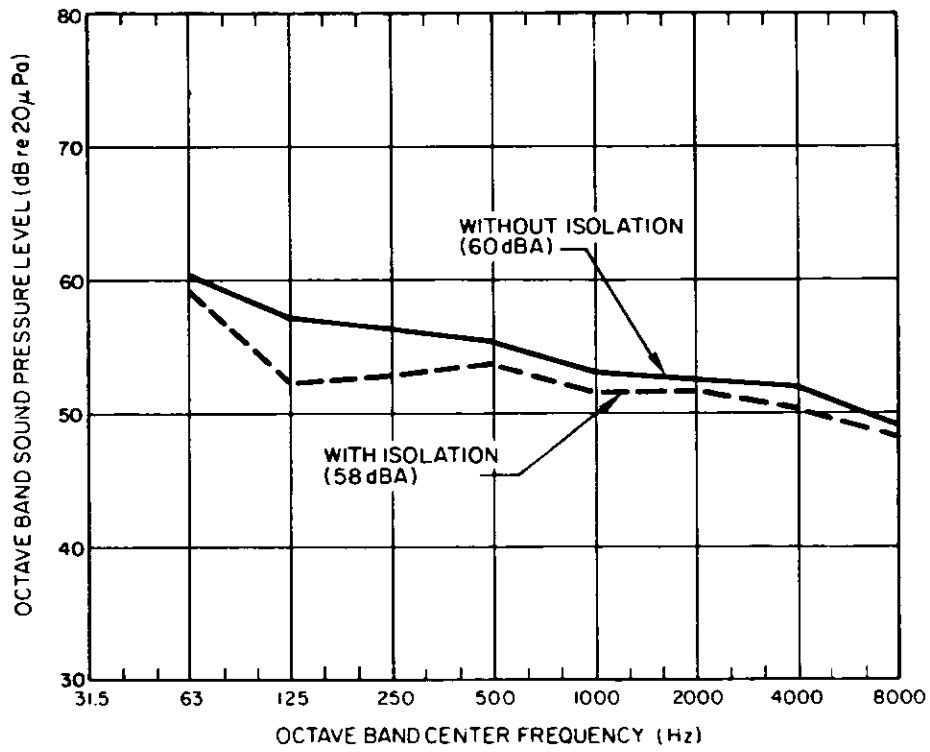

Figure 6.60.5. Enclosed teletype noise spectra with and without resilient pad in place.

CASE HISTORY 61: PROCESS PLANT NOISE CONTROL AT THE PLANT  
DESIGN STAGE  
(Hearing Conservation Noise Problem)

F.W. Buehner  
Arthur G. McKee & Company  
6200 Oak Tree Blvd.  
Cleveland, Ohio 44131  
(216) 524-9300

This case history is unique in that it incorporates noise control considerations for an industrial plant that had not yet been built. This case history demonstrates that industrial noise environments can be predicted and the information gleaned from the predictions used to identify potential problem areas. Of course, early identification of problem areas allows for remedial techniques for those problems to be integrated most conveniently into construction plans.

The case history described herein is for a catalytic hydrodesulfurizing (CHD) facility designed to process about 70,000 barrels/day.

#### Problem Analysis

Equipment noise emission data, obtained mainly from equipment vendors and supplemented with an Arthur G. McKee Company data base, formed the basis for generating estimates of the after-installation noise environment around the CHD facility while the facility was in the design stage. The noise data for each piece of equipment were used to delineate the acoustic field surrounding each piece of equipment, and, with help from a computer program, the emissions from the individual equipment were summed at preselected grid points covering the entire facility location. Contours of the anticipated noise environment (in 5-dB-wide intervals, beginning at 85 dBA) were then generated from the predicted grid data.

The predicted sound level contour plots were then compared with the design objective (85 dBA maximum at normal work stations; 87 dBA maximum in passageways and maintenance areas) to highlight possible problem areas. The problem areas were then reviewed to determine which of the noise emitters contributes significantly to the problem.

Once the problem equipment was identified, noise control treatments were conceptualized and new iterations of the sound level contour generated (on the basis of expected new values of noise emissions of treated equipment) to help determine the appropriateness of the anticipated treatments.

## Results

Figure 6.61.1 shows the first iteration contours for this case history, generated with vendor-guaranteed noise data for 78 pieces of as-purchased equipment and simplified assumptions as to on-site noise source location and noise propagation. The figure clearly shows areas of potential concern. These areas were studied in detail, and the main problem noise sources delineated.

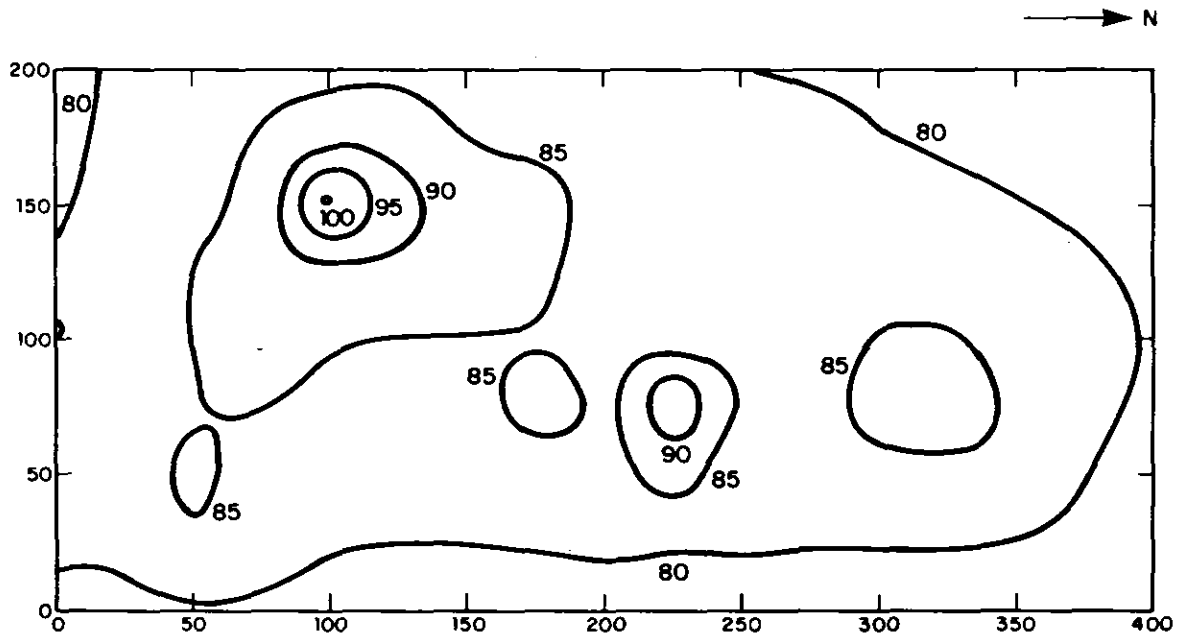

Figure 6.61.1. First iteration A-weighted sound level contours (dBA) generated for CHD site.  
Note: Contour lines are labeled on the decreasing side.

Simple treatment, consisting mainly of equipment repositioning, was considered and noise contours recomputed. Problem areas were still evidenced (Figure 6.61.2). Standard and off-the-shelf noise controls were assumed applied to the problem equipment, and a third profile developed. The third iteration (Figure 6.61.3) indicated application of the treatments considered would bring about compliance regarding overall plant noise.

Subsequently, the plant was built following noise control recommendations assumed in the prediction scheme, and an operational

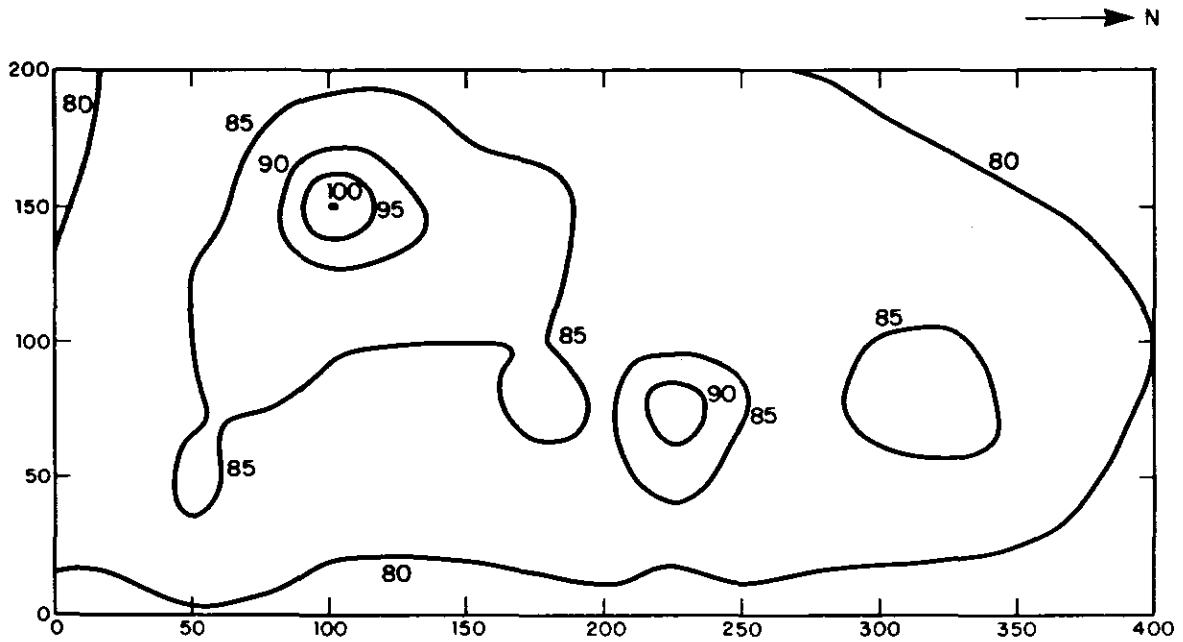

Figure 6.61.2. Second iteration A-weighted sound level contours (dBA) generated for CHD site.  
 Note: Contour lines are labeled on the decreasing side.

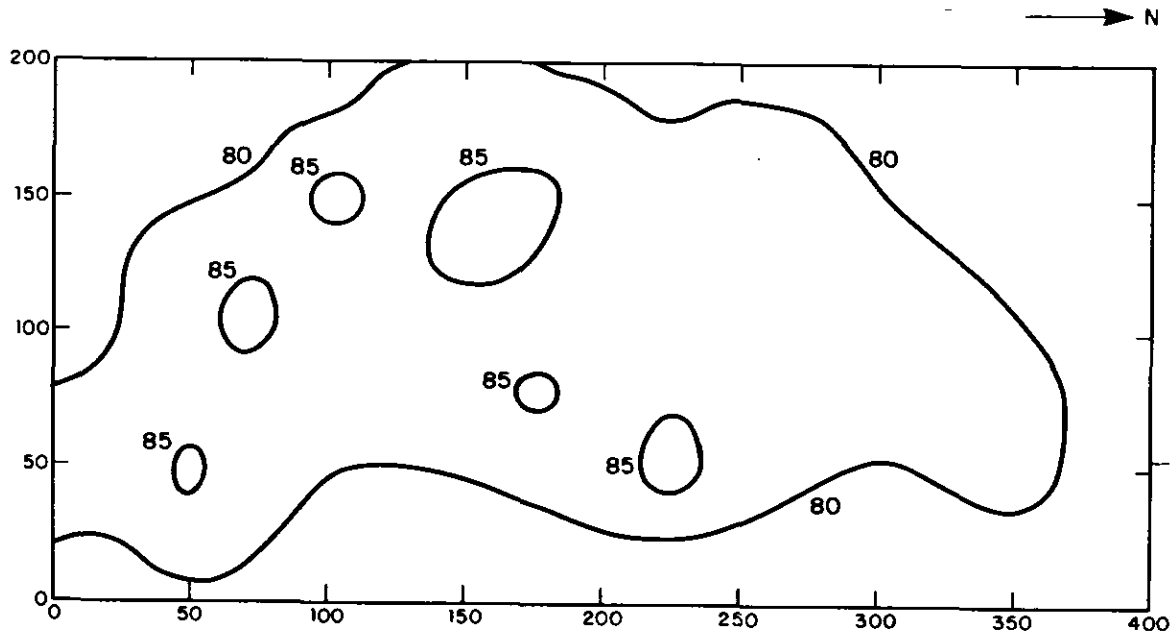

Figure 6.61.3. Third iteration A-weighted sound level contours (dBA) generated for CHD site.  
 Note: Contour lines are labeled on the decreasing side.

noise test for the unit was performed. Figure 6.61.4 shows the measured contours. Comparison between predicted and measured contours indicates general similarity, especially for the contours nearest the site boundary, but significant departures from prediction at close-in locations.

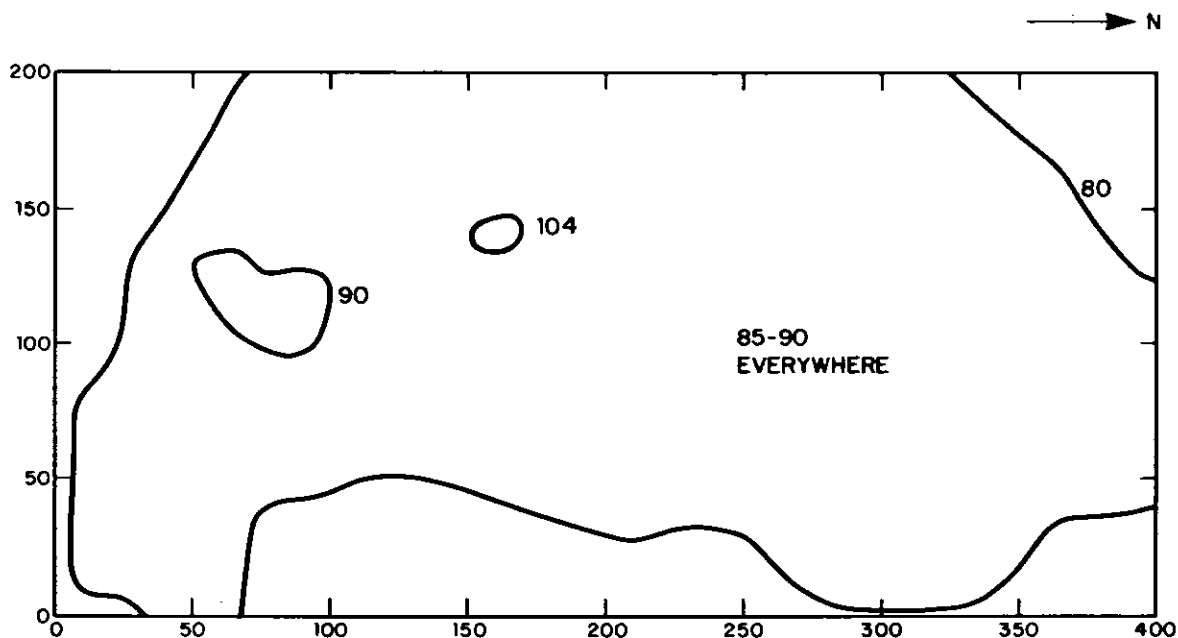

Figure 6.61.4. A-weighted sound level contours actually measured at CHD site.

The variations between predicted and actual contours were traced to several noise sources: an unexpectedly noisy stripper bottoms pump, two valves which were improperly insulated, and an unexpectedly noisy coupling which dominated as a noise source in the western portion of the plant.

It was relatively easy to treat these few remaining noise sources, once the plant was operational.

#### Comments

The above outline of the procedure employed in this problem analysis suggests the methodology is straightforward. In practice, however, the noise control engineer should anticipate



certain complications. The most frustrating of the possible difficulties is obtaining baseline noise emission data for the equipment to be installed. Not all equipment suppliers have, or have resources to obtain immediately, noise emission information. Gaps in the data base have to be filled, by using educated guesses or conservative assumptions or a data base developed from previous work.

Also, when noise data are provided, the noise control engineer may find the information ill-defined, nonstandard, and otherwise difficult to use directly. Fortunately, the latter problem is gradually being alleviated because of a greater awareness about noise and willingness to provide information on the part of equipment vendors, as well as by development of national standards to measure noise emissions. An example of vendor awareness is the stripper off gas compressor coupling in this case history. Continuous tube coupling guards are now available for dry couplings, because of owner-vendor resolution of the noise problem.

Aside from raw baseline data, other complications can arise. Equipment trains purchased as a package unit and guaranteed as such may have noncompliance items included that must be separated and investigated individually. Piping insulation specifications may not allow insulation of flanges and valve bodies in process stream service; these gaps often produce an unacceptable acoustical system. In addition, fibrous acoustical insulation may also be disallowed by specification for piping systems. Explanation of the mechanisms of fibrous vs hard (calcium silicate) insulation and their acoustical absorption properties is usually required. Simple assumptions about noise propagation may be inappropriate; shielding effects from nearby structures and terrain, directional patterns of noise radiation, and other influences may each be significant. All these factors can be integrated into the programming used to generate the contours, or considered separately, but it certainly takes additional work to do so. Another difficulty that becomes apparent, as decisions are made about input data for the computer program, is what operating modes should be considered. Certain combinations always operate simultaneously. Some equipment may emit noise intermittently. Decisions must be made there that are dependent, in part, on the nature of the overall program objectives.