

COMBINATIONS OF TREATMENTS

- Case History 51: Steel Wire Fabric Machine
- Case History 52: Barley Mill
- Case History 53: Punch Press
- Case History 54: Cut-Punch Press
- Case History 55: Punch Press
- Case History 56: Newspaper Printing Press
- Case History 57: Letterpress Rotary Printing Machines
- Case History 58: Chemical Process Plants
- Case History 59: Vibration Table
- Case History 60: Teletype Machine .
- Case History 61: Process Plant Noise Control at the
Plant Design Stage

CASE HISTORY 51: STEEL WIRE FABRIC MACHINE
(OSHA Noise Problem)

Problem Description

This 8-ft fabric machine manufactures wire netting spaced at 6-in. spacings, starting with individual wires from large spools that run through the length of the machine. A perpendicular wire, known as staywire, is fed across at 6-in. intervals and spot-welded at each intersection. This staywire is then cut off at the left-hand side of the machine. The long wires are then moved through the machine another 6 in., and the staywire operation is repeated. This machine produces 6 × 6 in. No. 8 or No. 10 wire netting, which is used as concrete reinforcement in the home building industry. The machine is made by Keystone Steel and Wire Company.

Problem Analysis

At the operator position, the sound level was found to be 99 dBA and 102 dBC, indicating low-frequency components. This kind of noise ($L_C - L_A = 3$) is very unpleasant.

The daily noise dose was found to be 2.5; the acceptable level is 1.0.

Criteria were established to reduce the noise exposure to 1.0 or less, a level equivalent to 90 dBA or less.

The octave-band sound pressure level measurements made at the main drive gear, at the operator station, and at the wire spool area (Figure 6.51.1) showed that noise sources included (1) general mechanical noise because of needed maintenance, (2) the wire wrapper, a ratchet-action machine operated from main drive gears and found to cause 1000-Hz peak noise, and (3) mechanical sources within the machines, which could lend themselves to isolation.

Control Description

In addition to the direct noise corrections implied above, another solution could have been to construct a noise shelter for the operator. This solution was dropped in favor of working on specific noise sources. A program was established to:

(1) Overhaul the machine: replace bearings, reduce metal-to-metal banging, replace worn gears, and so on.

(2) Replace ratchet-type drive on wire wrapper with chain drive. (This device pulled the long wires through the fabric machine.)

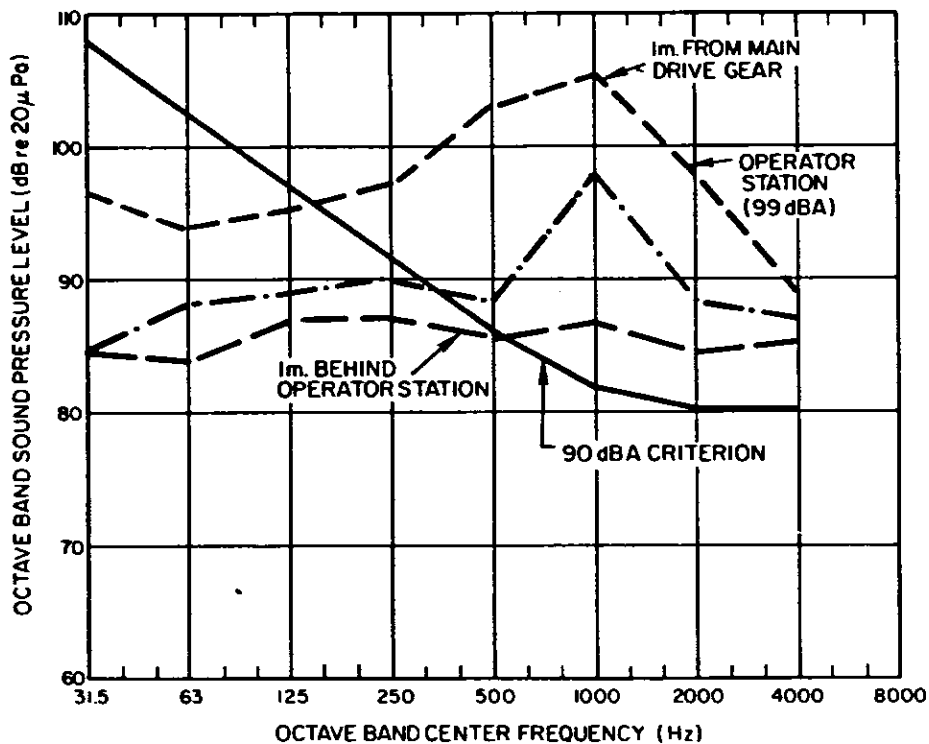

Figure 6.51.1. Sound pressure levels at 8-ft fabric machine.

(3) Add steel plates (10 lb/ft²) to the frame of the machine. These plates were welded to the frame to block direct air path noise to the operator. The machine frame casting had many openings, which were covered by these steel plates, as shown in Figure 6.51.2.

Results

The sound level at the operator station was reduced from 99 dBA to 93 dBA (93 dBC). With this reduction, an additional source was noted and determined to be the staywire lifter arms. These were covered with a 3/8-in.-thick piece of Lexan (see Figure 6.51.3) for the full length of the operator position, hinged so that it could be easily removed for maintenance.

The sound level was reduced to 89 dBA at the operator station and OSHA compliance was achieved.

Costs were mainly internal plant labor for machine overhaul, plus the cost of the steel barrier plates welded to the frame (estimated at less than \$100), plus the cost of the piece of Lexan at \$5.00/ft², or about \$50 plus installation labor.

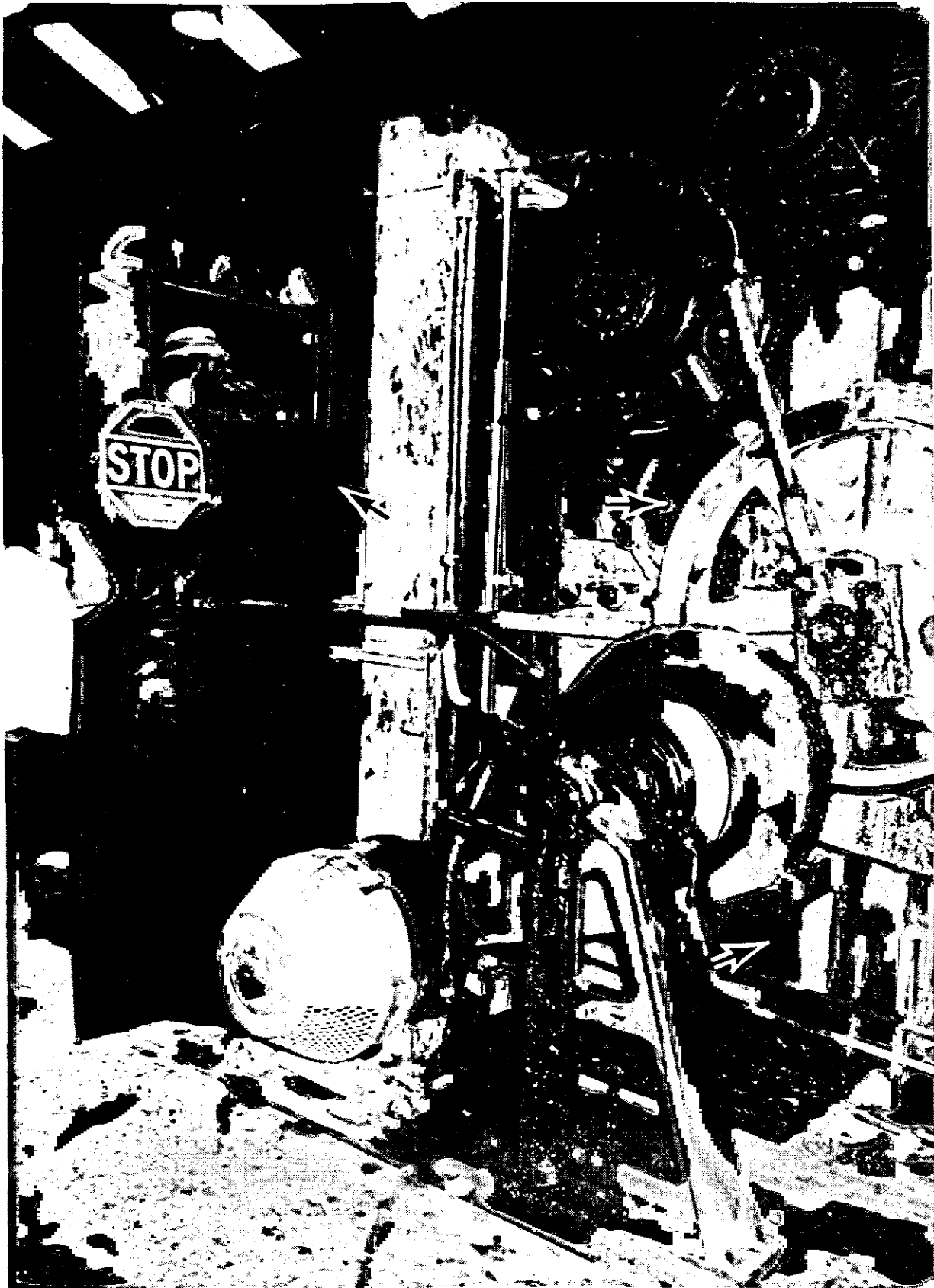

Figure 6.51.2. Steel plate barrier with window (stop sign hung on it).

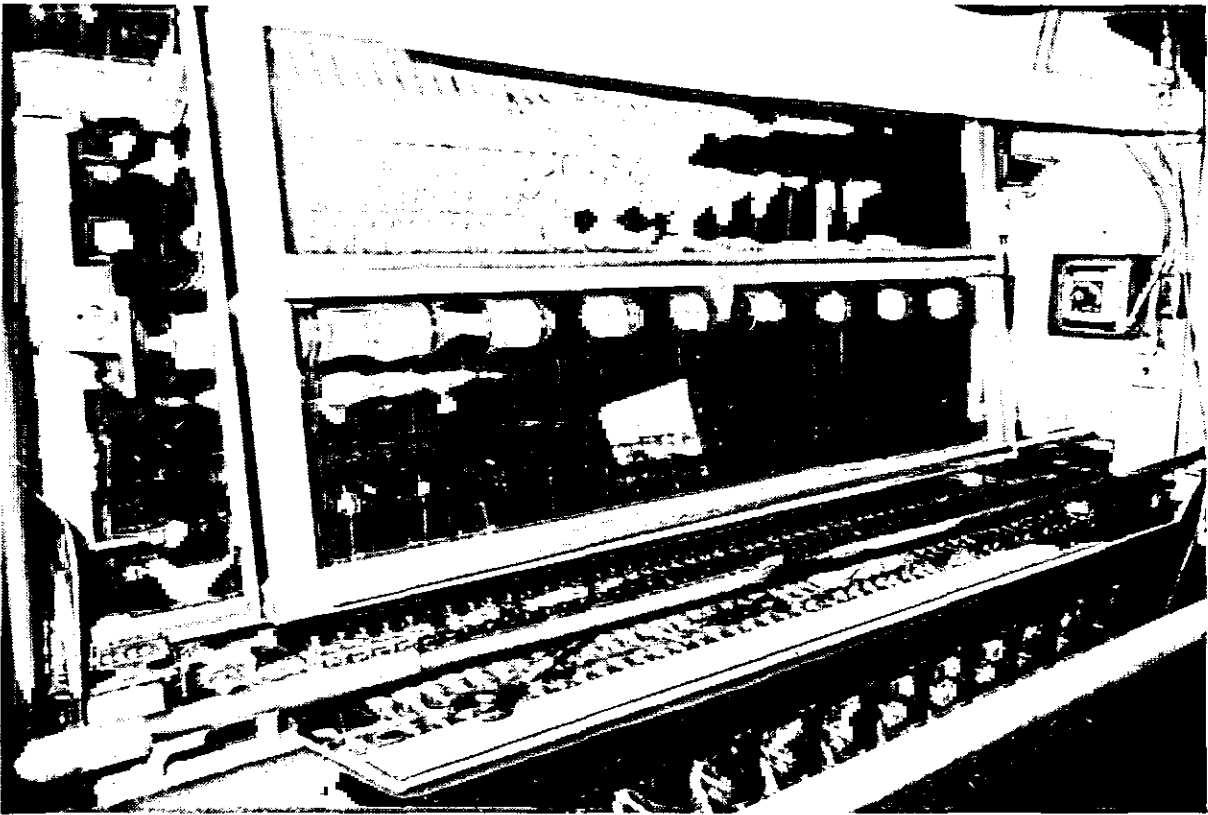

Figure 6.51.3. Lexan barrier in two sections; slides up for access.

Comments

A shelter could have solved the problem, but, where possible, attack on direct noise is recommended. When major noise sources are reduced, the contribution of other noise sources can be better determined and corrected. By replacing the ratchet-type drive on the wrapper with a chain drive, the production rate was increased by 50%.

A major pitfall in this kind of approach is moving too fast. Testing each technique under actual conditions is far better than moving rapidly into failure. From beginning to end, this solution took two years to develop.

CASE HISTORY 52: BARLEY MILL
(OSHA Noise Problem)

Problem Description

Excessive sound levels existed around the Moorspeed and Ross barley mills (rolls 8-in.-diameter, 15-in.-long), a hay shredder, and a control operator's chair in a cattle feed grinding mill. The objective was to reduce the sound level at the operator's position for OSHA compliance.

Problem Analysis

A- and C-weighted sound levels and octave-band sound pressure level measurements were made between the Moorspeed and the Ross mills and at the hay shredder with both mills in normal continuous operation. With $L_C - L_A = 9$ dB, excessive low-frequency sound levels were predicted. These were confirmed by octave-band sound pressure level measurements. Octave-band sound pressure level measurements at the control operator's chair, the mills, and at the hay shredder are shown in Figure 6.52.1. Figure 6.52.2 is a sketch of the room, showing the relative location of the equipment.

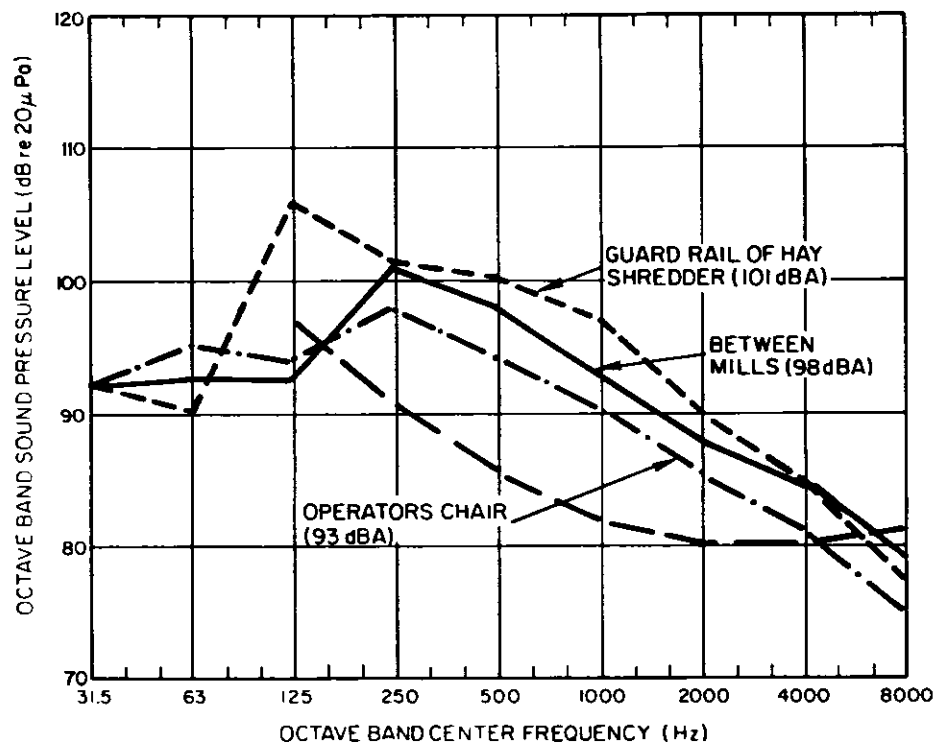

Figure 6.52.1. Sound pressure levels at mills, hay shredder, and operator's chair.

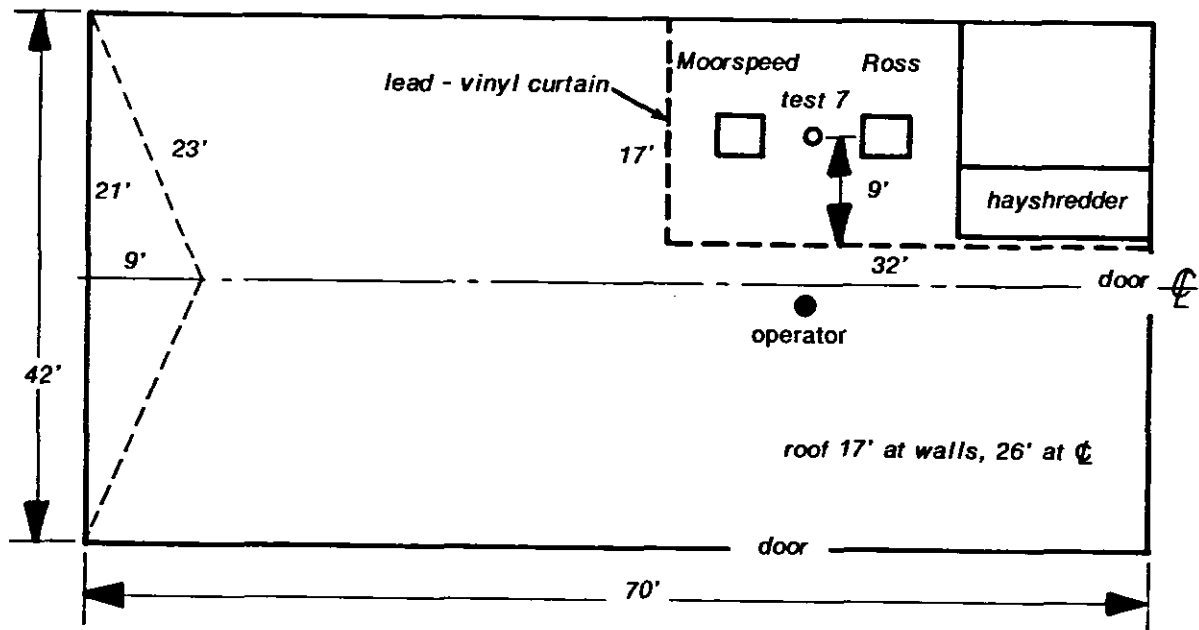

Figure 6.52.2. Floor plan of barley mill.

Roller crushing actions produced high sound levels, and correction by machine redesign was believed to be too costly a method for solving this problem. When the source is too difficult or uneconomical to attempt to correct, working on the noise path will often result in a more economical solution. Therefore, a partial enclosure, open at the top, was chosen.

Control Description and Design

Although walls can be of solid construction with a minimum of access doors, in this case access was needed for adjustment, maintenance, repair, and roll replacement. For roll replacement, a forklift truck entry was required. For ease of quick access, a fixed barrier wall was discarded in favor of a lead-vinyl curtain wall extending, if required, up to the 17-ft height of the roof support beams. All three noise sources could be enclosed by two curtain walls at the corner of the building, as shown in Figure 6.52.2. The curtains run on rails for easy sliding back and are held together by Velcro closures.

Figure 6.52.1 shows that, if the sound pressure levels from 250 Hz up are reduced by at least 14 dB, the resulting A-weighted sound level readings would be less than 90 dBA for compliance outside the curtain walls.

Barrier wall attenuation is limited in three ways: (1) direct transmission loss in each octave band, (2) noise over the wall, and (3) room absorption, noise-source side.

(1) Direct transmission loss (TL): The manufacturer of lead-vinyl fiberglass curtains, 0.75 lb/ft², was chosen. Manufacturer's literature gave the transmission loss in each octave band as follows:

	<u>125 Hz</u>	<u>250 Hz</u>	<u>500 Hz</u>	<u>1000 Hz</u>	<u>2000 Hz</u>
TL =	11 dB	16 dB	20 dB	26 dB	31 dB

It is seen that the transmission loss is not a limiting factor.

(2) Noise over wall: Barrier wall attenuation can be estimated from data in Beranek (1971*) using the dimensions from Figure 6.52.2 and from the sectional view in Figure 6.52.3.

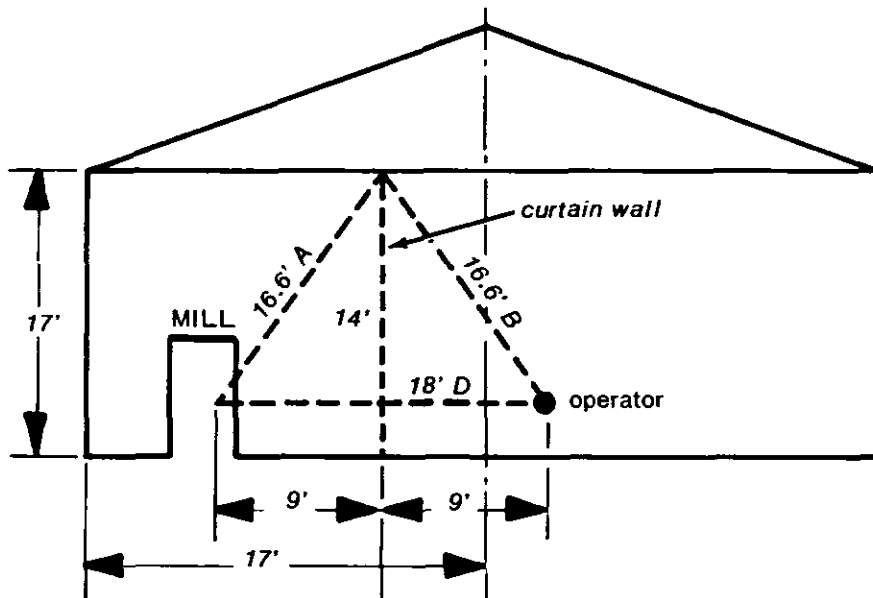

Figure 6.52.3. Sectional view of barley mill.

$$N = \frac{2}{\lambda} (A + B - D) = \frac{2}{\lambda} (16.6 + 16.6 - 18)$$

$$N = \frac{30.4}{\lambda} \text{ (Fresnel number)}$$

*Beranek, L.L. 1971. Noise and Vibration Control, McGraw-Hill, New York, N.Y. p. 178.

	<u>125 Hz</u>	<u>250 Hz</u>	<u>500 Hz</u>	<u>1000 Hz</u>	<u>2000 Hz</u>
$\lambda =$	9.6 ft	4.8	2.4	1.2	0.6
$N =$	3.2	6.3	12.6	25.2	50.4
Attenuation (dB)	14	16	18	20	20

(Beranek, 1971, graph on page 178). In practical situations, the attenuation is limited to about 20 dB.

By a rough first approximation procedure, we can obtain an estimate of the reduction afforded by the curtain walls. In the listing below, we start with the worst-case octave-band sound pressure levels of Figure 6.52.1 and then list the transmission loss and barrier effects just calculated. Subtracting the minimum of these two reduction mechanisms yields a tentative spectrum of the resulting sound in the room. After A-weighting and combining of sound pressure levels, the predicted reduced room sound level is 85 dBA.

<u>Octave bands</u>	<u>125</u>	<u>250</u>	<u>500</u>	<u>1000</u>	<u>2000</u>
Noise source	106	101	98	97	90
Direct TL	11	16	10	26	31
Over wall	14	15	18	20	20
Reduced sound pressure levels	95	85	80	79	70
A-weighting	-16	-9	-3	0	1
A-weighted	79	76	77	77	71
A-weighted sound level	84 dBA				

For visual access, the enclosure can have 10- × 20-in. plastic windows placed to order; use only the minimal number. To reduce leaks, the curtains should be long enough to drag a bit on the floor. Some rerouting of power, steam, and air lines may be required.

The approximate 1973 costs were: \$4.00/ft² for curtains made to order with grommets; Velcro fasteners, \$3.00/ft; track, \$1.50/ft; rollers (one per grommet), about \$2.50 each; windows, \$25.00 each; total cost about \$4,000.

The preceding simplified treatment neglects an important fact: We have not gotten rid of the noise, but have merely redistributed it. Thus, the total sound power from the machines escapes from the topless enclosure and spreads throughout the room. Close to the curtains, there should be some reduction, but very little farther away. Absorption is required for actual reduction of the sound power. This was considered next.

(3) Absorption, noise-source side of wall: When noise sources are confined to a space with less absorption than before, they may build up higher sound levels because of reverberation. The sound barrier curtain material can be obtained with sections of sound absorbent on the inside, to counteract this effect. In the barley mill, however, this choice was not recommended as the porous open material could easily become dust-clogged. Shortly after this noise control job was completed, absorbents covered with a plastic film became available. At the time, the recommendation was for an easily installed and maintained material, Owens-Corning Fiberglas Noise Stop Baffles.* These are 23 x 48 x 1.5-in. baffles, which comprise an absorbent board wrapped in a washable, noncombustible plastic film; each baffle is supplied with two wires through the 23-in. dimension. These wires terminate in hooks; to install, stretch wires, 3 ft on center, parallel to the line joining the two mills and about flush with the top of the enclosure rails.

The enclosure developed by the curtain walls is, in effect, a separate small room, and the noise reduction can be estimated from the relationship of total absorption before and after adding the sound absorption panels. This relationship is

$$\text{dB Attenuation} = 10 \log A_2/A_1,$$

where: A_2 is new total absorption

A_1 is original absorption

(from Bibliography: Harris, Handbook of Noise Control, pages 18-19[†]).

*These are no longer sold by OCF, but can be readily fabricated from acoustical insulation board.

[†]Harris, C.M., ed. 1951. Handbook of Noise Control, McGraw-Hill, New York, N.Y.

Original absorption, A_1 :

	Area	Coefficient = Absorption (Sabins)
Long wall	32 ft × 17 ft × 2 × 0.02	22
End wall	17 ft × 17 ft × 2 × 0.02	11
Roof	17 ft × 20 ft × 1 × 0.02	$\frac{7}{40}$ ft ² -Sabin

Absorption by adding 100 panels 2 × 4 ft

100 × 2 ft × 4 ft × 2 sides × 0.8 (average A-weighted absorption coefficient of panel) = 1280

Original absorption 40

New total absorption 1320 ft²-Sabin

$$\text{dB attenuation} - 10 \log \frac{A_2}{A_1} = 10 \log \frac{1320}{40} = 15.2 \text{ dB}$$

Resultant level = measured level - reduction = 86 dBA.

Result

The measured final sound level was 87 dBA, a reduction of 7 dB. This level was 3 dB lower than the maximum desired sound level, and was the result of paying careful attention to elimination of leaks. The room formed by the curtain did not realize such a reduction, but since these machines required no attention while running, the noise exposure of personnel was significantly reduced below unity. The major remaining path is reflection from the ceiling.

Comments

Barrier walls of various heights can often be used between a noise source and a machine operator. A major pitfall is that, in a room with a high level of reverberant noise, the partial barrier will be short-circuited by the reflected noises from walls, ceilings, and other surfaces. In such cases, attenuation based on the partial wall theory will not be obtained, and the result may often be no attenuation at all in highly reverberant rooms. Curtain walls must be kept closed to get attenuation. Sound-absorbing units must be kept clean to be efficient.

Even in a semireverberant room, a reduced barrier height can be used. In this case, a 7-ft barrier should ideally reduce the level to 89 dBA at the receiving location. However, since the semireverberant conditions will introduce more reflected sound with the lower barrier, the high wall used in this case history is recommended because the added absorption within the barrier area has, in effect, made a separate small room and created the condition on which the barrier wall theory was based.

CASE HISTORY 53: PUNCH PRESS
(OSHA Noise Problem)

Problem Description

Punch presses in use in this shop were Summit, Bliss Diamond, and Benchmaster. Within the room were four large presses and four small punches. One of the Summit presses was chosen as representative of the large press group, and the Benchmaster was chosen as representative of the small press group. The general room layout is shown in Figure 6.53.1.

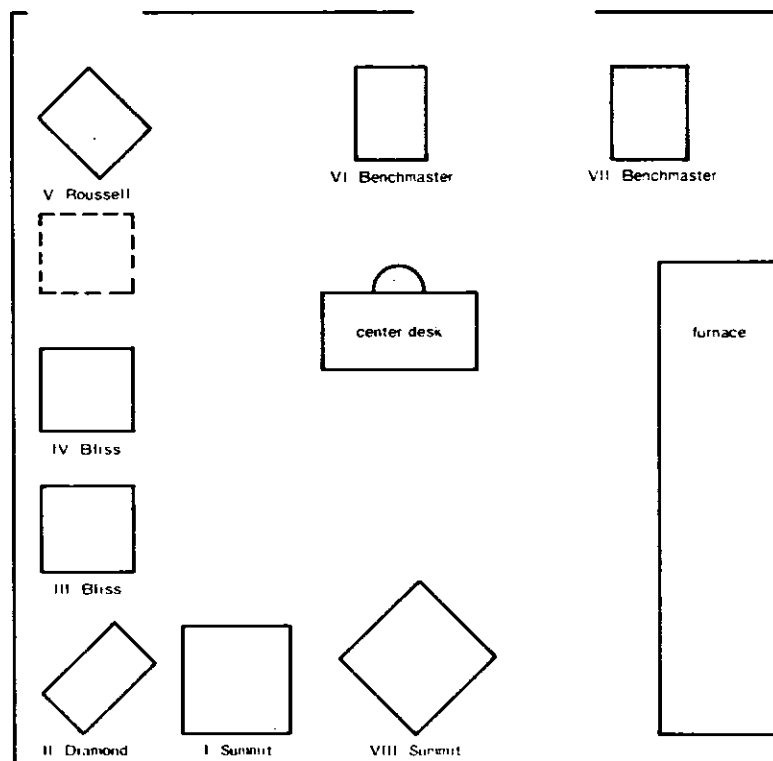

Figure 6.53.1. Layout of punch press room.

Problem Analysis

Octave-band sound pressure level measurements were made of the ambient when all the presses and nearby furnaces were shut down. Readings were taken near the central supervisor's desk. The A-weighted sound level was a very low 58 dBA, indicating that there were no other serious noise sources. Also noted was the difference in sound level with and without the furnaces. With the furnace on, the sound level increased to 69 dBA, still quite low for most industrial situations. Thus, the furnace was also eliminated as an irritant noise source.

Figure 6.53.2 is an octave-band analysis taken from the center desk with two Summit presses, two Bliss punches, and one Benchmaster in operation. The sound level at the desk is 97 dBA, a definite overexposure condition.

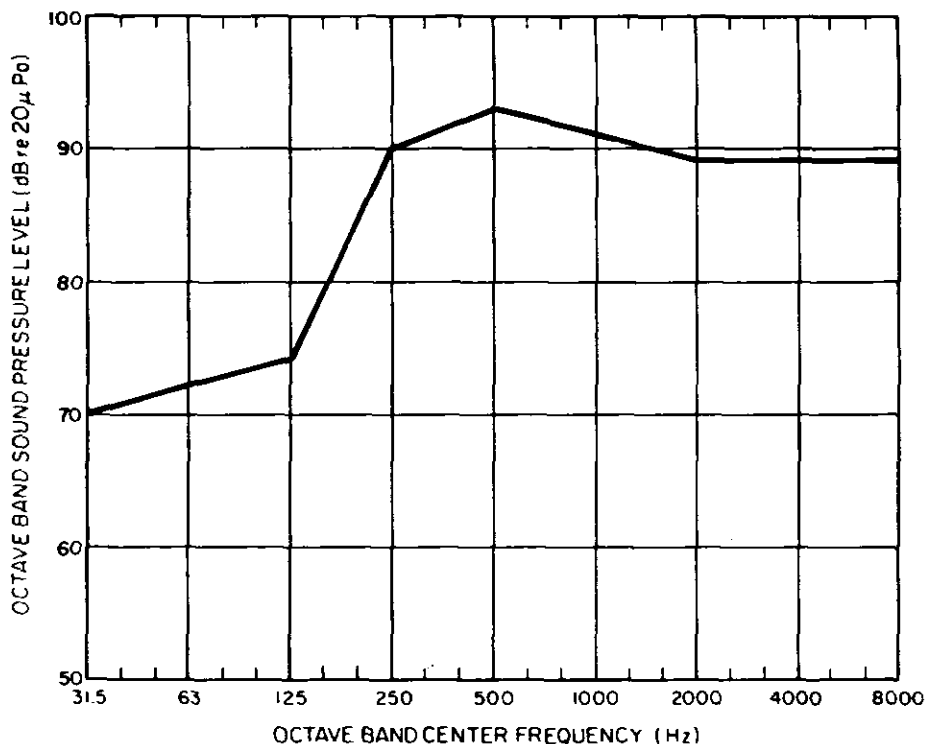

Figure 6.53.2. Ambient sound pressure levels with furnace on, two Summit, two Bliss, and one Benchmaster presses in operation (microphone 1.5 m above floor, directly above desk chair).

The Summit punch, Location I in Figure 6.53.1, was chosen as a typical large press. Operator sound levels, shown in Figure 6.53.3, were 106 dBA during the operating cycle and 90 dBA during preparation with Punch I off. At 106 dBA, the permitted exposure time is 0.87 hr. The octave-band analysis showed that important noise contributions came from the 500-Hz and higher bands.

Figure 6.53.3 also shows the spectrum of noise from operation with nothing in the die. Although a reduction was noted in the 500-Hz band and a small reduction in the 250-Hz and 1000-Hz bands, the 2000- to 8000-Hz bands, which were main contributors to the A-weighted sound level, remained the same as with the full operation. The 2000- to 8000-Hz bands were apparently due to the effect of air exhaust noise from jets for removing parts and pushing them into the collection chute. For these higher frequencies and short wavelengths, barriers are efficient. Close-in diagnostic measurements were made behind the press, but no new noise sources were noted except the directionality of some of the air ejection noise.

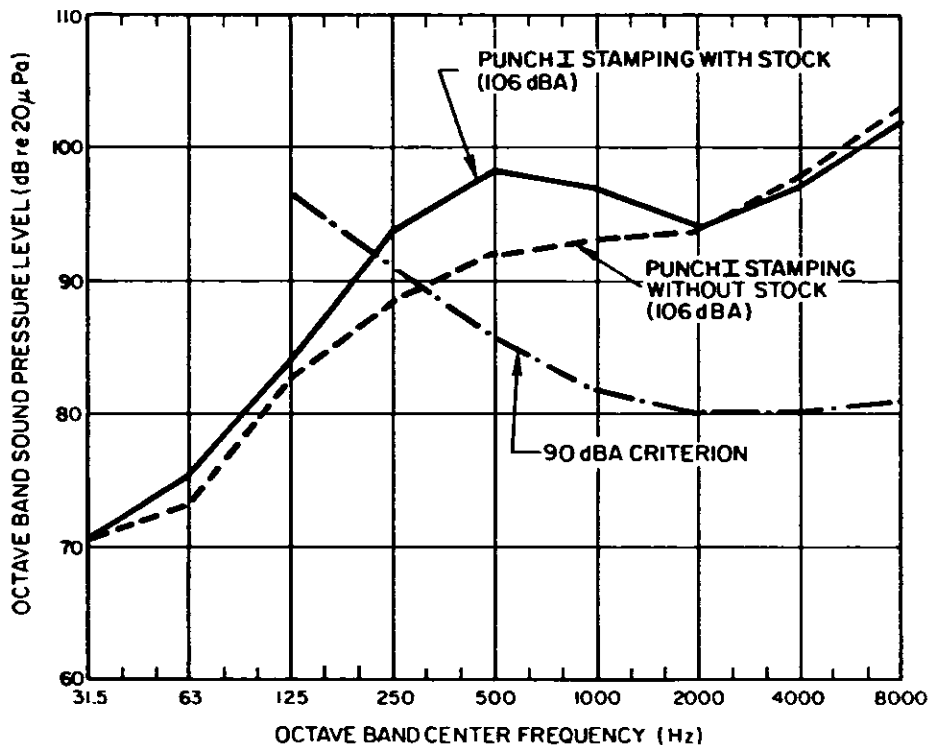

Figure 6.53.3. Sound pressure levels at Punch I.

The reduction sought was from 106 dBA to 86 dBA, with 90 dBA acceptable. This level required reductions of about:

- 13 dB in 500-Hz band
- 20 dB in 1000-Hz band
- 26 dB in 2000-Hz band
- 28 dB in 4000-Hz band
- 31 dB in 8000-Hz band.

For a separate study of a typical small press, the Benchmaster (Punch VII) was chosen. The operator's position octave-band analysis in Figure 6.53.4 shows somewhat less noise than the large press; it has the same general configuration and air jet noise source. Figure 6.53.4 also shows the sound levels with no stock in the press, and with the press in punching operation with no stock and no air ejection. Again, data were very similar to those for the larger press.

The recommendations were: Reduce air noise along path by installing a barrier between noise source and operator, and reduce noise from air ejection at the source. The latter was considered first.

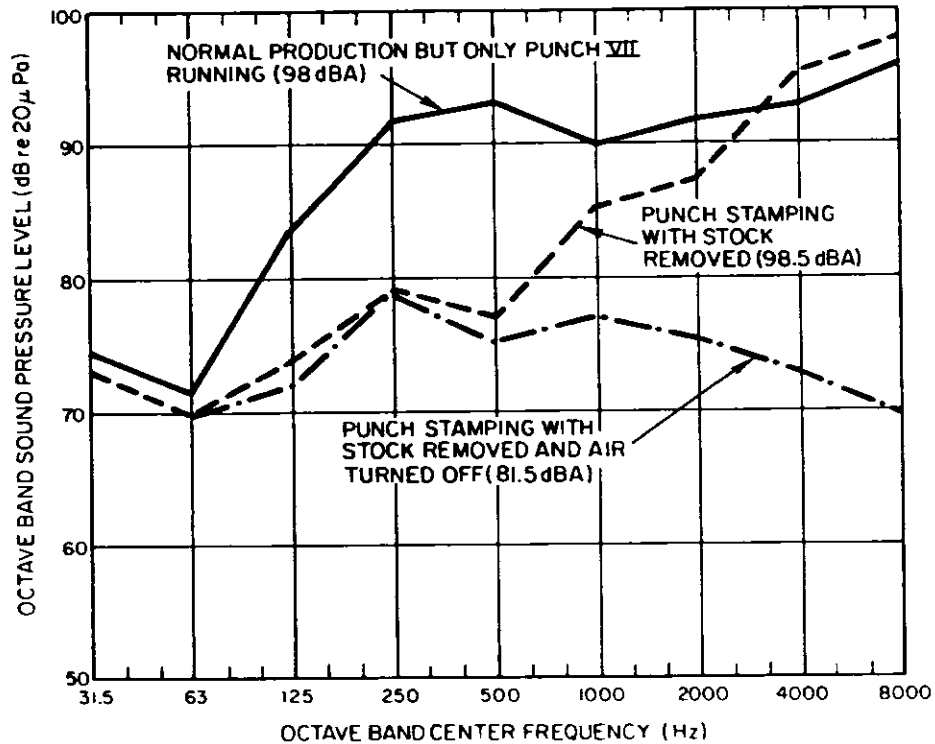

Figure 6.53.4. Sound pressure levels at the operator position of Punch VII.

Noise caused by high air velocity can be reduced by decreasing the linear flow velocity by increasing the nozzle opening, for same air mass flow. If the diameter of the nozzle is doubled, in a constant volume velocity system, flow velocity is reduced to one-fourth, and noise level is reduced nearly 30 dB (noise of air jet varies approximately as fifth power of velocity). However, thrust would also be reduced to one-fourth of original value. For proper ejection, the nozzle should be aimed more accurately and more efficiently toward the target. Experiments should be conducted to determine the maximum thrust required for minimum noise.

A barrier between source and operator can add to the attenuation obtained. The barrier could be box-shaped around the die (with far side and bottom missing). This barrier replaces the present guard, and handles both mechanical and acoustical guard functions. Materials suggested include 1/4-in. plywood, 1/4-in. Plexiglas or Lexan, made with airtight corner joints. Noise-absorbent material, Mylar-faced for dirt and oil protection, was added inside the box; it must be kept clean during normal operations.

Control Description

Based on suggested possible methods of nozzle construction, a quiet nozzle cover was made. The design of this nozzle is shown in Figure 6.53.5. Air pressure, controlled by a reducing valve,

was reduced to the minimum to do the ejection job. (Low-noise air jets are also available commercially.)

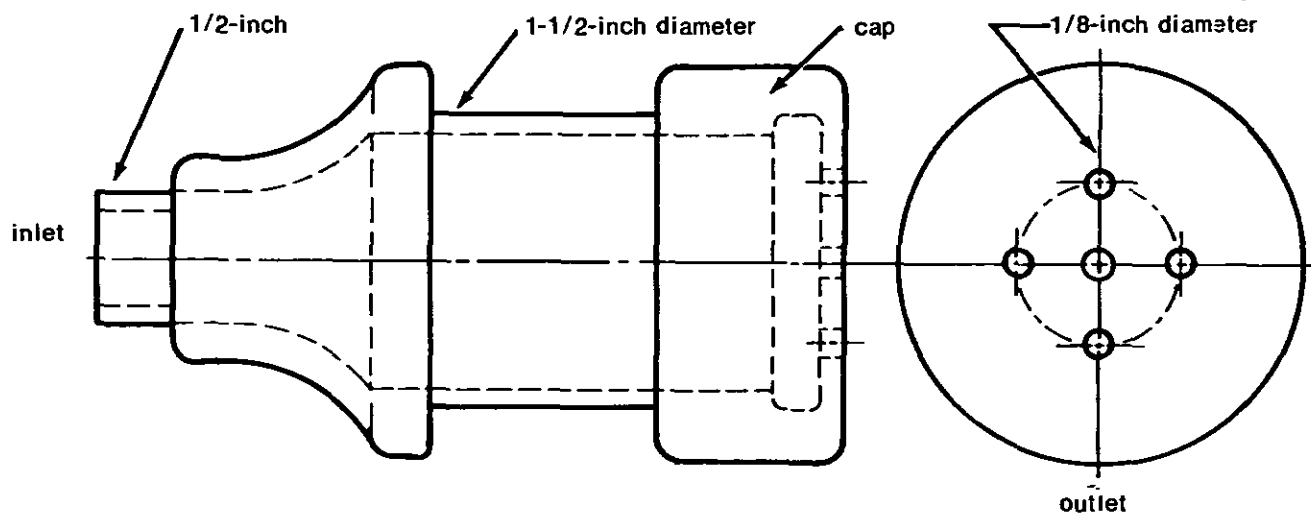

Figure 6.53.5. Design of nozzle.

A sketch of the barrier is shown in Figure 6.53.6. To afford visual access, the material chosen for the barrier was 1/4-in. Plexiglas. The three-sided barrier was locally designed, aiming to have minimum leakage at bottom of barrier (toward the operator).

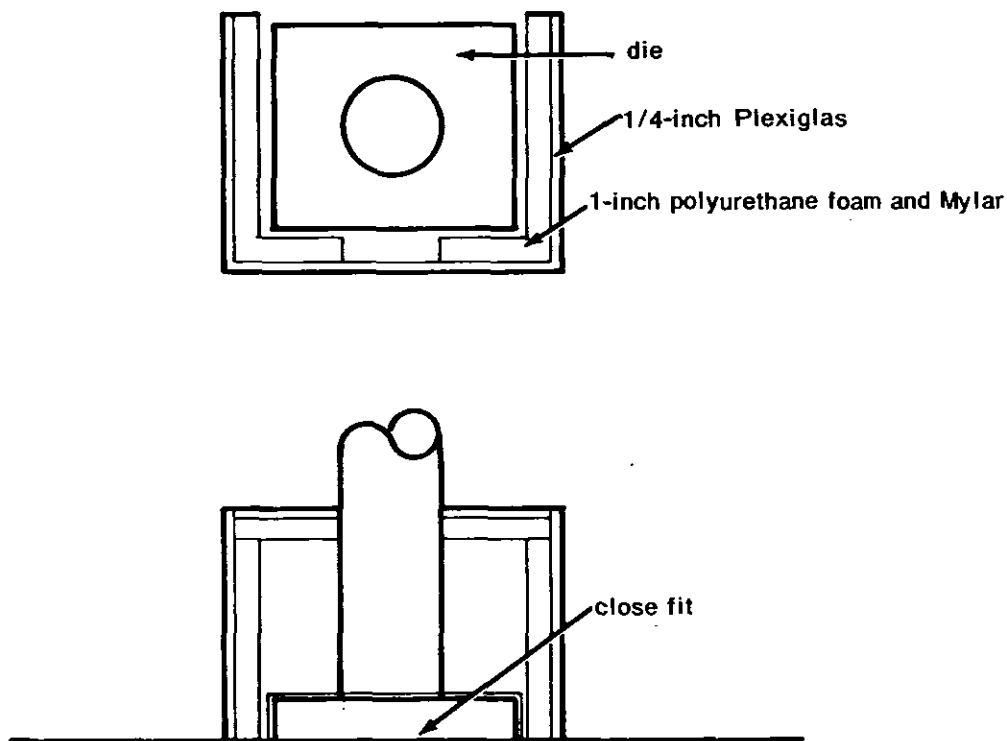

Figure 6.53.6. Sketch of Plexiglas barrier.

For absorption, 1-in. acoustical (fully reticulated) polyurethane, with Mylar film covering for ease of cleaning, was glued to the inside surface, leaving a minimum uncovered portion for operator viewing of punch action.

Accurate costs were not available for this in-plant effort; however, the materials were less than \$100 and labor was estimated at \$250.

Results

After experiments with reduced jet velocity and with the barriers described, the following sound levels were attained:

Large punch press reduced from 106 dBA to 85 dBA;

Small punch press reduced from 99.5 dBA to 82.5 dBA.

Comments

The major pitfall for barriers will be to see that they are used. Also, when used, the bottom opening or noise leak toward the operator should be kept at a minimum. Another pitfall to continued efficiency will be allowing the Mylar-covered noise absorbent to become dirt- and grease-laden; periodic cleaning is needed.

A pitfall associated with air volume reduction is the tendency of operators to increase pressure or remove the nozzle.

Attenuation will depend on the success of air velocity reduction in maintaining the needed thrust for ejection in conjunction with noise reduction of barrier. Unless these experiments involved the operators, they may not accept the alterations.

If a mechanical method could be developed to replace air jet part ejection, this would be the best alternative.

CASE HISTORY 54: CUT-PUNCH PRESS
(OSHA Noise Problem)

Problem Description

This punch press had been modified to produce metal stampings out to a predetermined size. This machine was the first stage of a stamping operation in which the metal was sized and roughly shaped. In two following stages, each part was finished.

Problem Analysis

Figure 6.54.1 gives the octave-band analysis of the operator exposure, which is 102 dBA while punching and 88 dBA during idling. Figure 6.54.2 shows close-in octave-band data for gear noise, illustrating the continuous nonpunching noise source in the gear mechanism. Figure 6.54.3 shows close-in measurements of the dog and flywheel noise and similar close-in measurements of noise from piston-collar impact on the air cylinder.

Clearly, punching noise is the critical part of this noise problem, yet it requires a large amount of noise reduction if one desires to bring maximum operator position sound levels down to no more than 90 dBA. The idling noise aggravates the problem.

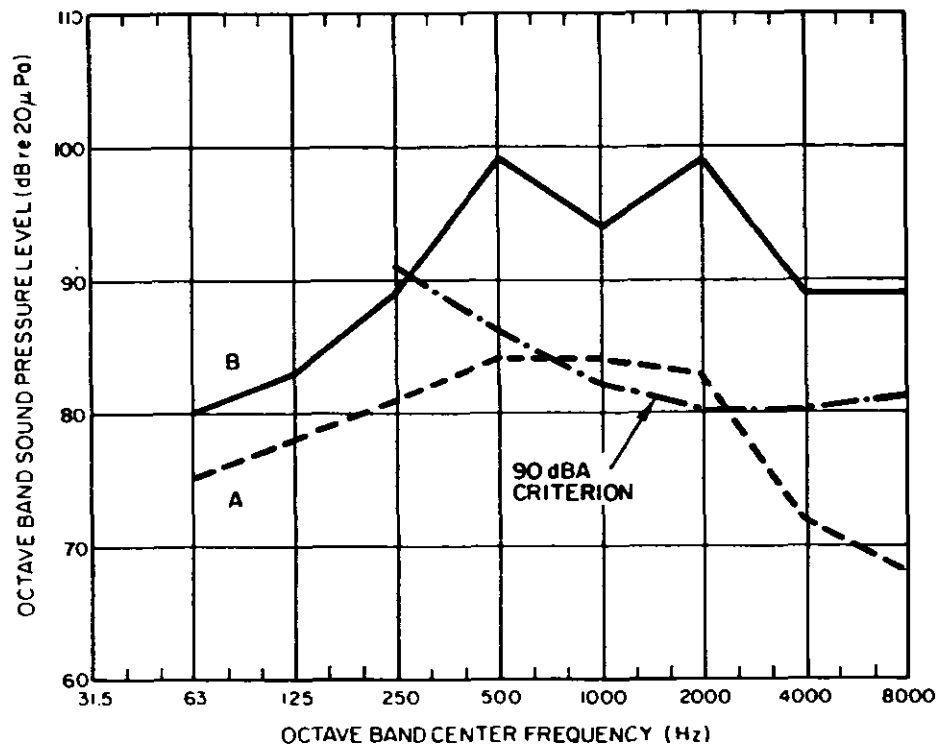

Figure 6.54.1. Cut-punch press operator position sound pressure levels. A, idling; B, punching.

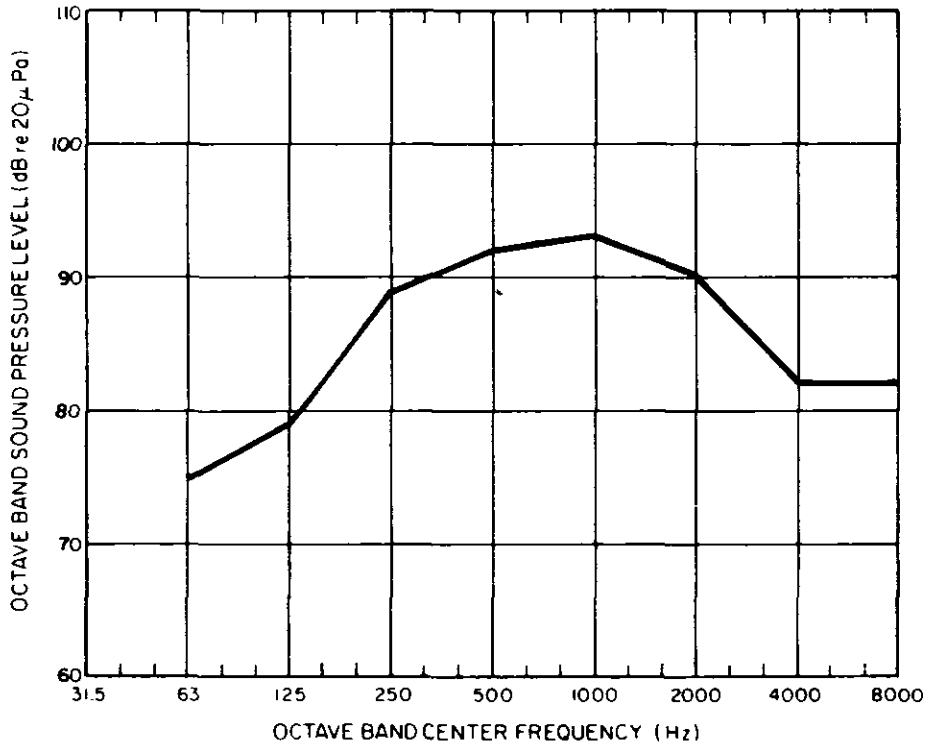

Figure 6.54.2. Cut-punch press, close-in diagnostic data, 14 cm from gears.

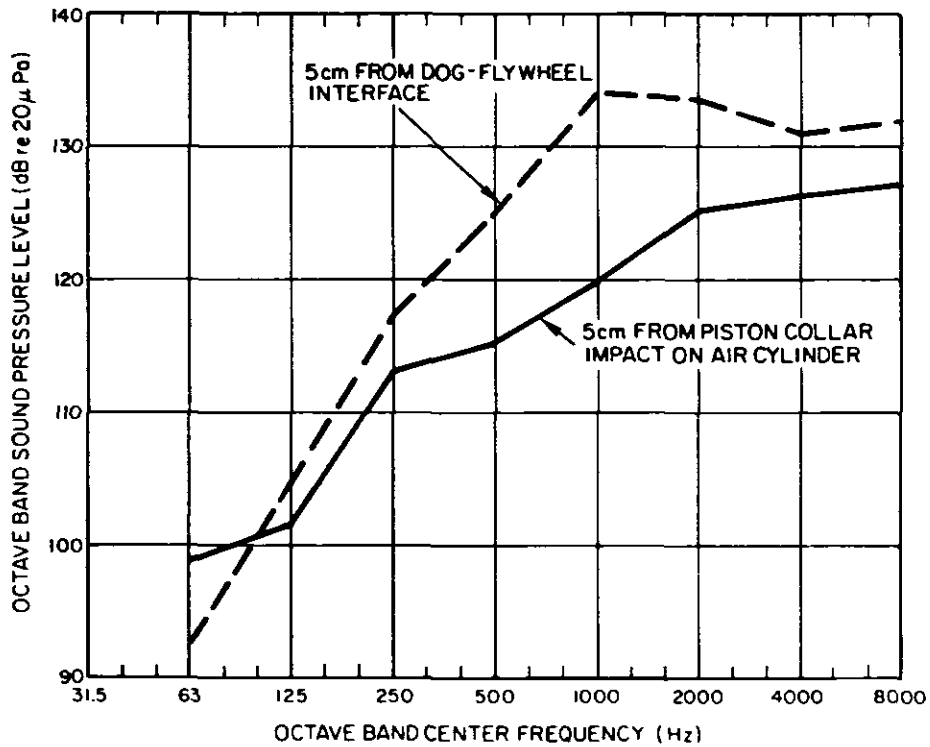

Figure 6.54.3. Cut-punch close-in data.

Recalling the principles of decibel addition, if we were to reduce punching noise to 90 dBA, idling noise would have to contribute no more than 81 dBA to enable the sound level to remain at 90 dBA. In this case, it was decided to aim for a 12-dB reduction in sound level in punching noise, together with a 7-dB reduction in sound level in idling noise, rather than for the 16-dB reduction in sound level in punching noise that would be required if the idling noise were left unchanged.

As machine change was not practical, changes had to be made in the noise transmission path to the operator on two of these noise sources. The other source, piston-collar impact on the air cylinder, was modified at the source by adding washers made from Unisorb Type D pad between the piston stop and the collar to reduce metal-to-metal impact noise.

Control Description

The gear noise and dog-flywheel impact noises were attenuated by constructing an extended barrier about these noise sources. To obtain the attenuation required, 1-in. plywood was used. The enclosure was attached to the right side of the press (as the operator looks at press) and extended upward to the top of the press, downward to operator chest level, and outward several inches past the flywheel guard. The top, bottom, and right-hand edges had a small 6-in. extension at the barrier extending 90° away from the operator, as shown in Figure 6.54.4.

An absorbent was added to both sides of enclosure, of Mylar covered with 1-in. acoustical foam absorbent, available from several suppliers. The joint between the enclosure and the right-hand side of the press was sealed to prevent noise leakage; a 2-in.-wide strip of closed cell foam weatherstripping was specified.

Normally, absorbing material is used only on the noise source side of a barrier wall; however, if other noise sources might reflect from the barrier wall to the operator, absorbing materials on the operator side will reduce this noise component.

Results

Sound levels during idling were reduced from 88 dBA to 81 dBA. Punch operational sound levels were reduced from 102 dBA to 88 dBA, thus bringing the entire operation into compliance.

Though not recorded, costs are estimated at less than \$200 for plywood, polyurethane foam, and the labor for attachment.

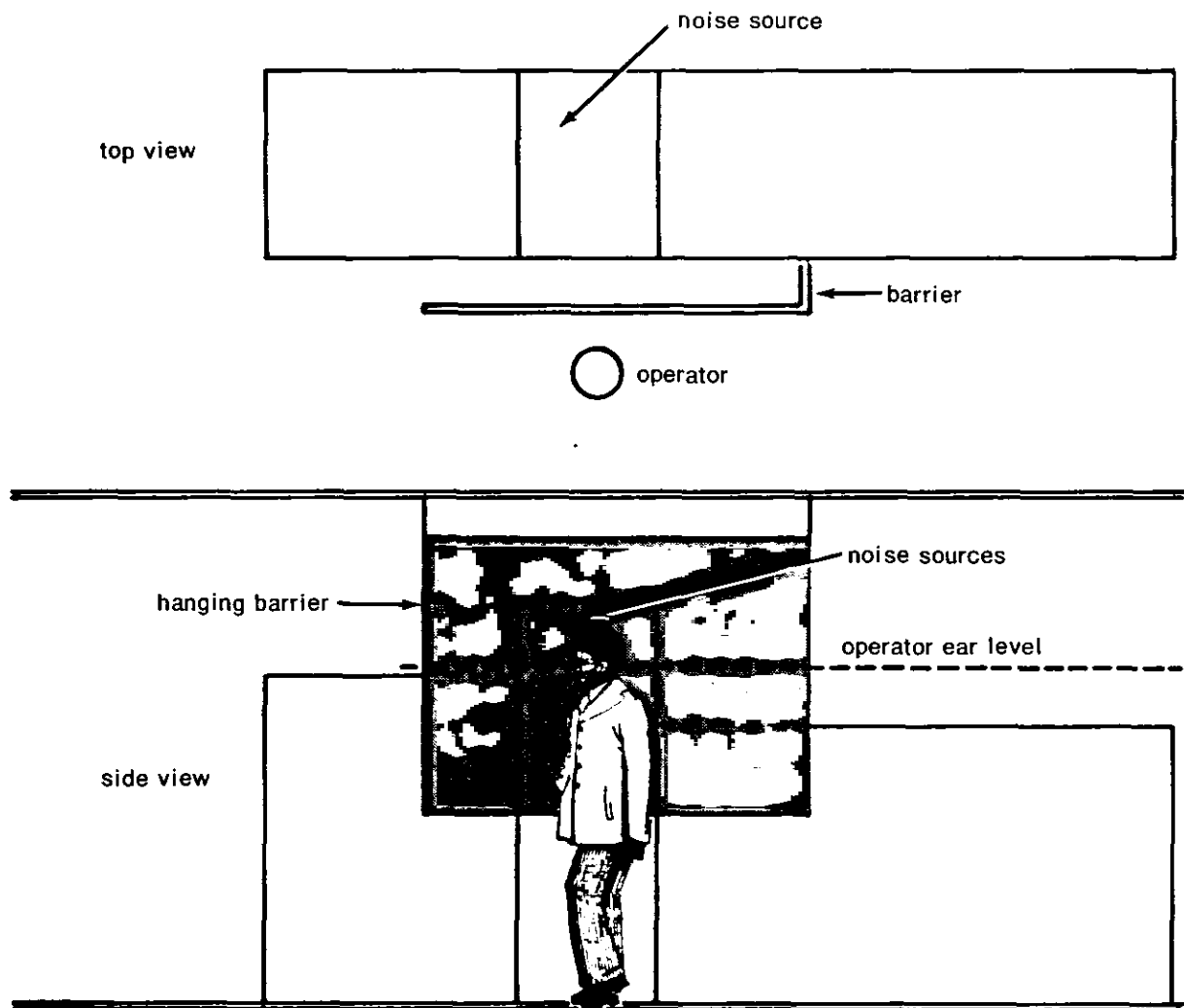

Figure 6.54.4. Sketch of hanging barrier for cut-punch press.

CASE HISTORY 55: PUNCH PRESS*
(OSHA Noise Problem)

Problem Description

Punch presses constitute a most troublesome source of industrial noise, both because of their number and because of their high noise output.

Problem Analysis

From various papers on the subject of punch presses, the following list of noise sources has been gathered. These may not all be present on any one press but are listed as a guide to specific press noise source analysis.

- (1) Shock excitation of the workpiece, machine guards, floor and building
- (2) Gears, drive, bearings, and components, such as clutch and brake mechanism and drive shaft;
- (3) Plunger resonance;
- (4) Air ejection, air jet cleaning, and air cylinder exhausts;
- (5) Die design;
- (6) Stripper plate design;
- (7) Ejection of parts leaving press on chute or bin;

*American Industrial Hygiene Association. 1966. Industrial Noise Manual. AJHA, Detroit, Michigan. Examples 11.C, 11.EE.

Allen, C.H., and Ison, R.C. 1974. A practical approach to punch press quieting. Noise Control Eng. 3 (1): 18.

Bruce, R.D. 1971. Noise control of metal stamping operations. Sound and Vibration 5 (11): 41.

Shinaishin, O.A. 1972. On punch press diagnostics and noise control. Proc. Inter-Noise 72: 243.

Shinaishin, O.A. 1974. Sources and control of noise in punch presses. Proc. Purdue University Conference on Reduction of Machine Noise, p. 240.

Stewart, N.D., Daggerbart, J.A., and Bailey, J.R. 1974. Identification and reduction of punch press noise. Proc. Inter-Noise 74: 225.

- (8) Vibration of sheet metal being fed to the press;
- (9) Start and stop of automatic feed to the press;
- (10) Building acoustics.

Control Description

Shock excitation of surrounding structures: This effect can be minimized by properly designed vibration mounts for the entire press to reduce excitation of floors, walls, and other equipment. As an example of this minimization, see Case History 3.

Drives, etc.: Good maintenance can contribute to noise reduction. The noise of drive gears can be reduced by damping the gear body, improving gear surface quality and tolerances, precision installation and bearings, better lubrication, and/or changing gear material for a better damped material. On existing equipment, many of the above aids cannot be added at reasonable expense, but gear drives are often enclosed in a box-like structure whose surfaces radiate noise. These surfaces can be damped with off-the-shelf materials, or the drive unit, if space is available, can be enclosed, fully or partially. Heat dissipation should be considered. Solid metal or plastic guards can be changed to expanded metal or wire mesh for less noise, or the guard surface can be vibration damped. The entire guard, if solid, should be vibration-isolated from the vibrating machine.

Plunger resonance: If a hollow plunger or ram is a Helmholtz resonant type of noise source, its noise radiation can often be reduced by covering the hole in the plunger. See Case History 10.

Air ejection of punched parts: If possible, substitute mechanical ejection to eliminate a large noise source. One comparison, shown in Figure 6.55.1, (AIHA 1966), resulted in an 8-dB reduction in sound level. Multiple jet nozzles are also available for reduced noise. Reduce the air velocity used for ejection to a minimum (since sound level is related to velocity) by reducing the air pressure available. Achieve better air jet efficiency by accurate setting and aiming where needed.

Shield the area of punch-air ejection from the operator. An example of the result of this method, in Figure 6.55.2, shows the sound levels of a press with and without a 24- x 48-in. shield to protect operator from air ejection noise.

Die design: Changes in die design can reduce noise by spreading the punching action, slanting the blanking punch or die, or other means of promoting consecutive shear action instead of instant

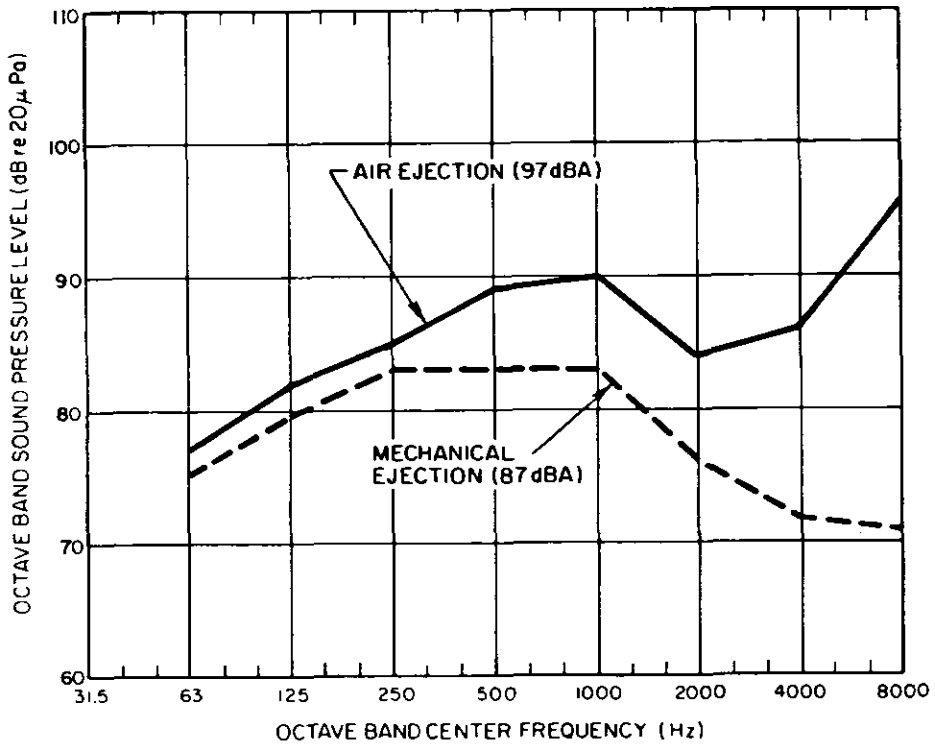

Figure 6.55.1. Comparison of punch press sound pressure levels with air ejection and with mechanical ejection.

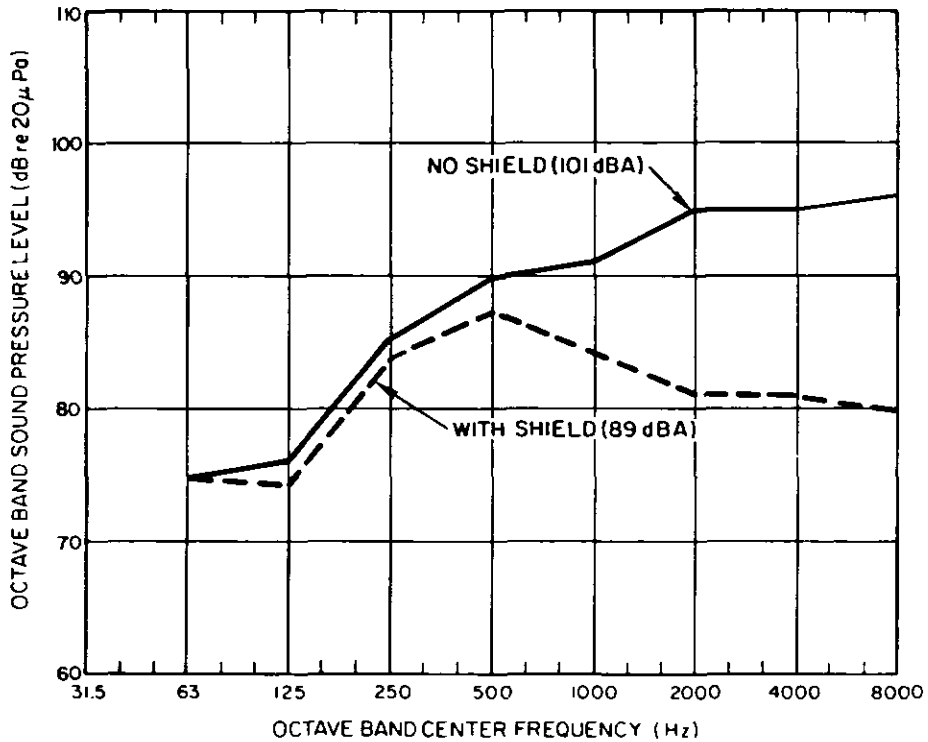

Figure 6.55.2. Comparison of punch press sound pressure levels with and without a shield between operator and air ejection noise.

action. Shinaishin reported the results of a slanted die, as shown in Figure 6.55.3. Changes in die materials can reduce noise. As presses produce sound energy from vibration of metal plates upon impact, the velocity of impact can be reduced by using hard rubber mounts (snubbers). Another possibility is a laminated and more massive plate, reducing the size of the plate and radiating area.

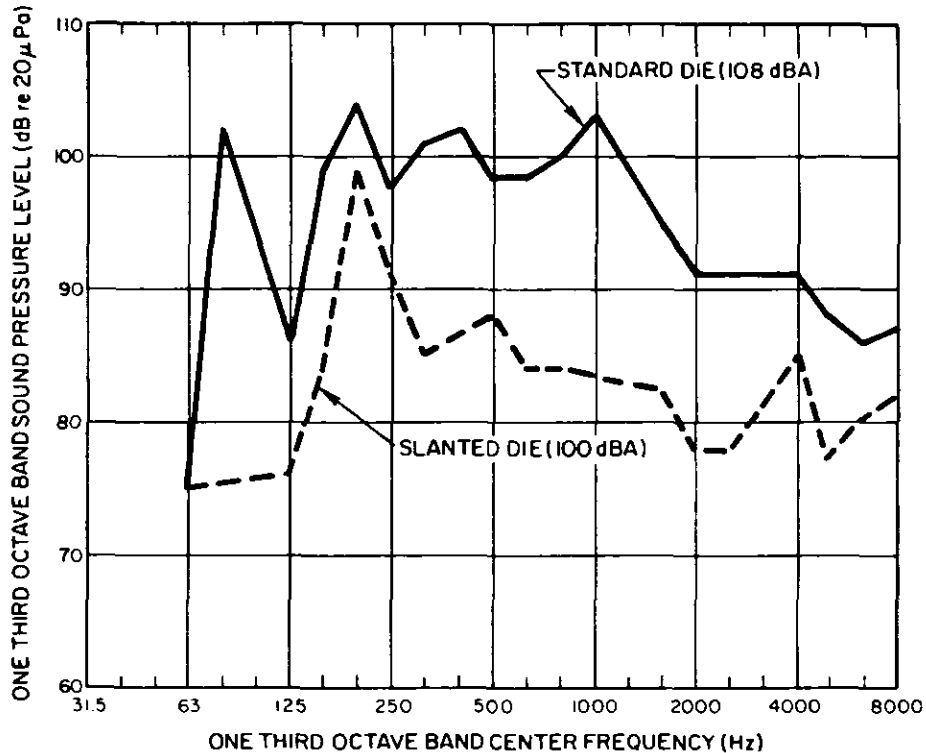

Figure 6.55.3. Comparison of punch press sound pressure levels: standard die vs slanted die.

A change of work stock material from steel to a lead-steel composition has also reduced impact noise; Shinaishin reported a 14-dB reduction with this test method. Noise radiation can be lessened by reducing plate area by cutting out surface areas that perform no function.

These comments emphasize that the tool engineer must now consider designing for noise reduction as well as for mechanical performance. Within such a general framework as outlined, any improvements in sound level will come by experiment and testing results.

Stripper plates: Stripper plates in some dies contribute to sound levels because of metal-to-metal contact, which could be changed to plastic or elastomeric contact with better damping and reduced noise.

Ejection of parts to chute or bin: Sound levels can be reduced by damping metal chutes, using damping materials on the market or making a constrained layer design. See Case History 6.

Vibration of sheet metal being fed to press: Sound levels can be reduced by preventing vibration, such as by adding a hold-down conveyor. The noise can also be constrained by using an acoustic tunnel infeed, or the operator can be shielded by properly designed barriers.

Start and stop feed mechanisms: Noise can be reduced by redesign: Substitute with plastic contact areas where possible; enclose the noise source partially; or add barriers between noise source and operator.

Building acoustics: In a room with many noise sources, the operator may be in the reverberant field. Such noise can be reduced by adding absorption. From Bruce, an example of use of absorption to reduce noise in a press room is shown in Figure 6.55.4, 30 ft from presses. Closer to presses, noise reduction would be less — with probably no more than 2 to 3 dB at the operator position. The press area can also be enclosed or walled off from the rest of the plant.

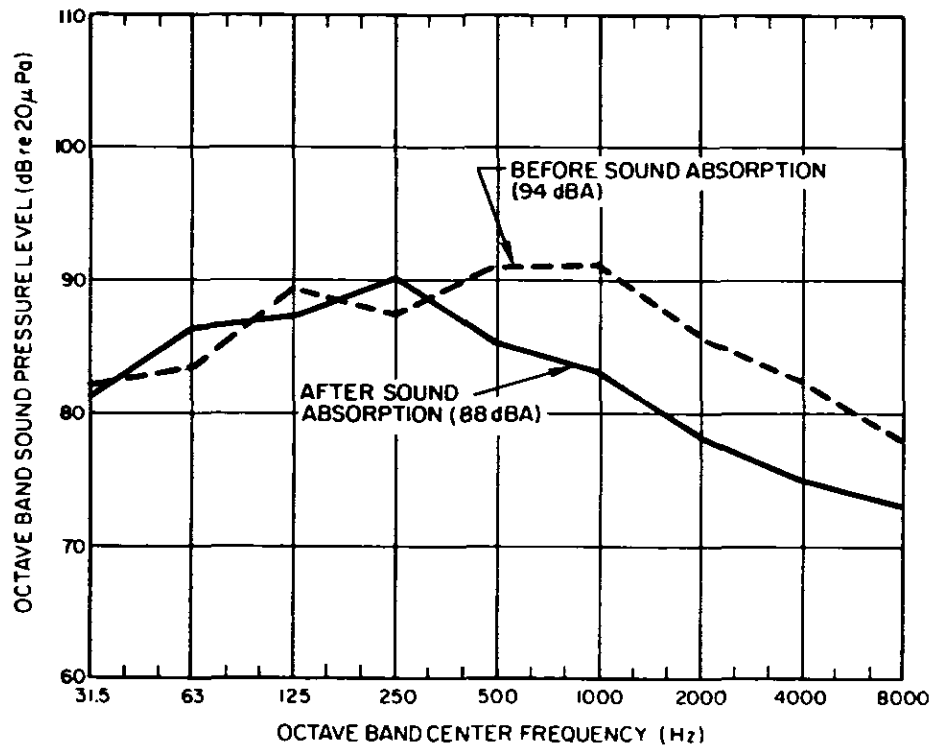

Figure 6.55.4. Sound pressure levels 30 ft from bench press area before and after sound absorption treatment.

Results

Allen and Ison (1974), p. 18, reported a partial enclosure of ram, die, infeed, and ejection on a 50-ton test press. A sound level reduction of 13 dB was obtained for an enclosure; see Figure 6.55.5. The model enclosure was made of cardboard, 1/2 lb/ft², lined with 1 in. of polyurethane foam. Later a steel enclosure was installed, for durability.

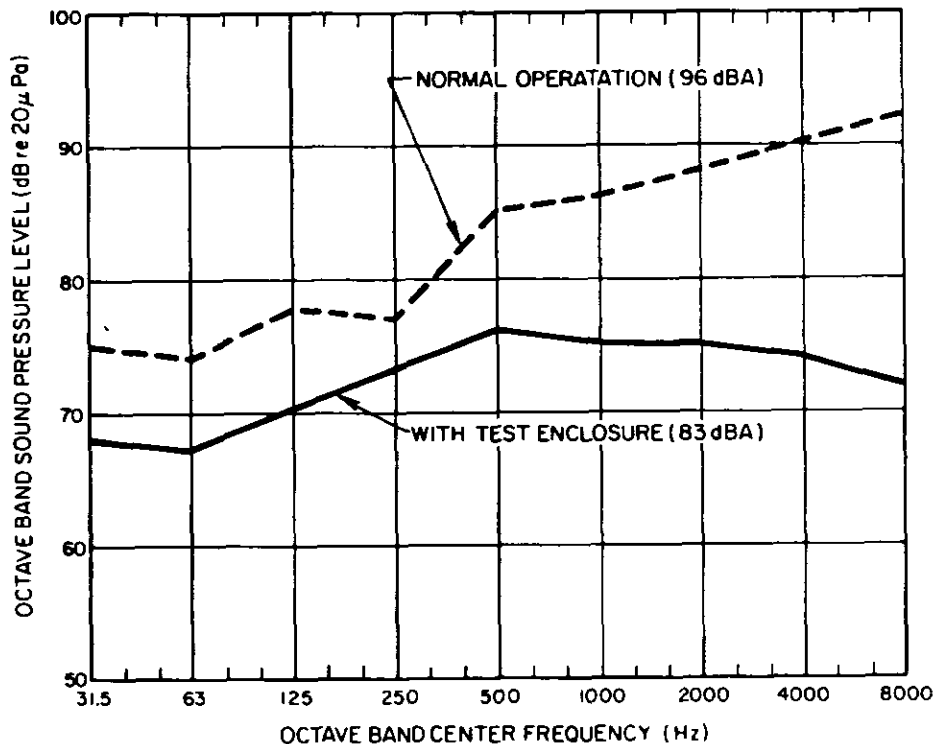

Figure 6.55.5. Data 30 in. from punch press before and after test cardboard enclosure.

Total enclosures with opening via an acoustic tunnel may be required.

Comments

The remaining radiation came chiefly from the flywheel cover, which was neither damped nor vibration-isolated. Diagnostic measurements should indicate the relative contributions from each source, so that the residual noise will be known.

CASE HISTORY 56: NEWSPAPER PRINTING PRESS*
(OSHA Noise Problem)

Problem Description

This pressroom is equipped with five double 3-to-2 Hoe folders and four double 2-to-1 Hoe folders with a complement of 45 Colormatic press units.

Control Description

The following methods were used for noise reduction:

Enclosures for folders reduced noise from 111 to 101 dBA.

In the reel room, all openings in the floor or deck plates between the pressroom level and the reel room were sealed and isolated. The opening in the arch of the press was closed to the smallest dimension that would still allow paper to feed through to the unit. On the basis of dosimeter data, the noise exposure was reduced to acceptable levels.

On the pressroom floor, an existing folder enclosure was retained and improved. A control booth was constructed for noise isolation. An 8-ft wall was added on the pressroom floor as a noise barrier, plus a 4-ft panel at the top of the wall, angled upward and toward the press. Wall surfaces were lined with 2-in. absorbent polyurethane. The 8-ft wall was constructed of: 26-gauge metal, 1/8-in. masonite, 3/4-in. airspace, and 3/8-in. plywood. The panel was 2-in. polyurethane, 1/2-in. plywood, and 26-gauge metal.

Sound traps were made at the tops of ladders at catwalk level. No isolation of the stairs, from reel room to pressroom, was necessary, as they are outside the press enclosures and not affected by the high sound levels of the press. Wall panels are easily removed for maintenance.

Pressmen going inside the enclosure for adjustments on a short-time basis wear ear protection.

Materials used for sound absorption were flame resistant and approved by insurance inspection.

Result

Sound levels were reduced to comply with OSHA standard.

*From Editor & Publisher, November 10, 1973.

CASE HISTORY 57: LETTERPRESS ROTARY PRINTING MACHINES
(Hearing Conservation Noise Problem)

Kjell Lundin
IFM Akustikbyrån AB
Warfvinges väg 26
S-112 51 Stockholm, Sweden
(08) 131220

Problem Description

This case history concerns a "Nohab-Ampress Colormatic" letterpress rotary machine, a machine that prints, cuts, combines, and folds newspapers. Printing is done by five rotary units, and other operations are carried out by a folder unit. Operators work all around the 15-m-long machine, but spend most of their time near the folder and at the control console. At a production level of 50,000 copies/hr, sound levels at the various operator positions range between 95 and 105 dBA during press operation. Noise exposure is limited to approximately 2 hr during which the machine is run. An ultimate goal of no more than 85 dBA at all operator positions was established by the printing house for this problem.

Problem Analysis

Printing press sounds are typically dominated by noise emissions from the folders. This case revealed the dominance of folder noise through sound level measurements of the folders and the press units, which were run one at a time. Sound levels were indeed up to 10 dB higher by the folder than at other comparable positions near the press units. Noise reached the operators primarily by airborne radiation; vibration measurements on structural panels indicated the panel vibration did not materially contribute to operator noise exposures. These facts suggested that containment of press sound would be an effective noise control.

Sound-proofed control rooms were considered as a possible solution for this problem, but they were rejected because of the need to work directly on the printing units. Also considered was the possibility of utilizing wall and ceiling surface linings to reduce reverberation, but they would have been only a partial solution, because only 3 to 4 dB of improvement could be expected from such treatment alone. The possibility of reducing the noise at its source was rejected because of the complexity of doing so.

Control Description

The solution consisted of installation of a series of screens and doors along the open control side of the machine. They effectively contain sounds emitted by the press and the folder. The

screens and doors are supplemented by a specially designed tunnel at the folder discharge (the delivery point for completed copies of the newspaper) and by acoustical absorption strategically placed on the walls and ceiling near the machine. (See Figure 6.57.1 for treatment locations.)

Designing the controls called for several constraints. They included:

- Sturdiness of the components (to enable the control to stand up to expected demands of day-to-day operations)
- Accessibility to the crosswalks between operating units for routine adjustments and repairs
- Limited interference with material flow around the press
- Maintenance of access to the walkways for proper machine operation as well as for safety (to prevent workers from being trapped unseen in the walkways).

All elements of the treatments were constructed with sturdy sheet steel and profiled steel sections to ensure treatment strength compatible with the strength of the machine itself. All doors were designed to open 180° to eliminate aisle congestion. All doors were made extra high and were carefully fitted to eliminate the need for sills that would otherwise interfere with material flow. As a precaution against acoustical leaks at the door bottoms, an inverted U-profile was fitted to the door bottoms, filled with sound-absorbent material, and covered with perforated steel plate. This treatment acted as an acoustically lined duct at this potential source of leaks.

All doors and screens were designed to be supported entirely by peripheral framework attached to the press or folder structure, to eliminate any obstructing frames when elements were removed for servicing the machine. All elements can be readily disassembled, as no more than four bolts secure each one in place.

Screens and door elements were designed with large window areas to give operators a good view into the press. Windows were made of laminated glass for the sake of safety and of minimizing abrasion from cleaning. All screens and doors were gasketed with rubber seals to minimize acoustical leaks.

The acoustical tunnel at the folder discharge helps prevent sounds from escaping out the discharge opening. The tunnel is designed to function as a step when it is in place, making the area safer than before, when the original sideframes at the delivery served as steps.

The wall and ceiling absorption prevent reverberant sounds from short-circuiting the effectiveness of the acoustical shields.

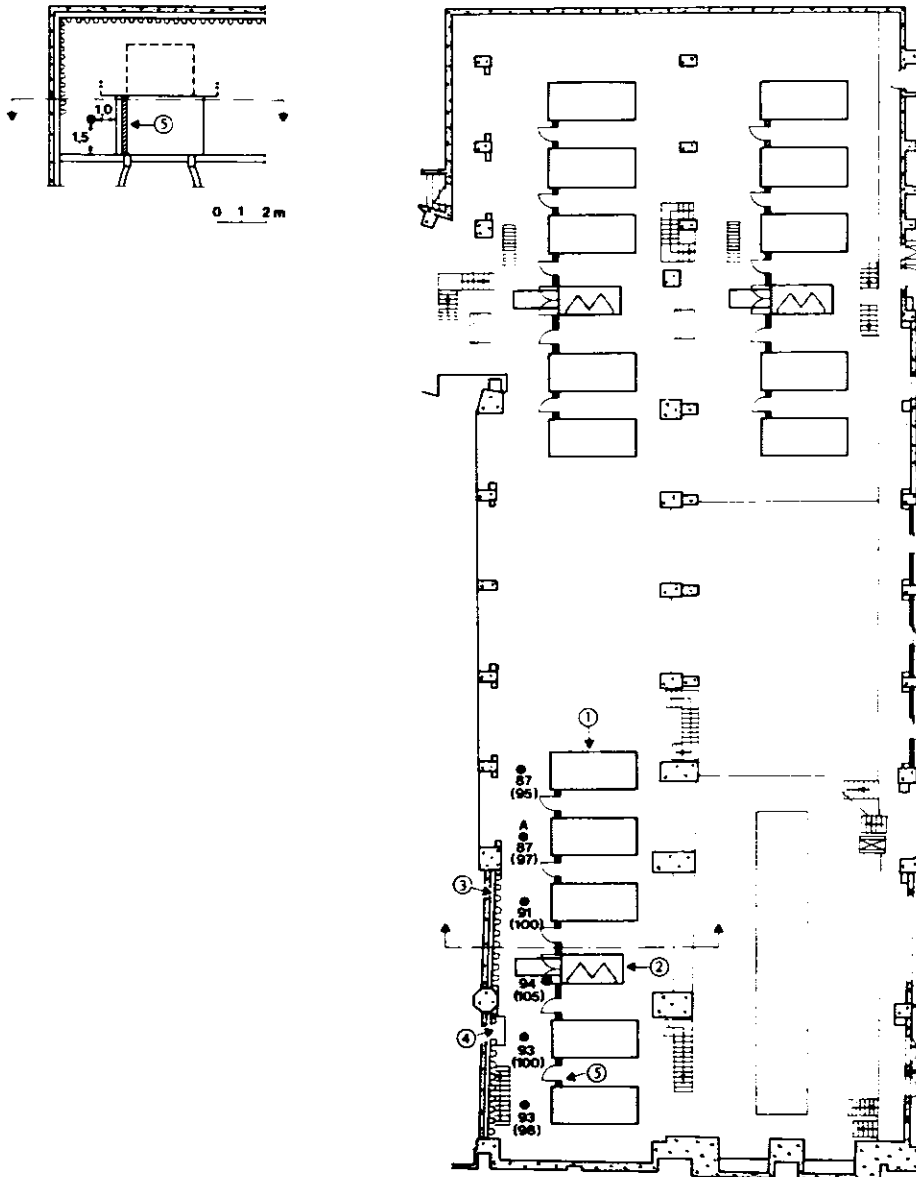

Figure 6.57.1. Floor plan of the rotary pressroom at "Politiken" in Copenhagen. The sound levels in dBA measured before and after the fitting of noise reduction materials are shown beside the printing units (1) and folders (2) of the three Nohab-Ampress "Colormatic" letterpress rotary machines (earlier figures in parentheses). The wall areas marked with a wave line (3) have been lined with sound-absorbent materials. 4 = control console, 5 = screens.

Results

Sound levels, after installation of the screens, were up to 11 dB lower than before. Figure 6.57.2 shows a typical before-and-after spectrum of aisle position sound pressure levels. Press crews are satisfied with the control measures and always keep the doors closed during printing. Accessibility is still considered good, and service and maintenance work can proceed as before. The controls described in this case history reduced sound levels at the operator position by amounts within 2 dB of predicted values. Additional noise control is now being planned to achieve a maximum sound level of 85 dBA.

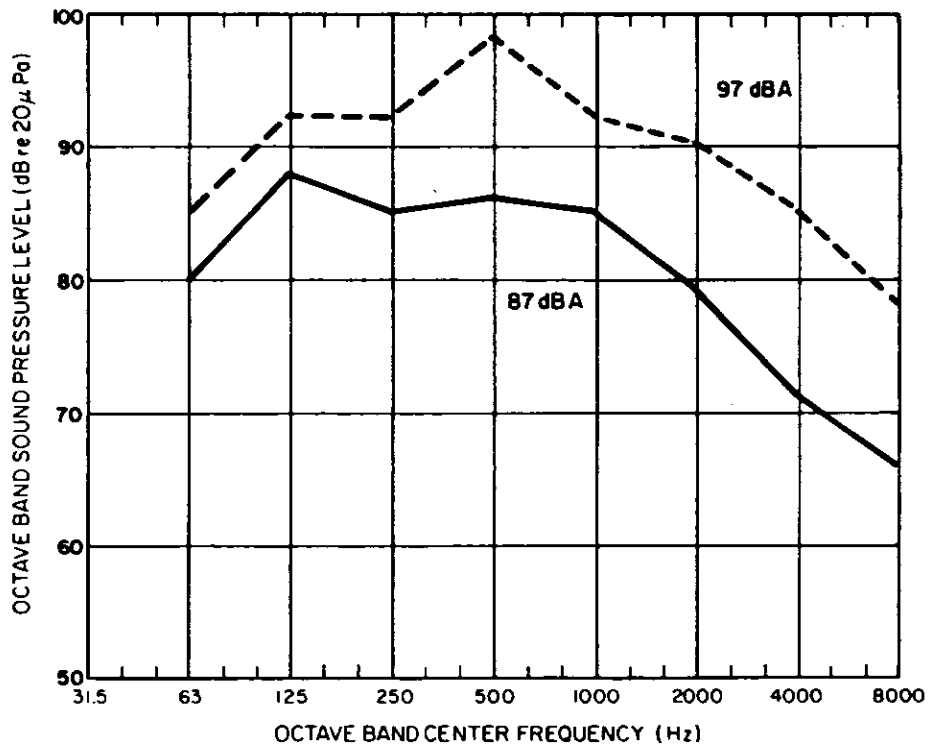

Figure 6.57.2. The octave-band levels measured at Point A in Figure 6.57.1 before (---) and after (—) the fitting of screens.