

Oxygen and Nitrate New Production and Remineralization in the North Atlantic Subtropical Gyre

JORGE L. SARMIENTO,¹ GERHARD THIELE,² ROBERT M. KEY,¹ AND WILLARD S. MOORE³

New estimates are obtained of oxygen utilization rates on isopycnal surfaces in the North Atlantic subtropical gyre thermocline based on tritium inventories ($2.4\text{--}3.5 \text{ mol m}^{-2} \text{ yr}^{-1}$) and ^{228}Ra measurements ($8.5 \pm 0.8 \text{ mol m}^{-2} \text{ yr}^{-1}$). Arguments are given for why the tritium inventory oxygen utilization rate estimate may be too low. The ^{228}Ra results are combined with recent estimates of oxygen utilization within the thermocline (Jenkins, 1987) as well as estimates of oxygen production in the mixed layer (Spitzer and Jenkins, 1989; Musgrave et al., 1988), to suggest a tentative overall oxygen balance for the whole water column. The new production of oxygen in the surface ocean ($\sim 4.6 \pm 1.6 \text{ mol m}^{-2} \text{ yr}^{-1}$) appears to be lower than the estimated utilization within the thermocline ($\sim 8.5 \pm 0.8 \text{ mol m}^{-2} \text{ yr}^{-1}$), suggesting that there may be a net lateral import of organic matter into the thermocline equivalent to a new production of $\sim 3.9 \pm 1.8 \text{ mol m}^{-2} \text{ yr}^{-1}$. The nitrogen balance is consistent with these results. An estimate for the total nitrogen remineralization rate in the thermocline is obtained from the oxygen utilization rate by using an $-\text{O}_2:\text{N}$ Redfield ratio of 9.1 ± 0.4 for remineralization (Minster and Boulahdid, 1987), giving a nitrogen remineralization rate of $\sim 0.93 \pm 0.10 \text{ mol m}^{-2} \text{ yr}^{-1}$. Subtracting off the estimated lateral export of nitrate of $\sim 0.51 \pm 0.21 \text{ mol m}^{-2} \text{ yr}^{-1}$, which is presumed to be balanced by a lateral import of dissolved organic nitrogen (Rintoul and Wunsch, 1990), gives a nitrate flux into the surface of $\sim 0.42 \pm 0.23 \text{ mol m}^{-2} \text{ yr}^{-1}$, which is comparable to the estimate of $0.6 \pm 0.2 \text{ mol m}^{-2} \text{ yr}^{-1}$ obtained by Jenkins (1988) near Bermuda as well as the 100-m particulate nitrogen flux of $0.33 \text{ mol m}^{-2} \text{ yr}^{-1}$ obtained Altabet (1989) near Bermuda.

1. INTRODUCTION

The distribution of nonanthropogenic CO_2 between the ocean and atmosphere is affected strongly by the cycling of carbon by organisms within the water column. Primary production is the removal of dissolved inorganic CO_2 and nutrients from the euphotic region by photosynthesis, which converts them into particulate and dissolved organic matter and releases oxygen. Most of the organic matter thus produced is recycled by organisms within the euphotic zone (regenerated production). The remaining highly variable and rather poorly known fraction of order 30% [Platt et al., 1989] manages to escape to the thermocline and abyssal waters. There it is remineralized by metabolic processes which convert organic matter back to dissolved inorganic CO_2 , PO_4^{3-} , and NO_3^- , consuming oxygen in the process. This export of organic matter from the surface is commonly referred to as new production. It must, on the average, be balanced by a net import of new inorganic CO_2 , nitrate, and phosphate from below, as well as an export of oxygen to the atmosphere by gas exchange and to the thermocline by vertical exchange processes. There is also a relatively minor input from rivers and the atmosphere, which we ignore in the following discussion. One can readily infer from the above that the oceanic CO_2 , oxygen, and nutrient cycles will be out of balance unless the new production at the surface is equal to the integrated remineralization below the surface when

averaged over sufficient time and space to remove seasonal, interannual, and spatial variability.

The new production is a quantity of great interest for a variety of reasons, not the least of them being that it is the major mechanism by which the surface ocean and atmospheric CO_2 contents are maintained at levels approximately a factor of 2 lower than would be the case otherwise. Furthermore, the significantly lower atmospheric CO_2 content observed during the last ice age may have been caused by an increase in the efficiency of CO_2 removal by new production relative to the supply of CO_2 -enriched waters by vertical exchange in high-latitude deep water formation regions [Sarmiento and Toggweiler, 1984; Siegenthaler and Wenk, 1984; Knox and McElroy, 1984] (Sarmiento et al. [1988] give a recent overview of this and related topics). This mechanism could conceivably play a role in determining the near-future atmospheric CO_2 content in response to the fossil CO_2 transient as well.

Platt et al. [1989] and Eppley [1989] recently reviewed the problem of determining oceanic new production. Biological oceanographers commonly make use of techniques based on *in vitro* incubations to estimate the new production from measurements of the photosynthetic uptake of nitrate using the isotope ^{15}N as a tracer. Ammonium and nitrate uptake are thought to be related directly to regenerated production and new production, respectively. This approach has numerous difficulties [cf. Platt et al., 1989]. One of the greatest of these, which is relevant to estimating an overall steady state balance, is the problem of obtaining long-term averages. *In vitro* measurements have an intrinsic time scale of only a few hours. Models and observations suggest considerable variability of the new production.

An alternative to the above approach is to find the new production or remineralization rate as a residual of the nutrient transport terms. The divergence of advective and diffusive transport is equal to the new production or remineralization plus the time rate of change of nutrient concentration. Another alternative is to use tracers to give a

¹Atmospheric and Oceanic Sciences Program and Department of Geology and Geophysics, Princeton University, Princeton, New Jersey.

²Deutsche Forschungs- und Versuchsanstalt für Luft- und Raumfahrt, Astronautenbüro, Linder Höhe, Cologne, Federal Republic of Germany.

³Department of Geology, University of South Carolina, Columbia.

Copyright 1990 by the American Geophysical Union.

Paper number 90JC01049.
0148-0227/90/90JC-01049\$05.00

measure of time over which a change in nutrient concentration due to new production or remineralization occurs. The time scale of such estimates can be seasonal, annual, or even longer. This gives some hope of obtaining an overall steady state balanced budget for the various constituents involved in biological cycling. *Riley* [1951] was perhaps the first to try this approach. He estimated the regeneration rate in the Atlantic main thermocline based on a geostrophic velocity and mixing model of the oxygen transport. *Rintoul and Wunsch* [1990] recently carried out a study in the North Atlantic subtropical gyre of the nutrient balance which used the same basic approach but with a more rigorous estimate of the transport terms. *Jenkins* [1977, 1980, 1982a, 1987] carried out a series of studies giving estimates of the oxygen utilization rates (OUR) at several locations in the North Atlantic based on tritium and helium 3 observations. There are, in addition, numerous other estimates of new production based primarily on surface mixed layer tracer observations and transport divergence calculations [e.g., *Shulenberg and Reid*, 1981; *Jenkins and Goldman*, 1985; *Lewis et al.*, 1986; *Peng et al.*, 1987; *Emerson*, 1987; *Musgrave et al.*, 1988; *Jenkins*, 1988b; *Spitzer and Jenkins*, 1989].

Sediment trap data [e.g., *Martin et al.*, 1987] give an estimate of the new production removed by larger particles. However, it appears likely that sediment traps catch only a portion of the new production in many regions of the ocean. The flux of new production out of the surface by smaller suspended particles not caught by traps has been shown in at least one case (at Bermuda) to be more than 50% of the large particle flux [*Altabet*, 1989]. Furthermore, there is increasing evidence from both measurements and models that a large fraction of the flux of new production out of the surface may be as dissolved organic matter [e.g., *Suzuki et al.*, 1985; *Sugimura and Suzuki*, 1988; *Sarmiento et al.*, 1988; *Toggweiler*, 1988, 1989; *Williams and Druffel*, 1988; *Najjar*, 1990; *Rintoul and Wunsch*, 1990].

The purpose of this paper is to present two new estimates of the OUR in the North Atlantic main thermocline based on tritium inventories and ^{228}Ra measurements. These new estimates are combined with previous work from the same region to construct a tentative oxygen and nitrate cycling budget. One of the major challenges is to reconcile the widely divergent estimates obtained by different techniques.

2. OUR ESTIMATES

We begin by discussing the box model approach used to estimate OUR from tritium inventories. This is followed by the derivation of a set of "age" equations based on apparent oxygen utilization (AOU, defined as the saturation oxygen concentration at the potential temperature of a given water parcel minus the observed concentration) and ^{228}Ra . The equations illustrate the relationship between AOU, ^{228}Ra , age, and OUR. We also show the analogy between our approach and the tritium and helium 3 age approach first used by *Jenkins* [1982a].

2.1. Tritium Box Modeling Approach and OUR Estimates

Sarmiento [1983] developed the box model illustrated in Figure 1 in order to study the exchange of thermocline waters with surface waters, i.e., "ventilation," using tritium inventories as a constraint. The box model equation is

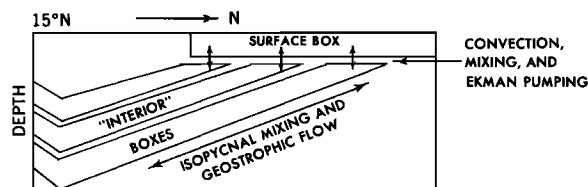

Fig. 1. A schematic depiction of the tritium box model. Mechanisms of exchange between the surface and interior boxes and of spreading on interior boxes are suggested. Taken from *Sarmiento* [1983].

$$\frac{\partial T_I}{\partial t} = \frac{1}{\tau_{\text{box}}} (T_s - T_I) - \lambda_T T_I \quad (1)$$

where T_I is the average concentration in the interior box (essentially a measure of the inventory), T_s is the concentration at the surface given by *Dreisigacker and Roether* [1978], and τ_{box} is the "ventilation" time, which represents the effect of advective, diffusive, and convective exchange between the thermocline and surface waters. *Jenkins* [1980] used essentially the same approach to find ventilation time scales from tritium and helium 3 measurements in the Sargasso Sea, assuming that the few measurements he had were representative of the entire recirculation region.

Table 1 shows the τ_{box} values calculated by *Sarmiento* [1983] using mid-1971 to mid-1973 North Atlantic tritium observations (see *Sarmiento et al.* [1982] for a discussion of the data set used to calculate the inventories). The thermocline is represented by a stack of boxes defined by constant potential density surfaces of thickness $\Delta\sigma_\theta = 0.1$ centered on $\sigma_\theta = 26.2$ to 27.4 in the region between 15°N and the wintertime outcrops determined from the data of *Levitus* [1982]. The average depths of the density surfaces, shown in Table 1, lie between 140 and 696 m, with the northernmost outcrop occurring at $\sim 55^\circ\text{N}$. The tritium data indicate that exchange across $\sim 15^\circ\text{N}$ is very slow [*Sarmiento et al.*, 1982]. This is approximately the boundary between the "ventilated thermocline" to the north and poorly ventilated "shadow zone" to the south, concepts that were first introduced by the theoretical studies of *Luyten et al.* [1983]. Diapycnal exchange is also thought to make a negligible

TABLE 1. OUR Calculated From Tritium Inventory

σ_θ	Mean Depth, m	AOU,* $\mu\text{mol kg}^{-1}$	τ , years	OUR, $\mu\text{mol kg}^{-1}$ yr^{-1}
26.2	140	21.4	7.2	3.0
26.3	153	25.4	7.3	3.5
26.4	175	28.1	7.5	3.7
26.5	210	33.3	8.2	4.1
26.6	255	41.7	9.3	4.5
26.7	299	51.0	10.7	4.8
26.8	339	60.6	12.3	4.9
26.9	381	69.2	13.7	5.1
27.0	428	78.1	14.6	5.3
27.1	476	87.0	16.1	5.4
27.2	540	96.9	19.1	5.0
27.3	614	105.6	28.9	3.7
27.4	696	109.8	38.8	2.8

*AOU_s is assumed to be $0 \mu\text{mol kg}^{-1}$.

contribution on the time scale of the tritium transient [e.g., Jenkins, 1980].

The AOU equation for the box model has the same form as (1) with $-\lambda_T T_I$ replaced by $+OUR$.

$$\frac{\partial AOU_I}{\partial t} = \frac{1}{\tau_{\text{box}}} (AOU_s - AOU_I) + OUR$$

Assuming that $\partial AOU_I / \partial t = 0$, gives

$$OUR = (AOU_I - AOU_s) / \tau_{\text{box}} \quad (2)$$

This equation is used to find an average interior OUR from observations of AOU and the tritium box model τ_{box} values. The results are given in Table 1. Equation (2) is equivalent to that used by Jenkins [1980].

2.2. Age Equation Derived From Oxygen Conservation

The oxygen conservation equation in terms of AOU is

$$dAOU/dt = \nabla \cdot (K \nabla AOU) + OUR \quad (3)$$

where $dAOU/dt$ is the total derivative, including the advection terms, and K is the diffusion tensor. If OUR is assumed to be constant on isopycnal surfaces within the region under consideration and diapycnic processes are ignored, one can divide through by OUR to obtain

$$d\tau_{O_2}/dt = \nabla_h \cdot (K \nabla_h \tau_{O_2}) + 1 \quad (4)$$

where

$$\tau_{O_2} = AOU/OUR \quad (5)$$

is a measure of the time since last contact with the surface. Only the along isopycnal terms are included for ∇_h and $d(\)/dt$. Changes in isopycnal thickness have been ignored. This age tracer has a source, the $+1$ term, that is linear with time (i.e., τ_{O_2} increases linearly with t). Age defined this way therefore mixes conservatively. We shall see below that radioactive tracers, because they decrease exponentially with time due to decay, define an age which does not mix conservatively. Equation (4) thus defines an ideal tracer of age since last contact with the surface against which the ages determined by other tracers can be compared (see Thiele and Sarmiento [1990] for a discussion of this concept).

2.3. Radium 228 Age Equation and OUR Estimates

The ^{228}Ra equation

$$d^{228}\text{Ra}/dt = \nabla \cdot (K \nabla ^{228}\text{Ra}) - \lambda_{\text{Ra}} ^{228}\text{Ra} \quad (6)$$

can also be cast in terms of an age since last contact with the surface by using the decay equation to define

$$\tau_{\text{Ra}} = [\ln (^{228}\text{Ra}_s / ^{228}\text{Ra})] / \lambda_{\text{Ra}} \quad (7)$$

where $^{228}\text{Ra}_s$ is the ^{228}Ra concentration at the surface and $\lambda_{\text{Ra}} = 3.82 \times 10^{-9} \text{ s}^{-1}$ is the ^{228}Ra decay constant. Equation (7) is solved for ^{228}Ra and substituted into (6) to obtain

$$d\tau_{\text{Ra}}/dt = \nabla \cdot (K \nabla \tau_{\text{Ra}}) + 1 - \lambda_{\text{Ra}} K(\nabla \tau_{\text{Ra}})^2 \quad (8)$$

This equation is identical to (4), i.e., $\tau_{\text{Ra}} = \tau_{O_2}$, if $\lambda_{\text{Ra}} K(\nabla \tau_{\text{Ra}})^2$ is negligible. In such a case, and if the boundary

conditions for τ_{O_2} and τ_{Ra} are identical, we can substitute τ_{O_2} from (7) into (5) to obtain

$$^{228}\text{Ra} = ^{228}\text{Ra}_s e^{-\lambda(AOU - AOU_s)/OUR} \quad (9)$$

Are the boundary conditions for τ_{O_2} and τ_{Ra} identical? Both ages are defined with respect to the concentration of the respective tracer at the surface of the ocean, from whence it is presumed that the tracer enters the thermocline. In fact, the major source of radium 228 to the surface ocean is continental shelf sediments, particularly (in the case of the North Atlantic) the North American shelf. However, maps of the distribution of radium 228 on isopycnal surfaces which we are preparing for publication suggest that radium 228 enters the thermocline through the same pathway as the oxygen, i.e., primarily from the northeast [Sarmiento *et al.*, 1982]. In support of this, measurements of radium 228 and O_2 north of the Gulf Stream, on the shallower density surfaces which have high-shelf radium 228 input, fall well above the trend of the radium 228 versus AOU plots in Figure 2. This suggests little direct interaction between shelf and thermocline waters. We believe that the major pathway for entry of North American shelf radium 228 into the thermocline is by advection around the edge of the subtropical gyre and spreading at the surface, followed by subduction by the same mechanisms that bring oxygen down from the surface.

Figure 2 shows least squares fits of (9) to the Transient Tracers in the Oceans (TTO) North Atlantic Study data reported by Key *et al.* [1985] as well as additional results from the TTO Tropical Atlantic Study (see Brewer *et al.* [1985] for station locations) and measurements made on three 1986 sections across the Gulf Stream at approximately $32^\circ\text{N } 73^\circ\text{W}$ to $34^\circ\text{N } 76^\circ\text{W}$, $35^\circ\text{N } 71^\circ\text{W}$ to $38^\circ\text{N } 74^\circ\text{W}$, and $34^\circ\text{N } 63^\circ\text{W}$ to $43^\circ\text{N } 64^\circ\text{W}$, as well as a section between $34^\circ\text{N } 63^\circ\text{W}$ and $32^\circ\text{N } 73^\circ\text{W}$, all as part of a tracer study of western boundary exchange. Data south of 15°N , shoreward of the Gulf Stream, north of the wintertime outcrop of the density surface, or having negative AOU values are excluded. The OURs thus obtained are given in Table 2. The $^{228}\text{Ra}_s$ values given in the table are the intercept values (at $AOU = 0$). They are all in the range of observed concentrations at the surface.

2.4. Tritium and Helium 3 Age Equation

Jenkins [1987] has taken the tritium and helium 3 conservation equations

$$dT/dt = \nabla \cdot (K \nabla T) - \lambda_T T \quad (10)$$

$$d^3\text{He}/dt = \nabla \cdot (K \nabla ^3\text{He}) + \lambda_T T \quad (11)$$

with an age defined as

$$\tau_{\text{He}} = \{\ln [(T + ^3\text{He})/T]\} / \lambda_T \quad (12)$$

to obtain

$$d\tau_{\text{He}}/dt = \nabla \cdot (K \nabla \tau_{\text{He}}) + 1 + K \nabla \ln [T(T + ^3\text{He})] \nabla \tau_{\text{He}} \quad (13)$$

The equation obtained by assuming that the final term in (13) is negligible gives (4), in which case we can use τ_{He} as a

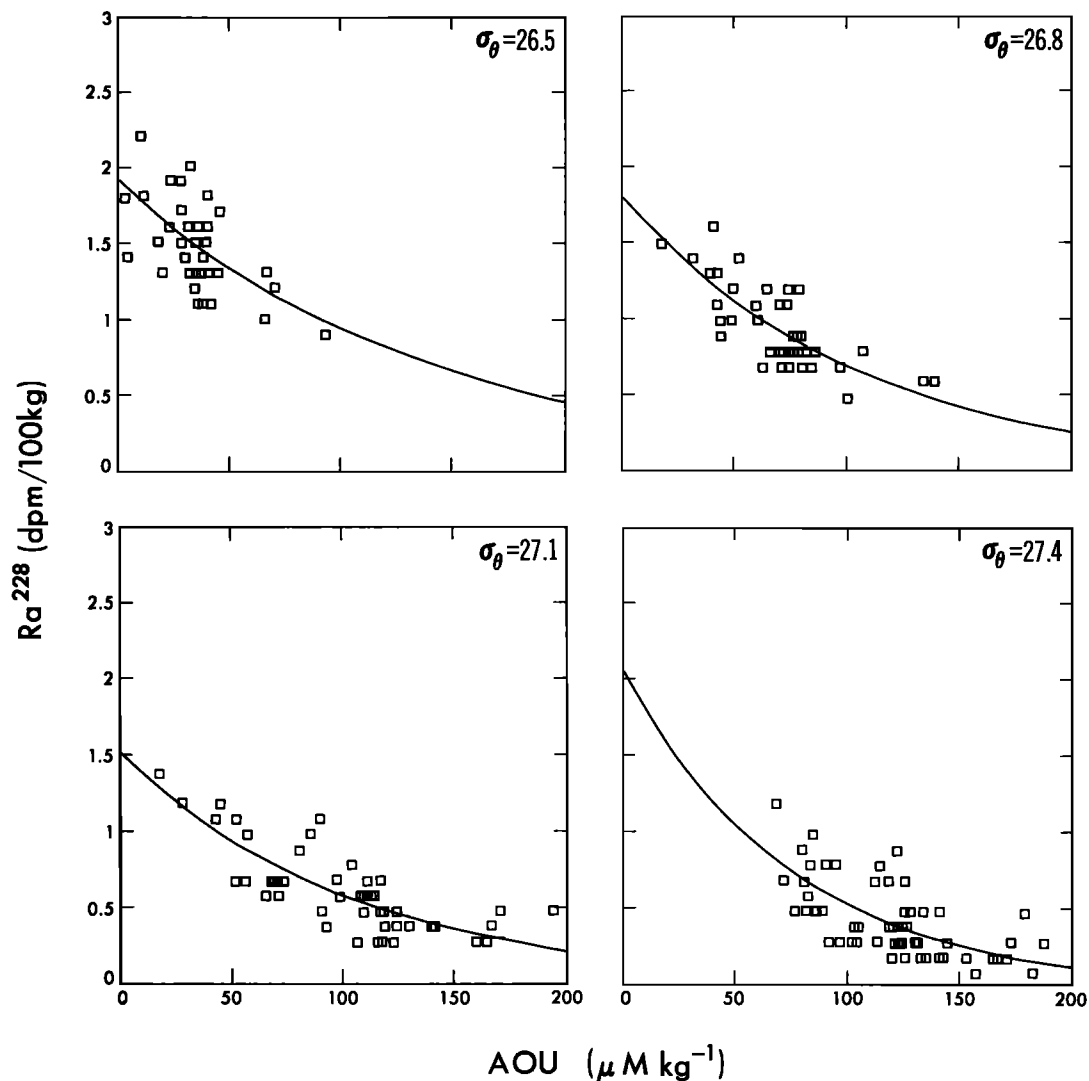

Fig. 2. Radium 228 as a function of apparent oxygen utilization (AOU) for four σ_θ surfaces in the North Atlantic. The solid curves represent the best line fit using the simple model given in the text.

proxy for τ_{O_2} in (5) in order to obtain OUR, as long as the boundary conditions for both are the same. This is essentially the approach that Jenkins has followed in his estimates of OUR at the Beta Triangle site centered on 54°S and 45°N

[Jenkins 1982a, 1987] and shows that our work with ^{228}Ra is directly analogous.

3. DISCUSSION

Table 3 summarizes all the oxygen and nitrate based new production and remineralization estimates for the North Atlantic of which we are aware. The remineralization estimates of Jenkins and Goldman [1985] and Lewis *et al.* [1986] are not included because the former is based on an extrapolation of estimates of oxygen loss over only a portion of the year and the latter is based on only 2 weeks worth of measurements.

There are a number of relatively large differences in the estimates in Table 3, particularly among the thermocline remineralization estimates calculated by us from the OURs in Figure 3 which are shown in the upper part of Table 3. The OURs in Figure 3 tend to fall into two groups: (1) the Jenkins [1987] Beta Triangle estimates and our ^{228}Ra -based estimates are generally higher than (2) the box model estimates of Jenkins [1980] and our own tritium-inventory-based box

TABLE 2. OUR Calculated From Radium 228 Age

σ_θ	Mean Depth, m	$^{228}\text{Ra}_s$, dpm/100 kg	OUR, $\mu\text{mol kg}^{-1} \text{yr}^{-1}$
26.5	210	1.90 ± 0.12	16.7 ± 3.9
26.8	339	1.80 ± 0.15	12.4 ± 1.7
27.1	476	1.54 ± 0.13	12.6 ± 1.3
27.4	696	2.06 ± 0.45	8.9 ± 1.4

Due to the limited vertical resolution of ^{228}Ra measurements we did not calculate OUR on more than just the isopycnal surfaces given in the table. The fits were made using the nonlinear least squares fitting technique of Wolberg [1967]. AOU's were assumed to have a $4 \mu\text{mol kg}^{-1}$ error, and ^{228}Ra values either a 0.1 dpm/100 kg error or a 15% error, with no significant difference in the results. Table 2 and Figure 2 show results from the calculation with a 0.1 dpm/100 kg error. All data were linearly interpolated to the respective potential density surfaces.

TABLE 3. New Production and Remineralization Estimates in the North Atlantic

Source	Technique	Region	Depth Range, m	New Production or Remineralization, mol m ⁻² yr ⁻¹
<i>Oxygen-Based Remineralization Rates*</i>				
Riley [1951]	Geostrophic transport and mixing model	54°S to 45°N	100–750	2.5 (1.6 to 3.1)
Jenkins [1980]	Tritium/ ³ He box model	Sargasso Sea	100–750	7.2
Jenkins [1987]	τ_{The} versus AOU regression	Beta Triangle (~30°N 30°W)	100–750	6.4 ± 0.3
This study	Tritium box model	15°N to $\sigma_{\theta} = 27.45$ outcrop	100–750	2.8 (2.4 to 3.5)
This study	Radium-228	15°N to $\sigma_{\theta} = 27.45$ outcrop	100–750	8.5 ± 0.8
<i>Mixed Layer Oxygen New Production Rates</i>				
Peng et al. [1987]	O ₂ production in mixed layer	64°N 28°W		5.1
Musgrave [1989]	Upper ocean O ₂ balance model	near Bermuda (32°N 64°W)		3–4
Spitzer and Jenkins [1989]†	Upper ocean O ₂ balance model	near Bermuda (32°N 64°W)		5.6 ± 1.5
<i>Nitrogen Balance Estimates</i>				
Jenkins [1988b]	Model of nitrate supply to mixed layer	near Bermuda (32°N 64°W)	mixed layer	0.6 ± 0.2
Altabet [1989]	Particulate nitrogen flux estimate	near Bermuda (32°N 64°W)	at 100 m	0.33
Rintoul and Wunsch [1990]‡	Model of NO ₃ transport	24°N to 36°N	whole water column	-0.51 ± 0.21

*All the remineralization rates in this portion of the table are calculated by us from the raw OUR results given in the various papers and shown in Figure 3. The oxygen utilization rate of 5.7 ± 0.5 mol m⁻² yr⁻¹ obtained by Jenkins [1982a] is not included in the table since it is based on a collection of OURs obtained in several different regions with different techniques, all of which have been included in the table.

†Jenkins and Goldman [1985] made an earlier oxygen utilization rate estimate of ~ 5 mol m⁻² yr⁻¹ for the same location, but with a cruder approach and less data constraints. Part of the reason for the difference between the Spitzer and Jenkins [1989] estimate and the Musgrave [1989] estimate may be due to the fact that the two calculations cover different time spans.

‡Rintoul and Wunsch [1990] estimate a net loss of nitrate from the 24°N to 36°N region. The transport across 24°N is ~ 0 but there is a large northward transport across 36°N.

model estimates. Riley's [1951] estimates fall into the lower group. We emphasize that with the exception of Riley's estimates (which were obtained from a geostrophic velocity and mixing model) the high OURs are all obtained from the age equation approach, whereas the lower OURs are all based on box models. The only major exceptions to the overall grouping of the results in Figure 3 are the upper two Jenkins [1980] OURs, which are higher than any of the other estimates. We do not give great weight to the reliability of these two OURs, however, since the actual ages used to obtain them are extremely short (0.42 and 0.96 years, for the shallower and deeper data points, respectively), and the AOU's are relatively small. Errors that would be considered small at depths with more typical ages of >5 years and much higher AOU's would have a major impact on these two shallower data points. They also would be more subject to temporal variability.

We also tend to discount the Riley [1951] results. His geostrophic calculations are based on a very sparse data set. In addition, Rintoul and Wunsch [1990] have shown, with a far more rigorous treatment of the transport in the North Atlantic than that carried out by Riley, that the transport of nutrients is very sensitive to the reference level chosen for geostrophic velocity estimates. The oxygen does not show as much sensitivity because it is rather uniform at depth in the region covered by the Rintoul and Wunsch study, but

this is not the case over the larger region covered by Riley's study.

Our discussion will focus on an analysis of the two model approaches that give rise to the high OURs (the age equation approach) and low OURs (the tritium box model approach) in order to determine which value for the remineralization is most appropriate. This will be followed in the conclusion section by a suggestion for a tentative oxygen and nitrogen balance for the subtropical gyre.

We first examine the age equation approach. A possible explanation for the difference in results obtained from the tritium box model and ²²⁸Ra age techniques is that the final term on the right-hand side of (8) is not negligible, as has been assumed. If this term is large, then the estimated ages would be too low, and the OURs would be high. Nir [1964], Nir and Lewis [1975], and Lewis and Nir [1978] have discussed some aspects of this problem as it relates to age estimates. A simple one-dimensional model solution of O₂ and ²²⁸Ra helps illustrate the point and allows us to study the sensitivity of the age estimates to mixing. We will also solve the one-dimensional model for *T* and ³He so that we can examine the importance of the final term on the right-hand side of (13).

We assume that we are following a trajectory around the gyre that is open to the surface at both ends. The length of the trajectory, *L*, is taken to be 6000 km. Mixing can occur

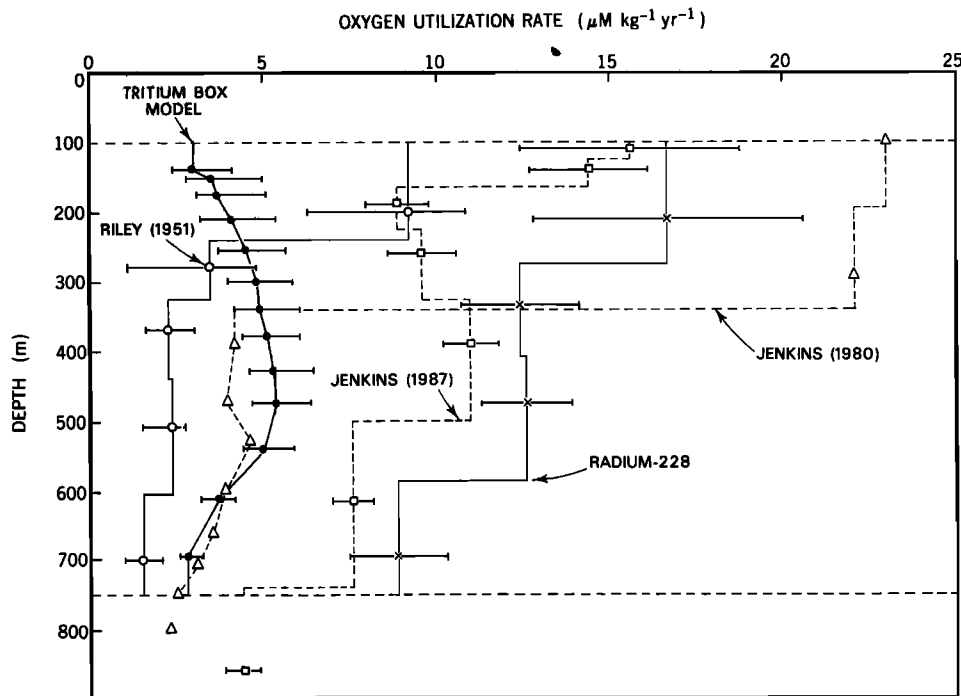

Fig. 3. Apparent oxygen utilization rates from our tritium box model and ²²⁸Ra age estimates, from Jenkins' [1980] box model near Bermuda, and from Jenkins' [1987] tritium/³He age estimates in the Beta Triangle region. Also included for comparison are the OUR estimates of Riley [1951]. The lines show how the integral was performed to find the remineralization rate.

along the trajectory only. A two-dimensional case allowing mixing across trajectories is dealt with by Thiele and Sarmiento [1990]. The equations we solve are

$$O = -u\partial\tau_{O_2}/\partial x + K\partial^2\tau_{O_2}/\partial x^2 + 1 \quad (14)$$

$$O = -u\partial^{228}\text{Ra}/\partial x + K\partial^2^{228}\text{Ra}/\partial x^2 - \lambda_{\text{Ra}}^{228}\text{Ra} \quad (15)$$

$$\partial T/\partial t = -u\partial T/\partial x + K\partial^2 T/\partial x^2 - \lambda_T T \quad (16)$$

$$\partial^3\text{He}/\partial t = -u\partial^3\text{He}/\partial x + K\partial^2^3\text{He}/\partial x^2 + \lambda_T T \quad (17)$$

with boundary conditions at $x = 0$ and $x = L$ specified as $\tau_{O_2} = 0$, $^{228}\text{Ra} = ^{228}\text{Ra}_s$, $T = T_s$ as given by Dreisigacker and Roether [1978], and $^3\text{He} = 0$. Equations (14) and (15) have relatively straightforward analytical solutions, but (16) and (17) are solved numerically to more readily include the time variation of the tritium boundary condition. The tracer results are then used to calculate τ_{Ra} and τ_{He} from (7) and (12).

In analyzing the model results and their sensitivity to relative magnitudes of advection and mixing, it is convenient to consider the Peclet number, ux/K , where x is a scale length which is here defined from the solution to equation (15):

$$^{228}\text{Ra} = ae^{x/x_+} + be^{x/x_-} \quad (18)$$

where

$$x_{\pm} = \frac{1}{2\lambda} [u \pm (u^2 + 4\lambda K)^{1/2}] \quad (19)$$

and a and b are integration constants that are obtained from the boundary conditions. Both x_+ and x_- are of relevance,

one, x_+ , applying to the region where advection enters from the surface carrying tracer with it, and the other, x_- , applying to the other end of the model where tracer can only enter by diffusing upstream. The corresponding Peclet numbers are

$$Pe_{\pm} = \frac{ux_{\pm}}{K} = \frac{Pe_{\lambda}^2}{2} \left[1 \pm \left(1 + \frac{4}{Pe_{\lambda}^2} \right)^{1/2} \right] \quad (20)$$

where the radiotracer Peclet number, $Pe_{\lambda} = u/(\lambda K)^{1/2}$, is as defined by Jenkins [1988a].

We therefore see that Pe_{λ} is the critical term. When $Pe_{\lambda} \ll 1$, that is to say when $\lambda K \gg u$, then $Pe_{\pm} \sim \pm Pe_{\lambda}$. Figure 4 shows the ratio $\tau_{\text{Ra}}/\tau_{O_2}$ for the extreme case where $u = 0$ for various values of K . It should be noted that the τ_{O_2} includes mixing in it (cf. equation (4)), so that the comparison in Figure 4 is quite different than the comparison of the

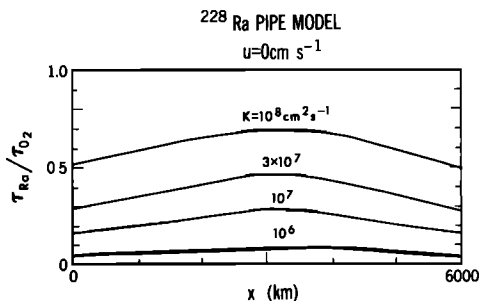

Fig. 4. Solution of one-dimensional pipe model with diffusion only ($u = 0$). Note that the ratio $\tau_{\text{Ra}}/\tau_{O_2}$ gets closer to 1 with increasing mixing.

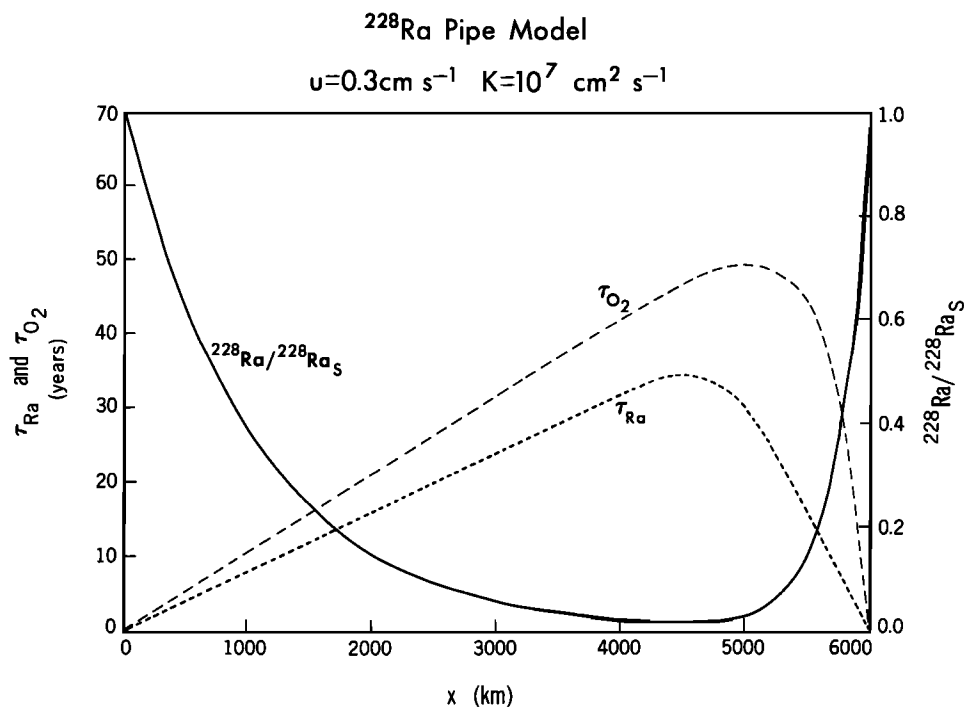

Fig. 5. Normalized radium concentration, τ_{O_2} and τ_{Ra} for the case $u = 0.3\text{ cm s}^{-1}$ and $K = 10^7\text{ cm}^2\text{ s}^{-1}$. Advection is to the right.

τ_{The} with the “box-car” advection only time scale of *Jenkins* [1988a]. One sees that when mixing is dominant the ratio is directly related to K , with small K leading to small $\tau_{\text{Ra}}/\tau_{\text{O}_2}$, and vice-versa.

At the other extreme, when $Pe_\lambda \gg 1$, (20) defines two regions, one, $0 > Pe_- > -1$, where diffusion is dominant, and the other, $Pe_+ \rightarrow \infty$, where advection is dominant. Figure 5 shows a solution for ^{228}Ra in an intermediate range, where $u = 0.3\text{ cm s}^{-1}$ and $K = 10^7\text{ cm}^2\text{ s}^{-1}$, giving $Pe_- = -0.76$ and $Pe_+ = 3.1$ with corresponding scale lengths $x_- = -252\text{ km}$ and $x_+ = 1040\text{ km}$, respectively; u is positive to the right in this diagram. The ^{228}Ra reflects the pattern of advection distinctly, with much greater penetration where the water flows in from the surface. The model results shown in Figure 5 have ^{228}Ra ages as high as 35 years. In fact, with the present detection limit for radium 228 of the order of 0.1 dpm (disintegrations per minute) per 100 kg and with $^{228}\text{Ra}_s \sim 2\text{ dpm}/100\text{ kg}$ (Table 2), the maximum resolution of τ_{Ra} is approximately 25 years. This is comparable to the time since the maximum entry of tritium into the oceans in 1963, which sets an upper limit for the resolution of τ_{The} .

Figure 6 shows the sensitivity of $\tau_{\text{Ra}}/\tau_{\text{O}_2}$ to mixing for $u = 0.3\text{ cm s}^{-1}$ and 1.0 cm s^{-1} and various values of K . The corresponding scale lengths and Peclet numbers are summarized in Table 4. We see that in the advectively dominated Pe_+ region to the left of the diagram, changes in mixing have the opposite effect from the pure diffusion case shown in Figure 4. Increased mixing makes $\tau_{\text{Ra}}/\tau_{\text{O}_2}$ smaller, rather than larger. The diffusively dominated Pe_- region to the right of the diagram has the same sensitivity to mixing as the pure diffusion case only for the cases with very small u and large K (see upper panel of Figure 6).

Figures 7 and 8 for the tritium- ^3He simulations exhibit the same basic behavior as the ^{228}Ra simulations. The kinks in

the tritium- ^3He -based curves are due to the time history of the tracer input and not to any numerical problems. The τ_{The} age given is for the tritium and ^3He distribution predicted in 1977. The peak tritium input occurred in 1963, which means that with 1977 data the tritium- ^3He clock is not very effective for dating waters >14 years. Much of the τ_{The} deviation from τ_{O_2} is due to this. Note that the $\tau_{\text{The}}/\tau_{\text{O}_2}$ is somewhat greater than 1 in certain parameter ranges whereas $\tau_{\text{Ra}}/\tau_{\text{O}_2}$ can never be greater than 1.

What can we conclude from the experiments illustrated in Figures 4–8? The conclusion of greatest relevance to the present study is that it would take relatively extreme parameter ranges to compromise the calculations of OUR from τ_{Ra} and τ_{The} by the factor of ~ 2 to 3 that would be needed to reduce the age-based OUR estimates so that they agreed with the box model estimates. *Jenkins* [1987] gives horizontal diffusivity and velocity estimates in the Beta Triangle region of order $5 \times 10^6\text{ cm}^2\text{ s}^{-1}$ and 0.5 cm s^{-1} , respectively. The velocity estimates are, of course, higher at shallower depths and lower at greater depths. The value chosen is approximately representative of the $\sigma_\theta = 27.1$ surface. Figures 6 and 8 show that it takes horizontal diffusivities as high as $3 \times 10^7\text{ cm}^2\text{ s}^{-1}$ and velocities as low as 0.3 cm s^{-1} to reduce the OUR estimates by a factor of approximately 2. Furthermore, τ_{The} is more sensitive than τ_{Ra} , whereas we would want the reverse to be the case. The effect of mixing on the tritium/ ^3He -based estimates has been investigated very carefully by *Jenkins* [1987] in the Beta Triangle region. He concludes from his study that the mixing has a negligible impact on his estimates. We have no reason, based on the above or on the two-dimensional study of *Thiele and Sarmiento* [1990], to disagree with his arguments.

We examine the box modeling approach next. *Doney and Jenkins* [1989] have recently investigated the effect of the

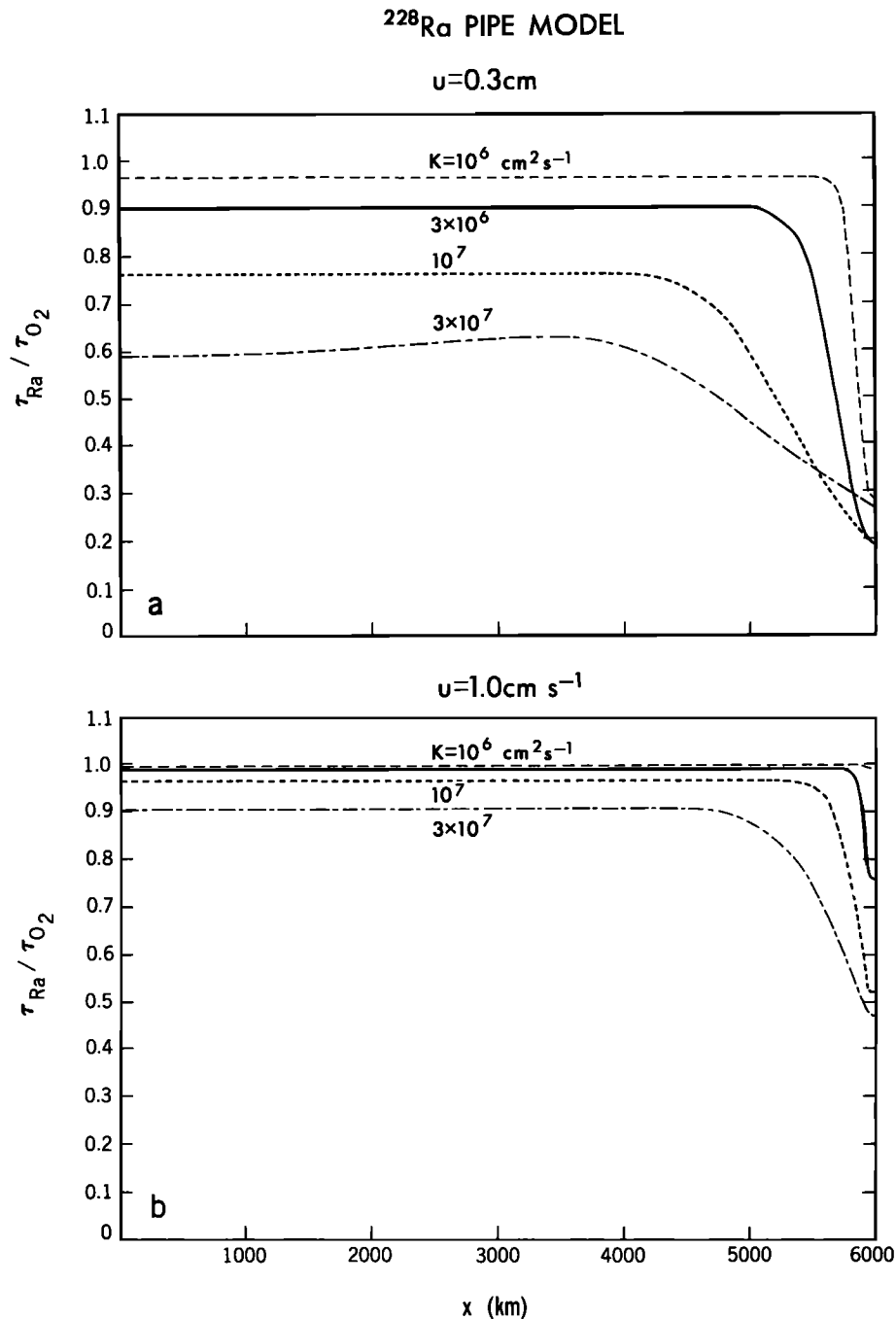

Fig. 6. The ratio $\tau_{\text{Ra}}/\tau_{\text{O}_2}$ for the pipe model for various values of mixing and (a) $u = 0.3 \text{ cm s}^{-1}$ and (b) $u = 1.0 \text{ cm s}^{-1}$. Note that here, unlike Figure 4, the age ratio gets smaller with increasing mixing, except in the region to the right of the diagram with $u = 0.3 \text{ cm s}^{-1}$, where entry of tracer is diffusively dominated and the sensitivity to K is as in Figure 4.

boundary condition, T_s in (1), on tracer estimates of thermocline ventilation rates, with particular application to estimates based on tritium inventories as compared with those that are based on helium 3. The salient result is that unless one uses wintertime surface tritium concentrations to drive the ocean model, tritium-based ventilation rate estimates will be too low, particularly near the surface. This study serves nicely to explain the rather peculiar result, from the tritium inventory calculations, of the OUR being approximately constant above $\sigma_\theta \sim 27.2$ (see Figure 3), when in fact

one would expect it to increase at shallow depths. The shallower layers are more sensitive to the inclusion of wintertime dilution than are the deep layers, so the Doney and Jenkins approach gives shorter ventilation time scales (which would result in higher OUR rates) on the shallower surfaces than Sarmiento [1983] obtained.

There is little wintertime tritium data to test the extent to which the Doney and Jenkins' hypothesis is correct. There are strontium 90 data, however. Figure 9 shows the *Dreissgacker and Roether* [1978] strontium 90 surface concentra-

TABLE 4. Scale Lengths and Peclet Numbers for Values of u and K Used in Figures 6 and 8

u , cm s^{-1}	K , $\text{cm}^2 \text{s}^{-1}$	x_+ , km	x_- , km	Pe_+	Pe_-
0.3	10^6	820	-32	24.5	-0.96
0.3	3×10^6	875	-90	8.8	-0.90
0.3	10^7	1040	-252	3.1	-0.76
0.3	3×10^7	1360	-577	1.4	-0.58
1.0	10^6	2630	-10	263.0	-1.00
1.0	3×10^6	2650	-30	88.2	-0.99
1.0	10^7	2710	-96	27.1	-0.96
1.0	3×10^7	2890	-272	9.6	-0.91

tion obtained with the same model as the tritium concentration boundary condition that Sarmiento [1983] used. Also shown on the same figure are winter to summer extremes obtained by averaging unpublished data from eight weather-ship stations (A, B, C, D, E, I, J, and K) that were obtained by V. Bowen's laboratory at Woods Hole Oceanographic Institution, Woods Hole, Massachusetts, during various portions of the period 1962–1974. The data at all eight weather-ship stations were normalized to weather-ship station C at $52^\circ 15' \text{N}$ $35^\circ 39' \text{W}$ before averaging. Table 5 shows the normalization factors that were used, which were obtained by averaging the ratio of all combined “summer” (August, September, October) and “winter” (February, March, April) averages to weather-ship C averages. The months chosen to represent summer and winter are those generally showing the maximum seasonal excursion. Station C was chosen as the reference station because it has the most complete set of data. The increasing trend towards the south is a result of the strontium 90 fallout pattern [cf. Sarmiento and Gwinn, 1986]. The Dreisigacker and Roether concentra-

tions are in all cases greater than the wintertime concentrations at the weather-ship stations. Note, however, that the extent of the difference depends on which station is chosen for reference. If the average ratio of 1.06 had been used, or if weather-ships D, E, or K, more centrally located in the subtropical gyre, had been used, the difference between the Dreisigacker and Roether function and the winter observations would be smaller.

It remains to be seen if the differences between the wintertime strontium 90 concentrations and the Dreisigacker and Roether [1978] function that do exist are sufficient, when translated into the equivalent effect in tritium, to give an effect as large as Doney and Jenkins found in their work. If they are, a very rough estimate of OURs from the ventilation ages obtained by Doney and Jenkins [1989] and average AOU_Is estimated from the figures in Jenkins [1987] suggests that vertically integrated remineralization estimates based on tritium may be as much as a factor of 1.5 to 2.0 lower than those based on helium 3, which is relatively insensitive to the aforementioned effect since it has such a rapid atmosphere-ocean equilibration time.

The other major uncertainty regarding the tritium box model is the assumption that the tritium and AOU concentrations in the outflow from the interior box, T_I and AOU_I, can be represented by the average tritium and AOU concentrations in the box (see Sarmiento [1983] for a discussion of this point). If the appropriate value for T_I is in fact higher than the average, then τ_{box} would be overestimated and OUR underestimated by using the average. Similarly, if AOU_I is in fact higher than the average, the OUR would be underestimated by using the average. Without direct measurements of the correlation between tracer concentrations and velocities at the outcrop of the interior box, we have no way of knowing for certain what values for T_I and AOU_I are appropriate. In view of the fact that the ^{228}Ra and tritium/

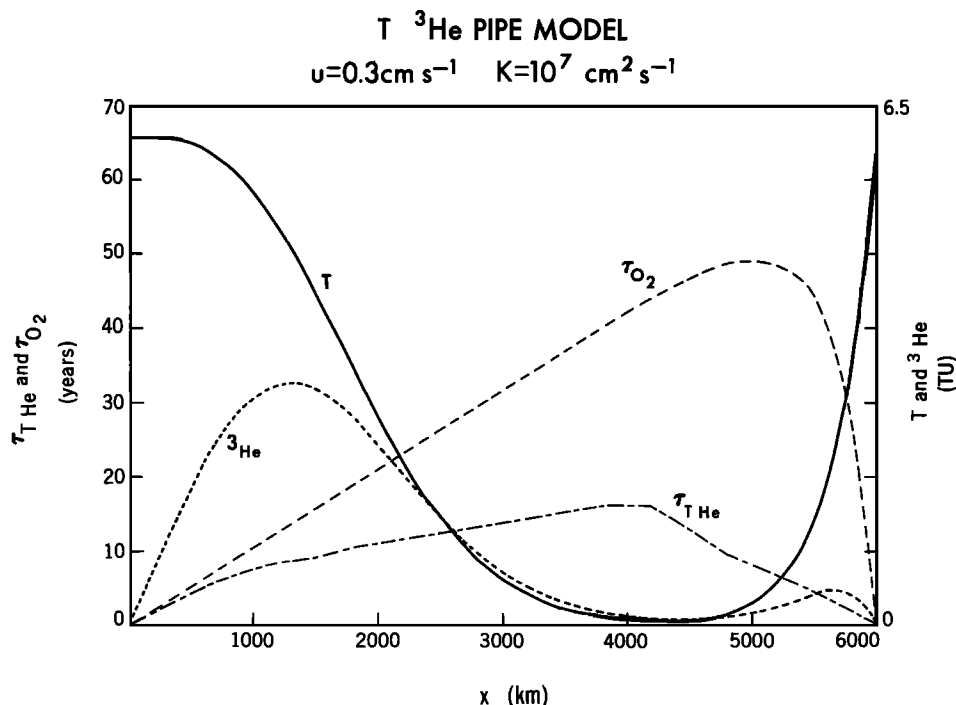

Fig. 7. Tritium and ^3He concentrations, and τ_{O_2} and τ_{THe} for $u = 0.3 \text{ cm s}^{-1}$ and $K = 10^7 \text{ cm}^2 \text{ s}^{-1}$.

T ^3He PIPE MODEL

Fig. 8. The ratio τ_{THe}/τ_{O_2} as described for τ_{Ra}/τ_{O_2} in Figure 6 for (a) $u = 0.3 \text{ cm s}^{-1}$, (b) $u = 1.0 \text{ cm s}^{-1}$.

helium 3 age approaches appear to be reasonably solid, we strongly suspect that the problem lies in some combination of our assumption regarding the value of AOU_1 and/or T_1 and some of the issues raised by the *Doney and Jenkins* [1989] study.

An additional possible explanation for the differences in the OUR estimates shown in Figure 3 is that they are due to spatial or temporal variability. It will be difficult to say anything very solid about these topics until more observations are obtained. One of the attractive aspects of the various techniques used in obtaining the OUR estimates is that they average out short-term temporal variability. Tem-

poral variability on a time scale of a year or even a few years is therefore not likely to be an important factor in the OUR estimates. For example, in the Beta Triangle region, *Jenkins* [1987] finds OUR by taking the slope of AOU versus tritium/ ^3He age. The age ranges, and therefore the time over which one is in a sense averaging, are greater than 1 year on the shallowest surfaces and in excess of a decade on deeper surfaces. The calculations in the Sargasso Sea location [*Jenkins*, 1980] have somewhat shorter but not dissimilar time scales except in the shallowest two data points. The other techniques used to obtain the OURs in Figure 3, those presented here, and that of *Riley* [1951], are large-scale

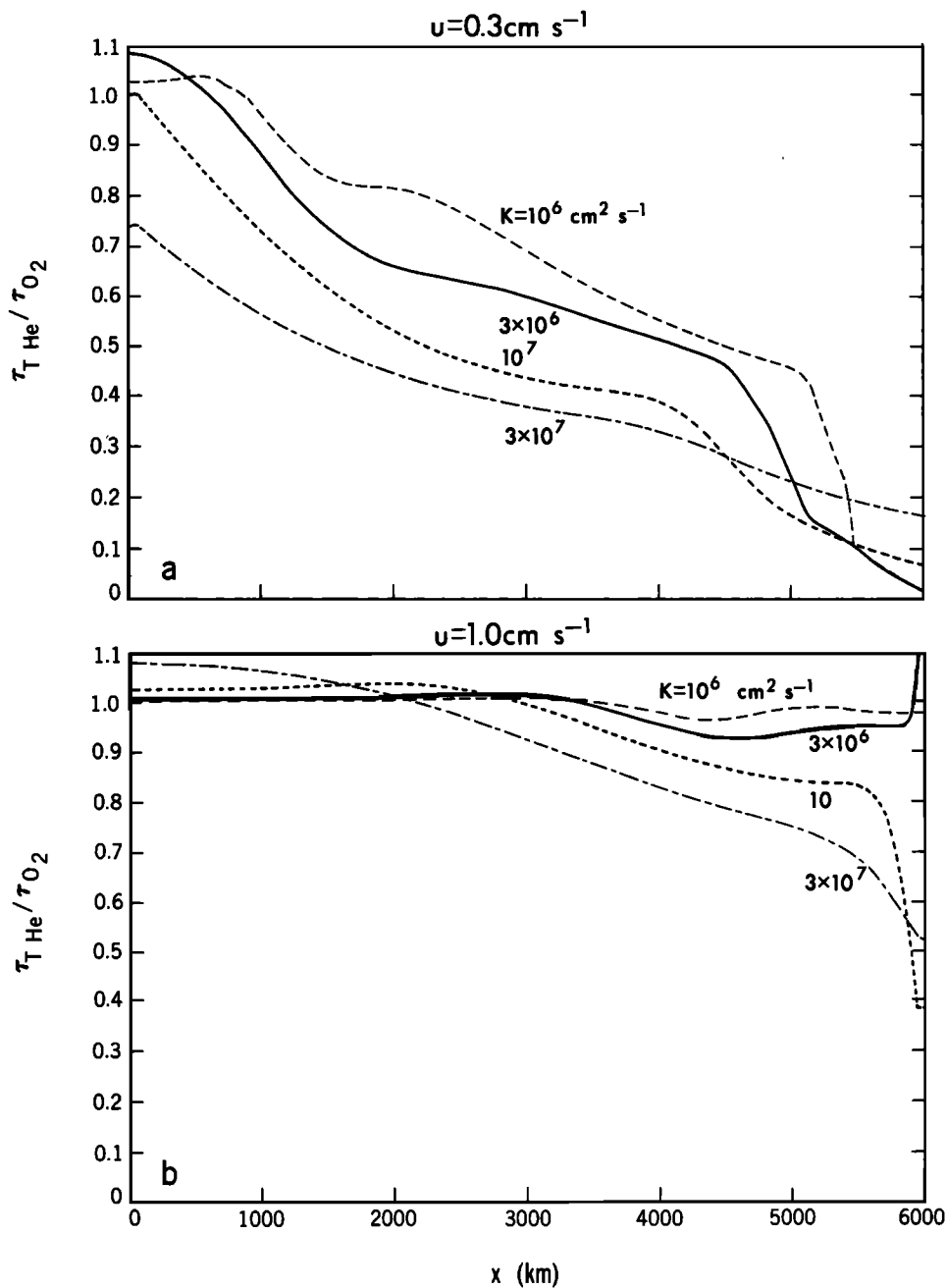
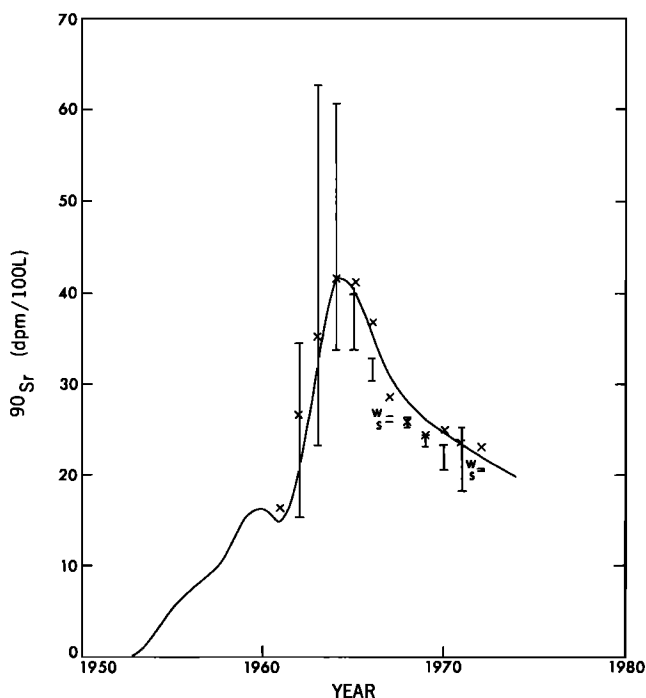

Fig. 9. Strontium 90 surface concentrations estimated from observations by *Dreisigacker and Roether* [1978] (crosses); estimated by a model *Dreisigacker and Roether* [1978] (solid line); and estimated by us from unpublished weathership data from V. Bowen's laboratory at Woods Hole Oceanographic Institution. Table 5 shows the location of the stations. The weathership averages are indicated by bars, with the top being nominal summertime concentrations (August, September, October) and the lower being nominal wintertime concentrations (February, March, April). In 1967 and 1972 the wintertime concentrations were slightly higher than the summertime concentrations.

spatial averages (see Table 3) and thus, in effect, also temporal averages over many years.

What about spatial variability? The Beta Triangle region [*Jenkins*, 1987] has higher OURs than the region near Bermuda [*Jenkins*, 1980] except for the top two data points at the latter site, which anyway appear to be anomalous. Is the Beta Triangle region more productive? It is difficult to tell with the type of data presently available [e.g., *Koblentz-Mishke et al.*, 1970]. The region from which data were obtained for *Riley's* [1951] OUR estimates differs from that used in our tritium inventory and ^{228}Ra estimates. Resolving the role of spatial variability will be difficult until the full TTO data set becomes available for tritium and helium 3 so

TABLE 5. Average Normalization Factors for Seasonal ^{90}Sr Data Relative to Weathership Station C

Station	Position	Normalization
A	62°00'N 35°00'W	0.88
B	56°30'N 51°00'W	0.93
C	52°15'N 35°30'W	1.00
D	44°00'N 41°00'W	1.19
E	35°00'N 48°00'W	1.23
I	59°00'N 19°00'W	0.98
J	52°30'N 20°00'W	1.03
K	45°00'N 16°00'W	1.21
Average		1.06

the various techniques can be compared directly at the same location.

4. CONCLUSION

Given the foregoing, we conclude that the tracer age equation based estimates are more reliable than the tritium box model estimates. In putting together an oxygen balance for the subtropical gyre as a whole we choose the ^{228}Ra estimate of $8.5 \pm 0.8 \text{ mol m}^{-2} \text{ yr}^{-1}$ as most representative since it is based on measurements from the entire region. This number may actually be an underestimate, in that it covers only the 100- to 750-m depth range. On the other hand, mixing would tend to make the estimate too large (by at most a few tens of percent), judging from Figure 6.

Unfortunately, we have no equivalent gyre-scale estimate of the new production at the surface. The estimates of *Musgrave et al.* [1988] and *Spitzer and Jenkins* [1989], which give an average O_2 production of $\sim 4.6 \pm 1.6 \text{ mol m}^{-2} \text{ yr}^{-1}$, are from the time series station near Bermuda, which may or may not be representative of the subtropical gyre as a whole. This estimate of new production is lower by $3.9 \pm 1.9 \text{ mol m}^{-2} \text{ yr}^{-1}$ than our estimate of the remineralization.

Until recently, we would have felt obliged to conclude that this inconsistency between new production and remineralization rates represented a problem with the models used to obtain these estimates or a problem with spatial coverage. The recent work of *Rintoul and Wunsch* [1990] on the nitrate balance in the 24°N to 36°N region, which shows a net export of nitrate across 36°N which they believe to be balanced by an import of dissolved organic matter, and the recent work of *Sugimura and Suzuki* [1988] and *Suzuki et al.* [1985], which show that the dissolved organic carbon content in the oceans is much larger than had previously been thought, suggest the possibility of a different interpretation. It is still not possible to eliminate spatial coverage as a problem, but the above numbers are entirely consistent with the import of organic matter that is required by *Rintoul and Wunsch*. We therefore propose these numbers as a tentative budget for oxygen in the subtropical gyre, subject to future confirmation with more appropriate spatial coverage.

We obtain an estimate for nitrogen remineralization by dividing our oxygen remineralization of $8.5 \pm 0.9 \text{ mol m}^{-2} \text{ yr}^{-1}$ by 9.1 ± 0.4 , which is the $-\text{O}_2:\text{N}$ remineralization ratio estimated from GEOSECS and TTO data by *Minster and Boulaiddid* [1987]. This gives a nitrogen remineralization rate of $\sim 0.93 \pm 0.11 \text{ mol m}^{-2} \text{ yr}^{-1}$. *Rintoul and Wunsch* [1990] obtain a net export of nitrate from the 24°N to 36°N region which is equivalent to an average loss rate of $0.51 \pm 0.21 \text{ mol m}^{-2} \text{ yr}^{-1}$. The difference between the total remineralization and lateral export gives an export of nitrate into the mixed layer, i.e., a new production, of $0.42 \pm 0.24 \text{ mol m}^{-2} \text{ yr}^{-1}$. This is consistent with the nitrogen new production estimate of $0.6 \pm 0.2 \text{ mol m}^{-2} \text{ yr}^{-1}$ that *Jenkins* [1988b] obtained for the site near Bermuda and with the 100-m particle flux of $0.33 \text{ mol m}^{-2} \text{ yr}^{-1}$ that *Altabet* [1989] obtained, also near Bermuda. The new production $-\text{O}_2:\text{N}$ ratio of 11.0 ± 7.1 which we obtain is also consistent with the particulate $-\text{O}_2:\text{N}$ ratios of 10.2 to 13.4 obtained by *Martin et al.* [1987] for the upper 1000 m from sediment trap observations. This agreement is probably fortuitous, given the large errors involved. Note that the foregoing balances require that the laterally imported organic matter which is

regenerated in the thermocline must have a rather low $-O_2:N$ ratio of 7.6 ± 4.8 .

We again run into the problem that the spatial coverage of the ^{228}Ra data set is not equivalent to the region studied by *Rintoul and Wunsch* [1990]. We tried using a subset of our ^{228}Ra data to obtain an oxygen utilization rate in the 24°N to 36°N region. The value we obtained, $13.6 \pm 1.7 \text{ mol m}^{-2} \text{ yr}^{-1}$, is equivalent to a nitrogen remineralization of $1.5 \pm 0.2 \text{ mol m}^{-2} \text{ yr}^{-1}$. However, we distrust this estimate since it leaves out many of the data points at the more extreme ranges of age and AOU which help to define the curves shown in Figure 2.

The major overall point we wish to emphasize with the above considerations is that we need to be open to the possibility first suggested by *Rintoul and Wunsch* [1990] that the oxygen and nitrogen remineralization rates may be greater (or smaller) than the new production, with the balance being made up by an import (or export) of dissolved organic matter. The measurements of *Sugimura and Suzuki* [1988] and *Suzuki et al.* [1985] in the Pacific Ocean are consistent with this, in that they show substantial gradients of dissolved organic carbon and nitrogen throughout the water column.

We also wish to emphasize the value of being able to put together budgets for oxygen as well as nitrogen. These two tracers, phosphate also being of use, respond to different processes and thus provide complementary information. Nitrogen can be transported in organic as well as inorganic form. Thus the case for transport of dissolved organic matter made by *Rintoul and Wunsch* [1990] would have been difficult to make with oxygen observations alone. Another example in the mixed layer is that nitrate is supplied primarily by transport from below, whereas oxygen can be gained or lost by gas exchange at the air-sea interface. Requiring mixed layer models such as that of *Musgrave et al.* [1988] to obtain an internal consistency between the oxygen and nitrogen new production estimates would be a powerful constraint on the models.

A final point concerns the relationship of the oxygen utilization rate to thermocline ventilation. The tritium box model, which gives a low oxygen utilization rate of 2.4 to 3.5 $\text{mol m}^{-2} \text{ yr}^{-1}$, compared with a ^{228}Ra -based estimate of $8.5 \pm 0.8 \text{ mol m}^{-2} \text{ yr}^{-1}$, also gives a thermocline ventilation rate of $40 \times 10^6 \text{ m}^3 \text{ s}^{-1}$. This ventilation rate is consistent with the recent modeling study of *Huang* [1990]. Could the thermocline ventilation in fact be several times larger, as implied by the difference between the above oxygen utilization rate results? The box model study of *Doney and Jenkins* [1989] supports such a picture of greater thermocline ventilation, but we are convinced that a final answer to this issue is going to require us to address even more precisely than *Doney and Jenkins* the nature of exchange between the surface mixed layer and the thermocline in such box models. The flux of oxygen from the surface mixed layer into the interior can vary greatly for a given physical exchange rate depending on what the concentration gradient at the interface is. This concentration gradient may be significantly underrepresented by using the average interior AOU concentration for AOU_I in (2). We will address this topic in a future study.

Acknowledgments. Discussions with J. R. Toggweiler and the assistance of Johann Callan and Phil Tunison in the preparation of

this manuscript are gratefully acknowledged. A review by Scott Doney helped greatly to improve the manuscript. Richard Rotter and Rochelle Slater contributed to the measurement of radium 228. The research of J.L.S. and R.M.K. was supported by NSF grants OCE-8215261, OCE-85-17014, and OCE-86-13326. G.T. was supported by a postdoctoral stipend from the German Research Society, and W.S.M. was supported by NSF grant OCE-8216611.

REFERENCES

- Altabet, M. A., Particulate new nitrogen fluxes in the Sargasso Sea, *J. Geophys. Res.*, **94**, 12,771–12,780, 1989.
- Brewer, P. G., J. L. Sarmiento, and W. M. Smethie, The Transient Tracers in the Oceans (TTO) program: The North Atlantic study, 1981; The Tropical Atlantic study, 1983, *J. Geophys. Res.*, **90**, 6903–6906, 1985.
- Doney, S. C., and W. J. Jenkins, The effect of boundary conditions on tracer estimates of thermocline ventilation rates, *J. Mar. Res.*, **46**, 947–965, 1989.
- Dreisigacker, E., and W. Roether, Tritium and Sr-90 in North Atlantic surface water, *Earth Planet. Sci. Lett.*, **38**, 301–312, 1978.
- Emerson, S., Seasonal oxygen cycles and biological new production in surface waters of the Subarctic Pacific Ocean, *J. Geophys. Res.*, **92**, 6535–6544, 1987.
- Eppley, R. W., New production: History, methods, problems, in *Productivity of the Ocean: Present and Past*, edited by W. H. Berger, U. S. Smetacek, and G. Wefer, pp. 85–97, John Wiley, New York, 1989.
- Huang, R.-X., On the three-dimensional structure of the wind driven circulation in the North Atlantic, *Dyn. Atmos. Oceans*, in press, 1990.
- Jenkins, W. J., Tritium-helium dating in the Sargasso Sea: A measurement of oxygen utilization rates, *Nature*, **196**, 291–292, 1977.
- Jenkins, W. J., Tritium and ^3He in the Sargasso Sea, *J. Mar. Res.*, **38**, 533–569, 1980.
- Jenkins, W. J., Oxygen utilization rates in the North Atlantic subtropical gyre and primary production in oligotrophic systems, *Nature*, **300**, 246–248, 1982a.
- Jenkins, W. J., ^3H and ^3He in the Beta Triangle: Observations of gyre ventilation and oxygen utilization rates, *J. Phys. Oceanogr.*, **17**, 763–783, 1987.
- Jenkins, W. J., The use of anthropogenic tritium and helium-3 to study subtropical gyre ventilation and circulation, *Philos. Trans. R. Soc. London, Ser. A*, **325**, 43–61, 1988a.
- Jenkins, W. J., Nitrate flux into the euphotic zone near Bermuda, *Nature*, **331**, 521–523, 1988b.
- Jenkins, W. J., and J. C. Goldman, Seasonal oxygen cycling and primary production in the Sargasso Sea, *J. Mar. Res.*, **43**, 465–491, 1985.
- Key, R. M., J. L. Sarmiento, and W. S. Moore, Preliminary data report, Distribution of Ra-228 and Ra-226 in the Atlantic Ocean, *Tech. Rep. 85-1*, TTO Test Cruise, TTO NAS Legs 1–3, November, 1985.
- Knox, F., and M. McElroy, Changes in atmospheric CO_2 : Influence of marine biota at high latitudes, *J. Geophys. Res.*, **89**, 4629–4637, 1984.
- Koblentz-Mishke, O. J., V. V. Volkovinsky, and J. G. Kabanova, Plankton primary production of the world ocean, in *Scientific Exploration of the South Pacific*, edited by W. S. Wooster, pp. 183–193, National Academy of Science, Washington, D. C., 1970.
- Levitus, S., Climatological atlas of the world ocean, *NOAA Professional Paper 13*, U.S. Government Printing Office, Washington, D. C., 173 pp., 1982.
- Lewis, M. R., W. G. Harrison, N. S. Oakey, D. Hebert, and T. Platt, Vertical nitrate fluxes in the oligotrophic ocean, *Science*, **234**, 870–873, 1986.
- Lewis, S., and A. Nir, On tracer theory in geophysical systems in the steady and non-steady state, part II, Non-steady state-theoretical introduction, *Tellus*, **30**, 260–271, 1978.
- Luyten, J. L., J. Pedlosky, and H. Stommel, The ventilated thermocline, *J. Phys. Oceanogr.*, **13**, 292–309, 1983.
- Martin, J. H., G. A. Knauer, D. M. Karl, and W. W. Broenkow, VERTEX: carbon cycling in the northeast Pacific, *Deep Sea Res.*, **34**, 267–286, 1987.
- Minster, J.-F., and M. Boulahdid, Redfield ratios along isopycnal

- surfaces—A complementary study, *Deep Sea Res.*, **34**, 1981–2003, 1987.
- Musgrave, D. L., Numerical studies of tritium and helium-3 in the thermocline, *J. Phys. Oceanogr.*, **20**, 344–373, 1990.
- Musgrave, D. L., J. Chou, and W. J. Jenkins, Application of a model of upper-ocean physics for studying seasonal cycles of oxygen, *J. Geophys. Res.*, **93**, 15,679–15,700, 1988.
- Najjar, R. C., Simulations of the phosphorus and oxygen cycles in the world ocean using a general circulation model, Ph.D. thesis, Princeton Univ., Princeton, N. J., 1990.
- Nir, A., On the interpretation of tritium “age” measurements of groundwater, *J. Geophys. Res.*, **69**, 2589–2595, 1964.
- Nir, A., and S. Lewis, On tracer theory in geophysical systems in the steady and non-steady state, part I, *Tellus*, **27**, 372–382, 1975.
- Peng, T.-H., T. Takahashi, and W. S. Broecker, Seasonal variability of carbon dioxide, nutrients and oxygen in the northern North Atlantic surface water: Observations and a model, *Tellus, Ser. B*, **39B**, 439–458, 1987.
- Platt, T., W. G. Harrison, M. R. Lewis, W. K. W. Li, S. Sathyendranath, R. E. Smith, and A. F. Vezina, Biological production of the oceans: The case for a consensus, *Mar. Ecol. Prog. Ser.*, **52**, 77–88, 1989.
- Riley, G. A., Oxygen, phosphate, and nitrate in the Atlantic Ocean, *Bull. Bingham Oceanogr. Coll.*, 127 pp., 1951.
- Rintoul, S., and C. Wunsch, Mass, heat, oxygen, and nutrient fluxes and budgets in the North Atlantic Ocean, *Deep Sea Res.*, in press, 1990.
- Sarmiento, J. L., A tritium box model of the North Atlantic thermocline, *J. Phys. Oceanogr.*, **13**, 1269–1274, 1983.
- Sarmiento, J. L., and E. Gwinn, Strontium 90 fallout prediction, *J. Geophys. Res.*, **91**, 7631–7646, 1986.
- Sarmiento, J. L., and J. R. Toggweiler, A new model for the role of the oceans in determining atmospheric P_{CO_2} , *Nature*, **308**, 621–624, 1984.
- Sarmiento, J. L., C. G. H. Rooth, and W. Roether, The North Atlantic tritium distribution in 1972, *J. Geophys. Res.*, **87**, 8047–8056, 1982.
- Sarmiento, J. L., J. R. Toggweiler, and R. Najjar, Ocean carbon-cycle dynamics and atmospheric P_{CO_2} , *Philos. Trans. R. Soc. London, Ser. A*, **325**, 3–21, 1988.
- Shulenberg, E. L., and J. L. Reid, The Pacific shallow oxygen maximum, deep chlorophyll maximum, and primary productivity, reconsidered, *Deep Sea Res.*, **28A**, 901–919, 1981.
- Siegenthaler, U., and T. Wenk, Rapid atmospheric CO_2 variations and ocean circulation, *Nature*, **308**, 624–626, 1984.
- Spitzer, W. S., and W. J. Jenkins, Rates of vertical mixing, gas exchange and new production: Estimates from seasonal gas cycles in the upper ocean near Bermuda, *J. Mar. Res.*, **47**, 169–196, 1989.
- Sugimura, Y., and Y. Suzuki, A high-temperature catalytic oxidation method of non-volatile dissolved organic carbon in seawater by direct injection of liquid samples, *Mar. Chem.*, **24**, 105–231, 1988.
- Suzuki, Y., Y. Sugimura, and T. Itoh, A catalytic oxidation method for the determination of total nitrogen dissolved in seawater, *Mar. Chem.*, **16**, 83–97, 1985.
- Thiele, G., and J. L. Sarmiento, Tracer dating and ocean ventilation, *J. Geophys. Res.*, **95**, 9377–9391, 1990.
- Toggweiler, J. R., Deep-sea carbon, a burning issue, *Nature*, **334**, 468, 1988.
- Toggweiler, J. R., Is the downward dissolved organic matter (DOM) flux important in carbon transport?, in *Productivity of the Ocean: Past and Present, Dahlem Workshop Report*, edited by W. H. Berger, V. Smetacek, and D. Wefer, pp. 65–84, John Wiley, New York, 1989.
- Williams, P. M., and E. R. M. Druffel, Dissolved organic matter in the ocean: Comments on a controversy, *Oceanography*, **1**, 14–17, 1988.
- Wolberg, J. R., *Prediction Analysis*, 221 pp., D. Van Nostrand, Princeton, N. J., 1967.
- R. M. Key and J. L. Sarmiento, Atmospheric and Oceanic Sciences Program and Department of Geology and Geophysics, Princeton University, Princeton, NJ 08544.
- G. Thiele, Deutsche Forschungs- und Versuchsanstalt für Luft- und Raumfahrt, Astronautenbüro, Linder Höhe, D-5000 Köln 90, Federal Republic of Germany.
- W. S. Moore, Department of Geology, University of South Carolina, Columbia, SC 29208.

(Received August 17, 1989;
revised January 8, 1990;
accepted April 14, 1990.)