

NATIONAL TOXICOLOGY PROGRAM
Technical Report Series
No. 314



TOXICOLOGY AND CARCINOGENESIS
STUDIES OF
METHYL METHACRYLATE
(CAS NO. 80-62-6)
IN F344/N RATS AND B6C3F₁ MICE
(INHALATION STUDIES)

U.S. DEPARTMENT OF HEALTH AND HUMAN SERVICES
Public Health Service
National Institutes of Health

NATIONAL TOXICOLOGY PROGRAM

The National Toxicology Program (NTP), established in 1978, develops and evaluates scientific information about potentially toxic and hazardous chemicals. This knowledge can be used for protecting the health of the American people and for the primary prevention of disease. By bringing together the relevant programs, staff, and resources from the U.S. Public Health Service, DHHS, the National Toxicology Program has centralized and strengthened activities relating to toxicology research, testing and test development/validation efforts, and the dissemination of toxicological information to the public and scientific communities and to the research and regulatory agencies.

The NTP is made up of four charter DHHS agencies: the National Cancer Institute (NCI), National Institutes of Health; the National Institute of Environmental Health Sciences (NIEHS), National Institutes of Health; the National Center for Toxicological Research (NCTR), Food and Drug Administration; and the National Institute for Occupational Safety and Health (NIOSH), Centers for Disease Control. In July 1981, the Carcinogenesis Bioassay Testing Program, NCI, was transferred to the NIEHS.

NTP TECHNICAL REPORT
ON THE
TOXICOLOGY AND CARCINOGENESIS
STUDIES OF
METHYL METHACRYLATE
(CAS NO. 80-62-6)
IN F344/N RATS AND B6C3F₁ MICE
(INHALATION STUDIES)



NATIONAL TOXICOLOGY PROGRAM
P.O. Box 12233
Research Triangle Park, NC 27709

October 1986

NTP TR 314

NIH Publication No. 87-2570

U.S. DEPARTMENT OF HEALTH AND HUMAN SERVICES
Public Health Service
National Institutes of Health

NOTE TO THE READER

These studies are designed and conducted to characterize and evaluate the toxicologic potential, including carcinogenic activity, of selected chemicals in laboratory animals (usually two species, rats and mice). Chemicals selected for testing in the NTP Carcinogenesis Program are chosen primarily on the bases of human exposure, level of production, and chemical structure. Selection per se is not an indicator of a chemical's carcinogenic potential. Negative results, in which the test animals do not have a greater incidence of cancer than control animals, do not necessarily mean that a test chemical is not a carcinogen, inasmuch as the experiments are conducted under a limited set of conditions. Positive results demonstrate that a test chemical is carcinogenic for animals under the conditions of the test and indicate that exposure to the chemical has the potential for hazard to humans. The determination of the risk to humans from chemicals found to be carcinogenic in animals requires a wider analysis which extends beyond the purview of this study.

Five categories of interpretative conclusions were adopted for use in June 1983 in the Technical Reports series to specifically emphasize consistency and the concept of actual evidence of carcinogenicity. For each definitive study result (male rats, female rats, male mice, female mice), one of the following quintet will be selected to describe the findings. These categories refer to the strength of the experimental evidence and not to either potency or mechanism.

- **Clear Evidence of Carcinogenicity** is demonstrated by studies that are interpreted as showing a chemically related increased incidence of malignant neoplasms, studies that exhibit a substantially increased incidence of benign neoplasms, or studies that exhibit an increased incidence of a combination of malignant and benign neoplasms where each increases with dose.
- **Some Evidence of Carcinogenicity** is demonstrated by studies that are interpreted as showing a chemically related increased incidence of benign neoplasms, studies that exhibit marginal increases in neoplasms of several organs/tissues, or studies that exhibit a slight increase in uncommon malignant or benign neoplasms.
- **Equivocal Evidence of Carcinogenicity** is demonstrated by studies that are interpreted as showing a chemically related marginal increase of neoplasms.
- **No Evidence of Carcinogenicity** is demonstrated by studies that are interpreted as showing no chemically related increases in malignant or benign neoplasms.
- **Inadequate Study of Carcinogenicity** demonstrates that because of major qualitative or quantitative limitations, the studies cannot be interpreted as valid for showing either the presence or absence of a carcinogenic effect.

Additionally, the following concepts (as patterned from the International Agency for Research on Cancer Monographs) have been adopted by the NTP to give further clarification of these issues:

The term *chemical carcinogenesis* generally means the induction by chemicals of neoplasms not usually observed, the earlier induction by chemicals of neoplasms that are commonly observed, or the induction by chemicals of more neoplasms than are generally found. Different mechanisms may be involved in these situations. Etymologically, the term *carcinogenesis* means induction of cancer, that is, of malignant neoplasms; however, the commonly accepted meaning is the induction of various types of neoplasms or of a combination of malignant and benign neoplasms. In the Technical Reports, the words *tumor* and *neoplasm* are used interchangeably.

This study was initiated by the National Cancer Institute's Carcinogenesis Bioassay Program, now part of the National Institute of Environmental Health Sciences, National Toxicology Program. The studies described in this Technical Report have been conducted in compliance with NTP chemical health and safety requirements and must meet or exceed all applicable Federal, state, and local health and safety regulations. Animal care and use were in accordance with the U.S. Public Health Service Policy on Humane Care and Use of Animals. All NTP toxicology and carcinogenesis studies are subjected to a data audit before being presented for peer review.

Although every effort is made to prepare the Technical Reports as accurately as possible, mistakes may occur. Readers are requested to identify any mistakes so that corrective action may be taken. Further, anyone who is aware of related ongoing or published studies not mentioned in this report is encouraged to make this information known to the NTP. Comments and questions about the National Toxicology Program Technical Reports on Toxicology and Carcinogenesis Studies should be directed to Dr. J.E. Huff, National Toxicology Program, P.O. Box 12233, Research Triangle Park, NC 27709 (919-541-3780).

These NTP Technical Reports are available for sale from the National Technical Information Service, U.S. Department of Commerce, 5285 Port Royal Road, Springfield, VA 22161 (703-487-4650). Single copies of this Technical Report are available without charge (and while supplies last) from the NTP Public Information Office, National Toxicology Program, P.O. Box 12233, Research Triangle Park, NC 27709.

CONTENTS

	PAGE
ABSTRACT	11
CONTRIBUTORS	13
PEER REVIEW PANEL	14
SUMMARY OF PEER REVIEW COMMENTS	15
I. INTRODUCTION	17
II. MATERIALS AND METHODS	23
PROCUREMENT AND CHARACTERIZATION OF METHYL METHACRYLATE	24
GENERATION OF METHYL METHACRYLATE VAPOR	25
SINGLE-EXPOSURE STUDIES	26
ELEVEN-DAY STUDIES	26
TEN-DAY STUDIES	26
FOURTEEN-WEEK STUDIES AT INDUSTRIAL BIOTEST LABORATORIES	28
FOURTEEN-WEEK STUDIES AT BATTELLE PACIFIC NORTHWEST LABORATORIES	28
TWO-YEAR STUDIES	31
STUDY DESIGN	31
SOURCE AND SPECIFICATIONS OF ANIMALS	31
ANIMAL MAINTENANCE	31
CLINICAL EXAMINATIONS AND PATHOLOGY	31
STATISTICAL METHODS	32
III. RESULTS	35
RATS	36
SINGLE-EXPOSURE STUDIES	36
ELEVEN-DAY STUDIES	36
TEN-DAY STUDIES	36
FOURTEEN-WEEK STUDIES AT INDUSTRIAL BIOTEST LABORATORIES	38
FOURTEEN-WEEK STUDIES AT BATTELLE PACIFIC NORTHWEST LABORATORIES	38
TWO-YEAR STUDIES	40
BODY WEIGHTS AND CLINICAL SIGNS	40
SURVIVAL	42
PATHOLOGY AND STATISTICAL ANALYSES OF RESULTS	42
MICE	47
SINGLE-EXPOSURE STUDIES	47
ELEVEN-DAY STUDIES	47
TEN-DAY STUDIES	47

CONTENTS (Continued)

	PAGE
FOURTEEN-WEEK STUDIES AT INDUSTRIAL BIOTEST LABORATORIES	49
FOURTEEN-WEEK STUDIES AT BATTELLE PACIFIC NORTHWEST LABORATORIES ..	49
TWO-YEAR STUDIES	51
BODY WEIGHTS AND CLINICAL SIGNS	51
SURVIVAL	53
PATHOLOGY AND STATISTICAL ANALYSES OF RESULTS	53
IV. DISCUSSION AND CONCLUSIONS	59
V. REFERENCES	63

TABLES

TABLE 1	PHYSICAL PROPERTIES OF METHYL METHACRYLATE	18
TABLE 2	IDENTITY AND SOURCE OF LOTS USED IN THE INHALATION STUDIES OF METHYL METHACRYLATE	24
TABLE 3	WATER CONTENT AND GAS CHROMATOGRAPHIC RESULTS FOR METHYL METHACRYLATE	24
TABLE 4	GENERATION OF CHAMBER CONCENTRATIONS IN THE INHALATION STUDIES OF METHYL METHACRYLATE	25
TABLE 5	SUMMARY OF CHAMBER CONCENTRATIONS IN THE TWO-YEAR INHALATION STUDIES OF METHYL METHACRYLATE	25
TABLE 6	DISTRIBUTION OF MEAN DAILY CONCENTRATIONS OF METHYL METHACRYLATE DURING THE TWO-YEAR INHALATION STUDIES	26
TABLE 7	EXPERIMENTAL DESIGN AND MATERIALS AND METHODS IN THE INHALATION STUDIES OF METHYL METHACRYLATE AT INDUSTRIAL BIOTEST LABORATORIES	27
TABLE 8	EXPERIMENTAL DESIGN AND MATERIALS AND METHODS IN THE INHALATION STUDIES OF METHYL METHACRYLATE AT INDUSTRIAL BIOTEST LABORATORIES AND BATTELLE PACIFIC NORTHWEST LABORATORIES	29
TABLE 9	SURVIVAL AND MEAN BODY WEIGHTS OF RATS IN THE SINGLE-EXPOSURE INHALATION STUDIES OF METHYL METHACRYLATE	36
TABLE 10	SURVIVAL AND MEAN BODY WEIGHTS OF RATS IN THE ELEVEN-DAY INHALATION STUDIES OF METHYL METHACRYLATE	37
TABLE 11	SURVIVAL AND MEAN BODY WEIGHTS OF RATS IN THE TEN-DAY INHALATION STUDIES OF METHYL METHACRYLATE	37

TABLES (Continued)

		PAGE
TABLE 12	SURVIVAL AND MEAN BODY WEIGHTS OF RATS IN THE FOURTEEN-WEEK INHALATION STUDIES OF METHYL METHACRYLATE AT IBT	38
TABLE 13	SURVIVAL AND MEAN BODY WEIGHTS OF RATS IN THE FOURTEEN-WEEK INHALATION STUDIES OF METHYL METHACRYLATE AT BNW	39
TABLE 14	INCIDENCES OF RATS WITH INFLAMMATION OF THE NASAL TURBINATES IN THE FOURTEEN-WEEK INHALATION STUDIES OF METHYL METHACRYLATE AT BNW	39
TABLE 15	MEAN BODY WEIGHTS AND SURVIVAL OF RATS IN THE TWO-YEAR INHALATION STUDIES OF METHYL METHACRYLATE	40
TABLE 16	SURVIVAL OF RATS IN THE TWO-YEAR INHALATION STUDIES OF METHYL METHACRYLATE	42
TABLE 17	ANALYSIS OF MONONUCLEAR CELL LEUKEMIA IN FEMALE RATS IN THE TWO-YEAR INHALATION STUDY OF METHYL METHACRYLATE	44
TABLE 18	CLASSIFICATION OF MONONUCLEAR CELL LEUKEMIA IN FEMALE RATS IN THE TWO-YEAR INHALATION STUDY OF METHYL METHACRYLATE	44
TABLE 19	ANALYSIS OF PITUITARY GLAND AND PREPUTIAL GLAND TUMORS IN MALE RATS IN THE TWO-YEAR INHALATION STUDY OF METHYL METHACRYLATE	45
TABLE 20	INCIDENCES OF RATS WITH SELECTED NONNEOPLASTIC LESIONS IN THE TWO-YEAR INHALATION STUDIES OF METHYL METHACRYLATE	46
TABLE 21	SURVIVAL AND MEAN BODY WEIGHTS OF MICE IN THE SINGLE-EXPOSURE INHALATION STUDIES OF METHYL METHACRYLATE	47
TABLE 22	SURVIVAL AND MEAN BODY WEIGHTS OF MICE IN THE ELEVEN-DAY INHALATION STUDIES OF METHYL METHACRYLATE	48
TABLE 23	SURVIVAL AND MEAN BODY WEIGHTS OF MICE IN THE TEN-DAY INHALATION STUDIES OF METHYL METHACRYLATE	48
TABLE 24	SURVIVAL AND MEAN BODY WEIGHTS OF MICE IN THE FOURTEEN-WEEK INHALATION STUDIES OF METHYL METHACRYLATE AT IBT	49
TABLE 25	SURVIVAL AND MEAN BODY WEIGHTS OF MICE IN THE FOURTEEN-WEEK INHALATION STUDIES OF METHYL METHACRYLATE AT BNW	50
TABLE 26	INCIDENCES OF MICE WITH LESIONS IN THE FOURTEEN-WEEK INHALATION STUDIES OF METHYL METHACRYLATE AT BNW	50

TABLES (Continued)

		PAGE
TABLE 27	MEAN BODY WEIGHTS AND SURVIVAL OF MICE IN THE TWO-YEAR INHALATION STUDIES OF METHYL METHACRYLATE	51
TABLE 28	SURVIVAL OF MICE IN THE TWO-YEAR INHALATION STUDIES OF METHYL METHACRYLATE	53
TABLE 29	INCIDENCES OF MICE WITH SELECTED NONNEOPLASTIC LESIONS IN THE TWO-YEAR INHALATION STUDIES OF METHYL METHACRYLATE	55
TABLE 30	ANALYSIS OF LUNG TUMORS IN MALE MICE IN THE TWO-YEAR INHALATION STUDY OF METHYL METHACRYLATE	56
TABLE 31	ANALYSIS OF PITUITARY GLAND TUMORS IN FEMALE MICE IN THE TWO-YEAR INHALATION STUDY OF METHYL METHACRYLATE	56
TABLE 32	ANALYSIS OF LIVER TUMORS IN MICE IN THE TWO-YEAR INHALATION STUDIES OF METHYL METHACRYLATE	57

FIGURES

FIGURE 1	GROWTH CURVES FOR RATS EXPOSED TO METHYL METHACRYLATE BY INHALATION FOR TWO YEARS	41
FIGURE 2	KAPLAN-MEIER SURVIVAL CURVES FOR RATS EXPOSED TO METHYL METHACRYLATE BY INHALATION FOR TWO YEARS	43
FIGURE 3	GROWTH CURVES FOR MICE EXPOSED TO METHYL METHACRYLATE BY INHALATION FOR TWO YEARS	52
FIGURE 4	KAPLAN-MEIER SURVIVAL CURVES FOR MICE EXPOSED TO METHYL METHACRYLATE BY INHALATION FOR TWO YEARS	54
FIGURE 5	INFRARED ABSORPTION SPECTRUM OF METHYL METHACRYLATE (LOT NO. 4-0091)	157
FIGURE 6	NUCLEAR MAGNETIC RESONANCE SPECTRUM OF METHYL METHACRYLATE (LOT NO. 4-0091)	159
FIGURE 7	INFRARED ABSORPTION SPECTRUM OF METHYL METHACRYLATE (LOT NO. 4-15-014)	162
FIGURE 8	NUCLEAR MAGNETIC RESONANCE SPECTRUM OF METHYL METHACRYLATE (LOT NO. 4-15-014)	164
FIGURE 9	NUCLEAR MAGNETIC RESONANCE SPECTRUM OF METHYL METHACRYLATE (REANALYSIS OF LOT NO. 4-15-014)	167

FIGURES (Continued)

	PAGE
FIGURE 10 INFRARED ABSORPTION SPECTRUM OF METHYL METHACRYLATE (LOT NO. 03-54832)	169
FIGURE 11 NUCLEAR MAGNETIC RESONANCE SPECTRUM OF METHYL METHACRYLATE (LOT NO. 03-54832)	170
FIGURE 12 INFRARED ABSORPTION SPECTRUM OF METHYL METHACRYLATE (LOT NO. 6-5486)	174
FIGURE 13 NUCLEAR MAGNETIC RESONANCE SPECTRUM OF METHYL METHACRYLATE (LOT NO. 6-5486)	175
FIGURE 14 INFRARED ABSORPTION SPECTRUM OF METHYL METHACRYLATE (LOT NO. 377109)	179
FIGURE 15 NUCLEAR MAGNETIC RESONANCE SPECTRUM OF METHYL METHACRYLATE (LOT NO. 377109)	180
FIGURE 16 METHYL METHACRYLATE VAPOR GENERATION SYSTEM	187
FIGURE 17 WEEKLY MEAN CONCENTRATION AND STANDARD DEVIATION IN 250-ppm FEMALE RAT EXPOSURE CHAMBER FOR THE TWO-YEAR INHALATION STUDY OF METHYL METHACRYLATE	188
FIGURE 18 WEEKLY MEAN CONCENTRATION AND STANDARD DEVIATION IN 500-ppm RAT AND MOUSE EXPOSURE CHAMBER FOR THE TWO-YEAR INHALATION STUDIES OF METHYL METHACRYLATE	189
FIGURE 19 WEEKLY MEAN CONCENTRATION AND STANDARD DEVIATION IN 1,000-ppm RAT AND MOUSE EXPOSURE CHAMBER FOR THE TWO-YEAR INHALATION STUDIES OF METHYL METHACRYLATE	190
FIGURE 20 POLYMER CONTENT OF INHALATION CHAMBER ATMOSPHERE OF METHYL METHACRYLATE BY NUCLEAR MAGNETIC RESONANCE SPECTROSCOPY	192

APPENDIXES

	PAGE
APPENDIX A	SUMMARY OF THE INCIDENCE OF NEOPLASMS IN RATS IN THE TWO-YEAR INHALATION STUDIES OF METHYL METHACRYLATE 69
TABLE A1	SUMMARY OF THE INCIDENCE OF NEOPLASMS IN MALE RATS IN THE TWO-YEAR INHALATION STUDY OF METHYL METHACRYLATE 70
TABLE A2	SUMMARY OF THE INCIDENCE OF NEOPLASMS IN FEMALE RATS IN THE TWO-YEAR INHALATION STUDY OF METHYL METHACRYLATE 73
TABLE A3	INDIVIDUAL ANIMAL TUMOR PATHOLOGY OF MALE RATS IN THE TWO-YEAR INHALATION STUDY OF METHYL METHACRYLATE 76
TABLE A4	INDIVIDUAL ANIMAL TUMOR PATHOLOGY OF FEMALE RATS IN THE TWO-YEAR INHALATION STUDY OF METHYL METHACRYLATE 82
APPENDIX B	SUMMARY OF THE INCIDENCE OF NEOPLASMS IN MICE IN THE TWO-YEAR INHALATION STUDIES OF METHYL METHACRYLATE 89
TABLE B1	SUMMARY OF THE INCIDENCE OF NEOPLASMS IN MALE MICE IN THE TWO-YEAR INHALATION STUDY OF METHYL METHACRYLATE 91
TABLE B2	SUMMARY OF THE INCIDENCE OF NEOPLASMS IN FEMALE MICE IN THE TWO-YEAR INHALATION STUDY OF METHYL METHACRYLATE 93
TABLE B3	INDIVIDUAL ANIMAL TUMOR PATHOLOGY OF MALE MICE IN THE TWO-YEAR INHALATION STUDY OF METHYL METHACRYLATE 96
TABLE B4	INDIVIDUAL ANIMAL TUMOR PATHOLOGY OF FEMALE MICE IN THE TWO-YEAR INHALATION STUDY OF METHYL METHACRYLATE 102
APPENDIX C	SUMMARY OF THE INCIDENCE OF NONNEOPLASTIC LESIONS IN RATS IN THE TWO-YEAR INHALATION STUDIES OF METHYL METHACRYLATE 109
TABLE C1	SUMMARY OF THE INCIDENCE OF NONNEOPLASTIC LESIONS IN MALE RATS IN THE TWO-YEAR INHALATION STUDY OF METHYL METHACRYLATE . . 110
TABLE C2	SUMMARY OF THE INCIDENCE OF NONNEOPLASTIC LESIONS IN FEMALE RATS IN THE TWO-YEAR INHALATION STUDY OF METHYL METHACRYLATE . 115
APPENDIX D	SUMMARY OF THE INCIDENCE OF NONNEOPLASTIC LESIONS IN MICE IN THE TWO-YEAR INHALATION STUDIES OF METHYL METHACRYLATE 121
TABLE D1	SUMMARY OF THE INCIDENCE OF NONNEOPLASTIC LESIONS IN MALE MICE IN THE TWO-YEAR INHALATION STUDY OF METHYL METHACRYLATE . 122

APPENDIXES (Continued)

	PAGE
TABLE D2	SUMMARY OF THE INCIDENCE OF NONNEOPLASTIC LESIONS IN FEMALE MICE IN THE TWO-YEAR INHALATION STUDY OF METHYL METHACRYLATE . 126
APPENDIX E	ANALYSES OF PRIMARY TUMORS IN RATS AND MICE IN THE TWO-YEAR INHALATION STUDIES OF METHYL METHACRYLATE 131
TABLE E1	ANALYSIS OF PRIMARY TUMORS IN MALE RATS IN THE TWO-YEAR INHALATION STUDY OF METHYL METHACRYLATE 132
TABLE E2	ANALYSIS OF PRIMARY TUMORS IN FEMALE RATS IN THE TWO-YEAR INHALATION STUDY OF METHYL METHACRYLATE 135
TABLE E3	ANALYSIS OF PRIMARY TUMORS IN MALE MICE IN THE TWO-YEAR INHALATION STUDY OF METHYL METHACRYLATE 137
TABLE E4	ANALYSIS OF PRIMARY TUMORS IN FEMALE MICE IN THE TWO-YEAR INHALATION STUDY OF METHYL METHACRYLATE 139
APPENDIX F	HISTORICAL INCIDENCES OF TUMORS IN F344/N RATS AND B6C3F ₁ MICE RECEIVING NO TREATMENT 143
TABLE F1	HISTORICAL INCIDENCE OF LEUKEMIA IN FEMALE F344/N RATS RECEIVING NO TREATMENT 144
TABLE F2	HISTORICAL INCIDENCE OF ALVEOLAR/BRONCHIOLAR TUMORS IN MALE B6C3F ₁ MICE RECEIVING NO TREATMENT 145
TABLE F3	HISTORICAL INCIDENCE OF HEPATOCELLULAR TUMORS IN MALE B6C3F ₁ MICE RECEIVING NO TREATMENT 146
TABLE F4	HISTORICAL INCIDENCE OF HEPATOCELLULAR TUMORS IN FEMALE B6C3F ₁ MICE RECEIVING NO TREATMENT 147
TABLE F5	HISTORICAL INCIDENCE OF PITUITARY GLAND TUMORS IN FEMALE B6C3F ₁ MICE RECEIVING NO TREATMENT 148
APPENDIX G	GENETIC TOXICOLOGY OF METHYL METHACRYLATE 149
TABLE G1	MUTAGENICITY OF METHYL METHACRYLATE IN <i>SALMONELLA TYPHIMURIUM</i> .. 150
TABLE G2	MUTAGENICITY OF METHYL METHACRYLATE IN L5178Y/TK ^{+/-} MOUSE LYMPHOMA CELLS IN THE ABSENCE OF S9 151
TABLE G3	MUTAGENICITY OF METHYL METHACRYLATE IN L5178Y/TK ^{+/-} MOUSE LYMPHOMA CELLS IN THE PRESENCE OF S9 152
TABLE G4	INDUCTION OF SISTER-CHROMATID EXCHANGES IN CHINESE HAMSTER OVARY CELLS BY METHYL METHACRYLATE 153

APPENDIXES (Continued)

	PAGE
TABLE G5	INDUCTION OF CHROMOSOMAL ABERRATIONS IN CHINESE HAMSTER OVARY CELLS BY METHYL METHACRYLATE 153
APPENDIX H	CHEMICAL CHARACTERIZATION OF METHYL METHACRYLATE 155
APPENDIX I	GENERATION AND MEASUREMENT OF CHAMBER CONCENTRATIONS AT BATTELLE PACIFIC NORTHWEST LABORATORIES 185
APPENDIX J	RESULTS OF SEROLOGIC ANALYSES 193
TABLE J1	MURINE VIRUS ANTIBODY DETERMINATIONS FOR RATS AND MICE IN THE TWO-YEAR INHALATION STUDIES OF METHYL METHACRYLATE 194
APPENDIX K	INGREDIENTS, NUTRIENT COMPOSITION, AND CONTAMINANT LEVELS IN NIH 07 RAT AND MOUSE RATION 195
TABLE K1	INGREDIENTS OF NIH 07 RAT AND MOUSE RATION 196
TABLE K2	VITAMINS AND MINERALS IN NIH 07 RAT AND MOUSE RATION 196
TABLE K3	NUTRIENT COMPOSITION OF NIH 07 RAT AND MOUSE RATION 197
TABLE K4	CONTAMINANT LEVELS IN NIH 07 RAT AND MOUSE RATION 198
APPENDIX L	DATA AUDIT SUMMARY 201

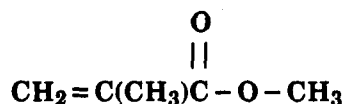

Methyl Methacrylate

CAS No. 80-62-6

C₅H₈O₂

Molecular weight: 100.11

Synonyms:	Acrylic acid, 2-methyl-, methyl ester	Methyl-2-methylpropenoate
	Methacrylic acid, methyl ester	Methyl-2-methyl-2-propenoate
	Methyl α-methylacrylate	2-Methyl-2-propenoic acid methyl ester
	Methyl methylacrylate	MME

ABSTRACT

Toxicology and carcinogenesis studies of methyl methacrylate, a liquid chemical intermediate used in the plastics industry in the manufacture of plexiglass and other acrylic products, were conducted by exposing groups of F344/N rats and B6C3F₁ mice by inhalation for 14 weeks and 2 years.

In the 14-week studies, groups of 10 male and 10 female rats and mice were exposed to methyl methacrylate at concentrations of up to 5,000 ppm. All male and female rats and eight male and eight female mice exposed at 5,000 ppm died, one male and nine female rats and four male and no female mice exposed at 3,000 ppm died, and one male and three female rats and two male and one female mouse exposed at 2,000 ppm died; all rats and mice exposed at 500 or 1,000 ppm survived. Compared with the controls, the body weights of the exposed male and female rats and mice were lower. Compound-related lesions included inflammation associated with necrosis and loss of olfactory epithelium in the nasal turbinates in both male and female rats; malacia and gliosis in female rats; inflammation of the nasal turbinates and nasal epithelium metaplasia in both male and female mice; and renal cortical necrosis, renal cortical tubular degeneration, renal focal mineralization, and liver necrosis in male mice. Based on these results, 2-year inhalation toxicology and carcinogenesis studies were conducted in which groups of 50 male rats were exposed to methyl methacrylate at 0, 500, or 1,000 ppm; female rats at 0, 250, or 500 ppm; and male and female mice at 0, 500, or 1,000 ppm.

In the 2-year studies, the body weights of the low dose and high dose male and female rats were within 10% of those of the controls. There was no difference in survival between the dosed male and female rats and the controls. Incidences of inflammation of the nasal cavity and degeneration of the olfactory sensory epithelium were greater in the dosed male and female rats than in the controls, with lesions seen in virtually all high dose animals.

An increased incidence of mononuclear cell leukemia was observed in female rats exposed to methyl methacrylate at 500 ppm compared with the controls (control, 11/50; 250 ppm, 13/50; 500 ppm, 20/50). This increase was not significant by life table tests, the method of analysis most appropriate for this fatal neoplasm.

The mean body weights of the dosed male and female mice were 5%-8% lower than those of the controls at the end of the 2-year studies. However, during most of the second year of the studies, body weights of dosed male mice and the high dose female mice were 10%-18% lower than those of the controls. Survival rates of the dosed and control mice were similar.

Incidences of inflammation and epithelial hyperplasia of the nasal cavity and degeneration of the olfactory sensory epithelium were significantly greater in all dosed groups of male and female mice compared with those of the controls. Compound-related neoplastic lesions were not found in the dosed mice.

Significant dose-related decreases were observed in the incidences of pituitary gland and preputial gland tumors in male rats, alveolar/bronchiolar adenomas or carcinomas (combined) in male mice, hepatocellular adenomas in both male and female mice, and pituitary gland adenomas or adenocarcinomas (combined) and uterine adenocarcinomas in female mice.

Methyl methacrylate was not mutagenic in strains TA100, TA1535, TA97, or TA98 of *Salmonella typhimurium* in the presence or absence of male rat or hamster liver S9 when assayed by a preincubation protocol but gave a positive response in L5178Y/TK^{+/-} mouse lymphoma cells in the presence or absence of male rat liver S9. In cultured Chinese hamster ovary cells, methyl methacrylate produced a reproducible, dose-related increase in the frequency of sister-chromatid exchanges, both with and without rat liver S9. A slight, dose-related increase in chromosomal aberrations was also induced in cultured Chinese hamster ovary cells in the absence of S9; in the presence of S9, an increase in the frequency of aberrations was seen only at the highest, near-lethal dose of 5 mg/ml.

An audit of the experimental data was conducted for the 2-year carcinogenesis studies on methyl methacrylate. No data discrepancies were found that influenced the final interpretations.

Under the conditions of these 2-year inhalation studies, there was *no evidence of carcinogenicity** of methyl methacrylate for male F344/N rats exposed at 500 or 1,000 ppm, for female F344/N rats exposed at 250 or 500 ppm, or for male and female B6C3F₁ mice exposed at 500 or 1,000 ppm. Inhalation of methyl methacrylate was associated with inflammation of the nasal cavity and degeneration of the olfactory sensory epithelium in male and female rats and mice; epithelial hyperplasia of the nasal cavity was also observed in exposed mice.

*Categories of evidence of carcinogenicity are defined in the Note to the Reader on page 2.

A summary of the Peer Review comments and the public discussion on this Technical Report appears on page 15.

CONTRIBUTORS

The NTP Technical Report on the Toxicology and Carcinogenesis Studies of Methyl Methacrylate is based on 14-week studies that began in March 1977 and ended in June 1977 at Industrial Biotest Laboratories, 14-week studies that began in September 1979 and ended in January 1980 at Battelle Pacific Northwest Laboratories, and 2-year studies that began in January 1981 and ended in January 1983 at Battelle Pacific Northwest Laboratories.

National Toxicology Program (Evaluated Experiment, Interpreted Results, and Reported Findings)

Po C. Chan, Ph.D., Chemical Manager

Jack Bishop, Ph.D.

Rajendra S. Chhabra, Ph.D.

Scot L. Eustis, D.V.M., Ph.D.

Joseph K. Haseman, Ph.D.

James Huff, Ph.D.

C.W. Jameson, Ph.D.

E.E. McConnell, D.V.M.

G.N. Rao, D.V.M., Ph.D.

B.A. Schwetz, D.V.M., Ph.D.

NTP Pathology Working Group (For Rats) (Evaluated Slides and Prepared Pathology Report on 12/06/84)

Marilyn Wolfe, D.V.M., Ph.D. (NTP) (Chair)

Gary A. Boorman, D.V.M., Ph.D. (NTP)

James Popp, D.V.M., Ph.D.

Chemical Industry Institute of Toxicology

Marion Valerio, D.V.M.

Litton Bionetics, Inc.

Katsuhiko Yoshitomi, D.V.M., Ph.D.

NTP

NTP Pathology Working Group (For Mice) (Evaluated Slides and Prepared Pathology Report on 11/29/84)

Marilyn Wolfe, D.V.M., Ph.D. (NTP) (Chair)

Steven Becker, D.V.M. (Toxicogenics)

Bhola Gupta, B.V.Sc., Ph.D. (NTP)

Kevin Morgan, D.V.M., Ph.D.

Chemical Industry Institute of Toxicology

John Sagartz, D.V.M.

Pathology Consultant

Katsuhiko Yoshitomi, D.V.M., Ph.D.

NTP

Principal Contributors at Battelle Pacific Northwest Laboratories (Conducted Studies and Evaluated Tissues)

William J. Clarke, D.V.M., Ph.D.

Principal Investigator

R. Renne, D.V.M.

Pathologist (for rats)

R.B. Westerberg, Ph.D.

Chemist

E. Giddens, D.V.M., Ph.D.

Pathologist

Principal Contributors at Experimental Pathology Laboratory (Provided Pathology Quality Assurance)

Melvin Hamlin, D.V.M.

J. Gauchat, Pathology Coordinator

Principal Contributors at Carltech Associates, Inc. (Contractor for Technical Report Preparation)

William D. Theriault, Ph.D.

Project Manager

Abigail C. Jacobs, Ph.D.

Senior Scientist

John Warner, M.S.

Chemist/Statistician

PEER REVIEW PANEL

The members of the Peer Review Panel who evaluated the draft Technical Report on methyl methacrylate on December 9, 1985, are listed below. Panel members serve as independent scientists, not as representatives of any institution, company, or governmental agency. In this capacity, Panel members have five major responsibilities: (a) to ascertain that all relevant literature data have been adequately cited and interpreted, (b) to determine if the design and conditions of the NTP studies were appropriate, (c) to ensure that the Technical Report presents the experimental results and conclusions fully and clearly, (d) to judge the significance of the experimental results by scientific criteria, and (e) to assess the evaluation of the evidence of carcinogenicity and other observed toxic responses.

National Toxicology Program Board of Scientific Counselors Technical Reports Review Subcommittee

Jerry B. Hook, Ph.D. (Chair)
Vice President, Preclinical Research and Development
Smith Kline & French Laboratories, Philadelphia, Pennsylvania

Frederica Perera, Dr. P.H.
Division of Environmental Sciences
School of Public Health, Columbia University
New York, New York

James Swenberg, D.V.M., Ph.D.
(Principal Reviewer)
Head, Department of Biochemical
Toxicology and Pathobiology
Chemical Industry Institute of Toxicology
Research Triangle Park, North Carolina

Ad Hoc Subcommittee Panel of Experts

John J. Crowley, Ph.D.
Division of Public Health Science
The Fred Hutchinson Cancer Research Center
Seattle, Washington

Franklin E. Mirer, Ph.D. (Principal Reviewer)
Director, Health and Safety Department
International Union, United Auto
Workers, Detroit, Michigan

Kim Hooper, Ph.D.
Hazard Evaluation System and
Information Services
Department of Health Services
State of California, Berkeley, California

I.F.H. Purchase, Ph.D.
Central Toxicology Laboratory
Imperial Chemical Industries, PLC
Alderley Park, England

Thomas C. Jones, D.V.M.
Professor, Comparative Pathology
New England Regional Primate Research Center
Harvard Medical School
Southborough, Massachusetts

Robert A. Scala, Ph.D. (Principal Reviewer)
Senior Scientific Advisor, Medicine and
Environmental Health Department
Research and Environmental Health
Division, Exxon Corporation
East Millstone, New Jersey

Richard Kociba, D.V.M., Ph.D.
Dow Chemical USA
Midland, Michigan

Steven R. Tannenbaum, Ph.D.
Professor, Department of Nutrition and
Food Science, Massachusetts Institute of
Technology, Cambridge, Massachusetts

David Kotelchuck, Ph.D.*
Environmental Health Science Program
Hunter School of Health Sciences
New York, New York

Bruce W. Turnbull, Ph.D.
Professor and Associate Director
College of Engineering, Cornell
University, Ithaca, New York

*Unable to attend

**SUMMARY OF PEER REVIEW COMMENTS
ON THE TOXICOLOGY AND CARCINOGENESIS STUDIES OF
METHYL METHACRYLATE**

On December 9, 1985, the draft Technical Report on the toxicology and carcinogenesis studies of methyl methacrylate received peer review by the National Toxicology Program Board of Scientific Counselors' Technical Reports Review Subcommittee and associated Panel of Experts. The review meeting was held in the Conference Center, Building 101, South Campus, National Institute of Environmental Health Sciences, Research Triangle Park, North Carolina.

Dr. P. Chan, NTP Chemical Manager, introduced the toxicology and carcinogenesis studies of methyl methacrylate by reviewing the experimental designs, results, and proposed conclusions (no evidence of carcinogenicity for rats and mice of each sex).

Dr. Scala, a principal reviewer, agreed with the conclusions as written. He said that discussion of the results of the mutagenicity tests needed a better focus regarding the results.

As second principal reviewer, Dr. Mirer agreed with the conclusions as written. He asked for comment on the significance of the dose-related increases in cytoplasmic vacuolization of the adrenal cortex and focal hyperplasia of the adrenal gland medulla in rats, with the dose-related trend most apparent in female rats. Dr. S. Eustis, NIEHS, stated that the vacuolization probably represented lipid accumulation and that the adrenal gland lesions were not considered biologically important. Dr. Mirer questioned the statement that methyl methacrylate was a weak mutagen. Dr. Chan agreed to delete the adjective.

As third principal reviewer, Dr. Swenberg also agreed with the conclusions as written. He asked that the results and discussion be expanded in the description of the olfactory epithelial degeneration, particularly with regard to the 13-week studies and any sensory nerve damage. Dr. Chan responded that the degeneration of the olfactory epithelium was observed during the 13-week studies, but nerve damage was not seen. Dr. Eustis added that the olfactory lesions, although present at high incidence in the 2-year studies, were not severe and were generally focal or multifocal, not diffuse.

Dr. Scala moved that the Technical Report on methyl methacrylate be accepted with the conclusions as written, no evidence of carcinogenicity for rats and mice of each sex. Dr. Swenberg seconded the motion, and it was approved by 10 affirmative votes with 1 abstention (Dr. Purchase).

I. INTRODUCTION

I. INTRODUCTION

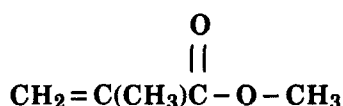

Methyl Methacrylate

CAS No. 80-62-6

$\text{C}_5\text{H}_8\text{O}_2$

Molecular weight: 100.11

Synonyms: Acrylic acid, 2-methyl-, methyl ester	Methyl-2-methylpropenoate
Methacrylic acid, methyl ester	Methyl-2-methyl-2-propenoate
Methyl α -methylacrylate	2-Methyl-2-propenoic acid methyl ester
Methyl methacrylate	MME

Methyl methacrylate is a colorless liquid with an acrid, fruity odor. The monomer is readily polymerized by light, heat, oxygen, ionizing radiation, and catalysts. It is flammable and explosive in concentrations of 2.12%-12.5% by volume in air (IARC, 1979; Sax, 1984).

TABLE 1. PHYSICAL PROPERTIES OF METHYL METHACRYLATE

Specific gravity = 0.944 at 20° C
Refractive index = 1.4142 at 20° C
Melting point = -48° C
Boiling point = 100°-101° C
Slightly soluble in water
Soluble in most organic solvents
Moderately volatile--vapor pressure = 40 mm Hg at 25.5° C
Vapor density = 3.45 (air = 1)
Flash point, open cup, 10° C

Commercial production of methyl methacrylate in the United States was first reported in 1937. Current production figures are not available. In 1975, three companies in the United States produced 248 million kilograms and Japanese companies produced 114 million kilograms. Western European countries produced 220 million kilograms in 1976 (IARC, 1979). An estimated 400 million kilograms was produced in the United States in 1982 (Gerry et al., 1983). Methyl methacrylate is produced in the United States by reacting acetone and hydrogen cyanide to form acetone cyanohydrin, which is treated with concentrated sulfuric acid. The resultant methacrylamide sulfate is reacted directly with methanol to produce crude methyl methacrylate. The crude product is purified by distillation, giving a

commercial product that is at least 99.6% pure (99.8% in the United States) (IARC, 1979).

Methyl methacrylate is used mainly as a chemical intermediate in the plastics industry. About 60% of it is used in the manufacture of polymethyl methacrylate, which is the main constituent of acrylic sheets, acrylic molding, and extrusion powders. Approximately 22% of the compound is used to produce copolymers that act as coating binders in acrylic surface coatings such as latex paint and lacquer. About 10% of the monomer is used in the manufacture of emulsion polymers such as floor polishes, textile backing coatings, paper coating, sealants, and adhesive cements. Methyl methacrylate is also used in dental and orthopedic surgery as a "bone cement" to fill space in bones and in the manufacture of dental prostheses.

Methyl methacrylate is widely used in industry and can often be found in workplace air and plant exhausts. Approximately 3.6 million kilograms of methyl methacrylate was emitted to the ambient air in the United States during 1974 (Patterson et al., 1976). Residual methyl methacrylate has been detected in commercial polystyrene plastics at a concentration of 36 mg/kg (Kleshcheva et al., 1969). Methyl methacrylate has also been found in plant sewers and waste water, in river water (Shackelford and Keith, 1976), and in drinking water (USEPA, 1975; Dowty et al., 1975). Methyl methacrylate has been found in the tissues of patients receiving "bone cement" in dental or orthopedic surgery; the highest concentration was found in the

fatty components of bone marrow (Willert et al., 1973).

Methyl methacrylate is metabolized via the citric acid cycle, which may involve the mitochondria (Bratt and Hathway, 1977). Incubated with rat liver slices in vitro, methyl methacrylate was hydroxylated to a primary alcohol, which was then oxidized to an aldehyde, and finally deformed to pyruvic acid (Pantucek, 1969). In rats, 65% of a single oral dose (5.7 mg/kg body weight) of methyl [¹⁴C]methacrylate was excreted as [¹⁴C]carbon dioxide in expired air within 2 hours and 88% within 10 days. About 1% of the administered methyl methacrylate was exhaled unchanged. A small fraction was retained, and the rest was excreted in the urine as metabolites. The urinary metabolites included [¹⁴C]methyl malonate, [¹⁴C]succinate, β-[¹⁴C]hydroxyisobutyrate, and 2-[¹⁴C]formyl propionate (Bratt and Hathway, 1977). After methyl methacrylate was administered intraperitoneally to rats (0.70 mmol/kg), mercapturic acid, thioether, and methacrylic acid were identified as urinary metabolites. These results suggest that a carboxylesterase is involved in methyl methacrylate detoxification (Delbressine et al., 1981).

In humans, methyl methacrylate has irritated the skin, eyes, or mucous membranes and caused allergic dermatitis or stomatitis (Fisher, 1954; Pegum and Medhurst, 1971). Workers in plants manufacturing methyl methacrylate have complained of headaches, pains in the extremities, fatigue, sleep disturbance, irritability, and loss of memory (IARC, 1979). The use of methyl methacrylate as bone cement in surgery has caused severe hypotension in patients, which may be followed by cardiac arrest (Lee, 1974) and even death (Kepes et al., 1972). Handlers of methyl methacrylate cement have developed paresthesia of the fingers (Fries et al., 1975; Kassis et al., 1984). Dental technicians who used bare fingers to mold and shape methyl methacrylate putty had significantly slower distal sensory conduction velocities from the digits, implicating mild axonal degeneration on the area of contact with methyl methacrylate (Sepalainen and Rajaniemi, 1984). Methyl methacrylate was used for several years in a fingernail-lengthener product; the Food and Drug

Administration obtained a preliminary injunction in 1974 against the manufacture, shipment, and sale of this product because of reported dermatologic problems. In a study of 676 workers exposed to methyl methacrylate, Makarov et al. (1981) reported that the chemical is adipogenic in women but not in men and caused hormonal disturbances, particularly in levels of insulin, somatotrophic hormone, and prolactin.

The short-term exposure limit for methyl methacrylate has been set at 125 ppm (510 mg/m³) and the maximum 8-hour time-weighted-average exposure at 100 ppm (410 mg/m³) (OSHA, 1976; ACGIH, 1981). The National Academy of Sciences has calculated that an acceptable daily intake of methyl methacrylate is 0.1 mg/kg per day (Safe Drinking Water Committee, 1977).

Animal studies showed that the toxic effects of methyl methacrylate are due to the monomer; the polymer appears to be inert. Thus, the severity of toxic reactions induced by methyl methacrylate is believed to be inversely proportional to the degree of polymerization prior to use in the tissues (Bohling et al., 1977). Methyl methacrylate applied directly to skin or eyes caused moderate skin irritation and eye injury to rabbits (Spealman et al., 1945). It is a potential sensitizer; both humans (Spealman et al., 1945) and guinea pigs (Chung and Giles, 1977) developed strong skin reactions when rechallenged with methyl methacrylate. Subcutaneous injection of methyl methacrylate (0.1 ml) to guinea pigs induced local necrosis and inflammation (Mohr, 1958). Acute inhalation (46.8 mg/liter) or oral (5 ml/kg) exposure of dogs to methyl methacrylate led to central nervous system depression, a drop in blood pressure, liver and kidney damage, and death due to respiratory arrest (Spealman et al., 1945; Homsy et al., 1972). The toxic effects of methyl methacrylate on the nervous tissues may be due to its diffusion into the nerve cells, causing lysis of the membrane lipids and destruction of the myelin sheath (Mohr, 1958). Studies in frog desheathed myelinated sciatic nerve in vitro showed that methyl methacrylate induced a dose-dependent decrease of the amplitude of the compound action potential and a hyperpolarization of the nerve membrane. Methyl methacrylate at 100 mM induced an

I. INTRODUCTION

irreversible depolarization as a result of solubilization of lipids on the myelin sheath (Bohling et al., 1977). Propulsion of glass microspheres in the oropharyngeal cavity of frogs exposed to methyl methacrylate (400 ppm) in air was significantly reduced (Tansy et al., 1980). The animal data suggest that the effects of methyl methacrylate are not cumulative (Spealman et al., 1945).

In mature male rats exposed to methyl methacrylate vapor at 116 ppm, 7 hours per day, 5 days per week for 6 months, the tracheal mucosa was denuded of cilia, and the number of microvilli on the epithelium was reduced. No other compound-related lesions were observed (Tansy et al., 1980). Degenerative changes in the liver were observed in guinea pigs and dogs exposed to methyl methacrylate vapors at 65.5 mg/liter and 46.8 mg/liter, respectively (Spealman et al., 1945).

Rats exposed to methyl methacrylate (up to 2,000 ppm) in drinking water for 2 years showed no compound-related lesions (Borzelleca et al., 1964). Dogs administered methyl methacrylate for 2 years at dietary equivalent concentrations up to 1,500 ppm dissolved in corn oil in gelatin capsules also showed no chemically related lesions. Rabbits given methyl methacrylate orally at 23 mg/kg for a total of 24 doses over a 33-day period exhibited no toxic effects (Treon et al., 1949). Dermal application of methyl methacrylate to rats, 3 days per week for 4 months, induced no local tumors (Oppenheimer et al., 1955).

Subcutaneous implants of polymerized methyl methacrylate induced local fibrosarcomas in rats (Lavorgna et al., 1972) and mice (Laskin et al., 1954). Intraperitoneal carcinomas were found in rats that had disks of methyl methacrylate implanted intraperitoneally (Oppenheimer et al., 1955). These studies were considered to be inadequate because of insufficient data on survival and pathologic effects, the small number of animals, the short duration of dosing, and the lack of controls (IARC, 1979).

Methyl methacrylate administered intraperitoneally to pregnant Sprague-Dawley rats on

days 5, 10, and 15 of pregnancy at up to 0.44 ml/kg induced a dose-related increase in gross abnormalities (hemangiomas) in the offspring and a reduction in fetal weight. Skeletal malformations were not observed (Autian, 1975; Singh et al., 1972). Methyl methacrylate (36 μ mol) in acetone, administered to chicken eggs, induced a 20% incidence of malformation in the surviving chick embryos (Korhonen et al., 1983). Pregnant rats exposed to methyl methacrylate vapor at a concentration of 110 mg/liter for 54 minutes per day on days 6 through 15 of gestation had reduced body weight and feed consumption compared with the controls. The fetuses of exposed rats had significantly lower body weight and crown-rump length, higher death rates, and increased incidences of gross (hematomas) and skeletal (delayed ossification) anomalies compared with the controls (Nicholas et al., 1979).

Methyl methacrylate at up to 1.0 mg per plate did not induce reverse mutations in a modified plate incorporation or liquid preincubation assay with *Salmonella typhimurium* strains TA1535, TA1537, TA1538, TA98, or TA100 with or without metabolic activation (Lijinsky and Andrews, 1980). Hachitani et al. (1981) and Waegemaekers and Bensink (1984) reported similar negative results with these same strains in plate tests at doses of up to 4.7 and 10.0 mg per plate, respectively. Poss et al. (1979) reported the induction of forward mutation to 8-azaguanine-resistance in *S. typhimurium* strain TM677 with methyl methacrylate exposure (50-100 mM) in the presence of phenobarbital-induced rat liver S9 using 50-100 mM, but the effect was seen only at doses that resulted in 80% cell mortality. In the bone marrow micronucleus test, methyl methacrylate administered to mice by gavage at a single dose of 250 mg/kg or at 125 mg/kg per day for 4 days did not produce an increase in micronucleated erythrocytes (Hachitani et al., 1981).

In studies conducted for NTP, methyl methacrylate at up to 10.0 mg/plate was not mutagenic in strains TA100, TA1535, TA97, or TA98 of *S. typhimurium* in the presence or absence of Aroclor 1254-induced male Sprague-Dawley rat or male Syrian hamster liver S9 when assayed with a preincubation protocol (Appendix G, Table G1). Methyl methacrylate at doses in the

I. INTRODUCTION

range of 0.125 to 1.000 $\mu\text{l/ml}$ or greater was mutagenic in L5178Y/TK^{+/-} mouse lymphoma cells in the presence or absence of Aroclor 1254-induced male F344 rat liver S9 (Tables G2 and G3). In cultured Chinese hamster ovary cells, methyl methacrylate produced a reproducible, dose-related increase in the frequency of sister-chromatid exchanges both with and without Aroclor 1254-induced male Sprague-Dawley rat S9 (Table G4). A slight dose-related increase in chromosomal aberrations was also induced in cultured Chinese hamster ovary cells in the absence of S9; in the presence of S9, an increase in the frequency of aberrations was seen only at the highest, near-lethal dose of 5 mg/ml (Table G5).

Anderson et al. (1979) reported that methyl methacrylate produced some chromosomal damage not related to dose levels in a cytogenetic study with rat bone marrow cells.

Study Rationale: Methyl methacrylate was nominated for study because of widespread human exposure, the finding that methyl methacrylate and a related compound (glycidyl methacrylate) were mutagenic (USEPA, 1979), and the inadequacy of previously conducted long-term oral, dermal, and inhalation studies. The inhalation route of exposure was chosen for the current studies because it is a major route of human exposure.

II. MATERIALS AND METHODS

**PROCUREMENT AND CHARACTERIZATION OF
METHYL METHACRYLATE**

**GENERATION OF METHYL METHACRYLATE VAPOR
SINGLE-EXPOSURE STUDIES**

ELEVEN-DAY STUDIES

TEN-DAY STUDIES

**FOURTEEN-WEEK STUDIES AT INDUSTRIAL BIOTEST
LABORATORIES**

**FOURTEEN-WEEK STUDIES AT BATTELLE PACIFIC
NORTHWEST LABORATORIES**

TWO-YEAR STUDIES

Study Design

Source and Specifications of Animals

Animal Maintenance

Clinical Examinations and Pathology

Statistical Methods

II. MATERIALS AND METHODS

PROCUREMENT AND CHARACTERIZATION OF METHYL METHACRYLATE

Methyl methacrylate containing 10 ppm of the monomethyl ether of hydroquinone as an inhibitor of polymerization was obtained from Rohm and Haas Co. in five lots (Table 2). Purity and identity analyses were conducted at Midwest Research Institute (Appendix H).

All five lots of the chemical were identified as methyl methacrylate by spectroscopy. All infrared and nuclear magnetic resonance spectra were consistent with the structure of methyl methacrylate and with literature spectra

(Appendix H). The ultraviolet/visible spectra were consistent with the structure. Cumulative data from elemental analysis and gas chromatography indicated that the purity of all lots was greater than 99%. Gas chromatographic results and water content are summarized in Table 3.

Methyl methacrylate was found to be stable for 2 weeks at 60° C (Appendix H). The methyl methacrylate study material was stored in steel drums at room temperature during the study. Results of periodic analysis of the bulk chemical at the study laboratory by infrared spectroscopy and gas chromatography indicated that methyl methacrylate was stable under these storage conditions.

TABLE 2. IDENTITY AND SOURCE OF LOTS USED IN THE INHALATION STUDIES OF METHYL METHACRYLATE

	Single-Exposure, Eleven-Day, Ten-Day, and Fourteen-Week Studies at IBT (a)	Fourteen-Week Studies at BNW (b)	Two-Year Studies
Lot Number	4-0091	4-15-014; 03-54832	6-5486; 377109
Date of Initial Use of Each Lot	N/A	For the final 33 exposures	1/28/81
Supplier	Rohm & Haas, Tennessee, Inc. (Knoxville, TN)	Rohm & Haas, Tennessee, Inc. (Knoxville, TN)	Rohm & Haas, Co. (Philadelphia, PA)

(a) IBT, Industrial Biotest Laboratories

(b) BNW, Battelle Pacific Northwest Laboratories

TABLE 3. WATER CONTENT AND GAS CHROMATOGRAPHIC RESULTS FOR METHYL METHACRYLATE

Lot Number	Percent Water	Gas Chromatographic System 1 (a)		Gas Chromatographic System 2 (b)	
		Number of Impurity Peaks	Percent Area Relative to Major Peak	Number of Impurity Peaks	Total Percent Area of Impurities Relative to Major Peak
4-0091	0.078 ± 0.003(δ)	1	0.1	(c) 6	<0.3
4-15-014	0.017 ± 0.001(δ)	1	0.05	1	0.12
03-54832	0.046 ± 0.003(δ)	2	0.16	3	0.27
6-5486	0.020 ± 0.01(δ)	None	--	3	Individual areas <0.1
377109	0.040 ± 0.002(δ)	None	--	1	<0.1

(a) Porapak Q or QS column; see Appendix H for details.

(b) SP2100 column; see Appendix H for details.

(c) Includes three peaks with relative areas less than 0.01%

II. MATERIALS AND METHODS

GENERATION OF METHYL METHACRYLATE VAPOR

During the 2-year studies, methyl methacrylate was vaporized at 50° C, diluted with air, and introduced into the chambers (Table 4; Appendix I). The uniformity of the vapor concentration in the exposure chambers was measured periodically throughout the studies. The vapor generation system is illustrated and described in Appendix I.

Methyl methacrylate concentrations were monitored on-line twice during each exposure hour, initially by a photoionization detector and later

by gas chromatographic analysis (Appendix I). Average weekly exposure concentrations for the 2-year studies are summarized in Appendix I, Figures 17-19. Mean daily concentrations were within 2% of the target concentrations (Tables 5 and 6; Appendix I). A study was performed to determine if polymer was formed from the methyl methacrylate study material in the process of generating the inhalation test atmosphere. Nuclear magnetic resonance (NMR) was used to determine polymer content. The study results determined that the maximum polymer concentration of the study material can be estimated to have been less than 0.1% of the methyl methacrylate concentration (Appendix I).

TABLE 4. GENERATION OF CHAMBER CONCENTRATIONS IN THE INHALATION STUDIES OF METHYL METHACRYLATE

	Single-Exposure, Eleven-Day, Ten-Day, and Fourteen-Week Studies at IBT (a)	Fourteen-Week Studies at BNW (b)	Two-Year Studies
Preparation	Methyl methacrylate was metered into the chamber air supply so that it was well mixed by turbulence.	Methyl methacrylate was vaporized at 100° C, diluted with air, and introduced into the chamber.	Methyl methacrylate was pumped from a stainless steel reservoir to a vaporizer by a stable micrometering pump with adjustable drift-free pump rates. The vaporizer was heated to 50° ± 2° C, and the study material vapor, along with an air stream, entered the test chamber.

(a) IBT, Industrial Biotest Laboratories

(b) BNW, Battelle Pacific Northwest Laboratories

TABLE 5. SUMMARY OF CHAMBER CONCENTRATIONS IN THE TWO-YEAR INHALATION STUDIES OF METHYL METHACRYLATE

Target Concentration (ppm)	Total Number of Readings	Mean Concentration (a) (ppm)
250	4,399	249 ± 11
500	4,482	499 ± 17
1,000	4,449	984 ± 36

(a) Mean ± standard deviation

TABLE 6. DISTRIBUTION OF MEAN DAILY CONCENTRATIONS OF METHYL METHACRYLATE DURING THE TWO-YEAR INHALATION STUDIES

Range of Concentration (percent of target)	Number of Days Mean Within Range		
	250 ppm	500 ppm	1,000 ppm
>120	0	0	0
110-120	3	2	0
100-110	209	232	199
90-100	268	252	272
80-90	10	4	19
<80	0	0	0

SINGLE-EXPOSURE STUDIES

Male and female F344/N rats and B6C3F₁ mice were obtained from Frederick Cancer Research Center. Information on the age of the animals and quarantine time was unavailable. According to the initial weights recorded, the rats were approximately 8-10 weeks old and the mice 8 weeks old when the studies began. The short-term studies conducted at Industrial Biotest Laboratories were not used in designing the 2-year studies or for evaluating the toxic potential of methyl methacrylate; they are described here for completeness of the records.

Groups of five rats and five mice of each sex were exposed to air containing methyl methacrylate at concentrations of 1,191, 2,159, 2,220, 4,055, 4,446, 4,632, or 16,000 ppm for approximately 4 hours. Rats and mice were observed daily and weighed on days 0 and 15. A necropsy was performed on animals that lived to the end of the studies. Details of animal maintenance are presented in Table 7.

ELEVEN-DAY STUDIES

Male and female F344/N rats and B6C3F₁ mice were obtained from Frederick Cancer Research Center and observed for 11 days before being placed on study. According to the weights recorded, the animals were approximately 6 weeks old when the studies began. The studies were conducted at Industrial Biotest Laboratories.

Groups of five rats and five mice of each sex were

exposed to air containing methyl methacrylate at target concentrations of 0, 500, 1,000, 2,000, 3,000, or 5,000 ppm, 6 hours per day, for a total of 10 exposures over 11 days. Rats and mice were observed daily and weighed on days 0, 4, 8, and 12. A necropsy was performed on animals that lived to the end of the studies. A histologic examination was performed on one or two male mice from the 500-, 1,000-, 2,000-, and 3,000-ppm groups. Details of animal maintenance are presented in Table 7.

TEN-DAY STUDIES

Male and female F344/N rats and B6C3F₁ mice were obtained from Frederick Cancer Research Center and observed for 12 days before being placed on study. According to body weights recorded, the rats and mice were approximately 8 weeks old when the studies began. The studies were conducted at Industrial Biotest Laboratories.

Groups of five rats and five mice of each sex were exposed to air containing methyl methacrylate at target concentrations of 0, 75, 125, 250, 500, or 1,000 ppm, 6 hours per day (only 1 hour on day 5), for nine exposures over 10 days. Rats and mice were observed daily and weighed on days 0, 4, 8, and 11. A necropsy was performed on animals that lived to the end of the studies. Five mice of each sex in the control and 1,000-ppm groups, five male mice from the 125-ppm group, and one mouse of each sex in the 500-ppm groups were examined histologically. Details of animal maintenance are presented in Table 7.

TABLE 7. EXPERIMENTAL DESIGN AND MATERIALS AND METHODS IN THE INHALATION STUDIES OF METHYL METHACRYLATE AT INDUSTRIAL BIOTEST LABORATORIES

	Single-Exposure Studies	Eleven-Day Studies	Ten-Day Studies
EXPERIMENTAL DESIGN			
Size of Study Groups	5 males and 5 females of each species	Same as single-exposure studies	Same as single-exposure studies
Doses	1,191, 2,159, 2,220, 4,055, 4,446, 4,632, or 16,000 ppm methyl methacrylate by inhalation	0, 500, 1,000, 2,000, 3,000, or 5,000 ppm methyl methacrylate by inhalation	0, 75, 125, 250, 500, or 1,000 ppm methyl methacrylate by inhalation
Date of First Exposure	10/25/76, 10/26/76, 10/27/76, 10/29/76, 11/1/76, 11/2/76, or 10/28/76	11/30/76	1/18/77
Date of Last Exposure	N/A	12/10/76	1/27/77
Duration of Exposure	Single 4-h exposure	6 h/d for a total of 10 exposures over 11 d	6 h/d for 9 d, except for d 5 (1 h only) over a 10-d period
Type and Frequency of Observation	Observations daily throughout exposure and 14-d observation period; weighed d 0 and 15	Observed 1 × d; weighed on d 0, 4, 8, and 12	Observed 1 × d; weighed on d 0, 4, 8, and 11
Necropsy and Histologic Examination	Necropsy performed on all animals that lived to the end of the studies	Necropsy performed on all animals that lived to the end of the studies. Histologic exam performed on one or two male mice from the 500-, 1,000-, 2,000-, and 3,000-ppm groups; tissues examined: heart, lung, kidneys, salivary gland, mammary gland, and nose	Necropsy performed on all animals that lived to the end of the studies. Histologic exams were not performed on rats. Five male and five female mice from the control groups and from the 1,000-ppm groups, five males from the 125-ppm group, and one of each sex from the 500-ppm groups were examined histologically. Tissues examined: lung, nasal cavity, kidneys, and nose
ANIMALS AND ANIMAL MAINTENANCE			
Strain and Species	F344/N rats; B6C3F ₁ mice	F344/N rats; B6C3F ₁ mice	F344/N rats; B6C3F ₁ mice
Animal Source	Frederick Cancer Research Center (Frederick, MD)	Same as single-exposure studies	Same as single-exposure studies
Method of Animal Identification	Not available	Not available	Ear notch
Time Held Before Study	Not available	11 d	12 d
Age When Placed on Study	8-10 wk	39 d	Approximately 8 wk
Age When Killed	10-12 wk	50 d	Approximately 10 wk
Necropsy Dates	11/9/76-11/17/76	12/11/76	1/28/77

TABLE 7. EXPERIMENTAL DESIGN AND MATERIALS AND METHODS IN THE INHALATION STUDIES OF METHYL METHACRYLATE AT INDUSTRIAL BIOTEST LABORATORIES (Continued)

	Single-Exposure Studies	Eleven-Day Studies	Ten-Day Studies
ANIMALS AND ANIMAL MAINTENANCE (Continued)			
Method of Animal Distribution	Assigned to groups such that the average group weights were approximately equal	Same as single-exposure studies	Same as single-exposure studies
Feed	Not available, but presumed to be Wayne Lab Blox®	Wayne Lab Blox® (Allied Mills, Chicago, IL); available ad libitum except during exposure periods	Same as 11-d studies
Bedding	None	None	None
Water	Automatic watering system; available ad libitum	Same as single-exposure studies	Same as single-exposure studies
Cages	Stainless steel mesh; chamber--stainless steel and glass	Same as single-exposure studies	Same as single-exposure studies
Animals per Cage	1	1	1
Other Chemicals on Study in the Same Room	Acrylonitrile and propylene oxide	Same as single-exposure studies	None
Animal Room Environment	Not available; presumed to be light 12 h/d	Not available; presumed to be light 12 h/d	Light 12 h/d

FOURTEEN-WEEK STUDIES AT INDUSTRIAL BIOTEST LABORATORIES

F344/N rats and B6C3F₁ mice were obtained from Frederick Cancer Research Center, observed for 14 days, and then assigned to groups according to a table of random numbers. Feed and water were freely available except during exposure periods when water only was available. According to body weight records, the rats and mice were approximately 8 weeks old when the studies began.

Groups of 10 rats and mice of each sex were exposed to air containing 0, 63, 125, 250, 500, or 1,000 ppm methyl methacrylate, 6 hours per day, 5 days per week for 64 exposure days (mice) or 65 exposure days (rats) over a 14-week period. Further experimental details are summarized in Table 8.

Animals were checked once per day; moribund animals were killed. Body weights were recorded weekly. Survivors were killed after 97 (rats) or 96 (mice) days. A necropsy was performed on all animals except those excessively autolyzed. Tissues and groups examined are listed in Table 8.

FOURTEEN-WEEK STUDIES AT BATTELLE PACIFIC NORTHWEST LABORATORIES

Because of the absence of clear toxicologic effects in the 14-week studies conducted at Industrial Biotest Laboratories, 14-week studies were repeated at Batelle Pacific Northwest Laboratories to determine the concentrations to be used in the 2-year studies.

TABLE 8. EXPERIMENTAL DESIGN AND MATERIALS AND METHODS IN THE INHALATION STUDIES OF METHYL METHACRYLATE AT INDUSTRIAL BIOTEST LABORATORIES AND BATTELLE PACIFIC NORTHWEST LABORATORIES

	Fourteen-Week Studies at IBT (a)	Fourteen-Week Studies at BNW (b)	Two-Year Studies
EXPERIMENTAL DESIGN			
Size of Study Groups	10 males and 10 females of each species	10 males and 10 females of each species	50 males and 50 females of each species
Doses	0, 63, 125, 250, 500, or 1,000 ppm methyl methacrylate by inhalation	0, 500, 1,000, 2,000, 3,000, or 5,000 ppm methyl methacrylate by inhalation	Male rats, male and female mice--0, 500, or 1,000 ppm methyl methacrylate by inhalation; female rats--0, 250, or 500 ppm methyl methacrylate by inhalation
Date of First Exposure	3/3/77	9/27/79	1/28/81
Date of Last Exposure	Rats--6/7/77; mice--6/6/77	1/2/80	1/14/83
Duration of Exposure	Rats--6 h/d, 5 d/wk for 65 exposures over 97 d; mice--6 h/d, 5 d/wk for 64 exposures over 96 d	6 h/d, 5 d/wk over 14 wk; rats--65 exposures; mice--64 exposures	6 h/d, 5 d/wk for 102 wk
Type and Frequency of Observation	Observed 1 × d; weighed on d 1 and 1 × wk thereafter	Observed 1 × d; weighed on d 1 and 1 × wk thereafter	Observed 2 × d, weighed 1 × wk for the first 13 wk and monthly thereafter; individual clinical exams were made at weighing
Necropsy and Histologic Examination	Necropsy performed on all animals. Histologic exams performed on all animals in the high dose and control groups and on all animals that died before the end of the studies; also performed on some animals of other dose groups.	Complete histologic examination performed on all rats exposed at 3,000 ppm, on rats and mice at 5,000 ppm, and on all controls and those dying before the end of the studies; tissues examined: nasal turbinates, lungs, liver, kidneys, brain, vagina; mice--testes, ovaries; rats--heart, thymus, skin, large intestine, small intestine, adrenal glands, urinary bladder. Nasal turbinates, larynx, trachea, lungs, and brain examined for all 1,000-ppm rats and survivors of the 2,000-ppm rats; liver (males only), lung, and nasal turbinates (females only) were examined from surviving mice at 3,000 ppm; lung, nasal turbinates, and brain were examined from surviving males at 2,000 ppm; nasal turbinates and brain from males at 1,000 ppm; nasal turbinates and lung from females at 3,000 ppm and survivors at 2,000 ppm, and nasal turbinates from females at 1,000 ppm	Necropsy and histologic examination performed on all animals; the following tissues were examined: gross lesions and tissue masses, regional lymph nodes, mandibular lymph node, sternbrae including marrow, thyroid gland, parathyroids, small intestine, rectum, colon, liver, mammary gland, prostate/testes/epididymis or ovaries/uterus, lungs and mainstem bronchi, nasal cavity and turbinates, skin, heart, esophagus, stomach, salivary gland, brain, thymus, trachea, pancreas, spleen, kidneys, adrenal glands, urinary bladder, pituitary gland, preputial or clitoral gland, and tracheobronchial lymph nodes

TABLE 8. EXPERIMENTAL DESIGN AND MATERIALS AND METHODS IN THE INHALATION STUDIES OF METHYL METHACRYLATE AT INDUSTRIAL BIOTEST LABORATORIES AND BATTELLE PACIFIC NORTHWEST LABORATORIES (Continued)

	Fourteen-Week Studies at IBT (a)	Fourteen-Week Studies at BNW (b)	Two-Year Studies
ANIMALS AND ANIMAL MAINTENANCE			
Strain and Species	F344/N rats; B6C3F ₁ mice	F344/N rats; B6C3F ₁ mice	F344/N rats; B6C3F ₁ mice
Animal Source	Frederick Cancer Research Center (Frederick, MD)	Charles River Breeding Laboratories (Portage, MI)	Charles River Breeding Laboratories (Portage, MI)
Study Laboratory	Industrial Biotest Laboratories	Battelle Pacific Northwest Laboratories	Battelle Pacific Northwest Laboratories
Method of Animal Identification	Ear notch	Ear tags	Ear tags
Time Held Before Study	14 d	34 d	22 d
Age When Placed on Study	Approximately 8 wk	9-10 wk	Rats--7-8 wk; mice--8-9 wk
Age When Killed	Approximately 22 wk	23-24 wk	Rats--111-112 wk; mice--113-114 wk
Necropsy Dates	Rats--6/8/77; mice--6/7/77	12/30/79	1/24/83-1/28/83
Method of Animal Distribution	According to a table of random numbers	According to a table of random numbers	According to tables of random numbers
Feed	Wayne LAB BLOX® (Allied Mills, Inc., Chicago, IL); available ad libitum except during inhalation exposure	Wayne LAB BLOX® rodent diet (Allied Mills, Inc., Chicago, IL); available ad libitum except during inhalation exposure	NIH 07 Rat and Mouse Ration (Zeigler Bros., Gardners, PA); until 4/23/81 and after 5/8/81. Wayne LAB BLOX® from 4/23/81 to 5/8/81. Available ad libitum except during exposure
Bedding	None	None	None
Water	Available ad libitum	Automatic watering system (Edstrom Industries, Waterford, WI); available ad libitum	Automatic watering system (Edstrom Industries, Waterford, WI); available ad libitum
Cages	Stainless steel mesh cages	Stainless steel wire cages (Harford Metal, Inc., Aberdeen, MD)	Stainless steel wire cages (Lab Products, Inc., Rochelle Park, NJ)
Animals per Cage	1	1	1
Other Chemicals on Study in Same Room	Propylene oxide	None	Ethyl chloride
Animal Room Environment	Not available	Temp--68°-80° F; humidity--47%-75%; fluorescent light 12 h/d; room air flow--1,800 ft ³ /min	Temp--72°-79° F; humidity--45%-65%; fluorescent light 12 h/d; 20 room air changes/h

(a) IBT, Industrial Biotest Laboratories

(b) BNW, Battelle Pacific Northwest Laboratories

II. MATERIALS AND METHODS

Four- to five-week-old F344/N rats and B6C3F₁ mice were obtained from Charles River Breeding Laboratories, observed for 34 days, and then assigned to groups according to a table of random numbers. Feed and water were freely available except during exposure periods when only water was available.

Groups of 10 rats and mice of each sex were exposed to air containing 0, 500, 1,000, 2,000, 3,000, or 5,000 ppm methyl methacrylate, 6 hours per day, 5 days per week for 64 (mice) or 65 (rats) exposure days over a 14-week period. Further experimental details are summarized in Table 8.

Animals were checked daily; moribund animals were killed. Individual animal weights were recorded weekly. At the end of the 14-week studies, survivors were killed. A necropsy was performed on all animals except those excessively autolyzed. Tissues and groups examined are listed in Table 8.

TWO-YEAR STUDIES

Study Design

Groups of 50 male rats and 50 mice of each sex were exposed 6 hours per day, 5 days per week, to air containing methyl methacrylate at target concentrations of 0, 500, or 1,000 ppm for 102 weeks. Groups of 50 female rats were exposed at concentrations of 0, 250, or 500 ppm on the same schedule.

Source and Specifications of Animals

The male and female F344/N rats and B6C3F₁ (C57BL/6N, female, × C3H/HeN MTV⁻, male) mice used in these studies were produced under strict barrier conditions at Charles River Breeding Laboratories under a contract to the Carcinogenesis Program. Breeding stock for the foundation colonies at the production facility originated at the National Institutes of Health Repository. Animals shipped for study were progeny of defined microflora-associated parents that were transferred from isolators to barrier-maintained rooms. Rats were shipped to the study laboratory at 4-5 weeks of age and mice, at 5-6 weeks. The animals were quarantined at the

study laboratory for 3 weeks. Thereafter, a complete necropsy was performed on five animals of each sex and species to assess their health status. The rats were placed on study at 7-8 weeks of age and the mice, at 8-9 weeks of age. Results of serologic analyses for murine viruses in control animals at the end of the studies are given in Appendix J.

A quality control skin grafting program has been in effect since early 1978 to monitor the genetic integrity of the inbred mice used to produce the hybrid B6C3F₁ study animal. In mid-1981, data were obtained that showed incompatibility between the NIH C3H reference colony and the C3H colony from a Program supplier. In August 1981, inbred parental lines of mice were further tested for genetic integrity via isozyme and protein electrophoresis profiles that demonstrate phenotype expressions of known genetic loci.

The C57BL/6 mice were homogeneous at all loci tested. Eighty-five percent of the C3H mice monitored were variant at one to three loci, indicating some heterogeneity in the C3H line from this supplier. Nevertheless, the genome of this line is more homogeneous than that of randomly bred stocks.

Male mice from the C3H colony and female mice from the C57BL/6 colony were used as parents for the hybrid B6C3F₁ mice used in these studies. The influence of the potential genetic non-uniformity in the hybrid mice on these results is not known, but results of the studies are not affected because concurrent controls were included in each study.

Animal Maintenance

Animals were housed individually in stainless steel cages within the exposure chambers. Feed and water were freely available except during exposure periods when only water was available. Details of animal maintenance are summarized in Table 8.

Clinical Examinations and Pathology

All animals were observed twice daily, and clinical signs were recorded once per week. Body weights by cage were recorded once per week for

II. MATERIALS AND METHODS

the first 13 weeks of the study and once per month thereafter. Mean body weights were calculated for each group. Animals found moribund and those surviving to the end of the studies were humanely killed. A necropsy was performed on all animals including those found dead, unless they were excessively autolyzed or cannibalized, missexed, or found missing. Thus, the number of animals from which particular organs or tissues were examined microscopically varies and is not necessarily equal to the number of animals that were placed on study.

During necropsy, all organs and tissues were examined for grossly visible lesions. Tissues were preserved in 10% neutral buffered formalin, embedded in paraffin, sectioned, and stained with hematoxylin and eosin. Three separate sections of the nasal turbinates were examined. One section was made at the level just caudal to the incisor teeth, the second section was midway between the incisors and first molar, and the third section was at the middle of the second molar. Tissues examined microscopically are listed in Table 8.

When the pathology evaluation was completed, the slides, paraffin blocks, and residual wet tissues were sent to the NTP Archives for inventory, slide/block match, and wet tissue audit. The slides, individual animal data records, and pathology tables were sent to an independent quality assessment laboratory. The individual animal records and tables were compared for accuracy, slides and tissue counts were verified, and histotechnique was evaluated. All tumor diagnoses, all target tissues, and all tissues from a randomly selected 10% of the animals were evaluated by a quality assessment pathologist. The quality assessment report and slides were submitted to the Pathology Working Group (PWG) Chairperson, who reviewed all target tissues and those about which there was a disagreement between the laboratory and quality assessment pathologists.

Representative slides selected by the Chairperson were reviewed by the PWG, which includes the laboratory pathologist, without knowledge of previously rendered diagnoses. When the consensus diagnosis of the PWG differed from

that of the laboratory pathologist, the laboratory pathologist was asked to reconsider the original diagnosis. This procedure has been described, in part, by Maronpot and Boorman (1982) and Boorman et al. (1985). The final diagnoses represent a consensus of contractor pathologists and the NTP Pathology Working Group. For subsequent analysis of pathology data, the diagnosed lesions for each tissue type are combined according to the guidelines of McConnell et al. (1986).

Slides/tissues are generally not evaluated in a blind fashion (i.e., without knowledge of dose group) unless the lesions in question are subtle or unless there is an inconsistent diagnosis of lesions by the laboratory pathologist. Nonneoplastic lesions are not examined routinely by the quality assessment pathologist or PWG unless they are considered part of the toxic effect of the chemical.

Statistical Methods

Data Recording: Data on this experiment were recorded in the Carcinogenesis Bioassay Data System (Linhart et al., 1974). The data elements include descriptive information on the chemicals, animals, experimental design, survival, body weight, and individual pathologic results, as recommended by the International Union Against Cancer (Berenblum, 1969).

Survival Analyses: The probability of survival was estimated by the product-limit procedure of Kaplan and Meier (1958) and is presented in the form of graphs. Animals were censored from the survival analyses at the time they were found dead of other than natural causes or were found to be missing; animals dying from natural causes were not censored. Statistical analyses for a possible dose-related effect on survival used the method of Cox (1972) for testing two groups for equality and Tarone's (1975) life table test for a dose-related trend. When significant survival differences were detected, additional analyses using these procedures were carried out to determine the time point at which significant differences in the survival curves were first detected. All reported P values for the survival analysis are two-sided.

II. MATERIALS AND METHODS

Calculation of Incidence: The incidence of neoplastic or nonneoplastic lesions is given as the ratio of the number of animals bearing such lesions at a specific anatomic site to the number of animals in which that site was examined. In most instances, the denominators include only those animals for which the site was examined histologically. However, when macroscopic examination was required to detect lesions (e.g., skin or mammary tumors) prior to histologic sampling, or when lesions could have appeared at multiple sites (e.g., lymphomas), the denominators consist of the number of animals on which a necropsy was performed.

Analysis of Tumor Incidence: Three statistical methods are used to analyze tumor incidence data. The two that adjust for intercurrent mortality employ the classical method for combining contingency tables developed by Mantel and Haenszel (1959). Tests of significance included pairwise comparisons of high dose and low dose groups with controls and tests for overall dose-response trends.

For studies in which compound administration has little effect on survival, the results of the three alternative analyses will generally be similar. When differing results are obtained by the three methods, the final interpretation of the data will depend on the extent to which the tumor under consideration is regarded as being the cause of death. Continuity-corrected tests are used in the analysis of tumor incidence, and reported P values are one-sided.

*Life Table Analyses--*The first method of analysis assumed that all tumors of a given type observed in animals dying before the end of the study were "fatal"; i.e., they either directly or indirectly caused the death of the animal. According to this approach, the proportions of tumor-bearing animals in the dosed and control groups were compared at each point in time at which an animal died with a tumor of interest. The denominators of these proportions were the total number of animals at risk in each group. These results, including the data from animals killed at the end of the study, were then combined by the Mantel-Haenszel method to obtain an overall P value. This method of adjusting for

intercurrent mortality is the life table method of Cox (1972) and of Tarone (1975). The underlying variable considered by this analysis is time to death due to tumor. If the tumor is rapidly lethal, then time to death due to tumor closely approximates time to tumor onset. In this case, the life table test also provides a comparison of the time-specific tumor incidences.

*Incidental Tumor Analyses--*The second method of analysis assumed that all tumors of a given type observed in animals that died before the end of the study were "incidental"; i.e., they were merely observed at necropsy in animals dying of an unrelated cause. According to this approach, the proportions of tumor-bearing animals in dosed and control groups were compared in each of five time intervals: weeks 0-52, weeks 53-78, weeks 79-92, week 93 to the week before the terminal-kill period, and the terminal-kill period. The denominators of these proportions were the number of animals on which a necropsy was actually performed during the time interval. The individual time interval comparisons were then combined by the previously described method to obtain a single overall result. (See Haseman, 1984, for the computational details of both methods.)

*Unadjusted Analyses--*Primarily, survival-adjusted methods are used to evaluate tumor incidence. In addition, the results of the Fisher exact test for pairwise comparisons and the Cochran-Armitage linear trend test (Armitage, 1971; Gart et al., 1979) are given in the appendix containing the analyses of primary tumor incidence. These two tests are based on the overall proportion of tumor-bearing animals and do not adjust for survival differences.

Historical Control Data: Although the concurrent control group is always the first and most appropriate control group used for evaluation, there are certain instances in which historical control data can be helpful in the overall assessment of tumor incidence. Consequently, control tumor incidences from the NTP historical control data base (Haseman et al., 1984) are included for those tumors appearing to show compound-related effects.

III. RESULTS

RATS

SINGLE-EXPOSURE STUDIES

ELEVEN-DAY STUDIES

TEN-DAY STUDIES

FOURTEEN-WEEK STUDIES AT INDUSTRIAL BIOTEST LABORATORIES

FOURTEEN-WEEK STUDIES AT BATTELLE PACIFIC NORTHWEST LABORATORIES

TWO-YEAR STUDIES

Body Weights and Clinical Signs

Survival

Pathology and Statistical Analyses of Results

MICE

SINGLE-EXPOSURE STUDIES

ELEVEN-DAY STUDIES

TEN-DAY STUDIES

FOURTEEN-WEEK STUDIES AT INDUSTRIAL BIOTEST LABORATORIES

FOURTEEN-WEEK STUDIES AT BATTELLE PACIFIC NORTHWEST LABORATORIES

TWO-YEAR STUDIES

Body Weights and Clinical Signs

Survival

Pathology and Statistical Analyses of Results

III. RESULTS: RATS

SINGLE-EXPOSURE STUDIES

Five of five males and 4/5 females that were exposed to methyl methacrylate at 16,000 ppm died before the end of the studies (Table 9). Rats exposed at higher concentrations gained less weight than did rats exposed at lower concentrations, although final body weights tended to be greater in groups of animals exposed at higher concentrations due to marked differences in initial weights.

Hypoactivity, dyspnea, and anesthesia were considered compound-related effects. No compound-related effects were observed at necropsy.

ELEVEN-DAY STUDIES

All rats exposed at 5,000 ppm and 2/5 females exposed at 3,000 ppm died before the end of the studies (Table 10). Ruffled fur was the only compound-related effect observed in animals that lived to the end of the studies. Final mean body weights of rats exposed at 2,000 or 3,000 ppm were 10%-19% lower than those of controls.

TEN-DAY STUDIES

None of the rats died before the end of the studies (Table 11). Final mean body weights of exposed rats were within 6% of those of the controls. No compound-related clinical signs or gross pathologic effects were observed.

TABLE 9. SURVIVAL AND MEAN BODY WEIGHTS OF RATS IN THE SINGLE-EXPOSURE INHALATION STUDIES OF METHYL METHACRYLATE

Concentration (ppm)	Survival (a)	Mean Body Weights (grams)		
		Initial (b)	Final	Change (c)
MALE				
1,191	5/5	113 ± 3	181 ± 7	+ 68 ± 4
2,159	5/5	122 ± 5	188 ± 8	+ 66 ± 4
2,220	5/5	128 ± 2	194 ± 4	+ 66 ± 2
4,055	5/5	138 ± 2	196 ± 2	+ 58 ± 1
4,446	5/5	151 ± 10	204 ± 10	+ 53 ± 2
4,632	5/5	153 ± 7	210 ± 7	+ 57 ± 3
16,000	(d) 0/5	130 ± 4	(e)	(e)
FEMALE				
1,191	5/5	87 ± 1	120 ± 2	+ 33 ± 2
2,159	5/5	104 ± 1	132 ± 2	+ 28 ± 1
2,220	5/5	103 ± 1	129 ± 2	+ 26 ± 1
4,055	5/5	113 ± 2	133 ± 2	+ 20 ± 1
4,446	5/5	106 ± 1	125 ± 2	+ 19 ± 1
4,632	5/5	110 ± 2	133 ± 2	+ 23 ± 1
16,000	(d) 1/5	99 ± 1	124	+ 23

(a) Number surviving/number initially in group

(b) Initial mean group body weight ± standard error of the mean. Subsequent calculations are based on those animals surviving to the end of the study.

(c) Mean body weight change of the survivors of the group ± standard error of the mean

(d) All deaths occurred within 1 hour of the beginning of exposure.

(e) No data are reported due to the 100% mortality in this group.

TABLE 10. SURVIVAL AND MEAN BODY WEIGHTS OF RATS IN THE ELEVEN-DAY INHALATION STUDIES OF METHYL METHACRYLATE

Concentration (ppm)	Survival (a)	Mean Body Weights (grams)			Final Weight Relative to Controls (percent)
		Initial (b)	Final	Change (c)	
MALE					
0	5/5	106 ± 3	162 ± 4	+ 56 ± 2	--
500	5/5	105 ± 3	156 ± 5	+ 51 ± 3	96
1,000	5/5	107 ± 4	158 ± 5	+ 51 ± 2	98
2,000	5/5	105 ± 3	145 ± 3	+ 40 ± 1	90
3,000	5/5	105 ± 5	131 ± 4	+ 26 ± 2	81
5,000	(d) 0/5	108 ± 2	(e)	(e)	
FEMALE					
0	5/5	91 ± 3	121 ± 2	+ 30 ± 2	--
500	5/5	90 ± 3	116 ± 4	+ 26 ± 1	96
1,000	5/5	90 ± 2	113 ± 3	+ 23 ± 1	93
2,000	5/5	88 ± 2	107 ± 3	+ 19 ± 1	88
3,000	(f) 3/5	91 ± 3	100 ± 3	+ 13 ± 1	83
5,000	(g) 0/5	91 ± 2	(e)	(e)	

- (a) Number surviving/number initially in group
 (b) Initial mean group body weight ± standard error of the mean. Subsequent calculations are based on those animals surviving to the end of the study.
 (c) Mean body weight change of the survivors ± standard error of the mean
 (d) Day of death: 1, 2, 2, 2, 3
 (e) No data are reported due to the 100% mortality in this group.
 (f) Day of death: 4, 6
 (g) Day of death: 1, 1, 2, 3, 3

TABLE 11. SURVIVAL AND MEAN BODY WEIGHTS OF RATS IN THE TEN-DAY INHALATION STUDIES OF METHYL METHACRYLATE

Concentration (ppm)	Survival (a)	Mean Body Weights (grams)			Final Weight Relative to Controls (percent)
		Initial (b)	Final	Change (c)	
MALE					
0	5/5	126 ± 5	168 ± 6	+ 42 ± 2	--
75	5/5	128 ± 4	160 ± 1	+ 32 ± 4	95
125	5/5	128 ± 3	167 ± 4	+ 39 ± 2	99
250	5/5	127 ± 5	158 ± 6	+ 31 ± 2	94
500	5/5	128 ± 6	165 ± 8	+ 37 ± 3	98
1,000	5/5	130 ± 5	163 ± 6	+ 33 ± 2	97
FEMALE					
0	5/5	103 ± 3	120 ± 3	+ 17 ± 2	--
75	5/5	103 ± 3	120 ± 3	+ 17 ± 1	100
125	5/5	103 ± 3	120 ± 1	+ 17 ± 2	100
250	5/5	103 ± 3	119 ± 3	+ 16 ± 1	99
500	5/5	104 ± 3	118 ± 3	+ 14 ± 2	98
1,000	5/5	104 ± 3	115 ± 3	+ 11 ± 2	96

- (a) Number surviving/number initially in the group
 (b) Initial mean group body weight ± standard error of the mean
 (c) Mean body weight change ± standard error of the mean

III. RESULTS: RATS

FOURTEEN-WEEK STUDIES AT INDUSTRIAL BIOTEST LABORATORIES

No compound-related deaths occurred (Table 12). Final mean body weights were not adversely affected by methyl methacrylate. No compound-related gross or microscopic pathologic effects were observed.

FOURTEEN-WEEK STUDIES AT BATTELLE PACIFIC NORTHWEST LABORATORIES

All rats exposed at 5,000 ppm, 1/10 males and 9/10 females exposed at 3,000 ppm, and 1/10 males and 3/10 females exposed at 2,000 ppm died before the end of the studies (Table 13). Final mean body weights were 20% lower than those of the controls for males and 25% lower for females exposed at 3,000 ppm and 7% and 11% lower for males and females exposed at 2,000 ppm. Compound-related clinical signs observed during the first 2 days included listlessness, serous ocular discharge, nasal discharge, and prostration. Inflammation in the nasal cavity associated with necrosis and loss of olfactory epithelium occurred in exposed male and female rats (Table 14). Changes in the nerve bundles in the submucosa could not be ascertained by light

microscopy. Other compound-related pathologic effects included follicular atrophy of the spleen in 4/10 males and bone marrow atrophy in 8/10 males in the 5,000-ppm group. Extensive cerebellar congestion and hemorrhage in the cerebellar peduncles were found in early-death females in the 3,000- and 5,000-ppm groups; malacia and gliosis of the brain were found in surviving females at 3,000 ppm and in females at 5,000 ppm which died late in the study. Malacia and gliosis were observed in 5/9 females exposed at 2,000 ppm and 1/8 females at 1,000 ppm.

Dose Selection Rationale: Because of the deaths, incidences of lesions of the nasal turbinates and brain, and weight gain depression at higher concentrations, the concentrations selected for rats for the 2-year studies were 500 and 1,000 ppm methyl methacrylate for males and 250 and 500 ppm for females. The dose selection was based entirely on the results of the 14-week studies conducted at Battelle Pacific Northwest Laboratories. The results reported by Industrial Biotest Laboratories were not used in the design of subsequent experiments or for evaluation of the toxic potential of methyl methacrylate; they are presented here for completeness of the records.

TABLE 12. SURVIVAL AND MEAN BODY WEIGHTS OF RATS IN THE FOURTEEN-WEEK INHALATION STUDIES OF METHYL METHACRYLATE AT IBT (a)

Concentration (ppm)	Survival (b)	Mean Body Weights (grams)			Final Weight Relative to Controls (percent)
		Initial (c)	Final	Change (d)	
MALE					
0	(e) 9/10	118 ± 5	302 ± 4	+ 180 ± 4	--
63	10/10	121 ± 3	298 ± 5	+ 177 ± 5	99
125	10/10	119 ± 4	300 ± 5	+ 181 ± 3	99
250	10/10	121 ± 3	282 ± 4	+ 161 ± 3	93
500	10/10	121 ± 3	300 ± 4	+ 179 ± 2	99
1,000	10/10	124 ± 3	292 ± 5	+ 168 ± 5	97
FEMALE					
0	10/10	100 ± 2	187 ± 5	+ 87 ± 4	--
63	(f) 9/10	98 ± 3	183 ± 4	+ 82 ± 4	98
125	10/10	100 ± 2	185 ± 2	+ 85 ± 2	99
250	10/10	100 ± 2	182 ± 4	+ 82 ± 3	97
500	10/10	100 ± 2	182 ± 3	+ 82 ± 3	97
1,000	10/10	102 ± 2	178 ± 3	+ 76 ± 2	95

(a) IBT, Industrial Biotest Laboratories

(b) Number surviving/number in group

(c) Initial mean group body weight ± standard error of the mean. Subsequent calculations are based on those animals surviving to the end of the study.

(d) Mean body weight change of the survivors of the group ± standard error of the mean

(e) Week of death: 3

(f) Week of death: 7

TABLE 13. SURVIVAL AND MEAN BODY WEIGHTS OF RATS IN THE FOURTEEN-WEEK INHALATION STUDIES OF METHYL METHACRYLATE AT BNW (a)

Concentration (ppm)	Survival (b)	Mean Body Weights (grams)			Final Weight Relative to Controls (percent)
		Initial (c)	Final	Change (d)	
MALE					
0	10/10	202 ± 3	334 ± 6	+ 132 ± 4	--
500	10/10	203 ± 3	329 ± 6	+ 126 ± 7	99
1,000	10/10	206 ± 3	333 ± 5	+ 127 ± 4	100
2,000	(e) 9/10	206 ± 4	309 ± 5	+ 103 ± 3	93
3,000	(f) 9/10	202 ± 4	268 ± 10	+ 67 ± 7	80
5,000	(g) 0/10	203 ± 4	(h)	(h)	(h)
FEMALE					
0	10/10	140 ± 3	199 ± 3	+ 59 ± 3	--
500	10/10	140 ± 2	193 ± 3	+ 53 ± 2	97
1,000	10/10	138 ± 2	181 ± 2	+ 43 ± 2	91
2,000	(i) 7/10	137 ± 2	178 ± 2	+ 39 ± 2	89
3,000	(j) 1/10	137 ± 3	150	+ 10	75
5,000	(k) 0/10	138 ± 2	(h)	(h)	(h)

- (a) BNW, Battelle Pacific Northwest Laboratories
 (b) Number surviving/number in group
 (c) Initial mean group body weight ± standard error of the mean. Subsequent calculations are based on those animals surviving to the end of the study.
 (d) Mean body weight change of the survivors of the group ± standard error of the mean
 (e) Week of death: 11
 (f) Week of death: 3
 (g) Week of death: 1, 1, 1, 1, 1, 1, 1, 1, 2, 2
 (h) No data are reported due to the 100% mortality in this group.
 (i) Week of death: 2, 3, 5
 (j) Week of death: 2, 2, 2, 2, 2, 2, 2, 3
 (k) Week of death: all 1

TABLE 14. INCIDENCES OF RATS WITH INFLAMMATION OF THE NASAL TURBINATES IN THE FOURTEEN-WEEK INHALATION STUDIES OF METHYL METHACRYLATE AT BNW (a)

Concentration (ppm)	Incidence and Severity
MALE	
0	0/10
1,000	Not examined
2,000	0/10
3,000	7/10--minimal to mild
5,000	10/10--mild to marked
FEMALE	
0	1/10--minimal
1,000	1/10--moderate
2,000	8/10--minimal to moderate
3,000	10/10--mild to moderate
5,000	10/10--mild to moderate

(a) BNW, Battelle Pacific Northwest Laboratories

III. RESULTS: RATS

TWO-YEAR STUDIES

Body Weights and Clinical Signs

Mean body weights of 1,000-ppm male rats were 5%-10% lower than those of the controls after

week 81 (Table 15 and Figure 1). Mean body weights of 500-ppm female rats were 6%-11% lower than those of the controls after week 73.

TABLE 15. MEAN BODY WEIGHTS AND SURVIVAL OF RATS IN THE TWO-YEAR INHALATION STUDIES OF METHYL METHACRYLATE

Weeks on Study	Control		Low Concentration			High Concentration		
	Av. Wt. (grams)	No. of Survivors	Av. Wt. (grams)	Wt. (percent of controls)	No. of Survivors	Av. Wt. (grams)	Wt. (percent of controls)	No. of Survivors
MALE								
			500 ppm			1,000 ppm		
0	153	50	151	99	50	155	101	50
1	187	50	179	96	50	182	97	50
2	214	50	214	100	50	214	100	50
3	235	50	236	100	50	237	101	50
4	256	50	256	100	50	255	100	50
5	273	50	271	99	50	269	99	50
6	285	50	284	100	50	282	99	50
7	300	50	296	99	50	295	98	50
8	313	50	308	98	50	305	97	50
9	318	50	316	99	50	316	99	50
10	320	50	329	103	50	325	102	50
11	335	50	327	98	50	331	99	50
12	342	50	338	99	50	340	99	50
13	345	50	339	97	50	339	97	50
17	371	50	362	98	50	364	98	50
21	385	50	380	99	50	375	97	50
25	399	50	391	98	50	390	98	50
29	418	50	410	99	50	398	96	50
34	428	49	422	99	50	415	97	50
39	429	49	423	99	50	418	97	50
43	435	49	429	99	50	418	98	50
47	444	49	442	100	50	429	97	50
52	454	49	448	99	50	440	97	50
56	481	48	455	99	50	442	96	50
60	487	48	480	99	50	453	97	50
65	475	47	488	98	50	458	98	49
69	477	45	489	98	50	458	98	49
73	477	45	468	98	49	460	96	49
77	475	45	463	97	48	458	96	49
81	468	41	453	97	48	439	94	47
86	467	38	443	95	45	425	91	42
89	472	37	443	94	42	424	90	40
93	470	33	446	95	38	437	93	31
98	460	28	440	96	34	435	95	29
102	451	26	439	97	30	426	94	29
FEMALE								
			250 ppm			500 ppm		
0	118	50	117	99	50	119	101	50
1	134	50	137	102	50	127	95	50
2	145	50	148	102	50	142	98	50
3	155	50	153	99	50	156	101	50
4	162	50	165	102	50	160	99	50
5	177	50	172	97	50	168	95	50
6	177	50	176	99	50	177	100	50
7	180	50	186	103	50	182	101	50
8	187	50	188	101	50	186	99	50
9	194	50	190	98	50	190	98	50
10	196	50	198	101	50	195	99	50
11	198	50	199	101	50	197	99	50
12	202	50	194	96	50	200	99	50
13	205	50	202	99	50	202	99	50
17	213	50	207	97	50	209	98	50
21	220	50	220	100	50	213	97	50
25	223	50	224	100	50	218	98	50
29	234	50	233	100	50	228	97	50
34	242	50	237	98	50	236	98	50
39	239	50	238	100	50	236	99	50
43	252	50	246	98	50	244	97	50
47	261	50	260	100	50	252	97	50
52	271	50	267	99	50	264	97	50
56	284	50	275	97	50	272	96	50
60	290	50	285	98	50	277	98	49
65	306	49	294	96	50	292	95	49
69	309	49	304	98	50	298	98	47
73	320	46	307	96	50	302	94	47
77	321	45	307	96	49	303	94	47
81	318	43	297	93	47	291	92	45
86	316	42	294	93	46	282	89	45
89	318	39	296	93	43	284	89	41
93	324	37	309	95	40	298	92	38
98	328	34	317	97	37	304	93	35
102	337	30	314	93	30	306	91	29

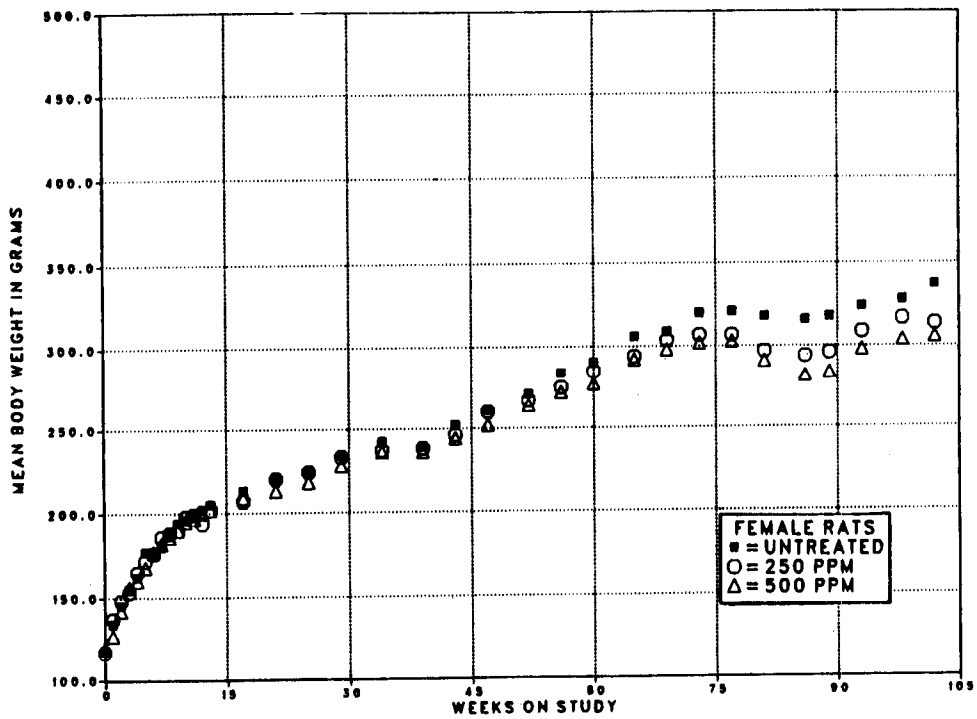
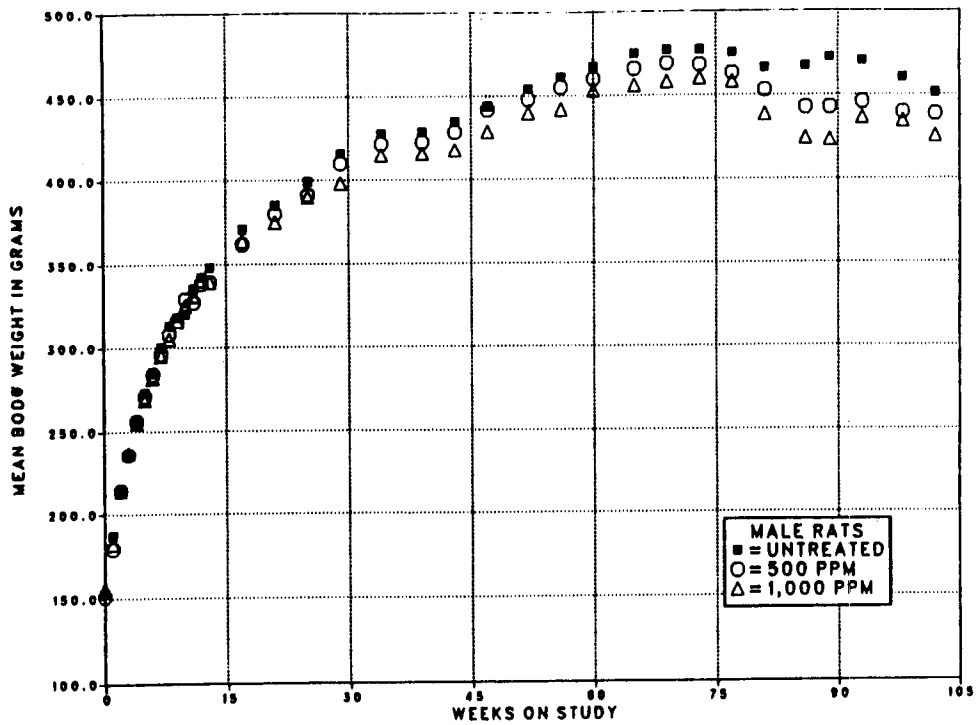

FIGURE 1. GROWTH CURVES FOR RATS EXPOSED TO METHYL METHACRYLATE BY INHALATION FOR TWO YEARS

III. RESULTS: RATS

Survival

Estimates of the probabilities of survival for male and female rats exposed to methyl methacrylate at the concentrations used in these studies and for controls are shown in the Kaplan and Meier curves in Figure 2. No significant differences in survival were observed between any groups of either sex (Table 16).

Pathology and Statistical Analyses of Results

This section describes the significant or noteworthy changes in the incidences of rats with neoplastic or nonneoplastic lesions of the

hematopoietic system, pituitary gland, preputial gland, nasal cavity, olfactory sensory epithelium, and lung. Histopathologic findings on neoplasms in rats are summarized in Appendix A (Tables A1 and A2); Appendix A (Tables A3 and A4) also gives the survival and tumor status for individual male and female rats. Findings on nonneoplastic lesions are summarized in Appendix C (Tables C1 and C2). Appendix E (Tables E1 and E2) contains the statistical analyses of those primary tumors that occurred with an incidence of at least 5% in one of the three groups. The statistical analyses used are discussed in Chapter II (Statistical Methods) and Appendix E (footnotes). Historical incidences of tumors in control animals are listed in Appendix F.

TABLE 16. SURVIVAL OF RATS IN THE TWO-YEAR INHALATION STUDIES OF METHYL METHACRYLATE

MALE (a)	Control	500 ppm	1,000 ppm
Animals initially in study	50	50	50
Nonaccidental deaths before termination (b)	23	21	22
Accidentally killed	1	0	0
Killed at termination	26	29	28
Survival P values (c)	0.761	0.547	0.792
FEMALE (a)	Control	250 ppm	500 ppm
Animals initially in study	50	50	50
Nonaccidental deaths before termination (b)	20	23	21
Killed at termination	30	27	28
Died during termination period	0	0	1
Survival P values (c)	0.978	0.924	0.917

(a) Terminal-kill period: week 104

(b) Includes animals killed in a moribund condition

(c) The result of the life table trend test is in the control column, and the results of the life table pairwise comparisons with the controls are in the dosed columns.

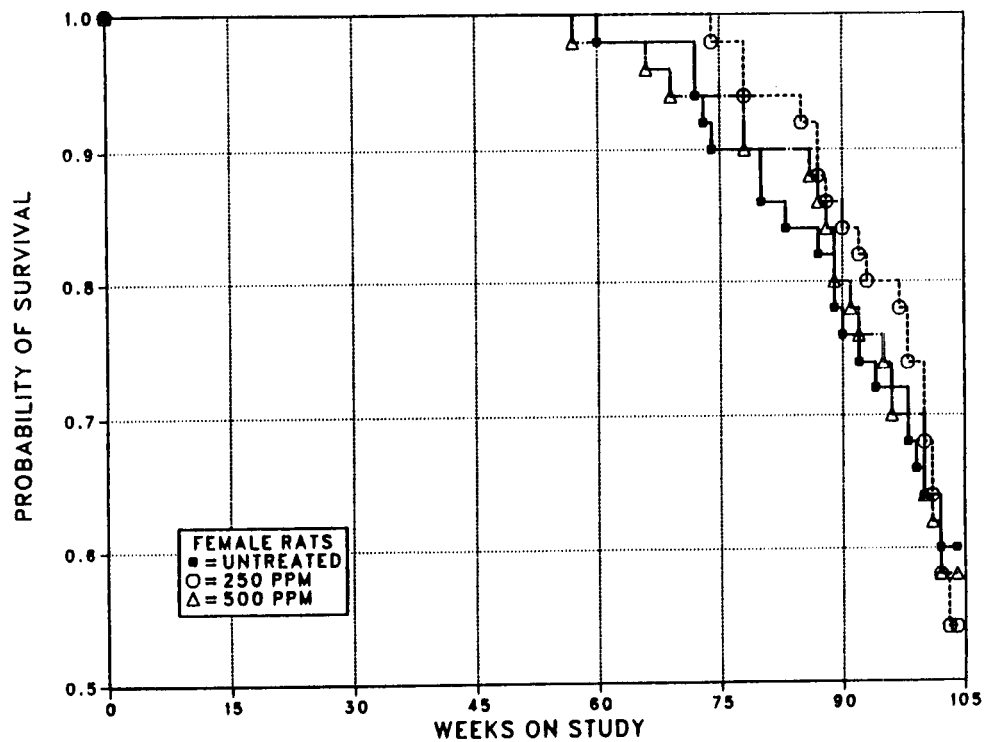
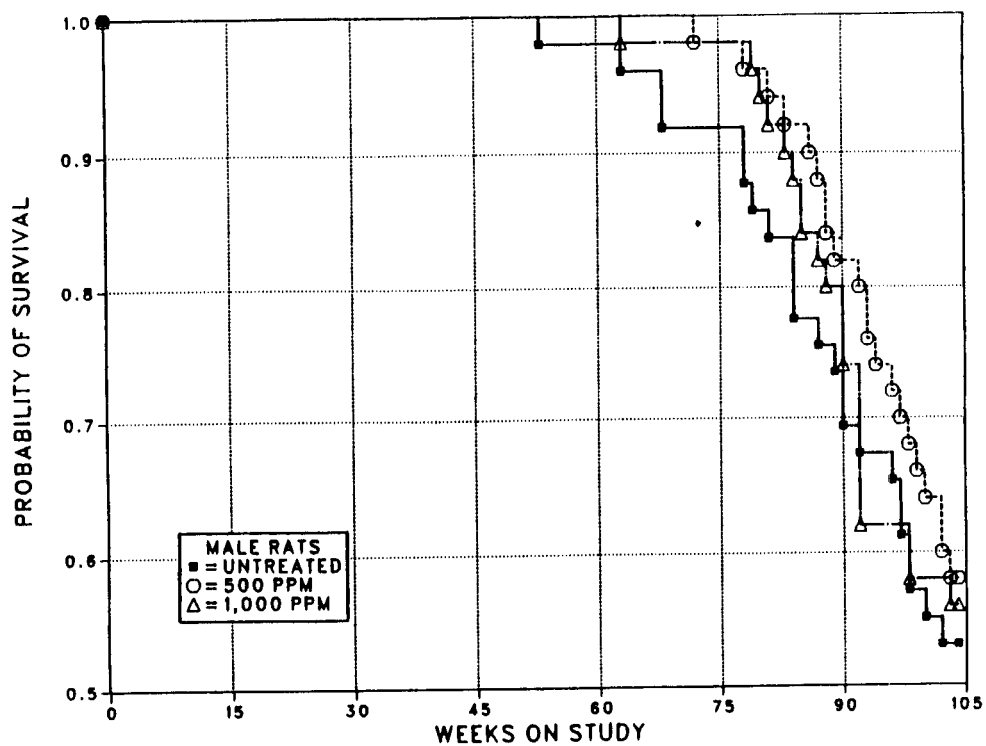

FIGURE 2. KAPLAN-MEIER SURVIVAL CURVES FOR RATS EXPOSED TO METHYL METHACRYLATE BY INHALATION FOR TWO YEARS

III. RESULTS: RATS

Hematopoietic System: Mononuclear cell leukemia in female rats occurred with a significant positive trend, and the incidence in the 500-ppm group was significantly greater than that in the controls by the incidental tumor test but not by life table analysis (Table 17). The latter test procedure is generally considered more appropriate for life-threatening lesions. The incidences of mononuclear cell leukemia in the three groups of male rats were not statistically different by life table analysis.

The mononuclear cell leukemia in female rats in the control and dosed groups was classified according to the extent of involvement of the spleen and its advancement to other organs. The following criteria were used:

Stage 1. Spleen not enlarged or only slightly enlarged with small numbers of neoplastic mononuclear cells in the red pulp; no or very few mononuclear cells in the liver sinusoids. No identifiable neoplastic cells in other organs.

Stage 2. Spleen moderately enlarged with

moderate to large numbers of mononuclear cells in the red pulp; architectural features including lymphoid follicles and periarteriolar lymphocytic sheaths remain intact. Minimal to moderate involvement of the liver. Mononuclear cells may be evident in blood vessels in other organs, but aggregates/masses of neoplastic cells generally limited to spleen and liver.

Stage 3. Advance disease with multiple organ involvement. Spleen usually markedly enlarged with effacement of normal architectural features by accumulated neoplastic cells. Liver moderately to markedly enlarged and nodular; hepatic parenchyma shows variable degenerative changes associated with the accumulation of neoplastic cells. Accumulations of neoplastic mononuclear cells in other organs including lung, lymph nodes, kidney, brain, and adrenal gland.

According to these criteria, there were no differences in the character of the mononuclear cell leukemia found in the dosed female rats and the controls (Table 18).

TABLE 17. ANALYSIS OF MONONUCLEAR CELL LEUKEMIA IN FEMALE RATS IN THE TWO-YEAR INHALATION STUDY OF METHYL METHACRYLATE (a,b)

	Control	250 ppm	500 ppm
Overall Rates	11/50 (22%)	13/50 (26%)	20/50 (40%)
Adjusted Rates	26.7%	34.3%	48.4%
Terminal Rates	2/30 (7%)	5/27 (19%)	9/29 (31%)
Week of First Observation	72	85	57
Life Table Tests	P=0.051	P=0.438	P=0.070
Incidental Tumor Tests	P=0.028	P=0.586	P=0.042

(a) The statistical analyses used are discussed in Chapter II (Statistical Methods) and Appendix E (footnotes).

(b) Historical incidence for chamber controls at study laboratory (mean \pm SD): 73/249 (29% \pm 6%); historical incidence for untreated controls in NTP studies: 375/2,021 (19% \pm 7%)

TABLE 18. CLASSIFICATION OF MONONUCLEAR CELL LEUKEMIA IN FEMALE RATS IN THE TWO-YEAR INHALATION STUDY OF METHYL METHACRYLATE

Group	Number of Animals with Mononuclear Cell Leukemia	Stage		
		1	2	3
Control	11	0	3 (27%)	8 (73%)
250 ppm	13	1 (8%)	3 (23%)	9 (69%)
500 ppm	20	3 (15%)	4 (20%)	13 (65%)

III. RESULTS: RATS

Pituitary Gland: Pituitary gland adenomas or carcinomas (combined) in male rats occurred with a significant negative trend, and the incidence in the 1,000 ppm group was significantly lower than that in the controls (Table 19). The incidences of pituitary gland adenomas in the three groups of female rats were not different statistically.

Preputial Gland: Preputial gland adenomas and carcinomas occurred in male rats with a significant negative trend, and the incidence in the high dose group was significantly lower than that in the controls (Table 19).

Nasal Cavity and Olfactory Sensory Epithelium: Serous and suppurative inflammation and degeneration of the olfactory epithelium in the nasal cavity were observed at increased incidences in exposed male and female rats relative to controls (Table 20). Serous inflammation was

characterized by noncellular mucus in the lumen of the posterior region of the nasal cavity. Suppurative inflammation was characterized by an infiltration of neutrophils and varying numbers of mononuclear cells into the mucosa and submucosa of the nasal turbinates and wall of the nasal cavity. Degeneration of the olfactory epithelium was characterized by a loss of sensory neuroepithelial cells from the epithelium (atrophy) and, in the most severely affected areas, replacement by respiratory epithelium (metaplasia). This degeneration was accompanied by variable atrophy of the nerve bundles in the submucosa.

Lung: Alveolar macrophages were observed at increased incidences in exposed male and female rats (Table 20). The severity in all groups was considered minimal. Focal or multifocal fibrosis was observed at an increased incidence in 500-ppm female rats.

TABLE 19. ANALYSIS OF PITUITARY GLAND AND PREPUTIAL GLAND TUMORS IN MALE RATS IN THE TWO-YEAR INHALATION STUDY OF METHYL METHACRYLATE

	Control	500 ppm	1,000 ppm
Pituitary Gland: Adenoma or Carcinoma			
Overall Rates	24/45 (53%)	20/47 (43%)	13/48 (27%)
Adjusted Rates	66.9%	53.5%	39.1%
Terminal Rates	14/25 (56%)	13/29 (45%)	9/27 (33%)
Week of First Observation	63	81	79
Life Table Tests	P=0.010N	P=0.132N	P=0.014N
Incidental Tumor Tests	P=0.004N	P=0.193N	P=0.011N
Preputial Gland: Adenoma or Carcinoma			
Overall Rates	5/50 (10%)	4/50 (8%)	0/50 (0%)
Adjusted Rates	14.8%	12.8%	0.0%
Terminal Rates	2/26 (8%)	3/29 (10%)	0/28 (0%)
Week of First Observation	78	97	
Life Table Tests	P=0.024N	P=0.428N	P=0.030N
Incidental Tumor Tests	P=0.029N	P=0.532N	P=0.028N

TABLE 20. INCIDENCES OF RATS WITH SELECTED NONNEOPLASTIC LESIONS IN THE TWO-YEAR INHALATION STUDIES OF METHYL METHACRYLATE

Site/Lesion	Concentration (ppm)		
MALE	Control	500	1,000
Nasal cavity			
Serous inflammation	0/50	37/50	44/50
Suppurative inflammation	11/50	21/50	30/50
Olfactory sensory epithelium			
Degeneration	7/50	39/50	42/50
Lung			
Alveolar macrophages	6/49	20/49	16/50
Focal or multifocal fibrosis	6/49	6/49	5/50
FEMALE	Control	250	500
Nasal cavity			
Serous inflammation	4/50	17/50	32/50
Suppurative inflammation	7/50	12/50	12/50
Olfactory sensory epithelium			
Degeneration	2/50	39/50	44/50
Lung			
Alveolar macrophages	9/50	14/50	16/50
Focal or multifocal fibrosis	1/50	2/50	7/50

III. RESULTS: MICE

SINGLE-EXPOSURE STUDIES

All the mice that were exposed to methyl methacrylate at 16,000 ppm died before the end of the studies (Table 21). Final mean body weights of mice were not affected by exposure to methyl methacrylate. Hypoactivity, dyspnea, and anesthesia were considered compound-related effects. No compound-related effects were observed at necropsy.

ELEVEN-DAY STUDIES

Deaths occurred in all exposed groups of male

mice; all animals exposed at 5,000 ppm died (Table 22). The final mean body weights of exposed mice were not concentration related. Dyspnea and redness and swelling of the nasal region were compound-related effects. No compound-related effects were observed at necropsy.

TEN-DAY STUDIES

None of the exposed mice died before the end of the studies (Table 23). Final mean body weights of exposed mice were not adversely affected. No compound-related gross or microscopic pathologic effects were observed.

TABLE 21. SURVIVAL AND MEAN BODY WEIGHTS OF MICE IN THE SINGLE-EXPOSURE INHALATION STUDIES OF METHYL METHACRYLATE

Concentration (ppm)	Survival (a)	Mean Body Weights (grams)		
		Initial (b)	Final	Change (c)
MALE				
1,191	(d) 4/5	23.4 ± 0.5	26.3 ± 0.5	+ 2.8 ± 0.3
2,159	5/5	23.2 ± 0.2	26.0 ± 0.6	+ 2.8 ± 0.5
2,220	5/5	22.2 ± 0.6	26.2 ± 0.6	+ 4.0 ± 0.0
4,055	5/5	23.0 ± 0.6	25.4 ± 0.7	+ 2.4 ± 0.5
4,446	(e) 4/5	23.8 ± 1.1	25.3 ± 0.9	+ 1.3 ± 0.6
4,632	5/5	23.2 ± 0.2	27.8 ± 0.4	+ 4.6 ± 0.5
16,000	(f) 0/5	21.8 ± 0.5	(g)	(g)
FEMALE				
1,191	5/5	16.6 ± 0.4	19.6 ± 0.2	+ 3.0 ± 0.5
2,159	5/5	17.6 ± 0.4	20.4 ± 0.2	+ 2.8 ± 0.2
2,220	5/5	17.2 ± 0.2	21.0 ± 0.8	+ 3.8 ± 0.9
4,055	(e) 4/5	17.6 ± 0.4	21.0 ± 0.4	+ 3.0 ± 0.4
4,446	5/5	17.8 ± 0.4	21.2 ± 0.2	+ 3.4 ± 0.4
4,632	5/5	20.0 ± 0.4	23.8 ± 0.5	+ 3.8 ± 0.8
16,000	(f) 0/5	17.4 ± 0.2	(g)	(g)

(a) Number surviving/number initially in group

(b) Initial mean group body weight ± standard error of the mean. Subsequent calculations are based on those animals surviving to the end of the study.

(c) Mean body weight change of the survivors of the group ± standard error of the mean

(d) Day of death: 7

(e) Day of death: 1

(f) All deaths occurred within 1 hour of the beginning of exposure.

(g) No data are reported due to the 100% mortality in this group.

TABLE 22. SURVIVAL AND MEAN BODY WEIGHTS OF MICE IN THE ELEVEN-DAY INHALATION STUDIES OF METHYL METHACRYLATE

Concentration (ppm)	Survival (a)	Mean Body Weights (grams)			Final Weight Relative to Controls (percent)
		Initial (b)	Final	Change (c)	
MALE					
0	5/5	23.8 ± 1.2	25.6 ± 0.6	+ 1.8 ± 0.7	--
500	(d) 3/5	22.2 ± 0.7	25.0 ± 0	+ 2.0 ± 1.0	97.7
1,000	(e) 4/5	22.8 ± 0.7	24.8 ± 0.5	+ 2.0 ± 0.4	96.9
2,000	(f) 2/5	23.0 ± 0.9	22.5 ± 0.5	+ 1.5 ± 0.5	87.9
3,000	(g) 1/5	22.4 ± 1.0	25.0	0.0	97.7
5,000	(h) 0/5	22.2 ± 0.2	(i)	(i)	(i)
FEMALE					
0	5/5	17.6 ± 0.7	22.4 ± 0.5	+ 4.8 ± 0.4	--
500	5/5	18.0 ± 0.7	22.4 ± 0.7	+ 4.4 ± 0.5	100.0
1,000	5/5	18.6 ± 0.5	20.8 ± 0.4	+ 2.2 ± 0.4	92.9
2,000	5/5	18.2 ± 0.6	20.8 ± 0.7	+ 2.6 ± 0.5	92.9
3,000	5/5	18.6 ± 0.4	22.0 ± 0.6	+ 3.4 ± 0.5	98.2
5,000	(j) 0/5	17.6 ± 0.5	(i)	(i)	(i)

(a) Number surviving/number initially in group
 (b) Initial mean group body weight ± standard error of the mean. Subsequent calculations are based on those animals surviving to the end of the study.
 (c) Mean body weight change of the survivors ± standard error of the mean
 (d) Day of death: 8, 9
 (e) Day of death: 8
 (f) Day of death: 6, 8, 10
 (g) Day of death: 2, 3, 6, 8
 (h) Day of death: 1, 1, 1, 2, 2
 (i) No data are reported due to the 100% mortality in this group.
 (j) Day of death: all 1

TABLE 23. SURVIVAL AND MEAN BODY WEIGHTS OF MICE IN THE TEN-DAY INHALATION STUDIES OF METHYL METHACRYLATE

Concentration (ppm)	Survival (a)	Mean Body Weights (grams)			Final Weight Relative to Controls (percent)
		Initial (b)	Final	Change (c)	
MALE					
0	(d) 4/5	23.8 ± 0.6	23.3 ± 0.3	- 0.8 ± 0.6	--
75	5/5	24.0 ± 0.3	24.8 ± 0.4	+ 0.8 ± 0.4	106.4
125	5/5	23.8 ± 0.5	21.8 ± 0.4	- 2.0 ± 0.7	93.6
250	5/5	23.0 ± 0.5	24.0 ± 0.3	+ 1.0 ± 0.3	103.0
500	5/5	23.8 ± 0.6	24.4 ± 0.5	+ 0.6 ± 0.2	104.7
1,000	5/5	23.8 ± 0.6	25.8 ± 0.7	+ 2.0 ± 0.5	110.7
FEMALE					
0	5/5	17.8 ± 0.6	19.2 ± 0.6	+ 1.4 ± 0.2	--
75	5/5	19.0 ± 0.5	19.6 ± 0.2	+ 0.6 ± 0.4	102.1
125	5/5	17.0 ± 0.6	18.8 ± 0.2	+ 1.8 ± 0.5	97.9
250	5/5	17.6 ± 1.0	19.6 ± 0.2	+ 2.0 ± 0.8	102.1
500	5/5	17.8 ± 0.2	20.6 ± 1.2	+ 2.8 ± 1.1	107.3
1,000	5/5	18.6 ± 0.7	20.2 ± 0.5	+ 1.6 ± 0.2	105.2

(a) Number surviving/number initially in the group
 (b) Initial mean group body weight ± standard error of the mean. Subsequent calculations are based on those animals surviving to the end of the study.
 (c) Mean body weight change of the survivors of the group ± standard error of the mean
 (d) Day of death: 10

III. RESULTS: MICE

FOURTEEN-WEEK STUDIES AT INDUSTRIAL BIOTEST LABORATORIES

No compound-related deaths occurred, except for one male in the 500-ppm group (Table 24). The final mean body weight for males that were exposed at 1,000 ppm was 7% lower than that of the controls. No compound-related gross or microscopic pathologic effects were observed.

FOURTEEN-WEEK STUDIES AT BATTELLE PACIFIC NORTHWEST LABORATORIES

Eight of 10 males and 8/10 females exposed at 5,000 ppm, 4/10 males exposed at 3,000 ppm, and 2/10 males and 1/10 females exposed at 2,000 ppm died before the end of the studies (Table 25). The final mean body weights of all groups of exposed male mice were lower than that of the

controls by 13%-27%. The final mean body weights of all groups of exposed female mice were lower than that of the controls by 6%-18%. Compound-related effects in mice included renal cortical necrosis, cortical tubular degeneration and/or focal mineralization, inflammation with necrosis and loss of olfactory epithelium in the nasal cavity, extensive liver necrosis in males, and inflammation of the nasal turbinates in females (Table 26). All mice exposed to methyl methacrylate had metaplasia of the nasal epithelium.

Dose Selection Rationale: Because of deaths and histopathologic lesions of the nasal turbinates and kidney which were observed at higher concentrations, the concentrations selected for mice for the 2-year studies were 500 and 1,000 ppm methyl methacrylate.

TABLE 24. SURVIVAL AND MEAN BODY WEIGHTS OF MICE IN THE FOURTEEN-WEEK INHALATION STUDIES OF METHYL METHACRYLATE AT IBT (a)

Concentration (ppm)	Survival (b)	Mean Body Weights (grams)			Final Weight Relative to Controls (percent)
		Initial (c)	Final	Change (d)	
MALE					
0	10/10	22.7 ± 0.5	31.0 ± 0.5	+ 8.3 ± 0.4	--
63	10/10	22.9 ± 0.3	31.7 ± 0.6	+ 8.8 ± 0.4	102.3
125	10/10	22.9 ± 0.4	31.6 ± 0.5	+ 8.7 ± 0.5	101.9
250	10/10	23.0 ± 0.4	30.1 ± 0.6	+ 7.1 ± 0.6	97.1
500	(e) 9/10	23.0 ± 0.3	29.4 ± 0.2	+ 6.7 ± 0.4	94.8
1,000	10/10	23.4 ± 0.3	28.7 ± 0.4	+ 5.3 ± 0.3	92.6
FEMALE					
0	10/10	17.8 ± 0.4	26.7 ± 0.8	+ 8.9 ± 0.6	--
63	10/10	17.9 ± 0.4	25.7 ± 0.4	+ 7.8 ± 0.4	96.3
125	10/10	18.0 ± 0.4	26.8 ± 0.4	+ 8.8 ± 0.4	100.4
250	10/10	17.9 ± 0.3	26.1 ± 0.4	+ 8.2 ± 0.2	97.8
500	10/10	18.2 ± 0.4	26.2 ± 0.4	+ 8.0 ± 0.2	98.1
1,000	10/10	18.3 ± 0.3	25.5 ± 0.5	+ 7.2 ± 0.2	95.5

(a) IBT, Industrial Biotest Laboratories

(b) Number surviving/number in group

(c) Initial mean group body weight ± standard error of the mean. Subsequent calculations are based on those animals surviving to the end of the study.

(d) Mean body weight change ± standard error of the mean

(e) Week of death: 1

TABLE 25. SURVIVAL AND MEAN BODY WEIGHTS OF MICE IN THE FOURTEEN-WEEK INHALATION STUDIES OF METHYL METHACRYLATE AT BNW (a)

Concentration (ppm)	Survival (b)	Mean Body Weights (grams)			Final Weight Relative to Controls (percent)
		Initial (c)	Final	Change (d)	
MALE					
0	10/10	28.6 ± 0.6	34.9 ± 0.8	+ 6.3 ± 0.4	--
500	10/10	27.7 ± 0.5	30.3 ± 0.6	+ 2.6 ± 0.3	86.8
1,000	10/10	27.7 ± 0.5	29.2 ± 0.5	+ 1.5 ± 0.5	83.7
2,000	(e) 8/10	28.8 ± 0.8	28.5 ± 0.5	- 0.5 ± 0.9	81.7
3,000	(f) 6/10	27.8 ± 0.7	27.7 ± 1.1	- 0.5 ± 0.2	79.4
5,000	(g) 2/10	29.2 ± 0.4	25.5 ± 0.5	- 2.0 ± 1.0	73.1
FEMALE					
0	10/10	22.2 ± 0.5	28.5 ± 0.6	+ 6.3 ± 0.6	--
500	10/10	22.8 ± 0.3	26.9 ± 0.3	+ 4.1 ± 0.3	94.4
1,000	10/10	21.9 ± 0.4	26.7 ± 0.4	+ 4.8 ± 0.6	93.7
2,000	(h) 9/10	21.8 ± 0.6	25.1 ± 0.8	+ 3.2 ± 0.7	88.1
3,000	10/10	22.8 ± 0.5	25.1 ± 0.4	+ 2.3 ± 0.6	88.1
5,000	(i) 2/10	23.2 ± 0.5	23.5 ± 0.5	- 0.5 ± 0.5	82.5

(a) BNW, Battelle Pacific Northwest Laboratories

(b) Number surviving/number in group

(c) Initial mean group body weight ± standard error of the mean. Subsequent calculations are based on those animals surviving to the end of the study.

(d) Mean body weight change of the survivors of the group ± standard error of the mean

(e) Week of death: 1, 2

(f) Week of death: all 2

(g) Week of death: 1, 1, 1, 1, 2, 2, 10, 10

(h) Week of death: 2

(i) Week of death: 1, 1, 1, 1, 1, 4, 5, 5

TABLE 26. INCIDENCES OF MICE WITH LESIONS IN THE FOURTEEN-WEEK INHALATION STUDIES OF METHYL METHACRYLATE AT BNW (a)

Site/Lesion	Concentration (ppm)			
	0	2,000	3,000	5,000
MALE				
Kidney				
Cortical necrosis, cortical tubular degeneration, and/or focal mineralization	0/10	1/10	3/10	5/10
Nasal turbinates				
Inflammation	0/10	4/10	5/10	8/10
Nasal epithelium				
Metaplasia	0/10	10/10	10/10	10/10
Liver				
Extensive necrosis	0/10	(b)	0/10	3/10
FEMALE				
Nasal turbinates				
Inflammation	0/10	5/10	4/10	8/10
Nasal epithelium				
Metaplasia	0/10	10/10	10/10	10/10

(a) BNW, Battelle Pacific Northwest Laboratories

(b) Only two early-death animals were examined; necrosis was not observed.

III. RESULTS: MICE

TWO-YEAR STUDIES

Body Weights and Clinical Signs

Mean body weights of exposed male and female mice were lower than those of the controls throughout most of the studies (Table 27 and

Figure 3). At necropsy, an animal in the 500-ppm female group was found to be a male. The animal was discarded, and microscopic examination of tissues was not performed.

TABLE 27. MEAN BODY WEIGHTS AND SURVIVAL OF MICE IN THE TWO-YEAR INHALATION STUDIES OF METHYL METHACRYLATE

Weeks on Study	Control		500 ppm			1,000 ppm		
	Av. Wt. (grams)	No. of Survivors	Av. Wt. (grams)	Wt. (percent of controls)	No. of Survivors	Av. Wt. (grams)	Wt. (percent of controls)	No. of Survivors
MALE								
0	24.8	50	23.2	94	50	24.4	98	50
1	25.2	50	24.3	96	50	24.4	97	50
2	27.0	50	25.4	94	49	23.2	86	49
3	26.6	50	27.2	101	49	28.1	105	48
4	28.2	50	26.9	95	49	26.8	95	48
5	28.6	50	27.8	97	49	27.7	97	48
6	28.6	50	29.2	102	49	26.7	93	48
7	28.6	50	29.6	103	49	28.6	100	48
8	29.5	50	29.6	100	49	27.5	93	48
9	31.2	50	30.2	97	49	29.1	93	48
10	30.8	50	29.2	95	49	29.3	95	48
11	30.2	50	32.4	107	49	30.0	99	48
12	31.8	50	30.7	97	49	31.7	100	48
13	31.4	50	31.0	99	49	29.9	95	48
17	32.5	50	31.6	97	49	29.9	92	48
21	33.3	50	31.1	93	49	29.7	89	48
25	35.7	50	31.7	89	49	30.5	85	48
29	35.3	50	32.5	92	49	30.2	86	48
34	37.2	50	33.3	90	49	31.3	84	48
39	38.2	50	31.6	83	49	32.1	84	48
43	40.2	50	33.9	84	49	33.1	82	48
47	36.0	50	33.3	93	49	32.9	91	48
52	39.2	50	32.9	84	49	33.4	85	48
56	40.2	50	33.2	83	49	33.3	83	48
60	38.3	50	34.1	89	49	31.9	83	48
65	40.6	50	32.8	81	49	33.6	83	48
69	41.2	50	33.6	82	49	34.1	83	48
73	40.7	50	33.9	83	48	33.8	83	48
77	39.8	50	35.0	88	48	35.0	88	48
81	40.5	50	36.1	89	46	34.8	86	48
86	42.3	49	34.5	82	46	35.0	83	47
89	41.2	47	36.3	88	45	36.5	89	47
93	39.4	47	34.9	89	45	35.6	90	47
96	40.6	45	36.2	89	43	35.6	88	47
102	37.3	45	34.3	92	43	34.9	94	47
FEMALE								
0	19.2	50	19.4	101	50	20.0	104	50
1	21.7	49	22.1	102	50	21.7	100	50
2	22.3	49	22.9	103	49	22.7	102	50
3	23.5	49	25.6	109	49	22.6	96	50
4	24.5	49	23.4	98	49	18.2	66	50
5	24.0	49	23.2	97	49	24.3	101	48
6	24.9	49	27.2	109	49	25.6	103	48
7	22.3	49	25.4	114	49	25.8	116	48
8	24.7	49	25.2	102	49	26.5	104	48
9	23.6	49	26.9	114	49	26.2	112	48
10	26.1	49	27.6	108	49	27.3	108	48
11	26.4	49	26.5	100	48	27.3	103	48
12	27.8	49	27.9	100	48	24.5	88	48
13	27.4	49	28.1	103	48	28.1	103	48
17	28.6	49	28.6	101	48	28.4	99	48
21	26.9	49	33.1	123	48	29.2	109	48
25	29.3	49	30.4	104	48	29.3	100	48
29	29.3	49	29.0	99	48	28.3	97	47
34	31.7	49	30.1	95	47	30.3	96	47
39	32.7	49	28.8	88	47	29.0	89	46
43	34.8	49	29.4	84	47	28.8	83	46
47	33.9	49	30.0	88	47	30.7	91	46
52	34.0	49	31.4	92	47	30.9	91	46
56	33.7	49	30.2	90	47	30.3	90	45
60	33.7	49	31.5	93	47	30.4	90	45
65	35.3	48	30.8	87	47	31.6	90	43
69	36.2	48	32.5	90	47	31.1	86	43
73	37.6	47	32.6	87	47	31.3	83	43
77	37.1	47	33.7	91	45	32.0	86	43
81	37.4	45	33.5	90	45	31.8	84	42
86	37.0	40	33.5	91	41	32.0	86	42
89	36.9	38	33.4	91	40	32.8	89	40
93	36.7	35	32.9	90	36	31.1	85	38
96	35.7	32	34.1	96	29	32.7	92	36
102	34.7	29	32.9	95	27	32.4	93	35

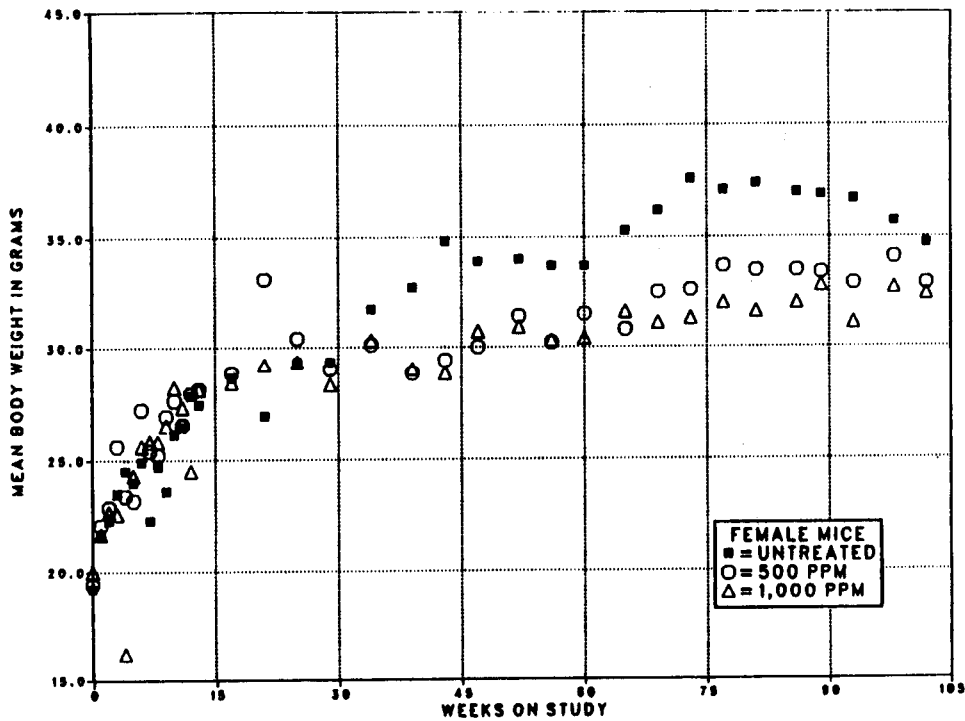
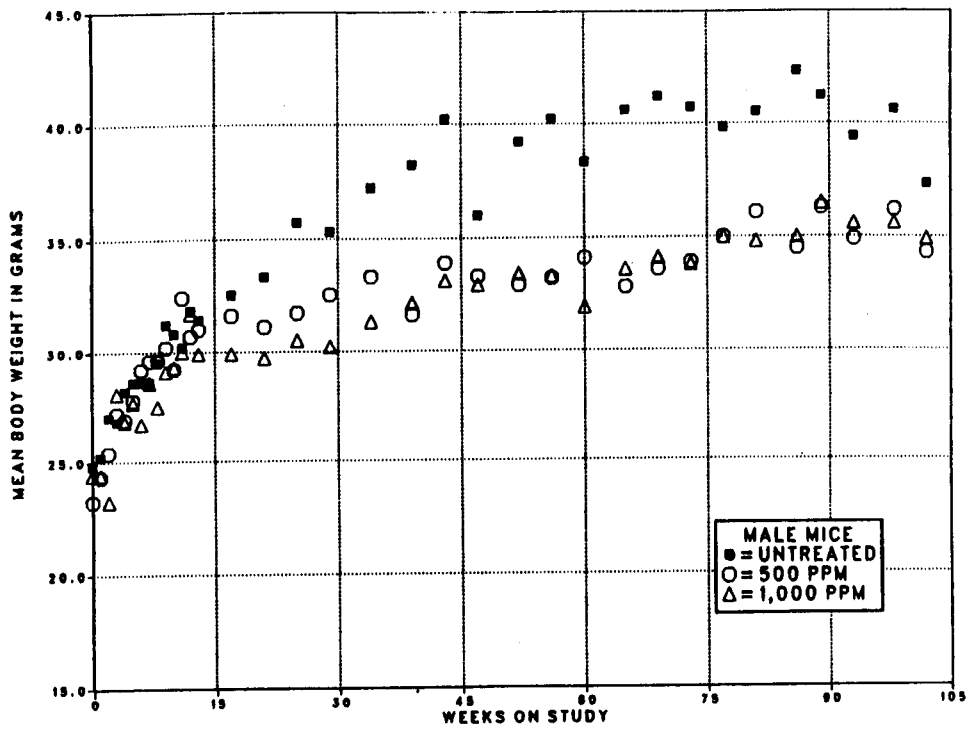

FIGURE 3. GROWTH CURVES FOR MICE EXPOSED TO METHYL METHACRYLATE BY INHALATION FOR TWO YEARS

III. RESULTS: MICE

Survival

Estimates of the probabilities of survival for male and female mice exposed to methyl methacrylate at the concentrations used in these studies and for controls are shown in the Kaplan and Meier curves in Figure 4. No significant differences in survival were observed between any groups of either sex (Table 28).

Pathology and Statistical Analyses of Results

This section describes the significant or noteworthy changes in the incidences of mice with neoplastic or nonneoplastic lesions of the nasal

cavity, nasal mucosa, olfactory sensory epithelium, uterus, lung, pituitary gland, and liver. Histopathologic findings on neoplasms in mice are summarized in Appendix B (Tables B1 and B2); Appendix B (Tables B3 and B4) also gives the survival and tumor status for individual male and female mice. Findings on nonneoplastic lesions are summarized in Appendix D (Tables D1 and D2). Appendix E (Tables E3 and E4) contains the statistical analyses of those primary tumors that occurred with an incidence of at least 5% in one of the three groups. The statistical analyses used are discussed in Chapter II (Statistical Methods) and Appendix E (footnotes). Historical incidences of tumors in control animals are listed in Appendix F.

TABLE 28. SURVIVAL OF MICE IN THE TWO-YEAR INHALATION STUDIES OF METHYL METHACRYLATE

	Control	500 ppm	1,000 ppm
MALE (a)			
Animals initially in study	50	50	50
Nonaccidental deaths before termination (b)	6	8	3
Killed at termination	42	42	47
Died during termination period	2	0	0
Survival P values (c)	0.472	0.718	0.517
FEMALE (a)			
Animals initially in study	50	50	50
Nonaccidental deaths before termination (b)	22	21	16
Accidentally killed	1	2	1
Animals missexed	0	1	0
Killed at termination	27	26	33
Survival P values (c)	0.319	0.987	0.352

(a) Terminal-kill period: week 104

(b) Includes animals killed in a moribund condition

(c) The result of the life table trend test is in the control column, and the results of the life table pairwise comparisons with the controls are in the dosed columns.

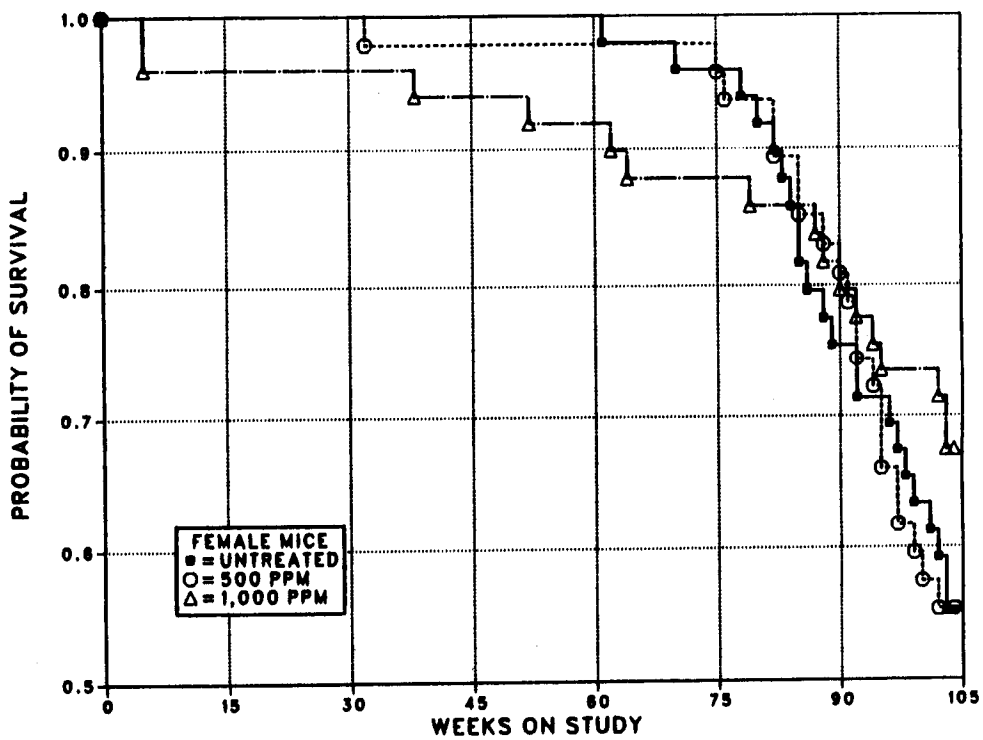
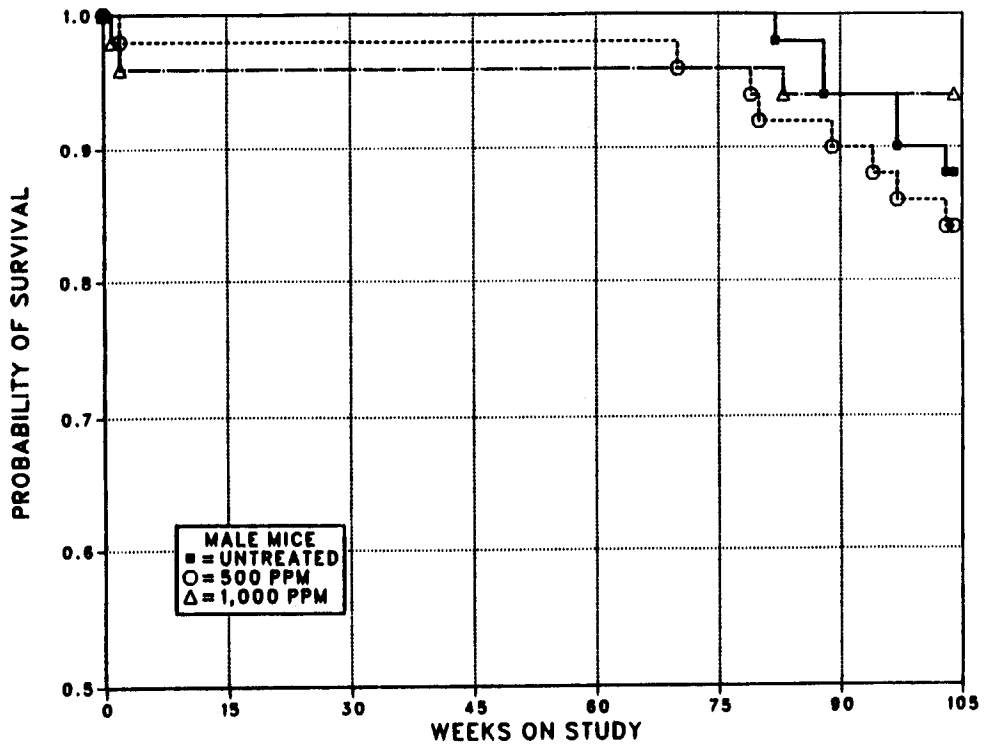

FIGURE 4. KAPLAN-MEIER SURVIVAL CURVES FOR MICE EXPOSED TO METHYL METHACRYLATE BY INHALATION FOR TWO YEARS

III. RESULTS: MICE

Nasal Cavity and Olfactory Sensory Epithelium: Acute and chronic inflammation, epithelial hyperplasia, cytoplasmic inclusions in the epithelial cells, and degeneration of the olfactory epithelium in the nasal cavity occurred at greater incidences in exposed male and female mice relative to controls (Table 29). The inflammation was characterized by infiltration of varying numbers of neutrophils, lymphocytes, and macrophages into the mucosa and submucosa of the turbinates and wall of the nasal cavity. Neutrophils and cellular debris were often present in the lumens of submucosal glands, and a suppurative exudate was sometimes present in the lumen of the nasal cavity. Epithelial hyperplasia consisted of increased numbers of submucosal glands in the nasal septum and naso- and

ethmoid turbinates. Accumulation of homogeneous, eosinophilic material in the cytoplasm of cells, primarily of the respiratory epithelium (cytoplasmic inclusions), was more severe and frequent in exposed mice. Degeneration of the olfactory epithelium was similar to that occurring in exposed rats and was characterized by loss of sensory neuroepithelial cells, focal or multifocal replacement by respiratory epithelium, and atrophy of nerve bundles in the submucosa.

Uterus: Adenocarcinomas occurred in female mice with a significant negative trend (control, 3/48, 6%; low dose, 0/47; high dose, 0/47; $P=0.042$, incidental tumor test), but the incidences in the two dosed groups were not significantly different from those in the controls.

TABLE 29. INCIDENCES OF MICE WITH SELECTED NONNEOPLASTIC LESIONS IN THE TWO-YEAR INHALATION STUDIES OF METHYL METHACRYLATE

Site/Lesion	Concentration (ppm)		
	0	500	1,000
MALE			
Nasal cavity			
Acute/chronic inflammation	1/50	37/50	42/50
Epithelial hyperplasia	2/50	44/50	46/50
Nasal mucosa			
Cytoplasmic inclusion	14/50	46/50	46/50
Olfactory sensory epithelium			
Degeneration	0/50	48/50	48/50
Lung			
Interstitial inflammation	1/50	0/50	8/50
FEMALE			
Nasal cavity			
Acute/chronic inflammation	2/50	42/49	45/50
Epithelial hyperplasia	1/50	43/49	47/50
Nasal mucosa			
Cytoplasmic inclusion	24/50	44/49	46/50
Olfactory sensory epithelium			
Degeneration	2/50	44/49	47/50
Lung			
Interstitial inflammation	0/49	0/49	1/50

III. RESULTS: MICE

Lung: Interstitial inflammation was observed at an increased incidence in 1,000-ppm male mice (Table 29). Alveolar/bronchiolar adenomas and alveolar/bronchiolar adenomas or carcinomas (combined) occurred with significant negative trends in male mice, and the incidences in the exposed male mice were significantly lower than those in the controls (Table 30).

Pituitary Gland: Adenomas and adenomas or adenocarcinomas (combined) in female mice occurred with significant negative trends, and the incidences in the exposed groups were significantly lower than those in the controls (Table 31).

TABLE 30. ANALYSIS OF LUNG TUMORS IN MALE MICE IN THE TWO-YEAR INHALATION STUDY OF METHYL METHACRYLATE (a)

	Control	500 ppm	1,000 ppm
Alveolar/Bronchiolar Adenoma			
Overall Rates	10/50 (20%)	1/50 (2%)	3/50 (6%)
Adjusted Rates	22.0%	2.4%	6.4%
Terminal Rates	9/44 (20%)	1/42 (2%)	3/47 (6%)
Week of First Observation	82	104	104
Life Table Tests	P=0.011N	P=0.007N	P=0.030N
Incidental Tumor Tests	P=0.013N	P=0.007N	P=0.040N
Alveolar/Bronchiolar Carcinoma			
Overall Rates	3/50 (6%)	0/50 (0%)	1/50 (2%)
Alveolar/Bronchiolar Adenoma or Carcinoma (b)			
Overall Rates	11/50 (22%)	1/50 (2%)	4/50 (8%)
Adjusted Rates	24.3%	2.4%	8.5%
Terminal Rates	10/44 (23%)	1/42 (2%)	4/47 (9%)
Week of First Observation	82	104	104
Life Table Tests	P=0.015N	P=0.004N	P=0.037N
Incidental Tumor Tests	P=0.017N	P=0.004N	P=0.047N

(a) The statistical analyses used are discussed in Chapter II (Statistical Methods) and Appendix E (footnotes).

(b) Historical incidence at study laboratory (mean \pm SD): 53/249 (21% \pm 10%); historical incidence in NTP studies: 351/2,080 (17% \pm 8%)

TABLE 31. ANALYSIS OF PITUITARY GLAND TUMORS IN FEMALE MICE IN THE TWO-YEAR INHALATION STUDY OF METHYL METHACRYLATE

	Control	500 ppm	1,000 ppm
Adenoma			
Overall Rates	12/49 (24%)	3/44 (7%)	1/39 (3%)
Adjusted Rates	37.9%	11.5%	3.6%
Terminal Rates	7/26 (27%)	3/26 (12%)	1/28 (4%)
Week of First Observation	85	104	104
Life Table Tests	P<0.001N	P=0.016N	P=0.001N
Incidental Tumor Tests	P<0.001N	P=0.015N	P=0.006N
Adenocarcinoma			
Overall Rates	0/49 (0%)	0/44 (0%)	1/39 (3%)
Adenoma or Adenocarcinoma (a)			
Overall Rates	12/49 (24%)	3/44 (7%)	2/39 (5%)
Adjusted Rates	37.9%	11.5%	6.1%
Terminal Rates	7/26 (27%)	3/26 (12%)	1/28 (4%)
Week of First Observation	85	104	94
Life Table Tests	P=0.001N	P=0.016N	P=0.004N
Incidental Tumor Tests	P=0.004N	P=0.015N	P=0.020N

(a) Historical incidence at study laboratory (mean \pm SD): 45/227 (20% \pm 9%); historical incidence in NTP studies: 190/1,815 (10% \pm 10%)

III. RESULTS: MICE

Liver: Hepatocellular adenomas and hepatocellular adenomas or carcinomas (combined) in exposed males and females occurred with significant negative trends; the incidences of

hepatocellular adenomas in high dose males and of hepatocellular adenomas or carcinomas (combined) in exposed males were significantly lower than those in the controls (Table 32).

TABLE 32. ANALYSIS OF LIVER TUMORS IN MICE IN THE TWO-YEAR INHALATION STUDIES OF METHYL METHACRYLATE

	Control	500 ppm	1,000 ppm
MALE			
Hepatocellular Adenoma			
Overall Rates	9/50 (18%)	3/48 (6%)	2/49 (4%)
Adjusted Rates	20.5%	7.3%	4.3%
Terminal Rates	9/44 (20%)	3/41 (7%)	2/46 (4%)
Week of First Observation	104	104	104
Life Table Tests	P=0.011N	P=0.078N	P=0.023N
Incidental Tumor Tests	P=0.011N	P=0.078N	P=0.023N
Hepatocellular Carcinoma			
Overall Rates	8/50 (16%)	4/48 (8%)	5/49 (10%)
Hepatocellular Adenoma or Carcinoma (a)			
Overall Rates	16/50 (32%)	7/48 (15%)	7/49 (14%)
Adjusted Rates	33.9%	16.1%	15.2%
Terminal Rates	13/44 (30%)	5/41 (12%)	7/46 (15%)
Week of First Observation	82	89	104
Life Table Tests	P=0.016N	P=0.050N	P=0.025N
Incidental Tumor Tests	P=0.043N	P=0.048N	P=0.072N
FEMALE			
Hepatocellular Adenoma			
Overall Rates	7/50 (14%)	2/48 (4%)	2/49 (4%)
Adjusted Rates	22.4%	7.4%	6.1%
Terminal Rates	5/27 (19%)	1/26 (4%)	2/33 (6%)
Week of First Observation	84	102	104
Life Table Tests	P=0.028N	P=0.094N	P=0.050N
Incidental Tumor Tests	P=0.046N	P=0.100N	P=0.079N
Hepatocellular Carcinoma			
Overall Rates	0/50 (0%)	2/48 (4%)	1/49 (2%)
Hepatocellular Adenoma or Carcinoma (b)			
Overall Rates	7/50 (14%)	4/48 (8%)	2/49 (4%)
Adjusted Rates	22.4%	13.5%	6.1%
Terminal Rates	5/27 (19%)	2/26 (8%)	2/33 (6%)
Week of First Observation	84	91	104
Life Table Tests	P=0.036N	P=0.285N	P=0.050N
Incidental Tumor Tests	P=0.066N	P=0.309N	P=0.079N

(a) Historical incidence at study laboratory (mean \pm SD): 83/249 (33% \pm 7%); historical incidence in NTP studies: 627/2,084 (30% \pm 8%)

(b) Historical incidence at study laboratory (mean \pm SD): 19/248 (8% \pm 4%); historical incidence in NTP studies: 181/2,080 (9% \pm 5%)

IV. DISCUSSION AND CONCLUSIONS

IV. DISCUSSION AND CONCLUSIONS

A series of short-term inhalation toxicity studies of methyl methacrylate, including 14-week studies, were conducted at Industrial Biotest Laboratories. The results of those studies were disregarded in setting exposure concentrations of methyl methacrylate for the 2-year studies. The 14-week studies were repeated at Battelle Pacific Northwest Laboratories, and inflammation associated with necrosis and loss of olfactory epithelium was observed in the nasal cavity of exposed rats and mice. In addition, malacia and gliosis of the brain were found in exposed rats, and renal cortical necrosis, cortical tubular degeneration, liver necrosis, and nasal epithelial metaplasia were observed in exposed mice. Based on the deaths, body weights, and lesions observed in the 14-week studies, the concentrations of methyl methacrylate selected for the 2-year studies were 0, 250, and 500 ppm for female rats and 0, 500, and 1,000 ppm for male rats, male mice, and female mice.

In the 2-year studies, the body weights of the male and female rats exposed to methyl methacrylate at the low or high concentrations were slightly lower (about 5%) than those of the controls during the first 1½ years of the studies. During the last half year, the body weights of the 500-ppm male rats were within 5% of those of the controls; those of the high-exposure male rats and the two groups of exposed female rats were about 5%-10% lower. Survival rates of the exposed and control male and female rats were comparable (see Table 16).

The body weights of the exposed male and female mice were about 10% lower than those of the controls throughout the 2-year period, although at times their body weights were as much as 17%-18% lower than the controls. The survival rates of the exposed male and female mice and the controls were similar (see Table 28). However, the survival of the 1,000-ppm male mice (94%) was unusually high. Although historical survival rates of control male B6C3F₁ mice in inhalation studies are not available, Haseman et al. (1985) reported that, in recent 2-year NTP carcinogenesis studies, the overall survival rate was 74% for untreated male B6C3F₁ mice and 67% for corn oil gavage control male B6C3F₁ mice.

A positive trend in the incidences of mononuclear cell leukemia was observed in the female rats exposed to methyl methacrylate, and the incidence in the 500-ppm female rats was greater than that in the controls (control, 11/50; low dose, 13/50; high dose, 20/50). Mononuclear cell leukemia develops spontaneously in Fischer rats of both sexes (Moloney et al., 1970). The overall NTP historical incidence of mononuclear cell leukemia in untreated control female F344/N rats is 18.6% (375/2,021) with a range of 6%-38% (Appendix F, Table F1). The historical incidence of mononuclear cell leukemia in female F344/N rats in inhalation control studies at Battelle Pacific Northwest Laboratories is 29.3% (73/249) with a range of 22%-36% (Table F1). In the present studies, the incidence of mononuclear cell leukemia in the female control rats was 22%; this is the lowest incidence observed at this laboratory. The incidence (40%) observed for this neoplasm in the 500-ppm female rats was slightly greater than the upper range observed for the untreated controls in both the overall NTP studies (38%) and in studies at this laboratory (36%). The slight increase in mononuclear cell leukemia in the 500-ppm female rats is not considered biologically significant, since life table tests, the most appropriate method of analyses for this life-threatening neoplasm, show that the increase was not significant; classification of the leukemia into three stages of severity shows that there were no differences in the characteristics of the leukemia between the dosed female rats and the controls (see Table 18); and an increased incidence was not observed in the 1,000-ppm male rats.

Increased incidences of serous and suppurative inflammation of the nasal cavity were observed in methyl methacrylate-exposed male and female rats. Degeneration of the olfactory sensory epithelium, characterized by loss of neuroepithelial cells, was also observed in exposed male and female rats. In exposed male and female mice, inflammation of the nasal cavity, epithelial hyperplasia in the nasal mucosa (increased number of submucosal glands), and degenerative changes of the olfactory sensory epithelium were observed. In addition, methyl methacrylate caused interstitial inflammation of the lung in high dose male mice.

IV. DISCUSSION AND CONCLUSIONS

In humans, methyl methacrylate has been reported to cause allergic dermatitis and stomatitis (Fisher, 1954; Pegum and Medhurst, 1971; Lee, 1974). Paresthesia of the fingers developed in persons who handled methyl methacrylate cement (Fries et al., 1975; Kassis et al., 1984). Dental technicians who handled methyl methacrylate without wearing gloves had significantly lower distal sensory conduction velocities from the digits, which indicated axonal degeneration in areas of the hand directly in contact with methyl methacrylate (Seppalainen and Rajaniemi, 1984). In experimental studies, methyl methacrylate induced degenerative changes of the myelin sheath of nerve cells by disrupting the lipids in the membrane bilayers and caused cell membrane lipid dissolution (Mohr, 1958). In the present inhalation studies, the nasal cavity of rats and mice was in direct contact with methyl methacrylate vapor. The damage to the olfactory sensory epithelium in the nasal cavity observed in exposed rats and mice confirmed that degenerative changes occur in tissues in direct contact with the chemical. However, long-term exposure to methyl methacrylate appears to cause no preneoplastic or neoplastic lesions in the respiratory system of rats and mice.

Significant negative trends occurred in the incidences of pituitary gland and preputial gland adenomas and adenomas or carcinomas (combined) in male rats, of alveolar/bronchiolar adenomas in male mice, of pituitary gland and uterine adenocarcinomas in female mice, and of hepatocellular adenomas in male and female mice. The overall incidence of tumors in the exposed mice was also notably lower than that in the control mice (Appendix B, Tables B1 and B2). Diet restriction and lower body weight have been associated with lower tumor incidence (Tucker, 1979; Haseman et al., 1984). In the present studies, the body weights were lower in exposed rats and mice compared with the controls. Further work is required to understand

the inhibitory effects of methyl methacrylate on the development of spontaneous tumors in F344/N rats and B6C3F₁ mice.

Results from NTP studies indicate that methyl methacrylate is mutagenic for mammalian cells in culture, both with and without metabolic activation, but nonmutagenic for bacteria. An increased frequency of forward mutations was observed in the mouse lymphoma assay in both the presence and absence of S9. However, the response in the presence of S9 was proportional to dose, increased throughout the entire dose range tested, and was observed at lower doses than in the absence of S9. This finding suggests that a metabolite of methyl methacrylate may be contributing to its activity in the mouse lymphoma assay. Increases in the frequencies of chromosomal aberrations and sister-chromatid exchanges in Chinese hamster ovary (CHO) cells were also observed in both the presence and absence of S9. The reproducible dose-related increases in chromosomal aberrations observed at lower concentrations in the absence of S9 are a more convincing indicator of methyl methacrylate's clastogenic activity than the very pronounced increase in aberrations observed only at the highest, and toxic, dose in the presence of S9. These results indicate that methyl methacrylate per se has limited mutagenic activity, but some mutagenic metabolite may also be produced by cultured mammalian cells.

Conclusions: Under the conditions of these 2-year inhalation studies, there was *no evidence of carcinogenicity** of methyl methacrylate for male F344/N rats exposed at 500 or 1,000 ppm, for female F344/N rats exposed at 250 or 500 ppm, or for male and female B6C3F₁ mice exposed at 500 or 1,000 ppm. Inhalation of methyl methacrylate was associated with inflammation of the nasal cavity and degeneration of the olfactory sensory epithelium in male and female rats and mice; epithelial hyperplasia of the nasal cavity was also observed in exposed mice.

*Categories of evidence of carcinogenicity are defined in the Note to the Reader on page 2.

A summary of the Peer Review comments and the public discussion on this Technical Report appears on page 15.

V. REFERENCES

V. REFERENCES

1. American Council of Governmental and Industrial Hygienists (ACGIH) (1981) *Threshold Limit Values for Chemical Substances and Physical Agents in the Workroom Environment*. Cincinnati, OH: ACGIH.
2. Anderson, D.; Longstaff, E.; Ashby, J. (1979) An assessment of the carcinogenic and mutagenic potential of methyl methacrylate. *Toxicol. Appl. Pharmacol.* 48:A29 (Abstr).
3. Armitage, P. (1971) *Statistical Methods in Medical Research*. New York: John Wiley & Sons, Inc., pp. 362-365.
4. Autian, J. (1975) Structure-toxicity relationships of acrylic monomers. *Environ. Health Perspect.* 11:141-152.
5. Berenblum, I., Ed. (1969) *Carcinogenicity Testing: A Report of the Panel on Carcinogenicity of the Cancer Research Commission of UICC, Vol. 2*. Geneva: International Union Against Cancer.
6. Bohling, H.; Borchard, U.; Drouin, H. (1977) Monomeric methylmethacrylate (MMA) acts on the desheathed myelinated nerve and on the node of Ranvier. *Arch. Toxicol.* 38:307-314.
7. Boorman, G.A.; Montgomery, C.A., Jr.; Eustis, S.L.; Wolfe, M.J.; McConnell, E.E.; Hardisty, J.F. (1985) Quality assurance in pathology for rodent carcinogenicity studies. Milman, H.; Weisburger, E., Eds.: *Handbook of Carcinogen Testing*. Park Ridge, NJ: Noyes Publications, pp. 345-357.
8. Borzelleca, J.; Larson, P.; Hennigar, G., Jr.; Huf, E.; Crawford, E.; Smith, R., Jr. (1964) Studies on the chronic oral toxicity of monomeric ethyl acrylate and methyl methacrylate. *Toxicol. Appl. Pharmacol.* 6:29-36.
9. Bratt, H.; Hathway, D. (1977) Fate of methyl methacrylate in rats. *Br. J. Cancer* 36:114-119.
10. Chung, C.; Giles, A., Jr. (1977) Sensitization potentials of methyl, ethyl, and *n*-butyl methacrylates and mutual cross-sensitivity in guinea pigs. *J. Invest. Dermatol.* 68:187-190.
11. Clive, D.; Johnson, K.; Spector, J.; Batson, A.; Brown, M. (1979) Validation and characterization of the L5178Y/TK[±] mouse lymphoma mutagen assay system. *Mutat. Res.* 59:61-108.
12. Cox, D. (1972) Regression models and life tables. *J. R. Stat. Soc.* B34:187-220.
13. Decker, J.; Moss, O.; Kay, B. (1982) Controlled-delivery vapor generator for animal exposures. *Am. Ind. Hyg. Assoc. J.* 43:400-402.
14. Delbressine, L.; Seutter-Berlage, F.; Seutter, E. (1981) Identification of urinary mercapturic acids formed from acrylate, methacrylate, and crotonate in the rat. *Xenobiotica* 11:241-247.
15. Dowty, B.; Carlisle, D.; Laseter, J. (1975) New Orleans drinking water sources tested by gas chromatography-mass spectrometry. Occurrence and origin of aromatic and halogenated aliphatic hydrocarbons. *Environ. Sci. Technol.* 9:762-765.
16. Fisher, A. (1954) Allergic sensitization of the skin and oral mucosa to acrylic denture materials. *J. Am. Med. Assoc.* 156:238-242.
17. Fries, I.; Fisher, A.; Salvati, E. (1975) Contact dermatitis in surgeons from methylmethacrylate bone cement. *J. Bone Jt. Surg.* 57A:547-549.
18. Gakhokikze, A. (1947) Condensation of ketones with esters of organic acids. I. Condensation of acetone with esters of formic, acetic, and propionic acids. *J. Gen. Chem. USSR* 17:1327-1331.
19. Gallant, R. (1968) *Hydrocarbon Process*. *Petrol. Refiner* 47:223-229.
20. Galloway, S.; Bloom, A.; Resnick, M.; Margolin, B.; Nakamura, F.; Archer, P.; Zeiger, E. (1985) Development of a standard protocol for in vitro cytogenetic testing with Chinese hamster ovary cells: Comparison of results for 22 compounds in two laboratories. *Environ. Mutagen.* 7:1-51.

21. Gart, J.; Chu, K.; Tarone, R. (1979) Statistical issues in interpretation of chronic bioassay tests for carcinogenicity. *J. Natl. Cancer Inst.* 62:957-974.
22. Gerry, R.; Bakker, J.; Shimosato, J. (1983) Methyl methacrylate. *Chemical Economics Handbook*. Stanford, CA: Stanford Research Institute International, Section 674.5421 I.
23. Hachitani, N.; Takeya, A.; Takazawa, Y. (1981) Mutagenicity study on environmental substances. 3. Ames test and mouse bone marrow micronucleus test on acrylic resin monomer and other additives. *Nippon Koshu Eisei Zasshi* 29:236-239.
24. Haseman, J. (1984) Statistical issues in the design, analysis and interpretation of animal carcinogenicity studies. *Environ. Health Perspect.* 58:385-392.
25. Haseman, J.; Huff, J.; Boorman, G. (1984) Use of historical control data in carcinogenicity studies in rodents. *Toxicol. Pathol.* 12:126-135.
26. Haseman, J.; Huff, J.; Rao, G.; Arnold, J.; Boorman, G.; McConnell, E. (1985) Neoplasms observed in untreated and corn oil gavage control groups of F344/N rats and (C57BL/6N × C3H/HeN)₁ (B6C3F₁) mice. *J. Natl. Cancer Inst.* 75:975-984.
27. Haworth, S.; Lawlor, T.; Mortelmans, K.; Speck, W.; Zeiger, E. (1983) Salmonella mutagenicity test results for 250 chemicals. *Environ. Mutagen. (Suppl. 1)* 5:3-142.
28. Homsy, C.; Tullos, H.; Anderson, M.; Diferante, N.; King, J. (1972) Some physiological aspects of prosthesis stabilization with acrylic polymer. *Clin. Orthop. Relat. Res.* 83:317-328.
29. International Agency for Research on Cancer (IARC) (1979) Methyl methacrylate and polymethyl methacrylate. *IARC Monographs on the Evaluation of the Carcinogenic Risk of Chemicals to Humans*, Vol. 19. Lyon, France: IARC, pp. 187-211.
30. Kaplan, E.; Meier, P. (1958) Nonparametric estimation of incomplete observations. *J. Am. Stat. Assoc.* 53:457-481.
31. Kassis, V.; Vedel, P.; Darre, E. (1984) Contact dermatitis to methyl methacrylate. *Contact Dermatitis* 11:26-28.
32. Kepes, E.; Underwood, P.; Beesey, L. (1972) Intraoperative death associated with acrylic bone cement. *J. Am. Med. Assoc.* 222:576-577.
33. Kleshcheva, M.; Balandina, V.; Usacheva, V.; Koroleva, L. (1969) Determination of the residual monomer content in some polystyrene plastics by gas chromatography. *Vysokomol. Soedin., Ser. A*, 11:2595-2597. (Chem. Abstr. 72:55912r)
34. Korhonen, A.; Hemminki, K.; Vainio, H. (1983) Embryotoxic effects of acrolein, methacrylates, guanidines and resorcinol on three day chicken embryos. *Acta. Pharmacol. Toxicol.* 52:95-99.
35. Laskin, D.; Robinson, I.; Weinmann, J. (1954) Experimental production of sarcomas by methyl methacrylate implants. *Proc. Soc. Exp. Biol. Med.* 87:329-332.
36. Lavorgna, J.; Burstein, N.; Schiller, A.; Harris, W. (1972) The carcinogenesis of plastics used in orthopedic surgery. An assessment of the incidence in rats and the possible relevance to man. *Clin. Orthop. Relat. Res.* 88:223-227.
37. Lee, D. (1974) Possible hazards of methacrylate monomer. *Br. Med. J.* 1:126.
38. Lijinsky, W.; Andrews, A. (1980) Mutagenicity of vinyl compounds in *Salmonella typhimurium*. *Teratog. Carcinog. Mutag.* 1:259-267.
39. Linhart, M.; Cooper, J.; Martin, R.; Page, N.; Peters, J. (1974) Carcinogenesis bioassay data system. *Comp. Biomed. Res.* 7:230-248.
40. Makarov, I.; Makarenko, K.; Desjatnikova, N. (1981) Adipogenic effect of some industrial poisons. *Gig. Trud. Prof. Zabol.* 12:29-31.
41. Mantel, N.; Haenszel, W. (1959) Statistical aspects of the analysis of data from retrospective studies of disease. *J. Natl. Cancer Inst.* 22:719-748.

V. REFERENCES

42. Maronpot, R.; Boorman, G. (1982) Interpretation of rodent hepatocellular proliferative alterations and hepatocellular tumors in chemical safety assessment. *Toxicol. Pathol.* 10:71-80.
43. McConnell, E.; Solleveld, H.; Swenberg, J.; Boorman, G. (1986) Guidelines for combining neoplasms for evaluation of rodent carcinogenesis studies. *J. Natl. Cancer Inst.* 76:283-289.
44. Mohr, H. (1958) Pathologic anatomy and causal genesis of tissue changes due to autopolymerizing methacrylate. *Z. Ges. Exp. Med.* 130:41-69.
45. Moloney, W.; Boschetti, A.; King, V. (1970) Spontaneous leukemia in Fischer rats. *Cancer Res.* 30:41-43.
46. National Cancer Institute (NCI) (1976) Guidelines for Carcinogen Bioassay in Small Rodents. NCI Carcinogenesis Technical Report Series No. 1. U.S. Department of Health, Education, and Welfare, Public Health Service, National Institutes of Health.
47. National Institutes of Health (NIH) (1978) NIH Specification, NIH-11-133f, November 1.
48. Nicholas, C.; Lawrence, W.; Autian, J. (1979) Embryotoxicity and fetotoxicity from maternal inhalation of methyl methacrylate monomer in rats. *Toxicol. Appl. Pharmacol.* 50:451-458.
49. Occupational Safety and Health Administration (OSHA) (1976) Occupational Safety and Health Standards. Subpart Z--Toxic and Hazardous Substances. U.S. Code Fed. Reg., Title 29, Ch. XVII, Sec. 1910.1000, p. 31:8303.
50. Oppenheimer, B.; Oppenheimer, E.; Danishefsky, I.; Stout, A.; Eirich, F. (1955) Further studies of polymers as carcinogenic agents in animals. *Cancer Res.* 15:333-340.
51. Pantucek, M. (1969) On the metabolic pathway of methylmethacrylate. *FEBS Lett.* 2:206-208.
52. Patterson, R.; Bornstein, M.; Garshick, E. (1976) Assessment of Methyl Methacrylate as a Potential Air Pollution Problem, Vol. IX. Contract No. 68-02-1337, Task 8. Research Triangle Park, NC: U.S. Environmental Protection Agency. Springfield, VA: National Technical Information Service, No. PB-258361.
53. Pegum, J.; Medhurst, F. (1971) Contact dermatitis from penetration of rubber gloves by acrylic monomer. *Br. Med. J.* 2:141-143.
54. Poss, R.; Thilly, W.; Kaden, D. (1979) Methylmethacrylate is a mutagen for *Salmonella typhimurium*. *J. Bone Jt. Surg.* 61A:1203-1207.
55. Sadtler Standard Spectra, Sadtler Research Laboratories, Philadelphia, PA, IR No. 2226; NMR 10507.
56. Safe Drinking Water Committee (1977) Drinking Water and Health. Washington, DC: National Academy of Sciences, pp. 745-747.
57. Sax, N. (1984) Dangerous Properties of Industrial Materials, 6th ed. New York: Van Nostrand Reinhold, pp. 1870-1871.
58. Seppalainen, A.; Rajaniemi, R. (1984) Local neurotoxicity of methyl methacrylate among dental technicians. *Am. J. Ind. Med.* 5:471-477.
59. Shackelford, W.; Keith, L. (1976) Frequency of Organic Compounds Identified in Water. EPA-600/4-76-062. Athens, GA: U.S. Environmental Protection Agency, p. 153.
60. Singh, A.; Lawrence, W.; Autian, J. (1972) Embryonic-fetal toxicity and teratogenic effects of a group of methacrylate esters in rats. *J. Dent. Res.* 51:1632-1638.
61. Spealman, C.; Main, R.; Haag, H.; Larson, P. (1945) Monomeric methyl methacrylate. Studies on toxicity. *Ind. Med.* 14:292-298.

V. REFERENCES

62. Tansy, M.; Hohenleitner, F.; White, D.; Oberly, R.; Landin, W.; Kendall, F. (1980) Chronic biological effects of methyl methacrylate vapor. III. Histopathology, blood chemistries, and hepatic and ciliary function in the rat. *Environ. Res.* 21:117-125.
63. Tarone, R. (1975) Tests for trend in life table analysis. *Biometrika* 62:679-682.
64. Treon, J. et al. (1949) The toxicity of methyl and ethyl acrylate. *J. Ind. Hyg. Toxicol.* 31:317.
65. Tucker, M. (1979) The effect of long-term food restriction on tumors in rodents. *Int. J. Cancer* 23:803-807.
66. U.S. Environmental Protection Agency (USEPA) (1975) Preliminary Assessment of Suspected Carcinogens in Drinking Water. Report to Congress. EPA-56014-75-005 PB. 260961. Washington, DC.
67. U.S. Environmental Protection Agency (USEPA) (1979) Report of mutagenicity evaluation of glycidyl methacrylate. Chemical Information Division, Office of Toxic Substances, Washington, DC.
68. Waegemaekers, T.; Bensink, M. (1984) Non-mutagenicity of 27 aliphatic acrylate esters in the Salmonella microsome test. *Mutat. Res.* 137:95-102.
69. Willert, H.; Frech, H.; Bechtel, A. (1973) Measurements of the quantity of monomer leaching out of acrylic bone cement into the surrounding tissues during the process of polymerization. *Am. Chem. Soc., Div. Org. Coat. Plast. Chem.* 33:370-370g.

APPENDIX A

SUMMARY OF THE INCIDENCE OF NEOPLASMS IN RATS IN THE TWO-YEAR INHALATION STUDIES OF METHYL METHACRYLATE

TABLE A1. SUMMARY OF THE INCIDENCE OF NEOPLASMS IN MALE RATS IN THE TWO-YEAR INHALATION STUDY OF METHYL METHACRYLATE

	CONTROL (CHAMBER)	LOW DOSE	HIGH DOSE
ANIMALS INITIALLY IN STUDY	50	50	50
ANIMALS NECROPSIED	50	50	50
ANIMALS EXAMINED HISTOPATHOLOGICALLY	50	50	50
INTEGUMENTARY SYSTEM			
*Skin	(50)	(50)	(50)
Papilloma, NOS	1 (2%)		
Trichoepithelioma		1 (2%)	
Keratoacanthoma	2 (4%)	3 (6%)	1 (2%)
*Subcutaneous tissue	(50)	(50)	(50)
Fibroma	1 (2%)	4 (8%)	2 (4%)
RESPIRATORY SYSTEM			
*Nasal cavity	(50)	(50)	(50)
Squamous cell carcinoma, invasive	2 (4%)		
#Lung	(49)	(49)	(50)
Carcinoma, NOS, metastatic	1 (2%)		
Alveolar/bronchiolar adenoma		1 (2%)	
Alveolar/bronchiolar carcinoma	1 (2%)	1 (2%)	
HEMATOPOIETIC SYSTEM			
*Multiple organs	(50)	(50)	(50)
Malignant lymphoma, NOS		1 (2%)	
Malignant lymphoma, histiocytic type	1 (2%)		
Leukemia, mononuclear cell	19 (38%)	23 (46%)	23 (46%)
#Thymus	(35)	(30)	(31)
Thymoma, malignant	1 (3%)		
CIRCULATORY SYSTEM			
#Heart	(50)	(49)	(50)
Paraganglioma, NOS	1 (2%)		
DIGESTIVE SYSTEM			
*Palate	(50)	(50)	(50)
Papilloma, NOS	1 (2%)		
Squamous cell carcinoma	2 (4%)		
*Tongue	(50)	(50)	(50)
Squamous cell carcinoma			1 (2%)
#Liver	(50)	(50)	(49)
Neoplastic nodule		2 (4%)	
Hepatocellular carcinoma		1 (2%)	2 (4%)
#Colon	(48)	(48)	(50)
Adenomatous polyp, NOS			1 (2%)
URINARY SYSTEM			
None			
ENDOCRINE SYSTEM			
#Anterior pituitary	(45)	(47)	(48)
Carcinoma, NOS		2 (4%)	
Adenoma, NOS	24 (53%)	18 (38%)	13 (27%)
#Adrenal medulla	(49)	(49)	(50)
Pheochromocytoma	5 (10%)	4 (8%)	9 (18%)
Pheochromocytoma, malignant			1 (2%)

TABLE A1. SUMMARY OF THE INCIDENCE OF NEOPLASMS IN MALE RATS IN THE TWO-YEAR INHALATION STUDY OF METHYL METHACRYLATE (Continued)

	CONTROL (CHAMBER)	LOW DOSE	HIGH DOSE
ENDOCRINE SYSTEM (Continued)			
#Thyroid	(50)	(49)	(50)
Follicular cell carcinoma	2 (4%)	1 (2%)	
C-cell adenoma	2 (4%)	3 (6%)	2 (4%)
C-cell carcinoma	2 (4%)	1 (2%)	1 (2%)
#Pancreatic islets	(50)	(47)	(48)
Islet cell adenoma	2 (4%)	1 (2%)	3 (6%)
Islet cell carcinoma	1 (2%)		1 (2%)
REPRODUCTIVE SYSTEM			
*Mammary gland	(50)	(50)	(50)
Fibroadenoma			2 (4%)
*Preputial gland	(50)	(50)	(50)
Carcinoma, NOS	2 (4%)	3 (6%)	
Adenoma, NOS	3 (6%)	1 (2%)	
#Testis	(50)	(48)	(50)
Interstitial cell tumor	35 (70%)	41 (85%)	45 (90%)
NERVOUS SYSTEM			
#Cerebrum	(50)	(50)	(50)
Astrocytoma			1 (2%)
SPECIAL SENSE ORGANS			
*Zymbal gland	(50)	(50)	(50)
Carcinoma, NOS	2 (4%)		1 (2%)
MUSCULOSKELETAL SYSTEM			
None			
BODY CAVITIES			
*Mediastinum	(50)	(50)	(50)
Sarcoma, NOS			1 (2%)
*Pleura	(50)	(50)	(50)
Alveolar/bronchiolar carcinoma, invasive	1 (2%)		
*Pericardium	(50)	(50)	(50)
Sarcoma, NOS, invasive			1 (2%)
*Tunica vaginalis	(50)	(50)	(50)
Mesothelioma, NOS	1 (2%)	2 (4%)	2 (4%)
ALL OTHER SYSTEMS			
None			
ANIMAL DISPOSITION SUMMARY			
Animals initially in study	50	50	50
Natural death	9	6	5
Moribund sacrifice	14	15	17
Terminal sacrifice	26	29	28
Accidentally killed, NOS	1		

TABLE A1. SUMMARY OF THE INCIDENCE OF NEOPLASMS IN MALE RATS IN THE TWO-YEAR INHALATION STUDY OF METHYL METHACRYLATE (Continued)

	CONTROL (CHAMBER)	LOW DOSE	HIGH DOSE
TUMOR SUMMARY			
Total animals with primary tumors**	50	50	50
Total primary tumors	111	114	112
Total animals with benign tumors	47	46	48
Total benign tumors	76	77	78
Total animals with malignant tumors	27	30	29
Total malignant tumors	33	33	30
Total animals with secondary tumors##	4		1
Total secondary tumors	4		1
Total animals with tumors uncertain-- benign or malignant	2	3	3
Total uncertain tumors	2	4	4

* Number of animals receiving complete necropsy examination; all gross lesions including masses examined microscopically.

** Primary tumors: all tumors except secondary tumors

Number of animals examined microscopically at this site

Secondary tumors: metastatic tumors or tumors invasive into an adjacent organ

TABLE A2. SUMMARY OF THE INCIDENCE OF NEOPLASMS IN FEMALE RATS IN THE TWO-YEAR INHALATION STUDY OF METHYL METHACRYLATE

	CONTROL (CHAMBER)	LOW DOSE	HIGH DOSE
ANIMALS INITIALLY IN STUDY	50	50	50
ANIMALS NECROPSIED	50	50	50
ANIMALS EXAMINED HISTOPATHOLOGICALLY	50	50	50
INTEGUMENTARY SYSTEM			
*Skin	(50)	(50)	(50)
Basal cell carcinoma	2 (4%)		
Trichoepithelioma		1 (2%)	
*Subcutaneous tissue	(50)	(50)	(50)
Fibrous histiocytoma, malignant		1 (2%)	
RESPIRATORY SYSTEM			
#Lung	(50)	(50)	(50)
Alveolar/bronchiolar carcinoma			1 (2%)
Fibrous histiocytoma, metastatic		1 (2%)	
HEMATOPOIETIC SYSTEM			
*Multiple organs	(50)	(50)	(50)
Malignant lymphoma, histiocytic type		1 (2%)	
Leukemia, mononuclear cell	11 (22%)	13 (26%)	20 (40%)
CIRCULATORY SYSTEM			
None			
DIGESTIVE SYSTEM			
*Palate	(50)	(50)	(50)
Papilloma, NOS		1 (2%)	
#Liver	(50)	(50)	(50)
Neoplastic nodule			2 (4%)
#Jejunum	(50)	(48)	(47)
Leiomyoma		1 (2%)	
#Colon	(48)	(47)	(48)
Adenocarcinoma, NOS			1 (2%)
URINARY SYSTEM			
#Urinary bladder	(49)	(45)	(46)
Papilloma, NOS		1 (2%)	
ENDOCRINE SYSTEM			
#Anterior pituitary	(50)	(50)	(47)
Carcinoma, NOS	1 (2%)	1 (2%)	
Adenoma, NOS	30 (60%)	32 (64%)	29 (62%)
#Adrenal medulla	(49)	(49)	(48)
Pheochromocytoma	4 (8%)	3 (6%)	4 (8%)
#Thyroid	(48)	(48)	(50)
Follicular cell adenoma	1 (2%)	3 (6%)	
Follicular cell carcinoma	1 (2%)		
C-cell adenoma	1 (2%)	1 (2%)	1 (2%)
C-cell carcinoma		1 (2%)	2 (4%)
#Pancreatic islets	(49)	(50)	(46)
Islet cell adenoma		2 (4%)	

TABLE A2. SUMMARY OF THE INCIDENCE OF NEOPLASMS IN FEMALE RATS IN THE TWO-YEAR INHALATION STUDY OF METHYL METHACRYLATE (Continued)

	CONTROL (CHAMBER)	LOW DOSE	HIGH DOSE
REPRODUCTIVE SYSTEM			
*Mammary gland	(50)	(50)	(50)
Adenocarcinoma, NOS		1 (2%)	
Fibroadenoma	10 (20%)	8 (16%)	16 (32%)
*Clitoral gland	(50)	(50)	(50)
Carcinoma, NOS	2 (4%)		
Adenoma, NOS		1 (2%)	
#Uterus	(48)	(48)	(48)
Endometrial stromal polyp	7 (15%)	5 (10%)	8 (17%)
Endometrial stromal sarcoma		2 (4%)	
#Ovary	(50)	(50)	(50)
Papillary adenocarcinoma			1 (2%)
Granulosa cell tumor	1 (2%)		
NERVOUS SYSTEM			
#Cerebrum	(50)	(50)	(49)
Oligodendroglioma		1 (2%)	
#Brain	(50)	(50)	(49)
Carcinoma, NOS, invasive	1 (2%)		
SPECIAL SENSE ORGANS			
*Zymbal gland	(50)	(50)	(50)
Carcinoma, NOS	1 (2%)		
MUSCULOSKELETAL SYSTEM			
None			
BODY CAVITIES			
None			
ALL OTHER SYSTEMS			
*Multiple organs	(50)	(50)	(50)
Fibrous histiocytoma, invasive		1 (2%)	
ANIMAL DISPOSITION SUMMARY			
Animals initially in study	50	50	50
Natural death	5	5	6
Moribund sacrifice	15	18	16
Terminal sacrifice	30	27	28

TABLE A2. SUMMARY OF THE INCIDENCE OF NEOPLASMS IN FEMALE RATS IN THE TWO-YEAR INHALATION STUDY OF METHYL METHACRYLATE (Continued)

	CONTROL (CHAMBER)	LOW DOSE	HIGH DOSE
TUMOR SUMMARY			
Total animals with primary tumors**	40	46	44
Total primary tumors	72	80	85
Total animals with benign tumors	39	44	36
Total benign tumors	53	59	58
Total animals with malignant tumors	16	20	23
Total malignant tumors	18	21	25
Total animals with secondary tumors##	1	1	
Total secondary tumors	1	2	
Total animals with tumors uncertain-- benign or malignant	1		2
Total uncertain tumors	1		2

* Number of animals receiving complete necropsy examination; all gross lesions including masses examined microscopically.

** Primary tumors: all tumors except secondary tumors

Number of animals examined microscopically at this site

Secondary tumors: metastatic tumors or tumors invasive into an adjacent organ

TABLE A3. INDIVIDUAL ANIMAL TUMOR PATHOLOGY OF MALE RATS: CHAMBER CONTROL
(Continued)

ANIMAL NUMBER	WEEKS ON STUDY																				TOTAL TISSUES TUMORS	
	0 2	0 3	0 4	0 5	0 6	0 7	0 11	0 12	0 13	0 14	0 15	0 16	0 17	0 18	0 19	0 20	0 21	0 22	0 23	0 24		
INTEGUMENTARY SYSTEM																						
Skin																						
Papilloma, NOS																						
Keratoacanthoma																						
Subcutaneous tissue																						
Fibroma																						
RESPIRATORY SYSTEM																						
Lungs and bronchi																						
Carcinoma, NOS, metastatic																						
Alveolar/bronchiolar carcinoma																						
Trachea																						
Nasal cavity																						
Squamous cell carcinoma, invasive																						
HEMATOPOIETIC SYSTEM																						
Bone marrow																						
Spleen																						
Lymph nodes																						
Thymus																						
Thymoma, malignant																						
CIRCULATORY SYSTEM																						
Heart																						
Paranglioma, NOS																						
DIGESTIVE SYSTEM																						
Oral cavity																						
Papilloma, NOS																						
Squamous cell carcinoma																						
Salivary gland																						
Liver																						
Bile duct																						
Gallbladder & common bile duct																						
Pancreas																						
Esophagus																						
Stomach																						
Small intestine																						
Large intestine																						
URINARY SYSTEM																						
Kidney																						
Urinary bladder																						
ENDOCRINE SYSTEM																						
Pituitary																						
Adenoma, NOS																						
Adrenal																						
Pheochromocytoma																						
Thyroid																						
Follicular cell carcinoma																						
C-cell adenoma																						
C-cell carcinoma																						
Parathyroid																						
Pancreatic islets																						
Islet cell adenoma																						
Islet cell carcinoma																						
REPRODUCTIVE SYSTEM																						
Mammary gland																						
Testis																						
Interstitial cell tumor																						
Prostate																						
Preputial/clitoral gland																						
Carcinoma, NOS																						
Adenoma, NOS																						
NERVOUS SYSTEM																						
Brain																						
SPECIAL SENSE ORGANS																						
Zymbal gland																						
Carcinoma, NOS																						
BODY CAVITIES																						
Pleura																						
Alveolar/bronchiolar carcinoma, inv																						
Tunica vaginalis																						
Mesothelioma, NOS																						
ALL OTHER SYSTEMS																						
Multiple organs, NOS																						
Malig. lymphoma, histiocytic type																						
Leukemia, mononuclear cell																						

* Animals necropsied

**TABLE A3. INDIVIDUAL ANIMAL TUMOR PATHOLOGY OF MALE RATS: LOW DOSE
(Continued)**

ANIMAL NUMBER	WEEKS ON STUDY																				TOTAL TISSUES TUMORS								
	0 7	0 8	0 1	0 3	0 6	0 7	0 1	0 2	0 2	0 3	0 3	0 3	0 3	0 3	0 3	0 3	0 3	0 3	0 3	0 3		0 4	0 4	0 4	0 4	0 4	0 6	0 8	0 9
INTEGUMENTARY SYSTEM																													
Skin	+	+	+	+	+	+	+	+	+	N	+	+	+	+	+	+	+	+	+	+	+	+	+	+	+	+	+	+	*50
Trichoepithelioma																													1
Keratoacanthoma		X															X												3
Subcutaneous tissue	+	+	+	+	+	+	+	+	+	N	+	+	+	+	+	+	+	+	+	+	+	+	+	+	+	+	+	+	*50
Fibroma											X																		4
RESPIRATORY SYSTEM																													
Lungs and bronchi	+	+	+	+	+	+	+	+	+	+	+	+	+	+	+	+	+	+	+	+	+	+	+	+	+	+	+	+	49
Alveolar/bronchiolar adenoma																													1
Alveolar/bronchiolar carcinoma										X																			1
Trachea	+	+	+	+	+	+	+	+	+	+	+	+	+	+	+	+	+	+	-	+	+	+	+	+	+	+	+	+	48
HEMATOPOIETIC SYSTEM																													
Bone marrow	+	+	+	+	+	+	+	+	+	+	+	+	+	+	+	+	+	+	+	+	+	+	+	+	+	+	+	+	49
Spleen	+	+	+	+	+	+	+	+	+	+	+	+	+	+	+	+	+	+	+	+	+	+	+	+	+	+	+	+	50
Lymph nodes	+	+	+	-	+	+	+	+	+	-	+	+	+	+	+	+	+	+	+	+	+	+	+	+	+	+	+	-	45
Thymus	+	-	-	-	+	+	+	-	-	-	+	-	-	+	+	+	+	+	+	+	+	+	+	+	+	+	+	-	30
CIRCULATORY SYSTEM																													
Heart	+	+	+	+	+	-	+	+	+	+	+	+	+	+	+	+	+	+	+	+	+	+	+	+	+	+	+	+	49
DIGESTIVE SYSTEM																													
Salivary gland	+	+	+	+	+	+	+	+	+	+	+	+	+	+	+	+	+	+	+	+	+	+	+	+	+	+	+	+	50
Liver	+	+	+	+	+	+	+	+	+	+	+	+	+	+	+	+	+	+	+	+	+	+	+	+	+	+	+	+	50
Neoplastic nodule																											X	+	2
Hepatocellular carcinoma																											X	+	1
Bile duct	+	+	+	+	+	+	+	+	+	+	+	+	+	+	+	+	+	+	+	+	+	+	+	+	+	+	+	+	50
Gallbladder & common bile duct	N	N	N	N	N	N	N	N	N	N	N	N	N	N	N	N	N	N	N	N	N	N	N	N	N	N	N	N	*50
Pancreas	+	+	+	+	+	+	+	+	+	+	+	+	+	+	+	+	+	+	+	+	+	+	+	+	+	+	+	+	47
Esophagus	+	+	+	-	-	+	+	+	+	+	+	+	+	+	+	+	+	+	+	+	+	+	+	+	+	+	+	+	44
Stomach	+	+	+	+	+	+	+	+	+	+	+	+	+	+	+	+	+	+	+	+	+	+	+	+	+	+	+	+	49
Small intestine	+	+	+	+	+	+	+	+	+	+	+	+	+	+	+	+	+	+	+	+	+	+	+	+	+	+	+	+	49
Large intestine	+	+	+	+	+	+	+	+	+	+	+	+	+	+	+	+	+	+	+	+	+	+	+	+	+	+	+	+	48
URINARY SYSTEM																													
Kidney	+	+	+	+	+	+	+	+	+	+	+	+	+	+	+	+	+	+	+	+	+	+	+	+	+	+	+	+	50
Urinary bladder	+	+	+	+	+	+	+	+	+	+	+	+	+	+	+	-	+	+	+	+	+	+	+	+	+	+	+	+	47
ENDOCRINE SYSTEM																													
Pituitary	+	+	+	+	+	+	+	+	+	+	+	+	+	+	+	+	+	+	+	+	+	+	+	+	+	+	+	+	47
Carcinoma, NOS																													2
Adenoma, NOS		X		X				X	X	X		X				X	X		X							X	X	18	
Adrenal	+	+	+	+	+	+	+	+	+	+	+	+	+	+	+	+	+	+	+	+	+	+	+	+	+	+	+	+	49
Pheochromocytoma	X																							X		X	+	4	
Thyroid	+	+	+	+	+	+	+	+	+	+	+	+	+	+	+	+	+	+	+	+	+	+	+	+	+	+	+	+	49
Follicular cell carcinoma										X																		+	1
C cell adenoma	X															X									X			3	
C cell carcinoma							X																					+	1
Parathyroid	+	-	+	+	-	+	-	+	-	+	+	+	+	-	+	+	+	-	+	+	+	+	+	+	+	+	+	+	33
Pancreatic islets	+	+	+	+	+	+	+	+	+	+	+	+	+	+	+	+	+	+	+	+	+	+	+	+	+	+	+	+	47
Islet cell adenoma																												1	
REPRODUCTIVE SYSTEM																													
Mammary gland	+	N	N	N	N	N	+	N	+	+	N	+	N	+	+	+	+	+	+	+	N	+	+	N	+	N	+	N	*50
Testis	+	+	+	+	+	+	+	+	+	+	+	+	+	+	+	+	+	+	+	+	+	+	+	+	+	+	+	+	48
Interstitial cell tumor	X	X	X	X	X	X	X	X	X	X	X	X	X	X	X	X	X	X	X	X	X	X	X	X	X	X	X	X	41
Prostate	-	+	+	+	+	+	+	+	+	+	+	+	+	+	+	+	+	+	+	+	+	+	+	+	+	+	+	+	39
Preputial/choral gland	N	N	N	N	N	N	N	N	N	N	N	N	N	N	N	N	N	N	N	N	N	N	N	N	N	N	N	N	*50
Carcinoma, NOS																													3
Adenoma, NOS	X										X														X			1	
NERVOUS SYSTEM																													
Brain	+	+	+	+	+	+	+	+	+	+	+	+	+	+	+	+	+	+	+	+	+	+	+	+	+	+	+	+	50
BODY CAVITIES																													
Tunica vaginalis	+	+	+	+	+	+	+	+	+	+	+	+	+	+	+	+	+	+	+	+	+	+	+	+	+	+	+	+	*50
Mesothelioma, NOS				X																						X		+	2
ALL OTHER SYSTEMS																													
Multiple organs, NOS	N	N	N	N	N	N	N	N	N	N	N	N	N	N	N	N	N	N	N	N	N	N	N	N	N	N	N	N	*50
Malignant lymphoma, NOS																													1
Leukemia, mononuclear cell	X				X						X	X	X								X							X	23

* Animals necropsied

TABLE A3. INDIVIDUAL ANIMAL TUMOR PATHOLOGY OF MALE RATS: HIGH DOSE
(Continued)

ANIMAL NUMBER	0																				TOTAL: TISSUES TUMORS
	7 9 2 6 7 8 0 2 4 5 8 9 0 2 3 3 3 3 4 5 8 1 2 3 4 5 9 0																				
WEEKS ON STUDY	1 1																				
	4 4																				
INTEGUMENTARY SYSTEM																					
Skin	+ N + +																				*50 1
Keratoacanthoma																					
Subcutaneous tissue	+ N + +																				*50 2
Fibroma																					X
RESPIRATORY SYSTEM																					
Lungs and bronchi	+ +																				50
Trachea	+ +																				50
HEMATOPOIETIC SYSTEM																					
Bone marrow	+ + + + + + - + + + + + + + + + + + + + + + + + + +																				47
Spleen	+ +																				49
Lymph nodes	+ +																				47
Thymus	+ + + + + + - + + + + + + + + + + + - + + + + + + +																				31
CIRCULATORY SYSTEM																					
Heart	+ +																				50
DIGESTIVE SYSTEM																					
Oral cavity	N N																				*50
Squamous cell carcinoma																					1
Salivary gland	+ +																				49
Liver	+ -																				49
Neoplastic nodule																					2
Bile duct	+ -																				49
Gallbladder & common bile duct	N N																				*50
Pancreas	+ + + + + + + + + + + + - + + + + + + + + + + + + +																				48
Esophagus	+ +																				49
Stomach	+ +																				50
Small intestine	+ +																				50
Large intestine	+ +																				50
Adenomatous polyp, NOS																					1
URINARY SYSTEM																					
Kidney	+ +																				50
Urinary bladder	+ - +																				49
ENDOCRINE SYSTEM																					
Pituitary	+ + + + + + + + + + + + + + + + - + + + + + + + + +																				48
Adenoma, NOS	X + + + + + + + + + + X X X + + + + + X X X X X X X X																				13
Adrenal	+ +																				50
Pheochromocytoma	X X																				9
Pheochromocytoma, malignant																					1
Thyroid	+ +																				50
C-cell adenoma																					2
C-cell carcinoma																					1
Parathyroid	- + + + - + + + + + + + + + + - + - + - + - + + + +																				33
Pancreatic islets	+ + + + + + + + + + + + - + + + + + + + + + + + + +																				48
Islet cell adenoma																					3
Islet cell carcinoma																					1
REPRODUCTIVE SYSTEM																					
Mammary gland	+ N + + + + + + + + + N + N N + + + + + + + + + +																				*50
Fibroadenoma	X																				2
Testis	+ +																				50
Interstitial cell tumor	X X																				45
Prostate	+ - -																				47
NERVOUS SYSTEM																					
Brain	+ +																				50
Astrocytoma																					1
SPECIAL SENSE ORGANS																					
Zymbal gland	N N																				*50
Carcinoma, NOS																					1
BODY CAVITIES																					
Mediastinum	N N																				*50
Sarcoma, NOS																					1
Pericardium	N N																				*50
Sarcoma, NOS, invasive																					1
Tunica vaginalis	+ +																				*50
Mesothelioma, NOS																					2
ALL OTHER SYSTEMS																					
Multiple organs, NOS	N N																				*50
Leukemia, mononuclear cell	X X																				23

* Animals necropsied

TABLE A4. INDIVIDUAL ANIMAL TUMOR PATHOLOGY OF FEMALE RATS IN THE TWO-YEAR INHALATION STUDY OF METHYL METHACRYLATE: CHAMBER CONTROL

ANIMAL NUMBER	038	044	050	053	061	062	066	068	074	077	085	087	090	091	092	093	094	095	096	097	098	099	100	101	102	103	104	105
WEEKS ON STUDY	06	07	07	07	07	08	08	08	08	08	09	09	09	09	09	09	10	10	10	10	10	10	10	10	10	10	10	10
INTEGUMENTARY SYSTEM																												
Skin	+	+	+	+	+	+	+	+	+	+	+	+	+	+	+	+	+	+	+	+	+	+	+	+	+	+	+	+
Basal cell carcinoma																											X	
RESPIRATORY SYSTEM																												
Lungs and bronchi	+	+	+	+	+	+	+	+	+	+	+	+	+	+	+	+	+	+	+	+	+	+	+	+	+	+	+	+
Trachea	+	+	+	+	+	+	+	+	+	+	+	+	+	+	+	+	+	+	+	+	+	+	+	+	+	+	+	+
HEMATOPOIETIC SYSTEM																												
Bone marrow	-	-	+	+	+	+	+	+	+	+	+	+	+	+	+	+	+	+	+	+	+	+	+	+	+	+	+	+
Spleen	+	+	+	+	+	+	+	+	+	+	+	+	+	+	+	+	+	+	+	+	+	+	+	+	+	+	+	+
Lymph nodes	+	+	+	+	+	+	+	+	+	+	+	+	+	+	+	+	+	+	+	+	+	+	+	+	+	+	+	+
Thymus	+	-	+	-	+	+	+	-	+	+	+	+	+	+	+	+	+	+	+	+	+	+	+	+	+	+	+	+
CIRCULATORY SYSTEM																												
Heart	+	+	+	+	+	+	+	+	+	+	+	+	+	+	+	+	+	+	+	+	+	+	+	+	+	+	+	-
DIGESTIVE SYSTEM																												
Salivary gland	+	-	+	+	+	+	+	+	+	+	+	+	+	+	+	+	+	+	+	+	+	+	+	+	+	+	+	+
Liver	+	+	+	+	+	+	+	+	+	+	+	+	+	+	+	+	+	+	+	+	+	+	+	+	+	+	+	+
Bile duct	+	+	+	+	+	+	+	+	+	+	+	+	+	+	+	+	+	+	+	+	+	+	+	+	+	+	+	+
Gallbladder & common bile duct	N	N	N	N	N	N	N	N	N	N	N	N	N	N	N	N	N	N	N	N	N	N	N	N	N	N	N	N
Pancreas	+	+	+	-	+	+	+	+	+	+	+	+	+	+	+	+	+	+	+	+	+	+	+	+	+	+	+	+
Esophagus	+	+	+	+	+	+	+	+	+	+	+	+	+	+	+	+	+	+	+	+	+	+	+	+	+	+	+	+
Stomach	+	+	+	+	+	+	+	+	+	+	+	+	+	+	+	+	+	+	+	+	+	+	+	+	+	+	+	+
Small intestine	+	+	+	+	+	+	+	+	+	+	+	+	+	+	+	+	+	+	+	+	+	+	+	+	+	+	+	+
Large intestine	+	-	+	+	+	+	+	+	+	+	+	+	+	+	+	+	+	+	+	+	+	+	+	+	+	+	+	+
URINARY SYSTEM																												
Kidney	+	+	+	+	+	+	+	+	+	+	+	+	+	+	+	+	+	+	+	+	+	+	+	+	+	+	+	+
Urinary bladder	+	+	+	+	+	+	+	+	+	+	+	+	+	+	+	+	+	+	+	+	+	+	+	+	+	+	+	+
ENDOCRINE SYSTEM																												
Pituitary	+	+	+	+	+	+	+	+	+	+	+	+	+	+	+	+	+	+	+	+	+	+	+	+	+	+	+	+
Carcinoma, NOS																												
Adenoma, NOS	X			X		X		X	X				X	X			X		X	X	X				X			X
Adrenal	+	+	+	+	+	+	+	+	+	+	+	+	+	+	+	+	+	+	+	+	+	+	+	+	+	+	+	+
Pheochromocytoma																												
Thyroid	+	-	+	+	+	+	+	+	+	+	+	+	+	+	+	+	+	+	+	+	+	+	+	+	+	+	+	+
Follicular cell adenoma																												
Follicular cell carcinoma																												
C-cell adenoma																												
Parathyroid	-	-	+	+	+	-	-	+	-	-	+	+	+	-	-	-	+	+	-	-	+	-	-	+	-	-	+	-
REPRODUCTIVE SYSTEM																												
Mammary gland	+	+	+	+	+	+	+	N	+	+	+	+	N	N	+	+	+	+	+	+	+	+	+	+	+	+	+	+
Fibroadenoma																												
Preputial/clitoral gland	N	N	N	N	N	N	N	N	N	N	N	N	N	N	N	N	N	N	N	N	N	N	N	N	N	N	N	N
Carcinoma, NOS																												
Uterus	+	+	+	+	+	+	+	-	+	+	+	+	+	+	+	+	+	+	+	+	+	+	+	+	+	+	+	+
Endometrial stromal polyp		X																										
Ovary	+	+	+	+	+	+	+	+	+	+	+	+	+	+	+	+	+	+	+	+	+	+	+	+	+	+	+	+
Granulosa cell tumor																												
NERVOUS SYSTEM																												
Brain	+	+	+	+	+	+	+	+	+	+	+	+	+	+	+	+	+	+	+	+	+	+	+	+	+	+	+	+
Carcinoma, NOS, invasive																												
SPECIAL SENSE ORGANS																												
Zymbal gland	N	N	N	N	N	N	N	N	N	N	N	N	N	N	N	N	N	N	N	N	N	N	N	N	N	N	N	N
Carcinoma, NOS																												
ALL OTHER SYSTEMS																												
Multiple organs, NOS	N	N	N	N	N	N	N	N	N	N	N	N	N	N	N	N	N	N	N	N	N	N	N	N	N	N	N	N
Leukemia, mononuclear cell	X								X	X				X	X	X	X	X	X	X	X	X	X	X	X	X	X	X

+: Tissue examined microscopically
 -: Required tissue not examined microscopically
 X: Tumor incidence
 N: Necropsy, no autolysis, no microscopic examination
 S: Animal missexed

: No tissue information submitted
 C: Necropsy, no histology due to protocol
 A: Autolysis
 M: Animal missing
 B: No necropsy performed

**TABLE A4. INDIVIDUAL ANIMAL TUMOR PATHOLOGY OF FEMALE RATS: CHAMBER CONTROL
(Continued)**

ANIMAL NUMBER	07	09	00	01	02	05	06	09	00	02	03	04	07	09	00	02	03	04	05	06	01	02	05	07	09	TOTAL: TISSUES TUMORS
WEEKS ON STUDY	14	14	14	14	14	14	14	14	14	14	14	14	14	14	14	14	14	14	14	14	14	14	14	14	14	
INTEGUMENTARY SYSTEM																										
Skin	+	+	+	+	+	+	+	+	N	+	+	+	+	+	+	+	+	+	+	N	+	+	+	+	+	*50
Basal cell carcinoma																									X	2
RESPIRATORY SYSTEM																										
Lungs and bronchi	+	+	+	+	+	+	+	+	+	+	+	+	+	+	+	+	+	+	+	+	+	+	+	+	+	50
Trachea	+	+	+	+	+	+	+	+	+	+	+	+	+	+	+	+	+	+	+	+	+	+	+	+	+	50
HEMATOPOIETIC SYSTEM																										
Bone marrow	+	+	+	+	+	+	+	+	+	+	+	+	+	+	+	+	+	+	+	+	+	+	+	+	+	47
Spleen	+	+	+	+	+	+	+	+	+	+	+	+	+	+	+	+	+	+	+	+	+	+	+	+	+	50
Lymph nodes	+	+	+	+	+	+	+	+	+	+	+	+	+	+	+	+	+	+	+	+	+	+	+	+	+	50
Thymus	+	+	+	+	+	+	+	+	+	+	+	+	+	+	+	+	+	+	+	-	-	-	+	+	+	41
CIRCULATORY SYSTEM																										
Heart	+	+	+	+	+	+	+	+	+	+	+	+	+	+	+	+	+	+	+	+	+	+	+	+	+	49
DIGESTIVE SYSTEM																										
Salivary gland	+	+	+	+	+	+	+	+	+	+	+	+	+	+	+	+	+	+	+	+	+	+	+	+	+	49
Liver	+	+	+	+	+	+	+	+	+	+	+	+	+	+	+	+	+	+	+	+	+	+	+	+	+	50
Bile duct	+	+	+	+	+	+	+	+	+	+	+	+	+	+	+	+	+	+	+	+	+	+	+	+	+	50
Gallbladder & common bile duct	N	N	N	N	N	N	N	N	N	N	N	N	N	N	N	N	N	N	N	N	N	N	N	N	N	*50
Pancreas	+	+	+	+	+	+	+	+	+	+	+	+	+	+	+	+	+	+	+	+	+	+	+	+	+	49
Esophagus	+	+	+	+	+	+	+	+	+	+	+	+	+	+	+	+	+	+	+	+	+	+	+	+	+	49
Stomach	+	+	+	+	+	+	+	+	+	+	+	+	+	+	+	+	+	+	+	+	+	+	+	+	+	50
Small intestine	+	+	+	+	+	+	+	+	+	+	+	+	+	+	+	+	+	+	+	+	+	+	+	+	+	50
Large intestine	+	+	+	+	+	+	+	+	+	+	+	+	+	+	+	+	+	+	+	+	+	+	+	+	+	48
URINARY SYSTEM																										
Kidney	+	+	+	+	+	+	+	+	+	+	+	+	+	+	+	+	+	+	+	+	+	+	+	+	+	50
Urinary bladder	+	+	+	+	+	+	+	+	-	+	+	+	+	+	+	+	+	+	+	+	+	+	+	+	+	49
ENDOCRINE SYSTEM																										
Pituitary	+	+	+	+	+	+	+	+	+	+	+	+	+	+	+	+	+	+	+	+	+	+	+	+	+	50
Carcinoma, NOS																										1
Adenoma, NOS	X	X	X	X	X	X	X	X	X	X	X	X	X	X	X	X	X	X	X	X	X	X	X	X	X	30
Adrenal	+	+	+	+	+	+	+	+	+	+	+	+	+	+	+	+	+	+	+	+	+	+	+	+	+	49
Pheochromocytoma			X																				X	X	X	4
Thyroid	+	+	+	+	+	+	+	+	+	+	+	+	+	+	+	+	+	+	+	+	+	+	+	+	+	48
Follicular cell adenoma																										1
Follicular cell carcinoma								X																		1
C-cell adenoma																										1
Parathyroid	-	-	-	-	-	+	+	+	+	-	+	-	+	-	+	+	+	+	+	+	-	-	-	-	-	22
REPRODUCTIVE SYSTEM																										
Mammary gland	+	+	+	+	+	+	+	+	+	+	+	+	+	+	+	+	+	+	+	+	+	+	+	+	+	50
Fibroadenoma								X		X		X	X												X	10
Preputial/clitoral gland	N	N	N	N	N	N	N	N	N	N	N	N	N	N	N	N	N	N	N	N	N	N	N	N	N	*50
Carcinoma, NOS																										2
Uterus	+	+	+	+	+	+	+	+	+	-	+	+	+	+	+	+	+	+	+	+	+	+	+	+	+	48
Endometrial stromal polyp			X																							7
Ovary	+	+	+	+	+	+	+	+	+	+	+	+	+	+	+	+	+	+	+	+	+	+	+	+	+	50
Granulosa cell tumor																									X	1
NERVOUS SYSTEM																										
Brain	+	+	+	+	+	+	+	+	+	+	+	+	+	+	+	+	+	+	+	+	+	+	+	+	+	50
Carcinoma, NOS, invasive																										1
SPECIAL SENSE ORGANS																										
Zymbal gland	N	N	N	N	N	N	N	N	N	N	N	N	N	N	N	N	N	N	N	N	N	N	N	N	N	*50
Carcinoma, NOS																										1
ALL OTHER SYSTEMS																										
Multiple organs, NOS	N	N	N	N	N	N	N	N	N	N	N	N	N	N	N	N	N	N	N	N	N	N	N	N	N	*50
Leukemia, mononuclear cell														X											X	11

* Animals necropsied

TABLE A4. INDIVIDUAL ANIMAL TUMOR PATHOLOGY OF FEMALE RATS IN THE TWO-YEAR INHALATION STUDY OF METHYL METHACRYLATE: LOW DOSE

ANIMAL NUMBER	038	005	002	004	001	004	003	002	004	003	000	000	003	000	003	005	002	003	000	000	001	003	004	000	000			
WEEKS ON STUDY	074	078	078	085	087	087	088	090	092	093	097	098	098	100	100	101	101	101	101	101	101	102	102	102	103	104	104	
INTEGUMENTARY SYSTEM																												
Skin	+ +																											
Trichoeplithelioma																												
Subcutaneous tissue	+ +																											
Fibrous histiocytoma, malignant	X																											
RESPIRATORY SYSTEM																												
Lungs and bronchi	+ +																											
Fibrous histiocytoma, metastatic	X																											
Trachea	+ +																											
HEMATOPOIETIC SYSTEM																												
Bone marrow	+ +																											
Spleen	+ +																											
Lymph nodes	+ +																											
Thymus	- -																											
CIRCULATORY SYSTEM																												
Heart	+ +																											
DIGESTIVE SYSTEM																												
Oral cavity	N N																											
Papilloma, NOS	X																											
Salivary gland	+ +																											
Liver	+ +																											
Bile duct	+ +																											
Gallbladder & common bile duct	N N																											
Pancreas	+ +																											
Esophagus	+ +																											
Stomach	+ +																											
Small intestine	+ +																											
Leiomyoma	- -																											
Large intestine	+ +																											
URINARY SYSTEM																												
Kidney	+ +																											
Urinary bladder	+ + + + - - + + + - + + + + + + + + + + + + + + + +																											
Papilloma, NOS																												
ENDOCRINE SYSTEM																												
Pituitary	+ +																											
Carcinoma, NOS	X																											
Adenoma, NOS	X X																											
Adrenal	+ +																											
Pheochromocytoma	X																											
Thyroid	+ + + - +																											
Follicular cell adenoma																												
C-cell adenoma	X																											
C-cell carcinoma																												
Parathyroid	- + + - - - + + - - - + + - + + + + + + + + - + + + + +																											
Pancreatic islets	+ +																											
Islet cell adenoma	X																											
REPRODUCTIVE SYSTEM																												
Mammary gland	+ + N + N + + N + N + + + + + + + + + + + + + + + +																											
Adenocarcinoma, NOS	X																											
Fibroadenoma	N X N N N N N N N N X N X N N N N N N N N N N N N N N N																											
Preputial/clitoral gland																												
Adenoma, NOS																												
Uterus	+ +																											
Endometrial stromal polyp	X X X																											
Endometrial stromal sarcoma																												
Ovary	+ +																											
NERVOUS SYSTEM																												
Brain	+ +																											
Oligodendroglioma																												
ALL OTHER SYSTEMS																												
Multiple organs, NOS	N N																											
Fibrous histiocytoma, invasive	X																											
Malignant lymphoma, histiocytic type	X X																											
Leukemia, mononuclear cell																												

**TABLE A4. INDIVIDUAL ANIMAL TUMOR PATHOLOGY OF FEMALE RATS: HIGH DOSE
(Continued)**

ANIMAL NUMBER	07	08	09	10	11	13	14	15	17	18	19	20	22	23	27	29	31	33	35	38	39	41	42	44	46	49	TOTAL TISSUES TUMORS
WEEKS ON STUDY	14	14	14	14	14	14	14	14	14	14	14	14	14	14	14	14	14	14	14	14	14	14	14	14	14	14	
RESPIRATORY SYSTEM																											
Lungs and bronchi	+	+	+	+	+	+	+	+	+	+	+	+	+	+	+	+	+	+	+	+	+	+	+	+	+	+	50
Alveolar/bronchiolar carcinoma																					X						1
Trachea	+	+	+	+	+	+	+	+	+	+	+	+	+	+	+	+	+	+	+	+	+	+	+	+	+	+	49
HEMATOPOIETIC SYSTEM																											
Bone marrow	+	+	+	+	+	+	+	+	+	+	+	+	+	+	+	+	+	+	+	+	+	+	+	+	+	+	46
Spleen	+	+	+	+	+	+	+	+	+	+	+	+	+	+	+	+	+	+	+	+	+	+	+	+	+	+	48
Lymph nodes	+	+	+	+	+	+	+	+	+	+	+	+	+	+	+	+	+	+	+	+	+	+	+	+	+	+	48
Thymus	-	+	+	+	+	+	+	+	+	+	+	+	+	+	+	+	+	+	+	+	-	+	-	+	+	+	39
CIRCULATORY SYSTEM																											
Heart	+	+	+	+	+	+	+	+	+	+	+	+	+	+	+	+	+	+	+	+	+	+	+	+	+	+	48
DIGESTIVE SYSTEM																											
Salivary gland	+	+	+	+	+	+	+	+	+	+	+	+	+	+	+	+	+	+	+	+	+	+	+	+	+	+	49
Liver	+	+	+	+	+	+	+	+	+	+	+	+	+	+	+	+	+	+	+	+	+	+	+	+	+	+	50
Neoplastic nodule																					X						2
Bile duct	+	+	+	+	+	+	+	+	+	+	+	+	+	+	+	+	+	+	+	+	+	+	+	+	+	+	50
Gallbladder & common bile duct	N	N	N	N	N	N	N	N	N	N	N	N	N	N	N	N	N	N	N	N	N	N	N	N	N	N	*50
Pancreas	+	+	+	+	+	+	+	+	+	+	+	+	+	+	+	+	+	+	+	+	+	+	+	+	+	+	48
Esophagus	+	+	+	+	+	+	+	+	+	+	+	+	+	+	+	+	+	+	+	+	+	+	+	+	+	+	49
Stomach	+	+	+	+	+	+	+	+	+	+	+	+	+	+	+	+	+	+	+	+	+	+	+	+	+	+	48
Small intestine	+	+	+	+	+	+	+	+	+	+	+	+	+	+	+	+	+	+	+	+	+	+	+	+	+	+	47
Large intestine	+	+	+	+	+	+	+	+	+	+	+	+	+	+	+	+	+	+	+	+	+	+	+	+	+	+	48
Adenocarcinoma, NOS																											1
URINARY SYSTEM																											
Kidney	+	+	+	+	+	+	+	+	+	+	+	+	+	+	+	+	+	+	+	+	+	+	+	+	+	+	50
Urinary bladder	+	+	+	+	-	+	+	+	+	+	+	+	+	+	+	+	+	+	+	+	+	+	+	+	+	+	46
ENDOCRINE SYSTEM																											
Pituitary	+	+	+	+	+	+	+	+	+	+	+	+	+	+	+	+	+	+	+	+	+	+	+	+	+	+	47
Adenoma, NOS		X	X		X	X	X	X	X	X	X	X	X	X	X	X	X	X	X	X	X	X	X	X	X	X	29
Adrenal	+	+	+	+	+	+	+	+	+	+	+	+	+	+	+	+	+	+	+	+	+	+	+	+	+	+	48
Pheochromocytoma									X											X		X					4
Thyroid	+	+	+	+	+	+	+	+	+	+	+	+	+	+	+	+	+	+	+	+	+	+	+	+	+	+	50
C-cell adenoma															X												1
C-cell carcinoma																				X							2
Parathyroid	+	-	-	-	+	+	+	+	-	+	+	+	+	+	-	-	+	+	+	X		-	+	-	+	+	29
REPRODUCTIVE SYSTEM																											
Mammary gland	N	+	+	+	+	+	+	+	+	+	+	+	+	+	+	+	+	+	+	+	+	+	+	+	+	+	*50
Fibroadenoma		X							X	X					X	X				X		X					18
Uterus	+	+	+	+	+	+	+	+	+	+	+	+	+	+	+	+	+	+	+	+	+	+	+	+	+	+	48
Endometrial stromal polyp				X	X			X																			8
Ovary	+	+	+	+	+	+	+	+	+	+	+	+	+	+	+	+	+	+	+	+	+	+	+	+	+	+	50
Papillary adenocarcinoma																											1
NERVOUS SYSTEM																											
Brain	+	+	+	+	+	+	+	+	+	+	+	+	+	+	+	+	+	+	+	+	+	+	+	+	+	+	49
ALL OTHER SYSTEMS																											
Multiple organs, NOS	N	N	N	N	N	N	N	N	N	N	N	N	N	N	N	N	N	N	N	N	N	N	N	N	N	N	*50
Leukemia, mononuclear cell										X										X	X	X	X	X	X	X	20

*Animals necropsied

APPENDIX B

SUMMARY OF THE INCIDENCE OF NEOPLASMS IN MICE IN THE TWO-YEAR INHALATION STUDIES OF METHYL METHACRYLATE

TABLE B1. SUMMARY OF THE INCIDENCE OF NEOPLASMS IN MALE MICE IN THE TWO-YEAR INHALATION STUDY OF METHYL METHACRYLATE

	CONTROL (CHAMBER)	LOW DOSE	HIGH DOSE
ANIMALS INITIALLY IN STUDY	50	50	50
ANIMALS NECROPSIED	50	50	50
ANIMALS EXAMINED HISTOPATHOLOGICALLY	50	50	50
INTEGUMENTARY SYSTEM			
*Subcutaneous tissue	(50)	(50)	(50)
Neurofibroma			1 (2%)
RESPIRATORY SYSTEM			
#Lung	(50)	(50)	(50)
Adenocarcinoma, NOS, metastatic			1 (2%)
Hepatocellular carcinoma, metastatic	1 (2%)		
Alveolar/bronchiolar adenoma	10 (20%)	1 (2%)	3 (6%)
Alveolar/bronchiolar carcinoma	3 (6%)		1 (2%)
HEMATOPOIETIC SYSTEM			
*Multiple organs	(50)	(50)	(50)
Malignant lymphoma, NOS	1 (2%)		
Malignant lymphoma, histiocytic type		1 (2%)	
Malignant lymphoma, mixed type	1 (2%)	1 (2%)	
#Spleen	(50)	(48)	(49)
Malignant lymphoma, histiocytic type	1 (2%)		
CIRCULATORY SYSTEM			
*Subcut tissue	(50)	(50)	(50)
Hemangiosarcoma		1 (2%)	
#Spleen	(50)	(48)	(49)
Hemangiosarcoma		1 (2%)	
#Lung	(50)	(50)	(50)
Hemangiosarcoma, metastatic			1 (2%)
#Liver	(50)	(48)	(49)
Hemangiosarcoma	1 (2%)	1 (2%)	1 (2%)
DIGESTIVE SYSTEM			
#Liver	(50)	(48)	(49)
Hepatocellular adenoma	9 (18%)	3 (6%)	2 (4%)
Hepatocellular carcinoma	8 (16%)	4 (8%)	5 (10%)
URINARY SYSTEM			
#Kidney	(50)	(50)	(50)
Tubular cell adenoma	1 (2%)		
ENDOCRINE SYSTEM			
#Pituitary	(42)	(43)	(47)
Acidophil carcinoma		1 (2%)	
#Adrenal	(50)	(48)	(50)
Cortical adenoma			1 (2%)
Cortical carcinoma	1 (2%)		
#Adrenal medulla	(50)	(48)	(50)
Pheochromocytoma		1 (2%)	
#Thyroid	(49)	(50)	(49)
Follicular cell adenoma		1 (2%)	

TABLE B1. SUMMARY OF THE INCIDENCE OF NEOPLASMS IN MALE MICE IN THE TWO-YEAR INHALATION STUDY OF METHYL METHACRYLATE (Continued)

	CONTROL (CHAMBER)	LOW DOSE	HIGH DOSE
REPRODUCTIVE SYSTEM			
#Testis	(49)	(50)	(49)
Interstitial cell tumor	1 (2%)	1 (2%)	
NERVOUS SYSTEM			
None			
SPECIAL SENSE ORGANS			
*Harderian gland	(50)	(50)	(50)
Adenoma, NOS	4 (8%)	2 (4%)	1 (2%)
Adenocarcinoma, NOS	2 (4%)		4 (8%)
*Ear	(50)	(50)	(50)
Fibrosarcoma		1 (2%)	
MUSCULOSKELETAL SYSTEM			
None			
BODY CAVITIES			
None			
ALL OTHER SYSTEMS			
None			
ANIMAL DISPOSITION SUMMARY			
Animals initially in study	50	50	50
Natural death	4	5	3
Moribund sacrifice	4	3	
Terminal sacrifice	42	42	47
TUMOR SUMMARY			
Total animals with primary tumors**	30	17	17
Total primary tumors	43	20	19
Total animals with benign tumors	22	7	8
Total benign tumors	25	9	8
Total animals with malignant tumors	15	10	10
Total malignant tumors	18	11	11
Total animals with secondary tumors##	1		2
Total secondary tumors	1		2

* Number of animals receiving complete necropsy examination; all gross lesions including masses examined microscopically.

** Primary tumors: all tumors except secondary tumors

Number of animals examined microscopically at this site

Secondary tumors: metastatic tumors or tumors invasive into an adjacent organ

TABLE B2. SUMMARY OF THE INCIDENCE OF NEOPLASMS IN FEMALE MICE IN THE TWO-YEAR INHALATION STUDY OF METHYL METHACRYLATE

	CONTROL (CHAMBER)	LOW DOSE	HIGH DOSE
ANIMALS INITIALLY IN STUDY	50	50	50
ANIMALS NECROPSIED	50	49	50
ANIMALS EXAMINED HISTOPATHOLOGICALLY	50	49	50
INTEGUMENTARY SYSTEM			
*Skin	(50)	(49)	(50)
Squamous cell carcinoma	1 (2%)		1 (2%)
*Subcutaneous tissue	(50)	(49)	(50)
Hibernoma	1 (2%)		
Osteosarcoma, invasive	1 (2%)		
RESPIRATORY SYSTEM			
#Lung	(49)	(49)	(50)
Adenocarcinoma, NOS, metastatic	1 (2%)		
Hepatocellular carcinoma, metastatic		1 (2%)	
Alveolar/bronchiolar adenoma	1 (2%)	4 (8%)	
Alveolar/bronchiolar carcinoma	1 (2%)	1 (2%)	
HEMATOPOIETIC SYSTEM			
*Multiple organs	(50)	(49)	(50)
Malignant lymphoma, NOS			2 (4%)
Malignant lymphoma, lymphocytic type	2 (4%)		3 (6%)
Malignant lymphoma, mixed type	4 (8%)	3 (6%)	
#Spleen	(50)	(47)	(50)
Malignant lymphoma, mixed type	1 (2%)	1 (2%)	1 (2%)
#Lymph node	(46)	(47)	(46)
Squamous cell carcinoma, metastatic	1 (2%)		
#Mandibular lymph node	(46)	(47)	(46)
Squamous cell carcinoma, metastatic	1 (2%)		
#Liver	(50)	(48)	(49)
Malignant lymphoma, NOS	1 (2%)		
#Kidney	(50)	(47)	(49)
Malignant lymphoma, mixed type		1 (2%)	
CIRCULATORY SYSTEM			
#Spleen	(50)	(47)	(50)
Hemangiosarcoma		1 (2%)	1 (2%)
Hemangiosarcoma, metastatic		1 (2%)	
#Uterus	(48)	(47)	(47)
Hemangioma	1 (2%)		
Hemangiosarcoma		1 (2%)	
DIGESTIVE SYSTEM			
#Liver	(50)	(48)	(49)
Hepatocellular adenoma	7 (14%)	2 (4%)	2 (4%)
Hepatocellular carcinoma		2 (4%)	1 (2%)
URINARY SYSTEM			
None			

TABLE B2. SUMMARY OF THE INCIDENCE OF NEOPLASMS IN FEMALE MICE IN THE TWO-YEAR INHALATION STUDY OF METHYL METHACRYLATE (Continued)

	CONTROL (CHAMBER)	LOW DOSE	HIGH DOSE
ENDOCRINE SYSTEM			
#Pituitary	(49)	(44)	(39)
Adenoma, NOS	12 (24%)	3 (7%)	1 (3%)
Adenocarcinoma, NOS			1 (3%)
#Pituitary intermedia	(49)	(44)	(39)
Adenoma, NOS	1 (2%)		1 (3%)
#Adrenal	(50)	(46)	(49)
Adenoma, NOS	1 (2%)	1 (2%)	
#Adrenal/capsule	(50)	(46)	(49)
Adenoma, NOS	2 (4%)		
#Thyroid	(49)	(44)	(48)
Follicular cell adenoma	4 (8%)	1 (2%)	1 (2%)
REPRODUCTIVE SYSTEM			
*Mammary gland	(50)	(49)	(50)
Acinar cell carcinoma	1 (2%)		
Adenosquamous carcinoma	1 (2%)		
Mixed tumor, malignant			2 (4%)
#Uterus	(48)	(47)	(47)
Adenocarcinoma, NOS	3 (6%)		
Endometrial stromal polyp	1 (2%)		
#Ovary	(50)	(47)	(47)
Cystadenoma, NOS			1 (2%)
Papillary cystadenoma, NOS		1 (2%)	1 (2%)
Luteoma	1 (2%)		
Sertoli cell tumor	1 (2%)		
Teratoma, NOS			1 (2%)
NERVOUS SYSTEM			
#Brain	(50)	(48)	(50)
Neurofibrosarcoma			1 (2%)
SPECIAL SENSE ORGANS			
*Harderian gland	(50)	(49)	(50)
Adenoma, NOS		2 (4%)	
MUSCULOSKELETAL SYSTEM			
None			
BODY CAVITIES			
*Thoracic cavity	(50)	(49)	(50)
Adenocarcinoma, NOS			1 (2%)
ALL OTHER SYSTEMS			
*Multiple organs	(50)	(49)	(50)
Osteosarcoma, metastatic	1 (2%)		
Shoulder			
Osteosarcoma	1		

TABLE B2. SUMMARY OF THE INCIDENCE OF NEOPLASMS IN FEMALE MICE IN THE TWO-YEAR INHALATION STUDY OF METHYL METHACRYLATE (Continued)

	CONTROL (CHAMBER)	LOW DOSE	HIGH DOSE
ANIMAL DISPOSITION SUMMARY			
Animals initially in study	50	50	50
Natural death	16	16	10
Moribund sacrifice	6	5	6
Terminal sacrifice	27	26	33
Accidentally killed, NOS	1	2	1
Animal missexed		1	
TUMOR SUMMARY			
Total animals with primary tumors**	34	18	19
Total primary tumors	49	24	22
Total animals with benign tumors	26	11	7
Total benign tumors	33	14	7
Total animals with malignant tumors	14	10	13
Total malignant tumors	16	10	14
Total animals with secondary tumors##	3	2	
Total secondary tumors	5	2	
Total animals with tumors uncertain-- benign or malignant			1
Total uncertain tumors			1

* Number of animals receiving complete necropsy examination; all gross lesions including masses examined microscopically.

** Primary tumors: all tumors except secondary tumors

Number of animals examined microscopically at this site

Secondary tumors: metastatic tumors or tumors invasive into an adjacent organ

TABLE B3. INDIVIDUAL ANIMAL TUMOR PATHOLOGY OF MALE MICE IN THE TWO-YEAR INHALATION STUDY OF METHYL METHACRYLATE: CHAMBER CONTROL

ANIMAL NUMBER	08	01	02	03	04	05	06	07	08	09	10	11	12	13	14	15	16	17	18	19	20	21	22	23	24
WEEKS ON STUDY	02	08	08	07	07	03	11	11	11	11	11	11	11	11	11	11	11	11	11	11	11	11	11	11	11
RESPIRATORY SYSTEM																									
Lungs and bronchi	+	+	+	+	+	+	+	+	+	+	+	+	+	+	+	+	+	+	+	+	+	+	+	+	+
Hepatocellular carcinoma, metastatic	X																								
Alveolar/bronchiolar adenoma	X																								
Alveolar/bronchiolar carcinoma																									
Trachea	+	+	+	+	+	+	+	+	+	+	+	+	+	+	+	+	+	+	+	+	+	+	+	+	+
HEMATOPOIETIC SYSTEM																									
Bone marrow	+	+	+	+	+	+	+	+	+	+	+	+	+	+	+	+	+	+	+	+	+	+	+	+	+
Spleen	+	+	+	+	+	+	+	+	+	+	+	+	+	+	+	+	+	+	+	+	+	+	+	+	+
Malg. lymphoma, histiocytic type	+	+	+	+	+	+	+	+	+	+	+	+	+	+	+	+	+	+	+	+	+	+	+	+	+
Lymph nodes	+	+	+	+	+	+	+	+	+	+	+	+	+	+	+	+	+	+	+	+	+	+	+	+	+
Thymus	-	+	-	+	+	-	-	+	-	-	-	+	+	+	+	+	+	+	+	+	+	+	+	+	+
CIRCULATORY SYSTEM																									
Heart	+	+	+	+	+	+	+	+	+	+	+	+	+	+	+	+	+	+	+	+	+	+	+	+	+
DIGESTIVE SYSTEM																									
Salivary gland	+	+	+	+	+	+	+	+	+	+	+	+	+	+	+	+	+	+	+	+	+	+	+	+	+
Liver	+	+	+	+	+	+	+	+	+	+	+	+	+	+	+	+	+	+	+	+	+	+	+	+	+
Hepatocellular adenoma																									
Hepatocellular carcinoma	X			X	X																		X	X	
Hemangiosarcoma																									
Bile duct	+	+	+	+	+	+	+	+	+	+	+	+	+	+	+	+	+	+	+	+	+	+	+	+	+
Gallbladder & common bile duct	N	+	N	+	N	+	+	+	+	+	+	+	+	+	+	+	+	+	+	+	+	+	+	+	+
Pancreas	+	+	+	+	+	+	+	+	+	+	+	+	+	+	+	+	+	+	+	+	+	+	+	+	+
Esophagus	+	+	+	+	+	+	+	+	+	+	+	+	+	+	+	+	+	+	+	+	+	+	+	+	+
Stomach	+	+	+	+	+	+	+	+	+	+	+	+	+	+	+	+	+	+	+	+	+	+	+	+	+
Small intestine	+	+	+	+	-	+	+	+	+	+	+	+	+	+	+	+	+	+	+	+	+	+	+	+	+
Large intestine	+	+	+	+	-	+	+	+	+	+	+	+	+	+	+	+	+	+	+	+	+	+	+	+	+
URINARY SYSTEM																									
Kidney	+	+	+	+	+	+	+	+	+	+	+	+	+	+	+	+	+	+	+	+	+	+	+	+	+
Tubular cell adenoma																									
Urinary bladder	+	+	+	+	+	+	+	+	+	+	+	+	+	+	+	+	+	+	+	+	+	+	+	+	+
ENDOCRINE SYSTEM																									
Pituitary	-	+	-	+	-	-	+	+	+	-	+	+	+	+	+	+	+	+	+	+	+	+	+	+	-
Adrenal	+	+	+	+	+	+	+	+	+	+	+	+	+	+	+	+	+	+	+	+	+	+	+	+	+
Cortical carcinoma							X																		
Thyroid	+	+	+	+	+	+	+	+	+	+	+	+	+	+	+	+	+	+	+	+	+	+	+	+	+
Parathyroid	+	-	+	-	-	-	-	-	-	-	-	-	-	-	-	-	-	-	-	-	-	-	-	-	-
REPRODUCTIVE SYSTEM																									
Mammary gland	N	N	N	N	N	N	N	N	N	N	N	N	N	N	N	N	N	N	N	N	N	N	N	N	N
Testis	+	+	+	+	-	+	+	+	+	+	+	+	+	+	+	+	+	+	+	+	+	+	+	+	+
Interstitial cell tumor																									
Prostate	+	+	+	+	+	+	+	+	+	+	+	+	+	+	+	+	+	+	+	+	+	+	+	+	+
NERVOUS SYSTEM																									
Brain	+	+	+	+	+	+	+	+	+	+	+	+	+	+	+	+	+	+	+	+	+	+	+	+	+
SPECIAL SENSE ORGANS																									
Harderian gland	N	N	N	N	N	N	N	N	N	N	N	N	N	N	N	N	N	N	N	N	N	N	N	N	N
Adenoma, NOS					X																				
Adenocarcinoma, NOS																								X	X
ALL OTHER SYSTEMS																									
Multiple organs, NOS	N	N	N	N	N	N	N	N	N	N	N	N	N	N	N	N	N	N	N	N	N	N	N	N	N
Malignant lymphoma, NOS					X																				
Malignant lymphoma, mixed type																X									

+: Tissue examined microscopically
 -: Required tissue not examined microscopically
 X: Tumor incidence
 N: Necropsy, no autolysis, no microscopic examination
 S: Animal sexed

: No tissue information submitted
 C: Necropsy, no histology due to protocol
 A: Autolysis
 M: Animal missing
 B: No necropsy performed

TABLE B3. INDIVIDUAL ANIMAL TUMOR PATHOLOGY OF MALE MICE: CHAMBER CONTROL (Continued)

ANIMAL NUMBER	WEEKS ON STUDY																				TOTAL TISSUES TUMORS						
	0 5	0 6	0 7	0 8	0 9	0 10	0 11	0 12	0 13	0 14	0 15	0 16	0 17	0 18	0 19	0 20	0 21	0 22	0 23	0 24		0 25	0 26	0 27	0 28	0 29	0 30
RESPIRATORY SYSTEM																											
Lungs and bronchi	+	+	+	+	+	+	+	+	+	+	+	+	+	+	+	+	+	+	+	+	+	+	+	+	+	+	+
Hepatocellular carcinoma, metastatic																											
Alveolar/bronchiolar adenoma			X																	X			X			X	
Alveolar/bronchiolar carcinoma																											
Trachea	+	+	+	+	+	+	+	+	+	+	+	+	+	+	+	+	+	+	+	+	+	+	+	+	+	+	+
HEMATOPOIETIC SYSTEM																											
Bone marrow	+	+	+	+	+	+	+	+	+	+	+	+	+	+	+	+	+	+	+	+	+	+	+	+	+	+	+
Spleen	+	+	+	+	+	+	+	+	+	+	+	+	+	+	+	+	+	+	+	+	+	+	+	+	+	+	+
Malig. lymphoma, histiocytic type																											
Lymph nodes																											
Thymus	+	-	+	-	-	+	+	-	+	-	+	+	+	-	+	+	+	+	-	+	+	+	-	+	-	+	+
CIRCULATORY SYSTEM																											
Heart	+	+	+	+	+	+	+	+	+	+	+	+	+	+	+	+	+	+	+	+	+	+	+	+	+	+	+
DIGESTIVE SYSTEM																											
Salivary gland	+	+	+	+	+	+	+	+	+	+	+	+	+	+	+	+	+	+	+	+	+	+	+	+	+	+	+
Liver	+	+	+	+	+	+	+	+	+	+	+	+	+	+	+	+	+	+	+	+	+	+	+	+	+	+	+
Hepatocellular adenoma																											
Hepatocellular carcinoma																											
Hemangiosarcoma	X					X																					
Bile duct	X																										
Gallbladder & common bile duct	+	+	+	+	+	+	+	+	+	+	+	+	+	+	+	+	+	+	+	+	+	+	+	+	+	+	+
Pancreas	+	+	+	+	+	+	+	+	+	+	+	+	+	+	+	+	+	+	+	+	+	+	+	+	+	+	+
Esophagus	+	+	+	+	+	+	+	+	+	+	+	+	+	+	+	+	+	+	+	+	+	+	+	+	+	+	+
Stomach	+	+	+	+	+	+	+	+	+	+	+	+	+	+	+	+	+	+	+	+	+	+	+	+	+	+	+
Small intestine	+	+	+	+	+	+	+	+	+	+	+	+	+	+	+	+	+	+	+	+	+	+	+	+	+	+	+
Large intestine	+	+	+	+	+	+	+	+	+	+	+	+	+	+	+	+	+	+	+	+	+	+	+	+	+	+	+
URINARY SYSTEM																											
Kitney	+	+	+	+	+	+	+	+	+	+	+	+	+	+	+	+	+	+	+	+	+	+	+	+	+	+	+
Tubular cell adenoma																											
Urinary bladder	+	+	+	+	+	+	+	+	+	+	+	+	+	+	+	+	+	+	+	+	+	+	+	+	+	+	+
ENDOCRINE SYSTEM																											
Pituitary	+	+	+	+	+	+	+	+	+	+	+	+	+	+	+	+	+	+	+	+	+	+	+	+	+	+	+
Adrenal	+	+	+	+	+	+	+	+	+	+	+	+	+	+	+	+	+	+	+	+	+	+	+	+	+	+	+
Cortical carcinoma																											
Thyroid	+	+	+	+	+	+	+	+	+	+	+	+	+	+	+	+	+	+	+	+	+	+	+	+	+	+	+
Parathyroid	-	+	+	+	-	-	+	+	+	+	+	+	+	+	+	+	+	+	+	+	+	+	+	+	+	+	+
REPRODUCTIVE SYSTEM																											
Mammary gland	N	N	N	N	N	N	N	N	N	N	N	N	N	N	N	N	N	N	N	N	N	N	N	N	N	N	N
Testis	+	+	+	+	+	+	+	+	+	+	+	+	+	+	+	+	+	+	+	+	+	+	+	+	+	+	+
Interstitial cell tumor																											
Prostate	+	+	+	+	+	+	+	+	+	+	+	+	+	+	+	+	+	+	+	+	+	+	+	+	+	+	+
NERVOUS SYSTEM																											
Brain	+	+	+	+	+	+	+	+	+	+	+	+	+	+	+	+	+	+	+	+	+	+	+	+	+	+	+
SPECIAL SENSE ORGANS																											
Harderian gland	N	N	N	N	N	N	N	N	N	N	N	N	N	N	N	N	N	N	N	N	N	N	N	N	N	N	N
Adenoma, NOS																											
Adenocarcinoma, NOS																											
ALL OTHER SYSTEMS																											
Multiple organs, NOS	N	N	N	N	N	N	N	N	N	N	N	N	N	N	N	N	N	N	N	N	N	N	N	N	N	N	N
Malignant lymphoma, NOS																											
Malignant lymphoma, mixed type																											

* Animals necropsied

TABLE B3. INDIVIDUAL ANIMAL TUMOR PATHOLOGY OF MALE MICE: LOW DOSE
(Continued)

ANIMAL NUMBER	WEEKS ON STUDY																			TOTAL TISSUES TUMORS					
	0	0	0	0	0	0	0	0	0	0	0	0	0	0	0	0	0	0	0		0				
	2	2	2	2	2	2	2	2	3	3	3	3	3	3	3	3	4	4	4	4	4	4	4		
	1	2	3	4	6	7	8	9	0	1	3	4	5	7	8	9	1	2	3	4	5	6	7	8	9
1	1	1	1	1	1	1	1	1	1	1	1	1	1	1	1	1	1	1	1	1	1	1	1	1	
0	0	0	0	0	0	0	0	0	0	0	0	0	0	0	0	0	0	0	0	0	0	0	0	0	
4	4	4	4	4	4	4	4	4	4	4	4	4	4	4	4	4	4	4	4	4	4	4	4	4	
INTEGUMENTARY SYSTEM																								*50 1	
Subcutaneous tissue Hemangiosarcoma																									
RESPIRATORY SYSTEM																								50 1 45	
Lungs and bronchi Alveolar/bronchiolar adenoma Trachea																									
HEMATOPOIETIC SYSTEM																								50 48 1 39 21	
Bone marrow Spleen Hemangiosarcoma																									
Lymph nodes Thymus																									
CIRCULATORY SYSTEM																									
Heart																									
DIGESTIVE SYSTEM																								48 48 3 4 1 48 49 50 50 49 49	
Salivary gland Liver Hepatocellular adenoma Hepatocellular carcinoma Hemangiosarcoma																									
Bile duct Gallbladder & common bile duct Pancreas Esophagus Stomach Small intestine Large intestine																									
URINARY SYSTEM																									
Kidney Urinary bladder																									
ENDOCRINE SYSTEM																									43 1 48 1 50 1 30
Pituitary Acidophil carcinoma Adrenal Pheochromocytoma Thyroid Follicular cell adenoma Parathyroid																									
REPRODUCTIVE SYSTEM																									
Mammary gland Testis Interstitial cell tumor Prostate																									
NERVOUS SYSTEM																									
Brain																									
SPECIAL SENSE ORGANS																									*50 2 *50 1
Harderian gland Adenoma, NOS Ear Fibrosarcoma																									
ALL OTHER SYSTEMS																									
Multiple organs, NOS Malignant lymphoma, histiocytic type Malignant lymphoma, mixed type																									

* Animals necropsied

TABLE B3. INDIVIDUAL ANIMAL TUMOR PATHOLOGY OF MALE MICE IN THE TWO-YEAR INHALATION STUDY OF METHYL METHACRYLATE: HIGH DOSE

ANIMAL NUMBER	0	1	2	3	4	5	6	7	8	9	10	11	12	13	14	15	16	17	18	19	20	21	22	23	24
WEEKS ON STUDY	0	0	8	0	0	0	0	0	0	0	0	0	0	0	0	0	0	0	0	0	0	0	0	0	0
INTEGUMENTARY SYSTEM																									
Subcutaneous tissue	+	+	+	+	+	N	+	+	+	+	+	+	+	+	+	+	+	+	+	+	+	+	+	+	
Neurofibroma																									
RESPIRATORY SYSTEM																									
Lungs and bronchi	+	+	+	+	+	+	+	+	+	+	+	+	+	+	+	+	+	+	+	+	+	+	+	+	
Adenocarcinoma, NOS, metastatic						X																			
Alveolar/bronchiolar adenoma																			X						
Alveolar/bronchiolar carcinoma																									
Hemangiosarcoma, metastatic			X																						
Trachea	+	+	+	+	-	-	+	+	+	+	+	+	+	+	+	+	+	+	+	+	+	+	-	-	
HEMATOPOIETIC SYSTEM																									
Bone marrow	+	+	+	+	+	+	+	+	+	+	+	+	+	+	+	+	+	+	+	+	+	+	+	+	
Spleen	+	+	+	+	+	+	+	+	+	+	+	+	+	+	+	+	+	+	+	+	+	+	+	+	
Lymph nodes	+	+	+	+	+	+	+	+	+	+	+	+	+	+	+	+	+	+	+	+	+	+	+	+	
Thymus	-	-	+	+	+	+	+	+	+	-	+	+	+	+	+	+	+	-	+	-	-	-	-	-	
CIRCULATORY SYSTEM																									
Heart	+	+	+	+	+	+	+	+	+	+	+	+	+	+	+	+	+	+	+	+	+	+	+	+	
DIGESTIVE SYSTEM																									
Salivary gland	+	+	+	+	+	+	+	+	+	+	+	+	+	+	+	+	+	+	+	+	+	+	+	+	
Liver	+	+	+	+	+	+	+	+	+	+	+	+	+	+	+	+	+	+	+	+	+	+	+	+	
Hepatocellular adenoma																									
Hepatocellular carcinoma																									
Hemangiosarcoma			X																						
Bile duct	+	+	+	+	+	+	+	+	+	+	+	+	+	+	+	+	+	+	+	+	+	+	+	+	
Gallbladder & common bile duct	+	+	+	+	+	+	+	+	+	N	N	+	+	+	+	+	+	+	+	+	+	+	+	N	
Pancreas	+	+	+	+	+	+	+	+	+	+	+	+	+	+	+	+	+	+	+	+	+	+	+	+	
Esophagus	+	+	+	+	+	+	+	+	+	+	+	+	+	+	+	+	+	+	+	+	+	+	+	+	
Stomach	+	+	+	+	+	+	+	+	+	+	+	+	+	+	+	+	+	+	+	+	+	+	+	+	
Small intestine	-	-	+	+	+	+	+	+	+	+	+	+	+	+	+	+	+	+	+	+	+	+	+	+	
Large intestine	+	+	+	+	+	+	+	+	+	+	+	+	+	+	+	+	+	+	+	+	+	+	+	+	
URINARY SYSTEM																									
Kidney	+	+	+	+	+	+	+	+	+	+	+	+	+	+	+	+	+	+	+	+	+	+	+	+	
Urinary bladder	+	+	+	+	+	+	+	+	+	+	+	+	+	+	+	+	+	+	+	+	+	+	+	+	
ENDOCRINE SYSTEM																									
Pituitary	+	+	+	+	+	+	+	+	+	-	+	+	+	+	-	+	+	+	+	+	+	+	+	+	
Adrenal	+	+	+	+	+	+	+	+	+	+	+	+	+	+	+	+	+	+	+	+	+	+	+	+	
Cortical adenoma											X														
Thyroid	-	+	+	+	+	+	+	+	+	+	+	+	+	+	+	+	+	+	+	+	+	+	+	+	
Parathyroid	-	-	+	-	-	+	+	-	-	-	+	+	+	-	+	+	+	-	-	-	-	-	+	+	
REPRODUCTIVE SYSTEM																									
Mammary gland	N	N	N	+	N	N	N	N	N	N	N	N	N	N	N	N	N	N	N	N	N	N	N	N	
Testis	+	+	+	+	+	+	+	+	+	+	+	+	+	+	+	+	+	+	+	+	+	+	+	+	
Prostate	+	-	+	+	+	+	+	+	+	+	+	+	+	+	+	+	+	+	+	+	+	+	+	+	
NERVOUS SYSTEM																									
Brain	+	+	+	+	+	+	+	+	+	+	+	+	+	+	+	+	+	+	+	+	+	+	+	+	
SPECIAL SENSE ORGANS																									
Harderian gland	N	N	N	N	N	N	N	N	N	N	N	N	N	N	N	N	N	N	N	N	N	N	N	N	
Adenoma, NOS																								X	
Adenocarcinoma, NOS									X													X			

**TABLE B3. INDIVIDUAL ANIMAL TUMOR PATHOLOGY OF MALE MICE: HIGH DOSE
(Continued)**

ANIMAL NUMBER	0 5	0 6	0 7	0 8	0 9	0 0	0 1	0 2	0 3	0 3	0 3	0 3	0 3	0 3	0 3	0 3	0 4	0 4	0 4	0 4	0 4	0 4	0 5	0 7	0 8	0 9	0 0	TOTAL: TISSUES TUMORS	
WEEKS ON STUDY	1 0	1 4	1 4	1 4	1 4	1 4	1 4	1 4	1 4	1 4	1 4	1 4	1 4	1 4	1 4	1 4	1 4	1 4	1 4	1 4	1 4	1 4	1 4	1 4	1 4	1 4	1 4		
INTEGUMENTARY SYSTEM																													
Subcutaneous tissue	+	+	+	+	+	+	+	+	+	+	+	+	+	+	+	+	+	+	+	+	+	+	+	+	+	+	+	*50 1	
Neurofibroma																								X					
RESPIRATORY SYSTEM																													
Lungs and bronchi	+	+	+	+	+	+	+	+	+	+	+	+	+	+	+	+	+	+	+	+	+	+	+	+	+	+	+	50 1 3 1 1 43	
Adenocarcinoma, NOS, metastatic																													
Alveolar/bronchiolar adenoma																													
Alveolar/bronchiolar carcinoma																													X
Hemangiosarcoma, metastatic																													
Trachea	+	+	+	+	+	+	+	+	+	+	+	+	+	+	+	+	+	+	+	+	+	+	+	+	+	+	+		
HEMATOPOIETIC SYSTEM																													
Bone marrow	+	+	+	+	+	+	+	+	+	+	+	+	+	+	+	+	+	+	+	+	+	+	+	+	+	+	+	50 49 42 31	
Spleen	+	+	+	+	+	+	+	+	+	+	+	+	+	+	+	+	+	+	+	+	+	+	+	+	+	+	+		
Lymph nodes	+	+	-	+	-	+	+	+	+	+	+	+	+	+	-	+	-	+	-	+	-	+	-	+	-	+	+		
Thymus	+	-	-	+	-	+	+	+	+	+	+	+	+	-	+	+	+	+	-	-	+	-	-	+	-	+	+		
CIRCULATORY SYSTEM																													
Heart	+	+	+	+	+	+	+	+	+	+	+	+	+	+	+	+	+	+	+	+	+	+	+	+	+	+	+	50	
DIGESTIVE SYSTEM																													
Salivary gland	+	+	+	+	+	+	+	+	+	+	+	+	+	+	+	+	+	+	+	+	+	+	+	+	+	+	+	50 49 2 5 1 49 *50 50 50 50 48 50	
Liver	-	+	+	+	+	+	+	+	+	+	+	+	+	+	+	+	+	+	+	+	+	+	+	+	+	+	+		
Hepatocellular adenoma																													
Hepatocellular carcinoma																													X
Hemangiosarcoma																													
Bile duct	-	+	+	+	+	+	+	+	+	+	+	+	+	+	+	+	+	+	+	+	+	+	+	+	+	+	+		
Gallbladder & common bile duct	+	N	+	+	+	N	+	N	+	+	+	+	+	+	+	+	+	+	+	+	+	+	+	+	+	+	+		
Pancreas	+	+	+	+	+	+	+	+	+	+	+	+	+	+	+	+	+	+	+	+	+	+	+	+	+	+	+		
Esophagus	+	+	+	+	+	+	+	+	+	+	+	+	+	+	+	+	+	+	+	+	+	+	+	+	+	+	+		
Stomach	+	+	+	+	+	+	+	+	+	+	+	+	+	+	+	+	+	+	+	+	+	+	+	+	+	+	+		
Small intestine	+	+	+	+	+	+	+	+	+	+	+	+	+	+	+	+	+	+	+	+	+	+	+	+	+	+	+		
Large intestine	+	+	+	+	+	+	+	+	+	+	+	+	+	+	+	+	+	+	+	+	+	+	+	+	+	+	+		
URINARY SYSTEM																													
Kidney	+	+	+	+	+	+	+	+	+	+	+	+	+	+	+	+	+	+	+	+	+	+	+	+	+	+	+	50 49	
Urinary bladder	+	+	+	+	+	+	+	+	+	+	+	+	+	+	+	+	+	+	+	+	+	+	+	+	+	+	+		
ENDOCRINE SYSTEM																													
Pituitary	-	+	+	+	+	+	+	+	+	+	+	+	+	+	+	+	+	+	+	+	+	+	+	+	+	+	+	47 50 1 49 21	
Adrenal	+	+	+	+	+	+	+	+	+	+	+	+	+	+	+	+	+	+	+	+	+	+	+	+	+	+	+		
Cortical adenoma																													
Thyroid	+	+	+	+	+	+	+	+	+	+	+	+	+	+	+	+	+	+	+	+	+	+	+	+	+	+	+		
Parathyroid	-	+	+	+	-	+	+	-	+	-	+	-	+	-	+	-	+	-	+	-	+	-	+	-	+	-	+		
REPRODUCTIVE SYSTEM																													
Mammary gland	N	N	N	N	N	N	N	N	N	N	N	N	N	N	N	N	N	N	N	N	N	N	N	N	N	N	N	*50 49 49	
Testis	+	+	+	+	+	+	+	+	+	+	+	+	+	+	+	+	+	+	+	+	+	+	+	+	+	+	+		
Prostate	+	+	+	+	+	+	+	+	+	+	+	+	+	+	+	+	+	+	+	+	+	+	+	+	+	+	+		
NERVOUS SYSTEM																													
Brain	+	+	+	+	+	+	+	+	+	+	+	+	+	+	+	+	+	+	+	+	+	+	+	+	+	+	+	50	
SPECIAL SENSE ORGANS																													
Harderian gland	N	N	N	N	N	N	N	N	N	N	N	N	N	N	N	N	N	N	N	N	N	N	N	N	N	N	N	*50 1 4	
Adenoma, NOS																													
Adenocarcinoma, NOS																													X

* Animals necropsied

**TABLE B4. INDIVIDUAL ANIMAL TUMOR PATHOLOGY OF FEMALE MICE: LOW DOSE
(Continued)**

ANIMAL NUMBER	0 4	0 5	0 6	0 7	0 0	1 3	1 6	1 7	1 8	1 9	1 1	2 2	2 7	2 8	3 0	3 2	3 6	3 8	3 9	4 0	4 2	4 3	4 4	4 5	4 9	TOTAL TISSUES TUMORS
WEEKS ON STUDY	1 4	1 4	1 4	1 4	1 4	1 4	1 4	1 4	1 4	1 4	1 4	1 4	1 4	1 4	1 4	1 4	1 4	1 4	1 4	1 4	1 4	1 4	1 4	1 4	1 4	
RESPIRATORY SYSTEM																										
Lungs and bronchi	+																								49	
Hepatocellular carcinoma, metastatic	+																								1	
Alveolar/bronchiolar adenoma	X																								4	
Alveolar/bronchiolar carcinoma	X																								1	
Trachea	+																								46	
HEMATOPOIETIC SYSTEM																										
Bone marrow	+																								47	
Spleen	+																								47	
Hemangiosarcoma	X																								1	
Hemangiosarcoma, metastatic	+																								1	
Malignant lymphoma, mixed type	+																								47	
Lymph nodes	+																								47	
Thymus	+																								24	
CIRCULATORY SYSTEM																										
Heart	+																								48	
DIGESTIVE SYSTEM																										
Salivary gland	+																								47	
Liver	+																								48	
Hepatocellular adenoma	+																								2	
Hepatocellular carcinoma	X																								2	
Bile duct	+																								48	
Gallbladder & common bile duct	+																								*49	
Pancreas	+																								48	
Esophagus	+																								47	
Stomach	+																								47	
Small intestine	+																								44	
Large intestine	+																								45	
URINARY SYSTEM																										
Kidney	+																								47	
Malignant lymphoma, mixed type	+																								1	
Urinary bladder	+																								42	
ENDOCRINE SYSTEM																										
Pituitary	+																								44	
Adenoma, NOS	X																								3	
Adrenal	+																								46	
Adenoma, NOS	X																								1	
Thyroid	+																								44	
Follicular cell adenoma	X																								1	
Parathyroid	-																								24	
REPRODUCTIVE SYSTEM																										
Mammary gland	N																								*49	
Uterus	+																								47	
Hemangiosarcoma	+																								1	
Ovary	+																								47	
Papillary cystadenoma, NOS	X																								1	
NERVOUS SYSTEM																										
Brain	+																								48	
SPECIAL SENSE ORGANS																										
Harderian gland	N																								*49	
Adenoma, NOS	X																								2	
ALL OTHER SYSTEMS																										
Multiple organs, NOS	N																								*49	
Malignant lymphoma, mixed type	X																								3	

* Animals necropsied

APPENDIX C

SUMMARY OF THE INCIDENCE OF NONNEOPLASTIC LESIONS IN RATS IN THE TWO-YEAR INHALATION STUDIES OF METHYL METHACRYLATE

TABLE C1. SUMMARY OF THE INCIDENCE OF NONNEOPLASTIC LESIONS IN MALE RATS IN THE TWO-YEAR INHALATION STUDY OF METHYL METHACRYLATE

	CONTROL (CHAMBER)	LOW DOSE	HIGH DOSE
ANIMALS INITIALLY IN STUDY	50	50	50
ANIMALS NECROPSIED	50	50	50
ANIMALS EXAMINED HISTOPATHOLOGICALLY	50	50	50
INTEGUMENTARY SYSTEM			
*Skin	(50)	(50)	(50)
Ulcer, NOS	1 (2%)		
Hyperkeratosis	1 (2%)	1 (2%)	
Acanthosis	1 (2%)	1 (2%)	
*Subcutaneous tissue	(50)	(50)	(50)
Inflammation, chronic focal			1 (2%)
RESPIRATORY SYSTEM			
*Nasal cavity	(50)	(50)	(50)
Foreign body, NOS	7 (14%)	5 (10%)	8 (16%)
Hemorrhage	1 (2%)	3 (6%)	
Inflammation, serous		37 (74%)	44 (88%)
Inflammation, suppurative	11 (22%)	21 (42%)	30 (60%)
Inflammation, chronic focal	5 (10%)		4 (8%)
Hyperplasia, epithelial	2 (4%)		3 (6%)
Metaplasia, squamous	2 (4%)	1 (2%)	3 (6%)
*Larynx	(50)	(50)	(50)
Foreign body, NOS		1 (2%)	1 (2%)
Inflammation, suppurative	8 (16%)	11 (22%)	5 (10%)
Inflammation, chronic	3 (6%)	3 (6%)	2 (4%)
Hyperplasia, epithelial	1 (2%)	1 (2%)	
*Laryngeal submucosa	(50)	(50)	(50)
Hemorrhage		1 (2%)	
#Trachea	(50)	(48)	(50)
Inflammation, suppurative	1 (2%)	1 (2%)	
Inflammation, chronic	1 (2%)		
#Lung/bronchus	(49)	(49)	(50)
Foreign body, NOS	1 (2%)		
Inflammation, chronic focal	1 (2%)		
Metaplasia, squamous	1 (2%)		
#Lung/bronchiole	(49)	(49)	(50)
Foreign body, NOS	1 (2%)		
Hemorrhage			1 (2%)
Inflammation, suppurative			1 (2%)
#Lung	(49)	(49)	(50)
Alveolar macrophages	6 (12%)	20 (41%)	16 (32%)
Hyperplasia, alveolar epithelium	5 (10%)	4 (8%)	5 (10%)
#Lung/alveoli	(49)	(49)	(50)
Edema, NOS		2 (4%)	2 (4%)
Hemorrhage	2 (4%)	3 (6%)	5 (10%)
Inflammation, suppurative	2 (4%)	3 (6%)	4 (8%)
Inflammation, chronic		1 (2%)	
Inflammation, chronic focal	6 (12%)	1 (2%)	5 (10%)
Inflammation, chronic diffuse			1 (2%)
Fibrosis, focal	4 (8%)	2 (4%)	1 (2%)
Fibrosis, multifocal	2 (4%)	4 (8%)	4 (8%)
Fibrosis, diffuse	1 (2%)		1 (2%)
Necrosis, focal		1 (2%)	
HEMATOPOIETIC SYSTEM			
#Bone marrow	(47)	(49)	(47)
Atrophy, NOS		1 (2%)	

TABLE C1. SUMMARY OF THE INCIDENCE OF NONNEOPLASTIC LESIONS IN MALE RATS IN THE TWO-YEAR INHALATION STUDY OF METHYL METHACRYLATE (Continued)

	CONTROL (CHAMBER)	LOW DOSE	HIGH DOSE
HEMATOPOIETIC SYSTEM (Continued)			
#Spleen	(50)	(50)	(49)
Hemorrhage		1 (2%)	1 (2%)
Fibrosis, focal	3 (6%)	2 (4%)	4 (8%)
Necrosis, focal	1 (2%)		
Hyperplasia, lymphoid	1 (2%)		
Hematopoiesis		1 (2%)	
#Splenic capsule	(50)	(50)	(49)
Fibrosis		2 (4%)	
#Mandibular lymph node	(49)	(45)	(47)
Dilatation, NOS	1 (2%)		
Hemorrhage	1 (2%)		
Inflammation, suppurative			1 (2%)
Hyperplasia, lymphoid	1 (2%)	1 (2%)	
#Mesenteric lymph node	(49)	(45)	(47)
Dilatation/sinus			1 (2%)
CIRCULATORY SYSTEM			
*Mediastinum	(50)	(50)	(50)
Periarteritis			1 (2%)
*Larynx	(50)	(50)	(50)
Periarteritis			1 (2%)
#Heart	(50)	(49)	(50)
Periarteritis			1 (2%)
#Heart/atrium	(50)	(49)	(50)
Multiple cysts			1 (2%)
Thrombosis, NOS	3 (6%)	5 (10%)	2 (4%)
#Myocardium	(50)	(49)	(50)
Inflammation, chronic	1 (2%)	1 (2%)	2 (4%)
Fibrosis	10 (20%)	9 (18%)	8 (16%)
#Endocardium	(50)	(49)	(50)
Fibrosis, focal			1 (2%)
#Cardiac valve	(50)	(49)	(50)
Inflammation, NOS	1 (2%)		
Fibrosis	1 (2%)		
Metaplasia, cartilaginous	6 (12%)	4 (8%)	6 (12%)
#Liver	(50)	(50)	(49)
Thrombus, canalized		1 (2%)	1 (2%)
#Pancreas	(50)	(47)	(48)
Periarteritis		2 (4%)	2 (4%)
#Testis	(50)	(48)	(50)
Periarteritis			2 (4%)
DIGESTIVE SYSTEM			
#Liver	(50)	(50)	(49)
Hemorrhage		2 (4%)	1 (2%)
Inflammation, suppurative	1 (2%)		
Inflammation, chronic focal	1 (2%)	1 (2%)	
Inflammation, granulomatous focal	3 (6%)	2 (4%)	1 (2%)
Fibrosis, focal			1 (2%)
Hepatocytomegaly	2 (4%)	5 (10%)	5 (10%)
#Liver/hepatocytes	(50)	(50)	(49)
Necrosis, focal	3 (6%)	1 (2%)	3 (6%)
Necrosis, diffuse		1 (2%)	
Cytoplasmic vacuolization	10 (20%)	10 (20%)	14 (29%)
Basophilic cyto change	13 (26%)	12 (24%)	17 (35%)
Eosinophilic cyto change	3 (6%)	1 (2%)	3 (6%)
#Bile duct	(50)	(50)	(49)
Fibrosis, multifocal		1 (2%)	2 (4%)
Hyperplasia, NOS	21 (42%)	32 (64%)	34 (69%)

TABLE C1. SUMMARY OF THE INCIDENCE OF NONNEOPLASTIC LESIONS IN MALE RATS IN THE TWO-YEAR INHALATION STUDY OF METHYL METHACRYLATE (Continued)

	CONTROL (CHAMBER)	LOW DOSE	HIGH DOSE
DIGESTIVE SYSTEM (Continued)			
#Pancreatic acinus	(50)	(47)	(48)
Atrophy, focal	25 (50%)	16 (34%)	26 (54%)
#Glandular stomach	(49)	(49)	(50)
Mineralization	1 (2%)	1 (2%)	
Ulcer, NOS	1 (2%)		
#Forestomach	(49)	(49)	(50)
Cyst, NOS			1 (2%)
Ulcer, NOS	3 (6%)	1 (2%)	1 (2%)
Inflammation, suppurative	1 (2%)		2 (4%)
Hyperplasia, epithelial	4 (8%)	1 (2%)	1 (2%)
Hyperkeratosis	2 (4%)	1 (2%)	
#Colon	(48)	(48)	(50)
Inflammation, chronic focal	1 (2%)		
Parasitism	3 (6%)	8 (17%)	11 (22%)
*Rectum	(50)	(50)	(50)
Inflammation, suppurative	1 (2%)		
Parasitism	1 (2%)	2 (4%)	2 (4%)
*Anus	(50)	(50)	(50)
Parasitism			1 (2%)
URINARY SYSTEM			
#Kidney	(50)	(50)	(50)
Mineralization	1 (2%)	1 (2%)	
Inflammation, suppurative			2 (4%)
Nephropathy	41 (82%)	48 (96%)	46 (92%)
#Kidney/cortex	(50)	(50)	(50)
Cyst, NOS		2 (4%)	1 (2%)
Abscess, NOS	1 (2%)		
Pigmentation, NOS			1 (2%)
#Kidney/tubule	(50)	(50)	(50)
Dilatation, NOS			1 (2%)
#Urinary bladder	(49)	(47)	(49)
Ulcer, NOS		1 (2%)	
Inflammation, suppurative		1 (2%)	1 (2%)
Hyperplasia, epithelial			2 (4%)
#Urinary bladder/submucosa	(49)	(47)	(49)
Hemorrhage	1 (2%)		1 (2%)
ENDOCRINE SYSTEM			
#Anterior pituitary	(45)	(47)	(48)
Hyperplasia, NOS	6 (13%)	6 (13%)	8 (17%)
#Adrenal cortex	(49)	(49)	(50)
Cytoplasmic vacuolization	5 (10%)	7 (14%)	4 (8%)
Hyperplasia, focal	1 (2%)	2 (4%)	1 (2%)
#Adrenal medulla	(49)	(49)	(50)
Necrosis, focal		1 (2%)	
Hyperplasia, focal	2 (4%)	14 (29%)	7 (14%)
#Thyroid	(50)	(49)	(50)
Ultimobranchial cyst			1 (2%)
Cystic follicles		1 (2%)	
Hyperplasia, C-cell	3 (6%)	6 (12%)	3 (6%)
#Parathyroid	(25)	(33)	(33)
Hyperplasia	1 (4%)		1 (3%)
#Pancreatic islets	(50)	(47)	(48)
Hyperplasia, focal			1 (2%)

TABLE C1. SUMMARY OF THE INCIDENCE OF NONNEOPLASTIC LESIONS IN MALE RATS IN THE TWO-YEAR INHALATION STUDY OF METHYL METHACRYLATE (Continued)

	CONTROL (CHAMBER)	LOW DOSE	HIGH DOSE
REPRODUCTIVE SYSTEM			
*Mammary gland	(50)	(50)	(50)
Galactocele	1 (2%)		1 (2%)
*Preputial gland	(50)	(50)	(50)
Cyst, NOS	1 (2%)		1 (2%)
Ulcer, NOS	1 (2%)		
Inflammation, suppurative	4 (8%)	8 (16%)	9 (18%)
Inflammation, chronic	2 (4%)		2 (4%)
Hyperplasia, epithelial		2 (4%)	
Acanthosis	1 (2%)	1 (2%)	1 (2%)
#Prostate	(43)	(39)	(47)
Inflammation, suppurative	1 (2%)	7 (18%)	2 (4%)
*Seminal vesicle	(50)	(50)	(50)
Inflammation, suppurative	19 (38%)	17 (34%)	10 (20%)
Inflammation, chronic	3 (6%)	1 (2%)	2 (4%)
#Testis	(50)	(48)	(50)
Mineralization		2 (4%)	1 (2%)
Atrophy, NOS	24 (48%)	35 (73%)	29 (58%)
Hyperplasia, interstitial cell	3 (6%)	1 (2%)	2 (4%)
*Epididymis	(50)	(50)	(50)
Inflammation, chronic focal	1 (2%)		
Hyperplasia, mesothelial	1 (2%)		
NERVOUS SYSTEM			
#Cerebrum	(50)	(50)	(50)
Hemorrhage	3 (6%)	1 (2%)	
Gliosis	1 (2%)		1 (2%)
Corpora amylacea		1 (2%)	
Atrophy, pressure	1 (2%)	2 (4%)	
#Cerebellum	(50)	(50)	(50)
Hemorrhage			2 (4%)
#Medulla oblongata	(50)	(50)	(50)
Hemorrhage		2 (4%)	
*Olfactory sensory epithelium	(50)	(50)	(50)
Foreign body, NOS	3 (6%)	1 (2%)	3 (6%)
Degeneration, NOS	7 (14%)	39 (78%)	42 (84%)
SPECIAL SENSE ORGANS			
*Eye/crystalline lens	(50)	(50)	(50)
Cataract	1 (2%)		2 (4%)
*Nasolacrimal duct	(50)	(50)	(50)
Inflammation, suppurative	3 (6%)	4 (8%)	4 (8%)
MUSCULOSKELETAL SYSTEM			
*Sternum	(50)	(50)	(50)
Fibrous osteodystrophy	1 (2%)		

TABLE C1. SUMMARY OF THE INCIDENCE OF NONNEOPLASTIC LESIONS IN MALE RATS IN THE TWO-YEAR INHALATION STUDY OF METHYL METHACRYLATE (Continued)

	CONTROL (CHAMBER)	LOW DOSE	HIGH DOSE
BODY CAVITIES			
*Peritoneal cavity	(50)	(50)	(50)
Necrosis, fat			1 (2%)
*Pleura	(50)	(50)	(50)
Fibrosis			1 (2%)
*Pericardium	(50)	(50)	(50)
Inflammation, chronic diffuse	1 (2%)		
Hyperplasia, diffuse	1 (2%)		
*Mesentery	(50)	(50)	(50)
Torsion		1 (2%)	
ALL OTHER SYSTEMS			
None			
SPECIAL MORPHOLOGY SUMMARY			
None			

* Number of animals receiving complete necropsy examination; all gross lesions including masses examined microscopically.
Number of animals examined microscopically at this site

TABLE C2. SUMMARY OF THE INCIDENCE OF NONNEOPLASTIC LESIONS IN FEMALE RATS IN THE TWO-YEAR INHALATION STUDY OF METHYL METHACRYLATE

	CONTROL (CHAMBER)	LOW DOSE	HIGH DOSE
ANIMALS INITIALLY IN STUDY	50	50	50
ANIMALS NECROPSIED	50	50	50
ANIMALS EXAMINED HISTOPATHOLOGICALLY	50	50	50
INTEGUMENTARY SYSTEM			
*Skin	(50)	(50)	(50)
Inflammation, chronic focal			1 (2%)
Acanthosis	1 (2%)		1 (2%)
RESPIRATORY SYSTEM			
*Nasal cavity	(50)	(50)	(50)
Foreign body, NOS	2 (4%)	4 (8%)	2 (4%)
Hemorrhage	1 (2%)	2 (4%)	
Ulcer, NOS		1 (2%)	
Inflammation, serous	4 (8%)	17 (34%)	32 (64%)
Inflammation, suppurative	7 (14%)	12 (24%)	12 (24%)
Inflammation, chronic		1 (2%)	
Inflammation, chronic focal			2 (4%)
Granuloma, foreign body			1 (2%)
Hyperplasia, epithelial	1 (2%)		1 (2%)
Metaplasia, squamous	3 (6%)	1 (2%)	
*Larynx	(50)	(50)	(50)
Foreign body, NOS		1 (2%)	
Inflammation, suppurative	8 (16%)	5 (10%)	6 (12%)
Inflammation, chronic	1 (2%)	2 (4%)	2 (4%)
Hyperplasia, epithelial	1 (2%)	1 (2%)	1 (2%)
*Laryngeal gland	(50)	(50)	(50)
Dilatation, NOS	1 (2%)		
#Trachea	(50)	(49)	(49)
Inflammation, suppurative	1 (2%)		
#Lung/bronchiole	(50)	(50)	(50)
Inflammation, suppurative			1 (2%)
Hyperplasia, epithelial			1 (2%)
#Lung	(50)	(50)	(50)
Aspiration, foreign body			1 (2%)
Inflammation, suppurative		2 (4%)	
Inflammation, chronic focal	1 (2%)	4 (8%)	2 (4%)
Alveolar macrophages	9 (18%)	14 (28%)	16 (32%)
Hyperplasia, alveolar epithelium			2 (4%)
#Lung/alveoli	(50)	(50)	(50)
Foreign body, NOS			1 (2%)
Hemorrhage	5 (10%)		6 (12%)
Inflammation, suppurative	2 (4%)	2 (4%)	6 (12%)
Inflammation, chronic focal			2 (4%)
Inflammation, granulomatous focal	1 (2%)	2 (4%)	1 (2%)
Fibrosis, focal	1 (2%)	1 (2%)	1 (2%)
Fibrosis, multifocal		1 (2%)	6 (12%)
HEMATOPOIETIC SYSTEM			
*Multiple organs	(50)	(50)	(50)
Hematopoiesis	1 (2%)		
#Bone marrow	(47)	(48)	(46)
Hyperplasia, megakaryocytic	1 (2%)		
#Spleen	(50)	(50)	(48)
Hemorrhage			1 (2%)
Fibrosis, focal	2 (4%)	2 (4%)	1 (2%)
Fibrosis, multifocal		1 (2%)	
Fibrosis, diffuse			1 (2%)
Necrosis, focal		1 (2%)	
Hematopoiesis		2 (4%)	

TABLE C2. SUMMARY OF THE INCIDENCE OF NONNEOPLASTIC LESIONS IN FEMALE RATS IN THE TWO-YEAR INHALATION STUDY OF METHYL METHACRYLATE (Continued)

	CONTROL (CHAMBER)	LOW DOSE	HIGH DOSE
HEMATOPOIETIC SYSTEM (Continued)			
#Splenic capsule	(50)	(50)	(48)
Fibrosis, focal			1 (2%)
#Mandibular lymph node	(50)	(46)	(48)
Hemorrhage		1 (2%)	
#Mesenteric lymph node	(50)	(46)	(48)
Hematoma, NOS		1 (2%)	
#Liver	(50)	(50)	(50)
Hematopoiesis			1 (2%)
#Adrenal	(49)	(49)	(48)
Hematopoiesis		1 (2%)	
#Thymus	(41)	(37)	(39)
Cyst, NOS			1 (3%)
CIRCULATORY SYSTEM			
*Multiple organs	(50)	(50)	(50)
Periarteritis	1 (2%)	1 (2%)	
#Lung	(50)	(50)	(50)
Periarteritis	1 (2%)		
#Heart/atrium	(49)	(49)	(48)
Thrombosis, NOS	1 (2%)	3 (6%)	2 (4%)
#Myocardium	(49)	(49)	(48)
Mineralization	1 (2%)		
Inflammation, chronic	1 (2%)		
Fibrosis	8 (16%)	9 (18%)	5 (10%)
#Cardiac valve	(49)	(49)	(48)
Metaplasia, cartilaginous	8 (16%)	8 (16%)	6 (13%)
*Mesenteric artery	(50)	(50)	(50)
Thrombosis, NOS		1 (2%)	
DIGESTIVE SYSTEM			
*Palate	(50)	(50)	(50)
Ulcer, NOS	1 (2%)	1 (2%)	
Ulcer, chronic			1 (2%)
Acanthosis		2 (4%)	1 (2%)
*Tooth	(50)	(50)	(50)
Malocclusion	1 (2%)		
#Liver	(50)	(50)	(50)
Cyst, NOS			1 (2%)
Inflammation, granulomatous focal	16 (32%)	12 (24%)	5 (10%)
Hepatocytomegaly	5 (10%)		1 (2%)
Angiectasis			1 (2%)
#Liver/hepatocytes	(50)	(50)	(50)
Necrosis, focal	3 (6%)	5 (10%)	1 (2%)
Cytoplasmic vacuolization	9 (18%)	6 (12%)	10 (20%)
Basophilic cyto change	16 (32%)	12 (24%)	15 (30%)
#Bile duct	(50)	(50)	(50)
Fibrosis, focal	1 (2%)	1 (2%)	
Fibrosis, multifocal			2 (4%)
Hyperplasia, NOS	8 (16%)	10 (20%)	14 (28%)
#Pancreas	(49)	(50)	(46)
Hemorrhage		1 (2%)	
#Pancreatic acinus	(49)	(50)	(46)
Atrophy, focal	7 (14%)	13 (26%)	9 (20%)
#Glandular stomach	(50)	(48)	(48)
Mineralization		1 (2%)	
Hemorrhage	1 (2%)		
#Forestomach	(50)	(48)	(48)
Ulcer, NOS	3 (6%)	2 (4%)	
Inflammation, suppurative	3 (6%)		
Hyperplasia, epithelial		2 (4%)	

TABLE C2. SUMMARY OF THE INCIDENCE OF NONNEOPLASTIC LESIONS IN FEMALE RATS IN THE TWO-YEAR INHALATION STUDY OF METHYL METHACRYLATE (Continued)

	CONTROL (CHAMBER)	LOW DOSE	HIGH DOSE
DIGESTIVE SYSTEM (Continued)			
#Duodenum	(50)	(48)	(47)
Erosion		1 (2%)	
#Colon	(48)	(47)	(48)
Parasitism	4 (8%)	10 (21%)	5 (10%)
*Rectum	(50)	(50)	(50)
Inflammation, suppurative			1 (2%)
Parasitism		4 (8%)	1 (2%)
URINARY SYSTEM			
#Kidney	(50)	(50)	(50)
Hamartoma	1 (2%)		
Nephropathy	46 (92%)	48 (96%)	43 (86%)
#Kidney/cortex	(50)	(50)	(50)
Cyst, NOS	1 (2%)		1 (2%)
Hyperplasia, epithelial			1 (2%)
#Perirenal tissue	(50)	(50)	(50)
Inflammation, suppurative			1 (2%)
#Kidney/tubule	(50)	(50)	(50)
Dilatation, NOS	1 (2%)		1 (2%)
#Kidney/pelvis	(50)	(50)	(50)
Mineralization	2 (4%)		
Hyperplasia, epithelial		2 (4%)	
#Urinary bladder/submucosa	(49)	(45)	(46)
Edema, NOS	1 (2%)		2 (4%)
Hemorrhage	1 (2%)		
ENDOCRINE SYSTEM			
#Anterior pituitary	(50)	(50)	(47)
Cyst, NOS			1 (2%)
Hyperplasia, NOS	7 (14%)	8 (16%)	5 (11%)
#Adrenal cortex	(49)	(49)	(48)
Cyst, NOS			1 (2%)
Hemorrhage	1 (2%)		
Necrosis, focal		1 (2%)	1 (2%)
Cytoplasmic vacuolization	4 (8%)	12 (24%)	16 (33%)
Cytomegaly	4 (8%)		
Hyperplasia, focal	1 (2%)		
#Adrenal medulla	(49)	(49)	(48)
Hemorrhage	1 (2%)		
Hyperplasia, focal	2 (4%)	5 (10%)	7 (15%)
#Thyroid	(48)	(48)	(50)
Ultimobranchial cyst	1 (2%)		
Cystic follicles		1 (2%)	1 (2%)
Hyperplasia, C-cell	7 (15%)	10 (21%)	5 (10%)
#Parathyroid	(22)	(35)	(29)
Hyperplasia, NOS	1 (5%)	1 (3%)	2 (7%)
#Pancreatic islets	(49)	(50)	(46)
Hyperplasia, focal		1 (2%)	
REPRODUCTIVE SYSTEM			
*Mammary gland	(50)	(50)	(50)
Galactoceles	1 (2%)	1 (2%)	1 (2%)
*Mammary duct	(50)	(50)	(50)
Inflammation, suppurative	1 (2%)		

TABLE C2. SUMMARY OF THE INCIDENCE OF NONNEOPLASTIC LESIONS IN FEMALE RATS IN THE TWO-YEAR INHALATION STUDY OF METHYL METHACRYLATE (Continued)

	CONTROL (CHAMBER)	LOW DOSE	HIGH DOSE
REPRODUCTIVE SYSTEM (Continued)			
*Clitoral gland	(50)	(50)	(50)
Cyst, NOS	2 (4%)	3 (6%)	2 (4%)
Inflammation, suppurative	5 (10%)	2 (4%)	
Inflammation, chronic		1 (2%)	
Hyperplasia, epithelial	1 (2%)	1 (2%)	2 (4%)
Hyperkeratosis	1 (2%)	1 (2%)	1 (2%)
Acanthosis	2 (4%)		1 (2%)
#Uterus	(48)	(48)	(48)
Prolapse		1 (2%)	
Hemorrhage			2 (4%)
#Uterus/endometrium	(48)	(48)	(48)
Cyst, NOS		1 (2%)	
Inflammation, suppurative	2 (4%)		2 (4%)
Hyperplasia, epithelial	1 (2%)	3 (6%)	6 (13%)
#Uterus/myometrium	(48)	(48)	(48)
Adenomyosis			1 (2%)
#Ovary/parovarian	(50)	(50)	(50)
Necrosis, fat	1 (2%)		
#Ovary	(50)	(50)	(50)
Cyst, NOS	3 (6%)	2 (4%)	3 (6%)
NERVOUS SYSTEM			
#Subdural space	(50)	(50)	(49)
Hemorrhage			1 (2%)
#Cerebrum	(50)	(50)	(49)
Mineralization		1 (2%)	
Hemorrhage	2 (4%)	5 (10%)	1 (2%)
Gliosis		1 (2%)	
Corpora amylacea		1 (2%)	
Cytoplasmic vacuolization			1 (2%)
Atrophy, pressure	1 (2%)	4 (8%)	4 (8%)
#Brain	(50)	(50)	(49)
Hemorrhage		1 (2%)	
Cytoplasmic vacuolization	3 (6%)	1 (2%)	
#Cerebellum	(50)	(50)	(49)
Mineralization		1 (2%)	
#Cerebellar white matter	(50)	(50)	(49)
Cytoplasmic vacuolization	1 (2%)		
#Medulla oblongata	(50)	(50)	(49)
Hemorrhage	2 (4%)		
*Olfactory sensory epithelium	(50)	(50)	(50)
Degeneration, NOS	2 (4%)	39 (78%)	44 (88%)
SPECIAL SENSE ORGANS			
*Eye/crystalline lens	(50)	(50)	(50)
Cataract			1 (2%)
*Eye/lacrimal gland	(50)	(50)	(50)
Hyperplasia, focal	1 (2%)		
*Nasolacrimal duct	(50)	(50)	(50)
Inflammation, suppurative	3 (6%)		5 (10%)
Acanthosis			1 (2%)
Metaplasia, squamous			1 (2%)
MUSCULOSKELETAL SYSTEM			
None			

TABLE C2. SUMMARY OF THE INCIDENCE OF NONNEOPLASTIC LESIONS IN FEMALE RATS IN THE TWO-YEAR INHALATION STUDY OF METHYL METHACRYLATE (Continued)

	CONTROL (CHAMBER)	LOW DOSE	HIGH DOSE
BODY CAVITIES			
*Pericardium	(50)	(50)	(50)
Inflammation, chronic	1 (2%)		
*Mesentery	(50)	(50)	(50)
Torsion	1 (2%)		
Necrosis, fat	1 (2%)	1 (2%)	
ALL OTHER SYSTEMS			
*Multiple organs	(50)	(50)	(50)
Mineralization	1 (2%)		
Inflammation, suppurative	1 (2%)		
Broad ligament			
Torsion	1		
Necrosis, fat	1		
SPECIAL MORPHOLOGY SUMMARY			
Auto/necropsy/histo performed			1

* Number of animals receiving complete necropsy examination; all gross lesions including masses examined microscopically.
 # Number of animals examined microscopically at this site

APPENDIX D

SUMMARY OF THE INCIDENCE OF NONNEOPLASTIC LESIONS IN MICE IN THE TWO-YEAR INHALATION STUDIES OF METHYL METHACRYLATE

TABLE D1. SUMMARY OF THE INCIDENCE OF NONNEOPLASTIC LESIONS IN MALE MICE IN THE TWO-YEAR INHALATION STUDY OF METHYL METHACRYLATE

	CONTROL (CHAMBER)	LOW DOSE	HIGH DOSE
ANIMALS INITIALLY IN STUDY	50	50	50
ANIMALS NECROPSIED	50	50	50
ANIMALS EXAMINED HISTOPATHOLOGICALLY	50	50	50
INTEGUMENTARY SYSTEM			
*Subcutaneous tissue	(50)	(50)	(50)
Multiple cysts			1 (2%)
RESPIRATORY SYSTEM			
*Nasal cavity	(50)	(50)	(50)
Inflammation, serous			1 (2%)
Inflammation, suppurative	3 (6%)	6 (12%)	2 (4%)
Inflammation, acute/chronic	1 (2%)	37 (74%)	42 (84%)
Hyperplasia, epithelial	2 (4%)	44 (88%)	46 (92%)
*Nasal mucosa	(50)	(50)	(50)
Inclusion, cytoplasmic	14 (28%)	46 (92%)	46 (92%)
*Maxillary sinus	(50)	(50)	(50)
Inflammation, suppurative		1 (2%)	
*Larynx	(50)	(50)	(50)
Inflammation, acute/chronic		1 (2%)	
#Lung	(50)	(50)	(50)
Congestion, NOS	2 (4%)	3 (6%)	1 (2%)
Edema, NOS	1 (2%)	1 (2%)	
Hemorrhage		1 (2%)	
Inflammation, interstitial	1 (2%)		8 (16%)
Inflammation, acute/chronic	1 (2%)		1 (2%)
Hyperplasia, alveolar epithelium	1 (2%)		
HEMATOPOIETIC SYSTEM			
#Bone marrow	(50)	(50)	(50)
Hypoplasia, NOS		1 (2%)	1 (2%)
Hyperplasia, granulocytic	1 (2%)		
Hyperplasia, plasma cell		1 (2%)	
Hyperplasia, lymphoid		1 (2%)	
Hypoplasia, erythroid			1 (2%)
#Spleen	(50)	(48)	(49)
Angiectasis			2 (4%)
Hyperplasia, lymphoid	1 (2%)	1 (2%)	
Hematopoiesis	1 (2%)		
#Splenic follicles	(50)	(48)	(49)
Atrophy, NOS			1 (2%)
#Mandibular lymph node	(46)	(39)	(42)
Hemosiderosis	1 (2%)		
Hyperplasia, lymphoid	2 (4%)	4 (10%)	3 (7%)
#Bronchial lymph node	(46)	(39)	(42)
Hyperplasia, lymphoid	1 (2%)	2 (5%)	1 (2%)
#Mesenteric lymph node	(46)	(39)	(42)
Angiectasis	1 (2%)		1 (2%)
#Renal lymph node	(46)	(39)	(42)
Hyperplasia, lymphoid		1 (3%)	
#Peyers patch	(49)	(49)	(48)
Hyperplasia, lymphoid	1 (2%)		
#Ileum	(49)	(49)	(48)
Hyperplasia, lymphoid		1 (2%)	

TABLE D1. SUMMARY OF THE INCIDENCE OF NONNEOPLASTIC LESIONS IN MALE MICE IN THE TWO-YEAR INHALATION STUDY OF METHYL METHACRYLATE (Continued)

	CONTROL (CHAMBER)	LOW DOSE	HIGH DOSE
CIRCULATORY SYSTEM			
#Heart	(50)	(50)	(50)
Inflammation, acute/chronic	1 (2%)		1 (2%)
Periarteritis		1 (2%)	
Perivasculitis	1 (2%)		
#Cardiac valve	(50)	(50)	(50)
Pigmentation, NOS	1 (2%)		1 (2%)
DIGESTIVE SYSTEM			
*Tooth	(50)	(50)	(50)
Congenital malformation, NOS	3 (6%)	4 (8%)	
Inflammation, suppurative		1 (2%)	
*Pulp of tooth	(50)	(50)	(50)
Inflammation, NOS		1 (2%)	
Abscess, NOS	1 (2%)	2 (4%)	2 (4%)
#Salivary gland	(50)	(48)	(50)
Inflammation, acute/chronic	3 (6%)	1 (2%)	6 (12%)
#Liver	(50)	(48)	(49)
Inflammation, acute suppurative	1 (2%)		
Inflammation, acute/chronic		1 (2%)	
Necrosis, focal			1 (2%)
Basophilic cyto change	1 (2%)		
#Stomach	(50)	(50)	(50)
Inflammation, suppurative			1 (2%)
Inflammation, acute/chronic		1 (2%)	
Hyperplasia, epithelial		1 (2%)	
#Gastric mucosa	(50)	(50)	(50)
Mineralization	1 (2%)		
#Glandular stomach	(50)	(50)	(50)
Dilatation, NOS			1 (2%)
Cyst, NOS			1 (2%)
#Gastric submucosa	(50)	(50)	(50)
Inflammation, acute/chronic		1 (2%)	
#Duodenum	(49)	(49)	(48)
Inflammation, acute/chronic	1 (2%)		
#Duodenal gland	(49)	(49)	(48)
Hyperplasia, NOS			1 (2%)
#Jejunum	(49)	(49)	(48)
Amyloidosis			1 (2%)
#Ileum	(49)	(49)	(48)
Amyloidosis	1 (2%)		2 (4%)
*Rectum	(50)	(50)	(50)
Inflammation, suppurative	1 (2%)	1 (2%)	
Inflammation, acute/chronic		1 (2%)	
*Rectal submucosa	(50)	(50)	(50)
Steatitis			1 (2%)
URINARY SYSTEM			
#Kidney	(50)	(50)	(50)
Mineralization			3 (6%)
Hydronephrosis		2 (4%)	
Glomerulonephritis, NOS		1 (2%)	
Inflammation, acute/chronic	10 (20%)	8 (16%)	5 (10%)
Inflammation, chronic focal	1 (2%)		
#Perirenal tissue	(50)	(50)	(50)
Lymphocytic inflammatory infiltrate		1 (2%)	
#Kidney/tubule	(50)	(50)	(50)
Cast, NOS	1 (2%)		

TABLE D1. SUMMARY OF THE INCIDENCE OF NONNEOPLASTIC LESIONS IN MALE MICE IN THE TWO-YEAR INHALATION STUDY OF METHYL METHACRYLATE (Continued)

	CONTROL (CHAMBER)	LOW DOSE	HIGH DOSE
URINARY SYSTEM (Continued)			
#Urinary bladder	(50)	(47)	(49)
Calculus, gross observation only		1 (2%)	
Distention	2 (4%)		
Inflammation, suppurative	1 (2%)	1 (2%)	1 (2%)
Inflammation, acute/chronic	1 (2%)		
#Urinary bladder/serosa	(50)	(47)	(49)
Calcification, focal	1 (2%)		
ENDOCRINE SYSTEM			
#Adrenal cortex	(50)	(48)	(50)
Hyperplasia, nodular	1 (2%)		
Hyperplasia, NOS		1 (2%)	
Hyperplasia, focal	6 (12%)	1 (2%)	
#Thyroid	(49)	(50)	(49)
Hyperplasia, follicular cell		2 (4%)	1 (2%)
#Thyroid follicle	(49)	(50)	(49)
Atrophy, focal	1 (2%)		
#Parathyroid	(23)	(30)	(21)
Cyst, NOS		2 (7%)	
REPRODUCTIVE SYSTEM			
*Penis	(50)	(50)	(50)
Gangrene, NOS	1 (2%)		
*Prepuce	(50)	(50)	(50)
Abscess, NOS	1 (2%)		
*Preputial gland	(50)	(50)	(50)
Cystic ducts	3 (6%)	3 (6%)	
Inflammation, suppurative	1 (2%)	1 (2%)	
Hyperkeratosis	1 (2%)		
#Prostate	(49)	(49)	(49)
Inflammation, suppurative	1 (2%)		
Inflammation, acute/chronic		1 (2%)	
*Seminal vesicle	(50)	(50)	(50)
Dilatation, NOS			1 (2%)
Distention	11 (22%)	2 (4%)	
Inflammation, chronic		1 (2%)	
#Testis	(49)	(50)	(49)
Mineralization		1 (2%)	1 (2%)
Necrosis, NOS			1 (2%)
*Epididymis	(50)	(50)	(50)
Inflammation, granulomatous		1 (2%)	
NERVOUS SYSTEM			
#Brain	(50)	(50)	(50)
Mineralization	29 (58%)	27 (54%)	36 (72%)
Congestion, NOS			1 (2%)
Hemorrhage		1 (2%)	
Inflammation, NOS			1 (2%)
Corpora amylacea		2 (4%)	
*Olfactory sensory epithelium	(50)	(50)	(50)
Degeneration, NOS		48 (96%)	48 (96%)
SPECIAL SENSE ORGANS			
*Eye	(50)	(50)	(50)
Atrophy, NOS	1 (2%)		
*Harderian gland	(50)	(50)	(50)
Degeneration, hyaline			1 (2%)

TABLE D1. SUMMARY OF THE INCIDENCE OF NONNEOPLASTIC LESIONS IN MALE MICE IN THE TWO-YEAR INHALATION STUDY OF METHYL METHACRYLATE (Continued)

	CONTROL (CHAMBER)	LOW DOSE	HIGH DOSE
MUSCULOSKELETAL SYSTEM			
None			
BODY CAVITIES			
*Peritoneum	(50)	(50)	(50)
Necrosis, fat			1 (2%)
ALL OTHER SYSTEMS			
*Multiple organs	(50)	(50)	(50)
Lymphocytic inflammatory infiltrate		1 (2%)	
Inflammation, acute/chronic	14 (28%)	14 (28%)	11 (22%)
Adipose tissue			
Inflammation, acute/chronic		1	
SPECIAL MORPHOLOGY SUMMARY			
No lesion reported	2		
Auto/necropsy/histo performed		1	

* Number of animals receiving complete necropsy examination; all gross lesions including masses examined microscopically.

Number of animals examined microscopically at this site

TABLE D2. SUMMARY OF THE INCIDENCE OF NONNEOPLASTIC LESIONS IN FEMALE MICE IN THE TWO-YEAR INHALATION STUDY OF METHYL METHACRYLATE

	CONTROL (CHAMBER)	LOW DOSE	HIGH DOSE
ANIMALS INITIALLY IN STUDY	50	50	50
ANIMALS NECROPSIED	50	49	50
ANIMALS EXAMINED HISTOPATHOLOGICALLY	50	49	50
INTEGUMENTARY SYSTEM			
*Skin	(50)	(49)	(50)
Inflammation, necrotizing		1 (2%)	
*Subcutaneous tissue	(50)	(49)	(50)
Steatitis	1 (2%)		
RESPIRATORY SYSTEM			
*Nasal cavity	(50)	(49)	(50)
Inflammation, serous	1 (2%)		
Inflammation, suppurative	2 (4%)	1 (2%)	
Inflammation, acute/chronic	2 (4%)	42 (86%)	45 (90%)
Hyperplasia, epithelial	1 (2%)	43 (88%)	47 (94%)
*Nasal mucosa	(50)	(49)	(50)
Inclusion, cytoplasmic	24 (48%)	44 (90%)	46 (92%)
*Nasal turbinate	(50)	(49)	(50)
Inflammation, suppurative		1 (2%)	
#Lung	(49)	(49)	(50)
Atelectasis		1 (2%)	
Congestion, NOS	1 (2%)		2 (4%)
Edema, NOS			1 (2%)
Hemorrhage	1 (2%)		
Lymphocytic inflammatory infiltrate	5 (10%)	5 (10%)	4 (8%)
Inflammation, interstitial			1 (2%)
Inflammation, suppurative		1 (2%)	
Inflammation, acute/chronic		2 (4%)	1 (2%)
Alveolar macrophages	1 (2%)		
Histiocytosis	1 (2%)		
HEMATOPOIETIC SYSTEM			
*Multiple organs	(50)	(49)	(50)
Hyperplasia, plasma cell			1 (2%)
Hematopoiesis	2 (4%)	6 (12%)	1 (2%)
#Bone marrow	(49)	(47)	(47)
Hyperplasia, hematopoietic	3 (6%)	3 (6%)	
Hyperplasia, granulocytic	4 (8%)	3 (6%)	5 (11%)
#Spleen	(50)	(47)	(50)
Congestion, NOS	1 (2%)		
Fibrosis, focal	1 (2%)		
Necrosis, NOS			1 (2%)
Necrosis, hemorrhagic		1 (2%)	
Infarct, healed	1 (2%)		
Pigmentation, NOS			1 (2%)
Atrophy, NOS			2 (4%)
Hyperplasia, lymphoid	6 (12%)	1 (2%)	2 (4%)
Hematopoiesis	2 (4%)	4 (9%)	2 (4%)
#Mandibular lymph node	(46)	(47)	(46)
Hemosiderosis	1 (2%)		
Hyperplasia, lymphoid	3 (7%)	4 (9%)	
#Bronchial lymph node	(46)	(47)	(46)
Abscess, NOS		2 (4%)	
Granuloma, NOS			1 (2%)
Hemosiderosis			1 (2%)
Histiocytosis		1 (2%)	1 (2%)
Hyperplasia, lymphoid	3 (7%)	4 (9%)	1 (2%)

TABLE D2. SUMMARY OF THE INCIDENCE OF NONNEOPLASTIC LESIONS IN FEMALE MICE IN THE TWO-YEAR INHALATION STUDY OF METHYL METHACRYLATE (Continued)

	CONTROL (CHAMBER)	LOW DOSE	HIGH DOSE
HEMATOPOIETIC SYSTEM (Continued)			
#Mesenteric lymph node	(46)	(47)	(46)
Angiectasis		1 (2%)	
#Renal lymph node	(46)	(47)	(46)
Hemorrhage, chronic	1 (2%)		
Hyperplasia, lymphoid		1 (2%)	
*Sternum	(50)	(49)	(50)
Hyperplasia, hematopoietic		1 (2%)	
#Liver	(50)	(48)	(49)
Hematopoiesis		1 (2%)	
#Jejunum	(50)	(44)	(44)
Hyperplasia, lymphoid			1 (2%)
#Ileum	(50)	(44)	(44)
Hyperplasia, lymphoid		1 (2%)	
#Uterus	(48)	(47)	(47)
Hyperplasia, lymphoid			1 (2%)
#Adrenal	(50)	(46)	(49)
Hematopoiesis	1 (2%)		
#Thymus	(31)	(24)	(31)
Necrosis, NOS	1 (3%)	1 (4%)	
CIRCULATORY SYSTEM			
#Heart	(50)	(48)	(49)
Inflammation, acute/chronic		1 (2%)	
Perivascularitis		1 (2%)	
#Cardiac valve	(50)	(48)	(49)
Pigmentation, NOS	2 (4%)		
Hemosiderosis		1 (2%)	
DIGESTIVE SYSTEM			
*Intestinal tract	(50)	(49)	(50)
Hamartoma	1 (2%)		
*Tongue	(50)	(49)	(50)
Hyperkeratosis			1 (2%)
*Tooth	(50)	(49)	(50)
Congenital malformation, NOS	2 (4%)	2 (4%)	1 (2%)
#Salivary gland	(50)	(47)	(47)
Inflammation, acute/chronic	2 (4%)		3 (6%)
#Liver	(50)	(48)	(49)
Cyst, NOS			1 (2%)
Torsion	1 (2%)		
Lymphocytic inflammatory infiltrate			1 (2%)
Inflammation, suppurative	1 (2%)		1 (2%)
Inflammation, acute/chronic	2 (4%)		1 (2%)
Necrosis, central			1 (2%)
Pigmentation, NOS			1 (2%)
#Liver/hepatocytes	(50)	(48)	(49)
Necrosis, NOS	1 (2%)		
#Pancreas	(50)	(48)	(47)
Cystic ducts	1 (2%)	1 (2%)	
Inflammation, acute/chronic		1 (2%)	1 (2%)
Atrophy, NOS		1 (2%)	
#Stomach	(49)	(47)	(48)
Mineralization	1 (2%)		
Inflammation, suppurative		2 (4%)	
Inflammation, proliferative	1 (2%)		

TABLE D2. SUMMARY OF THE INCIDENCE OF NONNEOPLASTIC LESIONS IN FEMALE MICE IN THE TWO-YEAR INHALATION STUDY OF METHYL METHACRYLATE (Continued)

	CONTROL (CHAMBER)	LOW DOSE	HIGH DOSE
DIGESTIVE SYSTEM (Continued)			
#Gastric mucosa	(49)	(47)	(48)
Mineralization			1 (2%)
#Glandular stomach	(49)	(47)	(48)
Dilatation, NOS	1 (2%)		
Cyst, NOS	1 (2%)		
#Ileum	(50)	(44)	(44)
Amyloidosis	4 (8%)	3 (7%)	
*Rectum	(50)	(49)	(50)
Inflammation, suppurative	3 (6%)		
URINARY SYSTEM			
#Kidney	(50)	(47)	(49)
Mineralization	1 (2%)		
Hydronephrosis	1 (2%)		
Glomerulonephritis, NOS	2 (4%)	3 (6%)	
Pyelonephritis, acute		2 (4%)	
Inflammation, acute/chronic	5 (10%)	2 (4%)	8 (16%)
Glomerulonephritis, chronic	1 (2%)		
Calcification, focal		1 (2%)	
#Kidney/glomerulus	(50)	(47)	(49)
Amyloidosis			1 (2%)
#Kidney/tubule	(50)	(47)	(49)
Dilatation, NOS		1 (2%)	
Pigmentation, NOS			1 (2%)
#Urinary bladder	(50)	(42)	(47)
Inflammation, suppurative		1 (2%)	
ENDOCRINE SYSTEM			
#Pituitary	(49)	(44)	(39)
Hemorrhagic cyst	1 (2%)		
Hyperplasia, focal	6 (12%)	7 (16%)	3 (8%)
Angiectasis	3 (6%)		
#Adrenal	(50)	(46)	(49)
Lymphocytic inflammatory infiltrate	1 (2%)		
#Adrenal cortex	(50)	(46)	(49)
Cyst, NOS			1 (2%)
Hyperplasia, focal		1 (2%)	1 (2%)
#Thyroid	(49)	(44)	(48)
Follicular cyst, NOS		1 (2%)	2 (4%)
Inflammation, acute/chronic		1 (2%)	1 (2%)
Hyperplasia, follicular cell	1 (2%)	1 (2%)	
REPRODUCTIVE SYSTEM			
*Mammary gland	(50)	(49)	(50)
Inflammation, suppurative			1 (2%)
*Clitoral gland	(50)	(49)	(50)
Inflammation, chronic suppurative			1 (2%)
*Vagina	(50)	(49)	(50)
Inflammation, suppurative			1 (2%)
Polyp, NOS	1 (2%)		
#Uterus	(48)	(47)	(47)
Dilatation, NOS			1 (2%)
Hydrometra			1 (2%)
Inflammation, suppurative	3 (6%)	5 (11%)	4 (9%)
Abscess, NOS	3 (6%)	3 (6%)	
Metaplasia, squamous			1 (2%)
Decidual alteration, NOS	1 (2%)	1 (2%)	

TABLE D2. SUMMARY OF THE INCIDENCE OF NONNEOPLASTIC LESIONS IN FEMALE MICE IN THE TWO-YEAR INHALATION STUDY OF METHYL METHACRYLATE (Continued)

	CONTROL (CHAMBER)	LOW DOSE	HIGH DOSE
REPRODUCTIVE SYSTEM (Continued)			
#Cervix uteri	(48)	(47)	(47)
Inflammation, suppurative	2 (4%)		
#Uterus/endometrium	(48)	(47)	(47)
Inflammation, suppurative			1 (2%)
Hyperplasia, NOS	13 (27%)	21 (45%)	18 (38%)
Metaplasia, squamous			1 (2%)
#Ovary	(50)	(47)	(47)
Mineralization		1 (2%)	1 (2%)
Cyst, NOS	11 (22%)	8 (17%)	7 (15%)
Hemorrhagic cyst	1 (2%)	1 (2%)	2 (4%)
Lymphocytic inflammatory infiltrate		1 (2%)	
Inflammation, suppurative	2 (4%)	1 (2%)	
Abscess, NOS	6 (12%)	14 (30%)	2 (4%)
Inflammation, acute/chronic			2 (4%)
Inflammation, chronic	2 (4%)	1 (2%)	1 (2%)
Granuloma, NOS		1 (2%)	
Pigmentation, NOS			1 (2%)
Atrophy, NOS		1 (2%)	2 (4%)
Angiectasis			1 (2%)
NERVOUS SYSTEM			
#Brain	(50)	(48)	(50)
Mineralization	23 (46%)	22 (46%)	28 (56%)
Lymphocytic inflammatory infiltrate	2 (4%)	1 (2%)	
Corpora amylacea	2 (4%)		1 (2%)
*Olfactory sensory epithelium	(50)	(49)	(50)
Degeneration, NOS	2 (4%)	44 (90%)	47 (94%)
SPECIAL SENSE ORGANS			
*Harderian gland	(50)	(49)	(50)
Inflammation, acute/chronic			1 (2%)
MUSCULOSKELETAL SYSTEM			
*Maxilla	(50)	(49)	(50)
Fibrous osteodystrophy	1 (2%)	4 (8%)	5 (10%)
*Sternum	(50)	(49)	(50)
Inflammation, suppurative		2 (4%)	
BODY CAVITIES			
*Peritoneum	(50)	(49)	(50)
Inflammation, suppurative	4 (8%)	5 (10%)	1 (2%)
Inflammation, acute/chronic			1 (2%)
Inflammation, chronic			1 (2%)
*Peritoneal cavity	(50)	(49)	(50)
Inflammation, suppurative		1 (2%)	
*Pleura	(50)	(49)	(50)
Inflammation, suppurative		1 (2%)	
Inflammation, chronic			1 (2%)

TABLE D2. SUMMARY OF THE INCIDENCE OF NONNEOPLASTIC LESIONS IN FEMALE MICE IN THE TWO-YEAR INHALATION STUDY OF METHYL METHACRYLATE (Continued)

	CONTROL (CHAMBER)	LOW DOSE	HIGH DOSE
ALL OTHER SYSTEMS			
*Multiple organs	(50)	(49)	(50)
Lymphocytic inflammatory infiltrate			1 (2%)
Inflammation, suppurative	5 (10%)	9 (18%)	
Inflammation, acute/chronic	23 (46%)	24 (49%)	14 (28%)
Pigmentation, NOS	1 (2%)		
Site unknown			
Cyst, NOS	1		
Adipose tissue			
Necrosis, NOS	1		
SPECIAL MORPHOLOGY SUMMARY			
Animal missexed/no necropsy		1	
Auto/necropsy/histo performed		2	

* Number of animals receiving complete necropsy examination; all gross lesions including masses examined microscopically.
 # Number of animals examined microscopically at this site

APPENDIX E

ANALYSES OF PRIMARY TUMORS IN RATS AND MICE IN THE TWO-YEAR INHALATION STUDIES OF METHYL METHACRYLATE

TABLE E1. ANALYSIS OF PRIMARY TUMORS IN MALE RATS IN THE TWO-YEAR INHALATION STUDY OF METHYL METHACRYLATE

	Control	500 ppm	1,000 ppm
Skin: Keratoacanthoma			
Overall Rates (a)	2/50 (4%)	3/50 (6%)	1/50 (2%)
Adjusted Rates (b)	6.2%	10.3%	2.5%
Terminal Rates (c)	1/26 (4%)	3/29 (10%)	0/28 (0%)
Week of First Observation	84	104	90
Life Table Tests (d)	P=0.367N	P=0.550	P=0.469N
Incidental Tumor Tests (d)	P=0.300N	P=0.520	P=0.357N
Cochran-Armitage Trend Test (d)	P=0.399N		
Fisher Exact Test (d)		P=0.500	P=0.500N
Subcutaneous Tissue: Fibroma			
Overall Rates (a)	1/50 (2%)	4/50 (8%)	2/50 (4%)
Adjusted Rates (b)	3.8%	11.2%	6.2%
Terminal Rates (c)	1/26 (4%)	1/29 (3%)	1/28 (4%)
Week of First Observation	104	88	92
Life Table Tests (d)	P=0.437	P=0.230	P=0.527
Incidental Tumor Tests (d)	P=0.429	P=0.237	P=0.584
Cochran-Armitage Trend Test (d)	P=0.406		
Fisher Exact Test (d)		P=0.181	P=0.500
Hematopoietic System: Mononuclear Cell Leukemia			
Overall Rates (a)	19/50 (38%)	23/50 (46%)	23/50 (46%)
Adjusted Rates (b)	55.8%	51.2%	55.3%
Terminal Rates (c)	12/26 (46%)	8/29 (28%)	11/28 (39%)
Week of First Observation	68	72	63
Life Table Tests (d)	P=0.364	P=0.475	P=0.402
Incidental Tumor Tests (d)	P=0.249	P=0.351	P=0.381
Cochran-Armitage Trend Test (d)	P=0.240		
Fisher Exact Test (d)		P=0.272	P=0.272
Oral Cavity: Papilloma or Squamous Cell Carcinoma			
Overall Rates (a)	3/50 (6%)	0/50 (0%)	1/50 (2%)
Adjusted Rates (b)	9.9%	0.0%	3.4%
Terminal Rates (c)	2/26 (8%)	0/29 (0%)	0/28 (0%)
Week of First Observation	84		103
Life Table Tests (d)	P=0.158N	P=0.104N	P=0.277N
Incidental Tumor Tests (d)	P=0.157N	P=0.122N	P=0.309N
Cochran-Armitage Trend Test (d)	P=0.176N		
Fisher Exact Test (d)		P=0.121N	P=0.309N
Liver: Neoplastic Nodule or Hepatocellular Carcinoma			
Overall Rates (a)	0/50 (0%)	3/50 (6%)	2/49 (4%)
Adjusted Rates (b)	0.0%	9.0%	7.4%
Terminal Rates (c)	0/26 (0%)	2/29 (7%)	2/27 (7%)
Week of First Observation		88	104
Life Table Tests (d)	P=0.211	P=0.147	P=0.246
Incidental Tumor Tests (d)	P=0.247	P=0.122	P=0.246
Cochran-Armitage Trend Test (d)	P=0.196		
Fisher Exact Test (d)		P=0.121	P=0.242
Pituitary Gland: Adenoma			
Overall Rates (a)	24/45 (53%)	18/47 (38%)	13/48 (27%)
Adjusted Rates (b)	66.9%	51.4%	39.1%
Terminal Rates (c)	14/25 (56%)	13/29 (45%)	9/27 (33%)
Week of First Observation	63	86	79
Life Table Tests (d)	P=0.009N	P=0.066N	P=0.014N
Incidental Tumor Tests (d)	P=0.005N	P=0.095N	P=0.011N
Cochran-Armitage Trend Test (d)	P=0.007N		
Fisher Exact Test (d)		P=0.108N	P=0.009N

TABLE E1. ANALYSIS OF PRIMARY TUMORS IN MALE RATS IN THE TWO-YEAR INHALATION STUDY OF METHYL METHACRYLATE (Continued)

	Control	500 ppm	1,000 ppm
Pituitary Gland: Adenoma or Carcinoma			
Overall Rates (a)	24/45 (53%)	20/47 (43%)	13/48 (27%)
Adjusted Rates (b)	66.9%	53.5%	39.1%
Terminal Rates (c)	14/25 (56%)	13/29 (45%)	9/27 (33%)
Week of First Observation	63	81	79
Life Table Tests (d)	P=0.010N	P=0.132N	P=0.014N
Incidental Tumor Tests (d)	P=0.004N	P=0.193N	P=0.011N
Cochran-Armitage Trend Test (d)	P=0.007N		
Fisher Exact Test (d)		P=0.204N	P=0.009N
Adrenal Gland: Pheochromocytoma			
Overall Rates (a)	5/49 (10%)	4/49 (8%)	9/50 (18%)
Adjusted Rates (b)	18.5%	13.1%	30.9%
Terminal Rates (c)	4/25 (16%)	3/29 (10%)	8/28 (29%)
Week of First Observation	92	102	98
Life Table Tests (d)	P=0.179	P=0.404N	P=0.252
Incidental Tumor Tests (d)	P=0.156	P=0.419N	P=0.233
Cochran-Armitage Trend Test (d)	P=0.149		
Fisher Exact Test (d)		P=0.500N	P=0.205
Adrenal Gland: Pheochromocytoma or Malignant Pheochromocytoma			
Overall Rates (a)	5/49 (10%)	4/49 (8%)	10/50 (20%)
Adjusted Rates (b)	18.5%	13.1%	32.7%
Terminal Rates (c)	4/25 (16%)	3/29 (10%)	8/28 (29%)
Week of First Observation	92	102	92
Life Table Tests (d)	P=0.117	P=0.404N	P=0.180
Incidental Tumor Tests (d)	P=0.112	P=0.419N	P=0.182
Cochran-Armitage Trend Test (d)	P=0.095		
Fisher Exact Test (d)		P=0.500N	P=0.140
Thyroid Gland: C-Cell Adenoma			
Overall Rates (a)	2/50 (4%)	3/49 (6%)	2/50 (4%)
Adjusted Rates (b)	5.8%	10.3%	6.2%
Terminal Rates (c)	1/26 (4%)	3/29 (10%)	1/28 (4%)
Week of First Observation	31	104	92
Life Table Tests (d)	P=0.567N	P=0.540	P=0.672N
Incidental Tumor Tests (d)	P=0.468	P=0.344	P=0.584
Cochran-Armitage Trend Test (d)	P=0.593		
Fisher Exact Test (d)		P=0.490	P=0.691
Thyroid Gland: C-Cell Adenoma or Carcinoma			
Overall Rates (a)	4/50 (8%)	4/49 (8%)	3/50 (6%)
Adjusted Rates (b)	13.3%	13.8%	9.7%
Terminal Rates (c)	3/26 (12%)	4/29 (14%)	2/28 (7%)
Week of First Observation	31	104	92
Life Table Tests (d)	P=0.386N	P=0.591N	P=0.465N
Incidental Tumor Tests (d)	P=0.510N	P=0.561	P=0.589N
Cochran-Armitage Trend Test (d)	P=0.424N		
Fisher Exact Test (d)		P=0.631	P=0.500N
Pancreatic Islets: Islet Cell Adenoma			
Overall Rates (a)	2/50 (4%)	1/47 (2%)	3/48 (6%)
Adjusted Rates (b)	7.7%	3.4%	9.5%
Terminal Rates (c)	2/26 (8%)	1/29 (3%)	2/27 (7%)
Week of First Observation	104	104	84
Life Table Tests (d)	P=0.416	P=0.462N	P=0.522
Incidental Tumor Tests (d)	P=0.457	P=0.462N	P=0.566
Cochran-Armitage Trend Test (d)	P=0.384		
Fisher Exact Test (d)		P=0.523N	P=0.480

TABLE E1. ANALYSIS OF PRIMARY TUMORS IN MALE RATS IN THE TWO-YEAR INHALATION STUDY OF METHYL METHACRYLATE (Continued)

	Control	500 ppm	1,000 ppm
Pancreatic Islets: Islet Cell Adenoma or Carcinoma			
Overall Rates (a)	3/50 (6%)	1/47 (2%)	4/48 (8%)
Adjusted Rates (b)	11.5%	3.4%	13.1%
Terminal Rates (c)	3/26 (12%)	1/29 (3%)	3/27 (11%)
Week of First Observation	104	104	84
Life Table Tests (d)	P=0.431	P=0.265N	P=0.525
Incidental Tumor Tests (d)	P=0.467	P=0.265N	P=0.563
Cochran-Armitage Trend Test (d)	P=0.394		
Fisher Exact Test (d)		P=0.332N	P=0.477
Preputial Gland: Adenoma			
Overall Rates (a)	3/50 (6%)	1/50 (2%)	0/50 (0%)
Adjusted Rates (b)	10.2%	3.4%	0.0%
Terminal Rates (c)	2/26 (8%)	1/29 (3%)	0/28 (0%)
Week of First Observation	89	104	
Life Table Tests (d)	P=0.052N	P=0.267N	P=0.110N
Incidental Tumor Tests (d)	P=0.042N	P=0.296N	P=0.082N
Cochran-Armitage Trend Test (d)	P=0.060N		
Fisher Exact Test (d)		P=0.309N	P=0.121N
Preputial Gland: Carcinoma			
Overall Rates (a)	2/50 (4%)	3/50 (6%)	0/50 (0%)
Adjusted Rates (b)	5.1%	9.5%	0.0%
Terminal Rates (c)	0/26 (0%)	2/29 (7%)	0/28 (0%)
Week of First Observation	78	97	
Life Table Tests (d)	P=0.187N	P=0.554	P=0.221N
Incidental Tumor Tests (d)	P=0.274N	P=0.448	P=0.315N
Cochran-Armitage Trend Test (d)	P=0.202N		
Fisher Exact Test (d)		P=0.500	P=0.247N
Preputial Gland: Adenoma or Carcinoma			
Overall Rates (a)	5/50 (10%)	4/50 (8%)	0/50 (0%)
Adjusted Rates (b)	14.8%	12.8%	0.0%
Terminal Rates (c)	2/26 (8%)	3/29 (10%)	0/28 (0%)
Week of First Observation	78	97	
Life Table Tests (d)	P=0.024N	P=0.428N	P=0.030N
Incidental Tumor Tests (d)	P=0.032N	P=0.532N	P=0.028N
Cochran-Armitage Trend Test (d)	P=0.029N		
Fisher Exact Test (d)		P=0.500N	P=0.028N
Testis: Interstitial Cell Tumor			
Overall Rates (a)	35/50 (70%)	41/48 (85%)	45/50 (90%)
Adjusted Rates (b)	89.5%	95.2%	97.8%
Terminal Rates (c)	22/26 (85%)	27/29 (93%)	27/28 (96%)
Week of First Observation	78	78	79
Life Table Tests (d)	P=0.125	P=0.473	P=0.158
Incidental Tumor Tests (d)	P=0.054	P=0.170	P=0.074
Cochran-Armitage Trend Test (d)	P=0.007		
Fisher Exact Test (d)		P=0.056	P=0.011

(a) Number of tumor-bearing animals/number of animals examined at the site

(b) Kaplan-Meier estimated tumor incidence at the end of the study after adjusting for intercurrent mortality

(c) Observed tumor incidence at terminal kill

(d) Beneath the control incidence are the P values associated with the trend test. Beneath the dosed group incidence are the P values corresponding to pairwise comparisons between that dosed group and the controls. The life table analysis regards tumors in animals dying prior to terminal kill as being (directly or indirectly) the cause of death. The incidental tumor test regards these lesions as nonfatal. The Cochran-Armitage and Fisher exact tests compare directly the overall incidence rates. A negative trend or lower incidence in a dosed group is indicated by (N).

TABLE E2. ANALYSIS OF PRIMARY TUMORS IN FEMALE RATS IN THE TWO-YEAR INHALATION STUDY OF METHYL METHACRYLATE

	Control	250 ppm	500 ppm
Hematopoietic System: Mononuclear Cell Leukemia			
Overall Rates (a)	11/50 (22%)	13/50 (26%)	20/50 (40%)
Adjusted Rates (b)	26.7%	34.3%	48.4%
Terminal Rates (c)	2/30 (7%)	5/27 (19%)	9/29 (31%)
Week of First Observation	72	85	57
Life Table Tests (d)	P=0.051	P=0.438	P=0.070
Incidental Tumor Tests (d)	P=0.028	P=0.586	P=0.042
Cochran-Armitage Trend Test (d)	P=0.031		
Fisher Exact Test (d)		P=0.408	P=0.041
Pituitary Gland: Adenoma			
Overall Rates (a)	30/50 (60%)	32/50 (64%)	29/47 (62%)
Adjusted Rates (b)	72.4%	77.5%	73.7%
Terminal Rates (c)	19/30 (63%)	18/27 (67%)	19/29 (66%)
Week of First Observation	60	74	87
Life Table Tests (d)	P=0.497N	P=0.365	P=0.526N
Incidental Tumor Tests (d)	P=0.536	P=0.525	P=0.566
Cochran-Armitage Trend Test (d)	P=0.470		
Fisher Exact Test (d)		P=0.418	P=0.515
Pituitary Gland: Adenoma or Carcinoma			
Overall Rates (a)	31/50 (62%)	33/50 (66%)	29/47 (62%)
Adjusted Rates (b)	73.2%	78.0%	73.7%
Terminal Rates (c)	19/30 (63%)	18/27 (67%)	19/29 (66%)
Week of First Observation	60	74	87
Life Table Tests (d)	P=0.431N	P=0.373	P=0.460N
Incidental Tumor Tests (d)	P=0.465N	P=0.542	P=0.512N
Cochran-Armitage Trend Test (d)	P=0.533N		
Fisher Exact Test (d)		P=0.418	P=0.571N
Adrenal Gland: Pheochromocytoma			
Overall Rates (a)	4/49 (8%)	3/49 (6%)	4/48 (8%)
Adjusted Rates (b)	13.8%	10.9%	13.3%
Terminal Rates (c)	4/29 (14%)	2/26 (8%)	3/28 (11%)
Week of First Observation	104	103	100
Life Table Tests (d)	P=0.559	P=0.554N	P=0.630
Incidental Tumor Tests (d)	P=0.571	P=0.499N	P=0.637
Cochran-Armitage Trend Test (d)	P=0.565		
Fisher Exact Test (d)		P=0.500N	P=0.631
Thyroid Gland: Follicular Cell Adenoma			
Overall Rates (a)	1/48 (2%)	3/48 (6%)	0/50 (0%)
Adjusted Rates (b)	2.4%	10.1%	0.0%
Terminal Rates (c)	0/29 (0%)	1/26 (4%)	0/29 (0%)
Week of First Observation	89	102	
Life Table Tests (d)	P=0.383N	P=0.300	P=0.495N
Incidental Tumor Tests (d)	P=0.355N	P=0.373	P=0.527N
Cochran-Armitage Trend Test (d)	P=0.366N		
Fisher Exact Test (d)		P=0.308	P=0.490N
Thyroid Gland: Follicular Cell Adenoma or Carcinoma			
Overall Rates (a)	2/48 (4%)	3/48 (6%)	0/50 (0%)
Adjusted Rates (b)	5.8%	10.1%	0.0%
Terminal Rates (c)	1/29 (3%)	1/26 (4%)	0/29 (0%)
Week of First Observation	89	102	
Life Table Tests (d)	P=0.209N	P=0.482	P=0.237N
Incidental Tumor Tests (d)	P=0.186N	P=0.561	P=0.254N
Cochran-Armitage Trend Test (d)	P=0.192N		
Fisher Exact Test (d)		P=0.500	P=0.237N

TABLE E2. ANALYSIS OF PRIMARY TUMORS IN FEMALE RATS IN THE TWO-YEAR INHALATION STUDY OF METHYL METHACRYLATE (Continued)

	Control	250 ppm	500 ppm
Thyroid Gland: C-Cell Adenoma or Carcinoma			
Overall Rates (a)	1/48 (2%)	2/48 (4%)	3/50 (6%)
Adjusted Rates (b)	2.6%	5.8%	9.4%
Terminal Rates (c)	0/29 (0%)	1/26 (4%)	2/29 (7%)
Week of First Observation	92	78	96
Life Table Tests (d)	P=0.230	P=0.509	P=0.312
Incidental Tumor Tests (d)	P=0.243	P=0.401	P=0.318
Cochran-Armitage Trend Test (d)	P=0.235		
Fisher Exact Test (d)		P=0.500	P=0.324
Mammary Gland: Fibroadenoma			
Overall Rates (a)	10/50 (20%)	8/50 (16%)	16/50 (32%)
Adjusted Rates (b)	26.4%	23.3%	44.3%
Terminal Rates (c)	5/30 (17%)	4/27 (15%)	10/29 (34%)
Week of First Observation	74	78	78
Life Table Tests (d)	P=0.104	P=0.419N	P=0.140
Incidental Tumor Tests (d)	P=0.099	P=0.453N	P=0.139
Cochran-Armitage Trend Test (d)	P=0.094		
Fisher Exact Test (d)		P=0.398N	P=0.127
Mammary Gland: Fibroadenoma or Adenocarcinoma			
Overall Rates (a)	10/50 (20%)	9/50 (18%)	16/50 (32%)
Adjusted Rates (b)	26.4%	25.0%	44.3%
Terminal Rates (c)	5/30 (17%)	4/27 (15%)	10/29 (34%)
Week of First Observation	74	78	78
Life Table Tests (d)	P=0.108	P=0.512N	P=0.140
Incidental Tumor Tests (d)	P=0.100	P=0.570N	P=0.139
Cochran-Armitage Trend Test (d)	P=0.097		
Fisher Exact Test (d)		P=0.500N	P=0.127
Uterus: Endometrial Stromal Polyp			
Overall Rates (a)	7/48 (15%)	5/48 (10%)	8/48 (17%)
Adjusted Rates (b)	19.7%	14.8%	23.7%
Terminal Rates (c)	3/29 (10%)	2/25 (8%)	5/28 (18%)
Week of First Observation	72	88	78
Life Table Tests (d)	P=0.436	P=0.409N	P=0.489
Incidental Tumor Tests (d)	P=0.434	P=0.361N	P=0.509
Cochran-Armitage Trend Test (d)	P=0.441		
Fisher Exact Test (d)		P=0.380N	P=0.500
Uterus: Endometrial Stromal Polyp or Sarcoma			
Overall Rates (a)	7/48 (15%)	7/48 (15%)	8/48 (17%)
Adjusted Rates (b)	19.7%	20.5%	23.7%
Terminal Rates (c)	3/29 (10%)	3/25 (12%)	5/28 (18%)
Week of First Observation	72	88	78
Life Table Tests (d)	P=0.438	P=0.582	P=0.489
Incidental Tumor Tests (d)	P=0.443	P=0.568N	P=0.509
Cochran-Armitage Trend Test (d)	P=0.444		
Fisher Exact Test (d)		P=0.613N	P=0.500

(a) Number of tumor-bearing animals/number of animals examined at the site

(b) Kaplan-Meier estimated tumor incidence at the end of the study after adjusting for intercurrent mortality

(c) Observed tumor incidence at terminal kill

(d) Beneath the control incidence are the P values associated with the trend test. Beneath the dosed group incidence are the P values corresponding to pairwise comparisons between that dosed group and the controls. The life table analysis regards tumors in animals dying prior to terminal kill as being (directly or indirectly) the cause of death. The incidental tumor test regards these lesions as nonfatal. The Cochran-Armitage and Fisher exact tests compare directly the overall incidence rates. A negative trend or lower incidence in a dosed group is indicated by (N).

TABLE E3. ANALYSIS OF PRIMARY TUMORS IN MALE MICE IN THE TWO-YEAR INHALATION STUDY OF METHYL METHACRYLATE

	Control	500 ppm	1,000 ppm
Lung: Alveolar/Bronchiolar Adenoma			
Overall Rates (a)	10/50 (20%)	1/50 (2%)	3/50 (6%)
Adjusted Rates (b)	22.0%	2.4%	6.4%
Terminal Rates (c)	9/44 (20%)	1/42 (2%)	3/47 (6%)
Week of First Observation	82	104	104
Life Table Tests (d)	P=0.011N	P=0.007N	P=0.030N
Incidental Tumor Tests (d)	P=0.013N	P=0.007N	P=0.040N
Cochran-Armitage Trend Test (d)	P=0.013N		
Fisher Exact Test (d)		P=0.004N	P=0.036N
Lung: Alveolar/Bronchiolar Carcinoma			
Overall Rates (a)	3/50 (6%)	0/50 (0%)	1/50 (2%)
Adjusted Rates (b)	6.8%	0.0%	2.1%
Terminal Rates (c)	3/44 (7%)	0/42 (0%)	1/47 (2%)
Week of First Observation	104		104
Life Table Tests (d)	P=0.165N	P=0.130N	P=0.282N
Incidental Tumor Tests (d)	P=0.165N	P=0.130N	P=0.282N
Cochran-Armitage Trend Test (d)	P=0.176N		
Fisher Exact Test (d)		P=0.121N	P=0.309N
Lung: Alveolar/Bronchiolar Adenoma or Carcinoma			
Overall Rates (a)	11/50 (22%)	1/50 (2%)	4/50 (8%)
Adjusted Rates (b)	24.3%	2.4%	8.5%
Terminal Rates (c)	10/44 (23%)	1/42 (2%)	4/47 (9%)
Week of First Observation	82	104	104
Life Table Tests (d)	P=0.015N	P=0.004N	P=0.037N
Incidental Tumor Tests (d)	P=0.017N	P=0.004N	P=0.047N
Cochran-Armitage Trend Test (d)	P=0.018N		
Fisher Exact Test (d)		P=0.002N	P=0.045N
Hematopoietic System: Lymphoma, All Malignant			
Overall Rates (a)	3/50 (6%)	2/50 (4%)	0/50 (0%)
Adjusted Rates (b)	6.6%	4.5%	0.0%
Terminal Rates (c)	2/44 (5%)	1/42 (2%)	0/47 (0%)
Week of First Observation	97	80	
Life Table Tests (d)	P=0.082N	P=0.524N	P=0.116N
Incidental Tumor Tests (d)	P=0.142N	P=0.513N	P=0.224N
Cochran-Armitage Trend Test (d)	P=0.082N		
Fisher Exact Test (d)		P=0.500N	P=0.122N
Circulatory System: Hemangiosarcoma			
Overall Rates (a)	1/50 (2%)	3/50 (6%)	1/50 (2%)
Adjusted Rates (b)	2.3%	6.6%	2.1%
Terminal Rates (c)	1/44 (2%)	1/42 (2%)	0/47 (0%)
Week of First Observation	104	89	83
Life Table Tests (d)	P=0.599N	P=0.294	P=0.755N
Incidental Tumor Tests (d)	P=0.368	P=0.300	P=0.657
Cochran-Armitage Trend Test (d)	P=0.610		
Fisher Exact Test (d)		P=0.309	P=0.753N
Liver: Hepatocellular Adenoma			
Overall Rates (a)	9/50 (18%)	3/48 (6%)	2/49 (4%)
Adjusted Rates (b)	20.5%	7.3%	4.3%
Terminal Rates (c)	9/44 (20%)	3/41 (7%)	2/46 (4%)
Week of First Observation	104	104	104
Life Table Tests (d)	P=0.011N	P=0.078N	P=0.023N
Incidental Tumor Tests (d)	P=0.011N	P=0.078N	P=0.023N
Cochran-Armitage Trend Test (d)	P=0.014N		
Fisher Exact Test (d)		P=0.070N	P=0.028N

TABLE E3. ANALYSIS OF PRIMARY TUMORS IN MALE MICE IN THE TWO-YEAR INHALATION STUDY OF METHYL METHACRYLATE (Continued)

	Control	500 ppm	1,000 ppm
Liver: Hepatocellular Carcinoma			
Overall Rates (a)	8/50 (16%)	4/48 (8%)	5/49 (10%)
Adjusted Rates (b)	16.9%	9.1%	10.9%
Terminal Rates (c)	5/44 (11%)	2/41 (5%)	5/46 (11%)
Week of First Observation	82	89	104
Life Table Tests (d)	P=0.207N	P=0.219N	P=0.260N
Incidental Tumor Tests (d)	P=0.431N	P=0.225N	P=0.535N
Cochran-Armitage Trend Test (d)	P=0.227N		
Fisher Exact Test (d)		P=0.199N	P=0.290N
Liver: Hepatocellular Adenoma or Carcinoma			
Overall Rates (a)	16/50 (32%)	7/48 (15%)	7/49 (14%)
Adjusted Rates (b)	33.9%	16.1%	15.2%
Terminal Rates (c)	13/44 (30%)	5/41 (12%)	7/46 (15%)
Week of First Observation	82	89	104
Life Table Tests (d)	P=0.016N	P=0.050N	P=0.025N
Incidental Tumor Tests (d)	P=0.043N	P=0.048N	P=0.072N
Cochran-Armitage Trend Test (d)	P=0.019N		
Fisher Exact Test (d)		P=0.035N	P=0.032N
Harderian Gland: Adenoma			
Overall Rates (a)	4/50 (8%)	2/50 (4%)	1/50 (2%)
Adjusted Rates (b)	8.8%	4.8%	2.1%
Terminal Rates (c)	3/44 (7%)	2/42 (5%)	1/47 (2%)
Week of First Observation	97	104	104
Life Table Tests (d)	P=0.110N	P=0.362N	P=0.167N
Incidental Tumor Tests (d)	P=0.149N	P=0.356N	P=0.282N
Cochran-Armitage Trend Test (d)	P=0.118N		
Fisher Exact Test (d)		P=0.339N	P=0.181N
Harderian Gland: Adenocarcinoma			
Overall Rates (a)	2/50 (4%)	0/50 (0%)	4/50 (8%)
Adjusted Rates (b)	4.5%	0.0%	8.5%
Terminal Rates (c)	2/44 (5%)	0/42 (0%)	4/47 (9%)
Week of First Observation	104		104
Life Table Tests (d)	P=0.246	P=0.249N	P=0.368
Incidental Tumor Tests (d)	P=0.246	P=0.249N	P=0.368
Cochran-Armitage Trend Test (d)	P=0.222		
Fisher Exact Test (d)		P=0.247N	P=0.339
Harderian Gland: Adenoma or Adenocarcinoma			
Overall Rates (a)	6/50 (12%)	2/50 (4%)	5/50 (10%)
Adjusted Rates (b)	13.2%	4.8%	10.6%
Terminal Rates (c)	5/44 (11%)	2/42 (5%)	5/47 (11%)
Week of First Observation	97	104	104
Life Table Tests (d)	P=0.394N	P=0.153N	P=0.458N
Incidental Tumor Tests (d)	P=0.461N	P=0.150N	P=0.588N
Cochran-Armitage Trend Test (d)	P=0.429N		
Fisher Exact Test (d)		P=0.134N	P=0.500N

(a) Number of tumor-bearing animals/number of animals examined at the site

(b) Kaplan-Meier estimated tumor incidence at the end of the study after adjusting for intercurrent mortality

(c) Observed tumor incidence at terminal kill

(d) Beneath the control incidence are the P values associated with the trend test. Beneath the dosed group incidence are the P values corresponding to pairwise comparisons between that dosed group and the controls. The life table analysis regards tumors in animals dying prior to terminal kill as being (directly or indirectly) the cause of death. The incidental tumor test regards these lesions as nonfatal. The Cochran-Armitage and Fisher exact tests compare directly the overall incidence rates. A negative trend or lower incidence in a dosed group is indicated by (N).

TABLE E4. ANALYSIS OF PRIMARY TUMORS IN FEMALE MICE IN THE TWO-YEAR INHALATION STUDY OF METHYL METHACRYLATE

	Control	500 ppm	1,000 ppm
Lung: Alveolar/Bronchiolar Adenoma			
Overall Rates (a)	1/49 (2%)	4/49 (8%)	0/50 (0%)
Adjusted Rates (b)	2.9%	14.8%	0.0%
Terminal Rates (c)	0/27 (0%)	3/26 (12%)	0/33 (0%)
Week of First Observation	97	102	
Life Table Tests (d)	P=0.334N	P=0.165	P=0.489N
Incidental Tumor Tests (d)	P=0.402N	P=0.187	P=0.594N
Cochran-Armitage Trend Test (d)	P=0.383N		
Fisher Exact Test (d)		P=0.181	P=0.495N
Lung: Alveolar/Bronchiolar Adenoma or Carcinoma			
Overall Rates (a)	2/49 (4%)	5/49 (10%)	0/50 (0%)
Adjusted Rates (b)	6.5%	17.1%	0.0%
Terminal Rates (c)	1/27 (4%)	3/26 (12%)	0/33 (0%)
Week of First Observation	97	92	
Life Table Tests (d)	P=0.194N	P=0.202	P=0.212N
Incidental Tumor Tests (d)	P=0.267N	P=0.218	P=0.266N
Cochran-Armitage Trend Test (d)	P=0.232N		
Fisher Exact Test (d)		P=0.218	P=0.242N
Hematopoietic System: Malignant Lymphoma, Lymphocytic Type			
Overall Rates (a)	2/50 (4%)	0/49 (0%)	3/50 (6%)
Adjusted Rates (b)	6.0%	0.0%	8.2%
Terminal Rates (c)	1/27 (4%)	0/26 (0%)	1/33 (3%)
Week of First Observation	85		90
Life Table Tests (d)	P=0.442	P=0.244N	P=0.560
Incidental Tumor Tests (d)	P=0.288	P=0.266N	P=0.356
Cochran-Armitage Trend Test (d)	P=0.391		
Fisher Exact Test (d)		P=0.252N	P=0.500
Hematopoietic System: Malignant Lymphoma, Mixed Type			
Overall Rates (a)	5/50 (10%)	5/49 (10%)	1/50 (2%)
Adjusted Rates (b)	15.3%	16.2%	3.0%
Terminal Rates (c)	3/27 (11%)	3/26 (12%)	1/33 (3%)
Week of First Observation	70	85	104
Life Table Tests (d)	P=0.068N	P=0.609	P=0.080N
Incidental Tumor Tests (d)	P=0.109N	P=0.571	P=0.116N
Cochran-Armitage Trend Test (d)	P=0.090N		
Fisher Exact Test (d)		P=0.616	P=0.103N
Hematopoietic System: Lymphoma, All Malignant			
Overall Rates (a)	8/50 (16%)	5/49 (10%)	6/50 (12%)
Adjusted Rates (b)	23.3%	16.2%	15.1%
Terminal Rates (c)	4/27 (15%)	3/26 (12%)	2/33 (6%)
Week of First Observation	70	85	64
Life Table Tests (d)	P=0.264N	P=0.307N	P=0.321N
Incidental Tumor Tests (d)	P=0.472N	P=0.332N	P=0.589N
Cochran-Armitage Trend Test (d)	P=0.326N		
Fisher Exact Test (d)		P=0.290N	P=0.387N
Liver: Hepatocellular Adenoma			
Overall Rates (a)	7/50 (14%)	2/48 (4%)	2/49 (4%)
Adjusted Rates (b)	22.4%	7.4%	6.1%
Terminal Rates (c)	5/27 (19%)	1/26 (4%)	2/33 (6%)
Week of First Observation	84	102	104
Life Table Tests (d)	P=0.028N	P=0.094N	P=0.050N
Incidental Tumor Tests (d)	P=0.046N	P=0.100N	P=0.079N
Cochran-Armitage Trend Test (d)	P=0.045N		
Fisher Exact Test (d)		P=0.090N	P=0.085N

TABLE E4. ANALYSIS OF PRIMARY TUMORS IN FEMALE MICE IN THE TWO-YEAR INHALATION STUDY OF METHYL METHACRYLATE (Continued)

	Control	500 ppm	1,000 ppm
Liver: Hepatocellular Adenoma or Carcinoma			
Overall Rates (a)	7/50 (14%)	4/48 (8%)	2/49 (4%)
Adjusted Rates (b)	22.4%	13.5%	6.1%
Terminal Rates (c)	5/27 (19%)	2/26 (8%)	2/33 (6%)
Week of First Observation	84	91	104
Life Table Tests (d)	P=0.036N	P=0.285N	P=0.050N
Incidental Tumor Tests (d)	P=0.066N	P=0.309N	P=0.079N
Cochran-Armitage Trend Test (d)	P=0.059N		
Fisher Exact Test (d)		P=0.286N	P=0.085N
Pituitary Gland: Adenoma			
Overall Rates (a)	12/49 (24%)	3/44 (7%)	1/39 (3%)
Adjusted Rates (b)	37.9%	11.5%	3.6%
Terminal Rates (c)	7/26 (27%)	3/26 (12%)	1/28 (4%)
Week of First Observation	85	104	104
Life Table Tests (d)	P<0.001N	P=0.016N	P=0.001N
Incidental Tumor Tests (d)	P<0.001N	P=0.015N	P=0.006N
Cochran-Armitage Trend Test (d)	P=0.001N		
Fisher Exact Test (d)		P=0.019N	P=0.003N
Pituitary Gland: Adenoma or Adenocarcinoma			
Overall Rates (a)	12/49 (24%)	3/44 (7%)	2/39 (5%)
Adjusted Rates (b)	37.9%	11.5%	6.1%
Terminal Rates (c)	7/26 (27%)	3/26 (12%)	1/28 (4%)
Week of First Observation	85	104	104
Life Table Tests (d)	P=0.001N	P=0.016N	P=0.004N
Incidental Tumor Tests (d)	P=0.004N	P=0.015N	P=0.020N
Cochran-Armitage Trend Test (d)	P=0.004N		
Fisher Exact Test (d)		P=0.019N	P=0.012N
Adrenal Gland or Adrenal Capsule: Adenoma			
Overall Rates (a)	3/50 (6%)	1/46 (2%)	0/49 (0%)
Adjusted Rates (b)	10.2%	3.8%	0.0%
Terminal Rates (c)	2/27 (7%)	1/26 (4%)	0/33 (0%)
Week of First Observation	98	104	
Life Table Tests (d)	P=0.049N	P=0.328N	P=0.096N
Incidental Tumor Tests (d)	P=0.061N	P=0.328N	P=0.134N
Cochran-Armitage Trend Test (d)	P=0.065N		
Fisher Exact Test (d)		P=0.341N	P=0.125N
Thyroid Gland: Follicular Cell Adenoma			
Overall Rates (a)	4/49 (8%)	1/44 (2%)	1/48 (2%)
Adjusted Rates (b)	13.2%	4.2%	2.5%
Terminal Rates (c)	2/27 (7%)	1/24 (4%)	0/32 (0%)
Week of First Observation	97	104	90
Life Table Tests (d)	P=0.085N	P=0.220N	P=0.147N
Incidental Tumor Tests (d)	P=0.141N	P=0.201N	P=0.290N
Cochran-Armitage Trend Test (d)	P=0.108N		
Fisher Exact Test (d)		P=0.216N	P=0.187N
Uterus: Adenocarcinoma			
Overall Rates (a)	3/48 (6%)	0/47 (0%)	0/47 (0%)
Adjusted Rates (b)	9.7%	0.0%	0.0%
Terminal Rates (c)	2/26 (8%)	0/26 (0%)	0/32 (0%)
Week of First Observation	82		
Life Table Tests (d)	P=0.033N	P=0.124N	P=0.103N
Incidental Tumor Tests (d)	P=0.042N	P=0.134N	P=0.137N
Cochran-Armitage Trend Test (d)	P=0.038N		
Fisher Exact Test (d)		P=0.125N	P=0.125N

TABLE E4. ANALYSIS OF PRIMARY TUMORS IN FEMALE MICE IN THE TWO-YEAR INHALATION STUDY OF METHYL METHACRYLATE (Continued)

- (a) Number of tumor-bearing animals/number of animals examined at the site
- (b) Kaplan-Meier estimated tumor incidence at the end of the study after adjusting for intercurrent mortality
- (c) Observed tumor incidence at terminal kill
- (d) Beneath the control incidence are the P values associated with the trend test. Beneath the dosed group incidence are the P values corresponding to pairwise comparisons between that dosed group and the controls. The life table analysis regards tumors in animals dying prior to terminal kill as being (directly or indirectly) the cause of death. The incidental tumor test regards these lesions as nonfatal. The Cochran-Armitage and Fisher exact tests compare directly the overall incidence rates. A negative trend or lower incidence in a dosed group is indicated by (N).

APPENDIX F

HISTORICAL INCIDENCES OF TUMORS IN F344/N RATS AND B6C3F₁ MICE RECEIVING NO TREATMENT

TABLE F1. HISTORICAL INCIDENCE OF LEUKEMIA IN FEMALE F344/N RATS RECEIVING NO TREATMENT (a)

Incidence in Controls	
Historical Incidence for Chamber Controls at Battelle Pacific Northwest Laboratories	
Propylene oxide	14/50
Methyl methacrylate	11/50
Propylene	13/49
Dichloromethane	17/50
Tetrachloroethylene	18/50
TOTAL	73/249 (29.3%)
SD (b)	5.69%
Range (c)	
High	18/50
Low	11/50
Overall Historical Incidence for Untreated Controls (d)	
TOTAL	375/2,021 (18.6%)
SD (b)	6.55%
Range (c)	
High	19/50
Low	3/50

- (a) Data as of August 30, 1985, for studies of at least 104 weeks
 (b) Standard deviation
 (c) Range and SD are presented for groups of 35 or more animals.
 (d) Does not include chamber controls from inhalation studies

TABLE F2. HISTORICAL INCIDENCE OF ALVEOLAR/BRONCHIOLAR TUMORS IN MALE B6C3F₁ MICE RECEIVING NO TREATMENT (a)

Study	Incidence in Controls		
	Adenoma	Carcinoma	Adenoma or Carcinoma
Historical Incidence for Chamber Controls at Battelle Pacific Northwest Laboratories			
Propylene oxide	14/50	2/50	15/50
Methyl methacrylate	10/50	3/50	11/50
Propylene	7/50	9/50	16/50
Dichloromethane	3/50	2/50	5/50
Tetrachloroethylene	3/49	4/49	6/49
TOTAL	37/249 (14.9%)	20/249 (8.0%)	53/249 (21.3%)
SD (b)	9.42%	5.83%	10.00%
Range (c)			
High	14/50	9/50	16/50
Low	3/50	2/50	5/50
Overall Historical Incidence for Untreated Controls (d)			
TOTAL	255/2,080 (12.3%)	105/2,080 (5.0%)	351/2,080 (16.9%)
SD (b)	6.74%	3.95%	8.07%
Range (c)			
High	14/50	8/48	17/50
Low	1/50	0/50	1/49

(a) Data as of August 30, 1985, for studies of at least 104 weeks

(b) Standard deviation

(c) Range and SD are presented for groups of 35 or more animals.

(d) Does not include chamber controls from inhalation studies

TABLE F3. HISTORICAL INCIDENCE OF HEPATOCELLULAR TUMORS IN MALE B6C3F₁ MICE RECEIVING NO TREATMENT (a)

Study	Incidence in Controls		
	Adenoma	Carcinoma	Adenoma or Carcinoma
Historical Incidence for Chamber Controls at Battelle Pacific Northwest Laboratories			
Propylene oxide	8/50	6/50	14/50
Methyl methacrylate	9/50	8/50	16/50
Propylene	5/50	9/50	14/50
Dichloromethane	10/50	13/50	22/50
Tetrachloroethylene	12/49	7/49	17/49
TOTAL	44/249 (17.7%)	43/249 (17.3%)	83/249 (33.3%)
SD (b)	5.33%	5.36%	6.60%
Range (c)			
High	12/49	13/50	22/50
Low	5/50	6/50	14/50
Overall Historical Incidence for Untreated Controls (d)			
TOTAL	228/2,084 (10.9%)	424/2,084 (20.3%)	627/2,084 (30.1%)
SD (b)	7.29%	6.85%	7.78%
Range (c)			
High	(e) 22/50	16/50	(f) 29/50
Low	0/49	4/50	8/50

- (a) Data as of August 30, 1985, for studies of at least 104 weeks
 (b) Standard deviation
 (c) Range and SD are presented for groups of 35 or more animals.
 (d) Does not include chamber controls from inhalation studies
 (e) Second high: 11/50
 (f) Second high: 20/50

TABLE F4. HISTORICAL INCIDENCE OF HEPATOCELLULAR TUMORS IN FEMALE B6C3F₁ MICE RECEIVING NO TREATMENT (a)

Study	Incidence in Controls		
	Adenoma	Carcinoma	Adenoma or Carcinoma
Historical Incidence for Chamber Controls at Battelle Pacific Northwest Laboratories			
Propylene oxide	1/50	2/50	3/50
Methyl methacrylate	7/50	0/50	7/50
Propylene	0/50	2/50	2/50
Dichloromethane	2/50	1/50	3/50
Tetrachloroethylene	3/48	1/48	4/48
TOTAL	13/248 (5.2%)	6/248 (2.4%)	19/248 (7.7%)
SD (b)	5.41%	1.67%	3.86%
Range (c)			
High	7/50	2/50	7/50
Low	0/50	0/50	2/50
Overall Historical Incidence for Untreated Controls (d)			
TOTAL	91/2,080 (4.4%)	(e) 94/2,080 (4.5%)	(e) 181/2,080 (8.7%)
SD (b)	4.23%	2.99%	4.85%
Range (c)			
High	9/49	7/48	10/49
Low	0/50	0/50	0/50

(a) Data as of August 30, 1985, for studies of at least 104 weeks

(b) Standard deviation

(c) Range and SD are presented for groups of 35 or more animals.

(d) Does not include chamber controls from inhalation studies

(e) One hepatoblastoma was also observed; the inclusion of this tumor would not affect the reported range.

TABLE F5. HISTORICAL INCIDENCE OF PITUITARY GLAND TUMORS IN FEMALE B6C3F₁ MICE RECEIVING NO TREATMENT (a)

Study	Incidence in Controls		
	Adenoma	Carcinoma	Adenoma or Carcinoma
Historical Incidence for Chamber Controls at Battelle Pacific Northwest Laboratories			
Propylene oxide	8/46	1/46	9/46
Methyl methacrylate	12/49	0/49	12/49
Propylene	(b) 13/41	0/41	(b) 13/41
Dichloromethane	4/46	0/46	4/46
Tetrachloroethylene	2/45	5/45	7/45
TOTAL	39/227 (17.2%)	6/227 (2.6%)	45/227 (19.8%)
SD (c)	11.16%	4.82%	8.73%
Range (d)			
High	13/41	5/45	13/41
Low	2/45	0/49	4/46
Overall Historical Incidence for Untreated Controls (e)			
TOTAL	(f) 177/1,815 (9.8%)	(g) 13/1,815 (0.7%)	(f,g) 190/1,815 (10.5%)
SD (c)	9.39%	1.44%	9.61%
Range (d)			
High	12/40	3/50	16/50
Low	0/48	0/49	0/48

- (a) Data as of August 30, 1985, for studies of at least 104 weeks
 (b) Includes 11 chromophobe adenomas
 (c) Standard deviation
 (d) Range and SD are presented for groups of 35 or more animals.
 (e) Does not include chamber controls from inhalation studies
 (f) Includes 14 chromophobe adenomas; no acidophil or basophil tumors were observed
 (g) Includes three chromophobe carcinomas and three adenocarcinomas, NOS

APPENDIX G

GENETIC TOXICOLOGY OF METHYL METHACRYLATE

TABLE G1. MUTAGENICITY OF METHYL METHACRYLATE IN *SALMONELLA TYPHIMURIUM*

Strain	Dose ($\mu\text{g}/\text{plate}$)	Revertants/plate (a,b)		
		-S9	+S9 (rat)	+S9 (hamster)
TA100	0	140 \pm 6.7	141 \pm 8.0	131 \pm 4.7
	33	118 \pm 5.6	--	--
	100	122 \pm 21.1	157 \pm 10.2	143 \pm 9.9
	333	126 \pm 10.5	143 \pm 7.1	145 \pm 4.1
	1,000	136 \pm 5.0	138 \pm 11.6	130 \pm 8.5
	3,333	129 \pm 8.8	121 \pm 10.7	116 \pm 6.2
	6,666	--	(c) 48 \pm 16.3	(c) 65 \pm 3.5
TA1535	0	26 \pm 4.4	9 \pm 1.5	6 \pm 0.6
	33	22 \pm 2.2	--	--
	100	18 \pm 1.7	6 \pm 1.2	6 \pm 0.7
	333	17 \pm 2.5	8 \pm 2.1	5 \pm 0.0
	1,000	16 \pm 2.3	7 \pm 1.0	5 \pm 0.7
	3,333	16 \pm 2.9	7 \pm 1.2	5 \pm 1.2
	6,666	--	(c) 4 \pm 0.9	(c) 4 \pm 1.3
TA97	0	145 \pm 4.5	180 \pm 9.4	248 \pm 105.5
	33	145 \pm 13.6	--	--
	100	151 \pm 16.6	175 \pm 11.6	152 \pm 9.1
	333	138 \pm 14.0	190 \pm 2.3	157 \pm 10.6
	1,000	149 \pm 1.0	195 \pm 4.3	158 \pm 6.3
	3,333	156 \pm 3.8	166 \pm 7.3	169 \pm 4.8
	6,666	--	(c) 64 \pm 31.8	(c) 89 \pm 7.7
TA98	0	22 \pm 2.3	29 \pm 4.9	26 \pm 2.0
	33	20 \pm 2.4	--	--
	100	18 \pm 1.5	32 \pm 2.2	24 \pm 2.6
	333	23 \pm 3.0	26 \pm 3.2	25 \pm 1.0
	1,000	17 \pm 1.0	27 \pm 1.5	22 \pm 2.1
	3,333	19 \pm 0.3	16 \pm 2.3	18 \pm 1.2
	6,666	--	(c) 0 \pm 0.0	(c) 5 \pm 2.1

(a) The S9 fractions were prepared from the liver of Aroclor 1254-induced male Sprague-Dawley rats and male Syrian hamsters. Cells and study compound or solvent (DMSO) were incubated for 20 minutes at 37° C in the presence of either S9 or buffer. After the addition of soft agar, the contents of each tube was poured onto minimal medium, and the plates were incubated at 37° C for 48 hours (Haworth et al., 1983). The experiment was performed twice, each in triplicate; because the results were similar, data from only one experiment are shown.

(b) Mean \pm standard error

(c) Slightly toxic

TABLE G2. MUTAGENICITY OF METHYL METHACRYLATE IN L5178Y/TK^{+/-} MOUSE LYMPHOMA CELLS IN THE ABSENCE OF S9 (a)

Compound	Dose (µl/ml)	Total Mutant Clones	Cloning Efficiency (percent)	Relative Total Growth (percent)	Mutation Frequency (mutants/10 ⁶ clonable cells)
<i>Absolute ethanol</i> (10% maximum final concentration)					
		104	70.0	101.0	50
		96	71.3	84.0	45
		60	84.5	115.0	24
<i>Methyl methanesulfonate</i>					
	5.000 (µg/ml)	473	63.3	38.9	249
		691	61.8	44.7	373
		617	53.0	51.8	388
<i>Methyl methacrylate</i>					
	0.125	97	73.5	35.2	44
		119	71.0	52.5	56
		59	70.8	101.5	28
	0.250	82	67.2	64.8	41
		65	73.5	67.6	29
		96	72.7	84.6	44
	0.500	99	49.3	33.1	67
		96	58.2	40.7	55
		162	65.0	52.3	83
	0.750	252	60.5	21.6	139
		226	38.8	13.0	194
		366	44.2	6.9	276
	1.000	339	47.7	13.2	237
		381	41.3	5.4	307
		482	53.7	5.6	299

(a) Experiments were performed twice, and all doses were tested in duplicate or triplicate. Because the results were similar, data from only one experiment are shown. The protocol was basically that of Clive et al. (1979). Cells (6×10^5 /ml) were treated for 4 hours at 37° C in medium, washed, resuspended in medium, and incubated for 48 hours at 37° C. After expression, 3×10^6 cells were plated in medium supplemented with trifluorothymidine for selection of cells that were mutant at the thymidine kinase (TK) locus, and 600 cells were plated in nonselective medium to determine the percentage of viable cells.

TABLE G3. MUTAGENICITY OF METHYL METHACRYLATE IN L5178Y/TK^{+/-} MOUSE LYMPHOMA CELLS IN THE PRESENCE OF S9 (a)

Compound	Dose (µl/ml)	Total Mutant Clones	Cloning Efficiency (percent)	Relative Total Growth (percent)	Mutation Frequency (mutants/10 ⁶ clonable cells)
100% Ethanol (10% maximum final concentration)					
		207	57.7	88.0	120
		167	60.5	103.0	92
		168	71.0	107.0	79
		207	59.7	102.0	116
Methylcholanthrene					
	2.500 (µg/ml)	608	26.8	6.5	755
		694	36.8	7.3	628
		677	33.2	28.7	680
Methyl methacrylate					
	0.125	267	60.3	88.4	148
		265	66.2	98.2	134
		365	79.2	93.9	154
	0.250	362	53.7	81.9	225
		305	48.5	70.2	210
		374	50.5	62.8	247
	0.500	460	63.3	61.3	242
		531	54.3	63.5	326
		480	63.8	75.2	251
	1.000	588	52.5	42.6	373
		557	59.3	35.9	313
		559	54.5	51.0	342
	1.500	663	54.2	20.5	408
		567	54.3	27.8	348
		552	49.5	28.3	372

(a) Experiments were performed twice, and all doses were tested in triplicate, except the solvent, which was tested in quadruplicate. Because the results were similar, data from only one experiment are shown. The protocol was basically that of Clive et al. (1979). Cells (6×10^5 /ml) were treated for 4 hours at 37° C in medium, washed, resuspended in medium, and incubated for 48 hours at 37° C. After expression, 3×10^6 cells were plated in medium supplemented with trifluorothymidine for selection of cells that were mutant at the thymidine kinase (TK) locus, and 600 cells were plated in nonselective medium to determine the percentage of viable cells. S9 was prepared from the liver of Aroclor 1254-induced male F344 rats.

TABLE G4. INDUCTION OF SISTER-CHROMATID EXCHANGES IN CHINESE HAMSTER OVARY CELLS BY METHYL METHACRYLATE (a)

		- S9 (b)		+ S9 (c)	
	Dose (µg/ml)	SCE/Cell (d)		Dose (µg/ml)	SCE/Cell (d)
DMSO	10 µl	8.2	DMSO	10 µl	7.4
Methyl methacrylate			Methyl methacrylate		
	750	10.7		500	8.6
	1,000	12.0		1,600	11.1
	1,250	14.4		3,000	10.5
	1,500	12.1			
Mitomycin C			Cyclophosphamide		
	0.005	29.6		2.0	41.7

(a) SCE = sister-chromatid exchange

(b) In the absence of S9, Chinese hamster ovary cells were incubated with study compound or solvent at 37° C; 2 hours after initiation of treatment, 10 µM BrdU was added, and incubation was continued for 24 hours. Cells were washed, fresh medium containing BrdU (10 µM) and colcemid (0.1 µg/ml) was added, and incubation was continued for an additional 22-24 hours. Cells were washed, fresh medium containing BrdU (10 µM) and colcemid (0.1 µg/ml) was added, and incubation was continued for 2-3 hours (Galloway et al., 1985).

(c) In the presence of S9, Chinese hamster ovary cells were incubated with study compound or solvent for 2 hours at 37° C. Then cells were washed, and medium containing 10 µM BrdU was added. Cells were incubated for a further 26 hours, with colcemid (0.1 µg/ml) present for the final 2-3 hours. S9 was from the livers of Aroclor 1254-induced male Sprague-Dawley rats (Galloway et al., 1985).

(d) Cells were collected by mitotic shake-off, treated for 3 minutes with potassium chloride (75 mM), washed twice with fixative, and dropped onto slides and air-dried (Galloway et al., 1985).

TABLE G5. INDUCTION OF CHROMOSOMAL ABERRATIONS IN CHINESE HAMSTER OVARY CELLS BY METHYL METHACRYLATE (a)

		- S9 (b)		+ S9 (c)	
	Dose (µg/ml)	Abs/100 Cells (percent cells w/abs)		Dose (µg/ml)	Abs/100 Cells (percent cells w/abs)
DMSO	10 µl	0 (0)	DMSO	10 µl	1 (1)
Methyl methacrylate			Methyl methacrylate		
	750	1 (1)		160	0 (0)
	1,000	2 (2)		500	3 (3)
	1,600	5 (5)		1,600	2 (2)
	3,000	6 (5)		5,000	44 (30)
Mitomycin C			Cyclophosphamide		
	0.005	113 (58)		50	117 (63)

(a) Abs = aberrations

(b) In the absence of S9, Chinese hamster ovary cells were incubated with study compound or solvent for 8-10 hours at 37° C. Cells were then washed, and fresh medium containing colcemid (0.1 µg/ml) was added. After a further 2-3 hours of incubation, cells were harvested by mitotic shake-off, fixed, and stained in 6% Giemsa (Galloway et al., 1985).

(c) In the presence of S9, cells were incubated with study compound or solvent for 2 hours at 37° C. Cells were then washed, fresh medium was added, and incubation was continued for 8-10 hours. Colcemid (0.1 µg/ml) was added for the last 2-3 hours of incubation; then cells were harvested by mitotic shake-off, fixed, and stained in 6% Giemsa. S9 was from the livers of Aroclor 1254-induced male Sprague-Dawley rats (Galloway et al., 1985).

APPENDIX H

CHEMICAL CHARACTERIZATION OF METHYL METHACRYLATE

APPENDIX H. CHEMICAL CHARACTERIZATION

I. Identity and Purity Determinations of Methyl Methacrylate Performed by the Analytical Chemistry Laboratory

A. Lot no. 4-0091

1. Physical properties	<u>Determined</u>	<u>Literature Values</u>
Appearance:	Clear, colorless liquid	
Boiling point:	100.4° ± 0.7(δ)° C at 738 mm (visual, micro boiling point)	101.0° C at 760 mm (Gallant, 1968)
Index of refraction:	n_D^{20} : 1.4151 ± 0.0002(δ)	n_D^{20} : 1.4698 (Gakhokikze, 1947)
Density:	d_{22}^{25} : 0.9380 ± 0.0001 g/ml	d^{25} : 0.943 g/ml read from graph (Gallant, 1968)
2. Spectral data		
Infrared		
Instrument:	Beckman IR-12	
Cell:	0.015 mm film between sodium chloride plates	
Results:	See Figure 5	Consistent with literature spectrum (Sadler Standard Spectra)
Ultraviolet/visible		
Instrument:	Cary 118	
Solvent:	Methanol	
Concentration:	1 mg/ml	
Results:	No absorbance between 800 and 350 nm. No maximum between 350 and 215 nm but a gradual increase in absorbance from 270 to 215 nm.	No literature reference found.

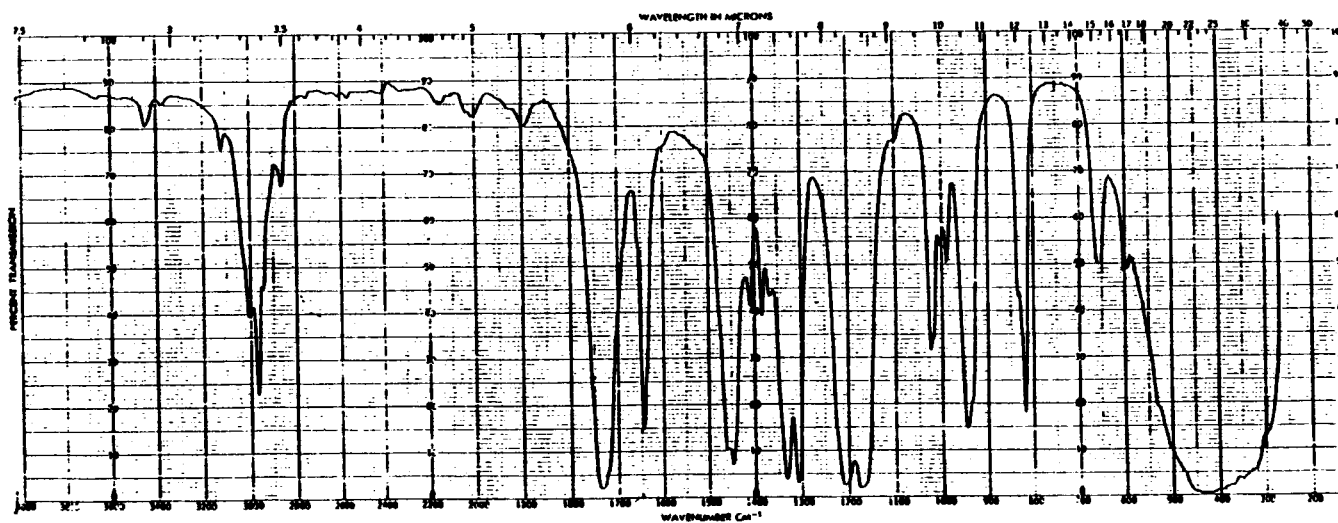

FIGURE 5. INFRARED ABSORPTION SPECTRUM OF METHYL METHACRYLATE (LOT NO. 4-0091)

APPENDIX H. CHEMICAL CHARACTERIZATION

Nuclear magnetic resonance	<u>Determined</u>	<u>Literature Values</u>
Instrument:	Varian HA-100	
Solvent:	Neat, tetramethylsilane added	
Assignments:	See Figure 6	Consistent with literature spectrum. (Sadtler Standard Spectra)
Chemical shift (δ):	a m, 1.89 ppm b s, 3.69 ppm c m, 5.55 ppm d m, 6.08 ppm	
Integration ratios:	a 3.02 b 2.79 c 1.11 d 1.08	

3. **Water analysis (Karl Fischer):** 0.078% \pm 0.003(δ)%

4. Elemental analysis

Element	<u>C</u>	<u>H</u>
Theory (T)	59.98	8.05
Determined (D)	59.79 59.90	8.07 8.19

5. Gas chromatography

Instrument: Tracor MT220

Detector: Flame ionization

Inlet temperature: 200° C

Detector temperature: 270° C

Oven temperature program: 5 min at 50° C, then to 200° C at 10° C/min

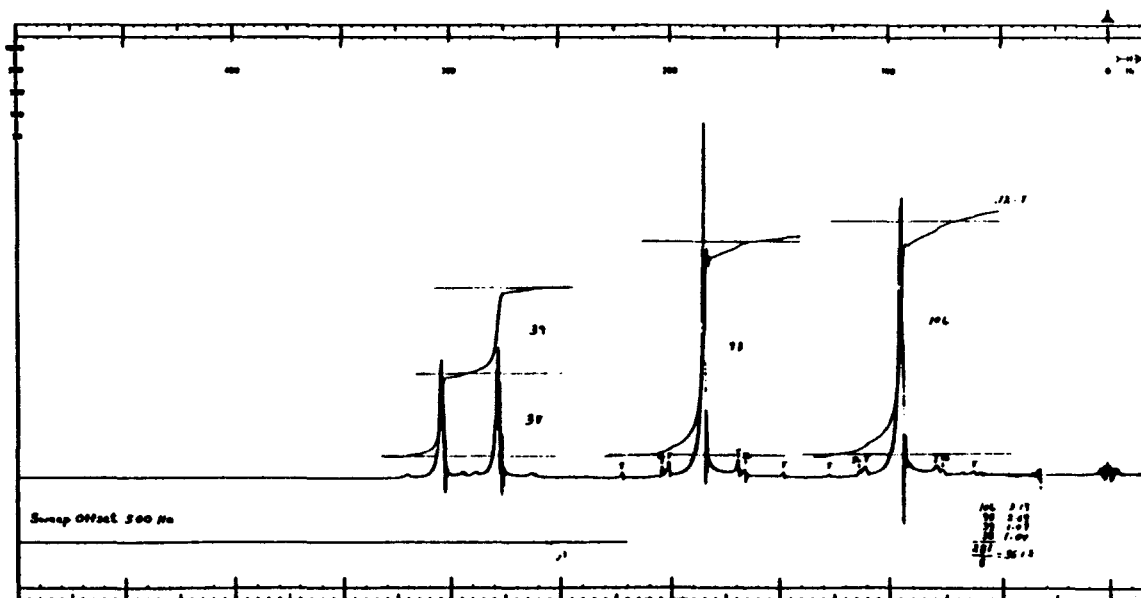

FIGURE 6. NUCLEAR MAGNETIC RESONANCE SPECTRUM OF METHYL METHACRYLATE (LOT NO. 4-0091)

APPENDIX H. CHEMICAL CHARACTERIZATION

System 1

Column: 80/100 Porapak Q, 1.8 m × 4 mm ID, glass

Results: Major peak and one impurity. The area of the impurity was 0.1% relative to that of the major peak area.

Peak No.	Retention Time (min)	Retention Time Relative to Major Peak	Area (percent of major peak)
1	20.4	1.00	100
2	22.5	1.10	0.1

System 2

Column: 20% SP2100/0.1% Carbowax 1500 on 100/120 Supelcoport, 1.8 m × 4 mm ID, glass

Results: Major peak and six impurities

Peak No.	Retention Time (min)	Retention Time Relative to Major Peak	Area (percent of major peak)
1	4.4	0.58	<0.01
2	6.3	0.84	0.02
3	7.5	1.00	100
4	8.8	1.18	0.2
5	9.4	1.26	0.04
6	11.6	1.54	<0.01
7	12.0	1.60	<0.01

6. **Conclusions:** The results of the elemental analysis agreed with the theoretical values. Gas chromatography by one system indicated six impurities with areas totaling <0.3% of the major peak area. A second system separated only one impurity. The infrared and nuclear magnetic resonance spectra were consistent with the structure.

APPENDIX H. CHEMICAL CHARACTERIZATION

B. Lot No. 4-15-014

1. Physical properties	<u>Determined</u>	<u>Literature Values</u>
Appearance:	Clear, colorless liquid	
Boiling point:	97.5° ± 1.1(8)° C at 738 mm (visual, micro boiling point). 104.0°-104.4° C at 739 mm (Dupont 900 DTA)	101.0° C at 760 mm (Gallant, 1968)
Index of refraction:	n_D^{20} : 1.4137 ± 0.0005(6)	n_D^{20} : 1.4698 (Gakhokikze, 1947)
Density:	d_{26}^{25} : 0.9397 ± 0.0015 g/ml	d^{25} : 0.943 g/ml read from graph (Gallant, 1968)
2. Spectral data		
Infrared		
Instrument:	Beckman IR-12	
Cell:	Thin film between silver chloride plates	
Results:	See Figure 7	Consistent with literature spectrum (Sadler Standard Spectra)
Ultraviolet/visible		
Instrument:	Cary 118	
Solvent:	Methanol	
Concentration:	1%, visible range; 0.01%, ultraviolet range	
Results:	No absorbance between 800 and 350 nm. No maximum between 350 and 215 nm but a gradual increase in absorbance from 270 to 215 nm.	No literature reference found.

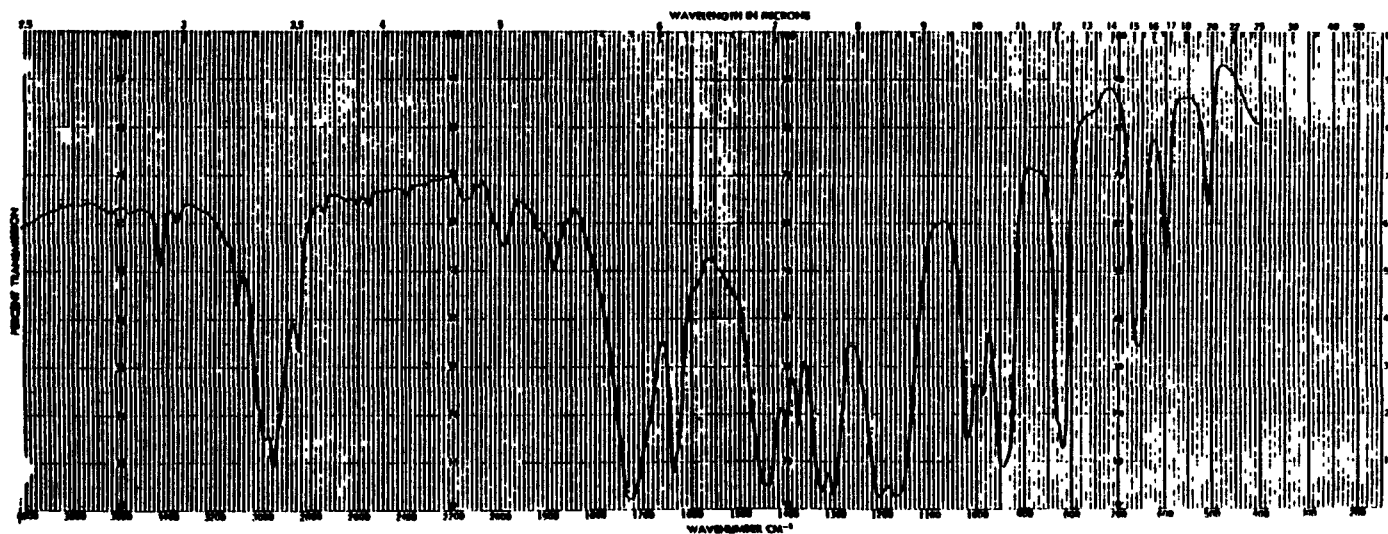

FIGURE 7. INFRARED ABSORPTION SPECTRUM OF METHYL METHACRYLATE (LOT NO. 4-15-014)

APPENDIX H. CHEMICAL CHARACTERIZATION

Nuclear magnetic resonance	<u>Determined</u>	<u>Literature Values</u>
Instrument:	Varian HA-100	
Solvent:	Neat, tetramethylsilane added	
Assignments:	See Figure 8	Consistent with literature spectrum. (Sadtler Standard Spectra)
Chemical shift (δ):	a m, 1.86 ppm b s, 3.62 ppm c m, 5.44 ppm d m, 5.96 ppm	
Integration ratios:	a 3.10 b 3.02 c 0.95 d 0.95	

3. **Water analysis (Karl Fischer):** 0.017% \pm 0.001(δ)%

4. Elemental analysis

Element	C	H
Theory (T)	59.98	8.05
Determined (D)	60.00 60.05	8.09 8.05

5. Gas chromatography

Instrument: Tracor MT220
Detector: Flame ionization
Inlet temperature: 200° C
Detector temperature: 270° C

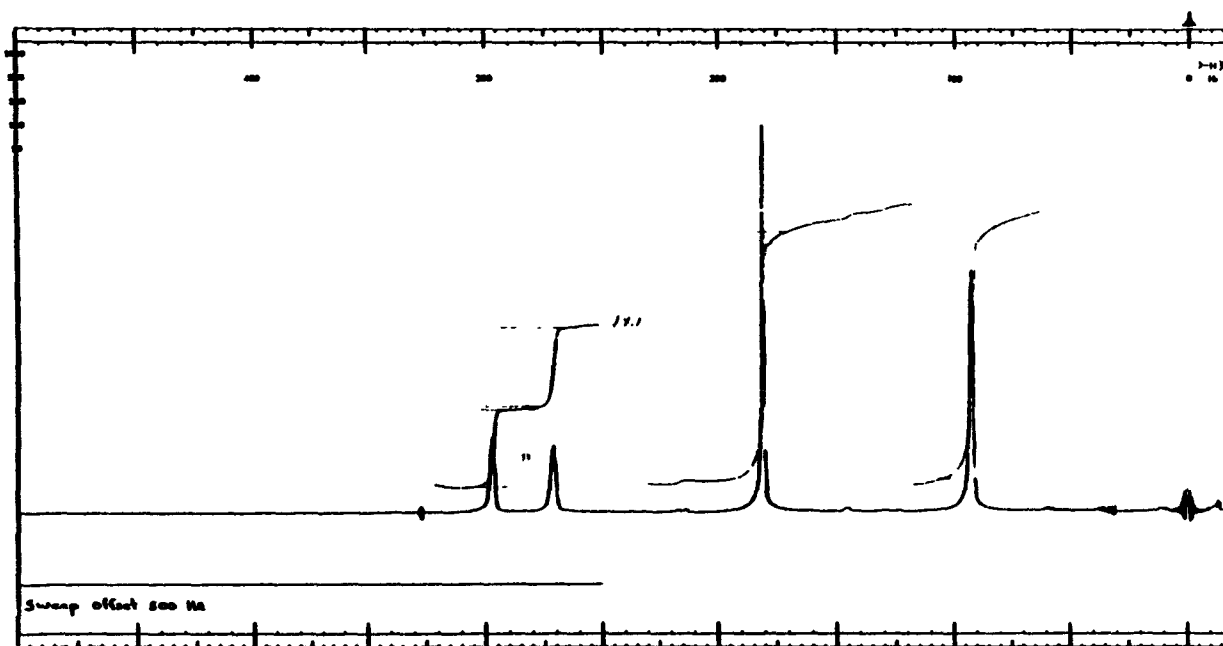

FIGURE 8. NUCLEAR MAGNETIC RESONANCE SPECTRUM OF METHYL METHACRYLATE (LOT NO. 4-15-014)

APPENDIX H. CHEMICAL CHARACTERIZATION

System 1

Column: 80/100 Porapak Q, 1.8 m × 4 mm ID, glass

Oven temperature program: 5 min at 50° C, then to 200° C at 10° C/min

Sample injected: 4 µl neat liquid, diluted to 1.0% and 0.5% in pentane to quantitate the major peak and check for overloading

Results: One major peak and one impurity. The area of the impurity was 0.05% relative to the major peak area.

Peak No.	Retention Time (min)	Retention Time Relative to Major Peak	Area (percent of major peak)
1	19.5	1.00	100
2	21.2	1.09	0.05

System 2

Column: 20% SP2100/0.1% Carbowax 1500 on 100/120 Supelcoport, 1.8 m × 4 mm ID, glass

Oven temperature program: 5 min at 50° C, then 50° C to 170° C at 10° C/min

Sample injected: 5 µl neat liquid, diluted to 1.0% and 0.5% in pentane to check for overloading

Results: One major peak and one impurity. The area of the impurity was 0.12% relative to the major peak area.

Peak No.	Retention Time (min)	Retention Time Relative to Major Peak	Area (percent of major peak)
1	6.0	1.0	100
2	7.6	1.3	0.12

6. **Conclusions:** The results of the elemental analysis agreed with the theoretical values. Gas chromatography by two systems separated only one impurity. One gas chromatographic system indicated the impurity to have an area 0.05% of that of the major peak; the second system showed the impurity as 0.12% of the area of the major peak. The infrared and nuclear magnetic resonance spectra were consistent with the structure.

APPENDIX H. CHEMICAL CHARACTERIZATION

C. Special bulk purity verification of lot no. 4-15-014

	<u>Determined</u>	<u>Literature Values</u>
1. Nuclear magnetic resonance		
Instrument:	Varian EM 360-A	
Solvent:	Neat, tetramethylsilane added	
Assignments:	See Figure 9	Consistent with literature spectrum (Sadler Standard Spectra)
Chemical shift (δ):	a 1.90 ppm b 3.68 ppm c 5.52 ppm d 6.03 ppm	
Integration ratios:	a 3.00 b 3.00 c 1.00 d 1.00	

2. Gas chromatography

Instrument: Varian 3700

Detector: Flame ionization

Inlet temperature: 200° C

Detector temperature: 250° C

Carrier gas: Nitrogen, 70 ml/min

Column: 20% SP2100/0.1% Carbowax 1500 on 100/120 Supelcoport, 1.8 m \times 4 mm ID, glass

Oven temperature program: 5 min at 50° C, then 50° C to 170° C at 10° C/min

Sample injected: 3 μ l neat liquid, diluted to 1.0% and 0.5% in pentane to check for overloading

Results: Major peak and one impurity.

Peak No.	Retention Time (min)	Retention Time Relative to Major Peak	Area (percent of major peak)
1	6.6	1.00	100
2	8.1	1.23	0.15

- 3. Conclusions:** The results of gas chromatography with a 20% SP2100/0.1% Carbowax 1500 column indicated the major peak and one impurity after the major peak with an area of 0.15% of the major peak and a relative retention time of 1.23. This corresponds to 0.12% impurity with a relative time of 1.3 found for this lot and this gas chromatographic system in the original analysis. The nuclear magnetic resonance spectrum was consistent with the previous spectrum of this lot and with the literature spectrum.

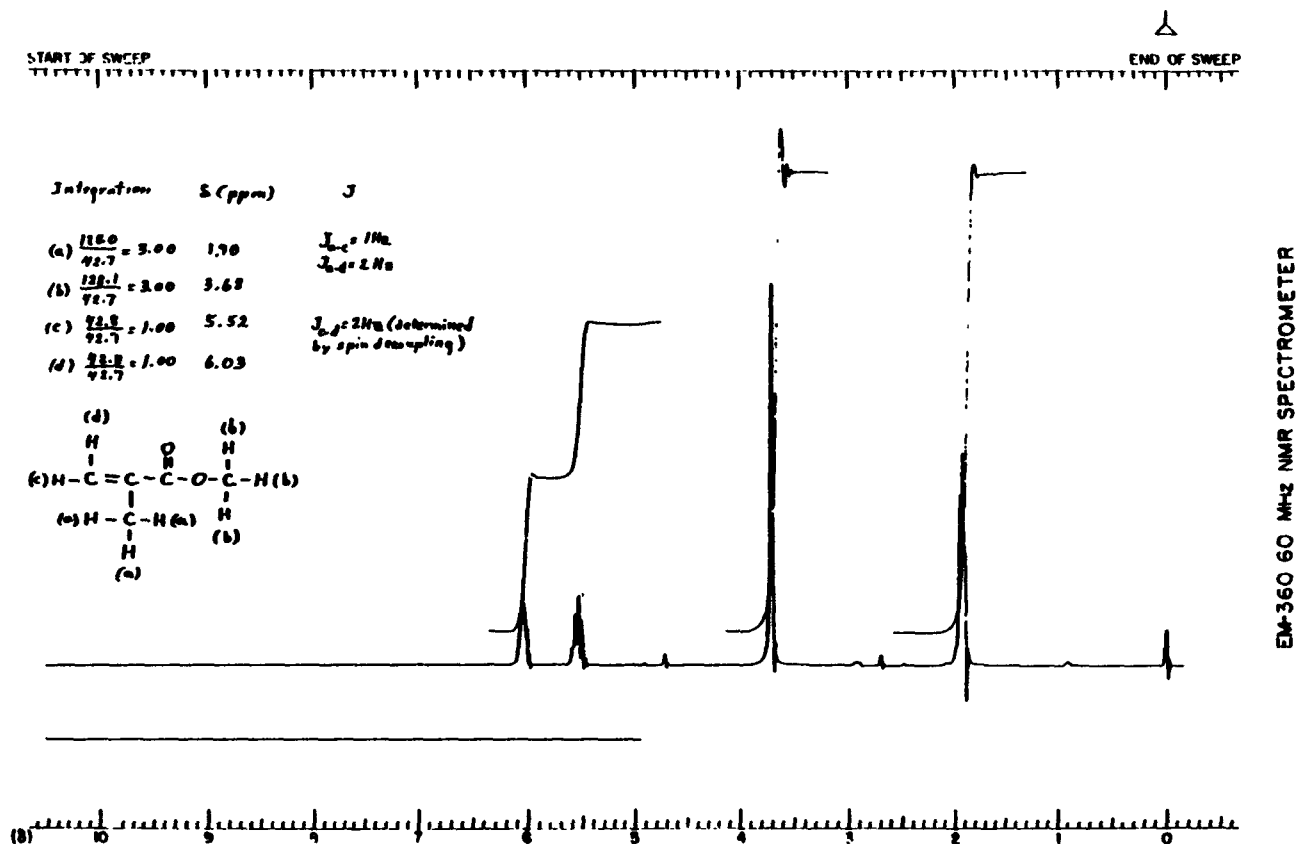

FIGURE 9. NUCLEAR MAGNETIC RESONANCE SPECTRUM OF METHYL METHACRYLATE
(Reanalysis of Lot No. 4-15-014)

APPENDIX H. CHEMICAL CHARACTERIZATION

D. Lot no. 03-54832

1. Appearance:	Clear, colorless liquid	
2. Spectral Data	<u>Determined</u>	<u>Literature Values</u>
Infrared		
Instrument:	Beckman IR-12	
Cell:	Thin film between silver chloride plates	
Results:	See Figure 10	Consistent with literature spectrum (Sadler Standard Spectra)
Ultraviolet/visible		
Instrument:	Cary 118	
Solvent:	Methanol	
Results:	No absorbance from 800 to 350 nm at a concentration of 1% (v/v). No maximum from 350 to 215 nm but a gradual increase in absorbance toward 215 nm at a concentration of 0.001% (v/v).	No literature reference found.
Nuclear magnetic resonance		
Instrument:	Varian HA-100	
Solvent:	Carbon tetrachloride with internal tetramethylsilane	
Assignments:	See Figure 11	Consistent with literature spectrum (Sadler Standard Spectra)

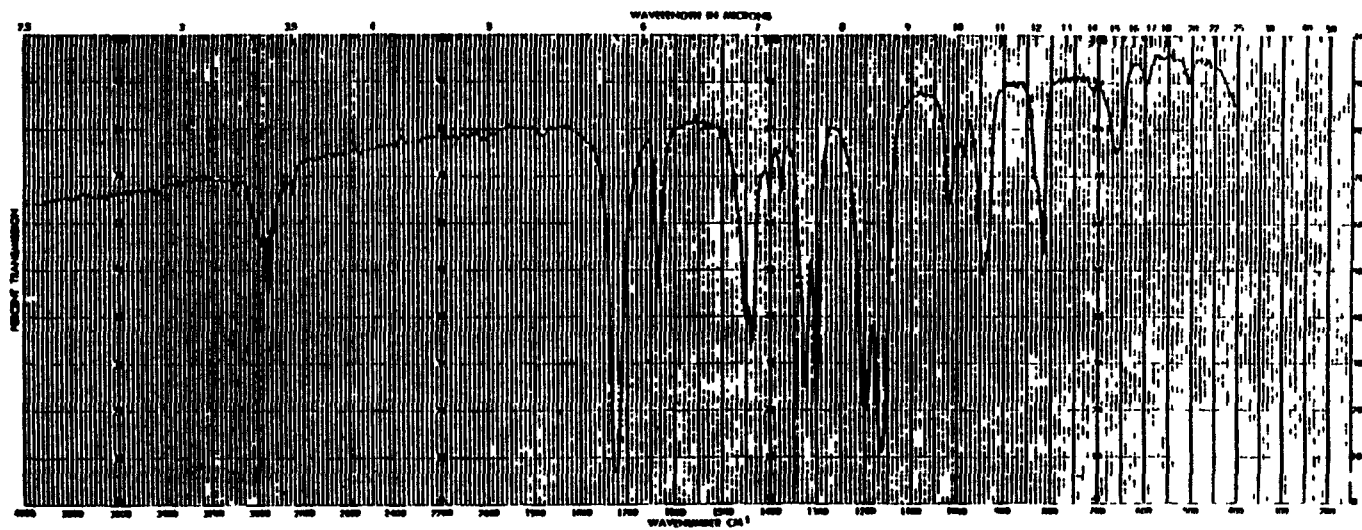

FIGURE 10. INFRARED ABSORPTION SPECTRUM OF METHYL METHACRYLATE (LOT NO. 03-54832)

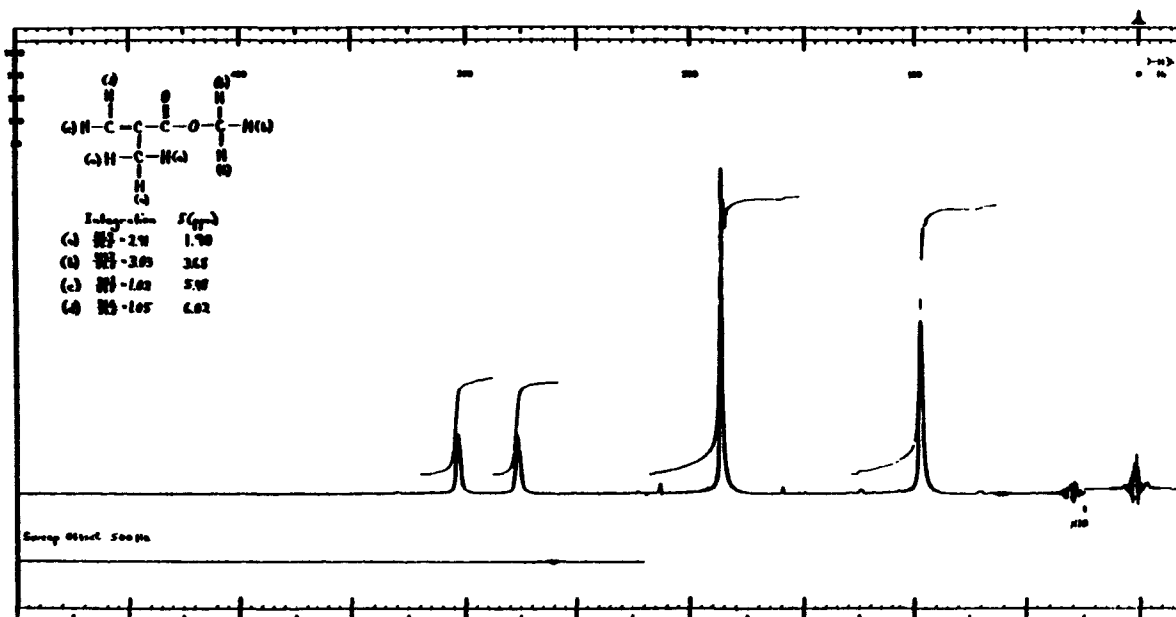

FIGURE 11. NUCLEAR MAGNETIC RESONANCE SPECTRUM OF METHYL METHACRYLATE (LOT NO. 03-54832)

APPENDIX H. CHEMICAL CHARACTERIZATION

Chemical shift (δ):

a	m, 1.90 ppm
b	s, 3.68 ppm
c	m, 5.48 ppm
d	m, 6.02 ppm

Integration ratios:

a	2.91
b	3.03
c	1.02
d	1.05

3. **Water analysis (Karl Fischer):** 0.046% \pm 0.003(δ)%

4. Elemental analysis

Element	C	H
Theory (T)	59.98	8.05
Determined (D)	59.56 59.35	8.24 8.22
Percent D/T	99.12	102.24

5. Gas chromatography

Instrument: Varian 3700
Detector: Flame ionization
Inlet temperature: 200° C
Detector temperature: 270° C
Carrier gas: Nitrogen, 70 ml/min

System 1

Column: 80/100 Porapak QS, 1.8 m \times 4 mm ID, glass
Oven temperature program: 5 min at 50° C, then 50° C to 200° C at 10° C/min
Sample injected: 3 μ l neat liquid and solutions diluted to 1.0% and 0.5% in *n*-pentane to quantitate the major peak and check for overloading

Results: Major peak and two impurities, one eluting before and one after the major peak, with a combined area totaling 0.16% of the major peak area.

Peak No.	Retention Time (min)	Retention Time Relative to Major Peak	Area (percent of major peak)
1	16.5	0.71	0.11
2	23.1	1.00	100
3	26.7	1.16	0.05

APPENDIX H. CHEMICAL CHARACTERIZATION

System 2

Column: 20% SP2100/0.1% Carbowax 1500 on 100/120 Supelcoport, 1.8 m × 4 mm ID, glass

Oven temperature program: 5 min at 50° C, then 50° C to 170° C at 10° C/min

Sample injected: 3.5 µl neat liquid and solutions diluted to 1.0% and 0.5% in *n*-pentane to quantitate the major peak and to check for overloading

Results: One major peak and three impurities (two eluting before and one after the major peak) with a combined area totaling 0.27% relative to the major peak area.

Peak No.	Retention Time (min)	Retention Time Relative to Major Peak	Area (percent of major peak)
1	1.0	0.20	0.15
2	4.2	0.86	0.01
3	4.9	1.00	100
4	7.0	1.43	0.11

6. **Conclusions:** The result of the elemental analysis for carbon was slightly low, whereas that for hydrogen was in agreement with the theoretical value. Karl Fischer analysis indicated 0.046% ± 0.003(δ)% water. Gas chromatography with a Poropak QS column indicated a major peak and two impurities with a combined area totaling 0.16% of the major peak area. A second gas chromatographic system with a 20% SP2100/0.1% Carbowax 1500 column indicated a major peak and three impurities with a combined area totaling 0.27% of the major peak area. The infrared, ultraviolet/visible, and nuclear magnetic resonance spectra were consistent with the structure of methyl methacrylate.

APPENDIX H. CHEMICAL CHARACTERIZATION

E. Lot no. 6-5486

1. Appearance:	Clear, nonviscous liquid	
2. Spectral data	<u>Determined</u>	<u>Literature Values</u>
Infrared		
Instrument:	Perkin-Elmer 284	
Cell:	Thin film between silver chloride plates	
Results:	See Figure 12	Consistent with literature spectrum (Sadler Standard Spectra)
Ultraviolet/visible		
Instrument:	Cary 118	
Solvent:	Methanol	
Results:	No maximum was observed between 800 and 350 nm at a concentration of 1% (v/v). No maximum was observed from 350 to 215 nm, but an increase in absorbance toward 215 nm at a concentration of 0.01% (v/v) was observed.	No literature reference found.
Nuclear magnetic resonance		
Instrument:	Varian EM-360	
Solvent:	Deuterated chloroform with tetramethylsilane internal standard	
Assignments:	See Figure 13	Consistent with literature spectrum (Sadler Standard Spectra)

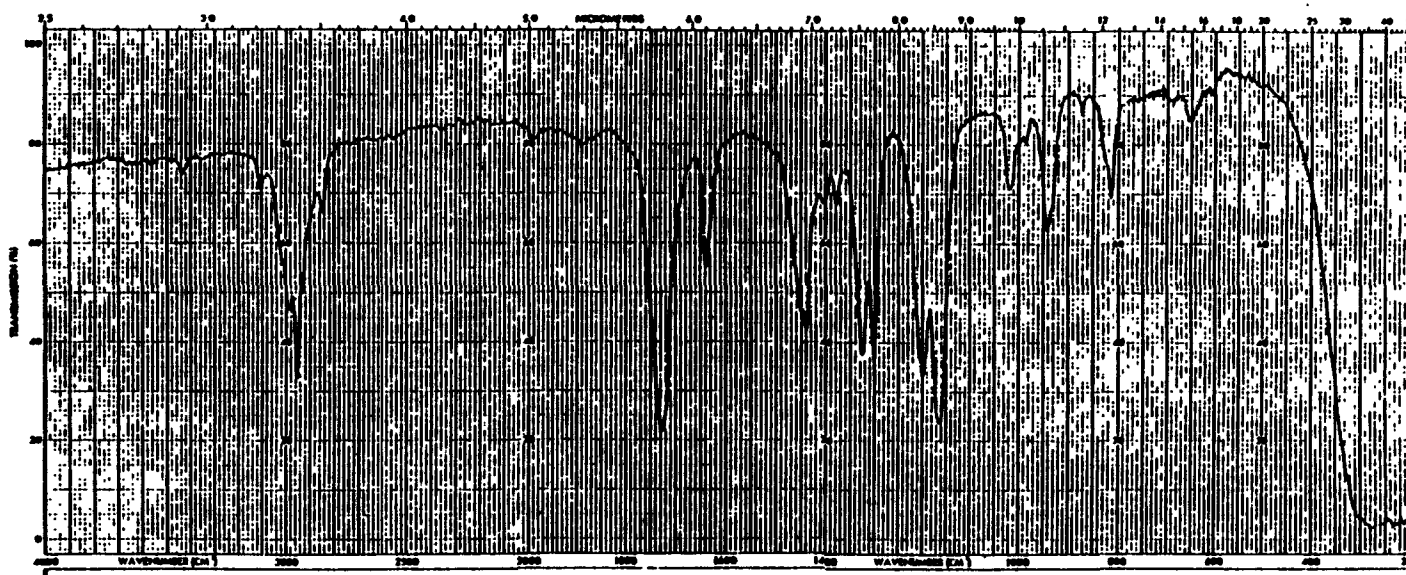

FIGURE 12. INFRARED ABSORPTION SPECTRUM OF METHYL METHACRYLATE (LOT NO. 6-5486)

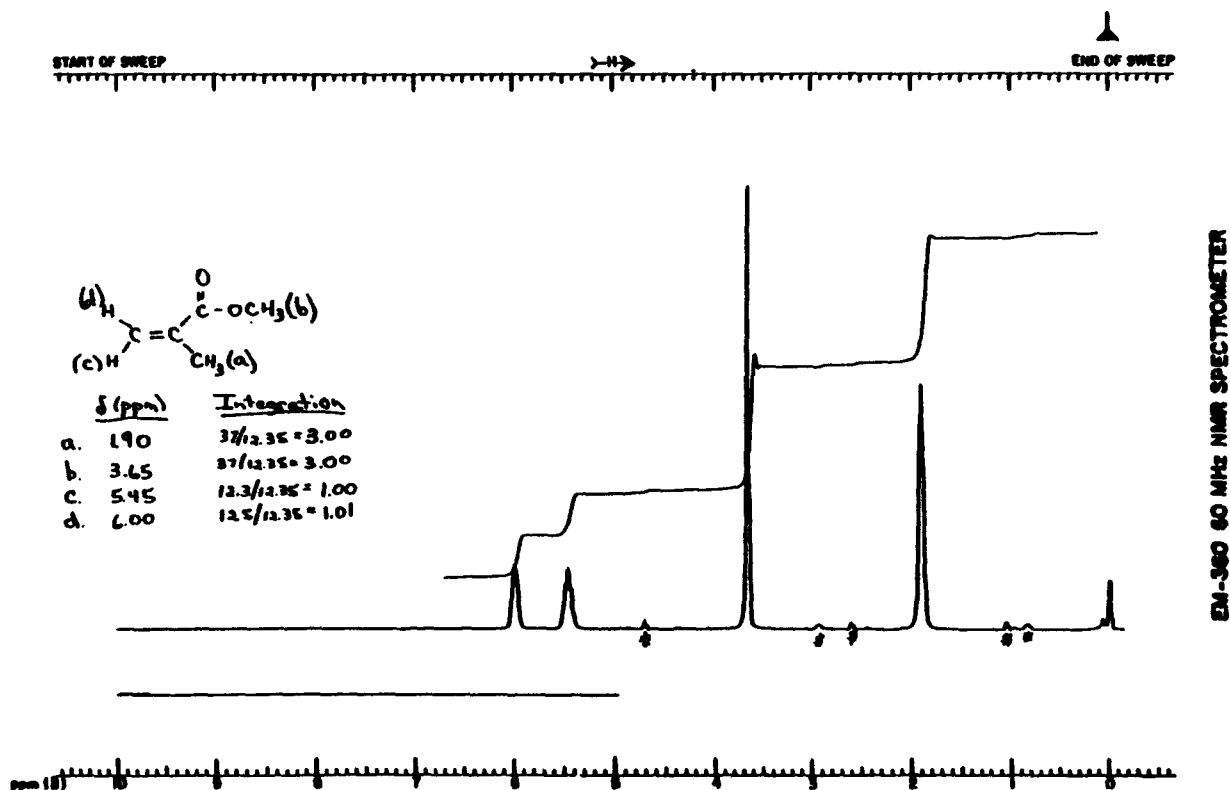

FIGURE 13. NUCLEAR MAGNETIC RESONANCE SPECTRUM OF METHYL METHACRYLATE (LOT NO. 6-5486)

APPENDIX H. CHEMICAL CHARACTERIZATION

Chemical shift (δ):

a	m,	1.90 ppm
b	s,	3.65 ppm
c	m,	5.45 ppm
d	m,	6.00 ppm

Integration ratios:

a	3.00
b	3.00
c	1.00
d	1.01

3. **Water analysis (Karl Fischer):** 0.020% \pm 0.01(δ)%

4. **Elemental analysis**

Element	C	H
Theory (T)	59.98	8.05
Determined (D)	59.88	7.98
Percent D/T	99.8	99.1

5. **Gas chromatography**

Instrument: Hewlett Packard 5730A

Detector: Flame ionization

Inlet temperature: 200° C

Detector temperature: 250° C

Carrier gas: Nitrogen, 70 ml/min

System 1 (to compare the contents of the two barrels of study material)

Column: 20% SP2100/0.1% Carbowax 1500 on 100/120 Supelcoport, 1.8 m \times 4 mm ID, silylated glass

Oven temperature program: 4 min at 70° C, then 70° C to 170° C at 8° C/min; held isothermally at 170° C for major peak area determination

Samples injected: Approximately 5 μ l of a 10% (w/v) solution in *n*-pentane from both barrels to detect and determine the area of impurities. Five microliters of 1% and 0.5% *n*-pentane solutions to determine the major peak area and detector response linearity.

Results: In samples from both barrels, a major peak, preceded by one and followed by two impurities with relative areas smaller than 0.1% of the major peak, was detected.

APPENDIX H. CHEMICAL CHARACTERIZATION

System 2

Column: 80/100 Porapak QS, 1.8 m × 4 mm ID, silylated glass

Oven temperature program: 4 min at 100° C, then 100° C to 200° C at 8° C/min; isothermal at 220° C to monitor detector response

Samples injected: Approximately 4 µl of 10%, 1.0%, and 0.5% (v/v) solutions in methanol to detect and determine the relative area of any impurities, to check linearity of detector response and to determine the major peak area.

Results: One homogeneous peak, 18.6 min retention time, was detected.

- 6. Conclusions:** The results of the elemental analysis for carbon and hydrogen were in agreement with the theoretical values. Karl Fischer analysis indicated 0.02% ± 0.01(8)% water. Gas chromatography with a 20% SP2100/0.1% Carbowax 1500 column indicated three impurities, one preceding and two following the major peak, with relative areas less than 0.1% of the major peak area. A second gas chromatographic system with a Porapak QS column indicated one homogeneous peak. The infrared, ultraviolet/visible, and nuclear magnetic resonance spectra were consistent with the structure of methyl methacrylate.

APPENDIX H. CHEMICAL CHARACTERIZATION

F. Lot no. 377109

1. Appearance:	Clear, colorless liquid	
2. Spectral data	<u>Determined</u>	<u>Literature Values</u>
Infrared		
Instrument:	Perkin-Elmer 283	
Cell:	Silver chloride plates, 0.25 mm	
Results:	See Figure 14	Consistent with literature spectrum (Sadtler Standard Spectra)
Ultraviolet/visible		
Instrument:	Cary 219	
Solvent:	Methanol	
Results:	No maximum was observed between 800 and 350 nm at a concentration of 1% (v/v). No maximum was observed from 350 to 220 nm, but an increase in absorbance toward 220 nm at a concentration of 0.01% (v/v) was observed.	No literature reference found.
Nuclear magnetic resonance		
Instrument:	Varian EM-360	
Solvent:	Deuterated chloroform with tetramethylsilane internal standard	
Assignments:	See Figure 15	Consistent with literature spectrum (Sadtler Standard Spectra)

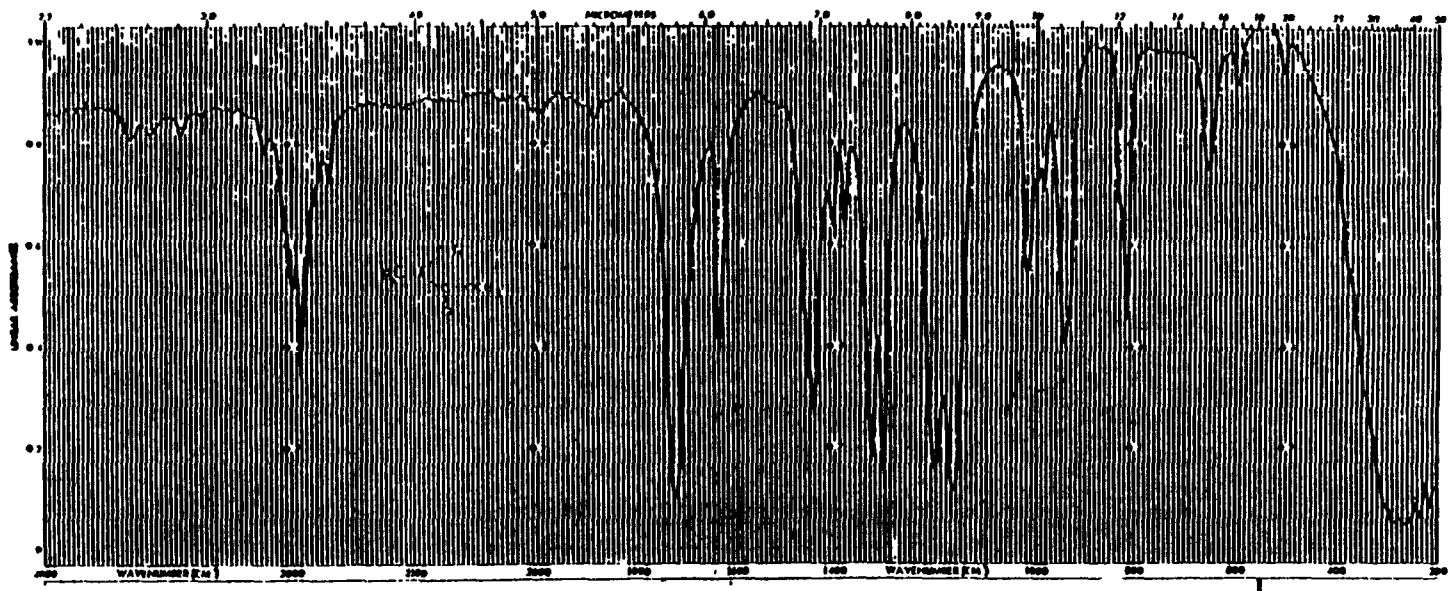

FIGURE 14. INFRARED ABSORPTION SPECTRUM OF METHYL METHACRYLATE (LOT NO. 377109)

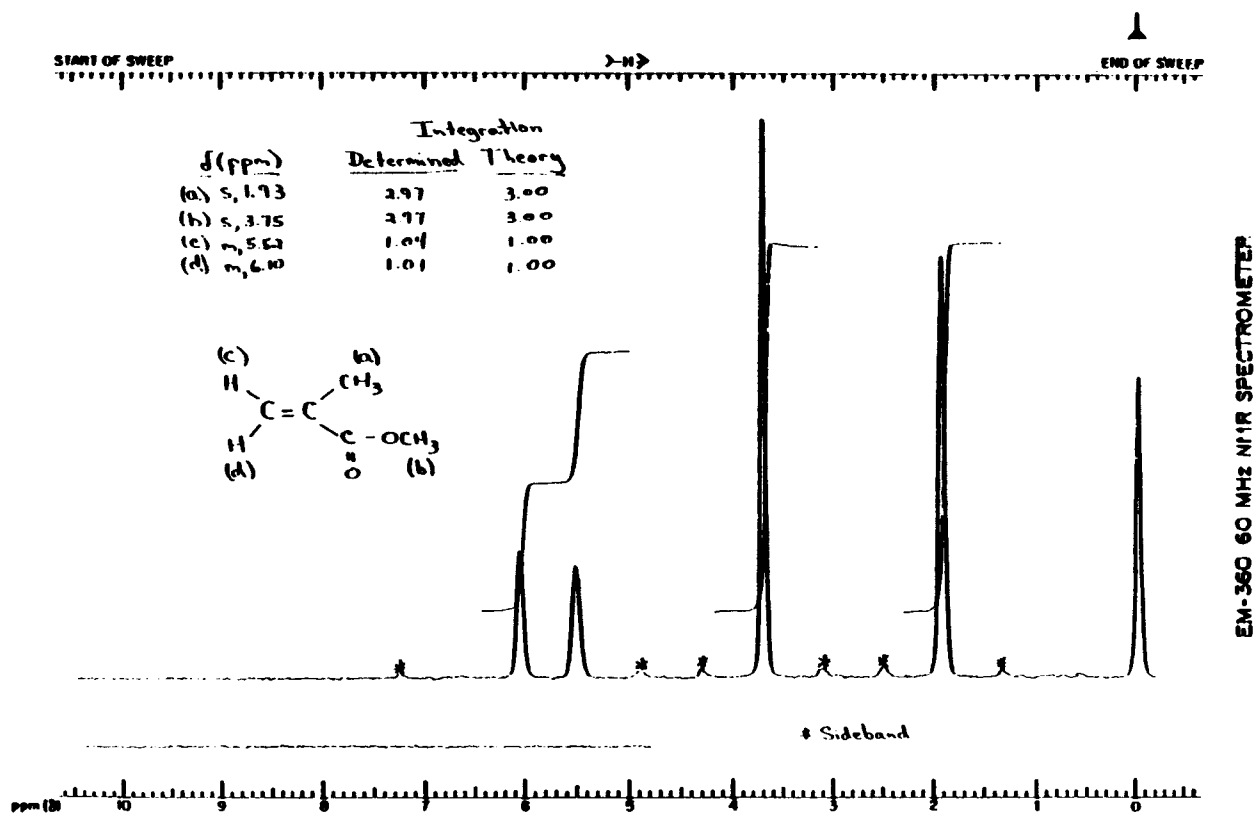

FIGURE 15. NUCLEAR MAGNETIC RESONANCE SPECTRUM OF METHYL METHACRYLATE (LOT NO. 377109)

APPENDIX H. CHEMICAL CHARACTERIZATION

	<u>Determined</u>	<u>Literature Values</u>
Chemical shift (δ):	a s, 1.93 ppm	
	b s, 3.75 ppm	
	c m, 5.52 ppm	
	d m, 6.10 ppm	
Integration ratios:	a 2.97	3.00
	b 2.97	3.00
	c 1.04	1.00
	d 1.01	1.00

3. **Water analysis (Karl Fischer):** 0.04% \pm 0.02(δ)%

4. Elemental analysis

Element	<u>C</u>	<u>H</u>
Theory (T)	59.98	8.05
Determined (D)	59.67	8.10
	59.49	7.95
Percent D/T	99.33	99.62

5. Gas chromatography

Instrument: Varian 3700
Detector: Flame ionization
Inlet temperature: 200° C
Detector temperature: 250° C
Carrier gas: Nitrogen, 70 ml/min

System 1

Column: 80/100 Porapak QS, 1.8 m \times 4 mm ID, glass
Oven temperature program: 4 min at 100° C, then 100° C to 200° C at 8° C/min
Samples injected: 3 μ l of neat chemical and 1.0% and 0.5% (v/v) solutions in methanol to quantitate impurities and determine linearity of detector response.

Results: One homogeneous peak, 17.7 min retention time, was detected.

APPENDIX H. CHEMICAL CHARACTERIZATION

System 2

Column: 20% SP2100/0.1% Carbowax 1500 on 100/120 Supelcoport

Oven temperature program: 4 min at 70° C, then 70° C to 170° C at 8° C/min

Samples injected: 4 µl of neat chemical and 1.0% and 0.5% (v/v) solutions in methanol to quantitate impurities and establish detector response linearity

Results: A major peak, 2.9 min retention time, followed by one impurity with a relative area <0.1% of the major peak area, was detected.

- 6. Conclusions:** The results of the elemental analysis for carbon and hydrogen agreed with theoretical values. Karl Fischer titrimetry indicated a water content of 0.040% ± 0.002%. One gas chromatographic system detected a major peak followed by one impurity with a relative area <0.1%. Infrared, ultraviolet/visible, and nuclear magnetic resonance spectra were consistent with literature references and the structure.

APPENDIX H. CHEMICAL CHARACTERIZATION

II. Stability Study of Methyl Methacrylate Lot No. 4-15-014 Performed by the Analytical Chemistry Laboratory

- A. **Sample storage:** Methyl methacrylate samples were stored for 2 weeks at -20°C and 60°C .
- B. **Analytical method:** The samples were analyzed by the gas chromatographic system described below.

Instrument: Tracor MT220

Detector: Flame ionization

Inlet temperature: 200°C

Detector temperature: 270°C

Carrier gas: Nitrogen, 70 ml/min

Column: 20% SP2100/0.1% Carbowax 1500 on 100/120 Supelcoport, 1.8 m \times 4 mm ID, glass

Oven temperature: 50°C , isothermal

Samples injected: 6 μl of 0.5% methyl methacrylate and 0.5% ethyl acetate as the internal standard in pentane. Sample peak areas were compared with internal standard peak areas.

Retention times: Major component, 5.4 min
Internal standard, 2.5 min

C. Results

Storage Temperature	Percent Purity
-20°C	$99.9 \pm 0.3(\delta)$
60°C	$100.4 \pm 0.3(\delta)$

- D. **Conclusion:** Methyl methacrylate is stable as the bulk chemical when stored for 2 weeks at temperatures up to 60°C .

APPENDIX H. CHEMICAL CHARACTERIZATION

III. Stability Study of Methyl Methacrylate at the Study Laboratory

A. Storage conditions: Reference, -20°C
Bulk chemical, room temperature

B. Analytical method

1. Purity determination: Gas chromatography

Instrument: HP5840A or HP5830 gas chromatograph
Column: 20% SP2100/0.1% Carbowax 1500 on 100/120 Supelcoport, 1.7 m \times 4 mm ID, glass
Detector: Flame ionization
Detector temperature: 275°C
Injector temperature: 200°C
Oven temperature program: 40°C for 5 min, then 40°C to 160°C at $10^{\circ}\text{C}/\text{min}$
Carrier gas: Helium, 60 ml/min
Samples injected: 1-2 μl of a 1% solution of methyl methacrylate in pentane

2. Identity determination: Infrared spectroscopy

Instrument: Beckman Acculab 6 or Beckman Acculab 8
Cell: Neat liquid between sodium chloride plates

C. Results

1. Purity

Date of Analysis	Percent Purity (a)	
	Bulk	Reference
09/22/80	(b) 99.71	(c) 99.79
11/12/80	(b) 99.83	(c) 99.83
01/26/81	(b) 99.84	(c) 99.90
05/22/81	(b) 99.86	(c) 99.91
09/16/81	(b) 99.80	(c) 99.72
01/11/82	(b) 99.81	(c) 99.85
05/21/82	(c) 99.86	(c) 99.87
10/01/82	(c) 99.98	(c) 99.98
11/23/82	(c) 99.65	(d) 99.75
02/10/83	(d) 99.88	(d) 99.88

(a) Values are the average of three determinations
(b) Lot no. 03-54832
(c) Lot no. 6-5486
(d) Lot no. 377109

2. Identity: Spectra were consistent with the reference spectra and with the spectra provided by the analytical chemistry laboratory.

D. Conclusions: No notable degradation of the study material occurred during the studies.

APPENDIX I

GENERATION AND MEASUREMENT OF

CHAMBER CONCENTRATIONS AT

BATTELLE PACIFIC NORTHWEST LABORATORIES

APPENDIX I. GENERATION AND MEASUREMENT

I. Vapor Generation System

The liquid to be vaporized was contained in a 1.6-liter stainless steel reservoir that was housed in a vapor hood within the exposure room. The liquid was pumped from this reservoir to a stainless steel cylinder covered with a glass fiber wick from which the liquid was vaporized (Decker et al., 1982). An 80-watt heater and a temperature-sensing element were incorporated within the cylinder. The heater maintained the vaporizer at $50^{\circ} \pm 2^{\circ}$ C. The surface temperature of the vaporizer was slightly lower than this temperature. Each cylindrical vaporizer was positioned in the fresh air duct leading directly into the exposure chamber to minimize material loss due to condensation on duct walls (Figure 16).

II. Vapor Concentration Monitoring

Two methods were used during the course of the 2-year studies to monitor the concentration of methyl methacrylate in the chambers. Initially, a photoionization monitor (Model PI-201, HNU Systems, Inc., Newton, Massachusetts) was used. After 277 exposure days, the photoionization monitor was replaced by a Hewlett-Packard Model 5840 gas chromatograph equipped with a flame ionization detector and an automatic sampling valve. All chambers and the room air were sampled approximately twice during each exposure hour. Starting on the 289th exposure day, hexane in nitrogen was added to the sampling sequence to establish instrumental performance. The calibration of both the photoionization monitor and the gas chromatograph was confirmed and corrected as necessary by periodic assay of grab samples from the chambers analyzed on a second gas chromatograph.

Weekly concentrations are graphically presented in Figures 17-19.

III. Vapor Concentration Uniformity in Chamber

Uniformity of vapor concentration in each exposure chamber was measured periodically throughout the study with a portable photoionization monitor. The standard deviations of the normalized average concentrations did not exceed $\pm 5\%$.

IV. Determination of Polymer Formation

A study was performed to determine if polymer was formed from methyl methacrylate in the process of generating the inhalation test atmosphere. Nuclear magnetic resonance (NMR) was selected as a straightforward, cost-efficient means of determining polymer content in a limited number of samples. Study results conservatively determined that the methyl methacrylate test atmosphere polymer content was less than 0.4% by weight. Only slightly less conservatively, the maximum polymer concentration of the study material can be estimated to be less than 0.1% of the methyl methacrylate concentration.

The exposure atmosphere was generated by pumping liquid methyl methacrylate from a stainless steel reservoir to a vaporizer. The liquid was pumped with a synchronous motor, adjustable stroke-volume, ceramic piston pump. The liquid was vaporized from a location in the air inlet duct leading directly into the animal exposure chamber. The vaporizer was a stainless steel cylinder covered by a fine glass fiber filter wick. The liquid was carried into the wick by capillary action and vaporized from the glass fiber surface. The temperature of the metal cylinder was maintained at the boiling point of methyl methacrylate (100° C). This design provided for gentle transfer and vaporization of the study material.

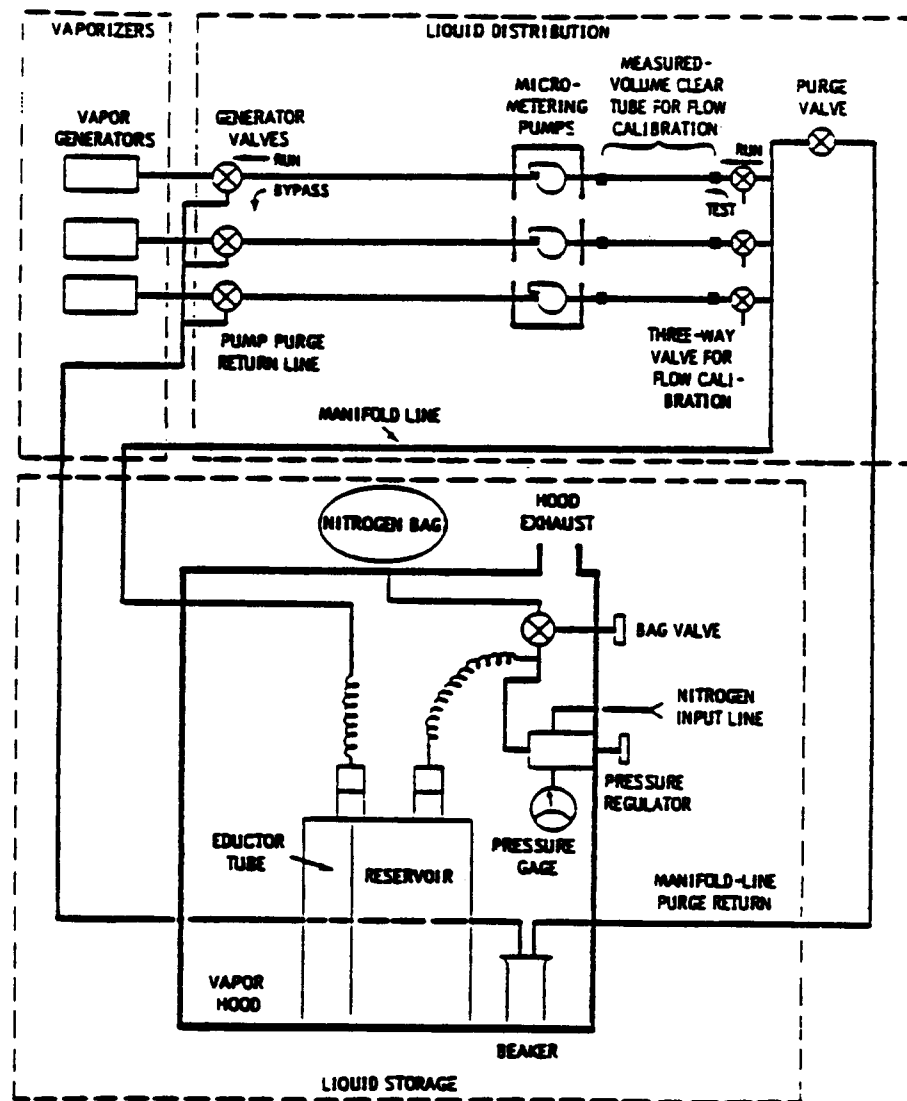

FIGURE 16. METHYL METHACRYLATE VAPOR GENERATION SYSTEM

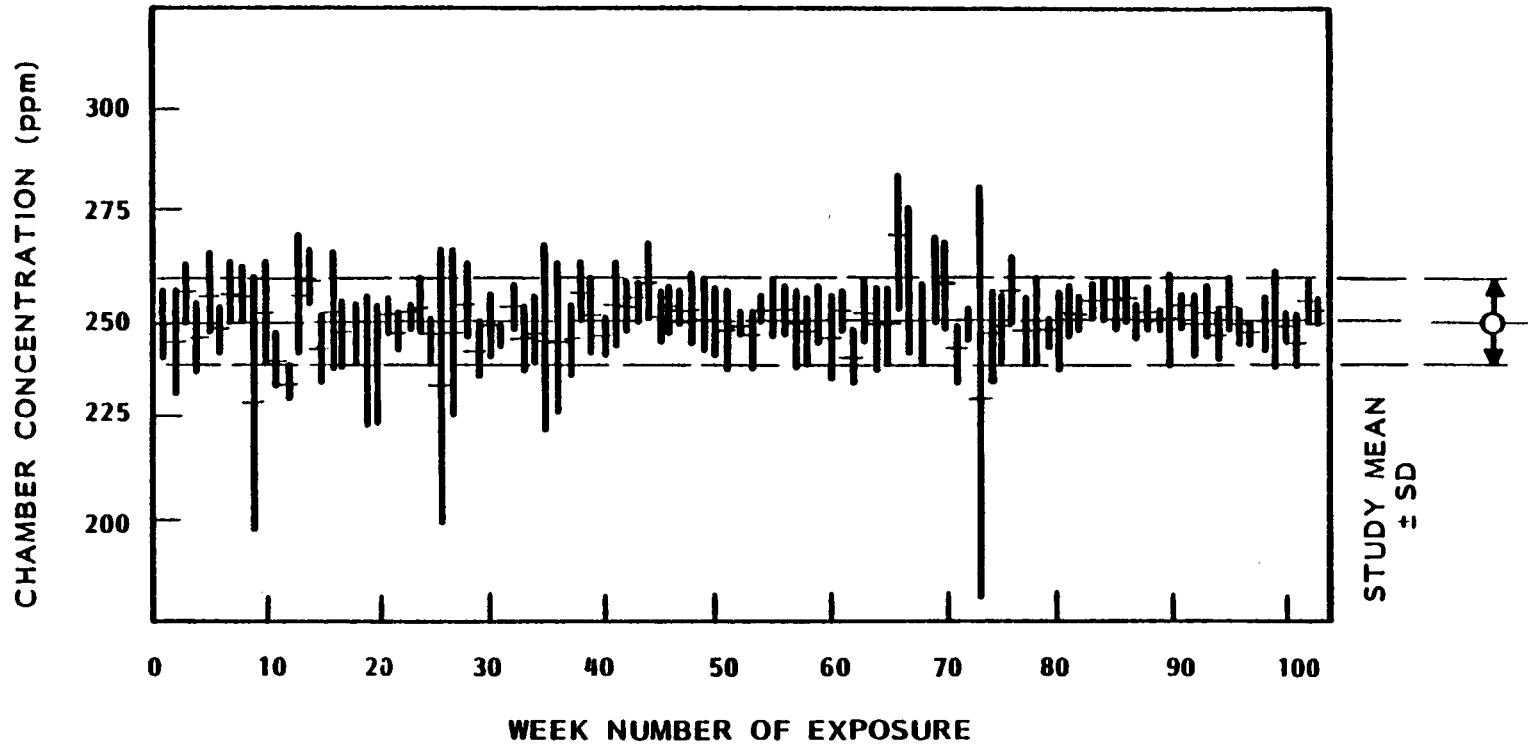

FIGURE 17. WEEKLY MEAN CONCENTRATION AND STANDARD DEVIATION (bars) IN 250-ppm FEMALE RAT EXPOSURE CHAMBER FOR THE TWO-YEAR INHALATION STUDY OF METHYL METHACRYLATE

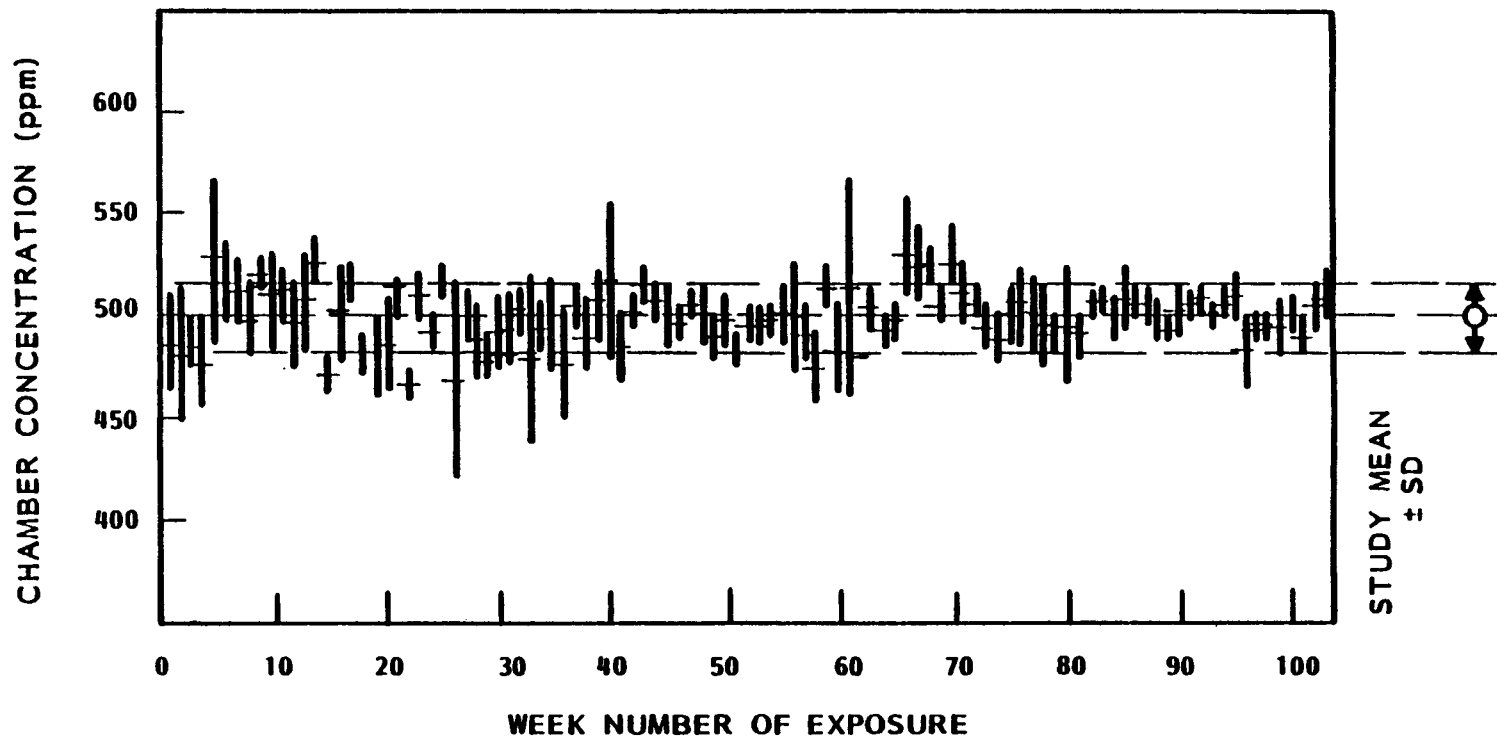

FIGURE 18. WEEKLY MEAN CONCENTRATION AND STANDARD DEVIATION (bars) IN 500-ppm RAT AND MOUSE EXPOSURE CHAMBER FOR THE TWO-YEAR INHALATION STUDIES OF METHYL METHACRYLATE

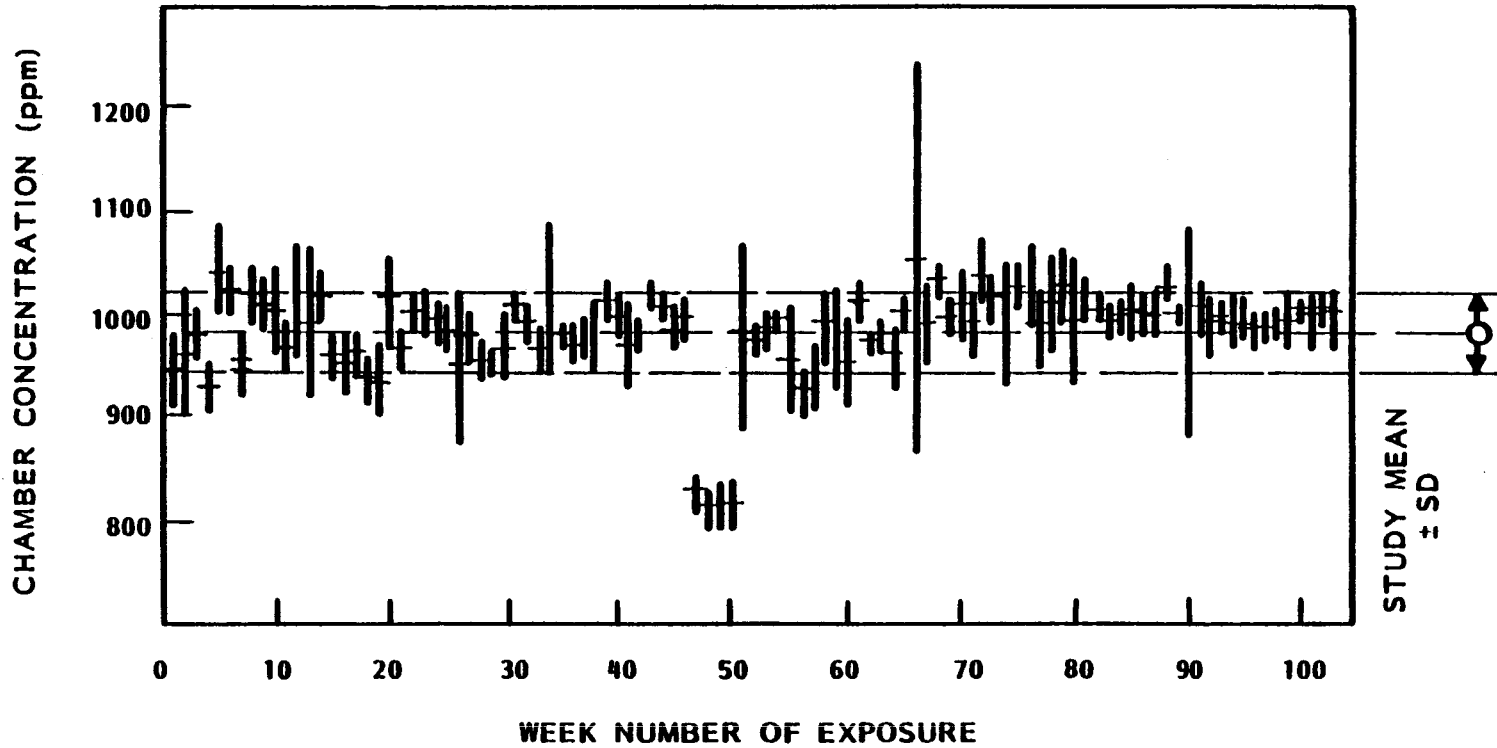

FIGURE 19. WEEKLY MEAN CONCENTRATION AND STANDARD DEVIATION (bars) IN 1,000-ppm RAT AND MOUSE EXPOSURE CHAMBER FOR THE TWO-YEAR INHALATION STUDIES OF METHYL METHACRYLATE

APPENDIX I. GENERATION AND MEASUREMENT

The most suspect portion of the generator with regard to polymer formation was the heated vaporizer. Polymeric material above some limiting molecular weight would not possess sufficient volatility to be present in the test atmosphere at a significant concentration.

The study described here was designed to perform a one-time confirmation of the absence of significant polymer formation. As a prelude to analysis of inhalation chamber grab samples, a simple feasibility study was performed.

The feasibility study involved examination of a sample of exposure material (lot no. 06-5486, received September 17, 1980, stored at room temperature since receipt) and two commercially available examples of methyl methacrylate polymer.* This study confirmed the chemical shifts of the polymeric versus monomer protons.

As a result of this study, the experimental plan was modified to improve sensitivity to the polymer. Modifications included collection of larger sample size and determination of monomer quantity by gas chromatography.

A sample of the chamber atmosphere from the high (1,000 ppm) exposure chamber was acquired on September 9, 1982. A 75-liter chamber atmosphere sample was drawn through two bubblers in series. The first bubbler was loaded with deuterated chloroform as the trapping solvent. The second bubbler was loaded with chloroform distilled in glass.

Based on the nominal concentration of the chamber and the sampling time, the bubbler collection efficiency was estimated at 90% by analyzing the contents of both bubblers by gas chromatography. Thirty-five percent of the material collected was captured by the back bubbler. Breakthrough of some methyl methacrylate through both bubblers accounts for the 90% collection efficiency. These data do not indicate 10% decomposition.

Quantitation by NMR was performed by using relative peak area measurements. Knowledge of the number of protons giving rise to the NMR peaks and the area under each peak allowed calculation of percent composition (Figure 20). The independent determination of monomer concentration by gas chromatography allowed determination of absolute concentration.

Interferences were found in the area of the CH₃ peak; therefore, the C-CH₂ integral was used in the analysis. No signal could be detected for these protons. The concentration of monomer determined by gas chromatography was used to determine the relative polymer content in the front bubbler as conservatively less than 0.4%. If the assumption is made that the polymer (being less volatile) would be collected at near 100% efficiency in the front trap, then the relative polymer content can be conservatively estimated at less than 0.2%. The actual concentration of the polymer is most likely less than 0.1%.

Thus, this study indicated that the animals in these studies were not exposed to significant amounts of polymeric methyl methacrylate.

*Aldrich poly(methyl methacrylate), average molecular weight 12,000; catalog no. 20,033-6; lot no. 04. Also Aldrich poly(methyl methacrylate), "low molecular weight"; catalog no. 18,233-0; lot no. 13.

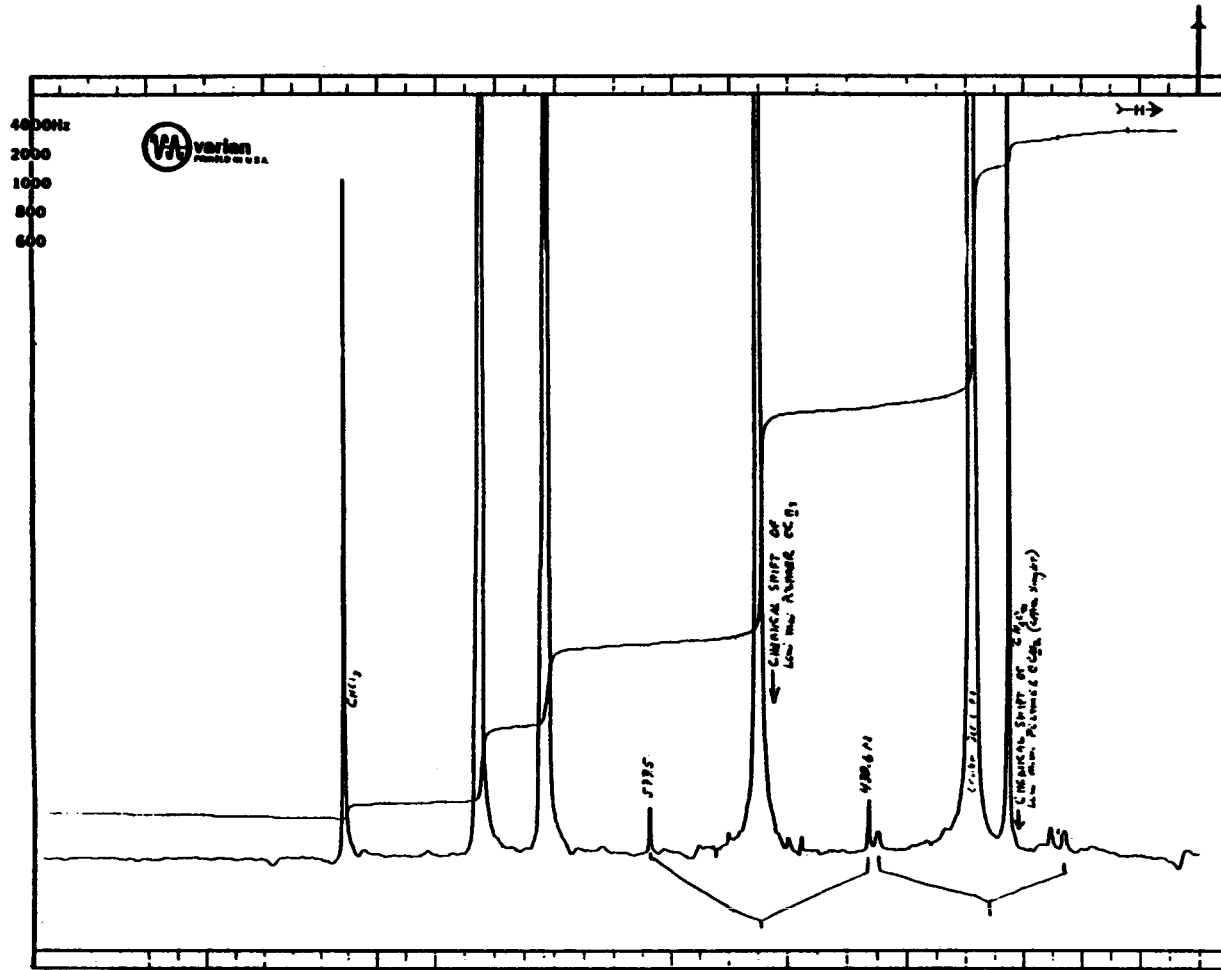

FIGURE 20. POLYMER CONTENT OF INHALATION CHAMBER ATMOSPHERE OF METHYL METHACRYLATE BY NUCLEAR MAGNETIC RESONANCE SPECTROSCOPY

APPENDIX J

RESULTS OF SEROLOGIC ANALYSES

APPENDIX J. SEROLOGIC ANALYSES

I. Methods

Rodents used in the Bioassay Program of the National Toxicology Program are produced in optimally clean facilities to eliminate potential pathogens that may affect test results.

Data from animals surviving 24 months were collected from 5/50 randomly selected control animals of each sex and species. The blood from each animal was collected and clotted, and the serum was separated. The serum was cooled on ice and shipped to Microbiological Associates' Comprehensive Animal Diagnostic Service for determination of the antibody titers. The following tests were performed:

	<u>Hemagglutination Inhibition</u>	<u>Complement Fixation</u>	<u>ELISA</u>
Mice	PVM (pneumonia virus of mice) Reo 3 (reovirus type 3) GDVII (Theiler's encephalomyelitis virus) Poly (polyoma virus) MVM (minute virus of mice) Ectro (infectious ectromelia) Sendai	M.Ad. (mouse adenovirus) LCM (lymphocytic choriomeningitis virus)	MHV (mouse hepatitis virus)
Rats	PVM Sendai KRV (Kilham rat virus) H-1 (Toolan's H-1 virus)	RCV (rat coronavirus)	

II. Results

TABLE J1. MURINE VIRUS ANTIBODY DETERMINATIONS IN RATS AND MICE IN THE TWO-YEAR INHALATION STUDIES OF METHYL METHACRYLATE

	Interval (months)	Number of Animals	Positive Serologic Reaction for
RATS	24	7/10	PVM
MICE	24	2/10 2/10	PVM MHV

(a) Blood samples were taken from control animals (5/sex) just before they were killed at the termination of the study and sent to Microbiological Associates, Inc. (Bethesda, MD) for the Animal Disease Screening Program.

APPENDIX K

INGREDIENTS, NUTRIENT COMPOSITION, AND CONTAMINANT LEVELS IN NIH 07 RAT AND MOUSE RATION

Pelleted Diet: December 1980 to January 1983

(Manufactured by Zeigler Bros., Inc., Gardners, PA)

TABLE K1. INGREDIENTS OF NIH 07 RAT AND MOUSE RATION (a)

Ingredients (b)	Percent by Weight
Ground #2 yellow shelled corn	24.50
Ground hard winter wheat	23.00
Soybean meal (49% protein)	12.00
Fish meal (60% protein)	10.00
Wheat middlings	10.00
Dried skim milk	5.00
Alfalfa meal (dehydrated, 17% protein)	4.00
Corn gluten meal (60% protein)	3.00
Soy oil	2.50
Brewer's dried yeast	2.00
Dry molasses	1.50
Dicalcium phosphate	1.25
Ground limestone	0.50
Salt	0.50
Premixes (vitamin and mineral)	0.25

(a) NIH, 1978; NCI, 1976

(b) Ingredients should be ground to pass through a U.S. Standard Screen No. 16 before being mixed.

TABLE K2. VITAMINS AND MINERALS IN NIH 07 RAT AND MOUSE RATION (a)

	Amount	Source
Vitamins		
A	5,500,000 IU	Stabilized vitamin A palmitate or acetate
D ₃	4,600,000 IU	D-activated animal sterol
K ₃	2.8 g	Menadione activity
<i>d</i> -α-Tocopheryl acetate	20,000 IU	
Choline	560.0 g	Choline chloride
Folic acid	2.2 g	
Niacin	30.0 g	
<i>d</i> -Pantothenic acid	18.0 g	<i>d</i> -Calcium pantothenate
Riboflavin	3.4 g	
Thiamine	10.0 g	Thiamine mononitrate
B ₁₂	4,000 µg	
Pyridoxine	1.7 g	Pyridoxine hydrochloride
Biotin	140.0 mg	<i>d</i> -Biotin
Minerals		
Iron	120.0 g	Iron sulfate
Manganese	60.0 g	Manganous oxide
Zinc	16.0 g	Zinc oxide
Copper	4.0 g	Copper sulfate
Iodine	1.4 g	Calcium iodate
Cobalt	0.4 g	Cobalt carbonate

(a) Per ton (2,000 lb) of finished product

TABLE K3. NUTRIENT COMPOSITION OF NIH 07 RAT AND MOUSE RATION (a)

Nutrient	Mean	Range	Number of Samples
Crude protein (percent by weight)	23.85 ± 0.78	22.7-25.3	24
Crude fat (percent by weight)	5.02 ± 0.44	4.2-5.7	24
Crude fiber (percent by weight)	3.31 ± 0.23	2.9-3.8	24
Ash (percent by weight)	6.44 ± 0.44	5.7-7.43	24
Essential Amino Acids (percent of total diet)			
Arginine	1.260	1.21-1.31	2
Cystine	0.395	0.39-0.40	2
Glycine	1.175	1.15-1.20	2
Histidine	0.553	0.530-0.576	2
Isoleucine	0.908	0.881-0.934	2
Leucine	1.905	1.85-1.96	2
Lysine	1.250	1.20-1.30	2
Methionine	0.310	0.306-0.314	2
Phenylalanine	0.967	0.960-0.974	2
Threonine	0.834	0.827-0.840	2
Tryptophan	0.175	0.171-0.178	2
Tyrosine	0.587	0.566-0.607	2
Valine	1.085	1.05-1.12	2
Essential Fatty Acids (percent of total diet)			
Linoleic	2.37		1
Linolenic	0.308		1
Arachidonic	0.008		1
Vitamins			
Vitamin A (IU/kg)	10,917 ± 1,876	8,210-15,000	24
Vitamin D (IU/kg)	6,300		1
α-Tocopherol (ppm)	37.6	31.1-44.0	2
Thiamine (ppm)	16.8 ± 2.0	14.0-21.0	(b) 23
Riboflavin (ppm)	6.9	6.1-7.4	2
Niacin (ppm)	75	65-85	2
Pantothenic acid (ppm)	30.2	29.8-30.5	2
Pyridoxine (ppm)	7.2	5.6-8.8	2
Folic acid (ppm)	2.1	1.8-2.4	2
Biotin (ppm)	0.24	0.21-0.27	2
Vitamin B ₁₂ (ppb)	12.8	10.6-15.0	2
Choline (ppm)	3,315	3,200-3,430	2
Minerals			
Calcium (percent)	1.25 ± 0.15	1.08-1.69	24
Phosphorus (percent)	0.98 ± 0.06	0.88-1.10	24
Potassium (percent)	0.809	0.772-0.846	2
Chloride (percent)	0.557	0.479-0.635	2
Sodium (percent)	0.304	0.258-0.349	2
Magnesium (percent)	0.172	0.166-0.177	2
Sulfur (percent)	0.278	0.270-0.285	2
Iron (ppm)	418	409-426	2
Manganese (ppm)	90.8	86.0-95.5	2
Zinc (ppm)	55.1	54.2-56.0	2
Copper (ppm)	12.68	9.65-15.70	2
Iodine (ppm)	2.58	1.52-3.64	2
Chromium (ppm)	1.86	1.79-1.93	2
Cobalt (ppm)	0.57	0.49-0.65	2

(a) One or two batches of feed analyzed for nutrients reported in this table were manufactured in January and/or April 1983.

(b) One batch (7/22/81) not analyzed for thiamine

TABLE K4. CONTAMINANT LEVELS IN NIH 07 RAT AND MOUSE RATION

Contaminant	Mean ± Standard Deviation	Range	Number of Samples
Arsenic (ppm)	0.48 ± 0.17	<0.29-1.06	24
Cadmium (ppm) (a)	<0.10		24
Lead (ppm)	1.00 ± 0.74	0.42-3.37	24
Mercury (ppm) (b)	< 0.05		24
Selenium (ppm)	0.29 ± 0.07	0.13-0.40	24
Aflatoxins (ppb) (a,b)	<10	<5.0-<10.0	24
Nitrate nitrogen (ppm) (c)	9.22 ± 3.62	3.8-17.0	24
Nitrite nitrogen (ppm) (c)	2.16 ± 1.53	0.4-6.9	24
BHA (ppm) (d)	6.68 ± 4.95	<0.4-17.0	24
BHT (ppm) (d)	3.45 ± 2.56	0.9-12.0	24
Aerobic plate count (CFU/g) (e)	40,557 ± 29,431	4,900-88,000	23
Aerobic plate count (CFU/g) (f)	77,617 ± 183,824	4,900-930,000	24
Coliform (MPN/g) (g)	16.6 ± 22.9	<3-93	22
Coliform (MPN/g) (h)	80.2 ± 236.3	<3-1,100	24
<i>E. coli</i> (MPN/g) (i)	<3		24
Total nitrosamines (ppb) (j,k)	4.63 ± 4.19	0.8-18.5	21
Total nitrosamines (ppb) (j,l)	27.15 ± 64.35	0.8-273.2	24
<i>N</i> -Nitrosodimethylamine (ppb) (j,k)	3.43 ± 3.96	0.8-16.5	21
<i>N</i> -Nitrosodimethylamine (ppb) (j,l)	25.71 ± 64.90	0.8-272	24
<i>N</i> -Nitrosopyrrolidine (ppb)	1.05 ± 0.49	0.3-2.9	24
Pesticides (ppm)			
α-BHC (a,m)	<0.01		24
β-BHC (a)	<0.02		24
γ-BHC-Lindane (a)	<0.01		24
δ-BHC (a)	<0.01		24
Heptachlor (a)	<0.01		24
Aldrin (a)	<0.01		24
Heptachlor epoxide (a)	<0.01		24
DDE (a)	<0.01		24
DDD (a)	<0.01		24
DDT (a)	<0.01		24
HCB (a)	<0.01		24
Mirex (a)	<0.01		24
Methoxychlor (a,n)	<0.05	0.09 8/26/81	24
Dieldrin (a)	<0.01		24
Endrin (a)	<0.01		24
Telodrin (a)	<0.01		24
Chlordane (a)	<0.05		24
Toxaphene (a)	<0.1		24
Estimated PCB's (a)	<0.2		24
Ronnel (a)	<0.01		24
Ethion (a)	<0.02		24
Trithion (a)	<0.05		24
Diazinon (a,n)	<0.1	0.2 4/27/81	24
Methyl parathion (a)	<0.02		24
Ethyl parathion (a)	<0.02		24
Malathion (o)	0.10 ± 0.07	<0.05-0.27	24
Endosulfan I (a)	<0.01		24
Endosulfan II (a)	<0.01		24
Endosulfan sulfate (a)	<0.03		24

TABLE K4. CONTAMINANT LEVELS IN NIH 07 RAT AND MOUSE RATION (Continued)

- (a) All values were less than the detection limit, given in the table as the mean.
- (b) The detection limit was reduced from 10 ppb to 5 ppb after 7/81.
- (c) Source of contamination: Alfalfa, grains, and fish meal
- (d) Source of contamination: Soy oil and fish meal
- (e) Mean, standard deviation, and range exclude one very high value of 930,000 obtained for the batch produced on 12/22/82.
- (f) Mean, standard deviation, and range include the high value listed in footnote (e).
- (g) Excludes one very high value of 1,100 obtained in the batch produced on 12/16/80 and one high value of 460 obtained for the batch produced on 9/23/82
- (h) Includes the high values listed in footnote (g)
- (i) All values were less than 3 MPN/g (MPN = most probable number).
- (j) All values were corrected for percent recovery.
- (k) Mean, standard deviation, and range exclude three very high values in the range of 115-273.2 ppb for batches produced on 1/26/81, 2/23/81, and 4/27/81.
- (l) Mean, standard deviation, and range include the very high values given in footnote (k).
- (m) BHC = hexachlorocyclohexane or benzene hexachloride.
- (n) There was one observation above the detection limit; the value and date it was obtained are given under the range.
- (o) Thirteen batches contained more than 0.05 ppm.

APPENDIX L

DATA AUDIT SUMMARY

APPENDIX L. DATA AUDIT SUMMARY

The archival data and pathology materials for the toxicology and carcinogenesis studies of methyl methacrylate in F344/N rats and B6C3F₁ mice were audited for accuracy, completeness, and consistency from April 29 through May 1, 1985. The studies were performed at Battelle Pacific Northwest Laboratories, under a subcontract with Tracor Jitco, Inc., from the National Cancer Institute. The studies conducted from January 1981 to January 1983 for mice and rats were initiated before the requirement of compliance to Good Laboratory Practice standards by the National Toxicology Program (NTP) in October 1981. The audit was conducted at Dynamac, Inc., Rockville, Maryland, and at NTP, Research Triangle Park, North Carolina. The audit involved the following Dynamac personnel: F. Cavender, Ph.D.; L. Keifer, Ph.D.; R. Schueler, D.V.M.; C. Sexsmith, B.S.; Eva Zurek; and M. Perreault, B.S. Additional participants were M. Shoaf and H. Odum (Pathology Associates, Inc.).

The complete audit has been approved by NTP personnel and is on file at the National Institute of Environmental Health Sciences, Research Triangle Park, North Carolina. The audit consisted of an in-depth review of the data and pathology materials collected during the conduct of the studies as well as a review of the correspondence. The review of the inlife toxicology data involved examination of 100% of the existing records on animal receipt and husbandry, mortality, and environmental conditions and examination of body weight data for 10% of the animals. In the review of the chemistry data associated with the studies, all of the available records concerning receipt, initial analysis, and stability study by Midwest Research Institute (MRI) were examined. In addition, records pertaining to receipt, bulk chemical reanalysis, exposure chamber monitoring, degradation studies, and chamber monitor calibration by the study laboratory were reviewed. The audit of the pathology materials included review of 100% of the Individual Animal Data Records for correlation between gross and microscopic diagnoses and for clerical errors, examination of wet tissues of 10% of the animals for unidentified lesions and correct animal identification, correlation of slides and tissue blocks for untreated and high dose groups, and verification of the reported microscopic pathology on a 10% sample of the animals.

A review of the toxicology data revealed a few discrepancies with respect to recordkeeping. Discrepancies that were noted included lack of documented clinical observations during the early months of studies, generally poor correlation between tissue masses/lesions noted in life and at time of necropsy, and poor documentation in raw data of animal disposition (moribund kill or found dead).

A complete review of the available analytical chemistry data indicated that original chromatographs from MRI analyses were not present. Raw data for chamber atmosphere uniformity tests from the study laboratory indicated that the exposure atmosphere in the chambers was uniform. Other records showed that the study material was received at the study laboratory and was used to generate target exposure atmospheres of 250, 500, and 1,000 ppm, that degradation studies were performed, that the bulk chemical was reanalyzed as required, and that the bulk chemical was regularly withdrawn to refill the vapor generator.

Findings noted during the audit of the pathology materials were limited to missing blocks and a few potential neoplasms in the target and nontarget organs of the rats.

Although a few discrepancies were identified as discussed in the audit report, these were considered not to affect the interpretation of the studies. The data examined in the audit are considered adequate to meet the objectives of the studies.