

**Laboratory Procedures used by
the Clinical Chemistry Division,
Centers for Disease Control,
for the
Second Health and Nutrition
Examination Survey
(HANES II)
1976-1980**

**Laboratory Procedures used by
the Clinical Chemistry Division,
Centers for Disease Control,
for the
Second Health and Nutrition
Examination Survey
(HANES II)
1976-1980**

*Elaine W. Gunter, Wayman E. Turner,
Jane W. Neese, Ph.D., and David D. Bayse, Ph.D.*

**First Edition, 1981
Revised Edition, 1985**

**U.S. DEPARTMENT OF HEALTH AND HUMAN SERVICES
Public Health Service
Centers for Disease Control
Center for Environmental Health
Nutritional Biochemistry Branch
Atlanta, Georgia 30333**



August 6, 1981

Dear Colleague:

The second National Health and Nutrition Examination Survey (HANESII) was conducted from January 1976 to June 1980 by the National Center for Health Statistics (NCHS) on 27,801 persons interviewed at 64 different geographical locations. Mobile vans staffed by NCHS medical teams, who conducted extensive medical examinations of participants and collected blood and urine specimens, traveled to the different localities. Participants were identified in advance and initially contacted by the U.S. Bureau of the Census to represent a national probability sampling of the non-institutionalized U.S. population between the ages of 6 months to 74 years old. In addition to a physician's examination and medical history, this survey also included taking body measurements; a dietary interview; and, dependent on the age of the participant, tests for hearing and certain allergies, a speech recording, x-rays of chest, neck or back, electrocardiogram, measure of breathing capacity, glucose tolerance test, breast examination, and test for venereal disease.

The bulk of the specimens collected were shipped to the Centers for Disease Control for chemical analysis. Many of the analytes were vitamins and trace elements, which occur in minute amounts in biological materials and whose analysis is difficult and complex. In general, they are attempted in only a few reference laboratories and research centers. In addition to performing most of the analyses, the Clinical Chemistry Division, Center for Environmental Health was responsible for developing and validating methods for analyzing specimens, determining how specimens should be collected and shipped, training collection teams and monitoring van operations, receiving and distributing samples, computer input of laboratory and other data, and design and implementation of internal and "blind" quality control surveillance. A total of 252,222 specimens were received and distributed; 357,415 chemical analyses were performed, and 138,854 data records were transmitted to the National Center for Health Statistics.

Results of this survey, mandated by Congress to assess health problems and the nutritional status of the nation, will have considerable impact on Federal programs and health care delivery. Data tapes are made available to other government agencies and can be obtained by private concerns. Expected outputs include measurement of the extent of environmental toxicity of lead, for example, and the studies on Vitamins A and C may be used by the National Cancer Institute to assess possible interrelationships of these substances with cancer. Results of glucose tolerance tests, analyzed by a modification of the glucose reference method, will address the magnitude of undiagnosed diabetes. And the nutritional aspects of the survey will help determine the augmentation of fortified food, since a focus of HANES II was on the extent and possible causes of anemia in the United States. The statistical design of the survey allows analysis of the data with respect to various demographic and socioeconomic factors. The extensive normative data base established will not only be used to identify current problems, but will also serve as a comparison to determine changes with time and effects of intervention efforts.

This manual details the methods used by the Clinical Chemistry Division for the chemical analyses, plus the quality control data generated over the course of the entire survey. Its purpose is threefold: 1) to use in interpreting survey results, 2) to serve as a link to investigators who wish to tie in to this data base; and 3) to provide nutritional methods in a new and expanding area of clinical chemistry.

Four critical factors with respect to the laboratory component of this survey were: 1) a lead time of only four months in which to develop methods and collection procedures, train staffs and implement quality control; 2) the complexity of the analytical techniques required; 3) the maintenance of a designated turnaround time, since return of results to each participant's personal physician was an inducement to participate in the survey; and 4) the high quality of results necessary to assure comparability of data generated over a five-year period. The quality of the data generated proved to be outstanding for such long-term, multicomponent study. All analyses were completed on schedule without the necessity for repeating large blocks of samples; within three months of the completion of the survey, all data tapes had been edited and forwarded to the National Center for Health Statistics. This present survey actually represents a

continuing collaboration which began in 1970 between the CDC and the NCHS, principally with the Division of Health Examination Statistics and the Division of Operations, NCHS. Results of the HANES II survey can be obtained by writing to:

National Center for Health Statistics
Scientific and Technical Information Branch
3700 East-West Highway, Room 1-57
Hyattsville, MD 20782

Sincerely,

A handwritten signature in black ink, appearing to read "Bayse", with a long horizontal line extending to the right from the end of the signature.

David D. Bayse, Ph.D.
Director
Clinical Chemistry Division
Center for Environmental Health

Contents

	<i>Page</i>
ACKNOWLEDGMENTS	iii
I. Introduction	1
II. Field Specimen Collection	2
A. Venipuncture Blood Collection	2
B. Capillary Blood Collection	3
III. Field Specimen Processing	3
A. Specimen Separation	3
1. Centrifugation	3
2. Serum Separation and Pooling	3
B. Specimen Allocation	3
1. Serum	3
2. Plasma	3
3. Whole Blood	3
C. Shipping Procedures	6
1. CDC Shipments	6
2. Other Shipments	6
a. Carboxyhemoglobin	6
b. Cholesterol/Triglycerides	6
c. Bile Salts	6
d. Pesticides	7
e. Creatinine	7
D. Storage Procedures	7
IV. Analytical Methods	8
A. Erythrocyte Protoporphyrin	8
B. Serum Iron and Total Iron-Binding Capacity	12
C. Serum Albumin	15
D. Serum Vitamin C	17
E. Serum Zinc and Copper	20
F. Serum Vitamin A	22
G. Serum and Red Cell Folate (Radioassay)	25
H. Serum Vitamin B ₁₂	27
I. Plasma Glucose	28
J. Whole Blood Lead	32
K. Serum Total Bilirubin	34
L. Serum Glutamic-Oxaloacetic Transaminase (SGOT)	39
M. Serum Alkaline Phosphatase	41
N. Serum and Red Cell Folate (Microbiological)	44
V. Quality Control	50
A. Preparation of Control Materials	50
B. System Description	50
C. Analysis of Variance Tables and Long-Term Quality Control Charts	51
VI. References for Analytical Methods	69

Acknowledgments

We acknowledge with appreciation the contributions of the following to methodology development and performance of the analyses for this study: George Bailey, Debbie Boelter, Jacqueline Brown, Clyde Bryant, Bettye Burgess, Richard Carter, Dennis Cox, Carolyn Duncan, Pat Duncan, Jim Gill, Jolene Hewett, Lloyd Horne, Vince Maggio, Barbara Miller, Donna Orti, Dawn Rector, Jim Samuels, Emily Sheard, Barbara Smarr, Bette Smith, Loraine Sneed, Philip Stroud, Gailya Walter, Ken Warso, Virginia Whitner, Del Wynne, Pat Yeager, Mike Staiger, Davis Lee, and Nancy VanVoorhis.

Jim Andrews was responsible for processing and distributing all of the samples for the second Health and Nutrition Examination Survey (HANES II), and for maintaining the flow of supplies to the field installations.

The analytical and quality control data for this survey were completely computerized for analysis by the Centers for Disease Control (CDC) and the National Center for Health Statistics (NCHS). Contributing to this effort were Ruth Lovejoy and Mildred Threadgill, who entered all the analytical data, and Jerry Hewett, Ed Wylie, John Donahue, and Ed Smith, who helped in the design of quality control and data management computer systems. Special thanks are due Gleason Pool, for providing endless assistance for programs, tapes, plots, and data analysis used for presentations, publication, and data transfer to NCHS.

Karen Colberg and Mary Brown are due great appreciation for their efforts in the typing and proofing of this manual and in preparing the quality control data for presentation.

Dr. Alan Mather provided valuable editorial advice and is responsible for revising the working description of the bilirubin method.

I. Introduction

This manual was designed to document the full scope of the biochemistry portion of the section national Health and Nutrition Examination Survey (HANES II). It is a complete, working laboratory manual for nutritional biochemistry analyses as they were performed in a field survey.

Sections II and III describe the procedures used by the field laboratory staff (who are part of the Health Examination Field Operations Branch, Division of Data Services, National Center for Health Statistics (NCHS)) to collect and process specimens from examinees for the laboratory analyses in HANES II. Analytical methods used by the Clinical Chemistry Division of the Centers for Disease Control (CDC) are described in their entirety in Section IV, and Section V presents the quality control data from these analyses.

The Nutritional Biochemistry Branch, Clinical Chemistry Division, Center for Environmental Health, CDC, served as the coordinating laboratory for biochemistry analyses for HANES II. In addition to performing analyses, the Branch also researched, developed, and validated clinical and nutritional biochemistry methods for future implementation.

Serum, plasma, and whole blood specimens collected from survey participants by the NCHS field laboratory personnel were sent to CDC from 64 different field locations during the survey. These specimens were inventoried and distributed for analyses to CDC laboratories as well as to several outside laboratories. Pertinent identification data and all biochemical and hematological data for 20,322 survey participants were entered and maintained in a master computer file; periodic updates and a final, complete master tape record were furnished to the NCHS.

Sixteen biochemistry analyses were performed by the Clinical Chemistry Division for HANES II. Analyses for protoporphyrin, iron, total iron-binding capacity, albumin, vitamin C, zinc, copper, serum and red cell folate, vitamin A, and vitamin B₁₂ were performed in the Technical Services Section, Nutritional Biochemistry Branch. Analyses for blood lead were performed in the Toxicology Branch. Measurements for glucose, alkaline phosphatase, serum glutamic-oxaloacetic transaminase, and bilirubin were performed in the Clinical Trials Section, Metabolic Biochemistry Branch. The methods used were investigated before the start of HANES II and were subjected to validation studies to confirm their analytical soundness. Before required changes in methods were instituted, such as for the folate assay, extensive comparison studies were performed. It was also necessary to develop biological control materials for use in assuring the quality and comparability of the data generated over the 4-year course of the Survey.

In conjunction with the Hematology Division, the Nutritional Biochemistry Branch provided training for the field laboratory personnel, developed sample collection and processing procedures, produced a laboratory manual of these procedures, and conducted periodic inspections of the field sites to ensure that proper techniques were being used.

II. Field Specimen Collection

A. VENIPUNCTURE BLOOD COLLECTION

Collect the following evacuated specimen tubes* from each age group:

Age Group (Years)	A <3	B 3-11	C 12-19	D 20-74 Bile Salts	E 20-74 GTT
Label Color Code	Red	Green	Yellow	Blue	Orange
Tube Type: 5-mL lavender-top (0.048 mL 15% K ₃ EDTA) Monoject #8881-011442**	1	2	2	2	2
15-mL red-top B-D #6432†	1	2	3	4	3
10-mL blue-top (trace metal) B-D #6526		1	1	1	1
5-mL gray-top (10 mg potassium oxalate +12.5 mg sodium fluoride) B-D #6471					3

*Use of trade names is for identification only and does not constitute endorsement by the Public Health Service or by the U.S. Department of Health and Human Services.

**Monoject, Division of Sherwood Medical Industries, St. Louis, MO.

†Becton-Dickinson Co., Rutherford, NJ.

B. CAPILLARY BLOOD COLLECTION

If a venipuncture is unsuccessful on children less than 5 years old, collect the following samples by finger stick, after cleaning the fingertip with surgical soap,* spraying the fingertip with silicone spray** (to minimize lead contamination), and allowing the finger to dry for several minutes:

1. Three 20- μ L capillary tubes (for white blood cell, red blood cell, and hemoglobin determinations).
2. Two heparinized hematocrit tubes (for hematocrit determinations).
3. Two lead-free 100- μ L capillary tubes† (for blood lead and erythrocyte protoporphyrin determinations).
4. Two blood smears on glass slides (for peripheral smear hematology evaluations).

* "Frepps" disposable swabs, 15% aqueous green soap solution, No. 26-03-00, Marion Scientific Corp., Rockford, IL.

** TMI silicone spray protective coating, Trace Metals Instruments, New York, NY.

† ESA heparinized and EDTA-treated capillary sets, Environmental Science Associates, Bedford, MA.

III. Field Specimen Processing

A. SPECIMEN SEPARATION

1. Centrifugation

Perform all processing work under the laminar-flow hood, using only those materials prescreened for trace metals contamination levels by CDC. Allow blood in each red- or blue-top tube to clot for 30-40 min at room temperature. For red-top tubes, remove the stopper, loosen the clot from the sides of the tube with a clean, wooden applicator stick, and replace stopper. Do not open blue-top tubes until after centrifugation, to prevent contamination. Centrifuge and separate plasma from gray-top tubes as soon as possible. Place all tubes in centrifuge carriers; balance and centrifuge at 2,400 rpm (RCF = 1115)* for 10 min.

2. Serum Separation and Pooling

Do not allow serum to remain in contact with the clot for longer than 1 h after the specimen is collected. Using a serum separator,** carefully remove the serum from the blue-top tube and pour it into the trace metals vial. Remove serum from all red-top tubes with serum separators and pool it into a 50-mL centrifuge tube, carefully avoiding the introduction of any cellular debris. If the serum from any red-top tube is grossly hemolyzed (for example, from traumatic venipuncture or mishandling), do not pool it with serum from the remaining tubes. If all the serum from an examinee is turbid, lipemic, or icteric, pool it and allocate as usual. (Not all biochemical tests may be performed on these specimens.) Stopper the 50-mL tube and mix its contents by inversion. Aliquot immediately or refrigerate at 4°C no longer than 4 h. Label each specimen as it is processed.

*Relative Centrifugal Force (RCF) = .0001118 X r X N², where r = 16.41 cm for the radius of the HL-4 rotor of a Sorvall GLC-1 centrifuge and N = 2,400 rpm.

**Accusep serum separators, No. AL-51-0037, Acculab, Division of Precision Technology, Norwood, NJ.

B. SPECIMEN ALLOCATION

Label all vials with examinee's identification number and allocate specimens as follows:

1. Serum

Using clear serum only, fill as many vials as possible in the order of priority shown in Table 1.* If the serum from the blue-top tube is grossly hemolyzed, do not send it for analysis, but note hemolysis under "comments" on the 411 worksheet. Prepare the serum extract for vitamin C analysis.

2. Plasma

Using a clean Pasteur pipette, remove plasma from each timed glucose tolerance test specimen after centrifugation and place in the appropriately labeled vial.

3. Whole Blood

For all age groups except A (<3 years), for which only one tube is filled, use the first lavender-top tube for hematological determinations and the second tube for biochemical specimen (erythrocyte protoporphyrin and blood lead) allocation to prevent contaminating the specimens for lead analysis. Prepare the whole blood hemolysate for red blood cell folate analysis. Save the remainder of the hematology-designated tube to ship to CDC for hemoglobinopathy studies.

*Table 2 is also presented to show the analytical protocol for each age group and specimen type.

TABLE 1
Hanes II Blood Processing Protocol
(Listed in Order of Priority)

Test Number	Test Name	Age Group(s)	Sample Size (mL)	Specimen* Type	Collection Type	Vial** Type	Special Handling	Analyzed By	Other Remarks
1.	Protoporphyrin	A,B,C,D,E	1	WB	5-mL EDTA lavender	3-mL W		CDC	100 µL if fingerstick on A or B
2.	RBC Folate	A,B,C,D,E	0.5	WB-HEM	5-mL EDTA lavender	3-mL W	1:5 dilution with ascorbic acid	CDC	500 µL SMI F pipette† 2000 µL SMI H pipette
3.	Lead	A,B,C,D,E	1	WB	5-mL EDTA lavender	5-mL P	Packard vial	CDC	100 µL if fingerstick on A or B subsample††
4.	Carboxy-hemoglobin	B,C,D,E	1	WB	5-mL EDTA lavender	3-mL W		Johns Hopkins	Do not freeze.
5. a,b,c	Glucose Tolerance	E	1,1,1	P	5-mL NaF gray	3-mL W		CDC	Glucola given. Fasting, 1 h, 2 h collected
6.	Iron/Total Iron Binding Capacity	A,B,C,D,E	3	S	15-mL red	3-mL W		CDC	
7.	Folate	A,B,C,D,E	2	S	15-mL red	3-mL W		CDC	
8.	Vitamin B ₁₂	A,B,C,D,E	2	S	15-mL red	3-mL W		CDC	
9.	Ferritin	B,C,D,E	1	S	15-mL red	3-mL W		Univ. Kans. Med. School	Send to CDC.
10.	Vitamin A	B	3	S	15-mL red	3-mL W		CDC	
11.	Vitamin C	B,C,D,E	0.75	S-EXT	15-mL red	6-mL W	1:5 extract in m-phosphoric acid	CDC	750 µL SMI G pipette 3000 µL SMI H pipette
12.	Albumin	B,C,D,E	1	S	15-mL red	3-mL W		CDC	
13.	Cholesterol/Triglycerides	D,E	3	S	15-mL red	6-mL F		Geo. Washington University	Must be in clear tube to detect lipemia
14.	Syphilis	C,D,E	0.5	S	15-mL red	3-mL W		CDC	
15.	Bile Salts	D	2	S	15-mL red	3-mL W		Cornell Univ. Med. School	(35-74 only) fat-loading - X-NOG used
16.	Pesticides	C,D	5	S	15-mL red	20-mL EPA	special vial	EPA	Urine sample to be collected. Subsample [€]
17.	Creatinine	C,D,E	2	S	15-mL red	3-mL W		Western Pathology	
18.	Zinc/Copper	B,C,D,E	5	S	10-mL blue	5-mL P	Packard vial	CDC	Entire collection process must be free of trace metal contamination.
19.	Reserve	A,B,C,D,E	2	S	15-mL red	3-mL W		CDC	
20.	Excess	C,D,E	1	S	15-mL red	3-mL W		CDC	
21.	Excess	C,D,E	1	S	15-mL red	3-mL W		CDC	

*Specimen Type: WB = Whole blood
WB-HEM = Whole blood hemolysate for RBC folate analysis (500 µL of EDTA-whole blood is added to 2.0 mL of 1 g/dL ascorbic acid, then mixed and frozen before shipping.)
P = Plasma
S = Serum
S-EXT = Serum extract for vitamin C analysis (750 µL of serum is added to 3.0 mL of 6 g/dL m-phosphoric acid, then mixed and frozen prior to shipment.)

**Vial Type: W = 3- or 5.5-mL Wheaton vial with dropper tip, #20272 and #20275 Wheaton, Inc., Millville, NJ.
P = "Mini-vial" plastic scintillation vial, 6 mL, #6000243, Packard Instruments Corp., Downers Grove, IL.
F = Falcon 2027 disposable polystyrene tube, Becton-Dickinson Co., Oxnard, CA.
EPA = 20-mL glass jar supplied by the Environmental Protection Agency to prevent contamination of pesticide analysis.

†Scientific Manufacturing Industries, Emeryville, CA.

††Lead analyses are performed on specimens from all children less than 7 years old and from persons 7 years old or older with even-numbered identification numbers.

€Pesticide analyses are performed on specimens from all persons with even-numbered identification numbers from groups C and D. A urine specimen is also collected on these persons.

TABLE 2
Analytical Protocol for Hanes II Specimens

AGE GROUP AGE (YRS) COLOR	A (<3) Red	B (3-11) Green	C (12-19) Yellow	D (20-74) Blue	E (20-74) Orange
WHOLE BLOOD					
	Lead	Lead	Lead	Lead	Lead
		Carboxy-hemoglobin	Carboxy-hemoglobin	Carboxy-hemoglobin	Carboxy-hemoglobin
	Protoporphyrin	Protoporphyrin	Protoporphyrin	Protoporphyrin	Protoporphyrin
	Red Cell Folate*	Red Cell Folate*	Red Cell Folate*	Red Cell Folate*	Red Cell Folate*
SERUM					
		Ferritin*	Ferritin*	Ferritin*	Ferritin*
				Bile Salts**	
				Cholesterol	Cholesterol
				Triglyceride	Triglyceride
			Pesticides	Pesticides	
			Creatinine	Creatinine	Creatinine
			Syphilis	Syphilis	Syphilis
	Iron	Iron	Iron	Iron	Iron
Total Iron Binding Capacity (TIBC)	TIBC	TIBC	TIBC	TIBC	TIBC
Folate*	Folate*	Folate*	Folate*	Folate*	Folate*
Vitamin B ₁₂ *	Vitamin B ₁₂ *	Vitamin B ₁₂ *	Vitamin B ₁₂ *	Vitamin B ₁₂ *	Vitamin B ₁₂ *
	Vitamin A				
	Copper		Copper	Copper	Copper
	Zinc		Zinc	Zinc	Zinc
	Albumin		Albumin	Albumin	Albumin
	Vitamin C		Vitamin C	Vitamin C	Vitamin C
PLASMA					
					Glucose Tolerance† (Fasting, 1, 2 h)

*Anemia Subgroup Only (See Table 3) for an explanation of the subgroup criteria.)

**To be tested only on a subgroup 35-74 years old. Patients were administered X-NOG^R, a high-fat eggnog drink with approximately 8.6% full milk cream and egg yolks (Syntex Laboratories, Palo Alto, CA). A blood specimen was collected 2 h later for bile salts analysis. CDC performed bilirubin, aspartate aminotransferase, and alkaline phosphatase measurements on samples with elevated bile salts.

†2 h glucose tolerance tests were performed on this age group. A fasting blood specimen was collected; the patient was given Glucola^R (#2604, Ames Diagnostics, Elkhart, IN), a 75-g carbohydrate-load cola solution. Additional specimens were collected 1 and 2 h after cola ingestion.

TABLE 3
Criteria for Inclusion into the Anemia Subgroup

(On the basis of these hematological indices, a sample person was selected for the anemia subgroup; serum and red cell folate, vitamin B₁₂, and ferritin assays and differential smear analyses were performed. A control group was composed of those normal sample persons whose identification numbers ended in 8.)

ASSESSMENT/SEX-AGE	VALUE	
	Less Than	Greater Than
White Cell Count (All)	3.5 (X 10 ³)	13.0 (X 10 ³)
Red Cell Count		
Males > 15 yrs	4.0 (X 10 ⁶)	6.0 (X 10 ⁶)
Females > 15 yrs } Children* }	3.8 (X 10 ⁶)	6.0 (X 10 ⁶)
Hemoglobin		
Males > 15 yrs	13.5 g/dL	18.5 g/dL
Females > 15 yrs	11.5 g/dL	16.5 g/dL
Children*	11.0 g/dL	—
Hematocrit		
Males > 15 yrs	38.0 %	56.0 %
Females > 15 yrs	32.0 %	50.0 %
Children*	31.0 %	—
Mean Corpuscular Volume		
Males > 15 yrs } Females > 15 yrs }	79.5 μ ³	105.0 μ ³
Children*	74.5 μ ³	100.0 μ ³

*Persons under 16.

C. SHIPPING PROCEDURES

Shipping instructions are discussed in their entirety in *HANES II Examination Staff Procedures Manual for the Health and Nutrition Examination Survey, 1976-1979*.*

1. CDC Shipments

All processed specimens from one "sample person" (with the exception of the hematology lavender-top tube) to be shipped to CDC are placed in a sealable plastic bag and frozen in an upright position. Shipments by priority mail are made on a daily basis in a large shipper containing the frozen samples, 12 pounds of cake dry ice, and the accompanying Deck 411 transmittal sheet originals. Hematology tubes are refrigerated and shipped to CDC on a weekly basis in a small shipper with a coolant to maintain sample integrity. Differential smears are collected in a slide box and are shipped at the end of a stand.

These vials are shipped to CDC: 1, 2, 3, 5a, 5b, 5c, 6, 7, 8, 9, 10, 11, 12, 14, 18, 19, 20, 21.

2. Other Shipments

a. Carboxyhemoglobin

No. 4 vials are accumulated in the refrigerator and shipped weekly in a small styrofoam shipper with a coolant and a copy of the Deck 405 transmittal form to: Johns Hopkins University, Department of Environmental Medicine, Baltimore, MD.

b. Cholesterol/Triglycerides

No. 13 clear plastic tubes are accumulated in the freezer and shipped weekly in special plastic shippers with dry ice and a copy of the Deck 430 transmittal form to: Lipid Research Clinic, George Washington University, Washington, DC.

c. Bile Salts

No. 15 vials are accumulated in the freezer and shipped weekly in a styrofoam shipper with dry ice and a copy of the Deck 420 transmittal form to: Cornell University Medical School, Department of Internal Medicine, New York, NY.

*National Center for Health Statistics: *HANES II Examination Staff Procedures Manual for the Health and Nutrition Examination Survey, 1976-1979*, part 15a. Public Health Service, Hyattsville, MD, August 1979, pp. 9-3 — 9-6.

d. Pesticides

The special glass containers provided by the Environmental Protection Agency (vial 16, serum, and a sample-number labeled vial with 20 mL of urine) are accumulated in the freezer and shipped weekly in a special metal shipper with dry ice and a copy of the Deck 400 transmittal form to: U.S. Environmental Protection Agency, Office of Pesticide Programs, Ecological Monitoring Branch, Washington, DC.

e. Creatinine

No. 17 vials are accumulated in the freezer and shipped weekly in a styrofoam shipper with dry ice and a copy of the Deck 415 transmittal form to: Western Pathology Associates, Oakland, CA.

D. STORAGE PROCEDURES

Upon arrival at CDC, the specimens are sorted by vial type and are stored at -20°C (with the exception of vial 11 for vitamin A analysis, which is stored at -70°C).

IV. Analytical Methods

A. ERYTHROCYTE PROTOPORPHYRIN

1. Principle

Erythrocyte protoporphyrin is measured by a modification of the method of Sassa and Granick¹. Protoporphyrin is extracted from EDTA-whole blood into a 2:1 (v/v) mixture of ethyl acetate-acetic acid, then back-extracted into dilute hydrochloric acid. The protoporphyrin in the aqueous phase is measured fluorometrically at excitation and emission wavelengths of 404 and 655 nm, respectively. Calculations are based on a processed protoporphyrin IX (free acid) standard curve. The final concentration of protoporphyrin in a specimen is expressed as micrograms per deciliter of packed red blood cells ($\mu\text{g}/\text{dL RBC}$); a correction for the individual hematocrit is made.

2. Instrumentation

- a. Perkin-Elmer Model MPF-2A spectrofluorometer, with R446 photomultiplier tube, and custom-made microcell (10- X 75-mm) holder positioned to allow the passage of light through the aqueous phase only.
(Perkin-Elmer Corp., Norwalk, CT)
- b. Model 56 recorder
(Perkin-Elmer Corp.)
- c. Cary Model 119 double-beam spectrophotometer
(Varian Associates, Palo Alto, CA)
- d. Vortex mixer
(Fisher Scientific Co., Fairlawn, NJ)
- e. Micromedic Model 25000 Automatic Pipette, with 1.0-mL sampling and dispensing pumps
(Micromedic Systems, Division of Rohm and Haas, Horsham, PA)
- f. SMI Micropettors, sizes A, B, C
(Scientific Manufacturing Industries, Berkeley, CA)
- g. Oxford Model M reagent dispensers
(Oxford Laboratories, Foster City, CA)
- h. Mettler Model H18 analytical balance
(Mettler Instrument Corp., Hightstown, NJ)
- i. Sorvall GLC-1 centrifuge
(DuPont-Sorvall Instrument Co., Newton, CT)

3. Materials

- a. Protoporphyrin IX, dimethyl ester, 99.3% purity, grade I (Sigma Chemical Co., St. Louis, MO)
Note: Store at -20°C over a desiccant. Purchase of one lot is recommended.
- b. Coproporphyrin III, 5 $\mu\text{g}/\text{vial}$, 99% purity
(Porphyrin Products, Logan, UT)
Note: Store at room temperature over a desiccant.
- c. Ethyl acetate, spectrophotometric quality
(J.T. Baker Co., Phillipsburg, NJ)
- d. Rhodamine B (no grade given)
(Allied Chemical Co., Morristown, NJ)
- e. Acetic acid, glacial, "Baker Analyzed"
(J. T. Baker Co.)
- f. Hydrochloric acid, concentrated, "Baker Analyzed"
(J. T. Baker Co.)
- g. Kimble 10- X 75-mm disposable glass culture tubes
(Kimble Div., Owens-Illinois Co., Toledo, OH)
- h. Parafilm M
(American Can Co., Greenwich, CT)
- i. Ethylene glycol, "Fisher Certified"
(Fisher Scientific Co., Fairlawn, NJ)
- j. Actinic glass volumetric flasks
(Corning Glassworks, Corning, NY)

Note: All nondisposable glassware used in this assay should be washed in 10% (v/v) nitric acid and rinsed 6 times with deionized water.

- k. Deionized water, ≥ 1.0 megaOhm-cm at 25°C
(Continental Water Co., Atlanta, GA)

4. Reagent Preparation

- a. *7.0 mol/L Hydrochloric acid (HCl)*
Dilute 551 mL concentrated HCl to volume with deionized water in a 1-liter volumetric flask.
- b. *1.79 mol/L HCl*
Dilute 141 mL concentrated HCl to volume with deionized water in a 1-liter volumetric flask.
- c. *1.0 mol/L HCl*
Dilute 79 mL concentrated HCl to volume with deionized water in a 1-liter volumetric flask.
- d. *0.43 mol/L HCl*
Dilute 68 mL concentrated HCl to volume with deionized water in a 2-liter volumetric flask.
Fill 1.0-mL reagent dispenser bottle daily with this reagent.
- e. *1.5 mol/L HCl*
Dilute 118 mL concentrated HCl to volume with deionized water in a 1-liter volumetric flask.
Note: These dilutions assume concentrated HCl to be 12.7 mol/L. The molar concentration of different lots of HCl should be calculated by using the following formula:
- $$\text{mol/L} = \frac{\text{relative density} \times \% \text{ HCl}}{35.453}$$
- f. *2:1 (v/v) Ethyl acetate – acetic acid*
Working under a hood, combine 200 mL ethyl acetate and 100 mL glacial acetic acid. Mix the solution well and pour into a 1.0-mL reagent dispenser bottle. This volume of solution is sufficient for the standards, controls, and 80 specimens. (Prepare this reagent daily, immediately before sampling the whole blood.)

5. Standard Preparation

Note: Prepare all standard solutions with actinic glass volumetric flasks.

- a. Rhodamine B (spectrofluorometer calibrator)
- (1) *40 mg/dL Stock Standard*
Dissolve 40 mg of Rhodamine B in 20 mL ethylene glycol in a 100-mL volumetric flask. Shake the flask vigorously, then dilute solution to volume with ethylene glycol. (Store at 4°C. The solution is stable for at least 6 months.)
- (2) *0.48 µg/dL Working Solution*
Dilute 1.0 mL of 40 mg/dL stock to volume in a 50-mL volumetric flask with ethylene glycol, to yield a 0.8 mg/dL solution. Dilute 5 mL of this solution to volume in a 1-liter volumetric flask with ethylene glycol, to yield a 4 µg/dL standard. Dilute 6 mL of the 4 µg/dL standard to volume in a 50-mL volumetric flask with ethylene glycol, to yield a 0.48 µg/dL standard for use as a daily instrument calibrator. (Prepare monthly; store at 4°C.)
- b. *Coproporphyrin III* (for monitoring performance of the spectrofluorometer)
Verify the concentration of the 0.5 µg/mL coproporphyrin III stock standard solution from Porphyrin Products by measuring its absorbance in 1.0 mol/l HCl diluent at 401 nm. Use a millimolar absorptivity of 470. (An absorbance of 0.357 would be expected for a standard concentration of 0.5 µg/dL.) Using the observed absorbance, calculate the actual coproporphyrin III concentration with the following formula:

$$\text{Coproporphyrin III concentration} = \frac{(\text{Absorbance}) (0.5 \mu\text{g/dL})}{0.357}$$

- (1) *1.0 µg/dL Intermediate Standard*
Dilute 4 mL of the 0.5 µg/mL stock standard to volume in a 200-mL volumetric flask with 1.0 mol/L HCl. (Prepare every 6 months; store at 4°C.)
- (2) *0.2 µg/dL Working Standard*
Dilute 20 mL of the 1.0 µg/dL intermediate standard to volume in a 100-mL volumetric flask with 1.0 mol/L HCl. (Prepare every 3 months; store at 4°C.)

- (3) *0.1 µg/dL Working Standard*
Dilute 10 mL of the 1.0 µg/dL intermediate standard to volume in a 100-mL volumetric flask with 1.0 mol/L HCl . (Prepare every 3 months; store at 4°C.)

c. *Protoporphyrin IX Standards* (Concentrations are expressed in terms of protoporphyrin IX free acid after the dimethyl ester has been hydrolyzed. The millimolar absorptivity of protoporphyrin IX free acid has conventionally been determined in 1.5 mol/L HCl ; thus, the daily absorbance reading of the hydrolysate is determined at this acid concentration².)

- (1) *20 mg/dL Protoporphyrin IX Free Acid Hydrolysate (Stock Standard)*
Measure 42.0 mg protoporphyrin IX dimethyl ester (PPIX DME). Dilute to volume in a 200-mL actinic volumetric flask with 7 mol/L HCl . Add a small stirring bar, cover the flask with aluminum foil, and mix contents at 20-25°C for 3 h, using a magnetic stirrer. (Prepare weekly.)

- (2) *1000 µg/dL Intermediate Stock*
After 3 h, dilute 25.0 mL of 20 mg/dL solution with deionized water to volume in a 500-mL actinic volumetric flask to yield a 1000 µg/dL solution, which is 0.35 mol/L with respect to HCl . (Prepare weekly.)

- (3) *100 µg/dL Standard for Daily Absorbance Readings*
Dilute 10.0 mL of 1000 µg/dL intermediate stock to volume in a 100-mL actinic volumetric flask with 1.79 mol/L HCl, to yield a 100 µg/dL protoporphyrin IX standard, which is 1.5 mol/L with respect to HCl . Use an aliquot of this standard for absorbance readings, as in Section 6.b.

Note: The theoretical concentration of this solution with respect to protoporphyrin IX free acid (PPIX FA) is calculated as follows:

$$\frac{42 \text{ mg PPIX DME}}{200 \text{ mL}} \times \frac{562.27 \text{ mg PPIX FA}}{590.73 \text{ mg PPIX DME}} = \frac{.1999 \text{ mg PPIX FA}}{\text{mL}}$$

$$\frac{.1999 \text{ mg PPIX FA}}{\text{mL}} \times \frac{25 \text{ mL}}{500 \text{ mL}} \times \frac{10 \text{ mL}}{100 \text{ mL}} = .0009975 \text{ mg/mL PPIX FA} \quad (99.75 \text{ µg/dL})$$

$$\frac{99.95 \text{ µg}}{1 \text{ dL}} \times \frac{1 \text{ mmol}}{562.27 \text{ mg}} \times \frac{10 \text{ dL}}{1 \text{ L}} \times \frac{1 \text{ mg}}{1000 \text{ µg}} = .00178 \text{ mmol/L PPIX FA}$$

- (4) *100 µg/dL Standard for Dilutions*
Dilute 5.0 mL of 1000 µg/dL intermediate stock to volume with 0.43 mol/L HCl in a 50-mL actinic volumetric flask.

- (5) *10-80 µg/dL Working Standards*
Prepare the following working standards daily by diluting the 100 µg/dL standard with 0.43 mol/L HCl according to the following dilution scheme, using a Micromedic Automatic Pipette equipped with 1.0-mL sampling and dispensing pumps:

Working Standard Concentration	Volume 100 µg/dL Standard	Volume 0.43 mol/L HCl Diluent	Final Volume	Final Dilution of 100 µg/dL Standard
80 µg/dL	1000 µL	250 µL	1250 µL	8:10
70 µg/dL	1000 µL	428 µL	1428 µL	7:10
60 µg/dL	500 µL	333 µL	833 µL	6:10
50 µg/dL	500 µL	500 µL	1000 µL	5:10
40 µg/dL	250 µL	375 µL	625 µL	4:10
30 µg/dL	250 µL	583 µL	833 µL	3:10
20 µg/dL	250 µL	1000 µL	1250 µL	2:10
10 µg/dL	250 µL	2250 µL	2500 µL	1:10

These solutions are photolabile and should be stored in foil-wrapped tubes and processed as rapidly as possible.

6. Procedure

Note: To protect hands against acids and solvents during sampling, wear latex gloves.

- a. Thaw specimens and quality control materials of frozen EDTA-whole blood at room temperature.
Note: Control pools with elevated levels of FEP are prepared from blood (EDTA-anticoagulated) collected from cows which have been administered lead acetate.
- b. Using the spectrophotometer, measure absorbance at λ -maximum of the 100 $\mu\text{g}/\text{dL}$ in 1.5 mol/L HCl standard solution against a blank of 1.5 mol/L HCl, scanning from 380-420 nm. (λ -maximum is approximately 407-408 nm.) This measurement will be used to determine standard concentrations.
- c. Prepare the working standard dilutions from 100 $\mu\text{g}/\text{dL}$ standard in 0.43 mol/L HCl, using 0.43 mol/L HCl as a diluent. These dilutions are unstable; therefore, prepare them as rapidly as possible.
- d. Prepare the 2:1 ethyl acetate-acetic acid mixture and use it to fill a dispenser bottle for delivering 1.0 mL of reagent. Fill another reagent dispenser bottle with 0.43 mol/L HCl for delivery of 1.0 mL.
- e. Before sampling, vortex thoroughly each standard dilution, quality control pool, or whole blood specimen. Using a size "C" SMI Micropettor, remove 10 μL of sample and place in a 10- X 75-mm disposable glass tube.
- f. Add 1.0 mL of the 2:1 ethyl acetate-acetic acid mixture to the sample in tube. Vortex thoroughly for 10 seconds.
- g. Add 1.0 mL of the 0.43 mol/L HCl to tube. Wrap tube with Parafilm and vortex thoroughly for 10 seconds.
- h. Proceed to the next specimen, sampling in this order: standards and quality control pools in quadruplicate; whole blood specimens in duplicate.
- i. Prepare two blank tubes with 1.0 mL each of ethyl acetate-acetic acid and 0.43 mol/L HCl.
- j. When all sampling is completed, centrifuge all tubes for 4 min at 1400 rpm. Store processed sample tubes in dark until fluorometric readings are to be done.
- k. For samples outside the range of the standard curve, use a smaller sample size or dilute sample with saline. For example,

5 μL = 1:2 dilution

2 μL = 1:5 dilution

100 μL sample and 900 μL saline = 1:10 dilution, 10 μL sample used

- l. Perkin-Elmer MPF-2A spectrofluorometer parameters:

Slit width	20 nm
Mode	Ratio
Reference sensitivity	1
Sample sensitivity	3
Photomultiplier tube	R446
Cuvettes	10- X 75-mm in microcell adapter

- m. Wavelength settings:

	Excitation λ	Emission λ
Rhodamine B	400	607
Coproporphyrin III	400	648
Protoporphyrin IX	404	655

- n. Using the rhodamine B wavelength settings, zero the spectrofluorometer with the processed blank solutions. Then, using an aliquot of 0.48 $\mu\text{g}/\text{dL}$ working rhodamine B, set its fluorescent intensity to 20-25 recorder units (that is, a constant setting that will make the 80 $\mu\text{g}/\text{dL}$ standard read full scale) to provide an instrument calibrator.
- o. To monitor the daily performance of the instrument, change wavelength settings to those of coproporphyrin, rezero with blank solution, and read the fluorescence of the 0.1 and 0.2 $\mu\text{g}/\text{dL}$ coproporphyrin III standards.
- p. Change wavelength settings to those of protoporphyrin and rezero with blank solution. Beginning with the 10 $\mu\text{g}/\text{dL}$ standard, read each of the standard tubes, then the controls, and then the specimens, resetting the blank periodically.
- q. After reading all protoporphyrin tubes, reset the wavelengths and check for instrument drift by reading the coproporphyrin and the rhodamine B tubes.

r. Calculations

The millimolar absorptivity of protoporphyrin IX free acid in 1.5 mol/L HCl has been determined in our laboratory to be 297 ± 1.0 (400 observations). Calculate the actual concentration of the 100 $\mu\text{g/dL}$ (.00178 mmol/L) working standard, using the following equation:

$$A = \epsilon bc, \text{ and } c = \frac{A}{\epsilon b}$$

Where:

A = absorbance reading

b = cuvette pathlength, 1 cm

c = concentration, in mmol/L

ϵ = millimolar absorptivity of protoporphyrin IX free acid in 1.5 mol/L HCl, 297.45 L/mmol-cm

For example, if the daily absorbance reading of the 100 $\mu\text{g/dL}$ standard at λ maximum is 0.520, then:

$$C = \frac{0.520}{(297 \text{ L/mmol-cm}) (1 \text{ cm})} = .00175 \text{ mmol/L}$$

Then: (.00175 mmol/L) (562.27 mg/mmol) (1000 $\mu\text{g/mg}$) (1L/10 dL) = 98.40 $\mu\text{g/dL}$
PPIX FA

Consider 98.40 as a percentage of 100 $\mu\text{g/dL}$ and correct the standard curve accordingly:

$$10 \mu\text{g/dL} \times .9840 = 9.84$$

$$20 \mu\text{g/dL} \times .9840 = 19.68, \text{ etc.}$$

Perform a linear regression with x = corrected standard concentration, and y = fluorescent intensity reading. Using the slope of the standard curve, and assuming zero intercept, calculate the concentration of protoporphyrin IX per deciliter of whole blood for each specimen. To correct for hematocrit and express results as $\mu\text{g/dL}$ of RBC, use this formula:

$$\frac{\mu\text{g/dL whole blood}}{\text{hematocrit}} \times 100 = \mu\text{g/dL RBC}$$

7. CDC Modifications

The following modifications of the original methods are based on CDC optimization experiments:

(a) sample size increased from 2 μL to 10 μL ; (b) ethyl acetate-acetic acid and 0.43 mol/L HCl volumes increased from 0.3 mL to 1.0 mL; (c) processed protoporphyrin IX standards used; (d) hydrolysis time for the dimethyl ester decreased from 48 h to 3 h, on the basis of the work of Culbreth *et al.*³; and (e) 0.43 mol/L HCl chosen for maximum fluorescent intensity of the extracted protoporphyrin IX.

B. SERUM IRON AND TOTAL IRON-BINDING CAPACITY

1. Principle

Serum iron and total iron-binding capacity (TIBC) are measured by a modification of the automated Technicon AAII-25 method, which is based on the procedures of Giovannello *et al.*⁴ and Ramsey⁵. Iron is quantitated by measuring the intensity of the violet complex formed in the reaction between ferrozine and Fe (II) in pH 4.7 acetate buffer at 562 nm.

In TIBC tests, serum is mixed with a 400 $\mu\text{g/dL}$ iron solution to saturate the iron-binding sites of the serum transferrin molecules. Magnesium carbonate is used to remove excess iron. After centrifugation to precipitate the magnesium carbonate, the supernatant is analyzed for iron.

2. Instrumentation

a. Technicon AutoAnalyzer I system (Technicon Instruments, Inc., Tarrytown, NY)

(1) Sampler II or III with 30/h 1:1 cam

(2) Pump II

(3) Dialyzer — 37°C, with two standard type C dialysis plates connected in series

(4) Colorimeter — with 50-mm I.D. flowcell and 570-nm filters

(5) Bristol Recorder

(6) Flow-rated tubing

- b. Micromedic Model 25000 Automatic Pipette, with 1.0-mL sampling and 5.0-mL dispensing pumps (Micromedic Systems, Division of Rohm and Haas, Horsham, PA)
- c. Vortex mixer (Fisher Scientific Co., Fairlawn, NJ)
- d. IEC Centrifuge, Model UV (International Equipment Co., Needham Heights, MA)

3. *Materials*

- a. 2.0-mL disposable conical bottom sample cups for AutoAnalyzers, HRI No. 8889-201409 (Lancer Division, Sherwood Medical Corp., St. Louis, MO)
- b. Disposable filtering columns (Whale Scientific Co., Denver, CO)
- c. "Ferrozine" iron reagent (3-(2 pyridyl)-5,6 bis (4-phenylsulfonic acid)-1, 2, 4, triazine, monosodium, monohydrate), 93.95% purity (Hach Chemical Co., Ames, IA)
- d. L-ascorbic acid, 99.9% purity (J. T. Baker Co., Phillipsburg, NJ)
- e. Magnesium carbonate (basic), Fisher certified (Fisher Scientific Co.)
- f. Sodium hydroxide (NaOH), electrolytic pellets, A.C.S. certified (Fisher Scientific Co.)
- g. Acetic acid, glacial, reagent grade (J. T. Baker Co.)
- h. Hydrochloric acid (HCl), concentrated, reagent grade (J. T. Baker Co.)
- i. Brij-35, 30% solution (Pierce Chemical Co., Rockford, IL)
- j. 15- X 85-mm disposable culture tubes (Corning Glass Works, Corning, NY), lot-tested for iron contamination
- k. Iron wire, 99.9% purity (Mallinckrodt Chemical Works, St. Louis, MO)
- l. Deionized water, ≥ 1.0 megaOhm-cm at 25°C (Continental Water Co., Atlanta, GA)
- m. Sodium chloride (NaCl), ACS certified (Fisher Scientific Co.)

4. *Reagent Preparation*

- a. *0.2 mol/L Hydrochloric Acid with 3 g/dL Sodium Chloride*
To 250 mL of deionized water in a 2-liter flask, add 34 mL of concentration HCl, 60 g of NaCl, and 0.5 mL of Brij-35, 30% solution. Mix well and dilute to 2 L with water. (Prepare as needed; stable at 25°C.)
- b. *1.0 g/dL Ascorbic Acid*
Add 8 g of L-ascorbic acid to 800 mL of 0.2 mol/L HCl with 3 g/dL NaCl. Mix well. (Prepare daily.)
- c. *0.75 mol/L Acetate Buffer, pH 4.7 at 25°C*
Add 45 g of glacial acetic acid and 19.5 g of NaOH pellets to 200 mL of deionized water in a 1-liter flask. Mix well, with stirring, and dilute to volume with deionized water. Check to ensure that final pH is 4.7 ± 0.1 and adjust if necessary with 0.1 N NaOH or 0.1 N HCl. (Prepare weekly; stable at 25°C.)
- d. *0.07 g/dL Ferrozine*
Add 0.7g ferrozine to 1 L of 0.75 mol/L acetate buffer solution and mix well. (Prepare weekly; stable at 25°C.)
- e. *0.5 ml/L Brij-35 Wash Solution*
Add 1.0 mL Brij-35, 30% solution, to 2 L deionized water and mix well. (Prepare weekly.)
- f. *0.1 mol/L Hydrochloric Acid (for Standards)*
Add 9.3 mL concentrated HCl to 500 mL deionized water in a 1-liter volumetric flask. Mix well and dilute to volume with water. Do not add Brij-35. (Approximately 5 L of this solution is required to prepare intermediate and working standards.)
- g. *400 µg/dL Iron Saturating Solution*
Dilute 2.0 mL of the 1.0 g/dL stock iron standard to volume in a 500-mL flask with deionized water. (Stable at 25°C.)

5. *Standard Preparation*

- a. *1.0 g/L Stock Iron Standard Solution*
Place 1.000 g iron wire in a 1-liter volumetric flask. Add 12 mL of concentrated HCl and dissolve wire with slight warming. After dissolution of wire is complete, cool flask to room temperature and dilute to volume with deionized water. (Stable indefinitely; store in a polyethylene container at 25°C.)
- b. *50.0 mg/L Iron Intermediate Stock Solution*
Dilute 25 mL of the 1.0 g/L stock iron solution to 500 mL with 0.1 mol/L HCl. (Prepare each time new working standards are required.)

c. *Working Iron Standards*

In a series of 500-mL volumetric flasks, prepare dilutions from the intermediate standard as shown below. Dilute to 500 mL with 0.1 mol/L HCl and mix well. (Prepare every 3 months.)

WORKING IRON STANDARDS (Dilute to 500 mL with 0.1 mol/L HCl)	
mL of 50 mg/L Intermediate Standard	Final Concentration $\mu\text{g/dL}$ Iron
3	30
5	50
8	80
10	100
15	150
20	200
25	250
30	300

6. *Procedure*

a. *Preparation of Serum Samples for Iron Assay*

Mix freshly drawn or thawed serum samples thoroughly, using a Vortex mixer. Filter about 1.5 mL of serum into a 2.0-mL AutoAnalyzer sample cup, using a disposable plastic filtration column to remove fibrin.

b. *Preparation of Samples for TIBC Assay*

Using the Micromedic Automatic Pipette, add 0.8 mL of well-mixed filtered serum to 1.6 mL of 400 $\mu\text{g/dL}$ iron saturating solution in 15- X 80-mm tubes. Mix well (vortex) and allow tubes to stand for at least 15 min (at this point, the samples may be tightly capped and kept at 4°C overnight if necessary). Add 0.2 g of basic magnesium carbonate directly to each tube of diluted serum. Vortex contents of tubes, then allow the tubes to stand for 45 min, mixing at 15-min intervals. Centrifuge the samples at 2500 rpm for 10 min to pack the magnesium carbonate. Decant the supernatant into 2.0-mL AutoAnalyzer sample cups and proceed as with the iron analysis.

c. *Quality Control Materials*

Assay quality control pools in the same manner as sample, with this exception: TIBC cannot be accurately determined on reconstituted lyophilized serum.

d. *Operation*

Follow standard AutoAnalyzer protocol as in *Practical Automation for the Clinical Laboratory*⁶.

Approximately 0.8 mL of serum or supernatant is required for each analysis. For every 40 specimens, standards and controls are analyzed in duplicate.

Change flow-rated pump tubing and type C dialysis membranes every 4 days of analysis. For maximal sensitivity, the 300 $\mu\text{g/dL}$ standard should read at least .350 absorbance units, making making the use of scale expansion unnecessary.

e. *Calculations*

Calculate serum iron concentrations of specimens and diluted TIBC samples from the slope and y-intercept of the standard curve. Then multiply the iron concentration of the diluted TIBC sample by the dilution factor of 3. Report serum iron and TIBC as micrograms of iron per deciliter of serum ($\mu\text{g/dL}$). Verify by dilution and/or reassay any serum iron concentrations less than 30 ($\mu\text{g/dL}$) or greater than 200 $\mu\text{g/dL}$ and TIBC concentrations less than 250 $\mu\text{g/dL}$ or greater than 500 $\mu\text{g/dL}$. The analysis is linear to 1000 $\mu\text{g/dL}$.

7. *CDC Modifications*

The following modifications to the Technicon AAII-25 method are noted: (a) The reagent concentrations used and their ratios are based in procedures developed at CDC, (b) two standard Technicon AutoAnalyzer I type C dialysis plate assemblies are connected in series to increase the efficiency of dialysis, (c) ferrozine is incorporated into the acetate buffer, and (d) a 50-mm flow-cell is used in the colorimeter to maximize sensitivity.

8. *Flow Diagram (See following page)*

SERUM IRON AND TOTAL IRON BINDING CAPACITY FLOW DIAGRAM

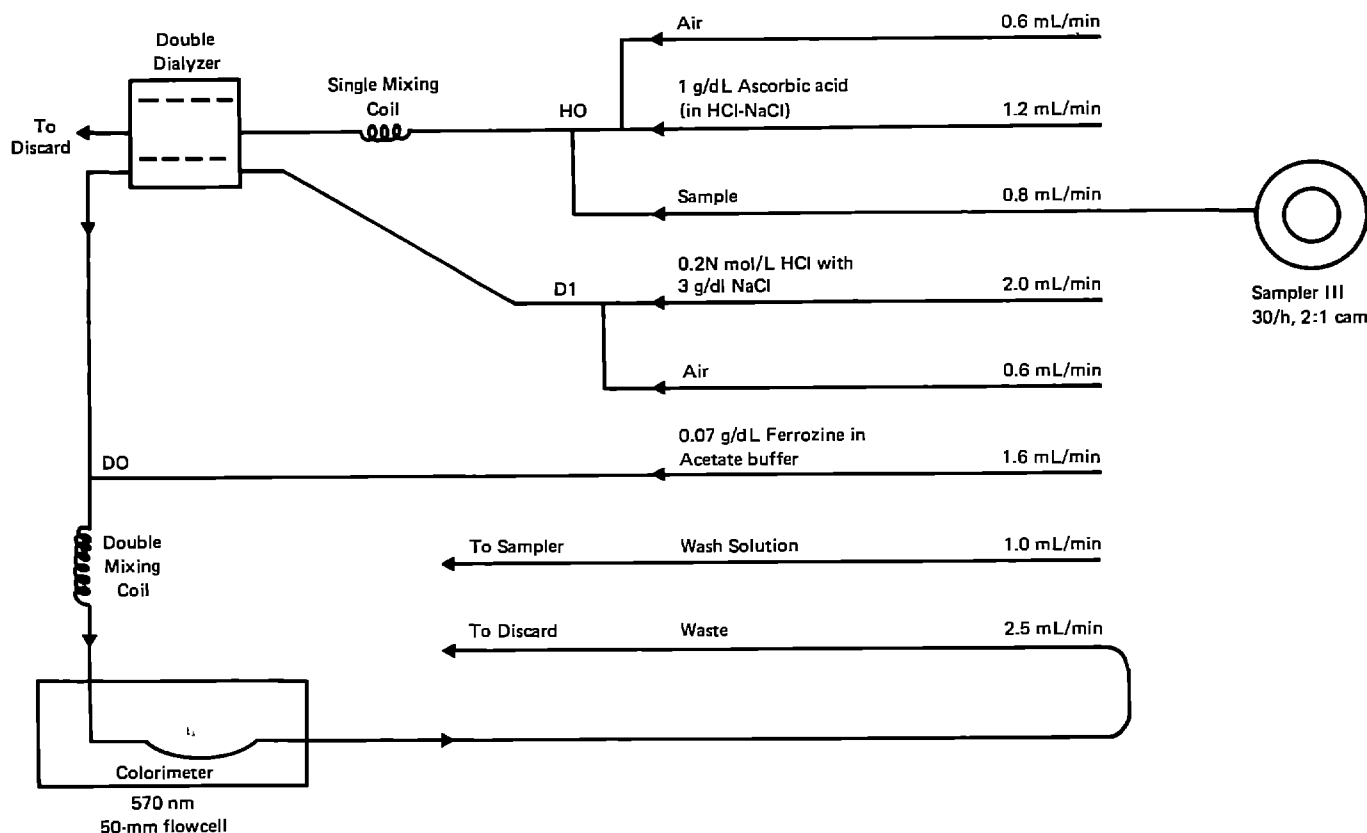

C. SERUM ALBUMIN

1. Principle

This automated method is a direct adaptation of the Technicon AutoAnalyzer II Bromcresol Green method⁷, which is based on the procedure of Doumas, Watson, and Biggs⁸. Bromcresol green dye binds selectively to albumin in human serum. The final dilution of the sample to BCG dye in pH 4.2 succinate buffer is 1:800. The albumin-BCG complex is measured at 630 nm.

2. Instrumentation

a. Technicon AutoAnalyzer II system with Albumin-BCG Manifold

OR:

- (1) Sampler Models II, III, or IV, with 60/h 1:1 cam
- (2) Proportioning Pump III with air bar
- (3) Colorimeter with 630-nm filters and 15-mm I.D. flowcell
- (4) Flow-rated tubing
- (5) Bristol recorder

(Technicon Instruments Corp., Tarrytown, NY)

b. Vortex mixer (Fisher Scientific Co., Fairlawn, NJ)

3. Materials

a. Brij-35, 30% solution (Pierce Chemical Co., Rockford, IL)

b. Working Bromcresol Green solution (No. T01-0573, Technicon or CS-103-1M, Fisher Scientific Co.) – ready-to-use reagent, made from BCG dye which is dissolved in dilute sodium hydroxide, then mixed in 0.1 mol/L succinate buffer and adjusted to pH 4.2.

OR:

c. Bromcresol Green, ACS certified (Allied Chemical Co., Morristown, NJ)

- d. Succinic acid, reagent grade (Fisher Scientific Co.)
- e. Sodium hydroxide (NaOH), reagent grade (Fisher Scientific Co.)
- f. Sodium chloride (NaCl), reagent grade (Fisher Scientific Co.)
- g. "Pentex" Human Albumin solution, Fraction V, 99.5% purity, 10 g/dL (Research Products Division, Miles Laboratories, Inc., Elkhart, IN)
- h. Disposable 0.5-mL conical bottom AutoAnalyzer sample cups, HRI No. 8889-20149 (Lancer Division, Sherwood Medical Co., St. Louis, MO)
- j. Falcon No. 2027 13- X 100-mm disposable plastic screw-cap tubes (Becton-Dickinson Co., Oxnard, CA)

4. Reagent Preparation

(If commercially prepared BCG working solution is not used, prepare reagents 1-4.)

- a. *0.1 mol/L, pH 4.0 Succinate Buffer*
Dissolve 23.8 g of succinic acid in about 1600 mL of distilled water. Adjust to pH 4.0 with 2 mol/L NaOH and dilute to 2 L with water. (Prepare weekly; store at 4°C.)
- b. *Stock BCG Solution*
Dissolve 419 mg BCG in 10 mL of 0.1 mol/L NaOH and dilute to 1 L with distilled water. (Prepare weekly; store at 4°C.)
- c. *Working BCG Solution*
Mix 200 mL of stock BCG solution and 500 mL of succinate buffer. Add 4.0 mL of Brij-35, 30% solution, and adjust to pH 4.2 using 2 mol/L NaOH. (Prepare daily; store at 4°C, bringing solution to room temperature prior to use.)
- d. *2 mol/L Sodium Hydroxide*
Add 80 g of NaOH pellets to 500 mL of distilled water in a 1-liter volumetric flask. Mix thoroughly by stirring until pellets are dissolved. Dilute to 1 L with distilled water. (Stable at 25°C.)
- e. *0.1 mol/L Sodium Hydroxide*
Dissolve 4 g of NaOH pellets in 1 L of water, with stirring. (Stable at 25°C.)
- f. *Brij-H₂O Diluent*
Add 0.5 mL Brij-25, 30% solution to 2 L distilled H₂O and mix thoroughly. (Do not exceed this concentration of Brij-35, or the binding of BCG to albumin may be affected.)
- g. *0.85 g/dL Sterile Saline (for standard preparation)*
Add 8.5 g of NaCl to 1 L of distilled water and mix well. Autoclave at 15 psi, 121°C, for 10 min, or filter-sterilize using 0.22-μ filter. (Store at 4°C.)

5. Standard Preparation

Using 0.85 g/dL sterile saline, dilute 10.0 g/L Pentex human albumin solution for 1 day's run, as follows: Make up all standard dilutions in disposable screw-capped plastic tubes, and mix thoroughly. (Store at 4°C during analysis, using aliquots as needed.)

mL of 10 g/dL Stock	mL 0.85 g/dL Saline	Final Conc. g/dL
1.0	4.0	2.0
1.5	3.5	3.0
2.0	3.0	4.0
2.5	2.5	5.0
3.5	1.5	7.0

Note: The actual assayed concentration of albumin may vary from lot-to-lot of the Pentex stock; correct the final concentrations appropriately.

6. Procedure

- a. *Preparation of Serum Samples*
Mix freshly drawn or thawed serum samples thoroughly, using a Vortex mixer. Filter about 0.4 mL of serum into the 0.5 mL sample cup, using a plastic filtration column to remove fibrin. To prevent the samples from evaporating, do not keep serum at room temperature for prolonged periods of time or leave sample trays uncovered.
- b. *Operation*
Follow standard AutoAnalyzer operation protocol, as shown in *Practical Automation for the Clinical Laboratory*⁹.

Assay all standards, three levels of quality control materials, and serum specimens in duplicate. Bracket every 40 specimens with standard curves to correct for "drift" in the system. Record absorbance values of samples.

c. *Calculations*

Calculate the albumin concentration of the serum specimens, using the slope and y-intercept of the standard curve. Report results as grams albumin per deciliter of serum (g/dL). Verify by reassay any sample with albumin concentration less than 3.0 g/dL or greater than 5.5 g/dL.

7. *CDC Modifications*

The following modifications to the original method are noted: (a) a 60/h 1:1 cam was substituted on the Technicon Sampler IV for the 60/h 9:1 cam specified in the BCG-Albumin AutoAnalyzer II methodology; and (b) all standards are prepared from 99.5% purity human albumin, Fraction V, and all quality control materials are prepared from human serum.

8. *Flow Diagram*

SERUM ALBUMIN FLOW DIAGRAM

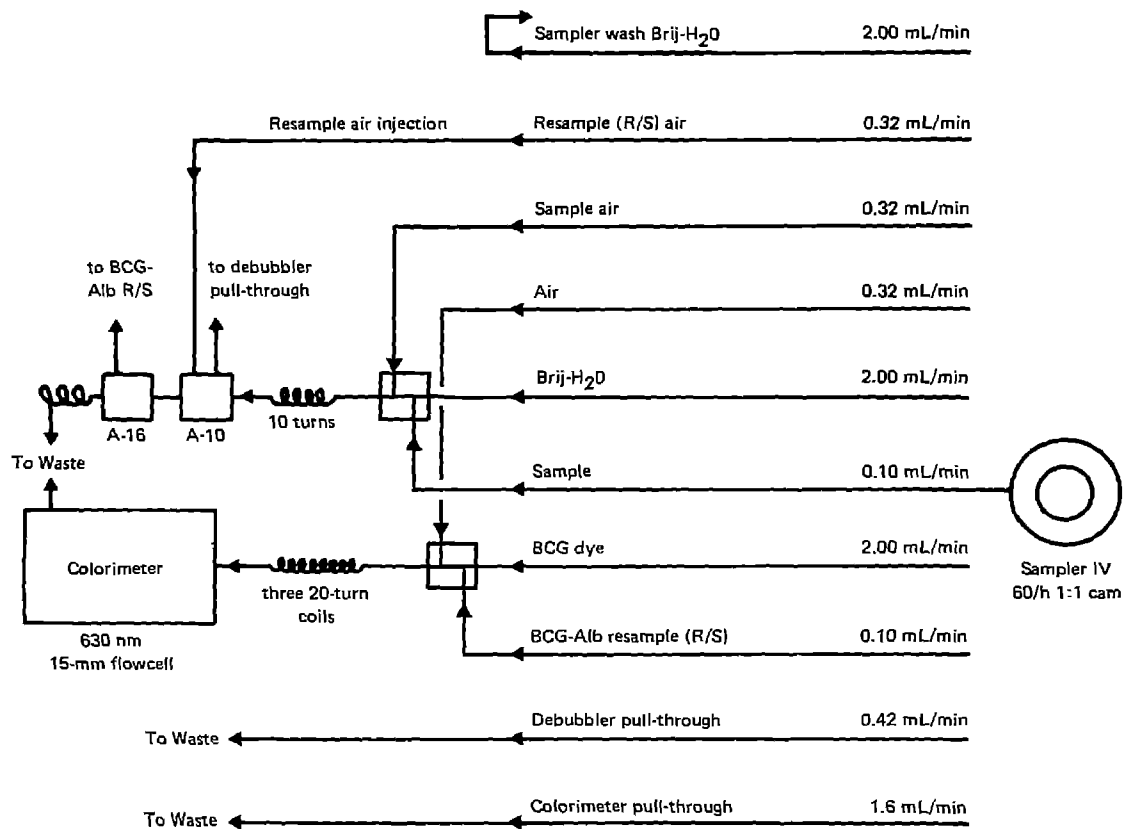

D. SERUM VITAMIN C

1. *Principle*

The vitamin C method is a modification of the ascorbic acid methodology of Roe¹⁰ and Kuether¹¹, and measures total vitamin C. Serum is diluted 1:5 (v/v) with meta-phosphoric acid to preserve ascorbic acid and to precipitate proteins. Ascorbic acid is converted to dehydroascorbic acid in the presence of thiourea and copper sulfate. Dehydroascorbic acid couples with 2, 4-dinitrophenylhydrazine in 9.0 mol/L sulfuric acid to form a bis-2, 4-dinitrophenylhydrazine derivative. When treated with 65% (v/v) sulfuric acid, this derivative yields a stable brownish-red color, which is measured with a spectrophotometer at 520 nm.

2. Instrumentation

- a. Micromedic MS-2 spectrophotometer
(Micromedic Systems, Division of Rohm and Haas, Horsham, PA), or: double-beam spectrophotometer for manual absorbance recordings
- b. Vortex mixer
(Fisher Scientific, Fairlawn, NJ)
- c. Water bath, circulating
(Blue M Electric Co., Blue Island, IL)
- d. Sorvall GLC-1 centrifuge
(DuPont Sorvall Instruments, Newtown, CT)
- e. SMI Micropettors, sizes G and H
(Scientific Manufacturing Industries, Emeryville, CA)
- f. Repipet dispensing bottles, 1.0- and 10.0-mL dispensing sizes
(LabIndustries, Berkeley, CA)

3. Materials

- a. m-Phosphoric acid, glacial, ACS grade
(Mallinckrodt Co., St. Louis, MO)
- b. Sulfuric acid (H_2SO_4), concentrated, ACS reagent grade (95-98% assay H_2SO_4)
(Fisher Scientific Co.)
- c. 2,4-Dinitrophenylhydrazine, with 10-20% H_2O
(Sigma Chemical Co., St. Louis, MO)
- d. Thiourea (Thiocarbamide), crystal, ACS certified
(Fisher Scientific Co.)
- e. Cupric sulfate (pentahydrate), crystal, "Baker-Analyzed"
(J. T. Baker, Phillipsburg, NJ)
- f. L-(+)-Ascorbic acid, $\geq 99.5\%$ purity, "Baker-Analyzed"
(J. T. Baker)

4. Reagent Preparation

- a. *6 g/dL Meta-Phosphoric Acid (MPA)*
Dissolve 60 g of m-phosphoric acid (a mixture of m-phosphoric acid and sodium metaphosphate crystals) in 400 mL of deionized water. Mix well, and dilute to a final volume of 1 L. (Prepare as needed, store at 4°C .)
- b. *4.5 mol/L Sulfuric Acid*
Wearing safety glasses or a face shield, carefully add 250 mL of concentrated sulfuric acid (18 mol/L) to 750 mL of deionized water. Mix well. (Prepare as needed.)
- c. *65% (v/v) Sulfuric Acid*
With caution (and while wearing a face shield, and mixing flask in an ice bath), add 1300 mL concentrated H_2SO_4 to 700 mL deionized water. (Cool mixture completely and store in 10-mL dispensing Repipet bottle at 4°C .)
- d. *2.2 g/dL 2,4-Dinitrophenylhydrazine (DNP)*
Dissolve 4.84 g of 2,4-DNP in 220 mL 4.5 mol/L sulfuric acid. Mix solution well, filter, and measure 200 mL to use in preparing DTC reagent. (Prepare weekly, store at 4°C .)
- e. *5 g/dL Thiourea*
Dissolve 5 g of thiourea in 20 mL of deionized water in a 100-mL volumetric flask. Mix well, and dilute to volume. (Prepare monthly, store at 4°C .)
- f. *1 g/dL Copper Sulfate Solution*
Dissolve 1.56 g of cupric sulfate ($\text{CuSO}_4 \cdot 5 \text{H}_2\text{O}$) in 20 mL of deionized water in a 100-mL volumetric flask. Mix, and dilute to volume. (Prepare monthly.)
- g. *Dinitrophenylhydrazine-Thiourea-Copper Sulfate Reagent (DTC)*
Combine 10 mL of 5 g/dL thiourea solution, 10 mL of 1 g/dL copper sulfate solution, and 200 mL of 2.2 g/dL DNP reagent. Mix well, and store at 4°C in 10-mL dispensing Repipet bottle. 100 mL of DTC is sufficient for 120 samples. (Prepare weekly.)

5. Standard Preparation

- a. *100 mg/dL (w/v) Ascorbic Acid Stock Standard*
Dissolve 100 mg of L-(+)-ascorbic acid in 30 mL of 6 g/dL MPA in a 100-mL volumetric flask. Mix and dilute to volume. (Prepare monthly, store at 4°C .)

- b. *2.5 mg/dL Ascorbic Acid Intermediate Standard*
Pipet 5 mL of stock standard into a 200-mL volumetric flask and dilute to volume with 6 g/dL MPA. (Prepare weekly, store at 4°C.)
- c. *Working Ascorbic Acid Standards*
In a series of 50-mL volumetric flasks, prepare dilutions from the intermediate standard as shown below. The actual concentration values of the standards represent the range of ascorbic acid levels in the serum samples after being diluted 1:5 with 6 g/dL MPA. Since the standard solutions are subjected to the same procedure after the original deproteinization as the serum samples, the assigned concentration values (actual concentration X 5 dilution factor) represent the concentration of vitamin C in mg/dL of serum. (Prepare daily.)

WORKING VITAMIN C STANDARDS
(Dilute to 50 mL with 6 g/dL MPA)

. mL Intermediate Std.	Actual Conc., mg/dL Standard Solution	Assigned Conc. mg/dL Serum
1.0	0.05	0.25
2.0	0.10	0.50
3.0	0.15	0.75
4.0	0.20	1.00
6.0	0.30	1.50
8.0	0.40	2.00
10.0	0.50	2.50
12.0	0.60	3.00
15.0	0.75	3.75
20.0	1.00	5.00

6. Procedure

a. *Sample Preparation*

Add 0.75 mL of fresh serum to 3.0 mL of 6 g/dL MPA in a disposable plastic tube, cap the tube, and mix thoroughly (vortex). This step stabilizes the ascorbic acid. If the samples are not analyzed the day they are prepared, the serum-MPA mixture can be stored at -20°C to -70°C for up to 3 months.

Note: During HANES II, the sample preparation step was performed in the field collection vans.

b. *Preparation of Quality Control Materials*

Prepare quality control pools in the same manner as specimens from fresh sterile-filtered human serum. Dispense 1.0 mL of serum into amber glass vials, then add 4.0 mL of 6 g/dL MPA. Cap vials and vortex contents thoroughly. Store vials at -70°C; use 1 vial per day.

c. *Analysis*

- (1) Set circulating water bath at 27°C and allow temperature to equilibrate.
- (2) Bring working standards, reagents, and frozen extracts of specimens and controls to room temperature on day of analysis.
- (3) Centrifuge specimens and controls at 2500 rpm for 20 min.
- (4) In duplicate, pipet 800 µL of the supernatant from the specimens or controls, 800 µL of each working standard dilution, and 800 µL of the 6 g/dL MPA for use as a blank, into 13-X 100-mm plastic screw-capped tubes, using a size G SMi Micropettor.
- (5) Add 0.27 mL of DTC reagent from the 1.0-mL Repipet dispenser to each tube. Cap tubes, mix contents thoroughly (vortex) and incubate in the 27°C bath for 20 h.
- (6) Remove the tubes from the water bath, and chill in an ice bath for about 10 min. Wearing safety glasses, add 1.3 mL of cold 65% sulfuric acid to each tube. Cap and mix tubes thoroughly (vortex).
- (7) Allow tubes to stand at room temperature for 30-45 min before measuring their absorbance levels. The yellow-orange color which develops is stable for several hours.
- (8) If using a double-beam spectrophotometer, measure absorbance of each tube at 520 nm in a 1-cm square cuvette, using 6 g/dL MPA as a blank solution.

(9) If using the Micromedic MS-2 Spectrophotometer, set wavelength at 520 nm aspirate reagent blank into the "test" and "blank" cuvettes, and zero the display, using the absorbance mode. Set the pressure gauge at "6" and the timer at "4." Read the standards, in ascending order, followed by controls, then specimens.

d. *Calculations*

Calculate the vitamin C concentrations of the serum specimens, using the slope and y-intercept of the absorbances of the standard curve. Report vitamin C concentration as milligrams ascorbic acid per deciliter of serum (mg/dL). Verify by reassay any results which are less than 0.3 mg/dL or greater than 3.5 mg/dL.

7. *CDC Modifications*

The following modifications to the original method are based on optimization studies performed at CDC: (a) the concentration of sulfuric acid was reduced from 85% to 65%, (b) the incubation temperature was decreased from 37°C to 27°C, and (c) the time of incubation was increased from 4 h to 20 h (overnight).

E. **SERUM ZINC AND COPPER**

1. *Principle*

Serum zinc and copper are measured by atomic absorption spectroscopy by using a CDC optimized method based on procedures from Instrumentation Laboratory, Inc.,¹² and Perkin-Elmer Corp.¹³ Quantitation is based on the measurement of light absorbed at 213.9 and 324.7 nm, respectively, by ground-state atoms of zinc and copper from hollow-cathode lamp light sources. Serum specimens, standards, and quality control samples are diluted 1:10 with 6% (v/v) n-butanol in 0.05 N HCl. The diluted samples are aspirated directly into a flame, and the concentration of zinc or copper is measured by the Perkin-Elmer Model 306 or 4000 atomic absorption spectrophotometer, which is calibrated with zero and 150 µg/dL standards to read directly in concentration units. All lots of materials used for collecting and processing samples have been screened for zinc and copper contamination, and all processing work is performed under laminar flow hoods.

2. *Instrumentation*

a. Perkin-Elmer Atomic Absorption Spectrophotometer (Perkin-Elmer Corp., Norwalk, CT)

Parameter	Model 306 Setting	Model 4000 Setting
Burner	Single-slot	Same
Lamp current	15 mA	Same
Zinc wavelength	213.9 nm	Same
Copper wavelength	324.7 nm	Same
Air pressure	40 psi	Same
Acetylene pressure	10 psi	15 psi
Aspiration time	6 sec	20 sec
Integration time	2 sec (1 avg.)	5 sec (1 avg.)
Operating mode	Concentration	Same

b. Perkin-Elmer Model 56 recorder

Range	10 mV
Chart speed	10 mm/min

(Perkin-Elmer Corp.)

c. Micromedic Model 25000 Automatic Pipette, with 1.0-mL sampling and 5.0-mL diluting pumps (glass-piston) (Micromedic Systems, Division of Rohm and Haas, Horsham, PA)

d. Agnew-Higgins Laminar-Flow Work Bench, with high-efficiency particle air (HEPA) filters to give class-100 air conditions (Agnew-Higgins, Inc., Garden Grove, CA)

e. Alcar ultrasonic bath (Alcar Industries, Inc., Belleville, NJ)

3. *Materials*

a. Zinc/copper pellets, 99.999% pure

(Research Organic-Inorganic Chemical Company, Garden City, NJ)

b. "Ultrex" concentrated hydrochloric (HCl) and nitric (HNO₃) acids (J. T. Baker Co., Phillipsburg, NJ)

- c. Triton^R X-100 – alkaryl polyether alcohol (Rohm and Haas, Horsham, PA)
- d. Falcon No. 2057 disposable culture tubes, 17- X 100-mm (Becton Dickinson Co., Cockeysville, MD)
- e. N-butanol, ACS certified (Fisher Scientific Co., Fairlawn, NJ)
- f. Deionized water, ≥ 1.0 megaOhm-cm at 25°C (Continental Water Co., Atlanta, GA)
- g. Acetylene, purified (Matheson Gas Co., East Rutherford, NJ)
- h. Compressed air, medical grade (Air Products Co., Atlanta, GA)

4. *Reagent Preparation*

(All nondisposable glassware is washed in 10% (v/v) HNO₃ and rinsed 6 times with deionized water.)

- a. *0.1 mol/L Hydrochloric Acid (HCl)*
Dilute 35 mL of Ultrex HCl to 4 L with deionized water, and mix well.
- b. *0.05 mol/L Hydrochloric Acid*
Dilute 17.6 mL of Ultrex HCl to 4 L with deionized water, and mix well.
- c. *6% (v/v) n-Butanol in 0.05 mol/L HCl*
Dilute 60 mL of n-butanol to 1 L with 0.05 mol/L HCl, and mix well.

5. *Standard Preparation*

a. *1.0 mg/mL Stock Standards*

(1)Copper

Weigh 1.00 g of copper shot and dissolve in 5 mL of Ultrex concentrated nitric acid. Dilute to 1 L with deionized water and mix well. (Stable indefinitely at 25°C in polyethylene bottles.)

(2)Zinc

Weigh 1.00 g of zinc shot and dissolve in 5 mL of Ultrex concentrated nitric acid. Dilute to 1 L with deionized water and mix well. (Stable indefinitely at 25°C in polyethylene bottles.)

b. *50 µg/mL Intermediate Standard*

Pipet 10 mL each of the copper and zinc stock standards into a single 200-mL volumetric flask and dilute to volume with 0.1 mol/L HCl. Prepare this standard each time new working standards are to be made. (Freshly prepared intermediate stock standard diluted 1:10 with 6% n-butanol should be within $\pm 1\%$ of the absorbance level of the old intermediate standard for both zinc and copper, analyzed in triplicate. If this criterion is not satisfied, prepare a new intermediate stock and repeat procedure. If the criteria for either zinc or copper are still not met, prepare new stock solution and repeat entire procedure.)

c. *Combined Linearity-Check Standards*

Prepare in 200-mL volumetric flask by adding the required amount of intermediate standard and diluting to the mark with 0.1 mol/L HCl, as follows:

mL Intermediate Stock	Concentrations µg/dL Zinc and Copper
2.0	50
4.0	100
6.0	150
8.0	200
10.0	250
12.0	300

(Prepare every 6 months, store at 25°C.)

Note: Enter the absorbances of freshly prepared working standards, read in triplicate versus the absorbances of the old working standards, into a linear regression calculation program. The slope should be 1.0 ± 0.01 , and the correlation coefficient $\geq .999$ for the new standards to be accepted. If these criteria are not met because one or more of the new standards appear to be improperly prepared, redilute the suspected working standard and repeat this verification procedure. Once the new working standards have met the above criteria, their adequacy is re-confirmed each analytical day by performing a linearity check in concentration mode. (See Section 6.b. - "Operation.")

d. *5.0 µg/dL Copper/0.5 µg/dL Zinc Absorbance-Check Standard*

Pipet 5 mL of copper stock standard and 0.5 mL of zinc stock standard into a 1-liter volumetric flask, and dilute to volume with 0.1 mol/L HCl.

6. *Procedure*

a. *Sample Preparation*

Prepare duplicate 1:10 dilutions of working standards, quality control materials, and serum specimens with 6% n-butanol in 0.05 mol/L of HCl. Using a Micromedic Automatic Pipette, dilute 0.35 mL of the serum sample with 3.15 mL diluent, and repeat to give 7.0 mL total volume. Dispense dilutions into 17- X 100-mm plastic tubes, cap the tubes, and mix contents by inversion. For the linearity-check standards and controls, make four complete dilutions into each tube to have adequate volume, yielding a total volume of 14.0 mL per tube. Prepare several zero standard tubes containing diluent only.

b. *Operation*

Follow Perkin-Elmer standard operating procedure for the 306 or 4000 atomic absorption spectrophotometers. (For optimum performance, the instrument parameters must be carefully adjusted for each element. Lamp and burner alignment, fuel flow, nebulization, and wavelength peaking are very critical.) To check nebulizer optimization, aspirate an aliquot of the absorbance check standards. Absorbance readings should be 0.250 to 0.300 for copper or 0.100 to 0.150 for zinc; otherwise, the nebulizer must be repeaked. After peaking the instrument on the proper wavelength for either zinc or copper, switch to concentration mode, autozero with a zero standard solution and set the scale expansion to read "150" with the 150 µg/dL standard. Perform a linearity check by analyzing each standard and control in duplicate. To determine acceptability of instrument conditions, enter the actual concentrations of the standards versus the expanded scale readout concentrations into a linear regression program. The correlation coefficient should be $\geq .999$; the slope, 1.0 ± 0.01 ; and the quality control values should be within their respective 95% confidence limits. Analyze the 150-µg/dL standard after every 10th sample. Three levels of quality control materials are included and analyzed with every 20 samples. Analyze zinc on all samples first, since zinc contamination is most easily incurred, then change lamps and parameters and analyze for copper. Report results as micrograms of zinc or copper per deciliter of serum (µg/dL). Verify by redilution and reassay any zinc results <60 µg/dL or >120 µg/dL and any copper results <70 µg/dL and >180 µg/dL.

7. *CDC Modifications*

The following modifications to the standard method are based on CDC optimization experiments: (a) HCl diluent concentration is changed from 0.1 to 0.05 mol/L; (b) for the Model 4000 AAS, 0.25 mL Triton X-100 is added per L of diluent to enhance nebulization; (c) dilution of sample is 1:10 rather than 1:4 to reduce protein clogging of the nebulizer and burner; and (d) a single-slot rather than triple-slot burner is used.

F. **SERUM VITAMIN A**

1. *Principle*

Serum vitamin A is quantitated by a modification of Roels' and Trout's¹⁴ adaptation of the method of Neeld and Pearson¹⁵. Serum is mixed with ethanolic potassium hydroxide to precipitate the proteins and saponify the retinyl esters. Retinol and carotenoids are then extracted in n-hexane and measured spectrophotometrically at 450 nm for quantitation of β-carotene. Then the solvent of the extract is evaporated and the residue is dissolved in chloroform. Trifluoroacetic acid is added to this solution and the intensity of the resulting transient blue color is measured at 620 nm. Correction is made for the contribution of carotene at 620 nm.

2. *Instrumentation*

- a. Perkin-Elmer Model 44 spectrophotometer
(Perkin-Elmer Corp., Norwalk, CT)
- b. Beckman 10 in chart recorder
(Beckman Instruments Company, Fullerton, CA)
- c. Vortex mixer
(Fisher Scientific Company, Fairlawn, NJ)
- d. Micromedic Model 25000 Automatic Pipette, with 1.0-mL sampling and 5.0 mL dispensing pumps
(Micromedic Systems, Division of Rohm and Haas, Horsham, PA)
- e. Heating bath, 50°C
(Precision Scientific Co., Chicago, IL)

- f. SMI Micropettor, size G
(Scientific Manufacturing Industries, Emeryville, CA)
- g. Sorvall GLC-1 centrifuge
(DuPont Sorvall Instruments, Newton, CT)

3. *Materials*

- a. Hexane, spectrophotometric quality
(Matheson Coleman Bell, Norwood, OH)
- b. Chloroform, spectrophotometric quality
(Mallinckrodt, Inc., St. Louis, MO)
- c. Ethanol, dehydrated, U.S.P.
(Publicker Industries, Linfield, PA)
- d. Potassium hydroxide (KOH) pellets, ACS certified
(Fisher Scientific Co.)
- e. Trifluoroacetic acid (TFA), ACS certified
(J. T. Baker Co., Phillipsburg, NJ)
- f. Vitamin A, U.S.P. Reference Standard. Each capsule contains approximately 250 mg of a solution in cottonseed oil to contain in each gm 33.4 mg of all-trans retinyl acetate, equivalent to 29.1 mg of retinol (Vitamin A)
(U.S. Pharmacopeial Convention, Inc., Rockville, MD)
- g. β -Carotene (all-trans)
Sigma Chemical Co., St. Louis, MO
(Product should have a molar absorptivity (ϵ) of 2518 at 451 nm in n-hexane, with λ -maxima at 451 and 479 nm, and λ -minimum at 468 nm.)
- h. Nitrogen gas, high purity, 99.99%
(Matheson Gas Co., East Rutherford, NJ)
- i. Corning disposable glass culture tubes, 10- X 75-mm, lot-tested for absorbance variance in performance as cuvetts (Corning Glass Works, Corning, NY)
- j. Repipet dispensing bottle, 2.0-mL delivery
(Lab Industries, Berkeley, CA)

4. *Reagent Preparation*

- a. *1.0 mol/L Ethanolic Potassium Hydroxide*
Dissolve 5.6 g KOH in 10 mL distilled water; then dilute to 100 mL with absolute ethanol. Prepare this solution each time assay is performed for sample preparation. For working standard preparation (weekly) as well, increase KOH to 28 g dissolved in 50 mL of distilled water and dilute to 500 mL with absolute ethanol.

5. *Standard Preparation*

- a. *3750 μ g/dL Stock Retinol Standard*
Weigh 129 mg U.S.P. Vitamin A reference standard in a glass micro-weighing boat. (129 mg U.S.P. standard X 2.91% retinol equivalence is equal to 3754 μ g retinol.) Dissolve the oil with ethanol, then transfer the mixture to a 100-mL volumetric flask, and dilute to volume with ethanol. (Prepare monthly; store at -20°C .)
- b. *750 μ g/dL Intermediate Standard*
Dilute 10 mL of 3750 μ g/dL stock standard to volume with ethanol in a 50-mL volumetric flask. (Prepare weekly.)
- c. *Working Vitamin A Standards*
Dilute 750 μ g/dL intermediate standard with 1.0 mol/L ethanolic KOH in 50-mL volumetric flasks, as follows:

mL 750 μ g/dL Standard	Final Volume, mL	Final Concentration μ g/dL
1	50	15
2	50	30
3	50	45
4	50	60
5	50	75

(Prepare weekly; store at -20°C .)

d. *β -Carotene Standards*

Prepare *all* carotene standards each time of assay; they are not stable. Store any unused crystalline β -carotene in an evacuated container under nitrogen at -20°C .

500 $\mu\text{g}/\text{mL}$ Stock β -Carotene Standard

Dissolve 50 mg of crystalline β -carotene in 100 mL of chloroform in a volumetric flask. Mix well.

e. *5000 $\mu\text{g}/\text{dL}$ Intermediate Standard*

Dilute 5.0 mL stock standard to volume with hexane in a 50-mL volumetric flask.

f. *Working β -Carotene Standards*

Dilute the 5000 $\mu\text{g}/\text{dL}$ intermediate standard with hexane in 100-mL volumetric flasks, as follows:

mL 5000- $\mu\text{g}/\text{dL}$ Inter. Std.	Final Volume, mL	Final Conc. $\mu\text{g}/\text{dL}$
0	100	0
1	100	50
2	100	100
3	100	150
4	100	200
5	100	250

6. *Procedure*

Analyze serum specimens, quality control pools, and standards in duplicate. The standards will be assayed by addition to a low vitamin A serum base pool.

a. *Sample Extraction*

- (1) Pipet 1.0 mL of the serum specimen or quality control pool, in duplicate, into 5-mL glass-stoppered centrifuge tubes. Pipet 1.0 mL of each working standard concentration, in duplicate, into similar tubes containing 1.0 mL of a low vitamin A level serum pool, and vortex each tube thoroughly. Prepare "processed" blanks with 1.0 mL of distilled water as sample.
- (2) Add 1.0 mL of 1.0 mol/L ethanolic potassium hydroxide to all tubes except the standards. Stopper tubes, and mix contents of tubes thoroughly.
- (3) Place all tubes in a 50°C water bath for 10 min.
- (4) Cool tubes to 20 - 25°C . Add 2.0 mL n-hexane to each tube, taking care to restopper quickly.
- (5) Centrifuge tubes at 1500-2000 rpm for 2 min.

b. *β -Carotene Measurement*

Remove 1.6 mL of the hexane layer of each tube with a long-tip graduated pipet, transfer it to a 10- X 75-mm glass tube previously purged with nitrogen, and seal with a cork stopper. Measure the absorbance of β -carotene of each sample at 450 nm versus a hexane blank, using a spectrophotometer.

c. *Vitamin A Measurement*

- (1) After completing carotene assessment, evaporate contents of each tube to dryness with nitrogen at 25°C . (This was accomplished by using a specially designed manifold with outlet ports for 20 samples, attached to a tank of nitrogen.) Add 0.9 mL of chloroform to the residue in each tube, and mix contents well.
- (2) Using the Micromedic Automatic Pipette, dispense 0.1 mL trifluoroacetic acid (TFA) to a tube containing 0.9 mL chloroform only. Vortex thoroughly and use this tube as a blank to zero the spectrophotometer at 620 nm. Dispense 0.1 mL of TFA to a "processed" blank and measure its absorbance. If absorbance of this reagent blank is greater than 0.005A, check reagents for contamination and repeat analysis. If the absorbance is satisfactory, zero the instrument with the reagent blank and continue by processing one tube at a time. Add 0.1 mL of TFA to the first standard tube, vortex, and read absorbance at 620 nm approximately 8-10 seconds (the "pause" point) after the TFA has been added. Then proceed with the rest of the standards, quality control pools, and serum specimens.

d. *Calculations*

- (1) Determine the slope of the vitamin A standards (0 $\mu\text{g}/\text{dL}$ is the "processed" blank) as added to the serum base pool, with x as concentration in $\mu\text{g}/\text{dL}$ and y as absorbance, using linear regression.

(2) Determine the vitamin A concentration of a serum specimen:

$$\text{Concentration Vitamin A} = [(Abs_{620} - (Abs_{450} * F_{\beta})) - a] / b$$

in $\mu\text{g/dL}$

where:

a = y-intercept, or the absorbance of the base pool at 620 nm

b = slope of the standard curve

F_{β} = the β -carotene correction factor, the ratio of the contribution of β -carotene at 620 and 450 nm, experimentally determined in our laboratory to be 0.76.

Results are reported as micrograms of vitamin A per deciliter of serum ($\mu\text{g/dL}$).

Note: Determine the β -carotene correction factor in the following manner: add 1.0 mL of the serum base pool and 1.0 mL of ethanolic KOH to each of twelve 5-mL glass centrifuge tubes. Analyze the contents of the tubes as in Section 6, substituting 2.0 mL of each β -carotene standard (0, 50, 100, 150, 200, 250) to a tube (in duplicate) for the hexane addition in Step 6.b. Record the absorbances of each standard at 450 and 620 nm and calculate the slopes of the standard curves at each wavelength.

Then: $F_{\beta} = \text{slope Abs}_{620} / \text{slope Abs}_{450}$

7. CDC Modifications

The following modifications in the method of Roels and Trout were made: (a) The saponification step was changed from 30 min at 60°C to 10 min at 50°C. (b) Evaporation temperature was changed from 60°C to 25°C. (c) One drop of acetic anhydride was not added to each tube containing chloroform. (d) Readings at 620 nm after TFA was added were made at 8-10 sec instead of 30 sec. (e) Standard curves were run by method of additions to a serum pool. (f) All volumes in the procedure were scaled-up by a factor of 2.

G. SERUM AND RED CELL FOLATE (Radioassay)

1. Principle

Serum and red cell folic acid are measured by using the Bio-Rad Laboratories "Quanta-Count Folate" radioassay kit¹⁶, which is based on assays described by Dunn¹⁷ and Waxman¹⁸.

Serum (or whole blood diluted 1:5 with 1.0 g/dL ascorbic acid) is mixed with a pH 9.4 borate-dithiothreitol buffer and radioactively labeled folate (¹²⁵I-pteroylglutamic acid) derivative. After the serum is heated, folate-binding protein is inactivated while the folate is stabilized by the buffer. A binding material, folate-binding milk protein (lactalbumin), is added to the mixture of ¹²⁵I-labeled and unlabeled (serum) folate in a quantity sufficient to bind some, but not all, of the folate present. During incubation, the labeled and unlabeled folates compete for the binding sites available on the folate-binding protein on the basis of their concentrations. The higher the folate concentration in the serum, the more unlabeled folate it contains, and therefore less ¹²⁵I-labeled folate will bind to the binding protein. The bound and free (unbound) folate is separated after incubation by using dextran-coated charcoal. The level of ¹²⁵I-labeled folate is measured by using an LKB Rackgamma II gamma counter. The higher the level of radioactivity, the more ¹²⁵I-folate has been bound and the less unlabeled folate originally present in the serum (or whole blood).

2. Instrumentation

- a. LKB Rackgamma II Gamma Spectrometer
(LKB Instruments Co., Rockville, MD)
- b. IEC Centra-7 centrifuge
(International Equipment Co., Needham Heights, MA)
- c. Vortex mixer
(Fisher Scientific Co., Fairlawn, NJ)
- d. Thelco Model 84 water bath
(Precision Scientific Co., Chicago, IL)
- e. SMI Micropettors, sizes E-I, and Repettor II adaptor
(Scientific Manufacturing Industries, Emeryville, CA)

3. *Materials*

- a. Bio-Rad Laboratories "Quanta-Count Folate" folate radioassay kit, 200-tube size (Bio-Rad Laboratories, Richmond, CA)
- b. Red cell folate reagent pack (lyophilized folate-free protein base and preservative) (Bio-Rad Laboratories)
- c. Ascorbic acid, crystallized, U.S.P. (J. T. Baker, Phillipsburg, NJ)
- d. Falcon No. 2063 12- X 75-mm disposable polypropylene tubes (Becton-Dickinson Co., Oxnard, CA)

4. *Reagent Preparation*

- a. Reconstitute the following reagents as directed in the *Quanta-Count Folate Instruction Manual*:
 - (1) *Folate Binding Protein Stock Solution* — Add 10.0 mL of distilled water. (Store at -20°C if not completely used on day of analysis.)
 - (2) *Dithiothreitol (DTT)* — Add 4 mL of borate buffer.
 - (3) *Folate (PGA) ¹²⁵I / Derivative Stock Trace Solution* — Add 1.3 mL of distilled water. (Store at 2-8°C. Less than 10μCi activity as ¹²⁵I-PGA.)
 - (4) *Red Cell Folate Diluent* — Add 5.0 mL of distilled water. (Store at -20°C if not completely used on day of analysis.)
- b. Using these stock solutions, prepare the following reagents:
 - (1) *Folate Binding Protein Working Solution*
Dilute 1 part of stock solution with 4 parts of distilled water. 1.0 mL of working solution will be required for each specimen or standard assayed.
 - (2) *Dithiothreitol-Borate Buffer, pH 9.4*
Add the remainder of the borate buffer to the DTT and mix. (Store at 2-8°C.)
 - (3) *Working Tracer Solution*
Dilute the ¹²⁵I-PGA stock tracer solution 1:100 with DTT-buffer; that is, for every tube analyzed, dilute 10 μL of tracer to 1 mL with buffer. (Each standard, control, and specimen requires two tubes; two blank tubes, and one total counts tube are also required.)

5. *Standard Preparation*

Reconstitute each of the serum-based PGA standards (1.0, 2.5, 5.0, 10.0, and 20.0 ng/mL) with 1.0 mL of distilled water. Reconstitute the "P-Zero" standard with 2.0 mL water. (If all of the kit is not to be used in one day, store aliquots of the standards at -20°C.)

6. *Procedure*

a. *Sample Preparation*

Perform the analysis for serum as described in the *Quanta-Count Folate Instruction Manual*. For whole blood analysis, upon collection, dilute 500 μL of whole blood with 2.0 mL of 1.0 g/dL ascorbic acid and freeze specimen. Before assaying, thaw the hemolysate, mix well, and dilute 500 μL of hemolysate with 600 μL of 1.0 g/dL ascorbic acid to give a 1:11 dilution of the whole blood. Then dilute 100 μL of this solution with 100 μL of the Red Cell Protein Diluent to give a final dilution of 1:22. Use 100 μL of the final solution to perform the assay.

Note: in Hanes II, the 1:5 hemolysate dilution was prepared in the field.

b. *Analysis*

- (1) Label two 12- X 75-mm reaction tubes for the blank, two for each standard, including the P-Zero, and two for each serum or red cell specimen.
- (2) To the blank tubes, add 100 μL P-Zero standard. To the standard tubes, add 100 μL of the appropriate standard — P-Zero, P-1.0, P-2.5, P-5.0, P-10.0, and P-20.0. Add 100 μL of each patient sample to the appropriate tubes.
- (3) To all tubes, add 1.0 mL of working tracer solution (prepared immediately before the assay). Mix all tubes gently.
- (4) Prepare a total counts tube by adding 1.0 mL of working tracer solution. Set aside until tubes are to be placed in the counter.
- (5) Place the tube rack containing all of the tubes in a boiling water bath for 15 min. Cap tubes loosely. Cool to room temperature by placing rack in a cold water bath.
- (6) Add 1.0 mL of distilled water to the blank. Add 1.0 mL of folate binding protein working solution to all other tubes. Mix all tubes well.
- (7) Incubate tubes at room temperature for 30 min.

- (8) After incubation, add one charcoal adsorbent tablet to each tube and allow tube to stand for 5 min. Vortex each tube for 10 sec, and allow to stand for 5 min.
- (9) Centrifuge all tubes for 10 min at 2000-3000 rpm to pack the adsorbent.
- (10) Decant the supernatants into appropriately labeled counting vials.
- (11) Count each supernatant and the total counts tube in the LKB Rackgamma II.

c. Calculations

The LKB Rackgamma II possesses full data-reduction capabilities. Method 4 (logit B/B_0 vs. \log_{10} concentration) is used, where $\text{logit } (B/B_0) = \ln ((B/B_0) / (1-B/B_0))$, B = corrected counts/min for each tube, and B_0 = nonspecific binding in the 0 standard. This method results in a linearized standard curve with an inverse relationship of levels of radioactivity to concentration of folate (as pteroylglutamic acid). Serum results are expressed as nanograms folate per milliliter of serum (ng/mL). Red cell folate values are multiplied by 22, the dilution factor of the whole blood. The serum folate level multiplied by (1.0-hematocrit) is subtracted and the resulting value is divided by the hematocrit to give ng/mL red cell folate:

$$\text{RBC folate} = \frac{\text{whole blood folate} - \text{serum folate} (1-\text{hematocrit}/100)}{\text{hematocrit} \times 100}$$

7. *CDC Modifications*

The following modifications are noted to the Bio-Rad *Instruction Manual*: (a) because the HANES specimens are collected in the field and shipped frozen, the 1:22 whole blood dilution is prepared from a 1:5 hemolysate rather than directly, (b) 1.0 g/dL ascorbic acid rather than 0.4 g/dL is used as the diluent; and (c) whole blood with diluent is not incubated, since a freeze-thaw cycle accomplishes maximum red cell conjugase-activating effect, as described by Mortensen¹⁹.

H. SERUM VITAMIN B₁₂

1. *Principle*

Serum vitamin B₁₂ (cobalamin) is analyzed by using the Bio-Rad Laboratories "Quanta-Count B-12" radioassay kit²⁰, which is based on the principles of saturation analysis described by Ekins²¹ and a radioassay described by Lau *et al.*²² Vitamin B₁₂ is bound to a serum protein, transcobalamin, and must be released by treatment with acid and heat. Radioactively labeled (⁵⁷Co) Vitamin B₁₂ is added, as well as a binding protein, porcine intrinsic factor, in quantities such that some, but not all, of the vitamin present will be bound by the intrinsic factor. Endogenous (serum) B₁₂ then competes with the radioactively labeled B₁₂ for binding sites available on the intrinsic factor molecule. After the mixture has been incubated to allow binding, the unbound serum or radioactive B₁₂ is removed by absorption, and total radioactivity of the bound B₁₂ is measured with an LKB Rackgamma II gamma counter. The level of radioactivity of bound B₁₂ will be inversely proportional to the level of B₁₂ originally present in the serum.

2. *Instrumentation*

- a. LKB Rackgamma II Gamma Spectrometer
(LKB Instruments, Rockville, MD)
- b. Vortex mixer
(Fisher Scientific Co., Fairlawn, NJ)
- c. IEC Centra-7 refrigerated centrifuge
(International Equipment Co., Needham Heights, MA)
- d. SMI Micropettors, sizes I, E, and G, and Repettor II adaptor
(Scientific Manufacturing Industries, Emeryville, CA)
- e. Thelco Model 84 water bath
(Precision Scientific Co., Chicago, IL)

3. *Materials*

- a. Bio-Rad Laboratories "Quanta-Count B-12" Vitamin B₁₂ Radioassay, 200-tube kit (Bio-Rad Laboratories, Richmond, CA)
- b. Falcon No. 2063 12- X 75-mm disposable polypropylene tubes (Becton-Dickinson Co., Oxnard, CA)

4. *Reagent Preparation*

- a. *Intrinsic Factor* (not purified human)
Reconstitute with 10.0 mL of distilled water. (Stable for 1 month at 2-8°C.)

- b. *Working Potassium Cyanide Solution (0.05 mg KCN/mL)*
Dilute each 5.0-mL vial of aqueous potassium cyanide (0.1 mg KCN/mL) with 5.0 mL of distilled water. (Stable 1 month at 2-8°C.)
- c. *Working Tracer Solution (< 1 μCi total activity as ⁵⁷Co)*
Prepare this solution immediately before performing the assay. For each tube to be counted, 1.0 mL of working tracer solution is required; it is prepared by mixing 10 μL ⁵⁷Co-tracer per 1.0 mL of B₁₂ Releasing Agent (saline in dilute HCl).
5. *Standard Preparation*
- a. *0.0 pg/mL Vitamin B₁₂ Standard*
Reconstitute with 4.0 mL of distilled water. (Stable for 1 month at 2-8°C.)
- b. *100, 250, 500, 1000, 2000 pg/mL Vitamin B₁₂ Standards*
Reconstitute each vial with 2.0 mL of distilled water. (Stable for 1 month at 2-8°C.)
6. *Procedure*
- a. *Analysis*
- (1) Label two 12- X 75-mm reaction tubes for the blank, two for each standard, including the zero, and two for each sample.
 - (2) To all tubes, add 1.0 mL of working tracer solution (prepared immediately before performing the assay).
 - (3) Add 200 μL of zero standard to the blank tubes. Add 200 μL of the appropriate standard tubes. Add 200 μL of each serum specimen to the appropriate tube. Mix all tubes gently after each addition.
 - (4) Add 100 μL of working potassium cyanide solution to all tubes. Mix gently.
 - (5) Place the rack containing all of the tubes in a boiling water bath for 15 min (to convert cobalamin to cyanocobalamin). Cool tubes to room temperature by placing rack in a cold water bath.
 - (6) Add 200 μL of Intrinsic Factor to all tubes *except* the blanks. Mix well.
 - (7) Incubate at room temperature for 30 min.
 - (8) At the end of the incubation period, add one adsorbent table to each tube and vortex tube vigorously for 10 seconds. Allow to stand 5 min and centrifuge 5-10 min at 2000-3000 rpm to pack the adsorbent.
 - (9) Decant the supernatants into appropriately labeled 12- X 75-mm tubes.
 - (10) Prepare a total counts tube by adding 1.0 mL of working tracer solution to a counting vial.
 - (11) Count the ⁵⁷Co activity in each tube by using the LKB Rackgamma II.
- b. *Calculations*
The LKB Rackgamma II has full data-reduction capabilities. Method 4, logit (B/B₀) versus log₁₀ concentration B₁₂, where $\text{logit } (B/B_0) = \ln \left(\frac{B/B_0}{1-B/B_0} \right)$ is selected for this analysis, in which B = corrected counts/min for each standard or sample tube, B₀ = corrected counts/min for zero standard tube, and the resulting standard curve is linearized, as described by Skelly et al.²³ Results are reported as picograms vitamin B₁₂ per milliliter (pg/mL) of serum. Samples greater than 1500 pg/mL are diluted 1:2 with saline and reanalyzed.

I. PLASMA GLUCOSE

1. Principle

Glucose is measured by a micro adaptation of the National Glucose Reference Method²⁴ on an Abbott ABA-100 Analyzer.²⁵ The determination is based on the enzymatic coupling of hexokinase and glucose-6-phosphate dehydrogenase and has been optimized for D-glucose. Specificity is enhanced by using sample deproteinization with barium hydroxide and zinc sulfate (Somogyi reagents) to remove kinases and oxidoreductases which utilize the coenzymes, carbohydrate modifying enzymes, ultraviolet absorbing proteins, and other possibly interfering chemicals which coprecipitate.

Hexokinase and excess adenosine triphosphate (ATP) are added to the supernatant, and in the presence of magnesium ions, phosphorylate the glucose to glucose-6-phosphate (G-6-P). In the presence of nicotinamide adenine dinucleotide (NAD), G-6-P is oxidized by glucose-6-phosphate dehydrogenase (G-6-PD) to 6-phosphoglucono-Δ-lactone and NADH. Spontaneous hydrolysis

of the unstable lactone occurs at the pH of the test, and the reaction sequence goes virtually to completion. The glucose present in the filtrate is measured by the reduction of NAD to NADH measured at 340 nm.

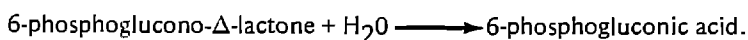
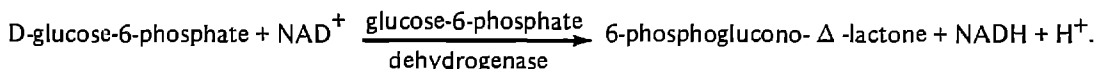
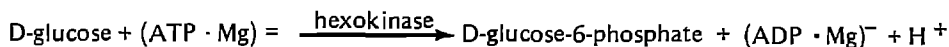

2. Instrumentation

- Abbott ABA-100 Bichromatic Analyzer (Abbott Laboratories, Pasadena, CA)
- Micromedic Model 25000 Automatic Pipettes (2) with 1.0-mL sampling and 5.0-mL dispensing pumps (Micromedic Systems, Division of Rohm and Haas, Horsham, PA)
- Sorvall GLC-1 centrifuge (Dupont-Sorvall Instruments, Newton, CT)
- Beckman Research Model 1019 pH meter (Beckman Instrument Co., Fullerton, CA)
- Mettler Model H-16 analytical balance (Mettler Instrument Co., Princeton, NJ)
- Acta-CV double-beam spectrophotometer (Beckman Instruments Co.)
- Vortex mixer (Fisher Scientific Co., Fairlawn, NJ)

3. Materials

- D-glucose, SRM No. 917 (National Bureau of Standards, Washington, DC)
- Benzoic acid, primary standard, meets A.C.S. specifications (J.T. Baker Co., Phillipsburg, NJ)
- Zinc sulfate, heptahydrate, meets A.C.S. specifications (Merck and Co., Rahway, NJ)
- Barium hydroxide, octahydrate, meets A.C.S. specifications (J.T. Baker Co.)
- Magnesium acetate, tetrahydrate, meets A.C.S. specification (J.T. Baker Co.)
- Tris (hydroxymethyl) aminomethane (Tris Base), reagent grade, 99.9% purity (Sigma Chemical Co., St. Louis, MO)
- Tris (hydroxymethyl) aminomethane hydrochloride (Tris-HCl), reagent grade. (Sigma Chemical Co.)
- Nicotinamide adenine dinucleotide, oxidized (NAD⁺), dihydrate, grade V: 99+% by formula weight (Sigma Chemical Corp.)
- Adenosine 5'-triphosphate (ATP), disodium salt, trihydrate, purity of 98% or better based on formula weight (ICN Pharmaceuticals, Cleveland, OH)
- Hexokinase (HK), from yeast, highly purified (Boehringer-Mannheim Co., Indianapolis, IN)
- Glucose-6-phosphate dehydrogenase (G-6-PD) from *Leuconostoc mesenteroides*, highly purified (Boehringer-Mannheim Co.)
- Bovine serum albumin, Pentex, Fraction V, 96-99% pure (Miles Laboratories, Elkhart, IN)
- Glucose-1-phosphate, disodium salt, tetrahydrate, 98% pure (Boehringer-Mannheim Co.)
- D-fructose, meets NAS/NRC specifications (J.T. Baker Co.)

4. Reagent Preparation

a. 1.0 g/L Benzoic Acid

Dissolve 1.0 g of benzoic acid in 300 mL of distilled water in a 1-liter volumetric flask, with heating. After dissolution is completed, dilute to volume with distilled water.

b. 22 g/dL Zinc Sulfate Solution

Dissolve 22.0 g of zinc sulfate (ZnSO₄·7H₂O) in 900 mL of hot, CO₂-free distilled water. Cover the container with a watch glass while the solution cools, then transfer to a 1-liter volumetric flask, dilute to volume with CO₂-free distilled water, and mix well. Store in a tightly stoppered, glass reagent bottle.

NOTE: Reagents used for sample deproteinization, which includes the zinc sulfate and both barium hydroxide solutions, are prepared with CO₂-free water. This is prepared by vigorously boiling distilled water to expel dissolved carbon dioxide (CO₂).

- c. *Saturated Barium Hydroxide*
Using a freshly opened bottle of barium hydroxide ($\text{Ba}(\text{OH})_2 \cdot 8\text{H}_2\text{O}$), dissolve 80 g in approximately 900 mL of hot, CO_2 -free distilled water. Cover the container with a watch glass while the solution cools, then transfer the solution to a 1-liter volumetric flask, dilute to volume with CO_2 -free distilled water, and mix well.
- d. *0.055 mol/L Barium Hydroxide*
Without disturbing the precipitate, transfer 245 mL of saturated barium hydroxide to a 1-liter volumetric flask. Dilute to volume with CO_2 -free distilled water. Titrate 10.0 mL of zinc sulfate solution with this dilute barium hydroxide solution to a faint pink end point with phenolphthalein indicator (2 drops 0.5 g/dL indicator in 95% ethanol). Ideally, 10.0 mL of zinc sulfate should require 10.0 ± 0.1 mL of barium hydroxide solution.
NOTE: If this limit is exceeded, add either saturated barium hydroxide or CO_2 -free distilled water in the appropriate calculated quantities to the 0.055 mol/L $\text{Ba}(\text{OH})_2$ and repeat the titration. Transfer the adjusted $\text{Ba}(\text{OH})_2$ solution to a glass reagent bottle fitted with a soda-lime trap and a syphon or decanting tube system. Each month check equivalence of this solution by titration.
- e. *Tris-HCl Stock Solution*
Dissolve 31.52 g of Tris-hydrochloride in distilled water in a 2-liter flask. Mix well and dilute to volume.
- f. *Tris Base Stock Solution*
Dissolve 6.06 g of Tris base in distilled water in a 500-mL volumetric flask. Mix well and dilute to volume.
- g. *0.1 mol/L Tris-Magnesium Buffer, pH 7.5 at 25°C*
Mix 800 mL of Tris-HCl solution and 200 mL of Tris base solution; then dissolve 1.1 g of magnesium acetate in the solution. Determine pH of the solution at 25°C. If necessary, adjust pH with either Tris-HCl or Tris base to $\text{pH } 7.5 \pm 0.1$. Filter the solution through a sterile 0.45μ membrane filter into a sterilized borosilicate glass, screw-cap storage bottle. (Stable for up to 6 months at 4°C if carefully handled.)
- h. *Tris-Albumin*
Dissolve 0.5 g of bovine serum albumin in Tris-magnesium buffer in a 250-mL volumetric flask. Mix well and dilute to volume. (Store at 4°C.)
- i. *Stock Hexokinase Solution*
Weigh or measure volumetrically an amount of hexokinase estimated to have a total activity of about 1250 IU at 25°C. Transfer this amount to a 250-mL volumetric flask and dilute to volume with Tris-magnesium buffer. (Store at 4°C and assay on day of preparation as described on pages 102 and 103 of reference 24.)
- j. *Stock Glucose-6-Phosphate Dehydrogenase Solution*
Weigh or measure an amount of G-6-PD estimated to have a total activity of 1250 IU at 25°C. Transfer this to a 250-mL volumetric flask and dilute to volume with Tris-magnesium buffer. (Store at 4°C and assay on day of preparation as described on pages 103 and 104 of reference 24.)
- k. *Stock NAD Solution*
Dissolve 0.9952 g of nicotinamide adenine dinucleotide in Tris-magnesium buffer in a 250-mL volumetric flask. Dilute to volume. (Store at 4°C and assay on day of preparation as described on pages 104 and 105 of reference 24.)
- l. *Stock ATP Solution*
Dissolve 0.826 g of adenosine triphosphate, disodium salt, in Tris-magnesium buffer in a 250-mL volumetric flask. Dilute to volume. (Store at 4°C and assay on day of preparation as described on page 105 of reference 24.)
- m. *Working Enzyme Reagent*
After all enzyme and coenzyme activities have been determined, add to a 1-liter volumetric flask the following amounts of these four components:
- Hexokinase—amount of stock solution equal to 800 IU
 - G-6-PD—amount of stock solution equal to 800 IU
 - NAD—200 mL of stock with concentration ≥ 0.0045 mM/mL
 - ATP—200 mL of stock with concentration ≥ 0.0045 mM/mL

Dilute to 1.0 L with Tris-magnesium buffer and mix contents thoroughly by inversion. Immediately after enzyme reagent is prepared, dispense 100 mL into each of 10 sterile, dry,

screw-cap 125-mL heavy borosilicate glass bottles and store at -20°C until used. (Stable for 6 months.) On the day of assay, remove the enzyme reagent from the freezer and place in a 25°C water bath or allow to thaw at room temperature. Before a new enzyme reagent is used, a portion of it is tested for adequacy by the procedures described on pages 106 and 107 of reference 24. Reagent which does not meet the criteria for adequacy cannot be used in this procedure.

Note: The actual composition of the working enzyme reagent is based upon the assays of the four solutions above (i through l).

5. Standard Preparation

a. 300 mmol/L (5400 mg/dL) Stock Glucose Standard

Dissolve 5.400 g of NBS D-glucose (dextrose) in 1.0 g/L benzoic acid in a 100-mL volumetric flask. Mix well and dilute to volume. Store at -20°C in 20-mL aliquots in tightly capped containers for preparing working standards. (Prepare a new stock each 6 months.)

b. Working Glucose Standards

Using a 20-mL aliquot of thawed and well-mixed stock standard, prepare the following dilutions, bringing each to 100-mL volume with 0.25 g/dL benzoic acid:

mL Glucose Stock Standard	mmol/L Concentration	mg/dL Concentration
1.0	3	54
2.0	6	108
3.0	9	162
4.0	12	216
5.0	15	270

Note: Reserve a 100-mL portion of benzoic acid diluent for use as a zero concentration standard. Store working standards in tightly capped bottles at 4°C. For use, mix and pour an aliquot for sampling; never insert pipets into the standard containers. If specimens with elevated glucose levels are to be analyzed, higher concentrations of standards should be included; the method is linear to 600 mg/dL (33.3 mmol/L). A 600 mg/dl standard, prepared by diluting 11.1 mL of stock glucose standard to 100 mL with benzoic acid diluent in a volumetric flask, is routinely analyzed at the beginning of each analytical day as a part of the enzyme reagent and instrument linearity check.

6. Procedure

a. Filtrate Preparation

- (1) Bring standards, quality control materials, and plasma specimens to room temperature. Mix each well.
- (2) Using a Micromedic Automatic Pipette, dilute 0.2 mL of each sample with 2.0 mL of 0.055 mol/L barium hydroxide into a 16- X 125-mm disposable screw-cap tube.
- (3) Immediately dispense 2.0 mL of zinc sulfate solution into the same tube, using a second Micromedic Pipette. Cap tube and mix contents using a Vortex mixer for 5 sec.
- (4) After all filtrates have been prepared, remix each tube. Centrifuge all tubes at 2000 RPM for 20 min.
- (5) Decant supernates into labeled smaller tubes and recentrifuge. Samples are now ready for analysis.

b. Enzymatic Reaction and Calculations

ABA-100 parameters, analytical procedure, calculations, and maintenance are as described in the Hexokinase Procedure of the *Instruction Manual*²⁵, with the following exceptions: (a) the ABA-100 procedure is based on direct analysis of serum; however, the dilution resulting from the preparation of a supernatant in this method necessitates the use of a special 1:11 syringe plate; (b) calculation of results in the ABA-100 manual is based on the published molar absorptivity of NADH; in this method the calibration factor is determined by using aqueous glucose standards taken through the entire procedure.

Note: The enzymatic reaction can also be performed manually by adding one part of supernatant to five parts of enzyme reagent, mixing, allowing 10 to 20 min for the reaction to go to completion, then recording absorbance on a good quality spectrophotometer at 340 nm versus distilled water. Calculations are performed by using the linear regression of the slope and intercept of the standard curve.

J. WHOLE BLOOD LEAD

1. Principle

Lead is measured in whole blood by atomic absorption spectroscopy by using a modification²⁶ of the Delves²⁷ method. Quantitation is based on the measurement of light absorbed at 283.3 nm by ground state atoms of lead from a lead hollow-cathode lamp source. Whole blood samples, bovine whole blood quality controls, and standards (bovine whole blood spiked with aqueous lead standards) are diluted with nitric acid as the oxidizing agent, dried, and ashed, and lead content is determined by using a Perkin-Elmer Model 360 atomic absorption spectrophotometer with deuterium background correction. All materials used for collecting and processing specimens were screened for possible lead contamination, and all processing work, except drying and ashing, is performed under laminar-flow hoods.

2. Instrumentation

- a. Perkin-Elmer Model 360 atomic absorption spectrophotometer with deuterium arc background correction, lead hollow-cathode lamp, and a micro-combustion assembly. (Perkin-Elmer Corp., Norwalk, CT)

Parameter	Setting
Wavelength	283.3 nm
Lamp current	10 mA
Slit	0.7 nm (normal mode)
Signal	TC-1 (Time Constant-1)
Operating mode	CONC (concentration)

- b. Perkin-Elmer Model 56 recorder
Range: 10 mV Chart speed: 10 mm/min
(Perkin-Elmer Corp.)
- c. Sample tray holder (20-cup capacity) and nickel micro-cups
(Perkin-Elmer Corp.)
- d. Gravity-type oven, set at 130-140°C
(Blue M. Electric Co., Blue Island, IL)
- e. Corning Model PC-35 ceramic-top heating plate, setting at 5.4 = approx. 370°C
(Corning Glassworks, Corning, NY)
- f. Heater control plate
(Perkin-Elmer Corp.)
- g. Micromedic Model 25000 Automatic Pipette, with 20- μ L sampling and 200- μ L dispensing pumps
(Micromedic Systems, Div. Rohm and Haas, Horsham, PA)
- h. Model D-003 ceramic high-temperature absorption tubes
(Trace Metals Instruments, Inc., New York, NY)
- i. Cooling cabinet for samples (stainless steel and glass)
(Brinkmann Instruments, Westbury, NY)
- j. Sonifier Cell Disruptor, Model W-140-E
(Heat Systems Ultrasonics, Inc., Plainview, NY)
- k. EAC Model 100-Plus Modular Unit vertical laminar-flow hood
(Environmental Air Control, Inc., Hagerstown, MD)
- l. Vortex mixer
(Fisher Scientific Co., Fairlawn, NJ)

3. Materials

- a. Lead nitrate, SRM No. 928
(National Bureau of Standards, Washington, DC)
- b. Redistilled concentrated nitric acid
(G. Frederick Smith Chemical Co., Columbus, OH)
- c. Acetylene, 99.9% purity
(Matheson Gas Co., East Rutherford, NJ)
- d. Bovine whole blood (EDTA as anticoagulant), from undosed cows for standard additions (10-20 μ g/dL), and from lead-dosed cows (20-65 μ g/dL) for various levels of quality control pools

4. Reagent Preparation

a. 0.5% (v/v) Nitric Acid

Dilute 5 mL of concentrated, redistilled nitric acid to volume in a 1-liter volumetric flask with deionized water and mix well. (Prepare as needed.)

b. 1.0% (v/v) Nitric Acid

Dilute 10 mL of concentrated, redistilled nitric acid to volume in a 1-liter volumetric flask with deionized water and mix well. (Prepare as needed.)

5. Standard Preparations

a. 1000 µg/mL Stock Lead Standard

Transfer 1.5985 g of NBS lead nitrate to a 1-liter volumetric flask. Dissolve lead nitrate with 1% nitric acid, then dilute to volume with additional 1% nitric acid. (Prepare every 6 months; store in polyethylene container.)

b. 10 µg/mL Intermediate Lead Standard

Transfer 1.0 mL of stock standard to a 100-mL volumetric flask and dilute to volume with 0.5% nitric acid. (Prepare on day of analysis.)

c. Working Lead Standards

Transfer the following volumes of intermediate standard to 100-mL volumetric flasks and dilute to volume with 0.5% nitric acid:

mL Intermediate Stock	Working Standard Conc., µg/dL
0	0
1.0	10
2.0	20
4.0	40
6.0	60
8.0	80

(Prepare on day of analysis. See 6.b. for method of spiking blood with aqueous lead standards.)

6. Procedure

a. Sample Preparation

(1) Allow frozen whole blood specimens (collected from the HANES II field stations) and quality control blood specimens to reach ambient temperature and mix well (vortex). Before sampling, invert each tube five times. If blood is clotted or contains microclots, place sonifer probe in tube and disrupt clots. Prepare 40 specimens in duplicate for 1 day's analysis.

(2) With the Micromedic Pipette, aspirate 10 µL of blood into delivery tip. Dispense sample and 50 µL of 0.5% nitric acid into a sample cup held in the sample tray. Aspirate air into the delivery tip and dispense 50 µL of 0.5% nitric acid into sample cup. Dispense again into sample cup to ensure maximal removal of blood from the pipet tip and to minimize carryover of blood. (Total volume of acid will be 150 µL.)

(3) As each 20-sample tray is filled, place it in an oven at 130-140°C and dry blood samples for 15-30 min. After drying, place tray on the heater control plate (on the hot plate) and ash samples at about 370°C for at least 15 min. After ashing, remove tray and allow it to cool in the cooling cabinet.

b. Spiked-Blood Standard Preparation

(1) With the Micromedic Automatic Pipette, aspirate 10 µL of EDTA-anticoagulated bovine whole blood (from non-dosed cows) and dispense with 50 µL of 0.5% nitric acid into sample cups.

(2) Aspirate 10 µL of the 0 µg/dL lead standard and dispense with 50 µL of 0.5% nitric acid into a sample cup. Aspirate air and dispense 50 µL of 0.5 nitric acid into the cup. Repeat procedure with remaining standards in their respective cups, preparing five sets of standards (0-80 µg/dL) for 1 day's analysis, to bracket four sets of 20 samples.

(3) Dry and ash the standard-blood mixtures in the same manner as samples, and allow cups to cool.

c. Instrument Preliminary Calibrations and Operation

(1) Set instrument parameters as in 2.a., verify the alignment of the absorption tube, and make a preliminary alignment of the sample cup under the aperture of the absorption tube. Ignite the flame, and allow the flame and the absorption tube to equilibrate (approximately 20-30 min). Adjust the flow rates of acetylene and air to give a flame that appears

almost completely blue with only slight vertical streaks of orange. Make the final alignment of the sample cup under the aperture of the absorption tube by igniting cups containing the 60 $\mu\text{g}/\text{dL}$ lead standard and expand signal with EXPANSION control to desired signal amplification. (2X-3X is appropriate.)

- (2) Place cooled sample cup into cup-loop of the micro-combustion assembly and introduce the cup into the flame.
- (3) Proceed with the sample sequence, alternating sets of standards with trays of 20 samples (bracketing) until all cups have been analyzed.
- (4) Record absorbance readings corresponding to peak heights on the recorder.

d. *Calculations*

- (1) Correct the absorbance values of the blood standards by subtracting the absorbance of the unspiked blood standard from the absorbances of the lead-spiked blood standards.
- (2) Calculate the concentration of each specimen from the slope and y-intercept of the averaged standard curve values which bracketed each tray of samples.
- (3) Repeat specimen analysis when duplicate absorbance of concentration values differ by more than 0.025A or 7 $\mu\text{g}/\text{dL}$. Reanalyze specimens containing more than 80 $\mu\text{g}/\text{dL}$ lead by using a 5- μL sample size.

7. *CDC Modifications*

The following modifications to the original method are noted: (a) nitric acid is used rather than hydrogen peroxide as the oxidizing agent, (b) drying and ashing constitute two steps rather than one; and (c) a deuterium background corrector is used to compensate for refractory blood components, such as sodium chloride, which can give a small, nonspecific absorption signal when blood is being analyzed at the 283 nm lead wavelength.

8. *Acknowledgments*

This methodology was developed by the Toxicology Branch, Clinical Chemistry Division, Center for Environmental Health, CDC.

K. SERUM TOTAL BILIRUBIN

1. *Principle*

Total serum bilirubin is measured by a CDC modification of the Gambino and Schreiber²⁸ automated adaptation of the Jendrassik and Grof²⁹ method, which employs the Technicon AutoAnalyzer I. The manifold was extended to provide 5-minute timing of the reaction. Conjugated bilirubin is solubilized by a caffeine-sodium benzoate mixture and, along with any unconjugated bilirubin in the sample, is coupled with diazotized sulfanilic acid; the reaction is stopped by adding ascorbic acid. The alkaline tartrate buffer produces the salt form of the complex ("dialzo blue"), which appears as a green color with the caffeine mixture, and the absorbance is measured at 600 nm. Serum blank colors were determined by replacing the diazo reagent with undiazotized sulfanilic acid, and the absorbances of the blank colors were subtracted from the total serum absorbance; the sample for the blank was obtained by a stream-splitter in the serum aspiration line.

2. *Instrumentation*

- a. Technicon AutoAnalyzer I
(Technicon Instruments Corp., Tarrytown, NY)
 - 1) Sampler I, with 40/h 2:1 cam
 - 2) Pump II
 - 3) Colorimeter, with 15-mm I.D. flowcell, and 600-nm filters
 - 4) Bristol recorder, dual pen
 - 5) Flow-rated tubing
- b. Vortex mixer
(Fisher Scientific Co., Fairlawn, NJ)
- c. Mettler Model 18 analytical balance
(Mettler Instrument Corp., Hightstown, NJ)
- d. Beckman Model 1019 Research pH meter
(Beckman Instruments Co., Fullerton, CA)
- e. Cary Model 118 double-beam spectrophotometer
(Varian Associates, Palo Alto, CA)
- f. Tek-Pro Heat/Stir 36 heating/magnetic stirring unit
(Scientific Products Corp., Evanston, IL)

3. *Materials*

- a. Bilirubin standard, SRM No. 916
(National Bureau of Standards, Washington, D.C.)
- b. Human Albumin Fraction V, powder, 98.7% purity
(Miles Laboratories, Kankakee, IL)
- c. Caffeine, > 98.5% purity
(Eastman Chemical Co., Rochester, NY)
- d. Sodium benzoate, ACS certified
(Fisher Chemical Co., Fairlawn, NJ)
- e. Sodium acetate, ACS certified
(Fisher Chemical Co.)
- f. Sodium hydroxide, pellets, ACS certified
(Fisher Chemical Co.)
- g. Potassium sodium tartrate, tetrahydrate, crystalline, ACS certified
(Fisher Chemical Co.)
- h. Sulfanilic acid, ACS certified
(Eastman Chemical Co.)
- i. Hydrochloric acid, concentrated, ACS certified
(Fisher Chemical Co.)
- j. Sodium nitrite, AutoAnalyzer Certified Reagent
(Technicon Instruments Corp., Tarrytown, NY)
- k. L-Ascorbic acid, crystal, ACS certified
(Fisher Chemical Co.)
- l. Potassium phosphate, monobasic and dibasic salts, ACS certified
(Fisher Chemical Co.)
- m. Hyland Lyophilized Elevated Bilirubin Control (20 mg/dL)
(Hyland Co., Houston, TX)
- n. Thymol Blue sodium salt
(Eastman Chemical Co.)

4. *Reagent Preparation*

- a. *1.6 mol/L Tartrate Buffer*
Dissolve 100 g of sodium hydroxide pellets and 350 g of potassium sodium tartrate in 1 L of deionized water, with stirring. Dilute to volume in a 2-liter volumetric flask with deionized water (Prepare as needed, store at room temperature, and filter before using.)
- b. *1.0 g/dL Sulfanilic Acid*
Dissolve 10 g of sulfanilic acid in 500 mL of deionized water. Add 15 mL of concentrated hydrochloric acid and dilute to volume in a 1-liter volumetric flask with deionized water. (Prepare as needed.)
- c. *0.129 mol/L Caffeine*
Dissolve 25 g of caffeine, 38 g of sodium benzoate, and 63 g of sodium acetate in 500 mL of deionized water, with stirring. Dilute to volume in a 1-liter flask with deionized water. (Prepare as needed and filter before using.)
- d. *0.05 mol/L Hydrochloric Acid (HCl)*
Dilute 8.4 mL of concentrated HCl to volume in a 2-liter volumetric flask with deionized water. (Prepare as needed.)
- e. *Diazo Reagent*
Add 0.45 g of sodium nitrite and 90 mL of deionized water to 900 mL of 1 g/dL sulfanilic acid. Mix well. (Prepare fresh before each run.)
- f. *0.4 mol/L Ascorbic Acid*
Dissolve 20 g of L-ascorbic acid in 500 mL of deionized water. Mix well (Prepare fresh daily.)
- g. *pH 7.4 Phosphate Buffer*
To 200 mL of deionized water in a 500-mL volumetric flask, add 1.35 g of monobasic potassium phosphate, 6.99 g of dibasic potassium phosphate, with stirring. Dilute to volume with deionized water and check to assure that pH is 7.4 ± 0.05 at 25°C. If necessary, adjust pH with dilute HCl or NaOH. (Prepare each time new standards are required.)
- h. *2.5 g/dL Albumin Solution*
Dissolve 5 g of crystallized Fraction V human albumin in 100 mL of pH 7.4 phosphate buffer

in a 200-mL volumetric flask, with stirring. Dilute to volume with phosphate buffer. (Prepare each time new standards are required.)

i. *Thymol Blue, 70 mg/dL*

Weigh 70 mg of Thymol Blue salt and dissolve in 1 L of distilled water.

5. *Preparation of Standards*

Because of the difficulties in preparing and maintaining a stable primary bilirubin standard, NBS Bilirubin is used as a primary standard against which a commercial serum bilirubin material is carefully analyzed to furnish a secondary standard for daily use. The ratio of the molar absorptivities of the primary and secondary standards is used to establish the concentration of each preparation of secondary standard which is used for calculating concentrations of all serum bilirubins assayed with that preparation.

a. *20 mg/dL Bilirubin Primary Stock Standard (for primary calibration)*

Weigh 20.0 ± 0.1 mg of NBS bilirubin SRM 916 in a glass microtube or weighing boat. Working rapidly and in subdued light, dissolve the bilirubin in 2 mL of 0.05 mol/L NaOH by agitation with a fine stirring rod. Within 4 min of weighing, transfer to a 100-mL volumetric flask; use 2-mL portions of 2.5 g/dL albumin solution to wash rod and tube into the volumetric flask until they are free of color; with gentle swirling, dilute contents of flask to volume with albumin solution and mix thoroughly. Deliver a 5.5-mL volume of stock standard into 18 tightly stoppered amber vials and freeze at -70°C . This stock is good for about 3 weeks to 1 month and is used to obtain repeated values for molar absorptivity and analysis of each new lot of the secondary serum standard.

b. *Dilute Primary Working Standards*

Thaw a vial of stock standard solution and bring to 20°C . Prepare a 2.5 mg/dL dilute standard by diluting 5.0 mL of stock with exactly 35 mL of 2.5 g/dL albumin and mix. Use the dilution to prepare the following standard dilutions, using Class A pipets:

mL 2.5 mg/dL Standard	mL Albumin Solution 2.5%	Final Bilirubin Conc., mg/dL
2.0	8.0	0.5
4.0	6.0	1.0
6.0	4.0	1.5
8.0	2.0	2.0
10.0	0.0	2.5

These standard solutions may be kept frozen for 1 week, but several sets of dilute working standards should be used in determining molar absorptivity of azobilirubin or in validating new lots of serum standard. (See Section d below.)

c. *Secondary Bilirubin Serum Standards*

(1) *Preparation of 3 mg/dL (Nominal) Secondary Standard*

Reconstitute 11 vials of Hyland lyophilized bilirubin control serum (in the range of 20 mg/dL) according to directions (2.0 mL of distilled water to each vial). Allow vials to stand for 30 min, then mix each thoroughly, and pool contents of all vials in an amber flask. Pipet 20 mL of the pooled serum into exactly 120 mL of distilled water to obtain a bilirubin concentration of approximately 3 mg/dL. Mix thoroughly. Dispense 6-mL aliquots of this solution into each of 23 10-mL amber glass vials and stopper the vials. Store at -70°C for up to 1 month. One vial may be thawed and used for 4 working days if it was stored at -70°C . (This dilution is designated as the "3 mg/dL" serum standard, but the actual assayed value is used in computing the analyzed values for specimen unknown in the automated analysis.)

(2) *Assay*

Each new lot of Hyland serum is analyzed by comparing the nominal "3 mg/dL" dilution with the NBS primary standard; the serum dilution must previously have been frozen overnight. Prepare one blank and three total-assay tubes of the "3 mg/dL" serum dilution and analyze by the manual procedure below.

Note: Once a consistent average absorbance for the NBS standard has been obtained by the manual assay, the 3 mg/dL serum dilution may be analyzed by comparing its absorbance with the average value for the 2.5 NBS standard:

$$\text{Concentration in mg/dL} = \frac{\text{Absorbance of 3 mg/dL serum std.}}{\text{Avg. absorbance of 2.5 NBS std.}} \times 2.5$$

(3) *Working Secondary Serum Standards*

Prepare the following standard concentrations daily, and run a standard curve at the beginning and end of each run:

Nominal Concentration*	mL "3 mg/dL" Standard	mL Dist. Water
3.0 mg/dL	(use undiluted)	0.0
1.2 mg/dL	2.0	3.0
0.6 mg/dL	2.0	8.0
0.3 mg/dL	5.0 ml of "0.6" above	5.0

*Use exact values as determined by analysis of the "3 mg/dL" serum standard.

d. *Manual Procedure for Determining Specific Absorptivity of Alkaline Azobilirubin and Secondary Serum Standards*

The following volumes of reagents are dispensed into 15- X 125-mm glass tubes, one tube for "blank" and another for "total" for each standard or serum sample. Duplicate sets of NBS standards (0.5 to 2.5 mg/dL) are set up for the calibration curve. If the "3 mg/dL" secondary serum standard is analyzed, set up one blank and three "total" tests.

Reagent	Blank Tube, mL	Total Bilirubin Tube, mL
Caffeine	—	2.0
HCl, 0.05 N	2.0	—
Sample or standard	0.5	0.5
Diazo reagent	—	1.0
Sulfanilic acid	1.0	—
Ascorbic acid	0.5	0.5
Tartrate buffer	1.5	1.5

- (1) Add the caffeine and HCl to their respective tubes.
- (2) Add the first sample to "total" tube and mix well.
- (3) Set a timer for 10 min. Add diazo reagent to the "total" tube, mix thoroughly, and start timer.
- (4) After 1 min, add the same sample to the first "blank" tube, and add sulfanilic acid and mix.
- (5) At timed intervals, add subsequent samples to "total" and "blank" tubes.
- (6) After the first "total" tube has stood for 10 min, add ascorbic acid to that tube and mix; then add tartrate buffer and mix; follow the same procedure for the "blank" tube.
- (7) Read the absorbance of each total bilirubin tube versus its corresponding blank tube on a spectrophotometer set at 600 nm at 10 min after adding tartrate buffer. The mean absorbance values of the duplicate primary standards should plot a straight line through the origin on an absorbance/ concentration graph.

e. *Calculations*

(1) *Molar Absorptivity*

For the 1.0 and 2.5 mg/dL primary standard dilutions calculate the molar absorptivity, using the respective exact concentrations and absorbance readings in the following formulas:

Absorbance = (molar absorptivity) (pathlength of cuvette) (concentration), which yields:

$$\text{Molar absorptivity} = \frac{(\text{absorbance}) (\text{molecular weight})}{(\text{pathlength}) (\text{std. conc.}^*) \left(\frac{\text{volume of sample used}}{\text{total reaction volume}} \right)}$$

Molecular weight of bilirubin = 584.7 g/mol

Std. conc. = 2.0 or 2.5 mg/dL (0.020 or .025 g/L)

Volume of sample = 0.5 mL

Total volume = 5.5 mL

Pathlength of cuvette = 1 cm

For example, if the absorbance of the 2.50 mg/dL standard is .273:

$$\text{Molar absorptivity} = \frac{(.273) (584.7 \text{ g/mol})}{(1 \text{ cm}) (.025 \text{ g/L}) \left(\frac{0.5 \text{ mL}}{5.5 \text{ mL}} \right)} = 70,234 \text{ L/mol-cm}$$

Average the four values obtained with the 2.0 and 2.5 primary standards.

(2) *Concentration of the Serum Standard:* Use the equation given in 5.c.(2).

6. *Procedure*

- Thaw specimens, quality control materials, and "3 mg/dL" secondary standard in reduced light to minimize bilirubin degradation.
- Following the usual AutoAnalyzer operating procedure, prepare simultaneous "total" and "blank" channels for operation. Determine the sample dilution ratio of the two systems by sampling 2.0 mL of 70 mg/L Thymol Blue solution until "steady state" is achieved. Then, if both systems are balanced:

$$\frac{\text{Abs. Thymol Blue "total" system}}{\text{Abs. Thymol Blue "blank" system}} = 1.0 \pm 0.05$$

*Standard concentration

- Prepare working standards from "3 mg/dL" secondary standard. Assay standards and quality control materials. Using the slope and y-intercept of the standard absorbance (y-axis)/concentration (x-axis) curve, calculate concentration of control pools. If the resulting control values are within 2 standard deviations of their respective means, proceed with analysis of the specimens. Place aliquots of "3 mg/dL" standard in positions 1 and 21 of every sample tray to monitor system drift and proceed with the analysis.
- Correct all absorbance readings:
Corrected Absorbance – "Total" Abs. = "Blank" Abs.
Calculate the concentration of the serum specimens from the slope and y-intercept of the standard curve. Report results as milligrams of bilirubin per 100 mL of serum (mg/dL).

7. *CDC Modifications*

The following modification of the original method is noted: both a primary NBS reference standard and a secondary commercial bilirubin-serum standard are used.

8. *Flow Diagram*

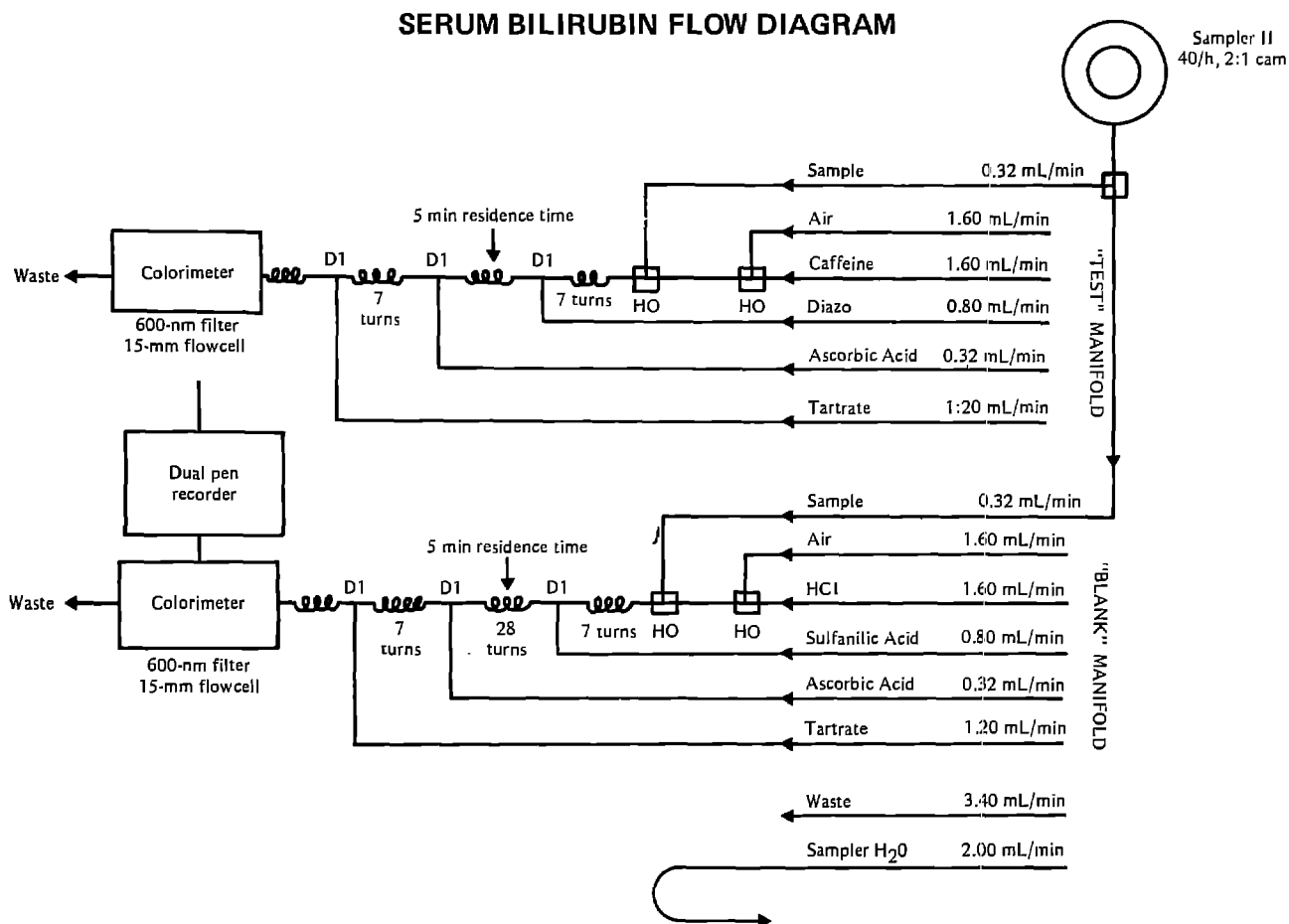

9. Acknowledgments

This method was developed by the Metabolic Biochemistry Branch, Clinical Chemistry Division, Center for Environmental Health, CDC.

L. SERUM GLUTAMIC-OXALOACETIC TRANSAMINASE (SGOT)

(EC No. 2.6.1.1, L-aspartate: 2-oxoglutarate aminotransferase)

1. Principle

Serum glutamic-oxaloacetic transaminase (or, aspartate aminotransferase) is determined by a modification³⁰ of the method of Henry³¹ *et al.*, based on the following reaction scheme:

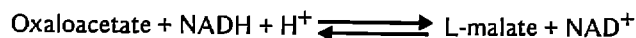

As oxaloacetate is formed in the transaminase reaction, it is reduced to malate by malate dehydrogenase as an equivalent amount of NADH is oxidized to NAD⁺. SGOT concentration is measured indirectly by measuring the decrease in absorbance of NADH at 340 nm, by using an Electro-Nucleonics GEMSAEC Centrifugal Fast Analyzer, at a temperature of 30°C.

2. Instrumentation

- a. GEMSAEC Centrifugal Analyzer
(Electro-Nucleonics Co., Fairfield, NJ)
- b. Micromedic Model 25000 Automatic Pipettes with 50- μ L sampling and 1.0-mL and 50- μ L dispensing pumps
(Micromedic Systems, Division of Rohm and Haas, Horsham, PA)
- c. Mettler Model H18 analytical balance
(Mettler Instruments Corp., Hightstown, NJ)
- d. Thelco heating oven
(Precision Scientific Co., Chicago, IL)
- e. Beckman Research Model 1019 pH meter
(Beckman Instruments Co., Fullerton, CA)

3. Materials

- a. Tris (hydroxymethyl) aminomethane (Tris Base), reagent grade (Sigma Chemical Co., St. Louis, MO)
- b. Tris (hydroxymethyl) aminomethane hydrochloride (Tris-HCl), reagent grade (Sigma Chemical Co.)
- c. L-Aspartic acid, certified purity
(ICN Pharmaceuticals Inc., Cleveland, OH)
- d. 2-Oxoglutaric acid (α -ketoglutaric acid), A grade
(Calbiochem-Behring Corp., La Jolla, CA)
- e. β -Nicotinamide adenine dinucleotide, reduced form (NADH), disodium salt, 100% purity, grade II. Store at 4°C in desiccator.
(Boehringer-Mannheim Corp., Indianapolis, IN)
- f. Malate dehydrogenase (MDH) in 50% glycerol, ACS reagent grade, specific activity about 1200 U/mg at 25°C. Store at 4°C in desiccator.
(Boehringer-Mannheim Corp.)
- g. Nitrogen, 99.99% purity, prepurified
(Selox, Inc., Chattanooga, TN)
- h. Sodium hydroxide (NaOH) pellets, ACS grade
(Fisher Scientific Co., Fairlawn, NJ)

4. Reagent Preparation

- a. 0.1 mol/L Tris-HCl Stock Solution
Dissolve 31.53 g of Tris-HCl in distilled water and dilute to volume in a 2-liter volumetric flask.
(Prepare every 2 months; store at 4°C.)

- b. *0.1 mol/L Tris Base Stock Solution*
Dissolve 12.12 g of Tris Base in distilled water and dilute to volume in a 1-liter volumetric flask. (Prepare every 2 months; store at 4°C.)
- c. *0.1 mol/L Tris Buffer, pH 7.8 at 30°C*
Warm aliquots of reagents 1 and 2 to 30°C.
Titrate 800 mL of Tris-HCl stock solution with the Tris base stock solution (200-300 mL) to pH 7.8 at 30°C. Filter, using a 0.45- μ Millipore. (Prepare every 2 months, store at 4°C.)
- d. *0.626 mol/L Stock Aspartate Solution*
Add 93.32 g of L-aspartic acid and 12.11 g of Tris base to 700 mL of distilled water, warming solution slightly to dissolve the aspartic acid. Adjust pH to 7.8 at 30°C with 10 mol/L NaOH. Cool solution and dilute to 1 L with distilled water. Transfer 50-mL aliquots to plastic screw-cap bottles. (Prepare every 2 months, store at -20°C.)
- e. *0.0667 mol/L 2-Oxoglutarate Solution*
Add 1.95 g of 2-oxoglutaric acid and 2.42 g of Tris base to 150 mL of distilled water in a 400-mL beaker. Warm to 30°C and adjust to pH 7.8 at 30°C with 10 mol/L NaOH. Transfer to a 200-mL volumetric flask, cool to 20-25°C, and dilute to volume with distilled water. Dispense 20-mL aliquots into plastic screw-cap vials. (Prepare monthly, store at -20°C, and use aliquot only on the day it is thawed.)
- f. *Mixed Substrate Solution*
Mix 50 mL of thawed 0.626 mol/L aspartate solution, 150 mL of 0.1 mol/L Tris buffer (at room temperature), 30 mg of NADH, and 20 μ L of MDH-glycerol solution (each of the latter two are brought to room temperature in a desiccator). In the first transfer disc analyzed in the GEMSAEC, measure the absorbance of this solution, which should be ≥ 1.000 . If the absorbance is less than 0.9, prepare fresh reagents. Store solution at 4°C, except when dispensing for analyses. (Prepare daily; may be used a second day if refrigerated and absorbance is not $< .900$.)
- g. *10 mol/L Sodium Hydroxide*
Dissolve 500 g of NaOH pellets with stirring in 600 mL of distilled water; when cool, dilute to 1 L. (Prepare as needed.)

5. Standard Preparation

L-Aspartate, 2-oxoglutarate, MDH, and NADH are used in excess so that the reaction rate is limited only by the amount of GOT present (that is, a zero-order reaction). The change in absorbance per min, ΔA , is directly related to the micromoles of NADH oxidized to NAD^+ and in turn to the micromoles of substrate transformed per min. A value of 6.22×10^3 L/mol-cm is used as the molar absorptivity for NADH. A standard, per se, is not used, since no reference SGOT is available. A serum pool is used for quality control purposes.

6. Procedure

a. GEMSAEC Centrifugal Analyzer Settings

- (1) Temperature = 30°C
- (2) Wavelength = 340 nm
- (3) Initial reading = 20 sec
- (4) Reading interval = 60 sec (60 sec on newer GEMSAEC models)
- (5) Number of readings = 4

b. Transfer Disc Preparation

Using the Micromedic Automatic Pipettes, load samples and reagents (all brought to 25°C) into the transfer discs.

- (1) Position No. 1 of each disc *always* contains water.
- (2) Position No. 2 of the first disc of the run contains 400 μ L of mixed substrate solution only. The absorbance of this solution should be ≥ 0.900 .
- (3) Position No. 3 of the first disc contains the reagent blank:

Well A	50 μ L water (as sample)
Well C	400 μ L mixed substrate solution
Well B	<u>50 μL 2-oxoglutarate solution</u>
	500 μ L total volume

(The absorbance of this solution is monitored for quality control purposes.)

- (4) For all sample positions:
- | | |
|--------|---|
| Well A | 50 μ L sample |
| Well C | 400 μ L mixed substrate solution |
| Well B | <u>50 μL 2-oxoglutarate solution</u> |
| | 500 μ L total volume |

- (5) Cover disc with a plastic Petri dish and place in a 30°C incubator for 20 min. (Not necessary with newer model GEMSAECs with temperature-controlled rotors. Sample will come to 30°C within 30 sec.)
- (6) Include two reference serum pools and two quality control pools with every 40 samples analyzed.

c. *Operation*

- (1) Perform a cuvette cleanliness check in the GEMSAEC well by using a disc containing water only, as outlined in the *GEMSAEC Automatic Analyzer Manual*^{3,2}. (Results should be 0.01 abs. for check and < 0.001 abs. for repeat. If these limits are exceeded, perform cuvette wash, and repeat washing until absorbances are acceptable.)
- (2) Place the first incubated disc into the GEMSAEC well and analyze for ΔA , the change in absorbance readings for each sample. Repeat for each additional disc.

d. *Calculations*

$$\text{Catalytic concentration in U/liter at 30°C} = \frac{(dA/dt)}{(\epsilon)(b)} \times \frac{V}{v}$$

V = total reaction volume (500 μ L)

v = sample volume (50 μ L)

dA = change in absorbance (A) at 340 nm

dt = change in time (min)

b = pathlength of the cuvette (1 cm)

ϵ = Molar absorptivity of NADH (6.22 X 10³ L/mol-cm)

Then:

Catalytic concentration in μ mol/min-L or Units/L at 30°C =

$$\frac{(dA/dt)}{(6220 \text{ L/mol-cm})(1 \text{ cm})} \times \frac{500 \mu\text{L}}{50 \mu\text{L}}$$

$$= (dA/dt) \times (1607.7 \mu \text{ mol/L}) \text{ at } 30^\circ\text{C}$$

Results are reported as units of SGOT per liter of serum at 30°C (U/L). One unit is equal to 1 micromole of substrate catalyzed per min.

7. *CDC Modifications*

This method is the same as the CDC Method used in the Cooperative Enzyme Experiment (1976 - reference 30) with this exception: incubation time is increased from 15 to 20 min.

8. *Acknowledgments*

This working method was developed by the Enzyme and Methodology Research Laboratory, Analytical Biochemistry Branch, Clinical Chemistry Division, Center for Environmental Health, CDC.

M. **SERUM ALKALINE PHOSPHATASE**

(EC No. 3.1.3.1., orthophosphoric monoester phosphohydrolase)

1. *Principle*

Alkaline phosphatase is measured by the method of Bowers and McComb^{3,3,34}. The procedure is based on the hydrolysis of p-nitrophenyl phosphate to p-nitrophenol and inorganic phosphorus, catalyzed by alkaline phosphatase.

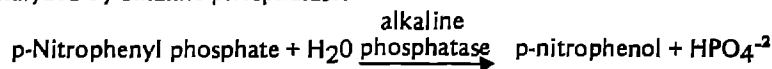

The change in absorbance of the reaction product, p-nitrophenol, is measured at 404 nm, by using an Electro-Nucleonics GEMSAEC Centrifugal Fast Analyzer at 30°C; p-nitrophenol is used as the standard material.

2. Instrumentation

- a. Electro-Nucleonics GEMSAEC Automatic Analyzer
(Electro-Nucleonics Co., Fairfield, NJ)
- b. Micromedic Model 25000 Automatic Pipettes with 20- μ L sampling, and 50- μ L and 1.0-mL dispensing pumps
(Micromedic Systems, Division of Rohm and Haas, Horsham, PA)
- c. Mettler Model H18 analytical balance
(Mettler Instruments Corp., Hightstown, NJ)
- d. Thelco heating oven
(Precision Scientific Co., Chicago, IL)
- e. Beckman Research Model 1019 pH meter
(Beckman Instruments Co., Fullerton, CA)

3. Materials

- a. 2-Amino-2-methyl-1-propanol (AMP), ACS reagent grade
(ICN Pharmaceuticals, Inc., Cleveland, OH)
- b. p-Nitrophenyl phosphate (PNPP), disodium salt, hexahydrate, $\geq 98\%$ purity
(Sigma Chemical Co., St. Louis, MO)
- c. p-Nitrophenol (PNP), A grade
(Calbiochem-Behring Corp., La Jolla, CA)
- d. Magnesium chloride, (MgCl_2), hexahydrate, ACS reagent grade
(Fisher Scientific Co., Fairlawn, NJ)
- e. Hydrochloric acid (HCl), concentrated, ACS reagent grade
(Fisher Scientific Co.)

4. Reagent Preparation

- a. *940 mmol/L 2-Amino-2-Methyl-1-Propanol Buffer, pH 10.3 at 30°C*
Dissolve 3.75 g of AMP in 30 mL of distilled water and adjust pH to 10.30 ± 0.05 at 30°C, using 5 mol/L HCl. Transfer to a 50-mL volumetric flask and dilute to volume at 20-25°C. (Prepare daily.)
- b. *1.5 mmol/L - Magnesium Chloride*
Dissolve 0.3 g of magnesium chloride in 1 L of distilled water. (Prepare daily.)
- c. *210 mmol/L p-Nitrophenyl Phosphate*
Dissolve 385 mg of PNPP in 5.0 mL of 1.5 mmol/L MgCl_2 . (Prepare daily.)
- d. *5 mol/L Hydrochloric Acid*
Add 400 mL of concentrated HCl to 600 mL of distilled water and mix well. (Based on a concentration of 12.5 mol/L for concentrated HCl from most Fisher lots.)

5. Standard Preparation

- a. *1.0 mol/L p-Nitrophenol Stock Standard*
Dissolve 139.1 mg of PNP in 1 L of distilled water. (Prepare every 2 months; store at 4°C.)
- b. *0.05 mmol/L p-Nitrophenol Working Standard*
Dilute 1.0 mL of 1.0 mmol/L standard to 25 mL with 840 mmol/L AMP buffer.
Determine the molar absorptivity of this solution:
 - (1) With a spectrophotometer, measure the absorbance of the 0.05 mmol/L PNP working standard at 404 nm against a water blank. Acceptable limits for absorbance are 0.740–0.760.
 - (2) Calculate the molar absorptivity:
 $A = (\epsilon) (b) (c)$ where $A = \text{absorbance} (.750)$
 $\epsilon = \text{molar absorptivity}$
 $b = \text{pathlength of cuvette (1 cm)}$
 $c = \text{concentration (0.04 mmol/L)}$

$$\text{Then } \epsilon = \frac{A}{(b) (c)} = \frac{.750}{(1 \text{ cm}) (4 \times 10^{-5} \text{ mol/L})} = 18,750 \text{ L/mol-cm}$$

6. Procedure

- a. *GEMSAEC Centrifugal Analyzer Settings*
 - (1) Temperature = 30°C
 - (2) Wavelength = 404 nm
 - (3) Initial reading = 20 sec (60 sec on newer model GEMSAEC)

(4) Reading interval = 60 sec

(5) Number of readings = 4

b. *Transfer Disc Preparation*

Incubate all serum specimens at 25°C for 24 h before analyzing to ensure maximum alkaline phosphatase activity. Bring all reagents to 25°C also.

Using the Micromedic Automatic Pipettes, load samples and reagents into the transfer discs:

(1) Position No. 1 of each disc is *always* water.

(2) Position No. 2 of the first disc analyzed contains 20 μL of 0.05 mM PNP working standard, to verify that the absorbance level is 0.740 - 0.760.

(3) Position No. 3 of the first disc contains the reagent blank:

Well A	20 μL water (as sample)
Well C	540 μL AMP buffer
Well B	40 μL PNP
	<hr/>
	600 μL Total volume

(The absorbance reading of this mixture is monitored for quality control purposes.)

(4) Load all sample positions as follows:

Well A	20 μL sample
Well C	540 μL AMP buffer
Well B	40 μL PNP
	<hr/>
	600 μL total volume

(5) Incubate transfer discs at 30°C for 15 min (not necessary in newer model GEMSAECs with temperature-controlled systems).

(6) Include two working standards and two quality control pools with every 40 samples analyzed.

c. *Operation*

(1) Perform a cuvette cleanliness check in the GEMSAEC well by using a disc containing water only, as outlined in the *GEMSAEC Automatic Analyzer Manual*³⁵. (Results should be < 0.01 abs. for check and < 0.001 abs. for repeat. If these limits are exceeded, perform cuvette wash and repeat washing until absorbances are acceptable.)

(2) Place the first incubated transfer disc into the GEMSAEC well and analyze for ΔA, the change in absorbance readings for each sample. Repeat for each additional disc.

d. *Calculations*

$$\text{Catalytic activity} = dc/dt = \frac{dA/dt}{\epsilon b} = \mu\text{mol}/\text{min} = U$$

$$\text{Catalytic concentration} = \frac{dA}{dt} \times \frac{1}{\epsilon b} \times \frac{V}{v}$$

in μM/min/L or U/L at 30°C

V = total reaction volume (600 μL)

v = sample volume (20 μL)

dc = change in concentration of substrate in μmol

dA = change in absorbance at 404 nm

dt = change in time in min

b = pathlength of cuvette (1 cm)

ε = molar absorptivity (for p-nitrophenol at pH 10.3 ε = 18.75 × 10³ L/mol-cm)

Then:

Catalytic concentration in mol/min-L or Units/L at 30°C

$$= \frac{dA}{dt} \times \frac{1}{(18.75 \times 10^3 \text{ L/mol-cm})(1 \text{ cm})} \times \frac{600 \mu\text{L}}{20 \mu\text{L}}$$

$$= \frac{dA}{dt} \times \frac{30}{18.75 \times 10^3} \times \frac{\text{mol}}{\text{L}} \times \frac{10^6 \mu\text{mol}}{\text{mol}}$$

$$= \frac{dA}{dt} \times 1600 \mu\text{mol}/\text{L} = U/\text{L at } 30^\circ\text{C}$$

Results are reported as units of alkaline phosphatase per liter of serum at 30°C (U/L).

7. *CDC Modifications*

The following modifications are noted to the Selected Method (reference 34) are noted: (a) AMP buffer concentration is 840 mmol/L instead of 890 mmol/L, and (b) PNPP concentration is 210 mmol/L instead of 225 mmol/L.

8. *Acknowledgments*

This working method was developed by the Enzyme and Methodology Research Laboratory, Analytical Biochemistry Branch, Clinical Chemistry Division, Center for Environmental Health, CDC.

N. SERUM AND RED CELL FOLATE (MICROBIOLOGICAL)

1. *Principle*

Serum and red cell folic acid is measured microbiologically by a semiautomated modification³⁵ of the methods described by Baker *et al.*³⁶ and Cooperman³⁷. Serum (or whole blood diluted with ascorbic acid) is extracted, and an aliquot is added to an assay medium containing all of the nutrients except folic acid necessary for the growth of *Lactobacillus casei* (ATCC 7469). The medium is then inoculated with this microorganism and incubated for 20-22 h at 37°C. Because the growth of *L. casei* is proportional to the amount of folic acid present in the serum/whole blood extract, the folic acid level can be quantitated by measuring the turbidity of the inoculated medium at 600 nm in a Technicon AutoAnalyzer I Colorimeter. Standards are prepared from pteroylglutamic acid (PGA, folic acid).

2. *Instrumentation*

- a. Technicon AutoAnalyzer I, with the following:
 - (1) Sampler II with 60/h 1:2 cam, with mixer
 - (2) Pump II
 - (3) Colorimeter, with 15-mm I.D. flowcell, and 620-nm filters
 - (4) Bristol recorder, dual pen
 - (5) Flow-rated tubing
(Technicon Instrument Corp., Tarrytown, NY)
- b. Corning Model 7 pH meter, single probe
(Corning Glassworks, Corning NY)
- c. Sorvall GLC-1 centrifuge
(DuPont Sorvall Instruments, Newtown, CT)
- d. Mettler Model 18 analytical balance
(Mettler Instrument Co., Hightstown, NJ)
- e. Amsco autoclave
(American Sterilizer Co., Plainview, NY)
- f. Blue M circulating water bath, 37°C
(Blue M Electric Co., Blue Island, IL)
- g. Micromedic Model 25000 Automatic Pipette, with 1.0-mL sampling and 5.0-mL dispensing pumps
(Micromedic Systems, Div. Rohm and Haas, Horsham, PA)
- h. Vortex mixer
(Fisher Scientific Co., Fairlawn, NJ)
- i. Beckman Model DB-GT double-beam spectrophotometer with 10 in strip chart recorder
(Beckman Instruments Corp., Fullerton, CA)
- j. Thelco Model 4 Incubator, 37°C
(Precision Scientific Co., Chicago, IL)

3. *Materials*

- a. Pteroylglutamic acid (PGA, folic acid), Sigma grade, 99-100% purity (Sigma Chemical Co., St. Louis, MO)
- b. Ethanol, dehydrated, U.S.P.
(Publicker Industries, Linfield, PA)
- c. *Lactobacillus casei*, lyophilized culture (ATCC 7469)
(American Type Culture Collection, Rockville, MD)
- d. Bacto-Lactobacilli agar and broth AOAC
(Difco Laboratories, Detroit, MI)

- e. "Vitamin-Free" enzymatic casein hydrolysate (5%)
(ICN Pharmaceuticals Inc., Cleveland, OH)
- f. L-Dextrose (d-glucose), ACS certified
(Fisher Scientific Co.)
- g. Sodium acetate, anhydrous, ACS certified
(Fisher Scientific Co.)
- h. Potassium phosphate, dibasic (K_2HPO_4), reagent grade
(Mallinckrodt Chemical Co., St. Louis, MO)
- i. Potassium phosphate, monobasic (KH_2PO_4), reagent grade
(Merck Co., Rahway, NJ)
- j. D,L-Tryptophane, $\geq 98.5\%$ purity
(ICN Pharmaceutical, Inc.)
- k. L-Cysteine hydrochloride, $\geq 98.5\%$ purity
(ICN Pharmaceuticals, Inc.)
- l. Xanthine, $\geq 98.5\%$ purity
(ICN Pharmaceuticals, Inc.)
- m. Sodium hydroxide (NaOH), 50% solution (12.5 mol/L) and pellets, reagent grade
(J. T. Baker Co., Phillipsburg, NJ)
- n. Tween^R-80 (polyoxyethylene-20 sorbitan monooleate)
(J. T. Baker Co.)
- o. Magnesium sulfate, heptahydrate, crystalline, Fisher certified
(Fisher Scientific Co.)
- p. Sodium chloride (NaCl), reagent grade
(Fisher Scientific Co.)
- q. Ferric sulfate, heptahydrate, crystalline, ACS certified
(Fisher Scientific Co.)
- r. Manganese sulfate, monohydrate, purified
(Fisher Scientific Co.)
- s. Hydrochloric acid (HCl), concentrated, ACS certified
(Fisher Scientific Co.)
- t. Adenine sulfate, $\geq 99\%$ purity
(ICN Pharmaceuticals, Inc.)
- u. Guanine hydrochloride, $\geq 98\%$ purity
(Sigma Chemical Co.)
- v. Uracil, $\geq 98.5\%$ purity
(ICN Pharmaceuticals, Inc.)
- w. Glutathione, reduced, $\geq 98.5\%$ purity
(ICN Pharmaceuticals, Inc.)
- x. Riboflavin, $\geq 98\%$ purity
(Sigma Chemical Co.)
- y. p-Aminobenzoic acid, potassium salt, $\geq 99\%$ purity
(ICN Pharmaceuticals, Inc.)
- z. Pyridoxine hydrochloride, $\geq 98\%$ purity
(Sigma Chemical Co.)
- (a) Thiamine hydrochloride, Baker grade
(J. T. Baker Co.)
- (b) Calcium pantothenate, A grade
(Calciochem-Behring Corp., La Jolla, CA)
- (c) Nicotinic acid, $\geq 98\%$ purity
(Eastman Kodak Co., Rochester, NY)
- (d) d-Biotin, $\geq 99\%$ purity
(ICN Pharmaceuticals, Inc.)
- (e) L-Asparagine, $> 98.5\%$ purity
(ICN Pharmaceuticals, Inc.)
- (f) L-Ascorbic acid, "Baker Analyzed" grade
(J. T. Baker Co.)
- (g) Sterile volumetric glassware and pipets or sterile disposable pipets, disposable 1-dram vials

- (h) Corning 13- X 125-mm and 16- X 150-mm disposable culture tubes
(Corning Glassworks, Corning, NY)
- (i) Bacti-Capall autoclavable caps
(Sherwood Medical Industries, Inc., St. Louis, MO)
- (j) Heavy-gauge aluminum foil (Alcoa Wrap)
(Aluminum Company of American, Pittsburgh, PA)
- (k) 2-mL conical bottom sample cups
(Sherwood Medical Industries)
- (l) Distilled water
- (m) Formaldehyde, 37% by weight, histological grade (Fisher Scientific Co.)
- (n) Brij-35, 30% solution (Pierce Chemical Co., Rockford, IL)

4. Reagent Preparation

a. *Lactobacillus Maintenance Agar and Transfer Broth*

Prepare as directed, dispense in screw-cap tubes in 10-mL volumes, and autoclave for 15 min at 121°C, 15 psi. (Store at 4°C.)

b. *Phosphate Buffer, pH 6.1 at 25°C*

Add 11.39 g of monobasic potassium phosphate and 2.96 g of dibasic potassium to 500 mL of distilled water in a 1-liter flask. Mix and bring to volume. Adjust pH to 6.1 with 0.1 mol/L NaOH. On day of use, add 100 mg of ascorbic acid per 100 mL of buffer required. (Store at 4°C.)

c. *1 g/dL Ascorbic Acid*

Dilute 10 g of L-ascorbic acid to 1 L with distilled water and mix well. (Prepare fresh each time hemolysates are prepared.)

d. *0.85 g/dL Saline*

Dilute 8.5 g of sodium chloride to 1 L with water. Mix well, aliquot in 10-mL volumes in screw-cap culture tubes, and autoclave for 15 min at 121°C, 15 psi. (Store at 4°C.)

e. *Double-strength Assay Medium, pH 6.8*

Prepare exactly as described by Baker *et al.* (Commercial sources of medium have yielded inconsistent assay results.) After preparing the medium, filter-sterilize it, dispense in 100-mL volumes in sterile glass screw-cap bottles, and store at -20°C. (Solution is concentrated twofold to minimize storage volume.)

f. *20% (v/v) Ethanol Solution*

Dilute 24 mL of anhydrous ethanol with 96 mL of distilled water.
(Prepare on day of use for standard solvent.)

g. *0.1 mol/L Sodium Hydroxide (NaOH)*

Dissolve 4 g of sodium hydroxide pellets (or 8 mL of 50% (v/v) solution) with stirring in 1 L of distilled water.

h. *0.05 mol/L Hydrochloric Acid (HCl)*

Dilute 4.0 mL of concentrated hydrochloric acid (12.5 mol/L) to 1 L with distilled water.
(Stable at room temperature.)

i. *Wash Solution*

Add 1.0 mL of 37% (w/v) formaldehyde and 2.0 mL of Brij-35, 30% solution, to 4 L of distilled water. (The formaldehyde helps limit bacterial growth in the pump tubing.)

5. Standard Preparation

a. *200 µg/mL Stock Pteroylglutamic Acid (PGA) Standard*

Mix 20 mg of PGA in 90 mL of 20% ethanol in a beaker. Adjust the pH of the mixture to 10.0 with 0.1 mol/L NaOH to dissolve the PGA, then adjust the pH to 7.0 with 0.05 mol/L HCl. Quantitatively transfer the contents of the beaker to a 100-mL volumetric flask. Wash the beaker with two 1.0-mL aliquots of 20% ethanol, and transfer the washes to the volumetric flask. Bring to volume with 20% ethanol. Divide this 200 µg/mL stock solution into 1.5-mL aliquots in 1-dram screw-cap glass vials. (Store at -70°C for up to 1 year.) After preparation and at periodic intervals, verify the ultraviolet absorption spectrum of the PGA by diluting the stock standard 1:20 with 0.1 mol/L NaOH to give a 10 µg/mL solution. Scan this solution in a 1-cm² cuvette with a double-beam spectrophotometer (such as the Beckman DB-GT) from 420 to 230 nm. Check for 3 absorbance maxima at approximately 257, 282, and 365 nm with millimolar absorptivities of 585, 570, and 206, respectively.

b. *2.0 ng/mL Intermediate Standard*

Thaw and mix well an aliquot of 200 µg/mL of stock PGA standard. Dilute 1.0 mL to 1 L with distilled water and mix well. Dilute 5 mL of this solution to 500 mL with distilled water to give a 2 ng/mL concentration.

c. *Working PGA Standards*

Pipette the following amounts of 2 ng/mL of PGA standard and distilled water into 16- X 150-mm disposable glass culture tubes:

mL of 2 ng/mL PGA Standard	mL of Distilled Water	Apparent Conc. ng/mL
0	10.0	0.0
0.5	9.5	1.0
1.0	9.0	2.0
2.0	8.0	4.0
3.0	7.0	6.0
4.0	6.0	8.0
5.0	5.0	10.0
6.0	4.0	12.0
7.0	3.0	14.0
8.0	2.0	16.0
9.0	1.0	18.0
10.0	0	20.0

Mix well and add 0.1 mL of each concentration to 1.9 mL of assay medium for the standard curve to give an apparent calculated concentration of 0 to 20 ng/mL.

6. Preparation of *Lactobacillus casei* organism

a. *Maintenance of Stock Culture*

Reconstitute a lyophilized *L. Casei* culture (ATCC 7469) with 10 mL of sterile broth and incubate culture for 24 h at 37°C. Transfer the organism to a new broth and incubate an additional 24 h. Vortex the second 24-h culture and use it to inoculate 30 stabs of agar. Incubate these stabs for 24 h at 37°C; then store them at 4°C until needed for daily inoculum preparations. Every 3 weeks, use 6 stabs to subculture 30 new stabs. Save five of the previous cultures as reserves for 6 months in case of contamination. If mutation of the organism appears to have occurred (as manifested by greatly reduced growth response), start process over with a new lyophilized culture.

b. *Daily Inoculum Preparation*

On the afternoon of the day before inoculation, transfer the stock culture from agar stab to broth and incubate for 18 h at 37°C. At the beginning of the next working day, vortex the 18 h broth culture and inoculate two new tubes of broth with 6 drops of culture, using a sterile cotton-plugged 0.5-mL pipet. Incubate these tubes for 6 h at 37°C. At the end of 6 h, centrifuge the two broth tubes at 2400 rpm for 5 min. Decant the supernatant of the tube with the largest cell sediment and wash and recentrifuge 3 times with 10 mL of sterile 0.85 g/dL saline. Dilute the cells 1:100 by adding 0.4 mL of the washed, resuspended cells to 40 mL of sterile saline. Add 1 drop of this inoculum to each tube of assay medium.

7. *Procedure*

The microbiological assay for serum and red cell folate requires 3 days. On the first day, the folate is extracted from the serum/whole blood hemolysate specimen and quality control materials. On the second day, the extracted samples and standards are diluted with folate-deficient assay medium and inoculated with *L. casei*. On the third day, the turbidity of the resulting growth is measured.

Note: Serum specimens or whole blood hemolysates that have not been properly prepared and frozen or inadvertently thawed are unacceptable for analysis because the folic acid has deteriorated.

a. *Day 1 – Extraction of Samples*

- (1) Thaw all serum and whole blood specimens and quality control materials and vortex each thoroughly.
- (2) Prepare the phosphate buffer for use by adding 100 mg of ascorbic acid per 100 mL of buffer to act as a preservative to keep the folate in the reduced state. Approximately 4 mL of buffer will be used for every sample specimen extracted.

- (3) Using the Micromedic Automatic Pipette, dilute 0.4 mL of serum with 3.6 mL of phosphate buffer into 16- X 150-mm tubes. The RBC samples (collected and processed in the field as 1:5 dilutions with 1 g/dL ascorbic acid) are extracted 1:10, 1:20, and 1:40 with phosphate buffer to give final dilutions of 1:50, 1:100, and 1:200 (because of the wide variance of possible red cell folate levels). These dilutions are made as follows:

mL of 1:5 Hemolysate	mL of Phosphate Buffer	Final Dilution
0.4	3.6	1:50
0.2	3.8	1:100
0.1	3.9	1:200

- (4) Vortex each tube, cover with an autoclavable cap, and autoclave for 3 min at 121°C, 15 psi, to precipitate the proteins and release the folic acid.
- (5) Allow the tubes to cool, then centrifuge at 2400 rpm for 5 min. Decant the supernatant into disposable 1-dram glass vials and store at -20°C if the extract is not to be assayed on the same day. (Stable up to 1 week at -20°C.)

b. *Day 2 – Preparation of Standards, Media Addition, and Inoculation of Samples*

- (1) Prepare the 6-h *L. casei* culture at the beginning of the working day.
- (2) Prepare the working standard dilutions.
- (3) Prepare the folic acid assay medium by thawing the frozen 2X concentrate. For every 100 mL of 2X medium used, add 90 mL of distilled water and 0.2 g of ascorbic acid and mix well. Approximately 600 mL of working medium will be required for assaying 100 samples.
- (4) Thaw and mix each extract. Dilute 0.1 mL of each extract with 1.9 mL of assay medium into 13- X 100-mm glass tubes. Prepare the samples in duplicate, the standards and quality control materials in triplicate, and the 12 “blanks” (containing distilled water as sample).
- (5) Cap all the tubes and autoclave at 121°C, 15 psi, for 3 min. Allow tubes to cool.
- (6) Prepare 1:100 dilution of inoculum in a sterile, 3-oz bottle. Mix inoculum well, shaking the bottle again each time the sterile dropper pipette is filled. Deliver 1 drop (0.05 mL) of inoculum to each tube except one set of three “uninoculated” blanks. Cover rack of tubes with aluminum foil and incubate in the 37°C circulating water bath for 20 h.

c. *Day 3 – Measurement of Organism Growth*

- (1) After 20-22 h of incubation, remove the tubes from the water bath and refrigerate at 4°C for at least 15 min to inhibit further growth of the *L. casei*.
- (2) Resuspend the cells in each tube by vortexing. Transfer the sample to a 2-mL conical bottom sample cup, place in the sampler tray, and position the Sampler II mixing assembly which will stir the specimen before sampling. Place an empty cup after each 20 samples to purge the sample system.
- (3) Record absorbances of sample peaks. Although *L. casei* is nonpathogenic, all tubes and sample cups should be autoclaved before discarding. Flush the AutoAnalyzer manifold with 1 mol/L NaOH for 10 min; then pump wash solution for 20 min.

d. *Calculations*

A nonlinear standard curve is obtained by plotting the absorbances of standards versus PGA concentration. Serum folic acid concentrations are read directly from the standard curve, as are red cell extract values. Serum results are reported as nanograms folate as PGA per milliliter of serum (ng/mL). For red cell folate concentrations, multiply by the appropriate dilution factor (that is, 1:50, 1:100, 1:200) to obtain whole blood folate levels.

Note: The appropriate dilution level to select is the one with an absorbance level between those of the 2- and 18-ng/mL standards.

Then:

$$\text{RBC folate as PGA} = \frac{\text{whole blood folate} - \text{serum folate (1-hematocrit/100)}}{\text{hematocrit/100}}$$

$$= \text{ng folate/mL red blood cells}$$

8. *CDC Modifications*

The following CDC modifications to the original methods are based on CDC studies: (a) the automated turbidity measurement is described by Slade *et al.*;³⁵ (b) the concentrations of standards differ from these described by Baker *et al.*³⁶ and Cooperman;³⁷ (c) the red cell folate dilutions

differ from those described by Hoffbrand *et al.*³⁸, to accommodate collection and preservation of samples from the field; and (d) no incubation period of whole blood with diluent is used, since a freeze-thaw cycle accomplishes maximum red cell conjugase-activating effect, as described by Mortensen¹⁹

9. Flow Diagram

MICROBIOLOGICAL FOLATE FLOW DIAGRAM

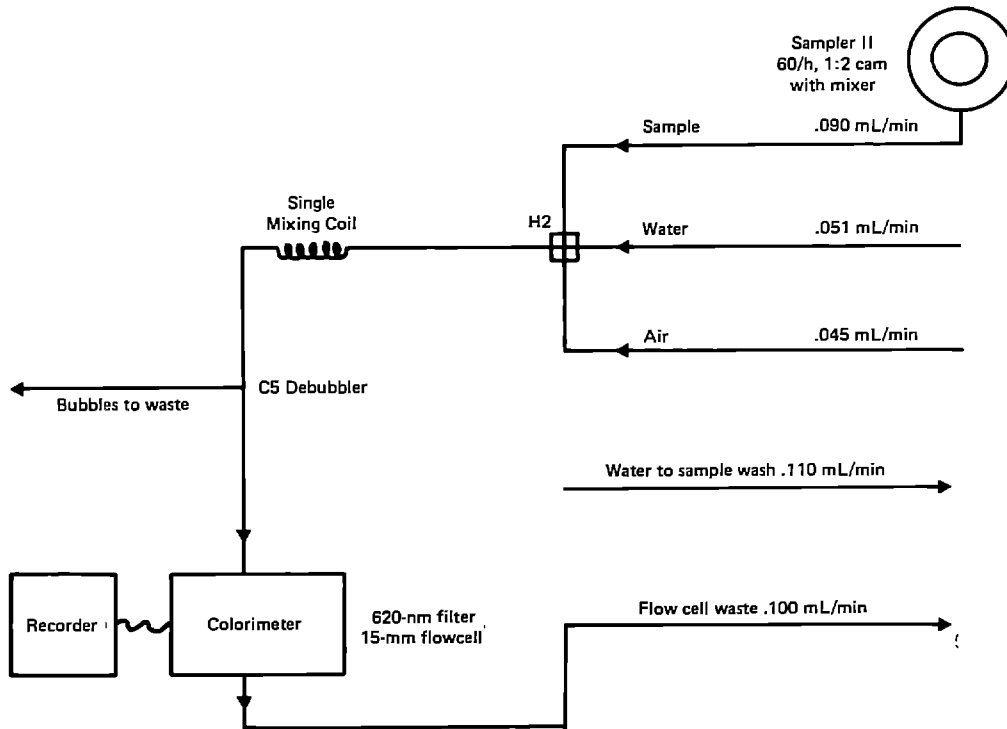

V. Quality Control

A. PREPARATION OF CONTROL MATERIALS

Serum (or plasma) quality control pools were prepared from pooled human serum (or plasma) with a low lipid content, which was well mixed and filtered through 0.45 and 0.20 μ Millipore* filters. Sterile techniques were used in dispensing the serum, which was mixed under a laminar-flow hood while being aliquoted into glass vials, sealed, labeled, and stored at -20° to -70°C.

Whole blood pools for lead and protoporphyrin were prepared from blood collected from cows dosed with lead acetate. Pools for red-cell folate were prepared from fresh human blood, with ascorbic acid added as a preservative to maintain the folic acid in a reduced state. These pools were mixed and dispensed in the same manner as serum.

Special precautions were taken in preparing trace metals quality control pools so that background contamination of copper and zinc would be minimal. High-density polyethylene vials with caps were found to be acceptable as storage containers.

To achieve low, normal, and high analyte levels in pools, we analyzed the pooled human serum or plasma for concentrations of the desired analyte(s), then divided the pool into three portions. We dispensed one portion as "normal," diluted the second portion by one-third with sterile 0.85 g/dL saline to achieve "low" concentration, and concentrated the third portion by Amicon** ultrafiltration to achieve "high" concentration.

Although analytes, such as the metals, are very stable, others, such as red cell folate, are very labile and cannot withstand "freeze-thaw" effects. Some pool materials, such as for serum folate, can be lyophilized to gain maximum stability; total iron-binding capacity, however, cannot be satisfactorily performed on reconstituted lyophilized serum.

*Millipore Corporation, Bedford, MA.

**Amicon Corporation, Lexington, MA.

B. SYSTEM DESCRIPTION

Two types of quality control systems were used for the major chemical analyses. These included all Analyses performed in the Nutritional Biochemistry Branch, glucose analyses performed in the Metabolic Biochemistry Branch, and blood lead analyses performed in the Toxicology Branch. These two systems were: (1) "bench" quality control pools inserted by the analyst and measured from 2-4 times in each analytical run to make judgements on the day of analysis and (2) "blind" quality control samples which were placed in vials, labeled, and processed so that they would be indistinguishable from regular HANES II samples. The results for the latter were decoded and reviewed by the quality control supervisor. If the average of replicate values of either "bench" or "blind" quality control samples fell outside their respective, established 95% confidence limits, the run was repeated. With both quality control systems, all levels of analyte concentration were assessed by taking these samples through the complete analytical process. The data from these materials could then be used to estimate methodological imprecision resulting from inherent errors, such as those in instruments reagents, and calibration procedures, and to assess the magnitude of any time-associated trends.

For each analyte, two levels of "blind" quality control pools were used. These pools were prepared in sufficient quantity to cover the duration of the survey. The levels chosen were generally in the "low normal" and "high normal" ranges. The pools were prepared in the same manner as "bench" quality control pools for each analyte, dispensed into vials identical to those used in the field for HANES II samples, labeled with pseudo-patient numbers corresponding to each geographical location and stored at -20°C. At least one "blind" sample was randomly incorporated with every 20 HANES II samples and analyzed in duplicate.

"Bench" quality control pools comprised three or more levels of concentration spanning the low, normal, and elevated range for each analyte.

For each quality control pool, either a one-way or two-way classification analysis of variance (ANOVA)* was performed, depending upon the "run" format. In the one-way analysis of variance, time in days was designated as the classification variable in order to estimate within-day and among-day components of variance and the total variance (sum of estimates of "within"

*Ostle, B. Statistics in Research. 2d ed. Ames, Iowa. The Iowa State University Press, 1963.

**Run = usually a set of consecutive assays performed without interruption.

The results are usually calculated from the set of calibration readings.

and "among" components). The two-way nested ANOVA was used when multiple runs occurred within a day. This analysis allows computation of the additional component attributable to among-run, within-day variance.

Long-term "bench" quality control plots for the pools used in HANES II from January 1976 to June 1980 are presented in section C, with tables summarizing the statistics for each pool for each analyte.

C. ANALYSIS OF VARIANCE TABLES AND LONG-TERM QUALITY CONTROL CHARTS

TABLE 4
HANES II QUALITY CONTROL SUMMARY

ANALYTE: Erythrocyte Protoporphyrin

Pool Number	Dates	Mean ($\mu\text{g/dL RBC}$)	Standard Deviation ($\mu\text{g/dL RBC}$)	Coefficient of Variation (%)	Number of Observations
2076	052576 - 043080	74.744	11.58	15.50	1525
1976	052576 - 093076	91.068	9.03	9.91	143
9976	052576 - 090176	135.793	10.91	8.03	98
3576	071576 - 020778	184.653	12.56	6.80	455
7176	110276 - 043080	42.214	4.23	10.01	1354
4677	042577 - 043080	133.763	10.05	7.52	1238
4577	042577 - 043080	199.414	12.65	6.35	1239
5677	070177 - 111679	66.204	7.38	11.15	979
4278	080578 - 043080	77.930	7.95	10.60	790

CHART 1

ERYTHROCYTE PROTOPORPHYRIN MONTHLY MEANS

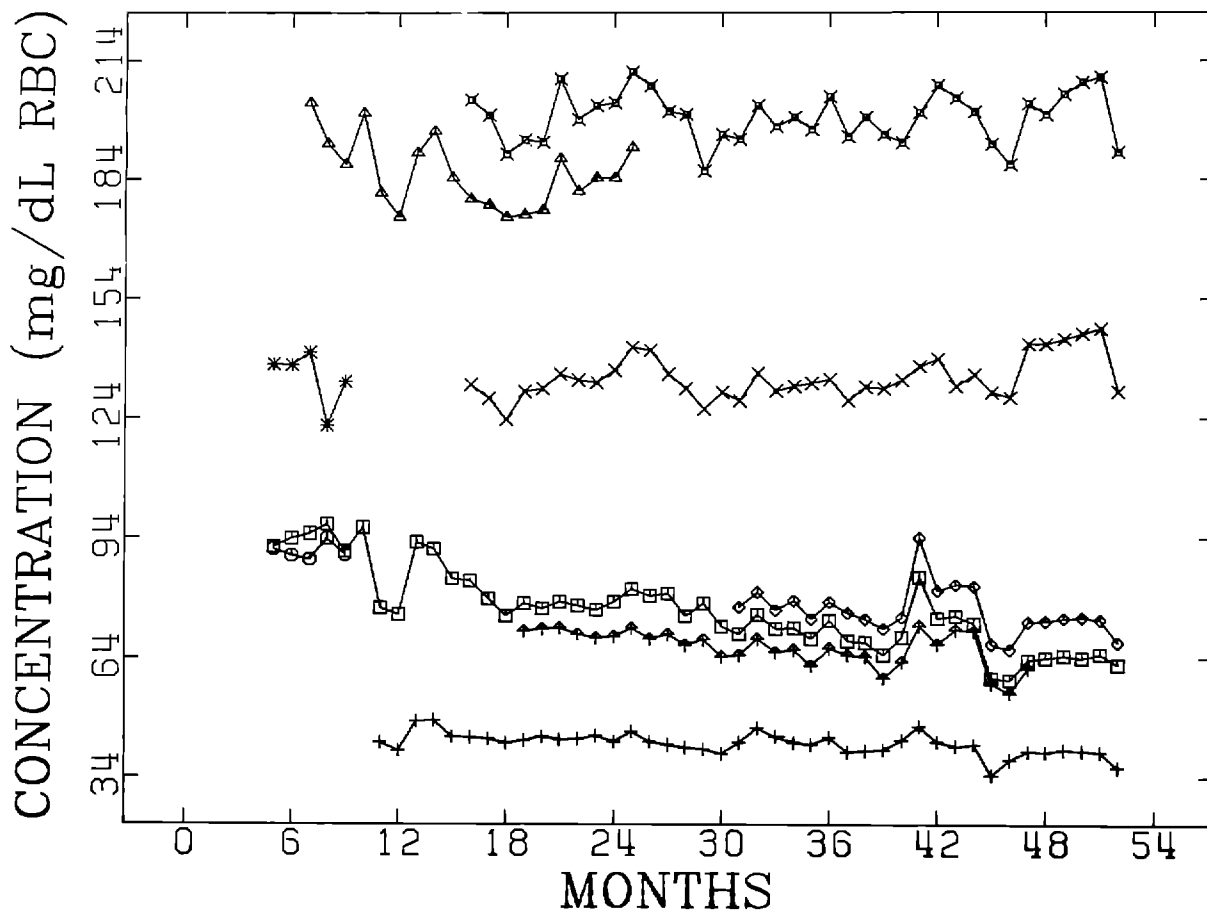

TABLE 5
HANES II QUALITY CONTROL SUMMARY

ANALYTE: Serum Iron

Pool Number	Dates	Mean ($\mu\text{g/dL}$)	Standard Deviation ($\mu\text{g/dL}$)	Coefficient of Variation (%)	Number of Observations
5776	062476 - 120777	61.477	1.22	1.98	457
5876	062476 - 112977	109.487	1.73	1.58	457
5976	062476 - 112977	151.397	2.15	1.42	455
7077	081677 - 120479	70.580	1.19	1.69	796
7177	081677 - 120479	109.750	1.63	1.49	803
7277	081677 - 120479	160.985	2.47	1.54	775
1679	072779 - 041780	76.837	1.60	2.08	183
1779	072779 - 041780	101.426	1.81	1.79	183
1879	072779 - 041780	162.320	2.69	1.66	186

CHART 2

*SERUM IRON
MONTHLY MEANS*

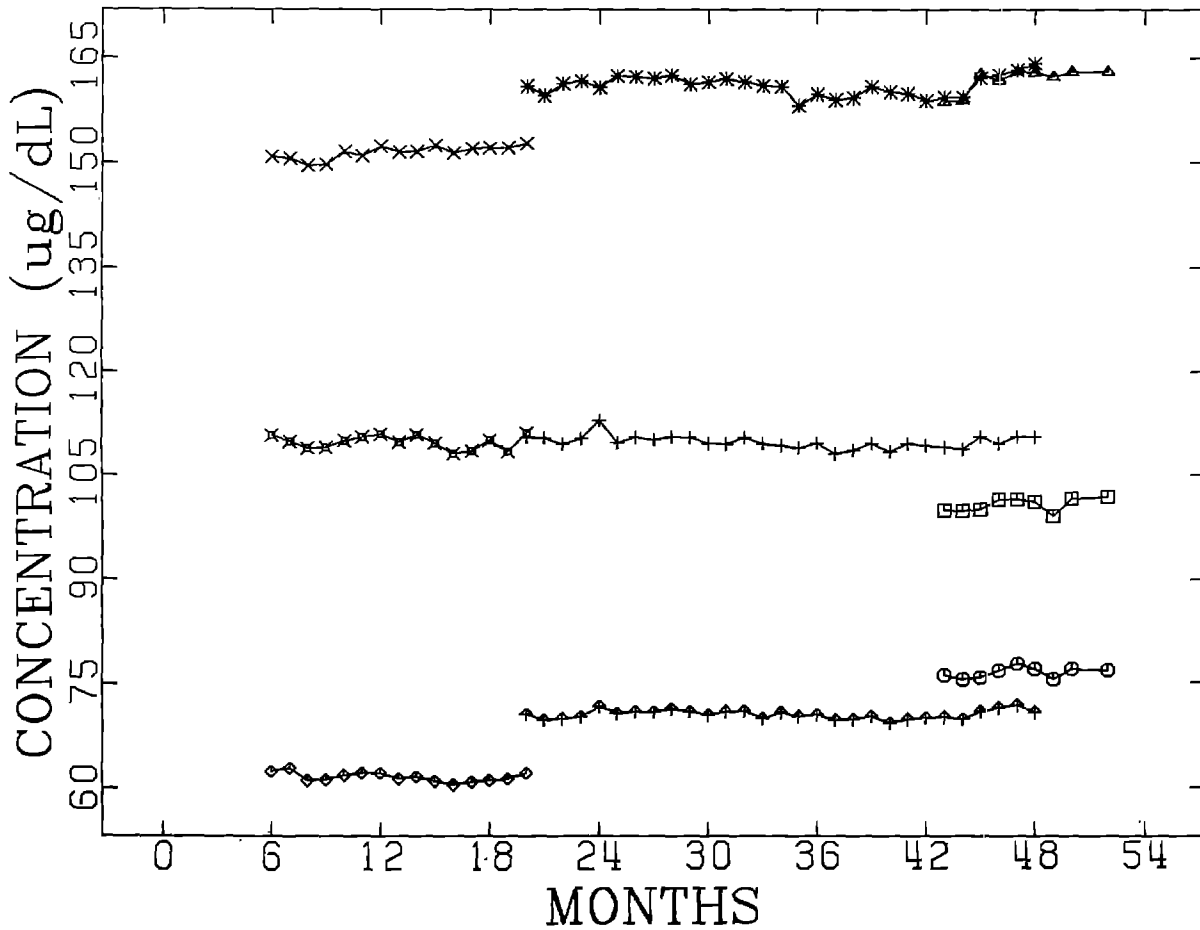

TABLE 6
HANES II QUALITY CONTROL SUMMARY

ANALYTE: Serum Total Iron-Binding Capacity

Pool Number	Dates	Mean (µg/dL)	Standard Deviation (µg/dL)	Coefficient of Variation (%)	Number of Observations
5776	◦ 070876 - 120177	231.25	6.09	2.64	373
5876	× 070876 - 120177	445.20	8.57	1.92	373
5976	× 070876 - 120177	599.96	9.49	1.58	372
7077	† 090977 - 120579	254.38	6.10	2.40	742
7177	+ 090977 - 120579	406.71	10.03	2.47	756
7277	* 090977 - 120579	609.10	17.22	2.83	737
1679	◦ 071979 - 061280	262.04	6.44	2.46	223
1779	◻ 071979 - 061280	374.44	9.36	2.50	216
1879	△ 071979 - 061280	574.37	11.75	2.05	219

CHART 3

*TOTAL IRON-BINDING CAPACITY
MONTHLY MEANS*

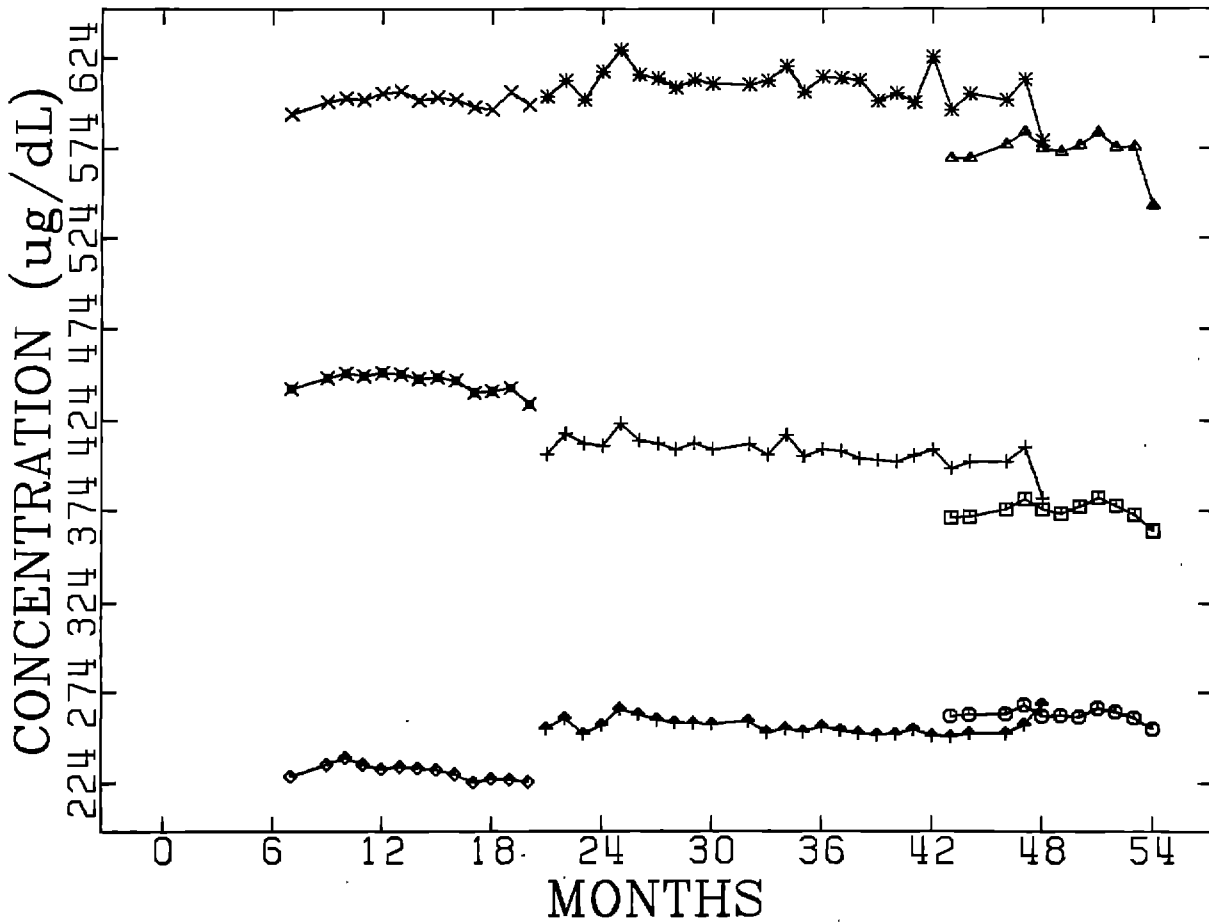

TABLE 7
HANES II QUALITY CONTROL SUMMARY

ANALYTE: Serum Albumin

Pool Number	Dates	Mean (g/dL)	Standard Deviation (g/dL)	Coefficient of Variation (%)	Number of Observations
5776 ◻	041976 - 112277	2.346	0.054	2.30	454
5876 ◊	041976 - 112277	4.434	0.071	1.61	450
5976 ×	041976 - 112277	6.549	0.106	1.62	449
6777 †	090877 - 042580	2.884	0.067	2.34	512
6877 †	090877 - 042580	4.593	0.079	1.73	517
6977 *	090877 - 042580	6.706	0.121	1.80	509
1979 ◊	071379 - 042580	3.225	0.093	2.89	100
2079 ◻	071379 - 042580	4.597	0.092	2.00	96
2179 ×	071379 - 042580	6.878	0.108	1.56	96

CHART 4

*SERUM ALBUMIN
MONTHLY MEANS*

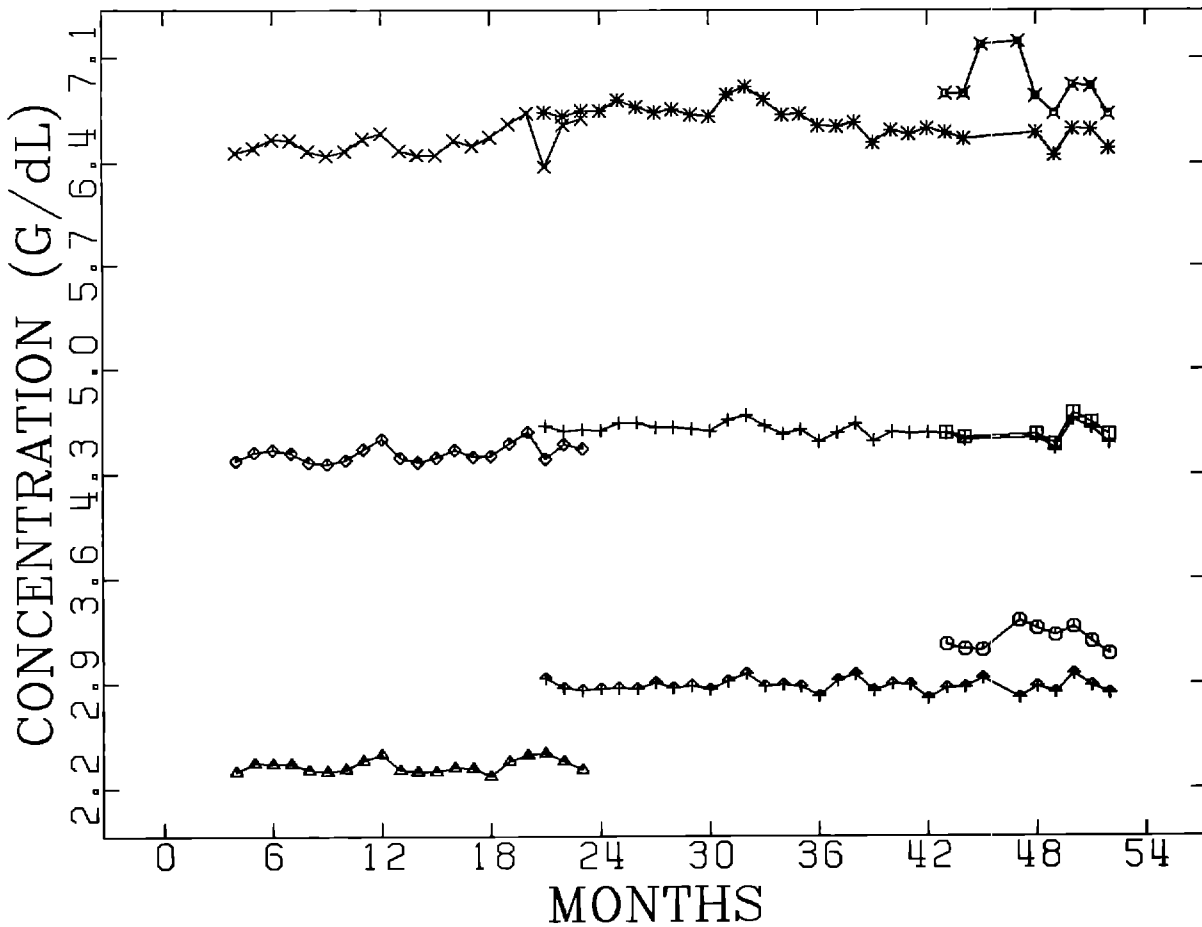

TABLE 8
HANES II QUALITY CONTROL SUMMARY

ANALYTE: Serum Vitamin C

Pool Number	Dates	Mean (mg/dL)	Standard Deviation (mg/dL)	Coefficient of Variation (%)	Number of Observations
6076 □	031676 - 06078	0.355	0.022	6.22	444
6176 ▲	120878 - 060678	1.184	0.035	2.97	512
6276 ○	031676 - 070877	2.248	0.040	1.76	333
6677 ×	110377 - 041180	0.345	0.021	6.17	247
7477 ×	103078 - 041180	1.106	0.028	2.57	134
4377 ○	062977 - 041180	2.590	0.079	3.06	289

CHART 5

*SERUM VITAMIN C
MONTHLY MEANS*

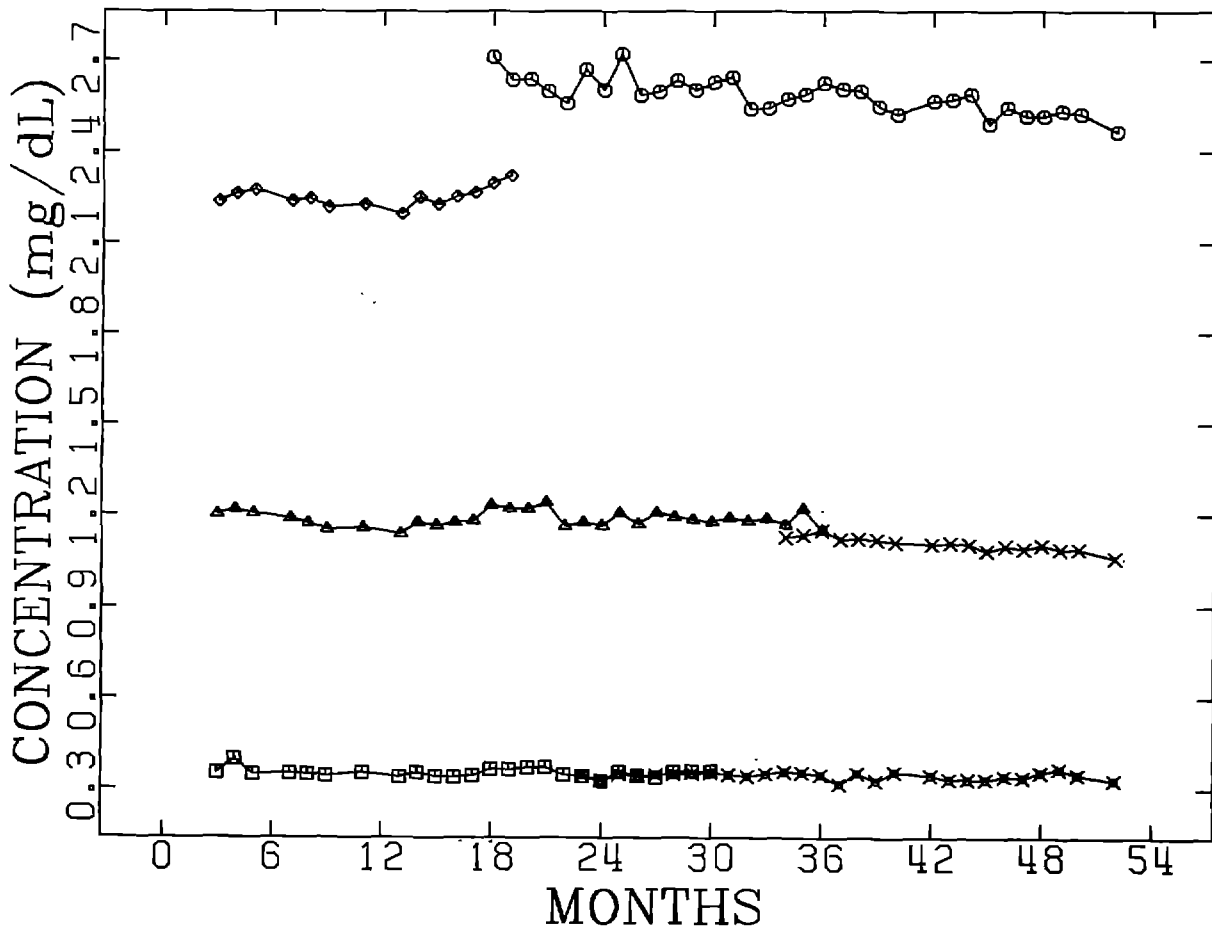

TABLE 9
HANES II QUALITY CONTROL SUMMARY

ANALYTE: Serum Zinc

Pool Number	Dates	Mean (µg/dL)	Standard Deviation (µg/dL)	Coefficient of Variation (%)	Number of Observations
0476 ◦	060276 - 061080	60.874	3.17	5.21	1970
0576 ◻	060276 - 061080	86.729	3.81	4.40	1991
0676 ▲	060276 - 061080	152.603	5.38	3.53	1977

CHART 6

*SERUM ZINC
MONTHLY MEANS*

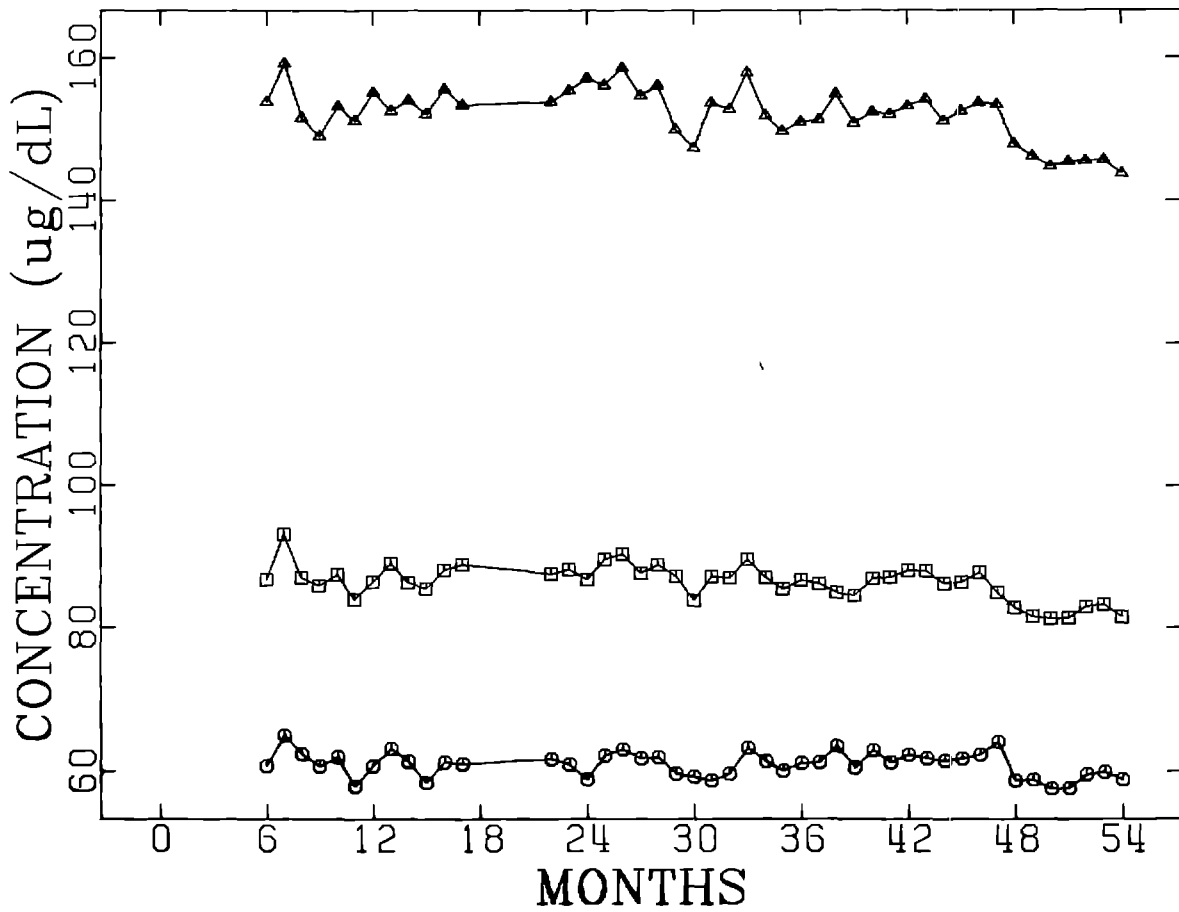

TABLE 10
HANES II QUALITY CONTROL SUMMARY

ANALYTE: Serum Copper

Pool Number	Dates	Mean (µg/dL)	Standard Deviation (µg/dL)	Coefficient of Variation (%)	Number of Observations
0476 ◊	060276 - 061080	82.738	2.73	3.30	2231
0576 ◻	060276 - 061080	132.556	3.40	2.57	2240
0676 ▲	060276 - 061080	201.583	5.20	2.58	2216

CHART 7

*SERUM COPPER
MONTHLY MEANS*

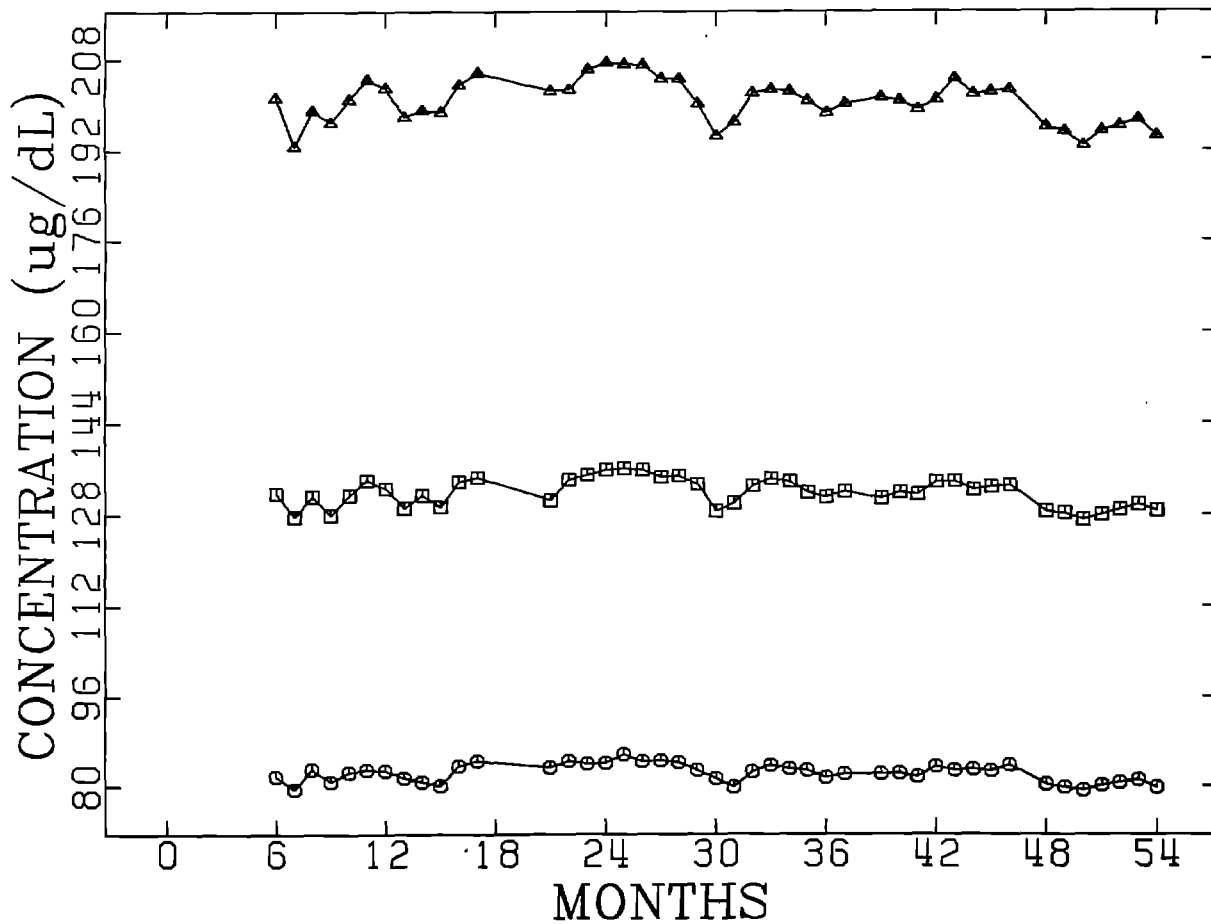

TABLE 11
HANES II QUALITY CONTROL SUMMARY

ANALYTE: Serum Vitamin A

Pool Number	Dates	Mean (µg/dL)	Standard Deviation (µg/dL)	Coefficient of Variation (%)	Number of Observations
1676 □	062176 - 111276	27.786	1.99	7.16	47
1776 △	062176 - 080878	52.146	2.75	5.27	215
1876 ◊	062176 - 033078	74.427	4.89	6.57	195
22222 *	041977 - 052578	39.329	1.88	4.80	95
5176 ×	110176 - 033178	25.056	1.34	5.33	173
6477 †	033078 - 050880	26.498	2.17	8.21	151
3578 ×	042578 - 050880	64.230	4.87	7.59	150
9979 †	072778 - 050880	49.073	6.24	12.73	120
0879 ◊	050879 - 050880	84.046	5.67	6.75	92

CHART 8

SERUM VITAMIN A
MONTHLY MEANS

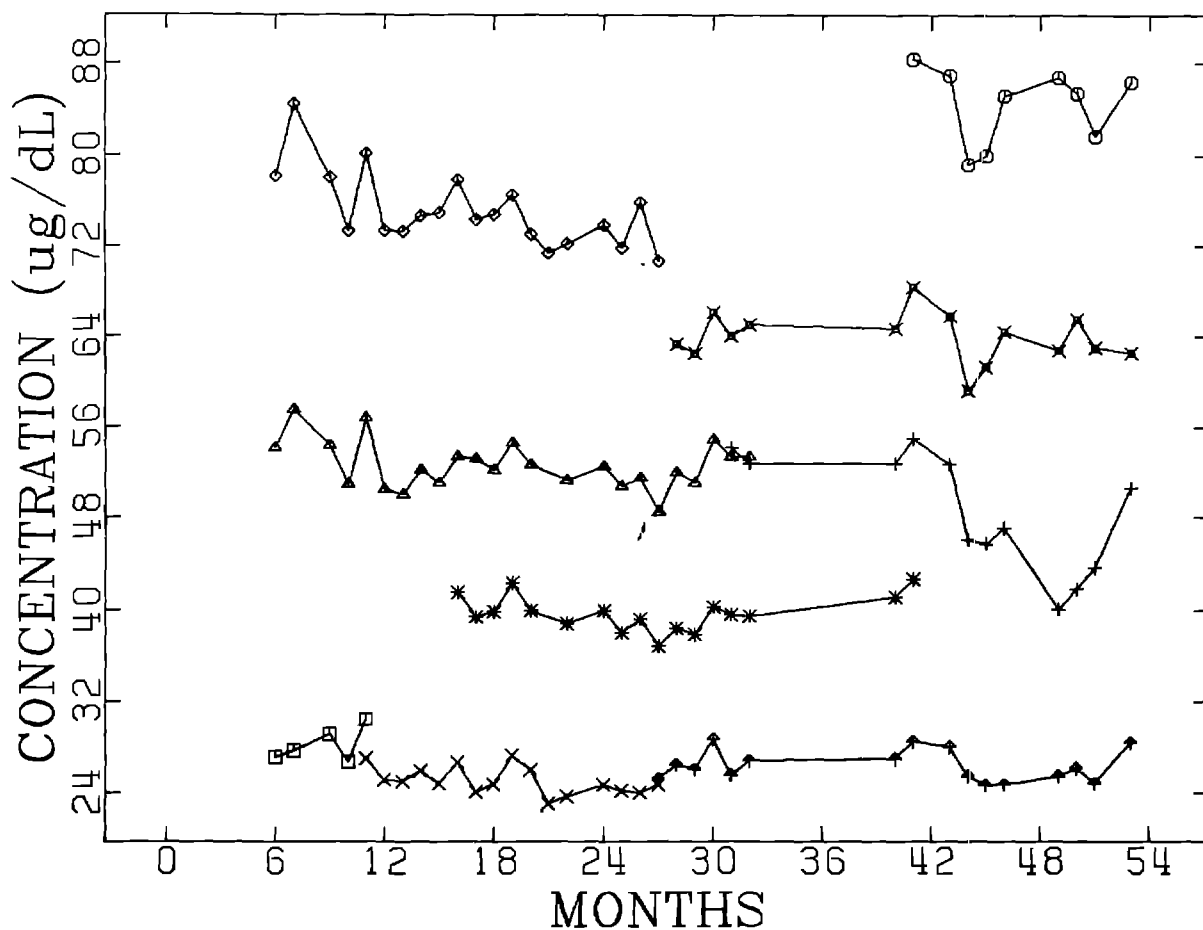

TABLE 12
HANES II QUALITY CONTROL SUMMARY

ANALYTE: Radioassay Serum Folate

Pool Number	Dates	Mean (ng/mL)	Standard Deviation (ng/mL)	Coefficient of Variation (%)	Number of Observations
4877 \circ	070578 - 050980	3.504	0.509	14.5	355
4977 \square	070578 - 050980	7.296	0.774	10.6	338
5077 \triangle	070578 - 050980	10.195	1.187	11.6	323
6077 \times	070578 - 050980	4.140	0.525	12.7	345

CHART 9

*RADIOASSAY SERUM FOLATE
MONTHLY MEANS*

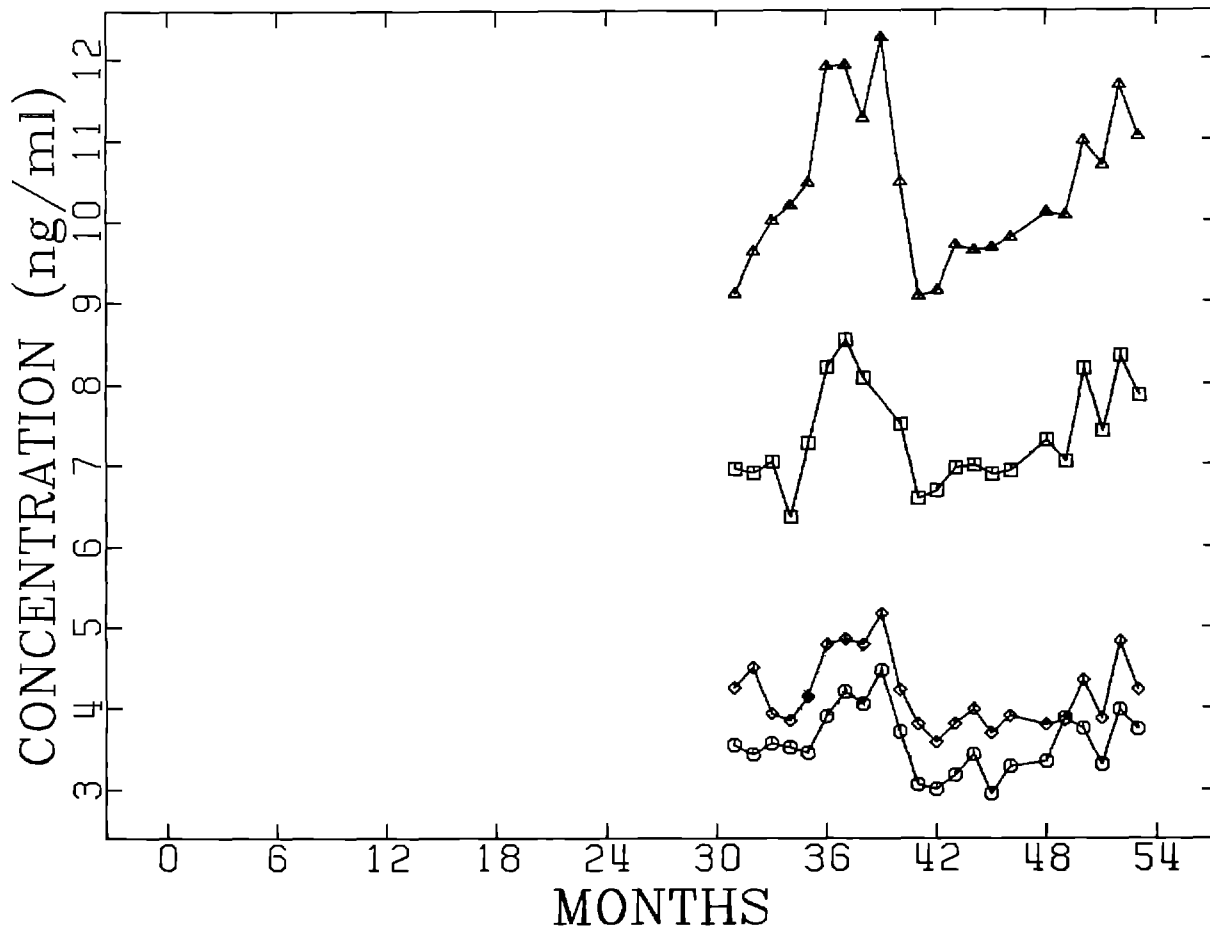

TABLE 13
HANES II QUALITY CONTROL SUMMARY

ANALYTE: Radioassay Red Cell Folate

Pool Number	Dates	Mean (ng/mL RBC)	Standard Deviation (ng/mL RBC)	Coefficient of Variation (%)	Number Observations
5177	+ 091978 - 120678	136.32	27.64	20.27	12
5277	+ 091978 - 120678	216.78	33.94	15.67	12
5377	* 091978 - 120678	438.03	54.72	12.49	12
3978	o 012279 - 061279	128.56	45.83	35.65	38
4078	x 012279 - 061879	220.85	33.67	15.25	45
4178	x 012279 - 061879	420.00	60.89	14.50	44
2279	o 072479 - 050980	137.04	45.41	33.14	53
2379	o 072479 - 050980	265.36	60.64	22.85	50
2479	* 072479 - 050980	583.11	75.45	12.94	50

CHART 10

*RADIOASSAY RED CELL FOLATE
MONTHLY MEANS*

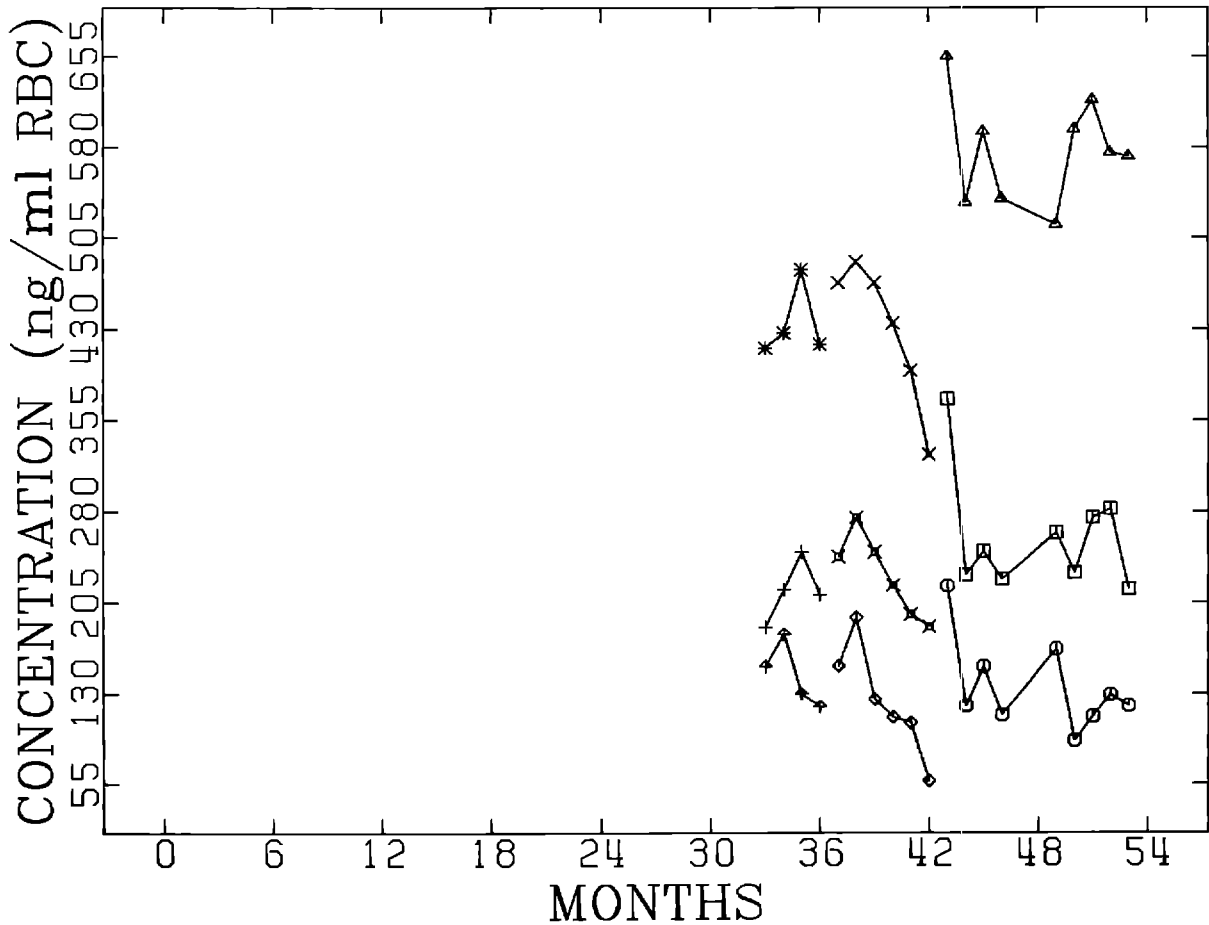

TABLE 14
HANES II QUALITY CONTROL SUMMARY

ANALYTE: Serum Vitamin B-12

Pool Number	Dates	Mean (pg/mL)	Standard Deviation (pg/mL)	Coefficient of Variation (%)	Number of Observations
5777 ◊	082277 - 051680	291.17	32.60	11.20	208
5877 ✕	071377 - 051680	692.83	66.21	9.56	221
5977 ∨	082277 - 051680	1250.51	136.61	10.90	198
2579 ⊖	121379 - 051680	340.29	39.43	11.59	27
2679 □	121379 - 051680	594.57	51.71	8.70	28
2779 △	121379 - 051680	1117.71	151.71	13.57	28

CHART 11

*SERUM VITAMIN B-12
MONTHLY MEANS*

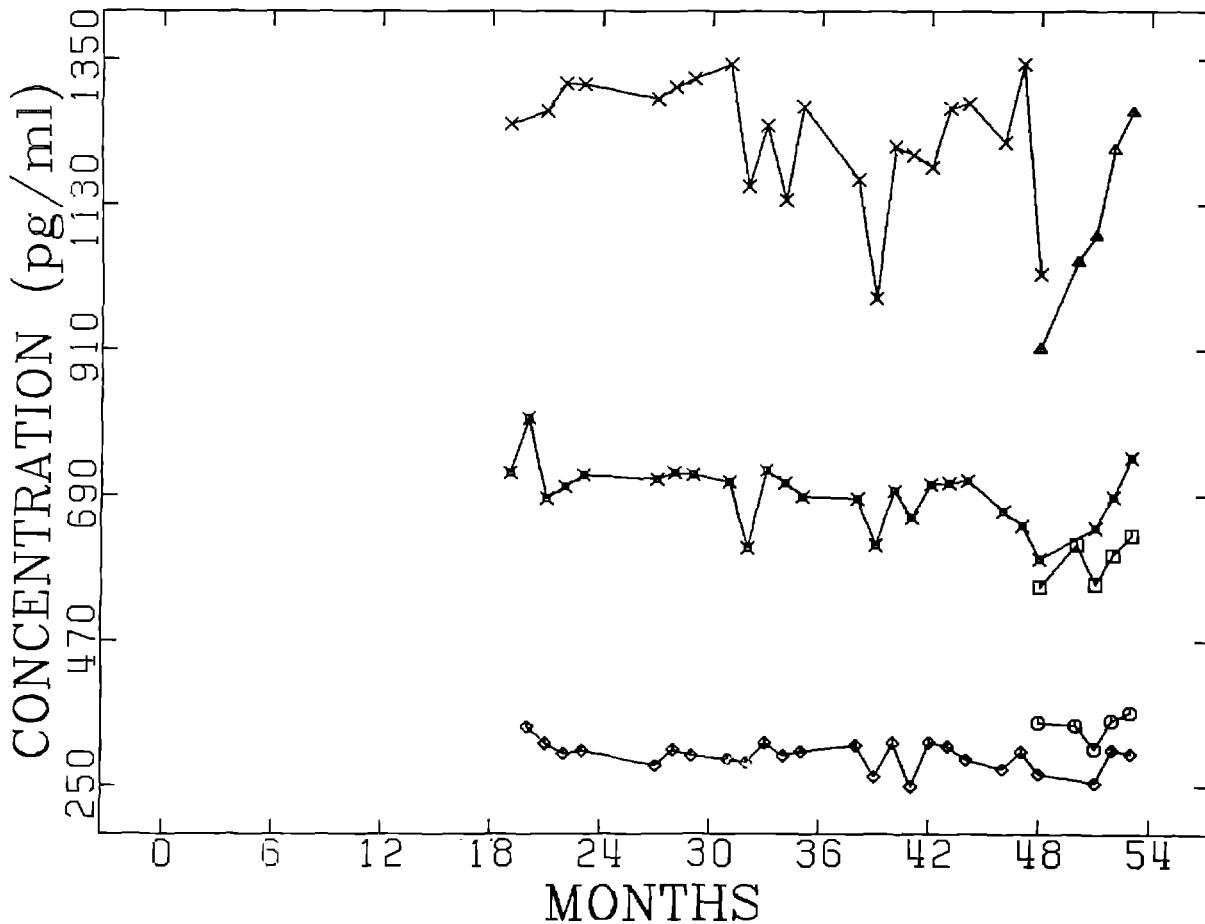

TABLE 15
HANES II QUALITY CONTROL SUMMARY

ANALYTE: Plasma Glucose

Pool Number	Dates	Mean (mg/dL)	Standard Deviation (mg/dL)	Coefficient of Variation (%)	Number of Observations
4476	041676 - 052880	162.18	2.10	1.29	271
6177	041676 - 032277	82.88	0.68	0.82	62
3777	041676 - 060277	189.92	1.54	0.81	74
6711	042077 - 110378	75.83	1.23	0.93	123
3677	060177 - 011580	166.99	1.99	1.19	203
3178	062978 - 052880	97.33	1.09	1.12	96
4679	021380 - 052880	124.22	2.04	2.53	9

CHART 12

*PLASMA GLUCOSE
MONTHLY MEANS*

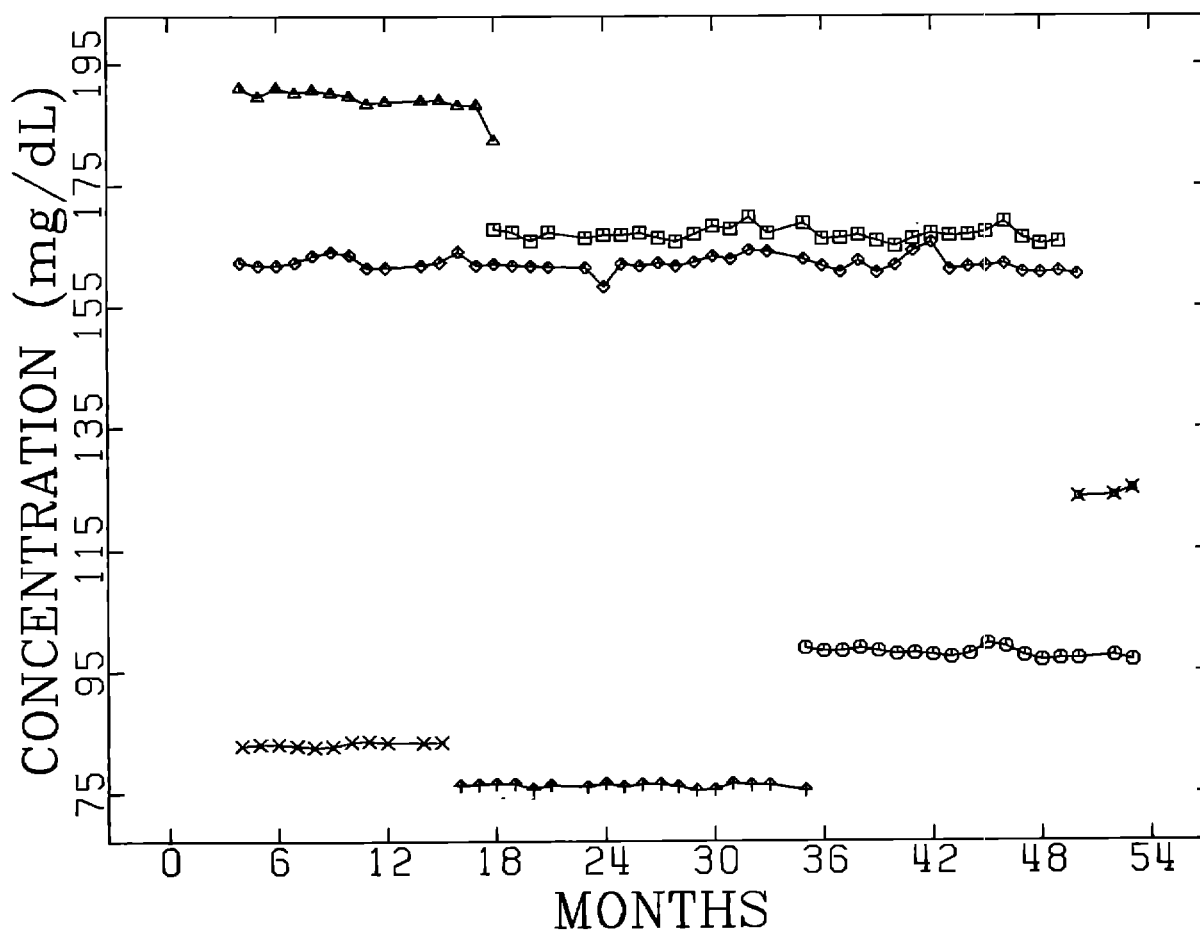

TABLE 16
HANES II QUALITY CONTROL SUMMARY

ANALYTE: Whole Blood Lead

Pool Number	Dates	Mean (µg/dL)	Standard Deviation (µg/dL)	Coefficient of Variation (%)	Number of Observations	
6020	†	072676 - 120176	27.269	3.00	10.99	92
6027	+	072676 - 120176	63.698	4.47	7.03	91
6039	x	120676 - 012077	21.294	2.87	13.46	16
6031	*	120676 - 012077	39.702	2.87	7.22	16
7039	.	050277 - 091477	22.660	3.16	13.93	81
7037	z	050277 - 091477	56.387	7.68	13.62	81
8037	o	011678 - 042078	11.632	1.76	15.15	99
8038	o	011678 - 042078	51.849	5.89	11.36	97
8039	▲	042478 - 083078	27.903	3.72	13.31	89
8040	o	042478 - 083078	44.601	6.35	14.23	91
7007	z	071078 - 032179	26.238	3.77	14.35	119
7018	y	071078 - 032179	39.481	5.68	14.38	119
7040	.	020579 - 091279	26.052	3.22	12.38	156
7041	●	020579 - 091279	52.538	6.53	12.44	156
9056	x	061479 - 101179	27.675	3.50	12.63	68
9054	▲	061479 - 101179	51.062	5.87	11.50	70
9066	x	031480 - 052780	31.240	3.46	11.07	65
9055	●	031480 - 052780	38.371	3.25	8.50	61

CHART 13

WHOLE BLOOD LEAD
MONTHLY MEANS

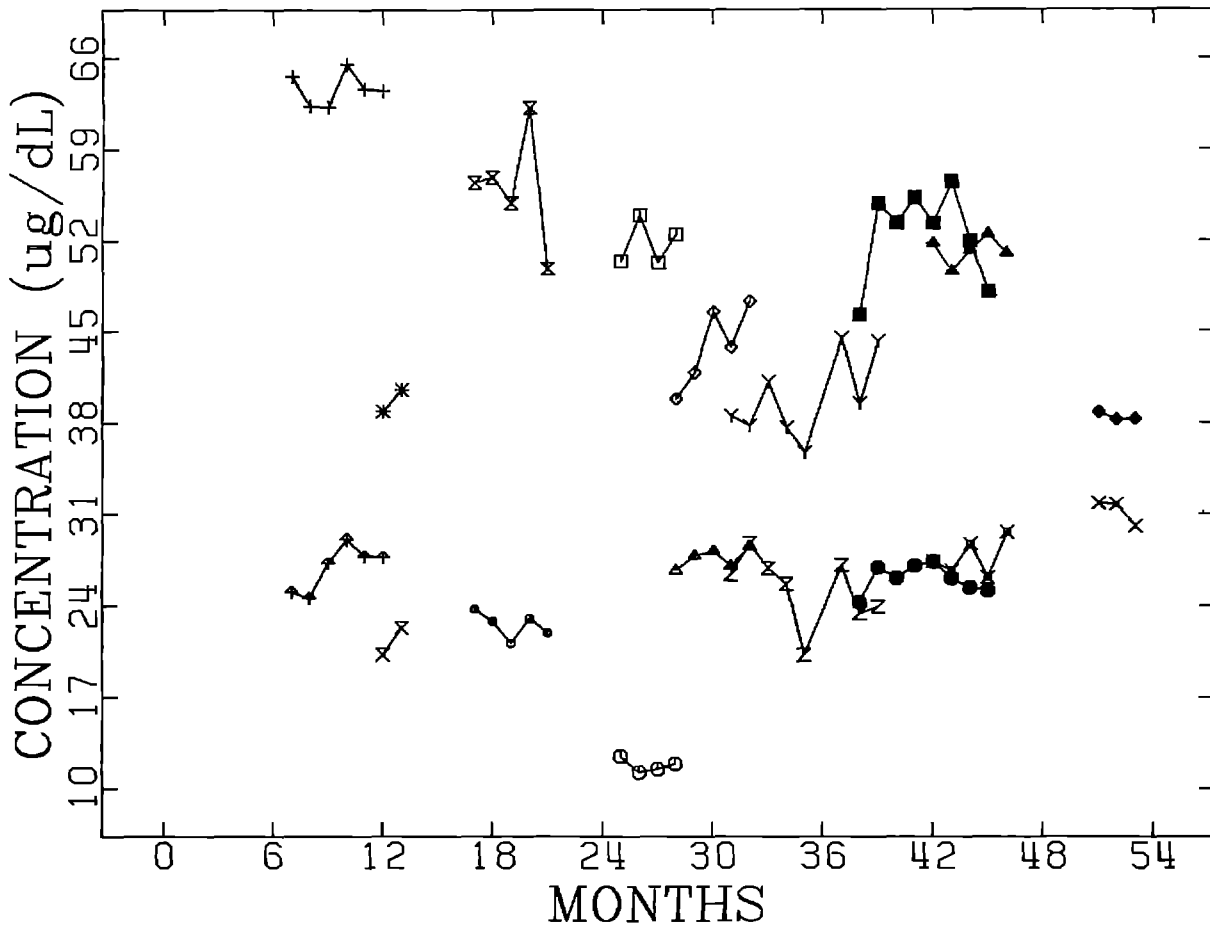

TABLE 17
HANES II QUALITY CONTROL SUMMARY

ANALYTE: Serum Total Bilirubin

Pool Number	Dates	Mean (mg/dL)	Standard Deviation (mg/dL)	Coefficient of Variation (%)	Number of Observations
3677 □	030178 - 083179	1.525	.041	2.672	355
1011 ○	030178 - 083179	2.916	.025	0.860	355
6876 ▲	030178 - 083179	0.680	.027	4.011	357

CHART 14

*SERUM TOTAL BILIRUBIN
MONTHLY MEANS*

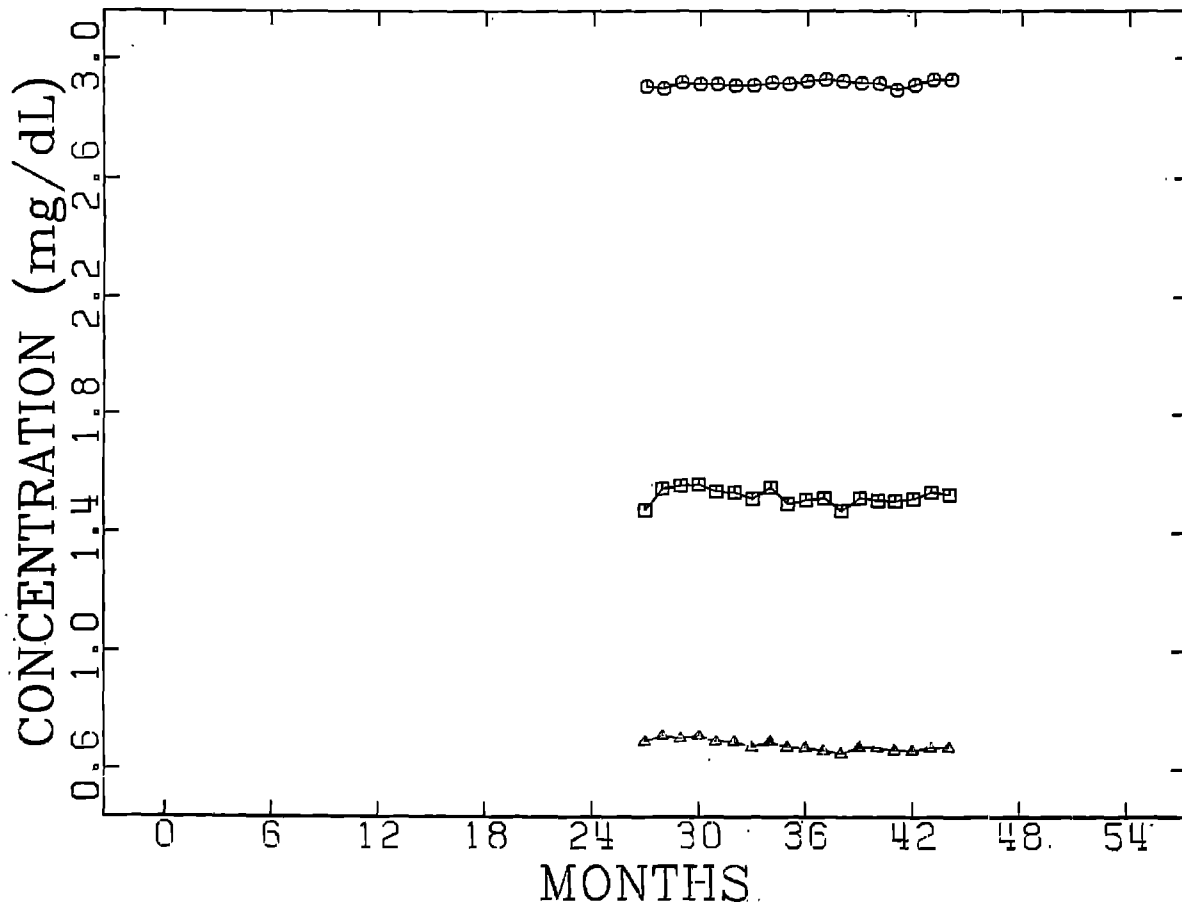

TABLE 18
HANES II QUALITY CONTROL SUMMARY

ANALYTE: Serum Glutamic-Oxaloacetic Transaminase

Pool Number	Dates	Mean (mg/dL)	Standard Deviation (mg/dL)	Coefficient of Variation (%)	Number of Observations
6876 □	030178 - 083179	16.562	1.132	6.834	300
2775 ○	030178 - 083179	22.058	1.293	5.860	297
4776 ▲	030178 - 052379	34.180	1.463	4.281	256

CHART 15

*SERUM GLUTAMIC-OXALOACETIC TRANSAMINASE
MONTHLY MEANS*

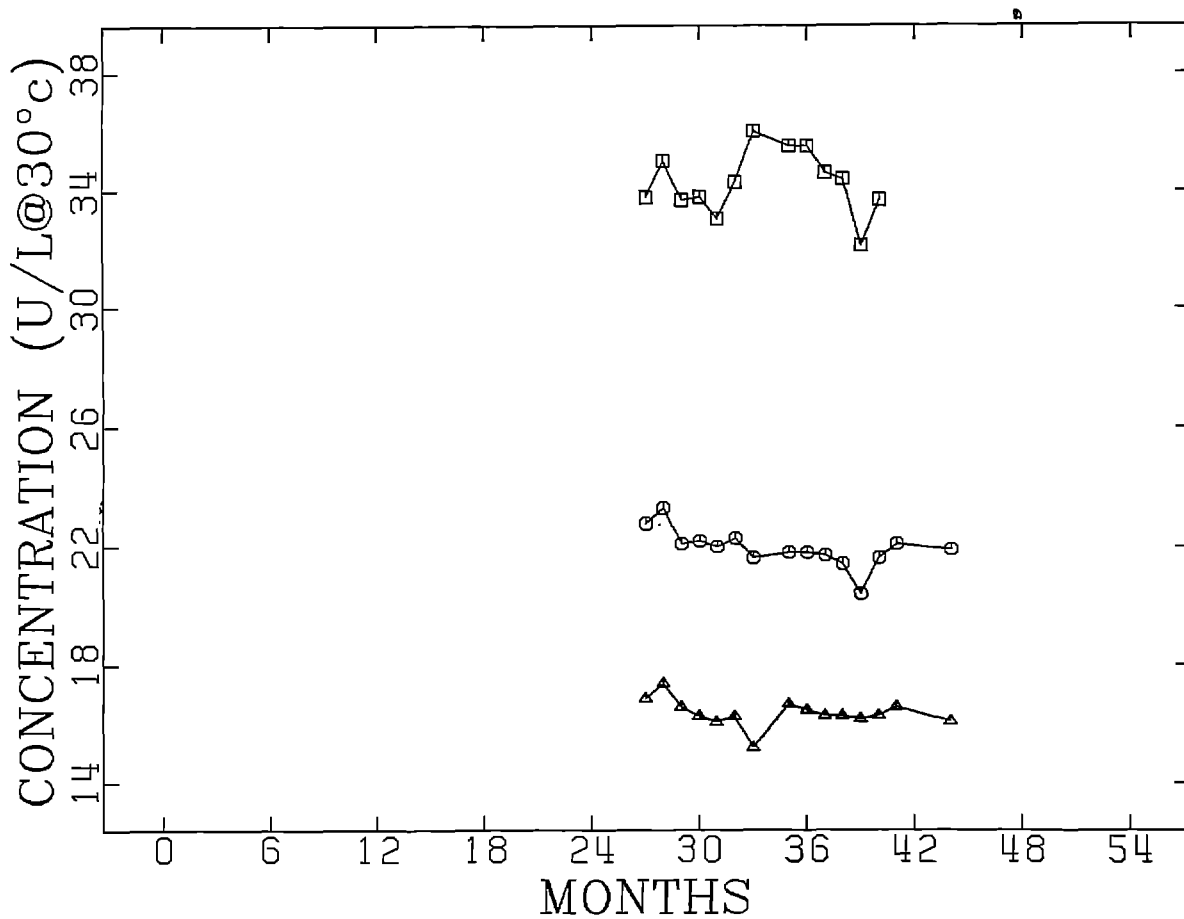

TABLE 19
HANES II QUALITY CONTROL SUMMARY

ANALYTE: Serum Alkaline Phosphatase

Pool Number	Dates	Mean (mg/dL)	Standard Deviation (mg/dL)	Coefficient of Variation (%)	Number of Observations
2275 ▲	030178 - 083179	73.367	2.388	3.255	291
7071 ○	030178 - 083179	78.224	2.167	2.770	293
6876 □	030178 - 083179	67.467	2.198	3.258	393

CHART 16

*SERUM ALKALINE PHOSPHATASE
MONTHLY MEANS*

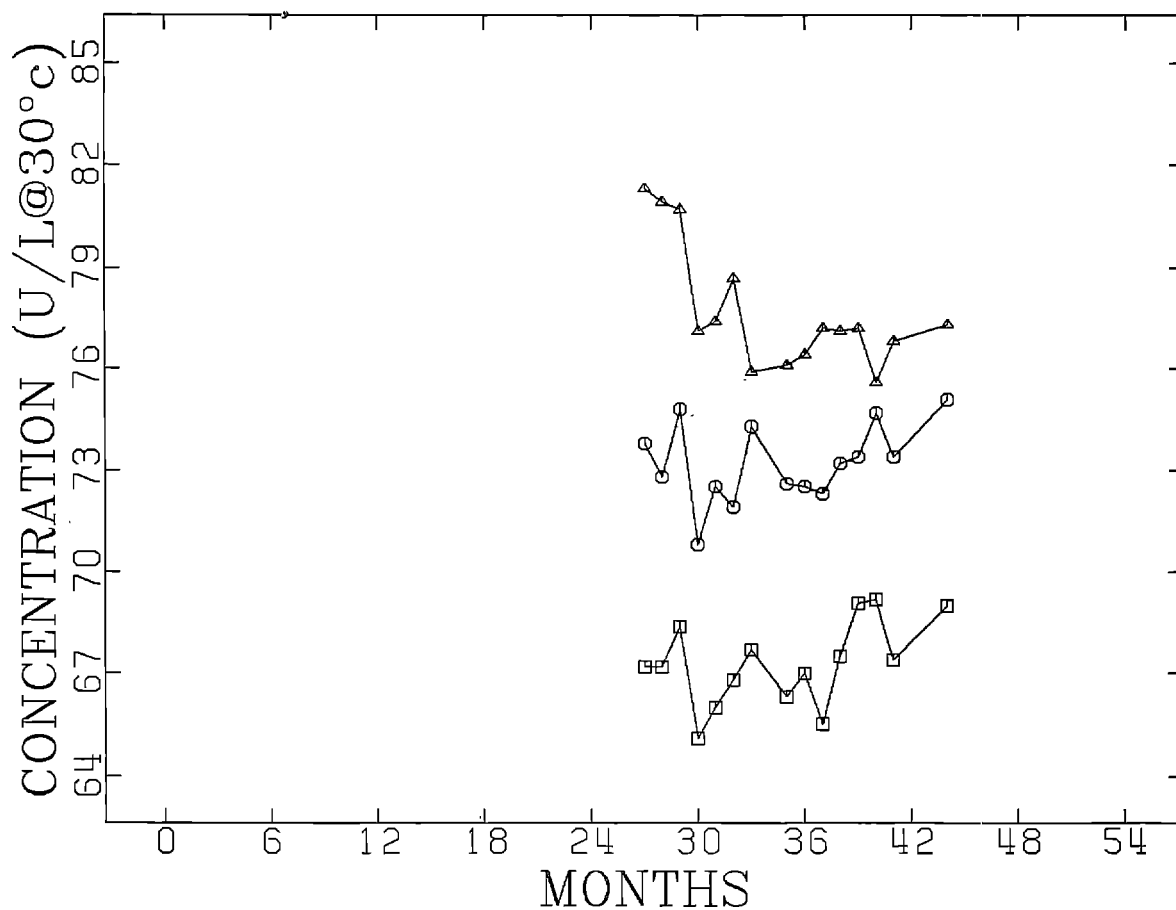

TABLE 20
HANES II QUALITY CONTROL SUMMARY

ANALYTE: Microbiological Serum Folate

Pool Number	Dates	Mean (ng/mL)	Standard Deviation (ng/mL)	Coefficient of Variation (%)	Number of Observations
7718 +	061676 - 021578	3.736	0.626	16.76	118
7719 *	061676 - 071377	2.654	0.439	16.56	99
7720 x	061676 - 033078	6.212	1.356	21.83	123
7721 z	061676 - 083178	14.320	2.271	15.86	122
2001 o	061676 - 083178	3.070	0.436	14.19	106
2002 □	061676 - 083178	8.669	1.278	14.74	119
2004 ▲	061676 - 102076	8.970	0.783	8.73	24
4877 •	011978 - 083178	2.745	0.446	16.25	35
4977 x	011978 - 083178	6.314	0.955	15.13	35
5077 x	011978 - 083178	9.757	0.928	9.52	35
6077 +	011978 - 083178	3.415	0.604	17.69	38

CHART 17

*MICROBIOLOGICAL SERUM FOLATE
MONTHLY MEANS*

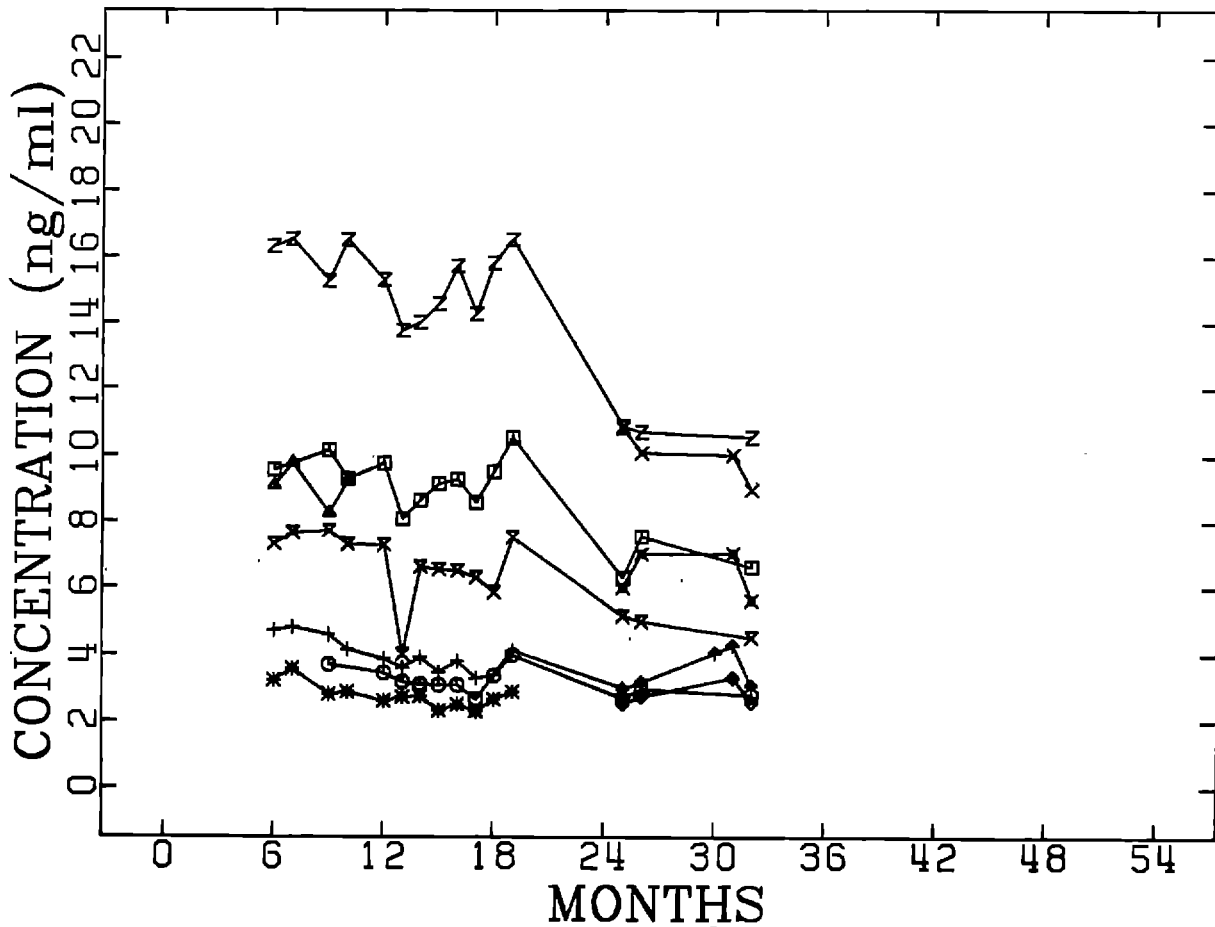

TABLE 21
HANES II QUALITY CONTROL SUMMARY

ANALYTE: Microbiological Red Cell Folate

Pool Number	Dates	Mean (ng/dL RBC)	Standard Deviation (ng/dL RBC)	Coefficient of Variation (%)	Number of Observations
8476 †	061676 - 091578	128.85	24.29	18.86	92
8576 †	061676 - 091578	132.68	27.65	20.84	93
8676 *	061676 - 091578	392.48	18.92	20.87	90
5177 °	081878 - 100678	46.50	6.23	13.41	18
5277 x	081878 - 100678	220.43	20.25	9.19	18
5377 x	081878 - 100678	443.94	47.07	10.60	18
3978 °	091578 - 111778	112.86	12.46	11.04	16
4078 □	091578 - 111778	155.22	20.31	13.08	16
4178 ▲	091578 - 111778	217.33	19.84	9.13	16

CHART 18

*MICROBIOLOGICAL RED CELL FOLATE
MONTHLY MEANS*

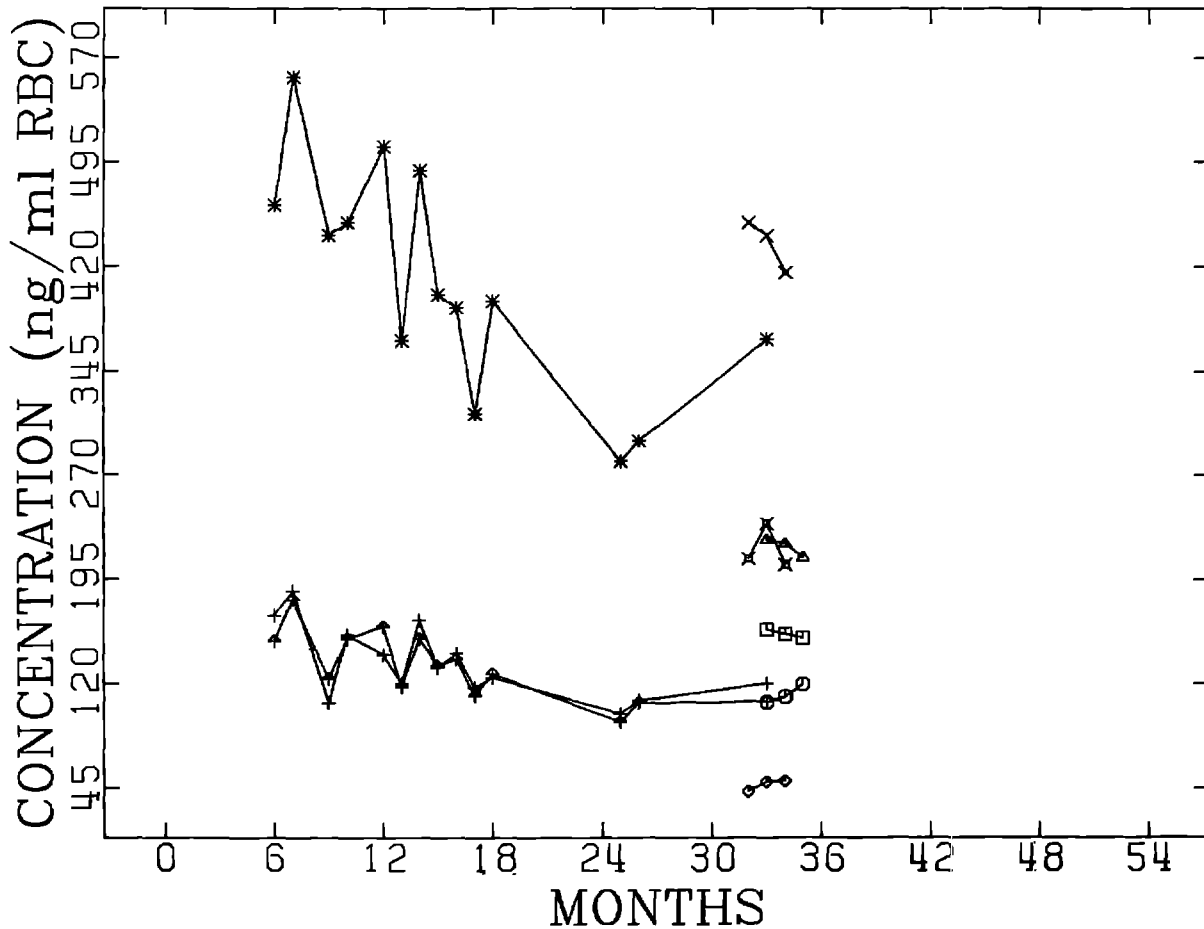

VI. References for Analytical Methods

1. Sassa, S., Granick, J. L., Granick, S., Kappas, A., and Levere, R. D.: Microanalyses of erythrocyte protoporphyrin levels by spectrophotometry in the detection of chronic lead intoxication in the subclinical range. *Biochem. Med.* 8:135-148, 1973.
2. Committee on Specifications and Criteria for Biochemical Compounds, National Research Council: *Specifications and Criteria for Biochemical Compounds*. 3d ed. Washington, DC. National Academy of Science, 1972.
3. Culbreth, P., Walter, G., Carter, R., and Burtis, C.: Separation of protoporphyrins and related compounds by reversed-phase liquid chromatography. *Clin. Chem.* 25:605-610, 1979.
4. Giovannello, T. J., Bendetto, G., Palmer, D. W., and Peters, T.: Fully and semiautomated methods for the determination of serum iron and total iron-binding capacity. *J. Lab. Clin. Med.* 71:874, 1968.
5. Ramsey, W. N. M.: The determination of the total iron-binding capacity of serum. *Clin. Chim. Acta.* 2:221, 1957.
6. White, W. L., Ericksen, M. M., and Stevens, S. C.: *Practical Automation for the Clinical Laboratory*. 2d ed. St. Louis, MO. C. V. Mosby Co., 1972.
7. Albumin: *Technicon Information Bulletin No. TN3-0160-20*, Technicon AutoAnalyzer II and SMA AutoAnalyzer Systems Bromocresol Green (BCG) Albumin Method. Tarrytown, NY. Technicon Instruments Corp., March 1973.
8. Doumas, B. T., Watson, W., and Biggs, H. C.: Albumin standards and the measurement of serum albumin with bromocresol green. *Clin. Chim. Acta.* 31:87-96, 1971.
9. White, W. L., Ericksen, M. M., and Stevens, S. C.: *Practical Automation for the Clinical Laboratory*. 2d ed. St. Louis, MO. C. V. Mosby Co., 1973.
10. Roe, Joseph H.: Ascorbic acid, in P. Gyorgy and W. N. Pearson, eds. *The Vitamins. Physiology, Pathology, Methods*. Vol. VII, 2d ed. New York, NY. Academic Press, 1967. pp. 27-49.
11. Roe, J. H., and Kuether, C. A.: The determination of ascorbic acid in whole blood and urine through the 2,4-dinitrophenylhydrazine derivative of dehydro-ascorbic acid. *J. Biol. Chem.* 147:399-407, 1943.
12. *Clinical Applications of Atomic Absorption/Emission Spectroscopy*. Lexington, MA. Instrumentation Laboratory, Inc., 1972.
13. *Analytical Methods for Atomic Absorption Spectroscopy*. Norwalk, CT. Perkin-Elmer Corp., 1973.
14. Roels, O. A., and Trout, M.: Vitamin A and carotene, in *Standard Methods of Clinical Chemistry*, G. Cooper, ed., Vol. 7. New York, NY. Academic Press, 1972. pp. 215-230.
15. Neeld, J. B., Jr., and Pearson, W. N.: Macro- and micromethods for the determination of serum vitamin A using trifluoroacetic acid. *J. Nutr.* 79:454-462, 1963.
16. *Instruction Manual*. Bulletin 4201. "Quanta-Count Folate." Richmond, CA. Bio-Rad Laboratories, April 1977.
17. Dunn, R. T., and Foster, L. B.: Radioassay of serum folate. *Clin. Chem.* 19:1101-1105, 1973.
18. Waxman, S., and Schreiber, C.: Measurement of serum folate levels and serum folic acid binding protein by ³H-PGA radioassay. *Blood* 42:281-293, 1973.
19. Mortensen, E.: Effect of storage on the apparent concentration of folate in erythrocytes as measured by competitive protein binding radioassay. *Clin. Chem.* 24(4):663-668, 1978.
20. *Instruction Manual*. Bulletin 4221. "Quanta-Count B-12." Richmond, CA. Bio-Rad Laboratories, Nov. 1978.
21. Ekins, R. P.: Assay for vitamin B₁₂ in blood. *Clin. Chim. Acta.* 4:453-455, 1960.
22. Lau, K. S., Gottlieb, C., Wassermann, L. R., and Herbert, V.: Measurement of serum vitamin B₁₂ level using radioisotope dilution and coated charcoal. *Blood* 26:202-208, 1965.
23. Skelly, D. S., Brown, L. P., and Besch, P. K.: Radioimmunoassay. *Clin. Chem.* 19:146-157, 1973.
24. Neese, J. W., Duncan, P., Bayse, D., Robinson, M., Cooper, T., and Stewart, C. Center for Disease Control: *Development and Evaluation of a Hexokinase/Glucose-6-Phosphate Dehydrogenase Procedure for Use as a National Glucose Reference Method*. DHEW Pub. No. (CDC) 77-8330. Public Health Service. Atlanta, GA, 1976.
25. *Instruction Manual for the ABA-100 Bichromatic Analyzer*, Rev. 3. South Pasadena, CA. Abbott Laboratories, Oct. 1976.
26. Barthel, W. F., Smrek, A. L., Angel, G. P., et al.: Modified Delves cup atomic absorption determination of lead in blood. *J. Assoc. Off. Anal. Chem.* 56:1253-1256, 1973.
27. Delves, H. T.: A micro-sampling method for the rapid determination of lead in blood by atomic-absorption spectroscopy. *Analyst* 95:431-438, 1970.
28. Gambino, S. R., and Schreiber, H.: The measurement and fractionation of bilirubin on the AutoAnalyzer by the method of Jendrassik and Grof, in *Automation in Clinical Chemistry*. Technicon Symposia. New York, NY. Mediad Inc., 1964. pp. 363-367.
29. Jendrassik, L., and Grof, P.: Vereinfachte photometrische Methodern fur Bestimmung des Blutbilirubins. *Biochem. Z.* 81:297-301, 1938.
30. Burtis, C. A., Sampson, E. J., Bayse, D. D., McKneally, S. S., and Whitner, V. S.: *AST Cooperative Enzyme Experiment*. DHEW Pub. No. (PHS) 740-265/7125. Public Health Service. Atlanta, GA. U.S. Government Printing Office, March 1978. pp. 88-91.
31. Henry, R. J., Chiamori, N., Golub, O. J., and Berkman, S.: Revised spectrophotometric methods for the determination of glutamic-oxaloacetic transaminase, glutamic-pyruvic transaminase, and lactic acid dehydrogenase. *Am. J. Clin. Path.* 34:381-398, 1960.
32. *GEMSAEC Automatic Analyzer Manual*. Fairfield, NJ. Electro-Nucleonics Co., 1972.
33. Bowers, G. N., Jr., and McComb, R. B.: A continuous spectrophotometric method for measuring the activity of serum alkaline phosphatase. *Clin. Chem.* 12:70-89, 1966.
34. Bowers, G. N., Jr., and McComb, R. B.: Measurement of total alkaline phosphatase activity in human serum. *Clin. Chem.* 21:1988-1995, 1975.
35. Slade, B. A., Harrison, J. W., and Shaw, W.: Effect of incubation time on folate values. *Am. J. Clin. Path.* 61(1):74-77, 1974.
36. Baker, H., Herbert, V., Frank, O., et al.: A microbiological method for detecting folic acid deficiency in man. *Clin. Chem.* 5:275-282, 1959.

37. Cooperman, J. M.: Microbiological assay of serum and whole blood folic acid activity. *Amer. J. Clin. Nutr.* 20: 1015-1020, 1967.
38. Hoffbrand, A., Newcombe, B. F., and Mollin, D. L.: Method of assay of red cell folate activity and the value of the assay as a test of folate deficiency. *J. Clin. Path.* 19:17-21, 1966.