

LA-UR-99-4241

**Decontamination and Decommissioning
of Structure TA-3-156 and
Building TA-3-163**

Historic Building Survey Report No. 174

Los Alamos National Laboratory

**July 23, 1999
Survey No. 773**

Prepared for the Department of Energy
Los Alamos Area Office

prepared by

**Kari L. M. Garcia
Alysia D. McLain**
Cultural Resource Managers

ESH-20 Cultural Resources Team
Environment, Safety, and Health Division
LOS ALAMOS NATIONAL LABORATORY

Abstract

In June 1999, historic building surveys were conducted for one abandoned structure and one abandoned building proposed for decontamination and decommissioning (D&D). The buildings are situated on Department of Energy managed land at Los Alamos National Laboratory Technical Area (TA) 3.

Structure TA-3-156 (a cooling tower) and building TA-3-163 (a pump house) were built between June 4, 1962 and April 15, 1963, during the early to middle Cold War years. Both of these properties are support/ancillary buildings to a large laboratory facility at TA-3. Because these properties were built during this significant time period at Los Alamos, historic building assessments (New Mexico Historic Building Inventory Forms, building plan drawings, and photographs) for these properties have been included in this report.

Through documentation it has been determined that both support properties (TA-3-156, TA-3-163) are not eligible for the National Register of Historic Places. Both were associated with the day to day operation of a large laboratory facility, which is also now abandoned, where Los Alamos National Laboratory's controlled thermonuclear research program was conducted until 1990.

The New Mexico State Historic Preservation Officer (SHPO) is requested to concur with the eligibility determinations contained in this report. Additionally, based on the status of these properties as support buildings and the information included in this report regarding the proposed effects and treatment of effects to the properties, the SHPO is requested to concur with a "Determination of No Effect." Through documentation the structure and building have been determined not eligible for inclusion on the National Register of Historic Places. Therefore, no further documentation of the structure (TA-3-156) and building (TA-3-163) is necessary prior to D&D project activities.

As a result of this historic building survey, this project complies with the National Historic Preservation Act of 1966 (as amended).

Provenience and Environmental Setting

Location: Technical Areas (TA) 3 Los Alamos National Laboratory (LANL)

Land Manager: The Department of Energy (DOE)

Legal Description: Township 19 North, Range 6 East, Section 17
NE ¼, SW ¼, SE ¼

Maps: USGS Frijoles Mountain 7.5 Minute Series (Appendix A, Maps 1 and 2)

Topography: Townsite Mesa

Nearest Drainage: Two Mile Canyon to the south

Elevation: 2261.6 meters (7420 feet)

Current Land Use: Developed TA-3

Project Description

As an inactive structure and building, TA-3-156 and TA-3-163, are subject to the DOE mission statement. "The DOE environmental vision and mission are based on operating all facilities in full compliance with applicable laws and regulations and cleaning up inactive sites and facilities so that no unacceptable risk to the public or environment remains" (U. S. Department of Energy 1994).

LANL proposes to decontaminate and decommission (D&D) one structure and one building. Both are inactive properties and are on the excess space list. These properties are located in TA-3, South Mesa Site, and both were built during the early to middle Cold War years at Los Alamos. Structure TA-3-156, a cooling tower, and building TA-3-163, its associated pump house, were built between June 4, 1962, and April 15, 1963. The proposed D&D project activities include the removal of the concrete masonry unit building and the transite panel structure, foundations, and the capping off and removal of all associated utilities. As a result of the decommissioning phase, the properties will be completely demolished.

Methods

In June 1999, an historic building evaluation was conducted for structure TA-3-156 and building TA-3-163 (Appendix A, Maps 1 and 2) by Kari L. M. Garcia and Alysia D. McLain, Environment, Safety, and Health Division, Ecology Group (ESH-20), LANL.

The historic building evaluations were accomplished by first conducting a field visit to TA-3. Both the structure and the building are abandoned support buildings for an abandoned large

laboratory facility at this TA. New Mexico Historic Building Inventory Forms were completed for both properties and photographs were taken (Appendix B). Records research at LANL was also carried out, and existing drawings were compiled for the buildings.

Culture History Overview

World War II and Early Cold War (1942–1956)

A. Site Selection, Acquisition

In 1942, Albert Einstein wrote a letter to President Franklin Roosevelt warning him of a possible German atomic bomb threat (Rothman 1992). President Roosevelt, acting on Einstein's concerns, gave approval to develop the world's first atomic bomb and appointed Brigadier General Leslie Groves to head the "Manhattan Project." Groves, in turn, chose Robert Oppenheimer to coordinate the design of the bomb.

A single research facility, isolated and secret, was proposed. General Groves had several criteria: security, isolation, a good water supply, an adequate transportation network, a suitable climate, an available labor force, and a locale west of the Mississippi located "at least 200 miles from any international border or the West Coast" (Rothman 1992). Oppenheimer, who had visited the Pajarito Plateau on a horseback trip, suggested the Los Alamos Ranch School.

B. Manhattan Project (1942–1945)

A suitable site selected, Oppenheimer and his staff moved to Los Alamos to begin work. The recruitment of the country's "best scientific talent" and the construction of technical buildings were top priorities. The University of California agreed to operate the site, code name "Project Y," under contract with the government (an arrangement that has continued to this day). Although the fission bomb was conceptually attainable, many difficulties still stood in the way of producing a usable weapon. Technical problems included the timing of the release of energy from fissionable material and the engineering aspects of producing a deliverable device. Nuclear material and high explosive (HE) studies were of immediate importance (Los Alamos National Laboratory 1995).

Two bomb designs appeared to be the most promising: a uranium "gun" method and a plutonium "implosion" method. The "gun" method bomb involved bringing fissionable material together to form a critical mass by firing one subcritical mass of uranium-235 at another. This method led to the development of the "Little Boy" device. Scientists were less confident about the second "implosion" method, a design that necessitated the compression of fissionable material using HE. The compression action would increase the density of a slightly subcritical mass of plutonium-239 and cause a critical reaction (Los Alamos National Laboratory 1995). In 1944, due to the uncertainties surrounding the second design, the search began for an appropriate test site for the implosion method, later used in the "Fat Man" device. The Alamogordo Bombing Range in south-central New Mexico was selected. A trial run involving 100 tons of TNT was

conducted at “Trinity Site” on May 7, 1945. This “dress rehearsal” provided measurement data and simulated the dispersal of radioactive products. The Trinity test was planned for July, and its objectives were “to characterize the nature of the implosion, measure the release of nuclear energy, and assess the damage” (Los Alamos National Laboratory 1995). The HE components of the “Trinity” device were test assembled in building TA-16-516 at Los Alamos in an area known as V-site. Other buildings at V-site were used to prepare and finish the HE components and to run preliminary tests on the “Trinity” bomb (Wilder 1991). The world's first atomic bomb was successfully detonated in the early morning of July 16, 1945. “Little Boy,” the untested uranium gun-type bomb, was exploded over the Japanese city of Hiroshima on August 6, 1945. “Fat Man” was exploded over Nagasaki three days later on August 9, 1945, thus essentially ending the war with Japan.

C. Early Cold War Era (1946–1956)

The Manhattan Project had come to a close with the end of World War II (WWII), and many Los Alamos scientists and site workers went back to their prewar existences. The future of Los Alamos was in question. With the beginning of the Cold War, continued weapons research was a top priority. Norris Bradbury had been appointed director of the Laboratory following Oppenheimer's departure from Los Alamos. Bradbury felt that the nation needed “a laboratory for research into military applications of nuclear energy” (Los Alamos National Laboratory 1993a). In 1945, stockpiling and development of additional atomic weapons was an important mission. In 1946, the Laboratory became involved in the technical direction of the atmospheric testing program in the Pacific, dubbed “Operation Crossroads.” Later in 1946, the U.S. Atomic Energy Commission (AEC) was established to act as a civilian steward for the new atomic technology born of WWII. The AEC formally took over the Laboratory in 1947, making a commitment to retain Los Alamos as a permanent weapons research facility. Postwar weapons research revolved around the development of advanced fission weapons and, acting on an idea born in 1942, the development of the hydrogen bomb. The combined work of Edward Teller and Stanislaw Ulam led to the beginning of the Laboratory's thermonuclear research program (Los Alamos National Laboratory 1993a).

In 1952, the first thermonuclear device, known as “Mike,” was detonated at Eniwetok atoll in the Pacific (Los Alamos National Laboratory 1993a). The Mike shot used liquefied deuterium fuel. The Castle-Bravo shot, conducted in the Pacific in 1954, was revolutionary in that it contained dry, solid thermonuclear fuel. Other early Cold War weapons-related developments include: (1) from 1952 to 1956, “improvements to the primary stage of a nuclear weapon” and (2) in 1956, “the first use of plastic-bonded explosives in a nuclear explosion” (Los Alamos National Laboratory 1995).

Technical Area 3 (South Mesa) Historical Background

TA-3, South Mesa Site, is a large developed technical area. It contains the Laboratory's main administration buildings, library, cafeteria, shops, several large laboratories for a wide variety of

research and development activities, warehouses, electrical generating plant, sewage treatment plant, and numerous other permanent and temporary buildings, transportable trailers, and transportainers.

TA-3 was originally built as a firing site prior to 1945, containing wooden buildings for administration, a shop, magazines, and fiberboard buildings for storage, minor assembly, and checkout of scientific hardware. There was also a burn pit for destroying explosives. This original TA-3 site was decommissioned and cleared in 1949 (Los Alamos National Laboratory 1993b).

Construction began in 1950 at the South Mesa site on the main buildings that were to replace the operational facilities in the current Los Alamos town site. The first buildings, including the Van de Graaff accelerator, laboratory, and support buildings; the communications building; the large chemistry and metallurgy laboratory, the site of critical chemistry and metallurgy supporting the Laboratory's weapons program; warehouses for general supplies and chemicals; shops; a fire station; and a large physics laboratory and office building became operational between mid-1951 and late-1952.

The Van de Graaff accelerator building at one time housed the world's highest voltage Van de Graaff accelerator (Hawkins et al. 1983, Los Alamos National Laboratory 1995). The chemistry and metallurgy laboratory conducts "operations involving plutonium, uranium, other radionuclides, metals, inorganic and organic compounds, acids, and solvents of every nature." The physics building at one time "housed two accelerators and a cyclotron" (Los Alamos National Laboratory 1993b:2-5). Radioactive materials including plutonium, uranium, and tritium, and metals and solvents have been used in the building over the years. To serve these facilities, a gas-fired electrical generating plant, a waste-water treatment plant, a service station, and maintenance garage were also constructed.

A second stage of construction at TA-3 occurred during the mid- to late-1950s. Several major buildings were completed during these years, including the Administration Building which houses offices, laboratories, shop, and photographic facilities, the Sigma Building that houses facilities for metallurgical and ceramics research and fabrication (Los Alamos National Laboratory 1993b), and the Sherwood Building that housed research facilities for LANL's controlled thermonuclear research program.

The structure (TA-3-156) and building (TA-3-163) discussed in this report are abandoned support structures for the Sherwood Building, which is also non functioning and scheduled for D&D work at a later time and will be discussed in detail in a separate report.

New facilities continued to be built during the 1960s and 1970s including office buildings, storage areas, shops, an addition to the waste-water treatment plant, a cement batch plant, and numerous transportable buildings. In the late 1960s to early 1970s the Scyllac Building was constructed for additional space for the controlled thermonuclear research program. In 1977 the Oppenheimer Study Center was constructed; in 1981 an addition to the Administration Building was constructed, and in the early 1990s a computer facility and several national centers for various scientific research activities were constructed (Los Alamos National Laboratory 1993b).

Description of Buildings

One structure and one building, TA-3-156 and TA-3-163, are proposed for demolition. Appendix A contains maps showing the locations of the properties proposed for demolition. Appendix B contains the Historic Building Inventory Forms, plan drawings, and photographs.

TA-3-156 Cooling Tower

Building Name: TA-3-156 Original Name: South Mesa-156 (SM-156)

Location:

City - Los Alamos, New Mexico

County - Los Alamos

UTMs - Zone 13 Easting 380399 Northing 3970629

Legal Description - Township 19 North, Range 6 East, Section 17

Surroundings - TA-3 is the Laboratory's administrative area, additionally there are also large laboratory research buildings located within this TA. It is a large developed technical area consisting of many permanent and temporary buildings of various construction styles and material types. Buildings include laboratories, office buildings, maintenance shops, medical facilities, and utilities.

Relationship to surroundings - Not similar.

Construction Date: 6/4/62 to 4/15/63

Original Use: Structure TA-3-156 was a cooling tower for the Sherwood Building, which is a large abandoned laboratory building used for controlled thermonuclear research. The cooling tower was a support structure for the daily operation and maintenance of the Sherwood Building.

Use History: Structure TA-3-156 has always served as a cooling tower for the Sherwood Building. It was part of the facilities drain plan.

Use at Time of Survey: The cooling tower TA-3-156 is abandoned and for the most part the Sherwood Building, which the cooling tower supported, is also abandoned and not in use. A small portion of the Sherwood Building that connects to the Administration Building is still occupied by Laboratory security personnel.

Condition at Time of Survey: Fair condition

Building Description: (see also Appendix B)

Building style – TA-3-156 is constructed of transite panels and louvers (asbestos containing material) on a reinforced concrete base with a flat open roof.

Foundation material - Reinforced concrete slab

Wall material/surface - Lower portion of walls are reinforced concrete and the upper portion are transite panels and louvers.

Architectural features - The cooling tower is an approximate 528-ft² rectangular structure situated on a reinforced concrete base. The reinforced concrete base contains a sump that has a slight slope. There are transite panels on all sides of the structure and transite louvers on two sides. Inside the structure there are two “V” shaped veins constructed of 2-in.-wide horizontal wood strips connected together on a wood frame. The structure does not have a conventional roof, but there is a guardrail around the top of the structure and metal gratings covering the interior of the structure.

Both the north and south elevations are completely transite panels. The south side has numerous pipes that connect the cooling tower to the pump house. The north elevation has a small door constructed of the same transite material that was used for servicing the interior equipment of the cooling tower. Also on the north elevation are the supports for the ladder that would have been for accessing the interior portion of the structure from the top, and there is also a gap in the guardrail where the ladder would have been positioned.

On both the east and west elevations there are transite louvers above the row of transite panels that runs around the structure on all four elevations and are situated directly above the concrete base.

Remodeling History: During 1990 Los Alamos’ CTR Division, which was conducting research on “Z” and “Theta Pinch” fusion technology, was disbanded and the Sherwood Building was vacated. Congress had reduced funding for all other branches of fusion research as an alternative energy source except for research on “Tokamak” technology. Sometime after the Sherwood Building was vacated the cooling tower and pump house were also taken out of service and abandoned. It is assumed that the ladder that would have been attached to the north elevation was removed for safety reasons.

Associated Buildings: TA-3-163 (the connected pump house) and TA-3-105 (the Sherwood Building) the laboratory research facility that the cooling tower and pump house served.

District Potential: None. This TA is the administrative area of the Laboratory. It is a conglomeration of a wide variety of permanent and temporary buildings of many different construction styles built throughout the late 1940s to the present. There are many facilities and Divisions with many different research thrusts, as well as this area being where the Laboratory's maintenance contractor and the Laboratory's administrative offices are.

Contamination Information: There is no record of any contamination existing within this structure other than the asbestos transite panels and louvers that it is constructed with.

TA-3-163 Pump House

Building Name: TA-3-163, Original Name: South Mesa-163 (SM-163)

Location:

City - Los Alamos, New Mexico

County - Los Alamos

UTMs - Zone 13 Easting 380399 Northing 3970621

Legal Description - Township 19 North, Range 6 East, Section 17

Surroundings - TA-3 is the Laboratory's administrative area, additionally there are also large laboratory research buildings located within this TA. It is a large developed technical area consisting of many permanent and temporary buildings of various construction styles and material types. Buildings include laboratories, office buildings, maintenance shops, medical facilities, and utilities.

Relationship to surroundings - Not similar

Construction Date: 6/4/64 to 4/15/63

Original Use: Building TA-3-163 was a pump house associated with the cooling tower (TA-3-156) for the Sherwood Building, which is a large abandoned laboratory building used for controlled thermonuclear research. The pump house was a support building for the daily operation and maintenance of the Sherwood Building.

Use History: TA-3-163 has always served as the pump house for the Sherwood Building. It was part of the facilities drain plan.

Use at Time of Survey: TA-3-163 is currently abandoned and for the most part the building it supported, the Sherwood Building, is also abandoned and not in use. A

small portion of the Sherwood Building that connects to the Administration Building is still occupied by Laboratory security personnel.

Condition at Time of Survey: Fair condition

Building Description: (See also Appendix B)

Building style - Small concrete masonry unit building with a flat roof

Foundation material – Concrete slab and footings

Wall material/surface – Concrete masonry units (pumice concrete blocks). The exterior walls are painted to seal the structure.

Architectural features - Building TA-3-163 is a small, 324-ft² concrete pump house with a flat roof. The roof is a three ply built up roof with a roof vent along the south side. There is galvanized metal flashing around the edge of the roof.

The north elevation faces and is connected by pipes to TA-3-156, the cooling tower. There also is a small louver on the northwest portion of the wall.

On the west elevation there is a window with nine individual glass panes.

The south elevation is devoid of windows, doors, or any defining features.

The building contains pumps, compressors, and other equipment related to the operation of the cooling tower.

Remodeling History: The 1962 engineering drawings show that there is a louver located on the south elevation of the building, however, the entire south elevation is devoid of any features.

During 1990 Los Alamos' CTR Division, which was conducting research on "Z" and "Theta Pinch" fusion technology, was disbanded and the Sherwood Building was vacated. Congress had reduced funding for all other branches of fusion research as an alternative energy source except for research on "Tokamak" technology. Sometime after the Sherwood Building was vacated the cooling tower and pump house were also taken out of service and abandoned.

Associated Buildings: TA-3-156 (the connected cooling tower) and TA-3-105 (the Sherwood Building) the laboratory research facility that the pump house and cooling tower served.

District Potential: None. This TA is the administrative area of the Laboratory. It is a conglomeration of a wide variety of permanent and temporary buildings of many different construction styles built throughout the late 1940s to the present. There are many facilities and Divisions with many different research thrusts, as well as this area being where the Laboratory's maintenance contractor and the Laboratory's administrative offices are.

Contamination Information: There is no record of any contamination existing within this structure other than the asbestos insulation that is around some of the equipment.

National Register Eligibility Determination

Based on the information gathered during this building survey, properties TA-3-156, a cooling tower, and TA-3-163, a pump house, are not eligible for nomination to the National Register of Historic Places.

The one structure and one building are ancillary support properties to the daily operations of a large research facility, are less than fifty years old, and lack any qualities to be considered eligible for the National Register.

Currently both properties are abandoned and no future use is designated for these properties; or for the large laboratory facility they are associated with, which is also scheduled for D&D sometime in the future. Because of this these properties are on the Laboratory's surplus space list and are currently scheduled for D&D this fiscal year.

Proposed Treatment of Effects

The proposed D&D activities at TA-3 will result in the destruction of structure TA-3-156 and building TA-3-163. Neither property is eligible for the National Register of Historic Places.

Even though the two support properties are not eligible for the National Register of Historic Places they were built during the middle Cold War years at Los Alamos, therefore the following documentation of the properties has been included in this report (New Mexico Historic Building Inventory Forms, building plan drawings, and photographs).

Recommendations

As stated above, both properties (TA-3-156 and TA-3-163) proposed for demolition are not considered significant historic properties based on their status as solely support properties for a large Laboratory research facility. Therefore, they are not eligible for nomination to the National Register of Historic Places. The SHPO is requested to concur with this determination and our assessment of "no effect" for this undertaking.

As a result of this historic building survey, this project complies with the National Historic Preservation Act of 1966 (as amended).

References Cited

- Hawkins, David, Edith C. Truslow, and Ralph Carlisle Smith
1983 "Project Y: The Los Alamos Story," Volume II in a series in *The History of Modern Physics, 1800-1950*. Tomash Publishers and the American Institute of Physics.
- Los Alamos National Laboratory
1993a *Los Alamos: Beginnings of an Era 1943-1945*. Los Alamos Historical Society, Los Alamos, New Mexico.
1993b *RFI Work Plan for Operable Unit 1114: Environmental Restoration Program*. LA-UR-93-1000, Los Alamos National Laboratory, Los Alamos, New Mexico.
1995 *Dateline: Los Alamos, Special Issue, LALP-95-2-6&7*. Los Alamos National Laboratory, Los Alamos, New Mexico.
- Rothman, Hal
1992 *On Rims and Ridges, The Los Alamos Area Since 1880*. University of Nebraska Press, Lincoln.
- U. S. Department of Energy
1994 *Environmental Restoration and Waste Management Five-Year Plan, Fiscal Years 1994-1998*. DOE/S-00097P, U.S. Department of Energy, Washington, D.C.
- Wilder, Edward, Jr.
1991 Early S-site Experiences. In *Manhattan District History: Nonscientific Aspects of Los Alamos Project Y, 1942 through 1946*. Written by Edith C. Truslow, edited by Kasha V. Thayer. Los Alamos Historical Society, Los Alamos, New Mexico.

APPENDIX A

Maps

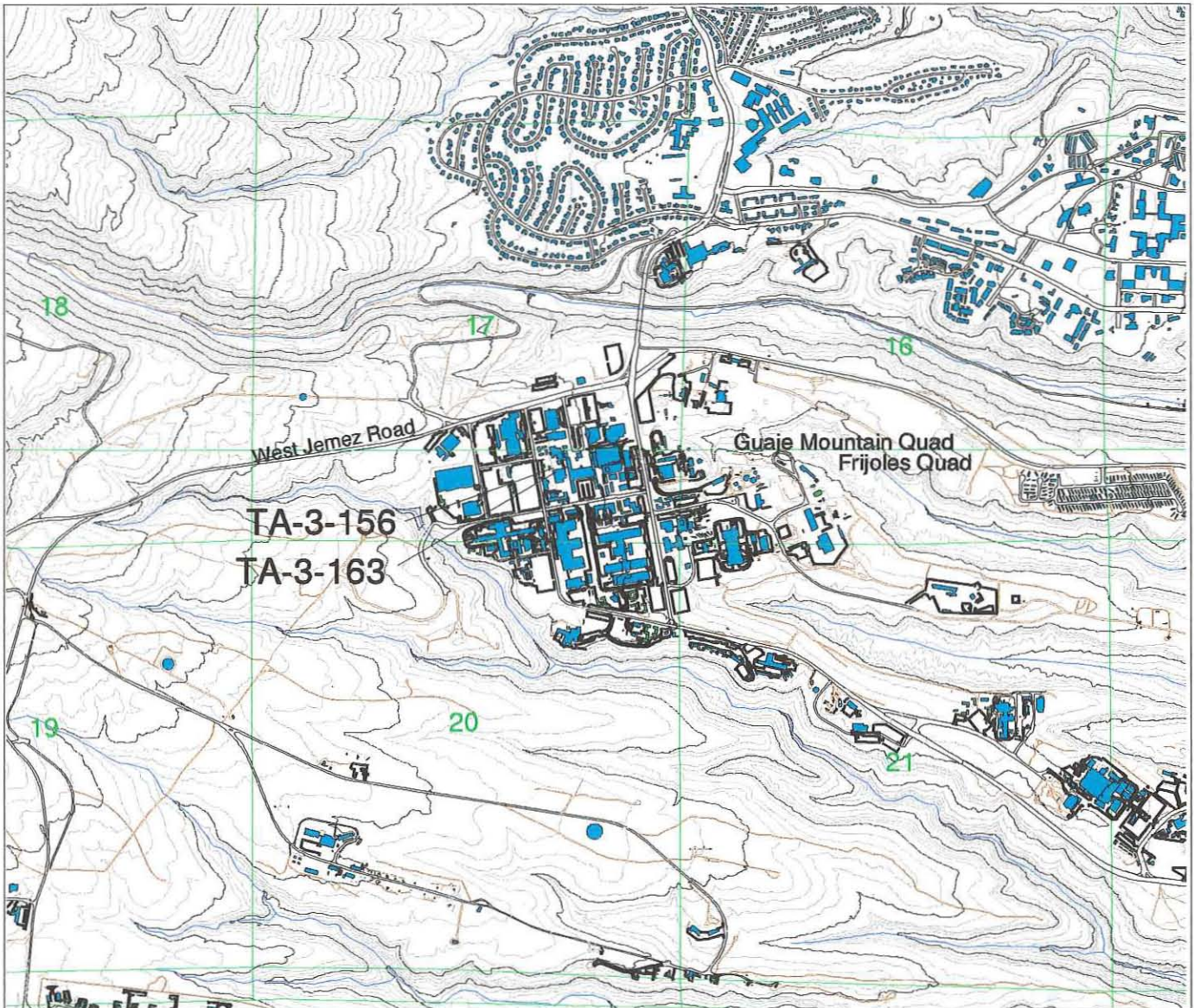

1:24000

300 0 300 600 900 1200 1500 Meters



1000 0 1000 2000 3000 4000 Feet



- Township, Range, Section
- USGS 7.5 Minute Quadrangle
- Drainage
- 20 Foot Contours
- 100 Foot Contours
- Roads - Dirt
- Parking - Dirt
- Roads - Paved
- Parking - Paved
- Structures - Perm Buildings
- Structures - Temp Buildings

Los Alamos
National Laboratory

Cultural Resources Team
ESH-20 Ecology Group

Cooling Tower TA-3-156 and Pump House TA-3-163

Project Location

Map1

Public disclosure of
archaeological site
locations is prohibited
by 36 CFR 296.18



1:3000



Los Alamos
National Laboratory

Cultural Resources Team
ESH-20 Ecology Group



- Township, Range, Section
- USGS 7.5 Minute Quadrangle
- Drainage
- 20 Foot Contours
- 100 Foot Contours
- Roads - Dirt
- Parking - Dirt
- Roads - Paved
- Parking - Paved
- Structures - Perm Buildings
- Structures - Temp Buildings

Cooling Tower TA-3-156 and Pump House TA-3-163

Closeup Project Area

Map 2

Public disclosure of
archaeological site
locations is prohibited
by 36 CFR 296.18

APPENDIX B

Historic Building Inventory Forms

NEW MEXICO HISTORIC BUILDING INVENTORY FORM

LA#

building threatened? yes	surveyed date 6/16/99 by Kari L. M. Garcia & Alysia D. McLain	County Los Alamos	ID no. TA-3-156
Field map LANL Orthotopo	number Sheet 4	UTM reference: easting 380399 northing 3970629 zone 13	
location description Technical Area (TA) 3,		city/town Los Alamos	land grant/reservation n/a
building name TA-3-156, Original name South Mesa (SM-156)		legal description USGS Guaje Mountain 7.5 Series tsp <u>19N</u> range <u>6E</u> sec <u>17</u> <u>NE</u> $\frac{1}{4}$ <u>SW</u> $\frac{1}{4}$ <u>SE</u> $\frac{1}{4}$	
film roll by nos. digital photos	Negative nos. digital photos on file with ESH-20 by building number	location of neg. LANL, ESH-20	date of construction _____ estimate <u>6/4/62 to 4/15/63</u> actual source Facilities Division Engineering 9 (F-9) records (LANL).
Style Utilitarian, cooling tower, of transite panels and louvers, wood frame on a reinforced concrete base (see below for more information)	Foundation material Reinforced concrete slab wall material/surface transite panels and louvers	Use <u>Present</u> residential <input checked="" type="checkbox"/> other cooling tower. <u>historic</u> residential <input checked="" type="checkbox"/> other cooling tower.	Condition ____ excellent <u>X</u> fair to ____ good <u>X</u> deteriorating
degree of remodeling <u>X</u> minor ____ moderate ____ major describe: During 1990 Los Alamos' CTR Division, which was conducting research on "Z" and "Theta Pinch" fusion technology, was disbanded and the Sherwood Building was vacated. Congress had reduced funding for all branches of fusion research, as an alternative energy source, except research on "Tokamak" technology. Sometime after the Sherwood Building was vacated the cooling tower and pump house were also taken out of service and abandoned. It is assumed that the ladder that would have been attached to the north elevation was removed for safety reasons.			
Surroundings Developed Laboratory Technical Area 3	Relationship to surroundings <u>X</u> similar ____ not similar	district potential ____ yes <u>X</u> no	
Significance ____ Eligible ____ of interest <u>X</u> none if not eligible, why? Cooling tower TA-3-156 is only an abandoned support structure for the Sherwood Building TA-3- 105.	Associated building? <u>X</u> yes What type? Industrial laboratory type building with an associated pump house If inventoried, list ID nos. TA-3-163 (pump house) and TA-3-105 (the Sherwood Building)	Photos and plan drawings are on following pages: ENG-C 27070 (sheet 2 of 20) Sherwood Cooling Tower Architectural-Plan, Section & Details March 27, 1962	

		<p>Photos and plan drawings are on following pages cont.:</p> <p>ENG-C 27072 (sheet 4 of 20) Sherwood Cooling Tower Architectural Sections & Details March 27, 1962</p> <p>ENG-AB 61 (sheet 1 of 2) As-Built Facility Drain Plan Cooling Tower and Pump House Civil: Site Plan, Storm Drain, & Sanitary Sewer System August 7, 1992</p> <p>ENG-AB 61 (sheet 2 of 2) As-Built Facility Drain Plan Cooling Tower and Pump House Mechanical: Storm Drain and Sanitary Sewer System August 7, 1992</p> <p>Size: Approximate 528 ft²</p>
<p>Architectural features: The cooling tower is an approximate 528-ft² rectangular structure situated on a reinforced concrete base. The reinforced concrete base contains a sump that has a slight slope. There are transite panels on all sides of the structure and transite louvers on two sides. Inside the structure there are two "V" shaped veins constructed of 2 in. wide horizontal wood strips connected together on a wood frame. The structure does not have a conventional roof, but there is a guardrail around the top of the structure and metal gratings covering the interior of the structure.</p> <p>Both the north and south elevations are completely transite panels. The south side has numerous pipes that connect the cooling tower to the pump house. The north elevation has a small door constructed of the same transite material that was used for servicing the interior equipment of the cooling tower. Also on the north elevation are the supports for the ladder that would have been for accessing the interior portion of the structure from the top and there is also a gap in the guardrail where the ladder would have been positioned.</p> <p>On both the east and west elevations there are transite louvers above the row of transite panels that runs around the structure on all four elevations and are situated directly above the concrete base.</p>		<p>Comments:</p>



TA-3-156 North Side



TA-3-156 East Side



TA-3-156 West Side



TA-3-163 North Side and TA-3-156 South Side

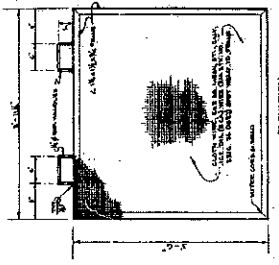
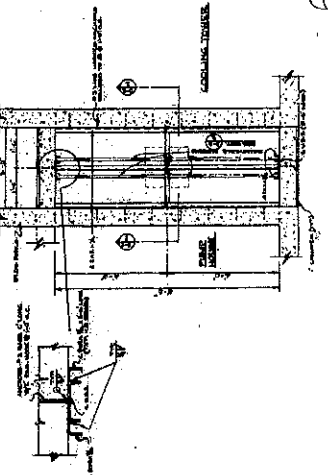
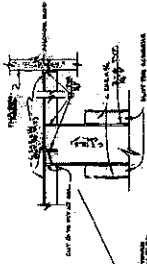
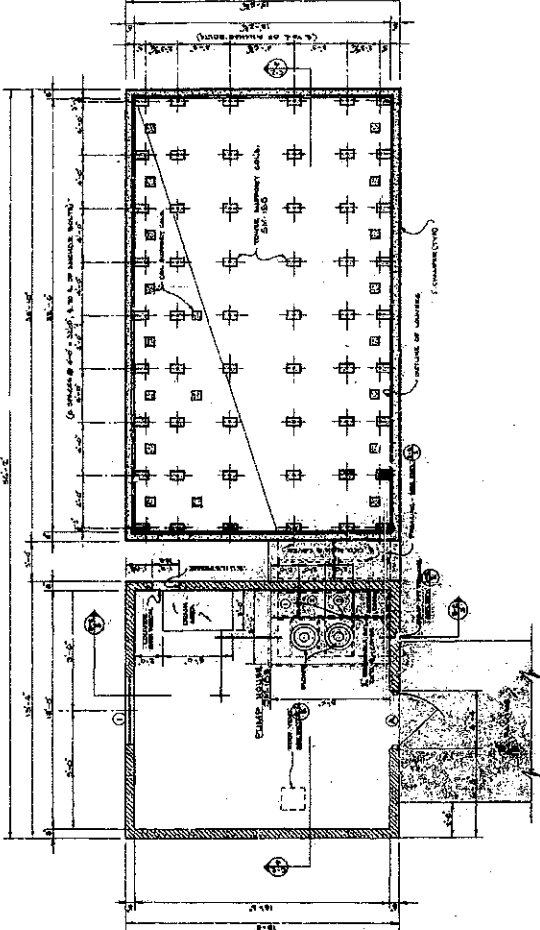
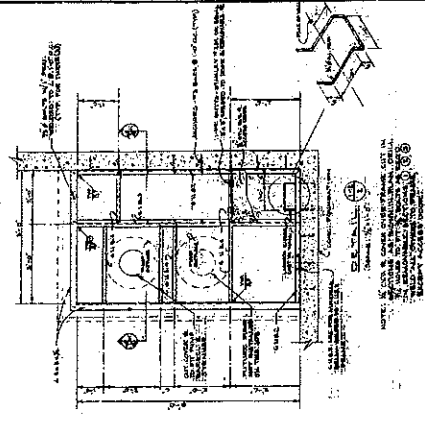
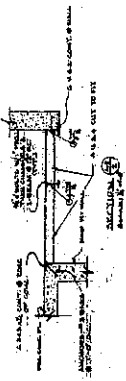

THE JOB MUST BE APPROVED AND NOT RECALCULATED APPROVED

UNIVERSITY OF CALIFORNIA - LOS ANGELES, NEW MEXICO

SHERWOOD COOLING TOWER

AREA PLAN, SECTIONS & DETAILS

NO.	DATE	REVISION
1	10/1/50	PRELIMINARY
2	10/1/50	REVISED
3	10/1/50	REVISED
4	10/1/50	REVISED
5	10/1/50	REVISED
6	10/1/50	REVISED
7	10/1/50	REVISED
8	10/1/50	REVISED
9	10/1/50	REVISED
10	10/1/50	REVISED
11	10/1/50	REVISED
12	10/1/50	REVISED
13	10/1/50	REVISED
14	10/1/50	REVISED
15	10/1/50	REVISED
16	10/1/50	REVISED
17	10/1/50	REVISED
18	10/1/50	REVISED
19	10/1/50	REVISED
20	10/1/50	REVISED
21	10/1/50	REVISED
22	10/1/50	REVISED
23	10/1/50	REVISED
24	10/1/50	REVISED
25	10/1/50	REVISED
26	10/1/50	REVISED
27	10/1/50	REVISED
28	10/1/50	REVISED
29	10/1/50	REVISED
30	10/1/50	REVISED
31	10/1/50	REVISED
32	10/1/50	REVISED
33	10/1/50	REVISED
34	10/1/50	REVISED
35	10/1/50	REVISED
36	10/1/50	REVISED
37	10/1/50	REVISED
38	10/1/50	REVISED
39	10/1/50	REVISED
40	10/1/50	REVISED
41	10/1/50	REVISED
42	10/1/50	REVISED
43	10/1/50	REVISED
44	10/1/50	REVISED
45	10/1/50	REVISED
46	10/1/50	REVISED
47	10/1/50	REVISED
48	10/1/50	REVISED
49	10/1/50	REVISED
50	10/1/50	REVISED
51	10/1/50	REVISED
52	10/1/50	REVISED
53	10/1/50	REVISED
54	10/1/50	REVISED
55	10/1/50	REVISED
56	10/1/50	REVISED
57	10/1/50	REVISED
58	10/1/50	REVISED
59	10/1/50	REVISED
60	10/1/50	REVISED
61	10/1/50	REVISED
62	10/1/50	REVISED
63	10/1/50	REVISED
64	10/1/50	REVISED
65	10/1/50	REVISED
66	10/1/50	REVISED
67	10/1/50	REVISED
68	10/1/50	REVISED
69	10/1/50	REVISED
70	10/1/50	REVISED
71	10/1/50	REVISED
72	10/1/50	REVISED
73	10/1/50	REVISED
74	10/1/50	REVISED
75	10/1/50	REVISED
76	10/1/50	REVISED
77	10/1/50	REVISED
78	10/1/50	REVISED
79	10/1/50	REVISED
80	10/1/50	REVISED
81	10/1/50	REVISED
82	10/1/50	REVISED
83	10/1/50	REVISED
84	10/1/50	REVISED
85	10/1/50	REVISED
86	10/1/50	REVISED
87	10/1/50	REVISED
88	10/1/50	REVISED
89	10/1/50	REVISED
90	10/1/50	REVISED
91	10/1/50	REVISED
92	10/1/50	REVISED
93	10/1/50	REVISED
94	10/1/50	REVISED
95	10/1/50	REVISED
96	10/1/50	REVISED
97	10/1/50	REVISED
98	10/1/50	REVISED
99	10/1/50	REVISED
100	10/1/50	REVISED

RECORD ENGINEERING LOGGED SHEET

REC'D ENG-334

LOGGED SHEET

HAULEY

ENG-C 27070

LAB. JOB NO. 21486-2

DETAIL

REMOVE 1/4" OF

REMOVABLE FILTER SCREEN - FINE (1/8")

EXHAUSTION

DETAIL

REMOVE 1/4" OF

REMOVABLE FILTER SCREEN - FINE (1/8")

EXHAUSTION

DETAIL

REMOVE 1/4" OF

REMOVABLE FILTER SCREEN - FINE (1/8")

EXHAUSTION

DETAIL

REMOVE 1/4" OF

REMOVABLE FILTER SCREEN - FINE (1/8")

EXHAUSTION

DETAIL

REMOVE 1/4" OF

REMOVABLE FILTER SCREEN - FINE (1/8")

EXHAUSTION

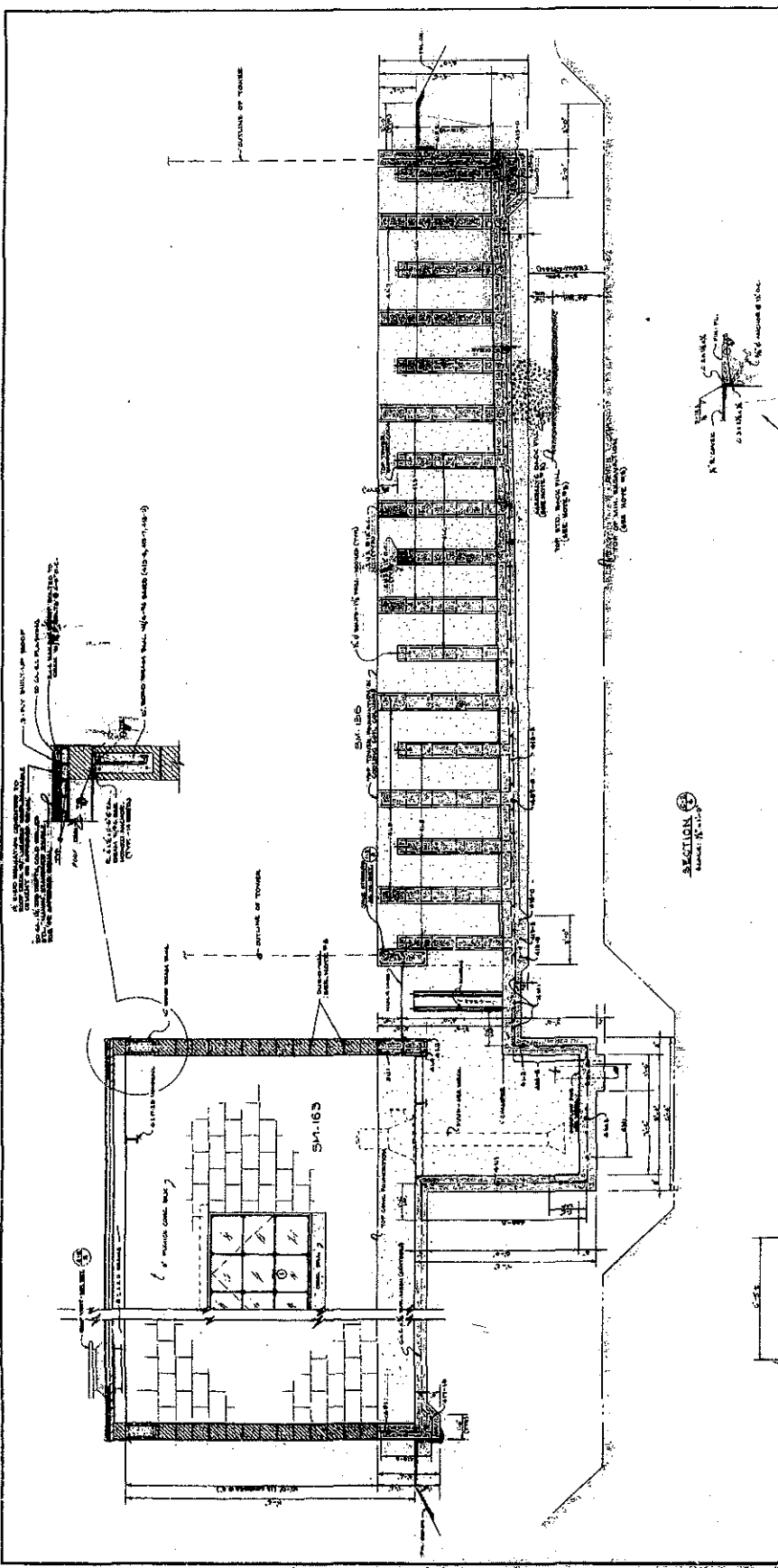

THIS PLAN MUST BE SUBMITTED TO THE ENGINEER IN CHARGE OF THE PROJECT FOR APPROVAL BEFORE CONSTRUCTION.

LOG ALAN'S SCIENTIFIC LABORATORY
 ENGINEERING DEPARTMENT
 UNIVERSITY OF CALIFORNIA - LOS ANGELES, LOS ANGELES, CALIF.

SHERWOOD COOLING TOWER
 ARCHITECTS, SECTIONS & DETAILS

DATE: 11/15/50
 DRAWN BY: [Signature]
 CHECKED BY: [Signature]
 PROJECT NO.: 27072
 SHEET NO.: 1 OF 2

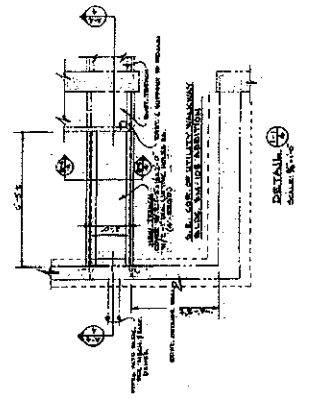
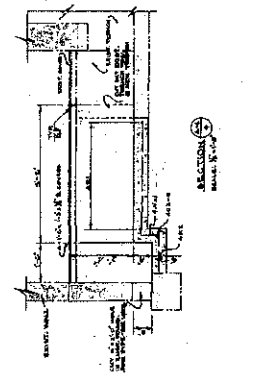
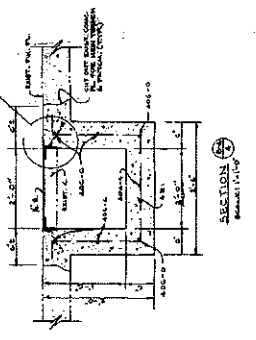

SECTION 3
 SCALE 1/4"

SECTION 4
 SCALE 1/4"

DETAIL 2
 SCALE 1/2"

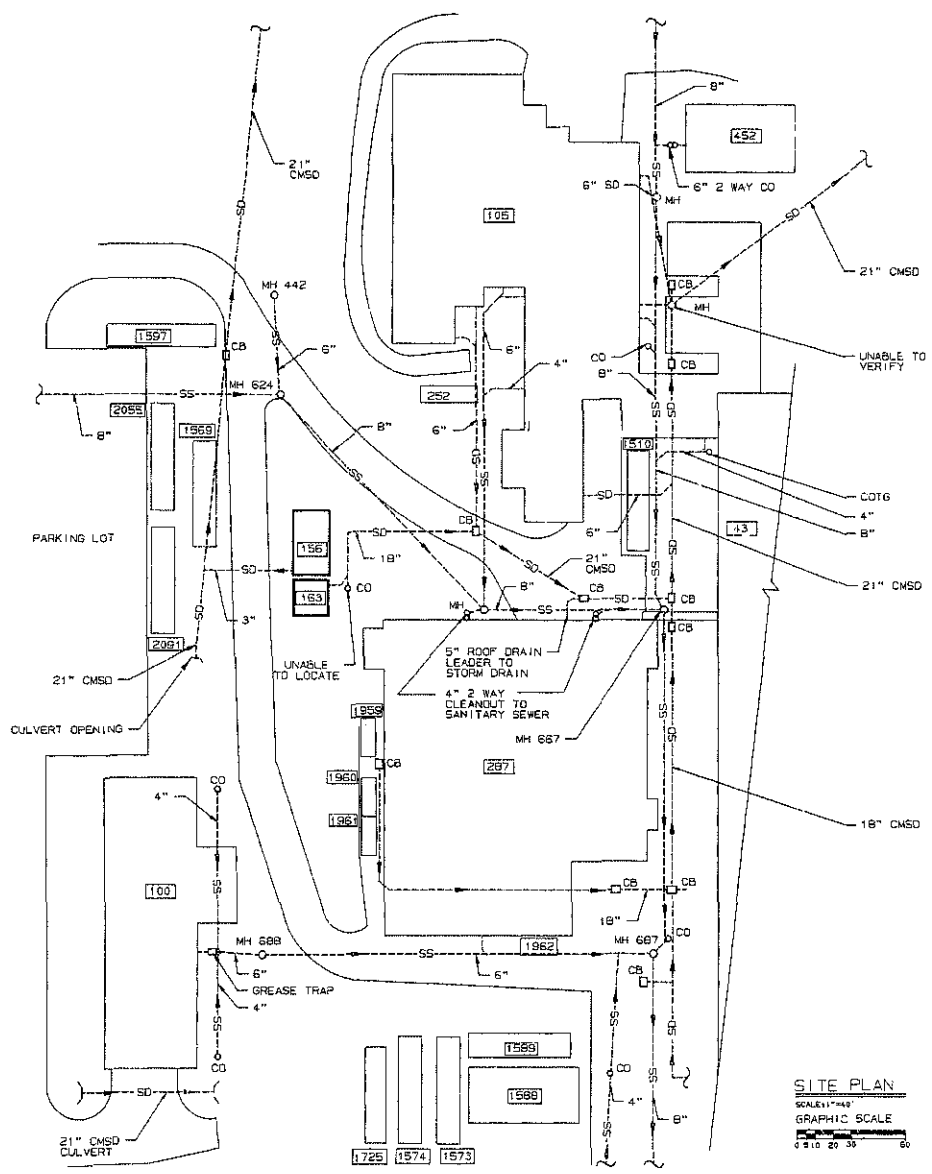

LOCATION OF BUILDING

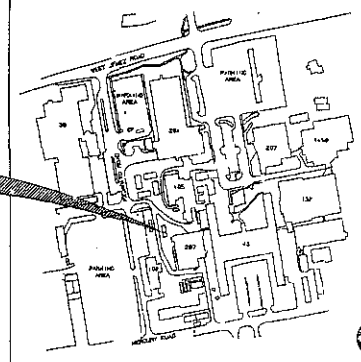

SITE PLAN
SCALE: NONE

- LEGEND
- SD BURIED STORM DRAIN
 - SS BURIED SANITARY SEWER
 - CMC/D CORR METAL STORM DRAIN
 - COT/G CLEANOUT TO GRADE
 - CB CATCH BASIN
 - 8 2 WAY CLEANOUT
 - CO CLEANOUT
 - MH MANHOLE

SITE PLAN
SCALE: 1"=40'
GRAPHIC SCALE
0 10 20 30 40 50 60

NO.	DATE	DESIGN REV.	REVISIONS	CHKD.	REV.	CHKD.	REV.	CHKD.	REV.
AS-BUILT FACILITY DRAIN PLAN COOLING TOWER AND PUMP HOUSE								DRAWN T. ROSETTA	VERIFIED B. HANE
CIVIL: SITE PLAN, STORM DRAIN AND SANITARY SEWER SYSTEM								CHECKED B. ROBERTS 10/10/92	RELEASED B. ROBERTS 10/10/92
BLDG. 156/163		TA-3		DATE		10-7-92			
SUBMITTED BY A. B. WHITE		DESIGNED BY G. L. Thompson		APPROVED BY G. L. Thompson		DATE 10/9/92			
Los Alamos Los Alamos National Laboratory Los Alamos, New Mexico 87545								SHEET C1	1 0 2
CLASSIFICATION U		REVISIONS		DATE		10-8-92			
LAB JOB NO.		DRAWING NO.		REV.					
11831-99		AB61							

FIELD VERIFIED ON 7-9-92

JCI 91-001

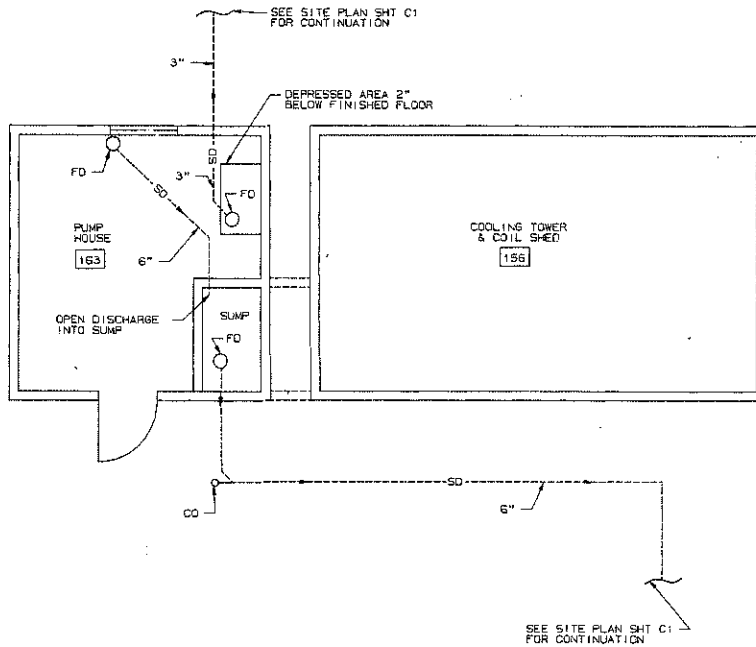

- LEGEND**
- SD --- BURIED STORM DRAIN
 - SS --- BURIED SANITARY SEWER
 - CO CLEANOUT
 - FD FLOOR DRAIN

STORM DRAIN PIPING PLAN
 SCALE 1/4" = 1'-0"
 GRAPHIC SCALE
 0 2 4 6 8 10

FIELD VERIFIED ON 7-9-92

NO.	DATE	CLASS. REF.	REVISIONS	OWN	VER	CHKD	REL	SUB	REC	APP
AS-BUILT FACILITY DRAIN PLAN COOLING TOWER AND PUMP HOUSE										DRAIN 10/24/92 VERIFIED 10/24/92 CHECKED 10/24/92 RELEASED 10/24/92
MECH: STORM DRAIN AND SANITARY SEWER SYSTEM										
BLDG. 156 & 163			TA-3			DATE		8-7-92		
SUBMITTED		DATE		REVISIONS		DATE		SHEET		
10/19/92		10/19/92		F. C. Thompson		10/19/92		2 / 2		
Los Alamos Los Alamos National Laboratory Los Alamos, New Mexico 87545			M1		DATE 10-9-92					
CLASSIFICATION: U										
REVISION: None										
PROJECT ID: 11831-99										
DRAWING NO.: AB61										

UCI 91-001

NEW MEXICO HISTORIC BUILDING INVENTORY FORM

LA#

building threatened? yes	surveyed date 6/16/99 by K. L. M. Garcia & Alysia D. McLain	County Los Alamos	ID no. TA-3-163
Field map LANL Orthotopo	number Sheet 4	UTM reference: easting 380399 northing 3970621 zone 13	
location description Technical Area (TA) 3, South Mesa		city/town Los Alamos	land grant/reservation n/a
building name TA-3-163, Original name: South Mesa (SM-163)		legal description USGS Guaje Mountain 7.5 Series tnsp 19N range 6E sec 17 NE¼ SW¼ SE¼	
film roll by nos. digital photos	Negative nos. digital photos on file with ESH-20 by building number	location of neg. LANL, ESH-20	date of construction _____ estimate 6/4/62 to 4/15/63 actual source Facilities Division Engineering 9 (F-9) records (LANL)
Style Utilitarian, pump house, of concrete masonry units, with one window and one pedestrian door. (see below for more information)	Foundation material concrete slab wall material/surface concrete masonry units painted to seal exterior surface.	Use Present residential ✓ other abandoned pump house containing pumps, compressors, and other equipment that was used during the operation of the cooling tower. historic residential ✓ other pump house	Condition ___ excellent ___ X fair to ___ good ___ deteriorating
degree of remodeling ___ X minor ___ moderate ___ major describe: The 1962 engineering drawings show that there is a louver located on the south elevation of the building, however, the entire south elevation is devoid of any features.			
Surroundings Developed Laboratory Technical Area 3	Relationship to surroundings ___ similar ___ X not similar	district potential ___ yes ___ X no	
Significance ___ Eligible ___ of interest ___ X none if not eligible, why? Pump house TA-3-163 is only an abandoned support structure for the Sherwood Building TA-3-105.	Associated building? ___ X yes What type? Industrial laboratory type building with an associated cooling tower If inventoried, list ID nos. TA-3-156 (cooling tower) and TA-3-105 (the Sherwood Building)	Photos and plan drawings are on the following pages: ENG-C 27070 (sheet 2 of 20) Sherwood Cooling Tower Architectural Plan, Section & Details March 27, 1962 ENG-C 27072 (sheet 4 of 20) Sherwood Cooling Tower Architectural Sections & Details March 27, 1962	

		<p>Photos and plan drawings are on the following pages: cont.:</p> <p>ENG-C 27073 (sheet 5 of 20) Sherwood Cooling Tower Roof Framing Plan, Sections & Details March 27, 1962</p> <p>ENG-C 34166 (sheet 1) Cooling Water System Instrumentation May 11, 1966</p> <p>ENG-AB 61 (sheet 1 of 2) As-Built Facility Drain Plan Cooling Tower and Pump House Civil: Site Plan, Storm Drain, & Sanitary Sewer System August 7, 1992</p> <p>ENG-AB 61 (sheet 2 of 2) As-Built Facility Drain Plan Cooling Tower and Pump House Mechanical: Storm Drain and Sanitary Sewer System May 11, 1992</p> <p>Size: Approximately 324-ft²</p>
<p>Architectural features: Building TA-3-163 is a small, 324-ft² concrete pump house with a flat roof. The roof is a three-ply built up roof with a roof vent along the south side. There is galvanized metal flashing around the edge of the roof.</p> <p>The north elevation faces and is connected by pipes to TA-3-156, the cooling tower. There also is a small louver on the northwest portion of the wall.</p> <p>On the west elevation there is a window with nine individual glass panes.</p> <p>The south elevation is devoid of windows, doors, or any defining features.</p> <p>The building contains pumps, compressors, and other equipment related to the operation of the cooling tower.</p>		<p>Comments:</p>



TA-3-163 South and East Sides



TA-3-163 West and South Sides

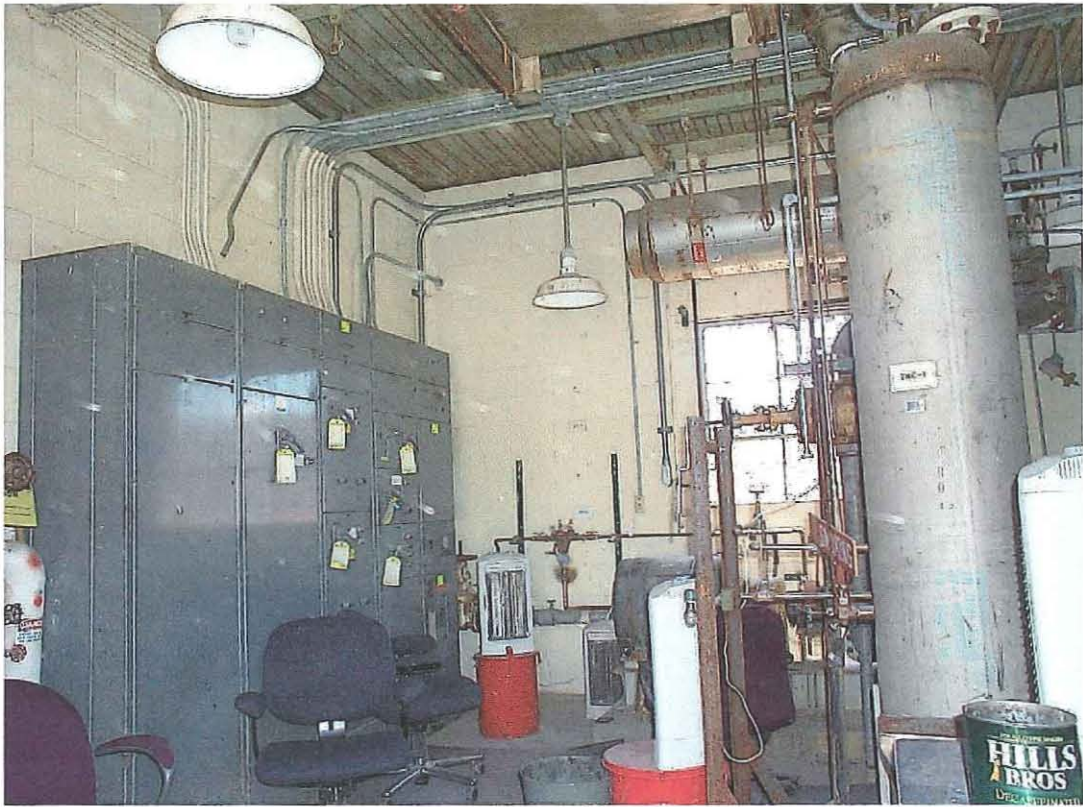

TA-3-163 Inside



TA-3-163 Inside

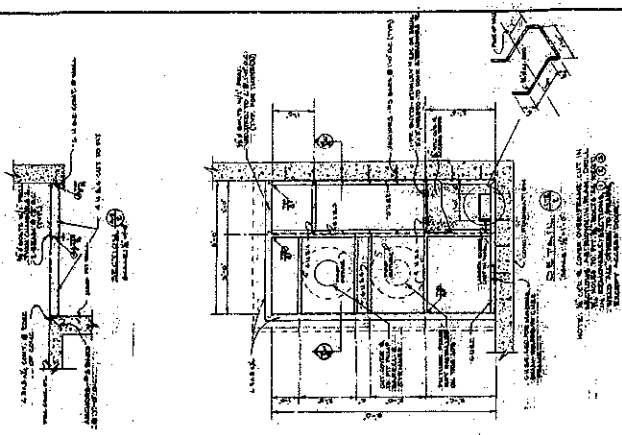

THE JOB MUST BE OBSERVED AND NOT REPRODUCED WITHOUT THE APPROVAL OF THE ARCHITECT.

UNIVERSITY OF CALIFORNIA - LOS ANGELES, NEW SCHOOL OF ARCHITECTURE, SECTION & DETAIL.

PROJECT: SHEERWOOD COOLING TOWER

DATE: 1/2/50

SCALE: 1/8" = 1'-0"

NO. 2 OF 2

ENGINEER: ENG-C 27070

ARCHITECT: SHEERWOOD ARCHITECTS

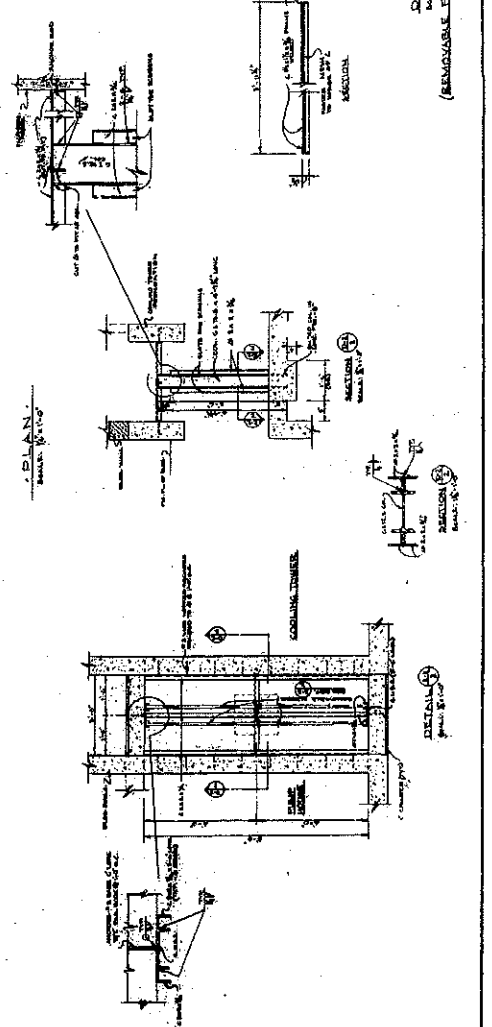
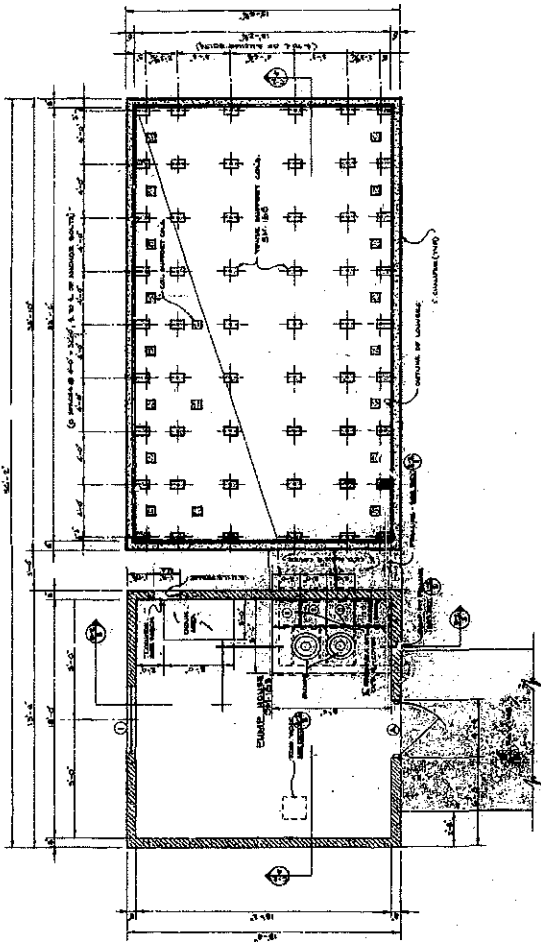
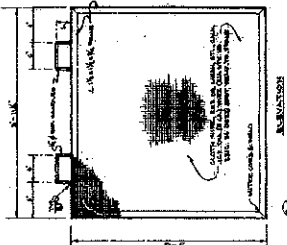

REPRODUCTION OF THIS DRAWING FOR ANY PURPOSE IS PROHIBITED WITHOUT THE WRITTEN PERMISSION OF THE ARCHITECT.

REPRODUCTION OF THIS DRAWING FOR ANY PURPOSE IS PROHIBITED WITHOUT THE WRITTEN PERMISSION OF THE ARCHITECT.

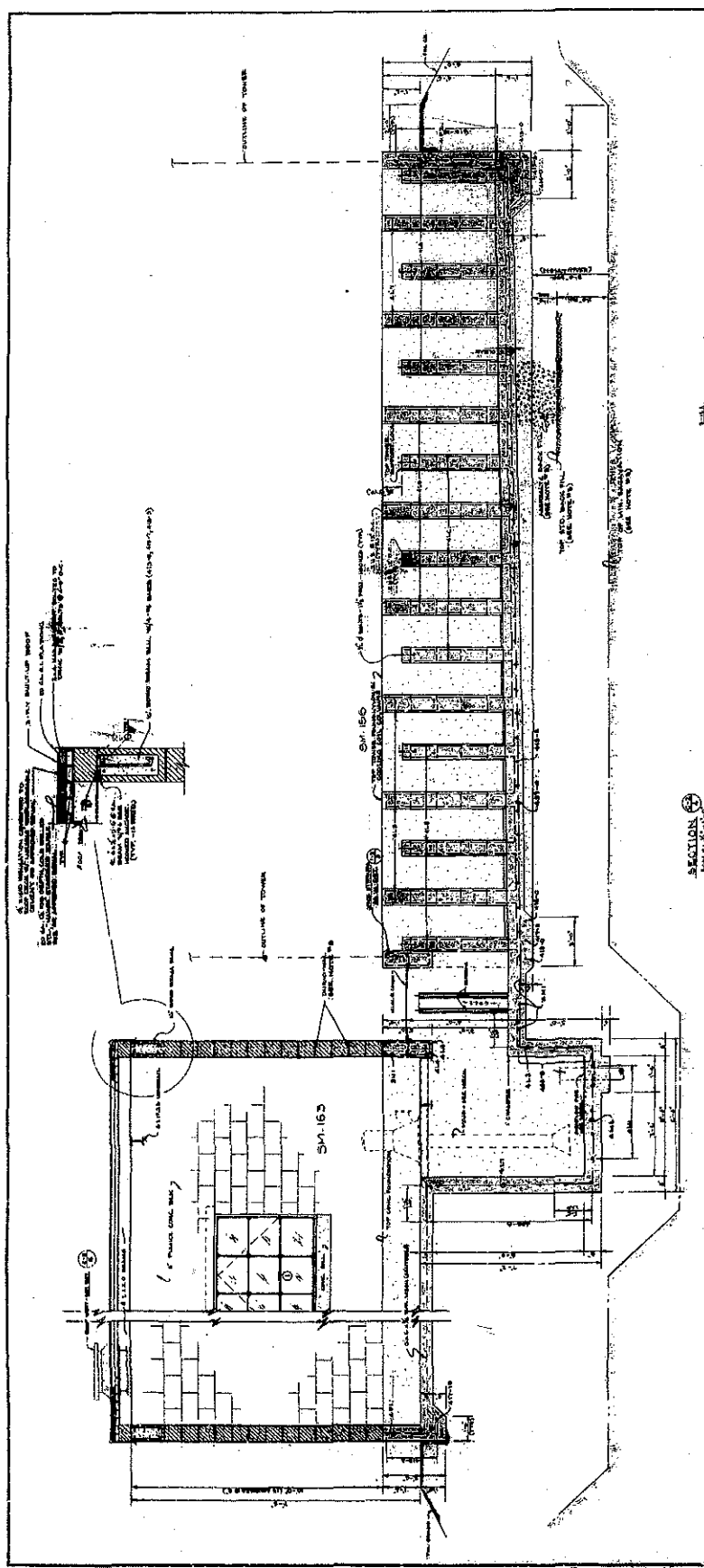

THIS JOB MUST BE INSPECTED AND APPROVED BY THE ARCHITECT BEFORE PROCEEDING WITH THE WORK.

DATE	APPROVED FOR	DATE	APPROVED FOR

LOS ALAMOS SCIENTIFIC LABORATORY
 UNIVERSITY OF CALIFORNIA - LOS ALAMOS, NEW MEXICO
 SHERWOOD COOLING TOWER
 SHERWOOD, JACKSON, & SUTLAND

PROJECT NO. 163
 DRAWING NO. 163-1
 DATE 3-27-53
 SCALE AS SHOWN
 SHEET NO. 1 OF 2
 ENG-C 271072

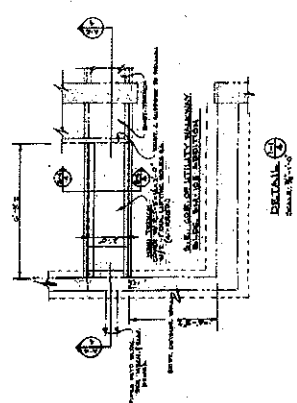
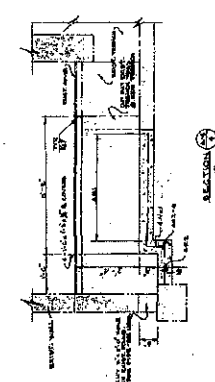
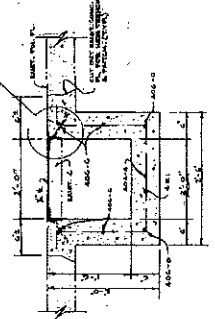

REC'D 10-3-53 AM 11:00 AM
 S. A. NO. 231 - LAB. JOB NO. 163-1

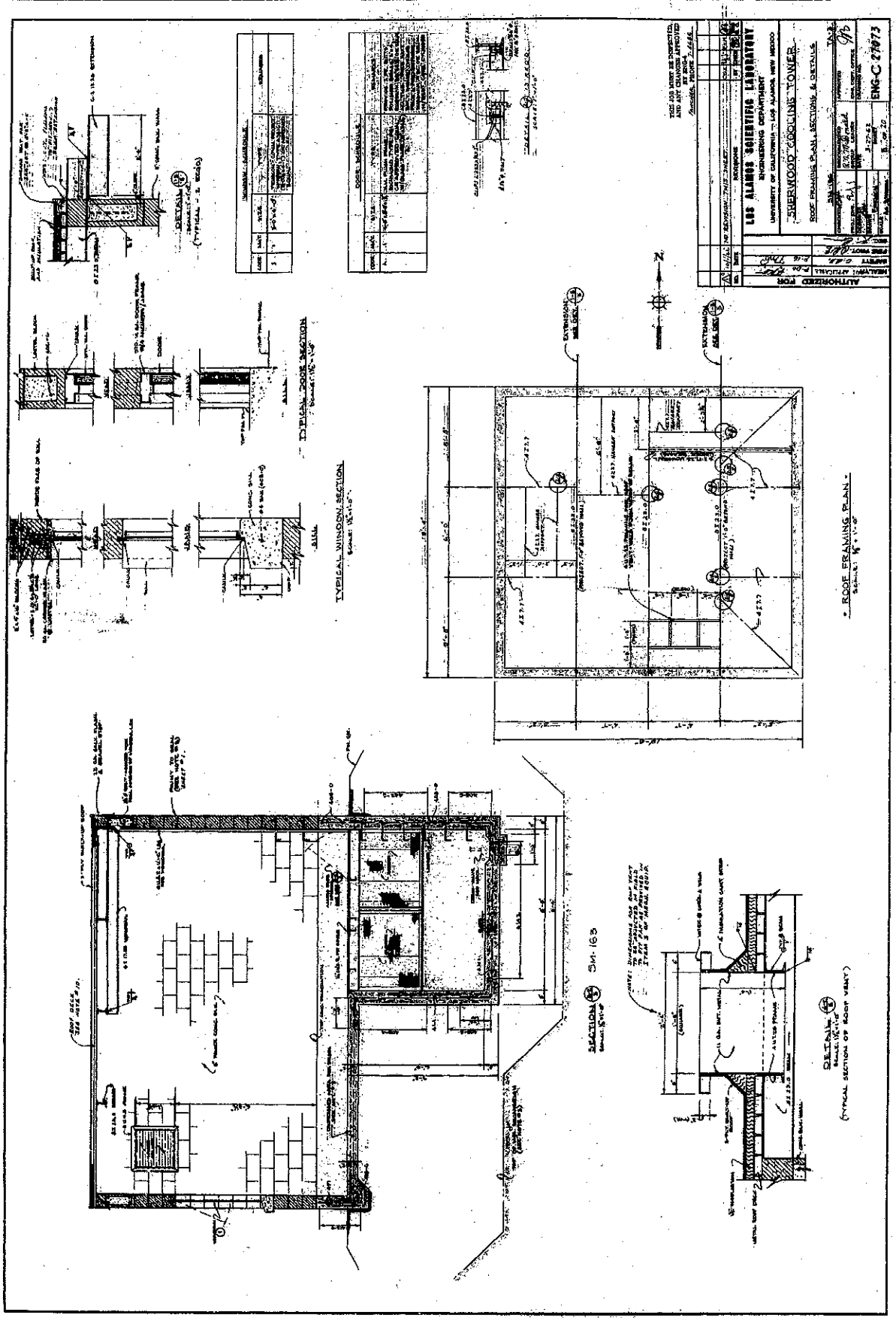

THIS JOB SHALL BE COMPLETED AND ALL WORK FINISHED IN ACCORDANCE WITH THESE SPECIFICATIONS.

PROJECT NO.	ENG-C-27873
DATE	10/15/53
DESIGNED BY	W. H. HARRIS
CHECKED BY	W. H. HARRIS
APPROVED BY	W. H. HARRIS
DATE	10/15/53
SCALE	AS SHOWN
PROJECT	LOS ALAMOS SCIENTIFIC LABORATORY
DEPARTMENT	ENGINEERING DEPARTMENT
LOCATION	UNIVERSITY OF CALIFORNIA - LOS ALAMOS
CONTRACT NO.	
CONTRACT DATE	
CONTRACT VALUE	
CONTRACT NO.	
CONTRACT DATE	
CONTRACT VALUE	
CONTRACT NO.	
CONTRACT DATE	
CONTRACT VALUE	

LOS ALAMOS SCIENTIFIC LABORATORY
ENGINEERING DEPARTMENT
UNIVERSITY OF CALIFORNIA - LOS ALAMOS
SHERWOOD JOCKLINE TOWER
ROOF FRAMING PLAN, SECTIONS & DETAILS

APPROVED FOR
W. H. HARRIS
10/15/53

REC'D ENG-3-10-53 10:00 AM '53

ROOF FRAMING PLAN
Sheet No. 1 of 1

SECTION 314-165
Roof Framing

DETAIL 1
(TYPICAL SECTION OF ROOF VERT.)

TYPICAL WINDOW SECTION
Roof Framing

TYPICAL DOOR SECTION
Roof Framing

DETAIL 2
(TYPICAL - 2' X 2')

DETAIL 3
SEE NOTE # 1

DETAIL 4
SEE NOTE # 1

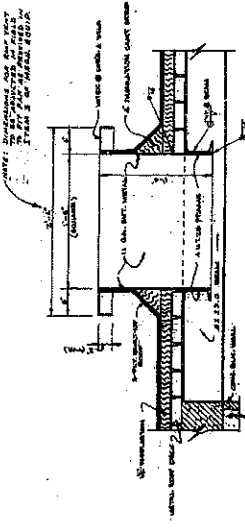
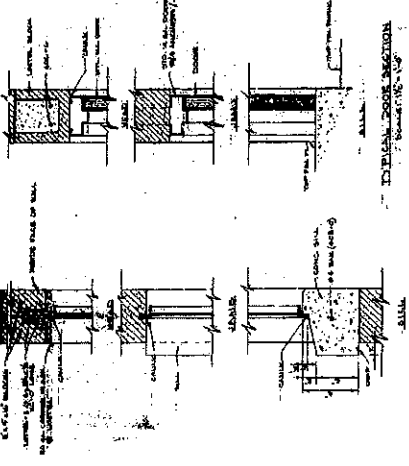
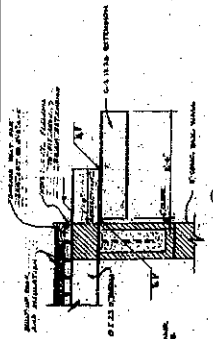
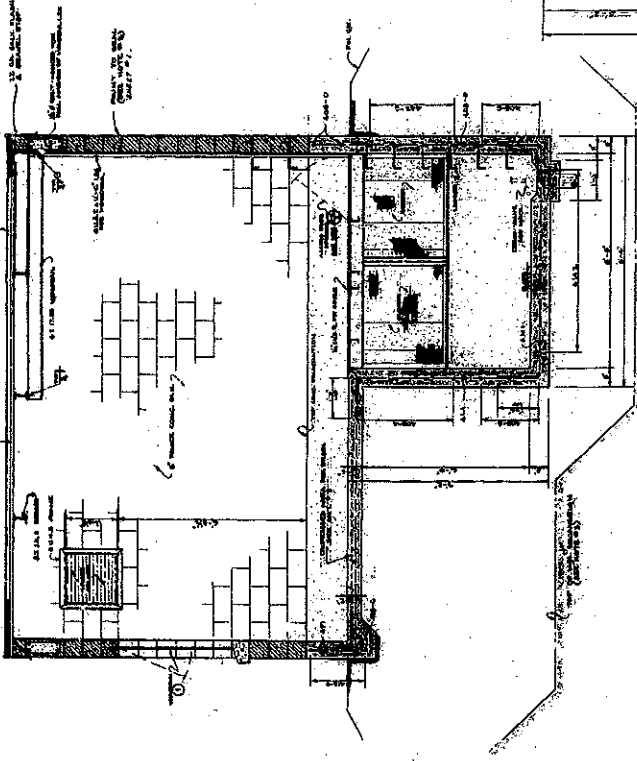
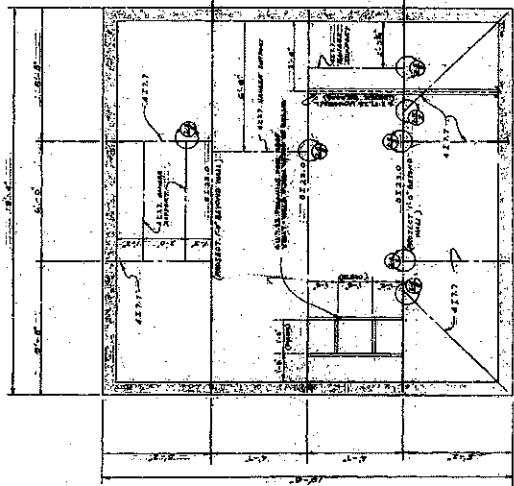

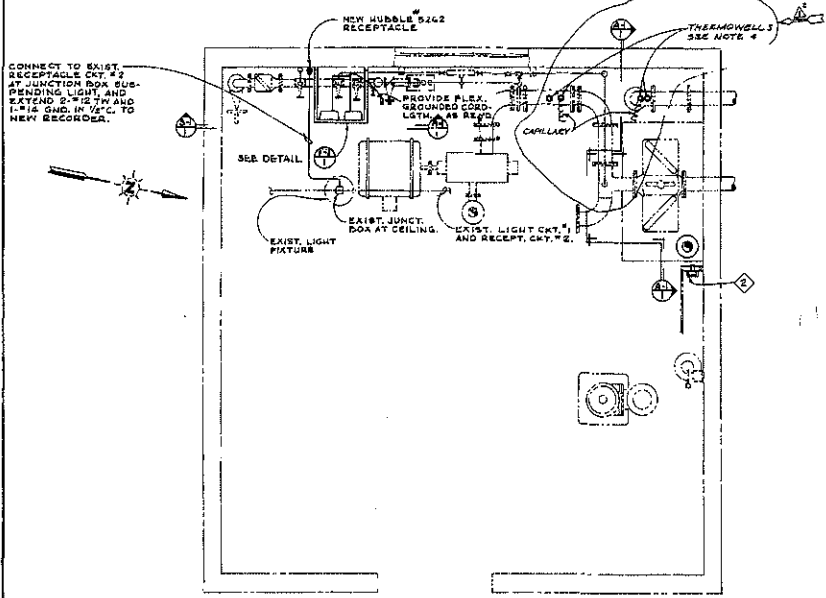

FLOOR PLAN SM-163
SCALE: 1/8" = 1'-0"

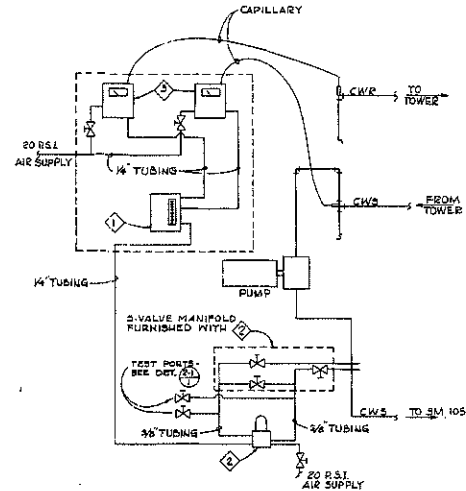

SCHEMATIC DIAGRAM FOR RECORDING SYSTEM
NO SCALE

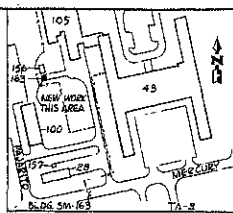

LOCATION PLAN

MECHANICAL EQUIPMENT LIST			
ITEM NO.	NO. REQ'D.	DESCRIPTION - MANUFACTURER OR APPROVED EQUAL	FURN. BY
1	1	RECORDER: FISCHER-PORTER MODEL #1202 WCO2-WCO2-WCO2	L.A.S.L.
2	1	D/P TRANSMITTER: FISCHER-PORTER MODEL #10214 2SA	L.A.S.L.
3	2	TEMPERATURE TRANSMITTERS: FISCHER-PORTER MODEL #14517-24, FURNISHED WITH TWO (2) THERMOWELLS EACH UNIT	L.A.S.L.
4	1	ORIFICE FLANGES: DANIEL ORIFICE FITTING CO. CAT. NO. 30 RW RAISED WELD NECK ORIFICE FLANGES 4\"/>	
5	1	ORIFICE PLATE: DANIEL ORIFICE FITTING CO. MODEL 120, 304 STAINLESS STEEL ORIFICE PLATE FOR 4\"/>	

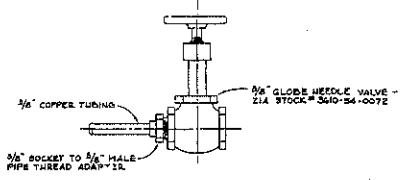

TEST PORT TERMINATION
DETAIL (A)
NTS

NAMEPLATE SCHEDULE	
REQ'D.	DESCRIPTION
1	CHILLED WATER SUPPLY
1	CHILLED WATER RETURN
1	CHS & CHR TEMP; FLOW GPM

L.A.S.L. FURNISHED, FABRICATED OF LAMINATED PLASTIC WITH 1/4" LETTERS

- GENERAL NOTES:
- ALL 1/4" TUBING FOR THIS INSTALLATION SHALL BE "POLY-FLO" TUBING AND IS AVAILABLE FROM STOCK.
 - ALL VALVES, TEES AND OTHER NECESSARY FITTINGS SHALL BE "POLY-FLO" AND ARE AVAILABLE FROM STOCK.
 - D/P TRANSMITTER SHALL BE MOUNTED IN A POSITION LOWER THAN THE ORIFICE.
 - NOTE THAT TWO THERMOWELLS ARE FURNISHED WITH EACH TEMPERATURE TRANSMITTER. ONE IS FOR THE TRANSMITTER SENSING BULB AND ONE IS FOR A CALIBRATION THERMOWELL.
 - FABRICATE NAMEPLATES FROM LAMINAR PLASTIC WITH 1/4" HIGH LETTERS.
 - CONNECT AIR SUPPLY TO EXISTING INSTRUMENT AIR IN ROOM.
 - INSTRUMENT CALIBRATION TO BE PERFORMED BY ENG-4 AND ENG-2.
 - ALL 3/8" TUBING SHALL BE TYPE "L" COPPER.
- REVISIONS MUST BE SUBMITTED AND ANY CHANGES APPROVED BY ENG-4 & ENG-2
MERRILL K. EMMETT
11-11-64

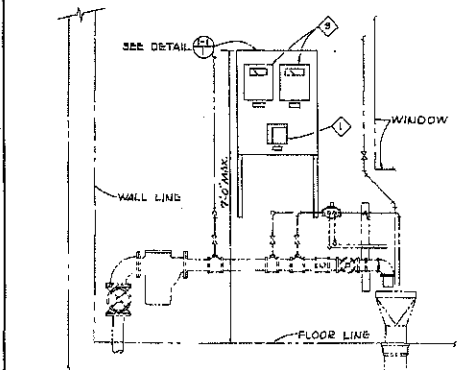

SECTION (A)
SCALE: 1/4" = 1'-0"

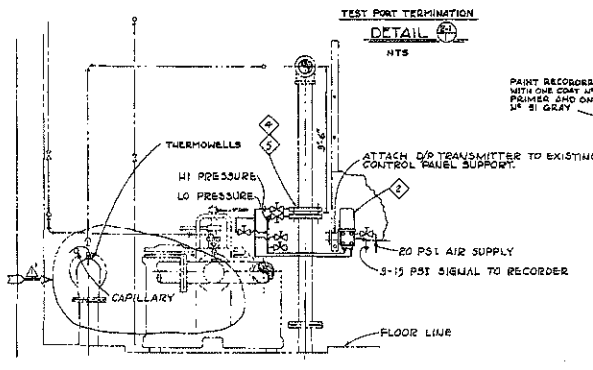

SECTION (B)
SCALE: 1/4" = 1'-0"

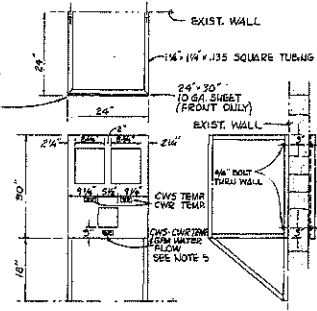

RECORDER PANEL DETAIL (A)
SCALE: 1/4" = 1'-0"

NO.	REV.	DESCRIPTION	BY	CHKD.	DATE
1	1	DELOCATED THERMOWELLS AS SHOWN	ELM/WR	ELM/WR	11-11-64

LOS ALAMOS SCIENTIFIC LABORATORY
ENGINEERING DEPARTMENT
UNIVERSITY OF CALIFORNIA - LOS ALAMOS, NEW MEXICO

COOLING WATER SYSTEM
INSTRUMENTATION

TA-3
DRAWN BY: RWH
CHECKED BY: M. G. G. G.
DATE: 11-11-64
DESIGNED BY: SCOTT
SCALE: AS NOTED
C.A. NO. R.A. NO. L.J. NO. 3882-3

APPROVED FOR: [Signature]
DATE: 11-11-64

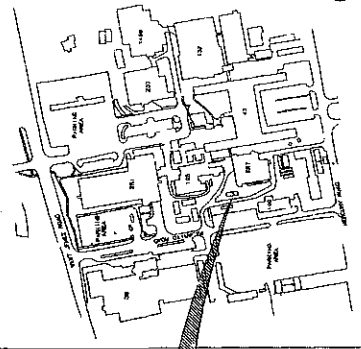

SITE PLAN
SCALE: 1/8" = 1'-0"

- LEGEND
- SD BURIED STORM DRAIN
 - SS BURIED SANITARY SEWER
 - DKLD CORR METAL STORM DRAIN
 - DOTS CLEANOUT TO GRADE
 - CB CATCH BASIN
 - 2 WAY CLEANOUT
 - CO CLEANOUT
 - MH MANHOLE

NO.	DATE	BY	CHKD	REL	SUB	REV	JTP

CONTRALS WORLD SERVICES, INC.

AS-BUILT FACILITY DRAIN PLAN
COOLING TOWER AND PUMP HOUSE

CIVIL: SITE PLAN, STORM DRAIN
AND SANITARY SEWER SYSTEM

PROJECT NO. 11831-99

DATE 10-28-92

REV. AB61

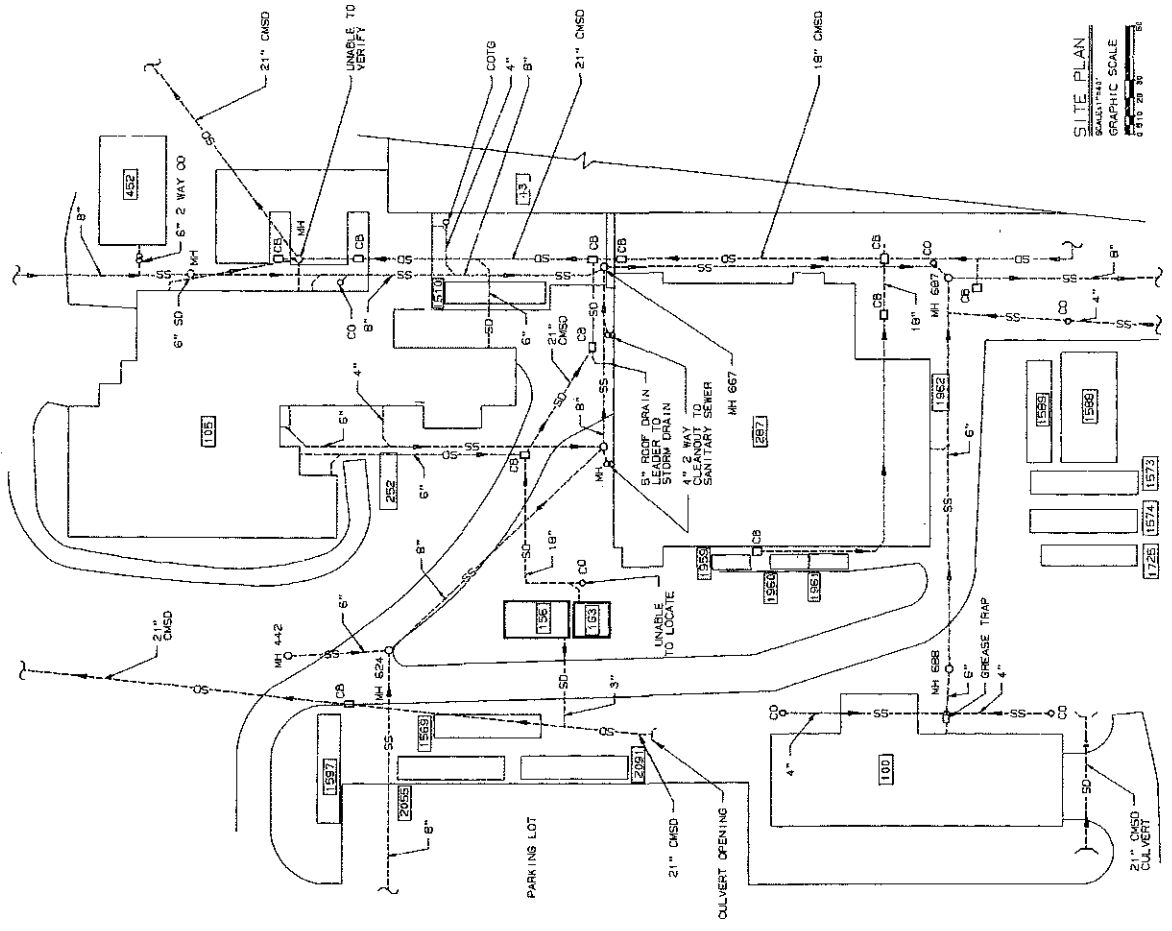

FIELD VERIFIED ON 7-9-92

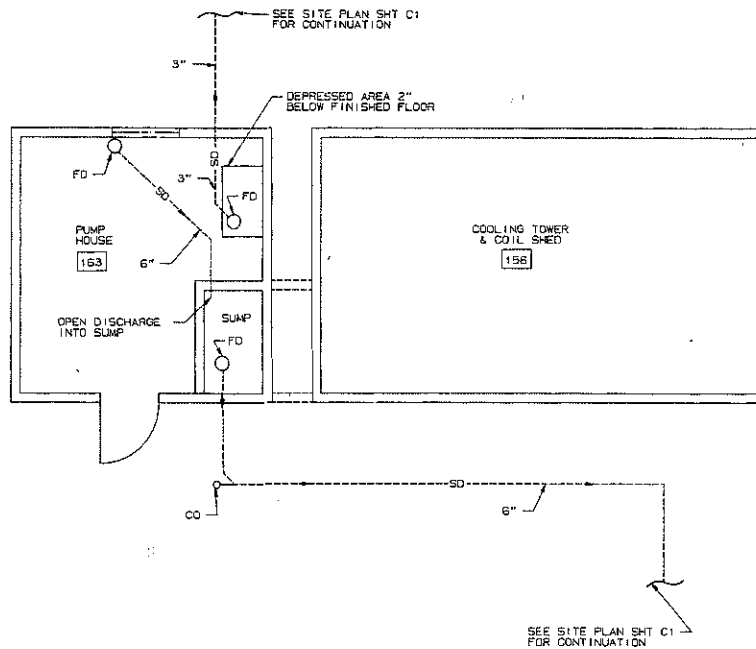

LEGEND

- SD --- BURIED STORM DRAIN
- SS --- BURIED SANITARY SEWER
- CO CLEANOUT
- FD FLOOR DRAIN

STORM DRAIN PIPING PLAN
 SCALE 1/4" = 1'-0"
 GRAPHIC SCALE
 0 2 4 6 8 10

FIELD VERIFIED ON 7-9-92

NO.	DATE	CLASS. RECD.	REVISIONS	DN	YR	DN	REL.	SUB.	REC.	APP.
JOHNSON CONTROLS WORLD SERVICES INC.										
AS-BUILT FACILITY DRAIN PLAN COOLING TOWER AND PUMP HOUSE										DATE 10/13/92
MECH: STORM DRAIN AND SANITARY SEWER SYSTEM										CHECKED BY J. C. Thompson
BLDG. 156 & 153										TA-3
SUBMITTED BY J. C. Thompson										DATE 10/13/92
Los Alamos										Los Alamos National Laboratory Los Alamos, New Mexico 87545
CLASSIFICATION L										SHEET M1 / 2
PROJECT ID 11831-99										DRAWING NO. AB61
DATE 7-9-92										REV.

JCI 91-001