



# Hubble Space Telescope

Servicing Mission 4  
Media Reference Guide



**LOCKHEED MARTIN** 



## Removing COSTAR

SM4 spacewalker astronauts carefully remove the Corrective Optics Space Telescope Axial Replacement (COSTAR) to make room for a new scientific instrument, the Cosmic Origins Spectrograph (COS).

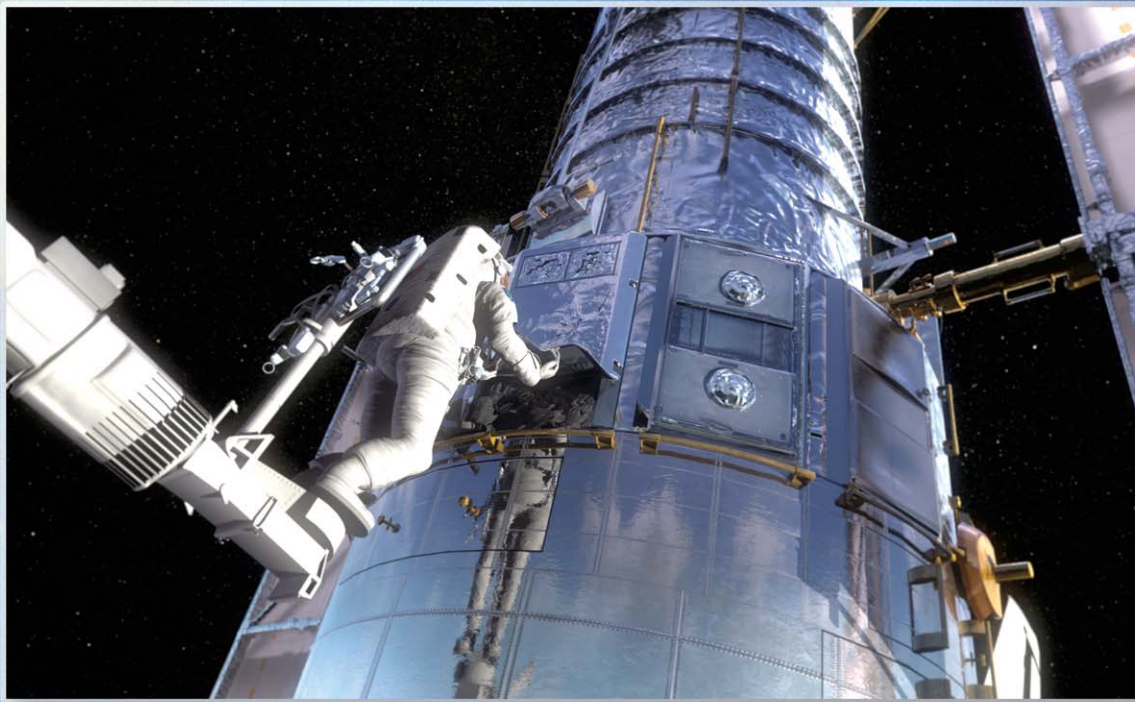
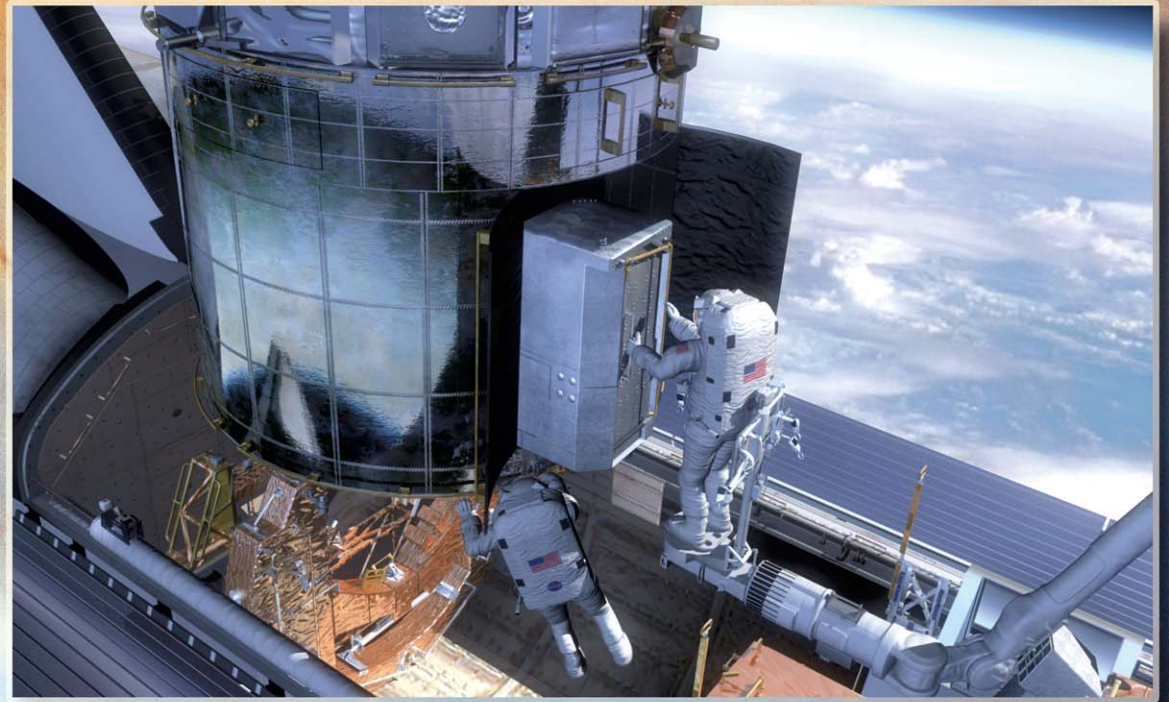

## Replacing Insulation

In preparation for installation of a New Outer Blanket Layer (NOBL) insulation panel on the Equipment Section, the old multi-layer insulation (MLI) is removed.



# Hubble Space Telescope

## Servicing Mission 4 Media Reference Guide



**Special thanks to everyone who helped  
pull this book together**

Buddy Nelson – Chief writer/editor  
Mel Higashi – Design and layout  
Pat Sharp – Text and graphics integration

Background information and images provided by  
Peter Leung, Dennis Connolly, Preston Burch, Mindy Deyarmin,  
Mark Jarosz, Susan Hendrix, Mike McClaire, Rob Navias,  
Stratis Kakadelis, Ray Villard, Dave Leckrone, Mike Weiss,  
Lori Tyahla, Roz Brown and Russ Underwood

**Prepared by Lockheed Martin for the  
National Aeronautics and Space Administration**

# About the Covers

The outside covers show the Hubble Space Telescope illuminated in orbit by the rising sun, with a thin crescent limb of Earth as a backdrop. Astronauts are installing the second of two new Solar Arrays during Servicing Mission 3B in March 2002.

Images on the inside covers and in Section 2 are stills from photo-realistic NASA animations depicting the primary activities that will take place during Servicing Mission 4.



# Who Was Edwin P. Hubble?



Photo courtesy of the Carnegie Institution of Washington

Edwin Hubble (1889–1953) at the 48-inch Schmidt telescope on Palomar Mountain

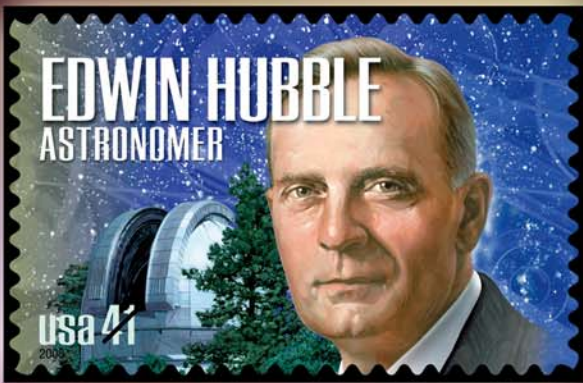

The U.S. Postal Service honored astronomer Edwin Hubble with a stamp in its American Scientists series, issued March 6, 2008. The stamp shows the dome of the Mount Wilson Observatory where Hubble made observations that revealed the expanding universe.

One of the great pioneers of modern astronomy, the American astronomer Edwin Powell Hubble (1889–1953), started out by getting a law degree and serving in World War I. However, after practicing law for one year, he decided to “chuck law for astronomy and I knew that, even if I were second rate or third rate, it was astronomy that mattered.”

He completed a Ph.D. thesis on the Photographic Investigation of Faint Nebulae at the University of Chicago and then continued his work at Mount Wilson Observatory, studying the faint patches of luminous “fog” or nebulae in the night sky.

Using the largest telescope of its day, a 2.5-meter reflector, he studied Andromeda and a number of other nebulae and proved that they were other star systems (galaxies) similar to our own Milky Way.

He devised the classification scheme for galaxies that is still in use today, and obtained extensive evidence that the laws of physics outside the galaxy are the same as on Earth—in his own words: “verifying the principle of the uniformity of nature.”

In 1929, Hubble analyzed the speeds of recession of a number of galaxies and showed that the speed at which a galaxy moves away from us is proportional to its distance (Hubble’s Law). This discovery of the expanding universe marked the birth of the “Big Bang Theory” and is one of the greatest triumphs of 20th-century astronomy.

In fact, Hubble’s remarkable discovery could have been predicted some 10 years earlier by none other than Albert Einstein. In 1917, Einstein applied his newly developed General Theory of Relativity to the problem of the universe as a whole. Einstein was very disturbed to discover that his theory predicted that the universe could not be static, but had to either expand or contract. Einstein found this prediction so unbelievable that he went back and modified his original theory in order to avoid this problem. Upon learning of Hubble’s discoveries, Einstein later referred to this as “the biggest blunder of my life.”

— ESA Bulletin 58

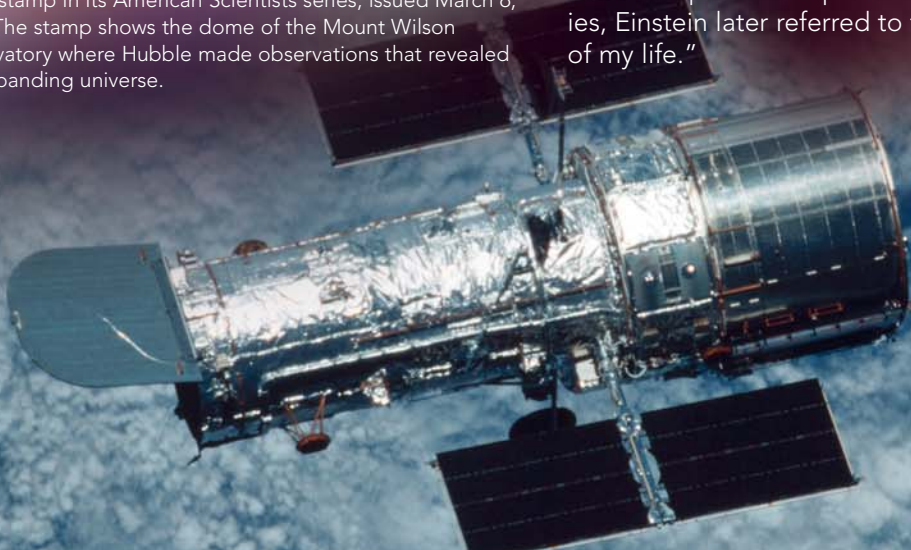



# A Truly Great Observatory

Few telescopes in history have had such a profound impact on astronomical research as the Hubble Space Telescope. In its 18 years of operation, Hubble has not only helped shape scientists' view of the universe, but it has also brought a glimpse of the wonders of the cosmos to homes worldwide. Here are some of its most riveting achievements.

Hubble has made the first measurements of the composition of the atmosphere of an extrasolar planet. It has detected sodium, carbon, water and even methane. These observations are a precursor to searches for the chemical signatures of life in worlds around other stars.

In collaboration with other telescopes, Hubble has shown that the expansion of our universe is accelerating, as if propelled by an unseen cosmic constituent dubbed "dark energy." Hubble has also taken the first steps in the attempt to characterize the properties of this dark energy, in terms of its strength and permanence.

Hubble has determined the rate of cosmic expansion (the Hubble Constant) to an accuracy of about four percent. The measured value indicates an age for the universe of 13.7 billion years. Hubble observations have also firmed up the scenario in which giant black holes feasting on matter reside in the centers of most galaxies. The mass of these black holes was found to be tightly correlated with the mass of the spherical bulges of stars surrounding galactic centers.

Finally, Hubble has taken long exposures of small patches of the sky—the Hubble Deep Fields—to obtain the deepest images of the universe in visible light. These observations have revealed the rate of star formation at large in the universe over cosmic time.

This magnificent telescope has allowed us to see, for the first time, features of the universe that humans were once able to probe only with their imaginations.

— Dr. Mario Livio, astronomer  
Space Telescope Science Institute





























# Media Reference Guide Introduction

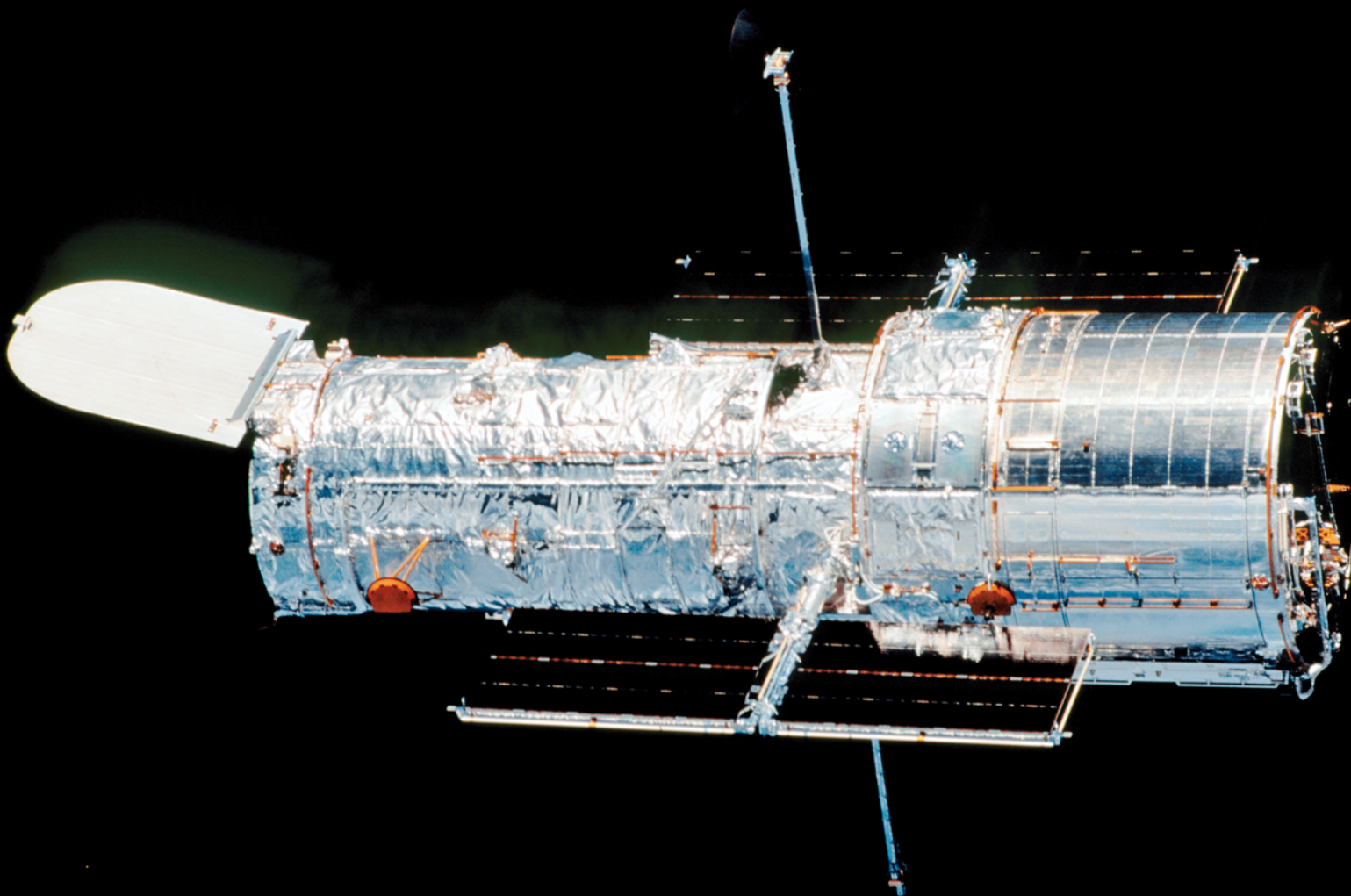





# Introduction



**G**azing through his first crude telescope in the 17th century, Galileo discovered the craters of the Moon, the satellites of Jupiter and the rings of Saturn. These early observations led the way to today's quest for in-depth knowledge and understanding of the cosmos. For more than 18 years, NASA's Hubble Space Telescope (HST) has continued and expanded this historic quest.



Since its launch in April 1990, Hubble has provided scientific data and images of unprecedented resolution that have generated many new and exciting discoveries. Even when reduced to raw numbers, the accomplishments of the 12.5-ton orbiting observatory are impressive:

- Hubble has taken about 860,000 exposures.
- Hubble has observed more than 27,000 astronomical targets.
- Astronomers using Hubble data have published over 7,055 scientific papers.
- Circling Earth every 96 minutes, Hubble has traveled approximately 2.72 billion miles.
- The Space Telescope Science Institute (STScI) has archived more than 33 terabytes of data from Hubble.

This unique observatory operates around the clock above Earth's atmosphere gathering information for teams of scientists who study the origin, evolution and nature of the universe. The telescope is an invaluable tool for examining planets, stars, star-forming regions of the Milky Way, distant galaxies and quasars, and the tenuous hydrogen gas lying between the galaxies.

HST can produce images of the outer planets in our solar system that approach the clarity of those from planetary flybys. Astronomers have resolved previously unsuspected details of numerous star-forming regions of the Orion Nebula in the Milky Way and have detected expanding gas shells blown off by exploding stars.

Using Hubble's high-resolution and light-gathering power, scientists have calibrated the distances to remote galaxies to precisely measure the expansion of the universe and thereby calculate its age. They have detected and measured the rotation of dust, gas and stars trapped in the gravitational field at the cores of galaxies that portend the presence of massive black holes.

Hubble's deepest views of the universe, unveiling a sea of galaxies stretching nearly back to the beginning of time, have forced scientists to rethink some of their earlier theories about galactic evolution. (Section 3 of this guide contains

additional information on the telescope's scientific discoveries.)

The HST mission is to spend at least 20 years probing the farthest and faintest reaches of the cosmos. Crucial to fulfilling this objective has been a series of on-orbit manned servicing missions. During these missions astronauts perform planned repairs and maintenance activities to restore and upgrade the observatory's capabilities. To facilitate this process, HST designers configured science instruments and vital subsystem components as Orbital Replacement Instruments (ORIs) and Orbital Replacement Units (ORUs)—modular packages with standardized fittings accessible to astronauts in pressurized suits (see Fig. 1-1).

The First Servicing Mission (SM1) took place in December 1993 and the Second Servicing Mission (SM2) in February 1997. Hubble's Third Servicing Mission was separated into two parts: Servicing Mission 3A (SM3A) flew in December 1999 and Servicing Mission 3B (SM3B) in March 2002. Servicing Mission 4 (SM4), the fifth visit to HST, is scheduled for launch in fall 2008.

SM4 astronauts will:

- Install two new science instruments, the Wide Field Camera 3 (WFC3) and the Cosmic Origins Spectrograph (COS).
- Replace all six gyroscopes.
- Replace all six nickel-hydrogen (NiH<sub>2</sub>) batteries.
- Attempt to repair the Advanced Camera for Surveys (ACS) by installing a box containing new circuit boards into its Wide Field Channel Charge-Coupled Device (CCD) Electronics Box (CEB) and attach a power supply module.
- Attempt to repair the Space Telescope Imaging Spectrograph (STIS) by replacing the Low Voltage Power Supply-2 (LVPS-2) board in the Main Electronics Box 1 (MEB1).
- Install a refurbished Fine Guidance Sensor (FGS-2).
- Install New Outer Blanket Layer (NOBL) insulation panels.
- Install the Soft Capture Mechanism (SCM).

WFC3 is designed to ensure that Hubble maintains its unique imaging capabilities until the end of its mission, while at the same time advancing its survey and



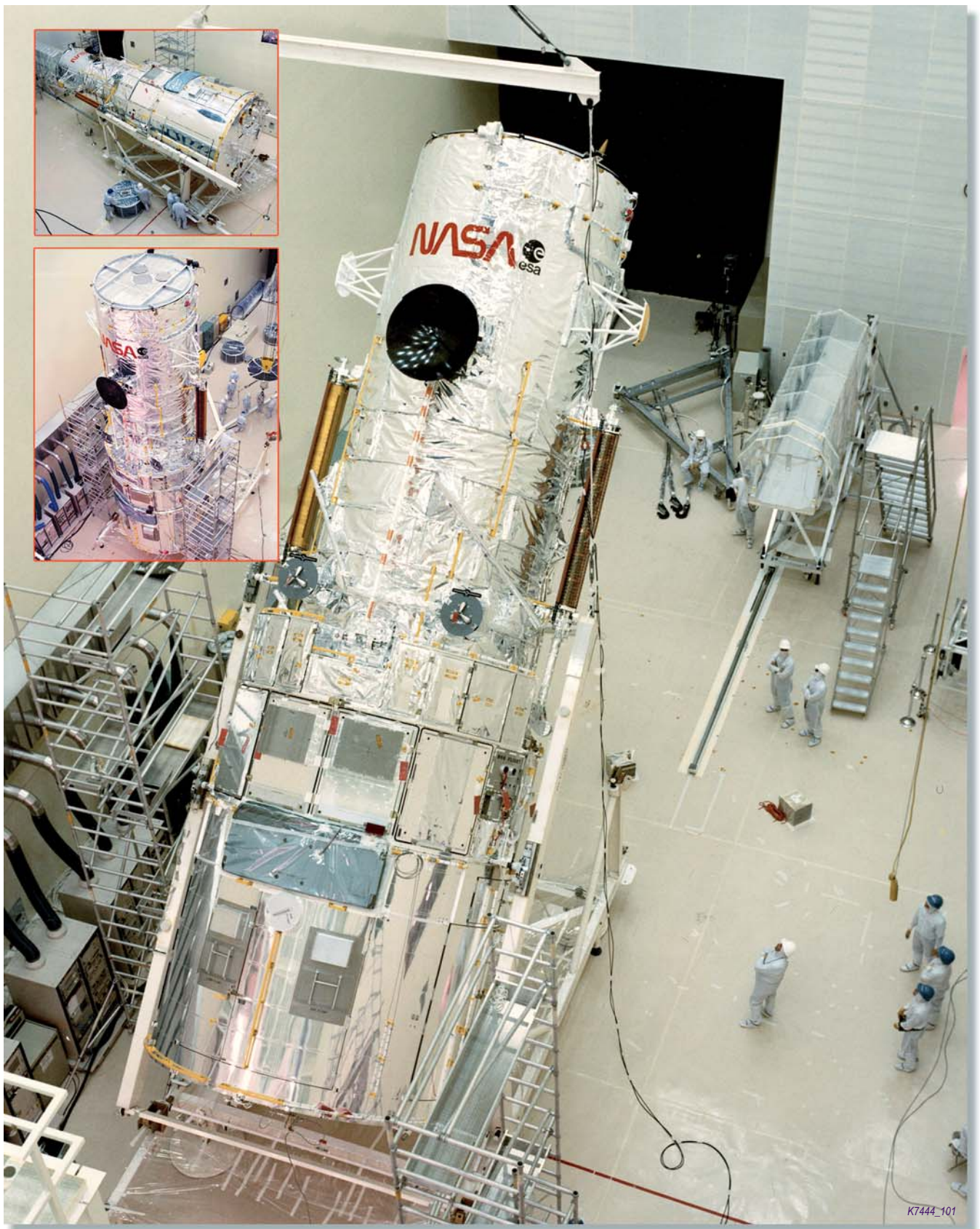

Fig. 1-1 The Hubble Space Telescope—shown in a clean room at Lockheed Martin Space Systems Company in Sunnyvale, Calif., before shipment to Kennedy Space Center—is equipped with science instruments and subsystems designed as Orbital Replacement Instruments and Orbital Replacement Units.





discovery capability through a combination of broad wavelength coverage, wide field of view and high sensitivity. It replaces the second-generation Wide Field and Planetary Camera 2 (WFPC2).

COS is a fourth-generation Hubble instrument designed to perform high-sensitivity, moderate- and low-resolution spectroscopy of astronomical objects in the wavelength range of 1150 to 3200 angstroms. It will be installed in the bay next to ACS, where the Corrective Optics Space Telescope Axial Replacement (COSTAR) currently resides.

Each of the six gyroscopes is packaged as a rate sensor assembly. These assemblies are housed in pairs inside three boxes called Rate Sensor Units (RSU). It is the RSU that astronauts change when they replace gyroscopes, so gyroscopes are always replaced two at a time. All three RSUs will be changed out during SM4.

Hubble's six NiH<sub>2</sub> batteries reside in two modules, each containing three batteries. They provide the observatory with a robust, long-life electrical energy storage system. Astronauts will replace all six batteries.

ACS is a third-generation imaging camera installed on SM3B. The camera is optimized to perform surveys or broad imaging campaigns.

STIS is a powerful general-purpose spectrograph that is complementary to COS. The repair during SM4 aims to return this instrument to working order by replacing a low-voltage power supply board that contains the failed component.

The FGS to be installed during SM4 is an optical sensor that will be used to provide pointing information for Hubble and at other times will function as a scientific instrument for astrometric science.

To maintain the normal operating temperature of critical HST electrical components, NOBL insulation panels will be installed to mitigate degradation of some of Hubble's thermal insulation.

Installation of the SCM on Hubble's aft bulkhead will aid rendezvous and capture of the telescope on a future mission, such as de-orbiting the observatory.

## Hubble Space Telescope Configuration

Figure 1-2 shows the overall telescope configuration and specifications. The major elements are:

- Optical Telescope Assembly (OTA)—two mirrors and associated structures that collect light from celestial objects
- Science instruments—devices used to analyze the images produced by the OTA
- Support Systems Module (SSM)—spacecraft structure that encloses the OTA and science instruments
- Solar Arrays (SA).

### Optical Telescope Assembly

The OTA consists of two mirrors, support trusses and the focal plane structure. The optical system is a Ritchey-Chretien design, in which two special aspheric mirrors form focused images over the largest possible field of view. Incoming light travels down a tubular baffle that absorbs stray light. The concave primary mirror—94.5 inches (2.4 meters) in diameter—collects the light and converges it toward the convex secondary mirror, which is only 12.2 inches (0.3 meters) in diameter. The secondary mirror directs the still-converging light back toward the primary mirror and through a 24-inch hole in its center into the Focal Plane Structure, where the science instruments are located.

### Science Instruments

From HST's initial deployment in 1990 through five servicing missions culminating in SM4, multiple suites of instruments have helped astronomers, astrophysicists and cosmologists achieve a more complete understanding of the universe. Stunning technological advances have provided new capabilities, greater wavelength coverage, improved resolution, and sensitivity, and increased productivity (see Fig. 1-3).

Hubble has eight instrument bays—five dedicated to science instruments and three for the guidance system. Four bays are mounted radially, or perpendicular to the main optical axis. The other four, called axial instruments, are aligned with the telescope's main optical axis and are mounted immediately behind the primary mirror.

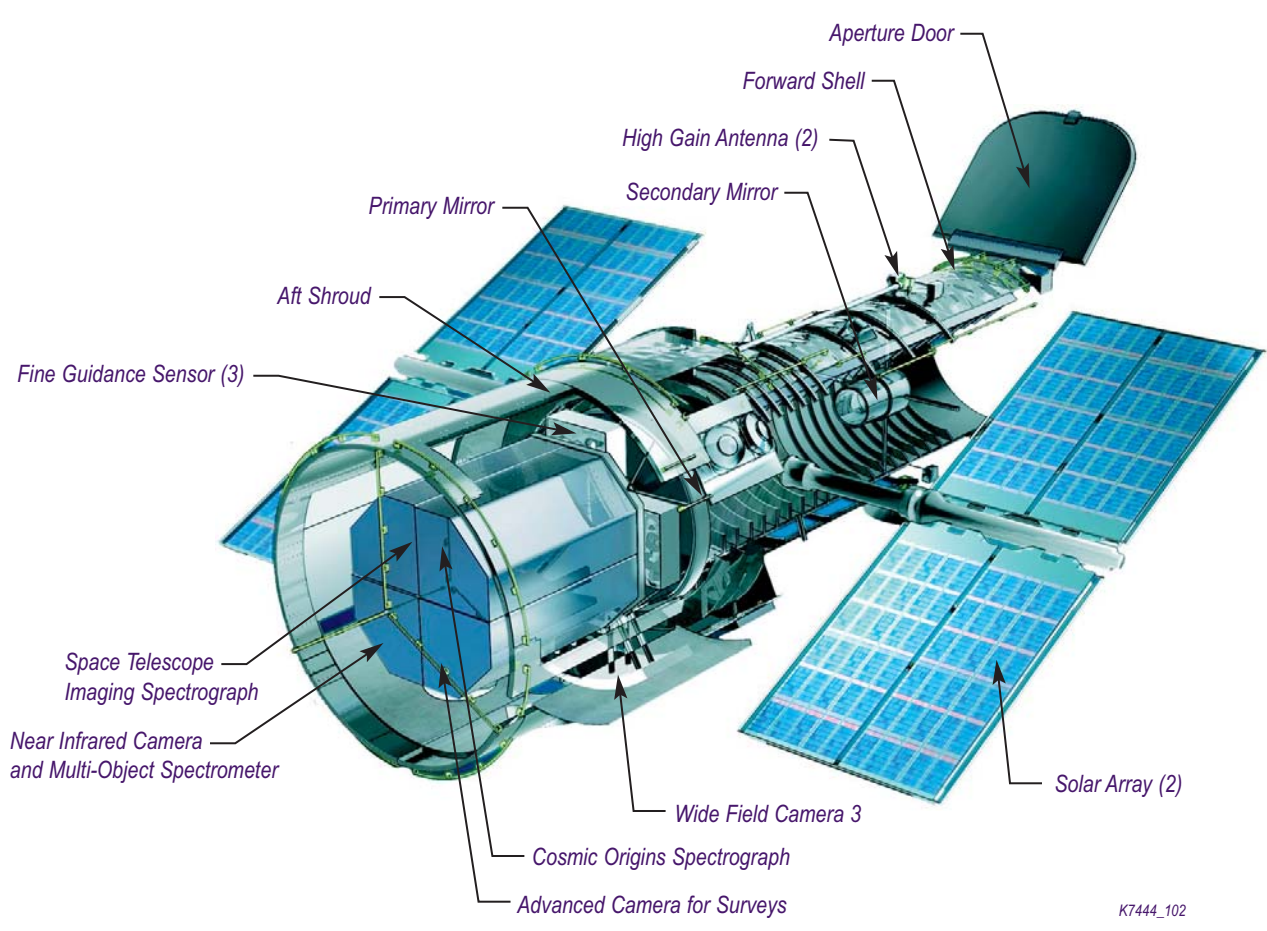

K7444\_102

### Hubble Space Telescope (HST)

Weight	24,500 lb (11,110 kg)
Length	43.5 ft (15.9 m)
Diameter	10 ft (3.1 m) Light Shield and Forward Shell
Optical system	14 ft (4.2 m) Equipment Section and Aft Shroud
Focal length	Ritchey-Chretien design Cassegrain telescope
Primary mirror	189 ft (56.7 m) folded to 21 ft (6.3 m)
Secondary mirror	94.5 in. (2.4 m) in diameter
Field of view	12.2 in. (0.3 m) in diameter
Pointing accuracy	See instruments/sensors
Magnitude range	0.007 arcsec for 24 hours
Wavelength range	5 m <sub>v</sub> to 30 m <sub>v</sub> (visual magnitude)
Angular resolution	1100 to 24,000 Å
Orbit	0.1 arcsec at 6328 Å
Orbit time	304 nmi (563 km), inclined 28.5 degrees from equator
Mission	96 minutes per orbit
	20+ years

Fig. 1-2 HST overall configuration and specifications

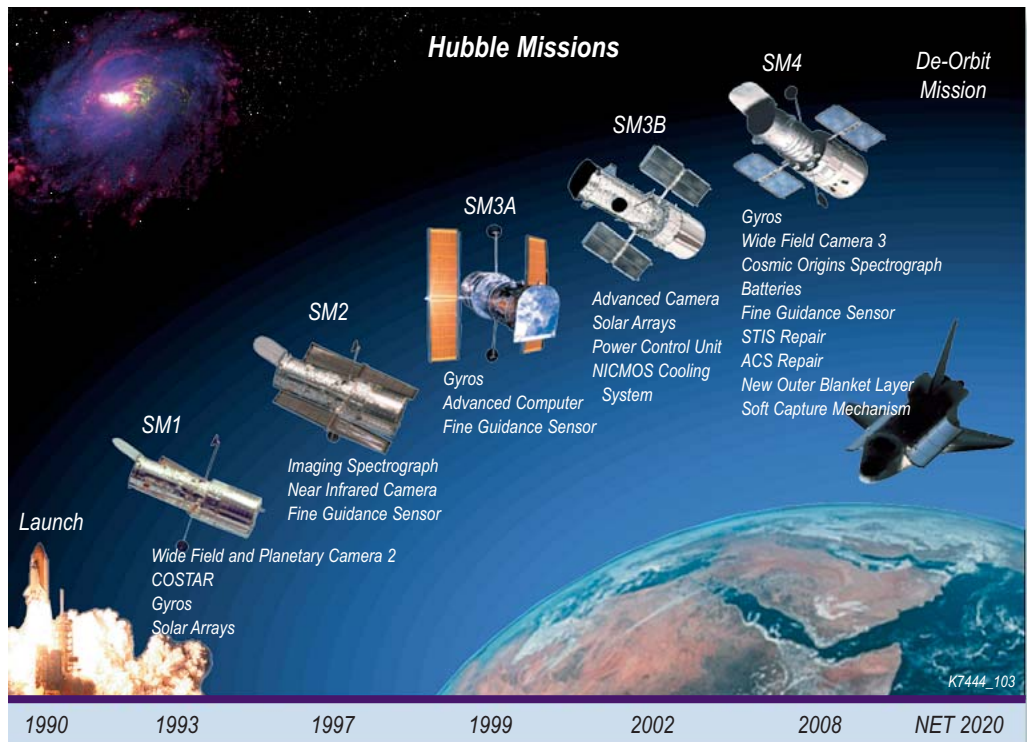

**Fig. 1-3** HST missions from launch through de-orbit. For each servicing mission—from SM1 through SM4—new instruments, repairs and upgrades are listed.

The radial instruments have remained relatively constant throughout the Hubble mission. One of them, the original WFPC, was replaced by WFPC2 during SM1. WFPC2 included an upgraded set of filters, advanced detectors and improved ultraviolet performance. But, perhaps most important, it was fitted with corrective lenses that nulled the spherical aberration in the HST main mirror discovered shortly after launch.

WFPC2 has been the instrument responsible for many of the most famous Hubble pictures, recording razor-sharp images of faraway objects in relatively broad views. Its 48 color filters have allowed scientists to study objects in a range of wavelengths. During SM4 WFC3 will replace WFPC2. With its expanded capabilities, WFC3 will build on the heritage of excellence of these remarkable cameras.

Three FGS units have occupied the other three radial positions on HST since deployment. A re-certified FGS replaced one of the original units during SM2, and another of the original units was replaced during SM3A. A third refurbished FGS will be installed during SM4, replacing the SM3A unit due to a light-emitting diode degradation problem. The FGS

units are located at 90-degree intervals around the circumference of the telescope.

The FGS units have two functions: (1) provide data to the spacecraft's pointing system to keep HST pointed accurately at a target when one or more of the science instruments is being used to obtain data and (2) act as a science instrument when not being used to guide the telescope. When functioning as a science instrument, two of the sensors lock onto guide stars and the third measures the brightness and relative positions of stars in its field of view. These measurements, referred to as astrometry, advance knowledge of the distances and motions of stars. The unit chosen to be the "astrometer FGS" is the one that has the best performance.

### Axial Instrument Configuration at Deployment (1990)

The **Faint Object Camera (FOC)** took early advantage of the telescope's superior optical resolution, capturing images of objects as dim as 28th magnitude.

The **Goddard High Resolution Spectrograph (GHRS)** was utilized to obtain high-resolution spectra of bright





targets in the ultraviolet for studying atmospheric composition and dispersion, the content of the interstellar medium, star formation and binaries, and quasars and other extragalactic objects.

The **Faint Object Spectrograph (FOS)** was designed to make spectroscopic observations of astrophysical sources from the near ultraviolet to the near infrared for studying galaxy formation, how supernovae could be used to test distance formulas, and the composition and origin of interstellar dust. FOS also had a polarimeter for the study of the polarized light from these sources.

The **High Speed Photometer (HSP)** was a relatively simple but precise light meter that measured the brightness of objects and any variations in that brightness over time. HSP provided astronomers an accurate map of stellar magnitudes.

### Axial Instrument Configuration Following SM1 (1993)

The **Corrective Optics Space Telescope Axial Replacement (COSTAR)** was installed, replacing the HSP. While not a scientific instrument, COSTAR deployed a set of optics into the region near the HST focal plane to intercept light that normally would be sensed by the axial instruments, replacing it with light corrected for the spherical aberration in the main mirror.

**FOC, GHRS** and **FOS** were all operational.

### Axial Instrument Configuration Following SM2 (1997)

The **Space Telescope Imaging Spectrograph (STIS)** was installed, replacing GHRS. STIS separates incoming light into its component wavelengths, revealing information about the atomic composition of the light source. It can detect a broader range of wavelengths than is possible from Earth because there is no atmosphere to absorb certain wavelengths. Scientists can determine the chemical composition, temperature, pressure and turbulence of the target producing the light—all from spectral data.

The **Near Infrared Camera and Multi-Object Spectrometer (NICMOS)** was

installed, replacing the FOS. It provided Hubble imaging capabilities in broad-, medium- and narrowband filters, broad-band imaging polarimetry, coronagraphic imaging and slitless grism spectroscopy in the wavelength range of 0.8 to 2.5 microns. NICMOS has three adjacent but not contiguous cameras, designed to operate independently, each with a dedicated array at a different magnification scale. In 1998 the cryogen in NICMOS was depleted and the instrument became dormant.

The **Faint Object Camera (FOC)** was decommissioned in 1997 to better allocate existing resources, but remained turned on and available to scientists until it was replaced by ACS during SM3B.

**COSTAR** was available to provide optical correction for the FOC if needed.

### Axial Instrument Configuration Following SM3A (1999)

**STIS** was operational. The **FOC** was decommissioned. **NICMOS** was dormant. **COSTAR** was available to provide optical correction for the FOC if needed.

### Axial Instrument Configuration Following SM3B (2002)

The **Advanced Camera for Surveys (ACS)** was installed, replacing the FOC. ACS increased the discovery efficiency of the HST by a factor of 10. This instrument consists of three electronic cameras and a complement of filters and dispersers that detect light from the ultraviolet to the near infrared (1200 to 10,000 angstroms). Following an anomaly on January 27, 2007, the Wide Field and High Resolution Channels stopped functioning, leaving only the Solar Blind Channel available for science observations.

During SM4 a cartridge containing four circuit boards will replace the original four circuit boards in the Wide Field Channel CEB. The new cartridge is wired in a way that bypasses the failed circuits in the two ACS main electronics boxes (MEB). The cartridge is powered by a new low-voltage power supply (LVPS) mounted externally on ACS and powered from a tee connector to be installed at the ACS input power connector. This will



enable the Wide Field and High Resolution Channels to be powered from the new LVPS, circumventing the failures in both ACS MEBs. The replacement is expected to restore functionality to both inoperative channels.

**NICMOS.** Dormant since 1998 due to cryogen depletion, this instrument was returned to service following the successful installation during SM3B of the NICMOS Cooling System (NCS).

**STIS** ceased science operations on August 3, 2004, due to the failure of a power supply within the Side-2 electronics. (The Side-2 electronics had powered the instrument since May 16, 2001, when a short circuit knocked out the Side-1 electronics.) Currently, STIS is in “safe mode”: the instrument and its onboard computer are switched off but the heaters are on to ensure a healthy, stable thermal environment. Repair of STIS will be attempted during SM4.

**COSTAR.** The COSTAR is no longer required because the FOC—the final instrument requiring optical correction—was removed during SM3B.

### Axial Instrument Configuration Following SM4 (2004)

**COS** and **NICMOS** will be operational. If SM4 repairs are successful, **ACS** and **STIS** will return to service.

Section 4 of this guide contains detailed descriptions of the post-SM4 science instruments.

### Support Systems Module

The SSM encloses the aft portion of the OTA and contains all of the structures, mechanisms, communications devices, electronics and electrical power subsystems needed to operate the telescope.

This module supports the Forward Shell and Light Shield and the Aperture Door that, when opened, admits light. The shield connects to the forward shell on which the SAs and high gain antennas (HGA) are mounted. Electrical energy from the SAs charges the spacecraft batteries to power all HST systems. Four

antennas—two high gain and two low gain—send and receive information between the telescope and the Space Telescope Operations Control Center (STOCC). All commanding occurs through the low gain antennas (LGA).

At the rear of the telescope, the Aft Shroud housing the science instruments is attached to the SSM.

### Solar Arrays

The SAs provide power to the spacecraft. They are mounted like wings on opposite sides of the telescope, on the forward shell of the SSM. The SAs are rotated so each wing’s solar cells face the sun. The cells absorb the sun’s light energy and convert it into electrical energy to power the telescope and charge the spacecraft’s batteries, which are part of the Electrical Power Subsystem (EPS). Batteries are used when the telescope moves into Earth’s shadow during each orbit.

### Computers

Hubble’s Data Management Subsystem (DMS) contains two computers: the Advanced Computer installed during SM3A and the Science Instrument Control and Data Handling (SI C&DH) unit. The Advanced Computer performs onboard computations and handles data and command transmissions between the telescope systems and the ground system. The SI C&DH unit stores and controls commands received by the science instruments, formats science data and sends data to the communications system for transmission to Earth.

## The Hubble Space Telescope Program

Hubble represents the fulfillment of a 50-year dream and 25 years of dedicated scientific effort and political vision to advance humankind’s knowledge of the universe. The HST program comprises an international community of engineers, scientists, contractors and institutions. It is managed by Goddard Space Flight Center for the Science Mission Directorate (SMD) at NASA Headquarters. Within Goddard, the program is in the Flight Projects

Directorate under the supervision of the associate director/program manager for HST. It is organized as two flight projects: (1) the HST Operations Project and (2) the HST Development Project.

Responsibilities for scientific oversight of HST are divided among the members of the Project Science Office (PSO). The PSO is designed to interact effectively and efficiently with the HST Program and the wide range of external organizations involved with Hubble. The HST senior scientist and supporting staff work in the Office of the Associate Director/Program Manager for HST. This group is concerned with the highest level of scientific management for the project.

Figure 1-4 summarizes the major organizations that oversee the program. The roles of NASA centers and contractors for on-orbit servicing of the HST are:

- Goddard Space Flight Center (GSFC)—Overall management of daily on-orbit operations of HST and the development, integration and test of replacement hardware, space support equipment, and crew aids and tools

- Johnson Space Center (JSC)—Overall servicing mission management, flight crew training, and crew aids and tools
- Kennedy Space Center (KSC)—Overall management of launch and post-landing operations for mission hardware
- Ball Aerospace—Design, development and provision of axial science instruments
- Jet Propulsion Laboratory (JPL)—Design, development and provision of WFPC1 and WFPC2
- Lockheed Martin—Personnel support for GSFC to accomplish (1) development, integration and test of replacement hardware and space support equipment; (2) system integration with the Space Transportation System (STS); (3) launch and post-landing operations and (4) daily HST operations
- Association of Universities for Research in Astronomy (AURA)—Responsible for the operation of the Space Telescope Science Institute (STScI), which oversees science operations for GSFC.



Organization	Function
NASA Headquarters Office of Space Science Directorate of Astronomy and Physics	<ul style="list-style-type: none"> <li>▪ Overall responsibility for the program</li> </ul>
Goddard Space Flight Center – Office of the Associate Director/ Program Manager for HST – HST Operations Project – HST Development Project	<ul style="list-style-type: none"> <li>▪ Overall HST program management</li> <li>▪ HST project management</li> <li>▪ Responsible for overseeing all HST operations</li> </ul>
Space Telescope Operations Control Center	<ul style="list-style-type: none"> <li>▪ Provides minute-to-minute spacecraft control</li> <li>▪ Schedules, plans and supports all science operations when required</li> <li>▪ Monitors telemetry communications data to the HST</li> </ul>
Space Telescope Science Institute	<ul style="list-style-type: none"> <li>▪ Selects observing programs from numerous proposals</li> <li>▪ Analyzes astronomical data</li> </ul>
Goddard Space Flight Center – HST Flight Systems and Servicing Project	<ul style="list-style-type: none"> <li>▪ Responsible for implementing HST Servicing Program</li> <li>▪ Manages development of new HST spacecraft hardware and science instruments</li> <li>▪ Manages HST Servicing Payload Integration and Test Program</li> <li>▪ Primary interface with the Space Shuttle Program at Johnson Space Center</li> </ul>

Fig. 1-4 Organization summary for HST program operational phase





Major subcontractors for SM4 include Analex, Alliant Techsystems (ATK), Computer Sciences Corporation, Eagle Pitchard Industries, FMW Composite Systems, Goodrich Corporation, Honeywell, Jackson and Tull, L-3 Communications, Mantech, Orbital Sciences Corporation, Stinger Ghaffarian Technologies, Inc. (SGT) and Swales.

The HST program requires a complex network of communications among GSFC, the telescope, space telescope ground system and STScI. Figure 1-5 shows communication links.

## The Value of Servicing

Hubble's visionary modular design has allowed NASA to equip it with new, state-of-the-art instruments every few years. These servicing missions have enhanced the telescope's science capabilities, leading to fascinating new discoveries about the universe. Periodic service calls have also permitted astronauts to tune up the telescope and replace limited-life components.

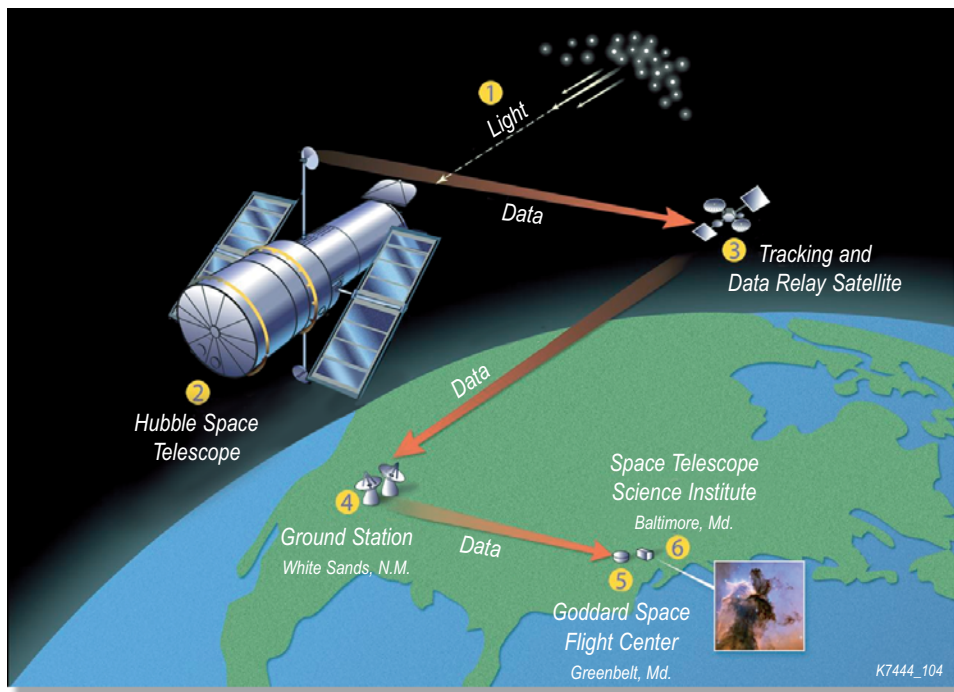

Fig. 1-5 HST data-collecting network

# Media Reference Guide HST Servicing Mission 4







## Hubble Space Telescope Servicing Mission 4



The Hubble Space Telescope (HST) is the first observatory designed for extensive maintenance and refurbishment in orbit. Its science instruments and many other components were planned as orbital replacement units (ORU)—modular in construction with standardized fittings and accessible to astronauts. Handrails, foot restraints and other built-in features help astronauts perform servicing tasks in the shuttle cargo bay as they orbit Earth at 17,500 mph.





NASA plans to launch HST Servicing Mission 4 (SM4), the fifth Hubble visit, in Fall 2008. Originally scheduled for 2004, SM4 was postponed after the Columbia Space Shuttle tragedy in 2003 because of NASA's safety concerns. But following the successful recovery of the Shuttle program and a thorough re-examination of SM4 risks, the agency approved the mission to Hubble.

During HST Servicing Mission 3B, flown in March 2002, accomplishments included replacement of both European Space Agency (ESA) flexible solar arrays with rigid solar arrays (SA3) and the associated diode box assemblies (DBA-2). A new science instrument, the Advanced Camera for Surveys (ACS), was installed. The power control unit (PCU) and reaction wheel assembly (RWA) were replaced. The Electronics Support Module (ESM) was installed. The Near Infrared Camera and Multi-Object Spectrometer (NICMOS) was retrofitted with a new cooling system, returning the dormant instrument to service. New Outer Blanket Layer (NOBL) insulation was placed over Bay 6.

SM4 is manifested as STS-125 aboard the Space Shuttle Atlantis (OV-104) and will be launched to a rendezvous altitude of approximately 304 nautical miles. During the planned 11-day mission, the Shuttle will rendezvous with, capture and berth the HST to the Flight Support System (FSS). Following servicing, the Shuttle will unberth Hubble and redeploy it to its mission orbit.

Five extravehicular (EVA) days are scheduled during the SM4 mission. Atlantis' cargo bay is equipped with several devices to help the astronauts:

- The FSS will berth and rotate the telescope.
- Large, specially designed equipment containers will house the ORUs.
- Astronauts will work and be maneuvered as needed from the Shuttle robot arm.

SM4 will benefit from lessons learned on NASA's previous on-orbit servicing missions: the Solar Maximum repair mission in 1984, HST First Servicing Mission (SM1) in 1993, HST Second Servicing Mission (SM2) in 1997, HST Third Servicing Mission (SM3A) in 1999

and HST Servicing Mission (SM3B) in 2002, which was actually the fourth visit to Hubble. NASA has incorporated these lessons in detailed planning and training sessions for Atlantis crewmembers: Commander Capt. USN, ret., Scott D. Altman, pilot Capt. Gregory C. Johnson and mission specialists USNRC K. Meagan McArthur, John M. Grunsfeld, Col. USAF Andrew J. Feustel, Michael J. Massimino and Michael Good.

## Reasons for Orbital Servicing

HST is a national asset and an invaluable international scientific resource that has revolutionized modern astronomy. To achieve its full potential, the telescope will continue to conduct extensive, integrated scientific observations, including follow-up work on its many discoveries.

Although the telescope has numerous redundant parts and safemode systems, such a complex spacecraft cannot be designed with sufficient backups to handle every contingency during a mission lasting more than 20 years. Orbital servicing is the key to keeping Hubble in operating condition. NASA's orbital servicing plans address three primary maintenance scenarios:

- Incorporating technological advances into the science instruments and ORUs
- Normal degradation of components
- Random equipment failure or malfunction.

**Technological Advances.** Throughout the telescope's life, scientists and engineers have upgraded its science instruments and spacecraft systems. For example, when Hubble was launched in 1990, it was equipped with the Goddard High Resolution Spectrograph and the Faint Object Spectrograph. A second-generation instrument, the Space Telescope Imaging Spectrograph (STIS), took over the function of those two instruments—adding considerable new capabilities—when it was installed during SM2. A slot was then available for the NICMOS, which expanded the telescope's vision into the infrared region of the spectrum. In addition, on both SM2 and SM3A a new state-of-the-art



solid-state recorder (SSR) replaced an Engineering/Science Tape Recorder (E/STR). During SM3A the original DF-224 computer was replaced with a faster, more powerful advanced computer based on the Intel 80486 microchip. Similarly, the ACS with most sensitive images at visible and near-infrared wavelengths was installed during the 2002 visit to Hubble.

**Component Degradation.** Servicing plans take into account the need for routine replacements, for example, restoring HST system redundancy and limited-life items such as spacecraft thermal insulation and gyroscopes.

**Equipment Failure.** Given the enormous scientific potential of the telescope—and the investment in designing, developing, building and putting it into orbit—NASA must be able to correct unforeseen problems that arise from random equipment failures or malfunctions. The Space Shuttle Program provides a proven system for transporting astronauts fully trained for on-orbit servicing of the telescope.

Originally, planners considered using the Shuttle to return the telescope to Earth approximately every five years for maintenance. However, the idea was rejected for both technical and economic reasons. Returning Hubble to Earth would entail a significantly higher risk of contaminating or damaging delicate components. Ground servicing would require an expensive clean room and support facilities, including a large engineering staff, and the telescope would be out of action for a year or more—a long time to suspend scientific observations.

Shuttle astronauts can accomplish most maintenance and refurbishment within an 11-day on-orbit mission with only a brief interruption to scientific operations and without the additional facilities and staff needed for ground servicing.

## Orbital Replacement Instruments and Orbital Replacement Units

Advantages of ORIs and ORUs include modularity, standardization and accessibility.

**Modularity.** Engineers studied various technical and human factors criteria to simplify telescope maintenance. Considering the limited time available for repairs and the astronauts' limited visibility, mobility and dexterity in the EVA environment, designers simplified the maintenance tasks by planning entire components for replacement.

ORUs are self-contained boxes installed and removed using fasteners and connectors. They range from small fuses to phone-booth-sized science instruments weighing more than 700 pounds (318 kg). Figure 2-1 shows the ORIs and ORUs for SM4.

**Standardization.** Standardized bolts and connectors also simplify on-orbit repairs. Captive bolts with 7/16-inch, double-height hex (hexagonal) heads hold many ORU components in place. To remove or install the bolts, astronauts need only a 7/16-inch socket fitted to a power tool or manual wrench. Some ORUs do not contain these fasteners. When the maintenance philosophy changed from Earth-return to on-orbit servicing, other components were selected as replaceable units after their design had matured. This added a greater variety of fasteners to the servicing requirements, including non-captive 5/16-inch hex head bolts and connectors without wing tabs. Despite these exceptions, the high level of standardization among units reduces the number of tools needed for the servicing mission and simplifies astronaut training.

**Accessibility.** To be serviced in space, Hubble components must be seen and reached by an astronaut in a bulky pressure suit, or they must be within range of an appropriate tool. Therefore, most ORUs are mounted in equipment bays around the perimeter of the spacecraft. To access these units, astronauts simply open a large door or doors that cover the appropriate bay.



**Cosmic Origins Spectrograph (COS)**  
Into Aft Shroud

**Wide Field Camera 3 (WFC3)**  
Into Aft Shroud Radial Bay

**Three Rate Sensor Units (RSU)**  
Into Aft Shroud

**Six batteries**  
Into Bays 2 and 3

**Advanced Camera for Surveys (ACS) repair**  
In Aft Shroud

**Space Telescope Imaging Spectrograph (STIS) repair**  
In Aft Shroud

**New Outer Blanket Layer (NOBL) insulation**  
Onto Bay 5

**New Outer Blanket Layer (NOBL) insulation**  
Onto Bay 8

K7444\_201

Fig. 2-1 Hubble Space Telescope Servicing Mission 4 Orbital Replacement Instruments (ORIs) and Orbital Replacement Units (ORUs)



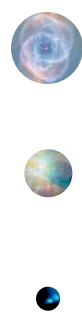

Handrails, foot restraint sockets, tether attachments and other crew aids are essential to safe, efficient on-orbit servicing. In anticipation of such missions, 31 foot-restraint sockets and 225 feet of handrails were designed into the telescope (see Fig. 2-2). Foot-restraint sockets and handrails greatly increase astronaut mobility and stability, affording them safe worksites conveniently located near ORUs.

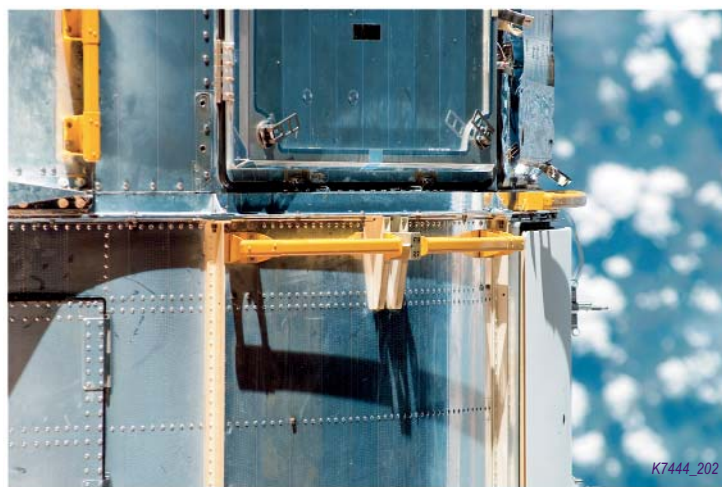

**Fig. 2-2** *The telescope has 225 feet of handrails to increase astronaut mobility and stability.*

Crew aids such as portable lights, special tools, installation guiderails, handholds and portable foot restraints (PFR) also ease servicing of Hubble components. Additionally, foot restraints, translation aids and handrails are built into various equipment and instrument carriers specific to each servicing mission.

## Shuttle Support Equipment

To assist astronauts in servicing the telescope, Atlantis will carry into orbit just over 11 tons of hardware consisting of the Space Support Equipment (SSE), new instruments, replacement hardware and crew aids and tools (CATS). The SSE comprises the FSS, Super Lightweight Interchangeable Carrier (SLIC), Orbital Replacement Unit Carrier (ORUC) and Multi-Use Light-weight Equipment (MULE) Carrier.

### Remote Manipulator System

The Atlantis RMS, more commonly known as the robotic arm, will be used extensively during SM4. The astronaut operating this device from inside the cabin is designated the intra-vehicular activity (IVA) crewmember. The RMS will be used to:

- Capture, berth and release the telescope
- Transport new components, instruments and EVA astronauts between worksites
- Provide a portable work platform for one of the EVA astronauts.

### Space Support Equipment

Ground crews will install four major assemblies essential for SM4 in the Atlantis payload bay—the FSS, SLIC, ORUC and MULE (see Fig. 2-3).

### Flight Support System

The FSS is a maintenance platform used to berth the HST in the payload bay after the Atlantis crew has rendezvoused with and captured the telescope (see Fig. 2-4). The platform was adapted from the FSS first used during the Solar Maximum repair mission and was converted to use with HST. It has a U-shaped cradle that spans the rear of the bay. A circular berthing ring with three latches secures the telescope to the cradle. The berthing ring can rotate the Hubble almost 360 degrees (176 degrees clockwise or counterclockwise from its null position) to give EVA astronauts access to every side of the telescope.

The FSS also has the capability to pivot the telescope, if required for servicing or reboosting. The FSS's umbilical cable provides power from Atlantis to maintain thermal control of the telescope during the servicing mission.

On SM4 the FSS also carries a Soft Capture Mechanism (SCM) on its berthing and positioning system platform. When attached to the HST aft bulkhead, the SCM will enable and assist in the safe de-orbit of the telescope at the end of its useful life by providing a docking interface that is intended to be compatible with future launch vehicles.

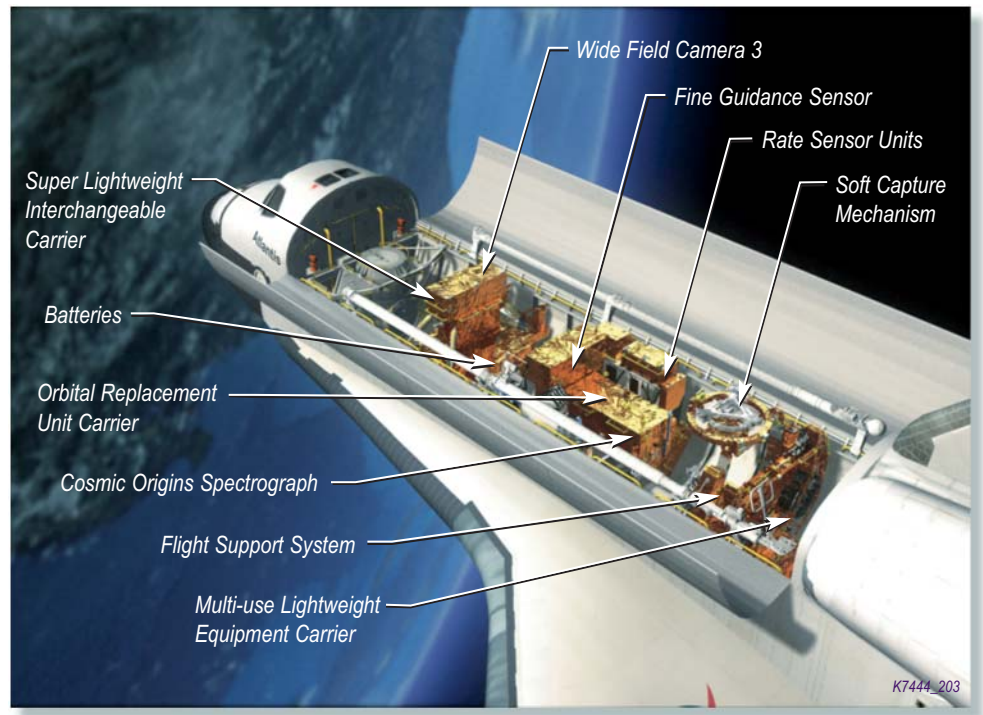

**Fig. 2-3** Servicing Mission 4 payload bay configuration

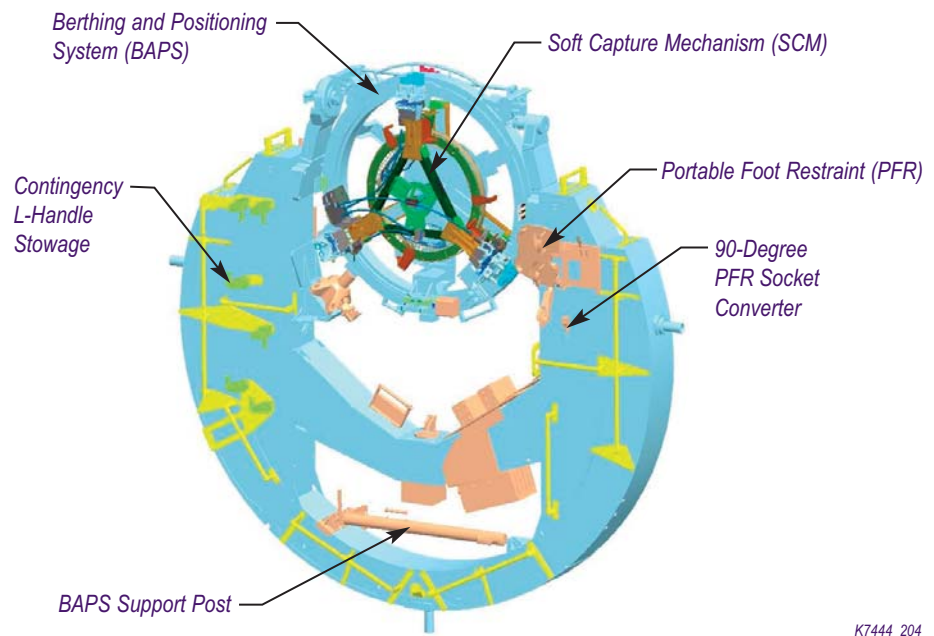
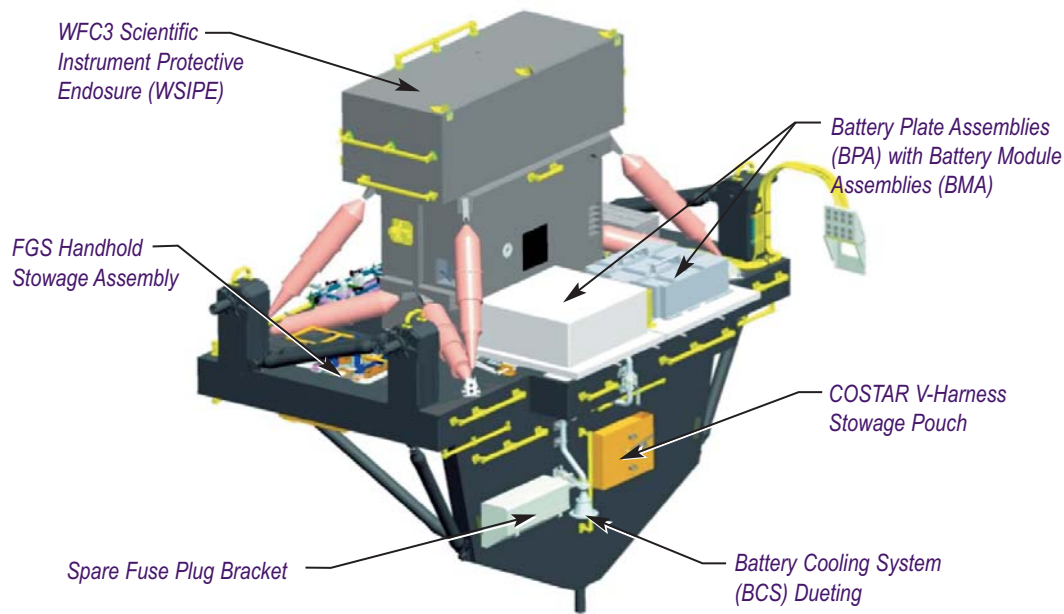

**Fig. 2-4** Flight Support System configuration

### Super Lightweight Interchangeable Carrier

The SLIC is located in Atlantis' forward payload bay (see Fig. 2-5). It has provisions for safe transport to orbit of the third-generation Wide Field Camera (WFC 3) and two nickel-hydrogen (NiH<sub>2</sub>)

battery modules. The SLIC also includes a spare wide-field handhold, one spare Fine Guidance Sensor (FGS) handhold, spare power distribution unit (PDU) fuse plugs, electrical power and Thermal Control Electronics (EP/TCE) fuse modules and a spare Corrective Optics Space



SLIC – Aft View

K7444\_205A

Fig. 2-5 Super Lightweight Interchangeable Carrier (SLIC) configuration

Telescope Axial Replacement (COSTAR) cross strap. Returning from orbit post-servicing, the SLIC will also carry home the Wide Field Planetary Camera (WFPC) 2 and the two original NiH<sub>2</sub> battery modules.

capture plate (FCP) enclosure to house miscellaneous crew aids and tools (CATS) for the STIS and ACS repair work, and eight aft shroud latch repair kits.

### Orbital Replacement Unit Carrier

The ORUC is centered in Atlantis' payload bay. It provides safe transport of instruments and ORUs to and from orbit (see Fig. 2-6). In the SM4 configuration:

- The Cosmic Origins Spectrograph (COS) is stored in the Axial Scientific Instrument Protective Enclosure (ASIPPE).
- The FGS is stored in the Radial Scientific Instrument Protective Enclosure (RSIPE).
- Three Rate Sensor Units (RSU) are stored on the starboard side Small ORU Protective Enclosure (SOPE).
- The ORUC houses other hardware, including the handholds for the FGS and the WFPC that are stored on the port side forward fixture, an aft fixture, a scientific instrument safety bar, a multi-layer insulation (MLI) repair tool, two STS PFRs and an extender, two translation aids (TA) and a STIS Main Electronics Box (MEB) replacement cover. It also carries two auxiliary transport modules (ATM), a Large ORU Protective Enclosure (LOPE), a New ORU Protective Enclosure (NOPE), a fastener

Some of the protective enclosures control the temperature of the new ORUs via heaters and thermal insulation, providing a controlled environment that keeps the hardware within normal operating temperatures. The ASIPE enclosure is isolated from the pallet to protect science instruments from loads generated at liftoff and during Earth return.

### Multi-Use Lightweight Equipment Carrier

The MULE is located in Atlantis' aft payload bay (see Fig. 2-7). It has provisions for safe transport of ORUs to orbit:

- The Contingency ORU Protective Enclosure (COPE) contains spare ORUs and tools.
- The MULE Integrated NOBL Container (MINC) contains the new NOBL protective coverings to be installed on the telescope's Support Systems Module Equipment Section (SSM-ES) bay doors.
- The MULE also carries the three Latch Over Center Kits (LOCKS) and low gain antenna protective covers (LGAPC).





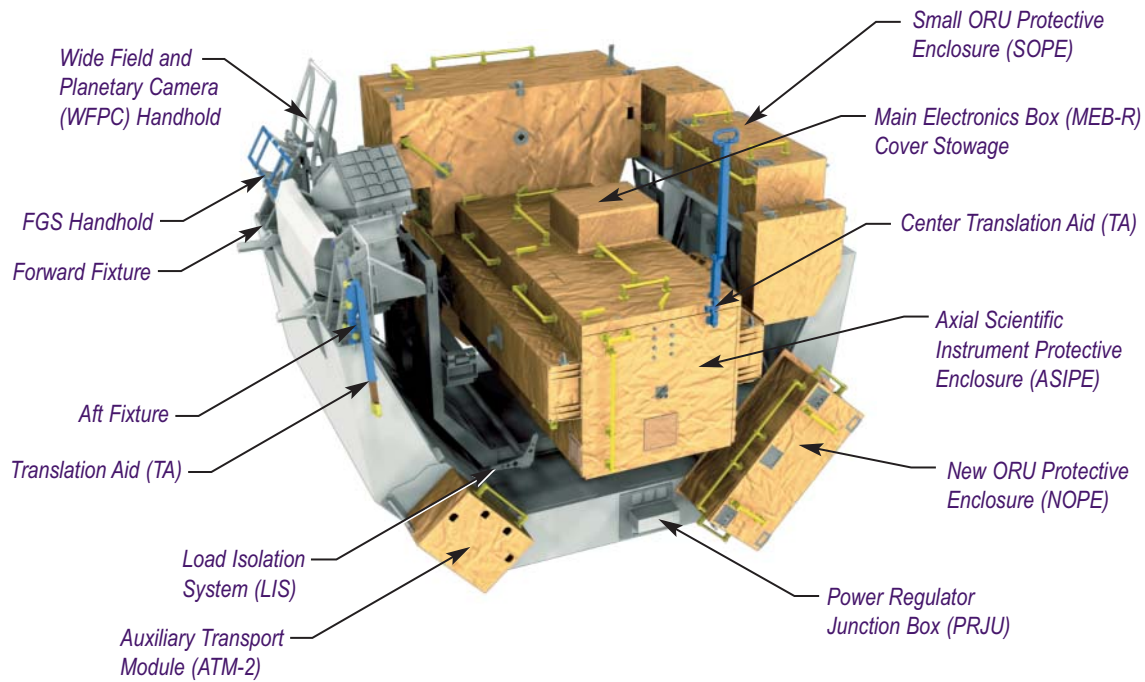

K7444\_206

**Fig. 2-6** Orbital Replacement Unit Carrier (ORUC) configuration

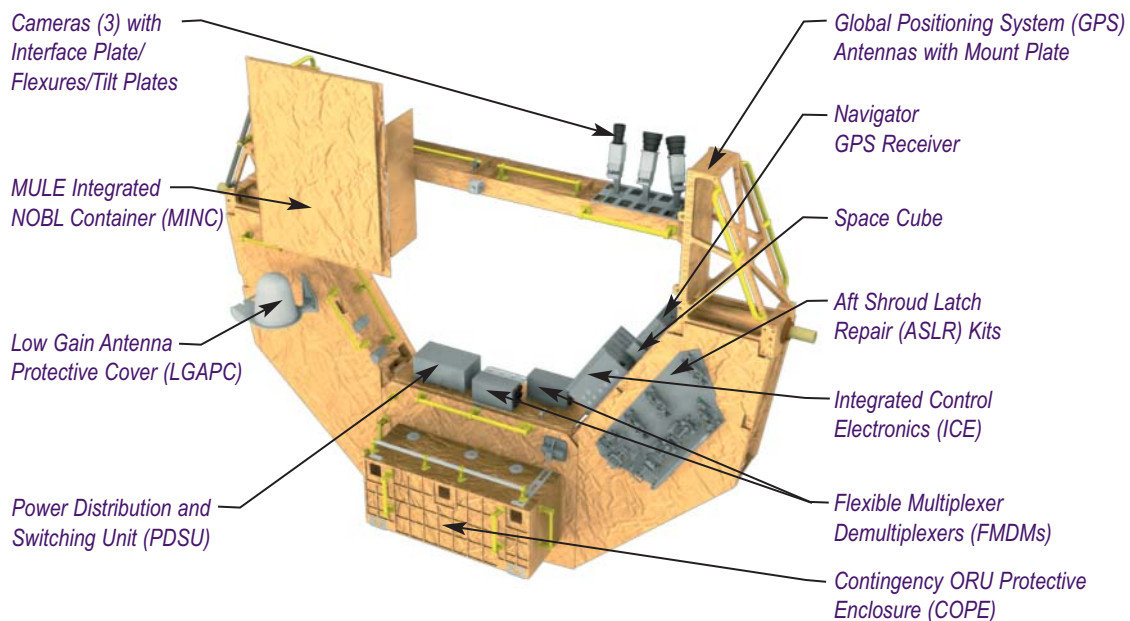

**MULE – Aft View**

K7444\_207

**Fig. 2-7** Multi-Use Lightweight Equipment (MULE) Carrier configuration

## Astronaut Roles and Training

To prepare for SM4, the seven-member Atlantis crew trained extensively at NASA's Johnson Space Center (JSC) in Houston, Texas, and Goddard Space Flight Center (GSFC) in Greenbelt, Md.

Although there has been extensive cross training, each crewmember also has trained for specific tasks. Training for Mission Commander Scott Altman and Pilot Gregory Johnson focused on rendezvous and proximity operations, such as retrieval and deployment of the telescope. The two astronauts rehearsed these operations using JSC's Shuttle Mission Simulator, a computer-supported training system. In addition, they received IVA training: helping the EVA astronauts into suits and monitoring their activities outside the Atlantis cabin.

The five mission specialists received specific training, starting with classroom instruction on the various ORUs, tools and crew aids, SSE such as the RMS (robotic arm) and the FSS. Principal operator of the robotic arm is Mission Specialist Megan McArthur, who also performs IVA activities. The alternate RMS operator is Commander Altman.

McArthur trained specifically for capture and redeployment of the telescope, rotating and pivoting the telescope on the FSS and handling related contingencies. These operations were simulated using JSC's Manipulator Development Facility, which includes a mockup of the robotic arm and a suspended helium balloon with dimensions and grapple fixtures similar to those on the telescope. Other RMS training took place at JSC's Neutral Buoyancy Laboratory (NBL), enabling the RMS operator and alternates to work with individual team members. For hands-on HST servicing, EVA crewmembers work in teams of two in the cargo bay. Astronauts John Grunsfeld, Andrew Feustel, Michael Good and Michael Massimino logged many days of training for this important role in the NBL, a 40-foot-deep (12 m), 6.2-million-gallon water tank (see Fig. 2-8).

In the NBL pressure-suited astronauts and their equipment are made neutrally buoyant, a condition that simulates weightlessness. Underwater mockups of the telescope, FSS, SLIC, ORUC, MULE, RMS and the Shuttle payload bay enabled the astronauts to practice the entire SM4 EVA servicing. This training helps them efficiently use the limited number of days (five) and duration (six hours) of each EVA period.

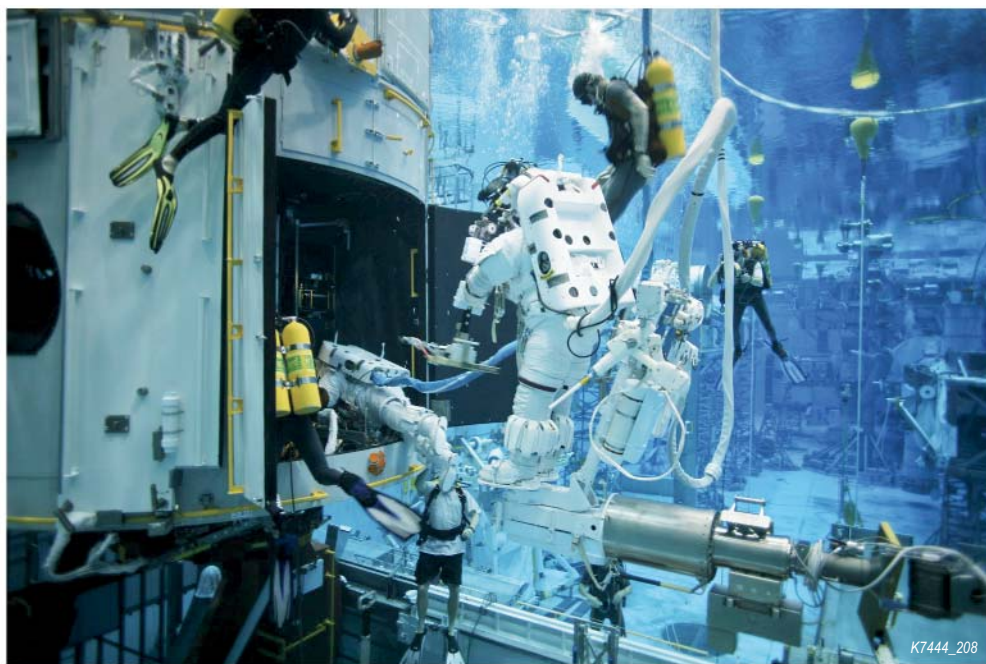

*Fig. 2-8 Neutral Buoyancy Laboratory at NASA Johnson Space Center*





Other training aids at JSC helped recreate orbital conditions for the Atlantis crew. In the weightlessness of space, the tiniest movement can set instruments weighing several hundred pounds, such as the COS, into motion. Astronauts used virtual reality technologies to practice handling large masses in space, such as nudging instruments into their proper locations. This kind of ultra-realistic simulation enabled the astronauts to “see” themselves next to the telescope as their partners maneuvered them into position with the robotic arm.

A WFC3 and an FGS 1-G simulator were built for the crews to practice guiderail alignment and mass handling techniques. A STIS simulator enabled crewmembers to practice removal of the 111 fasteners on the STIS covers with flight-like tools.

## Extravehicular Crew Aids and Tools

Astronauts servicing HST use three different kinds of foot restraints to counteract the weightless environment. When anchored in a manipulator foot restraint (MFR), an astronaut can be transported from one worksite to the next with the RMS. Using either the STS or HST PFR, an astronaut establishes a stable worksite by mounting the restraint to any of 30 receptacles placed strategically around the telescope or 17 receptacles on the SLIC, ORUC, FSS and MULE.

In addition to foot restraints, EVA astronauts have more than 150 CATS at their disposal. Some of these are standard items from the Shuttle’s toolbox while others are unique to SM4. All tools are designed for use in a weightless environment by astronauts wearing pressurized gloves.

The most commonly used ORU fasteners are those with 7/16-inch, double-height hex heads. These bolts are used with three different kinds of fittings: J-hooks, captive fasteners and keyhole fasteners. To replace a unit, astronauts use a 7/16-inch extension socket on a powered or manual ratchet wrench. Extensions up to two feet long are available to extend

their reach. Multi-setting torque limiters prevent over-tightening of fasteners or latch systems.

For units with bolts or screws that are not captive in the ORU frame, astronauts use tools fitted with socket capture fittings and specially designed capture tools so that nothing floats away in the weightless space environment. To grip fasteners in hard-to-reach areas, they can use wobble sockets.

Some ORU electrical connectors require special devices, such as a connector tool to loosen circular connectors. If connectors have no wing tabs, astronauts use a special tool to get a firm hold on the connector’s rotating ring.

Portable handles have been attached to many larger ORUs to facilitate removal or installation. Other tools and crew aids include tool caddies (carrying aids), tethers, transfer bags and a protective cover for the low gain antenna (LGA).

When working within the telescope’s aft shroud area, astronauts must guard against optics contamination by using special tools that will not outgas or shed particulate matter. All tools are certified to meet this requirement.

## Astronauts of Servicing Mission 4

NASA carefully selected and trained the SM4 STS-125 crew (see Fig. 2-9). Their unique set of experiences and capabilities makes them ideally qualified for this challenging assignment. Brief biographies of the astronauts follow.

### Scott D. Altman, NASA Astronaut (Commander, USN)

Scott Altman of Pekin, Ill., is commander of SM4. He received a Bachelor of Science degree in aeronautical and astronautical engineering from the University of Illinois in 1981 and a Master of Science degree in aeronautical engineering from the Naval Postgraduate School in 1990. Altman has logged over 4000 flight hours in more than 40 types of aircraft and over 664 hours in space.





Fig. 2-9 The seven STS-125 astronauts take a break from training to pose for the crew portrait. From the left are Mission Specialists Michael J. Massimino and Michael T. Good, Pilot Gregory C. Johnson, Commander Scott D. Altman, and Mission Specialists K. Megan McArthur, John M. Grunsfeld and Andrew J. Feustel.





He was the pilot on STS-90 in 1998, a 16-day Spacelab flight, and on STS-106 in 2000, a 12-day mission to prepare the International Space Station for the arrival of its first permanent crew. He was the commander of STS-109, the most recent Hubble Servicing Mission (SM3B) in 2002. Altman is also an experienced RMS operator. He was one of two operators of the robotic arm transporting the EVA crew during the STS-106 space walk. He served as the alternate RMS operator for SM3B and will serve again as the alternate RMS operator for SM4. STS-125 will be his second trip to Hubble.

### **Gregory C. Johnson, NASA Astronaut (Captain, USNRC)**

Gregory Johnson, the Atlantis pilot on SM4, is from Seattle, Wash. He received a Bachelor of Science degree in aerospace engineering from the University of Washington in 1977. He received his naval aviator wings in 1978, graduated from the U.S. Air Force Test Pilot School at Edwards AFB, Calif., in 1984 and did flight tests in A6E and F/A 18A aircraft. Johnson became a NASA research pilot at JSC in April 1990. He has served as the commanding officer of four Naval Reserve units and currently is assigned as senior research officer in the Office of Naval Research 113, based at the Naval Postgraduate School in Monterey, Calif. He has logged over 9000 hours in 50 aircraft and over 500 carrier landings. Johnson was selected as an astronaut candidate by NASA in 1998 and, having completed two years of training and evaluation, has qualified for flight assignment as a pilot on STS-125.

### **K. Megan McArthur, Ph.D., NASA Astronaut**

Megan McArthur, the RMS operator on SM4, is from Honolulu, Hawaii, but considers California to be her home state. McArthur received a Bachelor of Science degree in aerospace engineering from the University of California at Los Angeles in 1993 and a Doctorate in Oceanography from the University of California at San Diego in 2002. McArthur was selected as an astronaut candidate by NASA in 2000 and, having completed two years of training and evaluation, is qualified for flight assignment as a mission specialist on STS-125.

### **John M. Grunsfeld, Ph.D., NASA Astronaut**

John Grunsfeld is an astronomer and an EVA crewmember (EV1 on EVA days 1, 3 and 5) on the SM4 mission. He was born in Chicago, Ill. Grunsfeld received a Bachelor of Science degree in physics from the Massachusetts Institute of Technology in 1980 and a Master of Science degree and a Doctor of Philosophy degree in physics from the University of Chicago in 1984 and 1988, respectively. Grunsfeld reported to JSC in 1992 for a year of training and became qualified for flight selection as a mission specialist. He has logged over 835 hours in space. On his first mission, STS-67 in 1995, Grunsfeld and the crew conducted observations to study the far-ultraviolet spectra of faint astronomical objects and the polarization of ultraviolet light coming from hot stars and distant galaxies. Grunsfeld flew on STS-81 in 1991 on the fifth mission to dock with Russia's Mir Space Station and the second to exchange U.S. astronauts. STS-125 will be his third trip to service Hubble. He was aboard STS-103 in 1999, performing two space walks during SM3A, and aboard STS-109 in 2002, performing three space walks during SM3B.

### **Andrew J. Feustel, Ph.D., NASA Astronaut**

Andrew Feustel is an EVA crewmember (EV2 on EVA days 1, 3 and 5) on SM4. He was born in Lake Orion, Mich. Feustel received a Bachelor of Science degree in solid earth sciences and a Master of Science degree in geophysics, both from Purdue University, as well as a Doctorate in geological sciences specializing in seismology from Queen's University, Kingston, Ontario, Canada, in 1995. Feustel reported to JSC in 2000 and, having completed two years of training and evaluation, is qualified for flight assignment as a mission specialist on STS-125.

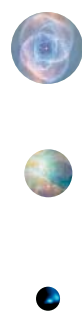

## Michael J. Massimino, Ph.D., NASA Astronaut

Mike Massimino is an EVA crewmember (EV1 on EVA days 2 and 4) on the SM4 mission. His hometown is Franklin Square, N.Y. He received a Bachelor of Science degree in industrial engineering with honors in 1984 from Columbia University. He also received Master of Science degrees in mechanical engineering and in technology and policy, and a mechanical engineering degree and a doctorate in mechanical engineering from the Massachusetts Institute of Technology in 1988, 1990 and 1992, respectively. Massimino flew as a mission specialist aboard STS-109 in 2002, performing two space walks to service Hubble during SM3B. STS-125 will be Massimino's second space flight, where he will perform two more space walks to service the telescope.

## Michael T. Good, NASA Astronaut (Colonel, USAF)

Michael Good is an EVA crewmember (EV2 on EVA days 2 and 4) on SM4. He was born in Parma, Ohio, but considers Broadview Heights, Ohio, to be his hometown. Good received a Bachelor of Science degree and a Master of Science degree in aerospace engineering from the University of Notre Dame in 1984 and 1986, respectively. He received his aviator wings in 1989, graduated from the U.S. Air Force Test Pilot School at Edwards AFB in 1994 and flew and tested the B-2

stealth bomber. His last duty was served as operations officer and F-15 test weapon systems officer. He has logged over 2100 hours in more than 30 different types of aircraft. Good was selected as an astronaut candidate by NASA in 2000 and, having completed two years of training and evaluation, is qualified for flight assignment as a mission specialist on STS-125.

## Servicing Mission Activities

After berthing the telescope on Flight Day 3 of SM4, the seven-person Atlantis crew will begin an ambitious servicing mission. Five days of EVA tasks are scheduled. Each EVA session is scheduled for six hours.

### Rendezvous with Hubble

Atlantis will rendezvous with Hubble in orbit 304 nautical miles (563 km) above Earth (see Fig. 2-10). Prior to approach, in concert with the Space Telescope Operations Control Center (STOCC) at GSFC, Mission Control at JSC will command HST to stow the high gain antennas (HGA) and close the aperture door. As Atlantis approaches the telescope, Commander Altman will control the thrusters to avoid contaminating HST with propulsion residue. During the approach the Shuttle crew will remain in close contact with Mission Control.

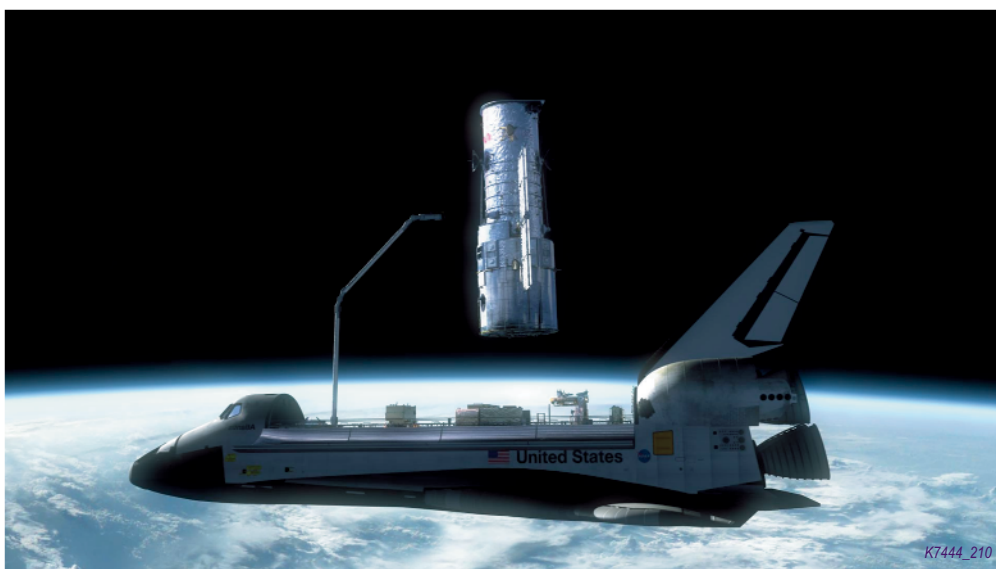

*Fig. 2-10 Atlantis rendezvous with Hubble*





As the distance between Atlantis and HST decreases to approximately 200 feet (60 m), the STOCC ground crew will command the telescope to perform a final roll maneuver to position itself for grappling. The Solar Arrays (SA) will remain fully deployed parallel to Hubble's optical axis.

When Atlantis and HST achieve the proper position, Mission Specialist McArthur will operate the robotic arm to grapple the telescope. Using a camera mounted at the berthing ring of the FSS platform in the cargo bay, she will maneuver the telescope to the FSS, where it will be berthed and latched.

Once the telescope is secured, the crew will remotely engage the electrical umbilical and switch Hubble from internal power to external power from Atlantis. Pilot Johnson will then maneuver the Shuttle so that the HST SAs face the sun, recharging the telescope's six onboard NiH<sub>2</sub> batteries.

### Extravehicular Servicing Activities Day by Day

Figure 2-11 shows the schedule for five planned 6.5 hour EVA servicing periods. Each servicing period shown is a planning estimate; the schedule will be modified as needed as the mission progresses.

During EVAs HST will be vertical relative to Atlantis' cargo bay. Four EVA mission specialists will work in two-person teams on alternate days. One team, Grunsfeld and Feustel, will conduct the first, third and fifth spacewalks and the other team, Good and Massimino, will conduct the second and fourth spacewalks.

One astronaut, designated EV1, accomplishes primarily the free-floating portions of the EVA tasks. He can operate from a PFR or while free floating. The other astronaut, EV2, works primarily from an MFR mounted on Atlantis' robotic arm (RMS), removing and installing the ORUs on Hubble. EV1 assists EV2 in removal of the ORUs and installation of the replaced units in the SM4 carriers. Inside Atlantis' aft flight deck, other crewmembers assist the EVA team by reading out procedures and operating the RMS.

### EVA Day 1: Replace Wide Field and Planetary Camera and Bay 3 nickel-hydrogen battery module.

During EVA Day 1 (the fourth day of the mission), the first team of EVA astronauts, John Grunsfeld and Andrew Feustel, will perform initial setup activities, the planned Day 1 HST servicing activities and some get-ahead tasks for the remaining EVAs.

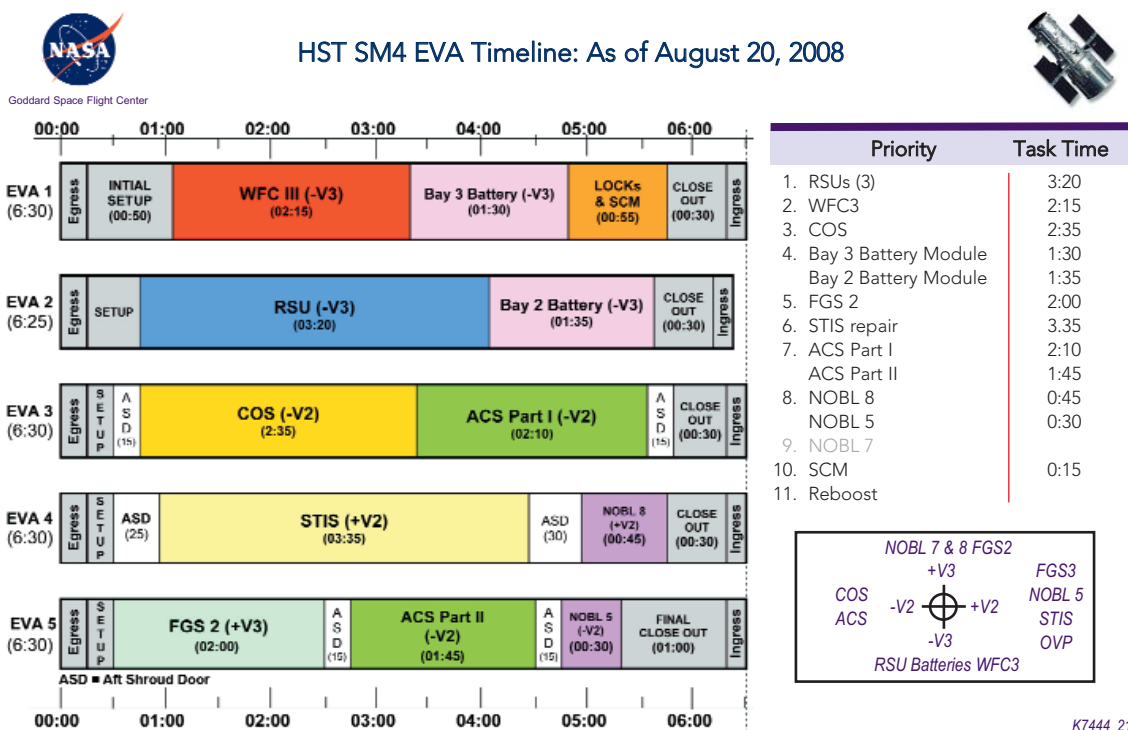
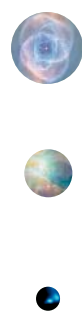

Fig. 2-11 Detailed schedule of extravehicular activities during SM4



They begin the EVAs by suiting up and passing through the Atlantis airlock into the cargo bay to perform the initial setup. To prevent themselves from accidentally floating off, they attach safety tethers to a cable running along the cargo bay sills.

Grunsfeld (EV1) does various tasks to prepare for the day's EVA servicing activities. These include removing the MFR from its stowage location and installing it on the RMS end effector and installing the Berthing and Positioning System (BAPS) Support Post (BSP) on the FSS. The BSP is required to dampen the vibration that servicing activities will induce into the deployed SAs. The crew then inspects the P105 and P106 umbilical covers for debris, deploys the center translation aid (TA), and installs the LGAPC. Meanwhile, Feustel (EV2) brings the CATs out of the airlock and attaches the MFR handle to the MFR on the RMS.

After the initial setup, the EVA crew proceeds with replacing WFPC2 with WFC3 and installing a new NiH<sub>2</sub> battery module into Bay 3. EV1, who is free floating, translates to ORUC and deploys the aft fixture used for temporarily stowing WFPC2 after it is removed from HST. EV2 retrieves the FGS handhold from the forward fixture and installs the handhold on WFPC2. He then disengages the WFPC2 blind mate connector, the WFPC2 ground strap bolt and the A-latch. Next EV2

removes WFPC2 from HST and stows it on the aft fixture.

The crew then opens the WSIPE and installs the WFPC2 handhold, which was retrieved from the forward fixture, to WFC3. Before removing WFC3 from the WSIPE, the crew disengages two vent valves, a ground strap and the A-latch. When these tasks are complete, EV2 maneuvers the WFC3 to the HST while on the RMS (see Fig. 2-12). EV1 assists with the installation of WFC3 into the HST aft shroud radial bay. EV2 engages the A-latch, ground strap and blind mate connector prior to removing the WFPC handhold for EV1 to stow. The crew gives a "go" to the ground to proceed with powering up the WFC3 while they proceed with stowing the WFPC2 into the WSIPE for return. EV2 installs WFPC2 into the WSIPE via RMS with assistance from EV1. When both tasks are complete, the crew closes the WSIPE and stows the instrument handholds and the forward and aft fixtures.

After installing the WFPC2 into the WSIPE, EV1 translates back to the SLIC to start the battery replacement task. EV2 opens the HST Bay 3 door and installs a manual door stay (see Fig. 2-13). Removing the replacement battery from SLIC involves disengaging 14 battery bolts to remove the replacement battery from the battery plate assembly (BPA).

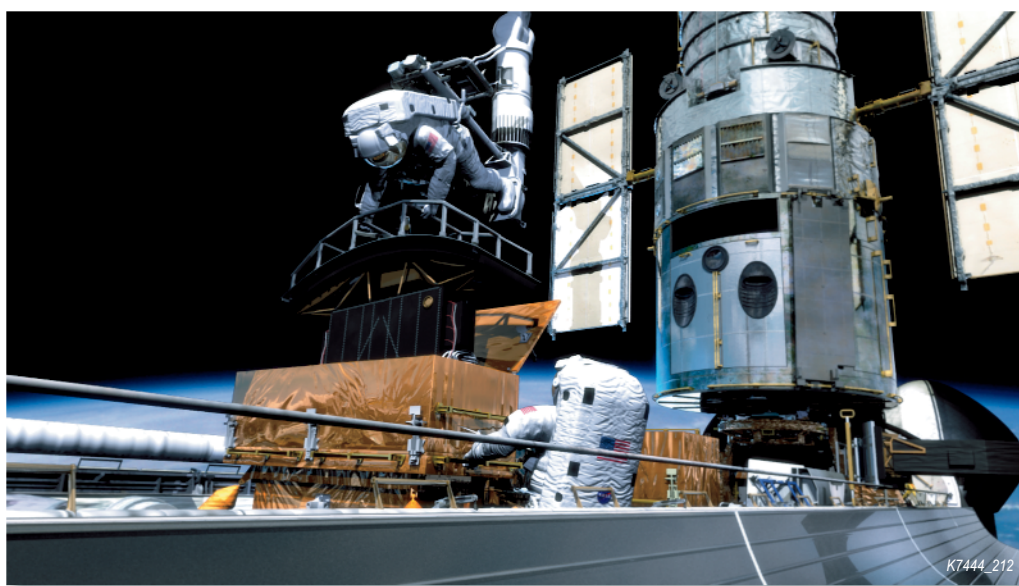

**Fig. 2-12** Astronaut Andrew Feustel, riding on the Shuttle's robotic arm, maneuvers the Wide Field Camera 3 out of its storage container for installation on Hubble.

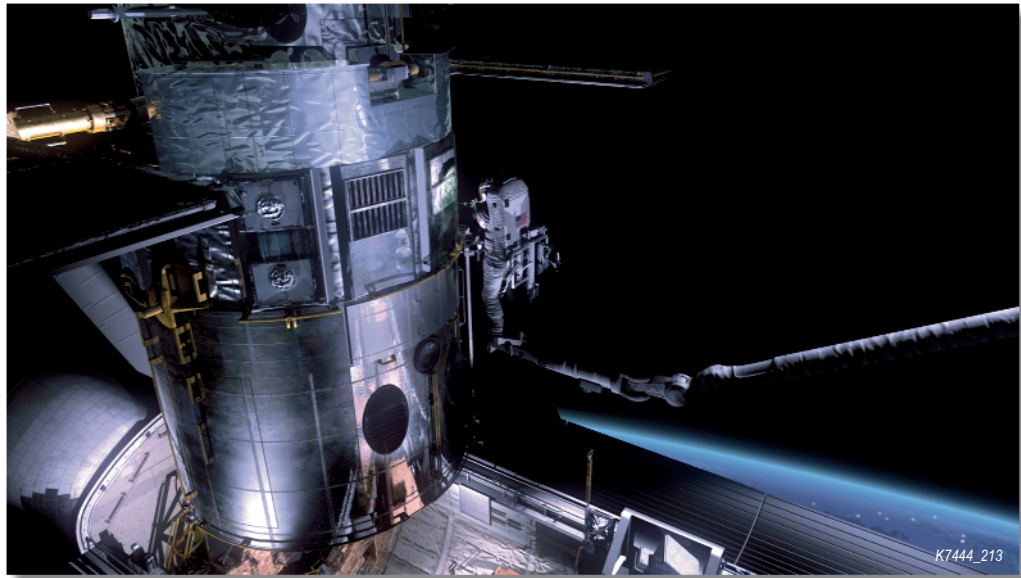

*Fig. 2-13 Andrew Feustel opens the Bay 3 door to install the first of two new battery modules.*

Before removing the HST Bay 3 battery, EV2 disconnects the battery harness connections one at a time and installs caps over the battery connectors for protection. After all connectors are secured, EV2 disengages the 14 ORU bolts and removes the battery. EV1 and EV2 perform these tasks in parallel, then swap the old batteries for the new. Both EV crewmembers reverse the procedures to secure the batteries on SLIC and HST. In a final step, EV2 rotates the battery isolator switch to the “on” position, thus activating the batteries, before closing the bay door.

If time permits, EV1 performs get-ahead tasks. These include installing LOCKs on the -V2 doors, lubing the +V2 and FGS-2 (+V3) door bolts, and activating the Soft Capture Mechanism (SCM).

Prior to ingressing the crew cabin, EV1 and EV2 complete daily payload bay closeouts to safe the Shuttle in the event they must release HST and terminate the mission early. EV1 inspects the FSS main umbilical mechanism, disengages the two center PIP pins on the BSP, configures the center TA and takes a tool inventory. Meanwhile EV2 prepares the CATs installed on the MFR handrail for return into the airlock and egresses the MFR. EV1 releases the MFR safety tether from the grapple fixture for contingency Earth return. After completing the EVA Day 1 tasks, both astronauts return to the airlock and perform the airlock ingress procedure.

### **EVA Day 2: Replace Rate Sensor Units (RSU), install Bay 2 nickel-hydrogen battery module and, if time permits, install Soft Capture Mechanism (SCM).**

During EVA Day 2, the second team of EVA astronauts, Mike Massimino (EV1) and Mike Good (EV2), will focus on replacing three RSUs (two gyros per RSU) and the Bay 2 NiH<sub>2</sub> battery module.

Fewer daily setup tasks are required for EVA Day 2 due to steps taken on EVA Day 1. After completing the airlock egress procedure, EV1 performs the following setup tasks for the EVA: configure the MFR and BAPS post and deploy the center TA. Meanwhile EV2 exits the airlock with some of the EVA Day 2 required CATs already installed on the MFR toolboard. The crew prepares the MFR and middeck CATs stowed prior to the EVA. Then they install the MFR with the toolboard on the RMS. The remaining CATs needed for the EVAs are stored in various containers known as ORU protective enclosures (OPEs) or auxiliary transport modules (ATMs) in the cargo bay.

To replace the RSUs, the crew needs to open the -V3 side of HST to access the three RSUs for changeout. The task to replace the Bay 2 battery is very similar to the Bay 3 battery changeout performed during EVA Day 1.



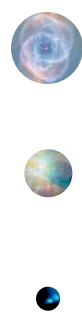

The EVA crew begins by gathering some more tools and the replacement RSU. The replacement RSUs are stowed in the SOPE. The new RSUs will be installed in the following order: RSU-2R, RSU-3R, RSU-1R. Together the astronauts retrieve the RSU-2R from the SOPE and the RSU Changeout Tool (RCT)—sometimes referred to as the Pic-Stik—from the SOPE lid. While EV2 configures his workstation for the task, EV1 assists in preparing RSU-2R by removing protective connector caps before EV2 stows it in a thermal protective bag for translation to the HST. The SOPE is temporarily closed by EV1 as he returns for the remaining two RSUs.

The astronauts now move to the -V3 aft shroud doors. From the RMS, EV2 retracts the Fixed Head Star Tracker (FHST) #2 and #3 door seal bolts before opening the doors. EV1 and EV2 then work as a team to disengage the door latch bolts and open the doors. Once secured, they reposition the Cross Aft Shroud Harness (CASH) to a lower angled handrail position in the aft shroud. This allows better access to the RSUs.

The RSU changeout now consists of setting up an STS PFR from which EV1 will secure himself so that he can assist in removal and installation of the RSU. EV1 handles the connector demating and removal/handoff of the RSU-2 being replaced. He also assists in the connector

remating after RSU-2R is installed. EV2 focuses on grappling the RSU-2 with the Pic-Stik and releasing the three bolts with the Pistol Grip Tool (PGT). Once released, EV1 is in position to reach and hold the RSU for handoff and stowage on the MFR until the new RSU is installed. Installation of the RSU-2R is a tricky process requiring precise alignment of the RSU onto the mounting plate with EV1 providing visual assistance (see Fig. 2-14). With Pic-Stik in one hand and PGT in the other, EV2 engages the bolts and then removes the Pic-Stik and stows it while EV1 mates the connectors.

Upon completion of the RSU-2 installation, the free floater EV1 reconfigures for the RSU-3 changeout task by stowing RSU-2 back in the SOPE and retrieving RSU-3R. The crew then repeats the process of translation, temporary stowage and installation only this time with RSU-3R. The task is the same and repeats for removal of RSU-1 and installation of RSU-1R.

When the RSU-1 tasks are complete, EV1 will have stowed all of the replaced RSUs (RSU 2, 3 and 1) in the SOPE where the replacement units were stored. He also retrieves and stows the STS PFR and RCT.

If time permits, EV1 will retrieve the Power Input Element (PIE) harness from the SOPE and partially install it as a get-ahead task for ACS on EVA Day 3. This is primarily because connector access is better from

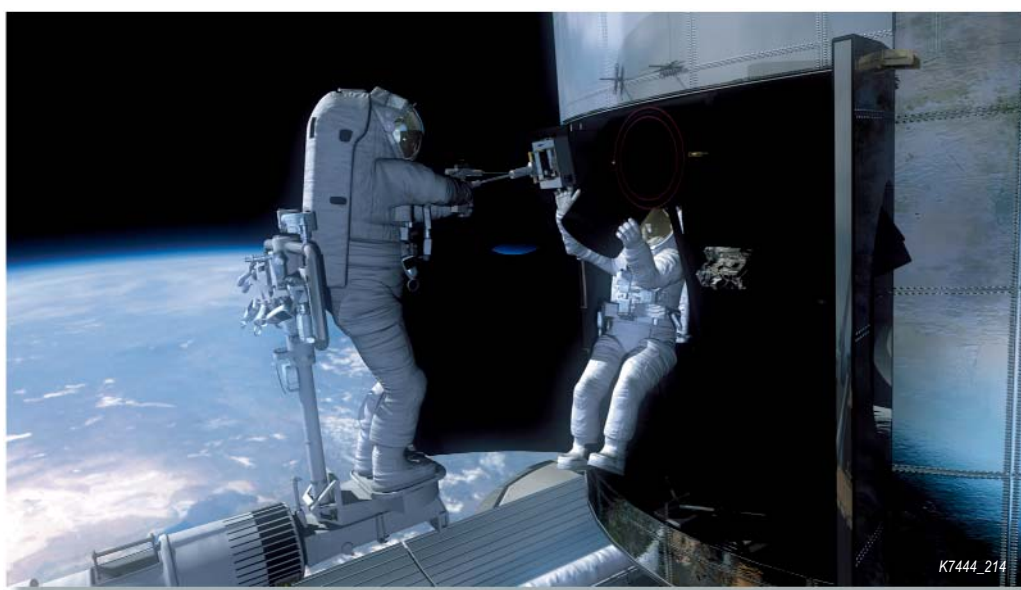

**Fig. 2-14** Astronaut Mike Good, on the Shuttle RMS, moves a replacement RSU into place in the -V3 aft shroud doors. Astronaut Mike Massimino provides visual assistance to ensure precise alignment of the RSU on its mounting plate.



the -V3 location. Both astronauts then reinstall CASH onto the aft shroud handrails, close the doors and engage the door latch bolts. The task is not complete until the FHST #2 and #3 door seals are re-extended. Before leaving the worksite, EV1 reconfigures the ASIPE PFR and port TA for COS installation on EVA Day 3.

The EVA crew now shifts their focus to replacing the Bay 2 NiH<sub>2</sub> battery module. This task is just like that planned on EVA Day 1 except that Bay 2 instead of Bay 3 will receive the new battery.

The remainder of EVA Day 2 is spent on any get-ahead tasks not performed on EVA Day 1, if time permits. Once again prior to ingressing back into the crew cabin, the EVs complete daily payload bay closeouts to safe the Shuttle in the event they must release HST and terminate the mission early. EV1 inspects the FSS main umbilical mechanism, disengages the two center PIP pins on the BSP, configures the center TA and takes a tool inventory. Meanwhile EV2 prepares the CATs installed on the MFR handrail for return into the airlock and egresses the MFR. EV1 releases the MFR safety tether from the grapple fixture for contingency Earth return. After completing the EVA Day 2 tasks, both astronauts return to the airlock and perform the airlock ingress procedure.

### **EVA Day 3: Replace the Corrective Optics Space Telescope Axial Replacement (COSTAR) with the Cosmic Origins Spectrograph (COS) and perform Advanced Camera for Surveys (ACS) Repair Part 1 tasks.**

EVA Day 3 will be a challenging and exciting day for astronauts John Grunsfeld (EV1) and Andrew Feustel (EV2). The crewmembers begin their first rotation, so this will be the second spacewalk for John and Andrew. They will remove the COSTAR, install the COS in its place and then perform the ACS repair. The planned repair will replace the computer and power supply in an attempt to revive the failed ACS. After the airlock egress procedure, EV1 and EV2 will perform the typical tool retrieval and setup of the MFR.

When the astronauts have completed the daily setup tasks, EV1 deploys the aft fixture and EV2 opens the -V2 aft shroud doors to access the COSTAR. EV1 and EV2 work together to remove the COSTAR from the telescope. EV1 releases the COSTAR Y-harness from the handrail and repositions it in the restraint tool installed on the center guiderail strut. EV1 then demates the four COSTAR connectors and disconnects the ground strap before they disengage the COSTAR A- and B-latches. While on the RMS, EV2 removes COSTAR from the telescope and temporarily stows it on the aft fixture.

Now the crew can retrieve the COS from the ASIPE. While working from the aft ASIPE PFR, EV1 opens the ASIPE lid, disconnects the COS ground strap and deploys the B-latch alignment aid prior to disengaging the A- and B-latches. EV2 removes the COS while on the RMS. Once it is removed, EV1 closes the ASIPE lid and engages one lid latch to maintain thermal stability inside the ASIPE. The astronauts will return to install COSTAR for Earth return after completing the COS installation. They continue to work together to install the COS along guiderails into the telescope aft shroud (see Fig. 2-15). The installation is aided by deployment of the B-latch alignment aid arm. Next the astronauts engage the A- and B-latches, stow the alignment aid, reinstall the HST ground strap and mate the four COS connectors. Together they close the -V2 aft shroud doors.

As they prepare to install COSTAR into the ASIPE, the ground has already been given the "go" to start testing the COS instrument. Installation of the COSTAR into the ASIPE is the reverse of the COS removal. After it is installed, EV2 closes the ASIPE lid and engages the five lid latches.

Meanwhile EV1 has begun setting up for the ACS repair task, which is also in the -V2 bay of the aft shroud. The ACS repair is a very delicate operation compared to the COS task. Due to limited EVA time on Day 3, the full ACS repair is not planned within one day. The second part will take place on EVA Day 5 unless a "go" is given during the Day 3 EVA to continue the task.

As a free-floating crewmember, EV1 maneuvers to the LOPE and NOPE to

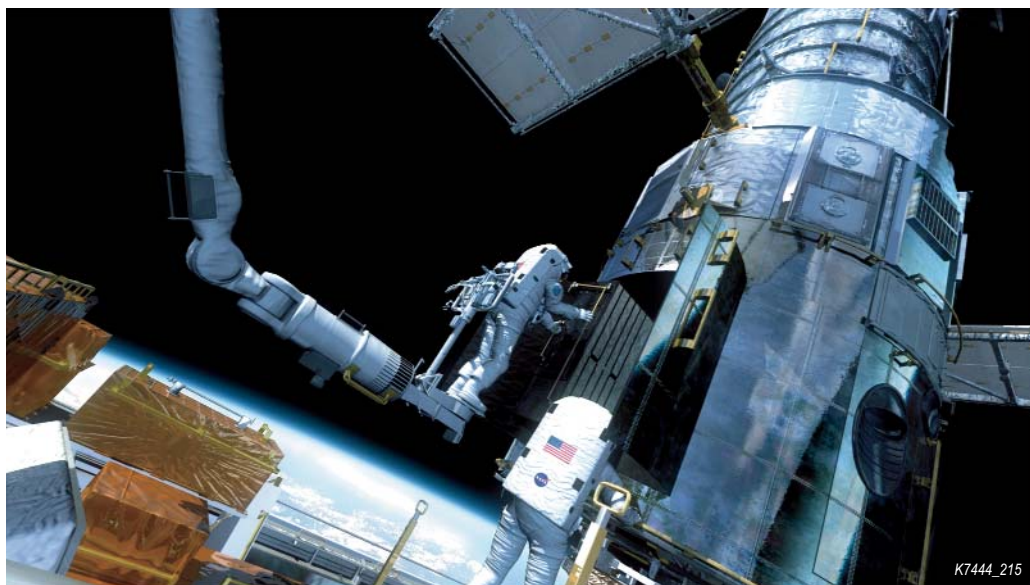
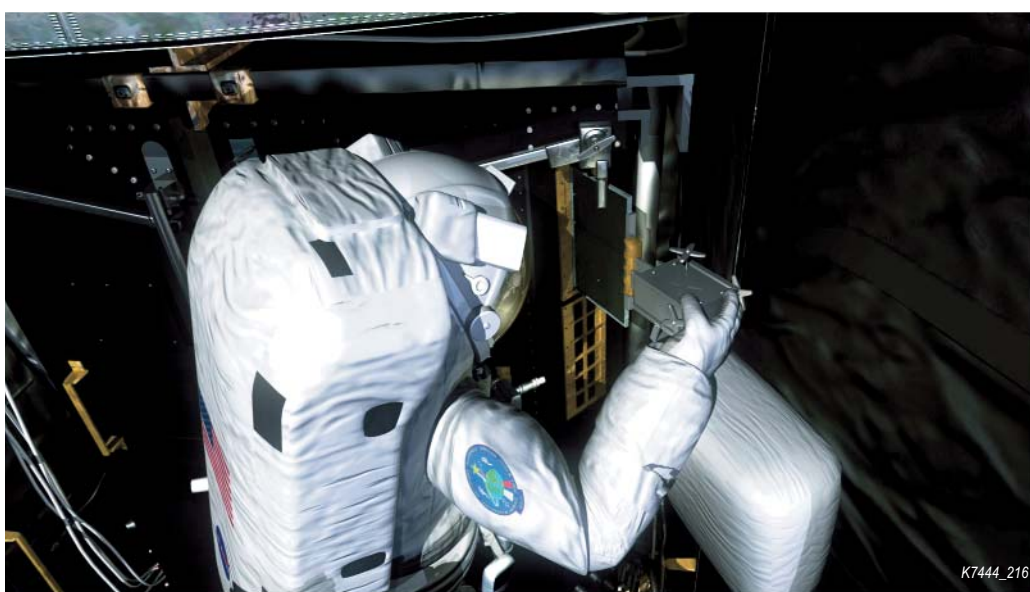

**Fig. 2-15** The refrigerator-sized Cosmic Origins Spectrograph is guided into place. Andrew Feustel holds the instrument as John Grunsfeld assesses alignment.

retrieve tools. EV1 ingresses the STS PFR within the aft shroud to perform most of the ACS repair. The ACS task involves many steps and tools. Using the S-band Single Access Transmitter (SSAT) tool, EV2 disengages four non-captive fasteners from the ACS WFC CEB assembly top cover and seats them in a fastener retention block (FRB). Next EV1 installs the electro-magnetic interference (EMI) grid cutter, cuts the grid from ACS WFC CEB assembly and restows the cutter/grid assembly into its transport enclosure. The grid removal leaves the CEB chassis cover exposed for access to the 32 small

fasteners that must be removed to replace the failed computer cards. The fastener capture plate (FCP) is installed for removal of all the captive fasteners. After all fasteners are released, the cover, screws and the FCP assembly are removed.

After EV1 removes the CEB cover, EV1 removes circuit cards #1 and #2 from the CEB chassis and installs the cards in the card stowage enclosure (see Fig. 2-16). A temporary cover is then placed over the CEB open computer chassis as a protection until EVA Day 5. If time permits and the crew is given a "go" to continue, the



**Fig. 2-16** John Grunsfeld carefully removes the first of two failed circuit cards from the Advanced Camera for Surveys. New cards will be installed and a power supply module attached to return the instrument to operation.





temporary cover will not be installed and EV1 will proceed with removal of the remaining two cards and installation of the new flight computer currently planned for EVA Day 5. EV2's primary duty throughout the task is to assist with the tool retrieval and stowage while EV1 performs the repair.

When either one or both parts of the ACS task are complete, depending on time available, the crew proceeds with nominal daily closeouts. EV1 inspects the FSS main umbilical mechanism, disengages the two center PIP pins on the BSP, reconfigures the center TA and takes a tool inventory. Meanwhile EV2 prepares the CATs installed on the MFR handrail for return into the airlock and egresses the MFR. EV1 releases the MFR safety tether from the grapple fixture for contingency Earth return. After the completion of the EVA Day 3 tasks, both astronauts return to the airlock and perform the airlock ingress procedure.

#### **EVA Day 4: Perform Space Telescope Imaging Spectrograph (STIS) repair and install New Outer Blanket Layer (NOBL).**

On EVA Day 4, astronauts Mike Massimino (EV1) and Mike Good (EV2) are scheduled for their second and final EVA. The day will focus on the restoring the failed STIS instrument and installing two NOBLs. The STIS repair will focus on the low-voltage power supply circuit card. This will be similar to the ACS repair task in that the instrument must be opened to access the internal computer boards. A major difference is that STIS requires 111 small fasteners to be removed compared to 32 for ACS.

The egress procedure and tool setup for the Day 4 EVA is similar to that of previous EVAs. After completing the daily setup tasks, the crew is ready to begin the STIS repair. EV1 translates to the ORUC to configure the ASIPE TA and then opens the ATM to retrieve STIS repair tools. EV1 performs the tools setup while EV2 opens the +V2 aft shroud doors. EV1 ingresses the PFR, which was placed within the HST aft shroud, while EV2 is on the RMS supporting the STIS repair task.

EV1 and EV2 now work in unison performing the delicate surgery on the STIS instrument. EV1 begins by installing the Clamp Removal Tool (CRT) onto the MEB clamp. After removing the clamp by disengaging a few fasteners, EV1 transfers the MEB clamp with the tools to EV2 for stowage into the trash bag.

Now the major challenge is to install the FCP on the MEB cover and remove 107 fasteners. The STIS FCP is much larger than the ACS FCP. While EV1 is working on the fasteners, EV2 egresses the MFR and translates to stow and retrieve tools from the ATM. After all fasteners have been removed, the FCP, screws and cover assembly can be removed. The crew must complete a final step by cutting a few thermistor wires to free the FCP/MEB cover assembly from the STIS enclosure. EV2 ingresses the MFR on the RMS and receives the FCP/MEB cover from EV1 and stows it temporarily.

With the MEB cover on the STIS enclosure removed, the astronauts begin the process of replacing the low-voltage power supply-2 (LVPS-2) card. EV1 receives tools from EV2, removes the LVPS-2 from the MEB and stows it in the card soft transport enclosure. EV1 hands off the failed power supply and receives the new LVPS-2R for installation into the MEB. Installation of this circuit card is a very delicate operation and extreme care must be taken with the exposed card. When installation is complete, he verifies that the card is properly installed, egresses the PFR and translates to the ASIPE lid to retrieve MEB-R. The MEB-R cover is much simpler to install with two EVA friendly latches in comparison to the 107 small fasteners. EV2 maneuvers to the ORUC to retrieve the MEB-R cover and hands it off to EV1 to install on the STIS enclosure. After the MEB cover is installed, the instrument is ready for the ground to verify a successful repair. The astronauts then clean up the worksite by stowing the STIS repair tools in the ATM and SOPE, removing the STS PFR from the aft shroud and closing the +V2 aft shroud doors.

After completing the STIS repair task, the EVA crew will install the Bay 8 NOBL, which is stowed within the MINC on the



MULE carrier. First, the old MLI must be removed from HST. EV1 retrieves the NOBL while EV2, who is on the RMS, removes the old MLI. EV2 then removes the upper and lower MLI patch kits and stows them in the MLI recovery bag. EV1 translates back to the MINC at the MULE, retrieves the Bay 8 NOBL, NOBL roller tool (NRT) and wire cutter. He hands the NOBL to EV2 and closes the MINC lid. Both astronauts translate to Bay 8 and install the Bay 8 NOBL onto the bay door (see Fig. 2-17). The new NOBL has a radiator that is rolled into place with the NRT.

After completing the EVA Day 4 tasks, the crew performs nominal daily cleanup and both astronauts return to the airlock for ingress.

### **EVA Day 5: Install the Fine Guidance Sensor-2 (FGS-2), perform Advanced Camera for Surveys Repair Part 2 and install NOBL Bay 5.**

During EVA Day 5, which is the final planned spacewalk on SM4, astronauts John Grunsfeld (EV1) and Andrew Feustel (EV2) will install the FGS, complete the remaining ACS repair tasks and install a final NOBL.

The crew airlock egress procedure for Day 5 is similar to the other EVA days.

Then the crew proceeds with tool retrieval and setup for the day's tasks. EV2 will install the FGS while on the RMS, which is the nominal mode for instrument installations. EV2 begins the task by being maneuvered to the forward fixture to retrieve the FGS handhold.

The FGS replacement is similar to the WFC3 task in the replacement of a radial instrument. Both astronauts open the +V3 FGS-2 doors and then de-mate eight FGS connectors and the ground strap. EV2 installs the FGS handhold on FGS-2, disengages the FGS A-latch, removes the FGS-2 from the telescope and stows it on the aft fixture.

Both crewmembers work to retrieve FGS-2R from the FSIPE. EV1 opens the FSIPE lid and disconnects the FGS-2R ground strap while EV2 disengages the A-latch. EV2 removes the FGS-2R from the FSIPE while EV1 assists and closes the FSIPE lid, engaging one lid latch to maintain thermal stability inside the FSIPE. The astronauts then maneuver and install FGS-2R into the telescope aft shroud (see Fig. 2-18). They insert FGS-2R along the guiderails until it is seated. EV2 then engages the A-latch while EV1 mates the ground strap. Both crewmembers reinstall the eight FGS connectors and close the doors. As a contingency, if the FGS door latches exhibit excessive running torque, EV2 will install the Aft Shroud

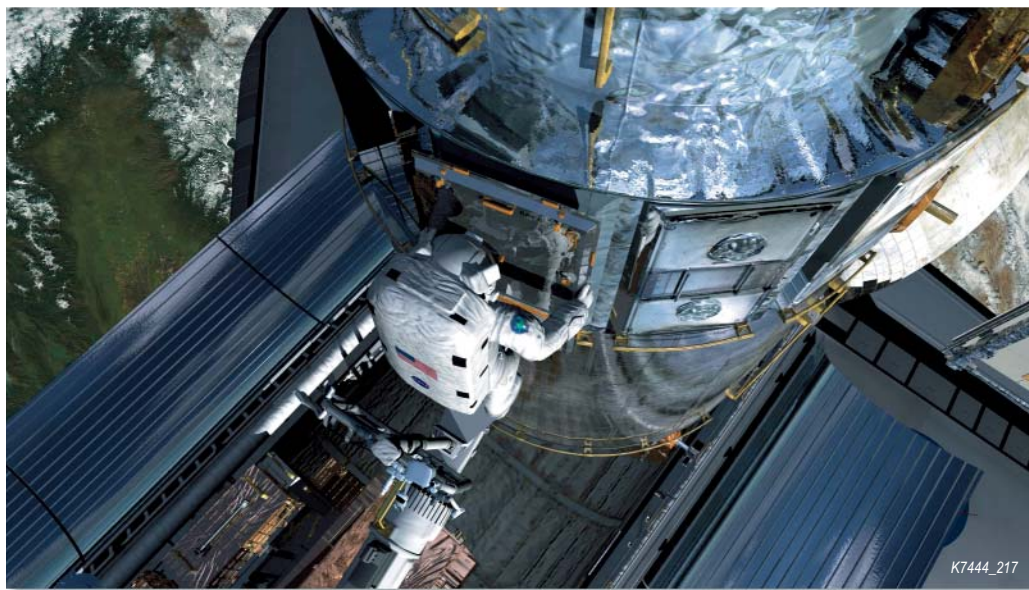

**Fig. 2-17** After removing the old degraded multi-layer insulation from Bay 8 of the Equipment Section on HST, Mike Good installs a New Outer Blanket Layer panel.

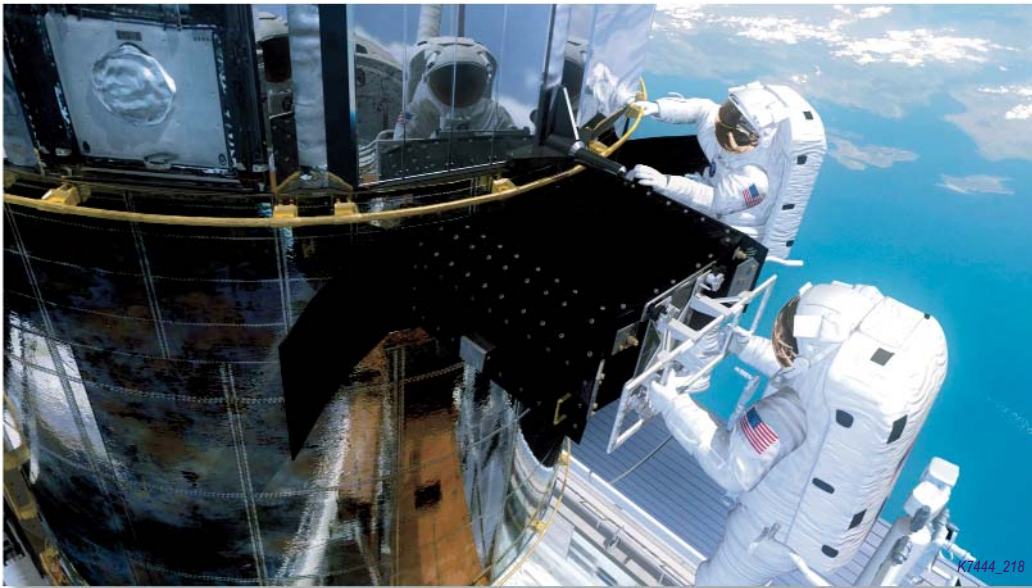

*Fig. 2-18 Andrew Feustel moves a refurbished Fine Guidance Sensor into position on Hubble with assistance from John Grunsfeld, to his right.*

Latch Repair (ASLR) kits on one or both latches, functionally replacing the degraded latches, and then engage the ASLR kit(s).

Installation of FGS-2 into the FSIPE is the reverse of the removal process for FGS-2R. EV2 retrieves FGS-2 from the aft fixture while EV1 re-opens the FSIPE lid. EV2 inserts FGS-2 into the FSIPE guiderails and engages the A-latch. EV1 installs the ground strap, closes the ASIPE lid and engages the three lid latches to complete the FGS-2 installation.

If the ACS task was not completed on EVA Day 3, the second part of the task will be performed on EVA Day 5. Part II involves removal of the remaining two computer cards and installation of the CEB and LVPS-R. The new computer and power supply will interface directly with the ACS detector and restore its capability.

EV1 begins by retrieving the ACS repair tools from the LOPE. Both astronauts open the aft shroud doors to get back to the ACS worksite. This task is easier than earlier in the mission due to the installation of the LOCKs. Once positioned at the ACS worksite PFR, EV1 removes the last two CEB computer cards while EV2 maneuvers to the LOPE to retrieve LVPS-R and CEB-R.

EV1 receives the new hardware and installs it into the CEB chassis and then

installs LVPS-R onto the ACS handle. All that remains to activate ACS is connection of the LVPS-R power output element (POE) harness to CEB-R and connection of the LVPS-R PIE cable connectors. The PIE was pre-staged in the HST aft shroud on EVA Day 2. This completes the ACS repair task as the "go" is given to begin the aliveness test to verify if the repair was successful. Together the astronauts close the aft shroud doors. Again, if the latches exhibit excessive running torque, EV2 will install the ASLR kits on one or both latches, functionally replacing the degraded latches, and then engage the ASLR kit(s).

The final planned EVA repair is replacement of the Bay 5 NOBL, which is stowed within the MINC on the MULE carrier. As with NOBL 8 installation, the MLI must be removed from HST. EV1 will retrieve the NOBL while EV2, who is on the RMS, removes the old MLI and stows it into a trash bag. EV1 translates back to the MINC at the MULE and retrieves the Bay 5 NOBL. He hands the NOBL to EV2 while closing the MINC lid. Both astronauts translate to Bay 5 and install the Bay 8 NOBL onto the bay door. If there is sufficient EVA time remaining, NOBL 7 may also be retrieved and installed.

The final closeout procedure is all that remains to complete the final EVA. EV1 inspects the FSS main umbilical mechanism and the P105/P106 covers, removes the



LGA protective cover from the telescope and reinstalls it on the MULE, disengages the two center PIP pins on the BSP, configures the center TA and takes a tool inventory. Meanwhile EV2 prepares the CATs installed on the MFR handrail for return into the airlock, egresses the MFR and performs the MFR stow procedure. After completing the EVA Day 5 tasks, both astronauts return to the airlock and perform the airlock ingress procedure.

## Redeploying the Telescope

The day following EVA Day 5 will be devoted to any contingency EVA tasks required for redeployment of HST into Earth orbit (see Fig. 2-19). Unlike previous missions, there is no "Contingency EVA Day" to complete

nominal EVA tasks that were not finished, thus making completion of activities on each EVA day more critical.

The SAs are slewed to the sun to generate electrical power for the telescope and to charge the batteries and the HGAs are commanded to their deployed position. When battery charging is complete, the RMS operator guides the robotic arm to engage HST's grapple fixture. The ground crew commands Hubble to switch to internal power. This accomplished, crewmembers command Atlantis' electrical umbilical to demate from Hubble and open the berthing latches on the FSS. If there are any failures with the release from the FSS or any telescope appendages fail to deploy properly, two mission specialists can perform EVA tasks, manually overriding any faulty mechanisms.



**Fig. 2-19** Viewed through an overhead window on the aft flight deck of Space Shuttle Columbia, Hubble (partially obscured) begins its separation from the orbiter as it is released from the robotic arm. The STS-109 crew redeployed the giant telescope on March 9, 2002, at the close of Servicing Mission 3B.

Media Reference Guide  
HST Science and Discoveries



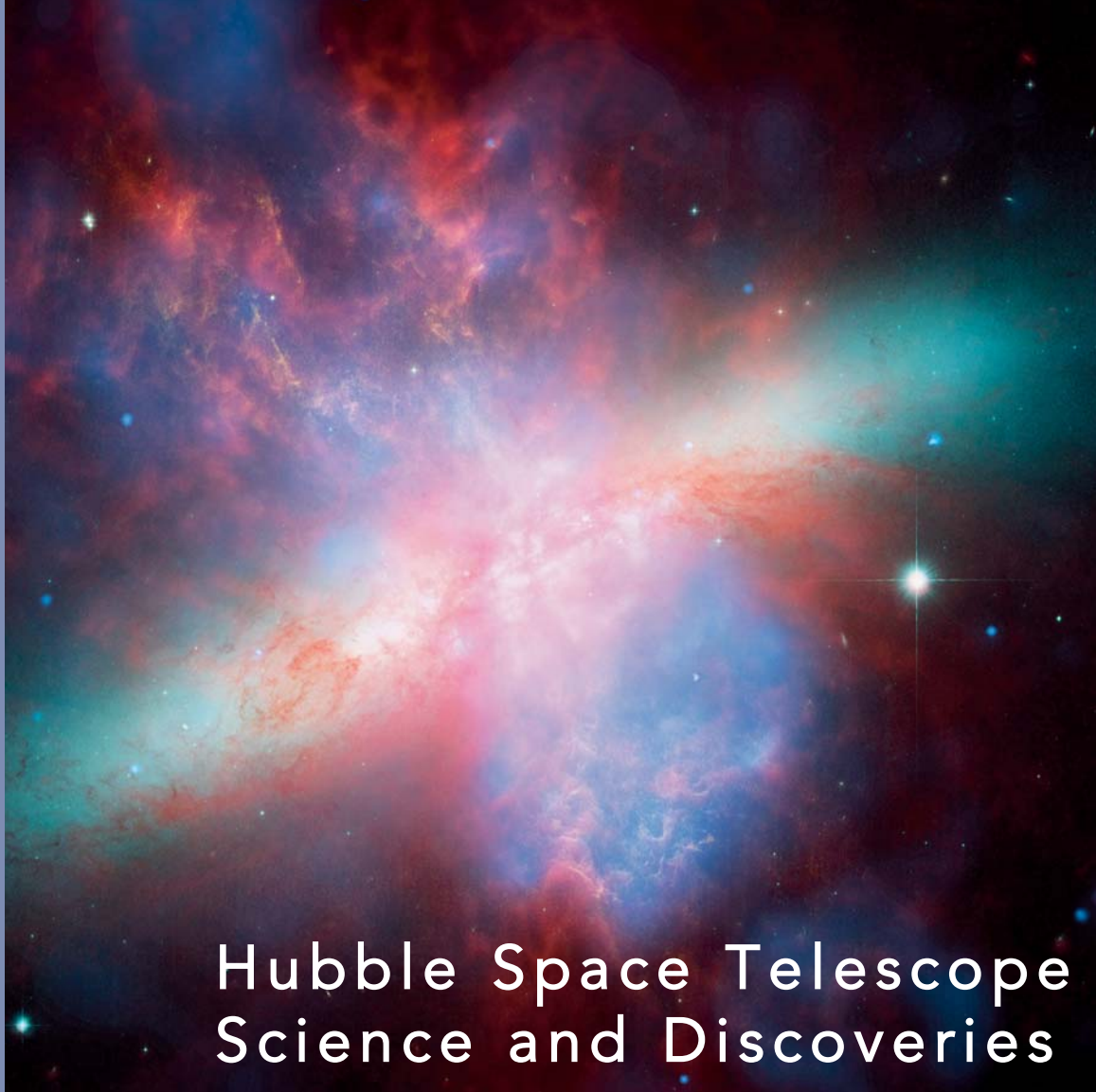

# Hubble Space Telescope Science and Discoveries

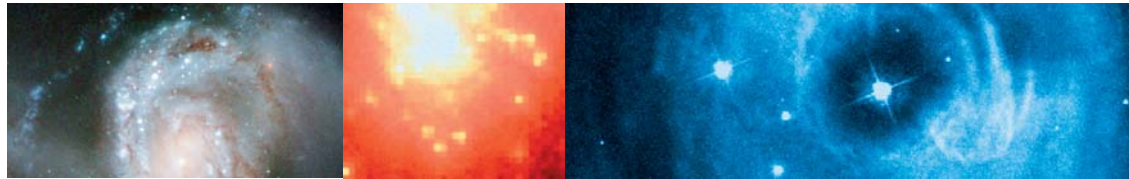

**T**he launch and deployment of NASA's Hubble Space Telescope (HST) ushered in a golden era of space exploration and discovery. For over 18 years, Hubble's rapid-fire rate of unprecedented discoveries has invigorated astronomy. Not since the invention of the telescope four centuries ago has our vision of the universe changed so radically in such a short stretch of time.





As the 12.5-ton Earth-orbiting observatory looks into space unburdened by atmospheric distortion, new details about planets, stars and galaxies come into crystal clear view. The telescope has produced a vast amount of information and a steady stream of images that have astounded the world's astronomical community and the public as well. It has helped confirm some astronomical theories, challenged others and often come up with complete surprises for which theories do not yet exist.

Hubble provides four basic capabilities:

- High angular resolution—the ability to image fine detail
- High sensitivity—the ability to detect very faint objects
- Ultraviolet performance—the ability to produce ultraviolet images and spectra
- Infrared performance—the ability to produce infrared images and spectra.

Each year the Space Telescope Science Institute (STScI) receives approximately a thousand new observing proposals from astronomers around the world. Observing cycles are routinely over-subscribed by a factor of six.

The telescope is extremely popular because it allows scientists to get their clearest view ever of the cosmos and to obtain information on the temperature, density, composition and motion of celestial objects by analyzing the radiation they emit or absorb. On average, 14 scientific papers per week based on Hubble observations are published in scholarly journals. Results of HST observations are presented regularly at meetings of the American Astronomical Society and other major scientific conferences.

Although Hubble's dramatic findings to date are too numerous to be described fully in this Media Reference Guide, the following paragraphs highlight some of the significant astronomical discoveries and observations in three basic categories:

- Galaxies and cosmology
- Formation and evolution of stars and planets
- Earth's solar system.

For further information, visit the STScI Web site at <http://hubblesite.org/news-center/>.

## Galaxies and Cosmology

In a tiny patch of sky just one-tenth the diameter of the full moon, the Hubble Space Telescope revealed an estimated 10,000 galaxies. Called the Hubble Ultra Deep Field (HUDF), the million-second-long exposure reveals the first galaxies to emerge from the so-called "dark ages," the time shortly after the big bang when the first stars reheated the relatively cool and opaque hydrogen and helium gas produced in the big bang, making it transparent to light. The image (see Fig. 3-1) should offer new insights into what types of objects reheated the universe long ago, leading ultimately to the universe as we see it today.

This historic new view is actually two separate sets of images taken by Hubble's Advanced Camera for Surveys (ACS) and the Near Infrared Camera and Multi-object Spectrometer (NICMOS) and stacked together to form a single extremely deep time exposure. The resulting composite image, the HUDF, reveals galaxies that are too faint to be seen by ground-based telescopes, or even in Hubble's previous faraway looks, the Hubble Deep Fields (HDFs), taken in 1995 and 1998. In ground-based images, the patch of sky in which the galaxies reside is largely empty. Located in the constellation Fornax, the region is below the constellation Orion.

The combination of ACS and NICMOS images has been used to search for nascent galaxies that were formed within the first billion years after the big bang, which occurred 13.7 billion years ago. To date, over 500 objects have been detected in the HUDF that emitted the light we see with Hubble when the universe was less than one billion years old (at a redshift of 6 or greater). At least one object has been detected at a redshift of 7.4, whose light started its journey toward us some 700 million years after the big bang. A key question for HUDF astronomers is in what respects the universe appeared different at this very early time, when star formation had just begun, than it did when the cosmos was between one and two billion years old, when the rate of star formation in the universe had dropped to a very low value.



NASA, ESA, S. Beckwith (STScI) and the HUDF Team

**Fig. 3-1** Hubble Ultra Deep Field

The final ACS image, in effect a very deep “core sample” across the universe and back in time, is studded with galaxies of various sizes, shapes and colors. In vibrant contrast to the image’s rich harvest of relatively nearby classic spiral and elliptical galaxies, a zoo of more distant oddball galaxies litters the field. Some look like toothpicks and others like links on a bracelet. A few appear to be interacting. Their strange shapes are a far cry from the majestic spiral and elliptical galaxies we see today. These oddball galaxies chronicle a period when the universe was more chaotic. Order and structure were just beginning to emerge.

HUDF observations began Sept. 24, 2003, and continued through Jan. 16, 2004. The ACS, which is the size of a phone booth, captured ancient photons of light that began traversing the universe even before Earth existed. Photons

of light from the very faintest objects arrived at a trickle of one photon per minute, compared with millions of photons per minute from nearer galaxies.

### ‘Death Star Galaxy’

A tightly focused jet from a supermassive black hole rages across 20,000 light years at nearly the velocity of light and plows into a neighboring galaxy. This never-before witnessed galactic violence could have a profound effect on planets in the jet’s path and trigger a burst of star formation in its destructive wake.

This “death star galaxy” was discovered through the combined efforts of both space and ground-based telescopes. NASA’s Chandra X-ray Observatory, Hubble Space Telescope and Spitzer Space Telescope were part of the effort. The Very Large Array (VLA) in Socorro, N.M., and the Multi-Element Radio



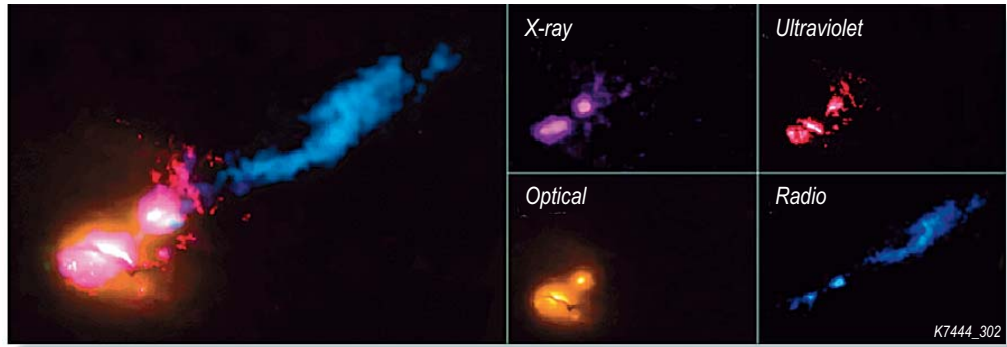

X-ray: NASA/CXC/CfA/D.Evans et al. Optical/UV: NASA/STScI. Radio: NSF/VLA/CfA/D.Evans et al., STFC/JBO/MERLIN

**Fig. 3-2** A powerful jet from a supermassive black hole blasts a nearby galaxy.

Linked Interferometer Network (MERLIN) telescopes in the United Kingdom also were needed for the finding (see Fig. 3-2).

Known as 3C 321, the system contains two galaxies in orbit around each other. Data from the Chandra X-ray Observatory show both galaxies contain supermassive black holes at their centers, but the larger galaxy has a jet emanating from the vicinity of its black hole. The smaller galaxy apparently has swung into the path of this jet.

Jets from supermassive black holes produce high amounts of radiation, especially high-energy X-rays and gamma rays, which can be lethal in large quantities. The combined effects of this radiation and particles traveling at almost the speed of light could severely damage the atmospheres of planets lying in the path of the jet. For example, protective layers of ozone in the upper atmosphere of planets could be destroyed.

Jets produced by supermassive black holes transport enormous amounts of energy far from the black holes and enable them to affect matter on scales vastly larger than the size of the black hole. Learning more about jets is a key goal for astrophysical research.

Another unique aspect of the discovery in 3C 321 is how relatively short-lived this event is on a cosmic time scale. Features seen in the Chandra and VLA images indicate that the jet began impacting the galaxy about one million years ago, a small fraction of the system's lifetime. This means that such an alignment is quite rare in the nearby universe, making 3C 321 an important opportunity to study such a phenomenon.

The event may not be all bad news for the galaxy being struck by the jet. The massive influx of energy and radiation from the jet could induce the formation of large numbers of stars and planets after its initial wake of destruction is complete. Cycles of destruction and creation are common in the universe but are rarely witnessed so starkly.

### Evidence for Dark Energy

Nearly a century ago, Albert Einstein predicted that a repulsive form of energy emanates from empty space. He had found that his equations for General Relativity didn't quite work for a static universe, so he threw in a hypothetical repulsive force that would fix the problem by balancing things out, an extra part he called the "cosmological constant." But like all scientists at that time, Einstein did not know the universe was expanding.

Now scientists using Hubble's unique capabilities in partnership with ground-based telescopes have discovered that there is indeed a mysterious repulsive force that causes an already expanding universe to expand at an increasing rate over time. Einstein's cosmological constant is now called "dark energy" and Hubble astronomers have found that it is not a new constituent of space, but rather has been present for most of the universe's history, boosting the expansion rate of the universe for as long as nine billion years.

Researchers also have found that ancient exploding stars—a class known as type Ia supernovae used to measure the expansion of space today—look remarkably similar to those that exploded nine





billion years ago and are just now being seen by Hubble. This important finding gives additional credibility to the use of these supernovae for tracking the cosmic expansion over most of the universe's lifetime. Only Hubble can measure the ancient supernovae because they are too distant, and therefore too faint, to be studied by the largest ground-based telescopes.

To study the behavior of dark energy of long ago, Hubble had to peer far across the universe and back into time to detect type Ia supernovae. The results are based on an analysis of the 24 most distant supernovae known, yielding the tightest constraints to date on the "strength" of the dark energy pressure and showing that it was present and obstructing the gravitational pull of the matter in the universe even before it began to win this cosmic tug-of-war.

Previous Hubble observations of the most distant supernovae known revealed that the early universe was dominated by matter whose gravity was slowing down the universe's expansion rate, like a ball rolling up a slight incline. The observations also confirmed that the expansion rate of the cosmos began speeding up about five to six billion years ago. That is when astronomers believe that dark

energy's repulsive force overtook gravity's attractive grip.

Without dark matter, spiral galaxies would rotate more slowly. Without its binding power, clusters of galaxies would fly apart. It is invisible to us, yet is believed to comprise most of the total mass of the universe. Its existence is inferred by measuring its gravitational influence.

The strongest evidence yet that dark matter exists comes in the discovery by Hubble astronomers of a ghostly ring that formed long ago during a titanic collision between two massive galaxy clusters (see Fig. 3-3). Researchers spotted the ring unexpectedly while they were mapping the distribution of dark matter within the galaxy cluster Cl 0024+17 (ZwCl 0024+1652), located 5 billion light-years from Earth. The ring measures 2.6 million light-years across. Although astronomers cannot see dark matter, they can infer its existence in galaxy clusters by observing how its gravity bends the light of more distant background galaxies.

Dark matter has been identified previously in other galaxy clusters, but has never been seen in an orientation where it is largely separated from the hot gas

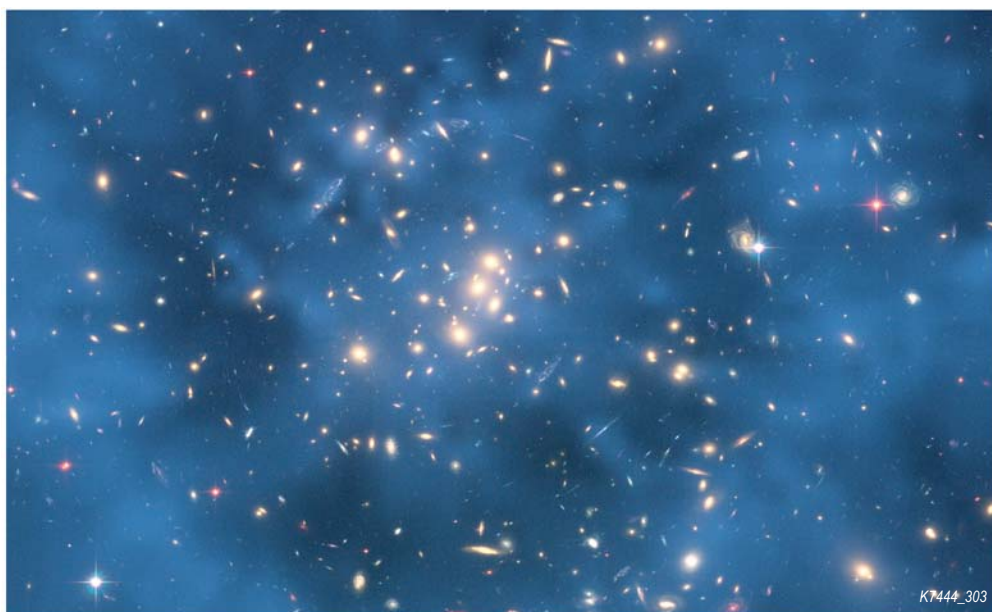

NASA, ESA, M.J. Jee and H. Ford (Johns Hopkins University)

**Fig. 3-3** A ring-like structure is evident in the blue map of a cluster's dark matter distribution. The map is superimposed on a Hubble image of the cluster.



and the galaxies that make up the clusters. Here galaxies and hot gas do not trace the dark matter structure, so scientists can study how it behaves differently from normal matter.

Why was the ring in the cluster and how did it form? Previous spectroscopic observations on the cluster's three-dimensional structure revealed two distinct groupings of galaxies, pointing to a massive collision between two clusters.

A fortuitous alignment along Earth's line of sight has given astronomers a head-on view of the collision. From this perspective, the dark-matter structure looks like a ring.

Computer simulations of galaxy cluster collisions show that when two clusters smash together, the dark matter falls to the center of the combined cluster and sloshes back out. As the dark matter moves outward, it begins to slow down under the pull of gravity and pile up, like cars bunched up on a freeway.

Tracing dark matter is not an easy task because it does not shine or reflect light. Astronomers can detect its influence only by how its gravity affects light. To find it, astronomers study how faint light from more distant galaxies is distorted and smeared into arcs and streaks by the gravity of the dark matter in a foreground galaxy cluster, a powerful trick called "gravitational lensing." By mapping the distorted light, astronomers can deduce the cluster's mass and trace how dark matter is distributed in the cluster.

The long-ago collision of these two galaxy clusters provided present-day astronomers, using Hubble's Advanced Camera for Surveys, a ripple of dark matter that left distinct footprints in the shapes of the background galaxies, displaying coherent changes in their shapes due to the presence of the dense ring.

Previous observations of the Bullet Cluster with Hubble and the Chandra X-ray Observatory presented a sideways view of a similar encounter between two galaxy clusters. In that collision, the dark matter was pulled apart from the hot cluster gas, but the dark matter still followed the distribution of cluster galaxies.

Cl 0024+17 is the first cluster to show a dark matter distribution that differs from the distribution of both the galaxies and the hot gas.

## Evolution of Stars and Planets

In January 2002 a dull star in an obscure constellation suddenly became 600,000 times more luminous than our Sun, temporarily making it one of the brightest stars in our Milky Way galaxy.

The mysterious star has long since faded back to obscurity, but Hubble observations of a phenomenon called a "light echo" have uncovered remarkable new features. These details have provided astronomers a CAT-scan-like probe of the three-dimensional structure of shells of dust surrounding an aging star. As the expanding wavefront of light from the eruption continues to reflect off the dust surrounding the star, continuously changing cross sections of the dust envelope come into view (see Fig. 3-4).

Astronomers used the Hubble images to determine that the ill-tempered star, called V838 Monocerotis (V838 Mon), is about 20,000 light-years from Earth. The star put out enough energy in a brief flash to illuminate surrounding dust. The star presumably ejected the illuminated dust shells in previous outbursts. Light from the latest outburst travels to the dust and then is reflected to Earth. Because of this indirect path, the light arrives at Earth months after light coming directly toward Earth from the star itself.

The outburst of V838 Mon was somewhat similar to that of a nova, a more common stellar outburst. A typical nova is a normal star that dumps hydrogen onto a compact white-dwarf companion star. The hydrogen piles up until it spontaneously explodes by nuclear fusion—like a titanic hydrogen bomb. This exposes a searing stellar core, which has a temperature of hundreds of thousands of degrees Fahrenheit.

By contrast, however, V838 Mon evidently did not expel its outer layers. Instead, it grew enormously in size, with its surface

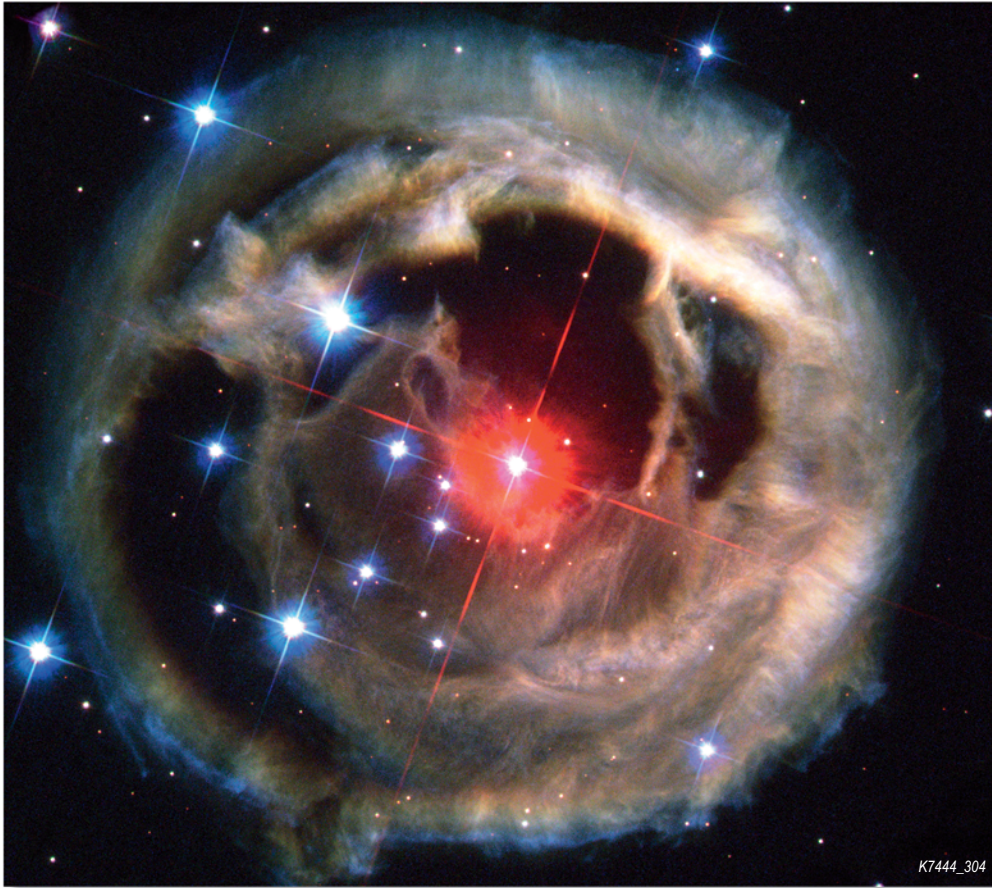

NASA, ESA and H.E. Bond (STScI)

**Fig. 3-4** Light echoes from the red supergiant star V838 Monocerotis.

temperature dropping to temperatures not much hotter than a light bulb and its color becoming extremely red. This behavior of ballooning to an immense size but not losing its outer layers is very unusual and completely unlike an ordinary nova explosion.

V838 Mon is so unique it may represent a transitory stage in a star's evolution that is rarely seen. The star has some similarities to highly unstable aging stars called eruptive variables, which suddenly and unpredictably increase in brightness.

The circular light-echo feature has now expanded to twice the angular size of Jupiter on the sky. Astronomers expect that it will continue expanding as reflected light from farther out in the dust envelope finally arrives at Earth.

### Suspected Black Hole

A well-known star cluster that glitters with the light of millions of stars may have a mysterious dark object tugging at its core.

Astronomers have found evidence of a medium-size black hole at the core of Omega Centauri, one of the largest and most massive globular star clusters orbiting within our Milky Way galaxy (see Fig. 3-5).

The intermediate-mass black hole is estimated to be roughly 40,000 times the mass of the sun. It was discovered using Hubble and the Gemini Observatory on Cerro Pachon in Chile. The ancient cluster is located 17,000 light-years from Earth.

Globular clusters are gravitationally bound swarms of typically up to a million stars. There are more than 200 globular clusters in the Milky Way.

Astronomers have debated the existence of medium-size black holes because they have not found strong evidence for them and there is no widely accepted mechanism for how these black holes could form. In contrast, astronomers have ample evidence that small black holes of a few solar masses are produced when giant





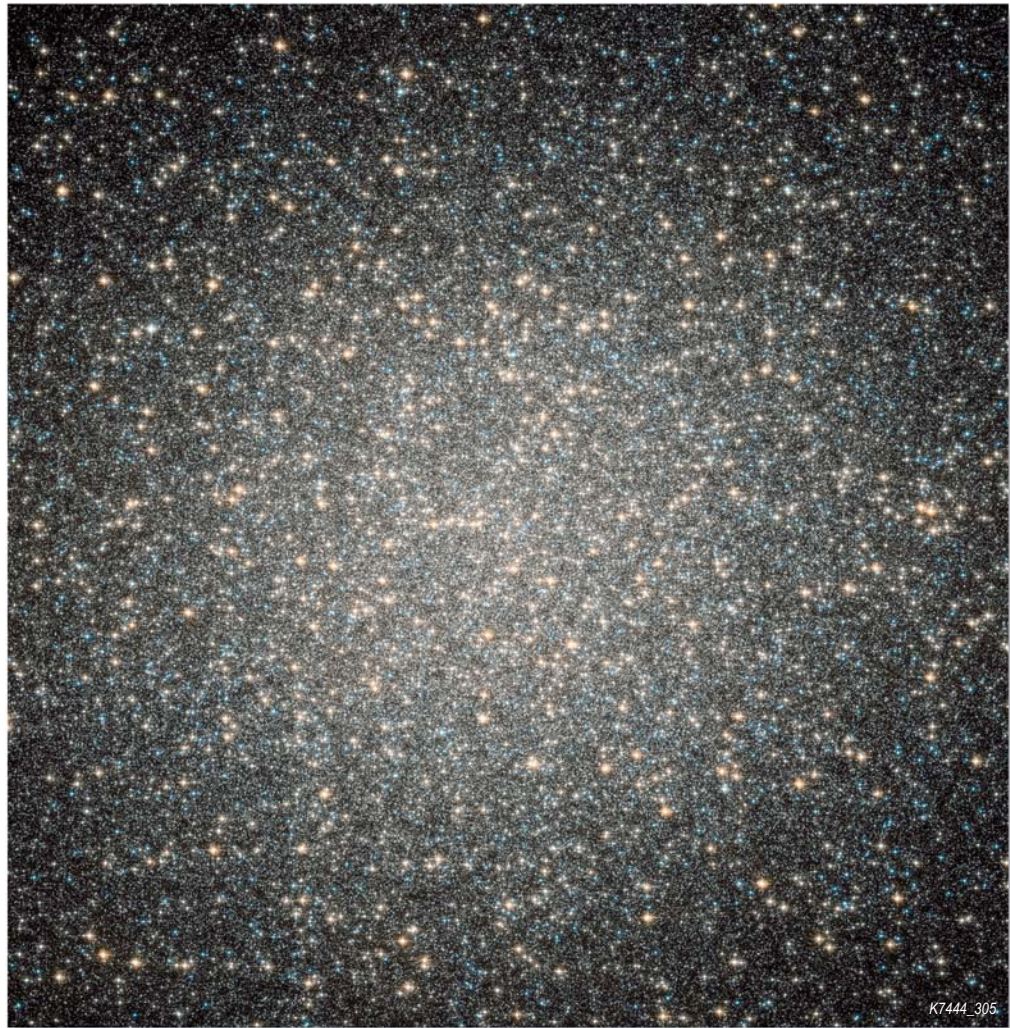

NASA, ESA and the Hubble Heritage Team (STScI/AURA)

*Fig. 3-5 The core of the spectacular globular cluster Omega Centauri glitters with the combined light of 2 million stars.*

stars die and similar evidence that supermassive black holes—weighing the equivalent of millions to billions of solar masses—sit at the heart of many galaxies, including the Milky Way.

This discovery in Omega Centauri suggests that there is a continuous range of masses for black holes, from supermassive to intermediate to small, stellar types. The finding is also significant because, according to theory, the formation of supermassive black holes requires intermediate-mass black holes to seed the process.

Hubble's Advanced Camera for Surveys showed how the stars are bunching up near the center of Omega Centauri, as seen in the gradual increase in starlight near the center. Using the Gemini

Observatory, astronomers measured the speed of the stars swirling near the cluster's center, finding that the stars closer to the core move faster than those farther away. The measurement implies that some unseen matter at the core is tugging on stars near it.

By comparing these results with standard models, astronomers determined that the most likely cause of this accelerating stellar traffic jam is the gravitational pull of a massive, dense object. They also used models to calculate the black hole's mass.

Although the presence of an intermediate-mass black hole is the most likely reason for the stellar speedway near the cluster's center, astronomers have considered a couple of other possible causes. In the

first scenario, the traffic jam of stars near the center is due to a collection of burned-out stars such as white dwarfs or neutron stars. Another possibility is that stars in the center of Omega Centauri have elongated orbits that would make the stars closest to the center appear to speed up. Both scenarios are considered very unlikely by astronomers. Models of the normal evolution of globular clusters do not result in stars behaving that way.

### Evaporating Planet

For the first time, astronomers using Hubble observed the atmosphere of an extrasolar planet evaporating into space. Much of the planet may eventually disappear, leaving only a dense core.

The planet is a type of extrasolar planet known as a "hot Jupiter." These giant gaseous planets orbit their parent stars very closely, even though they must have formed in the cold outer reaches of the star system and then spiraled into their close orbits.

The scorched planet, called HD 209458b, orbits only 4 million miles (7 million kilo-

meters) from its yellow, sun-like star (see Fig. 3-6). The Hubble observations reveal a hot, puffed-up evaporating hydrogen atmosphere surrounding the planet. This huge envelope of hydrogen resembles a comet with a tail trailing behind the planet, which circles the parent star in a tight, 3.5-day orbit.

HD 209458b is too close to the star for HST to photograph directly. However, astronomers could observe the planet indirectly because it blocks light from a small part of the star during transits across the disk of the star, thereby dimming it slightly. Light passing through the atmosphere around the planet is both scattered and absorbed by gases in the atmosphere and it acquires a signature from the atmosphere. Hubble's Space Telescope Imaging Spectrograph (STIS) was used to measure how much light from the star is filtered out by the planet's atmosphere and at what selective wavelengths of light the absorption is greatest. Encoded in these measurements is information about the chemical makeup of the atmosphere.

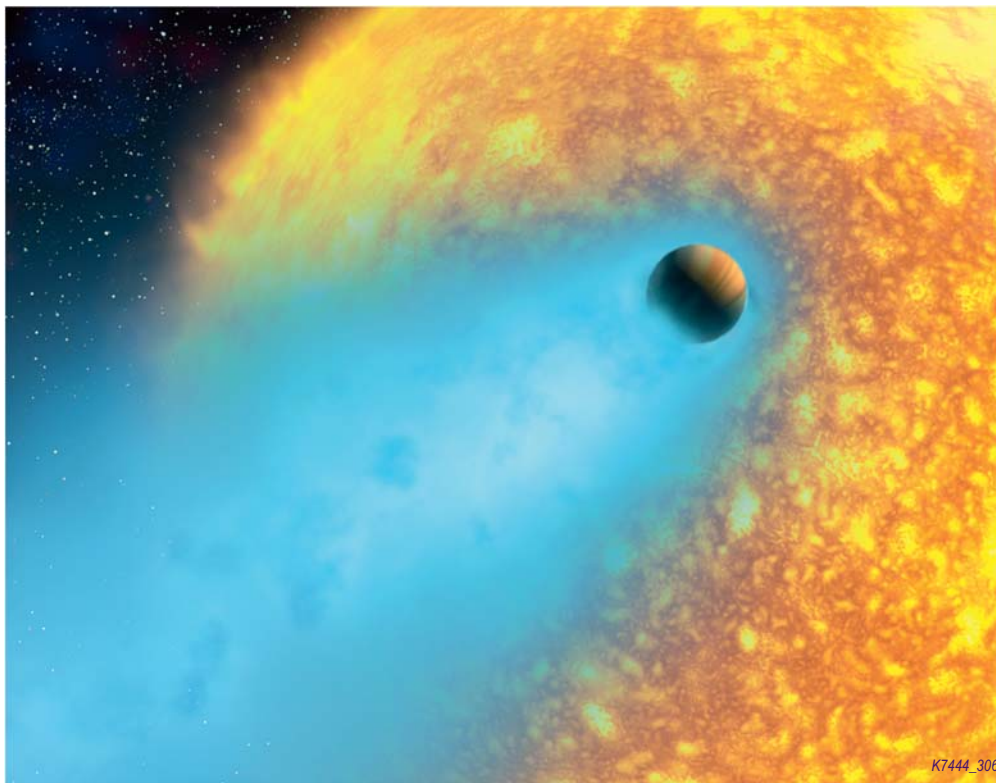

ESA, Alfred Vidal-Madjar (Institut d'Astrophysique de Paris, CNRS, France) and NASA

**Fig. 3-6** This artist's illustration shows a dramatic close-up of the scorched extrasolar planet HD 209458b in its orbit only 4 million miles from its yellow, sun-like star.





Astronomers saw a startling drop in the star's hydrogen emission. A huge puffed-up hydrogen atmosphere around the planet can best explain this result. The planet's outer atmosphere is extended and heated so much by the nearby star that it starts to escape the planet's gravity. Astronomers estimate the amount of hydrogen gas escaping HD 209458b to be at least 10,000 tons per second, but possibly much more.

HD 209458b has a diameter 1.3 times that of Jupiter and two-thirds the mass. Its orbit is one-eighth the size of Mercury's orbit around the sun. The parent star, which is similar to our sun, lies 150 light-years from Earth. It is visible with binoculars as a seventh magnitude star in the constellation Pegasus. In 1999 this star entered the astronomical "Hall of Fame" when HD 209458b was seen passing in front of the star and partly eclipsing it. This was the first confirmed transiting extrasolar planet ever discovered. In 2001 Hubble detected the element sodium in the lower part of HD 209458b's atmosphere, the first signature of an atmosphere on any extrasolar planet.

### Organic Molecule on Exoplanet

In May 2007 Hubble's NICMOS showed another "hot Jupiter," HD 189733b, to harbor the organic molecule methane in its atmosphere. HD 189733b orbits a star in the constellation Vulpecula, located 63 light-years away. This is the first-ever

detection of an organic molecule in the atmosphere of an exoplanet. NICMOS also confirmed the existence of water molecules in the planet's atmosphere, a discovery made originally by NASA's Spitzer Space Telescope in 2007.

The observations were made as the planet HD 189733b passed in front of its parent star in what astronomers call a transit. As the light from the star passed briefly through the atmosphere along the edge of the planet, the gases in the atmosphere imprinted their unique signatures on the starlight from the star HD 189733 (see Fig. 3-7).

Under the right circumstances, methane can play a key role in prebiotic chemistry—the chemical reactions considered necessary to form life as we know it. This breakthrough is an important step in eventually identifying signs of life on a planet outside our solar system. The discovery proves that Hubble and upcoming space missions, such as NASA's James Webb Space Telescope, can detect organic molecules on planets around other stars by using spectroscopy, which splits light into its components to reveal the "fingerprints" of various chemicals.

Although it has methane and water, HD 189733b is so massive and so hot it is considered an unlikely host for life. It is the size of Jupiter but orbits closer to its star than the tiny innermost planet

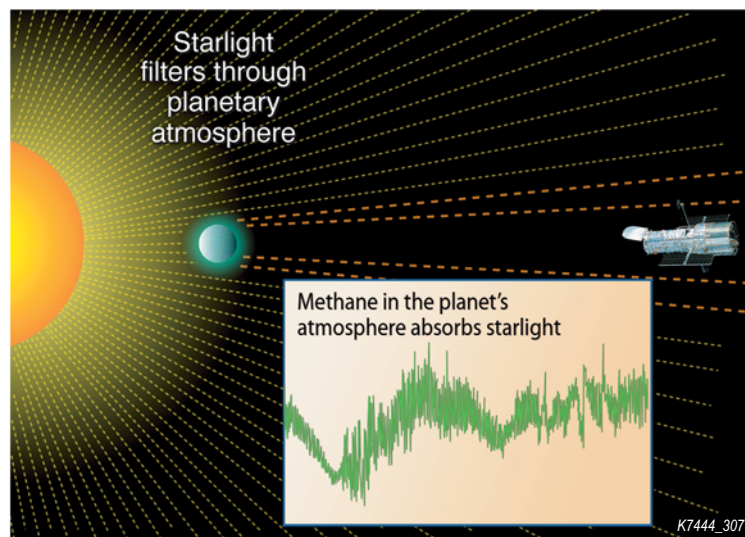

NASA, ESA and A. Feild (STScI)

**Fig. 3-7** Methane absorption by the atmosphere of an extrasolar planet, HD 189733b



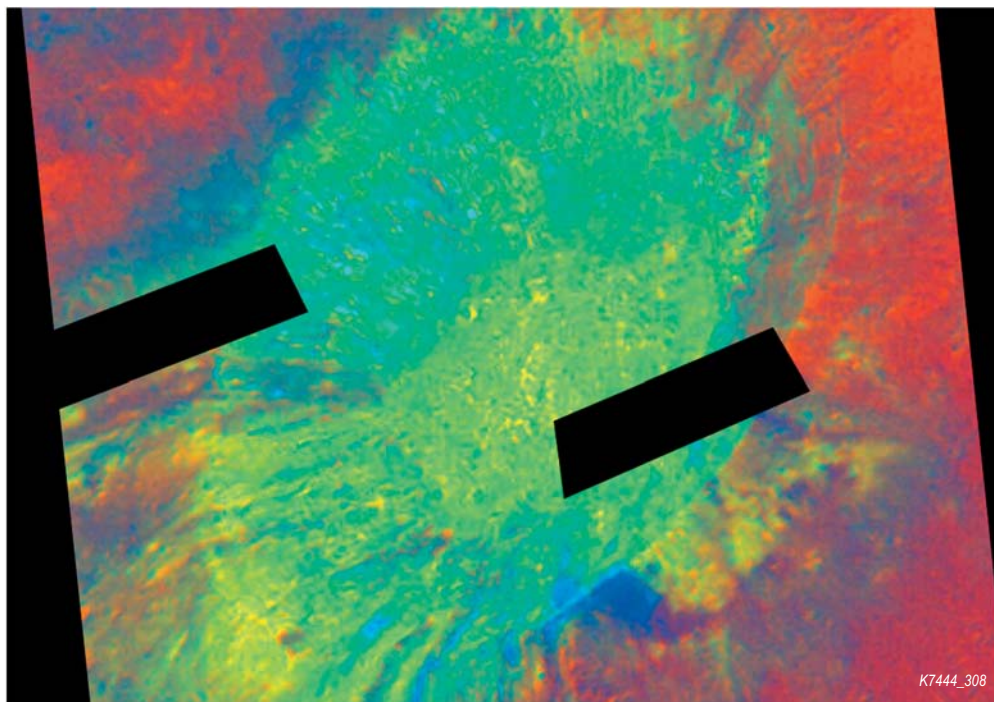

NASA, ESA and J. Garvin (NASA/GSFC)

**Fig. 3-8** This color composite focuses on the 26-mile-diameter (42-kilometer-diameter) Aristarchus impact crater and employs ultraviolet- to visible-color-ratio information to accentuate differences that potentially can diagnose ilmenite-bearing materials (i.e., titanium oxide) and pyroclastic glasses.

Mercury in our solar system, completing an orbit in just over two days. HD 189733b's atmosphere swelters at 1,700 degrees Fahrenheit, about the same temperature as the melting point of silver.

While HD 189733b is too hot for life as we know it, the ultimate goal of studies like these is to identify prebiotic molecules in the atmospheres of planets in the "habitable zones" around other stars, where temperatures are right for water to remain liquid rather than freeze or evaporate.

## Earth's Solar System

### Looking for Possible Moon Resources

When Americans return to the moon, they will have the Hubble Space Telescope to thank for a new class of scientific observations of Earth's nearest celestial neighbor.

Hubble's resolution and sensitivity to ultraviolet light have allowed it to search for important oxygen-bearing minerals on the moon. Since the moon does not have a

breathable atmosphere, minerals such as ilmenite (titanium and iron oxide) may be critical for a sustained human lunar presence. Ilmenite is a potential source of oxygen for breathing or powering rockets.

The new Hubble observations are the first high-resolution, ultraviolet images ever acquired of the moon (see Fig. 3-8). The images provide scientists with a new tool to study mineral variations within the lunar crust. Such data, in combination with other measurements, will help ensure the most valuable sites are targeted for future robotic and human missions.

In 2005 Hubble's Advanced Camera for Surveys captured ultraviolet and visible light images of known geologically diverse areas on the side of the moon nearest Earth. These included the Aristarchus impact crater and the adjacent Schroter's Valley, which neither humans nor robotic spacecraft have visited. Hubble also photographed the Apollo 15 and 17 landing sites, where astronauts collected rock and soil samples in 1971 and 1972.

Scientists are comparing the properties of the rock and soil samples from the



Apollo sites with the new Hubble images. The telescope's observations of Aristarchus crater and Schroter's Valley will help refine researchers' understanding of the diverse, scientifically interesting materials in the region and unravel their full resource potential.

### Largest Dwarf Planet

2006 was not a good year for Pluto. For 76 years it had been recognized as the solar system's ninth planet, but the announced discovery in 2005 of Eris—a Kuiper Belt object larger than Pluto—set off a debate over Pluto's designation. Astronomers realized they would have to call Eris the tenth planet if Pluto retained its own planetary status.

This led the International Astronomical Union to make a new class of solar system objects called dwarf planets. So, Pluto was demoted to dwarf planet status and—adding insult to injury—Hubble observations confirmed that Eris (originally nicknamed Xena and officially cataloged 2003 UB313) is both physically larger and more massive than Pluto.

Dwarf planets are officially defined as spherical bodies in hydrostatic equilibrium (objects that have sufficient gravity to

overcome their own rigidity and form a spherical shape) like the planets but, unlike the major planets in the solar system, they have not gravitationally cleared out the neighborhood of particles and small debris along their orbits.

Though previous ground-based observations suggested that Eris' diameter was about 30 percent greater than Pluto's, Hubble observations taken Dec. 9 and 10, 2005, showed Eris' diameter as 1,490 miles (with an uncertainty of 60 miles). Pluto's diameter, as measured by Hubble, is 1,422 miles.

Only a handful of images was required to determine the diameter of Eris. Located 10 billion miles from Earth and with a diameter a little more than half the width of the United States, the object is 1.5 pixels across in Hubble's view. That's enough to make a precise size measurement.

In 2007 Hubble teamed up with the W. M. Keck Observatory to precisely measure the mass of Eris. But the mass could be calculated only by observing the orbital motion of the moon Dysnomia around Eris. Hubble and Keck took multiple images of Dysnomia's movement along its orbit (see Fig. 3-9).

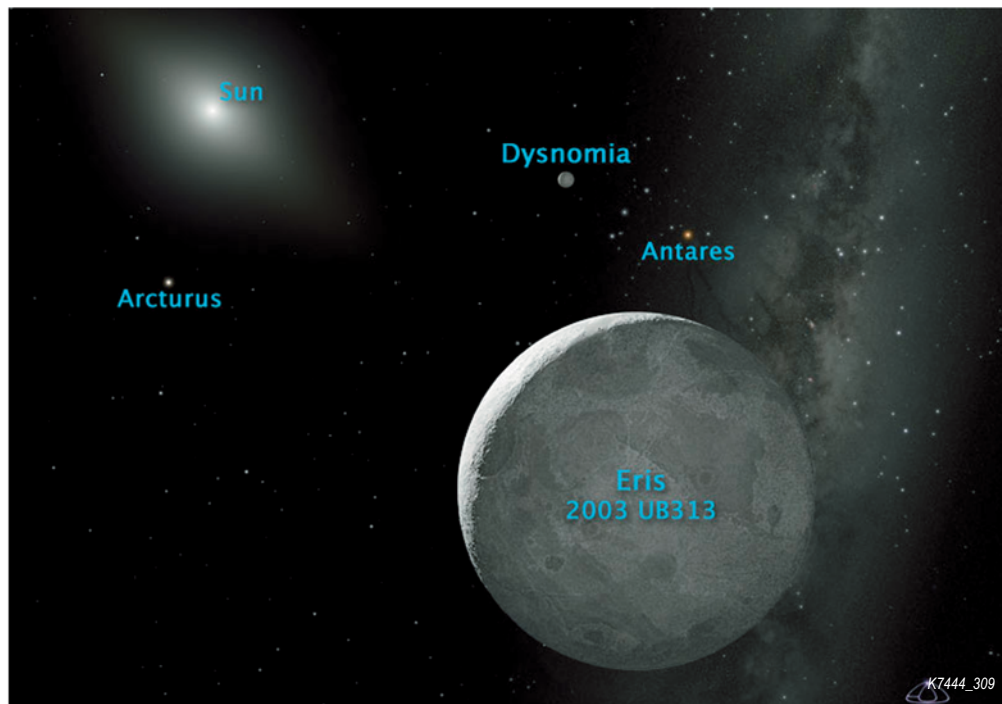

NASA, ESA and Adolph Schaller (STScI)

Fig. 3-9 Artist's view of Eris and Dysnomia



The astronomer who discovered Eris, Mike Brown of the California Institute of Technology in Pasadena, Calif., determined that Dysnomia is in a nearly circular 16-day orbit. This favors the idea that Dysnomia was born out of a collision between Eris and another Kuiper Belt object (KBO). A gravitationally captured object would be expected to be in a more elliptical orbit. (The Kuiper Belt is a vast ring of primordial icy comets and larger bodies encircling Neptune's orbit.)

The satellites of Pluto and the Earth-moon system are also believed to have been born out of a collision process where debris from the smashup goes into orbit and coalesces into a satellite.

By comparing mass and diameter, Brown has calculated a density for Eris of 2.3 grams per cubic centimeter. This is very similar to the density of Pluto, the large KBO 2003 EL61 and Neptune's moon Triton, which is likely a captured KBO. Their densities imply that these bodies are not pure ice but must have a significant rocky composition.

Eris takes about 560 years to orbit the sun, and it is now very close to aphelion (the point on its orbit that is farthest from

the sun). Brown next plans to use Hubble and other telescopes to study other recently discovered KBOs that are almost as large as Pluto and Eris.

### Uranus' Rings on Edge

Earthbound astronomers can see the rings of Uranus on edge only once every 42 years as the planet follows its leisurely 84-year orbit about the sun. However, the last time the rings were tilted edge-on to Earth, astronomers didn't even know they existed.

The rings were not discovered until 1977, so 2007 was the first time for a Uranus ring crossing to be observed from Earth. And Hubble captured the occasion. Earth's orbit around the sun permitted three opportunities to view the rings edge-on: Uranus made its first ring crossing as seen from Earth on May 3, 2007; its second on Aug. 16, 2007; and its third on Feb. 20, 2008.

This series of Hubble images (see Fig. 3-10) shows how the ring system around the distant planet Uranus appears at ever more oblique (shallower) tilts as viewed from Earth, culminating in the rings being seen edge-on in three observing opportunities. The best of these events

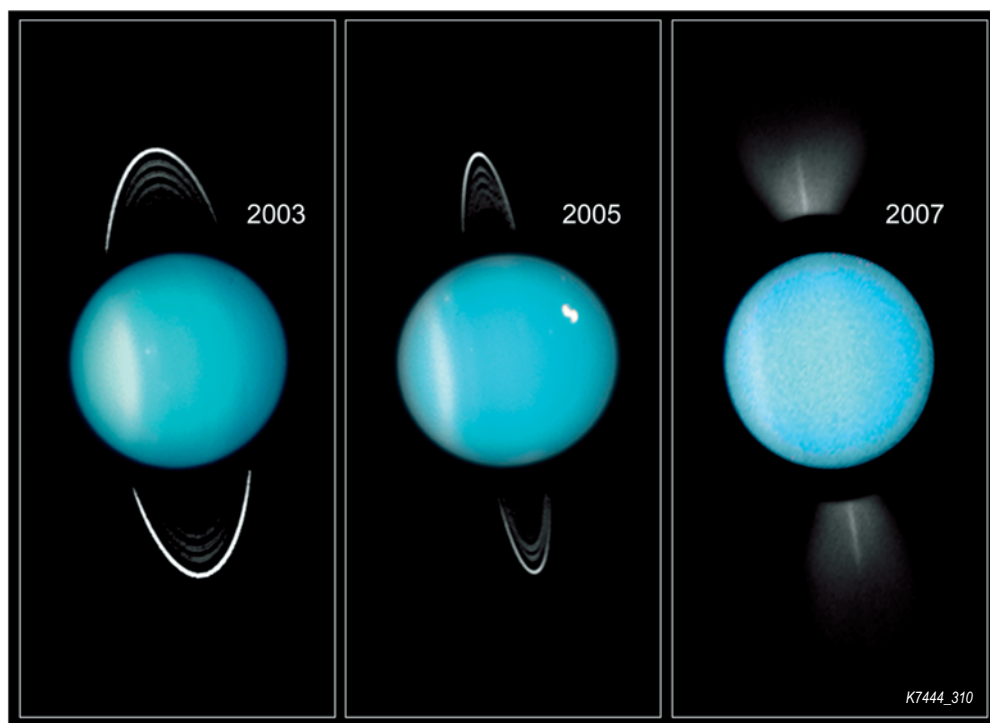

NASA, ESA and M. Showalter (SETI Institute)

**Fig. 3-10** Going, going, gone: Hubble captures Uranus' rings on edge.





appears in the far right image taken with Hubble's Wide Field and Planetary Camera 2 on Aug.14, 2007.

The edge-on rings appear as two spikes above and below the planet. The rings cannot be seen running fully across the face of the planet because the bright glare of the planet has been blocked out in the Hubble photo (a small amount of residual glare appears as a fan-shaped image artifact). A much shorter color exposure of the planet has been photo-composited to show its size and position relative to the ring plane.

Until Voyager 2 flew by Uranus in January 1986, the rings were known only from the way they temporarily blocked the light of stars passing behind the planet. Hubble provided some of the first images of the ring system as viewed from Earth's distance of approximately two billion miles. The advent of adaptive optics gave ground-based observers using large telescopes comparatively sharp views.

## Summary

The Hubble Space Telescope has established itself as a premier astronomical observatory that continues to make dramatic observations and discoveries at the forefront of astronomy. Among a long list of achievements:

- Hubble's ability to detect faint supernovae contributed to the discovery that the expansion rate of the universe is accelerating, indicating the existence of mysterious "dark energy" in space.
- Observations of Cepheid variable stars in nearby galaxies were used to establish the current expansion rate of the universe to better than 10 percent accuracy.
- The Hubble Ultra Deep Field provided our deepest view yet into the universe's distant past, allowing us to reconstruct how galaxies evolve and grow by swallowing other galaxies.

- Hubble provided the first direct measurements of the three-dimensional distribution of dark matter in space.
- Peering into nearby regions of star birth in the Milky Way galaxy, Hubble has revealed flattened disks of gas and dust that are the likely birthplaces of new planets.
- When sun-like stars end their lives, they eject spectacular nebulae. Hubble has revealed fantastic and enigmatic details of this process.
- Hubble made detailed measurements of a Jupiter-sized planet orbiting a nearby star, including the first detection of the atmosphere of an extra-solar planet.
- The explosive collision of Comet P/Shoemaker-Levy 9 with Jupiter gave Earthlings a cautionary tale of the danger posed by cometary impacts.
- Hubble observations have shown that monster black holes, with masses millions to billions times the mass of our sun, inhabit the centers of most galaxies.
- Hubble played a key role in determining the distances and energies of gamma-ray bursts, showing that they are the most powerful explosions in the universe other than the big bang itself.

After Servicing Mission 4, the telescope will view the universe anew with significantly expanded scientific capabilities from the new Wide Field Camera 3 and the new Cosmic Origins Spectrograph, as well as the reactivated Advanced Camera for Surveys and Space Telescope Imaging Spectrograph. These additions and the upgrades to Hubble's operating hardware hold the promise of momentous discoveries in the years ahead.



Media Reference Guide  
HST Science Instruments





# Hubble Space Telescope Science Instruments

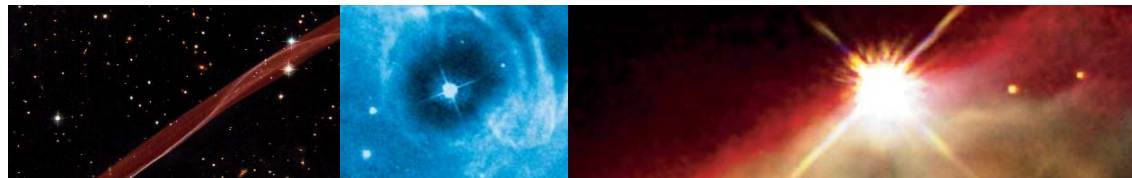

**F**our instruments are in active scientific use on the Hubble Space Telescope prior to Servicing Mission 4 (SM4):

- Wide Field and Planetary Camera 2 (WFPC2)
- Near Infrared Camera and Multi-Object Spectrometer (NICMOS)
- Fine Guidance Sensor 1R (FGS1R), designated as the prime FGS for astrometric science
- Advanced Camera for Surveys (ACS). Only the Solar Blind Channel (SBC) is available for science observations. The Wide Field Channel (WFC) and High Resolution Channel (HRC) stopped functioning in 2007.





Other instrument bays are occupied by the Space Telescope Imaging Spectrograph (STIS), now in “safe mode” due to the failure of a power supply within the Side-2 electronics in 2004, and the Corrective Optics Space Telescope Axial Replacement (COSTAR), a device no longer needed that was installed during Servicing Mission 1 (SM1) to correct for the spherical aberration in Hubble’s main mirror.

Two new instruments will be installed during SM4. The Cosmic Origins Spectrograph (COS) will be the most sensitive ultraviolet (UV) spectrograph ever flown on Hubble. The Wide Field Camera 3 (WFC3) will become the telescope’s only “panchromatic” instrument, with the ability to span the electromagnetic spectrum from the near ultraviolet through the optical and into the near infrared (NIR).

The replacement of two circuit boards in the ACS Wide Field Channel Charge-Coupled Device (CCD) Electronics Box during SM4 is expected to restore function to both down channels. For STIS, the replacement of a low-voltage power supply circuit board that contains a failed power converter is expected to bring the instrument back into full operation.

Hubble’s FGSs have undergone a systematic program of refurbishment and upgrading. During Servicing Mission 2 (SM2) and Servicing Mission 3A (SM3A), one FGS was replaced, returned to the ground, disassembled and refurbished, thus becoming available as a replacement for another FGS in a subsequent servicing mission to HST. The replacement unit FGS2R, inserted during SM3A in 1999, has developed a technical problem and will be replaced during SM4. The original FGS3 continues to operate well and with careful management should provide years of additional service.

## Wide Field Camera 3

WFC3 will occupy HST’s radial scientific instrument bay, where it will obtain on-axis direct images (see Fig. 4-1). During SM4 the Shuttle astronauts will install WFC3 in place of the WFPC2. WFPC2 was installed during SM1 in 1993 to replace the original Wide Field and Planetary Camera (WFPC1). Like WFPC2, WFC3 contains optics that correct for the spherical aberration discovered in the HST primary mirror following launch of the telescope in April 1990.



*Fig. 4-1 Wide Field Camera 3 in clean room at Goddard Space Flight Center*



WFC3 utilizes some components of the original WFPC1, thus seeing service once again onboard Hubble. This new camera is designed to ensure that HST maintains its unique imaging capabilities until the end of its mission, while at the same time advancing its survey and discovery capability through WFC3's combination of broad wavelength coverage, wide field of view (FOV) and high sensitivity.

WFC3 will also provide considerable redundancy for the partially inoperative ACS, which is scheduled for repair during SM4. In addition, many functions of the older-technology NICMOS instrument will be supplanted by WFC3.

By combining two optical/ultraviolet CCDs with NIR arrays, WFC3 will be capable of direct, high-resolution imaging over the entire wavelength range from 200 to 1700 nm. Equipped with a comprehensive range of wide-, intermediate-, and narrowband filters, WFC3 will have broad applicability to a variety of new astrophysical investigations.

WFC3 will study a diverse range of objects and phenomena, from young and extremely distant galaxies to much closer stellar systems, as well as objects within our solar system. WFC3 extends Hubble's capability not only by seeing deeper into the universe but also by providing wide-field imagery in all three regions of the spectrum—UV, visible and NIR. As an example, in the same galaxy, WFC3 will be able to observe young, hot stars (glowing predominantly in UV) and older, cooler stars (glowing predominantly in the red and NIR).

The Hubble Program at Goddard Space Flight Center jointly developed WFC3 with the Space Telescope Science Institute (STScI) in Baltimore, Md., and Ball Aerospace & Technologies Corporation in Boulder, Colo. A community-based Science Oversight Committee, led by Prof. Robert O'Connell of the University of Virginia, provided scientific guidance for its development.

## Instrument Description

The WFC3 optical design features two independent channels: the Ultraviolet/Visible (UVIS) Channel is sensitive at UV and optical wavelengths, approximately 200 to 1000 nm, and the IR Channel is sensitive at NIR wavelengths, approximately 800 to 1700 nm. A channel-selection mirror will direct on-axis light from the HST Optical Telescope Assembly (OTA) to the IR Channel, or the mirror can be removed from the beam to allow light to enter the UVIS Channel. This means that simultaneous observations with the UVIS and IR detectors are not possible. However, both UVIS and IR observations can be made sequentially, even during the same HST orbit. The extended wavelength range—combined with high sensitivity, high spatial resolution, large FOV and a wide selection of spectral elements—makes WFC3 an extremely versatile instrument (see Fig. 4-2).

WFC3's highly efficient, wide wavelength coverage is made possible by its dual-channel design using two detector technologies. The light-sensing detectors in both channels are solid-state devices. For the UVIS Channel, two large-format CCDs, similar to those found in digital cameras, are used. The CCDs, arrays of 2000 x 4000 pixels, are butted together, creating an effective 4000 x 4000-pixel detector. In the NIR detector, the crystalline photosensitive surface is composed of mercury, cadmium and tellurium (HgCdTe).

The high sensitivity to light of the 16-megapixel UVIS CCD array, combined with a wide FOV (160 x 160 arcseconds), yields about a 35 times improvement in discovery power versus HST's current, much smaller UV imager, the ACS HRC. The NIR Channel's HgCdTe detector is a more highly advanced and larger (one megapixel) version of the 65,000-pixel detectors in the current NIR instrument, NICMOS. The combination of FOV, sensitivity and low detector noise results in a 15 to 20 times enhancement in capability for WFC3 over NICMOS.

## WFC3 Optical Design

The returned hardware of the original WFPC1 instrument provided the foundation for the WFC3 design. However,

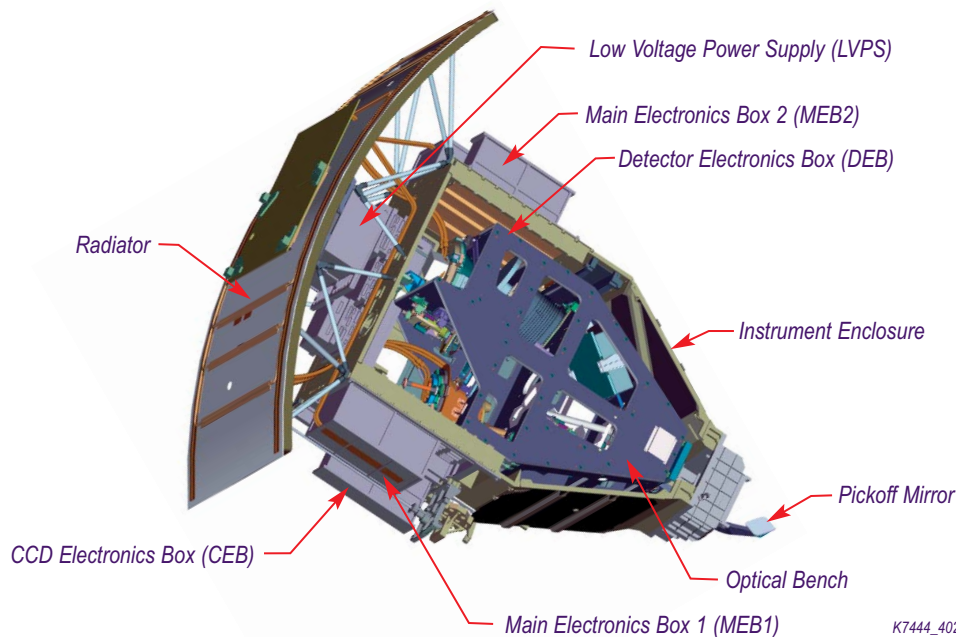

### Wide Field Camera 3 (WFC3)

Weight	890 lbs
Dimensions	
Camera	3 x 5 x 1.7 feet (1 x 1.3 x 0.5 m)
Radiator	2.6 x 7 feet (0.8 x 2.2 m)
Instrument scientist	Randy Kimble, Goddard Space Flight Center (GSFC)
Science Oversight Committee	Chaired by Bob O'Connell, University of Virginia
Contractor	Jointly developed by the HST Program, STScI and Ball Aerospace

**Fig. 4-2** Wide Field Camera 3 (WFC3)

a new optical bench was designed and built and the external enclosure, radiator and filter wheel assembly were retained and reworked for WFC3. As in WFPC1 and WFPC2, the physical layout captures the center of the telescope's FOV with a pickoff mirror, routing the light past a Channel Select Mechanism (CSM) that either reflects the beam into the IR Channel or lets it pass unhindered into the UVIS Channel.

Once in the UVIS Channel, the light falls onto an adjustable mirror that steers the beam onto a mirror containing the correction for the HST spherical aberration. This design and the actual corrector mechanism itself are close copies of the ACS WFC. The beam then transits the Selectable Optical Filter Assembly (SOFA), a shutter mechanism (copied from the ACS WFC shutter), and finally enters the CCD detector enclosure (also copied from the ACS WFC design).

When the CSM is in the IR Channel position, the beam is directed onto a fold mirror, then into a cold enclosure (-35°C) that reduces both the cooling requirements of the IR detector and the internal background at IR wavelengths. Within this enclosure it passes through a refractive corrector element (to remove the HST spherical aberration), a cold mask (for the HST pupil) and a selectable IR filter.

An important design innovation for the WFC3 NIR Channel results from tailoring its detector to reject IR light (effectively "heat") longer in wavelength than 1700 nm. In this way it becomes unnecessary to use a cryogen, such as liquid or solid nitrogen, to keep it cold. Instead the detector is chilled with an electrical device called a thermo-electric cooler. This greatly simplifies the design and will give WFC3 a longer operational life. Figure 4-3 shows the light path through the instrument and the primary characteristics of the two WFC3 channels.



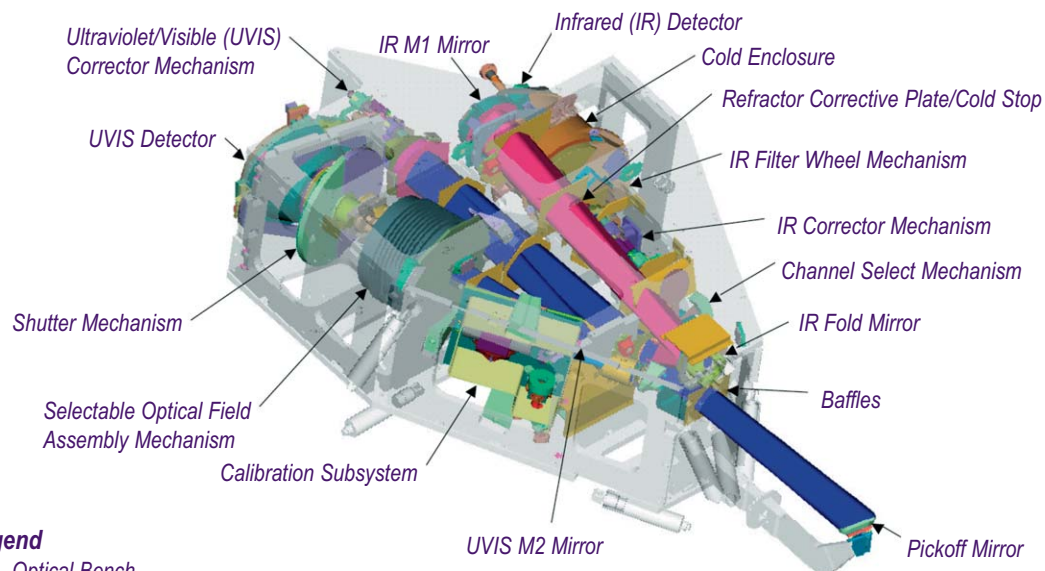

**Legend**  
 ■ Optical Bench  
 ■ UVIS Optical Path  
 ■ IR Optical Path

K7444\_403

WFC3 Characteristics	UVIS Channel	NIR Channel
Spectral range (nm)	200 – 1,000	800 – 1,700
Detector type	CCD	HgCdTe
Detector array size (pixels)	4096 x 4096	1024 x 1024
Field of view (arcsec)	160 x 160	123 x 137
Pixel size (arcsec)	0.04	0.13
Filter complement	62	15
Discovery factor over previous HST instruments	35x over ACS/HRC	15 – 20x over NICMOS

Fig. 4-3 WFPC optical path and channel characteristics

### Observations

WFC3's combination of panchromatic performance, wide FOV, high sensitivity and angular resolution makes it especially well suited to address numerous major themes of modern astronomical research. These include establishing the star-formation history of nearby galaxies; following the assembly of galaxies during the period of peak star formation and metal production activity 8 to 12 billion years ago; searching for the "End of the Dark Ages," the high-redshift transition between the neutral and ionized epochs of the universe; exploring the birth and death of stars; and studying water and ice on Mars and the satellites of the outer planets.

their light at UV and visible wavelengths. Looking farther out across the universe and back in time, however, that light shifts toward red and NIR wavelengths. A young proto-galaxy in the early universe blazes strongly in UV. By the time that light has reached Earth 13 billion years later, its wavelength has been stretched, or redshifted, by a factor of six to seven or more. With the WFC3's panchromatic imaging, astronomers will be able to follow galaxy evolution backward in time from the nearest neighboring galaxies to the earliest times when galaxies first began to form.

### Selected Science Goals

**Galaxy Evolution.** Galaxies with new star formation emit a substantial fraction of

**Detailed Studies of Star Populations in Nearby Galaxies.** WFC3's panchromatic coverage, particularly its high UV-blue sensitivity over a wide field, will enable astronomers to sort out in detail the various populations of stars in nearby galaxies to



determine their chemical abundances and learn when they were formed. Such observations provide clues to the internal history of individual galaxies. They sometimes also reveal a history of collisions and mergers between galaxies.

**Dark Energy and Dark Matter.** At visible wavelengths, a repaired ACS plus WFC3 will provide a 40 percent improvement in surveying efficiency over ACS alone. At the same time WFC3 will provide Hubble's first efficient surveying capabilities at UV and NIR wavelengths. Working in tandem, the two instruments provide an extremely powerful set of tools to advance our knowledge of the two greatest cosmic mysteries of our time: cold dark matter and the repulsive gravity called dark energy.

Both cameras are well suited to measure the amount and distribution of cold dark matter within clusters of galaxies: they can observe the highly distorted images of more distant galaxies along our line of sight beyond the galaxy clusters, produced by strong gravitational lensing. A gravitational lens is a concentration of mass—such as the blend of galaxies, intergalactic gas and cold dark matter in a galaxy cluster—whose gravity bends and focuses the rays of light passing through or near it. This phenomenon was predicted by Einstein's General Theory of Relativity and is frequently observed in Hubble images.

Working together, the cameras will provide Hubble's most powerful capability ever to survey thousands of galaxies distributed randomly over a wide swath of the sky and to measure the subtle distortions in their shapes, called weak lensing, that are produced by the concentrations of cold dark matter making up the underlying skeletal structure of the universe. Using these data, astronomers can produce three-dimensional maps that "illuminate" both the present-day distribution of this otherwise invisible, mysterious material in space and how its distribution has evolved throughout cosmic time.

Similarly, the combined surveying power of WFC3 and ACS is very well suited to efficient surveys for a specific type of exploding star, a type Ia supernova, that serves as a "standard candle," allowing the measurement of accurate distances

to galaxies far out across space and time. The relative motions of the galaxies away from Earth, caused by the expanding scale of the universe, can also be directly measured. This kind of observation, previously conducted by both HST and ground-based telescopes, has provided compelling evidence that the expansion of the universe long ago was slowing down, but today is accelerating.

The nature of the dark energy responsible for this observed behavior of space and time remains a mystery. Astronomers can make further progress by acquiring observations of a much larger statistical sample of type Ia supernovae. Ultimately this will require a specialized space mission, such as the Joint Dark Energy Mission.

Meanwhile, ACS and WFC3 will be able to survey the sky in parallel at visible wavelengths to locate exploding stars and, using the WFC3's NIR Channel, provide critical measurements of how the light from explosions rises and then fades away with time. The latter indicates the distance between an exploding star and its host galaxy. Ultimately, scientists want to know if dark energy is constant in magnitude with time and, if so, does it correspond to Einstein's famous "cosmological constant"? After SM4 Hubble will be extremely well poised to pursue these fundamental issues in modern physics.

## Cosmic Origins Spectrograph

COSTAR will be removed during SM4 to make room for COS (see Fig. 4-4). Introduction of COS to Hubble, coupled with the scheduled repair of STIS, will restore a full set of spectroscopic capabilities to Hubble's scientific arsenal. COS is designed to be extremely sensitive—able to probe far out across the universe to study its large-scale structure and to explore how galaxies, stars and planets formed and evolved. It will help determine how elements needed for life, such as carbon and iron, first formed and how their abundance has increased over the lifetime of the universe.

Rather than capture the majestic visual images that Hubble is known for, COS will

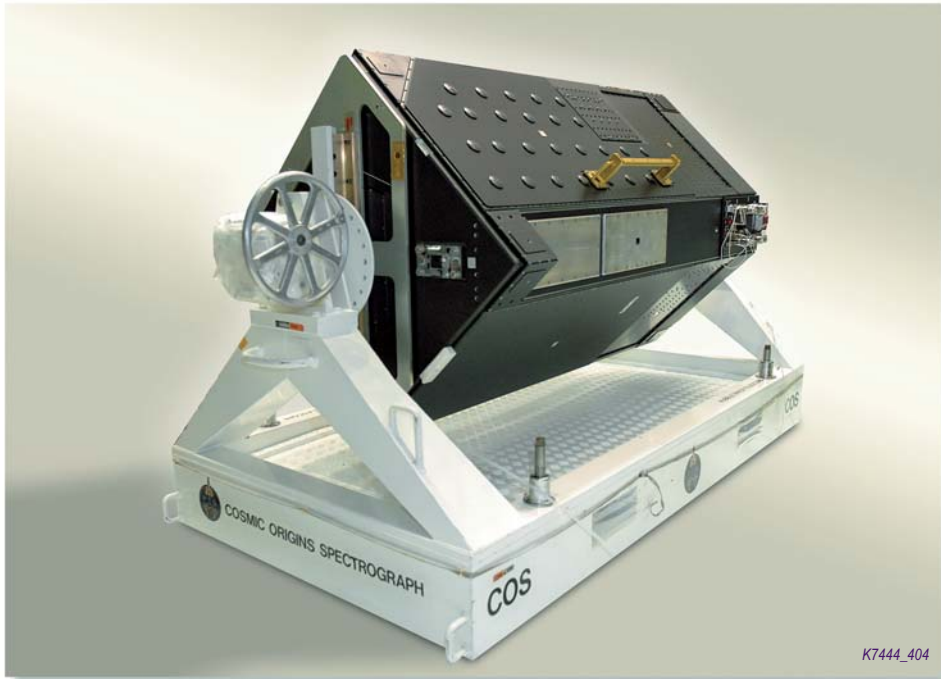

NASA

*Fig. 4-4 Cosmic Origins Spectrograph mounted on stand*

perform spectroscopy, the science of breaking up light into its individual component colors. Any object that absorbs or emits light can be studied with a spectrograph.

To gain an understanding of the origin and evolution of the universe, astrophysicists require quantitative measurements of physical parameters, such as the density, motion, temperature, chemical composition and magnetic fields of astronomical objects: planets, comets, stars, interstellar gas and dust, galaxies and the gas between the galaxies. These properties can be extracted from the high-quality spectroscopic data that COS will obtain. In particular, UV spectroscopy provides some of the most fundamental diagnostic data necessary for discerning the physical characteristics of these objects.

### **COS Instrument Design**

COS has two channels, the Far Ultraviolet (FUV) Channel covering wavelengths from 115 to 177 nm, and the Near Ultraviolet (NUV) Channel, covering 175 to 300 nm. UV light is more energetic than visible light; “near” UV refers to the part of the UV spectrum closer to the visible,

just beyond the color violet. Figure 4-5 shows the instrument’s specifications.

The light-sensing detectors of both channels are designed around thin micro-channel plates comprising thousands of tiny curved glass tubes, all aligned in the same direction. Incoming photons of light ultimately induce showers of electrons to be emitted from the walls of these tubes. The electron showers are accelerated, captured and counted in electronic circuitry immediately behind the micro-channel plates (see Fig. 4-6).

A key feature of COS—the one that makes it unique among Hubble spectrographs—is its maximized efficiency, or “throughput.” Each bounce of a light beam off an optical surface within an instrument takes some of the light away from the beam, reducing the throughput. This problem is especially acute in the UV, and the COS FUV Channel was designed specifically to minimize the number of light bounces. The incoming FUV beam makes one bounce off a selectable light-dispersing grating and goes directly to the detector. An additional advantage within COS is the very low level of scattered light produced by its light-dispersing gratings.





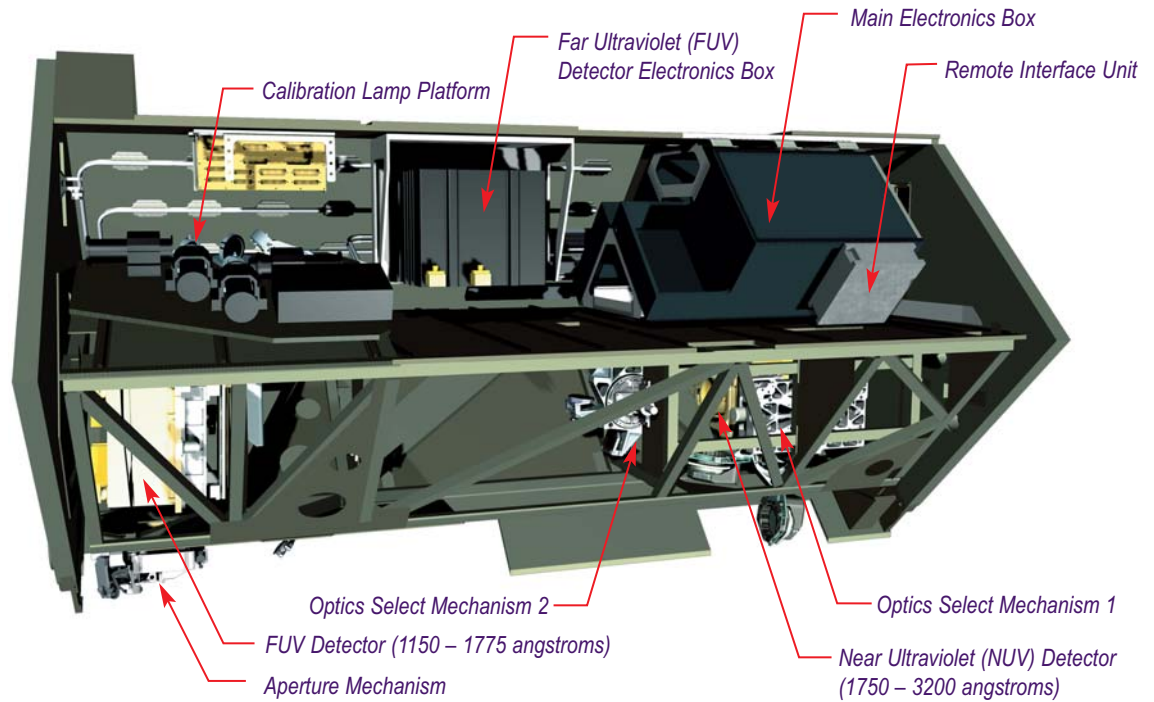

K7444\_405

### Cosmic Origins Spectrograph (COS)

Weight	850 lbs
Dimensions	3 x 7 x 7 feet (0.9 x 0.9 x 2.2 m)
Principal investigator	James C. Green, University of Colorado
Contractor	Ball Aerospace

**Fig. 4-5** Cosmic Origins Spectrograph (COS)

If astronauts can complete on-orbit repair of STIS during SM4, the two instruments will complement each other. The “all-purpose” STIS, installed in 1997 during SM2, suffered an electronics failure in 2004 and is currently in safe hold mode. By design, the COS does not duplicate all of STIS’s capabilities. Possessing more than 30 times the sensitivity of STIS for FUV observations of faint objects such as distant quasars, COS will enable key scientific programs that would not be possible using STIS alone.

On the other hand, STIS has the unique ability to observe the spectrum of light across spatially extended objects such as galaxies and nebulae, while COS is best suited to observing point sources of light such as stars and quasars. If STIS is repaired, the two spectrographs working in tandem will provide astronomers a full set of spectroscopic tools for astrophysical research.

### Observations

A primary science objective for COS is to measure the structure and composition of ordinary matter concentrated in what scientists call the “cosmic web”—long, narrow filaments of galaxies and intergalactic gas separated by huge voids. The cosmic web is shaped by the gravity of the mysterious, underlying cold dark matter, while ordinary matter serves as a luminous tracery of the filaments. COS will use scores of faint distant quasars as “cosmic flashlights” whose beams of light have passed through the cosmic web. Absorption of this light by material in the web will reveal the spectral fingerprints of that material, allowing Hubble observers to deduce its composition and specific location in space.

Such observations, covering vast distances across space and back in time, will illuminate both the large-scale structure of the universe and the progressive changes in chemical composition of matter as the universe has grown older.

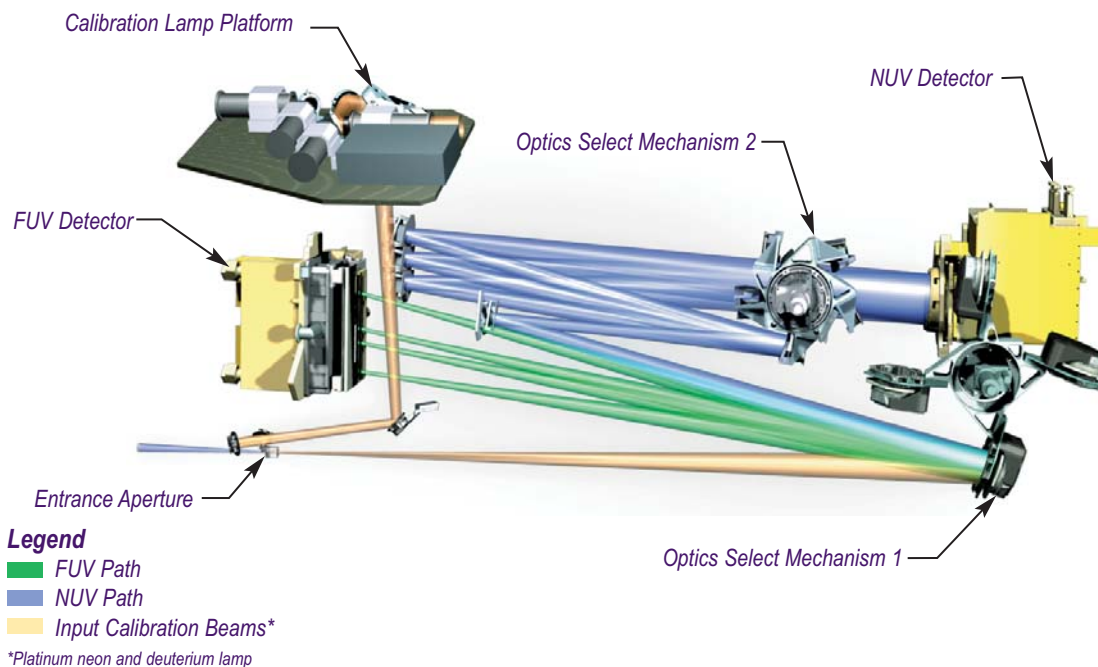

External light enters at lower left and follows a common path to the first element at lower right.

K7444\_406

COS Characteristics	FUV Channel	NUV Channel
Spectral range (nm)	115 – 205	170 – 320
Spectral resolution	16000 – 24000 medium 2000 – 3000 low	16000 – 24000 medium 2000 – 3000 low
Detector type	Cross-delay line	NUV MAMA
Detector array size (pixels)	32768 x 1024	1024 x 1024
Pixel size (microns)	6 x 24	25 x 25
Gratings	3	4
Enhancement factor over previous spectrograph	Detention of objects more than 30x fainter than with STIS	Detection of objects more than 2x fainter than with STIS

Fig. 4-6 COS optical path and channel characteristics

## Selected Science Goals

**Origin of Large-Scale Structures.** This goal uses COS's superior throughput to obtain absorption line spectra from the faint light of distant quasars as it passes through the nebulous intergalactic medium. The spectra will reveal the structure that is filtering the quasar light, thus enabling scientists to understand the hierarchal structure of the universe at its largest scales. Theories predict (and observations support) the notion of a cosmic web of structure.

COS will help determine the structure and composition of the ordinary baryonic matter concentrated in the cosmic web. Baryonic matter consists of protons and neutrons, like the atoms in our bodies. The distribution of baryonic matter over cosmic time can best be detected, ironically,

not by how much it glows (in stars and galaxies) but by how much light it blocks.

**Formation, Evolution and Ages of Galaxies.** This goal will also use quasar sightline observations. The light serves as a probe of the galactic halos through which it passes, sampling their contents. By sampling galaxies near and far, scientists will constrain galaxy evolution models and measure the production of heavy elements over cosmic time.

**Origin of Stellar and Planetary Systems.** As an instrument sensitive to UV light, COS can detect young, hot stars embedded in the clouds of gas and dust that gave rise to their birth, clarifying the phenomenon of star formation. COS will also be used to study the atmospheres of the outer planets in our solar system.



## Advanced Camera for Surveys

Astronauts installed ACS, a third-generation instrument, on HST during SM3B in 2002. The new camera was responsible for many of Hubble's most impressive images of deep space. With its wider FOV, sharper image quality and enhanced sensitivity, ACS doubled Hubble's FOV and significantly expanded its capabilities. ACS could see in wavelengths from the far ultraviolet to visible light, making it capable of studying some of the earliest activity in the universe. It was the most popular instrument for observers.

In January 2007, however, ACS experienced an electrical short that caused its three observing channels—the WFC, HRC and SBC—to cease operation. The SBC was returned to service in February 2007.

During SM4 astronauts will attempt to repair ACS by replacing the CCD Electronics Box (CEB) in the WFC. The replacement CEB will be powered by a replacement low-voltage power supply (LVPS), one completely independent of the failed unit. The replacement CEB will communicate with the WFC CCD—as well as with the rest of the instrument for command and data—via the edge connectors in the original CEB. The replacement LVPS draws power from the ACS primary power connectors, accessed via a splitter cable installed by the astronauts. While the highest priority is restoring the WFC, the ACS repair concept also provides a possible path for restoring the HRC.

ACS is a collaborative effort of Johns Hopkins University, NASA Goddard Space Flight Center, Ball Aerospace and the Space Telescope Science Institute.

The primary purpose of this third-generation instrument (see Fig. 4-7) is to increase the discovery efficiency of imaging with HST. ACS provides a combination of detector area and quantum efficiency surpassing that available from earlier instruments by a factor of 10. It consists of three independent cameras with wide-field, high-resolution and UV imaging capability and an assortment of filters designed for a broad range of scientific goals.

ACS is five times more sensitive than WFPC2 and has more than twice its viewing field. The ACS's wide-FOV, high-throughput mirrors with higher reflectivity and larger, more sensitive detectors have dramatically improved the telescope's ability to deliver valuable science data.

**Wide Field Channel.** The high sensitivity and wide field of the ACS WFC in visible and red wavelengths have made it the instrument of choice for imaging programs. Sky surveys with the WFC have studied the nature and distribution of galaxies, allowing scientists to set limits on the number of galaxies in the universe and determine the epoch of galaxy formation. Its red-light sensitivity allows the WFC to image old and distant galaxies whose spectra are redshifted due to the expansion of the universe.

**High Resolution Channel.** The ACS HRC can take extremely detailed pictures of the inner regions of galaxies and search neighboring stars for protoplanetary disks. ACS has a coronagraph that can suppress light from bright objects, enabling the HRC to observe fainter targets nearby, such as the galactic neighborhoods around bright quasars. The HRC allows astronomers to view the light at the centers of galaxies containing massive black holes as well as more prosaic galaxies, star clusters and gaseous nebulas. With its excellent spatial resolution, the HRC also can be used for high-precision photometry in stellar population programs.

**Solar Blind Channel.** The ACS SBC blocks visible light to enhance Hubble's vision in the UV portion of the spectrum. Some features—such as emission lines that indicate the presence of certain molecules—can be detected only in the UV. The SBC uses a highly sensitive photon-counting detector to enhance the visibility of these features. This channel can search for hot stars and quasars and study auroras and weather on planets in our solar system.

### Physical Description

ACS resides in an axial bay behind the HST main mirror. It is designed to provide HST with a deep, wide-field survey capability. The primary design goal of the ACS WFC is to achieve a factor of 10 improvement in discovery efficiency



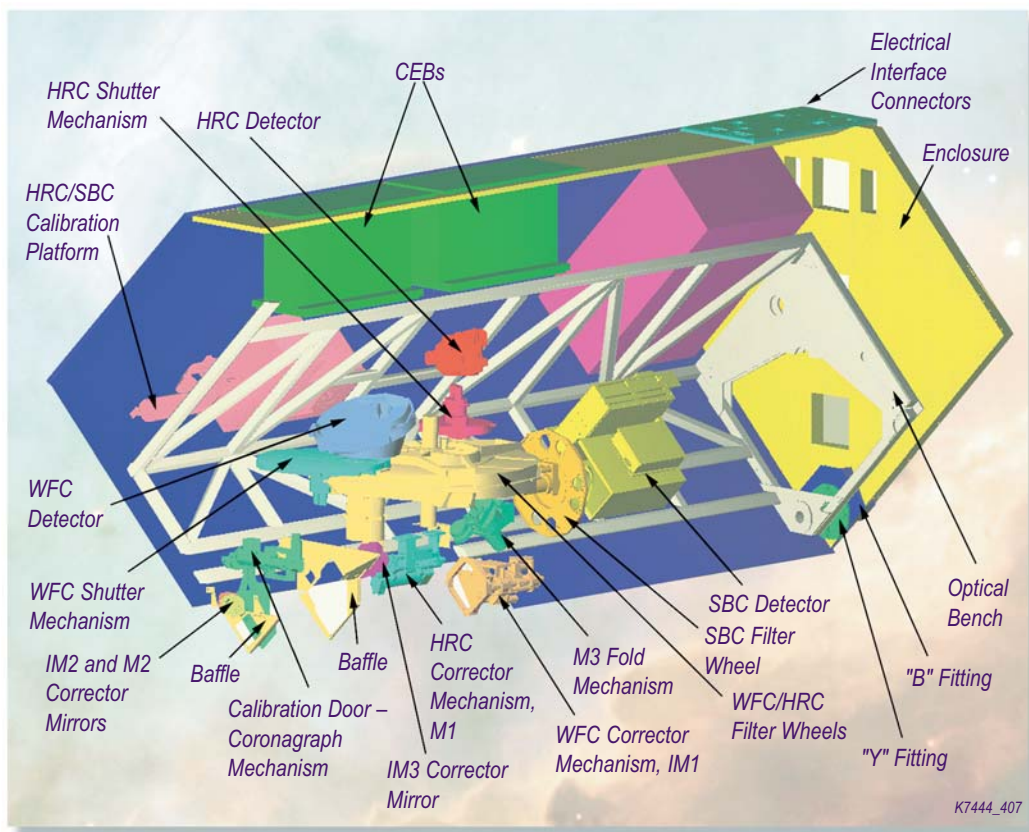

### Advanced Camera for Surveys (ACS)

Weight	875 lbs (397 kg)
Dimensions	3 x 3 x 7 feet (0.9 x 0.9 x 2.2 m)
Principal investigator	Dr. Holland Ford, Johns Hopkins University
Prime contractor	Ball Aerospace
Wavelength range	115 – 1050 nanometers

**Fig. 4-7** Advanced Camera for Surveys (ACS)

compared to WFPC2. Discovery efficiency is defined as the product of imaging area and instrument throughput.

In addition, ACS provides:

- Grism spectroscopy: low-resolution ( $R \sim 100$ ) wide-field spectroscopy from 5,500 to 11,000 Å, available in both the WFC and HRC
- Objective prism spectroscopy: low-resolution ( $R \sim 100$  at 2,000 Å) near-UV spectroscopy from 2,000 to 4,000 Å, available in the HRC
- Objective prism spectroscopy: low-resolution ( $R \sim 100$  at 1,216 Å) far-UV spectroscopy from 1,150 to 1,700 Å, available in the SBC
- Coronagraphy: aberrated beam coronagraphy in the HRC from 2,000 to 11,000 Å with 1.8 arcsecond- and 3.0 arcsecond-diameter occulting spots

- Imaging polarimetry: polarimetric imaging in the HRC and WFC with relative polarization angles of 0, 60 and 120 degrees.

### ACS Optical Design

The ACS design incorporates two main optical channels: one for the WFC and one shared by the HRC and SBC (see Fig. 4-8). Each camera has independent corrective optics to compensate for HST's spherical aberration. The WFC has three optical elements, coated with silver to optimize instrument throughput in visible light. The silver coatings cut off at wavelengths short of 3,700 Å. The WFC has two filter wheels shared with the HRC, offering the possibility of internal WFC/HRC parallel observing for some filter combinations.



Channel	Spectral Range (Nanometers)	Detector Array Size (Pixels)	Pixel Size (Microns)	Field of View (Arcsec)
Wide Field	350 – 1050	4096 x 4096	15 x 15	200 x 204
High Resolution	200 – 1050	1024 x 1024	21 x 21	26 x 29
Solar Blind	115 – 180	1024 x 1024	25 x 25	26 x 29

Fig. 4-8 ACS channel characteristics

The HRC and SBC cameras are selected by means of a plane fold mirror. To select the HRC, the fold mirror is inserted into the optical chain so that the beam is imaged onto the HRC detector through the WFC/HRC filter wheels. To select the SBC, the fold mirror is moved out of the beam to yield a two-mirror optical chain that images through the SBC filter wheel onto the SBC detector. To access the aberrated beam coronagraph, a mechanism is inserted into the HRC optical chain. This mechanism positions a substrate with two occulting spots at the aberrated telescope focal plane and an apodizer at the re-imaged exit pupil.

### Filter Wheels

ACS has three filter wheels: two shared by the WFC and HRC and one dedicated to the SBC. Each wheel also contains one clear WFC aperture and one clear HRC aperture. Parallel WFC and HRC observations are possible for some filter combinations, unless the user disables this option or the parallel observations cannot be added because of timing considerations. Note: Since the filter wheels are shared, it is not possible to independently select the filter for WFC and HRC parallel observations.

### Observations

With its wide FOV, superb image quality and exquisite sensitivity, ACS takes full advantage of Hubble's unique position as a space-based telescope. Although ACS sees in wavelengths ranging from ultraviolet to the far red (115 to 1050 nm), its principal strength is in its ability to conduct very efficient wide-field surveys of the sky at visible to red wavelengths. ACS and WFC3 are complementary, with the latter providing superior survey efficiency at UV wavelengths and superb coverage at IR wavelengths that are inaccessible to ACS. WFC3 was designed to complement and work in tandem with ACS.

Each of ACS's three specialized cameras plays a unique imaging role, enabling ACS to contribute to many different areas of astronomy and cosmology. Among the observations ACS will undertake are to:

- Search for transiting extra-solar planets and protoplanetary disks
- Observe weather and aurorae on planets in our own solar system
- Conduct vast sky surveys to study the nature and distribution of galaxies
- Probe the spatial distribution of cold dark matter and how it has changed over time
- Measure the distances and recession rate of galaxies over large look-back times to characterize dark energy
- Search for galaxies and clusters of galaxies in the early universe
- Examine the galactic neighborhoods around bright quasars.

## Near Infrared Camera and Multi-Object Spectrometer

NICMOS is a second-generation instrument installed on the HST during SM2 in 1997. Its cryogen was depleted in 1998. During SM3B in 2002, astronauts installed the NICMOS Cooling System (NCS), which utilized a new technology called a Reverse Brayton-Cycle Cryocooler (see Fig. 4-9), and NICMOS was returned to full, normal science operation. The mechanical cooler allows longer operational lifetimes than expendable cryogenic systems.

### Instrument Description

NICMOS is an all-reflective imaging system: near-room-temperature fore-optics relay images to three focal plane cameras contained in a cryogenic dewar system (see Fig. 4-10). Each camera covers the same spectral band of 0.8 to 2.5 microns with a different magnification and an



independent filter wheel. They look at different segments of the HST FOV simultaneously.

Light entering the instrument's entrance aperture falls on a flat folding mirror and is redirected to a spherical mirror. It is then re-imaged on the corrective mirror, which is mounted to an offset pointing mechanism. This mirror corrects the HST spherical aberration and also has a cylindrical deformation to correct for astigmatism in the optical path.

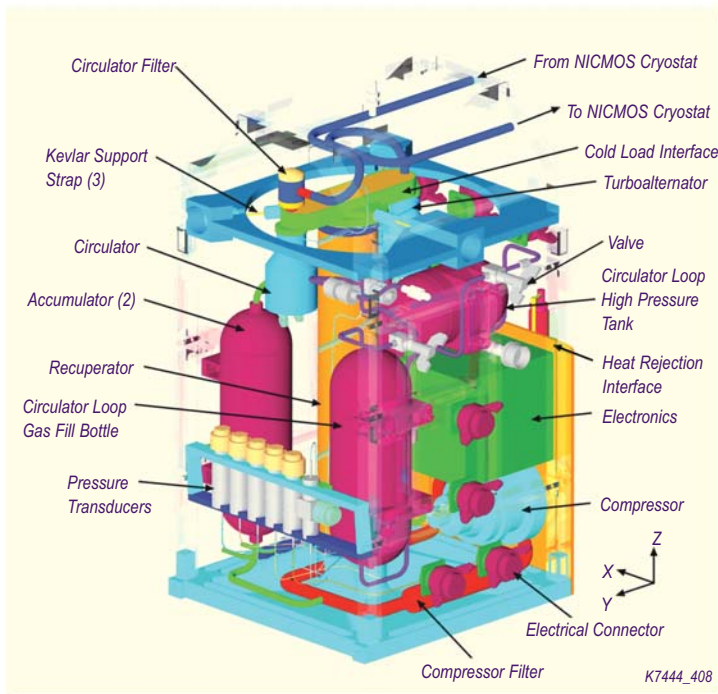
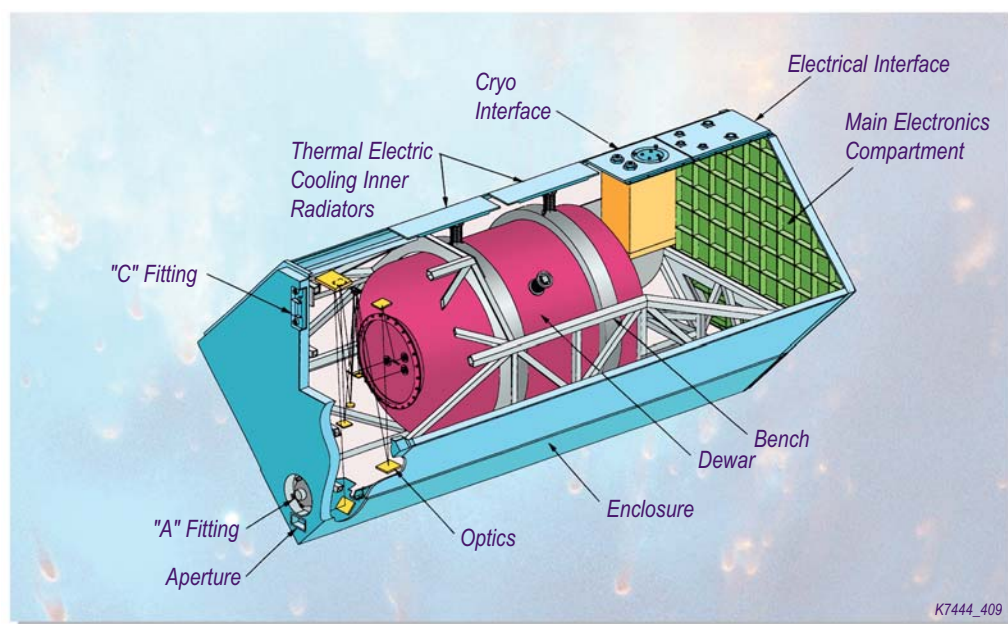

Fig. 4-9 NICMOS Cooling System (NCS)



### Near Infrared Camera and Multi-Object Spectrometer (NICMOS)

Weight	861 lbs (391 kg) in flight configuration
Dimensions	7.1 x 2.8 x 2.8 feet (2.2 x 0.88 x 0.88 m)
Principal investigator	Dr. Rodger I. Thompson, University of Arizona
Contractor	Ball Aerospace
Field of view	51.2 x 51.2 arcsec 19.2 x 19.2 arcsec 11.0 x 11.0 arcsec
Detectors	3 HgCdTe arrays 256 x 256 pixels

Fig. 4-10 Near Infrared Camera and Multi-Object Spectrometer (NICMOS)





Next the corrected image is relayed to a three-mirror field-dividing assembly, which splits the light into three separate, second-stage optical paths. In addition to the field-dividing mirror, each second-stage optic uses a two-mirror relay set and a folding flat mirror.

The field-dividing mirrors are tipped to divide the light rays by almost 4.5 degrees. The tip allows physical separation for the two-mirror relay sets for each camera and its FOV. The curvature of each mirror allows the required degree of freedom to set the exit pupil at the cold mask placed in front of the filter wheel of each camera.

A corrected image is produced in the center of the Camera 1 field mirror. Its remaining mirrors are confocal parabolas with offset axes to relay the image into the dewar with the correct magnification and minimal aberration.

Cameras 2 and 3 have different amounts of astigmatism because their fields are at different off-axis points from Camera 1. To correct the residual astigmatism, one of the off-axis relay mirrors in Camera 3 is a hyperbola and one of the relay mirrors in Camera 2 is an oblate ellipsoid. Camera 2 also allows a coronagraphic mode by placing a dark spot on its field-dividing mirror. During this mode the HST is maneuvered so that the star of observation falls within the Camera 2 field-dividing mirror and becomes occulted for coronagraphic measurements.

All the detectors are 256 x 256-pixel arrays of mercury, cadmium and tellurium (HgCdTe) with 40-micron pixel-to-pixel spacing. An independent, cold filter wheel is placed in front of each camera and is rotated by room-temperature motors placed on the external access port of the dewar.

A multilevel, flat-field illumination system corrects detector nonuniformities. The light source and associated electronics are located in the electronics section at the rear of the instrument. IR energy is routed to the optical system using a fiber bundle. The fiber bundle illuminates the rear of the corrector mirror, which is partially transparent and fits the aperture from the fiber bundle. The backside of

the element is coarsely ground to produce a diffuse source.

Three detector cables and three detector clock cables route electrical signals from the cryogen tank to the hermetic connector at the vacuum shell. The cables consist of small-diameter, stainless-steel wire mounted to a polymeric carrier film. They are shielded to minimize noise and crosstalk between channels. (Shielding is an aluminized polyester film incorporated into drain wires.) The cables also have low thermal conductivity to minimize parasitic heat loads. In addition, two unshielded cables connect to thermal sensors used during fill and for on-orbit monitoring.

Besides processing signals from and controlling the detectors, the electronics prepare data for transmission to the HST computer, respond to ground commands through the HST and control operation of the instrument. NICMOS uses an onboard 80386 microprocessor with 16 megabytes of memory for instrument operation and data handling. Two systems are provided for redundancy. The detector control electronics subsystem includes a microprocessor dedicated to operation of the focal plane array assemblies. Two microprocessors are provided for redundancy.

## Observations

NICMOS provides IR imaging and limited spectroscopic observations of astronomical targets between 1.0 and 2.5 microns.

NICMOS will be largely superceded by the NIR Channel of WFC3 at wavelengths less than 1.7 microns; however, it will continue to provide unique observing capabilities between 1.7 and about 2.5 microns.

NICMOS is well suited to the study of:

- Protostellar clouds, young star clusters and brown dwarfs ("failed stars")
- Obscured active galaxy nuclei
- Temporal changes in planetary atmospheres
- Young protogalaxies
- Protoplanetary disks.



## Space Telescope Imaging Spectrograph

STIS was installed on Hubble during SM2 in 1997 but has been in safe mode since a power failure in 2004. To repair STIS, SM4 astronauts will perform a spacewalk to replace a low-voltage power supply circuit board that contains a failed power converter. If successful, the repair effort will restore one of two fully redundant electronic chains (or “sides”) of the instrument.

Although the repair is straightforward, it requires diligence and Hubble engineers have designed special tools for the job. The astronauts will install a “fastener capture plate” over the top of a STIS electronics access panel and then use a power tool to remove the 111 fasteners (screws) that attach the panel to STIS.

The plate will ensure that the small fasteners are captured without astronauts having to grasp and stash them with gloved hands. After removing the panel (with capture plate and fasteners attached), the astronauts will remove the failed power supply card and click in the new one, much like replacing a circuit board on a computer. A new, simplified panel will then be installed over the open electronics cavity—only this time 111 fasteners will not be required. By throwing only two levers, the astronauts will latch the new panel securely into place.

STIS was developed under the direction of the principal investigator, Dr. Bruce E. Woodgate, jointly with Ball Aerospace (see Fig. 4-11). The spectrograph was designed to be versatile and efficient, taking advantage of modern technologies to provide a new two-dimensional capability to HST spectroscopy. The two

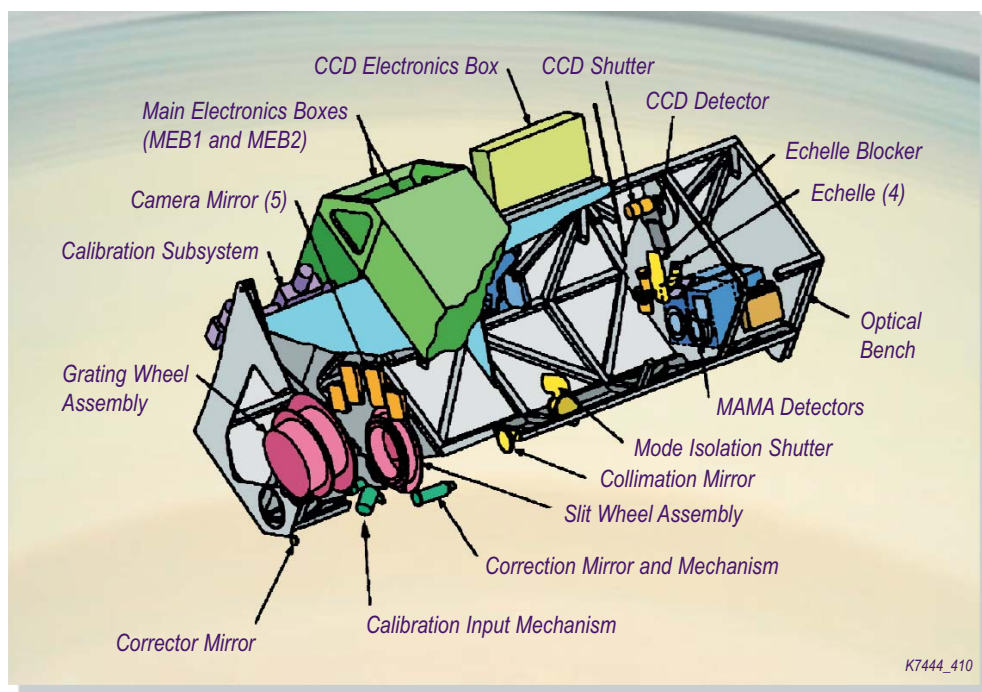

### Space Telescope Imaging Spectrograph (STIS)

Weight	825 pounds (374 kg)
Dimensions	7.1 x 2.9 x 2.9 feet (2.2 x 0.98 x 0.98 m)
Principal investigator	Dr. Bruce E. Woodgate, GSFC
Prime contractor	Ball Aerospace
Field of view	MAMA: 24.9 x 24.9 arcsec CCD: 51 x 51 arcsec
Pixel format	1024 x 1024
Wavelength range	115 – 1000 nanometers

Fig. 4-11 Space Telescope Imaging Spectrograph (STIS)



dimensions can be used either for “long slit” spectroscopy, where spectra of many different points across an object are obtained simultaneously, or in an echelle mode, at very high spectral resolution, to obtain more wavelength coverage in a single exposure. STIS also can take both UV and visible images through a limited filter set.

### Physical Description

STIS resides in an axial bay behind the HST main mirror. Externally, the instrument measures 7.1 x 2.9 x 2.9 feet (2.2 x 0.98 x 0.98 m) and weighs 825 pounds (374 kg). Internally, STIS consists of a carbon-fiber optical bench, which supports the dispersing optics and three detectors.

The spectrograph has been designed to work in three different wavelength regions, each with its own detector. Some redundancy is built into the design with overlap in the detector response and backup spectral modes. A mode selection mechanism (MSM) is used to select a wavelength region or mode. The MSM has 21 optical elements: 16 first-order gratings (including six order-sorting gratings used in the echelle modes), an objective prism and four mirrors. The optical bench supports the input corrector optics, focusing and tip/tilt motions, input slit and filter wheels, and MSM.

Light from the HST main mirror is first corrected and then brought to a focus at the slit wheel. After passing through the slit, it is collimated by a mirror onto one of the MSM optical elements. A computer selects the mode and wavelength. The MSM rotates and nutates to select the correct optical element, grating, mirror or prism and points the beam along the appropriate optical path to the correct detector.

For first-order spectra, a first-order grating is selected for the wavelength and dispersion. The beam then is pointed to a camera mirror, which focuses the spectrum onto the detector, or goes directly to the detector itself.

For an echelle spectrum, an order-sorting grating that directs the light to one of the four fixed echelle gratings is selected and the dispersed echellogram is focused

via a camera mirror onto the appropriate detector. The detectors are housed at the rear of a thermally controlled optical bench where they can easily dissipate heat through an outer panel. An onboard computer controls the detectors and mechanisms.

STIS has three detectors, each optimized for a specific wavelength region.

- Band 1, covering the wavelengths from 115 to 170 nm, uses a Multi-Anode Microchannel Plate Array (MAMA) with a cesium iodide (CsI) photocathode.
- Band 2, from 165 to 310 nm, also uses a MAMA but with a cesium telluride (CsTe) photocathode.
- Bands 3 and 4, from 305 to 555 nm and 550 to 1000 nm, use the same detector, a CCD.

**Entrance Apertures.** After a light beam passes through the corrector, it enters the spectrograph through one of several slits. The slits are mounted on a wheel and can be changed by wheel rotation.

There also are camera apertures of 50 x 50 and 25 x 25 arcsec. Some have occulting bars incorporated. The telescope can be positioned to place bright stars behind the occulting bars to allow viewing and observation of faint objects in the FOV. In addition, there is a special occulting mask or coronagraph—a finger in the aperture that can be positioned over a bright star to allow examination of any faint material nearby. In effect, it simulates a total eclipse of a nearby star. This mode is particularly useful to search for faint companion stars or planetary disks around stars.

**Mode Selection Mechanism.** The MSM is a rotating wheel with 16 first-order gratings, an objective prism and four mirrors. Its axis is a shaft with two inclined outer sleeves, one sleeve fitting inside the other. The sleeves are constructed so that rotation of one sleeve turns a wheel to orient the appropriate optic into the beam. Rotation of the second sleeve changes the inclination of the wheel axis or the tilt of the optic to select the wavelength range and point the dispersed beam to the corresponding detector. One of three mirrors can be selected to take an image of an object.





**Multi-Anode Microchannel Plate Array Detectors.** For UV modes, STIS employs two types of MAMA detectors. A photocathode optimizes each detector to its wavelength region. Each detector's photocathode provides maximum sensitivity in the wavelength region selected while it rejects visible light not required for the observations.

The heart of each MAMA detector is a microchannel plate (MCP)—a thin disk of glass approximately 1.5 mm thick and 5 cm in diameter that is honeycombed with small (12.5-micron) holes or pores. The front and back surfaces are metal coated. When a voltage is applied across the plate, an electron entering any pore is accelerated by the electric field. It eventually collides with the wall of the pore, giving up its kinetic energy to liberate two or more secondary electrons. (The walls are treated to enhance the secondary electron production effect.) The secondary electrons continue down the pore and collide with the wall, emitting more electrons, and so the process continues, producing a cascade of a million electrons at the end of the pore.

The anode array is a complex fingerlike pattern. When electrons strike certain anodes, a signal is sent to the computer memory indicating the position and time of arrival of the photon.

Only 132 circuits are required to read out all 1024 x 1024 pixels (picture elements) in the anode array. As the MAMA records the arrival of each photon, it can provide a time sequence. For instance, if an object is varying in time, like a pulsar, the data can be displayed to show if there is any periodicity. To create an image, data must be integrated in the computer memory before they are displayed. The MAMA data are recorded to a time resolution of 125 microseconds.

When used in the normal mode, each detector has 1024 x 1024 pixels, each 25 x 25 microns square. However, data received from the anode array can be interpolated to give a higher resolution, splitting each pixel into four 12.5 x 12.5-micron pixels. This is known as the high-resolution mode. It provides higher spatial resolution for looking at fine structural details of an object and ensures full

sampling of the optical images and spectra. Data taken in high-resolution mode can be transformed to normal resolution.

**Charge-Coupled Detector.** The STIS CCD was developed at Scientific Imaging Technologies (SITe) with GSFC and Ball input. Fabricated using integrated circuit technology, the detector consists of light-sensitive pixels deposited onto a thin wafer of crystalline silicon. Each element is 21 x 21 microns. The elements are arranged 1024 to a row in 1024 columns for a total of 1,048,576 pixels.

Each element acts as a small capacitance. As light falls on a pixel, it liberates electrons, which effectively charge the capacitance. The number of electrons stored is then proportional to the intensity or brightness of the light received. The charge in each pixel can be read out by applying a small voltage across the chip.

The CCD is most sensitive to red light, but the STIS chip has been enhanced through a "backside treatment" to provide a usable sensitivity in the near-UV. It is sensitive from approximately 200 nm to the NIR at 1000 nm.

The CCD can make exposures ranging from 0.1 seconds to 60 minutes. In space, above Earth's protective atmosphere, radiation from cosmic rays is higher than at Earth's surface. CCDs are sensitive to cosmic rays, which can produce large numbers of electrons in the pixels. For this reason, two shorter exposures of up to one hour are made. Comparison of the frames allows cosmic ray effects to be subtracted.

**Imaging Operational Modes.** STIS can be used to acquire an image of an object in UV or visible light. To do this, an open aperture is selected and a mirror placed in the beam by the MSM. The instrument has nine filters that can be selected. The cameras for the CCD and the MAMAs have different magnification factors. The FOV is 25 x 25 arcsec for the MAMAs and 50 x 50 arcsec for the CCD.

**Target Acquisition.** Normally an object is acquired using the CCD camera with a 50 x 50-arcsec field. Two short exposures are taken to enable subtraction of cosmic rays. The HST FGSs have a pointing



accuracy of  $\pm 2$  arcsec and the target usually is easily identifiable in the field. Once identified, an object is positioned via small angle maneuvers to the center of the chosen science mode slit position. Two more exposures are made, the calibration lamp is flashed through the slit to confirm the exact slit position and a further peak up on the image is performed. Acquisition can take up to 20 minutes.

**Data Acquisition.** The MAMAs take data in the high-resolution mode. For normal imaging and spectroscopy, the data are integrated in the onboard computer and stored in this format on the solid-state recorders for later downlink. The MAMAs also have a time-tag mode, where each photon is stored individually with its arrival time and location ( $x, y, t$ ). The data initially are stored in a 16-megabyte memory, then downloaded into the onboard recorder. The time-tag mode has a time resolution of 125 microseconds.

### Observations

Astronomers have used STIS in many investigations. Among them are to:

- Search for massive black holes by studying star and gas dynamics around the centers of galaxies
- Map fine details of planets, nebulae, galaxies and other objects
- Measure the chemical composition of the atmospheres of transiting extra-solar planets
- Obtain physical diagnostics, such as chemical composition, temperature, density and velocity of rotation or internal mass motions in planets, comets, stars, interstellar gas, nebulae, stellar ejecta, galaxies and quasars.

STIS performed brilliantly for 7.5 years before suspending operations in 2004 and its scientific potential is far from exhausted. Working side by side, COS and STIS will offer a full set of spectroscopic tools for astronomers. Each instrument partly backs up the other while providing its own unique capabilities.

## Astrometry (Fine Guidance Sensors)

When two FGSs lock on guide stars to provide pointing information for the telescope, the third FGS serves as a science instrument to measure the position of stars in relation to other stars. This astrometry helps astronomers determine stellar masses and distances.

Fabricated by Raytheon Optical Systems Inc., the sensors are in the focal plane structure, at right angles to the optical path of the telescope and 90 degrees apart. They have pickoff mirrors to deflect incoming light into their apertures (see page 5-22 for details.)

Each refurbished FGS has been upgraded by the addition of an adjustable fold mirror that allows HST's optical beam to be properly aligned to the internal optics of the FGS by ground command. The first-generation FGSs did not contain this feature and their optical performance suffered as a result of the telescope's unanticipated spherical aberration (see Figure 4-12).

During SM2 in 1997 and SM3A in 1999, re-certified FGSs were installed in the HST FGS Bay 1 and Bay 2, respectively. During SM4, the third re-certified FGS will be installed in Bay 2, replacing the FGS installed during SM3A, to correct a light-emitting diode degradation problem.

The FGS chosen to be the "astrometer FGS" is the one that has the best performance. Currently, that role is filled by the FGS in Bay 1. It is likely that it will continue as the astrometer FGS.

### Operational Modes for Astrometry

Astrometric observations of binary stars provide information about stellar masses that is important to understanding the evolution of stars. Once the two target-acquisition FGSs lock onto guide stars, the third sensor can perform astrometric operations on targets within the FOV set by the guide stars' positions. The sensor can measure stars as faint as 18 apparent visual magnitude.

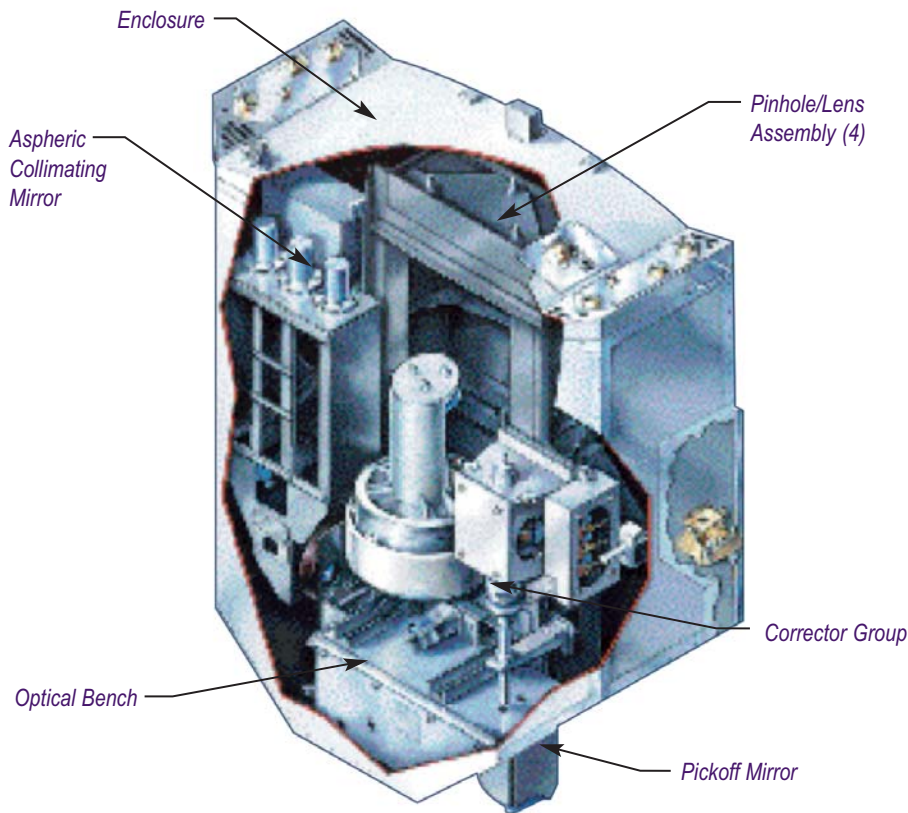

K7444\_411

### Fine Guidance Sensor (FGS)

Weight	485 pounds (220 kg)
Dimensions	1.6 x 3.3 x 5.4 feet (0.5 x 1 x 1.6 m)
Contractor	Raytheon Optical Systems
Astrometric modes	Stationary and moving target, scan
Precision	0.002 arcsec <sup>2</sup>
Measurement speed	10 stars in 10 minutes
Field of view	Access: 60 arcmin <sup>2</sup> Detect: 5 arcsec
Magnitude range	4 to 18.5 m <sub>v</sub>
Wavelength range	4670 – 7000 angstroms

**Fig. 4-12** Fine Guidance Sensor (FGS)

There are three operational modes for astrometric observations:

- Position
- Transfer-function
- Moving-target.

**Position mode** allows the astrometric FGS to calculate the angular position of a star relative to the guide stars. Generally, up to 10 stars are measured within a 20-minute span.

In the **transfer-function mode**, sensors measure the angular size of a target,

either through direct analysis of a single-point object or by scanning an extended target. Examples of the latter include solar system planets, double stars and targets surrounded by nebulous gases.

In **moving-target mode**, sensors measure a rapidly moving target relative to other targets when it is impossible to precisely lock onto the moving target, for example, measuring the angular position of a moon relative to its parent planet.





## Fine Guidance Sensor Filter Wheel

Each FGS has a filter wheel for astrometric measurement of stars with different brightness and colors and to classify the stars being observed. The wheel has a clear filter for guide-star acquisition and faint-star (greater than 13 apparent visual magnitude) astrometry. A neutral-density filter is used for observation of nearby bright stars. Two colored filters are used to estimate a target's color (temperature) index, increasing contrast between close stars of different colors or reducing background light from star nebosity.

## Astrometric Observations

Astronomers measure the distance to a star by charting its location on two sightings from Earth at different times, normally six months apart. Earth's orbit changes the perceived (apparent) location of the nearby star and the parallax angle between the two locations can lead to an estimate of the star's distance. Because stars are so distant, the parallax angle is very small, requiring a precise FOV to calculate the angle. Even with the precision of the FGSs, astronomers cannot measure distances by the parallax method beyond nearby stars in the Milky Way galaxy.

An important goal of the FGS astrometry project is to obtain improved distances to fundamental distance calibrators in the universe, for instance, to the Hyades star cluster. This is one of the foundations of the entire astronomical distance scale. Knowing the accurate distance to the Hyades makes it possible for astronomers to infer accurate distances to similar stars that are too distant for the direct parallax method to work.

Astronomers have found more than 250 nearby stars that have planetary systems, most of which are unlike our own solar system. Unfortunately, the great distances of stars and the relative faintness of their planets make it very difficult to detect such systems directly. Ground-based observers detect extra-solar planets around nearby stars by looking for the subtle radial motions, back and forth along our line of sight, caused by the gravitational pull that planets exert on the stars they are orbiting. The HST's FGS astrometer has been used to measure very precisely the tiny motions of stars perpendicular (tangential) to our line of sight due to this same gravitational tug of surrounding planets. Combining the radial and tangential motions leads to a well-established determination of the orbits of the planets and thus their masses.

Astronomers use the FGS in two modes of operation to investigate known and suspected binary star systems. Their observations lead to the determination of the orbits and parallaxes of the binary stars and therefore to the masses of these systems. For example, 40 stars in the Hyades cluster were observed with the FGS. Ten of the targets were discovered to be binary star systems and one of them has an orbital period of 3.5 years.

Other objects, such as nearby M dwarf stars with suspected low-mass companions, are being investigated with the FGS with the hope of improving the mass/luminosity relationship at the lower end of the main sequence.

# Media Reference Guide HST Systems





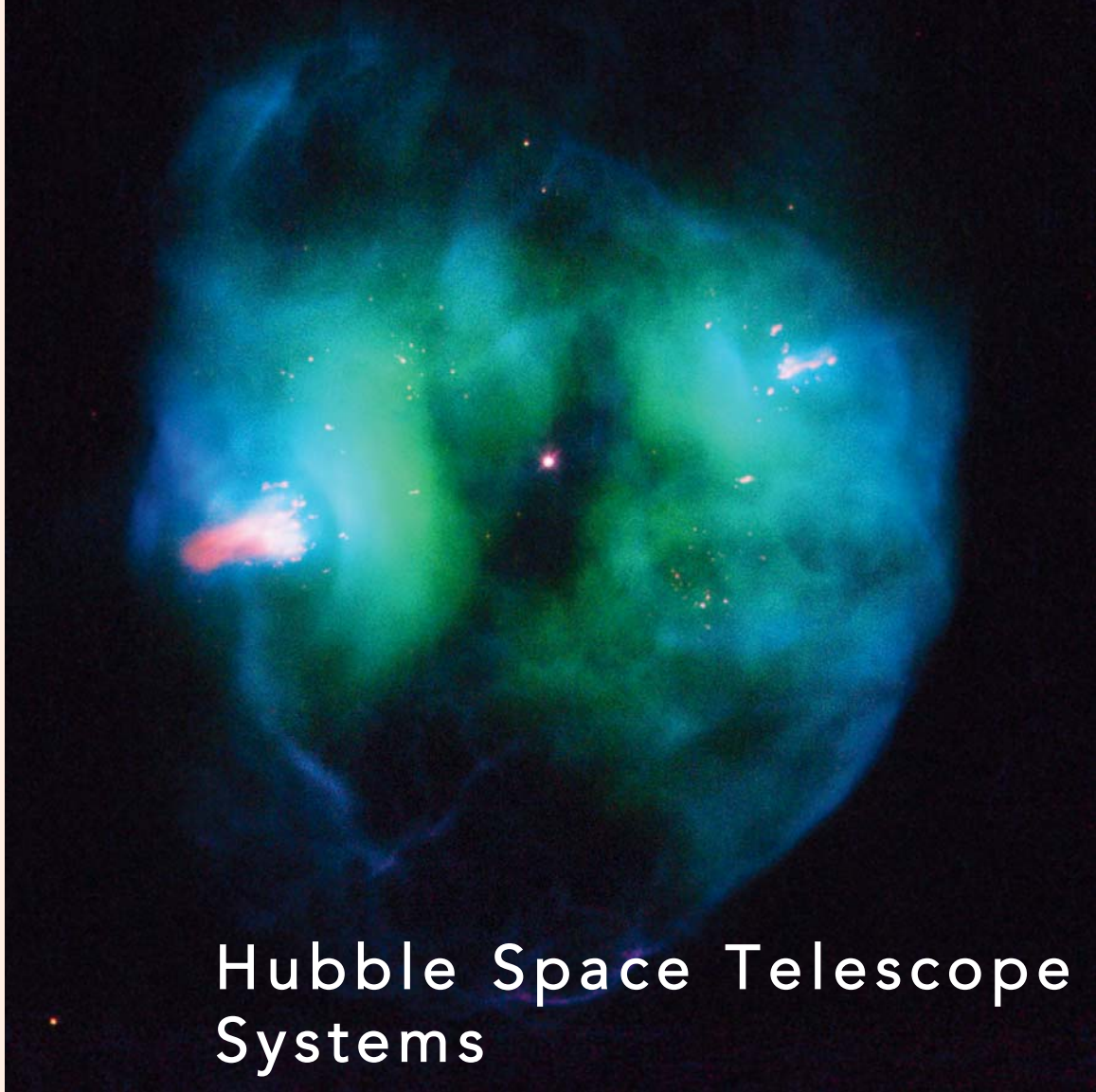

# Hubble Space Telescope Systems

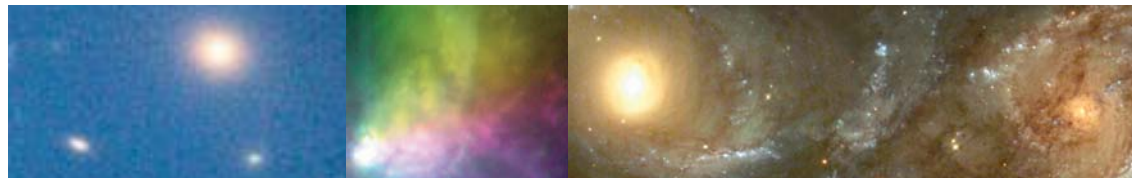

**H**ubble Space Telescope (HST) performs much like a ground-based astronomical observatory. It has three interacting systems:

- Support Systems Module (SSM), an outer structure that houses the other systems and provides services such as electrical power, data communications, pointing control and maneuvering.
- Optical Telescope Assembly (OTA), which collects and concentrates incoming light in the focal plane for use by the science instruments.
- Five major science instruments and three Fine Guidance Sensors (FGSs). The four axial science instruments are housed in an aft section Focal Plane Structure (FPS). The lone radial science instrument and three FGSs are located along the circumference of the spacecraft. The Science Instrument Command and Data Handling (SI C&DH) unit controls all the instruments.





The SSM communicates with the OTA, SI C&DH unit and instruments to ready an observation. Light from an observed target passes through the telescope and into one or more of the science instruments, where the light is recorded. This information goes to onboard computers for processing, then it is either temporarily stored or sent to Earth in real time, via the spacecraft communications system.

Two Solar Arrays (SA) also support HST operations. They generate electrical power for charging onboard batteries and powering the HST systems during the sunlit portion of each orbit.

Figure 5-1 shows the HST configuration.

The telescope completes one orbit every 96 minutes and maintains its orbital position along three axial planes. The primary axis, V1, runs through the center of the telescope. The other two axes parallel the SA masts (V2) and the high gain antenna (HGA) masts (V3) (see Fig. 5-2). The telescope points and maneuvers to new targets by rotating about its body axes. Pointing instruments use references to these axes to aim at a target in space, position the SA or change telescope orientation in orbit.

## Support Systems Module

Design features of the SSM include:

- An outer structure of interlocking shells
- Reaction wheels and magnetic torquers to maneuver, orient and attitude stabilize the telescope
- Two SAs to generate electrical power
- Communications antennas
- A ring of Equipment Section bays that contain electronic components, such as batteries, and communications equipment. (Additional bays are provided on the +V3 side of the spacecraft to house OTA electronics as described on page 5-21, OTA Equipment Section.)
- Computers to operate the spacecraft systems and handle data
- Reflective surfaces and heaters for thermal protection
- Outer doors, latches, handrails and footholds designed for astronaut use during on-orbit maintenance.

Figure 5-3 shows some of these features.

Major subsystems of the SSM are:

- Structures and Mechanisms
- Instrumentation and Communications

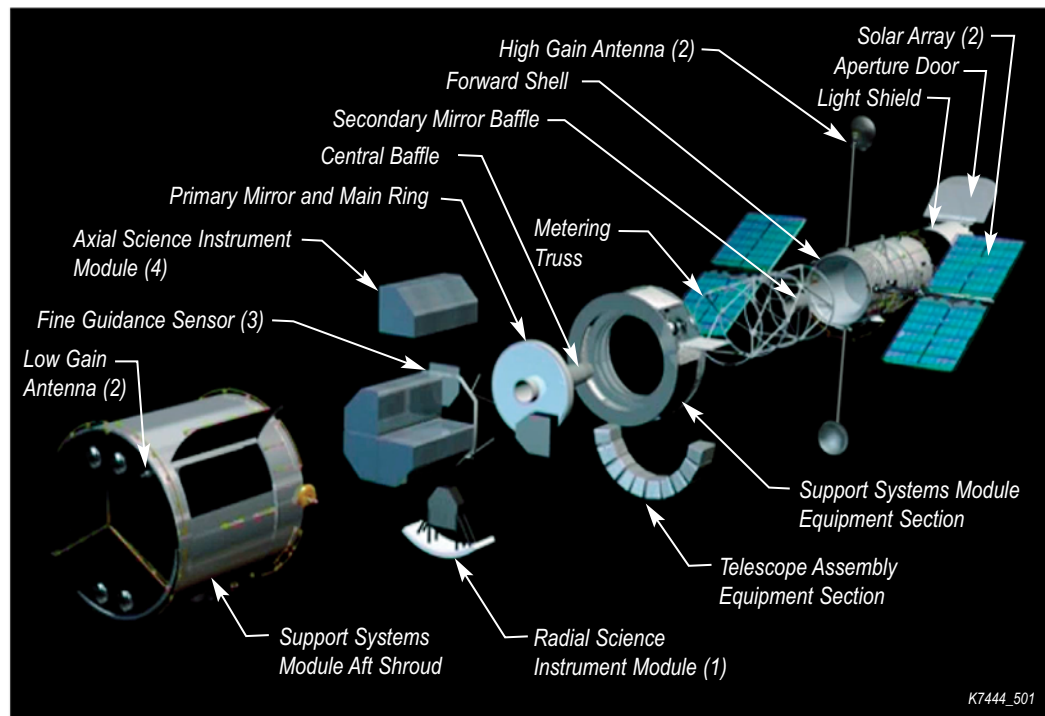

Fig. 5-1 Hubble Space Telescope – exploded view

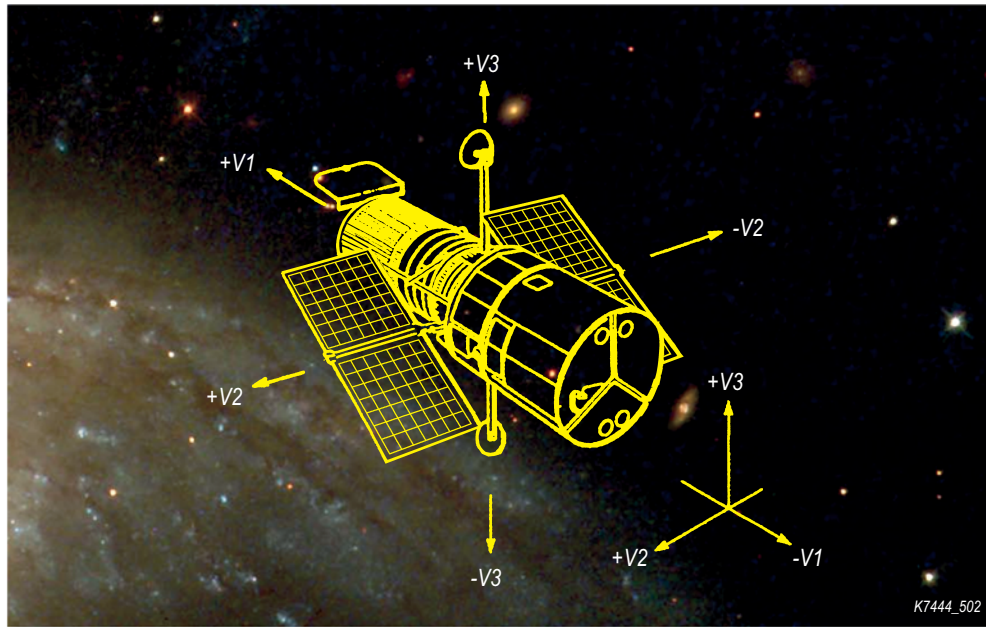

Fig. 5-2 Hubble Space Telescope axes

- Data Management
- Pointing Control
- Electrical Power
- Thermal Control
- Safing (contingency).

### Structures and Mechanisms Subsystem

The outer structure of the SSM consists of stacked cylinders, with the aperture door on top and the aft bulkhead at the bottom.

Fitting together are the light shield, the forward shell, the SSM Equipment Section and the aft shroud/bulkhead (see Fig. 5-4).

**Aperture Door.** A door approximately 10 feet (3 m) in diameter covers the opening to the telescope's light shield. The door is made from honeycombed aluminum sheets. The outside is covered with solar-reflecting material and the inside is painted flat black to absorb stray light.

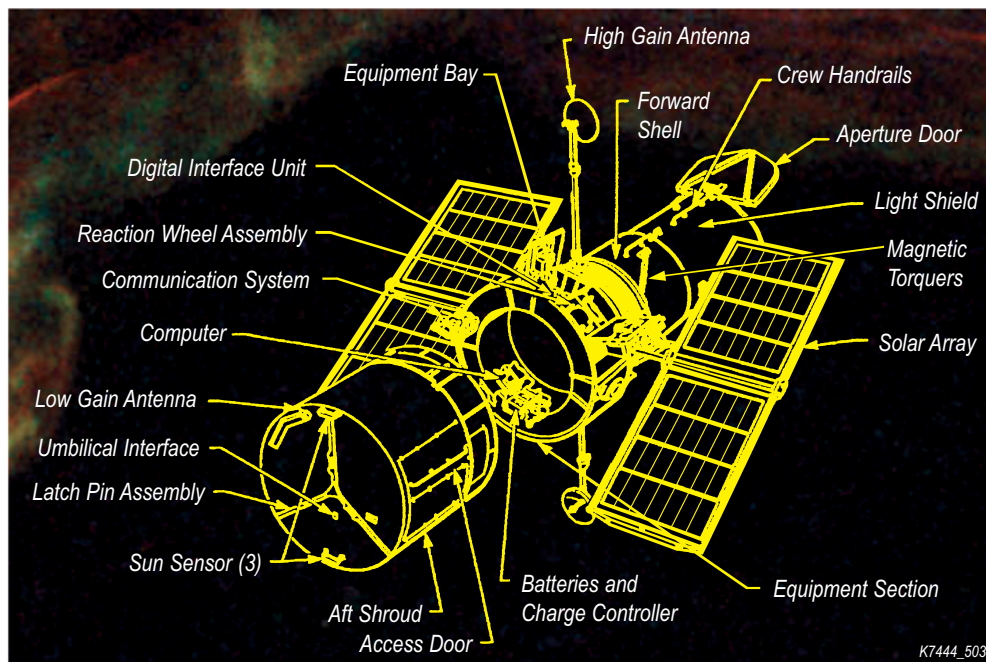
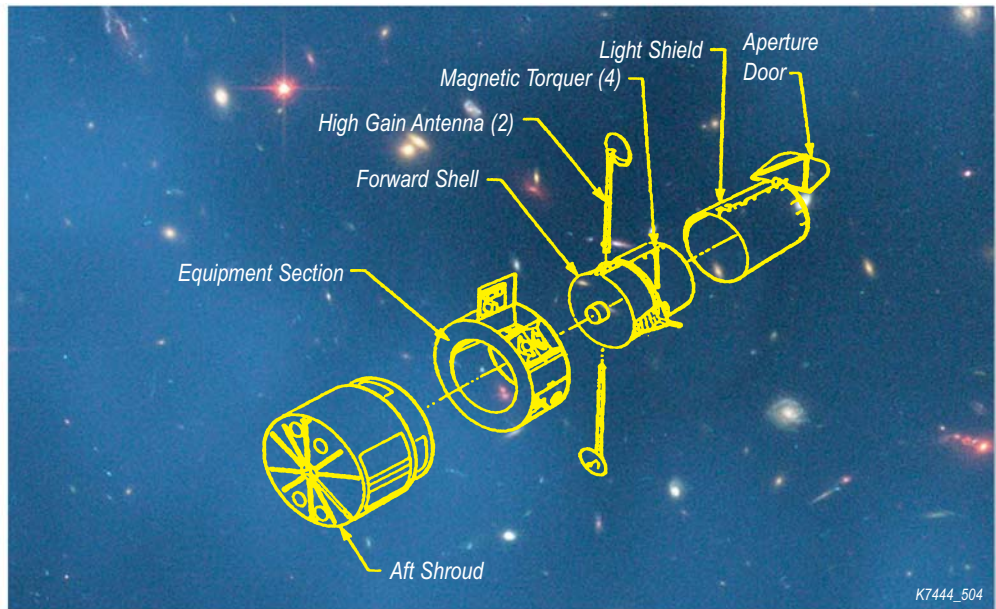

Fig. 5-3 Design features of Support Systems Module



**Fig. 5-4** Structural components of Support Systems Module

From the closed position, the door opens a maximum of 105 degrees. The telescope aperture allows for a 50-degree field of view (FOV) centered on the +V1 axis. Sun-avoidance sensors provide ample warning to automatically close the door before sunlight can damage the telescope's optics. The door begins closing when the sun is within  $\pm 35$  degrees of the +V1 axis and is closed by the time the sun reaches 20 degrees of +V1. This takes no longer than 60 seconds.

The Space Telescope Operations Control Center (STOCC) can override the protective door-closing mechanism for observa-

tions that fall within the 20-degree limit. An example is observing a bright object, using the dark limb (edge) of the moon to partially block the light.

**Light Shield.** Used to block out stray light, the light shield (see Figs. 5-4 and 5-5) connects to both the aperture door and the forward shell. The outer shell of the telescope has latches to secure the HGAs when they are stowed. A pair of scuff plates—large protective metal plates on struts that extend approximately 30 inches from the surface of the spacecraft—are attached to the +V2 and -V2 sides of the light shield. For launch,

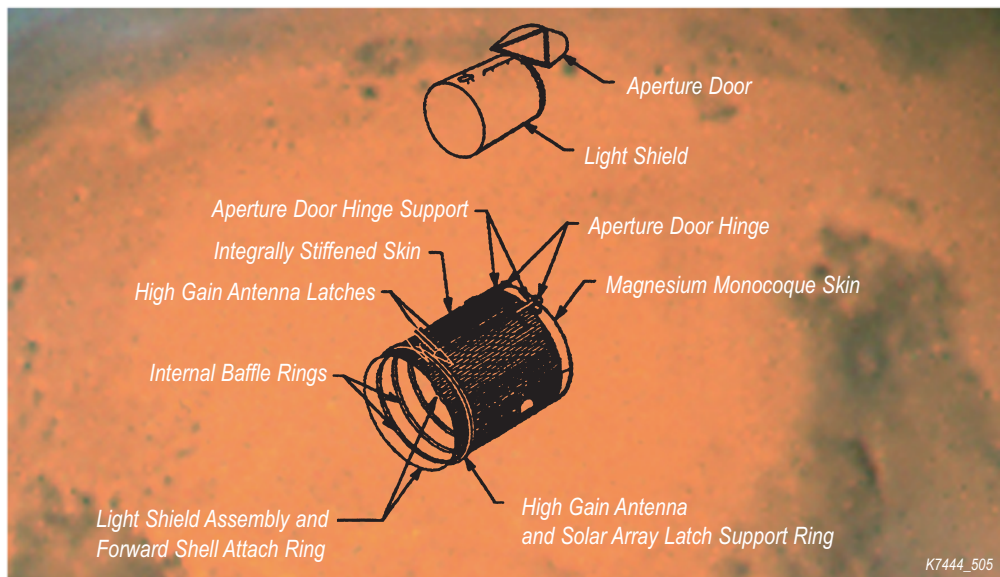

**Fig. 5-5** Aperture door and light shield





trunnions locked the telescope into the Shuttle cargo bay by hooking to latches in the bay. The light shield supports the forward low gain antenna (LGA) and its communications waveguide, two magnetometers and two sun sensors. Handrails encircle the light shield and built-in foot restraints support the astronauts working on the telescope.

The shield measures 13 feet (4 m) long and 10 feet (3 m) in internal diameter. It is a stiffened, corrugated-skin barrel machined from magnesium and covered by a thermal blanket. Internally the shield has 10 light baffles, painted flat black to suppress stray light.

**Forward Shell.** The forward shell, or central section of the structure, houses the OTA main baffle and the secondary mirror (see Fig. 5-6). When stowed, HGAs are latched flat against the forward shell and light shield. Four magnetic torquers are placed 90 degrees apart around the circumference of the forward shell. The outer shell has two grapple fixtures next to the -V3 HGA drive, where the Shuttle's Remote Manipulator System (RMS) can attach to the telescope. The forward shell also has handholds, footholds and a trunnion, which was used to lock the telescope into the Shuttle cargo bay for launch.

Machined from aluminum plating, the forward shell is 13 feet (4 m) long and 10 feet (3 m) in diameter. It has internal stiffened panels and external reinforcing rings. These rings are on the outside to ensure clearance for the OTA inside. Thermal blankets cover the exterior.

**Equipment Section.** This section is a ring of storage bays encircling the SSM that fits between the forward shell and aft shroud. It contains about 90 percent of the electronic components that run the spacecraft, including equipment serviced during extravehicular activities (EVA).

A forward frame panel and aft bulkhead enclose the Equipment Section. Six mounts on the inside of the bulkhead hold the OTA.

The Equipment Section contains 10 bays for equipment and two bays to support aft trunnion pins and scuff plates:

1. Bay 8 – pointing control and safemode hardware
2. Bay 9 – reaction wheel assembly (RWA)
3. Bay 10 – SI C&DH unit
4. Unnumbered trunnion support bay
5. Bay 1 – data management hardware
6. Bays 2, 3 and 4 – electrical power equipment
7. Unnumbered trunnion support bay
8. Bay 5 – communications hardware
9. Bay 6 – RWA
10. Bay 7 – mechanism control hardware.

The cross section of the bays is shaped like a trapezoid: the outer diameter (the door) is 3.6 feet (1 m) and the inner diameter is 2.6 feet (0.78 m). The bays are 4 feet (1.2 m) wide and 5 feet (1.5 m) deep. The Equipment Section is constructed of machined and stiffened aluminum frame panels attached to an inner aluminum barrel. Eight bays have flat, honeycombed aluminum doors mounted with equipment. In Bays 6 and 9, thermal-stiffened panel doors cover the reaction wheels.

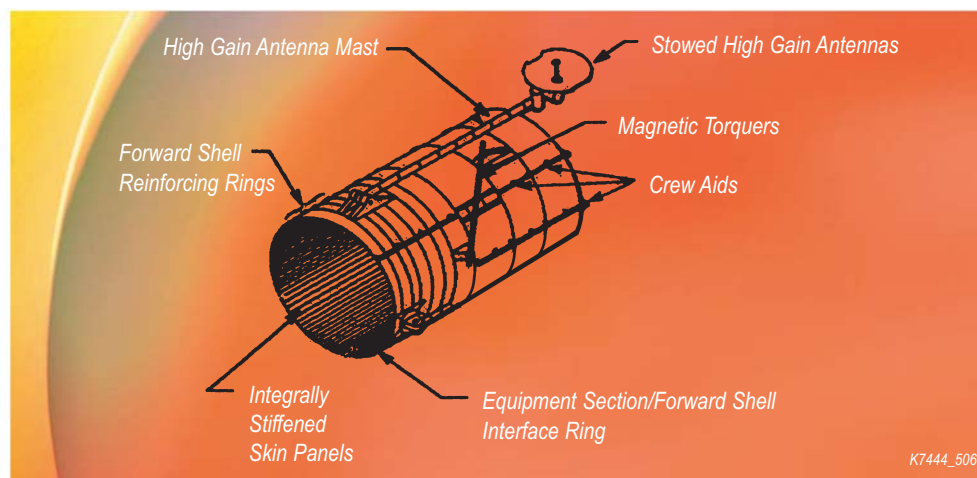

Fig. 5-6 Support Systems Module forward shell



**Aft Shroud and Bulkhead.** The aft shroud (see Fig. 5-7) houses the FPS containing the axial science instruments.

In the post-Servicing Mission 4 (SM4) configuration, the three FGSs and the Wide Field Camera 3 (WFC3) are housed radially near the connecting point between the aft shroud and SSM Equipment Section. Doors on the outside of the shroud allow astronauts to remove and change equipment and instruments easily. Handrails and foot restraints for the crew run along the length and circumference of the shroud. During maintenance or removal of an instrument, interior lights illuminate the compartments containing the science instruments. The shroud is made of aluminum—with a stiffened skin, internal panels and reinforcing rings—and 16 external and internal longeron bars for support. It is 11.5 feet (3.5 m) long and 14 feet (4.3 m) in diameter.

The aft bulkhead contains the umbilical connections between the telescope and the Shuttle, used during on-orbit maintenance. The rear LGA attaches to the bulkhead, which is made of 2-inch-thick honeycombed aluminum panels and has three radial aluminum support beams. The shroud and bulkhead support a gas

purge system that was used to prevent contamination of the science instruments before launch. All vents used to expel gases are light tight to prevent stray light from entering the OTA focal plane.

**Mechanisms.** Along the SSM structure are mechanisms that perform various functions, including:

- Latches to hold antennas
- Hinge drives to open the aperture door and erect antennas
- Gimbals to move the HGA dishes
- Motors to power the hinges and latches and to rotate arrays and antennas.

There are nine latches: four for antennas, four for arrays (no longer used because the roll-up arrays were replaced by rigid SAs on SM3B) and one for the aperture door. They latch and release using four-bar linkages. Stepper motors called rotary drive actuators (RDA) drive the latches.

There are three hinge drives, one for each HGA and one for the door. The hinges also use an RDA. Both hinges and latches have hex-wrench fittings so an astronaut can manually operate the mechanism to deploy the door or an antenna if a motor fails.

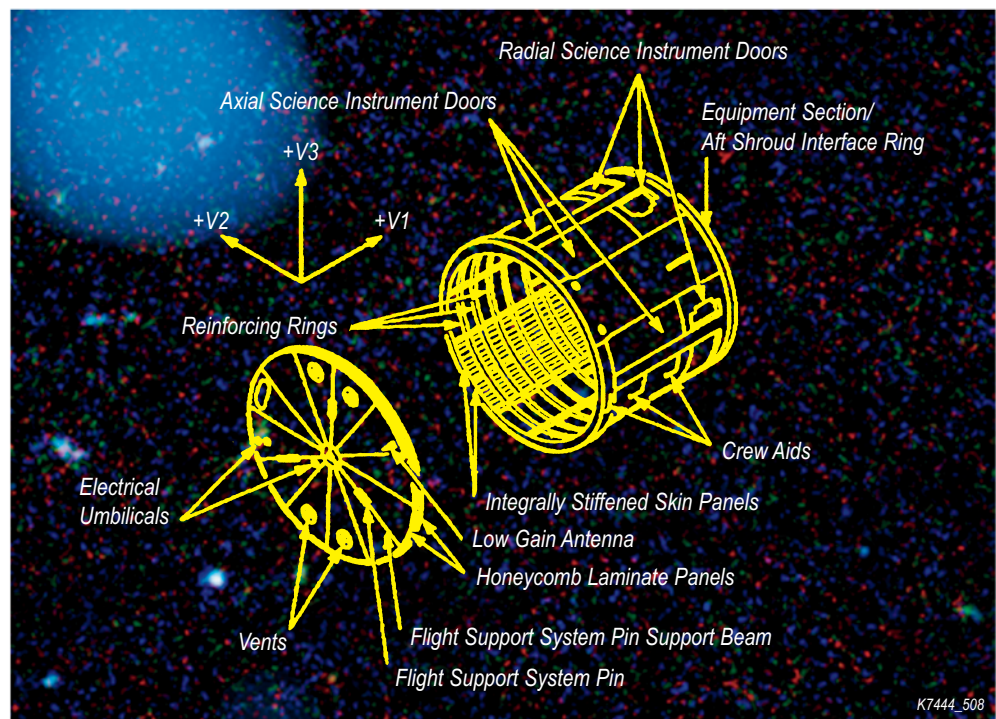

**Fig. 5-7** Support Systems Module aft shroud and bulkhead



## Instrumentation and Communications Subsystem

This subsystem provides the communications loop between the telescope and the Tracking and Data Relay Satellites (TDRS), receiving commands and sending data through the HGAs and LGAs. All information passes through the Data Management Subsystem (DMS).

**S-Band Single Access Transmitter (SSAT).** HST is equipped with two SSATs. “S-band” identifies the frequency at which the science data is transmitted and “single access” specifies the type of antenna on the TDRS satellite to which the data are sent.

**High Gain Antennas.** Each HGA is a parabolic reflector (dish) mounted on a mast with a two-axis gimbal mechanism and electronics to rotate it 100 degrees in either direction. The antenna dishes were designed and manufactured using honeycomb aluminum and graphite-epoxy facesheets.

The HGAs achieve a much higher radio frequency (RF) signal gain than the LGAs. The higher signal gain is required, for example, when transmitting high-data-rate scientific data. Because of their characteristically narrow beam widths, the HGAs must be pointed at the TDRSs. Each antenna can be aimed with a one-degree pointing accuracy. This accuracy is consistent with the overall antenna beam width of more than four degrees. The antennas transmit over two frequencies: 2255.5 MHz or 2287.5 MHz (plus or minus 10 MHz).

**Low Gain Antennas.** The LGAs are spiral cones that provide spherical (omnidirectional) coverage. They are set 180 degrees apart on the light shield and aft bulkhead of the spacecraft.

Operating in a frequency range of 2100 MHz to 2300 MHz, the LGAs receive ground commands and transmit engineering data. These antennas are used for all commanding of the telescope and for low-data-rate telemetry, particularly during telescope deployment or retrieval on orbit and during safemode operations.

## Data Management Subsystem

The DMS receives commands from the STOCC and data from the SSM systems, OTA and science instruments. It processes, stores and sends the information as requested (see Fig. 5-8).

Subsystem components are:

- Advanced Computer
- Data Management Unit (DMU)
- Four Data Interface Units (DIU)
- Three engineering/science data recorders
- Two oscillators (clocks).

The components are located in the SSM Equipment Section, except for one DIU stored in the OTA Equipment Section.

The DMS receives, processes and transmits five types of signals:

1. Ground commands sent to HST systems
2. Onboard computer-generated or computer-stored commands
3. Scientific data from the SI C&DH unit
4. Telescope engineering status data for telemetry
5. System outputs, such as clock signals and safemode signals.

**Advanced Computer.** The Advanced Computer is a general-purpose digital computer for onboard engineering computations. It executes stored commands, formats status data (telemetry), generates onboard commands to orient the SAs toward the sun, evaluates the health status of the telescope systems and commands the HGAs. It also performs all Pointing Control Subsystem (PCS) computations to maneuver, point and attitude stabilize the telescope.

Based on the Intel 80486 microchip, the Advanced Computer operates 20 times faster and has six times as much memory as the DF-224 computer, which it replaced on SM3A. It is configured as three independent single-board computers (SBC). Each SBC has 2 megabytes of fast static random access memory and 1 megabyte of non-volatile memory.



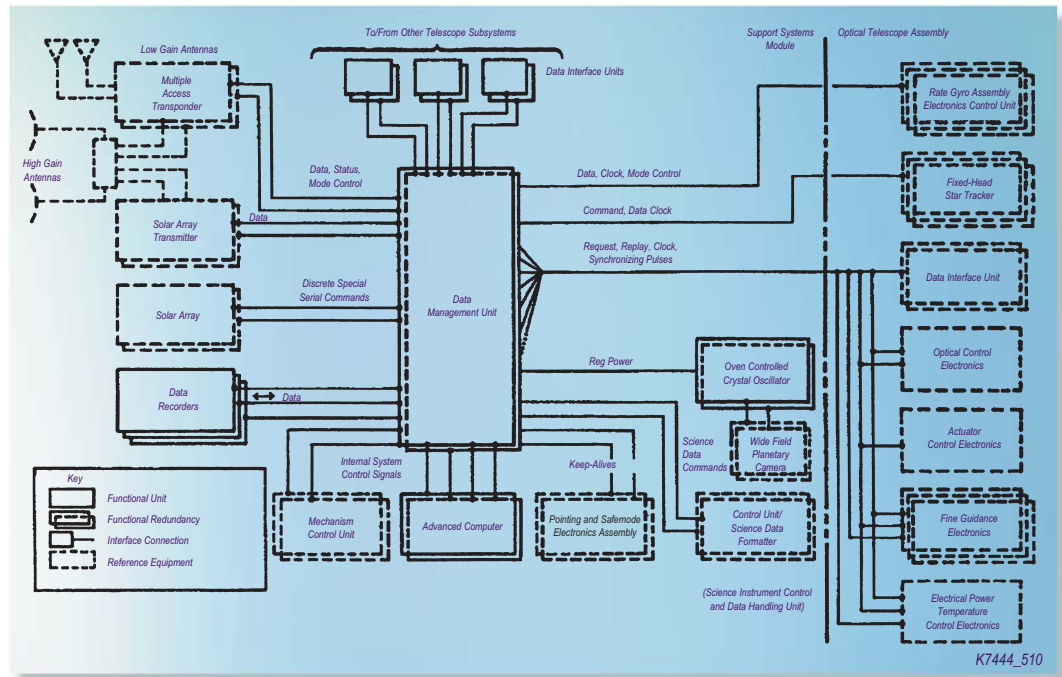

Fig. 5-8 Data Management Subsystem functional block diagram

The Advanced Computer communicates with the HST by using the direct memory access capability on each SBC through the DMU. Only one SBC controls the telescope at a time. The other SBCs can be off, in an idle state or performing internal tasks.

Upon power on, each SBC runs a built-in self-test and then copies the operating software from slower non-volatile memory to faster random access memory. The self-test can diagnose any problems with the Advanced Computer and report them to the ground. The Advanced Computer uses fast static random access memory to eliminate wait states and allow it to run at its full-rated speed.

The Advanced Computer (see Fig. 5-9) measures 18.8 x 18 x 13 inches (0.48 x 0.46 x 0.33 m) and weighs 70.5 pounds (32 kg). It is located in Bay 1 of the SSM Equipment Section.

**Data Management Unit.** The DMU links with the computer. It encodes data and sends messages to selected telescope units and all DMS units, powers the oscillators and serves as the central timing source. The DMU also receives and decodes all incoming commands, then transmits each processed command to be executed.

In addition, the DMU receives science data from the SI C&DH unit. Engineering data, consisting of sensor and hardware status readings (such as temperature or voltages), come from each telescope subsystem. The data can be stored in the onboard data recorders if direct telemetry via a TDRS is unavailable.

The DMU is an assembly of printed-circuit boards, interconnected through a backplate and external connectors and attached to the door of Equipment Section Bay 1 (see Fig. 5-10). The unit weighs 83 pounds (37.7 kg) and measures 26 x 30 x 7 inches (60 x 70 x 17 cm).

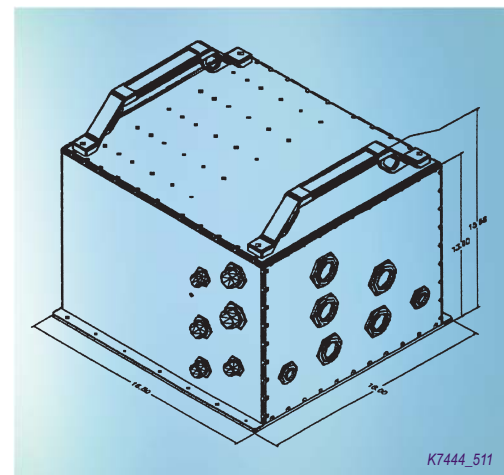

Fig. 5-9 Advanced Computer

### Data Interface Unit.

Four DIUs provide a command and data link between the DMS and other electronic boxes. The DIUs receive commands and data requests from the DMU and pass data or status information back to the DMU. The OTA DIU is located in the OTA Equipment Section; the other units are in Bays 3, 7 and 10 of the SSM Equipment Section. As a safeguard, each DIU is two complete units in one: either part can handle the unit's functions. Each DIU measures 15 x 16 x 7 inches (38 x 41 x 18 cm) and weighs 35 pounds (16 kg).

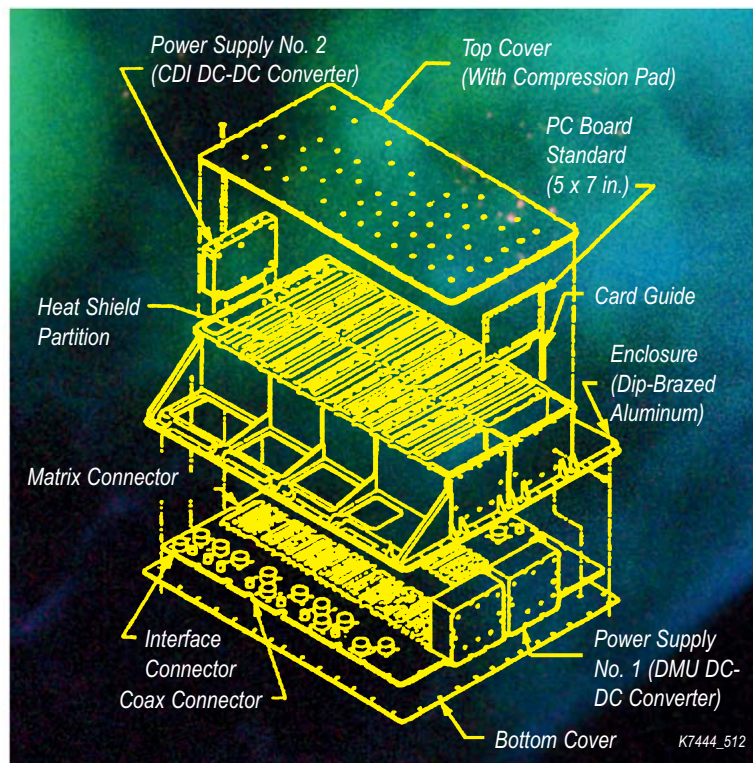

Fig. 5-10 Data Management Unit configuration

### Engineering/Science Data Recorders.

The DMS includes three data recorders that store engineering or science data that cannot be transmitted to the ground in real time. These recorders are located in Equipment Section Bays 5 and 8. Two solid-state recorders (SSR) are used in normal operations; the third, a backup, is a reel-to-reel tape recorder. Each recorder measures 12 x 9 x 7 inches (30 x 23 x 18 cm) and weighs 20 pounds (9 kg).

The SSRs have no reels or tape and no moving parts to wear out and limit lifetime. Data are stored digitally in computer-like memory chips until HST operators at Goddard Space Flight Center (GSFC) command the SSR to play it back. Although they are the same size as the reel-to-reel recorder, each SSR can store over 10 times more data—12 gigabits versus only 1.2 gigabits for the tape recorders they replaced.

Each SSR can record two data streams simultaneously, allowing both science and engineering data to be captured on a single recorder. In addition, data can be recorded and played back at the same time.

**Oscillator.** The oscillator provides a highly stable central timing pulse required by the telescope. It has a cylindrical housing that measures 4 inches (10 cm) in diameter and 9 inches (23 cm) long and weighs 3 pounds (1.4 kg). The oscillator and a backup are mounted in Bay 2 of the SSM Equipment Section.

### Pointing Control Subsystem

A unique PCS maintains telescope pointing stability and aligns the spacecraft to point to and remain locked on any target. The PCS is designed for pointing within 0.01 arcsec and holding the telescope in that orientation with 0.007-arcsec stability for up to 24 hours while HST orbits Earth at 17,500 mph. If the telescope were in Washington, D.C., it could hold a beam of light on a dime on top of the Empire State Building without the beam straying from the coin's diameter.

Nominally, the PCS maintains the telescope's precision attitude by locating guide stars in two FGSs and keeping the telescope in the same position relative to these stars. When specific target requests require repositioning the spacecraft, the



PCS selects different guide stars and moves the telescope into a new attitude.

The PCS utilizes the Advanced Computer, various attitude sensors and two types of devices, called actuators, to move the spacecraft (see Fig. 5-11). It also includes the Pointing/Safemode Electronics Assembly (PSEA) and the Retrieval Mode Gyro Assembly (RMGA), which are both used by the spacecraft safemode system. See page 5-14, Safing (Contingency) System, for details.

**Sensors.** The PCS uses five types of sensors: Coarse Sun Sensors (CSS), Magnetic Sensing System (MSS), Rate Gyro Assemblies (RGA), Fixed-Head Star Trackers (FHST) and FGSs.

Five CSSs, located on the light shield and aft shroud, measure the telescope's orientation to the sun. They also are used to calculate the initial deployment orientation of the telescope, determine when to begin closing the Aperture Door and point the telescope in special Sun-orientation modes during contingency operations. In addition, the CSSs provide signals to the PSEA, located in Bay 8 of the SSM Equipment Section.

The MSS measures the telescope's orientation relative to Earth's magnetic field. Two systems are located on the front end of the light shield. Each consists of magnetometers and dedicated electronic units that send data to the Advanced Computer and the Safemode Electronics Assembly.

HST has three RGAs, each consisting of a rate sensor unit (RSU) and an electronics control unit (ECU). An RSU contains two rate-sensing gyroscopes that measure attitude rate motion about their sensitive axes. Two sets of dedicated electronics in each ECU process this output.

The telescope was originally designed to use three rate-sensing gyroscopes to provide fine pointing control of the observatory during science observations. To conserve the lifetime of the HST gyros, one of the functioning gyros was turned off on Aug. 28, 2005, and a new attitude control system that functions with only two gyros was activated. In this mode, two gyros used in combination with the FGSs provide fine-pointing infor-

mation during science observations. HST instrument performance in two-gyro mode is indistinguishable from performance in three-gyro mode. The measured pointing jitter is also similar in both modes.

The RSUs are located behind the SSM Equipment Section, next to three FHSTs in the aft shroud. The ECUs are located inside Bay 10 of the SSM Equipment Section. The RGAs provide input to the PCS to control the orientation of the telescope's line of sight and to give attitude reference when maneuvering the telescope.

An FHST is an electro-optical detector that locates and tracks a specific star within its FOV. STOCC uses FHSTs as an attitude calibration device when the telescope maneuvers into its initial orientation. The trackers also calculate attitude information before and after maneuvers to help the FGS lock onto guide stars.

Three FGSs provide angular position with respect to the stars (see page 5-22, Fine Guidance Sensor, for details). Their precise fine-pointing adjustments, accurate to within a fraction of an arcsecond, pinpoint the guide stars. Two of the FGSs perform guide-star pointing and the third is available for astrometry, the positional measurement of specific stars.

#### **Pointing Control Subsystem Software.**

PCS software accounts for a large percentage of the flight code executed by Hubble's main computer. This software translates ground targeting commands into reaction wheel torque profiles that reorient the spacecraft and smooth spacecraft motion to minimize jitter during data collection. The software also determines telescope orientation, or attitude, from FHST or FGS data and commands the magnetic torquer bars to minimize reaction wheel speeds. In addition, the software provides various telemetry formats.

Since the telescope was launched, the PCS has been modified. An FGS re-centering algorithm improves FGS performance when the telescope is subjected to any SA vibration or jitter.

Software is used extensively to increase telescope robustness during hardware failures. Two additional software



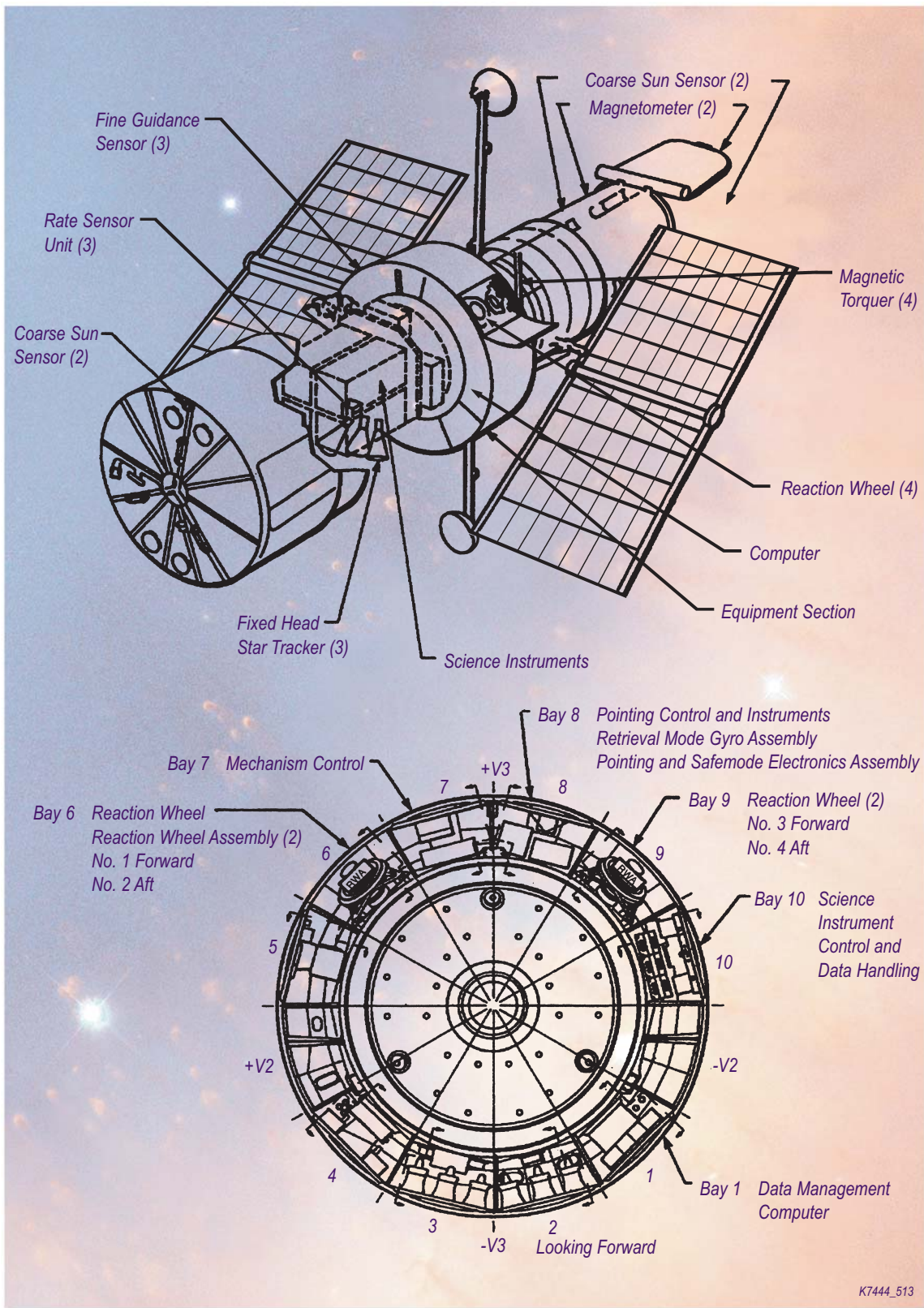

Fig. 5-11 Location of Pointing Control Subsystem equipment



safemodes have been provided. The spin-stabilized mode enables pointing of the telescope -V1 axis to the sun with only two of the four RWAs operating. The other mode allows sun pointing of the telescope without any input from the RGA. Magnetometer and CSS data are used to derive all reference information needed to maintain sun pointing (+V3 and -V1 are options).

A further software change “refreshes” the FGS configuration. Data are maintained in the Advanced Computer memory so information can be sent periodically to the FGS electronics, which are subject to single-event upsets (logic state change) when transitioning through the South Atlantic Anomaly.

**Actuators.** The PCS has two types of actuators: RWAs and magnetic torquers. Actuators move the spacecraft into commanded attitudes and provide control torques to stabilize the telescope’s line of sight.

The reaction wheels rotate a large fly-wheel up to 3,000 rpm or brake it to exchange momentum with the spacecraft. Wheel assemblies are paired, two each in Bays 6 and 9 of the SSM Equipment Section. The wheel axes are oriented so that the telescope can provide science with only three wheels operating. Each wheel measures 23 inches (59 cm) in diameter and weighs about 100 pounds (45 kg). Figure 5-12 shows the RWA configuration.

Magnetic torquers are primarily used to manage reaction wheel speed. The torquers react against Earth’s magnetic field. The torque reaction occurs in the direction that reduces the reaction wheel speed, managing the angular momentum.

Located externally on the forward shell of the SSM, the magnetic torquers also provide backup control to stabilize the telescope’s orbital attitude during contingency modes (refer to page 5-7, Instrumentation and Communications Subsystem). Each torquer

is 8.3 feet (2.5 m) long and 3 inches (8 cm) in circumference and weighs 100 pounds (45 kg).

**Pointing Control Operation.** To point precisely, the PCS uses the gyroscopes, reaction wheels, magnetic torquers, star trackers and FGSs. The latter provide the precision reference point from which the telescope can begin repositioning.

Flight software commands the reaction wheels to spin, accelerating or decelerating as required to rotate the telescope toward a new target. Rate gyroscopes sense the telescope’s angular motion and provide a short-term attitude reference to assist fine pointing and spacecraft maneuvers. The magnetic torquers reduce reaction wheel speed.

As the telescope nears the target area, star trackers locate pre-selected reference stars that stand out brightly in that region of the sky. Once the star trackers reduce the attitude error below 60 arc-sec, the two FGSs take over the pointing duties. Working with the gyroscopes, the FGSs make it possible to point the telescope within 0.01 arcsec of the target. The PCS can maintain this position, wavering no more than 0.007 arcsec, for up to 24 hours to guarantee faint-object observation.

## Electrical Power Subsystem

Power for the telescope and science instruments comes from the Electrical Power Subsystem (EPS). The major components are two SAs and their electronics, six batteries, six charge current controllers (CCC), one power control unit (PCU) and four power distribution units (PDU). All except the SAs are located in the bays around the SSM Equipment Section.

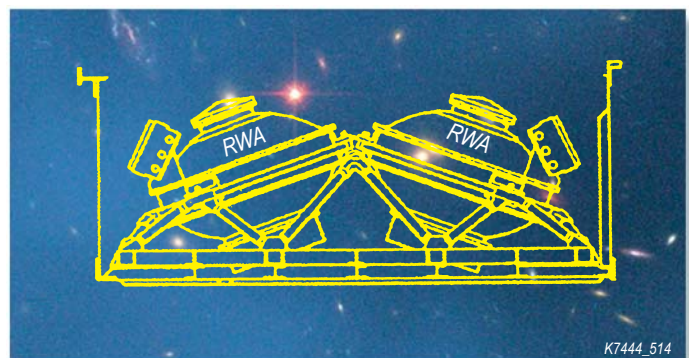

Fig. 5-12 Reaction Wheel Assembly



During the servicing mission, the Shuttle will provide the electrical power. After deployment, the SAs will begin converting solar radiation into electricity. Energy will be stored in nickel-hydrogen (NiH<sub>2</sub>) batteries and distributed by the PCUs and PDUs to all telescope components as shown in Fig. 5-13. Hubble will not be released until the batteries are fully charged.

**Solar Arrays.** The SA panels, discussed later in this section, are the primary source of electrical power. Each array has solar panels that convert the sun's energy into electrical energy. Electricity produced by the panels charges the telescope batteries and provides power to the various telescope systems.

Each array has associated electronics. These consist of a Solar Array Drive Electronics (SADE) unit to transmit positioning commands to the wing assembly and diode networks to direct the electrical current flow.

**Batteries and Charge Current Controllers.** Developed for the 1990 deployment mission, the telescope's batteries were NASA's first flight NiH<sub>2</sub> batteries. They provide the observatory with a robust, long-life electrical energy storage system.

Six NiH<sub>2</sub> batteries support the telescope's electrical power needs during three periods: when demand exceeds SA capability, when the telescope is in

Earth's shadow (eclipse) and during entry into safemode. The design, operation and handling of the batteries—including special nondestructive inspection of each cell—have allowed them to be “astronaut-rated” for replacement during a servicing mission. To compensate for the effects of battery aging, SM3A astronauts installed a voltage/temperature improvement kit (VIK) on each battery. The VIK provides thermal stability by precluding battery overcharge when the HST enters safemode, effectively lowering the CCC recharge current.

The batteries reside in SSM Equipment Section Bays 2 and 3. Each battery has 22 cells in series along with heaters, heater controllers, pressure measurement transducers and electronics, and temperature-measuring devices and their associated electronics. Three batteries are packaged into a module measuring roughly 36 x 36 x 10 inches (90 x 90 x 25 cm) and weighing about 475 pounds (214 kg). Each module is equipped with two large yellow handles that astronauts use to maneuver the module in and out of the telescope.

The SAs recharge the batteries every orbit following eclipse. Each battery has its own CCC that uses voltage-temperature measurements to control battery recharge.

Fully charged, each battery contains more than 75 amp-hours. This is sufficient

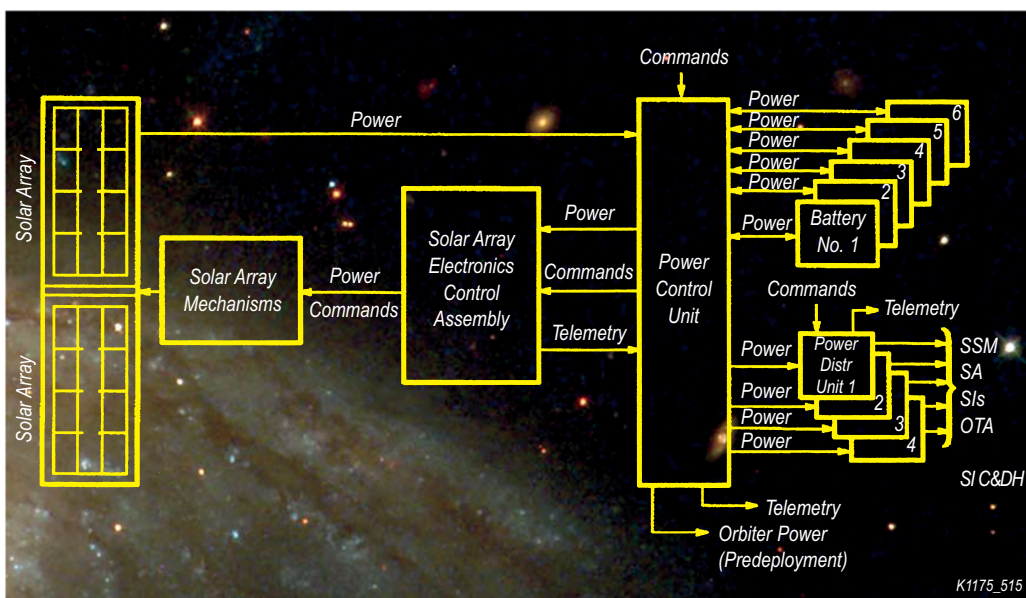

Fig. 5-13 Electrical Power Subsystem functional block diagram





energy to sustain the telescope in normal science operations mode for 7.5 hours or five orbits. The batteries provide an adequate energy reserve for all possible safemode contingencies and all enhancements programmed into the telescope since launch.

#### **Power Control and Distribution Units.**

The PCU, which was replaced on SM3B, interconnects and switches current flowing among the SAs, batteries and CCCs. Located in Bay 4 of the Equipment Section, the PCU provides the main power bus to the four PDUs. The PCU weighs 120 pounds (55 kg) and measures 43 x 12 x 8 inches (109 x 30 x 20 cm).

Four PDUs, located on the inside of the door to Bay 4, contain the power buses, switches, fuses and monitoring devices for electrical power distribution to the rest of the telescope. Two buses are dedicated to the OTA, science instruments and SI C&DH; two supply the SSM. Each PDU measures 10 x 5 x 18 inches (25 x 12.5 x 45 cm) and weighs 25 pounds (11 kg).

#### **Thermal Control**

Multilayer insulation (MLI) covers 80 percent of the telescope's exterior. The insulation blankets have 15 layers of aluminized Kapton and an outer layer of aluminized Teflon flexible optical solar reflector (FOSR). Aluminized or silvered flexible reflector tape covers most of the remaining exterior. These coverings protect against the cold of space and reflect solar heat. Supplemental electric heaters and reflective or absorptive paints also are used to keep Hubble's temperatures safe.

The SSM Thermal Control Subsystem (TCS) maintains temperatures within set limits for the components mounted in the Equipment Section and structures interfacing with the OTA and science instruments. The TCS maintains safe component temperatures even for worst-case conditions such as environmental fluctuations, passage from "cold" Earth shadow to "hot" solar exposure during each orbit and heat generated from equipment operation.

Specific thermal-protection features of the SSM include:

- MLI thermal blankets for the light shield and forward shell
- Aluminum FOSR tape on the Aperture Door surface facing the sun
- Specific patterns of FOSR and MLI blankets on the exteriors of the Equipment Section bay doors, with internal MLI blankets on the bulkheads to maintain thermal balance between bays
- Efficient placement of equipment and use of equipment bay space to match temperature requirements, such as placing heat-dissipating equipment on the side of the Equipment Section mostly exposed to orbit shadow
- Silvered FOSR tape on the aft shroud and aft bulkhead exteriors
- Radiation blankets inside the aft shroud doors and MLI blankets on the aft bulkhead and shroud interiors to protect the science instruments
- More than 200 temperature sensors and thermistors placed throughout the SSM, externally and internally, to monitor individual components and control heater operations.

Figure 5-14 shows the location and type of thermal protection used on the SSM.

During SM3A astronauts installed material to cover and restore some degraded MLI. The layer added to the SSM Equipment Section on SM3A is a composite-coated (silicone dioxide) stainless steel layer, known as the New Outer Blanket Layer (NOBL). The light shield/forward shell material is Teflon with a scrim backing for durability. During SM3A and SM3B, astronauts installed NOBLs on Bays 6, 9 and 10. The materials used were life-tested to an equivalent of 10 years.

#### **Safing (Contingency) System**

Overlapping or redundant equipment safeguards the telescope against any breakdown. In addition, a contingency or Safing System exists for emergency operations. Using dedicated PSEA hardware and many pointing control and data management components, this system maintains stable telescope attitude,

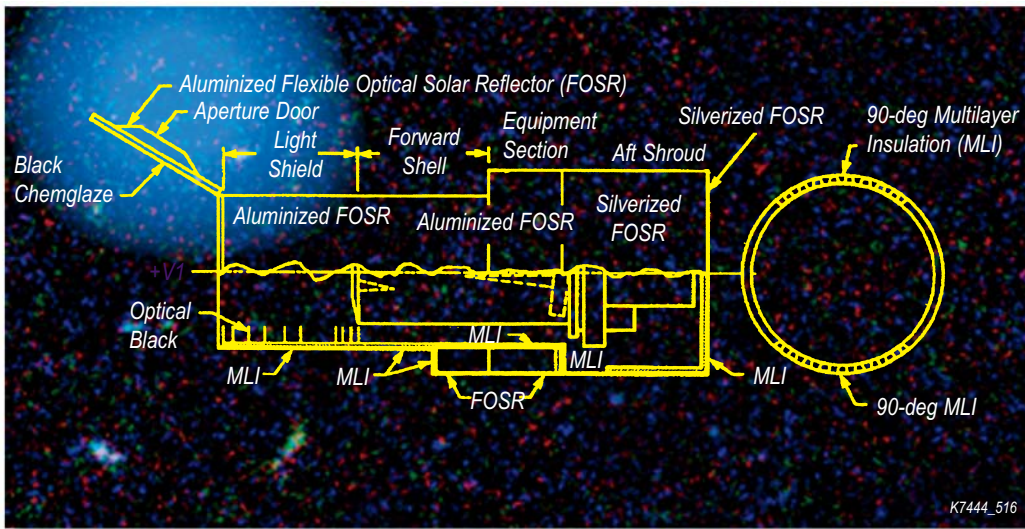

Fig. 5-14 Placement of thermal protection on Support Systems Module

moves the SAs for maximum sun exposure and conserves electrical power by minimizing power drain. The Safing System can operate the spacecraft indefinitely with no communications link to ground control.

During scientific observations (normal mode), the Safing System automatically monitors telescope onboard functions. It sends Advanced Computer-generated “keep-alive” signals to the PSEA that indicate all telescope systems are functioning. When a failure is detected, entry into the safemode is autonomous.

The Safing System is designed to follow a progression of contingency operating modes, depending on the situation aboard the telescope. If a malfunction occurs and does not threaten the telescope’s survival, the Safing System moves into Software Inertial Hold Mode. This mode holds the telescope in the last position commanded. If a maneuver is in progress, the Safing System completes the maneuver, then holds the telescope in that position, suspending all science operations. Only ground control can return to science operations from safemode.

If the system detects a marginal electrical power problem, or if an internal PCS safety check fails, the telescope enters Software Sun Point Mode. The Safing System maneuvers the telescope so the SAs point toward the sun to continuously generate maximum solar power. Telescope

equipment is maintained within operating temperatures and above survival temperatures, anticipating a return to normal operations. The STOCC must intercede to correct the malfunction before science operations or normal functions can be resumed.

Since deployment of the telescope in 1990, the Safing System has seen additional improvements to increase its robustness to survive hardware failures and still protect the telescope (refer to page 5-9, Pointing Control Subsystem). For the modes described above, the Safing System operates through computer software. If conditions worsen, the system turns over control to the PSEA in Hardware Sun Point Mode. Problems that could provoke this action include:

- Computer malfunction
- Batteries losing more than 50 percent of their charge
- Two of the three RGAs failing
- DMS failing.

If these conditions occur, the Advanced Computer stops sending keep-alive signals. This is the “handshake” mechanism between the flight software and the PSEA.

In Hardware Sun Point Mode, the PSEA computer commands the telescope and turns off selected equipment to conserve power. Components shut down include the Advanced Computer and, within two hours, the SI C&DH. Before this happens, a payload (instruments) safing sequence begins and, if it has not already done so,



the telescope turns the SAs toward the sun, guided by the CSSs. The PSEA removes operating power from equipment not required for telescope survival.

Once ground control is alerted to a problem, NASA management of the STOCC convenes a failure analysis team to evaluate the problem and seek the best and safest corrective action while the Safing System maintains control of the telescope. The failure analysis team is led by a senior management representative from NASA/GSFC with the authority not only to call on the expertise of engineers and scientists employed by NASA or its support contractors, but also to obtain support from any organization previously affiliated with the telescope project. The team is chartered to identify the nature of the anomaly and to recommend corrective action. This recommendation is reviewed at a higher management level of NASA/GSFC. All changes to the telescope's hardware and all software configurations require NASA Level I concurrence as specified in the HST Level I Operations Requirements Document.

**Pointing/Safemode Electronics and Retrieval Mode Gyro Assemblies.** These assemblies are installed in Bay 8. The PSEA consists of 40 electronic printed-board circuits with redundant functions to run the telescope, even in the case of internal circuit failure. It weighs 86 pounds (39 kg). A backup gyroscope package, the RMGA, is dedicated for the PSEA. The RMGA consists of three gyroscopes. These are lower quality rate sensors than the RGAs because they are not intended for use during observations.

## Optical Telescope Assembly

Although the OTA is modest in size by ground-based observatory standards and has a straightforward optical design, its accuracy—coupled with its place above Earth's atmosphere—renders its performance superior.

The OTA uses a "folded" design, common to large telescopes, which enables a long focal length of 189 feet (57.6 m) to be packaged into a small telescope length of 21 feet (6.4 m). (Several

smaller mirrors in the science instruments are designed similarly to lengthen the light path within them.) This form of telescope is called a Cassegrain. Its compactness is an essential component of an observatory designed to fit inside the Shuttle cargo bay.

Conventional in design, the OTA is unconventional in other aspects. Large telescopes at ground-based sites are limited in their performance by the resolution attainable while operating under Earth's atmosphere, but the HST orbits high above the atmosphere, providing an unobstructed view of the universe. Therefore, the OTA was designed and built with exacting tolerances to provide near-perfect image quality over the broadest possible region of the spectrum.

Hubble's OTA is a variant of the Cassegrain, called a Ritchey-Chretien, in which both mirrors are hyperboloidal in shape (having a deeper curvature than a parabolic mirror). This form is completely corrected for coma (an image observation with a "tail") and spherical aberrations to provide an aplanatic system in which aberrations are correct everywhere in the FOV. The only residual aberrations are field curvature and astigmatism. Both of these are zero exactly in the center of the field and increase toward the edge of the field. These aberrations are easily corrected within the instrument optics.

Figure 5-15 shows the path of a light ray from a distant star as it travels through the telescope to the focus. Light travels down the tube, past baffles that attenuate reflected light from unwanted bright sources, to the 94.5-inch (2.4-m) primary mirror. Reflecting off the front surface of the concave mirror, the light bounces back up the tube to the 12-inch (0.3-m)-diameter convex secondary mirror. The light is now reflected and converged through a 23.5-inch (60-cm) hole in the primary mirror to the telescope focus, 3.3 feet (1.5 m) behind the primary mirror.

After successful completion of SM4, five science instruments and three FGSs will share the focal plane by a system of mirrors. A small folding mirror in the center of the FOV directs light into the WFC3. The remaining "science" field is divided among four axial science instruments,



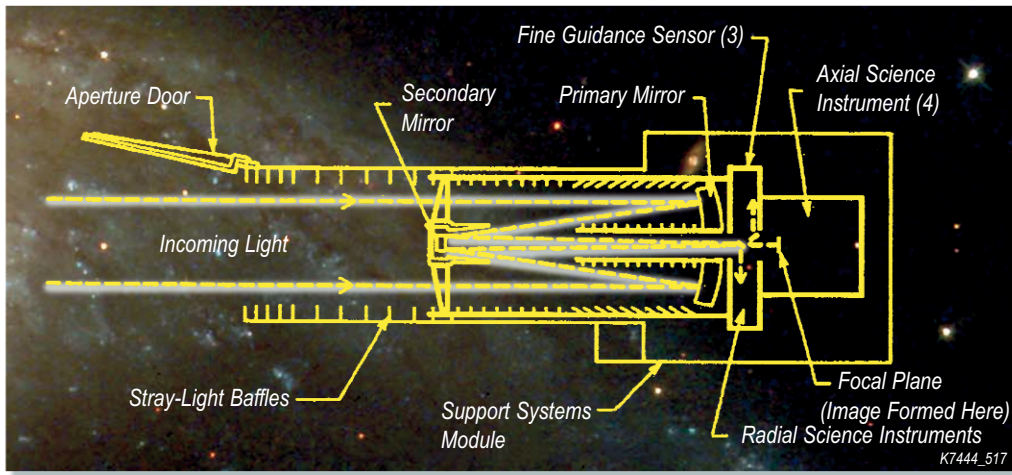

Fig. 5-15 Light path for the main telescope

each receiving a quadrant of the circular FOV. Around the outside of the science field, a “guidance” field is divided among the three FGSs by their own folding mirrors. Each FGS receives 60 arcmin<sup>2</sup> of field in a 90-degree sector. Figure 5-16 shows instrument/sensor FOVs.

The OTA hosts the science instruments and FGSs, maintaining the structural support and optical-image stability required for these instruments to fulfill their functions (see Fig. 5-17). Components of the OTA are the primary mirror, the secondary mirror, the FPS and the OTA Equipment Section.

### Primary Mirror Assembly and Spherical Aberration

As the telescope was first put through its paces on orbit in 1990, scientists discovered its primary mirror had a spherical aberration. The outer edge of the 8-foot (2.4-m) primary mirror was ground too flat by a width equal to 1/50 the thickness of a sheet of paper (about 2 microns). After the discovery, Ball Aerospace scientists and engineers built the Corrective Optics Space Telescope Axial Replacement (COSTAR). It was installed (in place of the High Speed Photometer, which was removed) during the First Servicing Mission (SM1) in December 1993

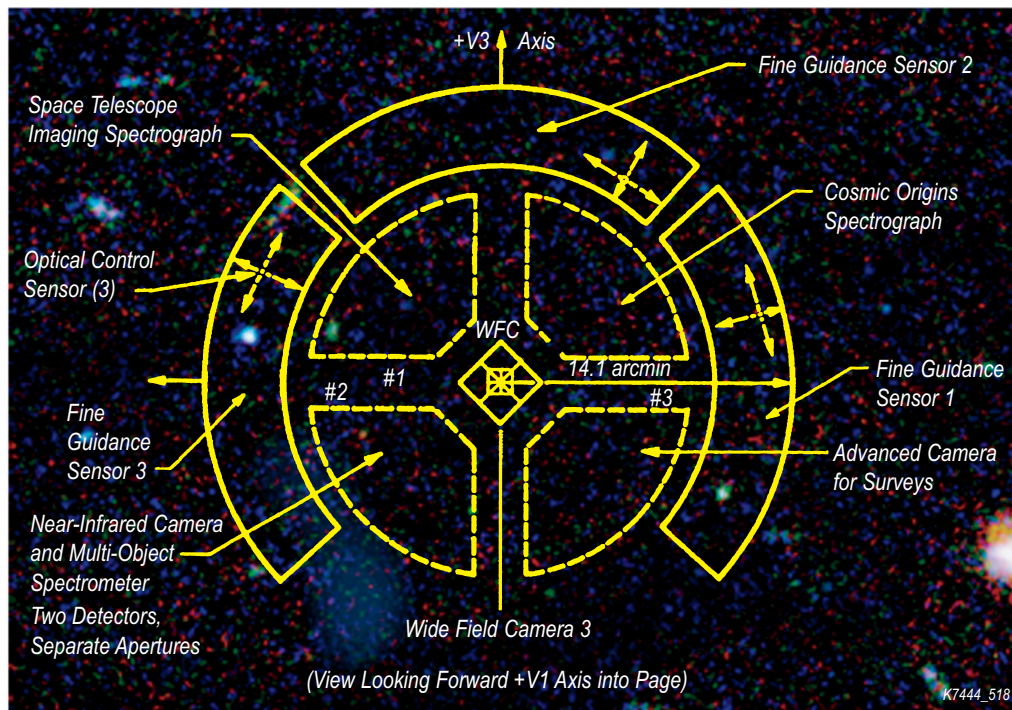
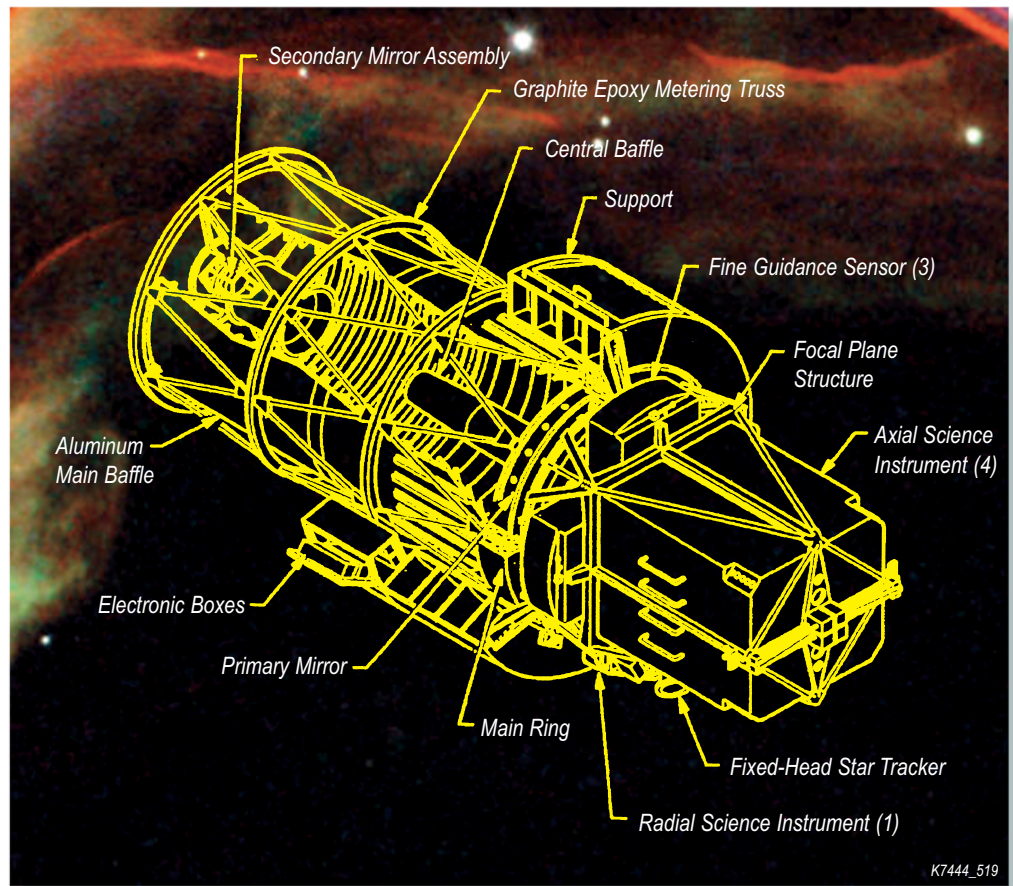

Fig. 5-16 Instrument/sensor field of view after SM4



**Fig. 5-17** Optical Telescope Assembly components

and brought the telescope back to its original specifications for the remaining three axial science instruments. WFPC1, which was a radial science instrument, was replaced during SM1 by WFPC2, which contained internal corrections for the spherical aberration in the primary mirror.

The primary mirror assembly consists of the mirror supported inside the main ring, which is the structural backbone of the telescope, and the main and central baffles (see Fig. 5-18). A set of kinematic brackets links the main ring to the SSM, providing the structural coupling to the rest of the spacecraft. The assembly also supports the OTA baffles. Its major parts are:

- Primary mirror
- Main ring structure
- Reaction plate and actuators
- Main and central baffles.

**Primary Mirror.** The primary mirror blank is made of ultralow-expansion glass. It has a very low expansion coefficient,

which ensures the telescope minimum sensitivity to temperature changes. The mirror has a “sandwich” construction: two lightweight facesheets separated by a core, or filling, of glass honeycomb ribs in a rectangular grid (see Fig. 5-19). This construction weighs 1,800 pounds (818 kg) whereas a solid-glass mirror would weigh 8,000 pounds (3,636 kg).

Perkin-Elmer ground the mirror blank, 8 feet (2.4 m) in diameter, in its large optics fabrication facility. When it was close to its final hyperboloidal shape, the mirror was transferred to the company’s computer-controlled polishing facility.

After being ground and polished, the mirror was coated with a reflective layer of aluminum 0.1-micrometer thick and a protective layer of magnesium fluoride 0.025-micrometer thick. The fluoride layer protects the aluminum from oxidation and enhances reflectance at the important hydrogen emission line known as Lyman-Alpha. The reflective quality of the mirror is better than 70 percent at





1216 angstroms (Lyman-Alpha) in the ultraviolet spectral range and better than 85 percent for visible light.

The primary mirror is mounted to the main ring through a set of kinematic linkages. The linkages attach to the mirror by three rods that penetrate the glass for axial constraint and by three pads bonded to the back of the glass for lateral support.

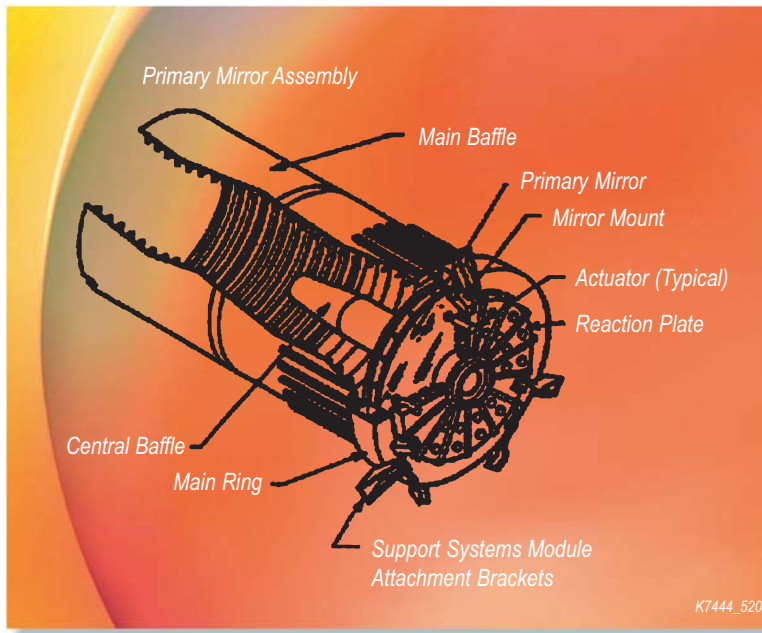

**Main Ring.** The main ring encircles the primary mirror; supports the mirror, main baffle, central baffle, and metering truss; and integrates the elements of the telescope to the spacecraft (see Fig. 5-20). This titanium ring, weighing 1,200 pounds (545.5 kg), is a hollow box beam 15 inches (38 cm) thick with an outside diameter of 9.8 feet (2.9 m). It is suspended inside the SSM by a kinematic support.

**Fig. 5-18** Primary mirror assembly

**Reaction Plate.** The reaction plate is a wheel of I-beams forming a bulkhead behind the main ring and spanning its diameter. It radiates from a central ring that supports the central baffle. Its primary function is to carry an array of heaters that warm the back of the primary mirror, maintaining its temperature at 70 degrees Fahrenheit. Made of lightweight,

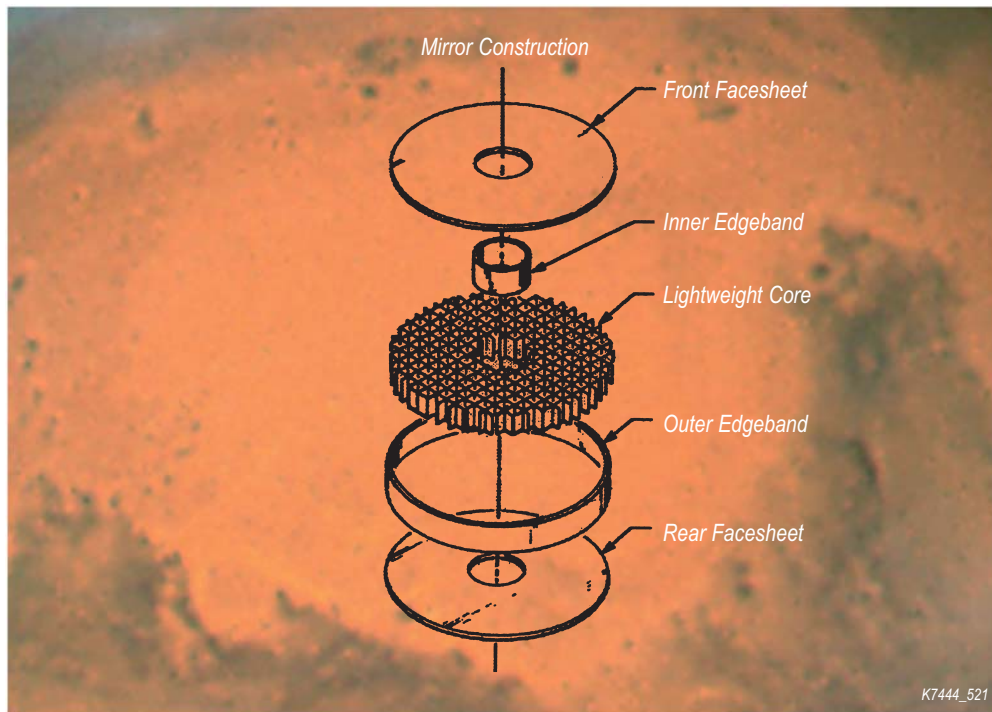

**Fig. 5-19** Primary mirror construction





stiff beryllium, the plate also supports 24 figure-control actuators attached to the primary mirror and arranged around the reaction plate in two concentric circles. These can be commanded from the ground, if necessary, to make small corrections to the shape of the mirror.

**Baffles.** The OTA's baffles prevent stray light from bright objects—such as the sun, moon and Earth—from reflecting down the telescope tube to the focal plane. The primary mirror assembly includes two baffles. Attached to the front face of the main ring, the outer (main) baffle is an aluminum cylinder 9 feet (2.7 m) in diameter and 15.7 feet (4.8 m) long. Internal fins help it attenuate stray light. The central baffle is 10 feet (3 m) long, cone-shaped and attached to the reaction plate through a hole in the center of the primary mirror. It extends down the centerline of the telescope tube. The baffle interiors are painted flat black to minimize light reflection.

### Secondary Mirror Assembly

The secondary mirror assembly cantilevers off the front face of the main ring and supports the secondary mirror at exactly the correct position in front of the primary mirror. The assembly consists of the mirror subassembly, a light baffle and an outer graphite-epoxy metering truss support structure (see Fig. 5-21).

The secondary mirror assembly contains the mirror, mounted on three pairs of alignment actuators that control its position and orientation. All are enclosed within the central hub at the forward end of the truss support.

The secondary mirror has a magnification of 10.4x. It converts the primary-mirror converging rays from  $f/2.35$  to a focal ratio system prime focus of  $f/24$  and

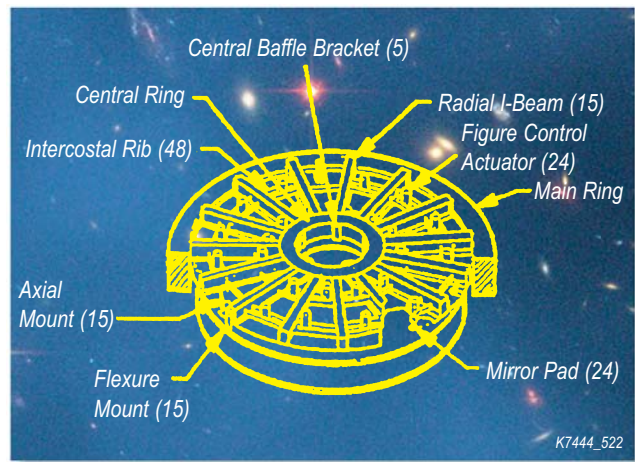
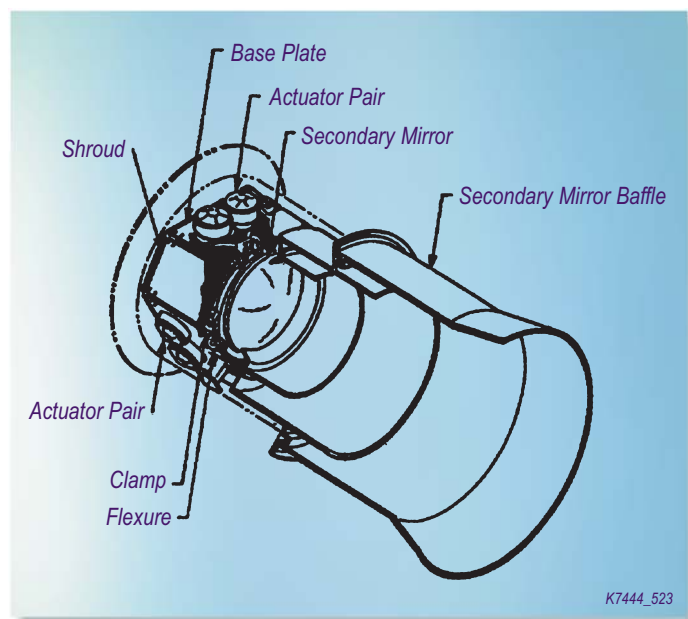

**Fig. 5-20** Main ring and reaction plate

sends them back toward the center of the primary mirror, where they pass through the central baffle to the focal point. The mirror is a convex hyperboloid 12 inches (0.3 m) in diameter and made of Zerodur glass coated with aluminum and magnesium fluoride. Steeply convex, it has a surface accuracy even greater than that of the primary mirror.

Ground command adjusts the actuators to align the secondary mirror to provide perfect image quality. The adjustments are calculated from data picked up by tiny optical control system sensors located in the FGSs.

The principal structural element of the secondary mirror assembly is the metering truss, a cage with 48 latticed struts attached



**Fig. 5-21** Secondary mirror assembly



to three rings and a central support structure for the secondary mirror. The truss, 16 feet (4.8 m) long and 9 feet (2.7 m) in diameter, is a graphite fiber-reinforced epoxy structure. Graphite was chosen for its high stiffness, light weight and low sensitivity to thermally induced changes in length. This is vital because the secondary mirror must stay perfectly placed relative to the primary mirror, accurate to within 0.0001 inch (2.5 micrometers) when the telescope operates.

At one end the truss attaches to the front face of the main ring of the primary mirror assembly. The other end has a central hub that houses the secondary mirror and baffle along the optical axis. Aluminized Mylar MLI in the truss compensates for temperature variations of up to 30 degrees Fahrenheit when the telescope is in Earth's shadow so that the primary and secondary mirrors remain aligned. The conical secondary mirror subassembly light baffle extends almost to the primary mirror. It reduces stray bright-object light from sources outside the telescope FOV.

### Focal Plane Structure Assembly

The FPS is a large optical bench that physically supports the science instruments and FGSs and aligns them with the image focal plane of the telescope. The -V3 side of the structure, away from the sun in space, supports the FHSTs and RSUs (see Fig. 5-22). It also provides facilities for on-orbit replacement of any

instruments and thermal isolation between instruments.

The structure is 7 feet (2.1 m) by 10 feet (3.04 m) long and weighs more than 1,200 pounds (545.5 kg). Because it must have extreme thermal stability and be stiff, lightweight and strong, the FPS is constructed of graphite-epoxy, augmented with mechanical fasteners and metallic joints at strength-critical locations.

The FPS cantilevers off the rear face of the main ring, attached at eight flexible points that adjust to eliminate thermal distortions. The structure provides a fixed alignment for the FGSs. It has guiderails and latches at each instrument mounting location so Shuttle crews can easily exchange science instruments, FGSs, and other equipment in orbit.

### OTA Equipment Section

The OTA Equipment Section is a large semicircular set of compartments mounted outside the spacecraft on the forward shell of the SSM (see Fig. 5-23). It contains the OTA Electrical Power and Thermal Control Electronics (EP/TCE) system, Fine Guidance Electronics (FGE), Actuator Control Electronics (ACE), Optical Control Electronics (OCE) and the fourth DMS DIU. The OTA Equipment Section has nine bays: seven for equipment storage and two for support. All bays have outward-opening doors for easy astronaut access, cabling and connectors for the electronics, and heaters and insulation for thermal control.

The EP/TCE System distributes power from the SSM EPS and the OTA system. Thermostats regulate mirror temperatures and prevent mirror distortion from the cold of space. The electrical and thermal electronics also collect thermal sensor data for transmission to the ground.

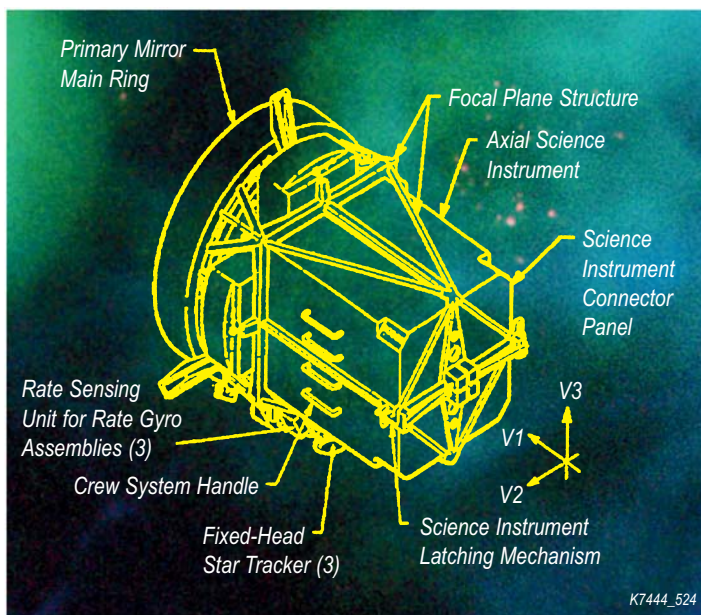

Fig. 5-22 Focal Plane Structure

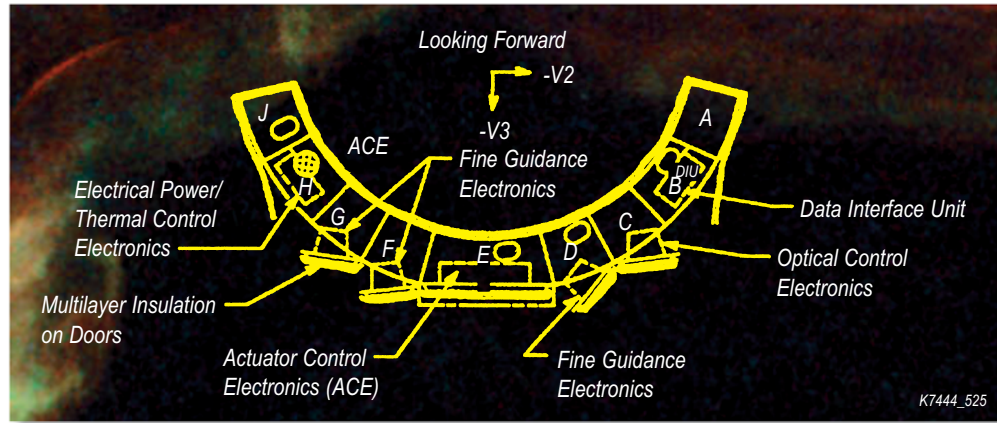

Fig. 5-23 Optical Telescope Assembly Equipment Section

Three FGE units provide power, commands and telemetry to the FGSs. The electronics perform computations for the sensors and interface with the spacecraft pointing system for effective telescope pointing and stabilization. There is a guidance electronics assembly for each guidance sensor.

The ACE unit provides the command and telemetry interface to the 24 actuators attached to the primary mirror and to the six actuators attached to the secondary mirror. These electronics select which actuator to move and monitor its response to each command. Positioning commands go from the ground to the electronics through the DIU.

The OCE unit controls the optical control sensors. These white-light interferometers measure the optical quality of the OTA and send the data to the ground for analysis. There is one optical control sensor for each FGS, but the OCE unit runs all control sensors. The DIU is an electronic interface between the other OTA electronics units and the telescope command and telemetry system.

## Fine Guidance Sensor

Three FGSs are located at 90-degree intervals around the circumference of the focal plane structure, between the structure frame and the main ring. Each sensor measures 5.4 feet (1.5 m) long and 3.3 feet (1 m) wide and weighs 485 pounds (220 kg).

Each FGS enclosure houses a guidance sensor and a wavefront sensor. The wavefront sensors are elements of the optical control sensor used to align and optimize the optical system of the telescope.

The telescope's ability to remain pointing at a distant target to within 0.005 arcsec for long periods of time is due largely to the accuracy of the FGSs. They lock on a star and measure any apparent motion to an accuracy of 0.0028 arcsec. This is equivalent to seeing from New York City the motion of a landing light on an aircraft flying over San Francisco.

When two sensors lock on a target, the third measures the angular position of a star, a process called astrometry. Sensor astrometric functions are discussed in Section 4, Science Instruments. During SM2 a re-certified FGS (S/N 2001) was installed as a replacement in the HST FGS Bay 1. During SM3A a re-certified FGS (S/N 2002) was installed in FGS Bay 2. During SM4 a third re-certified FGS (S/N 2004) will be installed in FGS Bay 2 because of a light-emitting diode degradation problem.





## FGS Composition and Function

Each FGS consists of a large structure housing a collection of mirrors, lenses and servos to locate an image, prisms to fine-track the image, beam splitters and four photomultiplier tubes (see Fig. 5-24). The entire mechanism adjusts to move the telescope into precise alignment with a target star. Each FGS has a large (60 arcmin<sup>2</sup>) FOV to search for and track stars and a 5.0 arcsec<sup>2</sup> FOV used by the detector prisms to pinpoint the star.

The sensors work in pairs to aim the telescope. The Guide Star Selection System, developed by the Space Telescope Science Institute, catalogs and charts guide stars near each observation target to make it easier to find the target. One sensor searches for a target guide star. After the first sensor locks onto a guide star, the second sensor locates and locks onto another target guide star. Once designated and located, the guide stars keep the image of the observation target in the aperture of the selected science instrument.

Each FGS uses a 90-degree sector of the telescope's FOV outside the central "science" field. This region of the FOV has the greatest astigmatic and curvature distortions. The size of the FGS's FOV was chosen to heighten the probability of finding an appropriate guide star, even in the direction of the lowest star population near the galactic poles.

An FGS "pickoff" mirror intercepts the incoming stellar image and projects it into the sensor's large FOV. Each FGS FOV has 60 arcmin<sup>2</sup> available. The guide star of interest can be anywhere within this field. After finding the star, the

sensor locks onto it and sends error signals to the telescope, telling it how to move to keep the star image perfectly still.

Using a pair of star selector servos, the FGS can move its line of sight anywhere within its large FOV. Each can be thought of as an optical gimbal: one servo moves north and south, the other east and west. They steer the small FOV (5 arcsec<sup>2</sup>) of the FGS detectors to any position in the sensor field. Encoders within each servo system send back the exact coordinates of the detector field centers at any point.

Because the exact location of a guide star may be uncertain, the star selector servos also can cause the detector to search the region around the most probable guide star position. It searches in a spiral pattern, starting at the center and moving out until it finds the guide star it seeks. Then the detectors are commanded to go into fine-track mode and hold the star image exactly centered in the FOV while the star selector servo encoders send information about the position of the star to the spacecraft PCS.

The detectors are a pair of interferometers, called Koester's prisms, coupled to photomultiplier tubes. Each detector

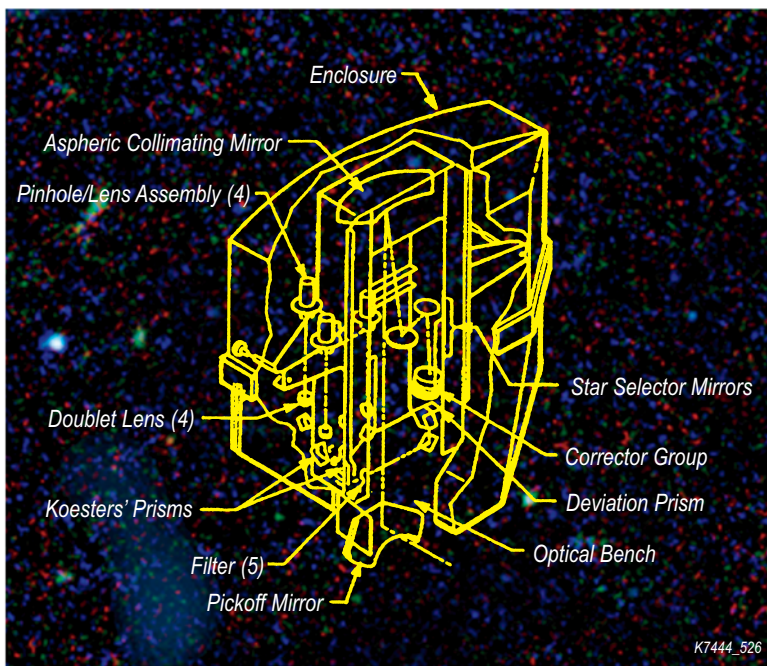

Fig. 5-24 Cutaway view of Fine Guidance Sensor



operates in one axis, so two detectors are needed. Operating on the incoming wavefront from the distant guide star, the interferometers compare the wave phase at one edge of the telescope's entrance aperture with the phase at the opposite edge. When the phases are equal, the star is exactly centered. Any phase difference shows a pointing error that must be corrected.

Along the optical path from telescope to detector are additional optical elements that turn or fold the beam to fit everything inside the FGS enclosure and to correct the telescope's astigmatism and field curvature. All optical elements are mounted on a temperature-controlled, graphite-epoxy composite optical bench.

### Articulated Mirror System

Analysis of the FGS on-orbit data revealed that minor misalignments of the optical pupil centering on a Koester's prism interferometer in the presence of spherical aberration prevented the FGS from achieving its optimum performance. In each of the recertified FGS units, including the final one to be installed during SM4, the fold flat mirror #3 in the radial bay module optical train was mechanized to allow on-orbit alignment of the pupil.

Implementation of this system utilized existing signals and commands by rerouting them with a unique interface harness enhancement kit (OCE-EK) interfacing the OCE, the DIU and the Fine Guidance System/Radial Bay Module (FGS/RBM). The OCE-EK was augmented with the actuator mechanism electronics (AME) and the fold flat mirror #3 actuator mechanism assembly (AMA) located internal to the FGS/RBM. Ground tests indicate a substantial increase in FGS performance with this innovative design improvement.

## Solar Arrays

New rigid SAs were attached to the telescope during SM3B. The original arrays fitted to Hubble—designed by the European Space Agency (ESA)—were two large rectangular panels of retractable solar cell blankets fixed on a two-stem frame. The blankets unfurled from a cassette in the middle of each array. A spreader bar at each end of the arrays stretched the blankets and maintained tension.

Following deployment in 1990, engineers discovered two problems: a loss of focus and images that jittered briefly when the telescope flew into and out of Earth's shadow. The jitter problem was traced to the two large SAs. Abrupt temperature changes, from -150 to 200 degrees Fahrenheit during orbit, caused the panels to distort twice during each orbit. As a temporary fix, software was written that commanded the PCS to compensate for the jitter automatically. The problem was mitigated during SM1 by replacement of the old arrays with new ones that had been modified to reduce thermal swings of the bi-stems.

The two SAs installed on SM3B were assembled from eight panels designed and built originally for the commercial Iridium communications satellites. At Goddard Space Flight Center in Greenbelt, Maryland, four panels were mounted onto each aluminum-lithium support structure.

The new array assemblies, which have higher efficiency gallium-arsenide solar cells, provided Hubble approximately 30 percent more power than the old arrays. In addition, their smaller cross section and rigidity have reduced aerodynamic drag and produced significantly less vibration than the old arrays (see Fig. 5-25).

New Solar Array Drive Mechanisms (SADM) were also installed during SM3B. These mechanisms maneuver the arrays to keep them constantly pointed at the sun. ESA designed, developed and tested the SADMs.

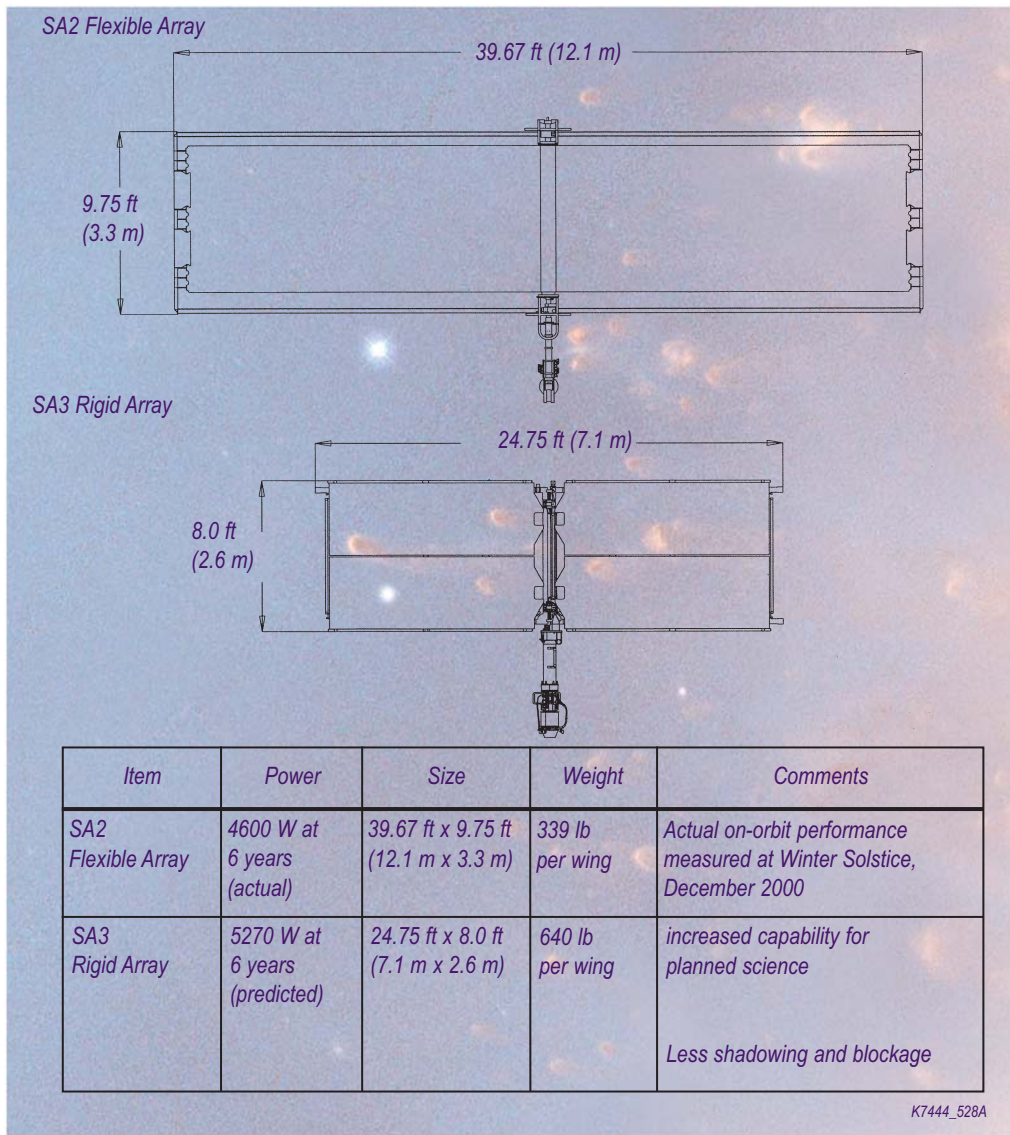

Fig. 5-25 Solar Array detail comparison

## Science Instrument Command and Data Handling Unit

The SI C&DH unit keeps all science instrument systems synchronized. It works with the DMU to process, format and temporarily store information on the data recorders or transmit science and engineering data to the ground.

### Components

The SI C&DH unit is a collection of electronic components attached to an Orbital Replacement Unit (ORU) tray mounted on the door of Bay 10 in the SSM Equipment Section (see Fig. 5-26). Small remote interface units (RIU), also part of the system, provide the interface to individual science instruments.

Components of the SI C&DH unit are:

- NASA Standard Spacecraft Computer (NSSC-1)
- Two standard interface circuit boards for the computer
- Two control units/science data formatter units (CU/SDF)
- Two central processing unit (CPU) modules
- A PCU
- Two RIUs
- Various memory, data and command communications lines (buses) connected by couplers.

These components are redundant so the system can recover from any single failure.

**NASA Computer.** The NSSC-1 has one CPU and eight memory modules, each holding 8,192 eighteen-bit words. An embedded software program (the "executive") runs



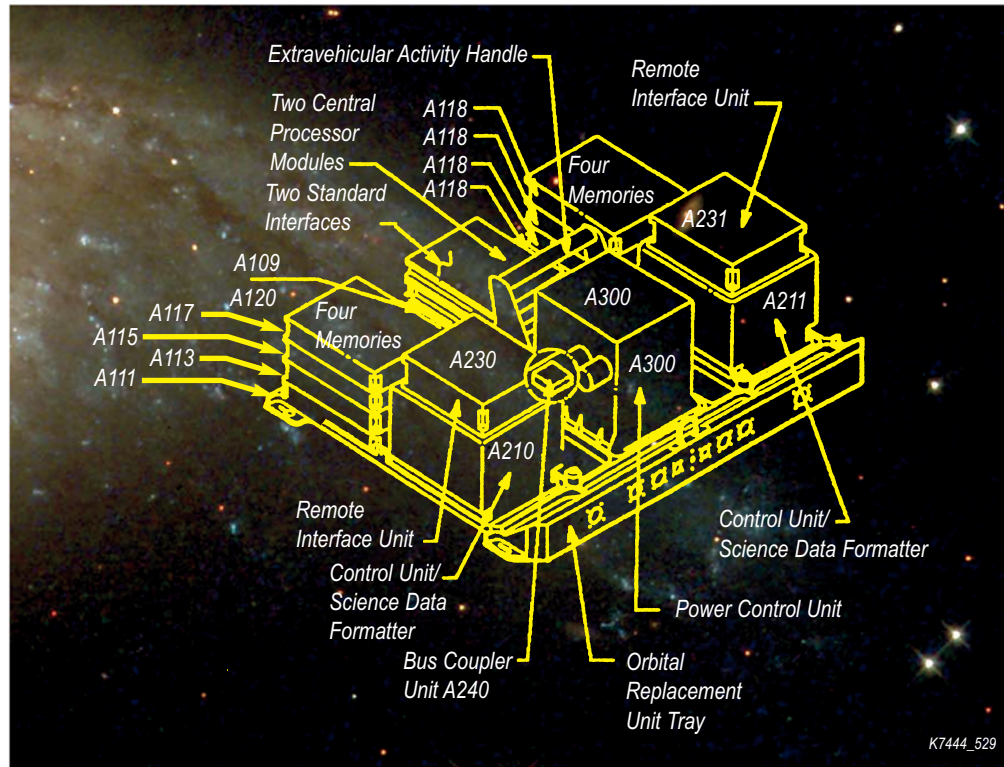

**Fig. 5-26** Science Instrument Control and Data Handling unit

the computer. It moves data, commands and operation programs (called applications) for individual science instruments in and out of the processing unit. The application programs monitor and control specific instruments, and analyze and manipulate the collected data.

The memory stores operational commands for execution when the telescope is not in contact with the ground. Each memory unit has five areas reserved for commands and programs unique to each science instrument. The computer can be reprogrammed from the ground for future requests or for working around failed equipment.

**Standard Interface Board.** The circuit board is the communications bridge between the computer and the CU/SDF.

**Control Unit/Science Data Formatter.** The heart of the SI C&DH unit is the CU/SDF. It formats and sends all commands and data to designated destinations such as the DMU of the SSM, the NASA computer and the science instruments. The unit has a microprocessor for control and formatting functions.

The CU/SDF receives ground commands, data requests, science and engineering data, and system signals. Two examples of system signals are “time tags”—clock signals that synchronize the entire spacecraft—and “processor interface tables”—communications codes. The CU/SDF transmits commands and requests after formatting them so that the specific destination unit can read them. For example, ground commands and SSM commands are transmitted with different formats because ground commands use 27-bit words and SSM commands use 16-bit words. The formatter translates each command signal into a common format. The CU/SDF also reformats and sends engineering and science data. Onboard analysis of the data is an NSSC-1 function.

**Power Control Unit.** The PCU distributes and switches power among components of the SI C&DH unit. It also conditions the power required by each unit. For example, the computer memory boards typically need +5 volts, -5 volts and +12 volts while the CU/SDF requires +28 volts. The PCU ensures that all voltage requirements are met.



**Remote Interface Unit.** RIUs transmit commands, clock and other system signals, and engineering data between the science instruments and the SI C&DH unit. However, the RIUs do not send science data. There are six RIUs in the telescope: five attached to the science instruments and one dedicated to the CU/SDF and PCUs in the SI C&DH unit. Each RIU can be coupled with up to two expander units.

**Communications Buses.** The SI C&DH unit contains data bus lines that pass signals and data between the unit and the science instruments. Each bus is multiplexed: one line sends system messages, commands and engineering data requests to the module units, and a reply line transmits requested information and science data back to the SI C&DH unit. A coupler attaches the bus to each remote unit. This isolates the module if the RIU fails. The SI C&DH coupler unit is on the ORU tray.

## Operation

The SI C&DH unit handles science instrument system monitoring (such as timing and system checks), command processing and data processing.

**System Monitoring.** Engineering data tell the monitoring computer whether instrument systems are functioning. At regular intervals, varying from every 500 milliseconds to every 40 seconds, the SI C&DH unit scans all monitoring devices for engineering data and passes data to the NSCC-1 or SSM computer. The computers process or store the information. Any failure indicated by these constant tests could initiate a "safing hold" situation and thus a suspension of science operations. Refer to page 5-14, Safing (Contingency) System.

**Command Processing.** Figure 5-27 shows the flow of commands within the SI C&DH unit. Commands enter the CU/SDF (bottom right in the drawing) through the SSM Command DIU (ground commands) or the DIU (SSM commands). The CU/SDF checks and reformats the commands, which then go either to the RIUs or to the NSCC-1 for storage. Time-tagged commands, stored in the computer's memory (top right of drawing), also follow this process.

Each command is interpreted as "real time," as if the SI C&DH just received it. Many commands actually are onboard

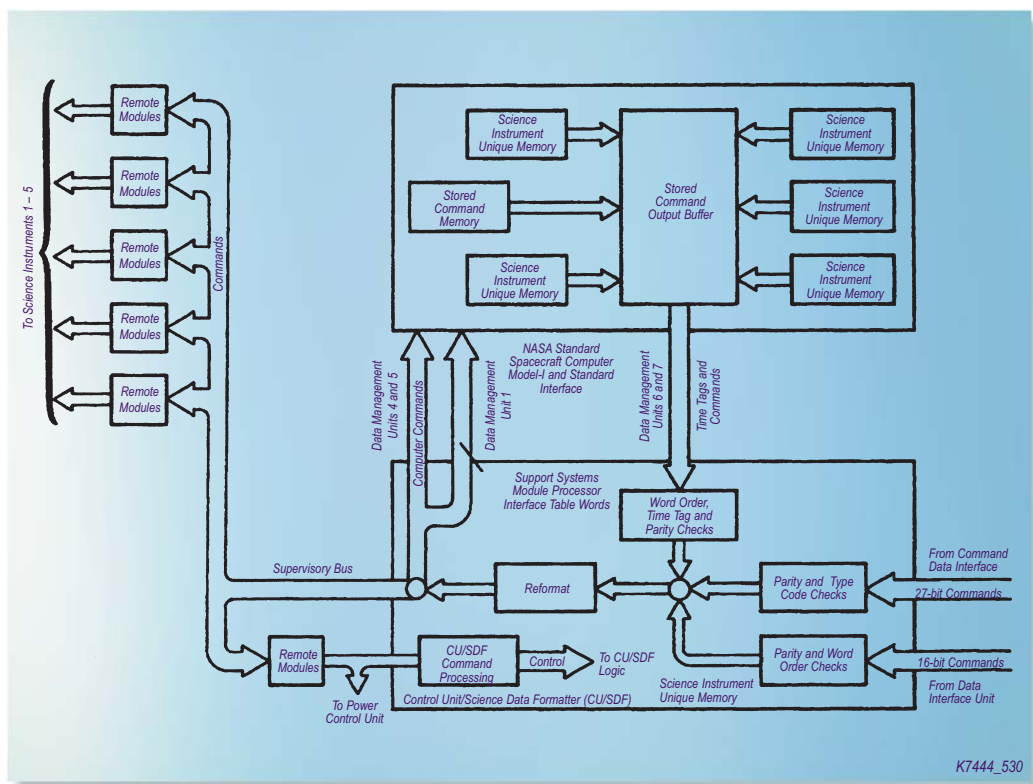

Fig. 5-27 Command flow for Science Instrument Control and Data Handling unit



stored commands activated by certain situations. For example, when the telescope is positioned for a programmed observation using the Cosmic Origins Spectrograph, that program is activated. The SI C&DH can issue certain requests to the SSM, such as to execute a limited number of pointing control functions to make small telescope maneuvers.

**Science Data Processing.** Science data can come from all science instruments at once. The CU/SDF transfers incoming data through computer memory locations called packet buffers. It fills each buffer in order, switching among them as the buffers fill and empty. Each data packet goes from the buffer to the NSCC-1 for further processing, or directly to the SSM for storage in the data recorders or transmission to the ground. Data return to the CU/SDF after computer processing. When transmitting, the CU/SDF must send a continuous stream of data, either full packet buffers or empty buffers called filler packets, to maintain a synchronized link with the SSM. Special checking codes (Reed-Solomon and pseudo-random noise) can be added to the data as options. Figure 5-28 shows the flow of science data in the telescope.

## Space Support Equipment

Hubble was designed to be maintained, repaired and enhanced while in orbit, extending its life and usefulness. For servicing, the Shuttle will capture and position the telescope vertically in the aft end of the cargo bay, then the crew will perform maintenance and replacement tasks. The Space Support Equipment (SSE) provides a maintenance platform to hold the telescope, electrical support of the telescope during servicing and storage for Orbital Replacement Instruments (ORI) and ORUs.

The major SSE items to be used for SM4 are the Flight Support System (FSS) and the Super Lightweight Interchangeable Carrier (SLIC), Orbital Replacement Unit Carrier (ORUC) and Multi-Use Lightweight Equipment (MULE) Carrier. Crew aids and tools also will be used during servicing. Section 2 of this guide describes details specific to SM4.

**Orbital Replacement Unit Carrier**  
An ORUC is a pallet outfitted with shelves and/or enclosures that is used to carry replacements into orbit and to return replaced units to Earth.

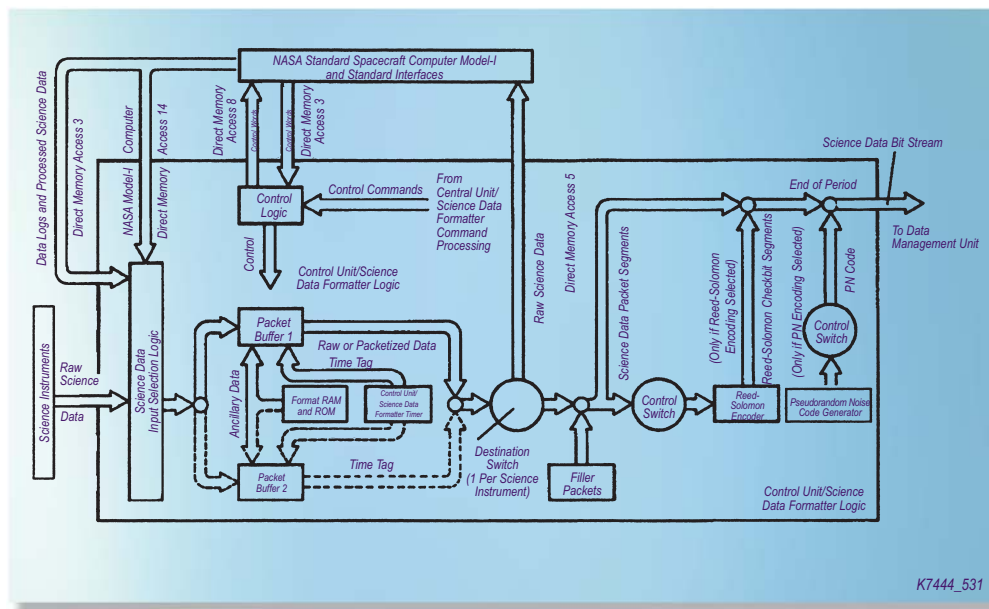

Fig. 5-28 Flow of science data in the Hubble Space Telescope





All ORUs and scientific instruments are carried within protective enclosures to provide them a benign environment throughout the mission. The enclosures protect the instruments from vibration and contamination and maintain the temperature of the instruments or ORUs within strict limits. Instruments are mounted in the enclosures using the same manually driven latch system that holds instruments in the telescope.

During the change-out process, replaced science instruments are stored temporarily in the ORUC. A typical change-out begins with an astronaut removing the old instrument from the telescope and attaching it to a bracket on the ORUC. The astronaut then removes the new instrument from its protective enclosure and installs it in the telescope. Finally, the astronaut places the old instrument in the appropriate protective enclosure for return to Earth.

The ORUC receives power for its TCS from the FSS. The carrier also provides temperature telemetry data through the FSS for readout in the Shuttle and on the ground during the mission.

## Crew Aids and Tools

Astronauts perform extravehicular activities using many tools to replace instruments and equipment, to move around the telescope and the cargo bay, and to operate manual override drives. Tools and equipment, bolts, connectors and other hardware are standardized not only for the telescope but also between the telescope and the Shuttle. For example, grappling receptacles share common features.

To move around the telescope, the crew uses 225 feet of handrails encircling the spacecraft. The rails are painted yellow for visibility. In addition, the crew can hold onto guiderails, trunnion bars and scuff plates fore and aft.

Astronauts can install portable handhold plates where there are no permanent holds, such as on the FGS. Another useful tool is the Portable Foot Restraint.

While the astronauts work, they use tethers to hook tools to their suits and tie replacement units to the telescope. Each crew member has a ratchet wrench to manually crank the antenna and array masts if power for the mast drives fails. A power wrench also is available if hand-cranking is too time consuming. Other hand tools include portable lights and a jettison handle, which attach to sockets on the aperture door and to the SA so the crew can push the equipment away from the telescope.



Media Reference Guide  
HST Operations





# Hubble Space Telescope Operations

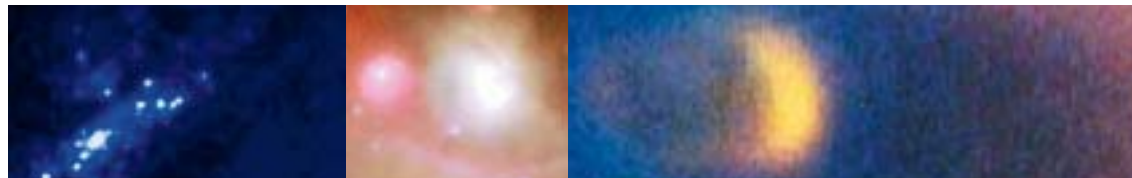

**H**ubble Space Telescope (HST) operations involve an elegant choreography of many spacecraft elements that point the telescope, acquire guide stars to precisely stabilize it, collect light from a distant target and send data to the ground for calibration and analysis.





These activities are commonly divided into science operations and mission operations, but are actually closely interwoven. Science operations include the planning required to observe celestial objects, formulating instructions to HST's science instruments and processing the resulting data. Mission operations include command and control of the telescope to execute the science plan and maintaining the performance of all of its subsystems.

Numerous calculations must be made and many rules followed to safely plan the use of the telescope and one or more science instruments to observe an astronomical target. Instructions are encoded in groups of commands sent to the HST spacecraft and payload computers. These commands are related to one another using time tags so that activities are done in the proper order at required times.

While Hubble observations are defined as part of science operations, mission operations elements monitor them to ensure that HST subsystems function correctly. Engineers watch spacecraft systems and science instruments for characteristics that could affect science data collection, such as instrument performance and pointing stability. The telescope's focus is also checked via periodic observation of standard star fields.

The mission operations ground systems provide all of the functions required to

operate HST and execute the science plan. These systems include the Space Telescope Operations Control Center (STOCC), the Packet Processing Facility (PACOR) and other institutional facilities at Goddard Space Flight Center (GSFC) in Greenbelt, Md. The Flight Operations Team conducts mission operations from the STOCC. The science operations ground systems provide the functions needed to plan and schedule HST science, translate schedules into command loads, and calibrate, archive and distribute science data to the scientific community.

## Space Telescope Science Institute

The Space Telescope Science Institute (STScI) on the campus of The Johns Hopkins University in Baltimore, Md., oversees science operations for GSFC (see Fig. 6-1). Among its functions are:

- Evaluating proposals for observing time and selecting observation programs
- Scheduling the selected observations and assisting guest observers in their work
- Generating an overall mission timeline and command sequences
- Storing and analyzing science data acquired by HST
- Releasing news of HST's scientific findings to the public.



*Fig. 6-1 Space Telescope Science Institute in Baltimore*



## Scientific Goals

The Association of Universities for Research in Astronomy (AURA) operates the STScI. AURA is a consortium of 34 institutions in the United States and eight international affiliates that runs several national and international facilities for astronomy. STScI conducts the science program to meet the overall scientific goals of the Hubble Space Telescope Program, which are set by NASA in consultation with committees representing the national and international astronomical communities.

## STScI Software

Computer hardware and software systems play an essential role in STScI's work. The Science Planning and Scheduling System (SPSS) and multiple science data calibration and archive systems are key among them. STScI also created the Guide Star Catalog used to support Hubble's precise pointing requirements. In addition, extensive science data analysis software (SDAS) provides analytical tools for astronomers studying observational data.

As part of the SPSS, the Guide Star Selection System (GSSS) provides target stars for HST's Fine Guidance Sensors (FGSs). GSSS selects "guide stars" that can be located unambiguously in the sky by the FGSs during fine-pointing operations that take place as part of every science observation. The Guide Star Catalog has information on 20 million celestial objects, created from 1,477 photographic survey plates covering the entire sky.

After STScI collects, edits, measures and archives the science data, observers can use SDAS to analyze and interpret the data.

## Selecting Observation Proposals

Any scientist may submit a proposal to STScI outlining an observing program and describing the scientific objectives and instrument(s) required. Each year astronomers from dozens of countries vie for precious minutes of Hubble's unrivaled view of the cosmos. Many of these countries are European Space Agency (ESA) member states. By virtue of ESA's contributions to the development of the telescope and continuing support of its operation, astronomers from ESA countries are guaranteed 15 percent of Hubble's observing time. ESA provides approximately 15 staff members

co-located with other STScI employees in Baltimore and operates its own data archive and analysis facility in Garching, Germany.

STScI evaluates proposals for technical feasibility and organizes a stringent peer review by panels of scientists from many institutions. The panels rank the proposals and recommend how the limited observing time should be allocated. Subsequently, a Telescope Allocation Committee comprising primarily the panel chairpersons assembles the panels' results and recommends the science program to be conducted in the coming year. The final decision rests with STScI's director.

Individual astronomers and astronomy teams submit many more proposals than can possibly be implemented. In fact, for the year following HST Servicing Mission 4 (SM4), six times more observing time has been requested than can be accommodated. The scientific concentration for the next science cycle (Cycle 17) is approximately the following:

- Cosmology: 26 percent
- Resolved stellar populations: 13 percent
- Individual hot and cool stars (combined): 13 percent
- Unresolved stellar populations and galaxy structures: 12 percent
- Quasar absorption lines and the intergalactic medium: 12 percent
- The solar system and extra-solar planets (combined): 8 percent
- Other: 16 percent.

As would be expected, the new, extremely powerful science instruments to be installed during SM4—Wide Field Camera 3 and Cosmic Origins Spectrograph—will be employed for approximately two-thirds of the Cycle 17 science program. The two instruments for which repairs will be attempted on SM4—Advanced Camera for Surveys and Space Telescope Imaging Spectrograph—will be involved in the remaining third.

A need for special, time-critical observations often arises throughout the year. Some events are completely unanticipated. The impact of the Comet P/Shoemaker-Levy 9 on Jupiter in July 1994 was one such instance. At other times, events can be forecast but require unusually intensive planning, such as the expected attempt by HST to observe the impact of the Lunar



Crater Observation and Sensing Satellite (LCROSS) on the moon sometime in 2009. Special tools are used to plan HST observations of moving bodies in the solar system. Other procedures exist to quickly interrupt a series of planned observations to obtain data on unpredictable events such as stellar novae in the Milky Way or supernovae in other galaxies.

### Scheduling Telescope Observations

The primary consideration when placing a science observation on the schedule for a given week is the visibility of the target, which is governed by its angular separation from the sun and its position relative to the plane of HST's orbit around Earth. For example, occasionally a very faint target must be observed when the telescope is in Earth's shadow. The schedule takes into consideration numerous rules and parameters, such as the instrument(s) being used, exposure times, locations of guide stars and system limitations that include allowable orientations of the spacecraft. Additionally, many science targets require repeated observations at regularly spaced intervals that must be compatible with the other constraints.

### Data Analysis and Storage

STScI is responsible for storing the massive amount of data collected by the telescope. The Hubble Data Archive catalog records the location and status of information as it pours into the storage banks. Observers and visiting astronomers can easily retrieve the stored data for examination and use data manipulation procedures created by STScI.

To calibrate the science data, STScI uses telescope and instrument engineering data (for example, instrument detector temperatures) and observations of "standard" astronomical sources whose physical properties are well known. In addition, the GSFC mission operations facility archives all of the engineering telemetry reported by HST's sensors and uses it to discover and trend changes in the performance of spacecraft systems.

The STScI processes science data within 24 hours of receipt. When STScI receives science data from PACOR, it automatically reformats the information and verifies its quality. STScI also calibrates data to remove the instruments' properties, such

as a variation in a detector's sensitivity across its surface. Then the data are placed on digital archive media from which they can be retrieved and distributed to an observer or archival researcher. Copies of HST data are also provided to ESA's data analysis facility and to the Canadian Astronomy Data Center. The latter supports use of the data by Canadian astronomers.

## Space Telescope Operations Control Center (STOCC)

The STOCC is the facility at GSFC that hosts the ground data systems and the Flight Operations Team (FOT). The FOT manages day-to-day spacecraft operations (see Fig. 6-2). In that capacity, the FOT's primary role is to send command loads to Hubble's computers, monitor the health and status of the orbiting observatory via real-time telemetry, and perform off-line support work that includes engineering data analysis and performance trending. One vital part of the off-line work is to ensure that the upcoming week's Tracking and Data Relay Satellite System (TDRSS) schedule meets the data communications needs of the telescope.

The HST Program's Control Center System (CCS) was built in the late 1990s to support HST Servicing Missions 3A and 3B. CCS's core capabilities include real-time command generation and transmission along with telemetry processing and display. The CCS has been updated and enhanced in preparation for SM4.

Nearly all spacecraft operations derive from time-tagged commands executed by Hubble's onboard software. STOCC's FOT uses CCS to uplink commands to HST's computers. In addition, ephemeris loads that contain the predicted orbital position of HST are uplinked weekly. The spacecraft's computer uses this information to maintain knowledge of its location and velocity and to provide its Pointing Control System other essential information.

Daily commands consist of one computer load that schedules basic spacecraft operations, such as when to turn on real-time





*Fig. 6-2 Space Telescope Operations Control Center at Goddard Space Flight Center*



telemetry and how to point the high gain antennas (HGAs). Two to three other loads are uplinked daily to the payload computer. These contain commands for configuring the science instruments for eight to 12 hours of observations.

Engineering telemetry is received in the STOCC via transmission through the NASA Integrated Services Network (NISN), which provides general communications services for HST and most other NASA space missions. The engineering telemetry—received in real time while HST is in contact with a Tracking and Data Relay Satellite (TDRS)—provides information on spacecraft subsystem health and status. Recorded engineering data, generated between the real-time TDRS contacts, are dumped to the ground at least twice every three days. All of the data are analyzed to ensure they are within proper operational limits and for longer-term trending that may reveal operational issues. Altogether, several thousand engineering parameters are generated continuously. Some telemetry reveals pointing control system operation and stability of the telescope during science observations; other telemetry reveals temperature trends of HST's batteries. Occasionally these latter trends require power system reconfigurations.

The initial step in ground system handling of HST science data is PACOR processing. When data arrive from NISN, PACOR reformats the information. It strips out bits

that have been added by the spacecraft and are essential to reliable data transmission, checks for noise or transmission problems and passes both the data and a data quality report to STScI. PACOR also reports transmission problems to the FOT so that, if necessary, a re-dump of missing science data can be obtained before data still on the recorder are overwritten. Another important function of the PACOR-STScI interface is to support observers requiring a "quick-look" analysis of data. Whenever STScI alerts PACOR to that need, the incoming data are specially handled and delivered to the observers.

## Operational Factors

Three major operational factors affect daily HST operations:

- The spacecraft's orbital parameters and characteristics and other environmental factors
- HST's maneuvering characteristics and target acquisitions
- Communications requirements for sending commands and receiving data.

### Orbital Characteristics

Hubble currently orbits approximately 350 statute miles (304 nautical miles, 560 kilometers) above Earth's surface. The orbit is inclined at an angle of 28.5 degrees to the equator because the Shuttle was launched due east from



Kennedy Space Center. In this orbit sunlight falls on the Solar Arrays most of the time. At other times batteries provide the electrical energy needed by HST. In addition, 350 statute miles is high enough that aerodynamic drag from the tenuous upper atmosphere decays HST's orbit slowly.

HST completes one orbit every 96 minutes, passing into Earth's shadow during each orbit. The time in shadow varies from 26 to 36 minutes. During a typical 30-day period, the variation is between 34.5 and 36 minutes. Similarly, depending on their location in the sky, different targets are visible to the telescope for as little as about 45 minutes (to be observed they need to be sufficiently separated from Earth's limb) to as much as the entire orbit. If Earth blocks a target from the telescope's view, HST reacquires the guide stars and the target as they next rise above Earth's limb. Faint object viewing is best while the telescope is in Earth's shadow.

TDRSS is used to obtain HST orbital tracking data approximately eight times daily and these data are sent to the Flight Dynamics Facility at GSFC. Although this helps predict future orbits quite well, some inaccuracy in predicting the precise times of orbital events, such as exit from Earth's shadow, is unavoidable. The phenomena that most influence Hubble's orbit are solar storms and the 11-year cycle of solar activity. Increased solar activity heats the upper atmosphere, causes it to expand and increases drag on the telescope—accelerating its rate of orbital decay. Shuttle resources permitting, HST will be boosted into a slightly higher orbit during SM4.

### Celestial Viewing

To perform the cutting-edge science that is HST's mission, the telescope is pointed toward celestial targets for science instrument exposure times that can be as short as seconds or sum in their aggregate to days. Occasionally, several continuous days of observation are devoted to a single target or patch of sky. The longest individual exposures using Hubble's cameras are about 20 minutes. Such

exposures can be compared with one another to aid in the removal of image artifacts caused when cosmic rays pass through the detectors, and they can be added to one another to produce composite exposures that reveal fainter targets than would otherwise be detected.

At any time, two HST continuous viewing zones (CVZs) exist. These zones are regions perpendicular to the orbital plane of the telescope that extend up to 18 degrees on either side of the north and south poles of the orbital plane (see Fig. 6-3). The famous Hubble Deep Field and Hubble Ultra-Deep Field were studied while the patches of sky containing them were located in one of the CVZs. The continuous visibility of the target fields allowed many more exposures to be obtained in the time allocated to these two sets of seminal observations.

The orientation of the telescope is normally selected to make the direction to the sun nearly perpendicular to the spacecraft's Solar Arrays. HST's thermal design also requires that the sun not be allowed to shine directly on a "side" or on the "underbelly" of the spacecraft. These limitations may affect the times of year during which a desired observation of a target may be acquired. For example, a specific orientation of the slit aperture of an HST spectrograph on a particular target will be achievable only on certain days.

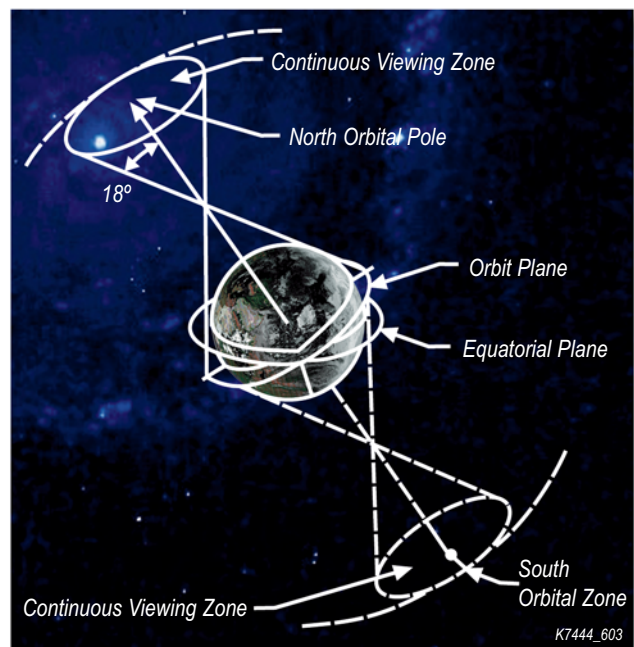

Fig. 6-3 Continuous viewing zone celestial viewing



STScI constructs and periodically updates a long range plan (LRP) for each 12-month cycle of HST science. The LRP process takes into account the requirements of each science program and makes all the geometric and other calculations needed to identify the candidate science for each week of HST observing. This and the detailed planning that follows has generated efficient and productive schedules of HST science, which have also evolved successfully to account for changes in Hubble's capabilities.

## Solar System Object Viewing

For Hubble to view objects in our solar system, the commands sent to HST must compensate for the relative, continuous motion of both the telescope and its target. For example, planning for an image of Mars must take into account both the orbit of Mars around the sun and Hubble's motion as it orbits Earth. Although some solar system objects are so bright that HST needs only a very short exposure to image the target, the motion of the target itself is usually accounted for during such observations. Tracking errors will cause blurred images if they are not compensated for during longer-exposure observations of, for example, much dimmer targets (moons, asteroids and comets). Similarly, longer exposures needed to obtain spectra of planets and faint moving targets require continuous corrections for the relative motion of HST and its target.

Without very special planning, no object is ever observed by HST when the direction to it is within 50 degrees of the direction to the sun. This limitation makes Hubble observations of Mercury impossible. The telescope has made only a few observations of Venus when it has been more than 45 degrees from the sun. These highly choreographed observations were made after it rose above Earth's limb, but prior to the sun's appearance as viewed by HST. They were timed so that HST could maneuver outside the 50-degree solar limit before the sun appeared above the limb.

## Natural Radiation

Energetic particles from different sources continuously bombard the telescope as it orbits Earth. Geomagnetic shielding blocks much of the solar particle radiation, but when HST passes through the South Atlantic Anomaly (SAA)—a region where

the Inner Van Allen Belt dips below HST's orbital altitude—charged particles can penetrate the interior of spacecraft compartments and interfere with its electronics and detectors.

Each day HST passes through the SAA for segments of eight or nine consecutive orbits and then has no contact with it for six or seven orbits. The FGSs cannot be used while the telescope is within the SAA, and its science instruments must be configured in ways that minimize the impact of the heightened radiation environment on their sensitivity. SAA encounters vary in duration and can last up to 25 minutes. Careful scheduling minimizes the effects of the SAA on Hubble productivity but it has some unavoidable impact.

Earth's magnetic field shields the region of near-Earth space through which HST orbits from solar flares and the bursts of energetic particles that accompany them. Occasionally, however, cosmic rays can penetrate the telescope's shielding and upset one of its electronic components. In such a case, recovery procedures are then used to return HST to full operation.

## Maneuvering Characteristics

HST has no propulsion system. Its orientation in space is altered by changing the spin rates of its four reaction wheels and then restoring the original rates. The effect involved is expressed in the principle called the Conservation of Angular Momentum. To conserve the spacecraft's total angular momentum, electric motor-driven increases in reaction wheel spin rates (producing a change in their angular momentum) cause the telescope to rotate in the opposite direction (to offset and null that change). Restoring the original rates halts the spacecraft's change in orientation. The spacecraft can maneuver approximately 90 degrees in 14 minutes. Figure 6-4 shows a roll-and-pitch maneuver.

After HST completes a large maneuver, its Fixed Head Star Trackers are used to remove most of any error between the actual and desired pointing of the telescope. The residual pointing error is usually less than 30 seconds of arc (eight thousandths of a degree). It then takes a few minutes for two FGSs to lock onto the guide stars to be used for scheduled observations.





When HST performs a maneuver from one target in the sky to another, it cannot allow the telescope aperture to point within 50 degrees of the sun. For example, if two targets just outside the 50-degree Solar Avoidance Zone are on opposite sides of the zone, HST follows an imaginary circle of 50 degrees around the sun until it reaches the second target (see Fig. 6-5).

### Target Acquisition

The major steps in the observation process are:

1. Vehicle maneuver, guide star acquisition, target acquisition (if needed to place a target in a precisely defined location) and science instrument exposure
2. Data storage and transmission
3. Data calibration, distribution and archive
4. Data analysis.

Each science instrument has one or more selectable apertures located in some portion of HST's focal plane. The use of small apertures can make precise target positioning a relatively lengthy procedure, especially when a target is faint. To center a target in a small aperture, microprocessor algorithms in the science instruments are used to finely sample the distribution of light coming through the aperture. At other times, precise calibrations are employed to move a target from one location in an instrument's field of view to another. If exposures of the target will span several orbits (and target occultations), the target acquisition process must be repeated for each orbit. However, information about the precise target positioning is retained from one orbit to the next, shortening subsequent acquisition times.

Most observations with HST are made while two FGSs are locked onto guide stars. Two guide stars allow the best pointing performance. However, to increase the probability of a successful acquisition, Hubble's flight software contains algorithms that allow a fail-down to single-star

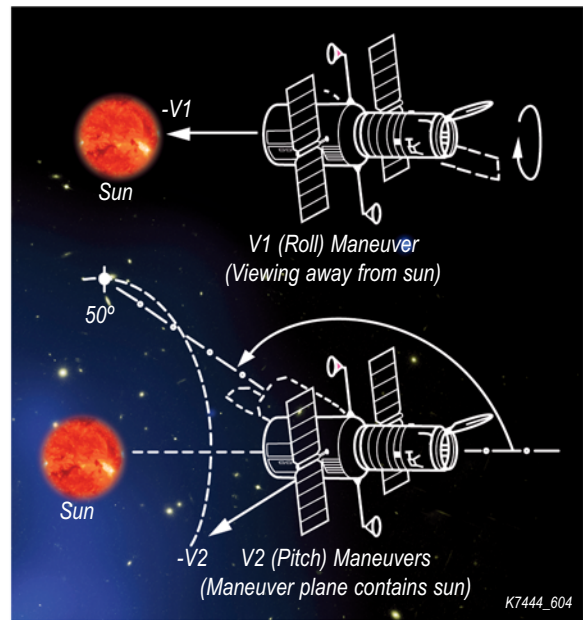

Fig. 6-4 HST single-axis maneuvers

guiding if an FGS cannot lock onto one of the guide stars. The telescope's pointing performance is still excellent when only one guide star is used and most observations are little affected.

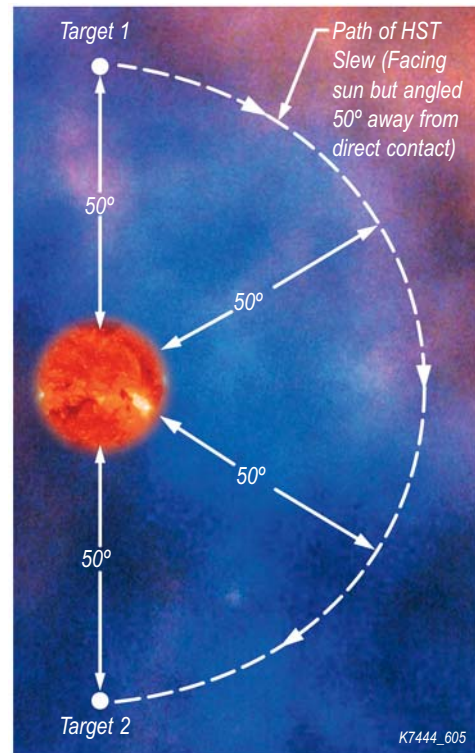

Fig. 6-5 Sun-avoidance maneuver



## Communications Characteristics

Hubble communicates with the ground via TDRSS, which is the orbital component of NASA's Space Network (SN). The SN's ground control facility, called the White Sands Complex (WSC) and located at White Sands, N.M., controls all TDRS spacecraft. In addition to the WSC, the SN has another ground terminal on Guam.

The typical HST weekly communications schedule has Hubble using only the east and west TDRSs. However, a recent enhancement to the ground and flight systems enables use of a combination of four different satellites. That is, while HST communicates only through a single TDRS at a time, mission planning can schedule up to four different TDRS satellites during a given week.

There is a small "zone of exclusion" where Earth blocks HST's line of sight to both the east and west satellites, but up to 91 percent of its orbit supports communications (see Fig. 6-6). TDRSs receive and send both single-access S-band radio transmissions—for Hubble's recorder-stored science and engineering data—and multiple-access (MA) radio transmissions—for Hubble's commands and real-time engineering data. To avoid unnecessary gaps in communication, each HST HGA points toward and tracks a TDRS whenever possible. Each antenna tracks "its" communication satellite, even during maneuvers. HST's two low gain antennas

provide at least 95 percent orbital coverage via a TDRS for the minimum MA command rate used.

WMC's Data Services Management Center (DSMC) schedules all TDRSS communications. HST has a general orbital communication schedule, supplemented by specific science requests. The DSMC prepares schedules 14 days before the start of each mission week.

A ground network of tracking stations that can receive engineering and science data provides a backup communications link to Hubble if the HGAs cannot transmit to the TDRSS. The longest continuous ground contact is between eight and nine minutes. The limiting factor of this backup system is the large gap in time between potential contacts with the telescope. This gap can be as short as 30 minutes but as long as nine hours; the average time is approximately one hour. The FOT performs routine monthly proficiency passes with the ground network stations to ensure preparedness if their use is required during an actual contingency event.

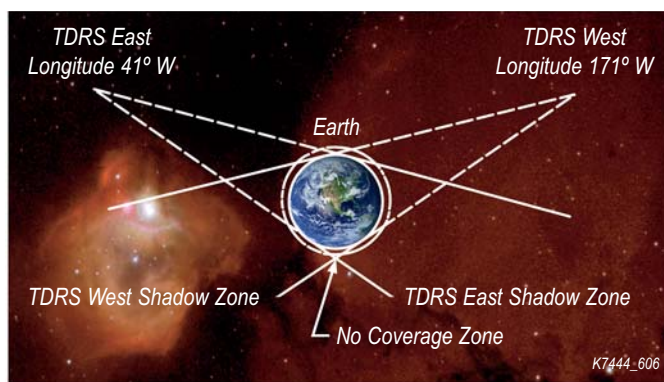
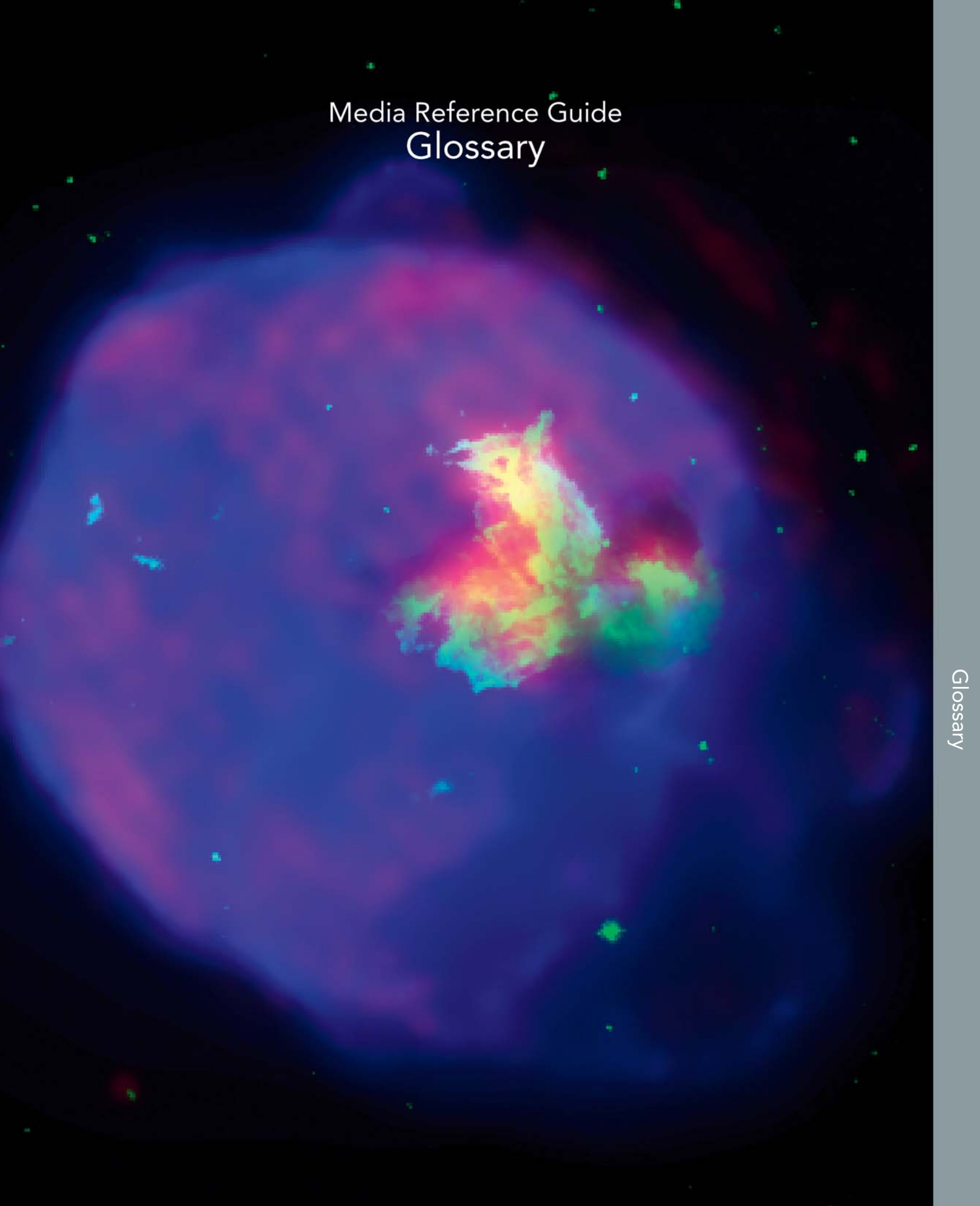

Fig. 6-6 TDRS-HST contact zones

# Media Reference Guide Glossary





















## Refreshing Hubble's Batteries

An SM4 spacewalker astronaut installs a new battery module on the inside of the Equipment Bay 2 door. A second new module will be installed on the Bay 3 door, giving Hubble a complete set of new batteries.

## Sending Hubble Back to Work

After spacewalks are done and on-orbit servicing is complete, Hubble is lifted out of the payload bay, the Aperture Door is opened, and the telescope is on its own again to explore the universe.





