

**A REVIEW OF SUSTAINED CASING
PRESSURE OCCURRING ON THE
OCS**

ADAM T. BOURGOYNE, JR., LSU

STUART L. SCOTT, LSU

WOJCIECH MANOWSKI, DOWELL-SCHLUMBERGER

Table of Contents

EXECUTIVE SUMMARY	2
INTRODUCTION	4
WHAT IS SUSTAINED CASING PRESSURE ?	4
OVERVIEW OF SCP PROBLEM	6
RISKS ASSOCIATED WITH SCP	6
CASE HISTORIES OF PROBLEMS CAUSED BY SCP	6
OCCURRENCE OF SCP.....	8
GOM - MMS Database	8
Geographical Distribution within GOM.....	8
Casing Strings Affected.....	9
Magnitude of SCP by Casing String	9
Occurrence by Type of Well	11
REGULATORY REQUIREMENTS.....	11
General Requirements for Exploration, Development and Production (30 CRF 250.2).....	11
Regulatory Background on Sustained Casing Pressure..	11
Current Practice	13
Request for Departure	14
Deepwater or Subsea Developments.....	15
Anticipated changes in SCP regulations.....	15
ORIGINS OF SUSTAINED CASING PRESSURE	16
TUBING AND CASING LEAKS	16
POOR PRIMARY CEMENT	17
DAMAGE TO PRIMARY CEMENT	17
PREVENTION METHODS	20
CEMENT FORMULATIONS	20
Compressible Cements.....	20
Surface-Foamed Cement	21
Thixotropic Cements.....	21
Expanding Cements.....	21
Right Angle Set Cement or Delayed Gel Cements.....	22
Impermeable Cements.....	22
Surfactant Cements	22
Emulsion Cements.....	23
QUALITY CONTROL.....	23
Application of annular back pressure	23
Cement Vibration During Setting.....	24
Top Cement Pulsation.....	24
Low rate casing rotation and reciprocation	25
Deep Set Annular Packer	25
PRODUCTION OPERATION CONSIDERATIONS.....	26
DIAGNOSTIC METHODS	27
FLOW TESTING AND SAMPLING.....	27
WELL LOG ANALYSIS	27
MONITORING FLUID LEVELS	28
PRESSURE BLEED-DOWN PERFORMANCE	28
WELLHEAD AND TUBULAR PRESSURE TESTING.....	28
PRESSURE BUILD-UP PERFORMANCE	29
WELLHEAD MAINTENANCE	29
REMEDIATION EFFORTS	30
BLEED OFF PRESSURE	31
Case History 1	32
LUBRICATE IN WEIGHTED BRINE OR MUD.....	34
Case History 2.....	35
Case History 3.....	35
CIRCULATION OF WEIGHTED BRINE OR MUD.....	36
ANNULAR INTERVENTION	37
CONCLUSIONS	38
RECOMMENDATIONS AND FUTURE RESEARCH NEEDS	40
BIBLIOGRAPHY	42
APPENDICES	
A - MMS POLICY LETTER	45
B - SAMPLE MMS RESPONSES TO DEPARTURE REQUESTS	48
C - BEST CEMENTING PRACTICES	59

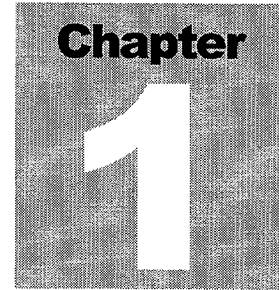

Executive Summary

This LSU study was funded by the Minerals Management Services U. S. Department of the Interior, Washington, D.C., under Contract Number 14-35-001-30749. This report has been reviewed by the Minerals Management Service and approved for publication. Approval does not signify that the contents necessarily reflect the views and policy of the Service, nor does mention of trade names or commercial products constitute endorsement or recommendation for use.

A large number of producing wells on the outer continental shelf (OCS) develop undesirable and sometimes potentially dangerous sustained pressure on one or more casing strings. The objectives of this study were to:

1. Compile information from MMS and operators on the magnitude of the sustained casing pressure problem,
2. Compile information from the literature and from offshore operators on various possible causes of sustained casing pressure,
3. Compile information from the literature and from operators on procedures for correcting or managing existing problems and reducing the number of future problems, and
4. assisting in the development of new technology for reducing the number of future problems.

An MMS database on sustained casing pressure (SCP) was made available for confidential internal use by the LSU research team. Database software was developed to assist with queries and data retrieval by the research team. Sustained casing pressure is seen in over 11,000 casing strings in over 8000 wells on the OCS. Reporting and record keeping requirements associated with sustained casing pressure requires a major effort by both the offshore oil and gas industry and by the Minerals Management Service.

Example areas were selected for further study from an analysis of the database. Procedures currently followed in industry for handling excessive casing pressure have been discussed with a number of operators. Members of the research team made several offshore trips to witness diagnostic test procedures and various remediation procedures. Data were provided by several of the operators showing the results of the remediation attempts over an extended period. Meetings were also held with service companies that were conducting research aimed at identifying the causes of the problem and developing new technology aimed at solving the problem.

Industry experience with problems resulting from sustained casing pressure has shown that the most serious problems have resulted from tubing leaks. When the resulting pressure on the production casing

EXECUTIVE SUMMARY

causes a failure of the production casing, the outcome can be catastrophic. The outer casing strings are generally weaker than the production casing and will also fail, resulting in an underground blowout. Flow rates through the tubing leak can quickly escalate if any produced sand is present in the flow stream. Thus, blowouts of sufficient flow rate to jeopardize the production platform are possible. The magnitude of the leak rate is as important as the magnitude of the pressure when determining the potential hazard posed by sustained casing pressure.

The most significant cause of sustained casing pressure in the outer casing strings, outside of the production casing, is a poor cement bond. Channeling of formation fluids through unset cement from high pressure zones to low pressure zones becomes more likely when the casing setting depth is extended by drilling ahead with mud densities approaching the equivalent density for formation fracture in the upper part of the open borehole. In addition, pressure and temperature changes introduced by completion and production operations have been shown to contribute to the development of cracks and micro-annuli (Jackson & Murphey, 1993 and Goodwin & Crook, 1990) in the cement sheath after the cement sets.

Industry experience on the OCS has also shown that there has been only minor pollution and no known injuries or fatalities due to problems related to SCP. The regulatory burden associated with managing sustained casing pressure was significantly reduced by a series of LTL's issued since 1991. This study has indicated that further substantial reductions in the regulatory efforts to manage the SCP problem on the OCS are possible without sufficiently increasing the risk of injury to offshore personnel or the risk of pollution.

Recommendations are given concerning changes in the regulation of SCP and concerning additional research for reducing the magnitude of the SCP problem. The most promising area for improvement is through prevention of SCP by use of better tubular connectors, by use of better primary cementing practices, and by maintaining a reasonable margin between pore pressure gradient and fracture pressure gradient in the open borehole being cemented. Once SCP develops outside of the production casing or outer casing strings, remediation is generally very difficult to achieve.

Introduction

The Minerals Management Service is concerned about wells on the Outer Continental Shelf (OCS) that exhibit significant sustained casing pressure because Congress has mandated that MMS is responsible for worker safety and environmental protection.

The invention of portland cement by Joseph Aspdin has allowed major advances in our civilization because of its low cost, strength, and ability to set under water. It has been used by the oil and gas industry since the early 1900's as the primary means of sealing the area between the open borehole and the casing placed in the well. Shown in Figure 2.1 is a typical well completion showing the placement of cement to seal off the interior of various casing strings from the subsurface formations exposed by the drill bit. Ideally, the well of Figure 2.1 should show pressure only on the production tubing. Gauges on all of the casing strings should read zero if:

- the well is allowed to come to a steady-state flowing condition, and
- the effect of any liquid pressurization due to heating of the casing and completion fluids by the produced fluids is allowed to bleed off by opening a needle valve.

Only a small volume of fluid has to be bled in order for the casing pressure to fall to atmospheric pressure if the pressure was caused by thermal expansion effects.

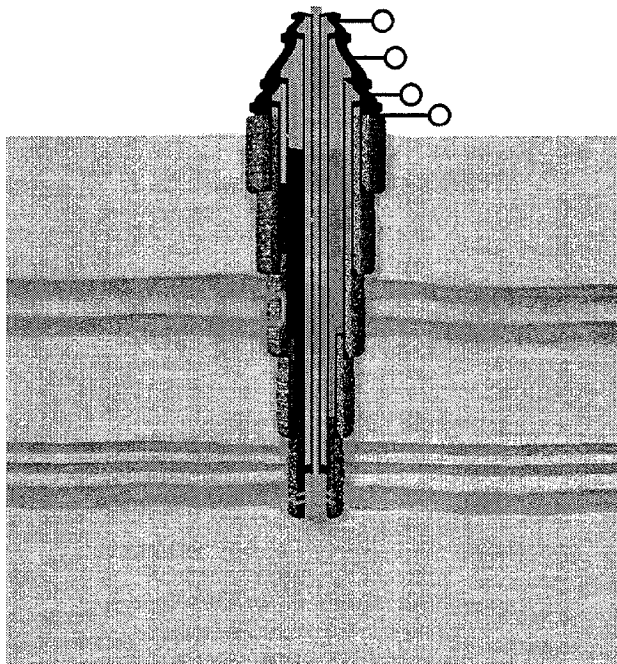

Figure 2.1 - Simplified Well Schematic.

What is Sustained Casing Pressure ?

If the needle valve is closed and the well remains at the same steady-state condition, then the casing pressure should remain at zero. If the casing pressure returns when the needle valve is closed, then the casing is said to exhibit sustained casing pressure (SCP). In some cases the pressure can reach dangerously high values. The Minerals Management Service is concerned about wells on the Outer Continental Shelf (OCS) that exhibit significant SCP because Congress has mandated that MMS is responsible for worker safety and environmental protection.

INTRODUCTION

At present, any measurable amount of sustained casing pressure seen on one or more casing strings of a well (excluding drive pipe and structural casing) is viewed as significant enough to trigger notification of MMS. The regulations do not address the accuracy and precision of the pressure gauges required to make this determination. Casing gauges generally have a full span greater than or equal to the working pressure of the casing and an accuracy of at least 2% of full scale. Some operators require that a gauge with an accuracy of at least 20 psi be used for measuring pressures less than 1000 psi and an accuracy of 100 psi for pressures greater than 1000 psi. Structural and drive pipe are excluded because it is recognized that gas of biogenic origin is sometimes encountered in the shallow sediments and can cause insignificant pressures on the drive and structural casing. SCP also triggers a requirement that records of the observed casing pressures be kept available for inspection in the operator's field office.

Strictly speaking, regulations under 30 CFR 250.517 state that the lessee shall immediately notify the MMS District Supervisor if sustained casing pressure is observed on a well. If the well is felt to be in an unsafe condition, the district supervisor can order that remedial actions be taken. However, provisions are made for a departure from 30 CFR 250.517 to be obtained. As part of the effort to streamline government and reduce burdensome paperwork, MMS developed guidelines under which the offshore operator could self-approve a departure for 30 CFR 250.517. Departure approval is automatic as long as the SCP is less than 20% of the minimum internal yield pressure and will bleed down to zero through a 0.5-in. needle valve in less than 24 hours. Diagnostic testing of *all casing strings in the well* is required if SCP is seen on any casing string.

Records of each diagnostic test must be maintained for each casing annulus with SCP. The diagnostic tests must be repeated whenever the pressure is observed to increase (above the value that triggered the previous test) by more than 100 psi on the conductor or surface casing or 200 psi on the intermediate or production casing. Well operations such as acid stimulation, shifting of sliding sleeves, and replacement of gas lift valves also require the diagnostic tests to be repeated. If at any time the casing pressure is observed to exceed 20% of the minimum internal yield pressure of the affected casing, or if the diagnostic test shows that the casing will not bleed to zero pressure through a 0.5-in. needle valve over a 24-hour period, then the operator is expected to repair the well under regulations 30 CFR 250.517. If the operator does not believe that it is economically justifiable to repair the well and also believes that the well can be operated safely in its current condition, a request for a departure from 30 CFR 250.517 can be made. Diagnostic test results must be submitted with the request for departure. If the request for a departure is denied, the operator normally has 30 days to correct the problem. When a departure is requested, MMS begins tracking the well's casing pressure data in an SCP database. Approval for departure from 30 CFR 250.517 is automatically invalidated if workover operations commence on the well. There are currently over 8000 wells with at least one casing annulus exhibiting sustained pressure. Many of these wells have sustained pressure in more than one annuli.

Unsustained casing pressure may be the result of thermal expansion or may be deliberately applied for purposes such as gas lift or to reduce the pressure differential across a downhole component. Unsustained casing pressure that is deliberately applied does not have to be reported. Unsustained casing pressure in excess of 20% of the internal yield of the casing must be tested and reported as such. Test data validating that the casing pressure is due to thermal effects includes either:

- a decline in the casing pressure to near zero during a shut-in period, or
- when the casing pressure is bled through a needle valve by 15-20% at a stabilized well production rate, a chart of casing pressure versus time shows no significant change over a 24-hour period after bleeding is stopped.

Overview of SCP Problem

Industry experience with problems resulting from sustained casing pressure has shown that the most serious problems have resulted from tubing leaks.

The principle concern for wells that exhibit a sustained casing pressure is that a down-hole situation is developing or has developed that can result in an underground blowout. Wells are designed so that the innermost casings are the strongest. Only the production casing is generally designed to withstand the pressure of the deepest producing formation. Thus, production casing provides a redundant barrier to a blowout in the event of a failure of the production tubing. This redundant protection allows the tubing to be safely repaired. However, if a tubing leak develops and pressure is allowed on the production casing, there is no longer a redundant barrier present. If the production casing fails, the next outer casing string is generally not designed to withstand formation pressure.

Risks Associated with SCP

Industry experience with problems resulting from sustained casing pressure has shown that the most serious problems have resulted from tubing leaks. When the resulting pressure on the production casing causes a failure of the production casing, the outcome can be catastrophic. The outer casing strings could also fail, resulting in an underground blowout. Flow rates through the tubing leak can quickly escalate if any produced sand is present in the flow stream. Thus, blowouts of sufficient flow rate to jeopardize the production platform are possible. The magnitude of the leak rate is as important as the magnitude of the pressure when determining the potential hazard posed by sustained casing pressure.

Case Histories of Problems Caused By SCP

The potential problem that can occur in wells exhibiting SCP is best understood by reviewing several example case histories. Shown in Figure 3.1 is a photograph of a blowout that resulted from an incident of SCP.

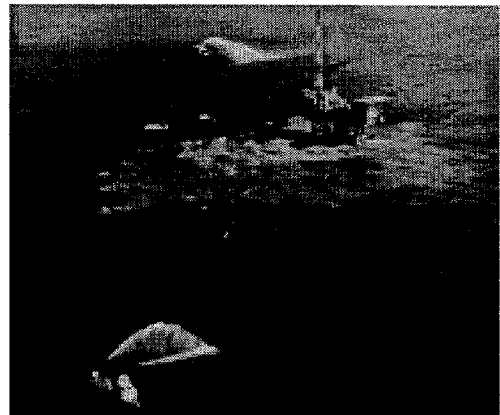

Figure 3.1 – Photograph of Blowout resulting from incident of SCP

OVERVIEW OF SCP PROBLEM

Case 1

Two wells on a platform developed SCP on the production casing about six years after the wells were completed. The operator requesting a departure indicated that the shut-in casing pressure was about 3400 psi and the minimum internal yield on the casing was about 6900 psi. Thus, the operator argued that a safe operation could be maintained. A departure was granted by MMS, and the well continued to be produced. Two years later, the well began blowing out from the annulus between the production casing and surface casing. The well was out of control for 46 days and released an estimated 600 MMSCF of gas and 3200 Bbl of condensate during this period. Pollution washed up on about 4 miles of beach. The well cratered and the platform tipped over. The blowout was killed using a relief well, and the platform and wells had to be abandoned and removed. The wells were plugged and cut off below the mudline. It is believed that the production casing became pressurized through tubing or packer leaks. Failure of the production casing led to pressure on the outer strings through which the blowout occurred.

Case 2

Five years after a well was put on production, SCP was seen on the production casing and a departure was requested. The departure was granted for a period of one year. At the end of this year, the operator requested that the departure be renewed, reporting that the SCP on the production casing ranged from 1400 psi to 1800 psi. MMS granted the renewal with a diagnostic monitoring program in place to periodically bleed down the pressure to determine the rate of pressure buildup. About six months later, the SCP began fluctuating and bubbles were observed below the platform. The underground blowout was confirmed in one of the wells that had been sidetracked during drilling operations because of a stuck drill string. The foundation below one of the platform legs eroded, and the platform began to shift and settle. This platform leg failed below the mudline. All of the wells on the platform were temporarily plugged, and work proceeded on repairing the platform and killing the underground blowout. A relief well was needed to kill the blowout. This work was eventually successful, with about 250,000 cubic yards of fill sand being needed to fill the crater around the platform leg. The wells were returned to production after about two years of blowout control and remediation work. Holes in the production tubing at and below about 1500 ft were found during the remediation work. The next two outer casing strings had also failed in the vicinity of the tubing leak.

Case 3

About four years after the well was drilled, the well began to flow mud, gas, and water from the annular space between the surface casing and the conductor casing. Some of the wells had SCP on the production casing. All of the six wells within the leg of the platform containing the flowing well were killed with mud. It was noted that the flow stopped when the SCP on an adjacent well was bled down from about 700 psi. The flow path was thought to be from the production casing of one well, into a shallow water sand, and up the surface casing/conductor casing annulus. A number of wells had to be abandoned and replacement wells drilled as a result of this problem.

Case 4

Soon after the well was completed and put on production, the operator requested a departure from MMS for SCP on the intermediate casing of 4600 psi, which was about 46% of the minimum internal yield point. When the departure was requested, it was thought that the casing pressure could have been due to thermal expansion. Eighteen months later, work was done on the well to determine why the production rates were lower than expected. Temperature and TDT logs were run and a BHP survey was made. It was determined that an underground blowout was in progress through holes in the tubing, production casing, and intermediate casing. Flow was exiting into a salt water sand below

OVERVIEW OF SCP PROBLEM

the surface casing. About two months were required to kill the underground blowout, and the well was plugged and abandoned. Some damage was done to the platform foundation, and some settlement of the platform occurred.

Occurrence of SCP

GOM - MMS Database

Information on wells granted departures by the MMS has been compiled into a database, and a user interface was created for use by the researchers. The database contains 6,049 individual records. The wells in the SCP database were divided into two main categories. The first category includes wells that have pressure only on the production casing string. Wells that have SCP only on the production casing were assumed to have a mechanical problem such as a tubing leak, or have applied pressure such as gas-lift pressure. The second category includes wells that have pressure on outer casing strings. Wells having pressure only on the production casing can generally be more easily repaired than wells with pressure on outer casing strings.

Geographical Distribution within GOM

Shown in Figure 3.2 is a summary of the occurrence of SCP on the outer casing strings in the Gulf of Mexico OCS region by block. The occurrence of SCP on production casing was assumed to be caused by tubing, packer, or wellhead seal leaks and thus not related to geology. For this reason, the reported occurrence of SCP on production casing is not included in the data of Figure 3.2. The left side of Figure 3.2 gives the occurrence of SCP on outer casing strings as a percentage of the wells completed in the various GOM areas. The right side of Figure 3.2 gives the total number of wells in which SCP was reported on one or more outer casing strings. Note that the occurrence of SCP is widespread and affects a large number of wells.

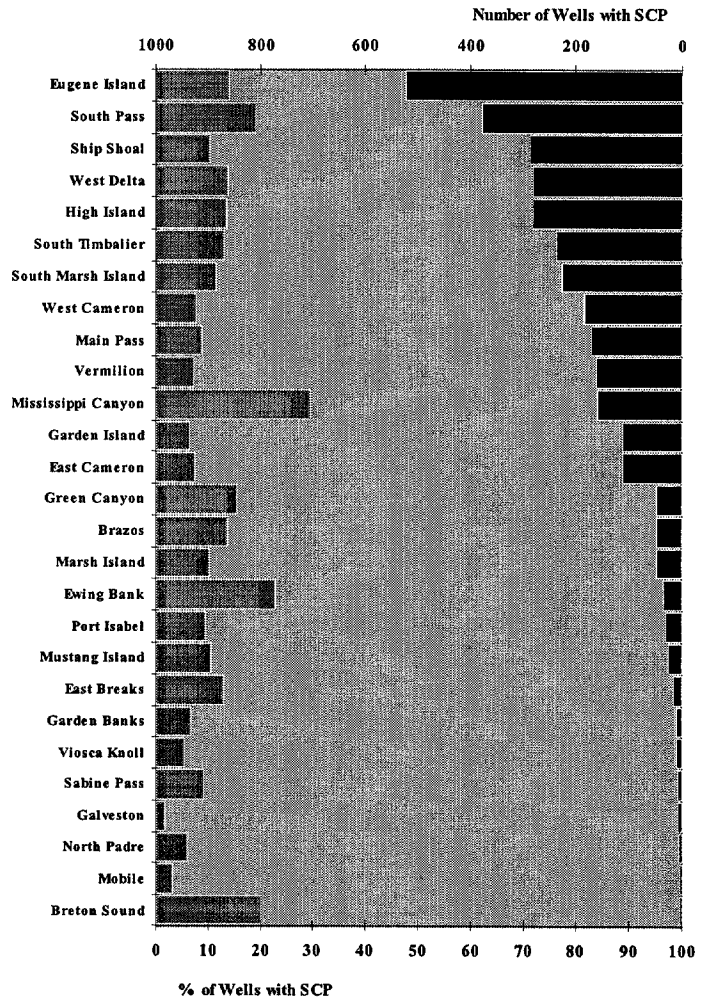

Figure 3.2 : Sustained Casing Pressure by Area

OVERVIEW OF SCP PROBLEM

Casing Strings Affected

As indicated by the bar graphs shown in **Figure 3.3** and **Figure 3.4**, the following trends may be observed:

- About 50% of the casing strings exhibiting sustained casing pressure are *production* casing.
- About 10% of the casing strings exhibiting sustained casing pressure are *intermediate* casing strings.
- About 30% of the casing strings exhibiting sustained casing pressure are *surface* casing strings.
- About 10% of the casing strings exhibiting sustained casing pressure are *conductor* casing strings.

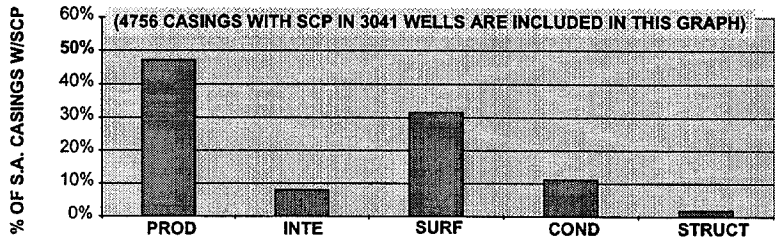

Figure 3.3 Self-approved Sustained Casing Pressure by Casing String.

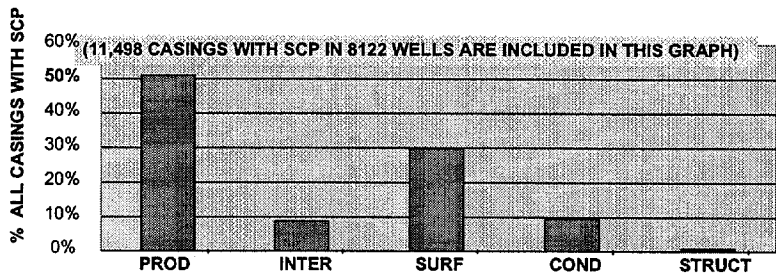

Figure 3.4: Sustained Casing Pressure in Combined Database by Casing String.

Magnitude of SCP by Casing String

Shown in **Figure 3.5** is a cumulative frequency plot of the occurrence of the magnitude of the SCP in units of psi for the various types of casing strings. Note that about 80 percent of the production casings and intermediate casings with SCP are less than 1000 psi. For the other casing strings, about 90 percent of the strings have SCP values less than 500 psi.

Figure 3.6 shows the cumulative frequency of SCP for all casing strings by pressure for wells with self-approved departures. **Figure 3.7** gives this same information for all wells with SCP. These plots show that about 90 % of sustained casing pressures observed are less than 1000 psi in magnitude.

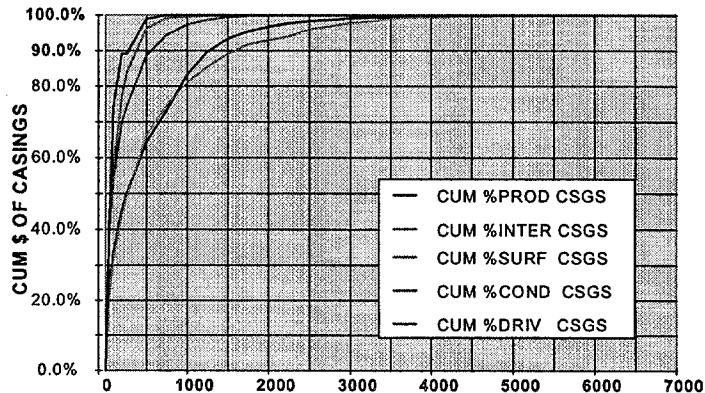

Figure 3.5: Pressure Distribution by Occurrence in Each Casing.

OVERVIEW OF SCP PROBLEM

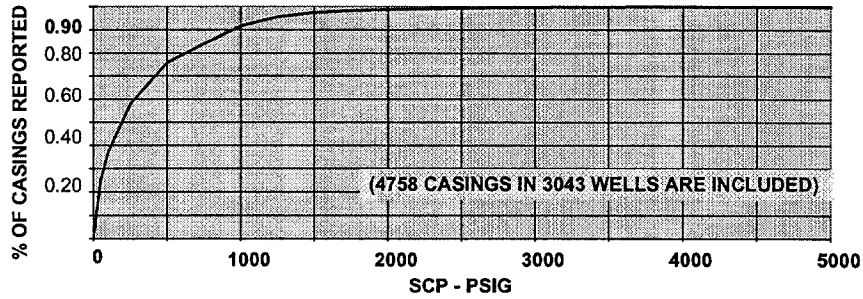

Figure 3.6: Cumulated percent of Casings with self-approved SCP less than plotted.

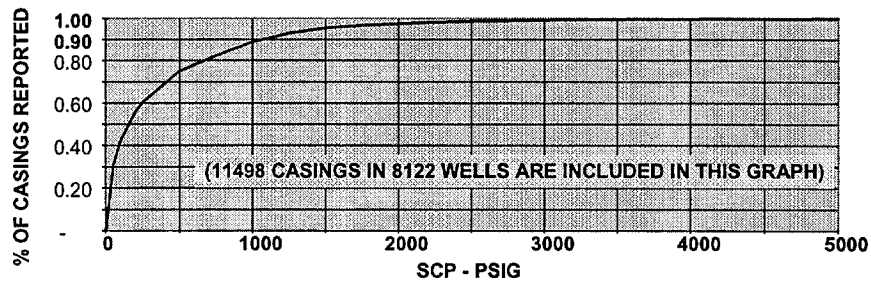

Figure 3.7: Cumulated percent of all casings with SCP less than plotted.

Figure 3.8 shows the same information as a percentage of minimum internal yield pressure. As indicated by Figure 3.8, more than 80% of all sustained casing pressures observed are less than 20 % of the minimum internal yield pressure (burst pressure) of the casing involved. Data on the collapse pressure of the inner string exposed to the SCP are not available. On old shut-in or abandoned wells, failure of the inner string due to SCP may also be of concern.

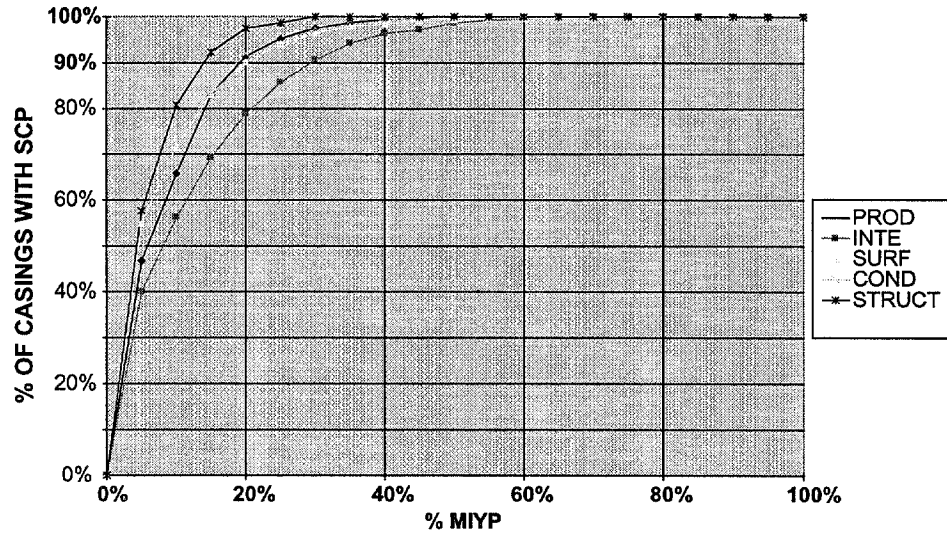

Figure 3.8: SCP distribution as a percentage of Minimum Internal Yield Pressure.

OVERVIEW OF SCP PROBLEM

Occurrence by Type of Well

As shown by Figure 3.9 and Figure 3.10, only about one-third of the casing strings exhibiting sustained casing pressure are in wells that are active and producing. Thus the majority of wells showing SCP are in wells that are shut-in or temporarily abandoned. Additional information regarding the type of wells with SCP are shown in Table 3.1. About equal numbers of oil wells and gas wells have casing strings with SCP. However, a higher percentage of the oil wells with SCP are active in a production status.

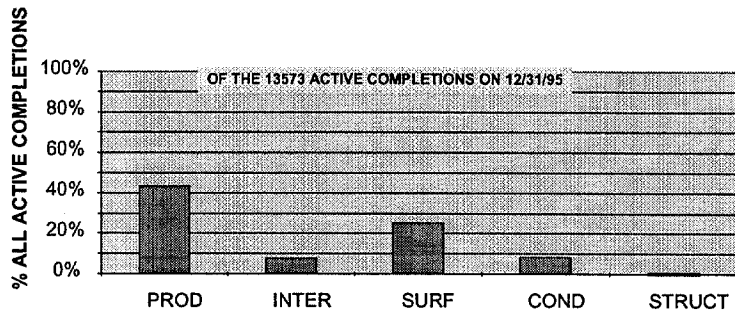

Figure 3.9: Percentage of Active Completions with Self-approved SCP.

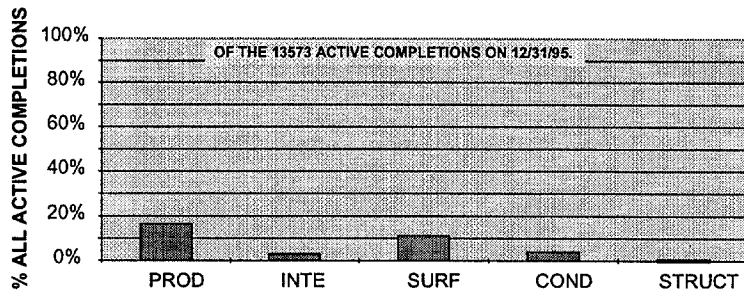

Figure 3.10: Percentage of All Active Completions with SCP.

Regulatory Requirements

General Requirements for Exploration, Development and Production (30 CFR 250.2)

All exploration, development and production activities are regulated by 30 CFR 250.2 which requires the lessee or a group of lessees to submit a proposed plan for the activity which is subject to the approval of the MMS Regional Supervisor. The lessee may propose to use new or alternative techniques so long as the alternative technique is equal to or better than the conventional technique with regards to safety, performance, and protection. The proposed plan should incorporate industry standards and recommended practices. Written approval from MMS is required prior to implementation of any planned activity.

Regulatory Background on Sustained Casing Pressure

In 1988, the regulations existing at that time were consolidated and included in what is now 30 CFR 250.517. These regulations required that all annuli be monitored for sustained casing pressure and that every occurrence of sustained casing pressure be reported immediately to the District Supervisor. Implementation of this regulation imposed a heavy regulatory burden on both the lessee and the MMS. As a result, discussions were initiated between MMS and the OOC. After some discussion, the OOC commenced a study of sustained casing pressure.

In 1989, the MMS and OOC resumed their discussions and held meetings to present the results of the OOC's study. Based on the results of the study, the MMS decided to streamline the departure process as recommended by the OOC study. The MMS developed new reporting procedures which were intended to reduce the volume of burdensome paperwork required by sustained casing pressures.

OVERVIEW OF SCP PROBLEM

SELF APPROVED SUSTAINED CASING PRESSURE WELLS

TYPE OF PRODUCTION	WELLS	SCP CASINGS-STATUS OF WELLS			
		TOTAL CSGS	ACTIVE	SHUT IN	OTHER
GAS	787	1104	587	517	0
OIL	757	1191	841	350	0
SULFUR	30	52	5	47	0
SERVICE	5	7	7	0	0
ABAND, TEMP ABAND, AND S. I.	678	1018	0	1018	0
UNDESIGNATED	784	1386	0	0	1386
TOTAL	3041	TOTAL 4758	ACTIVE 1440	SHUT IN 1932	UNK 1386

ALL SUSTAINED CASING PRESSURE WELLS

TYPE OF PRODUCTION	WELLS	SCP CASINGS-STATUS OF WELLS			
		TOTAL CSGS	ACTIVE	SHUT IN	OTHER
GAS	2888	4192	1352	2840	
OIL	2850	3959	2172	1787	
SULFUR	184	266	12	254	
SERVICE	5	6	6		
ABAND, TEMP ABAND, AND S. I.	357	578		578	
UNDESIGNATED	1838	2497			2497
TOTAL	8122	TOTAL 11498	ACTIVE 3542	SHUT IN 5459	UNK 2497

Table 3.1: Sustained Casing Pressure by Type of Production and Well Status.

In 1991, a Letter to the Lessees (LTL) was issued which dictated the changes in the sustained casing pressure policy. Prior to the issuance of the 1991 LTL, the results of *bleed down* and *build up* diagnostic tests had to be submitted to MMS for evaluation. If upon evaluation of the results MMS were to find that the well met the requirements for continued operation, the well would be approved for continued operation. The requirements for continued operation were as follows:

1. The sustained casing pressure is less than 20% of the minimum internal yield pressure, AND
2. The casing pressure bleeds to zero during the diagnostic tests.

As of the 1991 LTL, the diagnostic tests which met both of the requirements for continued operation were no longer required to be submitted for evaluation and approval. Wells meeting both of these criteria for self-approval were placed in a separate category and referred to as *Self-approved*. Self-approved wells were allowed to continue operations as long as operations adhered to the following conditions:

1. Well(s) with SCP must be monitored monthly and records of the sustained casing pressures observed and of any diagnostic test performed must be maintained and made available to MMS for inspection.

OVERVIEW OF SCP PROBLEM

2. If the casing pressure increases by 200 psi or more in the intermediate or production casing or by 100 psi or more in the conductor or surface casing, diagnostic tests must be conducted on all casing strings to re-evaluate the well. If either of the following conditions apply, the records of the diagnostic test must be submitted to MMS for evaluation:
 - a) The casing pressure is greater than 20% of the minimum internal yield pressure for the casing in question, OR
 - b) The casing pressure fails to bleed to zero during the diagnostic test.

The records submitted should contain the identification of the casing annulus with pressure, the magnitude of the sustained pressure, the time required to bleed the pressure down, the type of fluid, the volume of fluid recovered, the current rate of buildup, and the current shut-in and flowing tubing pressures.

3. Initiation of any workover operations on the well(s) invalidate such approval.
4. The casing should not be bled down without notifying MMS, except when performing a diagnostic test required by condition No. 2 above.

In 1994, a second Letter to Lessees concerning sustained casing pressure reporting policy was issued which superceded the 1991 LTL. The intent of the 1994 LTL was to clarify the policy changes stated in the 1991 LTL. The 1994 LTL clarified the 1991 policy changes regarding reporting and data submittal requirements, time to respond to a denial of continued operation, and unsustained pressure and subsea wells.

In 1995, a third Letter to Lessees concerning sustained casing pressure reporting policy was issued. The intent of the 1995 LTL was to summarize the evolution of the current sustained casing pressure reporting policy and to further clarify the policy changes implemented in 1991. The 1995 LTL states that requests for sustained casing pressure departure should be requested on a well basis rather than per casing string. The SCP on each casing string must be reported and a positive statement given regarding the casing strings that do not exhibit SCP. The 1995 LTL also ordered each operator to submit a status report on all SCP self-approved wells. Along with a listing of the SCP self-approved wells, MMS ordered that the most recent pressures on all annuli in each well be included in the report.

Current Practice

The current sustained casing pressure reporting practice is primarily set by the Letter to the Lessees issued on January 13, 1994 (See Appendices of this report). All casing head pressures, excluding drive or structural casing, must be reported to the District Supervisor immediately. The notification may be in writing or by telephone but must be no later than the close of business on the following working day. Diagnostic tests are required on a well when sustained pressure is first discovered on one or more casing strings and on a self-approved SCP well which exhibits the previously specified increase in sustained casing pressure. Diagnostic test records must contain:

- identification of the casing annulus;
- SCP value and initial pressures on tubing and all other casing strings at beginning of test;
- pressure bleed-down chart or pressures recorded once per hour showing time required to bleed pressure down to zero shown on the gauge;
- type of fluids bled;
- volume(s) of liquid(s) recovered;

OVERVIEW OF SCP PROBLEM

- pressure build-up chart or pressure recorded at least once per hour;
- shut-in and flowing tubing pressure;
- producing rates of gas, oil, and water; and
- well status.

The pressure bleed-down and build-up charts or tables should identify and record pressures on strings not being bled as well as the casing string being bled to detect possible communication between annuli.

Request for Departure

A departure is automatically granted to wells which meet the criteria (discussed previously) to qualify as a self-approved well. If the well no longer meets the criteria established to qualify for self-approved status, a request for departure must be submitted to MMS. A request for departure should contain the following information for EACH casing annulus with sustained casing:

- identification of casing annulus,
- magnitude of the pressure on each casing string prior to bleeding down,
- time required to bleed down through 0.5-inch needle valve,
- type of fluid recovered
- volume of fluid recovered,
- current rate of build-up shown graphically or tabularly in hourly increments of time,
- current shut in tubing pressure,
- current flowing tubing pressure,
- current production data, and
- current well status.

Should a request for a departure from 30 CFR 250.517 be denied, the operator must submit a plan to eliminate the sustained casing pressure. The correction plan must be submitted within 30 days of the departure denial unless MMS specifies otherwise for a particular condition. Departures are granted on a well basis if MMS judges that the well in question does not present a hazard to the offshore personnel, platform, formation, or the environment.

The granting of a departure allows the well to continue producing without elimination of the sustained casing pressure. An indefinite departure might be granted for the life of the completion or a departure might be granted subject to annual review if the sustained casing pressure is greater than 20% of the minimum internal yield pressure AND the casing pressure bleeds to zero.

The departure requests are processed through the Technical Assessment and Operations Support (TAOS) Section which issues the departures either verbally or in writing. The TAOS section also coordinates policy decisions. The District Office is responsible for handling the initial reports of sustained casing pressure and any follow-up actions which might be required following a denial of a request for departure. Special projects involving remediation of sustained casing pressure are addressed by both of these offices.

OVERVIEW OF SCP PROBLEM

Deepwater or Subsea Developments

Currently available subsea wellheads generally limit pressure monitoring to only the production casing below the mudline. However, it is anticipated that MMS will require all casing annuli to be monitored on subsea trees installed after January 1, 2005.

Single bore production risers between the subsea wellhead and the surface wellhead must be monitored for pressure on a continuous basis. In the event SCP is detected and confirmed through diagnostic testing, the operator must immediately either kill the well or set a subsea plug to eliminate the SCP in the tubing /riser annulus.

On concentric dual bore risers, a departure may be granted to maintain SCP on the inner bore only, if the SCP does not exceed 10% of the minimum internal yield pressure of the inner bore and if the SCP bleeds to zero in 4 hours or less. Requests for such departures must contain the documentation described above.

Anticipated changes in SCP regulations

MMS is currently obtaining public comments on a draft NTL addressing anticipated additional future changes and clarifications regarding SCP. The draft NTL no longer has provisions for a self-approved departure and requires all SCP to be reported immediately and a follow-up written submittal to be made within 10 working days. The data collection and reporting requirements of an SCP Diagnostic Test are also slightly expanded and clarified. Provisions for granting a departure with a "Life-of-Completion status" are described that are similar to the conditions currently required for a self-approved departure. The draft NTL also addresses new requirements for a plan of action for non-producing wells with SCP.

Origins of Sustained Casing Pressure

SCP results from tubing leaks, casing leaks, and the establishment of flow paths through the cemented annulus. Portland cement is a brittle material and susceptible to cracking when exposed to thermally induced or pressure induced tensile loads.

Casing pressure increase due to thermal expansion is a normal occurrence whenever well production rates are changed significantly. These thermal induced effects can be distinguished from SCP in that they rapidly bleed-off to zero pressure and do not persist when the well is produced in a continuous fashion. While it is often difficult to determine the precise cause of sustained casing pressure, the likely causes can be divided into three primary groups which are listed below and illustrated in **Figure 4.1**:

- Tubing and Casing leaks .
- Poor primary cement (i.e., channel caused by flow after cementing) .
- Damage to primary cement after setting (i.e., tensile crack due to temperature cycles, micro-annulus due to casing contraction).

Tubing and Casing Leaks

A common cause of high sustained casing pressure is the leakage of pressure from an inner casing and/or tubing string. These leaks can result from a poor thread connection, corrosion, thermal-stress cracking or mechanical rupture of the inner string. Leaks can often be identified by varying the pressure in the inner string and observing if the pressure in an adjacent string responds in a similar fashion. In extreme cases, it may be possible to identify a tubing leak from routine production data when tubing and casing pressures are plotted versus time. Past experience has shown that tubing leaks have the greatest potential for causing a significant problem.

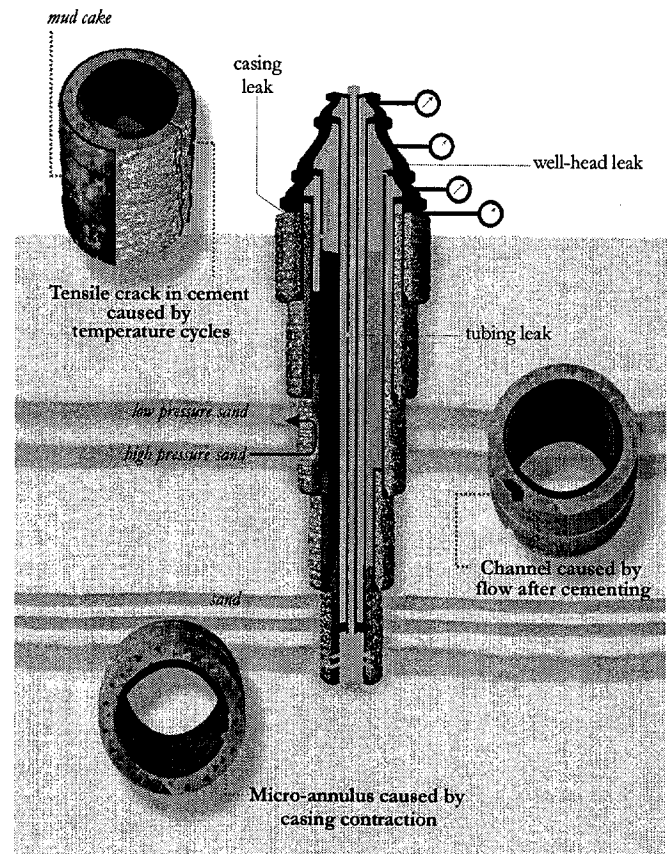

Figure 4.1: Origins of Sustained Casing Pressure

Poor Primary Cement

The primary cement job can be compromised in several ways to provide flow paths for gas migration. The most common problem occurring during primary cementing is the invasion of gas into the cement during the setting process. As cement gels it loses the ability to transmit hydrostatic pressure. During this period, fluids (water and/or gas) can invade the cement and form channels. This flow of formation fluids can be from the pay zone to the surface or can be cross-flow between zones of differing pressure. This type of short term fluid migration problem often leads to long term zonal isolation problems and SCP.

The risk of cross-flow between zones behind pipe is greatly increased when the margin between formation pore pressure gradient at the bottom of the interval and the fracture gradient at the top of the interval is allowed to become very small. MMS regulations call for at least a 0.5 lb/gal margin between the tested shoe strength and the mud density being used to drill ahead. However, operators often request and receive departures to this regulation. If casing is not set until the mud density needed to prevent formation flow has become essentially equal to the equivalent mud density for fracture, lost of circulation and /or flow of formation fluid into the well is often experienced while cementing the intermediate casing or liner. When this occurs, it is often necessary to squeeze cement at the casing seat and /or at the liner top. However, channels through the cement above the shoe area and below the liner top area generally cannot be repaired.

Mud quality while drilling also affects the quality of the primary cement job. If a substantial thickness of mud cake develops during the drilling process and is not removed prior to cementing, the formation/cement bond may not develop. Borehole instability leading to borehole enlargements while drilling also can result in a poor primary cement quality. Borehole instability problems generally can be overcome using an appropriate mud composition and density.

Damage to Primary Cement

Even a flawless primary cement job can be damaged by operations occurring after the cement has set. This damage can result in formation of a micro-annulus that will allow gas flow to the surface or to other zones. One of the first means of damaging cement is the mechanical impacts occurring during tripping drill collars, stabilizers and other tubulars. These mechanical shocks will play some role in weakening the casing cement bond. Changes in pressure and temperature result in expansion and contraction of the casing and cement sheath. The casing and cement do not behave in a uniform manner due to the greatly differing thermal and mechanical expansion properties of metal and cement. This can result in the separation of the casing from the cement.

Portland cement is a brittle material and susceptible to cracking when exposed to thermally induced or pressure induced tensile loads. Experimental test results indicated that all cement systems tested exhibited one or more failure modes. These thermal and pressure effects have been the focus of several recent research projects. Increasing and decreasing pressure of the internal casing string was considered by Jackson and Murphey (1993) and a recent investigation by Goodwin and Crook (1990) considered both pressure and temperature effects.

A number of common completion activities produce a sizable increase in internal casing pressure. Casing pressure tests are routinely conducted to confirm the competency of each string. Pressure tests are also performed prior to perforating, fracturing and after setting packers or bridge plugs. High pressures are also

ORIGINS OF SUSTAINED CASING PRESSURE

experienced during acidizing, fracturing, and cementing operations. In previous years, most Gulf of Mexico formation completion operations were performed at pressures below the fracturing gradient.

In the past few years, the Frac-Pack technique has radically changed the way many offshore wells are completed. For this operation, internal casing pressure well above the fracturing pressure is required. A typical pressure history for a Ship Shoal Frac Pack Treatment is shown in Figure 4.2. The Frac Pack

technique has the effect of increasing by several thousand psi the pressures experienced during well stimulation operations. These increases in the internal casing string pressure has the effect of expanding the internal casing string and compressing the cement sheath. When the pressure inside the casing is reduced, the cement may not experience full elastic recovery, resulting in damage to the casing/cement bond by creating a small micro annulus when this high pressure is released. Chevron

researchers (Jackson & Murphey, 1993) conducted experiments that examined the effect of increasing internal casing pressure. In this work, the cement was set with an internal casing pressure of 1,000 psi and then pressurized and depressurized to examine the effect of increasing internal casing pressure such as during pressure testing. A micro-annulus developed resulting in gas flow after a cycle to 8,000 psi followed by a depressurization to 1,000 psi. The micro-annulus remained active whenever internal casing pressure was below 3,000 psi (Figure 4.3).

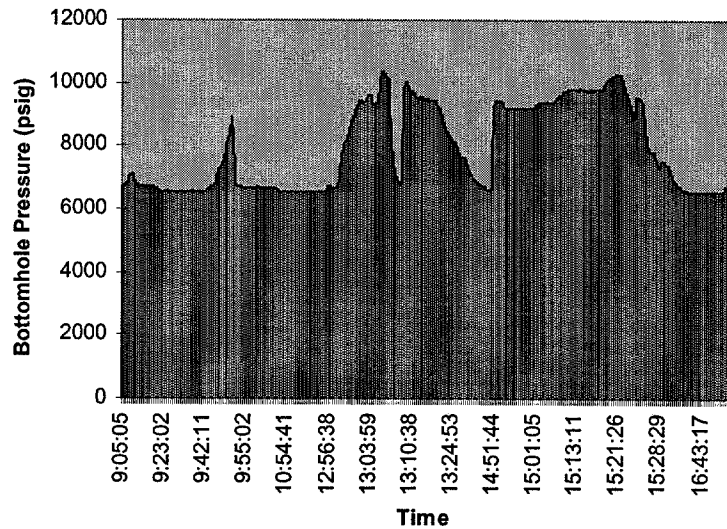

Figure 4.2: Typical Ship Shoal Frac Pack Treatment

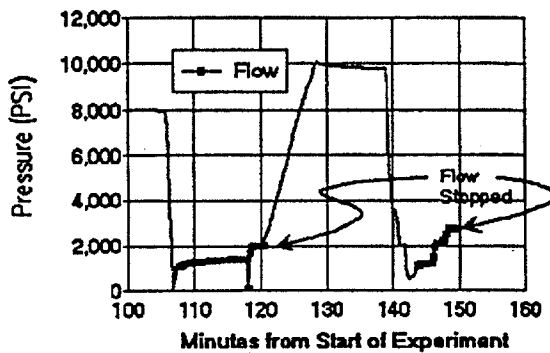

Figure 4.3: Flow through micro-annulus.

Decreasing the internal casing pressure is also common during completion and production operations. Underbalanced perforating, circulation operations, gas-lift operations or the reduction in reservoir pressure due to depletion all reduce internal casing pressure on the primary production string. Use of a lighter packer fluid or lighter muds during drilling a deeper zone may also produce periods of lower pressure in the internal casing than when the cement was allowed to set. So pronounced is this effect that wells are often pressurized prior to running CBL's to obtain a better identification of the location of cement in the annulus.

ORIGINS OF SUSTAINED CASING PRESSURE

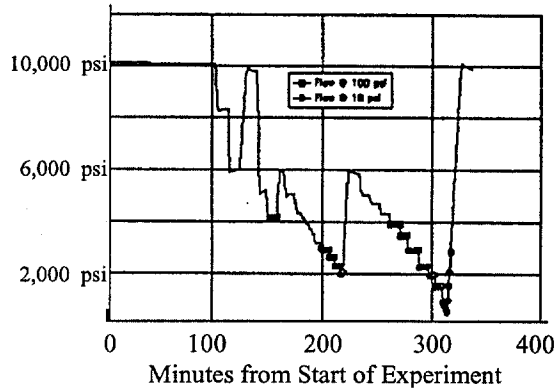

Figure 4.4: Effects of decreasing internal casing pressure.

Chevron (Jackson & Murphey, 1993) also performed experiment examining the effects of decreasing internal casing pressure. In this case, the cement was set at an internal pressure of 10,000 psi. Reduction of internal pressure to 3,000 resulted in a flowing micro- annulus that remained active whenever internal casing pressure was dropped below 4,000 psi. (Figure 4.4) Decreasing internal casing pressure may also contribute to thread leaks. Many casing couplings are designed to resist leaks most efficiently from higher internal pressure than external pressure.

Prevention Methods

Much work has been done on improved cement formulations for reducing the occurrence of gas flow through cement behind casing.

The widespread occurrence of sustained casing pressure has prompted interest in preventing problems through use of new drilling and completion techniques. Use of the following techniques are currently being reported by operators and in the literature:

1. New Cementing Formulations and Practices
2. Annular Casing Packer
3. Controlling Internal Pressure during Completion and Production

Cement Formulations

New cements are designed to prevent the occurrence of at least one of the mechanisms leading to flow after cementing. These mechanisms include the following:

- fluid loss,
- reduction of cement slurry volume, both bulk and internal, due to hydration reactions,
- development of porosity and permeability in cement as conduits for migrating fluids,
- development of gel strength and subsequent loss of hydrostatic pressure.

Compressible Cements

In the late seventies, it was found out that a rapid decrease in hydrostatic pressure exerted by a column of setting cement can be attributed to a volume reduction occurring in cement slurry. Due to very low compressibility of cement slurry, even a small volume loss results in a rapid pressure decrease. Pressure maintenance was thought to be improved if the compressibility of the cement slurry could be increased [Tinsley et al. (1979)]. An in-situ gas generating additive was developed and tested in the laboratory as a way of obtaining high compressibility. Results of lab testing were encouraging. An additive that would release hydrogen gas was chosen. It created some hazard problems since hydrogen is flammable and cases of hydrogen catching fire were reported. Also, there were problems with non-uniform distribution of the additive. Recently, this cement has been rarely used due to the controversy that the generated bubbles might coalesce downhole and promote gas flow rather than prevent it. Also, the amount of gas generated and its properties are hard to control. Moreover, at high pressures the gas will occupy little volume and its contribution to the overall compressibility increase may be insignificant.

Surface-Foamed Cement

Surface-foamed cements are obtained by the addition of a gas (often nitrogen) to a pre-mixed cement slurry before pumping the two-phase mixture downhole [de Rozieres and Ferriere (1991)]. They are especially useful for cementing of weak formations with low fracturing pressures. The foam is generated by adding a foaming agent (surfactant) that will lower the interfacial tension between the gaseous and liquid phases. Chemical properties of a foam cement will be essentially the same as of the base cement slurry. They are successful in preventing fluid migration because they exhibit low fluid loss, they have low permeability and high compressibility. Contrary to the in-situ generated gas cements, they form a stable foam, i.e. the gas bubbles do not coalesce over the hydration period of the cement. Also, the rheology of foam cement should be very beneficial in preventing fluid migration. Although there is a lack of direct experimental work on foamed cements, foams in general reveal high shear stress values at low shearing rates. Foam cements have been used recently in shallow cementing operations in the Gulf of Mexico due to the presence of weak formations in this region. One of the reasons for the growing number of cementing jobs run with foamed cement is that the quality of equipment used to generate foam has improved significantly over the last several years. The performance record of foam cements is very good. They can be used in a variety of conditions and they are recommended in most severe conditions for flow after cementing. They are, however, expensive, especially if cementing is performed offshore. The cost may be up to ten times of a typical cementing job with neat cement. Also, they do not displace mud as effectively as neat cement due to their density and disadvantageous rheological properties at higher shear rates.

Thixotropic Cements

The mechanisms of action of thixotropic cements is a decrease of transition time. Transition time is defined here as the time elapsing between the end of cement placement and the time the cement reaches sufficient strength to resist fluid migration. Thixotropic cements were also thought to have increased resistance to deformations caused by migrating fluids, [Stehle et al. (1985)]. These cements develop high early gel strengths by the addition of bentonite or polymers. Cementing job planning for a thixotropic system is not significantly different from planning for a conventional low-fluid-loss cement job. Every blend should be tested for thickening time and consistent concentrations of the additives should be maintained. Recently these cements have been used very rarely. Most formulations turn out to have high fluid losses.

Expanding Cements

Expanding cements were designed to prevent the volumetric reduction occurring in setting cement as a result of hydration reactions and create a better bond at the cement/formation and cement/casing interface [Seidel and Greene (1985)]. They were especially intended to prevent the occurrence of a micro-annulus between the casing and cement. The expansion of this cement is achieved by the addition of anhydrous calcium sulphonate, calcium sulphonate lime or other additives. The use of these additives results in up to 0.2% volumetric expansion, however this expansion occurs well after cement reaches an initial set. It should be noted that although these cements undergo a net bulk volume expansion, they also experience the same internal volume reduction as neat cements. They also exhibit a similar hydrostatic pressure decrease. Recent research also shows that although neat cements undergo a bulk volume reduction, they do not result in the generation of a micro-annulus [Bonett & Pafitis (1996)]. Expanding cements were designed in the mid 80's and field-tested then. They are rarely used today.

PREVENTION METHODS

Right Angle Set Cement or Delayed Gel Cements

These cements have different names depending on their vendor, but their mechanism of action is essentially the same [Sepos and Cart (1985); Sykes and Logan (1987)]. They are designed to decrease transition time. But contrary to the thixotropic cement, they do not develop high early gel strength by thixotropy. Their Static Gel Strength characteristic is shown schematically in Fig. 5.1.

SGS remains flat at the initial period of time. Then it starts to increase rapidly to achieve an early set. Depending on the length of the initial low-gel-strength period, these cements can be characterized as either accelerated Right-Angle-Set cement or retarded Delayed-Gel cement.

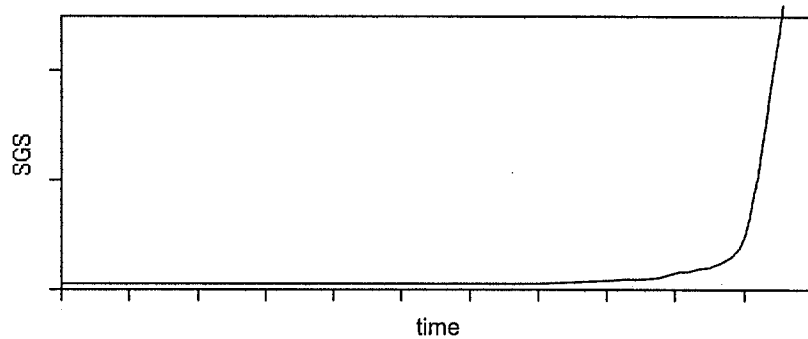

Fig. 5.1 Static Gel Strength development in a right-angle-cement, conceptual.

These properties are achieved by the addition of various additives, like certain modified acrylamid polymers. These cements usually exhibit good compressive strength characteristics. Retarded cements are especially good for deep well cementing. However, some problems have been reported for these cements. They do not perform well for all conditions and some additives are very expensive. Many polymers used are not stable at high temperatures, and retarded cements usually exhibit a high filtrate loss.

Impermeable Cements

Impermeable cements are designed to plug the pore spaces in the hydrating cement slurry and thus make it difficult for any fluid to flow through the matrix of the cement. This mechanism of flow is often referred to as micro-percolation as opposed to flow through fractures in the cement or flow through a micro-annulus between the cement and the casing. It also provides with a means of controlling filtration and excessive loss of water. Cement permeability and porosity are reduced by a number of means. Polymers have been used successfully include latex, styrene-butadiene rubber and cationic polymers. Most polymers viscosify water and deposit an impermeable film on the cement hydration products [Cheung and Beirute (1982)]. Micro-fine cements have been used recently. These are made of fly ash, silica fumes or blast furnace slag materials [Coker et al. (1992)]. Salt saturated cements were also reported to perform well [Lewis and Rang (1987)]. Salt precipitates as water is consumed in hydration, plugging pore throats.

Latex cements have been used widely and good results were reported by Ganguli (1991). Micro-fine cements have been used in deep water cementing recently. They perform well in low temperature, low density applications. Most impermeable cements demonstrate good rheological properties, low fluid loss and good bonding characteristics. Only salt cements are inexpensive. Other formulations tend to be very expensive and are not widely used.

Surfactant Cements

Surfactant cements are designed to trap migrating gas into a stable foam as a result of the addition of a surface-active agent [Stewart and Schouten (1988)]. Stable foam exhibits high resistance to deformation at

PREVENTION METHODS

low shears and thus may contain the propagation of gas. It was successfully tested both in the lab and in the field. Hibbeler et al. (1993) reported that surfactant cements work well in moderate gas-flow problems, but may not be as effective in cases of severe gas-flow potential. They are not useful in preventing flow of water from shallow abnormally pressured aquifers found in deep water leases in the Gulf of Mexico. Surfactant cements are relatively inexpensive.

Emulsion Cements

Emulsion cements are designed to reduce cement porosity and permeability, decrease free-water and trap either gas or water in an emulsion [Skalle & Sween (1991)]. They are obtained by forming a double emulsion (water in oil in water). Dry cement is added to the double emulsion. The developers of this cement claim that free water is eliminated by osmotic forces. Emulsion cement should exert high interfacial forces to migrating fluid. It will also have decreased permeability to water or gas by virtue of the presence of an oil phase. This cement showed superior rheological properties and good bond strength as well as no free-water in laboratory testing. It has not been used in the field yet. Potential problems that may arise if the cement is used in the field include the following :

- high fluid loss,
- difficult to prepare and handle,
- emulsion may not be stable in high temperatures,
- may be expensive.

In summary, it should be noted that although some cement formulations proved to be a good anti-migration solution in certain conditions, there is no special cement that would be effective every time for all conditions. Prevention of gas flow or water flow behind casing cannot be solved by looking only at the cementing system. An integrated solution considering drilling mud, bore-hole stability, margins between pore pressure and fracture pressure, as well as cementing practices must be applied.

Quality Control

New equipment has been developed to improve quality control during the cementing process. Reciprocation and rotation of casing during cementing has long been recognized as effective means of improving the displacement of mud by cement during cementing. A new technique has been proposed and is actively being tested by Texaco in which the cement is vibrated to improve the cement's ability to achieve zonal isolation. Mud systems are also being developed to minimize the thickness of the mud cake or to cause the mud cake to harden and become part of the cement.

Application of annular back pressure

The application of an annular back-pressure at the surface while the cement is setting was suggested by Levine et al. (1979) and field-tested by Cooke et al. (1982). The concept is simple. The decline of pressure exerted by cement column can be compensated for by the application of surface pressure by injecting water into the top of the sealed annulus. As discussed above, a problem that must be overcome when using this technique is cement Static Gel Strength (SGS) buildup that may prevent transmission of the applied pressure. Indeed, field measurements confirmed pressure of 60 psi applied 10 hrs after pumping had been completed was not transmitted below the depth of 1900 ft below top of cement. However, earlier application of pressure in the order of 60-100 psi appeared to prevent the loss of hydrostatic

PREVENTION METHODS

pressure well up to 5 hrs after pumping had been completed up to a depth of 4500 ft below the top of the cement column. Approximately 15 hrs after pumping had been completed, an application of 500 psi broke the SGS in the column down to 4400 ft below the top of the cement column and caused a surge of more than 1000 psi in recorded down-hole pressure. This experiment showed that SGS grows very rapidly in static columns of cement and indeed a high surface pressure would be necessary to break the gel and restore the pressure. Also, it showed that a rapid decline in the restored pressure follows. Overall, the field tests conducted showed that SGS would rebuild very quickly and that the application of annular pressure did not appear to be effective at reducing the tendency for flow after cementing over a long cement column.

Cement Vibration During Setting

The idea of vibrating the casing while and/or after cement is pumped is to minimize the cement transition time by fluidizing the slurry. Once vibration is ceased, the cement should set very quickly. A series of laboratory experiments conducted by Chow et al. (1988) which involved a cement sample subjected to an oscillatory deformations showed that an amplitude of 0.001 in. was enough to minimize the elastic modulus of the slurry. The frequency of the oscillations was found to have relatively little effect on the value of the elastic modulus. The frequency was, however, in the range of 20 Hz.

The laboratory procedure that was used simulated a concentric annulus. An electromagnetic driver capable of vibrating was attached to an inner pipe placed within a larger outer pipe. The effects of driver frequency and amplitude on the pressure near the bottom of the annulus were recorded. It was found that after 90 minutes of static conditions, vibrating with an amplitude of 0.015 in. was enough to restore the pressure to its original value. Frequencies in the lower range of the instrument appeared to be more effective at restoring pressures. A visual observation revealed that a thin layer of liquefied cement was created near the vibrated pipe, much like in the case of low rate pipe movement.

A field experiment utilizing a 200 ft long casing string was then carried out. Pressure transducers and accelerometers were attached to the casing and run. A geophysical truck capable of vibrating the casing was used. Vibration of the casing was successful in restoring hydrostatic pressure up to 230 minutes after placing the slurry. The results of the experiment showed that a frequency of 8 Hz was optimal. A temperature rise signaling the end of the dormant period of the cement began at 150 min. There was a strong correlation observed between this time and the time when hydrostatic pressure of the cement began to drop significantly. It indicates that the pressure loss in cement columns is affected mostly by hydration of cements. Cement slurry vibration has been shown to be an effective method of preventing the loss of hydrostatic pressure. It has not been used in the field since the tests. Apparently, all the heavy equipment needed to vibrate a long and heavy string of casing renders the method impractical.

Top Cement Pulsation (TCP)

This method is an extension of the application of annular pressure at the top of the cement column. Instead of applying constant pressure, pressure pulses are applied to the top of the sealed annulus. The objective is to maintain the cement slurry in a fluid state so that hydrostatic pressure would not decline. Once the pulsations are ended, the slurry will quickly develop a structure highly resistant to any deformation. This will minimize the slurry transition time. Another potential benefit from this technology is an improved Cement Bond Log (CBL) [Haberma (1996)].

The equipment used to reciprocate the slurry is very simple and inexpensive. The equipment consists of an air/water compressor and a back-pressure valve. Air or water is compressed and injected into the closed

PREVENTION METHODS

annulus within 5 seconds. When the pressure reaches 100 psi, the back pressure valve is opened and air/water is exhausted. The exhaust cycle takes about 5 seconds and the full cycle is about 10 seconds. During the compression cycle, the column of cement will displace downwards a short distance due primarily to the compressibility of the cement slurry, and to a lesser extent, the expansion of the bore-hole, and the compression of the casing.

CBL logs for cemented wells where TCP was applied indicated consistently a better bond as compared with those where cement was set undisturbed. With this technique, the fluidity of the slurry is monitored by periodically measuring the volume of water or gas pumped into the annulus to increase the pressure to 100 psi. Compressibility of the system obtained in this manner turned out to be 2 to 3 times greater than the compressibility of water for a given annulus. The change of compressibility due to cement setting is determined by the observation of the volume of fluid pumped into the annulus. In a field test, a rapid decline of the system compressibility was seen. This was thought to be caused by a relatively short thickening time due to slurry dehydration. Other possible explanations include attenuation of the pressure wave by the thickening cement slurry, decline of cement compressibility due to its thickening, and the cement slurry's inability to transmit horizontal stresses effectively due to its plasticity. This promising new technique is still being studied.

Low rate casing rotation and reciprocation

The reason for casing movement is to improve mud removal and to modify the cement transition time. The loss of pressure in the cement column is also delayed by the movement. Once casing is not moved any more, cement starts to set very quickly and develops high resistance to deformation so that formation fluids do not have enough time to migrate upwards. Not all wellheads permit this method to be used. When it can be used, it is known to be effective.

Laboratory tests done to study this technique showed that slow movement of a pipe creates a thin water layer around it. Once movement is over, the layer heals very fast, so the cement can create a bond with the pipe. It is interesting to compare transition times of a slurry setting under static conditions and the same cement slurry setting while the pipe was moving slowly. Sutton and Ravi (1991) showed that the transition time is much shorter when the pipe is moved for a period and then stopped. It was recommended that the casing be either rotated at the rate of 2-8 rpm, or reciprocated at 0.2 - 2 ft/min depending on the size of the casing. Also, it was found that the torque needed to rotate the casing was much less than torque calculated from the SGS. The observed torque for casing rotation or load for casing reciprocation are within the allowable range for casing thread and hook load according to the authors.

Deep Set Annular Packer

A deep set annular packer has been proposed as a method of eliminating excess casing pressure in new wells. This technique (Vrooman et al., 1992) received one of the 1992 Petroleum Engineering International Meritorious Engineering Awards. The technique eliminates gas and pressure migration to the surface in wells completed in this manner. However, SCP can develop under the packer where it could not be detected.

The annular packers inflate by means of an applied pressure. These devices are not thought to be against soft formations. This limitation is severe for most areas in the Gulf of Mexico where shallow sediments are often poorly consolidated. Thus, they are generally run near the bottom of the previous casing string. They were reported to set prematurely and sometimes tend to get damaged while the casing they are attached to is run down the hole. According to some critics, as they are set, they stop transmitting any

PREVENTION METHODS

pressure from above them. Thus, if set deep they may trigger or accelerate fluid migration and further exacerbate the problem rather than prevent it. If they are set too shallow, they function much like closing a valve on the casing so that pressures cannot be measured.

Production Operation Considerations

Strong evidence exists that repeated and extreme cycling of the internal casing pressure weakens the cement sheath thereby creating a micro-annulus path for gas flow. Although some reduction in tubing pressure is inevitable due to reservoir depletion, steps can be taken to minimize unnecessary pressure cycling of the casing. For example, casing integrity tests can be limited to only the necessary pressure and not some arbitrary percentage of rated burst pressure. In the small percentage of wells experiencing tortuosity during fracturing operations, steps can be taken to lower the treating pressure. Also, packer fluids and lead fluids in cementing operations can be designed to assist in maintaining internal casing pressure at a reasonable level.

Diagnostic Methods

Diagnostic methods are used to determine the source of the Sustained Casing Pressure and the severity of the leak. Tubing leaks, wellhead seal failures, packer failures, casing leaks, and flow through cement channels are potential causes of the SCP. Leaks that can be bled to atmospheric pressure thru a 0.5 -in. needle valve are regarded as minor.

Engineering analysis of sustained casing pressure can utilize data from a number of different sources. Much of this data is obtained from routine production monitoring methods used by all operators. MMS has specified a standardized diagnostic test procedure to assist in this analysis when SCP is detected. Some of the sources of data that can be used includes:

1. Fluid sample analysis
2. Well logging
3. Monitoring fluid levels
4. Pressure bleed-down performance
5. Pressure testing
6. Pressure build-up performance
7. Wellhead maintenance

Flow Testing and Sampling

The weight and composition of the fluid that flows from the well during pressure bleed-off operations can yield valuable information regarding the density of the annular fluid and the source of the behind pipe influx of fluids. Sampling of the hydrocarbons is often done to try to match identifying characteristics of the hydrocarbons with those of a known producing formation. It is often possible to determine if the source of gas is deep or of biogenic origin through detailed gas composition and isomer analysis.

Well Log Analysis

A number of cased hole logging tools are available that can provide information about gas or water flow behind casing. When flow behind casing is significant, noise and temperature logs can provide information regarding the fluid entry and exit points. An Oxygen Activation log can be used to detect a water flow channel by looking for oxygen in the water. The Cement Evaluation Tool (CET) is a cement bond log that evaluates the quality of the cement bond in eight directions with a very fine vertical resolution. The CET can also be used to map the presence of gas channels, that typically spirals around the outside of the casing.

DIAGNOSTIC METHODS

A Thermal Decay Time (TDT) log can also see gas accumulations in the annular space outside of casing, especially when it collects above the top of the cemented portion of the annulus.

Monitoring Fluid Levels

Monitoring fluid levels in the production casing can indicate the presence and sometimes location of tubing leaks. Some operators report success in shooting fluid levels in the production casing using a conventional acoustic test. Due to the difficulties presented by the annular geometry, gas cut fluids, and the 90 degree turns in the wellhead, routine monitoring of fluid levels may not always be possible.

Pressure Bleed-Down Performance

The process of bleeding-off pressure from an annulus presents one of the best opportunities to obtain information about the annular volume, gas content and channel/micro-annulus flow capacity. This operation is normally performed through a fix sized (1/2") needle valve and the liquid recovered is also measured. When bleeding dry gas, an orifice-type, gas-rate measurements device is sometimes utilized in series with the needle valve to allow a more accurate estimation of gas bleed rate during the bleed-down period.

Even when an orifice meter is not used, an approximate estimation of gas rate can be obtained from the casing pressure using critical flow calculations if a bleeding orifice of known size is attached to the needle valve and the absolute upstream pressure on the needle valve is more than two atmospheres. Integrating the area under the flow-rate versus time curve gives an approximate estimate of the total volume of gas bled.

MMS requires either recording the casing pressure once per hour or use of a data acquisition system or chart recorder during a pressure bleed-down test. The pressure on the tubing and the pressure on all casing strings should be recorded during the test to provide maximum information that could indicate communication between strings.

Wellhead and Tubular Pressure Testing

Wellhead, tubing and production casing leaks can often be identified by pressure testing. Pressure test procedures can be used to supplement the diagnostic bleed-down test required by MMS. Pressure testing of wellhead seals is generally performed after SCP has been bled down.

One operator has developed a methodology for estimating the worst case casing pressure that can be expected for a given well. The technique attempts to determine the deeper zone contributing to the SCP problem using the first indication of surface pressure and a knowledge of the density of the fluid left in the annulus. The calculation assumes that all of the fluid left in the annulus could eventually be replaced by gas. Using this method in the High Island area, the operator successfully identified a high-pressure, gas-bearing, shaly-sand string as the zone providing gas and pressure to the annulus of an outer casing string on several wells.

DIAGNOSTIC METHODS

Pressure Build-up Performance

MMS also requires the pressure build-up period to be monitored after bleeding off SCP. The rate of pressure build-up provides additional information about the size and possibly the location of the leak. The pressure build-up test is especially important when the SCP cannot be bled to zero through a 0.5-in. needle valve. As in the case of the pressure bleed-down test, the pressures on all strings should be monitored and recorded to provide maximum information about communication between strings.

Wellhead Maintenance

The point of communication from one casing string to another can sometimes be through the wellhead. This was observed by one operator where SCP in the outer 9 5/8" string (3,222 psi) communicated with the 7" casing through a small leak in the wellhead resulting in a SCP of about 2000 psi. In this case, periodic application of grease to the wellhead seals eliminated the problem.

Remediation Efforts

Tubing leaks, which are the most dangerous cause of SCP, are easily repaired by means of a well workover. However, remediation of flow through channels and cracks in cemented annuli have proven to be extremely difficult.

The primary remediation method for SCP is a well workover designed to block the leak path causing the problem. This can be relatively simple when the source of the leak is in the tubing string, a down-hole packer, or in the wellhead. Although technically straightforward, such workovers can be expensive and may not be economically justified if the well is near the end of its producing life-cycle. Remediation of flow through channels *outside* of the production casing are often technically difficult to achieve, even when an expensive well workover is performed. It is generally necessary to perforate or cut the production casing in order to attempt to squeeze cement into leak paths that are outside the production casing. The squeeze perforations can weaken the overall pressure integrity of the production casing and contribute to future leak paths.

Perforating or cutting the casing to squeeze cement is normally considered as a last resort. This is due to the low success rate of this type of operations (<50%) and also to the high costs. The success rate of these procedures is low due to the difficulty in establishing injection from the wellbore to the appropriate annular channel. As an example of the cost and success rate of this procedure, one operator reported spending 13 months and over 20 million dollars attempting to eliminate SCP by plugging seven wells. Both block and circulation squeezes were conducted. Even after this extensive effort, some of the wells are still reporting sustained casing pressure at the surface. Figures 7.1 and 7.2 show example wells in which SCP is still being observed after an extensive workover to block the leak paths.

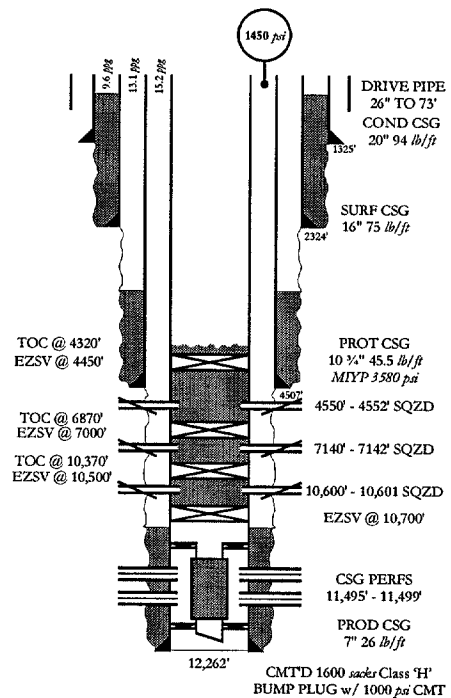

Figure 7.1 - Example 1 of Unsuccessful Workover for SCP

REMEDICATION EFFORTS

Because of the cost and uncertain effectiveness of workovers to remediate SCP problems, operators are investigating several remediation methods that can be accomplished without a workover rig. These methods include:

- Periodic bleeding of excessive pressure;
- Partial bleeding followed by lubricating in a higher density fluid; and,
- Insertion of a small diameter tubing into the annulus exhibiting SCP to allow shallow annular circulation.

Several operators have collected detailed data on the pressure behavior of wells that have undergone periodic bleeding. Several example case histories are summarized in this chapter. The procedure of periodic bleeding of casing pressure is perceived by some operators to worsen the sustained level of pressure. In some cases however, bleeding of SCP has been shown to temporarily reduce the severity of the problem.

CNG has developed a "stair-step" procedure that entails bleeding small amounts of light weight gas and fluid from the annulus followed by injecting zinc bromide brine into the annulus. Shell has also used this procedure in several wells. This process of systematically increasing annular fluid density temporarily reduced surface casing pressure in several wells. Occasionally, pressures will increase as a new "gas bubble" migrates to the surface.

Amerada-Hess has tried this same approach using mud instead of weighted brines. The extremely small volume of fluid that can be injected into the annulus using this method has generated interest in developing a method of circulating a higher density fluid to a depth of 1,000 ft. ABB Vetco Gray together with Shell has tested a prototype unit for inserting a small diameter tubing into the annulus to allow circulation of fluids into the well.

Bleed Off Pressure

The procedure of periodic bleeding of casing pressure is perceived by many operators to only exacerbate the problem. There is some evidence to support this perception. Some have documented cases that show a trend of increasing sustained pressure for wells that have been repeatedly bleed to atmospheric conditions. The fluid bleed-off is often gas, foam, or a light weight (<9.0 ppg) fluid. When liquids are removed from the well, this process can reduce the hydrostatic pressure and can potentially increase the influx of gas or light weight fluids into the annulus.

Many are in favor of changing the current MMS policy which require that excess casing pressure be bled to zero in order to obtain a sustained casing pressure waiver. Bleeding to an arbitrary pressure greater than atmospheric is preferred by some operators.

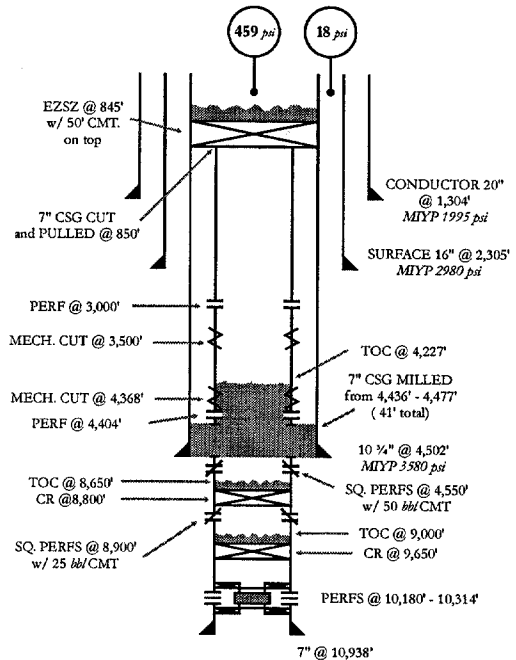

Figure 7.2 - Example 2 of Unsuccessful Workover for SCP

REMEDICATION EFFORTS

Some wells are cemented to the surface, severely limiting the remediation methods that can be applied. In these cases the volume of gas collecting near the surface is extremely small and continuous bleeding-off of surface pressure may be an effective means of mitigating the risks of casing burst. If the high pressure zone feeding the annulus is small, continuous bleeding may deplete this zone and eliminate the SCP altogether.

Case History 1

Case history 1 is an example for which periodic bleeding was successfully used to reduce the pressure on an intermediate string and continuous venting was used successfully to reduce the pressure on the conductor casing. The well schematic is shown in Figure 7.3. The point of gas entry into the casing annulus was established by temperature and noise logs to be the top of the 7-in. liner. The leak path to the surface is through a cemented annulus between the 7-in. production casing and the 9.625-in. intermediate casing. Cement was circulated all the way back to the surface.

This well was drilled and cased with one rig and then later completed with a smaller completion rig. A sustained casing pressure of 4400 psi developed on

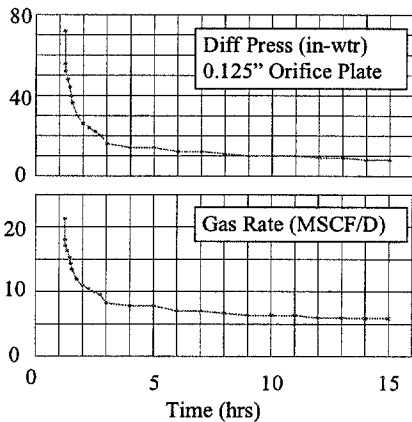

Figure 7. 4: Leak Rate measurement for Case History 1

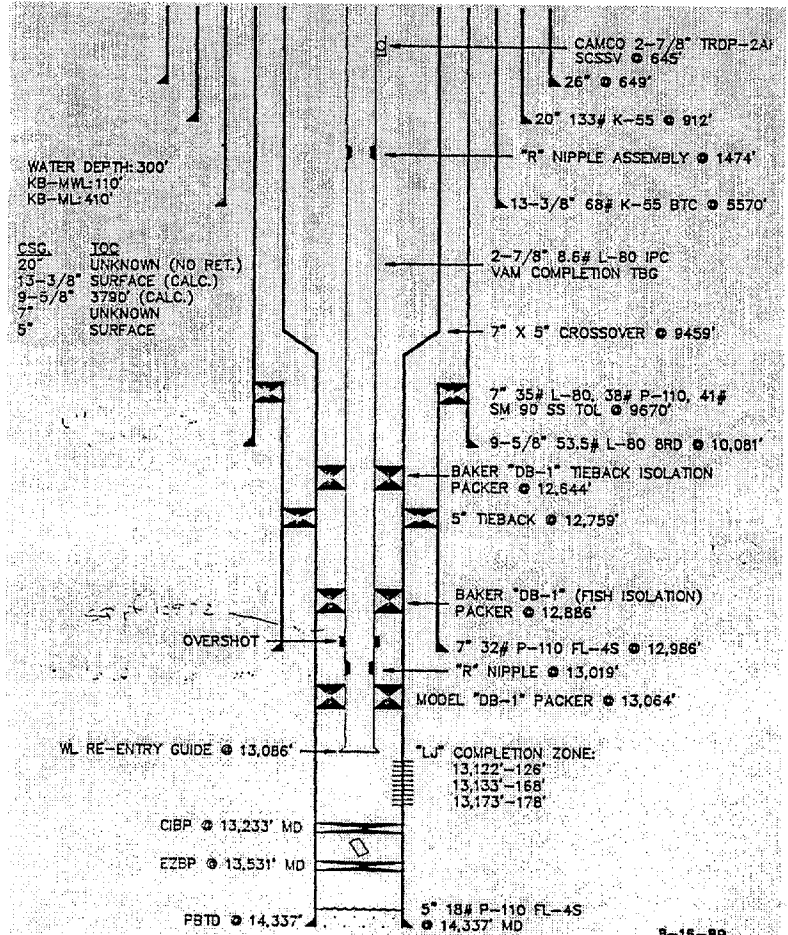

Figure 7.3: Wellbore Schematic for Case History 1.

the 9.625-in. intermediate casing before the completion rig was moved onto the well. The pressure could be bled to zero through a half-in. needle valve in less than a 24 hour period. Essentially dry gas was bled from the well. Shown in Figure 7.4 is the result of a rate test conducted with a 0.125-in. orifice plate. The leak rate through the cement column would stabilize at about 5 MCF/D after about 12 hours of continuous bleeding.

REMEDATION EFFORTS

The SCP history of this well is shown in **Figure 7.5**. The pressure on the 9.625-in. casing was kept low from 1984-88 by frequent periodic bleeding. During the next two years, bleeding was limited to diagnostic testing as required by MMS. Field instructions during this two year period were not to bleed without MMS approval. The SCP value on the 9.625-in. casing returned to about 4000 psi. During the third quarter of 1990, the pressure was bled to zero and only low values of SCP were noted for about a year. The SCP increased again after this period but has stayed below 1000 psi. It is suspected that the path through the cement is plugging intermittently. A hypothetical flow path for this case is illustrated in **Figure 7.6**. The leak path through the cement was over 10,000 ft in length. One would anticipate difficulty keeping such a restricted flow path open even if this was desired.

The leak rate of about 5 MCF/D measured for the Example Case 1 is a very low rate and would not pose any significant danger on an offshore production platform. This leak rate is on the order of supply gas releases on control systems and pilot lights on other production equipment. Shown in **Figure 7.7** is a photograph of a flame being fed by a leak of about this rate.

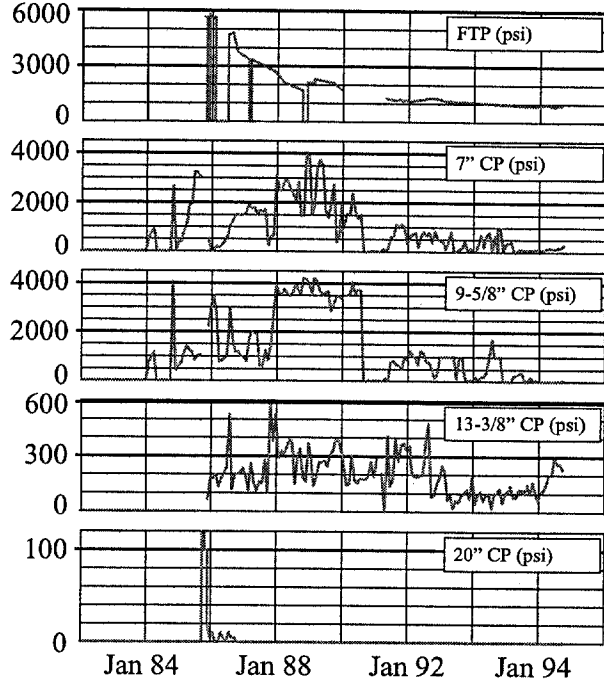

Figure 7.5: Pressure summary for Case History 1

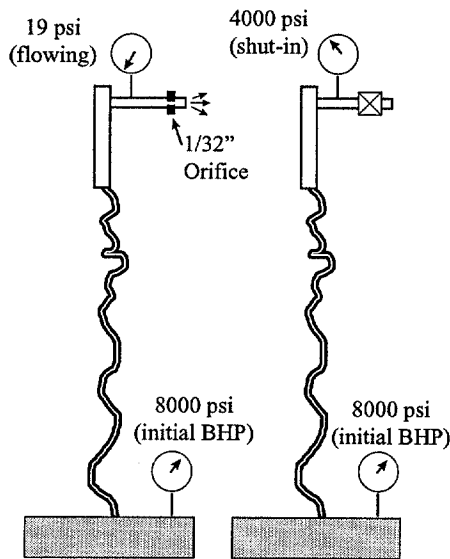

Figure 7.6: Flow Behavior for Case History 1

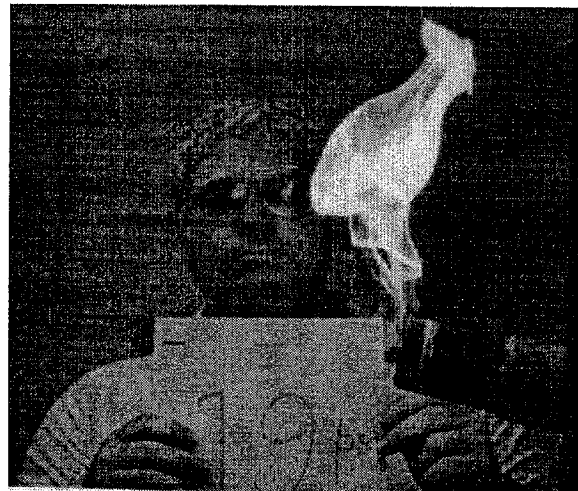

Figure 7.7: Diverter Exit Flare for 19 psi flowing pressure differential.

Note in **Figure 7.8** that this well also had sustained casing pressure on the production casing, the surface casing, and

REMEDATION EFFORTS

the conductor casing. Eventually it was determined that the pressure on the production casing was due to a wellhead leak. The pressure on the surface casing and conductor casing was thought to be related to an incident of flow through cement while cementing the surface casing of another well on the platform. This resulted in a shallow sand being pressurized. In order to eliminate SCP on the conductor casing, it was connected to a continuous venting system (Figure 7.8). Once the venting system was put into service, the 20-in casing no longer registered pressure when gas samples were taken.

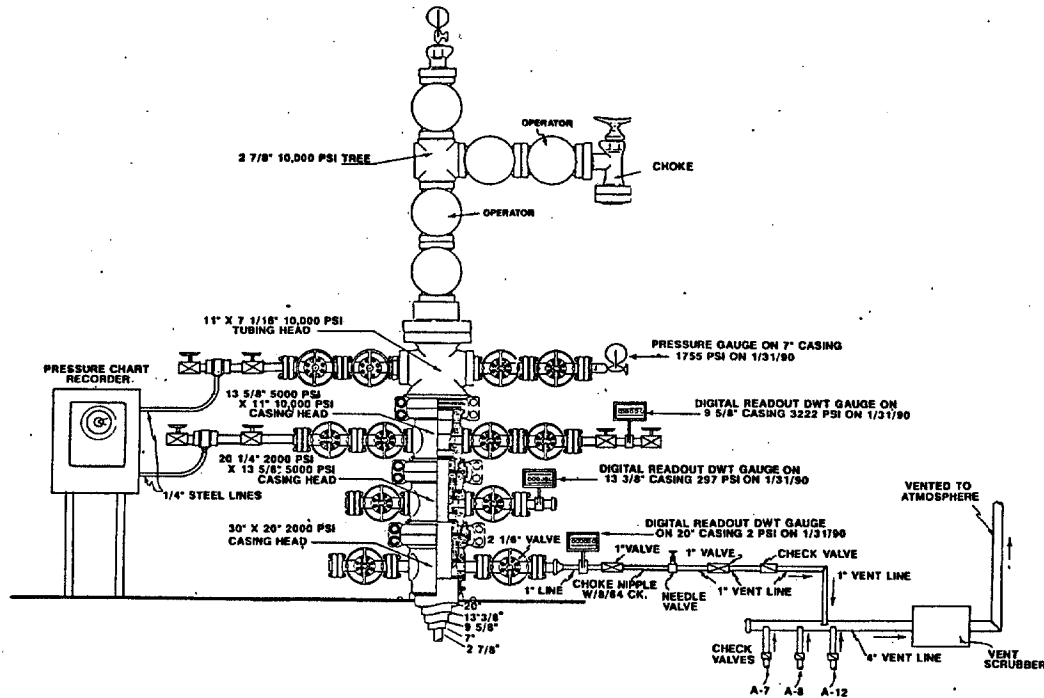

Figure 7.8: Schematic of casing venting system for Case History 1.

Lubricate in Weighted Brine or Mud

Several Gulf Coast operators have tried this method. The concept is to replace the gas and liquids produced during the pressure bleed-off process with a high density brine such as zinc bromide. It is hoped that the hydrostatic pressure in the annulus can gradually be increased using this technique. A pressure "stair-step" procedure that entails bleeding small amounts of light weight gas and fluid from the annulus and lubricating in zinc bromide brine is involved. Several operators have reported some reduction in surface casing pressures from the method. However, it has been observed that pressures can also increase while applying this method. It has been hypothesized that this occurs when a new "gas bubble" migrates to the surface. After trying this method for several years in several wells, the results have not been as promising as first indicated.

Other operators have injected mud instead of brine in an attempt to increase the hydrostatic pressure in the casing annulus. It was hoped that the solids in the mud could enhance plugging of the fractures in the cement. Mud also has the advantage of being less corrosive and less toxic, but is more difficult to inject

REMEDIATION EFFORTS

because of the large concentration of solids in the fluid. It was initially hoped that the presence of solids might contribute to plugging of the cracks and micro-annuli thought to exist in the cement.

Case History 2

This case history is an example of injecting mud into the annulus in an attempt to reduce or eliminate SCP. **Figure 7.9** is a schematic of Well A which had a SCP of about 1000 psi on the intermediate (10 3/4-in) casing. Mud with a density of about 15 ppg was injected into the intermediate casing on a daily basis for about 3 -1/2 months. The procedure used was to first record the initial casing pressure (which ranged between 700 & 900 psi) and then to slowly bleed the casing pressure off. After the bled-off pressure was recorded, heavy mud would be pumped into the annulus until the casing pressure was within about 200 psi of the initial casing pressure. The amount of mud pumped and the amount of mud bled were also recorded so that the net amount of mud being introduced into the casing could be measured. **Table 7.1** summarizes the observations which were taken over the first month and **Figure 7.10** gives the results over a seven month period. After initially pumping about 15,000 lbs of mud into the intermediate casing over a two month period, the SCP had not been

reduced by a noticeable amount. After this two month period, the annulus quit taking mud and a higher pump pressure was used in an attempt to inject more mud. Over a one month period the pressure was slowly increased until the annulus began taking mud. As shown in **Figure 7.10**, the break-over point corresponds to the an increase the production casing pressure indicating the creation of a new leak path from the intermediate casing into the production casing.

After this point there is a slight reduction in the intermediate casing pressure, but the creation of the new leak path confuses the analysis as to weather or not the mud injection technique was the cause.

Case History 3

Case History 3 involves Well B on the same platform as Case History 2. The casing program for this well was similar to the one shown in **Figure 7.9** for Well A. Both the surface casing and the intermediate casings had SCP and mud injection was attempted on both annuli.

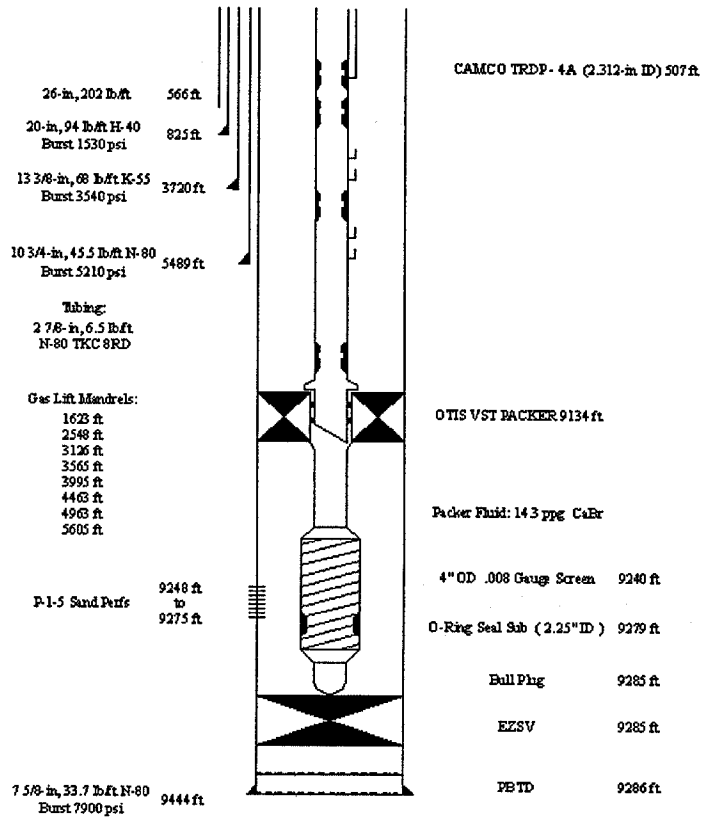

Figure 7.9 Case History 2, Well A

REMEDATION EFFORTS

DATE	INTERMEDIATE CASING							
	INITIAL PRESS	PRESS AFTER BLEEDING	PRESS AFTER PUMPING	MATERIAL PUMPED	DENSITY OF PUMPED MATERIAL	LBS MUD BLED OFF	LBS MUD PUMPED	MUD WT. DIFF.
	(psi)	(psi)	(psi)		(ppg)	0	0	0
3/24/96	980	100	500	MUD	15.0#	51	630	579
3/25/96	690	70	500	MUD	15.0#	184	630	446
3/26/96	700	100	500	MUD	15.0#	176	473	297
3/27/96	770	160	500	MUD	14.9#	273	313	40
3/28/96	680	140	500	MUD	14.8#	288	466	178
3/29/96	670	100	780	MUD	14.8#	312	1,243	931
3/30/96	820	140	760	MUD	14.8#	363	466	103
3/31/96	860	100	770	MUD	14.9#	345	782	437
4/1/96	880	140	750	MUD	18.8#	342	790	448
4/2/96	870	130	750	MUD	18.9#	354	397	43
4/3/96	870	90	750	MUD	18.9#	372	595	223
4/4/96	830	150	770	MUD	18.9#	387	595	208
4/5/96	850	90	700	MUD	18.9#	417	595	178
4/6/96	900	100	800	MUD	18.9#	420	595	175
4/7/96	850	100	800	MUD	18.9#	453	595	142
4/8/96	900	100	780	MUD	18.5#	462	971	509
4/9/96	850	60	770	MUD	18.5#	468	777	309
4/10/96	870	60	780	MUD	18.8#	444	790	346
4/11/96	930	120	730	MUD	18.5#	414	389	-25
4/12/96	900	190	780	MUD	18.4#	456	386	-70
4/13/96	860	260	740	MUD	18.4#	426	386	-40
4/14/96	920	130	750	MUD	18.2#	432	382	-50
4/15/96	860	120	800	MUD	18.3#	423	961	538
4/16/96	830	90	780	MUD	18.3#	432	769	337
4/17/96	780	80	760	MUD	19.2#	418	806	388
4/18/96	860	80	780	MUD	19.2#	516	806	290
4/19/96	900	80	780	MUD	19.2#	504	806	302

Table 7.1 - Example data sheet for Case history 2

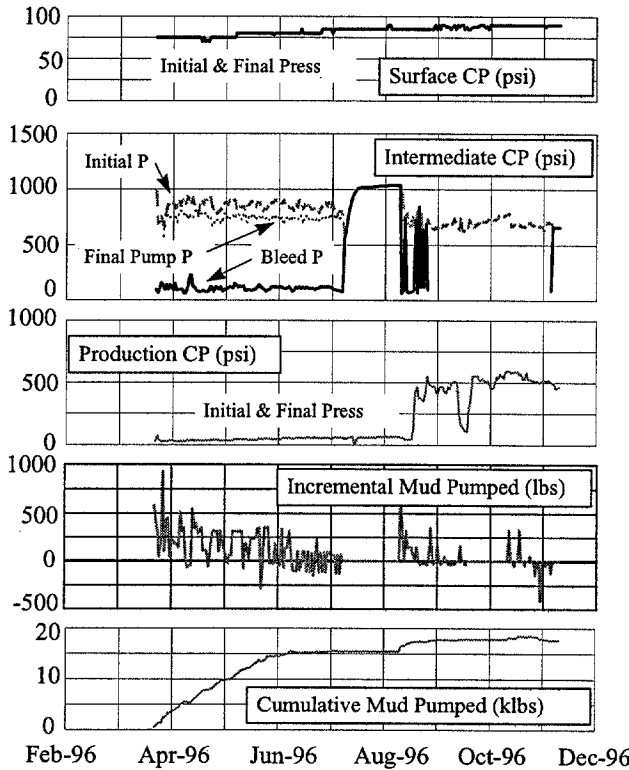

Figure 7.10 Pressure and injection summary for Case History 2

Figure 7.11 gives the pressure and injection summary that resulted from mud injection. After about two months, the surface casing showed a marked and sustained decrease from 400 psi to about 180 psi. The intermediate casing pressure was also reduced by about 250 psi, but began building within a month and within four months even exceeded the initial SCP of 700 psi by 300 psi.

The benefits of the brine and mud injection techniques are not clear and do not appear to have long term effects. Also, the risk of creating more problems than already exist is substantial.

Circulation of Weighted Brine or Mud

The extremely small volume of fluid that can be lubricated into the annulus has generated interest in developing a method of circulating a higher density fluid to a depth of 1,000 ft. A new system has been

REMEDATION EFFORTS

developed that is commercially available and several operators are trying this system in wells that are not cemented to surface. A small diameter flexible tubing is inserted into the annulus to allow circulation to some depth. The tubing can go through the 90 degrees turn from the wing valve into the annulus. Wellheads, with angled annular inlets are being considered to reduce this problem in future wells. If insertion of a circulation sting can be achieved, it could increase the ability to displace lighter weight fluids from the annulus and replace them with a weighted brine or mud.

Annular Intervention

If the effected casing is accessible, internal casing patches can be used to repair a leak. This device is normally run on elective line and can patch localized leaks. In the past, some operators have injected cement or resin to attempt to plug the flow path to the surface. Unfortunately, this approach may satisfy regulatory requirements by eliminating indication of surface pressure, but may mask increasing pressure in the annulus just below the surface in the same casing string.

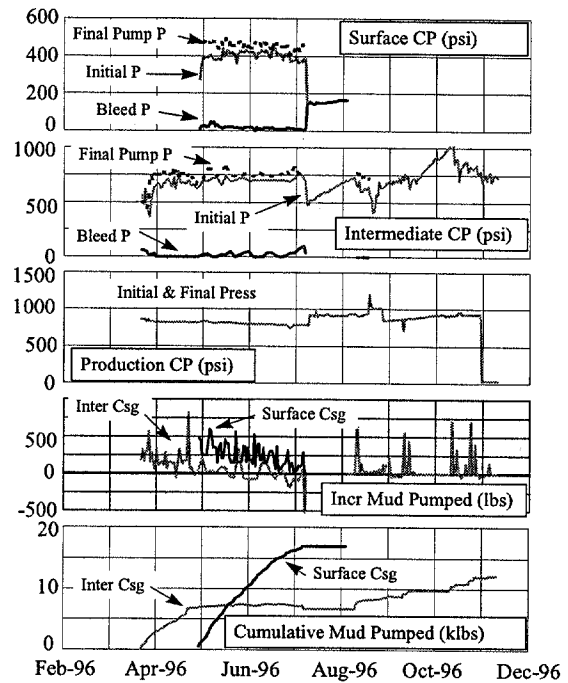

Figure 7.11: Pressure and Injection summary for Case History 3

Conclusions

Operator experience on the OCS has shown that Sustained Casing Pressure (SCP) problems can lead to blowouts of sufficient flow rate to jeopardize a production platform. However, there has been only minor pollution and no known injuries or fatalities due to problems related to SCP. This study has indicated that further substantial reductions in the regulatory efforts to manage the SCP problem on the OCS are possible without sufficiently increasing the risk of injury to offshore personnel or the risk of pollution.

Industry experience with problems resulting from sustained casing pressure has shown that the most serious problems have resulted from tubing leaks. When the resulting pressure on the production casing causes a failure of the production casing, the outcome can be catastrophic. The outer casing strings are generally weaker than the production casing and will also fail, resulting in an underground blowout. Flow rates through the tubing leak can quickly escalate if any produced sand is present in the flow stream. Blowouts of sufficient flow rate to jeopardize the production platform are possible.

- About 50 % of wells with sustained casing pressure have pressure on the production casing.
- The cause of pressure on production casing is generally easier to diagnose than pressure on one of the outer casing strings.
- Pressure on production casing is generally easier to correct than pressure on the outer strings.
- The magnitude of the leak rate is as important as the magnitude of the pressure when determining the potential hazard posed by sustained casing pressure.
- Gas flow or water flow through unset cement in a major cause of sustained casing pressure in the outer casing strings, outside of the production casing.
- Channeling of formation fluids through unset cement from high pressure zones to low pressure zones becomes more likely when the casing setting depth is extended by drilling ahead with mud densities approaching the equivalent density for formation fracture in the upper part of the open borehole.
- Portland cement is a brittle material and susceptible to cracking when exposed to thermally induced or pressure induced tensile loads. Experimental test results indicated that all cement systems tested exhibited one or more failure modes.
- About 10 % of the casing strings exhibiting sustained casing pressure are *intermediate* casing strings.
- About 30 % of the casing strings exhibiting sustained casing pressure are *surface* casing strings.
- About 10 % of the casing strings exhibiting sustained casing pressure are *conductor* casing strings.
- Only about one-third of the casing strings exhibiting sustained casing pressure are in wells that are active and producing.

CONCLUSIONS

- None of the remedial procedures to stop flow through cement outside of casing have been shown to be effective.
- About 90 % of sustained casing pressures observed are less than 1000 psi in magnitude.
- More than 90% of all sustained casing pressures observed are less than 30 % of the minimum internal yield pressure (burst pressure) of the casing involved.
- The regulatory burden associated with managing the sustained casing pressure problem on the OCS was significantly reduced by a series of LTL's issued since 1991.
- Further substantial reductions in the regulatory efforts to manage the sustained casing pressure (SCP) problem on the outer continental shelf (OCS) are possible without significantly increasing the risk of injury to offshore personnel or the risk of pollution.

Recommendations and Future Research Needs

Additional research is needed to develop improved diagnostic test procedures for wells with SCP and to better define the potential increase in SCP that could be caused by sustained bleeding through a small diameter bleeding nipple for various well situations.

Regulations concerning the management of SCP should be refined to better reflect the well conditions present. The regulatory burden associated with the management of SCP should be changed to better reflect the severity of the hazards involved. It is recommended that the following regulatory changes be considered.

1. Wells with SCP be redefined to include only wells with one or more casing strings having a pressure in excess of 100 psig.
2. For wells having SCP only on the production casing, departures be automatically given ("self-approved") if:
 - the SCP is less than 30% of the minimum internal yield pressure of the casing, and
 - the instantaneous leak rate does not exceed 5 MCF/D of gas when the pressure is reduced by 50% or more by bleeding through a half inch needle valve during a test that does not exceed 24 hours in duration, and
 - no more than one barrel of non-hydrocarbon liquid is recovered during the test.
3. For wells having SCP on the intermediate casing, surface casing, or conductor casing but not on the production casing, and the leak path is through a cemented annulus of more than 1000 ft in length, then the operator should be given the option of venting the casings having SCP to the production system or a flare stack as long as the flow rates are metered and the flow rate does not exceed 10 MCF/D of gas and 1 bbl/d of liquid. Venting should be conducted through a choke of no more than 1/8th inch in diameter and the well should be shut-in at least once a month to determine the SCP after a 24 hour shut-in. Venting should be stopped if the SCP upon shut-in increases more than 20 percent of its initial value.
4. For wells with SCP on the production casing, additional underground blowout diagnostic tests should be conducted if the gas leak rate is found to exceed 10 MCF/D. The additional diagnostics could include fluid level determinations, noise logs, and temperature logs conducted with the well shut-in. If a tubing leak is suspected, the tubing should be repaired.
5. For wells with SCP on the production casing that suddenly develop SCP on the intermediate casing, additional underground blowout diagnostic tests should be conducted.

It is also recommended that additional research is conducted with the goal of reducing tubing leaks and improving the long term sealability of cemented annuli. Specifically it is recommended that:

RECOMMENDATIONS AND FUTURE RESEARCH NEEDS

- 1.** Additional research be conducted to determine if the occurrence of SCP in the production casing can be correlated with the type of tubing connectors used.
- 2.** Additional research be conducted to develop improved diagnostic test procedures for wells with SCP and to better define the potential increase in SCP that could be caused by sustained bleeding through a small diameter bleeding nipple for various well situations.

BIBLIOGRAPHY

Bibliography

1. Bonett A., Pafitis D.: "Getting to the root of gas migration", Oilfield review, Spring 1996.
2. Cheung P.R., Beirute R.M.: "Gas Flow in Cements", SPE Paper 11207, 1982
3. Chow T. W. , McIntire L.V., Kunze K.R. and Cooke Claude E.: "The Rheological Properties of Cement Slurries: Effects of Vibration, Hydration Conditions, and Additives", SPE Production Engineering, November 1988.
4. Coker O.D., Harris K.L. and Williams T.A.: "Preventing Shallow Gas Migration in Offshore Wells: The Performance of Lead Cements", SPE Paper 24978, 1992.
5. Cooke C.E. Jr., Kluck M.P., and Medrano R.: "Field Measurements of Annular Pressure and Temperature During Primary Cementing", SPE Paper 11206, 1982.
6. De Rozieres J., and Ferriere R.: "Foamed-Cement Characterization Under Downhole Conditions and its Impact on Job Design", SPE Production Engineering, August 1991.
7. Ganguli K.K.: "A Cost-Effective Fluid-Loss/Gas-Control Cement Slurry Design", Unsolicited SPE Paper 22533, 1991.
8. Garcia J.A. and Clark C.R.: "An Investigation of Annular Gas Flow Following Cementing Operations", SPE 5701, 1976.
9. Goodwin, K.J. and R.J. Crook: "Cement Sheath Stress Failure," SPE paper 20453 presented at the SPE Fall Meeting, New Orleans (1990).
10. Graff K.F.: "Wave Motion in Elastic Solids", Ohio State University Press, 1975.
11. Grinrod M., Vassoy B., and Dingsoyr E.O.: "Development and Use of a Gas-Tight Cement", IADC/SPE Paper 17258, 1988.

BIBLIOGRAPHY

12. Haberman J. P.: "Sealing Gas Zones by Vibrating Cement Slurries", Gas TIPS, Spring 1996.
13. Haberman J.P., Wolhart S.L.: "Reciprocating Cement Slurries after Placement by Applying Pressure in the Annulus", SPE paper 37619, 1997.
14. Hibbeler J.C., DiLullo G., Thay M.: "Cost Effective Gas Control: A Case Study of Surfactant Cement", SPE Paper 25323, 1993.
15. Jackson, P.B. and C.E. Murphey: "Effect of Casing Pressure on Gas Flow Through a Sheath of Set Cement," paper presented at the 1993 SPE/IADC Drilling Conference, Amsterdam, February 23-25, 1993.
16. Levine Dennis C., Thomas Eugene W., Bezner H.P. and Tolle Glen C.: "Annular Gas Flow After Cementing: A Look at Practical Solutions", SPE Paper 8255, 1979.
17. Lewis W.J., and Rang C.L.: "Salt Cements for Improved Hydraulic Isolation and Reduced Gas Channeling", SPE 16386, 1987.
18. Seidel F.A, and Greene T.G.: "Use of Expanding Cement Improves Bonding and Aids in Eliminating Annular Gas Migration in Hobbs Grayburg-San Andres Wells", SPE Paper 14434, 1985.
19. Sepos D.J., and Cart B.W.: "New Quick-Setting Cement Solves Shallow Gas Migration Problems and Reduces WOC Time", SPE Paper 14500, 1985.
20. Skalle P., and Sween J.: "Emulsion Cement", SPE Paper 23075, 1991.
21. Soran T., Chukwu G.A. and Haltzignatiou D.G.: "A Unique Experimental Study Reveals How to Prevent Gas Migration in a Cemented Annulus", SPE Paper 26897, 1993.
22. Stehle Don, Sabins Fred, Gibson Jim, Theis Karl, and Venditto J.J.: "Conoco Stops Annular Gas Flow with Special Cement:, Petroleum Engineers International, April 1985.
23. Stewart R.B., Schouten F.C.: "Gas Invasion and Migration in Cemented Annuli: Causes and Cures", SPE Paper 14779, 1986.
24. Sutton D.L., Ravi K.M.: "Low-Rate Pipe Movement During Cement Gelation to Control Gas Migration and Improve Cement Bond", SPE Paper 22776, 1991.
25. Sutton D.L., Ravi K.M.: "New Method for Determining Downhole Properties That Affect Gas Migration and Annular Sealing", SPE Paper 19520, 1989.

BIBLIOGRAPHY

26. Sutton D.L., Sabins F.L., Faul R.: "New Evaluation for Annual Gas-Flow Potential", Oil and Gas Journal, December 17, 1984.
27. Sutton D.L., Sabins F.L.: "Interrelationship Between Critical Cement Properties and Volume Changes During Cement Setting", SPE Paper 20451, 1990.
28. Sutton David L., Sabins Fred, and Faul Ronald: "Preventing Annular Gas Flow - Two parts", Oil and Gas Journal, December 17, 1984.
29. Sykes R.L., and Logan J.L.: "New Technology in Gas Migration Control", SPE Paper 16653, 1987.
30. Tinsley John M., Miller Erik C., Sabins Fred I., and Sutton Dave L.: "Study of Factors Causing Annular Gas Flow Following Primary Cementing", SPE Paper 8257, 1979.
31. Vrooman, D. J. Garrett, A. Badalamenti and A. Duell: "Packer Collar Stops Gas Migration Mechanically," Petroleum Engineering International, pg. 18-22 (April 1992).
32. Webster W.W., and Eikerts J.V.: "Flow After Cementing - A Field and Laboratory Study", SPE Paper 8259, 1979.
33. Whorlow, R. W. : "Rheological techniques", E. Horwood ; New York : Halsted Press, 1980.
34. Winbow G.A.: "Method for Preventing Annular Fluid Flow Using Tube Waves", US Patent 5,361,837, 1992.
35. Yoshimura A.S., Prud'homme R.K.: "Viscosity Measurements in the Presence of Wall Slip in Capillary, Couette and Parallel-Disk Geometries", SPE Paper 14696, 1988.



MMS Policy Letter

This appendix contains a copy of a letter outlining MMS policy regarding sustained casing pressure dated January 13, 1994.

Since the following letter was drafted, the MMS has renumbered the regulations. Please note that the regulation referenced in the letter is no longer designated as 250.87 but is now designated as 250.517.



United States Department of the Interior

MINERALS MANAGEMENT SERVICE
Gulf of Mexico OCS Region
1201 Elmwood Park Boulevard
New Orleans, Louisiana 70123-2394



In Reply Refer To: MS 5221

Gentlemen:

This letter serves to inform lessees operating in the Gulf of Mexico Outer Continental Shelf of the current policy concerning sustained casing pressure according to the provisions of 30 CFR 250.17. The following policy - supersedes our last Letter to Lessees and Operators dated August 5, 1991, and is intended to streamline procedures and reduce burdensome paperwork concerning the reporting of sustained casing pressure conditions and the approval process for those wells that the Minerals Management Service (MMS) will allow to be produced with sustained casing pressure;

1. All casinghead pressures, excluding drive or structural casing, must be immediately reported to the District Supervisor. This notification by the lessee, to the District Supervisor can either be in writing or by telephone, with a record of the notification placed in the record addressed in paragraph 5 below, by the close of business the next working day after the casing pressure is discovered.

2. Wells with sustained casinghead pressure that is less than 20 percent of the minimum internal yield pressure of the affected casing and that bleed to zero pressure through a 1/2-inch needle valve in 24 hours or less may continue producing operations from the present completion with monitoring and evaluation requirements discussed below.

A diagnostic test that includes bleeddown through a 1/2-inch needle valve and buildup to record the pressures in at least 1-hour increments must be performed on each casing string in the wellbore found with casing pressure. The evaluation should contain identification of each casing annulus; magnitude of pressure on each casing; time required to bleed down through a 1/2-inch needle valve; type of fluid and volume recovered; current rate of buildup, shown graphically or tabularly in hourly increments; current shut-in and flowing tubing pressure; current production data; and well status. Diagnostic tests conducted on wells that meet the conditions described in paragraph 2 above do not have to be formally submitted for approval.

3. Wells having casings with sustained pressure greater than 20 percent of the minimum internal yield pressure of the affected casing or pressure that does not bleed to zero through a 1/2-inch needle valve, must be submitted to this office for approval. The information submitted for consideration of a sustained casing pressure departure under these conditions should be the same as described in the above paragraph.

4. The casing(s) of wells with sustained casinghead pressure should not be bled down without notifying this office except for required and documented testing. If the casing pressure from the last diagnostic test increases by 200 psig or more in the intermediate or production casing, or 100 psig or more in the conductor or surface casing, then a subsequent diagnostic test must be performed to reevaluate the well. Notification to this office is not necessary if the pressure is less than 20 percent of the minimum internal yield pressure of the affected casing and bleeds to zero pressure through a 1/2-inch needle valve. The recorded results of the subsequent diagnostic test must be kept at the field office. However, the results of this test must be submitted to this office for evaluation if the conditions as described in Paragraph 3 apply.

5. Complete data on each well's casing pressure information need only be retained for a period of 2 years, except that the latest diagnostic information must not be purged from the overall historical record that must be kept. Casing pressure records must be maintained at the lessee's field office nearest the OCS facility for review by the District Supervisor's representative(s).



United States Department of the Interior



MINERALS MANAGEMENT SERVICE
Gulf of Mexico OCS Region
1201 Elmwood Park Boulevard
New Orleans, Louisiana 70123-2394

6. The previous approval of a sustained casing pressure departure is invalidated if workover operations, as defined by 30 CFR 250.91, commence on the well. Also, operations such as acid stimulation, shifting of sliding sleeves, and gas-lift valve replacement require diagnostic reevaluation of any production or intermediate casing annulus having sustained pressure.

7. Unsustained casinghead pressure may be the result of thermal expansion or may be deliberately applied for purposes such as gas-lift, backup for packers, or for reducing the pressure differential across a packoff in the tubing string. Unsustained casinghead pressure which is deliberately applied does not need to be submitted to this office. Unsustained casinghead pressure, as the result of thermal expansion, greater than 20 percent of the minimum internal yield pressure of the affected casing or does not bleed to zero through a 1/2-inch needle valve needs to be submitted to this office with either of the following information:

a. The lessee must report the casing(s) pressure decline (without bleeddown) to near zero during a period when the well is shut in, or

b. With thoroughly stabilized pressure and temperature conditions during production operations, the lessee may bleed down the affected casing(s) through a 1/2-inch needle valve approximately 15 - 20 percent, and obtain a 24-hour chart which shows that the pressure at the end of the following 24-hour period is essentially the same as the bleeddown pressure at the start of the 24-hour period while production remains at a stabilized rate.

8. Subsea wells with remote monitoring capability must be monitored, analyzed, and reported as described above. If the casing valve(s) must be operated manually the monitoring, analyzing, and reporting frequency is 2 years at a maximum.

9. Should a request for a departure from 30 CFR 250.87 result in a denial, the operator of the well will have 30 days to respond to the MMS District Office with a plan to eliminate the sustained casinghead pressure. Based on well conditions, certain denials may specify a shorter time period for corrections.

If there are any questions regarding this matter, please contact Mr. B. J. Kruse at (504) 736-2634.

Sincerely,

(signed)
D. J. Bourgeois
Regional Supervisor
Field Operations

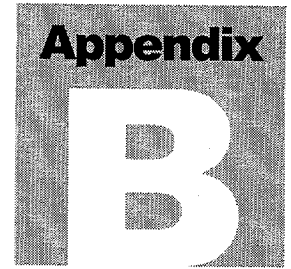

Sample MMS Responses to Departure Requests

This appendix contains sample letters which MMS personnel use when responding to departure requests made by an operator.

The sample letters contained within Appendix B include responses which address the following:

1. SCP Denial
2. Annual SCP Departure
3. Indefinite SCP Departure
4. Thermal Departure
5. Annual Shut-in Departure
6. Indefinite Shut-in Departure

APPENDIX B

SAMPLE - SCP DENIAL

In Reply Refer To: MS 5220

CERTIFTED MAIL -
RETURN RECEIPT REQUESTED

[Name]
[Company]
[Address]
[City, State Zip]

Your letter dated _____ requests a departure to maintain sustained casinghead pressure (SCP) on Well _____ Lease OCS-G _____ Block _____. The well is currently producing with a flowing tubing pressure of psig and can be expected to have a SCP of _____ psig on the conductor casing, _____ psig on the surface casing, _____ psig on the intermediate casing, and _____ psig on the production casing. Diagnostic data provided with your letter indicates the _____ casing pressure cannot be bled down to zero.

Our analysis of the situation results in a denial. High pressure on this casing combined with the inability to bleed pressure below _____ psig and recovery of _____ increases the potential for casing failure, uncontrolled flow and associated damages.

Based on these findings, Minerals Management Service requires you to submit plans that outline corrective measures needed to accomplish the intent of 30 CFR 250.517 (a) and (d) to the District Supervisor, _____ District, within 30 calendar days from the date of this letter.

Sincerely,

Donald C. Howard
Regional Supervisor
Field Operations

bcc: 1101-02(b)(3) Lease OCS-G _____, Well _____ (MS 5220)
Lease OCS-G _____, Well _____ (MS 5032)
MS 52 _____

<author>:jrc:g:____\scp______.den:final typed dd/mm/yy

SAMPLE - ANNUAL SCP DEPARTURE

In Reply Refer To: MS 5220

Date:

[Name]
[Company]
[Address]
[City, State Zip]

Gentlemen:

Your letter dated _____ requests a departure to maintain sustained casinghead pressure (SCP) on Well _____, Lease OCS-G _____ Block _____. A departure from the requirements of 30 CFR 250.517 is hereby approved for this well at a SCP of _____ psig on the conductor casing, _____ psig on the surface casing, _____ psig on the intermediate casing, and _____ psig on the production casing.

This departure from the requirements of 30 CER 250.517 is granted for a 1-year period, effective as of the date of this letter with the following stipulations:

1. Approval for a SCP departure request is granted on a well basis. You must list all casing annuli affected by SCP in any future request, and positively note that the remaining annuli do not have SCP.
2. The well must be monitored daily on a manned structure and weekly on an unmanned structure. A record of the well's observed casinghead pressure(s) and subsequent diagnostic tests performed must be made available for Minerals Management Service (MMS) inspection at the lessee's field office.
3. This departure is invalid if any of the following occur:
 - a. Workover operations commence on the subject well.
 - b. Sustained casinghead pressures increase 200 psig or more on the intermediate or production casing, or 100 psig or more on the conductor or surface casing. In this case a subsequent diagnostic test must be performed to reevaluate the well. Results from this diagnostic test must be submitted to this office if either the casing pressure prior to performing the test exceeds 20 percent of minimum internal yield pressure (MIYP), or the casinghead pressure fails to bleed to zero.
4. Should all the Casing annuli affected by sustained pressure (stabilized) decrease below 20 percent of the MIYP- and the casinghead pressure bleeds to zero, you must notify this office of such a change verbally, followed by a written notice within 30 days.
5. The casing(s) should not be bled down during this 1-year period without notifying this office, except during required diagnostic tests performed in accordance with paragraph 3 (b) above. Any diagnostic tests conducted on this well should evaluate all annuli exhibiting casing pressure.

APPENDIX B

6. The MMS reserves the right to rescind this departure and require any corrective measures needed to accomplish the intent of 30 CFR 250.517(a) and (d) if well bore conditions deteriorate or present a hazard to personnel the environment, the platform, or the producing formation. If there are any questions regarding this departure, please contact _____ at (504) 736-_____

Sincerely,

Donald C. Howard
Regional Supervisor
Field Operations

bcc: 1101-02(b)(3) Lease OCS-G_____, Well _____ (MS 5220)
Lease OCS-G_____, Well _____ (MS 5032)
MS 52_____

<author>:jrc:g:_____\scp_____.ann

SAMPLE- INDEFINITE SCP DEPARTURE

In Reply Refer To; MS 5220

Date:

[Name]
[Company]
[Address]
[City, State Zip]

Gentlemen:

Your letter dated _____ requests a departure to maintain sustained casinghead pressure (SCP) on Well _____ Lease QCS-G _____ Block _____. A departure from the requirements of 30 CFR 250.517 is hereby approved for this well at sustained casinghead pressures of _____ psig on the conductor casing, _____ psig on the surface casing, _____ psig on the intermediate casing, and _____ psig on the production casing.

This departure from 30 CFR 250.517 is granted for the life of this completion, effective as of the date of this letter with the following stipulations:

1. Approval of a SCP departure request is granted on a well basis. You must list all casing annuli affected by SCP in any future request, and positively note that the remaining annuli do not have SCP.
2. The well must be monitored at least monthly. A record of the well's observed casinghead pressure(s) and subsequent diagnostic tests performed must be made available for Minerals Management Service (MMS) inspection at the lessee's field office
3. This departure is invalidated if either of the following occurs:
 - a. Workover operations commence on the subject well.
 - b. Sustained casinghead pressures increase 200 psig or more on the intermediate or production casing, or 100 psig or more on the conductor or surface casing. In this case a subsequent diagnostic test must be performed to reevaluate the well. Results from this diagnostic test must be submitted to this office if either the casing pressure prior to performing the test exceeds 20 percent of the minimum internal yield pressure or the casinghead pressure fails to bleed to zero.
4. The casing(s) should not be bled down without notifying this office, except during required diagnostic tests performed in accordance with paragraph 3(b) above.

APPENDIX B

5. The MMS reserves the right to rescind this departure and require any corrective measures needed to accomplish the intent of CFR 250.517 (a) and (d) if well bore conditions deteriorate, presenting a safety hazard to personnel, the platform, or producing formation. If there are any questions regarding this departure, please contact _____ at (504) 736-_____

Sincerely,

Donald C. Howard
Regional Supervisor
Field Operations

bcc: 1101-02(b)(3) Lease OCS-G_____, Well _____ (MS 5220)
Lease OCS-G_____, Well _____ (MS 5032)
MS 52_____

<author>;jrc:g:_____\scp__________.ind

SAMPLE - THERMAL DEPARTURE

In Reply Refer To: MS 5220

Date

[Name]
[Company]
[Address]
[City, State Zip]

Gentlemen:

Your letter dated _____ forwarded casinghead pressure diagnostic information for Well _____, Lease OCS-G _____. The pre-diagnostic pressures were _____ psig affecting the conductor casing, _____ psig affecting the surface casing, _____ psig affecting the intermediate casing, and _____ psig affecting the production casing

We have completed the review of your diagnostic information, and have determined that the pressures are unsustained due to the thermal effects of producing the well at _____ MMCFPD and _____ BOPD. As such, a departure from 30 CFR 250.517 is not required. Should there be a change in the pressures affecting this well, where the casing pressure can be attributed to factors other than thermal, you must request a departure from this office using the guideline established in our policy letter dated January 13, 1994.

If there are any questions regarding this letter, please contact _____ at (504) 736-_____

Sincerely,

Donald C Howard
Regional Supervisor
Field Operations

bcc: 1101-02(b)(3) Lease OCS-G _____, Well _____ (MS 5220)
Lease OCS-G _____, Well _____ (MS 5032)
MS 52 _____

<author>:jrc:g:_____\scp__________.thm

SAMPLE ANNUAL SHUT-IN DEPARTURE

In Reply Refer To: MS 5220

Date:

[Name]
[Company]
[Address]
[City, State Zip]

Gentlemen;

Your letter dated _____ requests a departure to maintain sustained casinghead pressure (SCP) on Well _____, Lease OCS-G _____ Block _____. A departure from the requirements of 30 CFR 250.517 is hereby approved for this well at a SCP of _____ psig on the conductor casing, _____ psig on the surface casing, _____ psig on the intermediate casing, and _____ psig on the production casing.

The well is currently (shut-in/plugged/temporarily abandoned) and no specific use of the well bore has been provided which would justify the continued tolerance of SCP. Our policy governing SCP departures is intended to allow the continued production from existing completions. The policy was not developed to permit the indefinite postponement of needed repairs to (shut-in/plugged/temporarily abandoned) wells. The approval in no way guarantees that a departure will be granted for Well _____ in the future.

This departure is granted for a 1-year period, effective as of the date of this letter.

The following stipulations apply;

1. Approvals of a SCP departure request is granted on a well basis. You must list all casing annuli affected by SCP in any future request, and positively note that the remaining annuli do not have SCP.
2. The well must be monitored daily on a manned structure and weekly on an unmanned structure. A record of the well's observed casinghead pressure(s) and subsequent diagnostic tests performed must be made available for Minerals Management Service (MMS) inspection at the lessee's field office.
3. This departure is invalid if any of the following occurs:
 - a. Workover operations commence on the subject well.
 - b. Sustained casinghead pressures increase 200 psig or more on the intermediate or production casing, or 100 psig or more on the conductor or surface casing. In this case a subsequent diagnostic test must be performed to reevaluate the well. Results from this diagnostic test must be submitted to this office if either the casing pressure prior to performing the test exceeds 20 percent of the minimum internal

APPENDIX B

yield pressure (MIYP) or the casinghead pressure fails to bleed to zero.

.1

- c. Equipment capable of eliminating the SCP from this temporarily abandoned well is mobilized to the platform and becomes available for use to eliminate the pressures on the annuli of this well

- 4. Should all the casing annuli affected by sustained pressure (stabilized) decrease below 20 percent of the MIYP and the casinghead pressures bleed to zero, you must notify this office of such a change verbally, followed by a written notice within 30 days.

- 5. The casing(s) should not be bled down during this 1-year period without notifying this office, except during required diagnostic tests performed in accordance with paragraph 3(b) above. Any diagnostic tests conducted on this well should evaluate all annuli exhibiting casing pressure.

- 6. The MMS reserves the right to rescind this departure and require any corrective measures needed to accomplish the intent of 30 CFR 250.517 (a) and (d) if well bore conditions deteriorate presenting a safety hazard to personnel, the platform or producing formation.

If there are any questions regarding this letter, please contact _____
at (504) 736-_____

Sincerely,

Donald C Howard
Regional Supervisor
Field Operations

bcc: 1101-02(b)(3) Lease OCS-G _____, Well _____ (MS 5220)
Lease OCS-G _____, Well _____ (MS 5032)
MS 52 _____

<author>:jrc:g:_____\scp________.asi

SAMPLE - INDEFINITE SHUT-IN DEPARTURE

In Reply Refer To: MS 5220

Date:

[Name]
[Company]
[Address]
[City, State Zip]

Gentlemen;

Your letter dated _____ requests a departure to maintain sustained casinghead pressure (SCP) on Well _____, Lease OCS-G _____ Block _____. A departure from the requirements of 30 CFR 250.517 is hereby approved for this well at a SCP of _____ psig on the conductor casing _____ psig on the surface casing, _____ psig on the intermediate casing, and _____ psig on the production casing.

The well is currently shut in and no specific use of the well bore has been provided which would justify the continued tolerance of SCP. Our policy governing SCP departures is intended to allow the continued production from existing completions. The policy was not developed to permit the indefinite postponement of needed repairs to shut in wells. You are encouraged to assess options and take action necessary to either bring the well into production or eliminate SCP.

This departure is granted for an indefinite period, effective as of the date of this letter. The following stipulations apply:

1. Approvals of a SCP departure request is granted on a well basis. You must list all casing annuli affected by SCP in any future request and positively note that the remaining annuli do not have SCP.
2. The well must be monitored daily on a manned structure and weekly on an unmanned structure. A record of the well's observed casinghead pressure(s) and subsequent diagnostic tests performed must be made available for Minerals Management Service (MMS) inspection at the lessee's field office.
3. This departure is invalid if any of the following occurs;
 - a. Workover operations commence on the subject well.
 - b. Sustained casinghead pressures increase 200 psig or more on the intermediate or production casing, or 100 psig or more on the conductor or surface casing. In this case a subsequent diagnostic test must be performed to reevaluate the well. Results from this diagnostic test must be submitted to this office if either the casing pressure prior to performing the test exceeds 20 percent of the minimum internal yield pressure (MIYP) or the casinghead pressure fails to bleed to zero.

APPENDIX B

c. Equipment capable of eliminating the SCP from this shut in well is mobilized to the platform and becomes available for use to eliminate the pressures on the annuli of this well

4. Should all the casing annuli affected by sustained pressure (stabilized) decrease below 20 percent of the MIYP and the casinghead pressures bleed to zero, you must notify this office of such a change verbally, followed by a written notice within 30 days.

5. The casing(s) should not be bled down during this 1-year period without notifying this office, except during required diagnostic tests performed in accordance with paragraph 3(1)) above. Any diagnostic tests conducted on this well should evaluate all annuli exhibiting casing pressure.

6 The MMS reserves the right to rescind this departure and require any corrective measures needed to accomplish the intent of 30 CFR 250.517 (a) and (d) if well bore conditions deteriorate, presenting a safety hazard to personnel, the platform or producing formation. If there are any questions regarding this letter, please contact _____ at (504) 736-_____

Sincerely,

Donald C Howard
Regional Supervisor
Field Operations

bcc: 1101-02(b)(3) Lease OCS-G_____, Well _____ (MS 5220)
Lease OCS-G_____, Well _____ (MS 5032)
MS 52_____

<author>:jrc:g:_____\scp__________.isi

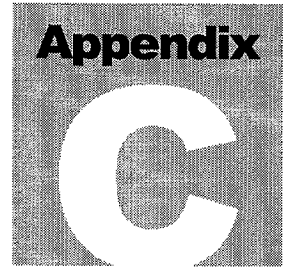

Best Cementing Practices

This appendix contains a summary of the best cementing practices compiled by MMS personnel using information gained from discussions with various cementing companies and a search of available technical literature.

Many sustained casing pressure problems may be the result of poor primary cement jobs. Paying more attention to cementing practices when designing and completing the well may prevent sustained casing pressure problems in many instances. MMS reports several new wells have been successfully completed without casing pressure in areas where SCP was historically a problem. MMS attributes these successes to following best cementing practices and adjusting the design of the well based on knowledge of SCP in the area.

Best Cementing Practices

A significant contributor to sustained casing pressure (SCP) in the GOM OCS is believed to be poor cementing practices. Data gathered by MMS indicates that a substantial number of all primary cement jobs result in wells that ultimately are affected by SCP. Channeling, micro annuli, fractures, uncemented zones, and poor bonding are all examples of communication that have developed in OCS wells. While attention continues to be paid by industry and MMS to remedial actions for SCP, preventative measures could play a significant role in the elimination of wells with annular pressure. Given the history of wells in the GOM regarding annular pressures, MMS believes it is advisable that operators take extra precaution in cementing casing strings. While this extra precaution is advisable for all wells, it becomes particularly important for those wells intended to use subsea production trees where only the pressures affecting the production annulus can be monitored. Wells drilled in areas prone to shallow gas and water flows also deserve the extra measure of precaution in performing cementing operations.

Listed below are best cementing practices that have been compiled from discussions with various cementing companies, and a literature search through technical reports, journal articles, and proceedings from technical conferences:

Cement Quality and Weight - The appropriate choice of cement slurry must be designed to solve the problems specific for each string of pipe prior to cementing. Knowledge of the wellbore conditions are essential, particularly at the time of drilling, so that any problems encountered can be integrated into the cement design. Use of premium grade cements is encouraged.

Waiting Time - The cement slurry should be held in place and under pressure until it hardens. A cement slurry is a time-dependent liquid and must be allowed to undergo a hydration reaction in order to produce a competent cement sheath. A fresh cement slurry can be worked as long as it is plastic, and the initial set of cement occurs during the rapid reaction stage. If the cement is not allowed to hydrate, it will be subject to changes in density, dilution, settling, water separation, and gas cutting that can lead to lack of zonal isolation with resultant bridging in the annulus.

Pipe Movement - This may be one of the most influential factors in hole cleaning (mud removal). Reciprocation and/or rotation with the use of wall cleaners on the casing mechanically breaks up gelled mud and constantly changes the flow patterns in the annulus for better cement bonding.

Mud Properties - Careful planning of mud properties such as plastic viscosity, gel strength, and filtrate loss should be done by a competent mud engineer to optimize hole cleaning and mud and filter cake removal prior to cementing.

Pre-Cementing Circulation - "Bottoms-up" circulation should occur twice, or until well-conditioned mud is being returned to the surface. The mud return should be void of cuttings, with an optimal annular velocity of 260 feet per minute (SPE/IADC 18617), if possible.

Flow Rate - Turbulent flow is one of the most desirable flow regimes for mud removal. If turbulence cannot be achieved, better mud removal is found when maximum flow energy is used. The maximum pump rate should be determined to obtain the best flow regime.

APPENDIX C

Hole Size - The optimum hole size recommended for good mud removal is 1.5 inches to 2 inches larger than the casing or liner size. Hole sizes larger than 2 inches annular space can be dealt with, but those that are smaller than 1.5 inches present difficult problems.

Pipe Centralization - Centralizing the pipe within the well are helps to create a uniform flow area perpendicular to flow direction, and improve the chance for cement to bond to both annulus surfaces (preventing fluid migration). At least a 70 percent standoff should be achieved for centralization. This is particularly important in directional holes. Special centralizers are available to aid in the maintenance of turbulent flow around the casing.

Rat Hole - When applicable, a weighted viscous pill in the rat hole can prevent cement from swapping with lighter weight mud when displacement stops

Shoe Joint - A shoe joint is recommended on all primary casings and liners. The length of the shoe joint will vary, with an accepted minimum length being one joint of pipe. If conditions exist in the well such that a bottom plug is not run in conjunction with the cement job, two joints should be considered to be a minimum requirement.

Spacer - When feasible in turbulent flow, a spacer should be used to minimize contamination of the cement.

Plugs - Top and bottom cement plugs are recommended on every primary cementing job. The bottom plug serves to minimize contamination of the cement as it is pumped. The top plug is also used to prevent any contamination of the cement slurry by the displacement fluid. The top plug also gives a positive indication that the cement has been displaced.

Gas Flow - A gas flow analysis should always be used to determine the potential for gas flow on any primary cement job. While going through its gelatin phase, the cement column loses its ability to transmit hydrostatic pressure onto the formation. During this period, fluids can freely migrate into the cement and begin to form channels. Although gas flow may not be apparent at the surface, gas migration in the annuli will likely lead to problems with SCP.

