

ROV/AUV Capabilities

by

**Robert Randall, Professor Civil Engineering
Texas A&M University
E. G. Ward, Associate Director
Offshore Technology Research Center**

**Proceedings & Final Workshop Report
Prepared for the Minerals Management Service
Under the MMS/OTRC Cooperative Research Agreement
1435-01-99-CA-31003
Task Order 85268
MMS Project Number 446**

September 2003

OTRC Library Number: 9/03ROV/AUV

“The views and conclusions contained in this document are those of the authors and should not be interpreted as representing the opinions or policies of the U.S. Government. Mention of trade names or commercial products does not constitute their endorsement by the U. S. Government”.



For more information contact:

Offshore Technology Research Center
Texas A&M University
1200 Mariner Drive
College Station, Texas 77845-3400
(979) 845-6000

or

Offshore Technology Research Center
The University of Texas at Austin
1 University Station C3700
Austin, Texas 78712-0318
(512) 471-6989

A National Science Foundation Graduated Engineering Research Center

Table of Contents

Executive Summary	1
Appendix A – Workshop Presentations	11
Session 1 - Workshop Plan and Agenda	
Session 2 - Introductory Keynote Presentation - Michel	
Session 3 - Panel Presentation - Johnson	
Session 3 - Panel Presentation - Siegmund	
Session 4 - Panel Presentation - McInnes	
Session 4 - Panel Presentation - Pfluger	
Session 4 - Panel Presentation - Voss	
Session 5 - Panel Presentation - Barksdale	
Session 5 - Panel Presentation - Geddes	
Session 5 - Panel Presentation - Hettinger	
Session 5 - Panel Presentation - Keith	
Session 5 - Panel Presentation - Stroud	
Session 6 - Panel Presentation - Connell	
Session 6 - Panel Presentation - Dale	
Session 6 - Panel Presentation - Morr	
Session 6 - Panel Presentation - Wadsworth	
Session 7 - Operator Views on Future Needs - Ward	
Session 7 - Summary of Day One - Randall and Ward	

Challenges of Interfacing Remotely Operated Vehicles and Autonomous Underwater Vehicles with Deepwater Subsea Systems

The Offshore Technology Research Center (OTRC) conducted a workshop to bring offshore oil and gas operators, subsea equipment manufacturers, and remotely operated vehicle (ROV) and autonomous underwater vehicle (AUV) engineers, manufacturers, and contractors together to discuss future prospects, technology gaps and industry needs to enable better, more economical, and faster subsea deepwater development. The workshop was sponsored by the Minerals Management Service (MMS).

The workshop “Challenges of Interfacing Remotely Operated Vehicles and Autonomous Underwater Vehicles with Deepwater Subsea Systems” was conducted April 10-11, 2003 in Houston, Texas. Approximately 50 participants attended the 1½ day workshop.

Objectives

The primary objective of this workshop was to develop a technical assessment of present and future AUV/ROV capabilities relevant to subsea deepwater oil and gas developments. ROV’s and AUV’s offer considerable promise for subsea development systems in deep and ultra-deep water. ROV and AUV technology is rapidly evolving in a highly competitive market. The ROV/AUV technology must interface with subsea well and production equipment to produce effective subsea development systems. An objective technical assessment of future ROV/AUV capabilities is needed to promote synergy and integration with subsea production systems. The assessment includes present technology as well as technology and capabilities that could be available in 5 – 10 years.

Workshop Plan

Day 1 of the workshop began with a keynote presentation reviewing the industry’s history as well as projections for the future.

Four Panel Discussions followed:

- Operators – Provided an offshore industry operator’s view on AUV, ROV, and subsea needs for future subsea developments.
- Subsea Equipment Manufacturers – Provided present and future industry capabilities which set the stage for the future functionality of AUV/ROV equipment.
- Remotely Operated Vehicle Manufacturers and Operators – Addressed the present and future ROV capabilities.
- Autonomous Underwater Vehicle Manufacturers and Operators – Addressed the present and future AUV capabilities.

On Day 2, four working groups in separate break out session each addressed the following items:

- Define a common vision of ROV/AUV capabilities needed for future subsea developments in the next 5-10 years
- Identify the gaps and development needs in ROV/AUV technologies
- Discuss options for paths forward

The workout groups then reported out to the entire Workshop. Key needs, learnings, and recommendations were captured, and are reported here.

Workshop Presentations

A detailed Agenda showing the moderators, panelists, and presenters is shown in Table 1 below.

Table 1. OTRC Workshop Agenda (April 10-11, 2003) - Challenges of Interfacing Remotely Operated Vehicles and Autonomous Underwater Vehicles with Deepwater Subsea Systems

Time	Topic	Purpose	Presenter Discussion Leader
Day 1			
08:10 – 8:30	Welcome		Bob Randall (OTRC)
	Workshop Plan & agenda		Skip Ward (OTRC)
8:30 –9:00	History of Subsea Intervention and Look to the Future	Introductory keynote presentation	Drew Michel
9:00 –9:50	Panel Discussion: Operator Views on ROV/AUV/Subsea Technology Needs for Future Subsea Development Projects	Presentations by Panel	Moderator: Skip Ward Panel: Skip Ward (OTRC) Mark Johnson (Manatee)
9:50 – 10:10		Discussion, Questions, & Clarifications	Mark Siegmund (BP)
10:30 – 11:20	Panel Discussion: Present & Future Subsea Equipment Capabilities & Needs (Operation, Maintenance, & Intervention)	Presentations by Panel	Moderator: Charles White, ABB Panel: Bobby Voss, ABB Ron Pfluger, Cameron Robert McGinnis, FMC
11:20 – 11:40		Discussion, Questions, & Clarifications	
1:00 –2:25	Panel Discussion: Present & Future ROV Capabilities	Presentations by Panel	Moderator: Drew Michel Panel: Tom Geddes (Halliburton Subsea 7) Doug Stroud (Canyon Offshore) Gordon Barksdale (Stolt Offshore) Fred Hettinger (Perry Slingsby) Robert Kieth (Sonsub)
2:25 – 3:00		Discussion, Questions, & Clarifications	
3:15 –4:25	Panel Discussion: Present & Future AUV Capabilities	Presentations by Panel	Moderator: Douglas Hernandez, BP Panel: Brian Morr (Technosphere, Inc.) Joe Wadsworth (Oceaneering Boeing Fugro) David Connell (C&C Technologies) Geoff Dale (Halliburton Subsea 7)
4:25 – 5:00		Questions & Clarifications	
Day 2			
8:00– 8:30	Summarize Learnings from	Clarify	Skip Ward

Time	Topic	Purpose	Presenter Discussion Leader
	Panel Discussions on Day 1 <ul style="list-style-type: none"> Operator Views on Future Needs Subsea Equipment ROV Capabilities AUV Capabilities 	Consensus	Bob Randall
8:30 – 10:15	Simultaneous Working Groups	<ul style="list-style-type: none"> Define a Common Vision of ROV & AUV Capabilities Needed for Future Subsea Development Projects Identify Gaps and Developments Needs in ROV & AUV Technology Define Options for a Path Forward to Meet These Technology Needs Brainstorm Ideas for a Course of Action, i.e. the Next Step 	All
10:30 – 11:30	Working Groups Report Out	<ul style="list-style-type: none"> Information Sharing & Clarification 	All
11:30 – 11:45	Group Discussion	<ul style="list-style-type: none"> Identify Most Pressing Needs/More Promising Ideas 	Skip Ward Bob Randall
11:45	Closing Remarks & Adjourn		Skip Ward Bob Randall

The presentations are included in Appendix A.

Panel Presentations and Discussions

Panel presentations highlighted current concerns which exist in the areas of technology, industry standardization, economics and human resources.

Technology Concerns:

There is a need for subsea transportation to maneuver heavy items such as subsea pumps and other subsea equipment. Miniaturized ROV interfaces are needed to meet the demands of the increased complexity of the subsea trees. There is also a need to combine sensors in order to reduce payload and power requirements.

The development of self-diagnosing smart tools, that are capable of indicating when systems are working or failing, is crucial to the industry. ROV and AUV's need to be able to connect into subsea power systems. A means to deliver these power systems to the seafloor is needed to allow ROV/AUV's to recharge batteries on the seafloor instead of changing out batteries.

Complete subsea development systems on the seafloor controlled from the office are on the horizon. No umbilical for subsea vehicles and an all electric valve operation were mentioned. Increased exploration and productivity on the seafloor is needed. The need for a 6,000-meter capability vehicle was suggested as a goal by some, while others suggested that it is a work in progress.

More powerful ROV/AUV systems are needed. However, there is also the need for improved assembly of the components so that the power utilization of the vehicle does not compromise the power needs of the AUV/ROV/SUBSEA system as a whole. Increased capability and smaller ROV's seemed to be desirable. Web interactive control systems are needed in the future. Ultra-

high voltage systems (12,000 volts), and tether excursions up to 3 kilometers are other future needs.

Inertial navigation systems and improved through-the-water data and signal transmission are needed especially for AUV's. Disposable AUV's that can do small tasks and not have the expense of deployment and recovery operation may be desirable.

Failure mode analysis is part of the system design, so integrating design function and maintenance with subsea equipment, tools, and vehicles in the life-cycle design is necessary.

It was noted that the industry may need to recognize and support the fact that failures may occur. Fear of failure may prevent good concept development due to lack of courage, or the financial support to proceed.

Additionally, there is a need to develop a program of technology transfer and information sharing

Standardization Concerns:

Whether or not the industry should adopt or challenge standardization remains a concern. There is the thought that when a subsea project is approached, it should be done holistically. While every project is unique in terms of surface issues, subsea systems remain constant. If a life-of-field approach is taken to optimize a project, it is unclear how standardization could be regulated or would apply. Regulatory codes and recommended practices according to API and ISO codes are sometimes out of date and therefore, may inhibit innovation.

Placement of the vehicle/tool interface was also discussed. Currently the thought is an interface exists between the tool, the vehicle, the subsea equipment, and the operator. It would be desirable to put things together in such a way that only one interface exists.

It has yet to be determined where the interfaces between the AUV and ROV community, the subsea community, and the operator community should be. It was suggested that only one interface exist, and that it should lie with the operator community.

Economic Concerns:

There was a large concern expressed that the operators need to invest more in the ROV/AUV technology and development costs. Contractors cannot afford to shoulder the costs given their competitive work environment. It was pointed out several times that an industry-led situation would result in a more powerful AUV/ROV community and capability. Project economics and contracts don't reward OPEX reduction. Consequently, there's little value in investing in intervention, long-term intervention, and in life-of-field planning. There is concern that ROV/AUV's are becoming a commodity. It is uncertain how the ROV/AUV business will advance and sustain itself if it is deemed a commodity.

Human Resource Concerns:

It is hard to interest and recruit new personnel. There are few formal training opportunities, and no one wants to allow training on their job. Mentoring programs are needed to meet the need for increased skill levels as the systems and operations become more complex.

Workshop Discussions

The charge for the workshop discussions was to develop

- a vision of future needs for ROV's, AUV's and SUBSEA systems
- identify the technology and non-technology gaps (needs)

In addition the groups suggested some paths forward to meet those gaps, and a course of action.

The discussions built upon the panel presentations and identified the following areas of concern:

- Technology
- Reliability
- Economics
- Standardization
- Human Resources

These concerns are discussed below.

Technology Gaps

Maximizing the vehicle/equipment utilization and availability is important to insure maximum uptime. In general, improvements that would enhance the reliability and uptime for AUV's and ROV's are:

- Increased power or increased power density
- Smaller vehicles that are more powerful
- Vehicles that are smaller in size
- Vehicles that have a smaller footprint.
- The ability to work longer distances using either a longer umbilical or no umbilical with increased battery or fuel cell power. In general, batteries and power sources or fuel cells need to be developed to give vehicles a longer-time-on-bottom and longer distance capability. Electrical voltage through the umbilical of 12,000 volts is needed. A 3 kilometer tether is needed to extend the ROV operating range.
- Better data transfer rates that allow real time communication with the AUV and possible video feedback.
- Most of the reliability problems now have moved from the ROV into the tooling. The transport systems are becoming fairly stable, but there are still big issues and the tooling is where the innovation is occurring.

- While power issues with AUV's remain, there is some improvement in this area. In addition, there is the thought that the power issues can be mitigated with good mission planning thereby reducing the amount of power needed.

Other Technology Gaps include:

- A need for improved information access, allowing for remote monitoring of an ROV rather than requiring the operator to be on-site. Sensors and equipment need to be built into these new subsea systems to get information back to the remote operators.. The technology exists, but a decision must be made to invest in that technology in order to reduce troubleshooting trips to the field. All-electric valve operation is needed in five years. Current technology theoretically would allow for a smart torque tool to be operated from a remote location. A web connection through the ROV umbilical would allow for tool operation from an office anywhere in the world.
- Software which allows vehicles and subsea systems to become smarter - complete with customer training which adequately educates the end-user concerning operation and benefits.
- Leak detection capabilities that allow for leak detection during pipeline surveys or cathodic protection surveys.
- AUV's that are capable of conducting well interventions without a host vessel on the surface.
- Development of full subsea processing with separation using booster pumps and subsea metering equipment. There is the need for the ability for a ROV/AUV to pull a pump, a compressor module, or a multiphase meter.
- The availability of AUV/ROV support vessels. In many cases, the proper ROV/AUV is available but the support vessel is not available.

Reliability Engineering Issues:

- Hardware manufacturers aren't usually aware of what the life results of their systems are after installation, which makes design improvements allowing for increased reliability more difficult. There is a need for consistent project teams to stay involved for the duration of a system's life cycle.
- While there are very sophisticated tools coming out of space and military research in terms of reliability engineering the offshore industry has yet to implement these tools. The automobile industry is also doing a considerably better job than the offshore industry due longer car warranties. A current practice for hardware suppliers in the offshore industry is to issue a one year warranty; however, it is not uncommon for equipment to lay dormant on the beach for half of the warranty period. This dynamic seems to be inhibiting the production of commercially complete reliable systems. There is a need for new contracting strategies from the operators that make reliability engineering practices profitable.

- There is a need to overcome existing barriers that inhibit the offshore community from incorporating the rugged technology/reliability engineering techniques from the space, military and automotive industries.
- Reliability engineering techniques need to be implemented prior to project development to allow for designs in advance of available technology.

Economic Concerns:

- Typically operators must see a large value in new technology before they are willing to invest in it. As an example, the operator wants to see a hundred dollars returned on a dollar investment before the technology is going to be of any interest to the operator. There is a disparity between project planning, which is CAPEX, and maintainability, which is OPEX.
- There is a need to provide an incentive for people to be the first user of something that is radically different. There is reluctance on the part of the end user to be the guinea pig when the entity involved is not the developer.
- Better cooperation between the subsea equipment designers and the ROV community is needed. The time when design engineers can best influence the cost is at the beginning of a project. As design decisions are made and prototypes are built the time for the engineer to make design changes becomes smaller.. Therefore, more workshops are needed where the ROV community can communicate what's possible; the hardware community can communicate what needs to be done; and the end customers understand the value of the system. At the same time, the designer can find out what customer's value drivers are as well as what their financial hurdles are.
- Financing of the vehicles is a concern. It is unclear whether oil companies will buy the units outright or if the ROV community will build and subsequently rent the units. There has been a move in the industry for the oil companies to shy away from doing pure research and development. Companies have tended to push research and development further down the ladder, and the suppliers are now being asked to do the technology development and bring finished products to the oil companies. Hardware vendors or ROV vendors do not have the financial resources to do research and development at the level that the operators used to do in the past.
- There are also an number of commercial strategic issues which include:
 - Concern over clients providing accurate goals down through to industry
 - How well do the forward thinkers stay connected with technology development?
 - Is forward thinking inline with commercial goals?
 - Is it possible to establish a network where all parties are involved as needed in the process?
- There is an ongoing problem with the interaction of contractors. There is a gulf of understanding between the hardware suppliers and the intervention suppliers whereby the

intervention suppliers largely feel excluded from the process. There is a need for improved integration.

- A business case for AUV ownership needs to be developed which clearly illustrates the profitability in ownership. Currently for industry to move projects forward it requires working for the operator as well as for the supplier.
- While technology development is important and has been discussed, it is felt the real issue is to understand the commercial goals of the operators and thereby insure that there is a commercial return for the suppliers.

Standardization Concerns:

- Standardization needs to be developed so that the benefits of standardization are achieved, but innovation is not stymied.

Human Resource Concerns:

- More and better trained staffs are needed.
- There is a need to attract young people to work in the industry as a whole. This includes ROV and AUV pilots as well as white and blue-collar workers.
- There is a need for better marketing of the industry. While the National Ocean Industry Association does a good job of marketing the industry, more programs and recruiting resources are needed.
- There's great potential to de-skill the tasks required to maintain an ROV and work with large replaceable unit maintenance. This results in replacing complete units rather than using diagnostic tools such as an oscilloscope. Strong self-diagnostic intelligence is needed inside the equipment. to reduce the amount of time needed to locate the failure source. Deskilling is currently a quicker solution than trying to up skill or maintain operator skill. The potential exists for personnel to work on good automation and autonomous technology for use in AUV's. It would be desirable to have this technology available in ROV's as well. .

Paths Forward

The breakout groups identified the following as possibilities for Paths Forward:

- Future workshops need to be designed with broader participation and increased advertising. A longer lead time from workshop announcement to workshop date is needed. . These workshops should include a broader range of clients, subsea equipment manufacturers, and installation contractors allowing for a better cross-section of industry representation. In addition the workshops should continue to provide the opportunity for governmental and regulatory body participation for education purposes.

- A champion needs to be identified that continues to organize and promote similar workshops that facilitate continued communications and advancement for the ROV/AUV/SUBSEA community.
- Better cooperation is needed between the subsea hardware manufacturer and the ROV/AUV designers to share information and system needs/capabilities
- A financial model needs to be developed to demonstrate the value of the AUV. It was suggested that a small group be convened to define a case for the first use of an AUV for a futuristic application such as a subsea well intervention. The group should include the user, the clients, the hardware manufacturers, and the ROV/AUV Community. The result may be the development of a hybrid vessel rather than an AUV. The Deep Star project was suggested as a potential resource for beginning work on this model. A case needs to be developed to sell the development expense to company management which outlines what is possible in terms of future economic benefit.
- Standardization on interfaces is needed. It was mentioned previously that the interface is either between the ROV and the tool package or between the tool package and subsea hardware. It is felt that a third-party consulting engineer or facilitator with time to devote to becoming a champion is needed to drive the standardization issue forward. This champion would be responsible for calling the meetings, setting the schedules, and publishing the minutes and results.

Course of Action

The ROV/AUV/SUBSEA Workshop brought together a broad range of participants with varying backgrounds. While the group presented a number of valuable views, the field is larger than was represented at this workshop. The workshop was able to identify focus areas for future workshops as well as provide an understanding of ROV/AUV/Subsea challenges, concerns and needs. The general consensus was that a champion is needed to develop a project that will address areas defined as a result of this workshop. The champion could be an industry organization or perhaps even the Offshore Technology Research Center (OTRC). It was suggested that a year-long project be developed and authorized that followed the timetable below:

Months 1-3:

- Define Project Objectives
- Establish Core Team
- Project Organization

Months 3-6:

- Build Organization Team Structure
- Develop Funding Model
- Develop Five-Year Vision
- Develop Intellectual Property Policy
- Secure Project Funding

Months 7-12:

- Implement Project Plan which outlines:
 - What should be developed
 - How to develop
 - Who develops
 - Long Term and Short Term Actions

This project should include a self-destruct clause so that the project doesn't become a career-type activity.

All three groups, ROV/AUV, Subsea, and operators, can work together to accomplish this goal. The ROV/AUV/Subsea workshop was a positive experience which allows for a good opportunity to follow up the workshop. A champion needs to be identified that will keep the ball rolling.

One of the biggest challenges in the industry is attracting new personnel. Professional organizations need to provide scholarships to students and other incentives to attract young people to the industry. The business case, future joint industry projects (JIPs), and additional workshops like this one need to be organized and conducted. It is important to get the operators involved in these workshops, identify technology gaps, and facilitate early integration of contractors and vendors.

The ROV/AUV/SUBSEA professional should involve themselves in current and forthcoming discussions of standardization organized by API and ISO to insure the economies of standards do not stymie the efforts towards innovation.

Appendix A – Workshop Presentations

CHALLENGES OF INTERFACING REMOTELY OPERATED VEHICLES AND AUTONOMOUS UNDERWATER VEHICLES WITH DEEPWATER SUBSEA SYSTEMS

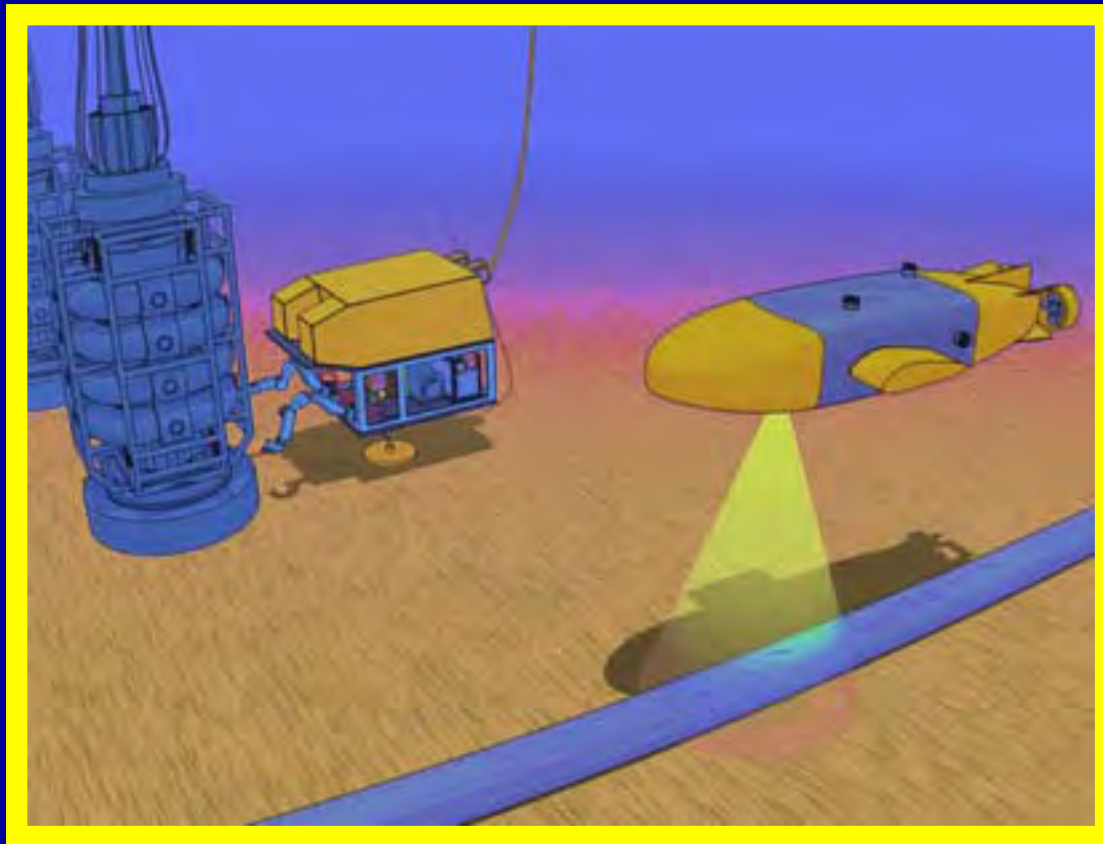

CHALLENGES OF INTERFACING REMOTELY OPERATED VEHICLES AND AUTONOMOUS UNDERWATER VEHICLES WITH DEEPWATER SUBSEA SYSTEMS



Goals -

- Bring together operator, ROV & AUV , and subsea communities
- Develop a consensus view of ROV & AUV technologies needs and how to get there

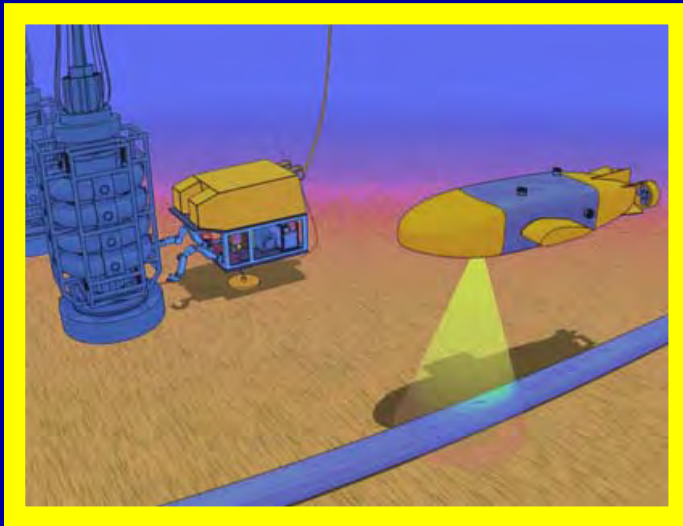

Objectives -

- Discuss future needs for subsea oil & gas developments
- Assess present ROV & AUV capabilities
- Identify technology gaps
- Identify possible paths forward

General



- **WORKshop**
- **Folder Contents**
- **Building**
 - ◆ **2nd & 11th Floors**
 - ◆ **Fire Exits**
 - ◆ **Restrooms**
- **Breaks**
- **Meals**



Workshop Plan

Day 1	
	<ul style="list-style-type: none">● Agenda● Keynote Address - History of Subsea Intervention & Look to the Future
Panel Discussions	● Operators View on ROV/AUV/ Subsea Technology Needs for Future Subsea Developments
	● Present & Future Subsea Equipment Capabilities & Needs (Operations, Inspection, Maintenance)
	● Present & Future ROV Capabilities
	● Present & Future AUV Capabilities
Dinner	● Enjoyable Working Dinner



Workshop Plan

Day 2 (until Noon)	
	<ul style="list-style-type: none">● Clarify/Consensus on Learnings from Day 1
Workshops (concurrent groups)	<ul style="list-style-type: none">● Define Common Vision of ROV & AUV Capabilities Needed for Future SS Developments
	<ul style="list-style-type: none">● Identify Gaps & Development Needs in ROV & AUV Technologies
	<ul style="list-style-type: none">● Identify Options for Paths Forward
	<ul style="list-style-type: none">● Brainstorm Course of Action, i.e. the Next Step
Report Out	<ul style="list-style-type: none">● Workshop Groups Report Out
	<ul style="list-style-type: none">● Group Prioritization of Needs & Paths Forward
	<ul style="list-style-type: none">● Consensus on Next Step?
Wrap Up	<ul style="list-style-type: none">● Summarize● Adjourn



Agenda – Thursday AM



	Topic	Moderator	Time
Goals & Objectives	Welcome Agenda	Bob Randall Skip Ward	08:10 – 08:30
Keynote Address	History of Subsea Intervention & Look to the Future	Drew Michel	08:30 – 09:00
Panel Discussion	Operators View on ROV/AUV/ Subsea Technology Needs for Future Subsea Developments	Skip Ward	09:00 – 10:10
	Discussion, Question, & Clarification (20 min)		
	Break		09:50 – 10:10
Panel Discussion	Present & Future SS Equipment Capabilities & Needs - Operation, Maintenance, & Intervention	Charles White	10:10 – 11:40
	Discussion, Question, & Clarification (20 min)		
	Lunch		11:40 – 01:00



Panel Discussion

Operators Views on ROV/AUV/ Subsea Technology Needs

Moderator: Skip Ward (OTRC)

- **Mark Siegmund (bp)**
- **Mark Johnson (bp/Manatee)**



Agenda – Thursday AM



	Topic	Moderator	Time
Goals & Objectives	Welcome Agenda	Bob Randall Skip Ward	08:10 – 08:30
Keynote Address	History of Subsea Intervention & Look to the Future	Drew Michel	08:30 – 09:00
Panel Discussion	Operators View on ROV/AUV/ Subsea Technology Needs for Future Subsea Developments	Skip Ward	09:00 – 10:10
	Discussion, Question, & Clarification (20 min)		
	Break		09:50 – 10:10
Panel Discussion	Present & Future SS Equipment Capabilities & Needs - Operation, Maintenance, & Intervention	Charles White	10:10 – 11:40
	Discussion, Question, & Clarification (20 min)		
	Lunch		11:40 – 01:00



Panel Discussion

Present & Future Subsea Equipment Capabilities & Needs

(Operations, Maintenance, Intervention, Safety)

Moderator: Charles White (ABB)

- **Bobby Voss (ABB)**
- **Ron Pfluger (Cameron)**
- **Robert McInnes (FMC)**





Agenda – Thursday PM

	Topic	Moderator	Time
Panel Discussion	Present & Future ROV Capabilities	Drew Michel	01:00 – 03:00
	Discussion, Question, & Clarification (35 min)		
	Break		03:00 – 03:15
Panel Discussion	Present & Future AUV Capabilities	Doug Hernandez	03:15 – 05:00
	Discussion, Question, & Clarification (35 min)		
Wrap Up Day 1	Closure & Plans for Friday		5:00
	Social Hour & Dinner		5:30 – 7:00



Panel Discussion

Present & Future ROV Capabilities

Moderator: Drew Michel

- **Tom Geddes (Halliburton Subsea 7)**
- **Doug Stroud (Canyon Offshore)**
- **Gordon Barksdale(Stolt Offshore)**
- **Fred Hettinger (Perry Slingsby)**
- **Robert Keith (Sonsub)**





Panel Discussion

Present & Future AUV Capabilities

Moderator: Doug Hernandez (bp)

- **Brian Morr (Technosphere)**
- **Joe Wadsworth (Oceaneering Boeing Fugro)**
- **Jay Northcutt (C&C Technologies)**
- **Geoff Dale (Halliburton Subsea 7)**

CHALLENGES OF INTERFACING REMOTELY OPERATED VEHICLES AND AUTONOMOUS UNDERWATER VEHICLES WITH DEEPWATER SUBSEA SYSTEMS

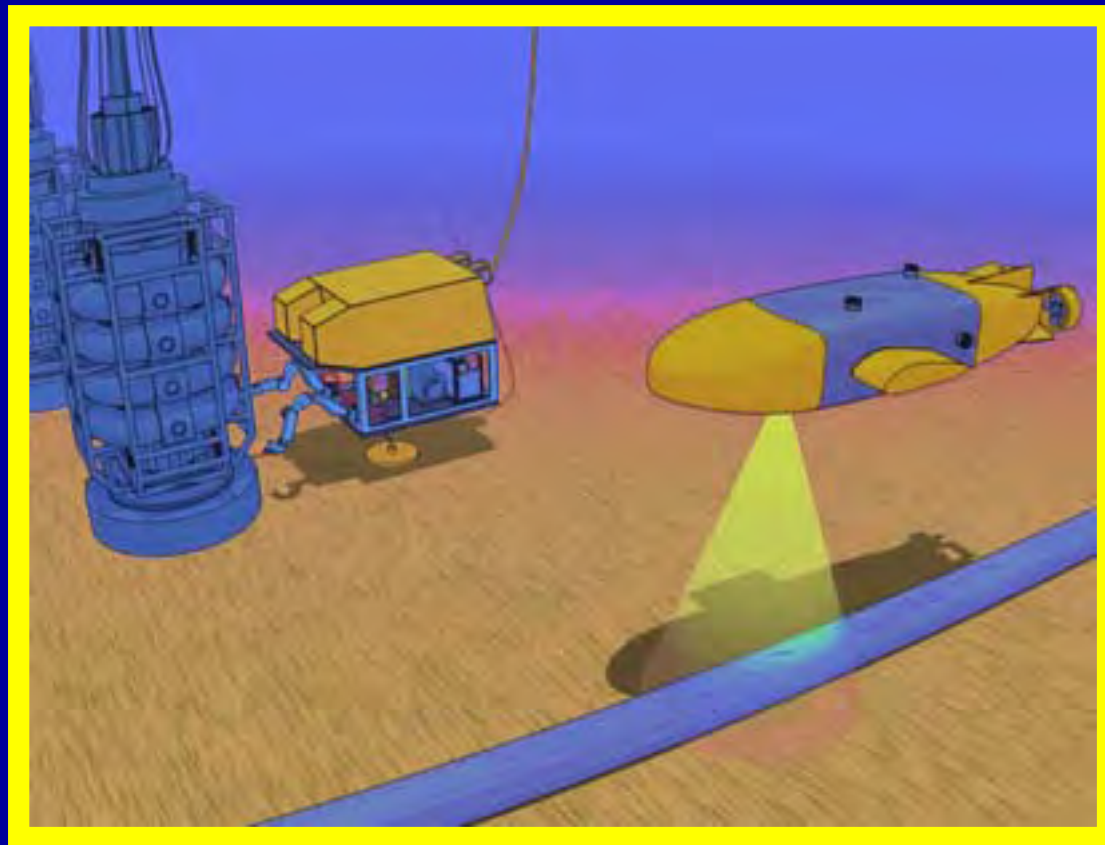

Agenda – Friday AM



	Topic	Moderator	Time
Review Day 1	Summarize Learnings from Day 1 Clarify/Consensus Workshop Group Assignments	Bob Randall Skip Ward	08:00 – 08:30
Workshops	Common Vision of Capabilities Needed for Future ROVs & AUVs	Workshop Leaders	08:30 – 10:15
	Technology Gaps & Development Needs for Future ROVs & AUVs		
	Options for Paths Forward to Meet Technology Development Needs		
	Course of Action – Next Step		
	Break		10:15 – 10:30
Report Out	Work Group Recommendations on Gaps, Needs, Paths Forward (15 min each)	Workshop Leaders	10:30 – 11:30
Conclusions	Prioritize Group Recommendations	Group	11:30 – 11:50
	Closing Remarks	Rick Mercier	11:50 – 12:00
	Adjourn		12:00





Technology Gaps

- **Subsea transport/maneuvering of heavy items (SS pumps and equipment)**
- **Increased work time on bottom for ROVs**
- **Miniaturized ROV interfaces due to increased SS tree complexity**
- **Few – ROV technology represents a solution looking for a problem**
- **No shared learnings on weaknesses & failures – everyone gets to make all of the mistakes**
- **Sensor fusion to reduce payload/power requirements**
- **AUV capability to hover**



Technology Gaps

- **Avoid Valley of Death**
- **Improve Technology (Failure Free Operation Period / Mean Time Between Failures)**
 - ◆ **Smart Tools (self diagnosing)**
- **Subsea power systems**
- **Subsea communications systems**
- **Progress SS Strategy, Systems Design, & Hardware along with ROV and AUV Capabilities**
- **ROV's that recharge batteries on subsea equipment.**

Design Issues



- **Holistic engagement of designers & users**
- **Standardization – adopt or challenge?**
- **Failure Mode Analysis as part of design**
- **Integrate design functionality & maintenance with SS equipment, tools, and vehicles in a life-cycle design**
- **More demanding construction activities leading to larger, more complex vehicles...is the the smartest way to achieve best life-of-field performance & costs?**
- **Where should vehicle/tool interface be**
 - ◆ **Complex, self-contained tools w/ simple vehicle**

Business Issues



- **Operators need to invest in ROV & AUV technology & development costs**
 - ◆ **AUV/ROV & SS contractors cannot afford**
 - ◆ **Industry led more powerful than contractor led**
- **Project economics/contracts do not reward OPEX reduction – therefore little value for investing in intervention or life-of-field planning**
- **Interfaces**
 - ◆ **ROV&AUV//SS//Operator**
 - ◆ **ROV&AUV + SS//Operator**
- **If ROV are now becoming commodities, how best for ROV business to advance/sustain?**



SS Personnel

- **Getting Gray/Bald**
- **Hard to interest/recruit new blood**
- **Few formal training opportunities**
- **No one wants to allow training on their job – getting experience**
- **Mentoring programs**
- **Higher skill level needed due to increased complexity**



Standardization

- **Standardization or Holistic Life of Field Design?**
 - ◆ **Holistic Life of Field**
 - All fields different
 - 20-30 year life for each field
 - ◆ **Standardization**
 - Same or slowly evolving



Regulatory & Codes/RP's

- **API & ISO Codes out of date & inhibit innovation**
- **Standard ROV & SS equipment interfaces**

Future Dreams



- **Unlimited Tie Back Distances**
- **Complete Subsea Development Systems Controlled from the Office**
- **No Umbilical**
- **All Electric Valve Operation**
- **More & more exploration & production activities on the seafloor**
- **6000 m ROV AUV capability**
- **More powerful systems**
- **Increased capability/smaller ROV systems**
- **Web interactive control system**

Future Dreams



- **Ultra-high voltage (12,000 V) power drive system**
- **Tether excursion up to 3 km**
- **Inertial navigational system**
- **Improved through the water data & signal transmission (AUV)**
- **Disposable AUV**

Agenda – Friday AM



	Topic	Moderator	Time
Review Day 1	Summarize Learnings from Day 1 Clarify/Consensus Workshop Group Assignments	Bob Randall Skip Ward	08:00 – 08:30
Workshops	Common Vision of Capabilities Needed for Future ROVs & AUVs	Workshop Leaders	08:30 – 10:15
	Technology Gaps & Development Needs for Future ROVs & AUVs		
	Options for Paths Forward to Meet Technology Development Needs		
	Course of Action – Next Step		
	Break		10:15 – 10:30
Report Out	Work Group Recommendations on Gaps, Needs, Paths Forward (15 min each)	Workshop Leaders	10:30 – 11:30
Conclusions	Prioritize Group Recommendations	Group	11:30 – 11:50
	Closing Remarks	Rick Mercier	11:50 – 12:00
	Adjourn		12:00



Workshop Locations

Workshop Group	Location	Time
Group 1	Auditorium	08:30 – 10:15
Group 2	Lg. Dining Room	
Group 3	Sm. Dining Room	
Group 4	214	
Break		10:15 – 10:30
Report Out	Auditorium	10:30 – 11:30



Agenda – Friday AM



	Topic	Moderator	Time
Review Day 1	Summarize Learnings from Day 1 Clarify/Consensus Workshop Group Assignments	Bob Randall Skip Ward	08:00 – 08:30
Workshops	Common Vision of Capabilities Needed for Future ROVs & AUVs	Workshop Leaders	08:30 – 10:15
	Technology Gaps & Development Needs for Future ROVs & AUVs		
	Options for Paths Forward to Meet Technology Development Needs		
	Course of Action – Next Step		
	Break		10:15 – 10:30
Report Out	Work Group Recommendations on Gaps, Needs, Paths Forward (15 min each)	Workshop Leaders	10:30 – 11:30
Conclusions	Prioritize Group Recommendations	Group	11:30 – 11:50
	Closing Remarks	Rick Mercier	11:50 – 12:00
	Adjourn		12:00

OTRC Workshop 10 April 2003

A Short History and Overview of the Commercial ROV & AUV Industry

by

Drew Michel

ROV Technologies, Inc.

The 1950's & 60's The Diving Industry is Formed

- The need for commercial divers grew as the oil & gas industry moved offshore
- Many small companies were formed, primarily by US Navy divers utilizing USN technology, but with help from West Coast and other civilian divers
- Companies grew larger, and developed new technology



Mid-1970's Commercialization of the ROV

- Military ROV technology was introduced to the offshore industry around 1975 when the first RCV-125 is operational in the Gulf of Mexico

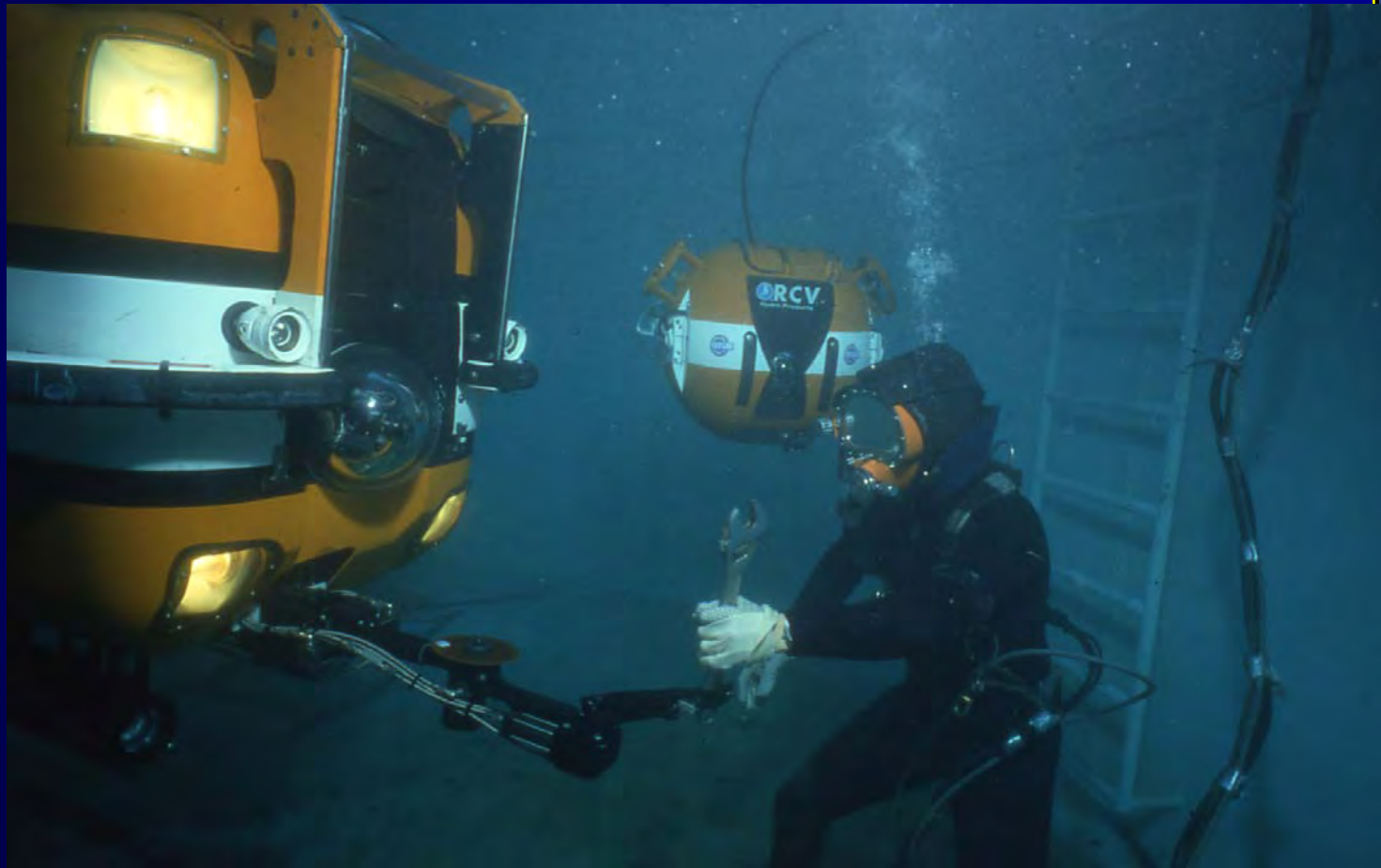

Late 1970's ROVs are "Tested" on More Applications

- Pioneering Days
- ROV's were used as observation and inspection tools, often with diving spreads
- During this period there were frequent failures with actual ROV operation time limited to a few hours each day

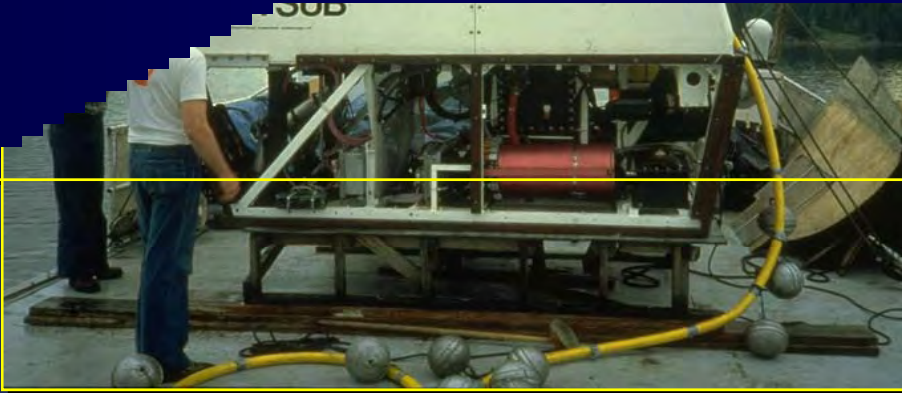

The Early 1980's Period of rapid growth

- Coincided with the boom in the oil industry
- Supported the development of production ROV systems
- Greatly improved reliability and performance
- ROV industry became a real business, with substantial growth potential



Mid 1980's The Oil & Gas Industry Collapse

- Development funds were severely curtailed and true Research & Development was non-existent
- In spite of the downturn, the use of ROVs continued to grow, primarily in the telecommunications industry.



Last decade - ROV Applications Expand

- Reliability, capability and performance levels reached the point that the industry began to design ROVs into projects as a primary tool
- ROVs matured to the point that services are essential in
 - Oil & Gas Industry
 - Telecommunications
 - Science
 - Salvage

The Present

- Capable and reliable machines that are an essential part of the subsea industry



ROV Classifications

- Observation Class

- Horse Power: <20
- Power Source: Electric
- Depth: Limited
- Payload: Minimal to None
- Utilization: Observation Only

- Light Work Class

- Horse Power: 20 to 75
- Power Source: Electro-Hydraulic or electric
- Depth: 1000-3000 meters
- Payload: Moderate Lift & Payload
- Utilization: P/L Survey, Minimal Drilling Support

ROV Classifications

- Work Class

- Horse Power: 75 to 100
- Power Source: Electro-Hydraulic
- Depth: 1000-3000 meters
- Payload: Heavy Lift & Payload
- Utilization: Construction, Pipelay, Drilling and Completion

- Heavy Work Class

- Horse Power: 150+
- Power Source: Electro-Hydraulic
- Depth: 2000-5000 meters
- Payload: Ultra heavy Lift & Payload
- Utilization: Major Construction and Telecommunications

Recent Developments

- Larger more powerful and capable systems
- An ever increasing array of tools
- “New” electric vehicles
- AUV Technology moves to industry
 - In the beginning lower survey costs
 - Next? Subsea completion intervention

ROV Contractors

Work Class ROV Systems

	GOM	World
• Oceaneering International, Inc.	48	118
• Subsea 7 (Halliburton/Subsea)	10	78
• Stolt (Stolt/Comex/Seaway)	12	69
• Sonsub (Saipem)	18	59
• Thales (ex Racal)	7	36
• Canyon (Cal Dive)	8	19
• Others- Approximate number of specialty systems, plus systems operated by smaller companies.	0	50
• Total Systems	103	429

Source – Drew Michel interviewing Contractors - Updated July 2002



Oceaneering ROV Systems

MAGNUM



QUANTUM



MILLENNIUM



RAIL - CURSOR SYSTEM



SONSUB INNOVATOR™

- Increased Performance
- Increased Reliability
- Simplified Systems
- High Voltage Power Drive System (4500V)
- Extended reach (850m) TMS with soft docking
- Increased Power & Thrust (1000 kg)



Innovator Umbilical Features

- Increased Power
 - (500 Electrical HP)
- Advantages
 - Reduces Umbilical Self weight
 - Reduces Handling System Size
- Reduced Core Diameter
 - (33 mm compared to 47 mm)
- Efficient Armor Package
 - (3200 kg/km compared to 4900 kg/km giving a 6000 kg 13,225 lbs weight saving)
- Extend Operating Temperature of Core
 - (150°C Compared to 70°C)

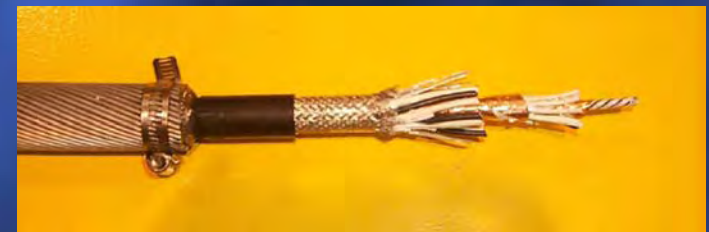

Touch-down Point Monitoring

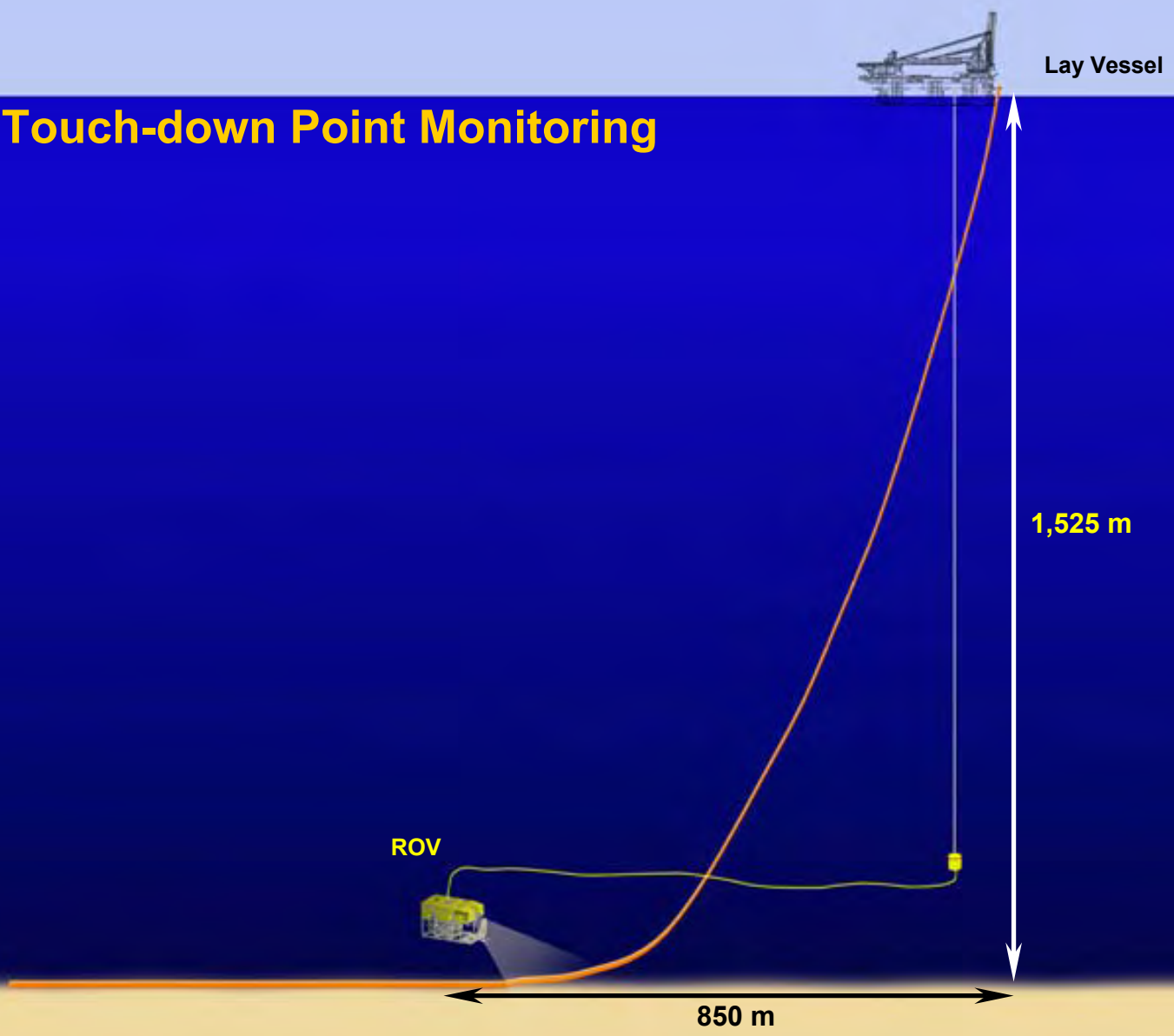

PIPELINE REPAIR TOOLING



Diamond Wire
Cutting Tool

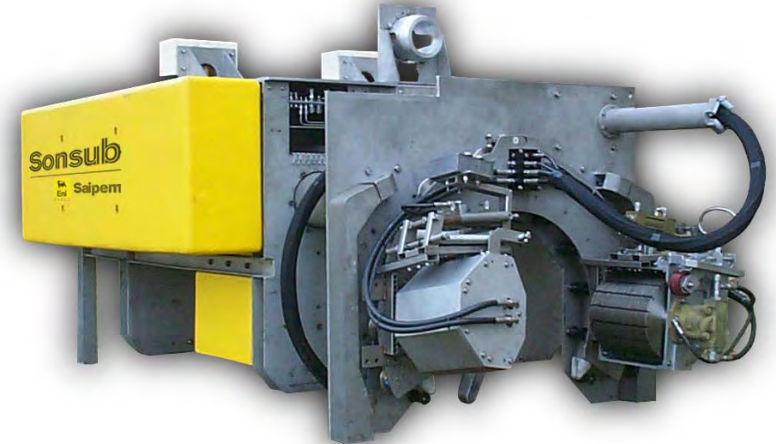

Concrete & FBE
Removal Tool



End Prep
Tool

INNOVATOR™ TECHNOLOGY BURIAL SYSTEMS

Centaur

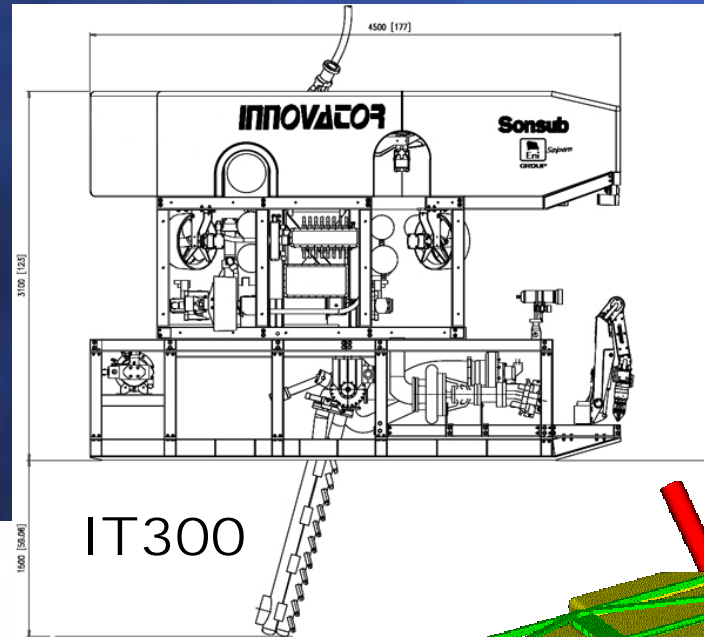

Sedna

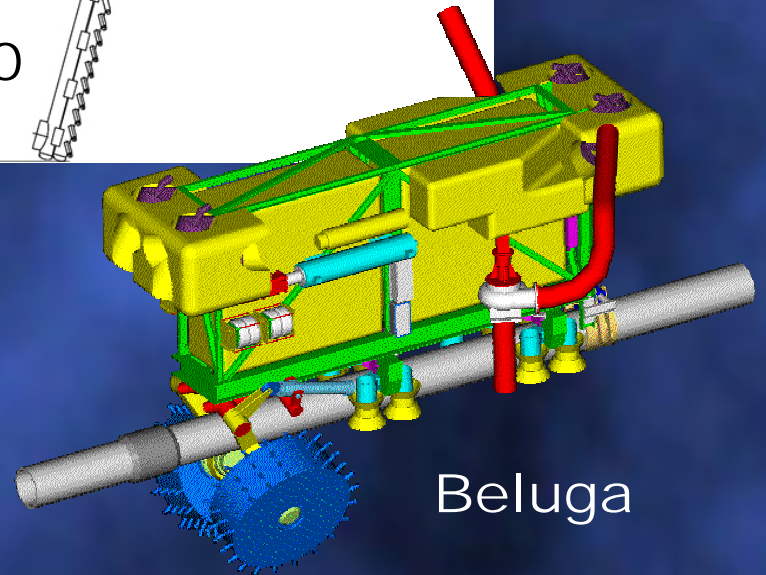

Beluga

Canyon Offshore

- Primarily provides Triton XL and Triton ST work class ROV systems



Quest Advantages

- Significantly reduced weight
- Significantly reduced footprint
- Improved performance
- Improved reliability
- Improved operability



Electric Thrusters

- Brushless Electric Ring
- **Single** Moving Part
- Seawater Lubricated
- Thermoplastic Construction
- 7.5 Kw Electrical
- 450 lb Thrust



SeaNet Communications

- Surface loop processing
- Distributed control
- Smart devices
 - Thrusters
 - Lights
 - Actuators
 - Manifold
 - Compensators
- Smaller electronics package
- Reduced complexity
 - 90% fewer electrical Interconnections
 - Single connector type

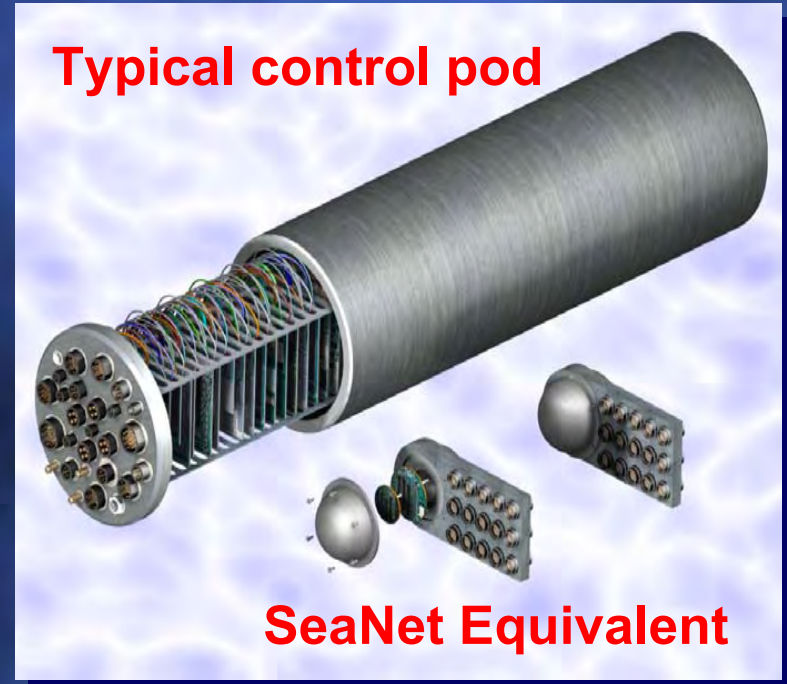

Improved Reliability

<u>Devices</u>	<u>Typical</u>	<u>Quest</u>
System Elements	250	50
Connector Types	25	1
Electrical Connections	800	145
Power Train moving parts	> 300	7



Quest uses only 1 cable/connector throughout system compared to the standard variety

Control Van

- 72" Multi-view Display
- Ergonomic design
- 16 simultaneous Video / VGA
- DVL based Station Keeping
- Clear uncomplicated diagnostics
- Tandem Control Stations
- Multi-purpose Hand Controllers
- Customer workstation



Increased Performance

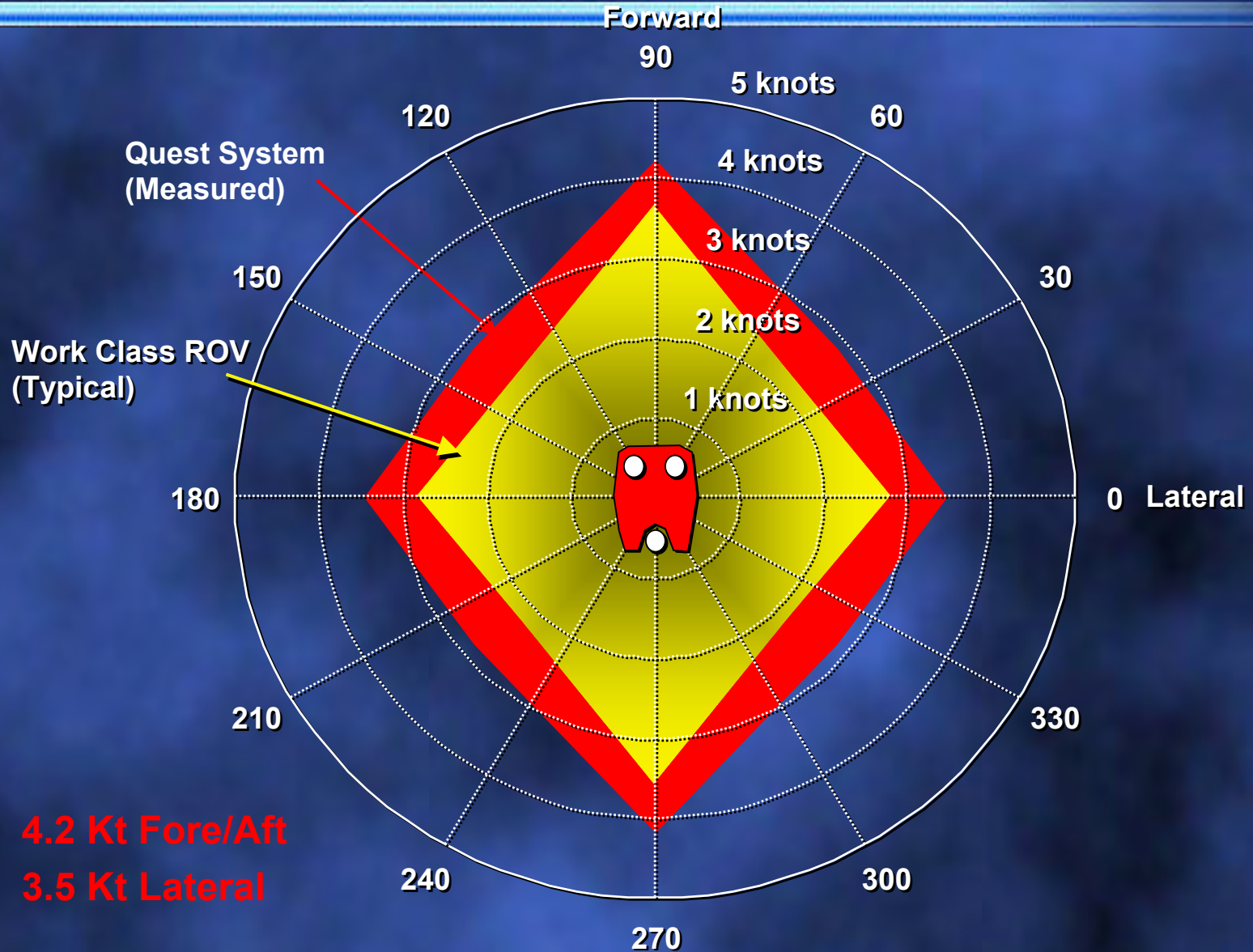

NAVAL OCEANOGRAPHIC OFFICE

SEAHORSE CLASS AUV

- Present Sensors: Sidescan, ADCP
- Future Sensors: Multibeam, Sidescan, Subbottom, Sediment Classifier, CTD, Optical, Chemical, Grav, Mag, ADCP
- Nav: INS / DGPS / Transponder Buoys
- 8.5m long by 1.1m diam. / 4500kg
- 9000 D Cells / 550km Range
- Max Depth 300m
- Undergoing Sea Trials w/ Sidescan



NAVAL POSTGRADUATE SCHOOL

ARIES AUV

- Sensors: Sidescan, Scanning Sonar, Video
- Nav: DGPS / DVL / 3-axis Motion Pack / Fluxgate
- Radio & Acoustic Telemetry
- 3m x 0.5m x 0.4m / 230kg
- Lead Acid / 30km Range
- Max Depth 300m
- Missions performed weekly in Monterey Bay



NAVAL UNDERSEA WARFARE CENTER (NUWC)

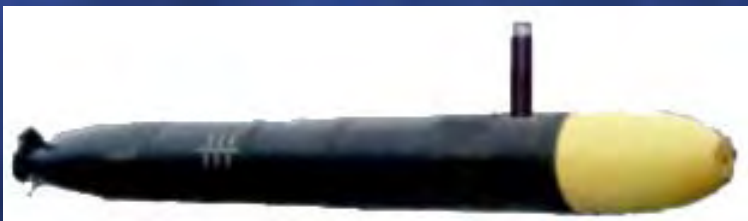

•LDUUV (LARGE DIAMETER UUV)

Mission: Military

Nav: GPS / INS

Silver Zinc & Lead Acid

Size: 7.6m long by 0.7m diam.

Speed 4 – 12 kts. / Range 65km



•21UUV

Mission: Mine Countermeasure

Submarine Tube Launch Silver

Zinc Battery

Speed: 3 – 18 kts. /

Range: 65km

Thrust Vectored Pump

Jet

•MANTA

Mission: Military

Status: Under Development



U.S. NAVY UUV PROGRAM OFFICE

LONG-TERM MINE RECONNAISSANCE SYSTEMS

(LMRS)

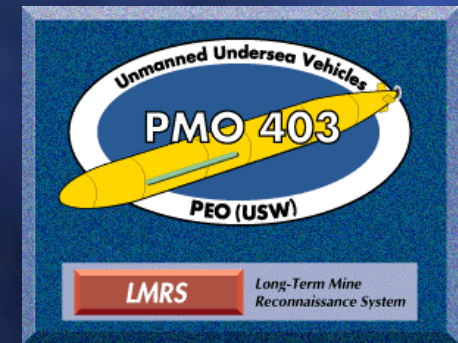
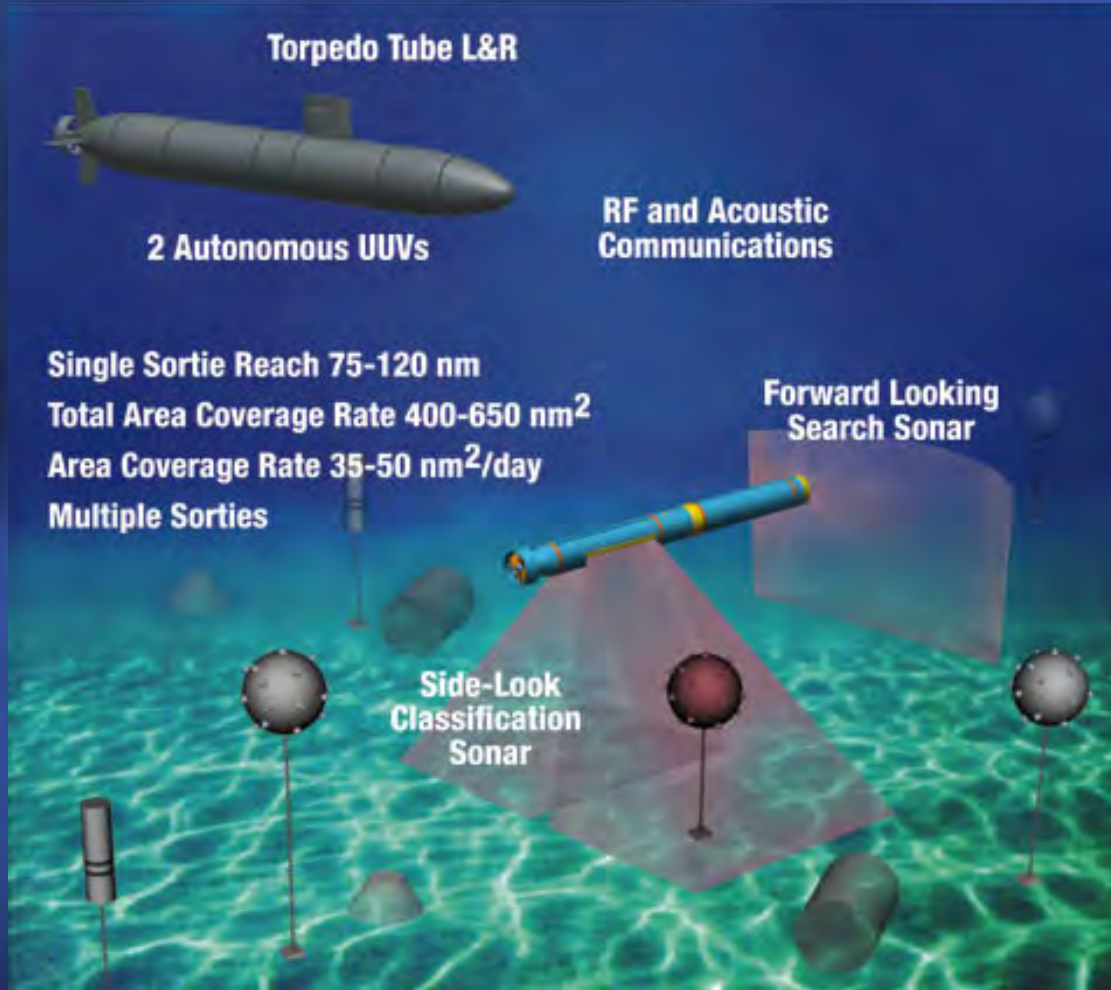

NRL - MC&G (US NAVY)

RMS(O)

- Diesel Engine (Semi-submersible)
- Sensors: Multibeam, Subbottom Classification, CTD, ADCP
- Nav: DGPS / Gyrocompass
- Size: 7.0m by 1.0m diam. / 5400kg
- Speed: 12kts
- Endurance: 2.5 – 3 days
- Range: 1100km



US NAVY / C & C TECHNOLOGIES

ORCA



- Diesel Engine (Semi-submersible)
- Sensors: Multibeam, Subbottom Classification, CTD, ADCP
- Nav: DGPS / Gyrocompass
- Size: 7.0m long by 1.0m diam. / 4000kg
- Speed: 12kts / Range: 600km
- Extensive Software Developed

LOCKHEED MARTIN *CETUS*

- Mission: Mine Countermeasures
- Sensors: Forward looking sonar
- Size: 1.8m x 0.8m x 0.5m / 150kg
- Lead Acid / 38km Range
- Speed 1.5 – 2.5 kts
- Rating: 200m (Al) or 4000m (Titanium)

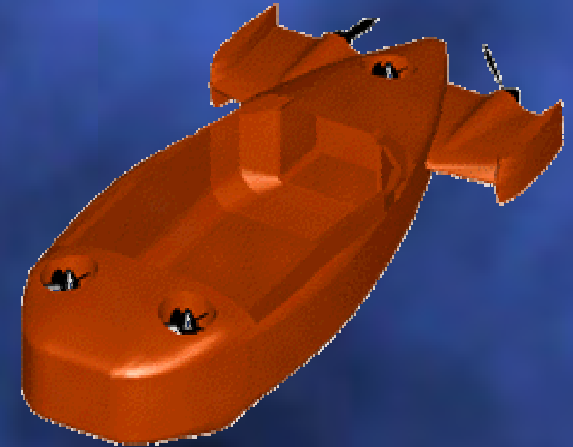

C. S. DRAPER LAB

VORTICITY CONTROL UNMANNED UNDERSEA VEHICLE (VCUUV)



- Mimics Yellow Fin Tuna
- Reduces Drag
- Improves Maneuverability
- High Acceleration, Short Stopping Dist.



MIT SEA GRANT ALTEX AUV

- Mission: Measure Ice Cap Thickness
- 14 Ice Penetrating Buoys w/ GPS & Argos
- Sensors: Echosounder, CTD
- Nav: INS / Map matching
- 5.0m long by 0.6m diam.
- Fuel Cell / 1500 Range @ 3 kts.
- Rated for 4500m
- Articulated tail cone
- Testing 6/00, Operation 6/01

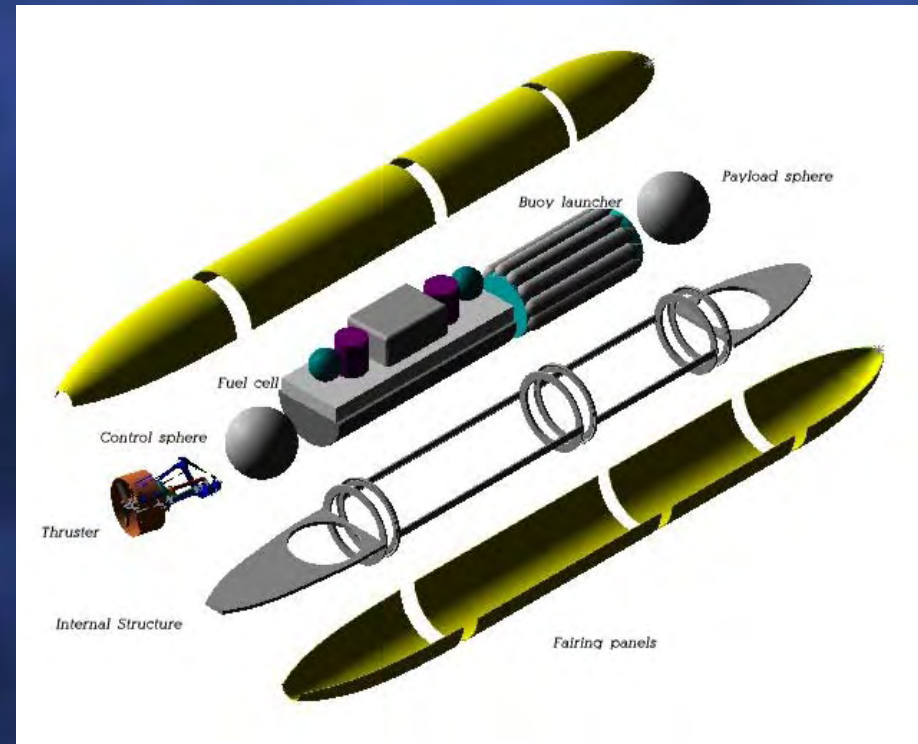

FLORIDA ATLANTIC UNIVERSITY

OCEAN EXPLORER

- Max Depth 200m
- Sensors: Sidescan, CTD
- Nav: DGPS / USBL or LBL / 3 – Axis Motion Pack / Compass / DVL
- 2.5 – 4m long by 0.5m diam. / 500kg
- Nickel Metal-Hydride / 140km Range
- 3 Vehicles / 1000 dives / Various Payloads



AUTONOMOUS UNDERSEA SYSTEMS INSTITUTE (AUSI)

SOLAR POWERED AUTONOMOUS UNDERWATER VEHICLE (SAUV)



- Mission: Long Endurance (1 Month+)
- Sensors: CTD, Flexible Payload
- Nav: DGPS / DR Submerged
- Size: 1.7m x 0.7m / 90kg
- 32 NiCD / Range: 1400km
- Speed: Max 2 kts / Cruise 1 kt
- Undergoing Sea Trials



WOODS HOLE OCEANOGRAPHIC INSTITUTE

REMOTE ENVIRONMENTAL MONITORING UNITS (REMUS)

- **Mission:** Multi-vehicle Monitoring / Surveying
- **Sensors:** Sidescan, CTD, ADCP
- **Nav:** USBL or LBL / Compass / DVL
- 1.3m long by 0.2m diam. / 30kg
- Lithium Battery / 75km Range
- 10 Vehicles built to date

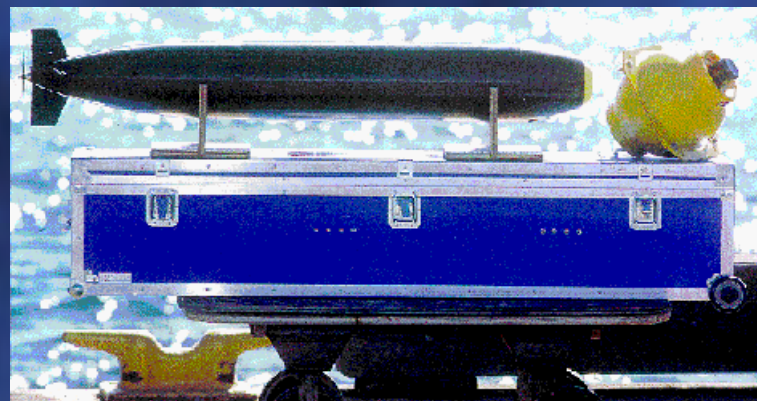

JAPAN MARINE SCIENCE & TECHNOLOGY CENTER (JAMSTEC)

JAMSTEC long distance AUV (plan)

Total length: 10 m
Total width: 1.5m
Total height: 1.5 m
Weight in air: 5.5 tons

Navigation distance: 300 km
Maximum operational depth: 3,500 m
Cruising speed: 3 kt
Maximum speed: 4 kt

Power source	Fuel cells (PEFC) and secondary lithium cells
Navigation instrument	Inertial navigation system combining ring-laser gyro and Doppler sonar, acoustic remote controls, and remoteoperation through thin fiberoptic cables
Survey instruments	CTDO, multi-beam, seawater sampler (maximum 200 samples), TV video camera, and a digital camera



KDD

AQUA EXPLORER 2

- Mission: Cable location and depth of cover
- Sensors: Two 3 - axis Magnetometers
- Nav: DGPS / USBL or LBL / 3 – Axis Motion Pack / Compass / DVL
- Size: 3.0m x 1.3m x 1.0m / 260kg
- Non-Rechargeable Lithium Battery
- 24 hours @ 1 kt. / Range 37km
- Rated to 500m
- Inspected a 460km cable in 1999



SOUTHAMPTON OCEANOGRAPHY CENTRE

AUTOSUB - 1

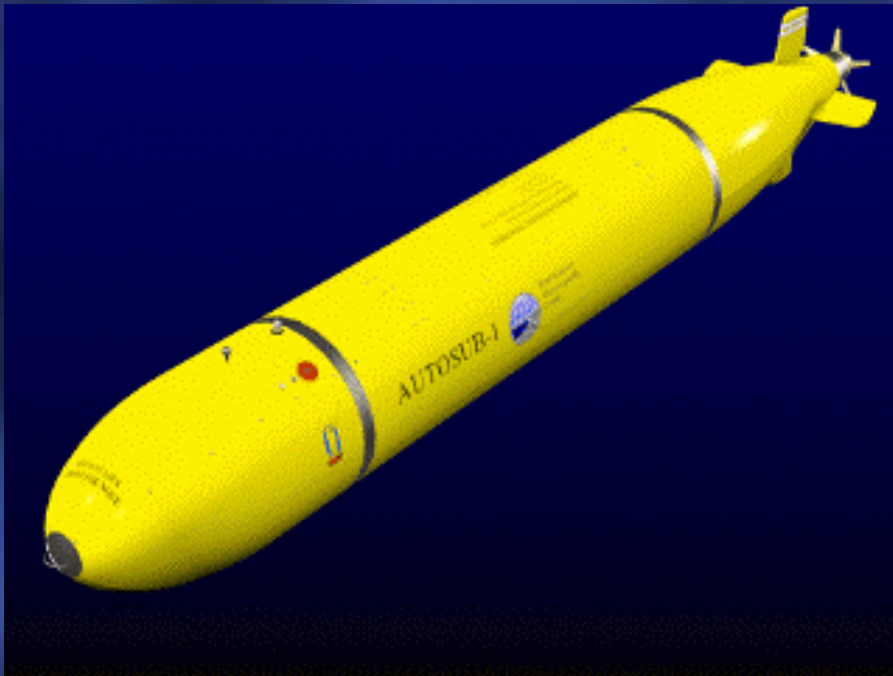

- Sensors: Echosounder, Pressure (depth), ADCP, Flexible Scientific Payload
- Nav: DGPS / Motion Pack / Compass / DVL
- Size: 7.0m long by 1.0m diam. / 1500kg
- Manganese Alkaline Batteries
- Range: 1100km / Speed: 1.9kts
- Rated for 2500m

MARIDAN A/S

MARIDAN AUV SERIES

- Present Sensors: Sidescan
- Future Sensors: Multibeam, Sidescan, Subbottom, Digital Still / Video
- Nav: INS / DGPS
- 4.6m x 2.0m x 0.4m / 1500kg
- Lead Acid Battery / 88km Range
- Currently rated to 150m

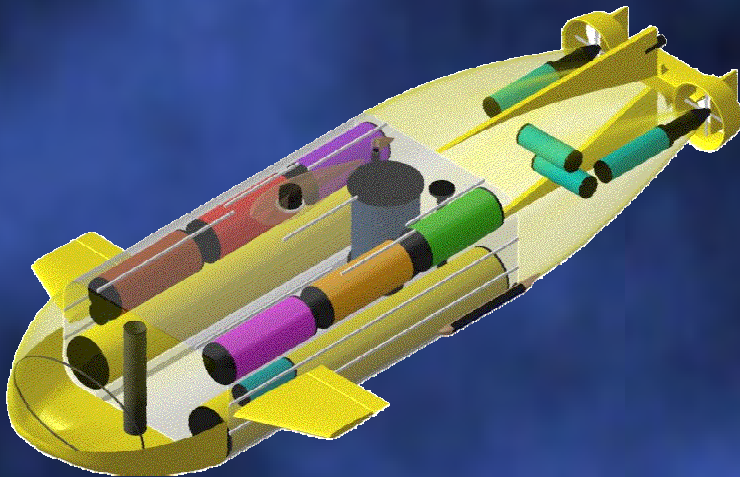

ISE *THESEUS*

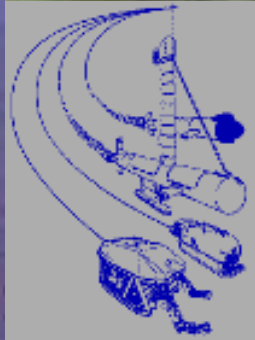

- Mission: Fiber cable laying under ice
- Nav: INS / DVL / Compass / Homing
- 20 Beam obstacle avoidance
- 11m long by 1.3m diam. / 8600kg
- Silver Zinc / 1000km Range @ 3.7 kts.
- Maximum cable capacity: 220km
- Laid 190km Arctic fiber in 1996

MIT SEA GRANT

ODESSEY IIb

- Sensors: Sidescan, CTD, Camera
- Nav: DGPS / USBL or LBL / 3 – Axis Motion Pack / Compass / DVL
- 2.4 – 4.0m long by 0.6m diam. / 500kg
- Silver Zinc / 60km Range
- Rated for 6000m
- 5 Vehicles / 400 dives / Various Payloads



DOCKING STATIONS

- Recharge Batteries
- Download Data
- Position Reference

- Nose First Method
- Belly Mount Stinger

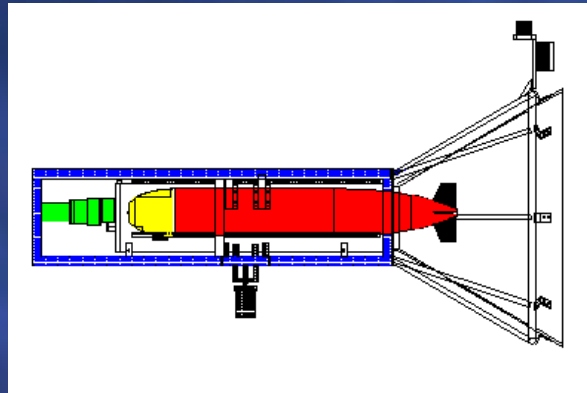

REMUS Docking Station



Eurodocking

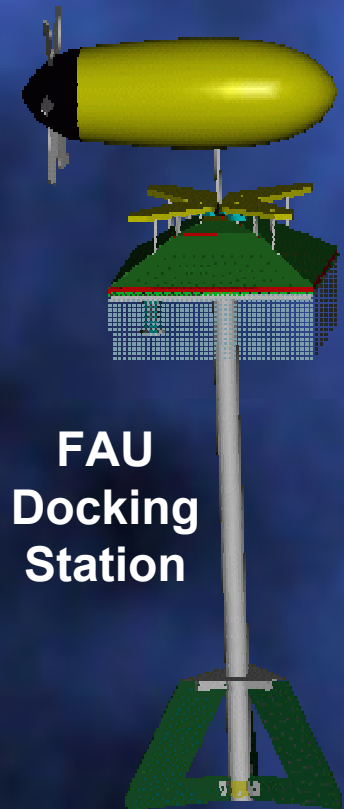

FAU
Docking
Station

How does all of this relate?

One-year Study by C&C Technologies Revealed:

- **Available AUV Options Primarily Academic:**
 - **Limited Depth Capabilities**
 - **Inadequate Electrical Power**
 - **Limited Sensor Packages**
 - **No Launch and Recovery Systems**
- **HUGIN AUV Provided:**
 - *** Aluminum-Oxygen Fuel Cell ***
 - *** Launch and Recovery System ***
 - *** Commercial Track Record ***

SPECIFICATIONS

- Depth Rating: 3,000 Meters
- Speed: 4 knots
- Endurance: 45 hours
- Range: 380 km
- Length: 5.4m
- Diameter: 1.0m



HUGIN 3000
C & C Technologies
& Kongsberg Simrad

DEEP TOW SONAR

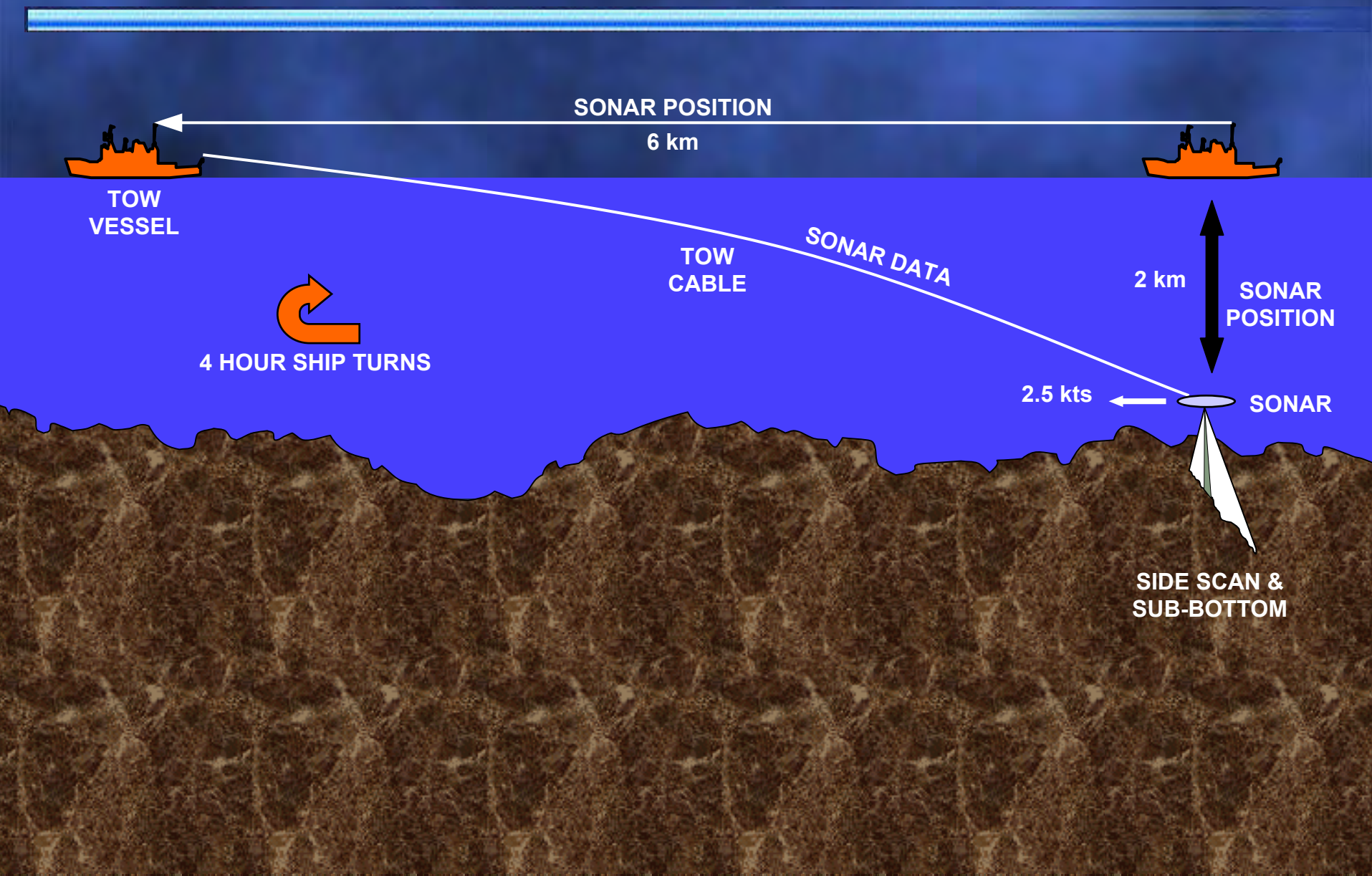

SONAR POSITION

6 km

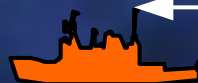

TOW
VESSEL



4 HOUR SHIP TURNS

TOW
CABLE

SONAR DATA

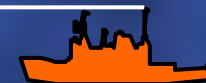

2 km

SONAR
POSITION

2.5 kts



SONAR

SIDE SCAN &
SUB-BOTTOM

AUV

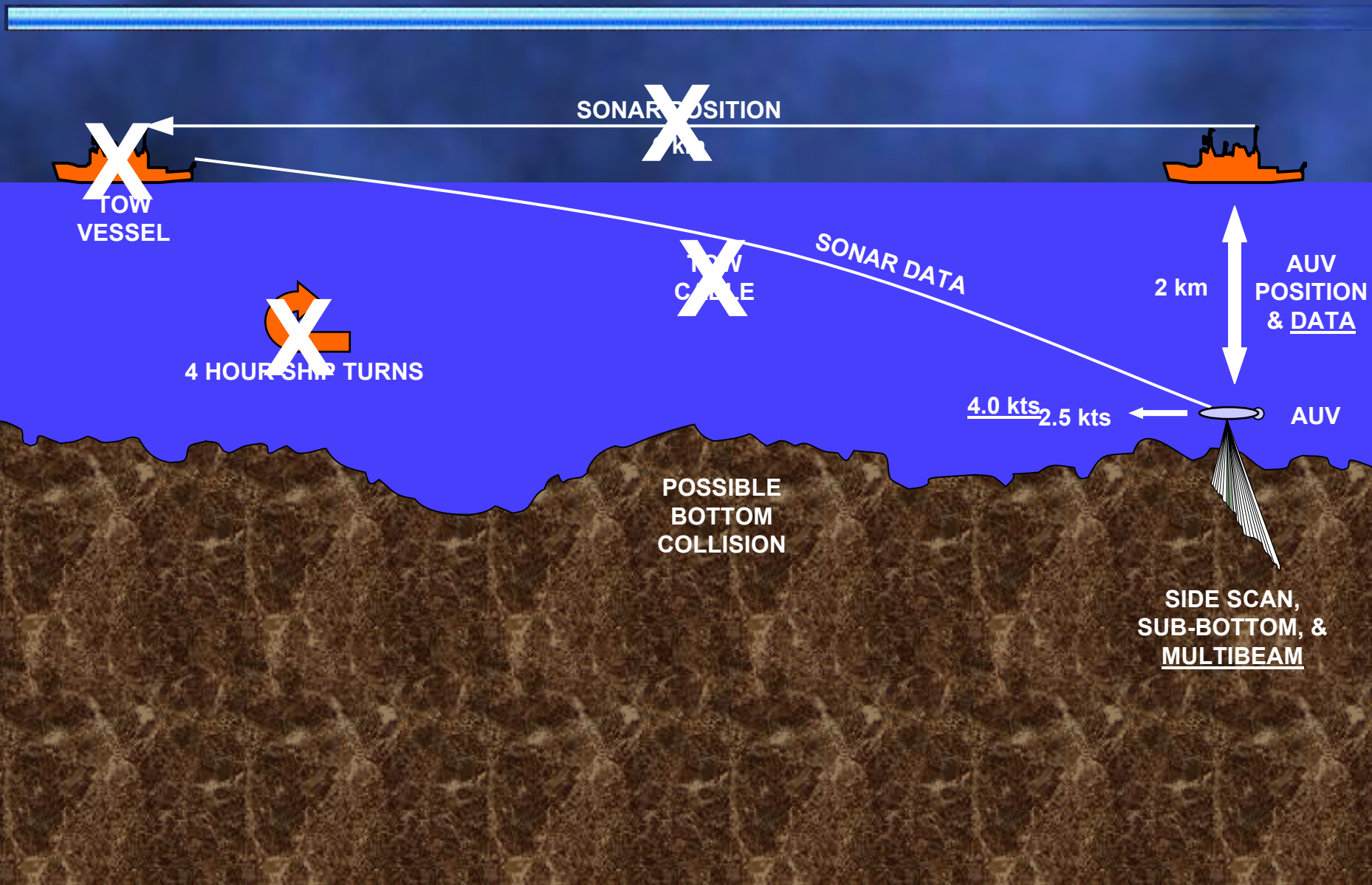

SONAR POSITION
X

TOW VESSEL
X

4 HOUR SHIP TURNS
X

TOW CABLE
X

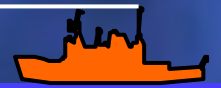

2 km
AUV POSITION & DATA

4.0 kts 2.5 kts
AUV

POSSIBLE
BOTTOM
COLLISION

SIDE SCAN,
SUB-BOTTOM, &
MULTIBEAM

ADVANTAGES OF AUVs

FASTER THAN DEEP TOWED SYSTEMS

Faster Speeds :



Deep Tow – 2.5kts
AUV – 4.0kts

Faster Line Turns:

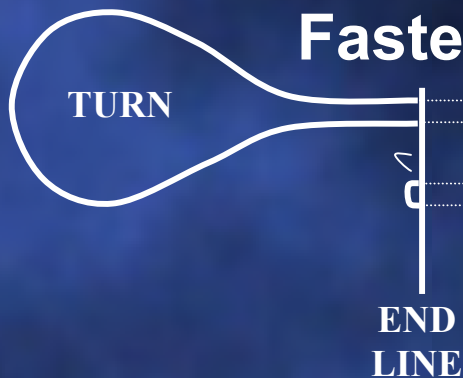

Deep Tow – 4 hours / turn
AUV – 0.1 hours / turn

HUGIN LAUNCH & RECOVERY SYSTEM



LINE THROWING GUN FOR RECOVERY



Are ROV & AUV Systems Critical Path Technology in Deepwater Development?

- ROV technology represents a solution looking for a challenge.
- Seafloor based E & P activity will be a reality.
- AUV technology is advancing at a rapid rate.
- The qualifier to these statements is that commercial issues will impede progress.

Our most serious Threat

- Personnel and Training issues
- Cyclic nature of the industry
- Demand from other technology segments
 - Computer, Entertainment, Auto, Aviation & space
- Mentoring programs
- OJT
- MAKE ROOM FOR
A TRAINEE



THANK YOU

For more information

- Operational Effectiveness of Unmanned Underwater Systems - On CD-ROM produced by the MTS ROV Committee
- MTS ROV Committee <http://rov.org>
- rovdrew@earthlink.net
- Phone 713-557-3159



Interventions

ROV, AUV, and AUT

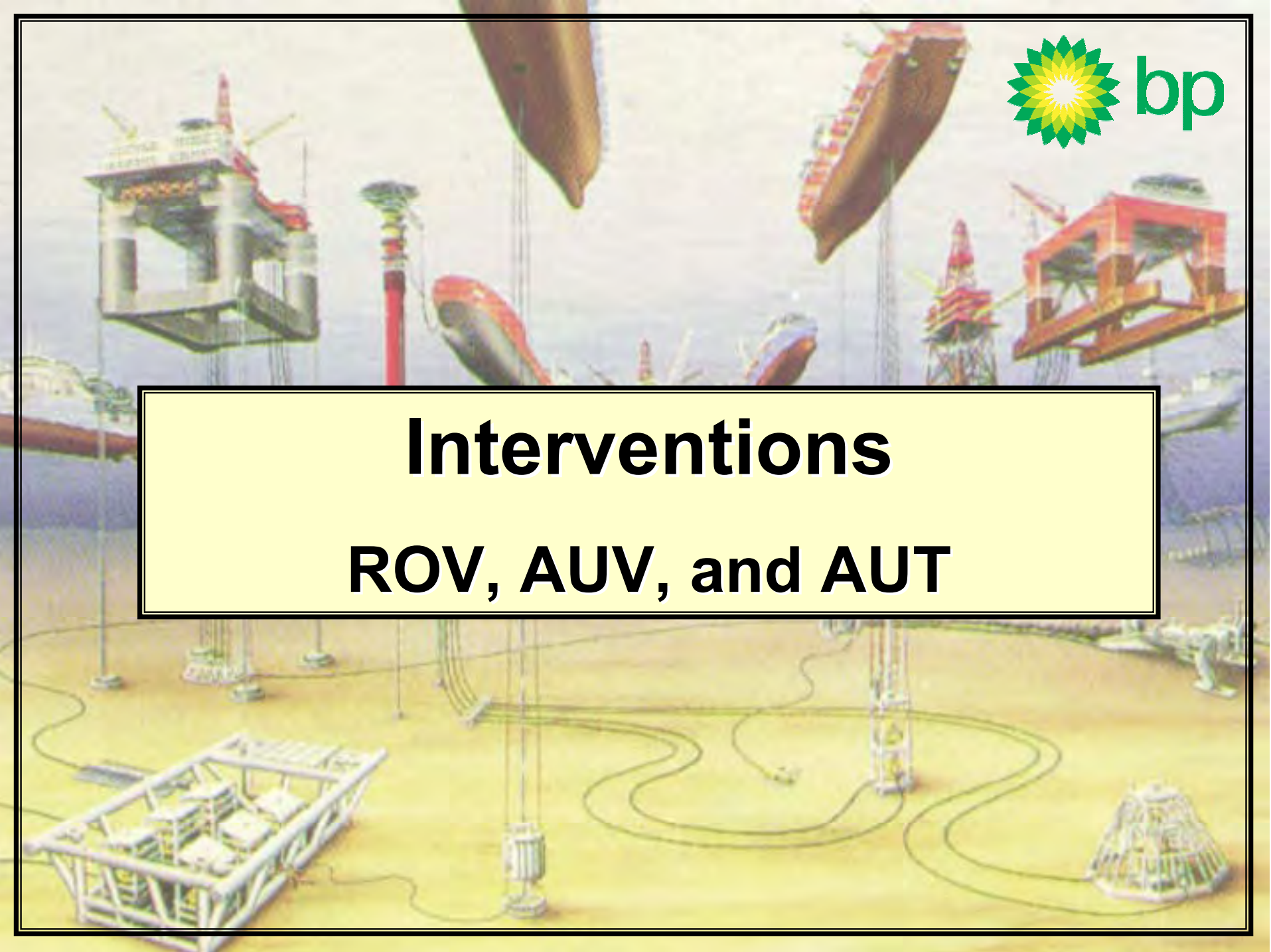

ROV Interventions

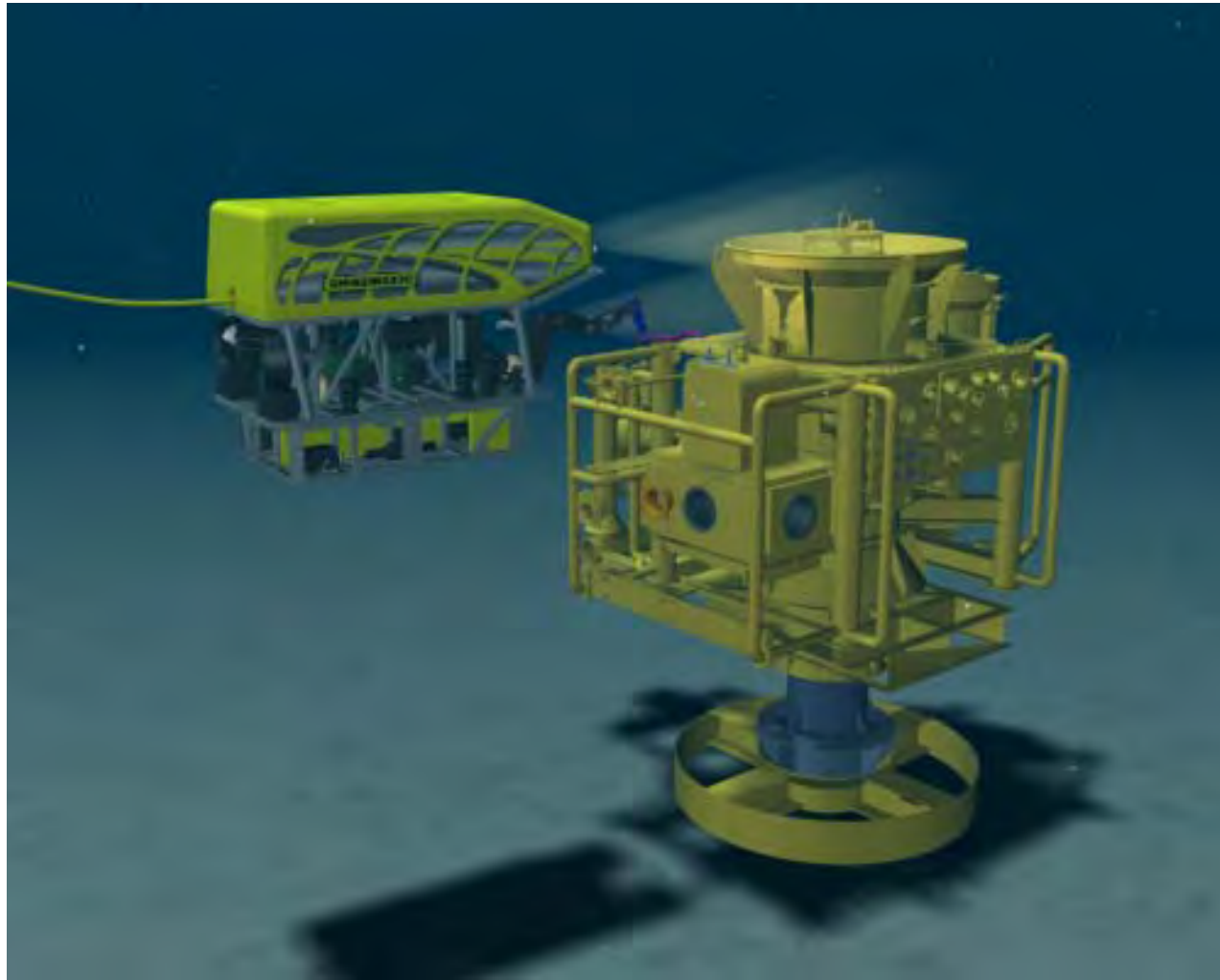

Survey AUV's: Reality

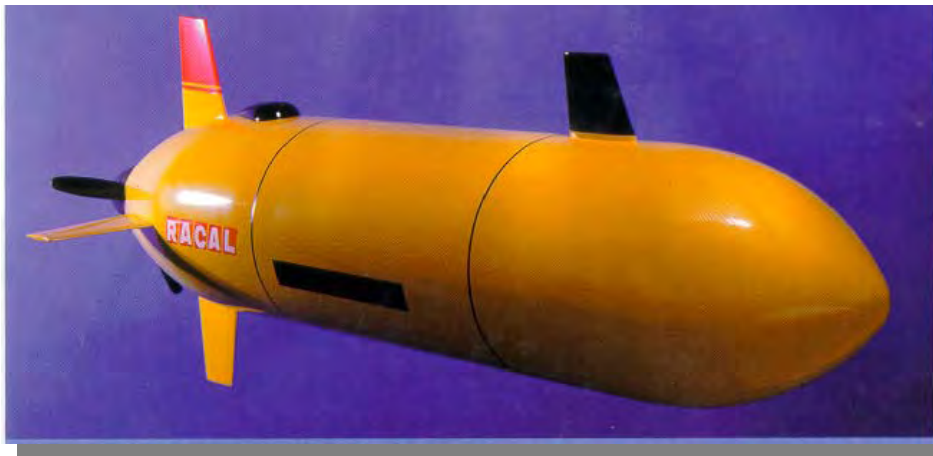

New Surveying Tools

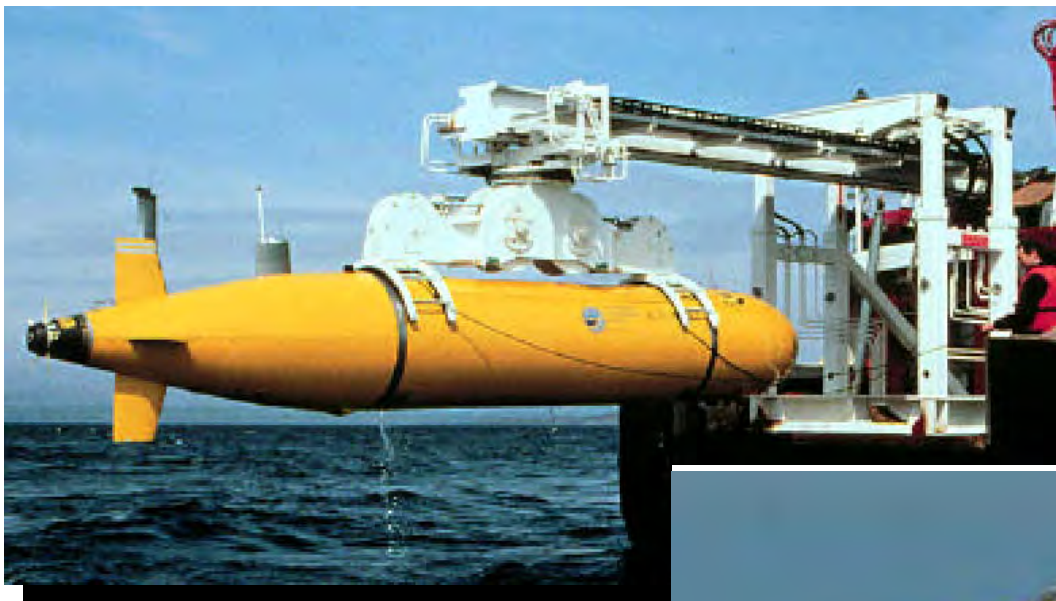

Deep Water Intervention Issues

- However:
- Now we're going deeper. Run times up and down are going to effect costs thru all operations.
- Limited vessels that can run interventions in those water depths.
- Current strategies have to be altered.
- Intervention groups working with subsea groups.

ROV w/tools onboard

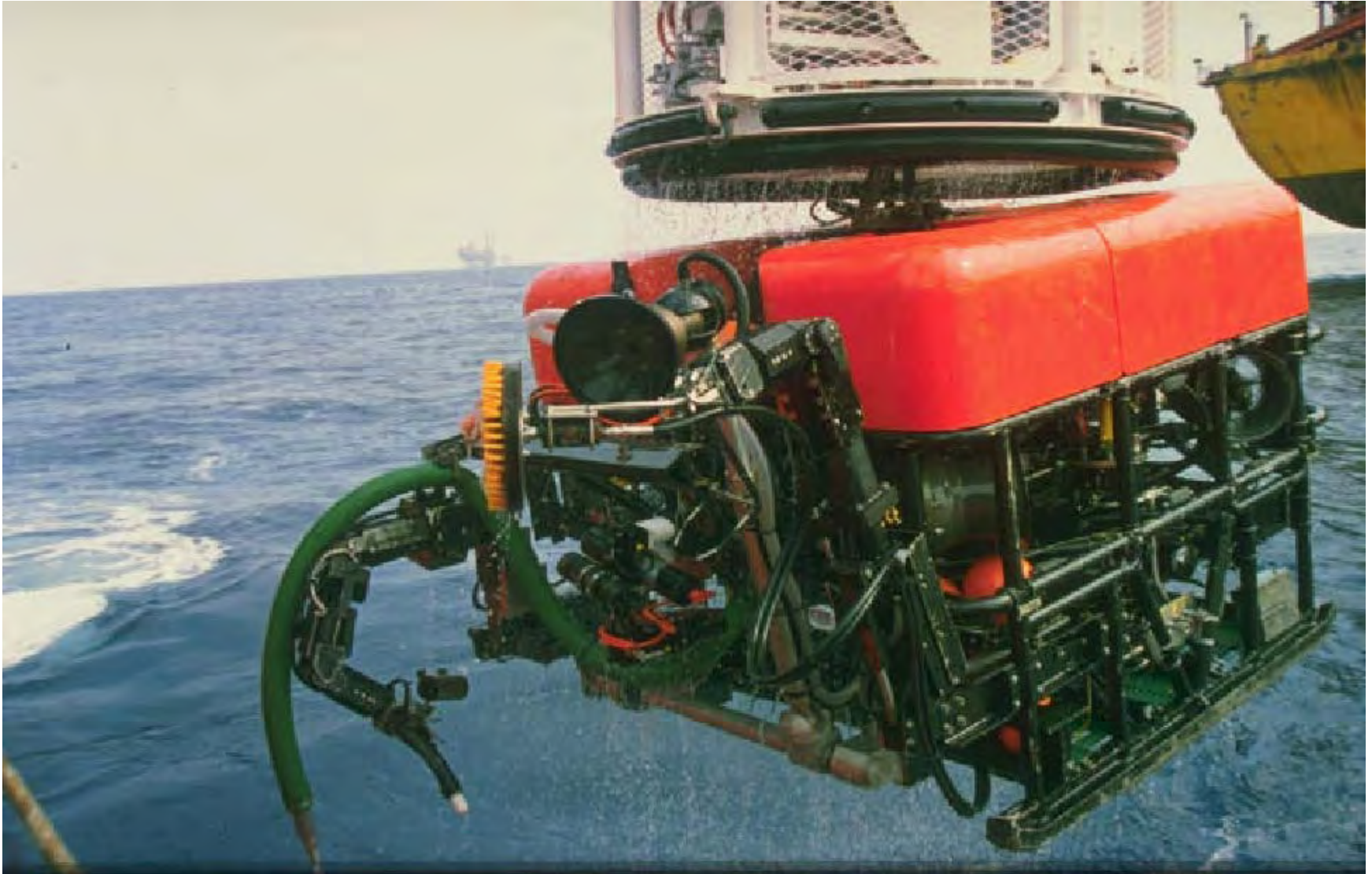

ROV with remote tooling package



Old Style Torque Tool



SMART Torque Tool



One Solution: Smart Tooling Skids

Smart Tooling feature:

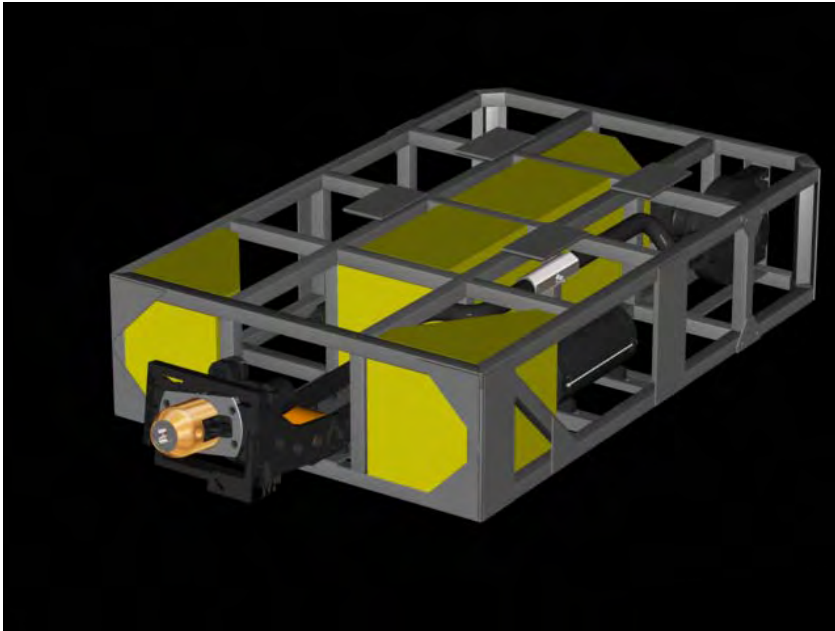

- Mounting Frame
- Hydraulic Power Supply
- Electrical Power Supply
- Skid Control Unit
- Hydraulic Junction Plate
- Electrical Flying Lead
- Emergency Disconnect

Deep Water Intervention Issues

- Intervention scheduling is driven by ship availability, not when work should be performed .
- Surveys are performed when cost effective.
- Interventions are performed usually after a visual inspection is performed, (“Let’s get out there and see what’s going on”).
- Tooling has to be retrofitted or rebuilt.
- Solutions scalable in time and cost for our current and near future needs.

Corollaries to ISS



Corollaries to deepwater production

- NASA is the prime operator for these systems sharing the same risks and burden.
- They perform tasks in remote locations.
- It cost huge \$ for an intervention.

Because of this:

- Interventions have to efficient and effective.
- Controllers understand exactly the nature of the problem before they begin planning the intervention.
- Failure analysis allow them to predetermine interventions before they are required.



NASA controls costs:

- NASA develops tools integrated with the systems.
- Hardware is developed to be self implementing, self diagnosing.
- Hardware is reliability tested and has built in components to alert controllers of eminent failure.
- Sufficient data and power infrastructure to support background tasks when in operation.
- The controllers and crew are highly trained.

Deep Water Intervention Solutions

- Introduce Failure mode analysis into development phase.
- Interventions quick and effective.
- Develop subsea power and communications systems.
- Remote sensing capabilities.
- Want ROV, AUV and AUT (Autonomous Technologies) AUS, (Autonomous Strategies) to progress in conjunction with subsea hardware and systems.
- Knowledge management at all levels.
- Well trained crews.



ROV & AUV WORKSHOP

April 10, 2003

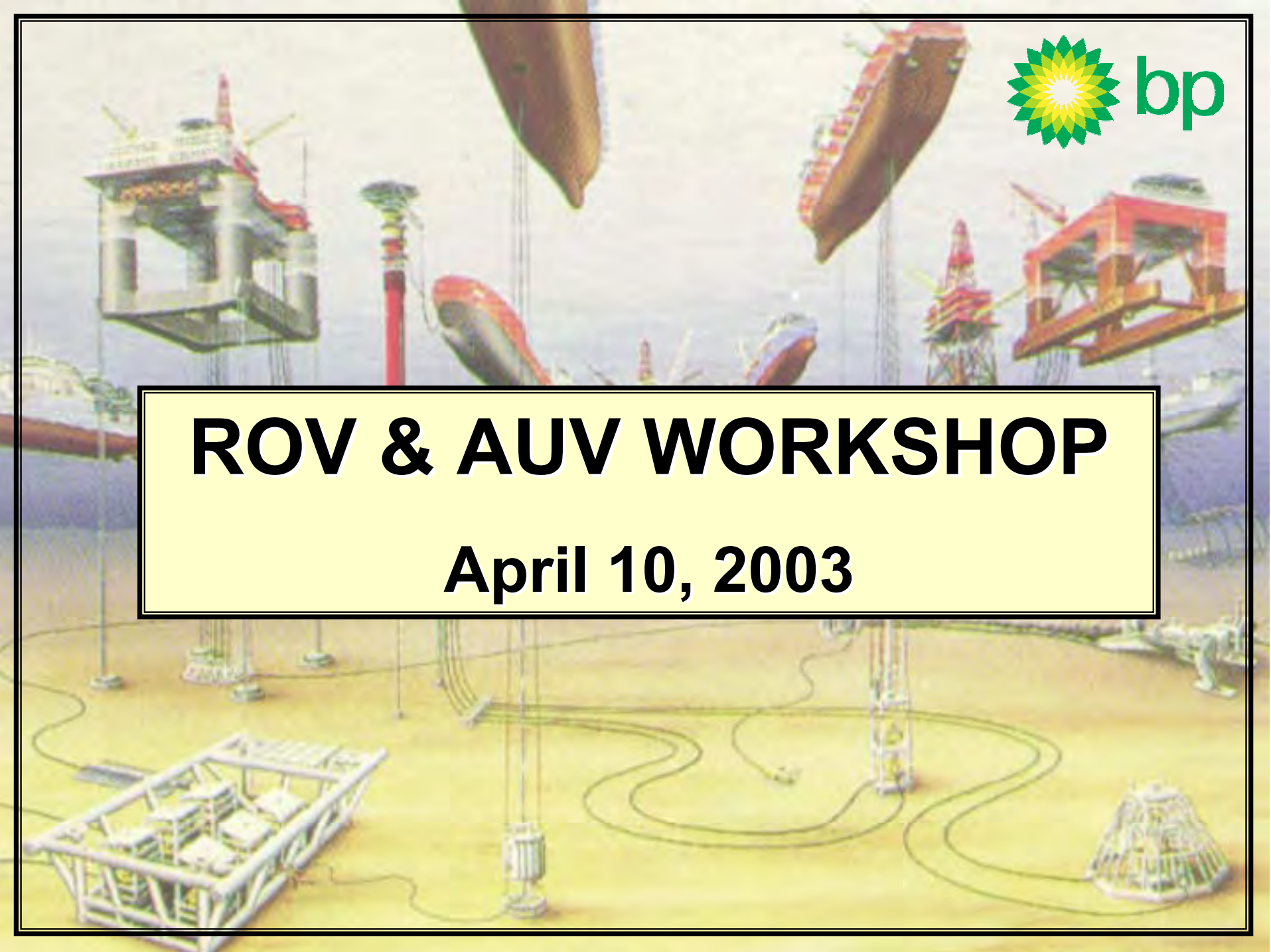

Background: BP's Position in the Gulf of Mexico Deepwater



- In 1985 industry had made only two discoveries >150 mmboe
- BP's portfolio has grown dramatically

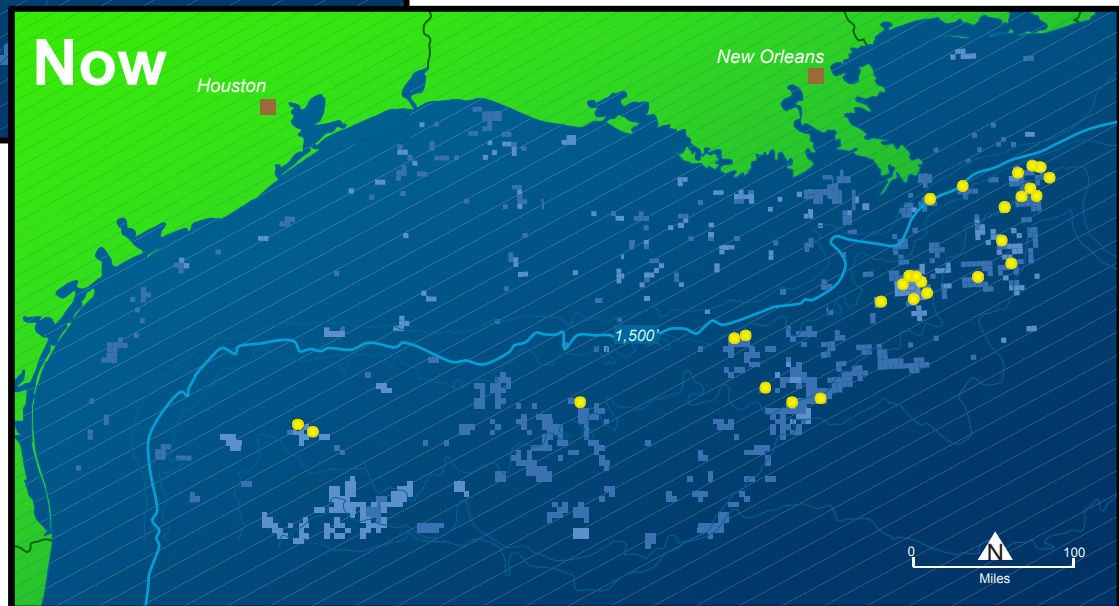

BP's Position in the Gulf of Mexico Deepwater



BP Operations in GoM Deepwater

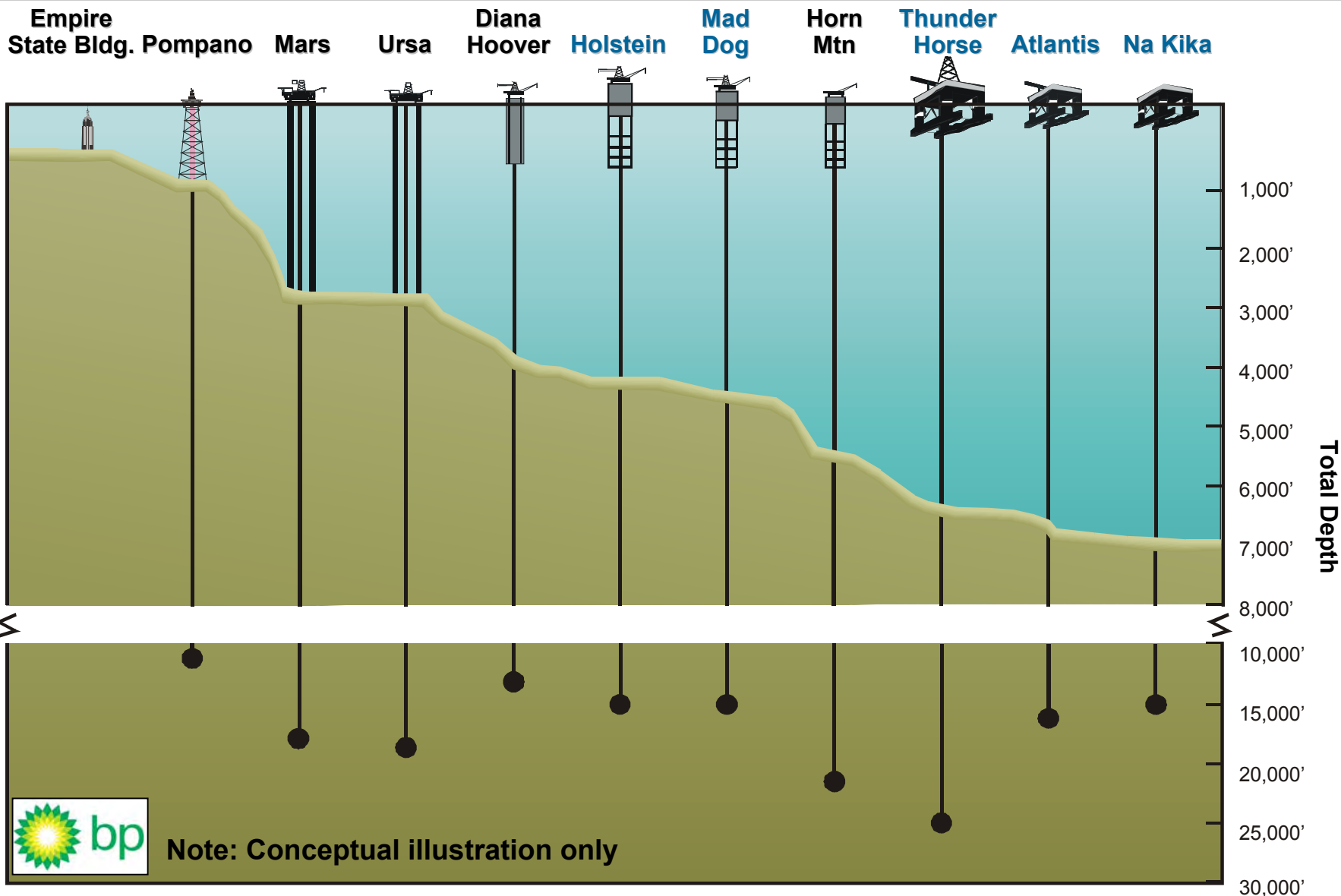

Note: Conceptual illustration only

- Giant fields
- Deep Water
- New technology is making a huge contribution
- Needs long-term commitment
- Managing conflict between pace and risk

How do we describe Technology ?

The normal response is likely to be:

- R&D
- Technical Service
- A piece of hardware or a process
- Engineering
- Information Technology
- or any combination of these

We would prefer to describe **Technology in the broadest sense as the development and application of “know-how”**

Why do we need to apply Technology ?

- To enhance the performance of our current assets
- To effect major improvements in capital productivity
- To develop new material options to transform the enterprise in which we work and the markets we serve

Technology allows us to:

- Do business that others can't do
- Do new business that we could not do previously
- Do business cheaper than others
- Do business faster than others

The Technology Valley of Death

How to Bridge?

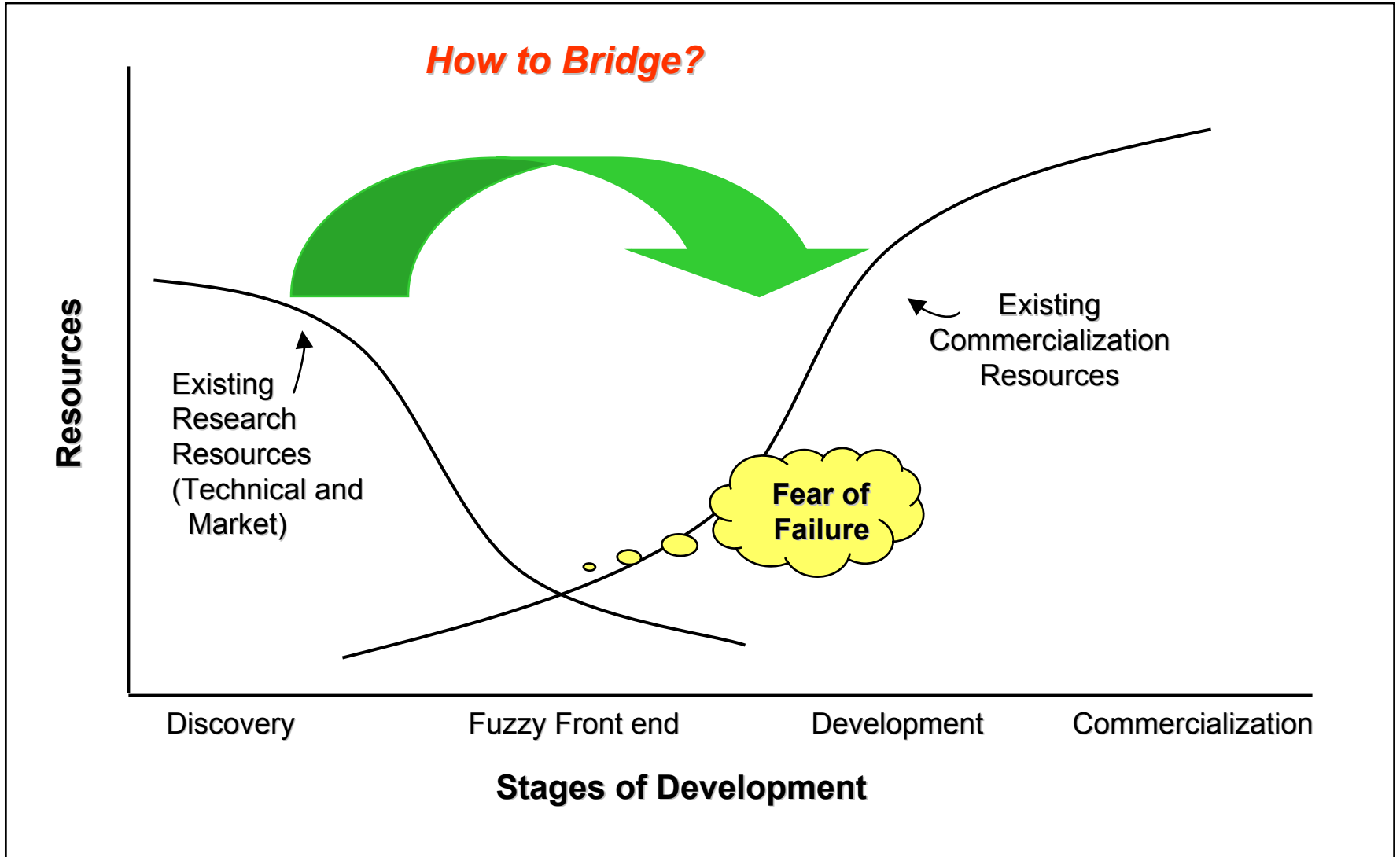

Subsea Reliability Initiative

- Challenge: Improve Subsea System Availability
 - Extend failure free operating period (reliability)
 - Reduce time to restore system (maintainability)
- Developed 13 Key Processes from Cranfield University
- Long-term Cultural Change
- Share lessons openly

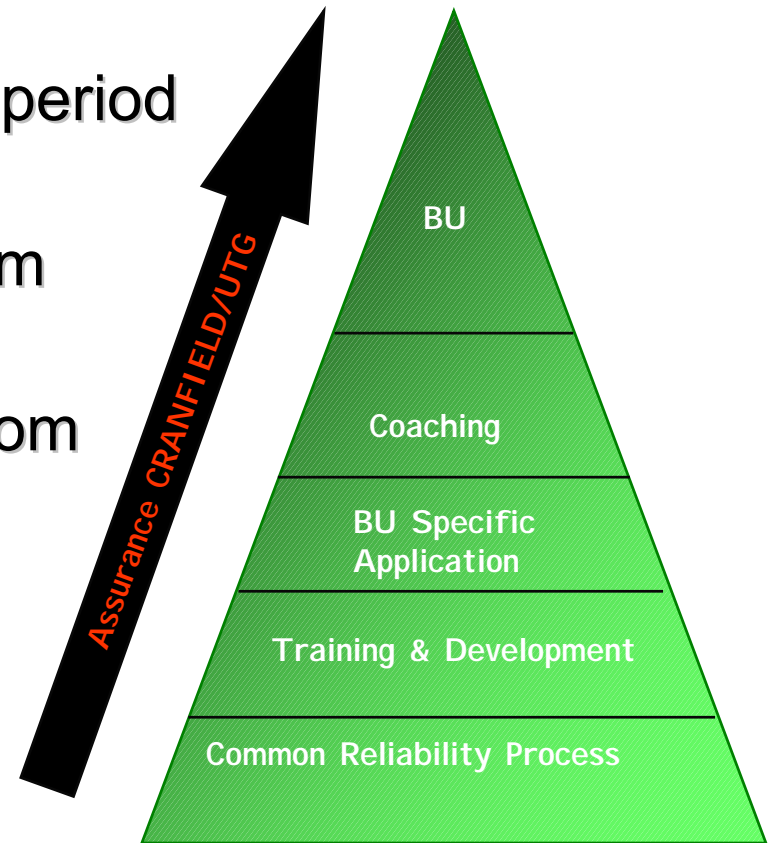

Key Deepwater Technologies

• Pre-set Mooring System

• Pre-set Mooring

Deepwater Pipeline & Equipment Installation

Pore Pressure Prediction & Management

Pore Pressure Prediction & Management

Subsalt Imaging

Riser Systems

Expandable Tubulars

Expandable Tubulars

Multilaterals

Novel Drilling Techniques

Polyester Moorings

Intelligent Wells

Seafloor Processing

Intervention

Intervention

Flow Assurance

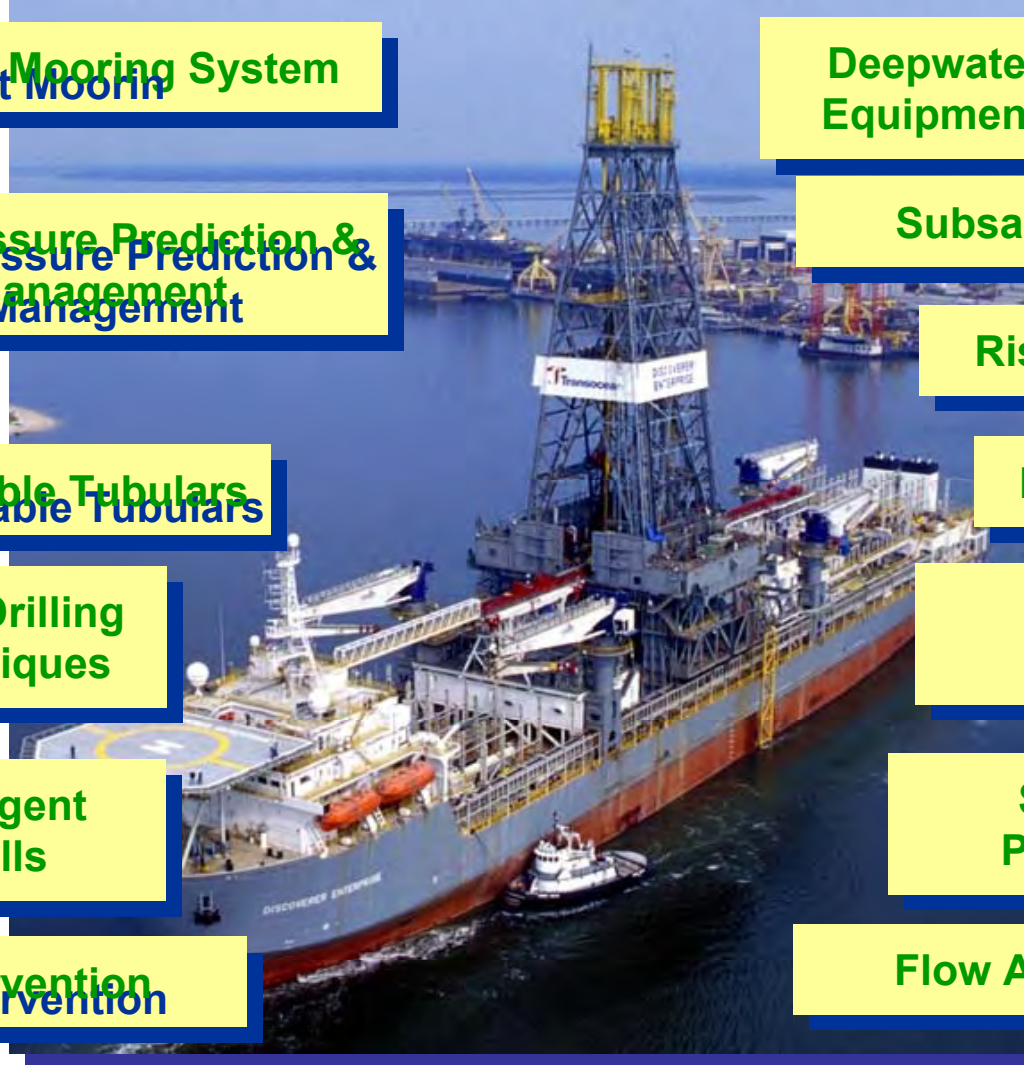

Flow Assurance Challenges

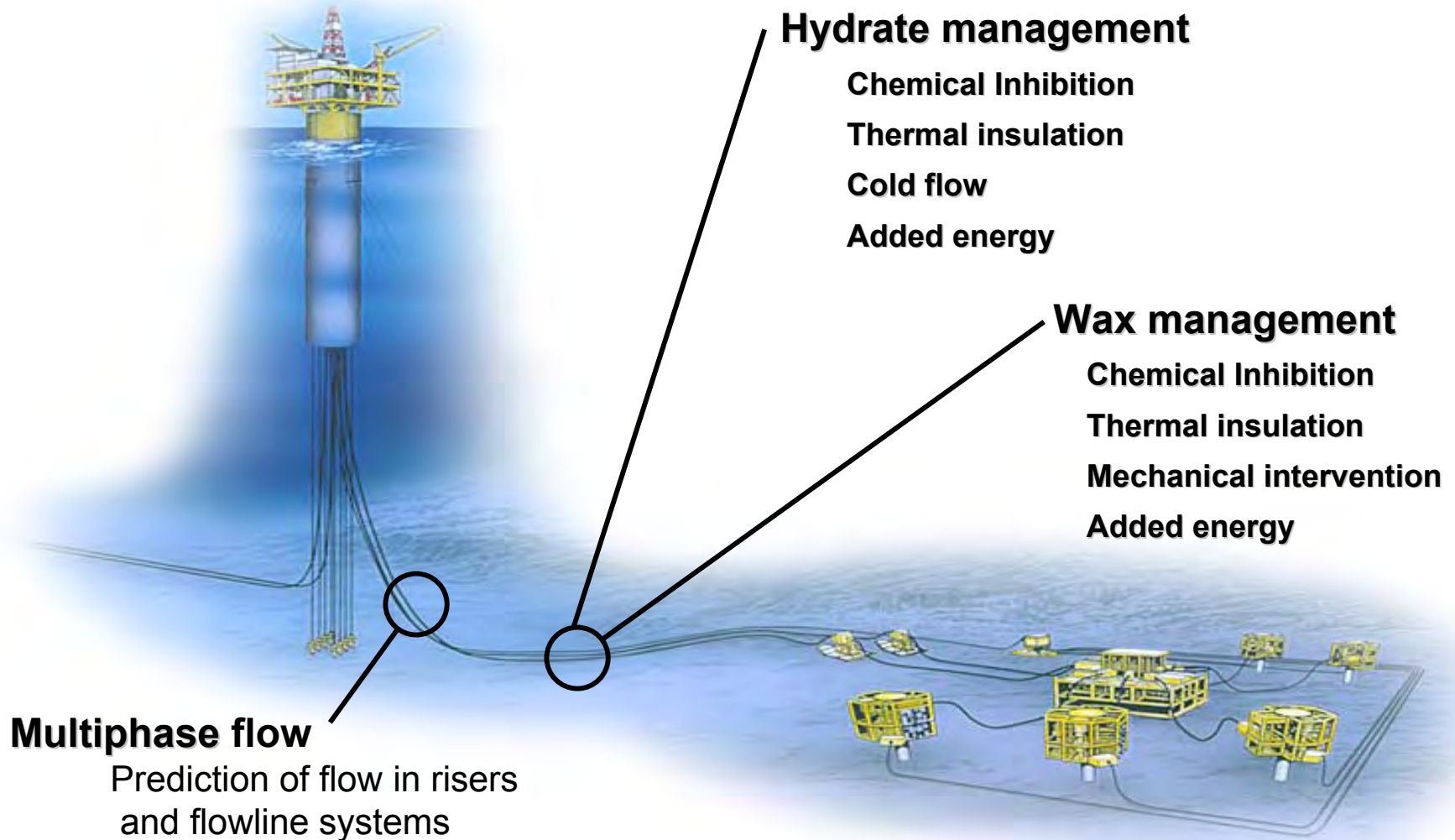

Deepwater – Opportunities and Challenges

- **Huge Potential – Giant Fields**
- **Tremendous opportunity for technology to reduce costs and uncertainties for example :**
 - **Improved seismic imaging**
 - **Intelligent wells and E field**
 - **Autonomous underwater vehicle technology**
 - **Seabed processing**
 - **All Electric Subsea Systems**
- **Increased subsurface and marine risk**

Wells Equipped at Completion with Downhole Controls and Sensors

Proactive Remediation of Fluid Inflow

- Remote controlled downhole zonal control valves
- Reservoir decisions without intervention

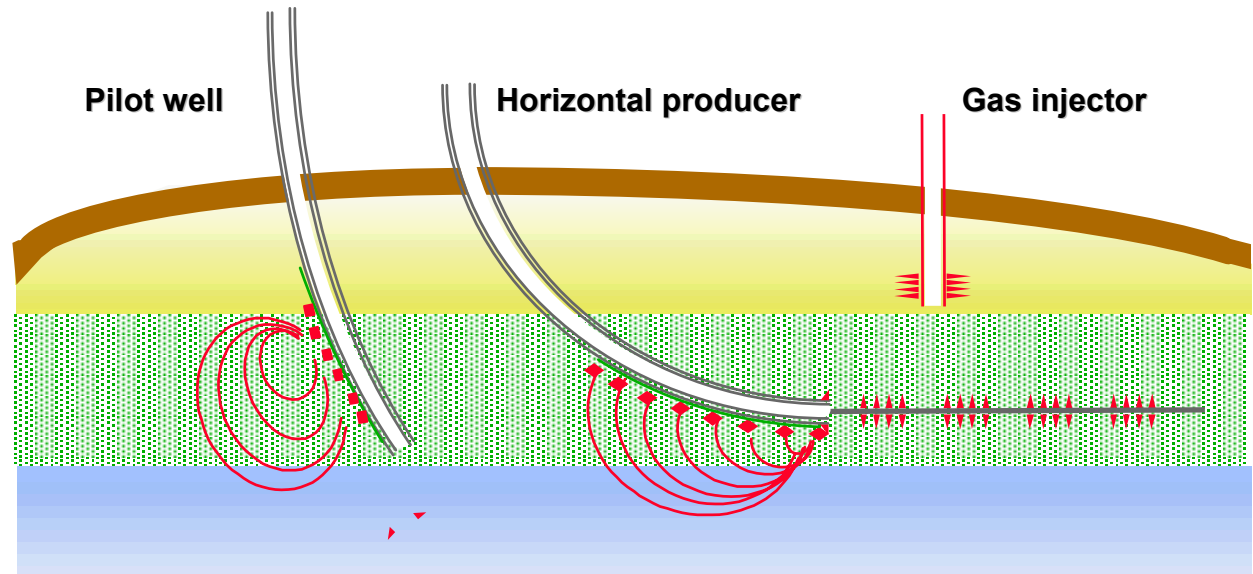

Continuous data from wells

Pressure	Inflow	Flowing
Performance	Distribution	Phase
Downhole	Reservoir	
Seismic	Saturation	

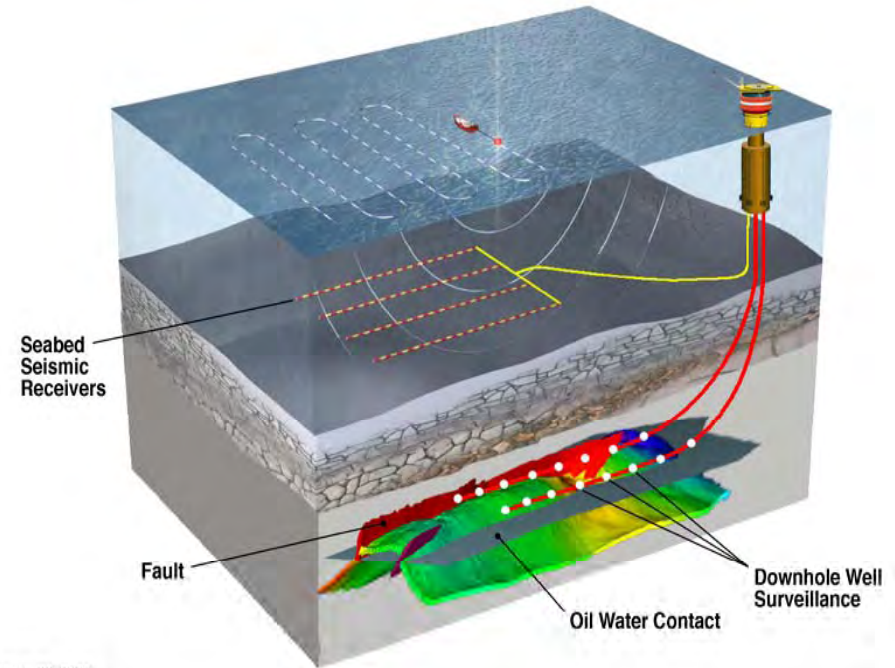
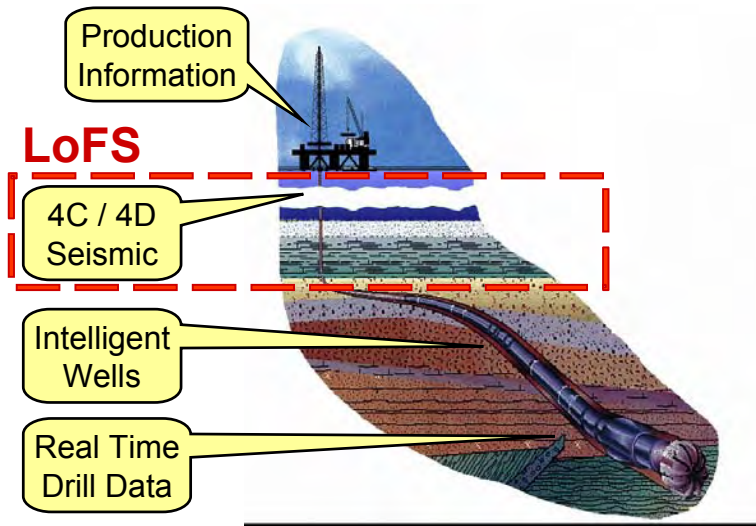

GeoQuest, Jun 2000, 03002053

To transform the way we manage fields

- Full life seismic 4C/4D
- Automated multilateral drilling and flow control
- Permanent downhole monitoring
- On-line 3D reservoir modeling / management

Fibre Optic limitations

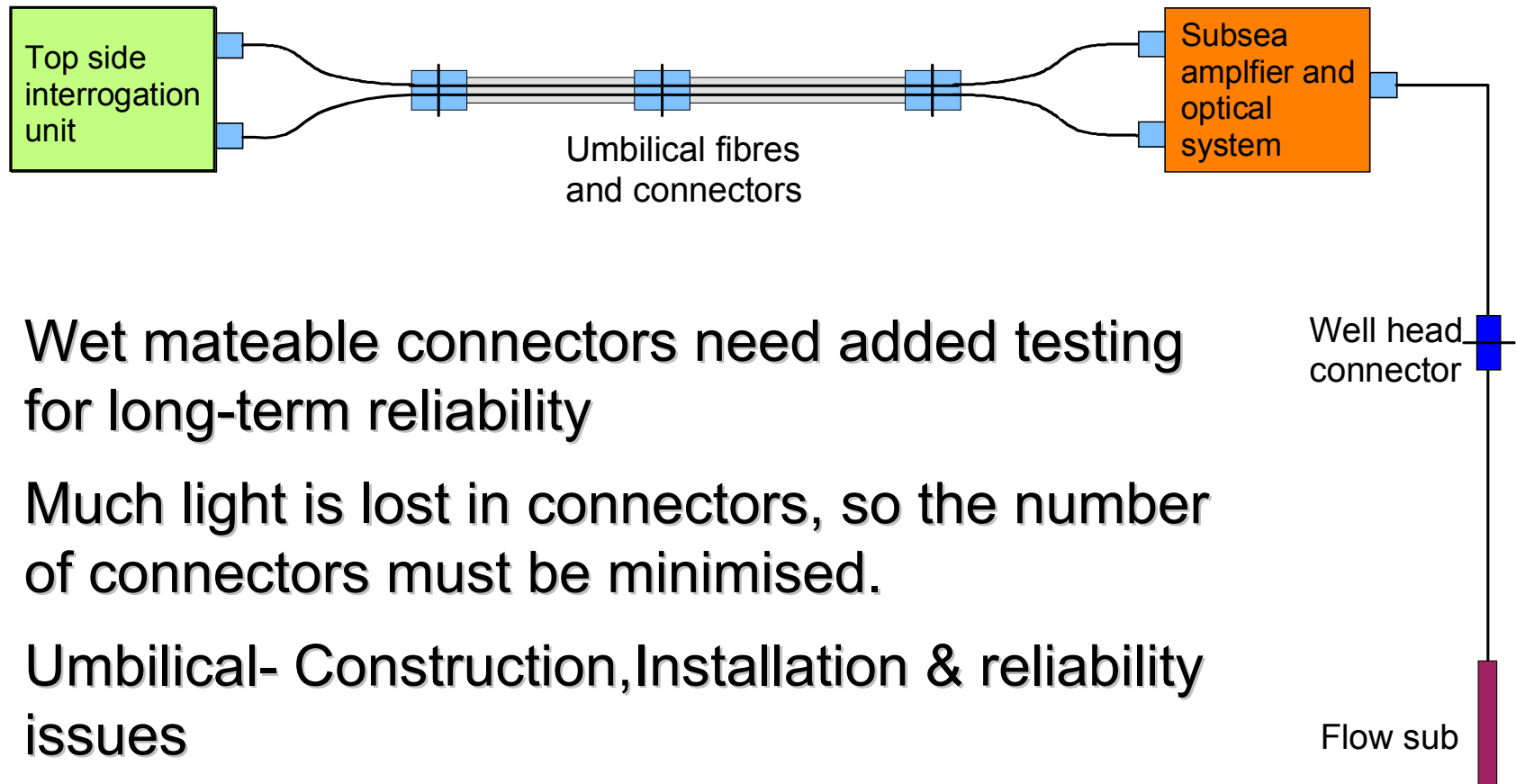

- Wet mateable connectors need added testing for long-term reliability
- Much light is lost in connectors, so the number of connectors must be minimised.
- Umbilical- Construction, Installation & reliability issues
- Tubing Hanger connector needed ASAP



Subsea Optical Connector Demonstration

Seabed Processing

- Unlocks development of new sub-sea fields
- Long distance tiebacks
- Low energy reservoirs
- Maximizes value of existing infrastructure - "keep the facility full of commercial products"
 - Increases development flexibility and tolerance of uncertainty
 - Maximizes energy efficiency and reduces topside / riser fluid inventory
- Improves reservoir recovery factors

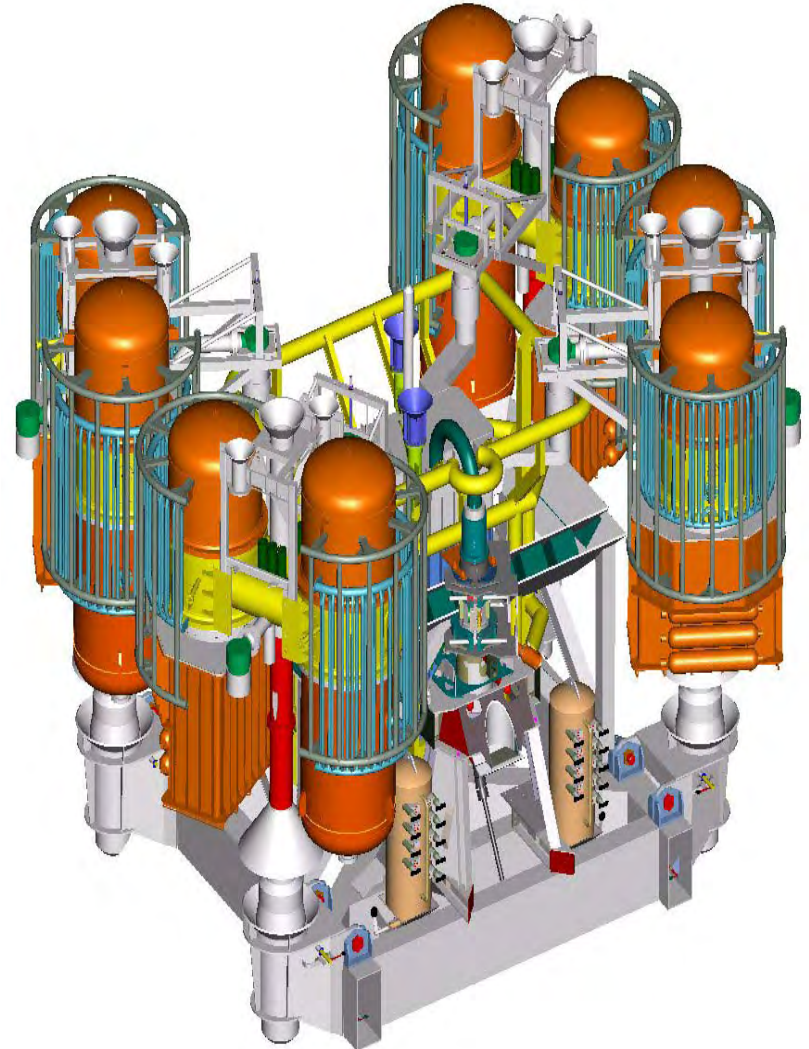

All Electric Subsea Equipment

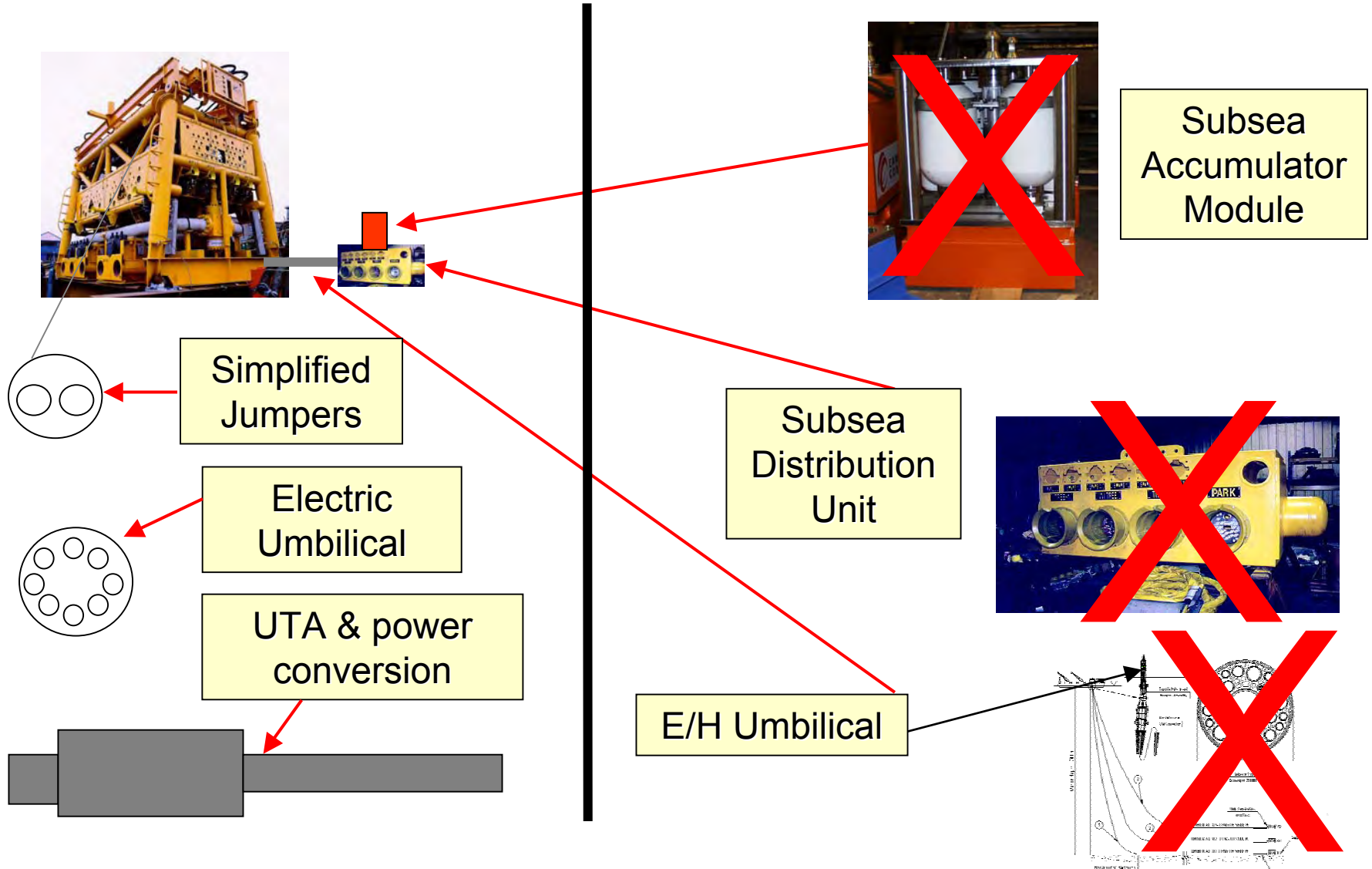

Field of the Future

Field Cockpit Analogue

- Pilots program the flight path, which is executed by the autopilot.
- The pilots monitor the flight systems, intervening when flying conditions change

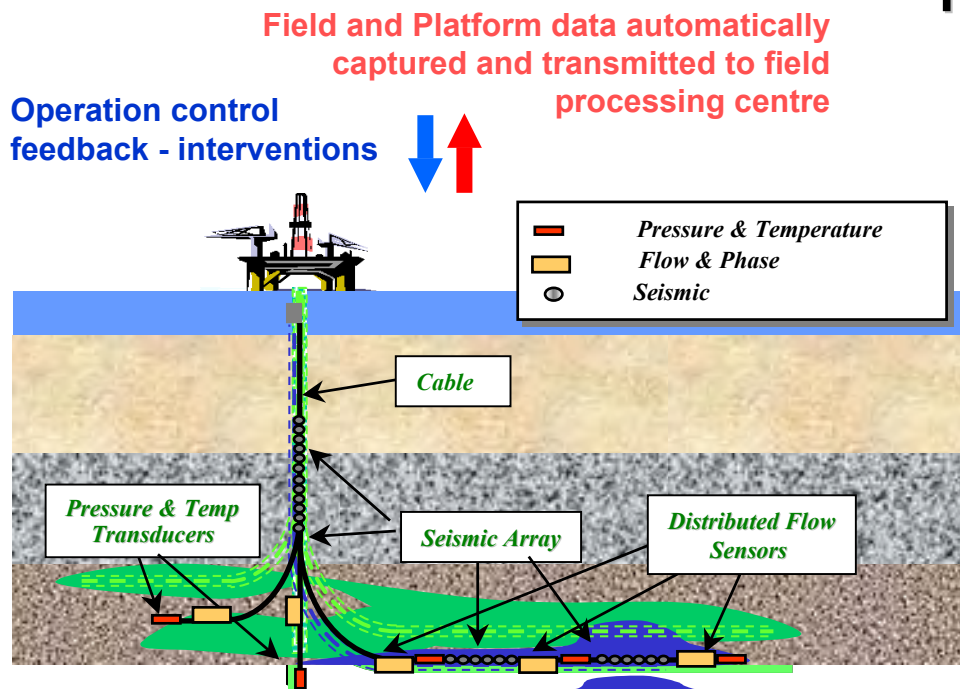

Field of the future

- Field constructed from modelled components.
- Driven by field pilots, who monitor reservoir status in field cockpit.
- The data feed from the field is in real time, to the processing and integration centre
- Routine field management is automated

Blue Skies Future



- **No limit to tie back distance**
- **Subsea Processing**
- **No offshore production surface facilities**
- **Beach based field control**
- **No umbilical**
- **Satellite with Broad band Control and communications**
- **All Electric valve operations**

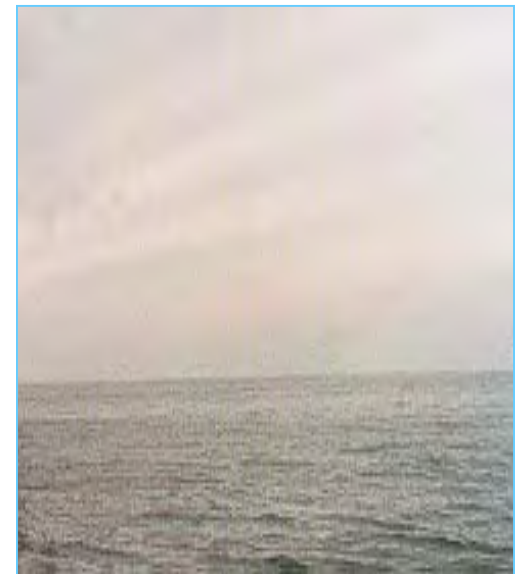

Development & Application “Know-How”

ROV/AUV community Challenges.....

- **Holistic Engagement with designers/ end users**
- **Technology Risks vs. Project pace**
- **Addressing Reliability (FFOP & MTTR)**
- **Designing the Interventions of the future**
- **Challenge or Adopt standardization?**
- **Avoiding the Technology “Valley of Death”**



SUBSEA EQUIPMENT (OPERATION, MAINTENANCE & INTERVENTION)

Manifolds & Tie-in Systems

Robert McInnes - FMCTI

HOW DOES ONE USE A ROV ?

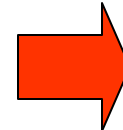
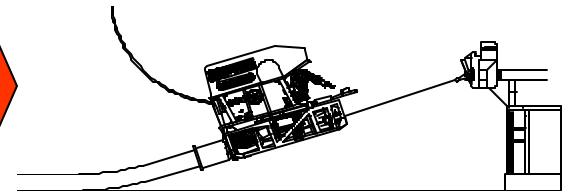
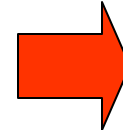
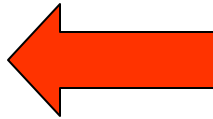
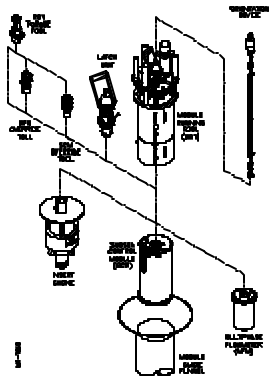
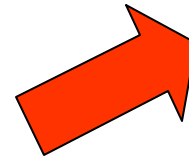
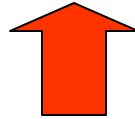
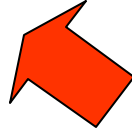
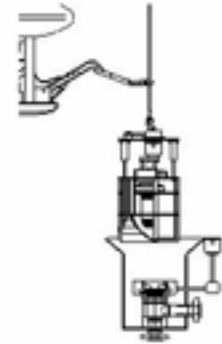
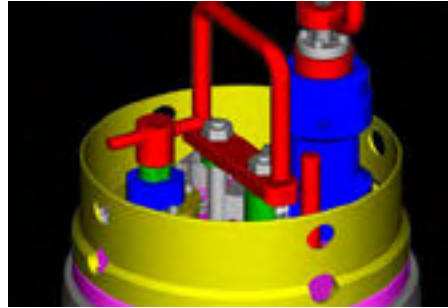
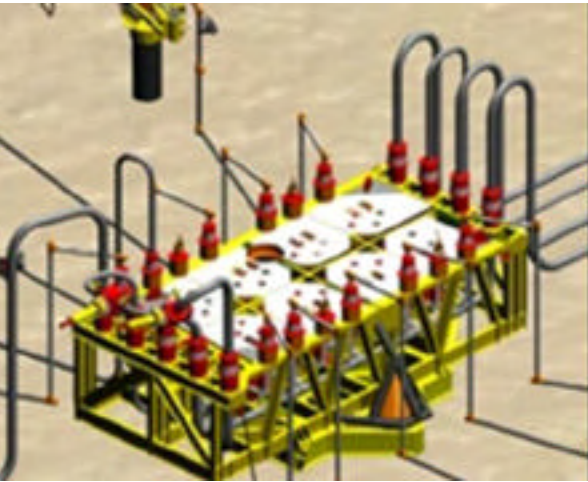

USES FOR ROV'S

- **Guiding Installation of Manifolds, PLETs & Jumpers**
- **Verifying Final Position, Verticality of Manifolds & PLETs**
- **Make-up of Connections (ROT) to Manifolds**
- **Make-up of Controls (Hydraulic & Electrical)**
- **Off-line Activities**
 - **Removing/Installing Pressure Caps (Jumper activities)**
 - **Hot Stab Operation (test, chemical injection, pigging)**
 - **Override Manipulation (Valves, Chokes, Connectors)**

ASSIST IN GUIDANCE

- Push Component or Tool to Landing point
- Attach/detach rigging lines
- Provide rough Rotational Alignment to reduce final alignment

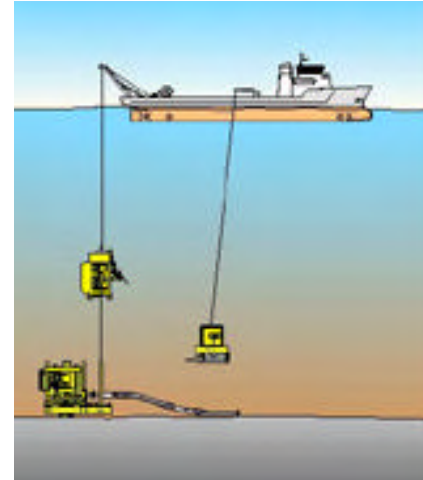

Dual Downline Method

– +/- 180°

+/- 30°

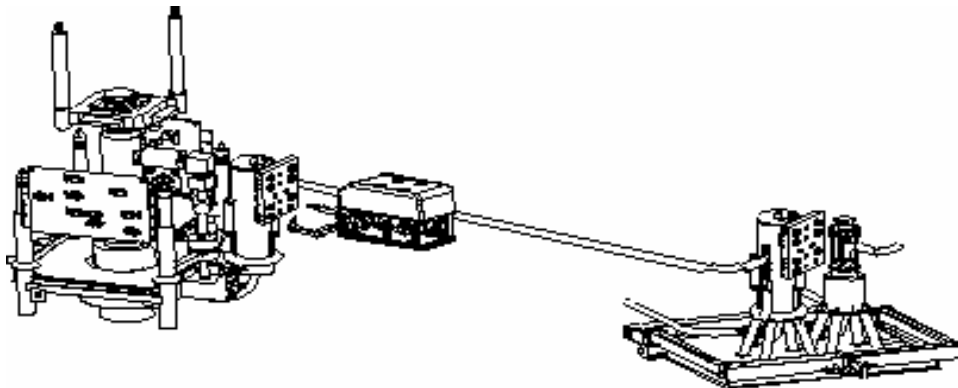

Use one end of jumper as fulcrum for other connection



Reduce funnel diameter by helping to position component

Reduce height of funnel and helix by reducing final alignment angle

OPEN ARCHITECTURE

ROV flying leads open field layout architecture for control and chemical lines

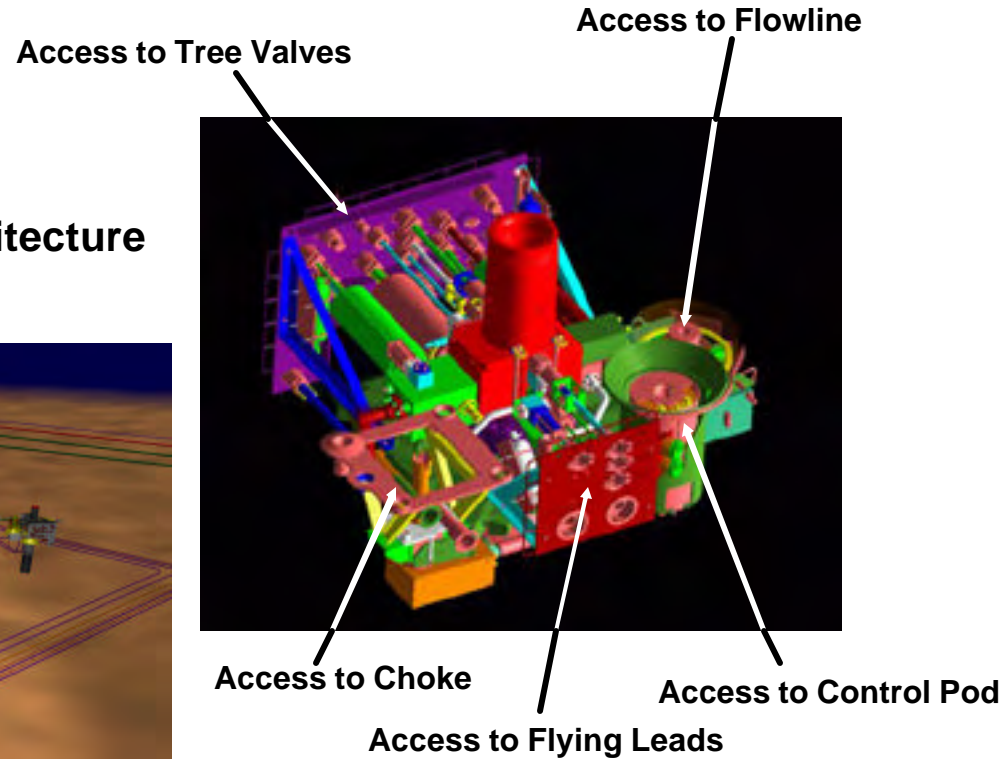
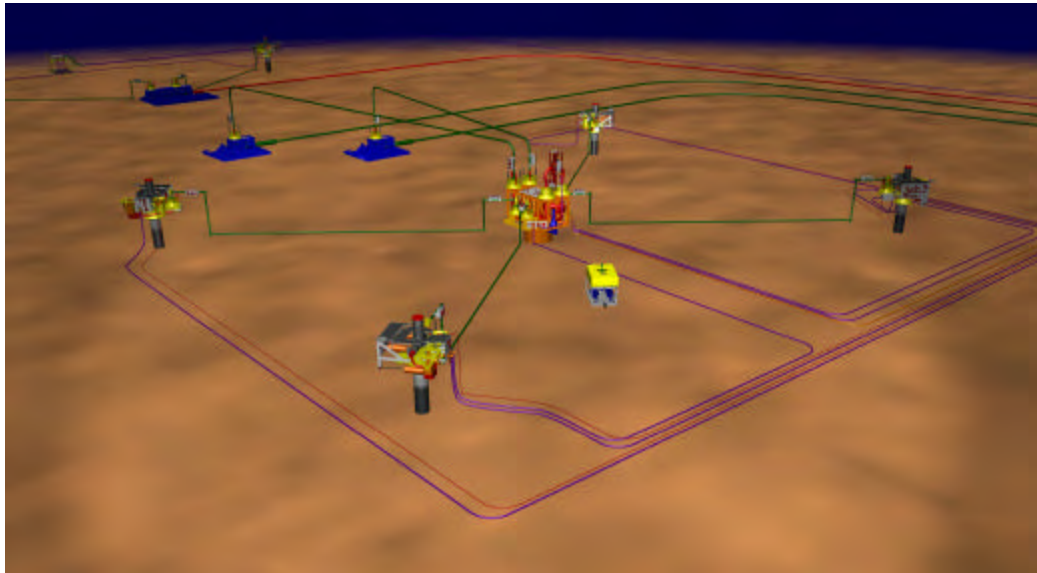

Open tree interface architecture around the perimeter

POSITIONING IS CRITICAL AT PUTTING PIECES TOGETHER



**Beacons used for
positioning and
repositioning
tree & manifold
heading**

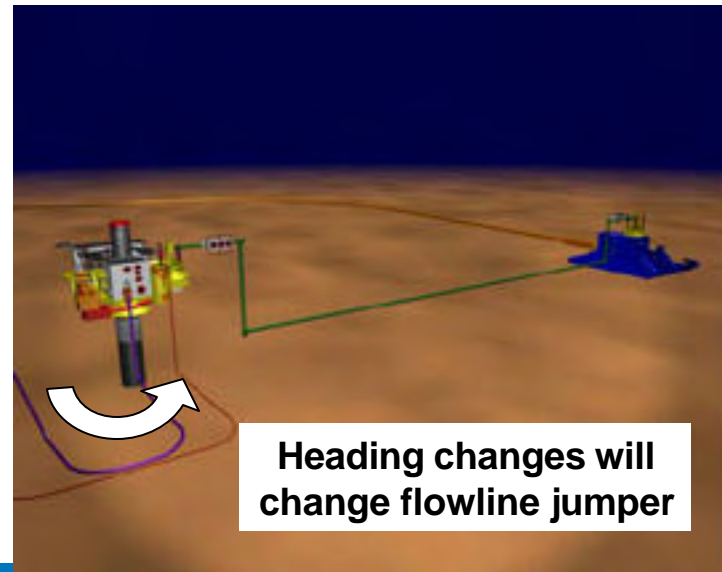
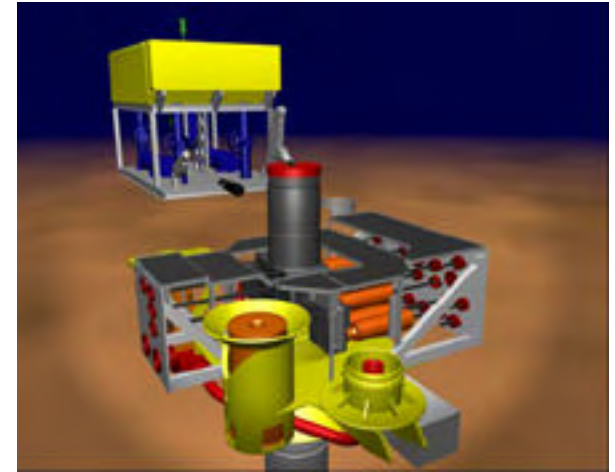

**Heading changes will
change flowline jumper**

FOUNDATIONS

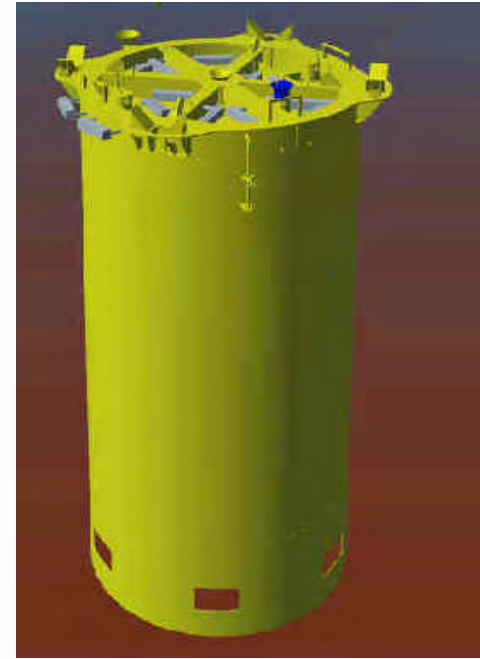
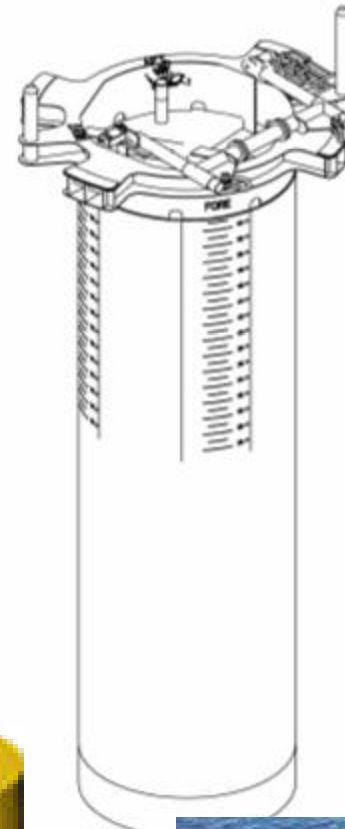
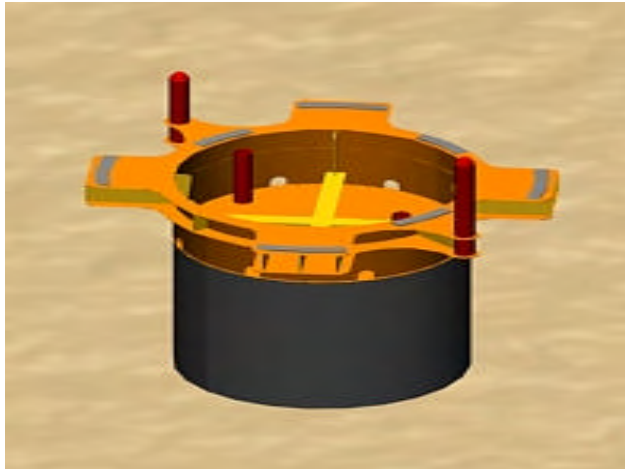

**Suction
Pile**

Mono-pile

Mud-mat

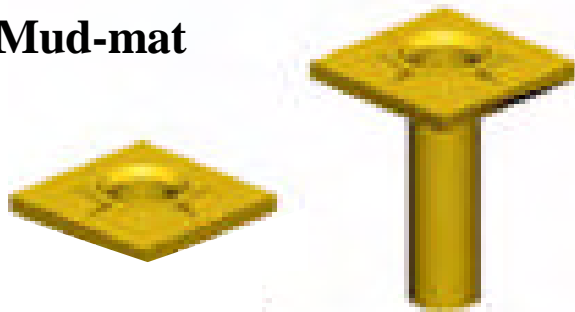

MANIFOLD INSTALLATION

**ROV used for Final
Maneuvering**

**Position &
Verticality based
on Suction Pile**

**Alignment
Criticality based
on Jumper Length**

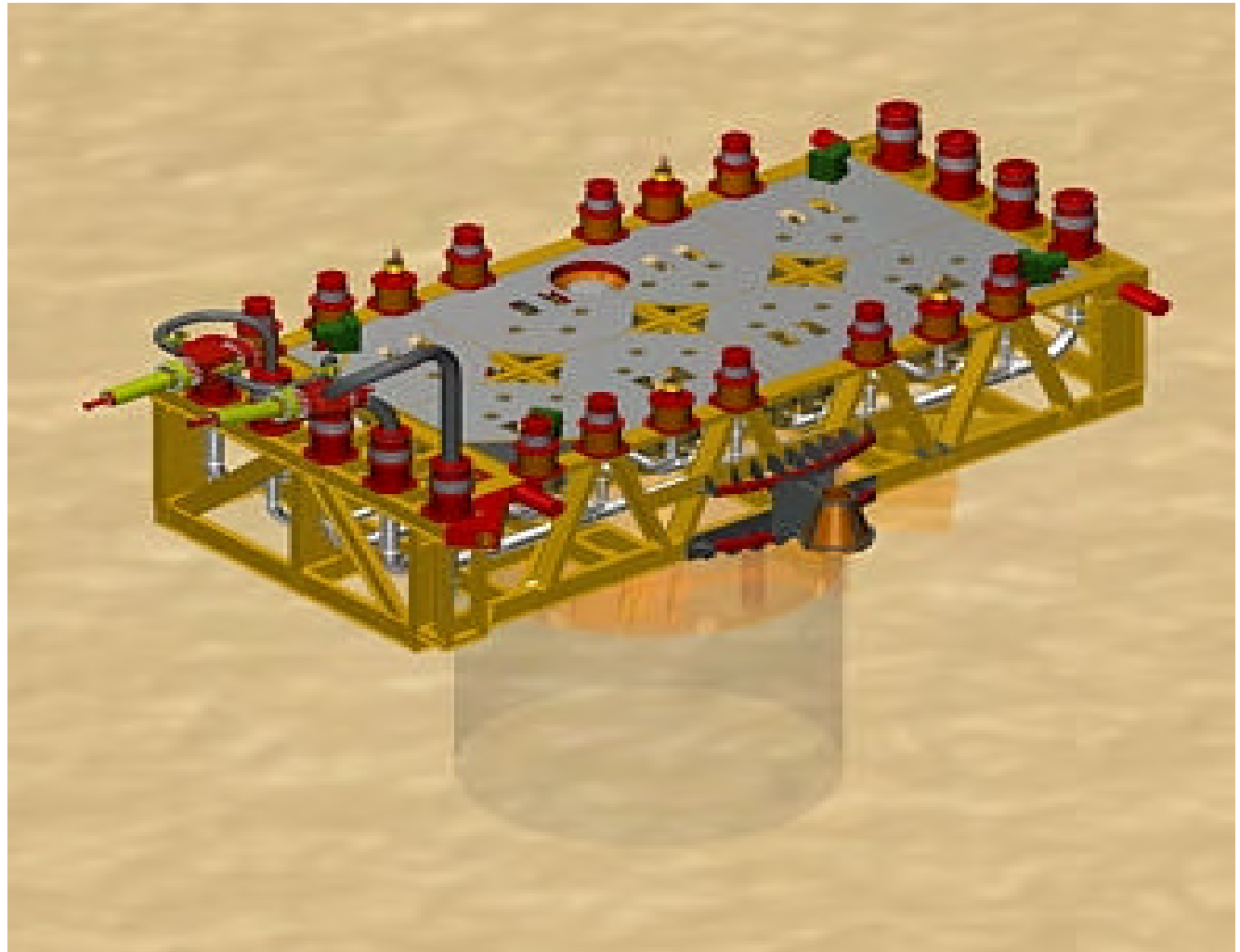

ROV ASSIST PULL-IN FLOWLINE CONNECTION (ROT)

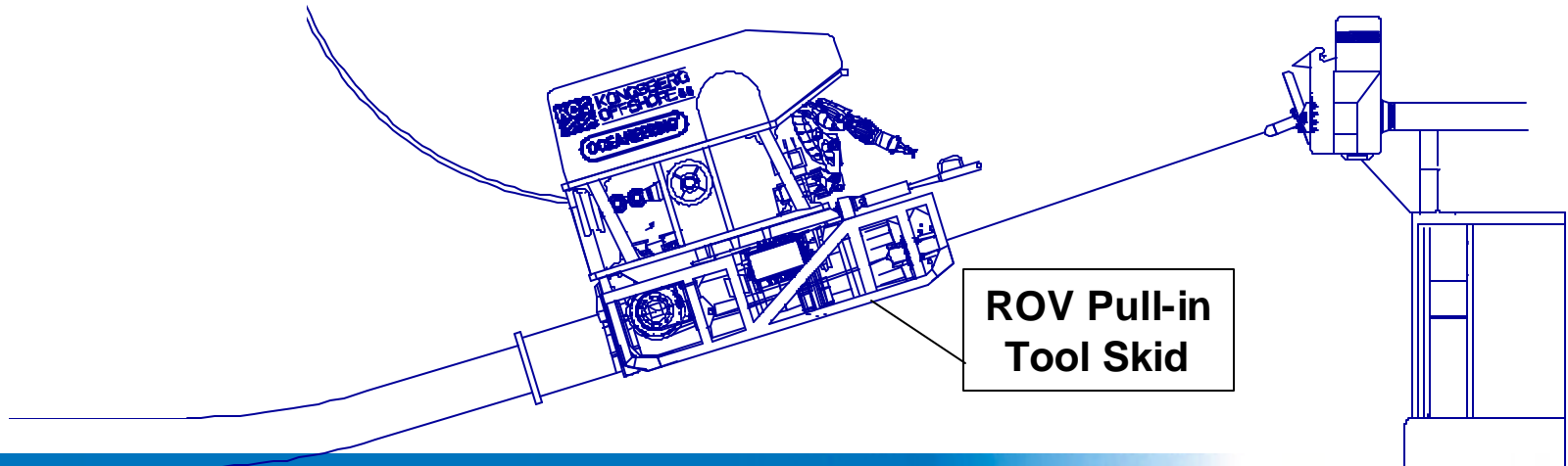
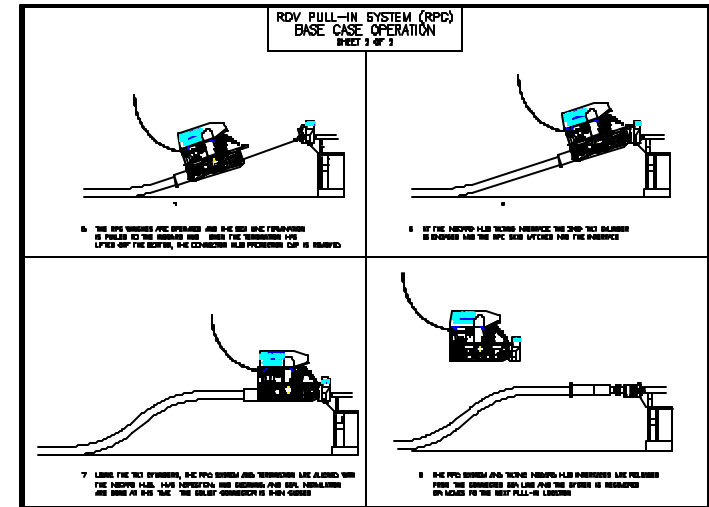
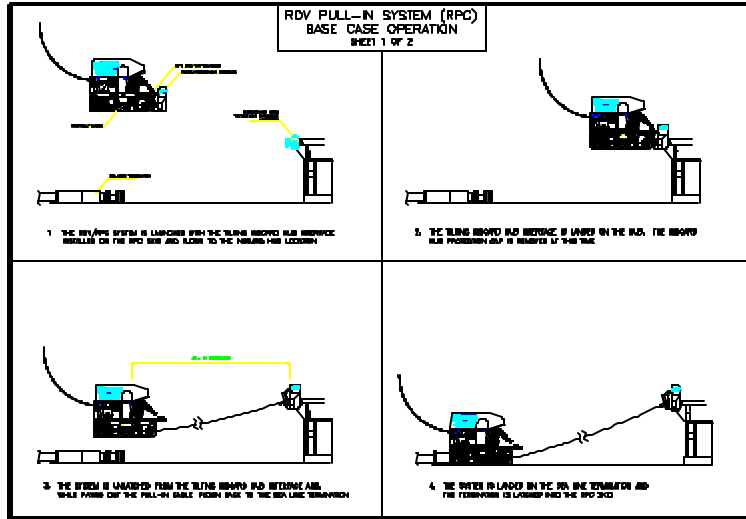

PIPE-LINE END TERMINATION (PLET) INSTALLATION



**FOLDING
WINGS**

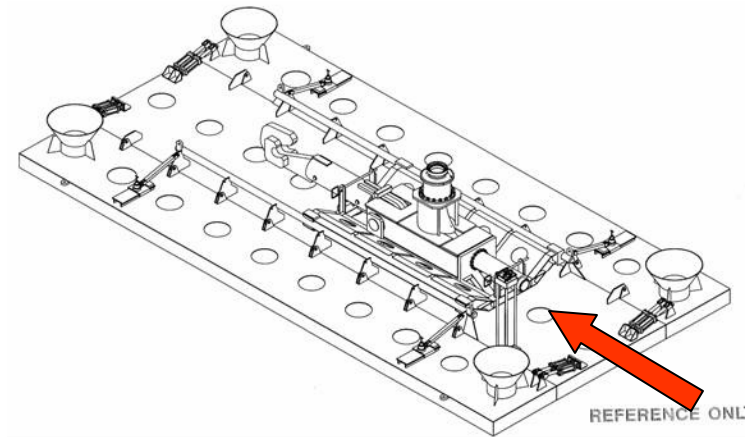
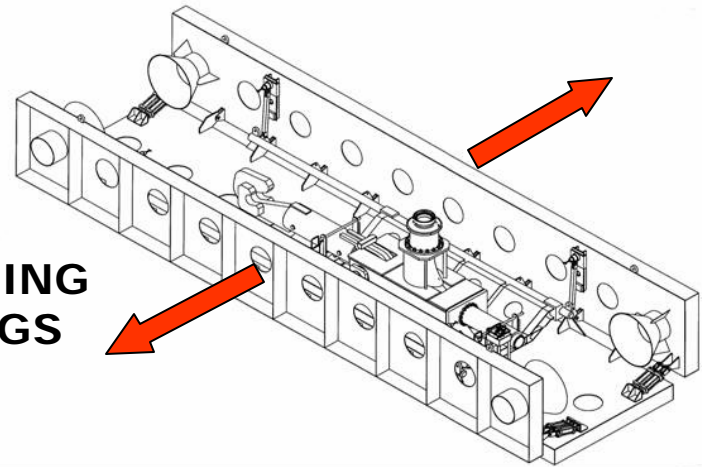

SLIDE MECHANISM

ROV ASSIST FLOWLINE CONNECTION

Install 1st End Connection

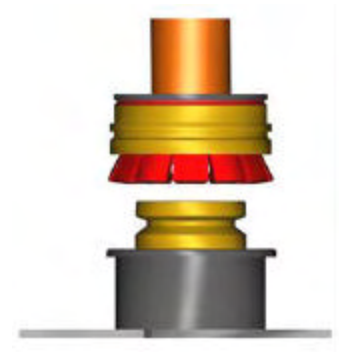

**ROV operates C.A.T.
(Soft land, connector lock/unlock, test)**

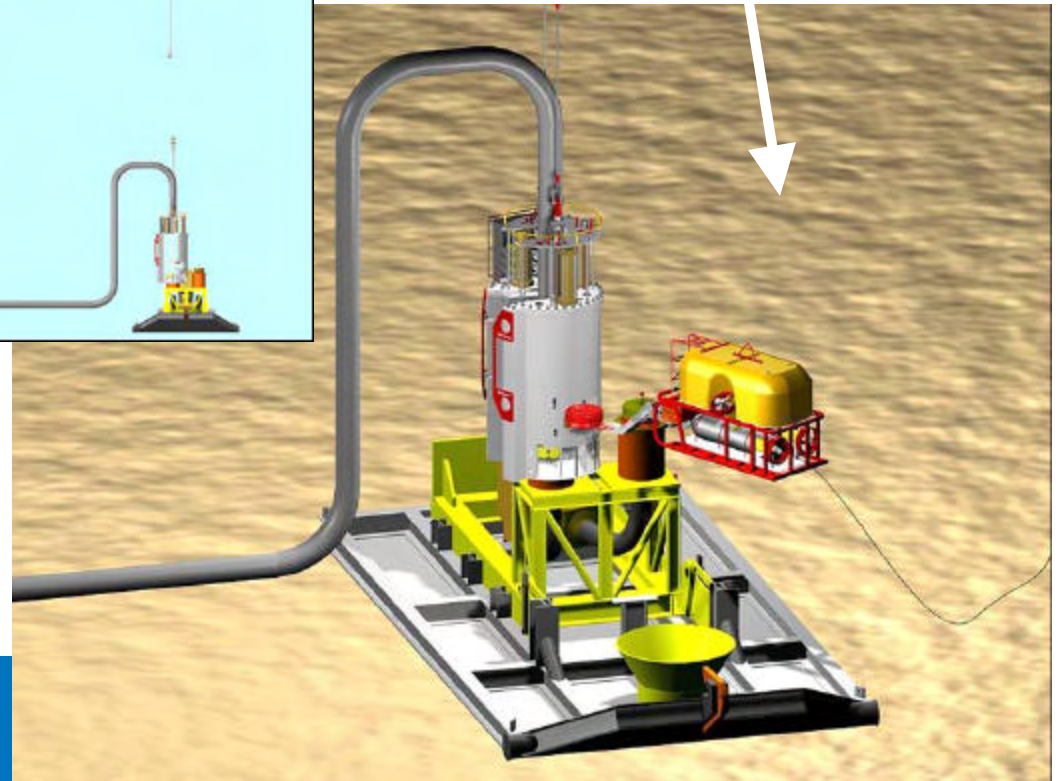
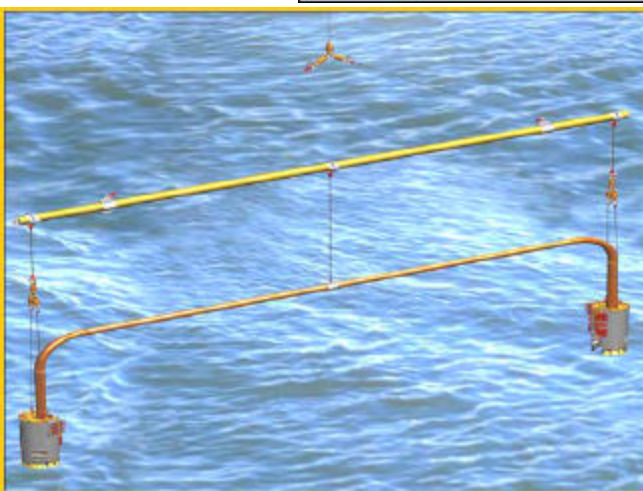
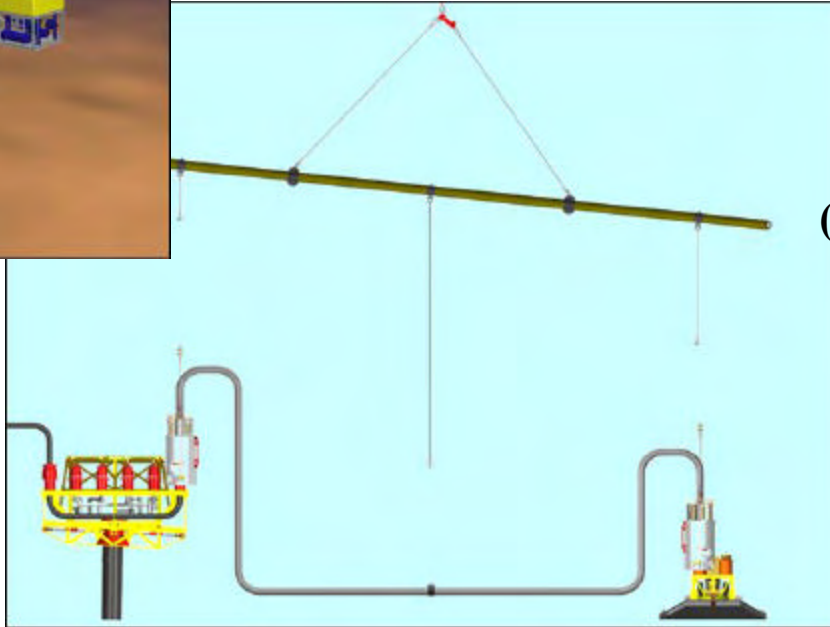
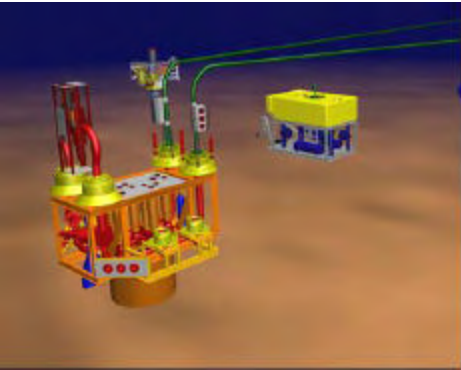

ROV USAGE TO DO THINGS "OFF LINE"

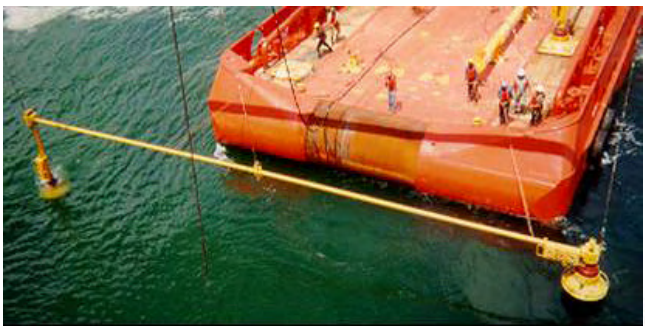

Jumper Installation

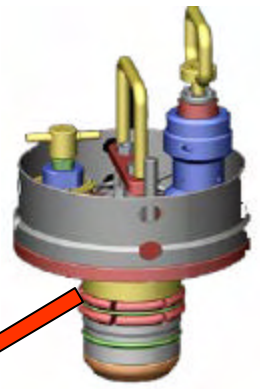

ROV Installable Pressure Cap & Inhibitor Injection

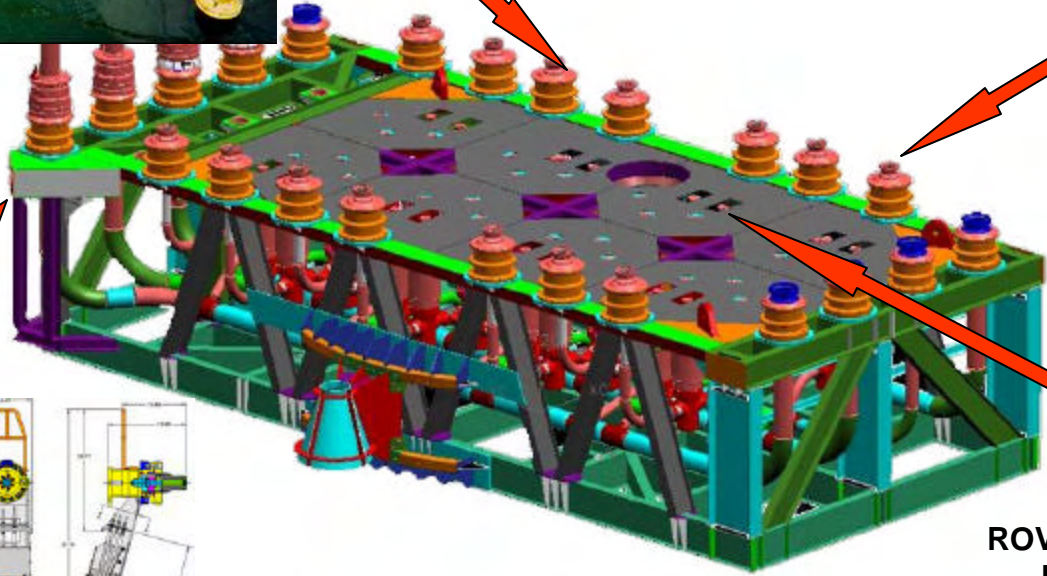

ROV Overrides & Hot Stabs

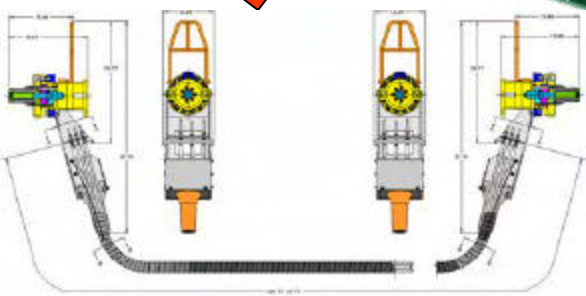
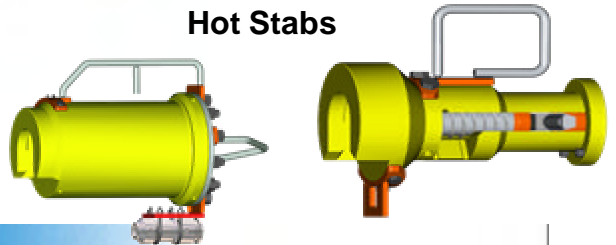

Umbilical Installation

CONTROLS INTERFACES - FLYING LEADS

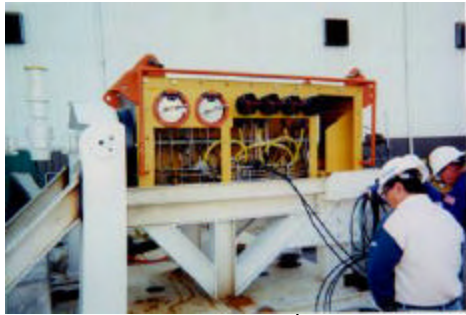
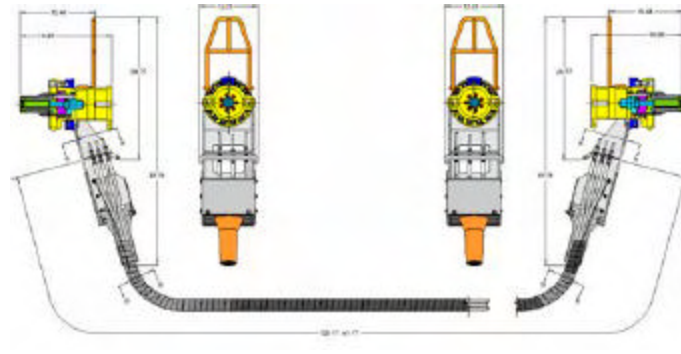

Flying Lead Assemblies

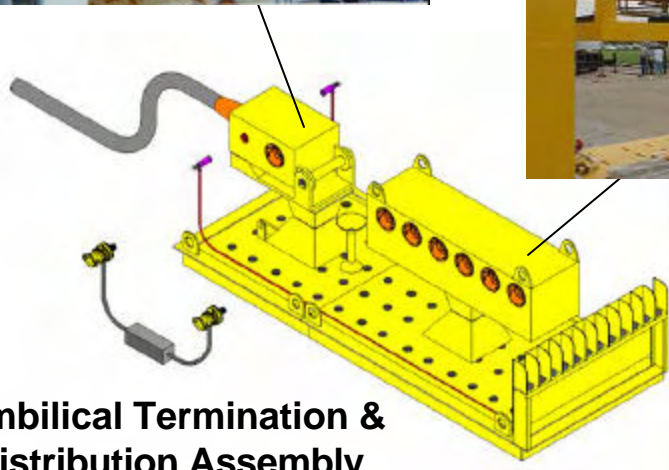

Umbilical Termination & Distribution Assembly

CONTROLS INTERFACES

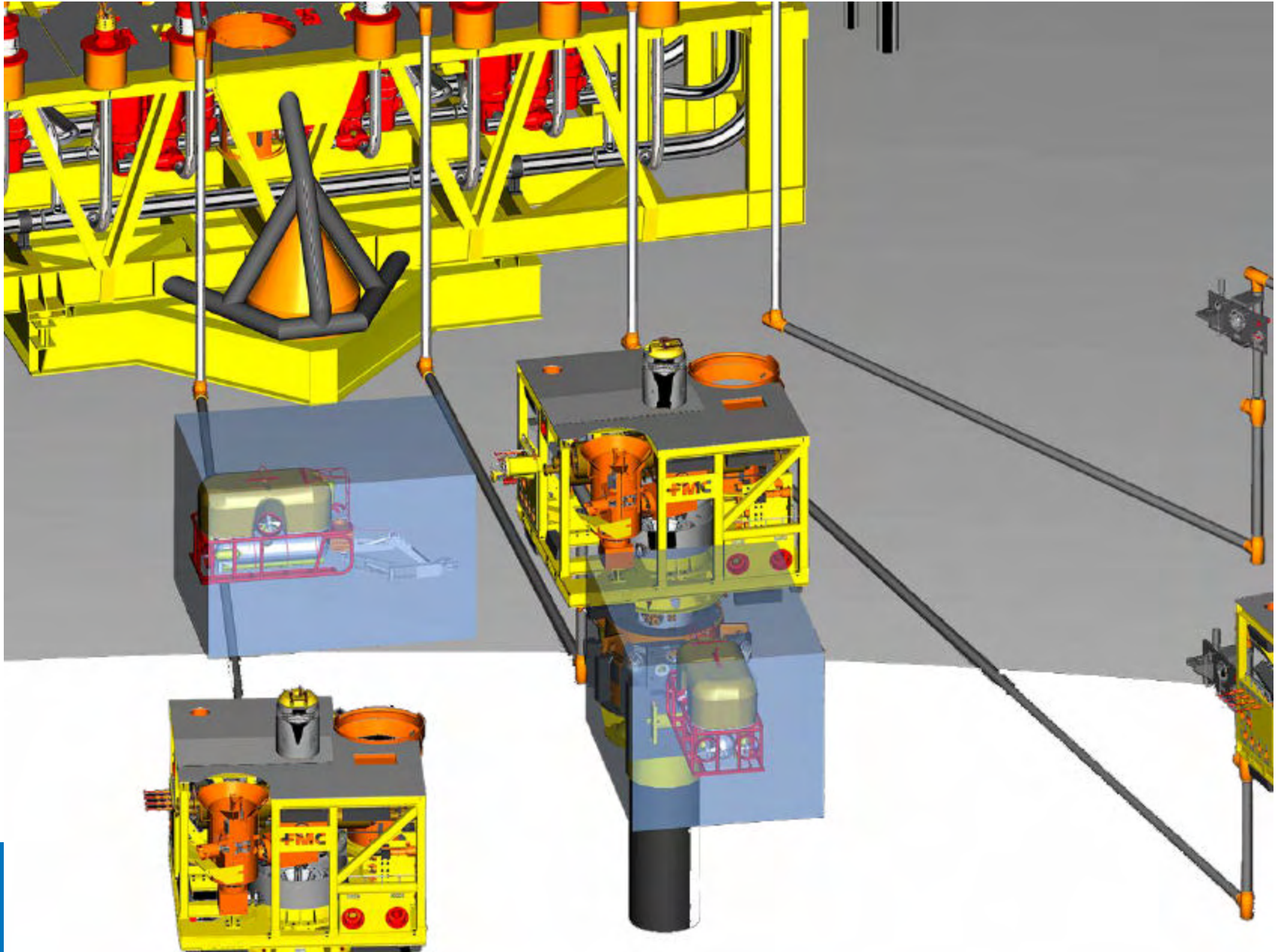

MANIFOLD ROV INTERFACES

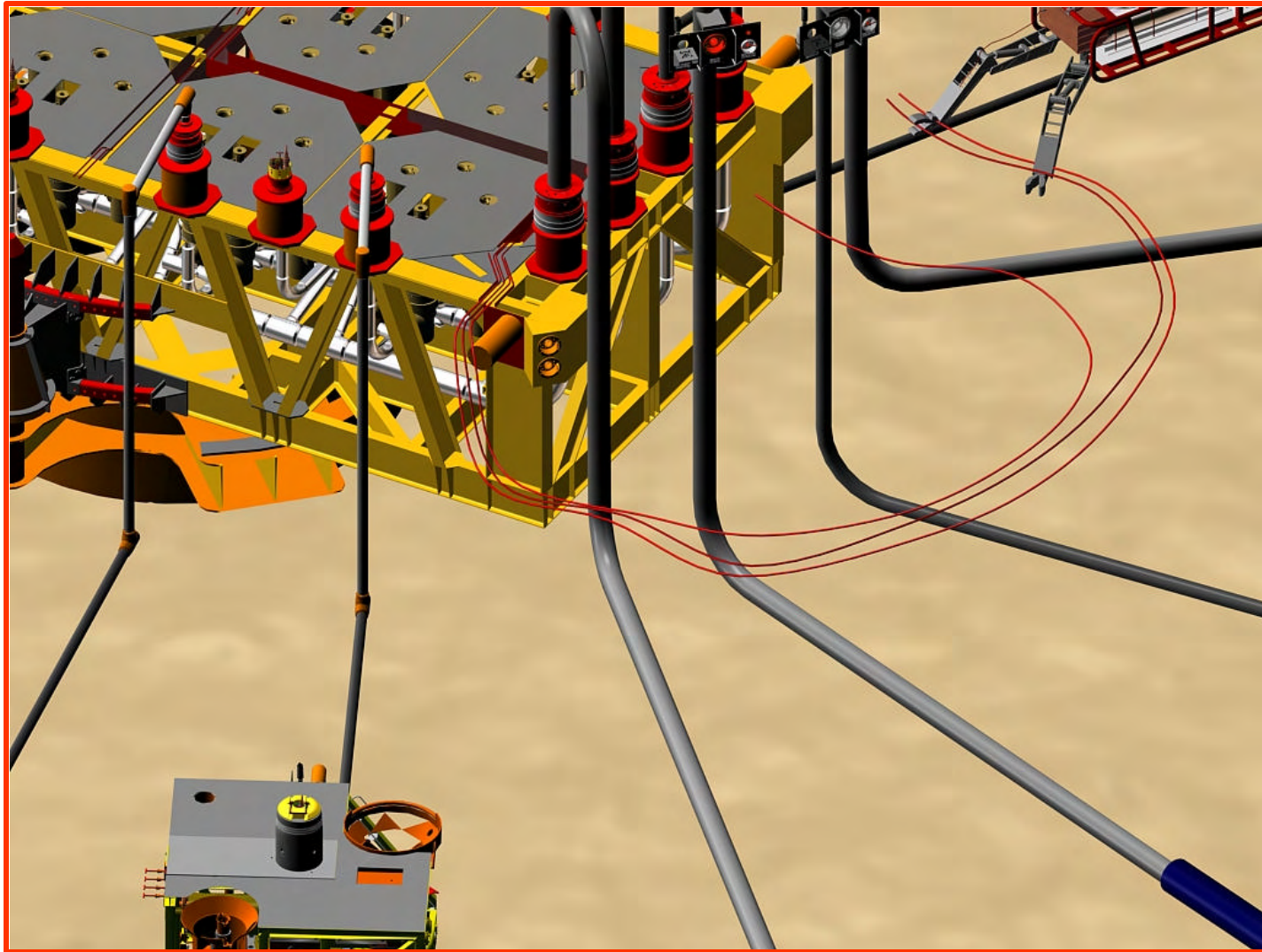

FULL FIELD ARCHITECTURE

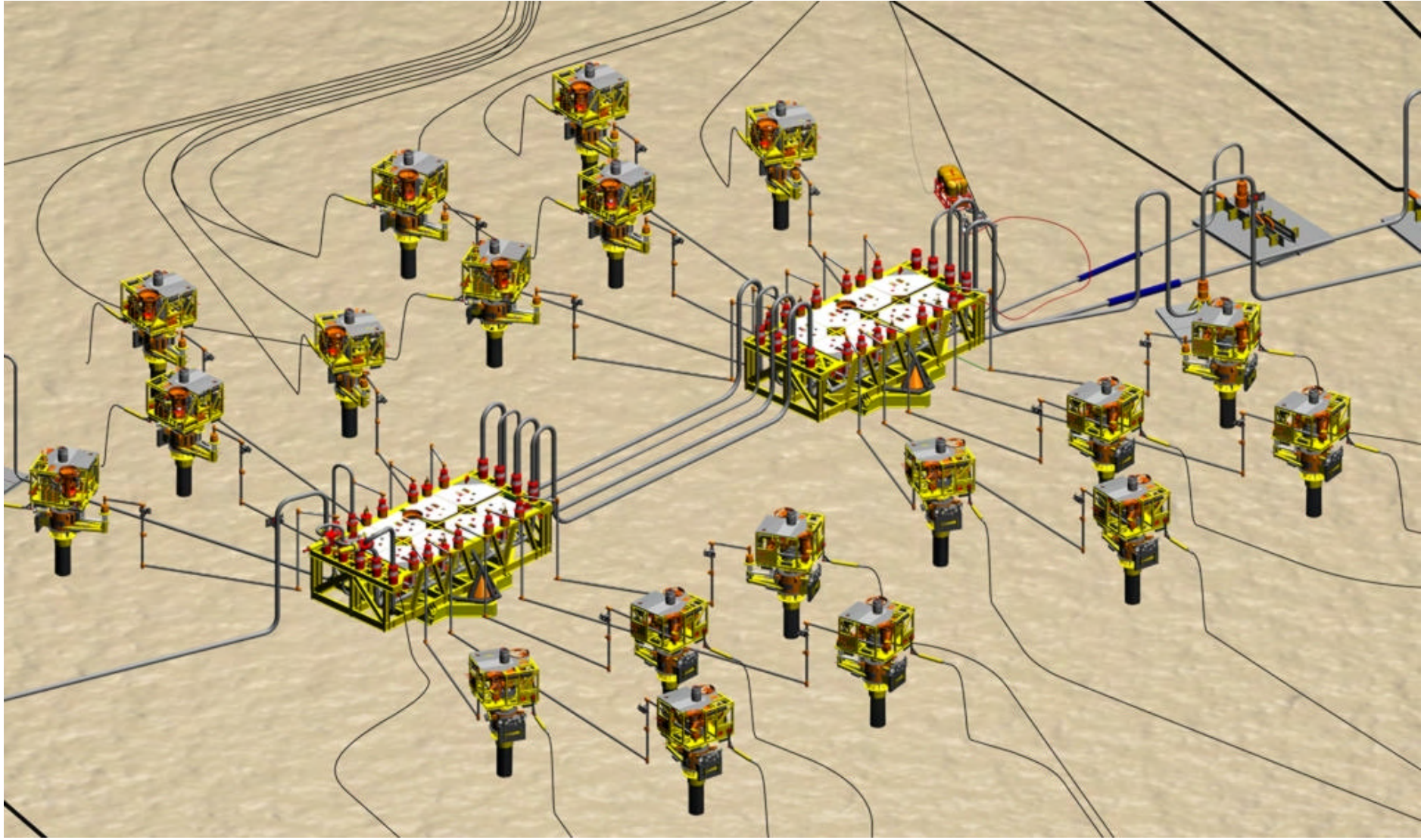

Autonomous Underwater Vehicle

SWIMMER

A hybrid AUV/ROV for IRM of deepwater subsea fields



Autonomous Underwater Vehicles (AUV) Future Requirements

- **Connect into production hydraulic controls system to pressure test connections**
- **Provide visual inspection & metrology status along system (expansions, settlement, unplanned events)**
- **Provides real-time data for corrosion/erosion monitoring points along system**
- **For transporting ROV, tools & replacements to/from subsea location**
- **Guidance of equipment into final position (docked) during installation operations**
- **Chemical injection on routine basis, to remote satellites**
- **Re-configure logic caps or manual valves on manifolds or PLETs**

Remote Operated Vehicle (ROV)



Remote Operated Vehicles (ROV) Future Requirements

- **Smaller & more powerful to allow better accessibility to 'busy operational envelope'**
- **Greater dexterity for tools operation, handling of flying leads, sling connections & override mechanisms**
- **Increased stability for working in heavy currents**
- **Re-charging capability for electric actuators, field signature monitors, assorted probes/sensors**
- **Operation via pre-installed (common) umbilical**
- **Electric-powered to minimize umbilical**
- **Improved visual range (infra-red)**
- **Greater longevity for working at depth, with feedback monitor diagnostics.**
- **Subsea transportation (separation modules, subsea pumps, SCM, choke insert, electric actuators) & construction activities**



The Future of Subsea Connections and ROVs

Subsea Connections and ROVs

- Introduction
- ROV activities required for connections
- Future capabilities of ROVs
- ROV interfaces
- Conclusion

Introduction

- The act of making a subsea connection in deep water is highly dependent on ROV operations
- As installations get deeper, trips take longer so avoiding trips for ROV or any equipment is advantageous
- As the amount of installed subsea hardware increases, so will the likelihood of subsea interventions

ROV Activities for Subsea Connections

- Inspection/cleaning of seal surfaces
- Guiding connection/tooling into position
- Functioning connector
- Seal verification and leak monitoring
- Removal of pressure containing end closures
- Subsea measurement for jumper fabrication

Inspection/Cleaning of Seal Surfaces

Currently

- Inspection using ROV and manipulator mounted cameras
- Cleaning by brushes, water jets, or suction pumps.

Future

- Large number of tie-in points on existing infra-structure will likely be used for future fields. Inspection and cleaning will be critical in allowing use of these tie-in points
- Inspection may need to include sampling of debris found on seal surfaces
- Refined inspection to give confidence that seal surfaces are acceptable
- More aggressive methods for cleaning seal surfaces will be necessary





Seal surface
cleaning brush



Guiding connector/tooling into position

Currently

- Bouyancy is used to allow heavy equipment to be carried by ROV
- Down lines are used to lower equipment and ROV guides equipment into place

Future

- Ability of ROV to carry heavier equipment without bulky bouyancy (5-7 tons)
- More powerful ROV to guide equipment on downlines to greater offsets. Necessary for large clusters with multiple vessels in the field.

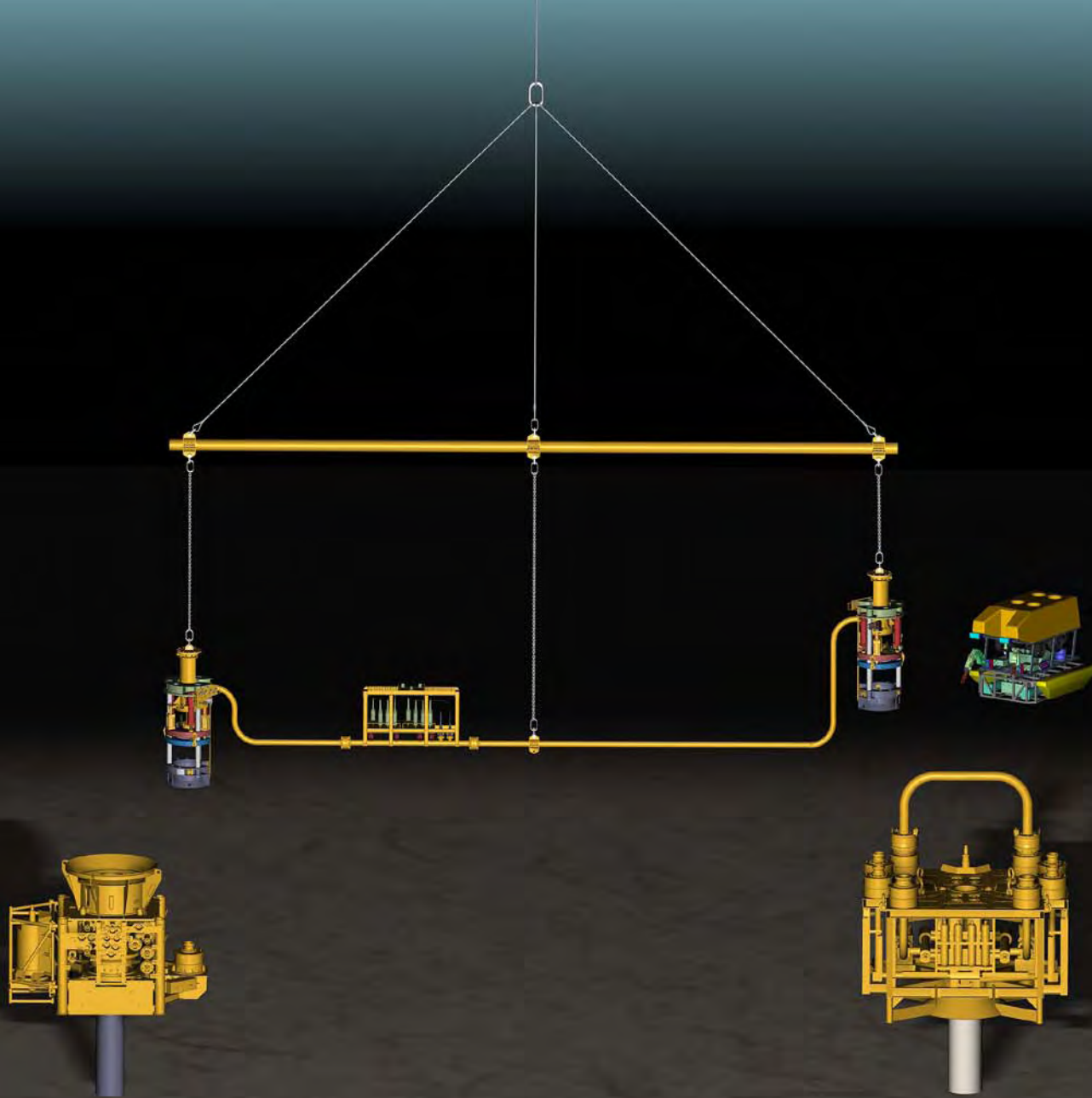

Connector functioning

Currently

- ROV supplies pre-regulated hydraulic pressure
- ROV torque tool or manipulator provides rotary motion

Future

- ROV capable of regulating hydraulic pressures subsea
- Improve reliability of hydraulic circuit and stabs to prevent seawater ingress

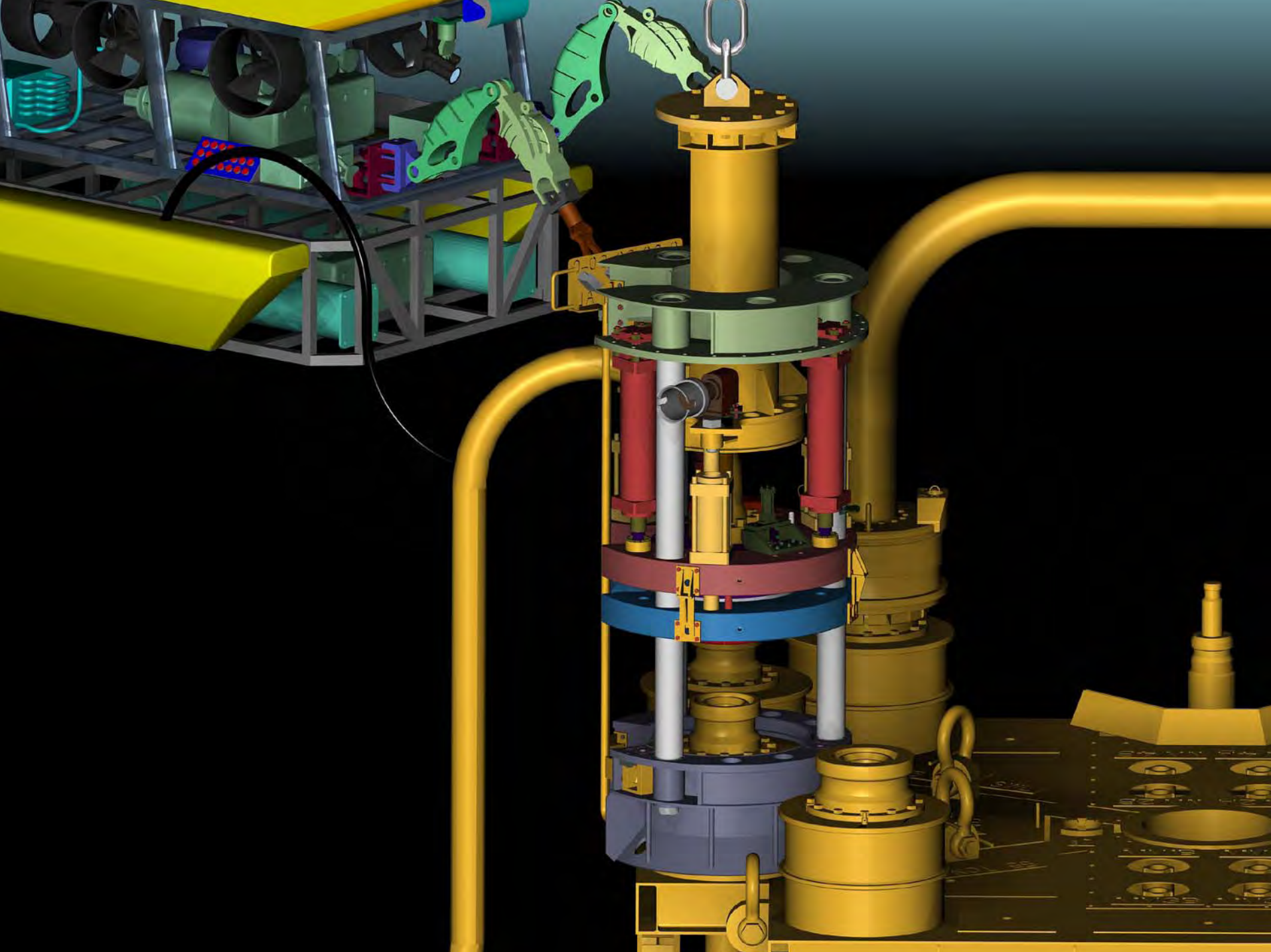

Seal verification and leak monitoring

Currently

- Pre-regulated hydraulic pressure used to conduct seal test

Future

- Subsea regulated hydraulic pressure would allow more flexibility in seal testing

Removal of end closures

Currently

- Pressure containing end closures are operated by ROV but many are too heavy to be carried by ROV

Future

- ROV capable of lifting an end closure weighing up to 2 tons
- ROV capable of heating end closures to melt hydrates

Pressure
containing end
closure



Subsea measurement for jumper fabrication

Currently

- Taut wire systems which are bulky and time consuming
- Acoustics systems placed by ROV but require surveyor to collect data

Future

- Acoustic system which only requires ROV operated devices to collect and transmit data

Future capabilities of ROVs

- Ability to maneuver heavier loads subsea without down lines and bouyancy
- Higher reliability of ROV during severe operations to allow for longer dives
- Hydrate remediation with heaters
- Eliminating the need of a tether to allow for long distance dives

ROV Interface Issues

- Interfaces defined by several different specifications (API, ISO.....)
- ROV operators all have personal preferences
- Many ROV companies and installation contractors follow their own standards
- Connection equipment is often rented and operated by many different companies

Conclusion

- Improved ROV capabilities have the potential for making connections subsea more economic particularly as water depths increase
- Improved commonality among ROV interfaces could lead to lower equipment cost and installation times
- There are numerous small improvements to ROVs which would have minor effects on connections but it would take major changes to have a dramatic effect.
- Improvements in ROV capabilities will result in an even higher dependence on ROVs during connection installation

OTRC ROV/AUV Workshop

Subsea Tree Equipment Capabilities and Needs

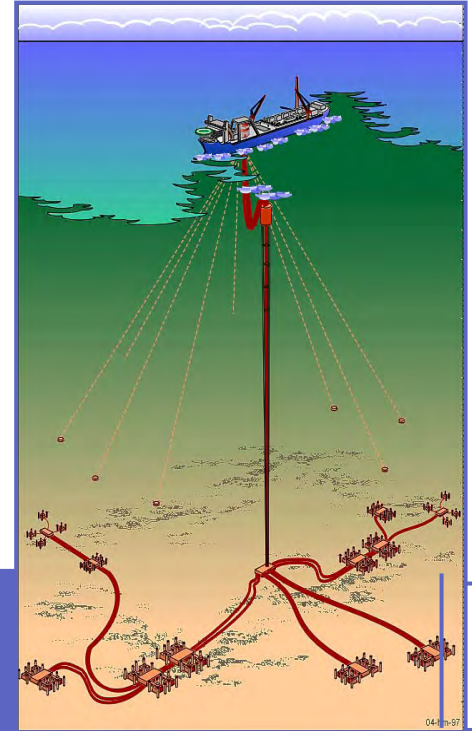

Bobby Voss
ABB Vetco Gray Inc.
April 10, 2003



Subsea Tree Equipment – Capabilities and Needs

Agenda

- Review of current deepwater trees and intervention tasks
- Trends in deepwater tree design
- Future deepwater Tree capabilities and needs

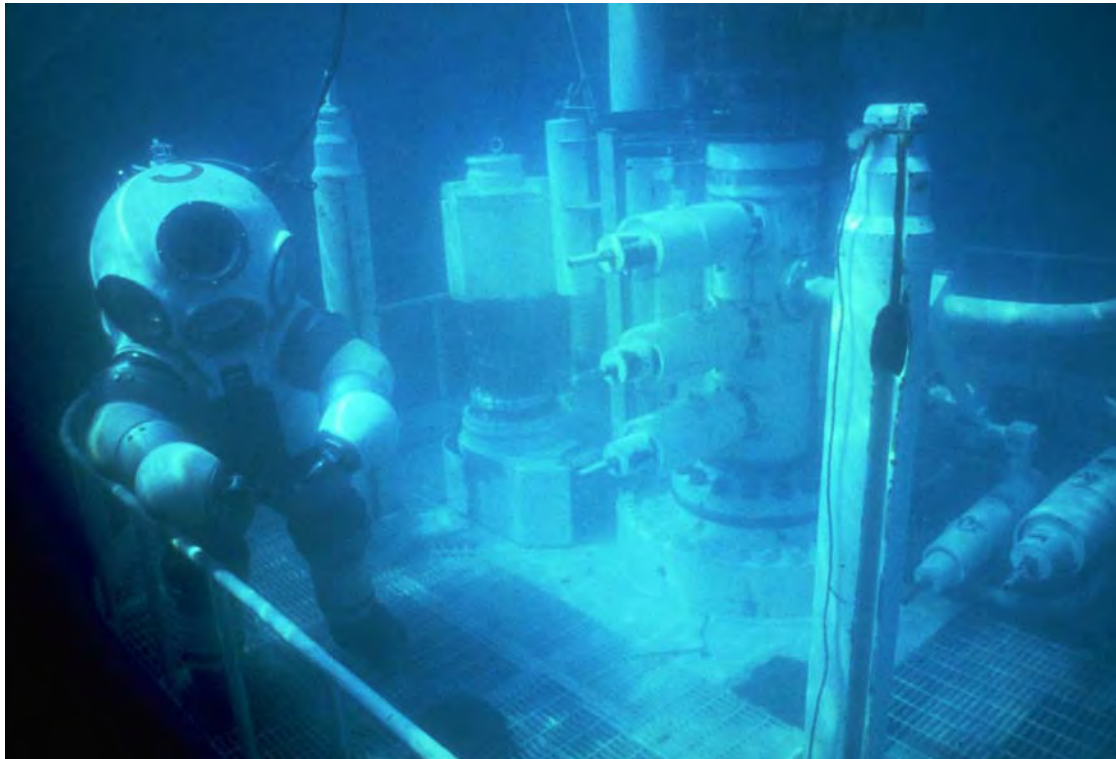

Subsea Tree – Typical Configuration Options



Cluster System

- Wells are discrete from Manifold
- Typical in GOM & WA
- Provides 360 degree ROV access.

Multi-well System

- Need for Multiple ROV's
- ROV tether reach across well center

Unitized System

- Wells are integral to manifold
- Typical in N. Sea
- ROV access is limited



Subsea Tree – Typical ROV Functionality

Mechanical Repair

- Guidepost replacement
- Connector over-ride
- Choke Replacement
- Sensor Replacement
- Seal Replacement

Inspection/Visual Aid

- Guidance Assistance
- Device Status
- Seal Profile Condition
- Debris
- Leaks

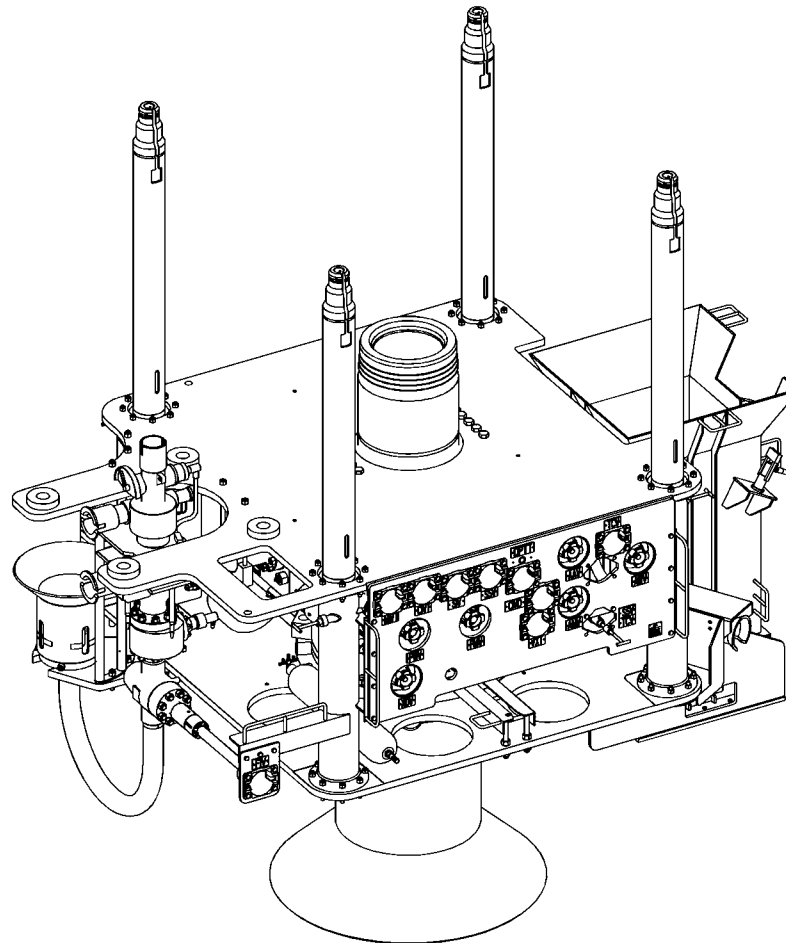

RT NUMBER H224170-1 (REV)

Connections

- Component Guidance
- Guideline Attachment
- HFL's and EFL's
- Connector make-up
 - Flowline
 - Pig Launcher
- Seal Testing

Valve Actuation

- Hydraulic Over-ride
- Manual Actuation



Subsea Tree – Detailed Function Count

- Valve Override
 - Qty 17
- Manual Valve Operation
 - Qty 9
- Hot Stabs
 - Qty 2
- Choke Clamp
 - Qty 1
- Connector Overrides
 - Qty 2
- Junction Plates
 - Qty 2
- Electrical Connectors
 - Qty 2
- TOTAL 35
 - Active 15
 - Passive 20

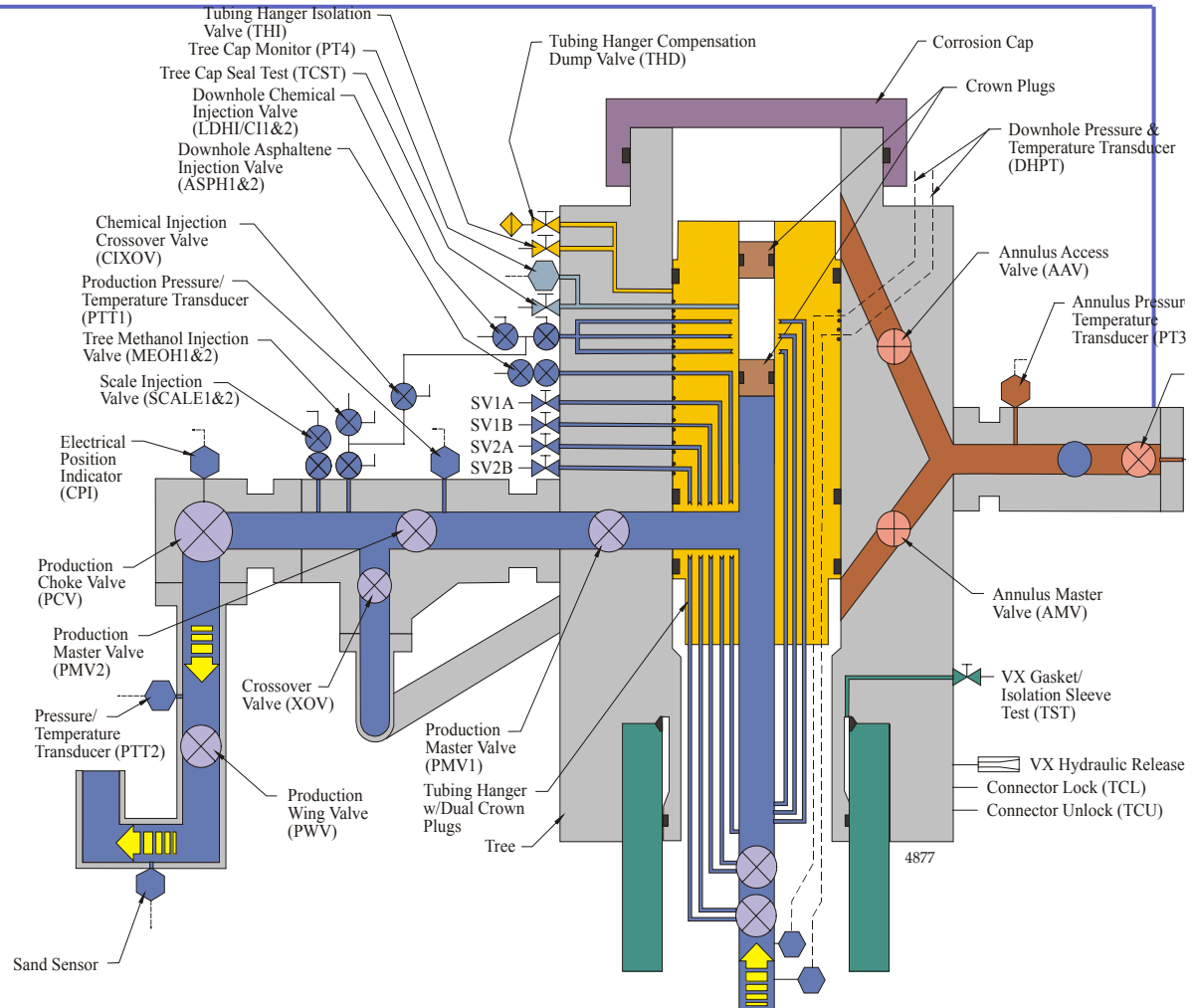

ROV Interface Methods

- Specification
 - API 17D
 - API 17H (draft)
 - ISO 13628-8
- Function Interfaces
 - Passive – ROV flies in Fixed Tools
 - Active – Coordinate Table mounted Tools
 - Manipulator or Manipulator deployed Tools
- Over-rides
 - Rotary (RVOT)
 - Linear (LVOT)
- Hydraulic
 - Hot Stab – Dual Port, Balanced
 - Junction Plate
- Electrical - Proprietary

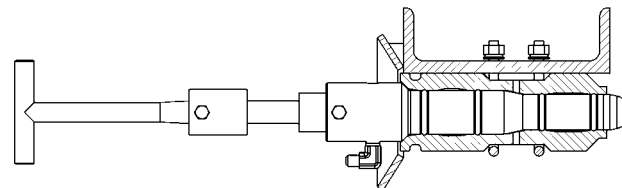
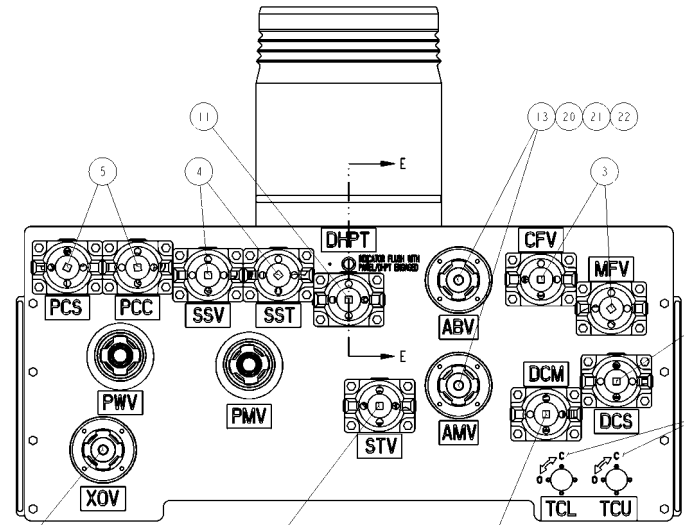
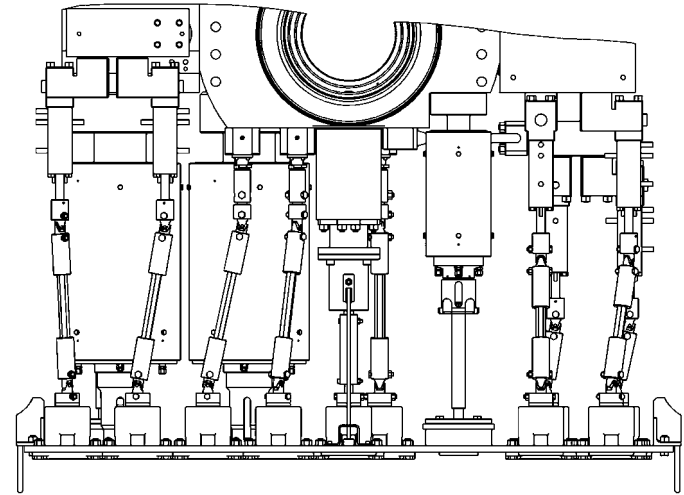

Typical Remote tasks being perform today

Production Tree Intervention

- ROV override of Production Tree Valves
- Make-up of Umbilical Stab plates

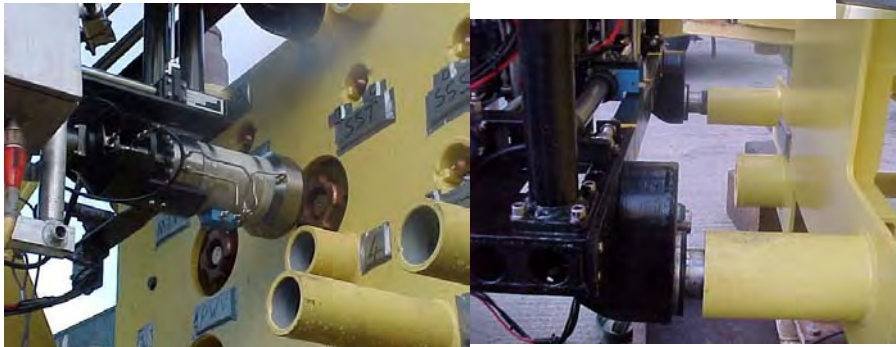
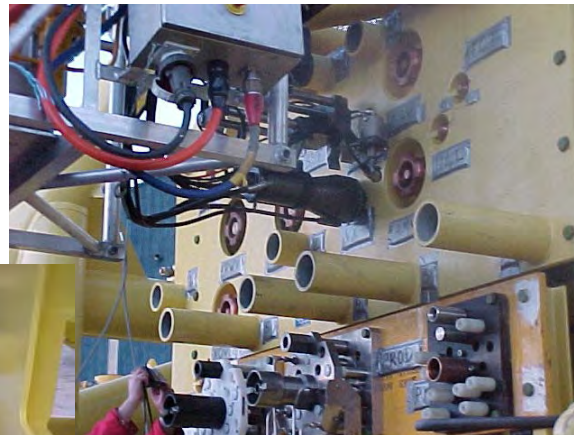
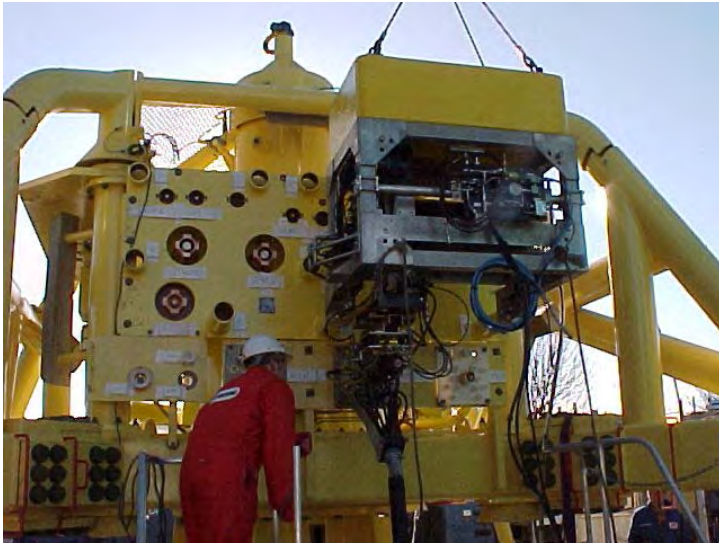
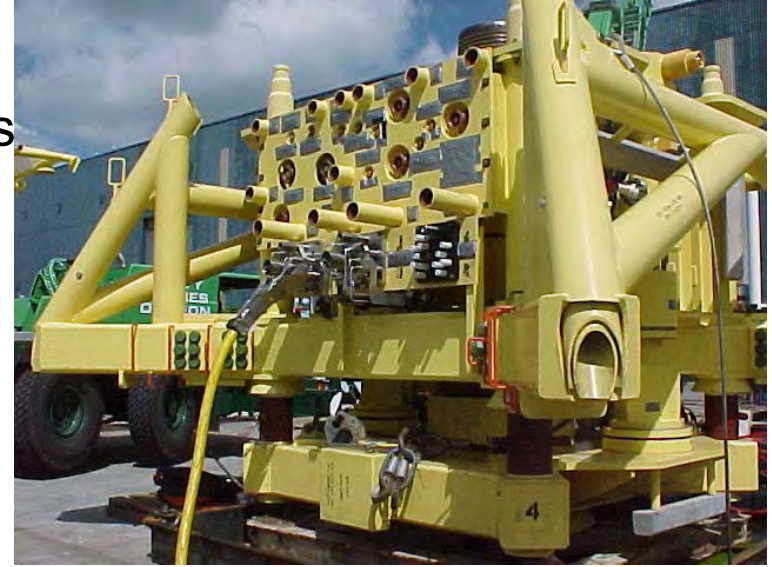

Remote Operated Tools - ROT



- * **Designed for Component replacement of heavier modules**
 - Control Pods
 - Chokes
 - Tree Caps
 - Instruments etc.

- * **ROT to 1500M**
 - Operated by “work class” ROV
 - Uses down line
 - Multiple trip

- * **ROT > 1500M**
 - Operated by “heavy duty” ROV
 - No Down-line
 - Single trip



ROV Support – Minor (through-tubing) Workovers



Modular Light Well Intervention System

- Workboat Deployed - Reduced day-rate & mobilization
- Full flexibility of running both Wireline and Coiled Tubing

SWILS(Subsea Wireline Lubricator System):

- Riserless wireline operations on subsea wells
- Capable of running both slick line and braided line

RICTIS(Riserless Coiled Tubing Intervention System)

- Coiled Tubing in open water
- Subsea Coiled Tubing Injector and lubricator
- Increased length of Coiled Tubing
- Coiled Tubing dimensions up to 3.5”

Future Systems

- Subsea WL & CT Units



ROV Interface Design & Test Verification

Verification of ROV access, operations and tooling:

- At Design Stage
- At System Integration Test

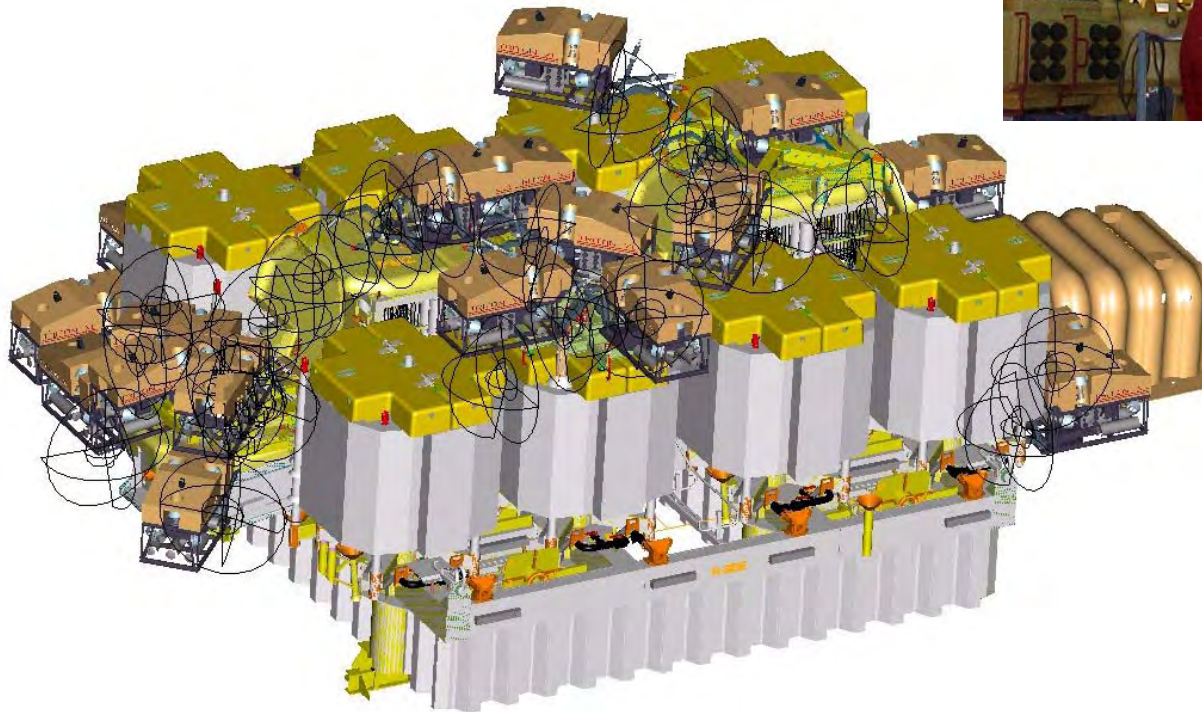
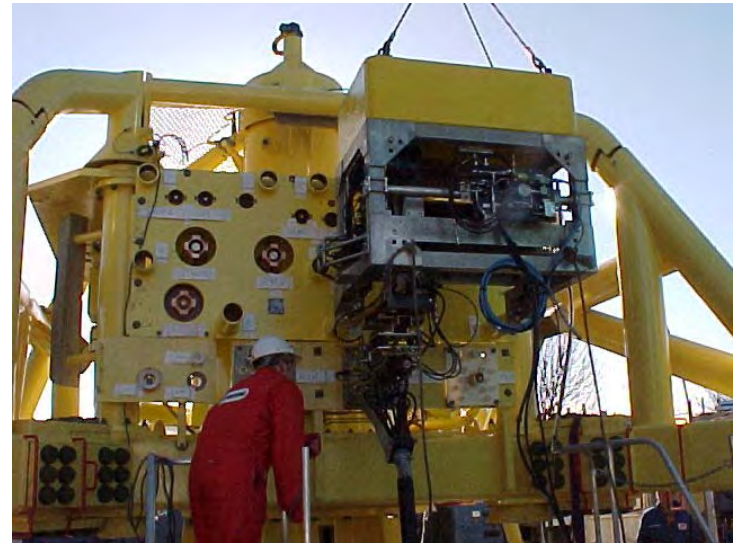

Trends in Deepwater Tree Design

Economic Consideration

- Subsea is generally a low cost option as regards initial CAPEX but to the detriment of OPEX
 - Cost of well intervention is 6.6x the cost of intervening on dry wells.
 - Recovery rates from dry wells are 15-25% higher

Reliability will need to increase.

- We need to aim for maximum mean time to failure of any subsea component.
- Avoid the situation that any one single failure leads to loss of production
- Provide redundant systems for critical control and monitoring functions
- Provide backup systems where temporary shutdown can be accepted
- Provide spare systems based on failure probability and effects

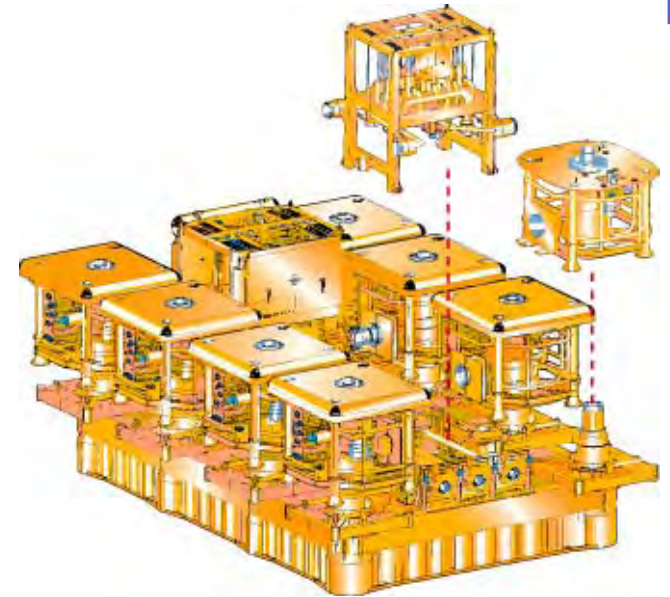

Trends in Deepwater Tree Design – Intervention Costs

- Monohull workover vessels instead of Semi-sub
- Increased use of ROV based solutions and lift-line run tools
- Focus on ROV operability in design of subsea equipment.
- Focus on ROV accessibility in design of subsea installation.
- Involve ROV contractor at an early stage.
- Carry out verification testing at simulated subsea conditions

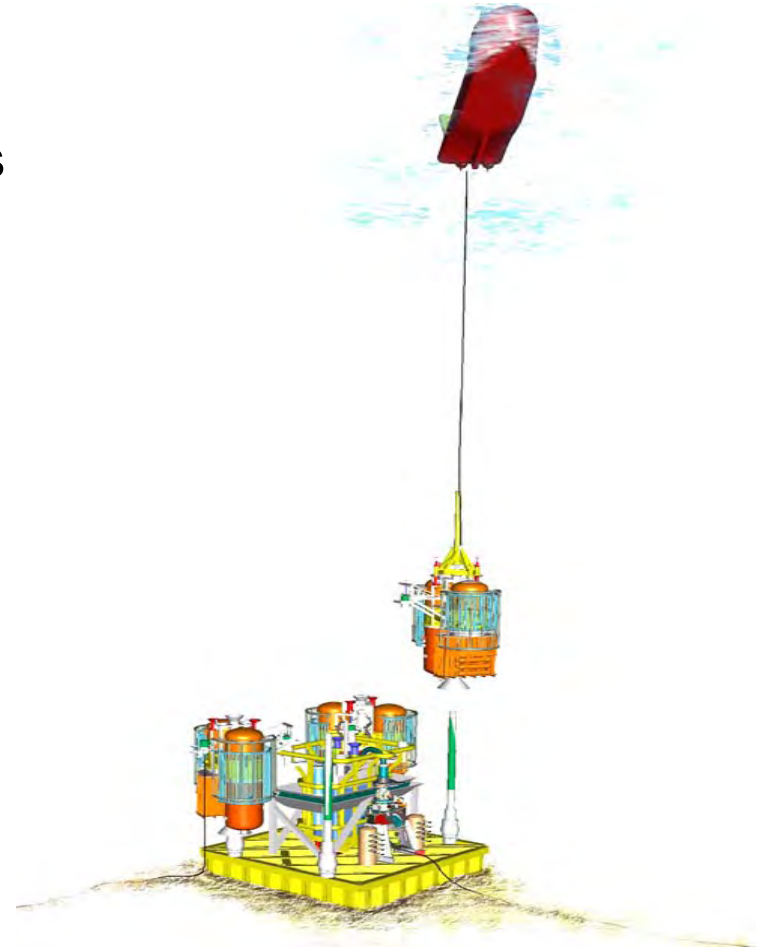

Future Deepwater Trees – Modular packages

Light Intervention
Friendly Tree (LIFT)

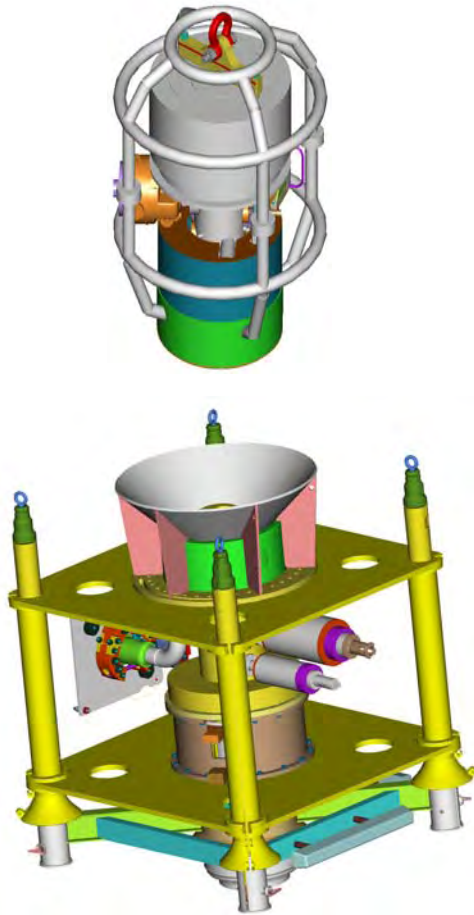

NuComp Deepwater
Tree Module

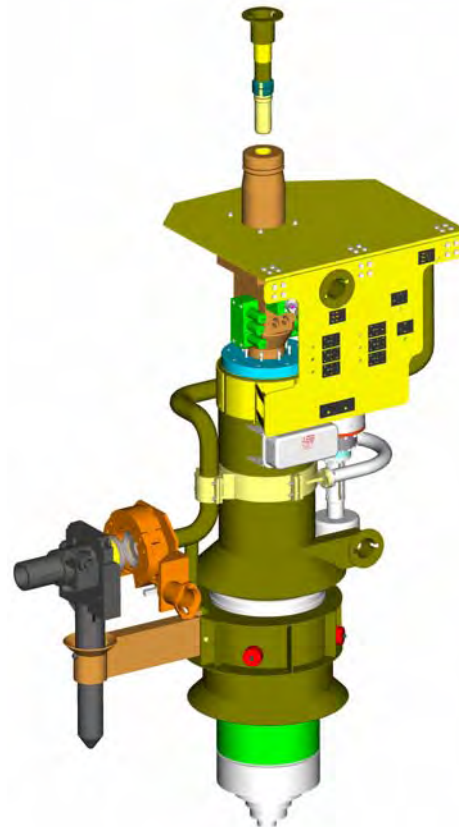

Downhole Trees

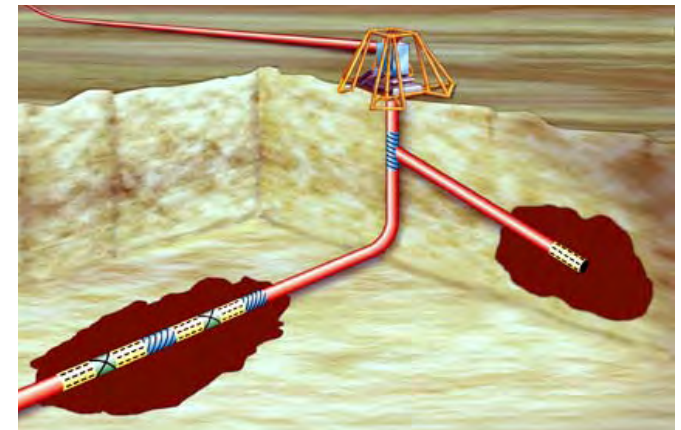

Future deepwater Tree capabilities and needs

- Tree Installation guidance-assist will become a more important ROV function for both MODU's and Construction Vessels.
- Component Change-out will become the norm using ROV assist, either with an ROT on downline, or neutrally buoyant ROT's. This will need to be accomplished off small Service Vessels.
- The increased usage of sensors and associated electronic devices will dictate the need for ROV replaceable units.
- The increased quantity of ROV functions on complex deepwater trees will dictate the need for the miniaturization of these ROV interfaces.
- The ROV Control System should be utilized for subsea tree installation and workover control duty.
- API/ISO ROV Interface Specifications were a good start, but further Standardization is required to ensure efficient deepwater operations.
- Standardized Tooling will allow us to afford Smart Tools.



Finally, Anticipate the Unanticipated

Effects of Deep Sea Hydrostatic Pressure on a Pipeline cutting operation:



ROV Video Courtesy of: ?





Stolt Offshore

TEXAS A&M

ROV Presentation

April 2003

Stolt Offshore's ROV Capabilities

Improvements to Technology

Future Capabilities

Issues Facing the Industry



Introduction

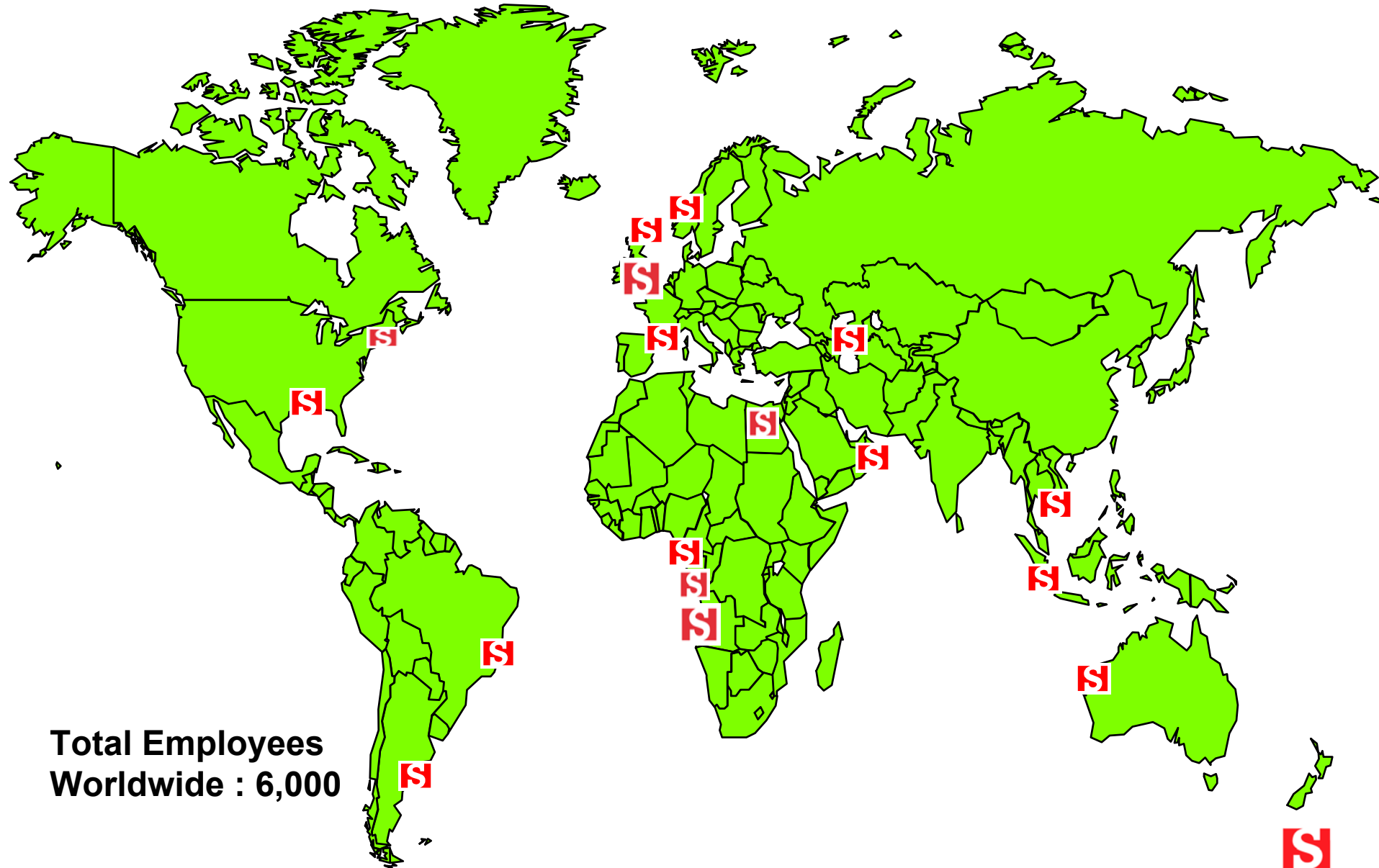

**Total Employees
Worldwide : 6,000**



INTERVENTION TECHNOLOGIES



SCS INTERNATIONAL ROV FLEET

- **TRENCHER**
- **SCV-100**
- **TRITON**
- **TRITON ST**
- **TRITON XL**

- **SCORPIO**
- **SCORPION**
- **SEA HAWK**
- **SEA OWL**
- **SEAWORKER**
- **SOLO**
- **SPRINT**
- **VIPER**
- **VOYAGER**

***Totaling 108 vehicles**

SCV 3000



TRITON ST

- Heavy Work ROV
- 10,000 ft Standard depth
- Custom Applications:
 - Telecommunication Support
 - Burial and Trenching
 - Deepwater Pipe Repair Systems
- Subsea Remote Intervention Capabilities
- Deploy Tools and Packages up to 2,000 kg (4,400 lbs.)



TRITON™ XL

- **Heavy Work ROV**
- **8,000 ft Standard Depth**
- **Custom Applications:**
 - **Telecommunication Support**
 - **Burial and Trenching**
 - **Deepwater Pipe Repair Systems**
- **Subsea Remote Intervention Capabilities**
- **Deploy Tools and Packages up to 3,000 kg (6,600 lbs.)**

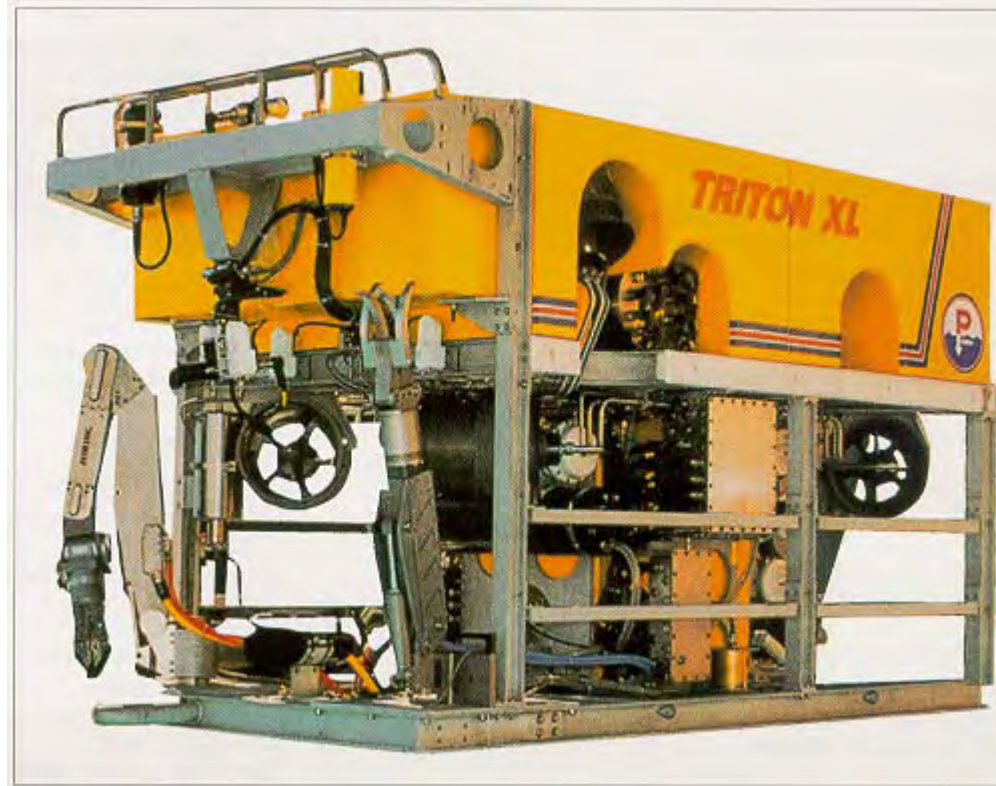

SCORPION™

- **Medium Work Class ROV**
- **1000m & 1,500m Units**
- **Pipe Survey and Inspection**
- **Construction and Pipe Support**
- **Deploy Tools <1,000 lbs.**
- **Drill Support**
- **S-20 & S-23**

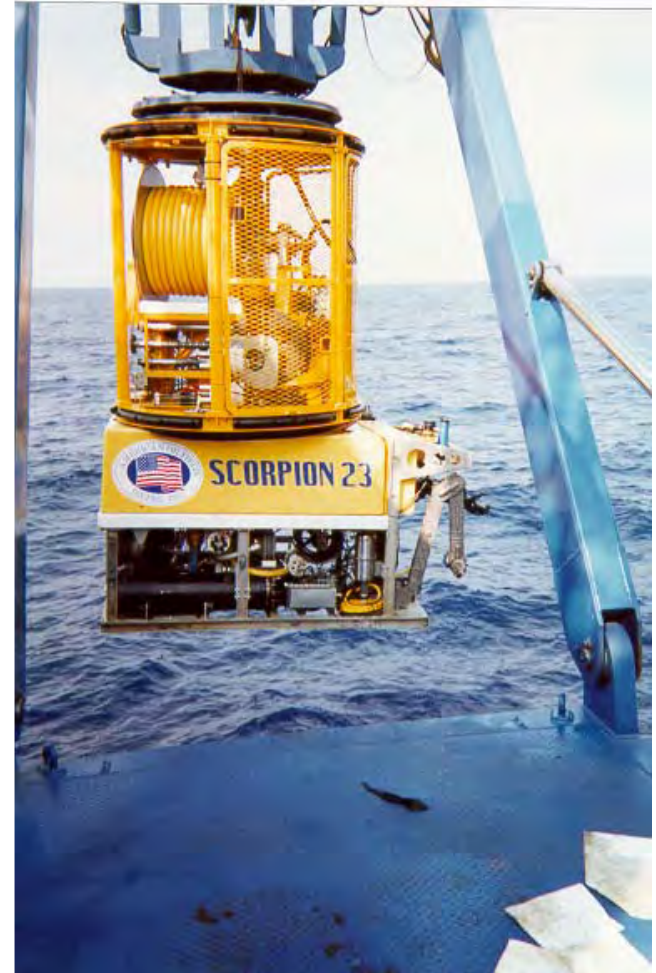

VIPER™

- **Small Footprint 200 Class ROV**
- **1,000m Standard**
- **50 Hp**
- **Drill Support Market**
- **Construction and General Pipe Lay Support**
- **Deploy Subsea Tools**
 - **Torque Wrenches (Small)**
 - **LP Water Jet**
 - **Brushes**
 - **AX Ring Tool**
 - **Wire Cutter**



VOYAGER™

- **Electric 100 Class Survey ROV**
- **Standard 610m Depth**
- **1,500m Depth Option**
- **Survey / Inspection Market**
- **Fiber Optic Data / Video**
- **Diver and ROV Support**
- **Deploys Optional:**
 - **1-3-Function Electric Arm**
 - **CP Probes**
 - **Still Camera**
 - **Small Rope and Wire Cutter**
 - **Pipe / Cable Tracker Systems**

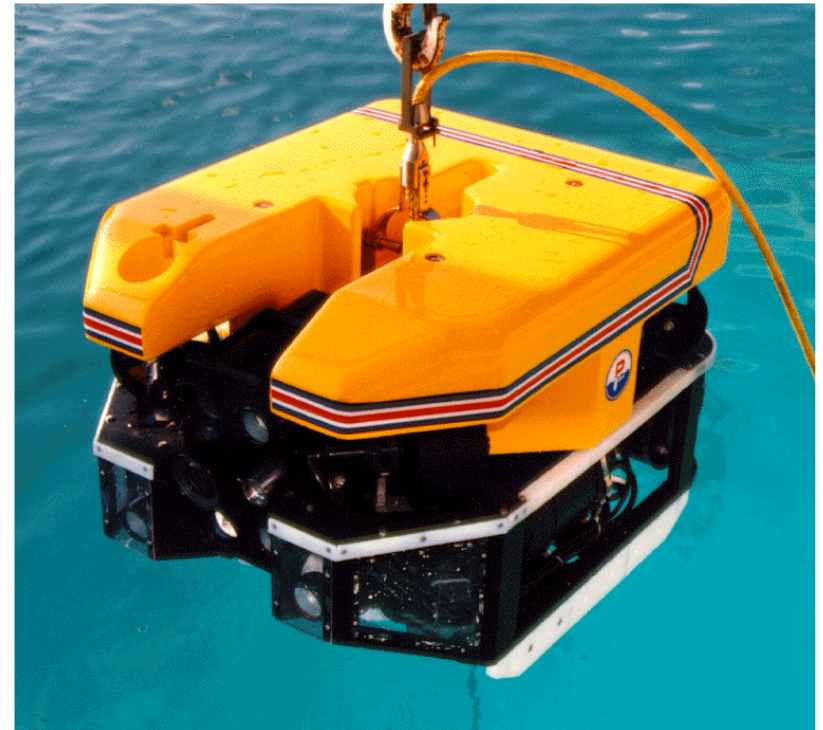

Stolt Offshore

MATIS

Diverless (API) Flange-ups



Modular Advanced Tie-In System (MATIS)

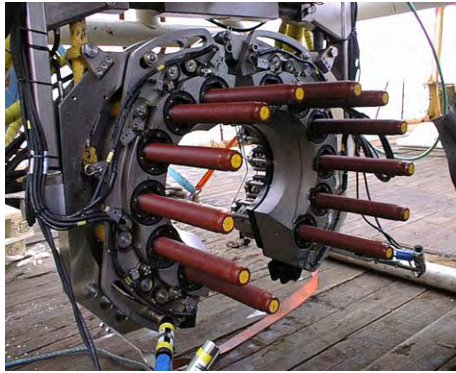

MATIS 2
Module w/ Alignment Frame



DEEP MATIS
4 inch - 16 inch

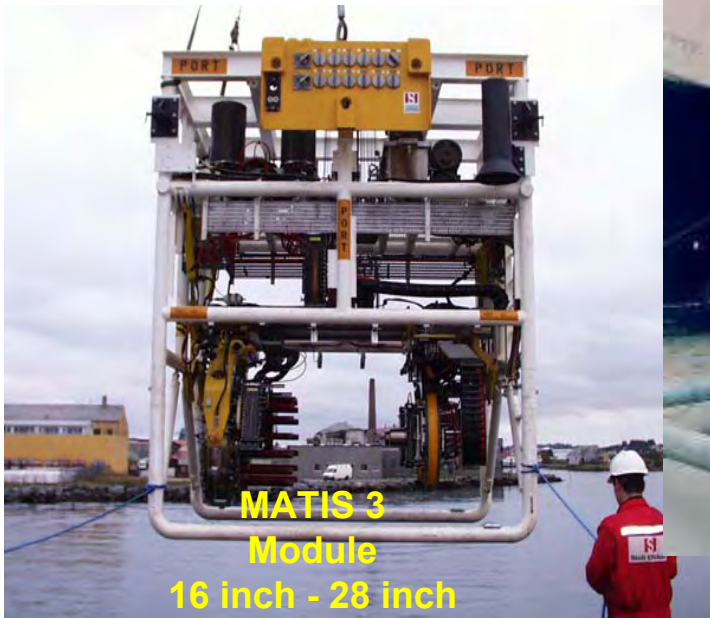

MATIS 3
Module
16 inch - 28 inch



DEEP MATIS

Rated for 9000 feet

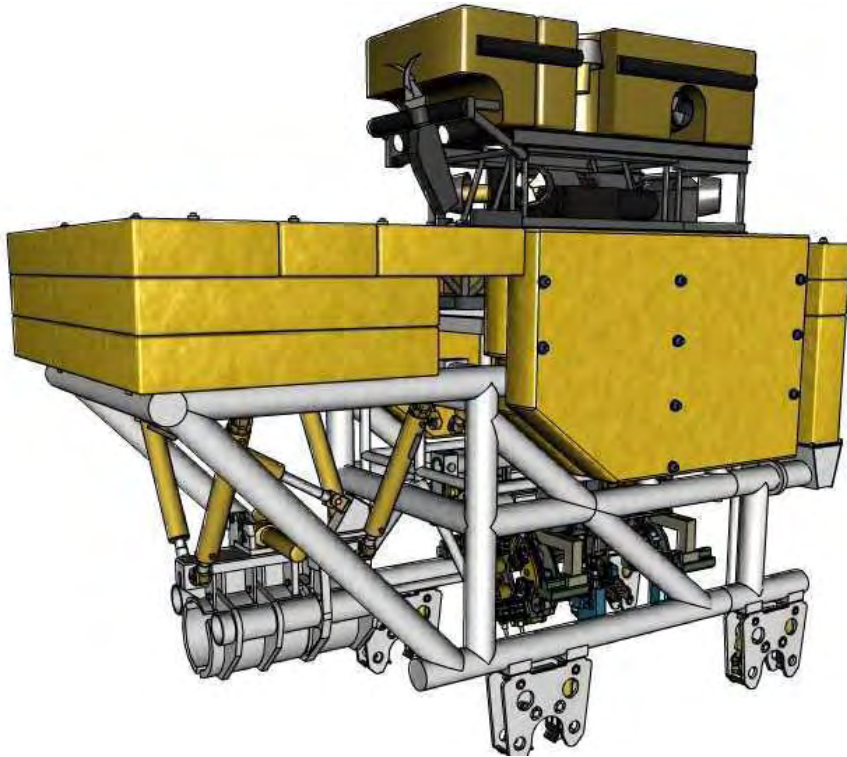

- 2000 MATIS 3 First tie-ins
Statoil - 600 feet of water
4 flanged 24"
- 2001 / 2002 Deepwater MATIS
Girassol flanged tie-ins 4700/
feet of water installed
65 vertical and horizontal
flanged tie-ins 9" & 13"
(with no leaks)

The Reliable Deepwater Subsea Connection “A Diverless Connector”

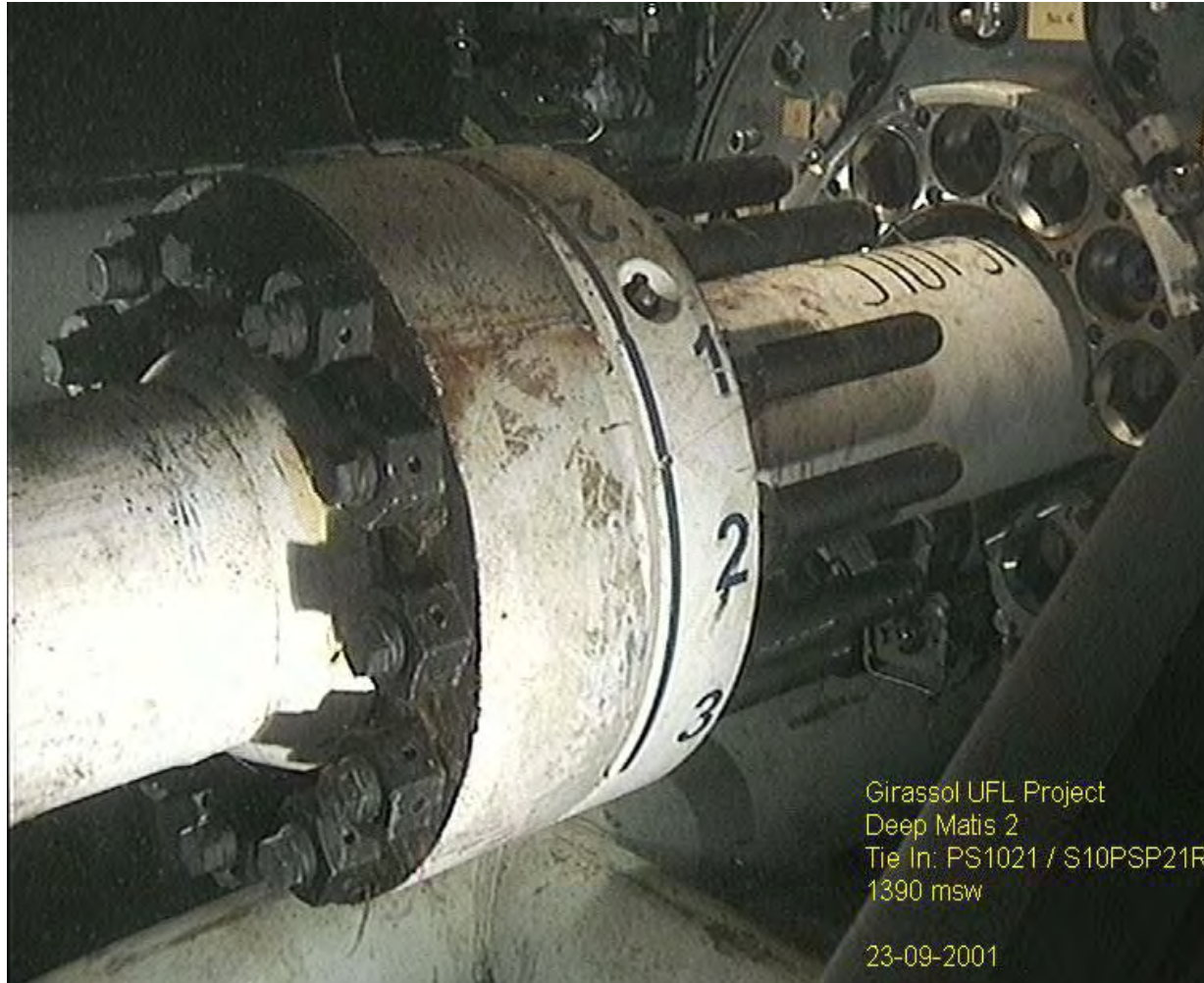

Girassol UFL Project
Deep Matis 2
Tie In: PS1021 / S10PSP21R
1390 msw

23-09-2001

Stolt Offshore



Stolt Offshore

ROV

Construction Ships



Seaway Hawk

Length overall :306'
Beam 62'
Mooring :D.P. 2
4 point anchor
Cranes :240/10 metric ton
Accommodations :210



Seaway Legend

Length overall :240'
Beam :62'
Mooring :D.P. 2
**Cranes :“A” Frame /
40 ton/10 ton**
Accommodations :54



Seaway Defender

Length overall: 220'
Beam: 45'
Mooring: DP 2
Cranes: 40 metric ton
Accommodations: 58



ROVER

Length overall: 234'
Beam: 40'
Mooring: DP 1
Cranes: 10/2 metric ton
Accommodations: 32



Seaway Explorer with Deep MATIS

Length overall	:	210'
Beam	:	40'
Mooring	:	DP-2 and Anchors
Cranes	:	50 ton
Accommodations	:	40



Seaway Eagle

Length overall: 440'
Beam: 62'
Mooring: DP 2
Cranes: 155 metric ton
250 ton A&R
Accommodations: 114



Seaway Kingfisher

Length overall: 288'
Beam: 55'
Mooring: DP 2
Cranes: 50 metric ton
Accommodations: 51



Seaway Discovery

Length overall: 380'
Beam: 62'
Mooring: DP 2
Cranes: 140/10 metric ton
Accommodations: 97



Seaway Harrier



Length overall: 268'
Beam: 62'
Mooring: DP 2
4 point anchor
Cranes: (2) 60 metric ton
Accommodations: 86
1 Hospital Bed

Seaway Kestrel

DP3- REEL PIPE & UMBILICAL LAY



Length overall:	315'
Beam:	79'
Mooring:	DP 3
Cranes:	400 metric ton
Accommodations:	80

Seaway Osprey

Length overall: 26324'
Beam: 70'
Mooring: DP 2
Cranes: 70/40 metric ton
Accommodations: 90



SIGNIFICANT TECHNOLOGY LEAPS TO DATE:

- **ROV Dependent Projects**
- **Depth Capability**
- **Equipment Reliability**
- **Construction Class Standardization**
- **Auxiliary Equipment Advances**
 - Manipulators
 - Sonars
 - Cameras
 - Leak Detection



FUTURE CAPABILITIES:

- **AUV Lending the Path for ROV's**
- **Multi-Tasking**
- **Longer Depth Duration**
- **Reliability**



CURRENT ISSUES FACING THE INDUSTRY:

- **Marketing the Oilfield**
- **Longevity of Current Personnel**
- **Training & Skill of Personnel**
- **Deepwater Intervention Schools**
- **Manning ROV Systems**
 - 6 men + 1
 - 2 ROV Systems



Stolt Offshore World



OTRC Workshop 10th&11th April 2003
ROV, AUV & Subsea Systems

Future ROV & ROV Tooling Capabilities

- Trends
- &
- Observations

Trends

- Larger vehicles
- Hardware manufacturers supplying tools
- More demanding construction tasks

Observations

- Built-in stagnation
- No reliable data on where weaknesses are
- Rare to see 'installed cost' responsibility
- Contractor-led development – limited benefits
- Industry-led development – powerful benefits

40 years of subsea innovation



PERRY SLINGSBY SYSTEMS
TECHNIP-COFLEXIP GROUP

www.perryslingsbysystems.com



PERRY SLINGSBY SYSTEMS

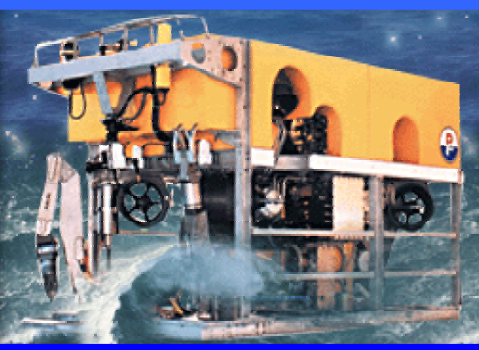

PRESENT ROV CAPABILITIES

Fred Hettinger

April 2003

TECHNIP-COFLEXIP



PRESENT ROV CAPABILITIES

TRITON® TXLS

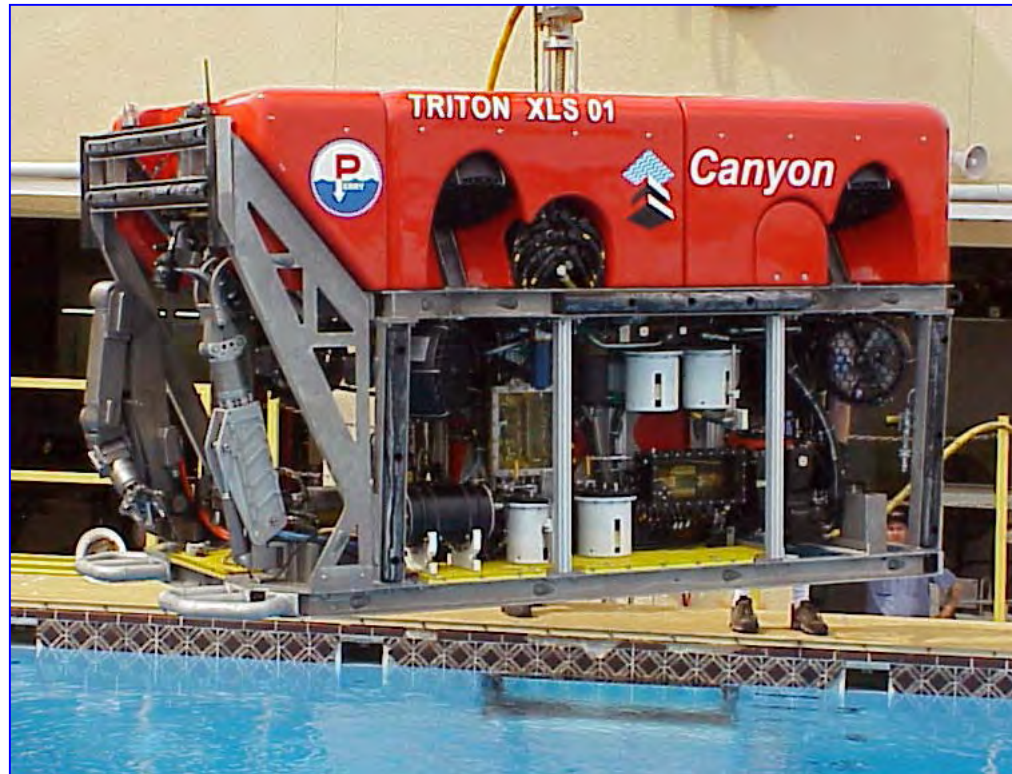



SUMMARY

TRITON® TXLS

- TYPE: OPEN-FRAME HEAVY WORK CLASS
- SIZE: 118" LENGTH X 73" WIDTH X 73" HEIGHT
- WEIGHT: 8,420 LBS. (AIR)
- PAYLOAD: 440 LBS.
- MAX LIFT: 6,615 LBS. (THRU FRAME)
- DEPTH: 10,000 FSW
- FWD SPEED: 3.0 KTS
- VRT SPEED: 2.0 KTS (UP) ; 1.8 KTS (DOWN)
- HYD HP: 100 SHAFT HP
- PRESSURE: 3,500 PSI WORKING HYDRAULIC
- HYD FLOW: 0 – 55 GPM



EQUIPMENT

TRITON® TXLS

- 7-FUNCTION SPATIALLY CORRESPONDENT MANIPULATOR
- 5-FUNCTION GRABBER MANIPULATOR
- THRUSTERS: 4 HORIZONTAL / 4 VERTICAL
- CAMERA PAN & TILT UNITS – 2 EA.
- DEPTH SENSOR: +/- 1.0 FT. / FULL OPERATING RANGE
- ALTIMETER: 7.62MM RESOLUTION / 30M RANGE
- HEADING TRANSDUCER: +/- 2.0 DEGREES
- PITCH / ROLL TRANSDUCER: +/- 0.2 DEGREES
- CP MEASUREMENT
- LIGHTS: 5 GROUPS W/ 2 LAMPS PER GROUP - 3,000W TOTAL
- SONAR
- CAMERAS: 8 – MIX OF LOW LIGHT LEVEL CCP/COLOR/ZOOM + B/W AS SELECTED



CURRENT ROV CAPABILITIES / TASKS

- HYDRAULIC SOURCE / HOT STABS
- VALVE OVERRIDE / REPLACEMENT
- VALVE OPERATION / LINEAR ACTUATOR / LOCKOUT
- TORQUE TOOLS / TURNS FEEDBACK (0 – 10,000 FT.LB)
- RIGID & FLEXIBLE FLOWLINE TIE-INS
- DIVERLESS PIPELINE REPAIR SYSTEMS
- FLOWLINE / JUMPER INSTALLATION SYSTEMS & TOOLS
- SEAL / GASKET REPLACEMENT
- FLYING LEAD INSTALLATION
- GLYCOL / CHEMICAL / CORROSION INHIBITOR INJECTION
- EMERGENCY RELEASE – MECH. & HYDRAULIC CONNECTORS



CURRENT ROV CAPABILITIES / TASKS

CONTINUED

- SCM & CHOKE INSERT REPLACEMENT
- TREE CAP / PRESSURE CAP INSTALLATION / REMOVAL
- PIPELINE STABILIZATION / SPAN RECTIFICATION
- GENERAL EQUIPMENT INSTALLATION / RETRIEVAL
- SUCTION PILE INSTALLATION
- HYDRATE REMEDIATION
- SUBSEA PULL-IN WINCH OPERATION
- SUBSEA PIG LAUNCHER / OPERATION
- RISER / PIPELINE / STRUCTURE ANODE REPLACEMENT
- SUBSEA GREASE INJECTION
- SUBSEA LEVELING SYSTEMS



FUTURE ROV CAPABILITIES/TASKS

- 5,000M ROV SYSTEM DEVELOPMENT
- NETWORKING / INTEGRATION OF SENSORS & DATA TRANSFER
- CONTROL SYSTEMS – WEB INTERACTIVE / DIAGNOSTICS
- ROV – REPLACEABLE SENSOR SYSTEMS
- SUBSEA FIELD-BASED POWER & COMMUNICATION SOURCES
- AUV / ROV HYBRID APPLICATIONS
- ADVANCED INTERVENTION SYSTEMS- SUBSEA PROCESSING, HYDRATE REMEDIATION, COIL TUBING



40 years of subsea innovation



PERRY SLINGSBY SYSTEMS
TECHNIP-COFLEXIP GROUP

www.perryslingsbysystems.com

Innovator[®]

Deepwater Remotely Operated Vehicle System

Sonsub

 Saipem

Develop New ROV to Address the Challenges of Operating in Deepwater.



INNOVATOR

INNOVATOR™



Innovator

- Length: 2.94m
- Width: 1.52m
- Height: 1.95m
- Payload: 1,000kg
- Depth Rating: 3,000msw

Hydraulic Power

- One 200 Hp Dual Shaft Electric Motor (150 Shaft HP)

Propulsion System

- Seven RHL hydraulic thrusters are provided

Thrust

- 2205 lb (1000 Kg) of Thrust compared to 1,430 lb (650 kg)

Environmental

- Auto hydraulic system shut down
- Precise level indicators on all compensators
- Operational on environmentally friendly fluids

- ◆ Extended Tether Excursion (750m)
- ◆ Soft Dock Extending Weather Operations
- ◆ Constant Tension Recovery Mode
- ◆ 4 Pole, 10 HP Dual Shaft Motor
- ◆ 10,000 Kg Latch Capability
- ◆ 3500 Kg in Air
- ◆ Reduced Complexity/ Increased Reliability
 - Single Sheave Wheel
 - Direct Drive Motor
 - Electro-hydraulic Level Wind
 - Standardization of Components

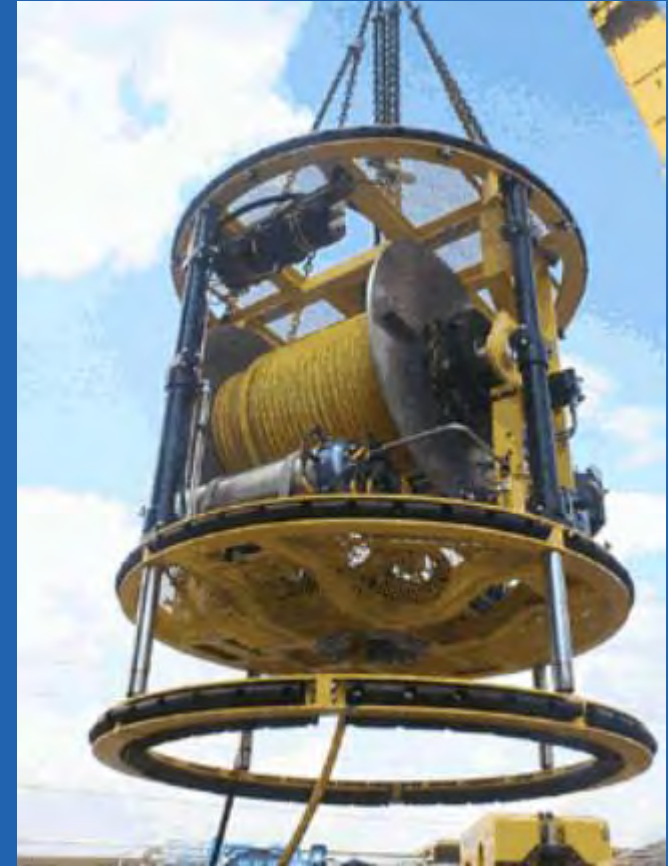

INNOVATOR



Standard ROV - 200 m (656ft.)



**Innovator[®] - 750 m (2,624ft.)
(optional 1,200 m)**



Innovator[®] (Future) Greater than 1,200 m

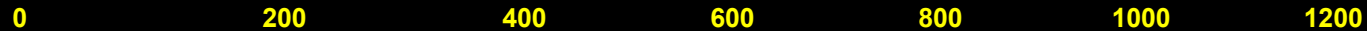

INNOVATOR

Spirit Energy Drill Ship

- ◆ Innovator[®] 8: (3500m depth rated)
- ◆ Max Depth : 2982 meters (to date)
- ◆ Total System Dives: 196 (to date)
- ◆ In Water Time: 4625 hrs (to date)
- ◆ Downtime: 21 hrs (to date)
- ◆ Mobilized: 04/26/00



INNOVATOR

- The Innovator® ROV System Provides the Client With a Highly Productive and Reliable, 3500 meter, Cost- Effective Solution Through Innovative Field-Proven Technology

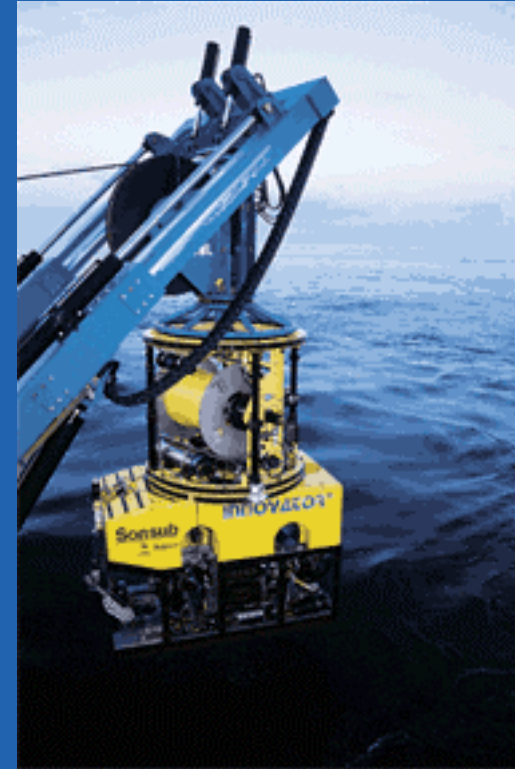

INNOVATOR

- 1) True 3000m+ Depth Capability
- 2) High Voltage Power Drive System (4500V)
- 3) Increased Power & Thrust (1000 kg of Thrust 3)
- 4) Extended Tether Excursion (up to 1.2 km)
- 5) Subsea Fluid Transfer and Top Up
- 6) Fiber Optic Gyro Compass
- 7) High Capability / Small Diameter Umbilical
- 8) Multi Purpose / Multi Port Hot Stab Control Systems
- 9) Various ROV Operated Tooling Systems

innovator

- 1) 6000m Depth Capability
- 2) Ultra High Voltage Power Drive System (12,000V)
- 3) Increased Thrust to 1500 kg
- 4) Tether Excursion up to 3 km
- 5) Inertial Navigation System
- 6) “Foolproof” Reliability
- 7) High Capability but Smaller ROV Systems
- 8) More Complex ROV Operated Tooling Systems

INNOVATION

Sonsub



Saipem

www.sonsub.com

OTRC ROV / AUV Workshop

April 10 /11 2003



Canyon Offshore



ROV Services



Overview

- **Market Definition**
- **Facility Types**
- **Facility ROV System Requirements**
- **Deepwater ROV Operations**
- **Future ROV Requirements**
- **Summary**



ROV Market Definitions

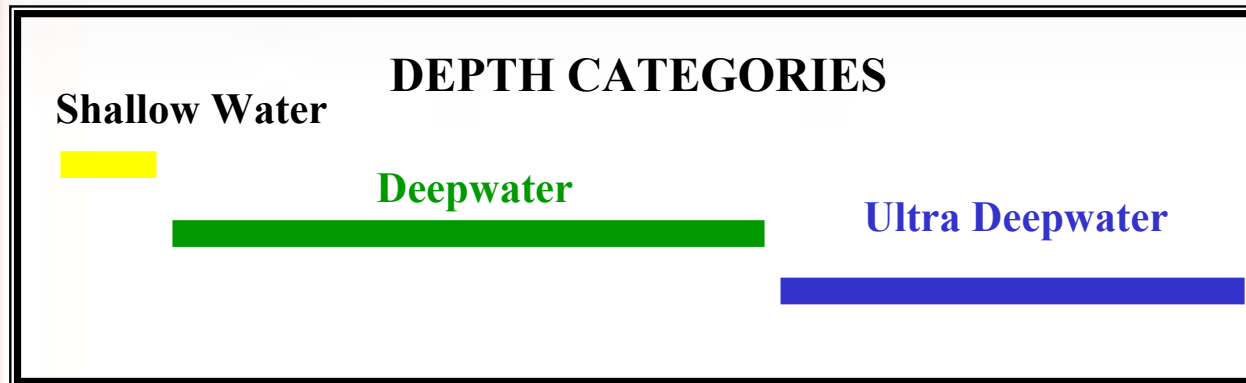
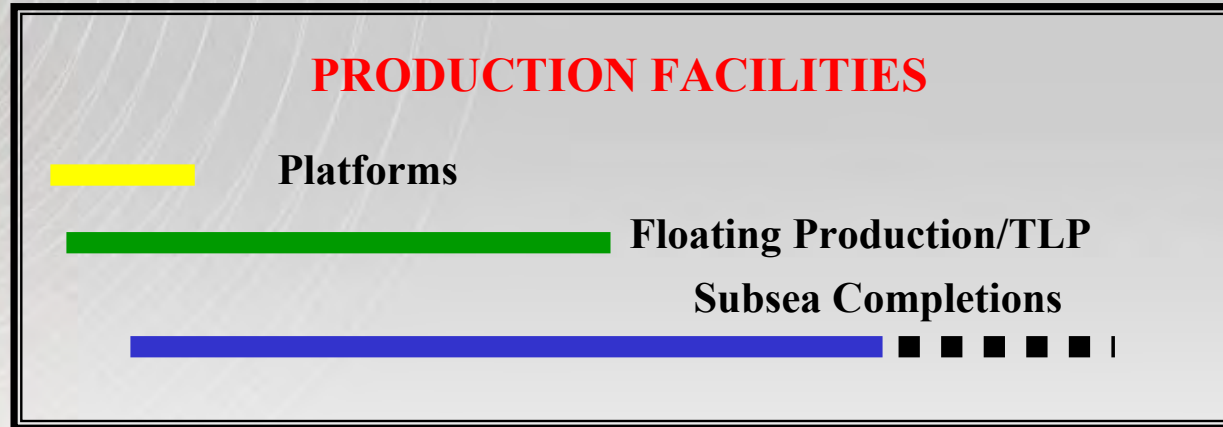



ROV's are Life of Field Tools

- ROV systems are required in all Deepwater (>1,000 fsw) activities from Drilling to Abandonment
- They are critical Path Assets
- They are used in every phase of project development
 - Exploration / Drilling
 - Construction
 - Production
 - IRM
 - Decommissioning / Abandonment
- Activities are mandated by MMS and others



Offshore Oil Operation Stages

- **Drilling** **0.25-1 Year**
- **Offshore Construction** **0.5-1 Year**
- **Production Operations** **5-20 Years**
- **Inspection & Maintenance** **5-20 Years**
- **Decommissioning** **0.5-1 Year**



ROV's Support Many Facilities

Surface Platforms

- Fixed Structures
- TLP, Spar,
- FPSO, FSO, FPO
- Riser Systems
 - Steel, Rigid
 - SCR
 - Hybrids-Steel, Flex Joints

Subsea Facilities

- Manifolds, Templates, Trees
- Pipelines, Rigid & Flexible,
- Maintenance Facilities
- Electrical / Hydraulic Supplies

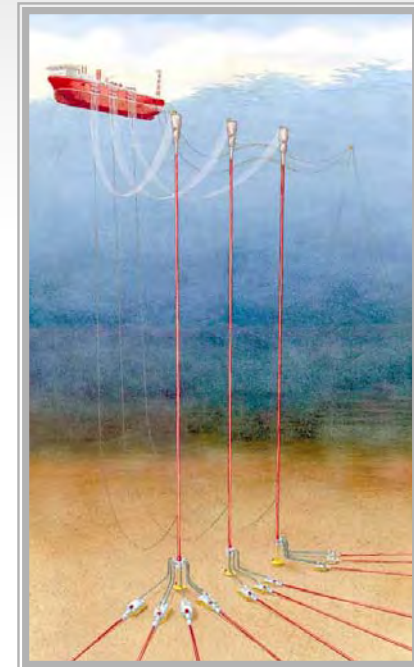



Vessels Provide Mobility

- Integrated Vessel & ROV Spreads are Common
- Deepwater ROV Vessels require:
 - Good Weather Abilities
 - Dynamic Positioning
 - Cranes and Winch Assemblies
 - Survey equipment
 - Communications and Computer Links
 - Heli-decks as we go farther out
 - Large Accommodations





Surface Facility & Vessel / ROV Considerations

- Deck Footprint
- Weight
- Electrical Budget
- Work Site Accessibility
- Manipulator & Tooling
- Depth Capability
- Weather Issues
 - Vessels Mainly
- HSE Issues
- Reliability or Critical Path Issues





ROV Operational Parameters

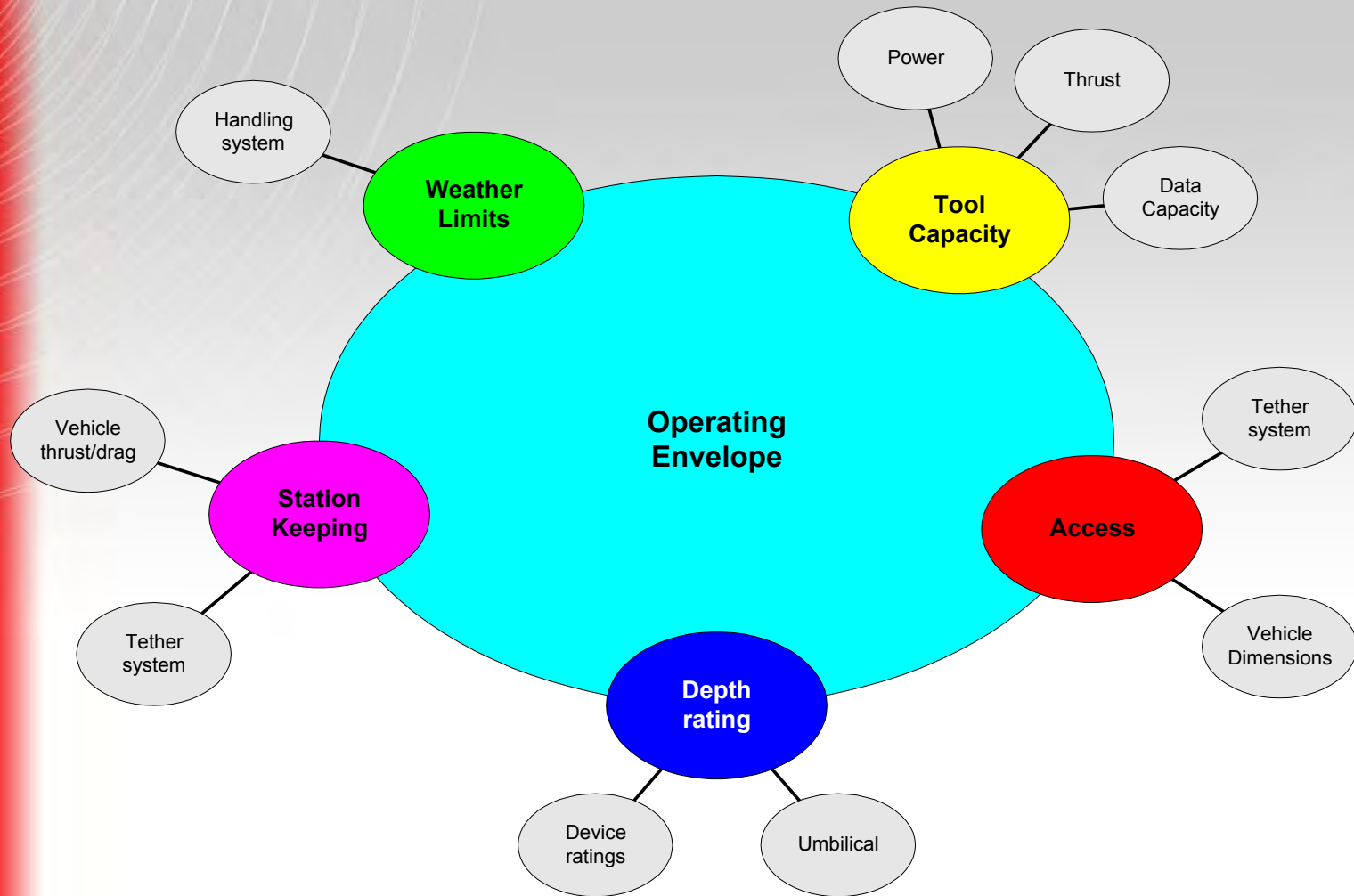



Drilling Operations

- Drilling Tasks
 - Mooring / Site Inspections
 - Template Installations and Spud
 - Riser Running & Inspection
 - Cuttings, Debris Removal
 - Maintenance / Intervention
 - Completions & Tree Sets





Subsea Construction & Intervention

- ROV Survey
 - Pre & Post Lay Survey
 - Array Sets & Calibration
 - Span Survey
 - Span Remediation
- ROV Intervention Support
 - Tie-Back Operations
 - Flow line Hook Up
 - Umbilical Connections
 - Flying Lead Installations
 - Rigging Release
 - Emergency Tasks
 - Innovation
 - Retrieve Objects

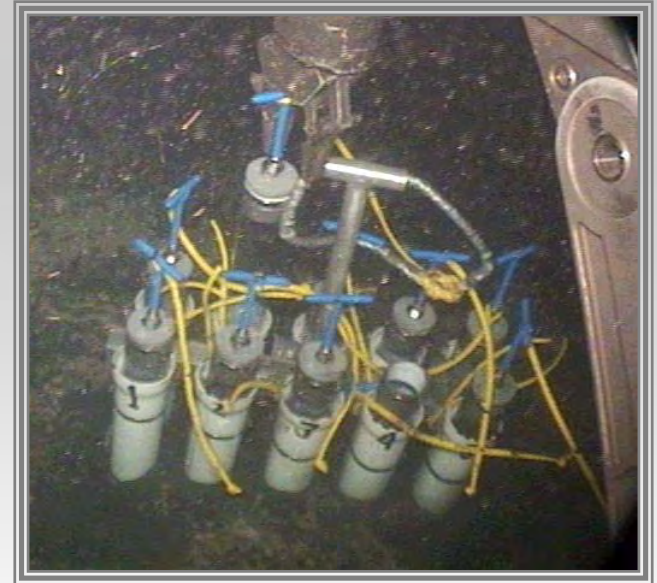



Production Operations

- Valve Operation
 - Flow Diversion for Well Test or Product Segregation
 - Choke Valve Adjustment
 - Chemical Injection
 - Valve & Connector Monitoring
- Leak Monitoring
- Corrosion Monitoring
- Contingency Operations
 - Override Valve Actuators
 - Control Bypass

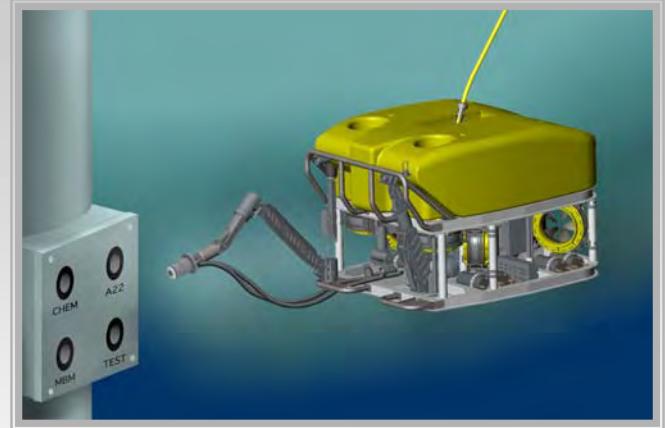



Maintenance & Inspection

- Regular Facility Inspection
- Well Work-over / Re-entry
- Hardware Maintenance:
 - Control Pods
 - Choke Valve Insert
 - Valve Stem Replacement
- Anode / coating Inspection
- Pipeline Inspection
- Hull / Mooring Inspection

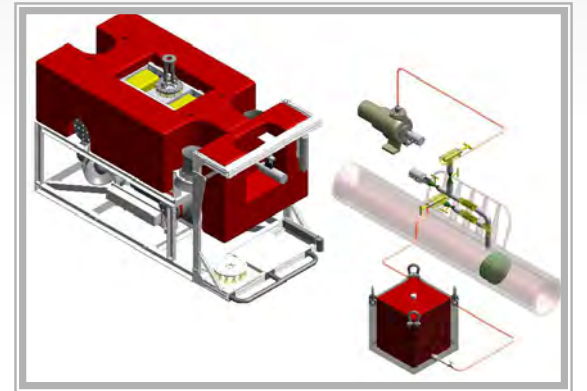



Typical ROV Intervention Tools



- Hydraulic Hot Stabs
- Torque Tools
- Hard Line Cutters
- Soft Line Cutters
- ROV Friendly Shackles & Tooling Skids
- Intervention Panels
- Custom Tooling Designs





Production & Flowline Tasks

- Rigid & Flexible Pipeline
 - Periodic Survey
 - Flow Assurance
 - Chemical Injection
 - Pig and Test
 - Leak Detection
 - Emergency Pipe Repair
 - Corrosion Monitoring
 - Crossing Protection

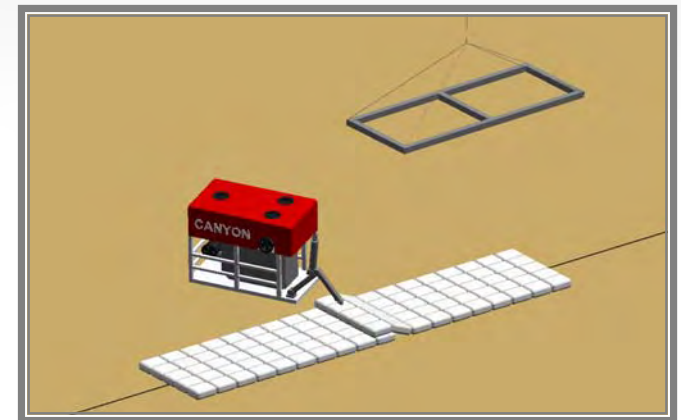
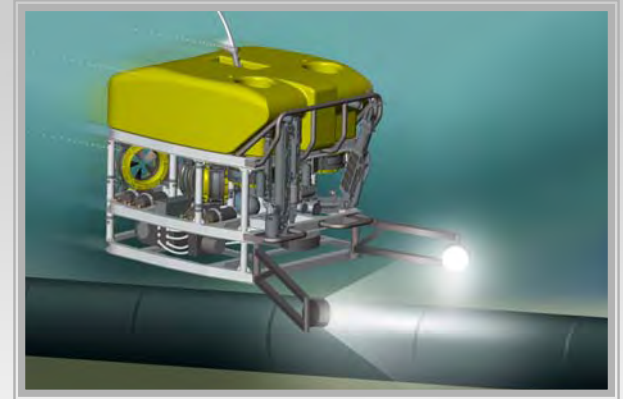



Flowline Burial Operations

- **Emerging Flow Assurance Tool due to:**
 - ✓ Small ,4-12 inch deepwater oil flowlines plug easier
 - ✓ Tie-Back Distances are greater
 - ✓ Augments other thermal remediation such as insulation
 - ✓ Burial is equivalent to about 2 inches of PU foam
- **ROV Based Trenchers Mature now**
 - Evolved from Cable Markets
 - Larger More Powerful systems available



PIP vs Buried and Coated Pipe

➤ **PIP is complex:**

- Fabrication
- Reeling
- Less Installation choices

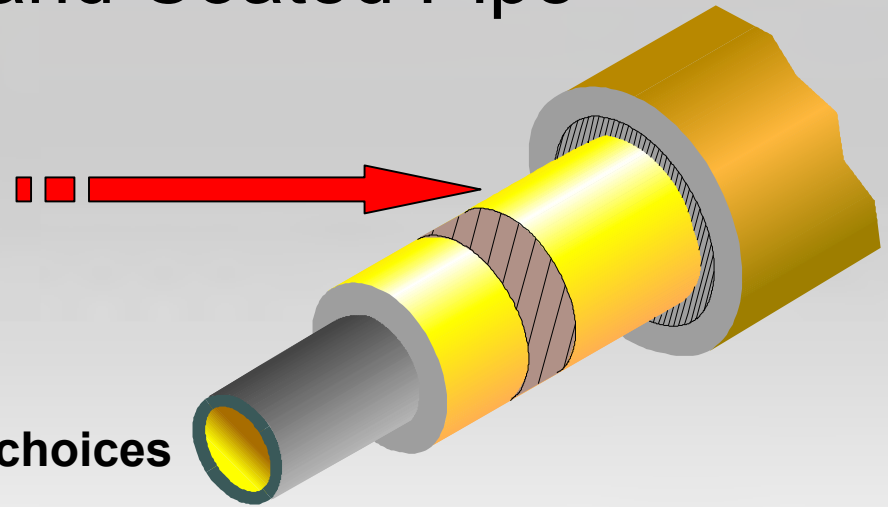

➤ **B&C Pipe offers simpler:**

- Fabrication
- Reeling
- Installation Choices

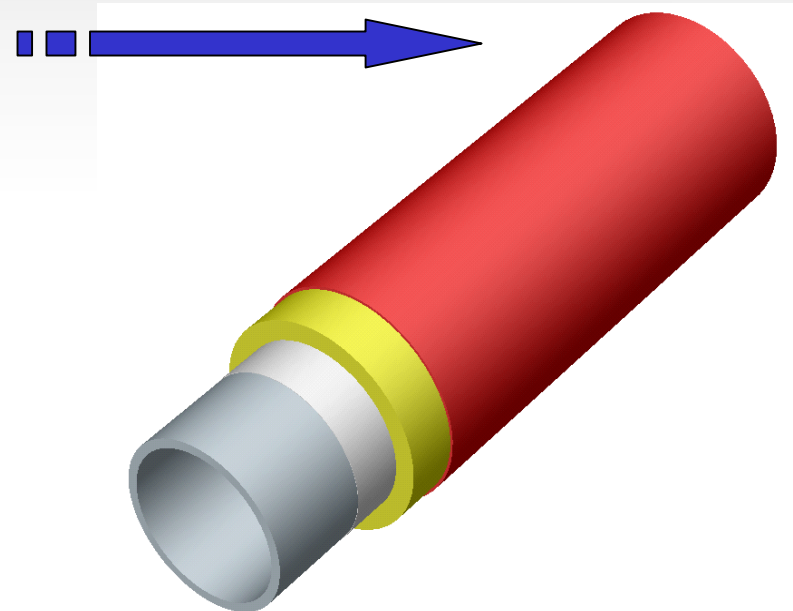



ROV Flowline Burial



Talon / T500 Trenching on Angus



GOM Flowline Burial-Angus 2800 fsw





New Flowline Super-Trencher 750 HP





ROV Future Plans: What you will See!

- Greater Depth Capability
 - 3,000m common today
 - 4,000m soon
- Size reduction to offset deepwater
- Smarter Controls
- More Powerful Systems
- Hybrid Systems
 - ROV / AUV Combination
 - “Cordless Screwdriver”
 - Subsea Power from the development
 - Subsea Mate-able Semi-residential



Improved Control Integration

ALSTOM SCHILLING ROBOTICS

AUTO

HEADING	SEMI ON	FULL OFF
300°		
DEPTH	ON	OFF
180 m		
ALTITUDE	ON	OFF
300 m		
PARK	ON	OFF
STATIONKEEP	ON	OFF

MOTION VECTOR

CANYON OFFSHORE: QUEST 1

ROV DEPTH	180m	ROV HEADING	300°
ROV-TMS DEPTH	30m	SEAFLOOR SPEED	3KN
TMS DEPTH	150m	ROLL	3°
ALTITUDE	300m	PITCH	4°

THRUSTER CONTROL

FORW	STARB	UP	PUCK SCREEN
3.77m	2.23m	-1.27m	
AFT	PORT	DOWN	ON OFF

THRUSTER CONTROL

ENABLE	DISABLE
--------	---------

SPEED

HALF FULL

FLIGHT MODE

NORMAL REVERSE

TMS COLLAR

LOCKED	READY	OPEN	UNLOCK LOCK
--------	-------	------	-------------

CAMERA

1. Front ROV

ZOOM IN OUT

FOCUS IN OUT

MANUAL AUTO

LIGHTS

1: Label1 ON OFF	1: Label1 ON OFF	1: Label1 ON OFF
------------------	------------------	------------------

PAN&TILT

P&T1 TMS ON OFF	P&T1 ROV PUCK SCREEN	P&T3 ROV SAVE
PAN 15°	TILT 15°	SP1 SP2

LEFT PUCK

TMS PT1

34. Unlatched from TMS
35. Thrusters on

TMS MOT TELEM GFD WATER COMP OTHER

12/31/2000 9:31 AM

RIGHT PUCK

RTC PILOT COPILOT

FLIGHT

ROV VIDEO TMS COMP ALARM HUB TOOLS POWER MOTOR



Tooling Evolution

- Smart Torque tools
- Tooling skids
- Field specific skids and work packages

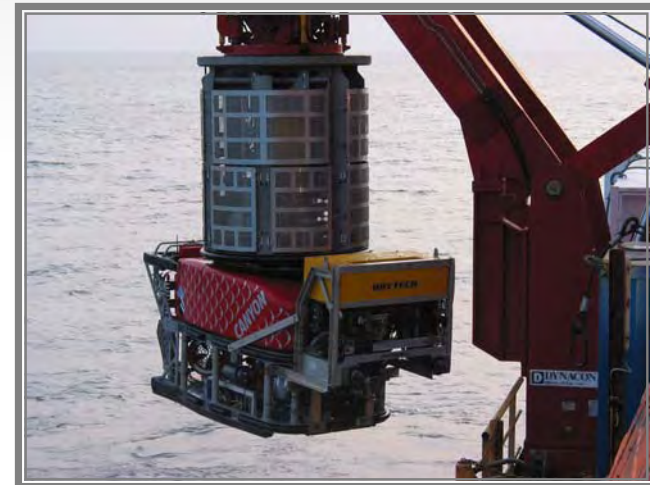
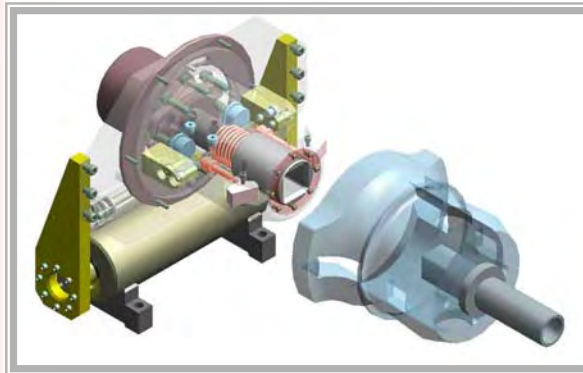
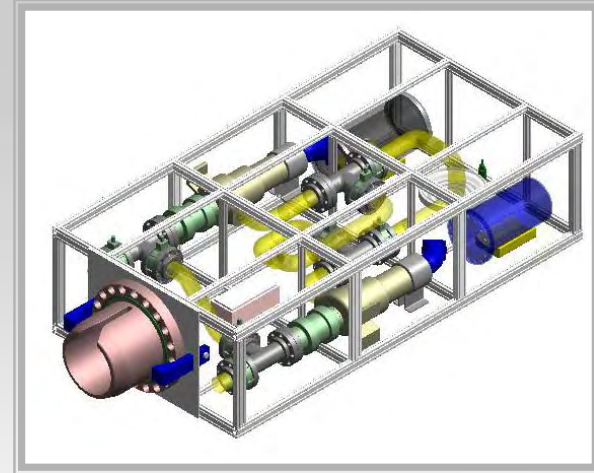



Tool Package and Control Development





Now and in the Future: Personnel



- Operator Shortage Today
 - Aging Workforce
 - Requires Higher Skills
 - Computer Skills
 - Hydraulic Skills
 - Project Planning Skills
- Writing and Communications
- Good Crews are expensive
- Bad crew is really expensive



ROV Future: What we need to Succeed

- Improved Planning with Operators
- More Trained, Skilled Personnel
- Deepwater Vessels –World Class
 - DP II
 - Accommodations
- Improved Economics
 - Industry Invest in ROV Technology
 - Involve ROV Planning for the future
 - Contractors have development burden
- Understand true “downtime costs” associated with critical Path and a poor equipment selection / match



Summary

- ROV's have a life cycle role
 - ROV requirements for all types of structures; surface, subsea
 - Intervention can be any post production support need, menial or critical.
 - Deepwater requires vessels, ROV's, trained personnel, ongoing R&D
 - Advances are in the works but slowly
 - ROV systems are irreplaceable but still are not considered at the beginning of key projects



Canyon Offshore



ROV Services

AUV SURVEYS
EXTENDING OUR REACH
20,000km LATER

OVERVIEW

C & C'S AUV VEHICLE REVIEW

C & C'S AUV OPERATIONS

AUV DATA SAMPLES

NEAR TERM UPGRADES

SUMMARY

C & C TECHNOLOGIES, INC.

Primarily a Hydrographic Surveying company

World Leader in Survey AUV Operations

Headquartered in Lafayette, LA

World Wide Experience

Established in 1992

165 Employees



RESEARCH & DEVELOPMENT



5-Years Program For the Navy:

- **Sensor Integration**
 - **Multibeam Bathymetry**
 - **Sub-bottom Profiler**
 - **Obstacle Avoidance Sonar**
- **Telemetry**
- **Video**
- **Survey Automation**
- **Auto-Survey**
- **Data Compression**
- **Mechanical Modifications**



AUV VEHICLE REVIEW

AUV VEHICLE'S CONSIDERED

- **MIT – BLUEFIN**
- **FLORIDA ATLANTIC**
- **WOODS HOLE**
- **NAVAL POSTGRADUATE SCHOOL**
- **SIMRAD**
- **ISE**
- **OTHERS**

KONGSBERG SIMRAD – HUGIN 3000

- **Proven (100+ Surveys)**
- **Commercial Company**
- **Fuel Cell Technology**
- **Multibeam Integration**
- **Launch & Retrieval**
- **C & C Software**



AUV DEVELOPMENT



C & C TECHNOLOGIES' AUV

SIMRAD HUGIN 3000

- **Rated for 3000 m**
- **Sensors: Multibeam, Sidescan, Subbottom, CTD**
- **Nav: DCPS / USBL / DVL/ INS**
- **Radio & Dual Acoustic Telemetry**
- **5.4 m long by 1.0 m diam. /1200kg**
- **Fuel Cell / 380 km Range @ 4kts (50 hrs)**
- **Fully Autonomous / Supervised Autonomous**
- **Hugin 3000 is Third Generation**
- **Delivered to C & C in August, 2000**
- **Fully Operational in January 2001**
- **Over 20,000 km Survey to Date**

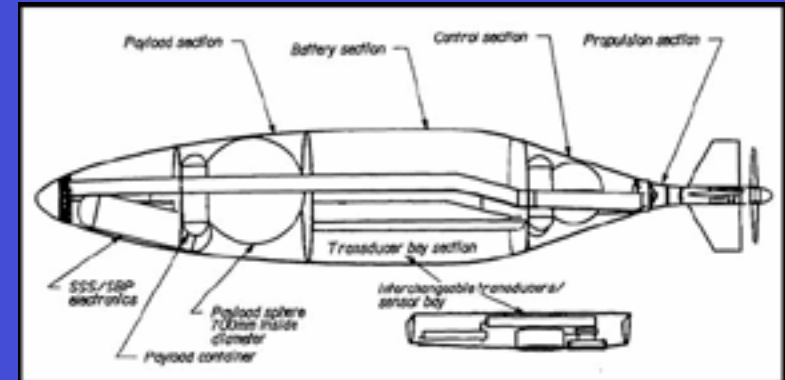

REAL TIME DISPLAY

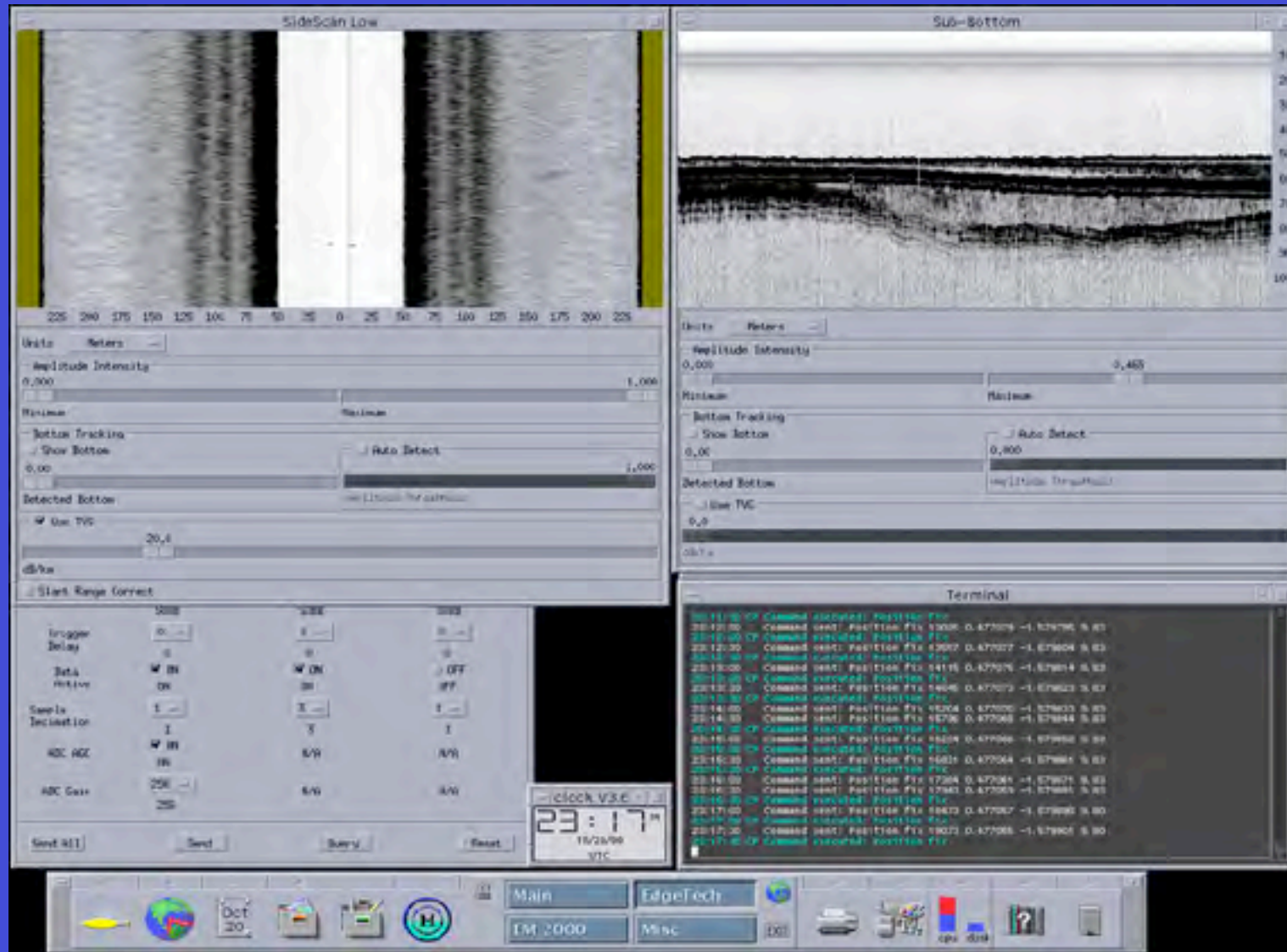

REAL TIME BATHYMETRY

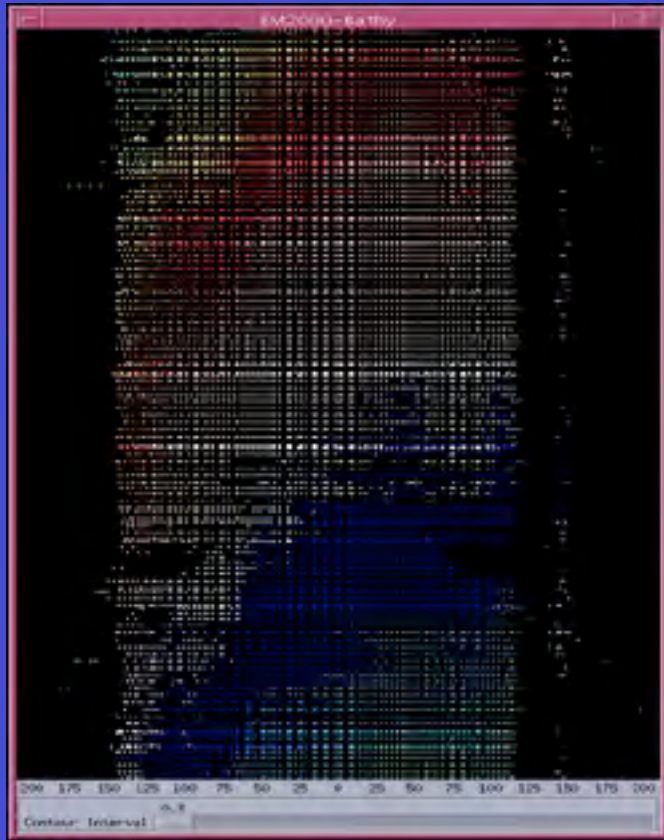

WATERFALL DISPLAY



COVERAGE MAP

C & C'S AUV DATA

MULTIBEAM BATHYMETRY DATA

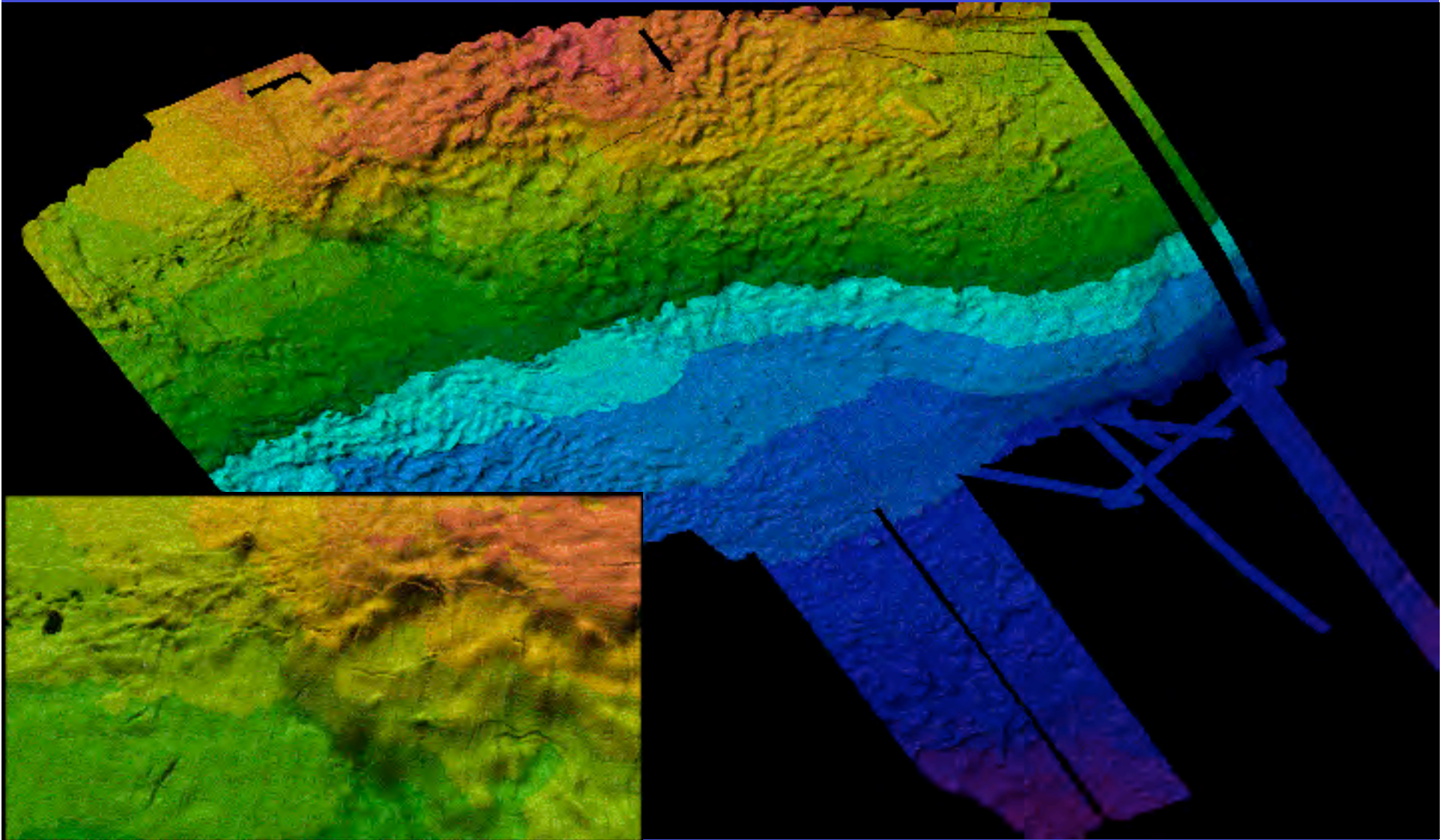

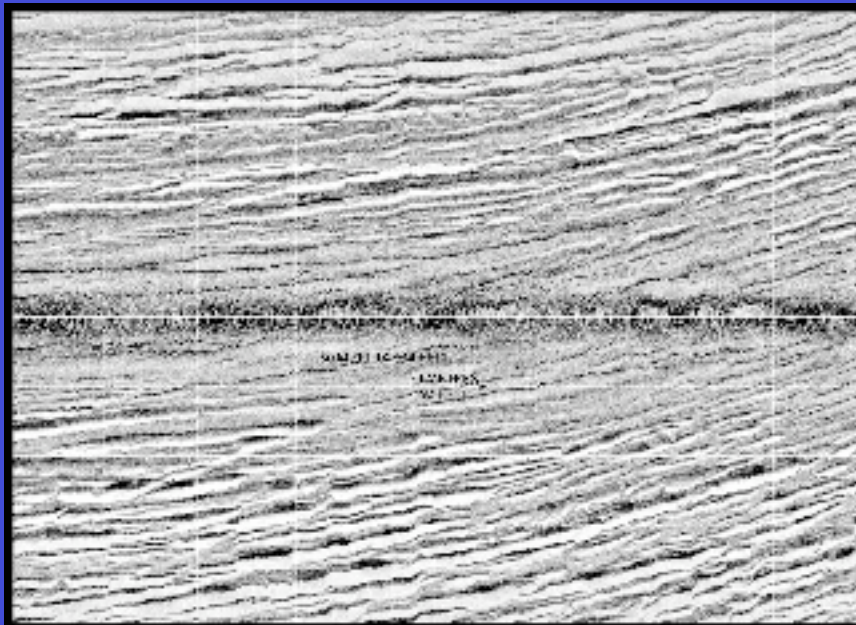
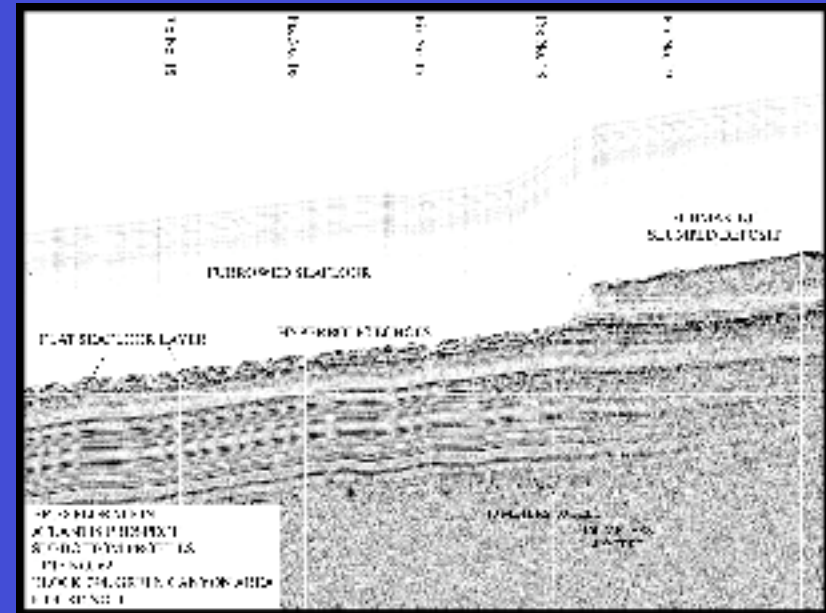
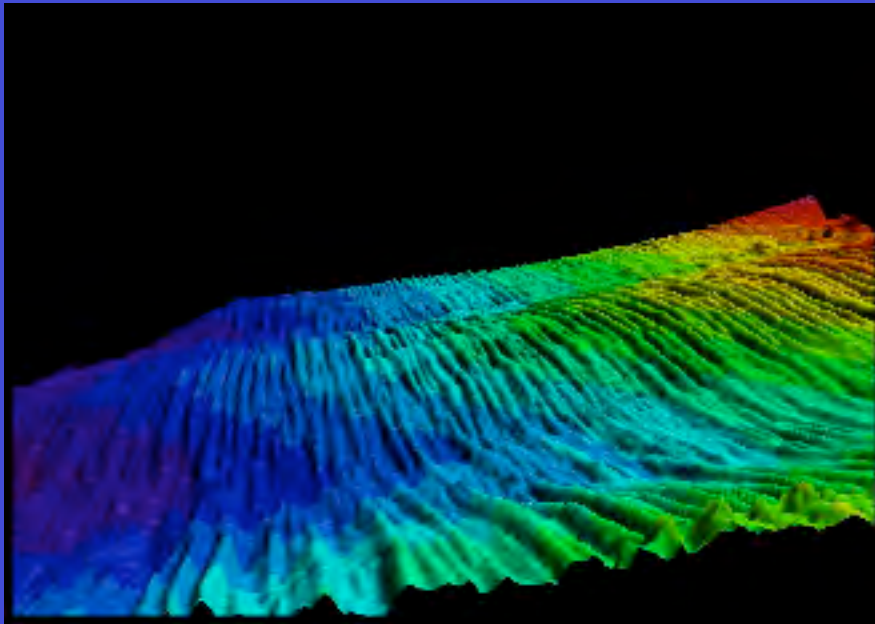

The Hugon simultaneously collected the side scan, multibeam, and sub-bottom data in the deep water Gulf of Mexico. In these water depths of greater than 2,000 meters, previously discovered 'megafurrows', (Bryant, W., Offshore Magazine, July, 2001) are clearly evident at the base of the Sigsbee Escarpment.

The Hugon maintains a fixed altitude across difficult bottom terrain. At left is a single Hugon sub-bottom profiler line collected across the Sigsbee Escarpment in water depths ranging from approximately 1,300 to 2,000 meters. The AUV reached pitch angles of greater than 45 degrees during this survey.

FLEDERMAUS 3-D MOVIE

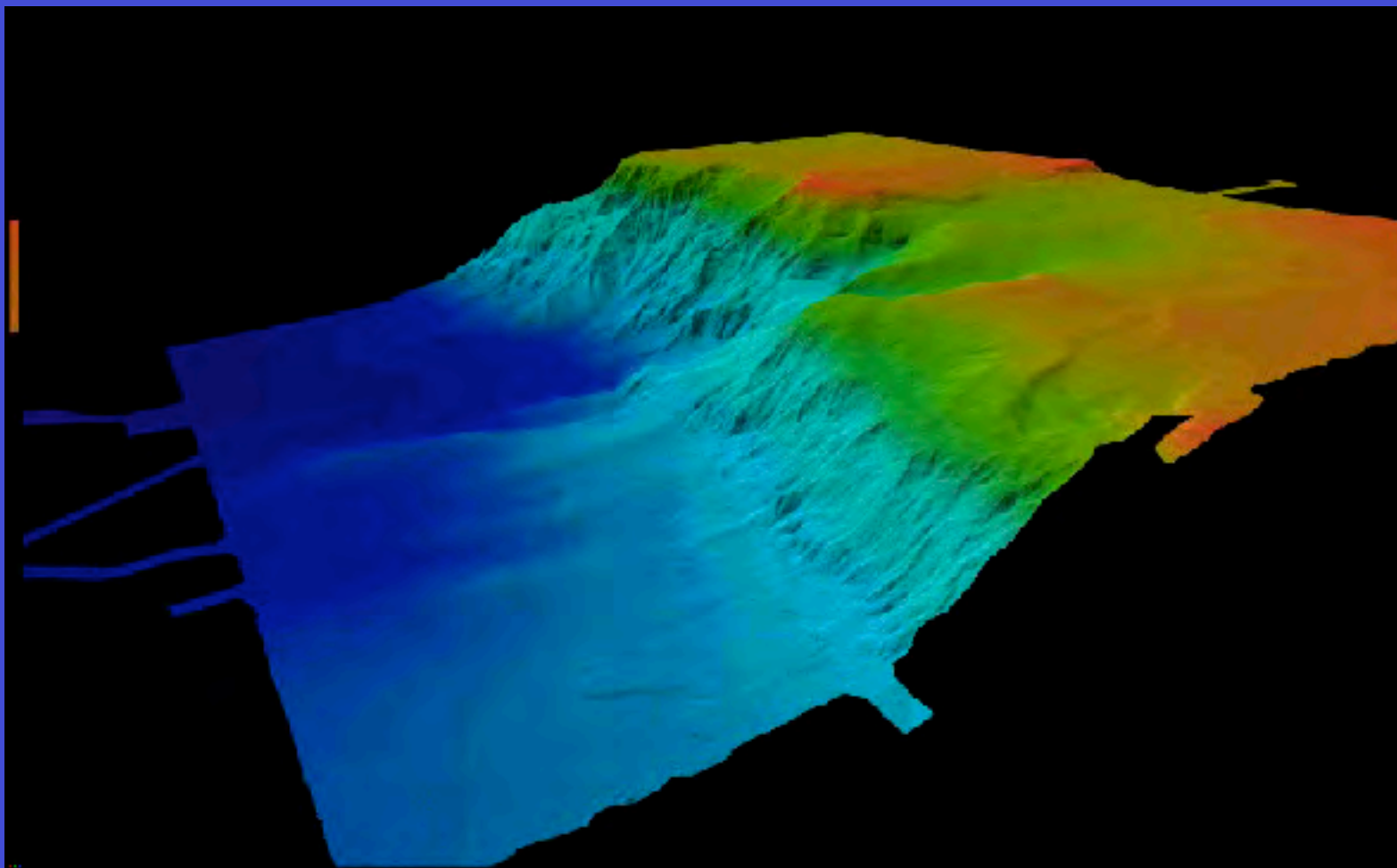

ATLANTIS

SIGSBEE ESCARPMENT SUBBOTTOM

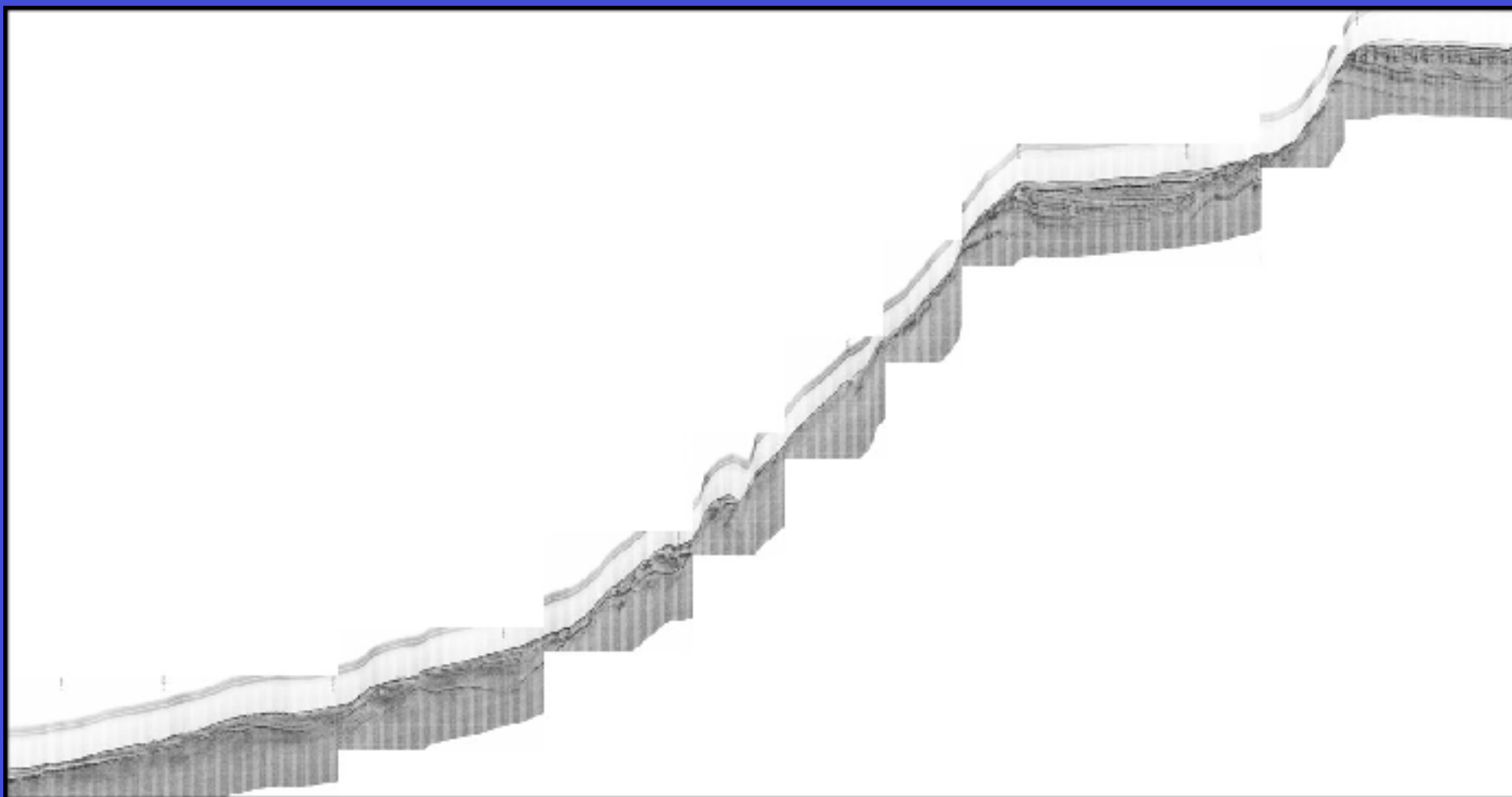

Sigsbee Escarpment Subbottom Data

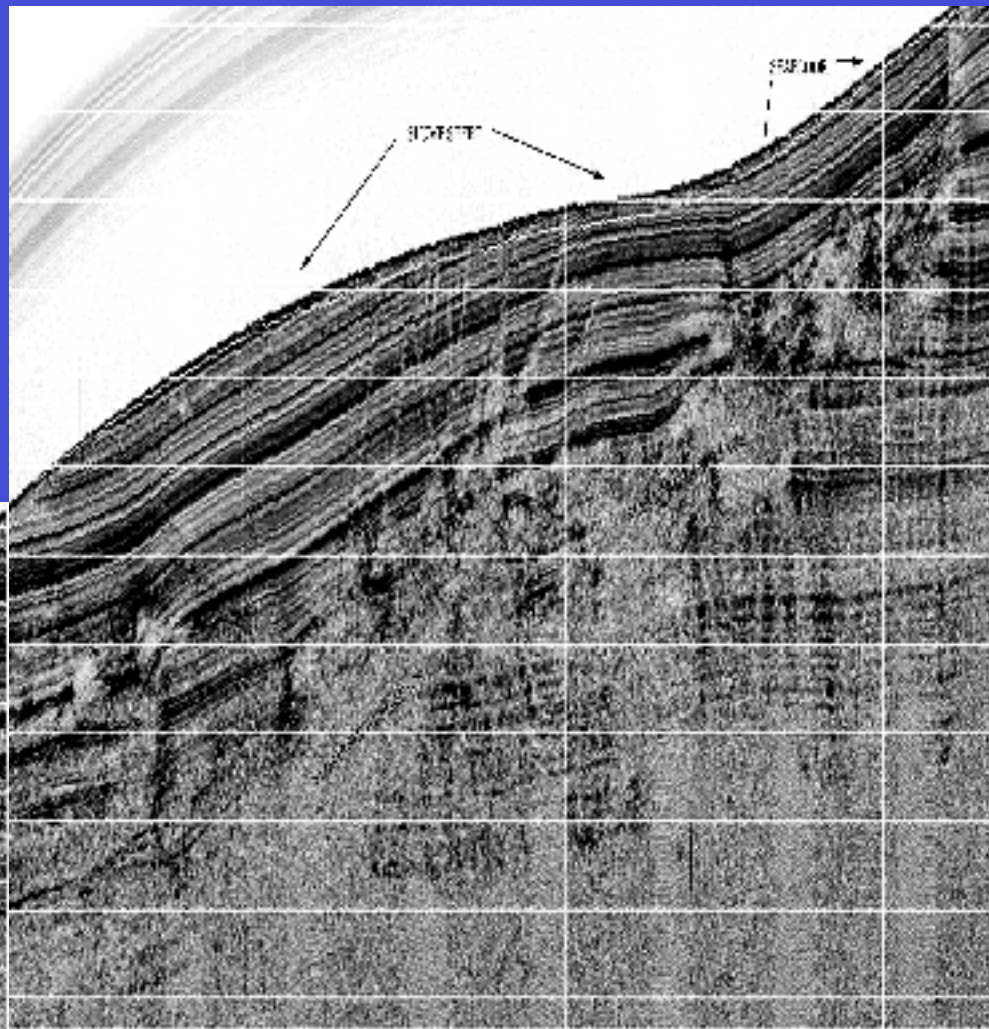
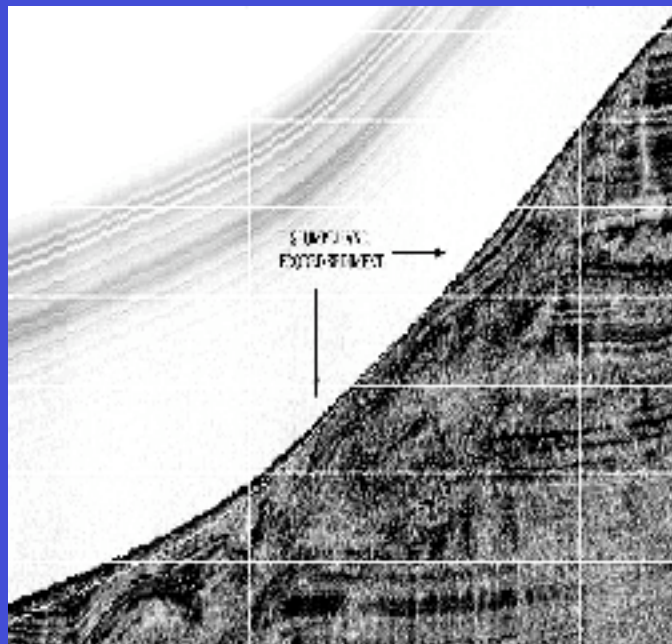

OFFSHORE NIGERIS

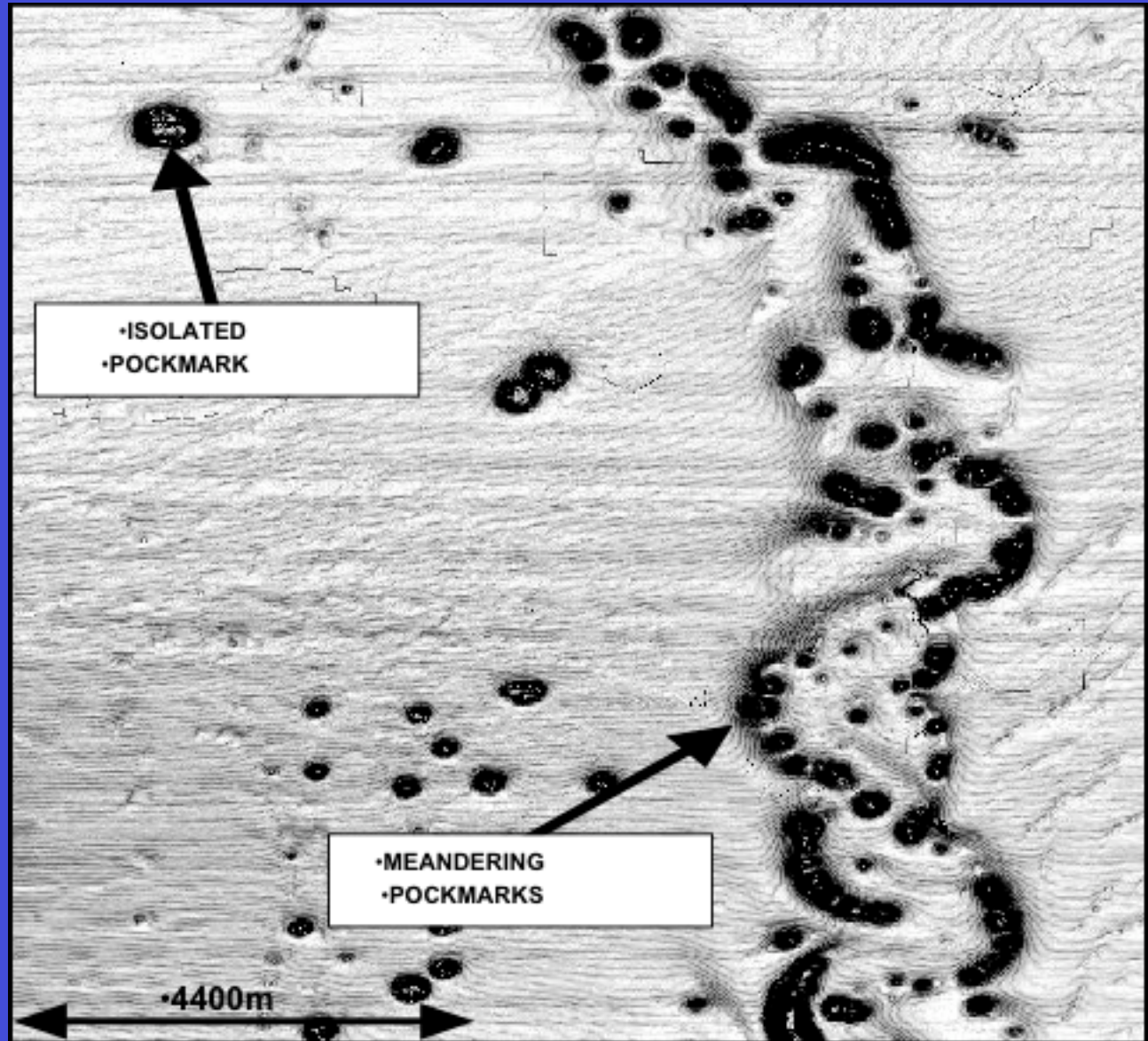

OFFSHORE NIGERIA

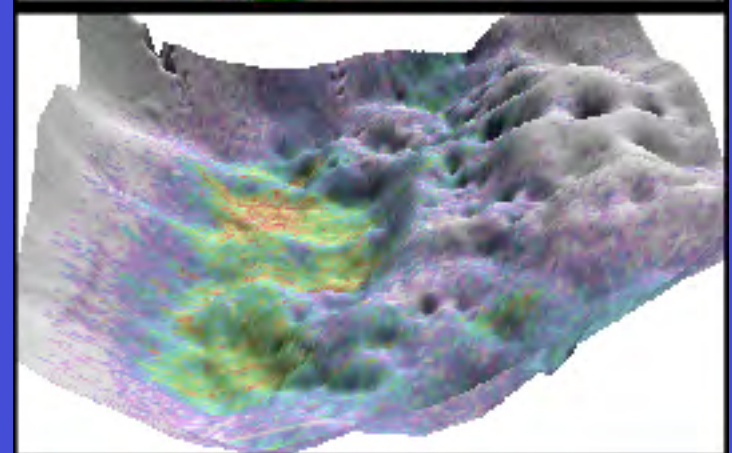
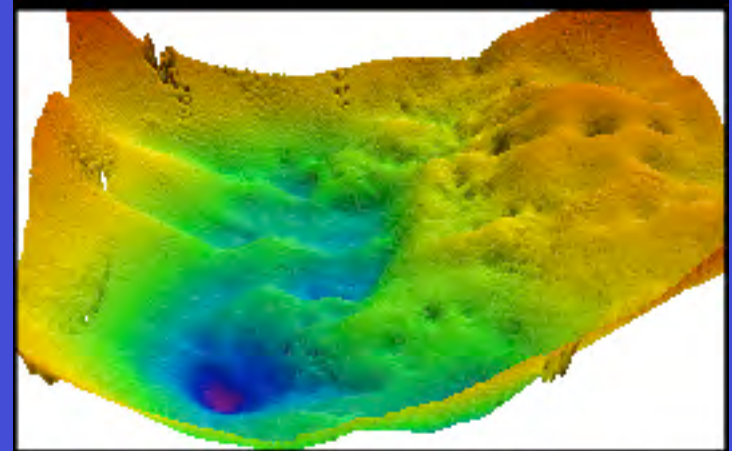
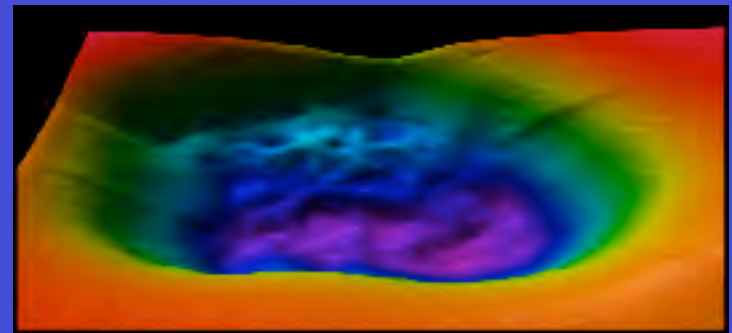
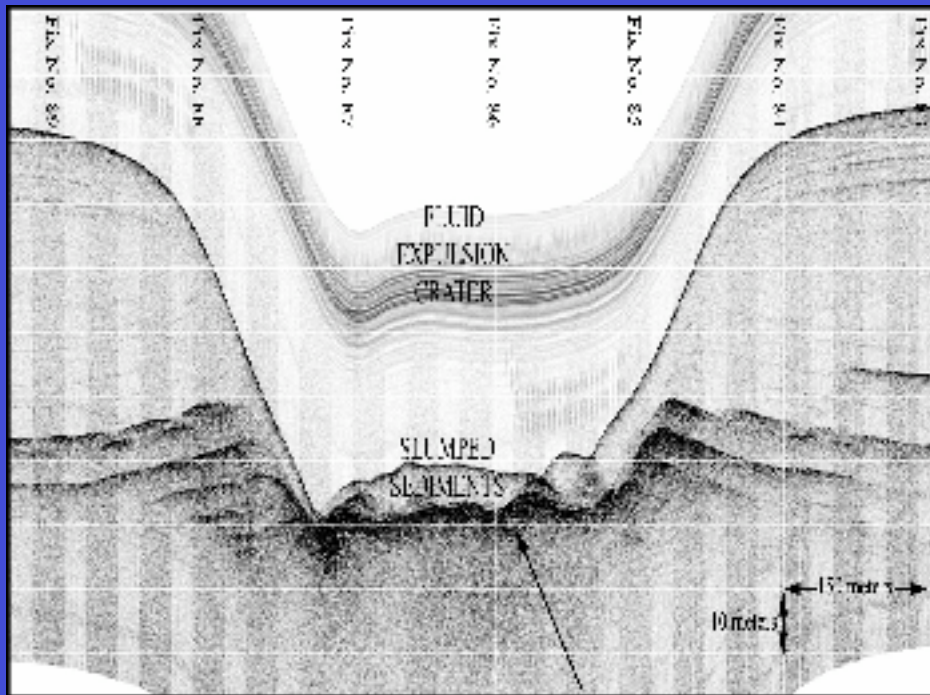

SS Alcoa Puritan Sunk 6 May 1942



HMS Ark Royal

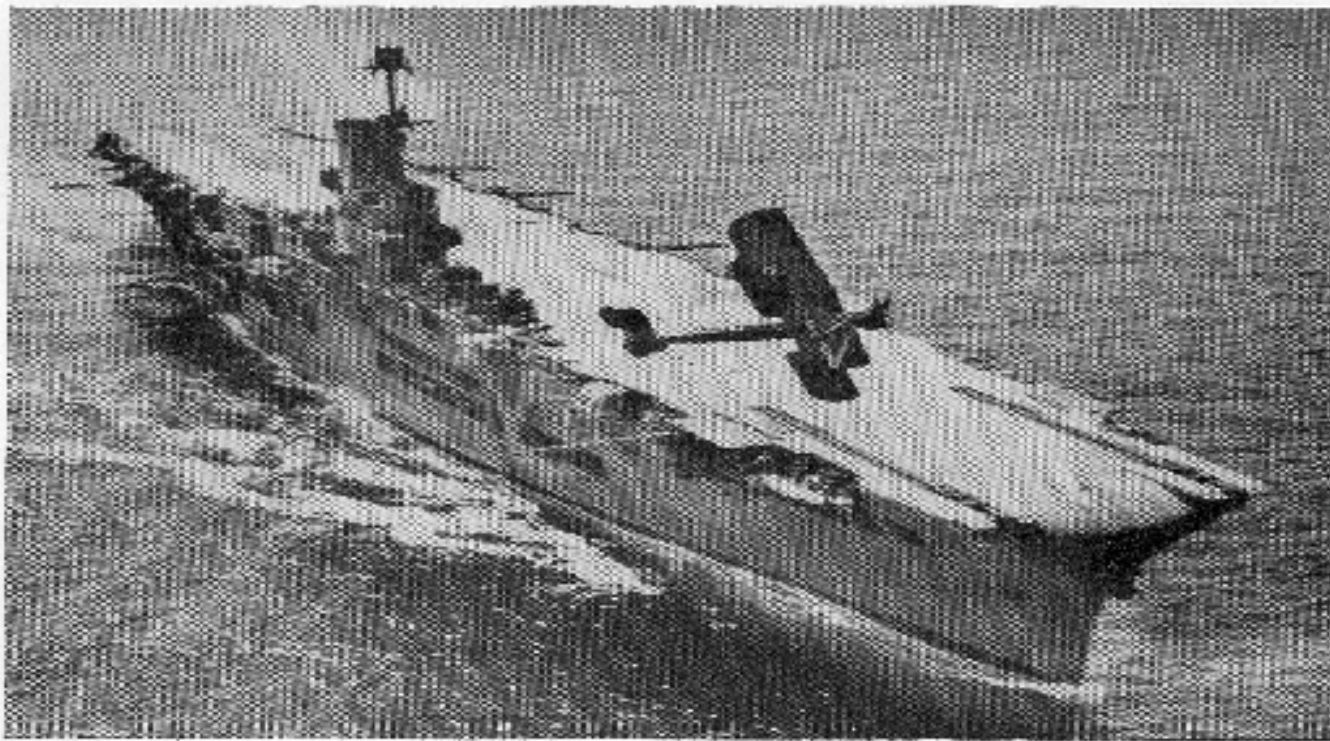

2. H.M.S. *Ark Royal*. The aircraft is a Fairey Swordfish—one of the famous "Stringbags"
From Jameson, William, *Ark Royal 1939-1941* (1957)

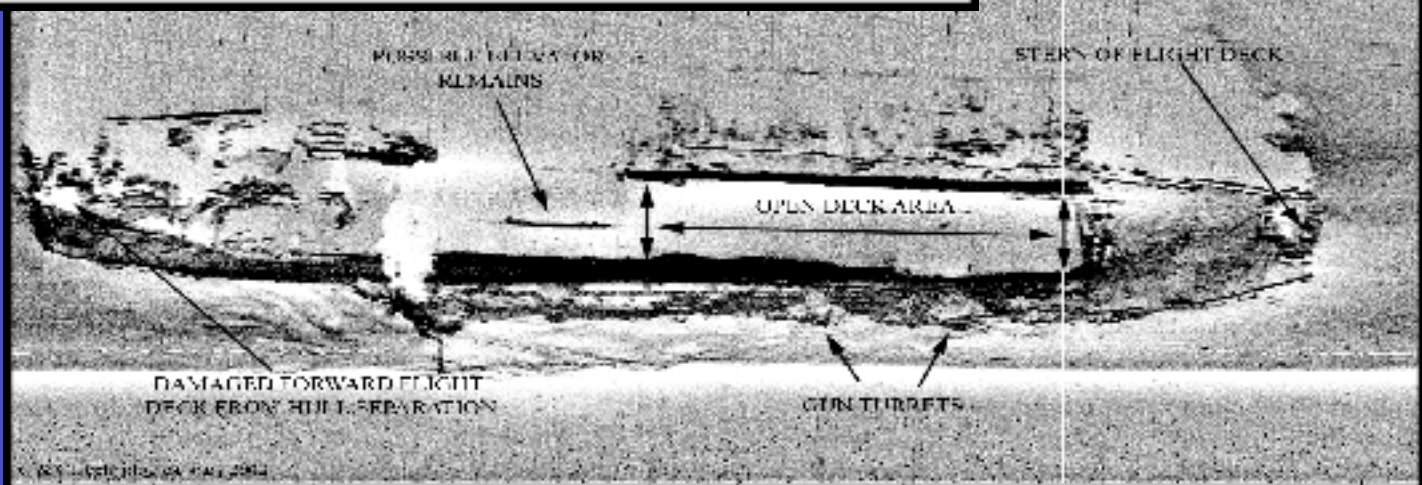

410 kHz SIDE SCAN SONAR OF THE GERMAN SUBMARINE U-166

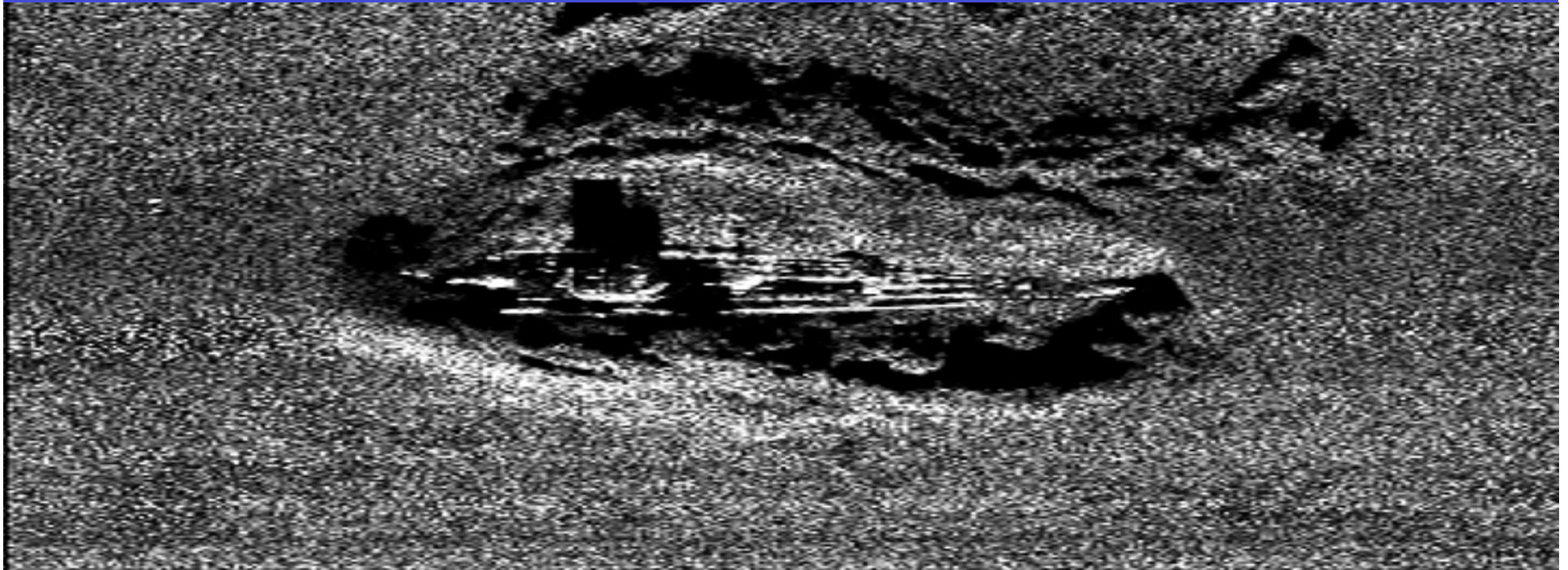

Navigational Accuracy

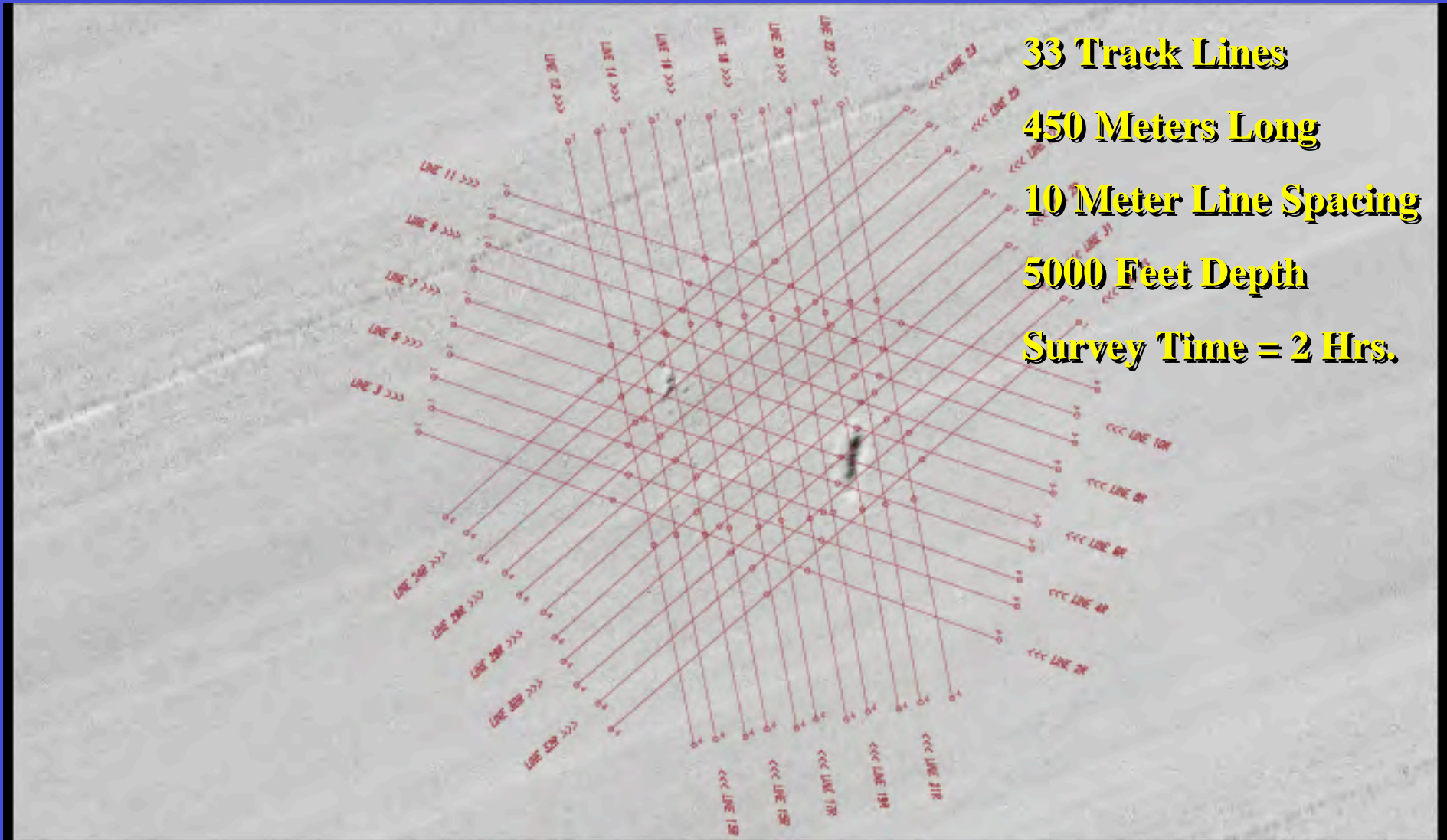

C & C'S CLIENTS AND AREAS WORKED

C & C Technologies, Inc.

HUGIN 3000

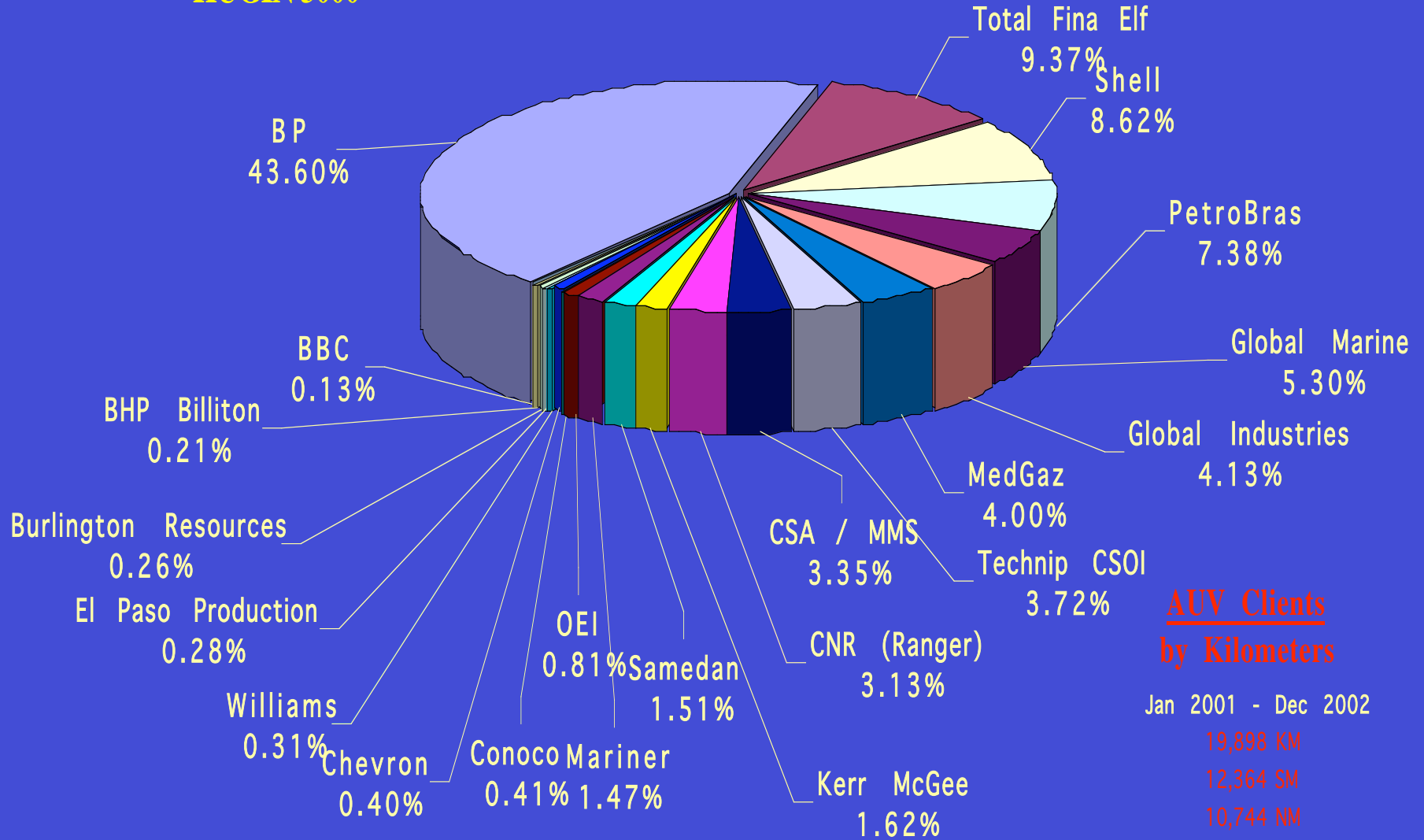

AUV Clients
by Kilometers
 Jan 2001 - Dec 2002
 19,898 KM
 12,364 SM
 10,744 NM

C & C Technologies, Inc.
HUGIN 3000

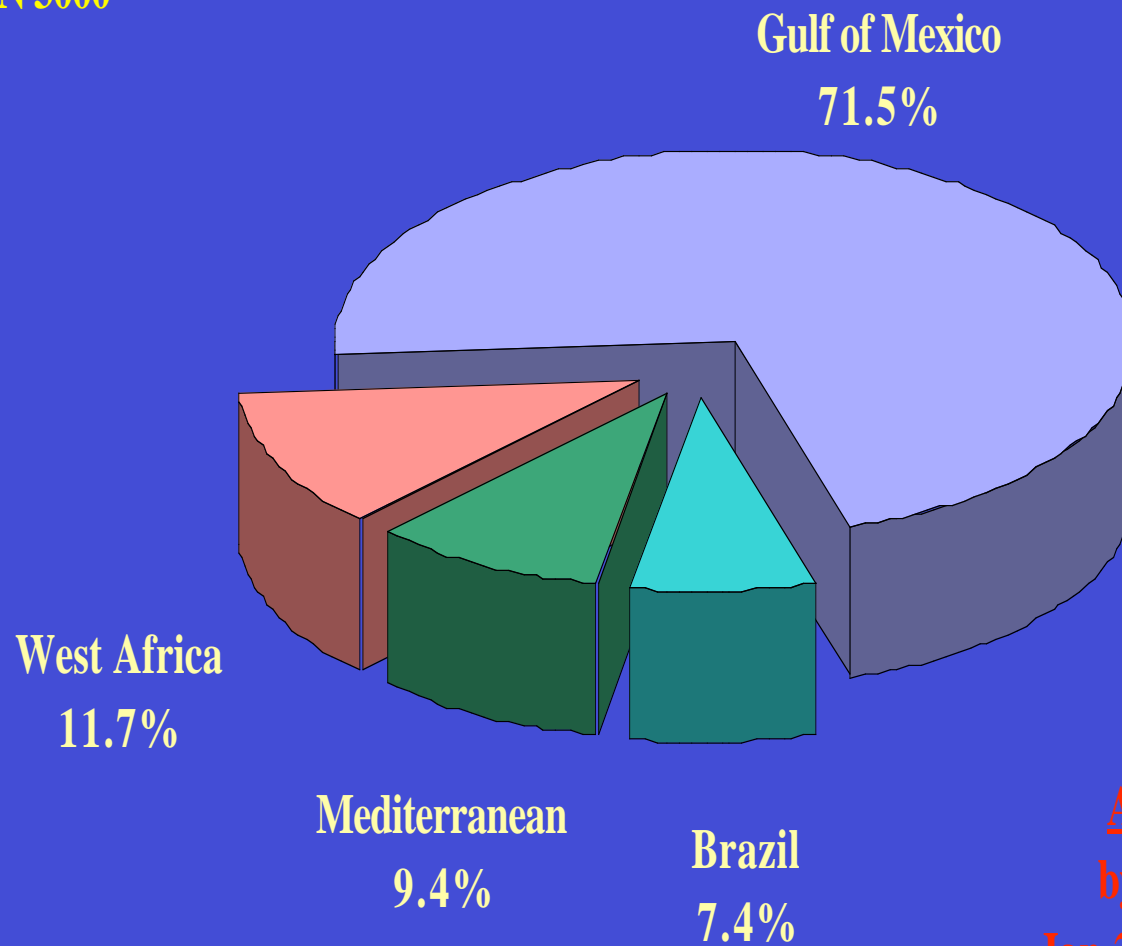

AUV Clients
by Kilometers
Jan 2001 - Dec 2002

FUTURE UPGRADES

NEAR TERM UPGRADES

•2003

- Update INS with GPS
- Iridium call back
- Synthetic LBL (single transponder)
- Dual Transponder LBL
- Upgrade Inertial

•2004

- Synthetic Aperture Sonar (SAS)
- Sea Water Battery

UNDERWATER TRANSPONDER POSITIONING(UTP)

- Measure range (and bearing) to One or more transponders from HUGIN
- Tight integration with INS
- HUGIN to carry transponders and deploy

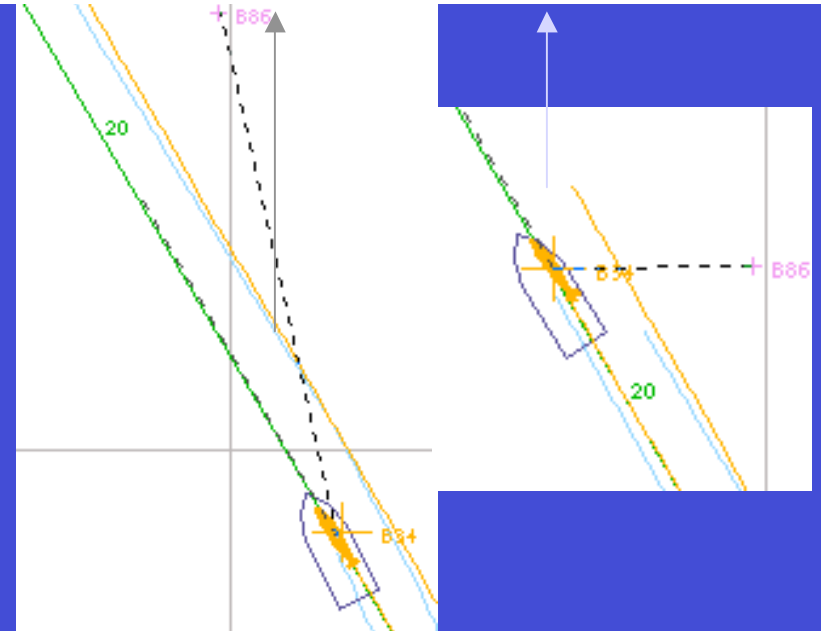
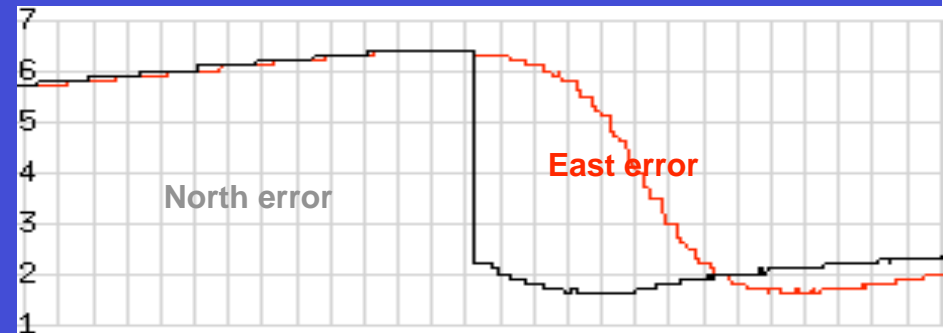

SAS EXPERIMENT

FFI/SA CLANTCEN/DERA

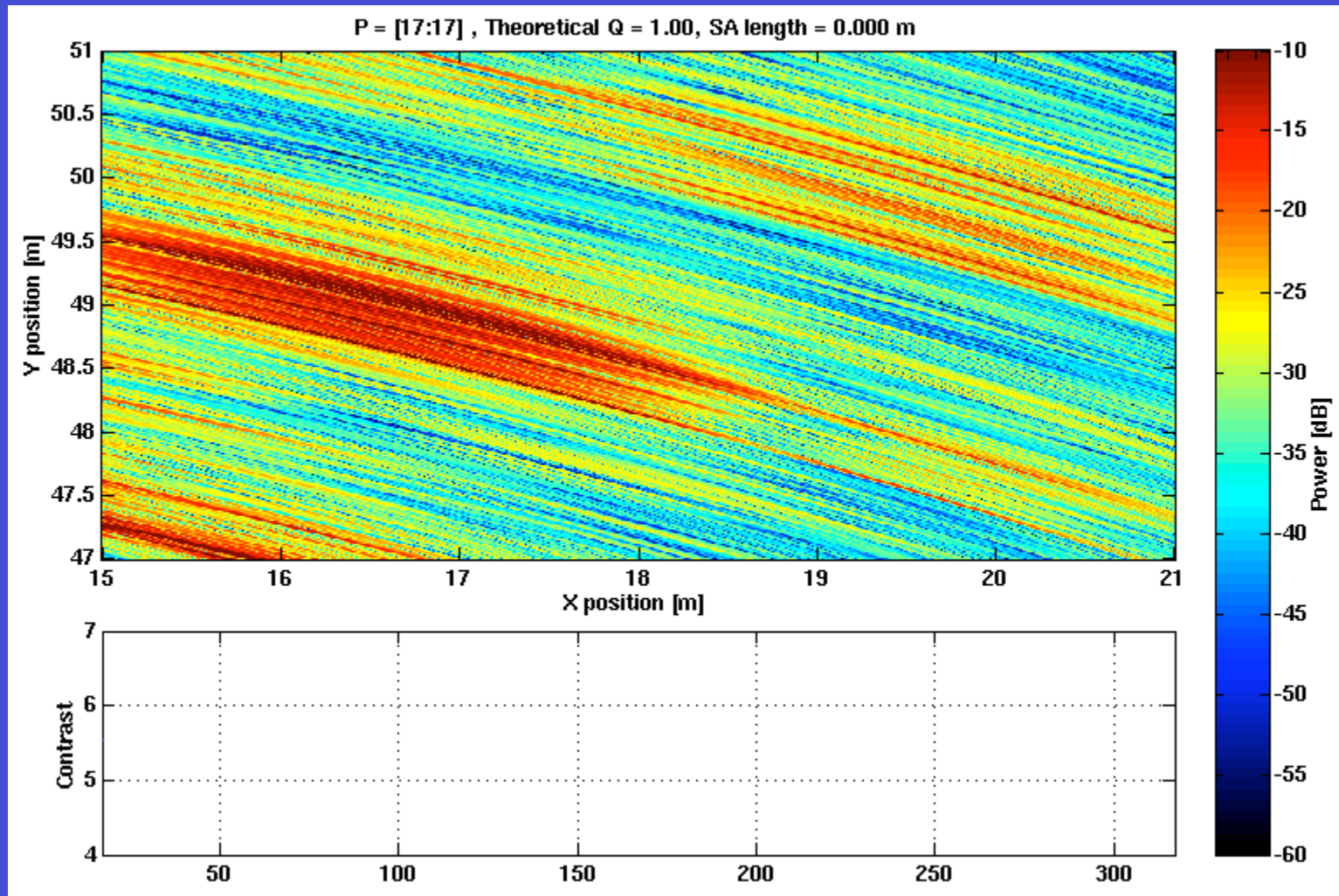

SUMMARY

- **C & C'S HUGIN 3000 AUV WAS DEVELOPED BY:
KONGSBERG SIMRAD, FFI & C & C TECHNOLOGIES**
- **AUV EXISTING FEATURES: SENSORS: MULTIBEAM,
SIDE SCAN, PROFILER, CTD POSITIONING: ACOUSTIC / DVL / GPS
/INERTIAL FULLY AUTONOMOUS, 3000m RATING, 50 hr DURATION**
- **C & C LEADS THE WORLD IN COMMERCIAL AUV SURVEYS**
- **C & C HAS PROVIDED CLIENTS WITH:
SIGNIFICANT TIME SAVINGS
SIGNIFICANT COST SAVINGS
SUBSTANTIALLY IMPROVED DATA
ON-SITE CHART DEVELOPMENT**

Thank You

Subsea7 Geosub

**An AUV from Research Tool
to
Commercial Survey Vehicle
and Beyond.....???**

Geoff Dale,
ROV and Survey Business Development (North America)

- Introduction
- Why we followed this path
- Where we are
- Where we are going (or at least hoping to go)

The “Southampton Oceanographic Center (SOC)” connection



**Southampton
Oceanography Centre**

UNIVERSITY OF SOUTHAMPTON AND
NATURAL ENVIRONMENT RESEARCH COUNCIL

10 year license agreement for :-

- Total access to Autosub technology.
- use in the oil and gas market.
- use in the subsea cable market.

Length	: 6.8m,	Diameter	: 0.9m
Weight in air	: 2400Kg		
Weight in water	: 5Kg positive		
Depth rating	: 3000m		
Continuous power	: 2.2Kw		
Endurance	: 30-48 hours,	Speed	: 2 to 4 knots



Assembly and Testing



Testing

- Components
- Assemblies
- Software
- Systems



Systems Developed for Subsea 7

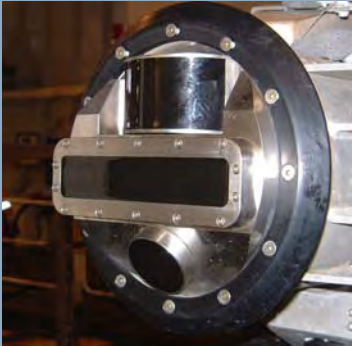

- Obstacle avoidance sonar (Marine Electronics Ltd)
- Lithium-ion battery pack (AEA technology)
- INS (Oceano-IXSEA U-Phins)
- Acoustic modem (Tritech International)
- Survey acquisition system (CODA Technologies)

System Integration Trials in Scapa Flow - Orkney Islands



- MV Guide
- March 2002
- Testing and integration of geophysical, navigation and acoustic sensors and acquisition systems
- Preliminary assessment of acoustic modems and obstacle avoidance sonar



Acoustic Interference Testing

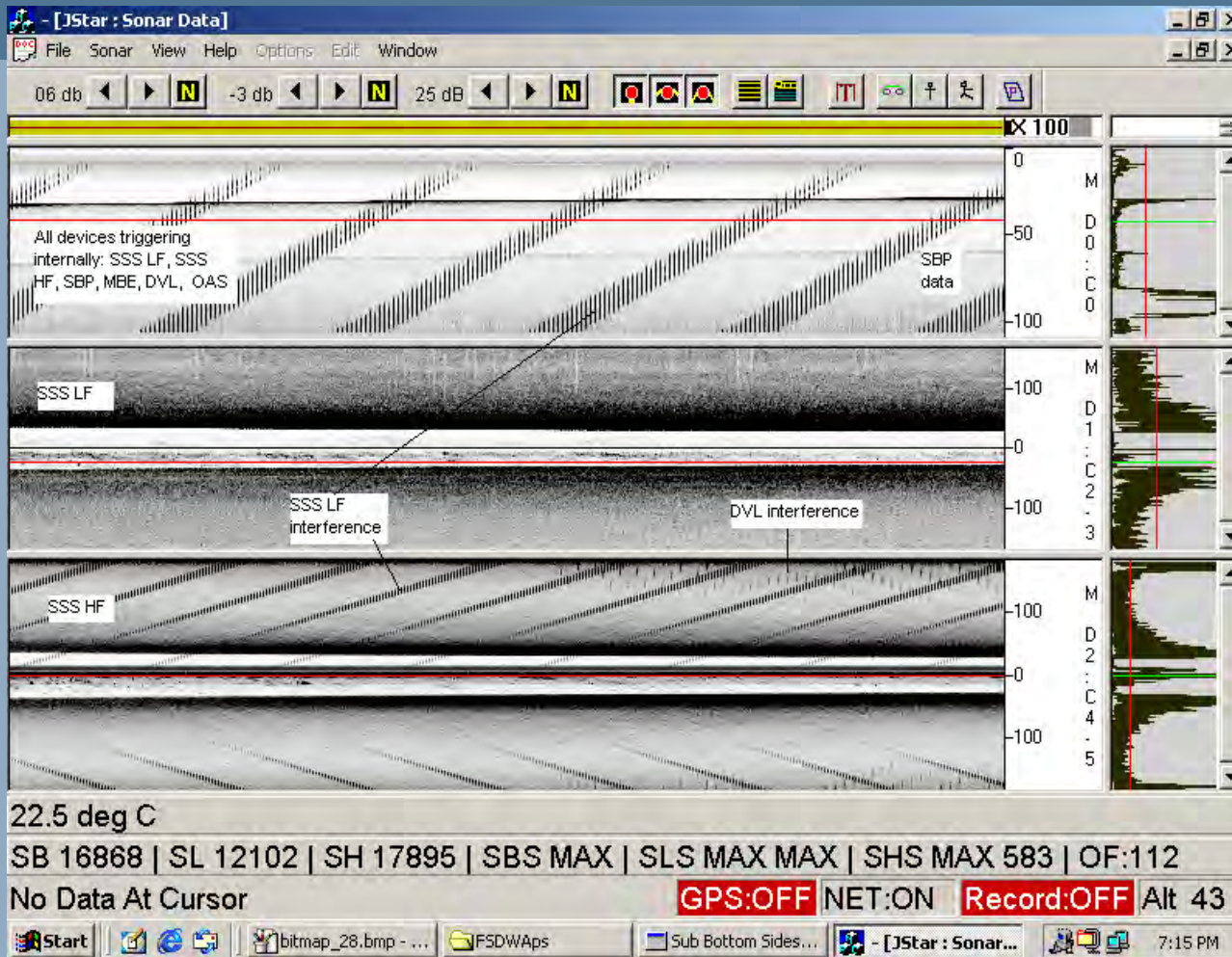

- Edgetech J-Star Software
- All sensors free running :
 - Edgetech FSAU
 - High frequency side scan sonar (425 khz)
 - Low Frequency side scan sonar (100khz)
 - Sub bottom profiler (2-16 khz)
 - RDI Doppler velocity Log
 - Simard EM2000 Multibeam echosounder (200khz)
 - Obstacle avoidance sonar (250khz)

Navigation Testing INS vs DGPS

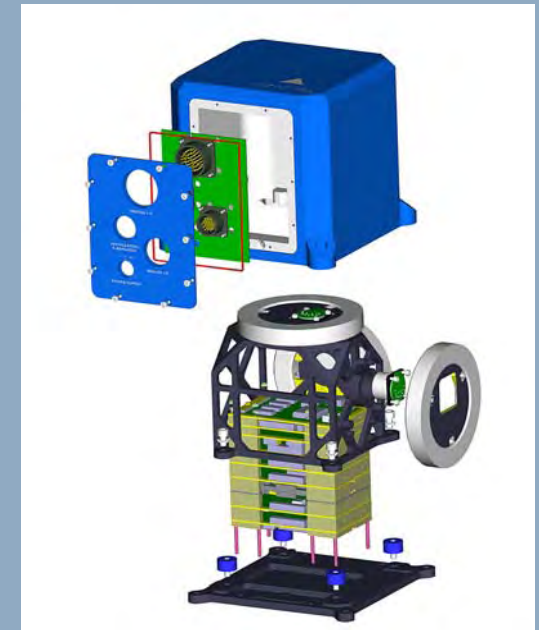
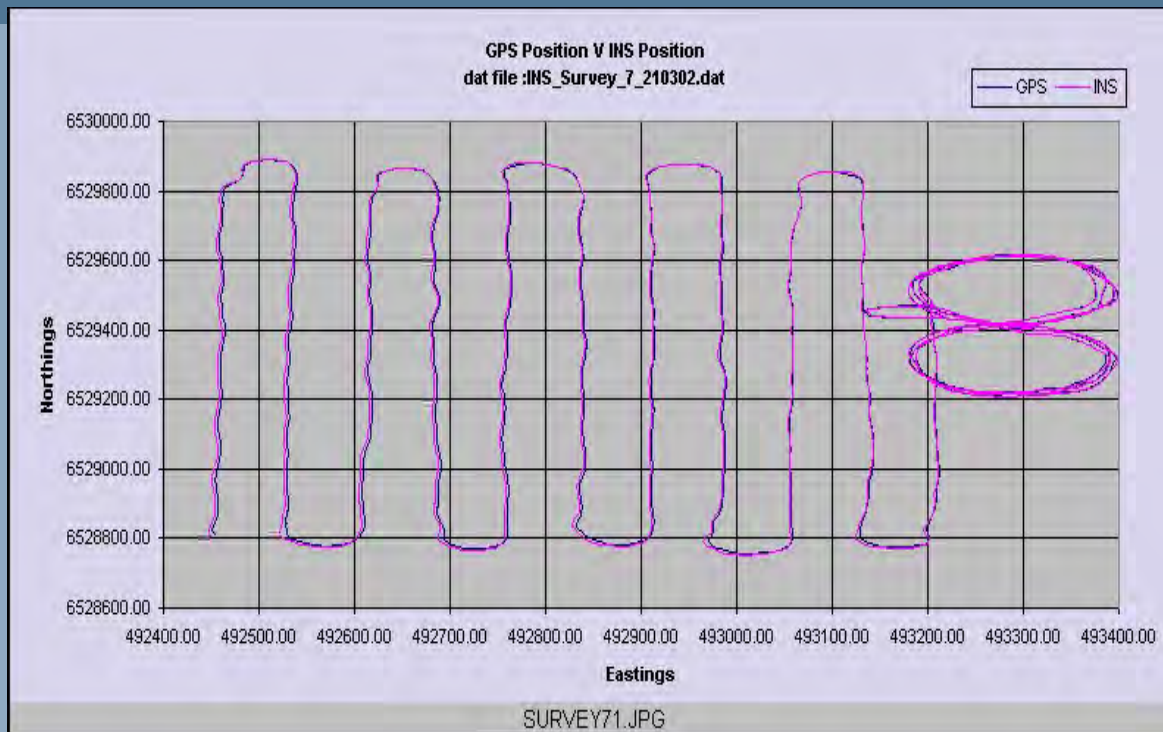

- Ixsea U-Phins FOG based INS
- 600khz RDI Doppler Velocity Log
- Comparisons RTK GPS vs INS positions
- Drift rates <5m / hour, trajectory dependent

Inshore Trials - Peterhead Harbour, July/August 2002



- System integration tests
- Vehicle control
 - first dive tests
- Vehicle software
- Launch and Recovery
- Navigation
- Sensor Data quality
- Obstacle Avoidance
- Acoustic Modem

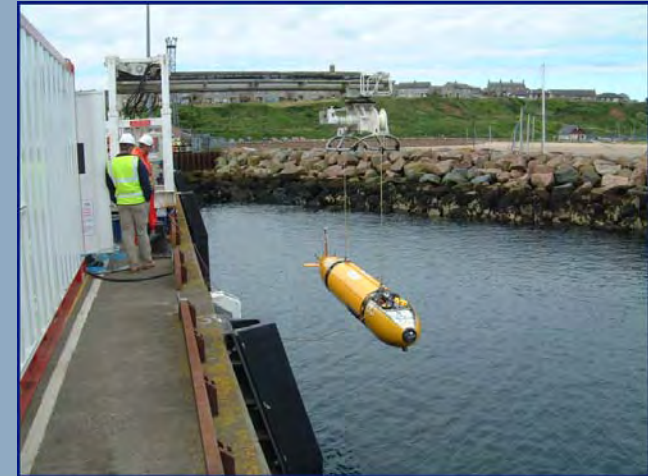

Problems Encountered

- Harbour traffic
- Shallow water
- Bad weather (FOG)

Subsea7 and Gardline Surveys AUV Services Co-Operation Agreement

Agreement to jointly promote /operate the *Subsea7 AUV* by combining resources and capability to provide a comprehensive service to clients requiring geophysical and geotechnical site and route investigations in West Africa and elsewhere.

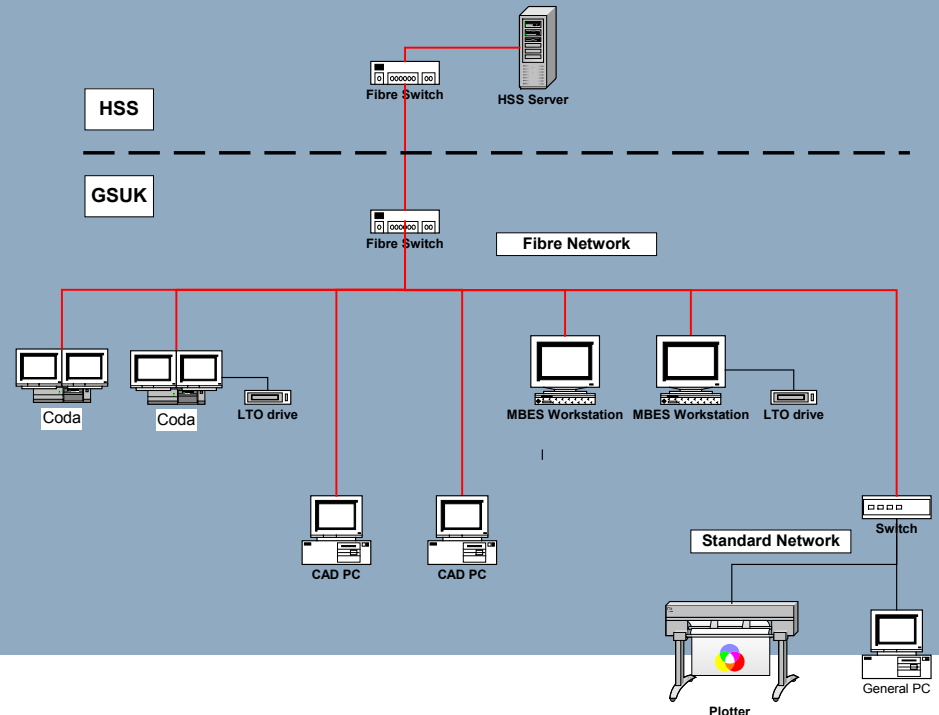

Phase 1 Offshore Trials KSS2000 - North Sea



- KSS2000
- September 2002
- BP Project
- 3 missions undertaken
- Maximum depth 100m



Phase 2 Offshore Trials

MSV KSS - Orkneys

subsea 7



- KSS
- December 2002
- Commissioning Trials
- Deep water dives
- Endurance Testing



Dive Incident – Scapa Flow

- Dive 4
- Recovery accident
- AUV hit by vessel propeller
- Damage to one pod, fibre glass panel and buoyancy
- Remaining test dives postponed
- New Test program following re-build is scheduled for June 2003



Ongoing Navigation Developments

- Terrain Matching
- Repeat Feature Recognition
- Pipeline Tracking
- Navigation/Depth Post Processing

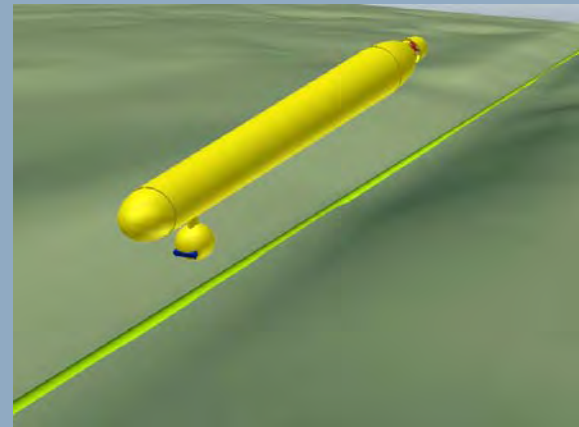

Near Term Application Developments

- Acoustic Pipeline Inspection
- Magnetic Pipetracker
- CP Monitoring of Pipelines
- Improved Onboard Decision Making (Artificial Intelligence)
- Ability to Hover
- Visual Pipeline Inspection

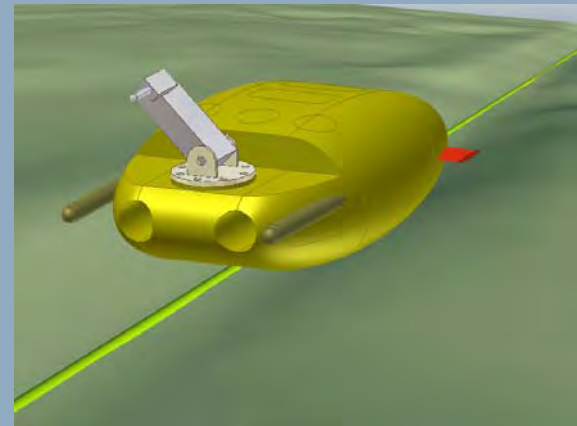

Future Application Developments

- Flexible Riser Inspection
- Structural Inspection
- Touchdown Monitoring

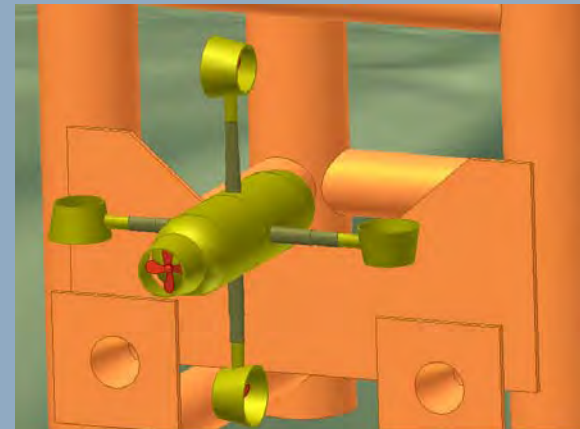
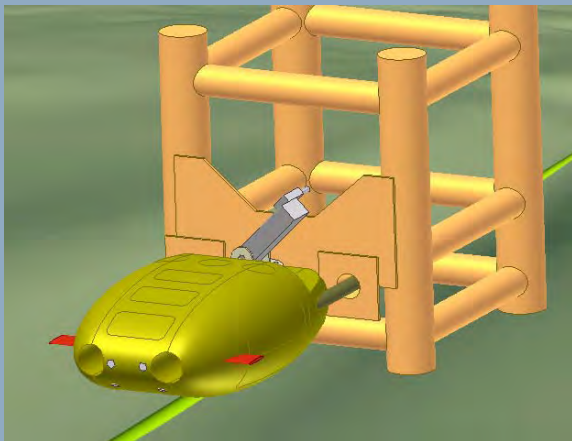

- Flying Tool Concept
- Intervention Tasks
- Module Change Out

Intervention AUV

Reduction in OPEX

No ROV Support vessel required

No long ROV umbilical

Light and compact topsides

AUV can (potentially) be small and light - no heavy umbilical

Utilises the aspects of autonomy already demonstrated in survey mode

Retains the close control associated with standard ROV operations

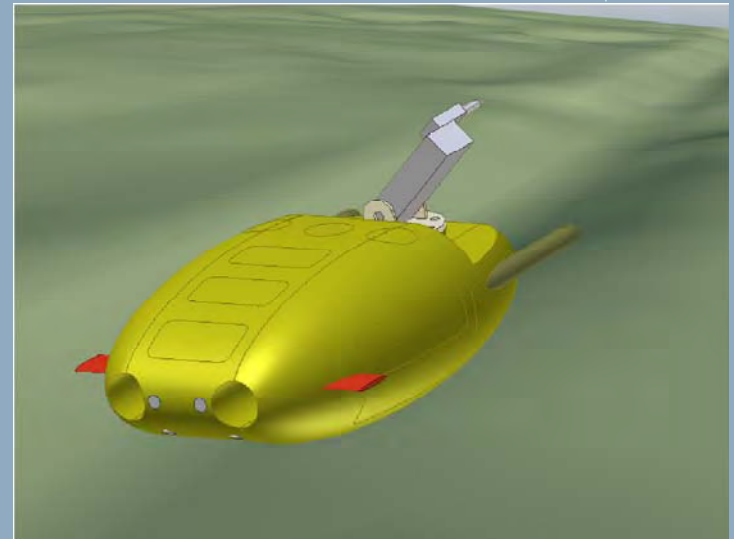

Structured Intervention

6 Degree of Freedom AUV under development

Well planned tasks and systems

High % of ROV tasks could be done by AUV using conventional ROV intervention panels

Capable of recognising an intervention panel

Low frame rate acoustic & video link
Acoustic critical command link

Power for tools from Panel + Control of tool ops

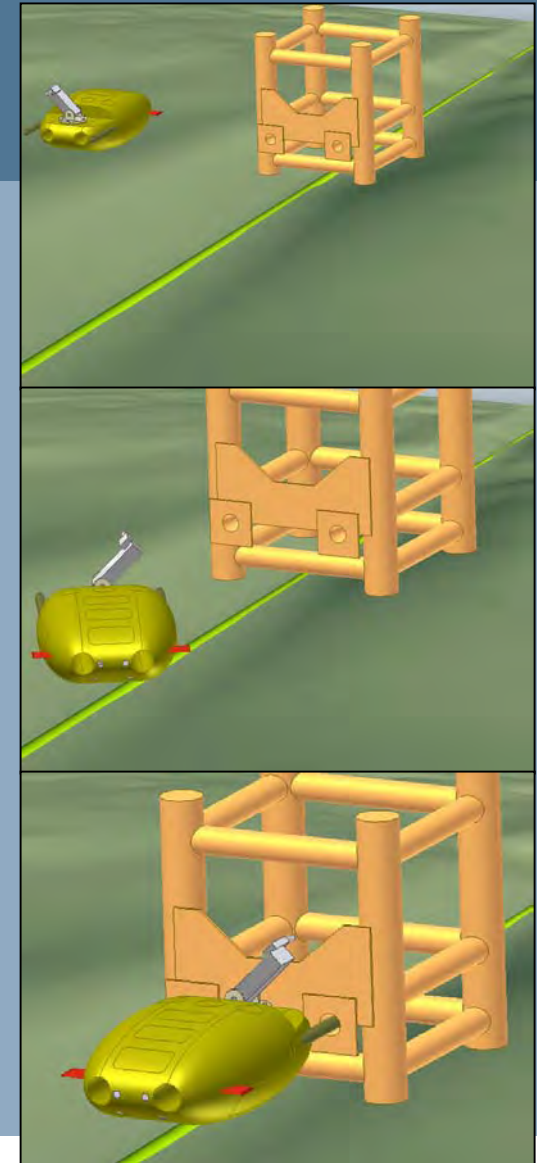

Propulsion Technology

- One moving part - high efficiency
- Low acoustic and magnetic signatures
- 2kwatt prototype built and tested
- 10kwatt production system on order

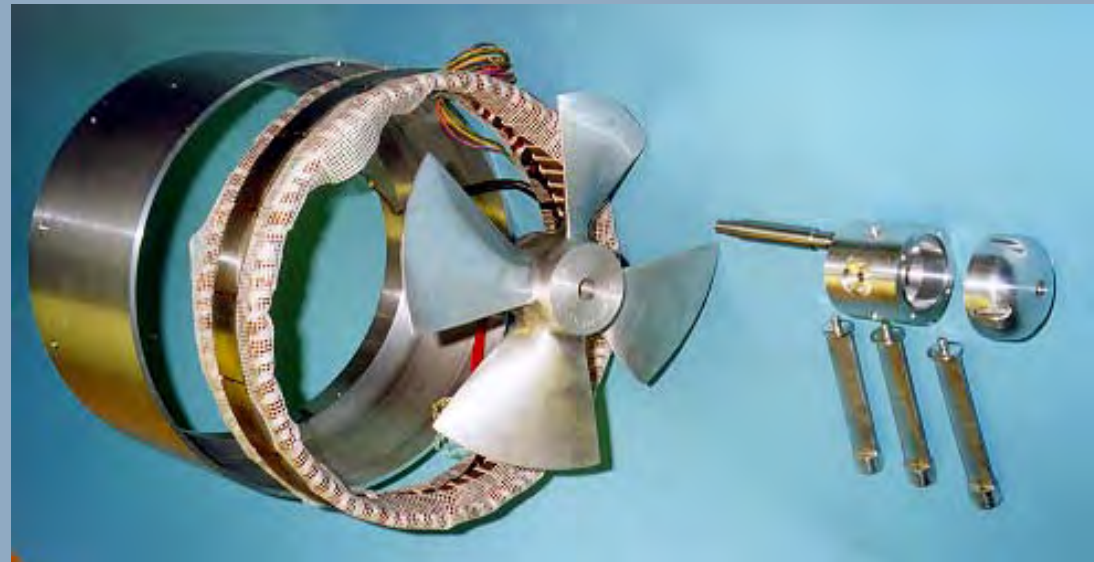
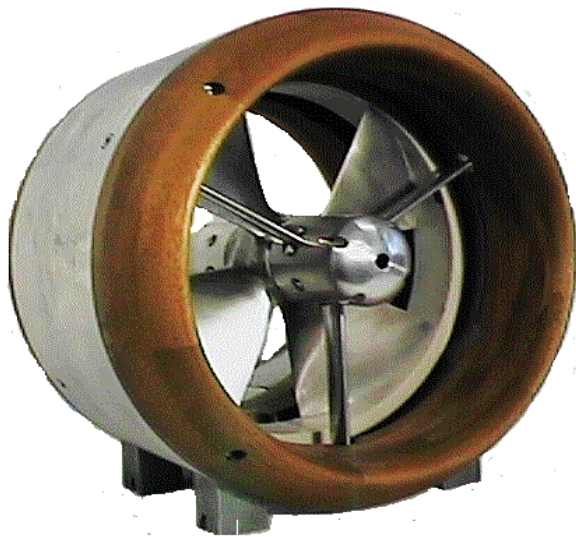

Mini Thruster



Ongoing Research and Development Projects

- Video Mosaics
- Video Compression
- Through Water Video Telemetry
- Object Recognition
- Six Degrees of Freedom Project
- Hydrocarbon Detector
- AUV Technology Study for Military Applications



Accepting the Subsea Interface Challenge



Houston, April 11th, 2003

50
100
150
200
250
300
350
400
450
500
550
600
650
700
750
800
#000
#050
#100
#150
#200
#250
#300
#350
#400
#450
#500
#550
#600
#650
#700
#750
#800
#850
#900
#950
#000
#050



- General Cybernetix
- AUVs and Hybrid AUV/ROVs
- Remote operated systems
- Instrumentation, Monitoring (General and Girassol)



- Cybernetix was formed in 1985 by COMEX : Remote Controlled Interventions in Hostile Environments.
- The Cybernetix Group today :
 - 450 persons,
 - 58 M € rev's (*2002 unaudited*)
 - 31% public
 - Worldwide
 - Fast growing
 - 5 Diversified branches : Offshore, Micro-electronics, Picking-Sorting-Logistics, Metrology-Optics-Vision, Telerobotics (incl nuclear)

Comex SA



Today

- Marseille test facilities (shallow and deep water)
- Oceanography, survey (Minibex, Janus)
- Comex Pro (Technology export, Observation ROV's..)
- Comanex (Diving systems maintenance)
- 40 % in Cybernetix
- 10 % in Principia



- Subsea Inspection, Maintenance, Repair and Monitoring services using autonomous vehicles and remote operated vehicles and systems.
- Focus on deep and ultra deep water.

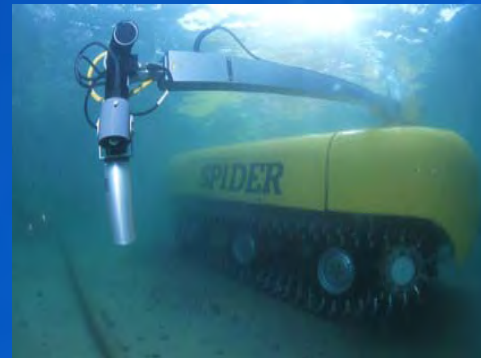

Cybernetix Offshore Branch



- Located at the Comex Marseille site with privileged access to the Comex Group know-how, resources and facilities.
- Own work shops (total >10,000 m²) with state of the art machining, tooling.





**How can AUVs assist in reducing
deepwater intervention costs ?**

Surface interventions



- Interventions on a 'dry tree producing facility' (platform, TLP) :

A process that has been improved over 40 + years in the industry.

- On surface
- In one place
- Human beings, working in teams



Deepwater interventions



- Interventions on a subsea field :

- New technologies
- Large area, dispersed
- Deep water
- ROVs and robots.....

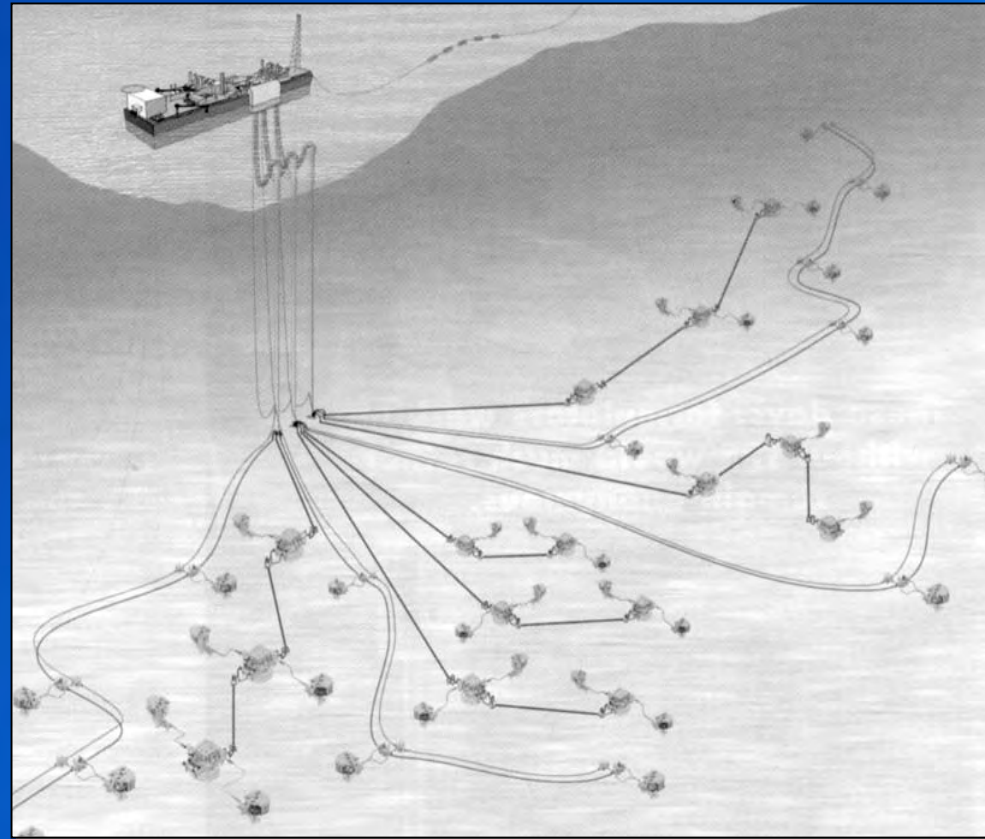

Deepwater interventions



- Currently, deepwater interventions are generally performed using Work ROVs, deployed from sophisticated DP vessels.



Deepwater interventions



This works, but :

- DP support vessels are expensive.
- Deepwater Work ROVs are versatile but are large and need heavy LAR systems. Also, the transit time of the ROV to the subsea site becomes time consuming and expensive.
- Long 'free' umbilicals are weak links in the system
- Vessel based ROVs may not be there when they are needed most (not available, weather...)

Deepwater interventions



Are there ways to :

- Do it cheaper ?
- Do it quicker ?
- Remove 'seabed to surface' umbilical related problems ?
- Ensure better availability of the intervention vehicle ?

Deepwater interventions



Are there ways to :

- Do it cheaper ? *Yes, remove the need for a sophisticated DP vessel*
- Do it quicker ? *Yes, remove the long umbilical between vehicle and the surface*
- Remove 'seabed to surface' umbilical related problems ? *Yes, see above*
- Ensure better availability of the intervention vehicle ? *Yes, keep vehicle on site (eg on FPSO..).*



AUV = Autonomous Underwater Vehicle (unmanned) :

- An underwater vehicle that has no power and control umbilical to the surface...
- Underwater communication with the vehicle is still possible using acoustic modems.

➤ **Interesting !**

- No sophisticated DP vessel required to support AUV operations
- No restraints anymore due to umbilicals...



Status of the AUV today :

- The AUV has evolved from a 'fire and forget' torpedo to an extremely efficient deepwater survey tool. (C&C Hugin in GoM, Mediterranean, W Africa, Brazil)
- It can be programmed to follow complicated routes and can interact with the environment (obstacle avoidance sonars).
- It can be operated safely from ***a basic vessel of opportunity***. It swims and turns ***fast*** and can work ***at a great distance and depth*** from the vessel (and return safely...).

AUVs



- So far the survey industry has seen the 'full' benefit of AUV technology.



- Great, but for other deepwater activities ?.....

ROV



Continuous power supply

Real time remote control

High payload

AUV



Limited power supply

Delay in data transmission

Limited payload



- Drilling assistance : with no DP vessel involved there are limited cost savings
- Construction: Real time full and precise control of the vehicle and manipulators is mandatory. Furthermore, you need a sophisticated vessel anyway.
- Inspection, Repair and Maintenance : A different story...



- IMR is required for the life of a field which can be 15-20 years...
- Although 'designed for minimum IMR' the reality is often different. In addition, the industry is at the low part of the learning curve for long term equipment performance
- IMR is a flow assurance & environmental issue, hence very important !

So, if we can live with AUVs' perceived handicaps there is an important cost saving potential....

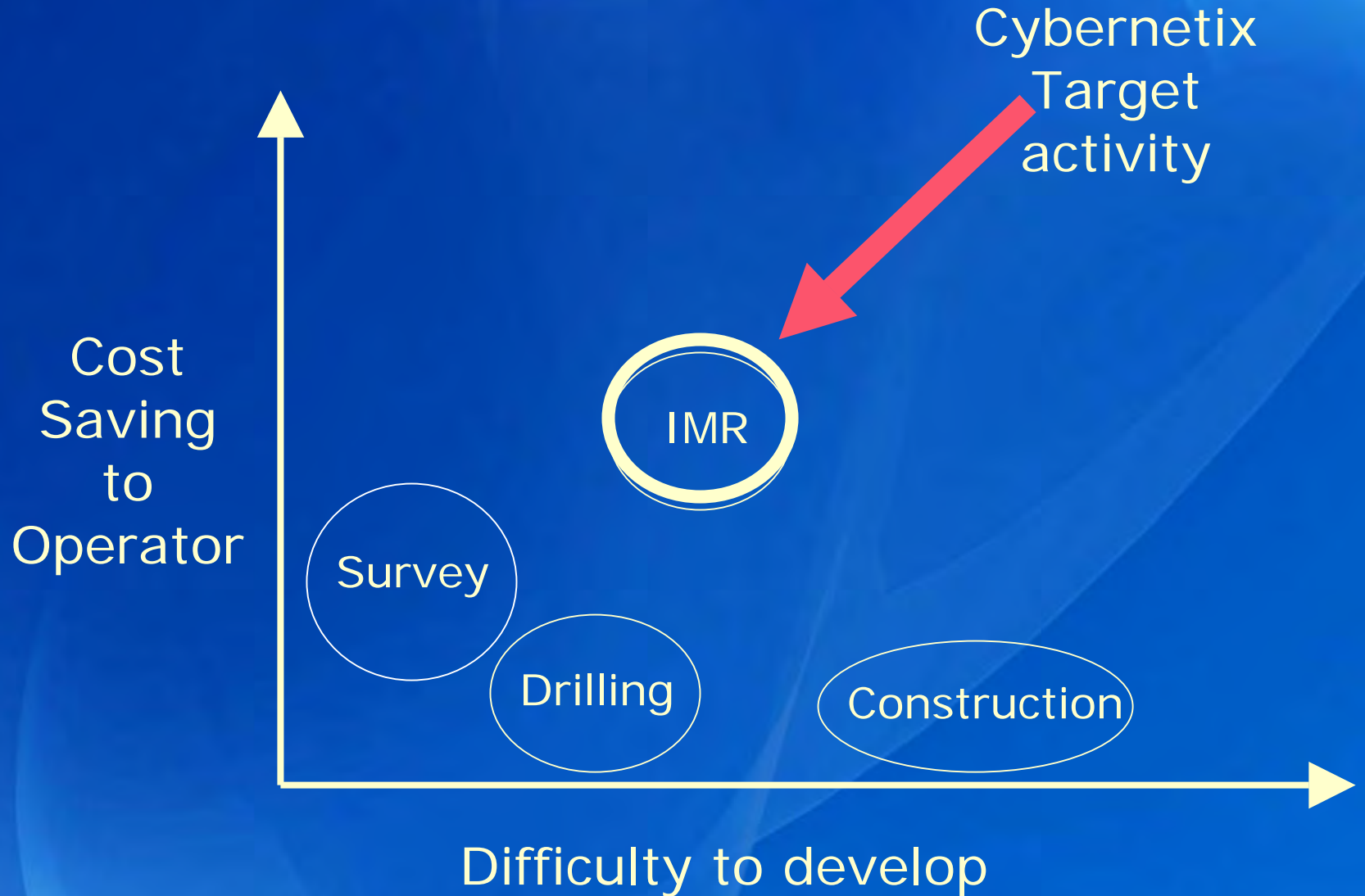



What has Cybernetix achieved ?

- Cybernetix has made excellent progress on the development of cost efficient alternatives for subsea IRM using AUV technology :
- *Swimmer* an AUV/ROV Hybrid for 'heavy' subsea IRM tasks
- *Alive* an intervention AUV for 'light' subsea IRM tasks.





Criteria :

- No dedicated DP vessel, use surface facility (FPSO..) or vessel of convenience
- No compromise on intervention capability of the ROV
- No umbilical between ROV and surface

Swimmer



- Use an AUV to transport a standard WorkROV to the seabed.
- Once there, plug the ROV into the ROV power and control which is part of the field production umbilical.
- Operate the ***standard*** ROV from the field surface support facility in ***real time***

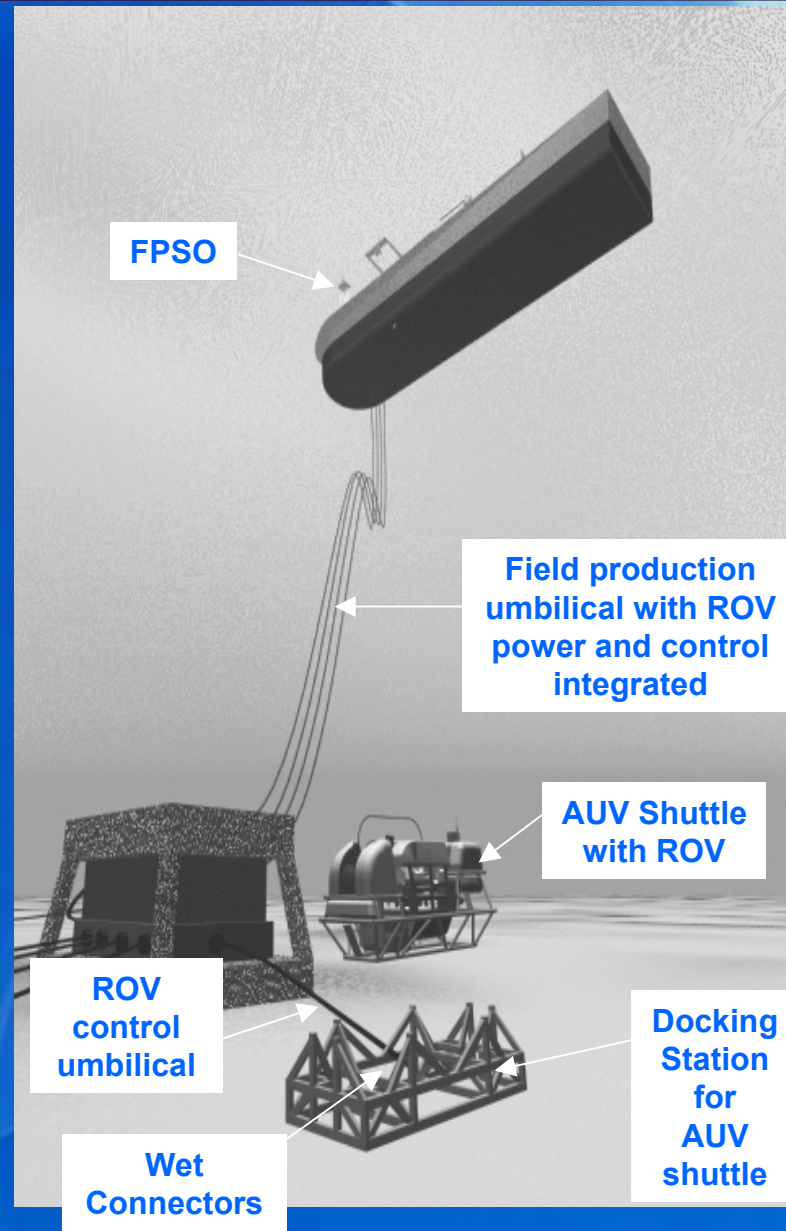



The *Swimmer* concept step by step.....

Swimmer



- Design start in 1998. Fabrication of an AUV shuttle prototype completed in 1st Q 2001.
- Various trials to debug system.....
- End 2001; offshore trials in 120 meters water depth where fully autonomous dockings were successfully achieved.





Extract of a fully autonomous docking of the Swimmer Shuttle on a docking station in 100 meters waterdepth (October 2001)

SWIMMER

Sea Trials
(October 2001)

Swimmer cost analysis – Typical field

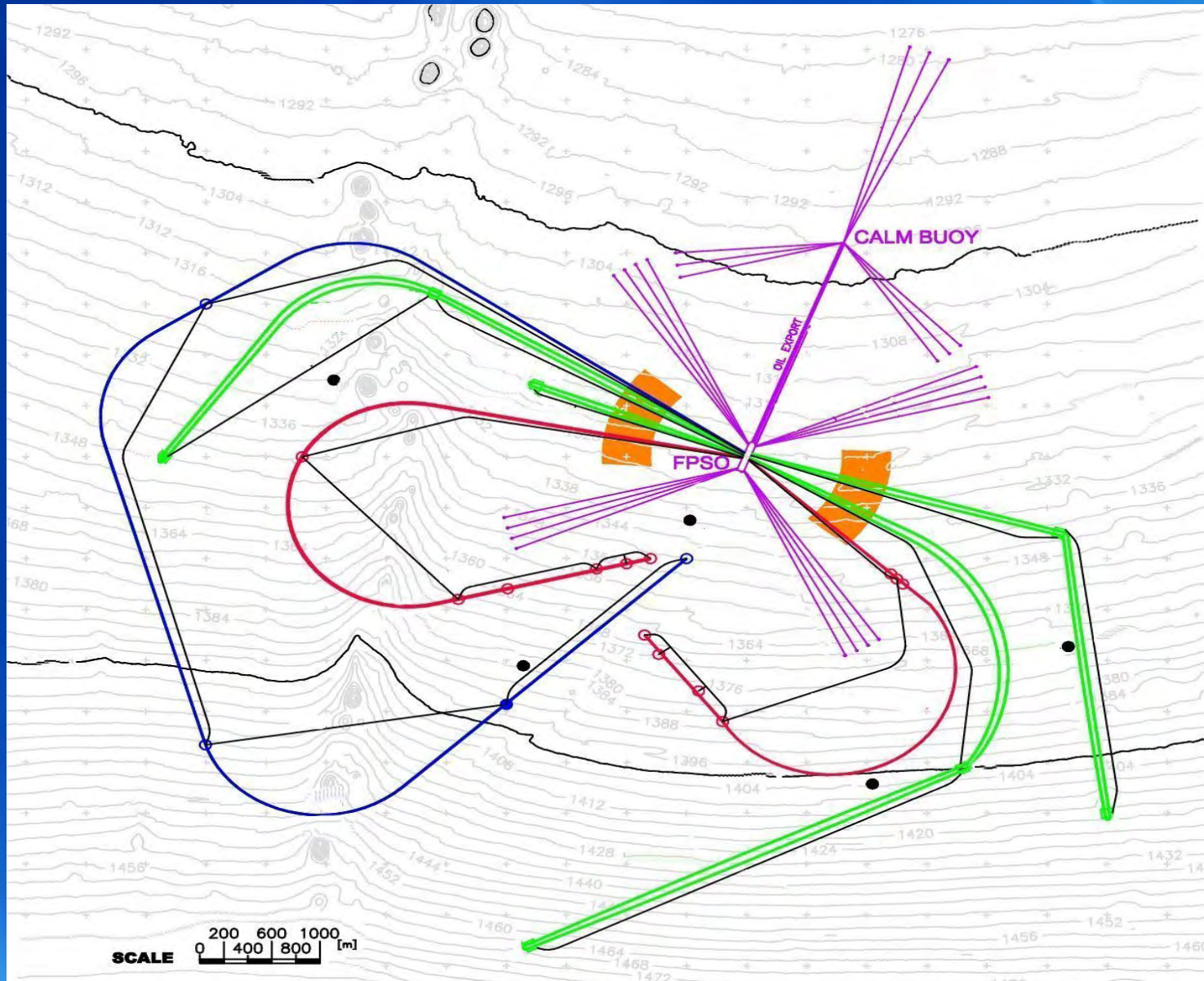

Swimmer cost analysis – Typical field



FIELD CASE : 1.1 - PRODUCTION WELLS ONLY (1 day/well)

FIELD DATA

Satellite wells	0
Cluster wells	
Nbr of wells per cluster	6
Nbr of clusters	7
Others (Manifold, SSIV, etc...)	0
Total umbilical length	26 150 m

OUTPUT DATA

Total Wells	42
Total Docking stations	7
Total intervention days/year	42 days
CAPEX (DS, Umb)	5 168 800 \$
Retrofit	n

INTERVENTION DATA

Nbr of interventions days/well/year	1	days
Nbr interventions days/other/year	0	days
ROVSV day rate (avg over 20 years)	40 000	\$/day
Avg ROVSV mob/demob site (each)	200 000	\$
Avg Swimmer mob/demob (each)	40 000	\$
N° mob/demobs per year	3	

ANNUAL INTERVENTION COSTS

ROVSV + ROV	2 616 000	\$/year
Swimmer	456 000	\$/year
20 YEAR COST DIFFERENCE	38	MUSD
COST SAVINGS AFTER YEAR	2,4	

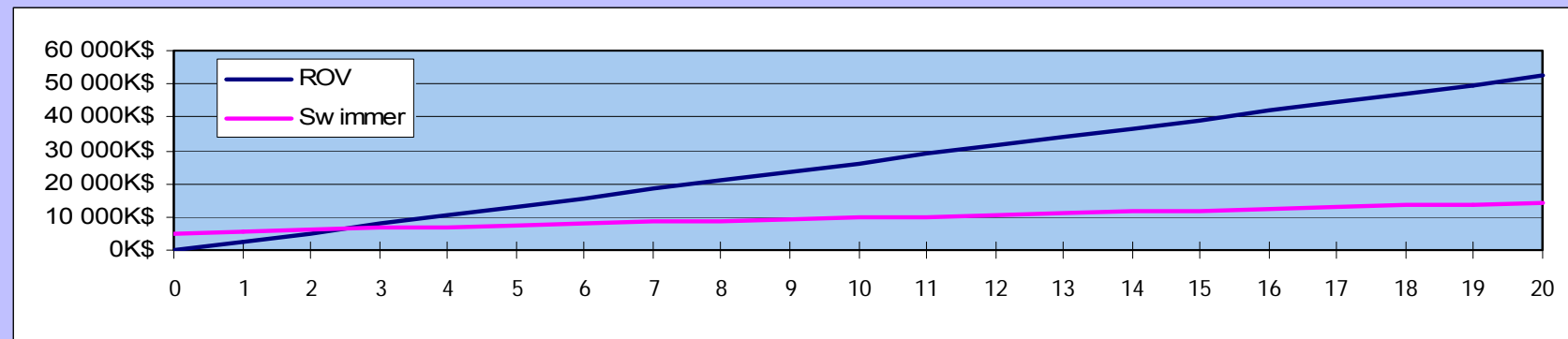



- The concept works and economic studies demonstrate that costs can be saved.
- Good feedback on concept and trials from oil & gas companies.
- Swimmer concept needs to be taken into account in initial field concept and design for optimum (cost) efficiency (but IMR is not yet a top priority....).
- Industry shift to subsea processing : Power will be available at the site
- (2002 GEP innovation award, nominated at ONS 2002 for the innovation price.)



- Continuation of the *Swimmer* development using the same operation and cost criteria.

But (partially based on industry feed-back) :

- Light and simple interventions in fully autonomous mode.
- Docking onto a typical ROV panel and/or defined locations with known dimensions of grabbing bars, valves(known environment)

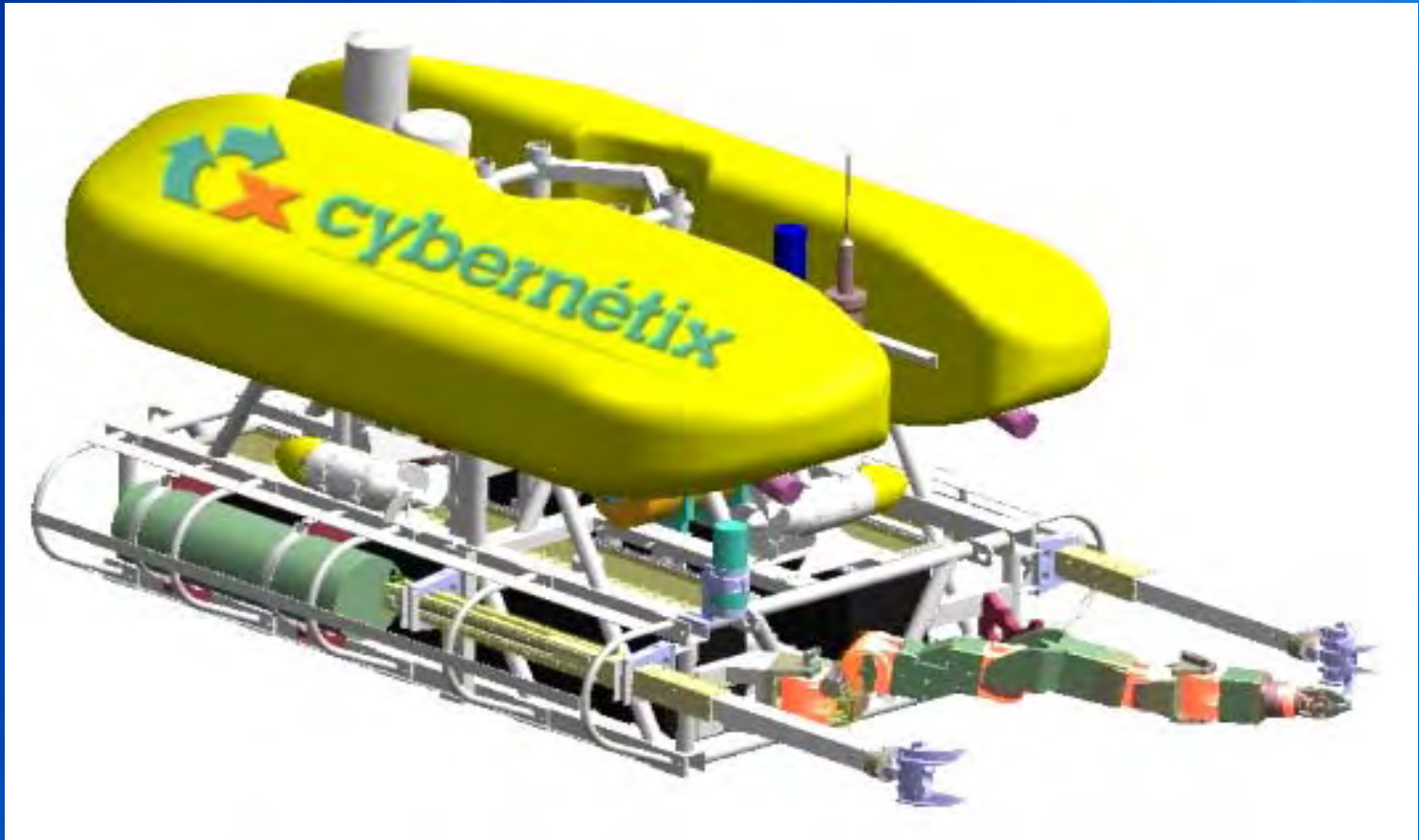

Autonomous Light Intervention AUV

- Autonomous transit to a 'safe landing area'
- Dynamic stabilisation (DP) for structure identification

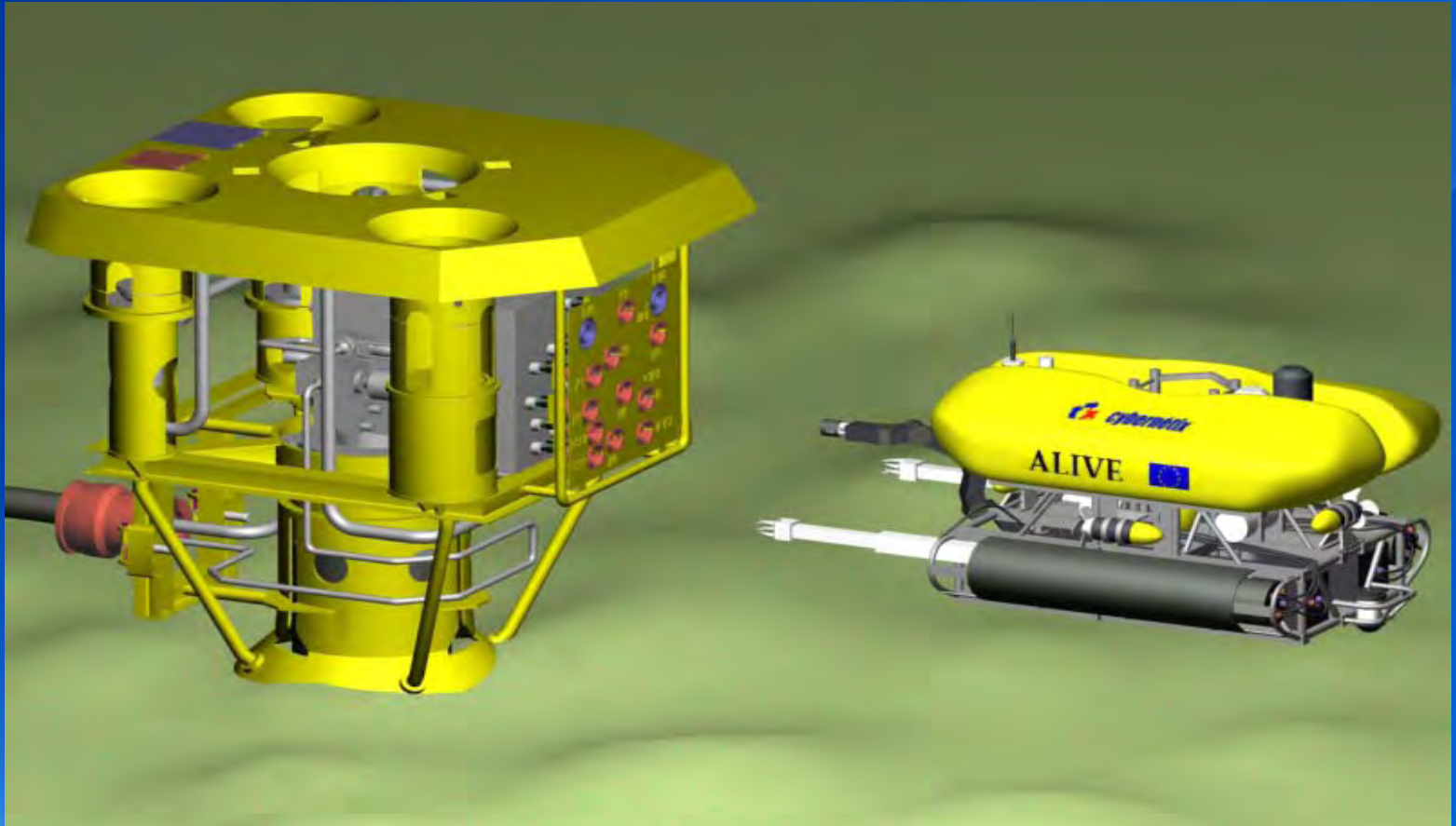

- Docking using sonar and video image processing
- Tele-manipulation in robotic mode with supervision through acoustic link

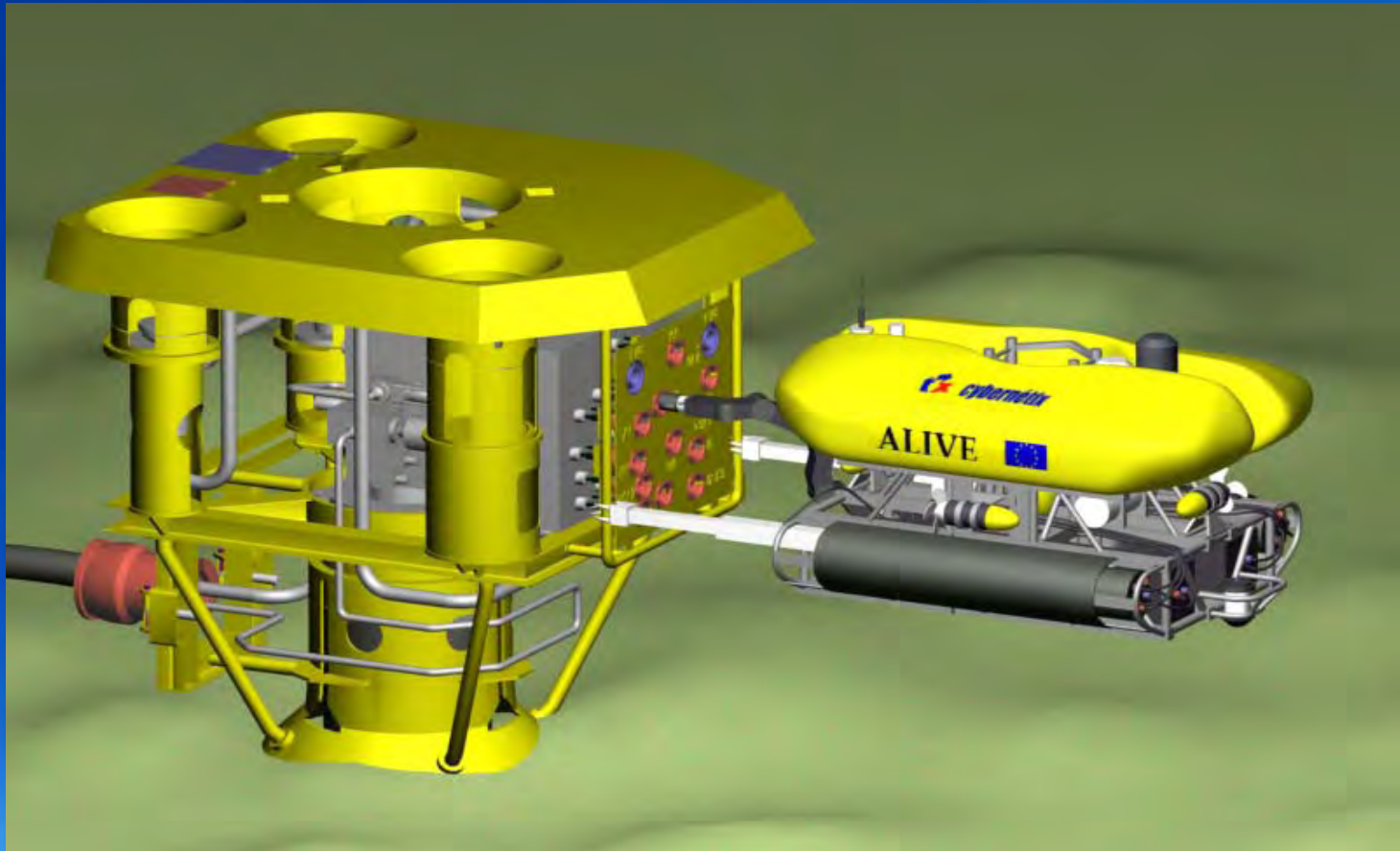

Alive



- Design completed, fabrication started in 2002
- Prototype ready for deepwater trials late 2003





*Can Intervention AUVs assist in
reducing the OPEX of
deepwater subsea fields ?*

In Conclusion



- The « Intervention AUV » is ideally suited for inspection, survey and monitoring and other basic tasks (the majority of ROV activities).
- No DP vessel required therefore direct cost saving.
- Vehicle is available on host facility so no delay in mobilisation.
- Swimmer could be a 'permanent' subsea system with no deployment delay and no weather sensitivity.

In Conclusion



- The answer is YES,
- BUT... although Swimmer and Alive are exciting advances in technology, further 'industrialisation' is required.
- Each field is a 'case' and needs to be studied.
- Operators are enthusiastic and it is expected that they will stimulate progress.
- BUT... innovation will not go faster than industry's needs.

Our Vision for the future



Fast Internet
Via Satellite

Control and Command
of the vehicle

Data Transmission
(Vehicle State and Images)

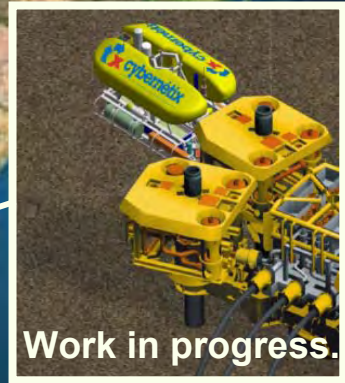

Work in progress.



AUV Control Center

Other Remote Operated Systems



Icare

- Remote operated anchor chain cleaning and inspection

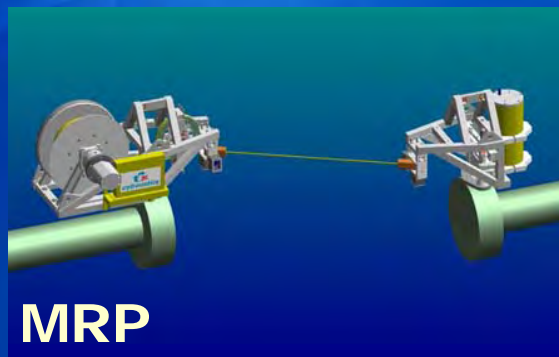

MRP

- ROV operated taut wire metrology



Spider

- Subsea crawler for pipeline inspection



Octopus

- Remote operated vehicle shiphull cleaning



MRP

- Fast and cost efficient
- Error $< 0.5^\circ$ and 0.1% of distance
- Only one equipment set-up (no need to interchange location)
- The system can be made available for demonstration on specific projects

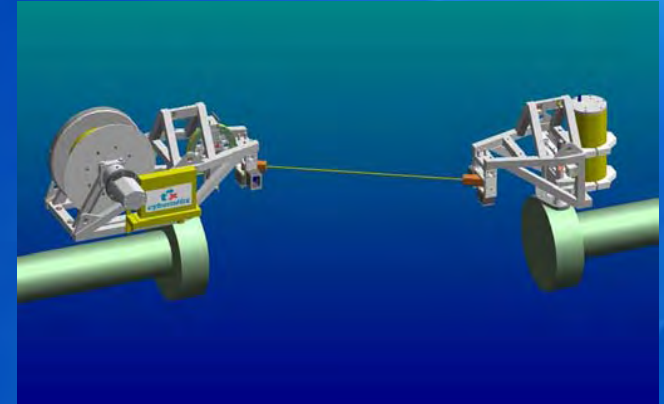



Junior

- Compact Obs ROV
- Toolskid
- Operated through Work ROV umbilical
- DP capability
- 3000 msw rating
- Under construction





cybernétix

Innovative Subsea Solutions

Marseille, France

HTTP:\\www.cybernetix.fr\offshore

Email: offshore@cybernetix.fr

Phone: +33 (0)4 91 21 77 53

Technosphere , inc .

An independent consultancy providing market development and representation services in Houston for offshore marine technology companies

Contact:

8584 Katy Freeway, Suite 435,
Houston, Texas 77024, USA

Tel: +1 713 973 1910

Fax: +1 467 0887

e-mail: info@t-sphere.com

Present and Future AUV Capabilities

Presentation for the
OTRC Workshop April 10-11, 2003

By

Joe Wadsworth

AUV Manager

Oceaneering International



OCEANEERING®

Present and Future AUV Capabilities

- Overview Oceaneering present AUV capability
- Oceaneering's concept for intervention class AUV's
- Enabling technology for future AUV development

An Alliance for AUV Survey Services

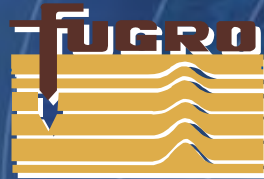

- **Team Role: Autonomous Underwater Vehicle Systems**
- **Rich legacy in autonomous software and UUV Development**
- **Prime contractor for LRMS**

- **Team Role: Survey Sensors and Data Processing, Surface Nav and Tracking**
- **World leader in marine surveys and geotechnics**
- **Established industry standard for integration of geophysical, geological and engineering data**

- **Team Role: Launch and Recovery System and other Topside Gear**
- **World leader in deep sea remote operations and intervention**
- **In-house capability to design, build, and operate deep ROV and Intervention Systems**

Echo Ranger Survey AUV



Single pass / multi-sensor route and site survey

o 3000m depth

o 5.5m length
x 1.27m height
x 1.27m width

o 5700 kg

o NiMH battery
with 28 hr duration

o 8 kts max speed

Echo Ranger Survey and Navigation Instrumentation

- Survey Payload
 - Edgetech full spectrum Side Scan and Sub-bottom Sonar
 - Simrad SM2000E Multi-beam Swath Bathymetry Sonar
- Acoustic Modem
 - LinkQuest 4010 QC modem
 - LinkQuest 3010 vehicle command and status modem
 - ECR for back-up emergency surface command
- Navigation
 - Kearfott KM 5053 ring laser gyro
 - RDI Workhorse DVL
 - Sonardyne USBL and LBL



Echo Ranger Capabilities



Features new to the market:

- Subsurface caged L&R
- Active ballast and trim control
- Passive loiter: moor on seafloor
- LBL self nav capability
- System diagnostics

Deepwater ROV and AUV Comparisons

	ROV	AUV	Hybrid
PRO	<ul style="list-style-type: none"> ▪ Real-time transmission of data ▪ Power available for long durations ▪ Flexible use of large suite of tools and instruments ▪ Wide availability 	<ul style="list-style-type: none"> ▪ No Large DP vessel reqd ▪ Complete Mission without Surface Vessel Support ▪ Stability of AUV platform decoupled from cable to surface 	<ul style="list-style-type: none"> ▪ Real-time transmission of data ▪ Power available for long durations ▪ Flexible use of large suite of tools and instruments ▪ No large DP vessel reqd
CON	<ul style="list-style-type: none"> ▪ Sea state limits during intervention ▪ Requires use of large DP vessel 	<ul style="list-style-type: none"> ▪ Limited to performing relatively simple, programmable operations ▪ Limited real-time data or control available ▪ Limited dive duration at high power levels 	<ul style="list-style-type: none"> ▪ Requires an umbilical to wellhead with conductors available for signal and/or power

Hybrid Workclass AUV

- Shuttle System – LASER (Linked Autonomous System for Extended Reach)
 - Shuttle AUV which houses a smaller ROV
 - Shuttle transits autonomously and docks
 - Small ROV flies out of/off of the shuttle to execute work
- Single System – TASER (Totally Autonomous System for Extended Reach)
 - Single AUV transits, docks, executes work

TASER

- Transits autonomously to satellite facilities
- Docks into power/video/signal outlet near wellhead
- Operates in an ROV mode on a short tether
- Requirements
 - Subsea equipment designed for docking and access
 - Wellhead umbilical needs to incorporate power/signal/video channels for TASER

TASER



TASER

Docked in Mission Upload/Recharging Station

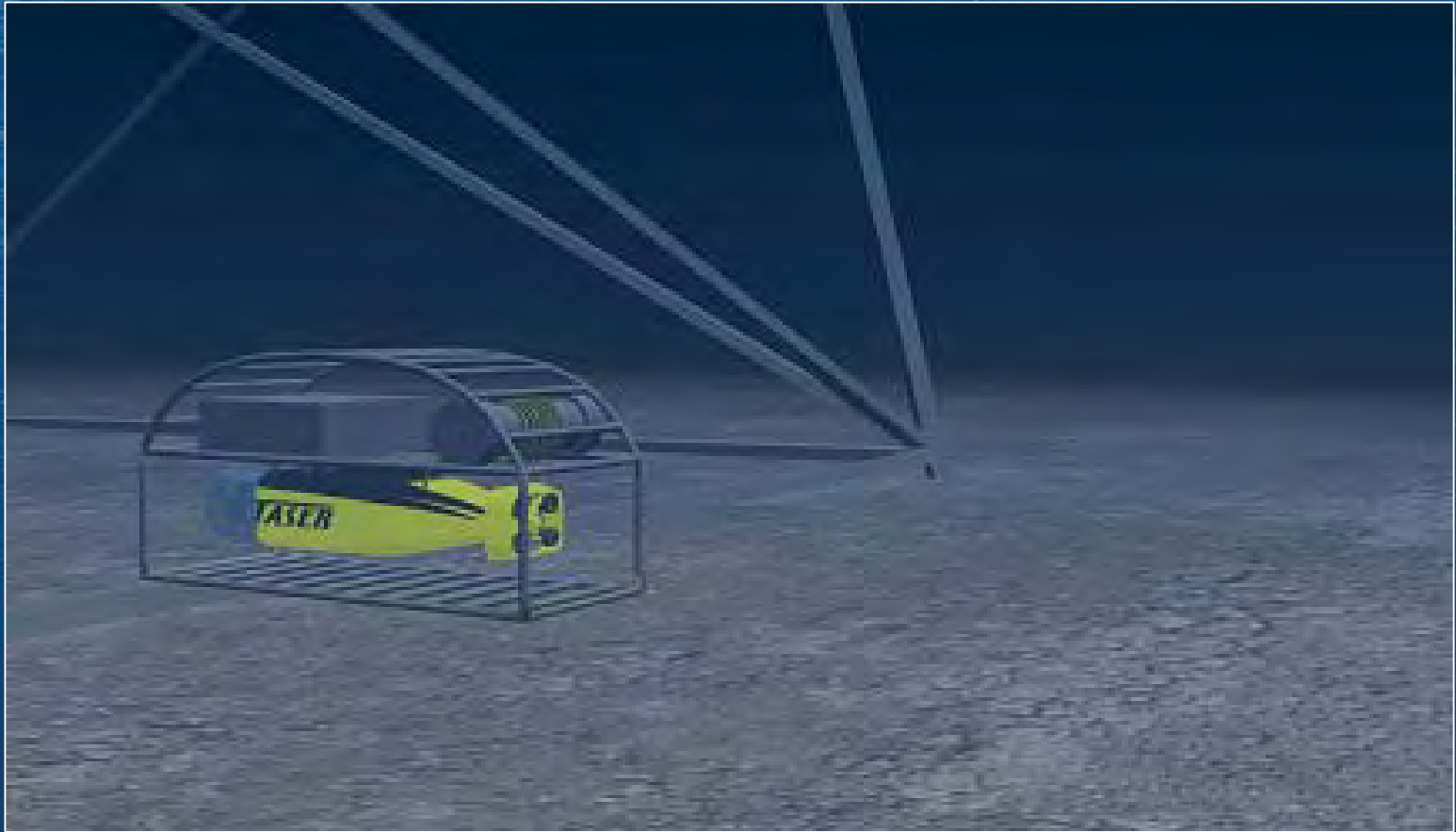

TASER

Exiting Docking/Recharging Station

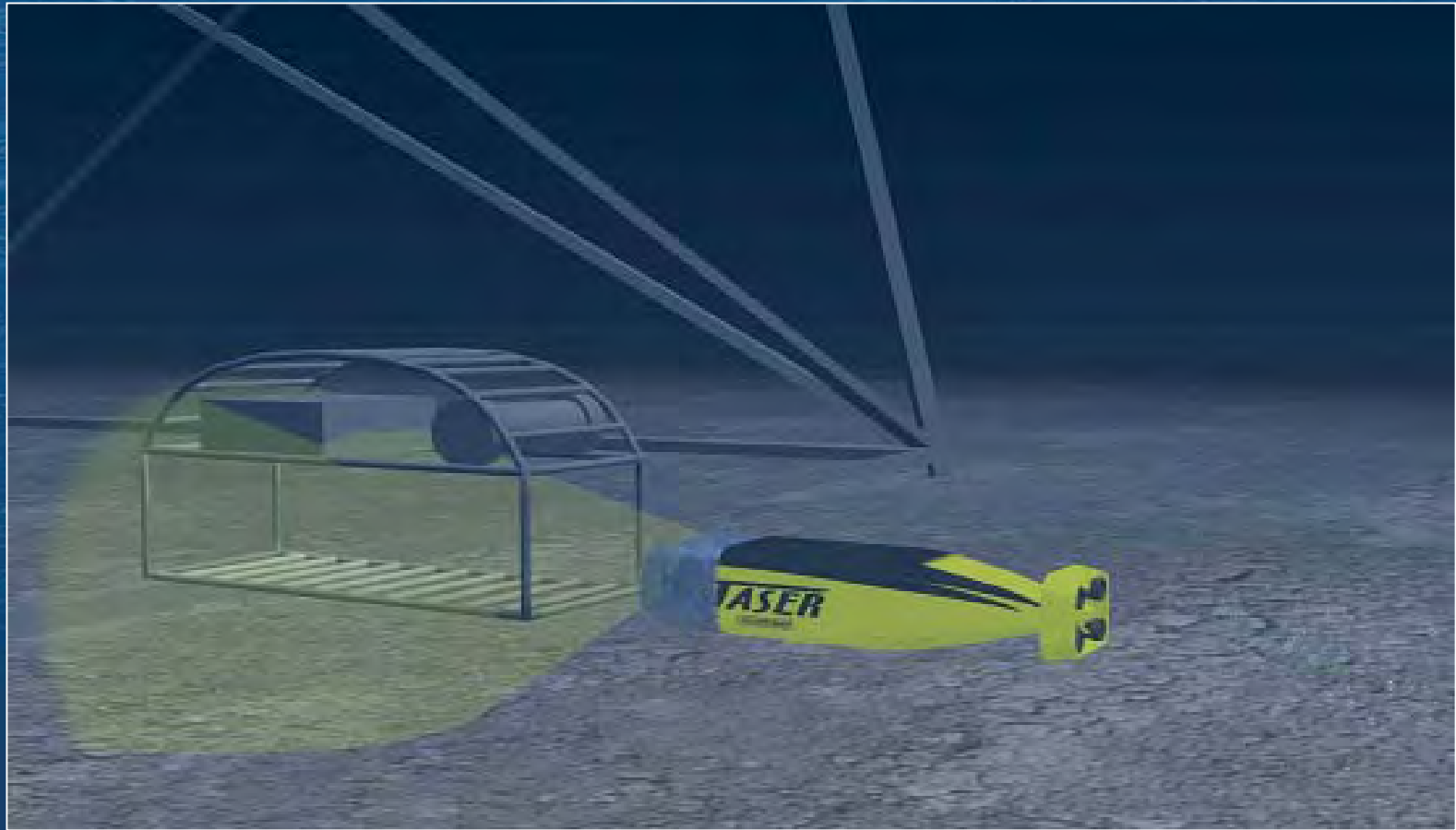

TASER

Beginning Transit to Satellite Facilities

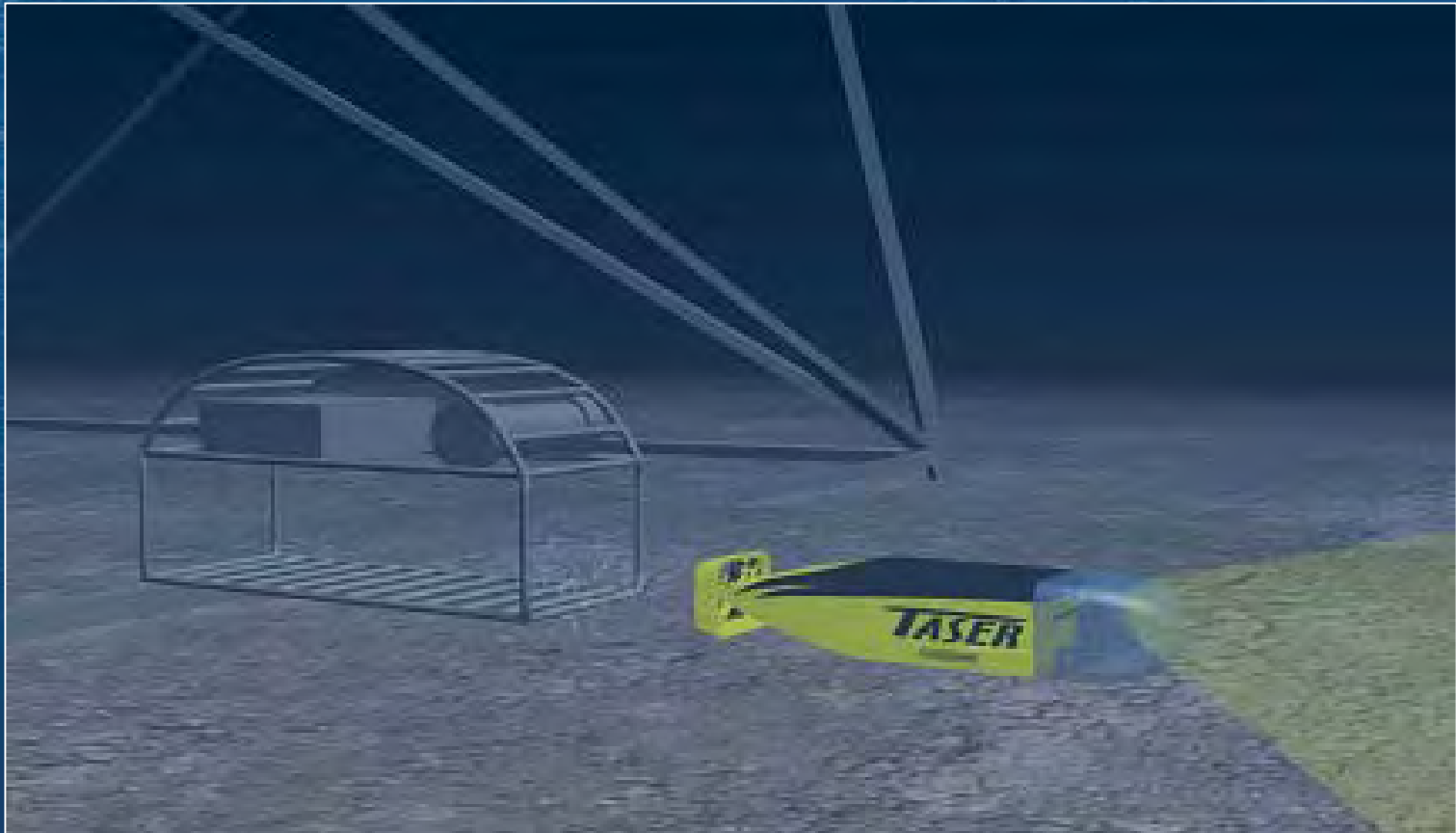

TASER

Approaching Satellite Facility

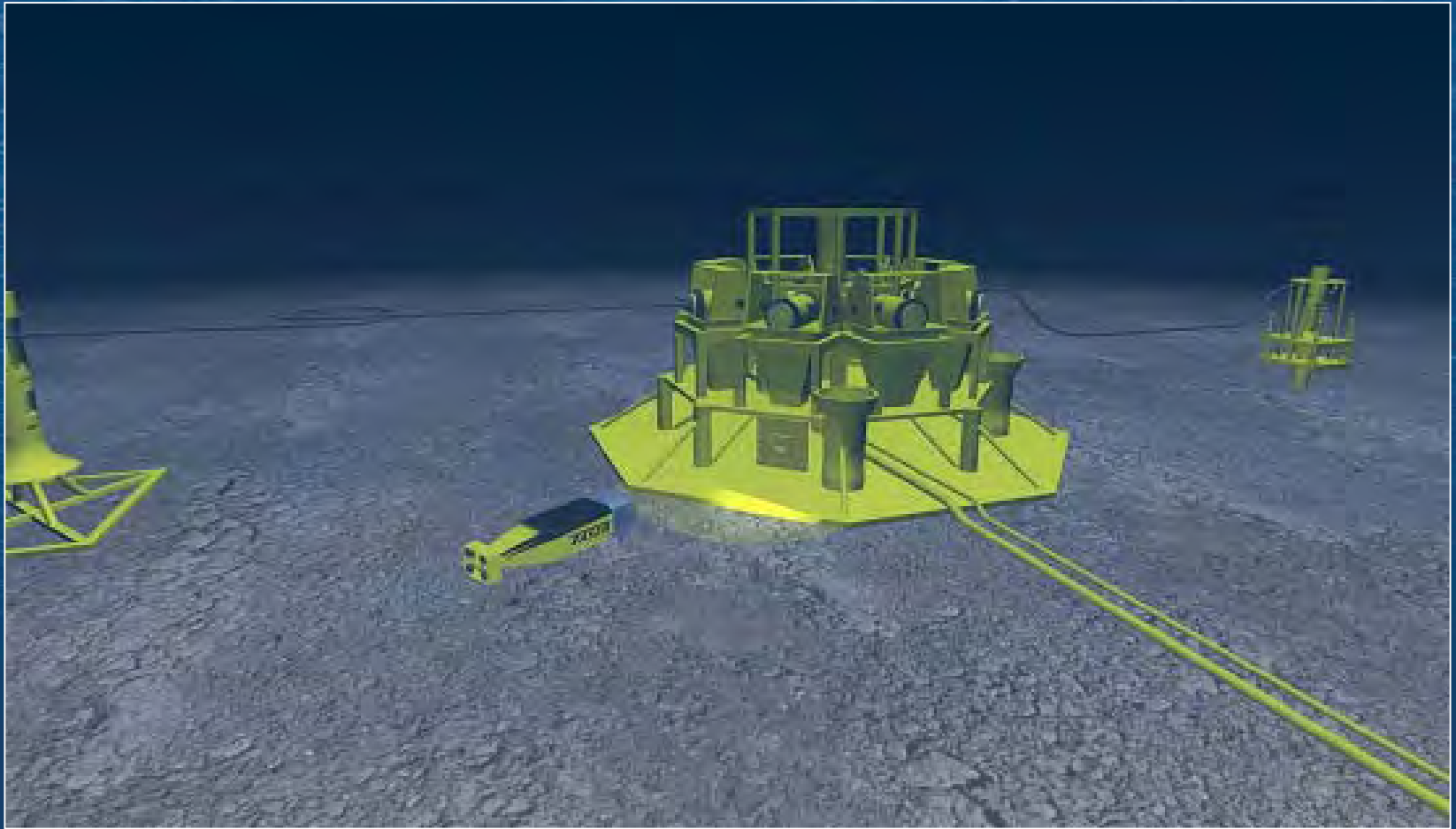

TASER

Docking with Power/Video/Signal Connector

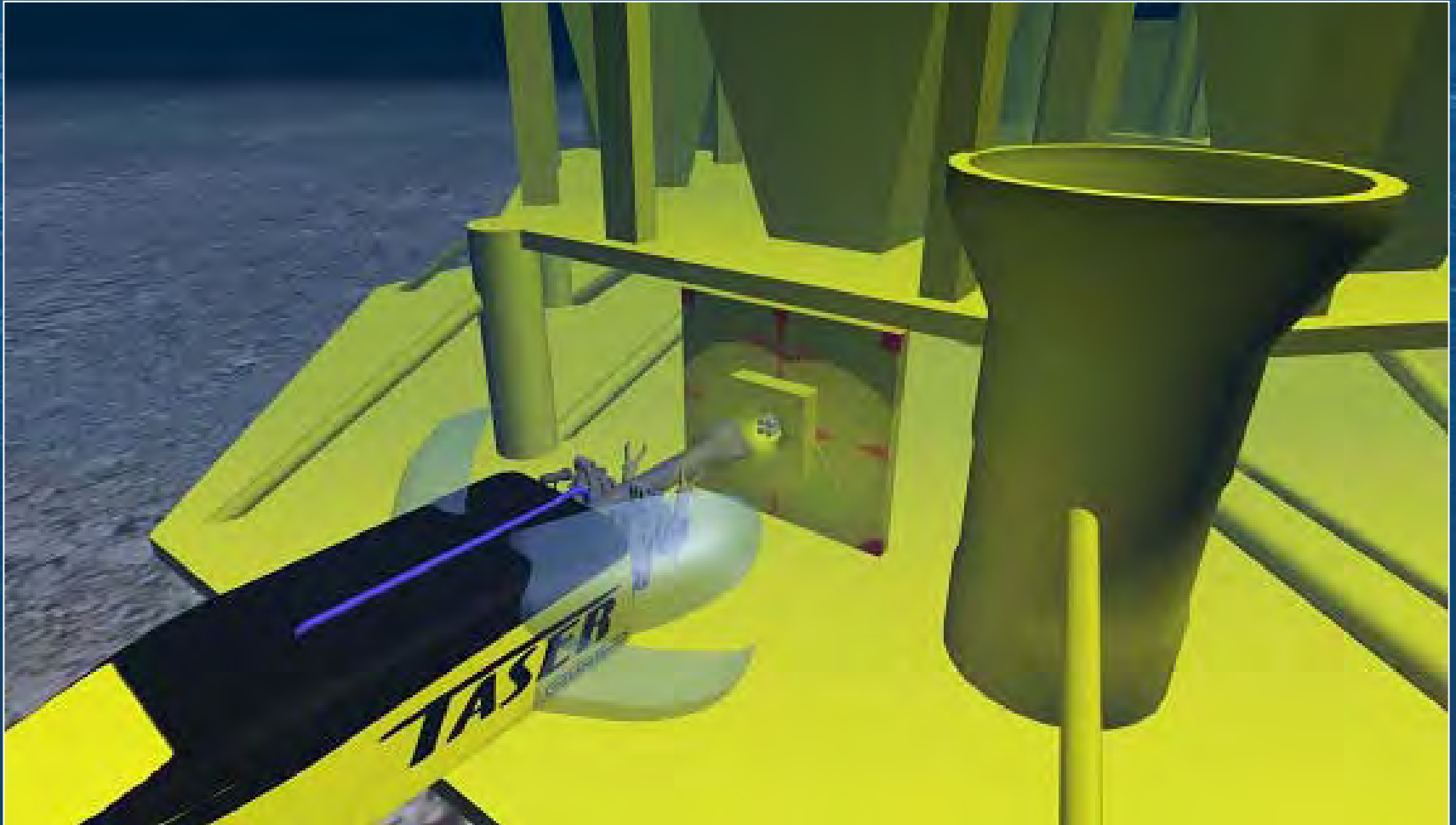

TASER

Operating as an ROV on Short Tether

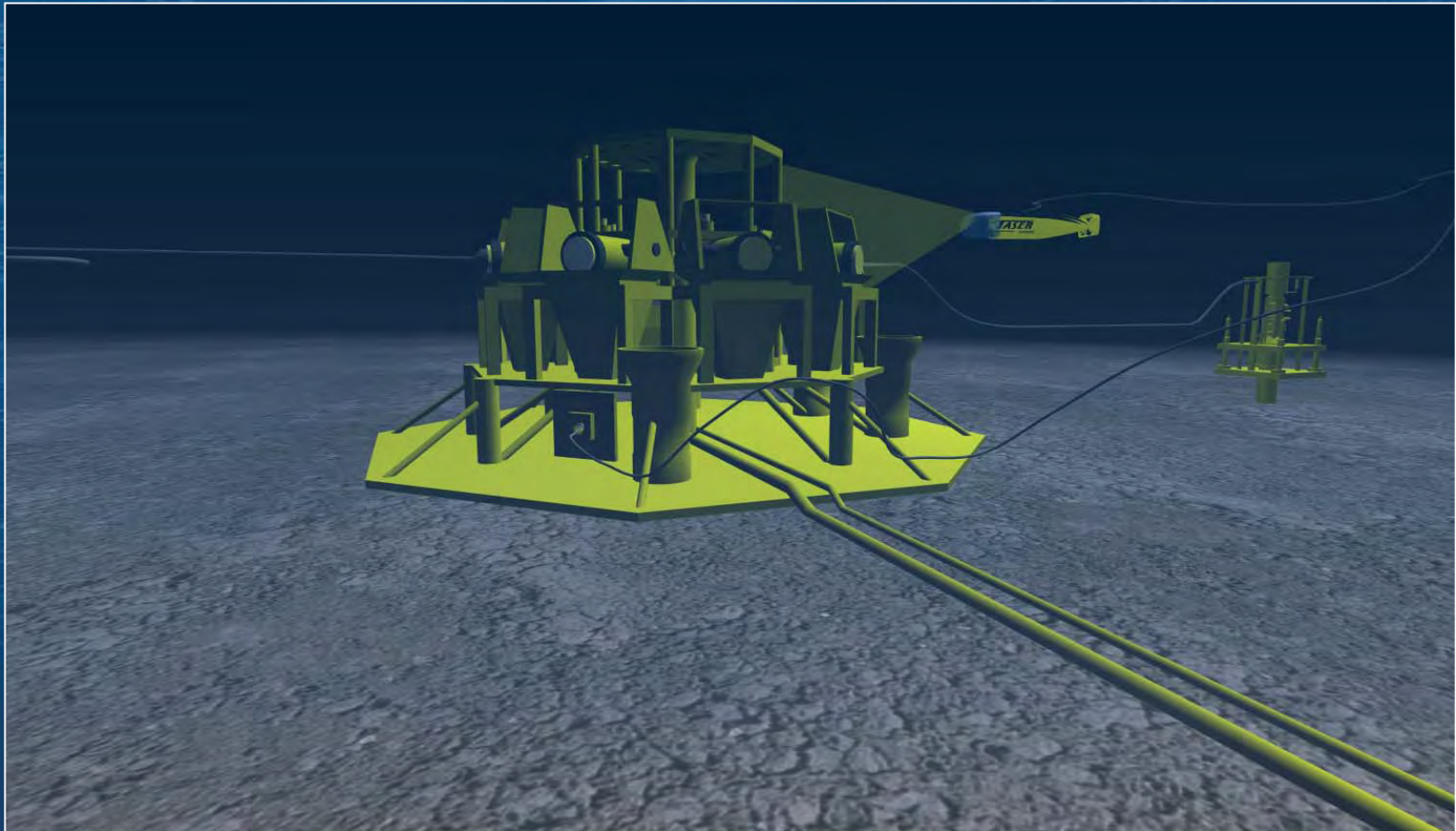

Enabling Technology for Pure Autonomous Intervention

- Improved bandwidth for through-the-water data and signal transmission
- Economics of scale from broader use of fuel cell and advanced battery types
- Sensor fusion to reduce payload weight, volume, and power demand
- Improved intervention interfaces to facilitate autonomous operations

CHALLENGES OF INTERFACING REMOTELY OPERATED VEHICLES AND AUTONOMOUS UNDERWATER VEHICLES WITH DEEPWATER SUBSEA SYSTEMS

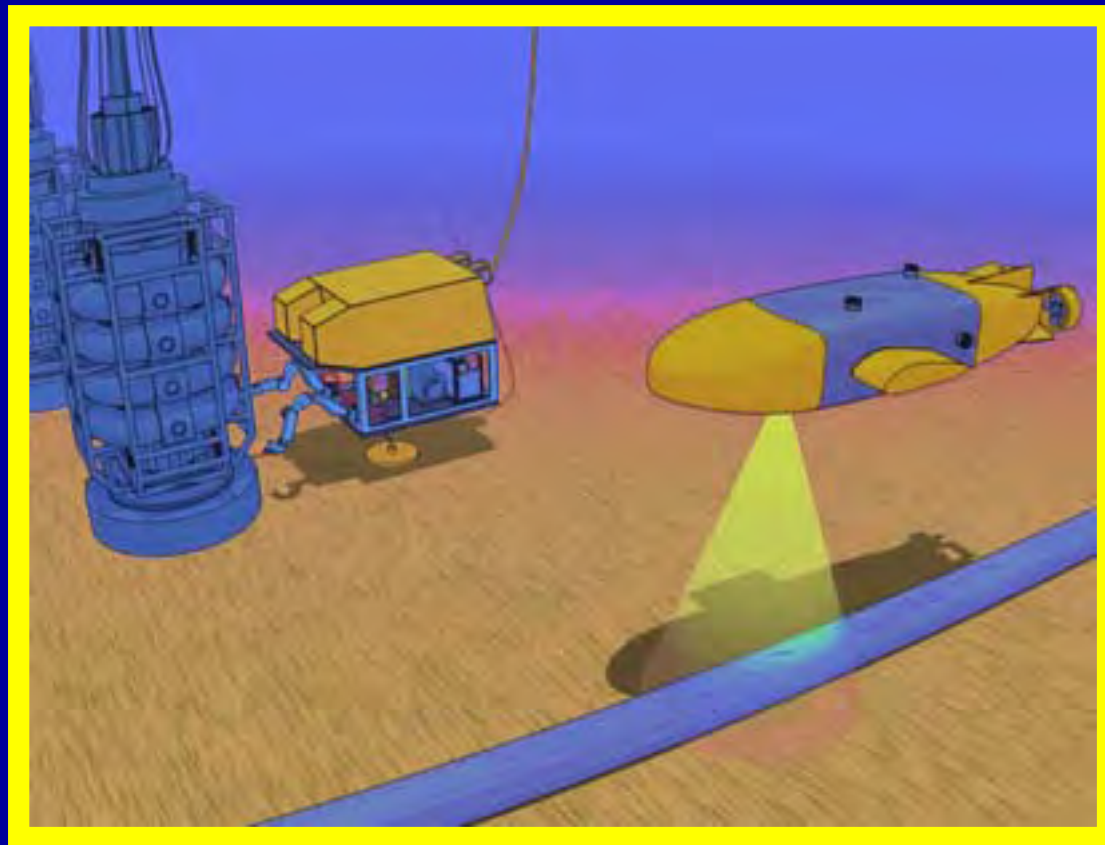



GOM Field Size Distribution

Cumulative Distribution of Published Reserves Fields in water depths exceeding 1,000 feet

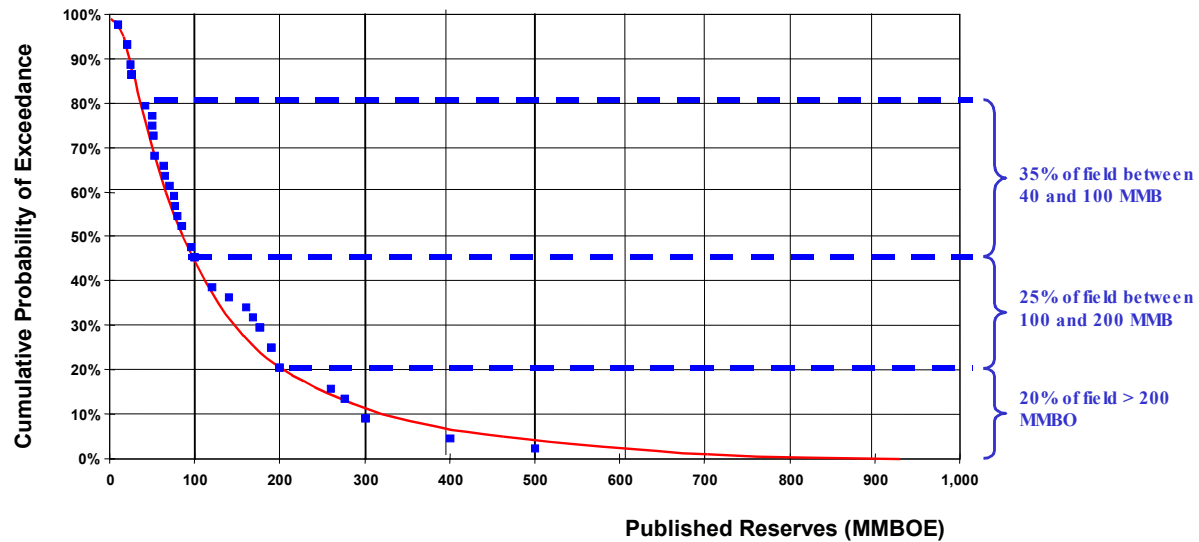

Source: PFC GoM Field Size Distribution Report Feb 2001
as reported by ABB at SNAME (Anderson, Jan.2003)

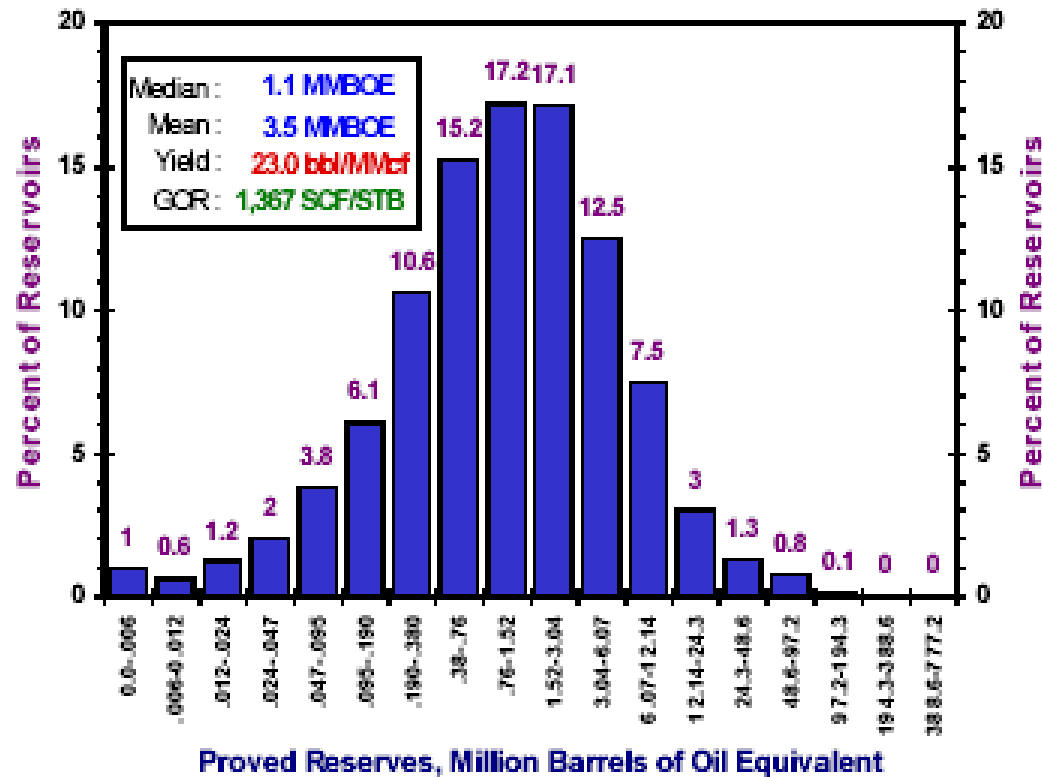

Figure 31. Reservoir-size distribution, 1,671 proved combination reservoirs.

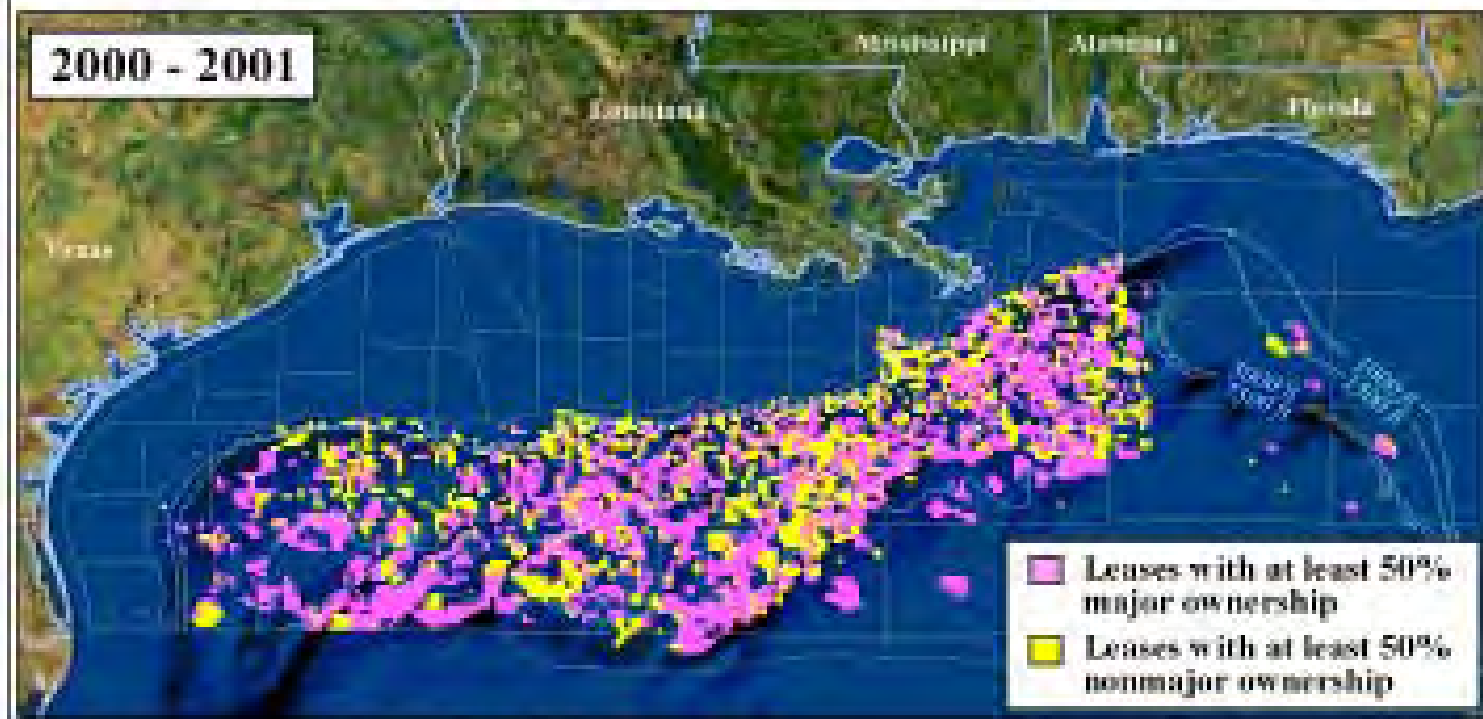
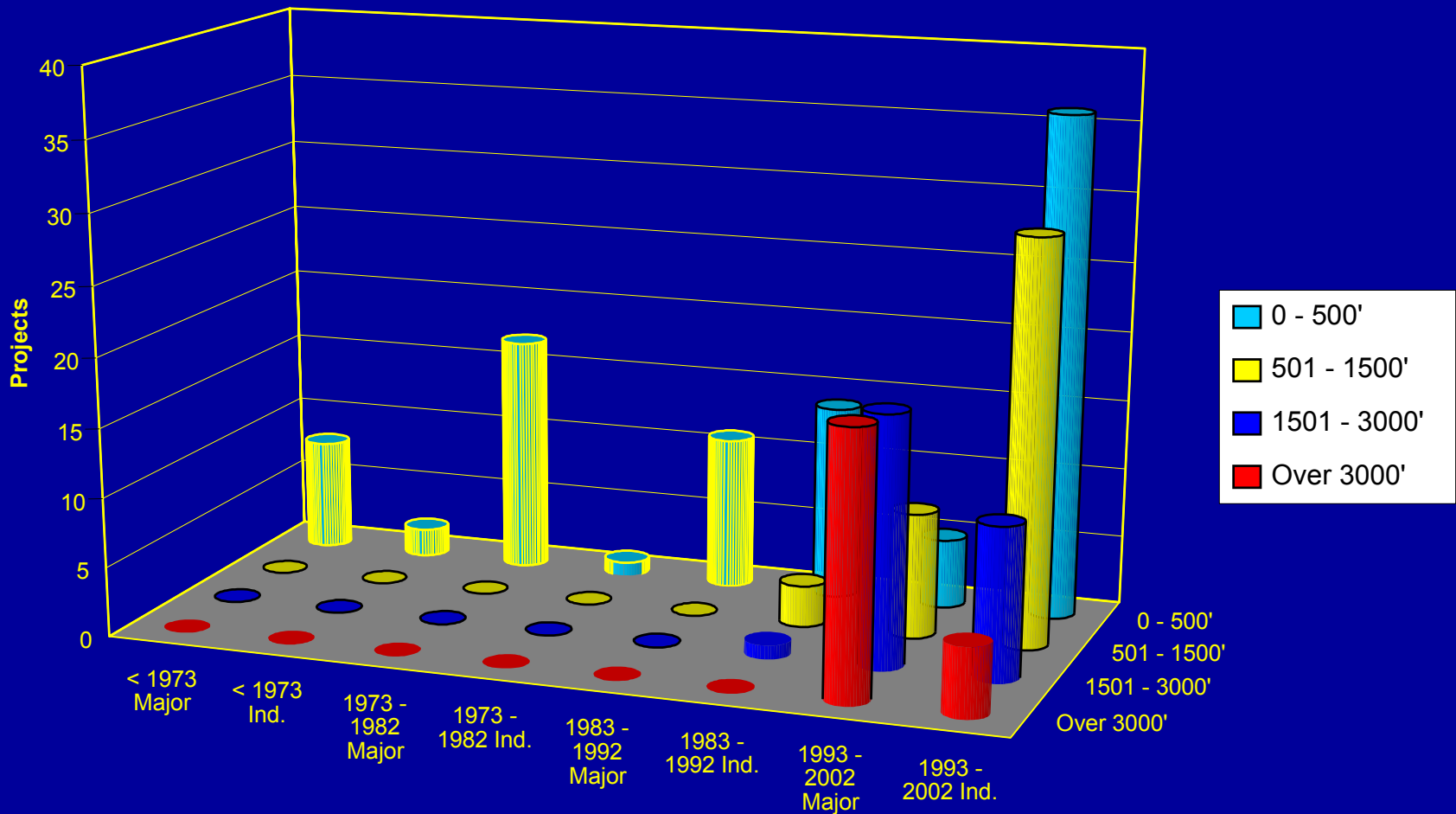

Figure 24. - *continued* - Ownership of deepwater leases.

174030085

GoM Majors Vs. Independents

Subsea Tiebacks



GoM Subsea Tiebacks



Increasing Offset Distances (Miles)

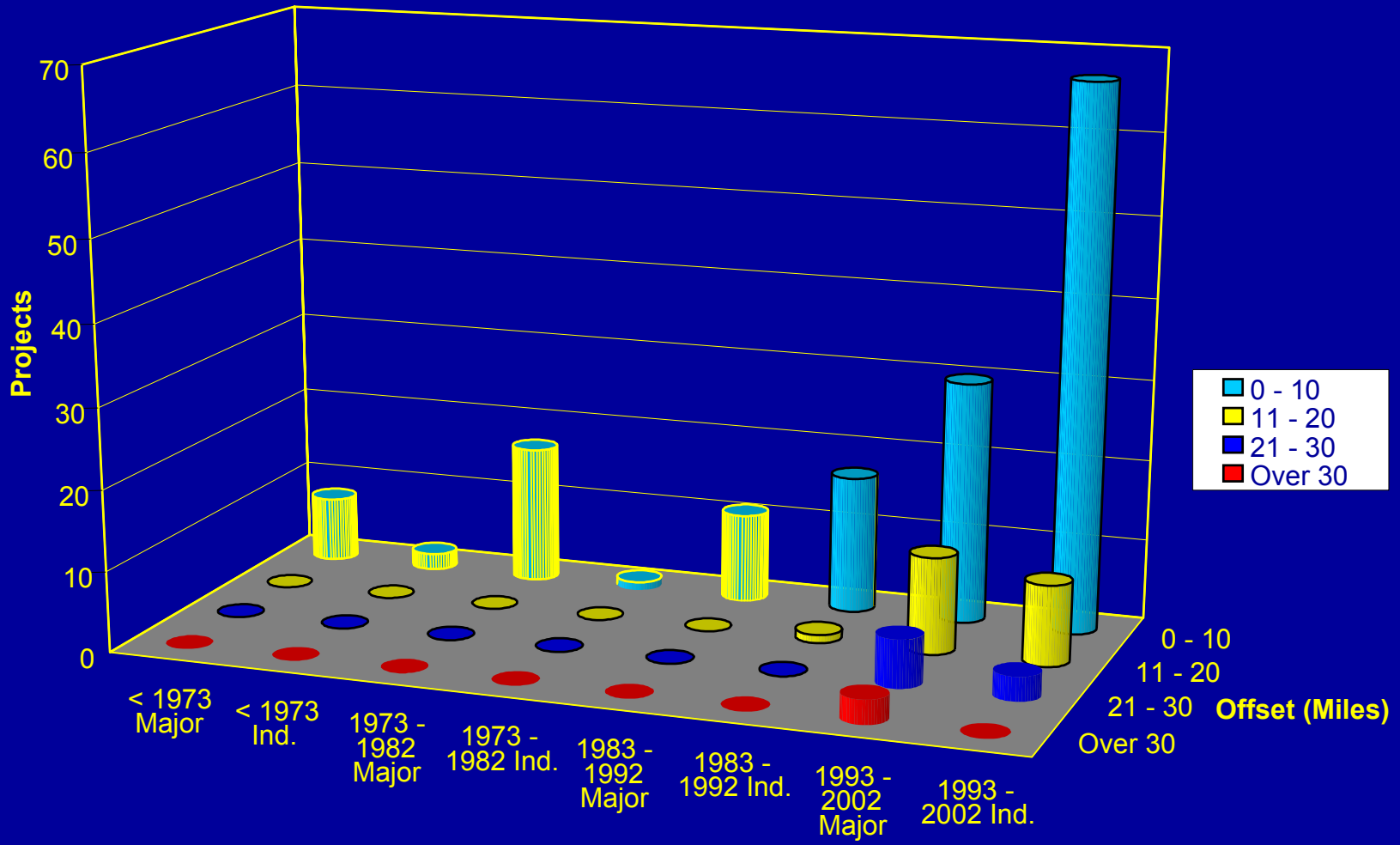

Discoveries

Announced Discoveries for Development 2002 & Beyond

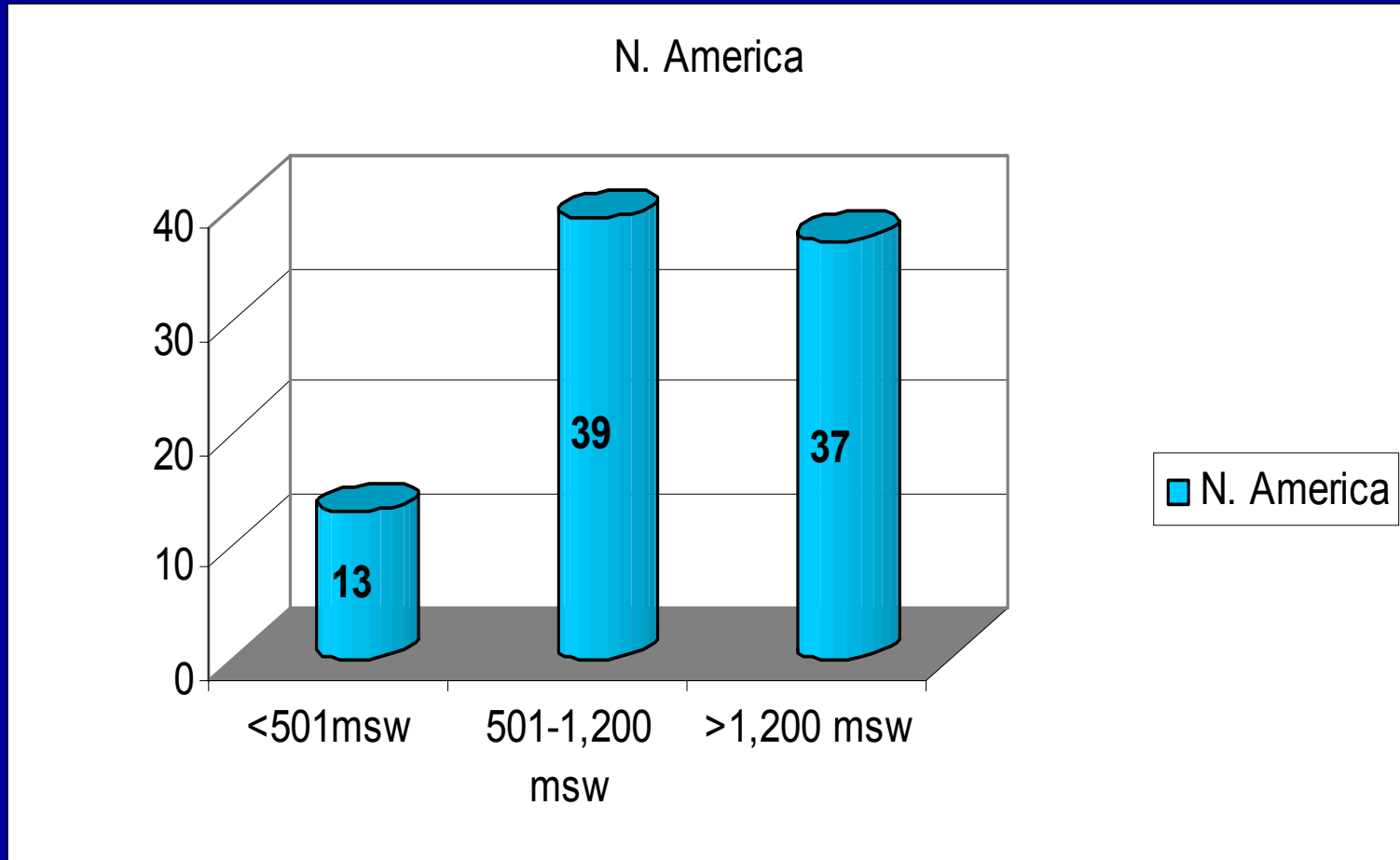

Source: Quest SUBSEA-DATA-BASE



Quest Offshore Resources, Inc.

GOM Deepwater Oil & Gas Daily Production Estimates 2002 - 2006

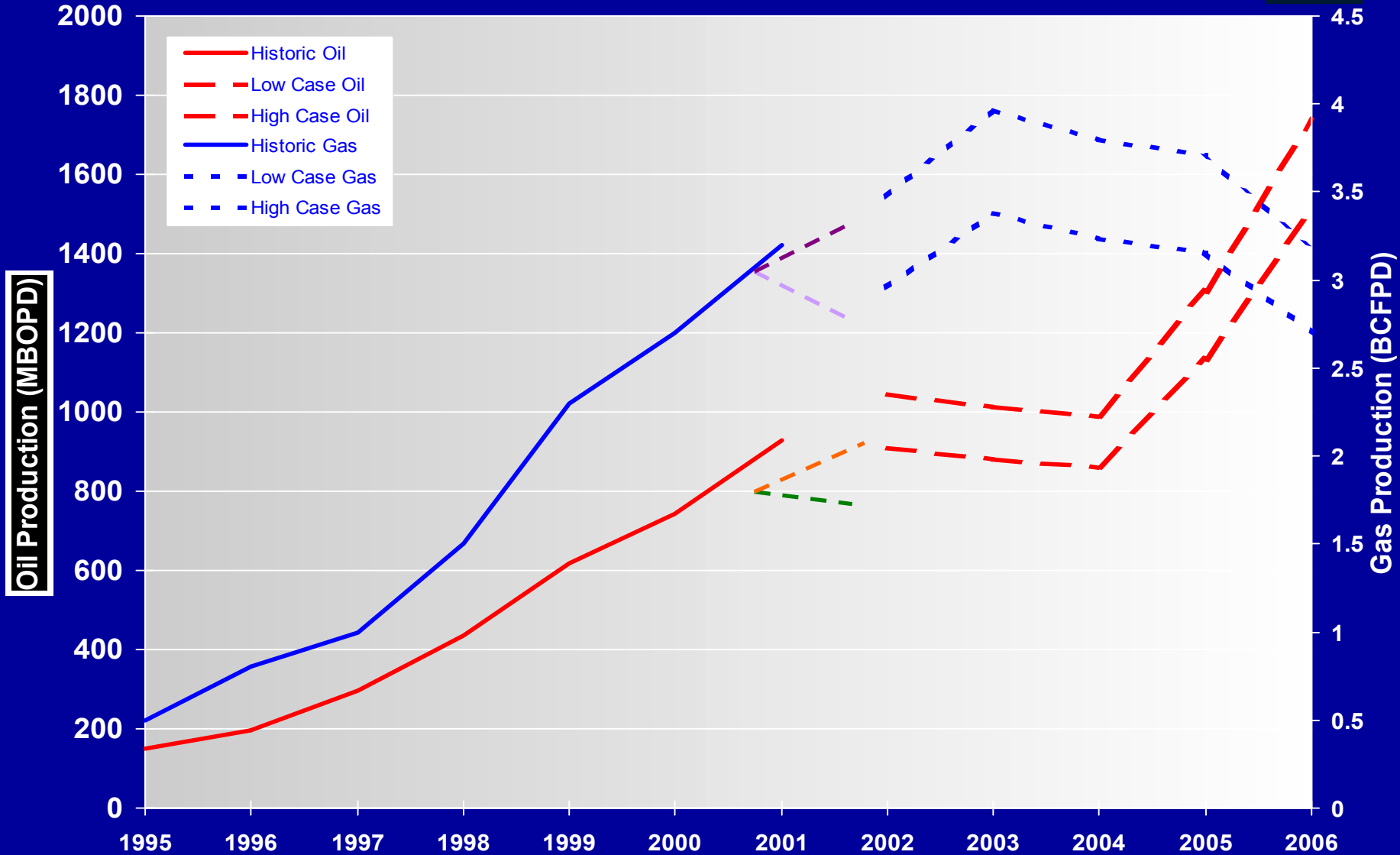

Source: Minerals Management Service



Quest Offshore Resources, Inc.



Global Subsea Market Outlook

Unprecedented Growth

Unprecedented Growth in Global Subsea Market

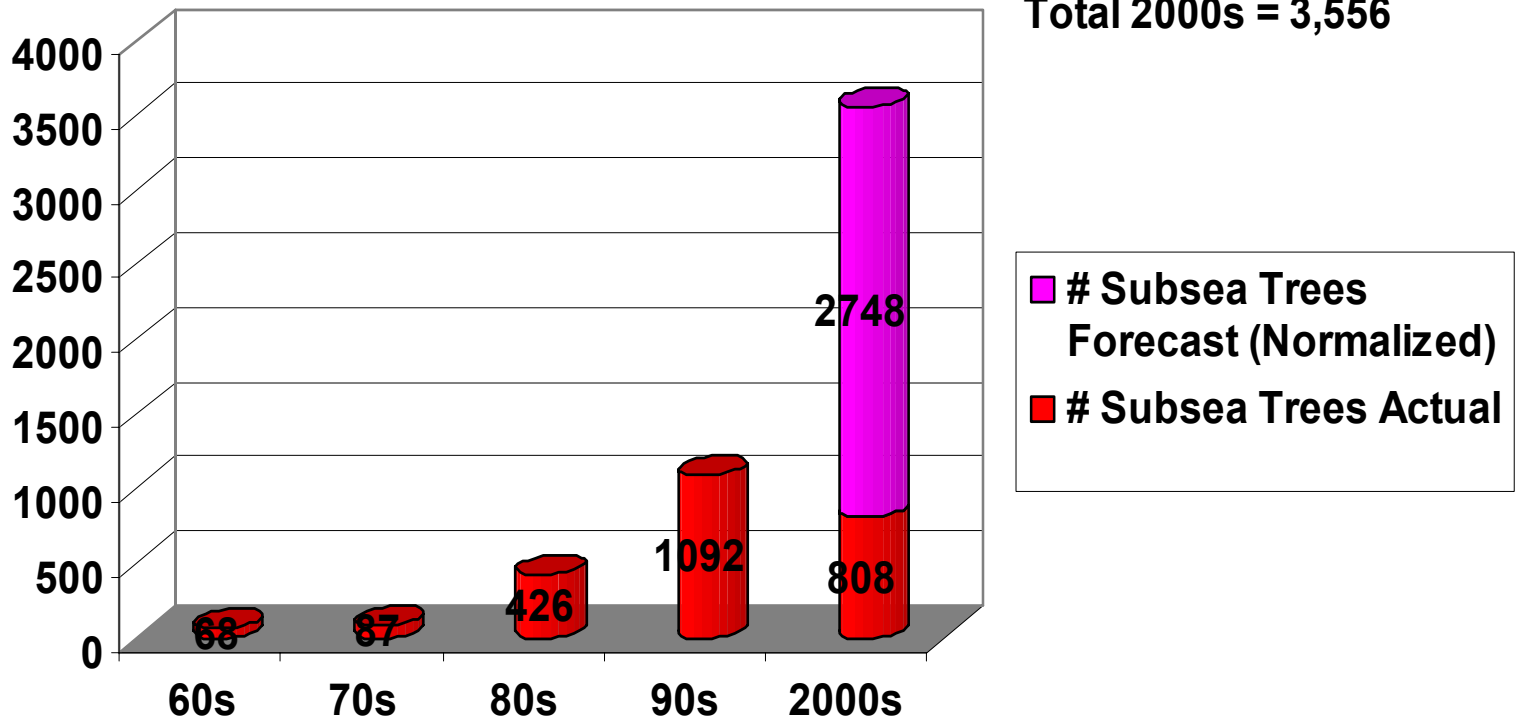

Global Subsea Forecast by Operator 2003 to 2008e



No. Projects

No. Completions

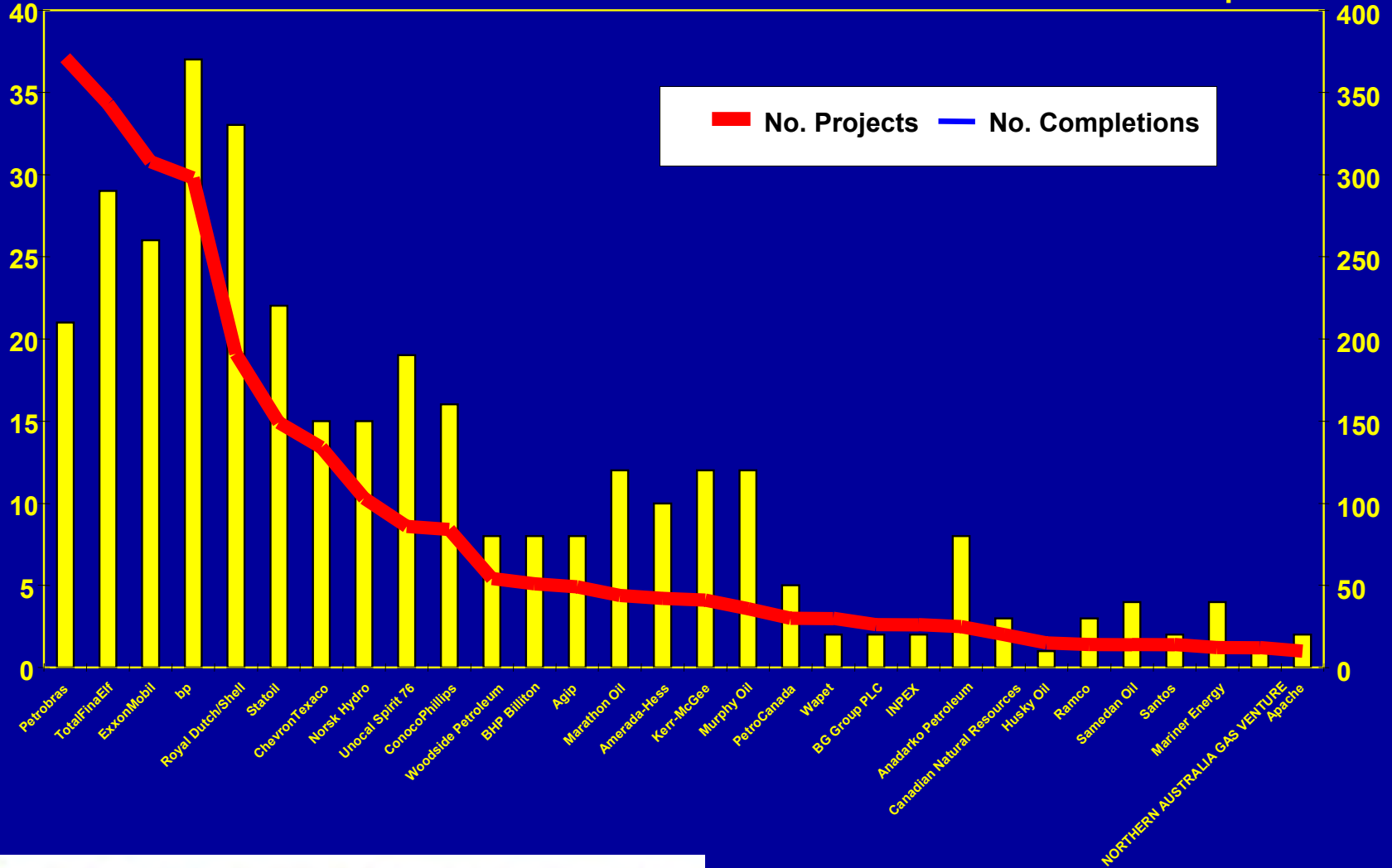

Quest Offshore Resources, Inc.

Global Floating Production Systems 1977 to Present



Global Floating Production Systems
Cumulative Total

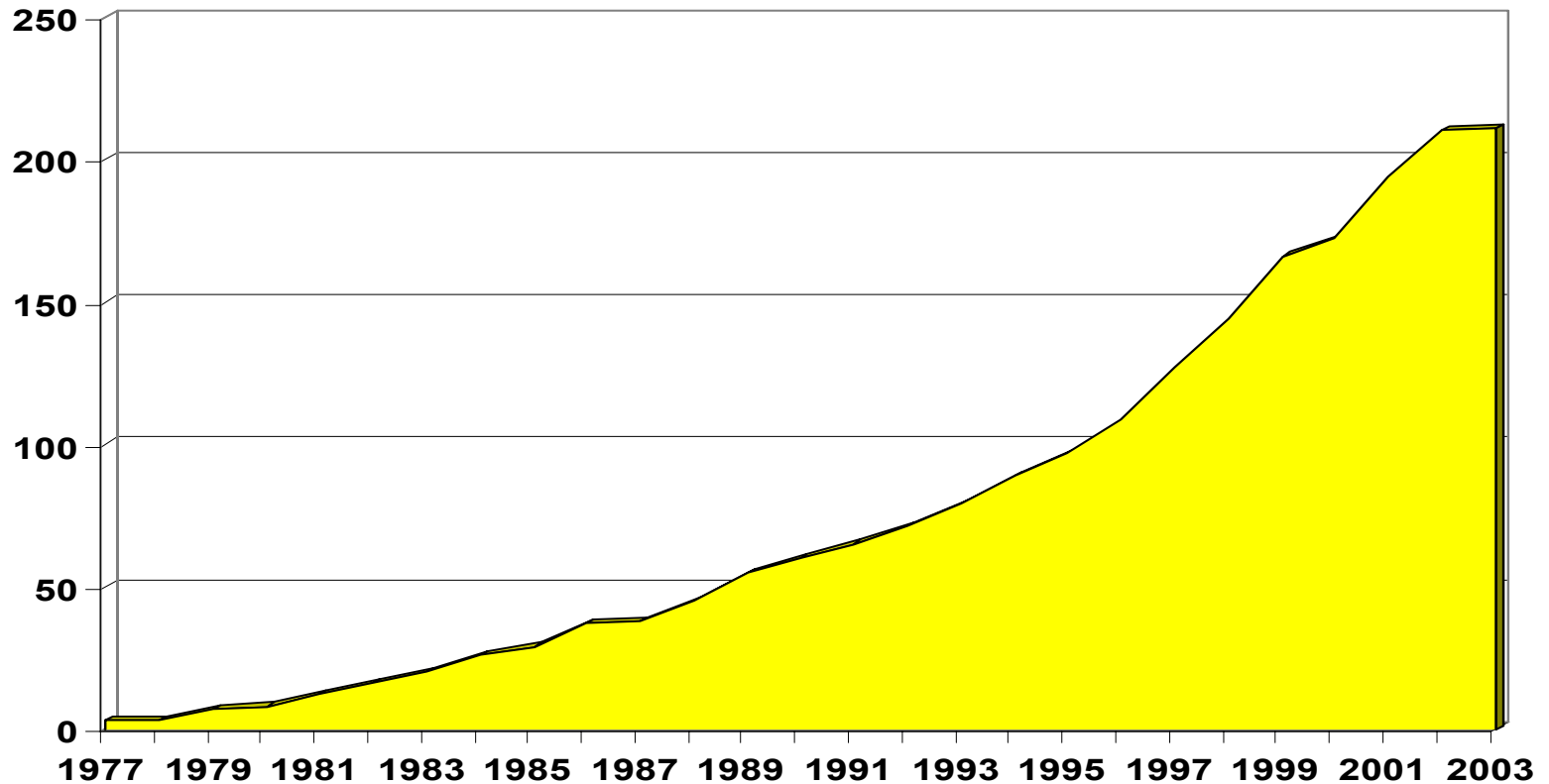

Worldwide Forecast 2003 to 2008e



2,611 Forecast Subsea Trees by Area by Year

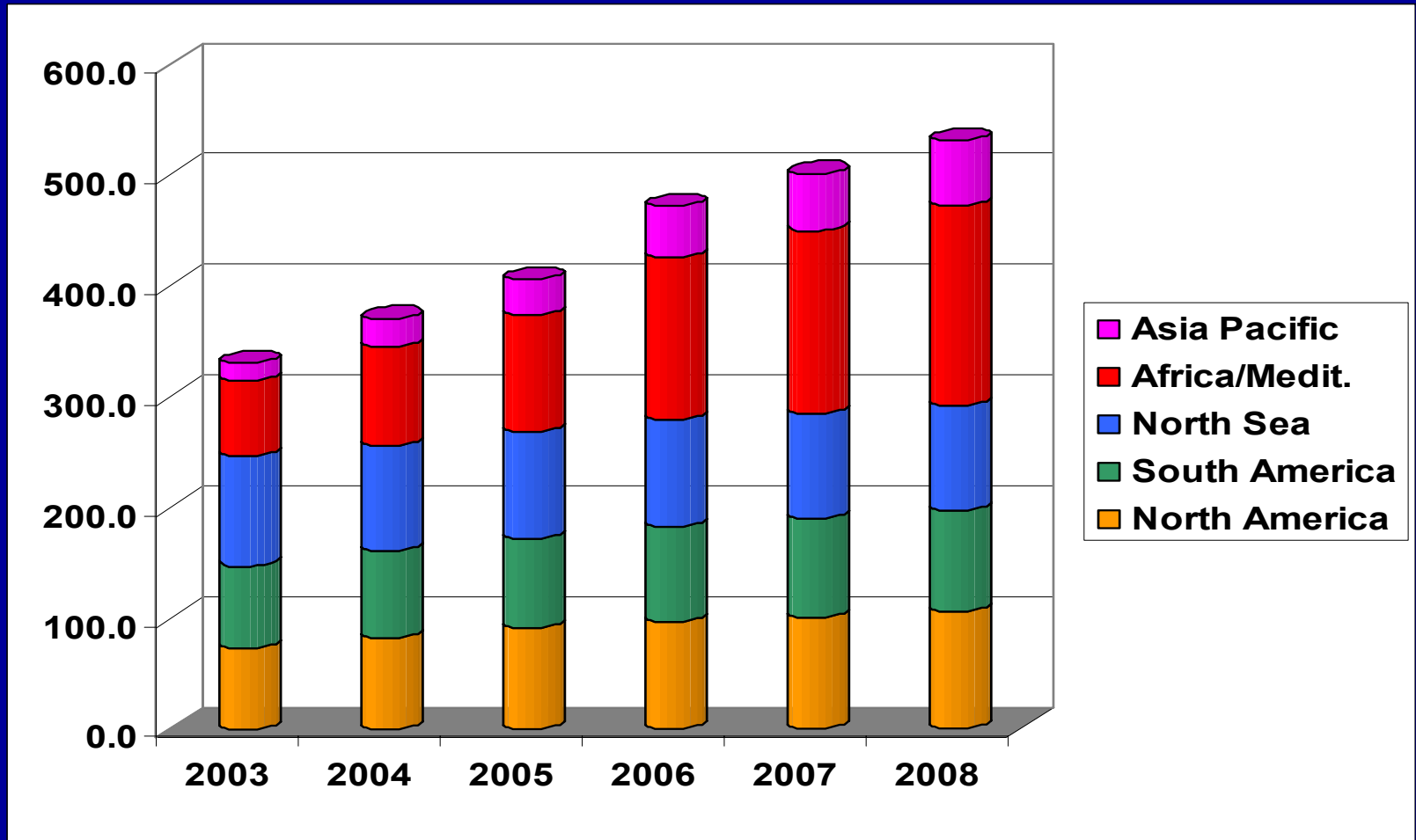







Floating Activity by Area

Floating Activity by Area

TOTAL = 221 Units

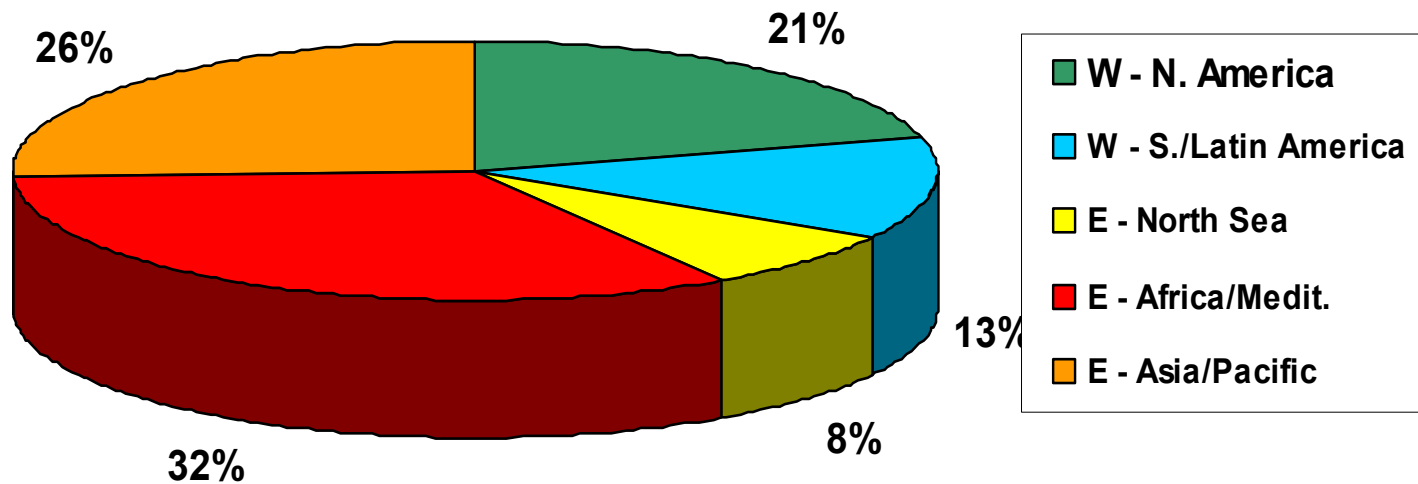



Floating Activity by Status

Forecast Floating Activity by Status

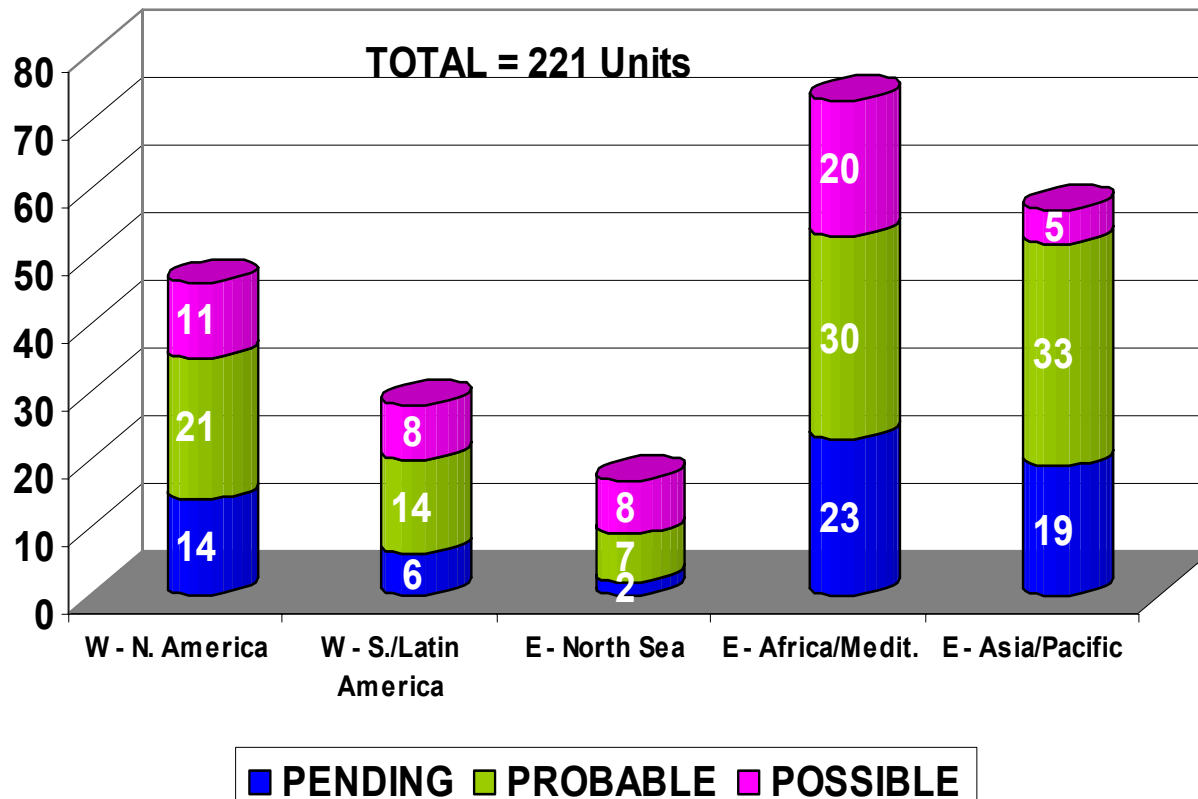

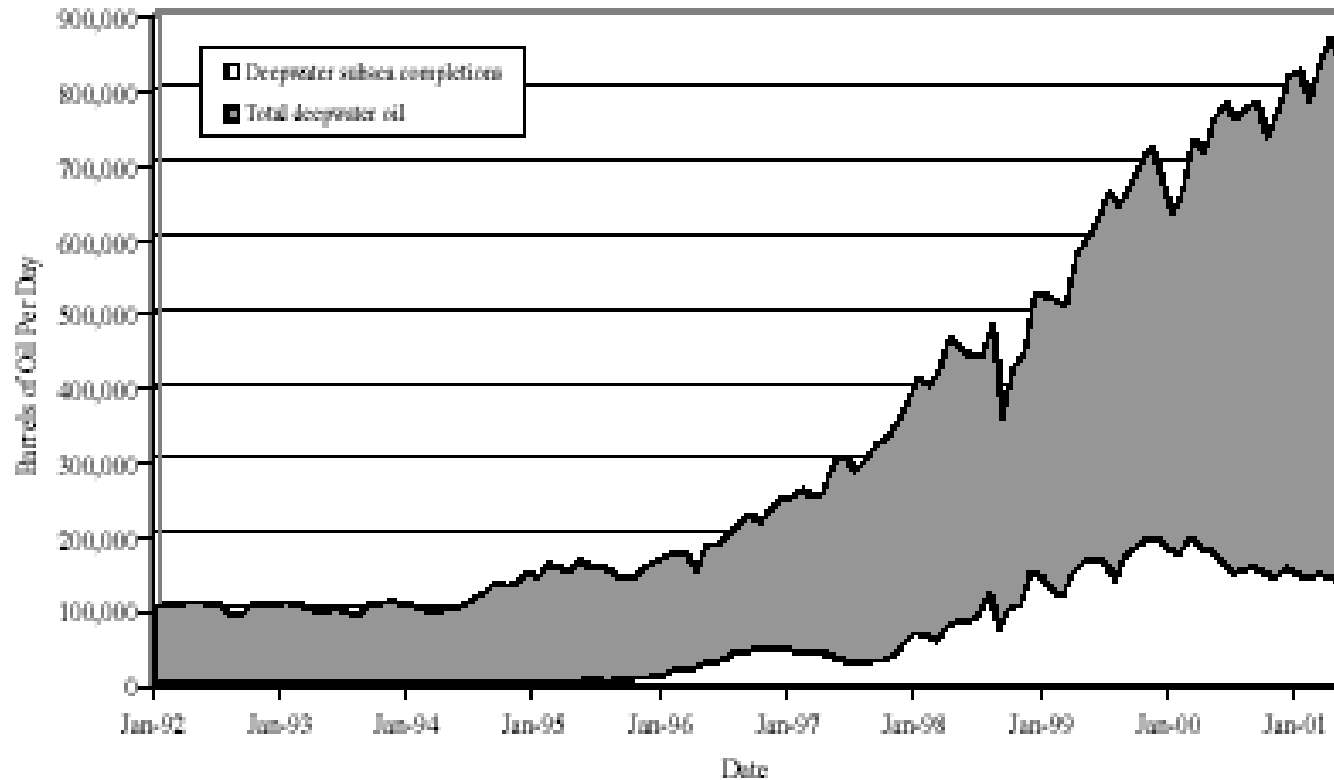

Figure 59. - Contributions from subsea completions toward total deepwater (a) oil production and (b) gas production.

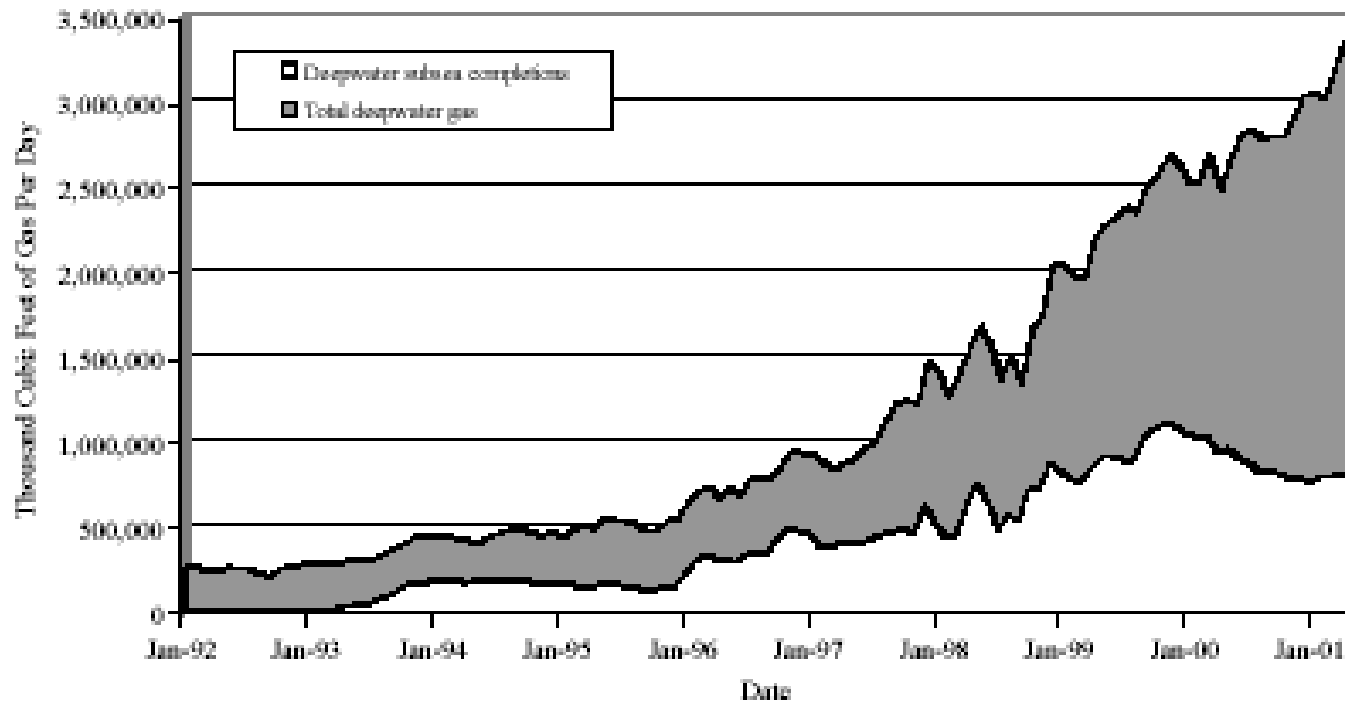

Figure 59. - Contributions from subsea completions toward total deepwater (a) oil production and (b) gas production.

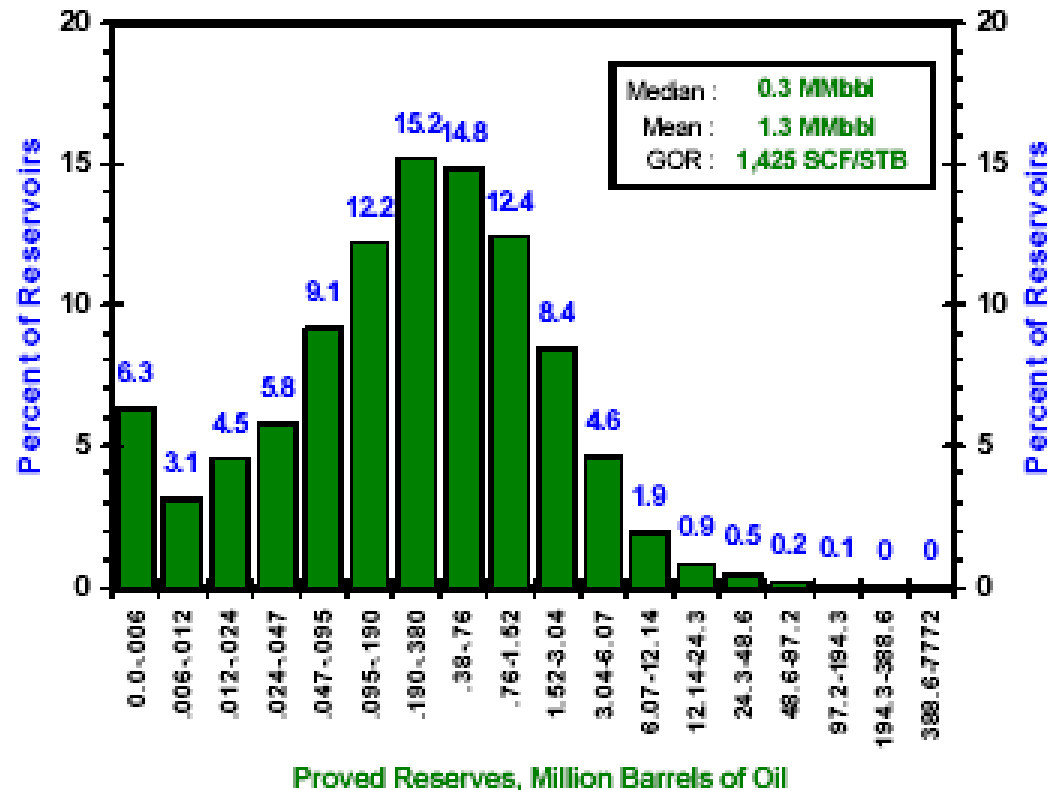
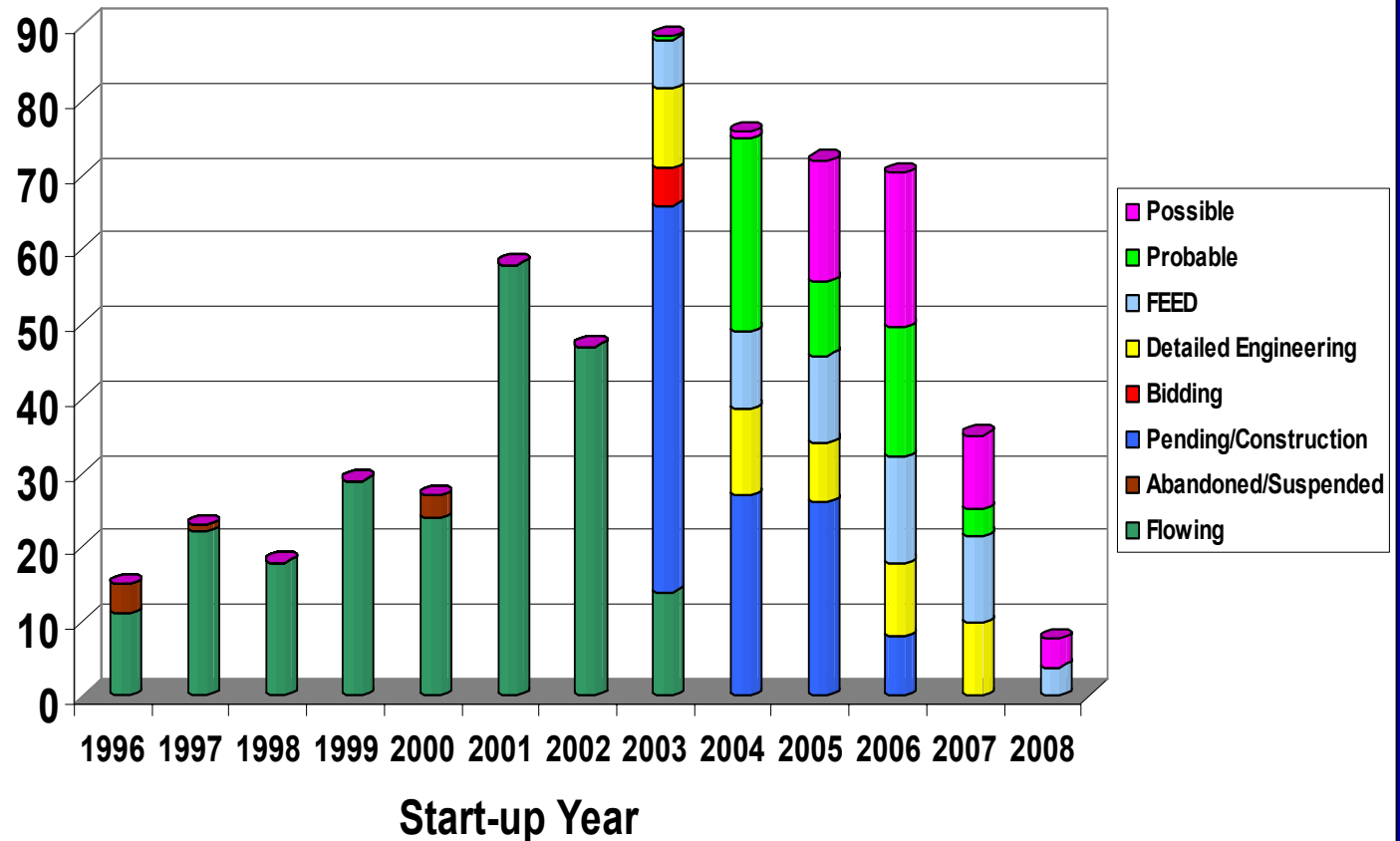

Figure 32. Reservoir-size distribution, 7,342 proved oil reservoirs.

Global Subsea Forecast (No. Wells) – N. America

350 Wells 2003-2008e



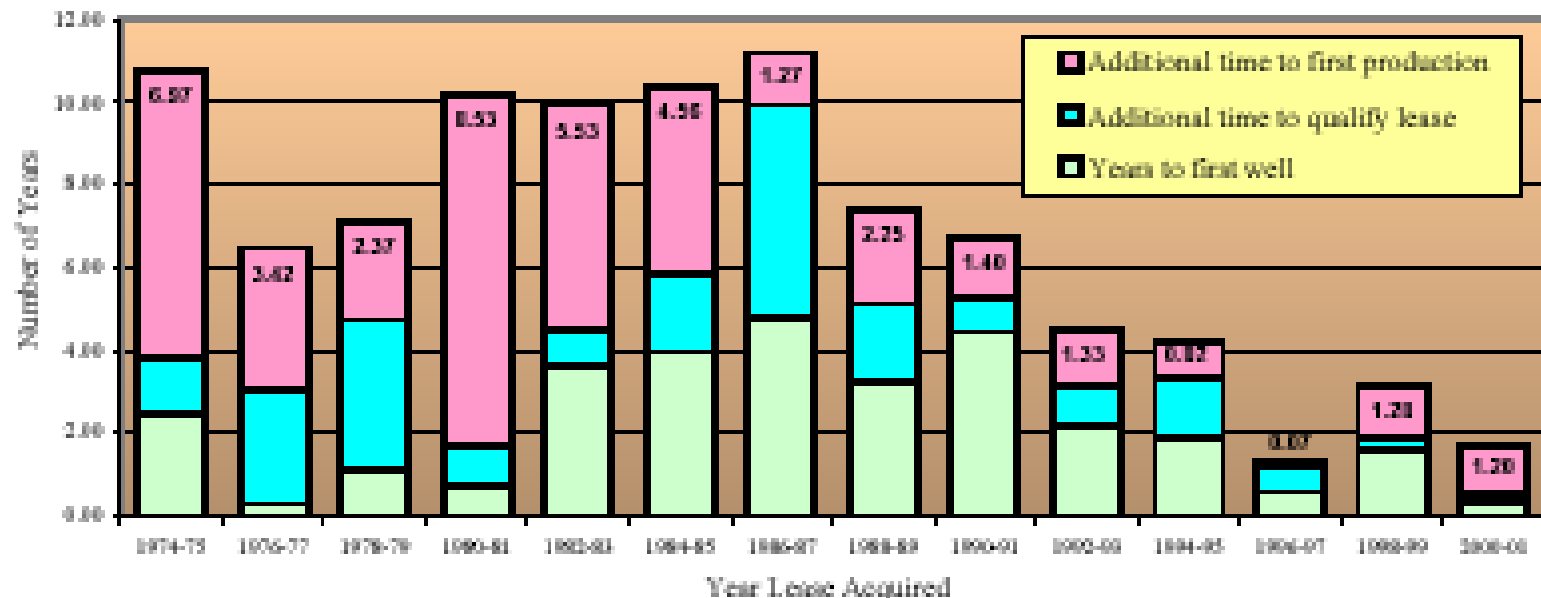

Figure 70c. - Lag from leasing to first production for producing deepwater fields.

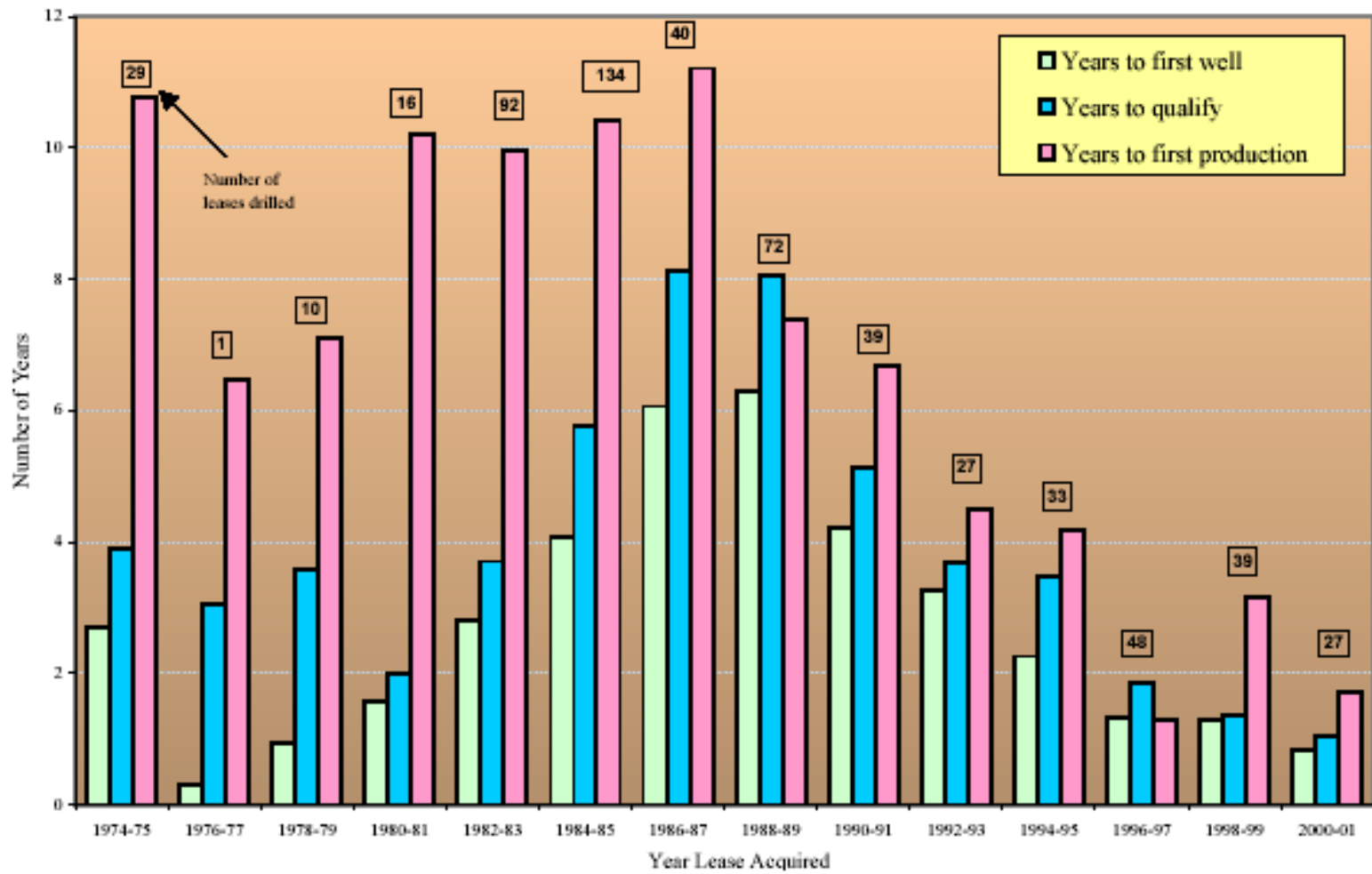

Figure 71. - Lag from leasing to first well, lease qualification, and first field production for all drilled deepwater leases.

Deepwater Reserves Distribution (Over 500 m)



< Technology Day 2001 >

Relative Distribution of Worldwide Discovered Reserves in Deep Water



Yearend 2000
Snapshot
(Greater than 500
meters water depth)

TOTAL: ~ 45 MMBOE - 70% OIL / 30% GAS



Quest Offshore Resources, Inc.

Announced Deepwater Discoveries for Development



2002 and Beyond (over 1/3 ultra-deep)

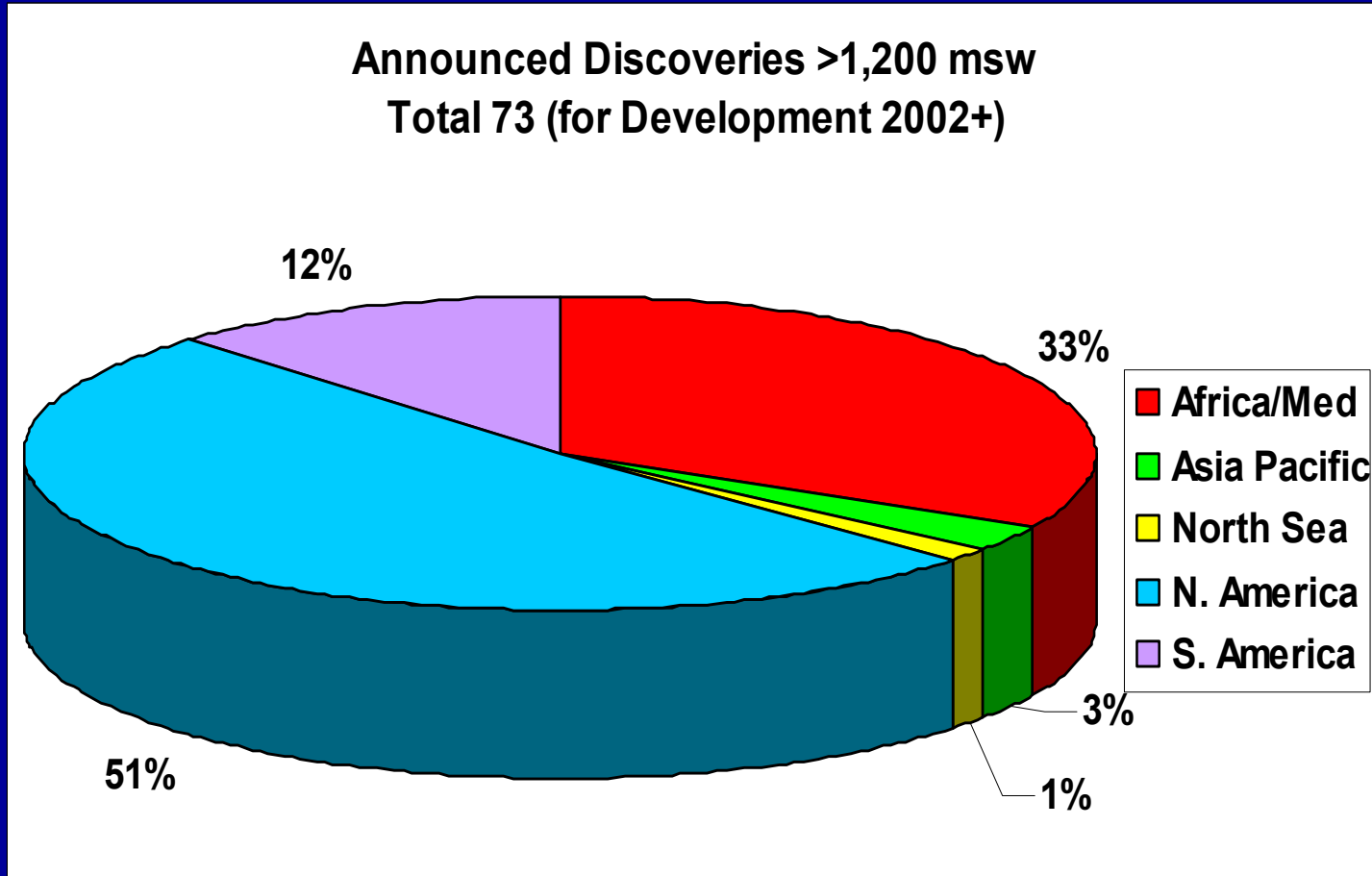

Source: Quest SUBSEA-DATA-BASE



Quest Offshore Resources, Inc.

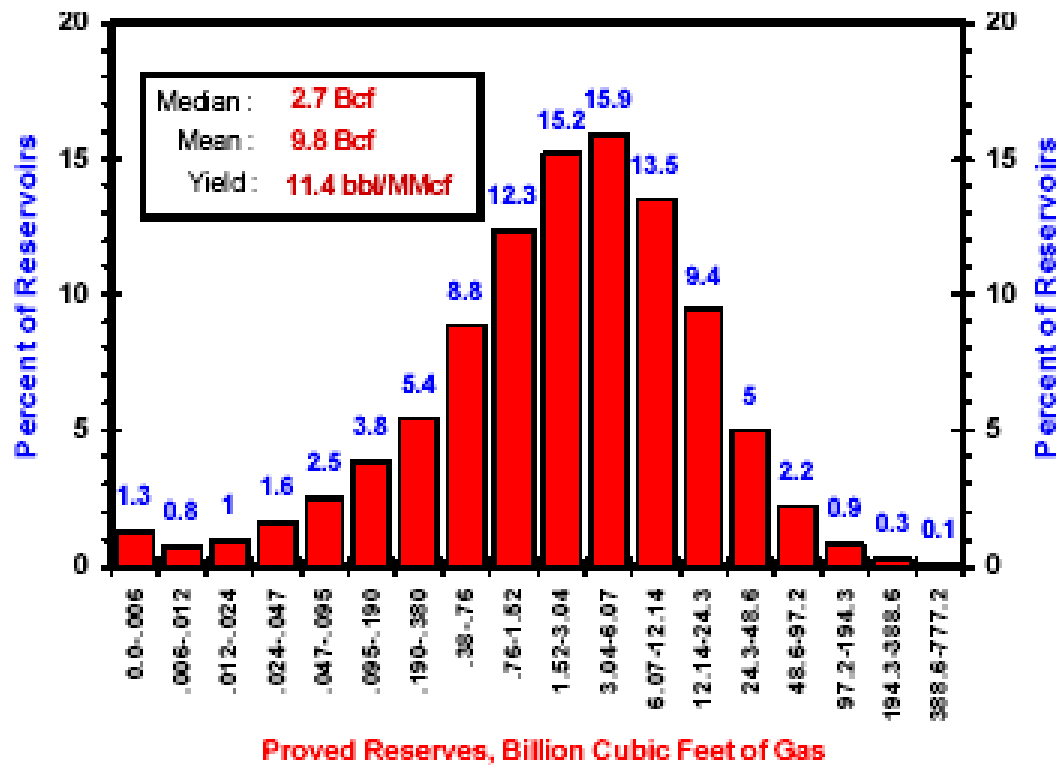

Figure 33. Reservoir-size distribution, 13,703 proved gas reservoirs.

GOM Proved Reserves (Million BOE)

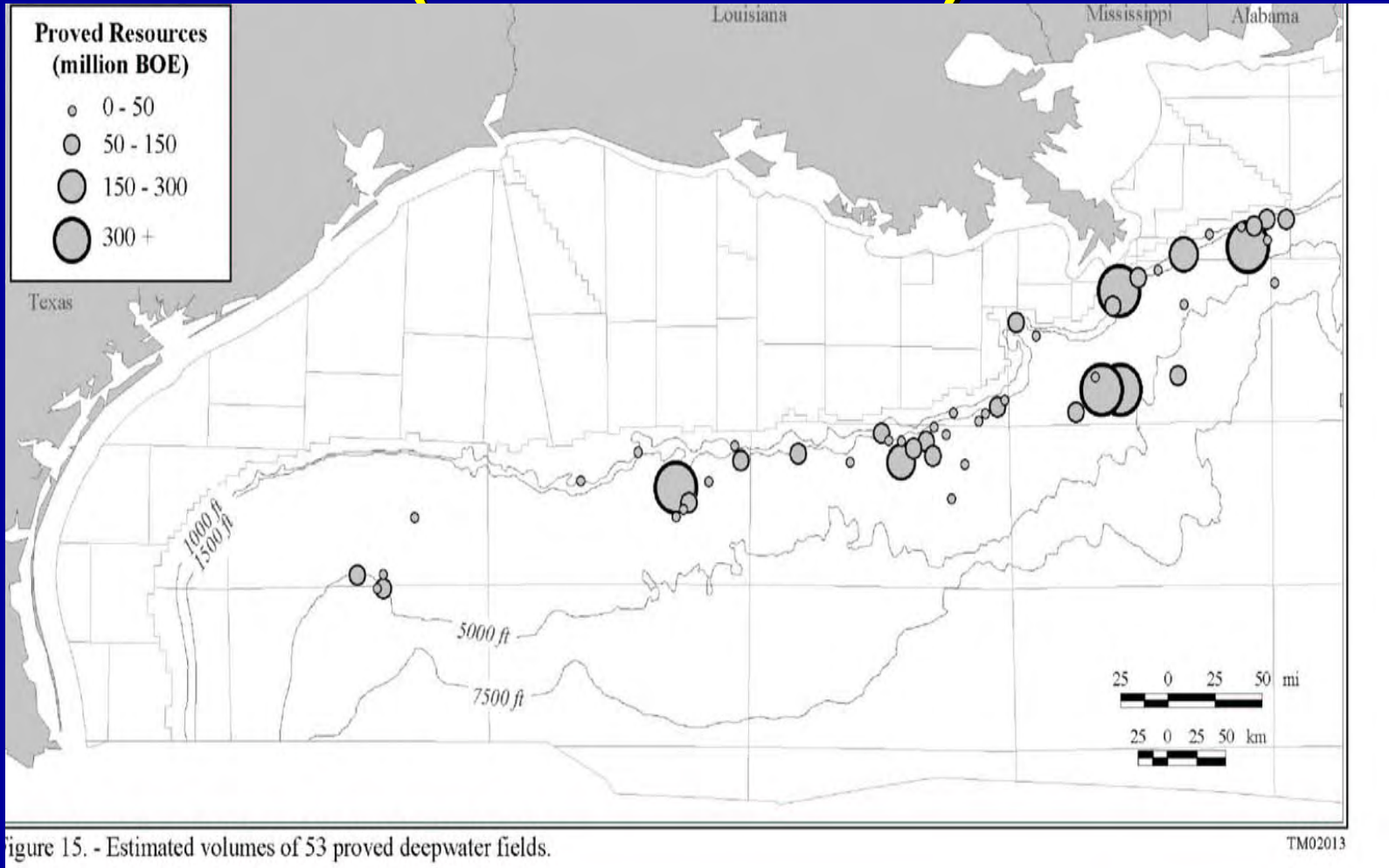

Figure 15. - Estimated volumes of 53 proved deepwater fields.

Technology Gaps

- Subsea transport/maneuvering of heavy items (SS pumps and equipment)
- Increased work time on bottom for ROVs
- Miniaturized ROV interfaces due to increased SS tree complexity
- Few – ROV technology represents a solution looking for a problem
- No shared learnings on weaknesses & failures – everyone gets to make all of the mistakes
- Sensor fusion to reduce payload/power requirements
- AUV capability to hover

Technology Gaps

- Avoid Valley of Death
- Improve Technology (Failure Free Operation Period / Mean Time Between Failures
 - Smart Tools (self diagnosing)
- Subsea power systems
- Subsea communications systems
- Progress SS Strategy, Systems Design, & Hardware along with ROV and AUV Capabilities
- ROV's that recharge batteries on subsea equipment.

Design Issues

- Holistic engagement of designers & users
- Standardization – adopt or challenge?
- Failure Mode Analysis as part of design
- Integrate design functionality & maintenance with SS equipment, tools, and vehicles in a life-cycle design
- More demanding construction activities leading to larger, more complex vehicles...is the the smartest way to achieve best life-of-field performance & costs?
- Where should vehicle/tool interface be
 - Complex, self-contained tools w/ simple vehicle
 - Simple tools w/ more complex, tool-supportive vehicles

Business Issues

- Operators need to invest in ROV & AUV technology & development costs
 - AUV/ROV & SS contractors cannot afford
 - Industry led more powerful than contractor led
- Project economics/contracts do not reward OPEX reduction – therefore little value for investing in intervention or life-of-field planning
- Interfaces
 - ROV&AUV//SS//Operator
 - ROV&AUV + SS//Operator
- If ROV are now becoming commodities, how best for ROV business to advance/sustain?

SS Personnel

- Getting Gray/Bald
- Hard to interest/recruit new blood
- Few formal training opportunities
- No one wants to allow training on their job
 - getting experience
- Mentoring programs
- Higher skill level needed due to increased complexity

Standardization

- Standardization or Holistic Life of Field Design?
 - Holistic Life of Field
 - All fields different
 - 20-30 year life for each field
 - Standardization
 - Same or slowly evolving

Regulatory & Codes/RP's

- API & ISO Codes out of date & inhibit innovation
- Standard ROV & SS equipment interfaces

Future Dreams

- Unlimited Tie Back Distances
- Complete Subsea Development Systems Controlled from the Office
- No Umbilical
- All Electric Valve Operation
- More & more exploration & production activities on the seafloor
- 6000 m ROV AUV capability
- More powerful systems
- Increased capability/smaller ROV systems
- Web interactive control system

Future Dreams

- Ultra-high voltage (12,000 V) power drive system
- Tether excursion up to 3 km
- Inertial navigational system
- Improved through the water data & signal transmission (AUV)
- Disposable AUV