

LA-UR-99-1425

**Decontamination and Decommissioning
of Buildings TA-3-42, TA-8-27,
TA-8-31, and TA-35-1**

Historic Building Survey Report No. 167

Los Alamos National Laboratory

**February 26, 1999
Survey No. 771**

Prepared for the Department of Energy
Los Alamos Area Office

prepared by

Kari L. M. Garcia

Archaeologist

ESH-20 Cultural Resources Team
Environment, Safety, and Health Division
LOS ALAMOS NATIONAL LABORATORY

Abstract

In February 1999, historic building surveys were conducted for four buildings proposed for decontamination and decommissioning (D&D). The buildings are situated on Department of Energy managed land at Los Alamos National Laboratory Technical Areas (TAs) -3, -8, and -35.

Building TA-3-42, a Guard House, was built in 1951 to 1953; TA-8-27, a vault, and TA-8-31, an explosives magazine, were built in 1950; and TA-35-1, a Guard House, was built in 1949 to 1951, during the early Cold War years at Los Alamos. All of these buildings are support/ancillary buildings to large laboratory facilities at these TAs. Because these properties were built during this significant time period at Los Alamos, historic building assessments have been included in this report.

Through documentation it has been determined that all four support buildings (TA-3-42, TA-8-27, TA-8-31, and TA-35-1) are eligible for the National Register of Historic under Criterion A, due to their association with events of exceptional importance during the early Cold War years at Los Alamos (criteria consideration G: properties that have achieved significance within the last fifty years) (U.S. Department of the Interior 1991). TA-3-42 is associated with the early technical machine shop. Buildings TA-8-27 and TA-8-31 are associated with the early development of x-ray techniques, some of which involved the use of contained radioactive sources. Building TA-35-1 is associated with the original laboratory and office building at TA-35 where activities involving early source preparation, radionuclide experimentation, and nuclear fission reactor development were being conducted.

The New Mexico State Historic Preservation Officer (SHPO) is requested to concur with the eligibility determinations contained in this report. Additionally, based on the status of these properties as support buildings and the information included in this report regarding the proposed effects and treatment of effects to the properties, the SHPO is requested to concur with a "Determination of No Adverse Effect." The documentation submitted in this report (New Mexico Historic Building Inventory Form, building plan drawings, and photographs) serves as mitigation of the adverse effects to these properties (TA-3-42, TA-8-27, TA-8-31, and TA-35-1) which will result from the proposed D&D project.

As a result of this historic building survey, this project complies with the National Historic Preservation Act of 1966 (as amended).

Provenience and Environmental Setting

Location: Technical Areas (TAs) -3, -8, and -35 Los Alamos National Laboratory (LANL)

Land Manager: The Department of Energy (DOE)

Legal Description: Township 19 North, Range 6 East,

Section 17

SE $\frac{1}{4}$, SW $\frac{1}{4}$, SE $\frac{1}{4}$

Section 19

SW $\frac{1}{4}$, NE $\frac{1}{4}$, SW $\frac{1}{4}$

NE $\frac{1}{4}$, SW $\frac{1}{4}$, SW $\frac{1}{4}$

Section 22

NW $\frac{1}{4}$, NW $\frac{1}{4}$, SE $\frac{1}{4}$

Maps: USGS Frijoles Mountain 7.5 Minute Series (Appendix A, Maps 1 and 2)

Topography: Townsite Mesa and Mesita del Buey

Nearest Drainage: Two Mile Canyon to the south for TA-3-42; Pajarito Canyon to the north for TA-8-27 and TA-8-31; and Mortandad Canyon to the north for TA-35-1.

Elevation: 2197 to 2336 meters (7208 to 7664 feet)

Current Land Use: Developed TAs-3, 8, and 35

Project Description

As inactive buildings, TA-3-42, TA-8-27, TA-8-31, and TA-35-1, are subject to the DOE mission statement. "The DOE environmental vision and mission are based on operating all facilities in full compliance with applicable laws and regulations and cleaning up inactive sites and facilities so that no unacceptable risk to the public or environmental remains" (U. S. Department of Energy 1994).

LANL proposes to Decontaminate and Decommission (D&D) four buildings. The four buildings are inactive facilities and are on the excess space list. These buildings are located in TA-3, South Mesa Site; TA-8, Anchor West Site; and TA-35, Ten Site. All of these buildings were built during the early Cold War years at Los Alamos. Building TA-3-42, the guard house (former station #328) was built in 1951 to 1953. Buildings TA-8-27, a vault and TA-8-31, an explosives magazine, were built in 1950. Building TA-35-1, a guard house (former station #410) was built in 1949 to 1951. The proposed D&D project activities include the removal of these concrete buildings, foundations, and the capping off and removal of all associated utilities. As a result of the decommissioning phase, the properties will be completely demolished.

Methods

In February 1999, an historic building evaluation was conducted for buildings TA-3-42, TA-8-27, TA-8-31, and TA-35-1 (Appendix A, Maps 3–5) by Kari L. M. Garcia, archaeologist, Environment, Safety, and Health Division, Ecology Group (ESH-20), LANL.

The historic building evaluations were accomplished by first conducting a field visit to TAs -3, -8, and -35. All of the buildings are support buildings for other large laboratory facilities at these TAs. New Mexico Historic Building Inventory Forms were completed for all four buildings and photographs were taken (Appendix B). Records research at LANL was also carried out, and existing drawings were compiled for the buildings.

Culture History Overview

World War II and Early Cold War (1942-1956)

A. Site Selection, Acquisition

In 1942, Albert Einstein wrote a letter to President Franklin Roosevelt warning him of a possible German atomic bomb threat (Rothman 1992). President Roosevelt, acting on Einstein's concerns, gave approval to develop the world's first atomic bomb and appointed Brigadier General Leslie Groves to head the "Manhattan Project." Groves, in turn, chose Robert Oppenheimer to coordinate the design of the bomb.

A single research facility, isolated and secret, was proposed. General Groves had several criteria: security, isolation, a good water supply, an adequate transportation network, a suitable climate, an available labor force, and a locale west of the Mississippi located "at least 200 miles from any international border or the West Coast" (Rothman 1992). Oppenheimer, who had visited the Pajarito Plateau on a horseback trip, suggested the Los Alamos Ranch School.

B. Manhattan Project (1942 – 1945)

A suitable site selected, Oppenheimer and his staff moved to Los Alamos to begin work. The recruitment of the country's "best scientific talent" and the construction of technical buildings were top priorities. The University of California agreed to operate the site, code name "Project Y," under contract with the government (an arrangement that has continued to this day).

Although the fission bomb was conceptually attainable, many difficulties still stood in the way of producing a usable weapon. Technical problems included the timing of the release of energy from fissionable material and the engineering aspects of producing a deliverable device. Nuclear material and high explosive (HE) studies were of immediate importance (Los Alamos National Laboratory 1995).

Two bomb designs appeared to be the most promising: a uranium “gun” method and a plutonium “implosion” method. The “gun” method bomb involved bringing fissionable material together to form a critical mass by firing one subcritical mass of uranium-235 at another. This method led to the development of the “Little Boy” device. Scientists were less confident about the second “implosion” method, a design that necessitated the compression of fissionable material using high explosives. The compression action would increase the density of a slightly subcritical mass of plutonium-239 and cause a critical reaction (Los Alamos National Laboratory 1995). In 1944, due to the uncertainties surrounding the second design, the search began for an appropriate test site for the implosion method, later used in the “Fat Man” device. The Alamogordo Bombing Range in south-central New Mexico was selected. A trial run involving 100 tons of TNT was conducted at “Trinity Site” on May 7, 1945. This “dress rehearsal” provided measurement data and simulated the dispersal of radioactive products. The Trinity test was planned for July, and its objectives were “to characterize the nature of the implosion, measure the release of nuclear energy, and assess the damage” (Los Alamos National Laboratory 1995). The HE components of the “Trinity” device were test assembled in building TA-16-516 at Los Alamos in an area known as V-site. Other buildings at V-site were used to prepare and finish the HE components and to run preliminary tests on the “Trinity” bomb (Wilder 1991). The world's first atomic bomb was successfully detonated in the early morning of July 16, 1945. “Little Boy,” the untested uranium gun-type bomb, was exploded over the Japanese city of Hiroshima on August 6, 1945. “Fat Man” was exploded over Nagasaki three days later on August 9, 1945, thus essentially ending the war with Japan.

C. Early Cold War Era (1946 – 1956)

The Manhattan Project had come to a close with the end of World War II, and many Los Alamos scientists and site workers went back to their prewar existences. The future of Los Alamos was in question. With the beginning of the Cold War, continued weapons research was a top priority. Norris Bradbury had been appointed director of the Laboratory following Oppenheimer's departure from Los Alamos. Bradbury felt that the nation needed “a laboratory for research into military applications of nuclear energy” (Los Alamos National Laboratory 1993a). In 1945, stockpiling and development of additional atomic weapons was an important mission. In 1946, the Laboratory became involved in the technical direction of the atmospheric testing program in the Pacific, dubbed “Operation Crossroads.” Later in 1946, the U.S. Atomic Energy Commission (AEC) was established to act as a civilian steward for the new atomic technology born of WWII. The AEC formally took over the Laboratory in 1947, making a commitment to retain Los Alamos as a permanent weapons research facility. Postwar weapons research revolved around the development of advanced fission weapons and, acting on an idea born in 1942, the development of the hydrogen bomb. The combined work of Edward Teller and Stanislaw Ulam led to the beginning of the Laboratory's thermonuclear research program (Los Alamos National Laboratory 1993a).

In 1952, the first thermonuclear device, known as “Mike,” was detonated at Eniwetok atoll in the Pacific (Los Alamos National Laboratory 1993a). The Mike shot used liquefied deuterium fuel. The Castle-Bravo shot, conducted in the Pacific in 1954, was revolutionary in that it contained dry, solid thermonuclear fuel. Other early Cold War weapons-related developments include: (1)

from 1952 to 1956, "improvements to the primary stage of a nuclear weapon" and (2) in 1956, "the first use of plastic-bonded explosives in a nuclear explosion" (Los Alamos National Laboratory 1995).

Technical Area 3 (South Mesa) Historical Background

TA-3, South Mesa Site, is a large developed technical area. It contains the Laboratory's main administration buildings, library, cafeteria, shops, several large laboratories for a wide variety of research and development activities, warehouses, electrical generating plant, sewage treatment plant, and numerous other permanent and temporary buildings, transportable trailers, and transportainers.

TA-3 was originally built as a firing site prior to 1945, containing wooden buildings for administration, a shop, magazines, and fiberboard buildings for storage, minor assembly, and checkout of scientific hardware. There was also a burn pit for destroying explosives. This original TA-3 site was decommissioned and cleared in 1949 (Los Alamos National Laboratory 1993b:5).

Construction began in 1950 at the South Mesa site on the main buildings that were to replace the operational facilities in the current Los Alamos town site. The first buildings including the Van de Graaff accelerator, laboratory and support buildings; the communications building; the large chemistry and metallurgy laboratory, the site of critical chemistry and metallurgy supporting the Laboratory's weapons program; warehouses for general supplies and chemicals; shops; a fire station; and a large physics laboratory and office building became operational between mid 1951 and late 1952.

The Van de Graaff accelerator building at one time housed the world's highest voltage Van de Graaff accelerator (Hawkins et. al. 1983, Los Alamos National Laboratory 1995). The chemistry and metallurgy laboratory conducts "operations involving plutonium, uranium, other radionuclides, metals, inorganic and organic compounds, acids, and solvents of every nature." . . . The physics building at one time "housed two accelerators and a cyclotron" (Los Alamos National Laboratory 1993b:2-5). Radioactive materials including plutonium, uranium, and tritium, and metals and solvents have been used in the building over the years. To serve these facilities a gas-fired electrical generating plant, a waste water treatment plant, a service station and maintenance garage were also constructed.

Building TA-3-42, a guard house for one of the original technical machine shops, was also constructed from 1951 to 1953. This is one of the buildings scheduled for D&D discussed in this report.

A second stage of construction at TA-3 occurred during the mid-to late-1950s. Two major buildings were completed during these years, the Administration Building which houses offices,

laboratories, shop, and photographic facilities and the Sigma Building that houses facilities for metallurgical and ceramics research and fabrication (Los Alamos National Laboratory 1993b:2-6).

New facilities continued to be built during the 1960s and 1970s including office buildings, storage areas, shops, an addition to the waste water treatment plant, a cement batch plant, and numerous transportable buildings. In 1977 the Oppenheimer Study Center was constructed; in 1981 an addition to the Administration Building was constructed, and in the early 1990s a computer facility and several national centers for various scientific research activities were constructed (Los Alamos National Laboratory 1993b:2-6).

Technical Area 8 (New Anchor West) Historical Background

TA-8 is known as New Anchor West, it was part of the original Anchor Ranch homestead that was acquired in 1943 for the Manhattan Project Gun-Firing site, which is referred to as Old Anchor West. The gun-firing site was established, on the west side of Anchor Ranch Road, for the development of the gun-assembled nuclear weapon known as Little Boy. Other "various x-ray and explosives development, production, and testing activities were also conducted in this area by the U.S. Army's Ordnance Division, which was responsible for the gun-assembly as well as the implosion programs" (Los Alamos National Laboratory 1993c:2-8).

Structures built in this area included buried concrete bunkers, which housed control rooms and various laboratory and storage facilities, and wooden structures used for office space, storage space, and a carpenter's shop. Prototypes of the Little Boy gun device were tested at the site in 1945. Gun testing was not resumed after World War II. "The gun weapon although reliable, required large amounts of enriched uranium, and the program was abandoned in favor of the development of implosion weapons" (Los Alamos National Laboratory 1993c:2-10). The gun-firing site, Old Anchor West, was abandoned in 1946, and, the wooden structures were removed between 1949 and 1968.

New construction began in TA-8 at the New Anchor West Site in 1949 and 1950 for a nondestructive test facility. These facilities were for Group X-1 (later GMX-1), which had been developing x-ray techniques at a different location. New buildings were constructed for use as office space; photographic-processing laboratories; laboratories for x-ray work, some involving the use of contained radioactive sources; laboratories for chemical detection of imperfections in parts; and utility buildings and lines, magazines, and support facilities (Los Alamos National Laboratory 1993c:2-10, 2-11). At this time of new construction many of the original buildings, were removed.

Buildings TA-8-27, a vault, and TA-8-31, an explosives magazine were constructed in 1950. These buildings are two of the buildings scheduled for D&D discussed in this report. The vault has always housed sealed fissionable materials and the magazine has always housed HE components and energetic materials used by the radiographic facility at TA-8 in various types of x-ray studies. The radiographic facility used x-ray tests to diagnostically check for imperfections

in fissionable materials and HE components, that had been pressed and machined elsewhere, which were to be parts or components of weapons (Los Alamos National Laboratory 1993c).

During the War, development, manufacture, and testing of HE was conducted at TA-8, Old Anchor West. Melt cast HE formulations were developed and poured into molds, allowed to solidify and then used for stock HE. These cast HE components were used in nuclear weapons. After the War in 1952, plastic-bonded explosives, were pressed and machined for incorporation into weapon components (Los Alamos National Laboratory 1993c:2-13).

Technical Area 35 (Ten Site) Historical Background

TA-35, Ten Site, is a large developed Laboratory technical area. It consists of many permanent and temporary buildings, and transportable storage and office trailers of various construction styles and material types. Buildings include laboratories, office buildings, machine shops, physics and laser laboratories, facilities, and utilities.

“The first laboratories and office [buildings] at TA-35 were completed in 1951”. Early “operations involved the preparation of kilocurie sources of radioactive lanthanum ¹⁴⁰La” (Los Alamos National Laboratory 1992:3-35). During the 1950s and 1960s operations included experimentation with plutonium and tritium, and nuclear fission reactor development.

The original laboratory and office building, TA-35-2, has been used for a wide variety of research operations. It has housed two experimental nuclear fission reactors (Los Alamos Power Reactor Experiment, LAPRE-1 and Los Alamos Molten Plutonium Reactor Experiment, LAMPRE). It also housed a hot cell used for preparing kilocurie-sources of radioactive lanthanum-140, plutonium research laboratories, and a facility at which lithium tritide components were developed and handled. A third reactor LAPRE-II was operated in a below-grade pit near the southeast corner of TA-35-2. LAPRE -1 operated in 1956, LAPRE-II operated in 1959, and LAMPRE operated from 1960 to 1964. In the basement of TA-35-2, a tritium facility was operated from 1954 until 1974 (Los Alamos National Laboratory 1992:3-23, 3-36).

Building TA-35-1, the guard house for the first laboratory and office building (TA-35-2), was constructed from 1949 to 1951. It is one of the buildings scheduled for D&D discussed in this report.

Currently several laboratory groups are conducting research in this building (TA-35-2) including research in ceramics, robotics, polymer synthesis, lasers, high-speed impact studies, and strain-rate measurements on a variety of materials including plutonium (Los Alamos National Laboratory 1992:3-23).

Other buildings in this TA include laboratories for research and development on various types of lasers, small reactor test pits, target fabrication facilities, and office and utilities.

Most of the work with radioactive materials was phased out by the 1970s and activities were focused on laser operations. As of the late 1980s several different Laboratory Divisions including the Physics (P) Division, Chemistry (CLS) Division, Materials Science and Technology (MST) Division, Applied Theoretical Physics (X) Division, and Energy (Q) Division (now N-Division) were conducting laser research at various laboratory buildings throughout the TA. Research included laser fusion, involving development, fabrication, and operation of lasers and laser targets; and nuclear safeguards research and development of assay instrumentation (Los Alamos National Laboratory 1992:3-23). "Experimentation and development of laser technology continues to the present. Research on optics, robotics, and nuclear safeguards are also ongoing at TA-35" (Los Alamos National Laboratory 1992:3-36).

Description of Buildings

Four buildings, TA-3-42, TA-8-27, TA-8-31, and TA-35-1, are proposed for demolition. Appendix A contains maps showing the locations of the buildings proposed for demolition. Appendix B contains the Historic Building Inventory Forms, plan drawings, and photographs. Appendix C contains black-and-white 35-mm photographs of the eligible properties.

TA-3-42 Guard House

Building Name: TA-3-42 Original Name: South Mesa-42 (SM-42)

Location:

City - Los Alamos, New Mexico

County - Los Alamos

UTMs - Zone 13 Easting 380506 Northing 3970427

Legal Description - Township 19 North, Range 6 East, Section 17

Surroundings - TA-3, is the Laboratory's administrative area. It is a large developed technical area consisting of many permanent and temporary buildings of various construction styles and material types. Buildings include laboratories, office buildings, maintenance shops, medical facilities, and utilities.

Relationship to surroundings - Not similar.

Construction Date: 1951 to 1953

Original Use: Structure TA-3-42 was a former guard house (station #328) for building TA-3-39 which is designated as technical machine shop.

Use History: Structure TA-3-42 served as a guard house, then it was used for storage.

Use at Time of Survey: TA-3-42 is currently abandoned and not in use.

Condition at Time of Survey: Fair condition to good condition

Building Description: (see also Appendix B)

Building style - Concrete masonry unit structure with flat roof

Foundation material - Concrete slab

Wall material/surface - Concrete masonry units

Architectural features - Only floor plans exist for this guard house. However, this building is an example of a standard building type at the Laboratory and is similar in size and design to at least five other guard houses (TA-8-20, TA-15-46, TA-16-1451, TA-22-32, and TA-36-22) with minor differences. Construction material varies between concrete masonry units and reinforced concrete, and the window treatment varies between size and number of glass panes. Elevation drawings for TA-22-32, one of the identical guard houses, are being submitted with the site from for TA-3-42.

The similar guard house, TA-16-1451, has been documented (McGehee 1995) and concurrence received from the State Historic Preservation Office on eligibility status (March 24, 1995). A plan was developed for the mitigation of adverse effects to the property from the Laboratory's D&D project (May 30, 1995).

Per the mitigation plan, measured drawings have been completed and archival 4 by 5 black-and-white photographs have been produced for TA-16-1451. This report has not been submitted because we are still completing all the requirements of the mitigation plan.

TA-3-42 is a 144 ft² building with a flat roof constructed of concrete masonry. It has two rooms: a main room and a restroom. The front, east side of the building has two windows each with three glass panes and a metal pedestrian door with a window. The north side has three windows, each with three glass panes. The west side has two windows, one is slightly larger than the other. This larger window is the only difference between this guard house and the other five guard houses built from identical plans. The larger window has three glass panes and the smaller has two glass panes. The smaller window is the window in the restroom. The south side has two windows each with three glass panes. Utility control panels and switch boxes are located on the south side of the building.

The lower portion of the walls from the ground to the top of the door and windows are exposed concrete masonry units where as the upper portion of the wall has a smoothed concrete surface.

The flat roof has a 4 ft 6 in. overhang/canopy on all four sides of the building. The roof is constructed in several layers. The lower or interior surface of the roof is 1 in. perforated pan type acoustical ceiling. Above the acoustical ceiling is a 1½-in., 20-gauge galvanized steel roof deck and covered with 2 in. rigid insulation. The final exterior surface is three ply tar and gravel roofing. There is galvanized metal flashing around all the edges.

Interior wall surfaces were painted with oil-base lead paint.

Remodeling History: None.

Associated Buildings: TA-3-39 is the technical machine shop that this guard house is associated with. It also was constructed in 1951 to 1953.

District Potential: None. This TA is the administrative area of the Laboratory. It is a conglomeration of a wide variety of permanent and temporary buildings of many different construction styles built throughout the late 1940s to the present.

Contamination Information: There is no record of any contamination existing within building TA-3-42 (Los Alamos National Laboratory 1990 and 1993b).

TA-8-27 Concrete Vault

Building Name: TA-27, Original Name: Anchor West -27 (AW-27)

Location:

City - Los Alamos, New Mexico

County - Los Alamos

UTMs - Zone 13 Easting 377986 Northing 3969098

Legal Description - Township 19 North, Range 6 East, Section 19

Surroundings - TA-8, Anchor West Site, is a developed Laboratory technical area now consisting of buildings for various types of x-ray work, some which involve the use of contained radioactive sources; photographic-processing laboratories; magazines; office space; and utility buildings, lines, and support facilities.

Relationship to surroundings - Similar in construction style to other small nearby buildings (TA-8-25, -26, -28, -29, -30, -31, and -32) magazines, guard stations, laboratories, and utility buildings also built out of reinforced concrete.

Construction Date: 1950

Original Use: Building TA-8-27 was a vault for fissionable materials associated with the radiography facility built at this TA in the early 1950s.

Use History: Building TA-8-27 served as a vault for the radiography facility.

Use at Time of Survey: TA-8-27 is currently abandoned and not in use.

Condition at Time of Survey: Fair condition

Building Description: (See also Appendix C)

Building style - Small reinforced concrete vault with flat roof

Foundation material - Reinforced concrete slab

Wall material/surface - Reinforced concrete, lined with steel plates painted with oil base lead paint

Architectural features - Building TA-8-27 is a small, two-roomed, 189-ft² reinforced concrete vault with a flat roof. The interior walls and ceiling are steel lined and the steel is painted with oil base lead paint. Exterior walls were left rough and coated with metallic waterproofing.

Remodeling History: The steel vault door was modified in 1961.

Associated Buildings: TA-8-28, a reinforced concrete guard station located directly to the southeast of the vault.

District Potential: None. Only three original buildings remain at this TA. New construction began in this TA in 1949/1950 and many of the original buildings, from during the war, were removed and one building was relocated within the site and later removed. The new buildings were constructed for use in the development of x-ray techniques, which were being developed at another location.

Contamination Information: "There is no evidence of any contamination associated with this building [TA-8-27]" (Los Alamos National Laboratory 1990 and 1993c:7-46).

TA-8-31 Concrete Magazine

Building Name: TA-8-31, Original Name: Anchor West-31 (AW-31)

Location:

City - Los Alamos, New Mexico

County - Los Alamos

UTMs - Zone 13 Easting 378183 Northing 3969352

Legal Description - Township 19 North, Range 6 East, Section 19

Surroundings - TA-8, Anchor West Site, is a developed Laboratory technical area now consisting of buildings for various types of x-ray work, some which involve the use of contained radioactive sources; photographic-processing laboratories; magazines; office space; and utility buildings, lines, and support facilities.

Relationship to surroundings - Similar, building TA-8-32 is another explosives magazine identical to TA-8-31

Construction Date: 1950

Original Use: Building TA-8-31 is an explosives magazine.

Use History: Building TA-8-31 has always served as an explosive magazine.

Use at Time of Survey: TA-8-31 is currently abandoned and not in use.

Condition at Time of Survey: Fair condition

Building Description: (See also Appendix C)

Building style - Small reinforced concrete magazine with flat roof and earthen berm

Foundation material - Concrete slab

Wall material/surface - Reinforced concrete painted with oil base lead paint

Architectural features - Building TA-8-31 is a small, reinforced concrete magazine. It is 168 ft² with earthen fill on three sides. The interior walls are smooth finished and painted with oil-base lead paint. There is a center bar joist on the ceiling. The exterior walls were left rough and waterproofed with three plies of felt and coal tar pitch. The magazine has a steel door on the north side of the structure. There are four steps up from the concrete/asphalt pad east of the magazine to a concrete dock that extends from the north side of the building.

Remodeling History: None

Associated Buildings: TA-8-32, is an identical magazine to TA-8-31.

District Potential: None. Only three original buildings remain at this TA. New construction began in this TA in 1949/1950 and many of the original buildings, from during the war, were removed and one building was relocated within the site and later removed. The new buildings were constructed for use in the development of x-ray techniques, which were being developed at another location.

Contamination Information: "There is no evidence of any contamination associated with this building [TA-8-31]" (Los Alamos National Laboratory 1990 and 1993c:7-45).

TA-35-1 Guard House

Building Name: TA-35-1 Original Name: Ten Site Laboratory -1 (TSL-1)

Location:

City - Los Alamos, New Mexico

County - Los Alamos

UTMs - Zone 13 Easting 383436 Northing 3969348

Legal Description - Township 19 North, Range 6 East, Section 22

Surroundings - TA-35, Ten Site, is a large developed Laboratory technical area. It consists of many permanent and temporary buildings of various construction styles

and material types. Buildings include laboratories, office buildings, machine shops, physics and laser laboratories and facilities, and utilities.

Relationship to surroundings – Not similar

Construction Date: 1949 to 1951

Original Use: Building TA-35-1 was a former guard house (station #410) for building TA-35-2 the original laboratory and office building at TA-35. This support building was the guard station for building TA-35-2, the original laboratory and office building at TA-35, also built in 1951.

Use History: Structure TA-35-1 served as a guard house then it was used for storage.

Use at Time of Survey: TA-35-1 is currently abandoned and not in use.

Condition at Time of Survey: Fair to good condition

Building Description: (see also Appendix B)

Building style - Reinforced concrete guard house with low pitched roof

Foundation material - Concrete slab

Wall material/surface - Reinforced concrete

Architectural features - Only floor plans exist for this guard house. However, this building is almost identical in size and design to at least one other guard house (TA-16-101) at the Laboratory with minor differences. Construction material varies between wood and reinforced concrete and the window treatment varies between size and number of glass panes. Elevation drawings for TA-16-101 are being submitted with the site from for TA-35-1.

Building TA-16-101 has been previously documented (McGehee 1995) and concurrence received from the State Historic Preservation Office on eligibility status (March 24, 1995) and a mitigation plan (May 30, 1995) for the mitigation of adverse effects to the property from the Laboratory's D&D project. Per the mitigation plan measured drawings have been completed and archival 4 by 5 black-and-white photographs have been produced.

Construction material varies between wood frame covered with concrete-filled sand bags for TA-16-101 and reinforced concrete for TA-35-1.

Building TA-35-1 is a 133 ft² rectangular building with a low pitched roof constructed of reinforced concrete. The building has two rooms: a main room and a restroom. The front, south side of the building has one window with two glass panes that slide open and a metal pedestrian door with window. The east side has two windows each with two glass panes that slide open. The north side has two windows, one larger than the other, also each with two glass panes that slide open. The smaller window is in the restroom. The west

side has one window with a single glass pane and a pedestrian door that was added sometime between 1959 and 1983.

The windows on the east and north sides are located at the north east corner of the building and the windows on the south and west sides are located at the southwest corner of the building.

The low-pitched roof slopes slightly from the south to north. It has an approximate 5 ft overhang/canopy in the front (south side) and the other three sides have an approximate 2 ft overhang/canopy. The roof construction is similar to that of guard house building TA-3-42. It appears to be constructed in several layers with a tar and gravel exterior surface. There is galvanized metal flashing around all the edges.

Interior wall surfaces **were most likely** painted with oil-base lead paint as were other structures constructed in the late 1940s early 1950s.

Remodeling History: At sometime between 1959 and 1983 a second pedestrian door was added on the west side of the building in the location where one of the windows was positioned.

Associated Buildings: TA-35-2 is the original laboratory and office building at TA-35. It also was constructed in 1951.

District Potential: None. TA-35 is a conglomeration of a wide variety of permanent and temporary buildings of many different construction styles built throughout the late 1940s to the present.

Contamination Information: There is no record of any contamination existing in building TA-35-1 (Los Alamos National Laboratory 1990 and 1992).

National Register Eligibility Determination

Based on the information gathered during this building survey, properties TA-3-42, TA-8-27, TA-8-31, and TA-35-1 are eligible for nomination to the National Register of Historic Places.

The four buildings are less than fifty years old and as such, must be associated with an event(s) of exceptional importance in order to be eligible for the National Register (criteria consideration G, under Criterion A) (U.S. Department of the Interior 1991).

All four buildings are eligible under Criterion A (criterion consideration G), even though they only functioned as support structures for main laboratory facilities constructed at each of the TAs during the early Cold War years at Los Alamos. TA-3-42 served as the guard house for entry into the technical machine shop located in the main administrative area of the Laboratory. TA-35-1 served as a guard house for the original laboratory building in TA-35. TA-8-27 and TA-8-31 served as a vault and explosives magazine respectively for the facilities that were built at the New Anchor West site for the development of x-ray techniques.

Two of the buildings (TA-8-27 and TA-35-1) had minor modifications during their time of use. The door on TA-8-27, the vault, was modified in 1961 and TA-35-1, a guard house, had an additional door installed sometime between 1959 and 1983.

Currently all of the buildings are abandoned and no future use is designated for these properties; therefore, they are on the Laboratory's surplus space list and scheduled for D&D. The magazine and vault's sole-use construction and small size make them unsuitable for reuse. The two guard houses, after being decommissioned from service, were temporarily used for storage before they were abandoned. The need for guard houses at the two locations, where TA-3-42 and TA-35-1 are situated, has become unnecessary and have therefore been vacated.

Proposed Treatment of Effects

The proposed D&D activities at TAs-3, -8, and -35 will result in the destruction of buildings TA-3-42, TA-8-27, TA-8-31, and TA-35-1. All four buildings are considered eligible for the National Register of Historic Places.

Adverse effects to properties determined to be eligible for the National Register should be mitigated to the fullest extent possible. It is deemed that the documentation submitted as part of this report (New Mexico Historic Building Inventory Form, building plan drawings, and photographs) serves as mitigation to the adverse effects to these properties which will result from the proposed D&D project.

Recommendations

As stated above, all four buildings (TA-3-42, TA-8-27, TA-8-31, and TA-35-1) proposed for demolition are considered significant historic properties and are eligible for nomination to the National Register of Historic Places under Criterion A (criterion consideration G). The SHPO is requested to concur with the eligibility determinations contained in this report. Based on the status of these buildings as support structures for main Laboratory facilities and the information regarding the proposed effects and treatment of effects, the SHPO is requested to concur with a "Determination of no Adverse Effect" for the D&D of properties TA-3-42, TA-8-27, TA-8-31, and TA-35-1. It is deemed that the documentation submitted as part of this report serves as mitigation to the adverse effects to the eligible properties that will result from the proposed D&D project.

As a result of this historic building survey, this project complies with the National Historic Preservation Act of 1966 (as amended).

References Cited

Hawkins, David, Edith C. Truslow, and Ralph Carlisle Smith

- 1983 "Project Y: The Los Alamos Story", Volume II in a series in *The History of Modern Physics, 1800-1950*. Tomash Publishers and the American Institute of Physics.

Los Alamos National Laboratory

- 1990 *Solid Waste Management Units Report, Los Alamos National Laboratory Environmental Restoration*, LA-UR-90-3400, Los Alamos National Laboratory, Los Alamos, New Mexico.
- 1992 *RFI Work Plan for Operable Unit 1129: Environmental Restoration Program* LA-UR-92-800, Los Alamos National Laboratory, Los Alamos, New Mexico.
- 1993a *Los Alamos: Beginnings of an Era 1943-1945*. Los Alamos Historical Society, Los Alamos, New Mexico.
- 1993b *RFI Work Plan for Operable Unit 1114: Environmental Restoration Program*. LA-UR-93-1000, Los Alamos National Laboratory, Los Alamos, New Mexico.
- 1993c *RFI Work Plan for Operable Unit 1157: Environmental Restoration Program*. LA-UR-93-1230, Los Alamos National Laboratory, Los Alamos, New Mexico.
- 1995 *Dateline: Los Alamos, Special Issue, LALP-95-2-6&7*. Los Alamos National Laboratory, Los Alamos, New Mexico.

McGehee, Ellen D.

- 1995 *Decontamination and Decommissioning of 28 "S Site" Properties: Technical Area 16*, Historic Building Survey Report No. 84, Vols 1-3. LA-UR-95-617. Los Alamos National Laboratory, Los Alamos, New Mexico.

Rothman, Hal

- 1992 *On Rims and Ridges, The Los Alamos Area Since 1880*. University of Nebraska Press, Lincoln.

U. S. Department of Energy

- 1994 *Environmental Restoration and Waste Management Five-Year Plan, Fiscal Years 1994-1998*. DOE/S-00097P, U.S. Department of Energy, Washington, D.C.

U.S. Department of the Interior

- 1991 *How to Apply the National Register Criteria for Evaluation*. In *National Register Bulletin*, No. 15. U.S. National Park Service, Washington, D.C.

Wilder, Edward, Jr.

- 1991 Early S-site Experiences. In *Manhattan District History: Nonscientific Aspects of Los Alamos Project Y, 1942 through 1946*. Written by Edith C. Truslow, edited by Kasha V. Thayer. Los Alamos Historical Society, Los Alamos, New Mexico.

APPENDIX A

Maps

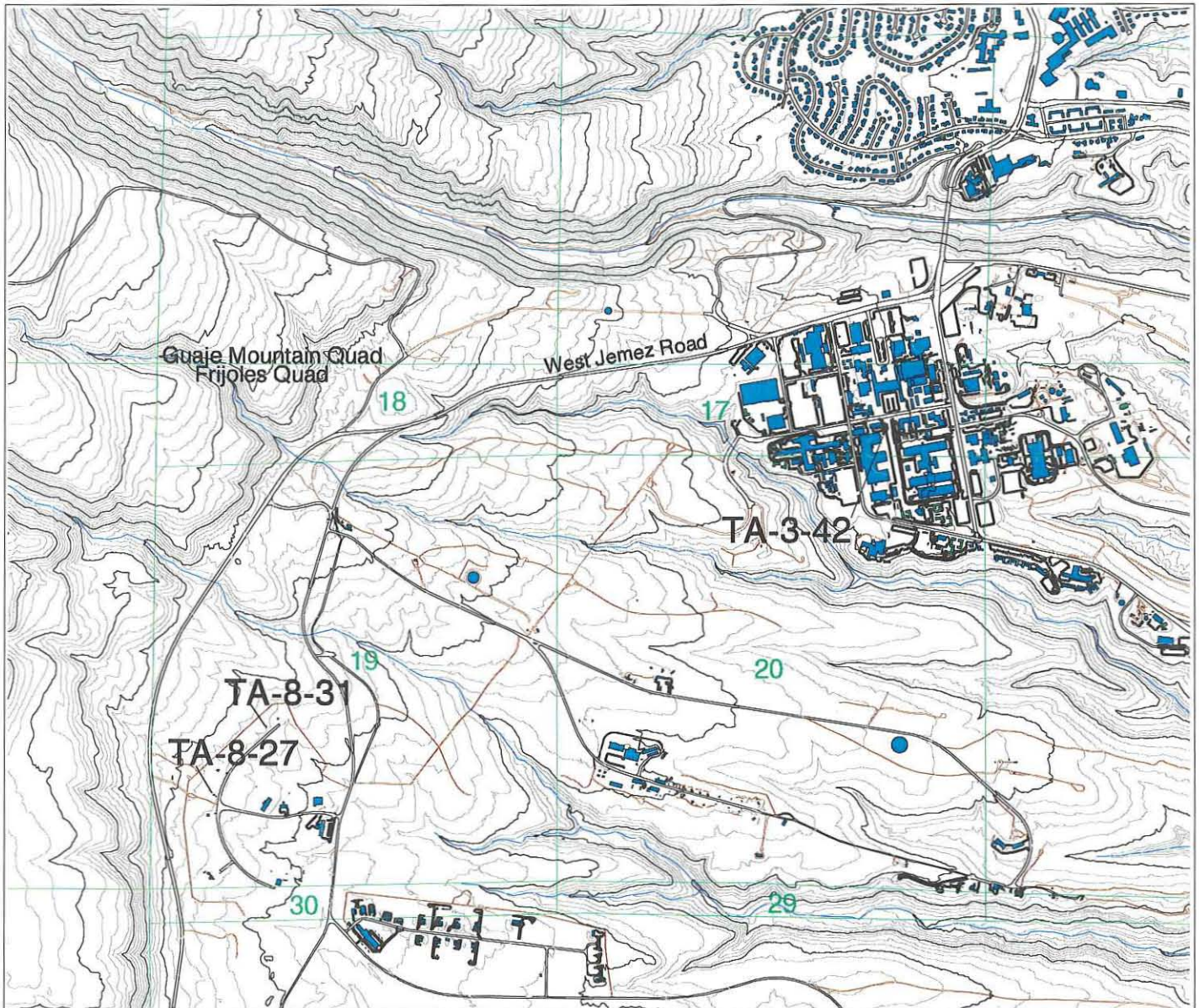

1:24000

Los Alamos National Laboratory

Cultural Resources Team
ESH-20 Ecology Group

300 0 300 600 900 1200 1500 Meters



1000 0 1000 2000 3000 4000 5000 Feet



D&D of TA-3-42, TA-8-27, TA-8-31, and TA-35-1

TA-3 and TA-8 Project Locations



- Township, Range, Section
- USGS 7.5 Minute Quadrangle
- 20 Foot Contours
- 100 Foot Contours
- Drainage
- Roads - Paved
- Roads - Dirt
- Structures - Perm Buildings
- Structures - Temp Buildings

Map 1

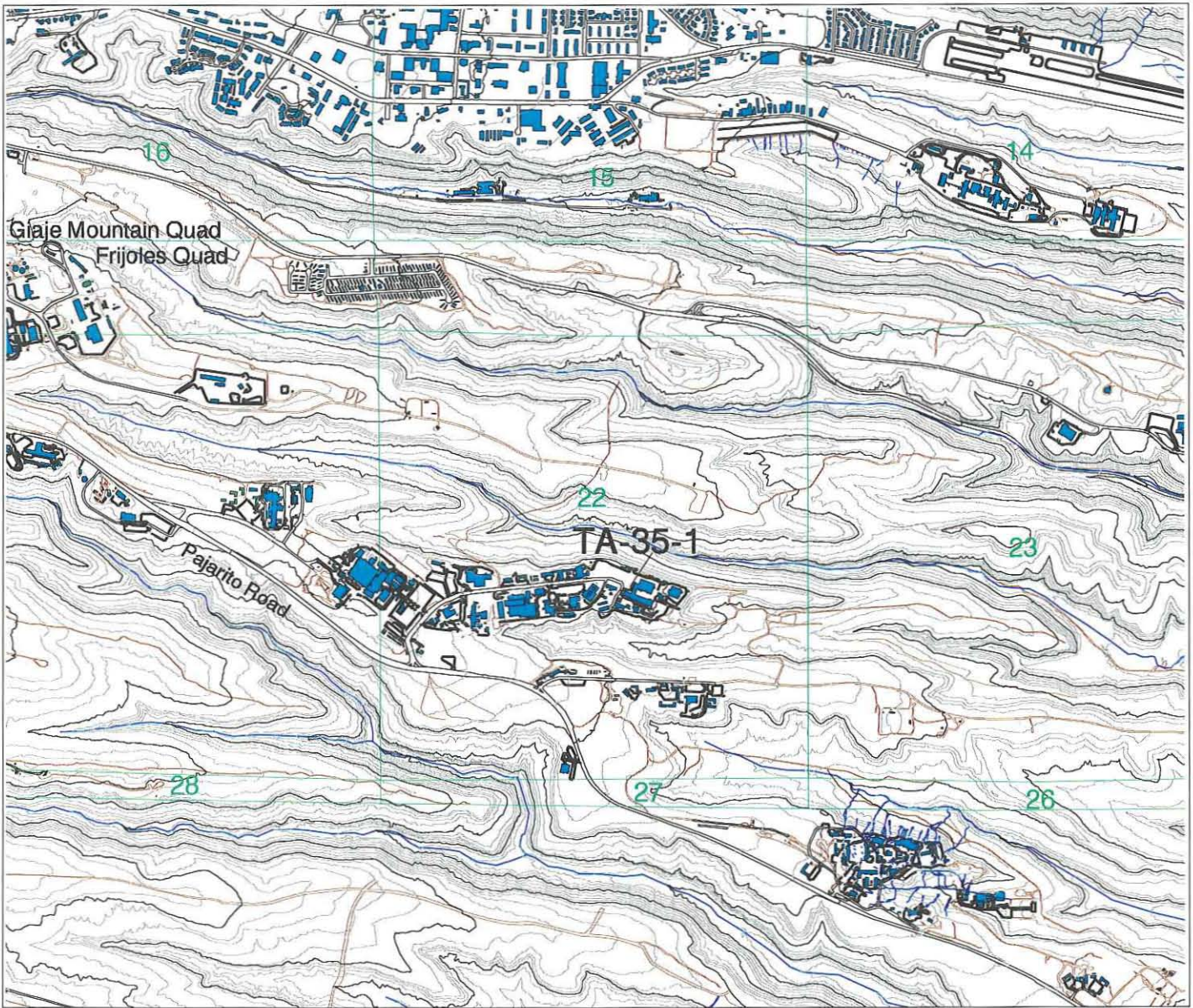

1:24000

Los Alamos National Laboratory

Cultural Resources Team
ESH-20 Ecology Group

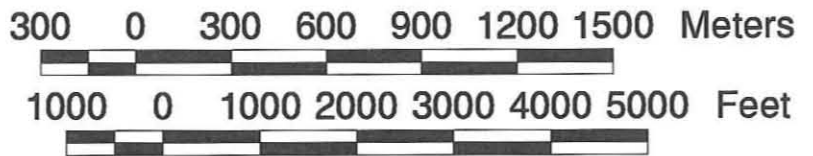

D&D of Buildings TA-3-42,
TA-8-27, TA-8-31,
and TA-35-1

TA-35 Project Location



- Township, Range, Section
- USGS 7.5 Minute Quadrangle
- 20 Foot Contours
- 100 Foot Contours
- Drainage
- Roads - Paved
- Roads - Dirt
- Structures - Perm Buildings
- Structures - Temp Buildings

Map 2

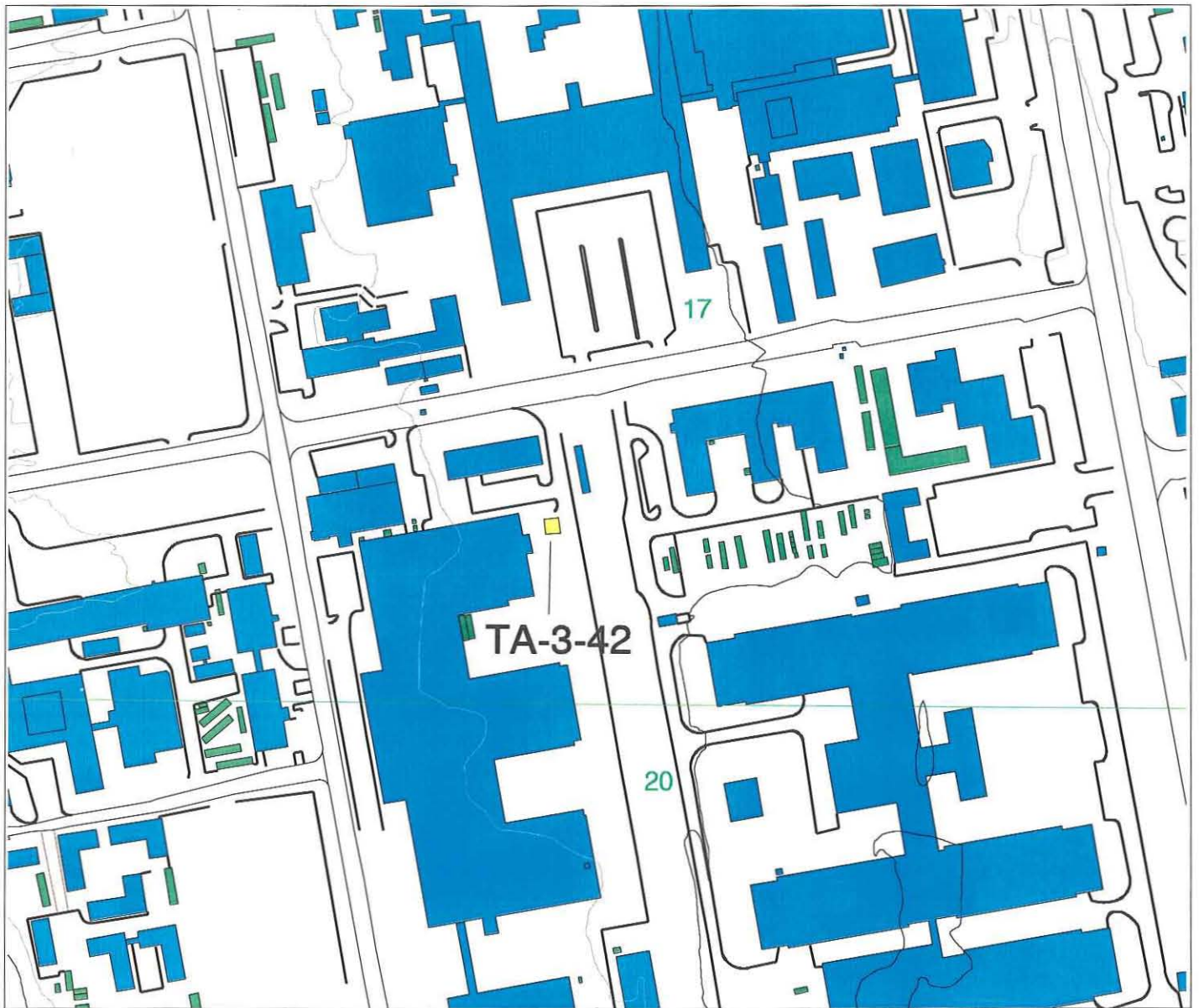

Frijoles 1984 7.5 Minute Quadrangle

Los Alamos
National Laboratory

Cultural Resources Team
ESH-20 Ecology Group

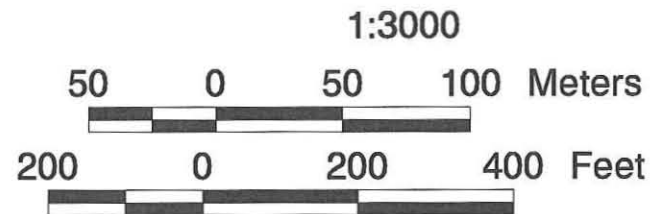

**D&D of TA-3-42,
TA-8-27, TA-8-31,
and TA-35-1**



- Township, Range, Section
- USGS 7.5 Minute Quadrangle
- 20 Foot Contours
- 100 Foot Contours
- Drainage
- Roads - Paved
- Roads - Dirt
- Structures - Perm Buildings
- Structures - Temp Buildings

TA-3-42 Location

Map 3

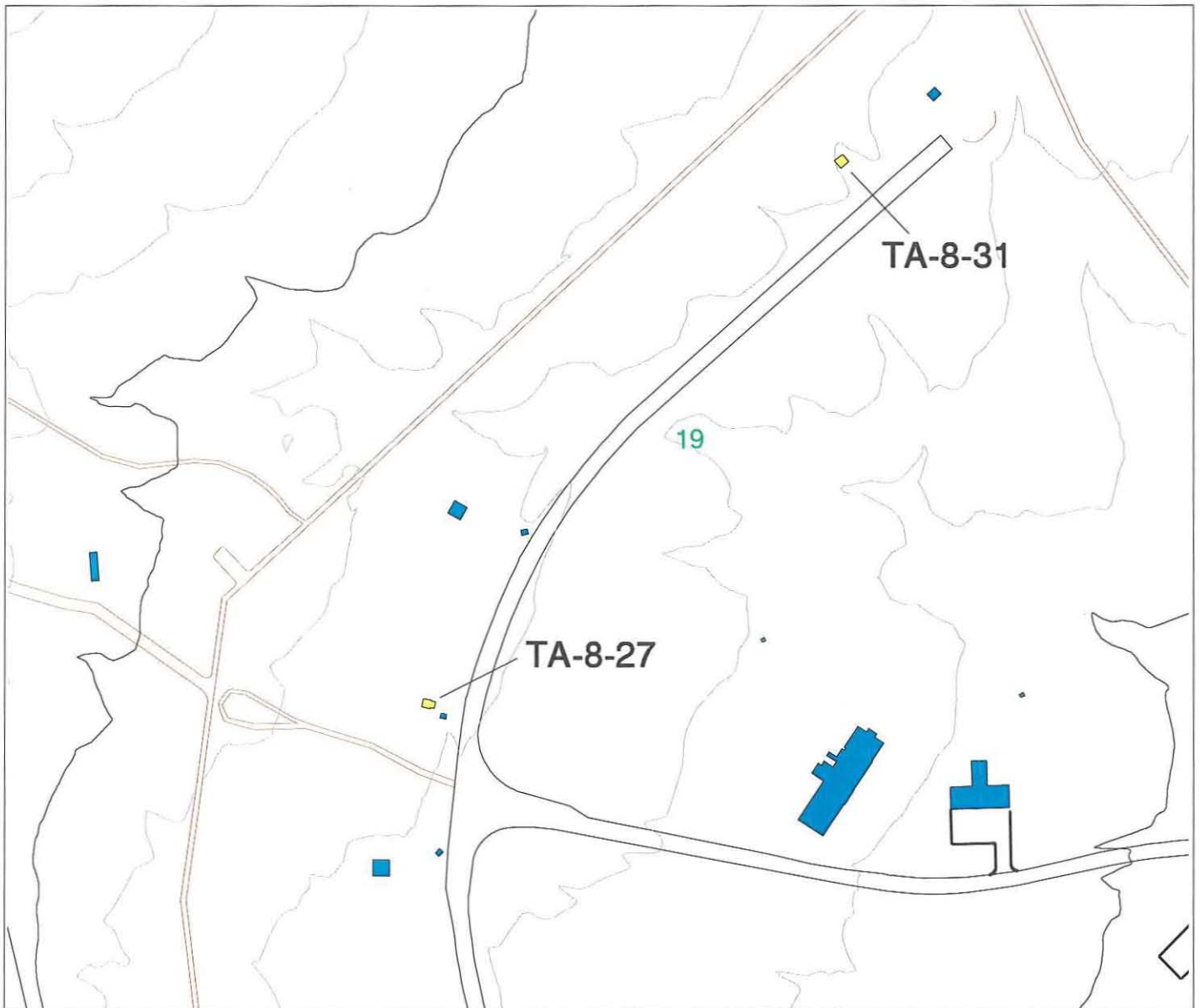

Frijoles 1984 7.5 Minute Quadrangle

Los Alamos
National Laboratory

Cultural Resources Team
ESH-20 Ecology Group

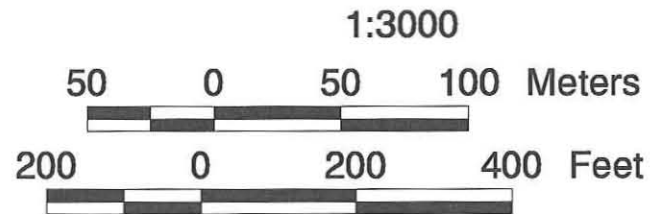

**D&D of TA-3-42,
TA-8-27, TA-8-31,
and TA-35-1**



- Township, Range, Section
- USGS 7.5 Minute Quadrangle
- 20 Foot Contours
- 100 Foot Contours
- Drainage
- Roads - Paved
- Roads - Dirt
- Structures - Perm Buildings
- Structures - Temp Buildings

**TA-8-27 and
TA-8-31 Locations**

Map 4

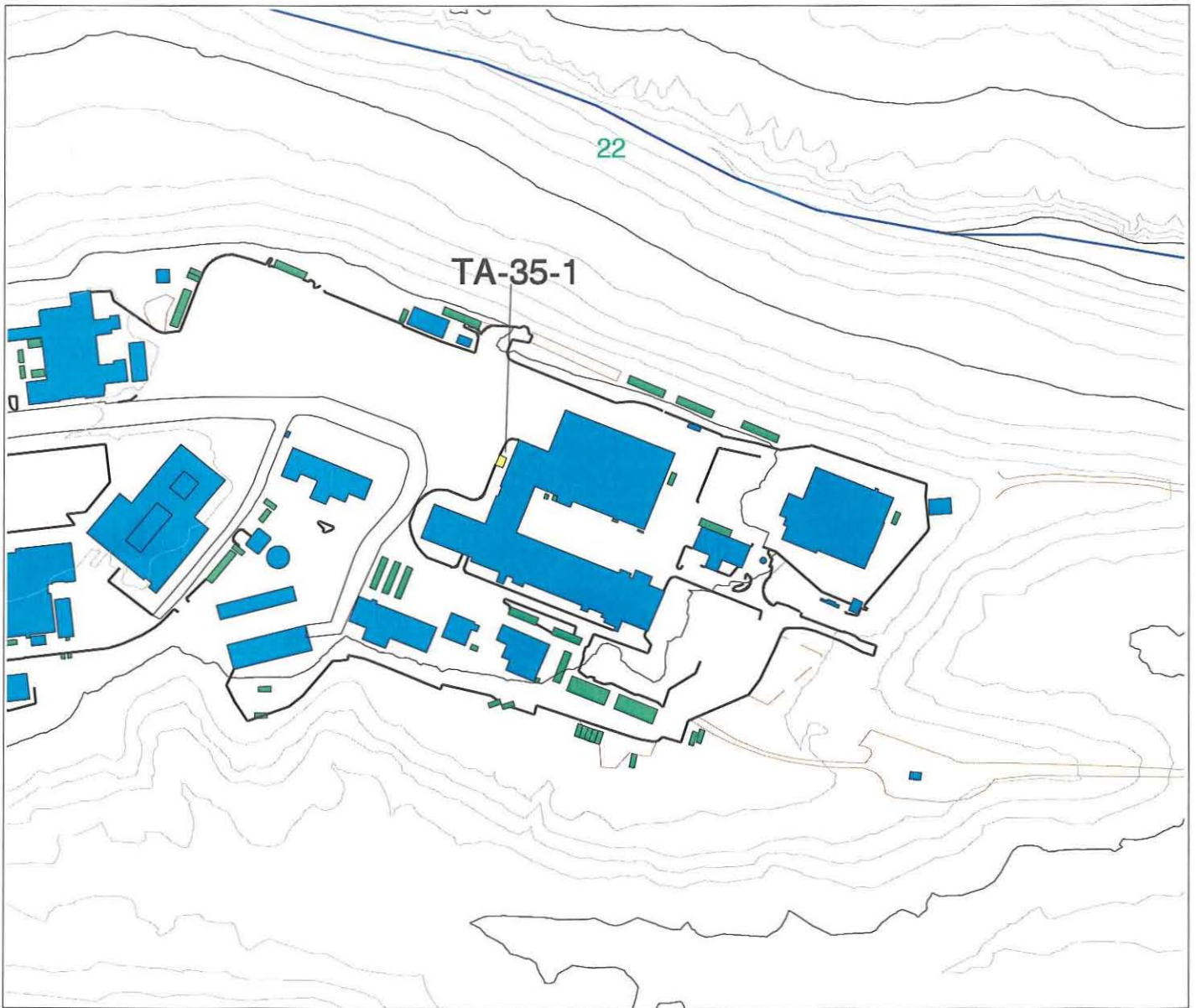

Frijoles 1984 7.5 Minute Quadrangle

Los Alamos
National Laboratory

Cultural Resources Team
ESH-20 Ecology Group

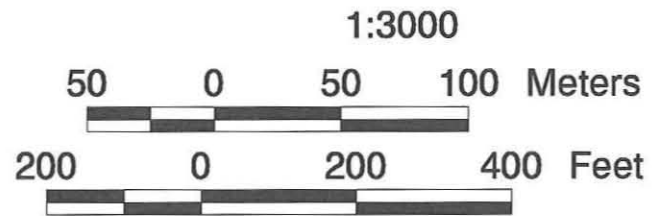

**D&D of TA-3-42,
TA-8-27, TA-8-31,
and TA-35-1**



- Township, Range, Section
- USGS 7.5 Minute Quadrangle
- 20 Foot Contours
- 100 Foot Contours
- Drainage
- Roads - Paved
- Roads - Dirt
- Structures - Perm Buildings
- Structures - Temp Buildings

TA-35-1 Location

Map 5

APPENDIX B

Historic Building Inventory Forms

NEW MEXICO HISTORIC BUILDING INVENTORY FORM

LA#

building threatened? Yes	surveyed date 2/9/99 by K. L. M. Garcia	County Los Alamos	ID no. TA-3-42
field map LANL Orthotopo	number Sheet 1	UTM reference: easting 380506 northing 3970427 zone 13	
location description Technical Area (TA) 3, South Mesa Site		city/town Los Alamos	land grant/reservation n/a
building name TA-3-42, Original name SM-42 (South Mesa-42)		legal description USGS Frijoles 7.5 Series tnsp 19N range 6E sec 17 SE¼ SW¼ SE¼	
film roll: 1048 by nos. ESH-20 Photos on file at ESH-20	Negative nos. 4A & 6A Also digital photos on file with ESH-20 by building number	location of neg. LANL, ESH-20	date of construction _____ estimate 1951-1953 actual source Facilities Division Engineering 9 (F-9) records (LANL)
Style Concrete masonry units with metal door and flat roof (see below for more information)	Foundation material Concrete slab Wall material/surface Concrete masonry units. Interior walls painted with lead and oil paint.	Use <u>Present</u> residential <input checked="" type="checkbox"/> other Abandoned <u>historic</u> residential <input checked="" type="checkbox"/> other Guard Station #328	Condition ___ excellent <u>X</u> fair to <u>X</u> good ___ deteriorating
degree of remodeling ___ minor ___ moderate ___ major describe: No apparent modifications	Surroundings Developed Laboratory Technical Area 3	Relationship to surroundings ___ similar <u>X</u> not similar	district potential ___ yes <u>X</u> no
Significance ___ Eligible <u>X</u> of interest ___ none if not eligible, why? Building TA-3-42 was a former guard house (station #328). This support building was the guard house for TA-3-39, the technical shop/inside machine shop at Technical Area 3. TA-3 is the administrative area of the Laboratory and it consists of a wide variety of permanent and temporary buildings of many different construction styles built throughout the late 1940s to the present.	Associated buildings? <u>X</u> yes what type? The reinforced concrete technical machine shop this guard house is associated with. if inventoried, list ID nos. TA-3-39	Photos and plan drawings are on following pages ENG-R 1738 Fire Alarm Equipment Plan Floor Plan March 5, 1959 ENG-R 3313 Guard House Floor Plan July 14, 1964 Below is the drawing for identical building (TA-8-20) which shows elevations: ENG-C 12393 (sheet 43 of 93) Plan Elevations & Details As Constructed Drawing May 17, 1949 size: 144 ft²	

<p>architectural features:</p> <p>Only floor plans exist for this guard house. However, this building is identical in size and design to at least five other guard houses (TA-8-20, TA-15-46, TA-16-1451, TA-22-32, and TA-36-22) at the Laboratory with the exception of minor differences. Construction material varies between concrete masonry units and reinforced concrete and the window treatment varies between size and number of glass panes.</p> <p>Building TA-16-1451 has been previously documented (McGehee 1995) and concurrence received from the State Historic Preservation Office on eligibility status (March 24, 1995) and a mitigation plan (May 30, 1995). Per the mitigation plan measured drawings have been completed and archival 4x5 black and white photographs have been produced.</p> <p>TA-3-42 is a square building constructed of concrete masonry units with a flat roof. It has two rooms, a main room and a restroom. The front, east side, of the building has a metal pedestrian door with a window, and two windows each with three glass panes. The north side has three windows each with three glass panes. The west side has two windows, one is slightly larger than the other. This larger window is the only difference between this guard house and the other five guard houses built from identical plans. The larger window has three glass panes and the smaller has two glass panes. The smaller window is the window in the restroom. The south side has two windows each with three glass panes. Utility control panels and switch boxes are located on the south side of the building.</p> <p>The lower portion of the walls from the ground up to the top of the door and windows are exposed concrete masonry units where as the upper portion of the wall has a smoothed concrete.</p> <p>The flat roof has a 4'6" overhang/canopy on all four sides of the building. The roof is constructed in several layers. The lower or interior surface of the roof is 1" perforated pan type acoustical ceiling. Then there is a 1½"-20 gauge galvanized steel roof deck and on top of that there is 2" rigid insulation. The final exterior surface is three ply tar and gravel roofing. There is galvanized metal flashing around all the edges.</p> <p>Interior wall surfaces were painted with lead and oil paint.</p>	<p>Comments: There is no record of any contamination existing within this buildings (Los Alamos National Laboratory 1900 and 1993).</p>
--	---

Los Alamos National Laboratory

1990 *Solid Waste Management Units Report, Los Alamos National Laboratory Environmental Restoration*, LA-UR-90-3400, Los Alamos National Laboratory, Los Alamos, New Mexico.

1993 *RFI Work Plan for Operable Unit 1114: Environmental Restoration Program*. LA-UR-93-1000, Los Alamos National Laboratory, Los Alamos, New Mexico.

1995 *Dateline: Los Alamos, Special Issue, LALP-95-2-6&7*. Los Alamos National Laboratory, Los Alamos, New Mexico.

McGehee, Ellen D.

1995 *Decontamination and Decommissioning of 28 "S Site" Properties: Technical Area 16*, Historic Building Survey Report No. 84, Volumes 1-3, LA-UR-95-617, Los Alamos National Laboratory, Los Alamos, New Mexico.

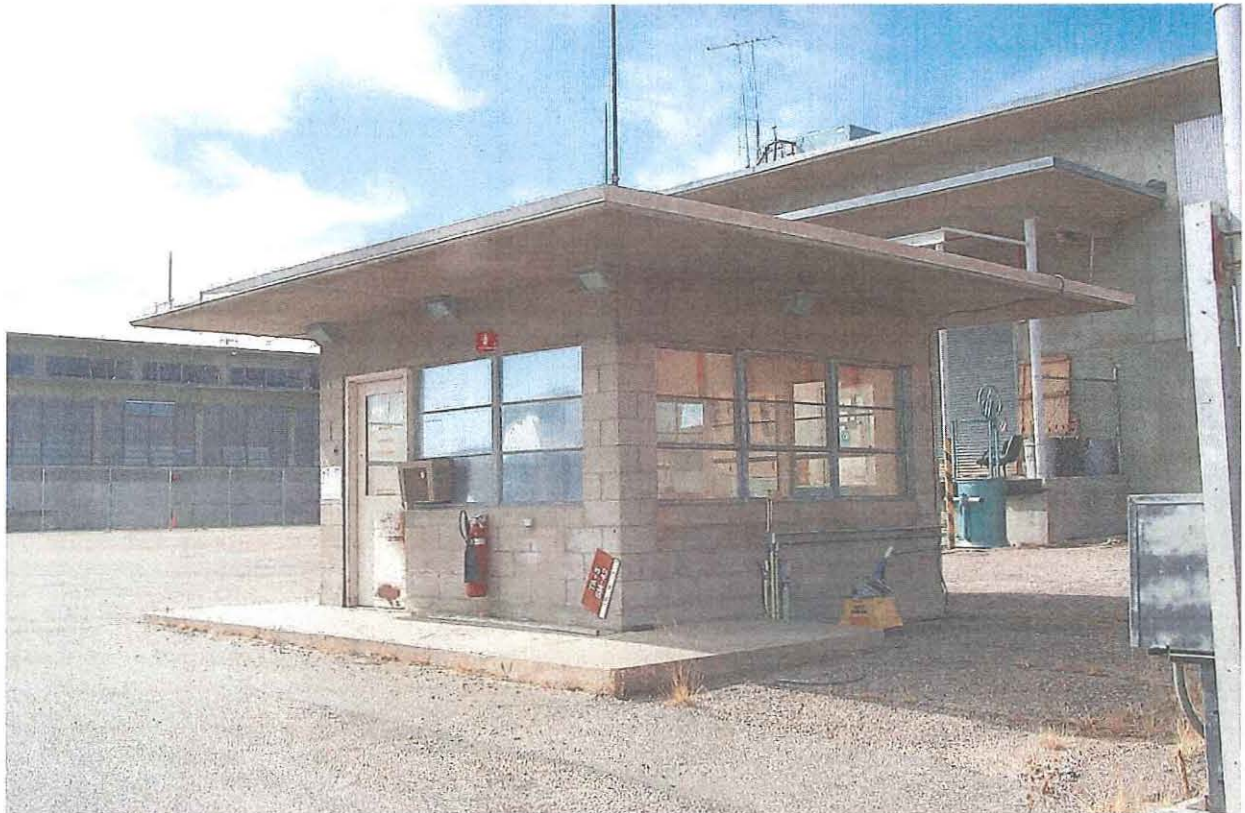

TA-3-42 East and North Sides



TA-3-42 North and West Sides

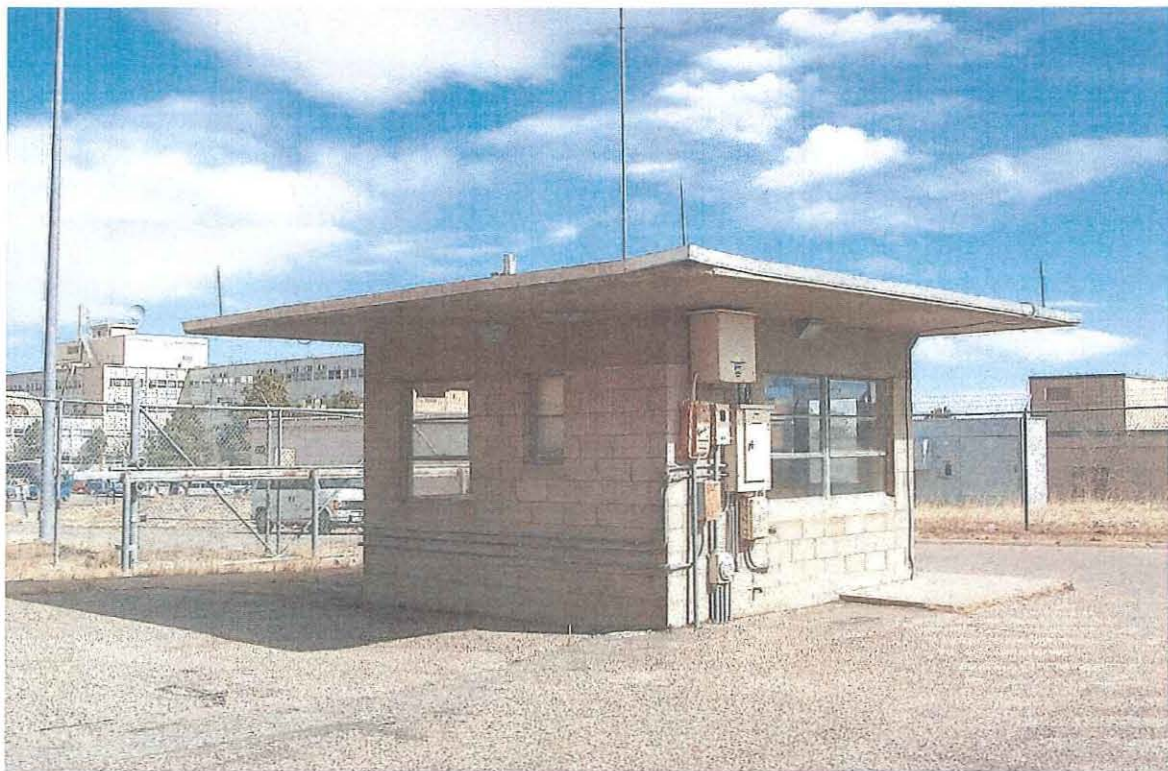

TA-3-42 West and South Sides

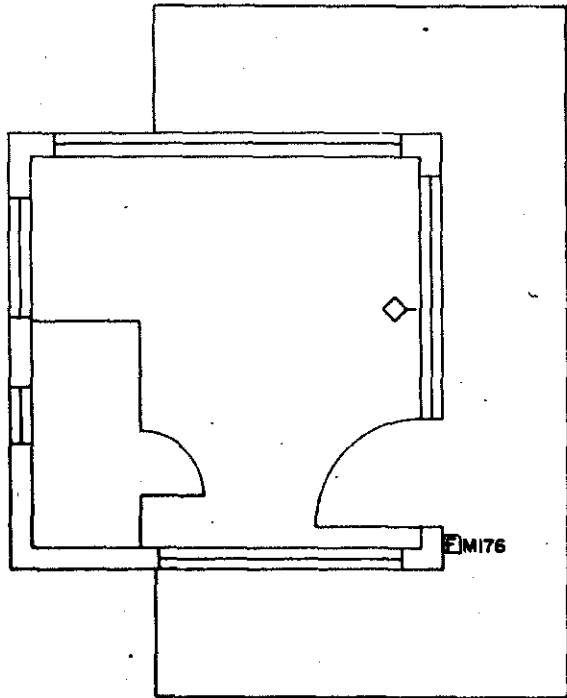

EMI76 (ZIA CONTROLLED)

- 1. FIRE ALARM EQUIPMENT
- 2. FIRE ALARM EQUIPMENT
- 3. FIRE ALARM EQUIPMENT
- 4. FIRE ALARM EQUIPMENT
- 5. FIRE ALARM EQUIPMENT
- 6. FIRE ALARM EQUIPMENT
- 7. FIRE ALARM EQUIPMENT
- 8. FIRE ALARM EQUIPMENT
- 9. FIRE ALARM EQUIPMENT
- 10. FIRE ALARM EQUIPMENT
- 11. FIRE ALARM EQUIPMENT
- 12. FIRE ALARM EQUIPMENT
- 13. FIRE ALARM EQUIPMENT
- 14. FIRE ALARM EQUIPMENT
- 15. FIRE ALARM EQUIPMENT
- 16. FIRE ALARM EQUIPMENT
- 17. FIRE ALARM EQUIPMENT
- 18. FIRE ALARM EQUIPMENT
- 19. FIRE ALARM EQUIPMENT
- 20. FIRE ALARM EQUIPMENT

REC'D 11/25 10:00 AM '59

TA-3-42
Fire Alarm Equipment Plan
Floor Plan
March 5, 1959

Rev. to status of 2-20-63 COF <i>[Signature]</i>		Rev. to status of 12-14-62 JMD <i>[Signature]</i>		LOS ALAMOS SCIENTIFIC LABORATORY ENGINEERING DEPARTMENT UNIVERSITY OF CALIFORNIA — LOS ALAMOS, NEW MEXICO		FIRE ALARM EQUIPMENT FLOOR PLAN BLDG. SM-42 TA-3	
APPROVALS: ENG. GROUP <u>3</u> <i>SEP</i>		DESIGN: DESIGNER: <u>S.G.B.</u>		DATE <u>3-6-59</u>		SCALE <u>1/4" = 1'-0"</u>	
DIVISION: ENG. DEPT. OFFICE: <i>[Signature]</i>		PROJ. ENG. <i>[Signature]</i>		SHEET <u>1 of 1</u>		SKETCH NO. ENG-R1736	

NO.	DATE	REVISIONS	BY	CHKD	GRP LDR	ENG D. O.
1	8-6-65	REVISED TO STATUS OF	MFM	AB	BER	JB

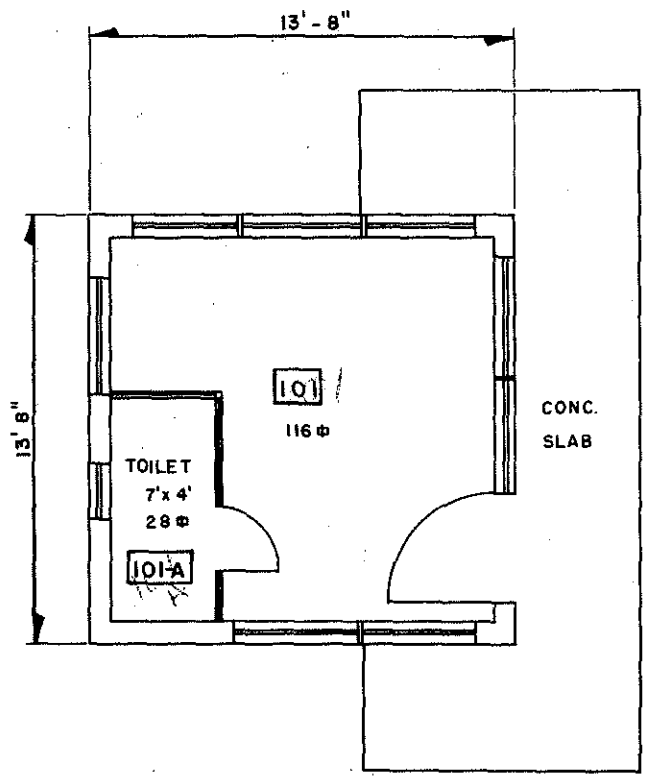

Note: Disposal, Classification TO VAULT 8/14/64

TA-3-42
Guard House Floor Plan
July 14, 1964

TOTAL SQ. FT. 144

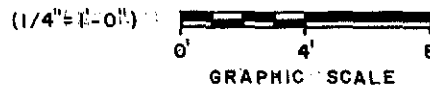

REV.	DATE	REVISION	BY	CHKD.	APP.
2	8-2-83	REVISED TO STATUS OF	B 2 83	HAN	EDR
UNIVERSITY OF CALIFORNIA Los Alamos Los Alamos National Laboratory Los Alamos, New Mexico 87545					
FACILITIES ENGINEERING DIVISION					
GUARD HOUSE FLOOR PLAN					SEC. CLASSIFICATION
					CLASS. <i>U</i>
BLDG. SM-42					REVIEWER <i>Produit</i>
TA-3					DATE 10-5-83
SUBMITTED <i>E. Traxville</i>		RECOMMENDED <i>Darin B...</i>		APPROVED <i>W.T. ...</i>	
DRAWN HARRISON	DATE 7-14-64	SHEET NO. 1 OF 1	DRAWING NO. ENG-R 3313		
CHECKED <i>D. Humble</i>					

K&E ALBANY® LA 0617
TRADING PAPER

REC'D LOGGED TO VAULT 11-3-83

8-12

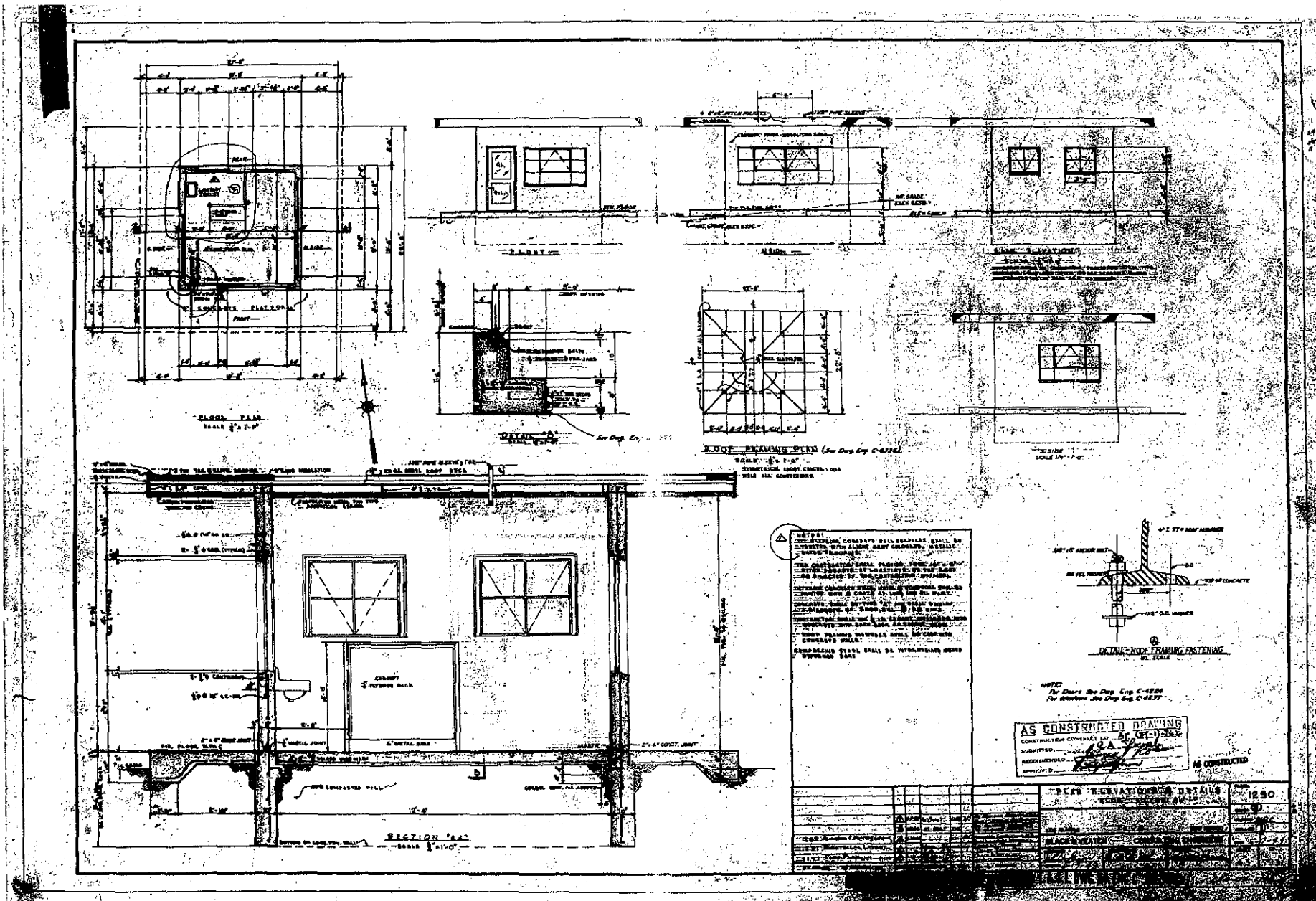

TA-8-20
 Plan Elevations & Details
 As Constructed Drawing
 May 17, 1949
 (Identical to TA-3-42)

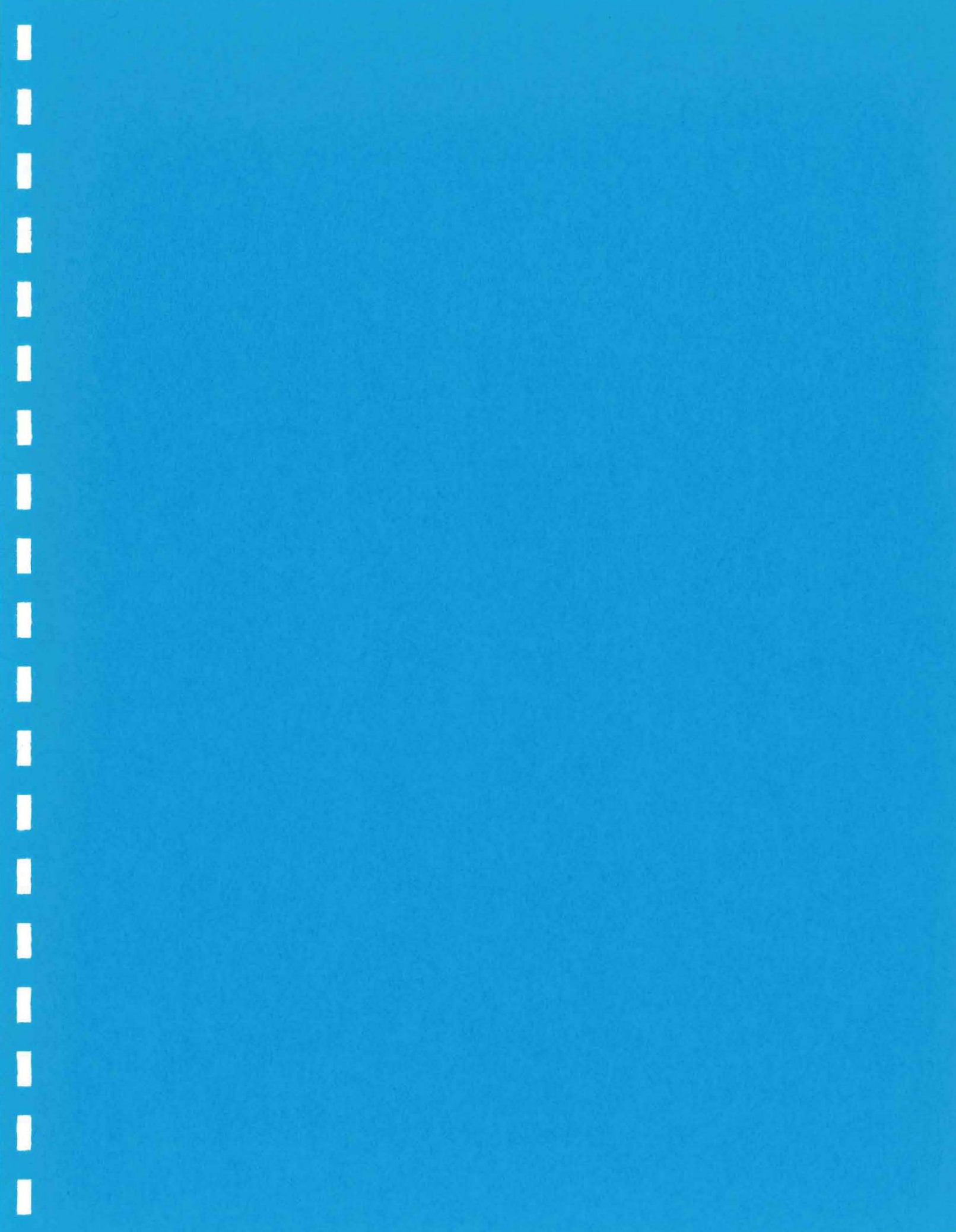

NEW MEXICO HISTORIC BUILDING INVENTORY FORM

LA#

building threatened? yes	surveyed date <u>2/9/99</u> by <u>K. L. M. Garcia</u>	County <u>Los Alamos</u>	ID no. <u>TA-8-27</u>
field map <u>LANL Orthotopo</u>	number <u>Sheet 2</u>	UTM reference: easting <u>377986</u> northing <u>3969098</u> zone <u>13</u>	
location description <u>Technical Area (TA) 8, Anchor Site West</u>		city/town <u>Los Alamos</u> land grant/reservation <u>n/a</u>	
building name <u>TA-8-27, Original name AW-27 (Anchor West - 27) (Project B, Building 85)</u>		legal description <u>USGS Frijoles 7.5 Series</u> tmsp <u>19N</u> range <u>6E</u> sec <u>19</u> <u>NE¼ SW¼ SW¼</u>	
film roll: <u>1048</u> by nos. <u>ESH-20</u> Photos on file at ESH-20	Negative nos. <u>10A & 12A</u> Also digital photos on file at ESH-20 by building number	location of neg. <u>LANL, ESH-20</u>	date of construction _____ estimate <u>1950</u> actual source <u>Facilities Division Engineering 9 (F-9) records (LANL)</u>
Style Reinforced concrete with flat roof (See below for more information)	Foundation material Concrete slab Wall material/surface Reinforced concrete with steel lined interior walls and ceiling.	Use <u>Present</u> residential <input checked="" type="checkbox"/> other Abandoned <u>historic</u> residential <input checked="" type="checkbox"/> other Vault	Condition ___ excellent <u>X</u> fair to <u>X</u> good ___ deteriorating
degree of remodeling <u>X</u> minor ___ moderate ___ major describe: Door modifications	Surroundings Developed Laboratory Technical Area 8	Relationship to surroundings <u>X</u> similar ___ not similar	district potential ___ yes <u>X</u> no

<p>Significance Eligible _____ of interest <u>X</u> none if not eligible, why? Building TA-8-27 is a storage vault.</p> <p>This vault was built in 1950 for fissionable materials associated with the new radiography facility that was built at this TA in the early 1950s.</p> <p>This TA was the original site of the Manhattan Project Gun-Firing Site (Old Anchor West) where prototypes of the Little Boy weapon (a gun-assembled nuclear weapon) were tested in 1945. "Gun testing was not resumed after the War. The gun weapon, although reliable, required large quantities of enriched uranium, and the program was abandoned in favor of the development of implosion weapons" (Los Alamos National Laboratory 1993:2-10).</p> <p>In 1949-1950 new construction began at TA-8 at the New Anchor West location. The new buildings were constructed to house the Group X-2 (later GMX-1), which had been developing x-ray techniques at another location. At this same time many of the original buildings were removed and one building was relocated within the site and later removed. These new buildings were for office space, photographic-processing labs, and laboratories for various types of x-ray work, some of which involved the use of contained radioactive sources.</p>	<p>associated buildings? <u>X</u> yes what type? A guard station and two magazines if inventoried, list ID nos. TA-8-28, a guard station; TA-8-31 and TA-8-32, magazines</p>	<p>Photos and plan drawings are on following pages</p> <p>ENG-C 12478 (sheet 20 of 113) Project B, TA-8 Structural Layout As Constructed Drawing September 8, 1949</p> <p>ENG-C 19340 Exterior Door Modifications Plans-Elevations-Section October 17, 1961</p> <p>ENG-R 2625 Vault Floor Plan August 26, 1983</p> <p>size: 189 ft²</p>
<p>Architectural features:</p> <p>Building TA-8-27 is a vault. It is a roughly rectangular building with a flat roof constructed of reinforced concrete. It has two rooms and a vault door.</p> <p>The interior walls and ceiling are steel lined. The steel is painted with oil base lead paint. The floor has a smooth monolithic cement finish.</p> <p>Exterior walls were left rough. The roof and exterior wall were coated with metallic waterproofing.</p> <p>The exterior door was modified in 1961.</p>	<p>Comments: There is no evidence of any radioactive contamination associated with this building (Los Alamos National Laboratory 1990 and 1993).</p>	

Los Alamos National Laboratory

1990 *Solid Waste Management Units Report, Los Alamos National Laboratory Environmental Restoration, LA-UR-90-3400, Los Alamos National Laboratory, Los Alamos, New Mexico.*

1993 *RFI Work Plan for Operable Unit 1157: Environmental Restoration Program. LA-UR-93-1230, Los Alamos National Laboratory, Los Alamos, New Mexico.*

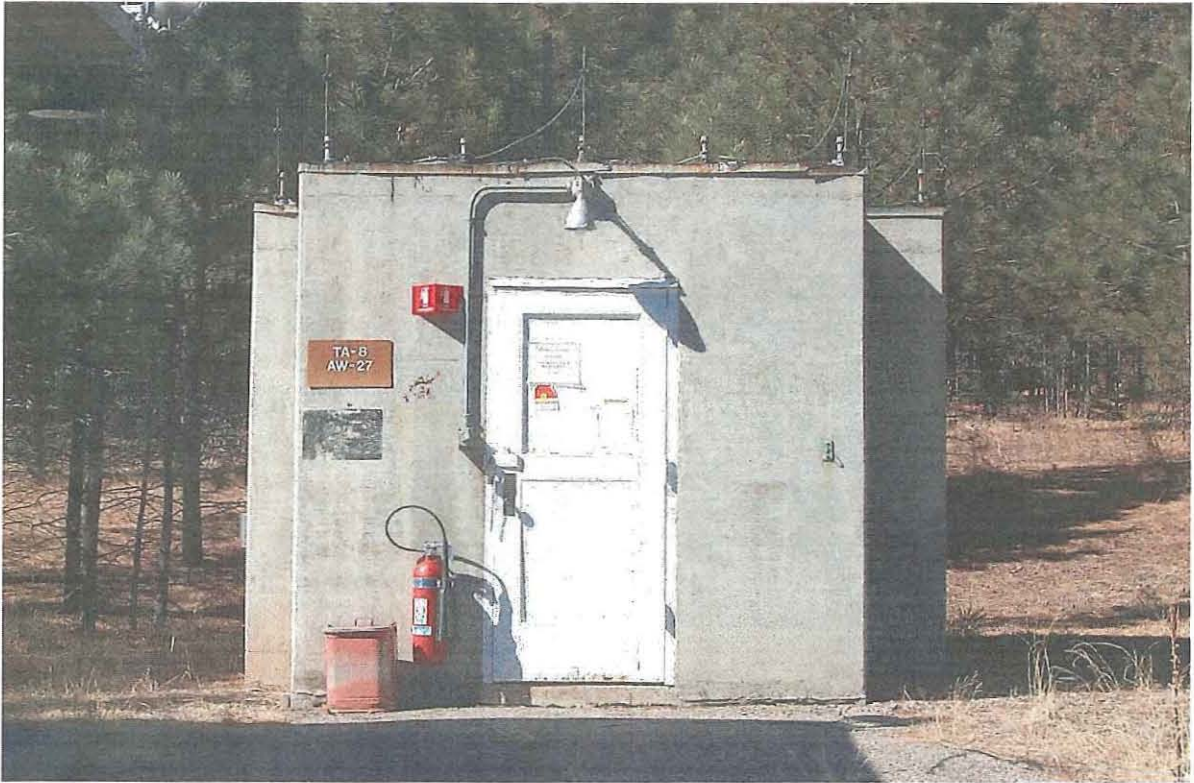

TA-8-27 East Side



TA-8-27 East and North Sides

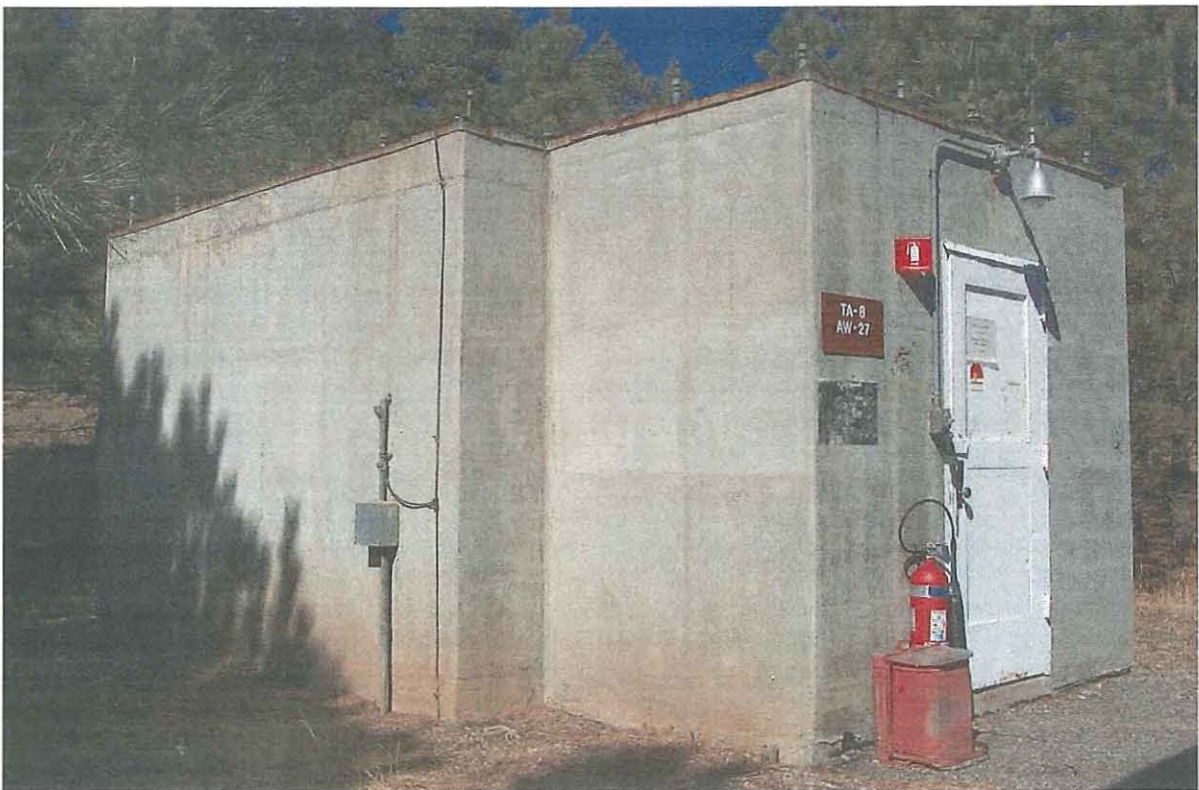

TA-8-27 South and East Sides

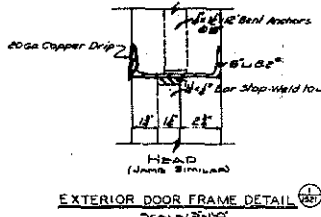
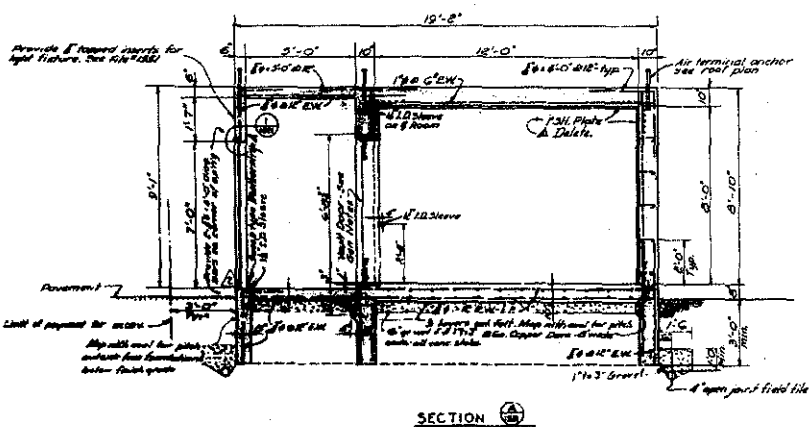
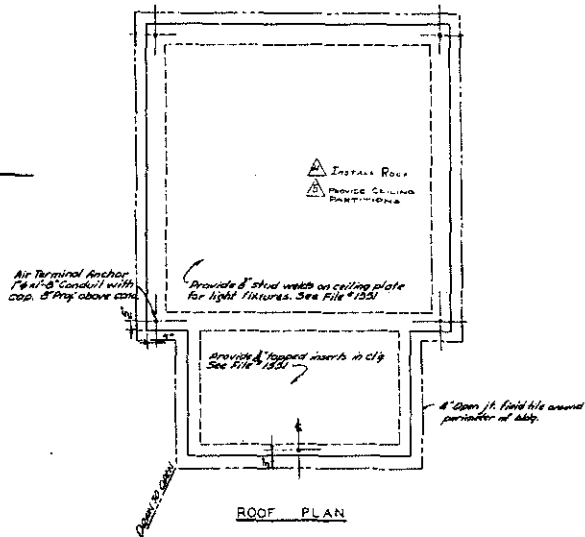
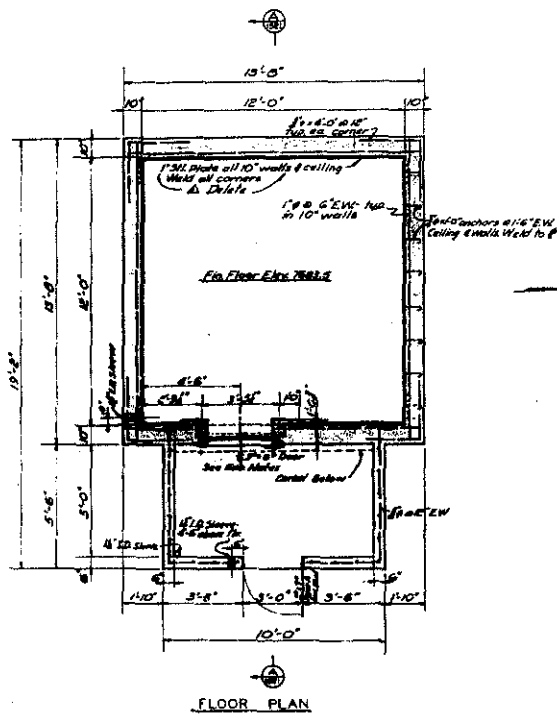

- GENERAL NOTES**
1. All concrete shall be Type A and shall develop a strength of 3,000 p.s.i. at 28 days.
 2. Use 1/2" cement plaster with each coat of cor. and lead.
 3. Reinforcement shall be intermediate grade deformed bars.
 4. Bond reinforcement by welding at 8'-0" intervals in each direction. Band all other metal to reinforcing steel by direct weld or suitable metal strap.
 5. Connect reinforcing to grounding system with #10 bare structural copper cable.
 6. All steel plates and anchors shall be mild steel.
 7. Steel plate lining shall be cast in place or may be used as form.
 8. Exterior walls may be left rough.
 9. Interior steel walls & ceiling shall be given 3 coats of lead and oil paint.
 10. All foundations shall be carried to solid bearing with a minimum excavation of 18" into rock (T&E).
 11. Foundation walls 6" below finish grade may be secured without forming provided trenches are cut to size.
 12. Floors shall be given a smooth marlithite cement finish.
 13. Roof and exterior walls shall be coated with metallic waterproofing.
 14. A Class E vault door as req'd by the National Bureau of Consistency & Security, Inc. partitions shall be furnished & installed by the contractor unless shown on drawings. Install per mfg's recommendations. Verify masonry core dimensions.
 15. Door shall be opened from the inside.
- Doors shall be extra foundation excavation as provided in special conditions shall be limited to 3'-0" outside conc. walls or cas. or heel face of footing whichever is greater.

- REFERENCE DRAWINGS**
- Plot Plan _____ Elys # 1444
 - General Layout _____ 1413
 - Electrical Layout _____ 1531
 - Lightning Protection Grounding Details _____ 1532
 - Doors see shop drawings _____ ENG-G-1518

AS CONSTRUCTED DRAWING
 CONSTRUCTION CONTRACT NO. 41207500
 SUBMITTED BY: [Signature]
 RECOMMENDED BY: [Signature]
 DATE: [Signature]

VERIFIED UNCLASSIFIED

Lester R. Pitt

TA-8-27
 Structural Layout
 As Constructed Drawing
 September 8, 1949

Scale: 1/4" = 1'-0" unless noted

NO.	REVISION	DATE	BY	DESCRIPTION
1	AS CONSTRUCTED	9-8-49	JMD	AS CONSTRUCTED
2	MODIFIED			
3	MODIFIED			
4	MODIFIED			
5	MODIFIED			

STRUCTURAL LAYOUT (BLDG. & SECTIONS)	1521
FLOOR PLAN, ROOF PLAN & SECTIONS	JMD
PROJECT	TA-8
LOG NUMBER	NEW MEXICO
BLACK & VEATCH CONSULTING ENGINEERS	9-8-49
DATE	20

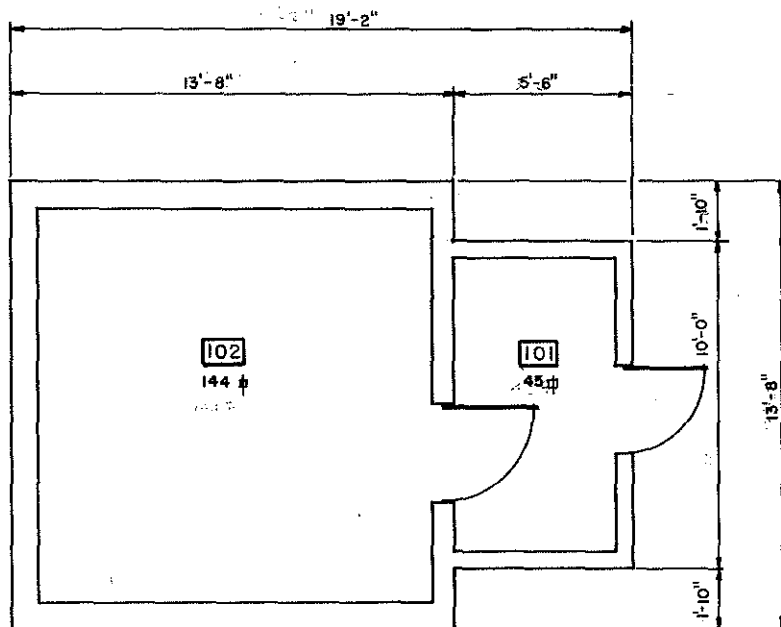

TA-8-27
Vault
Floor Plan
August 26, 1983



BLDG. TOTAL 1489 S.F.

UNCLASSIFIED

Susan Roth

REV. DATE		REVISION		BY	CHKD. AP
1 8-26-83		REDRAWN & REVISED TO STATUS OF 8-26-83		HBN	STP
UNIVERSITY OF CALIFORNIA					
Los Alamos			Los Alamos National Laboratory Los Alamos, New Mexico 87545		
FACILITIES ENGINEERING DIVISION					
VAULT FLOOR PLAN					SEC. CLASSIFICATION
					CLASS. <i>A</i>
REVIEWER <i>Thane</i>					DATE <i>10-12-83</i>
BLDG. <i>AW-27</i>		TA-8			
SUBMITTED <i>E. Trujillo</i>		RECOMMENDED <i>Dawn Rupp</i>		APPROVED <i>W.T. [Signature]</i>	
DRAWN HBN	DATE 8-26-83	SHEET NO. 1	OF 1	DRAWING NO. ENG-R 2625	
CHECKED <i>Thane</i>	HBN				

REC'D..... LOGGED..... TO VAULT/11-24-83

2625



NEW MEXICO HISTORIC BUILDING INVENTORY FORM

LA#

building threatened? Yes	surveyed date 2/9/99 by K. L. M. Garcia	County Los Alamos	ID no. TA-8-31
field map LANL Orthotopo	number Sheet 1	UTM reference: easting 378183 northing 3969352 zone 13	
location description Technical Area (TA) 8, Anchor Site West		city/town Los Alamos	land grant/reservation n/a
building name TA-8-31, Original name AW-31, Anchor West -31 (Project B, Building 86A)		legal description USGS Frijoles 7.5 Series tnsp 19N range 6E sec 19 SW¼ NE¼ SW¼	
film rolls: 236 & 1048 by nos. ESH-20 Photos on file at ESH-20	Negative nos. Roll 236 Frame 7; Roll 1048 Frames 14A, 15A, & 17A Also digital photos on file with ESH-20 by building number	Location of neg. LANL, ESH-20	date of construction _____ estimate 1950 actual source Facilities Division Engineering 9 (F-9) records (LANL)
Style Reinforced concrete magazine with flat roof (See below for more information)	Foundation material Concrete slab wall material/surface Reinforced concrete	Use <u>Present</u> residential <input checked="" type="checkbox"/> other Abandoned <u>historic</u> residential <input checked="" type="checkbox"/> other Magazine	Condition ___ excellent <input checked="" type="checkbox"/> fair to <input checked="" type="checkbox"/> good ___ deteriorating
Degree of remodeling ___ minor ___ moderate ___ major describe: No apparent modifications	Surroundings Developed Laboratory Technical Area 8	Relationship to surroundings <input checked="" type="checkbox"/> similar ___ not similar	district potential ___ yes <input checked="" type="checkbox"/> no

<p>Significance _____ Eligible <u> X </u> of interest _____ none If not eligible, Why? Building TA-8-31 magazine for High Explosives.</p> <p>This magazine was built in 1950, during the early Cold War years at Los Alamos, at the New Anchor West location and is not associated with the testing of the Little Boy weapon during World War II.</p> <p>This TA was the original site of the Manhattan Project Gun-Firing Site (Old Anchor West) where prototypes of the Little Boy weapon (a gun-assembled nuclear weapon) were tested in 1945. "Gun testing was not resumed after the War. The gun weapon, although reliable, required large quantities of enriched uranium, and the program was abandoned in favor of the development of implosion weapons" (Los Alamos National Laboratory 1993:2-10).</p> <p>In 1949-1950 new construction began at TA-8 at the New Anchor West location. The new buildings were constructed to house the Group X-1 (later GMX-1), which had been developing x-ray techniques at another location. At this same time many of the original buildings were removed and one building was relocated within the site and later removed. These new buildings were for office space, photographic-processing labs, and laboratories for various types of x-ray work, some of which involved the use of contained radioactive sources.</p>	<p>associated buildings? <u> X </u> yes what type? A magazine, a vault, and a guard house if inventoried, list ID nos. TA-8-32 is an identical magazine, TA-8-27 is a vault, and TA-8-28 is a guard house</p>	<p>Photos and plan drawings are on following pages</p> <p>ENG-C 12479 (sheet 21 of 113) Project B, TA-8 Plans and Sections (elevation) As Constructed Drawing September 8, 1949</p> <p>ENG-C 12480 (sheet 22 of 113) Project B, TA-8 Typical Details As Constructed Drawing September 8, 1949</p> <p>ENG-C 12567 (sheet 108 of 113) Project B, TA-8 Door Installation Assembly, 1/4" steel door As Constructed Drawing September 20, 1949</p> <p>ENG-C 12568 (sheet 109 of 113) Project B, TA-8 Frame Assembly, 1/4" steel door As Constructed Drawing September 20, 1949</p> <p>ENG-C 12569 (sheet 110 of 113) Project B, TA-8 Door Assembly, 1/4" steel door As Constructed Drawing September 20, 1949</p> <p>ENG-C 12570 (sheet 111 of 113) Project B, TA-8 Latch Details, 1/4" steel door As Constructed Drawing September 20, 1949</p> <p>ENG-C 12571 (sheet 112 of 113) Project B, TA-8 Door, Cover & Insulation Assembly, 1/4" steel door As Constructed Drawing September 20, 1949</p> <p>ENG -C 12572 (sheet 113 of 113) Project B, TA-8 Lock Details, 1/4" steel door As Constructed Drawing September 20, 1949</p> <p>ENG - R2629 Magazine AW-31, TA-8 Floor Plan October 14, 1983</p> <p>Size: 168 ft²</p>
---	---	--

<p>Architectural features:</p> <p>This building is a reinforced concrete magazine. It is roughly rectangular and has a flat roof.</p> <p>Interior wall forms are of plywood. The reinforced concrete walls are smooth finished. The interior walls, ceiling and all exposed metal are painted with oil base lead paint. The ceiling has a center bar joist. Floor slabs have a non-sparking conductive finish.</p> <p>Exterior walls were left rough. Those surfaces against the earthen fill are waterproofed with 3 piles felt and coal tar pitch.</p> <p>The magazine has a 1/4" steel door on the north side of the structure. There is a concrete dock with stairs at the front of the magazine on the northeast side.</p>	<p>Comments: There is no indication that high explosives (HE) contamination ever occurred in this building (Los Alamos National Laboratory 1990 and 1993).</p>
---	---

Los Alamos National Laboratory

1990 *Solid Waste Management Units Report, Los Alamos National Laboratory Environmental Restoration, LA-UR-90-3400, Los Alamos National Laboratory, Los Alamos, New Mexico.*

1993 *RFI Work Plan for Operable Unit 1157: Environmental Restoration Program. LA-UR-93-1230, Los Alamos National Laboratory, Los Alamos, New Mexico.*



TA-8-31 East and North Sides

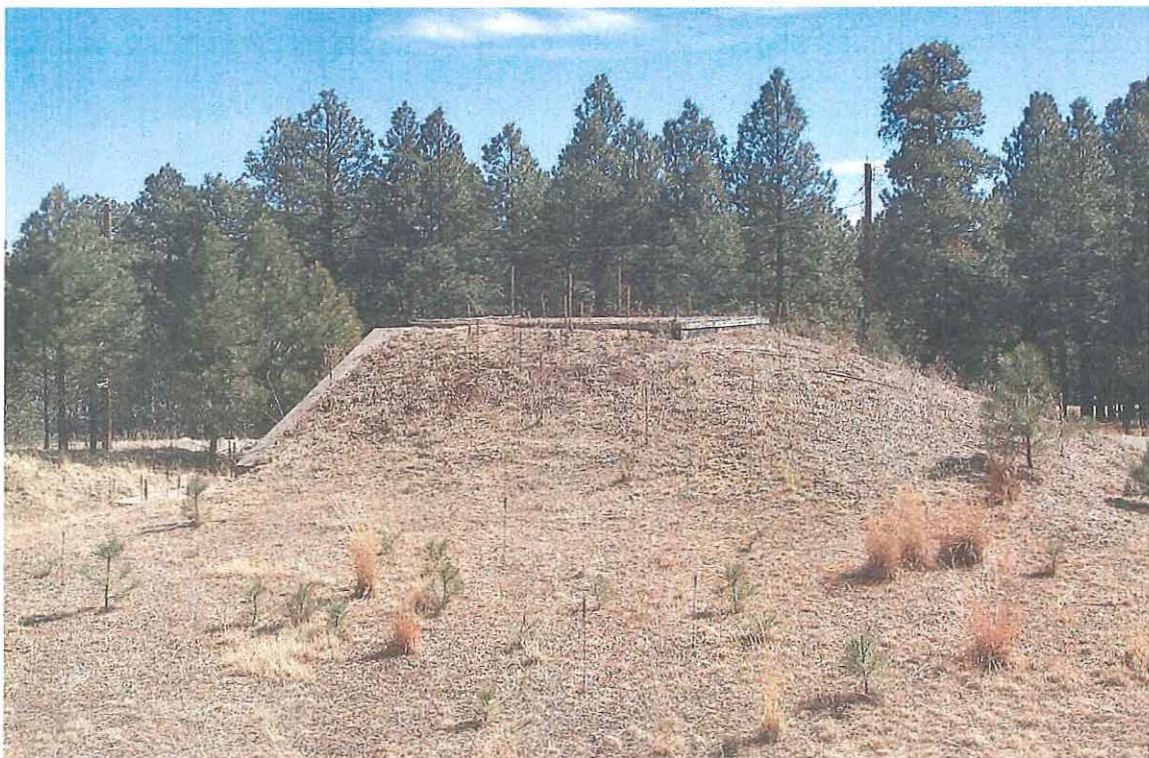

TA-8-31 West and South Sides

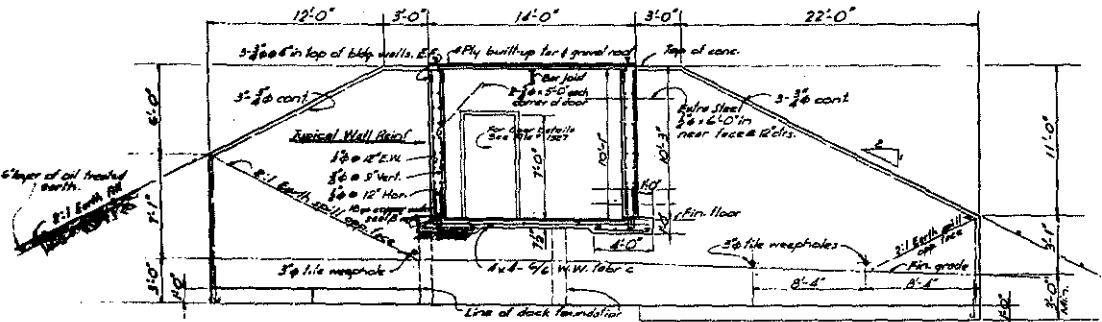
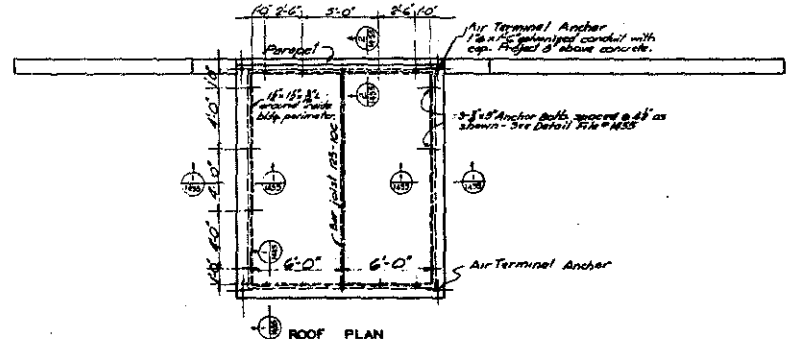
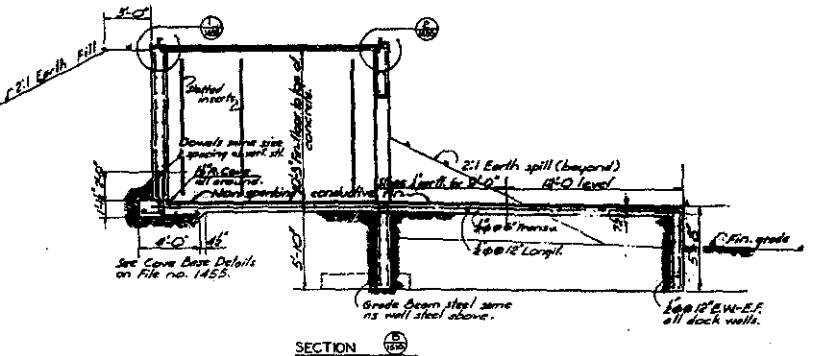
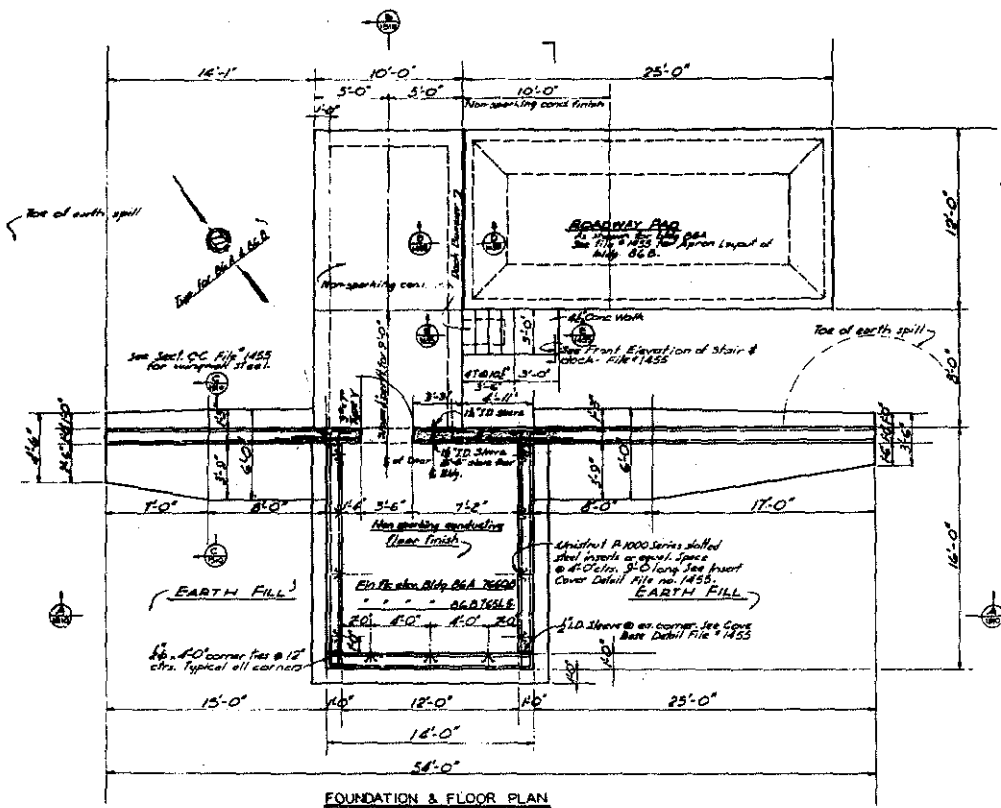

REFERENCE DRWG'S

Plot Plan	File no. 1448
General Layout	1419
Typical Details	1420
Floor Assembly	1422
Lightning Protection & Grounding Details	1522
Electrical Layout	1524
Steel Drawings	2102-2108

- NOTES**
1. All concrete shall be Type A-1, shall develop a strength of 3000 psi @ 28 days.
 2. All #6 cement diagonals with each set of cement steel.
 3. Reinforcement shall be of intermediate grade deformed bars.
 4. All wall rebar @ 8'-0" intervals in each direction for burial.
 5. Band all other metal to rebar steel by direct weld or suitable metal straps.
 6. Connected rebar to grounding system with #10 bare stranded copper cable.
 7. Where shown on plans, steel shall be given a red colored non-sparking conductive finish. Slabs shall be placed in two courses. Top course 18" thick including conductive finish.
 8. Interior wall forms shall be of plywood and walls shall be finished smooth;
 9. Exterior walls may be left rough.
 10. Exterior walls, ceiling & all exposed metal shall be given 3 coats lead & oil paint.
 11. Exterior building walls against fill, except intewalls, shall be waterproofed with 3 coats felt & coal tar pitch.
 12. All foundations shall be carried to solid bearing with a minimum of 4' below top.
 13. Foundation walls, 6" below top, grade may be poured without forming provided anchors are cut to sizes shown.
 14. Fills shall be carried up each side of manholes simultaneously.
 15. A 6" concrete surface of oil treated earth shall be applied over earth fill above original ground.
 16. Payment for extra foundation excavation as provided in special conditions shall be limited to 3'-0" outside zone, walls or cols. or near face of footing whichever is greater.

AS CONSTRUCTED DRAWING

CONSTRUCTION CONTRACT NO. 116-1-100
 SUBMITTED BY: [Signature]
 RECOMMENDED BY: [Signature]
 APPROVED BY: [Signature]

SCALE: 1"=10'

See also, File no. 1455

STRUCTURAL LAYOUT BLDGS NO. (86A) & (86B)	1510
PLANS & SECTIONS	
PROJECT B	
TA-8	
BLACK & VEATCH	CONSULTING ENGINEERS
NEW MEXICO	SEP 8 1949
21	113

VERIFIED AND ACCEPTED

[Signature]

TA-8-31
 Plans and Sections (elevation)
 As Constructed Drawing
 September 8, 1949

NO. 12479 SEP-FG-31

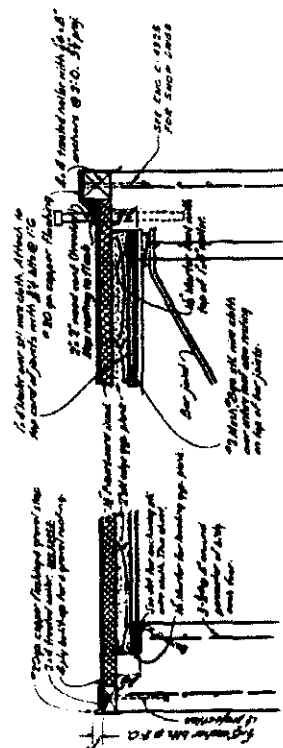
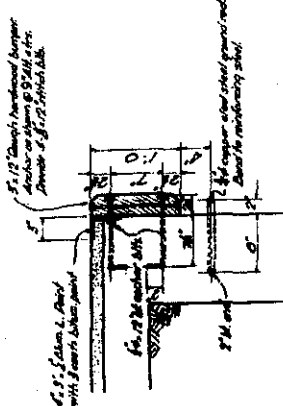
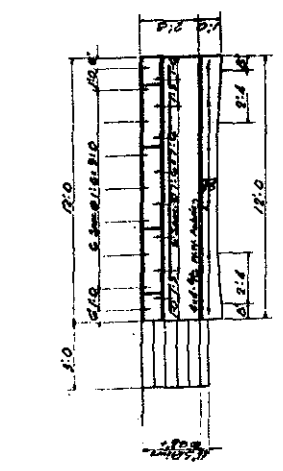

FRONT ELEVATION OF STAIR AND DOCK
Scale 1/4"

SECTION 3
Scale 1/4"

DETAIL 1
Scale 1/4"

SEE ENO C-4325/4327 FOR SHOP DWGS.

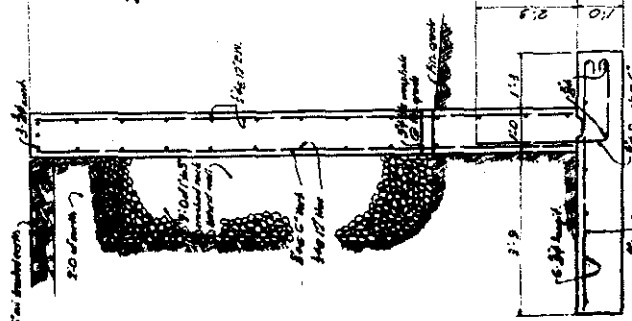
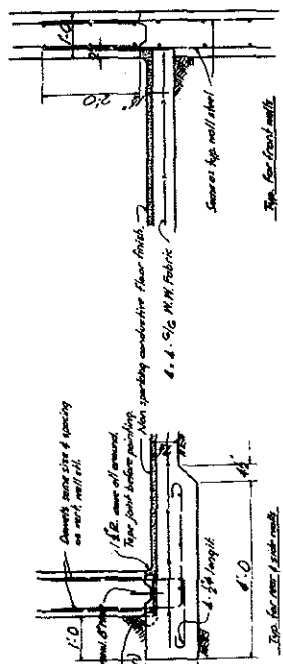

COVE BASE DETAILS
Scale 3/16"

SECTION 4
Scale 3/16"

DETAIL OF ANCHORING
STEEL WIRE CLOTH
Scale 3/16"

INSERT COVER DETAIL
Scale 3/16"

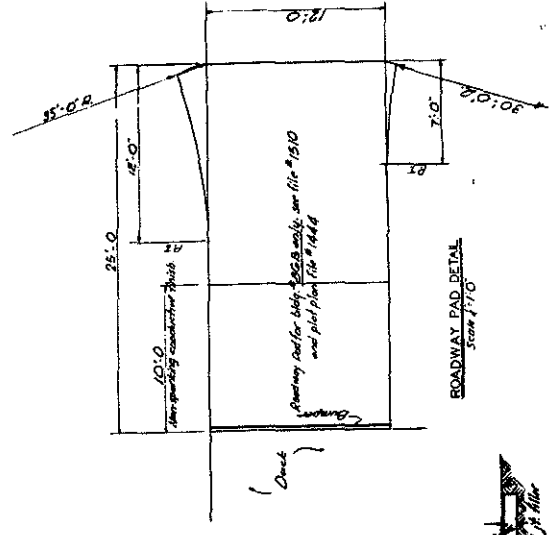

AS CONSTRUCTED DRAWING
CONSTRUCTED BY
SUBMITTED BY
APPROVED BY
DATE

PROJECT	TA-8-31
DATE	SEP 8 1949
ENGINEER	BLACK & VEATCH
CONSULTING ENGINEERS	
NO. OF SHEETS	1455
TOTAL SHEETS	
DATE	
BY	
CHECKED	
APPROVED	

TA-8-31
Typical Details
As Constructed Drawing
September 8, 1949

VERIFIED UNCLASSIFIED

Luzan Roth

BILL OF MATERIAL		
ITEM NO.	QTY.	DESCRIPTION
1	1	DOOR ASSEMBLY - SEE DWG. 1515
2	1	FRAME ASSEMBLY - SEE DWG. 1515
3	3	FILLER PLATE - SEE DETAIL

COMPLETE FINISH LIST
 & DRAWINGS -
 DWG. NO. 1515, 1516, 1517, 1518, 1519, 1520

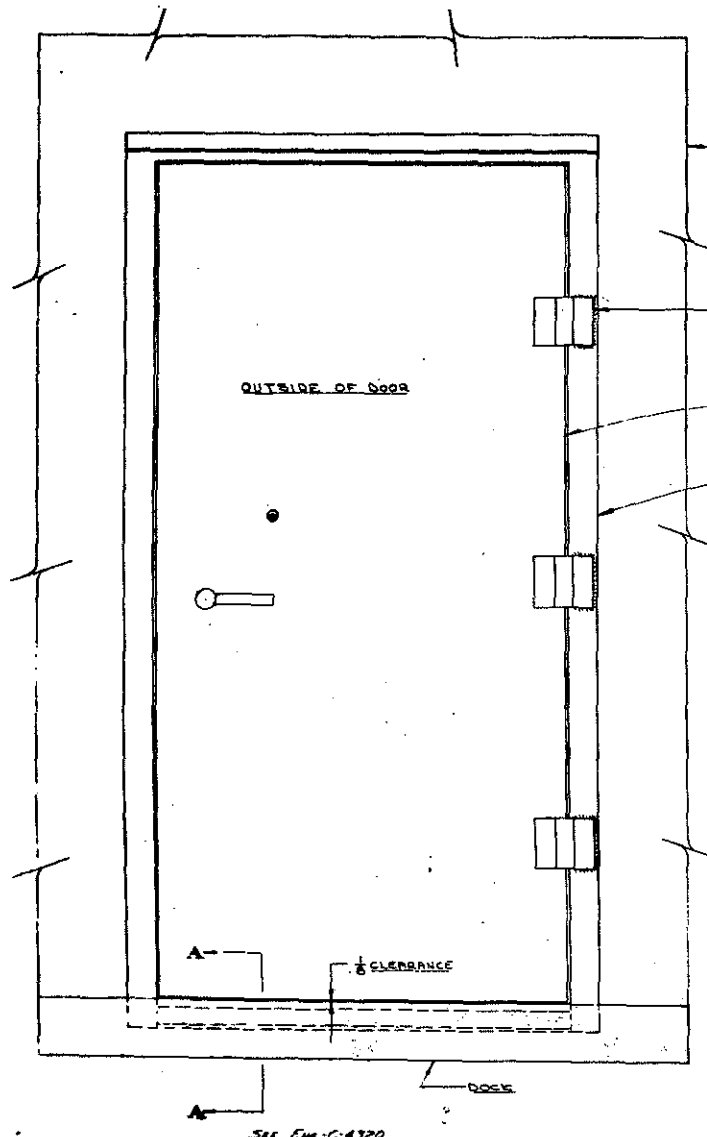

LOCATE DOOR IN FRAME WITH 1/8" BOTTOM CLEARANCE & EQUAL SIDE CLEARANCE. WELD WINGS LEAD TO FRAME AS SHOWN - 3 PLACES.

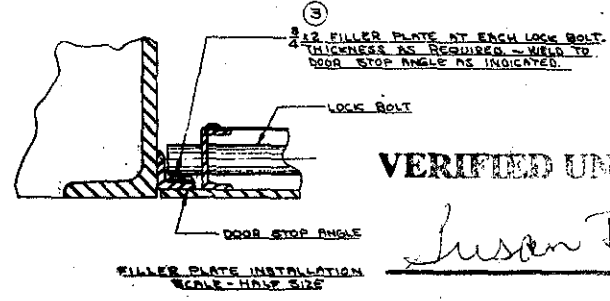

VERIFIED UNCLASSIFIED
Lusan Roth

REFERENCE DRAWING
 STRUCTURAL LAYOUT 3105, 3106, 3107, 3108, 3109

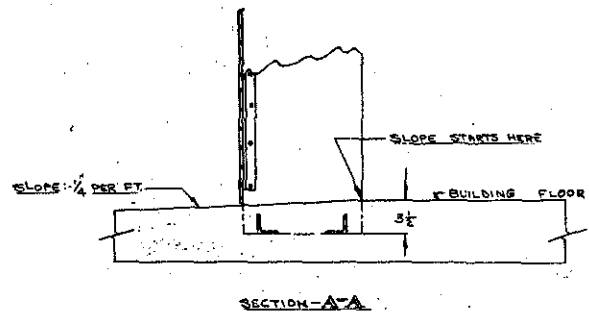

SEE ENG. C-4320

TA-8-31
 Door Installation Assembly
 As Constructed Drawing
 September 20, 1949

FOR OFFICE USE ONLY	
SCALE - 1/4\"/>	DOOR INSTALLATION ASSEMBLY
DATE	STEEL DOOR
PROJECT NO.	PROJECT B
DESIGNED BY	BLACK & VEATCH CONSULTING ENGINEERS
CHECKED BY	
APPROVED BY	

SEE DWG. NO. ENG. C-42567

NO.	DESCRIPTION
1	PLATE AS SHOWN ASTM A106
2	CHANNEL 2 1/2" X 3/8" ASTM A106
3	CHANNEL 2 1/2" X 3/8" ASTM A106
4	CHANNEL 2 1/2" X 3/8" ASTM A106
5	CHANNEL 2 1/2" X 3/8" ASTM A106
6	SCREW 2 DIA X 1/2" SAE 1020
7	SCREW 2 DIA X 1/2" SAE 1020
8	SCREW 2 DIA X 1/2" SAE 1020
9	1/2" ONE LOCK WASHER SEE DWG. 1522
10	1/2" ONE LOCK WASHER SEE DWG. 1522
11	HINGE STAYLEY NUMBER OR EQUAL
12	OUTSIDE HANDLE SEE DWG. 1522
13	SPARE PART SEE DWG. 1522
14	1/2" ONE LOCK WASHER
15	1/2" ONE LOCK WASHER
16	1/2" ONE LOCK WASHER
17	INSIDE HANDLE SEE DWG. 1522
18	BAR SEE DWG. 1510
19	1/2" HEX NUT AN. STD.

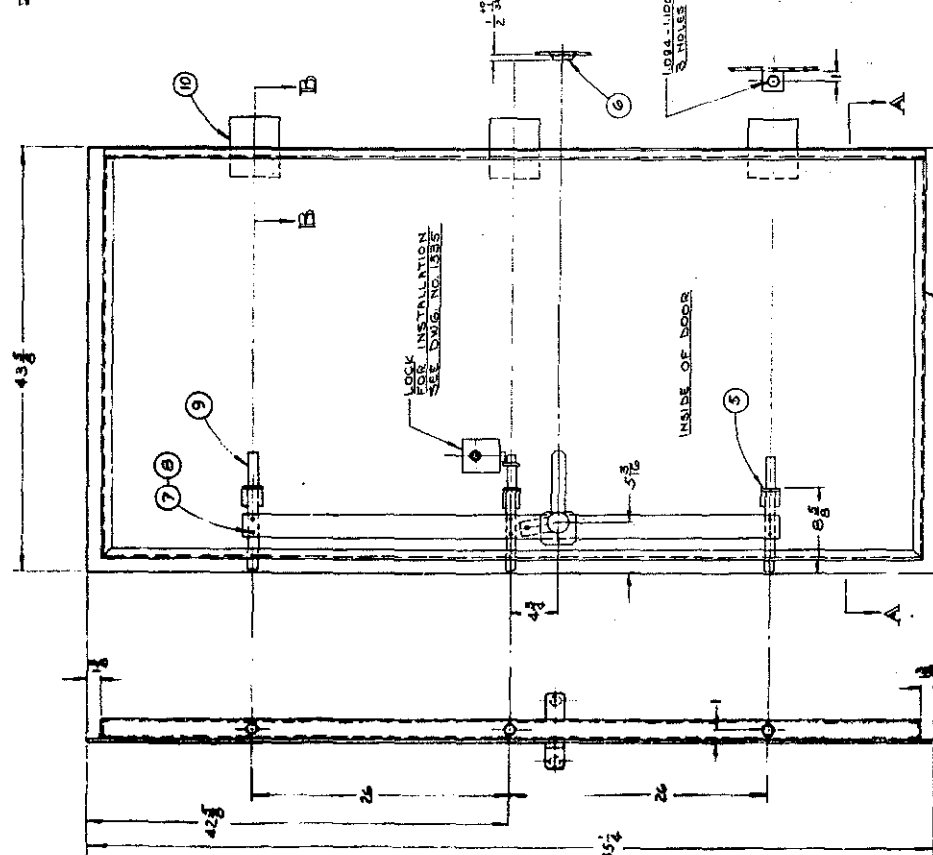
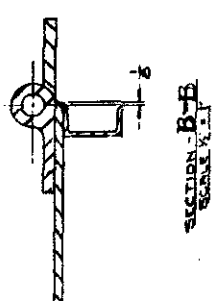
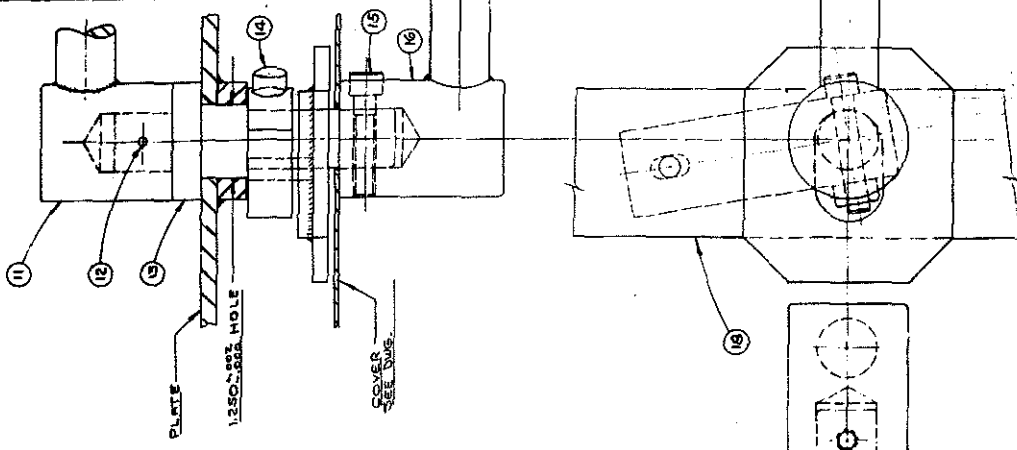

HANDLE ASSEMBLY
FULL SCALE

AS CONSTRUCTED DRAWING
 CONSTRUCTION BY: [Signature]
 SUBMITTED BY: [Signature]
 RECOMMENDED BY: [Signature]
 APPROVED BY: [Signature]

NEXT ASSEMBLY NO. 1527
 See DRAWING 206 C-4220

NO.	DESCRIPTION
1	PLATE AS SHOWN ASTM A106
2	CHANNEL 2 1/2" X 3/8" ASTM A106
3	CHANNEL 2 1/2" X 3/8" ASTM A106
4	CHANNEL 2 1/2" X 3/8" ASTM A106
5	CHANNEL 2 1/2" X 3/8" ASTM A106
6	SCREW 2 DIA X 1/2" SAE 1020
7	SCREW 2 DIA X 1/2" SAE 1020
8	SCREW 2 DIA X 1/2" SAE 1020
9	1/2" ONE LOCK WASHER SEE DWG. 1522
10	1/2" ONE LOCK WASHER SEE DWG. 1522
11	HINGE STAYLEY NUMBER OR EQUAL
12	OUTSIDE HANDLE SEE DWG. 1522
13	SPARE PART SEE DWG. 1522
14	1/2" ONE LOCK WASHER
15	1/2" ONE LOCK WASHER
16	1/2" ONE LOCK WASHER
17	INSIDE HANDLE SEE DWG. 1522
18	BAR SEE DWG. 1510
19	1/2" HEX NUT AN. STD.

TA-8-31
 Door Assembly
 As Constructed Drawing
 September 20, 1949

VERIFIED UNCLASSIFIED

[Signature]

TOLERANCE UNLESS OTHERWISE SPECIFIED SHALL BE AS SHOWN ON DRAWING

ITEM NO.	DESCRIPTION
1	DOOR ASSEMBLY SEE ONE
2	CAP SCREW SELF TAPPING 1/4" X 1/2"
3	COVER 1/8" X 1/2" X 1/2" WITH NO. 34 SCREW
4	INSULATION FIBRE BOARD 3/4" THICK

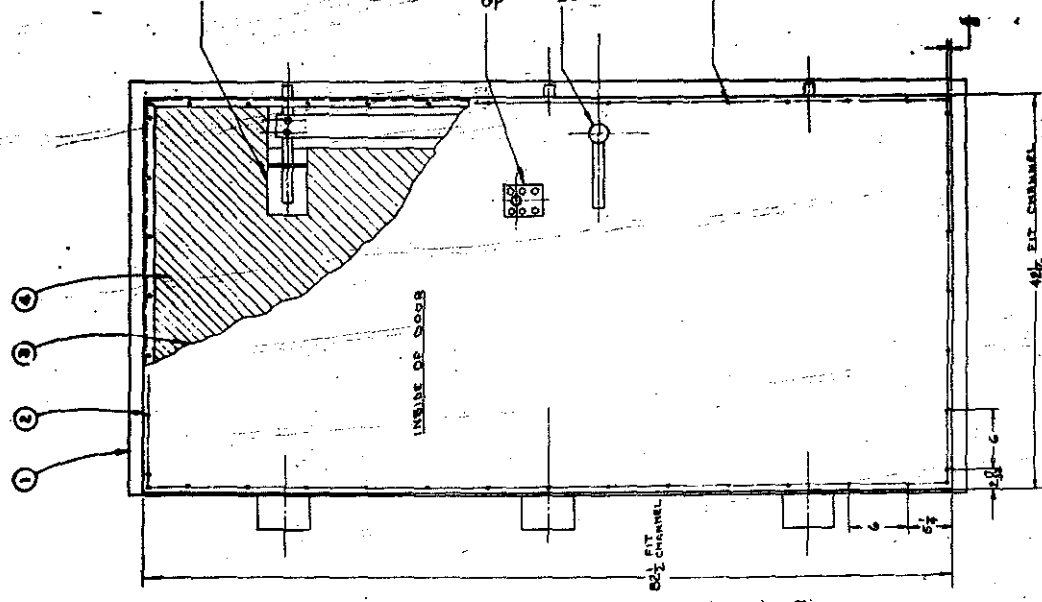

SEE INTERNAL INSULATION TO ASSURE
 PROPER SEALING OF DOOR ASSEMBLY
 TO PREVENT INHALE OF GASES FROM
 USING FIRE BOARD HEAVY BONY COVER

CUT SUITABLE OPENING IN COVER
 TO CLEAR LOCK MECHANISM

1/4" DIA. HOLE IN COVER TO
 CLEAR DOOR HANDLE SHAFT

DRILL 234-237 DIA. THRU COVER & CHANNEL
 ALL HOLES - DRILL 1/4" - 260 IN THRU
 COVER CHANNEL & HEAVY INSULATION COVER
 WITH SCREWS, DETAIL 2

NOTE
 LINES OF COVER TO BE FLUSH
 WITH CHANNEL ON DOOR ASSEMBLY

VERIFIED UNCLASSIFIED

Lusan R. Roth

NET ASSEMBLY NOS. 1227

AS CONSTRUCTED DRAWING
 CONTRACT NO. 100-100-100
 SUBMITTED BY *[Signature]*
 APPROVED: *[Signature]*

TA-8-31
 Door, Cover & Insulation Assembly
 As Constructed Drawing
 September 20, 1949

BILL OF MATERIAL

QTY	NO	NO REQ	DESCRIPTION
1	1		BLOCK - SEE DETAIL
2	1		COVER PLATE - SEE DETAIL
3	1		GUARD PLATE 1/2" X 3/4" SAE 1015
4	1		BLOCK - SEE DETAIL
5	6		3/8" - 18 X 1/4" RH STD. HEX CAP SC
6	6		3/8" SAE LOCK WASHER
7	1		LOCK - VALE & TONNE RIN DEAD LOCK

LOCATE LOCK & BLOCK TO GIVE THE CLEARANCES INDICATED. WELD BLOCK IN PLACE ON DOOR PLATE.

DRILL HOLE FOR LOCK GUNNER AFTER WELDING BLOCK IN PLACE. LOCATE TO FIT LOCK HARD.

WELD IN PLACE AS SHOWN

257-7 60 DIA. DRILL 7/8 DEEP - 3/4" ID TAP 1/4 DEEP - 4 HOLES - MUST MATCH HOLES IN COVER PLATE

4 MAKE BLOCK TO FIT BOLT & WELD IN PLACE. WELD TO CENTER BOLT ONLY. SAE 1015

MAKE NEW SCREW APP. AS SHOWN OR REMOVE SCREW SUPPLIED SO THAT LOCK IS OPERABLE WITH COVER PLATE IN PLACE AS SHOWN.

MOUNT LOCK IN BLOCK BY SCREWS INTO TAPPED HOLES. LOCATION AND SIZE OF SCREWS TO BE DETERMINED FROM LOCK HARD.

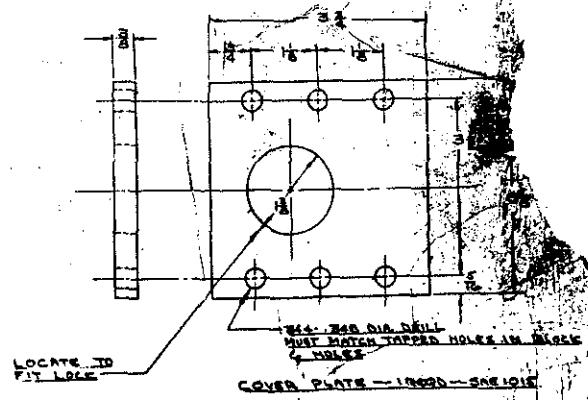
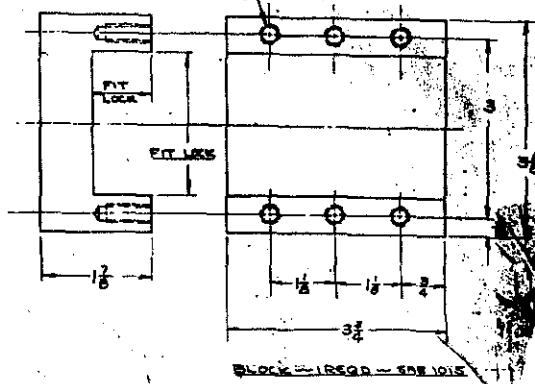

NEXT ASSEMBLY DWG. 1087

AS CONSTRUCTED DRAWING
 QUANTITY: 1
 CHECKED: [Signature]
 APPROVED: [Signature]

VERIFIED UNCLASSIFIED

Lusc...

TA-8-31
 Lock Details
 As Constructed Drawing
 September 20, 1949

SCALE: FULL
 LOCK DETAILS
 STEEL DOOR
 FOR OFFICIAL USE

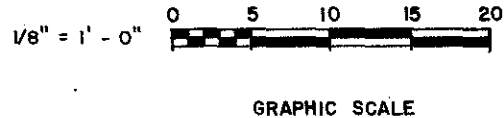
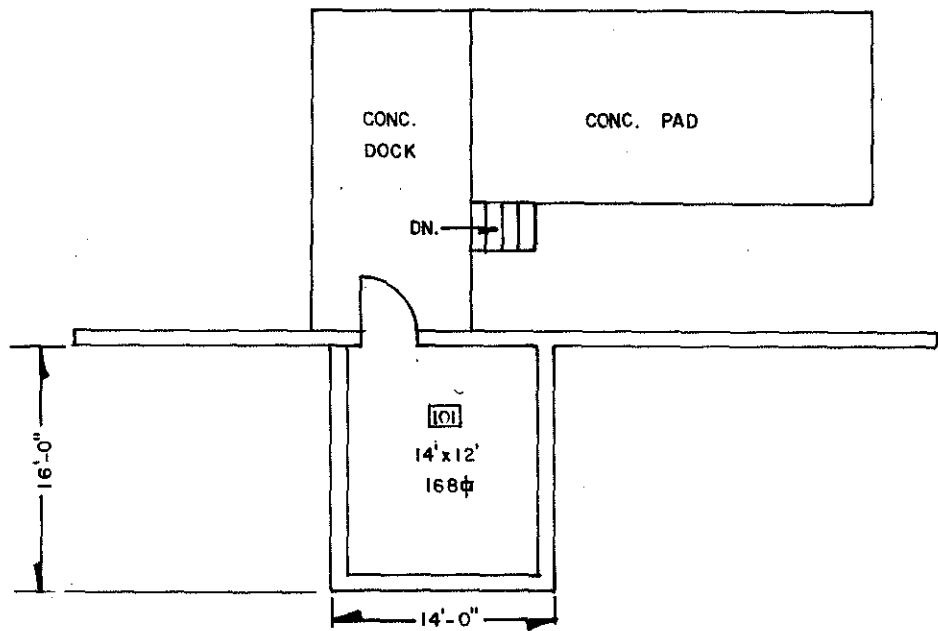

TA-8-31
Magazine AW-31, TA-8
Floor Plan
October 14, 1983

TOTAL SQ. FT. 168

REV.	DATE	REVISION	BY	CHKD.	APP.
1	8-31-83	REVISED TO STATUS OF AUGUST 31, 1983	H&N		
UNIVERSITY OF CALIFORNIA Los Alamos Los Alamos National Laboratory Los Alamos, New Mexico 87545					
FACILITIES ENGINEERING DIVISION					
MAGAZINE FLOOR PLAN					SEC. CLASSIFICATION
BLDG. AW-31					CLASS. 4
TA-8					REVIEWER <i>Humble</i>
					DATE 10.14.83
SUBMITTED <i>E. Toyella</i>		RECOMMENDED <i>Darin Ray</i>		APPROVED <i>W.T. Edwards</i>	
DRAWN H&N	DATE 8-31-83	SHEET NO. 1 OF 1	DRAWING NO. ENG-R2629		
CHECKED <i>Humble</i>	H&N				

VERIFIED UNCLASSIFIED

Susan Roth

REC'D LOGGED TO VAULT 11/22/83

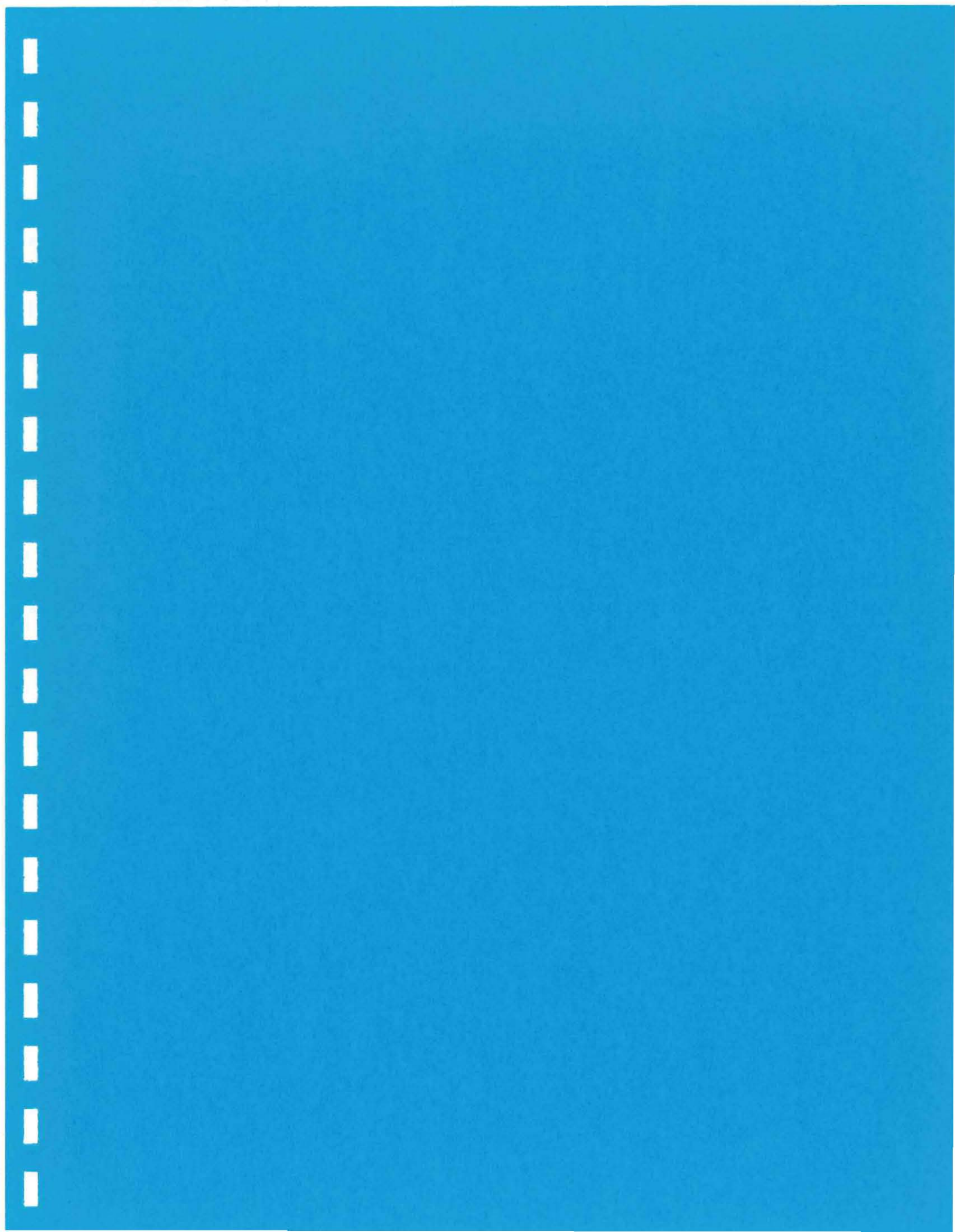

NEW MEXICO HISTORIC BUILDING INVENTORY FORM

LA#

building threatened? yes	surveyed date 2/9/99 by K. L. M. Garcia	County Los Alamos	ID no. TA-35-1
field map LANL Orthotopo	number Sheet 1	UTM reference: easting 383436 northing 3969348 zone 13	
location description Technical Area (TA) 35, Ten Site		city/town Los Alamos	land grant/reservation n/a
building name TA-35-1 Original name TSL-1 (Ten Site Laboratory-1)		legal description USGS Frijoles 7.5 Series t ^{ns} p 19N range 6E sec 22 NW¼ NW¼ SE¼	
film roll: 1048 by nos. ESH-20 Photos on file at ESH-20	Negative nos. 0A, 1A, & 2A Also digital photos on file with ESH-20 by building number	location of neg. LANL, ESH-20	date of construction _____ estimate 1949-1951 actual source Facilities Division Engineering 9 (F-9) records (LANL)
Style Reinforced concrete with steel door and low pitched roof	Foundation material concrete slab wall material/surface Reinforced concrete.	Use Present residential <input checked="" type="checkbox"/> other Abandoned historic residential <input checked="" type="checkbox"/> other Guard House	Condition ____ excellent <input checked="" type="checkbox"/> fair to <input checked="" type="checkbox"/> good ____ Deteriorating
degree of remodeling <input checked="" type="checkbox"/> minor ____ moderate ____ major describe: An additional exterior door was added to the west side of the building sometime between 1959 and 1983.	Surroundings Developed Laboratory Technical Area 35	Relationship to surroundings ____ similar <input checked="" type="checkbox"/> not similar	district potential ____ yes <input checked="" type="checkbox"/> no
Significance ____ Eligible <input checked="" type="checkbox"/> of interest ____ none If not eligible, Why? Building TA-35-1, was a former Guard house (station #410). This support building was the guard station for building TA-35-2, the original laboratory and office building at TA-35, also built in 1951. "The initial operations at TA-35 involved the preparation of kilocurie sources of radioactive lanthanum ¹⁴⁰La. This was preformed in a hot cell located in the basement at the east end of TA-35-2" (Los Alamos National Laboratory 1992:3-35 & 3-36). Experimentation with plutonium and tritium was conducted in the 1950s and 1960s. Additionally, three experimental nuclear fission reactors were developed and operated for short periods between 1956 and 1964. By the 1970s most of the work at this TA is on research and development of laser operations (Los Alamos National Laboratory 1992:3-36).	associated buildings? <input checked="" type="checkbox"/> yes what type? The original TA-35 laboratory and office building if inventoried, list ID nos. TA-35-2	Photos and plan drawings are on following pages ENG-R 1927 Fire Alarm Equipment Floor Plan March 5, 1959 ENG-R 3044 Floor Plan August 15, 1983 Below is the drawing for an almost identical building (TA-16-101) which shows elevations: ENG-C 21862 Relocate Guard House Station 635 Location, Plot and Foundation Plans September 22, 1961 size: 133 ft ²	

Architectural features:

Only floor plans exist for this guard house. However, this building is almost identical in size and design to at least one other guard station (TA-16-101) at the Laboratory with the exception of minor differences. Construction material varies between reinforced concrete and wood and the window treatment varies between size and number of glass panes.

Building TA-16-101 has been previously documented (McGehee 1995) and concurrence received from the State Historic Preservation Office on eligibility status (March 24, 1995) and a mitigation plan (May 30, 1995). Per the mitigation plan measured drawings have been completed and archival 4x5 black and white photographs have been produced.

Building TA-35-1 is slightly smaller (12'x15') where as TA-16-101 is (12'2" x 15'2"). Construction material varies between wood frame covered with concrete-filled sand bags for TA-16-101 and reinforced concrete for TA-35-1.

Building TA-35-1 is a rectangular building with a low pitched roof. The building has two rooms, a main room and a restroom. The front, south side, of the building has a metal pedestrian door with window, and one window with two glass panes that slide open. The east side has two windows each with two glass panes that slide open. The north side has two windows, one larger than the other, also each with two glass panes that slide open. The smaller window is in the restroom. The west side has one window with a single glass pane and a pedestrian door that was added sometime between 1959 and 1983.

The windows on the east and north sides are located at the northeast corner of the building and the windows on the south and west sides are located at the southwest corner of the building.

The roof is low pitched and slopes slightly from the south to north. It has an approximate 5' overhang/canopy in the front (south side) and the other three sides have an approximate 2' overhang/canopy.

The roof is similar to that of guard house building TA-3-42. It is appears to be constructed in several layers with a tar and gravel exterior surface. There is galvanized metal flashing around all the edges.

Interior wall surfaces were most likely painted with oil base lead paint as were other structures constructed in the late 1940s early 1950s.

Comments: There is no indication that this building was ever contaminated (Los Alamos National Laboratory 1990 and 1992).

Los Alamos National Laboratory

1990 *Solid Waste Management Units Report, Los Alamos National Laboratory Environmental Restoration, LA-UR-90-3400, Los Alamos National Laboratory, Los Alamos, New Mexico.*

1992 *RFI Work Plan for Operable Unit 1129: Environmental Restoration Program LA-UR-92-800, Los Alamos National Laboratory, Los Alamos, New Mexico.*

McGehee, Ellen D.

1995 *Decontamination and Decommissioning of 28 "S Site" Properties: Technical Area 16, Historic Building Survey Report No. 84, Volumes 1-3, LA-UR-95-617, Los Alamos National Laboratory, Los Alamos, New Mexico.*



TA-35-1 South Side

REC'D ALLOCATED TO FACILITY

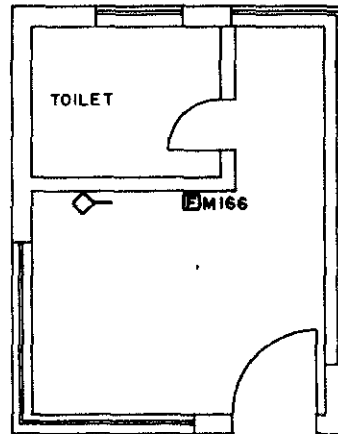

LEGEND

A. D. T. SYSTEM

- EM MANUAL TRANSMITTER
- ETEL TELETERM TRANSMITTER
- ES SUPERVISORY TRANSMITTER
- RET RETARD TRANSMITTER
- WF WATER FLOW TRANSMITTER
- AT AERO TRANSMITTER
- DR DETECTOR RELAY
- PU POWER UNIT
- ANN ANNUNCIATOR
- REC RECORDER
- EH EVACUATION HORN OR BELL
- BC BATTERY CHARGER
- FD FIRE DETECTOR
- S SWITCH

TA-35-1
 Fire Alarm Equipment
 Floor Plan
 March 5, 1959

LOS ALAMOS SCIENTIFIC LABORATORY
 ENGINEERING DEPARTMENT
 UNIVERSITY OF CALIFORNIA — LOS ALAMOS, NEW MEXICO

FIRE ALARM EQUIPMENT
 FLOOR PLAN
 BLDG. TSL-1 TA-35

APPROVALS:	DESIGN:	DATE	SCALE
ENG. GROUP: <u>3</u> <i>SER</i>	DESIGNER: <u>S.G.B.</u>	<u>3-5-59</u>	<u>1/4" = 1'-0"</u>
DIVISION:	PROJ. ENG. <i>[Signature]</i>	SHEET	SKETCH NO.
ENG. DEPT. OFFICE: <i>[Signature]</i>		<u>1 OF 1</u>	<u>ENG-R 1927</u>

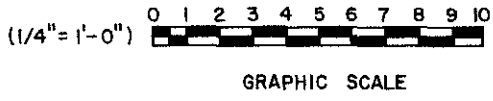
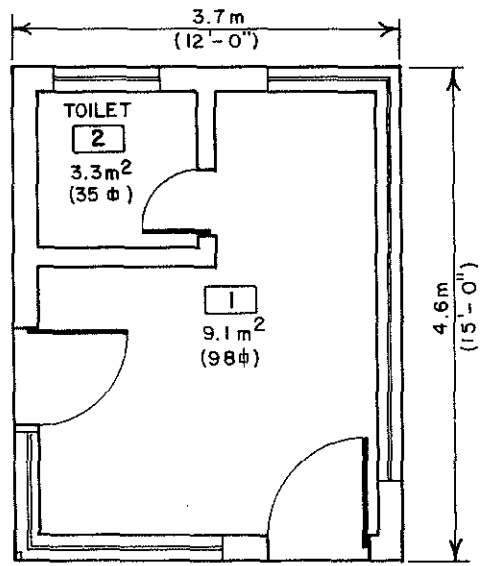

TA-35-1
Floor Plan
August 15, 1983

TOTAL $\frac{\text{ft}^2}{133}$

REV.	DATE	REVISION	BY	CKD.	APP.
M	8-15-83	REDRAWN AND REVISED TO STATUS OF 8-15-83	H&N	6/12	
UNIVERSITY OF CALIFORNIA Los Alamos Los Alamos National Laboratory Los Alamos, New Mexico 87545					
FACILITIES ENGINEERING DIVISION					
FLOOR PLAN					SEC. CLASSIFICATION
BLDG. TSL-1					CLASS. <i>U</i>
TA-35					REVIEWER <i>Pradice</i>
SUBMITTED <i>Go. Trujillo</i>					DATE <i>10-4-83</i>
RECOMMENDED <i>Don Borg</i>					APPROVED <i>W. E. L...</i>
DRAWN	GRANDENBERGER	DATE	8-15-83	SHEET NO.	1 OF 1
CHECKED	<i>Humble H&N</i>			DRAWING NO. ENG-R3044	

REC'D..... LOGGED / TO VAULT *9/2/83*

APPENDIX C

Black-and-White Photographs of Buildings

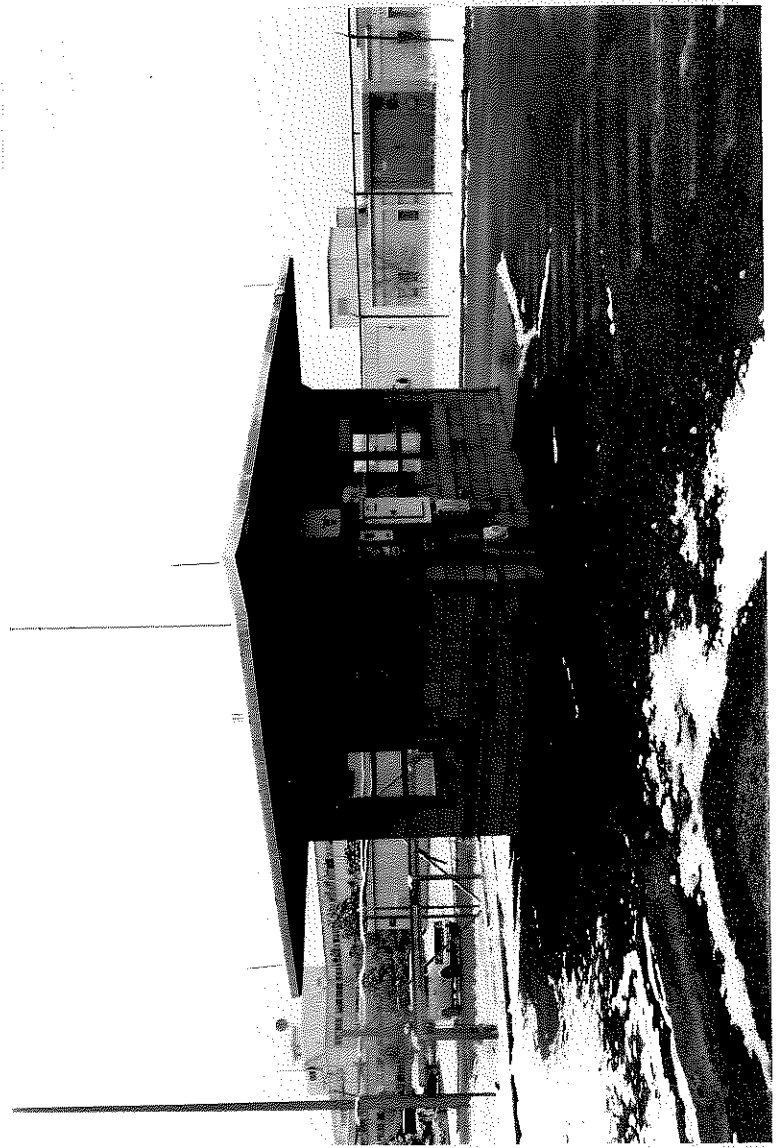

S006N0R P01R

TA-3-42
West and South Sides

S006N0R P009

TA-3-42
East and North Sides

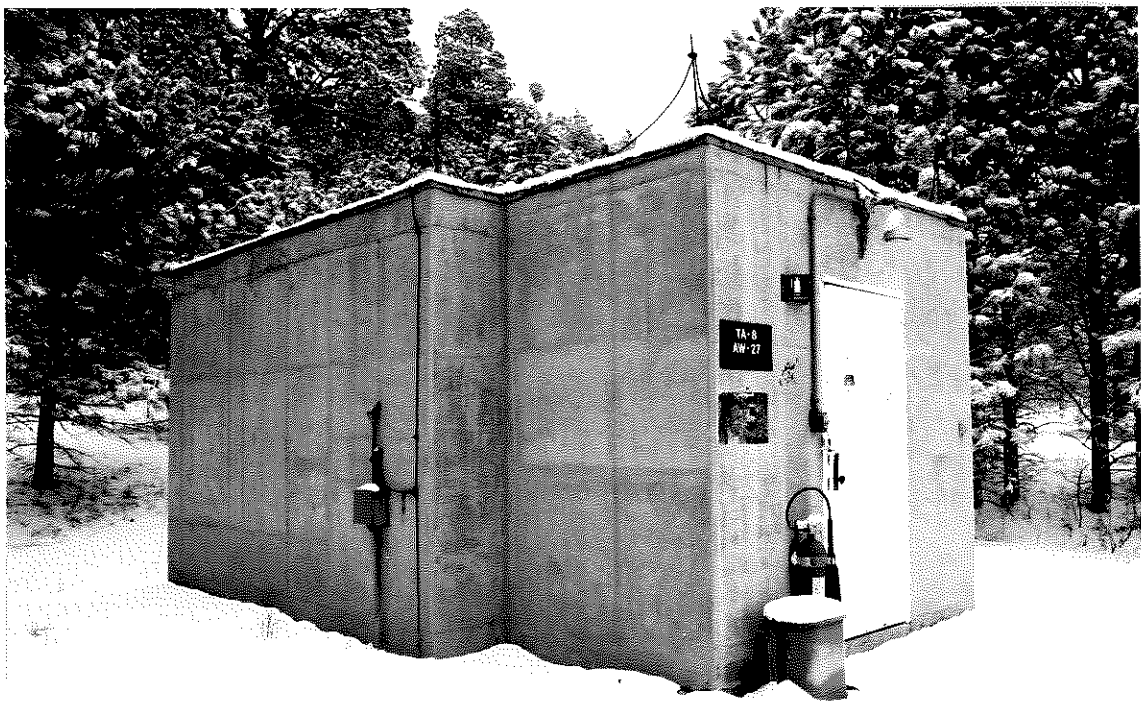
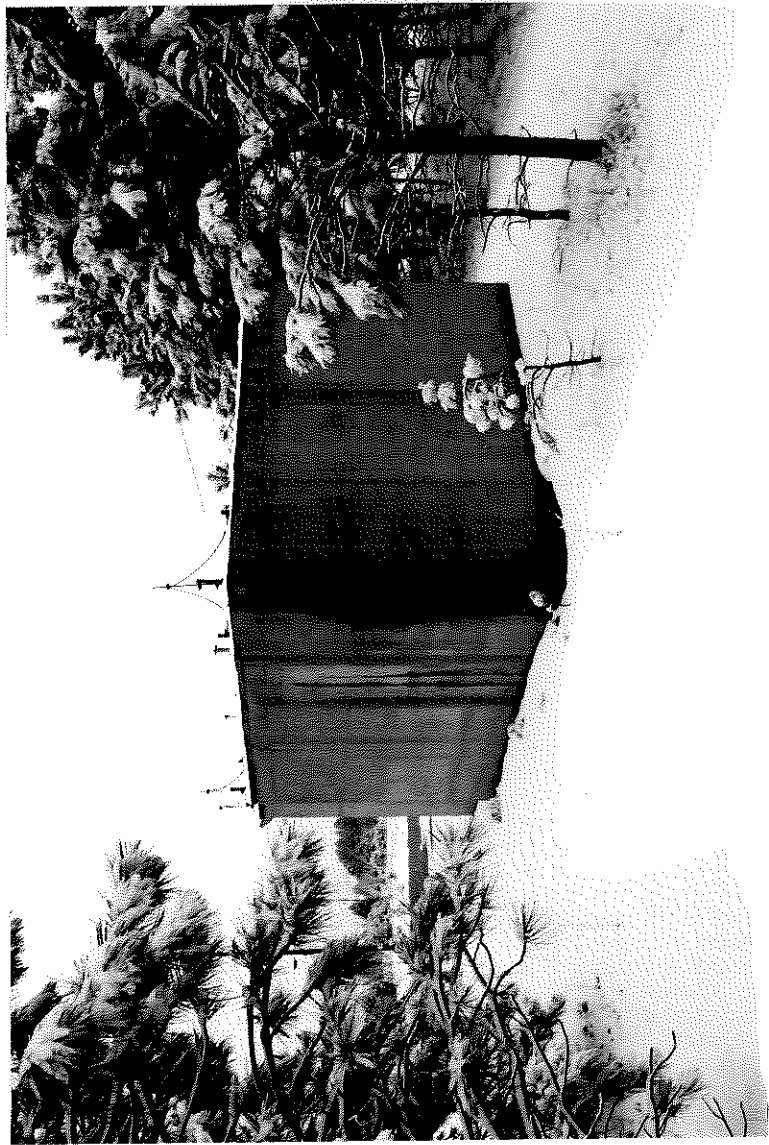

TA-8-27
South and East Sides

NO. 209313

TA-8-27
North and West Sides

SECTION 1021

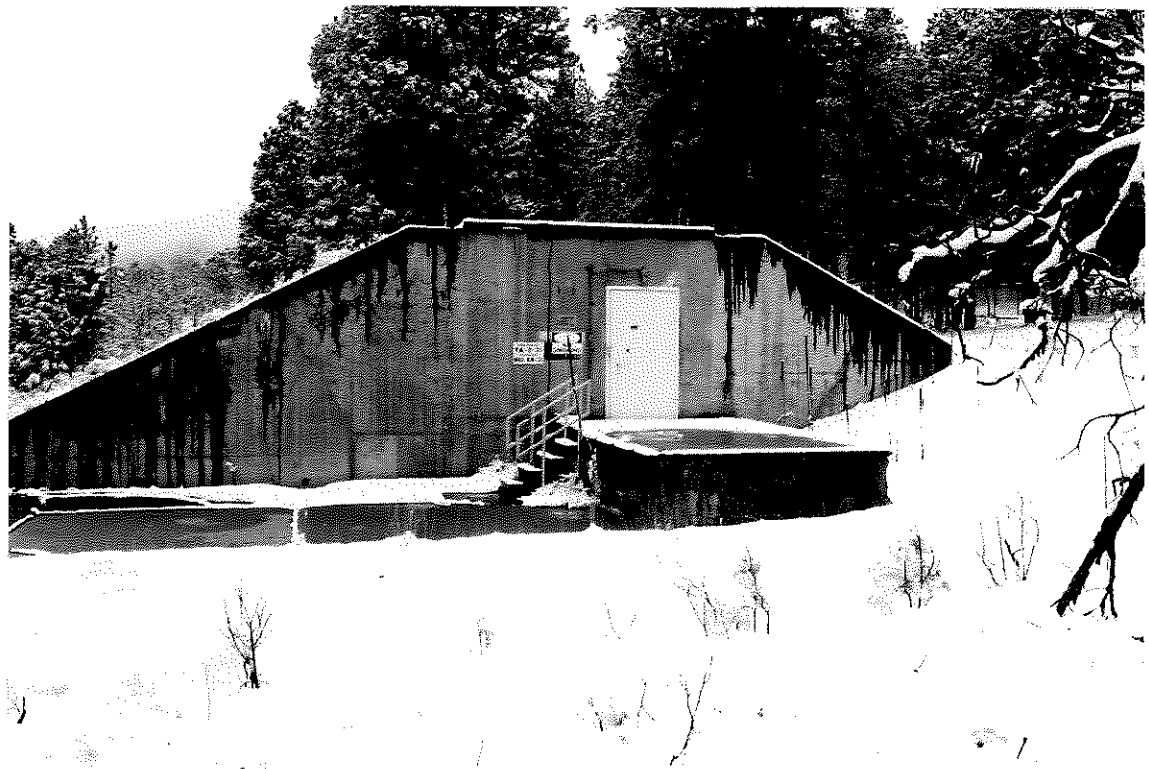

TA-8-31
North and West Sides

1001 30N9005

TA-8-31
East and North Sides

9201 30N9005

TA-8-31
North Side

3002 30N9005



TA-35-1
East and North Side

0000 0000000

TA-35-1
North Side

0000 0000000

TA-35-1
West and South Sides

0000 0000000