

LA-UR-05-3031

**Hydronuclear Experiments at TA-49:  
The Decommissioning of the Bottle House (TA-49-23)  
and the Cable Test Facility (TA-49-121)**

Historic Building Survey Report No. 243

**Los Alamos National Laboratory**

**April 22, 2005**  
Survey No. 984

Prepared for the Department of Energy,  
National Nuclear Security Administration,  
Los Alamos Site Office

prepared by

**Erik Loomis, Ellen D. McGehee, and Kari L. M. Garcia,**  
Cultural Resource Managers, LANL Ecology Group (ENV-ECO)  
**Ken Towery,** Architect, LANL Site and Project Planning Group (PM-1)  
**John Ronquillo,** Consulting Engineer, Sigma Science, Inc.

ENV-ECO Cultural Resources Team (CRT)  
Environmental Stewardship (ENV) Division



The World's Greatest Science Protecting America

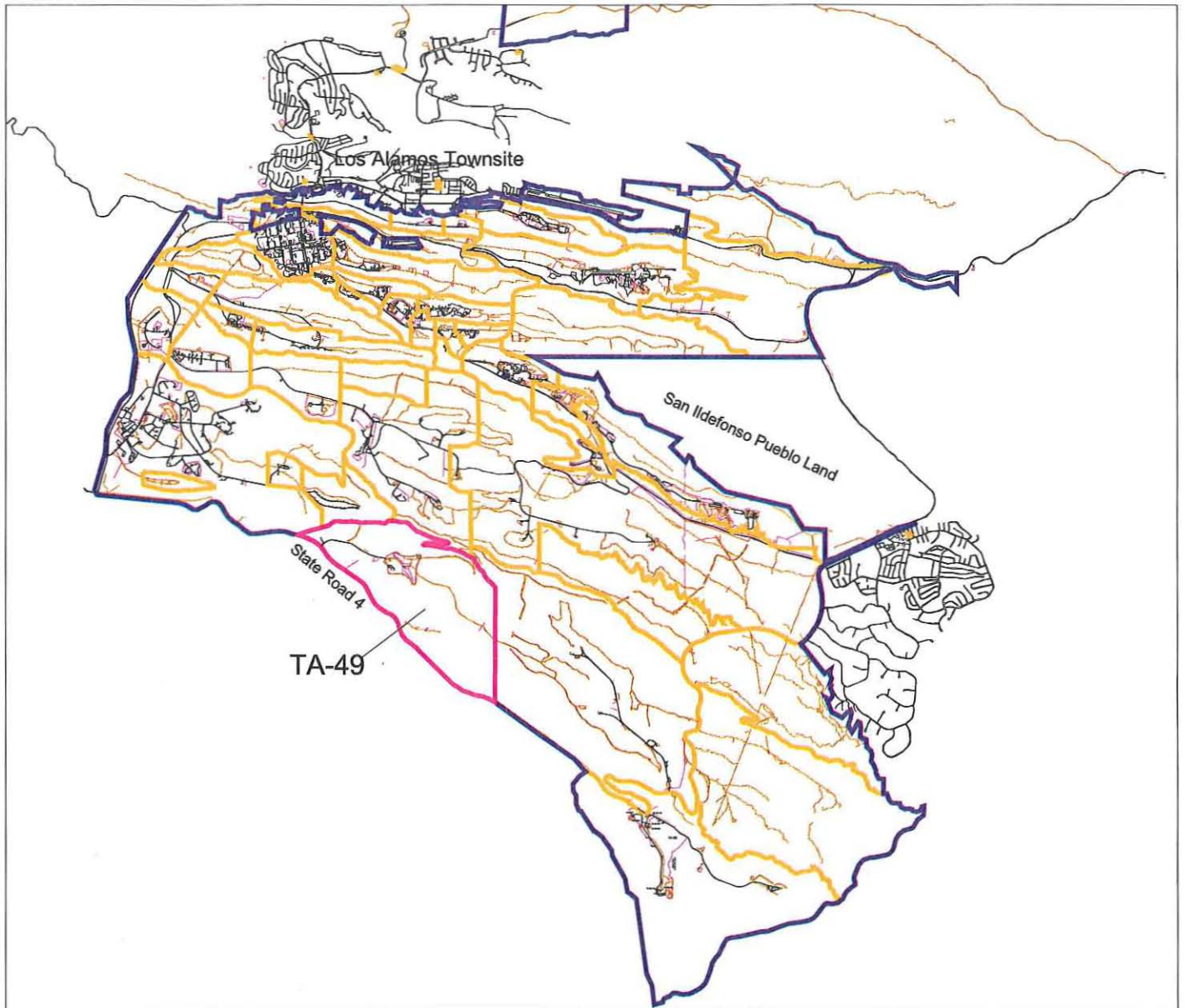
## **INTRODUCTION**

The U.S. Department of Energy, National Nuclear Security Administration, Los Alamos Site Office proposes to decommission, decontaminate, and eventually demolish two historic Los Alamos National Laboratory (LANL) properties located on Department of Energy land at Technical Area (TA) 49 (Maps 1 and 2). The Bottle House (TA-49-23) and the Cable Test Facility (TA-49-121) (Map 3) were built in the 1960s to support testing operations related to LANL's Cold War nuclear weapons program—specifically, Los Alamos's underground testing operations at the Nevada Test Site.

The following information has been prepared as part of a notification of potential adverse effect to building 23 and structure 121 at TA-49. Decontamination and decommissioning (D&D) activities will adversely affect the attributes that make these properties eligible for the National Register of Historic Places.

This report is intended to provide the background information necessary to initiate the Section 106 consultation process; additional documentation will follow when a treatment plan is developed and final mitigation is determined. This report contains a description of the proposed action, historical background information, brief property descriptions, integrity and contamination information, and a recommendation for National Register of Historic Places eligibility. Selected drawings and photographs are included in the Appendix.

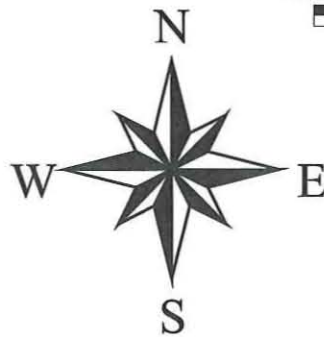
The State Historic Preservation Officer is requested to concur with the eligibility determination contained in this report and to concur that the proposed D&D action will adversely affect TA-49-23 and TA-49-121.



**Los Alamos**  
**National Laboratory**  
*Cultural Resources Team*  
*ENV-ECO Ecology Group*



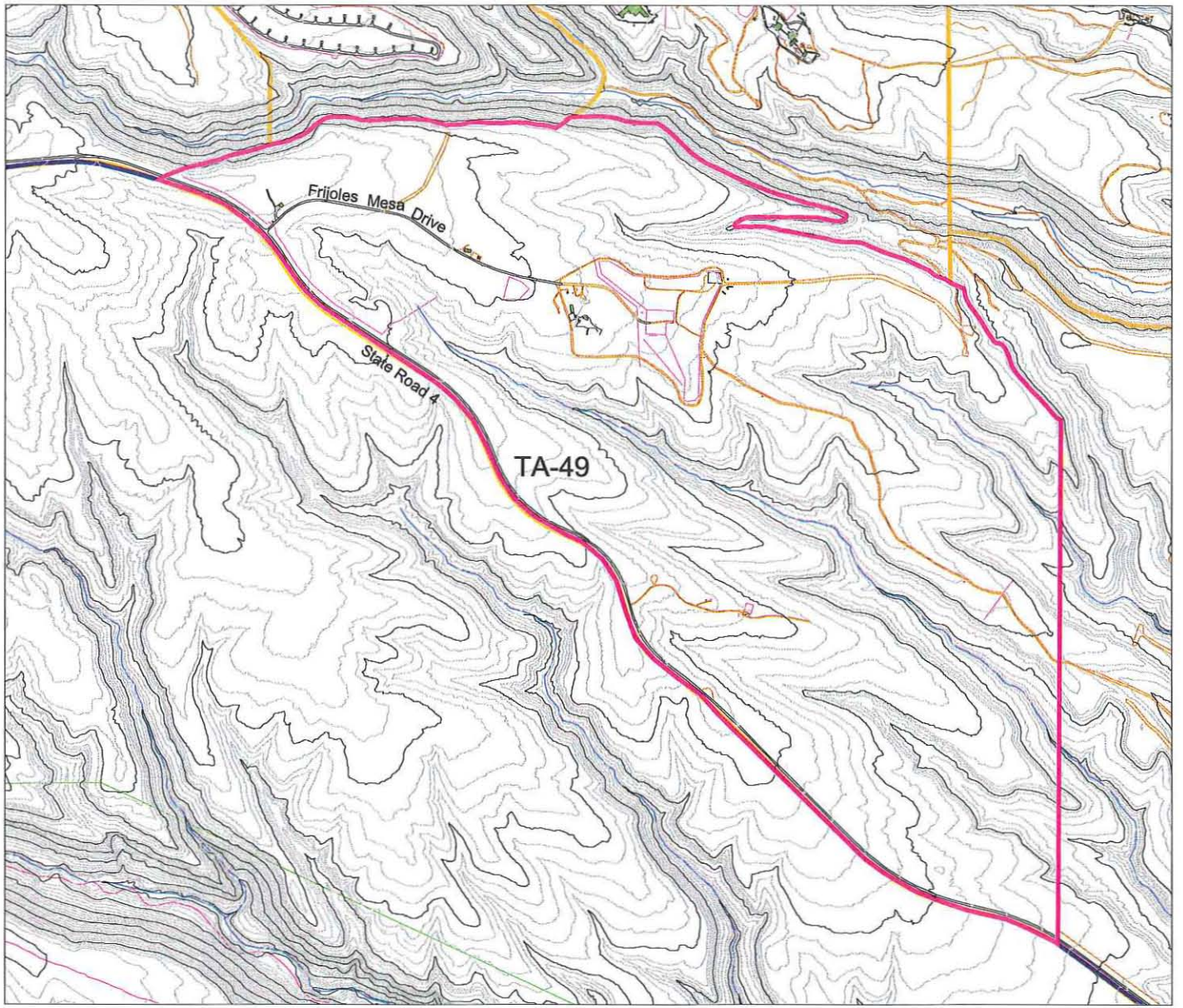
TA-49



- Tech Area 49
- LANL Boundary
- LANL Technical Areas
- Roads
- Road dirt
- Park paved
- Park dirt
- Fences

Map 1

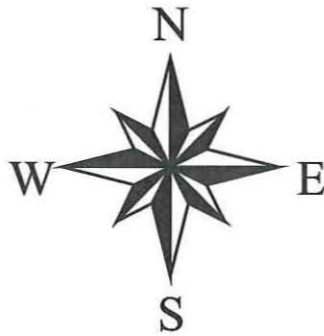
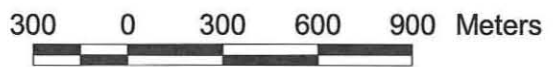
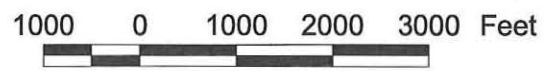




Frijoles Quad

**Los Alamos**  
**National Laboratory**  
*Cultural Resource Team*  
*ENV-ECO Ecology Group*

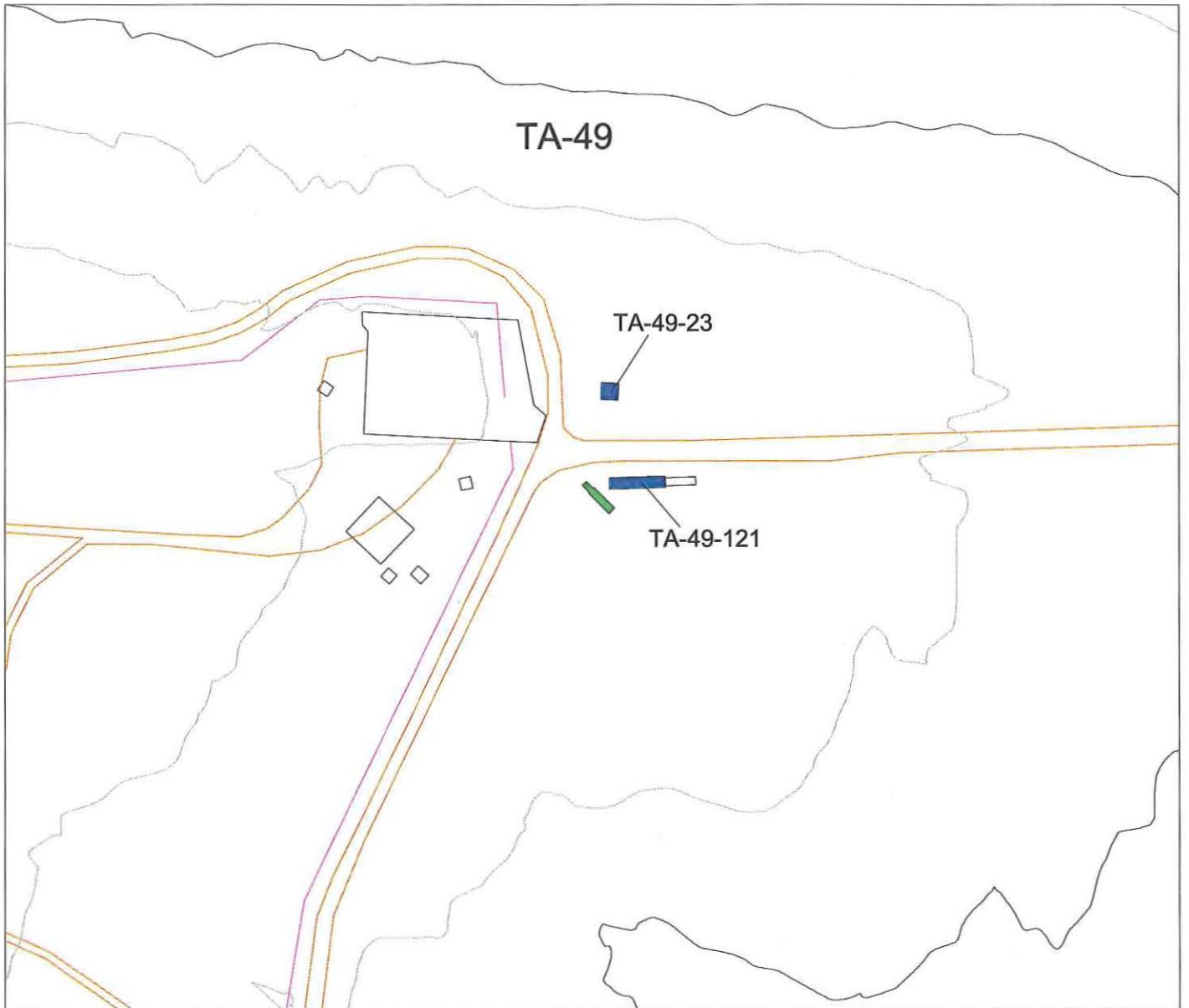
1:24000



TA-49

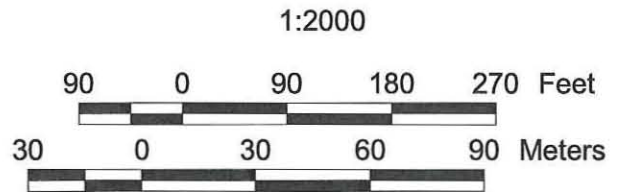
- TA-49-23 and -121
- Tech Area 49
- 20 Foot Contours
- 100 Foot Contours
- LANL Boundary
- Techarea
- Drainage
- Township, Section, Range
- USGS 7.5 Minute Quad
- Trails
- Roaddirt
- Parkpave
- Parkdirt
- Fences
- Buildings/Structures

Map 2



Frijoles Quad

**Los Alamos**  
**National Laboratory**  
 Cultural Resource Team  
 ENV-ECO Ecology Group



- TA-49-23 and -121
- Tech Area 49
- Buildings/Structures
- 20 Foot Contours
- 100 Foot Contours
- Techarea
- Drainage
- Township, Section, Range
- USGS 7.5 Minute Quad
- Trails
- Roads
- Roaddirt
- Parkpave
- Parkdirt
- Fences

TA-49

Map 3



## PROJECT DESCRIPTION

D&D activities proposed for TA-49 are part of LANL's routine phasing out of aging properties and will result in the eventual demolition of the Bottle House and the Cable Test Facility.

In March 2005, a historic building survey was conducted at TA-49 by Kari Garcia, Ecology Group, LANL; Ken Towery, Site and Project Planning Group, LANL; and John Ronquillo, Sigma Science, Inc. The building survey was accomplished by first conducting a field visit to TA-49. Digital photographs and architectural notes were taken during the initial field visit. Records research at LANL was also carried out, and representative drawings were compiled (Appendix).

## HISTORICAL BACKGROUND INFORMATION

### The 1958 Test Ban and Nuclear Safety

The United States and Britain began a voluntary suspension of nuclear weapons tests on October 31, 1958, a move followed by the Soviet Union two months later. However, at the same time, the United States continued to work on non-testing activities to improve the safety of its nuclear weapons arsenal. Many of these experiments took place at the Los Alamos Scientific Laboratory. Although the test ban was in effect, scientists and military officials deemed imperative the need to improve the arsenal's safety (Thorn and Westervelt 1987).

During the 1950s, the United States developed two major nuclear technologies and incorporated them into their weapons stockpile. The first was the thermonuclear weapon, or H-Bomb, approved by President Harry S. Truman in 1950. The United States detonated its first H-bomb in 1952 and the Soviet Union followed with a similar device in 1954. The second new weapons technology was the boosted fission primary, which underwent its first test in 1955. The boosted fission primary incorporated small amounts of deuterium and tritium, which markedly improved the efficiency of fission weapons.

Tests proving the effectiveness of this new technology led to new weapons that replaced the ponderous missile systems that the United States developed after World War II (Thorn and Westervelt 1987).

However, safety problems plagued the new boosted fission primary and it was to this problem that Laboratory scientists turned their attention during the voluntary nuclear test moratorium that lasted from 1959 until 1961. Boosted primaries complicated nuclear weapons safety because they made mechanical safety adjustments extraordinarily difficult. Specifically, Laboratory scientists believed that the boosted fission primaries would explode on a single-point initiation. In other words, the primaries had extreme sensitivity that could cause them to detonate unintentionally, for instance if an airplane accidentally dropped an atomic bomb. Los Alamos scientists strove to come up with a solution. The greatest difficulty that Laboratory scientists faced was not necessarily the theoretical solution to the safety issue. Rather, it was that the voluntary test ban made it impossible to redesign the nuclear weapons to include new safety modifications. In order to solve this problem while not breaking the test ban, Los Alamos scientists developed the Hydronuclear Safety Program (Thorn and Westervelt 1987, Kistiakowsky 1976).

### **Los Alamos Hydronuclear Experiments**

At TA-49, Laboratory scientists worked to solve the safety problem through hydronuclear experiments. These experiments consisted of a combination of a high explosive and fissile material, either enriched uranium or plutonium, whose quantity was reduced far below the amount required for a nuclear explosion. More generally, hydronuclear testing is part of the larger field of hydrodynamic testing which focuses on the hydrodynamic properties of materials as they undergo explosive and implosive forces (LANL 2000). Specifically, the principles of hydrodynamic testing investigate “the behavior of matter under the extreme pressures, shocks, and temperatures generated by high explosives. This specialized science is termed hydrodynamic because solids and metals seem to flow like liquids when driven by the detonation of high explosives” (Neal 1993). Such experiments had received no consideration when the test moratorium was announced. Thus, Laboratory leaders, including Director Norris Bradbury, had to make a proposal to

President Eisenhower and the Atomic Energy Commission to conduct such tests. Eisenhower approved the plan in September 1959. In addition, Bradbury received a message on December 31, 1959, stating that Eisenhower agreed that these tests were not nuclear weapons tests and therefore acceptable under the voluntary nuclear test ban (Thorn and Westervelt 1987).

Laboratory scientists from J Division (the Los Alamos nuclear testing division) conducted the first hydronuclear experiment on January 12, 1960, and this was followed by eight more tests that concluded on February 11. A second set of experiments began soon after the first set ended, the last on March 15, 1960. By April 1, the scientists had answered the most urgent safety questions surrounding boosted fission primaries. These experiments released a very tiny amount of fission energy and took place in pits 50 to 100 feet underground. The largest release was the equivalent of about one-thousandth of a pound of high explosive. Further safety tests followed these experiments, with releases of slightly higher fission energy releases that topped out at the equivalent of one-hundredth of a pound of high explosive material (Thorn and Westervelt 1987).

The true value of these experiments was proven in 1966 when a B-52 loaded with nuclear weapons crashed over Spain. Under the old design, a nuclear explosion would likely have occurred upon impact. But with the single-point safety problem resolved, the worst consequence of the crash was a scattering of plutonium around the crash area. While hardly an ideal situation, it did turn out much better than detonation of the weapons would have. Scientists estimated that without the hydronuclear program, the chances of a significant nuclear explosion would have been more than a thousand times greater (Thorn and Westervelt 1987).

Other nuclear programs underwent hydronuclear safety experiments during this time as well, and a few critical safety issues were resolved. However, scientists determined that they needed to conduct actual nuclear testing to solve the problems of most of the other systems. Overall, during the testing moratorium 35 hydronuclear experiments took place at Los Alamos with a smaller number conducted at Nevada Test Site. The hydronuclear



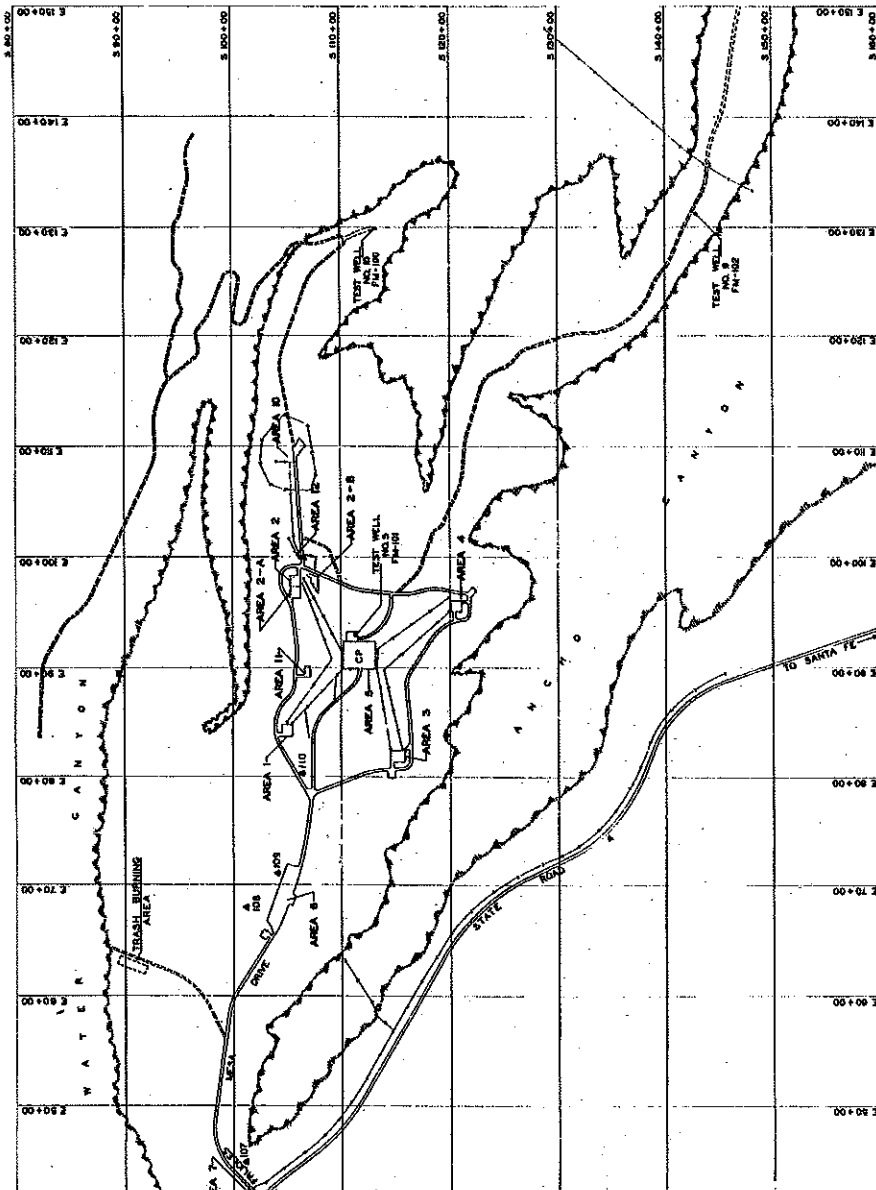
program ended in September 1961 when the Soviet Union pulled out of the moratorium and the United States went back to full-scale nuclear tests (Thorn and Westervelt 1987).

## **TA-49**

TA-49, the Frijoles Mesa (FM) Site, is approximately 1,280 acres in size located on the southwestern boundary of the Laboratory and was created in the mid-1940s to provide a buffer zone for firing sites in TA-15 and TA-39. The majority of activity at TA-49, however, took place between late 1959 and mid-1961, during which time Los Alamos conducted hydronuclear and related experiments at several locations within TA-49. Unlike many of the Laboratory's technical areas, TA-49 was split into different sub areas, where different kinds of work took place (Figure 1).

TA-49 historically contained Areas 1, 2, 2A, 2B, 3, 4, 5, 6, 7, 10, 11, and 12 (Figures 2 and 3). Areas 1 through 4 consisted of underground shaft areas. Area 5 was a central control area to monitor underground experiments. Area 6 served as a crafts area and an open burning and landfill operation. Area 7 was located at the main entrance into TA-49 and housed a guardhouse. Area 10 was an underground calibration chamber. Area 11 was a radiochemistry and small-scale shot area. Area 12 was the Bottle House and Cable Test Facility.

More generally, most of TA-49's activities consisted of limited radiochemistry operations and small-scale containment experiments involving high explosives detonations in shallow shafts. Facility researchers detonated high explosives and conducted nuclear device safety and related tests in underground shafts at TA-49. These operations used conventional explosives and small amounts of fissile material. The tests resulted in releases of high explosives, barium, uranium, plutonium-239, americium-241, cesium-137, tritium, lead, and beryllium in addition to other radioactive elements used and produced in the tests. The majority of the releases were in shafts at depths ranging from 31 to 108 feet below the ground surface (NMED 2002).



NOTE: RECALCULATED LATITUDE OF MESA 1, 2, 3, 4, 5, 6, 7, 8, 9, 10, 11, 12, 13, 14, 15, 16, 17, 18, 19, 20, 21, 22, 23, 24, 25, 26, 27, 28, 29, 30, 31, 32, 33, 34, 35, 36, 37, 38, 39, 40, 41, 42, 43, 44, 45, 46, 47, 48, 49, 50, 51, 52, 53, 54, 55, 56, 57, 58, 59, 60, 61, 62, 63, 64, 65, 66, 67, 68, 69, 70, 71, 72, 73, 74, 75, 76, 77, 78, 79, 80, 81, 82, 83, 84, 85, 86, 87, 88, 89, 90, 91, 92, 93, 94, 95, 96, 97, 98, 99, 100, 101, 102, 103, 104, 105, 106, 107, 108, 109, 110, 111, 112, 113, 114, 115, 116, 117, 118, 119, 120, 121, 122, 123, 124, 125, 126, 127, 128, 129, 130, 131, 132, 133, 134, 135, 136, 137, 138, 139, 140, 141, 142, 143, 144, 145, 146, 147, 148, 149, 150, 151, 152, 153, 154, 155, 156, 157, 158, 159, 160, 161, 162, 163, 164, 165, 166, 167, 168, 169, 170, 171, 172, 173, 174, 175, 176, 177, 178, 179, 180, 181, 182, 183, 184, 185, 186, 187, 188, 189, 190, 191, 192, 193, 194, 195, 196, 197, 198, 199, 200, 201, 202, 203, 204, 205, 206, 207, 208, 209, 210, 211, 212, 213, 214, 215, 216, 217, 218, 219, 220, 221, 222, 223, 224, 225, 226, 227, 228, 229, 230, 231, 232, 233, 234, 235, 236, 237, 238, 239, 240, 241, 242, 243, 244, 245, 246, 247, 248, 249, 250, 251, 252, 253, 254, 255, 256, 257, 258, 259, 260, 261, 262, 263, 264, 265, 266, 267, 268, 269, 270, 271, 272, 273, 274, 275, 276, 277, 278, 279, 280, 281, 282, 283, 284, 285, 286, 287, 288, 289, 290, 291, 292, 293, 294, 295, 296, 297, 298, 299, 300, 301, 302, 303, 304, 305, 306, 307, 308, 309, 310, 311, 312, 313, 314, 315, 316, 317, 318, 319, 320, 321, 322, 323, 324, 325, 326, 327, 328, 329, 330, 331, 332, 333, 334, 335, 336, 337, 338, 339, 340, 341, 342, 343, 344, 345, 346, 347, 348, 349, 350, 351, 352, 353, 354, 355, 356, 357, 358, 359, 360, 361, 362, 363, 364, 365, 366, 367, 368, 369, 370, 371, 372, 373, 374, 375, 376, 377, 378, 379, 380, 381, 382, 383, 384, 385, 386, 387, 388, 389, 390, 391, 392, 393, 394, 395, 396, 397, 398, 399, 400, 401, 402, 403, 404, 405, 406, 407, 408, 409, 410, 411, 412, 413, 414, 415, 416, 417, 418, 419, 420, 421, 422, 423, 424, 425, 426, 427, 428, 429, 430, 431, 432, 433, 434, 435, 436, 437, 438, 439, 440, 441, 442, 443, 444, 445, 446, 447, 448, 449, 450, 451, 452, 453, 454, 455, 456, 457, 458, 459, 460, 461, 462, 463, 464, 465, 466, 467, 468, 469, 470, 471, 472, 473, 474, 475, 476, 477, 478, 479, 480, 481, 482, 483, 484, 485, 486, 487, 488, 489, 490, 491, 492, 493, 494, 495, 496, 497, 498, 499, 500, 501, 502, 503, 504, 505, 506, 507, 508, 509, 510, 511, 512, 513, 514, 515, 516, 517, 518, 519, 520, 521, 522, 523, 524, 525, 526, 527, 528, 529, 530, 531, 532, 533, 534, 535, 536, 537, 538, 539, 540, 541, 542, 543, 544, 545, 546, 547, 548, 549, 550, 551, 552, 553, 554, 555, 556, 557, 558, 559, 560, 561, 562, 563, 564, 565, 566, 567, 568, 569, 570, 571, 572, 573, 574, 575, 576, 577, 578, 579, 580, 581, 582, 583, 584, 585, 586, 587, 588, 589, 590, 591, 592, 593, 594, 595, 596, 597, 598, 599, 600, 601, 602, 603, 604, 605, 606, 607, 608, 609, 610, 611, 612, 613, 614, 615, 616, 617, 618, 619, 620, 621, 622, 623, 624, 625, 626, 627, 628, 629, 630, 631, 632, 633, 634, 635, 636, 637, 638, 639, 640, 641, 642, 643, 644, 645, 646, 647, 648, 649, 650, 651, 652, 653, 654, 655, 656, 657, 658, 659, 660, 661, 662, 663, 664, 665, 666, 667, 668, 669, 670, 671, 672, 673, 674, 675, 676, 677, 678, 679, 680, 681, 682, 683, 684, 685, 686, 687, 688, 689, 690, 691, 692, 693, 694, 695, 696, 697, 698, 699, 700, 701, 702, 703, 704, 705, 706, 707, 708, 709, 710, 711, 712, 713, 714, 715, 716, 717, 718, 719, 720, 721, 722, 723, 724, 725, 726, 727, 728, 729, 730, 731, 732, 733, 734, 735, 736, 737, 738, 739, 740, 741, 742, 743, 744, 745, 746, 747, 748, 749, 750, 751, 752, 753, 754, 755, 756, 757, 758, 759, 760, 761, 762, 763, 764, 765, 766, 767, 768, 769, 770, 771, 772, 773, 774, 775, 776, 777, 778, 779, 780, 781, 782, 783, 784, 785, 786, 787, 788, 789, 790, 791, 792, 793, 794, 795, 796, 797, 798, 799, 800, 801, 802, 803, 804, 805, 806, 807, 808, 809, 810, 811, 812, 813, 814, 815, 816, 817, 818, 819, 820, 821, 822, 823, 824, 825, 826, 827, 828, 829, 830, 831, 832, 833, 834, 835, 836, 837, 838, 839, 840, 841, 842, 843, 844, 845, 846, 847, 848, 849, 850, 851, 852, 853, 854, 855, 856, 857, 858, 859, 860, 861, 862, 863, 864, 865, 866, 867, 868, 869, 870, 871, 872, 873, 874, 875, 876, 877, 878, 879, 880, 881, 882, 883, 884, 885, 886, 887, 888, 889, 890, 891, 892, 893, 894, 895, 896, 897, 898, 899, 900, 901, 902, 903, 904, 905, 906, 907, 908, 909, 910, 911, 912, 913, 914, 915, 916, 917, 918, 919, 920, 921, 922, 923, 924, 925, 926, 927, 928, 929, 930, 931, 932, 933, 934, 935, 936, 937, 938, 939, 940, 941, 942, 943, 944, 945, 946, 947, 948, 949, 950, 951, 952, 953, 954, 955, 956, 957, 958, 959, 960, 961, 962, 963, 964, 965, 966, 967, 968, 969, 970, 971, 972, 973, 974, 975, 976, 977, 978, 979, 980, 981, 982, 983, 984, 985, 986, 987, 988, 989, 990, 991, 992, 993, 994, 995, 996, 997, 998, 999, 1000.

|   |                      |                                   |     |
|---|----------------------|-----------------------------------|-----|
| 4   | APPROVED TO PRINT BY | 5-11-72                           | 100 |
| 3   | APPROVED TO PRINT BY | 5-11-72                           | 100 |
| 2   | APPROVED TO PRINT BY | 5-11-72                           | 100 |
| 1   | APPROVED TO PRINT BY | 5-11-72                           | 100 |
| <b>LOS ALAMOS SCIENTIFIC LABORATORY</b><br>UNIVERSITY OF CALIFORNIA - LOS ALAMOS, NEW MEXICO<br>ENGINEERING DEPARTMENT<br>STRUCTURE LOCATION PLAN<br>TA-49 FRIHOLES MESA SITE |                      |                                   |     |
| AUTHORIZED FOR<br>RELEASE   |                      | DATE<br>5-28-81<br>BY<br>J. W. H. |     |
| PROJECT NO.<br>2485   |                      | DRAWING NO.<br>ENGR-2485          |     |



REVIEWED BY *[Signature]*  
 CLASS *[Blank]* DATE *5/11/72*



Figure 1. TA-49, Site Layout Map

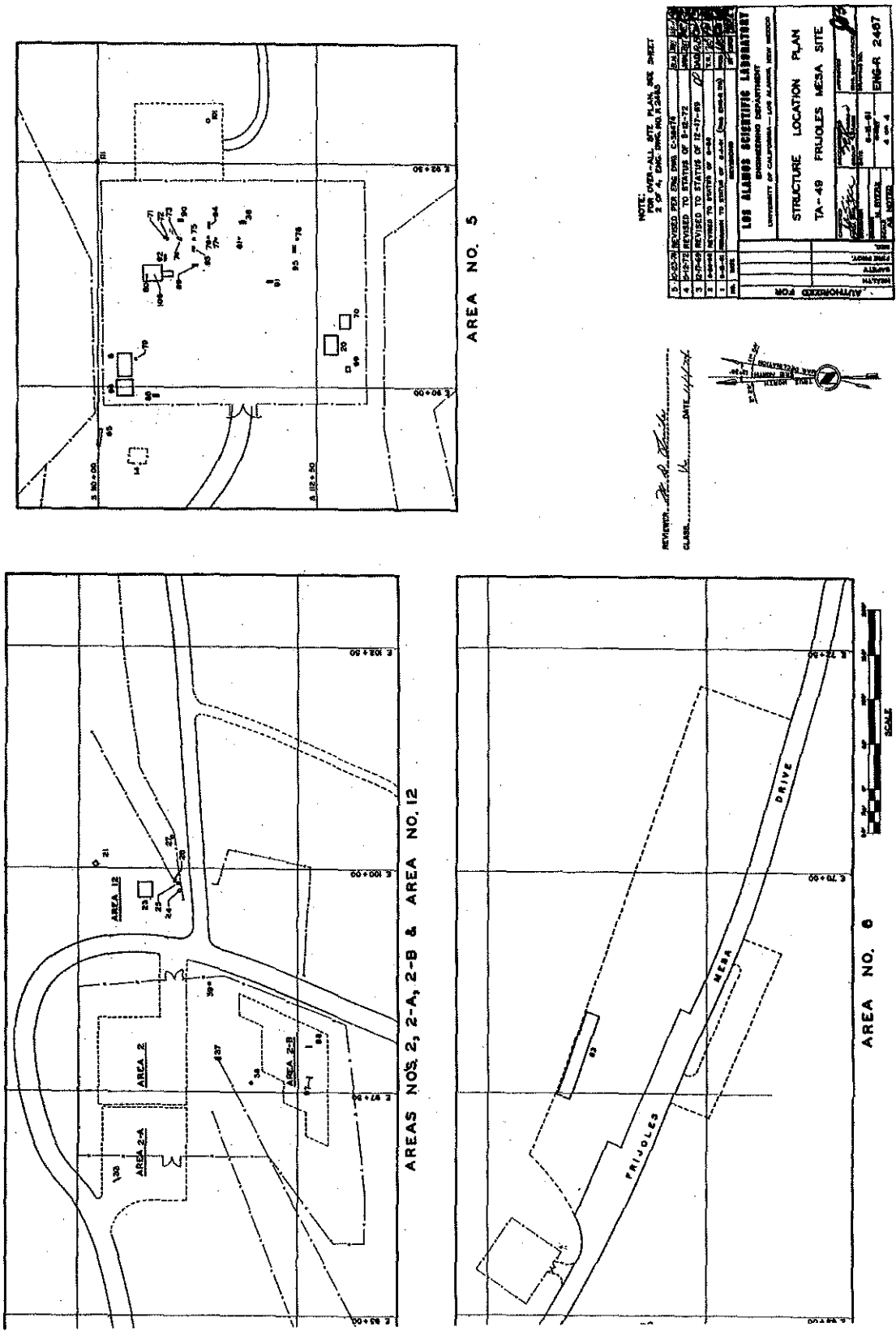


Figure 2. TA-49, Areas 2, 5, 6, and 12

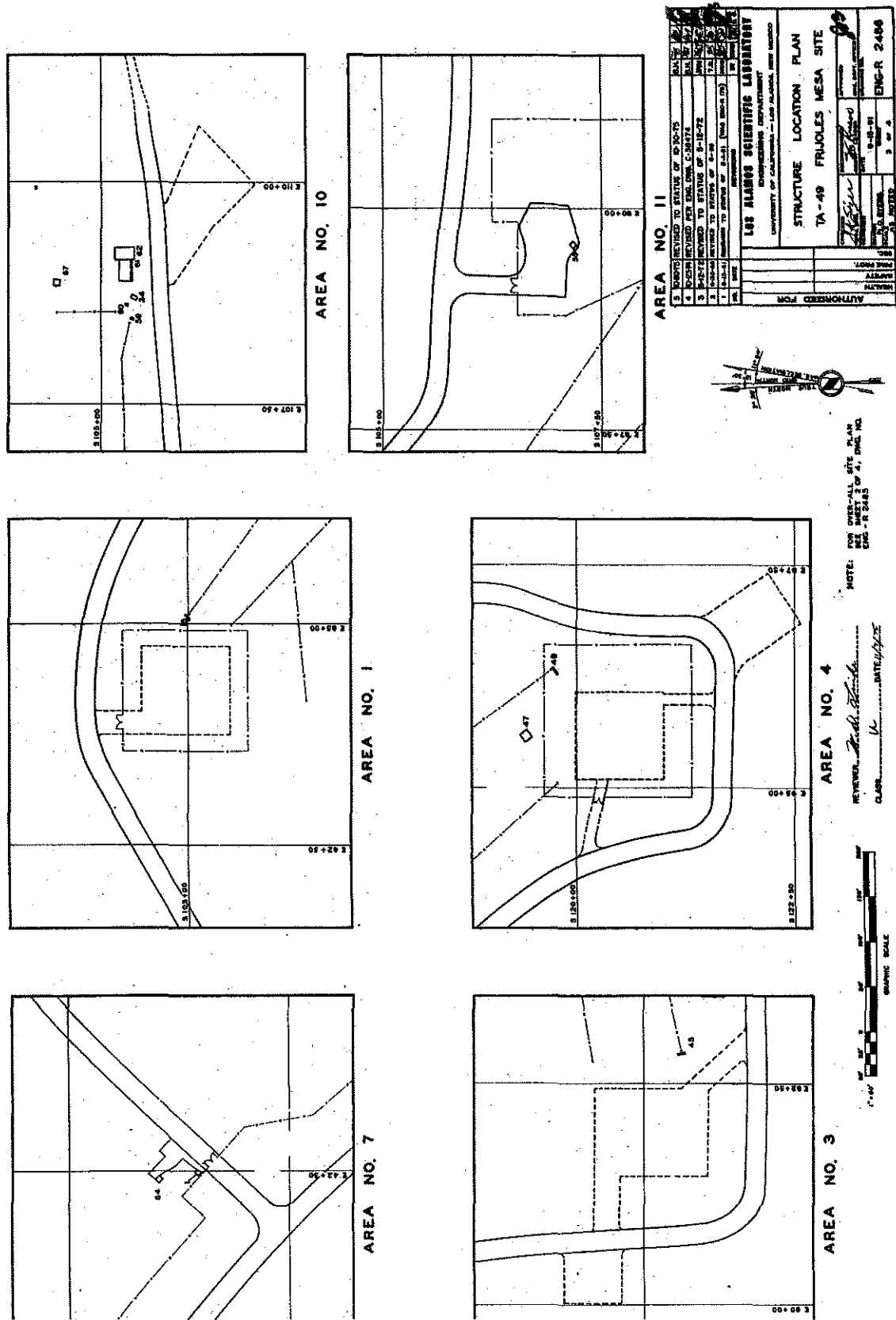
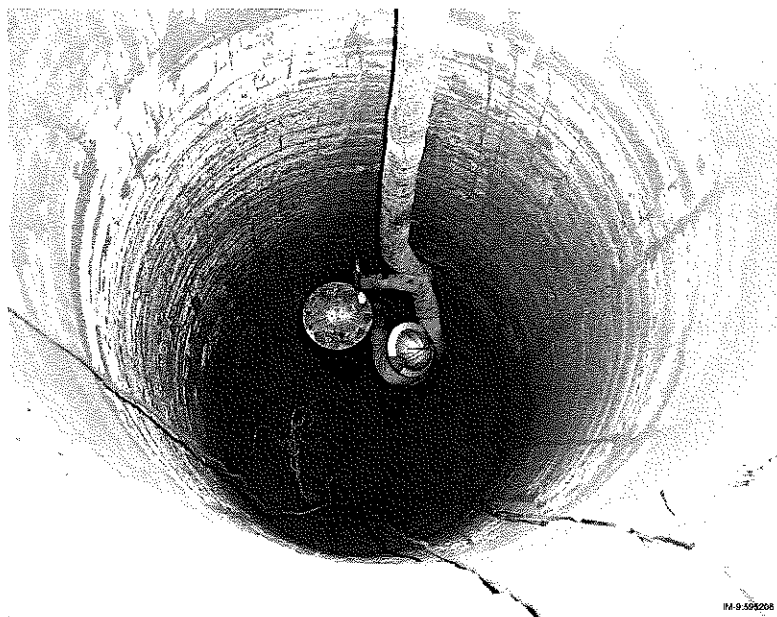


Figure 3. Areas 1, 3, 4, 7, 10, and 11



## Area 1

Area 1 was developed for containment studies in shafts (Photos 1 and 2), and later used for down hole studies involving uranium-238 and plutonium. Possible contaminants in the area include uranium-tracers, uranium-235 and -238, plutonium-239, and neptunium-239 tracers.



**Photo 1.** Containment Hole, TA-49, Frijoles Mesa Test, J-6  
LANL IM-9 Photography, Neg. # 595206 (1959)



**Photo 2.** J-6 Containment, TA-49, Frijoles Mesa Test  
LANL IM-9 Photography, Neg. # 594556 (1959)

### Areas 2, 2A, and 2B

Areas 2, 2A, and 2B are also underground shaft areas. Four accidental releases in Areas 2 and 2B resulted in contamination of the ground surface that resulted in closing and capping of Area 2 (Photo 3) in 1961 (NMED 2002).



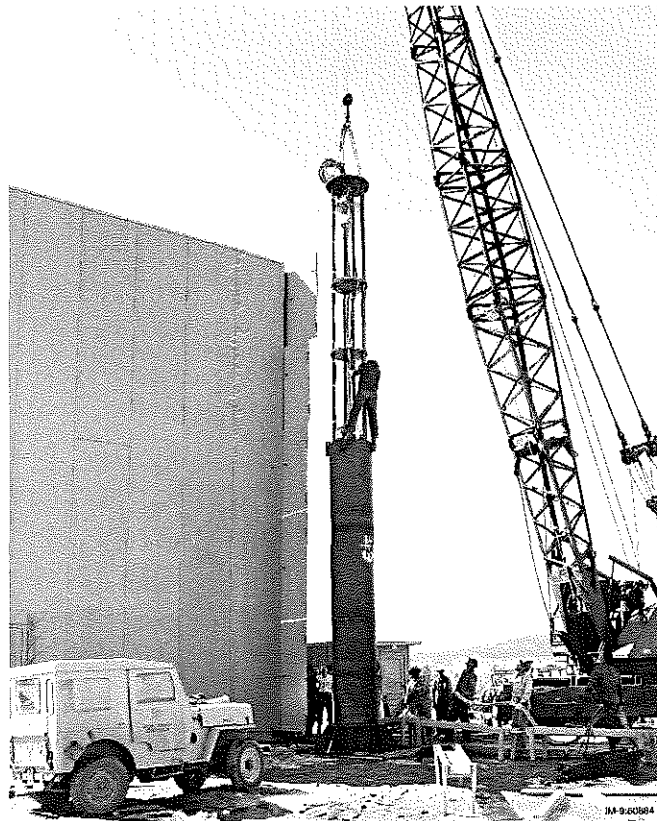
**Photo 3.** Area 2 (pad area) and Area 12 (building and structure at right)  
LANL IM-9 Photography, Neg. # RN91-234-135 (1991)

### Area 3

Area 3 was also an underground shaft area. Area 3 was used exclusively for development of confinement and sample recovery techniques that were subsequently used at Areas 1, 2 (including 2A and 2B), and 4.

### Area 4

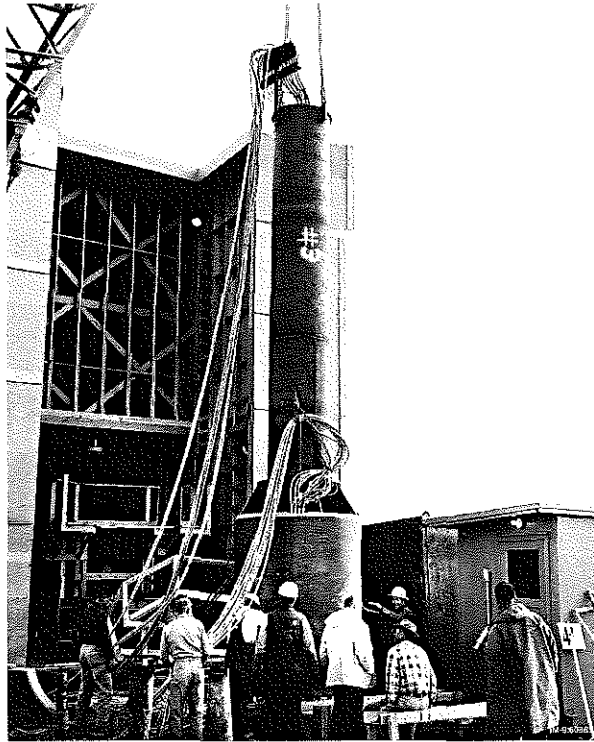
Area 4 was also an underground shaft area. Area 4 was used for containment experiments (Photos 4 through 8). Tritium, beryllium, and lead contamination have been detected at Area 4.



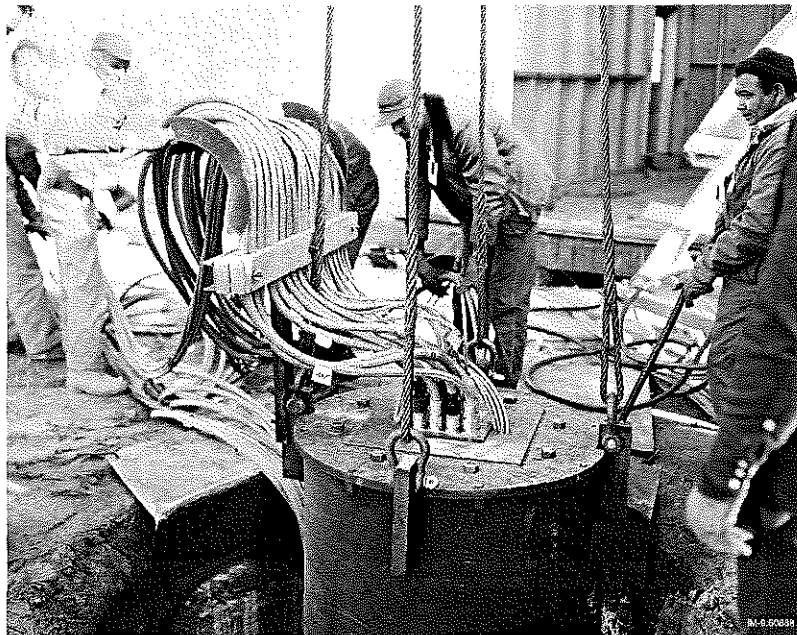
**Photo 4.** J-6, Assembly Hole 4W, TA-49-Frijoles Mesa  
LANL IM-9 Photography, Neg. # 60884 (1960)



**Photo 5.** J-6, Assembly Hole 4W, TA-49-Frijoles Mesa  
LANL IM-9 Photography, Neg. # 60885 (1960)

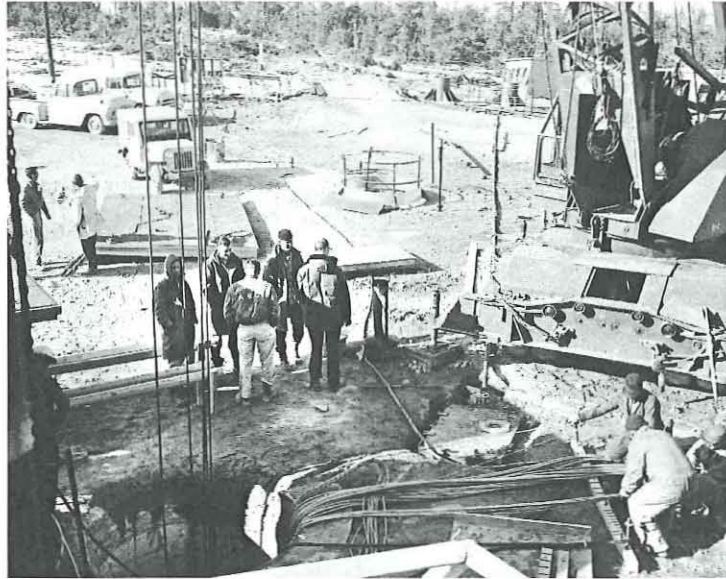


**Photo 6.** J-6, Assembly Hole 4W, TA-49-Frijoles Mesa  
LANL IM-9 Photography, Neg. # 60887 (1960)



**Photo 7.** J-6, Assembly Hole 4W, TA-49-Frijoles Mesa  
LANL IM-9 Photography, Neg. # 60888 (1960)





**Photo 8.** J-6, Assembly Hole 4W, TA-49-Frijoles Mesa  
LANL IM-9 Photography, Neg. # 60890 (1960)

## Area 5

Area 5 (Photo 9) served as the main control area or “CP” for the hydronuclear experiments. Close to 20 trailers were located at Area 5, housing Sandia, J-Division, and EG&G equipment and personnel (Figure 4).



**Photo 9.** Area 5 (center fenced area), Areas 2 and 12 (upper left)  
LANL IM-9 Photography, Neg. # RN91-232-089 (1991)

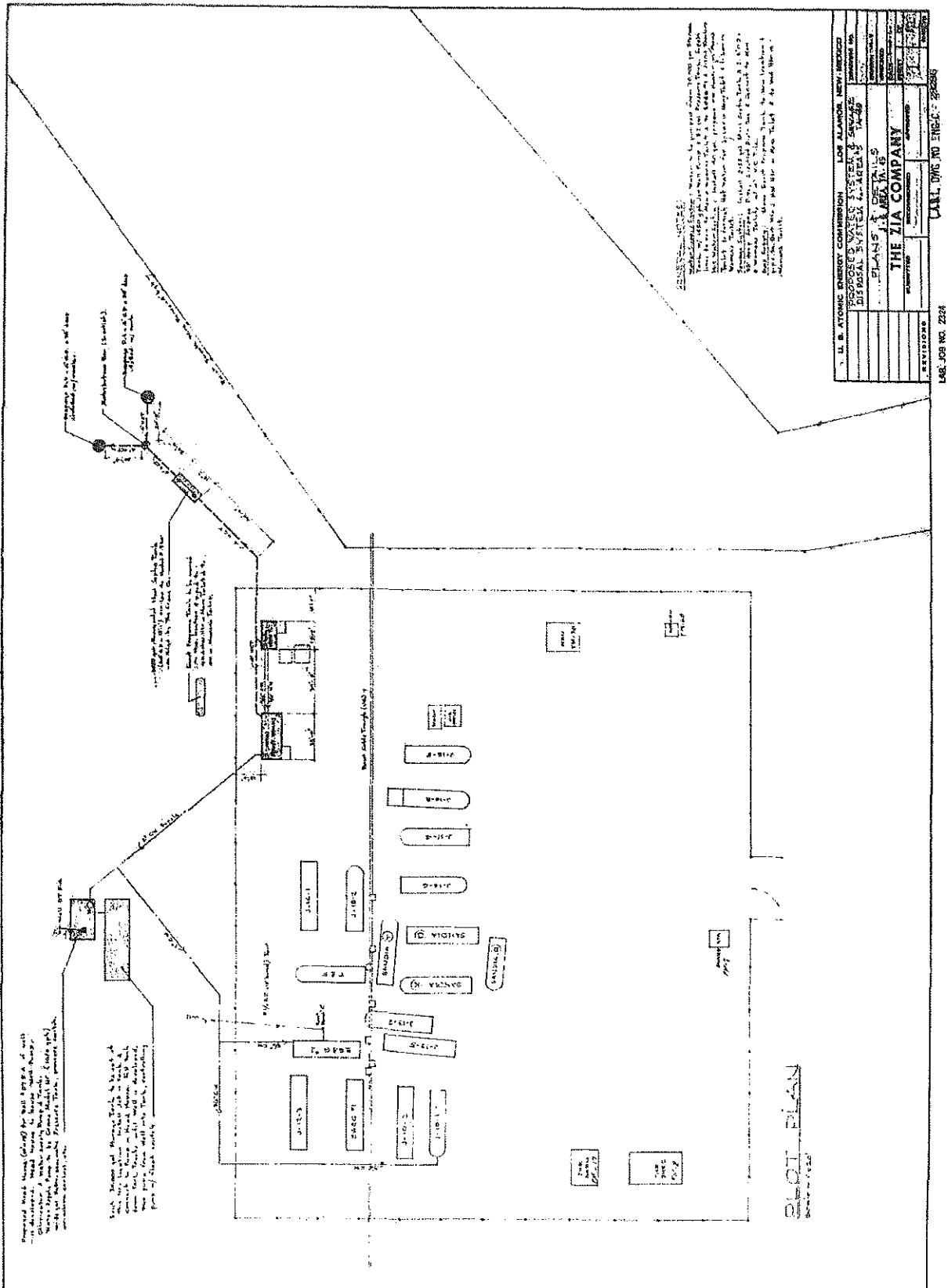
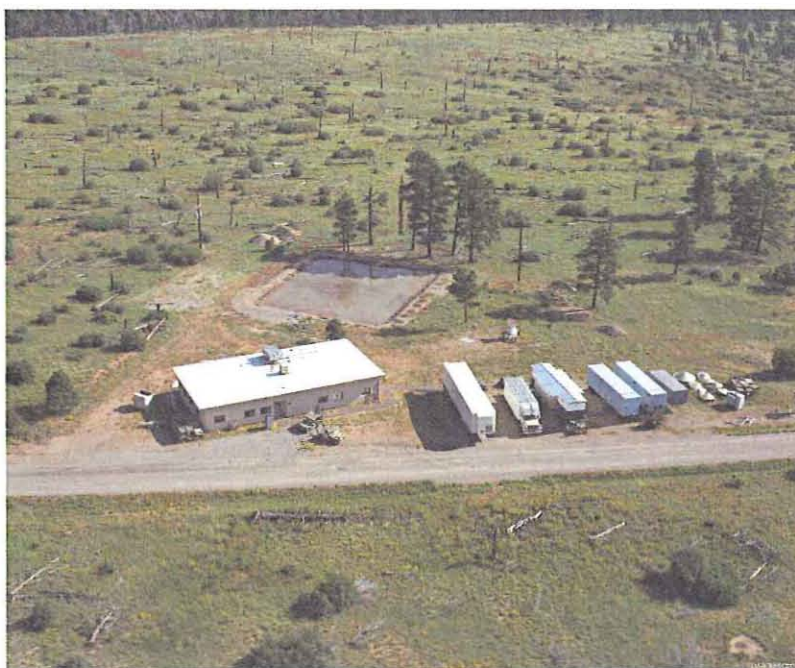


Figure 4. Trailers at Area 5

Area 5 supported hydronuclear testing conducted at Areas 1, 2, 2A, 2B, 3, and 4 located at TA-49. An elevated photo tower was constructed at Area 5 in late 1959 to photograph the hydronuclear experiments. Scientists also used TA-49-8 at Area 5 for calibration activities during 1960 or 1961. Trailer J-11-4 was used as a radiochemistry laboratory during this period as well. Lead shields were used at this trailer and at the other buildings in Area 5 to protect people during the counting of low-level radioactive samples (LANL 1992).

### Area 6

Area 6 (Photo 10) also supported hydronuclear testing conducted at Areas 1, 2, 2A, 2B, 3, and 4. During the hydronuclear period, the Laboratory used Area 6 for open pit burning of combustible construction wastes and for burial of uncontaminated residues generated during the experiments and related activities in the other areas of TA-49 (LANL 1992).



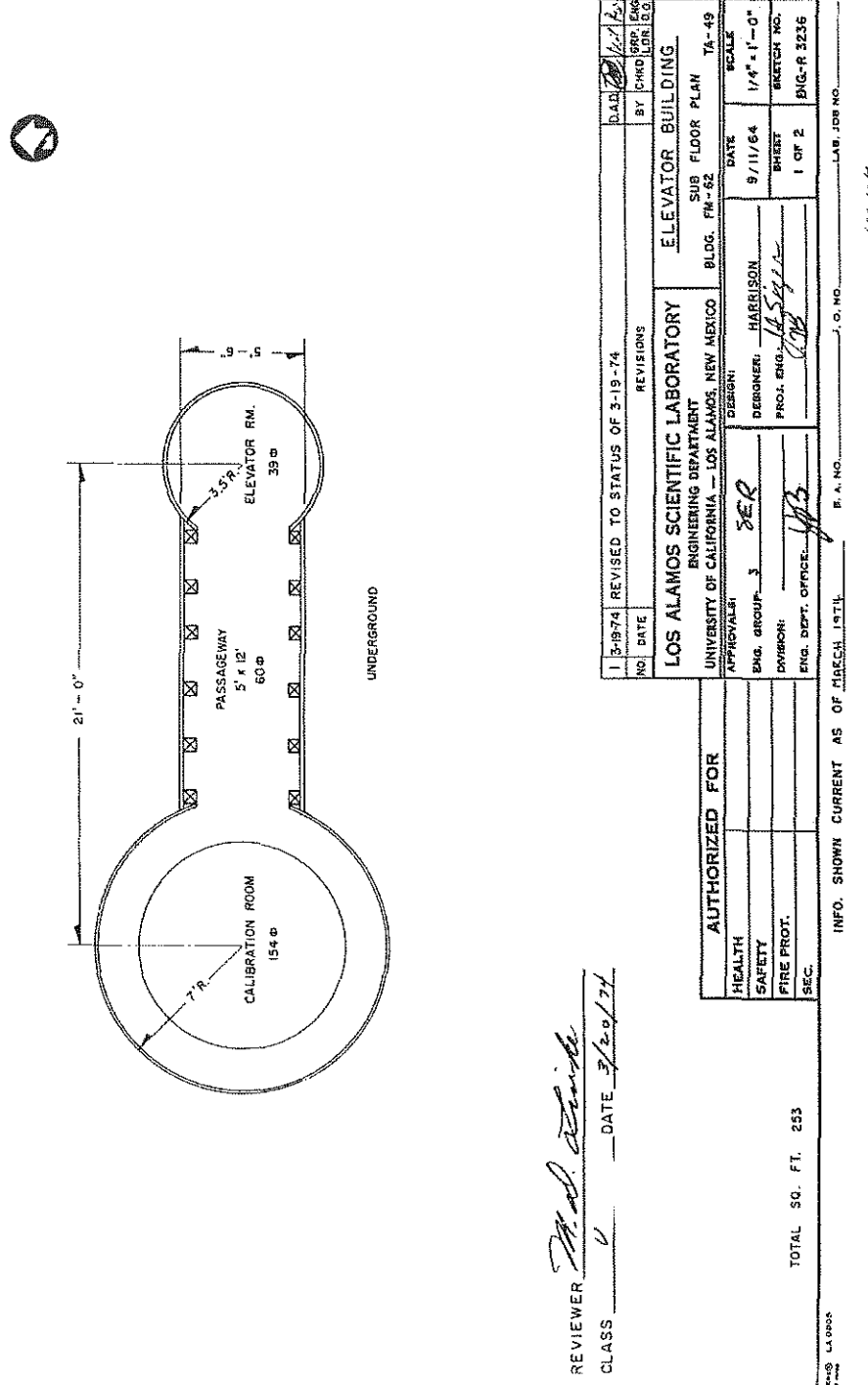
**Photo 10.** Area 6 (behind building and trailers)  
LANL IM-9 Photography, Neg. # RN91-207-027 (1991)

### Area 7

As mentioned above, Area 7 was the main entrance area into TA-49 and housed a guard station and latrine.

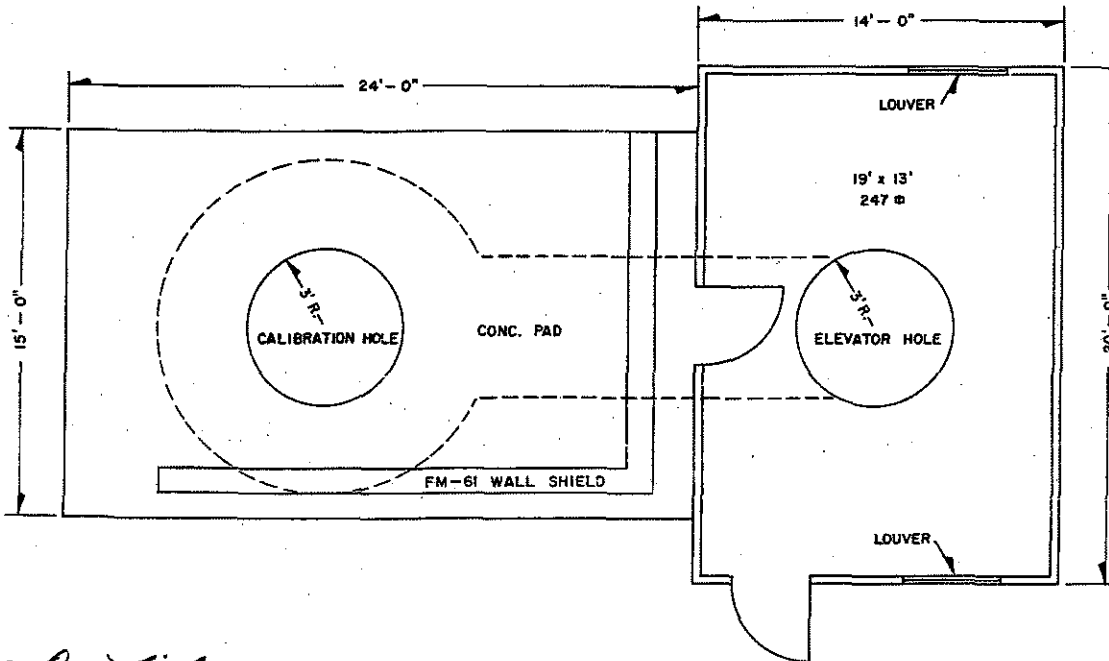
**Area 10**

Activities conducted at Area 10 supported TA-49's hydronuclear testing operations. Located to the east of Area 12, facilities at Area 10 included TA-49-62, an underground calibration facility. TA-49-62, or the Elevator Building, had an underground gallery connected by two shafts (Figures 5 and 6).



**Figure 5.** Building 49-62 at Area 10, Sub Floor





REVIEWER M. D. Link  
 CLASS U DATE 3/20/74

FIRST FLOOR TOTAL SQ. FT. 247  
 SUB FLOOR TOTAL SQ. FT. 253  
 TOTAL SQ. FT. 500

| AUTHORIZED FOR |  |
|----------------|--|
| HEALTH         |  |
| SAFETY         |  |
| FIRE PROT.     |  |
| SEC.           |  |

|   |                               |                              |  |                    |                    |                    |
|---|-------------------------------|------------------------------|--|--------------------|--------------------|--------------------|
| 1   | 5-19-74                       | REVISED TO STATUS OF 3-19-74 | DAD.   | <i>[Signature]</i> | <i>[Signature]</i> | <i>[Signature]</i> |
| NO.   | DATE                          | REVISIONS                    | BY   | CHKD               | GRP. LDR.          | ENG. D. O.         |
| LOS ALAMOS SCIENTIFIC LABORATORY<br>ENGINEERING DEPARTMENT<br>UNIVERSITY OF CALIFORNIA — LOS ALAMOS, NEW MEXICO |                               |                              | ELEVATOR BUILDING<br>FIRST FLOOR PLAN<br>BLDG. FM-62 TA-49 |                    |                    |                    |
| APPROVALS:  | DESIGN:                       | DATE                         | SCALE  |                    |                    |                    |
| ENG. GROUP. 3 <i>SER</i>  | DESIGNER: HARRISON            | 9/11/64                      | 1/4" = 1'-0"   |                    |                    |                    |
| DIVISION:   | PROJ. ENG. <i>[Signature]</i> | SHEET                        | SKETCH NO.   |                    |                    |                    |
| ENG. DEPT. OFFICE: <i>[Signature]</i>   |                               | 2 OF 2                       | ENG-R 3237   |                    |                    |                    |
| INFO. SHOWN CURRENT AS OF MARCH 1974  |                               | B. A. NO.                    | J. O. NO.  | LAB. JOB NO.       |                    |                    |

Figure 6. Building 49-62 at Area 10, First Floor

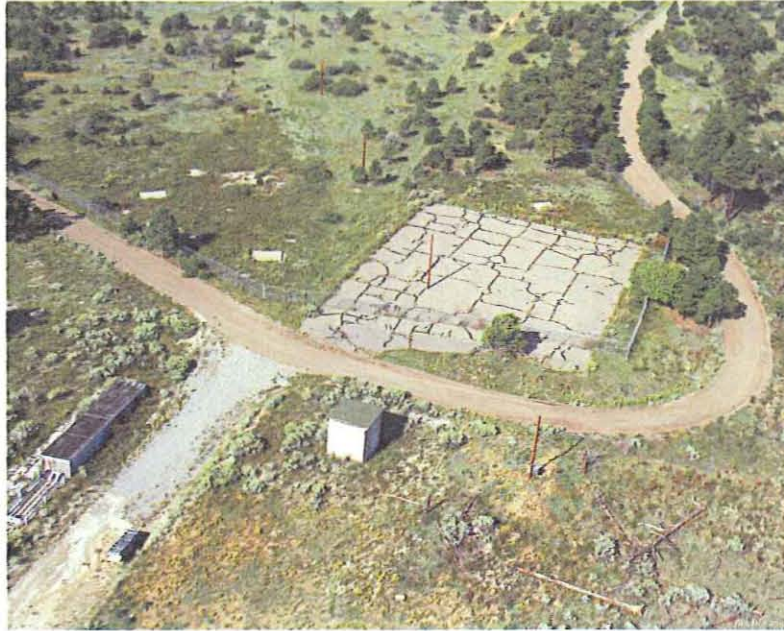
One of these was an elevator used to transport personnel and equipment that was later covered by a heavy but removable concrete cover. The second shaft was a calibration shaft used to position a portable pulse neutron source over calibration samples placed at the bottom of the shaft. A hydraulic platform was located at the bottom of the calibration chamber and a hydraulic line led to an oil reservoir at the surface. A calibration room was at the bottom of the shaft. These shafts and the chamber received only very limited use after the end of the hydronuclear experiments in 1961 (LANL 1992).

### **Area 11**

Radiochemistry operations took place in building TA-49-15, which was part of Area 11. Historically, Area 11 consisted of the former radiochemistry laboratory, its associated leach field, and a small-scale shot area. The radiochemistry laboratory was demolished in 1971 (LANL 1992). Activities conducted at Area 11 included radiochemistry operations and small-scale shot experiments involving high explosives detonations (some containing uranium-238 tracers, neptunium-239, and lead) in shallow shafts. In 1960, a fairly significant unplanned release of contaminants occurred when a shaft was drilled for an experiment. The drill entered a region contaminated in a previous experiment. No Laboratory workers were exposed to radiation but significant surface contamination did result (LANL 1992).

### **Area 12**

Buildings located at Area 12 included TA-49-23 (the Bottle House; see Photo 11), TA-49-22 (an equipment building), and TA-49-35 ("Gray House #5"), which was a building mounted on steel skids. These three interconnected buildings were built together during 1959. A latrine, also built in 1959, was located near buildings 22, 23, and 35. An unnumbered shed, used for bottle storage, was located south of TA-49-23. This building was salvaged in 1968 when the facility was converted to support the cable test operations at TA-49-121. Buildings 22 and 35 were removed around 1970.



**Photo 11.** Area 12: TA-49-121 (lower left), TA-49-23 (lower center); Area 2 (paved pad)  
LANL IM-9 Photography, Neg. # RN91-207-033 (1991)

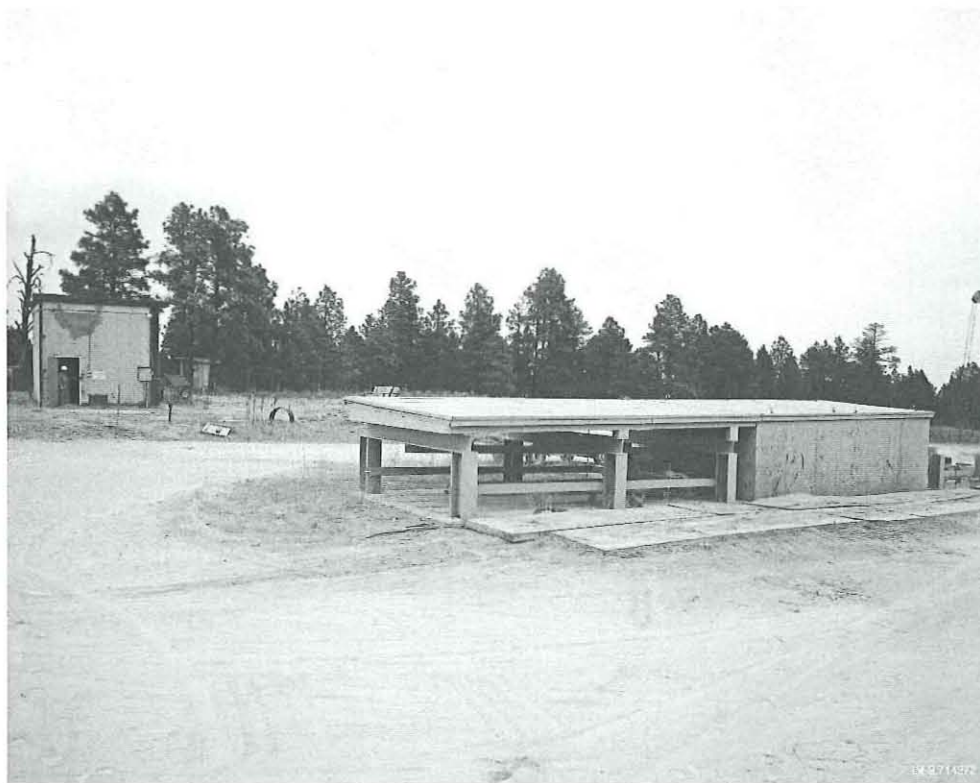
The first hydronuclear experiments at TA-49 were conducted at Area 12 and involved 13, twelve-foot-deep vertical holes encased in steel. Explosive charges were set off at the bottoms of the holes after filling the holes with sand to contain the explosions.

Confinement experiments also took place at Area 12 as part of the hydronuclear program. These experiments consisted of high explosives detonations in sealed metal bottles placed in a 30-foot-deep shaft. The Bottle House surrounded the shaft. Approximately 26 containment experiments involving high explosives detonations were carried out in the Area 12 shaft. Several of the experiments were radioactive as they used uranium-238 while six experiments involved a few microcuries of irradiated uranium tracer.

TA-49-121, better known as the Cable Test Facility (Photos 12, 13, and 14), was built in 1968 after the hydronuclear experiments had been discontinued for several years. Former Area 12 structures were used to support operations at the Cable Test Facility, constructed just across the road from the Bottle House. As part of the cable-stretching experiments conducted by Los Alamos's J Division, the shaft within the Bottle House was backfilled with sand and a hydraulic system (Photo 15) for the Cable Test Facility was installed in the building. An underground hydraulic line connected the two buildings (LANL 1992).

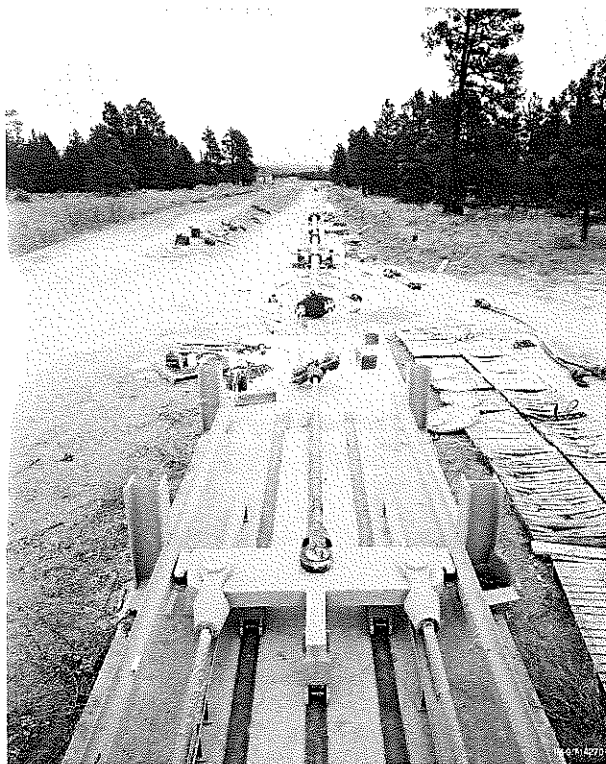


**Photo 12.** Area 12, Cable Test Facility anchors next to dirt road; Area 10 debris at center  
LANL IM-9 Photography, Neg. # RN91-234-136 (1991)

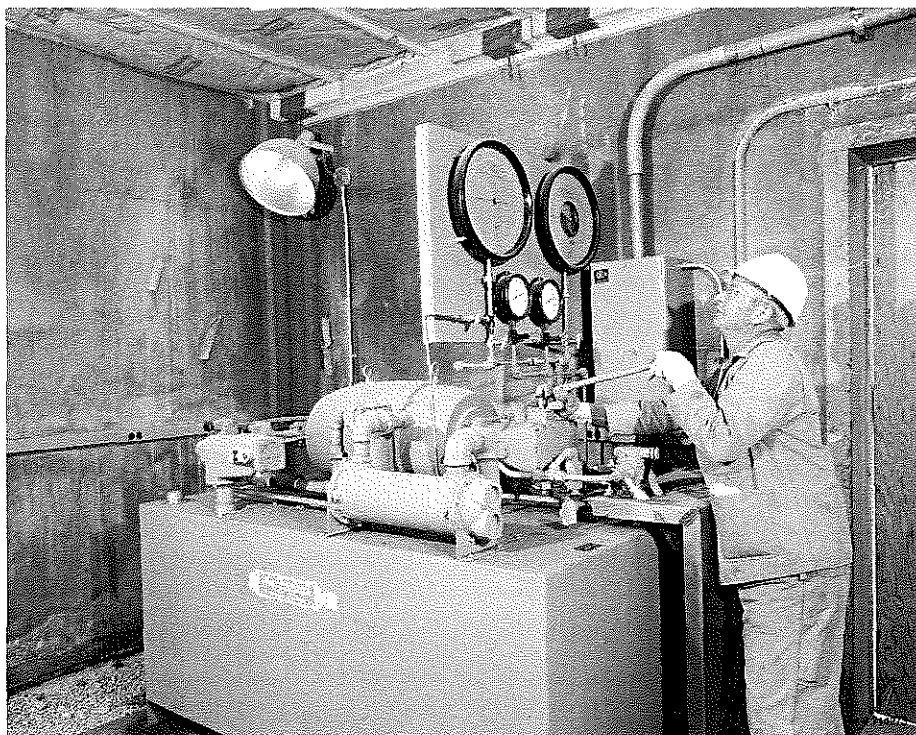


**Photo 13.** TA-49-23 (left) and TA-49-121 (right)  
LANL IM-9 Photography, Neg. # 714272 (1971)





**Photo 14.** Area 12, TA-49-121, Cable Test Facility  
LANL IM-9 Photography, Neg. #714270 (1971)



**Photo 15.** Area 12, TA-49-23, Hydraulic Piston Pump Housing  
LANL IM-9 Photography, Neg. # 714273 (1971)



## TA-49 after 1961

TA-49 received only limited use after the termination of the hydronuclear experiments. In 1962 and 1963, experiments in Area 10 involved firing assemblies, also known as squibs, to release pressurized gas that drove pistons against water in cylinders. A photographic tower in Area 5 became the home of lightning experiments conducted in 1965. Scientists conducted pulsed gas laser and shock tube experiments in unidentified areas of TA-49 in 1967 and 1968. In either Area 1 or Area 2, explosively driven plasma gun experiments were conducted in 1968. During that same year, lightning flash experiments using large capacitor banks were conducted in Area 12. During the early 1970s, the Area 5 tower was used for atmospheric observation experiments. Also during the early 1970s, an unidentified location at TA-49 hosted shock tube experiments. In 1977, experiments at TA-49 came to an end when the La Mesa forest fire burned much of the area, including the majority of TA-49's buildings. During the early 1990s, the Laboratory's High Power Microwave Group (AT-9) occasionally used TA-49-115 for equipment development and the road between Areas 10 and 12 as a microwave test range. Other groups used the area for small-scale explosives training exercises (LANL 1986, LANL 1992).

Currently the Hazardous Device Team uses the site as a training area and as an isolated location to render safe or dispose of suspicious items. The Hazardous Materials Response Group (HAZMAT) also uses TA-49 for training exercises, using fixed facility props, transportation props, and infrastructure for realistic, performance-based field training (Photo 16). TA-49 is also the location of the Laboratory's Antenna and Pulse Power Outdoor Range User Facility (Building 115) where outdoor tests are carried out on materials and equipment components that involve generating and receiving short bursts of high-energy, broad-spectrum microwaves (LANL 1986, LANL 1992).



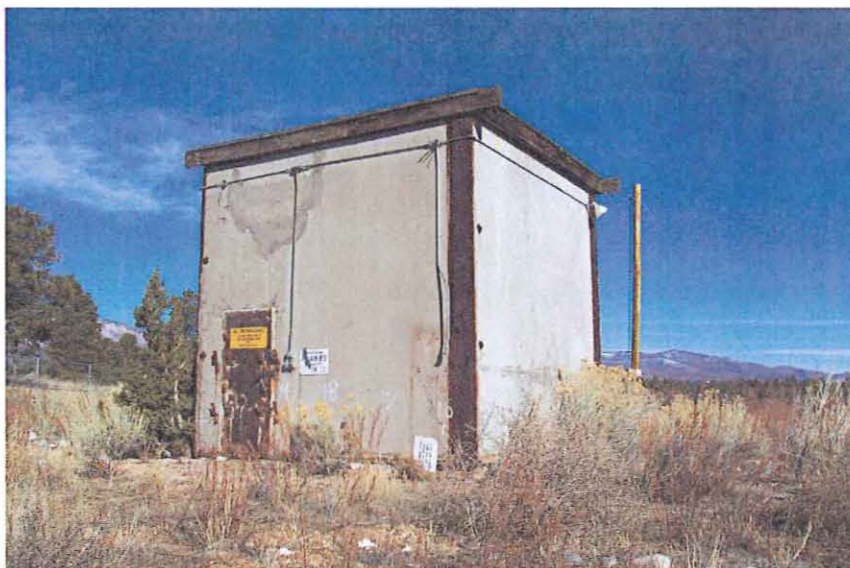
**Photo 16. HAZMAT Area**  
LANL IM-9 Photography, Neg. # RN91-207-011 (1991)

## PROPERTY DESCRIPTIONS

The properties located at TA-49 are identified using the current LANL system of placing the TA prefix before the building number. Historically, however, the “FM” prefix (for Frijoles Mesa Site) was used in front of the building number, and some of the drawings included in this report may use the old system of building identification. For example, the term “FM-23” may be used in place of TA-49-23 (Photo 17).

Architectural descriptions of the Bottle House and the Cable Test Facility are provided below. Site forms for both properties will be included in a subsequent report once a treatment plan to resolve the adverse effects has been developed.





**Photo 17.** Bottle House (TA-49-23)

This structure has served dual purposes since its construction in 1959. The original construction documents depict a 17-foot, 6-inch high by five-foot, five-inch diameter steel “bottle” buried beneath the structure. The bottle served as a blast containment vessel and was seated inside a 6-foot circular shaft. The bottle rested on a 2-inch-thick layer of neoprene or cold rubber similar to tire rubber, which rested in turn on a five-foot-high, heavy-duty concrete support located in the very bottom of the hole. The original bottle hole was protected by a removable pipe guardrail. In the late 1960s, the shaft was filled and a hydraulic oil compressor and tank, which supported the activities in the adjacent building, TA-49-121 (Photos 18 and 19), were installed.



**Photos 18 and 19.** Cable Test Facility (TA-49-121)

Building 23 is 16 feet by 16 feet square and is 15 feet high. The foundation is a thickened edge type footing with a reinforced 6-inch slab. The existing floor is dirt and gravel. The four walls are 12-inch-thick precast concrete panels. The concrete panels are each framed with imbedded steel “C” channels. The channels are welded and bolted together to form the square structure. The concrete panels were likely cast on site and lifted into place, then welded and bolted together. Two steel doors with cast-in-place steel frames provide access to the interior. Clip angles were mounted on the outside wall of the building near each door. These clips were used as holders for removable steel bars to hold the doors shut during the experiments. The original roof was an open weld of 1-inch wire rope supported by a frame, which is welded to the wall structure. According to building plans, a slightly pitched wooden roof was placed above this open wire weld. This roof was removable to allow for insertion of the bottle experiment and had a lifting eye located at each corner. During the installation of the hydraulic compressor a more permanent wood-framed roof structure was added and asphalt fabric roofing was installed.

The elevations of the building are simple, plain unpainted concrete. Electrical conduit and remnants of exterior lighting are evident. The exposed steel and wood elements of the structure are rusted and deteriorated. The concrete panels remain sound and robust. The Cable Test Facility was built in 1968 and includes a 25-foot-long by 18-inch-diameter hydraulic ram housed in a wooden structure. A compressor located in Building 23 adjacent and to the north of Building 121 supplied hydraulic pressure for the ram. The equipment layout continues beyond the footprint of the structure. The Cable Test Facility also includes concrete and steel anchorages, pulling yokes, and steel guides mounted in a concrete slab. Extensive foundations and a series of three underground cable test anchors are known from the construction documents. The westernmost anchor is attached to the hydraulic ram and serves to support the cable test structure. A dirt road bed extends approximately 1,350 feet to the east and connects to two additional steel “Deadmen” anchored into the soil—one at 950 feet from the ram and the second at 1,350 feet from the ram. Underground footings for the cable test anchors extend down close to 20 feet

below the surface. Remnants of the pulling cable are visible on and under the dirt surface.

The wood structure or hydraulic ram enclosure consists of two-by-four framing, plywood siding, and timber construction to form a cover and, in some areas, an insulated space over the equipment. The roof is flat and evidence of an asphalt tar and fabric roofing material is visible. Two wood doors and frames exist on the north elevation. The east and west portions of the structure are open and provide overhead protection only for the equipment. This structure provides basic weather protection for a significant machinery array and its extensive foundation system. It is apparent that the machinery and equipment were installed first and the basic wooden structure assembled over it. The wood structure provides very little head room and in some locations rests upon the steel framing of the equipment.

The structure is currently weatherworn and all evidence of paint and most of the roofing are gone. The equipment appears to be in good condition although not usable.

## **INTEGRITY ISSUES AND POTENTIAL FOR CONTAMINATION**

The LANL Cultural Resources Team has developed four integrity codes to assess potentially eligible properties. The integrity requirements for properties eligible under Criterion A are less stringent than for those properties eligible under Criterion C. A historically significant property with a level 3 integrity could still be eligible, especially if an element of historical uniqueness is involved. Properties eligible under Criterion C should have no lower than a level 2 integrity. Level 4 integrity properties are not eligible for the Register.

1. Excellent Integrity - the property is still closely associated with its primary context and retains integrity of location, design, setting, workmanship, materials, feeling, and



association. Little or no remodeling has occurred to the property and all remodeling is in keeping with its associated historic context/significant use period.

2. Good Integrity - the property's interior and exterior retain historic feeling and character but some of the original significant equipment may be gone. The property may have had minor remodeling.
3. Fair Integrity - a property in this category should retain original location, setting, association, and exterior design. All associated interior machinery/equipment may be absent but the essential question is "Is this property still recognizable to a contemporary of the building's historic period?"
4. Poor Integrity - the property has no connection with the historically significant setting, feeling, and context. Major changes to the property have occurred. The property would be unrecognizable to a contemporary.

### **Integrity**

Both properties at TA-49 have suffered a loss of physical integrity since their period of significance during the 1960s, primarily because they have been vacant for many years. However, the significance of their association with the events at TA-49 that supported nuclear testing outweighs the effects of abandonment and time.

### **Contamination**

The underground experiments conducted at Area 12 included high explosives and uranium-238; therefore, high explosive and radiological contamination could be present in the vicinity of both properties.

## **ELIGIBILITY RECOMMENDATION**

TA-49-23 and TA-49-121, although in fair to poor physical condition, are eligible for nomination to the National Register of Historic Places. This determination is made under Criterion A of the National Historic Preservation Act of 1966, due to their association with important events during the Cold War years at Los Alamos (U.S. Department of Interior 1991). Operations conducted at TA-49 from 1959 to 1961 supported critically important nuclear safety tests in a time when testing had been discontinued at the Nevada Test Site in accordance with the voluntary test ban that began in 1958. The Bottle House (TA-49-23) is significant because it is the last physical remnant of these Cold War hydronuclear experiments. The Cable Test Facility (TA-49-121) was in use during the 1960s and early 1970s, and, like the hydronuclear experiments at TA-49, also played a role in supporting the underground testing program at Nevada.

## REFERENCES CITED

Kistiakowsky, G.

- 1976 *A Scientist at the White House: The Private Diary of President Eisenhower's Special Assistant for Science and Technology*. Harvard University Press, Cambridge, Massachusetts.

Los Alamos National Laboratory

- 1986 Los Alamos CEARP Phase 1 Working Draft, TA-49 Frijoles Mesa Site. Los Alamos National Laboratory, Los Alamos, New Mexico.
- 1992 RFI Workplan for Operable Unit 1144, Environmental Restoration Program. Los Alamos National Laboratory, Los Alamos, New Mexico.
- 2000 Physics Division Progress Report; P-22: Hydrodynamics and X-Ray Physics. Los Alamos National Laboratory, Los Alamos, New Mexico.

New Mexico Environment Department

- 2002 Los Alamos National Laboratory Order. Portable document format (PDF) file available at <http://swrc.lanl.gov/programs/CompOrder/20021126CO.pdf>

Neal, T.R.

- 1993 AGEX I: The Explosives Regime of Weapons Physics. *Los Alamos Science* (21):54–62.

Thorn, R. and D. Westervelt

- 1987 *Hydronuclear Experiments*. LA-10902-MS. Los Alamos National Laboratory, Los Alamos, New Mexico.

U.S. Department of the Interior

- 1991 How to Apply the National Register Criteria for Evaluation. In: *National Register Bulletin*, No. 15, U.S. National Park Service, Washington, D.C.

## **Appendix**

### **Selected Photographs and Drawings: TA-49-23 and TA-49-121**



TA-49-23, Bottle House, south and east sides (2005)

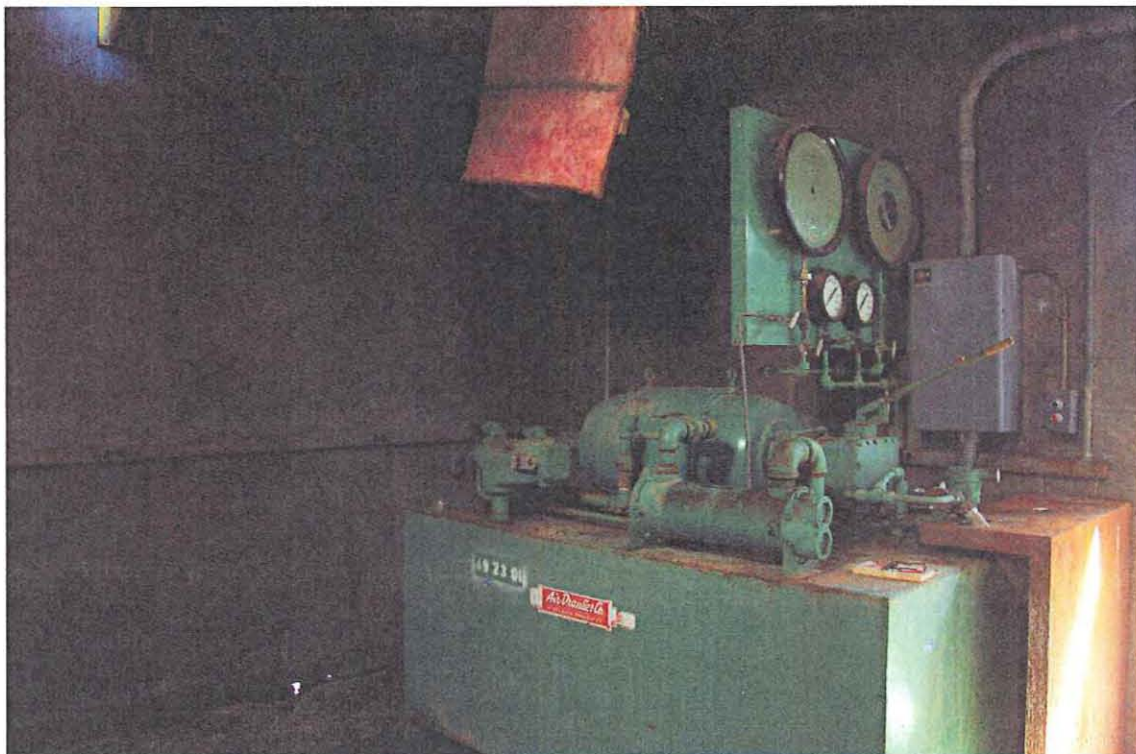


TA-49-23, Bottle House, north and west sides (2005)

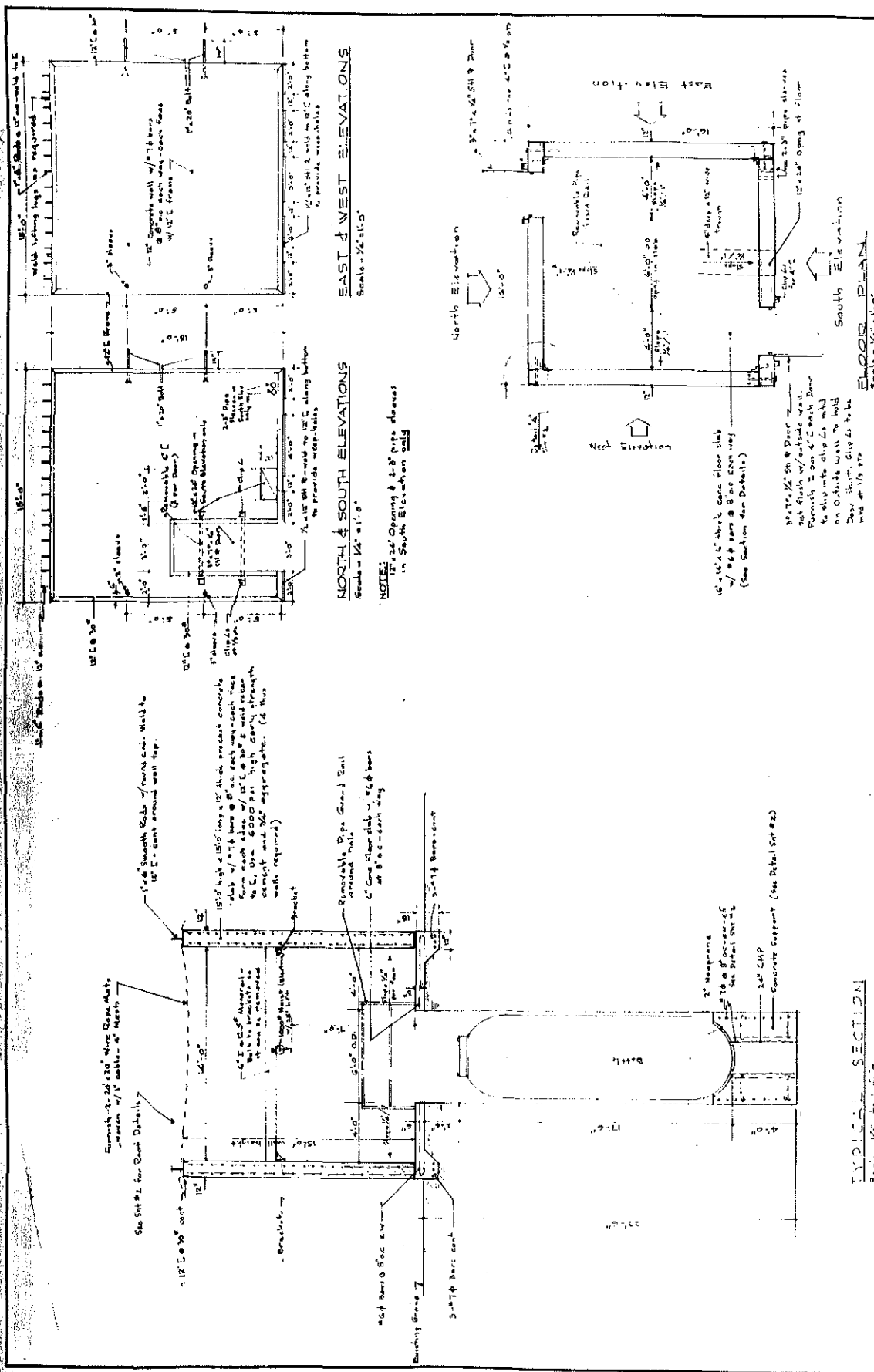




TA-49-23, hydraulic compressor for the Cable Test Facility (TA-49-121) (1971)

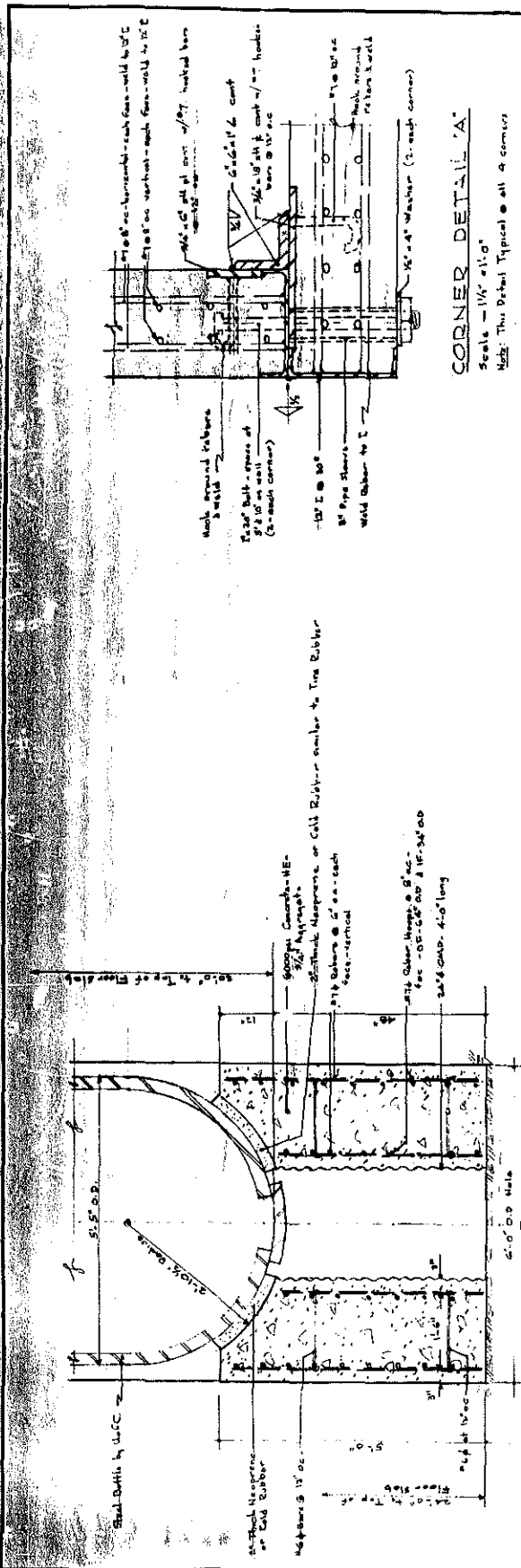


TA-49-23, hydraulic compressor for Cable Test Facility (TA-49-121) (1971)

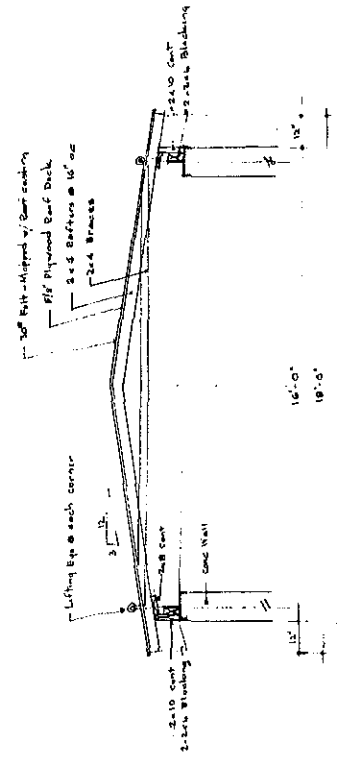


|                                |  |                                |  |
|--------------------------------|--|--------------------------------|--|
| U. S. ATOMIC ENERGY COMMISSION |  | LOS ALAMOS, NEW MEXICO         |  |
| DRAWING NO.                    |  | 12                             |  |
| DRAWN JF MUI                   |  | J. 6 AREA, TA. 49 BOTTLE HOUSE |  |
| CHECKED                        |  | PLANS & DETAILS FM:23          |  |
| DATE 1-11-50                   |  | THE ZIA COMPANY                |  |
| SHEET                          |  | APPROVED                       |  |
| 1                              |  | SUBMITTED                      |  |
| 2                              |  | RECOMMENDED                    |  |
|                                |  | APPROVED                       |  |

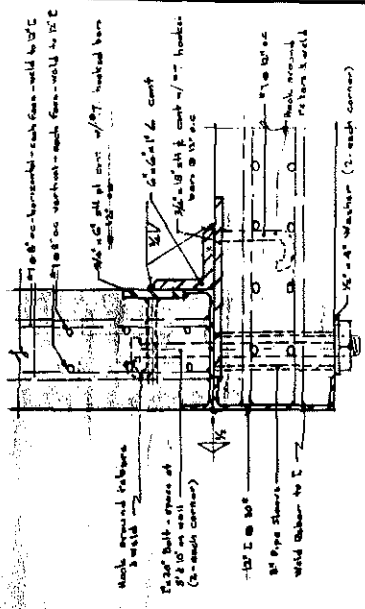
CONSULTED COPY  
L129.50 - JFM



**DETAIL OF CONCRETE SUPPORT FOR STEEL BOTTLE**  
 Scale - 3/4" = 1'-0"



**REMOVABLE ROOF DETAIL**  
 Scale - 3/4" = 1'-0"

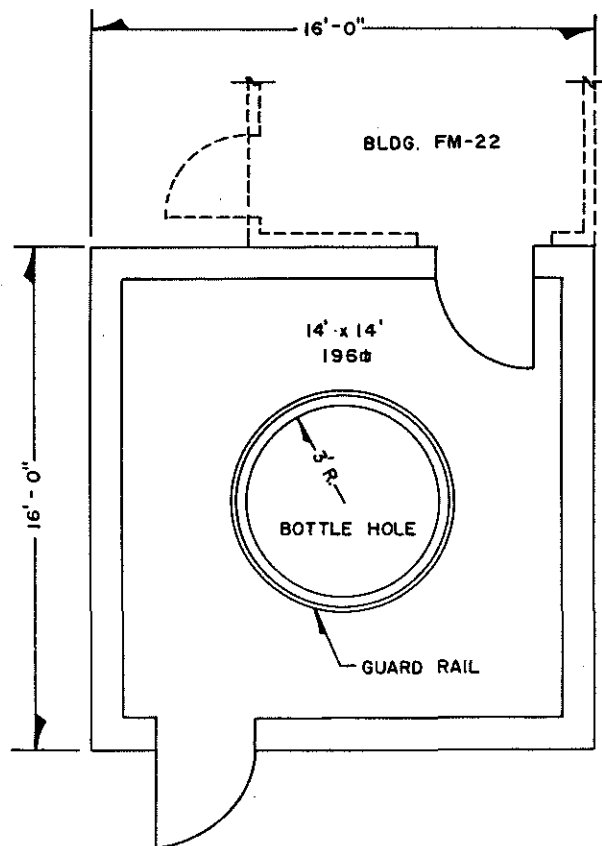


**CORNER DETAIL 'A'**  
 Scale - 1 1/4" = 1'-0"  
 Note: This Detail Typical @ all 4 corners

|                                |  |                        |  |
|--------------------------------|--|------------------------|--|
| U. S. ATOMIC ENERGY COMMISSION |  | LOS ALAMOS, NEW MEXICO |  |
| REVELATION                     |  | DRAWING NO.            |  |
| J-6 AREA, TA-49, BOTTLE HOUSE  |  | DRAWN J.P.L.           |  |
| DETAILS                        |  | CHECKED                |  |
| THE ZIA COMPANY                |  | DATE 1-17-60           |  |
| SUBMITTED                      |  | RECOMMENDED            |  |
| APPROVED                       |  | APPROVED               |  |
| REVISIONS                      |  | SHEET 2 OF 2           |  |
| REVISED                        |  | DRAWN                  |  |

CONNECTED COPY  
 1-28-60 - JPM

028275



REVIEWER M. D. [Signature]  
 CLASS V DATE 3/19/74

|     |         |                              |        |             |                     |
|-----|---------|------------------------------|--------|-------------|---------------------|
| 1   | 3-19-74 | REVISED TO STATUS OF 3-19-74 | D.A.D. | [Signature] | [Signature]         |
| NO. | DATE    | REVISIONS                    | BY     | CHKD        | GRP. ENG. LDR. D.O. |

**LOS ALAMOS SCIENTIFIC LABORATORY**  
 ENGINEERING DEPARTMENT  
 UNIVERSITY OF CALIFORNIA — LOS ALAMOS, NEW MEXICO

**BOTTLE HOUSE**  
 FLOOR PLAN  
 BLDG. FM-23 TA - 49

| AUTHORIZED FOR |  |
|----------------|--|
| HEALTH         |  |
| SAFETY         |  |
| FIRE PROT.     |  |
| SEC.           |  |

|                                       |                                |         |               |
|---------------------------------------|--------------------------------|---------|---------------|
| APPROVALS:                            | DESIGN:                        | DATE    | SCALE         |
| ENG. GROUP: <u>3</u> <u>SER</u>       | DESIGNER: <u>GLASS</u>         | 9/14/64 | 1/4" = 1'-0"  |
| DIVISION:                             | PROJ. ENG.: <u>[Signature]</u> | SHEET   | SKETCH NO.    |
| ENG. DEPT. OFFICE: <u>[Signature]</u> | <u>76</u>                      | 1 of 1  | ENG. - R 3214 |

TOTAL SQ. FT. 196





TA-49-121, Cable Test Facility, with Hydraulic Ram Enclosure, north side (2005)



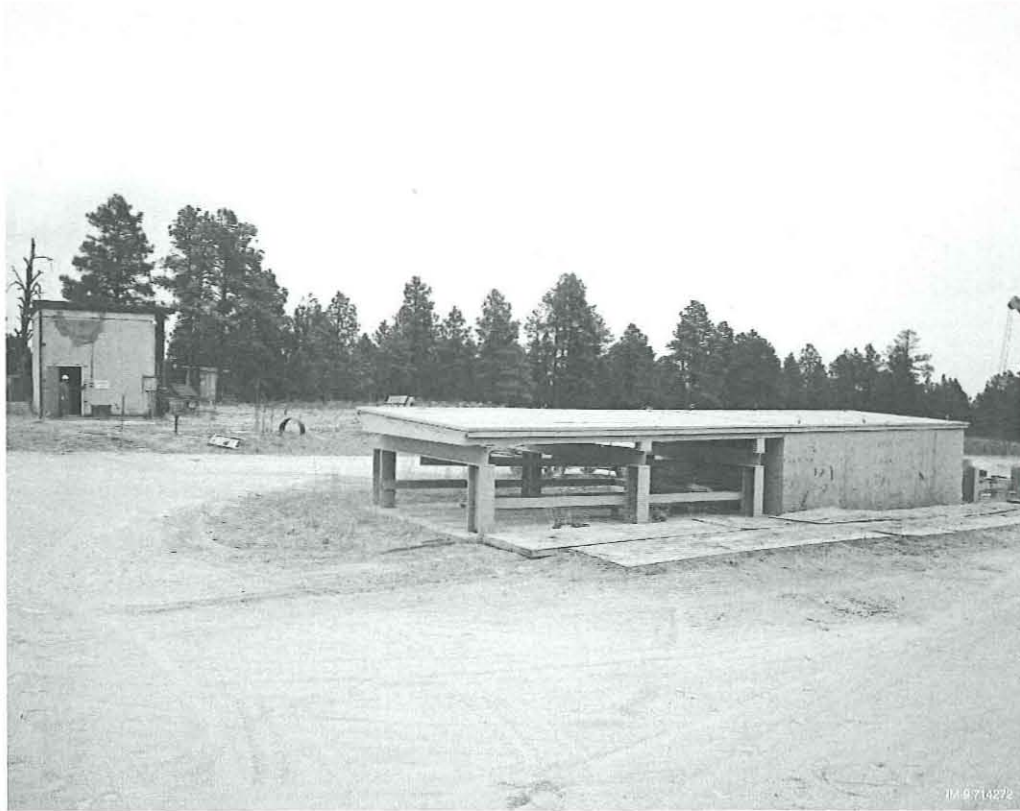


TA-49-121, Hydraulic Ram Enclosure, direction southeast (2005)



TA-49-121, Hydraulic Ram Enclosure, direction northwest (2005)



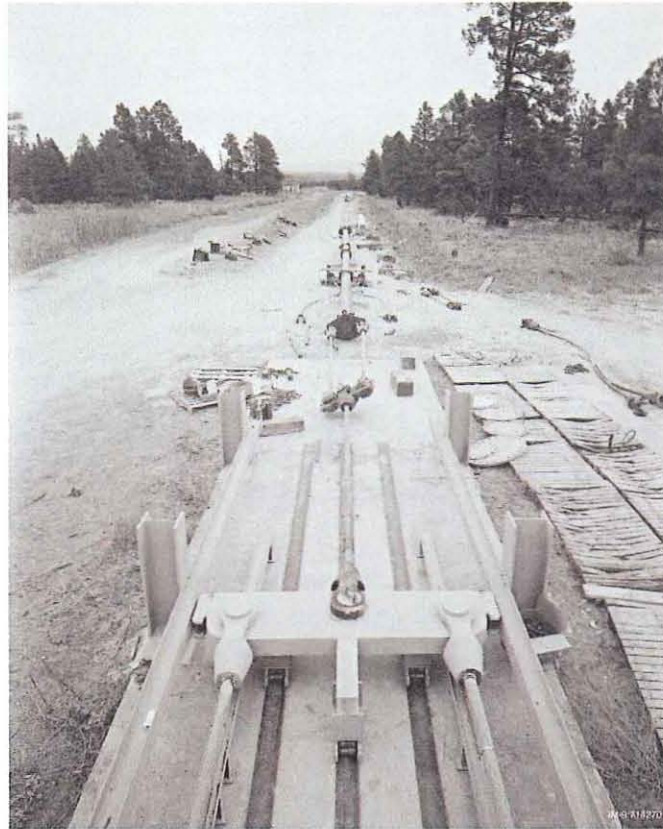


TA-49-121, west and south sides, TA-49-23 in left background (1971)

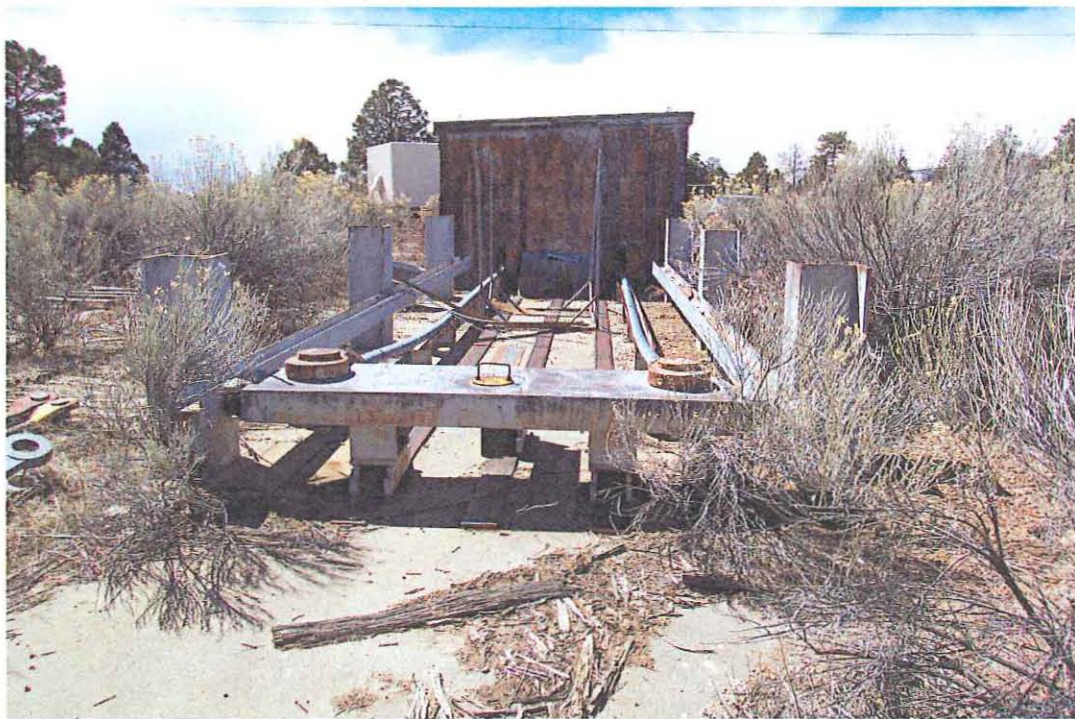


TA-49-121, east side, TA-49-23 in right background (2005)

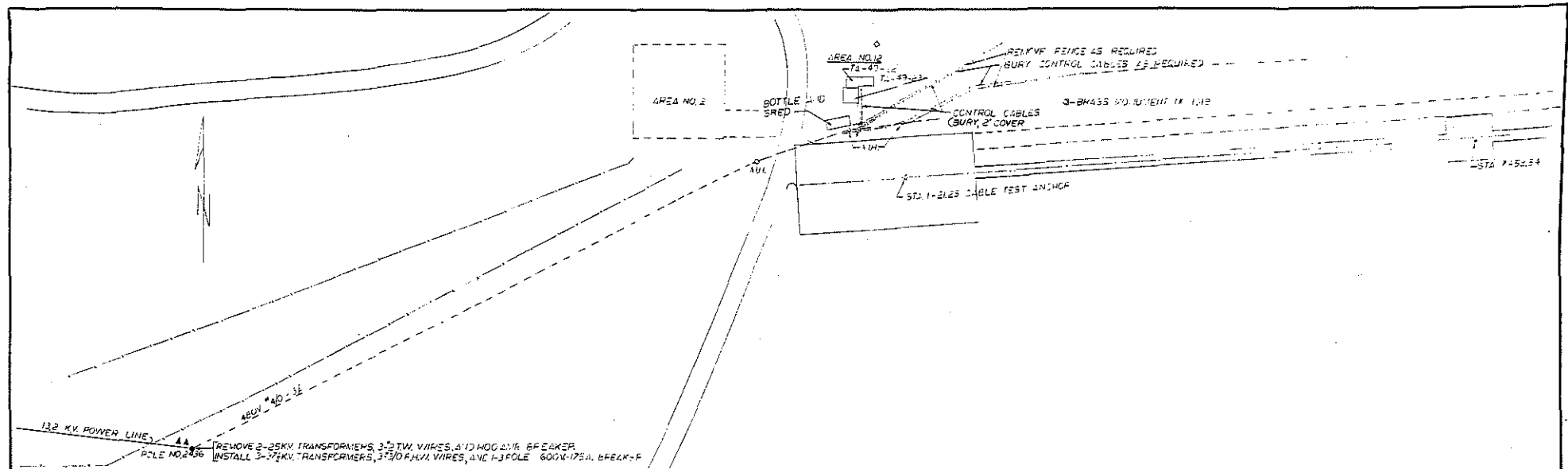




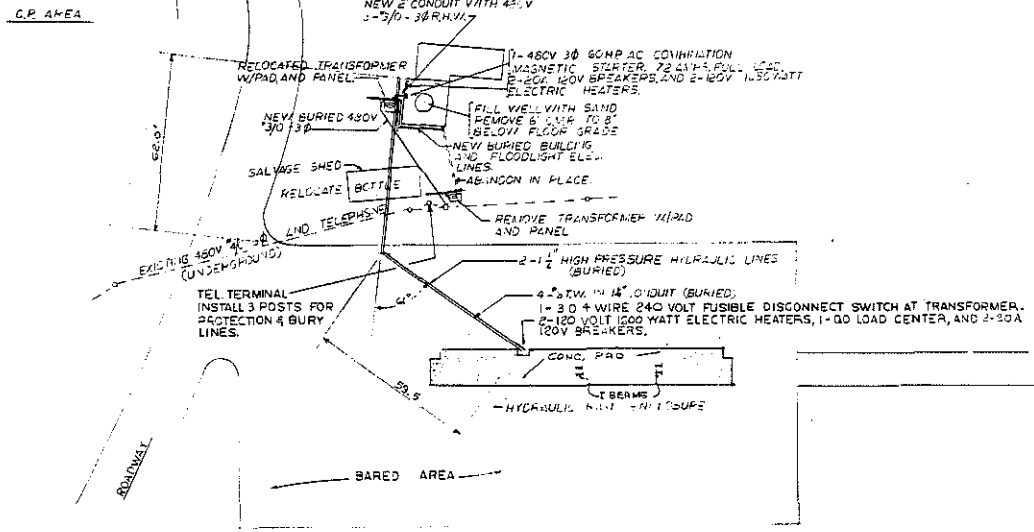
TA-49-121 cable system, east portion of Cable Test Facility and pallets located south of building, direction east (1971)



TA-49-121 cable system, east portion of Cable Test Facility, direction west (2005)



PLOT PLAN  
SCALE 1"=50'

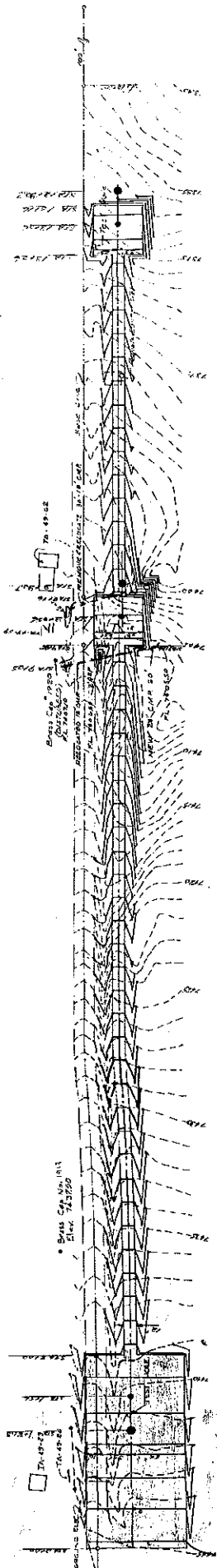


PLOT PLAN AREA NO. 12  
SCALE 1"=20'

|                                |             |                        |        |
|--------------------------------|-------------|------------------------|--------|
| U. S. ATOMIC ENERGY COMMISSION |             | LOS ALAMOS, NEW MEXICO |        |
| TA-49 CABLE TEST FACILITY      |             | DRAWING NO.            |        |
| AREA NO-12 PLOT PLAN           |             | DRAWN                  |        |
| THE ZIA COMPANY                |             | CHECKED                |        |
| REVISIONS                      |             | DATE                   |        |
| SUBMITTED                      | RECOMMENDED | APPROVED               | OF     |
| 1                              |             |                        | 1      |
|                                |             |                        | SHEETS |







PLOT PLAN  
SCALE 1" = 50'

|                               |                 |                      |          |
|-------------------------------|-----------------|----------------------|----------|
| U.S. ATOMIC ENERGY COMMISSION |                 | LOS ALAMOS, NEW MEX. |          |
| CABLE TEST FACILITY           |                 | 343                  |          |
| PROJECT NO.                   | 11-45           | DATE                 | 12-15-52 |
| DESIGNED BY                   | THE ZIA COMPANY | APPROVED BY          | 1        |
| REVISIONS                     |                 |                      |          |

NOTE: THE ABOVE DRAWING IS A PRELIMINARY DESIGN AND IS SUBJECT TO CHANGE WITHOUT NOTICE. THE CONTRACTOR SHALL BE RESPONSIBLE FOR OBTAINING ALL NECESSARY PERMITS AND APPROVALS FROM THE LOCAL AUTHORITIES. THE CONTRACTOR SHALL ALSO BE RESPONSIBLE FOR OBTAINING ALL NECESSARY PERMITS AND APPROVALS FROM THE LOCAL AUTHORITIES.

| NO. | DESCRIPTION | DATE | BY  | CHKD. |
|-----|-------------|------|-----|-------|
| 1   | ...         | ...  | ... | ...   |
| 2   | ...         | ...  | ... | ...   |
| 3   | ...         | ...  | ... | ...   |
| 4   | ...         | ...  | ... | ...   |
| 5   | ...         | ...  | ... | ...   |
| 6   | ...         | ...  | ... | ...   |
| 7   | ...         | ...  | ... | ...   |
| 8   | ...         | ...  | ... | ...   |
| 9   | ...         | ...  | ... | ...   |
| 10  | ...         | ...  | ... | ...   |
| 11  | ...         | ...  | ... | ...   |
| 12  | ...         | ...  | ... | ...   |
| 13  | ...         | ...  | ... | ...   |
| 14  | ...         | ...  | ... | ...   |
| 15  | ...         | ...  | ... | ...   |
| 16  | ...         | ...  | ... | ...   |
| 17  | ...         | ...  | ... | ...   |
| 18  | ...         | ...  | ... | ...   |
| 19  | ...         | ...  | ... | ...   |
| 20  | ...         | ...  | ... | ...   |
| 21  | ...         | ...  | ... | ...   |
| 22  | ...         | ...  | ... | ...   |
| 23  | ...         | ...  | ... | ...   |
| 24  | ...         | ...  | ... | ...   |
| 25  | ...         | ...  | ... | ...   |
| 26  | ...         | ...  | ... | ...   |
| 27  | ...         | ...  | ... | ...   |
| 28  | ...         | ...  | ... | ...   |
| 29  | ...         | ...  | ... | ...   |
| 30  | ...         | ...  | ... | ...   |
| 31  | ...         | ...  | ... | ...   |
| 32  | ...         | ...  | ... | ...   |
| 33  | ...         | ...  | ... | ...   |
| 34  | ...         | ...  | ... | ...   |
| 35  | ...         | ...  | ... | ...   |
| 36  | ...         | ...  | ... | ...   |
| 37  | ...         | ...  | ... | ...   |
| 38  | ...         | ...  | ... | ...   |
| 39  | ...         | ...  | ... | ...   |
| 40  | ...         | ...  | ... | ...   |
| 41  | ...         | ...  | ... | ...   |
| 42  | ...         | ...  | ... | ...   |
| 43  | ...         | ...  | ... | ...   |
| 44  | ...         | ...  | ... | ...   |
| 45  | ...         | ...  | ... | ...   |
| 46  | ...         | ...  | ... | ...   |
| 47  | ...         | ...  | ... | ...   |
| 48  | ...         | ...  | ... | ...   |
| 49  | ...         | ...  | ... | ...   |
| 50  | ...         | ...  | ... | ...   |
| 51  | ...         | ...  | ... | ...   |
| 52  | ...         | ...  | ... | ...   |
| 53  | ...         | ...  | ... | ...   |
| 54  | ...         | ...  | ... | ...   |
| 55  | ...         | ...  | ... | ...   |
| 56  | ...         | ...  | ... | ...   |
| 57  | ...         | ...  | ... | ...   |
| 58  | ...         | ...  | ... | ...   |
| 59  | ...         | ...  | ... | ...   |
| 60  | ...         | ...  | ... | ...   |
| 61  | ...         | ...  | ... | ...   |
| 62  | ...         | ...  | ... | ...   |
| 63  | ...         | ...  | ... | ...   |
| 64  | ...         | ...  | ... | ...   |
| 65  | ...         | ...  | ... | ...   |
| 66  | ...         | ...  | ... | ...   |
| 67  | ...         | ...  | ... | ...   |
| 68  | ...         | ...  | ... | ...   |
| 69  | ...         | ...  | ... | ...   |
| 70  | ...         | ...  | ... | ...   |
| 71  | ...         | ...  | ... | ...   |
| 72  | ...         | ...  | ... | ...   |
| 73  | ...         | ...  | ... | ...   |
| 74  | ...         | ...  | ... | ...   |
| 75  | ...         | ...  | ... | ...   |
| 76  | ...         | ...  | ... | ...   |
| 77  | ...         | ...  | ... | ...   |
| 78  | ...         | ...  | ... | ...   |
| 79  | ...         | ...  | ... | ...   |
| 80  | ...         | ...  | ... | ...   |
| 81  | ...         | ...  | ... | ...   |
| 82  | ...         | ...  | ... | ...   |
| 83  | ...         | ...  | ... | ...   |
| 84  | ...         | ...  | ... | ...   |
| 85  | ...         | ...  | ... | ...   |
| 86  | ...         | ...  | ... | ...   |
| 87  | ...         | ...  | ... | ...   |
| 88  | ...         | ...  | ... | ...   |
| 89  | ...         | ...  | ... | ...   |
| 90  | ...         | ...  | ... | ...   |
| 91  | ...         | ...  | ... | ...   |
| 92  | ...         | ...  | ... | ...   |
| 93  | ...         | ...  | ... | ...   |
| 94  | ...         | ...  | ... | ...   |
| 95  | ...         | ...  | ... | ...   |
| 96  | ...         | ...  | ... | ...   |
| 97  | ...         | ...  | ... | ...   |
| 98  | ...         | ...  | ... | ...   |
| 99  | ...         | ...  | ... | ...   |
| 100 | ...         | ...  | ... | ...   |

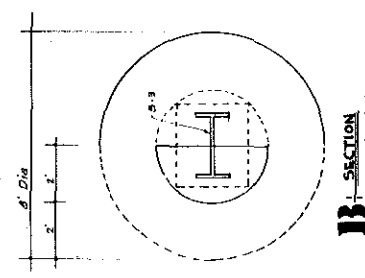


TA-49-121, pallets located south of building, direction northwest (2005)

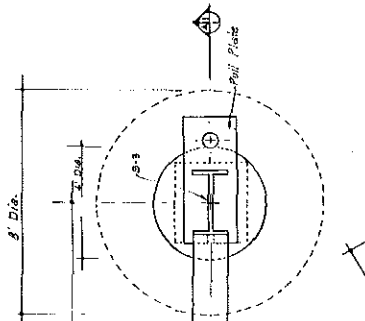


Anchor (above ground portion) located to the east of TA-49-121 Cable Test Facility, direction northeast (2005)

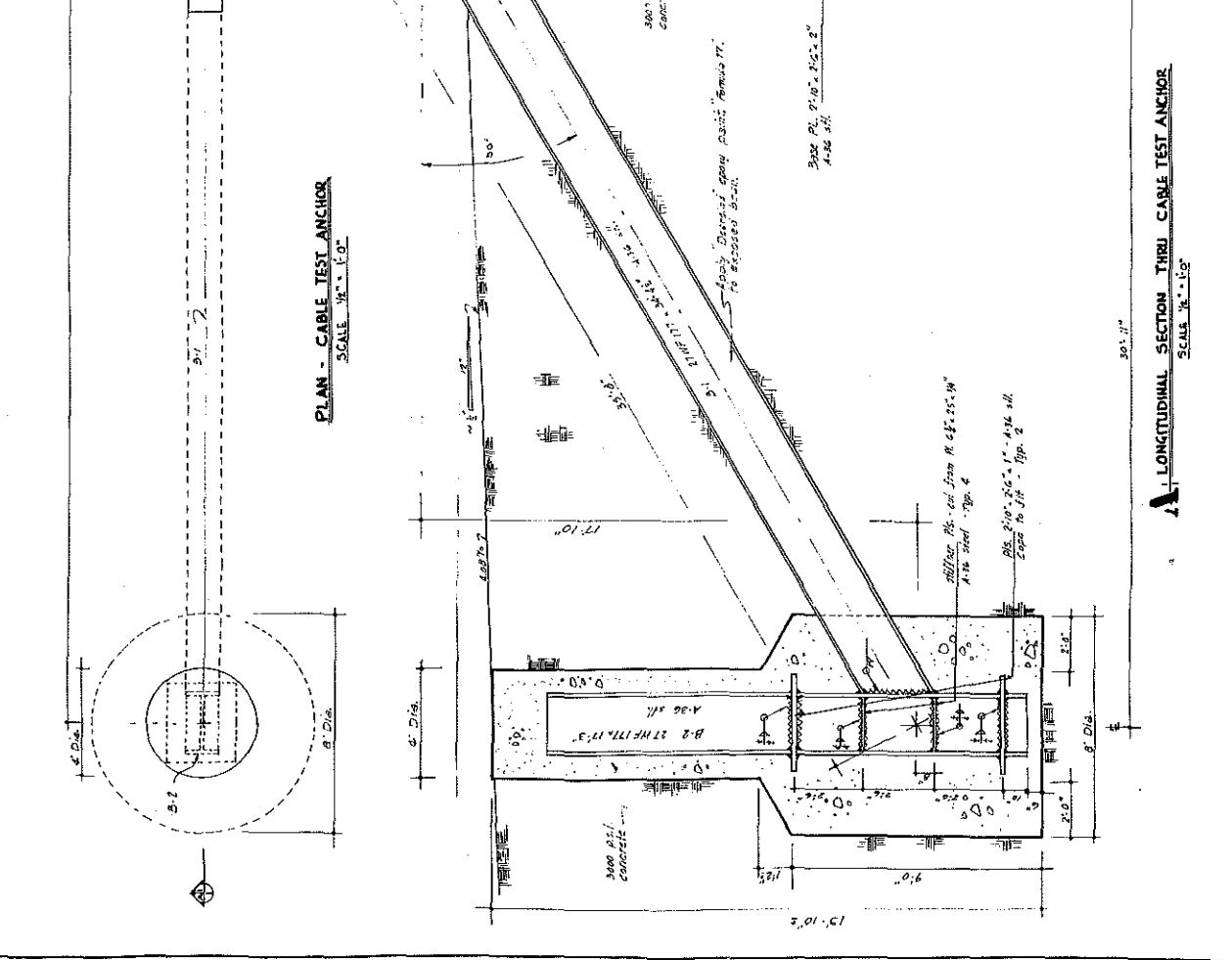




**B-B SECTION**  
SCALE 1/2" = 1'-0"



**A-A SECTION**  
SCALE 1/2" = 1'-0"



**LONGITUDINAL SECTION THRU CABLE TEST ANCHOR**  
SCALE 1/2" = 1'-0"

1. Fabricate in the shop the steel test anchor as shown.
2. Drill all diameter and fit diameter holes at their respective sizes.
3. Install fabricated steel parts in hole and fit dimensions as shown.
4. Make concrete in test hole as required.
5. The steel test anchor is subject to inspection and testing at location of Engineering.

SCALE OF WORK

|                                |                 |                        |          |
|--------------------------------|-----------------|------------------------|----------|
| U. S. ATOMIC ENERGY COMMISSION |                 | LOS ALAMOS, NEW MEXICO |          |
| TA-49 - CABLE TEST ANCHOR      |                 |                        |          |
| DESIGNED BY                    | THE ZIA COMPANY | DATE                   | 11/1/57  |
| CHECKED BY                     |                 | SCALE                  | AS SHOWN |
| APPROVED BY                    |                 | PROJECT NO.            | 1        |
| REVISIONS                      |                 |                        |          |

ENG-C 47238



TA-49-21, Latrine remains. TA-49-23, in the background, direction southwest (2005)