

### VIII. OBSERVATION WELLS TO MEET SPECIAL PERMIT CONDITIONS

The special permit conditions (dictated by the operating permit issued to the Department of Energy and the Los Alamos National Laboratory by the U.S. Environmental Protection Agency) required construction of special observation wells to monitor the quality of water in the alluvium.

Observation wells were constructed in Pueblo Canyon (one well), Los Alamos Canyon (five wells), Sandia Canyon (two wells), Mortandad Canyon (five wells), Potrillo Canyon (one core hole), Fence Canyon (one well), and Water Canyon (three wells). Generalized location of the wells and core hole are shown on Fig. VIII-A.

The observation well elevations and measuring points are shown on Table VIII-A, while well characteristics and water levels are shown on Table VIII-B. The types of wellhead security locks used on these wells are shown in Fig. VIII-B. Graphic presentations of the geologic logs and construction data are shown in Figs. VIII-C through VIII-T.

The observation wells were constructed using a

hollow-stem auger. The auger had an inside diameter of 6.25 in., and an outside diameter of 9.625 in. It was used with a 10.375-in.-diam bit. The holes were cased using 2-in.-diam plastic pipe in 5- or 10-ft lengths, with flush-joint, internal-upset, threaded-type connections. The hole packing material was 0.010–0.020-in.-diam Colorado silica sand with a compatible screen slot (of 0.010 in.) in the plastic casing.

### REFERENCES

R. A. Bailey, R. L. Smith, and C. S. Ross, "Stratigraphic Nomenclature of the Volcanic Rocks of the Jemez Mountains, New Mexico," U.S. Geological Survey Bulletin 1274-P (1969).

Environmental Protection Group HSE-8, "Perched Zone Monitoring Wells Analytical Results," Los Alamos National Laboratory document LA-UR-90-4300.

W. D. Purtymun and A. K. Stoker, "Perched Zone Monitoring Well Installation," Los Alamos National Laboratory document LA-UR-90-3230.

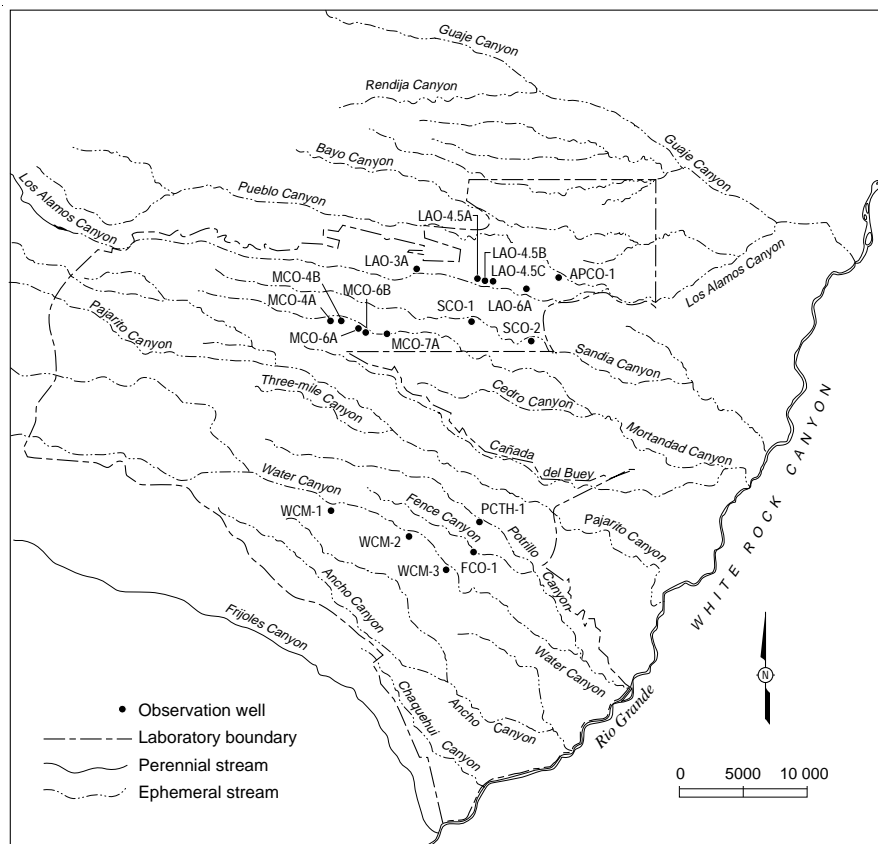
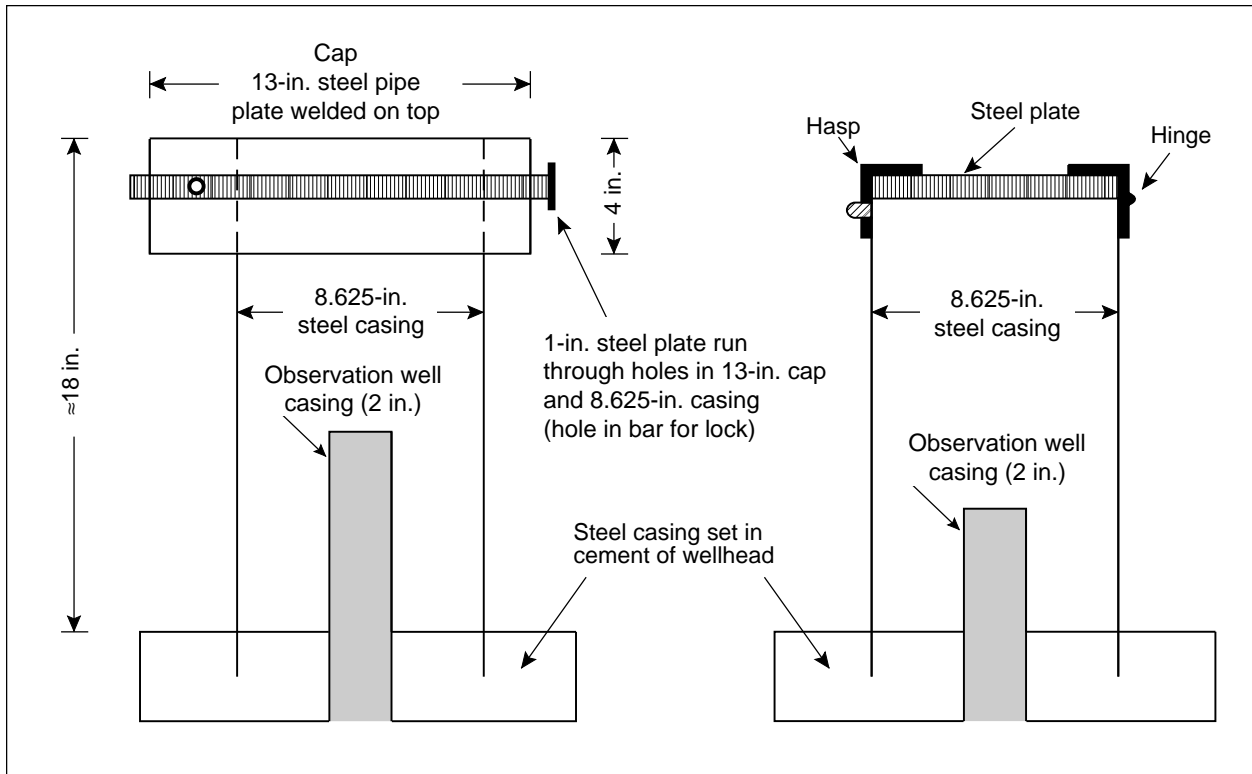
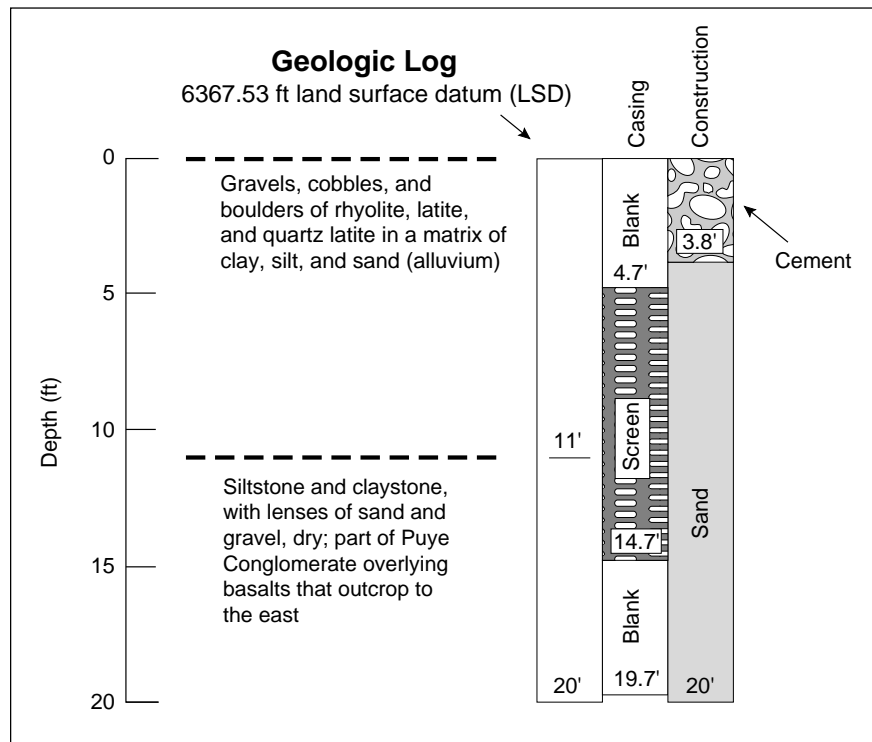


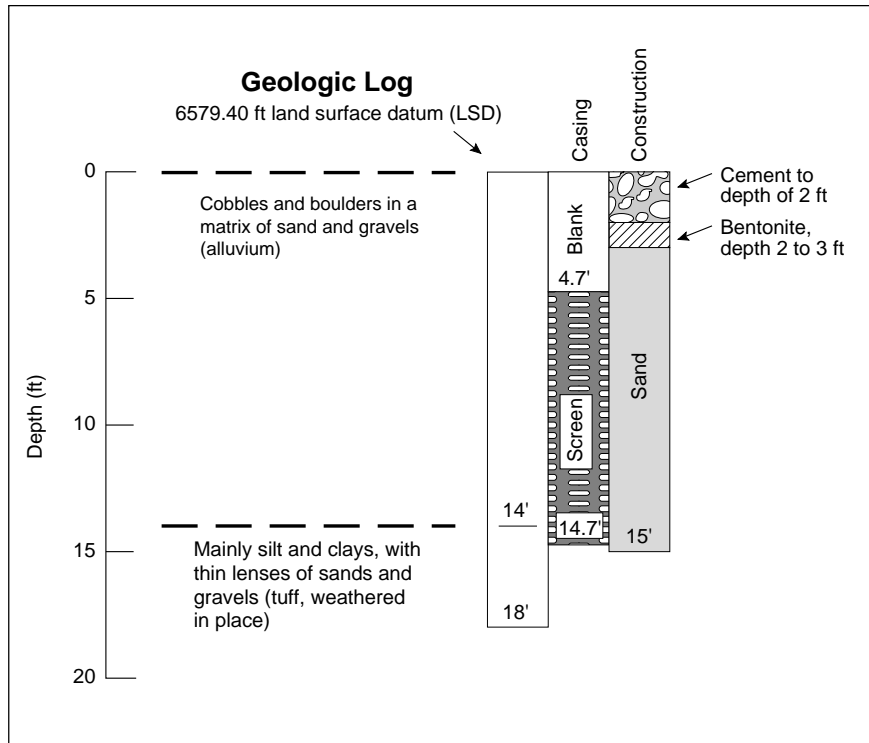
Fig. VIII-A. Locations of observation wells to meet special permit conditions.



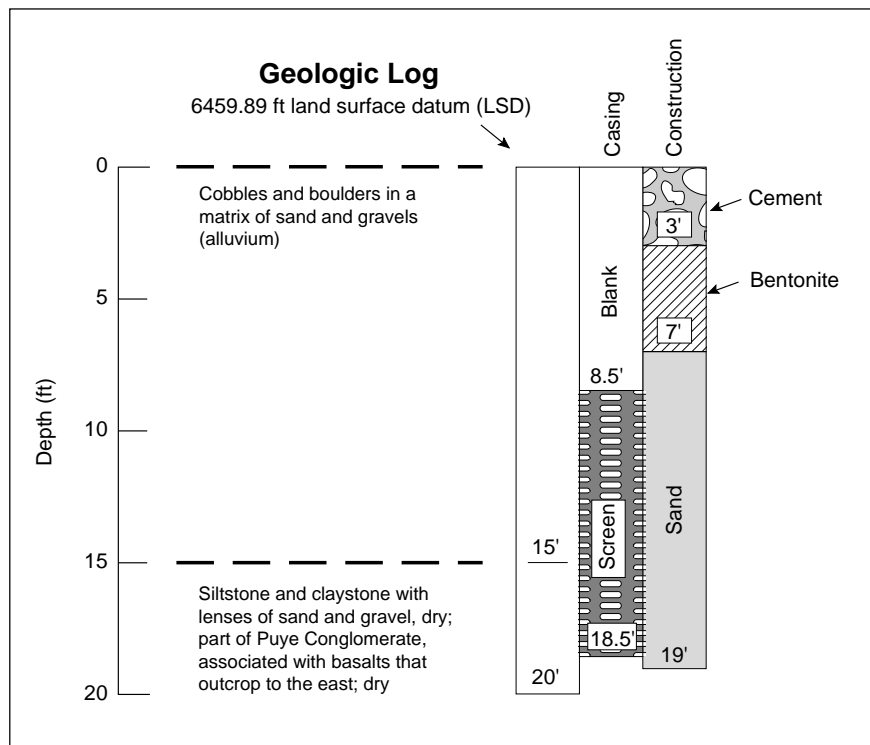
**Fig. VIII-B.** Type of wellhead security used on observation wells (Purtymun and Stoker 1990).



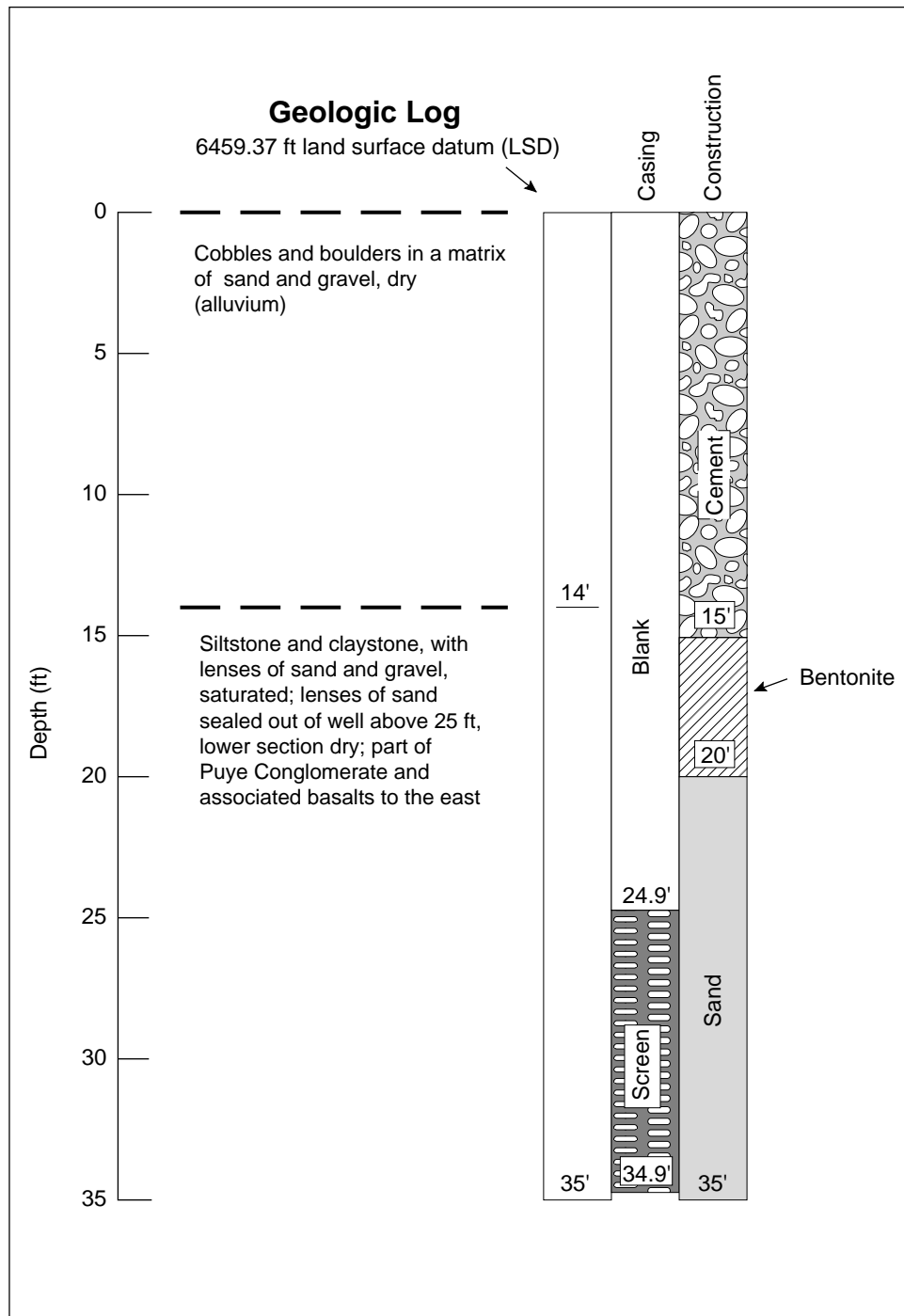
**Fig. VIII-C.** Pueblo Canyon observation well APCO-1, completed August 1990, water level 6.2 ft (Purtymun and Stoker 1990).



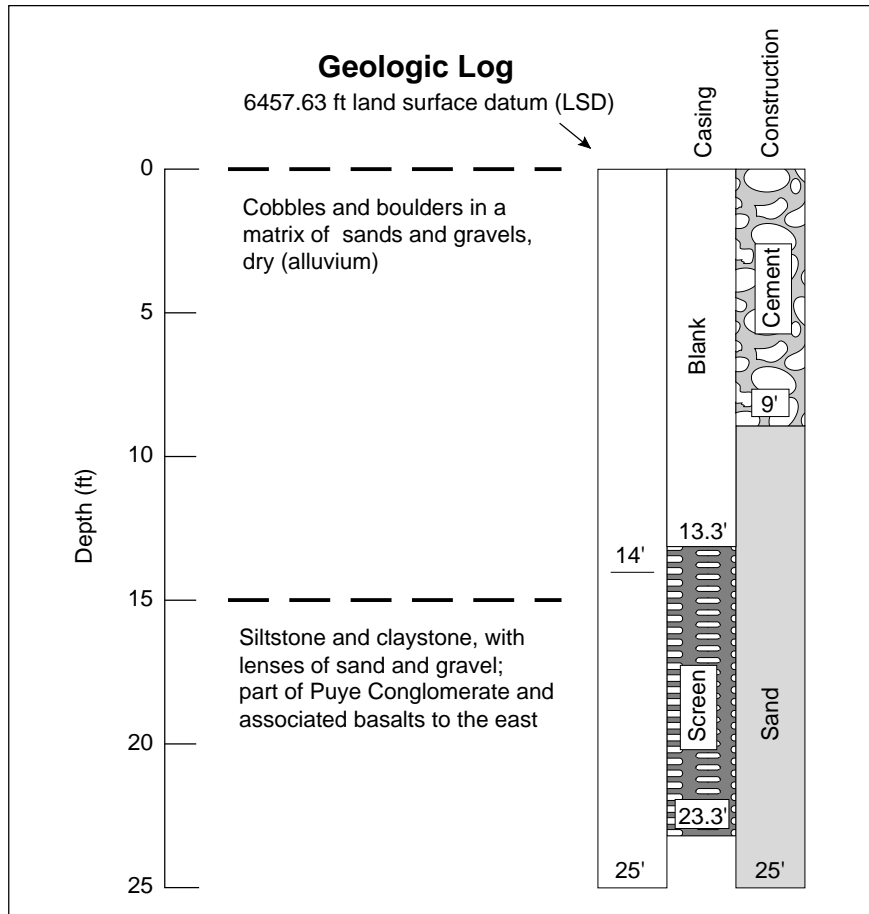
**Fig. VIII-D.** Los Alamos Canyon observation well LAO-3A, completed September 1989, water level 6.7 ft (Purtymun and Stoker 1990).



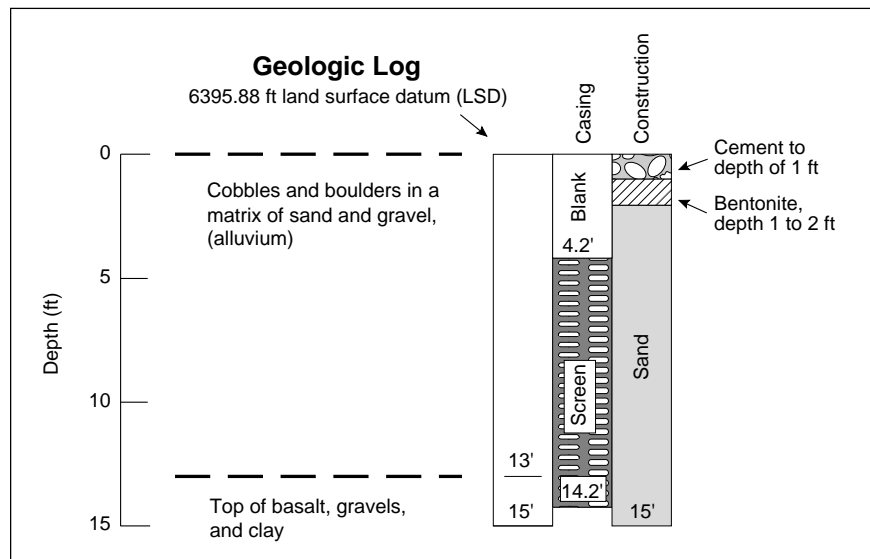
**Fig. VIII-E.** Los Alamos Canyon observation well LAO-4.5A, completed September 1989, dry (Purtymun and Stoker 1990).



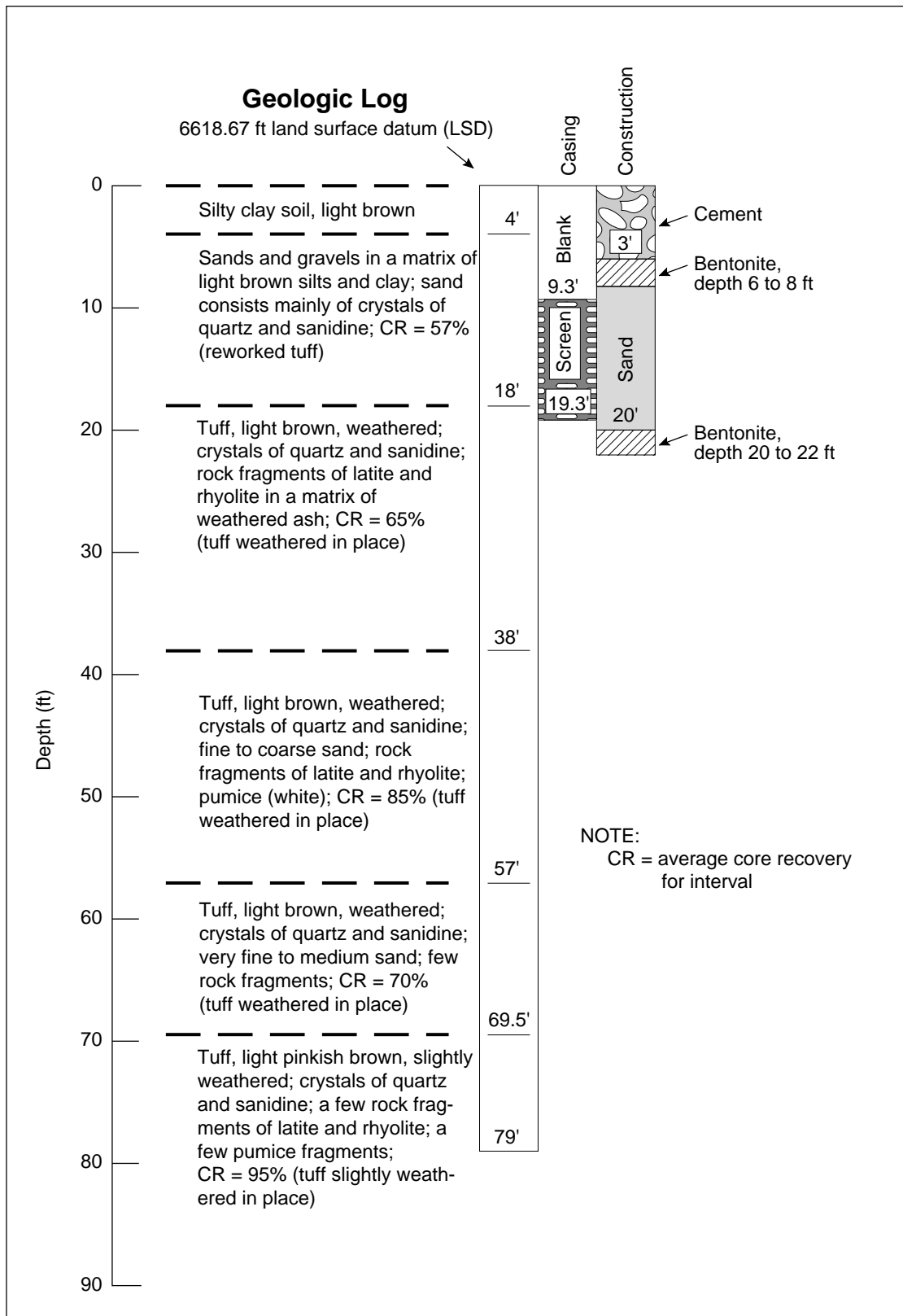
**Fig. VIII-F.** Los Alamos canyon observation well LAO-4.5B, completed September 1989, dry (Purtymun and Stoker 1990).



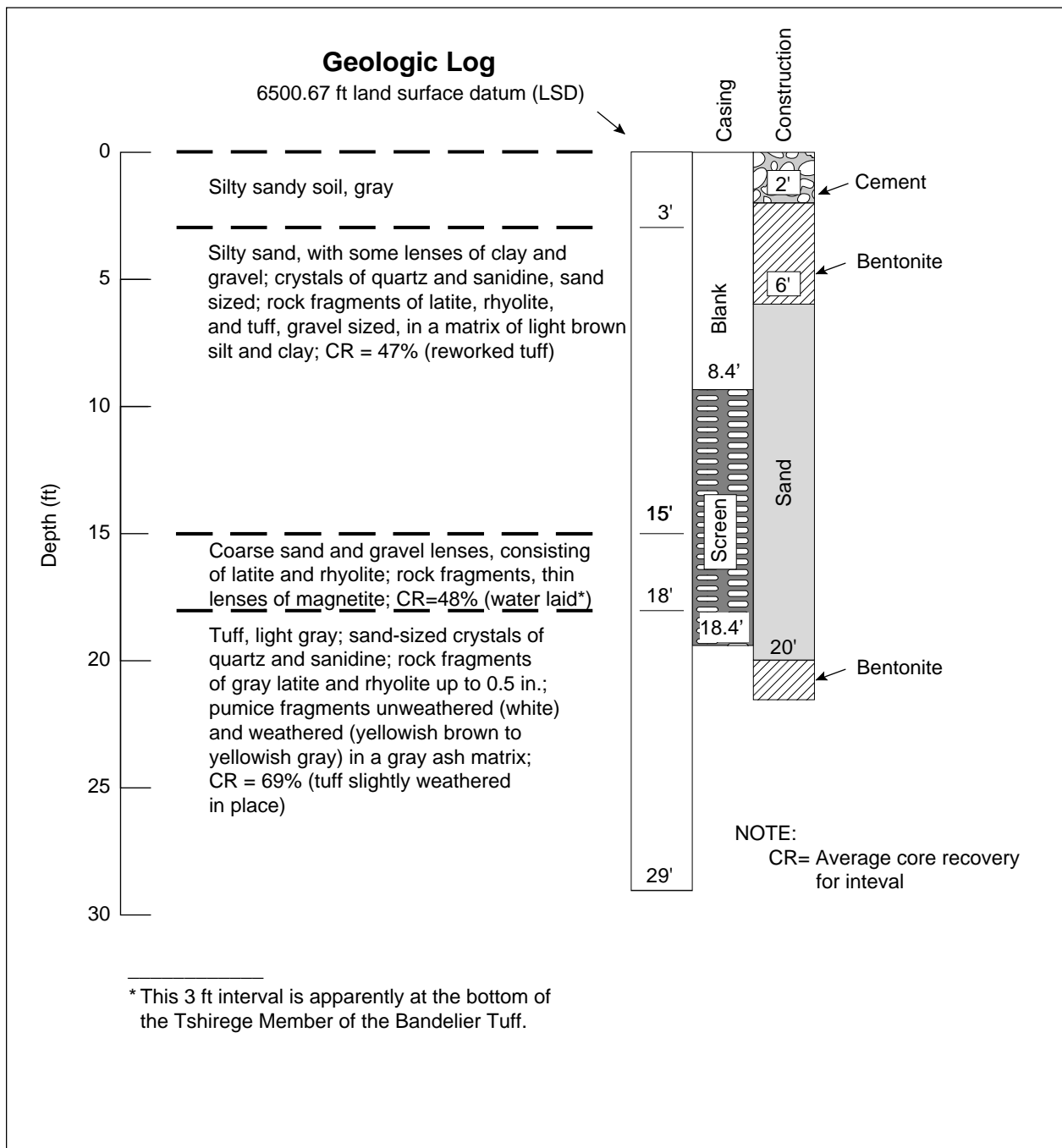
**Fig. VIII-G.** Los Alamos Canyon observation well LAO-4.5C, completed November 1989, water level 10.6 ft (Purtymun and Stoker 1990).



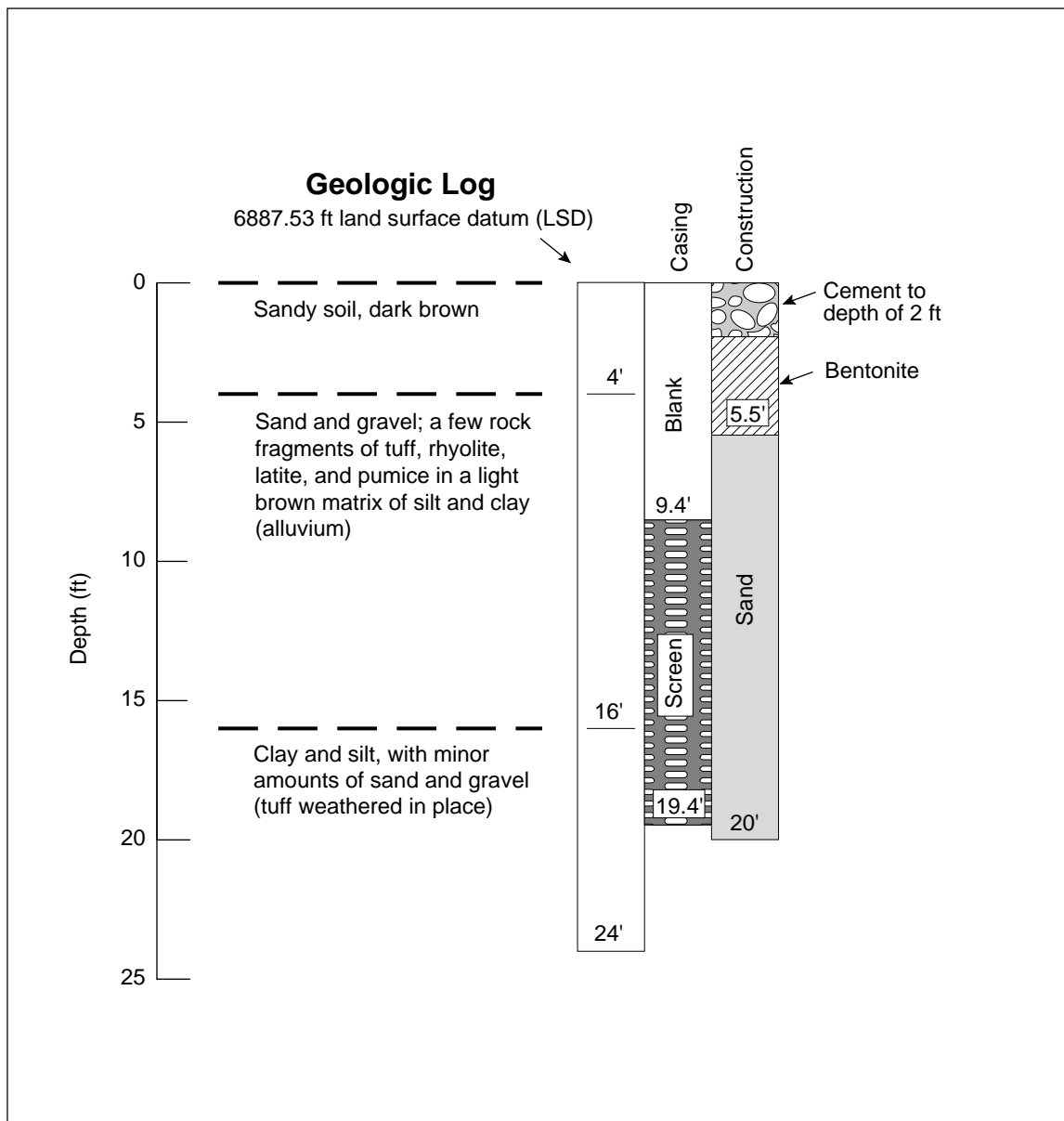
**Fig. VIII-H.** Los Alamos Canyon observation well LAO-6A, completed August 1989, water level 9.0 ft (Purtymun and Stoker 1990).



**Fig. VIII-I.** Sandia Canyon observation well SCO-1, completed August 1989, dry (Purtymun and Stoker 1990).

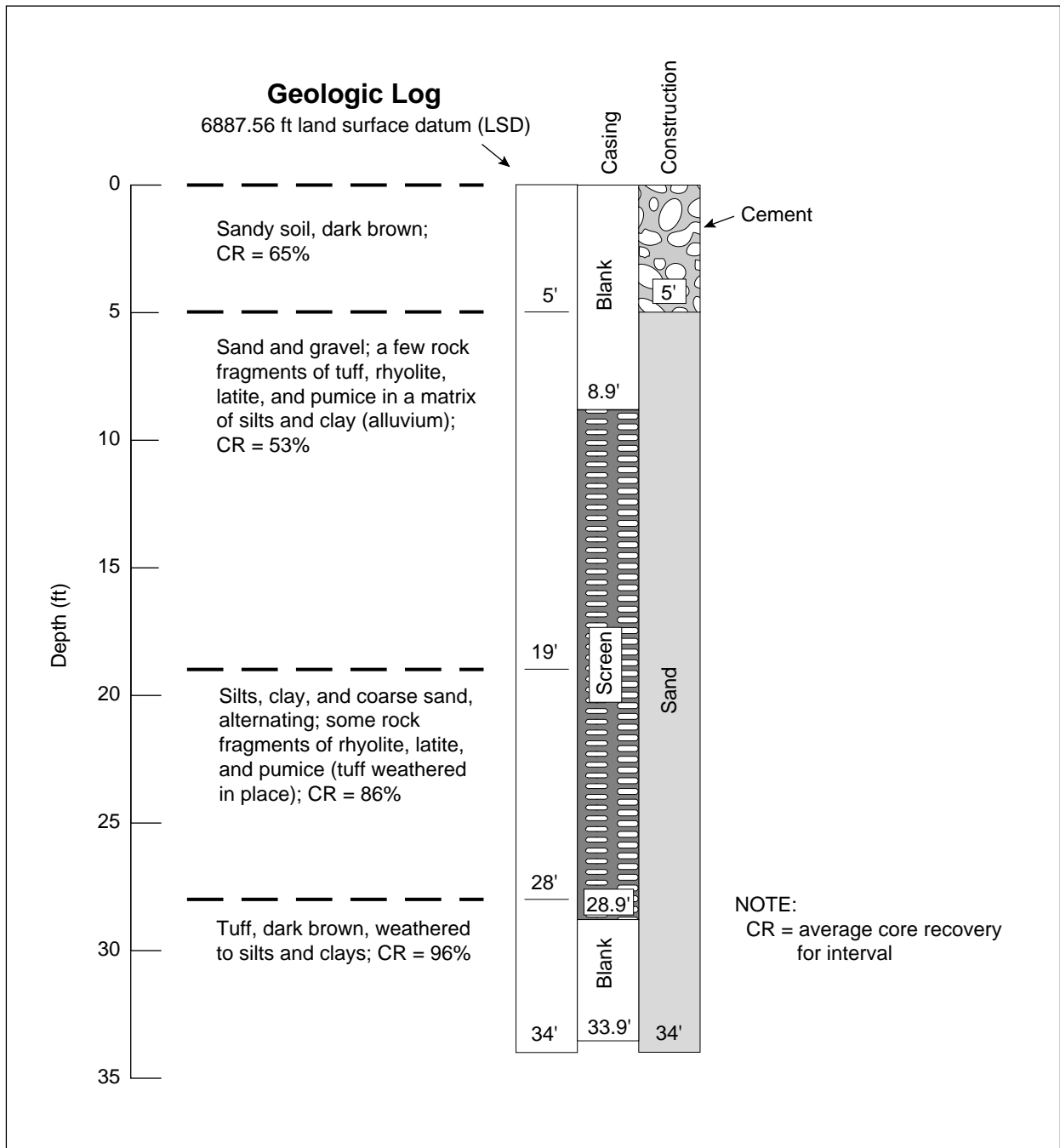


**Fig. VIII-J.** Sandia Canyon observation well SCO-2, completed August 1989, dry (Purtymun and Stoker 1990).

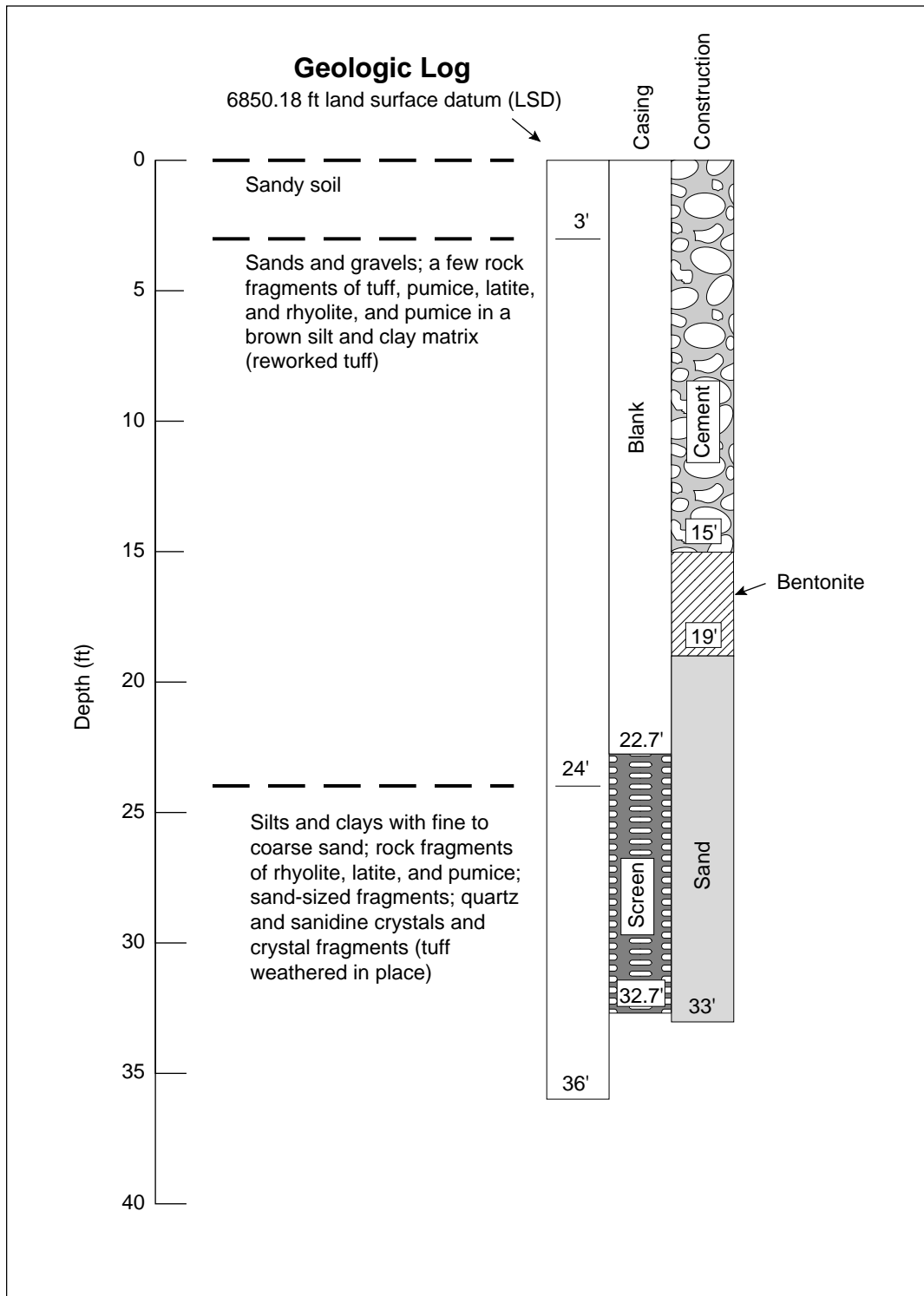


**Fig. VIII-K.** Mortandad Canyon observation well MCO-4A, completed November 1989, water level 5.1 ft (Purtymun and Stoker 1990).

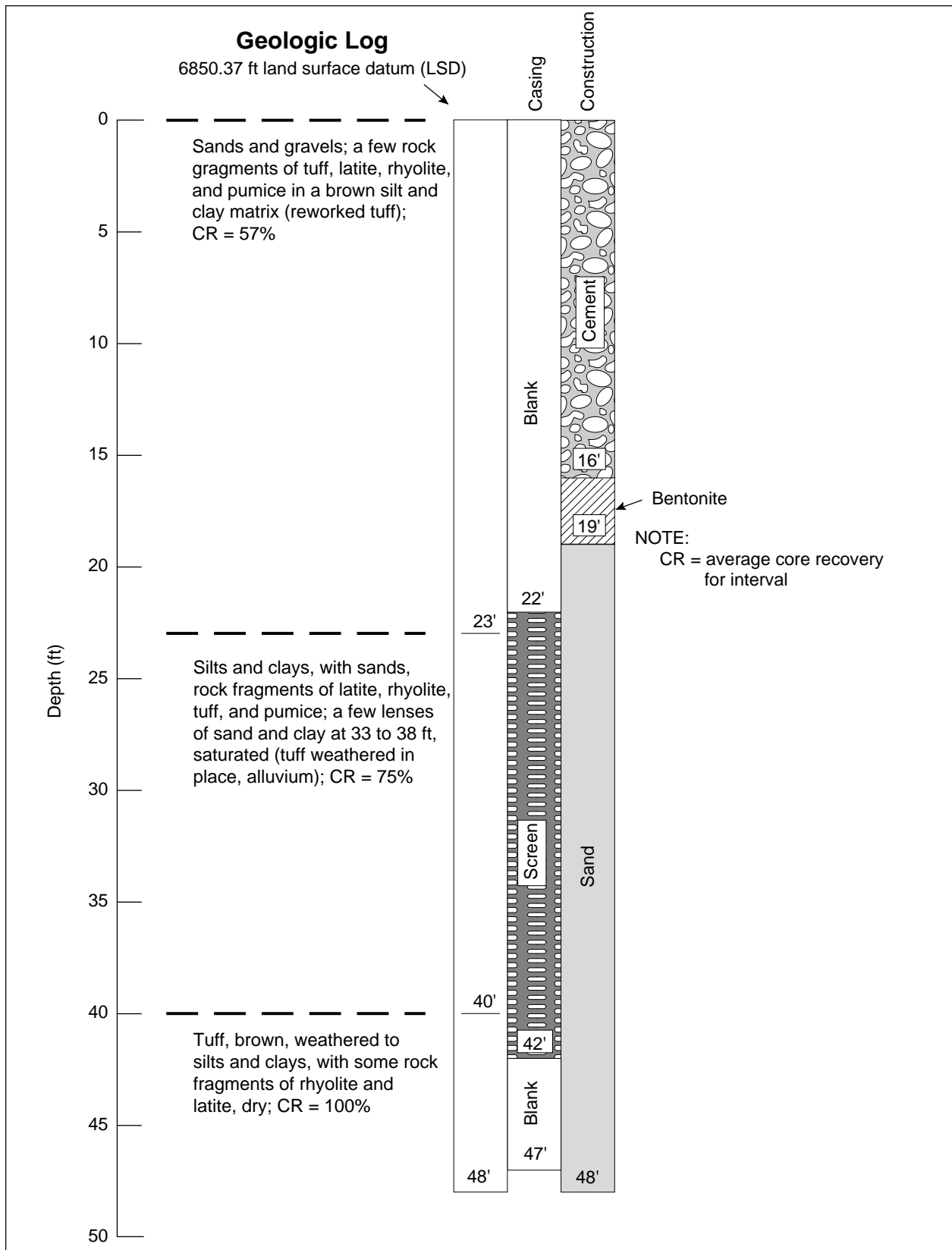




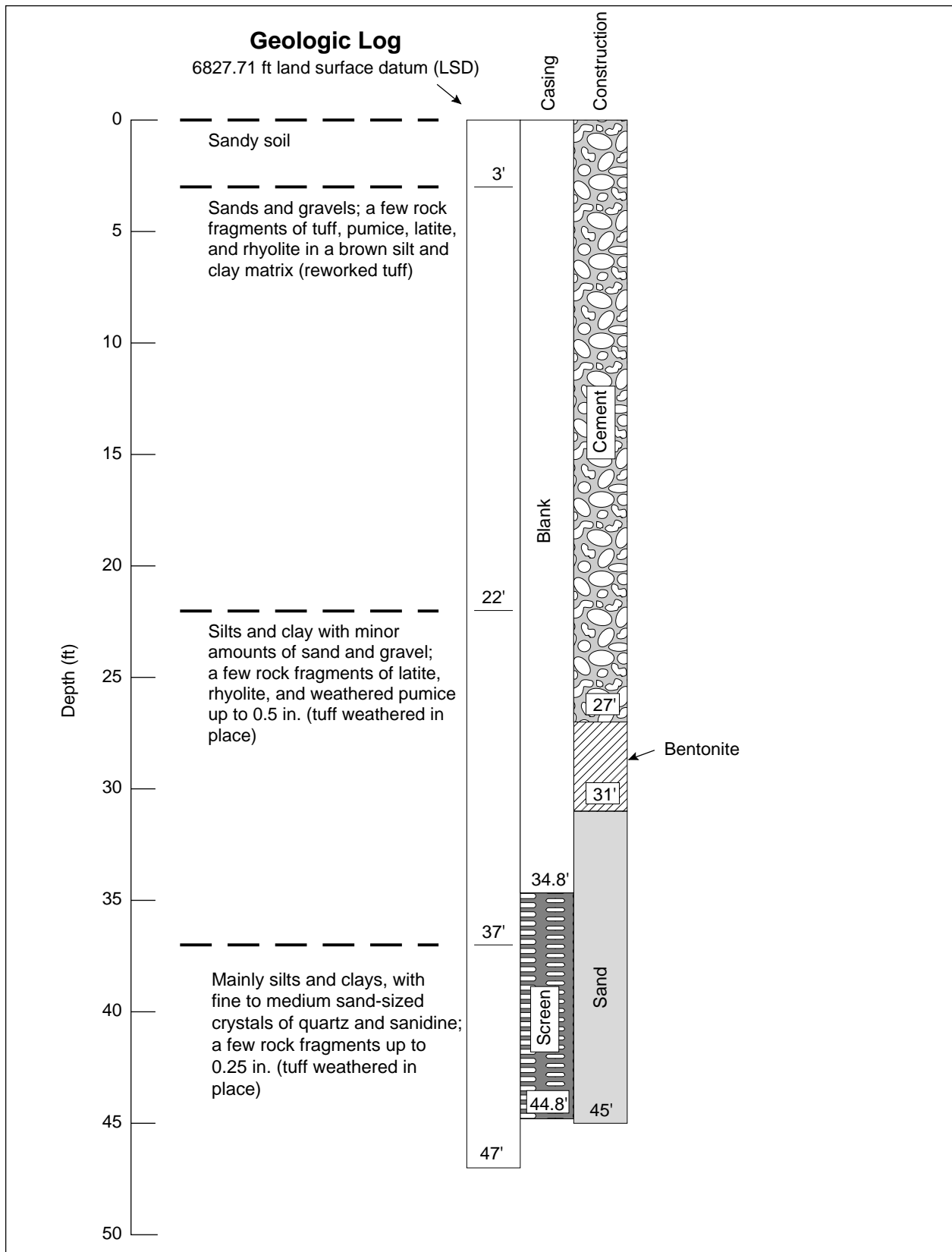
**Fig. VIII-L.** Mortandad Canyon observation well MCO-4B, completed August 1990, water level 21.7 ft (Purtymun and Stoker 1990).



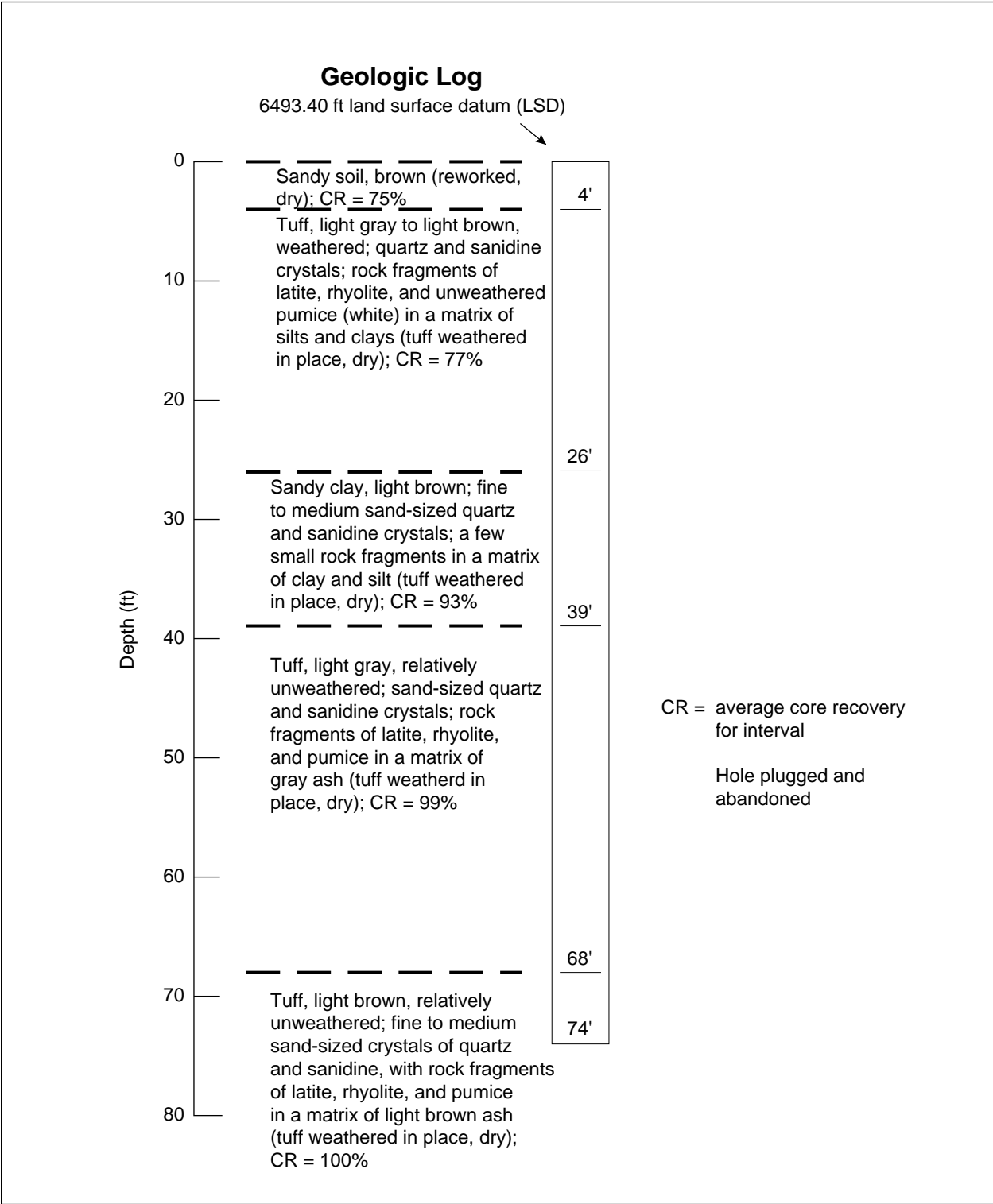
**Fig. VIII-M.** Mortandad Canyon observation well MCO-6A, completed November 1989, water level 30.3 ft (Purtymun and Stoker 1990).



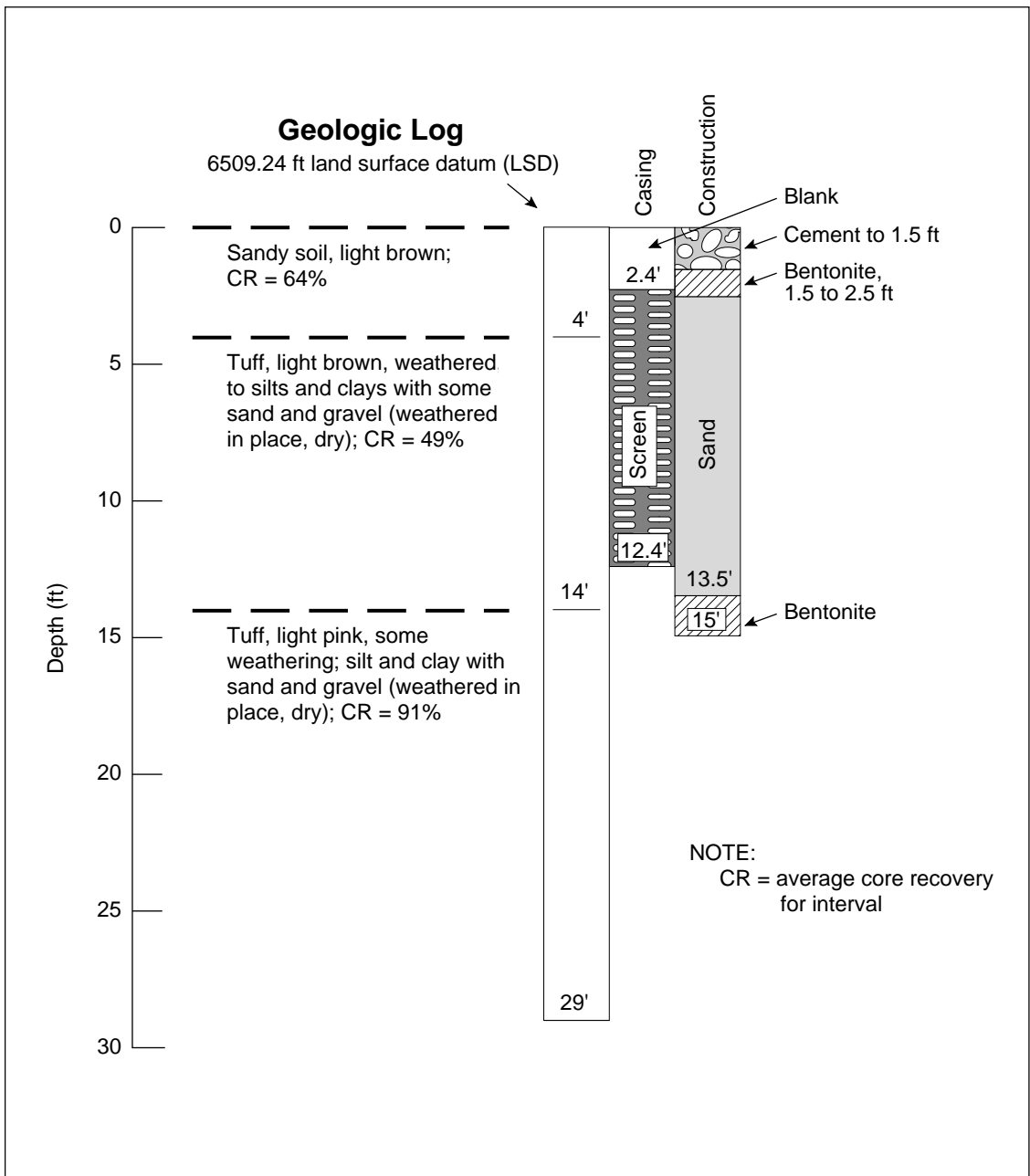
**Fig. VIII-N.** Mortandad Canyon observation well MCO-6B, completed August 1990, water level 32.2 ft (Purtymun and Stoker 1990).



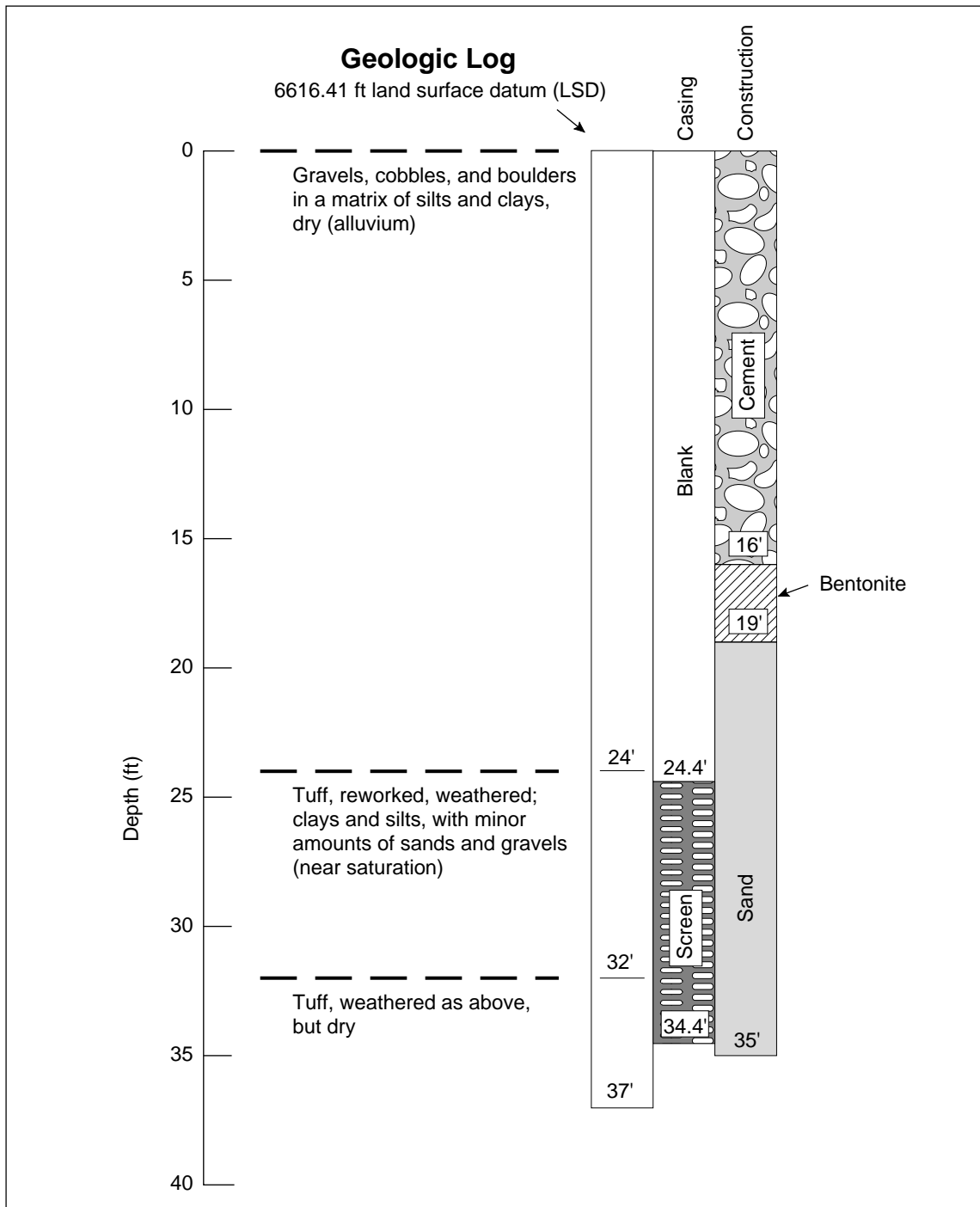
**Fig. VIII-O.** Mortandad Canyon observation well MCO-7A, completed November 1989, water level 35.2 ft (Purtymun and Stoker 1990).



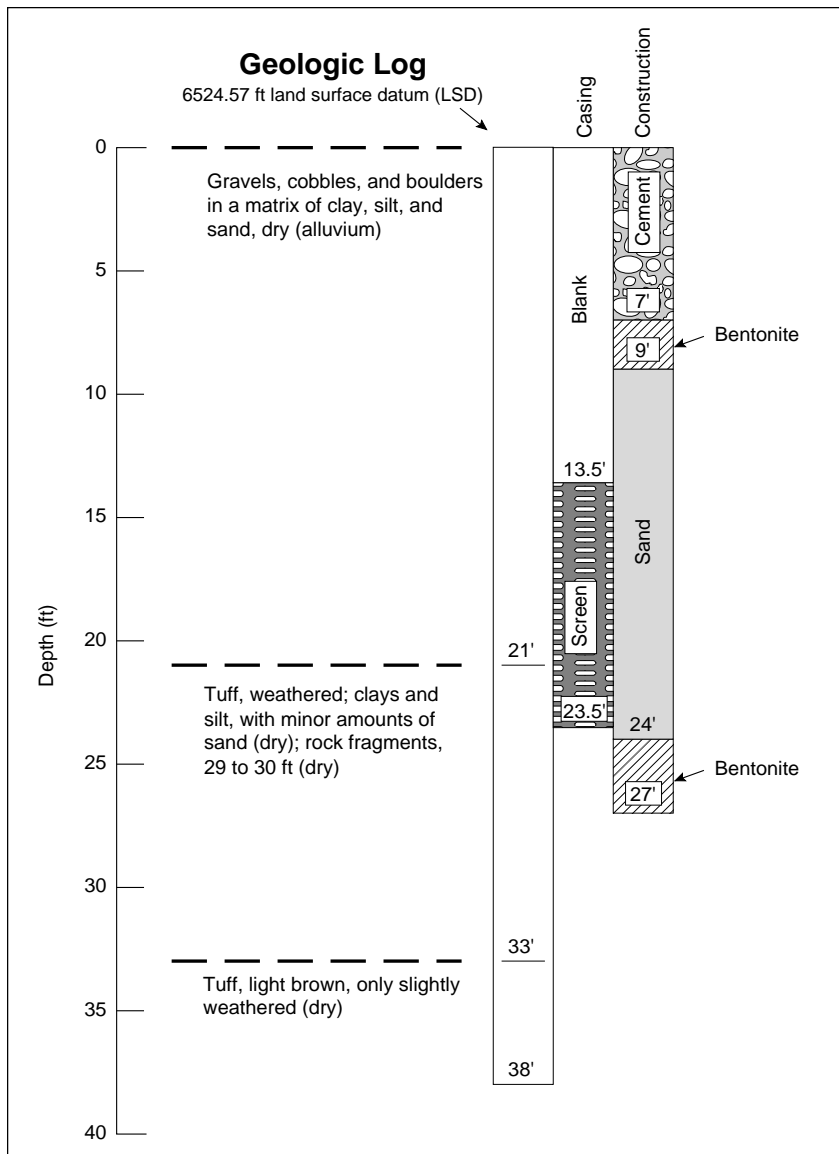
**Fig. VIII-P.** Potrillo Canyon test hole PCTH-1, completed October 1989, dry (Purtymun and Stoker 1990).



**Fig. VIII-Q.** Fence Canyon observation well FCO-1, completed August 1989, dry (Purtymun and Stoker 1990).



**Fig. VIII-R.** Water Canyon observation well WCO-1, completed October 1989, dry (Purtymun and Stoker 1990).



**Fig. VIII-S.** Water Canyon observation well WCO-2, completed October 1989, dry (Purtymun and Stoker 1990).

**Fig. VIII-T.** Water Canyon observation well WCO-3, completed October 1989, dry (Purtymun and Stoker 1990).

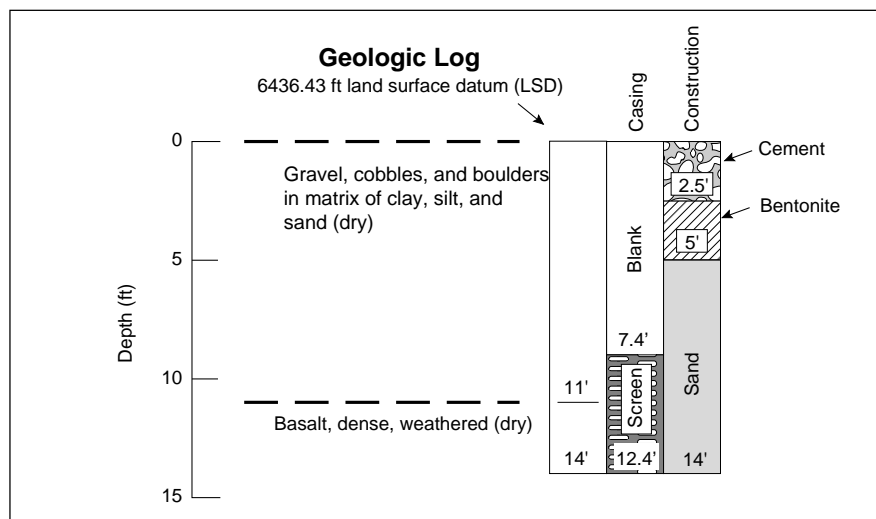




TABLE VIII-A. Locations, Elevations, and Measuring Points (NAD 1927)

	Top of Steel Casing	PVC Casing, Measuring Point	Land-Surface Datum of Brass Cap	Measuring Point to Land- Surface Datum	NAD 1927 Coordinates of Brass Cap	
<b><i>Pueblo Canyon</i></b>						
APCO-1	6368.95	6368.19	6367.53	-0.66	N 1,772,957.956	E 508 965.347
<b><i>Los Alamos Canyon</i></b>						
LAO-3A	6580.38	6579.83	6579.40	-0.43	N 1,773,037.645	E 497,736.545
LAO-4.5A	6461.58	6460.38	6459.89	-0.49	N 1,771,989.595	E 503,255.968
LAO-4.5B	6461.76	6460.59	6459.37	-1.22	N 1,771,992.471	E 503,268.080
LAO-4.5C	6459.23	6458.72	6457.63	-1.11	N 1,772,014.413	E 503,303.058
LAO-6A	6396.73	6396.26	6395.88	-0.38	N 1,771,281.902	E 505,977.349
<b><i>Sandia Canyon</i></b>						
SCO-1	6619.85	6619.33	6618.67	-0.66	N 1,769,440.143	E 502,053.375
SCO-2	6502.02	6501.52	6500.67	-0.85	N 1,767,801.850	E 507,014.910
<b><i>Mortandad Canyon</i></b>						
MCO-4A	6889.00	6888.24	6887.53	-0.71	N 1,769,638.132	E 491,784.644
MCO-4B	6889.13	6888.71	6887.56	-1.15	N 1,769,634.899	E 491,792.173
MCO-6A	6851.80	6851.45	6850.18	-1.27	N 1,768,899.886	E 493,388.651
MCO-6B	6851.84	6851.08	6850.37	-0.71	N 1,768,921.493	E 493,386.276
MCO-7A	6829.27	6828.75	6827.71	-1.04	N 1,768,447.198	E 494,259.239
<b><i>Potrillo Canyon</i></b>						
PCTH-1 <sup>a</sup>	—	—	6493.40	—	N 1,753,105.358	E 503,902.595
<b><i>Fence Canyon</i></b>						
FCO-1	6510.41	6509.99	6509.24	-0.75	N 1,751,120.043	E 502,168.229
<b><i>Water Canyon</i></b>						
WCO-1	6617.75	6617.06	6616.41	-0.65	N 1,755,007.161	E 492,514.547
WCO-2	6526.07	6525.25	6524.57	-0.68	N 1,753,166.432	E 496,626.165
WCO-3	6437.73	6437.25	6436.43	-0.82	N 1,750,558.320	E 498,968.371

<sup>a</sup>Cored test hole; plugged.

Source: Purtymun and Stoker 1990.

TABLE VIII-B. Characteristics and Water Levels of Observation Wells

	Date Drilled	Date Completed	Depth Drilled (ft)	Depth Completed (ft)	Water Level (ft below Land-Surface Datum)			
					Date	Water Level	Date	Water Level
<b><i>Pueblo Canyon</i></b>								
APCO-1	8-15-90	8-17-90	20	19.7	—	—	8-17-90	6.2
<b><i>Los Alamos Canyon</i></b>								
LAO-3A	9-14-89	9-14-89	18	14.7	9-14-89	6.7	6-21-90	5.5
LAO-4.5A	9-13-89	9-14-89	20	18.5	9-14-89	Dry	6-21-90	Dry
LAO-4.5B	9-15-89	9-16-89	35	34.9	9-16-90	Dry	6-21-90	Dry
LAO-4.5C	11-21-89	11-22-89	25	23.3	11-22-89	10.6	6-21-90	10.7
LAO-6A	8-17-89	8-17-89	15	14.2	8-17-89	9.0	6-21-90	Dry
<b><i>Sandia Canyon</i></b>								
SCO-1	8-14-89	8-15-89	79	19.3	8-15-89	Dry	6-22-90	Dry
SCO-2	8-16-89	8-16-89	29	18.4	8-16-89	Dry	6-22-90	Dry
<b><i>Mortandad Canyon</i></b>								
MCO-4A	11-01-89	11-01-89	24	19.4	11-14-89	5.1	8-15-90	Dry
MCO-4B	8-20-90	8-21-90	34	33.9	—	—	8-21-90	21.7
MCO-6A	11-02-89	11-06-89	33	32.7	11-09-89	30.3	6-02-90	Dry
MCO-6B	8-09-90	8-13-90	48	47.1	—	—	8-13-90	33.2
MCO-7A	11-06-89	11-14-89	47	44.8	11-09-89	35.2	6-21-90	37.2
<b><i>Potrillo Canyon</i></b>								
PCTH-1 <sup>a</sup>	10-18-89	10-20-89	74	—	10-20-89	Dry	—	—
<b><i>Fence Canyon</i></b>								
FCO-1	8-22-89	8-22-89	29	12.4	8-22-89	Dry	8-24-90	Dry
<b><i>Water Canyon</i></b>								
WCO-1	10-26-89	10-31-89	37	34.4	11-01-89	Dry	8-24-90	Dry
WCO-2	10-26-89	10-26-89	38	23.5	10-26-89	Dry	8-24-90	Dry
WCO-3	10-25-89	10-25-89	14	12.4	10-25-89	Dry	8-24-90	Dry

<sup>a</sup> Cored test hole; plugged.

Source: Purtymun and Stoker 1990.

## IX. TECHNICAL AREA 49

Technical Area 49 (TA-49) is an experimental area for which it was necessary to define the geology and hydrology of the mesa and adjacent canyons. TA-49 is located in the southern part of the Laboratory on Frijoles Mesa just to the north of Bandelier National Monument. The mesa is capped with a thick section of the Bandelier Tuff (the Tshirege Member, Otowi Member, and Guaje Member). This is underlain by the Puye Conglomerate and the Chaquehui Formation. Basalts were found interbedded with the Puye Conglomerate.

At TA-49 the Tshirege Member of the Bandelier Tuff has been subdivided into seven units that have been penetrated by test holes and test wells (Weir and Purtymun 1962). The type section of units exposed in the north wall of Water Canyon is shown in Fig. IX-A. Our subdivision of the Tshirege Member was based on the chemical and physical properties of the tuff. This was the first attempt to divide the Tshirege Member into a number of mappable units on the Pajarito Plateau. It does not correlate perfectly with the units established at Mortandad Canyon by Baltz et al. (1963), and no attempt has been made to change the terminology or units used at TA-49 to correspond to the type section at Mortandad Canyon. The correlation of units of the Bandelier Tuff at TA-49 with the type section at Mortandad is shown on Fig. IX-B.

The units penetrated in the test wells and core hole are described below from the oldest, Unit 1A, to the youngest, Unit 6.

Unit 1A consists of a light gray to light pinkish gray pumiceous, friable, nonwelded, rhyolite tuff that contains quartz and sanidine crystals and crystal fragments, and rock fragments of latite, rhyolite, and pumice in an ash matrix. At TA-49 the unit is 156 ft thick in Area 5.

Unit 1B is a light gray to very light orange rhyolite tuff that contains quartz and sanidine crystals and crystal fragments, large to small pumice fragments, and gray subrounded rhyolite and latite rock fragments up to cobble size. The unit was 203 ft thick in test well DT-5P at TA-49.

Unit 2 is a light pinkish gray to purplish gray welded rhyolite tuff. It is hard, welded, and contains coarse-sand- to granule-sized phenocrysts of quartz and sanidine crystals and crystal fragments, light gray to gray rhyolite and latite rock fragments, and gray pumice fragments up to 1/2-in. long in a fine-grained, glassy ash matrix. Unit 2 ranges from 94 to 111 ft in the four core holes drilled at TA-49.

Unit 3 is a friable, nonwelded, pumiceous rhyolite tuff composed of medium to very coarse sand-sized crystals of quartz and sanidine, gray and

white devitrified pumice fragments up 1/2 in. long, and an abundance of gray pumice and gray rhyolite and latite rock fragments in a fine-grained glassy ash matrix. The thickness of Unit 3 ranges from 52 to 76 ft in core holes and test wells at TA-49.

Unit 4 is a friable, nonwelded to moderately welded tuff with coarse-grain-sized crystals and crystal fragments of quartz and sanidine, some gray devitrified pumice fragments, and rock fragments of latite and rhyolite in an ash matrix. The average thickness of Unit 4 is about 50 ft.

Unit 5 is a thin layer of water-laid or blast-laid sand that is light gray, friable, and composed of coarse-grain-sized quartz and sanidine crystals and crystal fragments, a few small rock fragments of latite and rhyolite, and some white to gray pumice in a silty matrix of sand and ash. The unit has various bedding from foreset to parallel beds. In some places there are thin lenses of clay weathered to dark brown. The thickness of the unit varies from a knife edge between ash flows to a thickness of 6 to 8 ft (where it is in a scoured joint or fracture in a shaft in Area 10).

Unit 6 is a light gray moderately welded tuff with fine- to medium-sized quartz and sanidine crystals and crystal fragments, and some tan to gray pumice fragments, gray devitrified pumice fragments, and some light red and gray rhyolite rock fragments in a fine-grained light gray ash matrix. The average thickness of the unit is about 70 ft.

### A. Deep Test Wells

The locations of deep test wells (DT-series), core holes (CH-series), and test holes (TH-series) are shown in Fig. IX-C, and construction and hydrologic data are shown in Table IX-A.

Two deep test holes, DT-5P (Fig. IX-D) and DT-5 (Fig. IX-E) were drilled for geologic and hydrologic information, but did not reach the main aquifer. Three other deep test holes, DT-5A (Fig. IX-F), DT-9 (Fig. IX-G), and DT-10 (Fig. IX-H) were drilled into the main aquifer. The geologic logs and construction data for these five holes are found in Table IX-B. In the original presentation of the geologic logs of these last three holes (Weir and Purtymun 1962), a flow was penetrated and was logged as the Tschicoma Formation. It is unlikely that the Tschicoma Formation, which is found as massive flows containing latite and dacite near the flanks of the Sierra de los Valles, would be present so far away from the mountains. It is more likely that this unit was composed of the Basaltic Rocks of Chino Mesa Unit 2. This identification was confirmed by an examination of the exposed cuttings from the wells, especially those from well DT-9. The logs of DT-5A, DT-9, and DT-10 have been revised accordingly. The

basalts may not be from vents at Chino Mesa but are equivalent in age, as the basalts are interbedded with the fanglomerate member. These three wells that were completed as test wells into the main aquifer allowed us to determine the hydrologic characteristics of the aquifer.

### B. Core and Test Holes

Four core holes, CH-1, CH-2, CH-3, and CH-4 (Figs. IX-I, IX-J, IX-K, and IX-L, respectively) were cored in four experimental areas to determine some of the physical and hydrologic properties of the tuff. Alpha, Beta (located on the floor of Water Canyon), and Gamma holes were drilled for geologic information (Figs. IX-M, IX-N, and IX-O, respectively).

Five shallow test holes, test holes 1, 2, 3, 4, and 5 were drilled to determine if there was infiltration of precipitation into the soil and tuff around experimental Area 2 (Figs. IX-P, IX-Q, IX-R, IX-S, and IX-T, respectively). All wells and test holes were sealed at the surface with cement. The geologic logs and construction data for these test holes are presented in Table IX-C. Test holes and wells in Water Canyon north of TA-49 are shown in Fig. IX-U. In Water Canyon near Beta Hole there is a routine surface water sampling station.

### C. Moisture-Access Holes

To study and monitor the soil moisture on the surface of the mesa and in the experimental areas, 23 moisture-access holes were completed on the mesa (Fig. IX-V). We completed 2 shallow observation holes (WCM-1 and WCM-2) into the alluvium of Water Canyon to the north of the experimental areas (Fig. IX-U). Geologic logs and construction data for the 23 moisture-access holes and 2 shallow observation wells are presented on Table IX-D.

### REFERENCES

E. H. Baltz, J. H. Abrahams, and W. D. Purtymun "Preliminary Report on the Geology and Hydrology of Mortandad Canyon near Los Alamos, New Mexico with Special Reference to Disposal of Liquid Low-Level Radioactive Wastes," U.S. Geological Survey Open-File Report (1963).

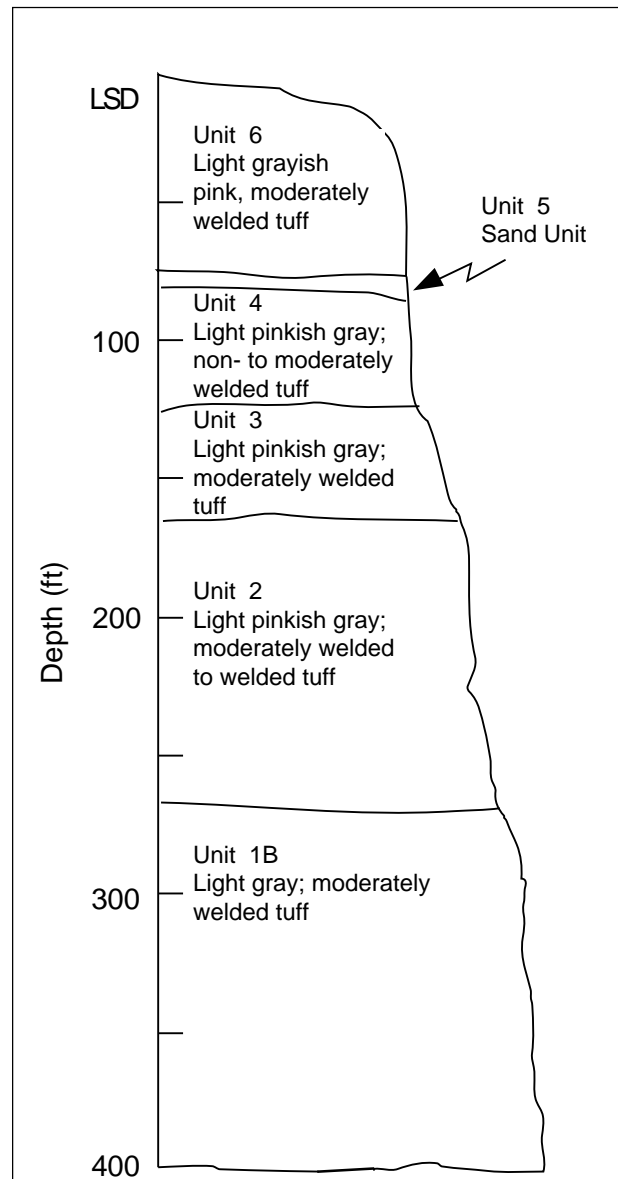
W. D. Purtymun, "Distribution of Moisture in the Soil and Underlying Tuff at Technical Area 49, Frijoles Mesa, Los Alamos County, New Mexico," U.S. Geol. Survey Admin. report (1962).

W. D. Purtymun, "Source Document Compilation: Los Alamos Investigations Related to the Environment, Engineering, Geology, and Hydrology,

1961–1990," Los Alamos National Laboratory report LA-12733-MS (1994), chapter 92.

W. D. Purtymun and A. K. Stoker, "Environmental Status of Technical Area 49, Los Alamos, New Mexico," Los Alamos National Laboratory report LA-11135-MS (1987).

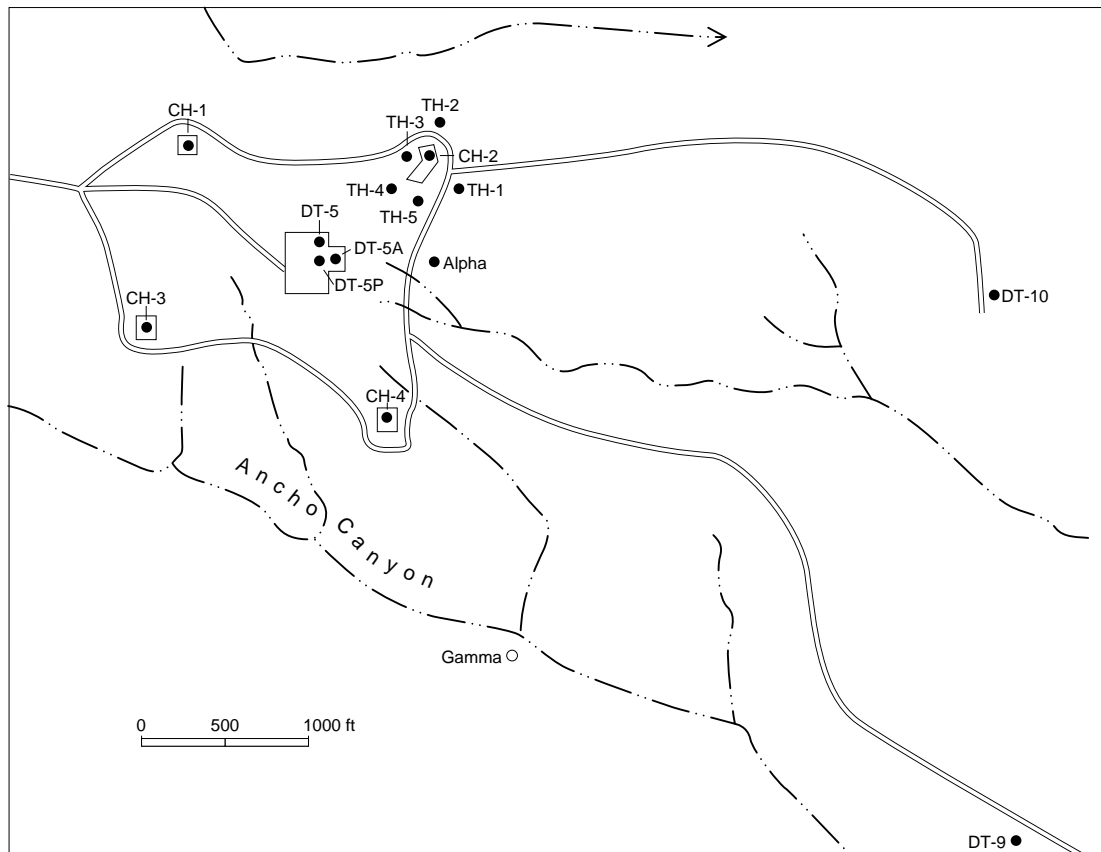
J. E. Weir and W. D. Purtymun, "Geology and Hydrology of Technical Area 49, Frijoles Mesa, Los Alamos County, New Mexico," U.S. Geol. Survey Admin. report (1962).



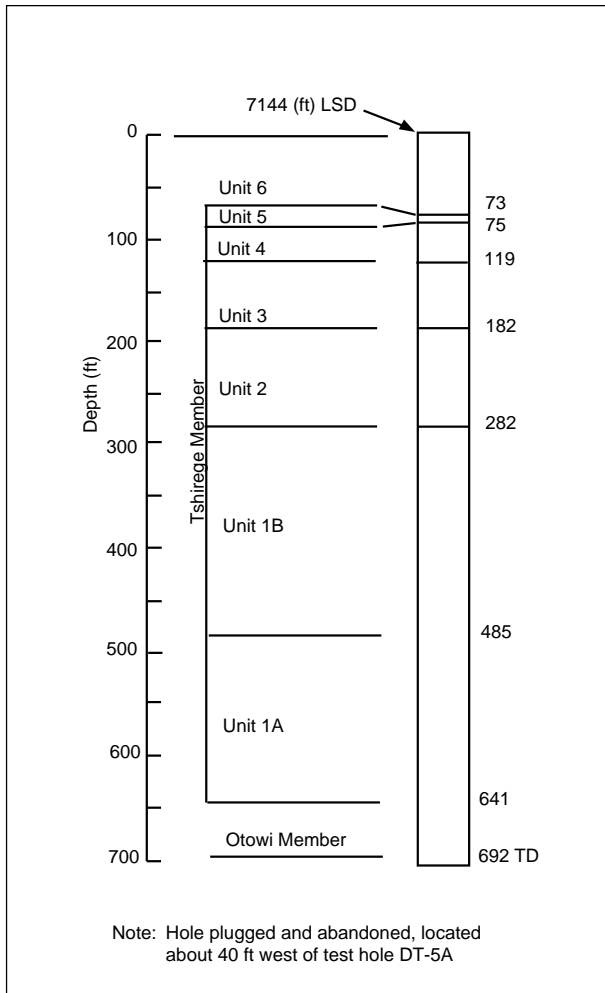
**Fig. IX-A.** Type section of the Tshirege Member of the Bandelier Tuff in Water Canyon north of TA-49 (Weir and Purtymun 1962).

TA-49 Weir and Purtymun 1962		Mortandad Canyon Baltz et al. 1963	
Unit 6			
Unit 5			
Unit 4			
Unit 3		Unit 3	
Unit 2		Unit 2B	
		Unit 2A	
Unit 1B		Unit 1B	
Unit 1A		Unit 1A	
Otowi Member		Otowi Member	

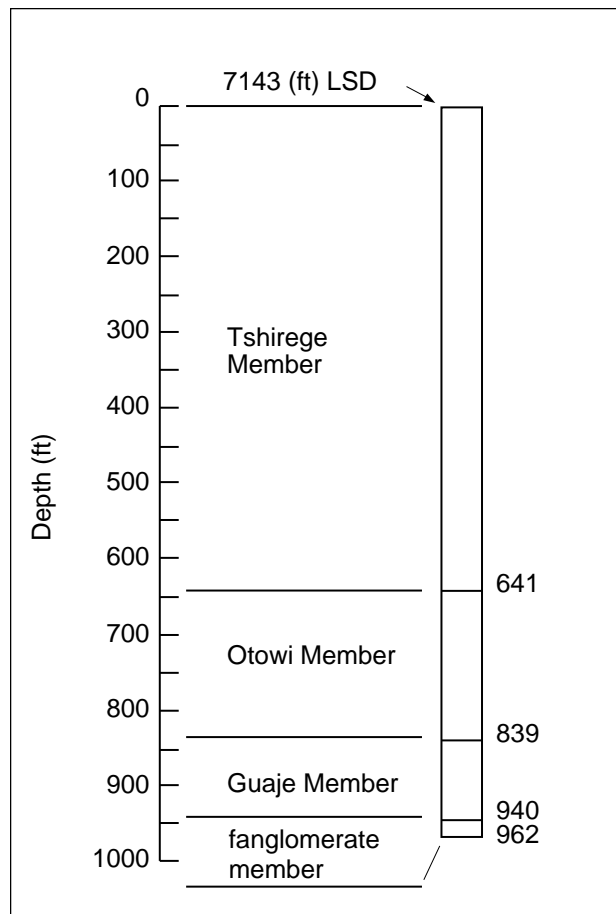
**Fig. IX-B.** Correlation of the units of the Tshirege Member of the Bandelier Tuff at TA-49 with the type section in Mortandad Canyon.



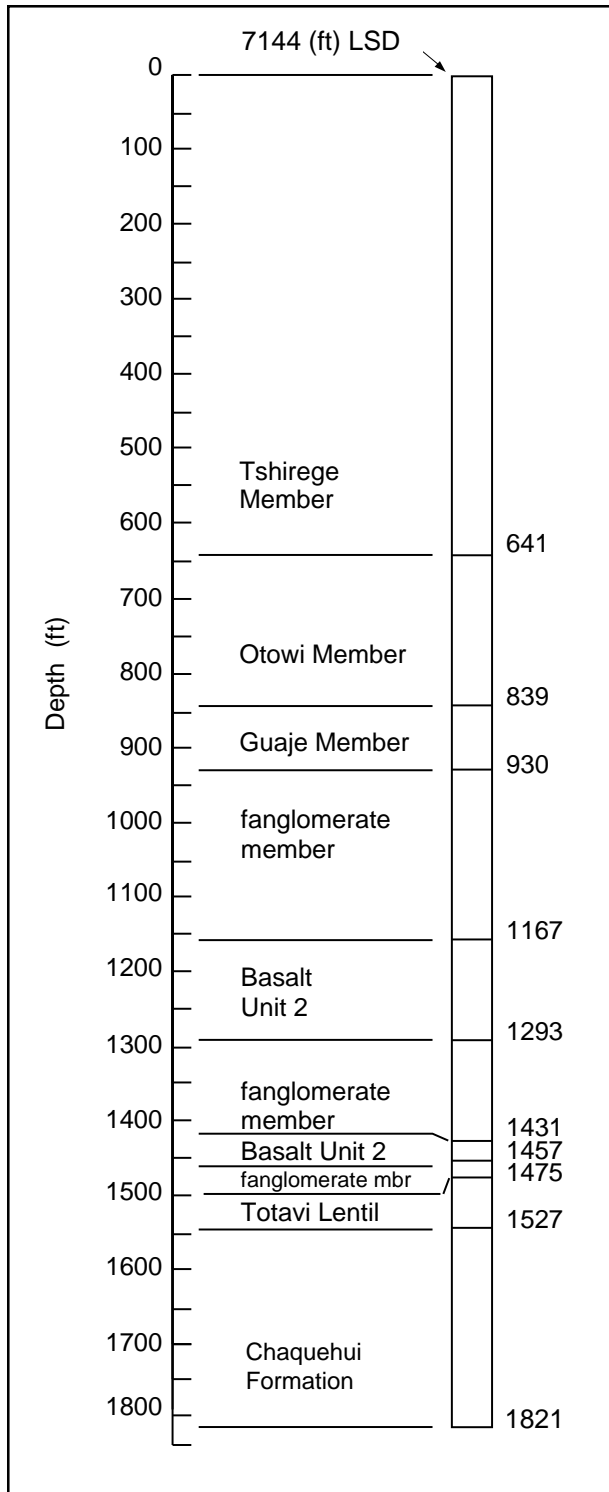
**Fig. IX-C.** Location of deep test wells (DT-series), core holes (CH-series), and test holes (TH-series) (Purtymun 1994).



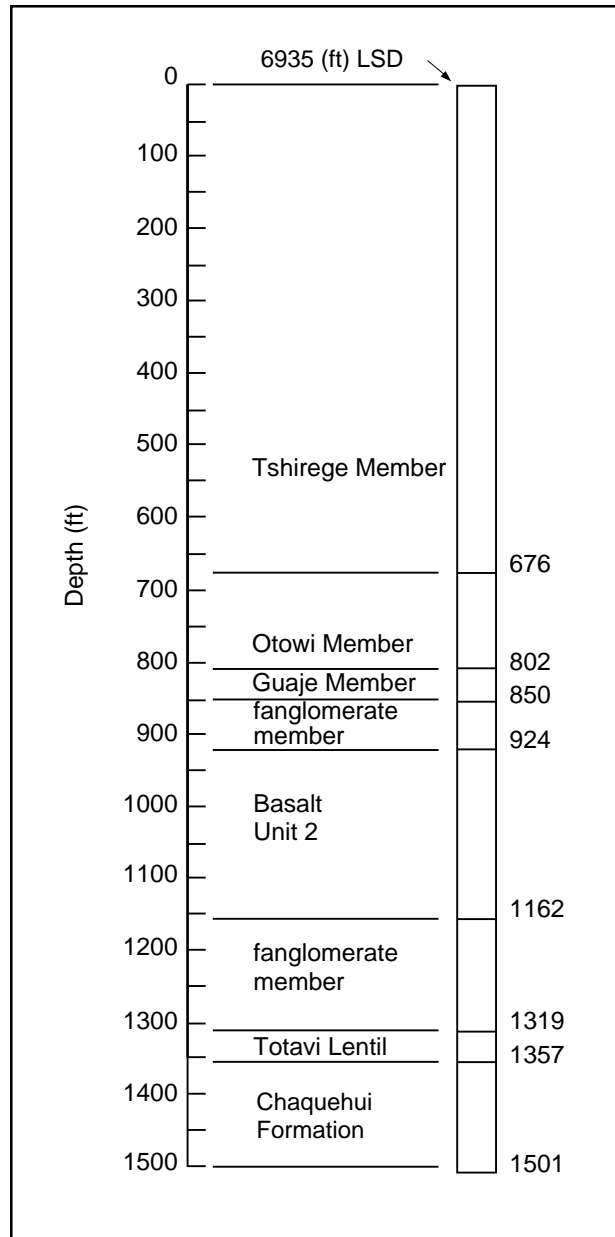
**Fig. IX-D.** Test hole DT-5P, completed October 1959, dry (Weir and Purtymun 1962).



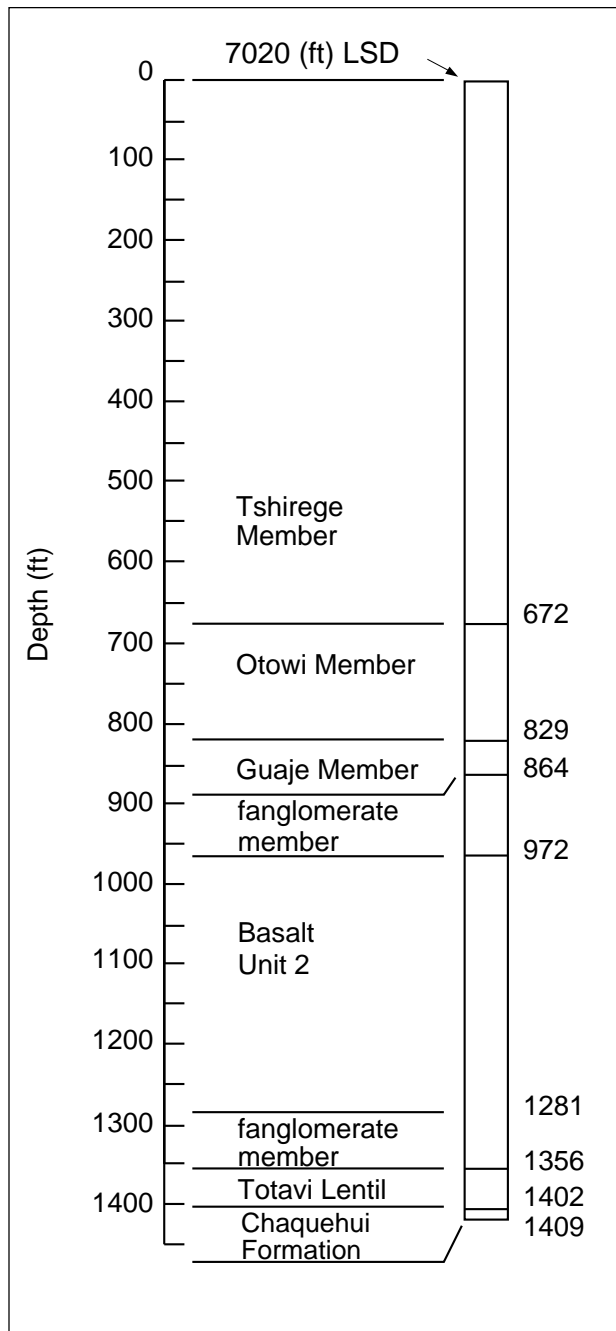
**Fig. IX-E.** Geologic log of test hole DT-5, completed November 1959, dry (Weir and Purtymun 1962).



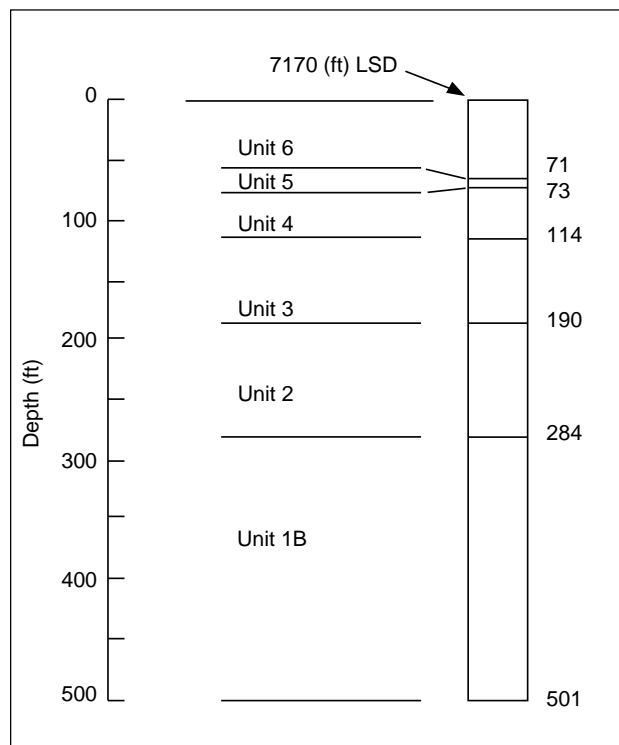
**Fig. IX-F.** Geologic log of test well DT-5A, completed January 1960, water level 1173 ft (Weir and Purtymun 1962, modified by Purtymun for this report).



**Fig. IX-G.** Geologic log of test well DT-9, completed February 1960, water level 1003 ft (Weir and Purtymun 1962, modified by Purtymun for this report).

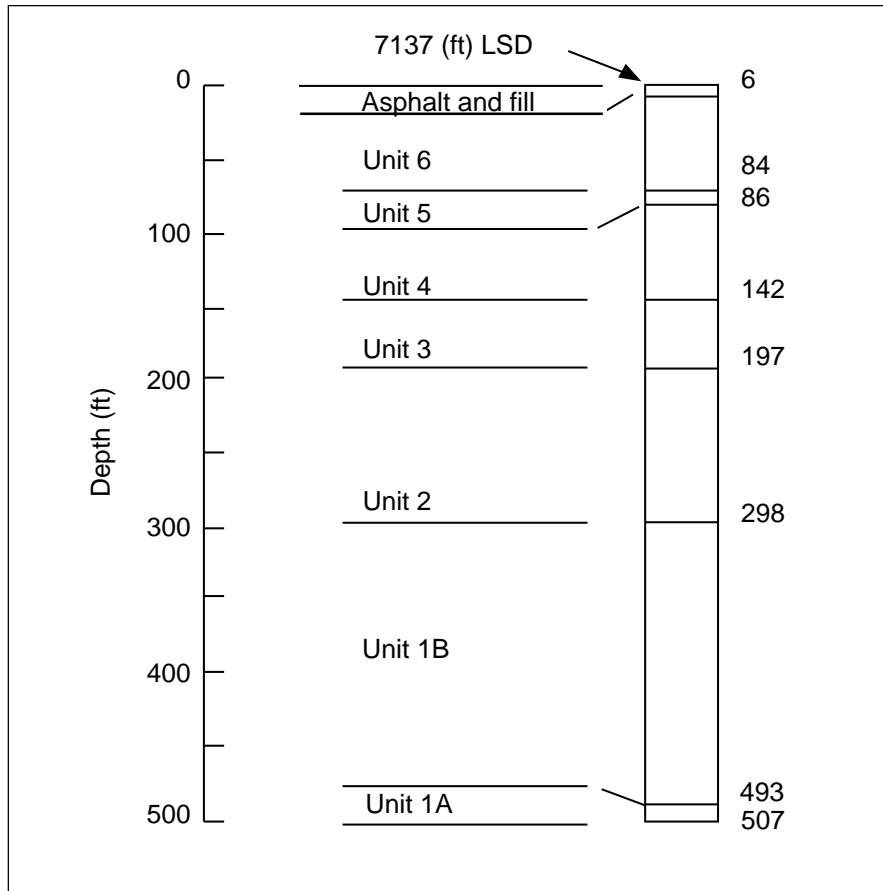


**Fig. IX-H.** Geologic log of test well DT-10, completed March 1960, water level 1085 ft (Weir and Purtymun 1962, modified by Purtymun for this report).

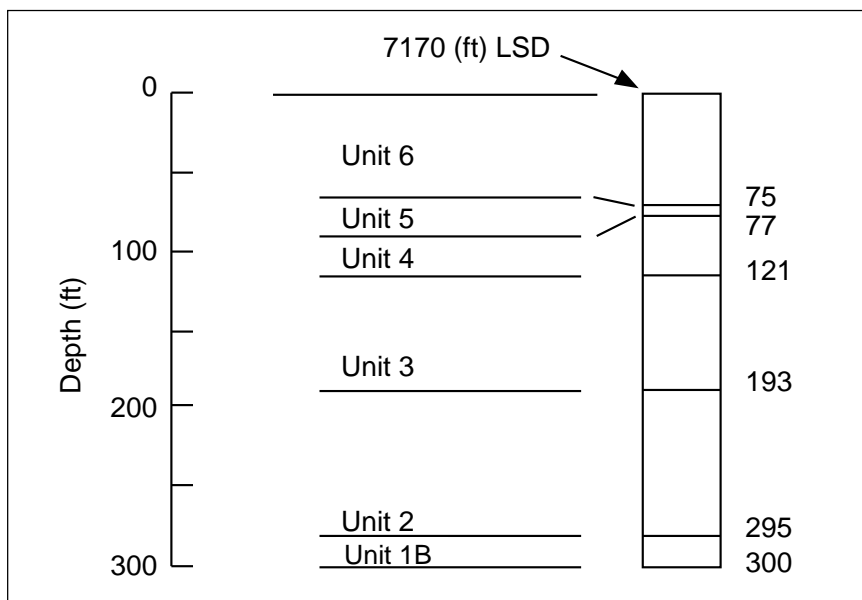


**Fig. IX-I.** Geologic log of core hole CH-1, completed December 1959, dry (Weir and Purtymun 1962).

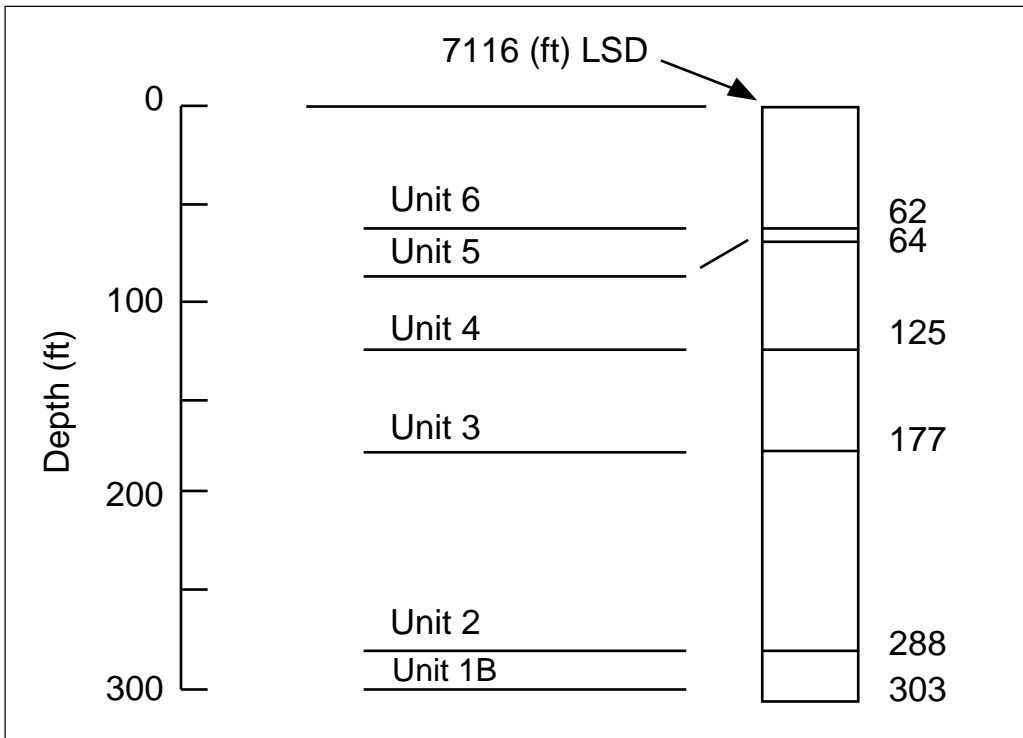




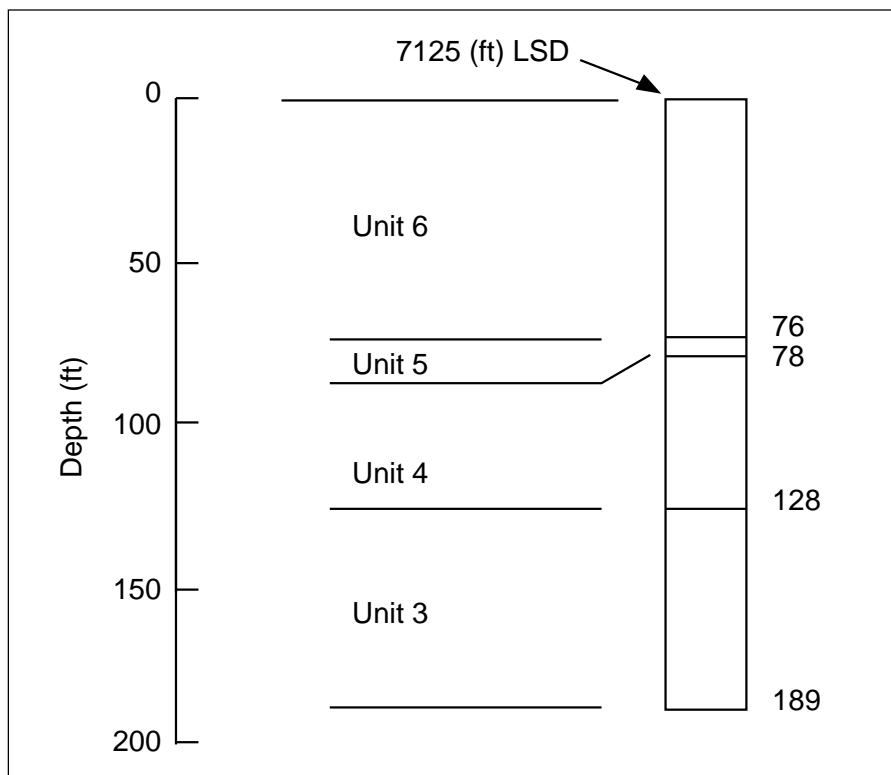
**Fig. IX-J.** Geologic log of core hole CH-2, completed November 1959, dry (Weir and Purtymun 1962).



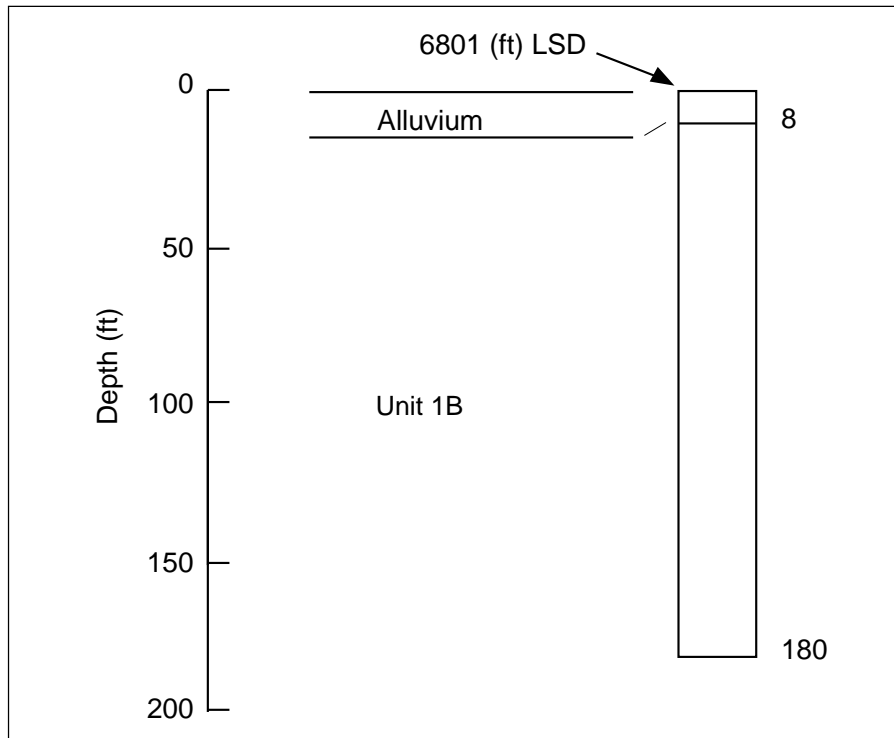
**Fig. IX-K.** Geologic log of core hole CH-3, completed February 1960, dry (Weir and Purtymun 1962).



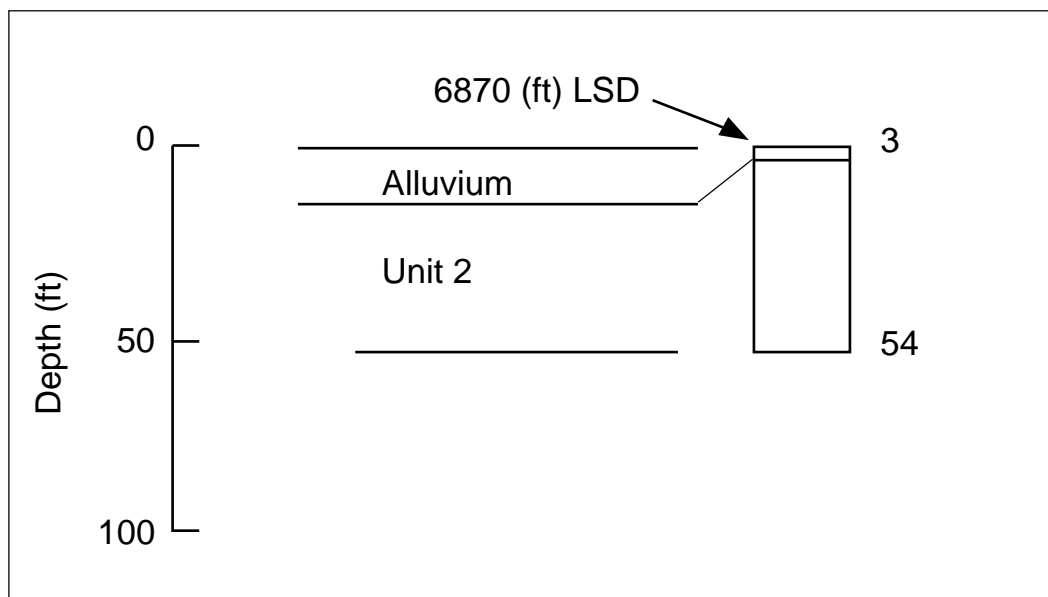
**Fig. IX-L.** Geologic log of core hole CH-4, completed February 1960, dry (Weir and Purtymun 1962).



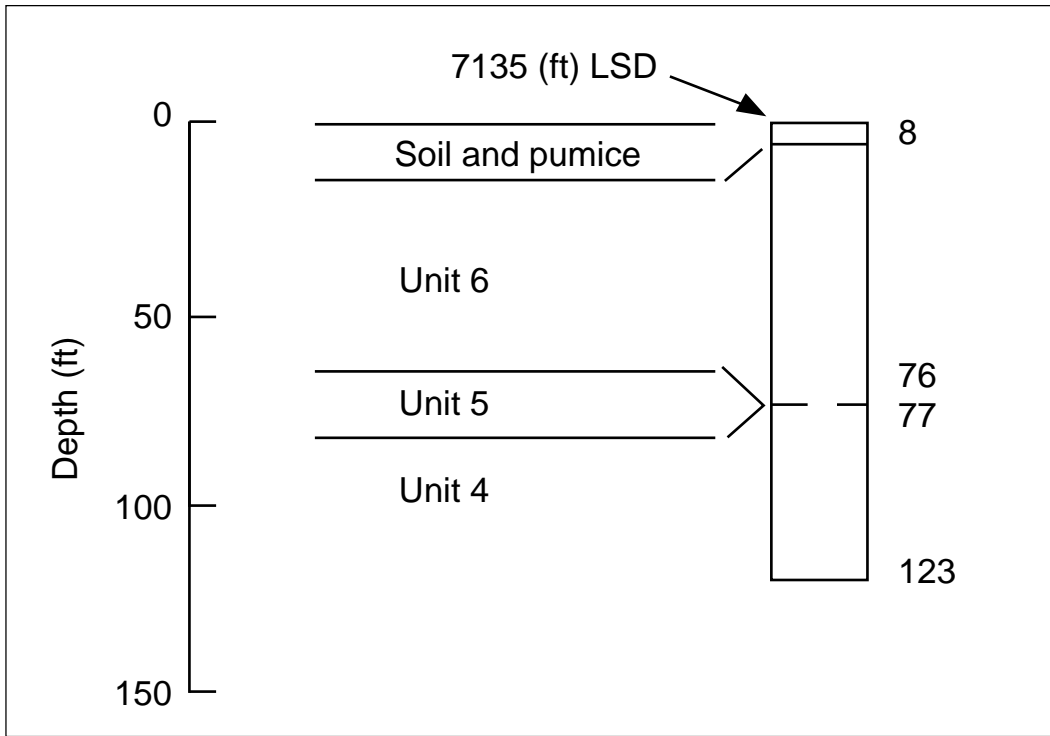
**Fig. IX-M.** Geologic log of Alpha Hole, completed February 1960, dry (Weir and Purtymun 1962).



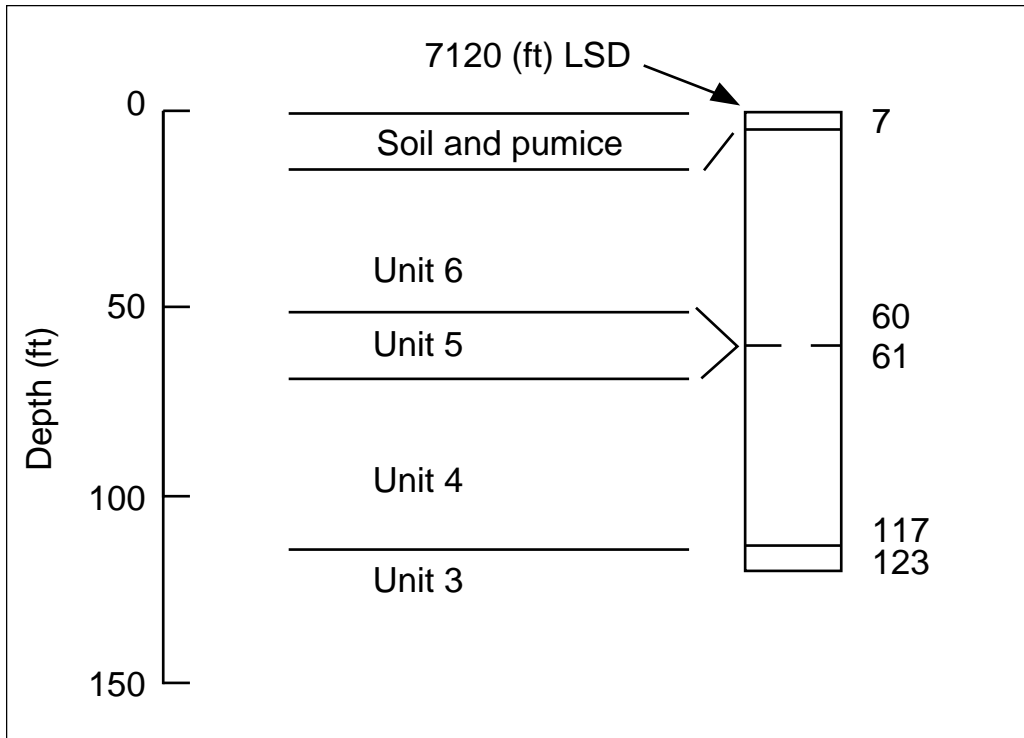
**Fig. IX-N.** Geologic log of Beta Hole, completed February 1960, dry (Weir and Purtymun 1962).



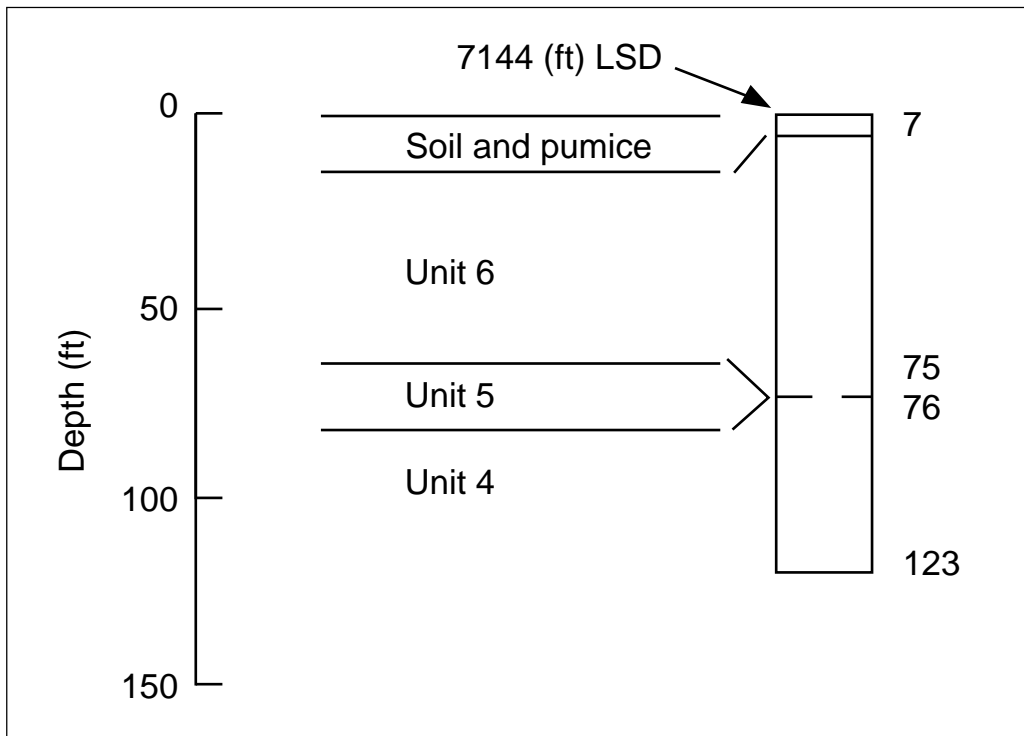
**Fig. IX-O.** Geologic log of Gamma Hole, completed March 1960, dry (Weir and Purtymun 1962).



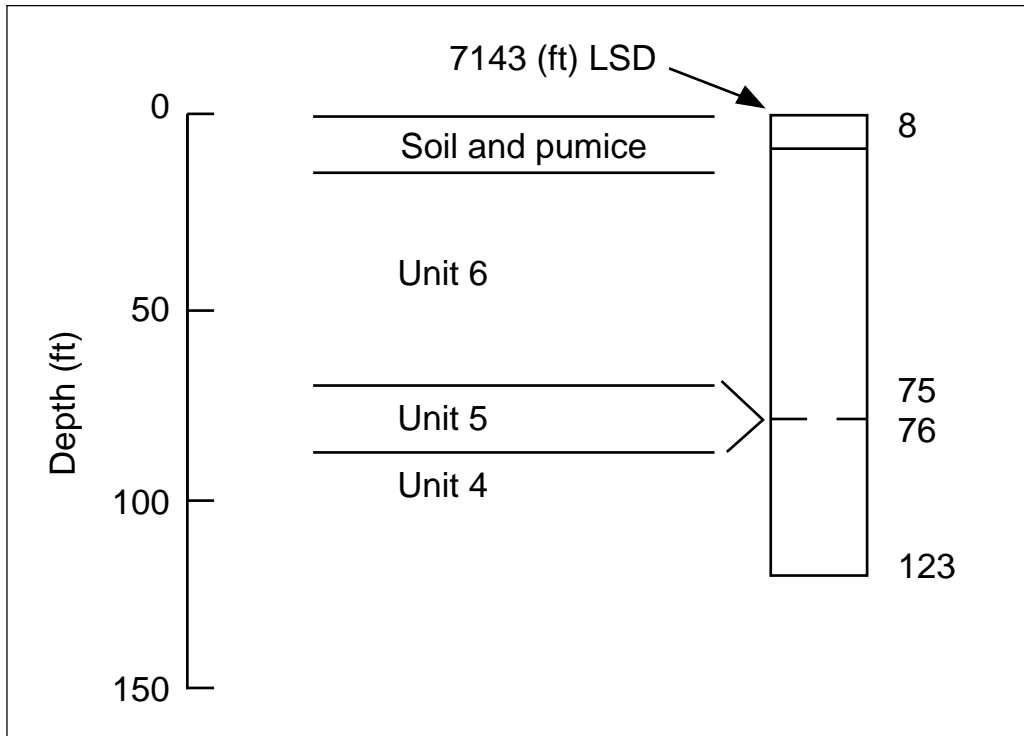
**Fig. IX-P.** Geologic log of Area 2 Test Hole 1, completed May 1980, dry (Purtymun 1994).



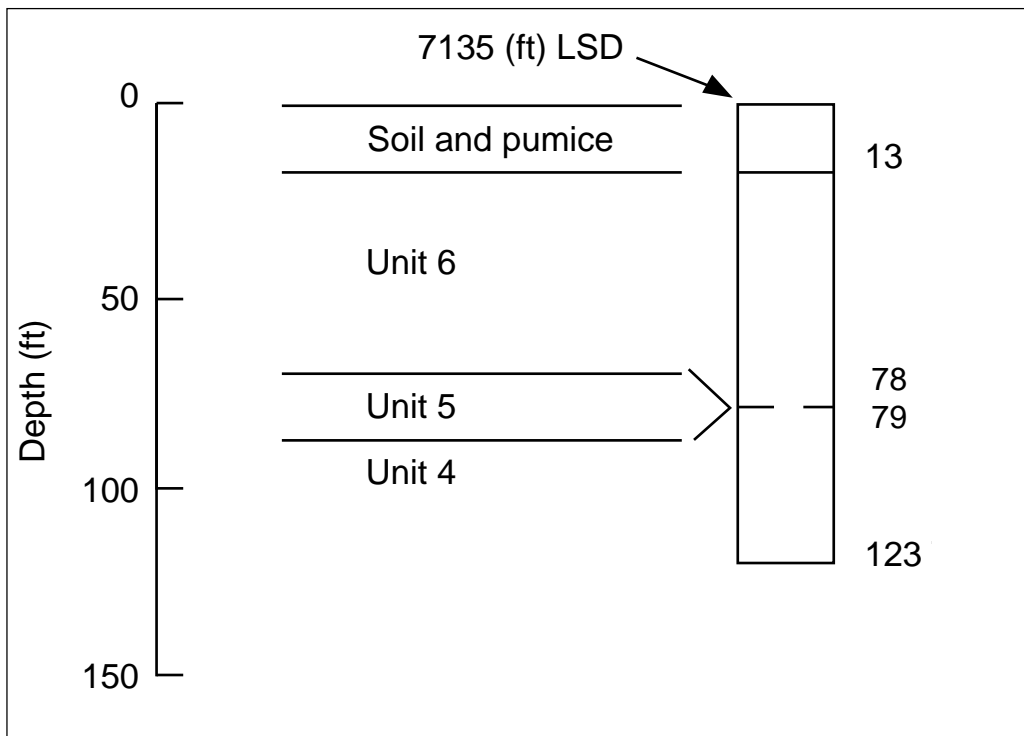
**Fig. IX-Q.** Geologic log of Area 2 Test Hole 2, completed May 1980, dry (Purtymun 1994).



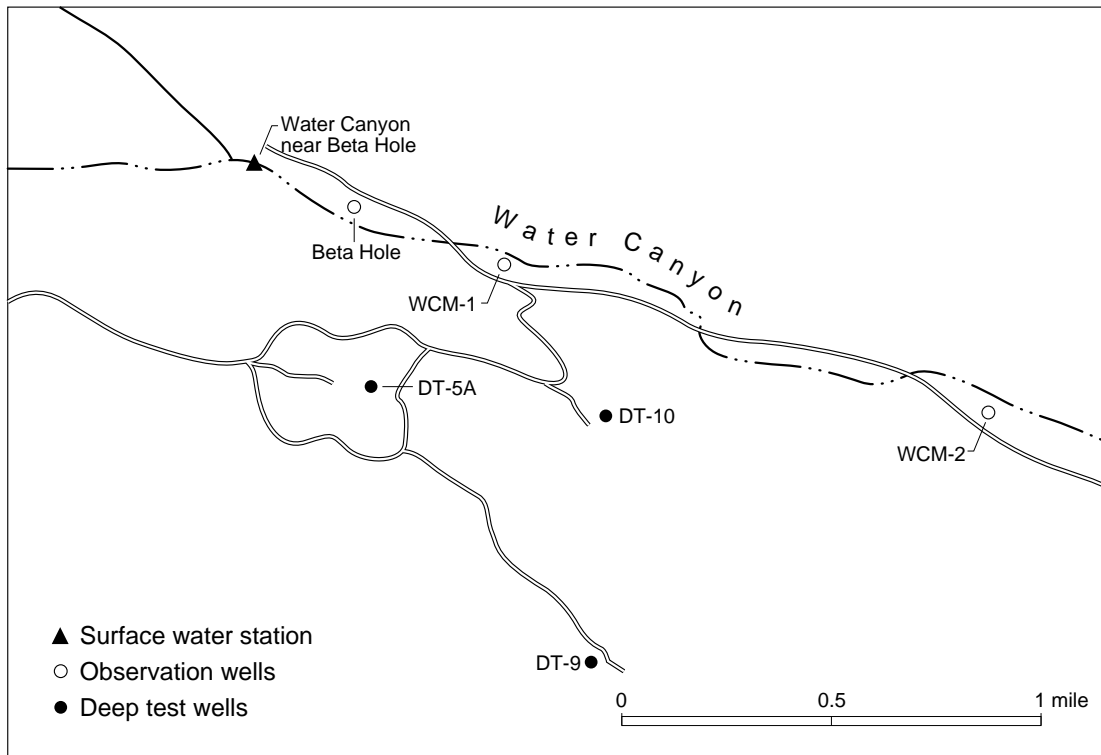
**Fig. IX-R.** Geologic log of Area 2 Test Hole 3, completed May 1980, dry (Purtymun 1994).



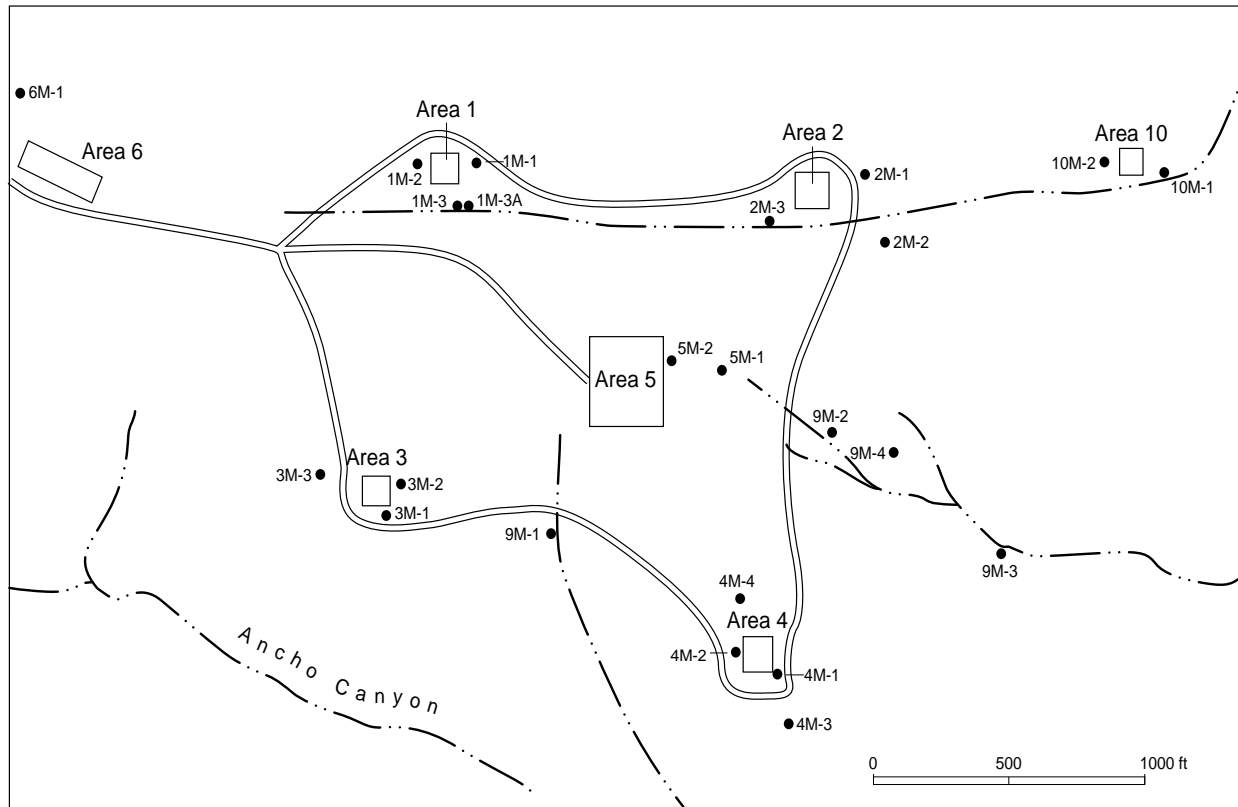
**Fig. IX-S.** Geologic log of Area 2 Test Hole 4, completed May 1980, dry (Purtymun 1994).



**Fig. IX-T.** Geologic log of Area 2 Test Hole 5, completed May 1980, dry (Purtymun 1994).



**Fig. IX-U.** Locations of wells, holes, and a surface water sampling station in Water Canyon north of TA-49.



**Fig. IX-V.** Locations of moisture-access holes at TA-49.

TABLE IX-A. Construction and Hydrologic Data for Test Holes, Test Wells, and Core Holes at TA-49

	Year Drilled	Elevation (ft)	Depth (ft)	Water Level Completion (ft)	Remarks
Test Hole DT-5P	1959	7144	692	Dry	
Test Hole DT-5	1959	7143	962	Dry	
Test Well DT-5A	1959	7144	1821	1173	pump equipped
Test Well DT-9	1960	6935	1501	1003	pump equipped
Test Well DT-10	1960	7020	1409	1085	pump equipped
Core Hole CH-1	1959	7170	501	Dry	
Core Hole CH-2	1959	7137	507	Dry	
Core Hole CH-3	1960	7170	300	Dry	
Core Hole CH-4	1960	7116	303	Dry	
Alpha Hole	1960	7125	189	Dry	
Beta Hole	1960	6801	180	Dry	
Gamma Hole	1960	6870	54	Dry	
Area 2 Test Hole 1	1980	7135	123	Dry	
Area 2 Test Hole 2	1980	7120	123	Dry	
Area 2 Test Hole 3	1980	7144	123	Dry	
Area 2 Test Hole 4	1980	7143	123	Dry	
Area 2 Test Hole 5	1980	7135	123	Dry	

Sources: Weir and Purtymun 1962; Purtymun 1994.

TABLE IX-B. Geologic Logs and Construction Data for Test Holes and Test Wells (5 Test Holes and Wells)

1. Test Hole DT-5P

Elevation (LSD) 7144 ft	Water Level: Dry	
<u>Geologic Log</u>	Thickness (ft)	Depth (ft)
Bandelier Tuff		
Tshirege Member		
Unit 6	73	73
Unit 5	2	75
Unit 4	44	119
Unit 3	63	182
Unit 2	100	282
Unit 1B	203	485
Unit 1A	156	641
Otowi Member	51	692

Note: Hole plugged and abandoned; located about 40 ft west of test well DT-5A.



TABLE IX-B. Geologic Logs and Construction Data for Test Holes and Test Wells (5 Test Holes and Wells)  
(Continued)

2. Test Hole DT-5

Elevation (LSD) 7143 ft	Water Level: Dry	
Thickness	Depth	
<u>Geologic Log</u>	<u>(ft)</u>	<u>(ft)</u>
Bandelier Tuff		
Tshirege Member	641	641
Otowi Member	198	839
Guaje Member	101	940
Puye Conglomerate		
Fanglomerate member	22	962

Casing Schedule

180 ft of 8-in.-diam steel casing set 0–180 ft; open hole 180–962 ft.

Geophysical Logs

Gamma-ray/neutron, induction-electrical, and temperature logs.

3. Test Well DT-5A

Elevation (LSD) 7144 ft	Water Level: 1173 ft, April 1960	
Thickness	Depth	
<u>Geologic Log</u>	<u>(ft)</u>	<u>(ft)</u>
Bandelier Tuff		
Tshirege Member	641	641
Otowi Member	198	839
Guaje Member	91	930
Puye Conglomerate		
Fanglomerate member	237	1167
Basaltic Rocks of Chino Mesa		
Unit 2 <sup>a</sup>	126	1293
Puye Conglomerate		
Fanglomerate member	138	1431
Basaltic Rocks of Chino Mesa		
Mesa Unit 2 <sup>a</sup>	26	1457
Puye Conglomerate		
Fanglomerate member	18	1475
Totavi Lentil	52	1527
Santa Fe Group		
Chaquehui Formation	294	1821

Casing Schedule

525 ft of 12-in.-diam steel casing cemented in 0–525 ft; 1821 ft of 8-in.-diam steel casing hung 0 to 1821 ft with a total of 220 ft of torch-cut slots throughout the area below 1172 ft.

Geophysical Log

Gamma-ray/neutron, induction-electrical, temperature, microlog-caliper, laterlog, and sonic logs.

<sup>a</sup>Logged by Weir and Purtymun (1962) as Tschicoma Formation (see text).

TABLE IX-B. Geologic Logs and Construction Data for Test Holes and Test Wells (5 Test Holes and Wells)  
(Continued)

4. Test Well DT-9

Elevation (LSD) 6935 ft	Water Level: 1003 ft, February 1960	
	Thickness	Depth
<u>Geologic Log</u>	<u>(ft)</u>	<u>(ft)</u>
Bandelier Tuff		
Tshirege Member	676	676
Otowi Member	126	802
Guaje Member	48	850
Puye Conglomerate		
Fanglomerate member	74	924
Basaltic Rocks of Chino Mesa		
Unit 2 <sup>a</sup>	238	1162
Puye Conglomerate		
Fanglomerate member	157	1319
Totavi Lentil	38	1357
Santa Fe Group		
Chaquehui Formation	144	1501

Casing Schedule

1335 ft of 12-in.-diam steel casing set 0–1335 ft, lower 295 ft torch slotted; 186 ft of 8-in.-diam steel casing swaged into the 12-in. casing at 1315 ft, set on bottom with 183 ft of torch-cut slots.

Geophysical Log

Gamma-ray/neutron, induction-electrical, temperature, laterlog, and sonic logs.

5. Test Well DT-10

Elevation (LSD) 7020 ft	Water Level: 1085 ft, April 1960	
	Thickness	Depth
<u>Geologic Log</u>	<u>(ft)</u>	<u>(ft)</u>
Bandelier Tuff		
Tshirege Member	672	672
Otowi Member	157	829
Guaje Member	35	864
Puye Conglomerate		
Fanglomerate member	108	972
Basaltic Rocks of Chino Mesa		
Unit 2 <sup>a</sup>	319	1291
Puye Conglomerate		
Fanglomerate member	65	1356
Totavi Lentil	46	1402
Santa Fe Group		
Chaquehui Formation	7	1409

Casing Schedule

1130 ft of 12-in.-diam steel casing set 0–1130 ft, lower 50 ft torch slotted; 310 ft of 8-in.-diam casing set swaged into the 12-in.-diam casing at 1098 ft, set on bottom with a total of 141 ft of torch-cut slots throughout the section.

Geophysical Log

Gamma-ray/neutron, induction-electrical, temperature, and sonic logs.

<sup>a</sup>Logged by Weir and Purtymun (1962) as Tschicoma Formation (see text).

Source: Weir and Purtymun 1962, modified by Purtymun for this report.

TABLE IX-C. Geologic Logs and Construction Data for Core and Shallow Test Holes (12 Core and Test Holes)

1. Test Hole CH-1

Elevation (LSD) 7170 ft	Water Level: Dry (drilled with air)	
	Thickness	Depth
<u>Geologic Log</u>	(ft)	(ft)
Bandelier Tuff		
Tshirege Member		
Unit 6	71	71
Unit 5	2	73
Unit 4	41	114
Unit 3	76	190
Unit 2	94	284
Unit 1B	217	501

Casing Schedule

500 ft of 2-in.-diam galvanized pipe set 0 to 500 ft, with the lower 20 ft slotted.

Geophysical Logs

Gamma ray.

2. Core Hole CH-2

Elevation (LSD) 7137 ft	Water Level: Dry (drilled with air) <sup>a</sup>	
	Thickness	Depth
<u>Geologic Log</u>	(ft)	(ft)
Asphalt and fill	6	6
Bandelier Tuff		
Tshirege Member		
Unit 6	78	84
Unit 5	2	86
Unit 4	56	142
Unit 3	55	197
Unit 2	101	298
Unit 1B	195	493
Unit 1A	14	507

Casing Schedule

507 ft of 2-in.-diam galvanized pipe set 0 to 507 ft with the lower 20 ft slotted.

Geophysical Logs

Gamma-ray, gamma-ray/neutron, induction-electrical, and temperature logs.

3. Core Hole CH-3

Elevation (LSD) 7170 ft	Water Level: Dry (drilled with air)	
	Thickness	Depth
<u>Geologic Log</u>	(ft)	(ft)
Bandelier Tuff		
Tshirege Member		
Unit 6	75	75
Unit 5	2	77
Unit 4	44	121

<sup>a</sup>Thousands of gallons of water and drilling mud are pumped into holes for geophysical logging.

TABLE IX-C. Geologic Logs and Construction Data for Core and Shallow Test Holes (12 Core and Test Holes)  
(Continued)

3. Core Hole CH-3 (Continued)

Tshirege Member		
Unit 3	72	193
Unit 2	102	295
Unit 1B	5	300

Casing Schedule

300 ft of 12-in.-diam galvanized pipe set 0 to 300 ft with the lower 20 ft slotted.

Geophysical Log

Gamma ray.

4. Core Hole CH-4

Elevation (LSD) 7116 ft	Water Level: Dry (drilled with air)	
	Thickness	Depth
<u>Geologic Log</u>	<u>(ft)</u>	<u>(ft)</u>
Bandelier Tuff		
Tshirege Member		
Unit 6	62	62
Unit 5	2	64
Unit 4	61	125
Unit 3	52	177
Unit 2	111	288
Unit 1B	15	303

Casing Schedule

300 ft of 2-in.-diam galvanized pipe set 0 to 300 ft with the lower 20 ft slotted.

Geophysical Log

Gamma ray.

5. Alpha Hole

Elevation (LSD) 7125 ft	Water Level: Dry (drilled with a bucket auger)	
	Thickness	Depth
<u>Geologic Log</u>	<u>(ft)</u>	<u>(ft)</u>
Bandelier Tuff		
Tshirege Member		
Unit 6	76	76
Unit 5	2	78
Unit 4	50	128
Unit 3	61	189

Casing Schedule

7 ft of 24-in.-diam corrugated metal pipe set from 0 to 7 ft; open hole 7 to 189 ft.

Geophysical Log

Gamma-ray/neutron and induction-electrical logs.

TABLE IX-C. Geologic Logs and Construction Data for Core and Shallow Test Holes (12 Core and Test Holes)  
(Continued)

6. Beta Hole

Elevation (LSD) 6801 ft	Water Level: Dry (drilled with a bucket auger)	
	Thickness	Depth
<u>Geologic Log</u>	(ft)	(ft)
Alluvium	8	8
Bandelier Tuff		
Tshirege Member		
Unit 1B	172	180

Casing Schedule

13 ft of 24-in.-diam corrugated metal pipe set from 0 to 13 ft; open hole 13 to 180 ft.

7. Gamma Hole

Elevation (LSD) 6870 ft	Water Level: Dry <sup>a</sup>	
	Thickness	Depth
<u>Geologic Log</u>	(ft)	(ft)
Alluvium	3	3
Bandelier Tuff		
Tshirege Member		
Unit 2	51	54

Casing Schedule

8 ft of 4-in.-diam steel casing set 0 to 8 ft, open hole 8 to 54 ft.

8. Area 2 Test Hole 1

Elevation (LSD) 7135 ft	Water Level: Dry (drilled with 4-in.-diam auger)	
	Thickness	Depth
<u>Geologic Log</u>	(ft)	(ft)
Soil and pumice	8	8
Bandelier Tuff		
Tshirege Member		
Unit 6	68	76
Unit 5	1	77
Unit 4	46	123

9. Area 2 Test Hole 2

Elevation (LSD) 7120 ft	Water Level: Dry (drilled with 4-in.-diam auger)	
	Thickness	Depth
<u>Geologic Log</u>	(ft)	(ft)
Soil and pumice	7	7
Bandelier Tuff		
Tshirege Member		
Unit 6	53	60
Unit 5	1	61

<sup>a</sup>Surface water ran in hole, spring 1960.

TABLE IX-C. Geologic Logs and Construction Data for Core and Shallow Test Holes (12 Core and Test Holes)  
(Continued)

9. Area 2 Test Hole 2 (Continued)

Tshirege Member		
Unit 4	56	117
Unit 3	6	123

Casing Schedule

4 ft of 4-in.-diam plastic pipe cemented in 0 to 3 ft; open hole 3 to 123 ft.

10. Area 2 Test Hole 3

Elevation (LSD) 7144 ft	Water Level: Dry (drilled with a 4-in.-diam auger)	
	Thickness	Depth
<u>Geologic Log</u>	<u>(ft)</u>	<u>(ft)</u>
Soil and pumice	7	7
Bandelier Tuff		
Tshirege Member		
Unit 6	68	75
Unit 5	1	76
Unit 4	47	123

Casing Schedule

4 ft of 4-in.-diam plastic pipe cemented in 0 to 3 ft; open hole 3 to 123 ft.

11. Area 2 Test Hole 4

Elevation (LSD) 7143 ft	Water Level: Dry (drilled with a 4-in.-diam auger)	
	Thickness	Depth
<u>Geologic Log</u>	<u>(ft)</u>	<u>(ft)</u>
Soil and pumice	8	8
Bandelier Tuff		
Tshirege Member		
Unit 6	67	75
Unit 5	1	76
Unit 4	47	123

Casing Schedule

4 ft of 4-in.-diam plastic pipe cemented in 0 to 3 ft; open hole 3 to 123 ft.

12. Area 2 Test Hole 5

Elevation (LSD) 7135 ft	Water Level: Dry (drilled with a 4-in.-diam auger)	
	Thickness	Depth
<u>Geologic Log</u>	<u>(ft)</u>	<u>(ft)</u>
Soil and pumice	13	13
Bandelier Tuff		
Tshirege Member		
Unit 6	65	78
Unit 5	1	79
Unit 4	44	123

Casing Schedule

4 ft of 4-in.-diam plastic pipe cemented in 0 to 3 ft; open hole 3 to 123 ft.

Sources: Weir and Purtymun 1962; Purtymun 1994.

TABLE IX-D. Geologic Logs of 23 Moisture-Access Holes and 2 Observation Wells at TA-49

Moisture- Access Hole	Elevation LSD (ft)	Extent of Casing below LSD (ft)	Log	
			Soil (ft)	Bandelier Tuff (ft)
1M-1	7162	49	4.5	44.5
1M-2	7170	19	1	18
1M-3	7171	19	4	15
1M-3A	7171	49	3	46
2M-1	7129	49	1	48
2M-2	7131	10	5	5
2M-3	7141	19	5	14
3M-1	7163	50	1	49
3M-2	7169	19	2.5	16.5
3M-3	7174	20	7	13
4M-1	7112	49	2	47
4M-2	7116	20	1.5	18.5
4M-3	7107	19	3	16
4M-4	7122	19	3	16
5M-1	7136	39	2.5	36.5
5M-2	7146	19	3	16
6M-1	7210	19	9	10
9M-1	7115	19	6	13
9M-2	7104	19	6.5	12.5
9M-3	7049	19	4	15
9M-4	7097	19	12.5	6.5
10M-1	7090	29	2	27
10M-2	7093	20	4	16
WCM-1 <sup>a</sup>	6745	10	10	—
WCM-2 <sup>a</sup>	6650	10	10	—

Note: Moisture-access holes and observation wells completed February 1960; drilled with 2-in.-diam wagon drill with 2-in.-diam plastic pipe forced into holes. All holes dry except WCM-1 and WCM-2 (completed in the alluvium of Water Canyon).

<sup>a</sup> Completed as observation wells in Water Canyon, lower 5 ft perforated (see Fig. IX-U for location).

Source: Weir and Purtymun 1962.

---



---

TABLE IX-E. Locations and Elevations (NAD 1927 and LANLC)

---

A. Surface Water

Water Canyon near Beta Hole	S 82 + 63	E 91 + 36	6800 ft
-----------------------------	-----------	-----------	---------

B. Deep Test Holes

DT-5P	S 111 + 32	E 94 + 36	7144 ft
DT-5	S 110 + 99	E 93 + 03	7143 ft
DT-5A	N 1,754,727	E 485,066	7144 ft
DT-9	N 1,751,431	E 488,750	6935 ft
DT-10	N 1,754,387	E 488,744	7020 ft

C. Core and Test Holes

CH-1	S 104 + 98	E 84 + 37	7170 ft
CH-2	S 105 + 70	E 97 + 85	7137 ft
CH-3	S 114 + 94	E 82 + 06	7170 ft
CH-4	S 120 + 33	E 95 + 68	7116 ft
Alpha Hole	S 111 + 16	E 97 + 54	7125 ft
Beta Hole	S 83 + 63	E 91 + 89	6801 ft
Gamma Hole	S 133 + 20	E 104 + 00	6870 ft
TH-1	N 1,755,200	E 485,700	7135 ft
TH-2	N 1,755,500	E 485,600	7120 ft
TH-3	N 1,755,300	E 485,400	7144 ft
TH-4	N 1,755,100	E 485,400	7143 ft
TH-5	N 1,755,200	E 485,500	7135 ft

D. Moisture-Access Holes

1M-1	S 104 + 40	E 85 + 48	7162 ft
1M-2	S 104 + 63	E 83 + 39	7170 ft
1M-3	S 105 + 92	E 84 + 95	7171 ft
1M-3A	S 105 + 92	E 85 + 02	7171 ft
2M-1	S 104 + 73	E 99 + 28	7129 ft
2M-2	S 107 + 12	E 100 + 05	7131 ft
2M-3	S 106 + 66	E 96 + 01	7141 ft
3M-1	S 115 + 97	E 82 + 03	7163 ft
3M-2	S 114 + 82	E 82 + 67	7169 ft
3M-3	S 114 + 56	E 79 + 96	7174 ft
4M-1	S 121 + 29	E 96 + 44	7112 ft
4M-2	S 120 + 57	E 94 + 70	7116 ft
4M-3	S 122 + 76	E 96 + 94	7107 ft
4M-4	S 118 + 72	E 94 + 94	7122 ft
5M-1	S 111 + 32	E 94 + 36	7136 ft
5M-2	S 111 + 05	E 92 + 38	7146 ft
6M-1	S 102 + 15	E 68 + 83	7210 ft
9M-1	S 116 + 67	E 88 + 44	7115 ft
9M-2	S 113 + 40	E 98 + 15	7104 ft
9M-3	S 117 + 02	E 104 + 57	7049 ft
9M-4	S 113 + 93	E 100 + 40	7097 ft
10M-1	S 104 + 96	E 110 + 31	7090 ft
10M-2	S 104 + 54	E 108 + 69	7093 ft
WCM-1	S 92 + 20 approx	E 111 + 20 approx	6745 ft approx
WCM-2	S 102 + 20 approx	E 145 + 00 approx	6650 ft approx

---



## X. AIR INJECTION SITE NEAR TA-52

To study the possibility of injecting, storing, and later venting low-level short-lived radioactive gases, a site was prepared by augering four 5-in.-diam holes into the tuff (Fig. X-A). The holes were augered to 97 ft (Table X-A). Two plastic tubes were run to the bottom of each hole, with the lower 10 ft of each tube perforated. These were to be used to inject air and to measure any buildup of pressure that might occur. The injection zone at the bottom of the hole was packed with pea-sized gravel. The injection zone in each hole was isolated by a cement plug.

A 4-in.-diam hole (NE-2) was drilled with air to a depth of 297 ft, north of the cluster of four holes. The hole has two injection zones, one near the bottom from 272 to 291 ft and another at about 160 ft. These were constructed with only one tube going to each zone.

In one experiment air was pumped from the tuff, from different depths in two test holes. In NE-2 air was pumped from the zone 272 to 291 ft and from NE-1 air was pumped from the zone 78 to 83 ft. Both air samples were analyzed for carbon dioxide. The test revealed that the carbon that was present was of mixed origin, part atmospheric and part biogenic. Radiocarbon ages for the carbon dioxide could not be determined.

### REFERENCE

J. L. Kunkler, "The Sources of Carbon Dioxide in the Zone of Aeration of the Bandelier Tuff, near Los Alamos, New Mexico," in U.S. Geol. Survey Prof. Paper 650-D (1969).

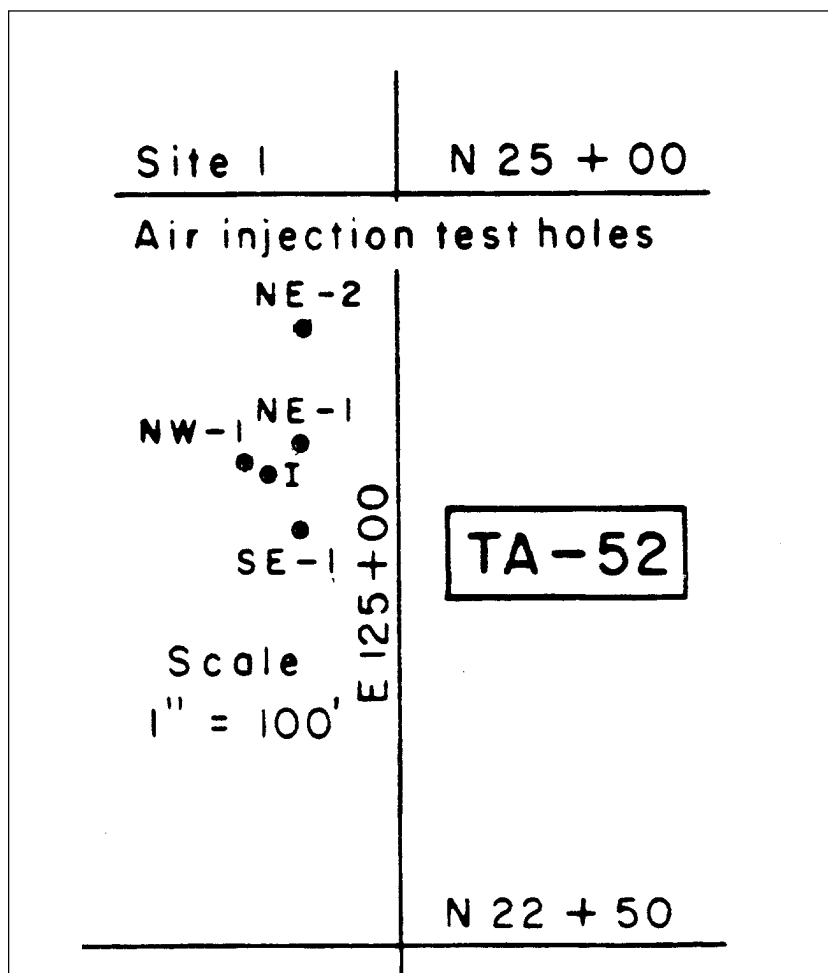


Fig. X-A. Locations of test holes at air injection site near TA-52.

TABLE X-A. Construction Data for Test Holes at Air-Tuff Transfer Site Near TA-52

Test Hole	Structure No.	Date Drilled	Elevation (LSD) (ft)	Diameter (in.)	Depth (ft)
I	TA-52-25	12/64	7168.8	5	97
NW-1	TA-52-24	12/64	7169.1	5	97
SE-1	TA-52-26	12/64	7167.4	5	97
NE-1	TA-52-23	12/64	7169.2	5	97
NE-2	TA-52-22	10/65	7171.5	4	295

Note: Holes I, NE-1, SE-1, and NW-1 have 6-in.-diam steel casing cemented into the top of the tuff. All holes have 10-ft-long gravel injection zones from 87 to 97 ft with tubes extending from the injection zones to the surface. Injection zones are isolated by cement plugs. All holes were dry.

TABLE X-B. Locations and Elevations (NAD 1927)

Hole I	N 1,768,138	E 488,802	7168.8 ft
Hole NW-1	N 1,768,140	E 488,799	7169.1 ft
Hole SE-1	N 1,768,119	E 488,811	7167.4 ft
Hole NE-1	N 1,768,144	E 488,812	7169.2 ft
Hole NE-2	N 1,768,182	E 488,816	7171.5 ft

## XI. AIR AND WATER INJECTION SITES NEAR TA-50

At Site 1 near TA-50, eight holes were augered or drilled with air to study the effect of atmospheric pressure change in different zones within the tuff (Fig. XI-A). All were completed in Unit 3 of the Tshirege Member of the Bandelier Tuff. Construction details are presented in Table XI-A.

At Site 2 near TA-50 seven holes were augered with a 5-in.-diam to depths ranging from 67 to 118 ft (Fig. XI-A). Two additional 4-in.-diam holes were rotary-air drilled to a depth of 295 ft (Table XI-B). The 67 ft hole was used as the injection well, with a 10-ft injection zone from 57 to 67 ft. Two lines were run into the injection zone, one to inject water and the second to measure the pressure at the center of the injection zone. The remaining holes were left open, with 4-in.-diam plastic pipe cemented in them. These holes were used to monitor the distribution of water and its movement out of the injection zone, through the use of a neutron moisture probe and scaler.

Additional 5-in.-diam holes (the C-series) were augered to a depth of 18 ft. These three holes were used for the calibration of the neutron probe and scaler. Each was cased with 2-in.-diam plastic tubing (Table XI-B).

All holes at both sites were destroyed during the construction of a new facility in early 1980.

### REFERENCES

J. L. Kunkler, "Measurement of Atmospheric Pressure and Subsurface-Gas Pressure in the Unsaturated Zone of the Bandelier Tuff, Los Alamos, New Mexico," in U.S. Geol. Survey Prof. Paper 650-D (1969).

W. D. Purtymun, E. Enyart, and S. G. McLin, "Hydrologic Characteristics of the Bandelier Tuff as Determined through an Injection Well System," Los Alamos National Laboratory report LA-11511-MS (1989).

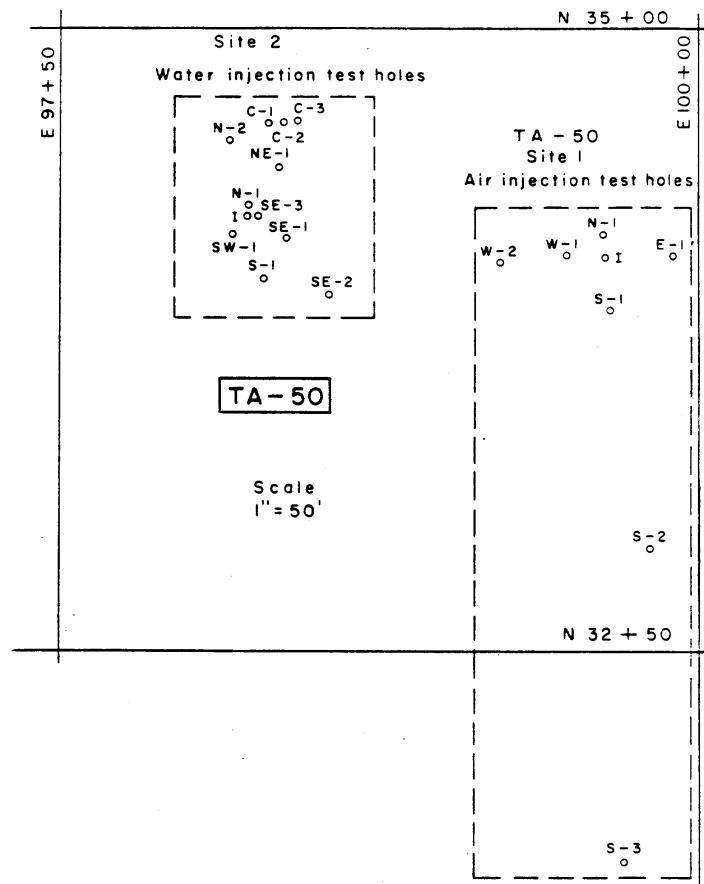


Fig. XI-A. Locations of test holes at Site 1 and Site 2 near TA-50.

TABLE XI-A. Construction Data for Test Holes at Air-Tuff Transfer Site 1 Near TA-50

Test Holes	Elevation (LSD) (ft)	Diameter (in)	Depth (ft)	Injection Zone				Remarks
				No. 1	No. 2	No. 3	No. 4	
E-1	7240.4	3	86	3-8	37-43	69-74	81-86	monitoring tubes
N-1	7241.8	5	94	3-6	25-30	54-60	86-94	injection and monitoring tubes
W-1	7241.7	3	91	3-8	39-44	69-74	86-91	monitoring tubes
W-2	7241.7	3	114	3-8	109-114	—	—	monitoring tubes
I	7241.6	5	60	3-8	25-30	55-60	—	injection and monitoring tubes
S-1	7239.7	5	90	3-8	24-29	55-60	83-90	injection and monitoring tubes
S-2	7231.6	5	56	49-56	—	—	—	water injection test
S-3	7218.3	5	43	—	—	—	—	open hole

Note: Holes E-1 and W-1 drilled air-rotary; all others augered. Injection zone consists of 3/8-in.-diam gravel. Monitoring tube is 1/2-in. plastic tubing perforated 1 foot from the bottom. Injection tube is 3/4-in. plastic tubing perforated 3 feet from the bottom. Perforations in each tube are separated from those of other tubes by lead plate. Tubes are cemented into the gravel-pack intervals. All holes were dry.

TABLE XI-B. Construction Data for Test Holes at Liquid Injection Site 2 Near TA-50

Test Hole	Date Drilled	Elevation (ft)	Diameter (in.)	Depth (ft)	Remarks
N-2	9/65	7247.7	5	112	
NE-1	9/65	7246.6	5	118	
N-1	11/64	7245.2	5	97	
I	11/64	7244.7	5	67	injection well
SE-3	10/65	7244.6	4	295	air rotary
SW-1	11/64	7244.4	5	97	
SE-1	11/64	7243.9	5	97	
S-1	10/65	7242.9	4	295	air rotary
SE-2	9/65	7241.6	5	112	
C-1	10/65	7248	5	18	
C-2	10/65	7248	5	18	
C-3	10/65	7248	5	18	

Note: All holes were completed in the tuff. Holes SE-3 and S-1 were drilled air-rotary; all others were augered. Hole I, an injection well with a gravel-pack injection zone from 55 to 65 ft, had an injection tube and observation hole extending from the injection zone to the surface. The hole was cemented from the surface to the top of the gravel pack at 55 ft. Holes C-1, C-2, and C-3 were calibration holes, cased with 2-in. plastic tubing. All other holes were open except for a short surface casing set through the soil zone. All holes were dry when drilled.

---



---

TABLE XI-C. Locations and Elevations (NAD 1927)

---

A. Air Study Site

Hole E-1	N 1,768,243	E 486,338	7240.4 ft
Hole N-1	N 1,769,251	E 486,354	7241.8 ft
Hole W-1	N 1,769,243	E 486,340	7241.7 ft
Hole W-2	N 1,769,242	E 486,314	7241.7 ft
Hole I	N 1,769,242	E 486,356	7241.6 ft
Hole S-1	N 1,769,321,	E 486,360	7239.7 ft
Hole S-2	N 1,769,123	E 486,368	7231.6 ft
Hole S-3	N 1,768,997	E 486,358	7218.3 ft

B. Water Study Site

Hole N-2	N 1,769,296	E 486,212	7247.7 ft
Hole NE-1	N 1,769,274	E 486,229	7246.6 ft
Hole N-1	N 1,769,270	E 486,219	7245.2 ft
Hole I	N 1,769,265	E 486,218	7244.7 ft
Hole SE-3	N 1,769,264	E 486,220	7244.6 ft
Hole SW-1	N 1,769,258	E 486,211	7244.4 ft
Hole SE-1	N 1,769,255	E 486,231	7243.9 ft
Hole S-1	N 1,769,240	E 486,221	7242.9 ft
Hole SE-2	N 1,769,231	E 486,247	7271.6 ft
Hole C-1	N 1,769,302	E 486,227	7248 ft
Hole C-2	N 1,769,302	E 486,232	7248 ft
Hole C-3	N 1,769,303	E 486,237	7248 ft

---



## XII. TEST HOLES AT TA-21

Thirteen test holes were drilled around the perimeter of the contaminated waste disposal pit Area B west of TA-21. The holes were augered and samples collected to determine if there had been any movement of contaminants from the pit into the adjacent tuff (Fig. XII-A). The holes were also logged using the neutron probe and scaler to determine the moisture content of the tuff *in situ*.

The samples were analyzed for moisture as well as gross alpha, gross beta, plutonium, and uranium. The results of the investigation indicated no lateral migration of contaminants from the waste pit into the adjacent soil or tuff. Geologic logs of the holes are found on Table XII-A.

## REFERENCE

W. D. Purtymun and W. R. Kennedy, "Distribution of Moisture and Radioactivity in the Soil and Tuff at the Contaminated Waste Pit near Technical Area 21," Los Alamos, New Mexico," U.S. Geol. Survey Open-File Report (1966).

TABLE XII-A. Geologic Logs of Test Holes Near Solid Waste Disposal Area B at TA-21

Test Hole	Elevation (ft)	Depth (ft)	Log	
			Soil (ft)	Bandelier Tuff (ft)
DPS-1	7190	50	3	47
DPS-2	7191	25	3	22
DPS-3	7194	50	3	47
DPS-4	7202	25	3	22
DPS-5	7214	50	3	47
DPS-6	7216	50	6	44
DPS-7	7185	25	3	22
DPS-8	7181	50	6	44
DPS-9	7180	25	4	21
DPS-10	7182	35	4	31
DPS-11	7192	50	4	46
DPS-12	7192	36	3	33
DPS-13	7210	35	2	33

Note: Holes augered February 1966; holes 4-in. diam; holes plugged and abandoned after study. All holes were dry.

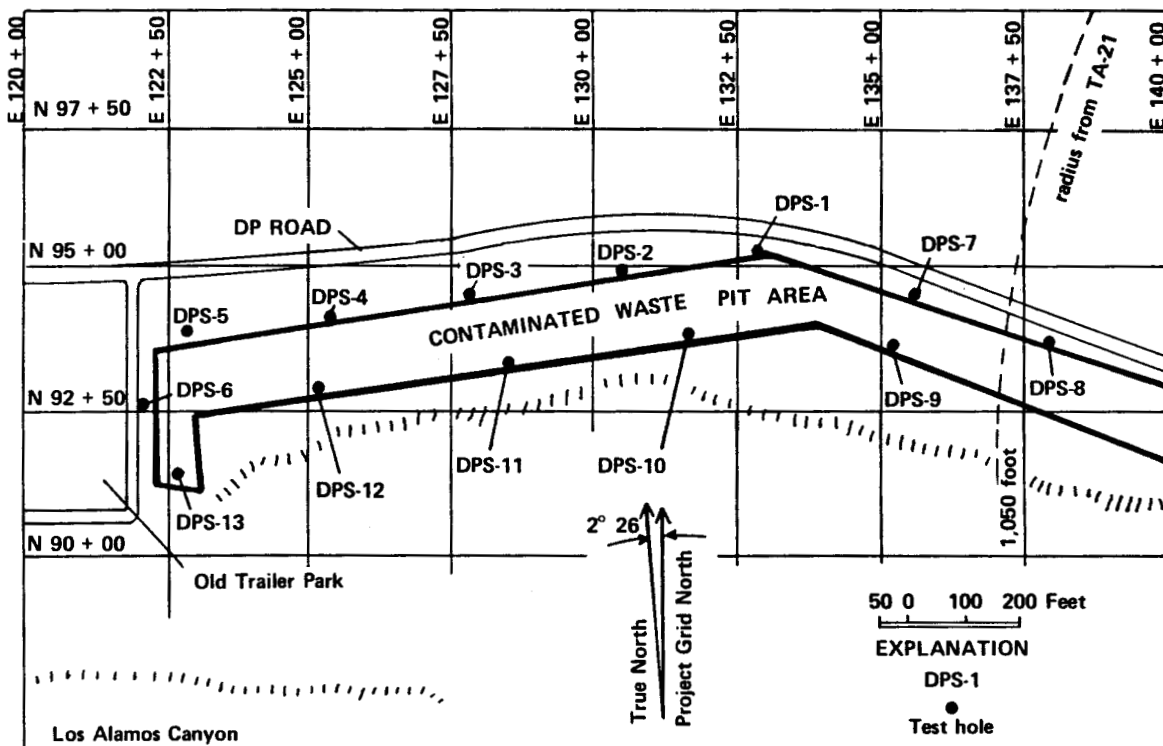


Fig. XII-A. Locations of test holes at solid waste Area B near TA-21.

---



---

TABLE XII-B. Locations and Elevations (NAD 1927)

---

DPS-1	N 1,775,197	E 489,945	7190 ft
DPS-2	N 1,775,172	E 489,702	7191 ft
DPS-3	N 1,775,149	E 489,432	7194 ft
DPS-4	N 1,775,130	E 489,233	7202 ft
DPS-5	N 1,775,108	E 488,928	7214 ft
DPS-6	N 1,774,989	E 488,848	7116 ft
DPS-7	N 1,775,113	E 490,213	7185 ft
DPS-8	N 1,775,028	E 490,447	7181 ft
DPS-9	N 1,775,041	E 490,160	7180 ft
DPS-10	N 1,775,056	E 489,796	7182 ft
DPS-11	N 1,775,024	E 489,490	7192 ft
DPS-12	N 1,774,997	E 489,159	7192 ft
DPS-13	N 1,774,967	E 488,909	7210 ft

---



### **XIII. TEST HOLES AT AREAS L AND G AT TA-54**

A study of the waste disposal area at Areas L and G at TA-54 was made during 1985–1986. The study was requested by the State of New Mexico Environmental Department. The Laboratory contracted with Bendix Corporation of Grand Junction, Colorado for Bendix to characterize the Bandelier Tuff. As a result of that study, the Environmental Protection Group, Hazardous and Solid Waste Section, had 10 additional holes drilled in 1988–1990 in Areas L and G. These holes were completed as pore-gas monitoring holes, to determine the extent of the organic vapor plume from Area L.

#### **A. Test Holes 1985 and 1986**

In 1985 and 1986, 18 test holes were cored or augered at Areas L and G to characterize the vadose zone in and around the chemical disposal pits and shafts (Area L) and the radioactive waste disposal pits and shafts (Area G). The holes ranged in depth from 60 to 145 ft (Fig. XIII-A and Table XIII-A). Numerous samples of the sections cored were analyzed for organic and inorganic chemicals and radionuclides and to learn the hydrologic properties of the tuff.

Areas L and G are located on a narrow south-east-trending mesa that is underlain by the Bandelier Tuff. The 18 holes drilled in 1985 are located on this mesa (Fig. XIII-A). The purposes of these test holes, and their geologic logs, are found in Table XIII-A. Special construction was used in some of the core holes to allow various types of tests. The construction consisted of packing off zones in the wells to allow special testing and sampling of vapors in the tuff, as well as equipping other zones with special equipment to measure pressures, moistures, and other hydrologic parameters.

Seven additional holes were cored by Bendix in 1986. The locations of these holes are shown in Fig. XIII-B, while their geologic logs and uses are found in Table XIII-B.

The holes drilled in 1985 and 1986 were completed in the Tshirege Member of the Bandelier Tuff. The tuff has been divided into four units described from the oldest (Unit 1A) to the youngest (Unit 2B) as in the type section in Mortandad Canyon (Fig. I-O); however, the Bendix report did not recognize the same boundaries or contacts as the

type section in Mortandad Canyon from Baltz et al. (1963) or Purtymun and Kennedy (1971). A correlation of the thicknesses of the units used in the Bendix reports with those of the type section in Mortandad Canyon appears in Fig. XIII-C. No attempt was made to change the thicknesses of the units described by Bendix to match those of the type section.

#### **B. Test Holes 1988–1990**

During the period 1988 through 1990 the Laboratory drilled 10 holes of 4-in. diam to monitor vapors in the tuff. A series of zones was set up with tubing to allow vapor sampling. The holes were located atop Mesita del Buey (Fig. XIII-D). All but the last 2 of the holes were drilled through the Tshirege, Otowi, and Guaje Members of the Bandelier Tuff into the top of the basalt (Purtymun 1990). The geologic logs and uses of the holes are shown in Table XIII-C. The logs in Table XIII-C reflect the description and thicknesses of the type section in Mortandad Canyon, thus the thicknesses may vary slightly from those of the logs in the Bendix report (Fig. XIII-C).

The geology used to describe the work 1988–1990 is presented in Purtymun and Kennedy (1971) and Purtymun (1990). In general, the four units thin to the southeast where the tuff was laid on top of the basalts (emplaced to the north and northwest) that came from vents east of the Rio Grande.

### **REFERENCES**

Vadose Zone Characterization of Technical Area 54, Waste Disposal Areas G and L, Los Alamos National Laboratory, Los Alamos, New Mexico: studies undertaken by Bendix Field Engineering Corporation, Grand Junction Operations, Grand Junction, Colo., resulted in four reports:

S. M. Rush and J. J. Dexter, "Report 1: Drilling and Logging Activities," (1985a).

Bendix Field Eng. Corp., "Report 2: Down-Hole Instrumentation and Pore-Gas-Sampling/Data-Collection Procedures," (1985b).

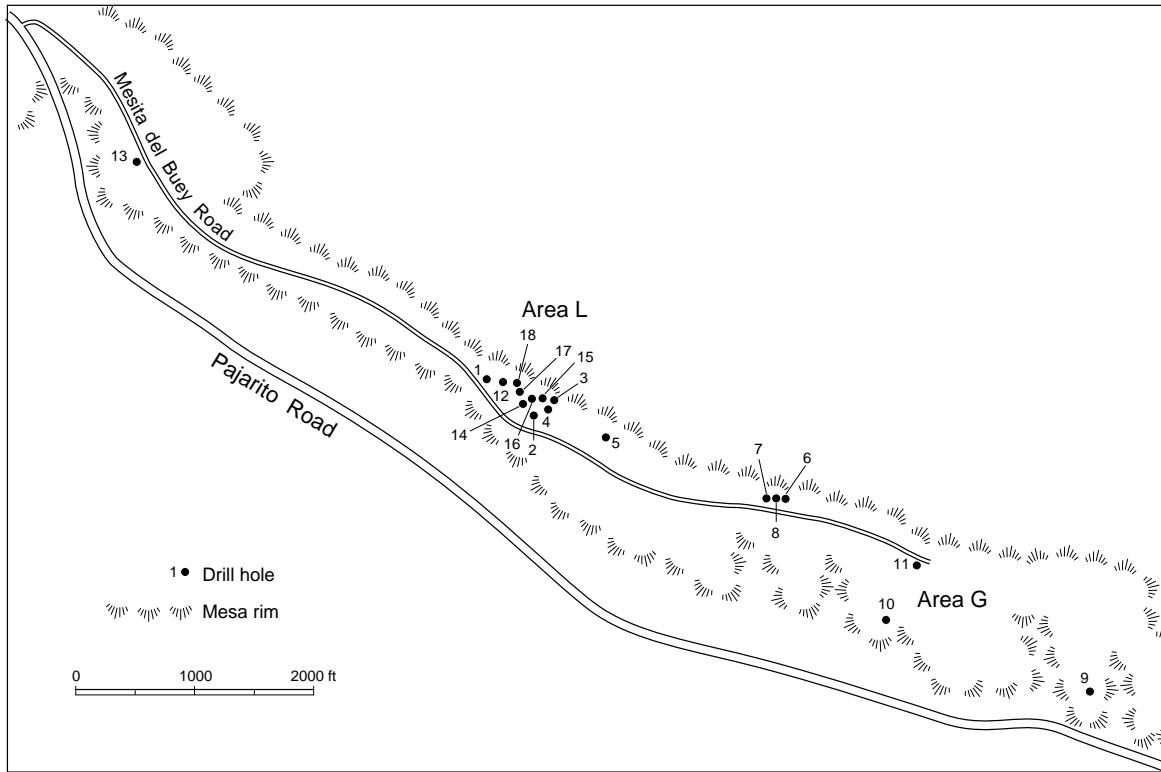
P. M. Kearl, J. J. Decker, and M. Kautsky, "Report 3: Preliminary Assessment of the Hydrologic System," (1986a).

P. M. Kearl, J. J. Dexter, and M. Kautsky, "Report 4: Preliminary Assessment of the Hydrologic System through Fiscal Year 1986," (1986b).

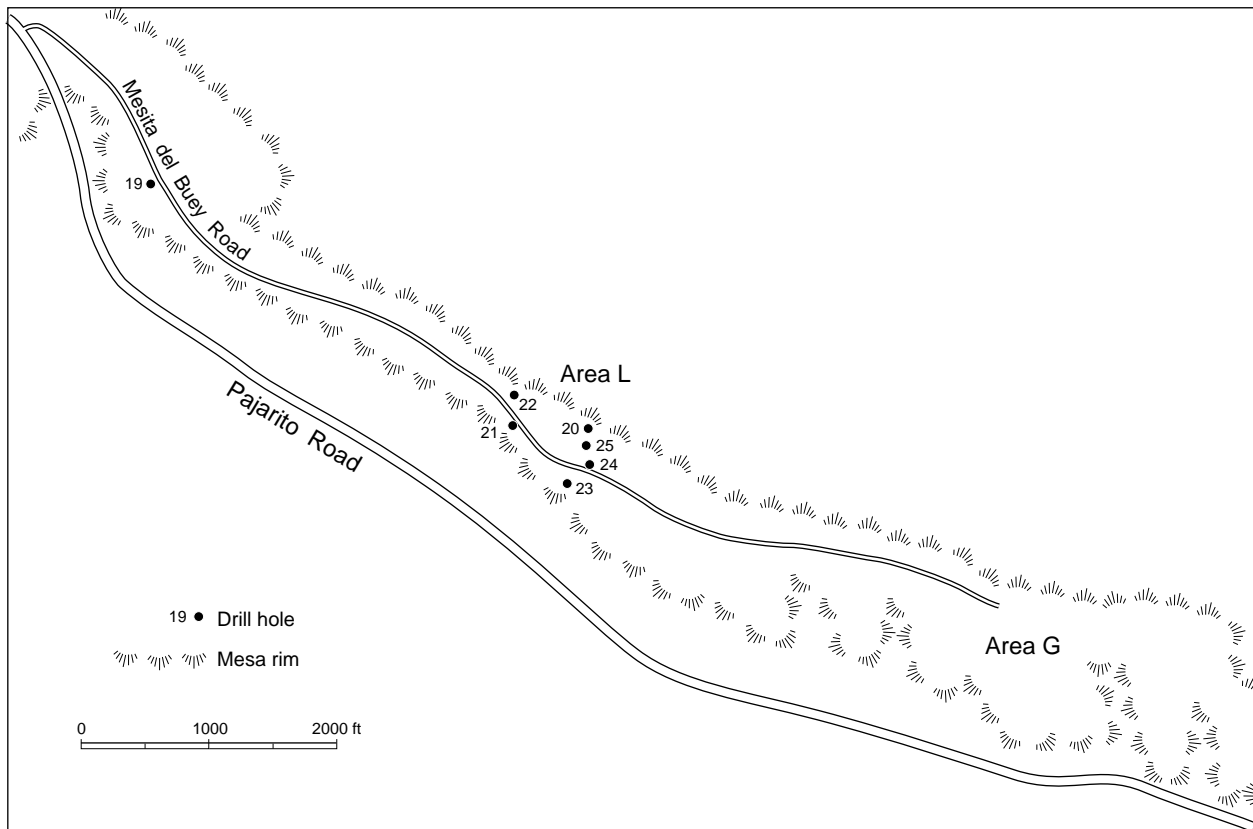
E. H. Baltz, J. H. Abrahams, and W. D. Purtymun, "Preliminary Report on the Geology and Hydrology of Mortandad Canyon near Los Alamos, New Mexico with Special Reference to Disposal of Liquid Low-Level Radioactive Wastes," U.S. Geological Survey Open-File Report (1963).

W. D. Purtymun, "Geology of Mesita del Buey, Results of Drilling Pore Gas Monitoring Holes," Los Alamos National Laboratory, unpublished HSE-8 document, 1990.

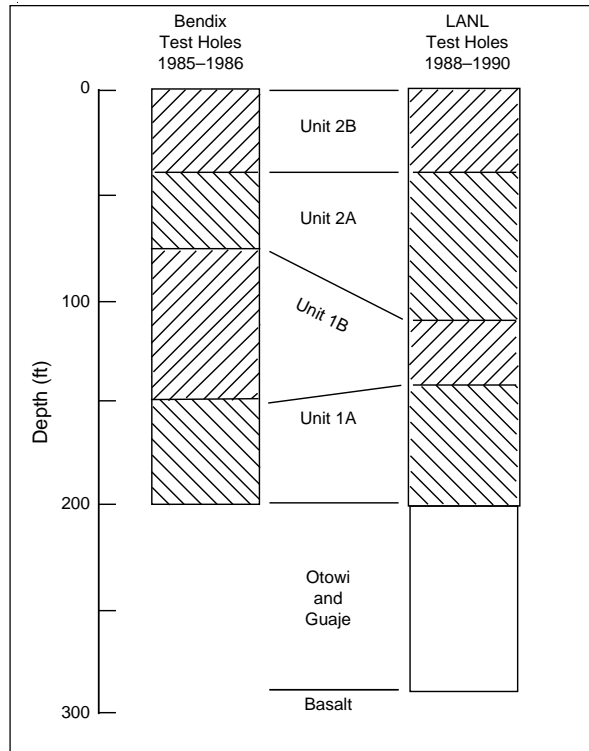
W. D. Purtymun and W. R. Kennedy, "Geology and Hydrology of Mesita del Buey," Los Alamos Scientific Laboratory report LA-4600 (1971).



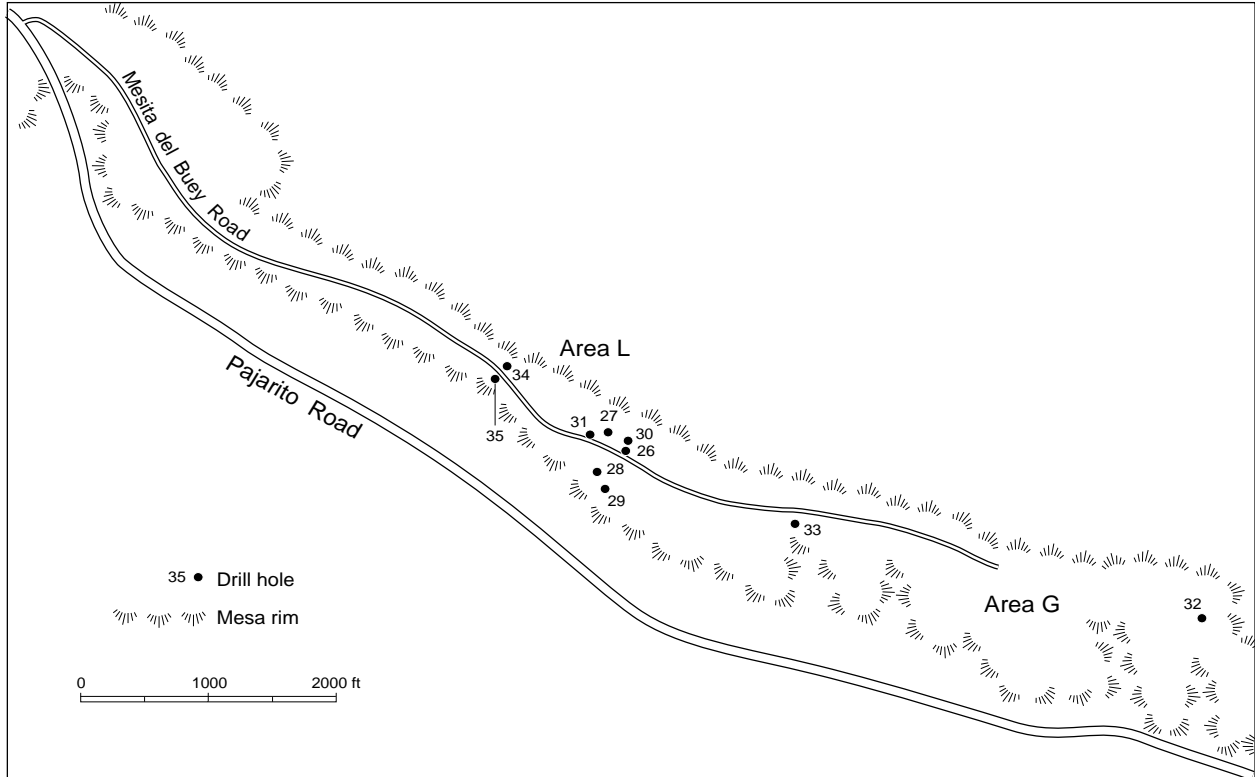
**Fig. XIII-A.** Locations of 18 test holes at Areas G and L on Mesita del Buey (Bendix 1985a).



**Fig. XIII-B.** Locations of seven test holes on Mesita del Buey (Bendix 1986a).



**Fig. XIII-C.** Correlation differences in the thicknesses of units of the Tshirege Member at Area L between Bendix test holes (1985-1986) and LANL test holes (1988-1990).



**Fig. XIII-D.** Locations of 10 test holes at Areas L and G on Mesita del Buey (Purtymun 1990).

TABLE XIII-A. Geologic Logs of Test Holes at Areas G and L, TA-54, Mesita del Buey (Bendix 1985a)

Hole Number	Elevation (ft)	Depth Cored (ft)	Total Depth Drilled (ft)	Geologic Log (ft)			
				Unit 2B	Unit 2A	Unit 1B	Unit 1A
LLM-85-01	6797.4	124	140	0 to 42	42 to 81	81 to 124+	—
LLM-85-02	6791.7	124	145	0 to 41	41 to 81	81 to 124+	—
LLP-85-03	6788.7	99	120	0 to 48	48 to 98	98 to 99+	—
LLN-85-04 <sup>a</sup>	6788.0	0	120	—	—	—	—
LLM-85-05	6772.5	124	145	0 to 39	39 to 74	74 to 124+	—
LGM-85-06	6730.0	124	60	0 to 37	37 to 61	61 to 107	107 to 124+
LGP-85-07	6731.7	49	60	0 to 32	32 to 49+	—	—
LGN-85-08 <sup>a</sup>	6731.5	0	120	—	—	—	—
LGC-85-09	6659.9	99	120	0 to 28	28 to 44	44 to 74	74 to 99+
LGC-85-10	6707.7	99	145	0 to 34	34 to 53	53 to 99+	—
LGM-85-11	6715.6	124	120	0 to 38	38 to 63	63 to 103	103 to 124+
LLC-85-12	6794.7	99	120	0 to 42	42 to 81	81 to 99+	—
LLC-85-13	6856.1	99	120	0 to 47	47 to 79	79 to 99+	—
LLC-85-14	6791.4	99	120	0 to 38	38 to 82	82 to 99+	—
LLC-85-15	6787.5	99	120	0 to 38	38 to 83	83 to 99+	—
LLC-85-16	6788.0	99	120	0 to 42	42 to 82	82 to 99+	—
LLC-85-17	6788.4	149	150	0 to 38	38 to 83	83 to 141	141 to 149+
LLC-85-18	6790.4	99	120	0 to 42	42 to 82	82 to 99+	—

Note: Cored 6 7/8-in.-diam hole; 3-in.-diam core; Total Depth Drilled is for the geophysical logging.

Hole Number : first letter “L,” Los Alamos; second letter “L” or “G,” Areas L or G at TA-54; third letter, use of hole: “M,” moisture hole; “C,” core and pore-gas sampling; “P,” Psychrometer holes; “N,” neutron moisture-access holes. All holes were dry.

<sup>a</sup> 4-in.-diam auger hole.

TABLE XIII-B. Geologic Logs of Test Holes at Area L, TA-54, Mesita del Buey (Bendix 1986a, 1986b)

Hole Numbers	Elevation (ft)	Depth Cored (ft)				
			Unit 2B	Unit 2A	Unit 1B	Unit 1A
LLC-86-19	6854.5	201	0–37	37–107	107–160	160–201+
LLC-86-20	6775.9	198	0–29	29–67	67–139	139–198+
LLC-86-21	6803.1	198	0–43	43–74	74–156	156–198+
LLC-86-22	6796.4	197	0–39	39–74	74–147	147–197+
LLC-86-23	6793.8	199	0–44	44–86	86–154	154–199+
LLC-86-24	6790.6	198	0–43	43–84	84–153	153–198+
LLC-86-25	6787.8	198	0–39	39–74	74–147	147–198+

Note: Cored 6 7/8-in.-diam hole, 3-in.-diam core. All holes were dry.

Hole Number: First letter “L,” Los Alamos; second “L,” Area L, TA-54; third letter “C,” core and pore-gas sampling.

TABLE XIII-C. Geologic Logs of Test Holes at Areas G and L, TA-54, Mesita del Buey (Purtymun 1990)

Hole Number	Elevation (ft)	Tshirege Member				Otowi and Guaje Members	Top of Basalt
		Unit 2B	Unit 2A	Unit 1B	Unit 1A		
LLC-88-26	6788.9	0–45	45–120	120–150	150–198	—	198
LLC-88-27	6784.5	0–45	45–110	110–140	140–190	190–263	263
LLC-88-28	6796.2	0–45	45–105	105–135	135–195	195–263	263–267
LLC-88-29	6793.4	0–45	45–120	120–150	150–225	225–298	298
LLC-89-30	6782.1	0–45	45–115	115–145	145–205	205–273	273
LLC-89-31	6803.7	0–45	45–125	125–155	155–225	225–291	291
LGC-89-32	6669.2	0–35	35–85	85–105	105–150	150–171	171
LGC-89-33	6747.0	0–40	40–105	105–130	130–180	180–293	293
LLC-90-34	6800.0	0–36	36–115	115–151	151–195	195–317	—
LLC-90-35	6810.0	0–40	40–111	111–161	161–201	201–351	—

Note: Augered with 4 1/2-in.-diam solid-stem auger; geologic correlations based on cuttings returned, down pressure, and drilling breaks. All holes dry.

Hole Number: First letter “L,” Los Alamos; second letter, “L” for Area L or “G” for Area G; third letter, “C,” for core or pore-gas sampling.

---



---

TABLE XIII-D. Locations and Elevations (NAD 1927)

---

A. Test Holes 1985

LLM-85-01	N 1,759,552.34	E 499,402.86	6797.4 ft
LLM-85-02	N 1,759,260.86	E 499,853.04	6791.7 ft
LLP-85-03	N 1,759,269.11	E 499,923.76	6788.7 ft
LLN-85-04	N 1,759,265.96	E 499,924.24	6788.0 ft
LLM-85-05	N 1,758,919.02	E 500,471.44	6772.5 ft
LGM-85-06	N 1,758,437.40	E 502,239.90	6730.0 ft
LGP-85-07	N 1,758,462.39	E 502,195.69	6731.7 ft
LGN-85-08	N 1,758,457.04	E 502,205.42	6731.5 ft
LGC-85-09	N 1,756,884.15	E 504,521.44	6659.9 ft
LGC-85-10	N 1,757,487.94	E 502,748.67	6707.7 ft
LGM-85-11	N 1,757,977.36	E 502,978.01	6715.6 ft
LLC-85-12	N 1,759,536.30	E 499,477.89	6794.7 ft
LLC-85-13	N 1,761,119.07	E 496,644.14	6856.1 ft
LLC-85-14	N 1,759,355.53	E 499,782.26	6791.4 ft
LLC-85-15	N 1,759,315.73	E 499,895.35	6787.5 ft
LLC-85-16	N 1,759,350.09	E 499,850.10	6788.0 ft
LLC-85-17	N 1,759,485.35	E 499,703.83	6788.4 ft
LLC-85-18	N 1,759,440.61	E 499,698.48	6790.4 ft

B. Test Holes 1986

LLC-86-19	N 1,761,074.07	E 496,703.56	6854.5 ft
LLC-86-20	N 1,759,299.65	E 500,085.17	6775.9 ft
LLC-86-21	N 1,759,469.53	E 499,299.71	6803.1 ft
LLC-86-22	N 1,759,625.55	E 499,334.54	6796.4 ft
LLC-86-23	N 1,759,020.31	E 499,761.74	6793.8 ft
LLC-86-24	N 1,759,107.27	E 499,988.54	6790.6 ft
LLC-86-25	N 1,759,276.58	E 499,929.08	6787.8 ft

C. Test Holes 1988–1990

LLC-88-26	N 1,758,964.89	E 500,177.78	6788.9 ft
LLC-88-27	N 1,759,154.35	E 500,142.61	6784.5 ft
LLC-88-28	N 1,758,866.71	E 499,970.19	6796.2 ft
LLC-88-29	N 1,758,759.69	E 500,031.46	6793.4 ft
LLC-89-30	N 1,759,053.59	E 500,274.07	6782.1 ft
LLC-89-31	N 1,759,324.81	E 499,395.23	6803.7 ft
LGC-89-32	N 1,757,701.88	E 504,886.63	6669.7 ft
LGC-89-33	N 1,758,382.90	E 501,560.33	6747.0 ft
LLC-90-34	hole destroyed before survey		6800.0 ft
LLC-90-35	hole destroyed before survey		6810.0 ft

---





#### **XIV. TEST HOLES AT AREA P AT TA-16**

Area P at TA-16 has been used as an industrial landfill, and studies have been undertaken to address closure and postclosure EPA requirements. The test holes drilled in and around the landfill were part of a study to determine the type and extent of contamination.

The holes drilled at the landfill are classed into several categories: (1) exploratory holes drilled for geologic and hydrologic information (plugged and abandoned after completion); (2) a vadose monitoring system; (3) test holes completed as observation wells; and (4) test holes drilled for geologic and hydrologic information and completed as moisture-access holes (to be used to determine moisture content of the tuff).

The test holes and observation wells were drilled and completed in the Tshirege Member of the Bandelier Tuff. The tuff has been divided into five units, from oldest (Unit 2) to youngest (Unit 3D). The units are probably comparable to the type section in Mortandad Canyon (Fig. I-O). The tuff is nearer to the source, the Valles Caldera; thus, the welding is greater (the rock is denser). Unit 2 combines Unit 2A and 2B. Unit 3 was subdivided.

Unit 2 consists of a welded to densely welded rhyolite tuff, light gray to pinkish gray, with a few rock fragments of pumice and rhyolite.

Unit 3A consists of a welded rhyolite tuff, dark yellowish brown with rock fragments of pumice and porphyritic quartz latite and rhyolite.

Unit 3B consists of a welded rhyolite tuff, pale yellowish brown with rock fragments of gray and red pumice, and a few rhyolite rock fragments.

Unit 3C consists of a moderately welded rhyolite tuff, brownish gray to yellowish brown, with rock fragments of gray pumice and a few rhyolite rock fragments.

Unit 3D consists of a moderately welded rhyolite tuff, yellowish brown with a few gray pumice fragments and some pebble-sized rhyolite rock fragments. This unit forms the surface in the area and is overlain by a thin clayey soil, derived from weathering of the unit. There are a few scattered deposits of El Cajete Pumice mixed with the soil.

##### **A. Exploratory Holes**

Exploratory holes B-1, B-2, B-3, B-4, and B-5 were augered through the landfill into the underlying tuff. They were augered to determine

where to site the vadose monitoring system. Test holes P-10, P-11, and P-15 were drilled to collect samples and geologic information (Fig. XIV-A). Geologic logs and data pertaining to these eight holes are shown on Table XIV-A. The holes were plugged and abandoned (Brown et al. 1988).

##### **B. Vadose Monitoring Holes**

Vadose monitoring, consisting of eight separate wells clustered together into four well nests, was set up by drilling into and below the landfill into the tuff (Fig. XIV-B). Each well nest (Table XIV-B) consisted of either a single or dual completion of a pressure-vacuum lysimeter in one bore hole and an adjacent neutron moisture-access hole (McLin 1989).

##### **C. Observation Wells**

Nine test holes were completed as ground water monitoring wells (Fig. XIV-C). The depth of these holes ranged from 10 to 35 ft, with the well completion depth from 7 to 35 ft (Table XIV-C). The wells were located above the stream channel and below the landfill. They were all completed into the tuff. All were dry and contained no free water; thus, any leachate from the landfill would be moving in the vadose zone immediately below the landfill as unsaturated flow (Brown et al. 1988).

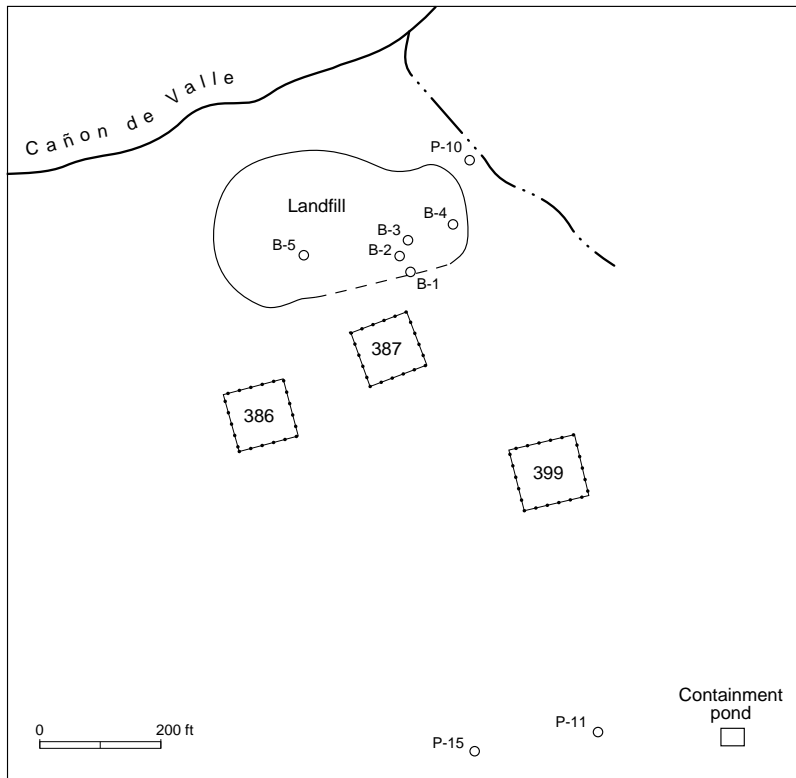
##### **D. Moisture-Access Holes**

Five test holes were completed as neutron moisture-access holes (Fig. XIV-D). They were augered to depths ranging from 85 to 200 ft (Table XIV-D). All were dry. The holes were completed as moisture-access holes to allow logging for moisture content with the neutron moisture logger and scaler (Brown et al. 1988; McLin 1989).

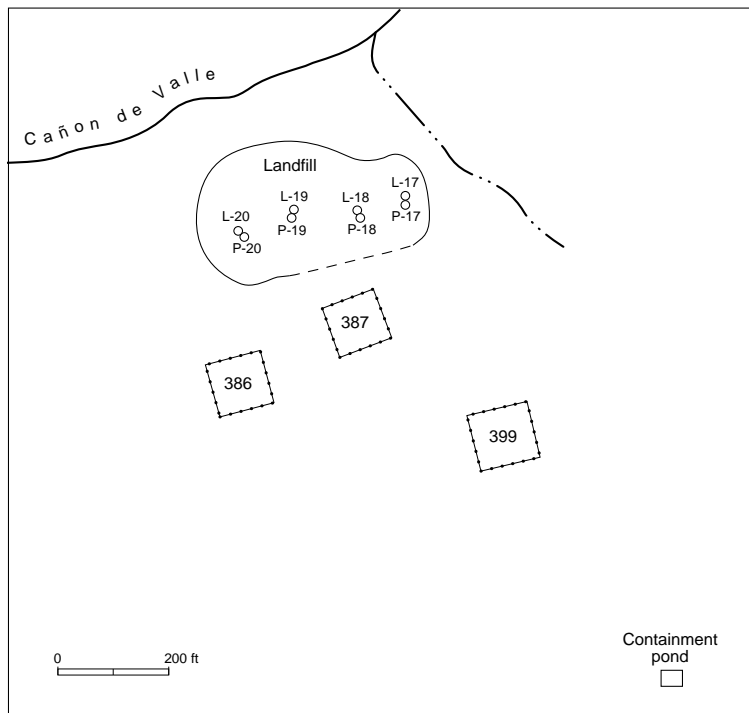
#### **REFERENCES**

F. Brown, W. D. Purtymun, A. Stoker, and A. Barr, "Site Geology and Hydrology of Technical Area 16, Area P," Los Alamos National Laboratory report LA-11209-MS (1988).

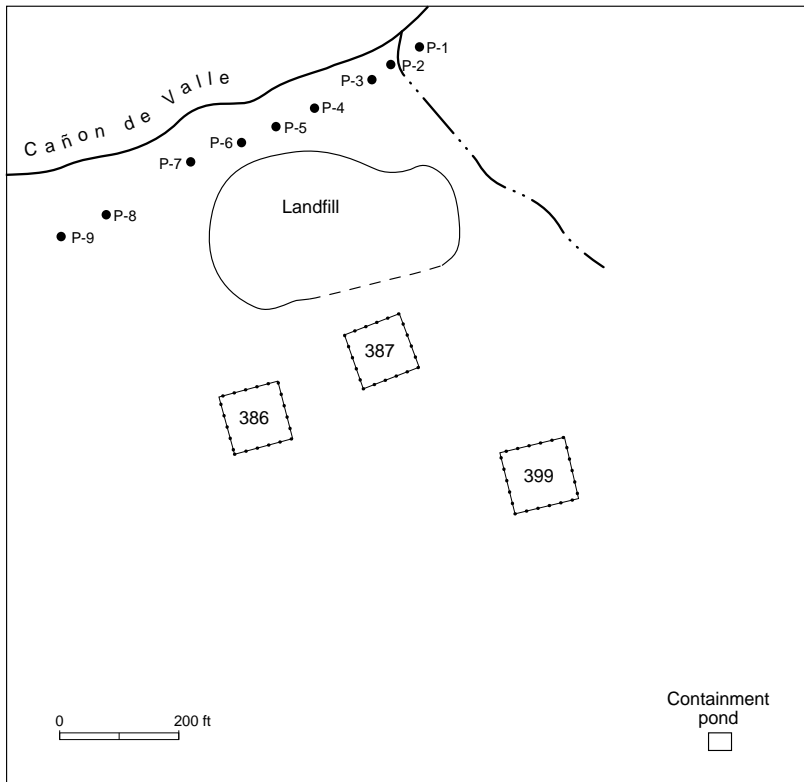
S. G. McLin, "Vadose Zone Monitoring Observations at the TA-16, Area P Landfill," Los Alamos National Laboratory report, Group HSE-8 document, 1989.



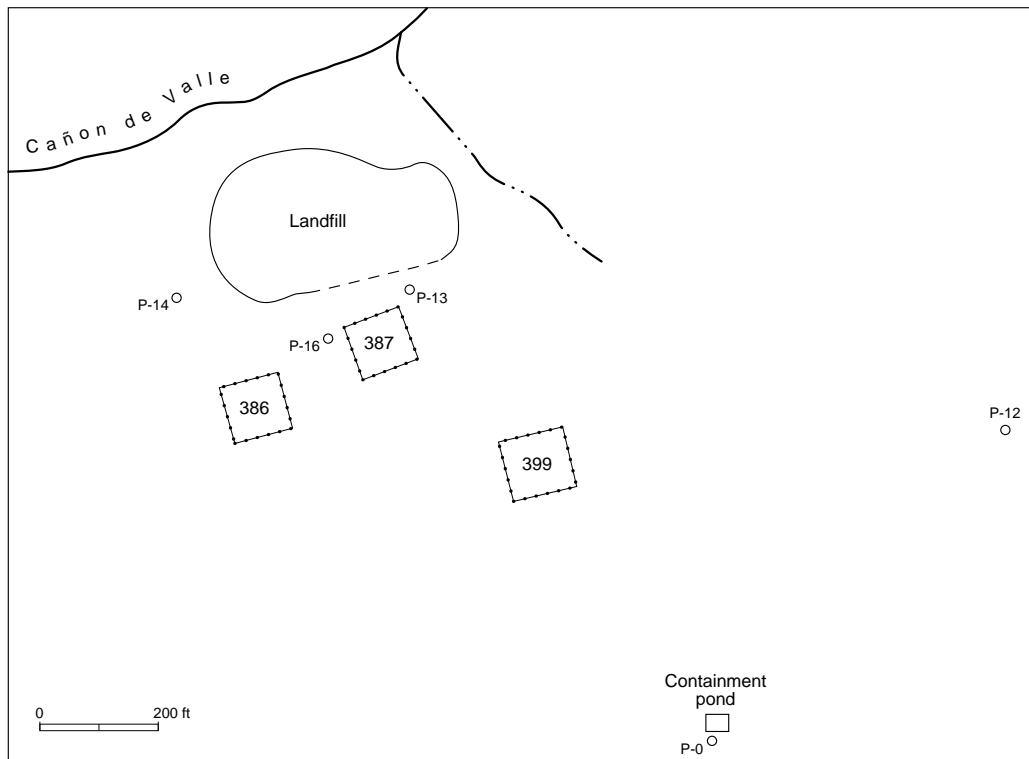
**Fig. XIV-A.** Locations of exploratory test holes at Area P, TA-16 (Brown et al. 1988).



**Fig. XIV-B.** Locations of four sets of cluster holes (L = Lysimeter hole; P = moisture-access hole) at Area P, TA-16 (McLin 1989).



**Fig. XIV-C.** Locations of ground water observation wells at Area P, TA-16 (Brown et al. 1988).



**Fig. XIV-D.** Locations of test holes completed as moisture-access holes at Area P, TA-16 (Brown et al. 1988; McLin 1989).

---



---

TABLE XIV-A. Geologic Logs of Exploratory Holes at TA-16 (8 Holes)

---



---

1. Test Hole B-1

Date Drilled: August 26, 1988  
 Elevation (LSD): 7445 ft

Water Level: Dry

<u>Log</u>	<u>Thickness</u> <u>(ft)</u>	<u>Depth</u> <u>(ft)</u>
Clayey soil, dark brown, moist	2	2
Clayey soil, sandy, dark brown, may be cover-fill material	3	5

Note: Exploratory hole; filled with drill cuttings and bentonite; abandoned; no samples collected.

2. Test Hole B-2

Date Drilled: August 26, 1988  
 Elevation (LSD): 7442 ft

Water Level: Dry

<u>Log</u>	<u>Thickness</u> <u>(ft)</u>	<u>Depth</u> <u>(ft)</u>
Clayey soil, dark brown, moist	2	2
Clayey soil, sandy, dark brown, may be cover-fill material	2	4

Note: Exploratory hole; filled with drill cuttings and bentonite; abandoned; no samples collected.

3. Test Hole B-3

Date Drilled: August 26, 1988  
 Elevation (LSD): 7438 ft

Water Level: Dry

<u>Log</u>	<u>Thickness</u> <u>(ft)</u>	<u>Depth</u> <u>(ft)</u>
Cover, sandy clay, dark brown, moist	1	1
Clay, brown and sand waste, mixture; white BaO crystals	3	4
Clay, dark brown with some gray sand; waste material, mixture of fragments of tuff and charcoal; moderate moisture	4	8
Clay, dark brown to black sticky, tuff fragments with wastes	5	13
Tuff, Unit 3D	1	14

Note: Exploratory hole; filled with drill cuttings and bentonite; abandoned; no samples collected.

4. Test Hole B-4

Date Drilled: August 30, 1988  
 Elevation (LSD): 7432 ft

Water Level: Dry

<u>Log</u>	<u>Thickness</u> <u>(ft)</u>	<u>Depth</u> <u>(ft)</u>
Clay, brown with black burn debris, low moisture	3	3
Clay, brown with black burn debris, low moisture	6	9
Clay, brown with sand and burn debris	5	14
Tuff, Unit 3D	5	19

Note: Debris at 3 ft confirms explosives, Lab reports <1% TNT, HMX, and RDX; exploratory hole; filled with drill cuttings and bentonite; abandoned; no other samples taken except as noted above.

---

---



---

TABLE XIV-A. Geologic Logs of Exploratory Holes at TA-16 (8 Holes) (Continued)

---

5. Test Hole B-5

Date Drilled: September 15, 1988

Elevation (LSD): 7450 ft

Water Level: Dry

<u>Log</u>	Thickness (ft)	Depth (ft)
Cover, crushed tuff, sand and clay mixture	1	1
Tuff, brown, crushed tuff cover-fill material	3	4
Tuff, brown, crushed tuff, cover-fill material (saturated lens 6 to 7 ft)	4	8
Tuff, brown, dense, dry, (tuff in place)	4	12

Note: Exploratory hole; filled with drill cuttings; abandoned.

6. Test Hole P-10

Date Drilled: July 30, 1987

Elevation (LSD): 7411 ft

Water Level: Dry

<u>Log</u>	Thickness (ft)	Depth (ft)
Sandy loam	3	3
Tuff, Unit 3C	47	50
Tuff, Unit 3B	70	120
Tuff, Unit 3A	30	150

Note: Exploratory hole; filled with cuttings and abandoned.

7. Test Hole P-11

Date Drilled: August 27, 1987

Elevation (LSD): 7409 ft

Water Level: Dry

<u>Log</u>	Thickness (ft)	Depth (ft)
Sandy loam	2	2
Tuff, Unit 3C	48	50
Tuff, Unit 3B	20	70

Note: Exploratory hole; filled with cuttings and abandoned.

8. Test Hole P-15

Date Drilled: August 27, 1987

Elevation (LSD): 7413 ft

Water Level: Dry

<u>Log</u>	Thickness (ft)	Depth (ft)
Sandy loam	4	4
Tuff, Unit 3C	51	55
Tuff, Unit 3B	15	70

Note: Exploratory hole; filled with cuttings and abandoned.

---

Source: Brown et al. 1988.

TABLE XIV-B. Geologic Logs and Construction Data for Vadose Monitoring Holes at TA-16  
(4 Sets of Holes)

1. Lysimeter Hole L-17

Moisture-Access Hole P-17

Date Drilled: September 6, 1988

Elevation (LSD): 7433 ft

Water Level: Dry

<u>Log</u>	<u>Thickness</u> (ft)	<u>Depth</u> (ft)
Topsoil cover	1	1
Waste in landfill	10	11
Tuff, Unit 3D, low moisture, light brown tuff with rhyolite rock fragments, nonwelded to moderately welded	19	30

Construction

Hole P-17 offset 6 ft from Hole L-17.

Lysimeter Hole L-17

Cement 0 to 2 ft  
Cuttings 2 to 4 ft  
Sand 4 to 6 ft  
Lysimeter 5 to 6 ft  
Cement 6 to 8 ft  
Cuttings 8 to 12 ft  
Sand 12 to 18 ft  
Lysimeter 16 to 17 ft  
Cuttings 18 to 19 ft

Moisture-Access Hole P-17

2- in.-diam aluminum pipe set 0 to 30 ft;  
set in 4-in.-diam hole; annulus between pipe  
and hole filled with medium silica sand.  
Pipe cemented in 0 to 1 ft.

2. Lysimeter Hole L-18

Moisture-Access Hole P-18

Date Drilled: September 8, 1988

Elevation (LSD): 7438 ft

Water Level: Dry

<u>Log</u>	<u>Thickness</u> (ft)	<u>Depth</u> (ft)
Sandy soil cover, light brown	1	1
Waste, light to dark brown clay with sand stringers	3	4
Waste, dark brown to black sticky clay with gray sand, some charcoal	9	13
Tuff, Unit 3D, light gray to light brown, nonwelded to moderately welded	17	30

Construction

Hole P-18 offset 6 ft from Hole L-18.

TABLE XIV-B. Geologic Logs and Construction Data for Vadose Monitoring Holes at TA-16  
(4 Sets of Holes) (Continued)

2. Lysimeter Hole L-18 (Continued)  
Moisture-Access Hole P-18

<u>Lysimeter Hole L-18</u>		<u>Moisture-Access Hole P-18</u>
Cement	0 to 2 ft	2-in.-diam aluminum pipe set 0 to 30 ft; set in 4-in.-diam hole; annulus between pipe and hole filled with medium silica sand. Pipe cemented in 0 to 1 ft.
Cuttings	2 to 5 ft	
Sand	5 to 6 ft	
Lysimeter	5 to 6 ft	
Cement	6 to 10 ft	
Cuttings	10 to 12 ft	
Sand	12 to 18 ft	
Lysimeter	17 to 18 ft	
Cuttings	18 to 19 ft	

3. Lysimeter Hole L-19  
Moisture-Access Hole P-19

Date Drilled: September 14, 1988  
Elevation (LSD): 7448 ft

Water Level: Dry

<u>Log</u>	<u>Thickness (ft)</u>	<u>Depth (ft)</u>
Sandy soil cover, dry	1	1
Crushed tuff fill, moderately dry	3	4
Crushed tuff fill, no waste apparent	10	14
Tuff, Unit 3D; light brown tuff with rhyolite rock fragments, nonwelded to moderately welded	16	30

Construction

Hole P-19 offset 6 ft from Hole L-19.

<u>Lysimeter Hole L-19</u>		<u>Moisture-Access Hole P-19</u>
Cement	0 to 2 ft	2-in.-diam aluminum pipe set 0 to 30 ft; set in 4-in.-diam hole; annulus between pipe and hole filled with medium silica sand. Pipe cemented in 0 to 1 ft.
Cuttings	2 to 10 ft	
Sand	10 to 12 ft	
Lysimeter	11 to 12 ft	
Cuttings	12 to 14 ft	

TABLE XIV-B. Geologic Logs and Construction Data for Vadose Monitoring Holes at TA-16  
(4 Sets of Holes) (Continued)

4. Lysimeter Hole L-20

Moisture-Access Hole P-20

Date Drilled: September 15, 1988

Elevation (LSD): 7446 ft

Water Level: Dry

<u>Log</u>	<u>Thickness</u> <u>(ft)</u>	<u>Depth</u> <u>(ft)</u>
Crushed tuff and soil mixture, sandy to sandy clay, light brown to dark brown; does not appear to be waste	15	15
Waste, tuff, and sand with charcoal fragments	6	21
Clay, brown, weathered in place	1	22
Tuff, Unit 3D; nonwelded, low moisture	8	30

Construction

Hole P-20 offset 6 ft from Hole L-20.

Lysimeter Hole L-20

Moisture-Access Hole P-20

Cement	0 to 1 ft	2-in.-diam aluminum pipe set 0 to 30 ft;
Cuttings	1 to 2 ft	set in 4-in.-diam hole; annulus between pipe
Sand	2 to 9 ft	and hole filled with medium silica sand.
Lysimeter	8 to 9 ft	Pipe cemented in 0 to 1 ft.
Cuttings	9 to 22 ft	
Cement	22 to 23 ft	
Cuttings	23 to 27 ft	
Sand	27 to 29 ft	
Lysimeter	28 to 29 ft	

Source: McLin 1989.



---



---

TABLE XIV-C. Geologic Logs and Construction Data for Observation Wells at TA-16 (9 Obs. Wells)

---

1. Observation Well P-1

Date Drilled: July 29, 1987

Elevation (LSD): 7344 ft

Water Level: Dry

<u>Log</u>	Thickness (ft)	Depth (ft)
Top soil	4	4
Tuff, Unit 3B	31	35

Construction

Bore hole diam 6 7/8 in.; 35 ft of 2-in.-diam teflon pipe with the lower 20 ft slotted (0.010-in.-wide slots) set in hole; cement 0–13 ft; bentonite 13 to 15 ft; medium-grained silica sand 15 to 35 ft.

2. Observation Well P-2

Date Drilled: July 23, 1987

Elevation (LSD): 7341 ft

Water Level: Dry

<u>Log</u>	Thickness (ft)	Depth (ft)
Sandy soil	3	3
Tuff, Unit 3B	7	10

Construction

Well plugged and abandoned.

3. Observation Well P-3

Date drilled: July 23, 1987

Elevation (LSD): 7342 ft

Water Level: Dry

<u>Log</u>	Thickness (ft)	Depth (ft)
Sandy soil	3	3
Tuff, Unit 3B	6	9

Construction

Bore hole diam 6 7/8 in.; 7 ft of 2-in.-diam teflon pipe with the lower 5 ft slotted (0.010-in.-wide slots) set in hole; cement and bentonite 0 to 2 ft; medium-grained silica sand 2 to 9 ft.

4. Observation Well P-4

Date drilled: July 28, 1987

Elevation (LSD): 7348 ft

Water Level: Dry

<u>Log</u>	Thickness (ft)	Depth (ft)
Sandy soil	4	4
Tuff, Unit 3B	6	10

Construction

Bore hole diam 6 7/8 in.; 8 ft of 2-in.-diam teflon pipe with the lower 5 ft slotted (0.010-in.-wide slots) set in hole; cement and bentonite 0 to 3 ft; medium-grained silica sand 3 to 10 ft.

5. Observation Well P-5

Date drilled: July 29, 1987

Elevation (LSD): 7353 ft

Water Level: Dry

<u>Log</u>	Thickness (ft)	Depth (ft)
Sandy soil	3	3
Tuff, Unit 3B	32	35

---

TABLE XIV-C. Geologic Logs and Construction Data for Observation Wells at TA-16 (9 Obs. Wells)  
(Continued)

5. Observation Well P-5 (Continued)

Construction

Bore hole diam 6 7/8 in.; 35 ft of 2-in.-diam teflon pipe with the lower 20 ft slotted (0.010-in.-wide slots) set in hole; cement 0 to 13 ft; bentonite 13 to 15 ft; medium-grained silica sand 15 to 35 ft.

6. Observation Well P-6

Date Drilled: July 28, 1987

Elevation (LSD): 7352 ft

Water Level: Dry

<u>Log</u>	<u>Thickness</u> <u>(ft)</u>	<u>Depth</u> <u>(ft)</u>
Sandy soil	4	4
Tuff, Unit 3B	6	10

Construction

Bore hole diam 6 7/8 in.; 7 ft of 2-in.-diam teflon pipe (with the lower 5 ft slotted) set in hole; cement and bentonite 0 to 2 ft; medium-grained silica sand 2 to 10 ft.

7. Observation Well P-7

Date Drilled: July 29, 1987

Elevation (LSD): 7356 ft

Water Level: Dry

<u>Log</u>	<u>Thickness</u> <u>(ft)</u>	<u>Depth</u> <u>(ft)</u>
Sandy soil	2	2
Tuff, Unit 3B	33	35

Construction

Bore hole diam 6 7/8 in.; 35 ft of 2-in.-diam teflon pipe with the lower 20 ft slotted (0.010-in.-wide slots) set in hole; cement 0 to 13 ft; bentonite 13 to 15 ft; medium-grained silica sand 15 to 35 ft.

8. Observation Well P-8

Date Drilled: July 28, 1987

Elevation (LSD): 7370 ft

Water Level: Dry

<u>Log</u>	<u>Thickness</u> <u>(ft)</u>	<u>Depth</u> <u>(ft)</u>
Sandy soil	3	3
Tuff, Unit 3B	7	10

Construction

Bore hole diam 6 7/8 in.; 7 ft of 2-in.-diam teflon pipe with the lower 5 ft slotted (0.010-in.-wide slots) set in hole; cement and bentonite 0 to 2 ft; medium-grained silica sand 2 to 10 ft.

9. Observation Well P-9

Date Drilled: July 29, 1987

Elevation (LSD): 7376 ft

Water Level: Dry

<u>Log</u>	<u>Thickness</u> <u>(ft)</u>	<u>Depth</u> <u>(ft)</u>
Sandy soil	3	3
Tuff, Unit 3C	12	15
Tuff, Unit 3B	20	35

---



---

TABLE XIV-C. Geologic Logs and Construction Data for Observation Wells at TA-16 (9 Obs. Wells)  
(Continued)

---

9. Observation Well P-9 (Continued)

Construction

Bore hole diam 6 7/8 in.; 35 ft of 2-in.-diam teflon pipe with the lower 20 ft slotted (0.010-in.-wide slots) set in hole; cement 0 to 13 ft; bentonite 13 to 15 ft; medium-grained silica sand 15 to 35 ft.

---

Source: Brown et al. 1988.

---



---

TABLE XIV-D. Geologic Logs and Construction Data for Moisture-Access Holes at TA-16  
(5 Moisture-Access Holes)

---

1. Test Hole P-0

Date Drilled: July 21, 1987

Elevation (LSD): 7399 ft

Water Level: Dry

<u>Log</u>	<u>Thickness</u> (ft)	<u>Depth</u> (ft)
Top soil	3	3
Tuff, Unit 3C	37	40
Tuff, Unit 3B	70	110
Tuff, Unit 3A	25	135

Construction

Bore hole diam 6 7/8 in.; cored; 2-in.-diam aluminum pipe set in hole 0 to 120 ft; cemented 0–1 ft; tuff cuttings from 1 to 135 ft around and below pipe.

2. Test Hole P-12

Date Drilled: August 21, 1987

Elevation (LSD): 7448 ft

Water Level: Dry

<u>Log</u>	<u>Thickness</u> (ft)	<u>Depth</u> (ft)
Top soil	3	3
Tuff, Unit 3D	47	50
Tuff, Unit 3C	52	102
Tuff, Unit 3B	71	173
Tuff, Unit 3A	22	195
Tuff, Unit 2	5	200

Construction

Bore hole diam 6 7/8 in.; cored; 171 ft of 2-in.-diam aluminum pipe 0 to 173 ft; cemented 0–1 ft; tuff cuttings from 1 to 200 ft around and below pipe.

---

TABLE XIV-D. Geologic Logs and Construction Data for Moisture-Access Holes at TA-16  
(5 Moisture-Access Holes) (Continued)

3. Test Hole P-13

Date Drilled: October 3, 1987

Elevation (LSD): 7445 ft

Water Level: Dry

<u>Log</u>	<u>Thickness</u> <u>(ft)</u>	<u>Depth</u> <u>(ft)</u>
Top soil	1	1
Tuff, Unit 3D	37	38
Tuff, Unit 3C	46	84
Tuff, Unit 3B	19	103

Construction

Bore hole diam 6 7/8 in.; cored; 92 ft of 2-in.-diam aluminum pipe set 0 to 92 ft; cemented 0–1 ft; tuff cuttings from 1 to 103 ft around and below pipe.

4. Test Hole P-14

Date Drilled: September 28, 1987

Elevation (LSD): 7437 ft

Water Level: Dry

<u>Log</u>	<u>Thickness</u> <u>(ft)</u>	<u>Depth</u> <u>(ft)</u>
Top soil	4	4
Tuff, Unit 3D	26	30
Tuff, Unit 3C	45	75
Tuff, Unit 3B	10	85

Construction

Bore hole diam 6 7/8 in.; cored; 79 ft of 2-in.-diam aluminum pipe set 0 to 79 ft; cemented 0–1 ft; tuff cuttings from 1 to 85 ft around and below pipe.

5. Test Hole P-16

Date Drilled: September 4, 1987

Elevation (LSD): 7452 ft

Water Level: Dry

<u>Log</u>	<u>Thickness</u> <u>(ft)</u>	<u>Depth</u> <u>(ft)</u>
Top soil	7	7
Tuff, Unit 3D	35	42
Tuff, Unit 3C	45	87
Tuff, Unit 3B	18	105

Construction

Bore hole diam 6 7/8 in.; cored; 88 ft of 2-in.-diam aluminum pipe set 0 to 88 ft; cemented 0–1 ft; tuff cuttings from 1 to 105 ft around and below pipe.

Sources: Brown et al. 1988; McLin 1989.

---



---

TABLE XIV-E. Locations and Elevations (NAD 1927)

---

A. Exploratory Holes

B-1	N 1,764,300	E 475,700	7445 ft
B-2	N 1,764,325	E 475,700	7442 ft
B-3	N 1,764,350	E 475,700	7438 ft
B-4	N 1,764,375	E 475,775	7432 ft
B-5	N 1,764,325	E 475,600	7450 ft
P-10	N 1,764,473	E 475,814	7411 ft
P-11	N 1,763,584	E 475,991	7409 ft
P-15	N 1,763,520	E 475,803	7413 ft

B. Vadose Monitoring Holes

L-17; P-17	N 1,764,400	E 475,750	7433 ft
L-18; P-18	N 1,764,375	E 475,675	7438 ft
L-19; P-19	N 1,764,350	E 475,550	7448 ft
L-20; P-20	N 1,764,325	E 475,475	7446 ft

C. Observation Wells

P-1	N 1,764,645	E 475,756	7344 ft
P-2	N 1,764,617	E 475,708	7341 ft
P-3	N 1,764,596	E 475,676	7342 ft
P-4	N 1,764,562	E 475,588	7348 ft
P-5	N 1,764,532	E 475,520	7353 ft
P-6	N 1,764,514	E 475,467	7352 ft
P-7	N 1,764,491	E 475,381	7356 ft
P-8	N 1,764,405	E 475,257	7370 ft
P-9	N 1,764,381	E 475,183	7376 ft

D. Moisture-Access Holes

P-12	N 1,764,036	E 476,664	7448 ft
P-13	N 1,764,264	E 475,720	7445 ft
P-14	N 1,764,251	E 475,365	7437 ft
P-16	N 1,764,200	E 475,550	7452 ft
P-0	N 1,763,523	E 476,215	7399 ft

---

Sources: Brown et al. 1988; McLin 1989.



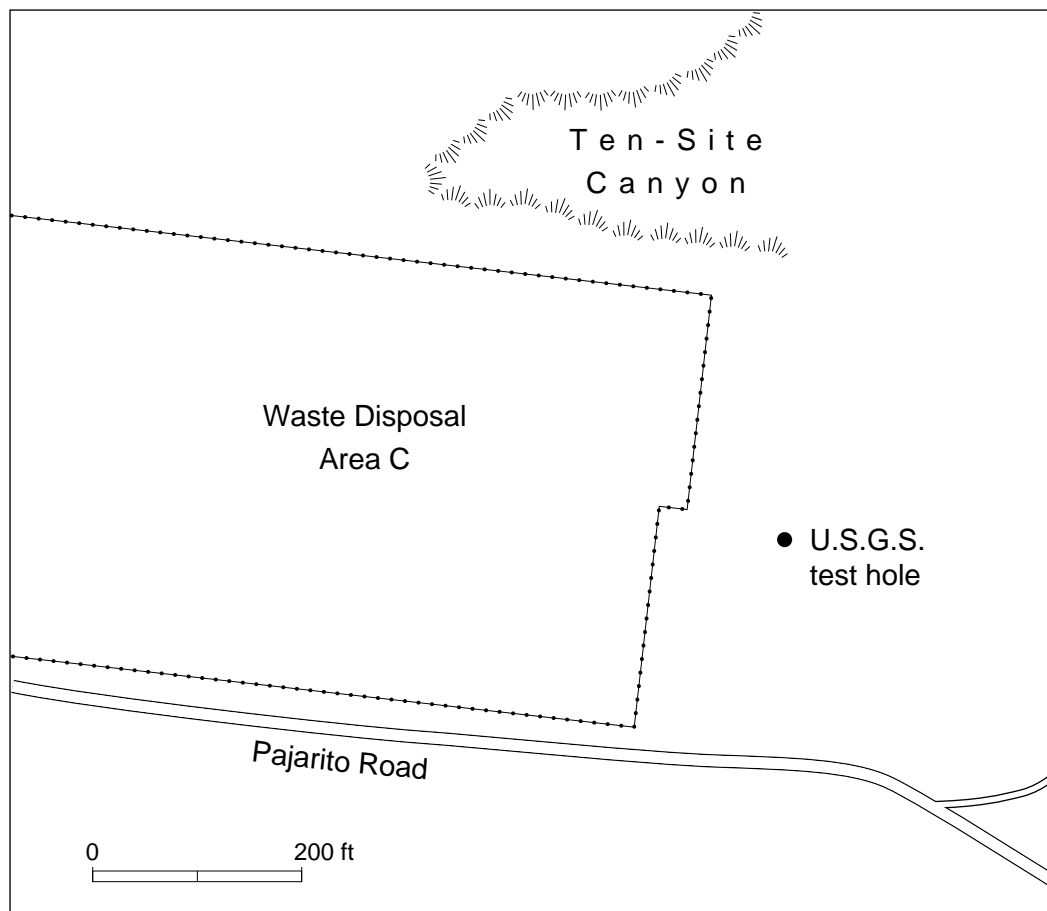
### XV. U.S. GEOLOGICAL SURVEY TEST HOLE NEAR TA-52

The U.S. Geological Survey cored an experimental hole to test the use of wireline-rotary air-coring techniques in the Bandelier Tuff. A modified standard wireline core-barrel system was used. The hole was located just east of Waste Disposal Area C (Fig. XV-A). The modified equipment was used to collect uncontaminated cores of unconsolidated ash and

indurated tuff to a depth of 210 ft. Core recovery was 92%. The hole was completed to study the characteristics of the vadose zone (Table XV-A).

#### REFERENCE

W. E. Teasdale and R. E. Pemberton, "Wireline-Rotary Air Coring of the Bandelier Tuff, Los Alamos, New Mexico," U.S. Geol. Survey Water Resources Investigation Report 84-4176 (1984).



**Fig. XV-A.** Location of U.S. Geological Survey test hole east of Waste Disposal Area C.

TABLE XV-A. Geologic Log and Construction Data for U.S. Geological Survey Test Hole near Waste Disposal Area C

Elevation (LSD) 7220 ft

Drilled: September 1983

Water Level: Dry

<u>Geologic Log</u>	<u>Thickness (ft)</u>	<u>Depth (ft)</u>
Bandelier Tuff		
Tshirege Member		
Unit 3, light gray moderately welded tuff	110	110
Unit 2, dark gray welded tuff	100	210

Construction

Completed as a vadose monitoring test hole.

Screen 1 190 to 195 ft

Screen 2 140 to 145 ft

Screen 3 105 to 110 ft

Screen 4 78 to 83 ft

Screen 5 50 to 55 ft.

Screen 6 25 to 30 ft

Instruments were set in screen sections, each section of screen sealed off with a mixture of grout (cement) and dry cuttings. Surface to 22 ft sealed with cement. Heat dissipation probe set in cuttings 118 to 122 ft. Electrical leads extend from instruments in screen section to land surface.

Geophysical Logs

Bulk density, neutron, gamma-ray, and caliper. Files available from the ESH-18 Geohydrology section.

TABLE XV-B. Locations and Elevations (NAD 1927)

U.S.G.S.TH	N 1,768,500	E 486,500	7220 ft
------------	-------------	-----------	---------



**XVI. CARBON ISOTOPE PRODUCTION HOLES AT TA-21 AND TA-46**

Carbon isotope production holes were drilled at TA-21 and TA-46 (Fig. XVI-A). The holes were used as part of a carbon 13 production plant using carbon monoxide distillation (Armstrong et al. 1970).

The preliminary testing and production of carbon 13 occurred at TA-21 building SM-3. In 1969 a hole to hold the distillation column was drilled in the northwest stairwell. The 36-in.-diam hole was augered to a depth of 125 ft. An 18-in.-diam casing was cemented in the hole. The casing extended about 15 ft above the floor level. The hole was completed in the Tshirege Member of the Bandelier Tuff. The hole was dry.

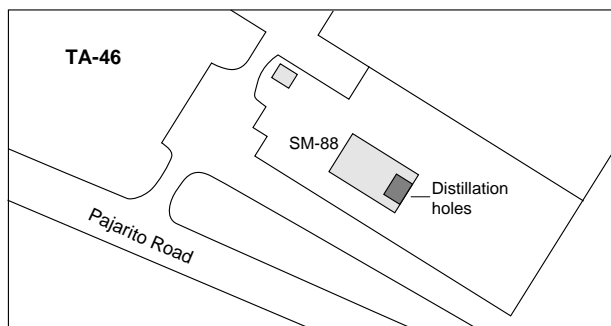
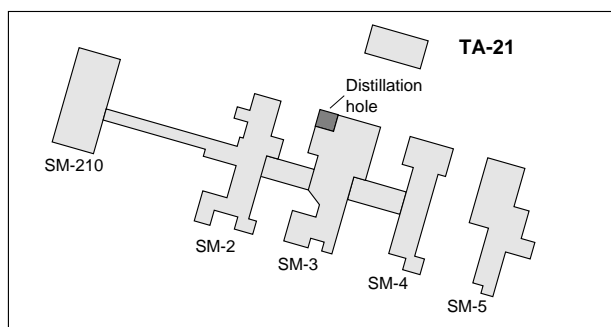
A production plant was built at TA-46 in building SM-88 in 1971. The eastern end of the building contained a large bay about 38 ft in height. The holes were drilled in the bay with a spacing of about 20 ft. The holes were reamed out to a 16-in. diameter to a depth of about 747 ft using a mud rotary. A 13 3/8-in.-diam casing was cemented in the holes.

The holes at TA-46 penetrated the total thickness of the Bandelier Tuff and were completed into the top of the Puye Conglomerate. The holes were dry (Purtymun 1994).

Geologic Log of TA-46 Holes

Elevation 7105 ft

	<u>Thickness</u>	<u>Depth</u>
	(ft)	
Bandelier Tuff		
Tshirege Member	360	360
Otowi Member	335	695
Guaje Member	32	727
Puye Conglomerate		
Sand, gravel, and boulders	20	747



**REFERENCES**

D. E. Armstrong, A. C. Briesmeister, B. B. McInteer, and R. M. Potter, "A Carbon 13 Production Plant Using Carbon Monoxide Distillation," Los Alamos Scientific Laboratory report LA-4391 (1970).

W. D. Purtymun, "Source Document Compilation: Los Alamos Investigations Related to the Environment, Engineering, Geology, and Hydrology, 1961–1990," Los Alamos National Laboratory report LA-12733-MS (1994), chapters 21 and 76.

**Fig. XVI-A.** Distillation holes at TA-21 and TA-46.

TABLE XVI-A. Locations and Elevations (NAD 1927)

TA-21	N 1,774,500	E 492,000	7150 ft
TA-46	N 1,765,500	E 499,500	7105 ft



## **XVII. TEST WELLS AND TEST HOLES ON THE PAJARITO PLATEAU**

Test holes and test wells were drilled into the Pajarito Plateau to provide geologic and hydrologic information (Fig. XVII-A and Table XVII-A). The test wells provide monitoring of perched aquifers and the main aquifer. Geologic logs and casing schedules of the test wells are shown in Table XVII-B.

Test wells TW-1 (Fig. XVII-B) and TW-2 (Fig. XVII-C) were drilled and completed to monitor the water in the main aquifer in Pueblo Canyon downgradient from the waste treatment plant at TA-45 (which was removed in 1964). Perched water was encountered in the basalts at TW-1 and in the fanglomerate member at TW-2. To monitor the water in the perched aquifers, offset wells TW-1A and TW-2A were drilled and completed as monitoring wells (Figs. XVII-B and XVII-C). Test hole TH-2B in Pueblo Canyon was an attempt to isolate a zone of perched water above the main aquifer and the water in the alluvium in the canyon. The perched aquifer was not there or was of such limited extent that it could not be located (Black and Veatch 1950; Griggs 1955).

Test well TW-3 monitors the water in the main aquifer beneath the alluvial aquifer in Los Alamos Canyon (Fig. XVII-D). Test well TW-4 (Fig. XVII-E) is located to monitor the water in the main aquifer in the vicinity of the old waste treatment plant at TA-21 (which has been removed) (Black and Veatch 1950; Griggs 1955).

Test holes TH-5, TH-6, and TH-7 were exploratory holes to determine the geology and determine if water occurred in the rocks underlying the alluvium (Figs. XVII-F through XVII-H) in Pajarito and Ancho Canyons (Griggs 1955).

Test well TW-8 was drilled and completed to test the quality of water of the main aquifer beneath Mortandad Canyon (Fig. XVII-I). Mortandad Canyon receives treated industrial effluents from the waste treatment plant at TA-50 (Baltz et al. 1963).

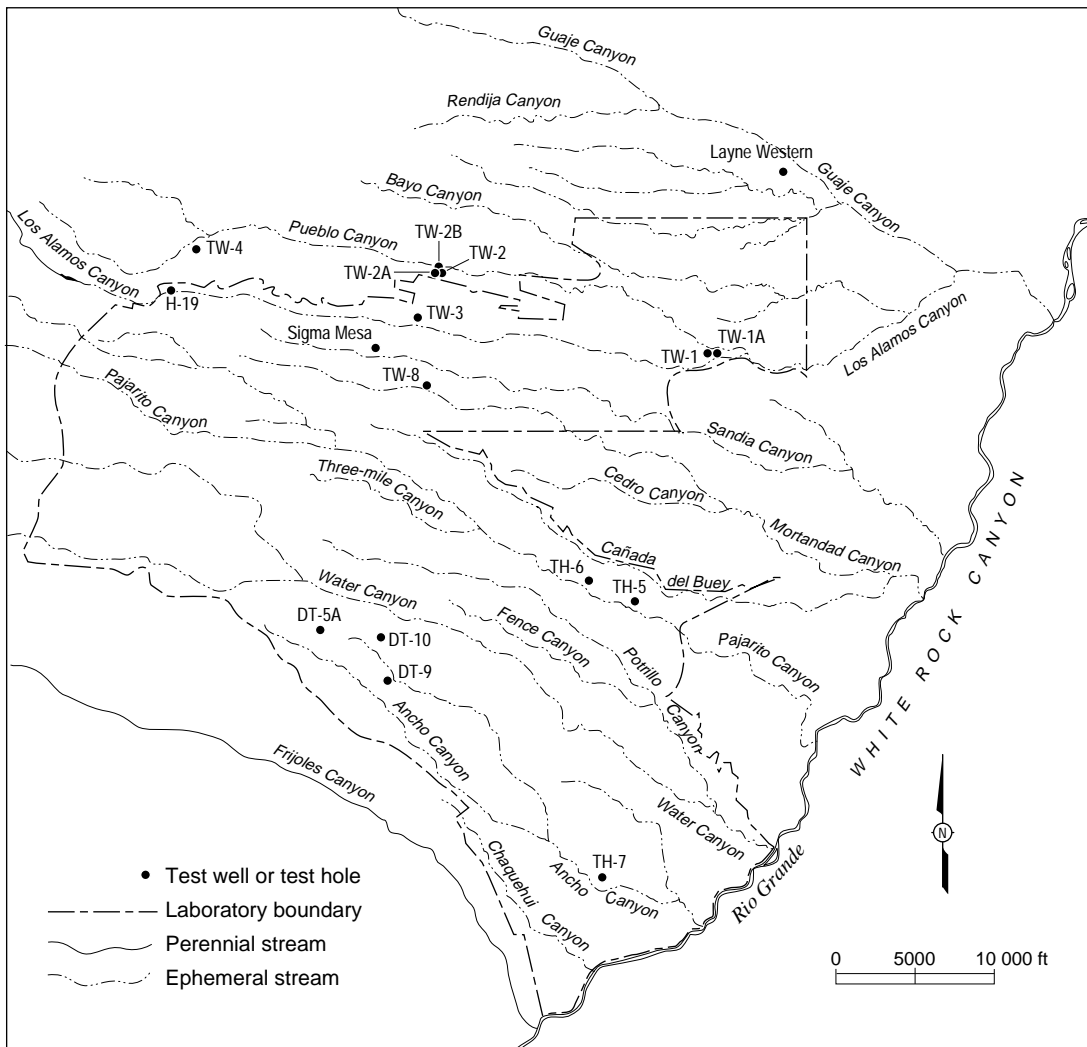
Test hole H-19 was drilled for geologic and hydrologic information (Fig. XVII-J). The test hole was drilled as part of the water investigation of the

Valles Caldera in 1949. The test hole encountered massive, thick sections of latite and dacite flows of the Tschicoma Formation. The hydrologic properties of the Tschicoma show that it is not capable of being developed as a water supply (Griggs 1955).

Test hole Sigma Mesa was intended as a test of the geothermal potential of the plateau area. The hole was targeted for a depth of 6000 ft. The hole was started on July 2, 1979. The hole experienced serious drilling problems with lost drilling fluids, essentially right out of the conductor pipe. The magnitude of the lost circulation problem is summarized in Table XVII-C. During July, 19 zones in the 1264 ft of hole drilled were cemented to shut off the zones that lost circulation. A total of 7280 sacks of cement were used. The last plug set (No. 19) indicates the lack of success of the operations; the cement plug disappeared completely into the formation. The drilling continued until December, when the project ran out of money and luck. The test hole was drilled to a total depth of 2292 ft. Most of the hole was drilled with little or no circulation or drill cutting returns. At a depth of about 2292 ft the drill string separated, leaving an unknown number of drill stems, drill collars, and the bit in the hole. The cuttings from the hole were few, while those captured contained much of the lost circulation material and redrilled sections. As a result, the geologic log prepared in 1979 was reviewed and revised using geophysical logs, a comparison of logs of nearby test wells and supply wells, and the R. F. Smith Corp. Geothermal Data Log of the hole (Table XVII-B and Fig. XVII-K).

Layne Western, located in Guaje Canyon, was drilled in 1950 (Tables XVII-A and XVII-B) to supply drilling water for the drilling and construction of the supply wells of the Guaje Field (Griggs 1955).

Four test holes were drilled in 1985 at the ski area on Pajarito Mountain west of the Laboratory. The westernmost hole encountered water and was completed as a well. The other three holes drilled to the east did not encounter water. They were drilled to depths of 400 ft through the volcanic rocks of the Bandelier Tuff and Tschicoma Formation (Tables XVII-A and XVII-B).



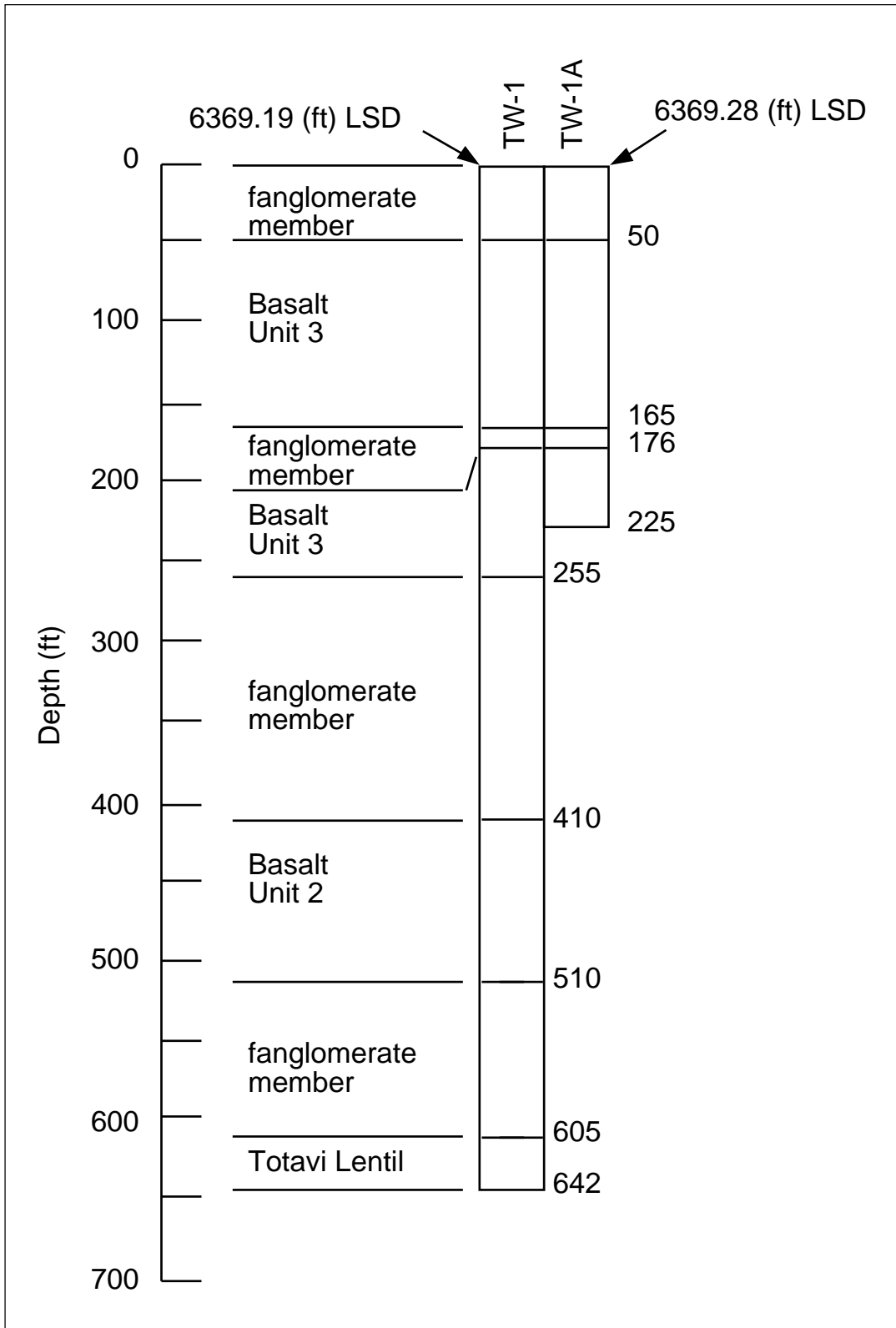
**Fig. XVII-A.** Test wells and test holes on the Pajarito Plateau.

**REFERENCES**

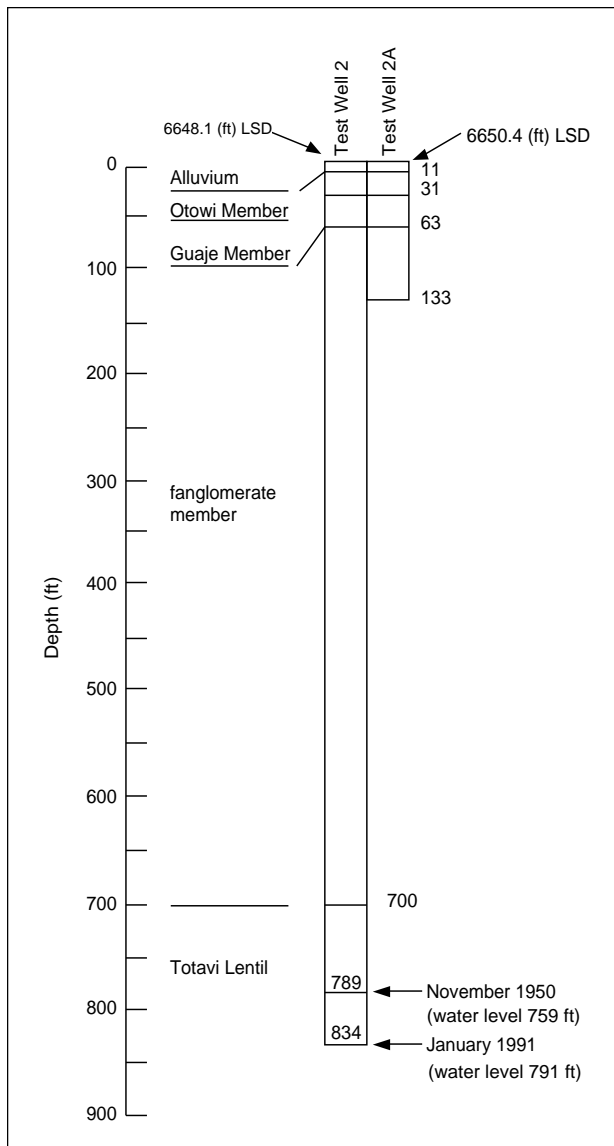
E. H. Baltz, J. H. Abrahams, and W. D. Purtymun, "Preliminary Report on the Geology and Hydrology of Mortandad Canyon, Los Alamos, New Mexico, with Special Reference to Disposal of Liquid Low-Level Radioactive Wastes," U.S. Geological Survey Open-File Report (1963).

Black and Veatch (Consulting Engineers), "Ground-Water Observation Wells, Los Alamos, New Mexico," Administrative Report prepared for the U.S. Atomic Energy Commission (1950).

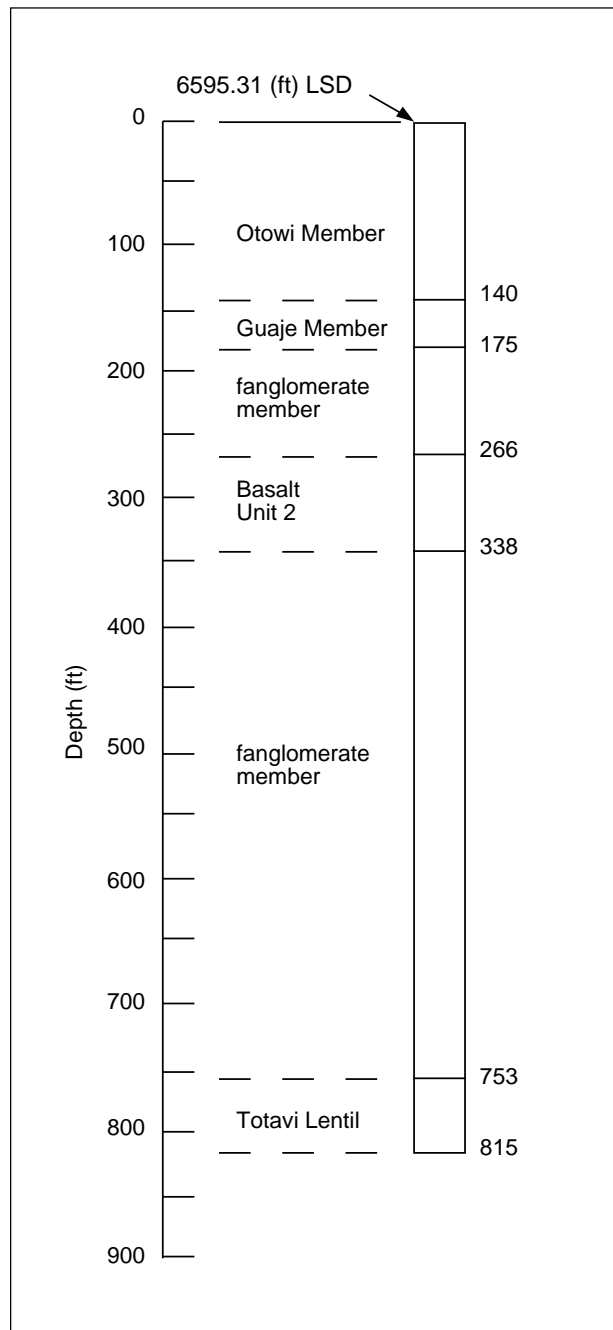
R. L. Griggs, "Geology and Ground-Water Resources of the Los Alamos Area, New Mexico," U.S. Geol. Survey Admin. Report to the U.S. Atomic Energy Commission (1955).



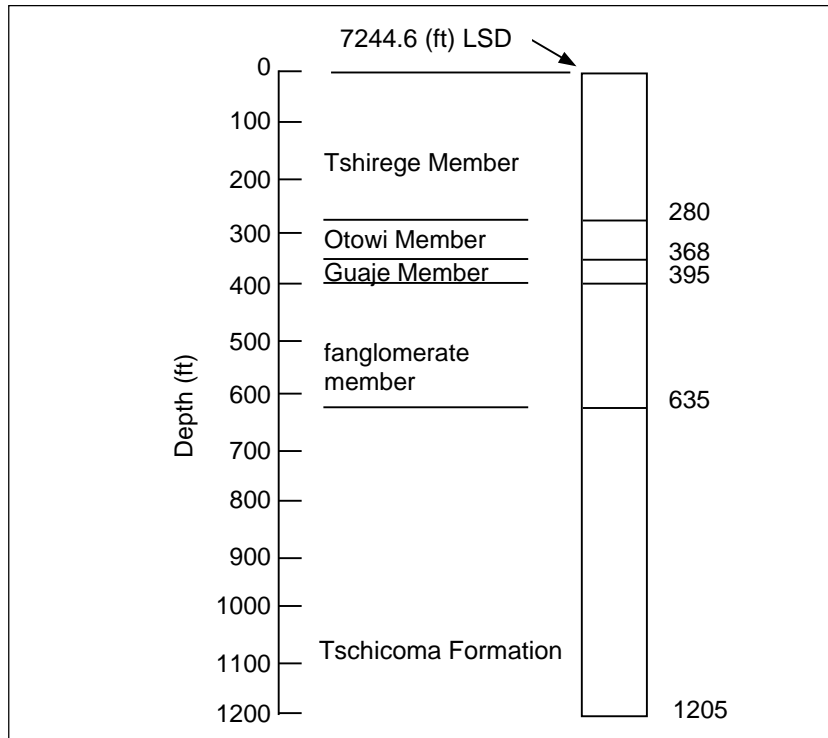
**Fig. XVII-B.** Geologic logs of test well TW-1, completed January 1950, water level 585 ft, and offset test well TW-1A, completed January 1950, water level 188 ft (Griggs 1955).



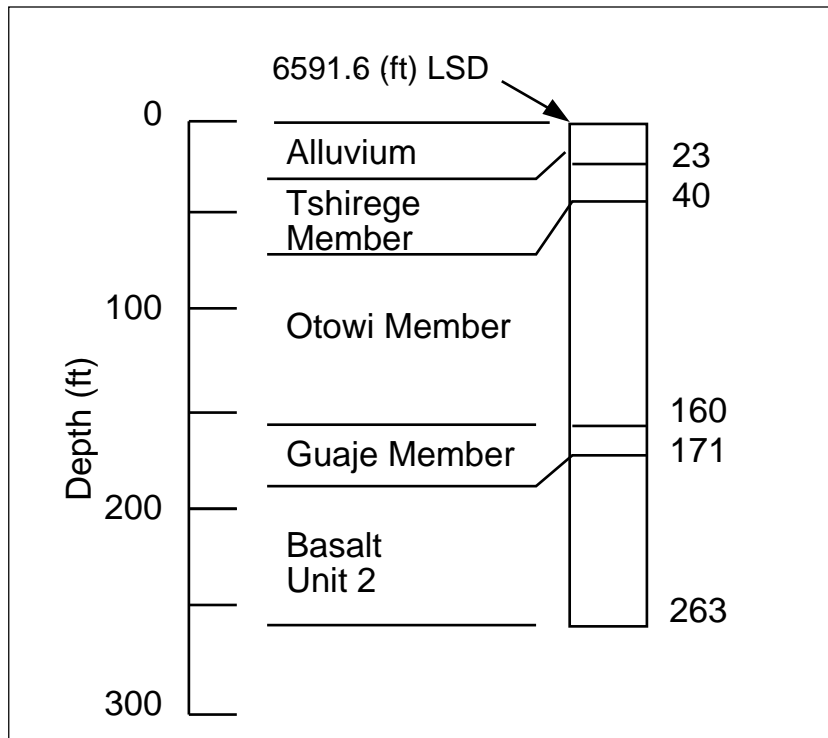
**Fig. XVII-C.** Geologic logs of test well TW-2, completed November 1949, water level 759 ft, and offset test well TW-2A, water level 121 ft (Griggs 1955).



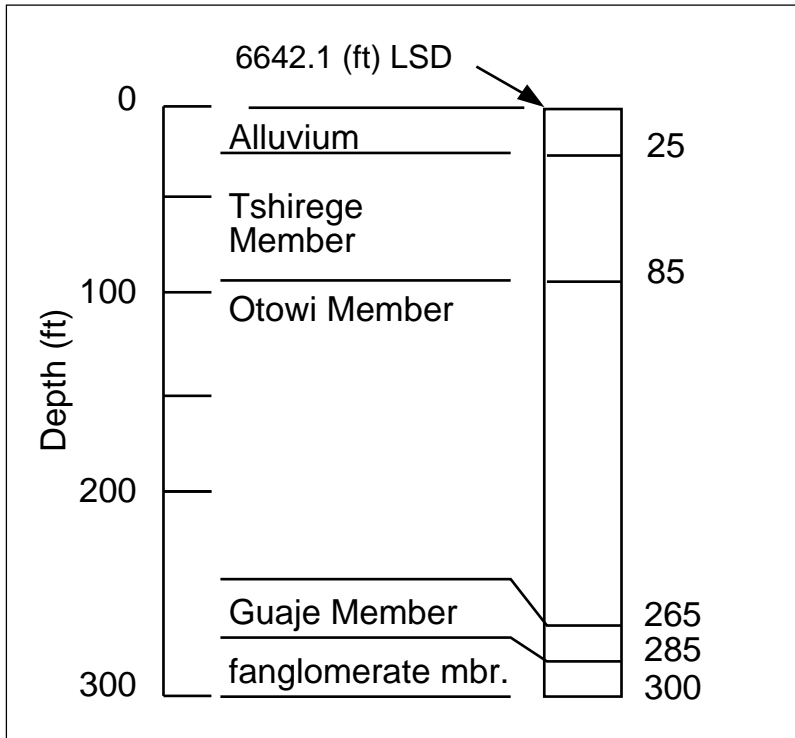
**Fig. XVII-D.** Geologic log of test well TW-3, completed November 1949, water level 743 ft (Griggs 1955).



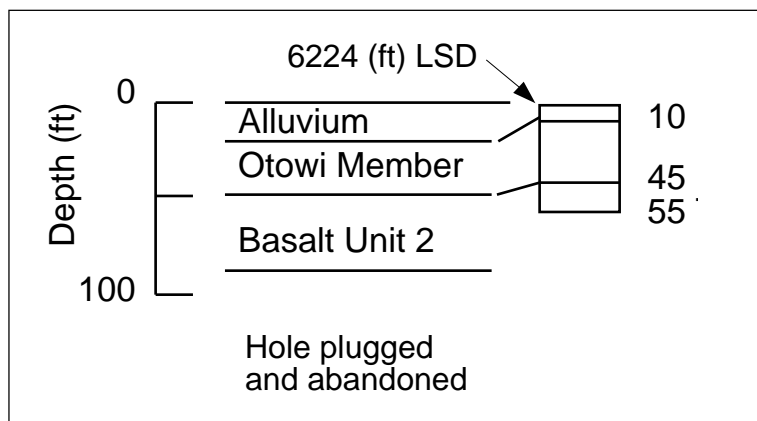
**Fig. XVII-E.** Geologic log of test well TW-4, completed March 1950, water level 1171 ft (Griggs 1955).



**Fig. XVII-F.** Geologic log of test hole TH-5, completed March 1950, dry (Griggs 1955).

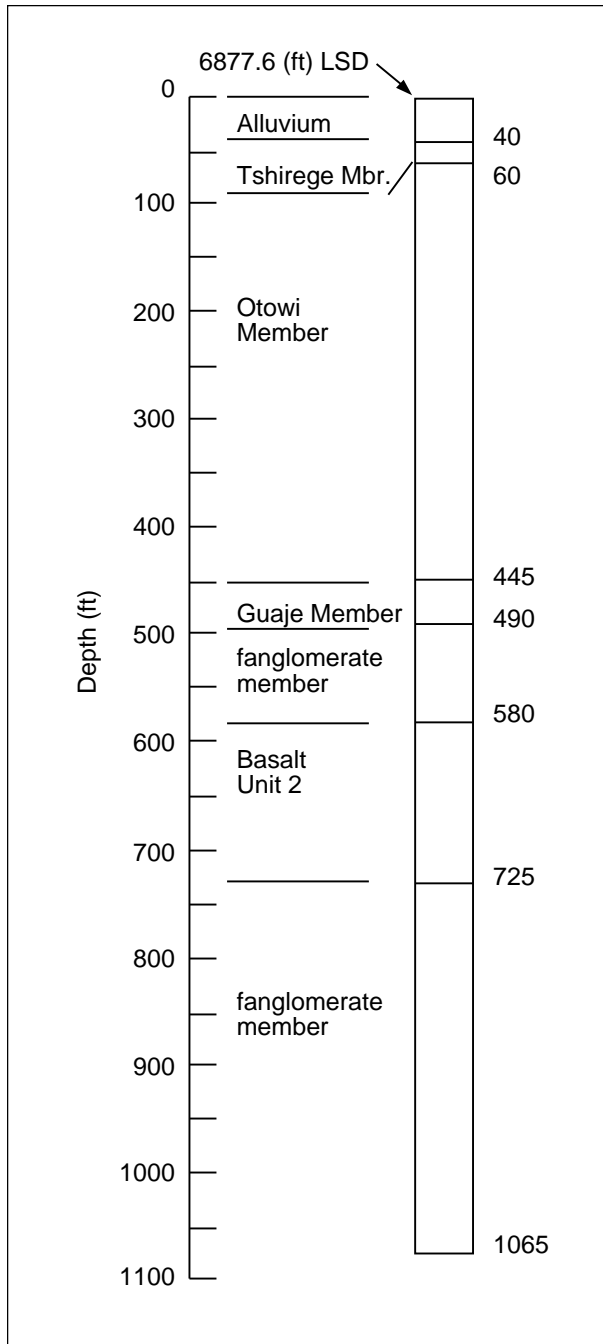


**Fig. XVII-G.** Geologic log of test hole TH-6, completed March 1950, dry (Griggs 1955).

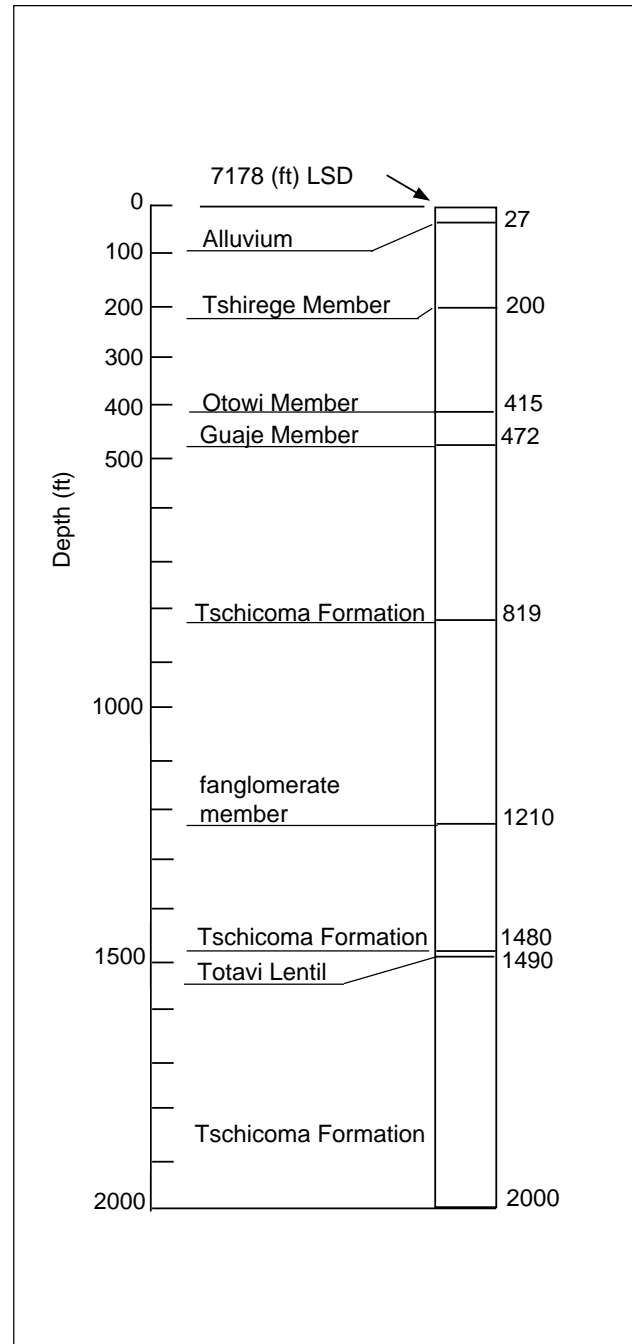


**Fig. XVII-H.** Geologic log of test hole TH-7, completed April 1950, dry (Griggs 1955).

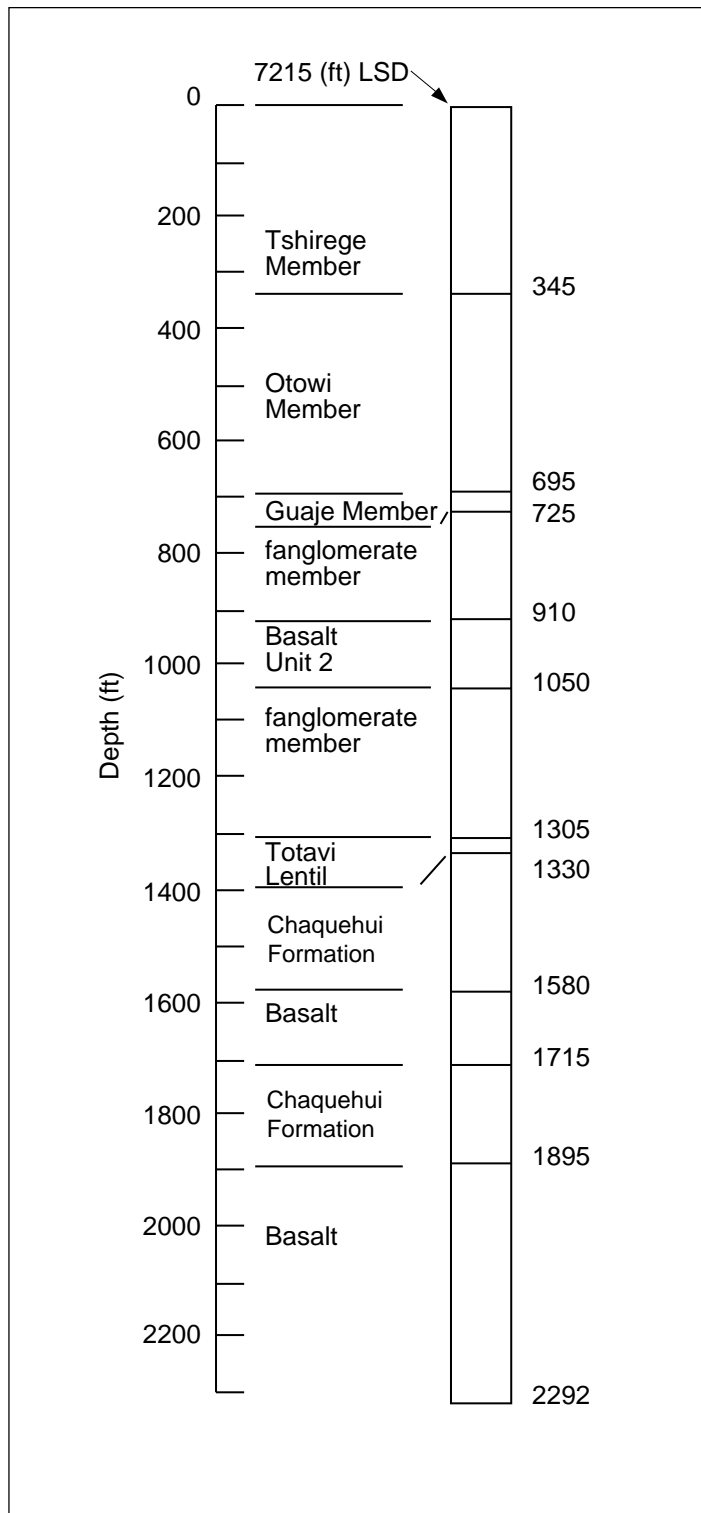




**Fig. XVII-I.** Geologic log of test well TW-8, completed December 1960, water level 968 ft (Baltz et al. 1963).



**Fig. XVII-J.** Geologic log of test hole H-19, completed September 1949, water level 950 ft (Griggs 1955).



**Fig. XVII-K.** Geologic log of test hole Sigma Mesa, drilled July–November 1979, water level about 1330 ft (data from unpublished log by Carolyn Potzich modified by Purtymun; see text and Table XVII-B).

TABLE XVII-A. Construction and Hydrologic Data for Test Wells and Test Holes on the Pajarito Plateau

Test Wells or Test Holes	Month Completed	Depth Drilled (ft)	Depth Completed (ft)	Elevation (LSD) (ft)	Water Level at Completion (ft)	Remarks
Test Well TW-1	1/50	642	642	6369.19	585	
Test Well TW-1A	1/50	225	225	6369.28	188	
Test Well TW-2	11/49	789	789	6648.1	759	
Test Well TW-2 <sup>a</sup>	1/91	834	834	6648.06	791	
Test Well TW-2A	11/49	133	133	6650.40	121	
Test Hole TH-2B	11/49	233	—	6647	Dry	
Test Well TW-3	11/49	815	815	6595.31	743	
Test Well TW-4	3/50	1205	1205	7244.6	1171	
Test Hole TH-5	3/50	263	—	6591.6	Dry	
Test Hole TH-6	3/50	300	—	6642.1	Dry	
Test Hole TH-7	4/50	55	—	6224	Dry	plugged and abandoned
Test Well TW-8	12/60	1065	1065	6877.62	968	
Test Hole H-19	9/49	2000	—	7178	950	plugged and abandoned
Test Hole Sigma Mesa	12/79	2292	1425	7215	1330	
Layne Western	3/50	157	147	5971	100	yielded water to drill Guaje wells
Ski Basin Well	6/85	400	392	9310	245	

<sup>a</sup> Well completed to 789 ft in 1949, drilled and cased to 834 ft in 1991.

TABLE XVII-B. Geologic Logs and Construction Data for Test Wells and Test Holes on the Pajarito Plateau  
(15 Test Wells and Test Holes)

1. Test Well TW-1

Elevation (LSD): 6369.19 ft

Water Level: 585 ft (1950)

<u>Geologic Log</u>	<u>Thickness (ft)</u>	<u>Depth (ft)</u>
Puye Conglomerate		
Fanglomerate member	50	50
Basaltic Rocks of Chino Mesa		
Unit 3	115	165
Puye Conglomerate		
Fanglomerate member	11	176
Basaltic Rocks of Chino Mesa		
Unit 3	79	255
Puye Conglomerate		
Fanglomerate member	155	410
Basaltic Rocks of Chino Mesa		
Unit 2	100	510
Puye Conglomerate		
Fanglomerate member	95	605
Totavi Lentil	37	642

Casing Schedule

<u>Inner Diam (in.)</u>	<u>Depth (ft)</u>	
16	0–52	
12	0–241	
8	0–627	
6	622–632	(swaged into bottom of 8-in. casing)

10 ft of 6-in.-diam screen from 632 to 642 ft swaged into the bottom of the 6-in. casing.

2. Test Well TW-1A

Elevation (LSD): 6369.28 ft

Water Level: 188 ft (1950)

<u>Geologic Log</u>	<u>Thickness (ft)</u>	<u>Depth (ft)</u>
Puye Conglomerate		
Fanglomerate member	50	50
Basaltic Rocks of Chino Mesa		
Unit 3	115	165
Puye Conglomerate		
Fanglomerate member	11	176
Basaltic Rocks of Chino Mesa		
Unit 3	49	225

Casing Schedule

<u>Inner Diam (in.)</u>	<u>Depth (ft)</u>
16	0–39
12	0–100
6	0–215

10 ft of 6-in.-diam screen from 215 to 225 ft swaged into the bottom of the 6-in. casing.

TABLE XVII-B. Geologic Logs and Construction Data for Test Wells and Test Holes on the Pajarito Plateau (15 Test Wells and Test Holes) (Continued)

3. Test Well TW-2

Elevation (LSD): 6648.1 ft	Water Level: 759 ft (1950)	
	Thickness	Depth
<u>Geologic Log</u>	(ft)	(ft)
Alluvium	11	11
Bandelier Tuff		
Otwi Member	20	31
Guaje Member	32	63
Puye Conglomerate		
Fanglomerate member	637	700
Totavi Lentil	134	834

Casing Schedule

<u>Inner Diam (in.)</u>	<u>Depth (ft)</u>	
16	0-57	
12	0-197	
10	0-519	
8	0-779	
6	0-834	(with slotted section 768 to 824 ft)

Note: Well completed to 789 ft in 1949; screen removed 779 to 789 ft and drilled and cased 0 to 834 ft December 1990.

4. Test Well TW-2A

Elevation (LSD): 6650.4 ft	Water Level: 121 ft (1950)	
	Thickness	Depth
<u>Geologic Log</u>	(ft)	(ft)
Alluvium	11	11
Bandelier Tuff		
Otwi Member	20	31
Guaje Member	32	63
Puye Conglomerate		
Fanglomerate member	70	133

Casing Schedule

<u>Inner Diam (in.)</u>	<u>Depth (ft)</u>
12	0-12
8	0-118
6	0-128

5 ft of 6-in.-diam screen run from the bottom of the 6-in. casing 128-133 ft.

5. Test Well TW-2B

Elevation (LSD): 6647 ft	Water Level: See Note	
	Thickness	Depth
<u>Geologic Log</u>	(ft)	(ft)
Alluvium	11	11
Bandelier Tuff		
Otwi Member	20	31
Guaje Member	32	63

TABLE XVII-B. Geologic Logs and Construction Data for Test Wells and Test Holes on the Pajarito Plateau  
(15 Test Wells and Test Holes) (Continued)

5. Test Well TW-2B (Continued)

Puye Conglomerate		
Fanglomerate member	160	223

Casing Schedule

<u>Inner Diam (in.)</u>	<u>Depth (ft)</u>
12	0-112
6	0-223

Geophysical Log

Caliper (3-20-69), files available from the ESH-18 Geohydrology section.

Note: Between 12-in. and 6-in. casing: water level 88.1 ft; in 6-in. casing, dry at 223 ft.

6. Test Well TW-3

Elevation (LSD): 6595.31 ft	Water Level: 743 ft (1949)	
	Thickness	Depth
<u>Geologic Log</u>	<u>(ft)</u>	<u>(ft)</u>
Bandelier Tuff		
Otowi Member	140	140
Guaje Member	35	175
Puye Conglomerate		
Fanglomerate member	91	266
Basaltic Rocks of Chino Mesa		
Unit 2	72	338
Puye Conglomerate		
Fanglomerate member	415	753
Totavi Lentil	62	815

Casing Schedule

<u>Inner Diam (in.)</u>	<u>Depth (ft)</u>
16	0-33
10	0-805

10 ft of 6-in.-diam screen swaged into the bottom of the 10-in. casing from 805 to 815 ft.

7. Test Well TW-4

Elevation (LSD): 7244.6 ft	Water Level: 1171 ft (1950)	
	Thickness	Depth
<u>Geologic Log</u>	<u>(ft)</u>	<u>(ft)</u>
Bandelier Tuff		
Tshirege Member	280	280
Otowi Member	88	368
Guaje Member	27	395
Puye Conglomerate		
Fanglomerate member	240	635
Tschicoma Formation		
Latite flows and interflow breccias	570	1205

TABLE XVII-B. Geologic Logs and Construction Data for Test Wells and Test Holes on the Pajarito Plateau  
(15 Test Wells and Test Holes) (Continued)

7. Test Well TW-4 (Continued)

Casing Schedule

<u>Inner Diam (in.)</u>	<u>Depth (ft)</u>
16	0–109
12	0–288
10	0–633
6	0–1195

10 ft of 6-in.-diam screen run from the bottom of the 6-in. casing, from 1195 to 1205 ft.

Geophysical Log

Gamma-ray (5-7-60), Files ESH-18.

Note: Water level 1168.9 ft (5-7-60); water level 1172 ft (7-20-92).

8. Test Hole TH-5

Elevation (LSD): 6591.6 ft

Water Level: Dry (1950)

<u>Geologic Log</u>	<u>Thickness (ft)</u>	<u>Depth (ft)</u>
Alluvium	23	23
Bandelier Tuff		
Tshirege Member	17	40
Otowi Member	120	160
Guaje Member	11	171
Basaltic Rocks of Chino Mesa		
Unit 2	92	263

Casing Schedule

<u>Outer Diam (in.)</u>	<u>Depth (ft)</u>
24	0–24
Open Hole	24–163

Note: Water in alluvium cased out of hole.

9. Test Hole TH-6

Elevation (LSD): 6642.1 ft

Water Level: Dry (1950)

<u>Geologic Log</u>	<u>Thickness (ft)</u>	<u>Depth (ft)</u>
Alluvium	25	25
Bandelier Tuff		
Tshirege Member	60	85
Otowi Member	180	265
Guaje Member	20	285
Puye Conglomerate		
Fanglomerate member	15	300

Casing Schedule

<u>Outer Diam (in.)</u>	<u>Depth (ft)</u>
8	0–120
Open Hole	120–300

Note: Water in alluvium cased out of hole.

TABLE XVII-B. Geologic Logs and Construction Data for Test Wells and Test Holes on the Pajarito Plateau  
(15 Test Wells and Test Holes) (Continued)

10. Test Hole TH-7

Elevation (LSD): 6224 ft	Water Level: Dry (1950)	
	Thickness	Depth
<u>Geologic Log</u>	<u>(ft)</u>	<u>(ft)</u>
Alluvium	10	10
Bandelier Tuff		
Otowi Member	35	45
Basaltic Rocks of Chino Mesa		
Unit 2	10	55

Hole plugged and abandoned.

11. Test Well TW-8

Elevation (LSD): 6877.62 ft	Water Level: 968 ft (1960)	
	Thickness	Depth
<u>Geologic Log</u>	<u>(ft)</u>	<u>(ft)</u>
Alluvium	40	40
Bandelier Tuff		
Tshirege Member	20	60
Otowi Member	385	445
Guaje Member	45	490
Puye Conglomerate		
Fanglomerate member	90	580
Basalt Unit 2	145	725
Fanglomerate member	340	1065

Casing Schedule

44 ft of 20-in. corrugated metal pipe from 0 to 44 ft; 64 ft of 14-in.-outside-diam steel casing 0 to 64 ft cemented in; 1065 ft of 8-in.-inside-diam steel casing from 0 to 1065 ft with the lower 112 ft slotted.

Geophysical Log

Gamma-ray (11-29-61), files available from the ESH-18 Geohydrology section.

12. Test Hole H-19

Elevation (LSD): 7178 ft	Water Level: 950 ft (1950)	
	Thickness	Depth
<u>Geologic Log</u>	<u>(ft)</u>	<u>(ft)</u>
Alluvium	27	27
Bandelier Tuff		
Tshirege Member	173	200
Otowi Member	215	415
Guaje Member	57	472
Tschicoma Formation	347	819
Puye Conglomerate		
Fanglomerate member	391	1210
Tschicoma Formation	270	1480
Puye Conglomerate		
Totavi Lentil	10	1490
Tschicoma Formation	510	2000



TABLE XVII-B. Geologic Logs and Construction Data for Test Wells and Test Holes on the Pajarito Plateau  
(15 Test Wells and Test Holes) (Continued)

12. Test Hole H-19 (Continued)

Casing Schedule

10 ft of 12-in.-diam surface casing set 0 to 10 ft. Exploratory hole drilled by cable tool, casing pulled at end of tests in 1949. Hole open to 265 ft (5-7-60); to 69 ft (7-20-92).

Geophysical Log

Gamma-ray (5-7-60), files available from the ESH-18 Geohydrology section.

13A. Test Hole Sigma Mesa EGH-LA-1 (1979)

Elevation (LSD): 7215 ft LSD

<u>Geologic Log</u> <sup>a</sup>	Thickness (ft)	Depth (ft)
Tshirege Member Bandelier Tuff	270	270
Ash flow of Otowi Member		
Bandelier Tuff	430	700
Guaje Pumice Bed	35	735
Puye Conglomerate with interbedded basalt	110	845
Aphyric Tschicoma Flow	80	925
Hornblende-bearing Tschicoma Flow	45	970
Fanglomerate member of Puye Conglomerate	365	1335
Totavi Lentil of the Puye Formation	65	1400
Chamita Formation of the Santa Fe Group	500	1900
Tschicoma Flow	35	1935
Chamita Formation of the Santa Fe Group	60	1995
Tschicoma Flow	297	2292

13B. Test Hole Sigma Mesa EGH-LA-1 (1992)

Elevation (LSD): 7215 ft LSD

Water Level: 1330 ft (1979, geophysical log)

<u>Geologic Log</u> <sup>b</sup>	Thickness (ft)	Depth (ft)
Bandelier Tuff		
Tshirege Member	345	345
Otowi Member	350	695
Guaje Member	30	725
Puye Conglomerate		
Fanglomerate member	185	910
Basalt Unit 2	140	1050
Fanglomerate member	255	1305
Totavi Lentil	25	1330
Santa Fe Group		
Chaquehui Formation	250	1580
Basalt and basalt breccias	135	1715
Chaquehui Formation	180	1895
Basalt and basalt breccias	397	2292

<sup>a</sup> Logged by Carolyn Potzich.

<sup>b</sup> Revised log by W. D. Purtymun from geophysical logs, comparison with logs of nearby supply and test wells, and R. F. Smith Corp. Geothermal Data Log.

---



---

TABLE XVII-B. Geologic Logs and Construction Data for Test Wells and Test Holes on the Pajarito Plateau  
(15 Test Wells and Test Holes) (Continued)

---

13B. Test Hole Sigma Mesa EGH-LA-1 (1992) (Continued)

Casing Schedule

Hole size: 36-in. diam to 85 ft, 26-in. diam to 2292 ft; casing size 30-in. diam to 85 ft, 20-in. diam to 1627 ft. Hole plugged with cement at about 1425 ft; unknown length of drill stem, drill collars, and bit lost in the bottom of the hole. The hole had a bad history of lost circulation throughout the entire depth drilled; large volumes of water, drilling mud, lost circulation materials, and cement were pumped into the hole. The hole was abandoned in December 1979.

Geophysical Logs

Temperature, compensated neutron-formation density; dual induction-SFL with linear correlation log; and R.F. Smith Corp. Geothermal Data Log (files available from the ESH-18 Geohydrology section).

14. Layne Western

Elevation (LSD): 5971 ft

Water Level: 100 ft (1950)

<u>Geologic Log</u>	<u>Thickness</u> (ft)	<u>Depth</u> (ft)
Alluvium	12	12
Puye Conglomerate		
Fanglomerate member	13	25
Totavi Lentil	50	75
Tesuque Formation		
Siltstone and sandstone	82	157

Casing Schedule

147 ft of 8-in.-diam casing set from 0 to 147 ft, screen from 127 to 147 ft.

15. Ski Basin Well

Elevation (LSD): 9310 ft

Water Level: 245 ft (June 1985)

<u>Geologic Log</u>	<u>Thickness</u> (ft)	<u>Depth</u> (ft)
Tough sandstone (probably Tshirege Member Bandelier Tuff, welded unit)	35	35
Lost circulation: same formation throughout, probably Tschicoma Formation latite and rhyolite flow, water perched on interflow breccia of pebbly cobbles in a matrix of silt and clay	365	400

Casing Schedule

392 ft of 4 1/2-in. plastic casing with perforations from 332 to 352 ft and 372 to 392 ft. Data from drillers' log.

TABLE XVII-C. Drilling Progress Report for Sigma Mesa EGH-LA-1

Lost Circulation Depth (ft)	Cement Plug (No.)	Number of Sacks of Cement	Top Depth after Setting Plug (ft)
787	1-8	3005	75
240	9	900	62
461	10	325	437
749	11	350	681
733	12	450	539
760	13	450	683
773 <sup>a</sup>	14	450	618
987	15	450	816
1133	16	225	1057
1412 <sup>b</sup>	17-19	675	1264
		Total	
		7280	

<sup>a</sup> Drilled without returns from 773 ft to 818 ft when plug 14 was set.

<sup>b</sup> Plug 17 was set at 1412 ft and tagged at 1348 ft. Lost 500 barrels of mud trying to establish returns. Set plug 18 at 1348 ft and tagged at 1264 ft. Still could not establish circulation, attempted to set plug 19. Plug 19 disappeared completely into the formation.

From the technical status report for July 1979.

TABLE XVII-D. Locations and Elevations (NAD 1927)

Test Well TW-1	N 1,772,014.8	E 509,797.3	6369.2 ft
Test Well TW-1A	N 1,772,003.7	E 509,812.7	6369.3 ft
Test Well TW-2	N 1,777,205.8	E 493,986.9	6648.1 ft
Test Well TW-2A	N 1,777,226.0	E 493,940.6	6650.4 ft
Test Well TW-2B	N 1,777,200	E 493,900	6647 ft
Test Well TW-3	N 1,773,075.9	E 497,483.2	6595.3 ft
Test Well TW-4	N 1,777,618.0	E 483,783.9	7244.6 ft
Test Hole TH-5	N 1,756,514.6	E 503,312.1	6591.6 ft
Test Hole TH-6	N 1,757,817.7	E 500,272.2	6642.1 ft
Test Hole TH-7	N 1,740,400	E 500,500	6224 ft
Test Well TW-8	N 1,769,444.6	E 492,329.6	6877.6 ft
Test Hole H-19	N 1,775,400	E 478,200	7178 ft
Sigma Mesa	N 1,771,800	E 484,100	7215 ft
Layne Western	N 1,783,200	E 516,000	5971 ft
Ski Basin Well	N 1,780,700	E 457,700	9310 ft

