



Interim Testing Protocols for Determining the Seismic Performance Characteristics of Structural and Nonstructural Components

FEMA 461 / June 2007



FEMA



Interim Testing Protocols for Determining the Seismic Performance Characteristics of Structural and Nonstructural Components

Prepared by the

APPLIED TECHNOLOGY COUNCIL
201 Redwood Shores Parkway, Suite 240
Redwood City, California 94065
www.ATCouncil.org

In Cooperation with the



MID-AMERICA EARTHQUAKE (MAE) CENTER
Urbana, Illinois



MULTIDISCIPLINARY CENTER FOR EARTHQUAKE ENGINEERING
RESEARCH (MCEER)
Buffalo, New York



PACIFIC EARTHQUAKE ENGINEERING RESEARCH (PEER) CENTER
Berkeley, California

Prepared for

FEDERAL EMERGENCY MANAGEMENT AGENCY
Department of Homeland Security (DHS)
Michael Mahoney, Project Officer
Washington, D.C.



FEMA



Notices

Any opinions, findings, conclusions, or recommendations expressed in this publication do not necessarily reflect the views of the Department of Homeland Security's Federal Emergency Management Agency (FEMA), the National Science Foundation (NSF), the Applied Technology Council (ATC), the Mid-America Earthquake (MAE) Center, the Multidisciplinary Center for Earthquake Engineering Research (MCEER), or the Pacific Earthquake Engineering Research (PEER) Center. Additionally, neither ATC, FEMA, MAE, MCEER, NSF, PEER, nor any of their employees makes any warranty, expressed or implied, nor assumes any legal liability or responsibility for the accuracy, completeness, or usefulness of any information, product, or process included in this publication. Users of information from this publication assume all liability arising from such use.

This work was supported in part by the Earthquake Engineering Research Centers Program of the National Science Foundation, under NSF Award Numbers EEC-9701785 (MAE Center), EEC-9701471, (MCEER), and EEC-9701568 (PEER Center).

Cover Photo: Roof-top Air Handling Unit being tested on a shake table in the Structural Engineering and Earthquake Simulation Laboratory at the University at Buffalo. Photo courtesy of the American Society for Heating Refrigerating and Air-Conditioning Engineers and MCEER.

Foreword

One of the primary goals of the Department of Homeland Security's Federal Emergency Management Agency (FEMA) is prevention or mitigation of this country's losses from hazards that affect the built environment. To achieve this goal, we as a nation must determine what level of performance is expected from our buildings during a severe event, such as an earthquake. To do this, several years ago FEMA contracted with the Applied Technology Council (ATC) to develop next-generation performance-based seismic design guidelines, which would allow stakeholders and their representatives to assess the probable seismic performance of new and existing buildings, and to be able to design or improve their structures to meet their performance goals. These guidelines could be voluntarily used by engineers and designers to: (1) assess and improve the performance of buildings that are currently designed to a building code "life safety" level, which would, in all likelihood, still suffer significant structural and nonstructural damage in a severe event; and (2) more effectively meet the performance targets of current building codes by providing verifiable alternatives to current prescriptive code requirements. This program is based on a long-term plan published as FEMA 445, which was developed with the input of the nation's leading seismic professionals.

One of the key requirements in performance based seismic design is the ability to test and evaluate the intended performance of the various structural and nonstructural components that make up a building. To develop this testing criteria, the project worked closely with the three Earthquake Engineering Research Centers (EERC) funded by the National Science Foundation. The three EERC's are:

- The Mid-America Earthquake Center (MAE)
- The Multidisciplinary Center for Research in Earthquake Engineering Research (MCEER)
- The Pacific Earthquake Engineering Research Center (PEER)

The three EERC's and others involved in the project have done an excellent job developing these interim testing protocols for structural and nonstructural components. These protocols will go a long way towards bringing consistency to the future testing of these components, and will help the various industries by providing a clear seismic performance target towards which they can now aim.

It is FEMA's hope that as performance based seismic design moves into the mainstream, these protocols will ultimately become standardized and more broadly used.

FEMA wishes to express its sincere gratitude to all who were involved in this project and in the development of this publication. The result of their hard work and dedication will play an important role in helping the nation move towards performance-based seismic design and reducing losses suffered by our citizens in future earthquakes.

—Federal Emergency Management Agency

Preface

In October 2001 the Applied Technology Council (ATC), with funding from the Federal Emergency Management Agency (FEMA), Department of Homeland Security, commenced work on a multi-year project to development performance-based seismic design guidelines for eventual incorporation in existing standards for the seismic design of new buildings and the upgrade of existing buildings (ATC-58 project). The plan for development of the guidelines is defined in the companion FEMA 445 report, *Next-Generation Performance-Based Seismic Design Guidelines, Program Plan for New and Existing Buildings*, which was prepared under the ATC-58 project and published by FEMA in 2006.

As part of the initial work on the ATC-58 project, interim recommended protocols (documented herein) were developed for testing of structural and nonstructural components and systems found in buildings, for the purpose of establishing their seismic performance characteristics. The protocols were developed through a cooperative effort of ATC and the three National Science Foundation-funded Earthquake Engineering Research Centers (EERCs): the Mid-America Earthquake (MAE) Center at the University of Illinois, Urbana; the Multidisciplinary Center for Earthquake Engineering Research (MCEER), University at Buffalo, The State University of New York; and the Pacific Earthquake Engineering Research (PEER) Center at the University of California, Berkeley.

Two interim protocol types are provided in this document:

- Interim Protocol I – Quasi-Static Cyclic Testing, which should be used for the determination of performance characteristics of components whose behavior is primarily controlled by the application of seismic forces or seismic-induced displacements (e.g., cladding panels, glazing panels, drywall partitions, piping and ducting system connections, ducts, and various types of anchors and braces); and
- Interim Protocol II – Shake Table Testing, which should be used to assess performance characteristics of components whose behavior is affected by the dynamic response of the component itself, or whose behavior is velocity sensitive, or sensitive to strain-rate effects (e.g., mechanical and electrical equipment).

The document also contains an introductory chapter that presents an overview of performance-based seismic design (to provide context for the recommended interim testing protocols) and discussions on a variety of topics and issues germane to these protocols. A Commentary is provided for each protocol (in the chapter immediately following the protocol), and an appendix is included that describes the process used to develop nonstructural component fragility functions based on laboratory testing.

Christopher Rojahn
ATC Executive Director

Acknowledgements

Numerous individuals and institutions deserve credit for the development of the interim protocols provided in this document. The need for the protocols was first recognized by the FEMA Performance-Based Seismic Design Project (ATC-58) Nonstructural Performance Products Team, consisting of Robert Bachman (Team Leader), David Bonowitz, Philip Caldwell, Andre Filiatrault, Robert Kennedy, Gary McGavin, Eduardo Miranda, and Keith Porter. The protocol development effort was carried out by three protocol teams: (1) the Shaking Table Testing Protocol Team, consisting of Andre Filiatrault (Team Leader), Philip Caldwell, Peter Dusicka, Tara Hutchinson, Ahmad Itani, Eduardo Miranda, Gokhan Pekcan, Andrei Reinhorn, Jose Restrepo, and James Wilcoski; (2) The Racking Testing Protocol Team, consisting of Helmut Krawinkler (Team Leader), David Bonowitz, Barry Goodno, Steven Kuan, Joseph Maffei, Ali Memari, Jose Restrepo, and Chia-Ming Uang; and (3) the Component Cyclic Testing Protocol Team, consisting of Manos Maragakis (Team Leader), George Antaki, Scott Campbell, and Robert Kennedy.

Additional guidance and input was provided by participants in the FEMA/ATC-58 Workshop on *Interim Protocols for Seismic Performance Assessment Testing of Nonstructural Component*, held on November 4-5, 2004 in the San Francisco Bay area. Participants included the individuals cited above as well as members of the Project Team, FEMA representatives, and invited participants: Dennis Alvarez, John Caffrey, James Carlson, Mary Comerio, Craig Comartin (Risk Management Products Team Leader), William Gates, Jeff Gatscher, Nathan Gould, Ronald Hamburger (Project Technical Director), Robert Hanson (FEMA Technical Monitor), Brian Kehoe, Charles Kircher (Risk Management Products Team Member), Richard Lloyd, Mike Mahoney (FEMA Project Officer), Sami Masri, Kelly Merz, Christopher Rojahn (Project Executive Director), Anshel Schiff, John Silva, Donald Smith, Greg Soules, William Staehlin, and Chris Tokas.

Project and Workshop coordination was provided by Bernadette Hadnagy, and editorial and publication services were provided by Gerald Brady and Peter Mork. The affiliations of these individuals and those cited above are provided in the list of Project Participants and the list of Workshop Participants at the end of this document.

This work was also supported in part by the Earthquake Engineering Research Centers Program of the National Science Foundation, under NSF Award Numbers EEC-9701785 (MAE Center), EEC-9701471, (MCEER), and EEC-9701568 (PEER Center).

Funding for the development of this report under the ATC-58 Performance-Based Seismic Design Project was provided by the Federal Emergency Management Agency through Contract EMW-2001-CO-0378. The leadership, insight, and support provided by Michael Mahoney (FEMA Project Officer) and the review comments by Robert Hanson (FEMA Technical Monitor) are gratefully acknowledged.

Contents

Foreword.....	iii
Preface.....	v
Acknowledgements.....	vii
List of Figures.....	xiii
List of Tables	xvii
Executive Summary	xix
1. Introduction and General Considerations	1
1.1 Purpose and Background	1
1.2 Performance Based Design	1
1.3 Fragility Functions.....	4
1.4 Relevant Damage States and Performance Levels.....	8
1.5 Uncertainty Issues.....	9
1.6 Damage and Repair Costs	10
1.7 Nonstructural Component Qualification.....	11
1.8 Protocol Types	12
2. Interim Protocol I – Quasi-Static Cyclic Testing.....	13
2.1 Scope	13
2.2 Applicability	14
2.3 Component Documentation	15
2.3.1 Structural Components	15
2.3.2 Nonstructural Components	15
2.4 Procurement, Fabrication and Inspection of Test Specimens	16
2.5 Extrapolation and Interpolation to Similar Components	16
2.6 Test Facility Standards.....	17
2.6.1 Laboratory.....	17
2.6.2 Equipment.....	17
2.7 Test Plan and Procedures	18
2.8 Loading and Load Control.....	20
2.8.1 Deformation-Controlled Testing.....	20
2.8.2 Force-Controlled Testing	21
2.8.3 Directions of Loading	21
2.9 Loading Histories.....	21
2.9.1 Unidirectional Testing	21
2.9.2 Bidirectional Testing.....	24
2.9.3 Force-Controlled Loading.....	24

	2.10	Reporting.....	26
C2.		Commentary on Interim Protocol I – Quasi-Static Cyclic Testing.....	29
	C2.6	Test Facility Standards	
		C2.6.2 Equipment	29
	C2.7	Test Plan and Procedures	29
	C2.8	Loading and Load Control	32
	C2.9	Loading Histories	39
3.		Interim Protocol II – Shake Table Testing	53
	3.1	General	53
		3.1.1 Scope.....	53
		3.1.2 Definitions.....	53
	3.2	Test Procedures	54
		3.2.1 Types of Testing and Sequence.....	54
		3.2.2 Pretest Inspection and Functional Verification	54
		3.2.3 Definition and Documentation of Functional Performance and Anticipated Damage States	55
		3.2.4 System Identification Tests	55
		3.2.5 Performance Evaluation Tests.....	57
		3.2.6 Failure Tests.....	57
	3.3	Intensities of Test Shaking	58
	3.4	Directions of Shaking.....	58
	3.5	Data Acquisition System.....	59
	3.6	Test Plan.....	59
	3.7	Input Motions	59
	3.8	Time Stamping and Damage State Documentation.....	61
	3.9	Notch Filtering of Input Motions	62
	3.10	Testing Equipment	63
		3.10.1 Shake Tables	63
		3.10.2 Instrumentation and Monitoring	64
		3.10.3 Data Acquisition.....	66
		3.10.4 Safety Procedures.....	66
	3.11	Test Report	67
		3.11.1 Test Specimen Description.....	67
		3.11.2 List of Specimens Tested	67
		3.11.3 Preliminary System Identification Tests and Report Requirements.....	68
		3.11.4 Measured Fidelity Data	68
		3.11.5 Performance and Failure Test Evaluations.....	68
		3.11.6 Photographs and Video Recordings	69
C3.		Commentary on Interim Protocol II – Shake Table Testing	71
	C3.1	General	
		C3.1.1 Scope.....	71
	C3.2	Test Procedures	
		C3.2.2 Pretest Inspection and Functional Verification	71
		C3.2.3 Definition and Documentation of Functional Performance and Anticipated Damage States	71
	C3.7	Input Motions	72

C3.9	Notch Filtering of Input Motions.....	89
C3.10	Testing Equipment.....	91
C3.10.1	Shake Tables.....	92
C3.10.2	Instrumentation and Monitoring.....	94
Appendix A:	Determination of Fragility Functions Based on Laboratory Data.....	95
A.1	Purpose.....	95
A.2	Background.....	95
A.3	General Procedure.....	97
References.....		101
Acronyms.....		103
Project Participants.....		105
Workshop Participants:	Workshop on Interim Protocols for Seismic Performance Assessment Testing of Nonstructural Components.....	111

List of Figures

Figure 1	Hypothetical cumulative probability fragility curvesxx
Figure 1-1	Hypothetical probability density function fragility curves6
Figure 1-2	Hypothetical cumulative probability fragility curves7
Figure 2-1	Sketch of deformation-controlled loading history22
Figure 2-2	Loading history for $a_1 = 0.048\Delta_m$24
Figure 2-3	Horizontal plane displacement orbit for drift-controlled bidirectional tests24
Figure 2-4	Illustration of conceptual approach for development of force-controlled loading history25
Figure 2-5	Illustrative force loading history for case illustrated in Figure 2-4.....25
Figure C2-1	Different sources of story drift: (a) shear drift, and (b) rotation drift30
Figure C2-2	Example of instrumentation and data acquisition system34
Figure C2-3	Example racking test facility at Penn State University with setup for testing curtain walls35
Figure C2-4	Example test setup for testing horizontally attached cladding panels on the Penn State facility35
Figure C2-5	Example test setup for testing vertically attached cladding panels on the Penn State Facility36
Figure C2-6	Example racking test facility at the University of Idaho36
Figure C2-7	Example test setup for testing cladding panels on the University of Idaho facility37
Figure C2-8	ASTM Standards generic test facility and setups for racking testing of shear-resisting wall panels38
Figure C2-9	Ordered relative excursions, pre-peak plus post-peak, $T = 0.2$ sec., SDOF systems42

Figure C2-10	Ordered relative excursions, pre-peak plus post-peak, $T = 0.3$ sec., SDOF and MDOF systems	43
Figure C2-11	Ordered relative excursions, pre-peak plus post-peak, $T = 0.5$ and 0.9 sec.	44
Figure C2-12	Normalized response displacement histories of an SDOF system, $T = 0.3$ sec.	44
Figure C2-13	Ordered relative excursions, separate for pre-peak and post-peak excursions, elastic SDOF system.	47
Figure C2-14	Monotonic force-deformation test on the component	49
Figure C2-15	Cyclic test on the component in deformation control: (a) applied deformation history; and (b) measured force history	50
Figure C2-16	(a) Cumulative low-cycle fatigue damage at the end of each test stage, and (b) force level at the end of each test stage.....	51
Figure 3-1	Recommended longitudinal input motion	60
Figure 3-2	Recommended transverse input motion	60
Figure 3-3	Recommended vertical input motion	61
Figure 3-4	5% damped, acceleration response spectra for recommended longitudinal, transverse and vertical input motions.....	61
Figure C3-1	Generated narrow-band random signal, Ran16 record.....	73
Figure C3-2	Generated narrow-band random signal, Ran18 record.....	74
Figure C3-3	Generated narrow-band random signal, Ran22 record.....	74
Figure C3-4	Generated narrow-band random signal, Ran31 record.....	75
Figure C3-5	Generated narrow-band random signal, Ran34 record.....	75
Figure C3-6	Response spectra for selected longitudinal records (5% of critical damping).	76
Figure C3-7	Spliced longitudinal record	77
Figure C3-8	Scale used for the longitudinal record, plotted in the frequency domain.....	77
Figure C3-9	Scale used for the longitudinal record, plotted in the time domain.....	78

Figure C3-10	Scaled narrow-band random longitudinal record, Long_3	78
Figure C3-11	Response spectra for scaled narrow-band random records.....	79
Figure C3-12	Generated narrow-band random signal, Ran7 record	81
Figure C3-13	Generated narrow-band random signal, Ran30 record	81
Figure C3-14	Generated narrow-band random signal, Ran55 record	82
Figure C3-15	Generated narrow-band random signal, Ran84 record	82
Figure C3-16	Response spectra of selected transverse records (5% of critical damping).	83
Figure C3-17	Spliced transverse record (Spliced_2).	83
Figure C3-18	Scale used for the transverse record, plotted in the frequency domain	84
Figure C3-19	Scale used for the transverse record, plotted in the time domain	84
Figure C3-20	Scaled narrow-band random transverse record.....	85
Figure C3-21	Generated narrow-band random signal, Ran9 record	85
Figure C3-22	Generated narrow-band random signal, Ran20 record	86
Figure C3-23	Generated narrow-band random signal, Ran21 record	86
Figure C3-24	Generated narrow-band random signal, Ran68 record	87
Figure C3-25	Generated narrow-band random signal, Ran90 record	87
Figure C3-26	Generated narrow-band random signal, Ran98 record	88
Figure C3-27	Response spectra of selected vertical records (5% of critical damping).	88
Figure C3-28	Spliced vertical record (Spliced_2).....	89
Figure C3-29	Scale used for the vertical record, plotted in the frequency domain	90
Figure C3-30	Scale used for the vertical record, plotted in the time domain	90
Figure C3-31	Scaled narrow-band random vertical record	91

Figure A-1 Hypothetical nonstructural component fragility
function 96

List of Tables

Table 2-1	Relative Loading History Deformation Amplitudes.....	23
Table 3-1	Time versus Center Frequency for Central Portion of Input Motions	63
Table C3-1	Narrow-Band Random Signal Generation Matlab Routine Parameters	73
Table C3-2	Narrow-Band Random Records Used for Splicing Transverse and Vertical Records	79

Executive Summary

The testing protocols provided in this document have been prepared to support the development of seismic performance assessment procedures, which when implemented will enable a better understanding of the probable performance of a building and its constituent components. The protocols are intended to serve as an interim basis for testing of building components and systems to establish their performance capability as measured by their fragility functions.

Fragility functions are mathematical relationships used to assess the performance of the individual components, of systems incorporating these components, and entire buildings containing these components, when subjected to loading caused by earthquake ground shaking. A fragility function indicates the probability that a component or system will experience damage at or in excess of a specific level, given that the component or system experiences a specific level of demand. Fragilities are expressed as probability distributions, rather than deterministic relationships in order to account for the uncertainties inherent in the process of predicting damage as a function of demand. These uncertainties include such factors as the random nature of ground shaking and the resulting response of structures, and the inability of simple engineering demand parameters, such as displacement and acceleration, to distinguish between this response variation and the damage it causes.

The testing protocols are interim pending further implementation and evaluation by researchers nationwide. They are not intended for seismic performance qualification testing of components to satisfy the requirements for such qualification testing under relevant building codes. However, these loading protocols could be used for that purpose if so determined by the Authority Having Jurisdiction as defined by the local building code.

Two interim protocol types are described in this document:

- Interim Protocol I – Quasi-Static Cyclic Testing; and
- Interim Protocol II – Shake Table Testing.

The introductory section of the document (Chapter 1) provides an overview of performance-based seismic design (to provide context for the recommended interim testing protocols) and discussions on a variety of topics and issues germane to these protocols: fragility functions, relevant damage states and performance levels, uncertainty issues, damage and repair

costs, and nonstructural component qualification. The document also contains commentaries for each protocol, as well as an appendix describing the process used to develop nonstructural component fragility functions based on laboratory testing.

Interim Protocol I – Quasi-Static Cyclic Testing

Protocol I should be used for the determination of performance characteristics of components, the behavior of which is primarily controlled by the application of seismic forces or seismic-induced displacements. In the protocols, these seismic effects are replicated by slow cyclic application of loads (or deformations) whose history (in terms of the applied load or in terms of the deformation caused by an applied load) follows a predetermined pattern. This protocol should not be applied to a component whose behavior is significantly affected by its dynamic response, or whose behavior is velocity sensitive. This includes components whose behavior is sensitive to strain-rate effects. This protocol may be used to determine fragility data for many structural and nonstructural components and in addition may be used to derive constituent force-deformation properties and hysteretic data for structural components needed for structural analysis and assessments. Examples of structural components that may be tested in accordance with this protocol include shear walls, beam-column assemblies and frame assemblies. Examples of nonstructural components for which this protocol is suitable include cladding panels, glazing panels, and drywall partitions. This protocol may also be used to derive force-deformation properties (of a nonstructural component) that can be used in the structural analysis of a nonstructural system of which the nonstructural component forms a part. Examples of nonstructural system components for which this protocol is suitable include piping and ducting system connections, ducts, and various types of anchors and braces.

The interim recommended testing procedures for Protocol I are described in Chapter 2. The scope of a testing program using this protocol for the development of fragility data is as follows:

- (a) Identification of relevant damage states;
- (b) Identification of a demand parameter, or set of demand parameters, that correlates well with the damage states identified in (a); and
- (c) Testing of the component in accordance with a well-defined test plan and a loading protocol that permits the establishment of relationships between the damage states and the associated demands.

Ideally the testing procedure involves a sufficiently large number of components to permit the quantification of variability, or, with appropriate

assumptions, identification of the type of probability distribution, the quantification of a central value, and a measure of dispersion.

The protocol provides detailed guidance and information on: (1) procurement, fabrication and inspection of testing specimens; (2) extrapolation and interpolation to similar components; (3) laboratory standards, including accreditation criterion, actuators, instruments, data acquisition systems, and safety procedures; (4) test plan and procedures; (5) loading and load control, including deformation-controlled testing, force-controlled testing, and directions of loading; (6) loading histories, including unidirectional testing, bidirectional testing, and force-controlled loading; and (7) reporting.

Commentary for selected portions of the protocol is provided in Chapter C2.

Interim Protocol II – Shake Table Testing

Protocol II should be used to assess performance characteristics of components whose behavior is affected by the dynamic response of the component itself, or whose behavior is velocity sensitive, or sensitive to strain-rate effects. This protocol should not be used, if in addition to fragility data, hysteretic data on force-deformation properties of a component are needed for use in structural analysis. Examples of nonstructural components for which this protocol is suitable include mechanical and electrical equipment.

The interim recommended testing procedures for Protocol II are described in Chapter 3. The shake table testing protocol is appropriate for use in establishing the fragility of components that are sensitive to the dynamic effects of motion imparted to the component at a single point of attachment, typically at its base.

The protocol provides detailed guidance and information on: (1) test procedures, including types of testing and sequence, pretest inspection and functional verification, definition and documentation of functional performance and anticipated damage states, system identification tests, performance valuation tests, and failure tests; (2) directions of shaking; (3) the data acquisition system; (4) test plan; (5) input motions; (6) time sampling and damage state documentation; (7) notch filtering of input motions; (8) test equipment, including shake tables, instrumentation and monitoring, data acquisition, and safety procedures; and (9) the test report, including test specimen description, list of specimens tested, preliminary system identification tests and report requirements, measured fidelity data, performance and failure test evaluations, and photographs and video recordings. Commentary for selected portions of the protocol, including background on the generation of the recommended acceleration records, is provided in Chapter C3.

Introduction and General Considerations

1.1 Purpose and Background

The testing protocols provided in this document are intended to serve as an interim basis for testing of building components and systems to establish their performance capability as measured by their fragility functions. The fragility functions are used to assess the performance of the individual components, of systems incorporating these components, and entire buildings containing these components, when subjected to loading caused by earthquake ground shaking. This performance assessment process can be implemented independently, to understand the probable performance of a building and its constituent components, or as part of a broader performance-based seismic design process. The testing protocols are not intended for seismic performance qualification testing of components to satisfy the requirements for such qualification testing under relevant building codes. However, these loading protocols could be used for that purpose if so determined by the Authority Having Jurisdiction as defined by the local building code.

In the following sections of this introduction, we provide an overview of performance-based seismic design (to provide context for the recommended interim testing protocols) and discuss a variety of topics and issues germane to these protocols: fragility functions, relevant damage states and performance levels, uncertainty issues, damage and repair costs, and nonstructural component qualification. Chapter 1 concludes with an introductory discussion on the applicability of the two interim protocol types provided in this document: Interim Protocol I, Quasi-Static Cyclic Testing, and Interim Protocol II, Shake Table Testing. Chapters 2 and 3, respectively, describe the details of Interim Protocols I and II. Immediately following each of these chapters is a commentary (Chapters C2 and C3) providing supplemental background and illustrative information for selected sections of the protocol.

1.2 Performance Based Design

Performance-based seismic design is a process that permits design of buildings with a realistic and reliable understanding of the risk of life, occupancy and economic loss that may occur as a result of future earthquakes. Basic steps in the performance-based seismic design process include: establishment of appropriate performance objectives that define expected building performance in future earthquakes; development of a preliminary design, believed capable of providing the desired performance; assessing whether the design is actually capable of providing this performance, through evaluation of the probability of experiencing losses of different types; and finally, adjusting the design until the performance assessment process indicates a risk of loss that is deemed acceptable.

This process may be used to achieve the following.

- Design individual facilities that are more loss-resistant than typical buildings designed using prescriptive building code criteria.
- Design individual facilities with a higher confidence that they will actually be able to perform as intended.
- Design individual facilities that are capable of meeting the performance intent of the building codes, but at lower construction cost than would be possible using the prescriptive criteria.
- Design individual facilities that are capable of meeting the performance intent of the prescriptive criteria, but which do not comply with all of the limitations of the prescriptive criteria with regard to configuration, materials and systems.
- Investigate the performance of typical structures designed using the prescriptive provisions of the building codes and develop judgments as to the adequacy of this performance.
- Formulate improvements to the prescriptive provisions contained in the building codes so that more consistent and reliable performance is attained by buildings designed using these prescriptive provisions.

A first generation of performance-based seismic design procedures was developed in the mid-1990s. The primary focus of the first-generation procedures was evaluation and upgrade of existing buildings. These first-generation procedures are embodied in such documents as the FEMA-356 Report, *Prestandard and Commentary for the Seismic Rehabilitation of Buildings* (ASCE, 2000) and the ATC-40 Report, *Seismic Evaluation and Retrofit of Concrete Buildings* (ATC, 1996). Since the development of these

first-generation procedures, there has been widespread interest in improving performance-based engineering procedures and extending their application to the design of new buildings. To this end, recommended programs for carrying out the development of performance-based seismic design guidelines for new and existing buildings have been prepared for FEMA. The first, FEMA 283, was prepared by the Earthquake Engineering Research Center, University of California (EERC, 1996) and was subsequently used by the Pacific Earthquake Engineering Research (PEER) Center to guide much of their work in this area. The second, FEMA 349, was prepared by the Earthquake Engineering Research Institute (EERI, 2000), which has guided the subsequent work funded by FEMA. Those efforts provided the stimulus and basis for the FEMA-funded project to develop next-generation performance-based seismic design guidelines for new and existing buildings (internally referred to as the ATC-58 project), under which these interim protocols were developed.

Under next-generation performance-based engineering procedures, performance is expressed as the probable consequences of earthquake damage including potential fatalities and serious injuries (combined as casualties), economic costs relating both to repair or replacement of damaged buildings, and to the duration of the interruption of occupancy or use. These potential losses can be expressed in a variety of formats including:

- intensity-based performance – the probable losses given that a specific intensity of ground shaking is experienced by the building,
- scenario-based performance – the probable losses given that a specific earthquake event occurs, or
- time-based performance – the probable losses over a period of time considering all earthquake events that may occur and the probability of each.

Each of these types of losses can be expressed as a confidence level, indicating the likelihood that the loss assessment will either under-predict or over-predict the actual losses incurred.

The basis for these next-generation performance-based design procedures is a framework for performance-based engineering developed by PEER. In its simplest form, used to calculate losses conditioned upon a single intensity of ground shaking, the framework appears mathematically as:

$$\text{Expected Loss} = \sum_{\text{systems}} \sum_{DS_i} \int P(\text{Loss} | DS_i) P(D > DS_i | DP = z) P(DP = z) d(z) \quad (1-1)$$

where:

$P(Loss|DS_i)$ is a mathematical function, termed a loss function, which expresses the conditional probability, P , of loss exceeding a given amount, given that a component or system is damaged to a particular damage state, DS_i .

$P(D>DS_i|DP=z)$ is a mathematical function, termed a fragility function, which expresses the conditional probability, P , of experiencing a given damage state, DS_i , as a function of demand characterized by the demand parameter, DP ,

$P(DP=z)dz$ is a mathematical function, that expresses the probability, P , of a given level of demand, DP , given the particular intensity of ground shaking,

DS_i is a unique damage state for the component or system,

D is the amount of damage sustained by a component or system,

DP is a demand parameter, such as acceleration, force or displacement that characterizes the loading on a given component or system.

The protocols presented in this document are intended for use in the development of fragility functions ($P(D>DS_i|DP=z)$) through testing. Guidelines and recommended procedures for the performance-based design process are being developed under the Performance-Based Seismic Design Project and will be presented separately.

1.3 Fragility Functions

A fragility function is a mathematical relationship that indicates the probability that a component or system will experience damage at or in excess of a specific level, given that the component or system experiences a specific level of demand, expressed herein as DP . Mathematically, this may be represented in the form:

$$f(DP) = P[D \geq DS_i | DP = z] \quad (1-2)$$

where:

D is the damage sustained by the component,

DS is a specific damage state, such as initiation of cracking of a partition, a piece of electrical equipment developing a short, or a mechanical seal losing integrity on a pressure-containing component,

DP is a parameter used to quantify the demand on the component or system. Typical demand parameters include enforced displacement Δ ; interstory drift ratio, δ ; acceleration, a , at point of attachment; and response acceleration, S_a , of the component.

Fragilities are expressed as probability distributions, rather than deterministic relationships in order to account for the uncertainties inherent in the process of predicting damage as a function of demand. These uncertainties include such factors as the random nature of ground motion records and the response they will produce in structures, and the inability of simple engineering demand parameters such as displacement and acceleration to distinguish between this response variation and the damage it causes.

As an example, two different ground motions may each produce peak interstory drift demands of four inches in a building. However, one of these ground motions may cycle the building to this drift level only once and then restore it to small oscillations about its original position, while the second ground motion may cycle the building to this drift level several times and leave the structure displaced nearly to this level. Clearly, the latter motion will be more damaging for the structural and nonstructural components than the first motion, though the value of the engineering demand parameter (interstory drift of four inches) is the same. Such effects are not predictable.

Additional uncertainty is introduced through such factors as a lack of precise definition of material strength, construction quality, and damping. It is theoretically possible to reduce these latter uncertainties through further study, including component-specific testing, but it is typically not practical to do so. Many uncertainties can be reduced through increased quality assurance measures.

Figure 1-1 shows a hypothetical set of fragility functions for a unitized building cladding system consisting of glazing panels set in a panelized framework of aluminum mullions and cross members. Damage to this system is principally caused by in-plane shear distortion, as represented by the interstory drift ratio parameter, δ . Feasible damage states of interest include loosening of joints in the aluminum framing such that leakage of air and moisture can occur, cracking of the glazing, fallout of the glazing from the framing panel, and permanent distortion of the aluminum framing. Each of these damage states has somewhat different consequences, which may be of interest to the performance assessment process. Loosening of the framing

joints may require repairs that include application of sealant to the joints, with associated repair cost. Cracking of the glazing will require replacement of the glazing, resulting both in repair cost and potential short-term occupancy interruption while the work is performed. In the performance-based design process, the fragility functions are used to estimate the probability that any of these damage states will be experienced, given that interstory drift of a given amount is predicted to occur.

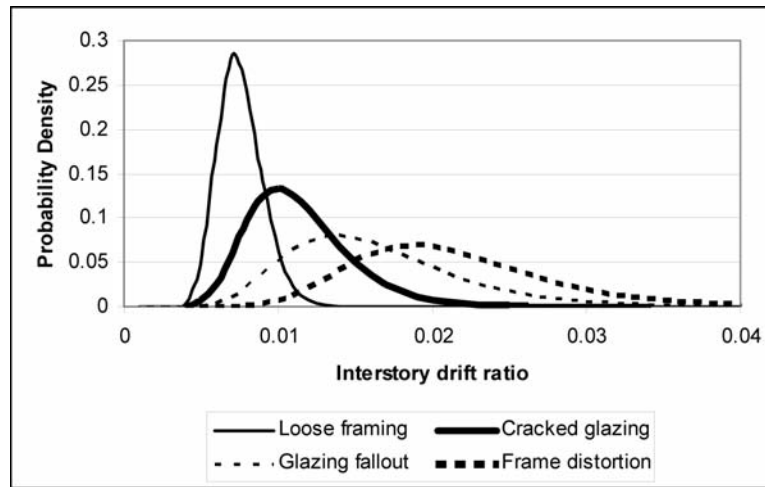

Figure 1-1 Hypothetical probability density function fragility curves

The fragility curves illustrated in Figure 1-1 are plotted in the form of probability density functions. In such plots, at any value of the index parameter, in this case interstory drift ratio, the area under a specific curve to the left of that value indicates the probability that the given damage state will have occurred. Thus, at an interstory drift ratio of 0.01, Figure 1-1 suggests that it is highly likely that the frame joints will have loosened, there is moderate probability that glazing will have cracked, small probability that glazing will have fallen out and negligible probability of permanent distortion of the framing. While such qualitative data can conveniently be obtained from such plots, the need to calculate these areas makes it difficult to obtain quantitative data on these probabilities from such curves. A more convenient way to plot this same data that permits quantitative evaluation of the probabilities of experiencing the various types of damage is in the form of cumulative probability distributions. Figure 1-2 is a plot of this same data in the form of cumulative probability distributions.

When plotted in the form of cumulative probability functions, the vertical axis of a fragility plot indicates the probability that the component or system will have experienced damage that is equal to or more severe than a given damage state. For example, in Figure 1-2, it can be seen that at an interstory drift ratio of 0.01, there is a 50% chance that wall damage will include

glazing cracks or more severe damage. When fragilities are plotted in this form, the probability that an assembly will be in a specific damage state is obtained by reading the difference in cumulative probability for the two appropriate curves. For the example illustrated in Figure 1-2, at an interstory

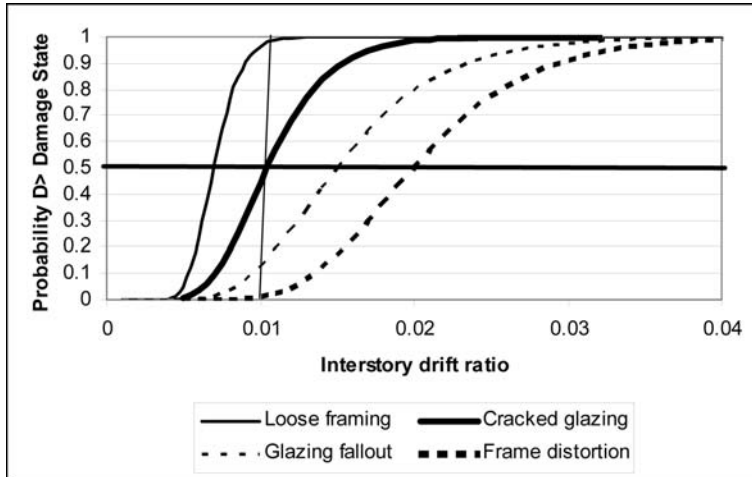

Figure 1-2 Hypothetical cumulative probability fragility curves

drift of 0.01, there is a virtual certainty (97%) that the aluminum framing will be loosened, or a more severe damage state will occur; a 50% chance that glazing will crack, or a more severe state occur; a 12% chance that glazing will actually fall out or a more severe state occur and a 2% chance that framing will permanently distort. The probability that glazing will crack but not fall out is obtained as the difference, at the given demand level, of the two cumulative probabilities. Thus, at an interstory drift ratio of 0.01, this fragility curve indicates that there is 38% chance (50% – 12%) that glazing will crack but not fall out of the wall system.

Fragility functions are commonly represented as lognormal distributions, characterized by a median value of the demand at which the damage state will occur, and the standard deviation of the natural logarithm of the values of this demand. For fragility functions, the median value is that value of the demand parameter at which there is a 50% probability of experiencing the particular damage. The standard deviation of the natural logarithm of the demand values is typically represented by the parameter, β . Lognormal distributions have the property that the mean (average value) of the distribution is related to the median value by the relation:

$$m_Y = \hat{m}_Y e^{\beta^2/2} \quad (1-3)$$

where:

m_Y is the mean (average) value of demand at which the damage will occur,

\hat{m}_Y is the median (50%) value of demand at which the damage will occur, and β is the standard deviation of the log of the demand values at which the damage occurs.

For small values, β is approximately equal to the coefficient of variation of the distribution of values.

Fragility functions are commonly represented by lognormal distributions for several reasons. First, the natural distribution of failure probabilities tend to be somewhat skewed. For example, there is zero probability that earthquake-induced failure of a component will occur at a zero value of demand. Lognormal distributions conform to this natural property. Also, lognormal distributions are mathematically convenient forms to integrate in the framework equation (Equation 1-1) through closed-form solution.

1.4 Relevant Damage States and Performance Levels

The basic purpose of the fragility functions developed in accordance with this protocol is to permit the estimation of three types of losses:

- life loss and serious injuries (casualties),
- direct economic loss resulting from repair or replacement of damaged components, and
- occupancy or service loss, resulting from inoperable components or systems (downtime).

For the purposes of this protocol, a relevant damage state is defined as any group of component conditions that:

- result in similar consequence with regard to potential casualties, direct economic loss, or downtime, and
- are predictable on the basis of a common demand parameter.

As an example, consider a hypothetical piece of electro-mechanical equipment that may incur a variety of types of earthquake damage that render it inoperable, and therefore unable to provide service. These could include, for example, arcing and burnout of an electrical component, development of imbalance in a mechanical component, and loosening of a seal of a pressure-containing component. Even though these types of damage are technically different they may result in similar consequences. For example, they all may pose no significant risk to life safety, will all cause loss of use of the equipment, and will all require replacement of the equipment with a new unit. Thus, in this example, the casualties, direct economic loss and downtime consequences of each of these types of damage are identical. If all

of these types of damage can be predicted by the same engineering demand parameter, say floor acceleration, then they can all be treated as a single damage state, perhaps termed equipment malfunction.

Often, however, different types of damage to a component will result in different consequences. For example, if the seal in the piece of equipment could be easily replaced requiring a simple service call, while the electrical short and mechanical imbalance requires unit replacement, then two separate damage states would be defined – repair by service call, and unit replacement. Finally, if the electrical short was most closely related to imposed velocity of the unit while the mechanical imbalance was related to unit acceleration, then three unique damage states would be defined: repair by service call, replacement related to excessive velocity, and replacement related to excessive acceleration.

An important step in the characterization of performance of components is the selection of appropriate damage states for which fragilities will be developed. Typically this will require the cooperative effort of persons knowledgeable in the method of operation of the component, the consequences of its failure in terms of life loss, and repair procedures.

1.5 Uncertainty Issues

Uncertainty introduces dispersion, or scatter, into the predictability of a behavior. In the fragility curves illustrated in Figure 1-1, the damage state associated with loosening of the aluminum framing is illustrated to have relatively low uncertainty, characterized by a tight band of demand values at which the damage is likely to occur, while fallout of the glazing and permanent distortion of the framing is indicated to have high uncertainty, evidenced by the broad range of demands at which the damage may occur.

Uncertainty of dispersion is accounted for by the parameter β in the fragility function. If β has a small value, say on the order of 0.2, this indicates that the behavior of the component is relatively predictable and that the damage state will initiate within a relatively small range of demands. On the other hand, as β becomes larger, this indicates that the onset of the damage state is relatively unpredictable and that the damage could initiate over a broad range of potential demand values. Typically values of β should not exceed a value of about 0.5. In those cases where β does exceed this value this may be an indication that the demand parameter being used to predict onset of the damage mode is not an appropriate one.

Uncertainty, represented by the parameter β , occurs from a variety of sources. There is natural variation resulting from randomness in material

strengths, randomness in ground-motion characteristics, and randomness in the adequacy with which a unit is constructed and installed. There is also uncertainty related to the way in which the behavior of the unit is predicted by modeling. For example, the behavior of a particular component may be related to both the acceleration and the displacement to which the component is subjected. However, we may decide that it is too difficult to use both parameters simultaneously to predict behavior, and that one of these parameters, say displacement, tends to be a more dominant predictor of the behavior. To the extent that the behavior is actually a function of both displacement and acceleration, we will either over-predict or under-predict the behavior based on displacement alone.

Some sources of uncertainty can be reduced by further study or more rigorous investigation. For example, by conducting rigorous quality assurance measures, uncertainty related to manufacturing and installation variability can be reduced. Similarly, by using a more accurate model to predict behavior, for example, using both acceleration and displacement in the above illustration, modeling uncertainty can be reduced. Other uncertainties cannot be reduced, either because it would be impractical to do the work necessary to gain the necessary knowledge or because we do not have sufficient understanding of the behavior.

In the development of fragility functions, uncertainty in the form of a β value can be derived by two basic means. The first is by testing a sufficient number of specimens using varying loading protocols to permit characterization of both the natural and modeling uncertainties. The second is to apply expert judgment. It is seldom possible to perform sufficient testing to allow characterization of the uncertainty by testing alone. Therefore, values of β must typically be set on the basis of expert judgment or a combination of test data and judgment.

It is recommended, that as a minimum, three specimens be used to provide data on the fragility of each nonstructural component. With three specimens, it is possible to determine a median value for fragility, \hat{m}_Y , as well as a coefficient of variation, which together with expert judgment can be used to develop an appropriate value of β . Development of fragility functions from laboratory test data is discussed in Appendix A.

1.6 Damage and Repair Costs

Component fragility functions are developed to permit the losses associated with damage to components and to systems comprised of these components to be estimated as part of the performance-based design process. The

consequences of a component damage state, in terms of, for example, loss of service, potential casualties, and cost of repair, are determined through application of loss functions. Loss functions indicate the conditional probability of experiencing a given level of loss, given that a component damage state has occurred. Loss functions typically have large associated uncertainty because they are inherently dependent on human behavior, which is often unpredictable. For example, the time required to repair a window in a building depends in large measure on how rapidly the building owner actually hires someone to make the repair. In general, a separate series of loss functions, indicating the probable casualty impacts, repair or replacement cost impacts, and service interruption impacts must be prepared for each damage state. The development of loss functions is beyond the scope of this protocol document.

1.7 Nonstructural Component Qualification

Some building codes and design specifications require that equipment and other types of nonstructural components be certified by the supplier as qualified to resist certain levels of ground shaking, or other seismic-induced loading, without failure. Several guidelines have been developed by evaluation services to guide manufacturers and suppliers on approaches to equipment qualification.

The procedures contained in this protocol document are intended to allow determination of the median loading at which damage of different types will occur in nonstructural components and the dispersion associated with this loading. This is not directly compatible with the intent of equipment qualification, which is to demonstrate that there is a very low probability that failure will occur at a specific level of loading. It should be noted that once a fragility curve, characterized by a median value and dispersion, has been developed for a nonstructural component and damage state, it should be possible to pick that level of loading (at which there is a sufficiently low probability of failure) on the fragility function as the loading level for which the component is qualified. This is commonly done in the nuclear industry for example, where equipment is considered as qualified for adequate performance if the fragility for the equipment indicates a 95% confidence level of less than a 5% chance of failure at the given loading.

The protocols presented herein could be used for equipment performance qualification, although such use is beyond the intended scope of this publication.

1.8 Protocol Types

Two separate protocols for laboratory testing of structural and nonstructural components are presented. These are:

- Protocol I – Quasi-Static Cyclic Testing of Structural and Nonstructural Components and Systems, and
- Protocol II – Shake Table Testing of Structural and Nonstructural Components and Systems.

Protocol I should be used for the determination of performance characteristics of components, the behavior of which is primarily controlled by the application of seismic forces or seismic-induced displacements. This protocol may be used to determine fragility data for many structural and nonstructural components and in addition may be used to derive constituent force-deformation properties and hysteretic data for structural components needed for structural analysis and assessments. Examples of structural components that may be tested in accordance with this protocol include shear walls, beam-column assemblies and frame assemblies. Examples of nonstructural components for which this protocol is suitable include cladding panels, glazing panels, and drywall partitions. This protocol may also be used to derive force-deformation properties (of a nonstructural component) that can be used in the structural analysis of a nonstructural system of which the nonstructural component forms a part. Examples of nonstructural system components for which this protocol is suitable include piping and ducting system connections, ducts, and various types of anchors and braces.

Protocol II should be used to assess the performance characteristics of components whose behavior is affected by the dynamic response of the component itself, or whose behavior is velocity sensitive, or sensitive to strain-rate effects. This protocol should not be used, if in addition to fragility data, hysteretic data on force-deformation properties of a component are needed for use in structural analysis. Examples of nonstructural components for which this protocol is suitable include mechanical and electrical equipment.

The protocols are interim pending further implementation and evaluation by researchers nationwide. Other protocols are also available for testing of structural components, including the ATC-24 *Guidelines for Cyclic Seismic Testing of Components of Steel Structures* (ATC, 1992) and the Consortium of Universities for Research in Earthquake Engineering (CUREE) Testing Protocol for Wood Frame Structures (Krawinkler et al., 2001).

Chapter 2

Interim Protocol I – Quasi-Static Cyclic Testing

2.1 Scope

This Chapter presents interim recommended testing procedures, loading histories, and documentation protocols for performance assessment of the characteristics of building components and subsystems using quasi-static cyclic testing. The performance characteristics are presented in the form of fragility functions that relate the probability that a component will be damaged to a defined damage state or more severe state, given that demand of specified value is experienced. Demands may be expressed in terms of any quantifiable parameter that may be predicted by structural analysis including imposed drift, acceleration, velocity, and accumulated energy. The scope of a testing program for the development of fragility data is as follows:

- (a) *Identification of relevant damage states.* The term “relevant” implies that the damage states are well defined, clearly discernible, and associated with actions whose costs or consequences can be quantified. Such an action could be: the application of a specific repair technique, for example, epoxy injection of cracks in a concrete wall; the need for replacement of the component; the creation of a life-threatening condition, for example, rapid depressurization of a pressure-containing vessel; or the need to declare the component incapable of fulfilling its function.
- (b) *Identification of a demand parameter, or set of demand parameters, that correlates well with the damage states identified in (a).* Typically, the demand parameter will be either a deformation quantity such as interstory drift ratio, (the relative horizontal displacement between two floor levels, normalized by the story height), or the transverse force applied to a component. Other demand parameters may be found to be more efficient in predicting component behavior.
- (c) *Testing of the component in accordance with a well-defined test plan and a loading protocol that permits the establishment of relationships between the damage states and the associated demands.* Ideally, this implies the testing of a sufficiently large number of components to permit the quantification of variability, or, with appropriate assumptions,

identification of the type of distribution, the quantification of a central value and a measure of dispersion.

2.2 Applicability

This protocol applies to performance testing of building parts or components when damage is best predicted by imposed deformation. Examples of components that may be tested in accordance with this protocol include partitions and their anchorages, cladding, pipes, ducts, and other equipment that is connected to floors above and below. Examples of structural components that may be tested in accordance with this protocol include shear walls, beam-column assemblies, and frame assemblies.

When non-structural components are tested using this protocol the intent, generally, is to obtain fragility data only. When structural components are tested using this protocol, in addition to obtaining fragility data, it is also important to obtain data on the hysteretic characteristics of the components that can be used to form analytical models of the behavior of structures incorporating these components.

The protocol consists of slow cyclic application of load or deformation with a predetermined loading pattern. This protocol is not appropriate for use in performance testing of components whose behavior is significantly affected by the dynamic response of the component, or whose behavior is sensitive to strain rate or velocity effects. Components sensitive to these dynamic effects should be tested using the Interim Protocol II – Shake Table Testing, as described in Chapter 3.

Two types of testing are covered by this Chapter:

- ***Racking Testing***. This type of testing is performed for components that either are not required to participate in a building's structural resistance or do not provide significant strength or stiffness modification of the building structure. These components will not typically be included in structural analytical models used to predict building performance.
- ***Hysteretic Testing***. This type of testing is performed for components that either are intended to provide structural resistance or significantly alter the strength or stiffness of a building structure. These types of components will typically be included in analytical models used to predict structural performance.

2.3 Component Documentation

This section specifies the information that should be documented for tested components. This information includes component description, functional and operational information, installation requirements, and information that can be used to extrapolate and interpolate performance characteristics for application to similar components.

2.3.1 Structural Components

A complete description of the component to be tested shall be provided. Information to be supplied, as applicable, includes, but is not limited to:

- materials of construction including standard ASTM grades as applicable,
- specimen specific strength tests, including, as applicable, yield strength, tensile strength, and compressive strength,
- assembly drawings showing specimen dimensions and connectivity, and
- details of fabrication and construction.

2.3.2 Nonstructural Components

A complete description of the component to be tested shall be provided. Information to be supplied, as applicable, includes, but is not limited to:

- manufacturer information,
- Model and Part Number,
- fabrication information,
- material type and characteristics, and
- relevant drawings.

The functional and operational requirements of components before, during, and after testing shall be specified.

Substitutions for operating requirements shall be described and justified.

Examples include using air rather than gas for pressurization, or substituting water for hazardous liquids.

Potential safety issues arising from operation during testing must be addressed.

2.4 Procurement, Fabrication and Inspection of Test Specimens

Test specimens should replicate in-situ conditions so that material properties, standard construction techniques, and boundary conditions encountered in actual buildings are properly simulated. Full-size specimens should be used whenever possible and where not possible, the scale of the specimens should be as close to full size as feasible, in order to minimize size effects.

Whenever feasible, test specimens should be fabricated and installed by construction workers who typically construct and install this type of component in real buildings so that typical construction quality is exercised. In case the specimen is fabricated and installed by lab personnel, all applicable fabrication and installation guidelines shall be followed and industry standard practice should be adhered to.

The fabrication and installation of the test specimen shall be fully documented, with an itemization of all parts (and their properties) on which the damage states depend. Before testing, the specimen shall be inspected by an expert who is qualified to attest that the test specimen and its boundary conditions represent average in-situ conditions.

The tested components shall be operational (if applicable) and randomly selected from manufacturer's or retailer's stock and shall be representative of those found in typical installed applications.

For manufactured components, installation instructions should be provided by the manufacturer and adhered to. Any deviation between the tested configuration and typical installed conditions shall be described and justified as being functionally equivalent.

2.5 Extrapolation and Interpolation to Similar Components

If the fragility function derived from a testing program is to be applied to components that vary in configuration, material properties, construction details, or boundary conditions, then analytical means could be employed to extrapolate from the observed fragility to different conditions (if this can be done with adequate confidence). In this case it will be necessary to complete supplementary testing programs that will quantify the properties of materials and sub-components to the extent needed to permit extrapolation of fragility results through analytical means.

If it is impossible to test a specimen close to full size, then additional tests will be needed to quantify size effects to the extent that will permit reliable extrapolation from reduced-scale tests to full-size behavior.

Test results may be extrapolated or interpolated to functionally similar components provided that:

- the untested components are completely described, with particular emphasis on differences with the tested components, and
- justification for the extrapolation or interpolation is provided, showing that the performance envelope of the untested component lies between two of the tested components, or is greater (in the sense of “better”) than the tested component.

2.6 Test Facility Standards

This section describes basic calibration and maintenance criteria for laboratories and equipment used for performance testing. The requirements of Sections 2.6.1 and 2.6.2 may be relaxed if the sole purpose of testing is the development of drift-dependent fragility data as opposed to derivation of load-deformation response for analytical modeling.

2.6.1 Laboratory

Testing laboratories shall comply with a national or international accreditation criterion such as the International Code Council (ICC) Evaluation Service (ES) *Acceptance Criteria for Laboratory Accreditation* (ICC, 2000) or satisfy the requirements of the Network for Earthquake Engineering Simulations (NEES) Consortium.

2.6.2 Equipment

2.6.2.1 Actuators

Actuators should be sized to provide reserve capacity for both force and displacement beyond the maximum anticipated as necessary for the test. Control of the actuators shall permit stopping immediately in any position and holding that position. If a power or computer failure occurs during testing, the actuators shall be capable of stopping immediately. Actuator mounting shall be designed so as to create loading in the desired direction only. During the loading cycle, minimize the off-axis forces and displacements created by rotations of the actuator or component under test.

2.6.2.2 Instruments

The model, type, location and orientation of instrumentation shall be documented and uniquely identified. Instrumentation calibrations shall conform to NIST traceable primary standards or other applicable standards. The instruments shall be recalibrated at least once each year. These calibrations shall be verified before each test.

2.6.2.3 Data Acquisition System

Data acquisition system calibrations shall conform to NIST traceable primary standards, or other applicable standards. The data acquisition system shall be recalibrated at least once every year. These calibrations shall be verified before each test. The sampling rate shall be sufficient to capture all aspects of the load-deformation response relevant to the analytical modeling of the component.

2.6.2.4 Safety Procedures

The testing laboratory shall follow the standard safety procedures individually developed at each test site. These procedures shall ensure the safety of the occupants and testing systems at all times. The minimum requirements and procedures should include but should not be limited to the following.

- Laboratory safety procedures as mandated by the testing facility to minimize hazard and danger to persons in the test area shall be followed.
- Personal safety during all phases of testing (including during post-test examination) shall be observed and may include hard-hat, protective eyewear, clothing, gloves, and safety shoes as appropriate.
- The testing could involve the use of hazardous materials, operations, and equipment. This document does not address specific safety issues associated with these uses. It is the responsibility of the laboratory implementing this recommended test protocol to establish appropriate safety precautions.

2.7 Test Plan and Procedures

A detailed test plan should be developed, documented and approved by responsible personnel prior to the execution of a test program. This test plan should address the following aspects:

- identification of test specimen and its relation to the component whose performance is to be evaluated,

- preliminary identification of damage states for which fragilities are to be determined,
- number of specimens to be tested,
- loading history,
- design of a test set-up that permits appropriate load simulation and proper simulation of all important boundary conditions,
- identification of all important response parameters, and an instrumentation plan for measurement of these parameters,
- detailed drawings of test specimens, test setup, boundary condition simulation, loading arrangement, and instrumentation,
- identification of needs for supplementary testing, and
- identification of a test schedule to ensure that the objectives of the testing program will be achieved in a timely and cost-effective manner.

Recommendations for specimen fabrication, material testing, planning and execution of experiments, test control, and specimen instrumentation shall be taken from existing standards and guidelines for testing of components and materials (see, for example, ASTM).

The component whose performance is to be evaluated needs to be isolated from its in-situ surroundings so that it can be tested in a laboratory environment. The lab should faithfully reproduce these in-situ conditions.

The number of test specimens is to be decided by the entity requesting the fragility tests.

The test plan should contain clear and well-documented procedures for the simulation of all boundary and initial conditions that may significantly affect any of the damage states of interest. The boundary conditions comprising the anchorage details and distribution of forces resulting from the imposed deformations shall be equivalent to those encountered in a typical application.

The test plan should contain a clear and well-documented plan for the measurement, recording, and documentation of all relevant data to be measured or visually observed during the test. For racking testing the primary parameter to be measured, with good accuracy, is the demand parameter that will be used to define the fragility function (typically an imposed deformation). For hysteretic testing all parameters of importance for analytical modeling should be identified, including forces, moments, and

shears, and axial, shear and flexural deformations. Instrumentation appropriate for accurate measurement of these parameters shall be provided.

2.8 Loading and Load Control

A test may be carried out under deformation control or force control (or a combination of the two when accurate force and deformation data are needed) within the elastic as well as the inelastic range.

2.8.1 Deformation-Controlled Testing

The deformation control parameter may be a displacement or other suitable deformation quantity (e.g., a rotation). However, it is important that this parameter can be correlated with a building deformation parameter, for example, interstory drift, that can be predicted by conventional structural analysis of a building structure. Items to consider include:

- feedback control of the deformation,
- appropriate control of the direction and speed, using suitable valving, hydraulic fluid control valves, and servo valves, and
- type of controller, hardware or software, considering the feedback update rate and the recording sample rate.

The deformation increment should be sufficiently small that:

- dynamic effects are negligible,
- the value of the deformation parameter, at which onset of the various damage states of interest initiate, is clearly identifiable,
- thermal effects due to work-hardening are not significant, and
- power requirements are not unreasonable.

The deformation increment should be sufficiently large that:

- the duration of the test is not excessive,
- material creep is not a significant effect (unless creep is considered to be part of the damage states of interest), and
- the number of cycles experienced by the component at the onset of significant damage states is of the same order of magnitude as that experienced by real components in buildings subjected to strong earthquake motion. Particular care should be taken to avoid introduction of low-cycle fatigue behavior that is unlikely to be experienced by real components in buildings.

2.8.2 Force-Controlled Testing

The force-control quantity shall be a measurable and controllable quantity that relates well to a demand quantity that can be predicted by structural analysis of a building structure. Considerations include:

- feedback control of the force,
- imposed force fluctuations during load reversals due to pressure fluctuations or mechanical inertia of the actuator,
- appropriate control of the direction and speed using suitable valving, hydraulic fluid control valves, and servo valves, and
- type of controller, hardware or software, considering the feedback update rate and the recording sample rate.

The force increment should be sufficiently small that:

- dynamic effects are negligible,
- the applied force initiating the various damage states of interest must be clearly identifiable,
- thermal effects due to work hardening are not significant, and
- power requirements are not unreasonable.

The force increment should be sufficiently large that:

- the duration of the test is not excessive, and
- material creep is not a significant effect (unless creep is considered to be part of the damage states of interest).

2.8.3 Directions of Loading

Imposed deformation or force will typically be applied in a single degree of freedom (unidirectional loading). Bidirectional loading (loading in two orthogonal horizontal directions) should be carried out whenever it is anticipated that such loading has a significant effect on any of the damage states and the associated fragility function. Written justification should be provided if it is decided in this case to apply only unidirectional loading.

2.9 Loading Histories

2.9.1 Unidirectional Testing

This section describes a recommended loading history appropriate for racking testing or hysteretic testing if a single specimen will be used to

quantify all damage states for which fragility functions are to be developed. Quantification implies that at least one data point will be obtained for the loading at which each damage state (DS_i) initiates (several data points can be obtained if multiple damage state interpretations are made by several experts). It is highly recommended to perform an additional monotonic test to provide a baseline for estimating the cumulative damage effect at each damage state.

Figure 2-1 presents a conceptual diagram of the recommended loading history. The loading history consists of repeated cycles of step-wise increasing deformation amplitudes. Two cycles at each amplitude shall be completed.

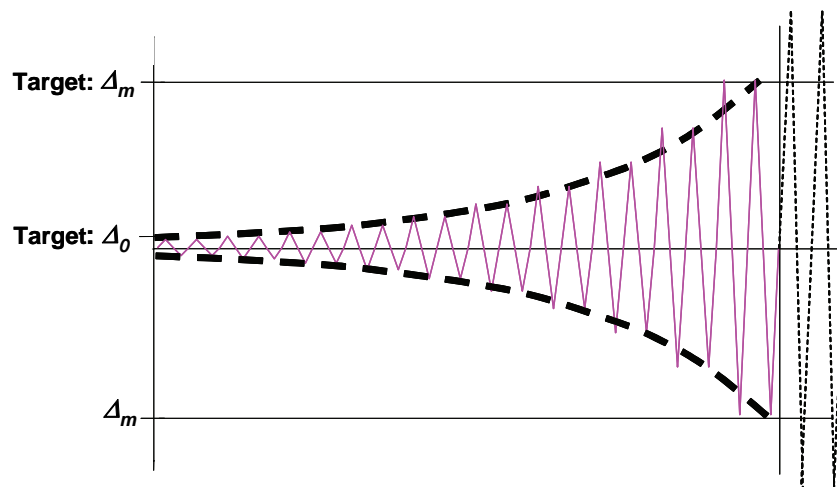

Figure 2-1 Sketch of deformation-controlled loading history

The loading history is defined by the following.

Δ_o = the targeted smallest deformation amplitude of the loading history. It must be safely smaller than the amplitude at which the lowest damage state is first observed. At the lowest damage state at least six cycles must have been executed. If no data exists regarding what amplitude of deformation is likely to initiate damage, a recommended value for Δ_o (in terms of story drift index, δ/h) is around 0.0015.

Δ_m = the targeted maximum deformation amplitude of the loading history. It is an estimated value of the imposed deformation at which the most severe damage level is expected to initiate. This value must be estimated prior to the test. (It can be estimated from a monotonic test). If the most severe damage initiates at a drift smaller than the target value, judgment must be used to assess whether the cumulative damage effect at the actual initiation of damage is indeed comparable

to that which would have occurred if the specimen had sustained the complete loading history. If the most severe damage state has not yet occurred at the target value, the loading history should be continued by using further increments of amplitude of $0.3\Delta_m$. A recommended value for this amplitude, lacking other evidence, such as the results of a prior monotonic test (in terms of story drift index, δ/h), is 0.03.

- n = the number of steps (or increments) in the loading history, generally 10 or larger.
- a_i = the amplitude of the cycles, as they increase in magnitude, i.e., the first amplitude, a_1 , is Δ_o (or a value close to it), and the last planned amplitude, a_n , is Δ_m (or a value close to it). Whenever possible, the test should be continued beyond Δ_m even if the most severe damage state has been attained. Tests should be terminated only when the capabilities of the test setup have been reached, e.g., the available stroke of the loading ram has been reached, or the test specimen has degraded so severely that no relevant additional information about performance can be acquired.

The amplitude a_{i+1} of the step $i+1$ (not of each cycle, since each step has two cycles) is given by the following equation:

$$a_{i+1} = 1.4a_i \quad (2-1)$$

where a_i is the amplitude of the preceding step, and a_n is the amplitude of the step close to the target, Δ_m .

If the specimen has not reached the final damage state at Δ_m , the amplitude shall be increased further by the constant increment $0.3\Delta_m$. If it is desired that the largest amplitude, a_n , be exactly equal to Δ_m , then the ratios a_i/a_n shall be as shown in Table 2-1. A loading history with $a_n = \Delta_m$ and $a_1 = 0.048\Delta_m$ (i.e., $n = 10$, number of cycles is $10 \times 2 = 20$ cycles) is shown in Figure 2-2.

Table 2-1 Relative Loading History Deformation Amplitudes

n	13	12	11	10	9	8	7	6	5	4	3	2	1
a_i/a_n	0.018	0.025	0.035	0.048	0.068	0.095	0.133	0.186	0.260	0.364	0.510	0.714	1.000

Note: Generally, the number of steps n should be 10 or larger.

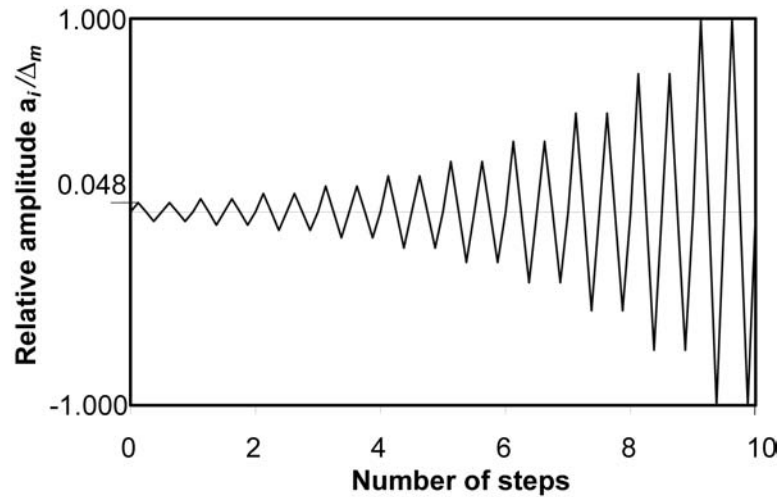

Figure 2-2 Loading history for $a_1 = 0.048\Delta_m$

2.9.2 Bidirectional Testing

When bidirectional testing is performed the loading path should follow the orbital pattern shown in Figure 2-3. The amplitude of loading, a , in the figure should follow the history described in the previous section on unidirectional testing.

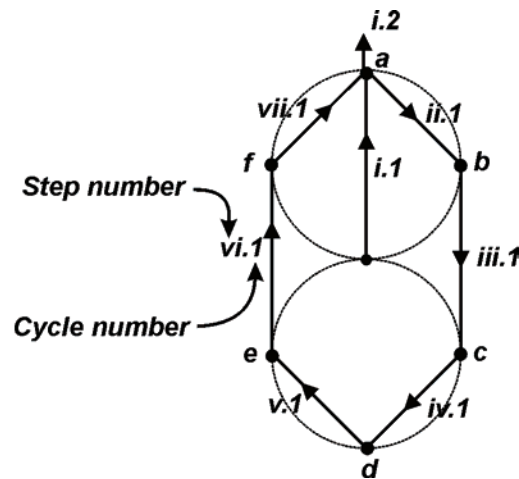

Figure 2-3 Horizontal plane displacement orbit for drift-controlled bidirectional tests. Displacements during the first cycle, containing seven steps (i through vii), are shown.

2.9.3 Force-Controlled Loading

Force-controlled testing should be performed if a force quantity controls performance of the component, or if a suitable deformation parameter cannot be found. The reference value on which to base the amplitudes of individual cycles is the maximum force to which the component or part may be subjected in a severe earthquake. Since the force demands will be greatly dependent on the type of component or part and on the in-situ conditions, it

is impossible to develop a general force-based loading protocol. The following guidelines should be employed to develop case-specific protocols.

The basic premise is that forces are consequences of deformations, and that the deformations, in relative magnitude, have the history shown in Figure 2-1 and are given by Equation 2-1. If the force-deformation characteristics of the force-sensitive component (or part) are known (from analytical predictions or from a monotonic test of the subsystem of which the force-sensitive component is part), then the cyclic loading history shown in Figure 2-1 and the load-deformation response of the component can be combined to develop a force history to be applied to the component. This is illustrated in Figure 2-4, where it is assumed that the force-deformation behavior of the component is given, and where it is also assumed that the maximum deformation in the component can be related to the Δ_m value of Figure 2-1. With this knowledge, the forces corresponding to all other amplitudes of the drift loading history can be deduced graphically, and a force history can be developed. The loading history for the case illustrated in Figure 2-4 is shown in Figure 2-5 for illustrative purposes.

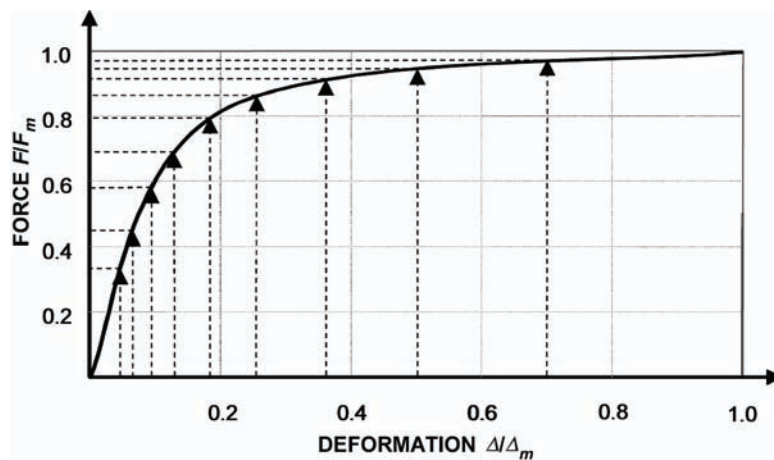

Figure 2-4 Illustration of conceptual approach for development of force-controlled loading history

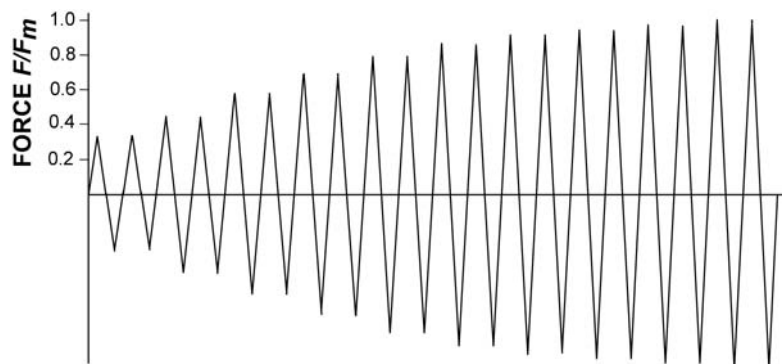

Figure 2-5 Illustrative force loading history for case illustrated in Figure 2-4

It is important to incorporate cyclic hardening in the subsystem of which the force-sensitive component is part when developing criteria for the maximum absolute force the force-sensitive component must sustain.

2.10 Reporting

Each test should be documented in a comprehensive test report. The test report should include information about the testing agency/laboratory and sponsoring agency, including location of the test site and contact information, test date, date of report, a statement that the test has been conducted based on this protocol (including identification of deviations from this protocol, as appropriate), and the name of the organization reporting the tests with names and signatures of members of the experimental team responsible for carrying out the tests. The report should also include any witnessing requirements such as a list of independent observers and any required verification/certifications of all test phases. Specific information to be contained in the report also includes:

- a detailed description of the test specimens, including, for example, manufacturer (if any component is supplied), type, material used, and dimensions, and, furthermore, details needed for the understanding of the design and manufacture of the specimen,
- if an equipment/instrument component is being tested, a description of the component under investigation including type, manufacturer/fabricator, model number, specification, calibration procedure, any available/required calibration certificates, material information and characteristics, manufacturing information, any specific handling requirements, functional requirements, and sketches and pictures of the component,
- a description of the physical and engineering characteristics of the material(s) (type, grade, size, yield point, tensile and compressive strength, density, moisture content, as applicable) of structural elements and details (dimensions, spacing, property) of anchoring elements and fasteners for nonstructural components,
- a summary table that describes all specimen configurations and their corresponding tests (i.e., the complete test matrix),
- a conceptual plan of the test facility and a sketch of the test setup. This sketch should include details of the attachment of the specimen to the testing frame with an indication of the location of the measuring devices (load cells, strain gages, deflection gages (LVDT), and any other applicable items),

- a description of the conditions under which the tests were carried out, including ambient conditions (e.g., temperature, relative humidity, and moisture content, as applicable),
- a complete description of measurement methods and devices, including direction of measurement, and technical specification of instruments used for load and displacement/deformation/strain measurement, and furthermore, a description of the conditions of the measurement instruments, tolerances, and accuracy,
- the following information for the data acquisition system: type, manufacturer name and model number, system identifications, all calibration procedures, any available/required calibration certificates, and schematic information flow,
- a description of the test specimen before the beginning of the test (including any unusual characteristics or defects) and after each test interval, including any modifications to the specimens during the test, [The description should include the observed performance of the specimen in relation to all damage states of interest and clear sketches and written descriptions of the visible characteristics of damage patterns and failure modes (e.g., cracking, fallout, brittle or ductile fracture, yielding, excessive deflection or distortion). The report should include photographs of specimens taken before, during, and after each test. Alternatively, video taping of the testing shall be performed and included as part of the test report. Links to download video clips of the test should be made available.]
- as applicable, the load versus time, displacement versus time and load-displacement relationships (i.e., a complete record in the form of tables, plots, hysteresis curves, and envelope curves) at all measurement locations. [The report should include a summary table of load and deformation values at all damage states of interest.]

Electronic dissemination of test procedures and results is strongly encouraged. If the information is available for public use, a link from which all the data as well as the test report can be downloaded shall be provided. As much as feasible, the data format should correspond to that developed by NEES for its data repository.

Chapter C2

Commentary on Interim Protocol I – Quasi-Static Cyclic Testing

Chapter C2 contains commentary for Sections 2.6, 2.7, 2.8 and 2.9 of Interim Protocol I – Quasi-Static Cyclic Testing. Commentary is not provided for the other sections.

C2.6 Test Facility Standards

C2.6.2 Equipment

The purpose of testing goes beyond the establishment of an empirical fragility curve. A test serves to improve understanding of behavior and, if appropriate, to provide the basis for analytical prediction of the behavior of the component and of the factors that contribute to damage. Since the action on the test specimen is the load causing a predetermined deformation, it is necessary to record the load (or loads) causing the resulting deformation(s).

Additional instrumentation should be provided as is deemed necessary to improve understanding of behavior and to quantify parameters on which the behavior depends. Since most components can be used in a variety of configurations, an attempt should be made to measure all relevant parameters on which behavior (or, specifically, damage states) depends. This may include geometry, thickness, and method of attachment. In this manner it should be possible to extrapolate fragility curves to different component configurations, if the measurements provide sufficient quantitative data to assess the effects of important parameters analytically.

Damage states, which are described in Section 1.4, can sometimes be quantified through direct measurements, and sometimes they have to be assessed through visual observations. A comprehensive log should be kept of all important visual observations and should be supplemented by frequently taken photos and other means of instantaneous or continuous visual documentation (e.g., sketches and videos).

C2.7 Test Plan and Procedures

Reproduction of in-situ conditions is perhaps the most critical aspect of a component testing program, as it requires isolation of a component, careful

simulation of boundary conditions, and realistic simulation of seismic effects.

In the context of a general testing protocol it is possible to provide broad guidelines on issues that should be considered, such as those discussed in the following.

- The isolated component must be representative of the actual in-service conditions the component will experience in a real building. In addition to the requirement that the condition of manufacture/construction and installation replicate the in-situ conditions as closely as possible, it is also important that the relationship between the loading parameter used in the tests and the damage states obtained from the testing program is representative of the conditions that will exist in buildings for the range of components for which the fragility function is to be applied.
- For many components, it is anticipated that the loading parameter used in the test will be intended to represent deformation induced in the component due to the interstory shear drift in a real building. The term “shear” implies a story distortion as shown in Figure C2-1(a), and not a story drift caused by cumulative rotation as the one shown in Figure C2-1(b). A component mounted on a floor of a building in a story that undergoes rotation drift, as illustrated in Figure C2-1(b) may not experience any real deformation demand. It is important that test boundary conditions replicate or can be converted to the mode of deformations that will actually occur in the building.

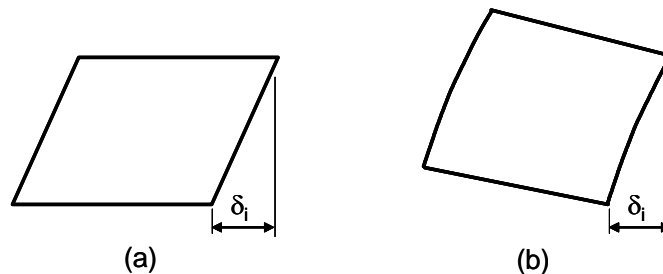

Figure C2-1 Different sources of story drift: (a) shear drift, and (b) rotation drift.

- Any deformation can be used as a loading parameter in a test. However, it is important that the deformation used in the test can be used to predict damage of components in a real building based on typical response quantities obtained from structural analysis of a building structure. The most convenient such deformation parameter is interstory drift. If the test specimen loading is controlled by a loading parameter other than the story shear drift, the relationship between this loading parameter and story shear drift should be clearly established so that the resulting

fragility functions can be transformed to a domain that is useful in predicting building damage.

- The way in which loading will be transferred between the real component in a building and the building's structural system must be properly simulated in the test. For instance, a nonstructural wall tied continuously to a framing system will behave differently from a nonstructural wall pushed at diagonally opposite corners. Thus, anchorage and boundary conditions must be well simulated, and the loading applied to a test specimen must be transferred to the test specimen as closely as possible to the way in which loading will be applied in a real building.

Fragility functions of the type discussed in Section 1.3 define the probability of being in or exceeding a specified damage state as a function of a relevant demand parameter that correlates well with the observed damage and can be predicted by structural analysis. The correlation with observed damage will never be perfect, which necessitates the development of probabilistic fragility functions. There are many sources of uncertainty that should be considered, including uncertainties caused by:

1. testing a component isolated from its in-situ conditions such as electrical conduits, piping, or supported floor slabs,
2. imperfect simulation of boundary conditions,
3. extrapolation to in-situ conditions not fully simulated in the test,
4. variability in configuration,
5. employment of a loading history that cannot precisely replicate the loading experienced by components in a real building responding to earthquake shaking,
6. uncertainty in the definition of the several damage states, and the input loading at which they initiate, and
7. variability in material properties and fabrication/construction methods and details.

The first four of the above can be reduced by careful planning of the testing program. The fifth one is believed to be small compared to some of the others. The last two can be considered explicitly in the testing program.

Criteria for damage states are not uniquely defined in most cases and the decision as to what loading initiates a specific damage state requires judgment, based mostly on experience. This uncertainty can be reduced by the development of well-defined criteria for damage states and by the

employment of experts capable of exercising good judgment. For a single specimen test, this uncertainty can be estimated by using a sufficiently large number of experts performing an independent assessment. Experts making the decision on damage states may not have to be present during the test if thorough and complete documentation is provided through measurements, sketches, photos, videos, and other means of observation. This encourages the employment of an instrumentation system that permits the measurement of physical parameters on which the damage states depend (e.g., crack width in a partition).

Uncertainties associated with the variability in material properties and construction methods and details can be evaluated only by testing of multiple specimens (unless analytical means can be employed to estimate the uncertainties from material and sub-component tests).

Thus, a testing program can range from a single-specimen, single-evaluator program to a multi-specimen, multi-evaluator program. A thorough pilot test on the latter is most desirable in order to gain insight into the various sources of dispersion that define the shape of fragility functions. A single-specimen, multi-evaluator program is desirable if the interpretation of damage states requires much expert judgment. A single-specimen, single-evaluator program is only recommended if the damage states can be clearly identified and if the material/construction uncertainties are known to be small compared with the other uncertainties enumerated above.

C2.8 Loading and Load Control

The boundary and initial conditions prior to testing a nonstructural component or system should be equivalent to those found in a typical application. Restraint forces due to temperature or shrinkage or other type of volumetric change should be emulated when such conditions are found and are significant in the application considered. Similarly, the effects of interstory shortening or elongation, beam shortening or elongation, and concentrated rotations should be emulated if the application considered is significantly affected by one or several of these conditions.

Gravity loading present in the element tested should be representative of the conditions found in the application. When testing a reduced-size component, additional gravity loading may have to be distributed throughout the test specimen. The arrangement of the additional loading should be reported, as specified in Section 2.10. It should be ensured that the mechanisms required to simulate the additional gravity loading will not cause spurious changes in stiffness or strength.

In-situ boundary conditions that contribute to the initiation and propagation of damage should be properly simulated. This should include anchorages to structural or nonstructural components other than that under test, as well as imposed force or deformation patterns that are caused by deformations in the elements surrounding the component to be tested (e.g., deformation pattern of structural framing elements to which a piece of cladding is anchored).

Simulation of boundary conditions also includes all relevant three-dimensional features that may have a significant effect on damage initiation and propagation. In particular, the effects of story deformations in two orthogonal horizontal directions and in the vertical direction should be considered when significant. If it is found that story deformations orthogonal to the primary loading direction have a clear effect on damage, the bidirectional loading option discussed in Sections 2.8.3 and 2.9.2 should be utilized.

Some component types can span upwards over more than one story. In such cases, the testing program should either contain tests of multi-story high specimens, or proper boundary conditions should be created to simulate attachment to more than one story. The boundary conditions that are critical include panel-to-panel joints (adjacent panels, horizontally and vertically), guides (with minimum friction) to restrain panels in-plane throughout racking tests, prevention of uplift in wall systems that may otherwise uplift when subjected to transverse load at the top, application of horizontally distributed load at the top (this is accomplished by proper attachments to the moving beams of the test facility), and connectors that attach the component to the moving beams.

Examples of test setups suitable for either racking or hysteretic testing of wall and cladding panel assemblies are provided in this commentary section.

A test facility can consist of a structural support (reaction) frame that is very strong and stiff (compared with the test frame and specimens) and is fixed to a strong floor, a frame that simulates the building structural system to which the wall specimen will be attached, hydraulic actuators, load cells, LVDTs, sliding or gliding steel members (e.g., structural tubing) to which specimens will be attached directly or indirectly, and various linkages.

A schematic diagram of a typical stroke control and data acquisition system for a test facility is shown in Figure C2-2. The system can consist of computer and interface instrument, controller console, function generator, digital oscilloscope, load cell signal conditioning, LVDT signal

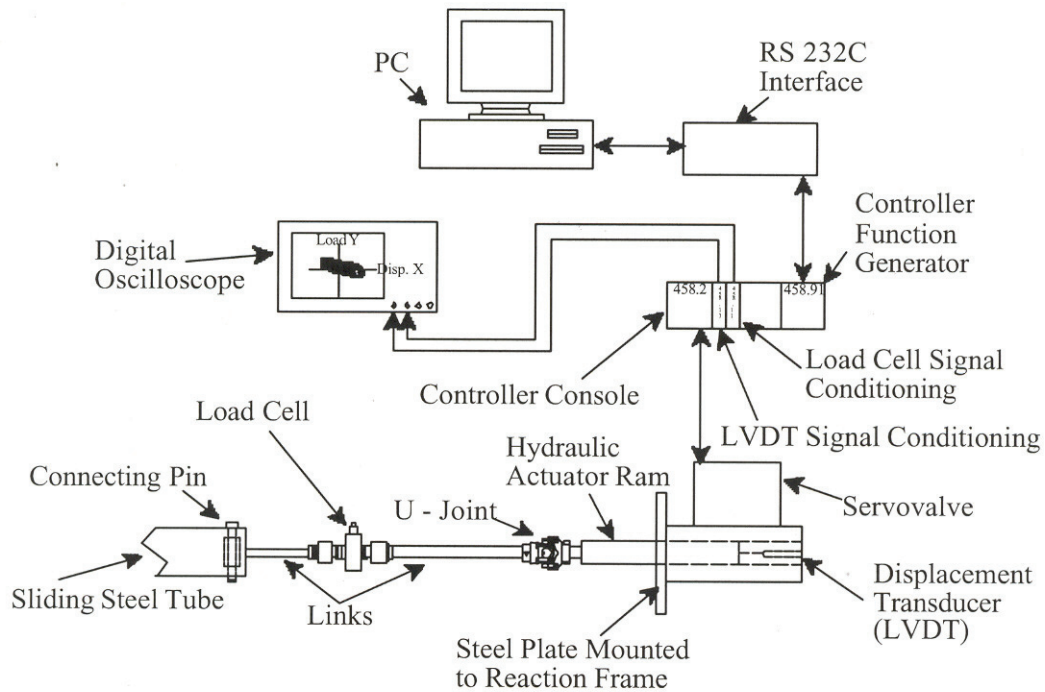

Figure C2-2. Example of instrumentation and data acquisition system

conditioning, and servovalve units. The test apparatus should include a means of recording all the necessary data.

For the example test facility shown in Figures C2-3 to C2-5, each specimen (e.g., curtain wall or cladding panel) should be centered between the sliding steel tubes of the test facility, and the wall specimen attached at all four corners to the facility's sliding members (e.g., steel tubes). The sliding members shown in these three figures are steel tubes that slide on roller assemblies in opposite directions by means of a fulcrum and pivot arm mechanism. The bottom sliding steel tube is displaced by a computer-controlled electrohydraulic servoactuator having a dynamic stroke capacity of ± 76 mm (± 3 in.). The fulcrum and pivot arm mechanism attached to the top and bottom sliding steel tubes doubles the effective servoactuator stroke capacity to ± 152 mm (± 6 in.).

For the example test facility shown in Figures C2-6 and C2-7, the test specimen (e.g., precast concrete cladding panels) is attached to the supporting frame with four connections, which can be of different types, e.g., flexible, bearing, or slotted. The test facility includes a support (test) frame that is used to represent a single bay of the building and in the figure

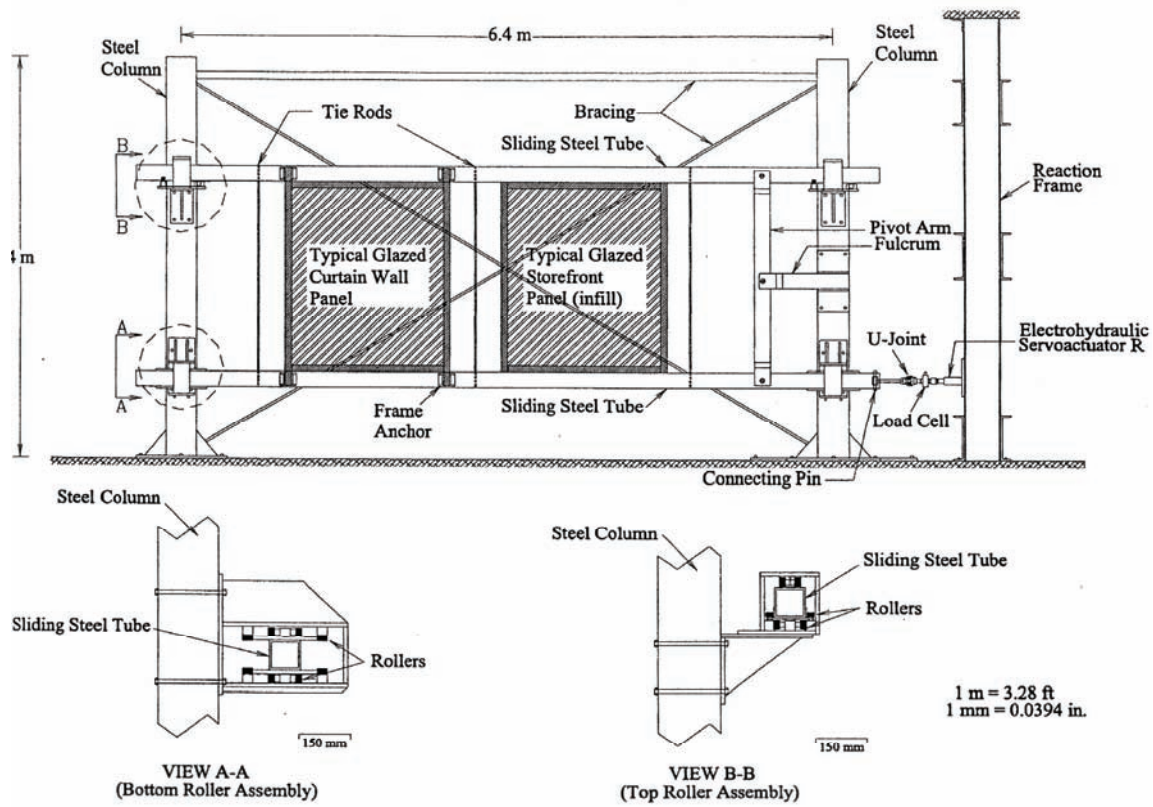

Figure C2-3 Example racking test facility at Penn State University with setup for testing curtain walls

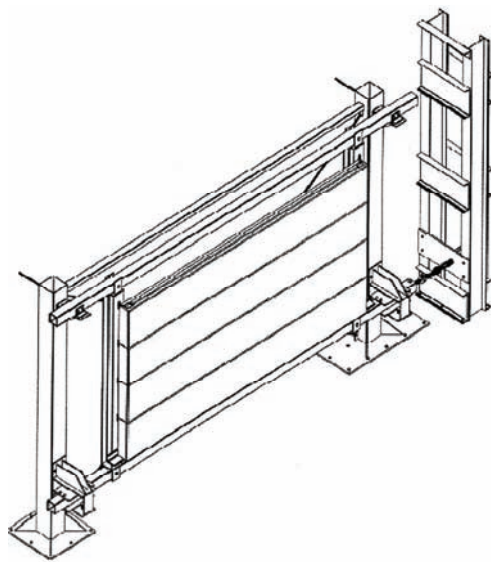

Figure C2-4 Example test setup for testing horizontally attached cladding panels on the Penn State facility.

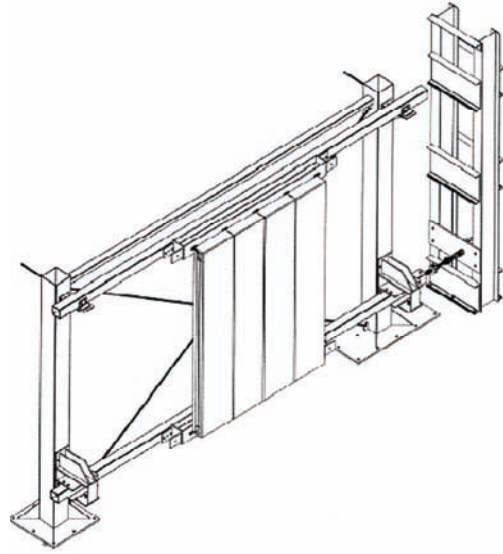

Figure C2-5 Example test setup for testing vertically attached cladding panels on the Penn State facility

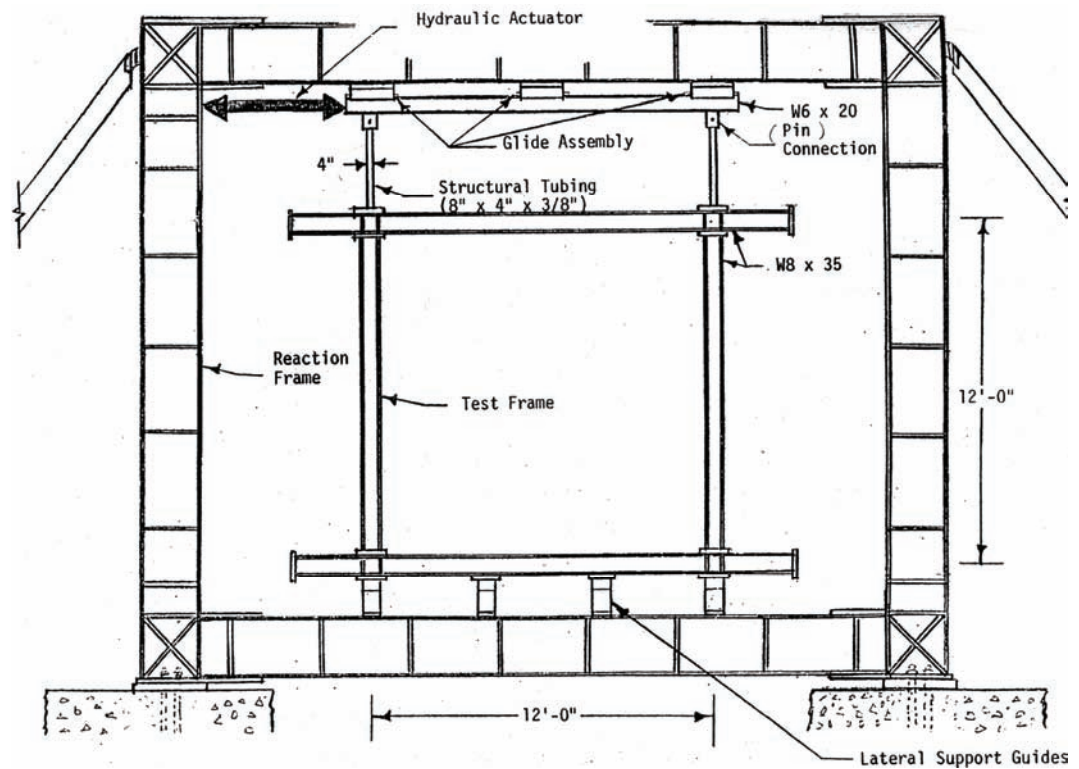

Figure C2-6 Example racking test facility at the University of Idaho

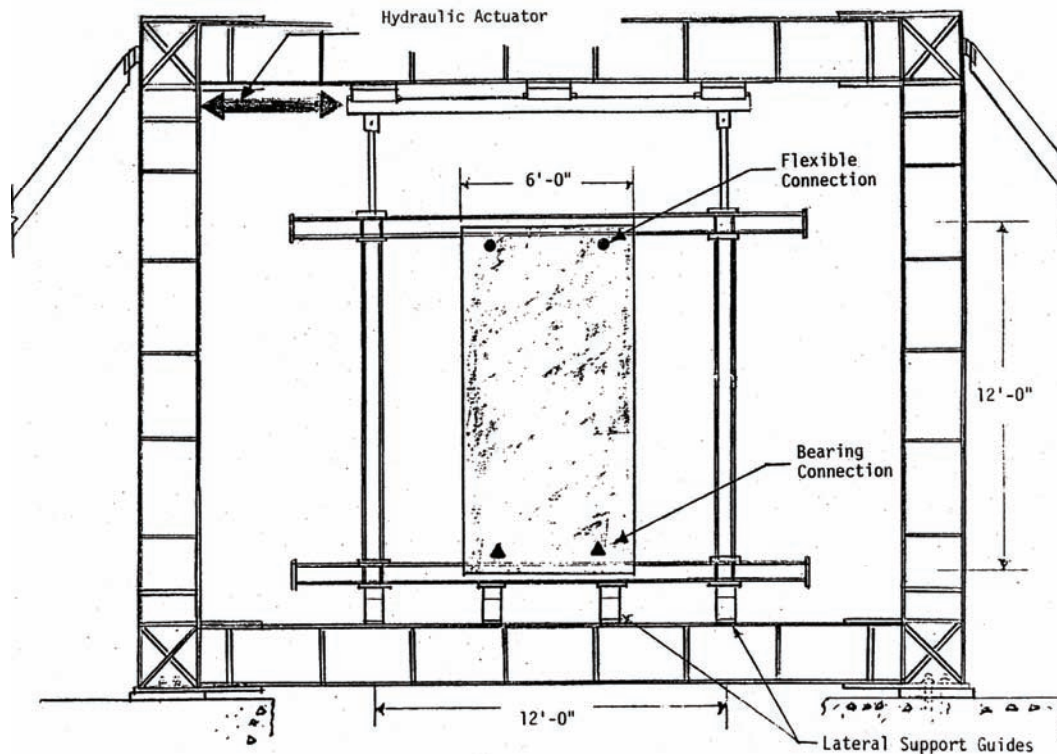

Figure C2-7 Example test setup for testing cladding panels on the University of Idaho facility

is shown as four W8x35 steel sections with moment-resisting joints. At the bottom of the support frame, there are four transverse guides (ball bearing) that prevent the specimen panel from moving out-of-plane during the racking movements. The guides may slightly add to the in-plane resistance due to friction. In the test facility shown in Figures C2-6 and C2-7, steel tubes (8 in. x 4 in. x 3/8 in.) connect the top of the support frame to the displacement-controlled system with moment connections at the test frame and pin connections at the displacement control system. The displacement control system, which is used to apply racking movements to the specimen panel, consists of a hydraulic actuator connected to a W6x20 steel beam suspended from a lubricated glide system. An external reaction frame is used to support the support frame, the specimen and racking loading equipment. The reaction frame is very stiff relative to the internal frame to act as a stationary support for the support frame.

The three schematic facilities shown in Figure C2-8 are generic ASTM Standard racking test facilities that are primarily for testing panels that are supported directly by the floor (e.g., a partition wall or an infill wall) and not attached to the building frame as a curtain wall or a cladding panel. The specimen in this case can be supported by a timber or steel member, which is in turn attached rigidly to the base of the loading frame or strong floor. The

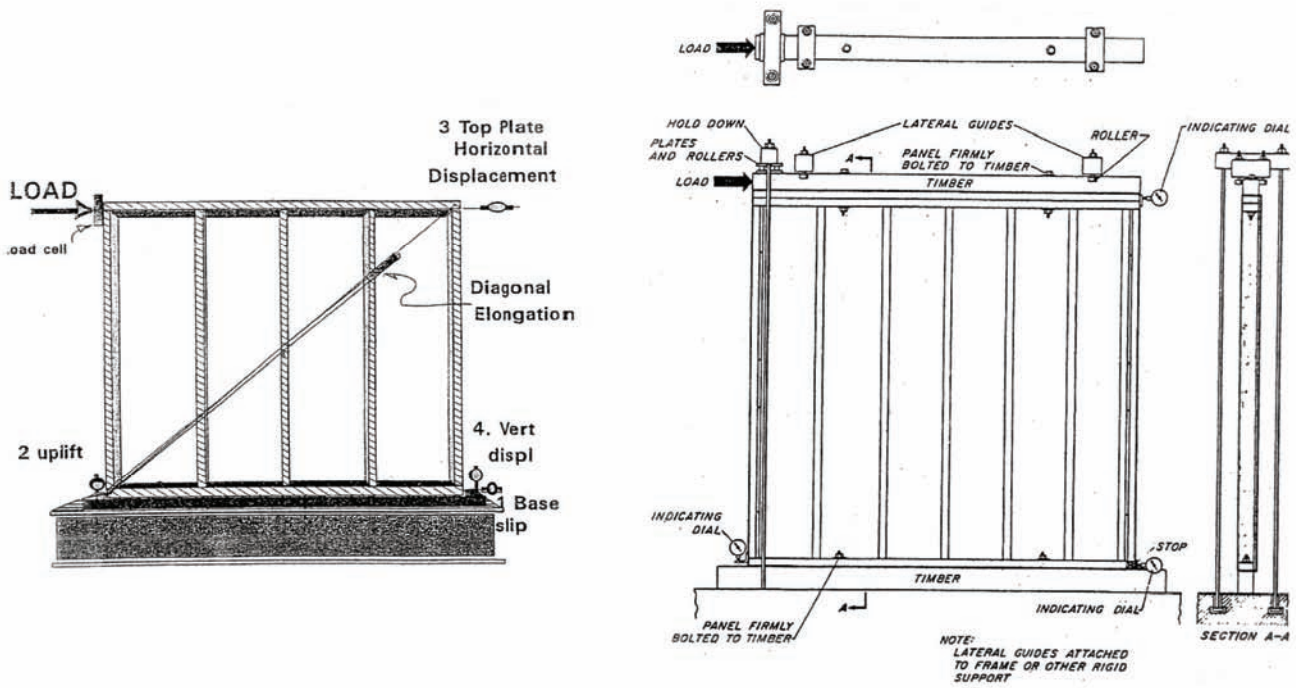
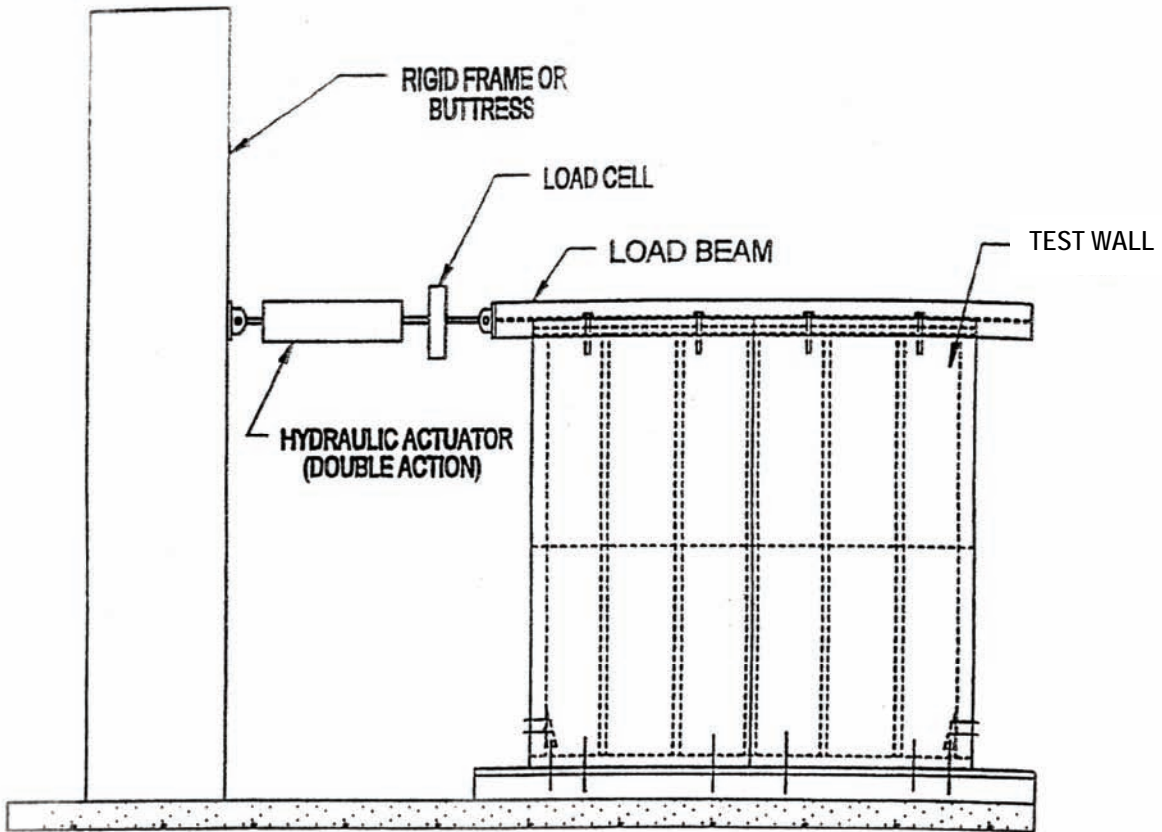

Figure C2-8 ASTM Standards generic test facility and setups for racking testing of shear-resisting wall panels.

sole plate of the specimen panel should be firmly attached (e.g., bolted or welded) to the base support member. Since the wall panel in this case will show large shear resistance, a hold-down mechanism such as rods or gravity loads should be provided to prevent the uplift tendency (rigid body rotation) as the racking loads are applied to the top of the wall. Mechanisms (e.g., rollers, sliding plates) should be provided to allow horizontal movement of the top of the wall panel with respect to the bottom without interference with the hold-down mechanism. In the facilities shown in Figure C2-8, the load is applied to the specimen top through a timber beam firmly bolted to the upper plate or part of the panel (to simulate connection of the wall top to floor above). Transverse guides (with minimum friction resistance) are also needed to prevent out-of-plane movement of the panel during the racking movements. For the tests on this type of facility, displacements should be measured to the nearest 0.25 mm (0.01 in.). The location of the dials shall be at all points where the data can be used to characterize properly the performance of the wall system, including the lower left, lower right, and upper right corners of the test assembly (assuming that the hold-down rods are on the left side). For the test setups shown in Figure C2-8, the lower left dial measures the rigid body rotation of the panel (because the hold-down rods could elongate and allow some rotation), the lower right dial measures the slippage (if any), and the upper right dial measures total deformation (including the effect of panel rigid body rotation and sliding).

C2.9 Loading Histories

Important Considerations

The following are important considerations that enter in the decision process for developing or selecting a loading history for slow cyclic testing of nonstructural components.

In general, there are several damage states to consider for each type of component. The options are to quantify all of them with a single specimen or to use separate specimens for each damage state. The usual preference is to use a single specimen, which appears justified unless cumulative damage becomes a dominant issue for low-damage states.

The use of a single specimen necessitates a step-wise increasing loading history in which the loading sweeps through the full range of realistic values that may trigger one of the damage states.

It is assumed that the fragility function is not conditioned on the structural system in which the component is mounted or on the ground motion experienced by the structure (i.e., the probability is assumed to be the same

regardless of the source and the history of the loading on the component). It is well known that this assumption is incorrect but nonetheless, this assumption has to be made in order to make the problem tractable.

The only reason why a cyclic loading protocol is needed is that damage is a cumulative process and is affected by the history of excursions (an excursion is the path from one peak loading value to the next loading peak value) that precede the initiating loading for a damage state that is represented by the fragility function.

Cumulative damage depends on the number and relative amplitudes of the excursions preceding the one at which the damage state is first observed, as well as on the sequence in which the excursions occur, the mean effect (since excursions are not symmetric with respect to the origin), and possibly on the “loading” rate at which the cyclic loading history is applied to the specimen. Mean effects and loading rate effects cannot be considered systematically in a slow static testing program. Mean effects (the fact that individual excursions are not symmetric with respect to the origin) are customarily neglected, i.e., each excursion is centered with respect to the undeformed configuration, resulting in a “symmetric” loading history. Load rate effects are neglected in favor of a testing process in which the load application is slow enough to permit visual observations of damage.

Sequence effects can be incorporated conservatively by assuming that all excursions in a response history occur before the maximum one (this clearly is not the case and leads to a severe over-estimation of cumulative damage). An alternative is to consider only so-called “pre-peak” excursions as described below. Both options are pursued here.

The task at hand is to develop a single loading history, which, in part by statistical evaluation of seismic response data and in part by judgment, represents all the cumulative damage effects at all the damage states that are to be quantified in a test.

The alternative is to use different test specimens for each damage state and apply to each specimen a statistically representative deformation history in which the maximum excursion is deemed to be the excursion at which the damage state is attained for the first time. In order to assist in estimating this target maximum excursion for each damage state, it is most helpful to perform first a monotonic test on a separate specimen in which the loadings associated with the initiation of the various damage states are estimated. (The expectation is that each loading initiating a damage state in a monotonic test will be somewhat larger than the corresponding initiating loading from the cyclic test. However, it also has to be considered that a monotonic test may mask damage states occurring in a cyclically loaded specimen). Thus, if m damage states are to be evaluated, this testing program would require $m+1$

test specimens to provide one data point for each damage state. This option is not pursued further.

Basis for the Recommended Loading History

The recommended loading history is based on the following assumptions, processes, reasoning, and observations.

The number and relative amplitude of individual excursions are based on the response of structures to a set of 20 “ordinary” (no near-fault effect) ground motion records. The set of records is the one used to develop the CUREE-CalTech Woodframe Project loading protocol (Krawinkler et al., 2001). Near-fault ground motions may cause larger demands on components but will generate fewer response cycles, i.e., they will not control the number and relative amplitudes of the excursions in a loading history.

This set of ground motions is used to perform response history analysis of elastic and inelastic (with a target ductility of 3) single-degree-of-freedom (SDOF) systems and multi-degree-of-freedom (MDOF) frame structures. Systems with periods of 0.2, 0.3, 0.5, 0.9 and 3.6 sec are evaluated. The hysteretic properties of the SDOF systems and the plastic hinge moment-rotation relationships of MDOF systems are assumed to be peak-oriented.

For each system the deformation response (displacement for SDOF systems and story drift for MDOF systems) for each ground motion is rearranged in excursions using the rainflow cycle counting method (ASTM, 2003). The deformation range (peak-to-peak value) of each excursion is centered with respect to the origin (i.e., the deformation amplitude is assumed to be half of the range, which implies that mean effects are ignored) and is normalized with respect to the amplitude of the largest excursion of the response. When ordered in magnitude, this results in a string of numbers from 2.0 on downwards, identifying the relative magnitudes of all excursions of the response.

For the set of 20 records, statistical measures (median and 84th percentile) of each normalized range (the largest one, the second largest one, the third largest one, and so on) are computed, providing statistical values of the ranges relative to the largest one. Examples of such statistical values are shown graphically for elastic and inelastic SDOF and MDOF systems in Figures C2-9 to C2-12. The figures show relative ranges ranging from the maximum to 6.67% of the maximum excursion, considering all excursions of response histories, regardless of whether they occur before the peak response (pre-peak excursions) or after the peak response (post-peak excursions).

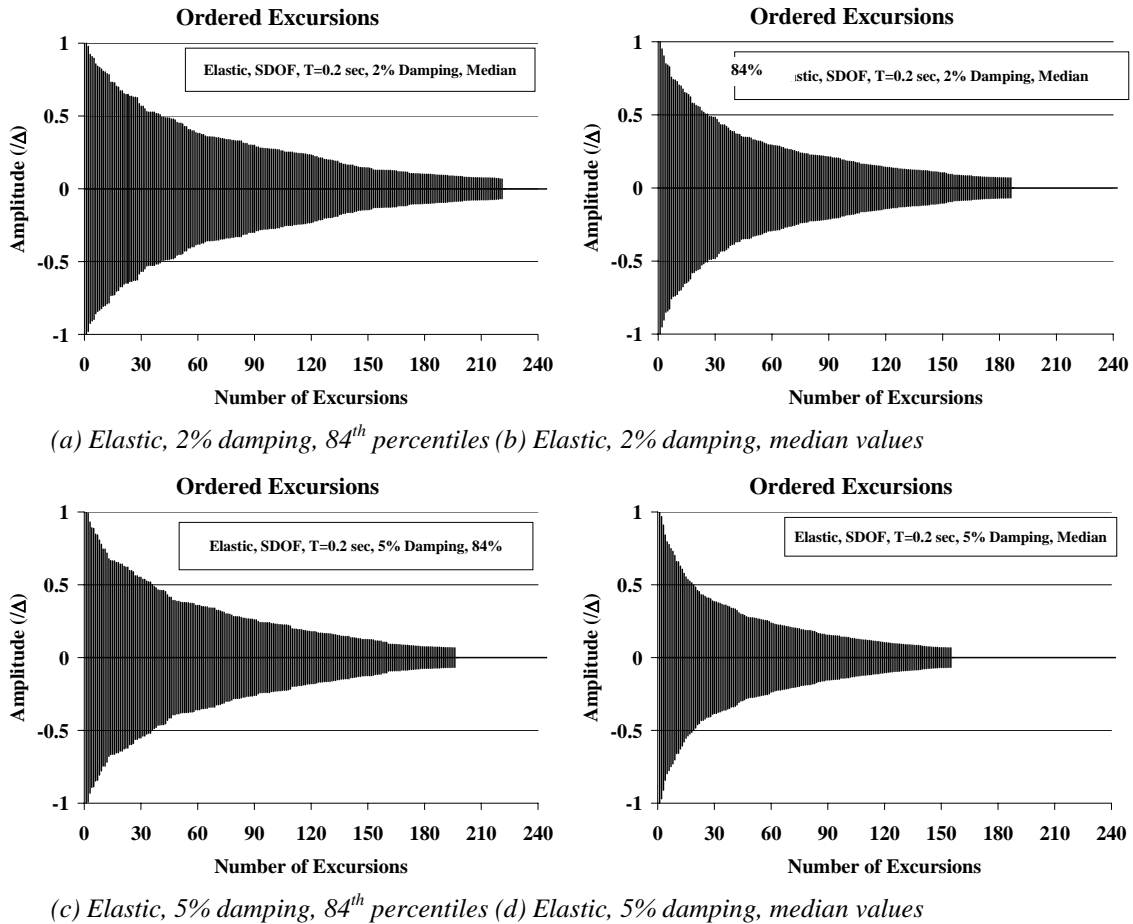
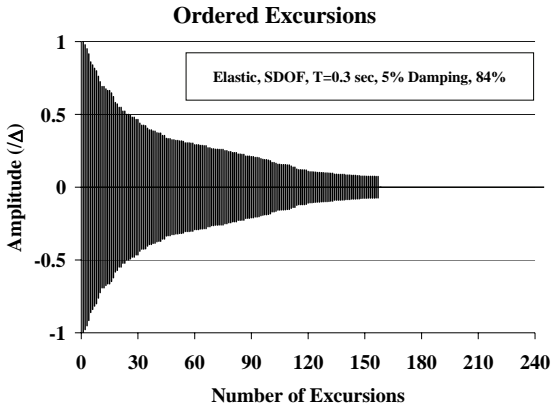

Figure C2-9 Ordered relative excursions, pre-peak plus post-peak, $T = 0.2$ sec., SDOF systems

The following are relevant observations from these figures (C2-9 through C2-12):

- For short-period structures the number of excursions between maximum and 6.67% of maximum is very large. The reason is that in the process followed here all excursions are counted, regardless of their sequence of occurrence. Depending on the ground motion, a large or very large portion of these excursions will occur after the peak response (see Figure C2-12 (a) and (b)).
- All elastic histories show similar tapered decays in deformation ranges.
- Inelastic histories show a more rapid decay and fewer excursions.
- The 84th percentile graphs result in a very large number of excursions. The number of excursions for the median values are about 10 to 20% smaller.



(a) Elastic SDOF, 5% damping, 84th percentiles

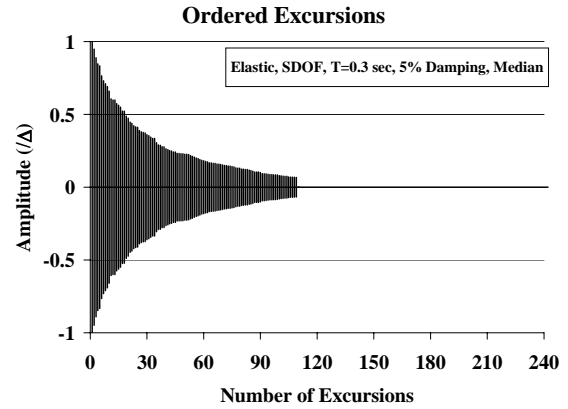

(b) Elastic SDOF, 5% damping, medians

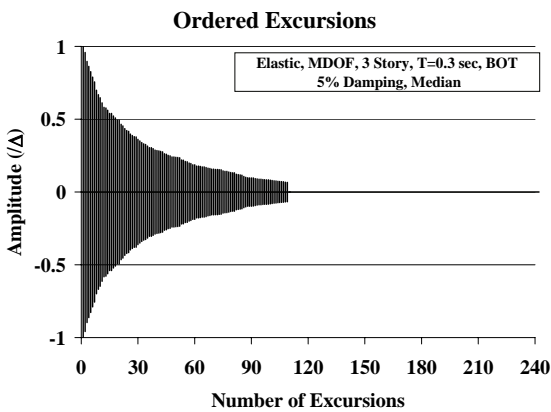

(c) Elastic MDOF, 5% damping, bottom story, median values

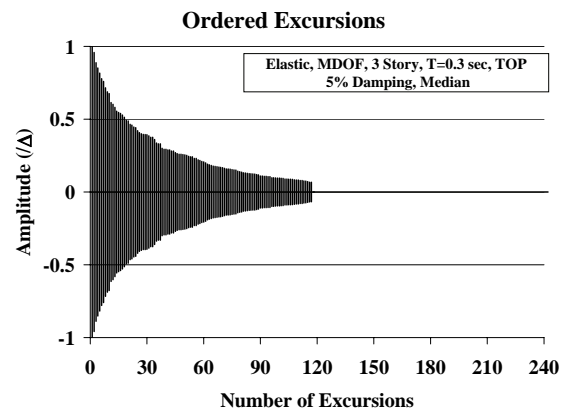

(d) Elastic MDOF, 5% damping, top story, median values

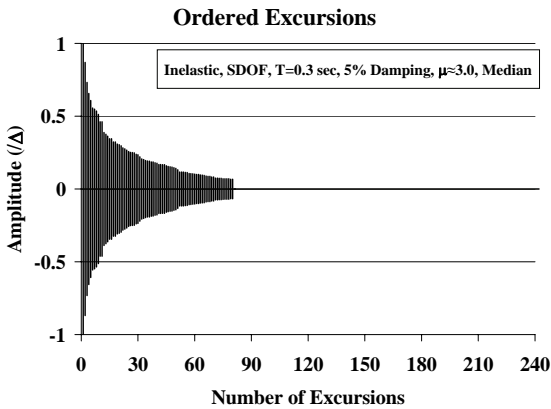

(e) Inelastic SDOF ($\mu \approx 3$), 5% damping, median values

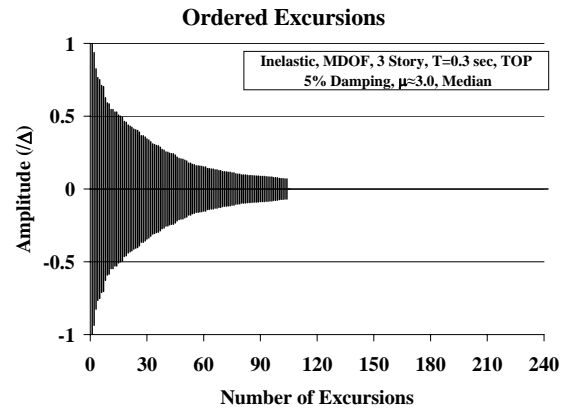

(f) Inelastic MDOF, 5% damping, top story, median values

Figure C2-10 Ordered relative excursions, pre-peak plus post-peak, $T = 0.3$ sec., SDOF and MDOF systems

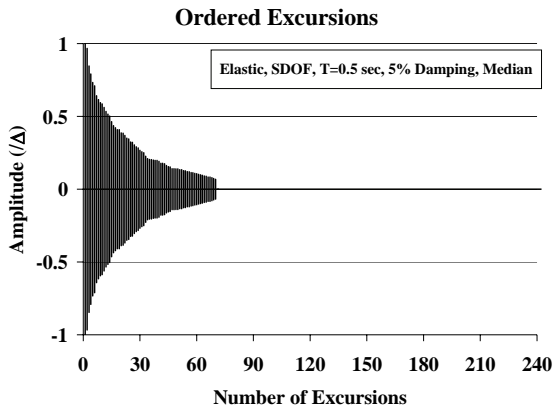

(a) Elastic SDOF, $T = 0.5$ sec., 5% damping, median values

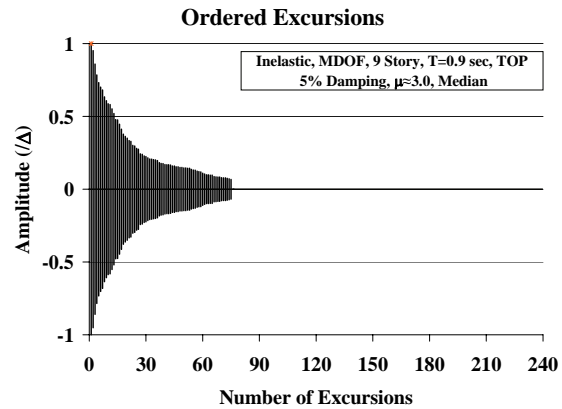

(b) Inelastic 9-story MDOF, 5% damping, top story, median values

Figure C2-11 Ordered relative excursions, pre-peak plus post-peak, $T = 0.5$ and 0.9 sec.

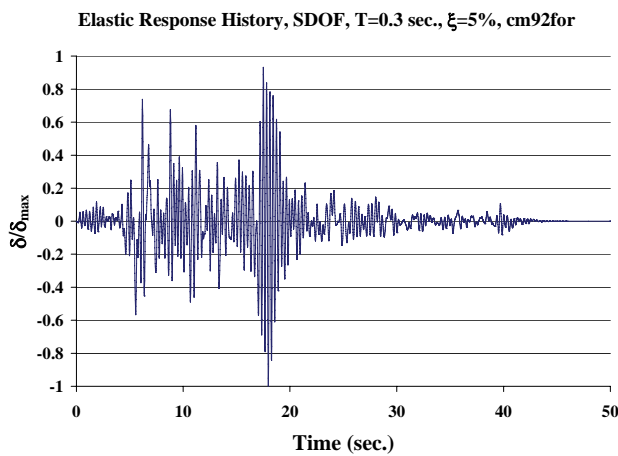

(a) Peak displacement response occurs relatively late

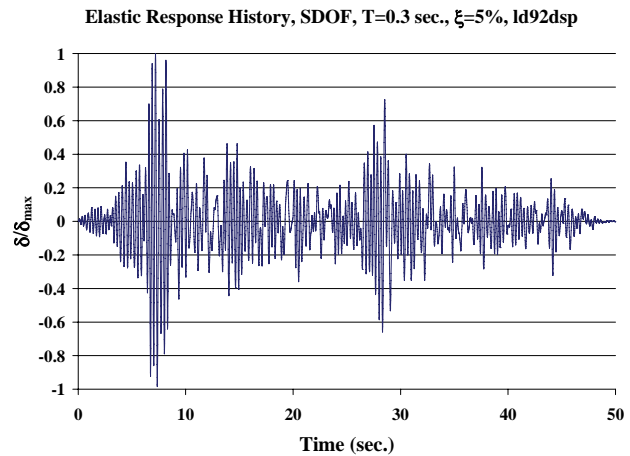

(b) Peak displacement response occurs relatively early

Figure C2-12 Normalized response displacement histories of an SDOF system, $T = 0.3$ sec.

- The responses of 5% damped systems have about 15% fewer excursions than the responses of 2% damped systems.
- For short-period MDOF systems the story drift responses are well correlated with the responses of the one-mode SDOF system. In general, the bottom story MDOF drifts decay slightly faster than the SDOF response, and the top story drifts decay slightly slower than the SDOF response. In the frame structures used in this study the top stories are flexible and weak, which in part explains the relatively slow decay. Considering all other uncertainties and judgmental decisions, it can be stated that the SDOF responses are adequate surrogates for the MDOF responses (at least for structures with not very important higher mode effects).

- For long-period MDOF systems the higher mode effects become more important and the top story shows a considerably larger number of excursions than the SDOF system with the same first-mode period. However, this number is smaller than that for short-period MDOF systems, which leads to the conclusion that short-period structures govern the response values (in terms of the number and relative amplitude of excursions) rather than longer-period structures.
- The number of excursions decreases consistently with an increase in the period of the system, which makes the $T = 0.2$ system the most critical one in terms of the number and relative amplitude of excursions.

The use of median values is appropriate because the objective of testing is to obtain fragility curves in which the effect of record-to-record variability should be represented as an average. (The use of the 84th percentile would provide high values of fragilities).

The use of structures with very short periods for the development of a generally applicable loading protocol is inappropriate. They overestimate the number and relative amplitude of excursions for most cases, and they are not representative for the full range of drift demands for which the performance of most nonstructural components has to be evaluated. The following argument supports this observation:

For SDOF systems the period T is given by

$$T = 2\pi \sqrt{\frac{W}{gK}} = 0.32 \sqrt{\frac{W}{F_y}} \delta_y = 0.32 \sqrt{\frac{\delta_y}{F_y/W}} \quad (\text{C2-1})$$

or
$$\frac{F_y}{W} = \frac{0.32^2}{T^2} \delta_y$$

Using an interstory drift ratio at yield (IDR_y) = 0.01 and $h = 144$ in., gives $\delta_y = 1.44$ in., and we obtain:

For $T = 0.2$ sec $\rightarrow F_y/W = 3.69$

$T = 0.3$ sec $\rightarrow F_y/W = 1.64$

This means that for short-period structures large demands on story drifts are possible only for very flexible and very strong structures, which will respond elastically even in a very large earthquake (probably not many of these structures exist). For inelastic story drifts to occur, the structure would have to be very stiff, in which case the drift demands will be very small, i.e., little (if any) drift-sensitive damage is to be expected.

This argument can be used to “disregard” the response characteristics of very short period structures (i.e., $T = 0.2$ sec).

The results from the analytical study show that, given an initiating value of loading for a damage state, the prior history will have more and relatively larger excursions if the response of the structure is elastic rather than inelastic (in general, the number and relative amplitude decrease with the degree of inelasticity). Thus, elastic response histories provide a conservative (high) estimate of the number and relative amplitude of excursions.

The number and relative amplitudes of the excursions should represent, on average, the history of the loading at each damage state that is to be quantified. This is not possible because lower damage states are associated with smaller earthquake intensities and higher damage states are associated with larger earthquake intensities. The use of a single loading history for all damage states is a compromise made necessary by the desire to catch all damage states with a single specimen. The consequence of using a single loading history for the evaluation of multiple damage states implies that for low-level damage states (a small amount of damage) the number and amplitude of excursions are “too small”, and for high levels of damage the number and amplitude of excursions are “too large”.

Experimental pilot studies with a loading history that was based on pre-peak plus post-peak excursions disclosed that the large cumulative damage caused by the many excursions may severely distort the behavior at high-level damage states (large damage). Since these are the damage states of greater interest, and since low-level damage states are less affected by cumulative damage, it was decided to develop a loading history that is based only on pre-peak excursions and that represents, statistically, the number and amplitude of damaging excursions associated with earthquakes causing the highest-level damage state.

Pre-peak excursions are those excursions that occur before both the maximum positive and maximum negative peaks in the response have been reached. As discussed in Krawinkler et al. (2001), it is the pre-peak excursions that cause most of the damage at high-level damage states. It is seen from Figure C2-12 that typically the peaks occur relatively early in the response history. Statistical data (median values) for the number and deformation ranges of pre-peak excursions (increasing from small to large values) and post-peak excursions (decreasing from large to small values) are shown in Figure C2-13 for elastic SDOF systems with $T = 0.3$ and 0.5 sec. It is seen that fewer than half of the total number of excursions are pre-peak excursions.

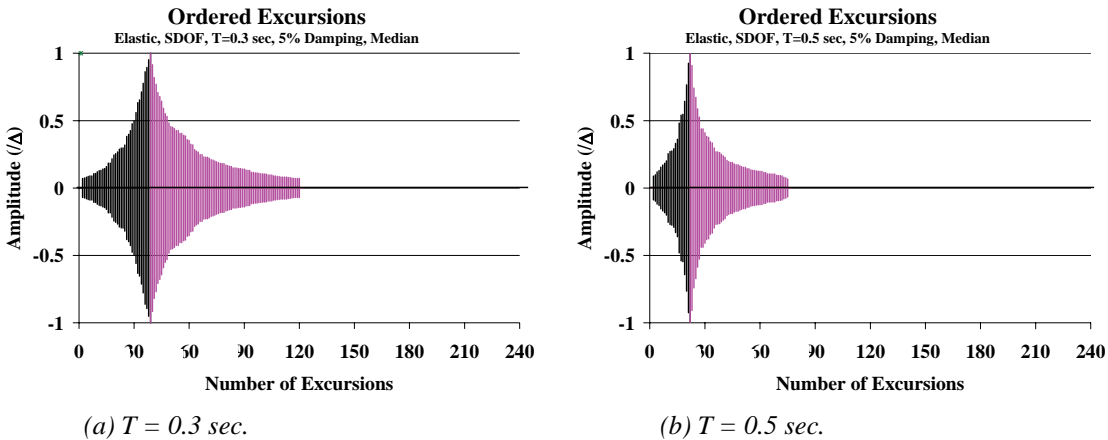

Figure C2-13 Ordered relative excursions, separate for pre-peak and post-peak excursions, elastic SDOF system.

Using an equation of the form given by Equation C2-1, a close match for pre-peak excursions was obtained by using a coefficient of 1.3 and 1.6 for $T = 0.3$ sec and 0.5 sec, respectively. The value of 1.4, as provided in Equation C2-1, is a compromise between these two coefficients.

Every loading history needs reference values for the loading. For nonstructural components with several damage states such reference values are case specific. Any reference story drift depends on the intensity of the ground motion and on the stiffness and strength of the structure. The drift is expected to be relatively small for lower stories in wall structures and relatively large for moment-resisting frames. Thus, rather than committing to fixed values of reference drifts, it is decided to use generic reference values Δ , and define all cycle amplitudes in terms of a target value of Δ associated with the largest damage level. The advantage is that the user has the freedom to choose appropriate values for Δ .

Low-Cycle Fatigue Considerations

The existence of cumulative damage is the primary reason for cyclic load testing. Low-cycle fatigue is one type of cumulative damage, which is usually associated with cracking or fracture in metals. Many low-cycle fatigue models exist, the simplest one being that based on the two hypotheses of a Manson-Coffin relationship and Miner's rule (Krawinkler et al., 1983). The first hypothesis postulates that for constant amplitude cycling the number of excursions to failure, N_f , and the plastic deformation range, $\Delta\delta_p$, are related by the following equation:

$$N_f = C^{-1}(\Delta\delta_p)^{-c} \quad (C2-2)$$

In this equation C and c are structural performance parameters that have to be determined experimentally. The equation implies that on a log-log plot the

relationship between N_f and $\Delta\delta_p$ is linear. The second hypothesis is Miner's rule of linear damage accumulation, which postulates that the damage per excursion is $1/N_f$, and that the damage from excursions with different plastic deformation ranges, $\Delta\delta_{pi}$, can be combined linearly. Thus the total damage D is given by the equation

$$D = C \sum_{i=1}^N (\Delta\delta_{pi})^c \quad (C2-3)$$

If this hypothesis were accurate, a total damage of $D = 1.0$ would constitute failure. Because of the known shortcomings of Miner's rule (neglect of mean deformation and sequence effects) and the scatter in the structural performance parameters C and c , the limit value of damage that constitutes failure cannot be expected to be exactly 1.0. Krawinkler et al. (1983) provide an extensive discussion of many issues associated with this damage model.

If this simple damage model is acceptable, if $D = 1.0$ indeed constitutes failure, and if the scatter in the model parameters C and c can be neglected, then tests with at least two specimens are needed to determine C and c . Most commonly, two constant amplitude tests (with very different amplitudes) are performed for this purpose. In the *ATC-24 Report, Guidelines for Cyclic Seismic Testing of Components of Steel Structures* (ATC, 1992), it is recommended to perform at least three tests. In the most simple case it may be adequate to make a reasonable assumption on the value of the exponent c , with 2.0 being an often-used value. If this can be done, the coefficient C can be estimated from a single specimen.

The determination of low-cycle fatigue parameters is essential if analytical means are employed to predict performance of a component or system affected by low-cycle fatigue. If the main objective is to estimate only the deformation amplitude at which failure is likely to occur, then a single test with the previously discussed loading protocol should be adequate. This can be justified by the observation that the exponent c usually is significantly larger than 1.0, which implies that low-cycle fatigue damage is dominated by the largest cycles, i.e., the damage due to the many smaller cycles is not relevant.

Suggested Loading Protocol

Alternatively, the following loading protocol is suggested to evaluate failure modes for items of systems that are deemed to be susceptible to low-cycle fatigue failures. These items are likely to include but are not be limited to piping and duct system connections. The following steps could be used to obtain the fragility curve for these items:

1. Conduct a monotonic force-deformation test on the component (Figure C2-14). Estimate the deformation at which the component undergoes complete damage (breaks, leaks or experiences unacceptable deformation). Call this ultimate deformation, Δ_{ult} . The cyclic test is started at $1/10^{\text{th}}$ of the ultimate deformation, $\Delta_1 = \Delta_{ult}/10$.

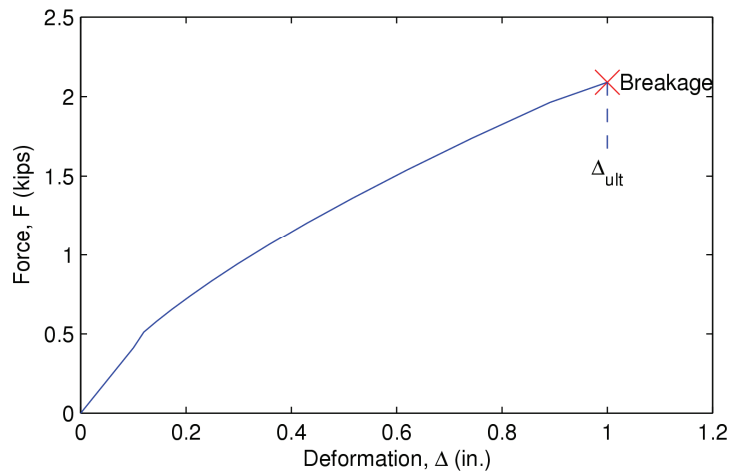

Figure C2-14 Monotonic force-deformation test on the component

2. In the 1st stage of the cyclic test, apply 10 cycles of deformation amplitude Δ_1 (Figure C2-15a). Measure the force throughout the test (Figure C2-15b). The force level will generally reduce from one cycle to the next due to stiffness degradation. The minimum force amplitude during the 1st stage is called F_1 .
3. For the 2nd stage of the cyclic test, increase the deformation amplitude by 20%, i.e., $\Delta_2 = 1.2\Delta_1$. Subject the component to three cycles of deformation amplitude, Δ_2 . Measure the force. The minimum force level during the 2nd stage is called F_2 .
4. For each subsequent stage, increase the deformation amplitude by 20% and subject the component to three deformation cycles. Record the minimum force amplitude during each stage: F_3 , F_4 , F_5 , and so on. Continue the cyclic test in this manner until the component suffers complete damage (breaks, leaks or undergoes unacceptable deformation). The last stage during which the component does not suffer complete damage is the n^{th} stage. The force amplitude in the n^{th} stage F_n corresponds to the 100% (complete) damage state. The force levels for the other damage states are established as follows.

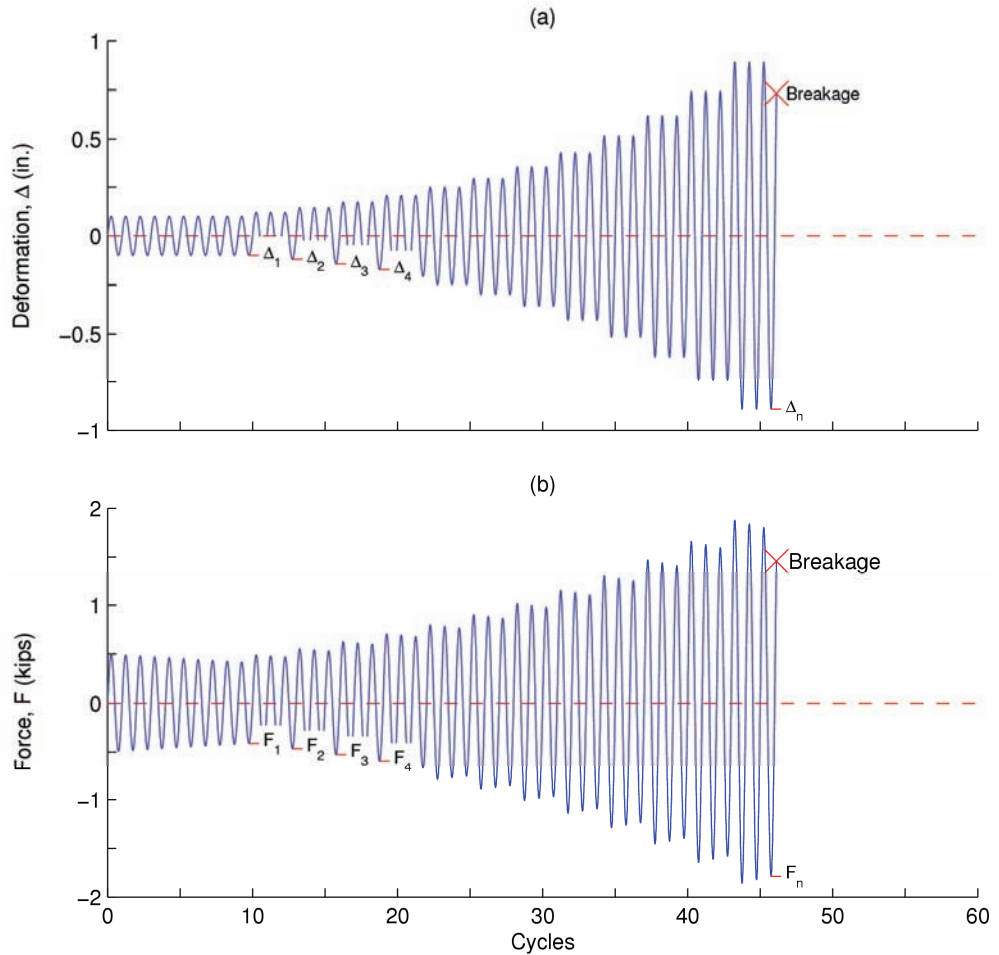

Figure C2-15 Cyclic test on the component in deformation control: (a) applied deformation history; and (b) measured force history.

- Obtain the normalized fatigue damage at the end of each test stage. (The normalized fatigue damage at the end of the n^{th} test stage is 100%.) The normalized fatigue damage at the end of the i^{th} test stage is:

$$D_i = \frac{\sum_{j=1}^i N_j \cdot \Delta_j^2}{\sum_{j=1}^n N_j \cdot \Delta_j^2} \times 100 \quad (\text{C2-4})$$

where N_j is the number of cycles in different test stages; $N_1 = 10$; $N_2 = N_3 = \dots = N_n = 3$.

- Plot D_i at the end of each test stage (See Figure C2-16). Identify the exact cycle during which the component reaches different damage states.
- Plot the force level at the end of each test stage (Figure C2-15b). Read the force corresponding to each damage state.

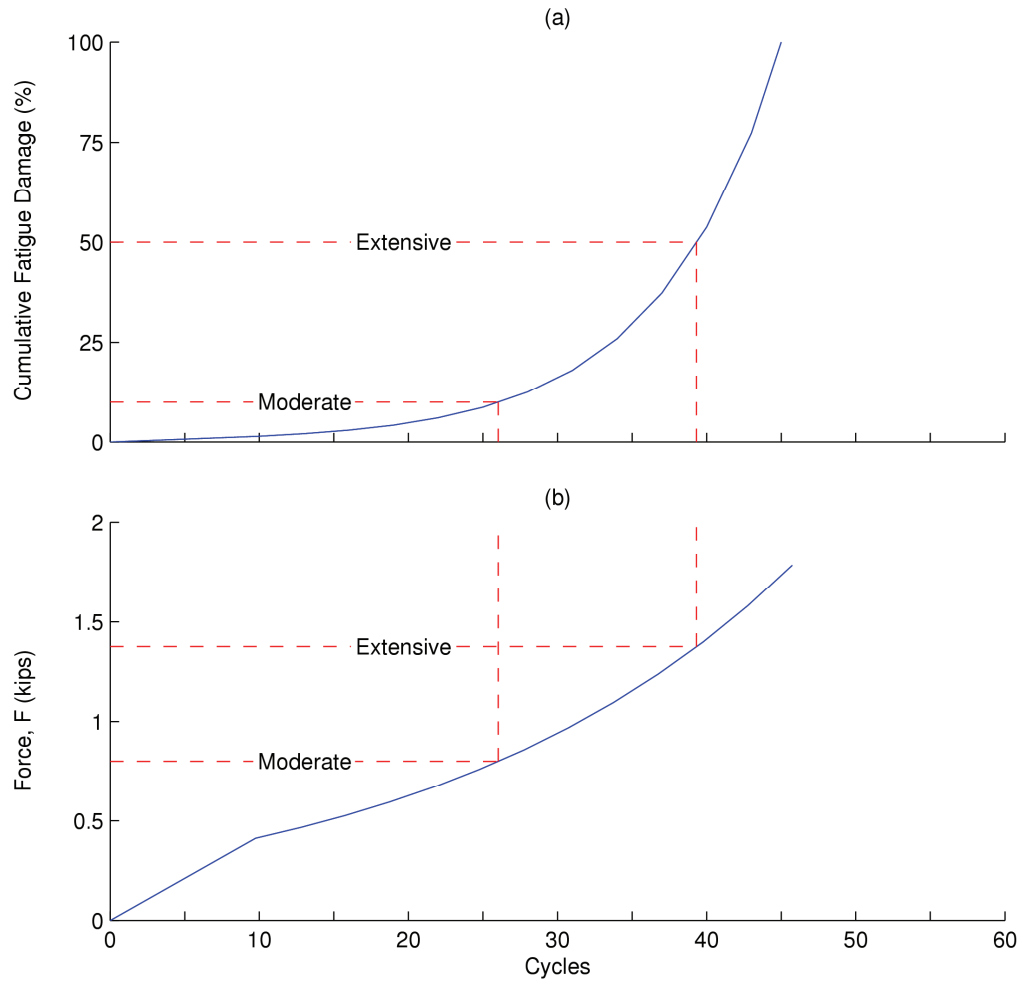

Figure C2-16 (a) Cumulative low-cycle fatigue damage at the end of each test stage, and (b) force level at the end of each test stage.

Chapter 3

Interim Protocol II – Shake Table Testing

3.1 General

3.1.1 Scope

This Chapter establishes a recommended protocol for shake table testing of structural and nonstructural building components for the purpose of determining fragilities for use in the seismic performance assessment process. This shake table testing protocol is appropriate for use in establishing the fragility of components that are sensitive to the dynamic effects of motion imparted to the component at a single point of attachment, typically its base.

Specimens sensitive to the relative motion of several connection levels, such as floor-to-ceiling partitions or vertical risers of piping systems should be tested using the protocol for quasi-static cyclic testing of structural and nonstructural components presented in Chapter 2 of this document.

3.1.2 Definitions

The following terms have the noted meanings in this interim shake table test protocol:

Damping: An energy dissipation mechanism that reduces the amplification and broadens the vibratory response in the region of resonance. Damping is expressed as a percentage of critical damping, that minimum damping level permitting a system to return to its rest position, after displacement from this position, without overshooting.

Input Motion Response Spectrum (IMRS): The response spectrum generated using one of the input motions detailed in Section 3.7.

Octave: The interval between two frequencies that have a frequency ratio of two.

One-Third Octave: The interval between two frequencies that have a frequency ratio of 2/3.

Test Response Spectrum: An acceleration response spectrum that is developed from the actual acceleration time-history of the motion of the shake table.

Triaxial Test: A dynamic test in which the test specimen is subjected to acceleration in two principal horizontal axes and the vertical axis simultaneously. The two horizontal components and the vertical acceleration component are derived from three different input signals that are phase-incoherent.

Uniaxial Test: A dynamic test in which the test specimen is subjected to acceleration in one principal axis. The acceleration components are derived from a single input signal.

3.2 Test Procedures

3.2.1 Types of Testing and Sequence

The test specimen should be subjected to a seismic fragility test program, consisting of the following sequential test elements:

(a) Pretest elements

- Pretest inspection and functional verification.
- Definition and documentation of functional performance and anticipated damage states.

(b) Testing elements

- System identification tests.
- Seismic performance evaluation tests.
- Failure tests.

All of the elements of the test program should be described in a test plan as described in Section 3.6. The test plan should be a complete document.

3.2.2 Pretest Inspection and Functional Verification

Upon arrival at the test facility, the test specimen should be visually examined by the testing laboratory personnel, to verify that no damage has occurred during shipping and handling. The facility should make adequate arrangements in order to reproduce the operating condition of the test specimen. Functional tests, operability tests, or both, should be performed by the testing laboratory to verify pretest functional performance. Alternatively, functional and operability testing could be performed at the manufacturing

facility before shipping if the laboratory is unable to reproduce the operating conditions of the test specimen. Test description and results should be documented.

3.2.3 *Definition and Documentation of Functional Performance and Anticipated Damage States*

Prior to testing, appropriate damage states should be defined for the component or system. Section 1.4 provides discussion of considerations relevant to selection of appropriate damage states. A preliminary estimate should be made of the excitation frequency and intensity expressed in peak spectral acceleration at the particular frequency, at which each damage state is expected to occur. Once damage states are defined, they should be documented as they occur in the test specimen during the testing program.

3.2.4 *System Identification Tests*

System identification tests should be conducted in order to identify, as much as possible, the dynamic characteristics of the test specimen and also the evolution of these dynamic characteristics throughout the test program. Single-axis system identification tests should be conducted in each principal direction of the test specimen before and after each of the performance evaluation tests and failure tests described in Sections 3.2.5 and 3.2.6, respectively.

For the purpose of identifying natural frequencies of the test specimen, at least one of the methods of Section 3.2.4.1, 3.2.4.2 or 3.2.4.4 should be used for each principal direction. The equivalent fundamental modal viscous damping of the test specimen should be determined based on one of the methods of Section 3.2.4.3 or 3.2.4.4 for each principal direction. If mode shapes of the test specimen are to be determined, they should be established in each principal direction by the relative intensities and phases between the resonant peaks of the power spectral density or transmissibility plots measured by the in-line test response monitoring sensors during the natural frequency evaluation tests. Equivalent modal viscous damping values for higher modes of the test specimen may be established, if needed, based on the half-bandwidth power method applied to the power spectral or point mobility plots obtained during the natural frequency tests. Special care should be taken to insure sufficient accuracy in the definition of resonant peaks in order to provide accurate damping values.

3.2.4.1 White Noise Tests

A low-intensity 0.50-30 Hz, clipped-band, flat and acceleration-controlled white noise should be used to excite the test specimen in each of its principal configurations. A narrower frequency band may be used if justified by the anticipated natural frequencies of the test specimen. The root-mean-square intensity of the white noise signal should be limited to 0.05 ± 0.01 g. A lower input level may be used to avoid damage to the test specimen. The natural frequencies should be obtained from the resonant peaks of the acceleration power spectral density plots recorded by the in-line test response monitoring sensors.

3.2.4.2 Single-Axis Acceleration-Controlled Sinusoidal Sweep Tests

Alternatively, a single-axis acceleration-controlled sinusoidal sweep from 0.50 to 30 Hz should be performed in each principal axis of the test specimen in order to determine its natural frequencies. The sweep rate should be two octaves per minute, or slower, to ensure adequate time to establish sufficient steady-state response of the test specimen. The peak intensity of the sweep should be limited to 0.1 ± 0.05 g. A lower input level may be used to avoid damage to the test specimen. The natural frequencies should be obtained from the peaks of the acceleration transmissibility plots recorded by the in-line test response monitoring sensors.

3.2.4.3 Resonance Tests

A low-intensity acceleration-controlled sinusoidal input at the previously identified fundamental frequency should be used to excite the test specimen in each of its principal configurations. The intensity of the sinusoidal input should be established based on recorded or visual response such that no damage to the test specimen under this resonance condition occurs. The duration of the sinusoidal input should not exceed 20 times the previously identified fundamental period of the test specimen. Once a steady-state response is established, the input should be suddenly stopped and the free vibration response decay should be recorded by in-line test response monitoring sensors. The fundamental equivalent modal viscous damping ratio of the test specimen should then be established by the logarithmic decrement method applied to the free vibration response decay curves.

3.2.4.4 Static Pull-Back Tests

The fundamental frequency and equivalent modal viscous damping ratio of the test specimen can be established by the free-vibration decay measured by

the in-line test response monitoring sensors as a result of a static pull-back test at the center of gravity of the test specimen. The intensity of the pull-back force should be small enough to avoid damage to the test specimen.

3.2.5 Performance Evaluation Tests

The seismic performance of the test specimen should be evaluated under simulated input motions of increasing intensities representative of the motion at the single level of a building structure on which the test specimen is located. The simulated input motions described in Section 3.7 should be used. Test description and results should be documented for each intensity level in order to be used for the seismic fragility assessment of the test specimen.

It should be anticipated that at the conclusion of the performance evaluation tests, the test specimen will have developed damage states resulting in loss of function or need for repair or replacement, but should not have experienced damaged states associated with potential life safety endangerment and should not have completely failed.

For mechanical and electrical components, it is highly desirable that the test specimen be in operation during the performance evaluation tests. If operation of the test specimen during testing may cause a safety hazard, the functional operation of the test equipment should be verified between each performance evaluation test. If the test facility is unable to reproduce the operating conditions of the test specimen, the functional operation of the test equipment should be verified at the manufacturing facility at the conclusion of the performance evaluation tests.

3.2.6 Failure Tests

Higher intensities of the simulated motions used in the performance evaluation tests should be used to induce damage states that could pose life safety risks and damage states corresponding to incipient failure of the test specimen. Multiple failure tests may be conducted if the test specimen is composed of various subsystems that reach incipient failure separately at various intensities. A failure test description and the results of such testing should be documented for each intensity level in order to be used for the fragility assessment. Special care should be taken to assure the safety of the test personnel and to avoid damage to the testing equipment during the high-level failure tests.

3.3 Intensities of Test Shaking

Unless otherwise specified for a particular type of test specimen, the input motion parameter used to define intensity should be the peak spectral acceleration at the appropriate natural frequency for the specimen and damage state.

The intensities of shaking used for system identification tests should be low enough to avoid any damage to the test specimen, as described in Section 3.2.4.

At least three different shaking intensities should be used for the performance evaluation tests described in Section 3.2.5. The intensities of the performance evaluation tests should be selected to induce damage states, the associated loss of function and repair or replacement. The intensity of the initial performance evaluation test should be based on the intensity estimates causing the damage states described in Section 3.2.4. In all cases, a 25% increase in intensity should be the minimum step size between intensity levels.

The intensity of shaking for the failure tests described in Section 3.2.6 should induce damage states associated with potential risks to life safety or incipient failure. If multiple failure tests are conducted, each of the shaking intensities should induce a damage state for a particular subcomponent of the test specimen. The intensity of the failure tests can be estimated by extrapolation from the results of the performance evaluation tests or by other analytical means. A 25% increase in intensity should be the minimum step size between intensity levels.

3.4 Directions of Shaking

The system identification tests should be applied as single axis tests in each principal direction of the test specimen. The performance evaluation and failure tests should be applied as triaxial tests with simulated input motions applied simultaneously in all principal axes of the test specimen.

Alternatively, biaxial (one horizontal and one vertical) performance evaluation and failure tests can be used. Horizontal (biaxial or uniaxial) performance evaluation and failure tests should be performed only if the effect of vertical motion on the seismic response of the test specimen is negligible. It may be acceptable to neglect the effect of vertical motion if the vertical fundamental frequency of vibration of the test specimen is at least 10 times its horizontal fundamental frequency or if the vertical natural

frequency of the test specimen falls outside the frequency range of the input motions specified in Section 3.7.

3.5 Data Acquisition System

All test data recorded should be acquired at a sampling rate of at least 10 times the highest fundamental frequency identified in any principal direction of the test specimen with a minimum rate of 200 samples per second, or Hz. All data should be low-pass filtered by a block-wall type filter having a corner frequency of at least two times the highest natural frequency of interest in any principal directional but not exceeding 30 Hz.

3.6 Test Plan

A test plan should be prepared before the beginning of the testing sequence described in Section 3.2. The test plan should include documentation of the following:

- the physical configuration of the test specimen including such details as dimensions and weight distribution,
- the dimensions, arrangements, and specifications of the hardware used to connect the test specimen to the shake table,
- a description of the monitoring instrumentation including an outline drawing of the test specimen showing the locations of all sensors using the same sensor numbering system as contained in the test report,
- a description of the data acquisition parameters including sampling rates and filtering techniques,
- a test schedule outlining the order of the system identification, performance evaluation and failure tests, including descriptions of damage states and methods of documentation, and
- other details necessary to describe the testing fully.

3.7 Input Motions

This section provides input motions for performing the performance evaluation and failure tests described in Sections 3.2.5 and 3.2.6, respectively.

The recommended shake table motions are narrow-band random sweep acceleration records, with scaled amplitudes depending on the sweep frequency, producing motions that have relatively smooth response spectra

amplitudes. Each record is phase-incoherent with the others. Commentary in Section C3.7 provides background on the generation of these records.

Figures 3-1 and 3-2 plot the horizontal acceleration records recommended for use in the longitudinal and transverse directions, respectively. Figure 3-3 plots the recommended acceleration record for vertical excitation of the test specimen. This vertical record is scaled to have a response spectrum that is approximately 80 percent of those for the longitudinal and transverse motions. Figure 3-4 plots the response spectra at 5 percent critical damping for the recommended horizontal and vertical motions.

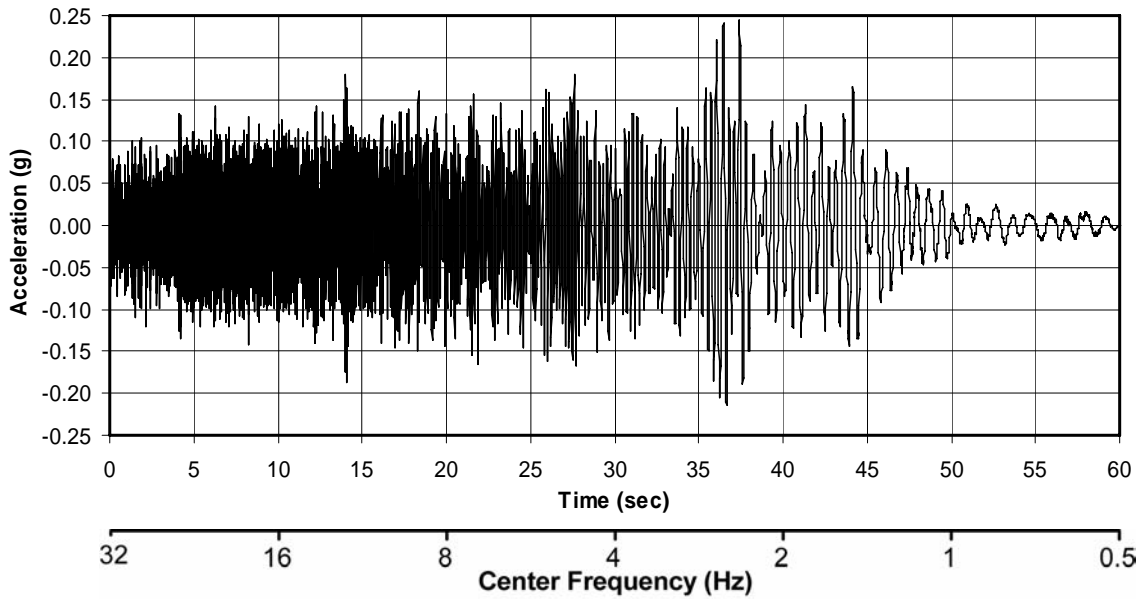

Figure 3-1 Recommended longitudinal input motion

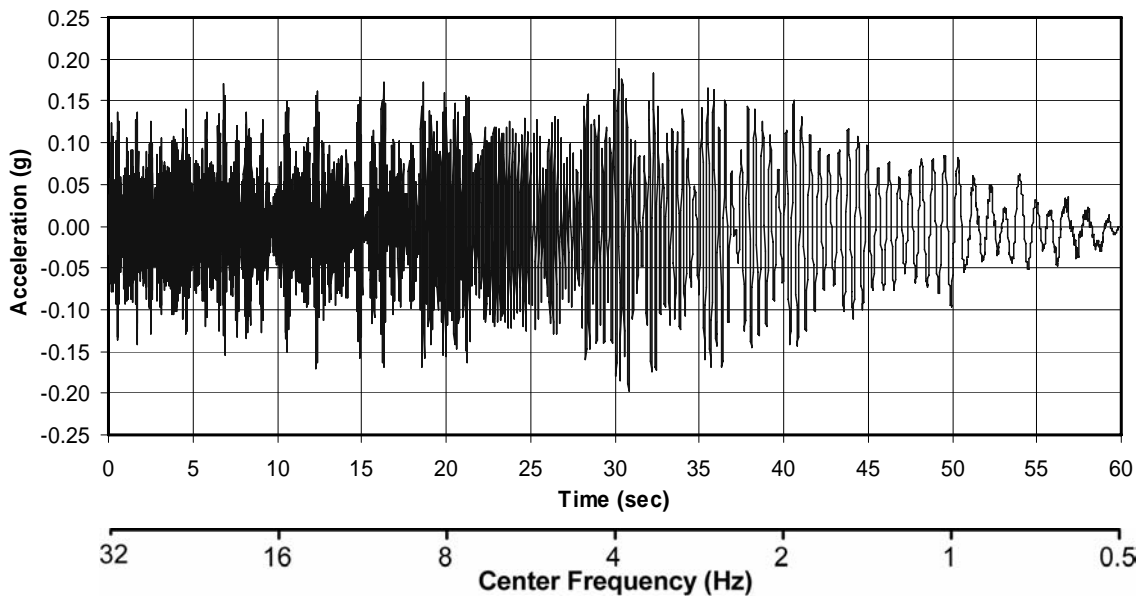

Figure 3-2 Recommended transverse input motion

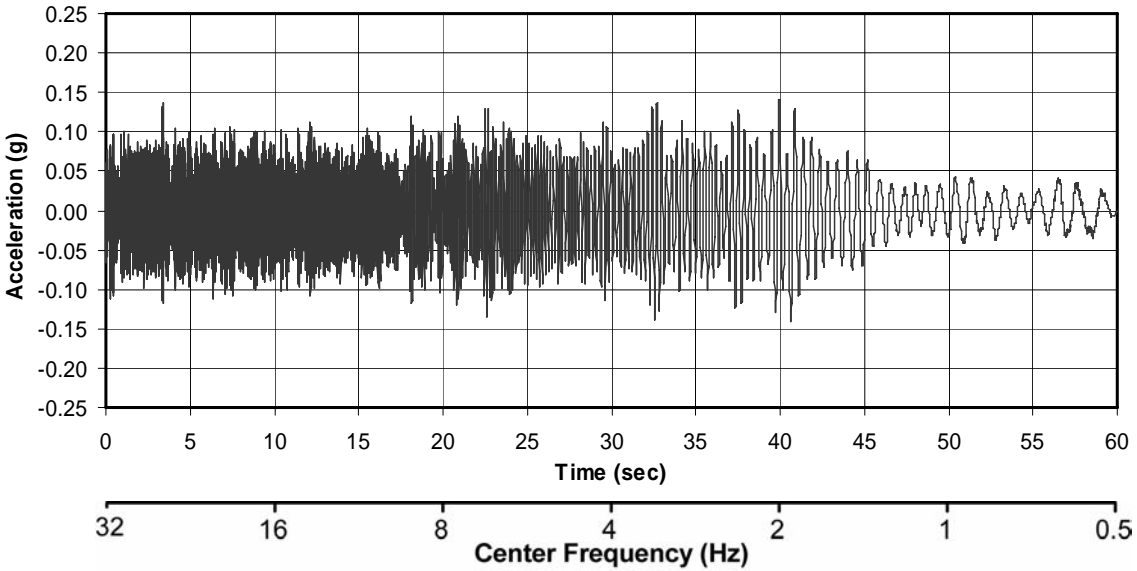

Figure 3-3 Recommended vertical input motion

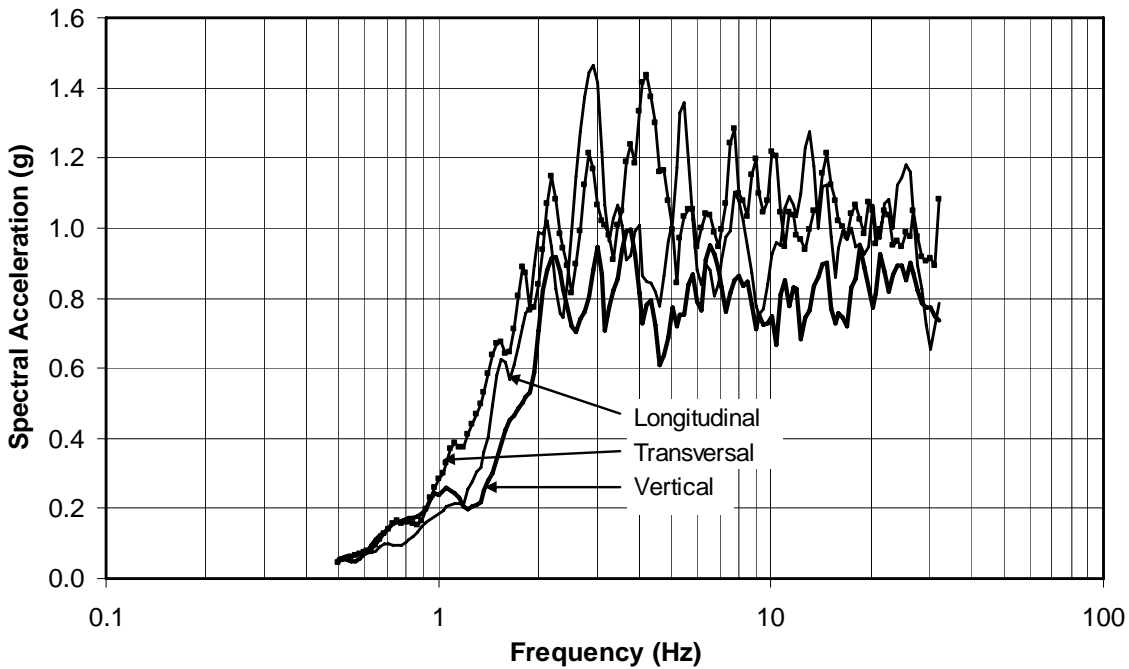

Figure 3-4 5% damped, acceleration response spectra for recommended longitudinal, transverse and vertical input motions

3.8 Time Stamping and Damage State Documentation

The performance evaluation and failure tests should all be triaxial, as described in Section 3.4. The motions should be applied at increasing intensities, as described in Section 3.3.

Visual or other monitoring procedures should be implemented in order to identify the occurrence of the anticipated damage states in the test specimen as they occur during the performance evaluation and failure tests. When a damage state is identified, the time of occurrence of the damage state should be recorded in order to determine the center frequency of the motion that caused the damage state to occur. The amplitude of motion that caused the damage state should be defined by generating a test response spectrum of the predominant direction of the motion that, based on observations, caused the damage state (longitudinal, transverse or vertical). The test response spectrum should be generated for 10 seconds of shake table motion beginning 10 seconds prior to the maximum measured response causing the damage state to occur. The amplitude of the peak of this test response spectrum is designated as the amplitude causing the damage state to occur, and the frequency at this peak is the frequency causing the damage state to occur. Each damage state shall be documented in a plot showing the spectral amplitude versus center frequency.

The record primarily responsible for the occurrence of the damage state should be notch filtered with respect to frequency and time as described in Section 3.9 below, and the testing should be continued at larger intensities in all three directions.

3.9 Notch Filtering of Input Motions

Notch filtering of the input motions may be used to remove energy near the excitation frequency that has already caused a damage state to occur. This notch filtering may become necessary in order to cause other damage states to occur at different frequencies and higher amplitudes of the input motions.

The width of the notch should be 1/3 octave. Table 3-1 shows the time and corresponding center frequency for the central portion of the three input records. Each data point in this table represents a 1/24 octave decrease in frequency, and 0.417 seconds in time. The notches should be centered (to the nearest 1/24 octave) at the excitation frequency causing the damage state. The notch should begin at 100 percent of the full record at 1/6 octave above the excitation frequency causing the occurrence of the damage state, then decrease linearly in time to 0 percent in 0.417 seconds (1/24 octave lower in frequency). The notch should be held constant at 0 percent for 2.917 seconds (7/24 octave), then ramp up linearly in 0.417 seconds (1/24 octave) to 100 percent of the record. Additional notches should be created when other damage states occur.

Table 3-1 Time versus Center Frequency for Central Portion of Input Motions

Octave	Time (s)	Center Frequency (Hz)	Octave	Time (s)	Center Frequency (Hz)
Full	10.000	16.000		20.417	7.772
	10.417	15.545		20.833	7.551
	10.833	15.102		21.250	7.336
	11.250	14.672		21.667	7.127
	11.667	14.254		22.083	6.924
	12.083	13.849		22.500	6.727
	12.500	13.454		22.917	6.536
	12.917	13.071	1/3	23.333	6.350
1/3	13.333	12.699		23.750	6.169
	13.750	12.338		24.167	5.993
	14.167	11.986		24.583	5.823
	14.583	11.645		25.000	5.657
	15.000	11.314		25.417	5.496
	15.417	10.992		25.833	5.339
	15.833	10.679		26.250	5.187
	16.250	10.375	1/3	26.667	5.040
1/3	16.667	10.079		27.083	4.896
	17.083	9.792		27.500	4.757
	17.500	9.514		27.917	4.621
	17.917	9.243		28.333	4.490
	18.333	8.980		28.750	4.362
	18.750	8.724		29.167	4.238
	19.167	8.476		29.583	4.117
	19.583	8.234	Full	30.000	4.000
Full	20.000	8.000			

3.10 Testing Equipment

For the purpose of executing the test sequence described in Section 3.2, it is recommended that the testing laboratory generally complies with the requirements of a national or international accreditation criterion such as International Accreditation Service Report AC89, *Accreditation Criteria for Testing Laboratories* (IAS, 2006), or Institute of Electrical and Electronic Engineers Standard No. 344-2004, *Recommended Practice for Seismic Qualification of Class 1E Equipment for Nuclear Power Generating Stations* (IEEE, 2004) as well as the testing requirements of the Network for Earthquake Engineering Simulation.

3.10.1 Shake Tables

The shake table and its components should have sufficient reserve capacity under the payload of the test specimen to simulate adequately the input motions described in Section 3.7.

In terms of achieving the requirements of Sections 3.7 and 3.11, the following shake table performance parameters shall be identified and confirmed against the imposed demand due to the required test sequence and test specimen characteristics of Section 3.2, and input motion characteristics as described in Section 3.7.

- Nominal payload at a prescribed performance level of the shake table, typically defined by the maximum mass (kg) that can be supported when the shake table is driven at a peak acceleration of 1 g.
- Nominal maximum achievable acceleration amplitude (in g's) at a reduced shake table performance (when the shake table supports the maximum test specimen mass (in kg), but the acceleration is typically limited by the vertical actuator dynamic force capacity or the supporting bearing system in the case of uniaxial or biaxial shake tables).
- Maximum static and dynamic actuator capacities in units of force.
- Peak-to-peak stroke in units of length.
- Maximum achievable velocity at the payload in units of length per second.
- Operational frequency bandwidth (minimum and maximum, in Hz) at the maximum acceleration amplitude.

3.10.2 Instrumentation and Monitoring

Measurements should be made of all response parameters that significantly affect the test specimen behavior and which will be used to evaluate and quantify important dynamic characteristics and damage states. Video recorders with time stamping capabilities should also be used to capture the behavior of the test specimen and determine the times of occurrence of various damage states.

If required, an extensive instrumentation design should be carried out and included in the final test report as described in Section 3.11. Accordingly, the model, type, location and orientation of instrumentation should be described and uniquely identified. The location and orientation of the instrumentation fixed to the test specimen should be reported relative to a common reference coordinate system.

The minimum required instrumentation is limited to that which clearly provides useful information for evaluating and quantifying the seismic fragility of the test specimen and should be located where it will provide data

that are representative of the entire test specimen. For this purpose, the following minimum instrumentation requirements should be implemented.

- Accelerometers to measure applied acceleration levels in two principal horizontal and one vertical axis of the shake table are required. Reference control accelerometers should be mounted on the shake table at a location near the base of the test specimen.
- Accelerometers to measure the absolute acceleration response of the test specimen are required. Accelerometers oriented in two principal horizontal and one vertical axis should be used to determine the acceleration response of the test specimen. The accelerometers should be located at a minimum of three different locations within the test specimen. Three locations should be identified as (i) just above the shake table – test specimen interface (connection point), (ii) the computed (or assumed) center of mass of the test specimen, and (iii) the top of the test specimen. This permits the recording of the average acceleration response in the three axes.
- If significant torsional or rocking response, or both, of the test specimen is expected, two sets of accelerometers should be located at all three locations, such that global torsional and rocking response can be captured effectively.
- Ideally, accelerometers should be located at those points within the test specimen that reflect the response associated with the fundamental natural frequencies. Accordingly, precise locations of these accelerometers may be determined based on either preliminary computational analysis of the test specimen or low-intensity system identification tests, as described in Section 3.2.4.
- Displacement (position) transducers to measure the absolute and relative deformation response of the test specimen are required. Displacement transducers should be used to determine deformation response of the test specimen. The displacement transducers should be located at the location of each one of the accelerometers such that deformations are measured in the same direction as the corresponding accelerometer.
- Load cell washers to measure anchor forces are required. Axial load cell washers should be used to determine anchor forces (tension and compression) during the various stages of the test sequence.

Sensors should have a minimum operational frequency range of 0.5 to 100 Hz. Load cell washers should have a minimum capacity of three times the tributary weight of the test specimen applied to a single washer.

Instrumentation, in addition to the minimum recommended, should be required wherever there is a concern regarding a condition that may affect the test specimen response. Typical reasons to require additional instrumentation may be to check design assumptions, to provide data to evaluate specific problems such as excessive cracking (using, for example, strain gages), to provide data to support design of remedial modifications, and to provide data to evaluate effectiveness of remedial work.

Instrument calibrations should conform to National Institute of Standards and Technology traceable primary standards. The instruments shall be recalibrated once every year and these calibrations shall be verified before each test.

3.10.3 Data Acquisition

Data acquisition system(s) used during testing should allow continuous, real-time recording of dynamic sensor data at predefined sampling rates (number of samples per second, or Hz) and should support continuous recording and storage of sensor data on digital storage device(s).

All test data recorded during the test program should be acquired at a sampling rate and low-pass filtered according to the requirements given in Section 3.5.

Data acquisition system calibration should conform to National Institute of Standards and Technology traceable primary standards. The data acquisition system should be recalibrated once every year. These calibrations should be verified before each test.

The reference time for all test data, including from all sensors and videos, should be common to allow for post-test analysis.

3.10.4 Safety Procedures

Testing presents several safety issues that must be considered during testing. Rules and procedures that are intended to assure the safety of all laboratory users, personnel, and visitors, should be provided and implemented by the testing facility. The requirements and procedures should include but should not be limited to:

- professional laboratory safety procedures as mandated by the testing facility to minimize hazard and danger to persons in the test area,
- a minimum distance to the laboratory equipment and test specimen before, during and after the experiments, because shake table testing may

cause a test specimen to rock and topple, and, in the extreme case, the entire test specimen, or parts of it, may dislodge and become airborne hazards, and

- personal safety during all test procedures, including safe practices during post-test examination: hardhats, protective eyewear, clothing, gloves and safety shoes as appropriate.

3.11 Test Report

A test report, including the corrected (as-tested) test plan described in Section 3.6 should be prepared. More specifically, the following items should be included in the main body of the test report along with additional observations and concluding remarks addressing the test objectives. Sufficient information should be provided to allow for potential reproduction of the test conditions and the results.

3.11.1 Test Specimen Description

The test specimen should be identified and the overall layout and general dimensions stated. The test plan should be constructed following the requirements of Section 3.6 and included as a part of the final test report. The documentation of the test plan should include the test sample selection rationale, test configuration, connection and support details and installation procedures. Supplemental data, such as manufacturers' specifications and assembly instructions for the test specimen, can be included as part of an appendix.

The model, type, location and orientation of instrumentation should be described and uniquely identified. The location and orientation of the test specimen and its instrumentation should be made relative to a common reference coordinate system.

3.11.2 List of Specimens Tested

The sequence of tests, including all subelements described in Section 3.2, should be listed in the order in which testing occurred. Deviations from the intended test procedure outlined in Section 3.6 should be highlighted and justifications for these deviations provided. Results of the pretest inspection and functional compliance verification described in Section 3.2 should be included in the test report.

3.11.3 Preliminary System Identification Tests and Report Requirements

The results of the system identification tests can depend on the amplitude of motion or displacement. The amplitude and duration of the system identification tests should be documented by the characteristic parameter applied, such as the maximum acceleration of sine sweep or the initial displacement of the static pullback tests.

For each test sequence, the natural frequencies and damping values obtained from the single-axis system identification tests as described in Section 3.2 should be reported. The appropriate plots of the acceleration power spectral density or transmissibility should be included for the identification of the natural frequency, and the decay curves should be included for identification of the damping values. Documentation should include both the raw data (e.g., measured response during sine sweeps and from free vibration tests) as well as the calculated values of frequencies of vibration and damping ratios.

3.11.4 Measured Fidelity Data

Comparison of the input drive signal and the resulting output should be made for individual motion time-histories in each principal direction. The various required horizontal and vertical input motion response spectra described in Section 3.7 should be compared with their corresponding test response spectra on the same plot at each intensity of shaking, as defined in Section 3.3.

The input motion response spectrum should be computed based on the input motion time histories described in Section 3.7, scaled to the intensity of Section 3.3, and the test response spectrum should be computed based on instrumentation located at the connection point of the test specimen. A damping value of 5% of critical should be used for scaled input motion response spectrum and test response spectrum, as specified in Section 3.7.

The Maximum Response Spectra (MRS) at each intensity, should meet but not exceed by more than 30% the input motion response spectrum in the frequency range between 0.5 and 32 Hz.

3.11.5 Performance and Failure Test Evaluations

A clear description of the intended functionality of the test specimen should be outlined and definition of performance and anticipated damage states should be given as described in Section 3.2.3. Upon the completion of each shake table test, an indication of each damage state achieved should be

documented. Justification of interpolation between the damage states should be included to develop appropriate fragility data. Based on the measured data, fragility curves should be plotted according to the calculations outlined in Section 1.3.

3.11.6 Photographs and Video Recordings

Photographs should be taken of critical components such as the overall layout of the test specimen, joints and connections prior to test and during the performance evaluation and failure tests. Video recordings of the time-histories should also be taken to document the dynamic response of the test specimen.

All photographs and video recordings submitted as part of the report should be in digital format and should be included as an appendix in the form of a CD-ROM. The digital photographs should be taken at a sufficient resolution for clear viewing of the subject and be electronically stored using a nonproprietary file format. Videos taken of the test specimen should be digitized at the highest practical resolution and stored using nonproprietary compression methods. A description key of the electronic files should be included as part of the appendix.

Chapter C3

Commentary on Interim Protocol II – Shake Table Testing

Chapter C3 contains commentary for sections 3.1, 3.2, 3.7, 3.9, and 3.10 of Interim Protocol II – Shake Table Testing. Commentary is not provided for the other sections.

C3.1 General

C3.1.1 Scope

Although the emphasis of this interim shake table testing protocol is on development of data used for seismic fragility quantification, the procedures established herein could also be used for the seismic qualification of single-level motion-sensitive components and systems. In this case, the resulting seismic qualification procedure should be reviewed by a panel independent from the testing laboratory to ensure that it fulfills the seismic qualification requirements of the specimen under test.

C3.2 Test Procedures

C3.2.2 Pretest Inspection and Functional Verification

It is highly desirable that the test specimen be operational during the pretest inspection and also during the entire fragility test program. Several damage states could be associated with functional operation of the test equipment and could therefore only be captured if the test equipment were operating during testing. Reproducing operational conditions may require the test facility to upgrade their power supply input (e.g., higher voltage) or make special arrangements to handle potentially hazardous materials (e.g., refrigerant or oil).

C3.2.3 Definition and Documentation of Functional Performance and Anticipated Damage States

Damage states should be identified as they occur in the test specimen. Examples of damage states are:

- unintended action, e.g., tripping a switch,
- repair required, e.g., minor leaks,
- replacement required,
- short-term loss of functionality,
- long-term loss of functionality, and
- life safety, e.g., spill of hazardous materials, fire, or catastrophic collapse.

Clear definitions of functional performance and anticipated damage states are necessary since a level of performance for one test specimen (e.g., an oil leak in a rotational bearing) may correspond to a failure mode for another test specimen (e.g., an oil leak in a transformer bushing). Identification of target damage states corresponding to the principal performance measures, that is, direct economic loss, occupancy or function impairment, and casualties, is required in order to compute seismic fragility curves for the test specimen.

C3.7 Input Motions

The shake table motions used to define the fragility (or capacity) of equipment are based on work done by the U.S. Army Construction Engineering Research Laboratory (Wilcoski et al., 1997). The motions are narrow-band, random, sweep records generated by a Matlab routine. For records generated for this protocol, the band-width is 1/3 octave and the center frequency of the records sweeps from 0.5 Hz up to 32 Hz, at a rate of 6 octaves per minute (the frequency doubles every 10 seconds), for a total signal duration of 60 seconds.

Table C3-1 shows the variables used in the Matlab routine to generate these records. The Matlab routine was developed to sweep up from a low frequency to a high value, but the records needed for this protocol sweep down in frequency, so the generated records were inverted. Table C3-1 shows that the beginning sweep rate can differ from the ending sweep rate, implying some variation in the sweep rate, and permitting, for example, a sweep rate that varies linearly with time and logarithmically with frequency. The records developed here, however, used a constant sweep rate of 6 octaves per minute. The Matlab routine generates a broad-band random signal with the lower frequency limit of 1/6 octave less (0.45 Hz) than the lowest frequency of interest (0.5 Hz) and high frequency limit 1/6th octave above (35.92 Hz) the highest frequency of interest (32 Hz). The routine then sweeps high- and low-pass filters over the record, where the low-pass filter is

1/3 octave greater than the high-pass at any moment in time. The resulting unitless records are each 60 seconds long, and they can be plotted with a dual abscissa axis of time and center frequency. Each generated record was inverted with respect to time, so the center frequency decreased from 32 to 0.5 Hz. Figures C3-1 through C3-5 show example records that were used in the development of the longitudinal record.

Table C3-1 Narrow-Band Random Signal Generation Matlab Routine Parameters

Parameter	Values Used for ATC-58 Records
Sample Rate (Hz)	100
Beginning Sweep Rate (octaves/min)	6
Ending Sweep Rate (octaves/min)	6
Beginning Center Frequency (Hz)	0.5
Ending Center Frequency (Hz)	32
Filter Bandwidth (octaves)	1/3
Filter Error (octaves)	0.2

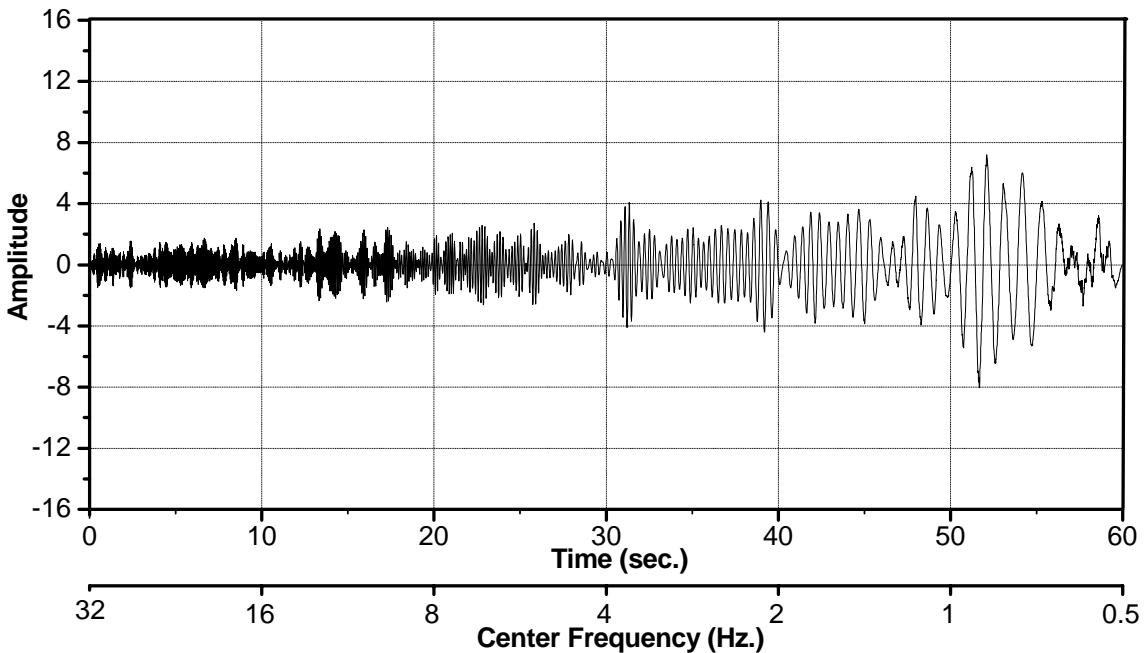

Figure C3-1 Generated narrow-band random signal, Ran16 record.

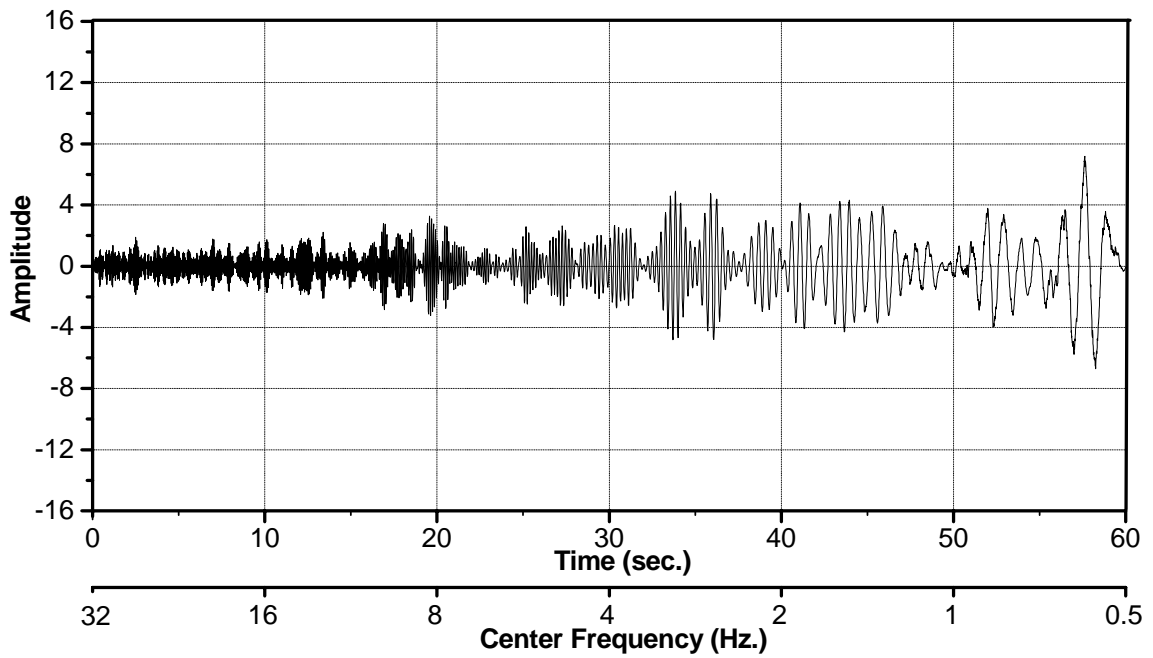

Figure C3-2 Generated narrow-band random signal, Ran18 record.

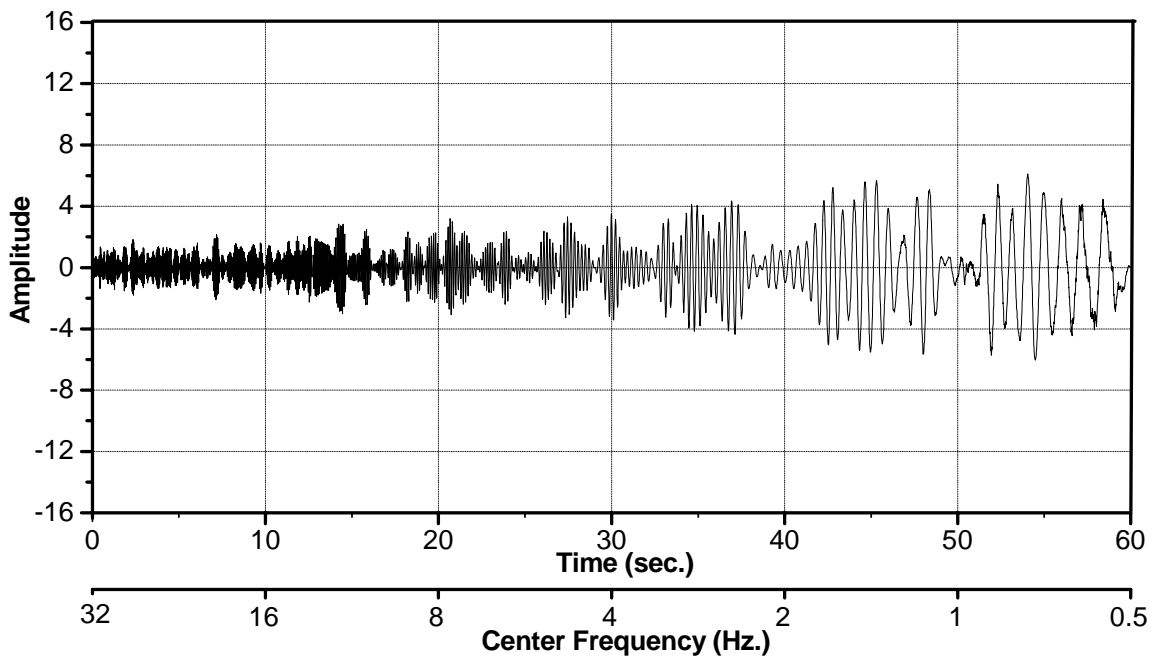

Figure C3-3 Generated narrow-band random signal, Ran22 record.

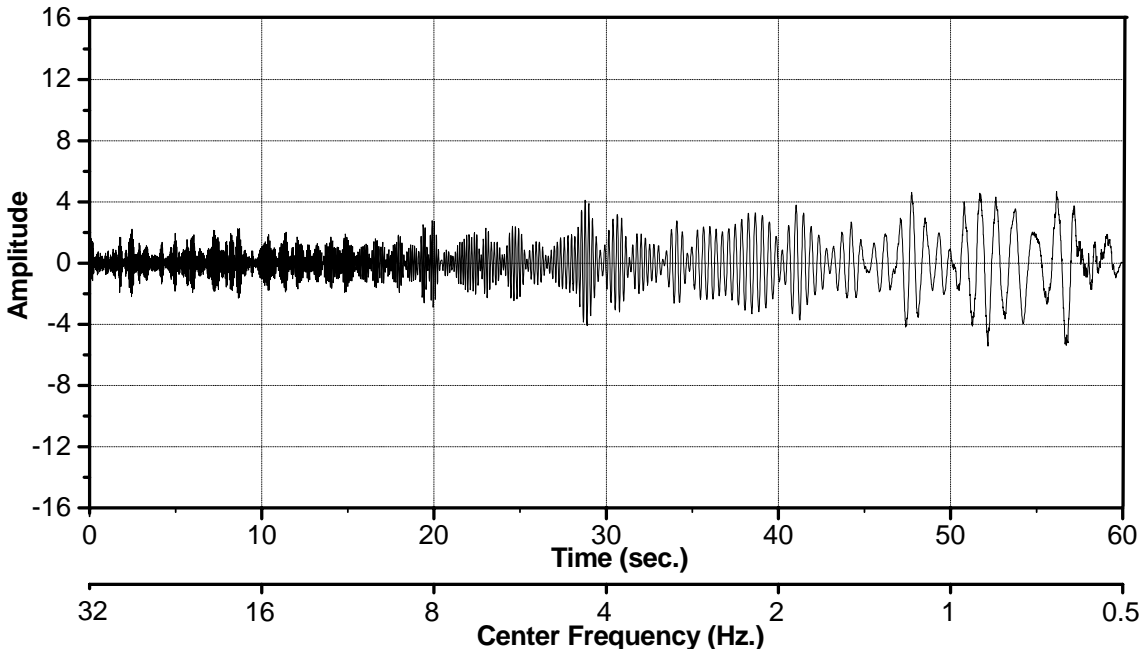

Figure C3-4 Generated narrow-band random signal, Ran31 record.

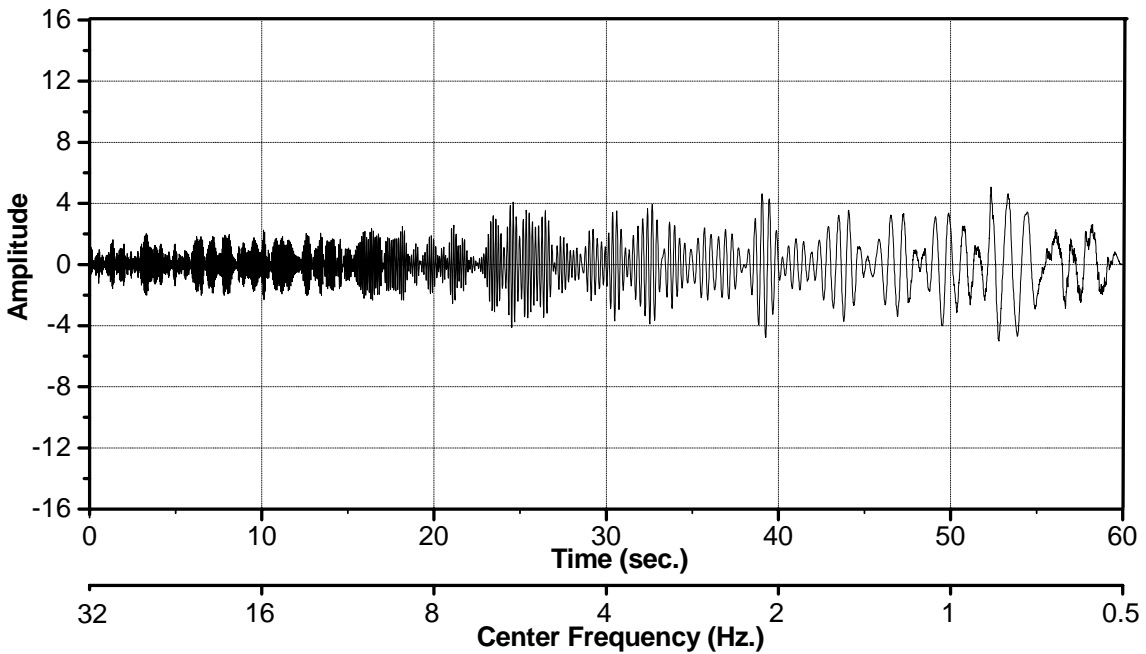

Figure C3-5 Generated narrow-band random record, Ran34 record.

The records plotted in Figures C3-1 through C3-5 were selected because they have relatively smooth response spectra. Figure C3-6 plots the response spectra for each record, using 5% of critical damping. This shows that the response spectra for even the selected records varies significantly. Therefore, it was decided to splice together, in time, selected portions of all five records

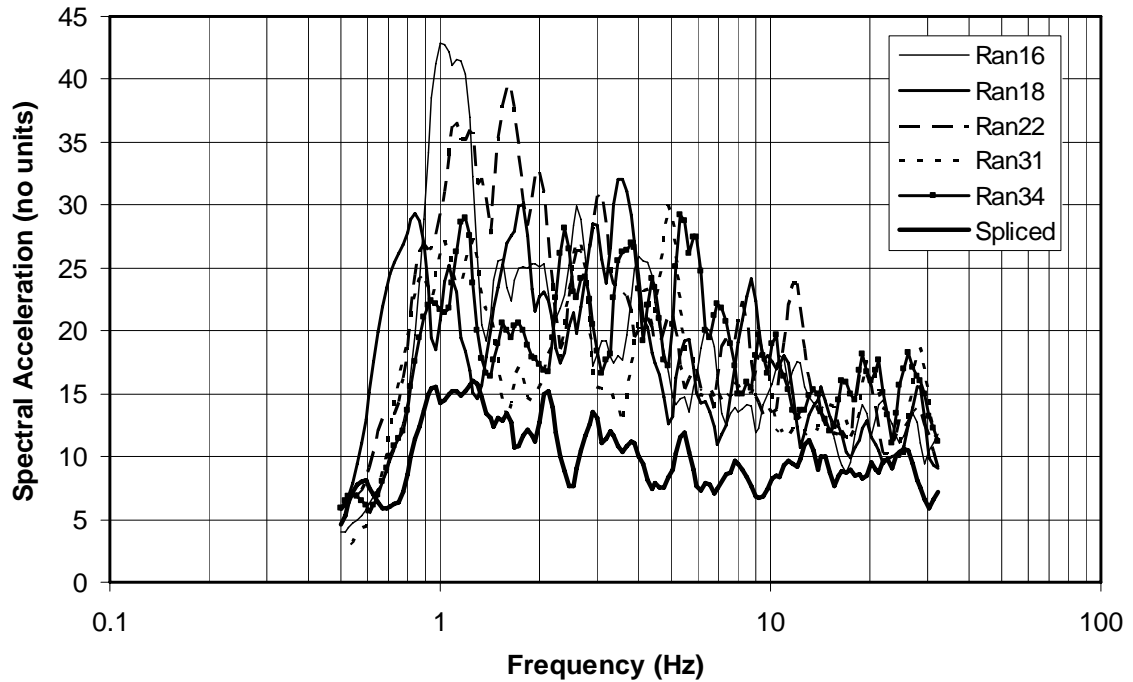

Figure C3-6 Response spectra for selected longitudinal records (5% of critical damping).

to create a spliced longitudinal record. Through this process, portions of records in time (and frequency due to the correlation) were selected that had fairly uniform amplitude cycles and a relatively flat response spectra, while portions of records that had very large or small amplitudes, or response spectra amplitudes that varied significantly were discarded. The records were spliced by shifting portions of records slightly in time as needed to transition smoothly from one source record to another, so that the frequency content of the records would be preserved. As expected, the resulting record began to look somewhat like a sine sweep record, but retained some random content. Figure C3-7 shows that the spliced longitudinal record had more uniform and reduced amplitudes relative to the source records in Figures C3-1 through C3-5. Figure C3-6 also plots the response spectrum for the spliced record, showing more uniform but reduced amplitude.

The spliced record was then scaled so that the response spectra amplitude would be approximately 1 g between 2 and 32 Hz. Below 2 Hz, the record was scaled so that the spectral displacement would be uniform. The scale was defined in the frequency domain by comparing the spectrum for the spliced record in Figure C3-6 with these goals. The same scale was then converted to the time domain, to scale the record shown in Figure C3-7. A response spectrum was generated from the resulting scaled record, which was again compared with the goals and the scale was adjusted as needed, and the process repeated until the achieved response spectra matched the goals of 1 g above 2

Hz and a uniform displacement spectra below. Figure C3-8 plots the final scale in the frequency domain, while Figure C3-9 plots the same scale in the time domain. Figure C3-10 plots the scaled longitudinal record (Long_3), without the frequency scale, and Figure C3-11 plots the response spectra. The Long_3 record name indicates the 3rd scale was final.

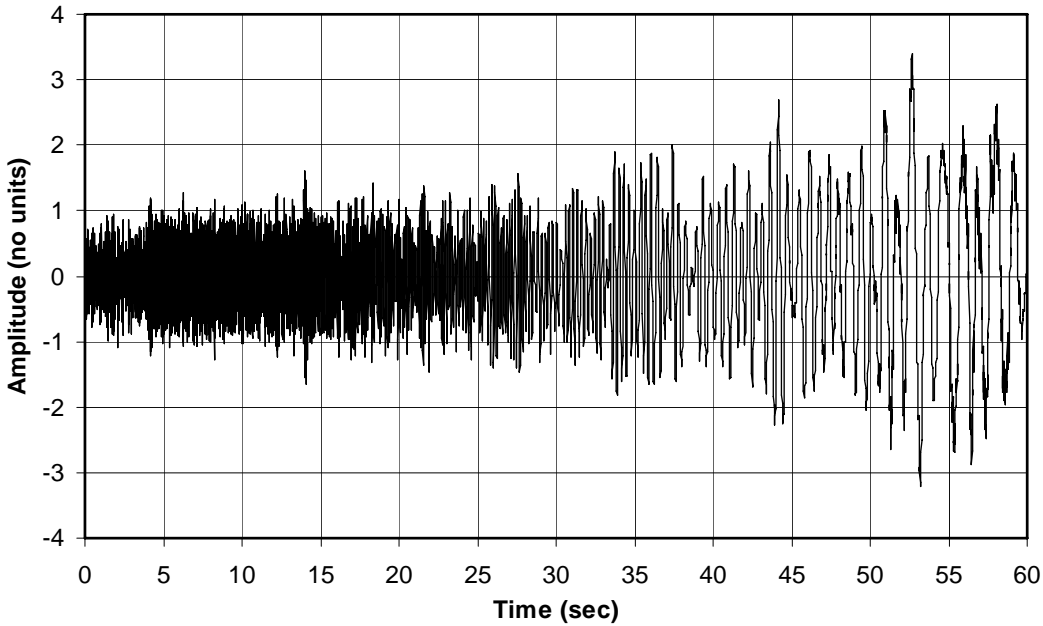

Figure C3-7 Spliced longitudinal record.

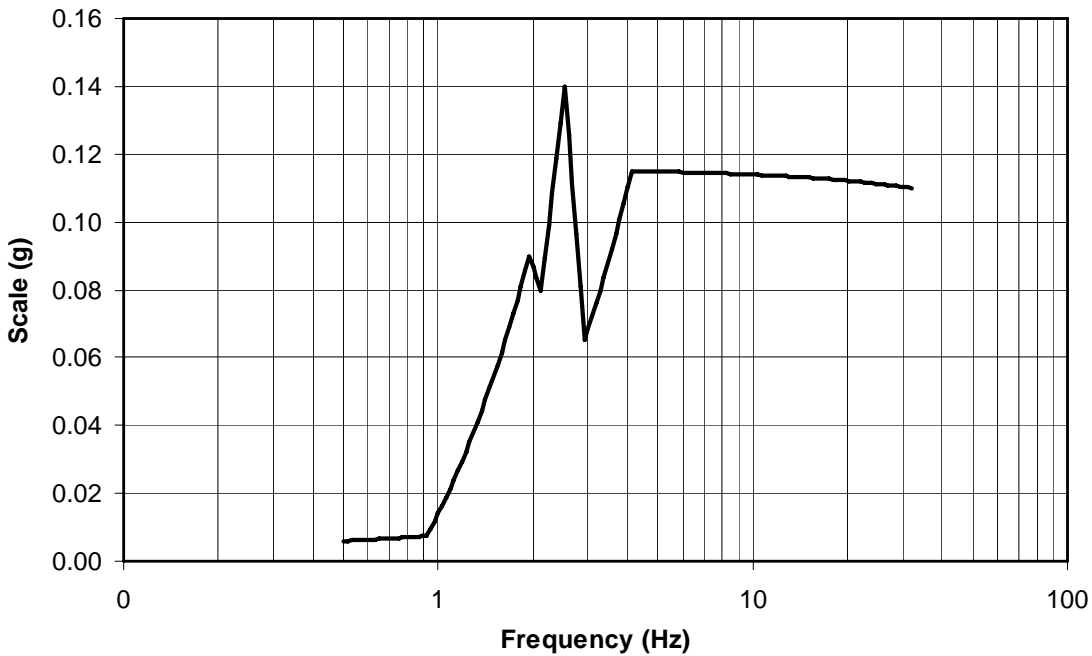

Figure C3-8 Scale used for the longitudinal record, plotted in the frequency domain.

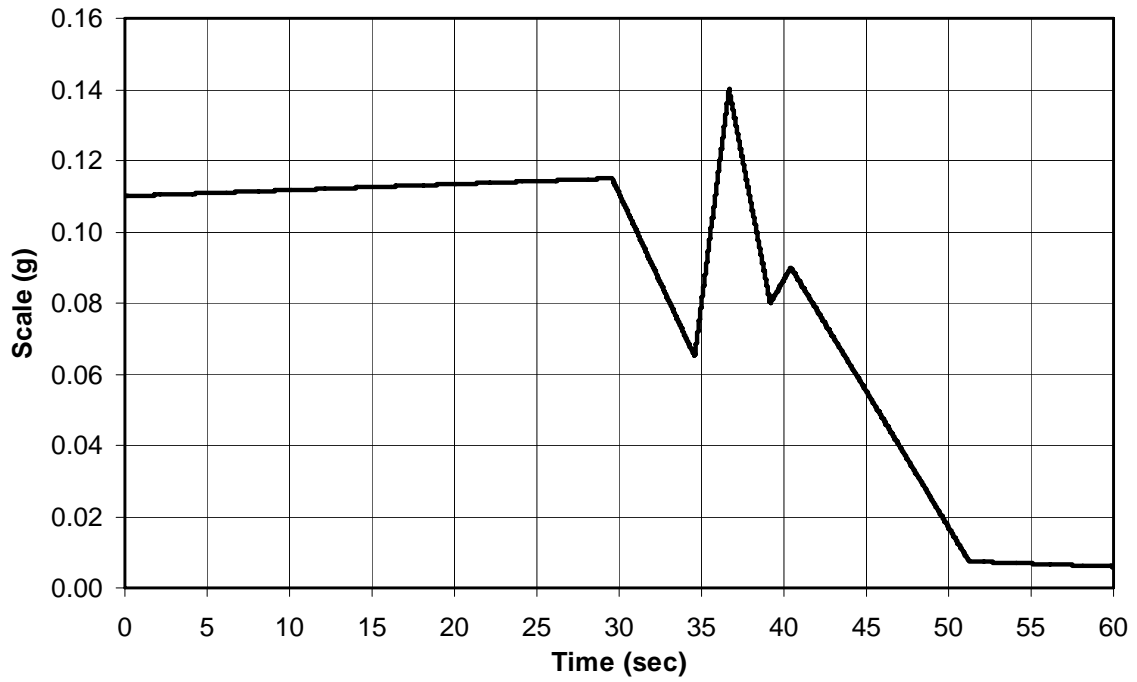

Figure C3-9 Scale used for the longitudinal record, plotted in the time domain.

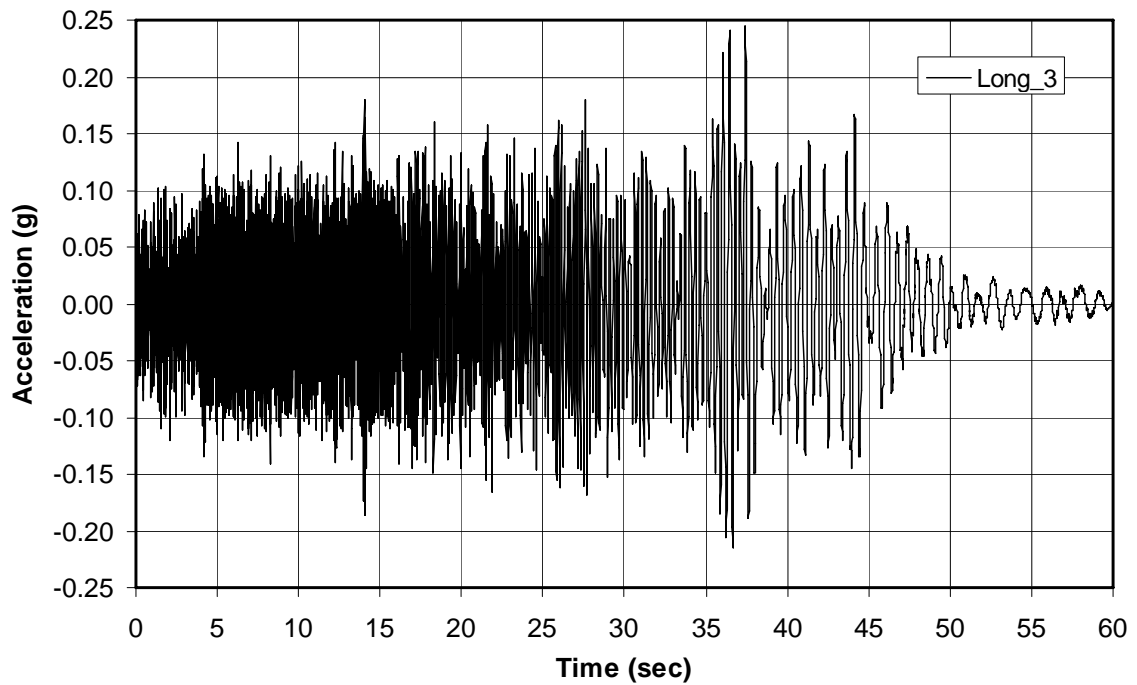

Figure C3-10 Scaled narrow-band random longitudinal record, Long_3.

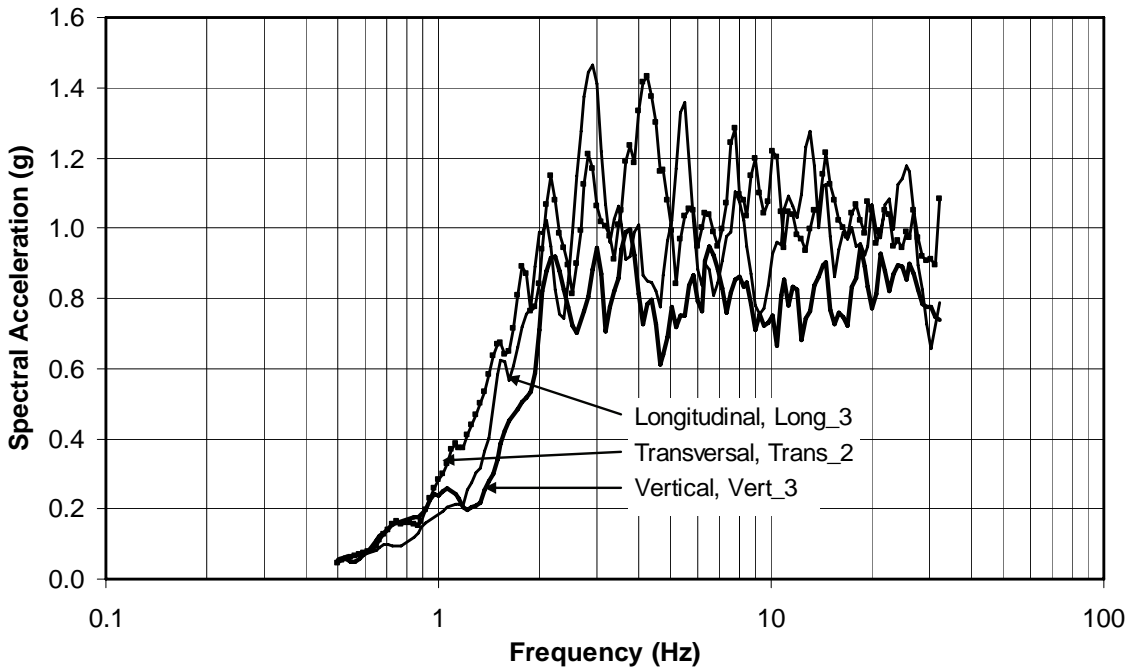

Figure C3-11 Response spectra for scaled narrow-band random records.

The same process was repeated for generating transverse and vertical records. However, a greater number (namely, 100) of narrow-band random records and response spectra were generated, providing a greater selection of records from which to splice the transverse and vertical records. From these one hundred records, records were selected that had a relatively uniform response spectrum within selected frequency ranges. Table C3-2 lists the records selected for the transverse and vertical motions, and shows the frequency ranges that had relatively uniform response spectrum amplitudes.

Table C3-2 Narrow-Band Random Records Used for Splicing Transverse and Vertical Records

Record Name	Frequency Range with Uniform Spectra
<i>Transverse Records</i>	
Ran 7	0.5 – 3 Hz; 7 – 10 Hz
Ran 30	0.5 – 1.2 Hz; 2 – 3.5 Hz; 14 – 29 Hz
Ran 55	2 – 5 Hz
Ran 84	5 – 32 Hz
<i>Vertical Records</i>	
Ran 9	0.5 – 1.2 Hz; 3 – 5.5 Hz
Ran 20	0.5 – 1.0 Hz; 12 – 28 Hz
Ran 21	2 – 5.1 Hz
Ran 68	1.2 – 2 Hz; 4 – 9.5 Hz
Ran 90	7 – 32 Hz
Ran 98	0.5 – 1.2 Hz; 6 – 20 Hz

Figures C3-12 through C3-15 plots those records selected for the transverse record, and Figure C3-16 plots the response spectra for them. Careful inspection of Figure C3-16 shows that the Ran 84 record had the most uniform response spectra of those selected for splicing the transverse record. For this record a greater effort was made to use many of the higher amplitude cycles of the original records, while still not using portions of the records that were either very high or low relative to other cycles in the frequency range of interest. Ran 84 was used for much of the transverse spliced record. Figure C3-17 plots the spliced transverse record. This spliced record decreased in amplitude relative to the source records, but not as dramatically as the longitudinal record. The source records plotted in Figures C3-12 through C3-15 show significant modulation in the amplitude of cycles, while the spliced record in Figure C3-17 reduces this effect, by splicing portions of source records that have similar amplitudes. Figure C3-16 plots the response spectrum for this spliced record, showing the more uniform and slightly reduced amplitudes. The transverse spliced record is called Spliced_2 in both Figures C3-16 and C3-17, because the splicing process was improved after the response spectrum of the initial spliced record revealed that improvements could be made. This was done by observing that response spectra of some source records better matched the spectrum of the spliced record in particular frequency regions.

The transverse spliced record was then scaled so the response spectrum spectral acceleration would be approximately 1 g above 2 Hz, and have a uniform spectral displacement below 2 Hz. This scaling was accomplished in the same way as for the longitudinal record, and Figure C3-18 and C3-19 plot the resulting scale in both the frequency and time domain, respectively. Figure C3-20 plots the scaled transverse record, and the response spectrum is included in Figure C3-11 (Trans_2). The Trans_2 name for this record indicates that the 2nd trial scale was the final scale used for this record.

Table C3-2 shows the narrow-band random source records that were used to create the vertical record. These are plotted in Figures C3-21 through C3-26, and Figure C3-27 plots their response spectra. Figure C3-28 plots the spliced vertical record. This spliced record also reduced the modulation seen in the source records (Figures C3-21 through C3-26) by splicing portions of source records that have similar amplitudes. The response spectrum for the spliced record plotted in Figure C3-27 has more uniform and reduced amplitudes than the source records. The vertical record is called Spliced_2 in both Figures C3-27 and C3-28, because of splicing improvements similar to that of the transverse record.

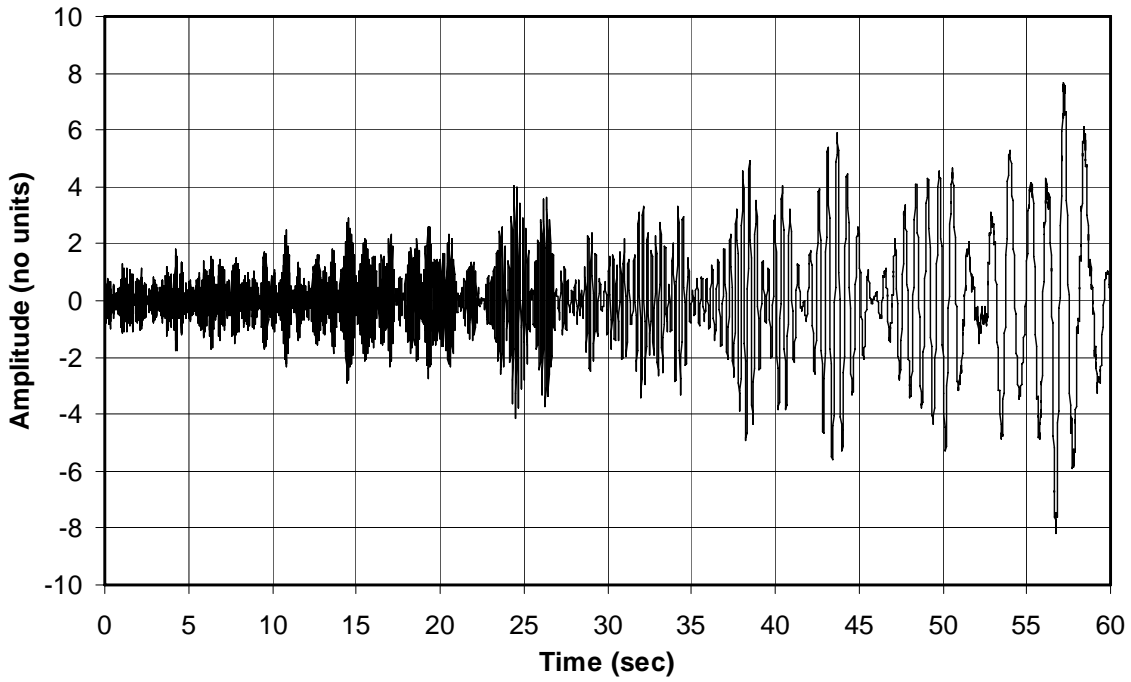

Figure C3-12 Generated narrow-band random signal, Ran7 record.

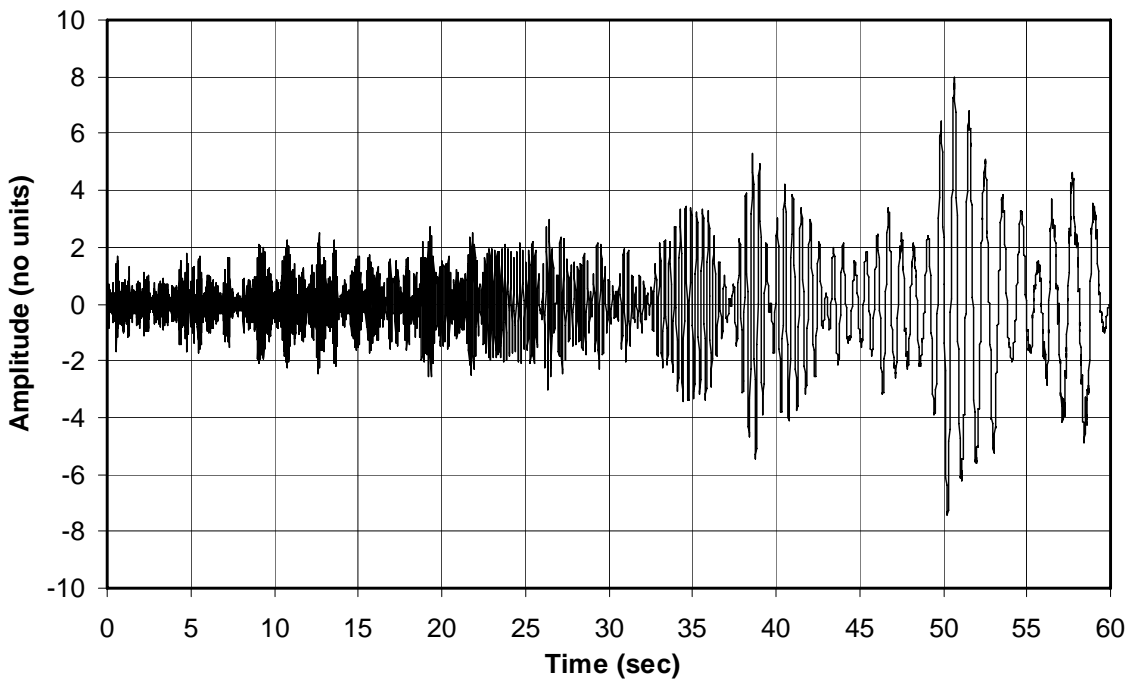

Figure C3-13 Generated narrow-band random signal, Ran30 record.

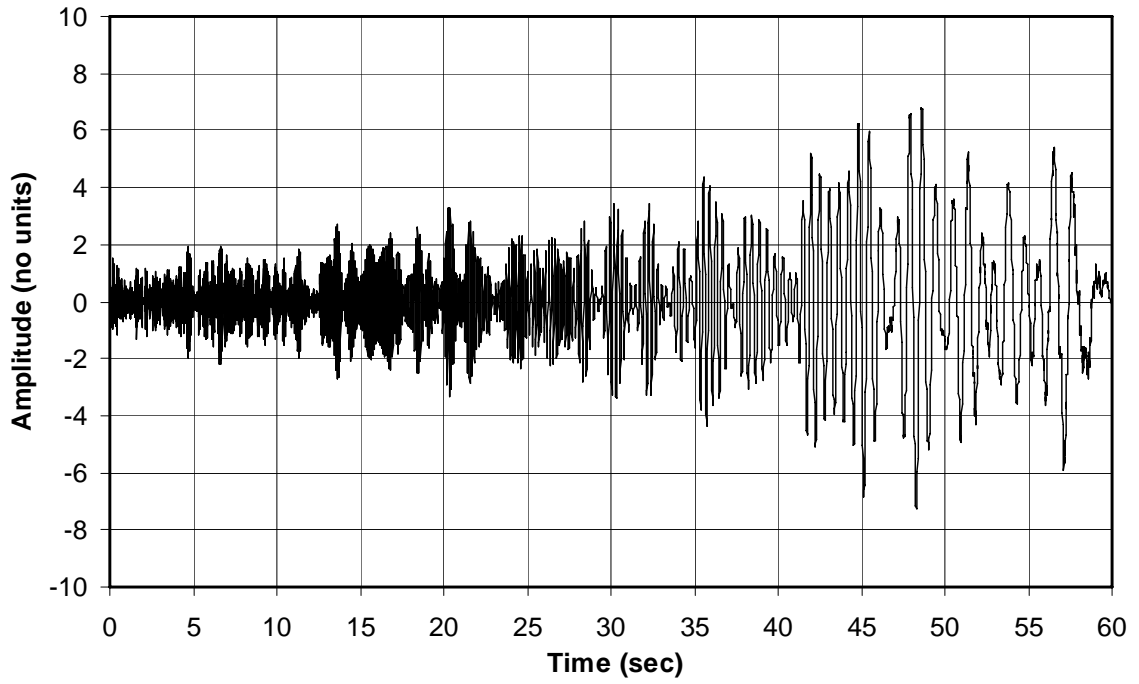

Figure C3-14 Generated narrow-band random signal, Ran55 record.

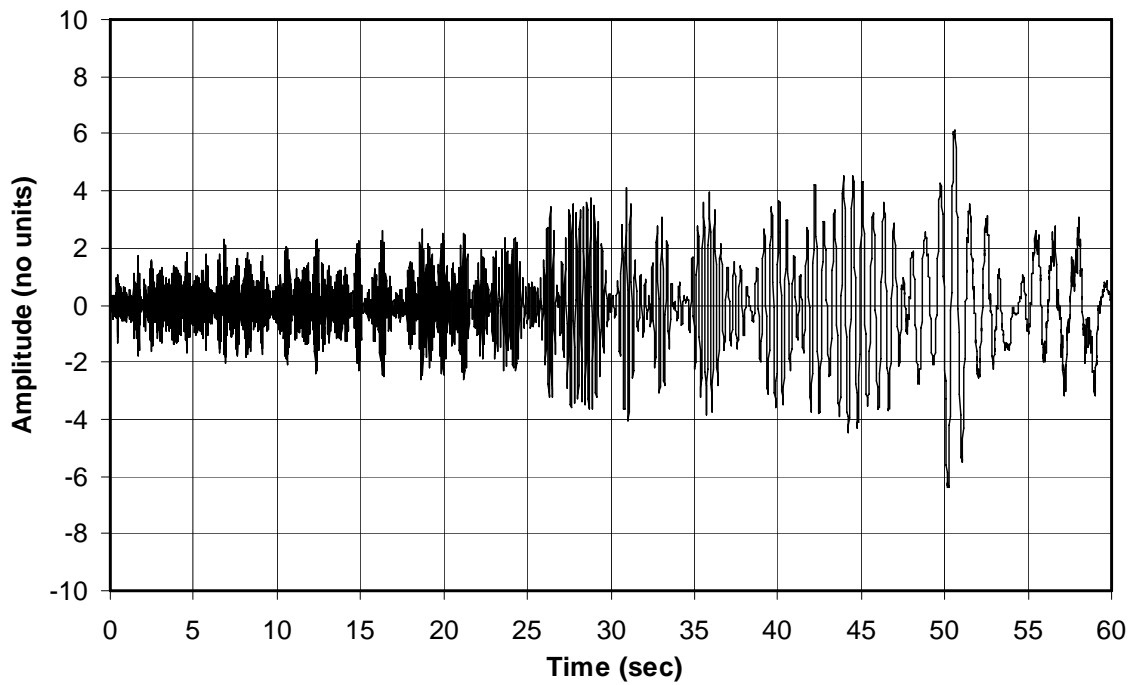

Figure C3-15 Generated narrow-band random signal, Ran84 record.

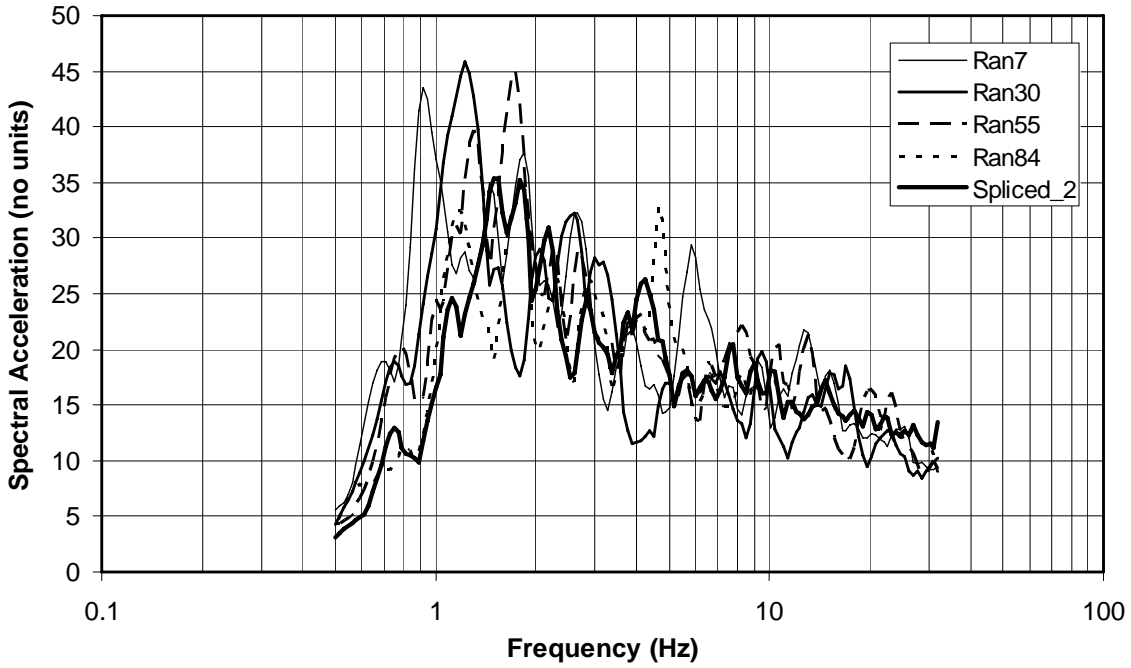

Figure C3-16. Response spectra of selected transverse records (5% of critical damping).

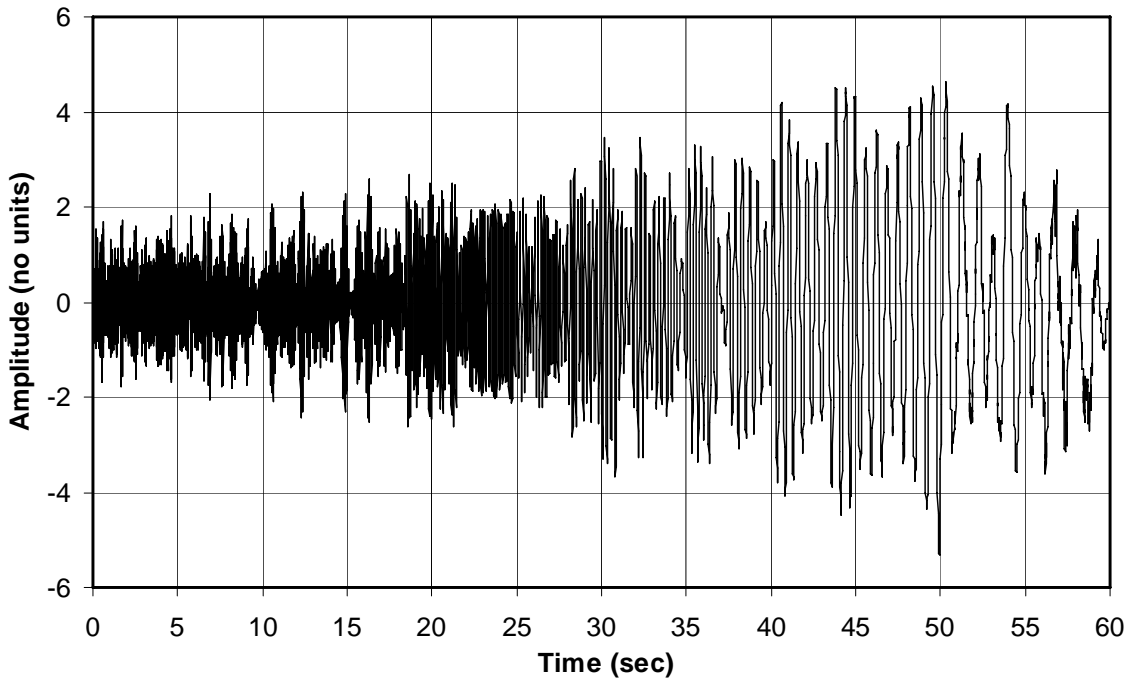

Figure C3-17 Spliced transverse record (Spliced_2).

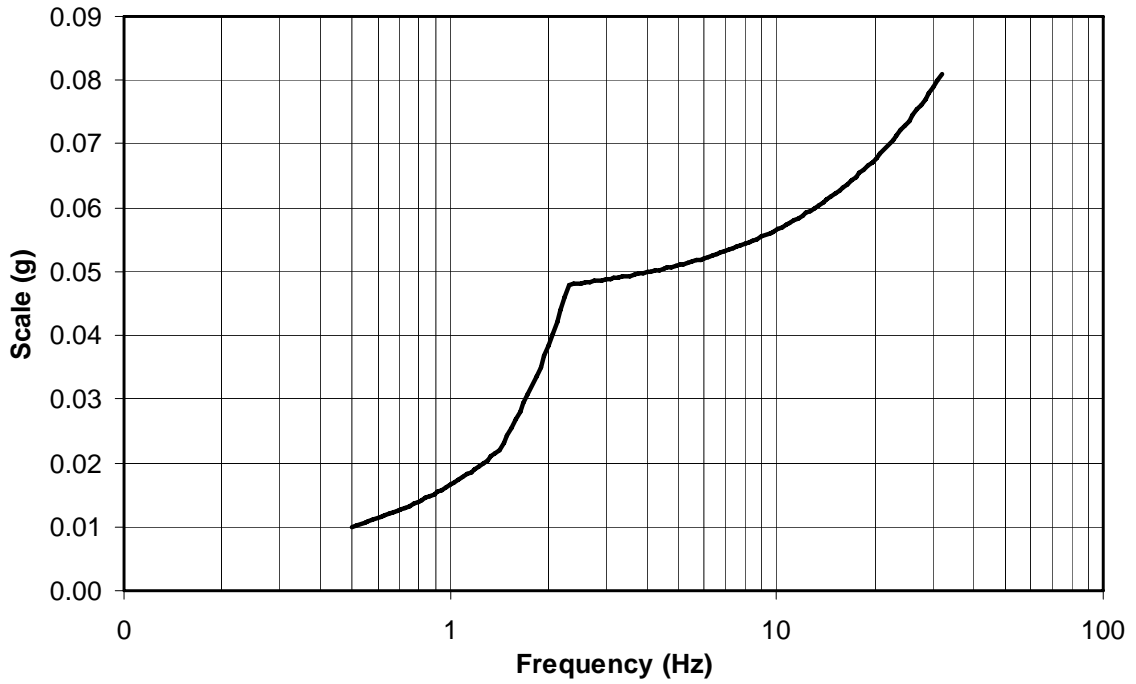

Figure C3-18 Scale used for the transverse record, plotted in the frequency domain

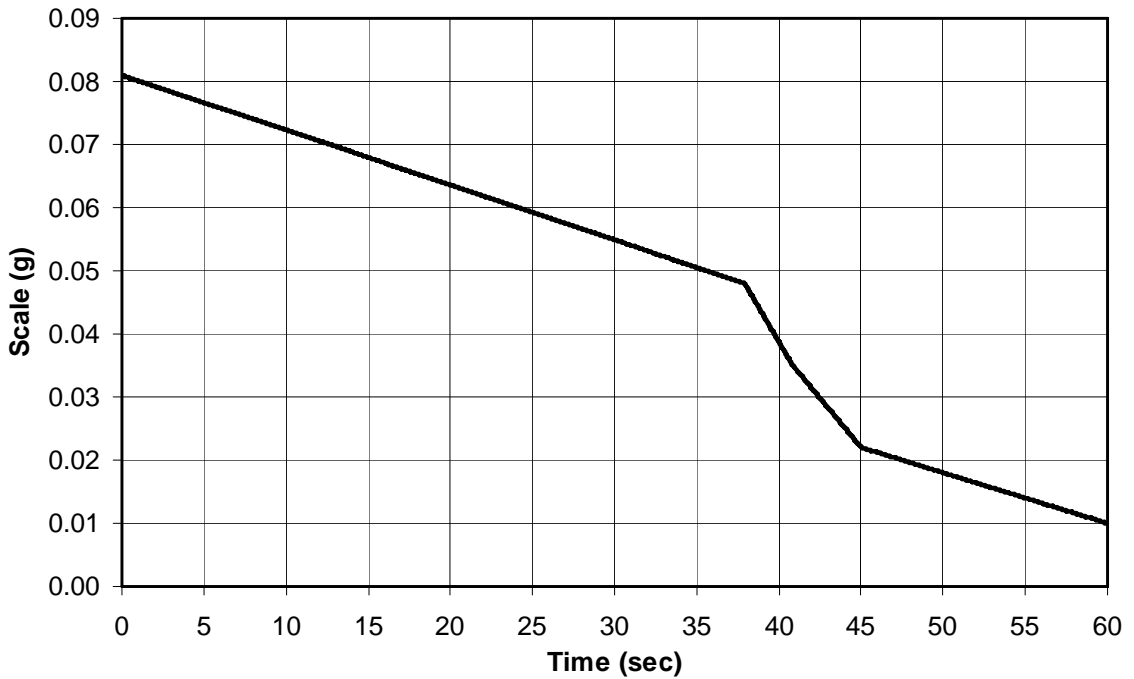

Figure C3-19 Scale used for the transverse record, plotted in the time domain.

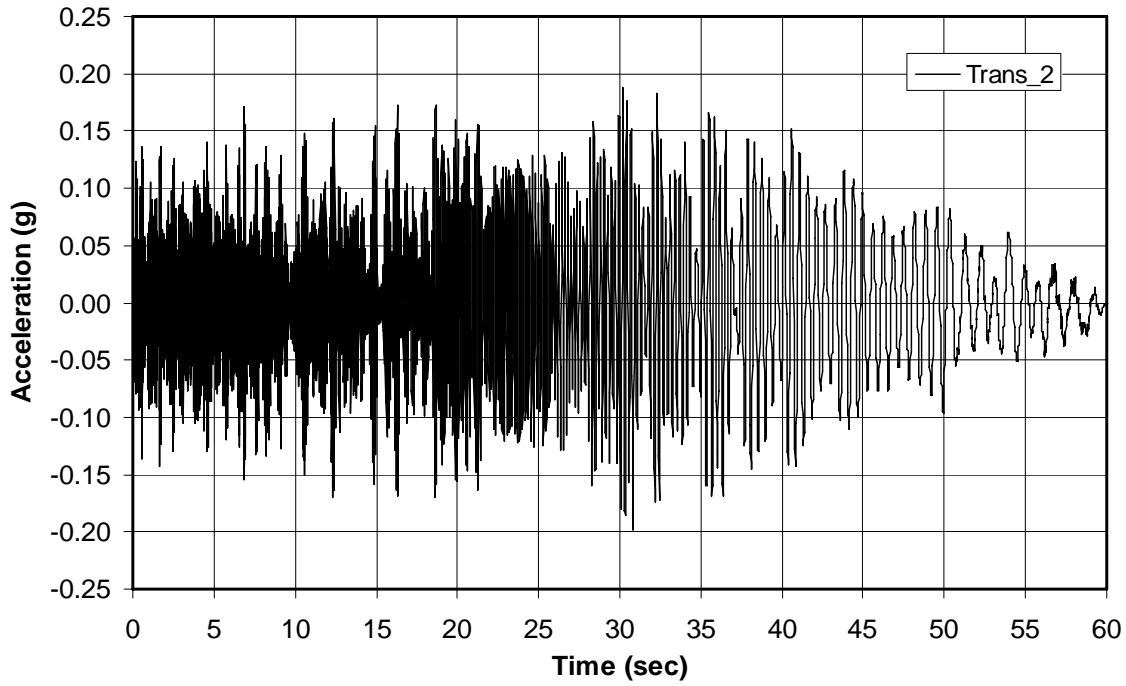

Figure C3-20 Scaled narrow-band random transverse record.

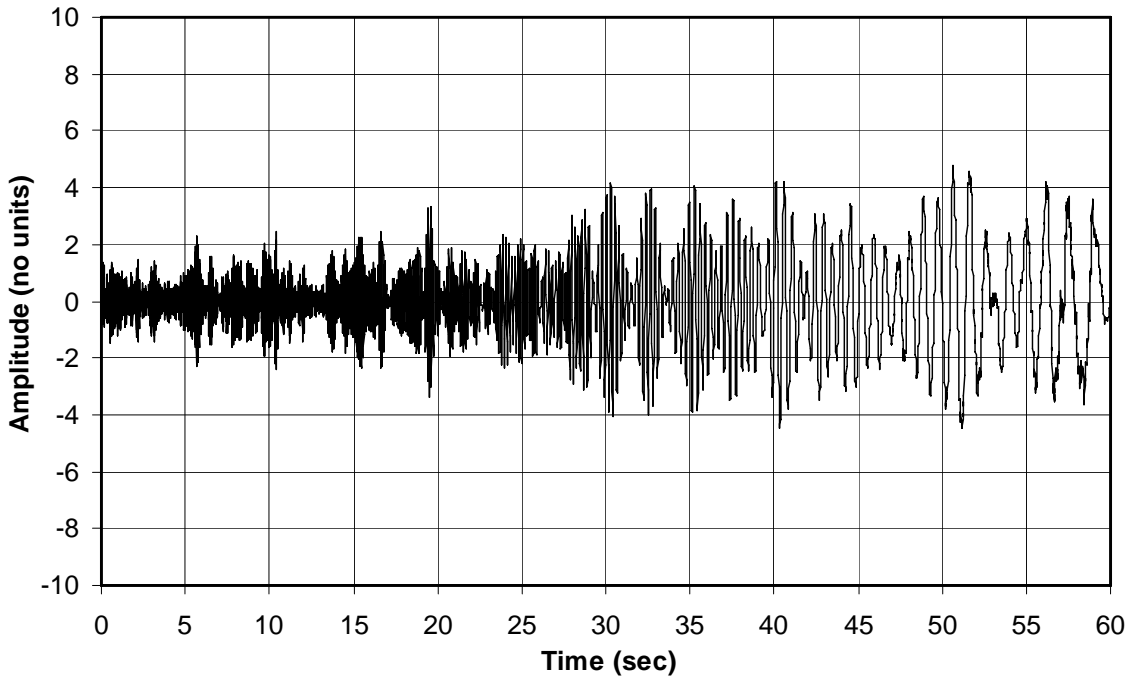

Figure C3-21 Generated narrow-band random signal, Ran9 record.

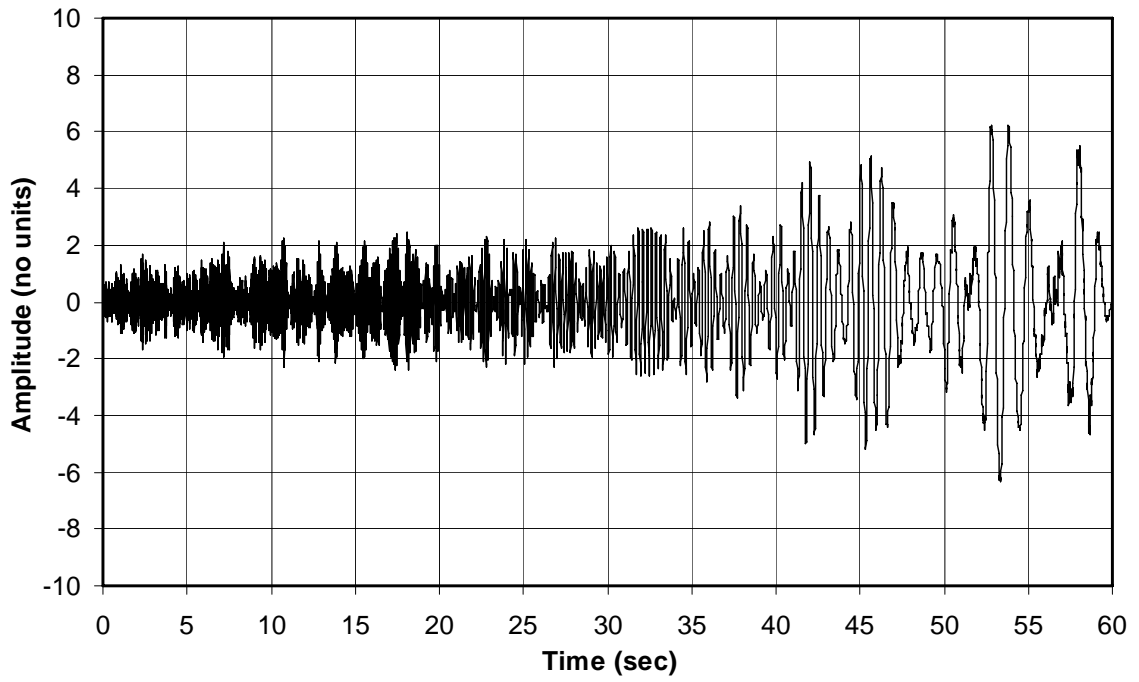

Figure C3-22 Generated narrow-band random signal, Ran20 record.

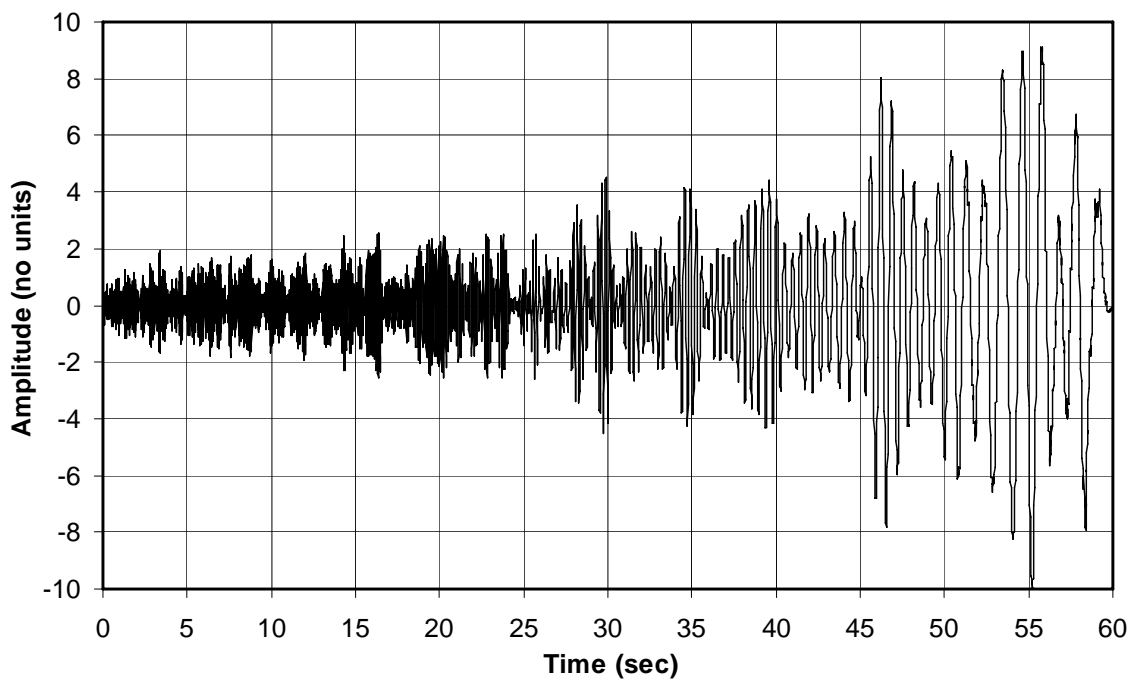

Figure C3-23 Generated narrow-band random signal, Ran21 record.

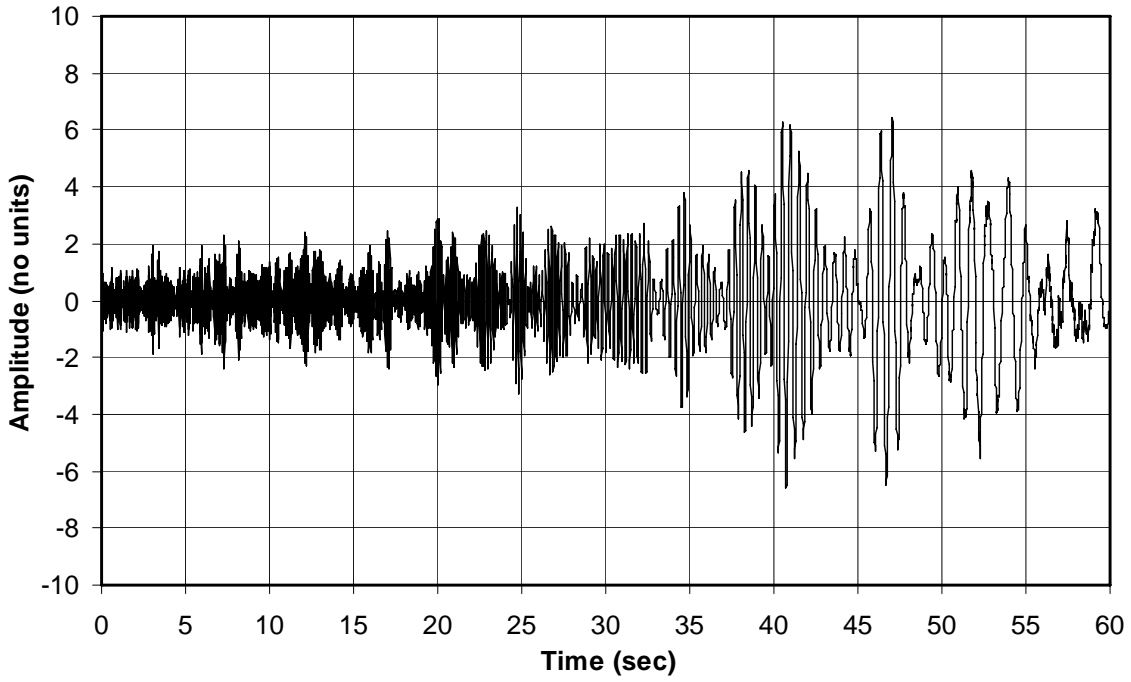

Figure C3-24 Generated narrow-band random signal, Ran68 record.

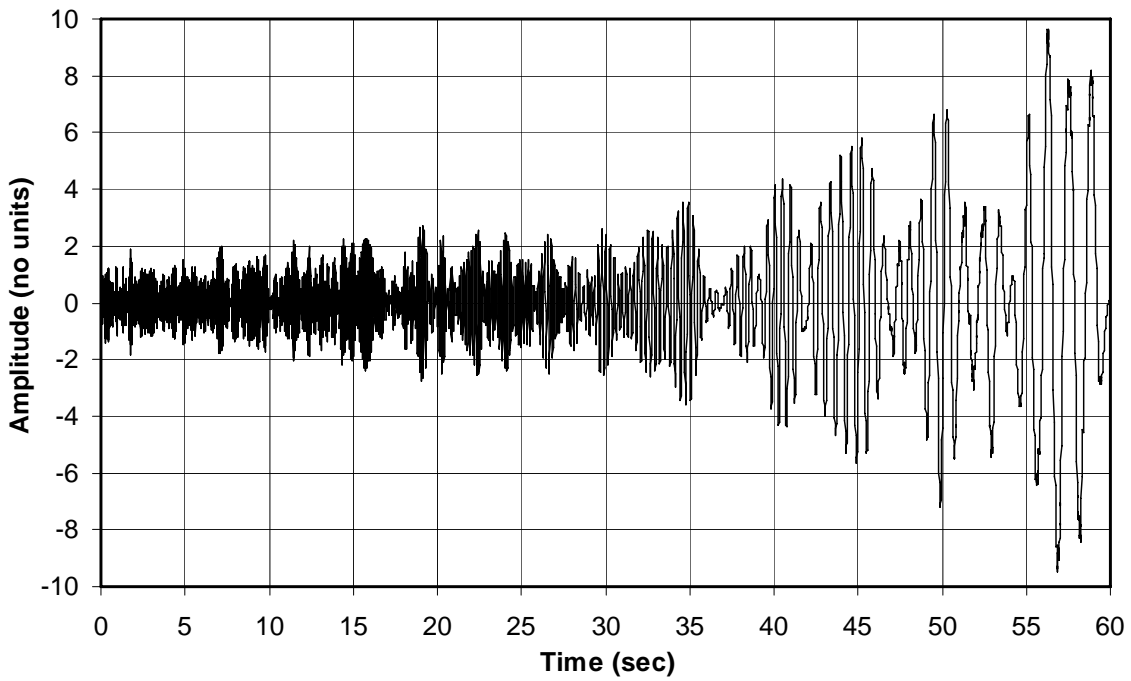

Figure C3-25 Generated narrow-band random signal, Ran90 record.

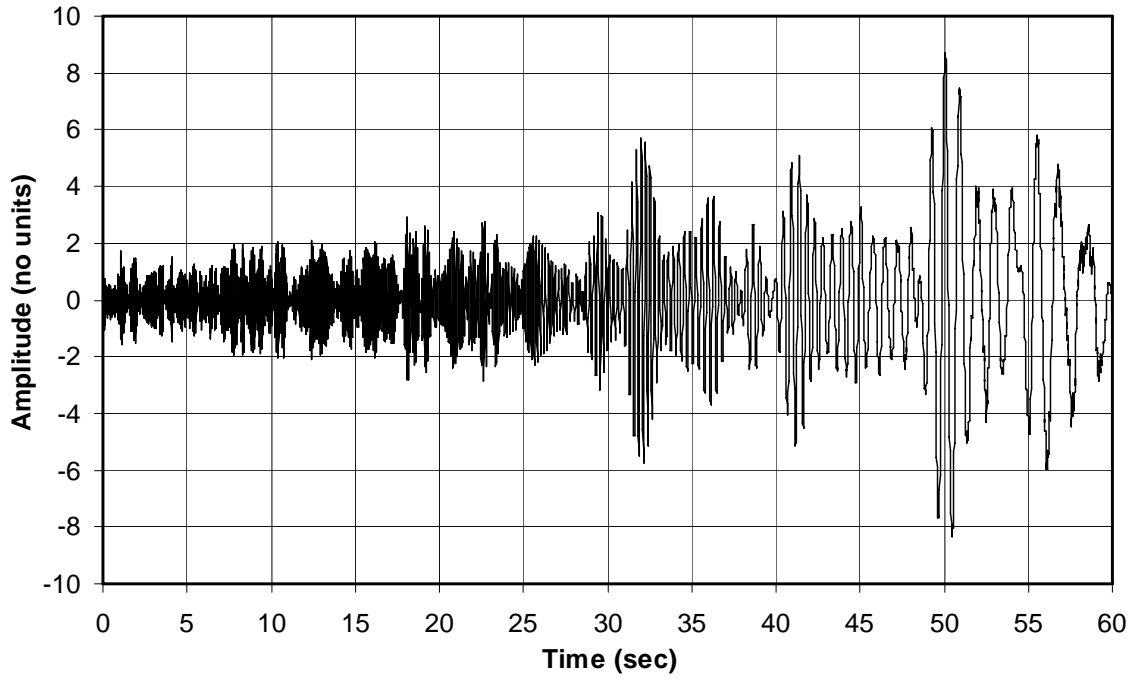

Figure C3-26 Generated narrow-band random signal, Ran98 record.

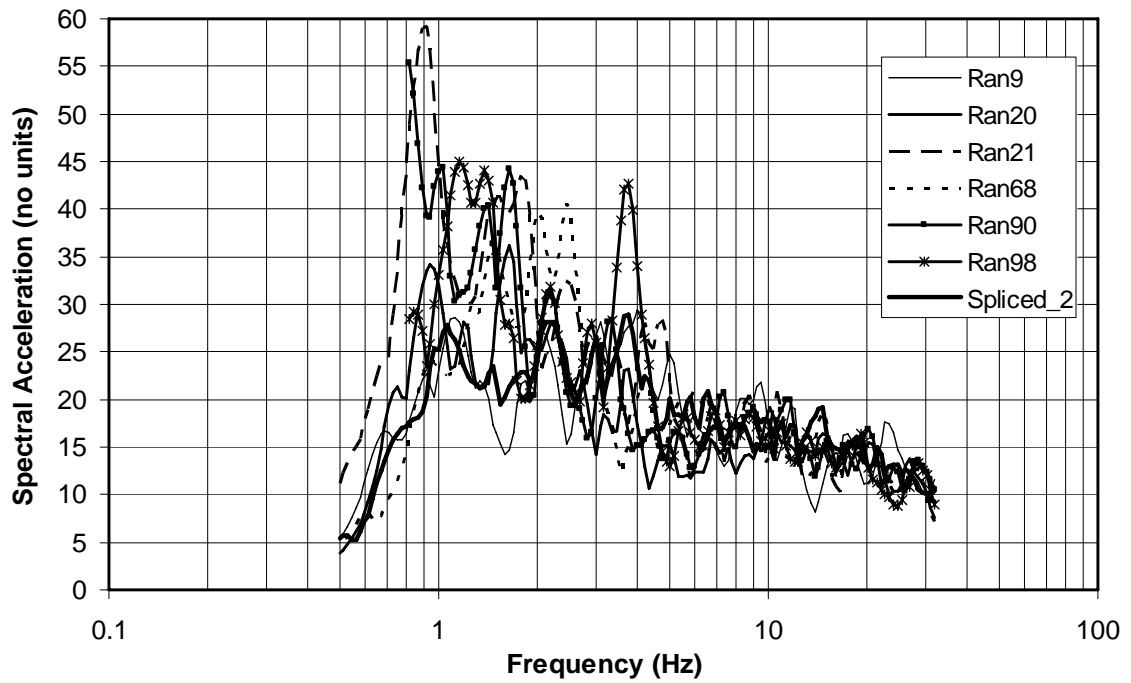

Figure C3-27 Response spectra of selected vertical records (5% of critical damping).

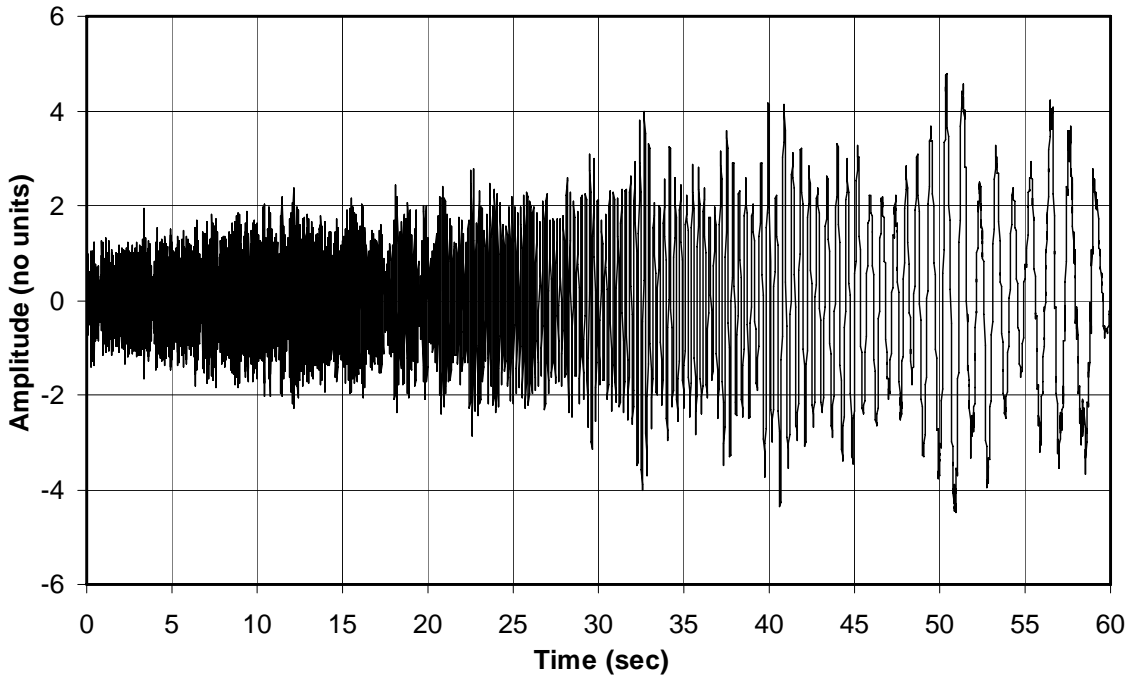

Figure C3-28 Spliced vertical record (Spliced_2).

The vertical spliced record was then scaled so the response spectrum spectral acceleration would be approximately 0.8 g above 2 Hz, and have a uniform spectral displacement below 2 Hz. This scaling was accomplished in the same way as for the two horizontal records, and Figures C3-29 and C3-30 plot the resulting scale in both the frequency and time domain, respectively. Figure C3-31 plots the scaled vertical record, and the response spectrum is included in Figure C3-11 (Vert_3). The Vert_3 name indicates that the 3rd trial scale was the final scale used for this record.

C3.9 Notch Filtering of Input Motions

It is possible that once a damage state has been caused by a particular excitation frequency and at a given amplitude, this damage state will be undesirably accentuated if the input motions are amplified in subsequent tests. This situation could prevent the occurrence and identification of other damage states. To alleviate this situation, notch filtering of the input motions may be used to remove energy near the excitation frequency that has already caused a damage state to occur.

Once a frequency has been removed from the input motions by notch filtering, that frequency will have negligible effect on higher damage levels. If different damage levels are dominated by the same frequency but by different intensities, notch filtering will prevent the occurrence of these other

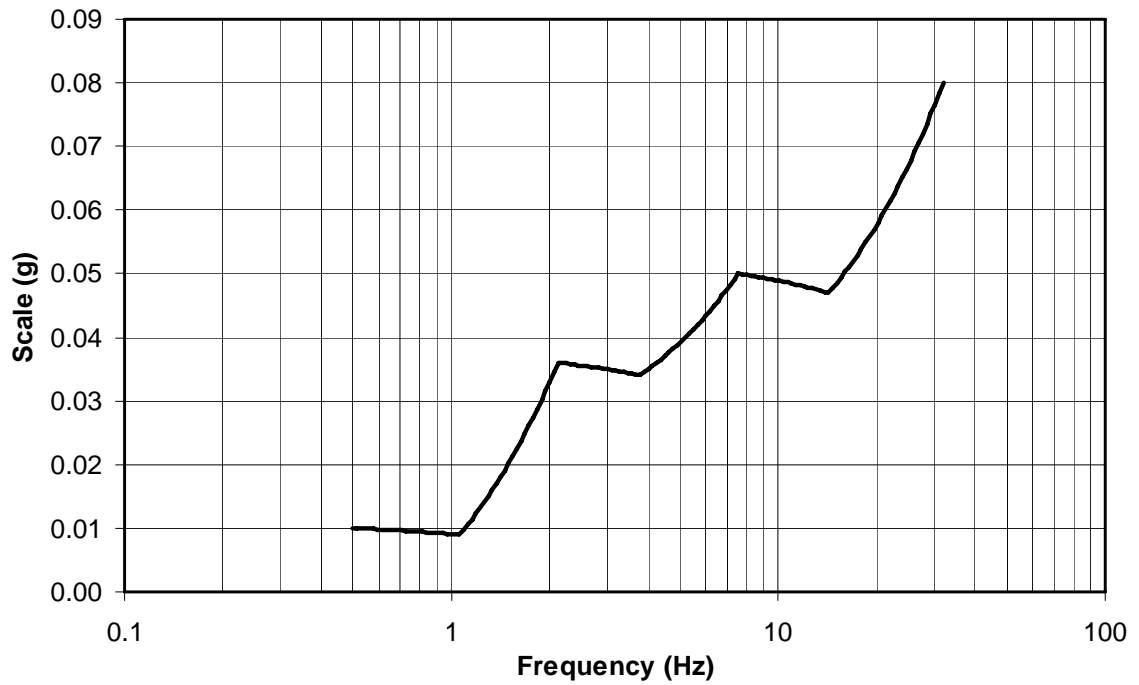

Figure C3-29 Scale used for the vertical record, plotted in the frequency domain

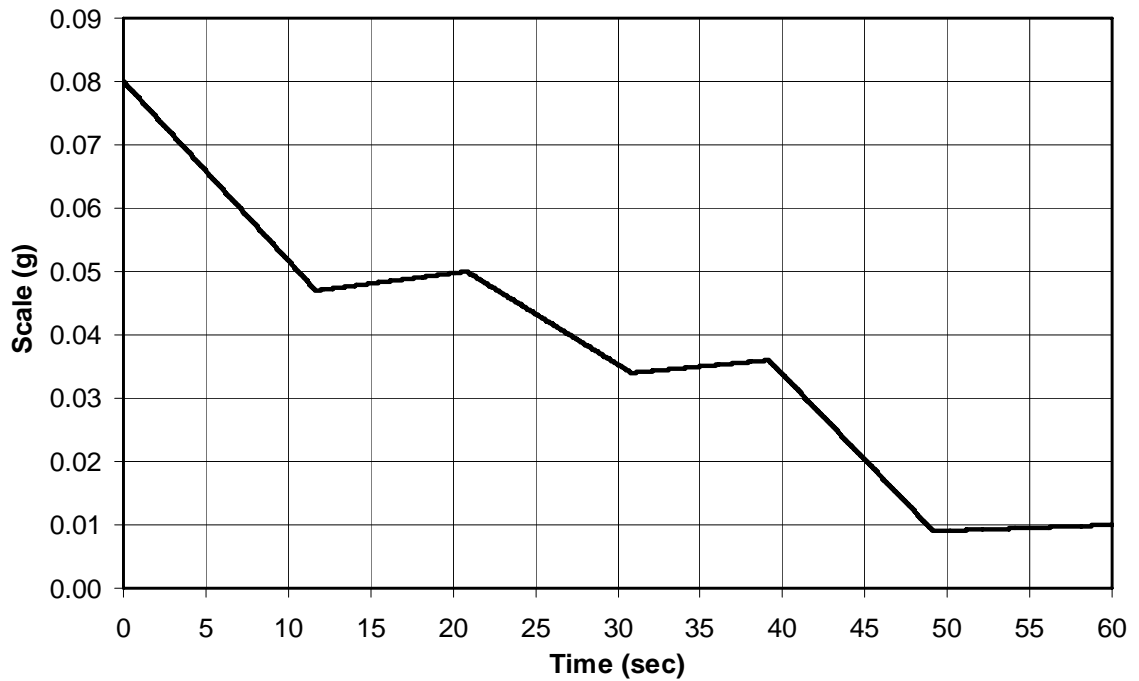

Figure C3-30 Scale used for the vertical record, plotted in the time domain.

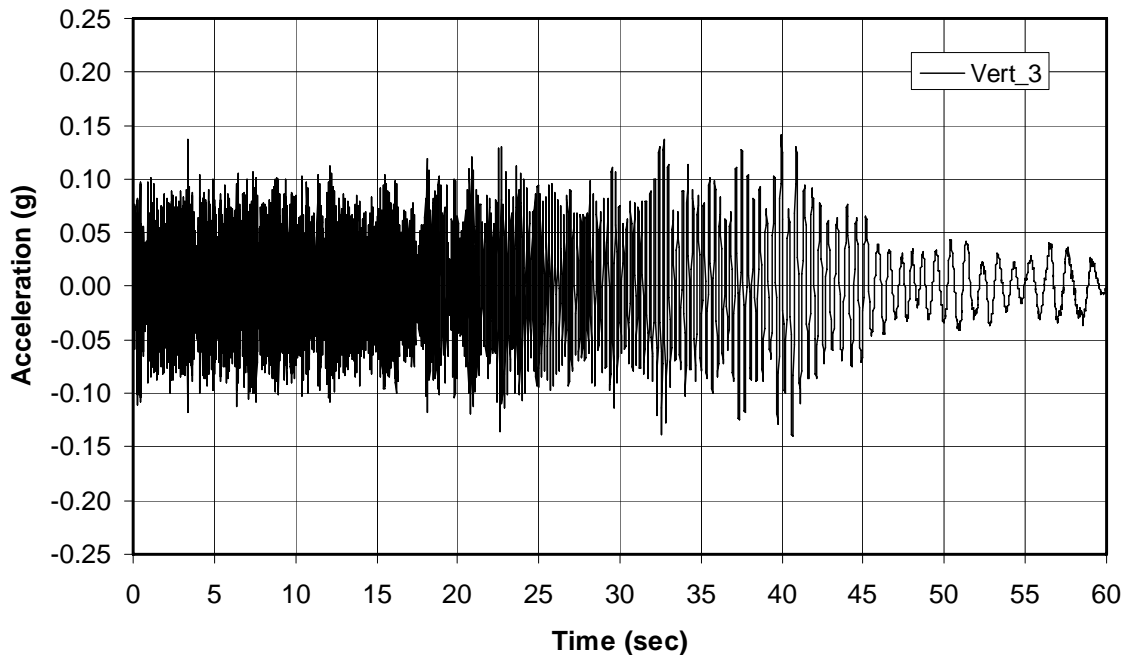

Figure C3-31 Scaled narrow-band random vertical record.

damage states. Therefore, the use of notch filtering must be assessed carefully during the experimental program.

C3.10 Testing Equipment

Major testing equipment required to execute the test sequence described in Section 3.2 is categorized in the following four groups.

1. A shake table is used to apply dynamic motion in one, two or three axes. It includes the platen structure upon which the test specimen is mounted and other subcomponents such as actuators, and electrical or hydraulic power. Most of the shake tables used for fragility testing are of the type driven by servo-hydraulic actuator systems that can deliver the best performance requirements of large force, velocity and stroke under large payloads (the total weight of the test specimen and other fixtures).
2. A control system can be either an analog or digital electronic system and is used to control the motions of the shake table.
3. Instrumentation (or sensors) measure physical quantities such as displacement, acceleration, velocity, strain, and force. Key considerations include (a) the proper identification of sensors for the purpose of collecting response data, and (b) sensor location, coordinate reference system, measurement characteristics, constraints, and sensor attachment methods.

4. Data acquisition includes equipment and appropriate software that is used to facilitate the reading, processing and recording of sensor output.

C3.10.1 Shake Tables

Typically, performance of a shake table is limited by the actuator stroke (i.e., displacement) at low frequencies, actuator velocity (servo capacity) at intermediate frequencies, and the ratio of actuator force to payload at higher frequencies. The velocity limit is controlled primarily by the flow capacity of the actuators' servo-valves as well as the pump and accumulator flow capacities. At higher frequencies, however, the shake table performance is acceleration-limited, the achievable peak acceleration being equal to the ratio of maximum actuator force capacity to the payload of the test specimen.

The operation of a real-time controller for a shake table system may be challenging due to the requirements of matching the time-history, response spectrum or power spectral density (PSD) between the target input motion and achieved input motion. The requirements must be met by the operator of the shake table due to the liability of an over-test, e.g., that may subsequently damage the test specimen.

The parameters affecting control-system design include:

1. payload (mass of the test specimen),
2. test specimen resonance, response nonlinearity and force feedback,
3. input motion, and
4. mechanical and performance limits of the earthquake simulator system.

Typically, controllers used in servo-hydraulic systems have a limited frequency bandwidth. Earthquake simulator controllers use advanced analog or digital controllers that incorporate displacement, velocity and acceleration signals for improved earthquake simulator response. Displacement, velocity and acceleration signals provide the low, intermediate and high frequency components necessary to create the desired earthquake simulator response to meet the input motion demand. The feedback signals are used to create and modify the drive signal for the earthquake simulator actuator(s).

Ideally, in order to achieve the required shake table response and conform to the recommendations of this protocol, the controller must know the feedbacks a-priori to create the proper corrected drive signal for the shake table actuators. However, this information is typically not available unless the test specimen is subjected to pretests of the prescribed levels of input motion to measure the shake table feedbacks so as to then modify the

subsequent drive signal. The risk of multiple testing of the same test specimen may, however, damage the test specimen before meeting the requirements.

There are several unique advantages of shake table testing of the type targeted by this interim protocol. The test specimen is generally lightweight and may therefore have low resonant feedback at the resonant frequency of the shake table – hydraulic system assembly (i.e., there is negligible shake table – test specimen interaction). These two advantages allow the shake table control system to compensate to meet the target acceleration time-history before the test specimen is placed on the shake table. If the test specimen is lightweight (low payload) relative to the shake table system, the shake table can be operated without the specimen in place. This allows the shake table system to converge on the target input motion through a process called iteration.

To iterate an input motion time-history, first a forward transfer function must be computed. This can be done by operating the table at a low-level random motion and computing the forward transfer function between the feedback and the reference signals. This function represents the shake table response in the frequency domain. Once this function is known, it can be used to amplify or attenuate the frequency components of the input time history and create a drive time-history. For example, if a 5 Hz, 1 g, sine wave is commanded to the table, and the table responds with a 2 g sine wave, the transfer function at 5 Hz has a gain of 2. If the command is then modified to 5 Hz at 0.5 g, then the table response would be 1g which is the target acceleration originally intended. This new command is called the drive signal.

In theory, the drive signal will produce a feedback identical to the target acceleration time-history. However, in reality, nonlinear oil flow through the valves and actuators, and the test specimen response prevents this “first iteration” from exactly matching the target. It is therefore necessary to take a percentage of the error between the target and the feedback and add it to the drive signal. In effect, the system compensates for the nonlinearity of the shake table response. This process shall be repeated as many times as necessary until the shake table feedback matches the target motion. It is apparent that multiple iterations are necessary. This prevents the procedure from being used when the test specimen is attached to the shake table system.

Real time adaptive control techniques can also be used to converge on the target motion, but these techniques take time to “anticipate” and modify the future drive signals. These are more complex techniques, which require

significant understanding on the part of the operator, and need to be used with caution even by experienced operators.

C3.10.2 Instrumentation and Monitoring

Within the context of this interim shake table testing protocol, the purpose of instrumentation and monitoring should be to record and monitor various types of response characteristics and behavior of the test specimen when subjected to the test sequence specified in Section 3.2. Hence, sufficient response monitoring instrumentation should be used to allow recording and determination of accelerations, velocities, absolute and relative displacements, strains and forces. The sensors used for this purpose should allow consistent measurement at various stages of response, such as in the proportionality range, nonproportionality range, and during failure of the test specimen.

Appendix A

Determination of Fragility Functions Based on Laboratory Data

A.1 Purpose

This appendix describes the process used to develop nonstructural component fragility functions based on laboratory testing. These fragility functions will be used to assess the seismic performance of a building containing a number of structural and nonstructural components as part of the performance-based seismic design process.

A.2 Background

Nonstructural component seismic fragility functions are mathematical expressions that indicate the conditional probability that a nonstructural component will experience damage equal to or more severe than a particular level, given that it experiences earthquake-induced demands of a particular intensity. The intensity of earthquake shaking can be expressed in the form of maximum imposed displacements, velocities or accelerations, or a combination of these parameters. Fragility functions typically are expressed in the form:

$$g_{DS_i}(z) = P[D \geq DS_i | EDP = z]$$

where:

D is the damage sustained by the component.

DS_i is a specific damage state, such as initiation of cracking of a partition, a piece of electrical equipment developing a short, or a mechanical seal on a pressure-containing component losing integrity.

EDP is an engineering demand parameter, used to quantify the intensity of shaking that the component or system is subjected to as described above.

Seismic fragility functions will typically be represented as lognormal functions, characterized by a median value and a variance. For a given

damage state DS_i , the median value of z , \hat{z} , is that value of z at which there is a 50% probability that damage will equal or exceed the specified level. The variance, typically represented by the parameter β , is the standard deviation of the natural logarithm of the values of z at which the damage is evaluated. Figure A-1 shows a representative nonstructural component seismic fragility function. In this particular function, the median value of z has a value of 1. The variance has a value of 0.25. As can be seen, at a shaking intensity level $z=1$, there is 50% probability that the component will be damaged to damage state DS_i , or a more severe level. At a shaking intensity level $z = 0.7$ there is approximately a 10% chance that the component will be damaged to DS_i , or a more severe level. At a shaking intensity level $z = 1.4$, there is approximately a 90% chance that the component will be damaged to damage state DS_i , or a more severe level.

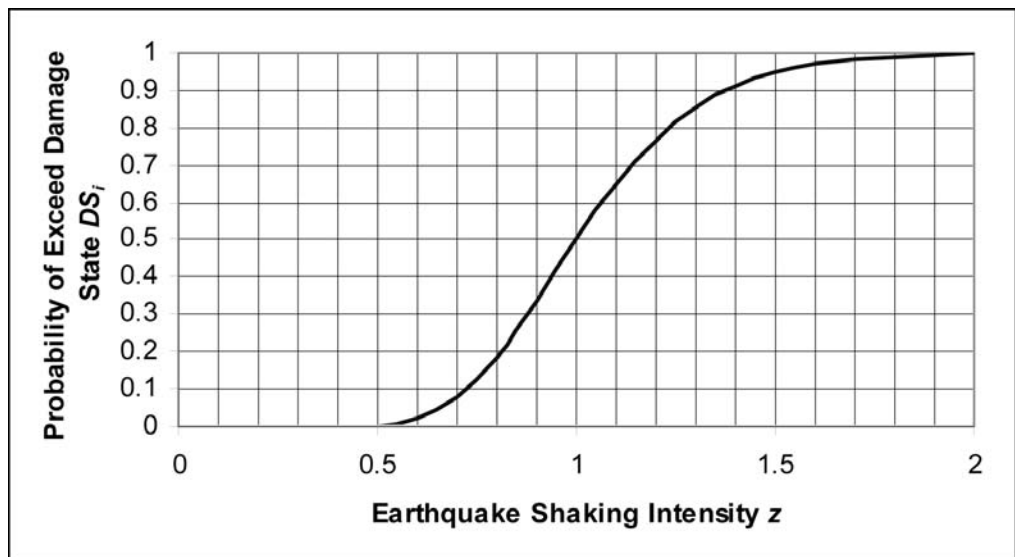

Figure A-1 Hypothetical nonstructural component fragility function

The variability exhibited by nonstructural component seismic fragility functions can be attributed to a variety of factors, including:

- random variations in the character of shaking at a given level of intensity – for example, if shaking intensity, z , is represented by the peak acceleration input experienced by the component, one earthquake may provide that peak value several times during the event, while other events, of similar intensity, may reach that peak value only one time,
- random variation in the strength or displacement capacity of the unit itself, owing to variability in the materials of its construction and the way in which the component is manufactured, and

- random variation in the manner in which the component is installed in the building, including, for example, the strength of anchors attaching the component to the structure.

Nonstructural component fragility functions can be established in several ways including:

Earthquake performance data. In this method, an attempt is made to investigate the performance of a number of actual installations of the component that have experienced shaking of differing intensities. If a large number of the components have been subjected to shaking of different intensities, it is possible to develop directly a distribution of the percentage of components subjected to a given intensity of shaking that have been damaged to different levels and directly construct the fragility function.

Simulation. In this method, a mathematical model of the component is developed and a simulation is performed to predict the damage sustained by the component when subjected to shaking. A large number of simulations must typically be performed to explore the effect of variation of ground motion character, manufacturing quality, and installation quality.

Laboratory testing. In this method, a representative sample of components is subjected to laboratory testing that represents the response of the components to actual shaking. As with simulation, ideally, a large number of tests should be performed to permit exploration of the effect of variation of ground motion character, manufacturing quality and installation quality on component behavior.

This appendix describes, in a general manner, the procedures that should be used to develop nonstructural component seismic fragility functions using laboratory testing.

A.3 General Procedure

As indicated in Section A.2, ideally, data from a large number of tests, that explore variability in shaking character, manufacturing quality, and installation quality would be available. However, since testing is typically expensive, data from only a limited number of tests will be available. Therefore, development of nonstructural component seismic fragility functions will require the application of some expert judgment to extrapolate the available data.

Development of nonstructural component seismic fragility functions should be conducted by a panel of experts. This panel should include engineers familiar with structural reliability methods and probabilistic analysis,

earthquake engineering experts and engineers familiar with the manufacture, installation and function of the particular component. Researchers who performed the testing upon which the seismic fragility will be based should be participants in the panel although these researchers should not be the sole members of the panel.

Data available from the test should include a description of the components tested, the test setup, the loading applied and for each test, the various damage states observed and the loading level at which each damage state occurred.

The panel should evaluate the following factors:

- the extent to which the test setup represents the actual installed condition of the component in a building and the extent that the laboratory setup may result in a systematic bias in the values of the loading at which the damage occurs,
- the variability of the reported values for which the damage state occurs and apparent repeatability of results from test to test,
- the insight of the researcher who performed the test, regarding the critical parameters that control the damageability of the component, including for example, the rigidity and strength of base anchorage or other bracing, the combined effects of multi-axial loading, whether the component is functioning at the time of the loading, and any other factors that appear to affect behavior – these factors should be reported together with the researcher’s insight as to the extent of the affect of each such parameter, and
- the variability in performance of similar types of components exhibiting similar behaviors as established by other seismic fragility development efforts.

Considering these data, the panel should establish values for the median and variance, as previously described. The median value should not be different from the median value of the reported test data unless there is specific reason to believe that the test setup resulted in identifiable bias in the results.

Generally, in order to establish a reliable estimate of the variance, based on test data alone, a large number of tests (in excess of 10) will need to be performed. Lacking such data, the variance should be established on the basis of expert judgment considering the identified factors that affect behavior, an evaluation of the amount of variability possible in each of these factors, the amount that variability in each of these factors will likely affect

the results, and an understanding of the degree of correlation, if any, between these various factors and the performance.

When establishing these fragility parameters, the panel must bear in mind that the intent is to establish unbiased predictions of fragility that neither over-predict nor under-predict the probability that the component will experience a given level of damage at a given level of shaking. The nonstructural component seismic fragility function should account only for the variability inherent in the behavior of the particular type of component. Variability in other external factors that can affect the performance of the component, but which are not directly related to the component should not be included in the fragility variability. Examples of variability that should not be included in nonstructural component seismic fragility functions include the following:

- uncertainty in the intensity of ground shaking,
- uncertainty in the response of the supporting structure, and
- uncertainty in the consequences of damage of the component.

The fragility parameters should be presented in a report, which is prepared by the panel, and which includes the following:

- a description of the component and the installation condition for which the fragility applies,
- identification of the panel members and their qualifications,
- a description of the damage state(s) for which the fragilities apply, including, in a qualitative manner, discussion of the consequences of this damage (for example, component will not function, component will leak, component must be repaired, or component must be replaced),
- a description of the data and factors considered by the panel, and
- the panel's recommendation for the median and variance.

References

- ASCE, 2002, *Prestandard and Commentary for the Seismic Rehabilitation of Buildings*, FEMA- 356 Report, prepared by the American Society of Civil Engineers for the Federal Emergency Management Agency, Washington, D.C.
- ATC, 1992, *Guidelines for Cyclic Seismic Testing of Components of Steel Structures*, ATC-24 Report, Applied Technology Council, Redwood City, California.
- ATC, 1996, *Seismic Evaluation and Retrofit of Concrete Buildings*, ATC-40 Report, Applied Technology Council, Redwood City, California.
- ASTM, 2003, *Standard Practices for Cycle Counting on Fatigue Analysis*, ASTM-1049, American Society for Testing and Materials, www.astm.org.
- EERC, 1996, *Performance-Based Seismic Design of Buildings – An Action Plan for Future Studies*, FEMA 283 Report, prepared by the Earthquake Engineering Research Center for the Federal Emergency Management Agency, Washington, D.C.
- EERI, 2000, *Action Plan for Performance-Based Seismic Design*, FEMA-349 Report, prepared by the Earthquake Engineering Research Institute for the Federal Emergency Management Agency, Washington, D.C.
- IAS, 2006, *Accreditation Criteria for Testing Laboratories*, Report AC 89, International Accreditation Service, Whittier, California.
- IEEE, 2004, *Recommended Practice for Seismic Qualification of Class 1E Equipment for Nuclear Power Generating Stations*, IEEE Standard No. 344-2004, Institute of Electrical and Electronics Engineers, Piscataway, New Jersey.
- Krawinkler, H., et al., 1983, *Recommendations for Experimental Studies on the Seismic Behavior of Steel Components and Materials*, John A. Blume Center Report No. 61, Department of Civil Engineering, Stanford University.
- Krawinkler, H., Parisi, F., Ibarra, L., Ayoub, A., and Medina, R., 2001, *Development of a Testing Protocol for Wood Frame Structures*, CUREE

Publication No. W-02, Consortium of Universities for Research in Earthquake Engineering.

Wilcoski, J., Gambill, J.B., and Smith, S.J., 1997, *CERL Equipment Fragility and Protection Procedure (CEFAPP)*, USACERL Technical Report 97/58, U.S. Army Construction Engineering Research Laboratory, Champaign, Illinois.

Acronyms

ASTM	American Society for Testing and Materials
ATC	Applied Technology Council
CalTech	California Institute of Technology
CD-ROM	compact disk, read-only memory
CUREE	Consortium of Universities for Research in Earthquake Engineering
FEMA	Federal Emergency Management Agency
ICC	International Code Council
ICC ES	ICC Evaluation Service
IMRS	input motion response spectrum
LVDT	linear variable differential transformer
MAE Center	Mid-America Earthquake Center
MCEER	Multidisciplinary Center for Earthquake Engineering Research
MDOF	multi degree of freedom
MRS	maximum response spectrum
NEES	Network for Earthquake Engineering Simulation
NIST	National Institute for Standards and Technology
PEER Center	Pacific Earthquake Engineering Research Center
PSD	power spectral density
SDOF	single degree of freedom

Project Participants

Project Management

Christopher Rojahn,
Project Executive Director
Applied Technology Council
201 Redwood Shores Parkway, Suite 240
Redwood City, California 94065

Ronald O. Hamburger,
Project Technical Director
Simpson Gumpertz & Heger
The Landmark @ One Market, Suite 600
San Francisco, California 94105

FEMA Oversight

Mike Mahoney, Project Officer
Federal Emergency Management Agency
500 C Street, SW
Washington, DC 20472

Robert D. Hanson, Technical Monitor
(Federal Emergency Management Agency)
2926 Saklan Indian Drive
Walnut Creek, California 94595-3911

Project Management Committee

Christopher Rojahn, Chair
Ronald Hamburger, Co-Chair

Peter May
University of Washington
Box 353530
Seattle, Washington 98195

Jon Heintz, Ex-officio
Applied Technology Council
201 Redwood Shores Parkway, Suite 240
Redwood City, California 94065

Jack P. Moehle
University of California Berkeley
325 Davis Hall – MC 1792
Berkeley, California 94720

William T. Holmes,
Steering Committee Chair (ex-officio)
Rutherford & Chekene
55 Second Street, Suite 600
San Francisco, California 94105

Maryann T. Phipps
Estructure
8331 Kent Court, Suite 100
El Cerrito, California 94530

John Gillengerten
Office of Statewide Health
Planning and Development
1600 9th St., Room 420
Sacramento, California 95814

Project Technical Committee

Ronald O. Hamburger, Chair
Christopher Rojahn, Ex-officio

Robert Bachman
Consulting Structural Engineer
25152 La Estrada Drive
Laguna Niguel, California 92677

Craig D. Comartin
Comartin Engineers
7683 Andrea Avenue
Stockton, California 95207-1705

Jon Heintz
Applied Technology Council
201 Redwood Shores Parkway, Suite 240
Redwood City, California 94065

Jack P. Moehle
University of California Berkeley
325 Davis Hall – MC 1792
Berkeley, California 94720

Maryann T. Phipps
Estructure
8331 Kent Court, Suite 100
El Cerrito, California 94530

Andrew S. Whittaker
University at Buffalo
Dept. of Civil Engineering
230 Ketter Hall
Buffalo, New York 14260

Steering Committee

William T. Holmes, Chair
Rutherford & Chekene
55 Second Street, Suite 600
San Francisco, California 94105

Dan Abrams
Mid-America Earthquake Center
University of Illinois
2118 Newmark Civil Engineering Lab
205 N. Mathews
Urbana, Illinois 61801

Deborah B. Beck
Beck Creative Strategies LLC
531 Main Street, Suite 313
New York, New York 10044

Randall Berdine
Fannie Mae
3900 Wisconsin Avenue, NW
Washington, DC 20016-2892

Roger D. Borchardt
U.S. Geological Survey
345 Middlefield Road, MS977
Menlo Park, California 94025

Michel Bruneau
MCEER, University at Buffalo
105 Red Jacket Quadrangle
Buffalo, New York 14261-0025

Terry Dooley
ACE Mentor Program
c/o Morley Builders
2901 28th Street, Suite 100
Santa Monica, California 90405

Amr Elnashai
Mid-America Earthquake Center
University of Illinois
1241 Newmark Lab
205 N. Mathews
Urbana, Illinois 61801

Steering Committee (continued)

Mohammed Ettouney
Weidlinger Associates, Inc.
375 Hudson Street
New York, New York 10014-3656

Jack Hayes
NEHRP Director
National Inst. of Standards & Technology
100 Bureau Drive, MS 8610
Gaithersburg, Maryland 20899-8610

William J. Petak
University of Southern California
School of Policy Planning and Development
MC 0626
Los Angeles, California 90089

Randy Schreitmueller
FM Global
1301 Atwood Avenue
Johnston, Rhode Island 02919

Jim W. Sealy, Architect
1320 Prudential Drive, No 101
Dallas, Texas 75235-4117

Jon Traw
Traw Associates Consulting
14435 Eastridge Drive
Whittier, California 90602-2745

Product 1 Team

Ronald L. Mayes, Team Leader
Simpson Gumpertz & Heger
The Landmark @ One Market, Suite 600
San Francisco, California 94105

Daniel Alesch
(formerly with University of Wisconsin)
909 Forest Hill Drive
Green Bay, Wisconsin 54311-5927

Bruce R. Ellingwood
Georgia Institute of Technology
790 Atlantic Drive
Atlanta, Georgia 30332-0355

James O. Malley
Degenkolb Engineers
225 Bush Street, Suite 1000
San Francisco, California 94104

Structural Performance Products Team

Andrew S. Whittaker, Team Leader
University at Buffalo
Dept. of Civil Engineering
230 Ketter Hall
Buffalo, New York 14260

Gregory Deierlein
Stanford University
Dept. of Civil & Environmental Engrg
240 Terman Engineering Center
Stanford, California 94305-4020

Andre Filiatrault
MCEER, University at Buffalo
105 Red Jacket Quadrangle
Buffalo, New York 14261-0025

John Hooper
Magnusson Klemencic Associates
1301 Fifth Avenue, Suite 3200
Seattle, Washington 98101

Andrew T. Merovich
A. T. Merovich & Associates, Inc.
1950 Addison Street, Suite 205
Berkeley, California 94704

Nonstructural Performance Products Team

Robert Bachman, Team Leader
Consulting Structural Engineer
25152 La Estrada Drive
Laguna Niguel, California 92677

David Bonowitz
Office of Court Construction & Mgmt.
Judicial Council of California
Administrative Office of the Courts
455 Golden Gate Avenue
San Francisco, California 94102-3688

Philip J. Caldwell
Square D Company
1990 Sandifer Blvd.
Seneca, South Carolina 29687

Andre Filiatrault
MCEER, University at Buffalo
105 Red Jacket Quadrangle
Buffalo, New York 14261-0025

Robert P. Kennedy
RPK Structural Mechanics Consulting, Inc.
28625 Mountain Meadow Road
Escondido, California 92026

Gary McGavin
McGavin Architecture
447 LaVerne Street
Redlands, California 92373-6015

Eduardo Miranda
Stanford University
Civil & Environmental Engineering
Terman Room 293
Stanford, California 94305-3707

Keith Porter
Consulting Engineer
769 N. Michigan Avenue
Pasadena, California 91104

Shake Table Testing Protocol Team

Andre Filiatrault, Team Leader
MCEER, University at Buffalo
105 Red Jacket Quadrangle
Buffalo, New York 14261-0025

Philip J. Caldwell
Square D Company
1990 Sandifer Blvd.
Seneca, South Carolina 29687

Peter Dusicka
Portland State University
Dept. of Civil & Environmental Engineering
P.O. Box 751
Portland, Oregon 97207-0751

Tara Hutchinson
University of California, San Diego
Jacobs School of Engineering
9500 Gilman Drive, MC 0085
La Jolla, California 92093-0085

Ahmad Itani
University of Nevada, Reno
Dept. of Civil Engineering
Mail Stop 258
Reno, Nevada 89557-0152

Eduardo Miranda
Stanford University
Civil & Environmental Engineering
Terman Room 293
Stanford, California 94305-3707

Gokhan Pekcan
University of Nevada, Reno
Dept. of Civil Engineering
Mail Stop 258
Reno, Nevada 89557-0152

Shake Table Testing Protocol Team (continued)

Andrei M. Reinhorn
University at Buffalo
Dept. of Civil Engineering
231 Ketter Hall
Buffalo, New York 14260

Jose Restrepo
University of California, San Diego
9500 Gillman Drive
La Jolla, California 92093-0085

James Wilcoski
U.S. Army Engineer Research and Development
Center
Construction Engineering Research Laboratory
P.O. Box 9005
Champaign, Illinois 61826-9005

Racking Testing Protocol Team

Helmut Krawinkler, Team Leader
Stanford University
Civil Engineering Department
Stanford, California 94305-4020

Joseph R. Maffei
Consulting Structural Engineer
427 Thirteenth Street
Oakland, California 94612

David Bonowitz
Office of Court Construction & Mgmt.
Judicial Council of California
Administrative Office of the Courts
455 Golden Gate Avenue
San Francisco, California 94102-3688

Ali M. Memari
Pennsylvania State University
Dept. of Architectural Engineering
104 Engineering Unit A
University Park, Pennsylvania 16802-1416

Barry J. Goodno
Georgia Institute of Technology
790 Atlantic Drive
Atlanta, Georgia 30332-0355

Jose Restrepo
University of California, San Diego
9500 Gillman Drive
La Jolla, California 92093-0085

Steven Kuan
Office of Housing & Construction Standards
P.O. Box 9844, Stn Prov Govt
Victoria, B.C. Canada V8W 9T2

Chia-Ming Uang
University of California, San Diego
409 University Center
La Jolla, California 92093-0085

Component Cyclic Testing Protocol Team

Manos Maragakis, Team Leader
University of Nevada, Reno
Dept. of Civil Engineering
Mail Stop 258
Reno, Nevada 89557-0152

Scott Campbell
Kinetics Noise Control
6300 Frelan Place
Dublin, Ohio 43017

George Antaki
Westinghouse Savannah River Company
Savannah River Site, Building 730-1B/214
Aiken, South Carolina 29808

Robert Kennedy
RPK Structural Mechanics Consulting, Inc.
28625 Mountain Meadow Road
Escondido, California 92026

Component Cyclic Testing Protocol Team (continued)

Praveen Malhotra
FM Global Research
1151 Boston-Providence Turnpike
Norwood, Massachusetts 02062

John F. Silva
Hilti Inc.
84 Mt. Rainier Drive
San Rafael, California 94903

Sami Masri
University of Southern California
Dept. of Civil Engineering
Los Angeles, California 90089-2531

Risk Management Products Team

Craig D. Comartin, Team Leader
Comartin Engineers
7683 Andrea Avenue
Stockton, California 95207-1705

Charles Kircher
Kircher & Associates, Consulting Engineers
1121 San Antonio Road, Suite D-202
Palo Alto, California 94303-4311

Brian J. Meacham, Team Associate Leader
Arup
1500 West Park Drive, Suite 180
Westborough, Massachusetts 01581

Farzad Naeim
John A. Martin & Associates, Inc.
1212 S. Flower Street, 4th Floor
Los Angeles, California 90015

C. Allin Cornell
Stanford University
Dept of Civil & Environmental Engineering
Terman Engineering Center
Stanford, California 94305

Robert D. Weber
R.D. Weber & Associates, Inc.
9784 Ice Box Canyon Court
Las Vegas, Nevada 89117

Gee Heckscher
Architectural Resources Group
Pier 9 The Embarcadero
San Francisco, California 94111

Publication and Management Support Services

A. Gerald Brady, Editor
735 DeSoto Drive
Palo Alto, California 94303

Peter N. Mork
I.T. Manager
Applied Technology Council
201 Redwood Shores Parkway, Ste 240
Redwood City, California 94065

Bernadette Hadnagy, Operations Manager
Applied Technology Council
201 Redwood Shores Parkway, Ste 240
Redwood City, California 94065

Workshop Participants

FEMA/ATC-58 Workshop on *Interim Protocols for Seismic Performance Assessment Testing of Nonstructural Components*

November 4-5, 2004
Doubletree Hotel, San Francisco Airport
835 Airport Blvd.
Burlingame, California

Dennis Alvarez
USG Corporation
35350 Chester Road
Avon, Ohio 44011

Mary Comerio
University of California, Berkeley
Dept. of Architecture, M/C 1800
Berkeley, California 94720

George Antaki
WGI
Savannah River Site, 730-1B
Aiken, South Carolina 29808

Craig D. Comartin
CDComartin Engineering
7683 Andrea Avenue
Stockton, California 95207-1705

Robert Bachman
R.E. Bachman, Consulting Structural Engineer
880 Dartmouth Street
San Francisco, California 94134

Peter Dusicka
Portland State University
Dept. of Civil & Environmental Engineering
P.O. Box 751
Portland, Oregon 97207-0751

John Caffrey
University of Southern California
Dept. of Civil & Environmental Engineering
KAP 268, Mail Code: 2531
Los Angeles, California 90089

Andre Filiatrault
MCEER, SUNY at Buffalo
Red Jacket Quadrangle
Buffalo, New York 14032

Philip J. Caldwell
Square D/Schneider Electric
1990 Sandifer Blvd.
Seneca, South Carolina 29682

William E. Gates
URS Corporation
915 Wilshire Blvd., Suite 700
Los Angeles, California 90017

Scott Campbell
Kinetics Noise Control
6300 Irelan Place
Dublin, Ohio 43017

Jeff Gatscher
Schneider Electric
1010 Airpark Center Drive
Nashville, Tennessee 37211

James A. Carlson
Seismic Source Company
P.O. Box 586
Springfield, Nebraska 68059

Barry Goodno
Georgia Institute of Technology
School of Civil Engineering
790 Atlantic Drive
Atlanta, Georgia 30332-0355

Nathan C. Gould
ABS Consulting Inc.
1844 Lackland Hills Pkwy.
St. Louis, Missouri 63146

Bernadette Hadnagy
Applied Technology Council
201 Redwood Shores Pkwy., Suite 240
Redwood City, California 94065

Ronald Hamburger
Simpson Gumpertz & Heger
The Landmark @ One Market, Suite 600
San Francisco, California 94105

Robert Hanson
FEMA
2926 Saklan Indian Drive
Walnut Creek, California 94595-3911

Brian Kehoe
Wiss, Janney, Elstner Associates, Inc.
2200 Powell Street, Suite 925
Emeryville, California 94608

Robert P. Kennedy
RPK Structural Mechanics Consulting, Inc.
28625 Mountain Meadow Road
Escondido, California 92026

Charles Kircher
Kircher & Associates
1121 San Antonio Road, Suite D-202
Palo Alto, California 94303-4311

Helmut Krawinkler
Stanford University
Dept. of Civil Engineering
Stanford, California 94305-4020

Steven Kuan
Public Works & Government Services Canada
800 Burrard Street, Room 641
Vancouver, BC Canada V6Z 2V8

Richard Lloyd
Mason Industries
2101 West Crescent Avenue, Suite D
Anaheim, California 92801

Joe Maffei
Rutherford & Chekene
427 Thirteenth Street
Oakland, California 94612

Mike Mahoney
Federal Emergency Management Agency
500 C Street, SW, Room 404
Washington, DC 20472

Manos Maragakis
University of Nevada, Reno
Dept. of Civil Engineering
Mail Stop 258
Reno, Nevada 89557

Sami Masri
University of Southern California
Dept. of Civil Engineering, MC 2531
Los Angeles, California 90089-2531

Ali M. Memari
Pennsylvania State University
Dept. of Architectural Engineering
104 Engineering Unit A
University Park, Pennsylvania 16802-1416

Kelly Merz
ARES Corporation
3010 Old Ranch Parkway
Seal Beach, California 90740

Eduardo Miranda
Stanford University
Dept. of Civil & Environmental Engineering
Terman Room 293
Stanford, California 94305-4020

Gokhan Pekcan
University of Nevada, Reno
Dept. of Civil Engineering
Mail Stop 258
Reno, Nevada 89557

Andrei M. Reinhorn
University at Buffalo
Dept. of Civil Engineering
231 Ketter Hall
Buffalo, New York 14260

Jose Restrepo
University of California at San Diego
9500 Gillman Drive, Dept. 0085
La Jolla, California 92093-0085

Christopher Rojahn
Applied Technology Council
201 Redwood Shores Pkwy., Suite 240
Redwood City, California 94065

Anshel Schiff
Precision Measurement Instruments
27750 Edgerton Road
Los Altos Hills, California 94022

John Silva
Hilti Inc.
84 Mt. Rainier Drive
San Rafael, California 94903

Don Smith
Wyle Laboratories
7800 Highway 20 West
Huntsville, Alabama 35806

Greg Soules
Chicago Bridge and Iron Co.
2103 Research Forest Drive
One CB&I Plaza
The Woodlands, Texas 77380-2624

William Staehlin
Division of the State Architect
1225 R Street
Sacramento, California 95814

Chris Tokas
OSHPD
1600 9th Street, Room 420
Sacramento, California 95814

Chia-Ming Uang
University of California, San Diego
Structural Engineering Department
409 University Center
La Jolla, California 92093-0085

James Wilcoski
ERDC-CERL
P.O. Box 9005
Champaign, Illinois 61826-9005

