

# Association of State Dam Safety Officials (ASDSO)/EPRI Spillway Gate Workshop

January 5 & 6, 2000



**WARNING:**  
Please read the License Agreement  
on the back cover before removing  
the Wrapping Material.

*Technical Report*

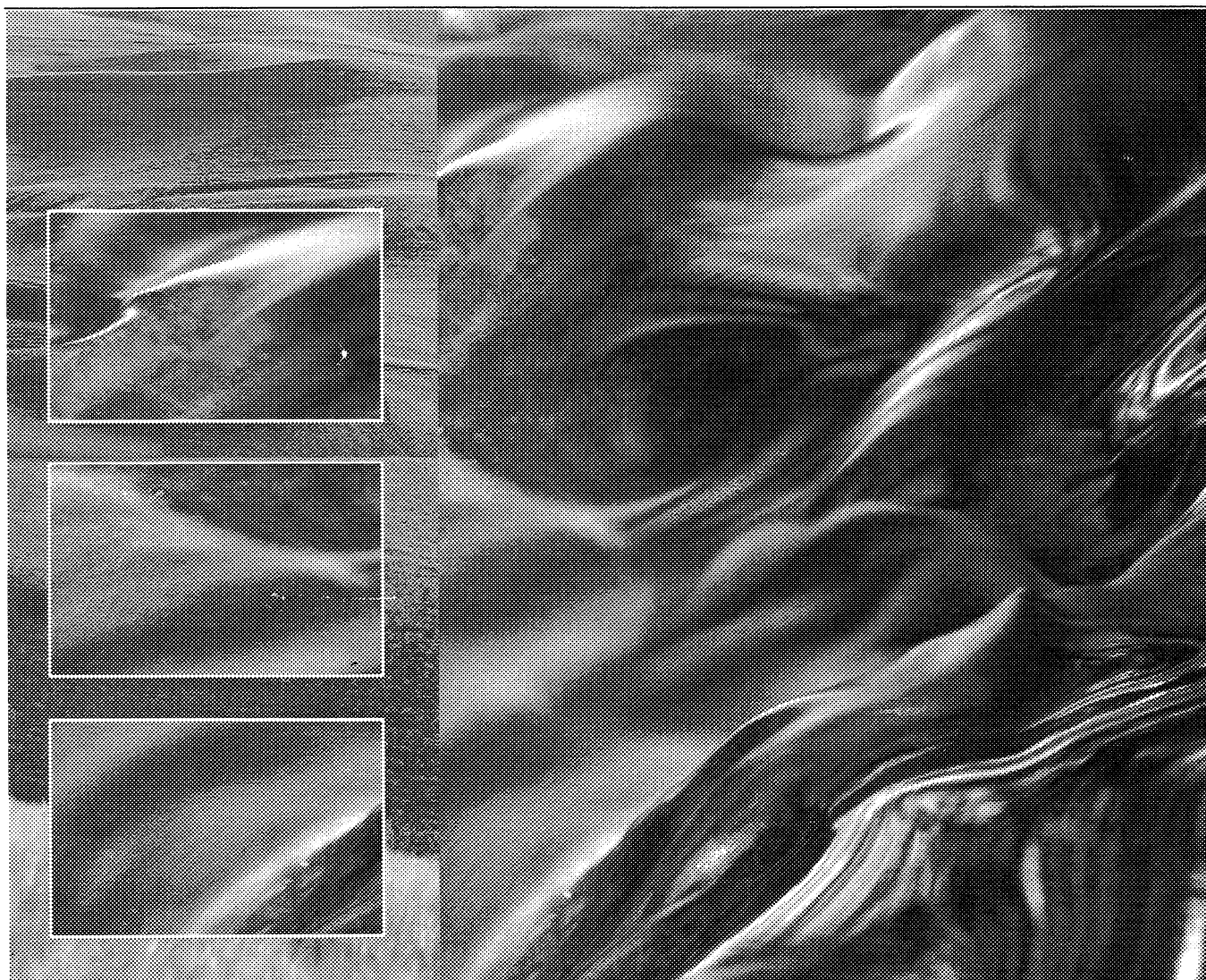

# **ASSOCIATION OF STATE DAM SAFETY OFFICIALS (ASDSO)/EPRI SPILLWAY GATE WORKSHOP**

January 5 & 6, 2000

**Product ID # 00000000001000101**

Final Report, June 2000

Cosponsor  
ASDSO  
450 Old Vine Street  
Lexington, KY 40507

EPRI Project Manager  
M. Bahleda

## **DISCLAIMER OF WARRANTIES AND LIMITATION OF LIABILITIES**

THIS DOCUMENT WAS PREPARED BY THE ORGANIZATION(S) NAMED BELOW AS AN ACCOUNT OF WORK SPONSORED OR COSPONSORED BY THE ELECTRIC POWER RESEARCH INSTITUTE, INC. (EPRI). NEITHER EPRI, ANY MEMBER OF EPRI, ANY COSPONSOR, THE ORGANIZATION(S) BELOW, NOR ANY PERSON ACTING ON BEHALF OF ANY OF THEM:

(A) MAKES ANY WARRANTY OR REPRESENTATION WHATSOEVER, EXPRESS OR IMPLIED, (I) WITH RESPECT TO THE USE OF ANY INFORMATION, APPARATUS, METHOD, PROCESS, OR SIMILAR ITEM DISCLOSED IN THIS DOCUMENT, INCLUDING MERCHANTABILITY AND FITNESS FOR A PARTICULAR PURPOSE, OR (II) THAT SUCH USE DOES NOT INFRINGE ON OR INTERFERE WITH PRIVATELY OWNED RIGHTS, INCLUDING ANY PARTY'S INTELLECTUAL PROPERTY, OR (III) THAT THIS DOCUMENT IS SUITABLE TO ANY PARTICULAR USER'S CIRCUMSTANCE; OR

(B) ASSUMES RESPONSIBILITY FOR ANY DAMAGES OR OTHER LIABILITY WHATSOEVER (INCLUDING ANY CONSEQUENTIAL DAMAGES, EVEN IF EPRI OR ANY EPRI REPRESENTATIVE HAS BEEN ADVISED OF THE POSSIBILITY OF SUCH DAMAGES) RESULTING FROM YOUR SELECTION OR USE OF THIS DOCUMENT OR ANY INFORMATION, APPARATUS, METHOD, PROCESS, OR SIMILAR ITEM DISCLOSED IN THIS DOCUMENT.

ORGANIZATION(S) THAT PREPARED THIS DOCUMENT

**EPRI**

## **ORDERING INFORMATION**

Requests for copies of this report should be directed to the EPRI Distribution Center, 207 Coggins Drive, P.O. Box 23205, Pleasant Hill, CA 94523, (800) 313-3774.

Electric Power Research Institute and EPRI are registered service marks of the Electric Power Research Institute, Inc. EPRI. POWERING PROGRESS is a service mark of the Electric Power Research Institute, Inc.

Copyright © 2000 Electric Power Research Institute, Inc. All rights reserved.

# CITATIONS

---

This report was prepared by:

EPRI  
3412 Hillview Ave.  
Palo Alto, CA 94304

Principal Investigators  
M. Bahleda  
B. Reuland

This report describes research sponsored by EPRI and the Association of State Dam Safety Officials (ASDSO).

The report is a corporate document that should be cited in the literature in the following manner:

*Association of State Dam Safety Officials (ASDSO)/ EPRI Spillway Gate Workshop: January 5 & 6, 2000.* EPRI, Palo Alto, CA, and the Association of State Dam Safety Officials, Lexington, KY: 2000. 000000000001000101.

# REPORT SUMMARY

---

Maintaining the integrity of dams at hydroelectric projects is essential to the protection of communities, the surrounding environment, and the power and resource management infrastructure. The Spillway Gate Workshop, sponsored by the Association of State Dam Safety Officials (ASDSO) and EPRI, and with funding from the Federal Emergency Management Agency (FEMA), focused on a critical aspect of the safety issues related to analysis, inspection, maintenance, and performance of spillway gates. The intent of the workshop was to discuss the Federal Energy Regulatory Commission (FERC) initiative on spillway gate safety, to assess the impact of the initiative and other related programs on gated spillways in general, and to propose future actions.

## **Background**

On July 17, 1995 the failure of a tainter gate at the United States Bureau of Reclamation's (USBR) Folsom Dam at Folsom, California caused much of the industry to reassess its inspection criteria and gate performance requirements. As part of the industry reassessment, the California Department of Dam Safety issued a letter to dam owners requiring them to evaluate the condition of their tainter gates and provide the Department with details of their gate operation, inspection, and maintenance practices. The intent was to ensure that adequate design, analysis, inspection, and maintenance programs were in place to preclude similar incidents at other facilities. The FERC's Division of Dam Safety and Inspection issued a similar letter to federal licensees.

The industry responded with the results of their individual programs. From these results, a consensus evolved indicating the need for a more uniform design, analysis, inspection, and maintenance program. The FERC was the logical organization to develop guidelines for federal licensees. For other dam owners, program guidelines would need to be developed by their respective regulatory authorities. This provided an opportunity to include the experience of various agencies and operators in the guidelines. The Interagency Committee on Dam Safety (ICODS) could also use this experience to develop more uniform recommendations across a broader spectrum of the industry.

## **Objectives**

- To assemble a forum of experts to discuss programs that resulted from FERC's initiative on tainter gate inspection and other industry initiatives that address issues applicable to all gate types
- To provide technical data on the state of the art so that industry and regulatory representatives could jointly develop programs for gate inspections that are effective, efficient, and cost-effective for operators

- To encourage an interchange of ideas between regulators, government agencies involved in generation, operators, and consultants
- To identify future research needs and make recommendations as to how these needs might be addressed

### **Approach**

With funding from FEMA, under the sponsorship of ASDSO, a two-day workshop was developed by EPRI.

On the first day, invited speakers presented papers on how their organizations were responding to the FERC initiative. In the case of other government agencies, the presentations focused on actions they were taking in parallel to the California Division of Dam Safety and FERC initiatives to ensure the integrity of structures under their jurisdiction. The majority of the second day of the workshop was devoted to the participants brainstorming on the major topic areas.

### **Results**

The workshop was held at EPRI's facilities in Palo Alto, California on January 5 and 6, 2000 and was attended by 28 professionals representing a broad cross-section of the dam safety community. Participants came away with a clear understanding of the current key concerns relative to spillway gates, available information on ongoing inspection programs, and approaches to field inspection. From this interactive group, a set of discussion points was developed and a set of action items was established for the future.

### **EPRI Perspective**

Dam safety in general, and gate safety in particular, are areas of great importance not only to the hydroelectric community but also to the general public. As demonstrated by the attendance at this workshop and the general interest of the dam safety community in the subject, utility interest in dam safety issues remains very high.

The ASDSO/EPRI Spillway Workshop was part of a plan by the ICODS Research Subcommittee. In concert with the FERC/EPRI Workshop on Tainter Gates, this workshop was intended to explore the specific issues related to spillway gate performance for the dam safety community and to develop future research objectives. This is part of EPRI's continuing commitment to dam safety. Information from both workshops will be used as part of an ongoing discussion of the most appropriate ways to address gated spillways and their impact on public safety.

**00000000001000101**

### **Keywords**

Spillway gates  
Spillways  
Tainter gates  
Drum gates  
Inflatable gates  
Lift gates

## **ABSTRACT**

---

One of the outcomes of the Folsom tainter gate failure was the general awareness of a need to revisit the issues related to gate performance and safety. In addition to the programs initiated by the Federal Energy Regulatory Commission (FERC) and the California Department of Dam Safety, the Interagency Committee on Dam Safety (ICODS) Research Subcommittee sponsored a plan to develop related research topics. The FERC and EPRI jointly organized the Tainter Gate Workshop held in Arlington, Virginia on October 26-27, 1999. Interested parties from across the industry were invited to share their perspectives on the FERC initiative regarding tainter gate safety and discuss how to improve the effectiveness of dam safety guidelines. A similar workshop was also developed that would address the same issues for other types of spillway gates with an emphasis on non-FERC jurisdictional dams. This workshop was developed by ASDSO and EPRI with funding from the Federal Emergency Management Agency (FEMA). The intent of this workshop was to integrate what had been learned from the tainter gate failure and apply it across the broad spectrum of spillway gates.

This report provides a summary of the ASDSO/EPRI workshop and recommendations for future efforts. It also serves as a reference for regulatory agencies as they refine regulatory requirements in this area.

# CONTENTS

---

<b>1 OVERVIEW</b> .....	<b>1-1</b>
<b>2 PURPOSE OF THE WORKSHOP</b> .....	<b>2-1</b>
<b>3 OUTLINE OF THE WORKSHOP AGENDA</b> .....	<b>3-1</b>
<b>4 SUMMARY OF WORKSHOP PRESENTATIONS</b> .....	<b>4-1</b>
4.1 <i>Spillway Gate Inspection, An Owner’s Perspective</i> —Tommy Duncan, Southern Company.....	4-1
4.2 <i>Failure Analysis of Gates</i> —Bernard Peters, URS Greiner Woodward Clyde .....	4-1
4.3 <i>California’s Radial Gate Inspection Program</i> —Fred Sage, California Division of Safety of Dams.....	4-1
4.4 <i>Overview of Tennessee Valley Authority’s (TVA) Gate Inspection Program</i> —Greg Lewis, TVA .....	4-2
4.5 <i>The United States Committee on Large Dams (USCOLD) Programs</i> —Dr. B.T.A. Sagar, ECI.....	4-2
4.6 <i>Performance Experience</i> —Norman Bishop, Stone and Webster .....	4-3
4.7 <i>Tainter Gate Initiative/Allowable Stresses</i> —Rick Poeppelman, Sacramento District/South Pacific Division, United States Army Corps of Engineers (COE).....	4-3
4.8 <i>Radial Gates Analysis, Seismic Issues</i> —Rashid Ahmad, California Division of Safety of Dams.....	4-4
4.9 <i>Condition Assessment of Gates and Related Components</i> —Stuart Foltz, Construction Engineering Research Laboratory, United States Army Corps of Engineers (COE) .....	4-4
4.10 <i>Structural Investigation of a Broken Gate Hoist Pillow Block</i> —Eugene Chan, Pacific Gas and Electric (PG&E).....	4-4
4.11 <i>How Safe is Safe Enough?</i> —Bruce Brand, Federal Energy Regulatory Commission (FERC).....	4-4
4.12 <i>Hydro Projects Gate Equipment Design Issues</i> —Chander K. Sehgal, Harza Engineering Co. ....	4-5
4.13 <i>Inspection of Dam Gate Structures</i> —Raymond H. Stokes, Burgess and Niple .....	4-5
4.14 <i>Radial Gate Inspections</i> —Wayne Edwards, HDR Engineering, Inc. ....	4-5



<b>5 BRAINSTORMING SESSIONS .....</b>	<b>5-1</b>
5.1 What Was Learned .....	5-1
5.2 What Don't We Know? .....	5-2
5.3 What We Need to Know .....	5-2
5.4 Action Items .....	5-3
<b>6 CONCLUSIONS AND RECOMMENDATIONS .....</b>	<b>6-1</b>
6.1 Conclusions .....	6-1
6.2 Recommendations .....	6-1
<b>7 SELECT BIBLIOGRAPHY .....</b>	<b>7-1</b>
7.1 Technical Reports .....	7-1
7.2 Journal Articles.....	7-3
7.3 Conference Papers .....	7-4
7.4 ASDSO Conference Papers.....	7-5
<b>A PRESENTATIONS .....</b>	<b>A-1</b>
<b>B ATTENDEES.....</b>	<b>B-1</b>
<b>C AGENDA.....</b>	<b>C-1</b>

# 1

## OVERVIEW

---

One of the outcomes of the Folsom tainter gate failure was the general awareness of a need to revisit the issues related to gate performance and safety. In addition to the programs initiated by the Federal Energy Regulatory Commission (FERC) and the California Department of Dam Safety, the Interagency Committee on Dam Safety (ICODS) Research Subcommittee sponsored a plan to develop related research topics. The FERC and EPRI jointly organized the Tainter Gate Workshop held in Arlington, Virginia on October 26-27, 1999. Interested parties from across the industry were invited to share their perspectives on the FERC initiative regarding tainter gate safety and discuss how to improve the effectiveness of dam safety guidelines. A similar workshop was also developed that would address the same issues for other types of spillway gates with an emphasis on non-FERC jurisdictional dams. The resulting workshop, developed by ASDSO and EPRI, with funding from the Federal Emergency Management Agency (FEMA), focused on the following three main themes related to gated spillways:

- What is known about gate failures
- What is not known about gate failures
- What knowledge is needed

The intent of this workshop was to integrate what had been learned from the tainter gate failure and apply it across the broad spectrum of spillway gates.

This report provides a summary of the ASDSO/EPRI workshop and recommendations for future efforts. It also serves as a reference for regulatory agencies as they refine regulatory requirements in this area.

# 2

## **PURPOSE OF THE WORKSHOP**

---

The purpose of the workshop on spillway gates was to:

- Develop a consensus on what the industry already knows about the proper and safe operation of gates
- Determine where the industry was still lacking in sufficient data
- Develop recommendations for new research that might be needed

Another important aspect of the conference was to provide guidance for the FEMA seminar on spillway gates scheduled for February 23, 2000. This seminar, which is part of the ICODS (Interagency Committee on Dam Safety) training program, identifies recommendations for design consideration, analysis, operations, and maintenance related to spillway gates.

# 3

## OUTLINE OF THE WORKSHOP AGENDA

---

The Workshop agenda is presented in Appendix C.

For the two-day workshop, ASDSO and EPRI had arranged for a number of presentations by organizations with recent experience in spillway gate inspections, design, analysis, and maintenance. Those presentations were included to help focus subsequent discussions on actual and potential problems and the associated maintenance and inspection activities that would address those problems.

The first day was devoted to presentations by a range of organizations including state and federal dam safety regulatory agencies, federal agencies that own and operate dams, electric utility representatives, and consulting engineering companies. All the presenters had been involved with gate inspections and/or analyses since the gate failure at Folsom Dam. The presenters discussed their safety and inspection procedures, their maintenance policies, the instrumentation they had used during the inspections, and discoveries they had made. By the end of the day, the workshop attendees had an excellent idea of the challenges of gate inspections and some of the solutions. Several aspects were identified that have a major effect on the cost or accuracy of inspection and analysis.

The second day concluded the presentations with a focus on design issues. This was followed by a brainstorming session that addressed the following four main points:

- What has been learned
- What is significant
- What remains unknown
- Action items

The action items were included to provide the industry with proposals for additional actions needed and how they might be pursued either through regulatory initiatives or joint actions within the industry.

# 4

## SUMMARY OF WORKSHOP PRESENTATIONS

---

This section provides some of the main points of the formal presentations given at the workshop. More detailed information can be obtained from the individual presentations reproduced in Appendix A of this report.

### **4.1 *Spillway Gate Inspection, An Owner's Perspective*—Tommy Duncan, Southern Company**

This presentation focused on the Southern Company's response to the FERC initiative on gate inspections and some of the insights they had gained in the process. Some of their responses had been procedural, such as timing of inspections and painting activities to gain efficiencies in scaffolding, or increasing hoist inspection frequencies to more fully incorporate them into routine preventive maintenance programs. There were also comments on the advantage of documents, like the FERC initiative, which provides an explanation of the need for inspection and maintenance programs.

### **4.2 *Failure Analysis of Gates*—Bernard Peters, URS Greiner Woodward Clyde**

Mr. Peters' presentation focused on gate analysis from a mechanical systems perspective. This perspective allows the operator to concentrate on the risk analysis of system components that might not be accessible in a routine visual inspection. As an example, visual inspection of trunnion pins in an operating environment would not necessarily identify corrosion that could lead to eventual failure. Possible solutions could include acoustic measurements to establish a baseline condition. Like amperage testing of gate motors, this could provide useful trending, although it would not identify specific problems.

### **4.3 *California's Radial Gate Inspection Program*—Fred Sage, California Division of Safety of Dams**

Mr. Sage presented the program that outlined the state of California's response to the Folsom tainter gate event. In recognition of the effectiveness of the FERC program and in part due to budget constraints, California concentrates its effort on non-licensed dams. Most of the other state jurisdictions that were represented also took this tack. There was recognition of the following two basic premises in Mr. Sage's presentation:

- That there is a need for coordination between overlapping jurisdictions such as the FERC and California Dam Safety

*Summary of Workshop Presentations*

- That gate performance and safety are the owner's responsibility. Regulators need to perform a review function to ensure that owners meet this responsibility.

#### **4.4 Overview of TVA's Gate Inspection Program—Greg Lewis, TVA**

The TVA presentation focused on their inspection program and issues common to the industry. Common issues included aging infrastructure and a general lack of original design information for older facilities. The combination of these two factors, along with restrictions on full height gate testing, makes it difficult to set up inspection programs that provide trending data measurable against a known base. Given this difficulty, several surrogate-monitoring programs might help to provide meaningful trending data. These surrogate-monitoring programs include motor current monitoring and routine oil sampling.

TVA's program has also shown that problems such as expansive aggregates and vibration under vertical lift gates can eventually lead to binding and ultimately to gate failure. These are indirect issues that need to be monitored in connection with gate performance.

#### **4.5 The United States Committee on Large Dams (USCOLD) Programs—Dr. B.T.A. Sagar, ECI**

Dr. Sagar's presentation discussed two primary issues. He first, presented an overview of related programs being conducted under the auspices of the USCOLD. These related programs include:

- USCOLD Committee on Hydraulics of Dams
- USCOLD Gates and Valves Subcommittee
- Bulletin: Improving Spillway Gate Reliability
- Bulletin: Large Valve Selection Criteria

He discussed these programs in the context of some of the major factors that need to be considered in the design process. Dr. Sagar sees the intent to make gates and, by extension, dams safe for the next 50 years. Some of the elements that need to be included in a program to upgrade gate safety include:

- Consideration of bottom gate geometry and the effects of vibration
- Corrosion
- Seal configuration
- Pin lubrication
- The importance of good maintenance records

One of Dr. Sagar's recommendations was to consider the development of mandatory inspection programs for gate pins.

#### **4.6 Performance Experience—Norman Bishop, Stone and Webster**

Mr. Bishop's presentation added to the list of factors that need to be considered as part of gate inspection and analysis programs. These included:

- Ductility of metals
- Rail and roller hardness mismatches
- Contact stresses that are significantly higher than original design calculations
- Alignment issues that result from combined bolted and welded construction
- Expansive aggregate issues
- Closer monitoring of hoist motor performance

Of Mr. Bishop's recommendations, one was for more detailed motor inspections including monitoring of voltage, power, and amperage during gate raising to develop performance trends. Another recommendation was for operators to observe all gate raisings, not just in test situations. This recommendation led to considerable discussion related to automated gate operation and labor costs.

#### **4.7 Tainter Gate Initiative/Allowable Stresses—Rick Poeppleman, Sacramento District/South Pacific Division, United States Army Corps of Engineers (COE)**

Mr. Poeppleman concentrated his discussion on the Corps' approach to the analysis aspect of the overall gate program. The Corps' guidance documents still leave some room for interpretation, with a sufficient safety factor margin to cover uncertainties. For this to be used effectively, certain key elements have to be considered as part of the analysis:

- The reasonableness of the original load criteria
- Determination of whether connections were originally designed for gravity loads only
- Factors not considered in the original design

These elements lead to the following additional steps that can be taken to reduce uncertainty in assessing how gates are likely to perform:

- Education of operations and maintenance personnel on design basis
- Inspection of anchorage points
- Material testing to verify load carrying capabilities, where analysis indicates that the original design might not have been adequate
- Model testing for gate performance under simulated seismic loads

#### **4.8 Radial Gates Analysis, Seismic Issues—Rashid Ahmad, California Division of Safety of Dams**

Mr. Ahmad's presentation discussed the seismic loading characteristics that need to be factored into gate analysis. Seismic load definition, seismic analysis, water level during an earthquake event, dynamics of radial gates, and the effect of hydrodynamic mass all influence the gate's performance. Determination of these factors can lead to a major increase in period and change in mode shape. Each factor can have different relative importance in various modes. Because of the uncertainty in earthquake loading conditions and the dynamic response of gates, more modeling and field instrumentation under actual event conditions is needed to help predict the significance of the hydrodynamic mass in altering mode shape and period. This might, in turn, establish a range of seismic safety factors dependant on reservoir levels.

#### **4.9 Condition Assessment of Gates and Related Components—Stuart Foltz, Construction Engineering Research Laboratory, United States Army Corps of Engineers (COE)**

Mr. Foltz's presentation discussed the COE's condition index techniques to assess gates and prioritize maintenance. COE tries to weigh the results to take into account such factors as age and wear on individual gate systems. Of key interest to the audience was the work being done on monitoring gate arm deflection. Although early in the process, this technique offers an opportunity to calculate strain and hinge friction effects. The approach offers a future research opportunity to better quantify hinge effects. COE is continuing its research in this area, which might lead to an opportunity for collaborative work.

#### **4.10 Structural Investigation of a Broken Gate Hoist Pillow Block—Eugene Chan, Pacific Gas and Electric (PG&E)**

Mr. Chan discussed the results from PG&E's inspection of their Poe River project following the failure of Gate #3 to open. After thorough analysis of the situation, PG&E determined that the lack of adequate lubrication led to a series of failure mechanisms, resulting in the break of one of the hoisting chains and, ultimately, the binding of the gate. The experience highlighted the criticality of proper and ongoing training programs for operations and maintenance (O&M) personnel to assure successful gate performance.

#### **4.11 How Safe is Safe Enough?—Bruce Brand, FERC**

Mr. Brand discussed the need for heightened awareness of gate design and maintenance practices. Basically, the most critical case is the one that hasn't been considered and prepared for. This highlights the need to look at the system from a holistic perspective. For example, particular attention should be paid to areas such as anchorage and chain connections.

This presentation also recognized that all gates do not present the same level of risk. Accordingly, the FERC is reviewing a matrix that will outline less frequent inspections based on potential impact. It would still be incumbent on dam owners to make a case justifying why less



frequent inspections are warranted in each case. This move was in direct response to concerns raised at the Tainter Gate Workshop held in Arlington, Virginia in October 1999. A copy of the proposed matrix is included with Mr. Brand's presentation in Appendix A. As this is still in the development phase, Mr. Brand stressed the need for more dam operators' input to round out the process.

#### **4.12 *Hydro Projects Gate Equipment Design Issues*—Chander K. Sehgal, Harza Engineering Co.**

Mr. Sehgal's presentation offered a comprehensive list of the issues that need to be considered in the design of gates and associated hoisting equipment. It provides an excellent checklist for review. He stressed the point that each gate is a custom designed product and, in many cases, over its life might be required to withstand larger loads than originally anticipated, a point that was reinforced by several other presentations. Accordingly, the following factors should be considered when designing or operating gates. These include the need to:

- Be conservative in performing the design
- Consistently train younger engineers in design techniques
- Keep accurate records of operational performance and provide continual feedback to the designers for meaningful improvements in future designs

#### **4.13 *Inspection of Dam Gate Structures*—Raymond H. Stokes, Burgess and Niple**

Mr. Stokes' presentation focused on the inspection program used by Burgess and Niple to assess gate structures. The program was developed initially for bridge inspection. Relying on mountain climbing techniques, the program allows for close hands-on inspection. This is supplemented by a database management system used to collect and store inspection data for retrieval and comparison.

This presentation led the group to discuss the need for a standardized tool that would aid in evaluation and training. This point was discussed in more detail during the brainstorming session.

#### **4.14 *Radial Gate Inspections*—Wayne Edwards, HDR Engineering, Inc.**

Mr. Edwards' presentation also dealt with gate inspection programs. His focus was on the criticality of original design information. Initially, original design data is needed for direct comparison to field observation. Once field information is collected, the analysis of actual versus design condition provides the basis for reassessing gate functionality and future remediation if needed.

This presentation included several examples from actual inspections to emphasize the need for a thorough program of operator awareness, field inspection, analysis, and comparison to original criteria.

# 5

## BRAINSTORMING SESSIONS

---

The second afternoon was devoted to a brainstorming session during which participants tried to recap what had been learned from the presentations. The intent was to use the information that had been presented to identify a set of recommendations for industry action and to identify where that action might best be taken. The following is a summary of the contents, direction, and results of the brainstorming session.

### 5.1 What Was Learned

In general what was learned from the session can be summarized as follows:

- **Gate performance is taken for granted.**

In many cases, a consistent ongoing detailed inspection, required for these significant components, was not performed. In a number of cases, this led to minor failures or situations where gate reliability in critical situations was questionable. The criticality of detailed inspection was highlighted in several instances by a post mortem failure analysis that identified the root cause or initiating event as a relatively minor issue that was easily preventable. This highlighted the ongoing need for operator training and increased awareness of the need for routine inspections.

- **There were a number of gate failures that simply did not get wide spread attention.**

There is still no uniform mechanism for reporting gate failures to a common database, which could then be used to analyze performance trends within the industry. The National Performance of Dams Program (NPDP) database at Stanford University provides a potential mechanism, but it is not uniformly utilized. Relatively minor items or incidents, which can be handled by plant personnel, do not routinely make it into the database. As such, trends in root cause issues go undetected. The industry needs more uniform rules for reporting incidents. To be effective, this might require mandatory reporting requirements similar to change-in-elevation reporting required for most run-of-river plants as part of their license conditions. This data could be trended for differing gate types and sizes.

- **The importance of coatings as a part of maintaining gates.**

In many of the anecdotal incidents discussed in the workshop, lack of appropriate coating was noted as one of the root causes of diminished integrity. The routine coating of exposed surfaces presents a good opportunity to perform inspections of less accessible areas of the gate structures. Good coating systems are also the first line of defense in the loss of structural integrity and, as such, are an integral part of assuring gate performance. The critical issue highlighted was that proper coating is a significant component of any gate maintenance program and has to be considered in the budgeting for gate work.

## 5.2 What Don't We Know?

- **Earthquake effects on gates.**

There is still a great deal that we do not understand about how gates perform in seismic situations. One of the most significant issues is related to their performance under the condition of different reservoir levels. To provide a clearer understanding of gate performance in extreme situations, the industry could benefit from both modeling and increased instrumentation of facilities in seismically active areas.

- **There is still a need for guidelines based on comments from industry representatives.**

It was reaffirmed in this workshop and in the workshop sponsored by the FERC that operators are looking for guidance from regulators. Operators want inspection and analysis programs that adequately address the issues and that take into account the cost of doing business. A tiered-approach, which takes into account the impact of a potential gate failure, could be very appealing. Under this kind of program, resources and efforts would be focused on structures that presented the greatest risk to the public or to the ongoing operation. It would allow for less stringent criteria or lower frequency of inspection where it could be demonstrated that the risks were not as great. This also ties into risk assessment techniques being developed in the industry.

- **There is a need for the compilation of the 1000+ gate inspections by FERC.**

This comment ties into the general comments made earlier on the need for collecting incident reports. The consensus was that the information already collected by FERC from licensees could provide the basis for beginning industry trending. The information needs to be categorized by type and size so that it can be used to provide guidance on design issues as well as on issues related to remediation. The group believed that the FERC data provides the start of a good program because the responses from licensees identify sizes and types of gates, along with information on condition and analysis of the gate's ability to perform as intended.

## 5.3 What We Need to Know

These are the areas where the group believes that further investigation is warranted and would be beneficial to the industry as a whole. Through the anecdotal information, it appeared that there were many unanswered issues and reoccurring problems. Issues raised included:

**Issue:** Seismic Analysis. As discussed in Mr. Ahmad's presentation of current modeling techniques, there is an area of uncertainty related to how gates will respond. Issues revolve around the influence of the various loading configurations that differing pond levels will have on actual gate response.

**Recommendation:** Expand the modeling work to look at the effect of different reservoir levels. To validate modeling results, this should be supplemented by instrumenting facilities located in active seismic regions. There was no consensus, however, as to which organization was best

equipped to pursue this expanded modeling program. A possible collaboration between federal agencies and the academic community was suggested.

**Issue:** Trunnions. This issue specifically relates to the adequacy of lubrication systems, lubricants, and the frequency of application. How does an operator test the lubrication system to assure that the original design intent is being met? The focus here is on the functioning of the lubrication system and not just the operation of the gate. In many cases, gate operation did not display significant loss of function in testing prior to failure. The impact was not necessarily visibly incremental in its effect.

**Recommendation:** Develop guidelines/a mechanism for assessing performance of bearing and lubrication systems.

**Issue:** Seals. This issue addresses the impact of bearing seals on bearing performance. For example, how do contaminants, moisture, and corrosion explicitly affect performance? There is a great deal of implicit information on the effect of preventing corrosion and reducing friction in a bearing, however, there is little documented field data when bearings are removed. There is little test data to predict improvement in bearing performance based on installation of proper seals.

**Recommendation:** Collect and analyze this type of data.

**Issue:** Incident Analysis. There is a lack of incident data related to gates.

**Recommendation:** There should be some means of analyzing the root cause of a failure based on data in a central database. This data could then be used to further define trends based on gate type and size considerations or recurring loading conditions.

## 5.4 Action Items

Based on the discussion of what had been learned thus far and on some of the remaining critical issues, the group tried to identify action items that could be recommended to the industry as the next step in trying to close the gap between the current state of practice related to gate performance and preferred practices identified from the workshop and other forums. The group tried to develop proposals that identified action by specific organizations and, where possible, that identified funding sources that could be pursued to implement proposed actions.

Following, are the action items that were developed in the workshop:

- **Develop a guideline or training program for day to day inspection and operations.** The USBR has a Dam Safety Training Course that could serve as the basis for such a guide. The thought was to update this training program using the information that had been gained since the Folsom incident. The program could be put on a CD-ROM or possibly posted on the Web to be downloaded. The intent was to make a training tool that was easily accessible to the broadest audience of operators. This would give smaller operations the chance to gain from the expertise of larger programs and improve gate maintenance and inspection overall. It was thought that this might be a candidate for FEMA research funding. Because of its broad

*Brainstorming Sessions*

application, it might also present an opportunity for co-funding from the USBR, COE, and possibly through EPRI's value package dealing with dam safety. Sale of the CD through ASDSO might present an opportunity to recoup some of the development cost but the group believes this should be a secondary consideration. The primary purpose should be to disseminate the information to the widest audience of operators.

- **Develop tainter gate instrumentation to collect data on trunnion friction and other load issues such as seismic response of gates.** Building on the work already done by the COE, the group looked at the possibility of a joint COE/ USBR program to continue the investigation into gate arm deflection monitoring. Depending on what the two agencies would be able to develop, this might also be a program that EPRI members would be able to participate in through the dam safety program. Because efforts thus far have been focused on large gates, EPRI member participation might be directed through a tailored collaboration by members with similarly sized gate structures. It was left to Stuart Foltz (COE) and Robert Todd (USBR) to follow up and determine what funding might be available and report back to FEMA.

The program dealing with deflection as it related to trunnion performance was seen as the project that would likely have the most support. Although the group saw the instrumentation for seismic monitoring as worth pursuing, funding was viewed as more questionable. There were no specific recommendations for developing a program and soliciting funding.

- **Develop and publish articles to maintain a general level of awareness about gate issues within the industry.** The group felt this was important in order to keep information on gate issues in front of operators. One way to do this would be to publish case history type articles about specific gate problems in industry periodicals such as the *ASDSO Newsletter*. This offers the advantage of broad distribution to regulators and operators. Operators could submit articles on subjects such as condition assessment on trunnion pins following maintenance and replacement. The industry would, thus, begin to build the database needed for the assessment of these types of issues.

Another part of this program could be a series of articles published in the newsletter based on papers already in publication. These would serve to keep the issues open for operators and provide the benefit of getting more expert information out to operators. Along with the articles by operators this would add to the compendium of information easily available to interested parties through ASDSO's Bibliographical Library.

- **Assemble data gathered from across the industry to facilitate trending analysis.** The FERC and organizations like the California Division of Dam Safety have collected a large amount of data through their initiatives. One possibility would be to use interns to transfer this data to a format that could easily be incorporated into the NPDP database at Stanford University. Funding for this activity could possibly come from FEMA research funds. This might allow the hiring of an intern to assemble data into a format that could be entered into the NPDP.
- **Provide a tool for operators to benchmark their programs with recognized good programs.** This was also one of the recommendations intended to maintain operator awareness of the issues related to gates, in addition to encouraging improved inspection and maintenance programs. The concept was that both the FERC and the California Division of Dam Safety, through their initiatives, had an opportunity to observe strong programs dealing

with inspection, maintenance, and analysis. Using these observations, both agencies could identify strong programs and the associated characteristics. This could be published in the *ASDSO Newsletter* or other publications such as an individual state's dam safety organization's newsletter. This would highlight strong programs to a broad audience of operators. Individual operators would have an opportunity to adopt the practice of these strong programs and improve their own efforts in this area.

- **Develop criteria for gate inspection that correlates risk issues and cost effectiveness.** Where gates do not represent a risk to public safety, there was opinion voiced that there should be some relaxation of requirements in recognition of the correlation between risk issues and cost-effectiveness. There was no consensus at the workshop as to a specific structure for guidelines relating to a less stringent review for less critical gates. The idea of rating gates according to a hazard rating system, similar to that used for dams, was discussed. Bruce Brand of the FERC presented a proposal for consideration that would take into account the differing level of risk. A table outlining the proposal is contained in his presentation in Appendix A. Mr. Brand encouraged participants to comment on the matrix, thus, helping the FERC to refine the concept.

# 6

## CONCLUSIONS AND RECOMMENDATIONS

---

### 6.1 Conclusions

The ASDSO/EPRI Spillway Gate Workshop addressed the primary issues suggested for discussion or that evolved from the workshop process. The ultimate success of the workshop will depend on the follow up actions of the participants and the industry in general. The presentations and the discussion at the workshop offered a wide perspective of how the industry is responding to the California Dam Safety and the FERC initiatives on spillway gates. They also demonstrated the industry's ongoing strong concern for safety.

The program highlighted the general state of maintenance being observed in most circumstances, the fact that the industry as a whole has a strong commitment to safety, and reinforced the industry's need for a continued strong effort.

There was a general recognition that this workshop and others like it represented a necessary ongoing dialogue on dam safety. Spillway gates are only the first of what should be a continual process between operators and regulators to ensure the safe performance of dams and other hydroelectric generating facilities.

### 6.2 Recommendations

Specific recommendations are covered in Section 5.4. They are generally focused on actions that the industry could reasonably take to address three areas:

- **Operator Education:** Increase education to make the broadest audience of operators aware of issues affecting gate performance and to provide tools for addressing these issues.
- **Research Needed:** Propose specific research to look at some of the most critical aspects related to gate performance, which are still unresolved. There was also recognition of what could reasonably be funded, given the diverse nature of the industry.
- **Technology Transfer:** Continue the dialogue on the topic among regulators, operators, academicians, consultants, and other concerned groups. The workshop format offered a means for exchange of information concerning gate operations among experts, which was seen as valuable. There was a general consensus that this approach could and should be applied to other dam safety topics.

Both the Spillway Gate Workshop, sponsored by the FERC, and this ASDSO/FEMA-sponsored workshop will provide input into the ICODS Seminar on Spillway Gates in February 2000. The ICODS program will offer a forum for even broader participation by the general industry.

*Conclusions and Recommendations*

EPRI is prepared to move forward in a cooperative effort in research and development that is of interest to the dam safety community. Input, comments, and suggestions are solicited for cooperative and innovative methods addressing analytical, inspection, and maintenance programs that enhance the performance of tainter gates and other spillway gate structures. EPRI believes that it is in a unique position to help the industry address safety-related issues and they seek continued input into identifying issues of concern within the industry, related to the safe production of hydroelectric power.



# 7

## SELECT BIBLIOGRAPHY

---

### 7.1 Technical Reports

- Alexander, T. W. *Discharge Ratings for Tainter and Roller Gates at Lock and Dam No. 25 on the Mississippi River Near Winfield, Missouri*. Rolla, MO: Geological Survey, Water Resources Division, 1992. NTIS, PB95-188561.
- Berte, C.M. *Load Testing of Bureau of Reclamation Radial Gate Hoists*. Denver, CO: Bureau of Reclamation, Technical Service Center, 1998. NTIS, PB99-106429/XAB.
- Burgi, P. H. *Hydraulic Model Studies of Jackson Lake Dam Baffle Blocks*. Denver, CO: Bureau of Reclamation, Office of Chief Engineer, 1970. NTIS, PB-194 001/XAB.
- EPRI, *Inspection and Performance Evaluation of Dams: A Guide for Managers, Engineers, and Operators*, EPRI, Palo Alto, CA: September 1986. AP-4714.
- Greiman, L. F., J. H. Stecker, T. A. Kraal, and S. D. Foltz. *REMR Management Systems-Navigation Structures, Condition Rating Procedures for Roller Dam Gates*. Champaign, IL: Construction Engineering Research Lab. (Army), June 1997. NTIS, AD-A330 894/7/XAB.
- Riquet, J.C. *Strengthening of the Spillway Gate Piers from Grangent Dam*. Paris (France): Ministere de l'Industrie, des Postes et Telecommunications et du Commerce Exterieur, 1996. NTIS, DE96759460.
- U.S. Army Corps of Engineers, New England Division. *National Program for Inspection of Non-Federal Dams, Packers Falls Dam (NH 00441, NHWRB 71.04) Piscataqua River Basin, Durham, New Hampshire. Phase I Inspection Report*, December 1980. NTIS, AD-A156 552/2.
- U.S. Army Corps of Engineers, New England Division. *National Program for Inspection of Non-Federal Dams, Crocker Pond Dam (MA 00638), Merrimack River Basin, Westminster, Massachusetts. Phase 1 Inspection Report*, June 80. NTIS, AD-A155 343/7.
- U.S. Bureau of Reclamation. *Radial Gate Evaluation, Angostura Dam, South Dakota*, March 1997. NTIS, PB-97-152359/XAB.
- U.S. Bureau of Reclamation. *Radial Gate Evaluation, Blue Mesa Dam, Colorado*, 23 June 1997. NTIS, PB97-179097.
- U.S. Bureau of Reclamation. *Radial Gate Evaluation, Boca Dam, California*, April 1997. NTIS, PB97-162853.
- U.S. Bureau of Reclamation. *Radial Gate Evaluation, Brantley Dam, New Mexico*, May 1997. NTIS, PB97-165922.

# **A**

## **PRESENTATIONS**

---

Target:  
Fossil/Hydro & Renewables

## About EPRI

EPRI creates science and technology solutions for the global energy and energy services industry. U.S. electric utilities established the Electric Power Research Institute in 1973 as a nonprofit research consortium for the benefit of utility members, their customers, and society. Now known simply as EPRI, the company provides a wide range of innovative products and services to more than 1000 energy-related organizations in 40 countries. EPRI's multidisciplinary team of scientists and engineers draws on a worldwide network of technical and business expertise to help solve today's toughest energy and environmental problems.

EPRI. Powering Progress

## SINGLE USER LICENSE AGREEMENT

**THIS IS A LEGALLY BINDING AGREEMENT BETWEEN YOU AND THE ELECTRIC POWER RESEARCH INSTITUTE, INC. (EPRI). PLEASE READ IT CAREFULLY BEFORE REMOVING THE WRAPPING MATERIAL.**

BY OPENING THIS SEALED PACKAGE YOU ARE AGREEING TO THE TERMS OF THIS AGREEMENT. IF YOU DO NOT AGREE TO THE TERMS OF THIS AGREEMENT, PROMPTLY RETURN THE UNOPENED PACKAGE TO EPRI AND THE PURCHASE PRICE WILL BE REFUNDED.

### 1. GRANT OF LICENSE

EPRI grants you the nonexclusive and nontransferable right during the term of this agreement to use this package only for your own benefit and the benefit of your organization. This means that the following may use this package: (I) your company (at any site owned or operated by your company); (II) its subsidiaries or other related entities; and (III) a consultant to your company or related entities, if the consultant has entered into a contract agreeing not to disclose the package outside of its organization or to use the package for its own benefit or the benefit of any party other than your company.

This shrink-wrap license agreement is subordinate to the terms of the Master Utility License Agreement between most U.S. EPRI member utilities and EPRI. Any EPRI member utility that does not have a Master Utility License Agreement may get one on request.

### 2. COPYRIGHT

This package, including the information contained in it, is either licensed to EPRI or owned by EPRI and is protected by United States and international copyright laws. You may not, without the prior written permission of EPRI, reproduce, translate or modify this package, in any form, in whole or in part, or prepare any derivative work based on this package.

### 3. RESTRICTIONS

You may not rent, lease, license, disclose or give this package to any person or organization, or use the information contained in this package, for the benefit of any third party or for any purpose other than as specified above unless such use is with the prior written permission of EPRI. You agree to take all reasonable steps to prevent unauthorized disclosure or use of this package. Except as specified above, this agreement does not grant you any right to patents, copyrights, trade secrets, trade names, trademarks or any other intellectual property, rights or licenses in respect of this package.

### 4. TERM AND TERMINATION

This license and this agreement are effective until terminated. You may terminate them at any time by destroying this package. EPRI has the right to terminate the license and this agreement immediately if you fail to comply with any term or condition of this agreement. Upon any termination you may destroy this package, but all obligations of nondisclosure will remain in effect.

### 5. DISCLAIMER OF WARRANTIES AND LIMITATION OF LIABILITIES

NEITHER EPRI, ANY MEMBER OF EPRI, ANY COSPONSOR, NOR ANY PERSON OR ORGANIZATION ACTING ON BEHALF OF ANY OF THEM:

(A) MAKES ANY WARRANTY OR REPRESENTATION WHATSOEVER, EXPRESS OR IMPLIED, (I) WITH RESPECT TO THE USE OF ANY INFORMATION, APPARATUS, METHOD, PROCESS OR SIMILAR ITEM DISCLOSED IN THIS PACKAGE, INCLUDING MERCHANTABILITY AND FITNESS FOR A PARTICULAR PURPOSE, OR (II) THAT SUCH USE DOES NOT INFRINGE ON OR INTERFERE WITH PRIVATELY OWNED RIGHTS, INCLUDING ANY PARTY'S INTELLECTUAL PROPERTY, OR (III) THAT THIS PACKAGE IS SUITABLE TO ANY PARTICULAR USER'S CIRCUMSTANCE; OR

(B) ASSUMES RESPONSIBILITY FOR ANY DAMAGES OR OTHER LIABILITY WHATSOEVER (INCLUDING ANY CONSEQUENTIAL DAMAGES, EVEN IF EPRI OR ANY EPRI REPRESENTATIVE HAS BEEN ADVISED OF THE POSSIBILITY OF SUCH DAMAGES) RESULTING FROM YOUR SELECTION OR USE OF THIS PACKAGE OR ANY INFORMATION, APPARATUS, METHOD, PROCESS OR SIMILAR ITEM DISCLOSED IN THIS PACKAGE.

### 6. EXPORT

The laws and regulations of the United States restrict the export and re-export of any portion of this package, and you agree not to export or re-export this package or any related technical data in any form without the appropriate United States and foreign government approvals.

### 7. CHOICE OF LAW

This agreement will be governed by the laws of the State of California as applied to transactions taking place entirely in California between California residents.

### 8. INTEGRATION

You have read and understand this agreement, and acknowledge that it is the final, complete and exclusive agreement between you and EPRI concerning its subject matter, superseding any prior related understanding or agreement. No waiver, variation or different terms of this agreement will be enforceable against EPRI unless EPRI gives its prior written consent, signed by an officer of EPRI.

© 2000 Electric Power Research Institute (EPRI), Inc. All rights reserved. Electric Power Research Institute and EPRI are registered service marks of the Electric Power Research Institute, Inc. EPRI. POWERING PROGRESS is a service mark of the Electric Power Research Institute, Inc.

 Printed on recycled paper in the United States of America

1000101

# **B**

## **ATTENDEES**

---

<b>Name</b>	<b>Company</b>
Cecil Bearden	Oklahoma Water Resources
Bernard J. Peters	URS Greiner Woodward Clyde
Wayne Edwards	HDR Engineering
Dick Rudolph	Northern States Power
Bruce Muller	U.S. Bureau of Reclamation
Chander Sehgal	Harza Engineering Co.
Sterling Yong	Hawaii Department of Natural Resources
Greg Lewis	Tennessee Valley Authority
Tommy Duncan	Southern Company
Delbert Shriver	West Virginia Dam Safety
James C. Wadge	Retired (U.S. Bureau of Reclamation)
B.T.A. Sagar	ECI
Robert Todd	U. S. Bureau of Reclamation
Bruce Brand	Federal Energy Regulatory Commission
Rashid Ahmad	California Division of Safety of Dams
Ron Delparte	California Division of Safety of Dams
Eugene Chan	Pacific Gas and Electric
Ray Stokes	Burgess and Niple

# C AGENDA

## ASDSO/EPRI GATE WORKSHOP

EPRI AUDITORIUM  
Palo Alto, CA

January 5 & 6, 2000

Day 1	Day 2
<b>INTRODUCTION</b>	
8:00 Introductions Bahleda	8:00 Items Identified in Day One Bahleda
8:15 Workshop Objectives ASDSO spokesman	
<b>1.0 WHAT WE KNOW ABOUT GATE FAILURES</b>	<b>3.0 WHAT DO WE NEED TO KNOW</b>
8:30 1.1 Owners Perspective Tommy Duncan	8:30 3.1 How Safe is Safe Enough Bruce Brand
9:00 1.2 Inspection & repair case histories Bernard Peters	9:00 3.2 Design Issues Chander Sehgal
9:30 1.3 CA Dam Safety's Prgram & Perspective Fred Sage	9:30 3.3 Design Issues Fred Locher Cancelled
10:00 BREAK	10:00 BREAK
10:15 1.4 TVA Perspective Greg Lewis	10:15 Design Issues Ray Stokes
10:45 1.5 USCOLD Programs B. T. A. Sagar	10:45 Inspection Issue Wayne Edwards
11:15 1.6 Gate Maintenance Dick Stutsman Cancelled	11:15 3.0 Recap & discussion
11:45 1.0 Recap & discussion	
12:00 LUNCH	12:00 LUNCH
<b>2.0 WHAT WE DON'T KNOW ABOUT GATE FAILURE</b>	<b>4.0 KEY FACTORS REGARDING DAM SAFETY</b>
1:00 2.1 Gate Performance Norman Bishop	1:00 Brainstorming
1:30 2.2 Allowable Stresses Rick Poeppleman	
2:00 2.3 Seismic Uncertainty Rashid Ahmad	
2:30 2.4 Analysis Richard Mattson Cancelled	
3:00 BREAK	3:00 BREAK
3:15 2.5 Condition Assessment Stuart Foltz	
3:45 2.6 Surprise Experiences from the Industry Eugene Chan	
4:15 2.0 Recap & discussion	4:00 Summarize Next Steps & Deliverables
5:00 Close for the day	5:00 Close Workshop

*Attendees*

Bill McStraw	U.S. Bureau of Reclamation
Gene Comoss	Pennsylvania Department of Natural Resources
Fred Sage	California Division of Safety of Dams
Noel Wong	URS Greiner Woodward Clyde
Bill Reuland	EPRI
Norm Bishop	Stone and Webster
Michael Bahleda	EPRI
Daniel Mahoney	Federal Energy Regulatory Commission

## **Spillway Gate Inspection, An Owner's Perspective**

*Tommy Duncan*  
*Southern Company*

# ***SPILLWAY GATE INSPECTION -AN OWNER'S PERSPECTIVE***

---

Tommy Duncan  
Southern Company  
January 5, 2000

---

## **Georgia Power's Dam Safety Program**

---

- Monthly Inspections By Plant Staff Using Checklist
- Quarterly Inspections By Hydro Engineering Staff
- Annual Ferc Inspections
- Biennial Inspections By "In-house" Dam Safety Team
- 5-year Consultant Inspections



# Gate Inspection And Testing

---

- Inspected From Accessible Vantage Points--Boat, Crest, or Toe of Dam
- Tested Annually (Partial Opening Only- usually Opened 2-3')
- Full Height Test Every 5 Years
- Monthly Testing of Back-up Power Source ..Emergency System Used to Raise Gate Annually

---

## So Why Change?

---

- Recent Failures of Gates or Gate Components
- Recognition that Visual Methods Currently Utilized Were Marginal at Best
- Regulatory Directives

# Gate Failures on GPC System

---

- Failure of Turnbuckles at Lifting Eyes
- Failure of Embed Channel Anchorage





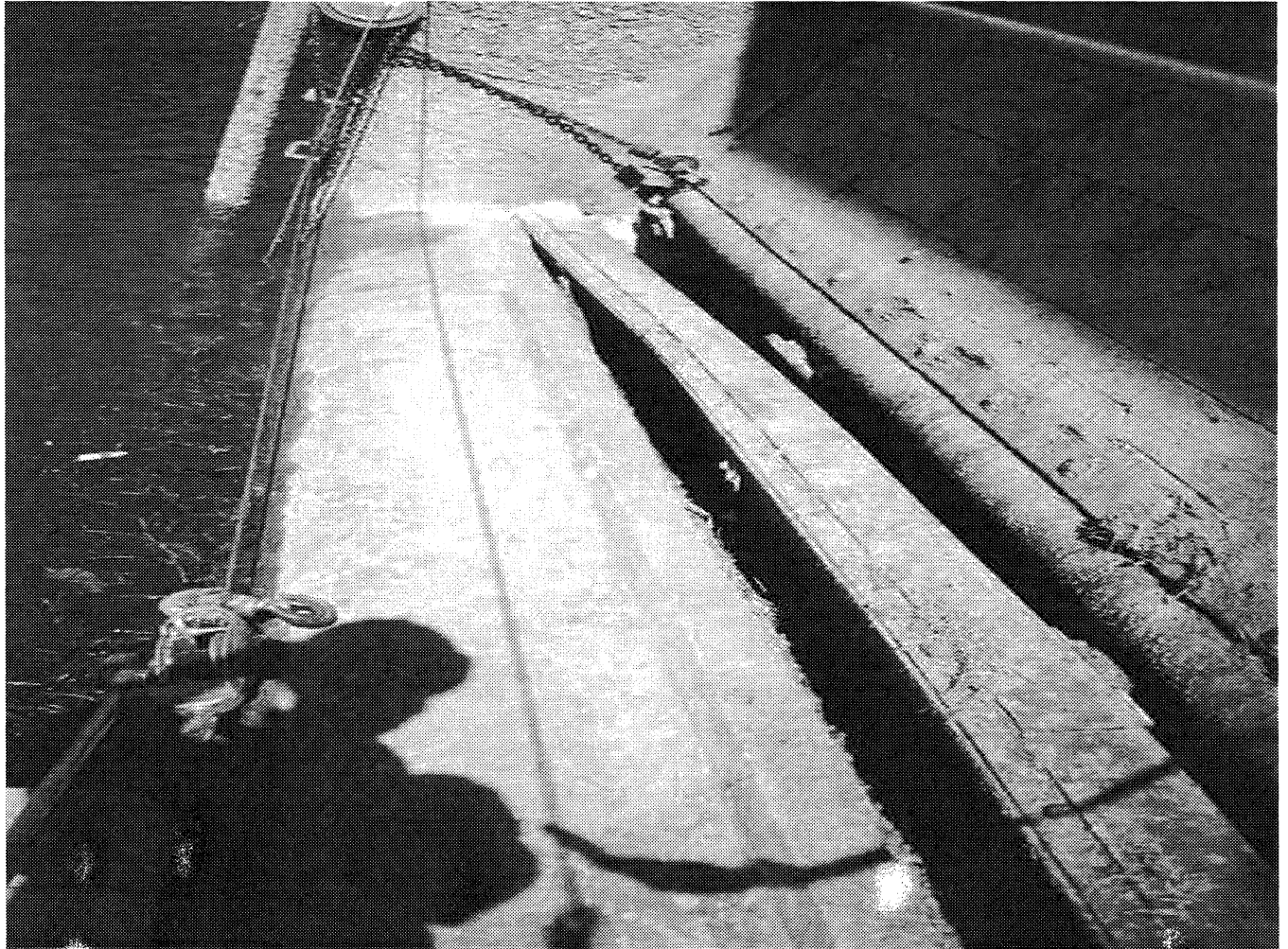

# GPC's Current Initiatives

---

## Primary Focus of Program

---

- Radial or Taintor Gates
- Bottom Hinged Flap Gates
- Vertical Lift Gates
- Flashboards

# Multi-phase Evaluation Program

---

- Review of Design Philosophy
- Review of Operational History
- Detailed Visual Inspection
- Structural Analysis of Radial Gates Using GTSTRUDL
- Evaluate of Results From Inspections and Analyses
- Development and Implementation of Corrective Measures

---

## Gate Inspection Team

- Program Coordination- Engineering and Generation Services
- Gate Preparation- Plant Personnel
- Field Inspections- HDR Engineering with Hydro Engineering Representative
- Structural Analyses- Engineering and Generation Services
- Repairs- Plant Personnel or Contractors

# Criteria for Establishing Inspection Schedule

---

- Coincide with Part 12 Safety Inspection
- Risk or Hazard Potential
- Known Problem Areas
- Age of Structure

---

## Schedule for Field Inspections

---

- Morgan Falls- October 1998
- Oliver- November 1998
- Wallace- March 1999
- Bartletts Ferry- April 1999
- Sinclair- May 1999
- Flint River- Spring 2000
- North Georgia Hydro-Summer 2000

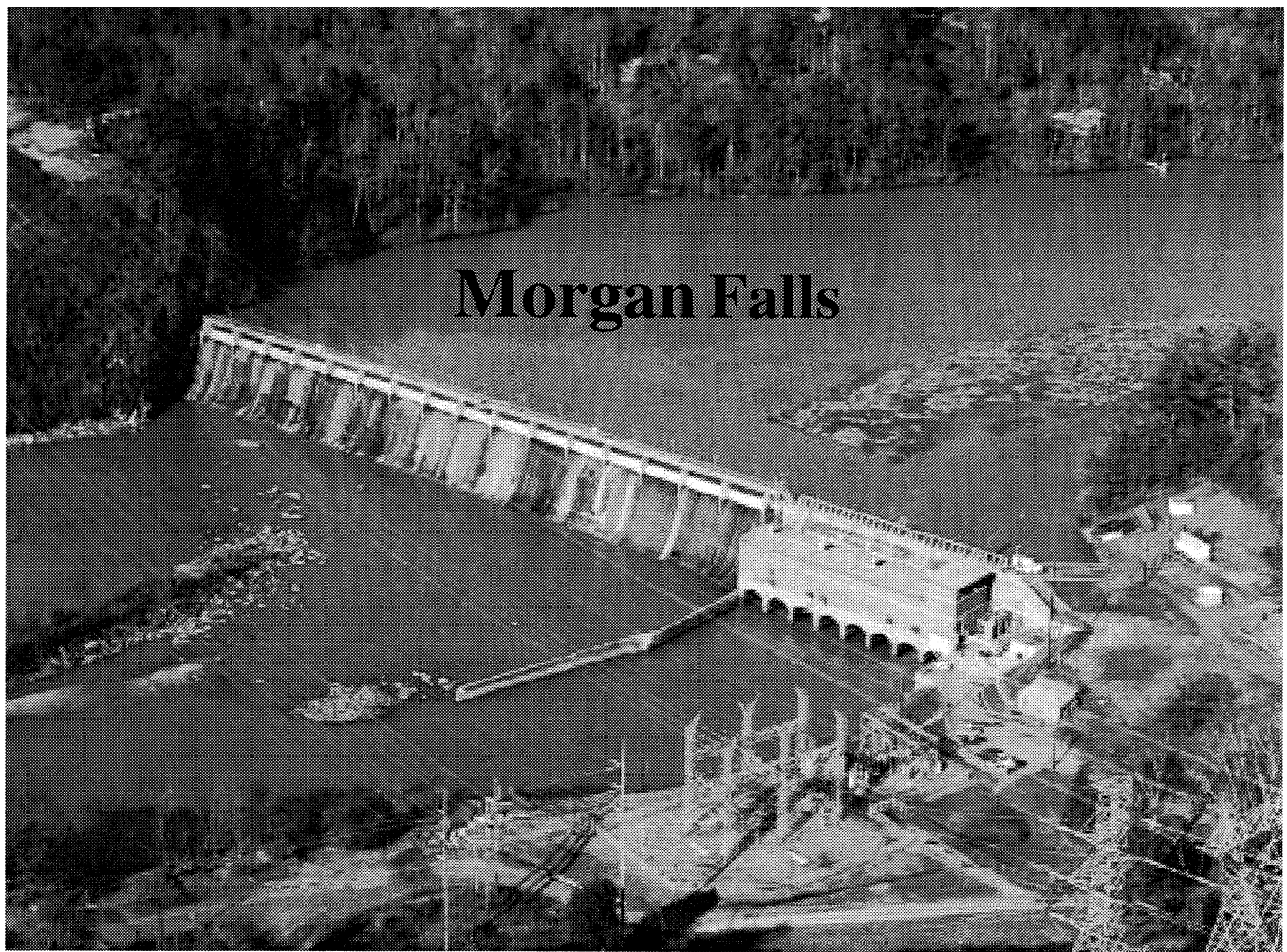

## Morgan Falls

## Morgan Falls

---

- Dam Constructed-1902-1904
- Gates Added- 1959-1960
- 16 Radial Taintor Gates
- Each Gate- 8' high x 40' wide

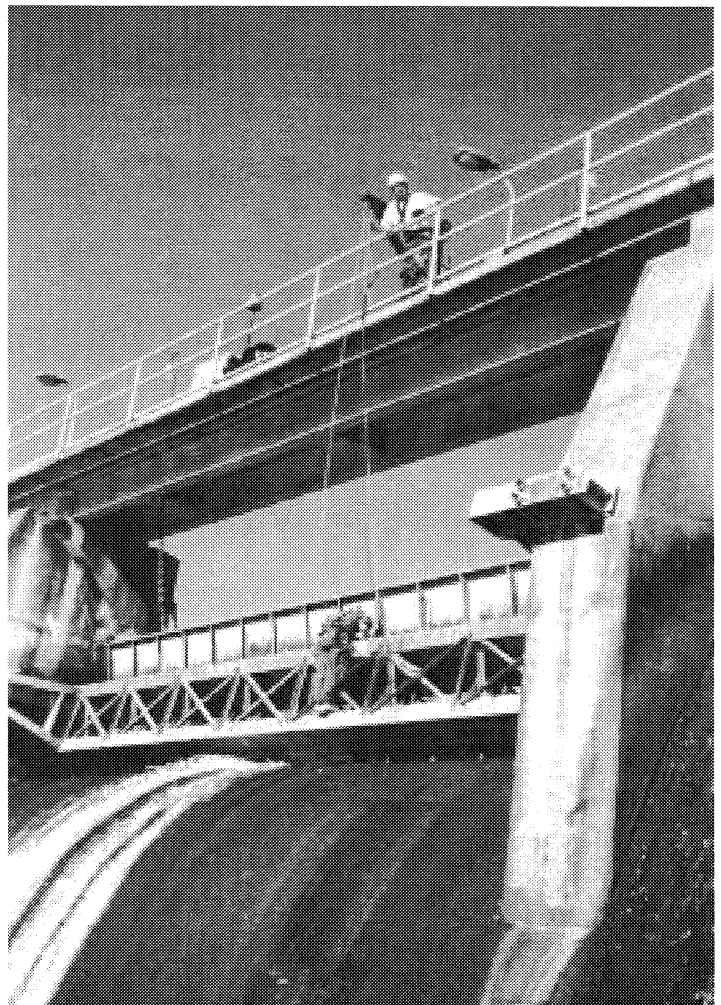



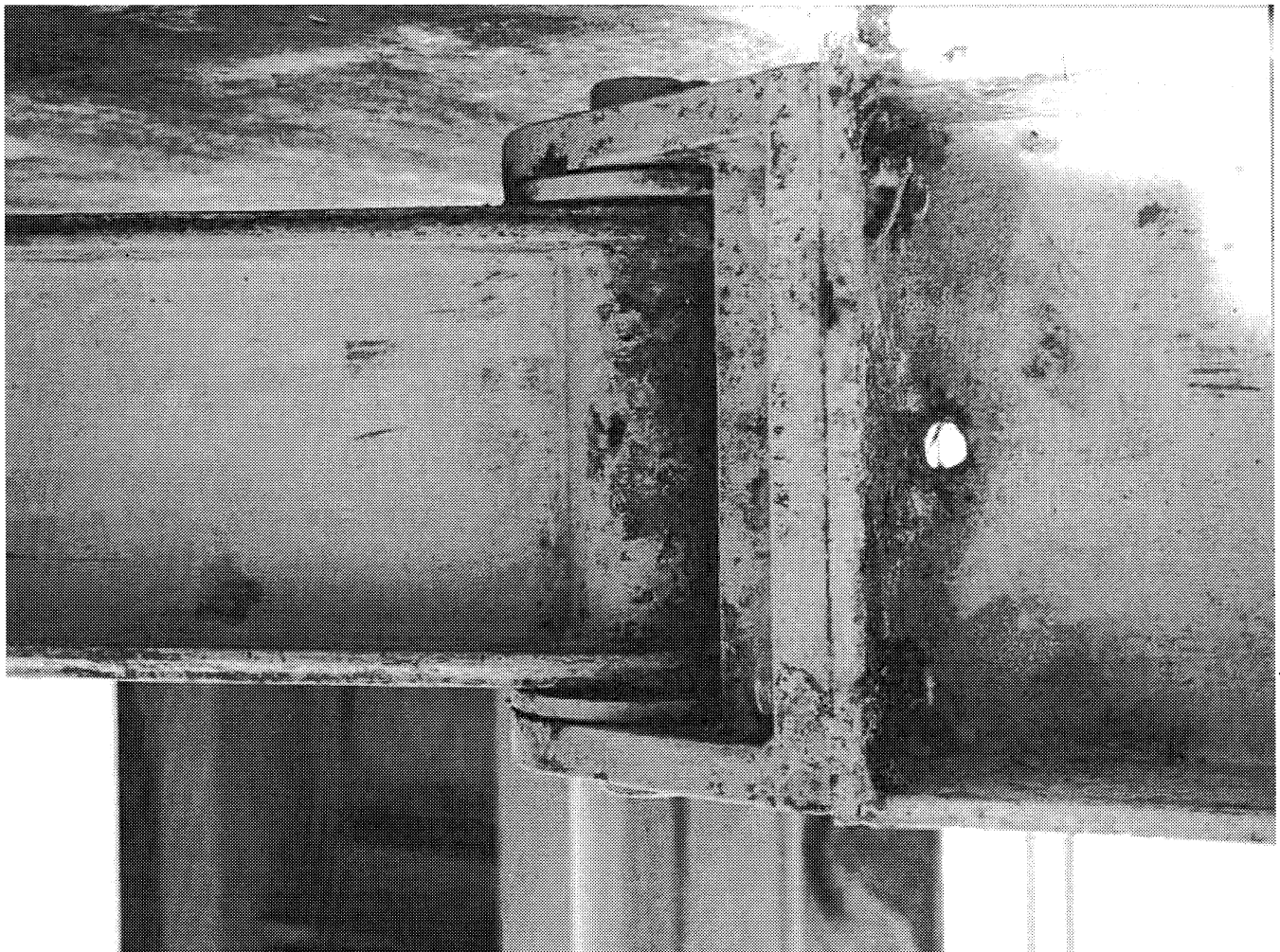
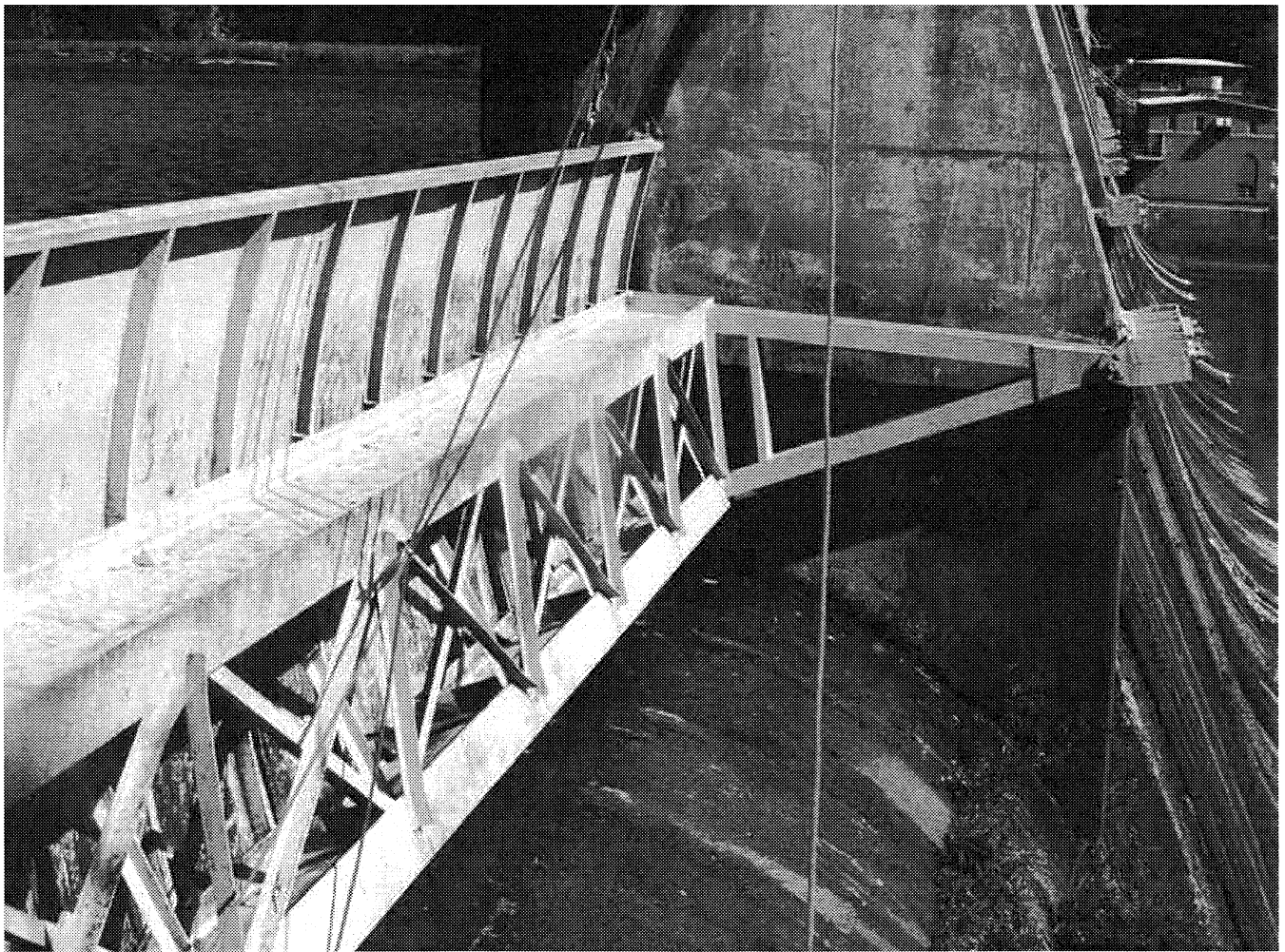

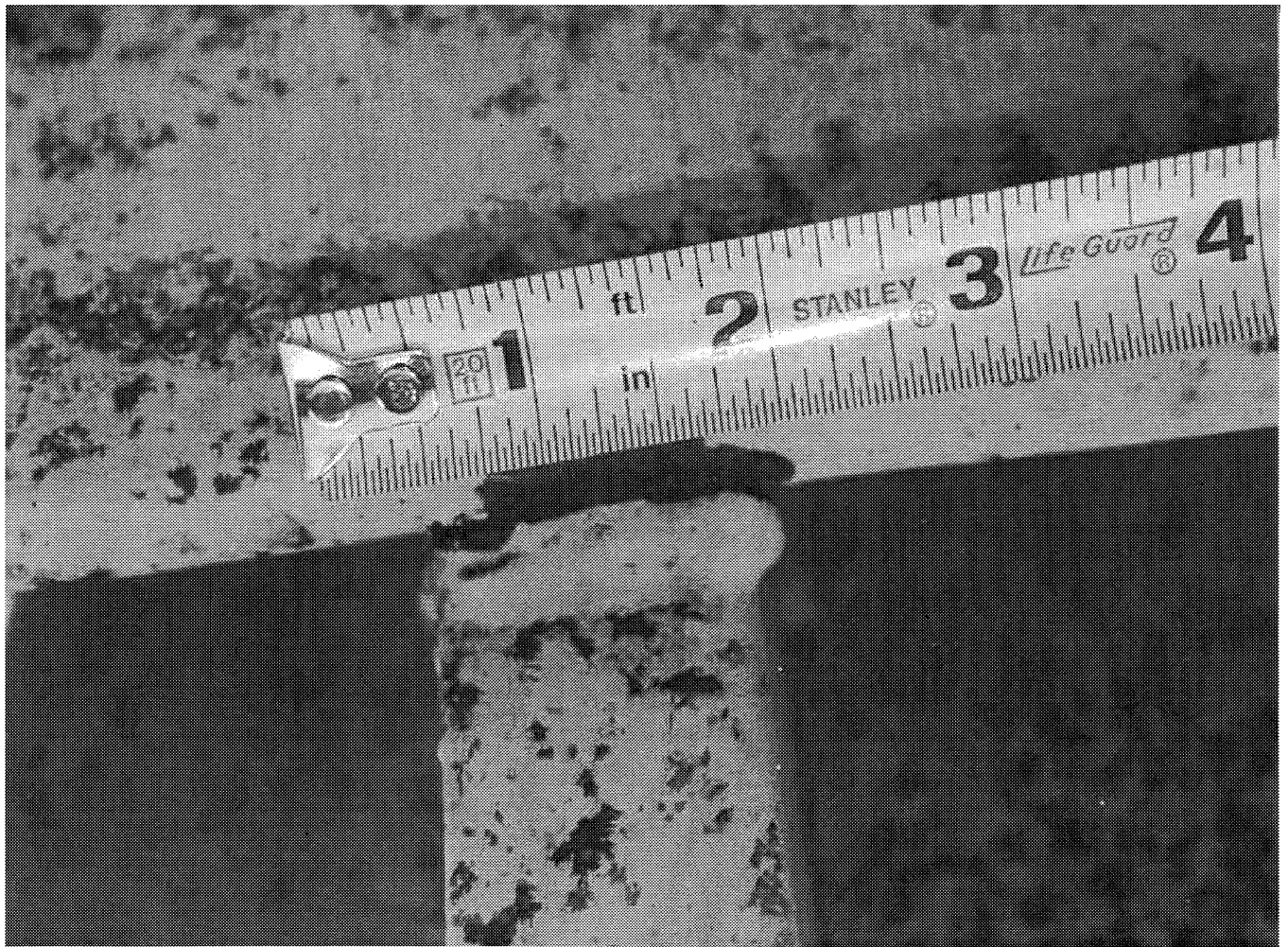

# Oliver Dam

33 gates-16' high x 35'-8" wide

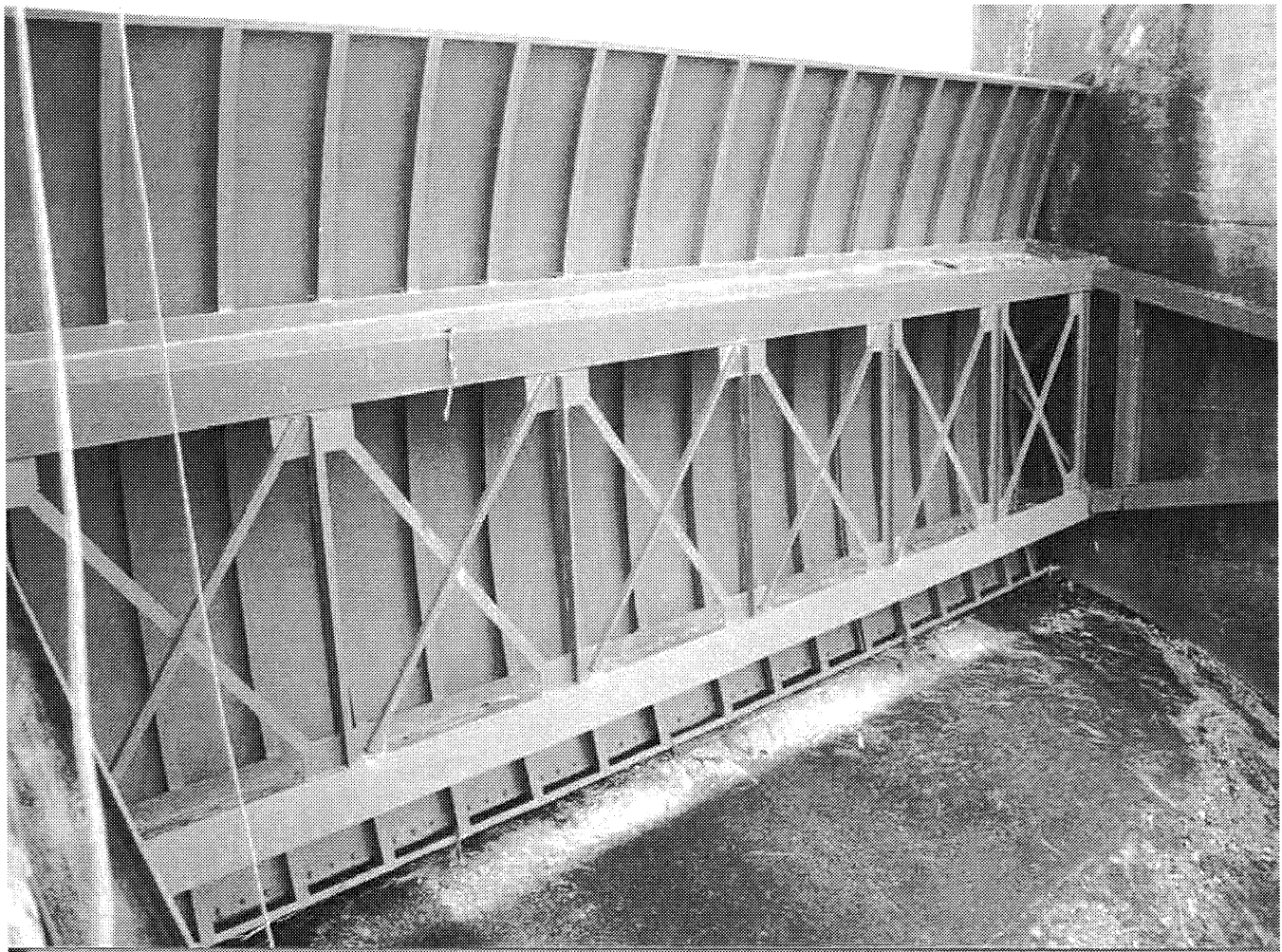
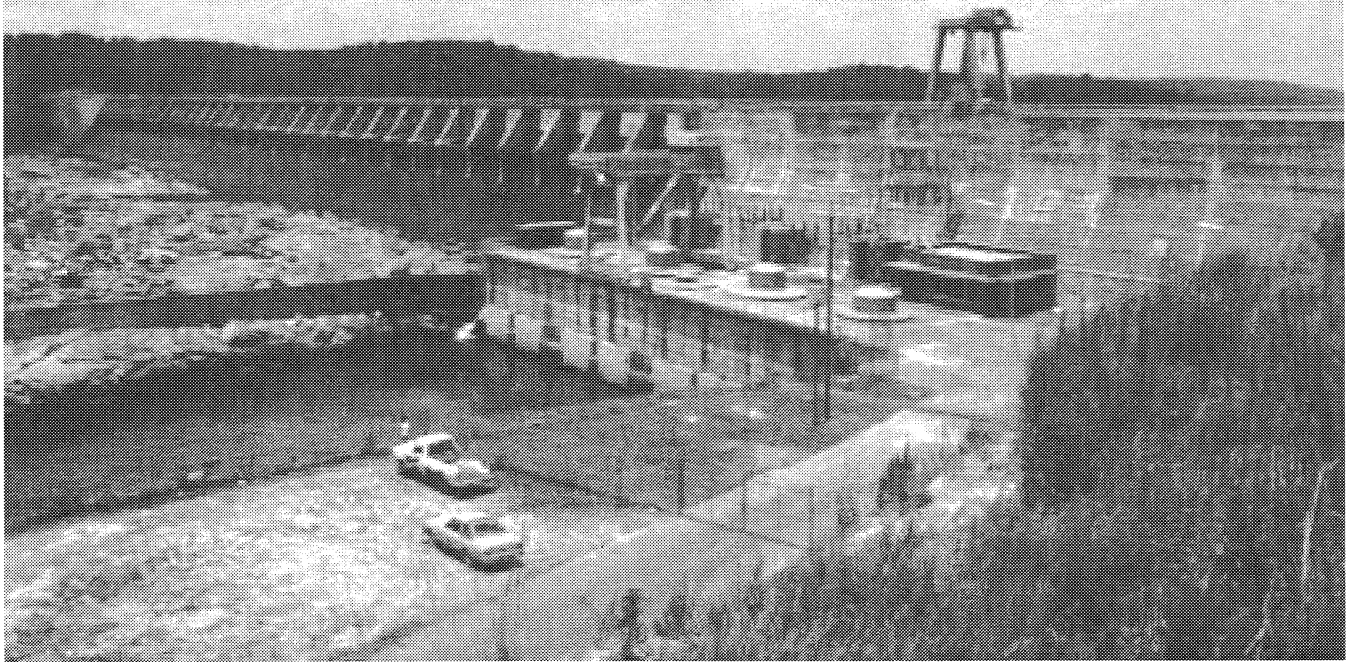

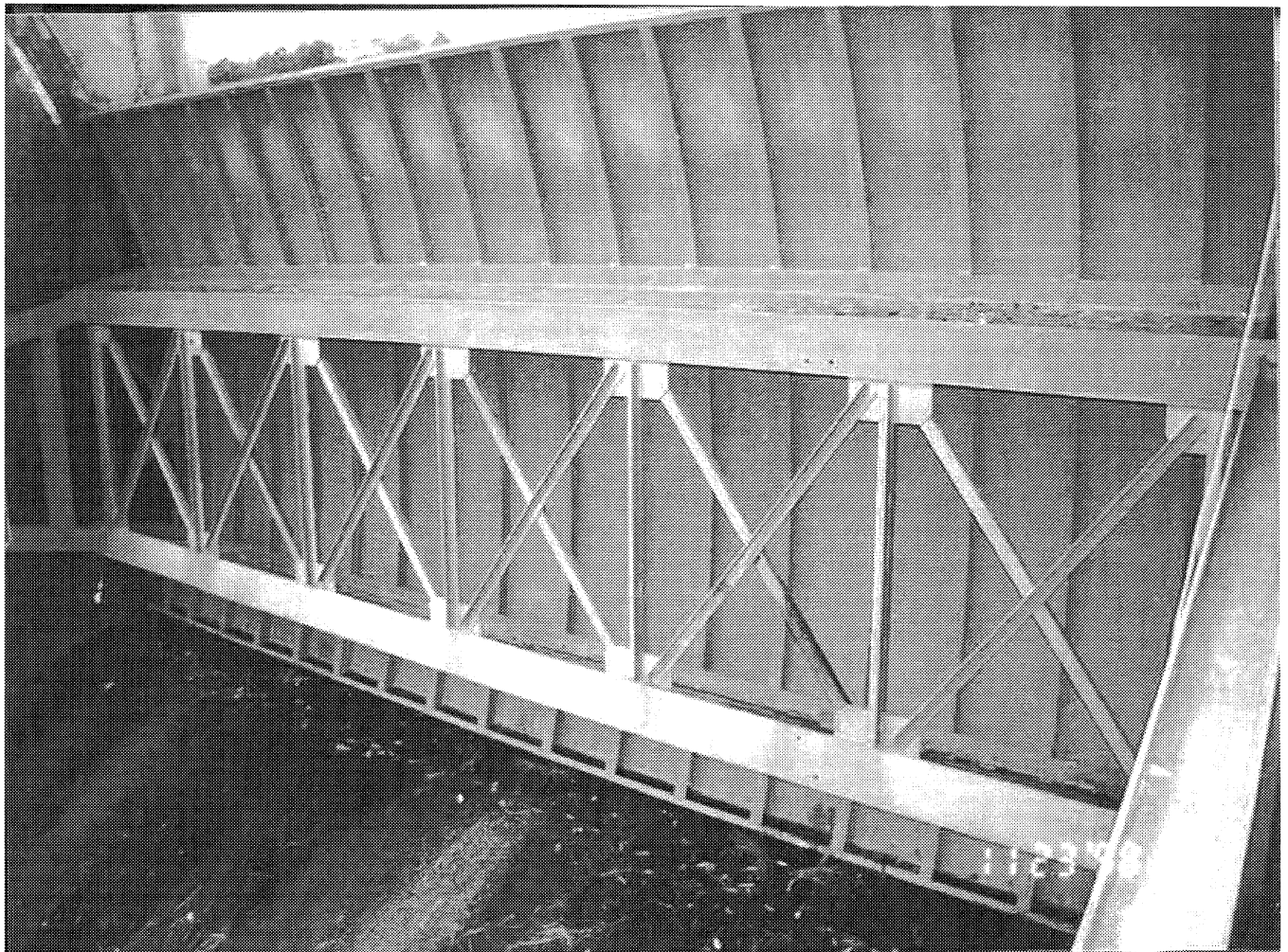
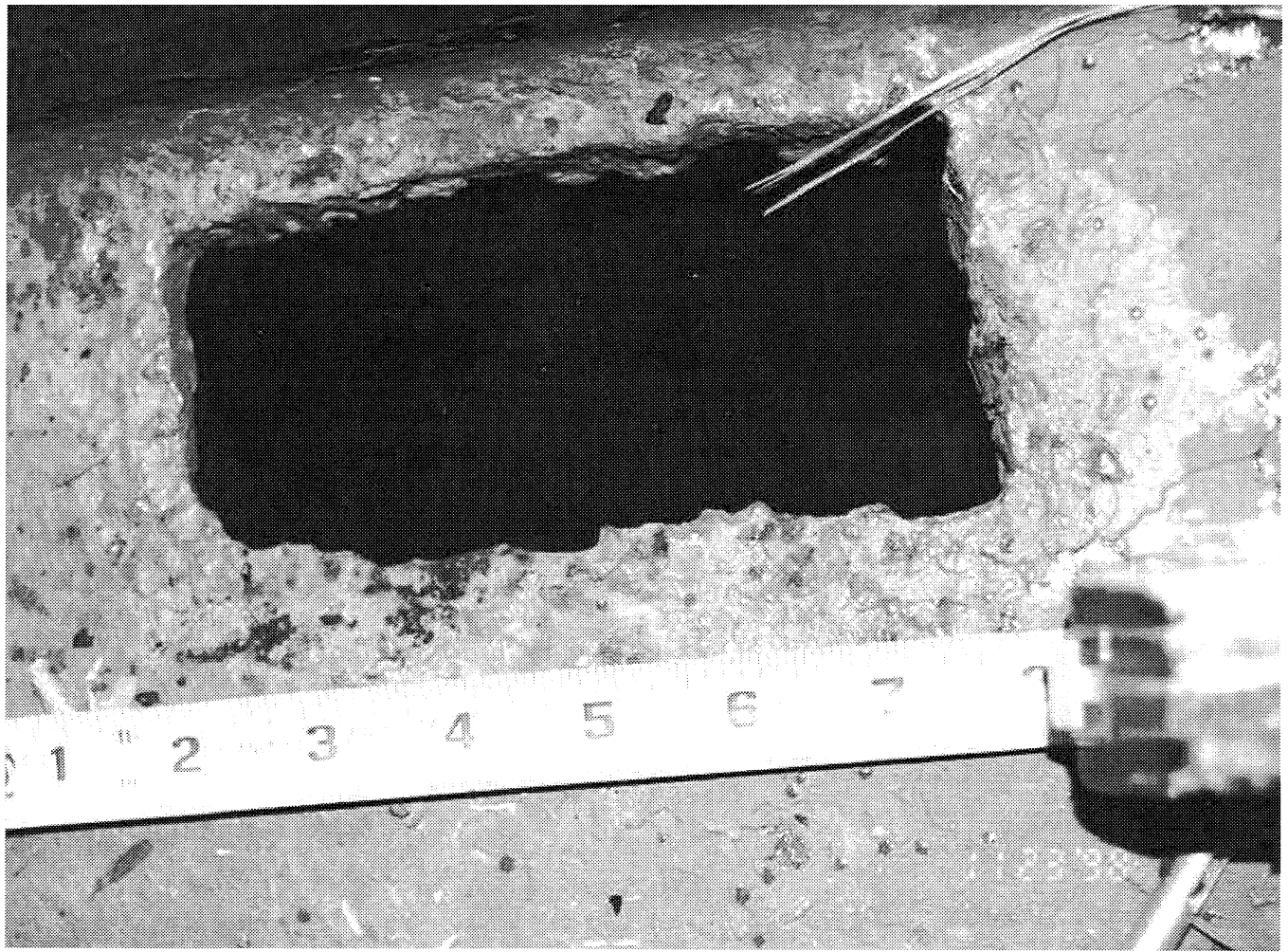

# *Wallace Dam*

5 gates- each 44' high x 42' wide

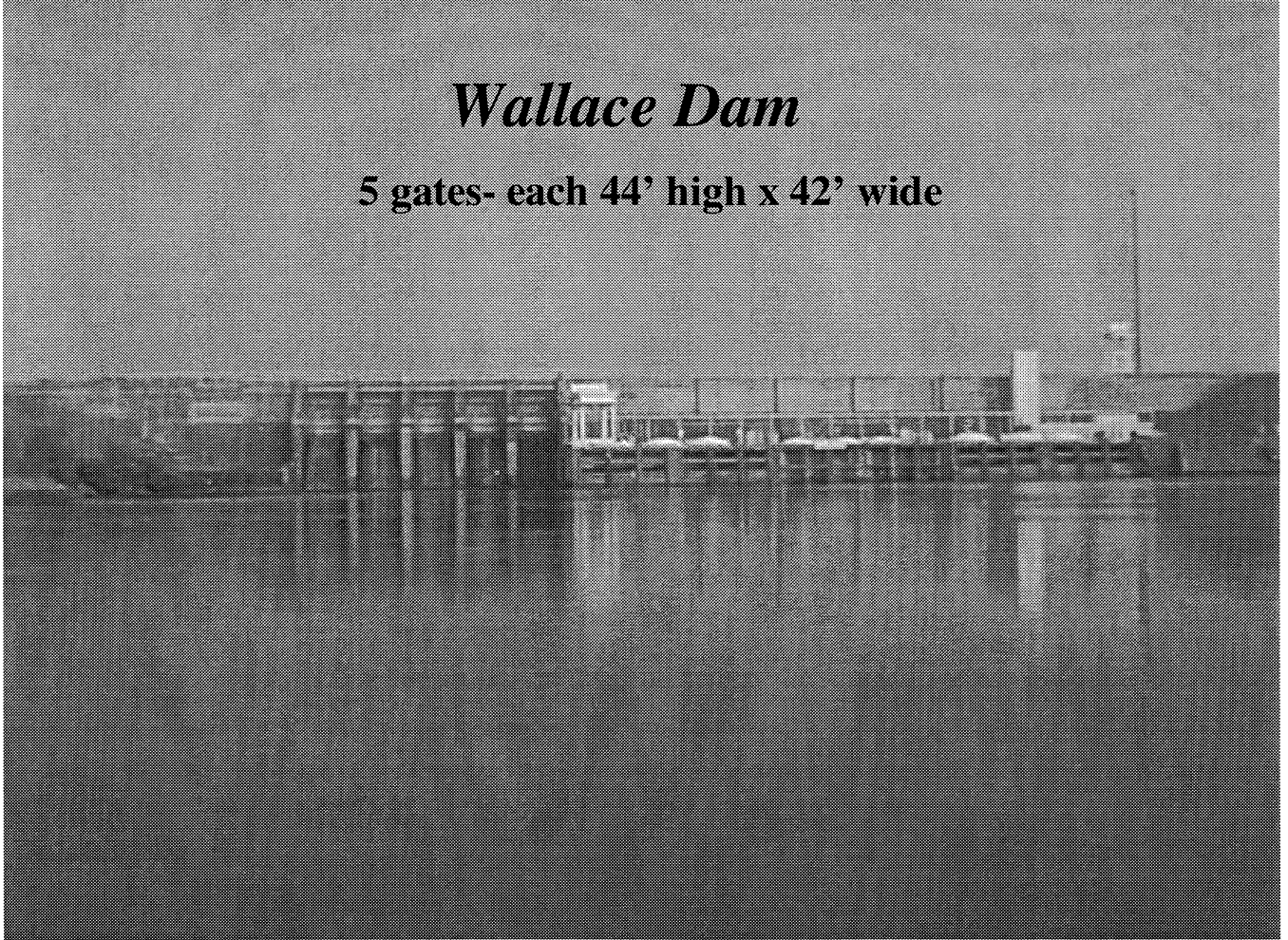



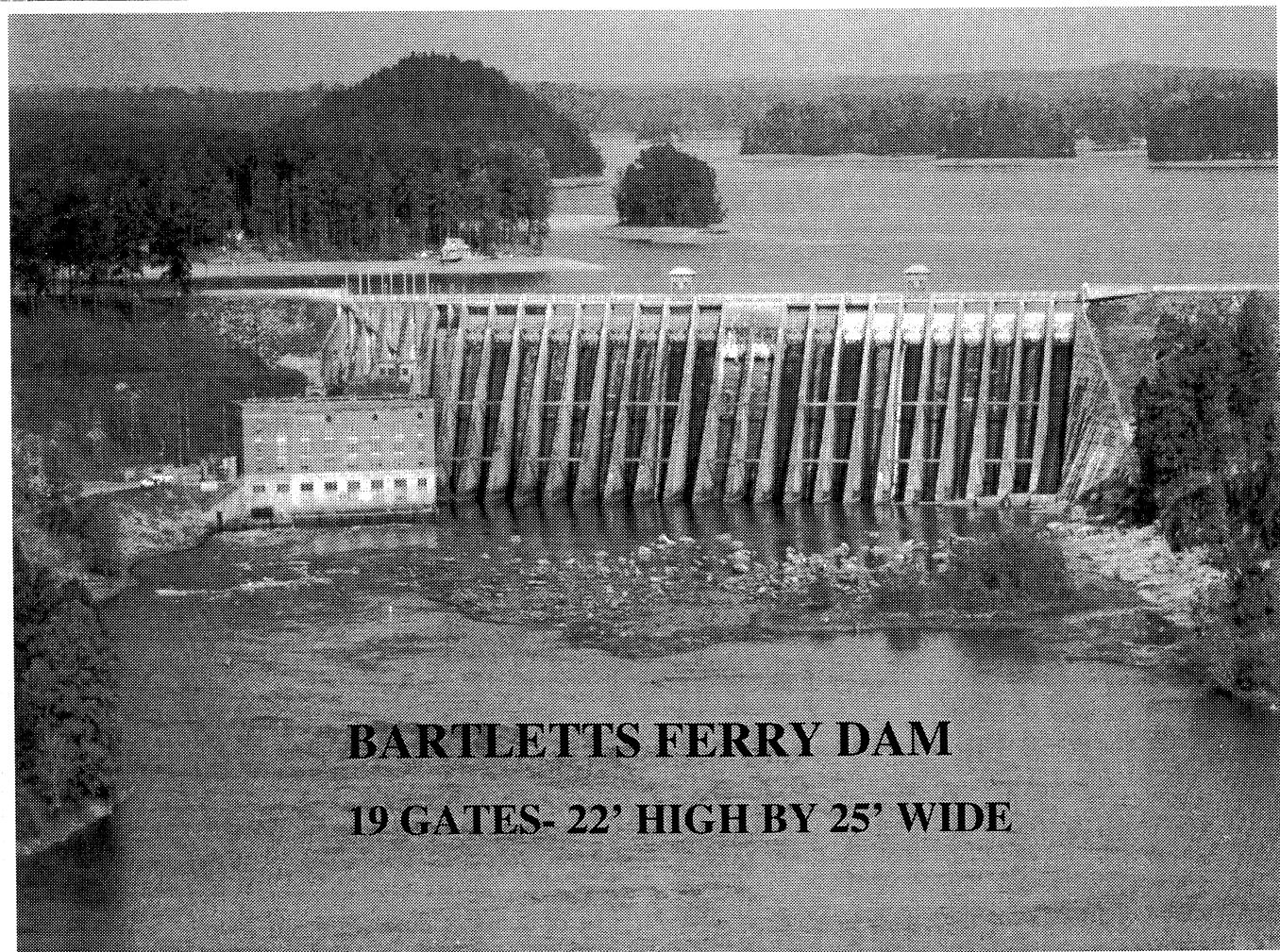

**BARTLETTS FERRY DAM**

**19 GATES- 22' HIGH BY 25' WIDE**

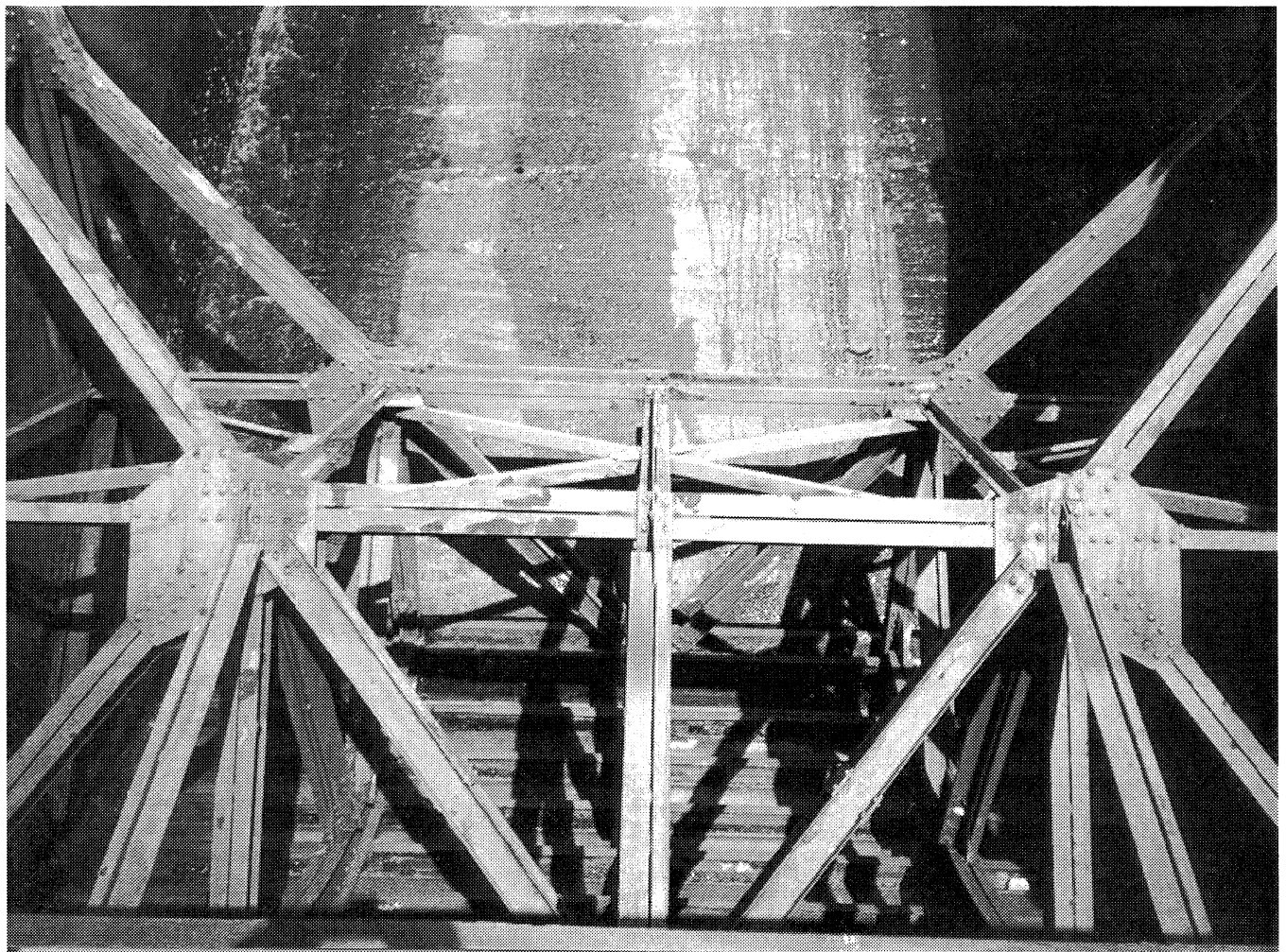
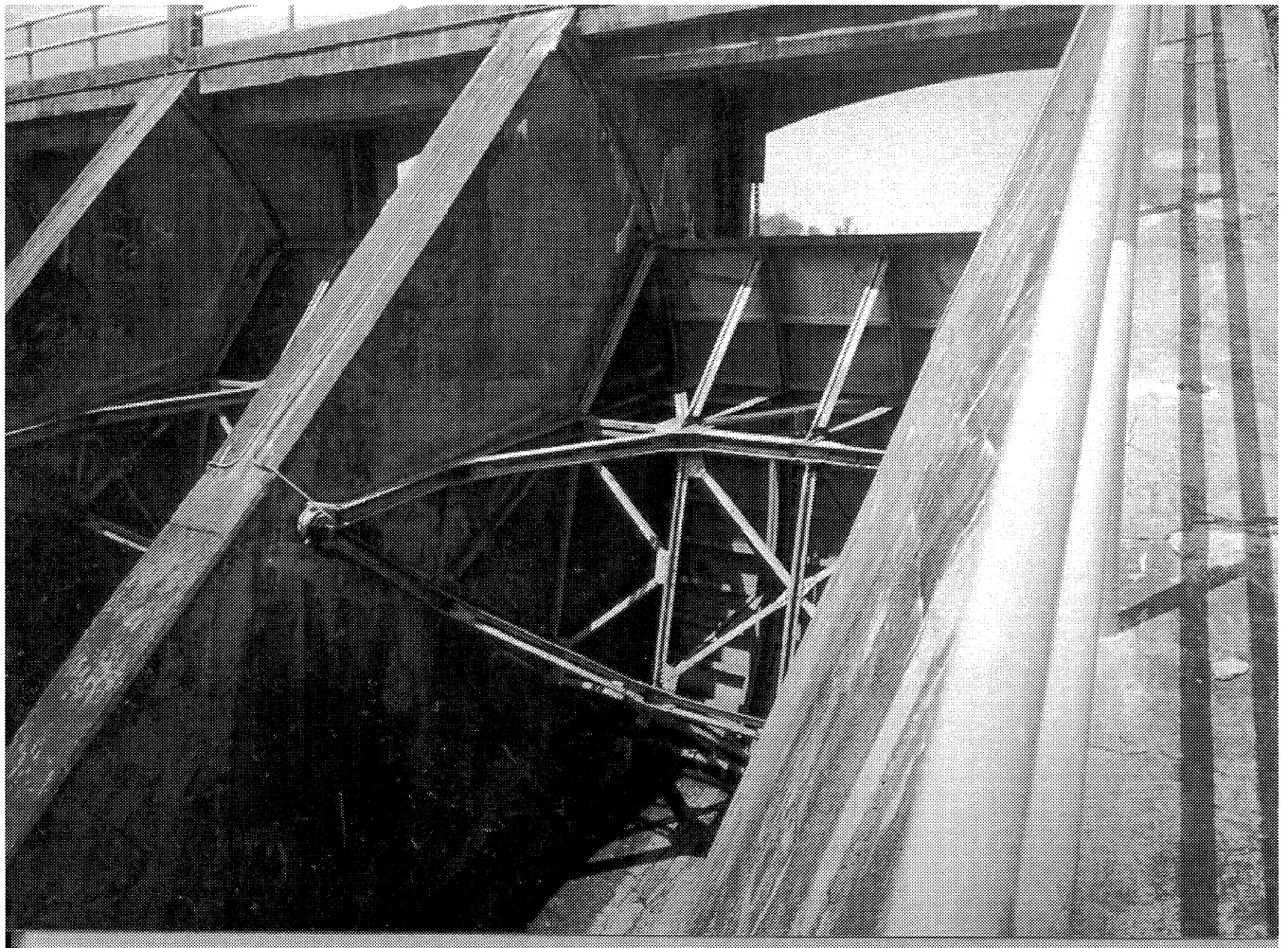



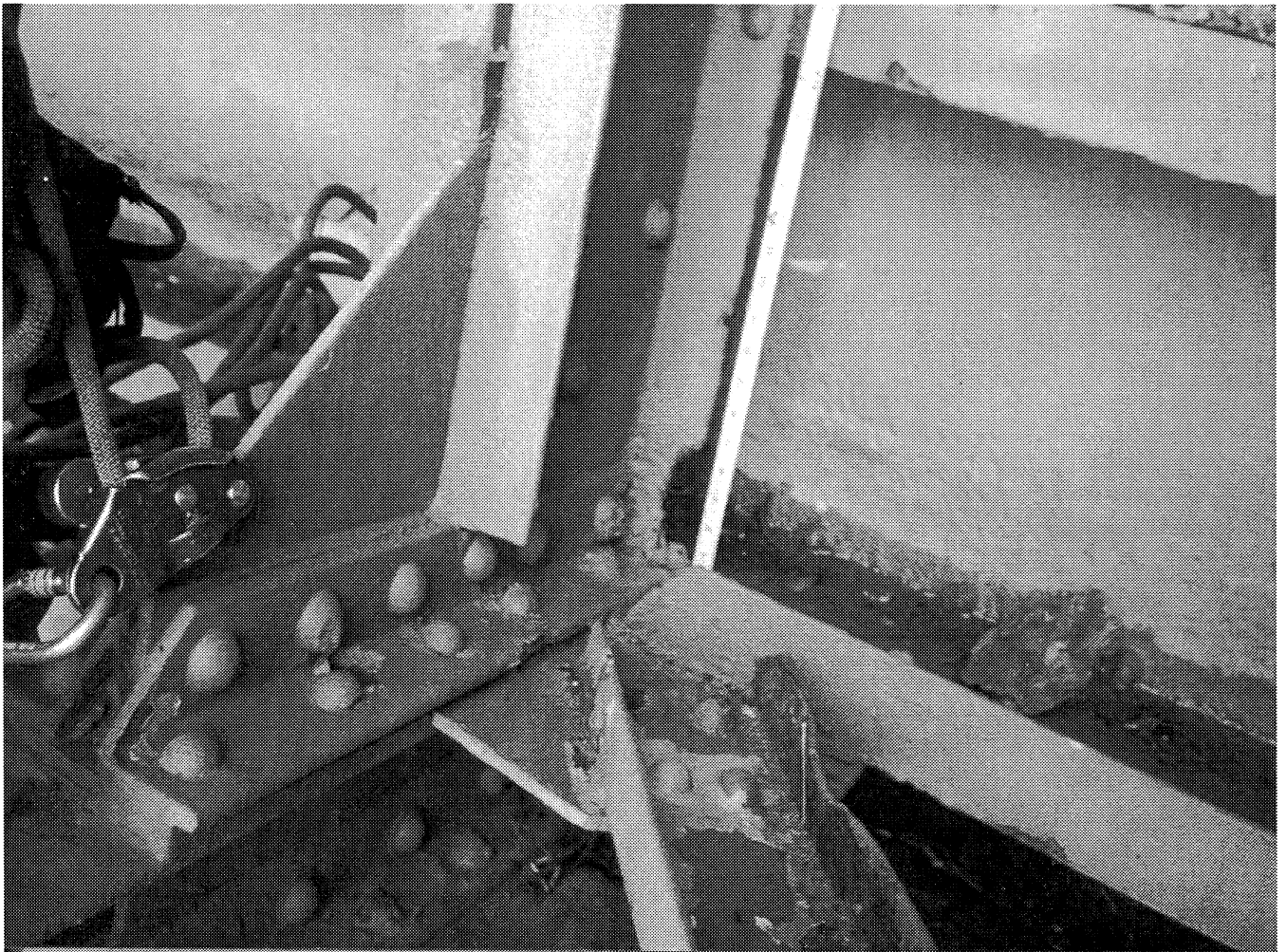

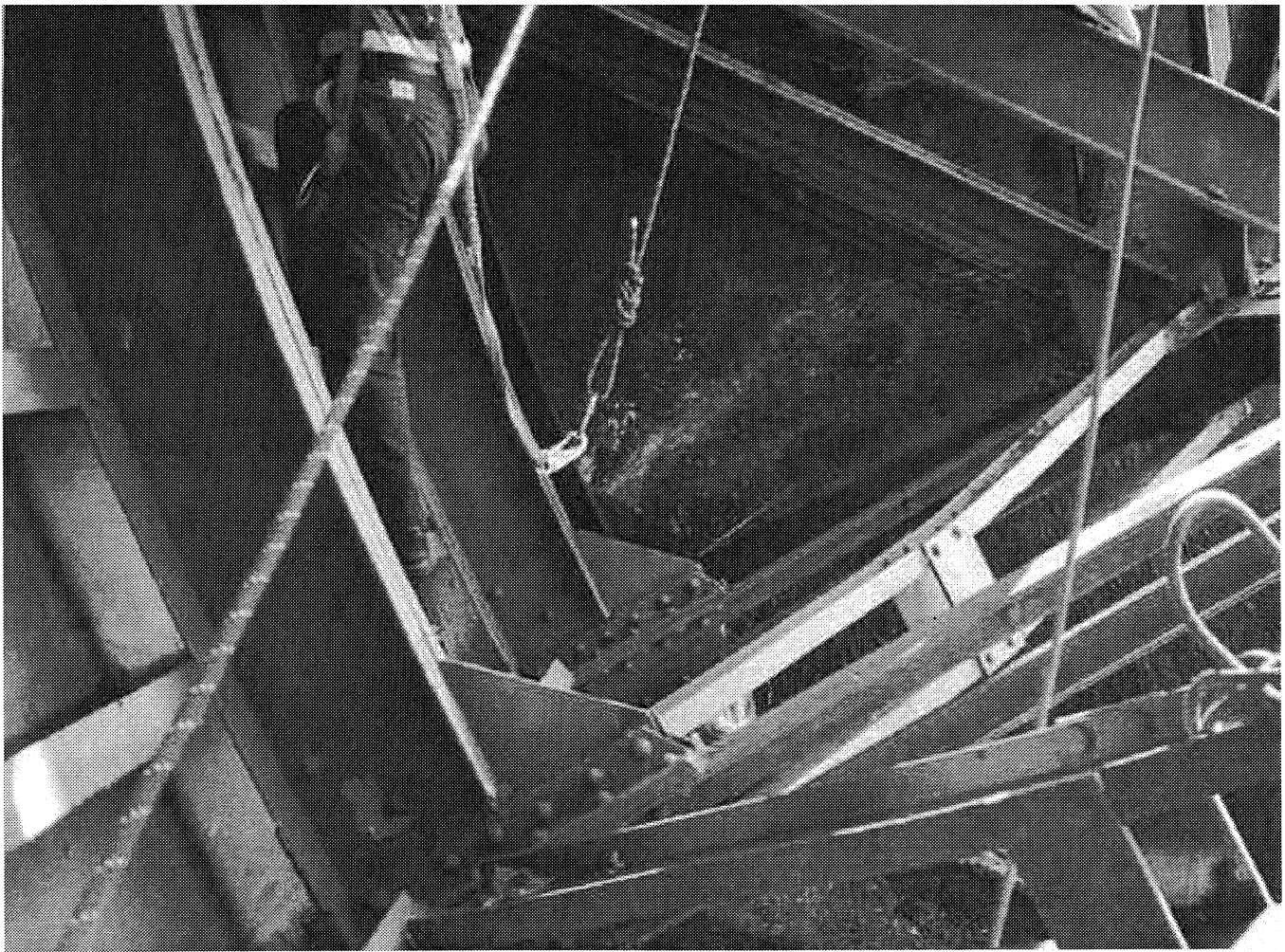

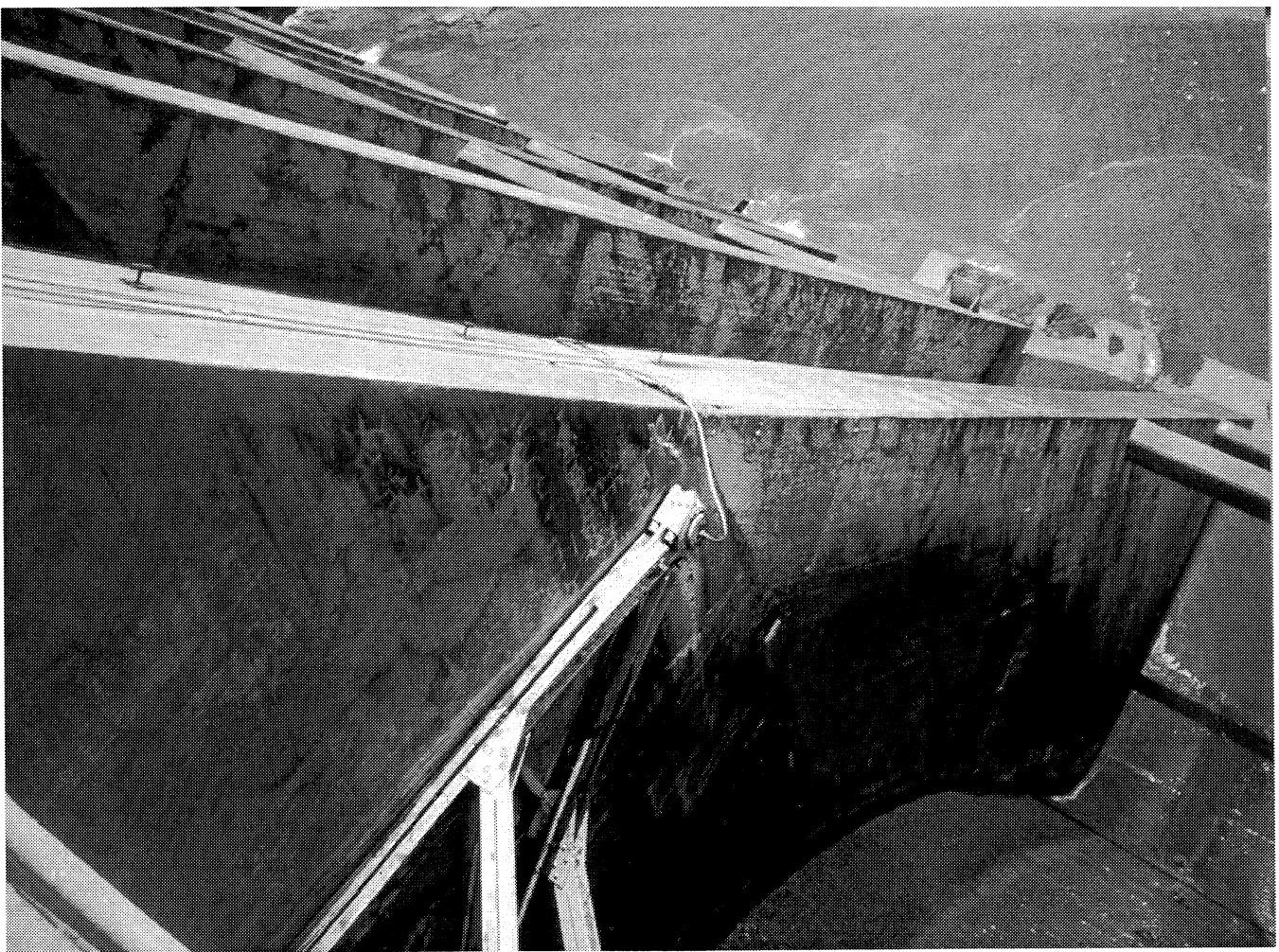

## Summary of Key Findings

---

- Broken welds between horizontal girders and vertical ribs
- Corrosion at connections--especially at lower X-bracing
- A few bent members and missing radial strut connection pins
- Inadequate lubrication at a few Trunnions

# Summary of Key Findings

---

- Insufficient Drainage in Web of Horizontal Girders--Trapping Debris and Sediment
- Evidence of Painting Over Rust
- Potential Failure of Bottom Seal Connection System

## Conclusions and Recommendations

---

- Annual testing does not catch all of the problems.
- You can't do a thorough inspection from the deck or in a boat--you must be able to see all of the members and connections.
- You should do a detailed, hands-on, inspection at least once every 5-10 years.

# Conclusions and Recommendations

---

- Ensure lubrication system is working properly.
- Improve drainage in horizontal girders.
- Direct drain discharge away from structural members.
- Eliminate sediment and vegetation on gate arms and girders.
- Ensure adequate surface preparation prior to painting, and establish guidelines for when to paint.

# **Failure Analysis of Gates**

*Bernard Peters*

*URS Greiner Woodward Clyde*

# **Field Inspection of PG&E Spillway Gates**

**Bernard J. Peter, B.S., P.E.  
Woodward-Clyde Consultants, Denver, Colorado, USA**

**Electric Power Research Institute**

**Dam Safety Issues Workshop  
June 9 and 10, 1998**

**Washington, D.C., USA**

**Woodward-Clyde** 

## **Synopsis**

- **Gate Structure**
- **Field Inspection**
- **Photographs**
- **Safety Concerns**
- **Design and Maintenance**

**Woodward-Clyde** 

# Radial Gate Design

- **Radial Gate generally considered**
  - Simple and Economical
  - Reliable and Easy to maintain
- **Used Throughout World For Regulation and Shut-off**
  - Spillways
  - Outlet Works
  - Check Structures
  - Culvert Valves (ship locks)

# Radial Gate Structure

- **Components**
  - Gate Leaf
  - Arm Columns
  - Trunnions
  - Anchorage
- **Concern**
  - None (Conservative)
  - Buckling
  - Friction
  - Corrosion
  - Domino Effect



# Field Safety Inspection

- **California DSOD Requested Owner Inspection Spillway Radial Gates**
- **Inspections Involved 6 Watersheds, 16 Dams, and 80 Radial Gates**

# Scope

- **Data Review**
  - Drawings
  - History
  - Reports
- **Field Inspection**
  - Observation
  - Interview
  - Additional Data

## Scope (cont'd)

- **Report**
  - Gate Details
  - Conditions
  - Response to California DSOD
- **Recommendation**
  - Maintenance
  - More Evaluation
- **Not Covered**
  - Structural Analysis
  - Hands-on Physical Examination
  - Member Measurement

## Gates Inspected

- **Large variety in design**
  - Built 1920's to 1970's
  - Small (13'x6') to Large (50'x41')
  - Peak flow from 2,000 cfs to 45,000 cfs
  - Riveted versus Welded and Bolted
- **Generally in Good Condition**

# Field Inspection

- **Designed versus As-built**
- **Modification**
- **Condition of Visible Parts**
- **Operation Problems**

# Other Things To Look For

- **Bends or Dents**
- **Deposits on Surface of Concrete Pier**
- **Marks on Side Seal Wall Plates**
- **Vibration during Operation**
- **Ripples in Discharge Flow**

## Seven 14'x15' Gates, 1939, & Three 14'x20' Gates, 1974

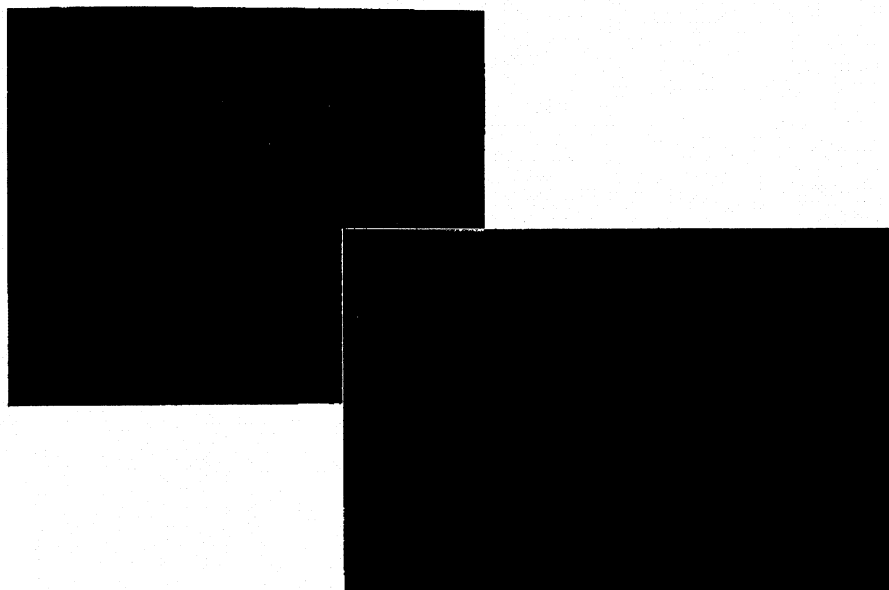

Woodward-Clyde 

11 - 1043

## 49'x42' Gate, Welded & Bolted Structure, 1964-1965

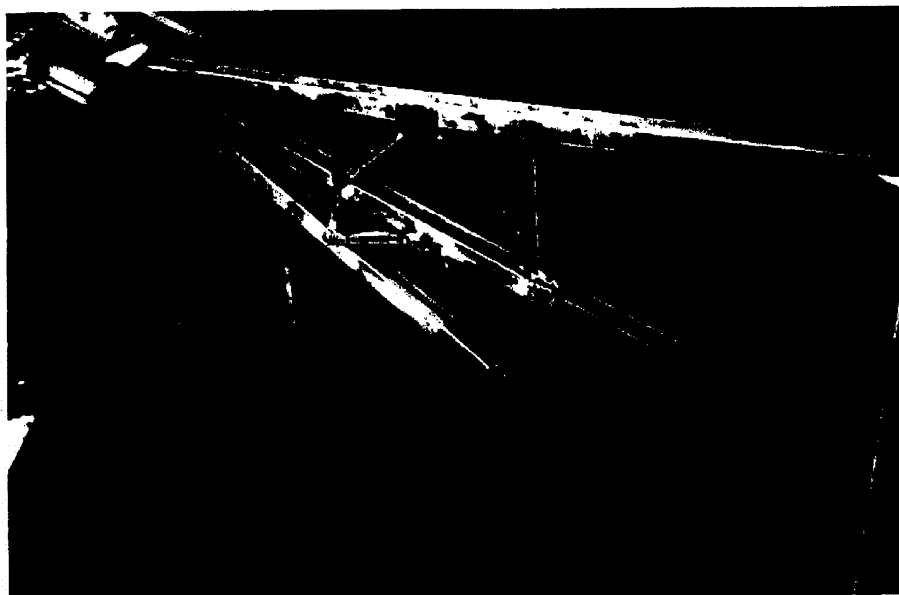

Woodward-Clyde 

12 - 1043

## Tunnion Anchor, 17" O.D. Pin, Four 5"x6" Tie Bars



Woodward-Clyde 

13 - 1043

## 20'x13.5' Gate, Truss Structure, 1930



Woodward-Clyde 

14 - 1043

## 22.5'x15' Gates, Twins With Varied Arm Bracing, 1949-1950

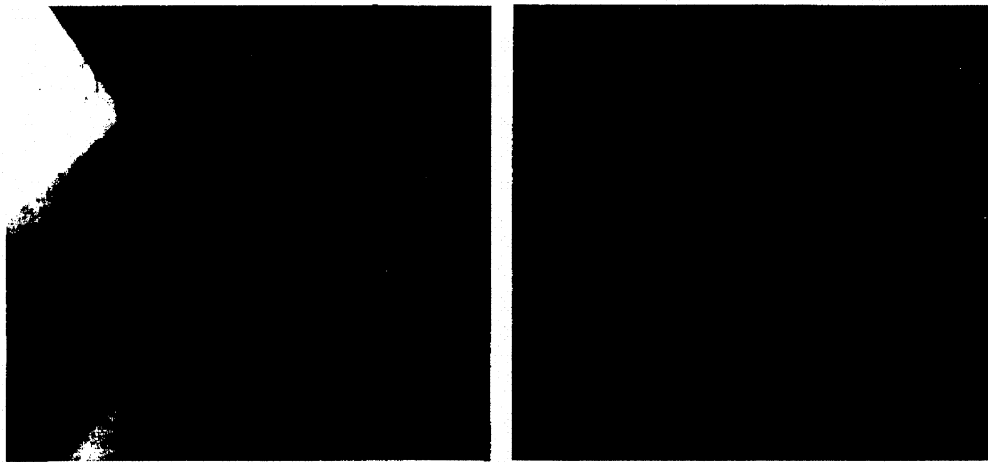

Woodward-Clyde 

15 - 1043

## 40'x11' Gate, Typical Pin Block

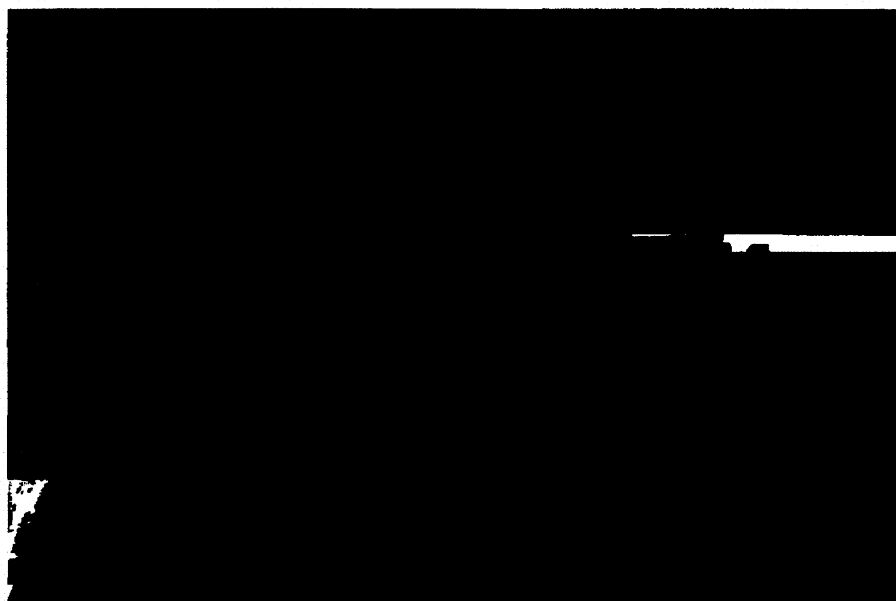

Woodward-Clyde 

16 - 1043

## 20'x6' Gate Built in 1930, 4' Flashboard Added 1977

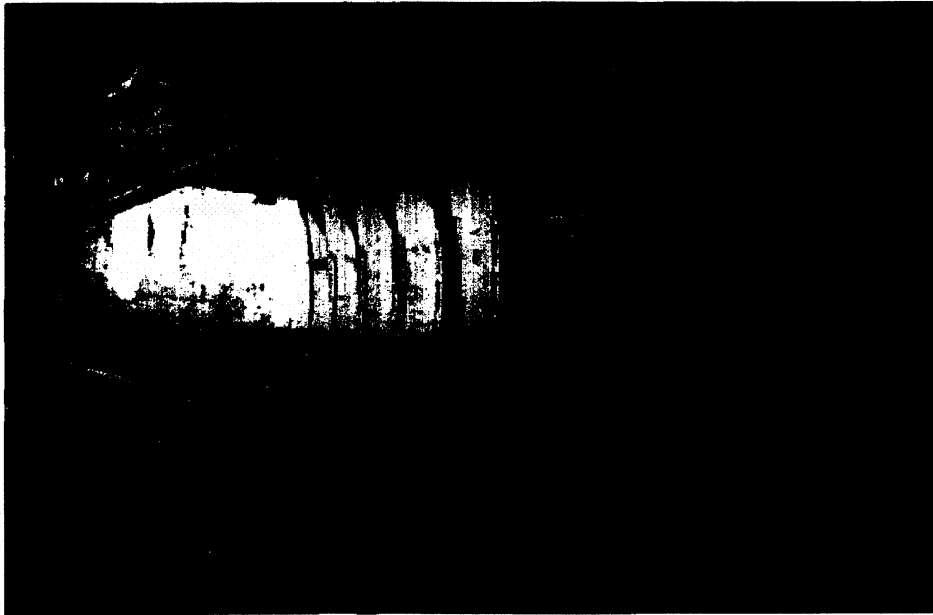

Woodward-Clyde 

17 - 1043

## Anchor Misalignment, 1920



Woodward-Clyde 

18 - 1043

## 40'x11' Gate, Coating Deterioration, 1946-1947

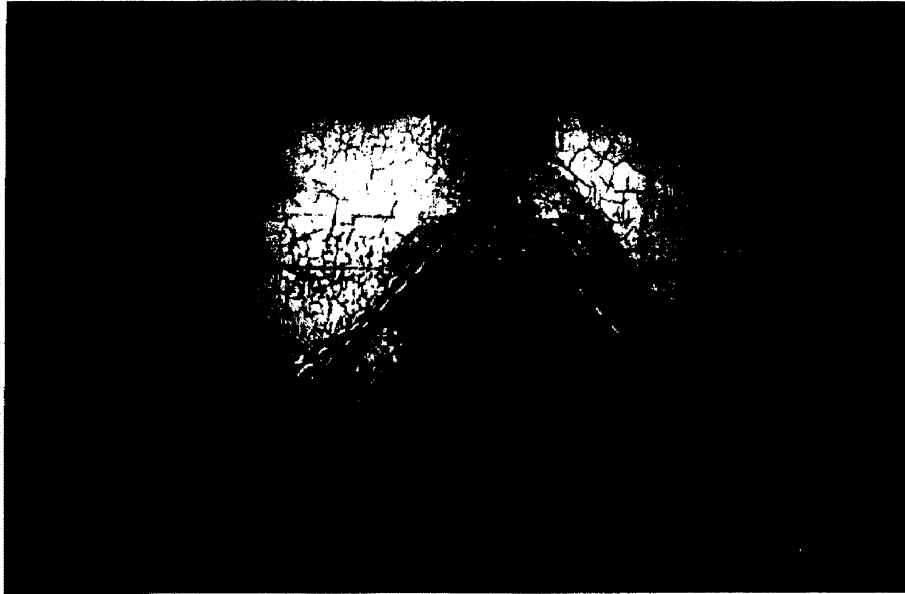

Woodward-Clyde 

19 - 1043

## Findings

- **PG&E Gates Were in Good Condition**  
– *(and well maintained)*
- **No Serious Loss of Metal**  
– *(from critical members)*
- **All Fasteners Were in Place**  
– *(with two exceptions)*
- **Coatings Were in Good Condition**  
– *(with some discoloration and cracking)*

Woodward-Clyde 

20 - 1043



# Safety Concerns Identified

- **Trunnions**

- Older Designs
  - Carbon-steel pins with Tobin-Bronze Bushings
  - Rotation on Bushing I.D.'s and O.D.'s
- Newer Designs
  - Stainless Steel (type 410) with Graphite Inserted Bushings

*Projected bearing pressures ranging from under 1000 - to over 7000 - lbs/in<sup>2</sup>. No seals. Both older and newer designs susceptible to corrosion and increased friction, with friction almost certainly doubled for older designs. No lubrication capacity at one dam.*

# Safety Concerns Identified (con't.)

- **Anchorage**

- Elongation of tie bars with load
- Migration of moisture between pin blocks and concrete
- Anchor corrosion within concrete
- Condition of concrete
  - Cracking
  - Mineral deposits
  - Carbonization

- **Strength**

- Were arm columns originally designed for combined compression and bending?
- What is present margin of safety in arm column strength?
- What is the effect of change in trunnion friction?

# Gate Design

- **Column Strength**
  - Effective Length
  - End Conditions
  - Bracing
- **Loads**
  - Water
  - Operating (trunnion friction)
- **Stress Analysis**
  - Stress Levels
  - Assess Effect of Changes in Trunnion Friction

# Loads

- **Applied Loads**
  - Water
  - Weight
  - Hoist
- **Induced Loads**
  - Trunnion Friction
  - Lateral Thrust Friction
  - Side Seal Friction
  - Bottom Seal Load
  - Vibration

# The Myth

Until the July 17, 1995, failure of the 42- by 50-foot spillway radial gate at Folsom Dam, gate trunnions were considered benign relative to gate support and operation. A routinely lubricated steel pin and bronze bushing arrangement (common in older gate designs) was presumed to have an indefinite life. The presence of a lubricant was considered sufficient to exclude pin corrosion and maintain a reasonable stable coefficient of friction. Even though friction change with age was recognized, friction was not considered critical unless the gravity closure of a gate was in jeopardy. As a result of the Folsom Gate forensic investigation, changing conditions (pin corrosion coupled with changes in scheduled lubrication and grease) within the gate trunnions were found to be significant, and resulted in critical loading of the supporting arm columns and bracing. Hence, trunnions can no longer be considered passive components of gate and hoist equipment with regard to long-term reliable gate operation.

# Lubricant Properties

- Prevent Rusting of Steel
- Prevent Corrosion of Bronze
- Low Friction of Steel vs Bronze
- Prevent Scuffing of Steel vs Bronze
- Resist Water Washout
- Does Not Harden in Lubrication Lines
- Easy to Pump and Distribute
- Strong Adherence to Metal Surfaces
- Long Life
- Oil and Gelling Agents Do Not Separate in Storage

# Back To The Future

- **Radial Gate Trunnions**
  - Heavily Loaded
  - Very Slow Moving
  - Boundary Lubrication
  - Materials/Corrosion
  - Protection
    - Seals
    - Weather Shields
- **Trunnion Lubrication**
  - Unloaded
  - Loaded
  - Frequency
  - Lubricant
  - Method of Lubrication

# Back To The Future (cont'd)

- **Arm Columns**
  - Bracing Configuration
  - Diagonals
    - Purpose
    - Carry Load
    - Transfer Load
  - Connections
- **Radial Gate Anchorage**
  - Venerability of Design
  - Existing Conditions
    - Visible Metalwork
    - Concrete Structure
    - Invisible Anchors

## Back To The Future (cont'd)

- **Maintenance**
  - Annual Cleaning of Gate Structure
  - Regular Physical Inspection
    - Corrosion
    - Loose Fasteners
  - Monitor
    - Trunnion Friction
    - Anchorage Conditions
- **Stress Computations**
  - Design Assumptions
  - Exclusions

## Maintenance

- **Hands-on Inspection of all Connections**
- **Monitor Corrosion & Damage to Members**
- **Gate Lubrication**
  - Annual Full Travel
  - Before Gate Operation
  - During Gate Operation
- **Hoist Lubrication**
  - Lift Chains
  - Operating Mechanism
- **Monitor Trunnion Friction**
  - Analyze Grease Sample
  - Measure Gate Movement

# Conclusion

**Long-term reliable radial gate operation is a co-function of adequate design strength and good maintenance.**

Woodward-Clyde 

31 - 1043

**California's Radial Gate Inspection Program**

*Fred Sage*  
*California Division of Safety of Dams*



**Fred Sage**  
**Northern Regional Engineer**  
**Division of Safety of Dams**  
**State of California**

---

## Radial Gate Inspection Program

- Introduction
- History
- Owners' Response
- Review of Owner Evaluation Reports
- DSOD Physical Inspection-Verification of Owners' Reports



# Radial Gate Inspection Program

- DSOD Independent Review of Required Structural Analysis
- Current Status of Program
- Lessons Learned
- Conclusions

---

## Radial Gate Inspection Program

### **INTRODUCTION**

**As the result of the Folsom Dam radial gate failure, the State of California, Division of Safety of Dams initiated a program to assess the safety of all radial gates under the States jurisdiction.**

**-19 owners**

**- 59 dams**

**- 239 gates initially identified.**

# Radial Gate Inspection Program

## HISTORY

July 17, 1995 Folsom Gate Failure

September 8, 1995 DSOD letter asking Owners of dams with radial gates to develop a comprehensive plan and schedule for an investigation and evaluation of their gates by October 15, 1995.

DAMS UNDER STATE JURISDICTION WITH RADIAL GATES							
DAMS OPERATED BY DEPARTMENT OF WATER RESOURCES							
DAM NO.	DAM NAME	COUNTY	OWNER	DAM TYPE	GATES	SIZE (WxH)	AGE
1-048	OROVILLE	BUTTE	DEPT OF WATER RES	ERTH	8	17.6x33	36
			DEPT OF WATER RES		3	26.7x25.8	
1-049	THERMALITO DIV	BUTTE	DEPT OF WATER RES	GRAV	14	40x23	28
1-054	THERMALITO FB	BUTTE	DEPT OF WATER RES	GRAV	1	17.9x17.6	28
1-055	THERMALITO AB	BUTTE	DEPT OF WATER RES	ERTH	5	14x14	28
1-064	CLIFTON COURT FB	CONTRA COSTA	DEPT OF WATER RES	ERTH	5	20x25.5	25
1-066	PYRAMID	LOS ANGELES	DEPT OF WATER RES	ERRK	1	40x31	22
DAMS NOT OPERATED BY DEPARTMENT OF WATER RESOURCES							
DAM NO.	DAM NAME	COUNTY	OWNER	DAM TYPE	GATES	SIZE (WxH)	AGE
1024-006	MCKAY'S POINT DIV	CALAVERAS	CALAVERAS COUNTY WD	CORA	1	4.5x6.5	6
11-000	GIBRALTAR	SANTA BARBARA	CITY OF SANTA BARBARA	GRAV	1	58x21.7	75
			CITY OF SANTA BARBARA		3	52x21	
14-000	LAKE CURRY	NAPA	CITY OF VALLEJO	ERTH	5	9x5	69
58-002	NEW EXCHEQUER	MARIPOSA	MERCED IRR DIST	ROCK	6	40x30	28

DAM NO.	DAM NAME	COUNTY	OWNER	DAM TYPE	GATES	SIZE (WxH)	AGE
61-002	BOWMAN	NEVADA	NEVADA IRR DIST	ROCK-ARCH	7	12x5.8	68
61-020	JACKSON MEADOWS	NEVADA	NEVADA IRR DIST	ROCK	3	30x23	30
62-004	BEARDSLEY	TUOLUMNE	OAKDALE SO SAN JOAQUIN IC	ERRK	4	40x32	38
62-005	DONNELLS	TUOLUMNE	OAKDALE SO SAN JOAQUIN IC	VARA	5	35x19	37
62-006	TULLOCH	CALAVERAS	OAKDALE SO SAN JOAQUIN IC	GRAV	7	40x30	37
63-003	LITTLE GRASS VALLEY	PLUMAS	OROVILLE WYANDOTTE I.D.	ROCK	2	40x14	34
63-006	SLY CREEK	BUTTE	OROVILLE WYANDOTTE I.D.	ERTH	1	54x16	34
91-000	COPCO NO. 1	SISKIYOU	PACIFIC POWER AND LIGHT	GRAV	13	14x14	73
91-002	COPCO NO. 2	SISKIYOU	PACIFIC POWER AND LIGHT	GRAV	5	26x17.5	70
93-005	POE	BUTTE	PACIFIC GAS AND ELECTRIC	GRAV	4	50x41	36
					1	22.5x15	
93-006	CRESTA	PLUMAS	PACIFIC GAS AND ELECTRIC	GRAV	1	22.5x15	46
93-007	ROCK CREEK	PLUMAS	PACIFIC GAS AND ELECTRIC	GRAV	1	22.5x15	45
95-003	CRANE VAL STOR	MADERA	PACIFIC GAS AND ELECTRIC	HYDF	2	17.6x10.75	85
95-008	KERCKHOFF DIV	MADERA	PACIFIC GAS AND ELECTRIC	VARA	14	20x14.3	75
95-010	MERCED FALLS	MERCED	PACIFIC GAS AND ELECTRIC	GRAV	3	20x13	94
97-007	KUNKLE	BUTTE	PACIFIC GAS AND ELECTRIC	HYDF	1	4x6	88
97-008	PHILBROOK	BUTTE	PACIFIC GAS AND ELECTRIC	ERTH	1	14.8x10.75	69
97-028	LAKE FORDYCE	NEVADA	PACIFIC GAS AND ELECTRIC	ERRK	2	14x15	69
97-029	LAKE SPAULDING	NEVADA	PACIFIC GAS AND ELECTRIC	VARA	3	14x20	82
			PACIFIC GAS AND ELECTRIC		7	14x15	

DAM NO.	DAM NAME	COUNTY	OWNER	DAM TYPE	GATES	SIZE (WxH)	AGE
97-058	SILVER LAKE	AMADOR	PACIFIC GAS AND ELECTRIC	CRIB	2	14.75x11.25	119
97-066	SALT SPRINGS	AMADOR	PACIFIC GAS AND ELECTRIC	ROCK	11	40x11	64
			PACIFIC GAS AND ELECTRIC		1	32x11	
			PACIFIC GAS AND ELECTRIC		1	6x14	
97-073	LYONS	TUOLUMNE	PACIFIC GAS AND ELECTRIC	VARA	4	20x10	65
97-099	PIT NO. 1 DIV	SHASTA	PACIFIC GAS AND ELECTRIC	GRAV	3	12x5.5	73
97-101	SCOTT	LAKE	PACIFIC GAS AND ELECTRIC	GRAV	5	32x10	74
97-105	TIGER CR. AB	AMADOR	PACIFIC GAS AND ELECTRIC	VARA	10	29.5x12	64
97-110	PIT NO. 1 FB	SHASTA	PACIFIC GAS AND ELECTRIC	ERTH	2	22.5x15	48
97-115	LOWER BEAR RIVER	AMADOR	PACIFIC GAS AND ELECTRIC	ROCK	1	8x14	43
97-117	MURPHYS AB	CALAVERAS	PACIFIC GAS AND ELECTRIC	ERTH	1	16x7	42
97-118	WISHON	FRESNO	PACIFIC GAS AND ELECTRIC	ROCK	6	40x12	37
97-120	CARIBOU AB	PLUMAS	PACIFIC GAS AND ELECTRIC	ERRK	4	22.5x15	36
97-121	PIT NO. 6	SHASTA	PACIFIC GAS AND ELECTRIC	GRAV	2	49x42	30
97-122	PIT NO. 7	SHASTA	PACIFIC GAS AND ELECTRIC	GRAV	2	49x42	30
97-123	MCCLOUD	SHASTA	PACIFIC GAS AND ELECTRIC	ERRK	3	27x24.5	30
97-128	NEW DRUM AB	NEVADA	PACIFIC GAS AND ELECTRIC	VARA	4	15x6	27
1030-000	L. L. ANDERSON	PLACER	PLACER COUNTY WA	ERRK	2	20x18.5	30
1030-003	INTERBAY	PLACER	PLACER COUNTY WA	GRAV	4	20x20	29
1030-004	RALSTON AB	PLACER	PLACER COUNTY WA	GRAV	5	30x40	29



# Radial Gate Inspection Program

## OWNERS RESPONSE

Initial owners response and DSOD comments on the response.

Reports by owners many were contracted to Consulting Engineering Firms

---

# Radial Gate Inspection Program

## DIVISION REVIEW OF OWNER EVALUATION REPORTS

Development of standardized radial gate check list.

- Taken from Folsom gate failure report
- Taken from compilation of owners responses

Comments on reports with any further requirements sent to owners, Independent structural review to follow pending verification of structural member dimensions. It was not uncommon to find field installations and as built plans that differ.

# Radial Gate Inspection Program

## DSOD PHYSICAL INSPECTION-VERIFICATION OF OWNERS REPORTS

1. Budget Change proposal to augment program for additional funding

2. Training of engineer climbers

Model Climbing after CalTrans industrial climbing training used for bridge inspection program. Harness and double rope protection

Training on inspection of steel structures

USCE manuals

CalTrans bridge inspection program

3. Gates prioritized - three year program

DAMS UNDER STATE JURISDICTION WITH RADIAL GATES											
Finl Pri- ority	DAM NO.	DAM NAME	TYPE	GATES	SIZE (WxH)	1995 AGE	Lake Area	gate height	gate storage	Hzd class	stor Pri- ority
1	1080-002	INDIAN VALLEY	ERTH	2	29.5x24	19	4000	24	96,000	4A	6
2	72-000	COYOTE PERCOL	FLBT	2	11x10	61	30	10	300	2B	53
3	72-006	VASONA PERCOL	ERTH	2	10X13	60	58	13	754	3C	49
4	11-000	GIBRALTAR	GRAV	1	58x21.7	75	335	22	7,370	3C	33
5	1-048	OROVILLE	ERTH	8	17.6x33	36	15805	87	1,375,035	4A	1
6	1-049	THERMALITO DIV	GRAV	14	40x23	28	323	23	7,429	3B	32
7	97-118	WISHON	ROCK	6	40x12	37	970	12	11,640	4B	24
8	68-007	DON PEDRO	ERRK	3	45x30	24	12960	30	388,800	4B	2
9	1034-000	NEW BULLARDS BAR	ERRK	3	30x53	25	4810	53	254,930	4B	3
10	58-002	NEW EXCHEQUER	ROCK	6	40x30	28	7147	30	214,410	4B	4
11	1-066	PYRAMID	ERRK	1	40x31	22	1360	31	42,160	4A	7
12	1009-003	UNION VALLEY	ERRK	2	40x16	32	2575	16	41,200	3A	8
13	1030-000	L. L. ANDERSON	ERRK	2	20x18.5	30	1344	18	24,192	4B	10
14	97-029	LAKE SPAULDING	VARA	3	14x20	82	698	20	13,960	4B	20
15	61-020	JACKSON MEADOWS	ROCK	3	30X23	30	938	23	21,574	2A	11
16	63-003	LITTLE GRASS VALLEY	ROCK	2	40x14	34	1433	14	20,062	3A	13
17	97-101	SCOTT	GRAV	5	32x10	74	2000	10	20,000	3D	14
18	97-122	PIT NO. 7	GRAV	2	49x42	30	470	42	19,740	3C	15
19	1-054	THERMALITO FB	GRAV	1	17.9x17.6	28	630	30	18,900	3B	16
20	104-023	VERMILION VALLEY	ERTH	1	15x8	41	1890	8	15,120	3C	17

Final Priority	DAM NO.	DAM NAME	TYPE	GATES	SIZE (WxH)	1995 AGE	Lake Area	gate height	gate storage	Hzd class	stor Priority
21	1-055	THERMALITO AB	ERTH	5	14x14	28	4302	30	129,060	3B	5
22	91-000	COPCO NO. 1	GRAV	13	14x14	73	1000	14	14,000	3B	19
23	62-004	BEARDSLEY	ERRK	4	40x32	38	650	32	20,800	4B	12
24	104-022	BIG CREEK NO. 7	GRAV	4	40x30	44	465	30	13,950	3A	21
25	95-008	KERCKHOFF DIV	VARA	14	20x14.3	75	160	14	2,240	3C	40
26	97-123	MCCLOUD	ERRK	3	27x24.5	30	520	24	12,480	2B	23
27	97-121	PIT NO. 6	GRAV	2	49x42	30	265	42	11,130	3B	26
28	95-003	CRANE VAL STOR	HYDF	2	17.6x10.75	85	1165	11	12,815	3B	22
29	97-066	SALT SPRINGS	ROCK	11	40x11	64	975	11	10,725	3B	27
30	1009-000	ICE HOUSE	ROCK	2	40x14	36	678	14	9,492	2A	29
31	63-006	SLY CREEK	ERTH	1	54x16	34	562	16	8,992	3B	30
32	62-005	DONNELLS	VARA	5	35x19	37	401	19	7,619	3A	31
33	97-058	SILVER LAKE	CRIB	2	14.75x11.25	119	385	11	4,235	2B	35
34	62-006	TULLOCH	GRAV	7	40x30	37	1260	30	37,800	2C	9
35	61-002	BOWMAN	K-ARCI	7	12x5.8	68	840	6	5,040	2C	34
36	1024-006	MCKAY'S POINT DIV	CORA	1	4.5x6.5	6	35	100	3,500	4A	36
37	97-110	PIT NO. 1 FB	ERTH	2	22.5x15	48	225	15	3,375	3C	37
38	93-006	CRESTA	GRAV	1	22.5x15	46	62	37	2,294	2B	38
39	93-007	ROCK CREEK	GRAV	1	22.5x15	45	80	28	2,240	3B	39
40	93-005	POE	GRAV	4	50x41	36	52	41	2,132	2B	41

Final Priority	DAM NO.	DAM NAME	TYPE	GATES	SIZE (WxH)	1995 AGE	Lake Area	gate height	gate storage	Hzd class	stor Priority
41	97-008	PHILBROOK	ERTH	1	14.8x10.75	69	190	11	2,090	2B	42
42	14-000	LAKE CURRY	ERTH	5	9x5	69	377	5	1,885	3C	43
43	97-073	LYONS	VARA	4	20x10	65	184	10	1,840	3C	44
44	1030-004	RALSTON AB	GRAV	5	30x40	29	45	40	1,800	2A	45
45	97-028	LAKE FORDYCE	ERRK	2	14x15	69	750	15	11,250	2C	25
46	97-105	TIGER CR. AB	VARA	10	29.5x12	64	105	12	1,260	2B	46
47	550-7	PHOENIX	ERTH	1	14x16	116	76	16	1,216	3C	47
48	97-115	LOWER BEAR RIVER	ROCK	1	8x14	43	710	14	9,940	3B	28
49	104-041	RHINEDOLLAR	ROCK	3	4x12	68	61	12	732	2B	50
50	97-120	CARIBOU AB	ERRK	4	22.5x15	36	42	15	630	2B	51
51	95-010	MERCED FALLS	GRAV	3	20x13	94	65	13	845	1C	48
52	1034-009	LAKE FRANCIS	HYDF	2	10x5	90	98	5	490	2D	52
53	1-064	CLIFTON COURT FB	ERTH	5	20x25.5	25	2500	6	15,000	2B	18
54	1030-003	INTERBAY	GRAV	4	20x20	29	7	20	140	1B	54
55	97-007	KUNKLE	HYDF	1	4x6	88	18	6	108	2C	55
56	91-002	COPCO NO. 2	GRAV	5	26x17.5	70	5	17	85	1B	56
57	97-128	NEW DRUM AB	VARA	4	15x6	27	10	6	60	2A	57
58	97-099	PIT NO. 1 DIV	GRAV	3	12x5.5	73	9	5	45	1B	58
59	97-117	MURPHYS AB	ERTH	1	16x7	42	2	7	14	3B	59

62-5a



62-5b

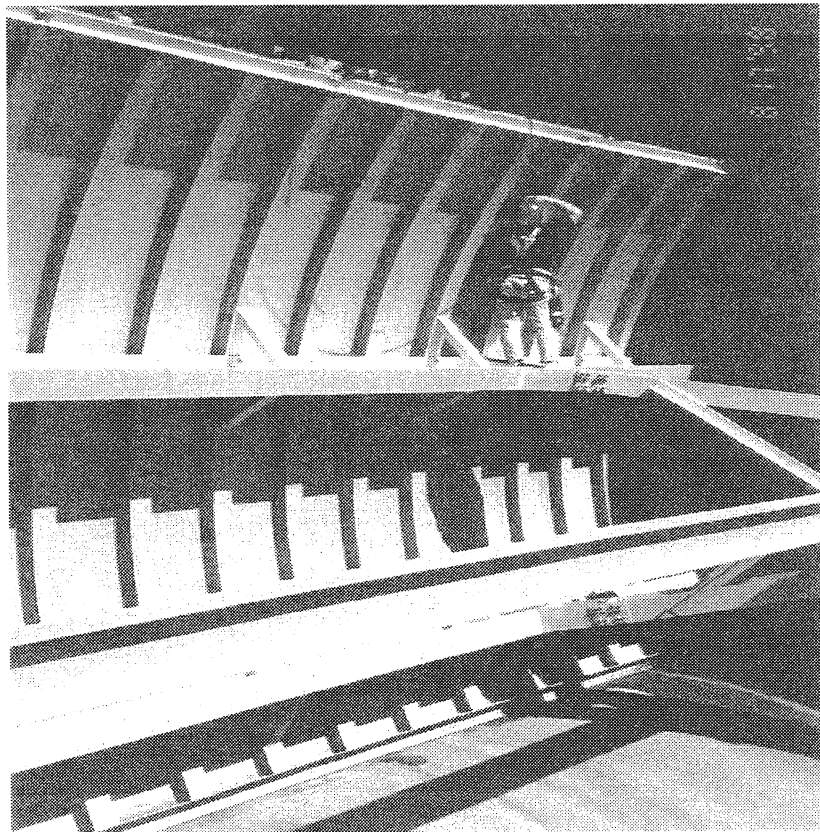



# Radial Gate Inspection Program

## DSOD INDEPENDENT REVIEW OF REQUIRED STRUCTURAL ANALYSIS

Training on use of FEM analysis

Development of Acceptable Loading Conditions

Development of Acceptable Load/Stress Levels

---

# Radial Gate Inspection Program

## CURRENT STATUS OF PROGRAM

Reports submitted and reviewed

Gates Climbed

Structural analyzes reviewed

# Radial Gate Inspection Program

## LESSONS LEARNED

Gates at Each Site	Year Constructed	Gate Dimensions W x H (ft)	DSOD FINDINGS
2	1976	29.5 x 24	Minor strengthening required due to high stresses from seismic load.
7	1927	12 x 2.8	Minor strengthening required due to high stresses from seismic load.
3	1956	30 x 15	Need field verification of members.
2	1963	40 x 16	Gates adequate.
2	1934	11 x 10	Owner replaced gates due to severe corrosion.
2	1935	10 x 13	Owner replaced gates due to severe corrosion.
1	1989	4.5 x 6.5	Gates adequate.
6	1967	40 x 30	Gates adequate.
6	1958	40 x 12	Member bent, minor strengthening required.
1	1971	58 x 22	Strengthening of major members required due to high stresses from seismic load.
3	1948	52 x 21	
3	1971	45 x 30	Gates adequate.
4	1957	40 x 32	Gates adequate pending correction of incomplete and poor quality welds found during inspection.

1030a



1030b

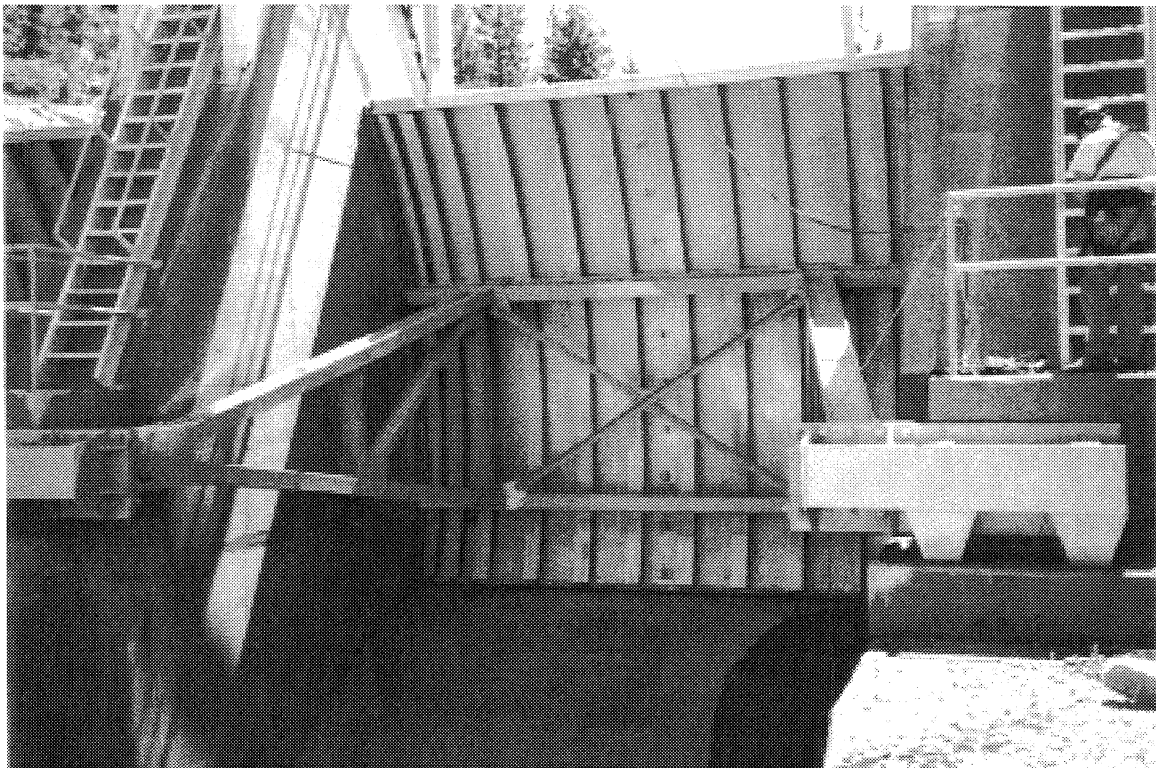

1030c

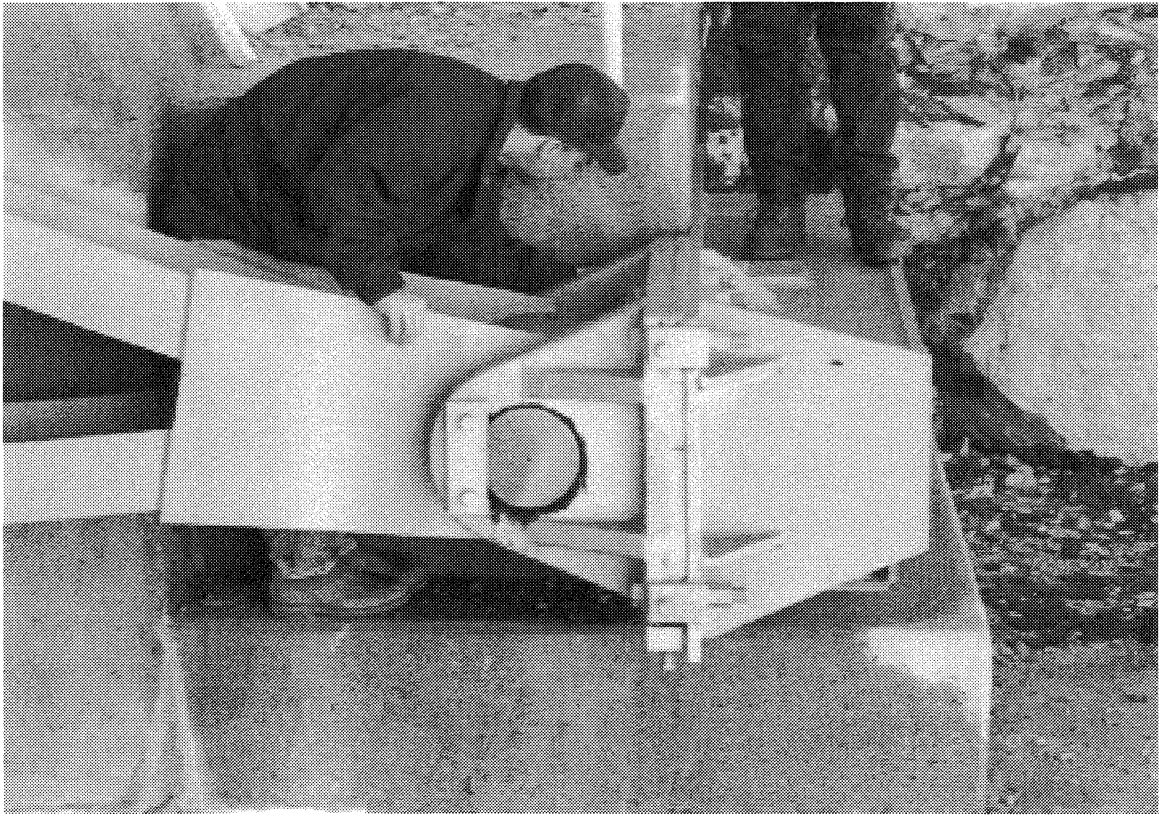

1030d

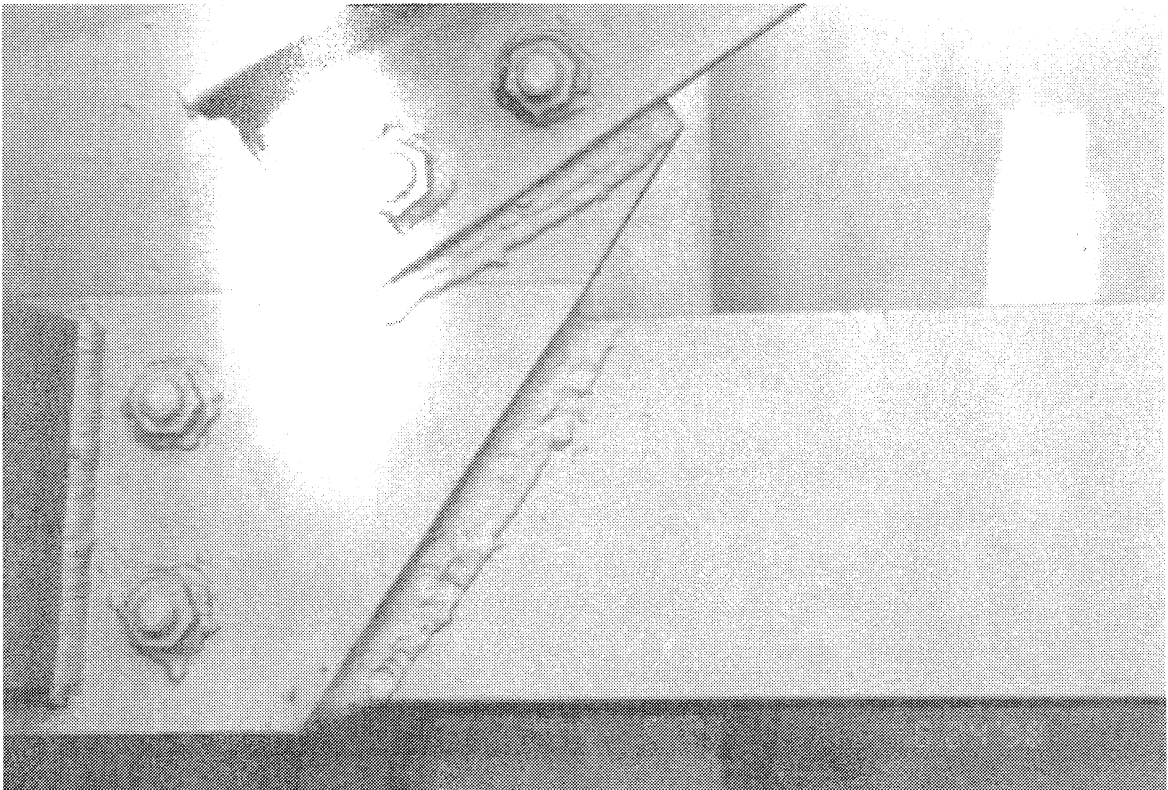

1030e

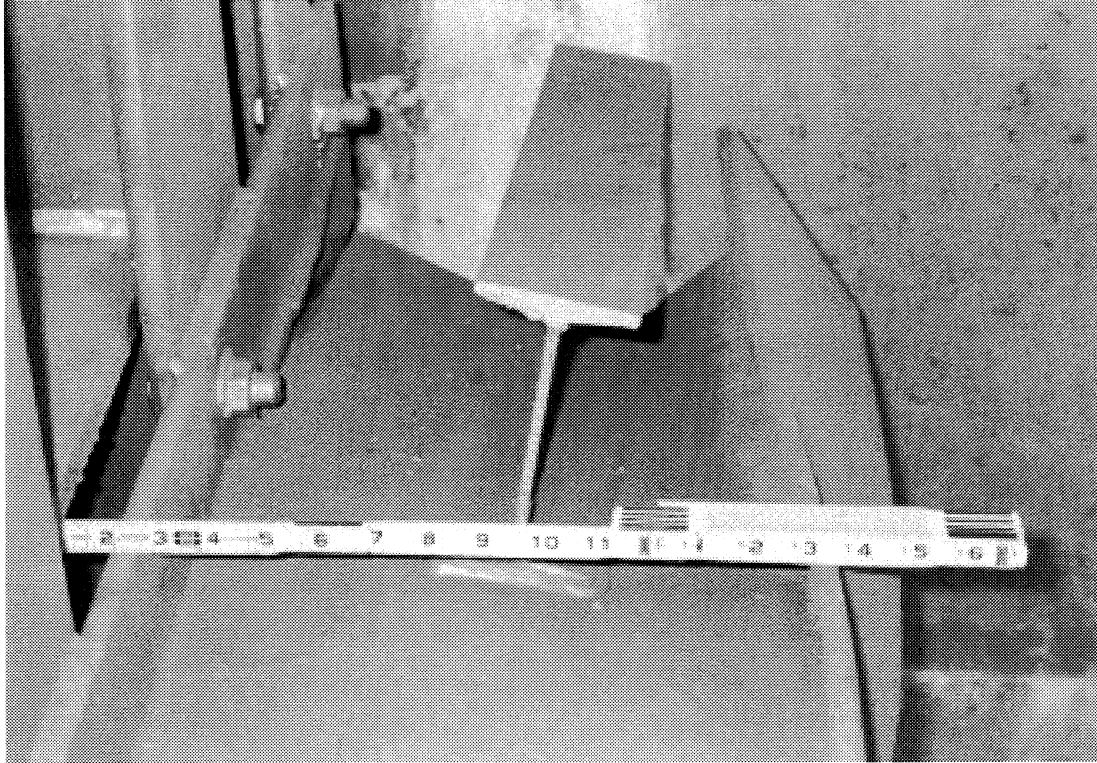

1080a

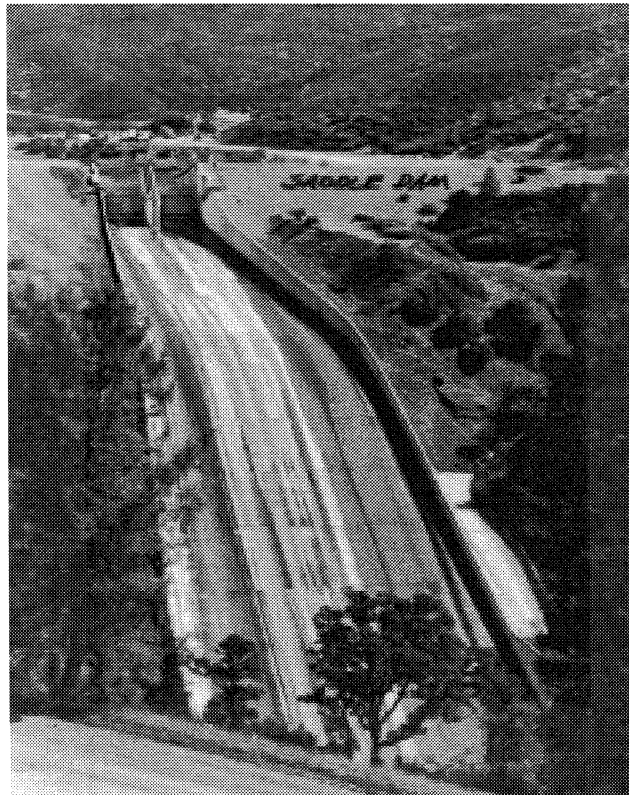

1080b

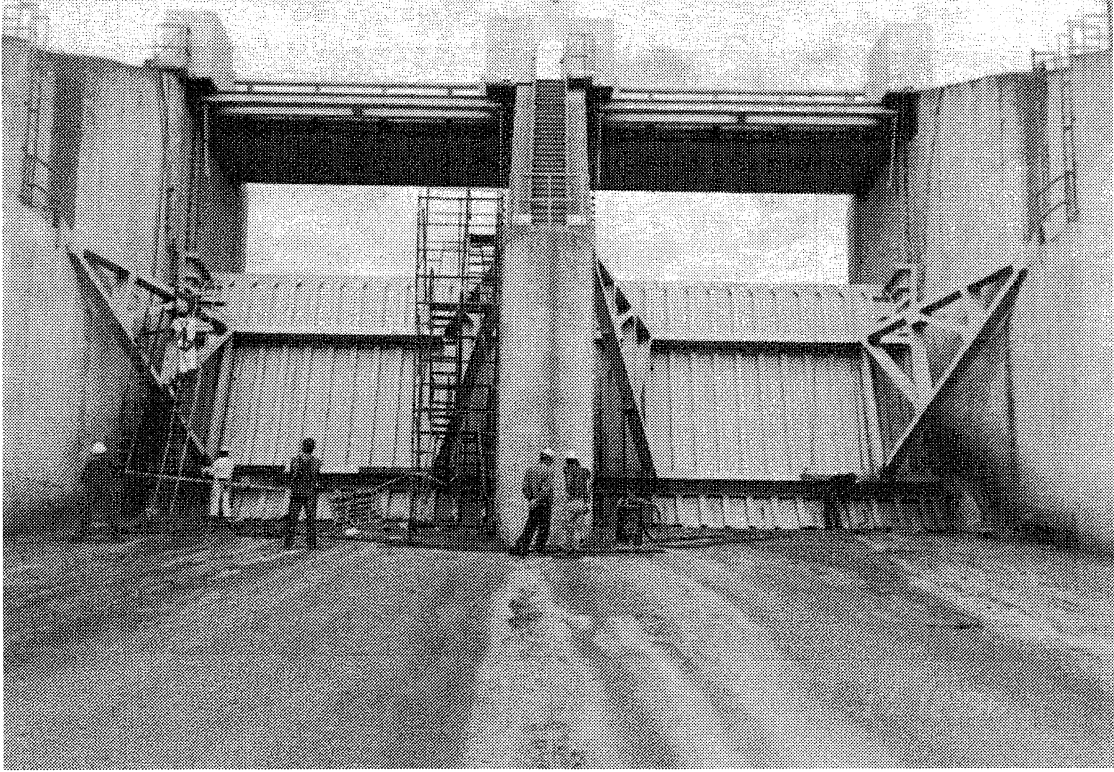

1080c



1080d

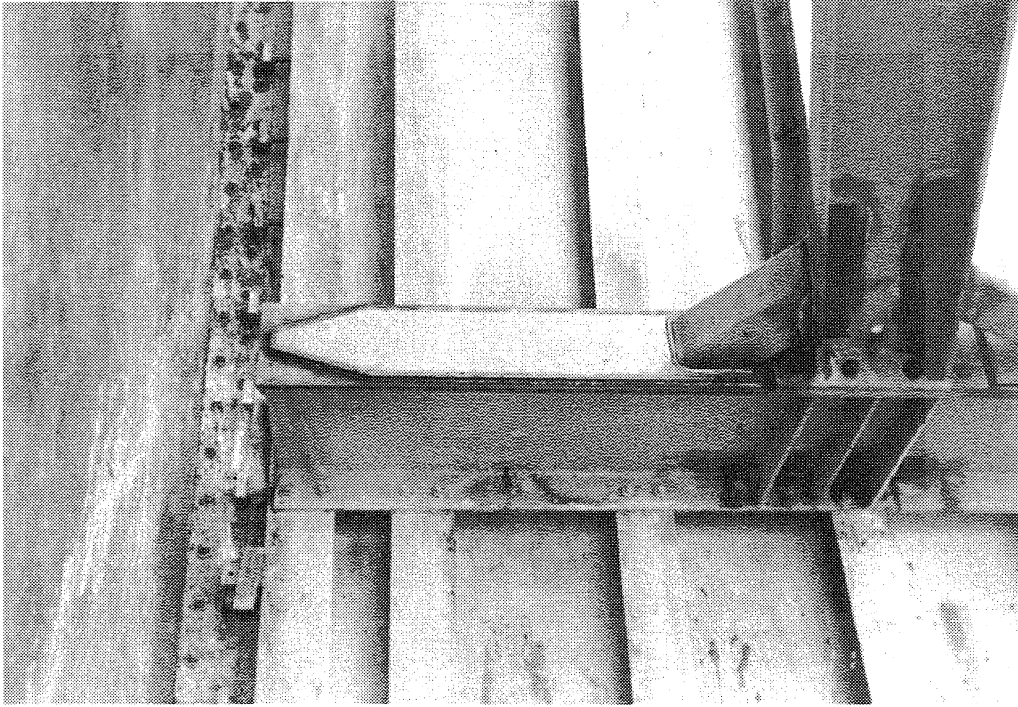

62-4a



62-4b

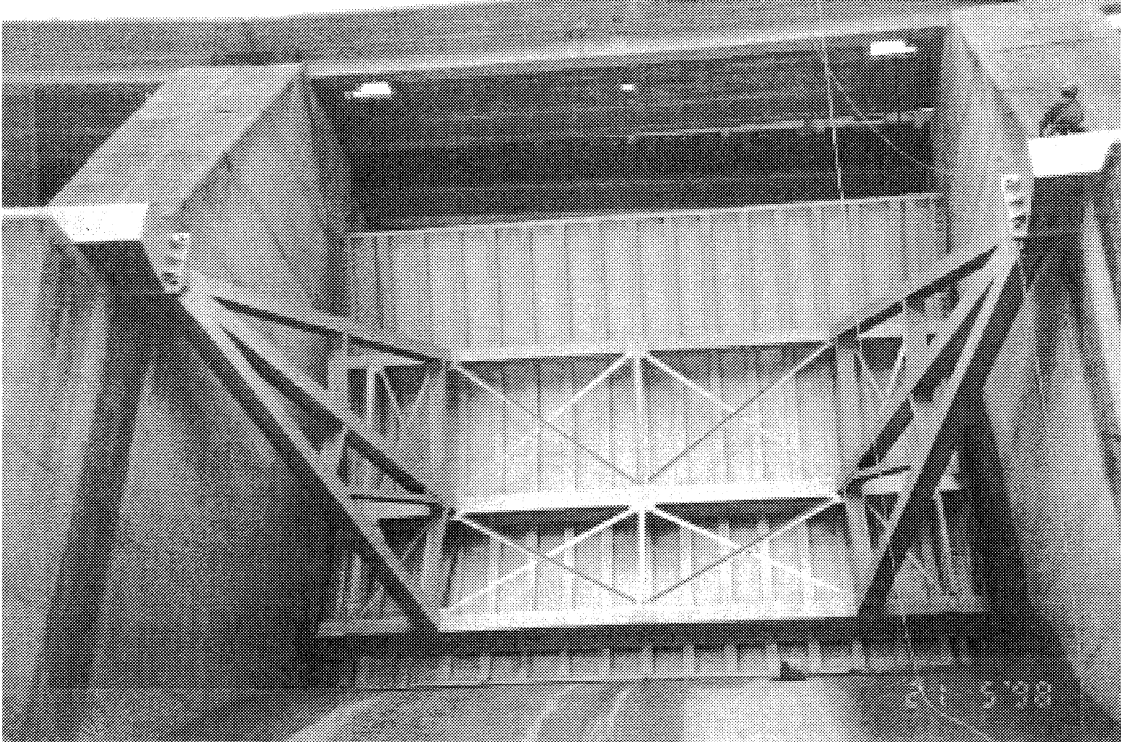

62-4c

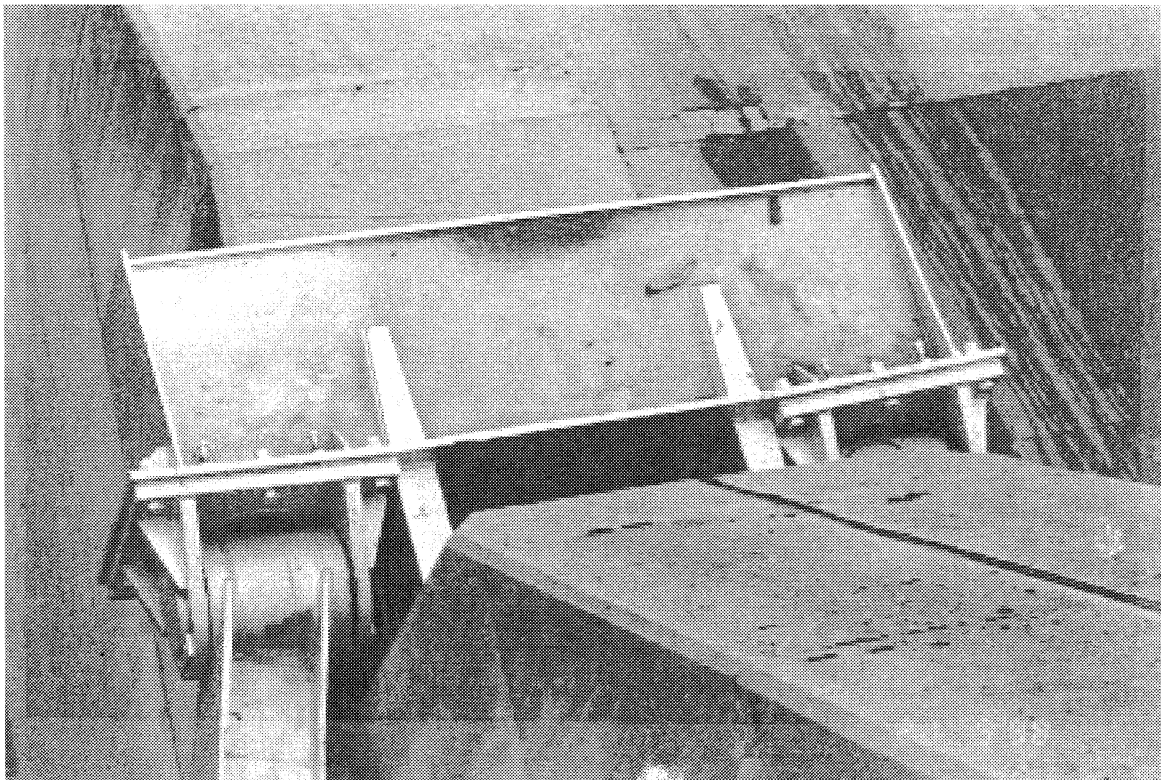



62-4d

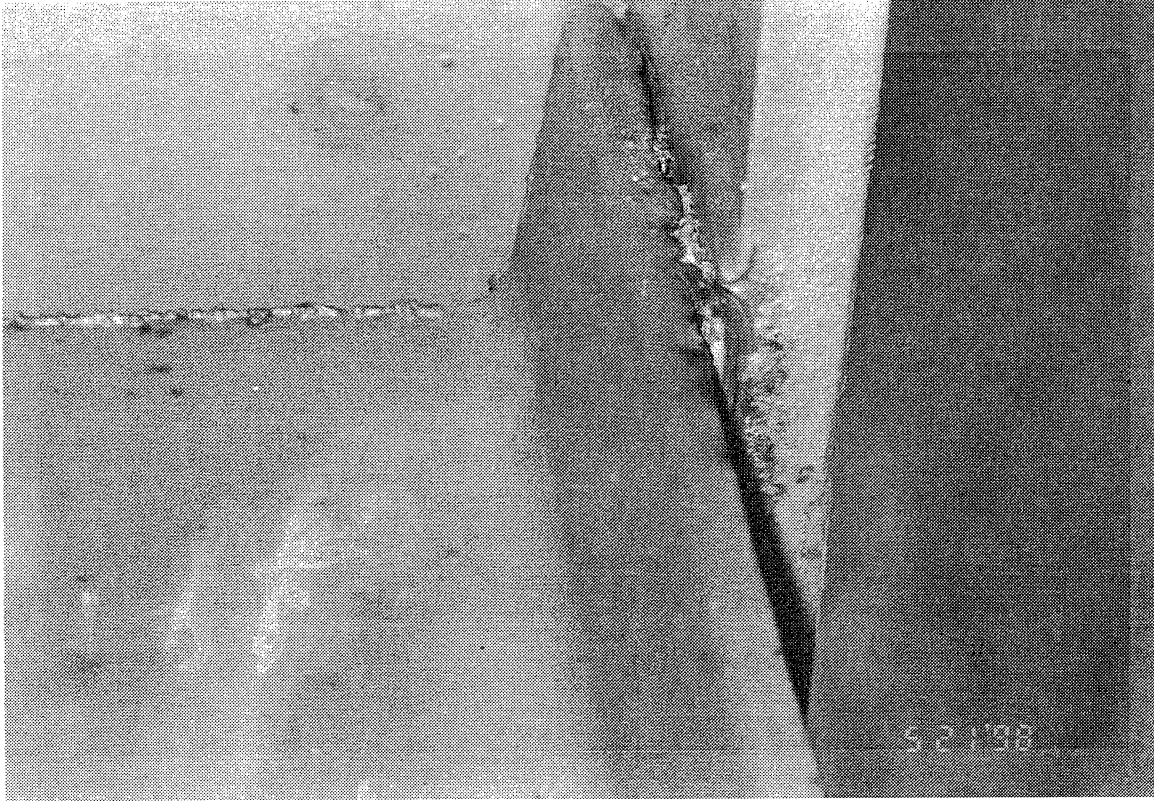

62-4e

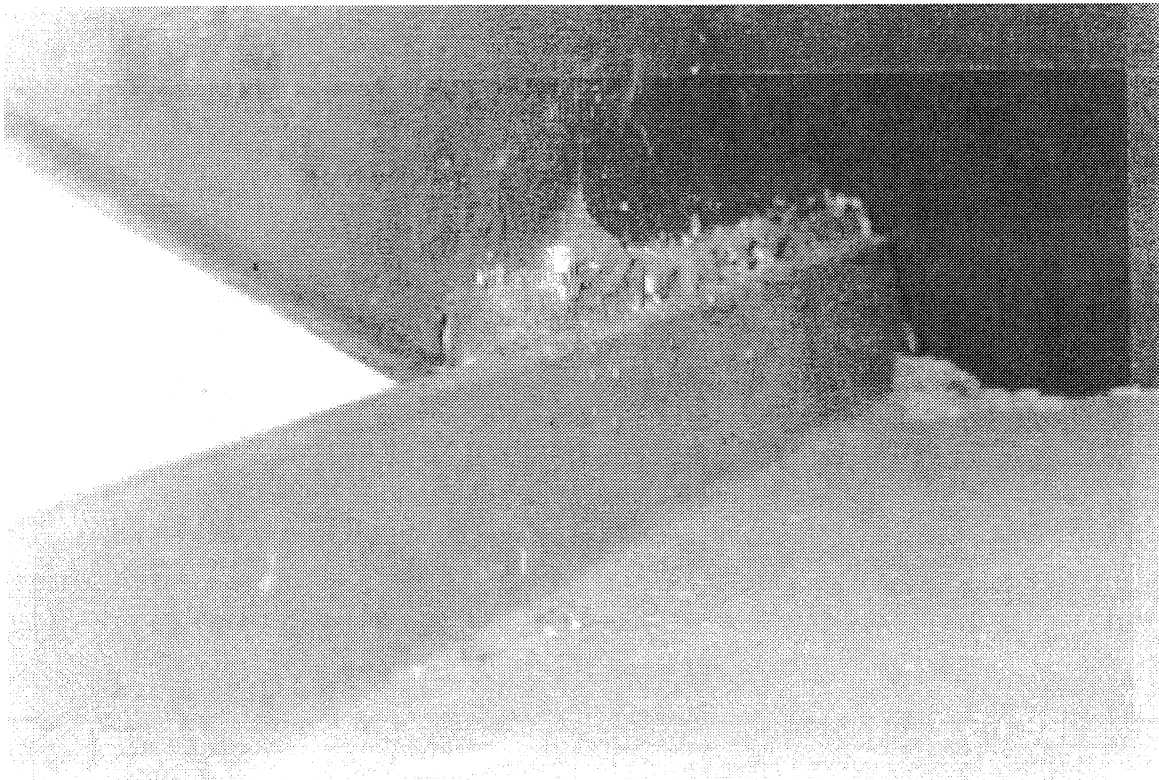

72-6a

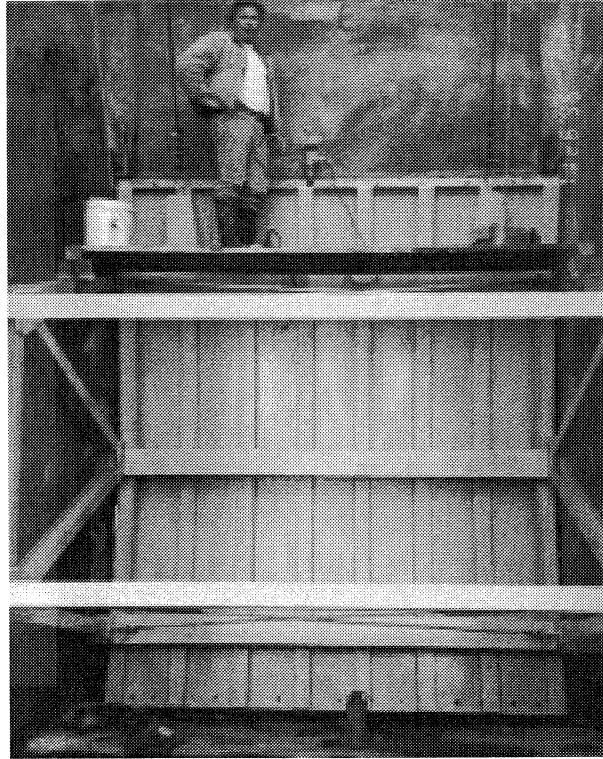

72-6b



72-6c



72-6d



**Overview of Tennessee Valley Authority's Gate Inspection  
Program**

***Greg Lewis***  
***Tennessee Valley Authority***



# OVERVIEW OF TVA's GATE INSPECTION PROGRAM

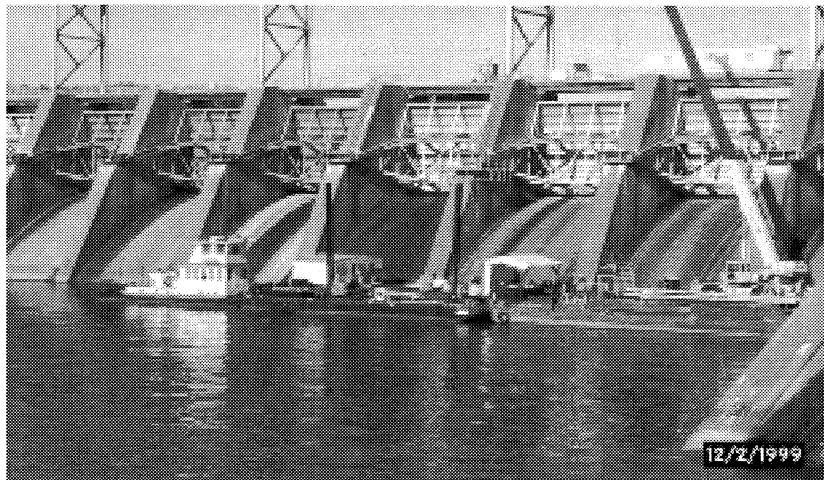

**PRESENTED BY:**

**River System Operations & Environment  
Dam Safety, Inspection and Instrumentation  
Greg Lewis, P.E. & Scott Kramer, P.E.**

1



## Topics in Presentation

- ◆ Overview of past TVA Gate & Machinery Inspection Program.
- ◆ Watts Bar - Gate Damage and Repairs.
- ◆ Opportunities for Improvements to the TVA Gate Inspection Program.

2



## Background of TVA

- ◆ 7 State Region in Southeast US.
- ◆ Total of 54 dams, with a mixture of earth embankment and concrete structures.
- ◆ Total of 203 tainter spillway gates.
- ◆ 232 vertical lift spillway gates.
- ◆ 87 low level sluice gates.
- ◆ 112 intake gates.

3



## Past Inspection Practices - Spillway Gates

- ◆ Spillway gates inspected from the deck every 2-1/2 years by Mechanical Engrs.
- ◆ Inspected from crest of the spillway if winter drawdown is available.
- ◆ If no drawdown, Bulkheads used (if available) every 10 years.
- ◆ Divers used if no bulkhead or drawdown
- ◆ Test operated to full travel if drawdown or bulkhead is available.

4



## **Past Inspection Practices - Spillway Gate Machinery**

- ◆ Multi-discipline approach - Mechanical Engineer & Electrical Engineer.
- ◆ Preventive Maintenance addressed during inspections.
- ◆ Inspect gears & brakes for wear.
- ◆ Electrical Engineers measure insulation resistance of cables & motors.
- ◆ Test operate all limit switches.

5



## **Past Inspection Practices - Spillway Gate Machinery (cont)**

- ◆ Motor current data is gathered during test operation.
- ◆ Inspect & test operate both normal & auxiliary power supplies.

6



# Example of Electrical Data

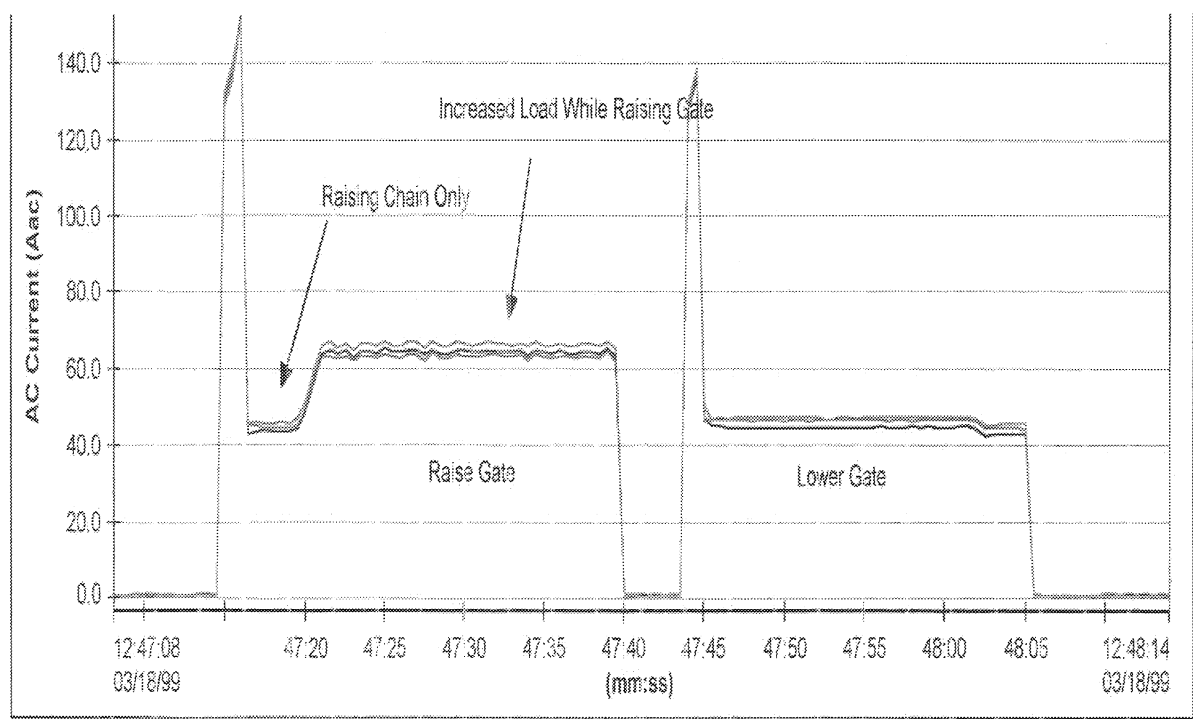

# Sluice Inspections

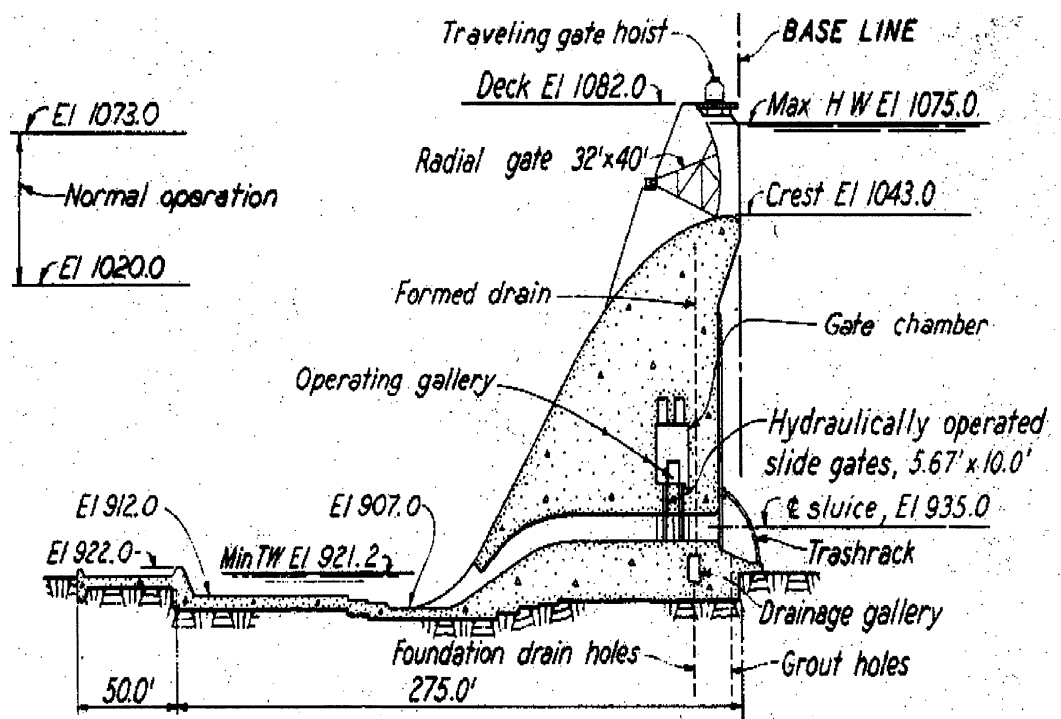



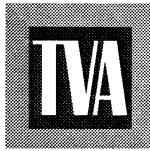

# Watts Bar Dam - Tainter Gate Strut Arms

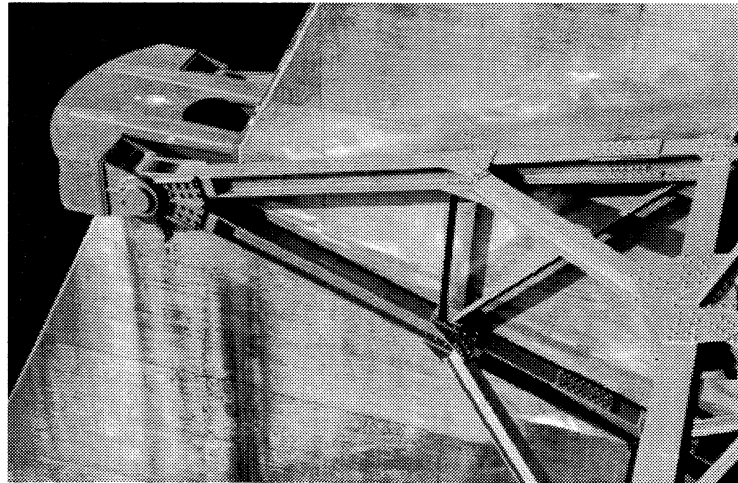

## Opportunities for Improvement

- ◆ Address items currently difficult to inspect.
  - “Hands-on” inspection of tainter gates
  - Low level sluice features
- ◆ Revisit test operation process.
- ◆ Other Improvements.



## **“Hands-On” Detailed Inspections**

- ◆ Awaiting future recommendations from ICODS / FERC / ASDSO.
- ◆ “Hands-On” inspections will be scheduled on 5 - 10 year intervals, depending on the condition of the gate and downstream hazard.
- ◆ Plan to conduct climbing/rappelling training in Spring 2000.

11



## **“Hands-On” Inspection Guidelines**

- ◆ Define “Hands-On” inspection as within 2’ of all critical members.
- ◆ Important to clean / pressure wash gates prior to hands on inspections.
- ◆ Team effort - Includes Structural and Mechanical Engineers. Electrical Engineers present during test operation.

12



## **Improve Low Level Sluice Inspections**

- ◆ Modify trashracks to allow diver or ROV access to inspect upstream surface & gate guides.
- ◆ Revisit the frequency that these inspections should occur.

13



## **Revisit Spillway Gate Test Operation Process**

- ◆ Frequency of “full travel” test operation.
- ◆ Process for reservoirs where no drawdown is allowed or bulkhead is unavailable.
  - Design / construct bulkheads
  - Test operate during a spill event

14



## Other Improvements

- ◆ Collect oil samples for analysis & trending.
- ◆ Vibration analysis for motor & equipment bearings.
- ◆ Implementation of TVA-wide Preventive Maintenance database.
  - Equipment history records
  - Automatically schedules PMs
- ◆ Access for lubricating trunnions.

**The United States Committee on Large  
Dams (USCOLD) Programs**

*Dr. B.T.A. Sagar*  
*ECI*

**2000 ASDSO  
SPECIALTY  
WORKSHOP ON GATE  
STRUCTURES ON  
DAMS**

**January 5-6, 2000**



---

**USCOLD PROGRAMS**

**by  
Dr. B.T.A. SAGAR**



# **USCOLD COMMITTEE ON HYDRAULICS OF DAMS**

**Chairman  
Earl Eikers**

**ECI**

---

## **GATES AND VALVES SUBCOMMITTEE**

**Chairman  
B.T.A. Sagar**

**ECI**

# **BULLETINS UNDER PREPARATION**

- **Improving Spillway Gate Reliability**
- **Large Valve Selection Criteria**

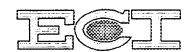

---

## **IMPROVING SPILLWAY GATE RELIABILITY**

### **CONTENTS**

- **Spillway Gate Type and Application**
- **Recommended Design Practices**
- **Investigation of Aging Spillway Gates**
- **Improving Gate Performance**
- **Automation**

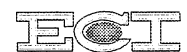



# **IMPROVING SPILLWAY GATE RELIABILITY**

## **CONTENTS (continued)**

- **Power Supply**
- **Examples of Gate Incidents**
- **Trunnion Lubrication**
- **Test Operation of Spillway Gates**
- **Balancing Criteria**
- **Design Examples**

**ECI**

---

# **LARGE VALVE SELECTION CRITERIA**

## **CONTENTS**

- **Functional Classification**
- **Common Types Currently Used**
- **Operators**
- **Cavitation**
- **Maintenance Issues**
- **Further Research Needed**

**ECI**

# MAJOR GATE INCIDENTS

- **Tainter Gate failure due to trunnion friction (Folsom Dam, CA USA)**
- **Tainter gate failure due to simultaneous overflow and underflow (Jammu-Tawi Dam, India)**

ECI

---

# MAJOR GATE INCIDENTS

(continued)

- **Tainter gate failure due to imperfect or forgotten welds in gate anchorage (Singur Dam in India)**
- **Outlet tunnel fixed wheel gate bonnet cover blow off (Bhakra Dam, India)**
- **Penstock fixed wheel gate catapulting (Mossy Rock Dam, USA)**

ECI

# **MAJOR GATE INCIDENTS**

**(continued)**

- **Earth dam settlement and failure due to fixed wheel gate vibrations  
(Panchet Dam, India)**
- **Dam failure due to spillway fixed wheel gate hoist malfunction  
(Kaddam Dam, India)**
- **Dam failure due to non operation of spillway gates (Morvi Dam, India)**

**ECI**

---

# **MAJOR GATE INCIDENTS**

**(continued)**

- **Outlet slide gate failure due to silt blockage (Lyman Dam, AZ USA)**
- **Loss of reservoir storage due to silt blockage of outlet slide gates (Nizamsagar Dam, India)**
- **Severe spillway fixed wheel gate vibrations threatening dam safety (Manganti Dam, Indonesia)**

**ECI**

# **SPILLWAY TAINTER GATE ISSUES**

**ECI**

## **ISSUES REQUIRING POLICY DECISIONS**

- **Spillway capacity based on inoperative gate(s)**
- **Number of gates considered inoperative**
- **Gates designed to prevent impingement of overflow on arms**
- **Impingement on existing gate arms without provisions for overflow**
- **Gate failure criterion**

**ECI**

# **ISSUES REQUIRING POLICY DECISIONS**

**(continued)**

- **Assumed trunnion friction for existing gates without regular or proper lubrication program**
- **Removal of trunnion pins for inspection and cleaning**
- **Mandatory use of corrosion resistant steel pins and self lubricating bushings for new gates**

**ECI**

---

# **ISSUES REQUIRING FURTHER RESEARCH**

- **Moment capacity of bolted joints between arms and horizontal girders**
- **Rigidity of bolted joints between bracing and arms**
- **Correlation between pin roughness and friction coefficient**

**ECI**

# SPILLWAY TAINTER GATES

## WITH SIDE SHIELDS

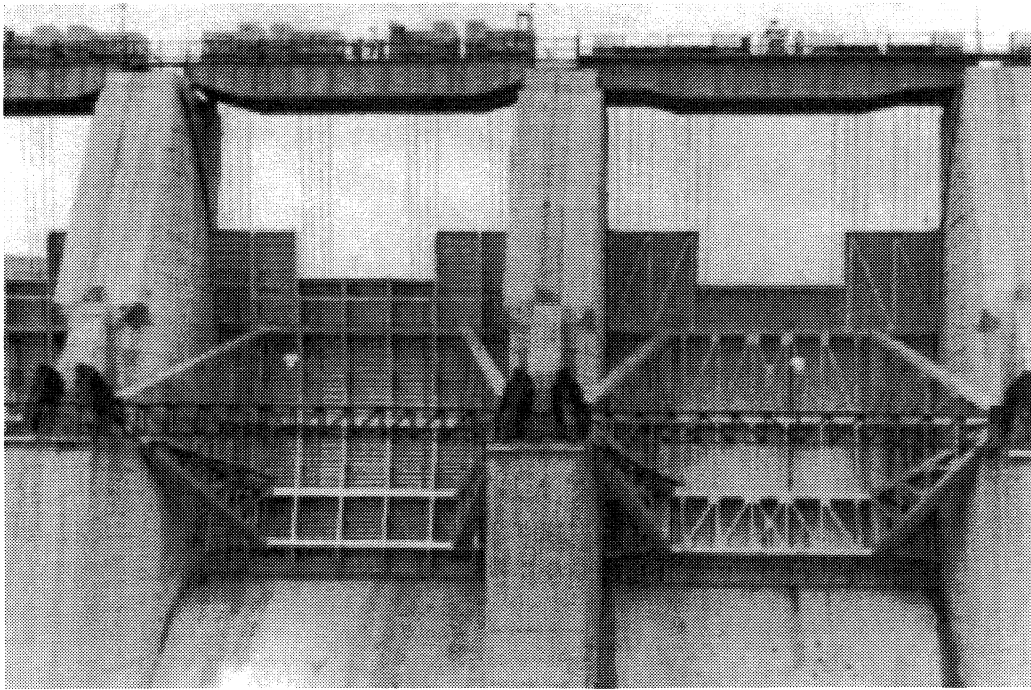

ECI

# TAINTER GATE

## OGEE LIP

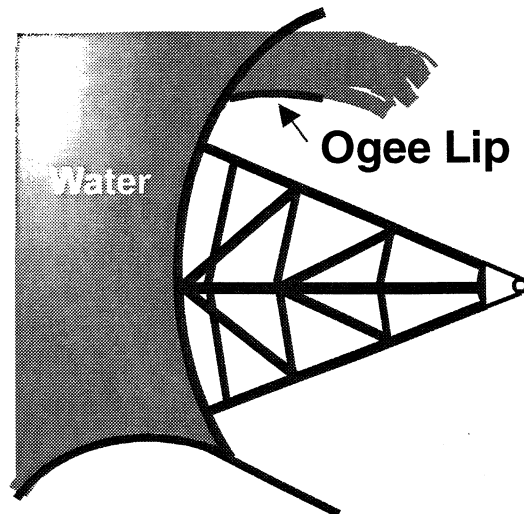

ECI

# ARM TO BRACING CONNECTION

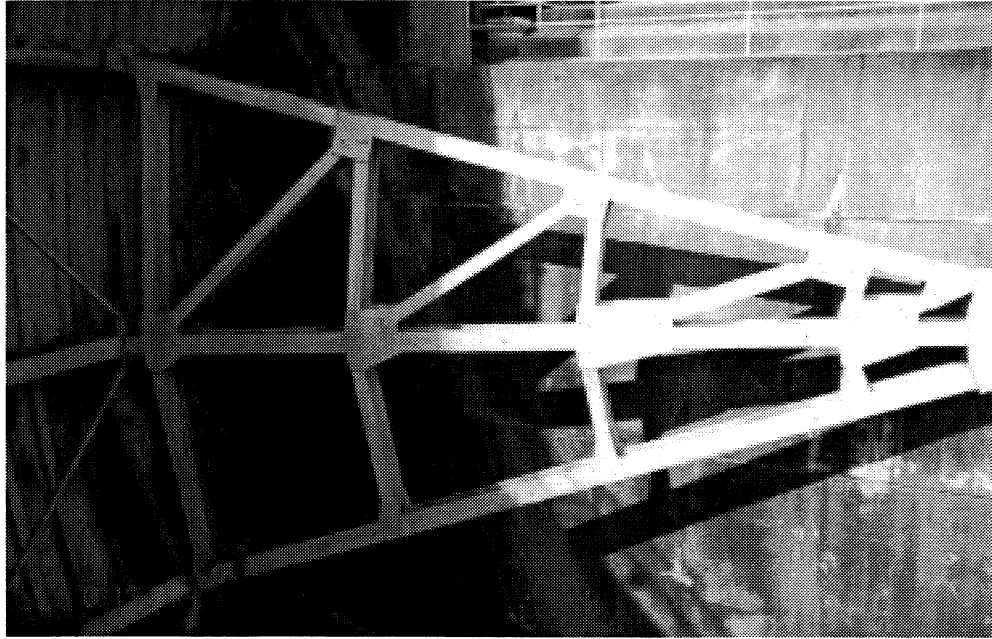

ECI



# ARM TO GIRDER CONNECTION

ECI

# FIXED WHEEL GATE



ECI

# TRUNNION BEAM

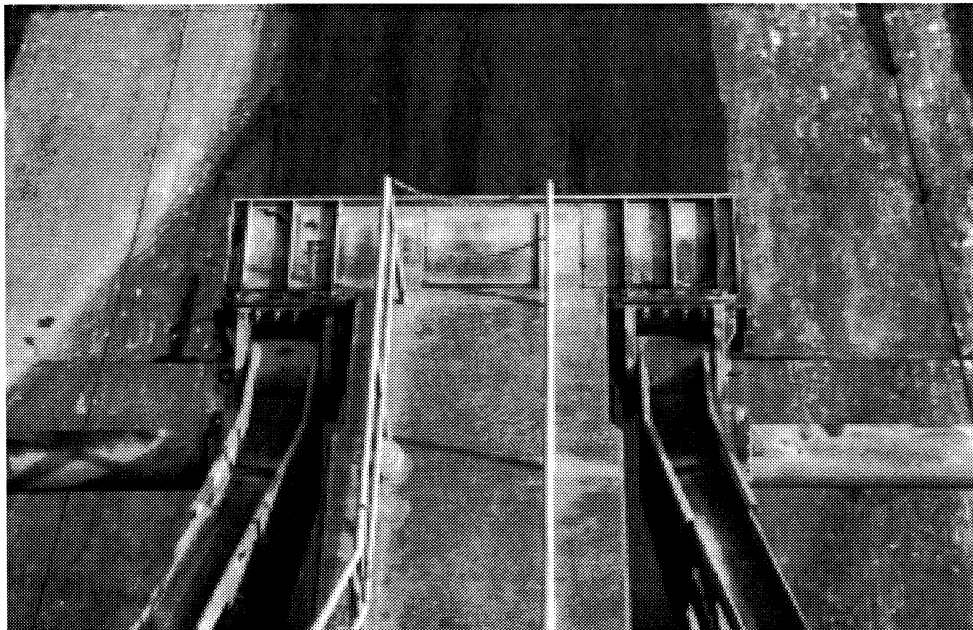

ECI



# TRUNNION PIN

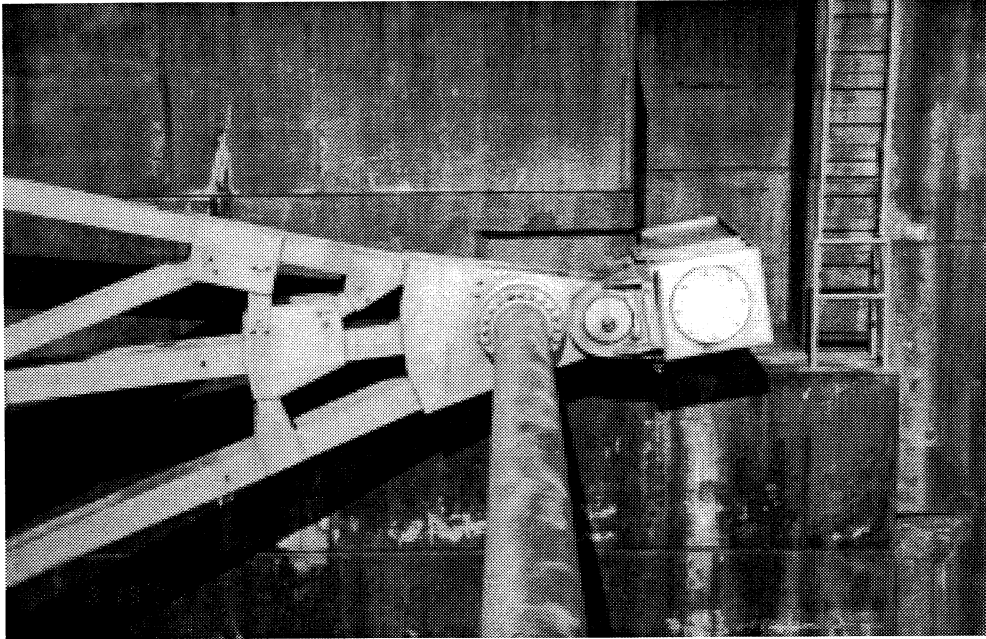

ECI

## Spillway Tainter Gates Proposed Recommendations

- **Ogee lip to permit overflow for normal design flood**
- **Side shields or deflectors to protect gate arms for normal design flood overflow**
- **Operate with overflow and underflow without vibrations for a reasonable flow depth**

ECI

# **Spillway Tainter Gates Proposed Recommendations**

(continued)

- **Teflon-clad side seals to minimize friction**
- **Corrosion resistant steel bolts for bracing to arm bolted connections**
- **Individual hoists for each gate**
- **Automatic online engine generator**
- **Automation to avoid operator error, where justified**

**ECI**

---

# **Fixed Wheel Spillway Gates Proposed Recommendations**

- **Ogee lip to permit overflow for normal design flood**
- **Operate with overflow and underflow without vibrations, wherever prudent**
- **Self Lubricating bronze bushings instead of roller bearings**

**ECI**

# **Fixed Wheel Spillway Gates Proposed Recommendations**

**(continued)**

- **Stainless steel ropes instead of chains to minimize maintenance**
- **Zinc metalizing instead of painting especially in locations with high corrosion potential**
- **Teflon clad side seals to minimize friction**

**ECI**

---

# **Fixed Wheel Spillway Gates Proposed Recommendations**

**(continued)**

- **Adequately sized drain holes on horizontal girders**
- **Individual hoists for each gate**
- **Automatic online engine generator**
- **Automation to avoid operator error, where justified**

**ECI**

# CLOSING REMARKS

- **Owners and engineers should publicize problems and failures**
- **Causes and lessons should be discussed in open forums**
- **Remedial and preventive measures developed**
- **Design criteria should reflect lessons learned**
- **Research should be rigorously encouraged**

**ECI**

## **Performance Experience**

*Norman Bishop  
Stone and Webster*



**Stone & Webster**

*Performance Experience*

*Norm Bishop*

*January 5, 2000*

**Stone & Webster**

***WHAT IS THE MOST  
COMMON HYDRAULIC  
GATE?***

**VERTICAL LIFT  
GATE**

**Stone & Webster**

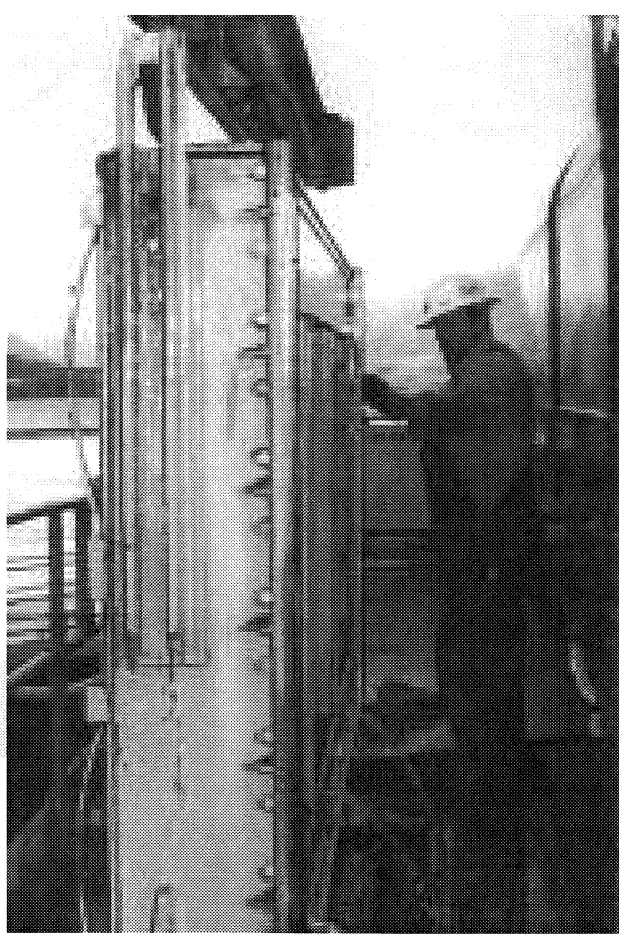

06/01/2000

3  Stone & Webster

# ***WHY ARE THERE SO MANY VERTICAL LIFT GATES?***

**SIMPLE DESIGN,  
FABRICATION,  
DURABILITY,  
REPAIRABILITY**

 Stone & Webster

# ***AGE***

In North America,  
1800s

In Europe, 1700s

 **Stone & Webster**

## ***WHY IS REPLACEMENT USUALLY UNNECESSARY?***

- ▲ STRUCTURAL FRAMES CAN BE STRENGTHENED.
- ▲ COVER PLATES CAN BE REINFORCED.
- ▲ SEALS CAN BE MODIFIED TO REDUCE SIDE FRICTION.
- ▲ BEARING SURFACES CAN BE MODIFIED TO REDUCE BEARING FRICTION
- ▲ WHEELS & SPRINGS CAN BE MODIFIED
- ▲ GUIDES CAN BE MODIFIED



# ***TYPES OF VERTICAL LIFT GATES***

- ▲ SLIDE GATES
- ▲ BULKHEAD GATES
- ▲ WHEELED GATES
- ▲ ROLLER GATES
- ▲ STOP LOGS
- ▲ TRACTOR GATES
- ▲ KNIFE GATES
- ▲ SLUICE GATES
- ▲ VERTICAL OVERFLOW GATES
- ▲ OTHER

06/01/2000

7 ▲ Stone & Webster

# ***ELEMENTS OF A VERTICAL LIFT GATE***

- ▲ BODY
- ▲ SKIN PLATE
- ▲ STRUCTURAL FRAME
- ▲ GUIDE, SLOT OR GAIN
- ▲ SEALS
- ▲ BEARING BLOCKS
- ▲ SPRINGS
- ▲ WHEELS OR ROLLERS

06/01/2000

8 ▲ Stone & Webster

# ***US DESIGN CODES & GUIDES***

- ▲ STEEL - AISC
- ▲ CONCRETE - ACI
- ▲ WELDING - AWS
- ▲ OTHER ACCEPTED GUIDELINES:
  - US ARMY CORPS OF ENGINEERS
  - BUREAU OF RECLAMATION
- ▲ SEISMIC - UNIFORM BUILDING CODE
- ▲ OTHER - FEDERAL & STATE

06/01/2000

9 ▲ Stone & Webster

# ***REHABILITATION PROCESS***

***INSPECT, EVALUATE,  
IDENTIFY NEED, PLAN,  
ENGINEER, SCHEDULE,  
CONTROL COSTS,  
IMPLEMENT***

▲ Stone & Webster

# Radial Gate Investigation Approach

Problem Focus  
↓

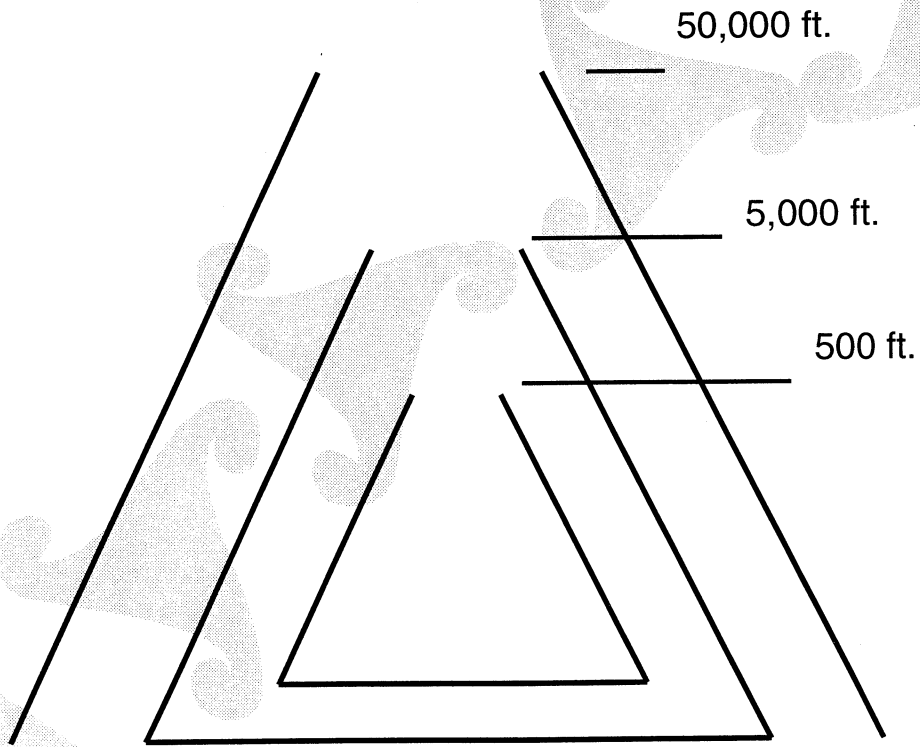

06/01/2000

## *INSPECTION*

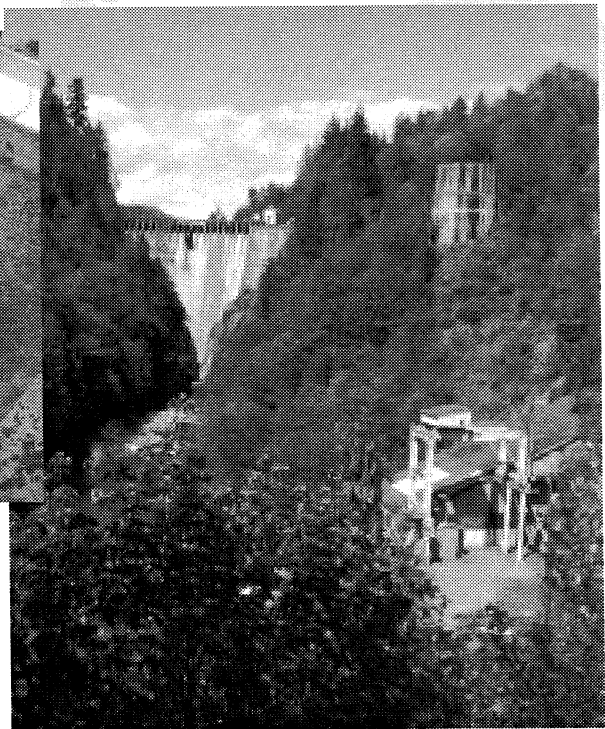
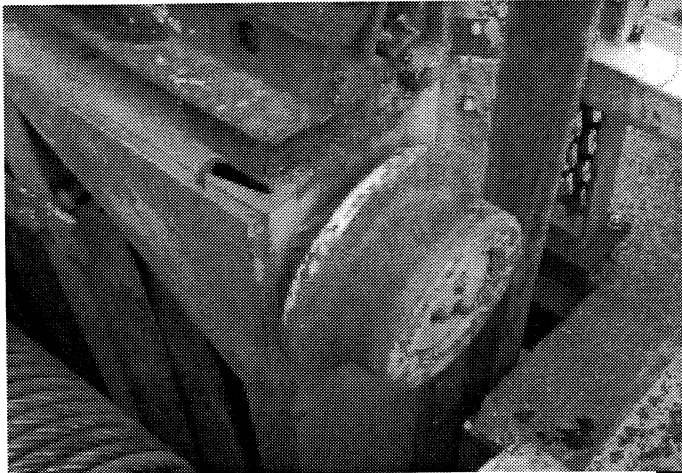

06/01/2000



06/01/2000

13  Stone & Webster



06/01/2000

14  Stone & Webster

# INSPECTION

- ▲ TARGET O & M PERSONNEL
- ▲ VISUALLY INSPECT GATE & COMPONENTS REGULARLY
- ▲ SET-UP PROGRAM FOR REPEATABILITY
- ▲ TAKE PICTURES
- ▲ AUTOMATE INSPECTION PROGRAM

06/01/2000

15 

## PREPARE INSPECTION CHECKLIST

**Vertical Lift Gate Visual Inspection Check List**

Inspector: \_\_\_\_\_ Signature: \_\_\_\_\_ Gate Location: \_\_\_\_\_ Date: \_\_\_\_\_

Project: \_\_\_\_\_ Hoist: \_\_\_\_\_ Yes No Type: \_\_\_\_\_ Date of Last Inspection: \_\_\_\_\_

Number of Gates or Stop Logs: \_\_\_\_\_ Lifting Beam: \_\_\_\_\_ Yes No Type: \_\_\_\_\_

Are More Than One Gate Required to Close an Opening?: \_\_\_\_\_ Yes No Number: \_\_\_\_\_

If More Than One Gate Required to Close an Opening, Are gates interchangeable?: \_\_\_\_\_ Yes No Explain: \_\_\_\_\_

Gate Size: H: \_\_\_\_\_ W: \_\_\_\_\_ T: \_\_\_\_\_ Gate Dry Weight: \_\_\_\_\_ Hoist Capacity: \_\_\_\_\_

Gate Checklist: E=Excellent Condition M=Maintenance Req'd  
G=Good Condition R=Replacement Req'd  
F=Fair Condition

Item	Side	No.	Condition				Further Explanation of Maintenance or Replacement
			E	G	M	R	
Gate Body							
Skin Plate							
Top Seal							
Side Seal							
Bottom Seal							
Bearing Block	Right	1					
Bearing Block	Right	2					
Bearing Block	Right	3					
Bearing Block	Right	4					
Bearing Block	Right	5					
Bearing Block	Left	1					
Bearing Block	Left	2					
Bearing Block	Left	3					
Bearing Block	Left	4					
Bearing Block	Left	5					
Guide Block	Right	1					
Guide Block	Right	2					
Guide Block	Right	3					
Guide Block	Left	1					
Guide Block	Left	2					
Guide Block	Left	3					
Wheel	Right	1					
	Right	2					
	Right	3					
	Right	4					
	Right	5					
Wheel	Left	1					
	Left	2					
	Left	3					
	Left	4					
	Left	5					
Lifting Hook	Right	1					
	Left	1					
Coating Condition	Right						
	Left						
	Top						
	Bot						
	Back						
Guide Surface	Right						
	Left						
Sealing Surface	Right						
	Left						
Bottom Seal							

Gate Fit for Service: Yes No Explain: \_\_\_\_\_

Gate Temporally Fit for Service: Yes No Explain: \_\_\_\_\_

Gate Sketch:

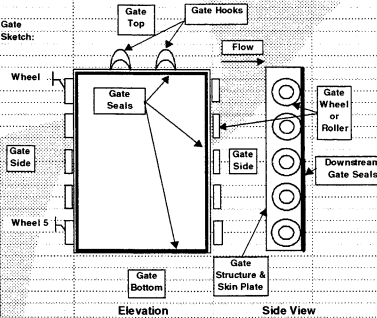

Elevation      Side View

Key: Right or Left is Looking Downstream; Numbers are top to bottom.

Loc. of Leakage:	Yes	No	Explain:
Roll Problem:	Yes	No	Explain:
Ice Problem:	Yes	No	Explain:
Lifting Problem:	Yes	No	Explain:
Binding Problem:	Yes	No	Explain:
Guide Problem:	Yes	No	Explain:
Coating Problem:	Yes	No	Explain:
Other Problem:	Yes	No	Explain:

Notes or Other Findings: \_\_\_\_\_

06/01/2000

16 

# ***VERTICAL LIFT GATE INSPECTION CHECK SHEET***

PLEASE LEAVE YOUR NAME, ADDRESS,  
PHONE NUMBER & E-MAIL ADDRESS AND  
STONE & WEBSTER WILL SEND YOU AN  
ELECTRONIC COPY OF THIS INSPECTION  
CHECK SHEET

 **Stone & Webster**

## **EVALUATE**

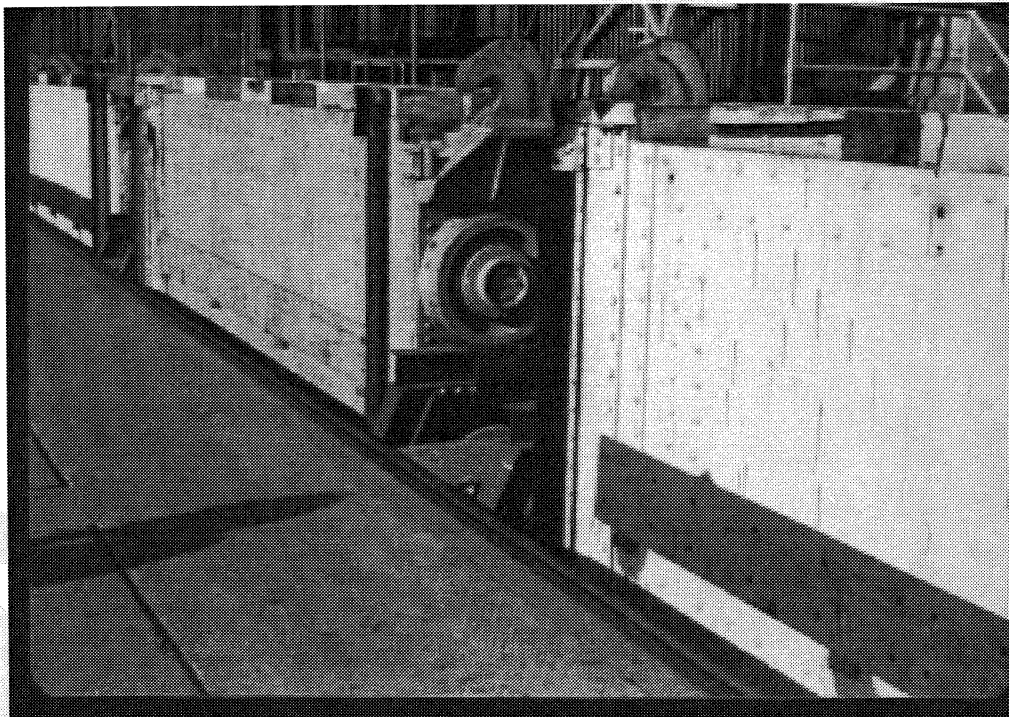

# EVALUATE

- ▲ GET AN EXPERIENCED MAINTENANCE FOREMAN OR ENGINEER INVOLVED.
- ▲ IDENTIFY THE PROBLEM; DON'T SOLVE THE PROBLEM BEFORE YOU'VE DEFINED THE PROBLEM.
- ▲ "THE SEALS ARE TORN" OR "THE WHEELS WON'T TURN" IS NOT THE PROBLEM. THESE ARE SYMPTOMS.



06/01/2000

19  Stone & Webster

# EVALUATE

- ▲ SEALS
- ▲ WHEELS
- ▲ SKIN PLATE
- ▲ STRUCTURAL FRAME
- ▲ HOOKS
- ▲ TOP WOOD SILL

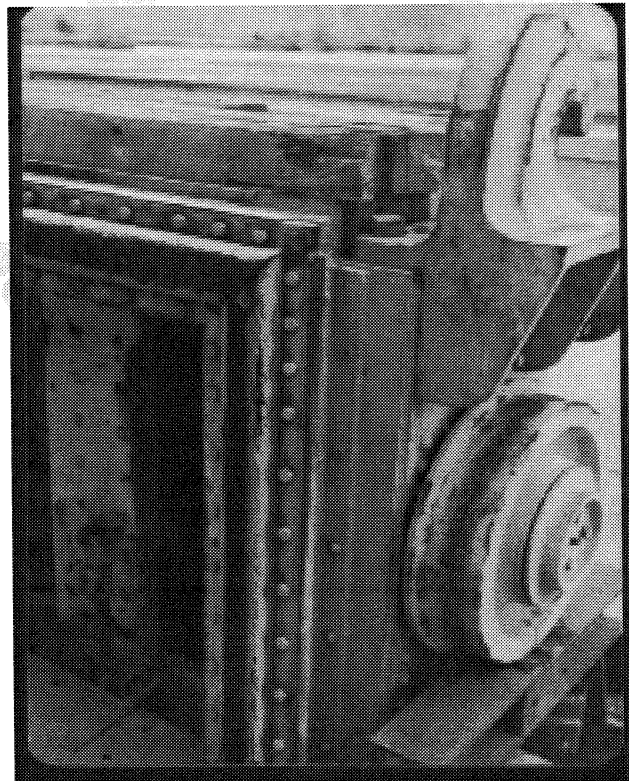

06/01/2000

20  Stone & Webster

## ***WHY REPLACE?***

- ▲ SELDOM IS REPLACEMENT NEEDED.
- ▲ NEW GATES ARE EXPENSIVE.
- ▲ PROBLEM MUST JUSTIFY REPLACEMENT.

06/01/2000

21 ▲ Stone & Webster

## ***IDENTIFY NEED***

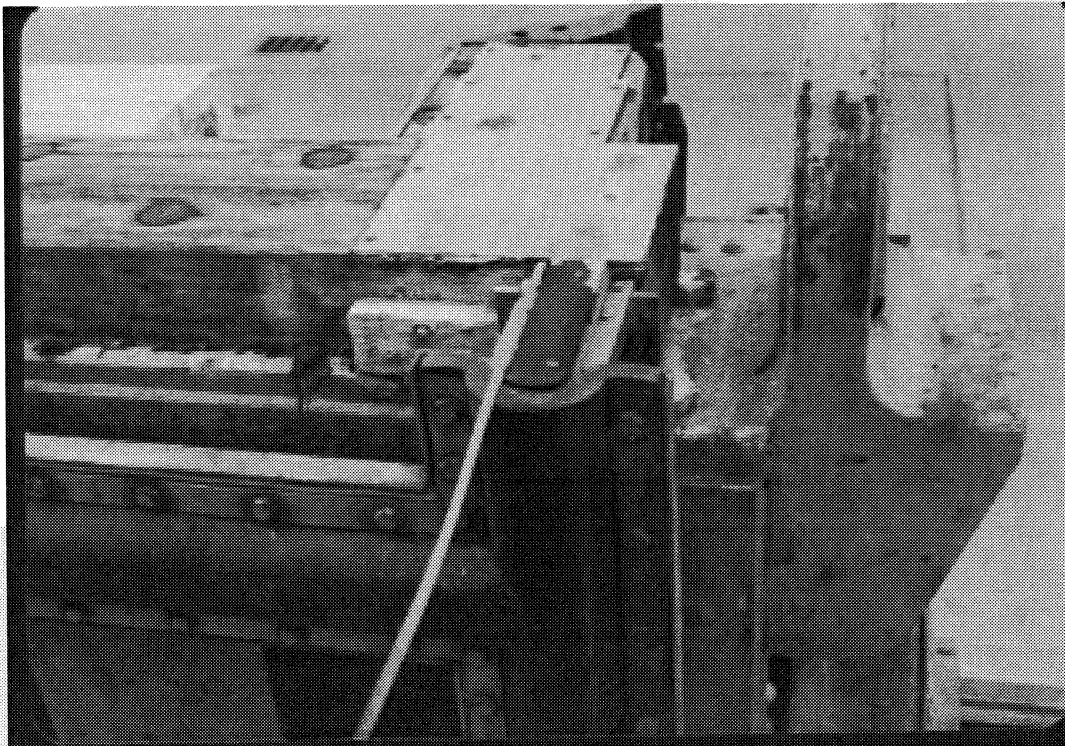

06/01/2000

22 ▲ Stone & Webster



# ***CAREFUL STUDY NEEDED***

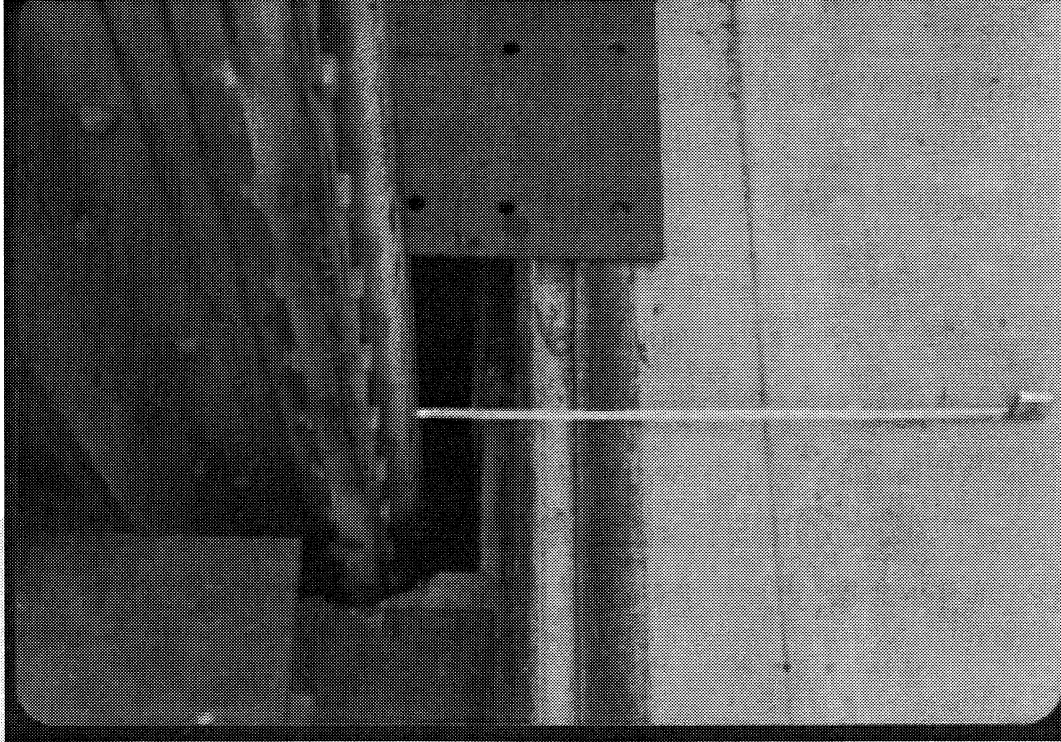

06/01/2000

23

 **Stone & Webster**

## ***NEED***

- ▲ RESERVOIR LEVEL INCREASED - STRUCTURAL ADEQUACY?
- ▲ WOOD SILLS TOP & BOTTOM LEAK
- ▲ CORROSION & PITTING

06/01/2000

24

 **Stone & Webster**

# *PLAN*

- ▲ IS EXISTING FRAME STRUCTURALLY ADEQUATE?
  - IS STRENGTHENING REQUIRED?
  - IS THE IN-SITU MATERIAL ULTIMATE STRENGTH HIGHER THAN ORIGINALLY SPECIFIED?
- ▲ IS SKIN PLATE STRUCTURALLY ADEQUATE?
- ▲ ARE WHEELS ADEQUATE?
  - IS THE BEARING SURFACE HARDNESS ACCEPTABLE?
  - IS WHEEL BEARING ADEQUATE?
  - ARE THE GUIDES ALIGNED PROPERLY?
  - ARE BEARING SURFACES WORN ON GUIDE OR WHEEL?
- ▲ WHAT IS REQUIRED TO PAINT THESE GATES?

06/01/2000

25

▲ Stone & Webster

# *ENGINEERING*

- ▲ STRUCTURAL FRAME WAS SLIGHTLY OVER STRESSED.
- ▲ SKIN PLATE WAS SLIGHTLY OVER STRESSED.
- ▲ WHEELS, BEARINGS AND GUIDE WEARING SURFACES WERE OK.
- ▲ GATES WERE TOO LARGE TO SHIP WITHOUT SLITTING IN HALF.
- ▲ SURFACE PREPARATION AND PAINTING WAS REQUIRED.
- ▲ WOOD SILLS NEEDED TO BE REPLACED; STEEL WAS RECOMMENDED
- ▲ COMPRESSION SEALS HAD LEAKED SINCE INSTALLATION; REPLACEMENT AND RECONFIGURATION WAS RECOMMENDED
- ▲ SPRINGS, SIDE ALIGNMENT BLOCKS OK.

06/01/2000

26

▲ Stone & Webster

# ***MATERIALS ENGINEERING***

- ▲ FRAME & SKIN PLATE OVER STRESSED; MECHANICAL COUPON DESTRUCTIVE TESTS RECOMMENDED.
- ▲ COUPON TESTS SHOWED YIELD AND ULTIMATE STRENGTH TO BE 10% HIGHER THAN SPECIFIED. NIL DUCTILITY NOT AN ISSUE.
- ▲ FRAME MEMBERS & SKIN PLATE WERE DIMENSIONED AND FOUND TO BE OF ADEQUATE GAGE.
- ▲ NEAR WHITE BLAST CLEANING RECOMMENDED.
- ▲ HIGH PERFORMANCE HIGH BUILD COATING RECOMMENDED.

06/01/2000

27  Stone & Webster

# ***STRUCTURAL ENGINEERING***

- ▲ GATE FRAME & SKIN PLATE ANALYSIS TO LATEST AISC CODE.
- ▲ NEW MECHANICAL PROPERTY INFORMATION USED.
- ▲ GATES FOUND TO BE STRUCTURALLY ACCEPTABLE FOR ALL LOADING CONDITIONS.
- ▲ RECOMMENDED NOT TO SPLIT GATES & MAKE NECESSARY MODIFICATIONS IN AN ADJACENT YARD NEXT TO DAM.
- ▲ GANTRY CRANE COVERAGE PROVIDED IN ADJACENT YARD AREA.

06/01/2000

28  Stone & Webster

# ***SCHEDULE***

- ▲ USE CLIENT MAINTENANCE PERSONNEL FOR SURFACE PREPARATION & COATING WORK.
- ▲ USE CLIENT OPERATING ENGINEERS TO HANDLE GATES.
- ▲ USE CLIENT MAINTENANCE PERSONNEL TO DISMANTLE WHEELS, WHEEL BEARINGS AND AXLES. REPAIR & REPLACE AS NEEDED.
- ▲ WORK PROGRAM REQUIRED DEDICATED CREWS & FOREMEN
- ▲ USE LOCAL FABRICATOR TO REPLACE TOP AND BOTTOM SILLS WITH STEEL.
- ▲ PREFABRICATE TOP AND BOTTOM STEEL COMPONENTS TO IMPROVE PRODUCTIVITY.
- ▲ USE COMBINATION OF BOLTED AND WELDED CONNECTIONS TO ASSURE ALIGNMENT AND MINIMIZE DISTORTION DURING WELDING
- ▲ REHAB A GATE EVERY FOUR WEEKS.

06/01/2000

29 **▲ Stone & Webster**

# ***CONTROL COSTS***

- ▲ COMPETITIVE BIDS OBTAINED FROM LOCAL FABRICATORS.
- ▲ BID DOCUMENTS ALLOWED FOR FABRICATOR INNOVATION.
- ▲ PRE-BID MEETING INCLUDED ALL STAKE HOLDERS.
- ▲ BID EVALUATION PROCESS INCLUDED ALL STAKE HOLDERS.
- ▲ EACH WORK TASK WAS BUDGETED WITH ITS REQUIRED DURATION.
- ▲ SCHEDULE WAS LAID OUT TO LIMIT OVERHEAD & INDIRECT COSTS.
- ▲ QUALITY CONTROL WAS REQUIRED THROUGHOUT THE WORK, NOT AT COMPLETION POINTS. NDE CONDUCTED ON NIGHT SHIFT.
- ▲ PROGRESS & BUDGETS MONITORED WEEKLY.

06/01/2000

30 **▲ Stone & Webster**

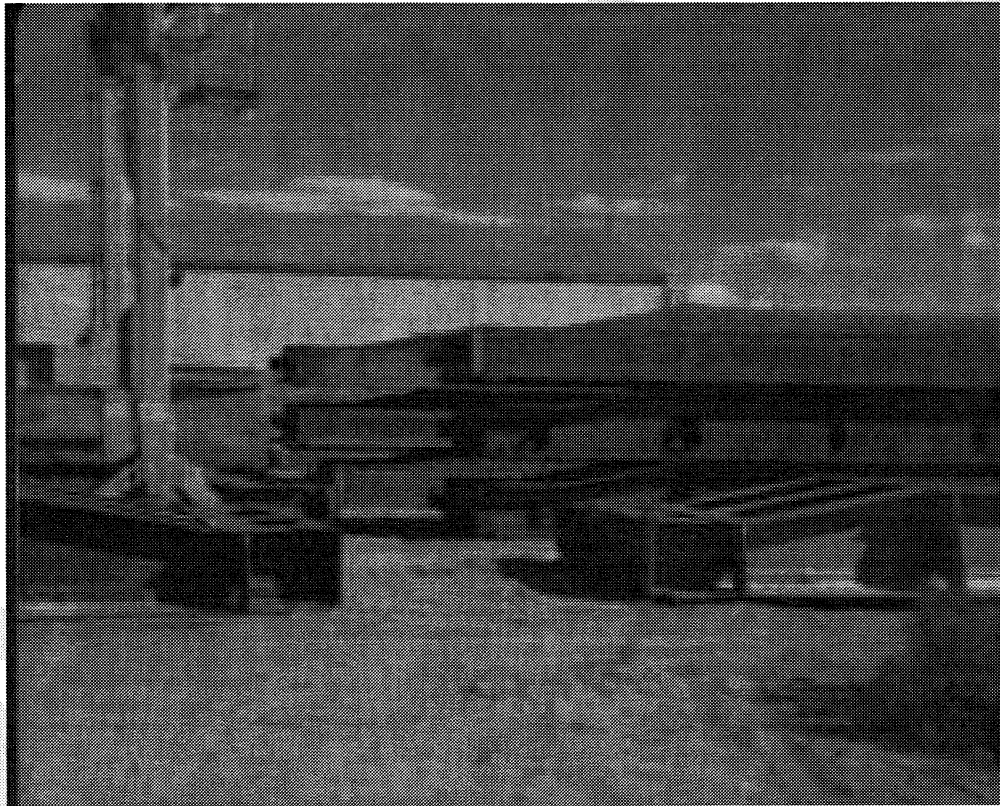

06/01/2000

31  Stone & Webster

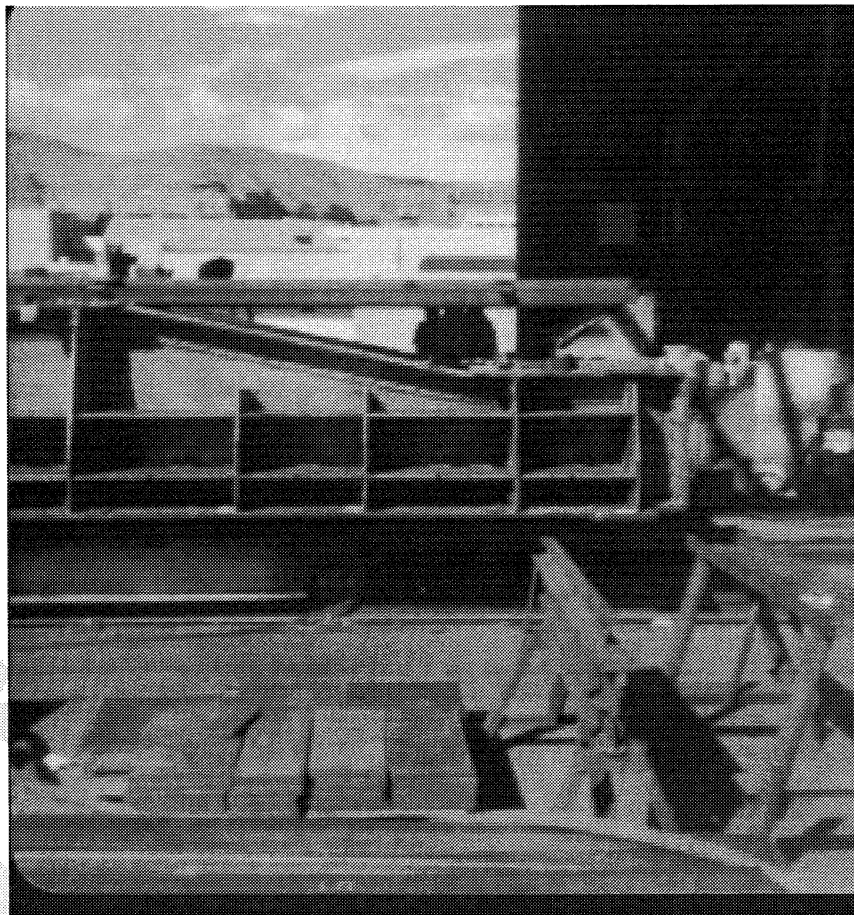

06/01/2000

32  Stone & Webster

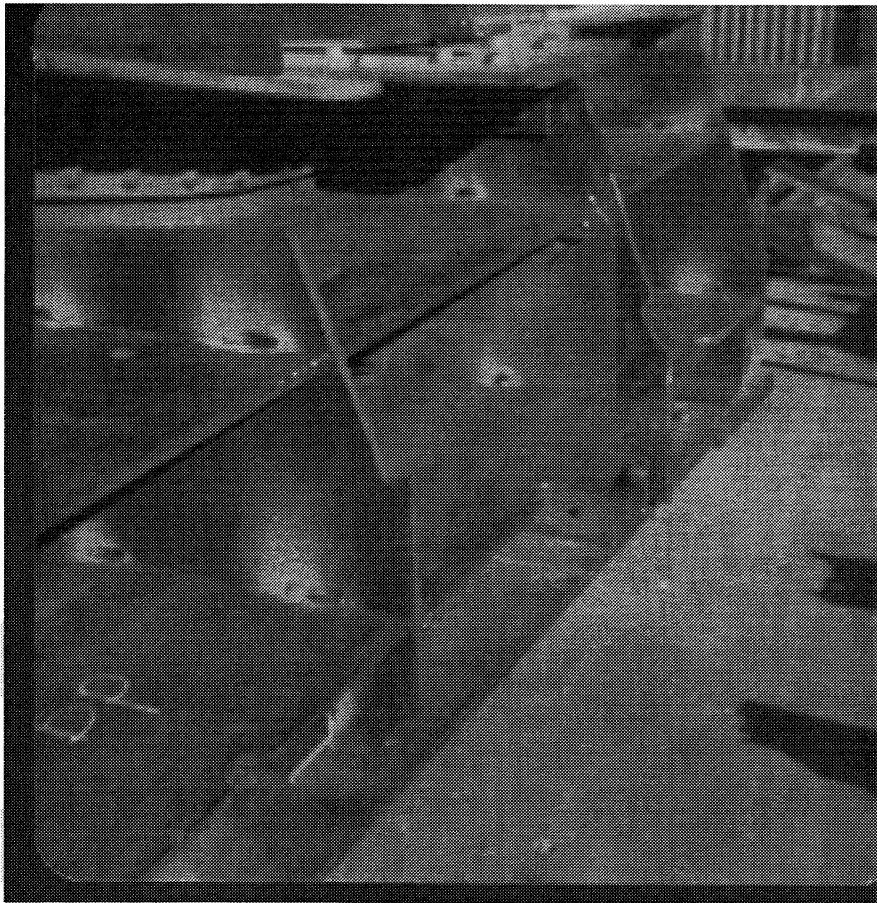

06/01/2000

33

 **Stone & Webster**

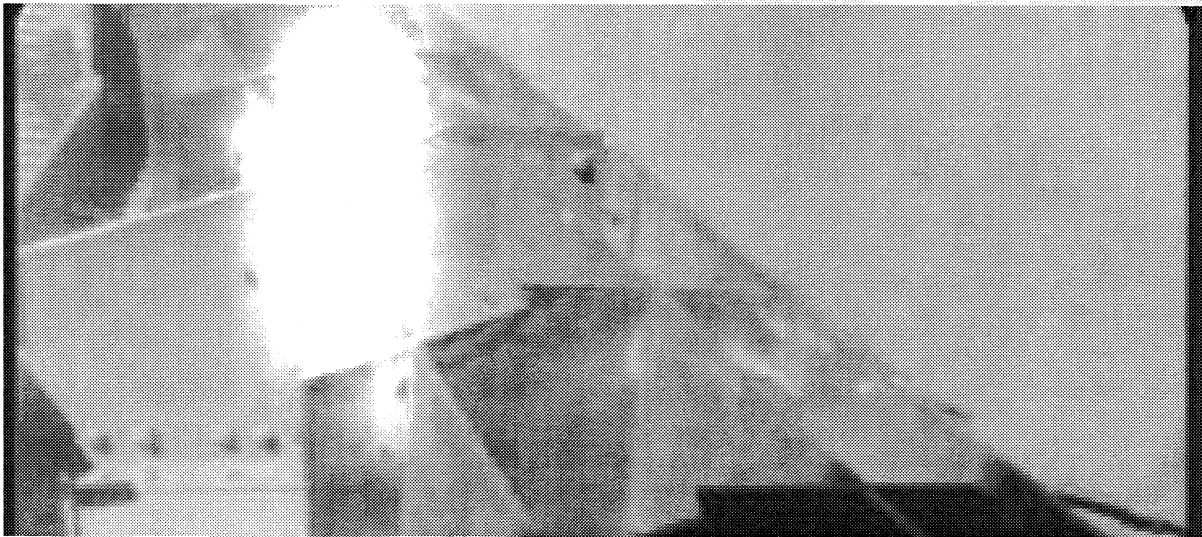

06/01/2000

34

 **Stone & Webster**

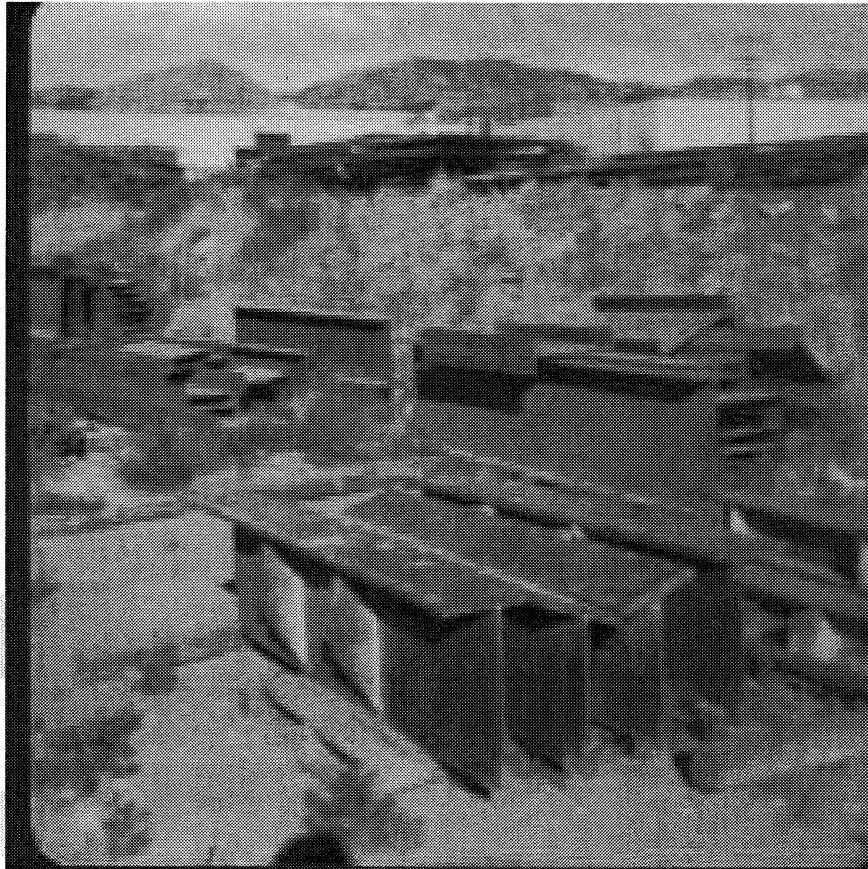

06/01/2000

35

 **Stone & Webster**

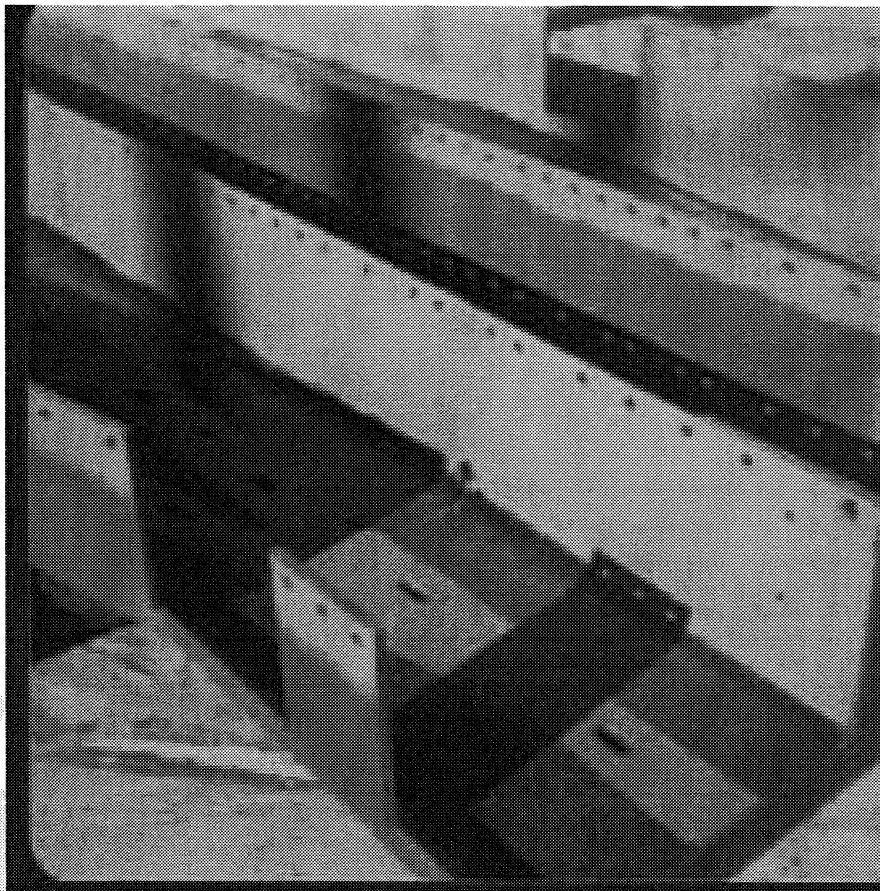

06/01/2000

36

 **Stone & Webster**

# ***IMPLEMENT***

- ▲ SURFACE PREPARATION & PAINTING EXPERIENCED WEATHER DELAYS & CURING ISSUES.
- ▲ PROGRESS AND PRODUCTIVITY IMPROVED AFTER INITIAL GATE.
- ▲ COMPONENT PREFABRICATION WAS SUCCESSFUL.
- ▲ SURFACE PREPARATION & COATING WAS SUCCESSFUL AFTER INITIAL ISSUES WERE RESOLVED.
- ▲ NIGHT SHIFT NDE ALLOWED DAY SHIFT NOT TO BE DISRUPTED.
- ▲ SIGNIFICANT PREVIOUS GATE LEAKAGE REDUCED TO LESS THAN ONE GALLON PER MINUTE.

06/01/2000

37 **Stone & Webster**

## ***VERTICAL GATE GUIDE REHAB***

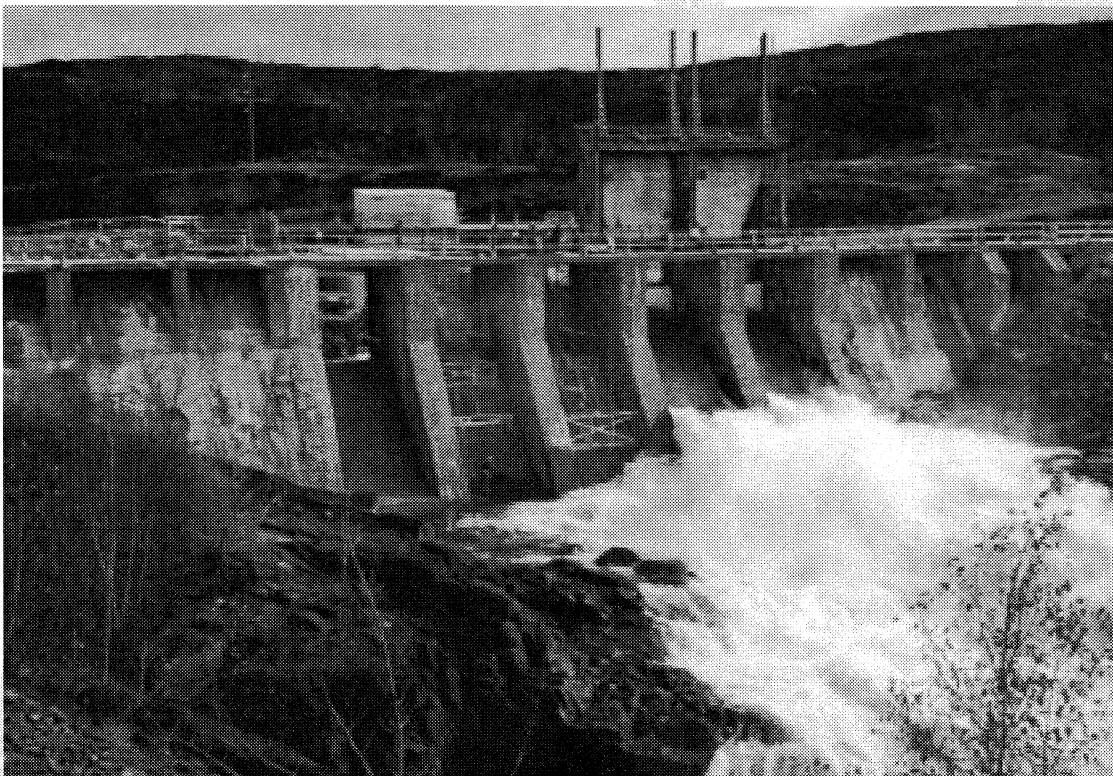

06/01/2000

38 **Stone & Webster**



# ***ALKALI AGGREGATE REACTIVITY (AAR)***

- ▲ DAM & SPILLWAY EXPERIENCED CONCRETE DETERIORATION
  - AAR
  - ICE DAMAGE
  - EROSION
- ▲ AAR HAD STABILIZED.
- ▲ REPAIR INCLUDED FACING CONCRETE, & GUIDE REPLACEMENT.
- ▲ GATE MODIFICATIONS.

06/01/2000

39 ▲ Stone & Webster



06/01/2000

40 ▲ Stone & Webster

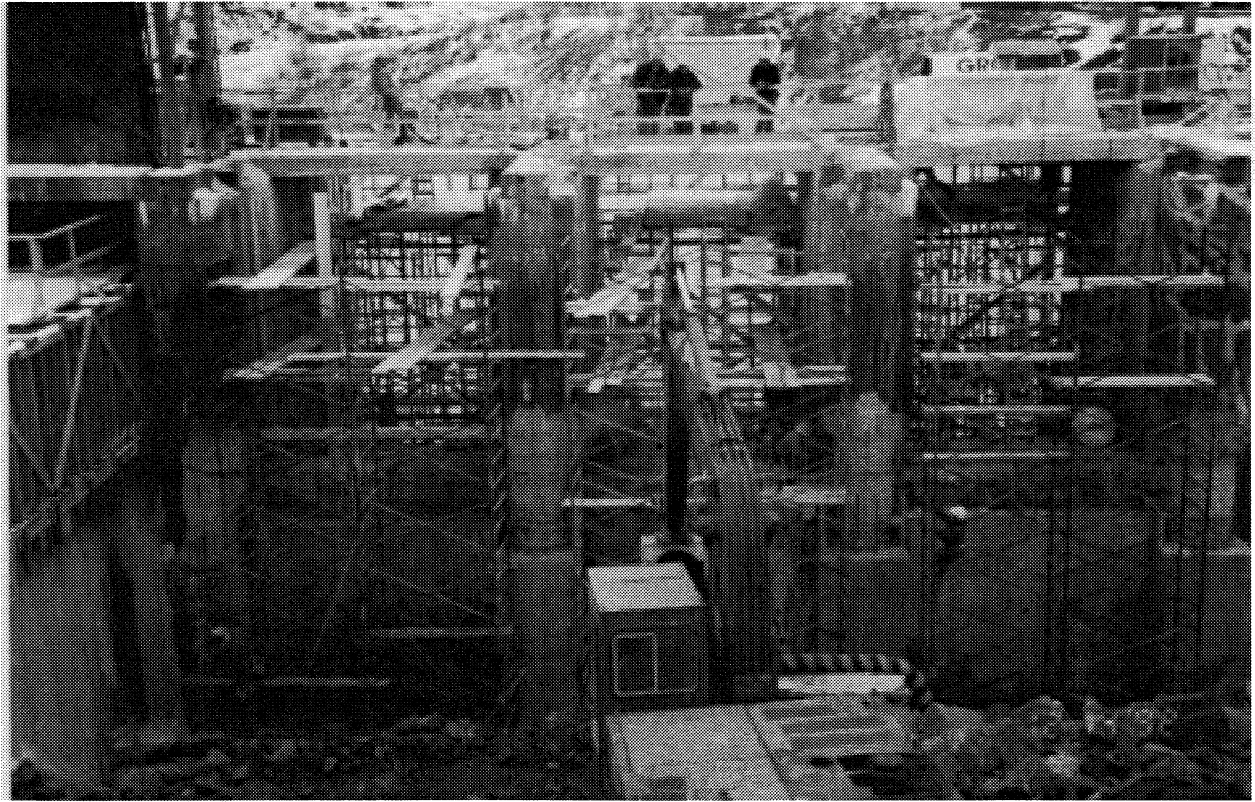

06/01/2000

41 **Stone & Webster**



06/01/2000

42 **Stone & Webster**



***STRUCTURED  
REHABILITATION PROCESS  
KEY TO SUCCESS***

***INSPECT, EVALUATE,  
IDENTIFY NEED, PLAN,  
ENGINEER, SCHEDULE,  
CONTROL COSTS,  
IMPLEMENT***

 **Stone & Webster**

---



***Radial Gates***



 **Stone & Webster**

## *Historical Perspective*

- ▲ Operation experience since 1950s has been good.
- ▲ Typical “design life”- 25 to 40 years.
- ▲ Design life exceeded, yet gates remain suitable for service.  
Why?
  - Low design head <70 ft. (30 psi)
  - Geometry-Span to Height Ratio <1.25
  - Design, Fabrication & Assembly Practices
  - Adequate Maintenance Practices
  - Operation Frequency

06/01/2000

45  **Stone & Webster**

## *Radial Gate Recorded Incidents*

- ▲ Trunnion Bearing/Friction Related
- ▲ Hoist Related
- ▲ Vibration Related
- ▲ Corrosion & Maintenance Related
- ▲ Seal or Structural Related

Source: NPDP, Technical Papers & Colleague Consultation

06/01/2000

46  **Stone & Webster**

## *Operational Problems*

- ▲ Gate doesn't open or stops during opening
- ▲ Inadequate spillway capacity
- ▲ Vibration
- ▲ Trash and debris
- ▲ Icing
- ▲ Hoist related issues
- ▲ Trunnion bearings

06/01/2000

47  **Stone & Webster**

## *Suitable for Service*

- ▲ Gate & Hoist is operable and annually exercised.
- ▲ Exposed gate components are routinely visually inspected by O&M personnel. Before and after each use. Monthly visual inspections are recommended, if not used.
- ▲ The gate and hoist meet current guidelines for hydraulic, structural, mechanical and electrical adequacy.

06/01/2000

48  **Stone & Webster**

## *Suitable for Service*

- ▲ Hoist motors and drive trains are checked once a year; and motor voltage, amperage and power are recorded. It is recommended that a power meter be used to make the record which takes approximately 10 to 20 samples per second. A record from motor activation for 30 seconds or longer is recommended for gate open and close sequences. Record of motor "in rush" characteristics and drive train engagement of the gate is the objective.

06/01/2000

49 ▲ Stone & Webster

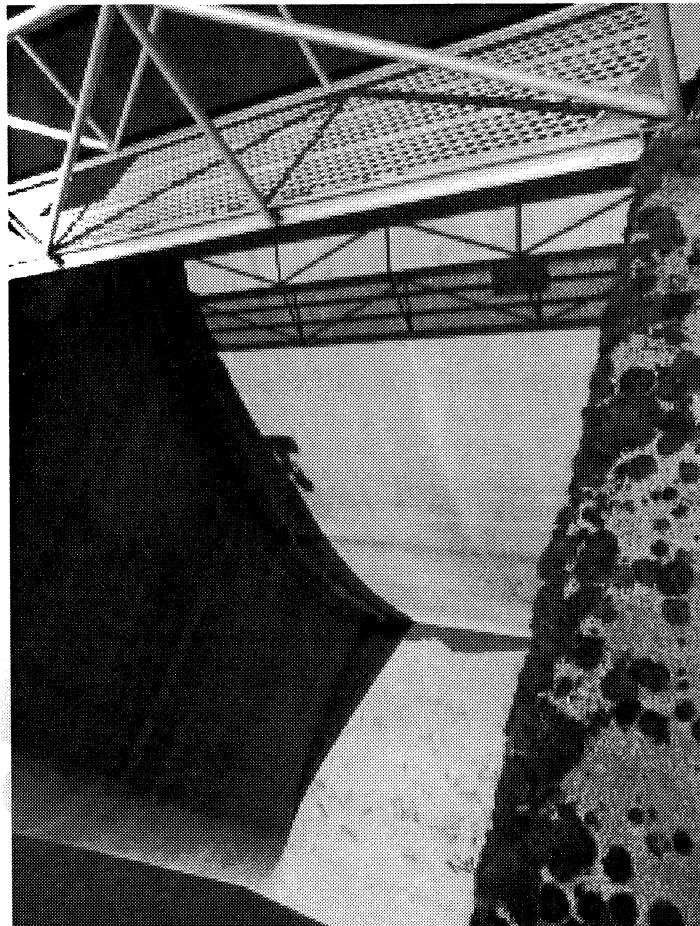

06/01/2000

50 ▲ Stone & Webster

## *Stop Radial Gate Operation, if*

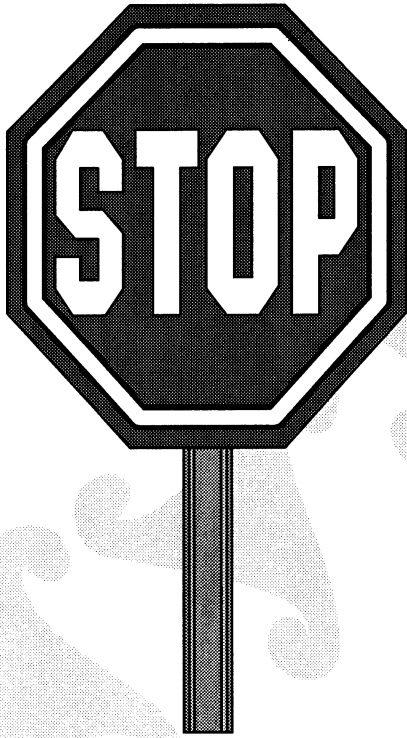

- ▲ gate doesn't begin to lift.
- ▲ gate begins to stall or makes unusual noises.
- ▲ gate begins to bind or warp.
- ▲ hoist wire rope or chain is damaged or frayed.

06/01/2000

51 ▲ Stone & Webster

## *Some Test Meters*

- ▲ Dranetz Power Analyzer (Requires Calibration)
  - Costs about \$5,000 to 15,000 to purchase
  - GE Supply rents for \$1500 per week (includes calibration)
- ▲ Yakogawa 3-phase Power Meter
- ▲ Output
  - ASCII Formatted File to PC Spreadsheet
- ▲ Record-Volts, Amps and kW

06/01/2000

52 ▲ Stone & Webster

# Priest Rapids & Wanapum Dams Columbia River, Washington

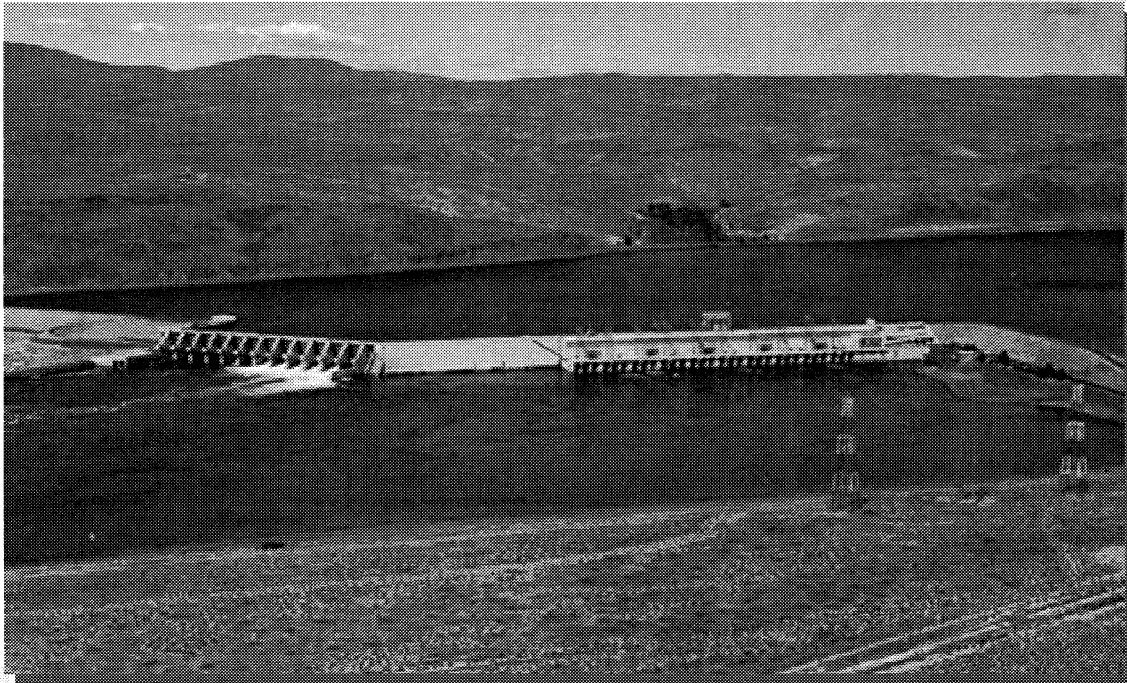

06/01/2000

53

 Stone & Webster

## Wanapum Spillway Gate Motor Data Gate 9

Data Location: Gate Hoist Panel  
Date: April 23, 1999

## SG-9 Hoist Motor Data

April 23, 1999

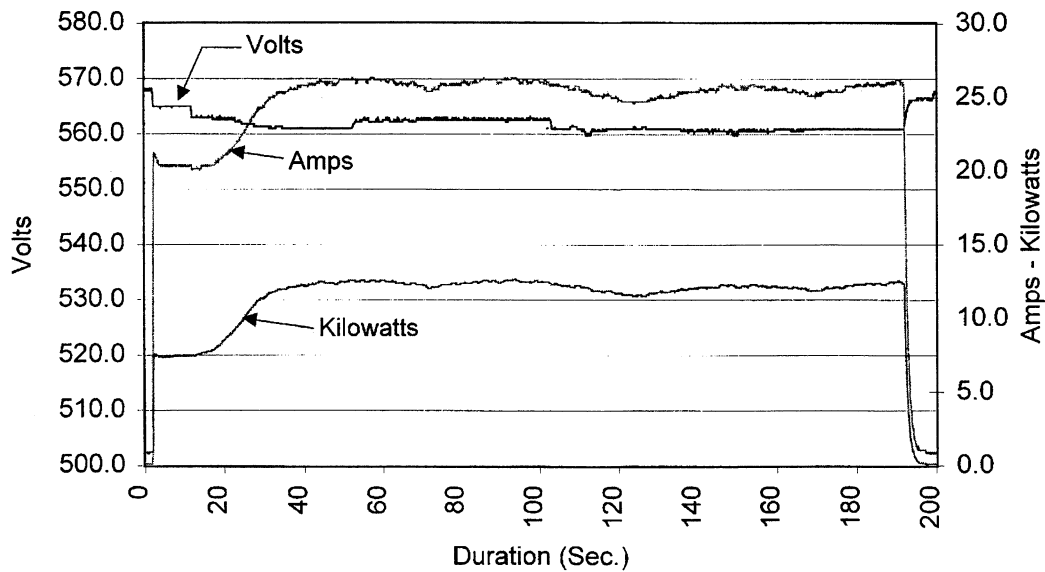

06/01/2000

54

 Stone & Webster



## Wanapum Spillway Gate Motor Data

### Gate 9

Data Location: Substation #1

Date: April 26, 1999

## SG-9 Hoist Motor Data

April 26, 1999

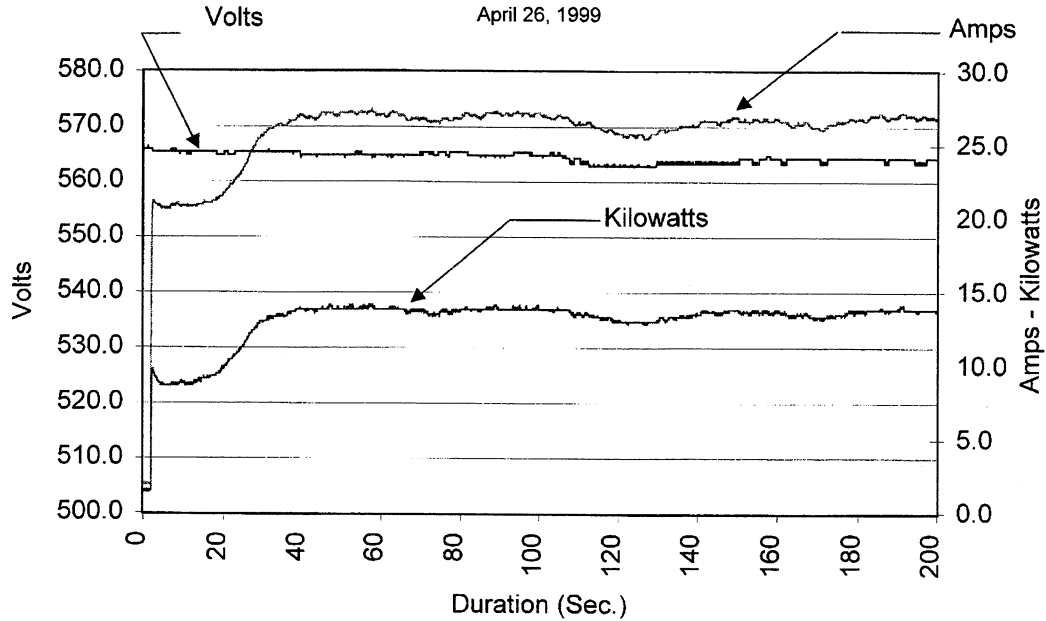

06/01/2000

55

Stone & Webster

## *Why isn't the "in rush" more pronounced?*

- ▲ Gearing clearances
- ▲ Engagement of the Drum or Sprocket
- ▲ Wire rope or chain is never completely "tight" even for partial openings
- ▲ Wire rope or chain elasticity
- ▲ Other machine related losses

06/01/2000

56

Stone & Webster

**Good hydraulics are key to long term performance**

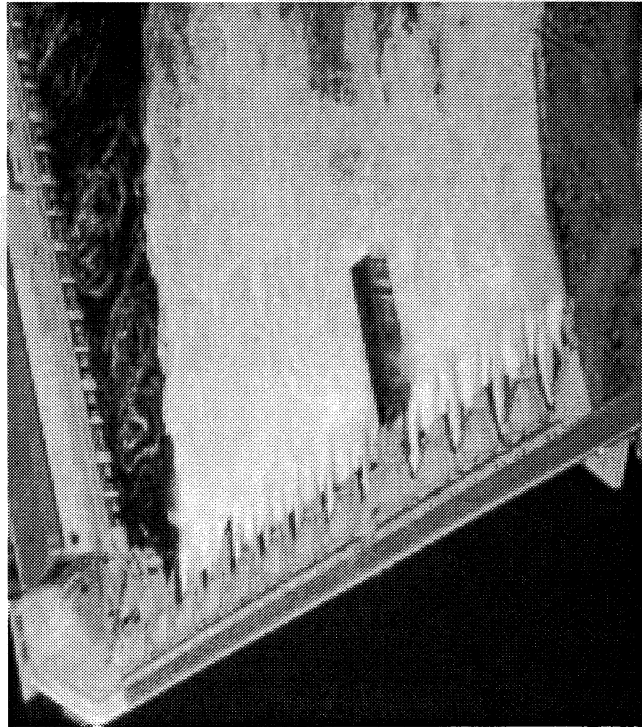

06/01/2000

57

**Stone & Webster**

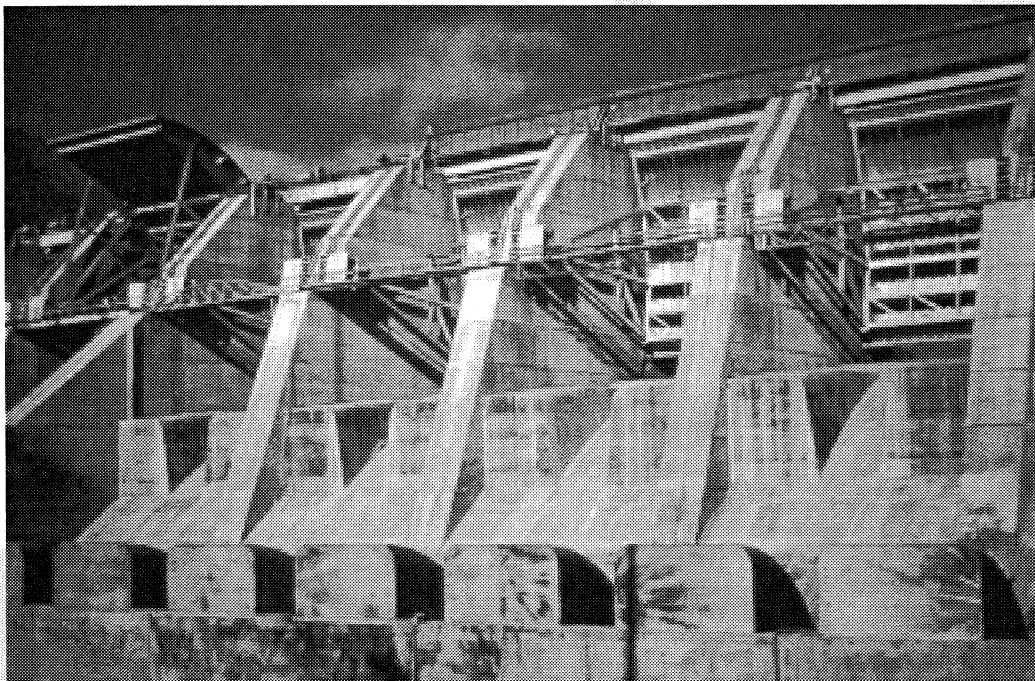

06/01/2000

58

**Stone & Webster**

# *Hydraulic Gate Operation*

- ▲ Orifice Discharge
- ▲ Open Channel Discharge
- ▲ Partially Submerged Discharge
- ▲ Submerged Discharge

06/01/2000

59  **Stone & Webster**

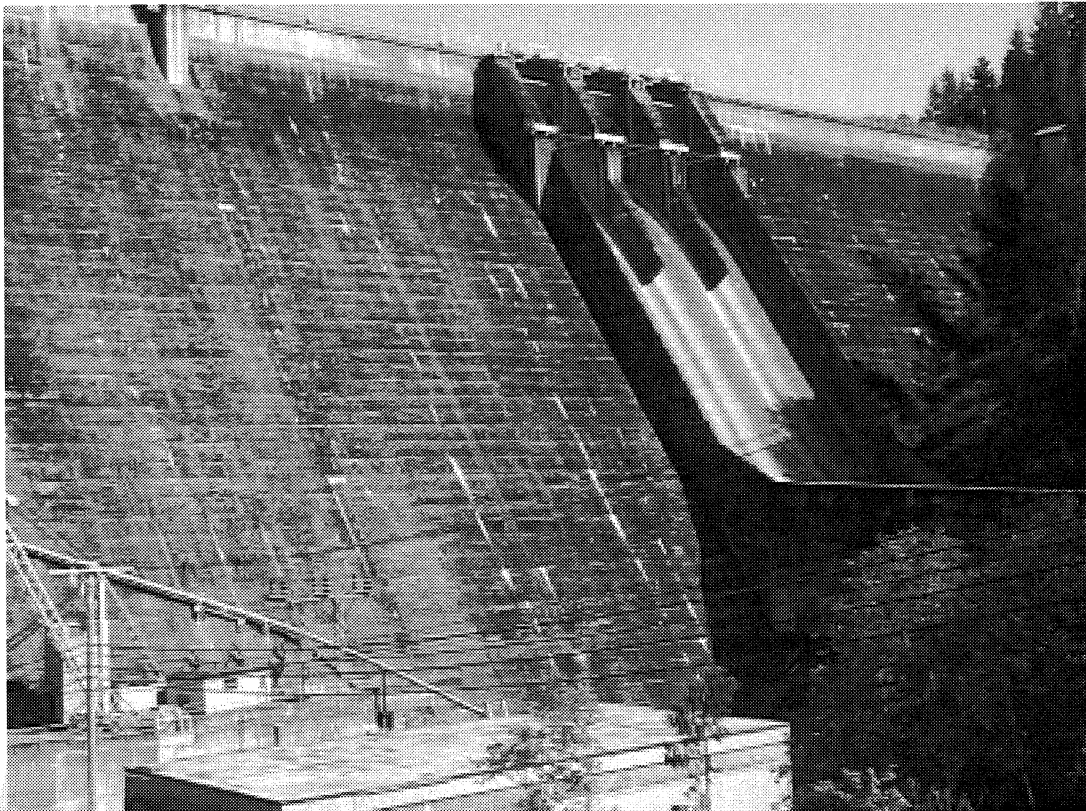

06/01/2000

60  **Stone & Webster**

# *Some Critical Hydraulic Conditions*

- ▲ Orifice Discharge
  - Usually after gate lifts off sill
- ▲ Partially Submerged Discharge
  - Transition from pure orifice discharge to partial submergence
  - Downstream flow instability
- ▲ Submerged Discharge
  - Downstream flow instability
  - Air demand instability
- ▲ Downstream Energy Dissipation Problem

06/01/2000

61 ▲ Stone & Webster

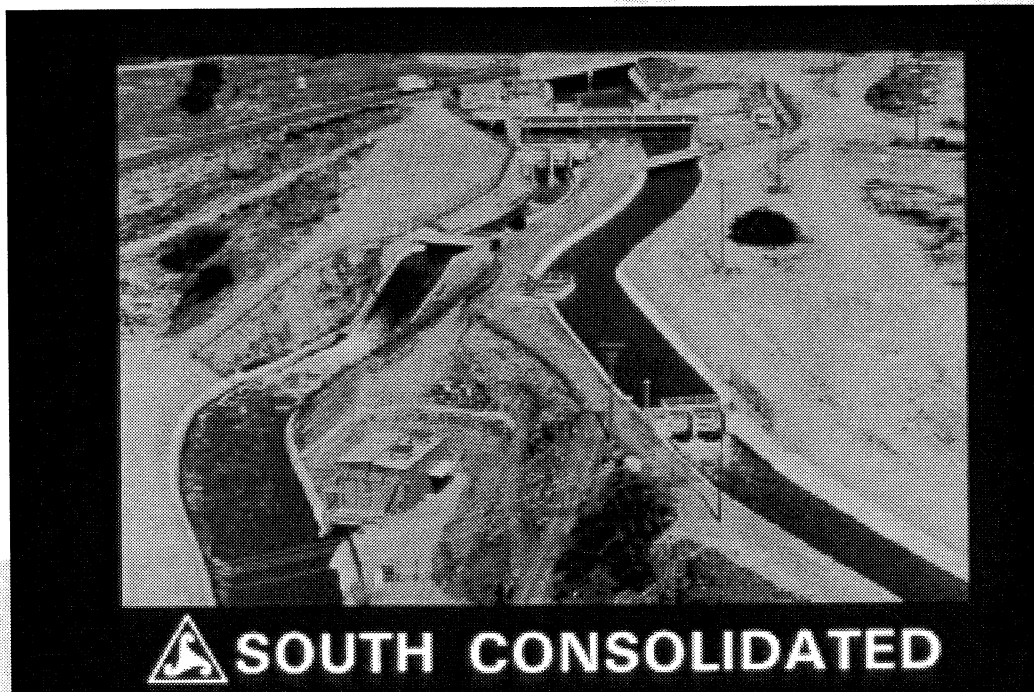

06/01/2000

62 ▲ Stone & Webster

## *What happened to “Good Vibrations”*

They stopped when the Beach Boys stopped singing.

 Stone & Webster

## *All Radial Gates Vibrate When Partially Open & Passing Water*

- ▲ Why?
  - Von Karmen affects
  - Opening “Pipe” characteristics
- ▲ Generally vibration is not critical
  - Amplitude is low
  - Frequency is low
  - Energy is low
- ▲ When Natural and Forcing Frequency are close to one another, significant vibration can and will occur.

## *Prolong Periods of Vibration*

- ▲ Can be detrimental to Gate Members & Embedments.
- ▲ Causes cracking in structural members and welds.
- ▲ Should be avoided. Typical practice is to avoid openings that cause significant vibration.
- ▲ If unavoidable due to operation requirements, vibration can be corrected.

06/01/2000

65  Stone & Webster

## *Vibration Mitigation*

- ▲ Stiffen the structural elements.
- ▲ Modify seal and bottom details; Use care when modifying seal details or replacing seals.
- ▲ If caused by impingement, correct impingement.
- ▲ Shape of spillway and piers does affect hydraulic streamline stability upstream, through and downstream of the gate opening
- ▲ Trash and debris can cause unstable flow conditions to exist and result in unexpected vibration. Remove trash and debris before gate opening.

06/01/2000

66  Stone & Webster

## *Train Engineers & O&M Personnel*

- ▲ Personnel are keen, intelligent and interested. We are all affected by retirement and younger less experienced personnel need to take over.
- ▲ To feel comfortable asking for assistance and advise.
- ▲ If a problem develops, what to do & who to call.

06/01/2000

67 ▲ Stone & Webster

## *Train Engineers & O&M Personnel*

- ▲ To visually check gates prior to opening, and initially as they opened.
- ▲ To recognize critical gate members.
- ▲ To have a basic understanding of the critical connections.
- ▲ To have a basic understanding of the gate design parameters or design criteria.
- ▲ Why it is important for the Trunnion bearings to be lubricated, if lubrication is required.
- ▲ Make sure side guide rollers are functional and not sliding on embedment

06/01/2000

68 ▲ Stone & Webster

# *Design Critical Members*

- ▲ Anchorages
- ▲ Trunnion Support Girder or Concrete Support Corbel
- ▲ Trunnion (Bearing, Pin, Housing)
- ▲ Arms
- ▲ Horizontal Girders or Trusses
- ▲ Skin Plate & Stiffeners
- ▲ Seal Support Members

06/01/2000

69 ▲ Stone & Webster

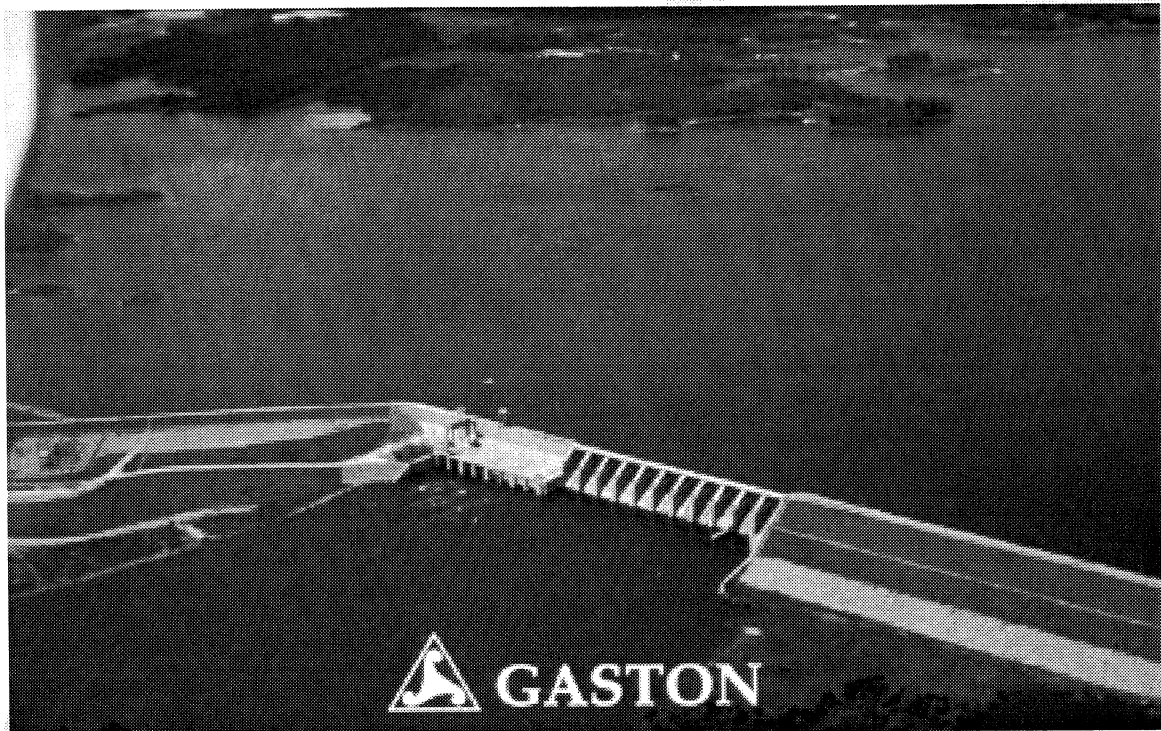

06/01/2000

70 ▲ Stone & Webster



# Gate Components Wear Out

- ▲ Side rollers
- ▲ Trunnion bearings
- ▲ Wire rope & chain attachments wear or corrode
- ▲ Seals wear or tear
- ▲ Pier embeddings become worn or undermined



06/01/2000

71  Stone & Webster

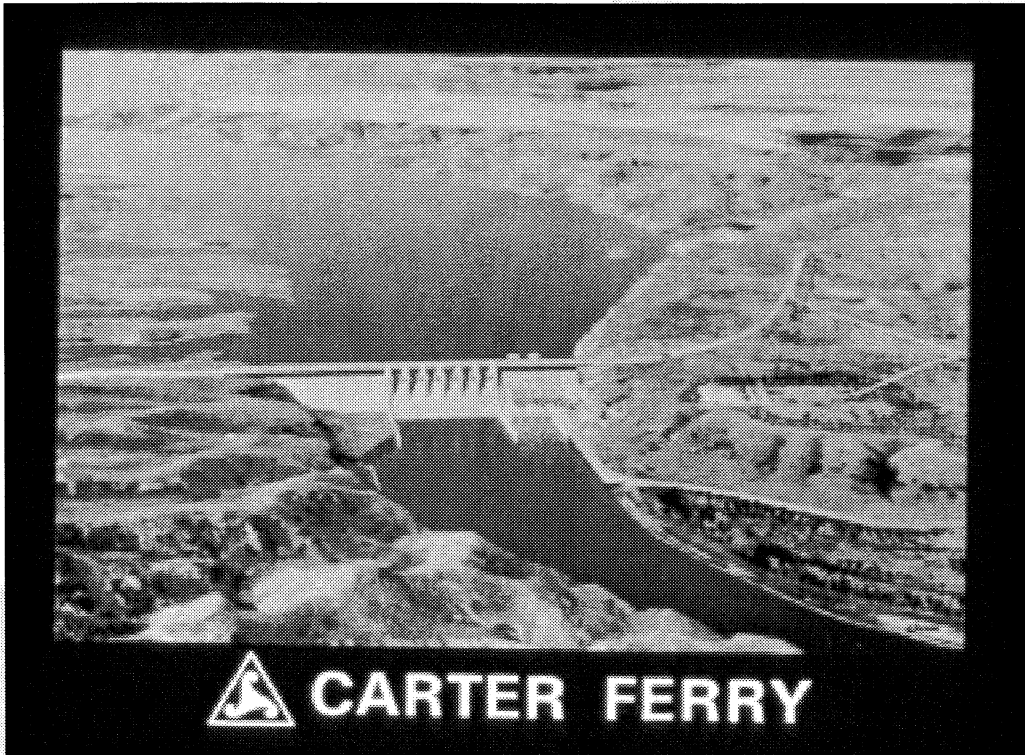

 CARTER FERRY

06/01/2000

72  Stone & Webster



06/01/2000

73 **Stone & Webster**

## *Trunnions*

- ▲ If the Trunnions do not work properly, the gate is not fit for service and trunnion repairs are required.
  - Trunnions have friction and this must be properly designed for.
  - Trunnion friction can increase as the bearing ages.
  - Bearings do wear out.
  - Bearings can be affected by environmental affects.
  - Bearings are machined components with special requirements that must be maintained.

06/01/2000

74 **Stone & Webster**



## *Two Types of Trunnion Bearings*

Journal  
Collar

 Stone & Webster

---

## *Trunnions*

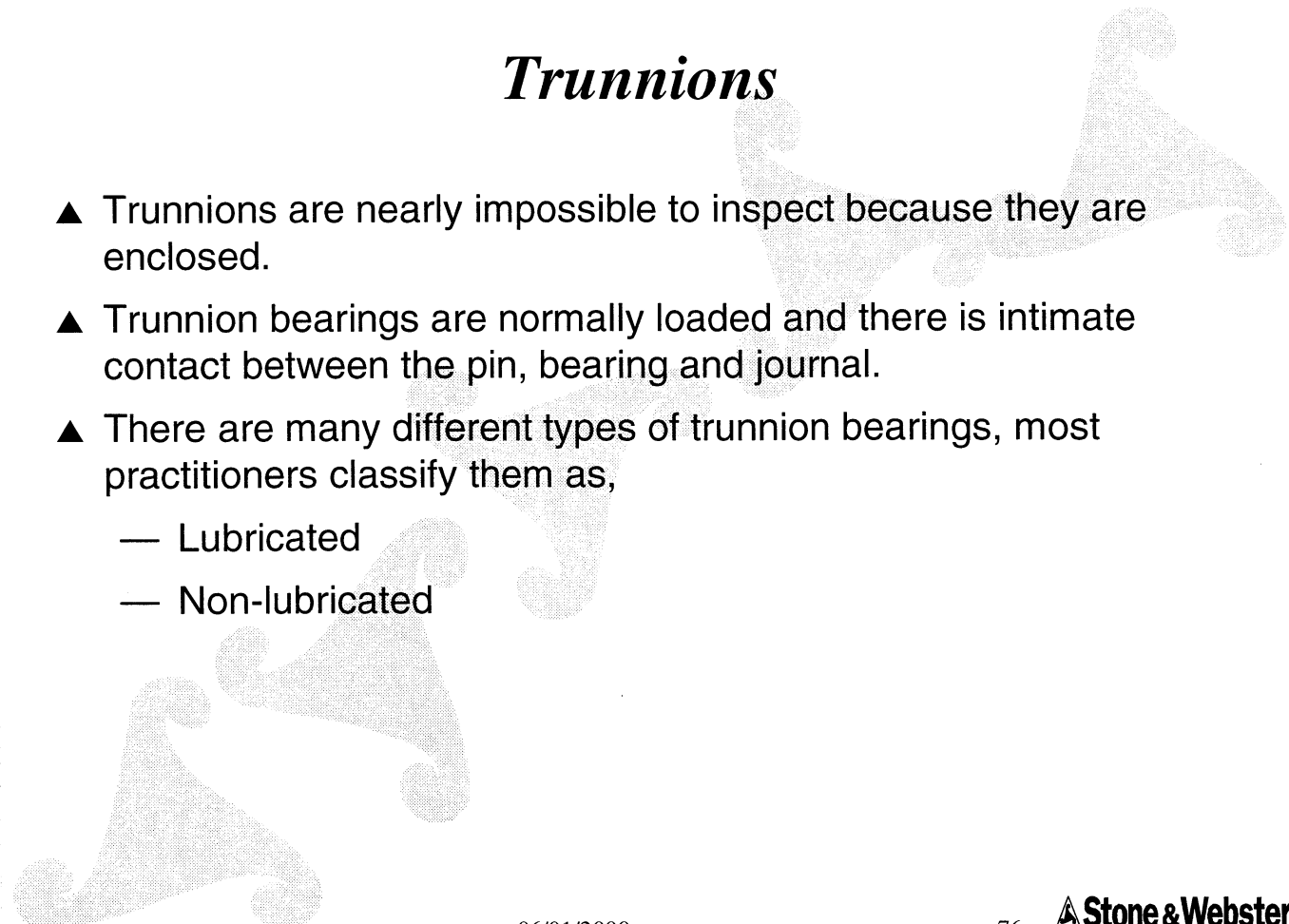
- 
- ▲ Trunnions are nearly impossible to inspect because they are enclosed.
  - ▲ Trunnion bearings are normally loaded and there is intimate contact between the pin, bearing and journal.
  - ▲ There are many different types of trunnion bearings, most practitioners classify them as,
    - Lubricated
    - Non-lubricated

# Lubricated Trunnions

- ▲ Lubricated trunnions need to be lubricated before each use.
- ▲ Even with proper lubrication, the bearing surfaces may not be fully lubricated and can wear.
- ▲ Typical trunnion rotation is 60 to 90 degrees. Never enough rotation to completely lubricate the bearing surfaces.
- ▲ Few trunnion bearings were equipped with a pressure lubrication system or the journal machine details to distribute the lubrication.
- ▲ However, some lubrication is better than no lubrication, but develop no false expectations.

06/01/2000

77 ▲ Stone & Webster

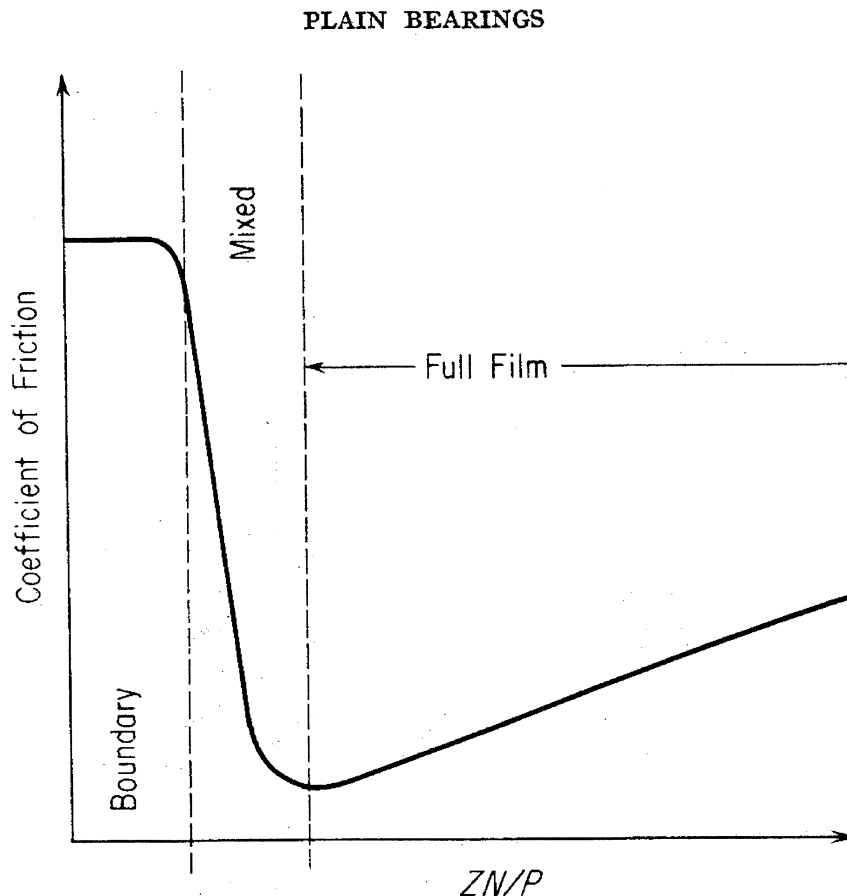

Fig. 1. Three modes of bearing operation.

▲ Stone & Webster

# JOURNAL BEARINGS

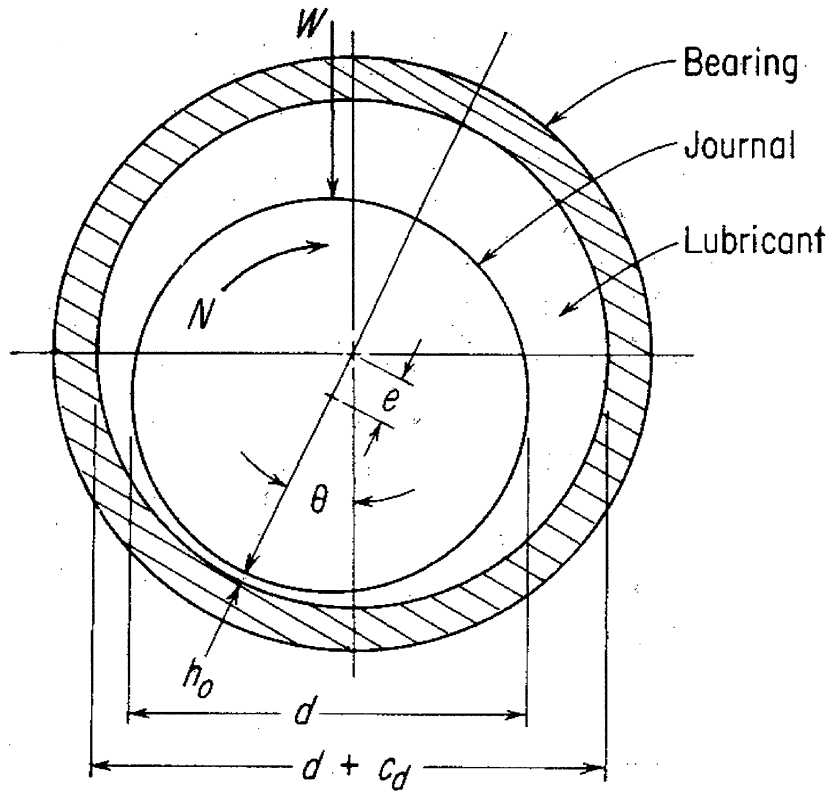

Fig. 3. Basic components of a journal bearing.

Stone & Webster

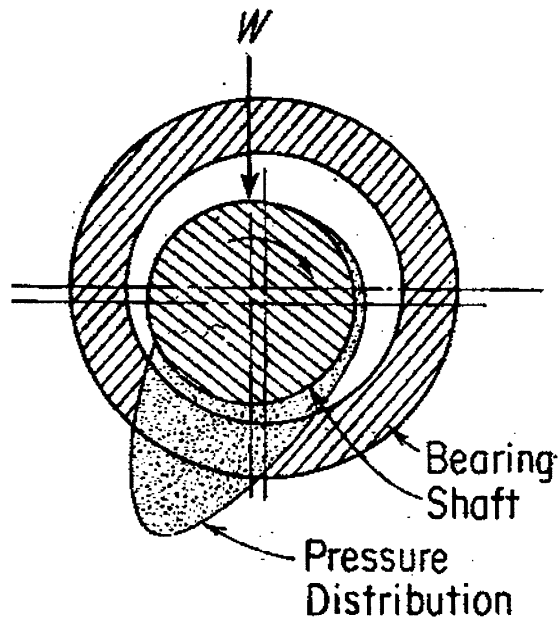

Fig. 4. Typical pressure profile of journal bearing.

## *Non-Lubricated Trunnion*

- ▲ Steel on steel; bolt or pinned joint
- ▲ Bronze
- ▲ Lubrite
- ▲ Lubron
- ▲ TFE
- ▲ Composite Materials
- ▲ Other

06/01/2000

81  Stone & Webster

## *Non-lubricated Bearings*

- ▲ Good design history
- ▲ Bearing friction changes with time, use and wear
- ▲ Environmental conditions can affect bearing

06/01/2000

82  Stone & Webster

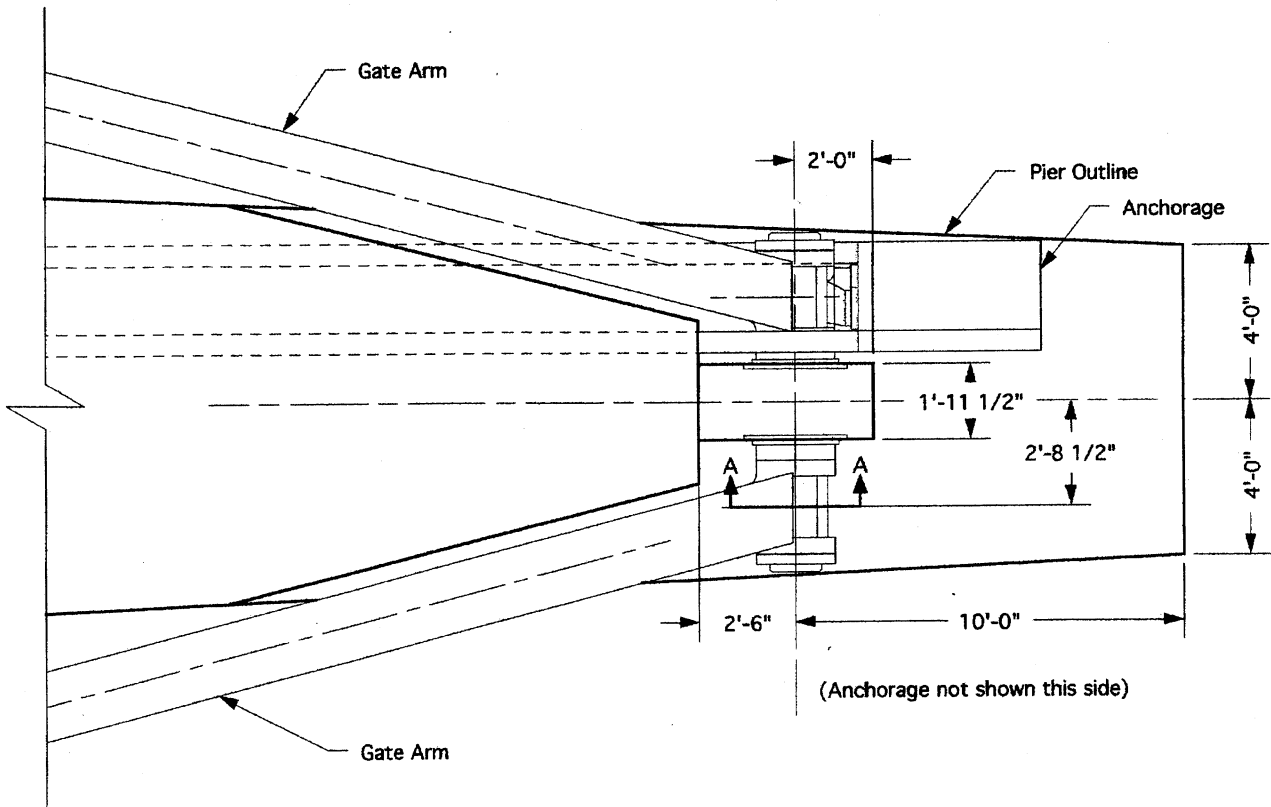

TYPICAL TRUNNION PLAN  
06/01/2000

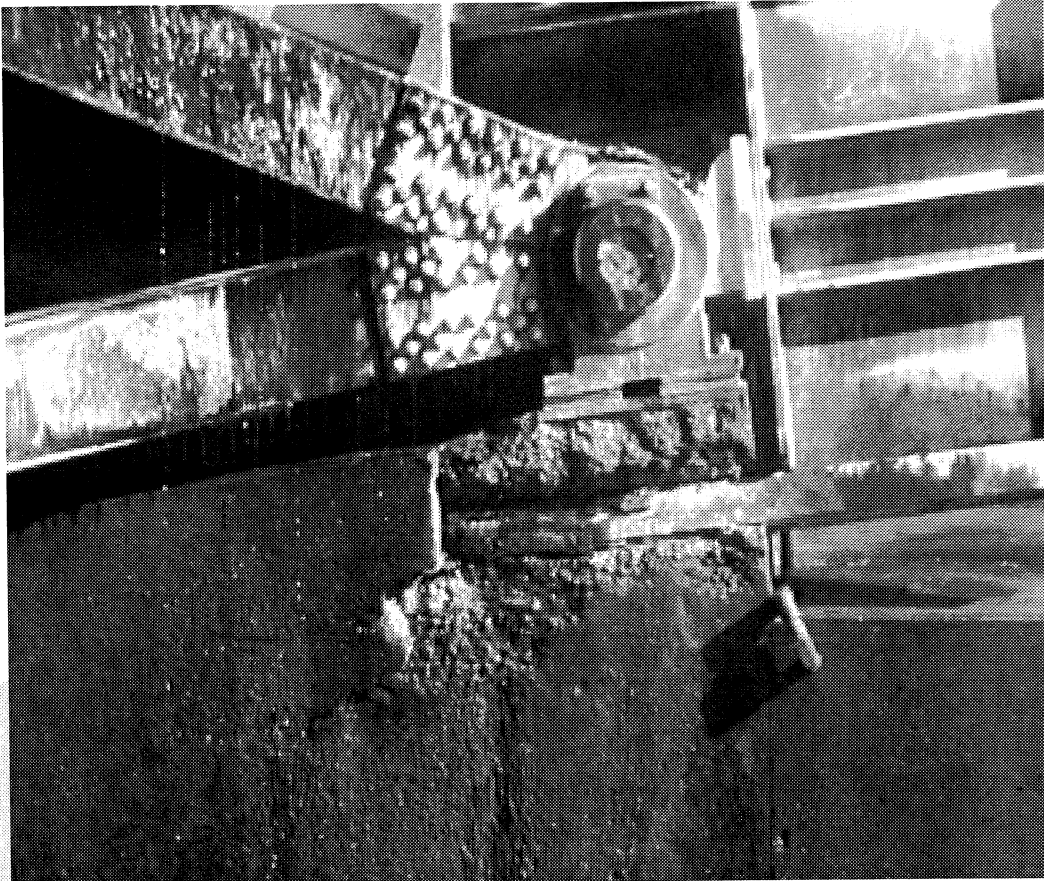

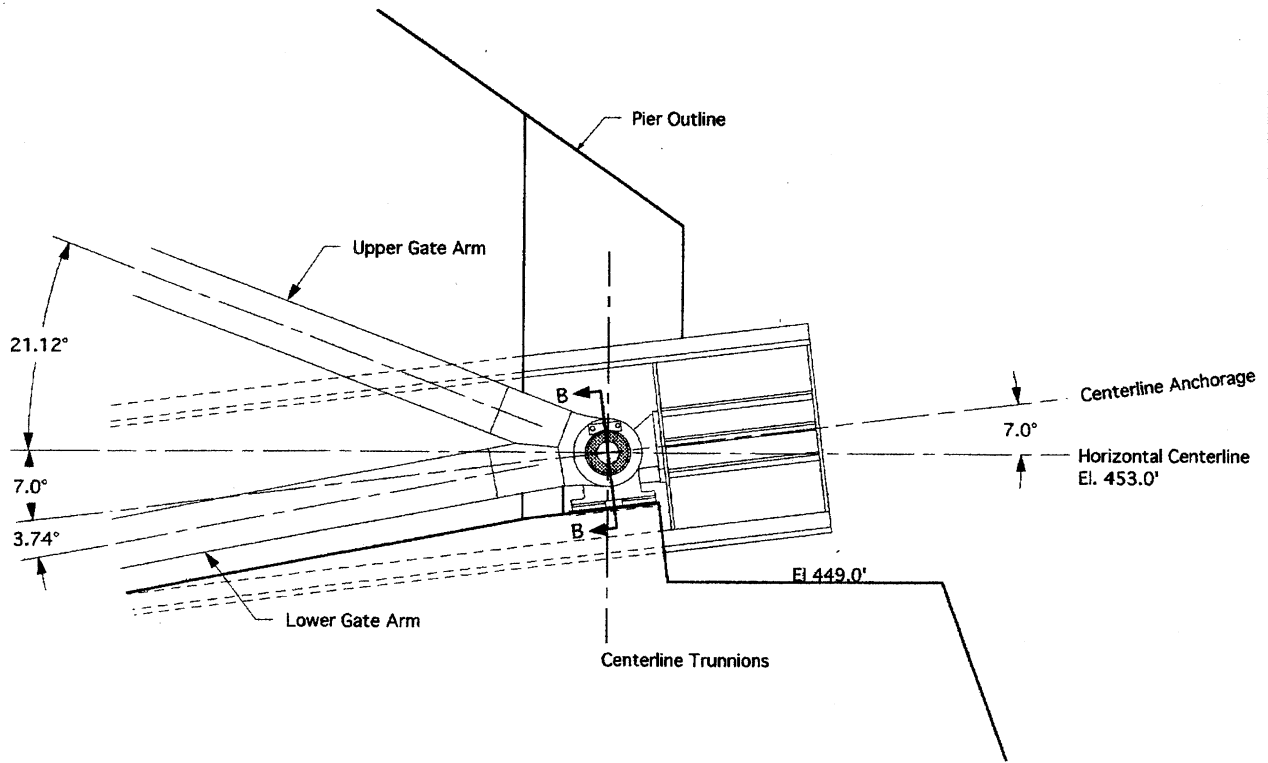

TYPICAL TRUNNION ELEVATION

06/01/2000

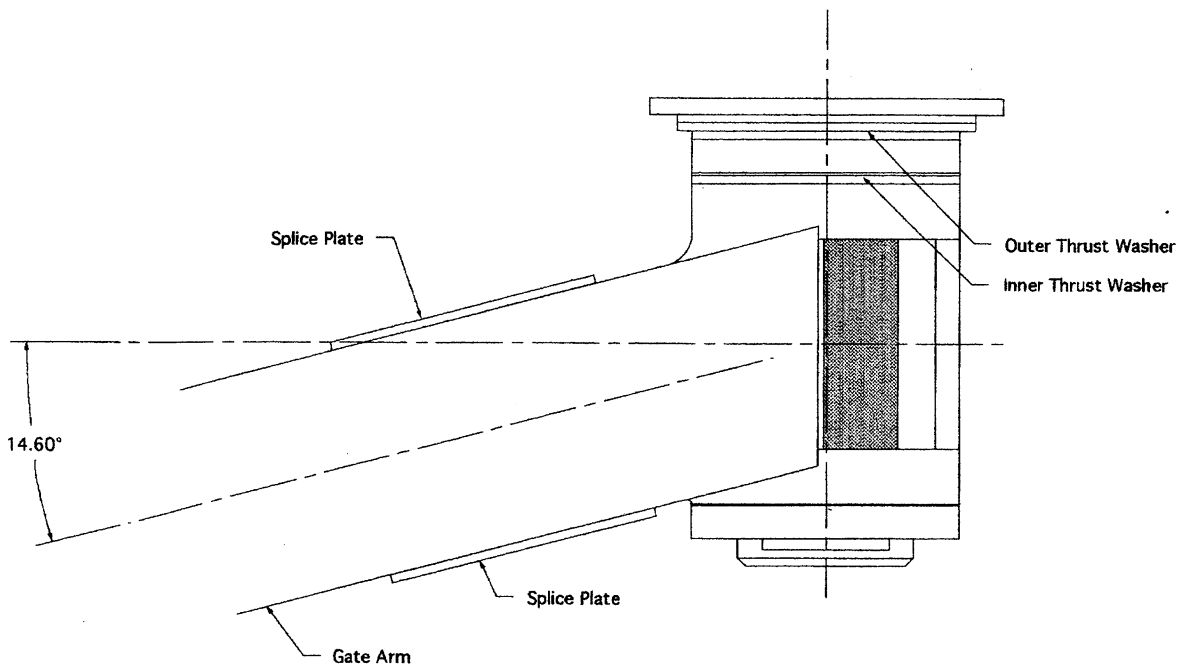

TYPICAL TRUNNION/ARM PLAN

06/01/2000





06/01/2000

87  Stone & Webster



06/01/2000

88  Stone & Webster

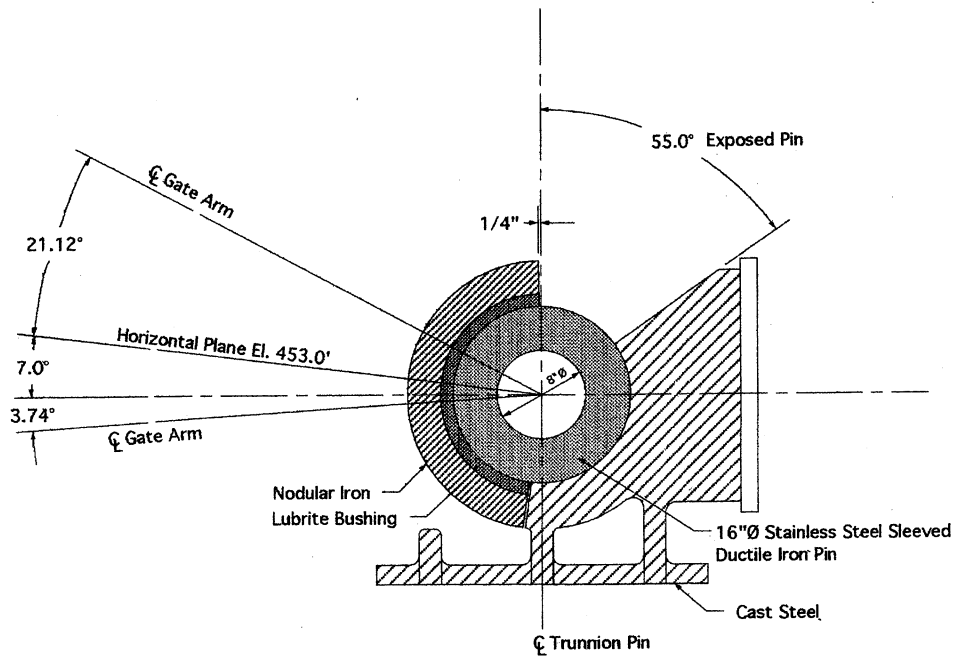

SECTION A-A  
(Gate arm not shown)

06/01/2000

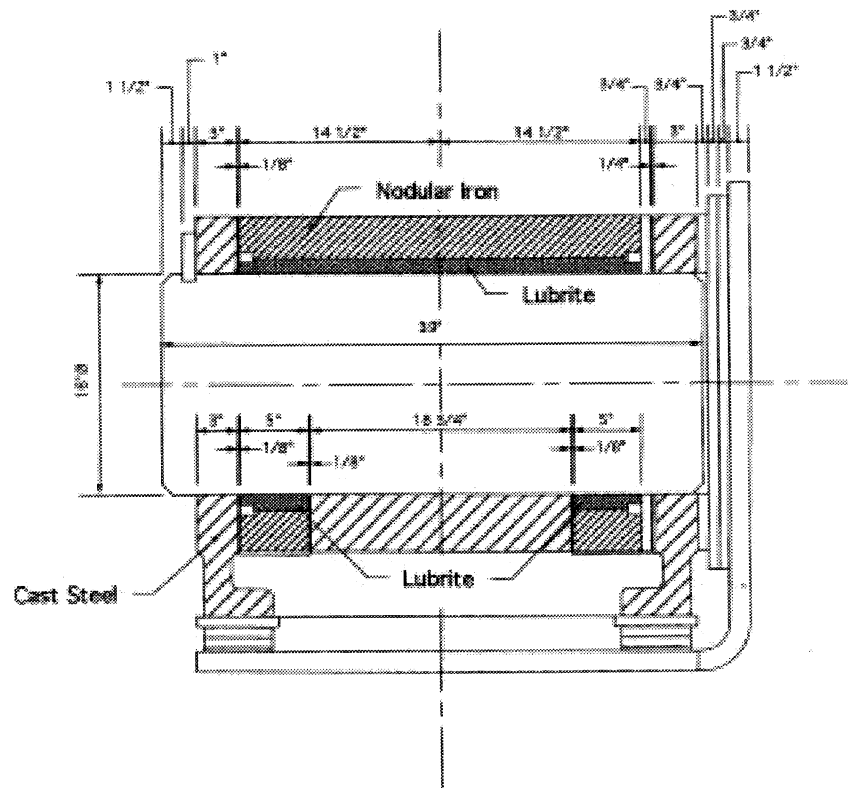

SECTION B-B



*End of Presentation*

06/01/2000

91  **Stone & Webster**



06/01/2000

92  **Stone & Webster**

# *Design Loads*

- ▲ Dead Loads
- ▲ Hydrostatic Loads
- ▲ Wind Loads
- ▲ Snow Loads
- ▲ Ice Loads
- ▲ Seismic & Hydrodynamic Loads
- ▲ Seal Loads
- ▲ Temperature Loads
- ▲ Lifting Loads
- ▲ Friction Loads
- ▲ Unbalanced Lifting Loads
- ▲ Construction Loads

06/01/2000

93  **Stone & Webster**

# *Load Combinations*

- ▲ Normal
- ▲ Intermittent & Lifting
- ▲ Emergency
- ▲ Exceptional
- ▲ Construction

06/01/2000

94  **Stone & Webster**

# *Maintenance*

- ▲ Hoist
- ▲ Hoist cables, chains, hydraulic cylinder
- ▲ Gate structural elements
- ▲ Gate arms
- ▲ Trunnions
- ▲ Trunnion supports
- ▲ Anchorages

06/01/2000

95  **Stone & Webster**

# *Radial Gates*

## *Hydraulics*

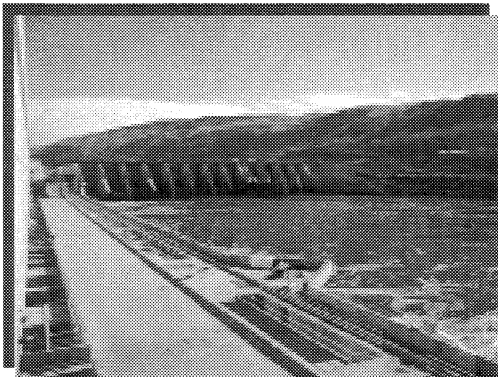

## *Gate Analysis*



06/01/2000

96  **Stone & Webster**

## **Tainter Gate Initiative/Allowable Stresses**

*Rick Poeppleman  
Sacramento District/South Pacific Division  
U.S. Army Corps of Engineers (COE)*



Sacramento District/South Pacific Division  
Corps of Engineers

---

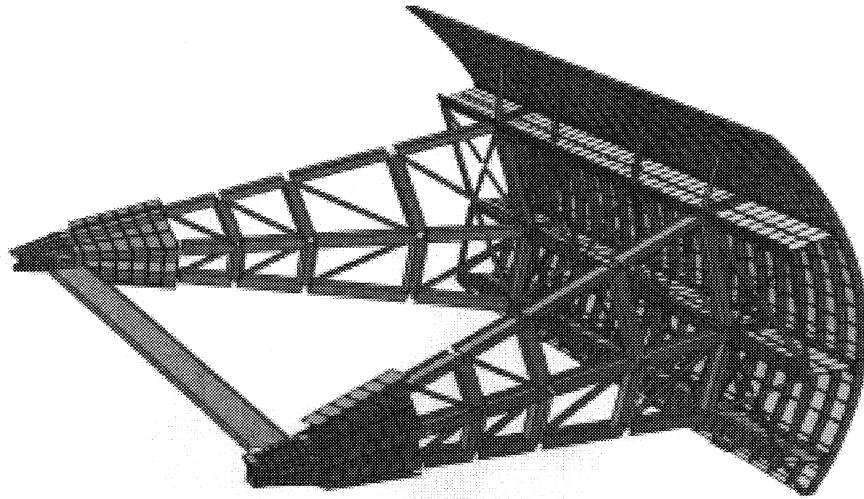

**Tainter Gate Initiative/Allowable Stresses**

---



Sacramento District/South Pacific Division Corps of  
Engineers

---

- Summary of Folsom Failure
  - Corps Initiative
  - Division/District Summary
  - Corps Design/Evaluation Criteria
  - Allowable Stresses
  - Pine Flat Dam
  - End Frame Design
  - Lubrication
  - Other Failures/Problems
  - Summary
-



## Folsom Dam Tainter Gate Failure

---

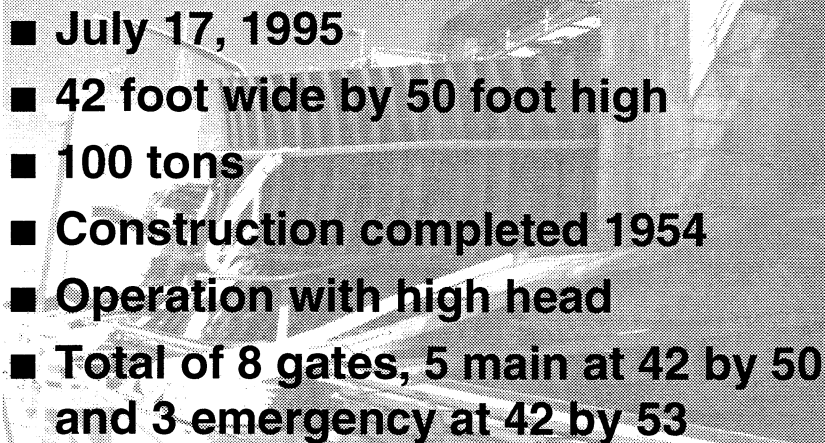
- 
- **July 17, 1995**
  - **42 foot wide by 50 foot high**
  - **100 tons**
  - **Construction completed 1954**
  - **Operation with high head**
  - **Total of 8 gates, 5 main at 42 by 50 and 3 emergency at 42 by 53**
- 



## Folsom Dam Tainter Gate Failure

---

- **Design and Constructed by Sacramento District Corps of Engineers**
  - **Operated and Maintained by USBR**
  - **Failure Investigation/Forensics**
    - Primary reason for failure was trunnion bearing friction not included in design.
    - Secondary reasons included corrosion of connections and increased bearing friction due to corrosion.
    - Vibration analyses.
    - Lubrication testing.
    - Lack of detailed dam safety inspections/evaluations by USBR and Corps.
-





## Folsom Dam Tainter Gate Failure

---

- Trunnion friction estimates from strain gage measurements and analytical results.

### ■ Actions

- Detailed inspections of 7 remaining gates, numerous cracked welds, sheared bolt, string line measurements.
  - Strengthening of 7 remaining gates.
  - Rotation of bearing pins.
  - New hoisting chains.
  - Replacement of failed gate.
  - Stoplogs/maintenance bulkheads added.
  - Automatic lubrication and operation.
- 



## Upstream View of Failure - Folsom

---

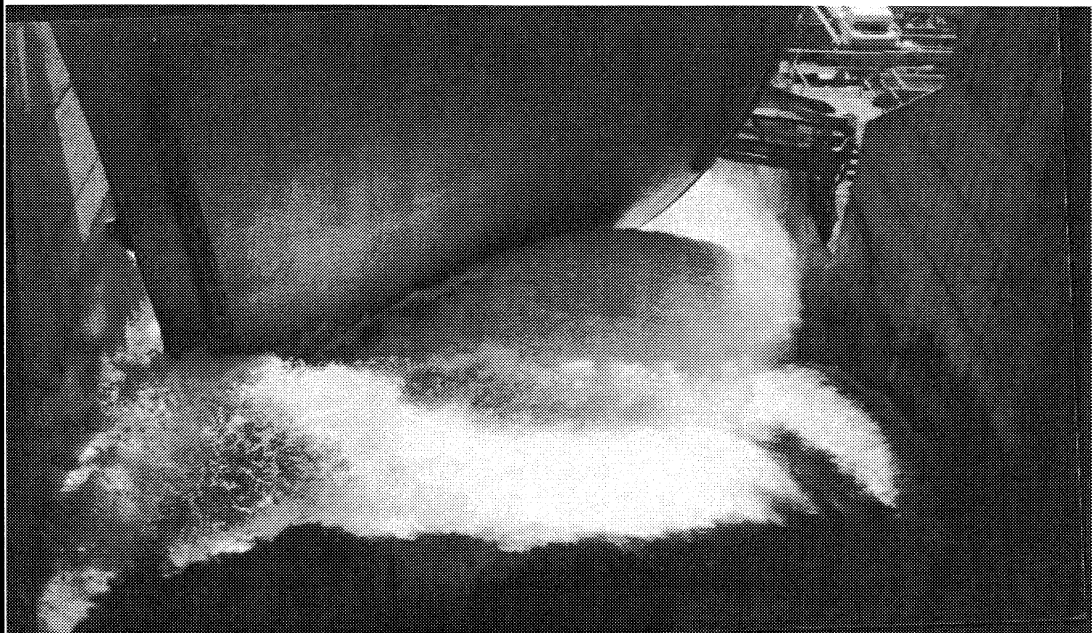



## Downstream View of Failure - Folsom

---

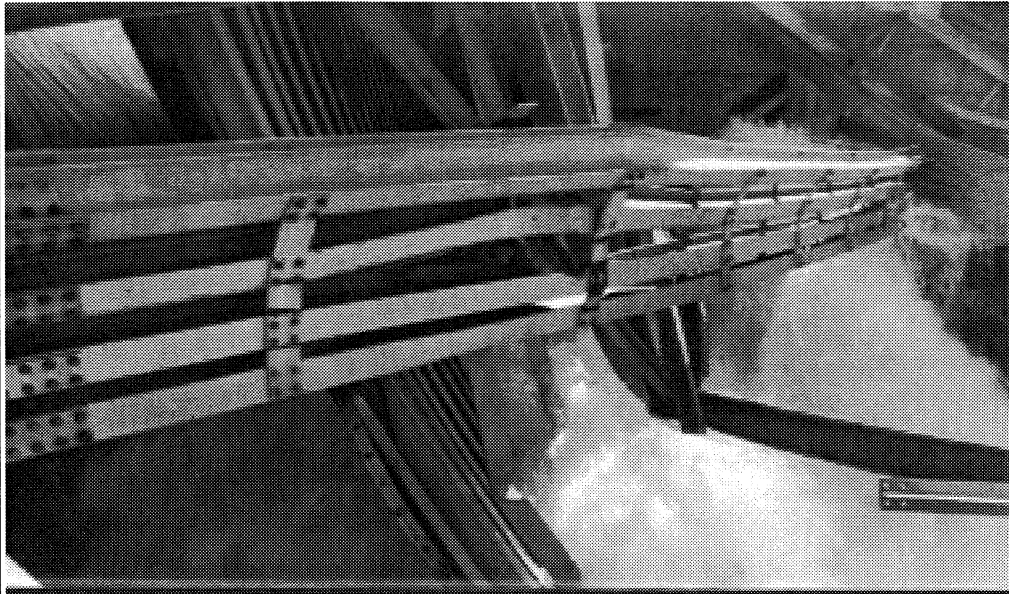

## Folsom Dam Trunnions

---

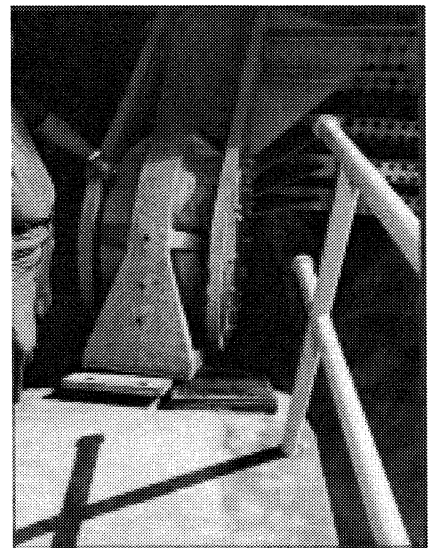
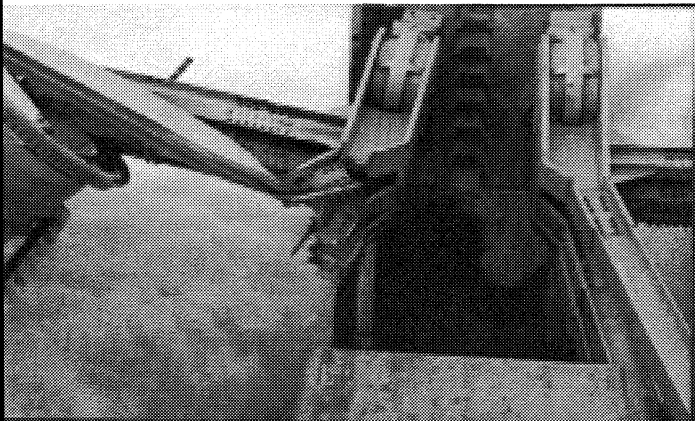



## Corps Initiative

---

- Responsibility of Divisions/Districts
  - Some Divisions/Districts pro-active others have apparently been inactive.
  - 1966 EM included design requirement for trunnion friction, 13 plus load cases.
  - Computer program developed 1978.
  - 1991 paper "Tainter Gate Analysis" by David J. Smith, Omaha District, included in Corps Structural Engineering Conference identified that many gate designs prior to 1960 failed to include trunnion friction.
  - Inspection criteria updated in early 1990s.
  - New EM in draft format, LRFD.
- 



## Corps Criteria

---

- ❖ ER 1110-2-100, Periodic Inspection and Continuing Evaluation of Completed Civil Works Structures, Feb 1995.
  - ❖ ER 1110-2-101, Reporting Evidence of Distress of Civil Works Projects, Jan 1993.
  - ❖ ETL 1110-2-351, Structural Inspection and Evaluation of Existing Spillway Gates, Mar 1994.
  - ❖ ETL 1110-2-346, Structural Inspection and Evaluation of Existing Welded Lock Gates, Sept 1993.
  - ❖ EM 1110-2-2105, Design of Hydraulic Steel Structures, Mar 1993.
  - ❖ EM 1110-2-2702, Design of Spillway Tainter Gates, Aug 1966. New Draft EM, LRFD Method.
  - ❖ AISC Steel Design Manual.
  - ❖ ER 1110-2-8157, Engineering and Design - Responsibility for Hydraulic Steel Structures, 31 January 1997.
-



# Allowable Stresses - Design

## ■ References

- EM 1110-2-2105, Design of Hydraulic Steel Structures, Mar 1993.
- AISC Manual of Steel Construction, Allowable Stress Design, 9th ed.

## ■ Groups I and II

- I - loads that remain constant for significant periods of time (gravity, hydrostatic, operating equipment), modified AISC allowable stresses
- II - loads that vary with time, short duration, infrequent (Impact, wind, wave, seismic), 1/3 increase in allowable stresses based on type

## ■ Types A, B, C

- A - emergency closures, severe dynamic loads, normally submerged, **0.75** times AISC (emergency gates, regulating gates with dynamic loads)
- B - normally loaded, insignificant dynamic loads, can be maintained and inspected on a regular basis, **0.83** (tainter and vertical lift crest gates)
- C - temporary closures for maintenance or inspection, **1.1** times AISC (bulkheads, stoplogs)



## Comparison of Allowable Stresses for Flexure

TYPE	AISC	GROUP I	GROUP II (1/3 over)
A, .75	0.66F <sub>y</sub>	0.50F <sub>y</sub>	0.66F <sub>y</sub>
B, .83	0.66F <sub>y</sub>	0.55F <sub>y</sub>	0.73F <sub>y</sub>
C, 1.1	0.66F <sub>y</sub>	0.73F <sub>y</sub>	NA



## Allowable Stresses/Loads - Evaluation

---

### ■ Realistic Loads

- reservoir pool elevation
- trunnion friction, .15, .30, .50? (measured)
  - ❖ Corps is not requiring 0.30 in new criteria
- Combined seismic and pool

### ■ Allowable Stresses

- frequency of load (low freq., increase allowable stresses)
- duration of load (short duration, increase allowable)
- probability of load (low probability, increase allowable)

### ■ Other Factors

- physical condition, O&M history, analytical methods, material properties
- 



## South Pacific Division

---

- Projects - approximately 10 with large radial gates that pre-date 1960.
  - Inspections - Most have had thorough inspections and review of designs.
  - Evaluations - 2
  - Modifications - Pine Flat underway, New Hogan planned.
  - 2 Projects with Tainter valves
  - Maintenance Bulkheads
  - Lock gates
-



## Pine Flat Dam

---

- 6 gates, 42' W x 38' H, 60 tons, Multi-purpose
  - Review of design calculations
  - Initial inspection
  - Detailed inspection
  - Evaluation
  - Design of modifications
  - Change in lubrication type, frequency, and automation
  - Load cells
- 



## Pine Flat Dam

---

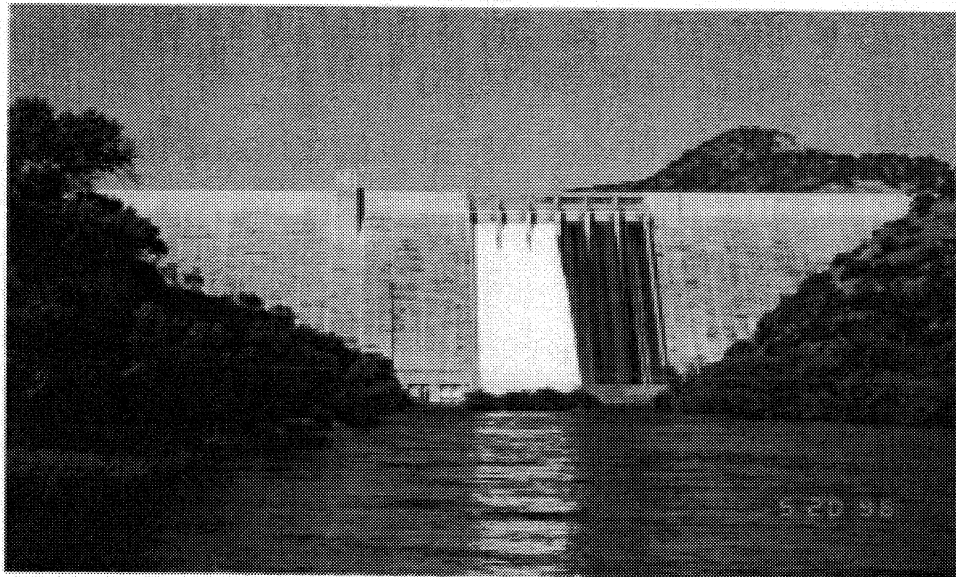

7. PINE FLAT DAM CONTROLLED SPILL  
20-23 MAY 96



# Pine Flat Existing Tainter Gates

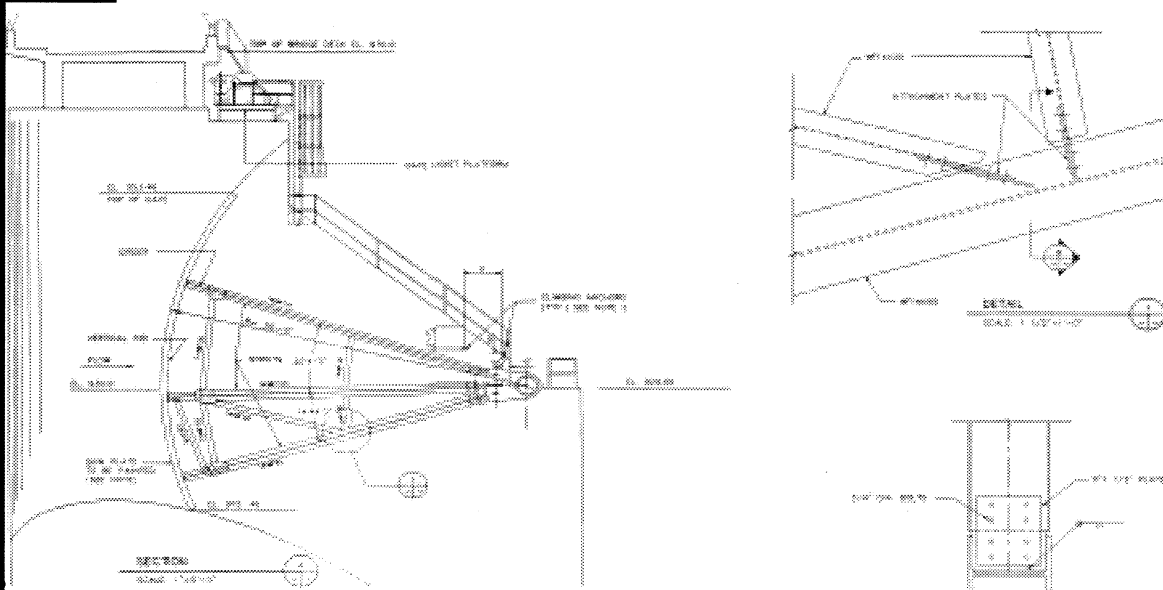

# Pine Flat Dam End Frames

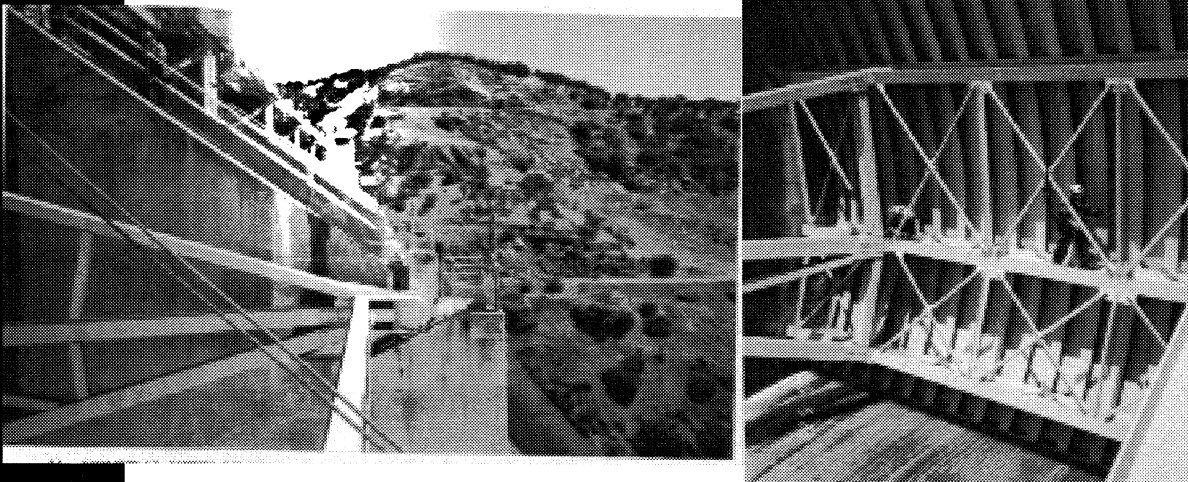



## Folsom End Frames - Original

---

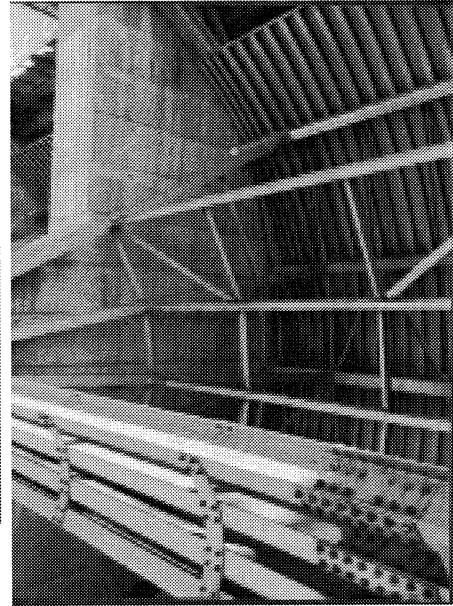

## Pine Flat Dam Tainter Gate Design/Evaluation

---

- Design Approach - Allowable Stress Design
  - Loads
    - Full pool, operation with coefficient of friction of 0.30
    - Full pool, gate resting on sill
    - Seismic (OBE) with 2 yr flood event pool
  - Allowable Stresses
    - 5/6 of AISC for normal load condition
    - 1/3 overstress for infrequent or short duration load conditions
-





## Structural Components/Trunnion Loads

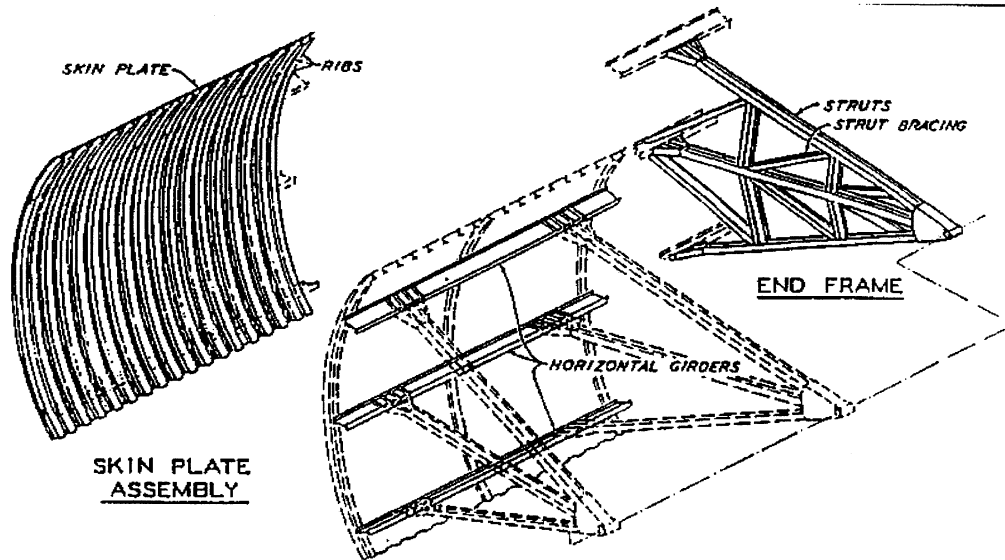

## Typical Trunnion Bearing Loads

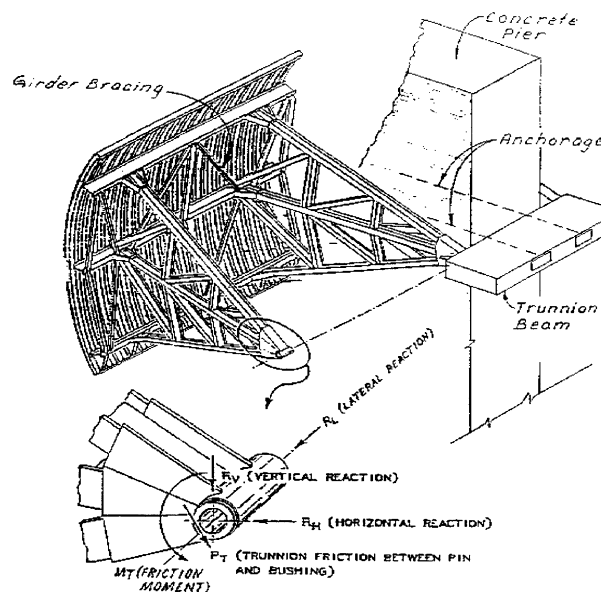



# Pine Flat Horizontal Frame Model - SAP90

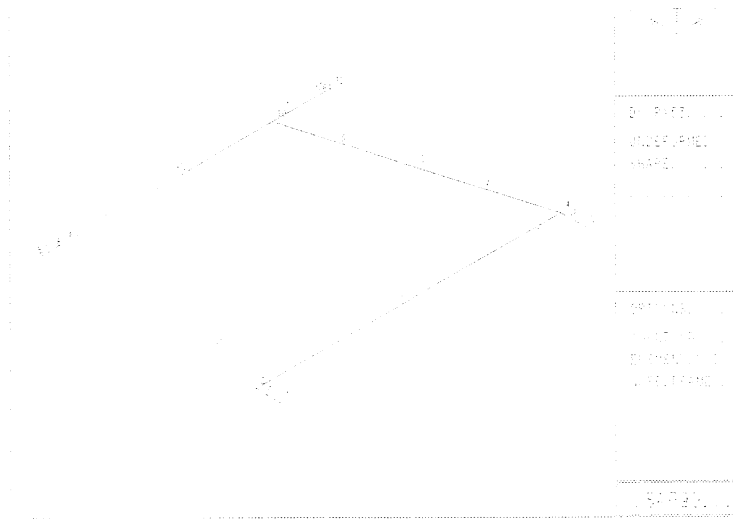

# Pine Flat End Frame Model - SAP90

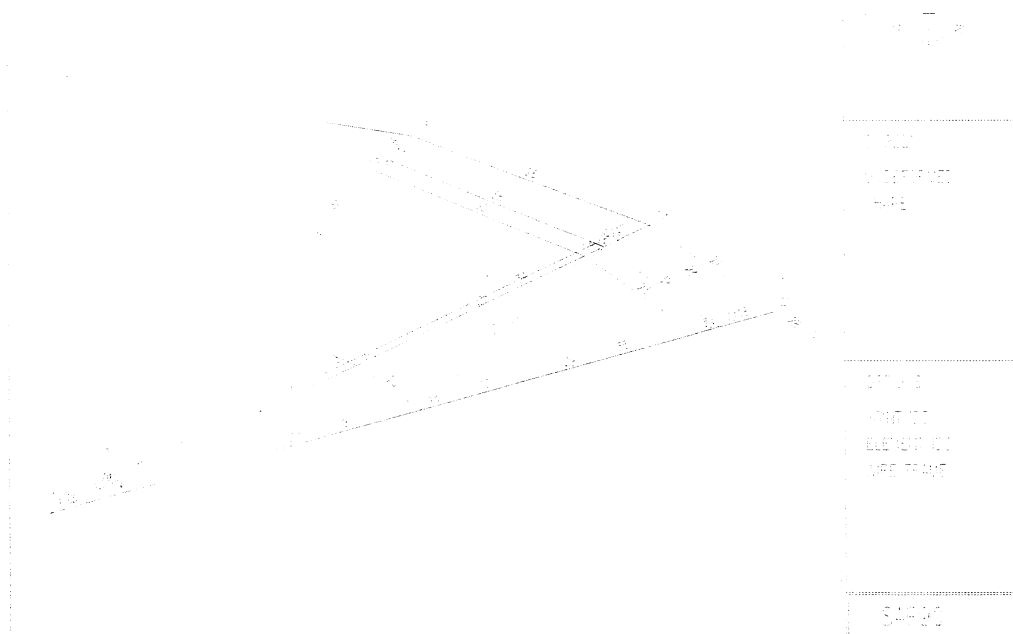



# Pine Flat Dam 3D Modelling - SAP2000

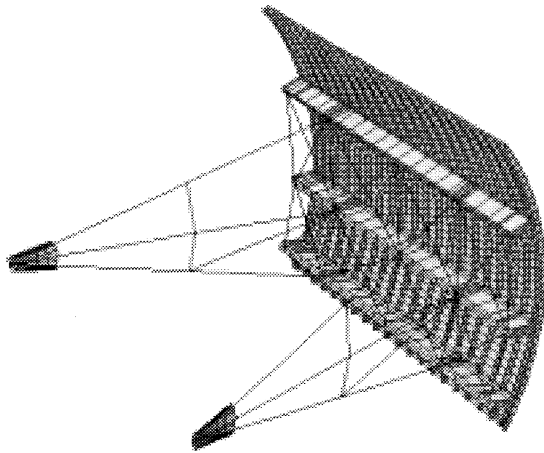

Existing Gate Model

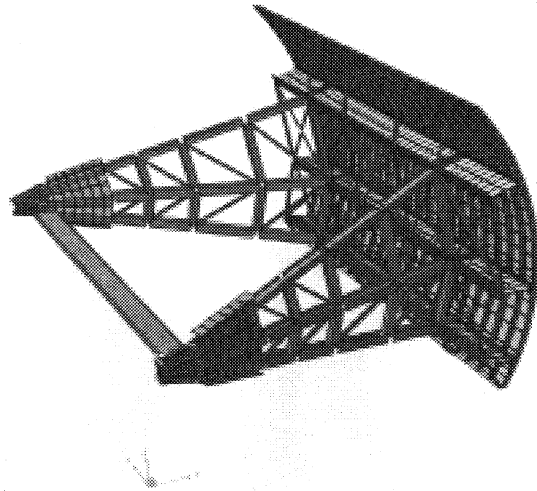

Modified Gate Model



# Pine Flat Dam Tainter Gate Mods

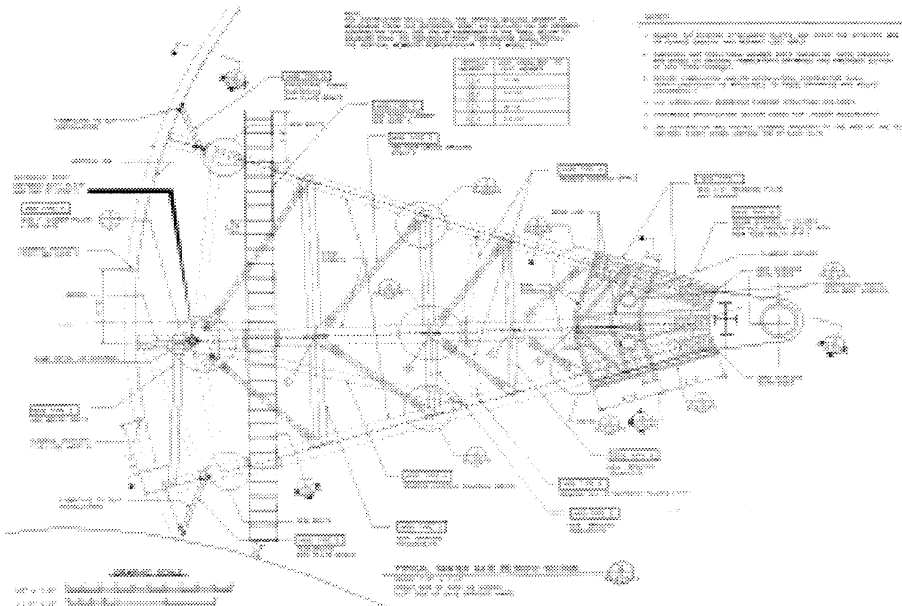



## End Frame Design/Analysis

---

- Include trunnion bearing friction
  - Account for 2nd order affects either thru non-linear analysis or code
  - Calculate effective length factor,  $k$ , based on relative stiffness of struts and braces.
  - Stiff braces with moment connections.
  - Include both directions of operation.
  - Extend trunnion plates 20 to 25 percent of strut length. (Triangular distribution of moment due to trunnion bearing friction.)
- 



## End Frame Design/Analysis

---

- Full head, operation of gate,  $I_{total} = 400$ ,  $I = 200$
  - Strut 2,  $P=413k$ , non-linear p-delta analysis
  - 1. Original Design,  $M=0$ 
    - coef. of friction = 0.0,  $k = 1.0$  (assumed)
    - $F_a = 13.85$  ksi,  $f_a = 13.65$  ksi,  $f_a/F_a = 0.99$
  - 2. Original Design and trun. fric.,  $M=1410k-in$ 
    - coef. Of friction = 0.30,  $k=1.0$  (assumed)
    - $F_a = 18.42$ ,  $f_a = 13.65$ ,  $f_a/F_a = 0.74$
    - $f_a/F_a + (amp)f_b/F_b = 0.74 + 24.5/20.6 = 1.93$  eqn H1-1
    - (amplification factor accounted for by p-delta analysis, always  $>1$ )
-



## End Frame Design/Analysis (cont)

---

- 3. Original Design,  $M=1410$  k-in,  $l=200$  in
    - coef. of friction = 0.30,  $k = 2.0$  (calculated, chart)
    - $F_a = 12.72$ ,  $f_a = 13.65$
    - $f_a/F_a + (\text{amp})f_b/F_b = 1.07 + 24.5/20.6 = \underline{2.26}$
  - 4. Original Design,  $M=1410$ k-in,  $l=400$  in
    - coef. of friction = 0.30,  $k=0.8$  (from AISC)
    - $F_a = 15.24$ ,  $f_a = 13.65$
    - $f_a/F_a + (\text{amp})f_b/F_b = 0.90 + 1.19 = \underline{2.09}$
    - **Failure?** Check by removing SF for allowable stresses and use realistic coef. of friction, 0.15.
    - SF on axial load approx. 1.70, SF on bending approx. 3.20
    - **w/o SF,  $0.58 + 0.37 = \underline{0.95} < 1.0$**
- 



## End Frame Design/Analysis (cont)

---

- 5. Replace existing brace with stiff brace and moment connection,  $M=1410$  k-in,  $l=200$  in
    - coef. of friction = 0.30,  $k = 1.2$  (calculated, chart)
    - $F_a = 17.48$ ,  $f_a = 13.65$
    - $f_a/F_a + (\text{amp})f_b/F_b = 0.78 + 1.19 = \underline{1.97}$
  - 6. Extend trunnion plates and add bracing.
-



## Lubrication

---

- Utilize best lubricant as determined by USBR testing at Folsom
  - Interim measures for frequency until mods are in place.
  - Automatic system
- 



## Automatic Lubrication System

---

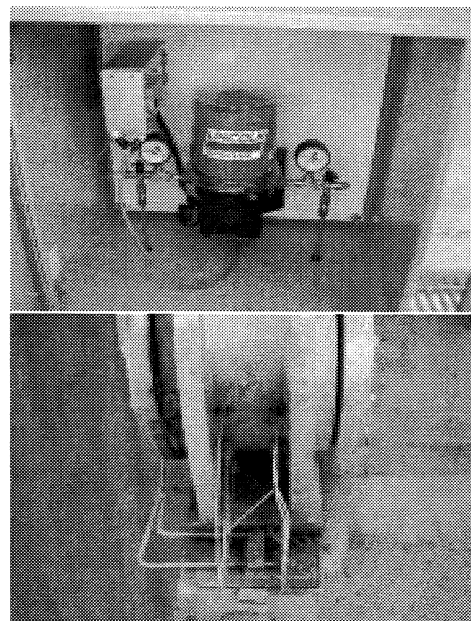
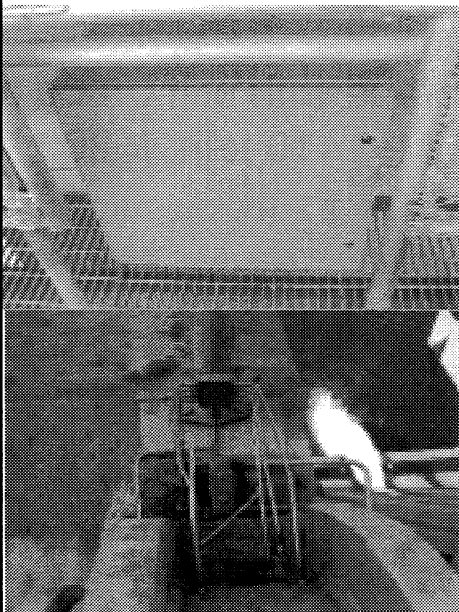



## Automatic Lubrication System

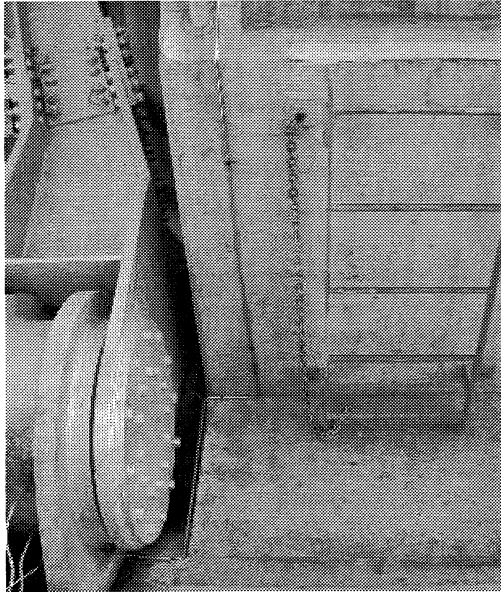

## Load Cells

### TAHITI GATE HOIST OVERHEAD PROTECTION DEVICE

Objective: The purpose of this device is to act as an alarm and safety shut off for our Tahiti gate hoist motor. It will operate whenever the total load on the differential load carried by the two chains exceeds a pre-determined amount.

Method: Load measurements will be made by load pins which are mounted in the lifting chains at the point of connection with the gate, and will be transmitted by hard wire to the processor which will be mounted in the motor control cabinet. An initial setting for the differential load will be made at 1000 lbs, and is adjustable in 500 lb increments. More experimentation will undoubtedly be required to determine what the "normal" acceptable differential force is. A time delay is used to prevent nuisance shut offs caused by startup spikes. Digital readouts (accurate to within 100 lbs) will be provided for the individual chain loads as well as the differential load.

Additional benefits: This device should provide a quantitative means for monitoring any changes in traction friction. Readings will be taken on a regular basis as part of our annual dry safety inspection program. This device provides "heads up" if the friction increases in either one of the trunnions.



# Load Cells

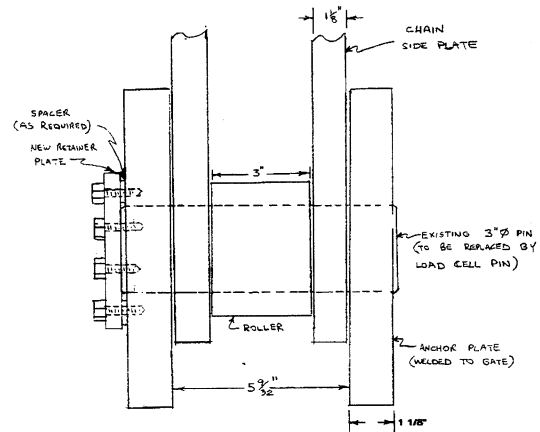
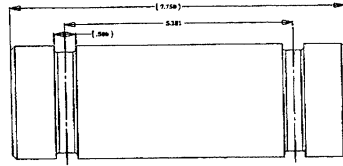
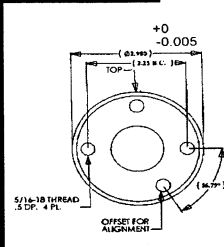

## PINE FLAT DAM - FAILED BOLTS TRUNNION/STRUT CONNECTION - 1" DIA A307 Removed December 1999

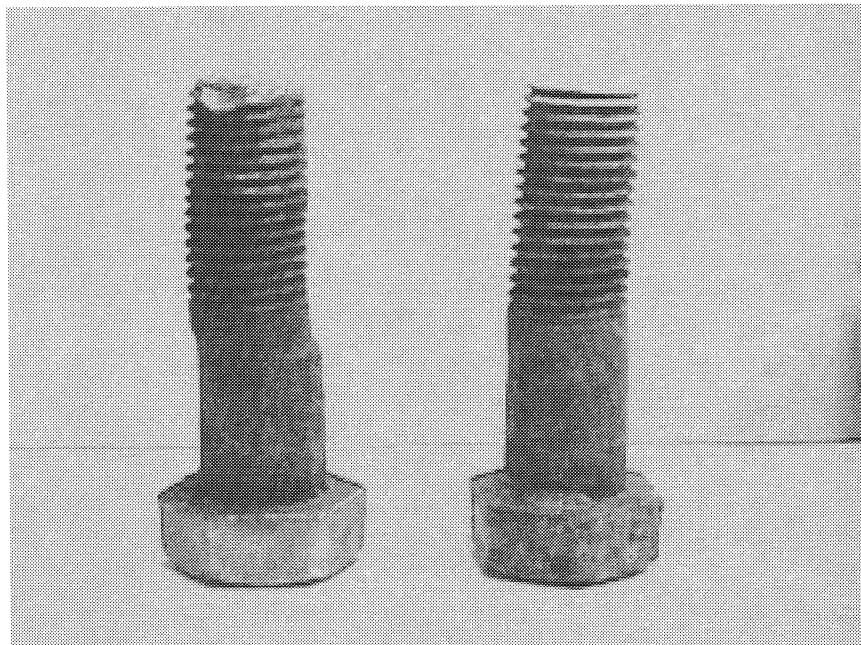





## Pine Flat Dam - Trunnion/Strut Connection

---

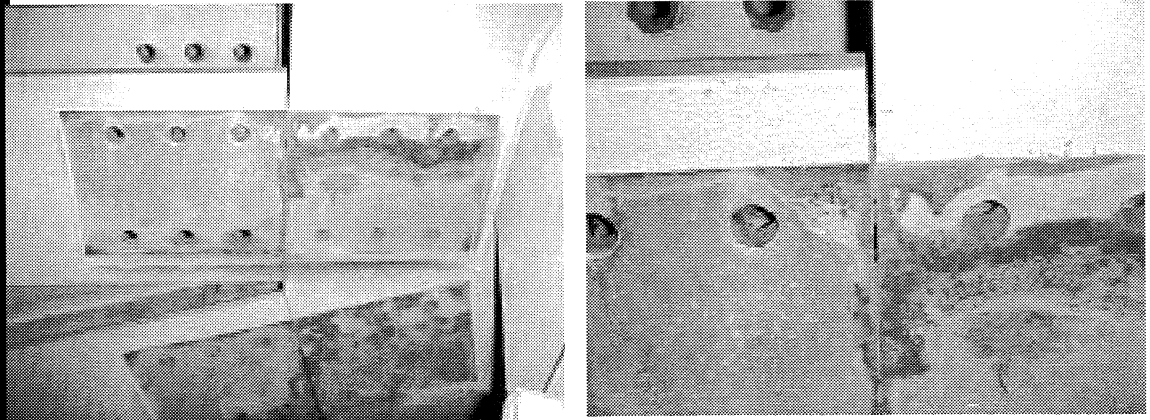

## Pine Flat Dam - Failed Bolts Summary

---

- Inspectors need to understand design/structure.
  - NDT testing of critical bolted and welded connections. (ultrasound, dye penetrant)
  - Failure resulted from construction fit-up which caused change in load path.
-



## Other Failures/Problems

---

- Warm Springs Dam - 15'X20' Bulkhead, failed hydraulic system
  - Coyote Valley Dam - 15'X20' Tainter valve, failed hydraulic rod (inproper operation, outside scope of design)
  - Little Rock District - bearings bound on large radial gates due to corrosion
  - Inspection of anchorages
  - ROV/Under water camera inspections
- 



## Summary

---

- Continue systematic evaluations
  - Modify New Hogan Dam gates
  - Install automatic lube systems
  - Detailed inspections at 5 year intervals for representative gate(s), all gates receive detailed inspection at least every 25 yrs.
  - Evaluate load cells at Pine Flat
  - Appropriate end frame analysis - frame stability/buckling
  - Re-visit laser level measurements.
-

# **Radial Gates Analysis, Seismic Issues**

*Rashid Ahmad*  
*California Division of Safety of Dams*



**Rashid Ahmad**  
**Senior Engineer**  
**Division of Safety of Dams**  
**State of California**

---

## **Radial Gates Analysis**

Seismic Issues

---

---

**Rashid Ahmad**  
California Division of Safety of Dams

# Radial Gates Analysis

---

## Loading Combinations

- **Max. Normal Water**
  - **Max. Normal Water + Lifting Force**
  - **Max. Normal Water + Seismic**
  - **Max. Flood Surface (Gates Closed)**
- 

# Radial Gates Analysis

---

## Seismic Analysis Issues

- **Dynamic Characteristics of Gates**
  - **Seismic Load Definition**
  - **Seismic Analysis**
  - **Water Level during EQ.**
-

# Radial Gates Analysis

## Dynamics of Radial Gates

- Added Mass of Water
- Period, Mode Shape
- Type of Analysis
- Seismic Load Definition

# Radial Gates Analysis

Hydrodynamic Mass on Vertical Surfaces

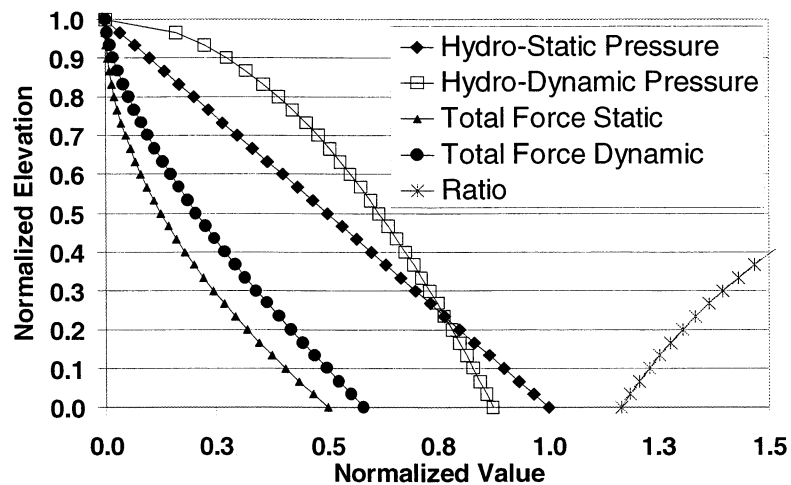

# Radial Gates Analysis

## Dynamics of Radial of Gates Significance of Hydrodynamic Mass

For 1 g Horiz. Accel.

**Hydrodynamic Force**

**= 69% of Weight of the dam**

**= 117% of Hydrostatic Load**

# Radial Gates Analysis

Dynamics of Radial Gate 1				
	Height	19	Resv.	19
		Mass (KIPS)	Period Dry	Period Full
	Gate Only	21	0.06	.215*
	Added (Westergaard)	249	*Estimated by	
	Westergaard/Gate	11.9	mass ratio	
Modal Participating Mass Ratios (%)				
Full Reservoir				
Mode	Period	US/DS	Cross	Vertical
1	0.145	4	0	2
2	0.119	0	0	0
3	0.106	72	0	1
4	0.104	13	0	6
5	0.099	0	0	0
6	0.092	7	0	2

# Radial Gates Analysis

## Mode 1

Mode 1 Period 0.1449 seconds

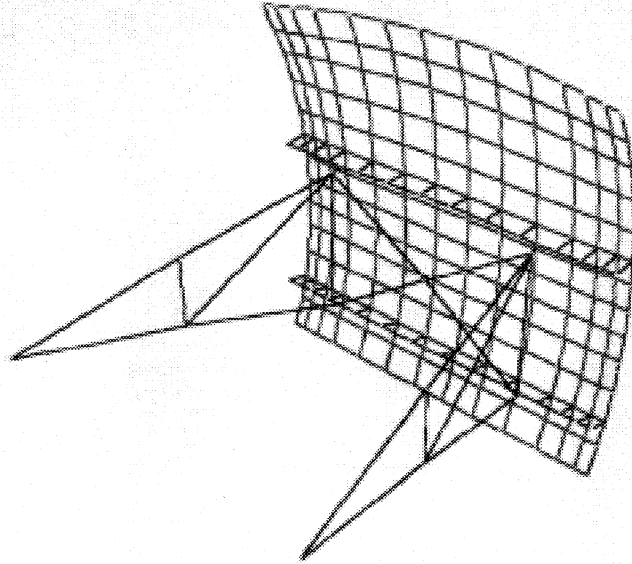

# Radial Gates Analysis

## Mode 2

Mode 2 Period 0.1184 seconds

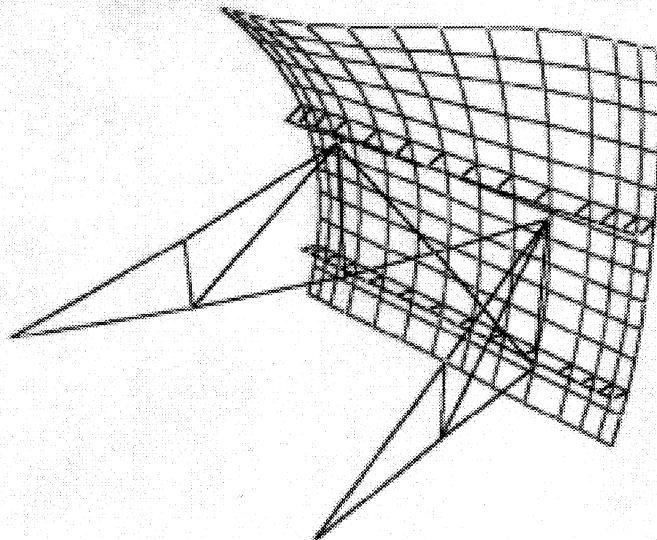



# Radial Gates Analysis

## Mode 3

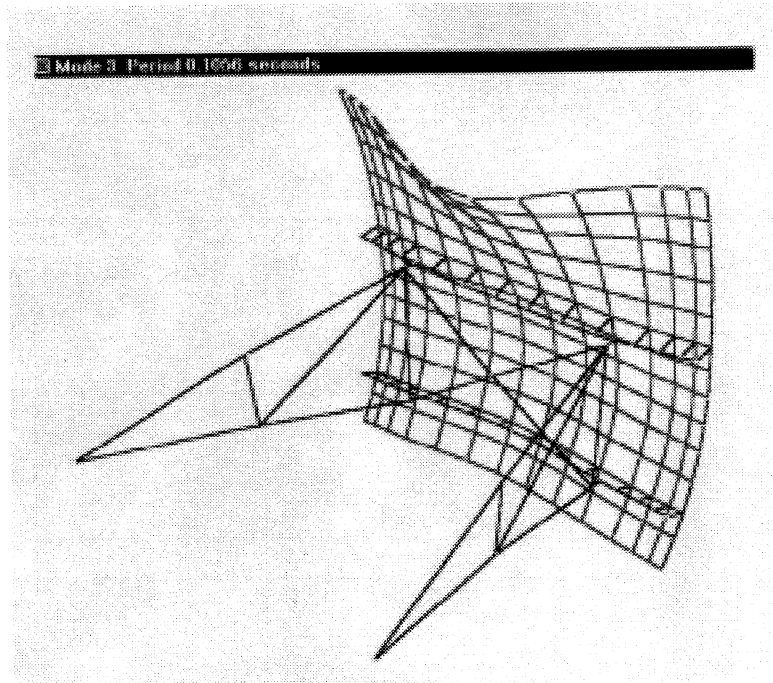

# Radial Gates Analysis

## Mode 4

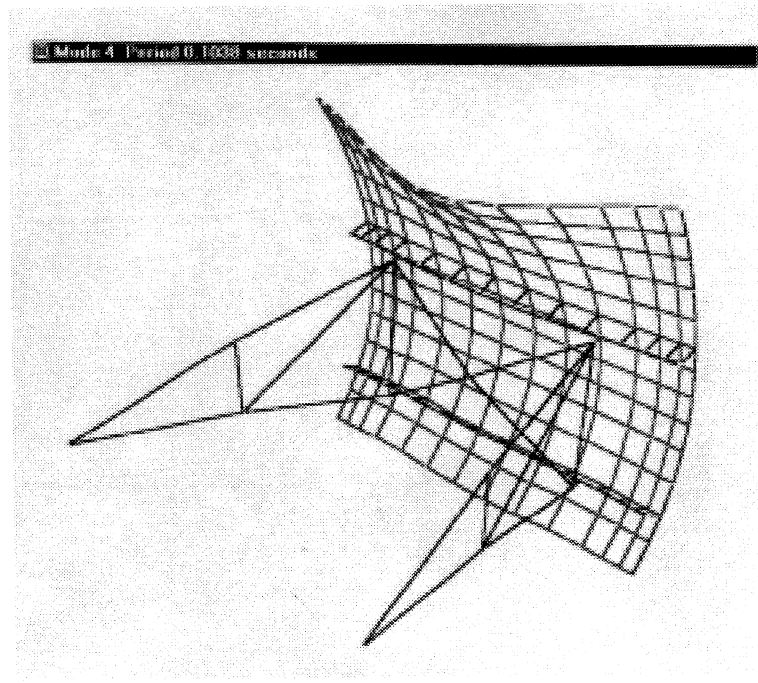

# Radial Gates Analysis

Dynamics of Radial Gate 2				
Height	35	Resv.	86	
Depth above top of Gate	51			
	Mass (KIPS)	Period (Sec)		
Gate Only	60	0.14	.91*	
Added (Westergaard)	2480	* Estimated by		
Westergaard/Gate	41.1	mass ratio		
Modal Participating Mass Ratios (%)				
Empty Reservoir				
Mode	Period (sec)	US/DS	Cross	Vertical
1	0.14	23	0	49
2	0.09	0	0	0
3	0.05	0	46	0
Full Reservoir				
1	0.67	71	0	2
2	0.41	0	0	0
3	0.28	13	0	0

# Radial Gates Analysis

Spectral Acceleration vs. Period  
Rock Site - (Sadigh)

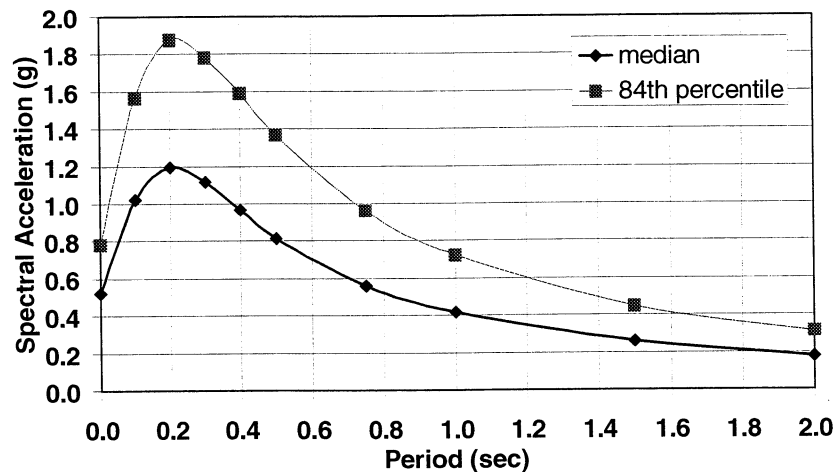

# Radial Gates Analysis

## **Dynamics of Radial of Gates Effect of Hydrodynamic Mass**

- **Major increase in Period**
- **Change in mode shape**
- **Relative importance of various modes**

# Radial Gates Analysis

## **Dynamics of Radial of Gates Effect of Hydrodynamic Mass**

- **Low water levels- shorter period.**
- **Lower Lake Level- Lower EQ load?**
- **Safety for all lake levels**

# Radial Gates Analysis

## Load-Analysis Matrix

<b>Gate</b>	<b>Spillway</b>	<b>Analysis</b>	<b>Load</b>
Rigid	Rigid	Pseudostatic	Unmodified
Flexible	Flexible	Resp. Spectrum	Modified

# Radial Gates Analysis

## SEISMIC LOAD

### Pseudostatic

- **Rigid Gates**
- **67% to 100% of PGA**
- **Westergaard's added mass**
- **Conservative**

## Radial Gates Analysis

### TABAS RECORD

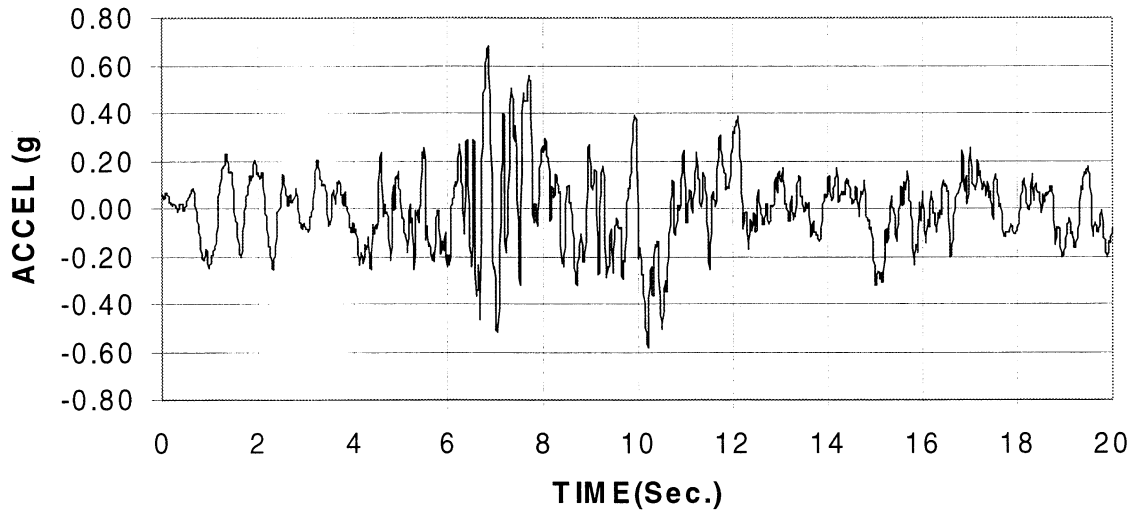

## Radial Gates Analysis

### Max. Moving Avg./ PGA Ratio

#### TABAS RECORD

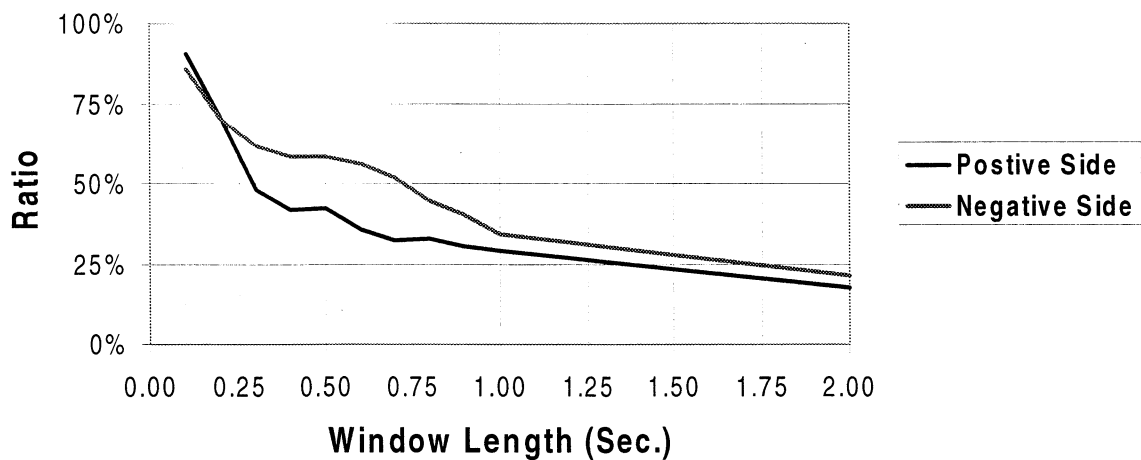

# Radial Gates Analysis

Seismic Load

**Modification by Gravity Dam**

Crest Spectra

- **Mode shape (standard)**
- **Period ( $H_s$ ,  $H_w$ ,  $E_s$ ,  $E_f$ )**
- **Ground Motion Response Spectrum**

# Radial Gates Analysis

Seismic Load

**Modification by Gravity Dam**

Crest Spectra

- **Participation factor (full reservoir)**
- **Hydrodynamic load on gate**
- **Estimate Max. Accel. at Trunnion.**

# Radial Gates Analysis

---

---

Seismic Load

## Modification by Arch Dams

- **Complex response**
  - **Finite Element method**
  - ***Other estimates***
- 

# Radial Gates Analysis

---

---

Seismic Load

## Cross Channel Component

- **No modification for gravity dams**
  - **Modification due to arch dams**
  - **Thin piers**
  - **Shear load transfer- gate to pier**
-

# Radial Gates Analysis

## Trunnion Anchors

- **Criteria-Load**
  - **Pre-stress Load**
  - **Applied Load**

# Radial Gates Analysis

## Un-Symmetric Gate Opening

- **Effect on pier stresses.**
- **Effect on anchor Loads.**



# Radial Gates Analysis

---

## Conclusions

- Uncertainty-EQ Load, Dynamic Properties
    - Testing of Gates
  - Hydro. mass effect is significant.
    - Mode shapes, periods & mass participation.
  - Gate safety for a range of lake levels.
  - Flexible gates - thorough evaluation.
-

# **Condition Assessment of Gates and Related Components**

***Stuart Foltz***

***Construction Engineering Research Laboratory,  
U. S. Army Corps of Engineers (COE)***

# Condition Assessment of Gates and Related Components

**Stuart Foltz**

**Construction Engineering Research Laboratory**



US Army Corps  
of Engineers

1

Engineer Research and Development Center

06/01/2000

## Briefing Topics

**Condition index overview**

**Tainter gate condition index**

**Trunion friction**

**Other gate indexes**

**Embankment dam condition index**

**Condition indexes and reliability**



US Army Corps  
of Engineers

2

Engineer Research and Development Center

# Condition Indexes?

- **Problem**
  - **HQUSACE requires assistance in evaluation of maintenance and repair requirements and priorities**
    - **Inspection procedures**
    - **Objective evaluation of condition**
    - **Determination of requirements**
    - **Establishing M&R priorities**
    - **Justifying resource allocation**



## Brief History of CI's

- **REMR: Operations Management**
  - **program closed SEP98**
- **Non-Deferrable Work Package Prioritization Aid**
  - **gauge physical deterioration**
  - **reduce subjectivity via data driven decisions**
  - **articulate needs in consistent manner**



# A Partial Solution

- ✓ Structure condition
- ✓ Structure performance
- X Structural analysis
- X Economics
- / Risk
- X Policies and priorities



## What is a Condition Index?

- A calculation based on condition inspection data:
  - A number between 0 and 100 (quantitative)
    - repeatable measurements where possible
    - guidance where subjectivity unavoidable
  - Representative of a structure's
    - Condition
    - Safety
    - Ability to function (to varying extents)
- Based on expert rules



Zone	Condition Index	Condition Description	Recommended Action
1	85 to 100	<b>Excellent:</b> No noticeable defects. Some aging or wear may be visible.	Immediate action is not required
	70 to 84	<b>Good:</b> Only minor deterioration or defects are evident.	
2	55 to 69	<b>Fair:</b> Some deterioration or defects are evident, but function is not significantly affected.	Economic analysis of repair alternatives is recommended to determine appropriate action.
	40 to 54	<b>Marginal:</b> Moderate deterioration. Function is still adequate.	
3	25 to 39	<b>Poor:</b> Serious deterioration in at least some portions of the structure. Function is inadequate.	Detailed evaluation is required to determine the need for repair, rehabilitation, or reconstruction. Safety evaluation is recommended.
	10 to 24	<b>Very Poor:</b> Extensive deterioration. Barely functional.	
	0 to 9	<b>Failed:</b> No longer functions. General failure or complete failure of a major structural component	

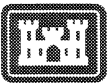

## Expert Rules - What are they?

06/01/2000

- A set of guidelines used to evaluate a component and quantify condition (expert model)
- Criteria for condition evaluation is arrived at by interviews of COE experts knowledgeable in operating equipment
- Includes site visits and testing of criteria to demonstrate usefulness of rule
- Rules are field tested for consensus of the experts, uniformity in different settings, repeatability of the evaluation, and the practical application of data gathering techniques



Operations Management - Condition Indexing for Civil Works Structures and Sub-Components

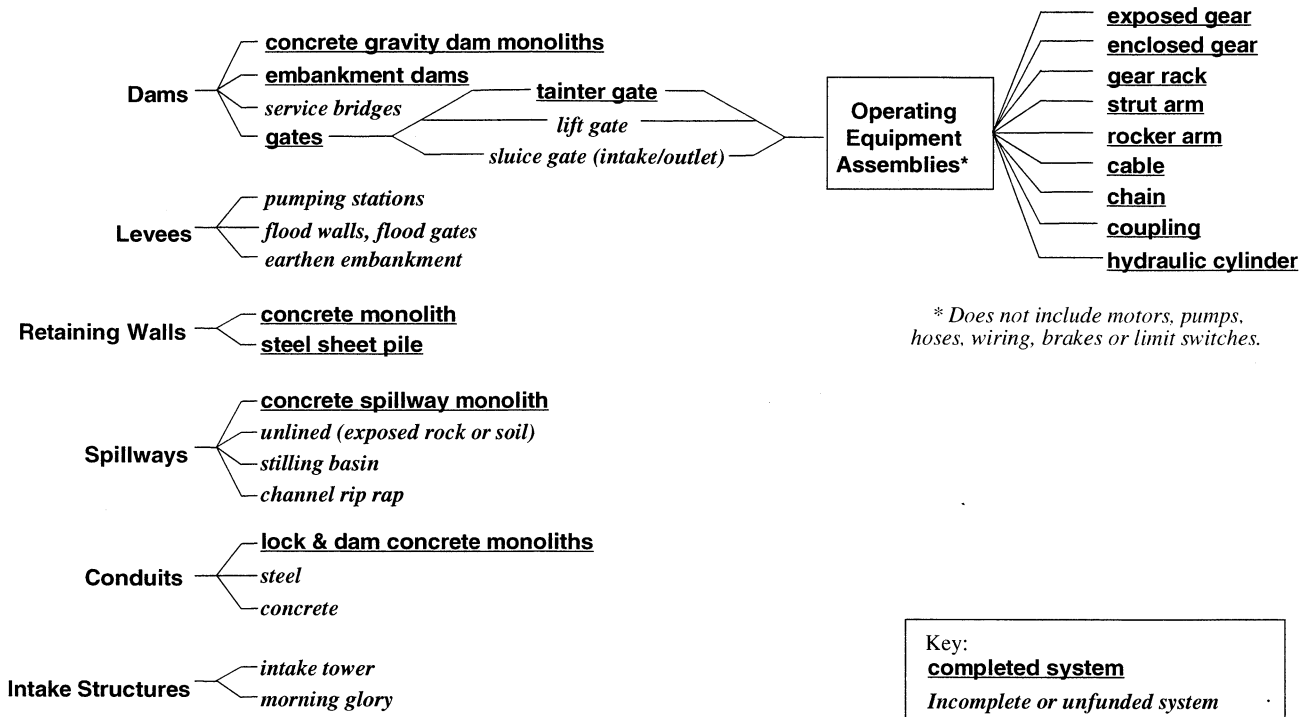

FLOOD DAMAGE REDUCTION

Operations Management - Condition Indexing for Civil Works Structures and Sub-Components

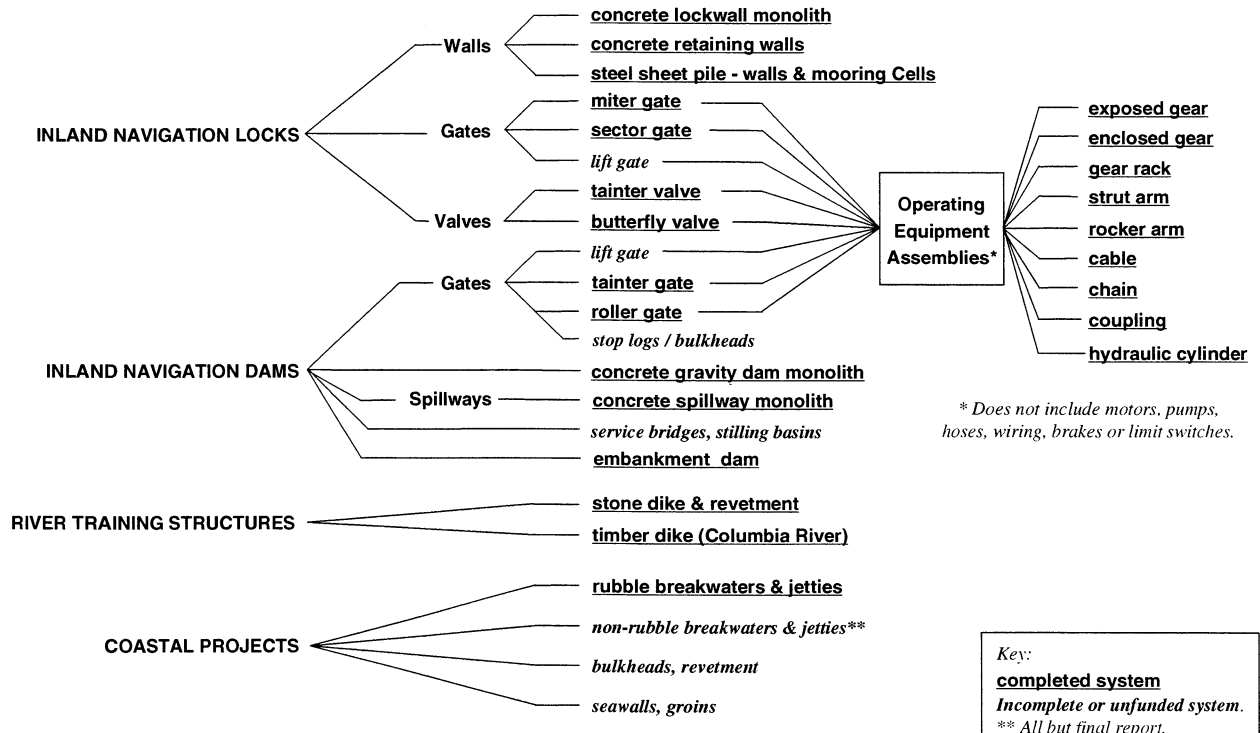

NAVIGATION

Operations Management - Condition Indexing for Civil Works Structures and Sub-Components

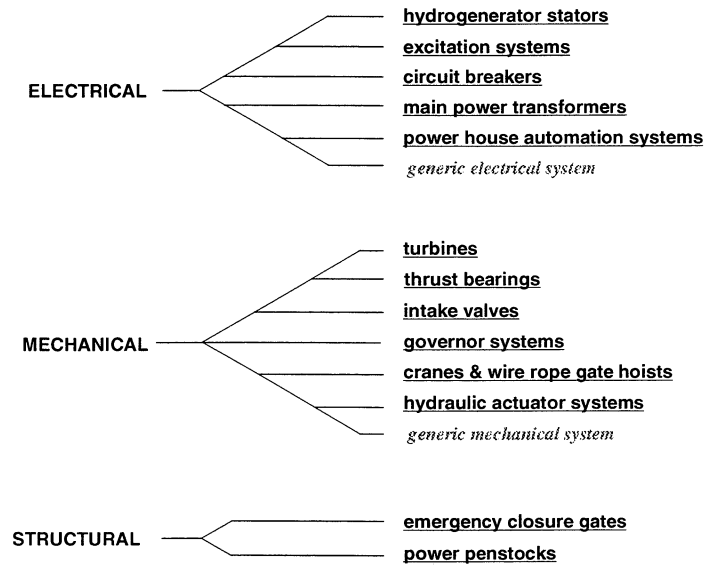

Note: Hydropower CI systems under continuous improvement.

Key:  
completed system  
*Incomplete or unfunded system.*

**HYDROPOWER**

Operations Management - Condition Indexing for Civil Works Structures and Sub-Components

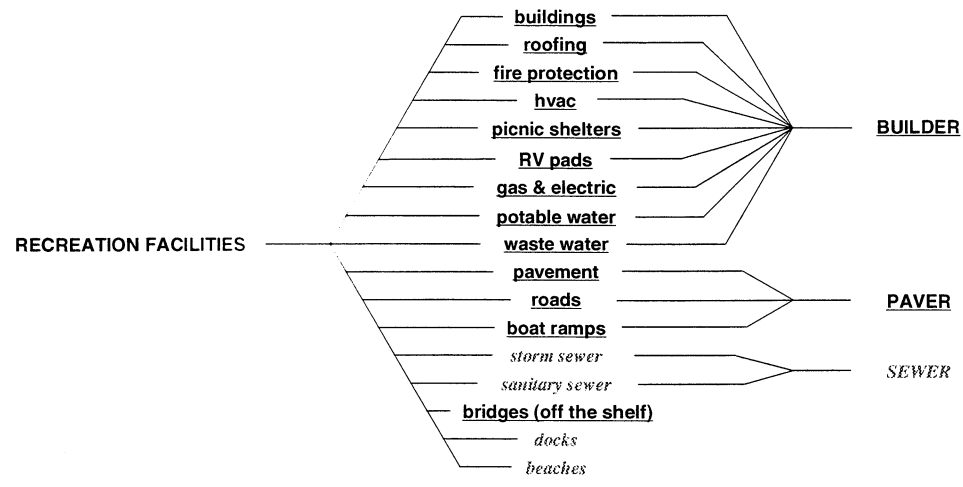

Key:  
completed system  
*Incomplete or unfunded system.*

**RECREATION**



# CI Benefits

- **Regimented, checklist style inspection**
  - "up close & personal"
- **Closer Monitoring of Structures**
  - Set benchmarks for comparison
  - Establish and track trends in condition
- **Discover hidden problems**
- **Knowledge institution**
- **Assist in setting M&R priorities**
- **Document M&R needs**
- **Justification for expenditures**
  - And for "non-expenditures"



# Negative Feedback

- **Already know condition**
- **Perceived as too costly for routine use**
- **Some systems still too subjective**
- **Could be simplified and get same info**



# Level of Effort

- **Tainter gate example: Trunion bushing wear and anchorage movement**
  - **Is the most complex measurement**



# Briefing Topics

**Condition index overview**

**Tainter gate condition index**

**Trunion friction**

**Other gate indexes**

**Embankment dam condition index**

**Condition indexes and reliability**



# Tainter Gate Condition Index

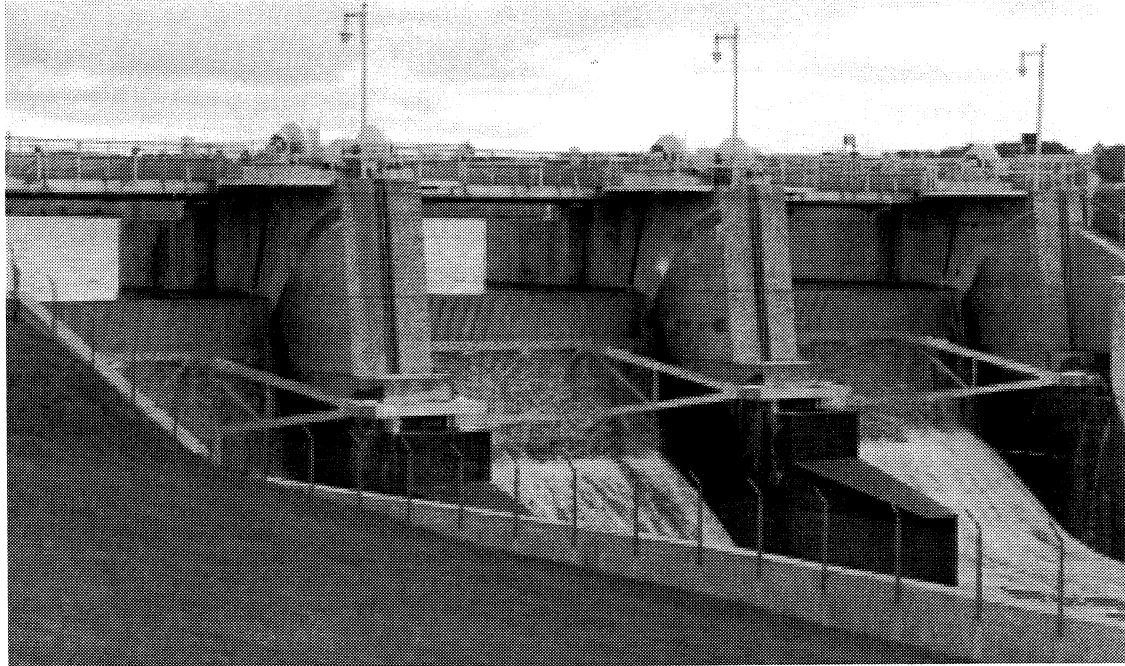

US Army Corps  
of Engineers

17

Engineer Research and Development Center

# Tainter Gate Condition Index

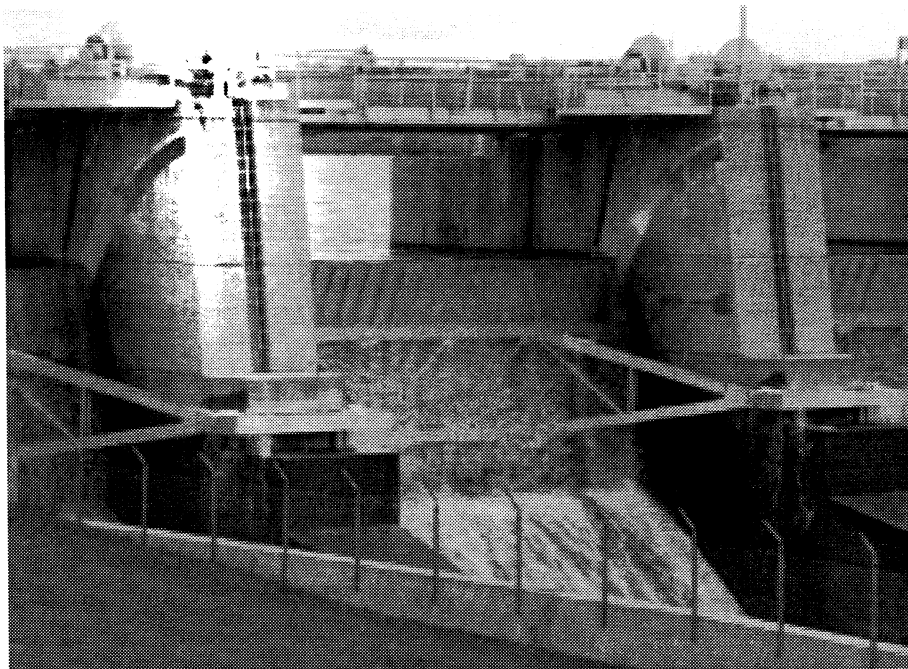

US Army Corps  
of Engineers

18

Engineer Research and Development Center

# Assembly Distresses for Tainter Gates

06/01/2000



US Army Corps  
of Engineers

19

Engineer Research and Development Center

06/01/2000

## Gate CI Algorithm

$$CI_{\text{gate}} = \sum CI_i \cdot W_i$$



US Army Corps  
of Engineers

20

Engineer Research and Development Center

# Distress Weight Adjustment Factor

06/01/2000

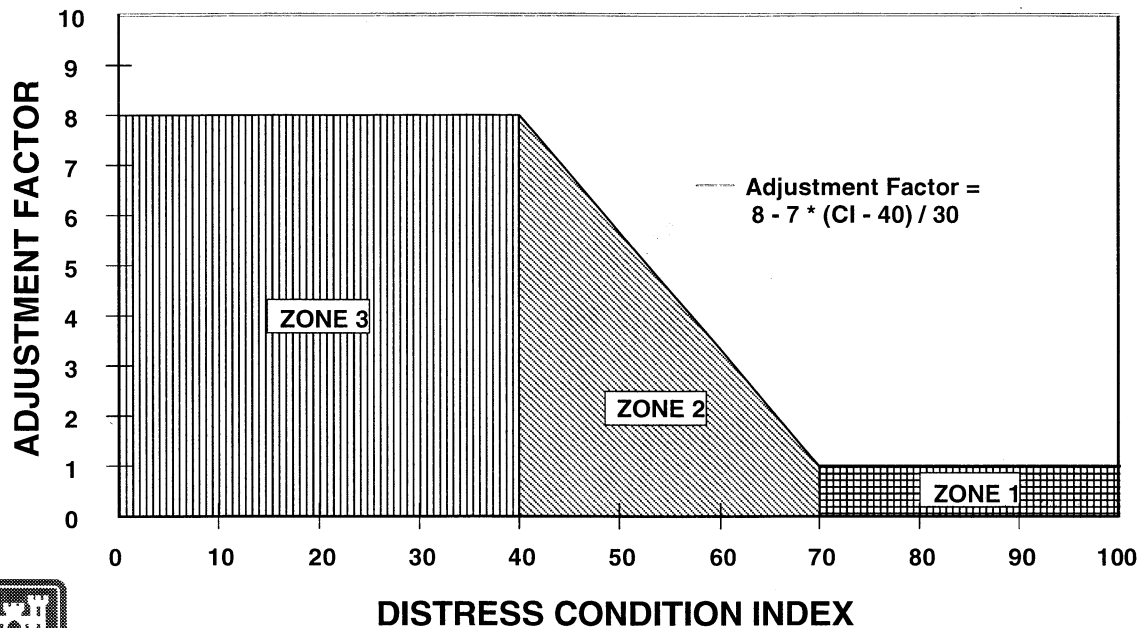

US Army Corps  
of Engineers

Engineer Research and Development Center

21

# Misalignment Distress Condition Rating

06/01/2000

- Differential horizontal movement of top and bottom of gate when it is opened 2 feet.
- Rating is based on an exponential function comparing measured movement to a pre-determined unacceptable relative movement



US Army Corps  
of Engineers

Engineer Research and Development Center

22

# Misalignment Measurement



US Army Corps  
of Engineers

23

Engineer Research and Development Center

# Misalignment Measurement



US Army Corps  
of Engineers

24

Engineer Research and Development Center

# Trunnion Assembly Wear

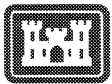
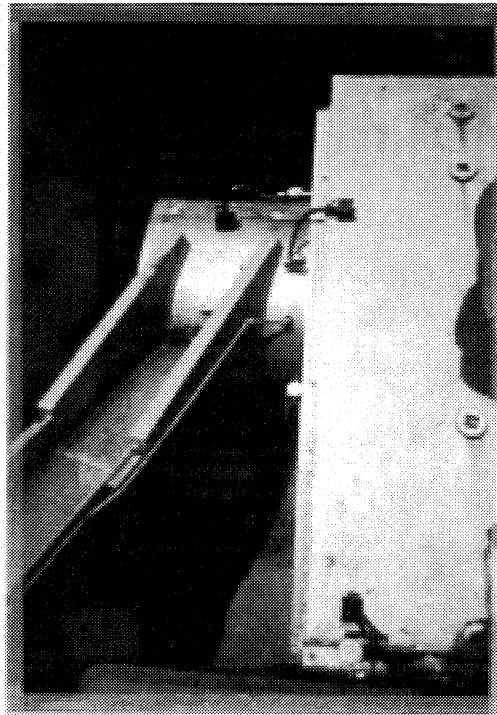

US Army Corps  
of Engineers

25

Engineer Research and Development Center

# Trunnion Assembly Wear



US Army Corps  
of Engineers

26

Engineer Research and Development Center

# Tainter Gate Inspection

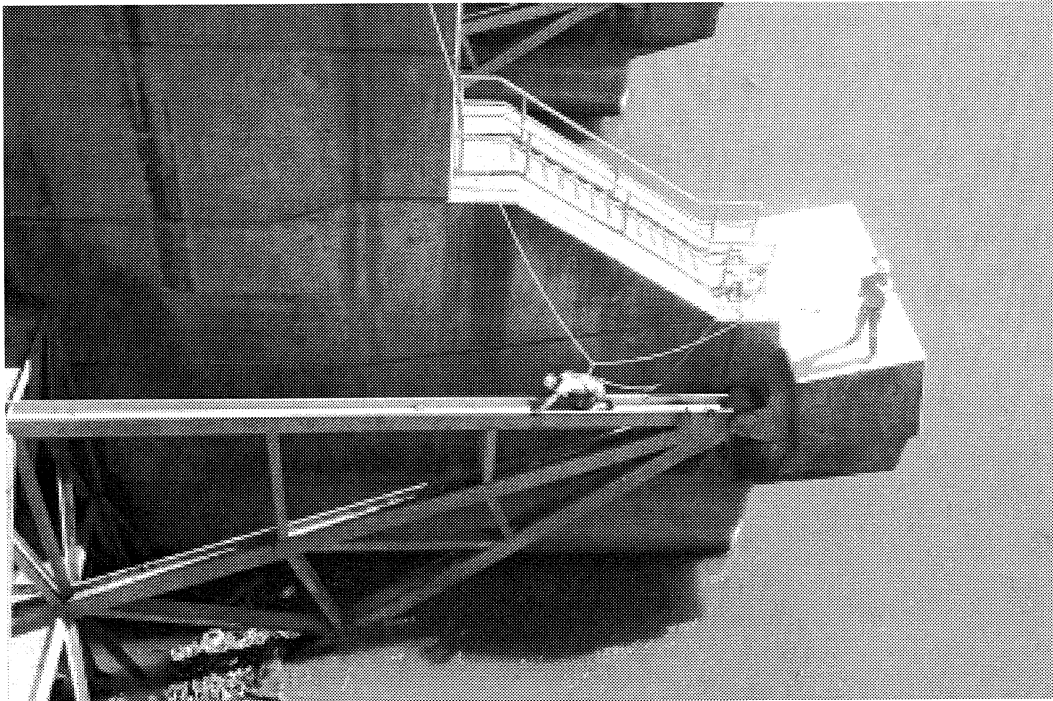

27



US Army Corps  
of Engineers

Engineer Research and Development Center

# Tainter Gate Inspection



28



US Army Corps  
of Engineers

Engineer Research and Development Center



# Tainter Gate Inspection

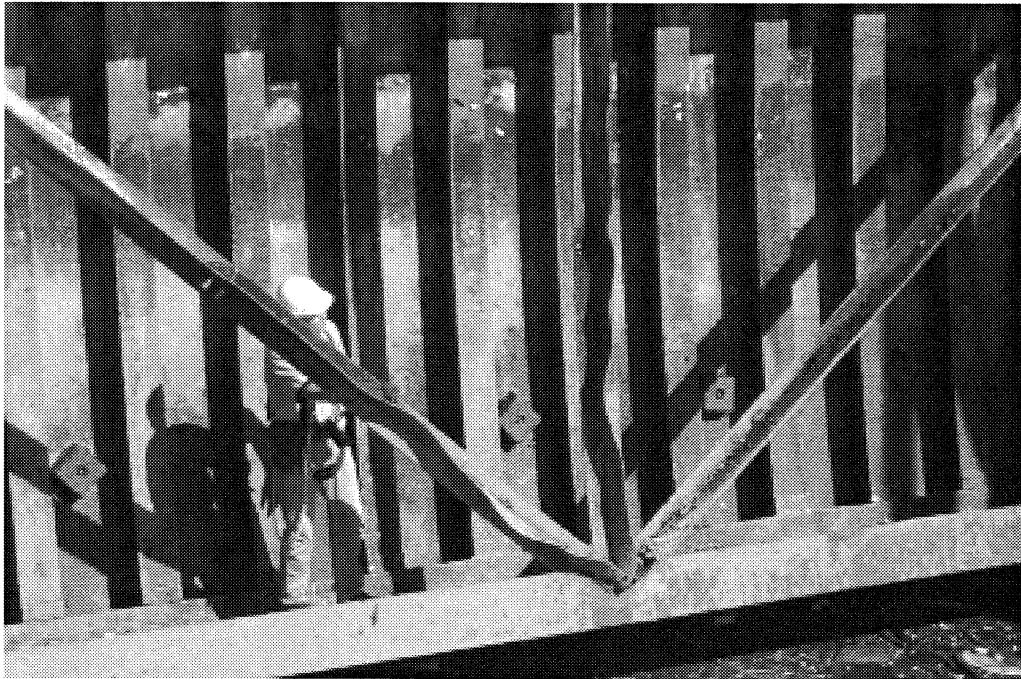

## Briefing Topics

**Condition index overview**

**Tainter gate condition index**

**Trunion friction**

**Other gate indexes**

**Embankment dam condition index**

**Condition indexes and reliability**



# Trunnion Friction

- **Attributed with causing failures**
- **Not considered or under-weighted in many designs**
- **Significantly impacted by maintenance and operational policies**
- **Not considered in Tainter Gate CI**



# Friction Measurement

- **Strain gages**
- **Load cell**
- **Motor load**
- **Laser sighting**
- **Cantilever**



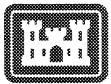
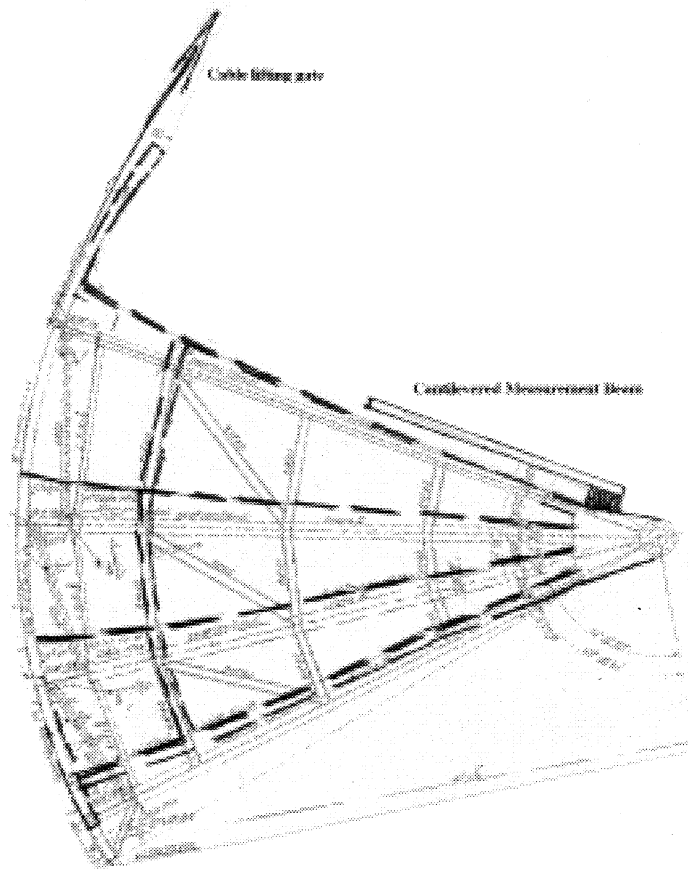

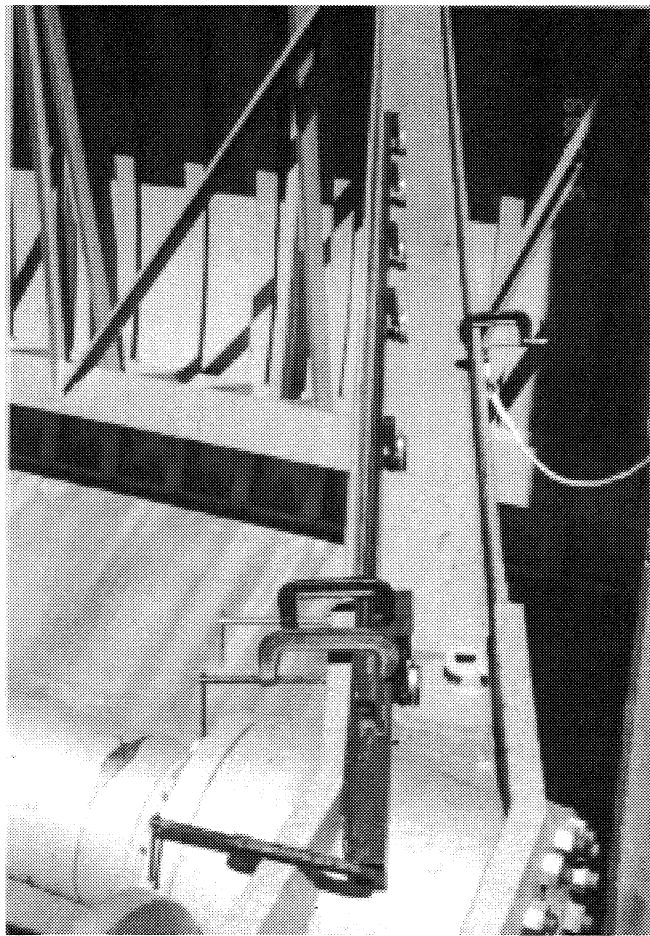

US Army Corps  
of Engineers

35

Engineer Research and Development Center

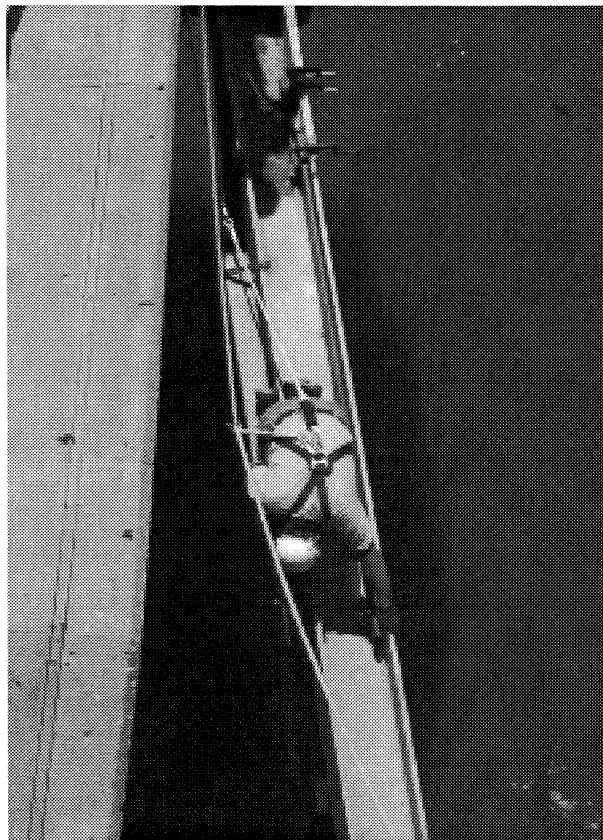

US Army Corps  
of Engineers

36

Engineer Research and Development Center

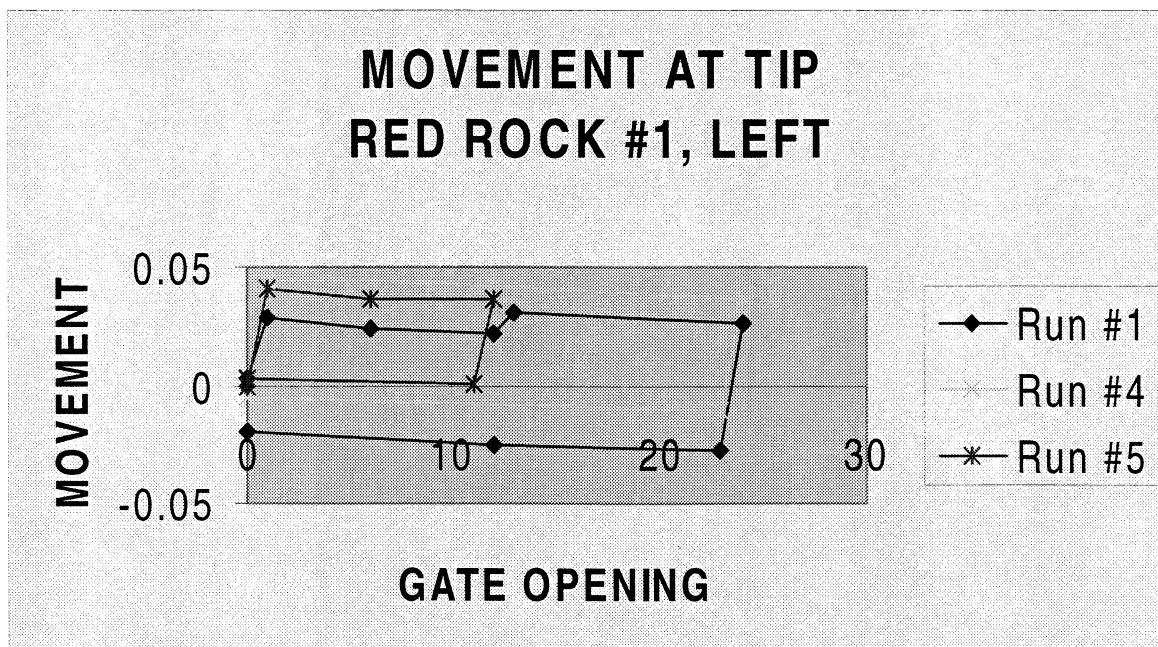
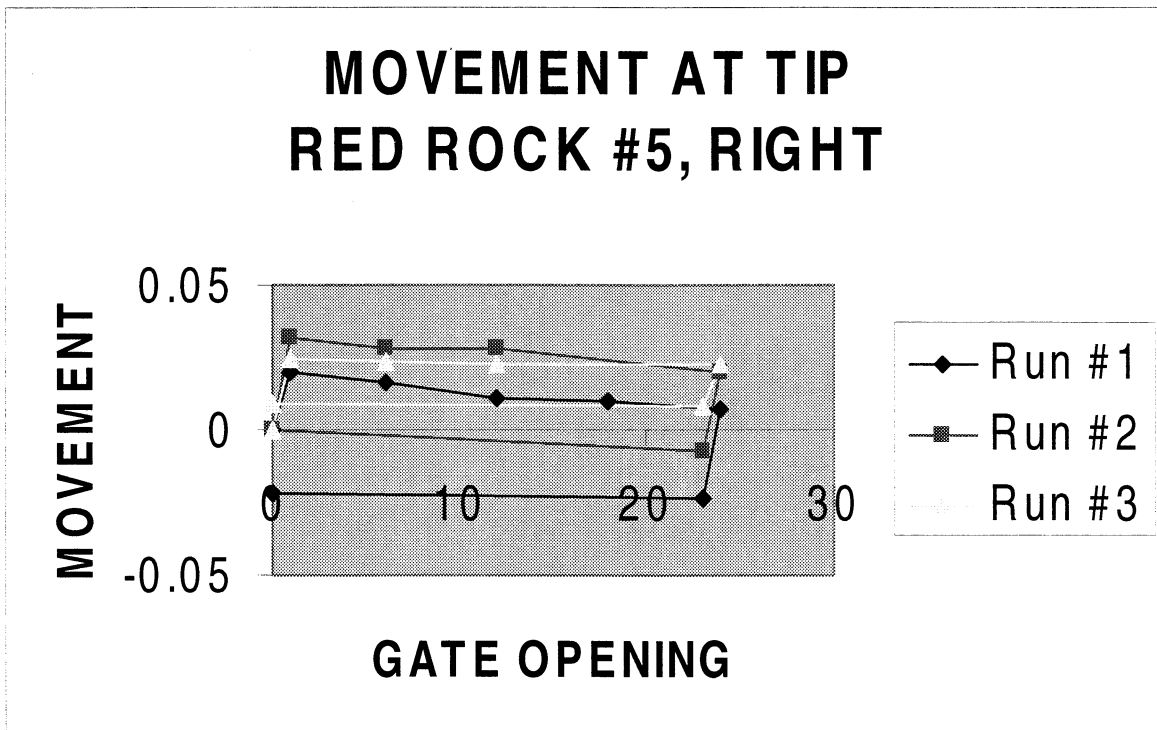

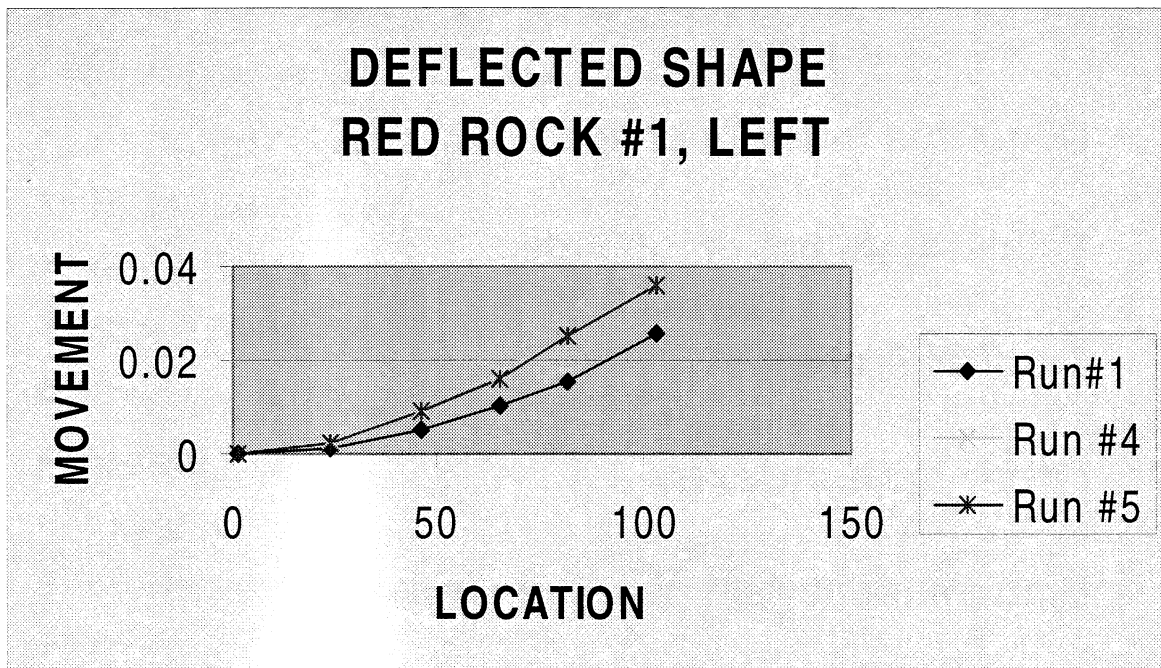

## Analysis

- **Calculations**
  - **Determination of strain**
  - **Determination of hinge friction**
- **Generic quantification**
  - **Repeatable**
  - **Simple**
  - **Universally applicable and consistent**

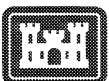

# Briefing Topics

**Condition index overview**

**Tainter gate condition index**

**Trunion friction**

**Other gate indexes**

**Embankment dam condition index**

**Condition indexes and reliability**



41

# Operating Equipment Condition Index

06/01/2000

- **Mechanical and hydraulic components related to moving lock or dam gates.**

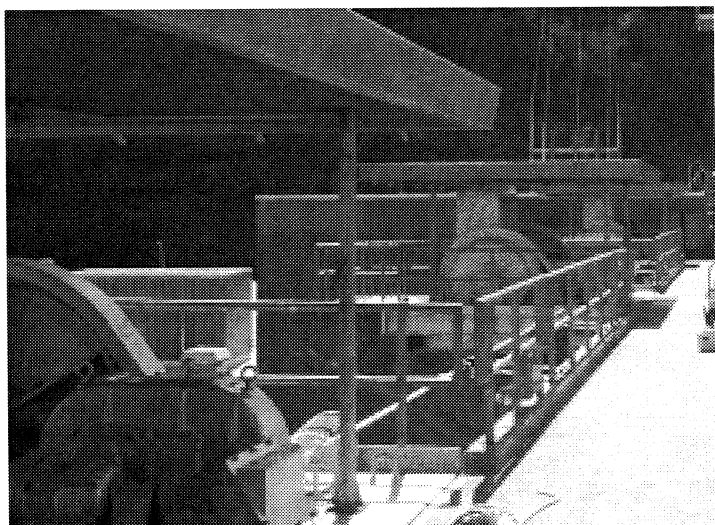

42

# Operating Equipment Assemblies

- Exposed Gear
- Enclosed Gear
- Gear Rack
- Strut Arm
- Rocker Arm
- Cable
- Chain
- Hydraulic Cylinder
- Coupling



US Army Corps  
of Engineers

43

Engineer Research and Development Center

06/01/2000

## Exposed Gears

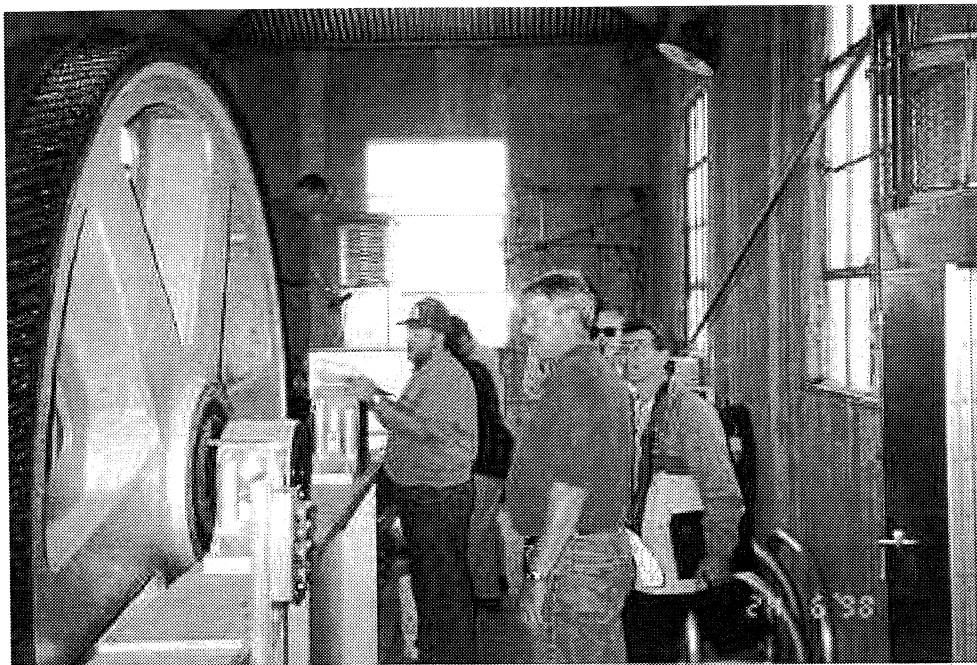

US Army Corps  
of Engineers

44

Engineer Research and Development Center



# Assembly Distresses for Exposed Gears

06/01/2000

- Noise, jump, and vibration 27.5%
- Anchorage movement/deterioration 26.8%
- Bearing/bushing wear 12.3%
- Roller supports wear/damage\* 7.0%
- Cracks critical
- Tooth wear 2.6%
- Reduced tooth contact 9.0%
- Damaged teeth 14.8%



US Army Corps  
of Engineers

45

Engineer Research and Development Center

## Distress Weight Adjustment Factor

06/01/2000

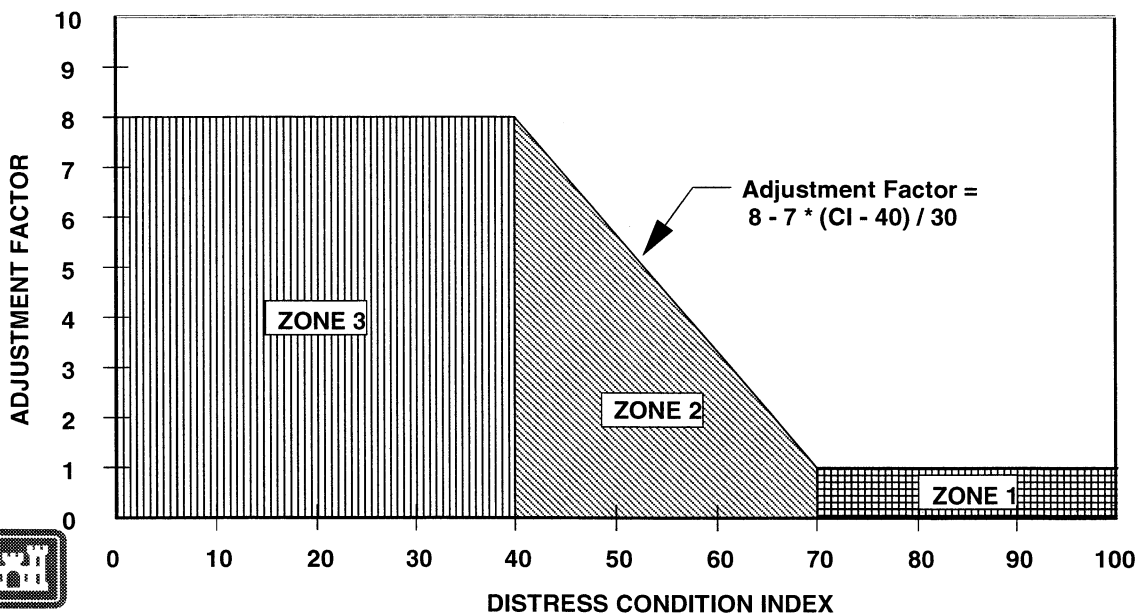

US Army Corps  
of Engineers

46

Engineer Research and Development Center

# Tooth Wear Measurement



47



US Army Corps  
of Engineers

Engineer Research and Development Center

# Roller Gate

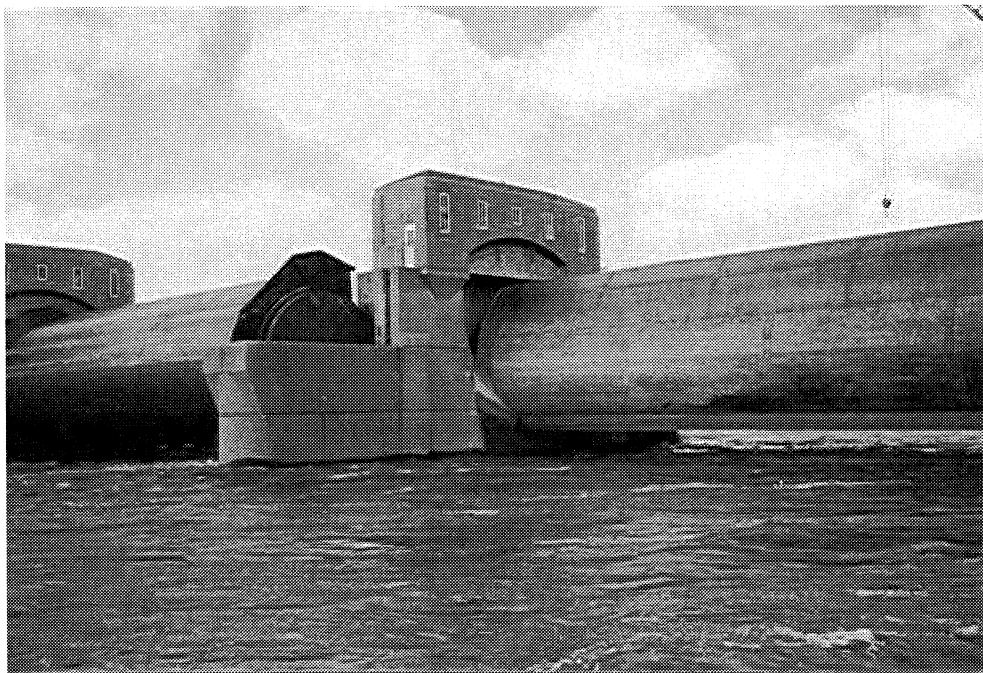

48



US Army Corps  
of Engineers

Engineer Research and Development Center

# Roller Gate

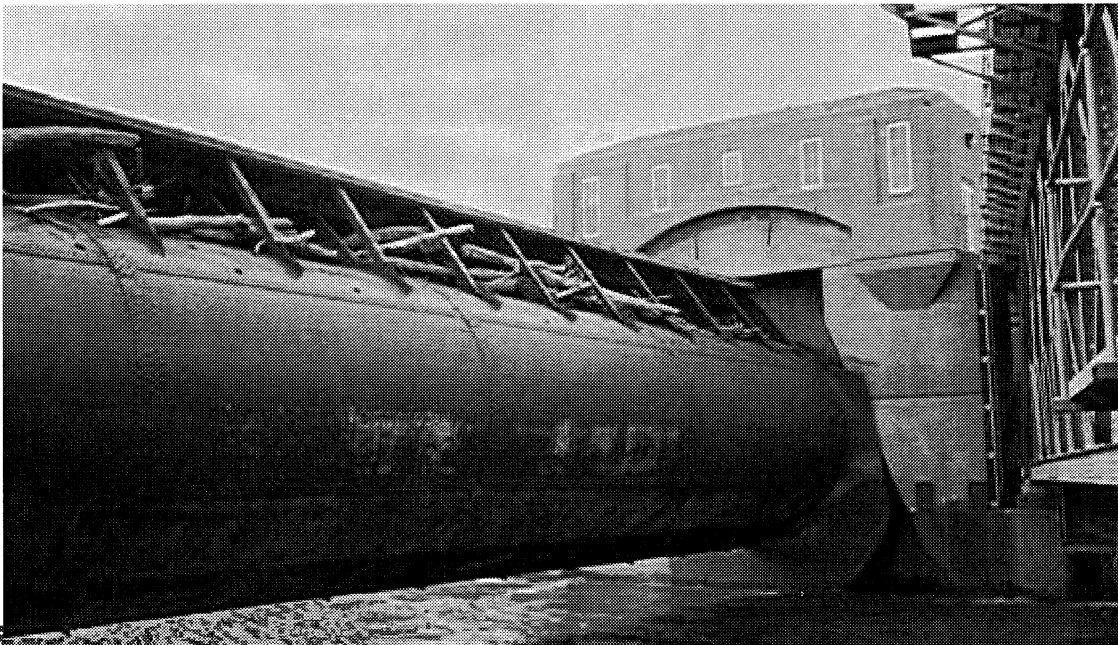

# Tainter Valve

- CI developed for navigation lock valves  
–Never used for dams



# Briefing Topics

**Condition index overview**

**Tainter gate condition index**

**Trunion friction**

**Other gate indexes**

**Embankment dam condition index**

**Condition indexes and reliability**



US Army Corps  
of Engineers

51

---

Engineer Research and Development Center

## Embankment Dam Condition Index <sup>06/01/2000</sup>

- **Extended the CI concept beyond a standardized and quantified inspection procedure**
- **Created a framework for evaluating and quantifying existing inspection and engineering information**
- **Limited ability to consider consequences**



US Army Corps  
of Engineers

52

---

Engineer Research and Development Center

# Focus

- **The intent of this condition index process is to focus attention on the most important components in the worst condition.**



# Matrix Methods

- **Hudson's interaction matrix**
- **Stanford cross impact method**
- **Analytical hierarchy**
- **Value engineering**
  
- **Expert elicitation**



# Flow Charts

06/01/2000

## Failure Prevention

## Failure Detection

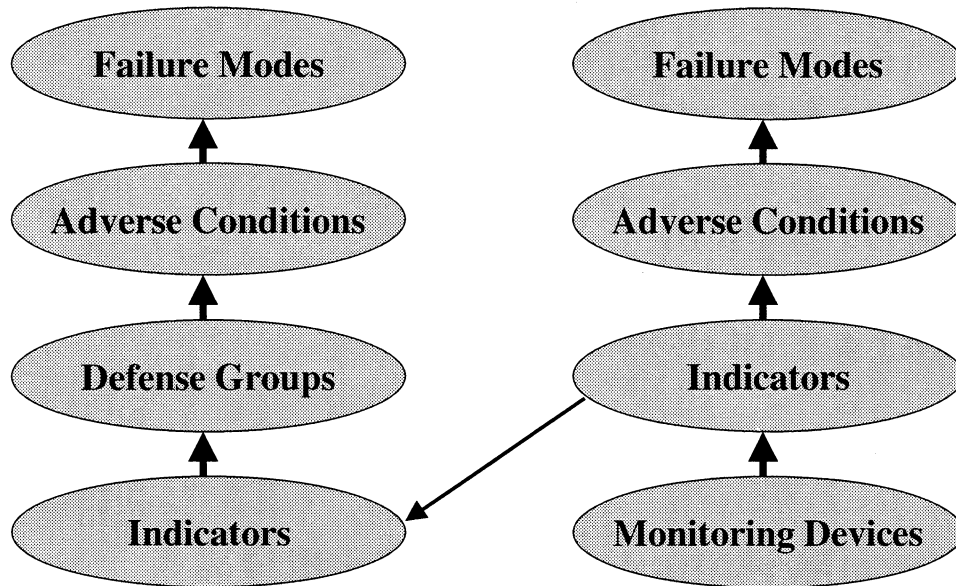

US Army Corps  
of Engineers

55

Engineer Research and Development Center

06/01/2000

# Benefits

- Evaluate importance of existing deficiencies
- Assist repair prioritization and justification
- Tool for communication with management
- Training tool
- Long-term condition tracking



US Army Corps  
of Engineers

56

Engineer Research and Development Center

# Briefing Topics

**Condition index overview**

**Tainter gate condition index**

**Trunion friction**

**Other gate indexes**

**Embankment dam condition index**

**Condition indexes and reliability**



US Army Corps  
of Engineers

57

---

Engineer Research and Development Center

# Some Reliability Analysis Basics

- **Statistically based estimates of failure probability**
  - Limited performance data
  - Age, cycle, or generic modeling of performance over time
- **Analytical or subjective estimates of performance**
- **Limited or no consideration of inspection information**
  - Need quantified data



US Army Corps  
of Engineers

58

---

Engineer Research and Development Center

# Condition Indexes and Reliability

06/01/2000

- **Parameter in a detailed reliability analysis (Tainter Gate CI)**
- **Screening tool for prioritization of more detailed reliability and risk analysis (Tainter Gate or Embankment Dam CI model)**
- **Primary component in simplified risk analysis (Embankment CI model)**



US Army Corps  
of Engineers

59

Engineer Research and Development Center

06/01/2000

## CI/Reliability Obstacles

- **No data to tie CIs to failure probability**
- **CIs don't directly correlate to specific failure modes.**
  - **Relation between various failure modes and CIs is variable**



US Army Corps  
of Engineers

60

Engineer Research and Development Center



# Software and Reports

<http://owww.cecceer.army.mil/fl/remr/remr.html>



US Army Corps  
of Engineers

61'

---

Engineer Research and Development Center

# **Structural Investigation of a Broken Gate Hoist Pillow Block**

*Eugene Chan*  
*Pacific Gas and Electric*

# Structural Investigation of a Broken Gate Hoist Pillow Block

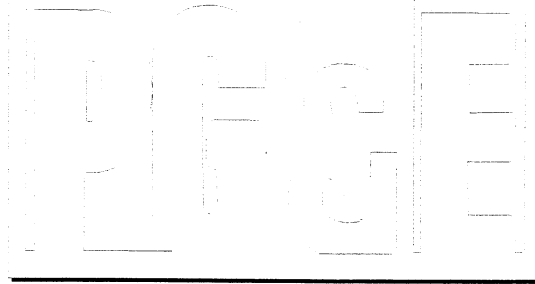

**Charles S. Ahlgren, P. E.**  
**Eugene K. Chan, P. E.**

**Poe Dam is  
located on the  
North Fork of  
the Feather  
River, about  
22 miles north  
of Oroville,  
California**

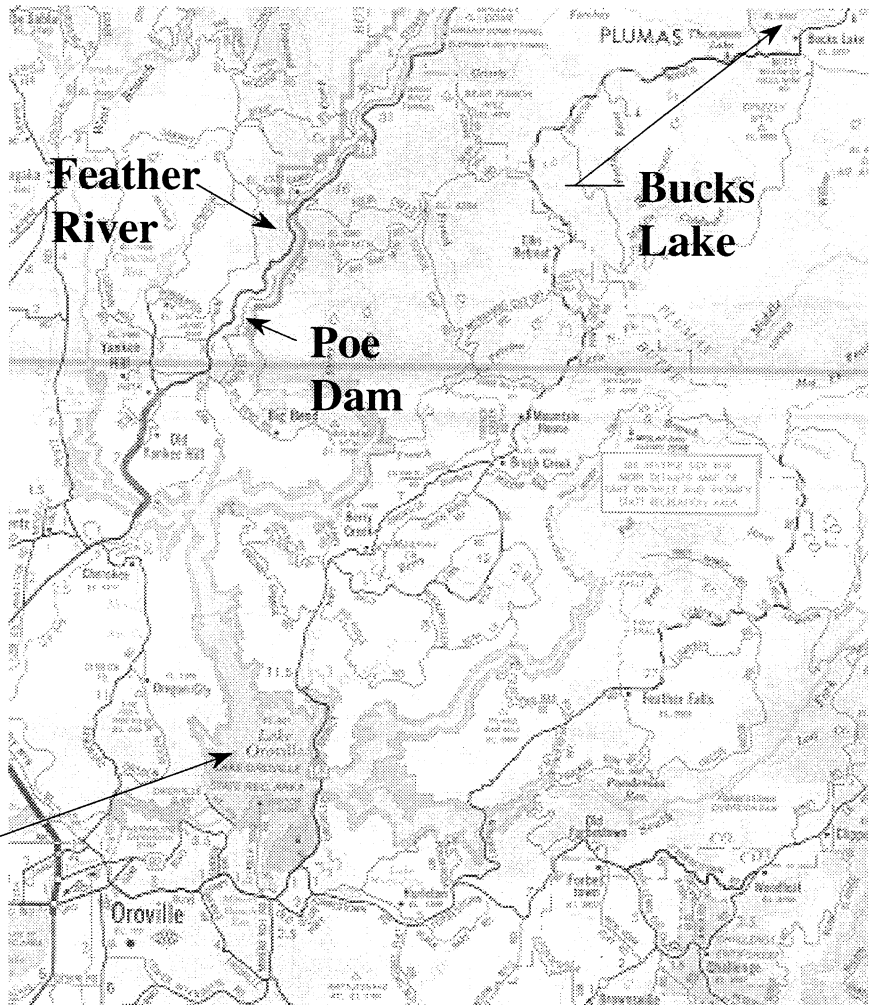

**Lake Oroville**

## **Downstream View of Poe Dam**

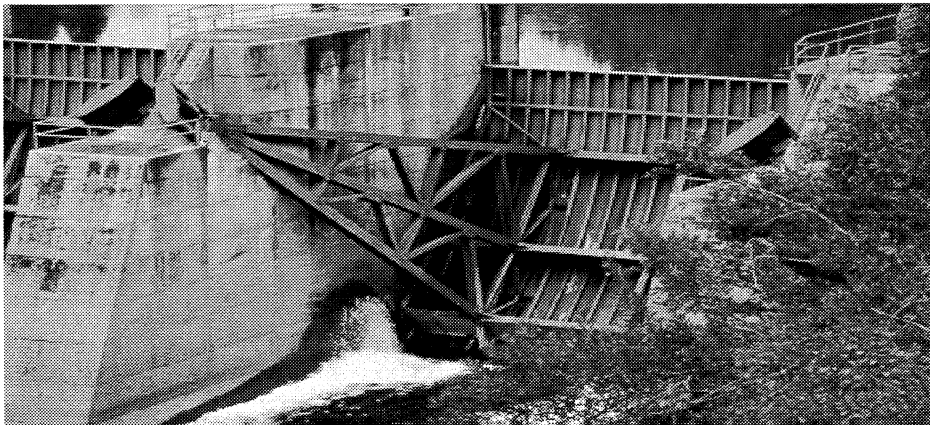
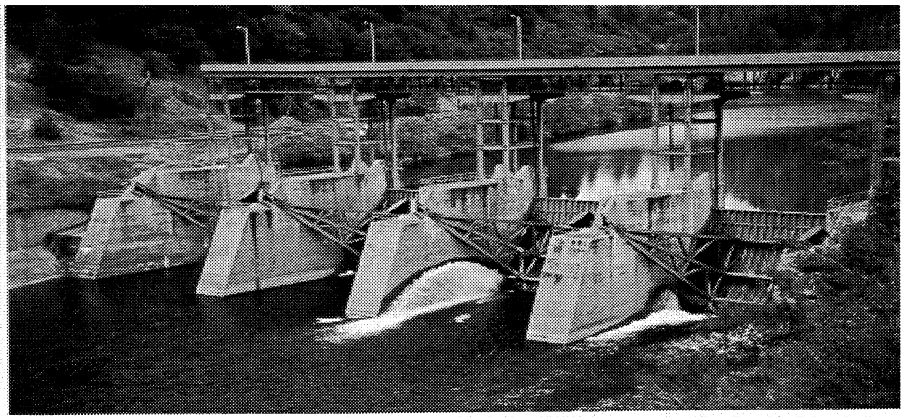

## **Close-up View of 50'(w) x 41' (h) Radial Gate**

# **Background**

- **In 1998, the gate hoist mechanism at gate no. 3 failed during a routine raising of the gate.**
- **Field examination showed that two anchor bolts on the pinion side of the pillow block bearing support were fractured, and the pillow block bearing support was badly distorted.**

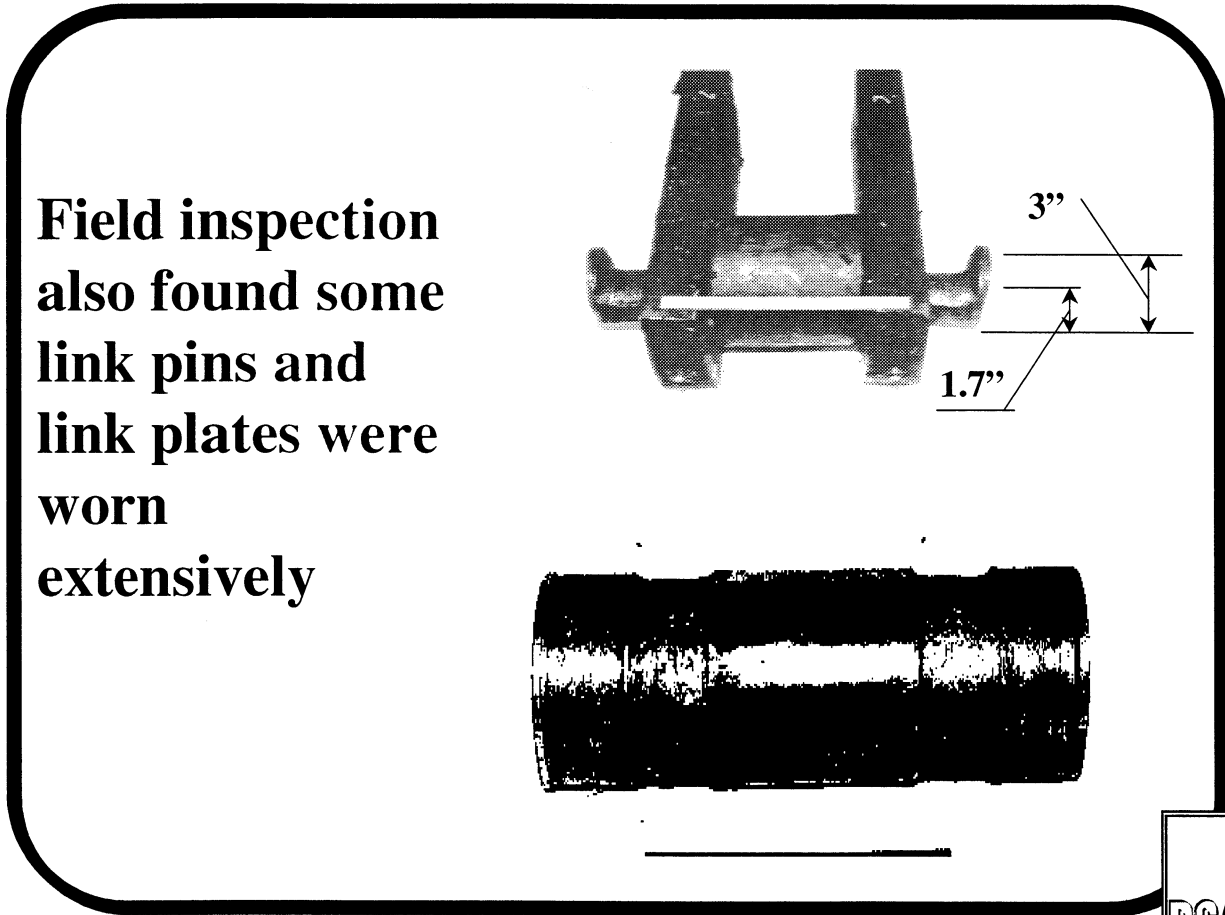
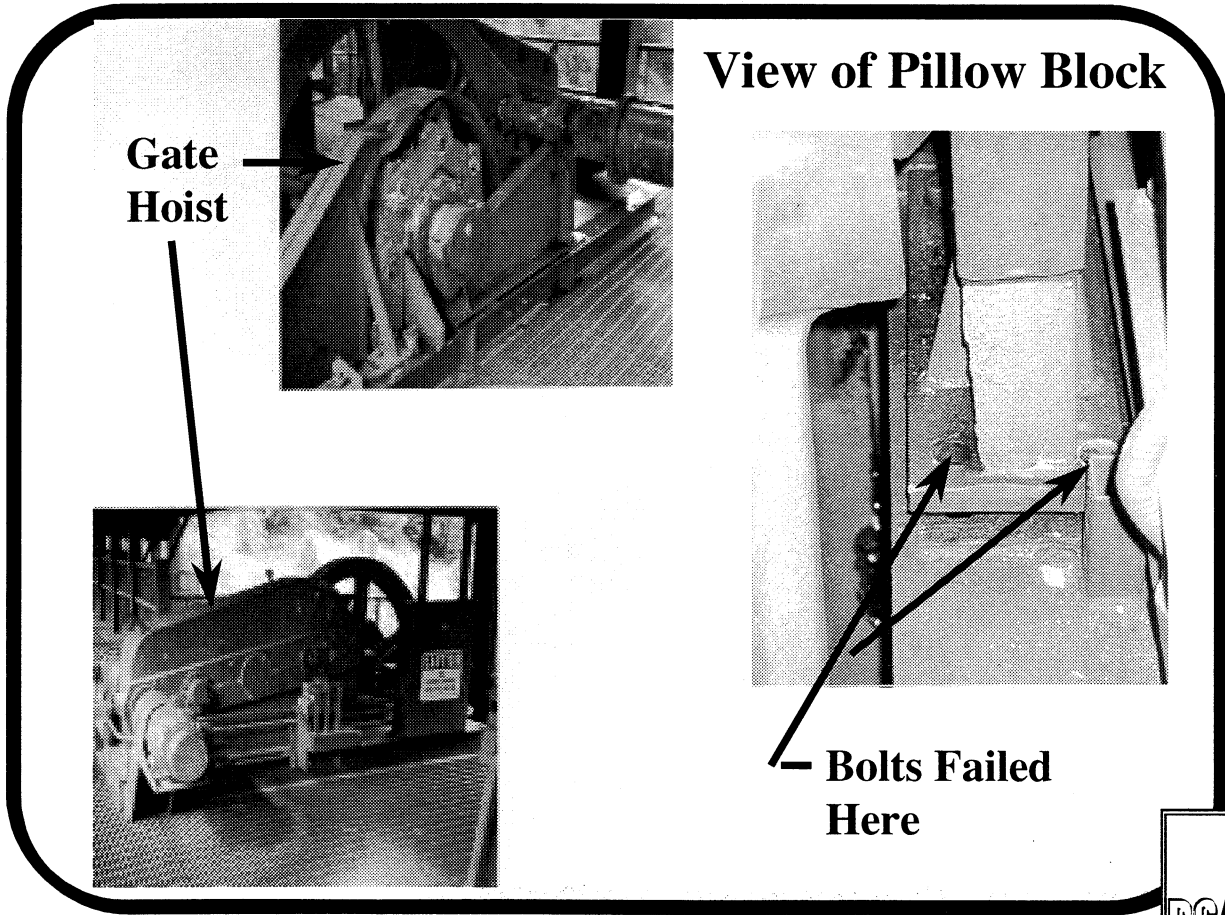

## Wear Damage to a Link Plate

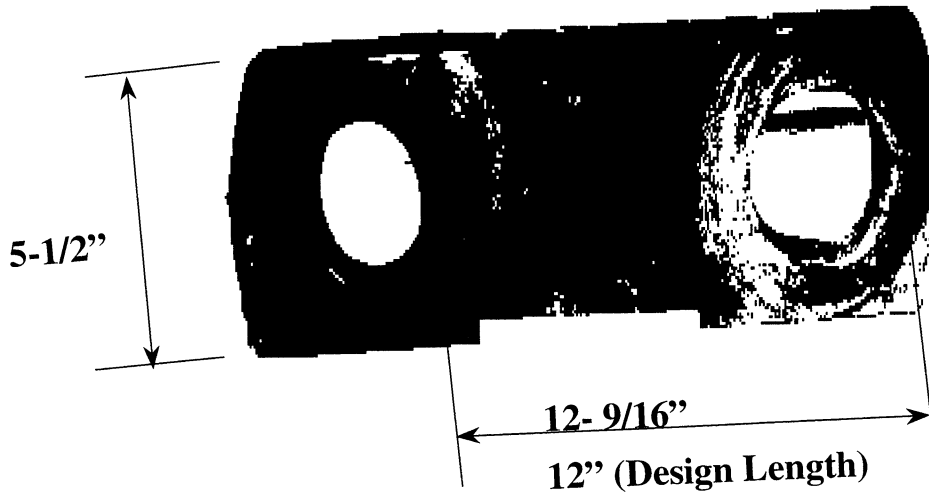

- 7 -



## Analysis of Bolt Stresses under Design Conditions

- Analysis showed that design loads are too low to cause failures
- Even without preload, bolts are capable of withstanding over a million cycles

- 8 -



# Evaluation of Bolt Loads with Side Slip

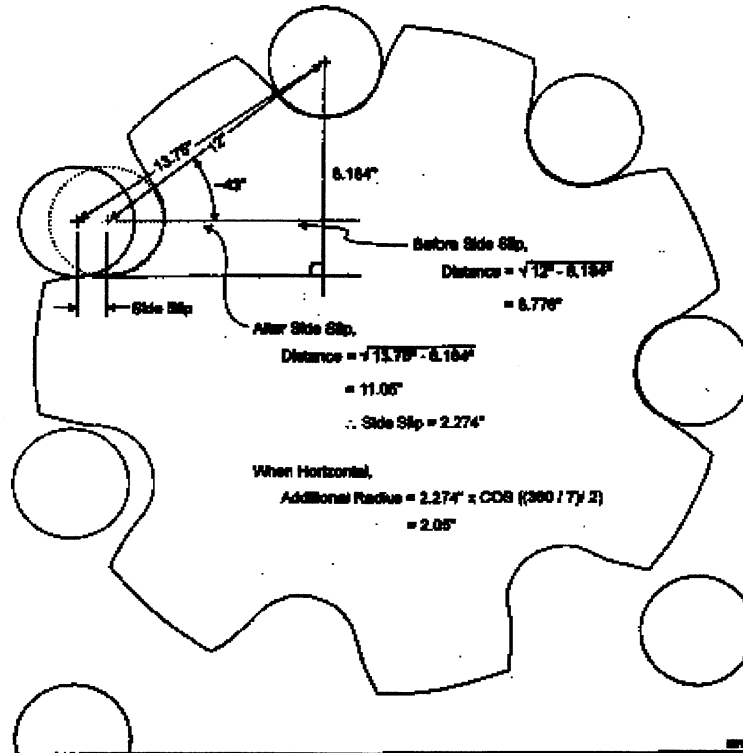

# Free Body Diagram of Reaction Forces

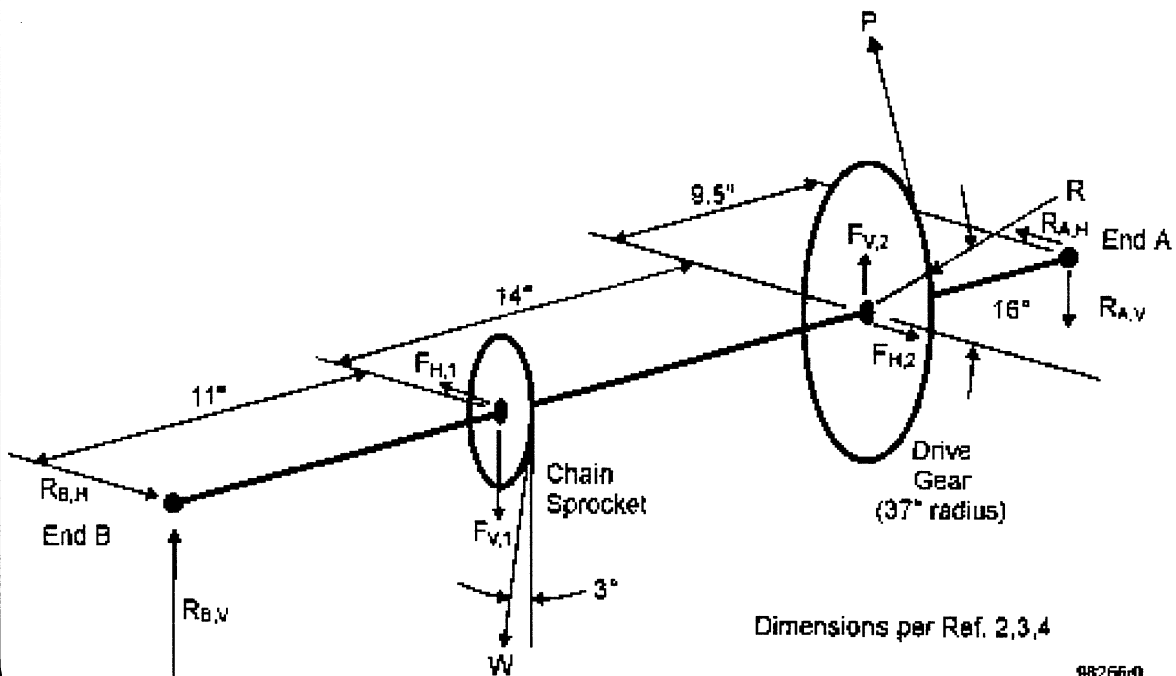

88266r0



## **Conclusions/Failure Scenario**

- **Lack of lubrication in the chain link resulted in wear of a link and pin.**
- **The wear of the hole in the plate and the reduction of the pin diameter resulted in one chain being longer than the other by almost 2 inches.**
- **Difference in length between two chains lifting the gate caused a rotation of the gate while moving worn link over the chain sprocket.**

- 11 -



## **Conclusions/Failure Scenario**

- **The rotation of the gate caused a kinking of the chain below the water surface, eventually causing ejection of a link pin resulting in the separation of one of the chains.**
- **With only one chain the gate bound up in the slot and exceeded the ultimate tensile strength of the bolts.**

- 12 -





# Lessons Learned

- **Failure analysis was based on preliminary visual inspection of chain and hoist mechanism only. No underwater inspection of chains was performed**



- 13 -

# Lessons Learned

- **Assumed hoist mechanism (clutches ) adjusted properly**
- **Special attention must be given to hoist of larger gates**



- 14 -

# Lessons Learned

- **Regularly inspect all electrical and mechanical parts of the hoist mechanism and its supporting structural members**
- **Inspect all lubrication in gear boxes. Replaced cover gaskets to prevent water mixing with the lubricants.**



- 15 -

# Lessons Learned

- **Lubricate chains at least annually**
- **Inspect the entire chain at regular intervals to determine if wear is occurring**
- **Replacement of chains is costly (100K per set of chain)**



- 16 -

## **How Safe is Safe Enough?**

***Bruce Brand  
Federal Energy Regulatory Commission***

# **HOW SAFE IS SAFE ENOUGH?**

## **TARGETING INSPECTION EFFORTS BASED ON CONSEQUENCES OF FAILURE**

- **NOT ALL GATE FAILURES LEAD TO CATASTROPHIC CONSEQUENCES**
- **THE CONSEQUENCES OF FAILURE ARE FAILURE MODE SPECIFIC**
- **CONSEQUENCES OF FAILURE DRIVE THE BUS**

---

## **THE FERC TAINTERGATE INITIATIVE**

**FEBRUARY 1998**

- 1) **FERC INSPECTORS VISUALLY INSPECT EACH GATE**
- 2) **LICENSEE'S DOCUMENT THEIR LUBRICATION PROCEDURES**
- 3) **STRUCTURAL ANALYSIS OF GATE INCLUDING THE EFFECTS OF TRUNNION FRICTION**
- 4) **MEASURE ELECTRIC CURRENT DRAW OF MOTORS WHEN LIFTING GATES**

## RISK FACTORS TO BE CONSIDERED

- > **Consequences of gate failure.** Gates can fail in both open and closed position. The upstream and downstream consequences of each failure scenario should be considered.
- > **Age/Condition/Maintenance Practices.** Well maintained gates indicate attention by the owner, which may allay some concerns.
- > **Redundancy.** Gate failure at a site with many small gates may not be as serious as gate failure at a site with few large gates.
- > **Operator Reliability.** If all gates are operated by one traveling hoist, then hoist failure becomes much more critical. (Common cause failure)
- > **Project function.** If failure of a gate makes it impossible for the project to function as intended, gate failure becomes more critical.
- > **Bulkhead Provisions.** If there is another method of stopping flow, the consequences of gate failure may be lessened.
- > **Public Relations.** Large, high profile gate failures such as Folsom reduce public confidence in the industry.

## PROPOSAL FOR GATE CLASSIFICATION WRT RISK

	P	Class 1	Class 2
		Critical Gates Hoist's structural failure would endanger downstream life property, Hoist's failure to open would significantly decrease the project's ability to pass a flood, or endanger upstream life property, Hoist's function is critical to the operation of the project.	Not class 1. Sites with many gates where an individual gate failure could be accommodated.
Climbing Inspection		10 yrs (every gate)	40% every 10 yrs
Visual Inspection		1 yr	2 yrs
Amperage Testing		1 yr	NA
Full Height Testing	6 yrs (every 10 yrs)	5 yrs (every gate)	40% every 10 yrs
Operation Test	1 yr	1 yr	2 yrs
Required Analysis	Static + Dynamic	Static + Dynamic	Static

The FERC will consider all tailergates Class 1 gates unless the licensee makes a case for a lower rating.

**THE MOST  
DANGEROUS LOAD  
CASE IS THE ONE YOU  
FAIL TO CONSIDER**

---

# **Hydro Projects Gate Equipment Design Issues**

*Chander K. Sehgal  
Harza Engineering Co.*

## HYDRO PROJECTS GATE EQUIPMENT DESIGN ISSUES

**CHANDER K. SEHGAL\***, P.E.  
MEMBER ASME, ASCE, USCOLD

### INTRODUCTION

The design of hydro projects gate equipment requires consideration of several issues for successful implementation. These issues vary with the type of application, type of gate, type of gate operating equipment, and operation and maintenance needs. The following is a summary of various issues involved for various applications and various types of the commonly used gates. This article does not cover various types of lock gates whose design requires several additional issues.

### GENERAL ISSUES (COMMON TO ALL GATE APPLICATIONS AND GATE TYPES)

#### 1. Coordination with project planners about the following:

- Type of gate suitable for a given application (radial, vertical lift, hinged crest, rubber dam, etc. for spillways; wheel, slide or top sealing radial gate for power intakes or miscellaneous uses such as sluiceways; unbonnetted or bonnetted slide or wheel gate, jet flow gate, or top sealing radial gate for low level outlet works or for miscellaneous uses).
- Selection of type of hoist depending on operation and maintenance requirements.
  - Hydraulic Cylinder type
  - Wire Rope Type
  - Screw Stem Type
  - Chain Type
  - Gantry Crane
  - Monorail Crane
- Number of hoists.
  - Dedicated for each of several similar gates

---

\*Senior Partner, Harza Engineering Company, Chicago



- Portable (Gantry crane; monorail hoist; wire rope or chain hoist mounted on a car traveling on rails; A-frame; and so on).
- Limitations in size of gate, considering gate's structural design and fabrication limitations and operating equipment design limitations.
- Arrangement of gate and operating equipment (location of gate trunnion and gate sill for radial gates; upstream or downstream sealing wheel or slide gates; location of gate hinge for hinged crest gates or anchors for rubber dams; submersible or non-submersible hydraulic cylinder type operator; upstream or downstream location of wire rope hoists for crest type radial gates; downstream or pier supported or torque tube type hydraulic cylinder operator for hinged crest gates; acceptability and arrangement of screw stem hoist).
- Manual or local/remote electrical operation.
- Automatic operation.
- Minimal size of blockouts needed considering estimated gate structural design and space needed for field installation and adjustment.
- Estimated loads transmitted by gate and operator to concrete.
- Permissible leakage.
- Isolation of gate and operator for maintenance (provision of stoplogs/bulkhead; needle panels; floating bulkhead).
- Provision for portable operator or diesel generator for powered emergency operation.
- Removal of gate for major maintenance or replacement.

## 2. **Cost Estimates (without performing full design)**

- Formulae for estimating weight for different types of gates (radial, wheel, slide, bonnetted, stoplogs/bulkheads, and so on) as a function of gate size and maximum hydrostatic head.
- Formulae for estimating weight of embedded parts for various types of gates.
- Formulae for estimating hoisting capacity for various types of gates and hoists.
- Fabrication and installation cost basis for gates in \$/kg.
- Fabrication and installation cost basis for embedded parts in \$/kg.

- Fabrication and installation cost basis for various types of hoists in \$/kg capacity/meter stroke.

### **3. Design of Gates**

- Material (A36, A572, Stainless Steel 304).
- Load cases (Normal; Overload including seismic and hydrodynamic loads where applicable).
- Operating loads including loads resulting from breakdown torque exerted on jammed gate by wire rope and chain hoists including monorail cranes, gantry cranes, and mobile cranes.
- Allowable stresses for various load cases for structural parts.
- Allowable stresses for various load cases for mechanical parts such as pins and bearings.
- Use of lateral guide rollers (spring loaded; shimmed).
- Number of guide rollers in contact with embedded parts when the gate is fully open.
- Use of fluorocarbon pads for sliding/bumper surfaces.
- Fabrication tolerances.
- Plumbness with respect to lifting points (vertical lift gates only).
- Loads on guide shoes caused by rotation of gate due to eccentric seating in fully closed position or due to eccentrically located dogging devices (vertical lift gates only).

### **4. Design of Embedded Parts**

- Material (stainless steel; painted or unpainted carbon steel; combination of stainless steel and painted carbon steel, with stainless steel used only for sealing and bearing surfaces; bronze).
- Design as beams on elastic foundation.
- Lateral load.
- Loads caused by jamming of gate.
- Loads caused by eccentric lifting or eccentric seating (vertical lift gates only).

- Stresses in concrete.
- Fabrication and installation tolerances.
- Splicing (fitted bolt connection plus field welding).
- Connection between side beams and lintel beam and between side beams and sill beam (fitted bolt connection plus field welding).
- Entrance taper at the top of lateral guides and the top of the lintel beam.
- Slot lining and downstream taper.
- Allowable stresses.
- Extension of rebars into second stage concrete.
- Welding pads and alignment studs; or anchor hooks extending from first stage into second stage concrete.
- Minimum diameter of alignment studs; any design loading consideration.

## **5. Design of Hydraulic Hoists**

- Materials.
  - Cylinder shell (carbon steel, stainless steel)
  - Piston rod (chrome plated 304, 316, or 17-4 PH stainless steel; non-plated 17-4 PH steel; chrome plated carbon steel; ceramic coated carbon steel)
  - Piping (carbon steel, stainless steel)
  - Hydraulic reservoir (stainless steel; painted carbon steel)
- System design pressure (2000 psi; 2500 psi; 3000 psi; other).
- Type of pump (fixed displacement; pressure compensated).
- Size of piping and hoses.
- Field adjustability of rod end eye.
- Use of counterbalance valves.
- Setting of main relief valve.

- Provision of relief valve in each cylinder chamber to prevent thermal expansion overload.
- Use of horizontal or inclined cylinders.
- Piston rod buckling design for gravity closure cylinders to withstand force caused by pump pressure after gate has fully closed.
- Use of double acting cylinders.
- Procedure for piston rod buckling design (or combined bending and buckling).
- Lowering of gravity closure gates without power, by opening a manual shut-off valve.
- Number of pumps (including stand-by service).
- Use of portable HPU.
- Interconnection of lines of various gates when a single HPU is used for several gates.
- Use of cushioning valves.
- Normal and emergency operation speeds.
- Use of accumulators.
- Use of suction filters.
- Provision of extension stems and stem guides.
- Drift control arrangement.
- Arrangement for sealing of piston rod for bonnetted gates.
- Selection of environmentally safe fluid.
- Selection of hydraulic fluid for cold region applications.
- Provision of mechanical locking for piston rod.
- Use of cylinder mounted overhead tank for gravity closure gates.

## **6. Design of Wire Rope Hoists**

- Materials.
  - Wire rope (carbon steel, stainless steel)
  - Drum and gears (structural steel, cast iron, cast steel)
  - Shafts (carbon steel, stainless steel)
- Factors of safety for design of wire rope and other components.
- Use of sheaves at the gate.
- Use of turnbuckles for adjustment.
- Synchronization of two units (use of line shaft or electrical synchronization).
- Location of motor (between the two units or on one side).
- Hand crank provision (plus load brake).
- Selection of motor.
- Lowering control using motor.
- Lowering control without power (use of fan or hydraulic brake; use of d.c. motor for braking action at the end of closing stroke).
- Wire rope lubrication including automatic cleaning and lubrication arrangement.
- Efficiency.
- Use of overload limiting devices.
- Use of load cells or other load measuring devices.
- Use of overtravel and slack rope limit switches.
- Stretching of wire ropes.

## **7. Design of Chain Hoists**

- Type of chain (roller type or link type).

- Materials.
  - Chain (painted carbon steel; stainless steel; combination)
  - Chain bearings (bronze bushing; self-lubricating bushing)
  - Sprocket (carbon steel, stainless steel)
- Efficiency.
- Cost of maintenance and replacement.
- Other items similar to wire rope hoist.

## **8. Design of Screw Stem Hoists**

- Materials.
  - Stem (carbon steel, stainless steel, bronze)
  - Nut (carbon steel, stainless steel, bronze)
  - Gears
  - Pedestal
- Type of threads (acme, square).
- Selection of threads per inch and lead.
- Self-locking threads.
- Design for buckling and provision of stem guides.
- Connection with gate.
- Use of stem cover.
- Rising or non-rising stem.
- Positive locking of drive to hold gate in fully or partially open position.
- Arrangement for sealing of stem for bonnetted gates.

## **9. Miscellaneous Items**

- Provision and design of lifting beams.
- Provision and design of dogging devices vs. remote storage; transportability to remote storage.

- Corrosion protection for carbon steel parts (type of paint; use of cathodic protection).
- Corrosion allowance for gates, embedded parts, and hoists.
- Minimum thickness of plates.
- Prevention of contact between submerged dissimilar metals.
- Use of non-galling materials sliding on each other.
- Provision for lubrication of self lubricating bearings.
- Design of hoist support frames (structural or mechanical allowable stresses?).
- Position indication arrangement
  - Cylinder mounted LVDT (stroke limitation)
  - Ceramax integrated measuring system (no stroke limitation)
  - Wire rope or chain hoist driven
  - Directly driven by the gate or piston rod or screw stem
  - Graduated screw stem

## **SPECIFIC REQUIREMENTS:**

### **SPILLWAY RADIAL GATES (CREST TYPE)**

#### **1. Design of Gates and Embedded Parts**

- Setting of gate geometry.
- Number of arms (two, three, or four).
- Location of gate trunnion with respect to flood flow nappe and maximum downstream water level.
- Maximum height of gate (acceptability of flow over the gate top during flood).
- Maximum opening of gate with respect to maximum water level and flood level.
- Location of arms connection to skinplate reinforcing beams along the width of the gate.
- Field bolted or field welded gate arms.

- Type of seals (bar or J-type rubber bottom seal; stainless steel gate bottom for metal to metal contact bottom seal; J or L-type rubber side seals).
- Horizontal or vertical framing.
- Bolted or welded field splices.
- Torsion in gate arms and other parts considering single cylinder holding, especially wide gates of small height.
- Use of self-lubricating bearings at gate trunnions and sealing of bearings to prevent entry of suspensions in water.
- Spherical or straight bearings at gate trunnions.
- Trial of gate motion before grouting of trunnion; consideration of load on trunnion caused by gate weight with gate raised high.
- Type of trunnion anchorage (tie-rod or post-tensioned type).
- Tolerances (gate radius, trunnion alignment, gate width).
- Leakage at gate bottom caused by gate deflection.
- Thermal expansion.
- Concrete growth.
- Use of wave deflector.
- Use of flow splitters.
- Position indication in degrees or percentage of gate rotation or in vertical opening.
- Calculation of trunnion load considering hydrostatic load as well as load contributed by hoisting forces.
- Consideration of hydrodynamic loads.
- Specific gate opening range for minimal vibration / cavitation.
- Discontinuation of embedded side seal plates above gate's fully closed position.
- Use of eccentric trunnions to minimize hoisting force.



- Layout of embedded parts for gates with eccentric trunnions.
- Hoisting force calculation considering various friction coefficient values.
- Cold regions application (ice loading; heating of embedded parts and gates; use of water/glycol or strip heaters; value of heat input).

## 2. Design of Hoists

### a. Hydraulic Hoists

- Optimal arrangement of cylinders with respect to the gate including location of connection point to gate (upper arm; upper main girder; lower main girder; other location) and location of cylinder trunnion (top of cylinder; middle of cylinder). Is higher hoisting force/lower stroke better than lower hoisting force/higher stroke?
- Universal joint type arrangement at cylinder trunnion (cardan ring).
- Piston rod combined bending and buckling design.
- Synchronization of cylinders.
- Position indication arrangement (mechanical counterweight type; cylinder mounted LVDT).
- Drift control arrangement to maintain gate at any desired opening.
- Stepped raising of gate with automatic stop every 1 ft or 2 ft.
- Minimum gate opening (to prevent vibration and cavitation).
- Number of HPUs for multi-gate spillway.
- Location of HPUs.
- Number of pumps per HPU.
- Hard wired or PC based local controls.
- Remote controls.
- Automatic operation.

b. Wire Rope Hoists/Chain Hoists

- Location (upstream/downstream).
- Gate protection from wire rope/chain contact for upstream located wire rope.
- Position indication arrangement (mechanical, counterweight type; mechanical, driven by the hoist drive).
- Use of turnbuckles for wire rope adjustment on each side/ arrangement for chain length adjustment.
- Stepped raising of gate.
- Minimum gate opening.
- Hard-wired or PC based local controls.
- Remote controls.
- Automatic operation.

### **TOP-SEALING RADIAL GATES FOR ORIFICE SPILLWAYS**

Same considerations as for crest type radial gates except design of top sealing arrangements to prevent flow from the top and from the top corners when the gate is partially open, and consideration of stainless steel skinplate.

### **SPILLWAY VERTICAL LIFT GATES**

#### **1. Design of Gates and Embedded Parts**

- Upstream sealing gate.
- Bottom and side seals arrangement.
- Wheel arrangement (cantilevered; supported on both sides).
- Flat wheels on spherical roller bearings or crowned wheels on cylindrical roller bearings; use of self-lubricating bushings and resulting high frictional forces; use of seals to prevent entry of water and suspensions into the wheel bearings.
- Material of wheel and wheel track (17-4 PH, 410, cast steel); hardness difference.

- Allowable contact stress between wheels and track.
- Splicing of track plate and backing beam; field welding restrictions.
- Minimum spacing of wheels.
- Eccentric wheel/axle arrangement for field adjustment of wheels.
- Total height of wheel track plate;
- Welded/bolted track plate.
- Analysis of track plate.
- Cross-section of trackplate in and above the working area.
- Consideration of one or two wheels sliding instead of rolling for determining the hoisting capacity and safety of gravity closure.
- Maximum allowable gate deflection.
- Selection of hoist (hydraulic/wire rope).
- Cold regions applications.
- Openings in gate to accommodate cylinders to minimize protrusion of hydraulic cylinders above the superstructure.
- Location of cylinders for hydraulic hoists (partially or fully above the hoist superstructure).
- Welded, bolted, pinned, or hinged connection between sections of sectionalized gates.

## **2. Design of Hoists**

- Synchronization of hydraulic cylinders if two cylinders are used per vertical lift gate.
- Design of superstructure (including wind load consideration).
- Other items similar to radial gates.

## **HINGED CREST GATES**

### **1. Design of Gates and Embedded Parts**

- Gate rotation angle between fully closed and fully open position.
- Maximum height.
- Bottom seal arrangement including protection from debris and connection with moving side seals.
- Side seal arrangement (need for sealing only in fully raised position or throughout the stroke).
- Arrangement of hydraulic cylinders (overhead, supported on side piers; torque tube torqued from one side, both sides, or the middle; or downstream location).
- Need for venting below the flow nappe and use of flow splitters.
- Effect of debris in the flow over the gate on cylinders in case of downstream cylinder arrangement.
- Access to downstream side including downstream cylinders for maintenance.
- Limiting of gate width for overhead cylinder arrangement and torque tube arrangement.
- Heating of gate and embedded parts (especially side seal plates) for cold region applications.
- Single cylinder holding.
- Thermal expansion considerations.
- Position indication in degrees or percentage of gate rotation or in vertical opening.
- Provision of maintenance stoplog/needle panels including arrangement for their handling.

### **2. Design of Hoists**

- Synchronization of cylinders.
- Protection of piston rods against damage by debris in flow.
- Submersible cylinder trunnion in case of high tailwater level.

- Drift control to maintain gate at any given opening.
- Other items similar to radial gates.

## **INTAKE WHEEL GATES (HIGH HEAD)**

### **1. Design of Gates and Embedded Parts**

- Upstream or downstream sealing gate.
- Gate bottom shape for upstream and downstream sealing gates.
- Hydrodynamic downpull and uplift considerations.
- Tolerances (especially for upstream sealing gates).
- Load on wheels track plate as gate moves from fully open to fully closed position against flow.
- Position of gate above the top of intake tunnel when gate is fully open.
- Need for gravity closure against full flow, with or without power; desirability of emergency closure tests before commissioning of the project.
- Other issues similar to spillway vertical lift wheel gates.
- Consideration of one or two wheels sliding instead of rolling, for determining maximum hoisting force and safety of gravity closure.

### **2. Design of Hoists**

- Selection (hydraulic/wire rope/gantry crane); wire rope hoist/gantry crane offers no safety against catapulting due to hydrodynamic uplift forces; economy in the use of gantry crane if several gates are involved.
- Normal opening and closing and emergency closing speeds.
- Use of cushioning devices.
- Use of accumulator or drift control mechanism to retain gate in fully raised position.
- Crack-opening of gate to fill penstock vs. separate fill line or filling valves located in gate body.

- Use of high pressure low speed pump for crack-opening of gate and low pressure high speed pump for opening the gate under balanced head condition.
- Use of double acting cylinder.
- Use of two cylinders per gate and their synchronization.
- Emergency closure without power (lowering control, especially for wire rope hoists).

## **LOW LEVEL OUTLET VERTICAL LIFT GATES (HIGH HEAD)**

### **1. Design of Gates and Embedded Parts**

- Bonnetted or unbonnetted gates.
- Use of jet flow gates.
- Use of wheel gates.
- Type of sealing and bearing surfaces for bonnetted gates (stainless steel/bronze; bronze/bronze; self-lubricating bronze/stainless steel).
- Size of side slots.
- Stainless steel slot lining and extent of slot lining.
- Downstream cut-out in slot sides.
- Bonnet design – consideration of concrete support.
- Minimum opening.
- Hydrodynamic downpull/uplift forces.
- Venting.
- Space for removal of bonnetted gate for repairs/replacement.
- Use of flap gate for maintenance of bonnetted gate.

## **2. Design of Hoists**

- Sealing of piston rod at bonnet cover.
- Provision of overhead monorail hoist for hoist maintenance.
- Other items similar to radial gates.

## **DESIGN OF LOW LEVEL OUTLET RADIAL GATES**

Similar to orifice spillway radial gates except consideration of problems associated with high head.

## **DESIGN OF BULKHEADS AND STOPLOGS**

- Number of sections to meet handling crane's capacity.
- Use of fluorocarbon bearing pads.
- Location of filling valves for spillway stoplogs.
- Use of upstream skinplate for spillway stoplogs to minimize collection of debris on beams.
- Lifting beam actuated filling valves for upstream and downstream sealing bulkheads/stoplogs for high head gates.
- Size of filling valves.
- Handling studies (space required for handling; mobile crane loads on concrete; use of floating plant).
- Storage including in-slot storage of spillway stoplogs and draft tube gates (minimum distance of stored sections bottom above maximum water level).
- Handling with gantry crane, monorail crane, mobile crane, or fixed hoist.
- Type of fixed hoist for draft tube gates (wire rope hoist preferred so that gate can be lifted above maximum water level; use of telescopic cylinder for smaller lifts).

## ADDITIONAL DESIGN ISSUES ( BASED ON GATES' USE TO DATE)

- What has been learnt from the last 50 to 100 years of gate operation:
  - Some gates were well designed and/or well maintained and continue to perform well.
  - Some gates were poorly designed and/or poorly maintained and need to be rehabilitated or replaced at very high costs.

The above universal fact with respect to the design and maintenance of the gates will continue to apply in the future except if an appropriate government agency formulates definite mandatory guidelines for the design, inspection and maintenance of gates to prevent poor design or maintenance.

- What life expectancy should the new or rehabilitated gates be designed for, considering the current problems ( what and how to inspect; availability of funds for inspection and rehabilitation; consequential effects ).
  - 50 years
  - 75 years
  - 100 years
- Life expectancy of the new or rehabilitated gates can be maximized using the following tools currently available:
  - Past experience
  - Availability of better materials
  - Availability of better techniques for structural analysis
  - Better fabrication techniques
  - Better corrosion protection systems
- Considering that each gate is a custom designed product and many a time required to withstand larger loads than originally anticipated, the following items should be kept in mind when designing or operating the gates:
  - Need to be conservative in performing the design.
  - Need to consistently train younger engineers in the design techniques.
  - Need for accurate record keeping of the operational performance and a continual feedback to the designers for meaningful improvements in future designs.



## REFERENCES

- Kaltsouni, M., Morgan, M. J., and Sehgal, C. K. :“Seismic Considerations in the Design of Gates,” Waterpower '99, Las Vegas, NV.
- Sehgal, C. K. and Morgan, M. J.: “Montgomery Point Lock and Dam Navigable Pass Gate Equipment,” Waterpower '97, Atlanta, GA.
- Sehgal, C. K.: “Design Guidelines for Spillway Gates,” ASCE’s Journal of Hydraulic Engineering, March, 1996.
- Sehgal, C. K. and Mikolajczyk, B. K.: “Proposed Modifications to Hiwassee Dam Radial Gate to Accommodate Concrete Growth on Piers,” USCOLD Second International Conference on Alkali-Aggregate Reactions, 1995, Chattanooga, TN.
- Sehgal, C. K.: “Gates and Valves,” Section 17, *Davis’ Handbook of Applied Hydraulics*, 4<sup>th</sup> Edition, McGraw-Hill, 1993.
- Sehgal, C. K., Fischer, S. H., and Sabri, R. G.: “Cushman Spillway Modifications,” USCOLD 1992 Annual Meeting, Fort Worth, TX.
- Sehgal, C. K. and Wirzberger, E. :“Position Indication Arrangement for Gates,” Waterpower '91, Denver, CO.
- Sehgal, C. K. and Padilla, F. A.: “Intake Wheel Gates Sealing Arrangements,” National Hydraulics Conference, San Diego, CA, August 1990.
- Sehgal, C. K.: “Critical Features of Custom Design Hydro Gates,” Waterpower '89, Niagara Falls, NY.
- Sehgal, C. K.: “Handling of Intake Bulkhead at King Talal Dam,” National Hydraulics Conference, New Orleans, LA, August 1989.
- Sehgal, C. K. and Ala, F. G.: “Operation and Maintenance of Hoisting Equipment for Floodgates for Locks and Dams,” American Society of Mechanical Engineers Second Biennial Movable Bridge Symposium, Florida, November 1987.
- Sehgal, C. K.: “Selection of Spillway Gates for Cold Regions,” presented at CEA/EPRI/Hydro-Quebec-Sponsored Ice Problems Workshop, Montreal, Canada, August, 1987.
- Sehgal, C. K. and Waffle, D. T.: “Operation of Jet Flow Gate at Bath County Pumped-Storage Project,” presented at Fourth ASME International Hydropower Symposium, December, 1986.

# **Inspection of Dam Gate Structures**

*Raymond H. Stokes  
Burgess and Niple*

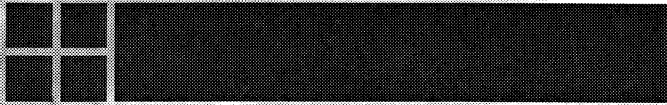

**BURGESS & NIPLE**

# ***Inspection of Dam Gate Structures***

*Presented by:*

**Raymond H. Stokes, Jr., PE  
Facility Inspection Director  
Burgess & Niple, Limited  
5085 Reed Road  
Columbus, OH 43220  
614.459.7272 Ext. 209  
rstokes@burnip.com**

*Presented for:*

**ASDSO Specialty Workshop  
on Dam Gate Structures  
EPRI-Palo Alto, CA  
January 5-6, 2000**

## ***Burgess & Niple***

- **Founded in 1912 in Columbus, Ohio**
- **More Than 680 Employees**
- **15 Offices in Seven States**
- **Four Core Business Areas**
  - **Architecture**
  - **Transportation**
  - **Environment**
  - **Utility Infrastructure**

# ***15 Offices in Seven States***

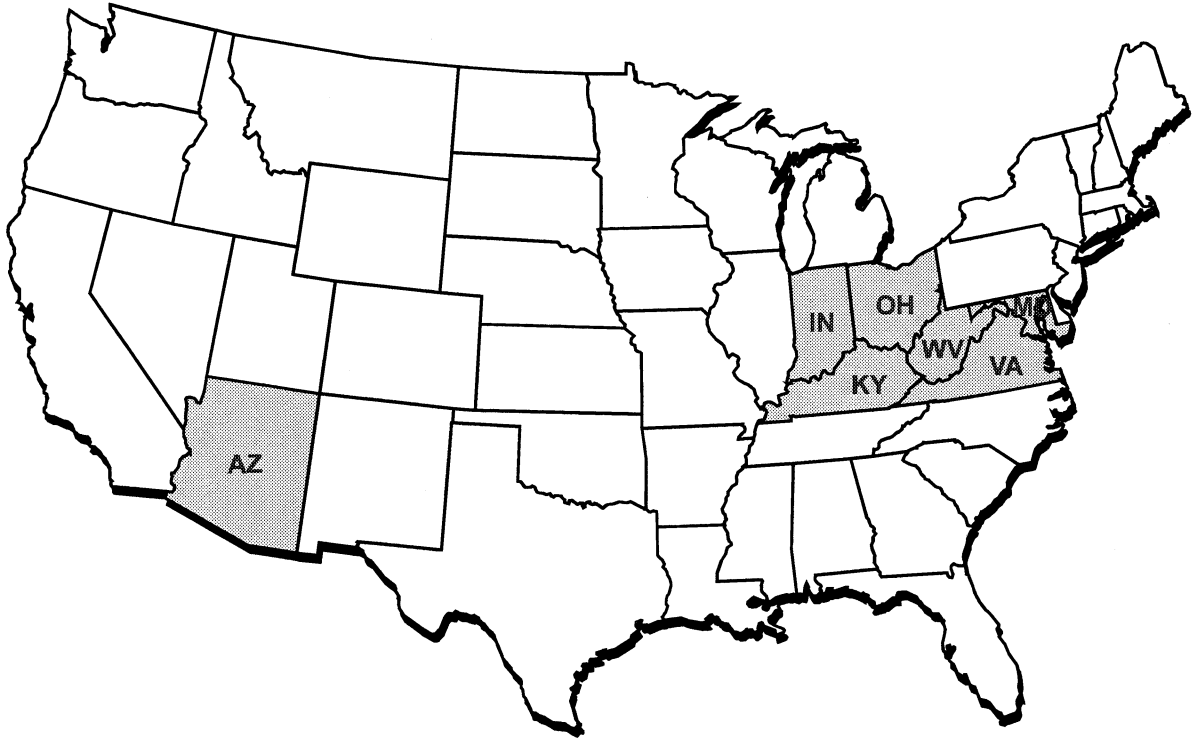

# ***Facility Inspection & Training: 1950-2000***

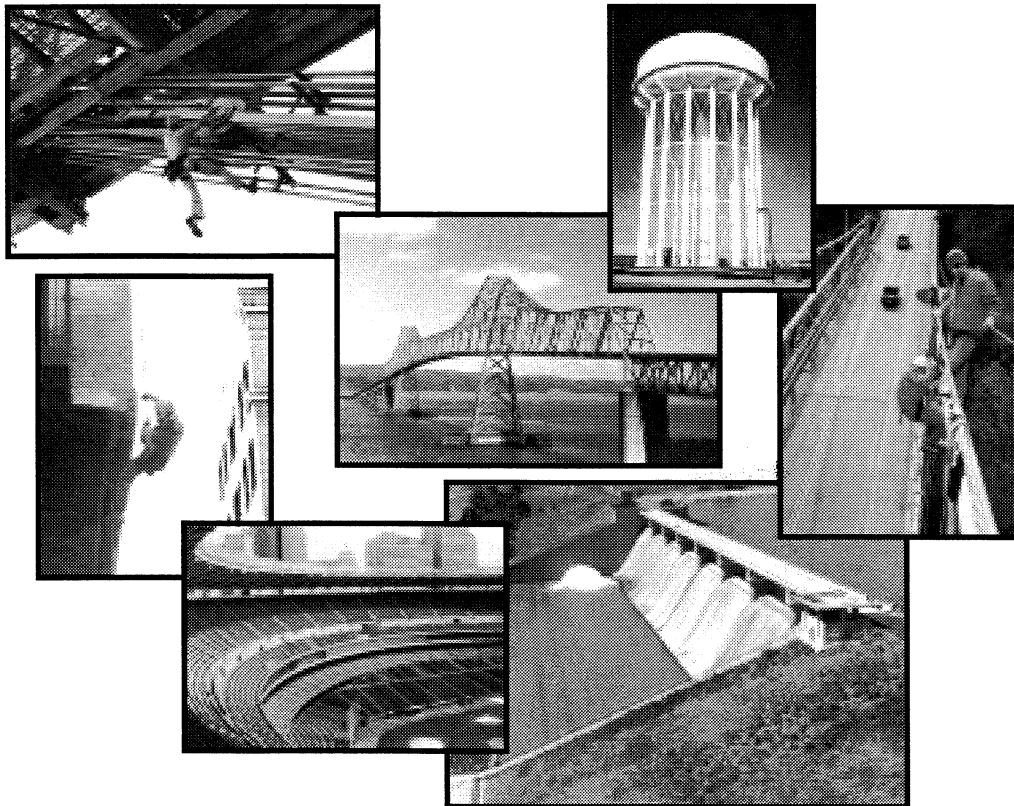

# ***Bridge Inspection: 1969-2000***

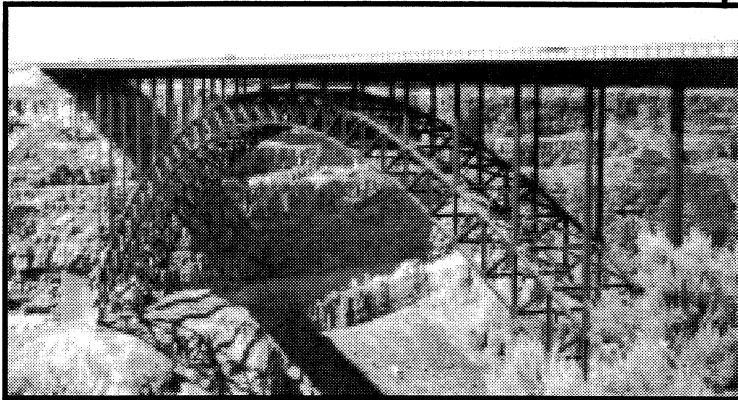

Perrine Bridge,  
Twin Falls, ID



## ***5,000 Inspections in 15 States Since 1969***

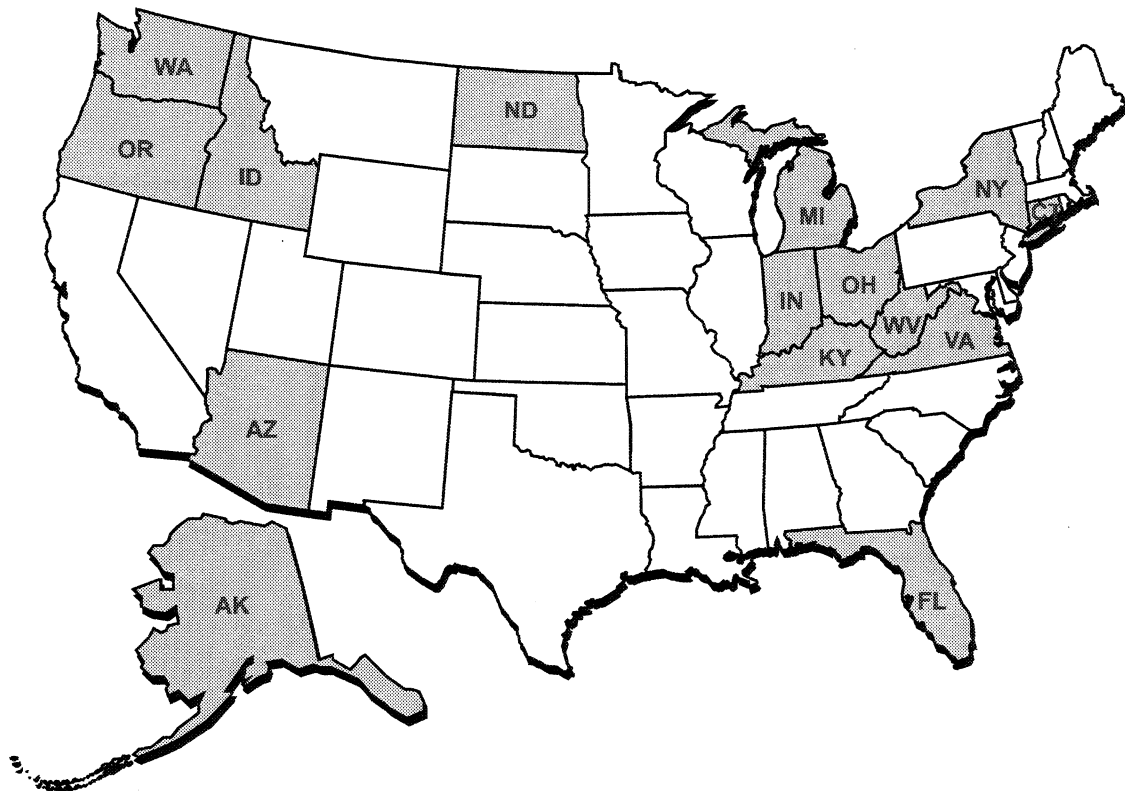

# ***32 Long Span Bridges***

**(Main Span >500 Feet)**

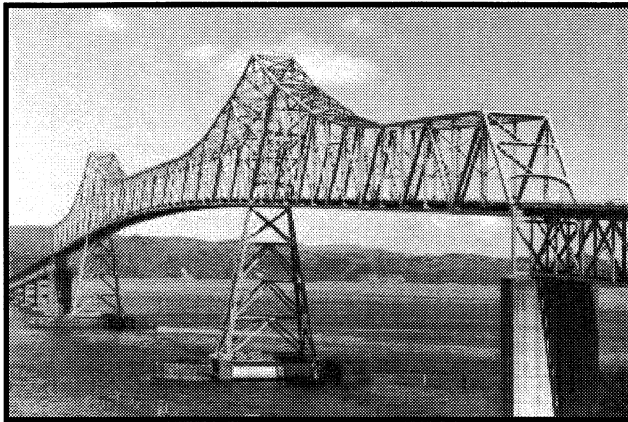

Astoria Bridge,  
Astoria, OR



Throgs Neck Bridge,  
New York, NY

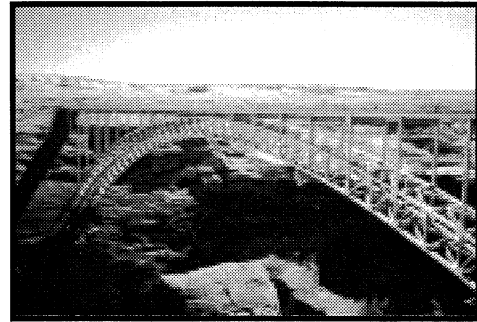

Glen Canyon Bridge,  
Page, AZ

# ***Over 2,000 Short Span Bridges***

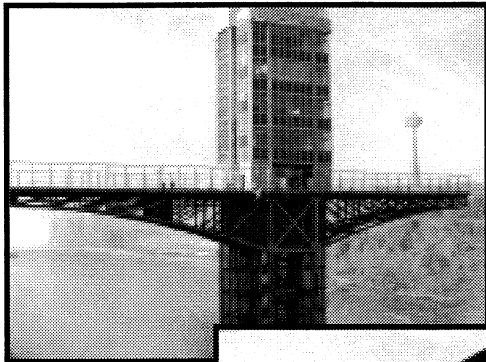

Observation Tower Bridge  
Niagara Falls, NY

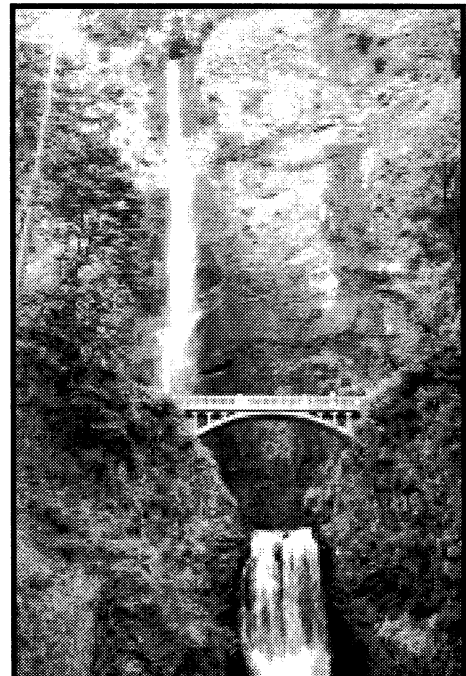
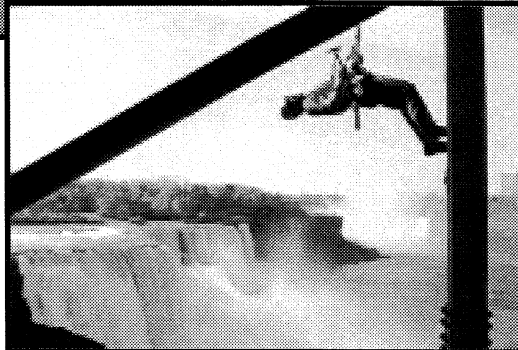

Multnomah Falls Bridge  
Portland, OR

# ***Climbed 500 Bridges Since 1981***

- **Up to 10,000 Feet Long and 700 Feet High**
- **Techniques Comply with OSHA and FRA Safety Rules**
- **\$10 Million Client Savings**

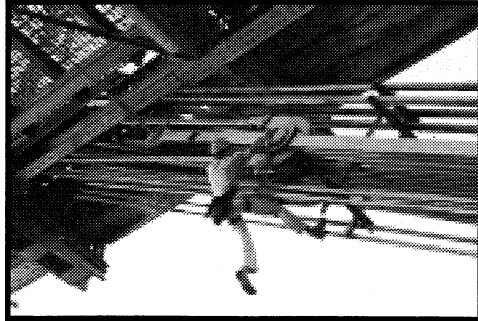

## ***Bridge Climbing Benefits***

- **Safe for Inspectors and Motorists - Zero Accidents**
- **Cost Effective - No Access Equipment or Lane Closures**
- **Hands-On Inspection at All Times**
- **Fast - No Mobilization, Demobilization, or Downtime**
- **Work Independently at Any Time**

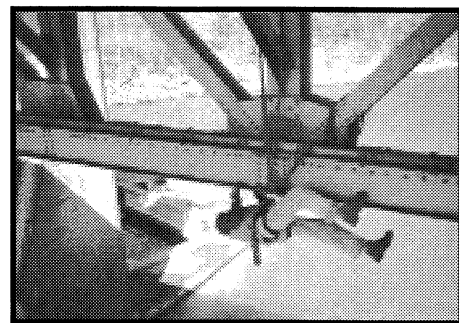
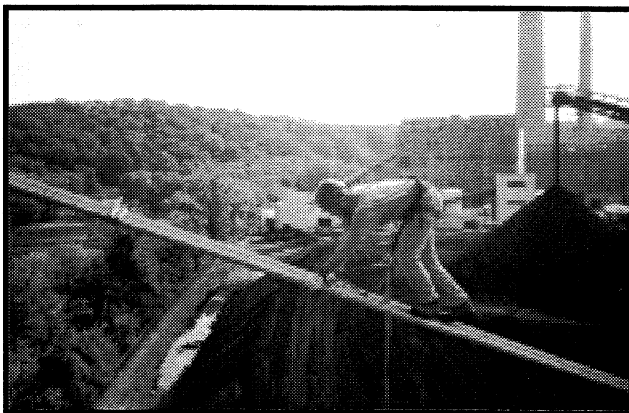

# ***U.S. Army Corps of Engineers – Huntington District***

**4 Navigation & 17 Flood Control Dam Service  
Bridges Throughout WV, OH, KY, VA**

- **Periodic Inspections Under ER-1110-2-111**
- **4 Deck Truss Bridges with Lengths Between 360 & 1,120 Feet**
- **17 Beam or Girder Bridges**

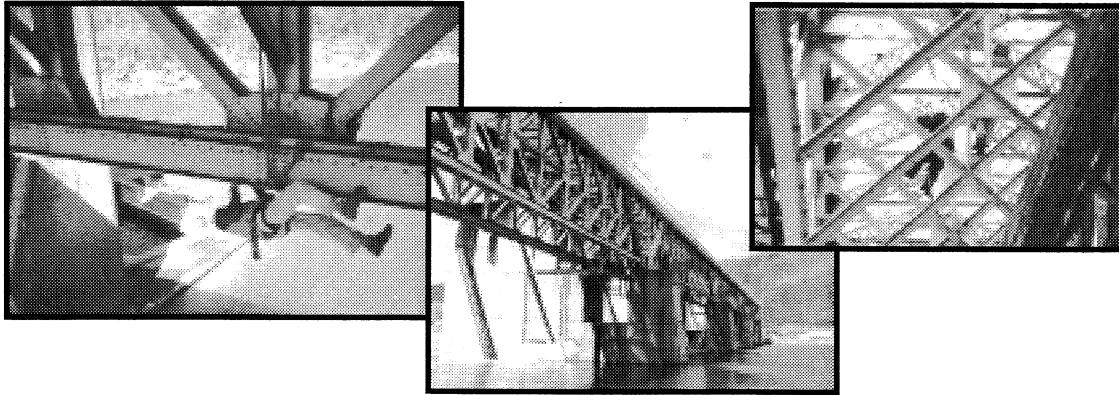

## ***Kentucky Transportation Cabinet*** **Fracture Critical Inspection of Six Major Ohio River Bridges**

- **Data Collected on Palm Tops**
- **Access Database**
- **Electronic Report Format**





# Palm Top with Key Pad

- Runs Word, Excel, and Access Programs
- Key Pad allows easier entry of text
- Pen and Touch Screen allows sketches to be drawn

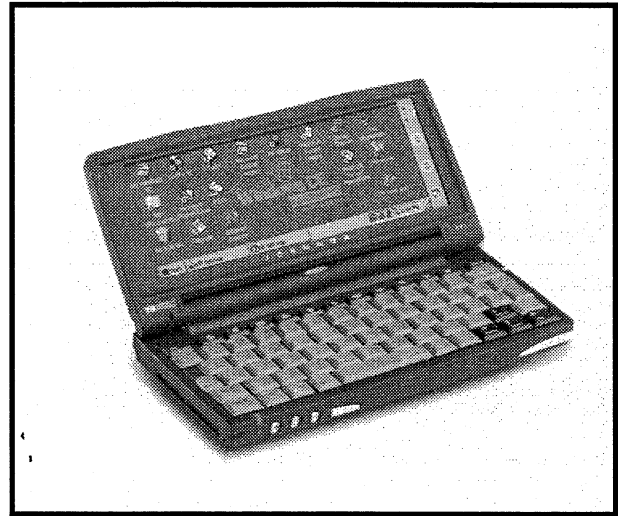

# Custom HPC Bridge Inspection Form

- Custom data collection forms are created for each bridge or project that are tailored to the Client's needs
- Forms feature "drop-down" comment choices and built-in list to speed data entry and standardize notes

**Sample Bridge Inspection Form**

Inspector:  Date/Time Stamp:

Truss:  Upstream  Downstream

Member:  Flag:

Member Condition:

Paint Condition:

Photo No.:  Photo Caption:

Misc. Comments:

Maintenance Recommendations:

Member	Condition	Remarks	Photo No.
U1	Light pitting up to 1/8" deep and sheared rivet at U1		R1P1
U2			
U3			
U4			

ABUT. 1 ABUT. 2

# Field Notes in Database Format

- Data is exported to a master database system on a laptop or desktop computer.
- Data from this system can be readily imported into most agencies' computer database systems.



Filters, sorts and queries can be applied to the resulting database. This simplifies report generation.

Member	Inspector	Truss	Date	Member Condition	Paint Condition	Photo No.	Caption	Notes	Maintenance Recommendations
U0U1	MEB	East	12/7/99	No significant	20% paint loss	R1F1	Typical light pack	1/8" packrust btwn	None
U1U2	MEB	East	12/7/99						
U2U3	BKM	East	12/7/99						
U3U4	BKM	East	12/7/99						

## Climbing Training 400 Trainees Since 1990

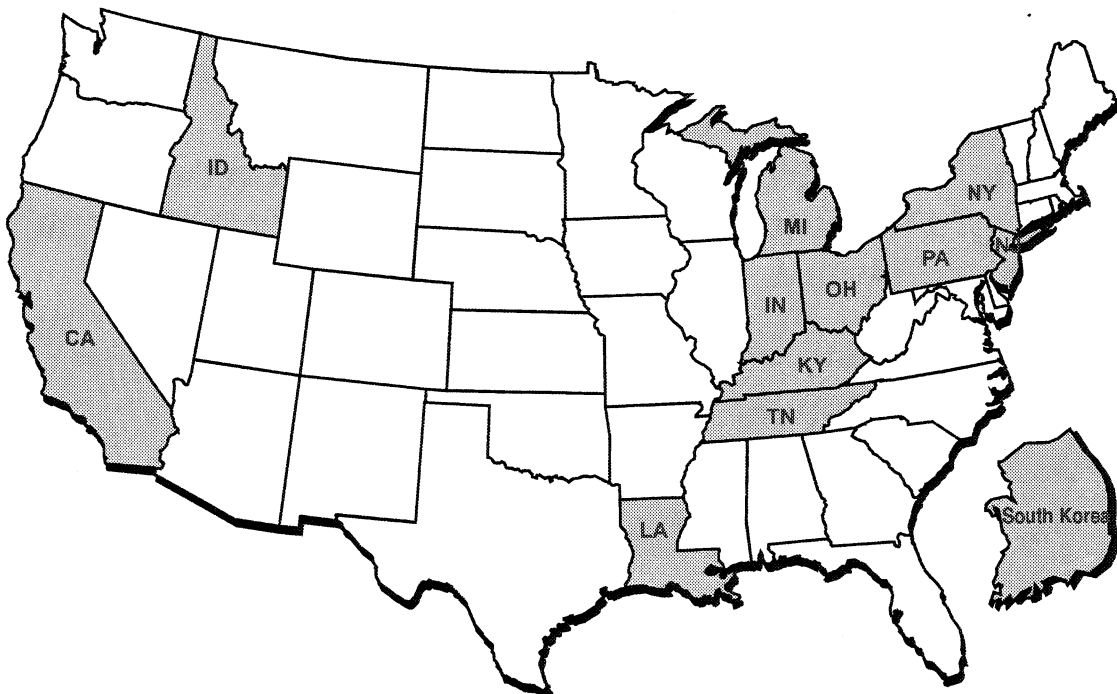

# ***Climbing Training Personnel***

- State
- Local
- Federal
- Authorities
- Railroads
- International

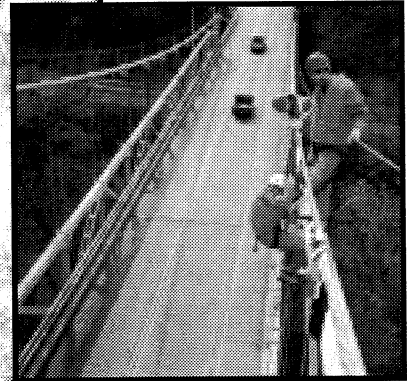
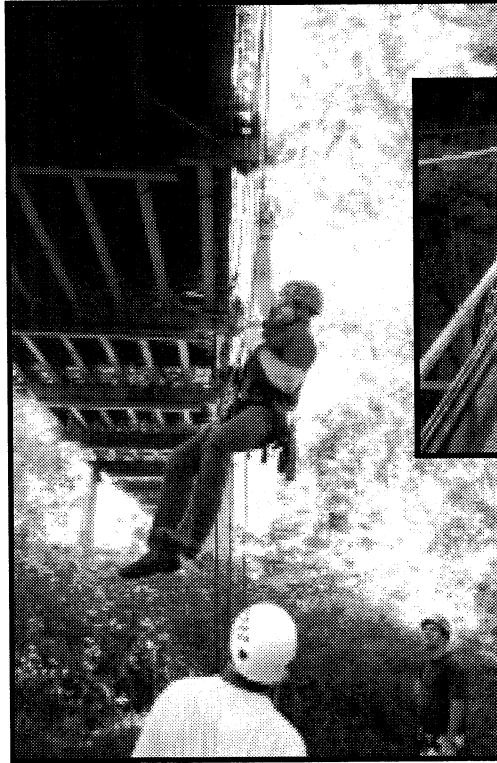

## ***U.S. Army Corps of Engineers – Sacramento District***

### **Climbing Training – Sacramento & Oakland, CA**

- Trained 12 U.S.A.C.O.E. & 1 BOR Personnel
- 3 Days at Folsom Dam – Sacramento
- 2 Days at Vertical Lift Railroad Bridge – Oakland
- Taught Safe Access to Tainter Gate & Bridge Components
- Written Tests & Field Evaluation Forms

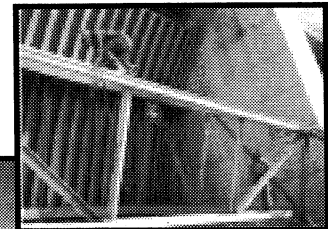
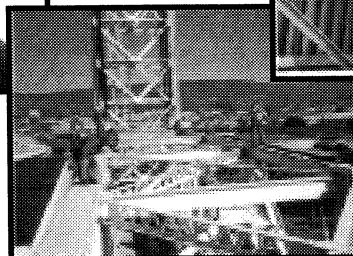
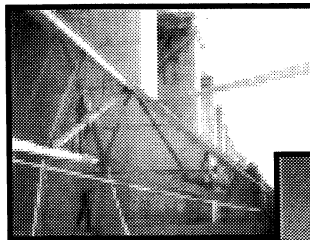

# ***Dam Inspection: 1960-2000***

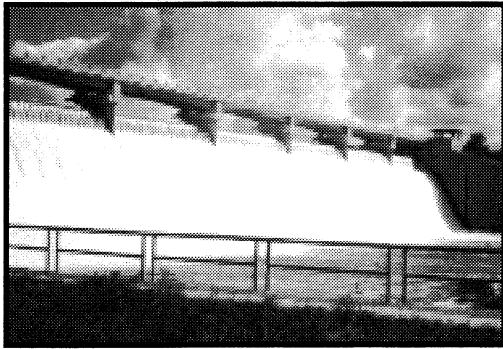

Hoover Dam, Columbus, OH

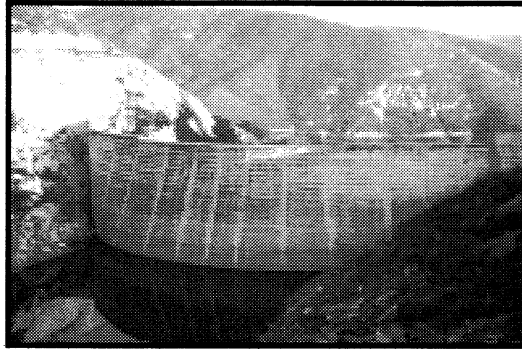

Loveland Dam, San Diego, CA

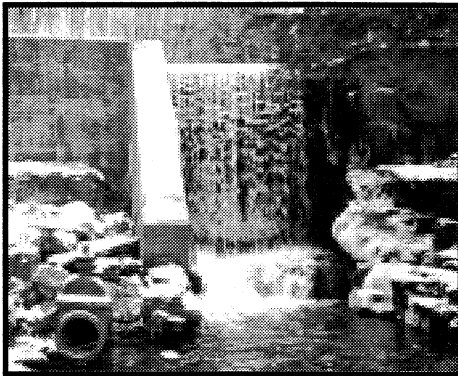

Reeds Pond Dam, Susquehanna, PA

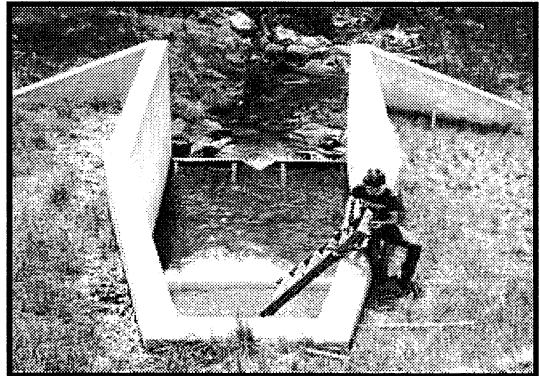

Cacapon St. Pk. Dam, Berkely Springs, WV

## ***350 Assignments in 13 States Since 1960***

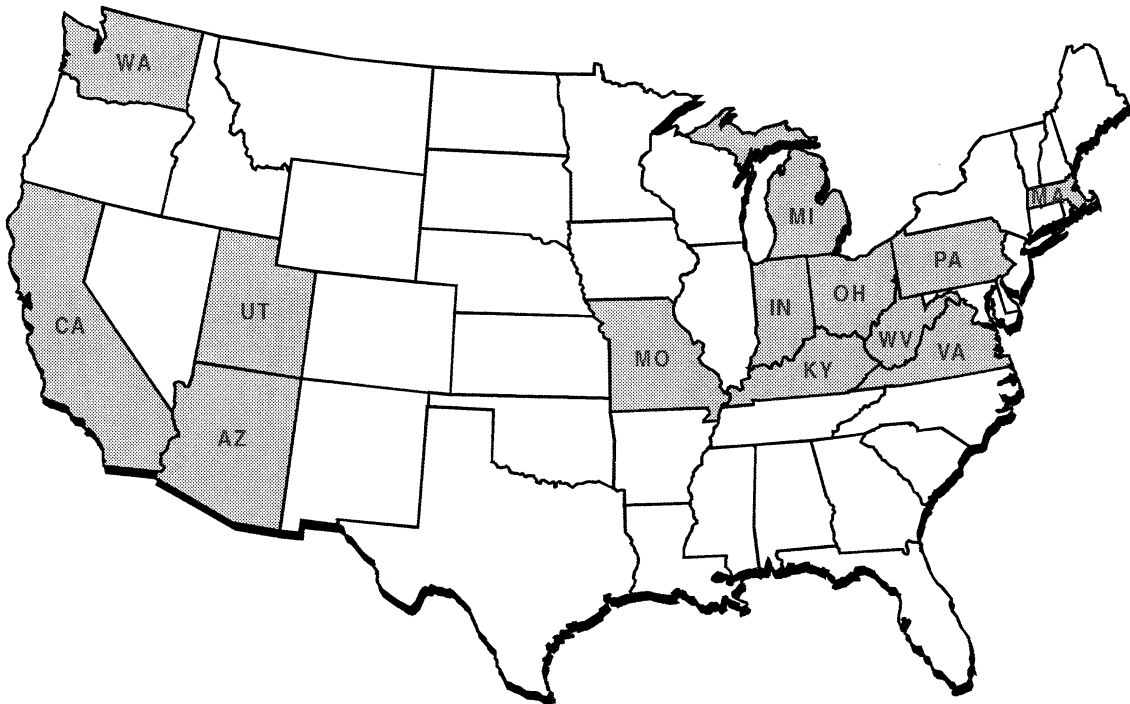

## ***Federal Agency Dam Safety Inspections***

- **U.S. Army Corps of Engineers for Louisville, Detroit & Pittsburgh Districts**
  - 53 Phase I Dam Safety Inspections in IN, MI & OH
- **Federal Energy Regulatory Commission**
  - Personnel Approved by FERC as Independent Consultants for Periodic Dam Safety Inspections

## ***City of Indianapolis, Indiana*** **Eagle Creek Dam Spillway Rehabilitation**

- 280-Foot Wide Concrete Spillway with 6 Tainter Gates
- Access by Climbing
- Sounded Concrete & Mapped Deterioration
- Tested Samples of Rubber Seals
- Prepared Rehab Plans

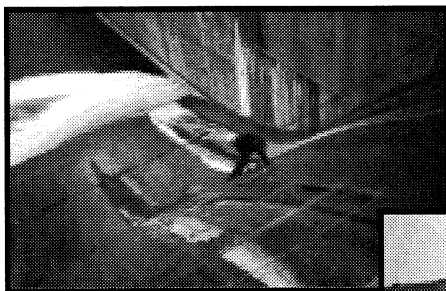

# ***Stadium Inspection: 1979-2000***



Cincinnati Riverfront Stadium



West Virginia University,  
Mountaineer Stadium

## ***City of Cincinnati & West Virginia University*** **Riverfront & Mountaineer Stadiums**

- **Hands-On, In-Depth Inspection**
- **Computerized Database Management System**
  - **Identifies Deficiencies on Photos & Plans**
  - **Prioritizes Repairs by Severity & Cost**
  - **Schedules Maintenance, Repairs & Future Inspections**

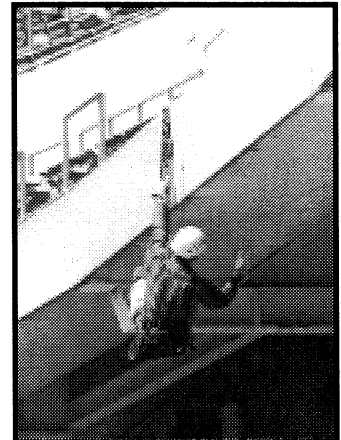
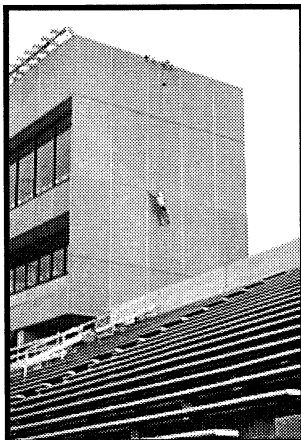



## ***Facility Inspection & Training Attributes***

- **Providing Services for 50 Years**
- **National Leader in Inspection**
- **Structural Engineers Perform Inspections**
- **Hands-On Access by Climbing**
- **Clients Involved with Projects**

# ***Dam Inspection: 2000 & Beyond***

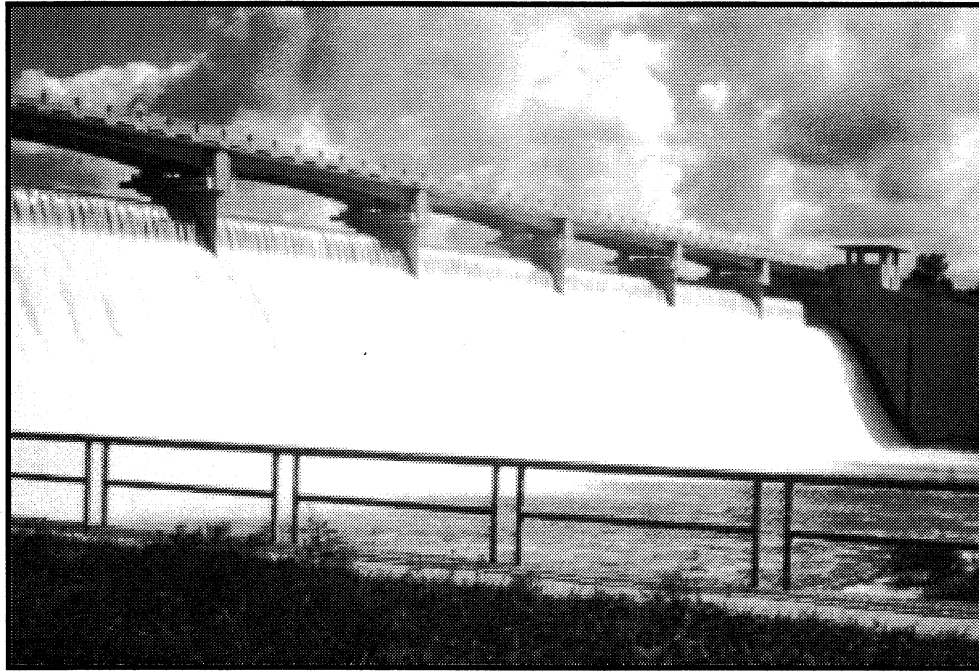

## ***Ohio Department of Natural Resources 10 Lock & Dam Structures***

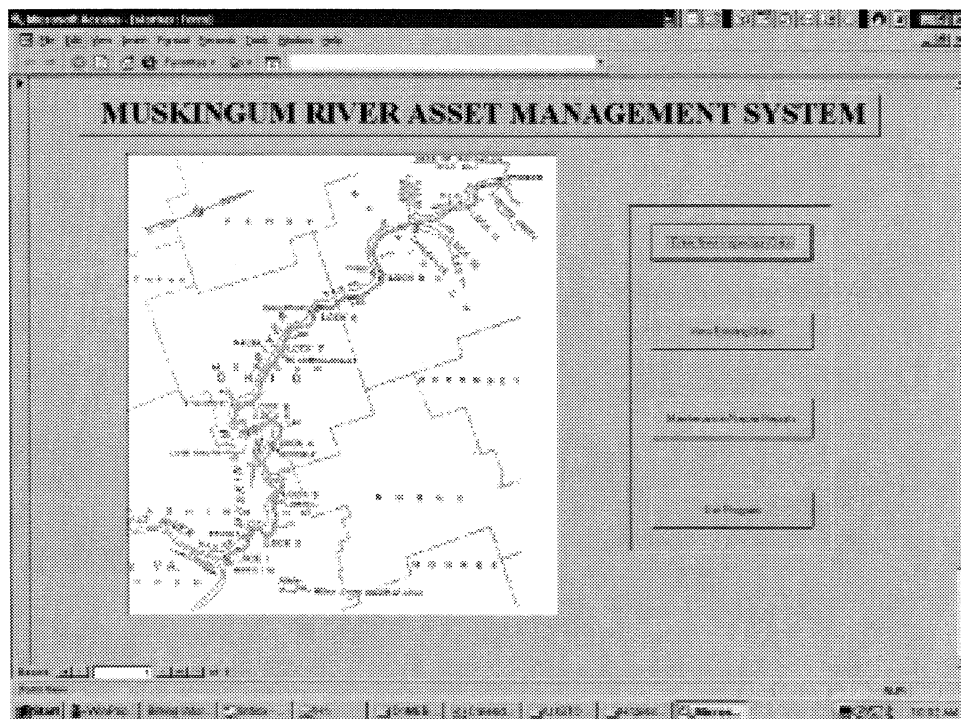



# Ohio Department of Natural Resources

## 10 Lock & Dam Structures

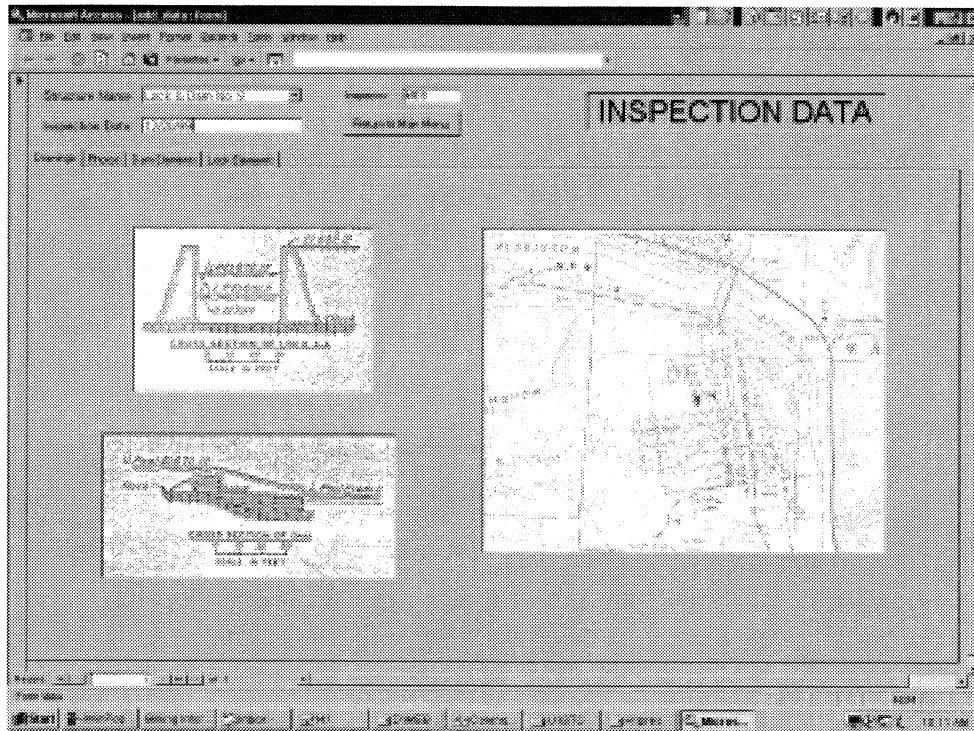

# Ohio Department of Natural Resources

## 10 Lock & Dam Structures



# Ohio Department of Natural Resources

## 10 Lock & Dam Structures

Microsoft Access [data - dsn:dbase1.mdb]

Structure Name: [Lock & Dam No. 3] Inspector: [44]

Inspection Date: [1/20/97] [Print to New Menu]

Database: [Data] Tables: [Lock Tables]

Element	Condition Rating	Maintenance/Remarks	Inspect. Notes	Repair Cost	Inspect. Status	Comments
Structure Surface	[1]	Remove structural concrete and patch cracks	Good	\$0.000.00	OK	Approximately 50% of 12 steel members require repairs
Concrete Piers	[1]		Good			
Concrete Spillway	[1]		Good			
Lock Gates	[1]		Good			
Right Approach	[1]		Good			

Microsoft Access [data - dsn:dbase1.mdb]

## U.S. Army Corps of Engineers

Engineer Regulation 1110-2-8157

Responsibility for Hydraulic Steel Structures (HSS)

January 31, 1997

- HSS Includes:
  - Lock Gates
  - Dam Spillway Gates
  - Tainter Gates
  - Flood Protection Gates
  - Stoplogs
  - Bulkheads
  - Lifting Beams
  - Operating Machinery
- Primary Distress – Fatigue Damage and/or Fracture
- Fatigue Cracking
  - Lack of Proper Detailing During Design
  - Poor Weld Quality During Fabrication
  - Poor Detailing & Execution of Repairs
- Deficient Welds in Stoplogs & Bulkheads
- Secondary Distress – Corrosion
- HSS Inspection Cycles
  - Every 25 Years Minimum
  - Fracture Critical Members (FCMs) Every 5 Years

# ***U.S. Army Corps of Engineers***

**Engineer Regulation 1110-2-8157**

**Responsibility for Hydraulic Steel Structures (HSS)**

**January 31, 1997**

- **Inspection Plan – Member Priority**
  - 1 **FCMs with Life Safety Impacts**
  - 2 **Other FCMs**
    - **Primary Tension Members or Tension Flanges**
    - **Primary Compression Members or Compression Flanges**
    - **Secondary Structural Members**
    - **Non-Structural Items**
- **Inspection Methods**
  - **Prepare Access Plan**
  - **Crack Detection by Close Visual & Non-Destructive Testing (NDT) if Necessary**
  - **Cleaning Members if Necessary**
  - **NDT of FCM Welded Connections**
  - **NDT of Other Critical Members if Failure Would Result in Large Economical Losses**
  - **NDT if Cracks on Critical Members are Identified by Visual Means**

# ***U.S. Army Corps of Engineers***

**Engineer Regulation 1110-2-8157**

**Responsibility for Hydraulic Steel Structures (HSS)**

**January 31, 1997**

- **Inspection Types**
  - **Operations – Frequent Inspection of Project Features**
  - **Routine – Periodic Inspection (ER 1110-2-100)**
    - **Regularly Scheduled**
    - **Sufficient Observations & Measurements to Determine Physical & Functional Condition of HSS**
    - **Note Changes from Previous Conditions**
    - **Identify Developing Problems**
    - **Ensure Structure Continues to Satisfy Present Service Requirements**
    - **Closely Examine Critical Components of HSSs Whose Failure Could Result in Loss of Life**
  - **Initial FCM – Special Inspection of Each FCM Whose Failure Would Result in Probable Loss of Life**
    - **Ensure FCMs & Connections Were Properly Fabricated & There Are No Defects**
    - **Damage – Special Inspection to Assess Structural Damage from Natural Causes, Accidents or Normal Wear**

# ***U.S. Army Corps of Engineers***

**Engineer Regulation 1110-2-8157**

**Responsibility for Hydraulic Steel Structures (HSS)**

**January 31, 1997**

- **Inspection Frequency**
  - **Initial FCM Inspection of Stoplogs, Bulkheads & Lifting Beams Completed Prior to Next Use**
  - **Initial FCM Inspection of Other HSS Completed By 12-31-98**
  - **Subsequent FCM Inspections Every 5 Years**
  - **Periodic Inspection Requires Dewatering & Thorough Examination of HSS Every 25 Years**
- **Inspection Evaluation**
  - **When Distress of a HSS is Noted, Evaluate Adequacy of Structure to Ensure Public Safety & Reliable Project Function**
  - **ER 1110-2-101 Defines Procedures to be Followed When Reporting Evidence of Distress**

# ***U.S. Army Corps of Engineers***

**Engineer Regulation 1110-2-8157**

**Responsibility for Hydraulic Steel Structures (HSS)**

**January 31, 1997**

- **Inspection Report**
  - **Report Prepared for Each HSS Inspection & Included in Next Periodic Inspection Report**
  - **Report to Identify Structure, Inspection Date, Results of Inspection Evaluation and Recommendations**
  - **Report to Describe All Modifications or Repairs, Including Weld Inspection Results Since Last Inspection**
  - **Report to Include NDT Reports, Photographs and Radiographs**



**US Army Corps  
of Engineers**

SUTTON LAKE  
SERVICE BRIDGE  
PERIODIC INSPECTION REPORT NO. 2  
ELK RIVER, WEST VIRGINIA

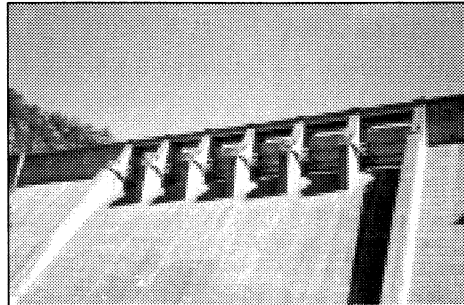

10 SEPTEMBER 1999

GREAT LAKES AND OHIO RIVER DIVISION  
HUNTINGTON DISTRICT

**BRIDGE INSPECTION FORM**

Date: 10 September 1999      Structure No: CUMORSHWVMS010  
 Inspector: F. Hubert A. Harvey      Structure Name: Service Bridge  
 Weather: Sunny      Location: Sutton Lake, WV  
 Features Inspected: Sutton Lake      ADP/Year: 1927/1992

58 OVERALL DECK CONDITION RATING: N 9(7) 6 5 4 3 2 1 0

Comments: \_\_\_\_\_

Deck Elements	Rating			Remarks
	Good	Fair	Poor	
Wearing Surface	(G)	F	P	N/A
Deck - Topside	(G)	F	P	N/A
Deck - Underside	(G)	F	P	Structural cracks
SP Form	(G)	F	P	N/A
Curb	(G)	F	P	N/A
Medians	(G)	F	P	Minor spalling and cracking
Sidewalks	(G)	F	P	N/A
Parapets	(G)	F	P	Minor spalling and cracking
Railing	(G)	F	P	N/A
Expansion Joint	(G)	F	P	N/A
Drainage System	(G)	F	P	Debris in pipes
Lighting	(G)	F	P	N/A
Utilities	(G)	F	P	N/A
	(G)	F	P	N/A

72 APPROACH ROADWAY ALIGNMENT APPRAISAL RATING: N 9(7) 6 5 4 3 2 1 0

Comments: \_\_\_\_\_

Approach Elements	Rating			Remarks
	Good	Fair	Poor	
Pavement Condition	(G)	F	P	N/A
Vert. Align. (Left)	(G)	F	P	N/A
Horiz. Align. (Left)	(G)	F	P	N/A
Vert. Align. (Right)	(G)	F	P	N/A
Horiz. Align. (Right)	(G)	F	P	N/A
Speed Limit @ _____ MPH	(G)	F	P	N/A
Signs & Road Markings	(G)	F	P	N/A

56 OVERALL SUPERSTRUCTURE CONDITION RATING: N 9(7) 8 5 4 3 2 1 0

Comments: \_\_\_\_\_

# ***Proposed Gate Inspection Program***

- **Inspection Guideline Manual**
  - Gate Component List & Drawings
  - Gate Component Description & Inspection
  - Inspection Procedures
- **Data Input & Documentation Forms**
- **Report Formats**
- **Computerized Management System**

## ***Proposed Gate Inspection Program*** **Gate Component List**

### Primary Structural Members

Horizontal Girders

End Frames

Trunnion Assembly

Lifting Bracket Assembly

### Secondary Structural Members

Skin Plate

Chain/Cable Bearing Plate

Ribs

Diagonal Bracing

Seals

Side Seal

Side Seal Guide

Bottom Seal

Sill Beam

### Substructure

Pier

Crest

Spillway

Trunnion Girder

Bulkhead Guides

### Mechanical

Cable U-bolts

Socket Blocks

Cables

Cable Drum

Bearings

Torque Reducer

Coupling

Torque Shaft

Brake

Limit Switches

Position Indicator

Generator

### Electrical

Motors

Brakes

Limit Switches

Wiring

Fuses

Control Panel

### Miscellaneous

Side Seal Heater

Air Bubbler System

# Proposed Gate Inspection Program

## Gate Component Drawings

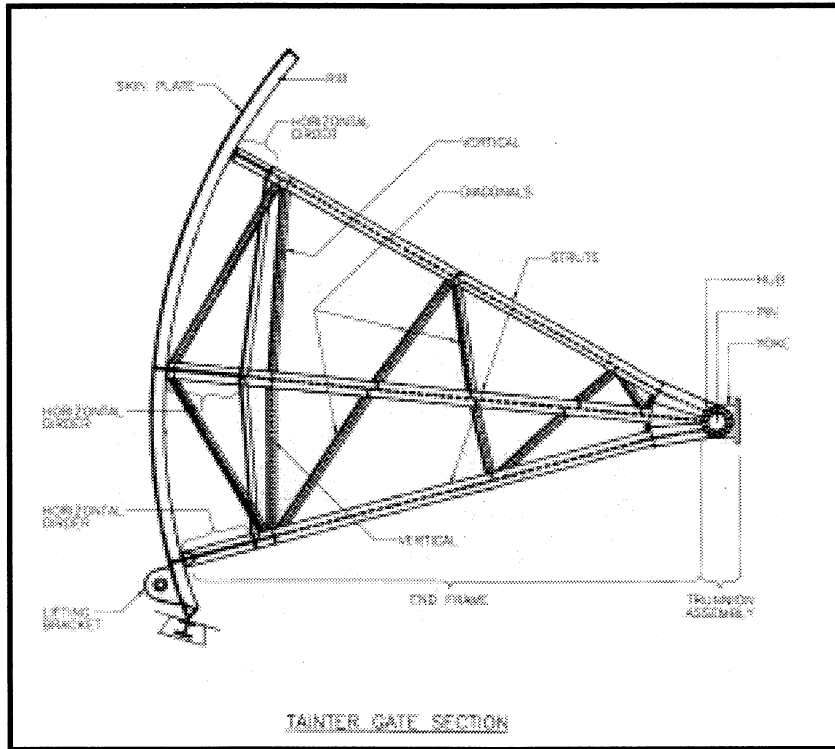

# Proposed Gate Inspection Program

## Gate Component Drawings

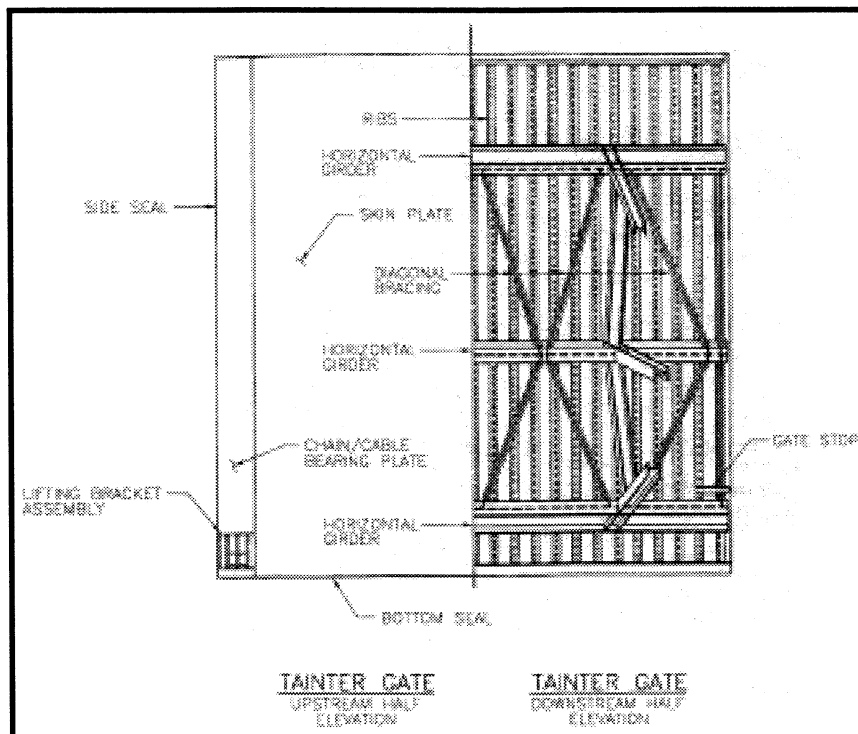

# Proposed Gate Inspection Program

## Gate Component Drawings

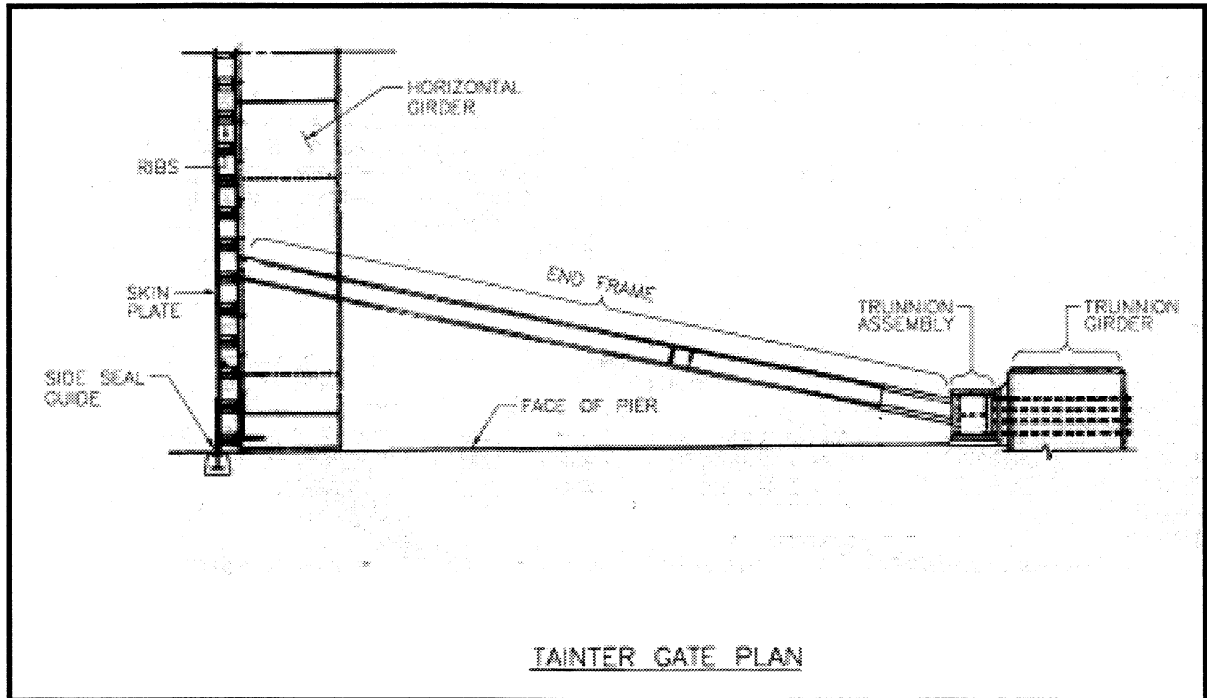

# Proposed Gate Inspection Program

## Gate Component Drawings

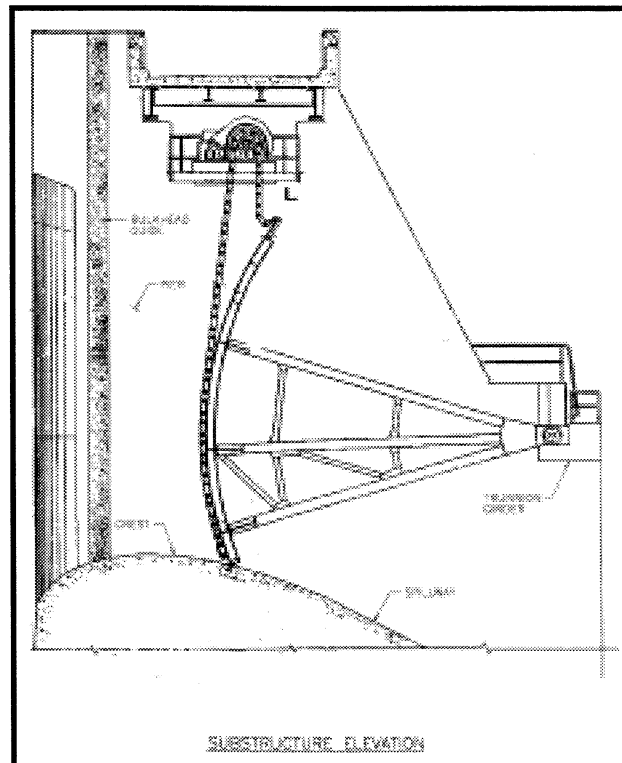



# Proposed Gate Inspection Program

## Gate Component Description & Inspection

### Primary Structural Members

**Horizontal Girders** – Horizontal member designed to take the load from the ribs and transmit them to the End Frames. The Horizontal Girders are supported by the End Frames at 1/5 of the Girder span length in from each end. This distance to supports minimizes bending stresses from being transferred into the end frames which would cause binding on the trunnion.

Inspection: Evidence of bending due to overload. Water ponding on member due to missing or clogged weep holes. Corrosion developing at connections with the ribs, struts and bracing causing section loss of the member or overstress of the connection.

**End Frames** – Transfers the load from the Horizontal Girders to the Trunnion. The end frames consist of Struts, which extend radial from the Trunnion, Diagonals and Verticals. The Diagonals and Verticals brace the struts and carry the shear load of the End Frames between the Lifting Bracket and Trunnion.

Inspection: Evidence of bending due to overload. End Frames should be inspected closely for evidence of buckling or cracks developing at the gusset plate to the Trunnion Hub. Water ponding on members due to missing or clogged weep holes. Corrosion developing causing section loss.

**Trunnion Assembly** – Trunnion Assembly consists of the Trunnion Hub, Pin and Yoke. The Trunnion carries the horizontal load from the End Frames to the Trunnion Girder. The Trunnion Assembly consists of a Hub around the Pin. The Pin connects the End Frame to the Trunnion Yoke. The End Frames are typically skewed from the point of connection with the Horizontal Girder to the Trunnion Assembly, causing a horizontal load downstream and a transverse load into the Pier at the Trunnion. The Hub typically has heavy flanges to transmit the horizontal load to the pin and the transverse load into the Pier. Grease fittings are installed in the Hub to allow for lubrication of the pin.

Inspection: Misalignment (both horizontal and transverse) between the Hub, Pin and Yoke. A solid grout pad between both the Trunnion Girder (for horizontal loads) and the Pier face (for transverse loads). A bushing should be present between the Hub and the Pin and Yoke. Any grease present in the Trunnion Assembly should be new and pliable. Water ponding on members and gusset plates at the Trunnion Assembly. Corrosion or loss occurring on the assembly.

**Lifting Bracket Assembly** – The Lifting Bracket Assembly consists of a bracket attached to the upstream face of the Taintor Gate near the Bottom Horizontal Girder. The bracket typically consists of a pin and connection with the Cable or Chain used to position the gate. A Lifting Bracket Assembly exists near both pier faces.

Inspection: Damage due to drift or ice.

# Proposed Gate Inspection Program

## Gate Component Description & Inspection

### Secondary Structural Members

**Skin Plate** – The Skin Plate consists of a steel plate used to hold back the water. The plate spans between the vertical Ribs and varies in thickness with the depth of water. Since the upstream face of the Skin Plate can be painted during periods of low water or with the installation of bulkheads, no allowance for section loss due to corrosion is made in the design. The Skin Plate also acts as the flange for the supporting Ribs.

Inspection: Corrosion occurring between the Skin Plate and the top flange of the Ribs. Corrosion or section loss of the Skin Plate. Damage due floating debris or ice. Broken welds between the Skin Plate and the Ribs.

**Cable/Chain Bearing Plate** – The Cable/Chain Bearing Plate is the Skin Plate under the lifting cable or chain. The plate is thicker than the Skin Plate due to the force of the cable and to account for any wear.

Inspection: Wear of the plate under the cable or chain. Corrosion or section loss of the Skin Plate.

**Ribs** – The Ribs consist of steel wide flange tees or standard rolled sections welded to the Skin Plate. Due to the possibility of corrosion developing between the Skin Plate and the rolled section flange, wide flange tees will generally require less maintenance. The vertical Ribs are supported by the Horizontal Girders. The Skin Plate acts as the top flange for the Ribs.

Inspection: Corrosion developing between the Skin Plate and the Ribs. Corrosion or section loss of the Ribs especially where the members are subject to spray from a leaking joint.

**Diagonal Bracing** – Diagonal Bracing consists of angles or other structural members attached to the downstream flange of the Horizontal Girders. The bracing is used to resist stresses when the gate is supported at one end and during field erection of the gate.

Inspection: Loose or buckled members. Corrosion or loss of members. Loose, broken or missing connection bolts.

# ***Proposed Gate Inspection Program***

## **Gate Component Description & Inspection**

**Seals** – The seals consist of the Side Seals and the Bottom Seal. The Side Seals are attached to the vertical edges of the gate and the Bottom Seal is sometimes used on the bottom of the gate. The Side Seals are made of a neoprene in the form of a “J” and are generally only visible from the upstream face of the gate. The Bottom Seal is bolted to the downstream face of the bottom of the gate. A Bottom Seal is often not used in dams for flood control as minimal leakage of water through the joint is not significant.

Inspection: Leaks between the Seal and the Seal Guide or Sill Beam. Wear, damage, or weathering of the Seals. Loose or missing connection bolts.

**Side Seal Guide** – Side Seal Guides consist of a corrosion resisting steel to provide a smooth surface for the Seals. The guides are imbedded in the pier walls and may have a heating system installed behind the guide plate.

Inspection: Deterioration of the grout adjacent to the Side Seal Guide plates. Nicks, corrosion, or pitting of the plates.

**Sill Beam** – The Sill Beam consists of a beam imbedded in the crest of the dam directly under the bottom edge of the Tainter Gate. The beam should be fabricated to have an exposed top flange composed of corrosion resisting steel and be positioned flush with the crest. The width of the beam top flange should be of such dimensions to accommodate the deflection of the Ribs and Bottom Horizontal Girder under different water levels.

Inspection: Deterioration of the grout adjacent to the Sill Beam top flange. Nicks, corrosion or pitting of the top flange. Bottom Seal or bottom of the Tainter Gate is within the limits of the Sill Beam under varying water levels.

---

# ***Proposed Gate Inspection Program***

## **Gate Component Description & Inspection**

### **Substructure**

**Pier** – The Pier consists of the vertical concrete units on either side of the Tainter Gate.

Inspection: Deterioration of the concrete due to freeze thaw damage. Spalls and cracks due to impact with floating debris, ice, equipment, etc.

**Crest** – The Crest consists of the top of the concrete dam under the Tainter Gate.

Inspection: Spalls, cracks or delamination of the concrete.

**Spillway** – The Spillway is the sloped concrete area downstream of the Tainter Gate. Water which passes over the Crest and past the Tainter Gate flows down the Spillway into the tail water of the dam.

Inspection: Deterioration of the concrete due to freeze thaw damage.

**Trunnion Girder** – The Trunnion Girder is the horizontal extensions from the pier which supports the Trunnion Yoke. The Trunnion Girder is heavily reinforced, often using prestress or post tension reinforcing. The Trunnion Girder resists the horizontal reaction from the water pressure acting on the Tainter Gate, as well as the vertical dead load of the gate and the torsion from the Trunnion Assembly when the gate is raised or lowered.

Inspection: Cracks and spalls developing in the Trunnion Girder. Deterioration of the concrete due to freeze thaw damage.

**Bulkhead Guides** – The Bulkhead Guides (also known as Stoplog Guides) are vertical slots made in the sides of the nosing of the Pier in the upstream side of the Tainter Gate. The Guides allow for the installation of a temporary wall to be installed to allow the upstream face of the Tainter Gate to be dewatered.

Inspection: Cracks or spalls developing in the concrete adjacent to the vertical guides.

# Proposed Gate Inspection Program

## Trunnion Assembly

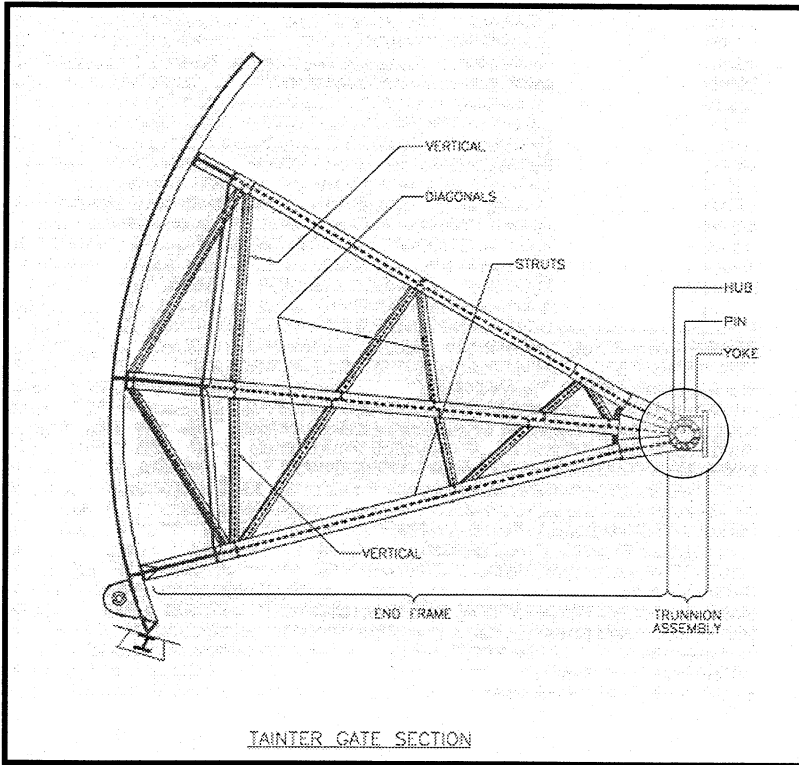

**Description:** Trunnion Assembly consists of the Trunnion Hub, Pin and Yoke. The Trunnion carries the horizontal load from the End Frames to the Trunnion Girder. The Trunnion Assembly consists of a Hub around the Pin. The Pin connects the End Frame to the Trunnion Yoke. The End Frames are typically skewed from the point of connection with the Horizontal Girder to the Trunnion Assembly, causing a horizontal load downstream and a transverse load into the Pier at the Trunnion. The Hub typically has heavy flanges to transmit the horizontal load to the pin and the transverse load into the Pier. Grease fittings are installed in the Hub to allow for lubrication of the pin.

**Inspection:** Misalignment (both horizontal and transverse) between the Hub, Pin and Yoke. A solid grout pad between both the Trunnion Girder (for horizontal loads) and the Pier face (for transverse loads). A bushing should be present between the Hub and the Pin and Yoke. Any grease present in the Trunnion Assembly should be new and pliable. Water ponding on members and gusset plates at the Trunnion Assembly. Corrosion or loss occurring on the assembly.

# Proposed Gate Inspection Program

## Gate Inspection Form

**Tainter Gate Inspection Form**

Date: \_\_\_\_\_  
 Temperature: \_\_\_\_\_  
 Inspector: \_\_\_\_\_  
 Location: \_\_\_\_\_

**STRUCTURAL PARTS**

\_\_\_\_\_

\_\_\_\_\_

Structural Component	Rating	Remarks/Photo
End Frame		
Trunnion Assembly		
Trunnion Hub		
Trunnion Pin		
Trunnion Yoke		
Trunnion Girder		
Trunnion Bolt		
Trunnion Nut		
Trunnion Washer		
Trunnion Gasket		
Trunnion Seal		
Trunnion Grease		

**MECHANICAL PARTS**

\_\_\_\_\_

\_\_\_\_\_

Mechanical Component	Rating	Remarks/Photo
Hub		
Pin		
Yoke		
Girder		
Strut		
Diagonal		
Vertical		
End Frame		
Trunnion Assembly		
Trunnion Hub		
Trunnion Pin		
Trunnion Yoke		
Trunnion Girder		
Trunnion Bolt		
Trunnion Nut		
Trunnion Washer		
Trunnion Gasket		
Trunnion Seal		
Trunnion Grease		

**MECHANICAL PARTS**

\_\_\_\_\_

\_\_\_\_\_

Mechanical Component	Rating	Remarks/Photo
Hub		
Pin		
Yoke		
Girder		
Strut		
Diagonal		
Vertical		
End Frame		
Trunnion Assembly		
Trunnion Hub		
Trunnion Pin		
Trunnion Yoke		
Trunnion Girder		
Trunnion Bolt		
Trunnion Nut		
Trunnion Washer		
Trunnion Gasket		
Trunnion Seal		
Trunnion Grease		

**STRUCTURAL PARTS**

\_\_\_\_\_

\_\_\_\_\_

Structural Component	Rating	Remarks/Photo
End Frame		
Trunnion Assembly		
Trunnion Hub		
Trunnion Pin		
Trunnion Yoke		
Trunnion Girder		
Trunnion Bolt		
Trunnion Nut		
Trunnion Washer		
Trunnion Gasket		
Trunnion Seal		
Trunnion Grease		

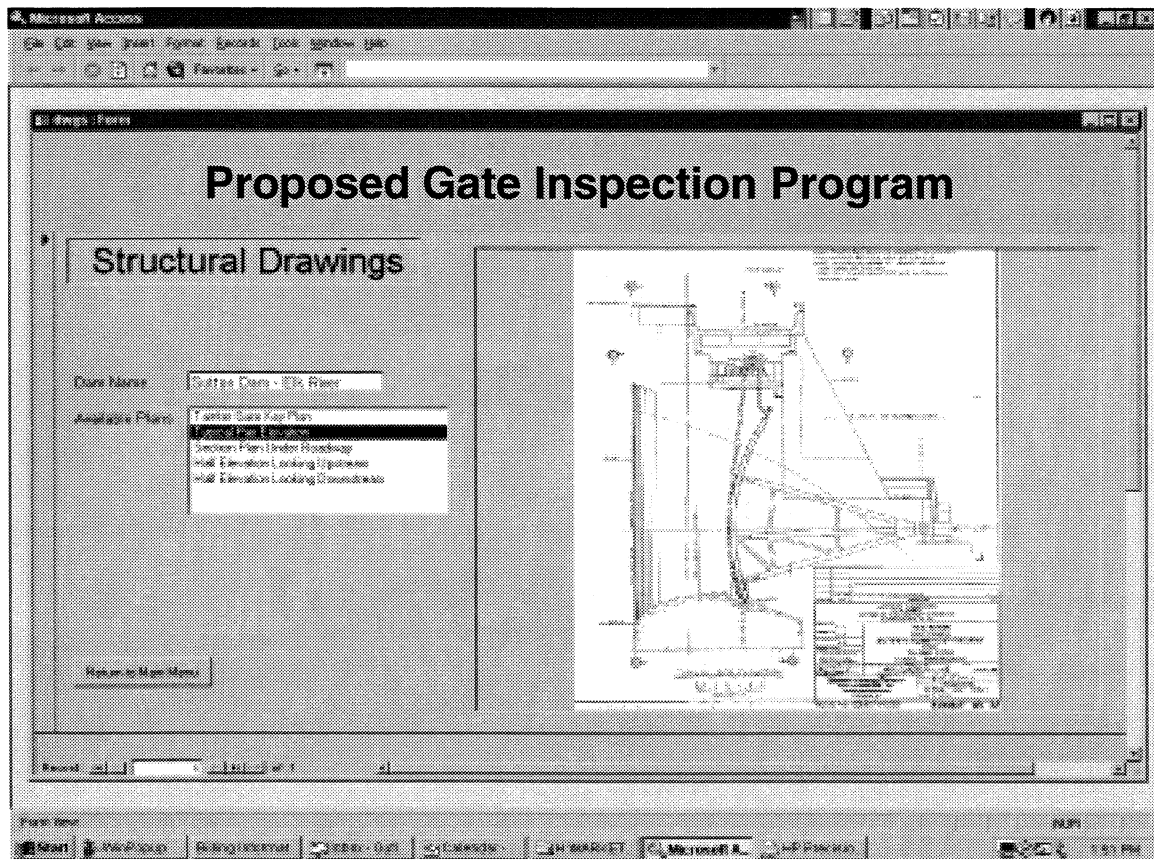
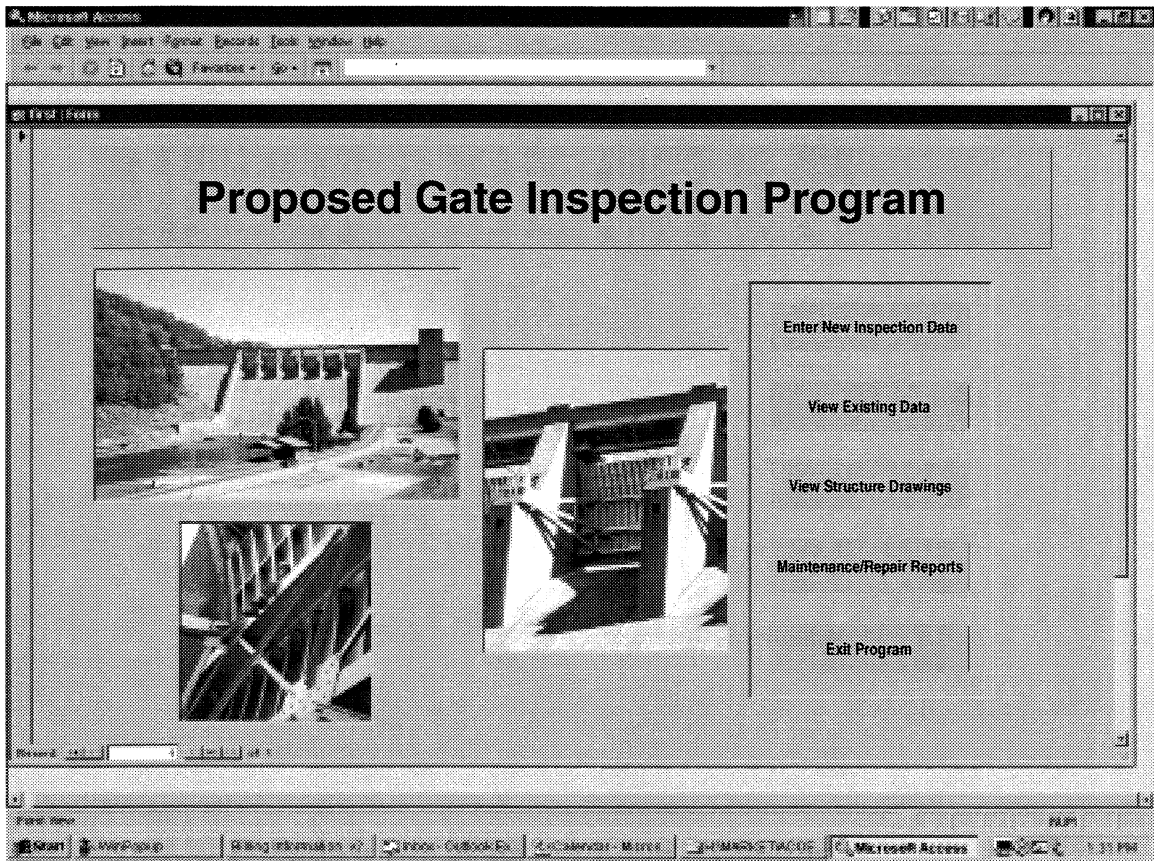

Microsoft Access - [add\_data1.ste] | Go Edit View Print Format Record Data Window Help

## Proposed Gate Inspection Program

**Inspection Data Input**

Dam Name:  Inspected By:   
Inspection Date:  Weather:   
Rain:  Temperature:   
Location:  [Database Main Menu](#)

### PRIMARY STRUCTURAL ELEMENTS

ELEMENT	CONDITION RATING	COMMENTS	SEVERITY PRIORITY	RECOMMENDATION	PROPOSED BY
Horizontal Under	<input type="text" value="Good"/>	No significant deficiencies noted.	<input type="text" value="N/A"/>	<input type="text" value="None"/>	<input type="text" value="B&amp;N"/> B&N
End Plates	<input type="text" value="Fair"/>	Light surface corrosion and patching present between plates. Patchwork indicates approx. 1/8"	<input type="text" value="Maintenance"/>	<input type="text" value="Monitor"/>	<input type="text" value="B&amp;N"/> B&N
Traverse Assembly	<input type="text" value="Fair"/>		<input type="text" value="2"/>		
Lifting Bracket Assembly	<input type="text" value="Fair"/>		<input type="text" value="2"/>		

### SECONDARY STRUCTURAL ELEMENTS

ELEMENT	CONDITION RATING	COMMENTS	SEVERITY PRIORITY	RECOMMENDATION	PROPOSED BY

Name:  Title:   
Print Date:  12/20/99 12:59 PM

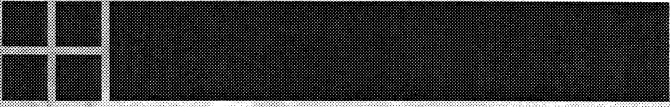
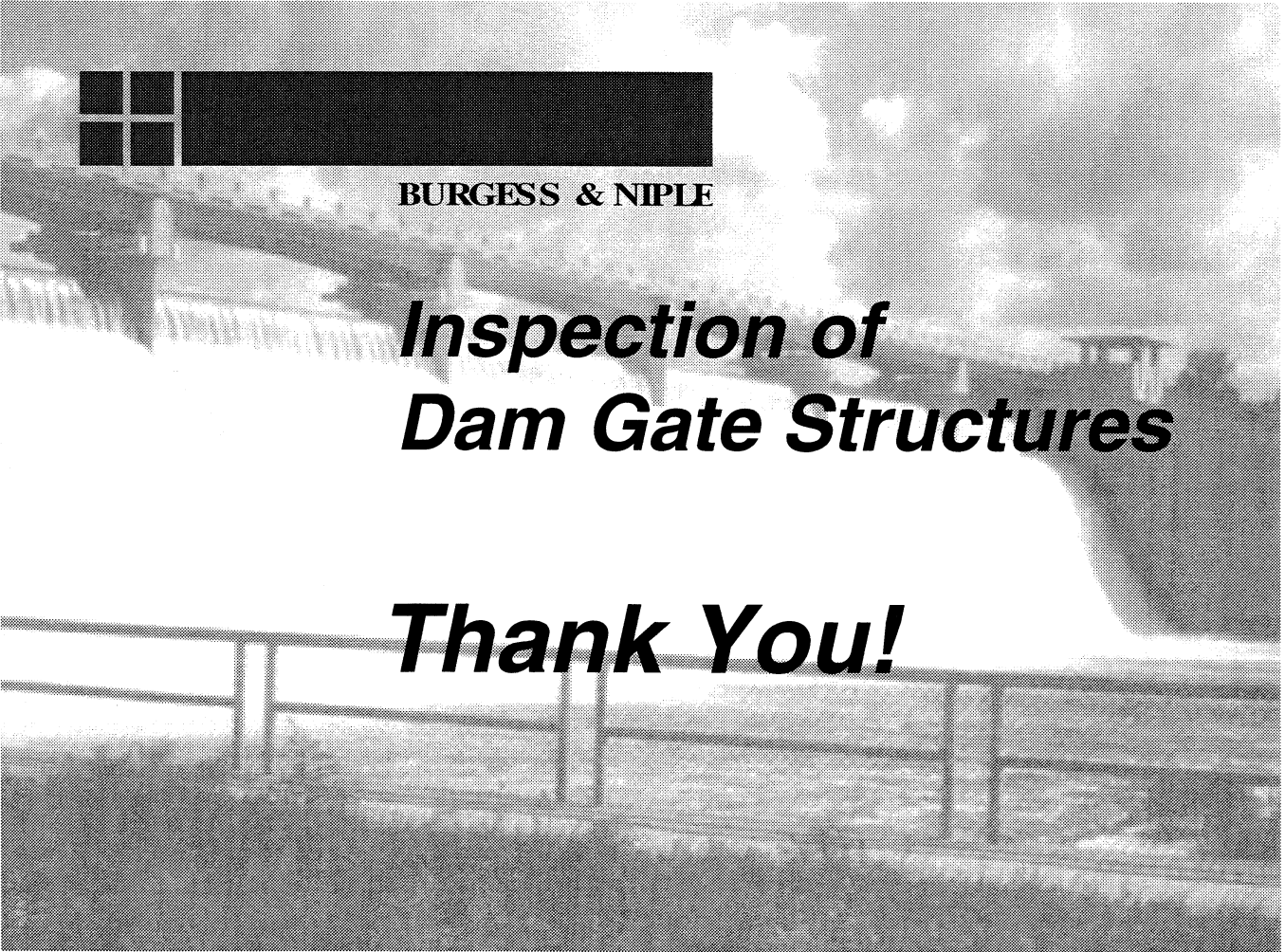

**BURGESS & NIPLE**

*Inspection of  
Dam Gate Structures*

*Thank You!*

## **Radial Gate Inspections**

*Wayne Edwards  
HDR Engineering, Inc.*

# Radial Gate Inspections

---

Wayne D. Edwards

January 6, 2000



## Inspection of Radial Gates

---

- Review Background Information
- Inspect Gates
- Perform Structural Analysis
- Implement Improved Maintenance
- Evaluate Rehabilitation Alternatives

# Background Information

---

- Construction drawings
- Shop drawings
- Design calculations
- Fabrication and installation specifications
- Operating procedures
- Operating history
- Maintenance history

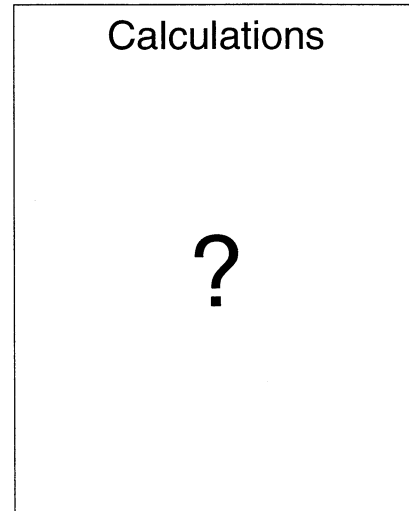

---

# Gate Inspection

---

- Assess condition of members and connections
- Verify as-built conditions
- Use safe climbing techniques and equipment
- Document observations



# Climbing Training

---

- Five day training course
- \$1,500 per person for tuition
- \$1500 per person for equipment
- Annual 8-hour re-certification training

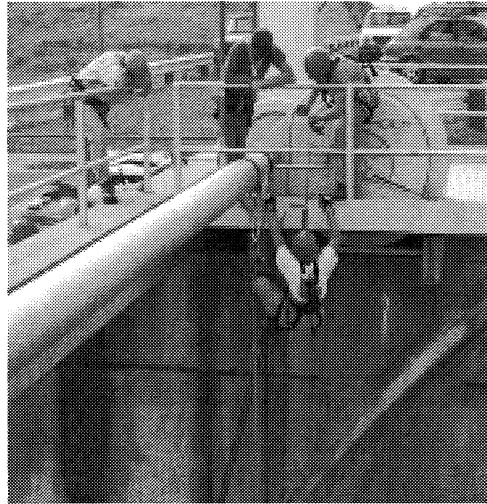

# Climbing Equipment

---

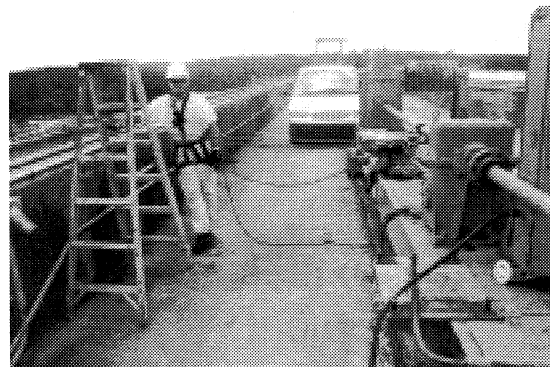

# Inspection Plan

---

---

- Access and rigging
- Work hours
- Operator Support
- Safety Plan
- QC Plan

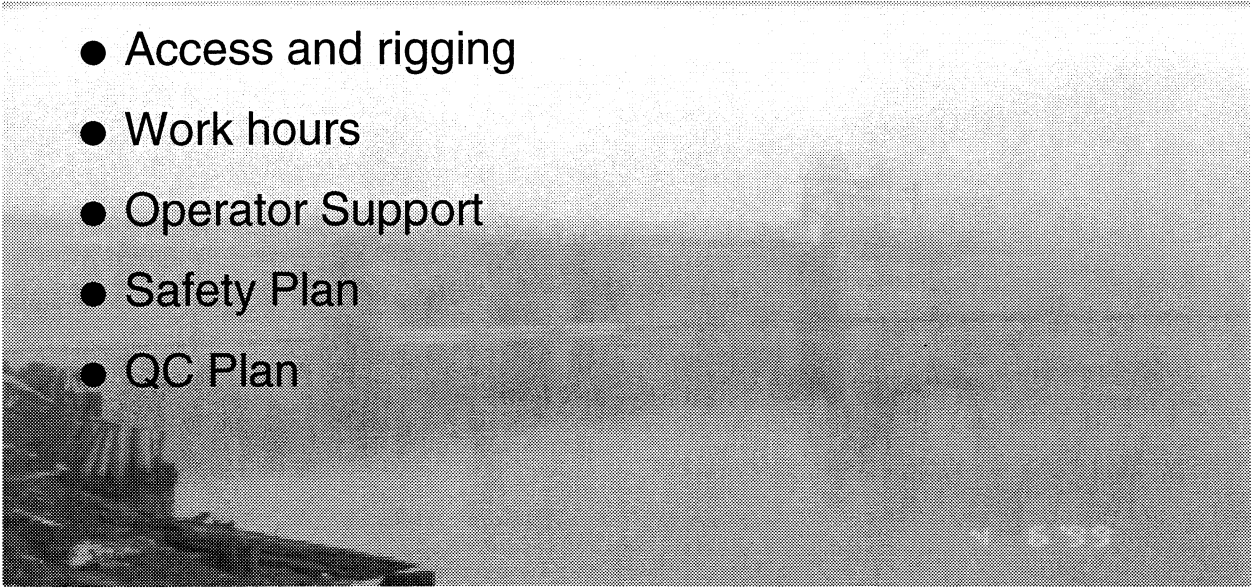

# Inspection Climbing

---

---

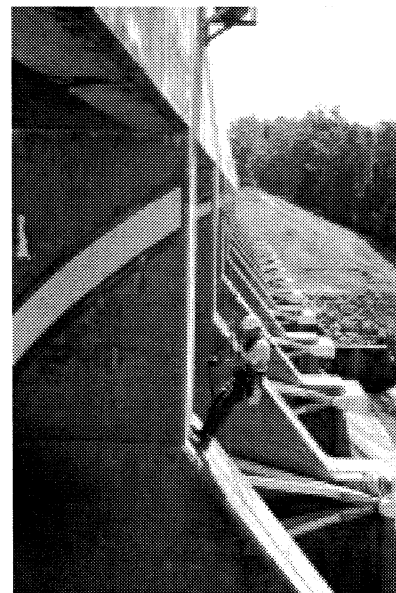
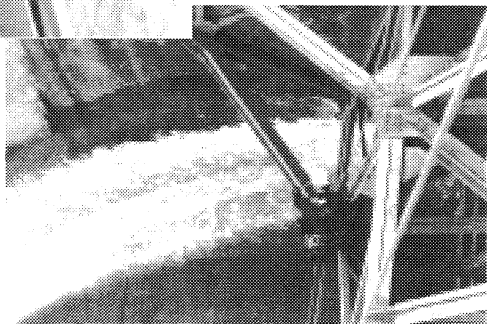

# Inspection Climbing

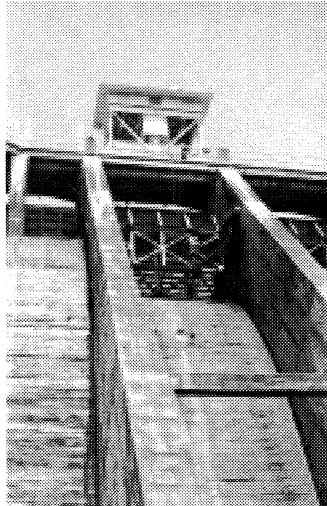

## Field Data Sheet



HDR Engineering, Inc.  
Southern Company - Georgia Power  
Bartlett's Ferry Dam Inspection

Inspection Team \_\_\_\_\_ Date \_\_\_\_\_  
Weather \_\_\_\_\_ Sheet \_\_\_\_\_

Gate No. \_\_\_\_\_ Left Frame A-A

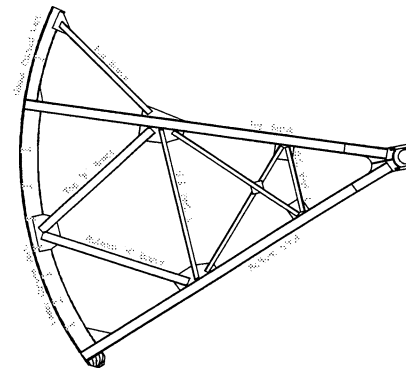

Notes:

\_\_\_\_\_

\_\_\_\_\_

\_\_\_\_\_

\_\_\_\_\_

\_\_\_\_\_

\_\_\_\_\_

\_\_\_\_\_

\_\_\_\_\_

Member	Type	Depth		Web		Flange(s)			
		Plan (in)	Measured (in)	Plan (in)	Measured (in)	Plan (in)	Measured (in)	Plan (in)	Measured (in)
Upper - Curved Vertical	C 8x13.75	8		5/16		2 - 3/8		3/8	
Lower - Curved Vertical	C 12x25	12		3/8		3		1/2	
Top Brace	C 5x9.0	5		5/16		1 7/8		5/16	
	L 4x3x3/8	4		3/8		3		3/8	
Top Strut	2 - C 7x16.4	7		5/16		3		3/8	
Bottom Strut	2 - C 7x16.4	7		5/16		3		3/8	
Top Front "K" Bracing	C 6x10.5	6		5/16		2		3/8	
	L 5x3x3/8	5		3/8		3		3/8	
Bot. Front "K" Bracing	C 6x10.5	6		5/16		2		3/8	
	L 5x3x3/8	5		3/8		3		3/8	
U.S. Vertical Angle	L 3x3x3/8	3		3.8		3		3/8	
D.S. Vertical Angle	L 3x3x3/8	3		3.8		3		3/8	
"X" Bracing Angles	L 3x3x3/8	3		3.8		3		3/8	
	L 3x3x3/8	3		3.8		3		3/8	

# Inspection Report

---

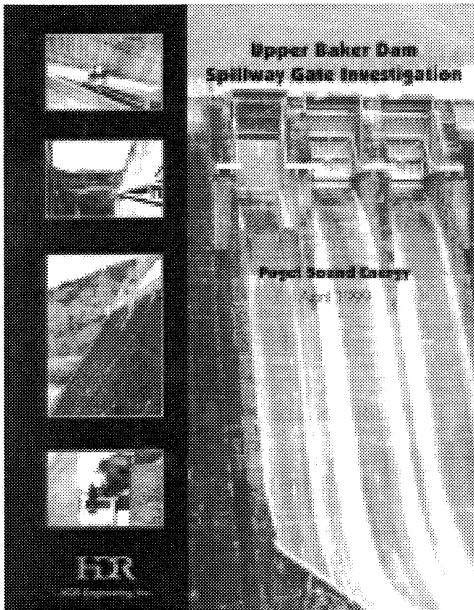

- 1) INTRODUCTION
  - Purpose
  - Scope of Investigation
  - Limitations
- 2) PROJECT BACKGROUND
  - Project Description
  - Gate Design and Construction
  - Gate Operation
  - Gate Maintenance
- 3) GATE INSPECTION
  - Procedures
  - Gates 1 through 24 - General Observations
  - Gates 1 through 24 - Individual Observations
- 4) RECOMMENDATIONS
- 5) FIELD INSPECTION SHEETS
- 6) AS-BUILT DRAWINGS

---

## Photo Documentation

---

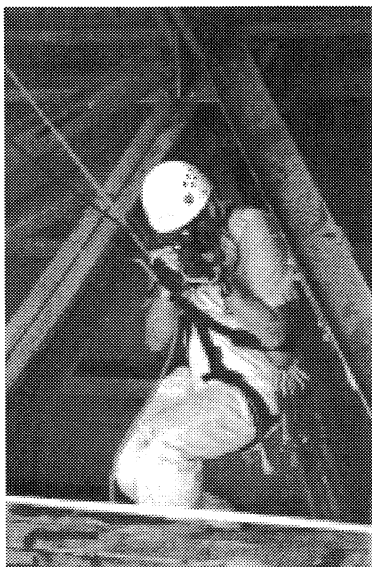

# Deformed Gate Members

---

---

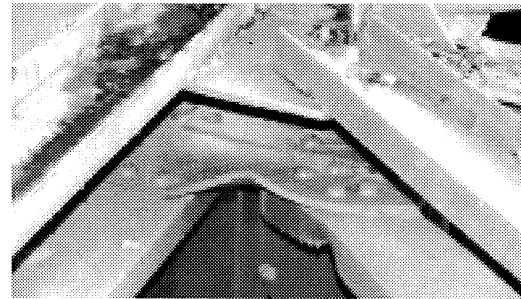
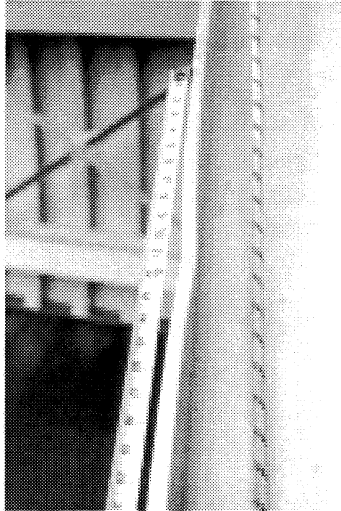

# Modified Gate Members

---

---

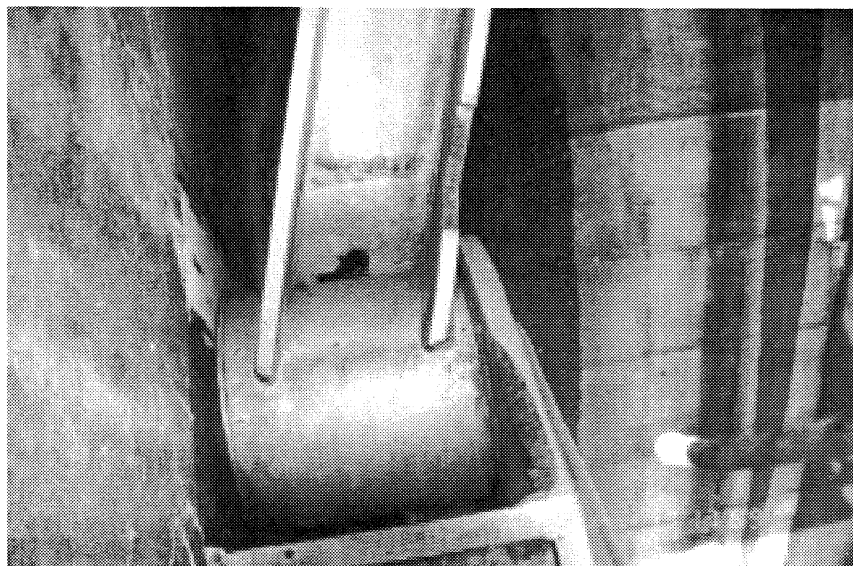

# Cracked Welds

---

---

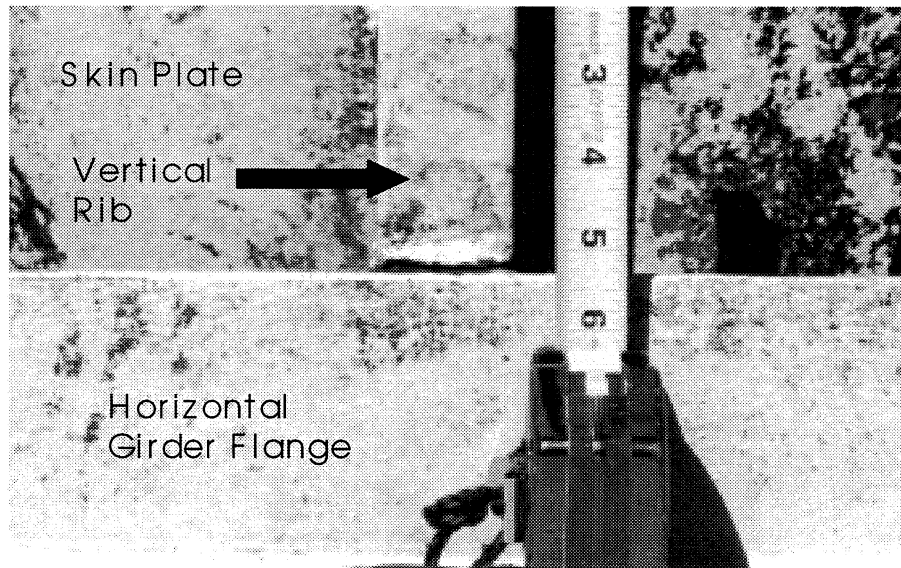

# Missing Bearing Pin

---

---

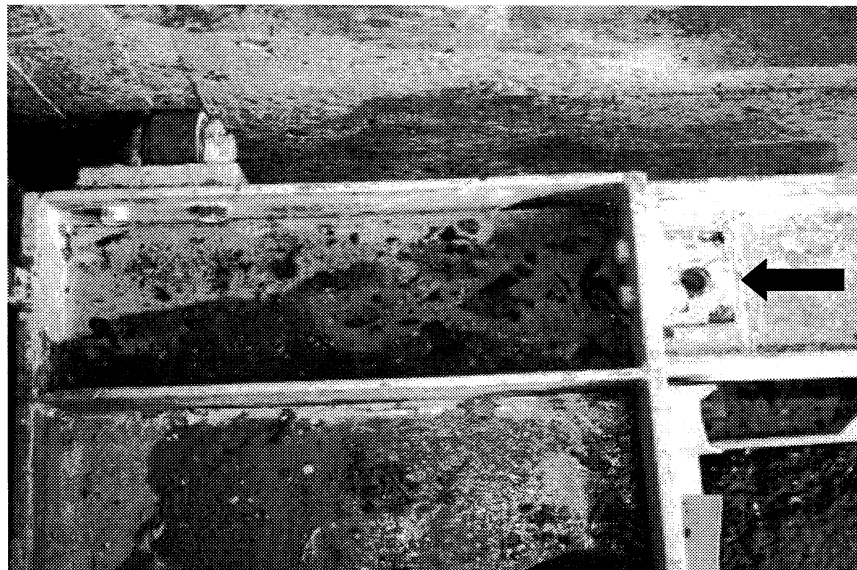

# Corroded Gate Members

---

---

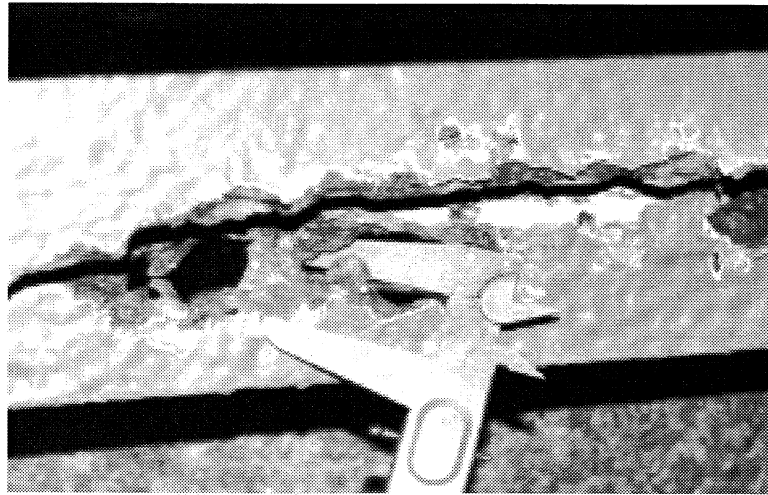
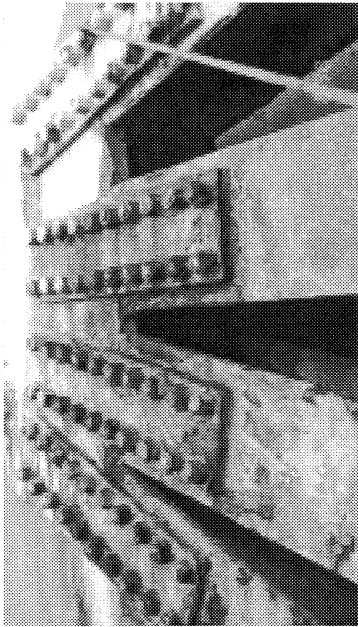

# Corroded Gate Members

---

---

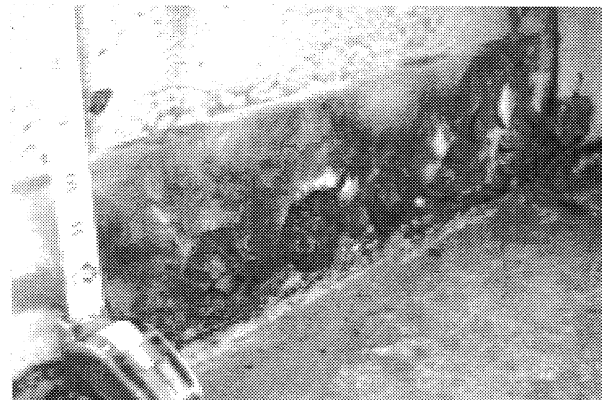
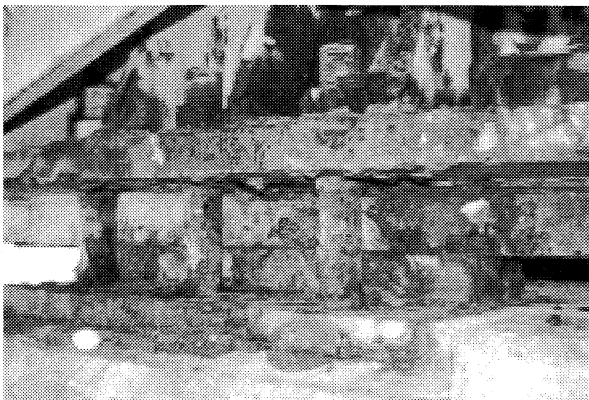

# Inadequate Drainage

---

---

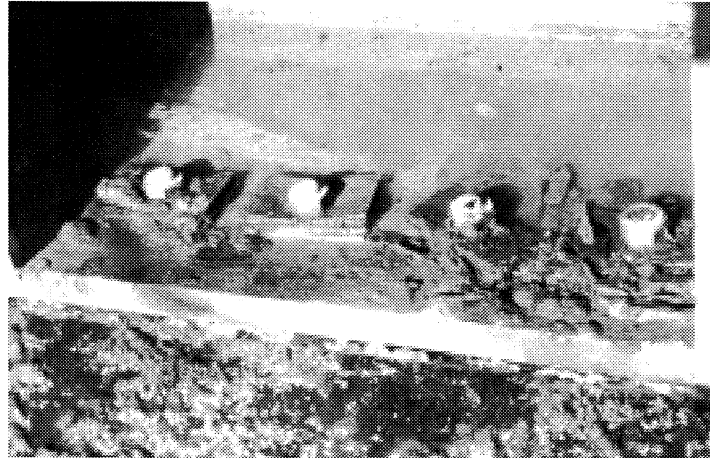

# Inadequate Drainage

---

---

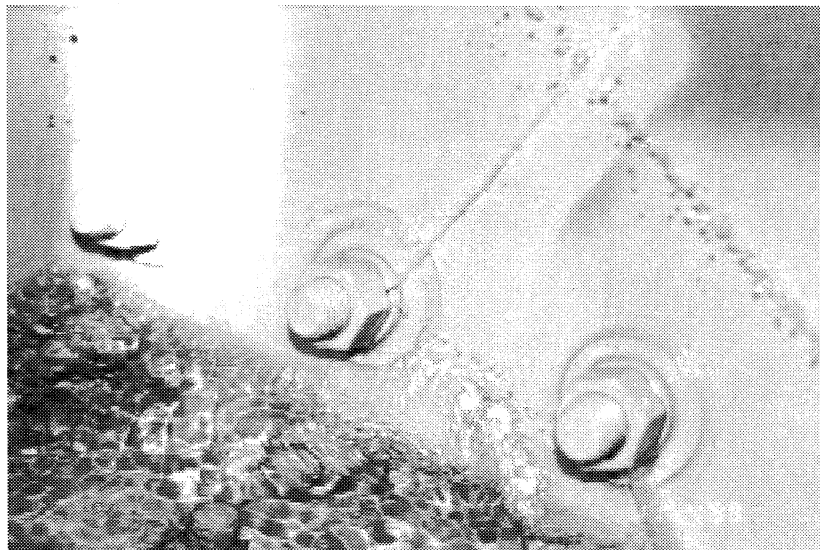



## Inadequate Trunnion Lubrication

---

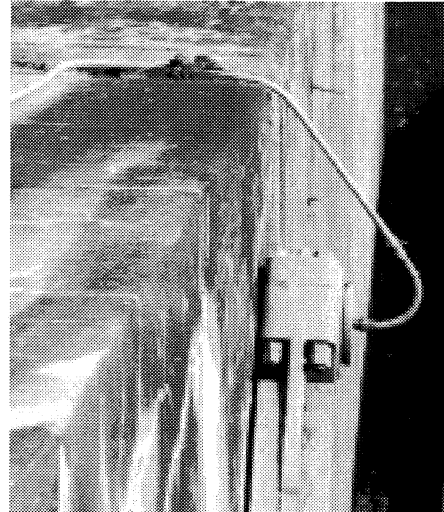
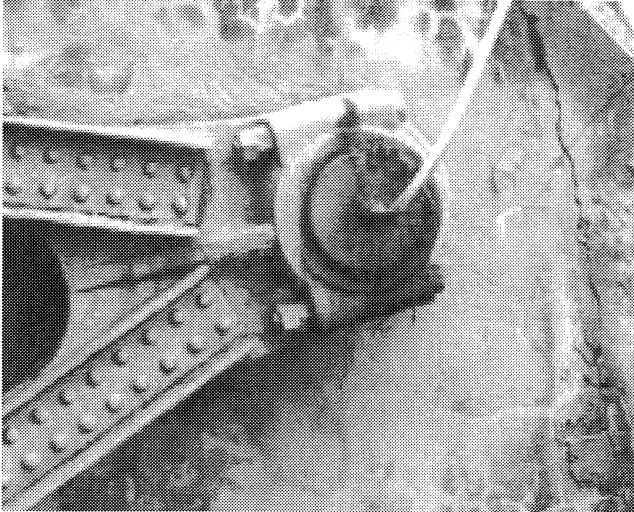

## Damaged Anchor Rods

---

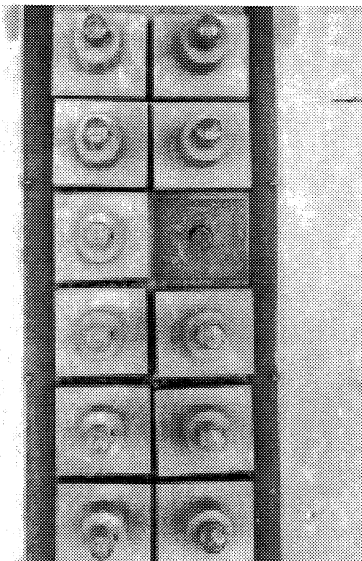
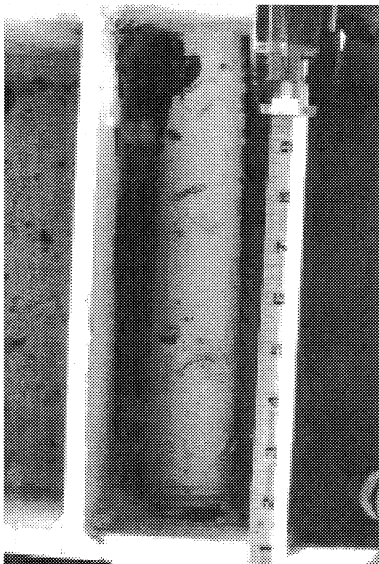

# Hoist Connections

---

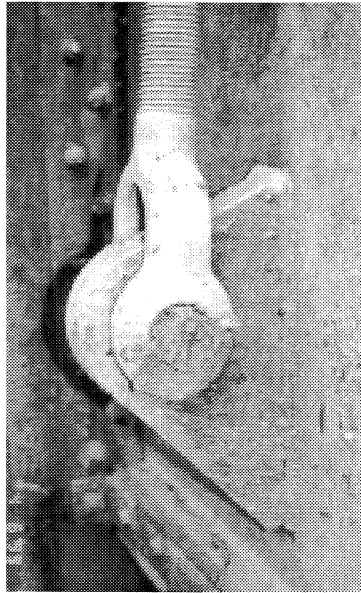
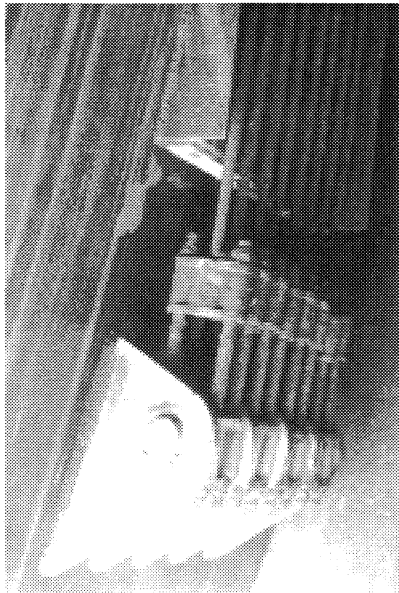

*Select Bibliography*

- U.S. Bureau of Reclamation. *Radial Gate Evaluation, Caballo Dam, New Mexico*, May 1997. NTIS, PB97-165914.
- U.S. Bureau of Reclamation. *Radial Gate Evaluation, Cedar Bluff Dam, Kansas*, April 1997. NTIS, PB97-157416.
- U.S. Bureau of Reclamation. *Radial Gate Evaluation, Enders Dam, Nebraska*, April 1997. NTIS, PB97-162234.
- U.S. Bureau of Reclamation. *Radial Gate Evaluation, Folsom Dam, California*, May 1997. NTIS, PB98-157795/XAB.
- U.S. Bureau of Reclamation. *Radial Gate Evaluation, Glen Canyon Dam, Arizona*, June 1997. NTIS, PB97-179105.
- U.S. Bureau of Reclamation. *Radial Gate Evaluation, Glen Elder Dam, Kansas*, April 1997. NTIS, PB97-157531.
- U.S. Bureau of Reclamation. *Radial Gate Evaluation, Imperial Dam, Arizona-California*, March 1997. NTIS, PB97-157523.
- U.S. Bureau of Reclamation. *Radial Gate Evaluation, Lovewell Dam, Kansas*, April 1995. NTIS, PB97-162226.
- U.S. Bureau of Reclamation. *Radial Gate Evaluation, Nimbus Dam, California*, May 1997. NTIS, PB97-166805.
- U.S. Bureau of Reclamation. *Radial Gate Evaluation, Norton Dam, Kansas*, April 1997. NTIS, PB97-162242.
- U.S. Bureau of Reclamation. *Radial Gate Evaluation, Olympus Dam, Colorado*, June 1997. NTIS, PB-97-186035/XAB.
- U.S. Bureau of Reclamation. *Radial Gate Evaluation, Palo Verde Dam, Arizona-California*, March 1997. NTIS, PB97-157515.
- U.S. Bureau of Reclamation. *Radial Gate Evaluation, Rye Patch Dam, Nevada*, April 1997. NTIS, PB97-162887.
- U.S. Bureau of Reclamation. *Radial Gate Evaluation, Sumner Dam, New Mexico*, May 1997. NTIS, PB97-165930.
- U.S. Bureau of Reclamation. *Radial Gate Evaluation, Vallecito Dam, Colorado*, 23 June 1997. NTIS, PB97-179071.
- U.S. Bureau of Reclamation. *Radial Gate Evaluation, Webster Dam, Kansas*, April 1997. NTIS, PB97-162259.
- Yamamoto, Koyu, Hideji Nakamura, and Sin'ichi Matsuura. *Study on Deterioration Assessment of Existing Dam-Gate Anchorages*. Chiba (Japan): Central Research Institute of Electric Power Industry, Technical Lab. No. 2, 1988. NTIS, DE89772380.

## 7.2 Journal Articles

- Back, P. A. A., "Designing Safety Into Dams," *International Water Power & Dam Construction*. Vol. 42, No. 2, p. 11-12 (February 1990).
- Boyarskij, V. M., A. V. Vasil'ev, V. V. Sokolov, A. A. Isaev, and A. M. Shvaipshtejn, "Installations for Passing Flows During the Operation of the Burejskij Water Power Development and Their Hydraulic Justification," *Gidrtoekhnicheskoe Stroitel'stvo* (Russia). Vol. No.10, p.35-40 (October 1995).
- Chaput, P., D. Gawish, and M. Limoges, "Out With the Old Intake Gates [Beauharnois Dam]," *International Water Power & Dam Construction*. Vol. 50, No.1, p. 28-31 (January 1998).
- "Dam Safety Program Spared; Dam Safety Act Extended," *Hydro Review*. Vol. 12, No. 1, p. 112 (February 1993).
- "Database Launched to Help Evaluate Structural Safety," *Engineering News-Record*. Vol. 233, No. 12, p. 9 (19 September 1994).
- "Folsom Dam Gate Fails," *Engineering News-Record*. Vol. 235, No. 4, p. 9 (July 24, 1995).
- Kawahara, M. and Y. Shimada, "Gradient Method of Optimal Control Applied to the Operation of a Dam Water Gate," *International Journal for Numerical Methods in Fluids*. Vol. 19, No. 6, p. 463 (1994).
- Leyland, B. W., G. R. Jessup, and S. R. Berry, "Automatic Controls for Spillway Gates and Outlets," *International Water Power & Dam Construction*. Vol. 38, No. 1, p.40-43 (January 1986).
- McCann, M.W. Jr., "Group Prepares Guidelines for Documenting Dam Performance," *Hydro Review*. Vol. 12, No. 4, p. 98 (June 1993).
- O'Shea, M. and A. Graves, "Engineers Find Climbing Techniques Work Well for Dam Inspections," *Hydro Review*. Vol.15, No. 69, p. 58-59 (1996).
- Rens, Kevin L., Lowell F. Greimann, James H. Stecker, and, Anthony M. Kao, "A Decision Support Tool for Managing the Nation's Aging Infrastructure," *Public Works*. Vol. 125, No. 6, p. 54-58 (May 1994).
- Rosenbaum, David B, "Spewing Spillway Plugged. (American River's Folsom Dam)," *Engineering News-Record*. Vol. 235, No. 6. p. 10 (August 7, 1995).
- Scotto, G.A. "Foundation Studies for Theodore Roosevelt Dam," *International Journal of Rock Mechanics and Mining Sciences* Vol. 34, No. 3-4, p. 579 (April-June 1997).
- Spragens, L. "ASDSO Identifies Trends in State Dam Safety Laws," *Hydro Review*. Vol. 11, No. 3, p. 102 (June 1992).
- Spragens, L. "States Report on Model Dam Safety Program," *Hydro Review*. Vol. 11, No. 6, p. 100-101 (October 1992).
- Spragens, L. "National Dam Inventory Provides Data for Analysis," *Hydro Review*. Vol. 11, No. 7, p. 116 (December 1992).
- Spragens, L. "ASDSO Updates Bibliography, Creates Support Database," *Hydro Review*. Vol. 12, No. 2, p. 97 (April 1993).

*Select Bibliography*

- Spragens, L. "States Improve Dam Safety Legislation and Regulations," *Hydro Review*. Vol. 12, No. 3, p. 100 (May 1993).
- "USBR Reviews Radial Gate Safety," *International Water Power & Dam Construction*. Vol. 48, No. 3, p. 15 (1996).
- Yamamoto, K. and S. Nakamura. "Kisetsu dam gate shijibu no rekka shindan gijutsu ni kansuru ichiteian," (Proposal on Technologies to Diagnose Degradation in the Existing Dam Gate Supporting Structures), *Denryoku Doboku* (Japan). Vol. 242, p. 73-80 (November 1992).
- "Year in perspective," *International Water Power & Dam Construction*. Vol. 50, p. 33 (12 December 1998).

**7.3 Conference Papers**

- Anami, K and N. Ishii. "In-Air and In-Water Natural Vibrations of Folsom Dam Radial Gate in California," *Experimental Mechanics: Advances in Design, Testing and Analysis*, p. 29-34, Rotterdam, Netherlands: A. A. Balkema, (1998).
- Anami, K. and N. Ishii. "In-Water Streamwise Vibration of Folsom Dam Radial Gates in California," ASME/JSME Pressure Vessels and Piping Conference, San Diego, CA, USA, (July 26-30, 1998). *Flow-Induced Vibration and Transient Thermal-Hydraulics, ASME/JSME Conference Proceedings*, Vol. 363, p. 87-94, Fairfield, NJ: ASME (1998).
- Burgi, Philip H. and Duane E. Krogstad, "Ice Management at Dickinson Dam Spillway Crest Gate," IAHR Symposium on Ice 1986. *IAHR Symposium Proceedings*, Vol. 2, p. 235-247, Iowa City: University of Iowa, (1986).
- Chen, C. T., A. E. Locke, and E. R. Brown, "Gate Replacement at the Upper Lake Falls Development," Canadian Dam Association Conference: System Stewardship for Dams and Reservoirs: Risk and Resource Management Toward the 21<sup>st</sup> Century, Halifax, Dartmouth, Canada (Sep. 27- Oct. 1 1998), p. 265-275, McCurdy Printing, Ltd., (1998).
- Ellis, R., D. Jeske, and P. Christensen, "Wanapum Dam Spillway Overflow Gate," International Conference on Hydropower, ASCE: New York (1997). Vol. 1, p. 579, *Waterpower '97*.
- Harkauli, A. N. and V.S. Bhide, "Recent Problems in High Head Gate Installations in India," International Congress on Large Dams, 13th, Transactions, New Delhi, India (Oct. 29 - Nov. 2, 1979), Vol. 3, p. 869-884. Paris, France: *International Comm. on Large Dams* (1979).
- McCann, Martin W. Jr., "National Performance of Dams Program," International Conference on Hydropower, ASCE: New York (1997). Vol. 1, p. 220-229, *Waterpower '97*.
- Mlakar, Paul and Larry Bryant, "Reliability Estimation for Vertical Lift Gate at Emsworth Dam," *Water Resource Infrastructure: Needs, Economics, and Financing*. p. 109-113, Boston: ASCE (1990).
- Oswalt, N. R., G. A. Pickering, and E. D. Hart, "Problems and Solutions Associated with Spillways and Outlet Works," International Congress on Large Dams, 13th, Transactions, New Delhi, India, (Oct. 29 - Nov. 2, 1979), Vol. 3, p. 273-291. Paris, France: *International Comm. on Large Dams* (1979).
- Rudolph, Richard M. and James A. Gundry. "Rehabilitating Old Gates," International Conference on Hydropower, ASCE: New York (1995). Vol. 3, p. 2583-89, *Waterpower '95*.
- Sagar, B. T. A., "Safe Practices for High Head Outlet Gates," International Congress on Large Dams, 13th, Transactions, New Delhi, India, (Oct. 29 - Nov. 2, 1979), Vol. 3, p. 459-467. Paris, France: *International Comm. on Large Dams* (1979).

Todd, Robert V., "Folsom Spillway Gate Failure and Lessons Learned," Energy and Water: Sustainable Development, *Proceedings: Congress of the International Association of Hydraulic Research (IAHR)*, Vol. D, p. 66-71, ASCE: New York (1997).

## 7.4 ASDSO Conference Papers

Auger, Richard Scotto, et al., "Condition Assessment of a Submerged Timber Gate Using Stress Wave Testing Methods," Association of State Dam Safety Officials, Inc., Lexington, Kentucky (1996). *Annual Conference Proceedings* (1996), p. 93-101.

Brighton, R., "Debris Management at BC Hydro's Facilities," Association of State Dam Safety Officials, Inc., Lexington, Kentucky (1999). *Annual Conference Proceedings* (1999), p.423-431.

Edwards, Wayne D. and Samuel M. Planck, "Recreating the Past: Inspection and Analysis of Spillway Radial Gates," Association of State Dam Safety Officials, Inc., Lexington, Kentucky (1998). *Annual Conference Proceedings*. (1998), p. 467-477.

Gutierrez, David A. and Fred J. Sage, "California Division of Safety of Dams Spillway Radial Gate Program," Association of State Dam Safety Officials, Inc., Lexington, Kentucky (1998). *Annual Conference Proceedings* (1998), p. 491-499.

Hutton, Charles C., "Tainter Gate Testing and Evaluation," Association of State Dam Safety Officials, Inc., Lexington, Kentucky (1998). *Annual Conference Proceedings* (1998), p. 479-489.

Lo, Sze-Hang, Bernard J. Peter, and Eugene K. Chan, "Safety Inspection and Design Review of Spillway Radial Gates," Association of State Dam Safety Officials, Inc., Lexington, Kentucky (1996). *Annual Conference Proceedings* (1996), p. 217-226.

Monaghan, Michael and Said Salah-Mars, "Indian Valley Dam Radial Gates Evaluation," Association of State Dam Safety Officials, Inc., Lexington, Kentucky (1999). *Annual Conference Proceedings* 1999), p. 421.

Rudolph, Richard M., et al., "Gate Inventory and Inspections: An Owner's Approach," Association of State Dam Safety Officials, Inc., Lexington, Kentucky (1999). *Annual Conference Proceedings* (1999), p. 409-420.