

Estimating the Permeation Resistance of Nonporous Barrier Polymers to Sulfur Mustard (HD) and Sarin (GB) Chemical Warfare Agents Using Liquid Simulants

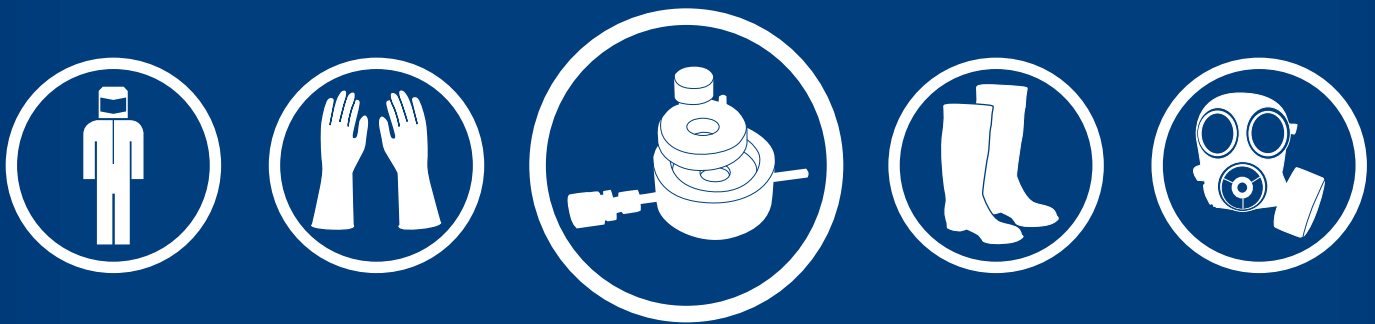

Estimating the Permeation Resistance of Nonporous Barrier Polymers to Sulfur Mustard (HD) and Sarin (GB) Chemical Warfare Agents Using Liquid Simulants

Donald Rivin, Ph.D.

Wendel J. Shuely

Frank Palya, Jr.

Robert S. Lindsay

Axel Rodriguez

Philip W. Bartram

DEPARTMENT OF HEALTH AND HUMAN SERVICES

Centers for Disease Control and Prevention

National Institute for Occupational Safety and Health

This document is in the public domain and may be freely copied or reprinted.

Disclaimer

Mention of any company or product does not constitute endorsement by the National Institute for Occupational Safety and Health (NIOSH). In addition, citations to Web sites external to NIOSH do not constitute NIOSH endorsement of the sponsoring organizations or their programs or products. Furthermore, NIOSH is not responsible for the content of these Web sites.

Ordering Information

To receive documents or other information about occupational safety and health topics, contact NIOSH at

Telephone: **1-800-CDC-INFO** (1-800-232-4636)

TTY: 1-888-232-6348

E-mail: cdcinfo@cdc.gov

or visit the NIOSH Web site at **www.cdc.gov/niosh**.

For a monthly update on news at NIOSH, subscribe to *NIOSH eNews* at www.cdc.gov/niosh/eNews.

DHHS (NIOSH) Publication No. 2008-141

July 2008

SAFER • HEALTHIER • PEOPLE™

Foreword

In March 1999, the National Institute for Occupational Safety and Health (NIOSH) cosponsored a Chemical and Biological Respiratory Protection Workshop with the Occupational Safety and Health Administration (OSHA) and the Department of Defense, U.S. Army Research, Development and Engineering Command (RDECOM). The objectives of this meeting were to: (1) identify and understand the hazards associated with a terrorist chemical and biological incident, (2) identify the different civilian responders and their respiratory protections needs, (3) determine which respirators and selection criteria are currently being used for response to these incidents, and (4) determine public and medical community concerns that must be considered in developing standards for chemical and biological respiratory protective devices. NIOSH began collaborating with the National Institute of Standards and Technology (NIST), OSHA and RDECOM, which includes Edgewood Chemical Biological Center (ECBC) and Natick Soldier Center (NSC), to address the concerns identified at the workshop, and to discuss the development of standards for emergency first responder respiratory protection.

In April 2001, NIOSH held a public meeting on developing and implementing standards for chemical, biological, radiological and nuclear (CBRN) respiratory protective devices. At the meeting it was announced that actual military chemical warfare agents (CWA) would be used in future NIOSH certification testing of CBRN respiratory protective devices. Sarin (GB) and sulfur mustard (HD) had been chosen as representative CWA in their categories. Respirator and other personal protective equipment (PPE) manufacturers requested that NIOSH identify chemical compounds that could be used as test simulants in lieu of GB and HD. These manufacturers expressed an interest in using CWA simulants for in-house material and product development testing and to pretest their respirator systems for CWA agent permeation resistance. Manufacturers do not have access to CWA to perform testing and there are a limited number of certified laboratories able to perform CWA testing because of the high cost, toxicity, and the extensive regulatory controls. This makes any type of CWA testing very expensive and inconvenient as a result of the required lead-time.

To address the needs of manufacturers, NIOSH initiated the Chemical Warfare Agent Simulant Project with ECBC and NSC. This yielded the development of a lower cost method to test the permeation resistance of candidate barrier materials for use in protective equipment and the identification of chemical compounds that can be used to simulate the permeation effects of GB and HD. I am pleased to release this document, which will assist manufacturers in providing CBRN protective devices to the first responders of a potential CBRN terrorist attack. In addition, I am also pleased to announce that NIOSH has released a NIOSH CBRN

standard for a self-contained breathing apparatus, an air-purifying respirator, an escape respirator, and a powered air-purifying respirator and that NIOSH is continuing its efforts to release CBRN standards for other respiratory protective devices.

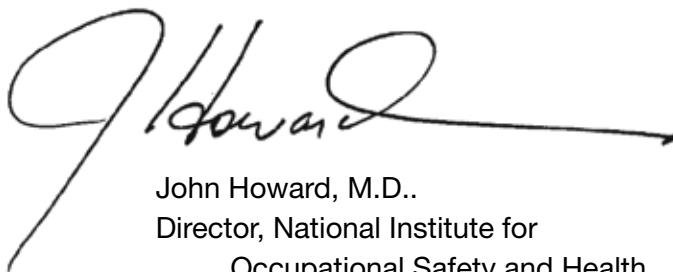
A handwritten signature in black ink, appearing to read "J. Howard", with a long horizontal stroke extending to the right.

John Howard, M.D..
Director, National Institute for
Occupational Safety and Health
Centers for Disease Control and Prevention

Contents

Foreword	iii
Tables	vii
Figures	vii
Acknowledgments	viii
Executive Summary	ix
1.0 Introduction	3
1.1 Background	3
1.2 Scope of Phase I.....	5
1.2.1 Experimental Design.....	5
1.2.2 Application of Test Method.....	6
1.2.3 Survey of the Applications of CWA Solvent Parameters and Solubility Phase Diagrams.....	7
1.2.4 Limitations of the Current Investigation.....	9
2.0 Procedures and Results	13
2.1 Selection of Simulants	13
2.1.1 Kinetic Property Screen: Molecular Cross Section or Molecular Volume.....	14
2.1.2 Kinetic Property Screen: Vapor Pressure	14
2.1.3 Thermodynamic and Molecular Screen: Aprotic, Dipolar Structure	14
2.1.4 Thermodynamic and Molecular Screen: Molecular Solvation Parameters....	14
2.1.5 Toxicity.....	15
2.1.6 Experimental Screening: Sorption Measurements	15
2.1.7 Experimental Screening: Exploratory Permeation Testing of Thickness Effects	15
2.2 Polymeric Materials for Sorption and Permeation Studies.....	17
2.2.1 Strategy for Material Selection	17
2.2.2 Documentation on the Selected Elastomers	21
2.2.3 Documentation of the Elastomer Compositions.....	22
2.2.4 Experimental Design for Elastomer Specimens	26
2.3 Immersion Methods for Determination of Solubility and Diffusion Coefficients	27
2.4 Permeation Methodology	27
2.4.1 Equipment in Research and Development Studies and Standardized Method	27
2.4.2 General Equipment.....	27
2.4.3 Edgewood Chemical Biological Center (ECBC) Permeation Equipment	28
2.4.4 Natick Soldier Center (NSC) Permeation Equipment	29
2.4.5 Permeation Conditions	31

2.5	Data Analysis of Solubility and Diffusion Properties	32
2.6	Immersion Results	33
2.7	Permeation Results.....	36
2.7.1	Characteristic Parameters of the Permeation Curve	36
2.7.2	Data Analysis of Permeation Parameters	37
2.7.3	Normalized Permeation Parameters for Comparisons Independent of Thickness.....	37
2.7.4	Permeation Parameter Ratios Relative to DCH and DCH-Butyl Rubber.....	38
3.0	Discussion	47
3.1	Safe-Sided Simulants and Tests.....	47
3.2	Solubility Test as a One-Sided Candidate Material Screen	48
3.3	Relative Criteria for Selecting Candidate Materials Based on Permeation Correlations	48
3.4	Absolute Criteria for Selecting Candidate Materials Based on Permeation Correlations	48
3.5	Permeation Curve Comparisons.....	49
3.6	Infinite Versus Finite Source Permeation Geometry	50
4.0	Summary	53
	References	57
	Bibliography: Application of Solvent-Solute Parameters and Solubility Phase Diagrams to Chemical Defense, Unlimited Distribution Publications	61
	Appendix A: Standard Test Method for Estimating Permeation Resistance of Nonporous Barrier Polymers to Liquid Chemical Warfare Agents (GB and HD) Using Liquid Simulants	67
	Appendix B: Liquid Permeation Cell Mechanical Drawings	85
	Appendix C: CWA Permeation Tables.....	95

Tables

Table 1.	Simulant selection criteria to match CWAs and simulants for sorption and permeation correlations	13
Table 2.	Candidate simulants for exploratory sorption and permeation testing with a spectrum of elastomer thickness values	16
Table 3.	Simulants selected based on kinetic, thermodynamic, toxicity, and experimental screening factors	17
Table 4.	Selection criteria for selection of materials in CWA simulant permeation studies	18
Table 5.	Commonly used materials in NIOSH-approved respirators.....	20
Table 6.	Elastomeric reference materials based on chemical defense respirators	22
Table 7.	Poly(dimethylsiloxane), silicone composition based on molding formulation	23
Table 8.	Poly(ethylenepropylene), (EPDM) composition based on molding formulation	24
Table 9.	Poly(isobutylene), (Butyl) composition based on molding formulation	25
Table 10.	Experimental design matrix and specimen inventory for flooded surface permeation for each material at one temperature and thickness	26
Table 11.	Solubility and diffusivity from immersion at 35°C	34
Table 12.	Mean permeation parameters compensated for specimen thickness	41
Table A-1.	Nominal Simulant Chemical Compounds	75

Figures

Figure 1.	Liquid Permeation Cell.....	28
Figure 2.	Flame ionization detector, SRI, Model 110	29
Figure 3.	Air heater controller, WPI, Model Air-Therm™	30
Figure 4.	Temperature control chamber, RDECOM, Natick Soldier Center	31
Figure 5.	Fractional weight gain (FWG).....	32
Figure 6.	Permeation curve with characteristic parameters	36
Figure 7.	Normalized breakthrough time relative to DCH value for the same elastomer compound.....	42
Figure 8a.	Average permeability coefficient from the mean of the replicates of the four polymers.	42
Figure 8b.	Average permeability coefficient from the mean of replicates of Butyl, EPDM, and Nitrile.....	43
Figure 9.	Permeation rate of CWAs and simulants in 12-mil Butyl rubber.....	49
Figure A-1a.	Liquid Permeation Cell schematic: side view.....	74
Figure A-1b.	Liquid Permeation Cell: top view.....	74
Figure A-2.	Example Setup of Permeation Test System	79
Figure A-3.	Typical Permeation Curve, Electronic Signal in Voltage Proportional to Permeation Rate.	80

Acknowledgments

This document was prepared by the National Institute for Occupational Safety and Health (NIOSH), National Personal Protective Technology Laboratory (NPPTL) in collaboration with the U.S. Army Research, Development and Engineering Command (RDECOM) including their staff from the Edgewood Chemical Biological Center (ECBC) and the Natick Soldier Center (NSC). Frank Palya, Jr. (NPPTL) was the project officer. Dr. Donald Rivin (NSC) was the principal investigator. Wendel J. Shuely, Science Applications International Corporation (SAIC) was the lead scientist under contract with ECBC. Robert S. Lindsay (ECBC) directed the chemical warfare agent (CWA) permeation resistance testing and assisted with the development of the test method. Axel Rodriguez (NSC) and Philip W. Bartram (ECBC) conducted laboratory experiments and provided technical expertise.

The following additional personnel from RDECOM are gratefully acknowledged for their contributions to the CWA Simulant Project:

William P. Ashman of the ECBC, Agent Chemistry Team, performed the initial literature search in an attempt to find credible reports on chemical compounds that could be used as Sarin (GB) and sulfur mustard (HD) simulants. In addition, Mr. Ashman provided invaluable technical advice throughout the course of the CWA Simulant Project.

Susan Procell and Elaina Harrison of the ECBC, Applied Chemistry Test Team, performed the permeation resistance testing on the selected barrier materials using actual GB and HD chemical warfare agents.

Monica Hall, of ECBC, assisted with the GB and HD sorption experiments.

Manuscript reviews were provided by Maryann D'Alessandro, Ph.D.; Pengfei Gao, Ph.D.; Paul Middendorf, Ph.D.; Leroy Mickelson, Ph.D.; Richard W. Niemeier, Ph.D.; and Capt. James S. Spahr (NIOSH); Lee Campbell (ECBC); Zane N. Frund (Mine Safety Appliances Company); and Larry A. Brey, Ph.D. (3M).

Acknowledgment is extended to NPPTL contracted personnel for their contribution in additional areas: Peter C. Bellina of EG&G Technical Services, Inc. (EG&G) for editorial support and for obtaining photographic releases from manufacturers for equipment depicted in this report and Candace A. Wolf (EG&G) for her technical support.

Executive Summary

The purpose of this document is to report the results of tests to identify appropriate simulants for testing permeation and to specify the laboratory procedure for estimating chemical warfare agent (CWA) permeation of personal protective equipment (PPE). Advancements in this research can benefit the first responder community by providing PPE manufacturers with information and testing techniques that will reduce the time and resources needed to engineer products that weigh less, have better permeation resistance, are less cumbersome, and are potentially less expensive.

The National Institute for Occupational Safety and Health (NIOSH) and the National Institute of Standards and Technology (NIST) signed an Interagency Agreement (IAA) in July 2000. Under this IAA, NIOSH initiated a collaborative effort with the Natick Soldier Center (NSC) and the Edgewood Chemical Biological Center (ECBC) of the U.S. Army Research, Development and Engineering Command (RDECOM) to develop standards for chemical, biological, radiological, and nuclear (CBRN) respiratory protective devices and to develop methods for certification testing of these devices, including evaluation of CWA permeation resistance. The NSC and ECBC are the primary organizations within the Department of Defense (DoD) that research, develop, engineer, and acquire equipment relating to nuclear, biological, and chemical (NBC) personal protection.

During the April 2001 NIOSH public meeting on developing and implementing standards for CBRN respiratory protective devices, it was announced that actual military CWAs would be used in future NIOSH certification testing of CBRN respiratory protective devices. Sarin (GB) and sulfur mustard (HD) were the CWAs selected by NIOSH to be used as the representative CWAs for certification testing. Manufacturers of respirators and other PPE requested that NIOSH identify less toxic chemical compounds (simulants) that could be employed for testing at their laboratories. This testing would include in-house material and product development testing and respirator system pretesting for CWA permeation resistance. During a January 2002 meeting that was held in Pittsburgh, Pennsylvania to discuss CBRN respirator standards development, the International Safety Equipment Association (ISEA) expressed the need for the NIOSH National Personal Protective Technology Laboratory (NPPTL) to identify simulant test agents for GB and HD. In subsequent periodic meetings, the ISEA continually expressed the need for simulant test agents. Manufacturers do not have access to CWAs to perform testing, and only a limited number of certified laboratories are able to perform CWA testing because of the high test cost, toxicity of CWAs, and extensive regulatory controls. Overall, testing with CWAs would substantially slow the identification of PPE that would protect against CWAs.

As part of the collaboration between NIST, RDECOM, and NIOSH to develop CBRN respirator standards, a literature search was conducted by RDECOM employing the Agent Simulant Knowledge (ASK) database in February 2002.

However, the search yielded few reports with data on CWAs and simulant permeation through barrier materials using consistent test methods and conditions. Thus simulants could not be identified from the literature. As a result, NIOSH determined that additional research was needed to address the requests of the PPE manufacturers and ISEA members to identify CWA simulants that can be used in testing.

In May 2002, the Chemical Warfare Agent Simulant Project was initiated with the following goals:

1. Identify chemicals (simulants) that simulate the permeation of GB and HD through elastomeric barrier materials that are commonly used in respirators.
2. Develop a convenient and reliable laboratory procedure (test method) that can be used by PPE manufacturers for estimating GB and HD permeation rates through barrier materials using the simulants.

Research was initiated when the NSC developed an inexpensive permeation test method that uses a liquid permeation cell for testing both hard and soft barrier materials up to 0.7 cm thick. This permeation test method uses the flooded surface technique in which the test liquid covers one surface of the specimen material.

A systematic methodology was employed to select three barrier materials to be used in the tests to identify the simulants with similar permeation characteristics to HD and GB. The three barrier materials selected are: polydimethylsiloxane [Silicone], poly(isobutylene) [Butyl], and poly(ethylene-co-propylene-co-diene) EP8A [EPDM].

Immersion experiments were used to identify simulants having a similar solubility to HD and GB in the three selected barrier materials. Nine liquids could be obtained commercially that had physicochemical properties similar to HD and GB and these were selected to test the permeability of barrier materials. From the nine liquids evaluated, the following four simulants were found to best replicate the permeation of GB and HD when challenging the three barrier materials: 1,6 dichlorohexane (DCH) and 2-chloroethyl phenyl sulfide (CEPS) are simulants for HD; diethyl methylphosphonate (DEMP) and diisopropyl methylphosphonate (DIMP) are simulants for GB.

Further testing is in progress to extend the CWA-simulant correlations to a wider range of barrier polymers.

The test method developed at NSC can be used to test a variety of materials used in PPE. It can be used to perform permeation resistance testing with any nonreactive liquid, including toxic industrial chemicals (TICs), in which the polymer does not decompose or dissolve. This document will assist PPE

manufacturers by providing them with a method to assist in selecting the materials for use in PPE. This test method may reduce product development time and costs for manufacturers by reducing development/engineering fees, testing, and lead times.

Introduction

1.0

1.0 Introduction

1.1 Background

The National Institute for Occupational Safety and Health (NIOSH) held several public meetings to address the stakeholder need for NIOSH to develop and implement standards for chemical, biological, radiological, and nuclear (CBRN) respiratory protective devices. When NIOSH's intent to use military chemical warfare agents (CWAs) was introduced to certify respiratory protective devices, some respirator and other personal protective equipment (PPE) manufacturers requested that NIOSH identify chemical compounds (simulants) that can be used to simulate the molecular permeation and defect penetration effects of CWAs on protective equipment. Similar concerns were expressed by the International Safety Equipment Association (ISEA) in a January 2002 meeting with NIOSH's National Personal Protective Technology Laboratory (NPPTL). In subsequent meetings hosted by the ISEA, this need for NPPTL to identify simulant test agents was continually expressed. Manufacturers want to use CWA simulants for product development and quality control testing and to test their respirators prior to submitting an application for NIOSH CBRN certification. Manufacturers do not have access to military CWAs to perform in-house material and product development testing and a limited number of certified laboratories are able to perform CWA testing. This is due to high cost, toxicity and regulatory controls; thus making any type of CWA testing very expensive and inconvenient.

In December 2001, while developing the NIOSH CBRN standard for an open-circuit, self-contained breathing apparatus (SCBA) [NIOSH 2001], NIOSH in collaboration with the U.S. Army Research, Development and Engineering Command (RDECOM), Edgewood Chemical Biological Center (ECBC), performed an evaluation of CWA and toxic industrial chemicals (TICs) listed in the USACHPPM Technical Guide 244 [U.S. Army 2000] and in the Draft National Fire Protection Association (NFPA) 1994 Standard [NFPA 1994]. NIOSH selected Sarin (GB) and sulfur mustard (HD) as the representative CWA test agents to be used in certification testing of respirators because they are among the most permeating through nonporous barrier materials and have the ability to penetrate through micro-pores resulting from material defects or poorly interfaced respirator components. In February 2002, a collaborative effort between NIOSH and ECBC was undertaken to identify viable GB and HD simulants to be used for permeation testing of elastomeric barrier materials. A literature search conducted by ECBC employed the Agent Simulant Knowledge (ASK) database in February 2002 which revealed few reports providing both CWA agent permeation as well as simulant permeation data for barrier materials. In most cases, the data found in these reports were obtained using test methods and conditions that were not consistent with each other. Therefore, due to the lack of data and inconsistent test

methods, a relationship could not be determined between CWA and simulant permeation rates with adequate confidence. Note, the term *correlation* is used in the general sense in this report, rather than indicating a specific relationship of one dependent variable and one independent variable with a regression and correlation coefficient. Most often, *correlation* refers to a correlated ranking of solubility and permeation values that allows one to deselect materials with potentially poor GB and HD resistance, based on simulant measurements.

NIOSH determined that a research study was needed to identify chemical compounds that simulate the permeation effects of GB and HD through barrier materials, and to derive a correlation between CWAs and their simulants. NIOSH's NPPTL collaborated with the Natick Soldier Center (NSC) and the ECBC both of the RDECOM in this research study by initiating the CWA Simulant Project in May 2002.

The CWA Simulant Project was sectioned into two phases. This document reports the test methods and results of experiments conducted during Phase I of the CWA Simulant Project. Phase I was completed in October 2003 and encompasses the initial work that was completed to accomplish the following goals:

1. Identify chemical compounds, with low toxicity relative to the CWAs, that simulate the permeation effects of GB and HD through elastomeric barrier materials.
2. Develop a convenient and reliable laboratory procedure (test method) that can be used by manufacturers for estimating GB and HD permeation using the simulants.

With continuing interest and support of the stakeholder community, the National Institute of Standards and Technology (NIST) funded the continuation of the project; hence, the continuing research effort designated as Phase II is being conducted by RDECOM in collaboration with NPPTL. The research will be conducted by RDECOM concurrently with publication of this Phase I report. The plan of Phase II includes selection of additional barrier materials, sorption/desorption and permeation testing in 2005–2007, and use of these results to improve predictions of simulant to CWA permeation behavior in 2007. The test method established in Phase I provides a standardized permeation method for testing of additional materials in Phase II. Manufacturers can begin using this Phase I method immediately after publication of this report, before completion of Phase II.

Phase II is not within the scope of this document and, therefore, only a brief outline of the methodology of that phase is provided here. Phase II encompasses the following goals:

1. Improve the estimation reliability of the new permeation procedure by testing additional simulants and a wider range of polymeric barrier compounds. Also, determine the quantitative relationship between permeation behavior observed using a flooded surface and that of traditional low-loading (“finite”) liquid drop challenge (5–10 g/m²).
2. Compare CWA and simulant sorption and desorption characteristics for a wide range of representative barrier materials.
3. Perform testing to elucidate trends in the barrier performance of polymer compounds based on readily available chemical and physical properties of the polymer and the permeating CWA molecules. Properties to be investigated include: permeant molecular volume and cross section, polymer free volume, crosslink density, molecular interaction factors such as solubility parameters, polymer cohesion phase diagrams, and viscoelastic parameters. Predictions will be validated using American Society for Testing and Materials (ASTM) standard methods and the test method described in the Procedures and Results section of this Phase I report.
4. Expand the solubility relationship of the more polar protective polymers, especially with respect to the solvent parameters of the chemical agents and simulants and the cohesion phase diagrams.

This document was written for technical experts on selecting materials for protective equipment; this test method report assumes a basic knowledge of the details of polymer chemistry, permeation testing, and sorption, solubility, and diffusion processes.

1.2 Scope of Phase I

This section describes the scope of Phase I of the CWA Simulant Project including experimental design, test methods, procedures, as well as the limitations of this phase of the project.

1.2.1 Experimental Design

This study was implemented using a small subset of possible barrier materials and CWAs. Only three barrier materials and two CWAs (GB and HD) were included in the experimental design. A full experimental design might include CWA compounds, simulants, material types, material compositions within each type, and experiment type. The CWA liquids studied could include several G-agents (GA, GB, GD, GF), vesicants, and V-agents. NIOSH selected GB and HD as the representative agents for CWAs when performing respirator certification testing [NIOSH 2001]; therefore, these two CWA compounds were selected for testing. This phase was limited to two simulants for each CWA that appeared to be representative of those reported in the literature, based on preliminary permeation

experiments with simulants (see Section 2.1) that differ in molecular cross section and solubility parameter.

In a full experimental design, the variables for materials could have included: physical state, such as elastomers or thermoplastics; structural type, such as acrylics or urethanes; chemical-material interaction type, such as dispersion, polar, or hydrogen bond donors; heterogeneity, unfilled or filled, such as composites or laminates. In this phase, the investigation was limited to three elastomers with primarily dispersion (London forces) interactions; the rationale is discussed in the Materials section. It was necessary to limit the field of materials to three elastomers because of the limited resources available. The three materials were selected based on past RDECOM experience with the materials where it was found that the materials provide an optimum combination of properties, as described in the section on materials selection.

Previous experimental designs for testing protective materials have included: permeation to steady state, permeation to breakthrough, sorption at specific time intervals, sorption to equilibrium solubility values, desorption diffusion and/or a set of chemical resistance tests. In this phase, experimentation was limited to immersion sorption, equilibrium solubility, and permeation to steady state since these provided the most fundamental comparison of protective performance based on chemical interaction with the elastomers.

This study employs an infinite-source, flooded-surface technique rather than the traditional finite-source droplet technique in order to obtain fundamental chemical-material permeation properties that allow direct comparisons of material performance. Future work will include comparisons of the flooded-cell versus droplet permeation conditions.

Other variables were limited to a single, controlled value in this phase. Temperature was held constant at 35°C, near skin temperature. Thickness was varied for each polymer type with the thickness effect normalized for the permeation parameters.

1.2.2 Application of Test Method

A new test method was developed in Phase I of this program and is detailed in Appendix A. Data interpretation techniques are presented that use permeation and immersion test results to assist PPE manufacturers in selecting the appropriate barrier materials for their product to resist CWA permeation. This document describes the required test equipment, test procedures, and data analysis techniques in sufficient detail so that a qualified technician can perform the following tasks:

- Select and operate test equipment
- Select material specimens
- Perform the permeation test
- Analyze the test results

Mechanical drawings of the permeation cell test fixture required for the test method are provided in Appendix B, enabling PPE manufacturers to reproduce the test fixture and obtain test results that can be compared with the permeation results contained in this document. The enclosed method is used to determine the barrier performance of flat nonporous films, membranes, and sheets up to 0.7 cm thick when one surface of the material is entirely exposed (or “flooded”) to a test liquid.

The test method can be used to test permeation of any liquid that does not decompose or dissolve the test specimen, which could include most industrial solvents and many TICs. Simulant permeation is correlated with that of GB and HD in order to reduce the need for testing with highly toxic liquids, such as CWAs. Permeation test results of poly(dimethylsiloxane) [Silicone], poly(isobutylene-co-isoprene) [Butyl], and poly(ethylene-co-propylene-co-diene) EP8A [EPDM] during liquid contact with GB, HD, and simulants are included in this test report to assist in future test data analysis. In addition, poly(butadiene-co-acrylonitrile) [Nitrile] was tested with only simulants as part of the preliminary screening of candidate materials and is included in this report.

The test method and data interpretation techniques were developed to provide PPE manufacturers with a lower cost, more rapid screening method, relative to CWA testing, for evaluating the performance of candidate barrier materials to be used in the development and production of PPE products such as respiratory protection devices and protective garments. This method was developed primarily so that PPE manufacturers could use accessible chemical compounds (simulants) that have lower toxicity while simulating the permeation effects of CWAs, specifically GB and HD. In conjunction with the development of this method, simulants were identified based on their physicochemical similarities to HD and GB [Rivin et al. 2005].

This publication describes a specific test method and test apparatus, and provides several simple, qualitative guidelines for applying the correlations between CWAs and simulants as given in the Discussion section. However, PPE material experts can apply other quantitative data reduction techniques to further rank their candidate materials, keeping in mind the caveats regarding overextending data analysis, given the multitude of nonlinear effects in solubility, diffusion, and permeation relationships.

1.2.3 Survey of the Applications of CWA Solvent Parameters and Solubility Phase Diagrams

Solvent-solute parameters are useful tools in screening materials for protective barrier performance. Given the time and resource constraints, a limited comparison of CWA and simulant solubility parameters was performed and a more thorough application was scheduled for future work. This area of

investigation was further limited because these values are generally not found in public documents, although the CWA solvent parameters from these diagrams had been measured and published at ECBC. Therefore, while performing this research, phase diagrams developed during the 1960s through the 1980s were used, but the specific values are not cited.

There are several systems of solubility parameter sets and polymer phase diagrams in general use and some of these are covered in the earlier documents [Barton 1983]. The values determined included the solubility parameter, hydrogen bond index, dielectric constant, and dipole moment. In addition, Hansen cohesion parameters, other cohesion parameters, linear solvation energy relationship (LSER) parameters, and molecular dimensions were estimated. The results of these estimates can be summarized by generalizing that the solubility parameters of the organophosphorus CWA (G and V series) were moderate, in the 17.4–19.4 MPa^{1/2} range.

The organophosphorus CWA dipole moments were high, in the 3.2–3.7 Debye range. The organophosphorus CWA hydrogen bond shifts or index values were moderately high. Coordinates of a dispersion, hydrogen bonding, and polarity parameter were plotted on the solubility phase diagram of polymers to estimate chemical resistance. The selection of simulants was based on both matching the coordinates with the target CWA and matching the vector distance from the liquid coordinates to the phase diagram center passing through the phase boundary for total miscibility. For more detailed information on this approach, see Bibliography in this document, Application of Solvent-Solute Parameters and Solubility Phase Diagrams to Chemical Defense, Unlimited Distribution Publications.

Given the CWA solubility parameter coordinates of the simulants employed, the solubility correlations obtained herein are likely limited to the evaluation of relatively nonpolar polymers containing predominantly dispersion forces. The 3-D solvent parameters of GB are substantially different from those of diisopropyl methylphosphonate (DIMP) or diethyl methylphosphonate (DEMP). Likewise, the 3-D solvent parameters of HD are substantially different from those of 2-chloroethyl phenyl sulfide (CEPS) or 1,6 dichlorohexane (DCH). However, for dispersion dominated polymers, the phase diagram boundary between solubility and insolubility has high vector distances from both the CWA and simulant liquid coordinates; therefore, a useful correlation can be obtained. For aprotic dipolar hydrogen bond acceptor or donor polymers, the phase diagram boundaries will be closer to the GB, HD, and simulant polymer solubility phase diagram coordinates and solubility differences will be magnified. Many of the protective materials are nonpolar polymers; therefore, the screening and further testing of nonpolar polymers is a productive starting point. Note that nonpolar polymers may not have the mechanical, thermal, or optical properties required for the spectrum of materials in a respirator ensemble; therefore, identification of candidate CWA-resistant materials in a wider category of polymers is underway.

1.2.4 Limitations of the Current Investigation

This phase of the work emphasizes fundamental comparisons of chemical-material interactions under one set of controlled conditions and does not address predicted performance due to the effects of high or low temperatures, moist elastomers, or other extreme environmental conditions.

In Phase I, the permeation of *single* layers of polymeric materials was measured and the measurement of laminates or multiple layers was not included, although models of the military M40 series of protective masks employ a resistant elastomer over the silicone facepiece. In general, coatings and bonded laminates can be evaluated with the methodology described by Rivin [Rivin et al. 2005].

Procedures and Results

2.0

2.0 Procedures and Results

The four sections of this chapter primarily deal with procedures and include the following topics: simulant selection, elastomer material selection, immersion solubility procedures, and permeation procedures.

2.1 Selection of Simulants

An overview of the criteria employed to screen candidate simulants can be obtained by reviewing Table 1. Permeation is a complex process that involves both kinetic (Table 1, items 1–2) and thermodynamic (Table 1, items 3–4) processes. The competitive kinetic processes are droplet evaporation versus diffusion into the protective material. The thermodynamic property is the equilibrium solubility of the test liquid in the barrier material. The candidate simulants for CWAs were evaluated with respect to both kinetics and thermodynamics; further details on these criteria are provided below. Relatively lower toxicity (Table 1, item 5) was also a criterion. Preliminary screening identified the most appropriate simulants and suitable specimen thicknesses that were targeted to provide breakthrough times greater than or equal to 1 hour and steady-state permeation in less than 24 hours (Table 1, items 6 and 7).

Table 1. Simulant selection criteria to match CWAs and simulants for sorption and permeation correlations

Number	Criterion
1	Kinetic property screen: molecular cross section or molecular volume
2	Kinetic property screen: vapor pressure
3	Thermodynamic and molecular screen: aprotic, dipolar structure
4	Thermodynamic and molecular screen: molecular solvation parameters
5	Relatively lower toxicity
6	Experimental screening: sorption measurements
7	Experimental screening: exploratory permeation testing of thickness effects

2.1.1 Kinetic property screen: molecular cross section or molecular volume

The selection of a kinetic simulant which has the same diffusion rate as a target CWA is dependent on the molecular cross section of the diffusing liquid. Matching the molecular cross section should allow similar jumps from one molecular-free volume site to another as chain motion provides access to adjacent free-volume sites. Matching only molecular volumes can cause an error since an identical molecular volume can be obtained from a long, narrow molecule and a more spherical molecule. Therefore, the minimum molecular cross section provided an appropriate correlation parameter. These values were surveyed and compared in the selection process.

2.1.2 Kinetic property screen: vapor pressure

Evaporation rate is another kinetic process that competes with diffusion into the barrier material; therefore, it was necessary to evaluate the vapor pressure property in order to screen candidates for evaporation. A close volatility match was not deemed as important for the flooded cell relative to the droplet geometry, since the surface of the specimen is always covered with liquid in this partially covered (not tightly sealed), low-evaporation cell design. However, vapor pressure was maintained as a screening property to maintain volatility in a reasonable range.

2.1.3 Thermodynamic and molecular screen: aprotic, dipolar structure

The G and H series chemical warfare agents are aprotic dipolar, hydrogen-bond acceptor liquids and the simulants selected were, therefore, aprotic dipolar, hydrogen-bond acceptor liquids, with the exception of DCH.

2.1.4 Thermodynamic and molecular screen: molecular solvation parameters

The selection of a simulant based on only thermodynamic factors would provide a “thermodynamic simulant;” this would provide a similar sorption level to sorption of a target liquid, such as a CWA for a material. This thermodynamic sorption behavior is controlled by molecular interactions comprised of: dispersion, dipolar, resonance, hydrogen bond acceptor, and hydrogen bond donor forces. The first choice is to select a simulant with values that are as close as possible to this set of interaction parameters. Since few compounds will match closely to all of these parameters, it is convenient to match the coordinates formed by this set of solvation parameters with the relative position on the polymer solubility phase diagram. Since phase diagrams are asymmetric, this equivalent, relative position is determined by constructing a vector from the asymmetric center to the phase diagram boundary (of insolubility), passing through the simulant versus an analogous vector for the CWA. One then matches fractional vector lengths.

This process is required for every polymer. The process is documented in detail in several DoD publications with limited access.

2.1.5 Toxicity

Simulants were screened for lower toxicity relative to the CWA using the ECBC ASK database employing all available toxicity data, but primarily oral-rat LD₅₀. The toxicity of diisopropylfluorophosphate (DFP) was used as an upper limit because this compound is the closest analogue of G-agents that can be purchased by laboratories for use as a simulant. However, DFP, itself, was rejected as a simulant because it would be too difficult for some laboratories to handle, store, and use due to its toxicity constraints. The carcinogenic oxygen analog of HD, bis(2-dichloroethyl)ether, was also rejected for the same reason.

After simulants were screened based on these structures and properties, samples were obtained of at least eight candidates (see Table 2) and screening experiments were performed. Although these simulants are safer than CWA, some lack critical toxicity data. Applicable manufacture safety data sheets (MSDS) should be consulted to inform workers of the dangers posed by handling these toxic substances. Appropriate safety procedures, adequate equipment and trained personnel should be in place prior to obtaining the recommended simulants. For more information relating to standard laboratory practice, safety and health precautions, refer to Appendix A, Section 7, Safety Precautions and Hazardous Waste Disposal, of this document.

2.1.6 Experimental screening: sorption measurements

Semi-quantitative sorption screening results were compared to CWA values or estimates to rank or deselect simulants.

2.1.7 Experimental screening: exploratory permeation testing of thickness effects

A limited number of thicknesses were available for each material. Therefore, simulants were screened to determine that the breakthrough times fell between about 0.5 and 24 hours. Breakthrough times of greater than 0.5 hours allow discrimination between the relatively rapid, defect penetration and slower permeation breakthrough (with the exception of rapid-permeating silicone). Breakthrough times of less than 24 hours are experimentally convenient and are less likely to require addition of liquid to prevent evaporation to dryness.

Table 2. Candidate simulants for exploratory sorption and permeation testing with a spectrum of elastomer thickness values

Identification codes	Chemical compounds
Simulants for bis-2-chloroethylsulfide	
HD:	
CEMS	2-Chloroethylmethylsulfide
CEiAS	2-Chloroethylisoamylsulfide
CECHS	2-Chloroethylcyclohexylsulfide
CEPS (CEPhS)	2-Chloroethylphenylsulfide
CnBE	Chloro-n-butylether
BCEM	bis(2-chloroethoxy)methane
BCEE	1,2-bis-(2-chloroethoxy)ethane
DCH	1,6-Dichlorohexane
Simulants for isopropyl methylphosphonofluoridate	
GB:	
DMMP	Dimethylmethylphosphonate
DEEP	Diethylethylphosphonate
DIMP	Diisopropylmethylphosphonate
DEMP	Diethylmethylphosphonate
TEPO	Triethylphosphate

In general, the candidate simulants in Table 2 were ranked by the criteria in Table 1 and the lower ranking simulants for each criterion were eliminated. Examples of additional pragmatic considerations included the inconsistent availability and/or purity of CEiAS and CECHS commercial samples. The final selection of simulants is shown in Table 3. These test chemicals were then used to obtain the permeation data for correlation with the chemical warfare agents bis (2-chloroethyl) sulfide (sulfur mustard, HD) and isopropyl methylphosphonofluoridate (Sarin, GB). All four candidates were evaluated as simulants for each CWA, regardless of structural types or their initial assignment as either a GB or HD simulant.

Table 3. Simulants selected based on kinetic, thermodynamic, toxicity, and experimental screening factors

ID Code	Chemical compound	CAS No.	Purity %	Source
HD: CEPS	2-Chloroethylphenylsulfide	5535-49-9	98	Lancaster synthesis
HD: DCH	1,6-Dichlorohexane	2163-00-0	98	Aldrich chemical
GB: DIMP	Diisopropylmethylphosphonate	1445-75-6	95	Alfa aesar
GB: DEMP	Diethylmethylphosphonate	683-08-9	97	Aldrich chemical

2.2 Polymeric Materials for Sorption and Permeation Studies

The description of the polymeric materials studied is divided into four sections: a strategy for material selection, characteristics of the selected elastomer set, composition of each elastomer compound, and an outline of the experimental design for the elastomer specimens.

2.2.1 Strategy for Material Selection

Several complementary strategies were devised for selecting a set of materials for the correlation of simulants with agents. The desired characteristics of the materials are summarized in terms of selection criteria in Table 4. Some of these criteria are *operational* characteristics; that is, the preferred materials would be chemically resistant (no. 1) or would be already in use in respirators (no. 2). Other criteria are geometry oriented, in terms of shape (no. 4) and thickness requirements (no. 5). Another pair of criteria refers to orthogonal molecular compositional characteristics (nos. 6 and 7). In addition, there was a requirement for availability of specimens in the quantities and thicknesses needed (no. 8). Each of these is outlined below.

Table 4. Selection criteria for selection of materials in CWA-simulant permeation studies

Number	Criterion
1	CWA chemical resistance. Chemical-agent-resistant elastomers to provide immediate assistance to NIOSH respirator manufacturers
2	Materials from NIOSH-approved respirators
3	Physical state: Material composition limited to elastomers
4	Geometry: Available in sheet form in quantities required for full evaluation
5	Thickness: Available in a thickness providing breakthrough between 0.5 and 24 hours for every agent-simulant combination.
6	Thermodynamic, orthogonal material interaction set
7	Kinetic orthogonal polymer set
8	Specimen availability

CWA chemical resistance. The decision was made to not only provide the requested simulant selection but to also attempt to provide low sorption, resistant polymers to assist the PPE manufacturers in their immediate need to identify chemical agent-resistant polymers. A chemically resistant polymer screen was compiled from chemical warfare agent experimental sorption and permeation data available in various databases or derived from experience with materials from fielded chemical defense protective equipment.

Materials from NIOSH-approved respirators. A list of commonly used polymeric materials in NIOSH-approved respirators was compiled by evaluating the material content of several different systems from different manufacturers. These materials were identified on the mechanical drawings provided to NIOSH by respirator manufacturers. Selection of materials from this list has the advantage of evaluating materials already in use by manufacturers for respirator systems. Table 5 contains examples of materials found in current respirator systems; however, the list is not intended to be comprehensive or complete. Manufacturers also use other polymeric materials in the construction of respirator systems.

Physical state. Thermoplastics, composites, laminates, and other more complex materials were considered; however, it was decided to begin with straightforward elastomeric materials.

Specimen geometry. The first phase was limited to elastomers that were available in *sheet form* in quantities required to complete the initial phase and to extend the correlations to additional simulants if needed for follow-on work.

Thickness. The sheets had to be available in a thickness that would provide permeation breakthrough times in a reasonable period. At the low end, a breakthrough time was desired that was longer than several gas chromatographic sampling cycle times in order to provide time resolution. At the longer periods, a breakthrough time was desired that did not allow the liquid to totally evaporate or did not extend the test cost.

Thermodynamic, orthogonal material interaction set. A thermodynamic, orthogonal polymer interaction set consists of polymers differing in dispersion, dipolarity, resonance, hydrogen bond acceptor, and hydrogen bond donor polymer properties. The aprotic dipolar organophosphorus and chloroethylsulfide liquids should interact uniquely with each polymer to cover the broadest spectrum of sorption and permeation levels. The disadvantage is that high levels of sorption and fast permeation are likely for several of these structural classes and the data obtained would not apply to the chemically resistant polymers of interest to respirator manufacturers.

Kinetic orthogonal polymer set. A kinetic orthogonal polymer set consists of elastomers with a wide range of diffusion rates for organic liquids. The extremes of the elastomer diffusion rate range often cited are poly(dimethylsiloxane) at the rapid extreme and poly(isobutylene) at the slower extreme.

Specimen availability and sources. A rigorous definition of the criteria for material selection was important; however, locating actual specimens that fulfilled even a small number of desired characteristics is always difficult. Several categories of specimen sources were surveyed: a variety of commercial sources, standards organizations such as ASTM and NIST, and ECBC's internal research and development or quality assurance/quality control standards.

Table 5. Commonly used materials in NIOSH-approved respirators

Item number	Material
1	Silicone rubber
2	Natural rubber
3	Butyl rubber
4	EPDM
5	Polycarbonate
6	Polyvinyl chloride
7	Neoprene
8	Fluorosilicone
9	Versamid (Nylon)
10	Polystyrene/polyphenylene oxide
11	Nylon 6/6
12	Polyphenyl sulfone
13	Nomex (fire-resistant material)
14	Synthetic rubber
15	Polyester
16	Fiberglass-filled polymer
17	Kevlar
18	Buna-N (Nitrile—sheet rubber gasket material)
19	Thermo plastic elastomer (TPE)

Based on a conceptual Venn diagram of the elastomer candidates that met the criteria in Table 4, specimens were selected from the chemical defense reference and control materials that consist of five elastomers and four thermoplastic material compositions that had been standardized, procured, and archived for use in chemical-material compatibility studies. These chemical defense polymers are documented in the following sections.

2.2.2 Documentation on the Selected Elastomers

In this section, the elastomers selected are documented from several viewpoints. The general compositional classes and several features are surveyed. Several thicknesses were available and the selection of one thickness that was used for evaluation is described here.

Composition. The materials that met all selection requirements are from Set 1 of the Chemical Defense Reference and Control Materials [Shuely 1999] and are shown as the first three elastomer compositions in Table 6. These specimens have physical and chemical properties that are the most appropriate for this phase of the study. The other two elastomer compositions have the potential to be used in future studies. In Table 6, the first column lists the chemical defense application of the elastomer. The second column lists the base elastomeric composition, often termed the gumstock composition. The final column lists the general recipe source for the formulation. Since many materials are produced to a performance specification, their compositions may vary with manufacturer and with time; however, these compositions have been standardized and held constant for this set of elastomers.

Elastomer set features. Cutting multiple specimens from the same molded sheet allowed testing at the same cure and crosslink density and, therefore, controlled the composition across different tests. Sheet-to-sheet comparisons of solubility were measured and the values agreed within experimental error. The ASTM Standard Procedure D 3182 had been employed for sample preparation. All elastomer compounding and mold curing was carried out by Smithers Scientific, Akron, Ohio. The specimens were stored in sealed Mylar bags at room temperature until use. Examples of tests that could be performed with Set 1 include permeation, sorption, and mechanical tests in accordance with the following test methods: ASTM F 739, D 471, D 543, D 2240, and D 1415.

Thickness. The nominal thickness ranged from 0.254–6.4 mm (10–250 mils), but the actual specimen thickness was measured before each test. The availability of a range of thickness values allowed the screening of thickness to obtain reasonable breakthrough times, between 0.5 and 24 hours. Sheet thickness was chosen as an experimental expedient to produce a completed permeation curve in a reasonable timeframe. The thickness selection can partially compensate for differences in barrier properties, which would facilitate comparison of permeation curves on a linear time scale. Initially, thickness can be selected to be near the end-use thickness and can then be decreased to produce breakthrough times within a reasonable period.

Table 6. Elastomeric reference materials based on chemical defense respirators

Chemical defense applications	Base elastomer composition	Source of formulation and elastomer compounding recipe
M40/42 Mask Faceblank	Dimethyl siloxane, GE	Mine Safety & Appliance
M40/42 Mask Drink Tube	Ethylene propylene	Generic Nordel 2744, DuPont EPDM
Protective gloves/suits	Poly(isobutylene) derived from chlorobutyl gumstock Polysar Corp.	Generic formulation based on Army Research Lab prototype
M43A1 Mask Faceblank	Blend of natural and bromobutyl rubber	Natural Rubber: SMR 5-CV60 DuPont Bromobutyl: Miles Corp.
M17A2/M24/M25A1 Mask Faceblank	Poly(isoprene), natural rubber	SMR-L-0836, DuPont

2.2.3 Documentation of the Elastomer Compositions

The compositions of the elastomers are documented in Tables 7 through 9. The rows contain a listing of each component. The second column contains the component identification. The third column indicates the function of each component. The fourth column contains the class, either estimated to be extractable (E) or nonextractable (NE). Only the lower molecular weight (MW), non-crosslinked compounds were assigned to the extractable class. The last column contains the proportional composition of each component in parts per hundred (pph). The convention in elastomer chemistry is to reference all other components to 100 pph of the elastomer gumstock. In the last two rows, the Total Extractables are summed and the Total Extractable Percent is reported. This is the maximum amount that can be extracted during a liquid sorption experiment [Shuely and Ince 2001] and provides a check on the experimental correction for extractables (see Table 11, column 4). This estimate of potential extractables is an important compositional variable since these additives can be extracted during

the sorption experiments and confound the determination of sorbent weight gain in an elastomer. The sum of the fraction of these potential extractables is noted in the tables by adding the fraction of the additives that have the potential to migrate, based on the molecular weight and polarity of their structure. The components marked as “unknown” are assumed to be nonextractable in the calculations. (Note that Smithers, Inc. has modified the Butyl formulation to improve the reproducibility of the sheets as permeation standards for quality acceptance testing; therefore, the actual composition of current or future Butyl quality acceptance standards might be slightly different.)

Table 7. Poly(dimethylsiloxane) silicone composition based on molding formulation

Number	Component	Remarks	Class*	Parts per hundred
1	Dow Corning TR55	Dimethylsiloxane Gumstock	NE	60
2	Dow Corning HS30	Dimethylsiloxane Gumstock	NE	40
3	HCC 11003 Green	Pigment	NE	1
4	Varox DBPH-50	Cure	NE	1
	Total			102
	Total potential extractables %:		E	~ 0/102 = ~ 0%

*Class: NE – nonextractable, E – extractable, UnK – unknown, assumed nonextractable
Cure, estimated, at 145°C for 0.75 hours; varied for different thickness levels

Table 8. Poly(ethylenepropylene) (EPDM) composition based on molding formulation

Number	Component	Remarks	Class*	Parts per hundred
1	Nordel 2744	Gumstock	NE	100
2	Carbon black FEF	Reinforcer	NE	110
3	Carbon black MT	Reinforcer	NE	50
4	Circosol 4240	Hydrocarbon oil	E	30
5	Stearic acid	Cure activator	UnK	1
6	Sulfur	Crosslinker	NE	2
7	ZnO	Crosslinker at C-Cl	NE	5
8	Agerite resin D	2,2,4-trimethyl-1,2 hydroquinoline polymer	UnK	1
9	Captax	2-Mercapto benzothiazole	UnK	1.5
10	Tetramethylthiuramdisulfide	Cure accelerator	UnK	0.8
11	Tellurac 80%		UnK	0.8
12	Tetrone A		UnK	0.8
	Total			302.9
	Total potential extractables %:		E	$\sim 30/302.9 = \sim 9.9\%$

*Class: NE – nonextractable, E – extractable, UnK – unknown, assumed nonextractable
Cure conditions: not available.

Table 9. Poly(isobutylene) (Butyl) composition based on molding formulation

Number	Component	Remarks	Class*	Parts per hundred
1	Chlorobutyl gumstock		NE	100
2	Carbon black N300	Reinforcer	NE	60
3	Carbon black N550	Reinforcer	NE	15
4	Stearic acid	Cure activator	Unk	1
5	Sulfur	Crosslinker	NE	1
6	MgO	Crosslinker at C-Cl	NE	0.5
7	ZnO	Crosslinker at C-Cl	NE	5
8	Altaz, Benzothiazyl disulfide	Cure accelerator	UnK	2
9	Tetramethylthiuram disulfide	Cure accelerator	UnK	1
10	Polyethylene AC617 low MW	Mold release	E	4
11	Kenaflex A	Plasticizer	E	5
12	Drakeol 35 mineral oil	Plasticizer	E	5
13	Paracin #1	Plasticizer	E	3
14	American cyanamid antioxidant		E	1
	Total			203.5
	Total potential extractables %:		E	$\sim 18/203.5 = \sim 8.8\%$

*Class: NE = nonextractable, E = extractable, Unk = unknown, assumed nonextractable.

2.2.4 Experimental Design for Elastomer Specimens

The number of permeation disk specimens available for each material is shown in Table 10. The large number of replicates, 22, was required to provide a low 95% confidence interval for a test with a relatively high variability, as often observed in CWA permeation tests. The simulant permeation had less variation (see Table 12) and, therefore, required fewer replicates, usually two to three. This specimen inventory relative to the experimental design size was necessary since the availability of specimens of identical material composition and thickness for all tests was a selection criterion.

Table 10. Experimental design matrix and specimen inventory for flooded surface permeation for each material at one temperature and thickness

Liquid	Natick simulant tests inventory	Natick simulant tests replicates	Inventory and replicates, ECBC CWA tests
G simulant 1: DEMP	6	2-3	0
G simulant 2: DIMP	6	2-3	0
H simulant 1: CEPS	6	2-3	0
H simulant 2: DCH	6	2-3	0
GB	0	0	22
HD	0	0	22
Other candidate simulants	6	1-2	0

2.3 Immersion Methods for Determination of Solubility and Diffusion Coefficients

CWA solubility in the elastomer compounds was determined at 35°C by the ASTM D 471 method, modified for use with toxic chemicals [Shuely and Ince 2001]. A correction for extraction of components from the elastomer compound into the liquid was performed by desorbing the post-immersion specimens to a constant weight using mild vacuum at up to 110°C.

Simulant solubility was determined by the same general method used for CWAs. Diffusion rates were obtained for pre-dried elastomer compounds immersed in excess liquid simulant at 35°C ± 0.1°C by removing and weighing (surface dry) the swollen specimens at timed intervals until steady state was achieved. Simulant solubility was taken as the weight gain at steady state, corrected for extractables, and was reported in units of g/cm³.

2.4 Permeation Methodology

The procedure employed for testing liquid CWAs and simulants with Silicone, Butyl, Nitrile and EPDM rubber is described in Appendix A. The standard test method, in Appendix A, that was developed during this investigation, can be used to perform permeation resistance testing with any nonreactive liquid, including TIC, in which the polymer does not decompose, react, or dissolve. When using the data interpretation techniques and the permeation data provided in this document, it is required that the test method described in Appendix A is used in order to obtain meaningful test results.

2.4.1 Equipment in Research and Development Studies and Standardized Method

There is a need to distinguish between the documentation of the specific equipment employed in this investigation and the generic equipment cited in the test method in Appendix A. This section documents the apparatus used in testing and provides an example of typical lab apparatus that are adequate for the measurements; any equipment with equivalent specifications can be substituted. The minimum specifications for the permeation system components are detailed in Appendix A.

2.4.2 General Equipment

Digital micrometer thickness gauge:

A digital micrometer thickness gauge (Mitutoyo, Inc. Model 293) that complied with Federal Specification GGG-C105C was used to obtain specimen thickness. A die set with approximately 3.8 cm diameter punch was employed to cut specimens from molded sheets. Other instrumentation and equipment are listed as part of the test method in Appendix A.

Permeation cell designs:

Several permeation cell designs were candidates for use in this study including the one- and two- inch ASTM F 739 cells, the U.S. Army Test and Evaluation Command (TECOM) Test Operation Procedure (TOP) 8-2-501 cell, the NSC Liquid Permeation Cell, and ECBC Quality Assurance permeation cell. The NSC Liquid Permeation Cell design was selected based on design simplicity, ease of sealing, minimization of permeant volume for a flooded surface geometry, and acceptance of hard and soft specimens up to 0.7 cm thick.

A photo of the liquid permeation cell (RDECOM, NSC design) is shown in Figure 1. (See the *Liquid Permeation Cell Mechanical Drawings* in Appendix B for design details).

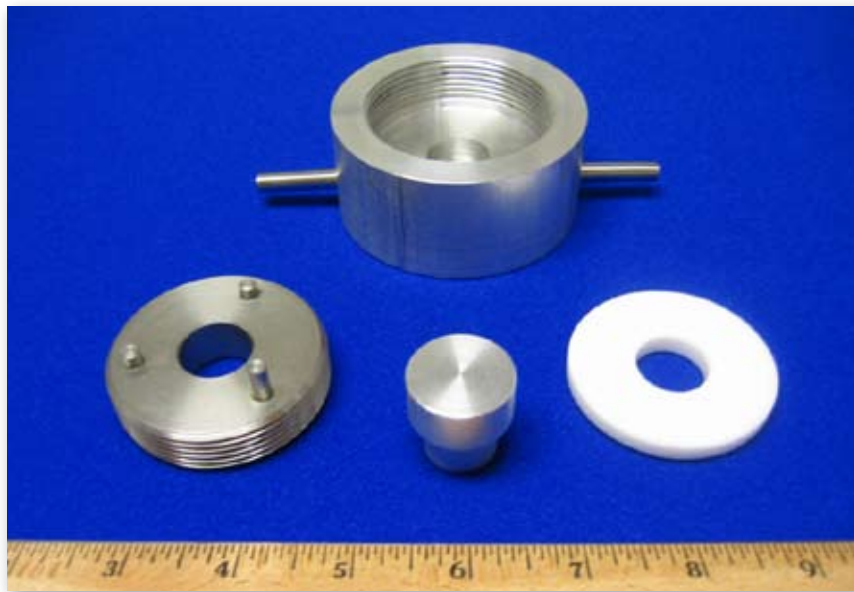

Figure 1. Liquid Permeation Cell
(Photo provided by Natick Soldier Center)

2.4.3 Edgewood Chemical Biological Center (ECBC) Permeation Equipment

The detection system used at ECBC is a MINIature Continuous Air Monitoring System (MINICAMS: OI Analytical), photo not included. The permeation equipment used at ECBC includes: a gas chromatograph equipped with a hydrogen flame emission detector and a pre-concentrator tube used for GB and HD detection. The detection system includes an internal data acquisition board and data acquisition system.

2.4.4 Natick Soldier Center (NSC) Permeation Equipment

This section describes all control and detection components used for permeation testing at NSC.

Flame ionization detector (FID) in a Gas Chromatograph (GC) system:

SRI, Model 110; used for simulant detection at NSC (Figure 2).



Figure 2. Flame ionization detector, SRI, Model 110 (Photo courtesy of SRI).

Data acquisition board—A/D converter:

Omega, PCI-DAS, 1001—a component of the simulant detection system at NSC (photo not provided).

Medium speed, PCI bus, 12 bit, analog input, digital IO

50-pin screw terminal board (Omega, CIO-MINI50)

100-pin ribbon cable (Omega, C100FF-2), 2' length

Personal computer—Dell, Optiplex model:

Integral to the simulant detection system at NSC (photo not provided).

Computer operating system: Microsoft Corporation, Windows 2000, integral to the simulant detection system at NSC;

Peripheral component interconnect (PCI) slot;

Portable high capacity storage medium with a minimum of 100 megabytes;

2.0 GHz with 400 MHz front-side bus.

Data acquisition software—National Instruments Corp., Omega, DASyLab Lite: A component of the simulant detection system at NSC (photo not provided).

Mass flow controller—MKS flow controller, Type 1179A:
General purpose mass flow controller; ¼ inch tube Swagelok connections (photo not provided).

Air heater controller—WPI, Model Air Therm™:
Used with the simulants at NSC (see Figure 3):
Air or high heat capacity dry (unnecessary if ambient temperature can be maintained at $35^{\circ}\text{C} \pm 2^{\circ}\text{C}$).



Figure 3. Air heater controller, WPI, Model Air-Therm™ (Photo courtesy of WPI).

Test liquid:

Test liquid (simulant chemical)—approximately 0.3 mL per test cell

Temperature control chamber:

Fabricated at RDECOM, NSC, no specific design requirements (Figure 4)

- Houses Liquid Permeation Cell
- Interfaces with the air heater controller to maintain constant temperature
- Contains ports for flame ionization detector sampling lines

Carrier Gas:

Permeation tests were performed with dry nitrogen (UN 1977) from a compressed or liquefied source or dry air (UN 1002) containing < 10 parts per million (ppm) water.

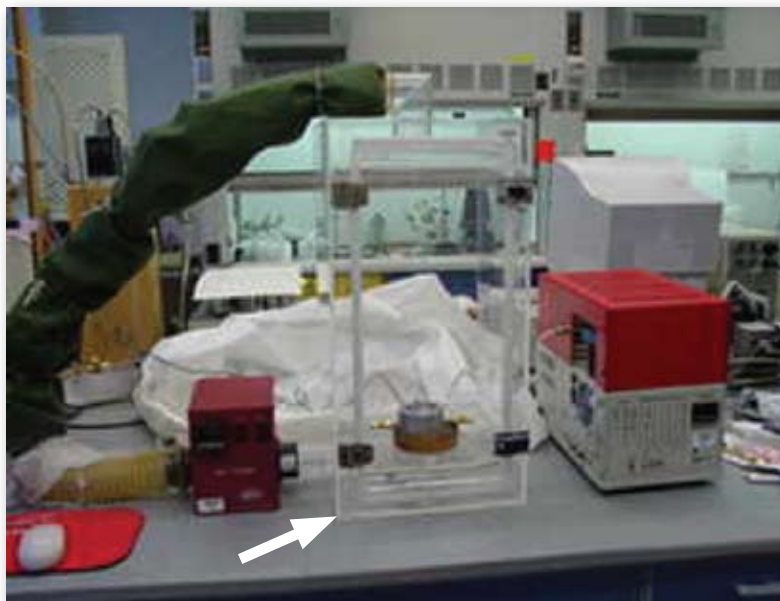

Figure 4. Temperature control chamber, RDECOM, Natick Soldier Center (Photo provided by Natick Soldier Center)

2.4.5 Permeation Conditions

Temperature. Tests were performed at $35^{\circ}\text{C} \pm 0.1^{\circ}\text{C}$ which is slightly below body temperature and near skin temperature. Higher or lower temperatures can be employed in order to control the duration of the test, however, it is usually difficult to accurately control temperature near ambient.

Preconditioning Specimens. Specimens are often conditioned for hours to days before testing at a specified temperature and humidity; this is often critical for hydrophilic barrier materials. For the hydrophobic elastomers studied here, only temperature conditioning of less than 1 hour was required to raise the specimen temperature to the cell test temperature.

Thickness. Thickness measurements were performed at four widely spaced sites within the middle 3 cm diameter circular area of the permeation specimens. Variations in thickness are quite small and the average value is reported.

Flow Rate. The carrier (sweep) gas flow rate was $130\text{ cm}^3/\text{min}$ for GB, $200\text{ cm}^3/\text{min}$ for HD, and $33\text{ cm}^3/\text{min}$ for the simulants. The flow rates were selected to optimize vapor concentration without incurring significant mass transfer limitations. Effluent vapor concentration was determined using a flame ionization detector (FID) for simulants and a MINICAMS™-FID for CWAs.

Repetitions. The number of replicates for simulants ranged from 2–3 for simulants and 22 for CWAs (see Table 10). Several test data sets for CWAs were discarded due to anomalous results or equipment failures.

2.5 Data Analysis of Solubility and Diffusion Properties

A brief explanation is provided here on the role of solubility and diffusion in permeation through a barrier material in order to provide the necessary background for the data reduction procedures employed.

For simple sorption (in the absence of relaxation and irreversible processes), the immersion of an elastomer specimen in the test liquid produces a diffusion flux that can be described by a unique diffusion coefficient or diffusivity (D_i) at constant temperature. This diffusion process is described by Fick's second law (equation 1) for diffusion at concentration c in the x dimension as a function of time.

$$\delta c / \delta t = D_i \delta^2 c / \delta x^2 \quad (1)$$

Fick's second law is plotted as fractional weight gain (FWG) versus square root of time ($t^{1/2}$). FWG is defined as the incremental sorption at time (t) divided by the plateau value representing the final steady-state weight increase. This plateau value representing the final steady state weight increase also defines the equilibrium solubility (S) for the liquid in the elastomer specimen with a specific cross-link density, filler content, and other characteristic properties. In Table 11, S is reported in units of g/cm^3 from a plot of absolute weight gain vs. square root of time, and diffusivity as cm^2/s . A representative Fick's law plot of fractional weight gain versus square root of time is shown in Figure 5 for dichlorohexane in Silicone.

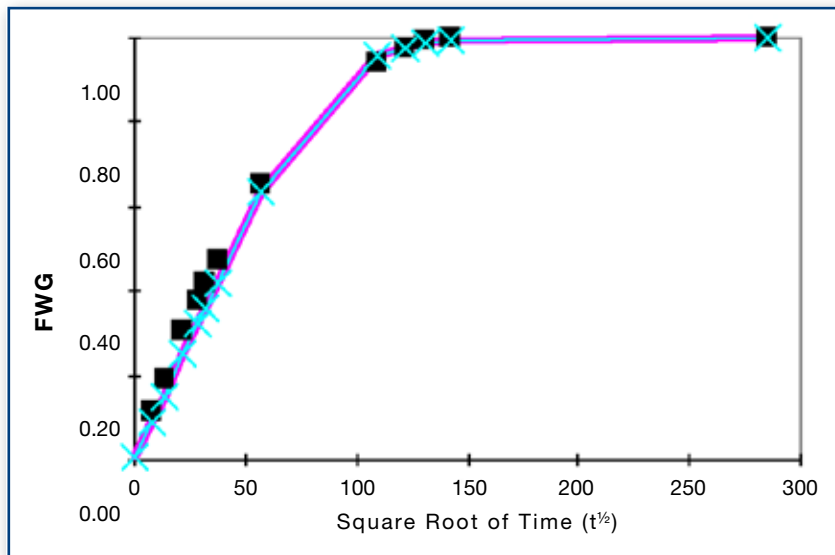

Figure 5. Fractional weight gain (FWG). FWG by immersion versus square root of time ($t^{1/2}$) for Silicone (0.323 cm thick) in dichlorohexane at $35^\circ\text{C} \pm 0.1^\circ\text{C}$. Points are experimental, line is Fickian curve when $D_i = 2.80\text{E}-06 \text{ cm}^2/\text{s}$. [Rivin et al. 2005]

For some of the liquids with low solubility or high extraction in the polymer under investigation, the diffusivity cannot be readily determined under kinetic diffusion conditions due to the low solubility value with respect to the confidence interval of the measurement; that is, the small, absolute value of the weight gain is within the uncertainty of the measurement. In these cases, solubility values can be obtained using the steady state method for directly determining equilibrium solubility at long sorption time, as noted in the Experimental Section of a previous publication [Rivin et al. 2005]. This was the case for some phosphonate liquids sorbed into Butyl or EPDM (see Table 11. DMMP in Butyl).

In determining D_p , it is assumed that specimen thickness is very small compared to face dimensions; this “edge effect” has been discussed in a previous publication [Barrer et al. 1962]. Note that this applies to diffusion coefficient determinations from sorption and not permeation experiments.

2.6 Immersion Results

Immersion results are presented in Table 11. The first column contains the polymer composition and the thickness for each specimen. Several different thickness levels were employed; equilibrium solubility does not depend on thickness; however, internal checks on the thickness effect on the diffusion coefficient were applied. The test liquid is listed in the second column. The weight gain in weight percent is listed under the “WG” heading in Column 3. The weight percent of extracted components is reported in the fourth column, and for polymer-liquid pairs showing a value under “Extract,” the solubility value in Column 5 has been corrected by addition of the measured extracted components to the raw weight gain data. All measured extract values are less than or equal to the maximum potential extractables that were calculated from the formulation content as a check on the measurement. In the fifth column, the weight gain, extractable correction, polymer density, and volume of the specimen are employed to calculate the solubility (S) in grams per cubic centimeter. The immersion diffusion coefficients, in cm^2/sec , obtained from a plot of fractional weight gain versus square root of time, are listed in the last column. Note that GB and HD were not tested with Nitrile rubber. Sorption versus time are listed in the last column. Sorption versus time measurement of immersion diffusion coefficients was not included in the experimental design for GB and HD.

Due to solvent-solute parameter *interaction differences*, the relative solubility of the simulants and agents differed between polymers. In many cases, the solubility of the simulants was greater than that of the agent; therefore, the simulants were safe-sided with respect to the solubility-screening component in protective permeation performance. An exception was the Butyl and EPDM elastomers in which at least one of the two alkyl phosphonate solubility values is comparable to the GB value.

Table 11. Solubility and diffusivity from immersion at 35°C

Polymer and thickness (cm [§])	Liquid	WG (wt%)	Extract* (wt%)	S [†] g/cm ³	D _i 10 ⁻⁷ cm ² /s
Silicone:					
0.074	HD	5.2	0.8	0.06	ND [‡]
0.074	GB	5.9	degraded	0.06	ND
0.318	DCH	21.6	ND	0.24	28.0
0.203	DCH	21.7	ND	0.24	21.0
0.318	CEPS	8.2	ND	0.09	30.0
0.318	DIMP	7.5	ND	0.08	23.0
0.318	DEMP	31.8	ND	0.35	10.0
Butyl:					
0.030	HD	24.6	8.6	0.27	ND
0.030	GB	11.4	4.2	0.13	ND
0.030	DCH	44.6	ND	0.49	2.40
0.051	DCH	45.6	ND	0.50	2.40
0.030	CEPS	29.4	9.4	0.32	1.20
0.051	CEPS	29.4	9.4	0.32	1.20
0.030	DEEP	11.8	ND	0.13	ND ^{††}
0.030	DIMP	22.6	6.9	0.25	0.30
0.051	DIMP	22.6	6.9	0.25	0.30
0.030	DMMP	1.42	ND	0.16	ND ^{††}
0.030	DEMP	9.9	4.1	0.11	0.50

(continued)

Table 11 (continued). Solubility and diffusivity from immersion at 35°C

Polymer and thickness (cm [§])	Liquid	WG (wt%)	Extract* (wt%)	S [†] g/cm ³	D _i 10 ⁻⁷ cm ² /s
EPDM:					
0.043	HD	9.0	2.4	0.10	ND
0.043	GB	2.5	0	0.03	ND
0.074	DCH	15.9	ND	0.18	3.30
0.048	DCH	13.4	ND	0.15	2.20
0.074	CEPS	10.0	2.2	0.11	2.95
0.048	CEPS	13.7	3.9	0.15	ND
0.048	DEEP	4.16	5.9	0.05	ND
0.048	DIMP	4.71	8.61	0.05	ND
0.048	DMMP	1.36	1.2	0.02	ND
0.048	DEMP	2.7	1.25	0.03	ND
Nitrile:					
0.0279	DCP**	115.8	ND	1.27	2.20
0.0279	CEPS	130.9	ND	1.44	1.10
0.0279	DIMP	26.8	ND	0.30	0.50
0.0279	DEMP	50.2	ND	0.55	0.65

*Steady-state method. Corrected value within ±10% of kinetic method.

†Density of elastomer compounds taken as 1.1 g/cm³ in order to convert from weight percent.

‡ND=not determined.

§Average thickness for individual specimens range from ± 0.005 cm for butyl and silicone to ± 0.003 for other polymers.

**Immersion data for dichloropentane.

††Low value with high standard deviation.

2.7 Permeation Results

In this section, the parameters that characterize a permeation curve are defined graphically and the equations that support the data analysis are described. Also presented in this section are the breakthrough time and permeability parameters, that were normalized for thickness (see section 2.7.3). Finally, several permeation parameters are presented as ratios, relative to reference values, so that the relative effects can be discerned.

2.7.1 Characteristic Parameters of the Permeation Curve

Permeation of a liquid through a polymer membrane is dependent on the solubility and molecular diffusion coefficient of the test material in the polymer matrix. Parameters that characterize this process are shown on the representative permeation curve in Figure 6. Early time behavior is best described by the breakthrough time (T_b) which is the intercept, extrapolated back to the baseline, of the initial linear rise of the permeation curve. The use of T_b is preferred to the time of first detection of test vapor because the latter is extremely instrument dependent.

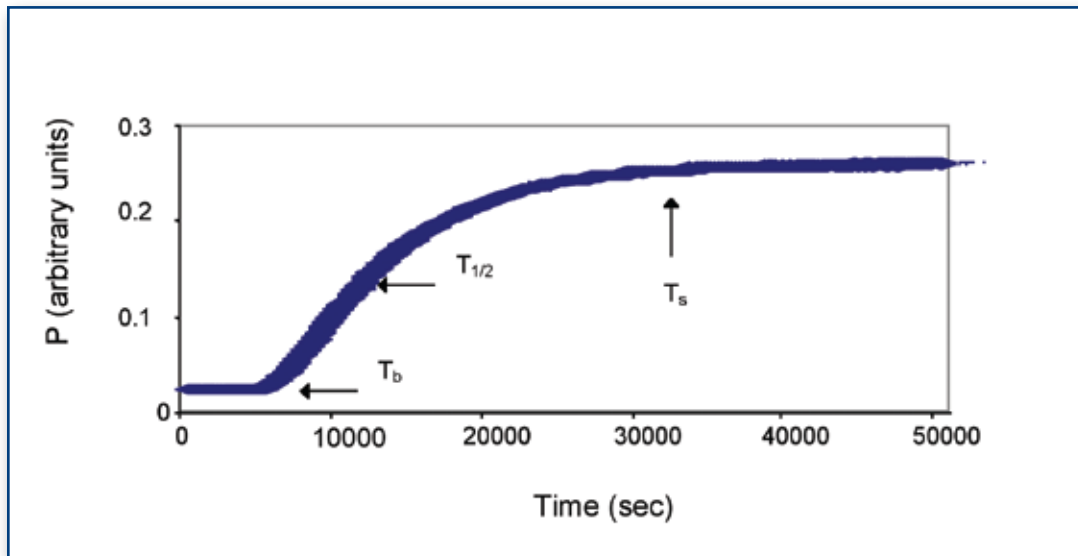

Figure 6. Permeation curve with characteristic parameters [Rivin et al. 2005]

As permeation through the membrane continues, permeation rates are related to $T_{1/2}$, the time at which permeation is half the steady-state value. Maximum permeation is given by the asymptotic steady-state permeation. The time at inception of steady state permeation (T_s) is a measure of the minimum duration of a complete experiment but has no theoretical utility.

2.7.2 Data Analysis of Permeation Parameters

The permeability coefficient (P) at steady state [Wijmans and Baker 1995] is the product of a diffusion coefficient (D_p), solubility (S) and reciprocal thickness (L^{-1}):

$$P = D_p S L^{-1} \quad (2)$$

D_p is primarily a function of the size and concentration of diffusing molecules in a specific polymer specimen; S is a function of the specific chemical interaction between these dissolved molecules and the polymer matrix, and is measured from the sorption isotherm. P is defined as the steady-state permeation flux for a 1 cm thick membrane over a 1 cm² area. Therefore, if two liquids have identical solubility in a polymer compound, their permeability coefficient will be inversely proportional to their molecular cross-section or volume. However, to account for major polymer-solvent interaction effects, the solubility of a selected simulant should be similar to that of the CWA in the protective material under study. Based on this criterion, solubility and permeation experiments were performed with four simulants (DCH, CEPS, DIMP and DEMP) and two CWAs (GB and HD).

T_b and $T_{1/2}$ are fundamental values related to D at very low and intermediate dissolved concentrations, respectively. These D values differ if D exhibits nonlinear concentration dependence and are often different from D_p , calculated from the steady-state permeation flux (equation 2). There is a good correlation between T_b and $T_{1/2}$ for each polymer-solvent pair [Rivin et al. 2005] but an exact solution of the permeation differential equation is obtained only for $T_{1/2}$ [Crank and Park 1981 and Meares 1965]. Equation 3 allows calculation of D in cm²/s from $T_{1/2}$ in seconds, and L in cm.

$$D_{1/2} = 0.139 (L^2) / T_{1/2} \quad (3)$$

Note: When D appears without subscripts, it refers to a generic diffusion coefficient with a magnitude dependent on the degree of swelling of the polymer. When subscripts are included, they refer to the method of determining D under different conditions and at different stages of the permeation process, each associated with a particular degree of swelling.

2.7.3 Normalized Permeation Parameters for Comparisons Independent of Thickness

Rationale and Definition. Normalized permeation parameters can be used to compare the permeation behavior of different materials independent of specimen thickness. Both T_b and $T_{1/2}$ are kinetic permeation parameters, independent of thermodynamic solubility (S), and related to a diffusion coefficient (D) and the square of the thickness (L). The limiting permeation is a thermodynamic parameter equal to the product of D, S, and thickness. Therefore, the normalized parameters, T_b/L^2 , $T_{1/2}/L^2$ and P (permeability coefficient, permeation per cm thickness), can be used to compare the permeation behavior of different materials

independent of specimen thickness. Normalization in the present context refers to dividing characteristic times by thickness squared in order to make comparisons at an identical unit thickness. As defined, P contains an inherent thickness correction. These normalized parameters should aid protective materials developers for CWAs in comparing results when materials of different thickness are employed for testing.

Thickness Normalization of Breakthrough Time. To evaluate a different elastomer with the same set of simulants, it is necessary to determine whether the values of T_b/L^2 and $T_{1/2}/L^2$ are equal to or larger than that of the CWAs or reference simulants in resistant materials such as Butyl and EPDM. If the new materials are similar to Butyl or EPDM, that indicates that the polymer is a candidate agent-resistant material. Most nonpolar and low polarity, nonhydrogen bonding polymers should fall between silicone, near the nonresistant extreme, and Butyl and EPDM near the resistant extreme. Next, the relative ratios of the four simulants should be examined to determine if similar rankings and ratios were observed, relative to the three polymers in Table 12 for which HD and GB results are available. These rankings are $DCH < CEPS \ll DIMP \sim Demp$. If these relative ratios are repeated for the four simulants, there is a high probability that the relative rankings of the agents would be maintained for the new polymer. If, however, it is desired to determine if the barrier material at a specific thickness achieves a specified level of protection, the permeation curve should be applied without normalization in conjunction with either a predetermined T_b or a minimum permeation effluent concentration.

Thickness Normalized Permeability. Barrier performance increases with smaller values of P , the opposite of the T_b/L^2 and $T_{1/2}/L^2$ values. Thus, P for a different elastomer can be compared directly with the values in the permeation column of Table 12.

Overall, these normalized parameters provide several useful ratios of the experimental results that can be used to relate simulant to CWA behavior. Additional ratios of experimental measurements to expand the comparison of simulant to CWA are provided in the following sections.

2.7.4 Permeation Parameter Ratios Relative to DCH and DCH-Butyl Rubber

Rationale for Parameter Ratios. In order to rank the protective performance of the set of polymers against CWA and simulant, further data reduction is required in order to set one of the liquids and one of the polymers as a baseline for comparisons. Three ratios were calculated to highlight three effects: (1) a liquid effect, (2) a polymer effect, and (3) a combined polymer-liquid effect. As a reference liquid, it was most useful to select DCH because of its high permeation rate. An overall liquid effect could then be calculated to allow a ranking of the

liquids for each polymer. One of the more permeation-resistant polymers, butyl, was selected as a reference polymer. An overall polymer effect could then be calculated and a polymer ranking identified. A combined overall baseline was then produced from the combined permeation parameters of DCH with butyl rubber; this is a combined polymer-liquid effect.

Ratio Results. The thickness normalized kinetic and thermodynamic parameters are summarized in Table 12 for GB, HD, and four liquid simulants in Silicone, Butyl, EPDM and Nitrile rubber compounds. Standard deviations for the three characteristic parameters (T_b/L^2 , $T_{1/2}/L^2$ and P) are shown in Table 12 for both CWAs, but are given only for simulant permeability due to limited replication (duplicate tests). In general, simulant results exhibited significantly less scatter than the corresponding data for the CWA (Appendix C).

Breakthrough Time Ratios. Similar trends in T_b/L^2 and $T_{1/2}/L^2$ are observed with all liquids, as represented for each parameter by the selectivity ratios R_{DP} (relative to dichlorohexane with respect to the specific polymer) and R_{DB} (relative to dichlorohexane with respect to Butyl). The coding employed defines R as the ratio, with the following subscripts: D for DCH, P for polymer, and B for Butyl. Thus, for example, the R_{DP} (Column 3 in Table 12) is the ratio of $[T_b/L^2]_{(\text{Challenge Chemical})}$ divided by $[T_b/L^2]_{(\text{DCH})}$ within the same polymer. The R_{DP} selectivity ratio provides a convenient “fingerprint” of the relative resistance of each polymer to CWAs and simulants, as shown in Figure 7. Bar graphs for HD and GB are not shown for Nitrile because CWA permeation was not determined for this polymer, however, as seen in Table 12, the simulant T_b profile for Nitrile is similar to that for EPDM.

Permeability Ratios. To provide a comparison of the polymer effect, the R_{DB} selectivity ratio was calculated by dividing the permeation parameters by the value for DCH in Butyl for all polymers:

$$(T_b/L^2 = 22,000 \text{ min/cm}^2).$$

$$\text{Thus, } R_{DB} = [T_b/L^2] / [T_b/L^2]_{(\text{DCH in Butyl})}$$

This allows a direct comparison of relative permeation across all polymer-liquid combinations. The remaining ratios (R_{DP} and R_{DB}) for $T_{1/2}$ and P in Table 12 were derived using the same method as described for the T_b ratios of R_{DP} and R_{DB} .

Rankings. Regarding the relative kinetic parameters, R_{DB} shows a large decrease in barrier performance with all liquids in the order: Butyl > EPDM ~ Nitrile >> Silicone. There are smaller differences between the liquid permeants as shown by the maximum range in R_{DP} , which varies from 2.9 for Silicone to 6 for Butyl, with EPDM and Nitrile having ratios near 4. Although, the permeation profile is different for each polymer, permeation parameters of simulants usually bracket the values for CWAs.

The permeability coefficient provides a similar relationship between the polymers Butyl, EPDM, and Nitrile. The values in Table 12 are plotted in Figure 8a and 8b. Figure 8b plots the same data without Silicone, so that the y-axis scale can show the relative rankings for the other polymers. As shown in Figure 8, each polymer compound also has a unique permeation profile that differs significantly from those obtained with kinetic parameters due to the effect of solubility.

Table 12. Mean permeation parameters compensated for specimen thickness

Polymer: liquid (replicates)	T_b/L^2		$T_{1/2}/L^2$		P				
	10^3 min/cm^2	R_{DP}^*	R_{DB}^\dagger	10^3 min/cm^2	R_{DP}	R_{DB}	$\frac{\text{ng} \cdot \text{cm}}{\text{cm}^2 \cdot \text{min}}$	R_{DP}	R_{DB}
Silicone:									
HD(22)	0.62 (12) [‡]	1.2	0.03	1.7 (6.7)	0.8	0.06	93.5 (14)	0.8	8.4
GB(22)	0.73 (11)	1.4	0.03	1.3 (3.4)	0.6	0.05	125 (20)	1.0	11.2
DCH(3)	0.51	1.0	0.02	2.2	1.0	0.08	120 (2.7)	1.0	10.7
CEPS(2)	0.93	1.8	0.04	3.6	1.6	0.13	76 (1.1)	0.6	0.8
DIMP(2)	1.5	2.9	0.07	3.7	1.7	0.13	115 (5.3)	1.0	10.3
DEMP(2)	1.4	2.7	0.06	2.8	1.3	0.10	93.5 (0.77)	0.8	8.4
Butyl:									
HD(21)	33 (31)	1.5	1.5	81 (11)	2.9	2.9	7.3 (22)	0.7	0.7
GB(22)	60 (36)	2.7	2.8	175 (24)	6.3	6.3	1.3 (24)	0.1	0.1
DCH(2)	22	1.0	1.0	28	1.0	1.0	11.2	1.0	1.0
CEPS(3)	40	1.8	1.9	65	2.3	2.3	8.3 (16)	0.7	0.7
DIMP(2)	133	6.0	6.0	222	7.9	7.9	2.5 (7.2)	0.2	0.2
DEMP(2)	130	5.9	5.9	226	8.1	8.1	0.87 (26)	0.08	0.08
EPDM:									
HD(22)	7.6 (24)	0.8	0.3	28 (6.2)	1.4	1.0	9.4 (14)	0.5	0.8
GB(17)	10 (36)	1.0	0.5	29 (42)	1.5	1.0	2.0 (15)	0.1	0.2
DCH(3)	10	1.0	0.5	20	1.0	0.7	18.4 (4.0)	1.0	1.6
CEPS(3)	15	1.5	0.7	31	1.6	1.1	16.9 (0)	0.9	1.5
DIMP(2)	35	3.5	1.6	88	4.4	3.1	2.51 (3.1)	0.1	0.2
DEMP(2)	39	3.9	1.8	84	4.2	3.0	1.24 (10)	0.1	0.1
Nitrile:									
DCH(1)	8.2	1.0	0.4	14	1.0	0.5	10.9	1.0	1.0
CEPS(1)	12	1.5	0.6	31	2.2	1.1	5.9	0.5	0.5
DIMP(1)	28	3.4	1.3	40	2.9	1.4	18.4	0.2	1.6
DEMP(2)	31	3.8	1.4	50	3.6	1.8	18.4 (20)	0.2	1.6

*Relative to DCH for the same polymer.

†Relative to DCH for butyl.

‡Numbers in parentheses = % standard deviation.

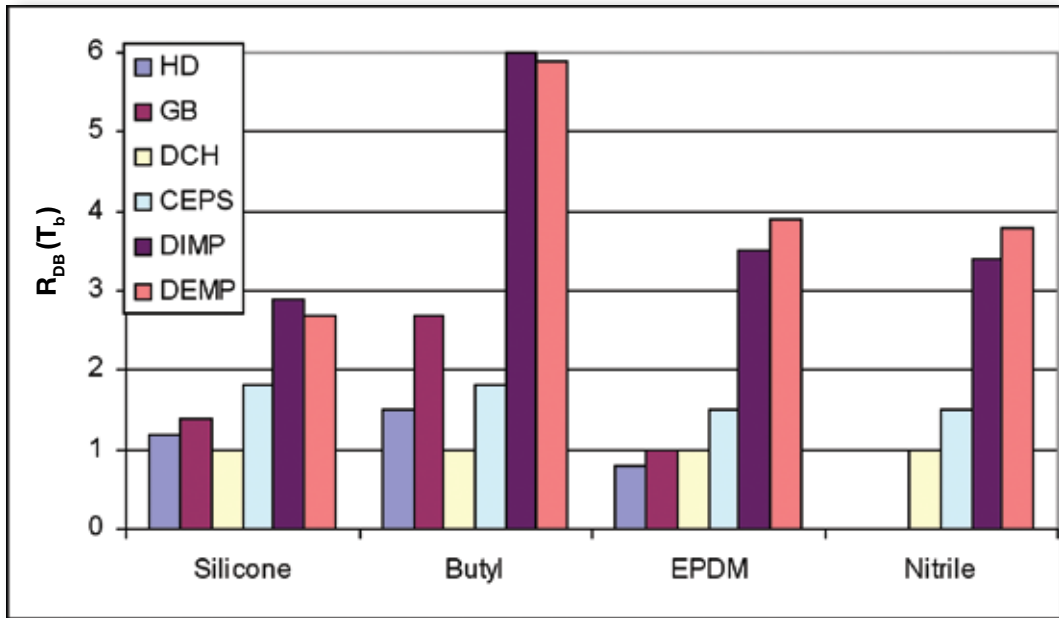

Figure 7. Normalized breakthrough time relative to DCH value for the same elastomer compound

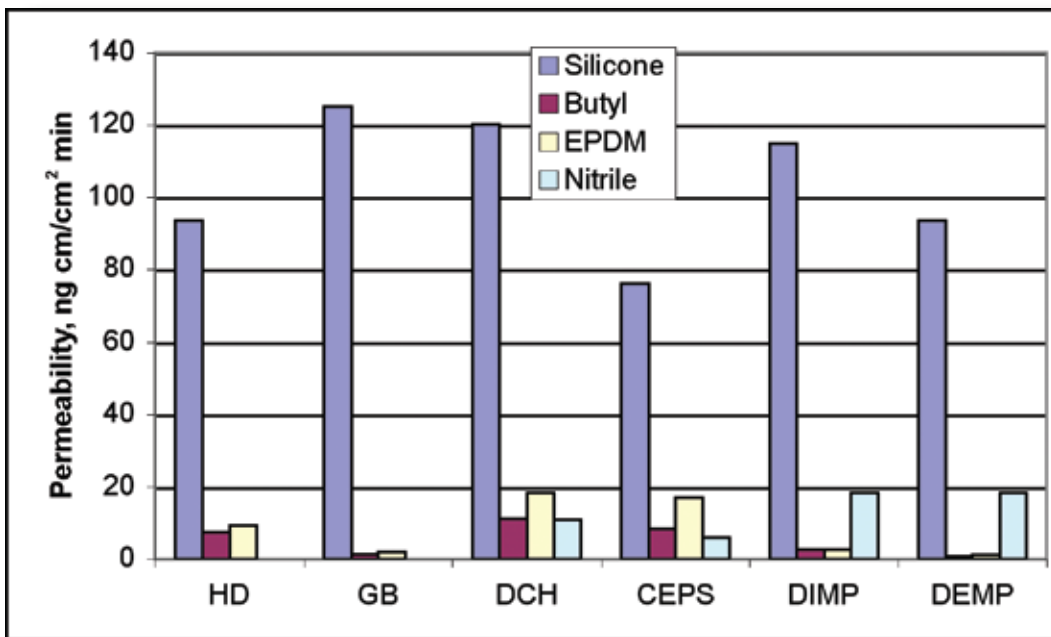

Figure 8a. Average permeability coefficient from the mean of the replicates of the four polymers

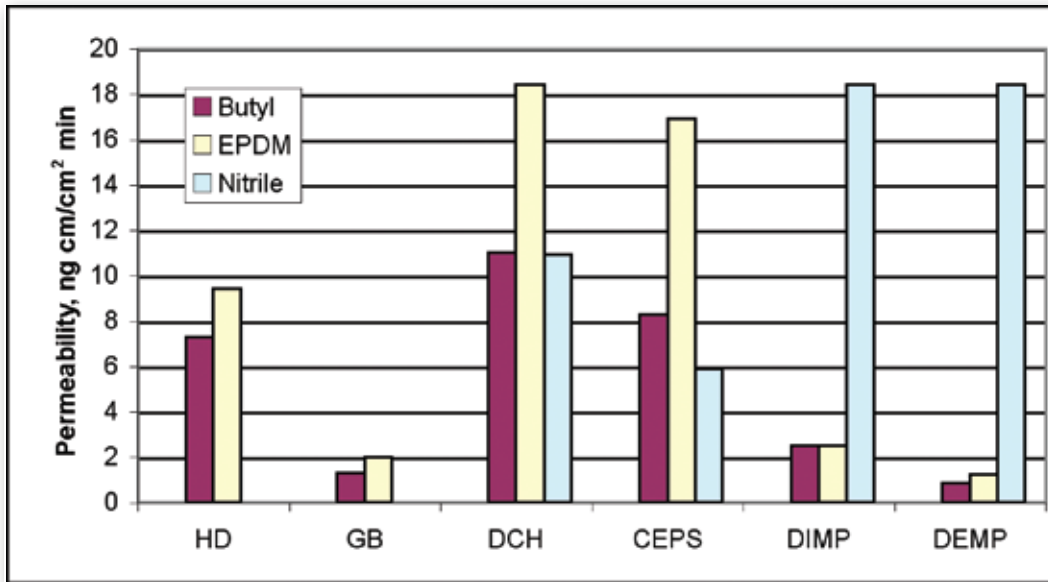

Figure 8b. Average permeability coefficient from the mean of replicates of Butyl, EPDM, and Nitrile (without silicone to show detailed rankings of the other polymers).

Discussion

3.0

3.0 Discussion

This discussion provides several approaches that can be applied by PPE manufacturers to screen and deselect candidate materials based on solubility and permeation with the simulants. These include: interpreting test results to make safe-sided selections of candidate materials, employing only solubility as a safe-sided screen, using the relative rankings and/or absolute values of permeation parameters, and finally, using direct graphical comparison of permeation curves as a tool for material evaluation.

In general, the respective simulant solubility values in Table 11 (solubility and diffusivity values) are higher or equivalent to those for GB and HD. The thickness normalized permeation parameters of the two simulants bracket those of HD for all three polymers and GB for two of three polymers, except for Silicone. Based on these results and the absolute permeation curves, the data interpretation techniques described below can be employed to select candidate GB and HD resistant materials based on simulant testing. Although protective clothing developers can apply their own data interpretation strategies to the CWA-simulant data sets provided, the discussion that follows should provide a useful starting point for selecting candidate protective materials for further testing.

3.1 Safe-Sided Simulants and Tests

Safe-sided simulants can be defined as simulants that bias the selection of candidate protective materials toward those with a high probability of providing equal or better protective performance against CWAs. The simulants selected from this study should provide a safe-sided screening tool for nonpolar protective polymers. The simulant solubility values and permeation results are generally higher than the CWA values. The flooded-cell permeation test is safe-sided relative to droplet permeation geometry. The disadvantage of safe-sided simulants is that potentially acceptable materials will rank low on a list of candidate materials for further testing. These materials might have a lower cost, have a greater durability, or have superior mechanical, thermal, optical or face-sealing properties. However, each PPE developer can apply their own judgment regarding an optimal testing strategy to screen candidate materials for CWA testing. Obviously, any highly soluble, rapidly diffusing liquid would not provide a useful safe-sided simulant. The best safe-sided simulants will have similar but slightly higher values of permeation when compared to the CWAs.

3.2 Solubility Test as a One-Sided Candidate Material Screen

A material selection strategy can employ only the CWA and simulant solubility results to screen materials. For most chemical-material series, the simulants had greater or similar equilibrium solubility, after correction for extractables. Therefore, a new candidate elastomer tested with the simulants that results in equivalent or lower solubility values might be a good candidate protective material. However, when results of solubility are compared to permeation using GB and HD on silicone, the solubility values are quite low, 5%–6%, yet the permeation was extremely rapid due to the higher diffusion coefficient component in the silicone permeation. Therefore, the equilibrium solubility screen can only be used as a one-sided test to eliminate materials with high solubility, but cannot be used to select candidate protective materials without a follow-on permeation or diffusion test.

3.3 Relative Criteria for Selecting Candidate Materials Based on Permeation Correlations

Another possible evaluation method consists of comparing the *relative* values of a new PPE candidate material with those reported in Table 12. After performing the permeation experiments with the new material and simulants DEMP, DIMP, CEPS, and DCH, one would perform the data reduction to the variables listed in the column heading of Table 12 and produce an equivalent table for the new candidate material. For T_b/L^2 and $T_{1/2}/L^2$, the higher the value, the longer the breakthrough time, and the slower the permeation. One would then determine if these favorable, high values were obtained for the new polymer by comparing with the simulant values in the table, relative to the CWA values. If the reduced data for the four simulants has a similar quantitative relationship to that shown in Table 12, then one can assume that the correlation with the agent permeation would be valid for the tested material; therefore, the material could remain a candidate for testing with the CWA. If the relative values are quite different and significantly lower than those in Table 12, then it is likely that the material is not a satisfactory barrier material to agent permeation.

3.4 Absolute Criteria for Selecting Candidate Materials Based on Permeation Correlations

For GB and HD with the materials studied here, Butyl and EPDM provide an estimate of an upper level for elastomer permeation performance as demonstrated by relatively long breakthrough times and low permeation. Silicone permeation performance is poor because of the short breakthrough times and high permeation. After the relative correlation process above has been completed, one can go to the next step of evaluating the absolute permeation performance by comparing the values of the new candidate PPE polymer being tested by the manufacturer with the values in Table 12 for reduced times and permeation.

If values for the new polymer are comparable to or better than the values for Butyl and EPDM, this would indicate that the polymer is a good candidate. If the absolute breakthrough values for the new material approach the values for silicone, the polymer would be a poor candidate for further testing. Obviously, this assignment as a poor candidate would apply even if the new material met the relative criterion of having breakthrough parameters similar to those of DCH and less than those of CEPS, DIMP, and DEMP because the absolute permeation resistance was so poor.

3.5 Permeation Curve Comparisons

Another approach using simulants to assess whether a particular item or barrier material provides adequate protection against CWAs or other toxic chemicals is to compare the material's permeation curve to that of a reference material under the same exposure conditions. For example, side-by-side comparison of the permeation flux curves (rather than thickness corrected permeability) obtained for HD, GB, and two simulants in 0.03 cm Butyl membranes (Figure 9) clearly shows the close correspondence between CEPS and GB, and the bracketing of HD between DCH and CEPS in this polymer. Flooded-surface permeation of HD

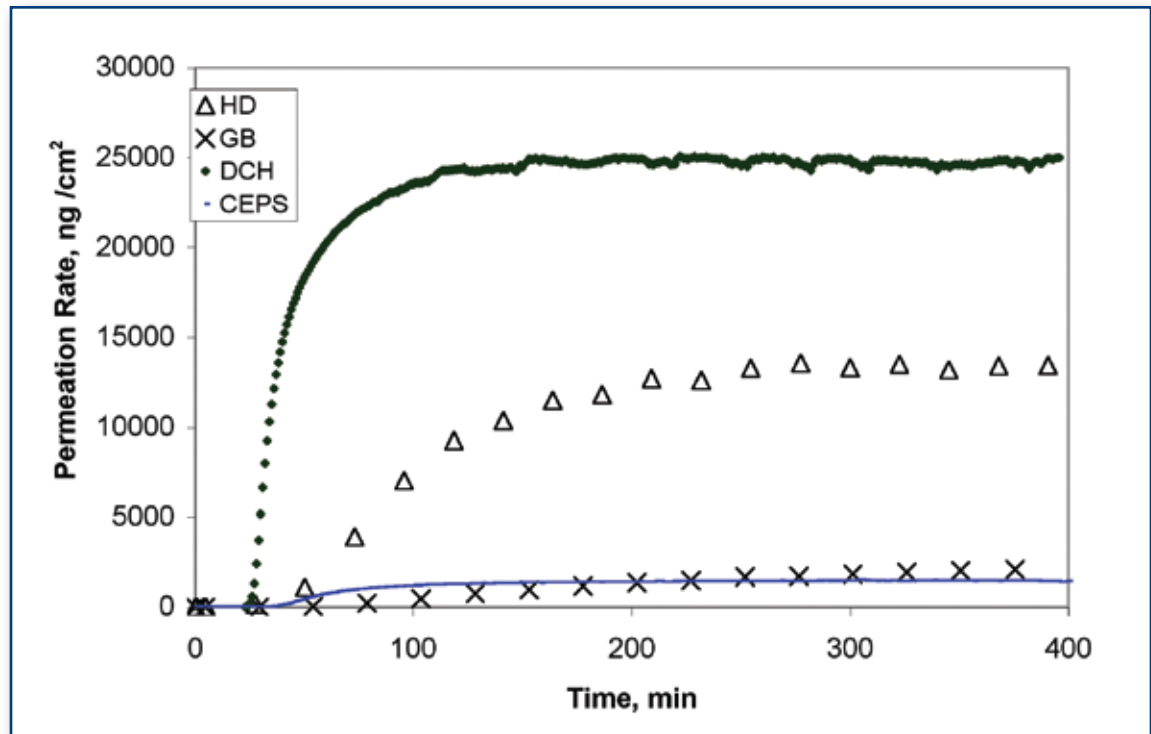

Figure 9. Permeation rate of CWAs and simulants in 12-mil Butyl rubber
In this figure, the permeation rate is the permeation flux at each of the times (expressed in minutes); whereas, the permeability coefficient is the steady-state permeation flux divided by the thickness.

exceeds that of GB in good barrier membranes so that comparing permeation of DCH and CEPS in a new candidate material specimen to a Butyl reference curve affords a rapid estimate of the relative barrier performance of the test material. The available data is not sufficient to derive a quantitative correlation for all polymer compounds but it strongly supports the concept of this comparative method.

3.6 Infinite Versus Finite Source Permeation Geometry

The infinite source (flooded surface) diffusion and permeation coefficients determined in this report provide a more systematic characterization for GB, HD, and related liquids with important barrier elastomers than the finite source droplet test geometries. The most common, current CWA permeation test method employs a liquid droplet challenge rather than a completely covered surface (i.e., flooded surface). Infinite source permeation represents an upper limit for each permeant-elastomer pair relative to the droplet tests. This is due to the following limitations in the latter: depletion of the drop mass via concurrent evaporation, lateral spreading toward adjacent unwetted areas, and insufficient applied liquid to attain the maximum concentration gradient in the membrane. Finite source droplet geometry is useful for determining the extent to which wear-time can be extended by evaporative loss of the permeant. However, the infinite source experiment is required to characterize the polymer-liquid interaction with respect to solubility, diffusion, and the permeability coefficient, especially for structure-property relationships.

Summary

4.0

4.0 Summary

A new test cell with associated control and analytical components has been developed to facilitate flooded surface permeation testing of barrier materials. Flat sheet specimens (< 0.7 cm thick) of any hardness are evaluated under flooded surface conditions using toxic or nontoxic liquids to provide a rapid assessment of barrier effectiveness. The permeation of CWAs and other toxic liquids can be estimated using a less toxic test liquid by comparison to a reference material, either by a direct match of the permeation curve or by calculation of normalized kinetic and thermodynamic parameters.

References

References

- Barrer RM, Barry JA, Rogers MG [1962]. Permeation through a membrane with mixed boundary conditions. *Trans Faraday Soc* 58:2473–2483.
- Barton AFM [1983]. CRC handbook of solubility parameters and other cohesion parameters. 2nd ed. Boca Raton, FL: CRC Press, pp. 139–190.
- Crank J, Park GS [1981]. Methods of measurement in J. Crank and G.S. Park (eds.), *Diffusion in polymers*. New York: Academic Press, pp. 1–39.
- Meares P [1965]. Transient permeation of organic vapors through polymer membranes. *J Appl Polymer Sci* 9:917–932.
- NIOSH [2001]. Chemical, biological, radiological, and nuclear (CBRN) standard for self-contained breathing apparatus statement of standard and supporting rationale. Pittsburgh, PA: U.S. Department of Health and Human Services, Centers for Disease Control and Prevention, National Institute for Occupational Safety and Health, National Personal Protective Technology Laboratory; Section 6; December 2001.
- NFPA [1994]. National fire protection association draft standard on protective ensembles for chemical/biological terrorism incidents, November 2000, Report of Proposal.
- Rivin D, Lindsay RS, Shuely WJ, Rodriguez A [2005]. Liquid permeation through nonporous barrier materials. *J Membr Sci* 246:39–47.
- Shuely WJ [1999]. Test methods and reference materials for selection of chemically resistant materials. Proc. 10th Annual Ground Systems Survivability Symposium, NDIA Conf., April 1999.
- Shuely WJ, Ince BS [2001]. Evaluation of systematic and random error in the measurement of equilibrium solubility and diffusion coefficient for liquids in polymers. ECBC-TR-090 November 2001. Approved for public release.
- U.S. Army Center for Health Promotion and Preventive Medicine (USACHPPM) [2000], Tech Guide 244, *The Medical NBC Battlebook*, May 2000.
- Wijmans JG, Baker RW [1995]. The solution-diffusion model. *J Membr Sci* 107:1–21.

Bibliography

Bibliography: Application of Solvent-Solute Parameters and Solubility Phase Diagrams to Chemical Defense, Unlimited Distribution Publications

Ince, Brian S., and Shuely, Wendel J., Comparison of Rheological Properties: Bis (2 chloroethyl) Sulfide Vs Model Liquids; in Material Interactions with Agents and Simulants, CRDEC SP 011, Proceedings of the Third International Simulant Workshop, CRDEC, 7–9 March 1989, Compiled by White, W.E., Ph.D., November 1989, UNCLASSIFIED Report.

Ince, Brian S., and Shuely, Wendel J., Solubility, Sorption and Desorption in a Set of Standard Elastomers; in Material Interactions with Agents and Simulants, CRDEC SP 011, Proceedings of the Third International Simulant Workshop, CRDEC, 7–9 March 1989, Compiled by White, W.E., Ph.D., November 1989, UNCLASSIFIED Report.

Ince, Brian S., and Shuely, Wendel J., Comparison of Agent and Simulant Measurements of Equilibrium Solubility and Diffusion Coefficient; in Materials Research Contributions to the Evaluation of Test Liquids, CRDEC SP 025, Proceedings of the Fourth International Simulant Workshop, CRDEC, 6–8 March 1990, Compiled by Famini, George R., July 1990, UNCLASSIFIED Report.

Ince, Brian S., and Shuely, Wendel J., Comparison of Equilibrium Sorption and Diffusion Coefficient Values for Agents and Simulants in Polymeric Materials; in Materials Research Contributions to the Evaluation of Simulants, CRDEC SP 034, Proceedings of the Fifth International Simulant Workshop, CRDEC, 5–7 March 1991, April 1992, UNCLASSIFIED Report.

Ince, Brian S., and Shuely, Wendel J., Scaling and Normalization to Allow Simulant Agent Comparisons of Material Sorption; in Materials Research Contributions to the Evaluation of Simulants, CRDEC SP 042, Proceedings of the Fifth International Simulant Workshop, CRDEC, 5–7 March 1991, April 1992, UNCLASSIFIED Report.

McHugh, Vincent M., Ince, Brian S., and Shuely, Wendel J., Solubility Behavior of Model Liquids with a Polymeric Viscoelastic Thickener; in Material Interactions with Agents and Simulants, CRDEC SP 011, Proceedings of the Third International Simulant Workshop, CRDEC, 7–9 March 1989, Compiled by White, W.E., Ph.D., November 1989, UNCLASSIFIED Report.

Shuely, Wendel J., Simulant Use in Materials Testing, CRDEC SP 86016, Proceedings of the Workshop on Methodology for Testing of Materials with Agents and Decontaminants, 9–11 July 1985, Compiled by Shuely, W.J., Schneider, N. and Matthews, S.C., May 1986, UNCLASSIFIED Report, ADB105018L.

Shuely, Wendel J, Simulant Use in Fabric Testing, NATICK/TR 88/070L, Proceedings of the Workshop on Methodology for Testing Permeable CD Materials with Chemical Agents, 19–20 May 1987, Compiled by Angelini, Pio, and Shuely, Wendel J, September 1988, UNCLASSIFIED Report, ADB128725L, ADD442088L.

Shuely, Wendel J., Physical and Polymer Chemistry in Simulant Development, CRDEC SP 002, Proceedings of the Second International Simulant Workshop, CRDEC, 1–3 March 1988, Compiled by White, W.E., Ph.D., December 1988, UNCLASSIFIED Report.

Shuely, Wendel J., Materials Coordination Overview; in Material Interactions with Agents and Simulants, CRDEC SP 011, Proceedings of the Third International Simulant Workshop, CRDEC, 7–9 March 1989, Compiled by White, W.E., Ph.D., November 1989, UNCLASSIFIED Report.

Shuely, Wendel J., Overview of Progress and Trends in Materials Research and Development with Relevance to Simulants; in Materials Research Contributions to the Evaluation of Test Liquids, CRDEC SP 025, Proceedings of the Fourth International Simulant Workshop, CRDEC, 6–8 March 1990, Compiled by Famini, George R., July 1990, UNCLASSIFIED Report.

Shuely, Wendel J., Abraham, Michael H., Ince, Brian S., and McHugh, Vincent M., Volatilization from Material Surfaces; in Material Interactions with Agents and Simulants, CRDEC SP 011, Proceedings of the Third International Simulant Workshop, CRDEC, 7–9 March 1989, Compiled by White, W.E., Ph.D., UNCLASSIFIED Report.

Shuely, Wendel J., and Abraham, Michael H., Liquid Properties Influencing Transport and Interactions with Materials: Surface Free Energy and Refractive Index Comparisons of Model Liquids with GD and HD; in Material Interactions with Agents and Simulants, CRDEC SP 011, Proceedings of the Third International Simulant Workshop, CRDEC, 7–9 March 1989, Compiled by White, W.E., Ph.D., November 1989, UNCLASSIFIED Report.

Shuely, W.J., Ince, B.S., and McHugh, V.M., Experimental Correlations Between Agent Simulant Transport Properties, CRDEC SP 002, Proceedings of the Second International Simulant Workshop, CRDEC, 1–3 March 1988, Compiled by White, W.E., Ph.D., December 1988, UNCLASSIFIED Report.

Shuely, Wendel J., and Ince, Brian S., Interactions with Optically Transparent Materials; in Material Interactions with Agents and Simulants, CRDEC SP 011, Proceedings of the Third International Simulant Workshop, CRDEC, 7–9 March 1989, Compiled by White, W.E., Ph.D., November 1989, UNCLASSIFIED Report.

Shuely, Wendel J., and Ince, Brian S., Normalization and Scaling of Material Liquid Interactions; in Materials Research Contributions to the Evaluation of Test Liquids, CRDEC SP 025, Proceedings of the Fourth International Simulant Workshop, CRDEC, 6–8 March 1990, Compiled by Famini, George R., July 1990, UNCLASSIFIED Report.

Shuely, Wendel J., and Ince, Brian S., Progress in the Development of Test Liquids for Acceptance of Butyl Coated Cloth, CRDEC SP 042, Proceedings of the Fifth International Simulant Workshop, CRDEC, 5–7 March 1991, April 1992, UNCLASSIFIED Report.

Shuely, Wendel J., and Ince, Brian S., Screening Strategies for Safety and Toxicity of Materials Simulants; in Materials Research Contributions to the Evaluation of Simulants, CRDEC SP 042, Proceedings of the Fifth International Simulant Workshop, CRDEC, 5–7 March 1991, April 1992, UNCLASSIFIED Report.

Appendix A

Appendix A: Standard Test Method for Estimating Permeation Resistance of Nonporous Barrier Polymers to Liquid Chemical Warfare Agents (GB and HD) Using Liquid Simulants

Introduction

The National Institute for Occupational Safety and Health (NIOSH) held several public meetings to address the concerns of the stakeholders on developing and implementing standards for CBRN respiratory protective devices. Sarin (GB), a nerve agent, and sulfur mustard (HD), a blistering agent, were chosen as representative chemical warfare agents (CWAs) to test for chemical permeation resistance of respiratory protective devices. When it was stated at these public meetings that NIOSH would use military CWAs to certify respiratory protective devices, some respirator and other personal protective equipment (PPE) manufacturers requested that NIOSH identify chemical compounds (simulants) that can be used to simulate the permeation and penetration effects of CWAs on protective equipment. Manufacturers do not have access to GB and HD CWAs to perform in-house material and product development testing. In addition, there are only a limited number of certified laboratories able to perform CWA testing due to the high cost, toxicity levels, required lead time, and regulatory controls. These factors make any type of CWA testing very expensive and inconvenient.

This test method was developed to provide respirator and other PPE manufacturers with a lower cost, more rapid screening method, relative to CWA testing, for evaluating the performance of candidate barrier materials to be used in the production of their PPE products such as respiratory protection devices and protective garments. This method was developed primarily so that PPE manufacturers could use accessible chemical compounds (simulants) that have lower toxicity to simulate the permeation effects of CWAs, specifically GB and HD. However, this permeation test can be performed with any nonreactive liquid including toxic industrial chemicals (TIC) in which the polymer does not decompose or dissolve. The simulant testing does not replace CWA testing for NIOSH certification of respirators.

1. Scope

- 1.1 This test method measures the resistance of nonporous materials to a liquid chemical under the conditions where the upper exposed test surface of the material specimen is wet (flooded) by the test chemical. The materials are used to manufacture personal protective equipment such as respirators, gloves, boots, and other types of protective clothing. The procedures can be applied to two types of liquids: (1) CWA simulants, for comparison with previously generated data to estimate permeation of GB and HD and (2) liquid TIC, to obtain direct permeation times for a particular TIC.
- 1.2 CWA Simulant Procedure. This procedure estimates the permeation resistance of flat nonporous films, membranes, and sheets up to 0.7 cm thick to liquid Sarin (GB) and sulfur mustard (HD) CWAs by using four simulant chemical compounds. Permeation of GB or HD through a candidate material can be estimated by comparison to those barrier materials that have been previously tested with GB, HD, and the four simulants. The permeation test results of polydimethylsiloxane [Silicone], poly(isobutylene) [Butyl], poly(ethylene-co-propylene-co-diene) EP8A [EPDM] after being exposed to GB, HD, and simulants are included in this test report to assist in future test data analysis with the correlation techniques. The following four CWA simulants are recommended for use with this test method: 1, 6-dichlorohexane (DCH), 2-chloroethyl phenyl sulfide (CEPS), diethyl methylphosphonate (DEMP) and diisopropyl methylphosphonate (DIMP).

Simulant/CWA permeation correlations have been developed and are discussed as an alternative to testing with GB and HD. In addition to permeation results with Silicone, Butyl, and EPDM, poly(butadiene-co-acrylonitrile) [Nitrile] was tested with only simulants as part of the preliminary screening of candidate materials. For additional details on the correlation between CWAs and simulants, refer to: *Liquid Permeation through Nonporous Barrier Materials*, D. Rivin, R.S. Lindsay, W.J. Shuely and A. Rodriguez, *Journal of Membrane Science*, Volume 246, Issue 1, 1 January 2005, Pages 39–47.

- 1.3 The TIC Procedure measures the permeation resistance of flat nonporous films, membranes, and elastomers, either a single layer or a composite of multiple layers, to any available non-reactive, liquid TIC in which the material does not decompose or dissolve. Permeation resistance times can be obtained directly when using this procedure; no correlation techniques are needed.

2. Reference Documents

2.1 ASTM Standards:

D 471 Test Method For Rubber Property-Effect of Liquids

D 543 Standard Test Method for Resistance of Plastics to Chemical Reagents

D 1415 Indentation Standard Test Method for Rubber Property—
International Hardness

D 2240 Standard Test Method for Rubber Property—Durometer Hardness

D 3182 Standard Practice for Rubber—Materials, Equipment, and Procedures for
Mixing Standard Compounds and Preparing Standard Vulcanized Sheets

E 17 Specification for Standard Atmospheres for Conditioning and Testing Flexible
Barrier Materials

F 739 Test Method for Resistance of Protective Clothing Materials to Permeation
by Liquids or Gases Under Conditions of Continuous Contact

F 1194 Standard Guide for Documenting the Results of Chemical Permeation
Testing of Materials Used in Protective Clothing

2.2 Military Standards

Evaluation of Systematic and Random Error in the Measurement of Equilibrium
Solubility and Diffusion Coefficient for Liquids in Polymers. Shuely, Wendel J. and
Ince, Brian S. ECBC-TR-090. November 2001. Approved for public release.

Liquid Permeation through Nonporous Barrier Materials, D. Rivin, R.S. Lindsay,
W.J. Shuely and A. Rodriguez, *Journal of Membrane Science, Volume 246, Issue 1, 1
January 2005, Pages 39–47* [1].

U.S. Army Test and Evaluation Command, Test Operations Procedure (TOP)
8–2–501, Permeation and Penetration of Air-permeable, Semipermeable, and
Impermeable Materials with Chemical Agents or Simulants (Swatch Testing),
1997.

MIL-STD-282, Methods 204–209 GB, VX, and Mustard: Resistance of
Impermeable Materials (Static Diffusion); in “Filter Units, Protective Clothing,
Gas-Mask Components and Related Products: Performance Test Methods”
(revised 1992).

2.3 Federal Standards

Federal Standard No. 191, Method 5030.2–4.1.3.; Determination of Thickness of Textile Materials.

2.4 Other Standards

ISO 6529:2001, Protective clothing—Protection against chemicals—Determination of resistance of protective clothing materials to permeation by liquids and gases

2.5 Material Safety Data Sheets (MSDS)

For MSDS information for the liquid test chemicals, contact the supply source using the CAS numbers and purity level of the chemicals.

3. Terminology

3.1 Definitions

- 3.1.1 *analytical technique*. A procedure to quantitatively determine the concentration of the liquid test chemical in a collection medium.
- 3.1.2 *breakthrough time*. The intercept on the baseline of the initial linear rise of the permeation curve.
- 3.1.3 *chemical warfare agents*. Chemicals that have been militarized for use in offensive operations in combat.
- 3.1.4 *diffusion*. The process in which molecules are transported from one location in a material to another location due to random molecular motion.
- 3.1.5 *diffusion coefficient*. The coefficient equating the rate of transport per unit area to the change in concentration of diffusing species per unit distance traveled by the species.
- 3.1.6 *flooded cell*. A permeation cell geometry in which the exposed portion of the top surface of the protective material specimen is totally covered with the liquid test chemical.
- 3.1.7 *fractional weight gain*. The incremental sorption at time (t) divided by the plateau value representing the final steady state weight increase.
- 3.1.8 *extraction error*. Weight loss due to extraction of chemical components of the protective equipment material specimen into the excess sorbing liquid during the immersion test. The chemical components are relatively low molecular weight, nonreactive additives to the material

specimen that can migrate out of the specimen during contact with liquid. The weight loss of these extractables masks the additional weight gain from the sorbing liquid.

- 3.1.9 *immersion test*. a procedure to determine liquid uptake by the material specimen that includes complete immersion of the material specimen into the test chemical to determine fractional weight gain and sorption as a function of time.
- 3.1.10 *permeation*. the overall process by which a chemical moves through a protective equipment material on a molecular level resulting in an emergent vapor flux.
- 3.1.11 *permeation curve*. the permeation flux per exposed material specimen area plotted versus time.
- 3.1.12 *simulant chemical*. a chemical that simulates some aspect of the permeation of Sarin (GB), sulfur mustard (HD), or other chemical warfare agents.
- 3.1.13 *solubility*. the mass of solute that dissolves into a material after a specified time under immersion conditions; equilibrium solubility is the maximum mass of solute that dissolves into a material after a period long enough for the weight gain versus time plot to show a plateau indicating equilibrium has been reached.
- 3.1.14 *steady-state permeation*. the constant rate of permeation that occurs after breakthrough when the chemical contact is continuous and all forces affecting permeation have reached equilibrium.
- 3.1.15 *sweep gas*. dry air or dry nitrogen from a pressurized tank that flows beneath the material specimen and is used to carry the permeation effluent to the detector for analysis.
- 3.1.16 *liquid test chemical*. liquid that is used to challenge the protective equipment material specimen.

3.2 Symbols

- 3.2.1 **A.** Area of material specimen exposed to liquid inside the liquid permeation cell.
- 3.2.2 **D_i .** The diffusion coefficient determined using Fick's second law in an immersion experiment.
- 3.2.3 **D_p .** The diffusion coefficient determined from the steady-state permeation and solubility.
- 3.2.4 **F.** Volumetric flow rate of the sweep gas flowing to the chemical detector.

- 3.2.5 **L.** Thickness of the protective equipment material specimen.
- 3.2.6 **P'**. Permeation flux (at steady state) through the exposed area of a material specimen during a unit of time.
- 3.2.7 **P.** The permeability coefficient is defined as the permeation per cm of material specimen thickness. Note: This is a *permeation parameter*.
- 3.2.8 **S.** Solubility of liquid in a polymer under immersion conditions at steady-state sorption or the concentration of dissolved molecules during steady-state permeation, which decreases continuously in the direction of permeant transport.
- 3.2.9 **T_½.** Time at which permeation is half the steady-state value.
- 3.2.10 **T_b.** Breakthrough time determined as the intercept on the baseline of the initial linear rise of the permeation curve.
- 3.2.11 **T_s.** The time at inception of steady-state permeation.
- 3.2.12 **R_{DB}.** The ratio of a permeation parameter for a given liquid and polymer relative to DCH in Butyl rubber.
- 3.2.13 **R_{DP}.** The ratio of a permeation parameter for a given liquid and polymer relative to DCH.
- 3.2.14 **T_½ / L².** Normalized halftime independent of material specimen thickness.
Note: This is a *permeation parameter*.
- 3.2.15 **T_b / L².** Normalized breakthrough time independent of material specimen thickness. Note: This is a *permeation parameter*.

3.3 Liquid Permeation Parameters:

- 3.3.1 Units
- 3.3.1.1 **A**, cm²
- 3.3.1.2 **D**, cm²/min
- 3.3.1.3 **F**, cm³/min
- 3.3.1.4 **L**, cm
- 3.3.1.5 **P'**, ng/cm²•min
- 3.3.1.6 **P**, ng•cm/cm²•min
- 3.3.1.7 **S**, ng/cm³
- 3.3.1.8 **T_½**, min

3.3.1.9 T_b , min

3.3.1.10 $T_{1/2} / L^2$, min/cm²

3.3.1.11 T_b / L^2 , min/cm²

4. Summary of Test Method

- 4.1 The permeation resistance of a protective equipment material to a chemical is measured by detecting initial breakthrough.
- 4.2 This permeation test can be performed with the identified simulant chemicals or with any liquid TIC in which the material specimen does not dissolve or decompose.
- 4.3 In the permeation test apparatus, the protective equipment material specimen partitions the challenging chemical from the collection media.

5. Significance and Use

- 5.1 This test method can be used to estimate the permeation resistance of GB and HD chemical warfare agents by using the four simulant chemicals identified in this Appendix in Section 6.4.1 and by using the data analysis techniques described in this Appendix in Sections 11 and 12.
- 5.2 The breakthrough time (T_b), halftime ($T_{1/2}$), and permeability coefficient (P) are key measures of the effectiveness of personal protective equipment material. Barrier effectiveness of a test material is most conveniently compared to that of a standard (e.g., Butyl rubber) using P or normalized time parameters (T_b / L^2 or $T_{1/2} / L^2$).
- 5.3 The sensitivity of the test method in detecting low permeation rates or amounts of the test chemical that permeates the material specimen is determined by the detection system selected. For this test, a minimum detection level of 1 µg/ L is recommended.

6. Apparatus

- 6.1 *Thickness Gauge*, suitable for measuring thickness to the nearest 0.0025 mm (or the nearest 0.0001 inch) that meets the specifications of Federal Specification GGG-C-105C shall be used to measure the thickness of the material specimens.
- 6.2 *Analytical Balance*, readable and reproducible to ± 0.5 mg, shall be used to determine weight per unit area of each material specimen.
- 6.3 *Liquid Permeation Cell*, as shown in Figures A-1a. and A-1b.; the test apparatus consists of a two-chambered test cell for contacting the material specimen with the test chemical on the specimen's normally outside surface and with a collection medium on the specimen's inside surface. Mechanical drawings of the U.S. Army Natick Soldier Center Liquid Permeation Cell are located in Appendix B.

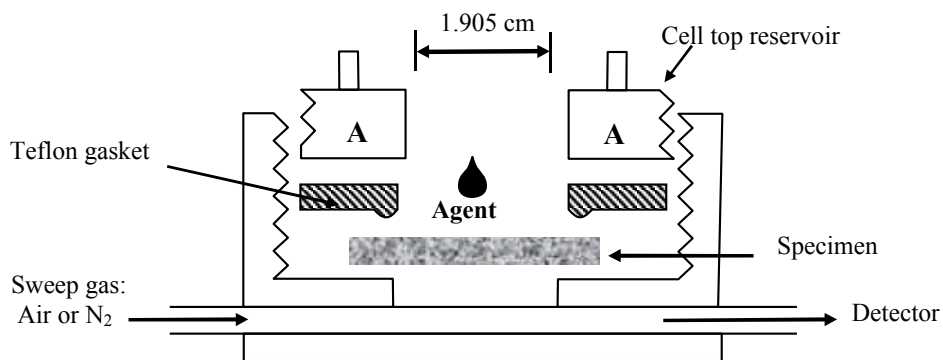

Figure A-1a. Liquid Permeation Cell schematic: side view (cross-section)

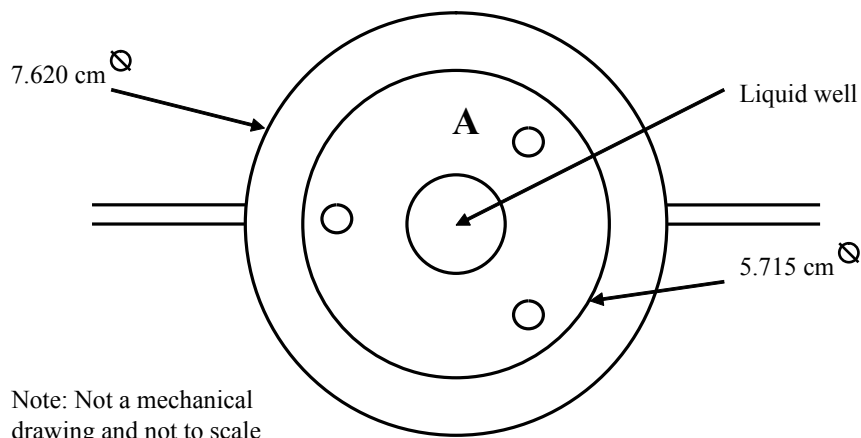

Figure A-1b. Liquid permeation cell: top view

- 6.3.1 Mount material specimen by performing the following steps:
 - 6.3.1.1 Unscrew (counter-clockwise) the Cell Top Reservoir and remove the Gasket.
 - 6.3.1.2 Place the material specimen concentrically into the center of the Cell Base Assembly.

Note: Ensure specimen’s outer surface is on top so it will be in contact with the liquid test chemical.

- 6.3.1.3 Place gasket on the material specimen with the ridge facing down so the ridge will be in contact with the specimen. If the specimen is rigid, an additional flat, Butyl rubber Gasket having an inside diameter of 2 cm and an outside diameter of 3 cm can be placed between the specimen and the gasket. The flat Butyl rubber gasket shall be 0.3 cm ± 0.1 cm in thickness.
- 6.3.1.4 Replace the Cell Top Reservoir by screwing it clockwise until it is tight enough to prevent the test liquid from seeping between the Gasket and the top of the material specimen.

6.4 *Liquid Test Chemical*

6.4.1 *Liquid simulant chemical*, a liquid that is placed on the protective equipment material specimen in a permeation test to simulate the permeation effect of Sarin (GB) or sulfur mustard (HD) chemical warfare agents. The liquids indicated as “nominal” simulants for GB or HD are similar to each CWA in chemical structure and properties. However, the permeation data shows a less specific relationship, such that, permeation curves for GB and HD in each barrier material, are bracketed by those of the four listed simulants in Table A-1.

Table A-1. Nominal Simulant Chemical Compounds				
ID Code	Chemical compound	CAS No.	Purity	Source
Nominal HD Simulants:				
DIMP	Diisopropylmethylphosphonate	1445-75-6	95%	Alfa Aesar
DEMP	Diethylmethylphosphonate	683-08-9	97%	Aldrich Chemical
Nominal GB Simulants:				
CEPS	2-Chloroethylphenylsulfide	5535-49-9	98%	Alfa Aesar
DCH	1,6-Dichlorohexane	2163-00-0	98%	Aldrich Chemical

- 6.4.2 *Liquid Toxic Industrial Chemical*, placed on the protective equipment material specimen as the liquid test chemical to obtain direct permeation data for a particular TIC.
- 6.5 *Detector*, must be capable of a minimum detectable quantity of 1 µg /L.
- 6.6 *CWA Simulant Procedure*, a flame ionization detector (FID) in a gas chromatograph or a stand-alone detector can be used to determine the effluent concentration of the four simulant chemicals; however, other detectors may be used that employ different technologies as, for example, ultraviolet (UV) and infrared (IR) spectrophotometry, flame photometry, mass spectrometry, and radionuclide tagging/detection counting.
- 6.7 *TIC Procedure*, the detector used depends on the liquid test chemical being used as the challenging chemical. A detector shall be used that employs a technology that is capable of detecting the selected liquid test chemical. The minimum detection level for the detector shall be 1 µg /L.
- 6.8 *Personal Computer*, used with a data acquisition software to obtain incremental chemical breakthrough time test data that has the following minimal requirements:
- Microsoft operating system (NT, Windows 2000 or later)
 - Peripheral component interconnect (PCI) slot
 - Portable high capacity storage medium with a minimum of 100 megabytes
 - 2.0 GHz with 400 MHz front side bus
- 6.9 *Carrier Gas*, (sweep gas), dry nitrogen (UN 1977) from a compressed or liquefied source or dry air (UN 1002) containing less than 10 ppm water.
- 6.10 *Thermostat*, used to maintain air temperature in the temperature control chamber at 35°C ± 2°C during the duration of the test.
- 6.11 *Temperature Control Chamber*, an enclosure to house the Liquid Permeation Cell and maintain a consistent temperature.
- 6.12 *Flow Controller*, regulates to ± 1% the sweep gas that passes underneath the material specimen mounted in the Liquid Permeation Cell used as the collection medium.
- 6.13 *Charcoal Trap*, removes the vapor of the challenging liquid test chemical from the sweep gas before it is released into a fume-hood or the atmosphere.

7. Safety Precautions and Hazardous Waste Disposal

- 7.1 Before carrying out this test method, safety precautions needed for handling potentially hazardous chemicals should be identified and reviewed to provide full protection to all personnel.
 - 7.1.1 For carcinogenic, mutagenic, teratogenic, and other toxic chemicals, the work area should be isolated, well vented, and meticulously clean. Involved personnel should be outfitted with protective clothing and equipment.
 - 7.1.2 For corrosive or otherwise hazardous chemicals, involved personnel should, as a minimum, be outfitted with protective clothing and equipment.
 - 7.1.3 As is standard laboratory practice, safety and health precautions should be taken consistent with the properties of the simulants given in each corresponding MSDS. It is an actionable violation of the OSHA Hazard Communication Standard (29 CFR 1910) to use a laboratory chemical without an appropriate MSDS. This standard requires that manufacturers and importers of hazardous materials conduct a hazard evaluation of the products they manufacture or import. If the product is found to be hazardous under the terms of the standard, containers of the material must be appropriately labeled and the first shipment of the material to a new customer must be accompanied by a MSDS. Employers, using the MSDSs they receive, must train their employees to recognize and avoid the hazards the materials present.
- 7.2 Emergency equipment, such as a safety shower, eyewash, and NIOSH-certified escape respirators approved for the protection against the chemical(s) in use, should be readily accessible in the test area. Also, NIOSH-certified, self-contained breathing apparatuses and the appropriate protective clothing should be available for reentry into the contaminated test laboratory.
- 7.3 Appropriate procedures for the disposal of the chemicals should be followed. The procedures must comply with all laboratory safety and handling procedures and federal, state and local hazardous waste disposal rules and regulations.

8. Test Specimen

- 8.1 The test specimen is a nonporous material specimen used in this test method to determine the material's permeation resistance to a liquid simulant chemical or a liquid toxic industrial chemical.
- 8.2 Each flat, nonporous specimen of protective equipment material may consist of either a single layer or a composite of multiple layers, not to exceed 0.7 cm in thickness. If material is representative of an actual clothing construction, the specimen's normally outer surface shall contact the liquid test chemical.
- 8.3 Each material specimen to be tested shall have a circular shape of $4.2 \text{ cm} \pm 0.3 \text{ cm}$ in diameter.
- 8.4 A minimum of six material specimens shall be tested.

9. Conditioning

- 9.1 Condition each protective equipment material specimen for a period of 1–24 hours by exposure to a temperature of $35^{\circ}\text{C} \pm 2^{\circ}\text{C}$ and a relative humidity of 30%–80% as described in Specification ASTM E 171. Hydrophobic materials should require only 1 hour of conditioning and hydrophilic materials might require up to 24 hours of conditioning.

10. Procedure

- 10.1 Measure the thickness of each conditioned material specimen at four widely spaced sites within the middle 3 cm diameter circular area of the permeation specimens; report the average value.
- 10.2 Determine material specimen weight per unit area $\pm 10\%$ and record.
- 10.3 Mount the material specimen in the Liquid Permeation Cell shown in Fig. A-1a. as described in section 6.3.1.
- 10.4 Equilibrate the Liquid Permeation Cell which contains the material specimen at a temperature of $35^{\circ}\text{C} \pm 2^{\circ}\text{C}$ and a relative humidity of 30%–80% for a period of 2 hours in the Temperature Control Chamber. This is accomplished by setting the Thermostat heat controller to 35°C indicated on Figure A-2.

- 10.5 Start the sweep gas that is used for the collection medium. The sweep gas rate shall be set for the detector in accordance with the manufacturer's recommendations. If a range is not provided by the detector's manufacturer, set the sweep gas rate to 33cm³/min, which should be adequate for all detectors.
- 10.6 Check all connections to ensure there are no leaks in the detection loop. See Figure A-2.

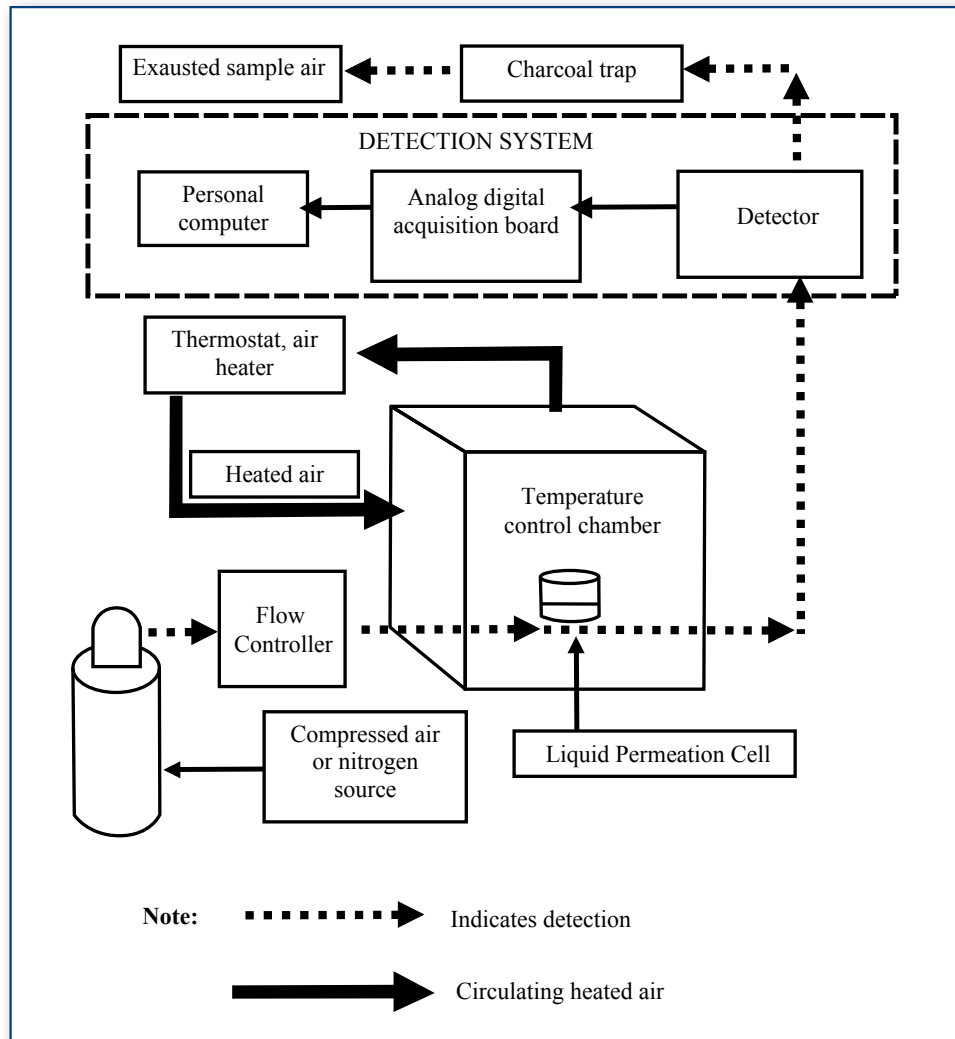

Figure A-2. Example setup of permeation test system

- 10.7 Check the seal between the Gasket and the material specimen by flowing sweep gas through the Liquid Permeation Cell and compare the outlet flow from the cell to the previously measured inlet flow reading at the delivered flow rate. If the readings are not the same (~10%) as the measured inlet flow, indicating a leak, tighten the Cell Top Reservoir. If tightening the Cell Top Reservoir fails to stop the leak, replace the specimen.

- 10.8 Initiate the data acquisition system on the personal computer and apply approximately 0.3 ml of liquid test chemical (one of the four identified simulant chemicals) to the material specimen in the center of the Cell Top Reservoir. Test time shall begin at the moment the liquid test chemical comes into contact with the material specimen. Confirm by visual inspection that sufficient liquid test chemical is present to cover the entire exposed surface of the specimen. Place the Cell Cap into the center of the Cell Top Reservoir to reduce evaporation. Caution must be taken not to overfill the reservoir with the liquid test chemical by not exceeding 1.2 ml because the Cell Cap will create pressure on the liquid and force it into the material specimen. Remove the Cell Cap and check if any dry spots appear on the specimen every 2 hours. If any dry spots appear, add additional liquid and replace Cell Cap.
- 10.9 Discontinue sampling and terminate the test after a steady state permeation rate is reached at $T > T_s$ (Figure A-3). See ASTM F 739, Figure 4, for a wide range of permeation curve shapes.
- 10.10 After test run is terminated, disconnect the sweep gas lines from the liquid permeation cell. Remove liquid permeation cell from the temperature control chamber, remove Cell Cap and remove excess liquid test chemical from top of the specimen by using a pipette or by absorbing the liquid in a disposable cloth. This procedure must comply with all laboratory safety and handling procedures and Federal, State and local hazardous waste disposal rules and regulations.
- 10.11 A minimum of six material specimens per liquid test chemical shall be tested.

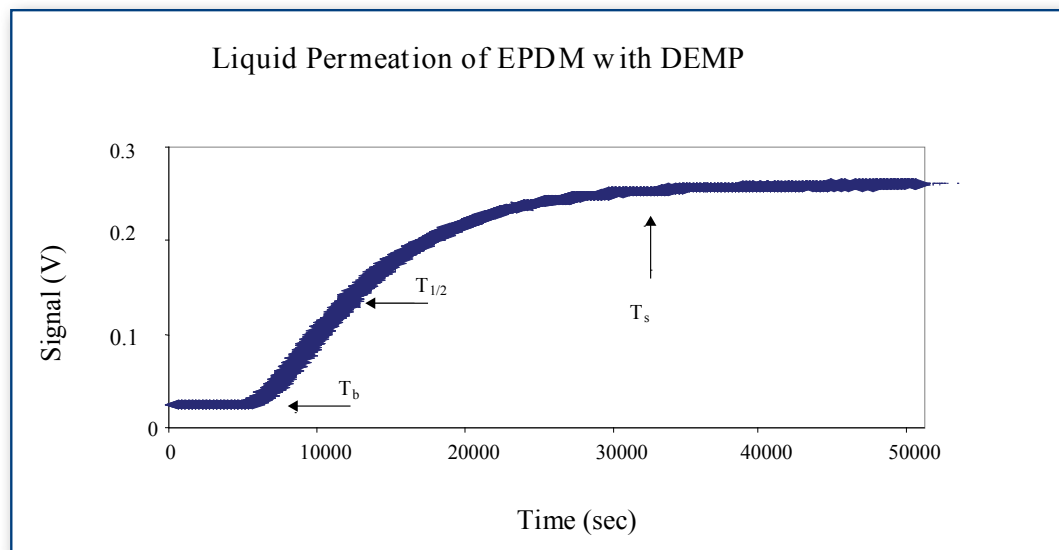

Figure A-3. Typical permeation curve, electronic signal in voltage proportional to permeation rate.

11. Calculations

11.1 Permeation Calculations

$$11.1.1 \quad P' = S F A^{-1}, \text{ ng/cm}^2 \cdot \text{min}$$

$$11.1.2 \quad P = P' L, \text{ ng} \cdot \text{cm/cm}^2 \cdot \text{min}$$

11.2 Data Reduction Techniques

Perform data reduction and calculations in accordance with:

- ASTM F 739
- Liquid Permeation through Nonporous Barrier Materials, D. Rivin, R.S. Lindsay, W.J. Shuely and A. Rodriguez, *Journal of Membrane Science, Volume 246, Issue 1, 1 January 2005, Pages 39–47.*
- Sections 2.6 and 2.7 of Estimating the Permeation Resistance Of Nonporous Barrier Polymers to Sulfur Mustard (HD) and Sarin (GB) Chemical Warfare Agents Using Liquid Simulants, D. Rivin, W.J. Shuely, F. Palya, R.S. Lindsay, A. Rodriguez, and P. Bartram; NIOSH Publication No. 2008-141, July 2008 (body of this publication).

12. Report

Construct Tables and Plots as shown in: Liquid Permeation through Nonporous Barrier Materials, D. Rivin, R.S. Lindsay, W.J. Shuely and A. Rodriguez, *Journal of Membrane Science, Volume 246, Issue 1, 1 January 2005, Pages 39–47.* Report results to the extent applicable in accordance with ASTM F 1194–99, Standard Guide for Documenting the Results of Chemical Permeation Testing of Materials Used in Protective Clothing.

Appendix B

Appendix B: Liquid Permeation Cell Mechanical Drawings

Page Number	Drawing Number	Drawing Nomenclature
84	TC-001	Cell Top Reservoir
85	TC-002	Cell Cap
86	TC-003	Gasket
87	TC-004	Permeation Cell Base
88	TC-005	Cell Base Assembly
89	TC-006	Liquid Permeation Cell

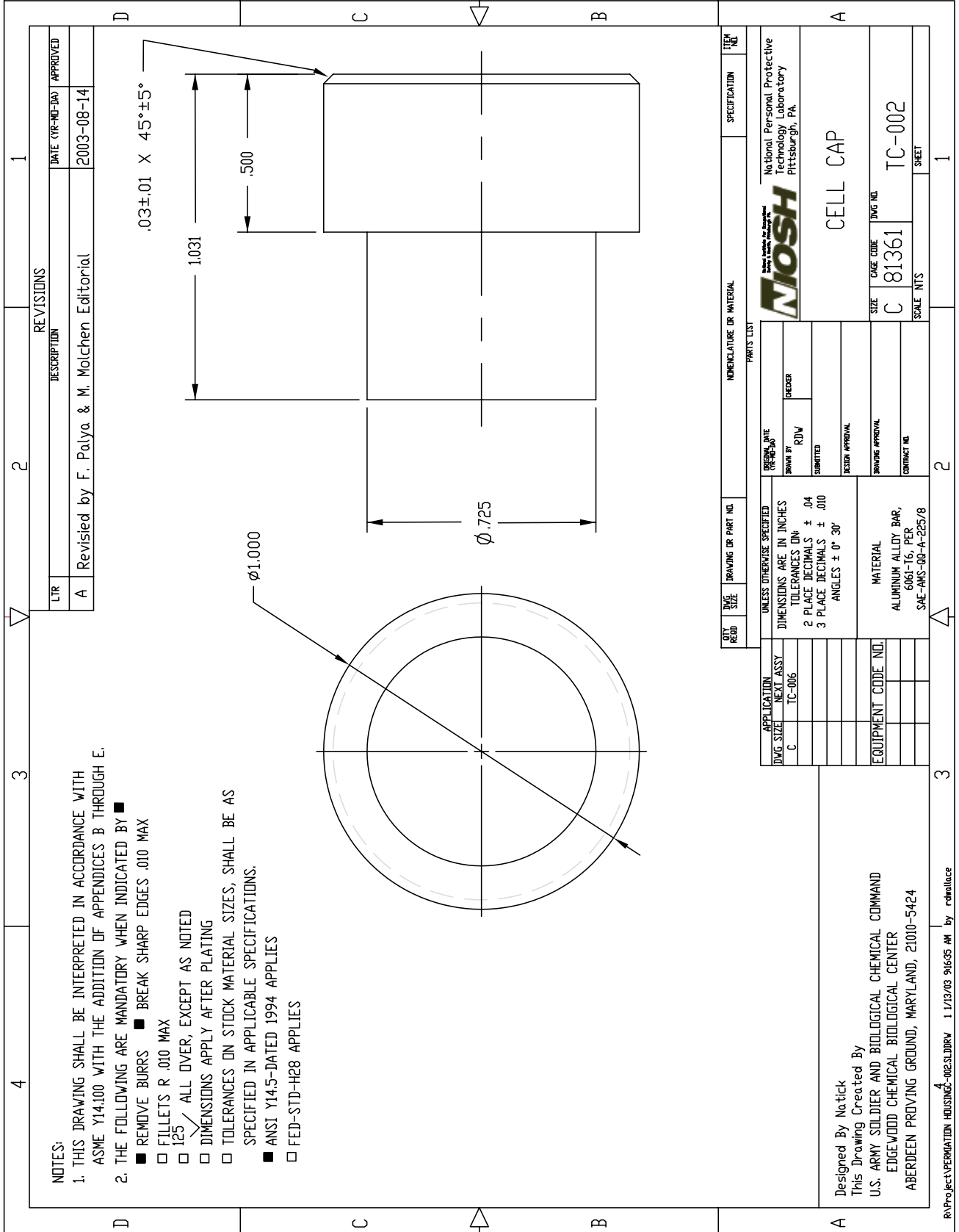

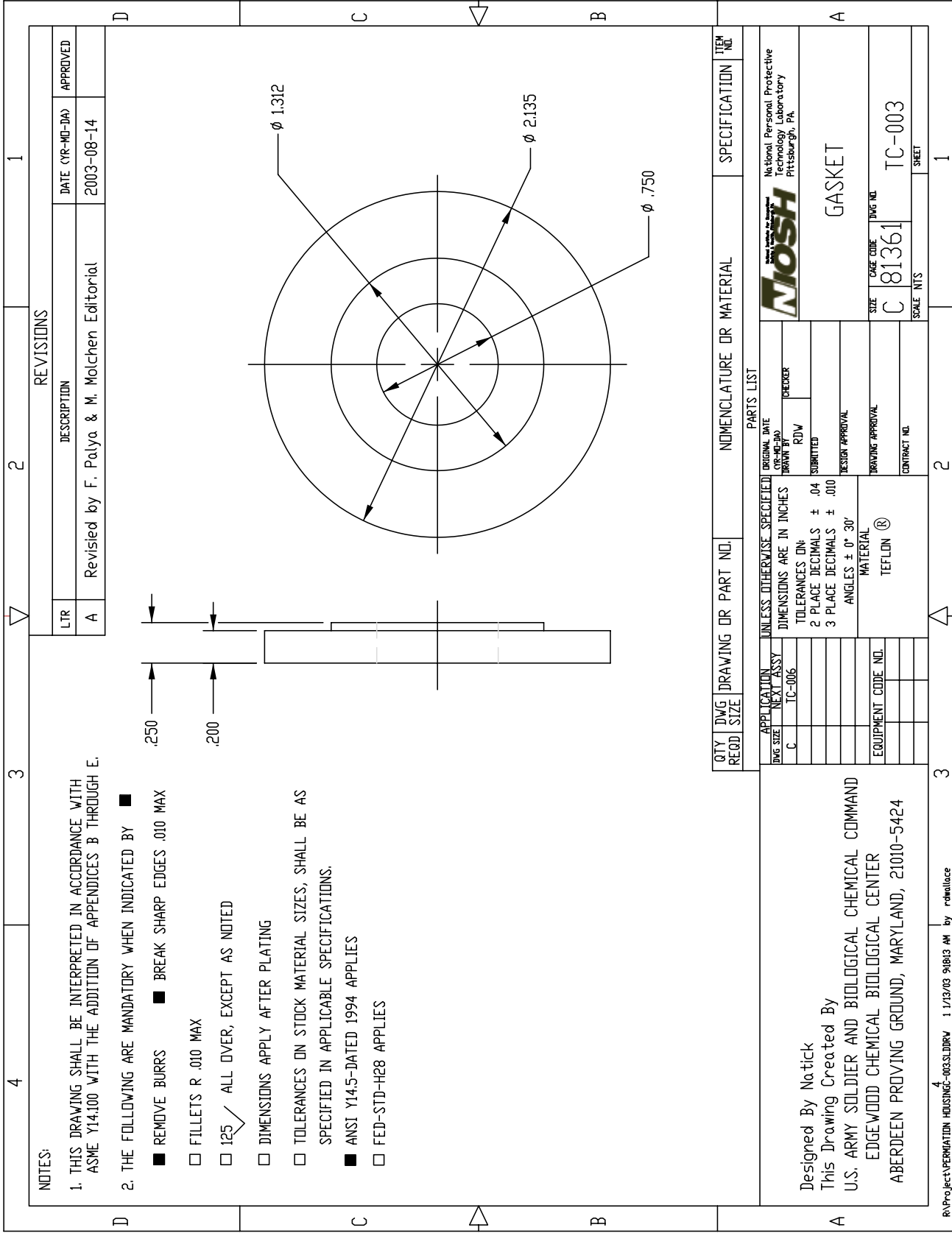

NOTES:

1. THIS DRAWING SHALL BE INTERPRETED IN ACCORDANCE WITH ASME Y14.100 WITH THE ADDITION OF APPENDICES B THROUGH E.
2. THE FOLLOWING ARE MANDATORY WHEN INDICATED BY ■
 - REMOVE BURRS ■ BREAK SHARP EDGES .010 MAX
 - FILLETS R .010 MAX
 - 125° ALL OVER, EXCEPT AS NOTED
 - DIMENSIONS APPLY AFTER PLATING
 - TOLERANCES ON STOCK MATERIAL SIZES, SHALL BE AS SPECIFIED IN APPLICABLE SPECIFICATIONS.
 - ANSI Y14.5-DATED 1994 APPLIES
 - FED-STD-H28 APPLIES

REVISIONS

LTR	DESCRIPTION	DATE (YR-MD-DA)	APPROVED
A	Revised by F. Palya & M. Molchen Editorial	2003-08-14	

QTY	DWG	DRAWING OR PART NO.	NOMENCLATURE OR MATERIAL	SPECIFICATION	ITEM NO.

APPLICATION		UNLESS OTHERWISE SPECIFIED	
DWG SIZE	TC-006	DIMENSIONS ARE IN INCHES	
NEXT ASSY		TOLERANCES ON	
		2 PLACE DECIMALS ± .04	
		3 PLACE DECIMALS ± .010	
		ANGLES ± 0° 30'	
EQUIPMENT CODE NO.		MATERIAL	TEFLON ®

ORIGINAL DATE	CHECKER
	RDW
DATE DRAWN BY	SUBMITTED
TESTING APPROVAL	DRAWING APPROVAL
CONTRACT NO.	

MOSH National Institute for Occupational Safety and Health National Personal Protective Technology Laboratory Pittsburgh, PA	
SIZE	C 81361
DWG NO.	TC-003
SCALE	NTS
SHEET	1

Designed By Natick
 This Drawing Created By
 U.S. ARMY SOLDIER AND BIOLOGICAL CHEMICAL COMMAND
 EDGEWOOD CHEMICAL BIOLOGICAL CENTER
 ABERDEEN PROVING GROUND, MARYLAND, 21010-5424

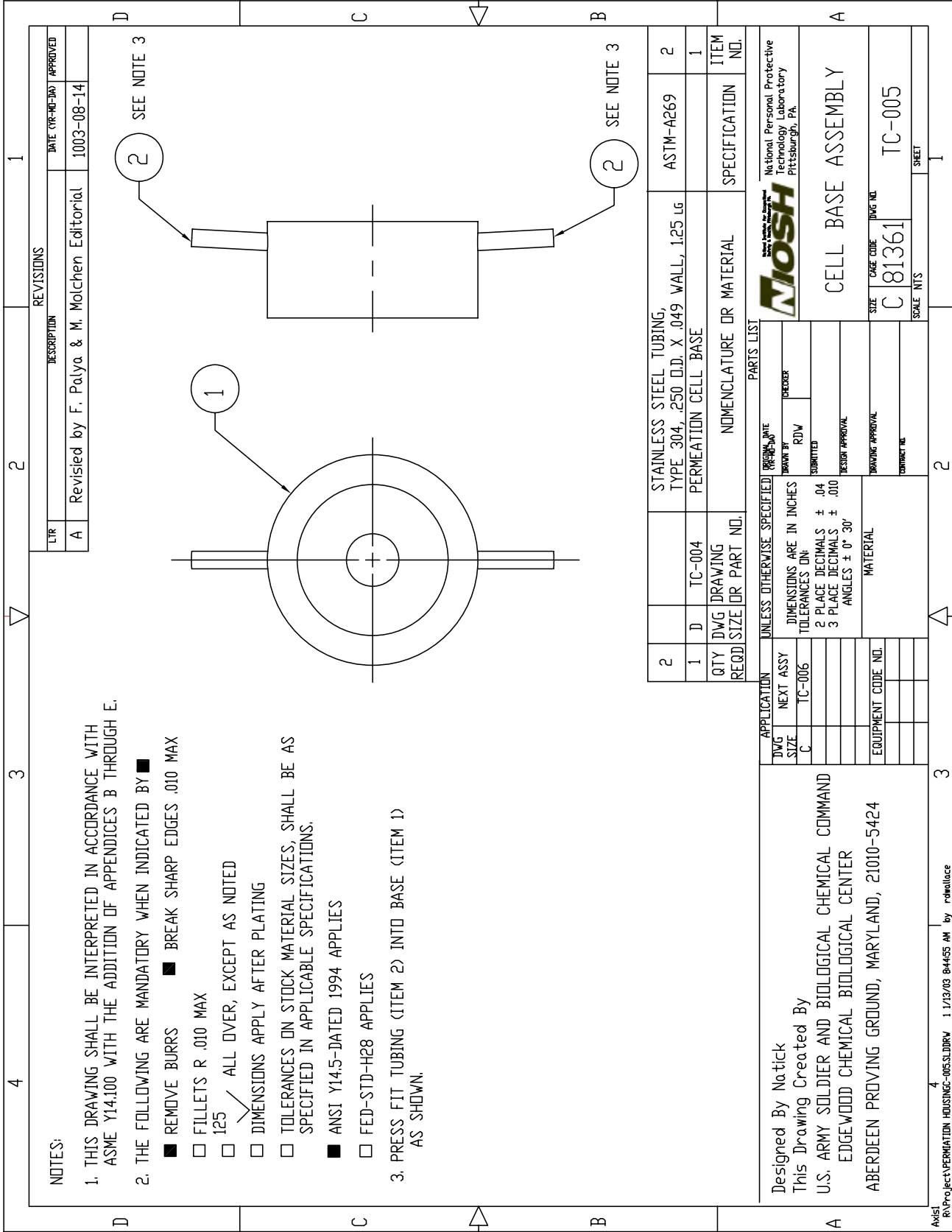

NOTES:

1. THIS DRAWING SHALL BE INTERPRETED IN ACCORDANCE WITH ASME Y14-100 WITH THE ADDITION OF APPENDICES B THROUGH E.
2. THE FOLLOWING ARE MANDATORY WHEN INDICATED BY ■
 - REMOVE BURRS ■ BREAK SHARP EDGES .010 MAX
 - FILLETS R .010 MAX
 - 125 ✓ ALL OVER, EXCEPT AS NOTED
 - DIMENSIONS APPLY AFTER PLATING
 - TOLERANCES ON STOCK MATERIAL SIZES, SHALL BE AS SPECIFIED IN APPLICABLE SPECIFICATIONS.
 - ANSI Y14.5-DATED 1994 APPLIES
 - FED-STD-H28 APPLIES
3. PRESS FIT TUBING (ITEM 2) INTO BASE (ITEM 1) AS SHOWN.

REVISIONS	
LT#	DESCRIPTION
A	Revised by F. Palya & M. Molchen Editorial
	DATE (YY-MM-DD) APPROVED
	1003-08-14

2		STAINLESS STEEL TUBING, TYPE 304, .250 O.D. X .049 WALL, 1.25 LG	ASTM-A269	2
1	TC-004	PERMEATION CELL BASE		1
QTY	DWG	DRAWING	NOMENCLATURE OR MATERIAL	SPECIFICATION
REQD	SIZE	OR PART NO.		ITEM NO.

UNLESS OTHERWISE SPECIFIED		PARTS LIST	
APPLICATION	PREPARED BY	DATE	CHECKER
DWG SIZE	TC-006	RDW	
NEXT ASSY		SUBMITTED	
		TESTER APPROVAL	
		TRAINING APPROVAL	
		CONTRACT NO.	
DIMENSIONS ARE IN INCHES		MATERIAL	
TOLERANCES ON:		CELL BASE ASSEMBLY	
2 PLACE DECIMALS ± .04		SIZE	
3 PLACE DECIMALS ± .001		CAGE CODE	
ANGLES ± 0° 30'		C 81361	
		DWG NO.	
		TC-005	
		SCALE	
		NTS	
		SHEET	
		1	

Designed By Natick
 This Drawing Created By
 U.S. ARMY SOLDIER AND BIOLOGICAL CHEMICAL COMMAND
 EDGEWOOD CHEMICAL BIOLOGICAL CENTER
 ABERDEEN PROVING GROUND, MARYLAND, 21010-5424

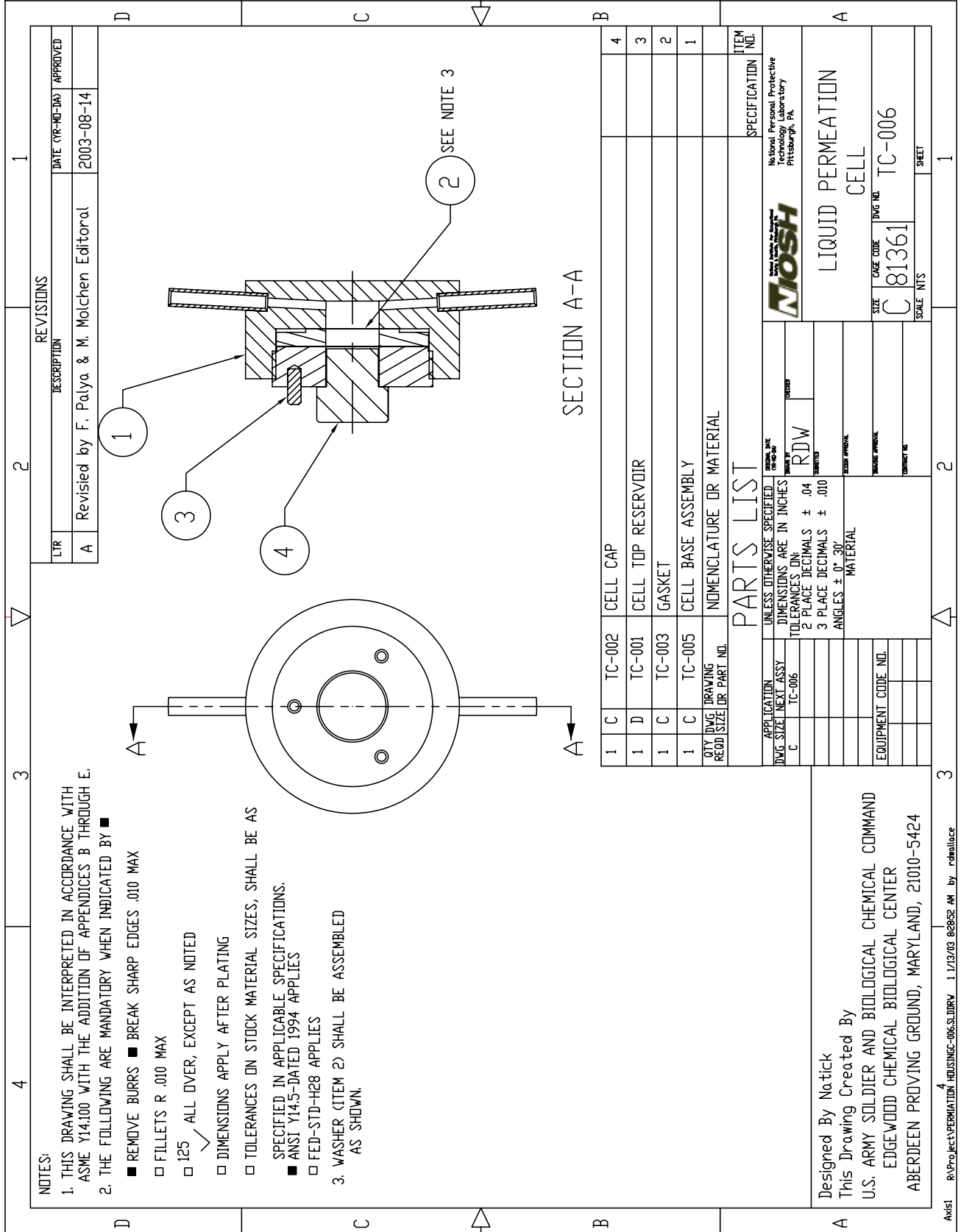

REVISIONS		DATE (YY-MM-DD)	APPROVED
LTR	DESCRIPTION		
A	Revised by F. Palva & M. Molchen Editorial	2003-08-14	

NOTES:

- THIS DRAWING SHALL BE INTERPRETED IN ACCORDANCE WITH ASME Y14.100 WITH THE ADDITION OF APPENDICES B THROUGH E.
- THE FOLLOWING ARE MANDATORY WHEN INDICATED BY ■
 - REMOVE BURRS ■ BREAK SHARP EDGES .010 MAX
 - FILLETS R .010 MAX
 - 125 ALL OVER, EXCEPT AS NOTED
 - DIMENSIONS APPLY AFTER PLATING
 - TOLERANCES ON STOCK MATERIAL SIZES, SHALL BE AS SPECIFIED IN APPLICABLE SPECIFICATIONS.
 - ANSI Y14.5-DATED 1994 APPLIES
 - FED-STD-H28 APPLIES
- WASHER (ITEM 2) SHALL BE ASSEMBLED AS SHOWN.

ITEM NO.	ITEM SPECIFICATION NO.
1	TC-002 CELL CAP
2	TC-001 CELL TOP RESERVOIR
3	TC-003 GASKET
4	TC-005 CELL BASE ASSEMBLY

PARTS LIST	
APPLICATION	UNLESS OTHERWISE SPECIFIED
DWG SIZE	DIMENSIONS ARE IN INCHES
TC-006	TOLERANCES ON:
	2 PLACE DECIMALS ± .04
	3 PLACE DECIMALS ± .010
	ANGLES ± 0°, 30° MATERIAL
EQUIPMENT CODE NO.	

Designed By Natick
 This Drawing Created By
 U.S. ARMY SOLDIER AND BIOLOGICAL CHEMICAL COMMAND
 EDGEWOOD CHEMICAL BIOLOGICAL CENTER
 ABERDEEN PROVING GROUND, MARYLAND, 21010-5424

AVIS1 RAProjectPERMATION HOUSING-006.SLDJRW 1/13/03 8:28:52 AM by rmollace 3 2 1

Appendix C

Appendix C: CWA Permeation Tables

Table C-1. Liquid HD permeation data at 35°C: Silicone

Thickness cm	BT* (min)	T _b (min)	T _{1/2} (min)	T _s (min)	Permeation rate (µg/cm ² • min)	Permeability coefficient (µg • cm/cm ² • min)	D _{1/2} (10 ⁻⁷ cm ² /s)	D _D (10 ⁻⁷ cm ² /s)
Sample:								S [†] =5.2%:
0.328	0	80	150	900	19.5	6.39	16.5	18.6
0.323	0	70	170	800	16.7	5.39	14.1	15.7
0.318	0	70	160	800	16.7	5.30	14.6	15.4
0.323	0	60	180	700	16.7	5.39	13.4	15.7
0.312	0	50	160	800	22.9	7.15	14.1	20.8
0.318	0	50	160	700	16.3	5.18	14.6	15.1
0.320	0	60	180	800	18.6	5.95	13.1	17.3
0.330	0	70	170	800	18.6	6.14	14.8	17.9
0.323	1	50	150	800	21.8	7.03	16.0	20.5
0.318	<1	60	160	700	18.7	5.94	14.6	17.3
0.318	<1	70	170	800	18.7	5.94	13.7	17.3
0.312	<1	60	170	800	21.2	6.62	13.3	19.3
0.315	<2	60	150	800	18.7	5.89	15.3	17.2
0.318	<2	70	170	900	16.0	5.08	13.7	14.8
0.310	<2	60	180	800	19.1	5.92	12.3	17.2
0.323	<2	70	180	900	19.0	6.13	13.4	17.9
0.323	1	60	170	900	14.5	4.68	14.1	13.6
0.320	1	50	160	900	16.9	5.41	14.8	15.8
0.315	1	60	160	800	15.6	4.91	14.3	14.3
0.312	<1	60	150	900	16.1	5.03	15.0	14.7
0.320	10	70	160	800	12.9	4.13	14.8	12.0
0.318	10	60	160	800	13.9	4.41	14.6	12.9

*BT= Breaththrough: Sampling time immediately after initial detection of effluent vapor

†S= Steady state solubility in wt%

Table C-2. Liquid HD permeation data at 35°C: Butyl

Thickness cm	BT* (min)	T _b (min)	T _{1/2} (min)	T _s (min)	Permeation rate (μg/cm ² • min)	Permeability coefficient (μg • cm/cm ² • min)	D _{1/2} (10 ⁻⁷ cm ² /s)	D _p (10 ⁻⁷ cm ² /s)
Sample:								S†=23.6%:
0.028	26	30	70	200	16.9	0.472	0.258	0.303
0.030	26	30	90	300	12.7	0.387	0.238	0.249
0.033	29	30	100	300	12.2	0.403	0.252	0.259
0.030	31	30	80	300	14.0	0.427	0.268	0.274
0.030	33	30	90	200	13.4	0.408	0.238	0.262
0.033	35	40	80	200	13.4	0.442	0.315	0.284
0.036	49	50	110	300	13.8	0.491	0.265	0.315
0.036	27	30	90	300	12.1	0.430	0.324	0.276
0.036	29	30	90	200	12.1	0.430	0.324	0.276
0.038	55	60	110	300	11.4	0.434	0.305	0.279
0.036	33	30	100	300	12.5	0.445	0.292	0.285
0.036	51	50	100	300	10.0	0.356	0.292	0.228
0.030	26	30	80	300	10.6	0.323	0.268	0.207
0.033	28	30	90	300	10.4	0.343	0.280	0.220
0.033	29	30	80	300	10.4	0.343	0.315	0.220
0.038	55	60	110	300	9.2	0.351	0.305	0.225
0.038	31	30	90	300	9.5	0.362	0.373	0.232
0.033	22	30	90	300	20.9	0.690	0.280	0.443
0.033	3	10	90	300	18.4	0.608	0.280	0.390
0.033	45	50	80	400	17.2	0.568	0.315	0.365
0.036	65	70	100	300	24.7	0.878	0.292	0.564

*BT=Breaththrough: Sampling time immediately after initial detection of effluent vapor

†S=Steady state solubility in wt%

Table C-3. Liquid HD permeation data at 35°C; EPDM

Thickness cm	BT* (min)	T _b (min)	T _½ (min)	T _s (min)	Permeation rate (µg/cm ² • min)	Permeability coefficient (µg • cm/cm ² • min)	D _½ (10 ⁻⁷ cm ² /s)	D _p (10 ⁻⁷ cm ² /s)
Sample:								S [†] =9.0%:
0.074	49	50	150	500	7.60	0.560	0.835	0.942
0.084	75	80	200	700	6.10	0.511	0.811	0.861
0.086	53	50	220	700	6.40	0.553	0.783	0.930
0.086	78	80	210	600	6.00	0.518	0.820	0.872
0.066	31	30	130	600	7.10	0.469	0.775	0.789
0.079	57	60	170	600	5.50	0.433	0.842	0.729
0.071	26	30	130	600	9.20	0.654	0.899	1.10
0.071	26	30	150	700	7.20	0.512	0.779	0.862
0.074	27	30	160	600	7.10	0.523	0.783	0.880
0.071	28	30	160	700	7.70	0.548	0.730	0.922
0.076	29	30	170	600	6.30	0.480	0.789	0.808
0.069	6	40	120	400	8.30	0.569	0.905	0.958
0.069	26	30	120	500	8.50	0.583	0.905	0.981
0.071	26	30	150	400	7.20	0.512	0.779	0.862
0.069	28	30	130	700	7.60	0.521	0.836	0.877
0.074	55	60	150	600	7.20	0.530	0.835	0.893
0.069	33	30	130	700	7.40	0.507	0.836	0.854
0.074	35	40	140	600	8.80	0.648	0.895	1.09
0.069	34	40	120	800	11.1	0.761	0.905	1.28
0.084	51	50	180	600	8.00	0.671	0.901	1.13
0.076	52	50	160	700	8.10	0.617	0.838	1.04
0.071	38	40	140	700	8.20	0.583	0.834	0.982

*BT=Breakthrough: Sampling time immediately after initial detection of effluent vapor.

†S=Steady state solubility in wt%.

Table C-4. Liquid GB permeation at 35°C: Silicone

Thickness cm	BT* (min)	T _b (min)	T _{1/2} (min)	T _s (min)	Permeation rate (µg/cm ² • min)	Permeability coefficient (µg • cm/cm ² • min)	D _{1/2} (10 ⁻⁷ cm ² /s)	D _p (10 ⁻⁷ cm ² /s)
Sample:								S [†] =5.9%:
0.312	72	70	130	500	28.5	8.90	17.3	22.9
0.310	72	70	130	500	27.2	8.43	17.1	21.6
0.318	73	70	140	500	26.1	8.29	16.6	21.3
0.320	74	80	140	500	26.0	8.32	16.9	21.4
0.312	73	70	130	500	17.5	5.47	17.3	14.0
0.320	76	80	140	500	16.6	5.31	16.9	13.6
0.310	63	80	130	500	17.4	5.39	17.1	13.8
0.312	61	80	130	400	19.0	5.94	17.3	15.2
0.318	76	80	140	500	17.9	5.68	16.6	14.6
0.325	77	80	140	500	17.1	5.56	17.4	14.3
0.318	78	80	140	500	18.9	6.00	16.6	15.4
0.318	64	80	130	500	19.0	6.03	17.9	15.5
0.318	61	60	130	400	27.4	8.70	17.9	22.3
0.320	63	60	130	500	28.7	9.19	18.2	23.6
0.315	64	60	130	500	26.8	8.44	17.6	21.7
0.323	66	70	130	500	27.6	8.90	18.5	22.9
0.310	66	70	130	500	29.0	8.99	17.1	23.1
0.312	62	60	120	500	25.2	7.87	18.8	20.2
0.315	68	70	130	500	28.4	8.94	17.6	23.0
0.320	68	70	130	500	28.1	8.99	18.2	23.1
0.196	9	10	50	300	38.7	7.57	17.7	19.4
0.196	10	10	50	300	38.6	7.55	17.7	19.4

*BT=Breaththrough: Sampling time immediately after initial detection of effluent vapor.

†S=Steady state solubility in wt%.

Table C-5. Liquid GB permeation at 35°C: Butyl

Thickness cm	BT* (min)	T _b (min)	T _{1/2} (min)	T _s (min)	Permeation rate (µg/cm ² • min)	Permeability coefficient (µg • cm/cm ² • min)	D _{1/2} (10 ⁻⁷ cm ² /s)	D _p (10 ⁻⁷ cm ² /s)
Sample:								S [†] =11.4%:
0.028	29	30	130	500	2.90	0.0810	0.139	0.108
0.033	83	80	210	600	1.70	0.0561	0.120	0.0746
0.030	85	90	200	600	2.20	0.0671	0.107	0.0891
0.033	85	90	180	700	2.10	0.0693	0.140	0.0922
0.033	87	90	230	700	1.90	0.0627	0.109	0.0834
0.036	115	120	270	700	1.50	0.0533	0.108	0.0709
0.038	117	120	280	600	1.40	0.0533	0.120	0.0709
0.028	63	60	150	500	2.20	0.0615	0.120	0.0817
0.030	38	40	150	500	2.80	0.0853	0.143	0.113
0.030	56	60	160	500	3.10	0.0945	0.134	0.126
0.036	85	90	220	700	2.30	0.0818	0.133	0.109
0.038	114	110	290	700	2.00	0.0762	0.116	0.101
0.038	114	110	310	800	2.00	0.0762	0.108	0.101
0.036	60	60	190	400	2.30	0.0818	0.154	0.109
0.033	63	60	130	600	2.70	0.0892	0.194	0.118
0.038	65	70	300	800	1.80	0.0686	0.112	0.0911
0.036	40	40	170	500	4.00	0.142	0.172	0.189
0.028	30	40	120	500	2.80	0.0782	0.150	0.104
0.036	46	50	230	800	2.40	0.0853	0.127	0.113
0.033	48	50	230	700	2.40	0.0792	0.109	0.105
0.036	64	60	240	800	2.20	0.0782	0.122	0.104
0.038	21	20	40	600	2.30	0.0876	0.838	0.116

*BT=Breakthrough: Sampling time immediately after initial detection of effluent vapor.

†S=Steady state solubility in wt%.

Table C-6. Liquid GB permeation at 35°C: EPDM

Thickness cm	BT* (min)	T _b (min)	T _½ (min)	T _s (min)	Permeation rate (µg/cm ² • min)	Permeability coefficient (µg • cm/cm ² • min)	D _½ (10 ⁻⁷ cm ² /s)	D _p (10 ⁻⁷ cm ² /s)
Sample:								S [†] =2.5%:
0.084	56	60	70	900	1.70	0.142	2.32	0.864
0.066	59	60	140	900	1.90	0.125	0.719	0.760
0.086	59	60	260	1000	1.40	0.121	0.662	0.733
0.084	62	60	100	700	1.10	0.0922	1.62	0.559
0.084	63	60	280	800	1.60	0.134	0.580	0.813
0.079	93	90	250	800	1.50	0.118	0.573	0.716
0.084	94	90	280	900	1.40	0.117	0.580	0.711
0.084	95	90	260	800	1.60	0.134	0.624	0.813
0.084	31	30	50	800	1.30	0.109	3.25	0.660
0.071	31	30	140	700	1.40	0.0996	0.834	0.603
0.084	34	30	200	800	1.00	0.0838	0.811	0.508
0.071	63	60	180	700	1.30	0.0925	0.649	0.560
0.076	92	90	230	800	1.40	0.107	0.583	0.647
0.084	93	90	260	800	1.20	0.101	0.624	0.610
0.084	68	70	80	600	1.30	0.109	2.03	0.660
0.066	1	1	90	700	2.00	0.132	1.12	0.800
0.076	6	10	30	600	1.70	0.130	4.47	0.785

*BT=Breakthrough: Sampling time immediately after initial detection of effluent vapor.

†S=Steady state solubility in wt%.



**Delivering on the Nation's Promise:
Safety and health at work for all people
through research and prevention**

To receive NIOSH documents or more information about occupational safety and health topics, contact NIOSH at

Telephone: **1-800-CDC-INFO** (1-800-232-4636)

TTY: 1-888-232-6348

E-mail: cdcinfo@cdc.gov

or visit the NIOSH Web Site at www.cdc.gov/niosh

For a monthly update on news at NIOSH,
subscribe to *NIOSH eNews* by visiting www.cdc.gov/niosh/eNews.

DHHS (NIOSH) Publication No. 2008-141

SAFER • HEALTHIER • PEOPLE™