



CHAPTER TEN

ENVIRONMENTAL EDUCATION COMMUNITY PROJECTS



There are an infinite number of ideas for doing excellent environmental education programs. How you and your community decide what works best in your community will depend on your particular circumstances. In this chapter, ideas are described and resources provided that can spark creativity as you and your partners explore environmental education options. There are many additional resources in libraries and on the Internet. You'll also find that local program managers, counterparts, teachers, and colleagues provide a wealth of knowledge and ideas.

In this chapter the following activities are described:

EDUCATIONAL ACTIVITIES

1. Traveling Road Shows
2. Dramatic Presentations
3. Media Campaigns
4. Special Events
5. Science and Eco-Fairs and Family Nights
6. Simulations
7. International Programs
8. Endangered Species Projects
9. Agriculture
10. Parks, Preserves, Protected Areas and Buffer Zones
11. Youth Projects and Activities



FIELD TRIPS

- 12. Field Trips
- 13. Field Ethics

FACILITIES AND TRAILS

- 14. Public Facilities
- 15. Nature Trails
- 16. Landscaping, Composting and Planting
- 17. Signs, Labels, and Guides
 - Making Signs
 - Making Labels
 - Trail Guides

EXHIBITS

- 18. Exhibits
 - Farmland Ecosystem Study Wheel
 - Hidden Uses of Forests
 - Life Pyramid
 - Wetland Connections
 - What Makes Soil?
 - Why Do We Need Trees on Hillsides?
 - Animal Skin Guessing Game
 - Bird Beaks
- 19. Collections
 - Displays
 - Insect Collections
 - Track Castings
 - Plant Collections
 - Tree Cookies
 - Water Organisms





- Soil Types
- Bones
- 20.** Living Museums
- 21.** Live Animals
 - Aquarium
 - Terrarium
 - Jar Terrarium
 - Desert Terrarium
 - Forest Terrarium
 - Ant Farm
 - Earthworm Colony
 - Insect Box
 - Mammal Cage
 - Attracting Birds

MATERIALS

- 22.** Flannel Boards and Pagivolt
- 23.** Pocket Charts
- 24.** Ecotrunks

FIELD EQUIPMENT

- 25.** Field Equipment
- 26.** Weather Stations
 - Weather Instruments
 - Thermometer
 - Rain Gauge
 - Barometric Pressure and Humidity
 - Wind Direction
 - Wind Speed
 - Cloud Cover and Type
- 27.** Plant Presses
- 28.** Watershed Models





29. Water Sampling Equipment

30. Measuring Acidity

RESEARCH

31. Field Research

32. Making Maps

- Making maps using a compass and measuring tape (or pacing)
- Making maps using a Global Positioning System (GPS) instrument

33. Transects



EDUCATIONAL ACTIVITIES

1 TRAVELING ROAD SHOWS

DESCRIPTION

A traveling road show travels from place to place and presents a program to a target audience that is spread out over a large geographical area. Road shows often attract attention and draw crowds.

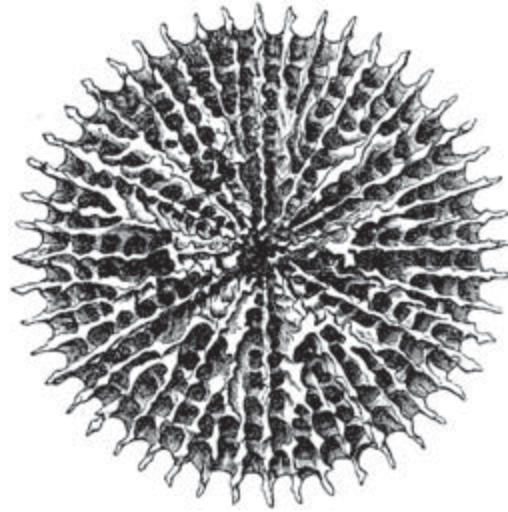

USES

Road shows are especially effective for remote audiences or for people who are beyond the reach of mass media.

EXPECTED OUTCOMES

Road shows can be used to increase awareness, knowledge, and skills. They can also be used to change attitudes or increase participation. The main focus is to bring environmental education to people who would not otherwise be involved.

EXAMPLES

Examples of programs include presentations with audiovisual aids, puppet shows, street theater, films, videos, or slide shows. A few specific examples of past Peace Corps' road shows include:

- ▶ Puppet shows to increase awareness about a particular threatened species.
- ▶ A compost demonstration.
- ▶ A community meeting to receive community input on some pertinent issue.
- ▶ A mobile interpretive station that can move to different parts of a park.



HOW TO DO IT

Once you have determined a need to get information or skills to a remote area, contact the communities to set up a time, place, and audience for the show. Consider your transportation to the communities. Will it be difficult to transport equipment to the community? Will there be cost associated with transportation and freight? Will all necessary materials be available? Will you have to build anything, such as a stage, at each site? Do you need to consider lodging and food? What is the most effective medium for communicating your message to these remote locations?

If you have a vehicle, cart, or other place where you could display interpretive materials, you may want to make a display board and carry informational literature with you. A display board can be made of plywood to exactly fit your vehicle or cart. When you arrive at a destination, set up the board and display the informational material. Consider ways to waterproof displays that will be outside. Paint it with acrylic or urethane, or make a roof for it. Plexiglass or plastic sheeting could be used to cover the information to keep it dry. Informational literature that is not on the board could be kept in a pocket chart (see Exhibits and Materials/Equipment below).



RESOURCE

Ham, Sam H., *Environmental Interpretation: A Practical Guide for People with Big Ideas and Small Budgets*. Golden, Colorado: Fulcrum Publishing, 1992 [ICE No. FC190].



2 DRAMATIC PRESENTATIONS

DESCRIPTION

Songs, parables, stories, dances, plays, street theater or other oral or musical presentations are powerful tools for getting an environmental message out. Potentially controversial issues can be presented in a non-confrontational manner. Many cultures have oral or musical traditions that lend themselves to environmental education. Ask co-workers and community members about this possibility.



USES

Dramatic presentations are fun, informative and profitable. They often introduce an idea or theme to an audience using humor. Role playing is used to involve the audience in entertaining ways. A puppet show is a non-threatening way to discuss controversial issues. Adaptation of local songs and stories to environmental themes can be used to introduce environmental concepts. For example, the story of the three little pigs can illustrate locally appropriate building materials.

Other types of dramatic presentations include:

- ▶ **Environmental theater:** a play with an environmental theme; this is probably the most ambitious of the dramatic presentations, but the most rewarding.
- ▶ **Talent show:** a collection of local talent; ask local performers to perform while you arrange for the master of ceremonies.
- ▶ **Open “mic” night:** similar to talent show, but all you do is advertise the event and invite local performers. The rest is unscripted.
- ▶ **Play:** a scripted performance that involves assigning parts, memorizing a script and having multiple rehearsals prior to the performance.
- ▶ **Skit:** an unscripted dramatic performance that has a theme, and one or two rehearsals.
- ▶ **Role play:** an unscripted impromptu dramatic presentation where participants act the part they have been assigned.
- ▶ **Community theater:** a local non-professional theater group; may produce a wide variety of theater from skits to scripted, rehearsed productions.
- ▶ **Street theater:** usually a group of people who produce skits or plays with a theme, and perform them in public squares, parks or in the street.



- **Puppet show:** performances using puppets; could be plays, skits or role plays. Puppet shows are entertaining and very versatile.

ENVIRONMENTAL THEATER — CHINA —

It is easily more than 100 degrees here where I am sitting in the sun watching the final rehearsal of my students' environmental program. I am nervous because in only a short hour the audience will arrive. This is the grand finale to a three-week long intensive environment and theater class conducted in English. It is (as far as I know) the first of its kind to be taught in Sichuan Province and certainly the first of its kind to be taught in the city of Mianyang. It has generated so much interest locally that the TV station has done a short documentary about the class and the radio has interviewed us about the performance that will happen shortly. The students who have participated in the experiment were hand picked from the top juniors in Nanshan High School. They were selected for excellence in English, environmental science and a desire to be creative. For most of them, this is their first time performing in front of an audience. Three weeks ago, these same students were shy, nervous bookworms but the class has transformed them into confident, creative actors.



The idea for the class came about one cold afternoon in February when a good friend was visiting me during her vacation from school. She had been studying in Beijing for the last semester and wanted to return to China in the summer to do a project for her university. After talking for some time, it was agreed that we should create an environmental education theater class together. Our vision was to take a group of students and give them the knowledge and tools to make their own performance that would educate the community about various environmental issues in China. It seemed like an impossible goal. There were so many questions to be answered. As the spring progressed, the serious planning of the project began and all the details quickly fell into place.

Now it is a few months after the show and school is back in session. I have had a chance to meet again with several of the students from the summer class and honestly discuss what the class was like for them. It has been overwhelmingly positive. The students say their English fluency is much higher along with their grades; they are much more confident and willingly participate in class; and many say they want to study environment, biology or urban planning in university. They want to make a difference in the future of China.

— Environment Volunteer, China



EXPECTED OUTCOMES

Dramatic presentations are highly effective at raising awareness and can be used to increase knowledge or change attitudes. They are public entertainment and, as such, are useful at reaching wide audiences. They are also a great deal of fun and can be powerful team-builders.

EXAMPLES

Some examples of dramatic presentations used for environmental education:

- ▶ Earth Day parades
- ▶ Musical festivals using an environmental theme
- ▶ Puppet shows about endangered species, recycling, etc.
- ▶ Skits that demonstrate good/bad solid waste disposal
- ▶ Weekly story hour using books with environmental themes
- ▶ Story presentations about traditional uses of resources

HOW TO DO IT

Decide on an appropriate message for the target audience. Plan what you want to do, contact or recruit the performers and arrange a time and place for auditions and the performance. Verify that equipment functions well, such as microphones and lighting. Allow enough time to prepare any stages, floats, costumes, or other materials.

Allow enough time to rehearse. Rehearsing is a good idea, not only because all the participants get a chance to practice, but because participants will have suggestions for improvements. Rehearsals also let you know what equipment or how much space may be needed.

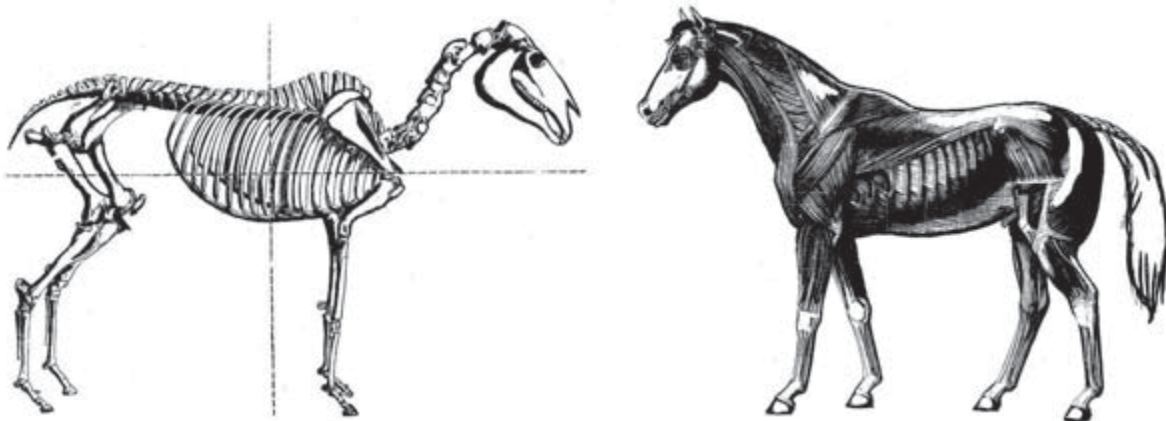



PUPPET THEATER



Puppet shows have universal appeal, and many cultures have a tradition of puppetry. Puppets can be people or animals and puppet shows can be on any topics. Puppets can be simply made or they can be quite elaborate. One advantage to puppet shows with environmental themes is that the puppets can broach controversial topics that people can't often discuss.

Puppets can be used as part of an interpretive talk or as part of a show. For example, a Canada goose puppet can speak for the geese about habitat, lifestyle, or migration patterns. The goose could also be the one to tell an audience about rules or expected behaviors. (It is often easier to deliver the rules with a puppet. People respond well to a puppet, but may respond with more resistance to a person delivering the same message.)

A puppet show would include two or more puppets and a story line about environmental themes such as habitat or the impact of human behavior. Or, they can be about related social issues such as land use decisions or hunting regulations. Often, slapstick is part of puppet shows.

Effective puppet shows are generally short (7–10 minutes), have a lot of action, and some dialogue. When planning a puppet script, base the cast on the people you have available. Tapes or radio can be used for sound effects. Use colorful cloth for the stage and paint plain cloth for backdrops. Expressive faces help establish puppets' personalities.

There are many types of puppets that can be used. Marionettes are puppets that are controlled by strings from above that move the head, arms and legs. Indonesian puppets are made of cut paper shapes and are controlled by sticks that are attached to the arms and legs of the puppets. The puppets are silhouetted on a screen with a light from behind. Hand puppets are made to fit over the puppeteer's hand. There may be rods attached to the hands or head of the puppets for more elaborate movement.

Puppets can be made from almost any material but the most common puppets are made from cloth. A wide variety of "found" materials can be used to make puppet faces, such as buttons, shells, yarn, beads or string. Puppet heads can be made of Styrofoam balls, wood, recycled plastic containers, stuffed socks, cardboard tubes or even vegetables.

The essence of a puppet stage is that the puppets will be seen but the puppeteers won't. Perform behind a simple stage built from light wood or cardboard. The puppeteers can be hidden by the panels forming the stage or by curtains.



RESOURCES

In some environmental education curricula, there are scripts for skits or suggestions for dramatic productions. Books or stories about environmental issues may be adapted to skits. An example of such a book is *The Lorax*, by Dr. Seuss.

There are quite a few tapes of environmental songs composed mostly for children. Check to find out if any are available to you.

Environmental Education in the Schools. Washington, DC: Peace Corps. [ICE No. M0044]
See the skit called "The Awful Eight" about air pollution, page 125.

Ham, Sam H., *Environmental Interpretation: A Practical Guide for People with Big Ideas and Small Budgets*. Golden, CO: Fulcrum Publishing, 1992. [ICE No. FC190]

Promoting Powerful People: A Process for Change. Washington, DC: Peace Corps. [ICE No. T0104]
pp. 249-258.

Web resources on making puppets:

<http://www.legendsandlore.com/sockpuppets.html>

<http://www.legendsandlore.com/puppet-resource.html>

<http://www.gis.net/~puppetco/>

<http://www.enchantedlearning.com/crafts/puppets/>

http://lala.essortment.com/childrenpuppets_rhws.htm

<http://www.newton.mec.edu/Angier/DimSum/Zodiac%20Puppet%20Lesson.html>

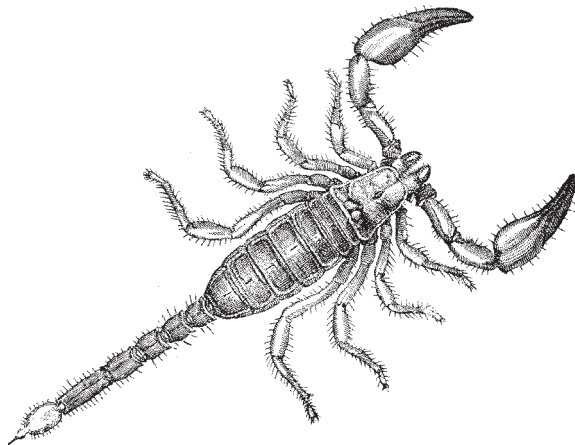



3 MEDIA CAMPAIGNS



DESCRIPTION

A media campaign is an effort to publicize ideas or events over a period of time. Media campaigns use radio, television, loudspeakers, the Internet, posters, flyers, newsletters or other printed materials to convey messages. To attract attention, the presentation of the message must be memorable but the content should be culturally appropriate and locally relevant. A media campaign spreads a message widely and often. It may include several types of media and/or several events, and use motivators such as prizes or recognition.

USES

Use media campaigns to announce events or educate. A media campaign is particularly useful for reaching large numbers of people.

Typically, mass media cover environmental events that are newsworthy. In some places, mass media are put to educational uses, especially when books and other educational materials are in short supply. Sometimes, radio or television stations are looking for local programming.

EXPECTED OUTCOMES

Generally media campaigns increase awareness and knowledge. A media campaign may change attitudes, and could increase participation by announcing events that bring people together to work on a specific task.

EXAMPLES

Environmental education can take place in the mass media in many forms:

- ▶ Weekly educational radio or television shows, or newspaper columns.
- ▶ One-time shows or articles.
- ▶ Newspaper columns or radio shows that feature a particular species or topic of interest, such as how to grow an herb garden.
- ▶ Radio or TV shows that highlight a demonstration project.
- ▶ Panel discussions (e.g., the best methods for reforestation or fisheries management).



- ▶ Contests or puzzles in newspapers that highlight environmental awareness or knowledge.
- ▶ Announcements of upcoming events, meetings or trainings.
- ▶ Recognition of community members for projects or achievements.
- ▶ Endorsements by local leaders of projects or programs.
- ▶ Interviews with local leaders, experts or people who have made a notable achievement.
- ▶ School programs.

The Internet has become a valuable tool for reaching people through websites and e-mail, but the target audience has to have access to computers and the ability and language skill to use them.

While print media, such as flyers, posters, coloring books, comic books, story books or giveaways with logos (like pencils with an environmental slogan on them) can be useful tools for environmental education, they must be designed and produced, and that can take time and money. However, print materials can often be reused and some print materials can be sold to raise money.



HOW TO DO IT

In designing a media campaign, think about how the audience will respond. Using phrases and idioms that are familiar to your audience will make your campaign more attractive. Likewise, use voices that the listeners trust. For example, if you are making a radio spot to ask farmers to use organic methods, use the voices of farmers who have tried the methods.

Each radio spot, flyer, TV promotional or newspaper article should focus on a single action or announcement. Radio and TV spots should be succinct and repeat the message at least twice. Radio and TV spots or programs are more effective if they sound natural and spontaneous, and they make people feel happy, confident or excited.

Involve community members in all phases to make it culturally appropriate and locally relevant. To learn the skills used to create the campaigns, community members should work as counterparts on all steps. There is the danger that media-savvy Volunteers can end up implementing a media campaign that locals are unable to duplicate.

Evaluate your media campaign after it has run for a while. Survey people to find out how many people have seen or heard the effort and what they have learned from it. If your goal is to change behavior, develop an assessment that will show if behavior has changed and how. You may want to develop a pre-campaign assessment for the target behavior, so that you can assess change after the campaign. For example, if you are going to launch a litter clean up campaign, think of some way to measure litter so that you can assess change. Take photographs around the community before and after the campaign. Collect all the litter along a 500-foot stretch of a public thoroughfare before and after to quantify change.

RESOURCES

Ham, Sam H., *Environmental Interpretation: A Practical Guide for People with Big Ideas and Small Budgets*. Golden, CO: Fulcrum Publishing, 1992. [ICE No. FC190]

Oberbillig, Deborah Richie, *Providing Positive Wildlife Viewing Experiences: A Practical Handbook*. Watchable Wildlife Incorporated, April 2001.

Promoting Powerful People. Washington, DC: Peace Corps. [ICE No. T0104] See “Developing and Using Locally Recorded Materials” p. 234-245.

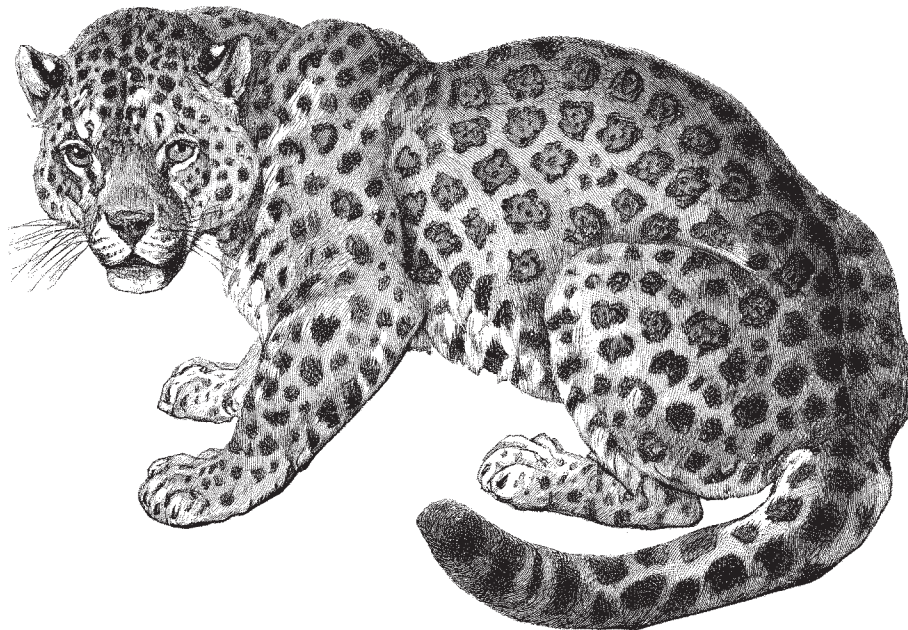



4 SPECIAL EVENTS

DESCRIPTION

Annual holidays or other special days are opportunities for environmental education. Most communities have annual days that celebrate historical events, honor famous people, or commemorate events on a local or national level.



EARTH DAY CELEBRATION — SLOVAKIA —

One Volunteer served in the protected area in central Slovakia and facilitated the cooperation among various local environmental NGOs. During the first year at her site, the Volunteer organized an Earth Day celebration to foster cooperation among the staff at the protected area, local schools, local government and NGOs. The first celebration took place with the support of a Small Projects Assistance (SPA) grant, and involved an eco-parade, natural crafts, production of post cards, tree planting, an eco-theater, an art contest and presentations/discussions of environmental problems. All agreed that Earth Day was a success and it was repeated the following year.



The following year, four local NGOs and 14 schools planned the Earth Day celebration. A planning committee began meeting well in advance of Earth Day, with representatives from each NGO and school contributing ideas for the overall plan. Eventually, the Volunteer served as a facilitator rather than the lead organizer. Part of the celebration was financed with proceeds from the previous year, and donations were solicited from local sponsors. The NGO community in the area prepared an advertising and fund-raising campaign. The program consisted of grammar school presentations in the morning, information booths on environmental topics during the day, and a town-square clean up in the evening, accompanied by live music. There were advertisements in the papers asking people to ride bikes or walk to work throughout the week in order to show that Earth Day is every day, not just one day of the year.

USES

Often special events take the form of parades or fairs. People participate by being part of the parade, acting in a performance or setting up an informational table or booth. An organization increases its visibility by sponsoring an activity.



EXPECTED

OUTCOMES

Special events are opportunities to increase visibility, recruit people to your cause or facilitate an educational activity.

EXAMPLES

Some international holidays that are especially appropriate:

- ▶ World Environment Day – 5 June
- ▶ Earth Day – 22 April
- ▶ World Water Day*
- ▶ Plant for the Planet tree planting campaign*
- ▶ Africa Environment Day – 3 March
- ▶ Clean Up the World Campaign*
- ▶ Arbor Day*

*These days have variable dates. Some vary by location, such as Arbor Day, while others change each year. Check the U.N. Environment Programme for details at: www.unep.org.

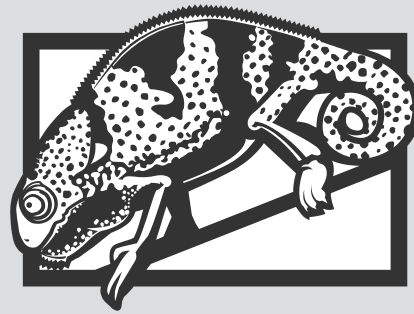

FESTIVALS

– MADAGASCAR –

A Volunteer and an agent of a local wildlife preservation trust put together a series of community festivals that focused on developing and sharing messages about the environment and local culture. First, they held two environmental education teacher trainings with local teachers spaced several months apart. This was done with the help of the Ministry of Education and World Wildlife Fund.

At the second teacher training, the Volunteer and her counterpart introduced the idea of the festivals and final competition. Twelve different communities had a school participating in the series of festivals.



Each school prepared a presentation that contained an environmental message and included an element of the local culture (myth, lore, music, dance, etc.). The Volunteer and her counterpart visited each town to assist teachers with program planning. On the day of the festival, a panel judged the presentations. Later, the winners went to the regional capital to compete with the other villages as part of the World Environment Day. Villages were encouraged to make a festival out of the presentations to ensure participation and increase the number of people hearing the messages.



PARADE OF THE SPECIES — ROMANIA —

“...the species parade was an unexpected success, with 50 percent more than expected attendance and perfect weather. It promoted collaboration among local governments, NGOs, schools and other community groups.”

One Volunteer developed a species parade activity for Earth Day that informed and educated school-aged children and the public on the importance of preserving biodiversity. The activity raised awareness about the importance of maintaining a conscious respect for the environment in the community’s everyday behavior. As part of her preparations, the Volunteer trained a community group on conducting environmental education and producing a large-scale community event. She also provided instructional materials. The participants in the species parade learned about the environmental implications of their everyday actions. They worked together as a team to construct art, music and dance creations for the event. Instructors guided them in channeling their creativity by using recycled materials, thus demonstrating conservation principles in using materials normally discarded in the community.

HOW TO DO IT

Your participation in a special event depends on the community and how they celebrate events. Below are some ideas for community participation.

Parades

- ▶ Make a float
- ▶ March in costume
- ▶ Carry a banner
- ▶ Perform (e.g., drill team, band, dance)

Fairs

- ▶ Informational booth
- ▶ Food booth
- ▶ Environmental activity (e.g., ecosystem mural)
- ▶ Forest crafts sale booth
- ▶ Demonstration project (e.g., composting)
- ▶ Organic or medicinal food products
- ▶ Sponsor trash cans or recycling bins

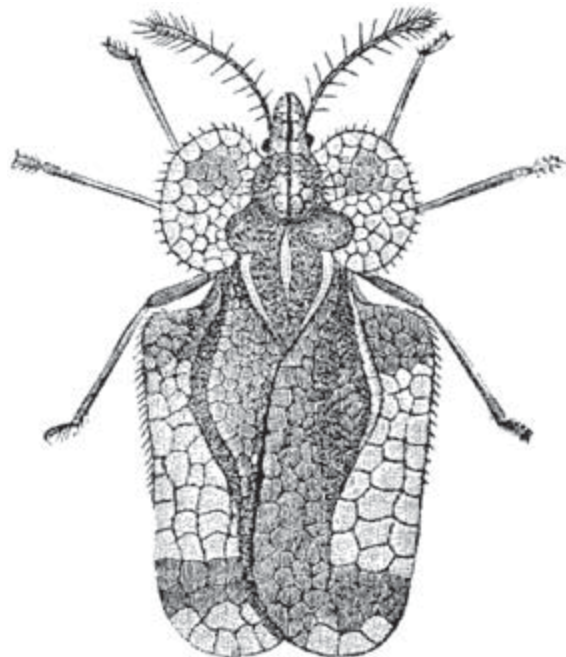



RESOURCES

Ham, Sam H., *Environmental Interpretation: A Practical Guide for People with Big Ideas and Small Budgets*. Golden, CO: Fulcrum Publishing, 1992. [ICE No. FC190]

Earth Day Network – current campaigns, programs and events
www.earthday.net

National Arbor Day Foundation
www.arborday.org

United Nations Environment Programme – World Environment Day ideas and themes as well as information about other celebrations
www.unep.org

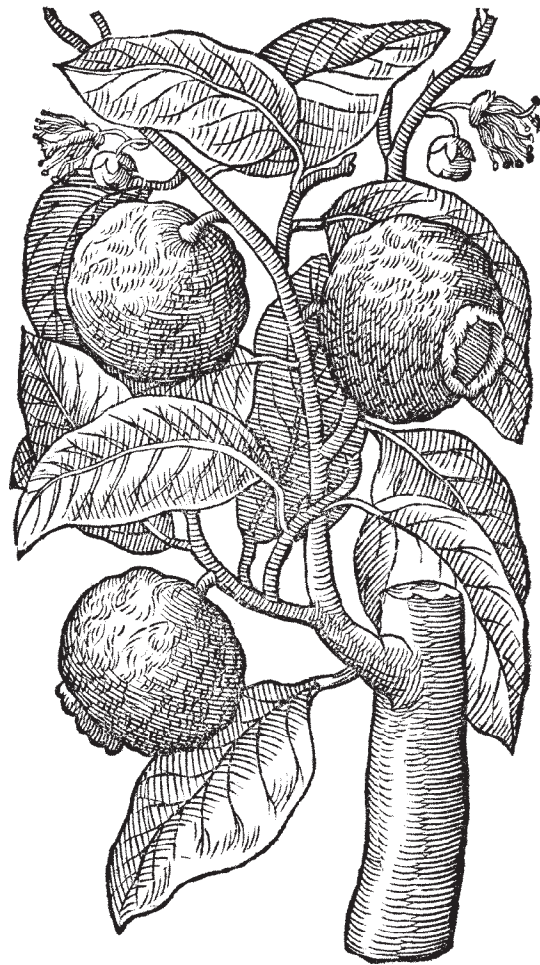



5 SCIENCE AND ECO-FAIRS AND FAMILY NIGHTS

DESCRIPTION

A science fair, eco-fair, or family night is an event that highlights environmental events, projects or products produced by local people. Like a state fair that highlights farm products, a science or eco-fair highlights science projects or ecological projects. A family night is a time when children conduct fun, educational activities and invite their families to participate.



USES

Science or eco-fairs effectively recognize and publicize work that students or other groups have been doing. Fairs are also useful to showcase locally produced products like organically grown vegetables or forest product crafts. Science and eco-fairs usually contain experiments, demonstrations or collections.

Family nights allow children to demonstrate their knowledge to parents and other community members. The events recognize the work of the children and raise the awareness or knowledge of the community members.

ECO-FAIR — HONDURAS —



Eight local agencies, in collaboration with Volunteers, organized the first Agricultural and Ecological Fair for a community. This three-day-long event included activities such as ecological parades, clean up campaigns, music and theater festivals, folk music presentations, organic production technical talks, sports competitions for youth and adults, dances, community exchange, educational trail walks, display booths of organic agriculture products, educational booths that provided information regarding host country agencies' (HCAs) work, and disaster preparedness

and mitigation. All these events were coordinated with local agencies and economically supported by the HCAs participating in the event. Thousands of participants came and state government officials actively participated.

As a result of this event, one of the Volunteers supported another regional Agriculture and Environmental Fair in the state capital. Farmers benefited directly, because they were trained and invited to participate in the booths delivering informal sessions to share their experiences. The host country agency, along with the Volunteer, developed a concrete follow-up plan to support farmers who participated and/or were trained during this event.



EXPECTED OUTCOMES

The two main advantages to fairs and family nights are that children learn a great deal about environmental issues by doing their projects; and visitors learn by observing the exhibits. An added benefit is that families become increasingly involved in their children's education.

EXAMPLES

Fairs and family nights can feature exhibits that demonstrate environmental principles or methods, such as recycling, composting, or make-and-take workshops (e.g., construct planters and take them home). Science or eco-fairs can show comparisons of products (e.g., which soap cleans the best or which fertilizer shows the greatest growth), demonstrations of methods (e.g., terracing, irrigation, replanting, etc.) or the results of scientific tests.

HOW TO DO IT

Fairs and family nights require significant advance planning. If you are planning a science fair for children, it will probably take a month or more to teach and conduct an experiment or demonstration. If you want to showcase existing community projects, participants will need enough advance warning to grow or prepare the items to be shown. Family nights may require less time if children are demonstrating concepts you have taught them. For example, if your students have been studying water quality, students could demonstrate the methods for testing water (acidity, dissolved oxygen, turbidity, etc.). Or a station might include a student showing adults how to do a soil nitrate test or how to identify medicinal plants.

Depending on what you are showcasing, you will need tables, stalls, pens or cages. Plan for the amount of space necessary to display the items so that all the visitors can see them without crowding. Decide what kinds of signs or instructions you will need to display.

RESOURCES

Use the keywords "science fair" to search the Teachers First website for information on how to plan and conduct a science fair. www.TeachersFirst.com

Other websites with science fair information are:

- ▶ National Science Teachers Association:
www.nsta.org
- ▶ Virtual Library of Science Fairs:
www.physics.usc.edu/~gould/ScienceFairs
- ▶ Internet Public Library:
www.ipl.org

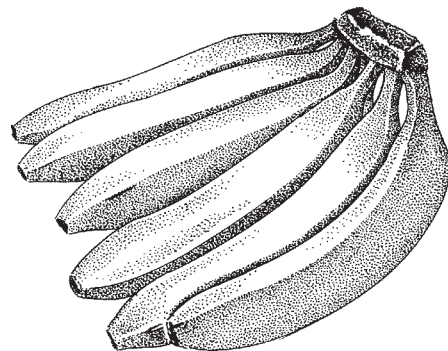



6 SIMULATIONS

DESCRIPTION

A simulation attempts to teach a principle by involving people in an activity that mimics the principle. You may be familiar with *Barnga*, a game used during pre-service training that teaches Volunteers about cultural differences by simulating the effect of cultural differences on human interaction. Players undergo a mini culture shock similar to actual experiences when entering a new culture. The players find they do not know the rules of the card game, but still must try to figure out how to play. It simulates the entry of people into a new culture where they don't know the rules and must figure them out.



Environmental simulations usually simulate some biological system or a public process. “The Commons Dilemma” from *Environmental Education in the Schools* highlights the problem of population growth and resource availability.

USES

Simulations are useful for teaching about complex principles or situations with many variables such as population dynamics or human water use. By involving people in an activity, they learn the dynamics of the situation better than if they were simply told.

EXPECTED OUTCOMES

Participants will be able to discuss complex ecological principles or environmental dilemmas.

EXAMPLES

Simulations are used to communicate concepts about many complex ecological principles, such as:

- ▶ Population dynamics
- ▶ Interdependence
- ▶ Animal behaviors
- ▶ Community issues
- ▶ Public processes for dealing with environmental issues





Some simulations available in Peace Corps' publications are:

“The Commons Dilemma” in *Environmental Education in the Schools*

“Key Mangrove” in *Environmental Education in the Schools*

“Mining the Moon” in *Environmental Education in the Schools*

HOW TO DO IT

Simulations are common in environmental education curricula, but you can also make your own to demonstrate a particular principle. You can find an appropriate simulation in an environmental curriculum that you can use or find a related simulation and adapt it to your needs. For curricula and a resource on adapting activities, see Resources at the end of this section.

Tips on creating simulations:

- ▶ Choose the concept or principle you want your audience to understand.

In the example “A Steppe in Time” below: How did farming affect the water and biodiversity around the Aral Sea in Kazakhstan?

- ▶ Decide the most important parts of the concept to simulate.

Interdependence of animals and farmers on water and land availability

Water and space as limiting factors

Impact of seasonal change, erosion, water use by wheat versus cotton, growth of cities, prices of crops, use of pesticides and accidents

Historical accuracy (Virgin Lands policy in former Soviet Union)

- ▶ Imagine a simple way to demonstrate the ideas. Often you can use common children's sports and games as models. The various forms of tag, Mother May I, card games (Old Maid, Concentration/Memory) or baseball are examples of sports and games that can be modified for use in simulations.

In this simulation, space is important, so desks were chosen to simulate finite space. Limited water resources became a limited number of cards that recycle, like water. Students represented the farmers and the animals. Change over time is shown through successive rounds of play. Historical political decisions, weather and erosion are represented on situation cards. Rules define parameters and control variables.

- ▶ Practice the simulation to find out if it will work. Do a dry run to make sure your numbers will work, the rules will work, and the simulation will go smoothly.
- ▶ Build in a discussion at the end so participants can process the ideas and deliver feedback.



When creating a simulation, it is important to control variables, that is, make sure you don't have too many things going on so that the point gets lost. The strong point of simulations is that they can demonstrate complex ecological principles that are very difficult to show in real life situations. The weak point is that they need to be designed carefully to isolate the desired principle without being confused by extraneous variables. Also, participants can get caught up in the fun of the simulation and lose the point, so it is important to design in a piece that checks for understanding.

– Simulation – A STEPPE IN TIME

Arrange a classroom such that the desks and tables become nine parcels of land, one of which is the Aral Sea. Students should then draw character cards to become two wheat farmers, one cotton farmer, three fish, three sheep, two saiga antelope, two birds, two wolves and two deer. Students who drew animal cards should choose one of the eight parcels of land to inhabit (maximum of four animals per parcel).

The Aral Sea receives 70 (out of 150) water cards; all fish live there. Each parcel begins the game with three water cards. Every parcel receives annual rain and all people and animals use water. Years are represented by rounds of the simulation. Situations are represented by cards.

RULES:

1. Every year it will rain three water cards per land area and five to the sea.
2. Fish have to pay five water cards per year to live.
3. Animals have to pay one water card per year to live.
4. No more than four animals may occupy an area at one time.
5. Wheat farmers need four water cards per year to operate.
6. Cotton farmers need six water cards per year to operate.
7. Farmers may farm an area for two years. After this, the area must remain fallow for one year (indicated by fallow card).
8. Fallow land receives rainfall, but may not be used by animals or farmers.
9. When a farmer takes over, animals must find another home, one that is not fallow or urban.
10. If a farmer leaves the game, his land becomes available to other animals or farmers.
11. If farmers need more water, they must first get it from the sea. If the sea dries up, farmers may then draw from adjoining land.
12. When crop prices fall, land must remain fallow for one year.
13. In the event that all of the fish in the Aral Sea die, another fish may be added when the sea again has 25 water cards; thereafter for each multiple of 25 water cards, add an additional fish (25, 50, 75, etc.).





PLAYING CARDS:

You will need to create playing cards according to the following charts for use with this game. Situation and character cards may be adapted for relevance to your particular environment.

SITUATION CARDS

Number of cards	Text of Card
2	Very rainy year. Steppe floods. <i>(Two extra water cards at three adjoining desks.)</i>
2	Hot, dry year. Drought. <i>(Only one water card per desk this year. Two go into the sea.)</i>
1	Urban Sprawl <i>(Desk is out of the game; it cannot ever be used.)</i>
1	Price of wheat drops. <i>(No wheat farms this year.)</i>
1	Price of cotton drops. <i>(No cotton farms this year.)</i>
1	Irrigation pipes burst spilling water. <i>(Six extra water cards here; no new water at adjacent desks.)</i>
1	Wind erosion ruins one wheat farm. <i>(Must remain fallow for three years.)</i>
1	Pesticides and chemicals used on the cotton fields spill into the sea. <i>(Remove five water cards from the sea.)</i>
1	Government opens land for agricultural development. <i>(One new wheat farm added.)</i>
1	Harsh winter weather. <i>(Animals at this desk perish.)</i>

CHARACTER CARDS

Number of cards	Text of Card
3	Wheat farmers <i>(One card reserved for related situation card.)</i>
1	Cotton farmer
3	Fish
3	Sheep
2	Saiga antelope
2	Birds
2	Wolves
2	Deer

WATER CARDS

Number of cards	Text of Card
100	Water
10	Water x 5





GENERAL ORDER OF STEPS EACH YEAR

Step Number	Action
1	Draw situation card <i>(Follow instructions on card.)</i>
2	Receive rainfall. <i>(Three cards to land parcels, five to sea.)</i>
3	Animals migrate if necessary.
4	Pay water usage. <i>(One per animal, five per fish, four per wheat farmer, six per cotton farmer.)</i>
5	Discuss what has occurred during round.
6	Record information on chart <i>(# of water cards in sea, # of animals, # of fish)</i>
7	Begin next round.

(Remember that one year = one round.)

ROUNDS:

- 1. Year One:** All desks have three water cards. All animals are in place. All animals must pay the water they have used (one water card). If there are no water cards, they must move or die. Make a chart showing the number of water cards in the Aral Sea, the number of animals and the number of fish for each year. Enter the starting numbers.
- 2. Year Two:** Pass out three water cards per desk (rain) and five to the lake. Analyze. Does anyone have to move? Pay water cards. Enter new information on chart.
- 3. Year Three:** Pass out water cards (rain). The government has decided to open up this area for agricultural development. They want to open it first to wheat farmers. Wheat farmers choose a land area to farm for two years. Does anyone have to move? All animals and farmers pay up water cards. Enter new information on chart.
- 4. Year Four:** Pass out water cards (rain). Since the wheat farming appears successful, the government is now opening the land to cotton farmers. Cotton farmers choose sites. Do any animals have to move? Wheat farmers are on their second year. All animals and farmers pay up water cards. Enter new information on chart.
- 5. All subsequent years:** Choose situation card and act accordingly. Pass out water cards. Do any farmers need to let land lay fallow and find new land? Do any animals need to move? Analyze what is happening in each round. All animals and farmers pay up water cards. Enter new information on chart. Are there any trends? What might need to be done?

DRAWING CONCLUSIONS

At the end, analyze what happened with the group and discuss what could have changed. Follow up with a discussion about making another simulation for another situation. What factors would have to be considered? Who and what would be impacted?



SUGGESTED DIALOGUE QUESTIONS: *(Please feel free to create your own.)*

- What is the relationship among water availability, agriculture, and animal biodiversity represented in this game?
- What happened to the amount of water in the lake after farms were established?
- Did the introduction of farms upset the natural balance (supply/demand) of water?
- In what ways could farmers reduce their impact on the natural environment?
 - Could/should the government have fostered a more environmentally sustainable method of introducing agriculture into this environment?
 - What factors need to be considered (e.g., type of crop, maximum number of players water system able to support, environmentally friendly farming practices, type of ecosystem, etc.)?
- How does this game represent the reality of your particular situation?

From “A Steppe in Time” by Rob Mocsarsky and Anja Pearson, Kaz 7, 1999. Personal communication.

RESOURCES

Environmental Education in the Schools. Washington, DC: Peace Corps. [ICE No. M0044] See page 125.

Windows on the Wild: Biodiversity Basics—An Educator’s Guide to Exploring the Web of Life. Tustin, CA: Acorn Publishing, 1999. [ICE No. FC258]

Ham, Sam H., *Environmental Interpretation: A Practical Guide for People with Big Ideas and Small Budgets.* Golden, CO: Fulcrum Publishing, 1992. [ICE No. FC190]

Adapting Environmental Education Materials. Washington, DC: Peace Corps. [ICE No. M0059]

Project Wet (Water Education for Teachers): K-12 Curriculum and Activity Guide. The Watercourse and the Council for Environmental Education, 1995. [ICE No. E0333d]

Project Learning Tree: Environmental Education Pre K-8 Activity Guide. American Forest Foundation, 1995. [ICE No. E0330]

Thiagarajan, Sivasailam, and Steinwachs, Barbara. *Barnaga.* Yarmouth, Maine: Intercultural Press Inc., 1990. [ICE No. TR098]





7 INTERNATIONAL PROGRAMS

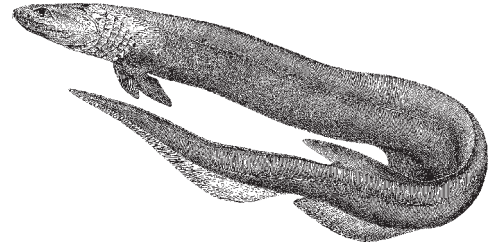

DESCRIPTION

International programs are environmental programs that community members can participate in on an international or local level. Four are listed below, but there are many more that Volunteers have collaborated on effectively.

USES

These programs are useful because you can use their program designs and apply them to your own activities. Participation in international programs can contribute to international scientific databases.

EXPECTED OUTCOMES

International programs allow communities to learn about other parts of the world. They may enable communication with other communities that are dealing with similar issues.

EXAMPLES

- ▶ **Adopt-a-Stream:** Adopt-a-stream programs are environmental education and habitat restoration programs based on stream monitoring. They were started by the Adopt-A-Stream Foundation (www.streamkeeper.org) in 1981. Adopting a stream means that people provide long-term care of a stream by establishing stream monitoring, restoration, and environmental education. It means testing for water characteristics and quality, monitoring fish populations or other important populations, restoring habitat, providing environmental interpretation and education to the public. Water quality monitoring is done on a regular basis and long term data are kept to assess changes. Habitat restoration and environmental education can be undertaken, as well.

This idea can be applied to other critical environmental areas, such as watersheds, forests, lakes, reefs, or rangelands. The interested group decides what area they will monitor, and then determines what types of data will tell them about the health of that area. With streams and other water bodies, data taken include turbidity (clarity of water), temperature, flow rate, acidity, dissolved oxygen, alkalinity, conductivity and indicator species populations. For descriptions of how to do these measurements using methods that require little or no technological equipment, see the “Water Sampling Equipment” section later in this chapter.

- ▶ **Global Learning to Benefit the Environment (GLOBE):** GLOBE is a coalition of scientists and students who are collecting data on earth systems. Data are collected in atmospherics, hydrology, soils, land cover, and earth systems. GLOBE teachers receive training in how to collect the data according to international scientific protocols. The data is then submitted to a database that both scientists and students access. GLOBE is available in those Peace Corps countries that have an official government agreement with this agency and have a country



coordinator in charge of training. Check the website to find out if there is a GLOBE program in your country. For more information see: www.globe.gov.

► **Journey North:** Journey North is a web-based program that brings together students and scientists to study migrations and seasonal change. Students track migrations and seasonal changes and compare their data with students from other places. Most participants are in North America, but every year Journey North seeks people from places all over the world for a project called Mystery Class. Mystery classes submit sunrise and sunset data over the course of the spring, and students try to identify the exact location of the mystery class. For more information see: www.learner.org/jnorth.

► **Birdathons:** Many organizations sponsor birdathons. Birdathons are a fun way of collecting data about bird populations. Often they are organized during migrations in an effort to understand complex migratory patterns and document species and numbers. Ideally, they are an annual event that produces long-term data.

A birdathon may be a school event during Earth Day or Wildlife Week celebrations, or a community event. A birdathon may be a competitive activity, used as a fundraiser, where teams of people try to find as many species of birds as they can in a 24-hour period. Usually, birdathons are held during spring migration to maximize the numbers of possible species. Serious competitors seek out potential “hot spots” prior to the birdathon day so they can have the winning number of species. The data collected can be used to establish which birds are in an area, and if there are any noticeable changes in species.

You can participate in a formal birdathon, or set up your own local event. To create your own, you need to decide on a time, and publicize the event. You will probably need to find a local bird book. You may need to help participants learn to identify local birds. Participants do not need to be bird experts to participate. You may want to have categories of participants – expert, novice, youth, or family. During the 24-hour period, participants look for birds in a specified area, and keep a list of species. At the end of the period, lists are compared. If there is a bird list for the area, it can be used as a resource. If not, your participants can start a bird list for the area.



BIRDATHONS

For more information about birdathons:

- Bird Studies Canada
www.bsc-eoc.org/brdathon.html
- SEEDS Foundation
www.greenschools.ca/seeds/May/Maystart.html
- Point Reyes Bird Observatory
www.prbo.org
- American Birding Association helps schools organize youth birdquests
www.americanbirding.org/ygbqstann.htm
- National Audubon Society
www.audubon.org/sa/birdathon
- Cornell Lab of Ornithology
www.ornith.cornell.edu
- Journey North
www.learner.org/jnorth
- Partners in Flight
www.PartnersInFlight.org/





8 ENDANGERED SPECIES PROJECTS

DESCRIPTION

Many endangered or threatened species are fascinating animals that can be used by environmental educators to attract people to their programs. These programs can raise awareness and knowledge, and change behavior.

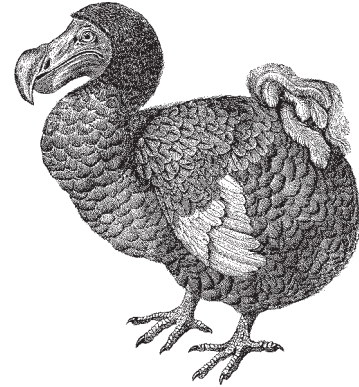

USES

Activities about threatened and endangered species increase awareness of the fragility of plant and animal populations. Participants gain knowledge about the species in their area and look at actions currently being taken to protect the species. They may also explore ways in which their behavior affects these species, for good or ill. By extension, they learn how their behavior affects all the species around them.

EXPECTED OUTCOMES

Participants understand concepts such as threatened, endangered and extinct. Participants identify threatened or endangered species in their region and discuss appropriate actions to protect these species.

EXAMPLES

Most environmental education curricula have activities about endangered and threatened species. In “Endangered Species Gallery Walk” from *Windows on the Wild*, participants research an endangered species and create a poster about that species. The posters are then displayed for others to see.

HOW TO DO IT

There are many ways of approaching the topic of endangered species. Listed here are some topics related to endangered species that could be used:

- ▶ Populations and population dynamics
- ▶ Habitat and habitat depletion
- ▶ Individual species adaptations, and how those adaptations can help or hurt the species
- ▶ How species adapt to climate change (or don't)
- ▶ How humans can threaten a species, and how populations can be returned to a healthy level



- ▶ Studies of specific cases of how animals became threatened, endangered or extinct, or how they were saved from extinction
- ▶ The role of food chains in animal population levels

Community projects about endangered or threatened species:

▶ Fact Finding

- Survey to determine the status of a species population, and any threats to its survival
- Long-term ecological study to identify the species' requirements, the factors limiting its population growth, and the relationship between the species and the local human population
- Ascertain the legal and enforcement situation

▶ Propose action

- To acquire land as a reserve
- To promote the formation by a government or other appropriate agency of a national park or nature preserve
- To establish a research foundation possibly within an existing organization (such as a university) that will focus scientific attention on the species concerned
- To create a continuing scientific presence by any other means
- To promote a program of captive propagation or translocation
- To offer bounties for successful rearing of young (chiefly applicable to birds)
- To control feral animal species or introduced animal species
- To increase food supply or living space



▶ Use of influence

- To persuade someone of importance to write a personal or official letter
- To send a high-level mission to confer with the heads of governments or ministers concerned
- To promote a local meeting on the subject
- To promote a resolution or recommendation at a conference
- To secure recognition in high places by some other means



► Publicity

- To promote a publicity campaign
- To propose the adoption by a group (e.g., city, school) of the species or project
- To promote the program of long-term education

► Finding

- To seek financial aid from an individual or organization that may be linked with the species or project
- To get help in-kind from industry or commerce
- To obtain the services of people able to give practical help

RESOURCES

The International Union for Conservation of Nature and Natural Resources (IUCN) maintains a database of endangered and threatened species called the Red List. Periodically a Red Book of endangered and threatened species is published. Often these Red Books (or Red Data Books) are for a particular region. They may be published by IUCN, or by governments or other organizations. Check libraries, particularly U.N. libraries, for Red Books for your region. See the IUCN website: www.redlist.org.

Publications having activities about endangered or threatened species include:

Windows on the Wild: Biodiversity Basics—An Educator’s Guide to Exploring the Web of Life. Tustin, CA: Acorn Publishing, 1999. [ICE No. FC258]

Environmental Education in the Schools. Washington, DC: Peace Corps. [ICE No. M0044]

Endangered Species: Wild and Rare. Ranger Rick’s Nature Scope, Vol. No. 3, 1989.

Project Wet (Water Education for Teachers): K-12 Curriculum and Activity Guide. The Watercourse and the Council for Environmental Education, 1995. [ICE No. E0333d]

Project Learning Tree: Environmental Education Pre K-8 Activity Guide. American Forest Foundation, 1995. [ICE No. E0330]



9 AGRICULTURE

DESCRIPTION

Agriculture Volunteers may be working with groups or individuals, in a center or in the field. Delivery of environmental education programs will depend on your working circumstances.

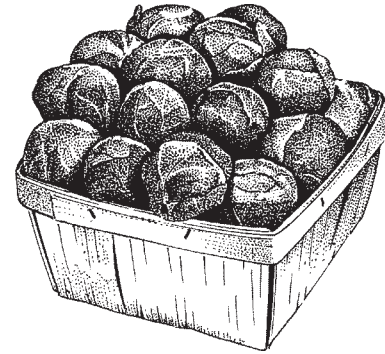

USES

Environmental education in agricultural settings may focus on identifying, analyzing and offering solutions for a wide variety of crop, livestock, or soil issues. Or it may be more narrowly focused on a single area such as fish farming, coffee growing or community forestry.

EXPECTED OUTCOMES

Agricultural environmental education is directed at farmers and groups that produce agricultural products. The expected outcome is that by adopting more environmentally friendly practices, the agricultural sector will become more ecologically sustainable.

EXAMPLES

Agricultural environmental education topics may include:

- ▶ Crops – new varieties, fertilizers, pesticides, treatment methods, rotation, intercropping
- ▶ Forests – conservation, thinning, propagation, logging methods, reforestation
- ▶ Livestock – varieties, feeding, rearing, fodder crops
- ▶ Grazing – enclosures to keep animals out in order to identify the effects of animals on plants and types of feed
- ▶ Water treatment
- ▶ Solid waste treatment
- ▶ Developing environmentally-friendly practices
- ▶ Analyzing costs and benefits of alternative agricultural practices
- ▶ Soil quality and crop growth
- ▶ Causes, consequences, and control of erosion





- ▶ Appropriate use of fertilizers and pesticides
- ▶ Soil improvement
- ▶ Fish farming/aquaculture/coral reef management
- ▶ Watershed management
- ▶ Alternative and organic farming methods
- ▶ Nutrient value of crops
- ▶ Irrigation systems
- ▶ Marketing products
- ▶ Developing value-added products using agricultural resources, such as fruit processing, nature tourism, handicrafts organic products, or recycling

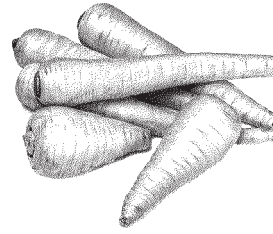

ORGANIC FARMING WITH WOMEN'S GROUPS — BOLIVIA —



A Volunteer in Bolivia worked with three women's groups in three separate communities. She worked with approximately 150 producers to implement organic farming practices and established three experimental agricultural plots to demonstrate sustainable farming practices.

The Volunteer worked to educate the local women on the benefits of organic farming, as well as the economic advantages created through such practices. In addition to garlic, the women harvested broad beans, mustard, quinoa, peas, and chamomile in the plots as part of a five-year rotation plan. Participation has been between 95–99 percent, with the women doing all of the organizing in their communities. The women plan to start an educational program on sustainable farming techniques using their plots as demonstration models.

In addition, the Volunteer also worked with the local growers' association to negotiate better prices for their products and promoted membership in the association to a variety of local producers. She has also educated farmers in several communities in greenhouse construction, production, and maintenance as a nutritional and economic alternative.

HOW TO DO IT

The techniques used will vary depending on your situation. Demonstration projects show community members what can happen if a particular method, technique, or technology is applied to a given circumstance. Usually demonstration projects use a small area to demonstrate or test an environmental management idea.



AGRICULTURE — NICARAGUA —

A Volunteer in Nicaragua was assigned to an agricultural program in a tiny community of the central-north region of Nicaragua. The program promoted sustainable agricultural practices, including contour cultivation, live barriers, soil conservation practices, and farm diversification. Although the community was quite accepting of the Volunteer, they were not quite as open to implementing new production practices.



After a few months of agricultural technical demonstrations with no interest or response from the community, the Volunteer and his counterpart decided to start working with the next community. There they found a disabled farmer with a keen interest in new methods. They established a successful two-by-two meter organic vegetable garden for family consumption. They grew radishes, carrots, tomatoes, basil, and cabbage. The experience was positive and translated into new ideas from the farmer, who wanted to grow vegetables for marketing.

Over the course of two years they established 0.34 hectare of cabbage and sold them very cheaply to the other community members, and 1.02 hectares of tomatoes for marketing purposes outside of the community.

GARDENING — GUATEMALA —

An agriculture Volunteer worked with a local farming association in a mainly coffee-growing community in the department of Zacapa. After her first trip to the market it was apparent that although the climate and soils were perfect for growing most vegetables, the people in town paid extremely high prices for vegetables that were brought 12 hours from the other side of the country. The Volunteer formed a group of eight women that had an interest in making a group garden in one of the small villages surrounding the department center. Together they used soil conservation techniques to make garden beds on a sloping hill, planted and harvested a variety of vegetables, and planted again with other vegetables. All of the gardens were managed organically.



RESOURCES

Nonformal Education Manual. Washington, DC: Peace Corps. [ICE No. M0042]

Refer to the ICE Catalog and the Peace Corps' Online Library for resources recommended for agriculture projects.





10 PARKS, PRESERVES, PROTECTED AREAS AND BUFFER ZONES

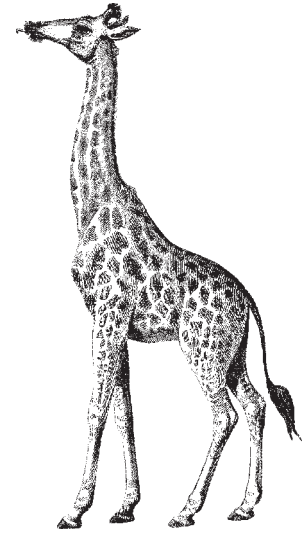

DESCRIPTION

There are two important components to working with parks and preserves: creating educational programs for visitors, park staff or people who use the resources of the park for subsistence or commercial purposes, as well as developing programs for the communities impacted by the park or buffer zones.

USES

Parks, preserves and protected areas often surround or are near communities, and the communities are impacted by the uses and regulations of the park. These communities are impacted economically as well, both positively and negatively. Perhaps the park brings visitors that generate income for the community. Perhaps the park does not allow certain traditional practices, such as hunting, that negatively impact the livelihood of the community members.

The boundaries of the park may be unclear, which means the boundaries of the buffer zone community are equally unclear. This can make it difficult for buffer-zone community members to know how and where they can use resources. Similarly, regulations and laws may either be unclear to community members, or conflict with traditional practices or cultural norms. Access to park resources by community members may be in question. There may be questions of enforcement of park regulations.

EXPECTED OUTCOMES

Generally, park visitors already value protected areas, but may or may not be interested and receptive to environmental messages. Providing information to visitors can help them develop more respect for the natural environment, and can mitigate their effect on the protected area by establishing appropriate behaviors. By working with the communities surrounding protected areas, Volunteers can increase the effectiveness of area personnel by taking the conservation message to the local communities and working with them to develop sustainable alternatives to traditional uses of the area's resources.

EXAMPLES

Park, preserve, and protected area environmental education programs typically include:

- ▶ Interpretation, natural history education, and appropriate behavior in the park.



- ▶ Training of park staff to learn interpretation techniques, explore resource management issues, or develop environmental policies.
- ▶ Programs that entail education on sustainable resource use and low impact practices. These resource users may be tour guides, hunters, loggers, miners, or beekeepers, but in all cases the park management will want them to understand appropriate resource use.

Issues that Volunteers may encounter when working in buffer-zone areas include:

- ▶ Adoption of non-extractive practices
- ▶ Absence of well-defined protected area and buffer-zone boundaries
- ▶ Absence of legal and official recognition of the protected area
- ▶ Acceptance of longer-term investments using fruit trees and woodlots over strictly annual crops
- ▶ Presentation of environmental education in schools utilizing proper teaching methodologies
- ▶ Promotion of community-level environmental organizations
- ▶ Determining the effect of ecotourism on natural resource management
- ▶ Motivation of service providers
- ▶ Absence of environmental education in official school curriculum
- ▶ Land tenure laws and cultural perception of them
- ▶ Marketing products and services from the buffer zone
- ▶ Need for participatory needs assessment of the buffer zone
- ▶ Access to buffer-zone communities year round
- ▶ Acceptance of different land use practices by Volunteers or by local residents
- ▶ Participation by the local population in the management of the resources (such as fishing and hunting limits)
- ▶ Need for activities which improve livelihood security. Volunteers may come in with sufficient training to look for these opportunities and help develop them. Volunteers can bring marketing skills and a new vision.
- ▶ Presentation of environmental education in schools utilizing proper teaching methodologies
- ▶ Consideration of indigenous knowledge

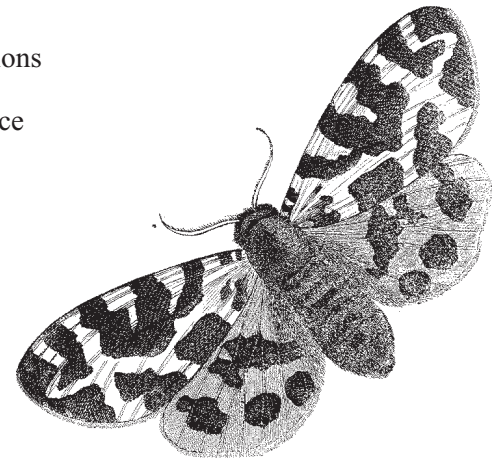



Environmental education programs in these areas may deal with:

- ▶ Ecological reasons that the park was created
- ▶ Ecology of park ecosystems or significant species
- ▶ Exploration of alternative uses of the park
- ▶ Development of economic activities that will replace lost sources of income, take advantage of the park visitors, or respond to increased interest in the park as an ecological system
- ▶ Community members may want to explore the level of their participation in management of resources in and around the park
- ▶ Exploration of the relationship between ecotourism and natural resource management
- ▶ Exploration of the relationship between park regulations and ecological systems, and the logic behind the regulations
- ▶ If the communities are agriculturally based, do land-use practices need to be changed and, if so, how? What alternative land-use practices might be developed that are non-extractive or require less clearing of forests? Are there long-term land-use options to annual crops, such as fruit trees or woodlots?

HOW TO DO IT

One possible activity is to conduct trainings for park personnel on issues such as sign making, constructing nature trails, or general interpretation techniques. Talk with the personnel first to determine their level of interest and specific course material.

Another productive activity is conducting nature talks or guided nature walks for park visitors. Have a plan beforehand where you will take the group, know what you're going to say, plan for emergencies, and carry a first-aid kit.

RESOURCES

Ham, Sam H., *Environmental Interpretation: A Practical Guide for People with Big Ideas and Small Budgets*. Golden, CO: Fulcrum Publishing, 1992. [ICE No. FC190]

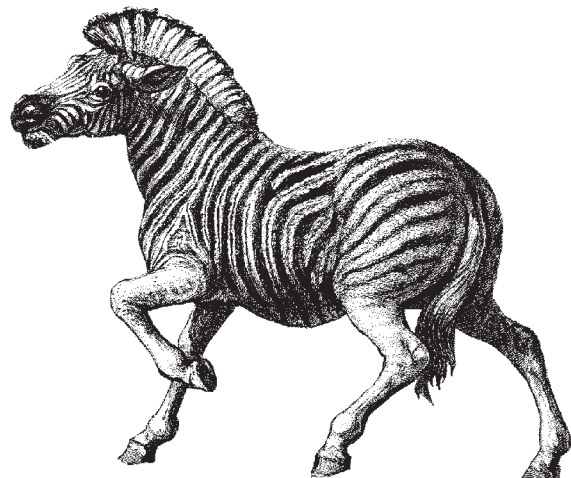



11 YOUTH PROJECTS AND ACTIVITIES



DESCRIPTION

Many Volunteers work with youth, and an increasing number of Peace Corps projects are focused on youth who are out of school and on the streets. Young people want to learn and to contribute to their communities. They are at an age when they have high energy and are passionate and impressionable. They often lack experience and need guidance to achieve their goals.

USES

Youth can be involved in camps, clubs, conservation and service organizations, income-generating activities, events, and education.

- ▶ Camps focus on environmental education, service projects, and skill building.
- ▶ Ecology clubs promote environmental understanding and community service in an enjoyable setting.
- ▶ Youth Conservation Corps (YCC) work on conservation projects such as construction of interpretive trails in parks, restoring wetlands, building public cabins or bunkhouses, or road repair in protected areas. Usually these projects require blocks of time, so YCCs are often conducted as summer camps or work camps where youth work in teams under a supervising adult.
- ▶ Service organizations or projects, such as housing construction and rehabilitation, park trail building and maintenance, solid waste management, canal maintenance and construction, elderly or disabled assistance projects, clean-up, erosion abatement or tree planting.
- ▶ Income generation, such as ecotourism (tour guides, food sellers, camp maintenance, tourist information, transportation rental), value-added resource products for manufacture and sale, or solid waste removal.
- ▶ Events such as Earth Day celebrations or environmental theater.
- ▶ Educational activities such as community school classes, income-generation skills training, basic education, or environmental science classes.

EXPECTED OUTCOMES

- ▶ Awareness, attitude and knowledge: Ecological knowledge, appreciation of natural systems, and understanding natural resource use help young people participate responsibly in sustainable community development.



- ▶ Life skills development: Young people want and need to develop skills and talents they can use for their own futures and to contribute to their communities.
- ▶ Building self-confidence: Young people want to discover their own worth, learn to be leaders, and become responsible citizens.

EXAMPLES

One activity that Volunteers frequently use with youth groups is an ecology club. Volunteers often form clubs at schools or universities. With a club, there is usually more freedom to choose what to teach because there is no established curriculum. Clubs often work well if there are field trips to a variety of places and projects (e.g., forest, stream, experimental farm).

Projects and activities for ecology clubs will depend on the purposes of the clubs and community interests. Usually the expectation is that the club will be fun for the club members while they are learning. Some possible types of activities are:

- ▶ Field trips to ecosystems, farms, fishponds, orchards, zoos, or other places of environmental interest. A club in the Philippines snorkels to learn about marine life.
- ▶ Stream monitoring or other long-term monitoring projects
- ▶ Local environmental research
- ▶ Public service projects such as media campaigns, urban park construction, recycling, litter clean-up campaigns, tree planting, butterfly gardens or trail building
- ▶ Environmental games
- ▶ Participatory ecology classes
- ▶ Team-building activities
- ▶ Fund-raising activities that both raise awareness in the community and raise funds to pay for club activities
- ▶ Planting gardens, raising rabbits, or other educational projects

HOW TO DO IT

To form an ecology club, first get to know your potential audience. Students are the most common members of clubs, but there may be other interested community members. Find out where their interests lie. Adults usually have fairly focused interests, such as organic gardening or hiking clubs. Youth clubs tend to be more flexible and relaxed. Clubs are voluntary, so you need to offer an appropriate incentive for the members to come. For adults it may be learning a skill, gaining knowledge, or working together on a project. For youth, the incentive is more likely to be enjoyment, socializing, interesting projects, community service projects or learning something that will benefit them in the short term (help pass exams, get extra credit, learn a useful skill that will help them get a job or get into a school). Knowing what your potential members want and expect will help you plan a club that will recruit excited members and maintain membership.



Include the members in the planning of activities, which will help them to be more committed. Be careful to schedule meetings at times that are convenient for the members. If they have too many conflicts with other commitments, they will not be able to come. Schedule regular group-building activities, such as picnics or pizza parties to keep interest high. Over time, develop traditions for the club. Design a logo and put it on t-shirts or notebooks. Develop slogans and nicknames. Publicize the club's meetings, activities and achievements. Since the club is voluntary, people will appreciate recognition. Publicity will also make the club look enticing and "cool."

At your first few meetings, you will not know how long it will take to get things done, so plan extra activities and assume you won't get to all of them. In the beginning, spend time getting to know the members and having icebreaking activities. Clubs often have an informal atmosphere, so you can chat with the members about their interests and hopes for the club. If possible, bring food, which helps to convey a relaxed and friendly atmosphere. In addition to icebreakers, plan one main ecological activity that is fun and informative and a shorter fun activity such as a song or skit or game. Start and end on time and, at the end, ask for feedback on how the meeting went and what they would like to do next time.

ENVIRONMENTAL CLUBS

— BENIN —

After environment Volunteers initiated environmental clubs in their areas, enthusiasm spread to many high school teachers who began to implement environmental education into their curriculum. Short-term activities include playing "environmental Chutes and Ladders" and reproductions of Dr. Suess' environmental classic *The Lorax*. Long-term activities include planting fruit tree orchards, indigenous tree nurseries and organic gardens.

Students appreciated the opportunity to break away from the normal classroom structure and rigid assignments and gained an appreciation for their environment, and the importance of individual action.

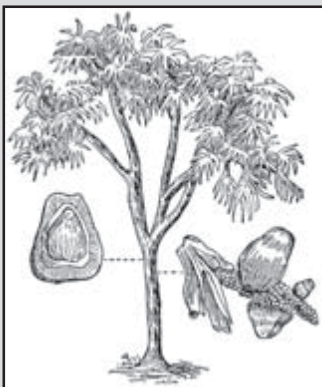

After a simulation activity on the importance of forests and reforestation in which students acted as trees in a local forest used for firewood, traditional medicine and construction, a Volunteer asked a student to describe the forest. She said: "It's overused, dead and ugly. All of the animals have fled or died. I wouldn't want to live there anymore." When the Volunteer asked what could have been done to prevent the destruction of the forest, students shouted out ideas ranging from "cut only the largest trees" to "always plant a tree for each one you cut" to "forbid cutting in the forest and start a special tree garden."

In another village, after the previous week's session on air pollution, an 11-year-old student approached the Volunteer and asked her why she took a taxi, which pollutes, to school; she has ridden her bike to club ever since!

(continued)



Beninese teachers were inspired by a weeklong workshop on environmental education and a few preschool teachers started incorporating practical environmental education activities into their lessons. Using local languages as a base, they teach French vocabulary and environmental appreciation at the same time. In a local language a teacher asked: “Who can tell me what the word for tree is in French?” Wanting to answer quickly, all hands went up. “And,” she continued, “who can find a tree in the school yard?” Again, all hands were in the air. When asked why the tree was there however, the students needed more time to think. One little boy finally ventured an answer: “Because we like trees!”

There are several principles that are helpful when working with youth:

- ▶ Focus on assets more than problems. People need to build from their strengths to move forward.
- ▶ Young people need clear expectations. They need to know exactly what you want, but they also need to know that you will listen to their ideas. As a group leader, you will need to create a balance between having some expectations, rules and standards, and listening and adapting to their ideas and needs.
- ▶ Help young people build their own goals, standards, and skills. Find out what their skill levels are, and what their needs are. Find out what their hopes are. Then help them get there.
- ▶ Help the young people in the community become part of the community. They need to know they belong and have a contributing role in the community. Service learning projects help young people to understand how they can be of service and participate in the community.
- ▶ Let them learn from experience and practice new skills such as leadership, decision-making, planning, assessment and revision. Let them learn by doing. Give youth responsibility. It is the best way for them to learn it. Teach them how to be self-directed.
- ▶ Model stability, patience, and perseverance.
- ▶ Start small and allow your project to grow by small increments. Be satisfied with small achievements.
- ▶ Provide a safe and caring atmosphere. You may be dealing with youth who have been living in frightening and unstable circumstances. Be trustworthy and considerate. Try to view your project from their perspective. Be free with praise, but private with advice.
- ▶ Consider the age, gender, and culture of participants.





TARGETING YOUTH AND WOMEN — ECUADOR —

One Volunteer was assigned as an environmental educator to two neighboring communities in the province of Carchi, Ecuador. Near these communities, there is a native forest that is one of the few remnants of cloud forests found in the Carchi Province. As with most natural areas of Ecuador, Nueva America Forest faces threats of size reduction and degradation of its resources due to the need for additional agricultural and grazing land. Additionally, resources such as timber and wildlife are also exploited for firewood, construction, and food.



In order to reduce the pressure on the natural resources of the Nueva America Forest, the Volunteer took two courses of action. The first was aimed at the youth by providing environmental education, and the second was with a women's group to generate income through the sale of medicinal plants.

With the youth, the Volunteer organized an ecological club named *Amigos del Bosque* (Friends of the Forest). Youth members met weekly to carry out activities such as clean ups of a lake, educational walks in the forest, painting a mural in the environmental education

center, establishing a small herbarium with plants of the forest and more recently, promoting bird guiding and bird conservation among the club's members.

With the women's group, she successfully implemented a small project to sell medicinal plants. She led the group in weekly meetings in which they planned to obtain a sanitary registration; designed and produced labels; collected, cleaned and dried plants; found markets; implemented an accounting workshop; and opened an office in Ibarra, a major city near Nueva America. Currently, the group is beginning to distribute their products for sale in Ecuador and market research is being done to export their products to Galapagos and the United States.

Sustaining youth programs can sometimes be difficult. Recruit adults who are committed to youth programs and can provide sustainability and leadership. Mentor these adults to encourage them to be caring positive role models. Build networks of interested people and organizations that will help sustain the youth programs.

RESOURCES

Working with Youth: Approaches for Volunteers. Washington, DC: Peace Corps. [ICE No. M0067]





FIELD TRIPS

12 FIELD TRIPS

DESCRIPTION

Field trips are an effective way of showing people real situations. Groups of people go into the field with an interpreter who shows them interesting and important aspects of an environment, and helps sharpen their observations.

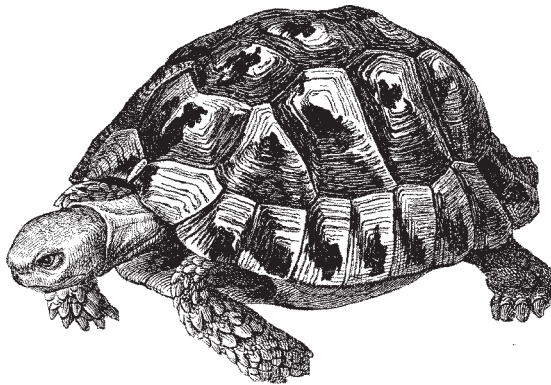

USES

Field trips encourage participants to look carefully at the environment around them. They are useful for teaching participants about ecosystems, human behavior and impact, or for determining future land use actions such as building trails.

EXPECTED OUTCOMES

Participants gain a more realistic understanding of the ecosystem, forest, farming practice or other place visited.

EXAMPLES

Often field trips are used to teach people about specific ecosystems, or to show them projects of interest, such as farming methods or forestry practices. Potential field trips include:

- ▶ Rainforest
- ▶ Wetlands
- ▶ Desert
- ▶ Grasslands
- ▶ Forest
- ▶ Specific plant community
- ▶ Specific habitat
- ▶ Organic farms
- ▶ Water treatment facilities
- ▶ Managed forest
- ▶ Game preserve
- ▶ Forest products' manufacturing site
- ▶ Fish farm
- ▶ Site of geological processes, such as erosion, rebound, etc.



HOW TO DO IT

Field trips are most effective when they have structured activities that participants understand beforehand. Structured activities may include:

- ▶ Treasure hunts or scavenger hunts that focus participant observations on plants, animal homes, sounds, smells, tracks and signs, or examples of human impact. You can add a bit of competition by asking who will see the most things on the list.
- ▶ Natural history interpretation by the leader. People are generally interested in what they are looking at, but having someone explain and point out interesting features can make the outing even more interesting and educational. See the section “Signs, Labels and Guides” later in this chapter for ideas.
- ▶ Data collection and transects. A transect is a sampling, or counting of all the species within a given plot. The plots lie along a line that crosses the area of interest. You may set a transect from a water line to a ridge top of a small hill to discover how the vegetation changes. Your field trip may have a particular focus that requires certain data to be collected, like canopy cover, species of birds, or soil characterization. See the section “Transects” later in this chapter.
- ▶ Awareness activities help broaden the focus of participants. For example, ask participants to find a spot where they can sit quietly for 20 minutes and listen to all the sounds. Ask participants to imagine that a tree is an apartment building, and, starting at the roots, tell you who lives there. Ask participants to identify odors in a particular environment.
- ▶ Games are particularly effective with children. Environmental education curricula have many examples of environmental games that are active and teach a concept.

In addition to structure, consider group size, terrain, safety, appropriate clothing and how you will introduce the field trip. Maximum group size is about 15 people per leader. If there are more, some participants will not be able to hear the leader, and may wander off or become distracted. Assess the outdoor experience of your participants, and choose the terrain accordingly. Many people do not get outdoors on a regular basis beyond their work, which may mean they are unaware of their own best pace, or of proper clothing. Watch the participants as you go and adjust your pace accordingly. Make sure they bring proper clothing, water, and food.

Assess the difficulty of the terrain and any safety risks. Will there be any tricky footing? Could anyone fall? Could wind or rain make the terrain slippery or treacherous, or decrease visibility? Once you have assessed any risks, decide how you will inform the participants. It is best to explain any risks to participants in advance of going on the field trip. You may also want to make some rules that will decrease the risks, such as requiring that everyone stay together, or using a buddy system. You may want participants to bring special clothing or wear an identifying pin or armband. You may ask participants to join hands when crossing streams or negotiating difficult terrain.

Before going on the field trip, brief all the participants on where you will be going, what you hope to accomplish, how they should dress, what they should bring and how they should behave. Focusing the field trip on the study of ecosystems helps people look at the whole system, and keeps people from focusing on animals and disturbing them. People find themselves very interested in parts of the ecosystem that they would normally ignore if the leader can tell them what is interesting. An example is slime molds. Slime molds have a repellent name, but a very interesting lifestyle. Once people know about the lifestyle, they become interested in looking for slime molds.





FIELD TRIP CHECKLIST

BEFORE THE FIELD TRIP

- Choose your objectives and theme for the field trip.
- Go over the route of the field trip in advance to find interesting sites to point out and to check for any difficulties or safety concerns.
- Plan a variety of activities for the field trip.
- Develop guidelines for field trip behavior either with participants or separately.
- For children, get permission slips and pertinent medical information about participants from parents. On some field trips, it may be wise to get medical information from adults as well.
- Gather materials and equipment.
- Announce meeting time and place, and notify participants about any special clothing, food, water or equipment. Tell them the expected return time.
- Pack all equipment, first-aid kit, teaching materials, food, water, clothing, bug repellent and sunscreen.
- Recruit co-leaders, parents or chaperones to achieve a good leader-to-participant ratio. For little children, there should be one adult for every five children. For older children and adults, the ratio can be one leader to every 10-15 participants in easy to moderate terrain.

STAGING THE FIELD TRIP

- Make sure all participants are present, and take a head count.
- Orient participants to the route, theme, and purpose of the field trip.
- Make sure all participants are prepared for the field trip and have proper clothing, supplies, and equipment.
- Make sure all participants understand any safety concerns and know all rules.

DURING THE FIELD TRIP

- Take head counts every so often to make sure no one gets lost.
- Stop at interesting sites and present enthusiastic, knowledgeable interpretations of the natural world.
- Ask questions and encourage questions from the participants.
- Know pertinent phrases in the local language, even if you are presenting in English.

(continued)



- Vary the activities. Mix nature interpretation with observation activities, taking measurements, identifying species, art and literature.
- Play an active game
- At the end of the trip, ask participants what they learned, and what they liked about the trip.

FIELD TRIP SAFETY

- Keep track of time.
- Take a compass and map of the area.
- Maintain frequent communication among leaders.
- Protect participants from the sun by limiting exposure, utilizing shady areas, and requiring them to wear hats or use umbrellas.
- Take plenty of water and high-energy foods along.
- Carry a whistle.
- Check the weather forecast beforehand if possible, and be prepared to deal with changes in weather.
- Be aware of background noise.
- Be aware of safety hazards such as poisonous plants, venomous animals, cliffs, loose rock, uneven footing, and have a plan to deal with them.
- Facilitators should look into the sun, not the participants.
- Have a plan in case of fire, wild animal contact or other emergency.
- Have a plan about any water bodies you may encounter. Will you allow swimming? Under what circumstances? Consider supervision for swimming. Participants should not drink alcohol or eat just before swimming.

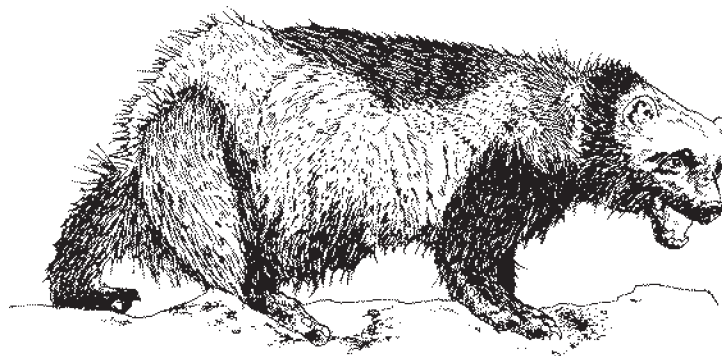



RESOURCES

Windows on the Wild: Biodiversity Basics—An Educator's Guide to Exploring the Web of Life. Tustin, CA: Acorn Publishing, 1999. [ICE No. FC258]

Environmental Education in the Schools. Washington, DC: Peace Corps, 1993. [ICE No. M0044]

Ham, Sam H., *Environmental Interpretation: A Practical Guide for People with Big Ideas and Small Budgets.* Golden, CO: Fulcrum Publishing, 1992. [ICE No. FC190]

Learning Local Environmental Knowledge: A Volunteer's Guide to Community Entry. Washington, DC: Peace Corps. [ICE No. M0071]

Adapting Environmental Education Materials. Washington, DC: Peace Corps. [ICE No. M0059]

Project Wet (Water Education for Teachers): K-12 Curriculum and Activity Guide. The Watercourse and the Council for Environmental Education, 1995. [ICE No. E0333d]

Project Learning Tree: Environmental Education Pre K-8 Activity Guide. American Forest Foundation, 1995. [ICE No. E0330]





13 FIELD ETHICS



DESCRIPTION

Taking community members out into the environment is a powerful learning tool. And, of course, the best place for environmental education is in the environment. However, questions of impact will arise. Ideally, people “take only photographs and leave only footprints,” but there are times when this may not work, and there are cultural considerations that affect behavior in natural settings. Perhaps you or community members may want to collect samples for further study. Some cultures are inclined to kill every snake they see. Some cultures revere certain types of trees, so those trees cannot be disturbed. There are also issues of land ownership or ownership of animals or plants.

USES

Codes of ethics may be used at the beginning of trips into the environment to explain to people what is expected of them. These codes may also be part of publications, exhibits, or signs at sensitive areas. Ethics are usually part of environmental education.

EXPECTED OUTCOMES

Codes of ethics or codes of conduct encourage people to behave responsibly.

HOW TO DO IT

It is important to develop a code of ethical outdoor behavior before taking people into the out of doors. Various organizations have developed codes or tips or suggested behaviors. Most have a few behaviors in common:

- ▶ All living things must be respected and should not be injured. This includes plants, insects, etc., not just birds and mammals.
- ▶ Staying on trails minimizes damage to plants and animals.
- ▶ All living things are best studied in their natural environment without interference from people.



- ▶ If collecting specimens is appropriate and instructionally powerful, decide in advance how much will be collected and from where, so as to minimize negative impact. Only collect if there is an abundance and only those specimens you can learn from while keeping damage to a minimum.
- ▶ Make sure to seek permission from land-owners before going onto their land.

RESOURCES

Oberbillig, Deborah Richie, *Providing Positive Wildlife Viewing Experiences: A Practical Handbook*. Watchable Wildlife Incorporated, April 2001.

Project Learning Tree: Environmental Education Pre K-8 Activity Guide. American Forest Foundation, 1995. [ICE No. E0330] See pages 379-382.

Leave No Trace
www.lnt.org/

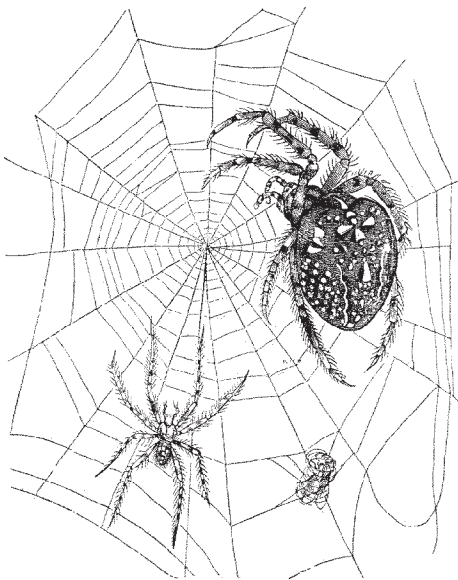

PRINCIPLES OF LEAVE NO TRACE

- Plan Ahead and Prepare
- Travel and Camp on Durable Surfaces
- Dispose of Waste Properly
- Leave What You Find
- Minimize Campfire Impacts
- Respect Wildlife
- Be Considerate of Other Visitors

The Leave No Trace Center for Outdoor Ethics is a national nonprofit organization dedicated to promoting and inspiring responsible outdoor recreation through education, research and partnerships. Leave No Trace builds awareness, appreciation and respect for our wildlands.

Principles printed with the permission of the Leave No Trace Center for Outdoor Ethics. For more information, Leave No Trace, www.lnt.org.





FACILITIES AND TRAILS

14 PUBLIC FACILITIES



DESCRIPTION

Public facilities include interpretive kiosks, viewing blinds, fences, rest stops, benches, restrooms, litter containers and parking. A facility may be as simple as a sign signifying a view or as complex as a nature center with multimedia interpretive displays and guided trails.

USES

Facility design can allow people to interact with the environment responsibly by attracting people to interesting outdoor experiences while managing their impact. For example, if you want to bring people to see waterbirds in a wetland, but you don't want people walking on delicate wetland plants or disturbing the birds, build a walkway and viewing area that channels people to walk in certain places, but not others. To attract them to the viewing area, a sign showing the types of waterbirds in the area, and a couple of benches will encourage people to use the area properly.

— Case Study — SHEEP VIEWING AREA

Herds of up to 100 bighorn sheep spend the winter close to a highway with heavy truck traffic. People who wanted to watch the wildlife pulled over on the side of the road and got out of their cars to take photographs. Some even climbed the fence into private property to get a closer look. The truckers on the highway were frustrated by the congestion; the landowner was upset by the trespassing and wanted to get rid of the sheep; the viewers were frustrated by having to dodge each other.



In this case, a highway patrolman took the lead to bring together biologists, landowners, engineers and the local community to create a partnership. They built a viewing area off the highway that concentrated viewers, solved traffic problems and created a facility that allowed the sheep to become habituated to viewers being in a specific place. Local students built a fence and benches. The local chamber of

(continued)





commerce marketed the viewing area. The landowner donated land for the viewing area, and became interested in the sheep. An interpretive kiosk and pullout completed the facilities.

Adapted with permission from *Providing Positive Wildlife Viewing Experiences: A Practical Handbook*. Marine on St. Croix, MN: Watchable Wildlife Incorporated, April 2001, page 28.

EXAMPLES

Facility design depends on the site sensitivity, access and target audience. Some sites require minimum facilities because the natural area itself offers an exciting viewing opportunity and encourages responsible behavior. You can take advantage of natural features to maximize enjoyment and minimize negative impact. For example, building a viewing area on the top of a bluff will offer good views and discourage people from walking into sensitive areas.

Other areas may require more elaborate facilities due to fragile environments or difficult access. One area in South Africa has a long tunnel with tarps and poles that lead to a blind for viewing vultures. The blind is a simple small building with a plastic window along one side. Viewers entered and departed using the tunnel so as not to disturb the birds.



HOW TO DO IT

The goal of the facility is to maximize viewing enjoyment while minimizing negative public impact. Assess the location of the site to determine the fragility of the environment. If the ecosystem and species in it can withstand the projected numbers of people with little or no disruption, then the facility can be simple. If the site contains a fragile environment or sensitive species, but is already being used, the aim of the facilities is to protect the species and environment while offering visitors a managed opportunity to view.

When designing the facility, start with an interpretive theme or message that is relevant to the ecosystems that will be viewed. Involve the community in the planning, including biologists, recreation planners, users, park officials, or other stakeholders. The goals of the facility are:

- ▶ To attract people to where you want them to be
- ▶ Protect sensitive areas
- ▶ Meet user and community expectations
- ▶ Create a quiet educational adventure



Apply nature's designs to the facilities. Mimicking natural systems makes the facility harmonize with the ecosystem and contributes to the educational value. Often using local materials can save money as well. There may be a need to balance the construction of facilities with the environment they are built to show. For example, if the construction of a viewing area could substantially change the area, then a more appropriate design may be necessary. As a general rule, the less disturbance the better.

Likewise, designing benches, picnic tables, fire pits, toilets or other "furniture" should take into consideration the available natural materials and designs. Often local low-tech designs will serve well.

RESOURCES

Oberbillig, Deborah Richie, *Providing Positive Wildlife Viewing Experiences: A Practical Handbook*. Watchable Wildlife Incorporated, April 2001.





15 NATURE TRAILS

DESCRIPTION

A nature trail can be very useful as an environmental education tool. It can be a single trail that traverses an area of ecological interest, or a system of trails that each has different highlights.

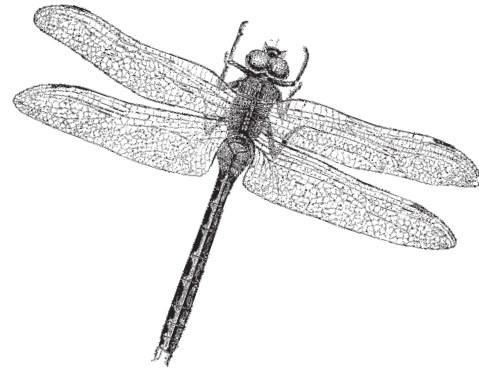

USES

In choosing a nature trail, consider the features to highlight, the route of the trail, traffic patterns, and trail maintenance.

- ▶ Who are the users? How will they use the trail? Will there be large or small groups?
- ▶ Where will you locate benches, overlooks or tranquil alcoves in order to highlight features of interest and invite people to slow down and let nature express itself?
- ▶ Where are signs of animal presence? A well-planned trail will allow animals to predict human behavior, and adapt accordingly. That may mean the animals will tolerate being viewed, if they know they will be safe.
- ▶ What natural vegetation can you take advantage of for viewing areas to minimize either cutting vegetation or building viewing areas?
- ▶ How will the different seasons affect the experience of the trail and the species present?
- ▶ How can you plan your trail to minimize people leaving the trail and creating their own?
- ▶ Respect wildlife corridors as much as possible, so as not to drive away wildlife.
- ▶ Are there any endangered or threatened species that need to be considered? How can they be protected?
- ▶ How will you monitor changes that affect the trail or its wildlife? Maintain flexibility so trail managers can respond to changes in ways that will protect wildlife and people.
- ▶ Which areas will people come to? Plan trails there, or they will make their own. Provide for peoples' interests and prevent damage.
- ▶ Design an interesting trail. What large trees can the trail pass or go under? Are there cliffs or rock outcroppings that the trail could highlight? Where can interesting curves in the trail be located? Winding trails give a sense of discovery.



- ▶ Take advantage of natural barriers that separate people from wildlife while allowing a view. For example, if the hippos are in the river, route the trail along a high embankment so the hippos can be seen but not approached.
- ▶ How can you use boardwalks, observation decks and towers to concentrate people and protect terrain? What materials will be most durable for constructing these facilities?
- ▶ What safety measures need to be taken to protect people and wildlife?
- ▶ How will you label features of interest? Where will you put interpretive signs that will attract people without interfering with the experience of the trail?

EXPECTED OUTCOMES

The purpose of a nature trail is to offer an enjoyable and interesting natural experience while protecting the environment. A nature trail is a teaching tool that can increase public awareness and knowledge.

EXAMPLES

Nature trails can be enhanced to offer interpretive information to walkers. Walkers can be given a printed guide to the trail that indicates points of interest. Interpretive signs along the way can point out a feature and how it fits in to the whole ecosystem. Keep signs separated from each other so people will stop and look without feeling rushed by the next sign. Nature guides may take groups of people and interpret the ecosystem for them. Printed trail guides can describe the features of the trail in detail and be coded to small signs or markers on the trail.

Possible features on a nature trail could be:

- ▶ Characteristics of a particular ecosystem – dominant trees or special plants, examples of animal homes or special geological features
- ▶ Grassy areas that show ways plants adapt to sun
- ▶ Sandy areas that demonstrate how plants hold soil
- ▶ Successional zones that show the sequence of plants colonizing an area
- ▶ Beaches that demonstrate plant adaptations to salt water or storms
- ▶ Rotting logs that are mini-systems showing decomposition
- ▶ Rocks with lichens that show soil formation and highlight these unique organisms
- ▶ Caves, rock shelters, and fallen tree-root systems that show animal homes and natural geological processes
- ▶ Historical features of local interest
- ▶ Browsed plants that show signs of animal foraging and plant adaptation to browsing
- ▶ Feeding areas that have tracks of the animals that use the area





- ▶ Road or trail cuts that show soil profiles with layers of sediments
- ▶ Streams that demonstrate the action of water and the adaptations of organisms that live in them
- ▶ Areas of human impact that demonstrate the effects of human activities
- ▶ Evidence of fungus or insect impact on trees, such as bore holes or burls
- ▶ Microclimate differences in plant growth between wet soils, sunny spots or shady areas

HOW TO DO IT

Nature trails are generally short—a mile or so—and are loops, or one loop with side loops for special interests. Nature trails are inviting and the trailhead is easy to locate. The trail should be wide enough for two people to walk side by side. It should be as flat as possible, smooth surfaced and free of obstacles. The trail should drain well so muddy places do not develop. If they do develop try to fill them, place logs or bamboo (a corduroy) across them for easy walking. It may be necessary to build a boardwalk along certain sections.

Place benches along the trail for rest stops. The walk should be easy and require no special clothing or shoes. The trail should be clean and well maintained with animal-proof waste receptacles. The route of the trail should be obvious with few, clearly marked intersections. Try to avoid switchbacks so people will not make short cuts. It may be necessary to restore areas that have been degraded, such as stream corridors or sections of trail.



RESOURCES

Proudman, Robert D. and Reuben Rajala. *Trail Building and Maintenance*, 2nd ed. Appalachian Mountain Club, 1981. [ICE No. FC196]

Oberbillig, Deborah Richie. *Providing Positive Wildlife Viewing Experiences: A Practical Handbook*. Watchable Wildlife Incorporated, April 2001.



16 LANDSCAPING, COMPOSTING, AND PLANTING



DESCRIPTION

Landscaping involves working with plants, soil, water, and space to improve outdoor surroundings, or to showcase natural systems. If you have an area in your community or around your center that will allow for landscaping, you can take the opportunity to highlight the natural plants and environmental features of the region. Careful selection of native plants can encourage wildlife to come to the area. Native plants show community members the assets they have right in front of them. If you are in an area that has few natural plants, you can landscape with rocks and gravel to make an attractive display of native materials.

USES

Landscaping provides an opportunity to demonstrate conservation methods, such as composting or terracing. It can also be an opportunity to highlight aspects of the local ecosystem, such as native plants or soil types. Interpretive signs or species labels increase the educational value of the landscaped area.

EXPECTED OUTCOMES

A beautifully landscaped area will attract people to visit. Landscaping can also attract local wildlife such as butterflies or birds. A landscaped area highlights native plants of the area, and educates people about those plants. Landscaping can also conserve soils, decrease erosion and provide shade.

EXAMPLES

Some examples of landscaped areas include:

- ▶ Herb garden
- ▶ Shaded sitting area
- ▶ Grasses that hold soil
- ▶ Butterfly gardens
- ▶ Plantings that attract birds
- ▶ Terracing
- ▶ Rock garden that shows xeric plants
- ▶ Alpine plants
- ▶ Native ornamentals
- ▶ Meditation gardens





HOW TO DO IT

Landscaping:

Planning: Start by making a plan for the land to be landscaped. Remember to leave space to allow for growth. It may take years for full results, especially if you are planting trees or shrubs. When planning, take advantage of natural features, such as rocks or paths or water sources. Check the soil to see if you need to add compost or other elements to enrich or loosen soil, or improve drainage. Plan for benches, walks, and play or viewing areas.

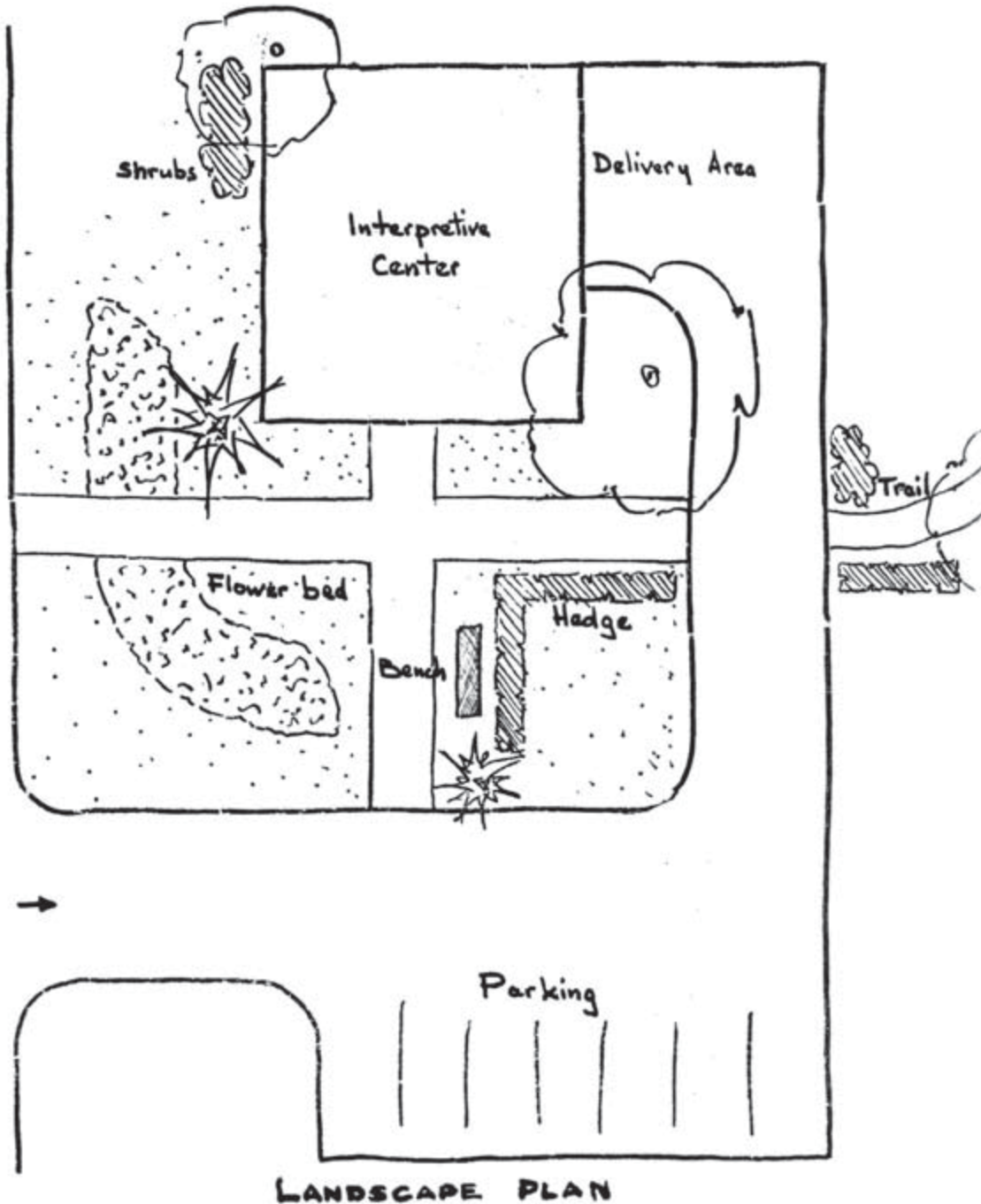



Choosing Plants: When choosing plants, consider the soil and climate. If you can't grow grass, look for another ground cover. If flowers won't grow in the soil, plant them in pots. Will you want shade trees? Or will you need to build shelters from the sun, rain or other elements? Will you need temporary shelters while trees grow? Which plants can you plant that will attract birds or other watchable wildlife? When choosing plants, try for variety and contrast of shapes and colors.

Composting:

Compost is a kind of fertilizer made from a variety of organic materials that have fermented or decomposed in a compost pile. The reason for making a compost pile is to make good use of all garbage, manures, vegetable waste and ashes, returning them to the soil to enrich it, and to help plants grow better.

A small compost pile should be cone-shaped so that rain will run off rather than into the pile. A large compost pile should be long and narrow to make mixing easy. A large compost pile can also be made in a pit. A pit bottom needs a drainage channel for water to escape. Compost piles can be in containers if attracting animals is a concern. If you are concerned about attracting large animals like bears, you may need to compost in an enclosed container or building to eliminate attracting odors.

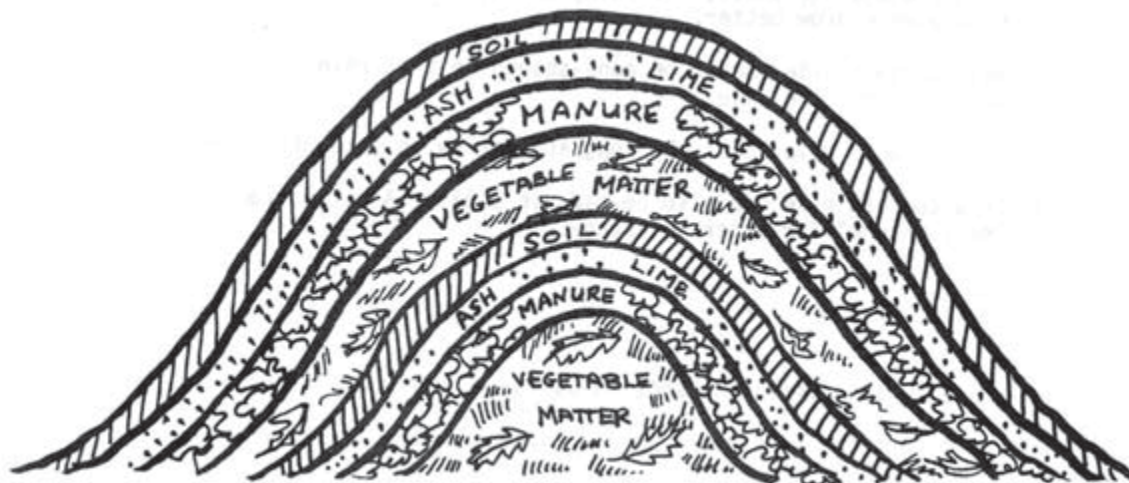



HOW TO MAKE A COMPOST PILE

1. Choose a permanent spot to build the pile away from homes.
2. Start the pile with a mixed layer of organic material such as:

soft leaves	garbage (no plastic, metal or glass)
grass cuttings	rice husks
straw	seed pods
paper	banana skins
3. Build up this layer approximately 30 cm high.
4. Put a layer of animal manure (pig, chicken, cow, horse or goat) on top of the first layer.
5. Sprinkle ashes and lime on the manure, and water if the pile is dry.
6. Add a thin layer of sand, fine soil or mud.
7. Repeat these layers of plant material, manure, ashes and lime, and soil, until the pile is about 1.5m high and 1.5m wide.
8. The pile should never become dry or the decomposition process stops.
9. Turn the pile every three weeks with a shovel for about three months.
10. If odor is a problem, you need to add more carbon (brown material, such as dried leaves, straw, paper, etc.), or turn the pile to allow air to circulate.
11. Use the pile in three months. It will have decayed and shrunk to about 1/10 of its original size.



TO SPEED UP THE PROCESS

- Make the same 1.5m x 1.5m pile of plant material, manure, and lime. This time, however, use more household garbage and animal manure. (Animal manure supplies nitrogen, a nutrient used by microorganisms during the decay process. A good compost mixture is about one shovel full of manure to 30 shovels full of the other organic materials).
- Mix the material well. Then cut all of it into small pieces, using a shovel, machete, scythe, etc. The pieces should be about 3 to 5 cm long. Cutting the material speeds the composting process.
- Turn the pile every few days. Use a shovel to mix it since composting is an aerobic process and depends on air. To test whether or not the composting process is occurring, put a stick into the middle of the pile. Leave the stick in the pile for three minutes, and then pull it out. If the stick is hot, you know that active composting is occurring, and you don't need to mix it yet. If the stick is dry, smelly, or cool, the pile must be turned to moisten it and allow air circulation. You may also have to add more carbon (dry, brown material such as straw, leaves, cardboard, etc.).
- Keep the pile moist, but not wet. Protect it from the rain. Urine can be used to keep the pile moist, and helps add nitrogen to the pile. A compost pile made in this way will be ready for use in only three weeks.



Planting:

- ▶ Try to transplant so that the plants are in the same soil, sun, and water conditions they are in the wild.
- ▶ Plants should be transplanted when they are dormant, such as just before the cold season, in spring before new growth, or before the rainy season.
- ▶ When digging up plant specimens, have a piece of burlap or plastic sheet ready to receive the roots and attached soil, and water, to keep the root ball moist. Dig the plant up with a spading fork so as not to cut the roots. The small feeding roots are more important than the large ones, which should be cut back to encourage new root growth.
- ▶ Replant the plant immediately in a hole 1/3 deeper and 1/3 wider than the root spread. A cool, cloudy day is best for transplanting.

1. Put topsoil or topsoil mixed with compost at the bottom of the hole before putting in the plant. If the soil does not have good drainage, a layer of gravel should be placed on the bottom, then topsoil or the mixture.
2. The old soil line on the plant should determine how much topsoil goes in the bottom.
3. Place the root ball of the plant in the hole, gently spreading the roots out.
4. Fill in the hole with more of the same soil or mixture. It should be very firmly packed so that there are no air holes.
5. Do not fill the hole quite to the ground level; leave a depression to catch and hold water.
6. Pile compost around the base of the plant.
7. Water the plant daily for a week while it adjusts to the change.
8. If the area is windy or the plant delicate, place a stick taller than the plant in the hole before planting. Tie the plant to the stick with a piece of plant material such as raffia.

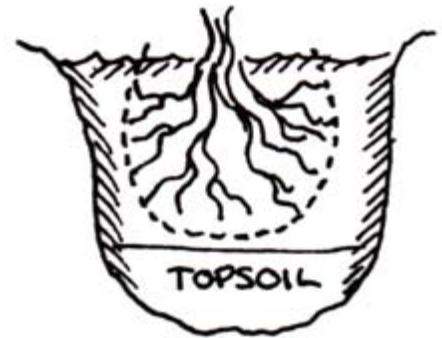

How to select and collect seeds:

Whether you are going to collect flower, shrub, or tree seeds, the basic methods apply to each.

1. Select adult plants that are healthy, strong, free from disease or insect infestation, from which to collect seeds.
2. Collect the seeds during the time of seed production.
3. Select species that grow in the same kind of environment as that in which the seedlings will be planted.





4. Select mature seeds.
5. Select seeds that are of the same color, size and shape.
6. Be certain that the seeds are free from disease.
7. Dry the seeds well before storing them. Those seeds that are naturally moist or sticky should be washed well before drying.
8. Do not mix seeds of different plants. Put them in jars or envelopes, labeling each by name, date and plant location.
9. If needed, a locally available dust insecticide can be mixed with the seeds to control insect pests.
10. Keep the seeds in a cool, dry place.

Growing seeds:

Seeds planted directly in the earth

Fine, small seeds should be covered with just a thin layer of soil that has first been turned over, mixed with compost, if needed, and raked to a fine texture. Lightly press the seeded earth with a board to make it firm. So that the seeds don't dry out, they should be gently watered in the late afternoons. (Use a seed shaker can with small holes punched in the bottom with a hammer and small nail.)

For larger seeds, plant them two or three times as deep as they are wide, pushing them into the soil, or placing them in an open row, then covering them over with the soil. Keep the earth moist. When seedlings are several centimeters high, pull out the weaker ones to leave the stronger ones more room to grow.



Ground cover

Ground cover of the variety recommended by the local agriculture agent should be sprinkled generously over soil that has been turned over, mixed with compost, if needed, and raked firm. Press seed into the soil with a board. The seeds should then be gently watered and protected from birds with a thin layer of straw or similar material. Seeded ground should not be walked on until the ground cover is growing well. Bare spots can be re-seeded.

Seeds for transplanting

Seeds of flowers, vegetables, shrubs and trees can be germinated for planting later in a permanent location. They can be started in pans, pots, cans, boxes or other containers. Seeds may germinate in a few weeks, or take as long as several months. Be patient. If the seeds have been started indoors, let them grow large enough to be able to withstand the open outdoor environment.



Prepare a soil of half sand and half soft rich soil (or compost). Place the soil in a container that has good drainage at the bottom, provided by gravel or pieces of broken pots. Plant the seeds as described above. Screen the top of the container with lattice, bamboo matting, a sheet of plastic or paper, so that the soil does not receive direct sun and dry out.

You need to keep seeds warm, moist and shaded, but not so moist or shaded that the seeds rot.

After the seeds have germinated and seedlings are several centimeters tall (4-6 cm), you can transplant them into individual containers whose soil is 3/4 of the former soil and 1/4 soil from where it will be permanently planted.

RESOURCES

Look for gardening books for your local area, or similar ecosystems. Search the following websites for current publications:

Volunteers in Technical Assistance (VITA)

www.vita.org

World Health Organization (WHO)

www.who.int

Smith, Marny and June Plecan. *School Garden Manual: A Step-By-Step Handbook for Teachers and Trainers Interested in Taking a First Step Towards Agricultural Development*. Save the Children, 1989. [ICE No. AG 243]





17 SIGNS, LABELS AND GUIDES

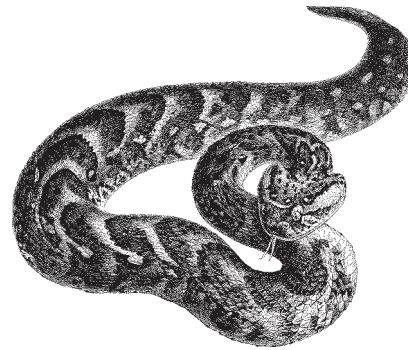

DESCRIPTION

Interpretive signs, labels and trail guides offer natural history, or other information to visitors, or notify them of locations or regulations. Planning for signs, labels and guides needs to begin when the site is being planned. Once the purpose of the site has been determined, the content of the interpretive signs, labels and guides can be decided.

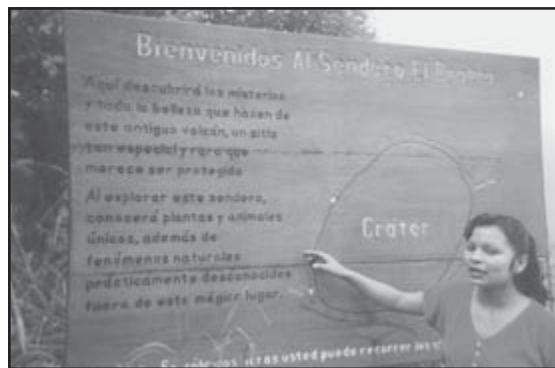

USES

Signs, labels, and guides should be accurate, simple, clearly understood, and attractive. They reflect the purpose of the interpretive site. For example, if you are creating a nature trail and you decide to highlight the cacti of the area, then the interpretive signs will be about cactus ecology and will identify types of cactus.

EXPECTED OUTCOMES

Signs, labels and guides help the visitor to notice important or interesting features. They identify species of plants, geological features, animal homes or use areas, and notify visitors of directions or expected behaviors.

EXAMPLES

► Signs

- Directions, distances, location of facilities
- Describe a view, ecosystem, or natural features
- Historical information
- Cultural information
- Maps
- Explain demonstration project
- Species information
- Code of ethics



- Expected behavior
- Warnings
- Regulations

► **Labels**

- Identify objects such as plant species

► **Guides**

- Self-guided nature trail information
- Give information about points along the trail
- Give seasonal information
- Include illustrations, graphs and charts
- Give directions and maps
- Describe habitats
- Describe natural features

**FEATURES TO HIGHLIGHT FOR SIGNS, LABELS
AND GUIDES ON A NATURE TRAIL**
— SOUTH EAST ASIA —

MAIN TRAIL

■ **OPEN FIELD:** In sun-filled areas like this, the plants have to deal with special problems: too much light, periods with too little water and, often, poor soil. Pick a blade of grass. Examine it. The size of the leaf is small so moisture will evaporate out slowly. The roots are a thick mass of fibers that can grip the hard soil, but they don't go very deep. They get their moisture mostly from rain and dew.



■ **EDGE OF FOREST:** Bigger plants like trees will slowly invade a field of bushes. They grow taller and make shade. This means that plants that love sunlight must slowly die and new plants that like more shade move in. The edge of the forest is rich in biodiversity.

■ **INSIDE THE FOREST:** Look around you and up in the air. Notice how the forest is made of several different layers. High above, the branches of the big trees weave together to form a canopy. Beneath these, we see a sparse layer of trees trying to grow up through the canopy. Lower down there is a layer of shrubs and small trees. Below that is a layer of small plants like ferns and seedlings.

■ **STRANGLER FIG TREE:** This is a fig tree. It grows around another tree. Its leaves shade out the sun until finally the other tree dies. Sometimes the original tree will rot away and the trunk of the fig tree will then be hollow.

■ **REST STOP:** (Any pretty place about halfway through the trail, especially good on top of a hill where people will want to stop anyway. Provide a log or a bench to sit on.) This is a good place to rest a minute. Sit and be absolutely quiet. Can you hear nature around you? The birds singing? The insects buzzing? The wind blowing?

(continued)





- **A BENT TREE:** As the tree grows, it twists and turns to reach as much light as possible. This tree may have started growing toward a hole in the forest canopy. At some point a new hole with more light opened up and the tree changed directions. Why might a hole in the canopy occur?
- **A BURL ON A TREE:** The lump on this tree is called a burl. It is caused by a virus infection. It does not kill the tree but it results in a malformation. The growth rings of the tree take on interesting shapes and the wood is used in tables, bowls and pipes.
- **CANOPIES:** High above your head, the branches of the tallest trees lace together to form another world. Trees bloom and fruit there, and animals live out their lives without touching the earth. Can you catch a glimpse of the happenings in that other world?
- **TREE STUMP:** This tree stump is decaying. It is becoming soil again. This process returns the energy that it used as a growing tree. Mosses, fungi, and insects are breaking it down.
- **YOUNG TREES IN A CLEARING:** As the old trees die, holes develop in the forest canopy and new spots of sunlight reach the forest floor. Here seeds sprout and new trees begin to take the old ones' places. The forest will regenerate itself, but if people destroy it, a tropical forest like this takes hundreds of years to grow again. The forestry department is protecting this land for your children.
- **SHADY AREA WITH BIG-LEAVED PLANTS:** Plants adapt to where they live. Usually big, thin or lacy leaves are for shady places because they allow the plant to catch as much sun as possible. They will not dry out because their environment is cool and moist. A fern is an example.
- **PATCH OF ABANDONED FARMLAND:** The soil was too thin for good farming here and the land was abandoned. The forest is returning in stages. First grasses, then thick brush, third low, thin jungle, and after many years, there will be tall, thick jungle.
- **BUTTRESS ROOTS:** Wide roots like these help to balance the tree. The roots cannot go deeply into the ground because it is hard clay just under the surface and all the nutrients are in the top two inches. The wide flanges give the trunk a wider base of support. Otherwise the weight of the trunk would tip and the roots would be pulled out of the ground.
- **CAVE:** This cave may have been formed many years ago when water slowly dissolved away some of the limestone in the earth. Some time later the surface of the earth changed, causing the cave to dry out and be revealed. Now it is a home for bats, snakes and other creatures.
- **A VERY TANGLED, DENSE AREA OF VEGETATION:** More kinds of plants and animals live in a tropical jungle than any place else in the world. Notice how dense the plant life is. A mixture of many things living together makes a stable environment because of the natural control all the species have on one another.
- **RATTAN PALM:** This rattan palm sends out long runners covered with thorns. They hook on to passing animals. They pull the runner to a new place where it can touch the earth and start another plant far away from the competition of the first.

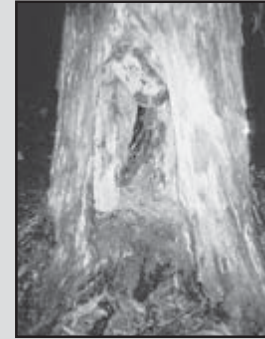

(continued)



SOIL LOOP

- **CLUMP OF PRETTY BUSHES:** Good soil allows plants to grow plentifully. It is a thin layer, however, and easily destroyed. Plants like these would soon die in a hot dry soil without water.
- **ROTTING LOG:** As this tree trunk rots, it builds up a soft, spongy layer of soil, called humus. This holds rainwater and provides food for other plants and insects. How does the rotting log feel? How does the ground nearby feel?
- **ROCK WITH LICHENS:** What looks like paint on this rock are actually lichens. A lichen is an alga and a fungus living together in a symbiotic relationship. They can live under very severe conditions, like on bare rock. They help to make soil by dissolving some of the rock into fine sand. Feel the rock around the lichen. Can you feel a sandy texture?
- **PLACE WITH MANY LEAVES ON THE FOREST FLOOR:** Leaves collect and rot, making new soil, just as the tree trunk did. Animal droppings and dead animals also add to the soil.
- **A WATER SPRING:** Rain soaks into the ground until it reaches a layer of rock that holds it. That water slowly moves underground until it comes out at springs or into rivers. If the soft topsoil is missing, the rain is not soaked up, but runs off. The water table underground is not replenished if the rain doesn't soak through the soil. The springs will then dry up.
- **EROSION SITE ON A TRAIL OR HILLSIDE:** Water is a powerful force. Can you see what it has done to the soil here? Compare this place to a place with plants. In a place with forest cover, the grid of roots holds the soft topsoil while the leaves slow the speed of the raindrops' fall. Shade keeps the ground from getting dry and hard.
- **DEEP CUT INTO A HILLSIDE WHERE A TRAIL OR ROAD WAS BUILT, WHERE SOIL LAYERS ARE VISIBLE:** Soil is found in layers. The top one is rich with plant food; the others are not. In the tropics the hot, wet weather makes things decay quickly, but topsoil does not build up because the food is utilized almost immediately by plants.



FOREST LOOP

- **VERY LARGE TREE:** Trees are the oldest living things on earth. Some can be more than 4,000 years old. They give us lumber, rich soil, clean air, and homes for wildlife.
- **A CLEARING OR BREAK IN THE FOREST WHERE THE SKY IS VISIBLE:** Look at the leaves of the trees above. Each one is helping you. Leaves produce the oxygen you breathe. They also take away carbon dioxide (which you breathe out) and other poisonous gases. Where does it smell the best, in the middle of the city or here? The leaves release moisture into the air, helping to form new clouds; they shade the ground and air, keeping them cool and comfortable. Think for a moment. Where is it cooler? Here or in the city?

(continued)





- **ROOTS ON A ROCK:** Just as the roots of this tree have encircled this rock, so they are holding the soil below it. Small roots weave a mat that traps the soil in tiny pockets. This protects the light topsoil, from the force of rainwater. If the forest is cut or burned, the roots no longer hold the soil, and in a short time the rich topsoil is washed away by rain.
- **TINY STREAM:** Forests help with the water supply. The leaves release moisture into the air, helping to form new rain clouds, while water in the spongy ground moves downhill slowly to emerge in springs and streams.
- **LEAVES ON THE GROUND:** Leaves fall all the time, but especially in the dry season when the trees don't want to lose moisture through their leaves. These leaves rot quickly in the rainy season and help make new soil.
- **TREE WITH HOLE IN TRUNK:** Trees provide a nesting place for animals to raise their young, to store their food, and to escape from their enemies.



WILDLIFE LOOP

- **ROCK LEDGE WITH ANIMAL HOLE:** Under the large rock in front of you is a former animal home. The occupant may have moved away because so many people looked into it. See what a dry place this animal chose.
- **TANGLED MASS OF BUSHES ON EDGE OF LARGE CLEARING:** The edges of forests often produce as much or more food and shelter for wildlife as the deep forest itself. Edges are good places to view wildlife.
- **DEAD TREE ON GROUND:** A dead tree is a home for a great variety of things as it decomposes. Under the bark there are beetles and termites. Millipedes eat the decaying wood; centipedes hunt for other insects to eat. Inside, perhaps a mouse, a weasel or a porcupine has dug out a den. The home territory of a wild animal is usually a place where it can easily find food and shelter—perhaps a patch of grass, a whole pond, or a fallen tree like this.
- **A SALT LICK:** Just as you like salt on your food, so animals like and need certain minerals in their diet. Water deep in the ground rises to the surface carrying dissolved minerals that are deposited there. Look in the mud around you and see how many kinds of animal tracks you can identify.



(continued)



- **CLEAR STREAMSIDE:** The water here is cool and clear. You may see some fish. Compare this to any of the streams outside the park. Is the color the same? Just as some animals need a forest where the canopy is complete, so certain fish, snails and insects need streams where the water is clean. The forest and its soil filter the water and keep it clean.
- **LARGE TREE THAT HAS FOOD FOR ANIMALS IN MONTH WHEN MOST VISITORS COME:** In the month of _____ this tree has fruit that is eaten by (name some animals, birds). This also attracts animals that eat the fruit-eaters. All these animals help the tree in return by spreading the seeds and fertilizing the soil.



HOW TO DO IT

The style of the signs and labels should be patterned after the environment of the region. Local materials can be used that reflect the ecosystem being highlighted. The signs and labels should blend in with their surroundings, and not outshine the objects they are explaining. They must be made of sturdy, weather-proof materials, and use a consistent style throughout.

Making signs:

Signs and their supports should be of natural materials of the region, such as wood, bamboo, or stone, to blend with the environment. The style of lettering should be the same for each sign. Signs should be varnished to protect them from rain, humidity, sun, etc. The following suggestions for making trail signs can be adapted to your needs and to local supplies.

1. Select good quality dry wood (or other suitable material).
2. Cut wood into desired sizes, depending on the amount of lettering or artwork planned.
3. Sand the flat sides and edges until smooth, if you are using wood.

TIPS FOR LOW TECH SIGNS AND LABELS

- Use local wood
- Paint or varnish on both sides
- Carve lettering and then use a soap bottle with a small opening in the lid to apply paint to the gouged letters
- Labels can be made from many materials but should be backed with wood if the materials can be torn, bent or broken
- Use waterproof ink
- Paper labels can be dipped in paraffin or put in a picture frame to protect them



4. Apply undercoat enamel (or varnish) to sides and edges. Let dry and apply another coat of enamel or varnish. Smooth with fine steel wool or sandpaper.
5. Trace letter pattern. Ink or paint the letters.
6. When letters are dry, apply two coats of waterproof varnish.
7. You may wish to soak your signposts in a preservative solution. Check locally for environmentally friendly options.
8. Place your signposts in well-drained holes by digging the holes an additional 25 cm deeper than post bottoms will be. Fill with 25 cm of gravel, then bury posts at the desired depth and apply the treatment preservative around the base, if desired.
9. Mount the sign with screws on posts. A center post mount 5 cm x 5 cm is good for small signs; a hanging post is good for larger signs (use screw hooks in a 10 cm x 10 cm post).

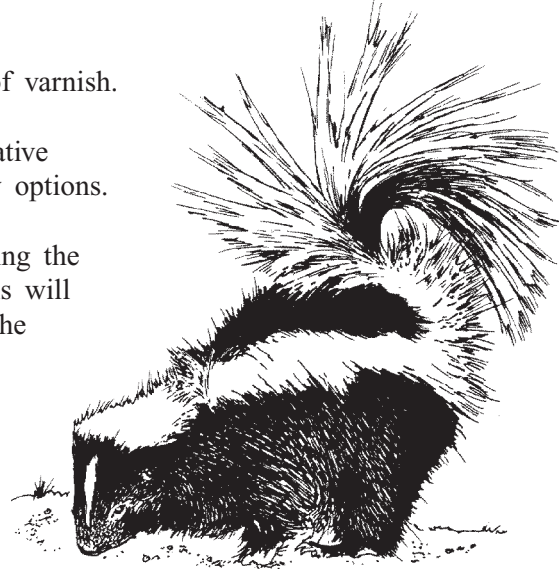

An alternate method of lettering is to trace a letter pattern on cut, sanded wood, then cut out the letters with gouging tools to a shallow depth (.3 cm). The cutout letters can then be painted a contrasting color (white paint on dark wood). A good way is to put the paint into a plastic bottle with a screw-top spout and squeeze the paint into the letters. When the paint is dry, apply two coats of waterproof varnish.

Making Labels:

Labels are generally smaller than signs and identify species along the trail. They enable the users to guide themselves over the trail. In addition to identifying the species, labels may have interesting information about the species including links to the visitor's experience.

A good label will be accurate, interesting, short and easy to read and understand. Labels can be made of paper, plastic, masonite, wood, plywood, sheet metal, cardboard, paper baggage tags. Labels can be backed by wood, metal or plastic to be mounted or seen better. Materials that could be torn, bent or broken can be glued to wooden blocks.

Lettering on the labels can be inked or painted by hand or stencil, or press-on letters, a typewriter or computer can be used. The writing should be neat and clear.

Paper labels should be waterproofed after they are lettered. To do this, melt some white wax or paraffin in a large can (coffee can, dry milk can); dip the label in the wax to cover it completely; dry. (Be careful: melted wax can cause burns.)

Nature trail labels can be mounted on simple stakes at the trailside.

For indoor use, in special cases where a newspaper clipping, magazine article or photograph needs special protection, a picture frame or plastic lamination can be used.



Trail guides:

Trail guides allow users to use a site by themselves. They are usually in booklet form that includes a map of the trail showing the location of the features of interest, and natural history of the area. Remember to include the smaller and less visible members of the ecosystem in trail guides, such as insect homes, lichens, mosses, etc. The lifestyles of these less flashy organisms can be very interesting to visitors.

Trail guides can be very attractive if they use a storytelling style. In addition to the statistics about an organism, the guide can relate a tale of its lifestyle. For example, when telling about a pine, the trail guide can describe the many ways pines are used by people, what organisms live in the pine, how the Pine Bark Beetle invades, and how the pines fight back. Key characteristics for identification help the visitor to learn about the organisms they are viewing.

RESOURCES

Ham, Sam H., *Environmental Interpretation: A Practical Guide for People with Big Ideas and Small Budgets*. Golden, CO: Fulcrum Publishing, 1992. [ICE No. FC190]

Oberbillig, Deborah Richie. *Providing Positive Wildlife Viewing Experiences: A Practical Handbook*. Watchable Wildlife Incorporated, April 2001.



Community Environmental Sourcebook

This project can be initiated with various community members and groups. The idea of an environmental sourcebook is to document community knowledge in visual and creative ways and make it accessible to community members to ponder and discuss. Suggestions for potential groups to involve include students of all ages, youth organizations, women's groups, farmers associations, religious organizations, and other community based organizations. A Community Environmental Sourcebook does not necessarily need to be in a classic book format, although that is an option. In conjunction with the community group, think of creative ways to display information about the environment in the community, and to represent people in the community.

From *Learning Local Environmental Knowledge: A Volunteer's Guide to Community Entry*, Washington, DC: Peace Corps. [ICE No. M0071]



EXHIBITS

18 EXHIBITS

DESCRIPTION

Exhibits explain and interpret the surrounding environment. Exhibits should be thematic, specific and informative. Photographs, charts, maps and models may be used to support the theme. Exhibits can be only for viewing, or they may be interactive. Exhibits mounted on panels usually include text, photos or illustrations, and maps, charts or graphs. To increase interest, they may ask questions or pose problems to the visitor, who can lift a flap to find the answer. If the technology is available, slide shows, videos or computer displays can be effective.

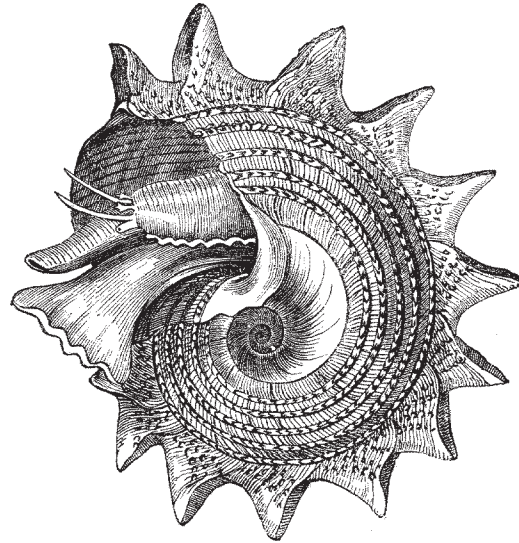

USES

- ▶ Exhibits display live animals in aquariums or terrariums.
- ▶ They might be mystery boxes that challenge the visitor to use the sense of touch to identify a sample from the ecosystem.
- ▶ Exhibits can include collections of identified specimens of bugs or minerals, or they may offer the visitor an opportunity to handle (sturdy) specimens.
- ▶ An exhibit may identify birds or trees in the area, or show all the ways the particular tree is used by local people.
- ▶ A panel may show the many inhabitants of a coral reef, or a rainforest canopy.
- ▶ Dioramas might compare ecosystems in the region, such as desert, alpine or woodland.
- ▶ An exhibit could describe endangered species in the area, or the effects of irrigation.
- ▶ A traveling interactive snow leopard board might describe leopard characteristics, habits, habitat, and other information. The board could be used in buffer-zone schools.
- ▶ Visitors can learn how to determine rock hardness by doing scratch tests, or learn about soil porosity by pouring water through several types of soil.
- ▶ Visitors can experiment with erosion by playing with a model watershed.



- ▶ Visitors can make leaf prints or fish prints.
- ▶ An exhibit could showcase a demonstration project on the effect of various fertilizers, or show people how to build a solar cooker.

When constructing exhibits, you will want to make them withstand visitor use. They should be attractive and easy to look at (or hear or touch). Pointing out relationships among parts of the ecosystem enriches the educational value. The exhibit should be designed for the target audience. Exhibits can be costly to construct, but often they will last a long time.





Exhibit Example

FARMLAND ECOSYSTEM STUDY WHEEL

How to do it:

The Farmland Ecosystem Study Wheel involves the visitor in learning about the components of a particular ecosystem. The components include the living and nonliving parts of the system. The non-living parts are sun, water, soil and air. The living components include the plants and animals that form the interdependent food webs of the system. In this exhibit, a simplified ecosystem that is characteristic of farmland is represented.

A spinning wheel with an arrow and a reading window is mounted over a set of information cards such that the arrow will point to a particular illustration and the reading window will show information about that illustration.

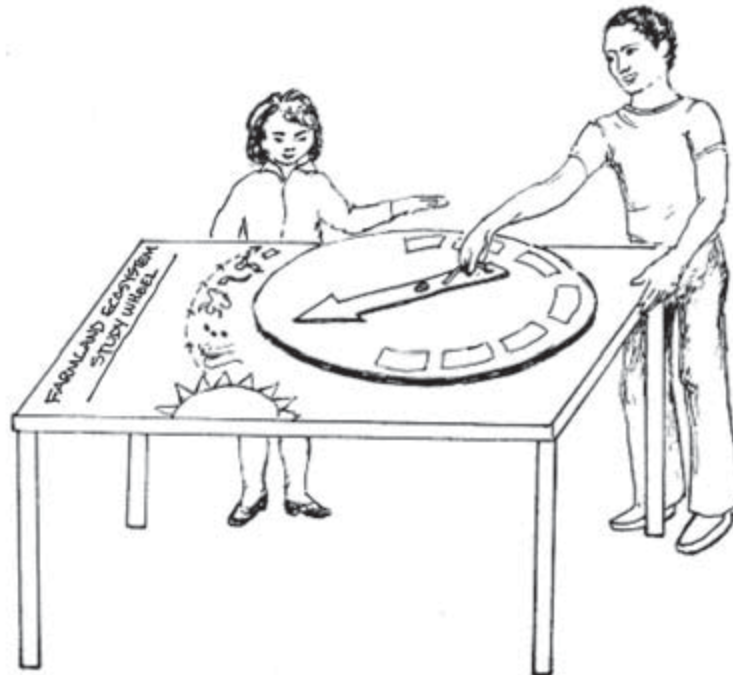

Study Wheel Figure 1

Illustrations and Cards

- 1. Sun:** The sun provides the heat and light needed by all living things.
- 2. Grain:** Plants use sunlight, water and soil to grow. Plant leaves give oxygen and water to the air. Grain grows better and stronger in soil rich in nutrients.
- 3. Insect:** Most insects are plant eaters. Some of them help to return dead plant material to the soil.
- 4. Frog:** Frogs and toads are insect eaters. There would be many more insects without insect eaters.



5. **Snake:** Snakes eat frogs and toads. Snakes will live where there are frogs to eat.
6. **Hawk:** Hawks hunt for snakes and other small animals. Since hawks can fly, their hunting area is very large.
7. **Dead bird:** When an animal like a bird dies, other animals use its body, or decomposers return it to enrich the soil.
8. **People:** People need good plentiful grain to be strong and healthy.

Materials needed:

- ▶ 1 board of medium plywood or heavy cardboard 100 cm x 100 cm
- ▶ 1 board of medium plywood or heavy cardboard 100 cm x 125 cm
- ▶ 1 strong bolt 5.5 cm with nut
- ▶ 6 washers
- ▶ 1 arched door handle or wooden knob
- ▶ 1 or 2 screws
- ▶ Small nails
- ▶ Assorted enamel paints
- ▶ 9 white cards 5 cm x 10 cm

Illustrations for Revolving Wheel:

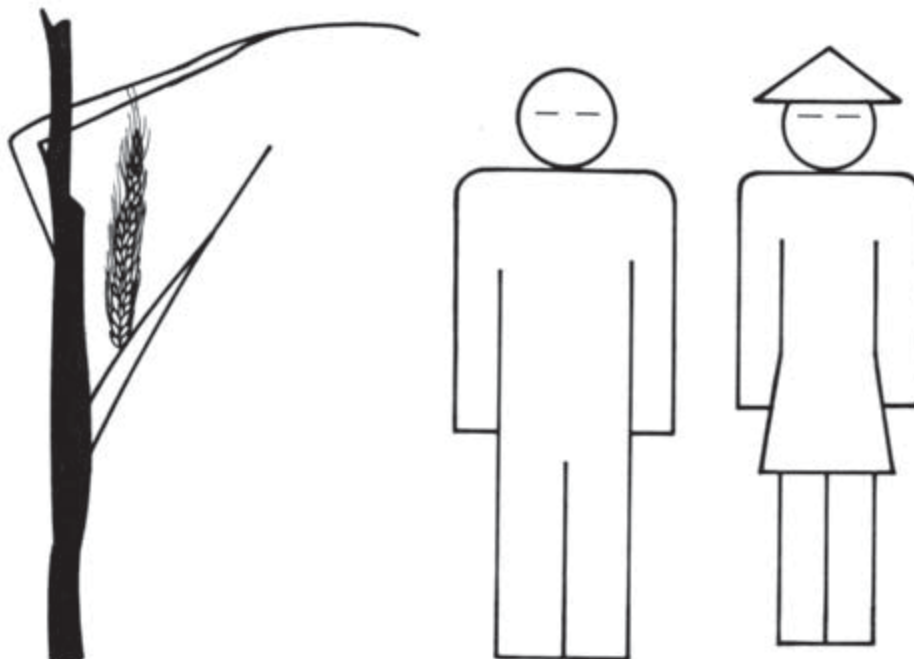

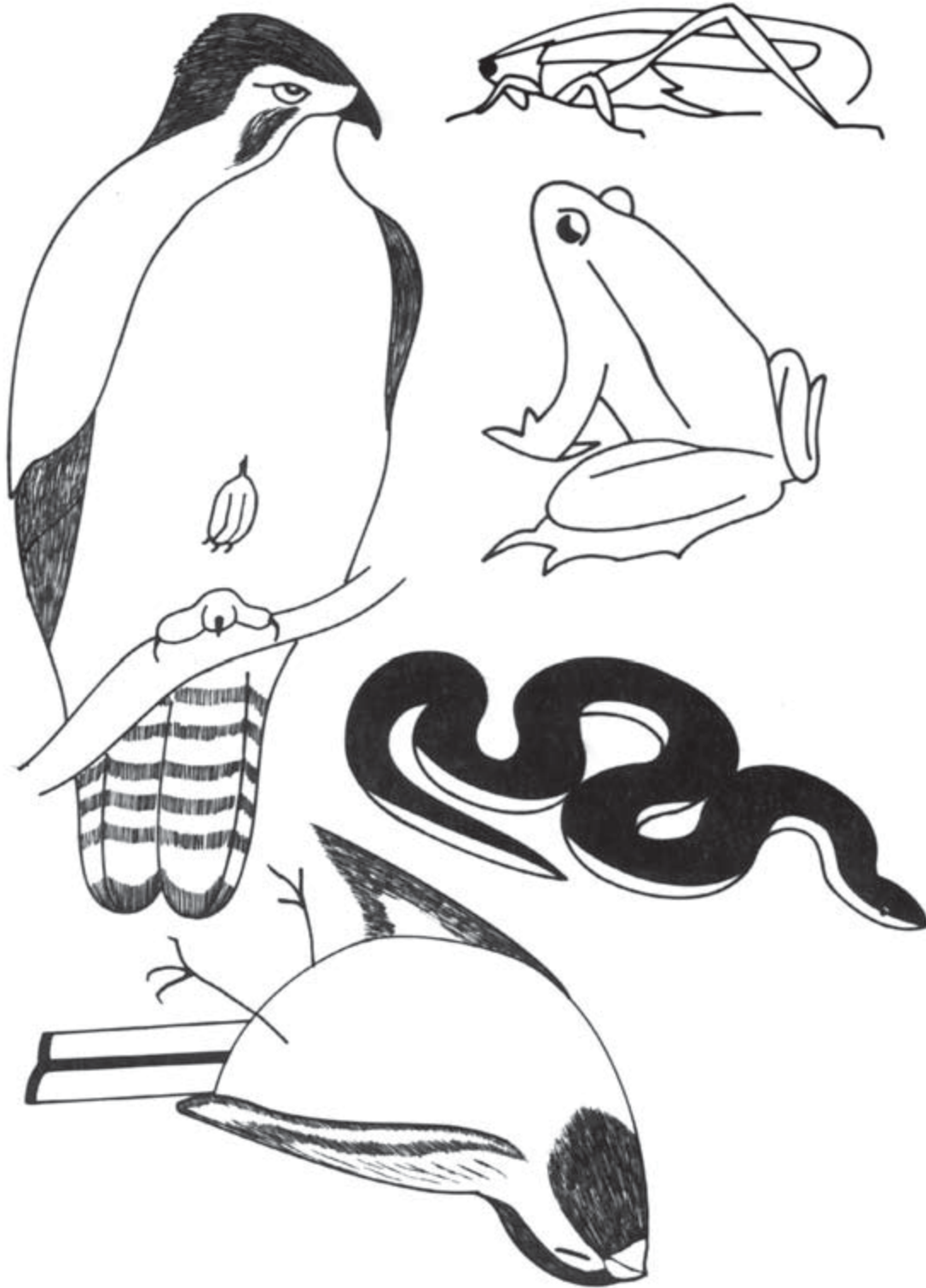

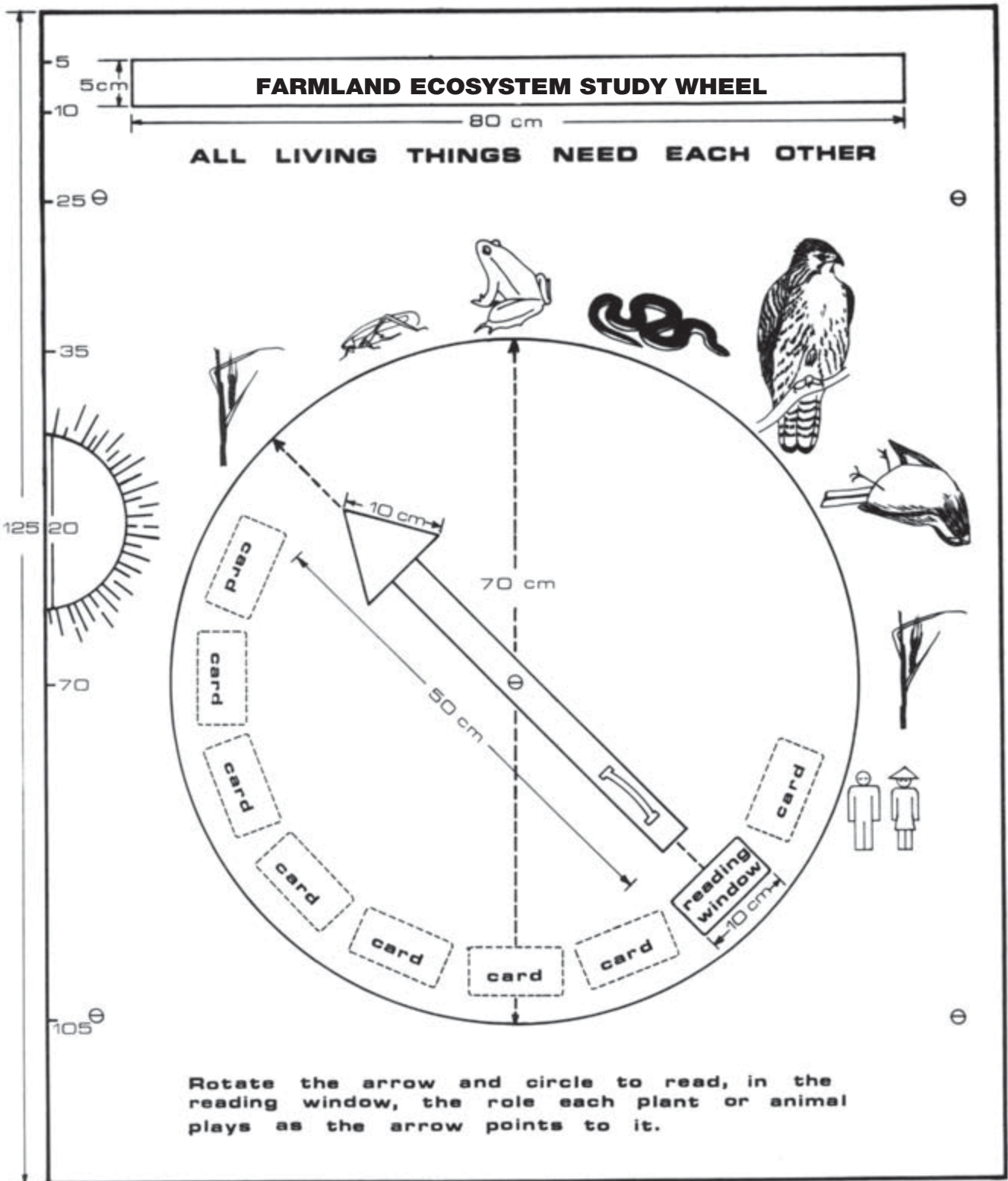

Study Wheel Figure 2



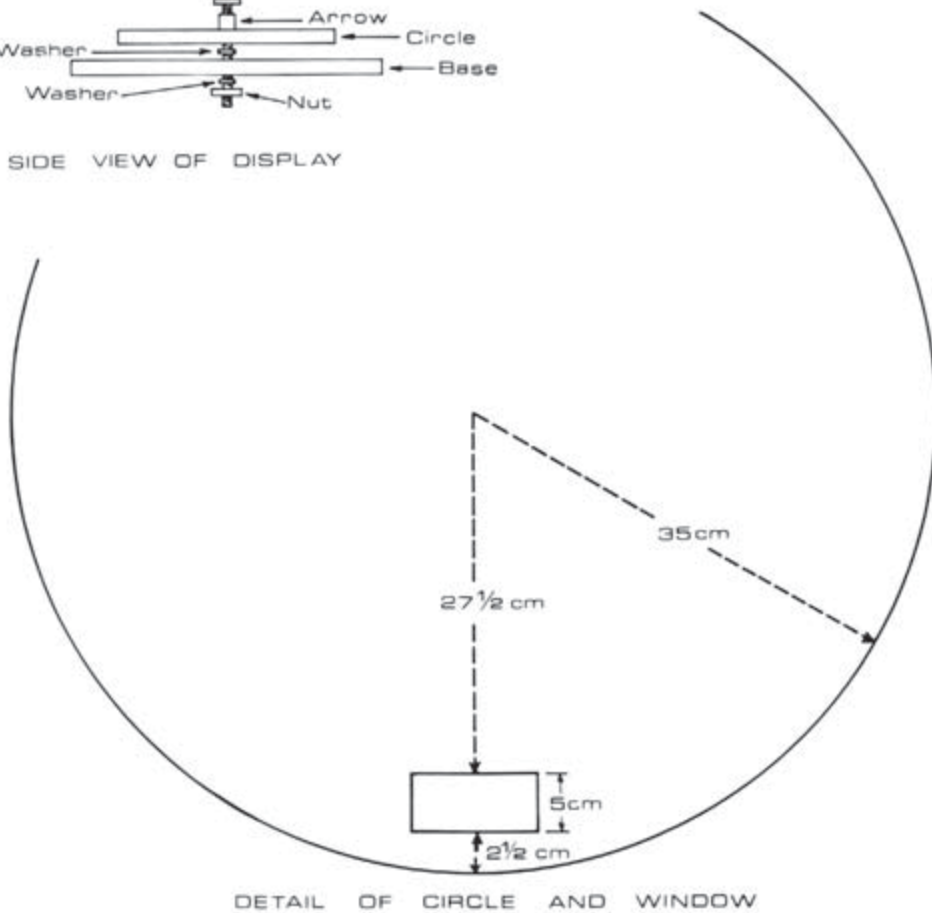
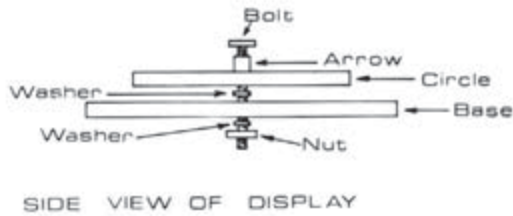
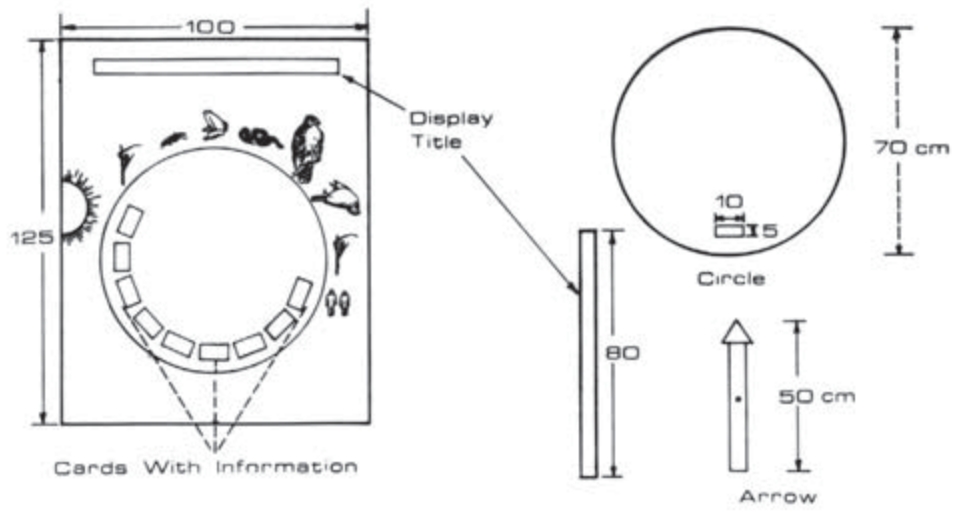

Study Wheel Figure 3



Procedure:

1. Cut out a 70 cm circle from the corner of 100 cm x 100 cm board.
2. Cut arrow 5 cm x 50 cm from 100 cm x 100 cm board.
3. Cut display title strip 80 cm x 5 cm from 100 cm x 100 cm board. (Title can also be lettered directly on base after base is painted.)
4. Paint the various parts: the baseboard, 100 cm x 125 cm might be dark green; the circle a lighter green; the arrow red.
5. Transfer outline drawings to the baseboard as shown in Study Wheel Figure 2. Use black ink outline, or paint in natural colors.
6. Type or print text on cards. Nail or glue cards on base, directly opposite the corresponding illustration.
7. Cut a 5 cm x 10 cm reading window in the circle.
8. Drill a hole for the bolt through the center of the arrow, the center of the circle and the center of the board.
9. Attach the handle or knob to the arrow with screws.
10. Nail the arrow with small nails to the circle so that the base of the arrow is directly above the reading window.
11. Pass the bolt through the arrow and circle, place washer(s) between the circle and the base; pass the bolt through the base; add washer(s) and the nut. Test the turning of the circle. Add washers until it turns easily.





Exhibit Example

HIDDEN USES OF A FOREST

The purpose of this exhibit is to highlight ecosystem services. On a display board showing a forest, lift-up panels are placed at strategic points to describe services provided by the forest. Visitors lift panels and read about ecosystem services.

How to do it:

Materials needed:

- ▶ 1 medium plywood or heavy cardboard 75 cm x 100 cm
- ▶ 7 medium plywood or heavy cardboard covers 5 cm x 10 cm
- ▶ 1 plywood or heavy cardboard sign strip 5 cm x 60 cm,
- ▶ 1 plywood or heavy cardboard sign strip 10 cm x 30 cm
- ▶ 14 lengths of leather lacing or string, 15 cm each
- ▶ Paint: green (leaves), brown (trunks and ground), blue (water), light blue (sky), black (roots, signs), yellow (sun), white
- ▶ 7 white cards, 5 cm x 10 cm for text under covers

Note: 1 plywood board 90 cm x 100 cm is sufficient for all parts

Procedure:

1. Using a grid, enlarge Forest Figure 1 onto the 75 cm x 100 cm board.
2. Drill 3 mm holes in the 7 covers and the main board as shown in Forest Figure 1 and below.
3. Paint the board picture as indicated under “paint” above.

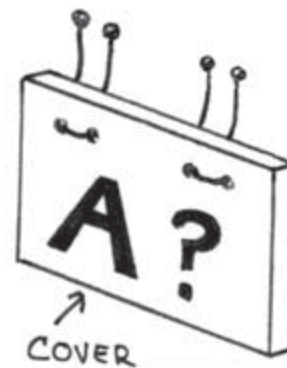
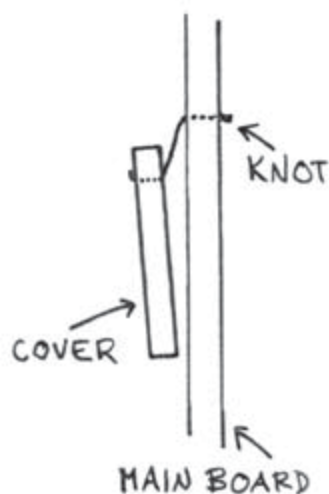

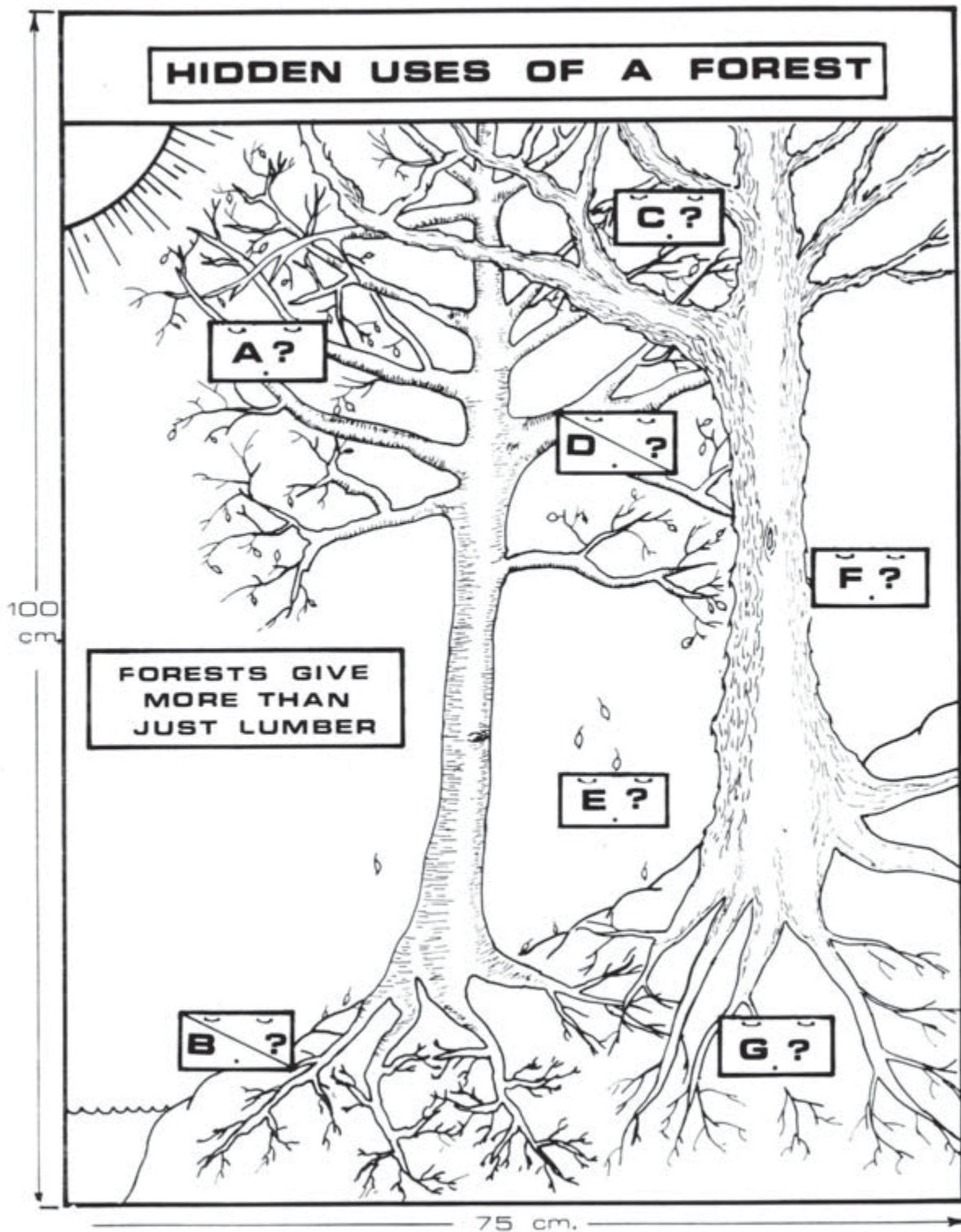

Forest Figure 1





4. Type or print text on cards.
5. Paint the covers.
6. Paint text on signs (black paint).
7. Paint black question mark (?) and letter on covers as in Forest Figure 1.
8. Glue or nail signs to main board as in Forest Figure 1.
9. Attach covers to main board by weaving the lacing or string through the drilled holes and tying a knot at the back as shown above.
10. Glue text cards under covers.

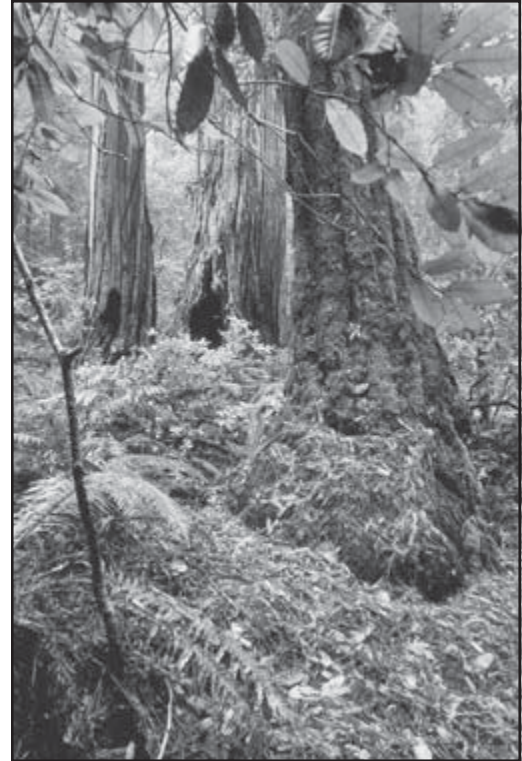

Text:

Panels

- A** = Leaves make oxygen that animals breathe.
- B** = Roots hold moisture and retain soil.
- C** = Leaves, flowers, bark, seeds, and fruit provide food for animals and people.
- D** = Tree canopy provides shade and shelter for plants, animals and people.
- E** = Trees add moisture and clean the air.
- F** = Trees provide homes for animals in their branches, trunk, canopy and root systems.
- G** = Roots and soil organisms work together to build soil, retain water and cycle nutrients.

5 cm x 60 cm sign strip = **Hidden Uses of a Forest**

10 cm x 30 cm sign strip = **Forests Give More Than Just Lumber**





Exhibit Example

LIFE PYRAMID

How to do it:

The life pyramid poster shows the trophic levels of an ecosystem and the relative numbers of organisms each can support. At the base of the pyramid are the producers; the plants that need soil, sun, air and water to grow. The next level has the primary consumers that eat plants and do not produce their own food. Secondary level consumers prey on primary consumers. Tertiary consumers prey on secondary consumers, and so on. Each trophic level has fewer organisms. For example each insect eats many plants, and each frog eats many insects. Trophic levels form a food chain, and the predators at the top of the food chain are dependent on all the organisms at the lower levels. At each trophic level energy is transferred up to the next level, but energy is also lost during the process.

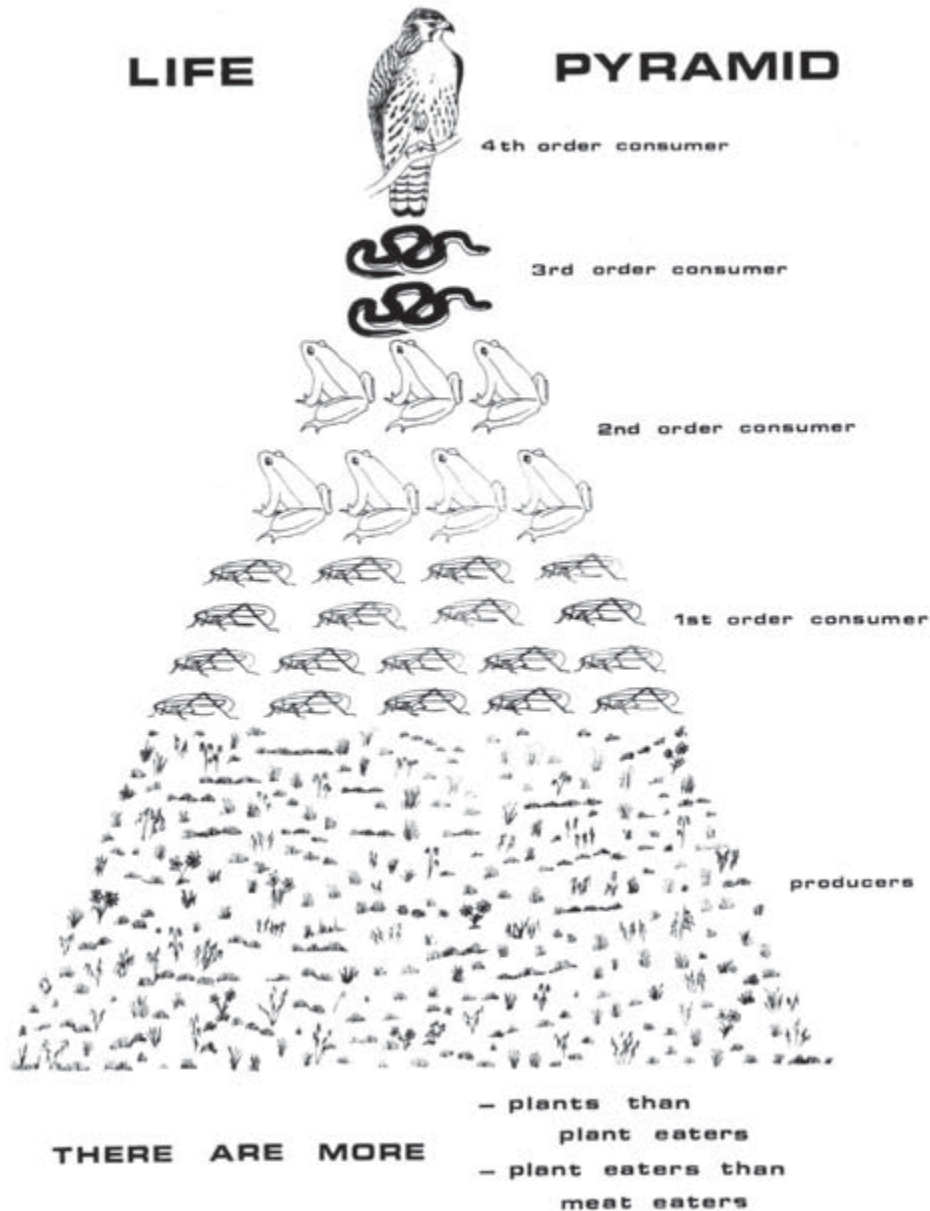



Exhibit Example

WETLAND CONNECTIONS

A Wetland Connections exhibit shows the complexity of interrelationships of organisms in a wetland. The visitor will discover the connections between the organisms in a wetland by tracing the energy from the eagle through the ecosystem back to its source, the sun.

How to do it:

Materials needed:

- ▶ 4' x 3' piece of plywood for background painting of wetland scene
- ▶ 13 small pieces of wood with pictures of organisms on them (organisms listed below)
- ▶ 13 small hinges for attaching wood pictures to plywood
- ▶ 13 cards with text to attach under the pictures (text below)



Organisms and text:

(Title) Wetland Connections: Where does an eagle get its energy?

Eagle: The eagle gets energy by eating ducks, large fish and mice. Where do ducks, fish and mice get their energy?

Duck: Ducks eat spiders, insects and plants. Where do they get their energy?

Large Fish: Large fish eat smaller fish and insects. Where do they get their energy?

Mouse: Mice eat seeds, fruits and grasses. Where do they get their energy?

Spiders: Spiders get their energy from eating insects. Where do insects get their energy?

Insects: Insects get their energy from eating zooplankton. What are zooplankton and where do they get their energy?

Small fish: Small fish get their energy by eating insects and zooplankton. Where do they get their energy?



Zooplankton: Zooplankton are very small creatures that live in the water. They do not make their own food, but eat even smaller creatures called phytoplankton. Where do phytoplankton get their energy?

Phytoplankton: Phytoplankton are very small organisms that can photosynthesize their own food. They get the energy to make their food from the sun.

Plants: Plants can make their own food from air and sunlight. They also get nutrients in the soil and water. Their energy mainly comes from sunlight.

The Sun: The sun is where it all starts. The energy from the sun is converted into plants and plant food. Plant eaters use the energy from plant food to grow and stay healthy. Consumers that eat plant eaters use their energy to grow and stay healthy. The eagle eats the consumers that ate the consumers that ate the plants that used the energy from the sun to make food.

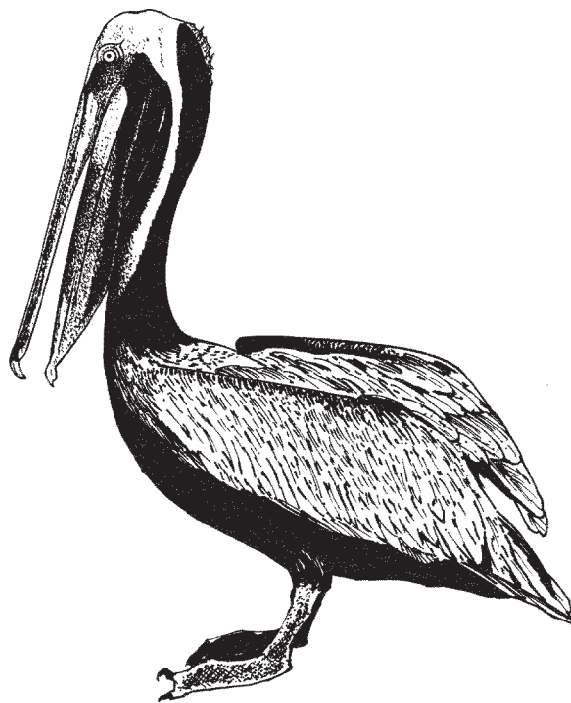
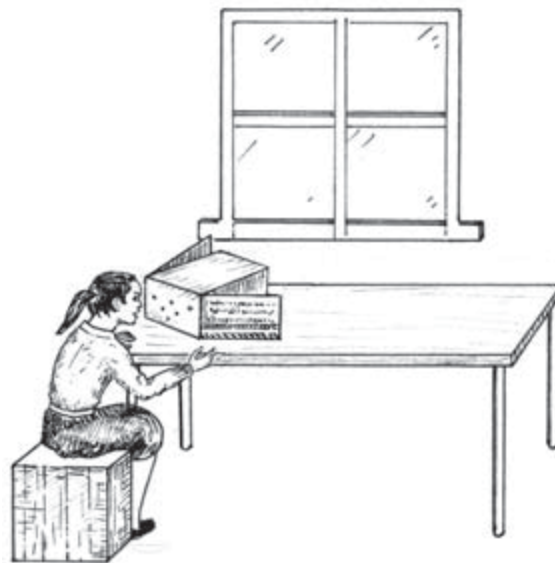



Exhibit Example

WHAT MAKES SOIL?

The soil exhibit is a peephole box that shows visitors pictures of soil-making animals that work on and beneath the soil. It describes three levels of soil and the organisms that live in them.



How to do it:

Illustrations:

- ▶ **Top level:** Millipede, Fungi, Beetle
- ▶ **Middle level:** Earthworm, Mole
- ▶ **Bottom level:** Water

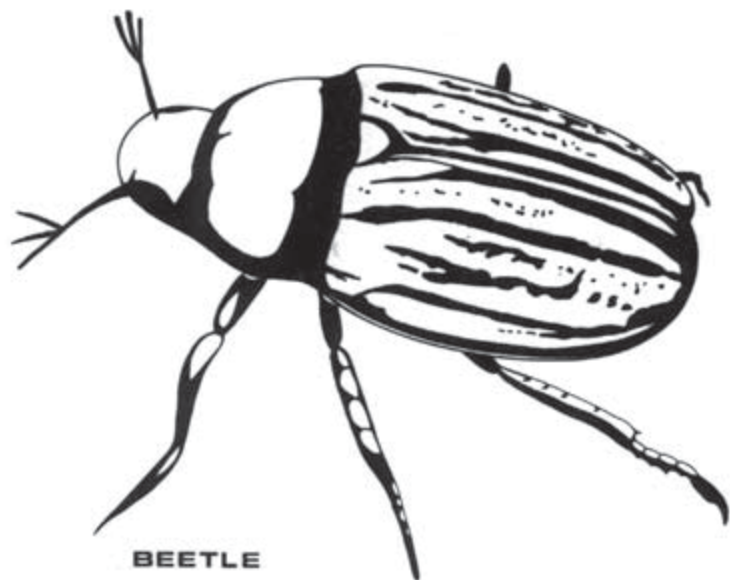

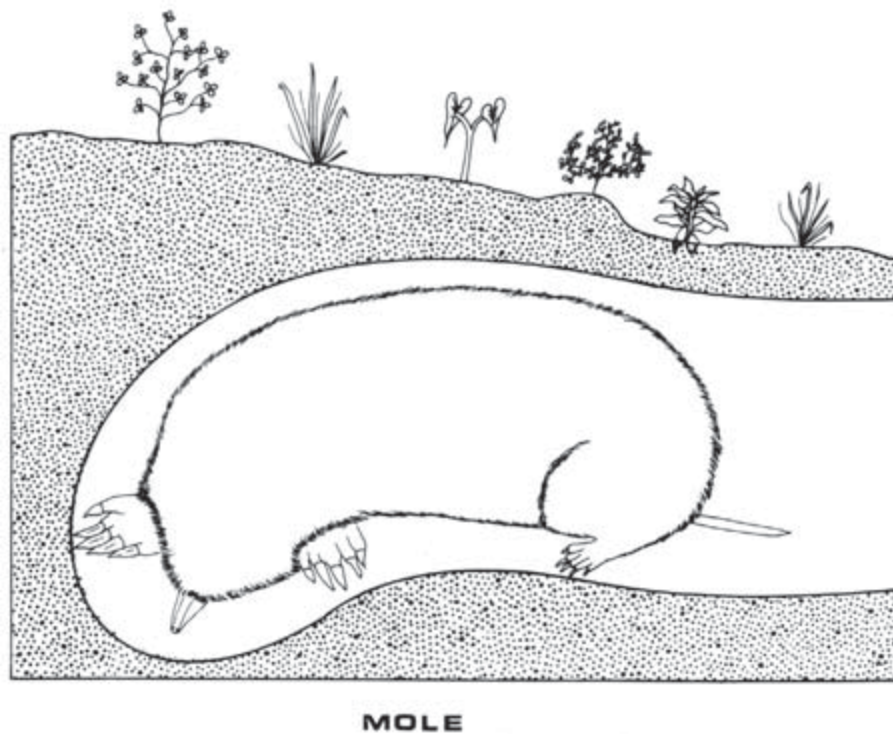
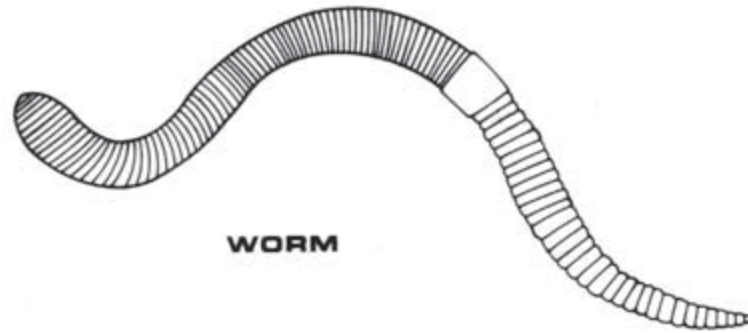

Materials needed:

- ▶ 2 plywood or heavy cardboard 100 cm x 150 cm
- ▶ 4 plywood or heavy cardboard 50 cm x 100 cm
- ▶ 1 plywood or heavy cardboard 50 cm x 150 cm
- ▶ 6 bamboo tubes 25 cm long, 2.5 - 3 cm diameter
- ▶ 12 wood blocks 5 cm x 5 cm x 10 cm
- ▶ 6 panes of glass*, frosted or covered with a thin coat of white paint, 20 cm x 20 cm
- ▶ 24 corner braces to hold glass
- ▶ 4 medium hinges



- ▶ 2 hooks and eyes
- ▶ enamel paint (optional): small amounts of gray, reddish brown, brown; tan for entire box

* Alternatives for the glass pane, especially if you are using cardboard, could be:

- Translucent polyethylene sheet, cut to size
- Transparent polyethylene sheet made translucent by rubbing with fine sandpaper
- Thin white paper
- White cloth

The illustrations could be transferred and inked directly onto these materials, which could be taped over the openings.

Procedure:

1. Measure and cut square holes 19.5 cm x 19.5 cm in one board 100 cm x 150 cm as in Soil Figure 1. This will be the back panel.
2. Place the other 100 cm x 150 cm board under the back panel, and mark the position for the viewing holes on the front panel so that they will be in the middle of each rear square.
3. Cut or drill the holes for the viewing tubes in the front panel; attach the wooden blocks at top and bottom of holes to support tubes; place tubes in position so that they point directly at each corresponding glass.
4. Assemble the box and paint tan (optional).
5. Letter the information on Soil Figure 2 onto the foldout wings and attach them to the box with hinges. Attach hooks and eyes to keep wings in position.
6. Glue paper illustrations with their names to the panes of glass; attach panes to rear panel with corner braces: top level: Millipede, Fungi, Beetle; middle level: Earthworm, Mole; bottom level: Water (use illustration of raindrops).
7. Place box at a window where light will shine through rear panel openings.

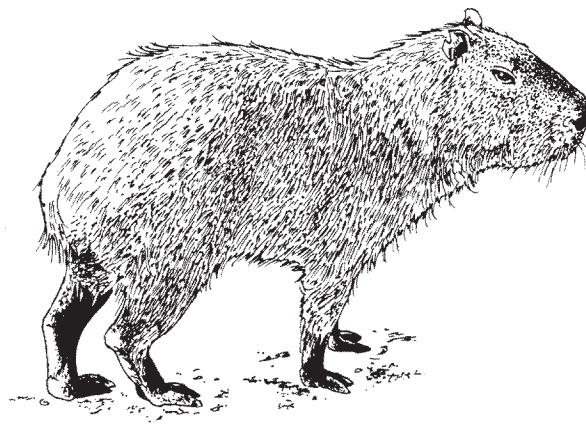

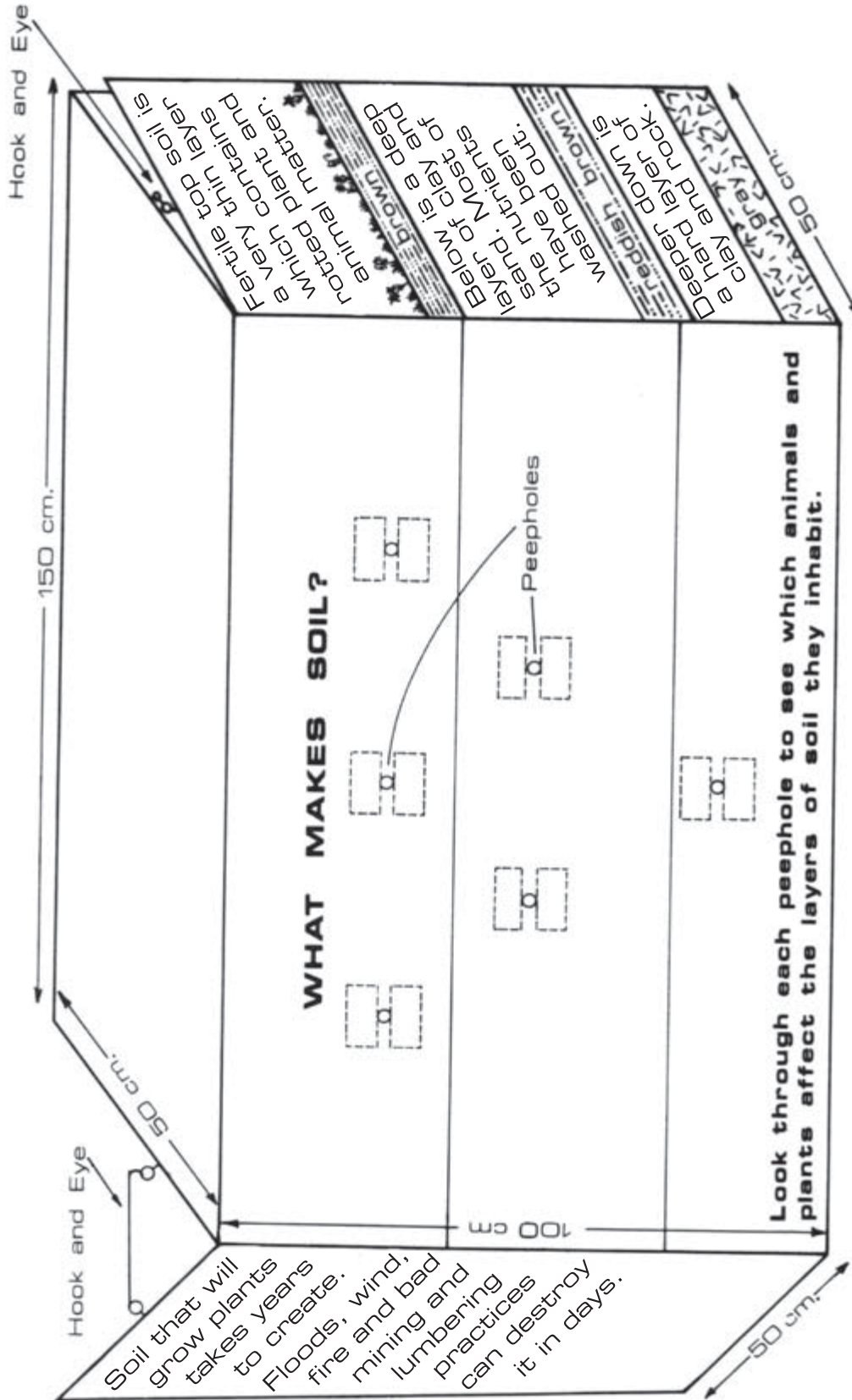

Soil Figure 1



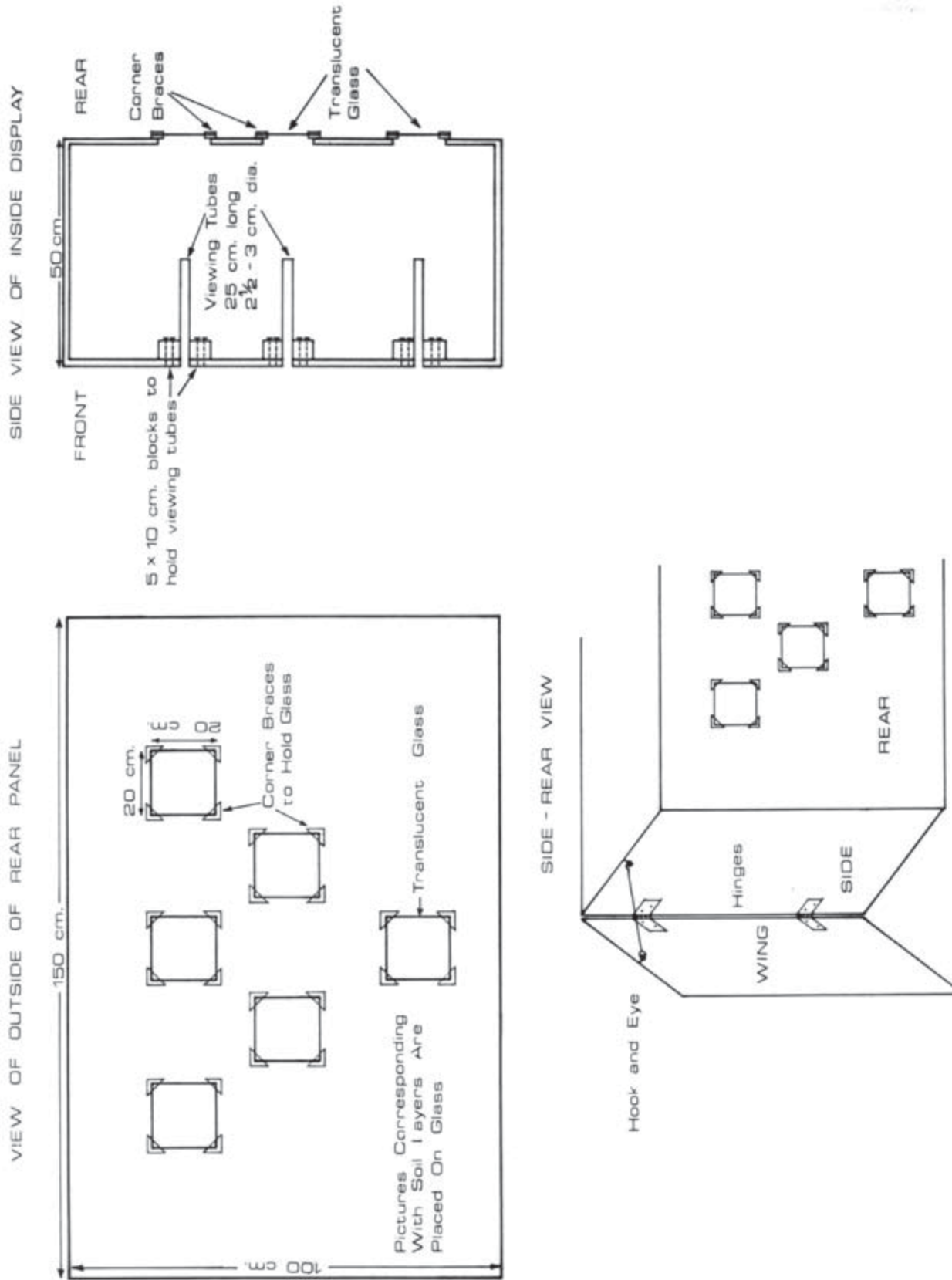

Soil Figure 2



Exhibit Example

WHY DO WE NEED TREES ON HILLSIDES?

This exhibit simulates a hillside with groups of trees. A tilted board simulates a hillside, with nails simulating trees. More trees are on one side than the other. Marbles are used to simulate the flow of water downhill. Visitors will see that the trees will slow the flow of water.

How to do it:

Materials Needed:

- ▶ 1 plywood board 65 cm x 109 cm
- ▶ 2 pieces of wood 2 cm x 2 cm x 5 cm (part D)
- ▶ 1 triangular block of wood 15 cm x 15 cm x 40 cm long
- ▶ 100 nails 5 cm long or slender sticks of wood or bamboo 6 cm long
- ▶ 12-15 marbles, cowrie shells, round stones, round beans
- ▶ green enamel paint

(*Optional:* brown paint; sheet of glass or plastic to cover top)

Procedure:

1. Cut a piece of plywood 50 cm x 75 cm for the main board.
2. From the remaining piece of plywood cut:
 - part A - 3 strips 5 cm x 75 cm
 - part B - 2 strips 5 cm x 50 cm
 - part C - 2 strips 2 cm x 42 cm
 - part E - 1 piece 20 cm x 50 cm
3. Attach A and B at the board's sides with nails to form an edge around the board, and to divide it up the middle. See Trees Figure 1.
4. Attach the two strips C on the bottom of the board to form parallel strips, then nail part D, the 2 cm x 2 cm x 5 cm wood pieces at each end so the board will stay on the triangle.
5. Label end board (part E) with text and nail into place, as in Trees Figure 1.
6. Hammer many nails approximately 1 cm into one side of the divider and only a few nails on the other side.
7. Paint the board green.



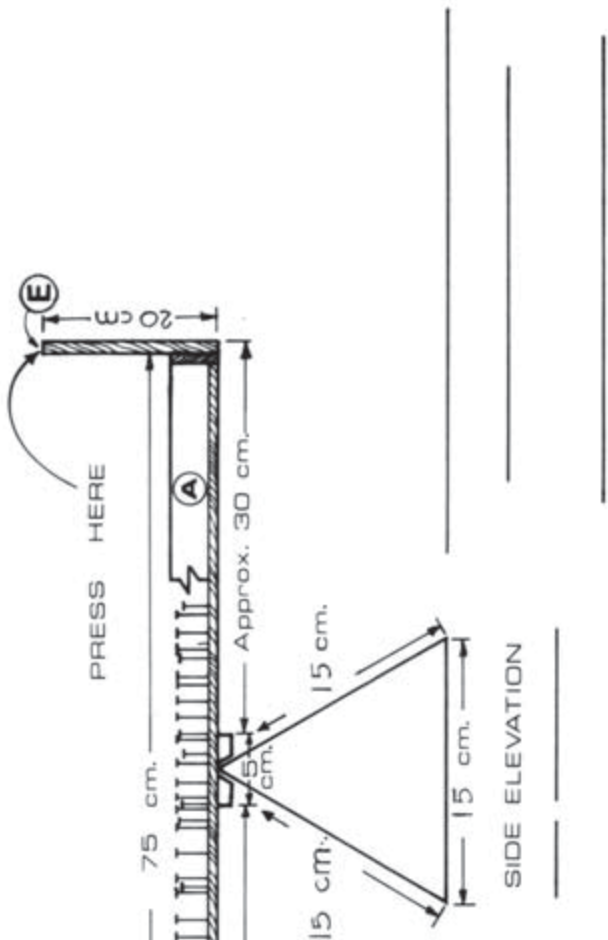

**WHY DO WE NEED TREES
ON HILLSIDES ?**

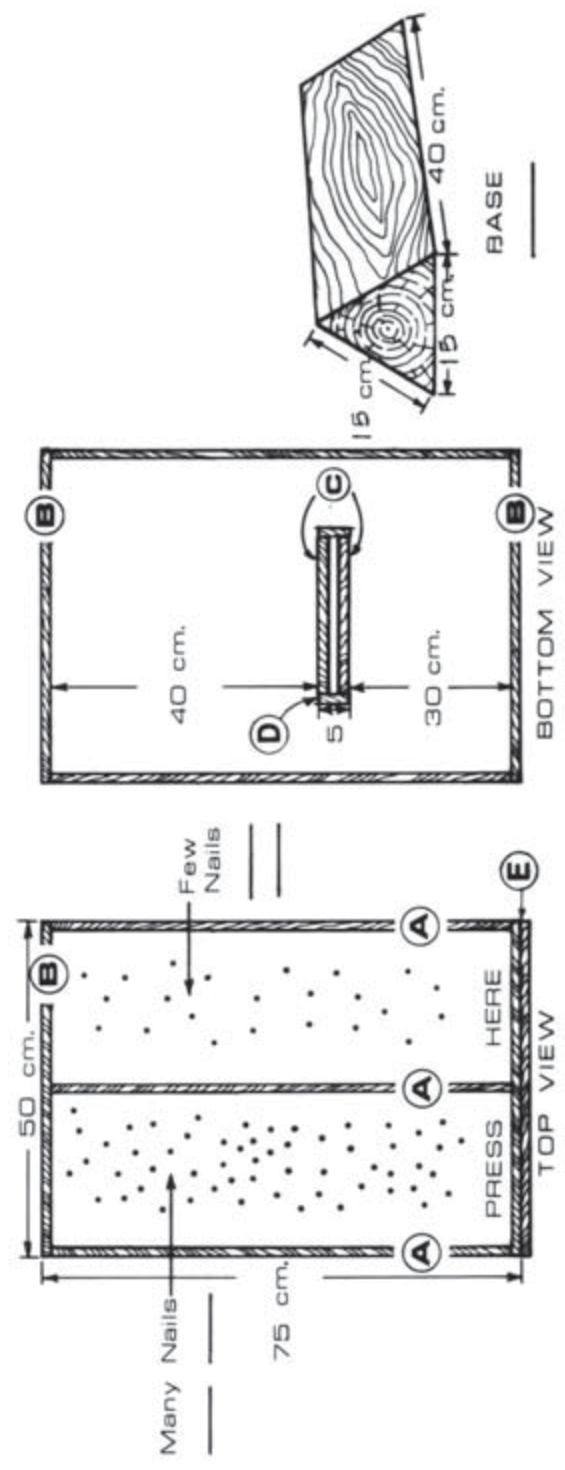

Trees Figure 1



(Optional: Add streaks of brown paint to the side with few nails to look like rain washing soil away. Glue balls of cotton colored green to the nails to look more like trees; Cover the top of the board with glass or plastic to protect marbles and keep out dust.)

- 8. Place the tilt-board on the triangle, on a surface approximately 75 cm high.

Text for end board:

Trees hold water on hillsides
Marbles = Water
Nails = Trees

Text for questions: (To be placed on cards next to exhibit)

- What happens if the water runs off quickly?
- What happens if the water sinks into the ground?
- Trees on slopes act as small dams. Have you ever noticed the way soil washing downhill is caught by tree trunks?

Other ways to make the board tilt:

- 1. Use two V-notched blocks, 10 cm high, in each of which pivots a section of bamboo nailed to a piece of wood secured to the bottom of the main board.

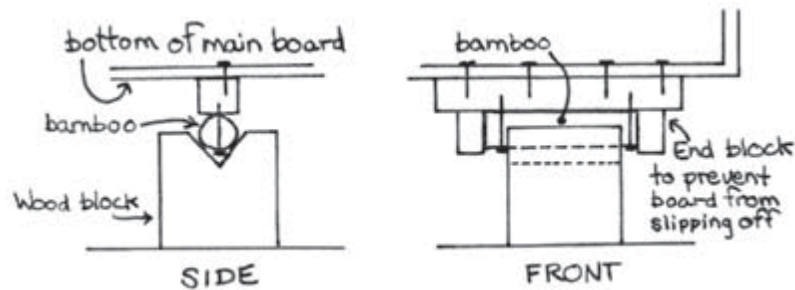

- 2. Nail 4 cm x 4 cm angle brackets, with the corners facing up, to an 8 cm x 10 cm wood block 40 cm long. Place tilt-board groove (part C) over angle.

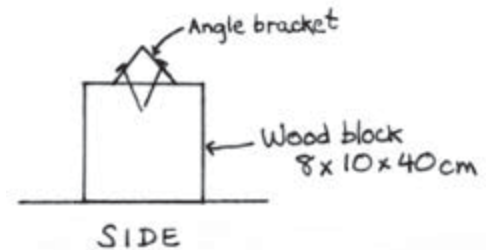

- 3. Onto an 8 cm x 10 cm x 40 cm block of wood, nail off-center a piece 2 cm x 2 cm x 40 cm. Against this piece lean a length 2 cm x 4 cm x 40 cm and nail also to the block. Place tilt board groove (Part C) over angle.

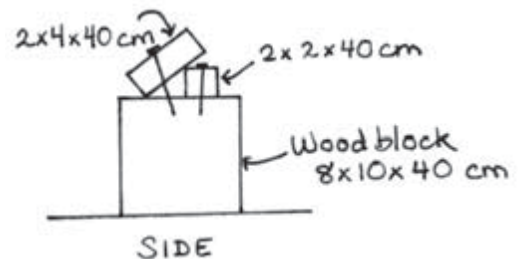
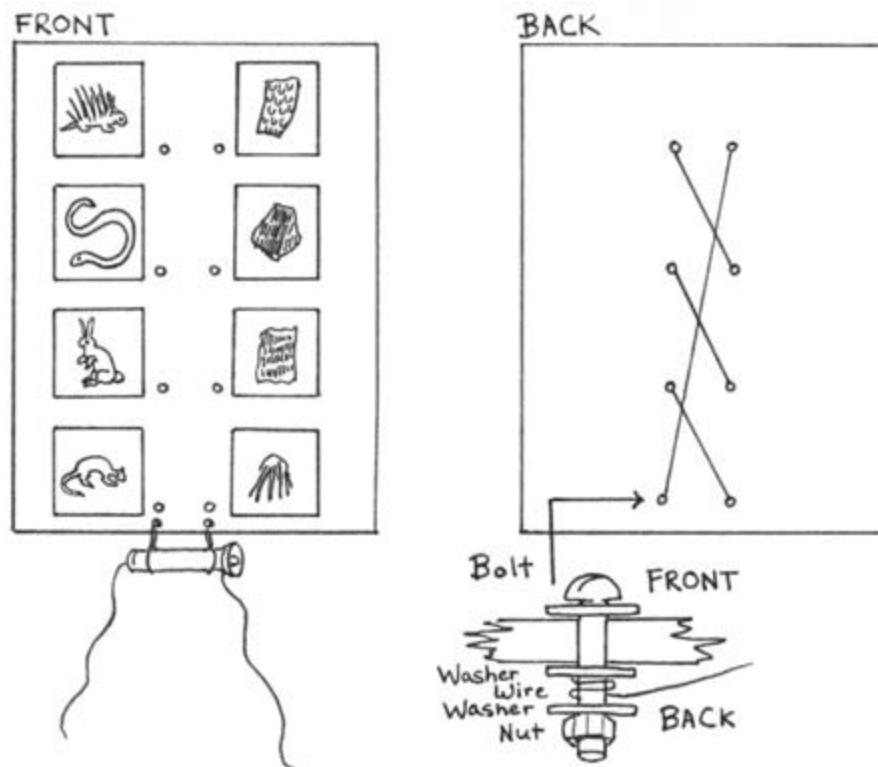



Exhibit Example

ANIMAL SKIN GUESSING GAME

The format used for this exhibit can be used for many other topics. It is a battery powered matching game where the visitor tries to match a sample of an animal skin to a picture of the animal. The visitor touches a wire to the bolt near the animal skin and another wire to a bolt next to the picture. If the visitor has chosen correctly, a small light bulb will go on. The principle of the game is that the wires behind the game board make a circuit when the correct choices are made.



How to do it:

Materials needed:

- ▶ 1 wooden board 60 cm x 80 cm (painted, whitewashed if desired)
- ▶ 8 wooden or heavy cardboard squares 15 cm x 15 cm
- ▶ 4 animal skin samples
- ▶ 4 pictures of animals corresponding to skins (sketches, photographs)
- ▶ 8 heavy metal bolts and nuts
- ▶ 24 metal washers
- ▶ 6 meters (approx.) electrical wiring
- ▶ Flashlight with batteries, light bulb



- ▶ 2 screw hooks
- ▶ Paint, varnish, whitewash (optional)
- ▶ Screws (optional)
- ▶ Glue or wire
- ▶ Drill

Procedure:

1. Paint or prepare wood or cardboard as necessary.
2. Glue or wire prepared skin samples to 4 of the 15 cm x 15 cm squares.
3. Glue pictures of animals to 4 of the 15 cm x 15 cm squares.
4. Screw (wood) or glue (cardboard) the four skin samples down one side of the board as illustrated.
5. Screw (wood) or glue (cardboard) the four animal pictures down the other side of the board. Be sure the pictures are not in the same order as the skins.

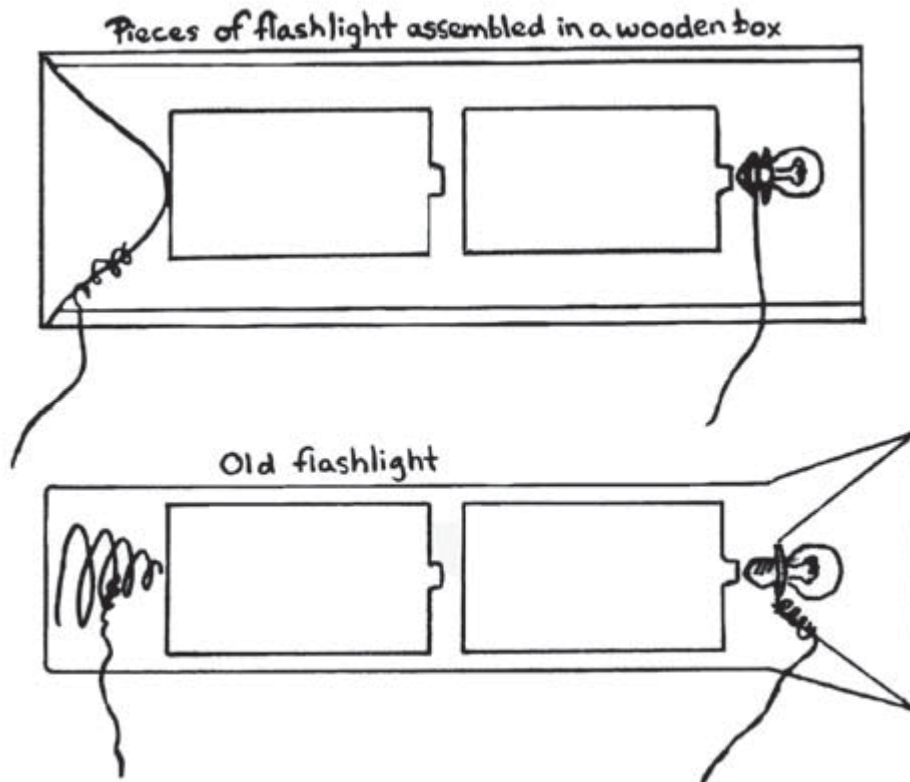



6. Drill holes for bolts next to each skin sample and picture, as illustrated.
7. Place a bolt and washer through each hole on the front of the board.
8. Place two washers, then a nut on each bolt at the back of the board.
9. Draw a line on the back of the board from the bolt of each skin sample to the bolt of its matching animal picture. Measure the length of each line.
10. Cut a length of electrical wire, plus 5 cm for each of these four measurements.
11. Peel back 2.5 cm of the rubber coating on each end of each of the four lengths of electrical wire, to leave metal wire bare.
12. Following the drawn lines on the back of the board, wrap the exposed end of the wire between the washers of each corresponding bolt (see back view illustration).
13. Take approximately 90 cm of electrical wire and wrap 2.5 cm of bare wire on the metal spring at the base of the flashlight.
14. Take approximately 90 cm of electrical wire and wrap 2.5 cm of bare wire on the metal sheath of the light bulb.
15. Hang the flashlight with wire on two screw hooks at the bottom of the board.
16. Take the free ends of the two flashlight wires and touch one to each of a wired pair of bolts. The light bulb will go on.

Note: You can assemble batteries, light bulb, wire and spring tightly in a wooden box to give the same result as a flashlight.

















Exhibit Example

BIRD BEAKS

The purpose is to show the relationship between beak size and shape and bird diet. The exhibit is in two parts. One is a poster display that shows pictures of beaks and food along with descriptions. The second part of the exhibit involves the visitor in using a variety of beaks (tools) to try to pick up different types of foods (nuts, bolts, seeds, buttons, etc.).

How to do it:

Bird Beaks display board:

	10	10	5	10	5	10	5	10	10
	WAYS BIRDS GATHER FOOD								
10		Curved Beak	Tearing prey						
10		Short, thick	Crack Seeds						
5		Crossed							
10		Slender, fine	Extract nectar						
5		Awl-like							
10		long, stout	catch marine life						
5		Short, wide, weak							
10		pointed, bristly	Catching insects						



Suggested types of beaks:	Adaptation for:
1. Hooked	tearing prey
2. Short, thick, strong	cracking seeds
3. Broad, shovel-like	scooping and straining
4. Awl-like	boring in wood
5. Crossed	extracting cone seeds
6. Slender, fine	extracting nectar
7. Long, stout	catching marine life
8. Slender, sensitive	probing in mud or water
9. Short, wide, weak	catching insects
10. Pointed, bristly	catching insects

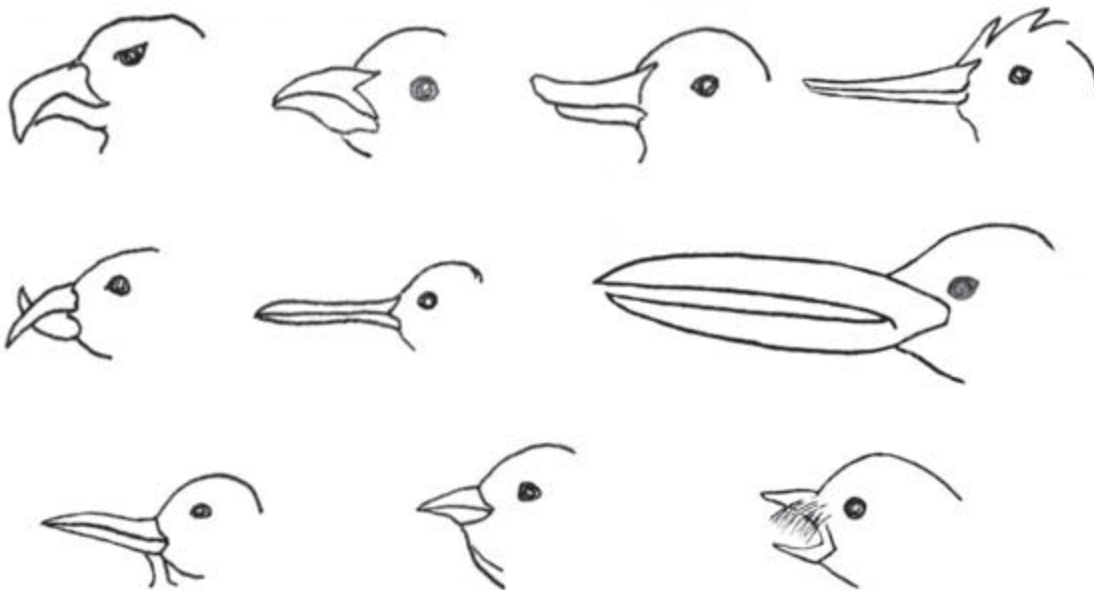

Materials needed:

For the display board -

- ▶ Plywood or cardboard 75 cm x 150 cm (painted, varnished, if desired)
 - *Note:* For horizontal use, two boards 75 cm x 75 cm can be used and hinged together with hinges, leather or cloth
- ▶ 16 wooden or heavy cardboard squares 10 cm x 10 cm (painted or varnished, if desired)



- ▶ 8 pictures of bird beaks (sketches or photographs)
- ▶ 8 samples or pictures of food eaten by the 8 birds
- ▶ Glue or paste
- ▶ Screws (optional)
- ▶ Wire (optional)
- ▶ Paint/varnish (optional)



For the interactive activity -

A variety of implements, such as:

- | | | |
|--------------|-----------------------|--------------|
| ■ Spoons | ■ Forks | ■ Tweezers |
| ■ Toothpicks | ■ Nutcracker | ■ Spatula |
| ■ Straws | ■ Needle-nosed pliers | ■ Chopsticks |

A variety of items to be used as food, such as:

- | | | |
|------------------------------|-------------------|---------------------|
| ■ Marbles or grapes | ■ Sunflower seeds | ■ Peanuts |
| ■ Glass of water | ■ Popcorn kernels | ■ Washers |
| ■ Nuts and bolts | ■ Coins | ■ Jell-O or pudding |
| ■ Cooked spaghetti or string | | |

Procedure:

For display board -

1. Prepare wood, cardboard or flannel board as necessary.
2. Glue bird beak pictures to eight of the 10 cm x 10 cm squares. (Varnish if desired.)
3. Glue pictures of wire samples of the birds' food to eight of the 10 cm x 10 cm squares.
4. Label eight of the 5 cm x 10 cm rectangles with the use adaptation of the beaks.
5. Label eight of the 5 cm x 10 cm rectangles with the beak descriptions.
6. Attach squares and rectangles to board, as illustrated, with screws for wood, with glue for cardboard or paper.

Notes:

- * This kind of exhibit can be adapted for kinds of teeth and food, skin coverings and camouflage, etc.
- * This kind of information can be adapted to a battery-powered electric game

**For interactive activity –**

1. Place “food” items in bowls on a table or other flat surface.
2. Lay out tools.
3. Attach instructions to table.

Instructions:

Title: “The Right Beak for the Right Job.” Certain beak shapes are suited for certain foods and food-gathering methods. Try it for yourself. Choose a tool and discover which type of food you can gather.

MAKING PAPER — ROMANIA —

At a GLOW (Girls Leading Our World) camp, Volunteers introduced girls to the life cycle of paper. They first asked the girls what they knew about the origins of paper: Where did paper come from? How was it made? etc. Next, the group made paper by ripping up collected scrap paper into tiny pieces, mixed it with water in a blender to make a slurry, and then poured it into tubs. The girls dipped small wooden frames covered with wire mesh into the tubs. After carefully pulling the frames up from the tub, with the slurry settling on the mesh, the leaders explained how to gently slough off the excess water, using sponges, and then to carefully flip the frame over and settle the paper on the stacks of newspaper. From the initial instructions, the girls came up with creative twists—adding flower petals, flowing threads, leaves, even some spurts of dye left over from tie-dying. As a final touch, the girls wrote a poem about trees on their homemade paper.





19 COLLECTIONS

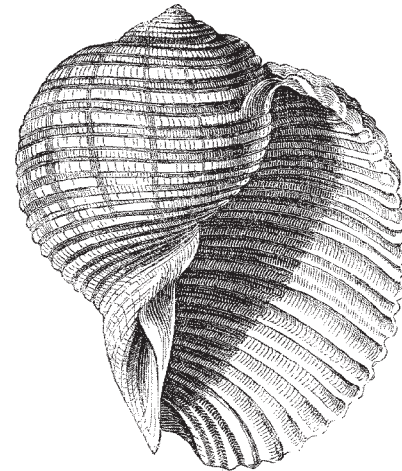

DESCRIPTION

Collections of living and non-living things from your local environment can be a very effective way to show the diversity of the area and to focus attention on parts of the environment people might not otherwise notice. Collections benefit the visitors who see them and the people who collect them.

Some ideas for collections are described below with tips for collecting the items. For collections of living things, please see the section on working with live animals. Remember to collect carefully. Usually a single sample is sufficient for the collection. When collecting, try to cause the least amount of disturbance possible and the least possible stress to organisms.

With some collections of live organisms, bring them back to look at for a short period of time, then return them to their previous location. This type of collection is especially useful for water animals.

USES

Use collections to display:

- Leaf types
- Insects
- Flowers
- Track castings
- Animal signs, such as browsed twigs
- Plants to transplant or to mount
- Animal homes that are no longer being used
- Rocks
- Bones
- Types of bark
- Feathers that have been molted
- Soil types
- Shells
- Water animals

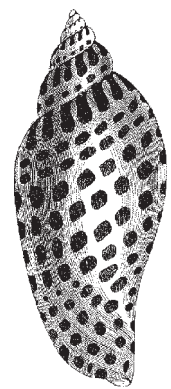
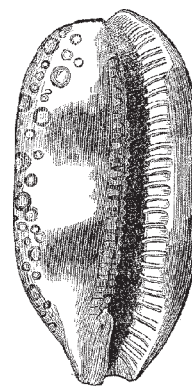
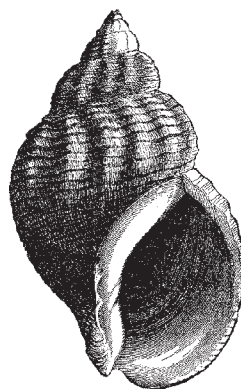
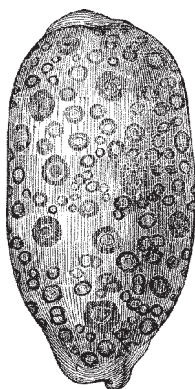



Collection Example

DISPLAYS

Most collections only require bags of some sort to make the collection in the field. Likewise, most collections require some sort of display.

How to do it:

For items such as rocks, shells, feathers and animal signs, a display box can be made by placing cotton or cloth in a box and spacing the items far enough apart to show each one off well. Choose a color that shows the items best. Cover the box with a transparent lid so people can see the items without disturbing them. Make sure to label the items clearly.

For items such as an old bird's nest or other animal homes, you may want to display them in a diorama that shows the environment they came from. Stand a box of the appropriate size on its side so it becomes a sort of stage for displaying the item. Using paint or cut paper or pictures, make a background for the item that indicates its habitat. Then mount the item in the middle of the box. For example, if you have a bird's nest, paint the background to show the bird's habitat, add a picture of the bird and mount the nest on a branch that shows where the bird built the nest.





Collection Example

INSECT COLLECTION

Insects can be collected live or dead. If you want to collect them live, put them in a terrarium (see section on terraria below). Remember you will have to feed them, so make sure you know what they eat. Some interesting insects to study live are caterpillars that will hatch into butterflies or moths, dragonflies that will molt into adults, and spiders. Most insects are harmless, but be careful not to choose an insect that can cause harm or damage.

Collections of dead insects for display might include insects in your area, butterflies, insects at all their life stages or insects and their food.

How to do it:

Materials:

- ▶ A collecting net
- ▶ Absorbent cotton
- ▶ Long, non-rusting straight pins
- ▶ Box, cardboard sheets, heavy cards, Styrofoam
- ▶ Mothballs or crystals of paradichloride of benzene
- ▶ Jars with screw tops
- ▶ Carbon tetrachloride or ether
- ▶ Paper strips

Collecting Net

A collecting net can be made from wire, flexible bamboo or willow, and mosquito netting, cheesecloth or other type of netting. Bend the wire or bamboo into a ring about 35 centimeters in diameter, and twist or tie in place. The netting can be cut and sewn into a cone about 35 centimeters in diameter and 60 centimeters long. The net is then sewn onto the wire or bamboo ring. A handle can be made of a stick or piece of bamboo 75 centimeters long. The stick is notched and lashed onto the ring and net.

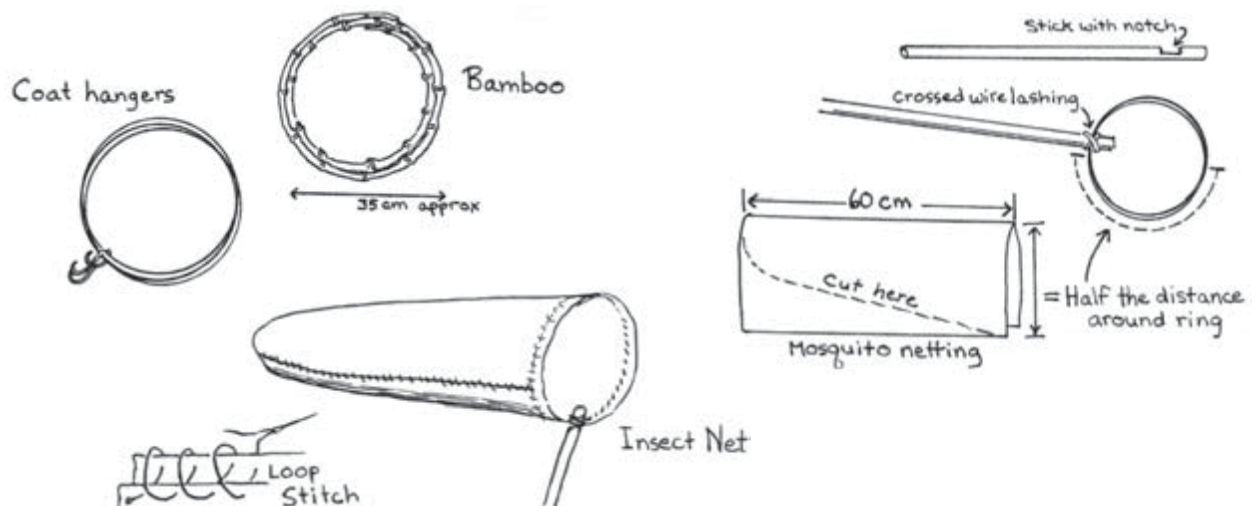



Insect Kill Jar

A kill jar or killing bottle is a wide mouthed jar with absorbent cotton in the bottom that has been soaked in carbon tetrachloride or ether. You can make a cardboard shelf for the insect that goes over the cotton. Do not add the carbon tetrachloride or ether until just before you go collecting. When you capture an insect in your net, shake it to the tip of the net and hold the net and insect in the kill jar until the insect is stunned. Then drop the insect in the jar and close it. The insect should be dead in 15 minutes.

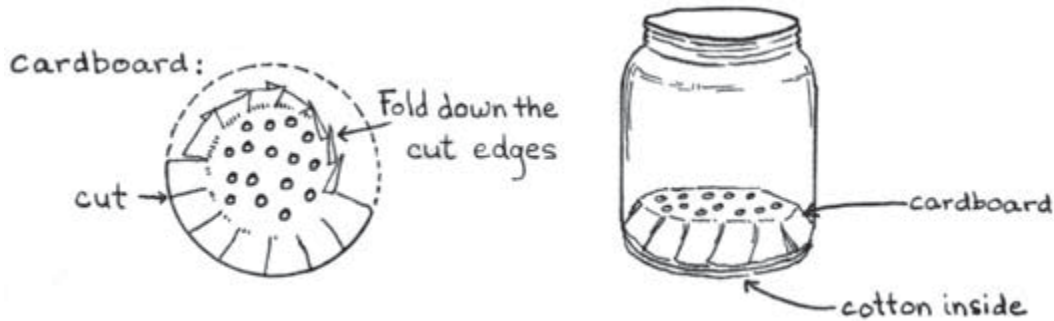

Insect Drying Board

Prepare a drying board from pieces of cardboard or styrofoam. See the diagram below. If it is a winged insect, position the insect so that its body lies in the slot. Pin the insect to the board by pushing a pin through the insect's thorax. Lay strips of paper over the wings and pin the strips of paper to the board. If the insect is not winged, press a pin through the thorax and into the board. Arrange the legs and pinchers neatly. Let the insects dry. When they are completely dry, they can be displayed.



Insect Collection Display Table

In some areas, there may be problems with live insects eating your mounted specimens. To prevent this, place mothballs in your display box. You can also modify the display table to prevent ants or other insects from climbing the legs. Place the legs of the table on small cans that are placed in larger cans containing oil, disinfectant or water with a layer of oil on top.

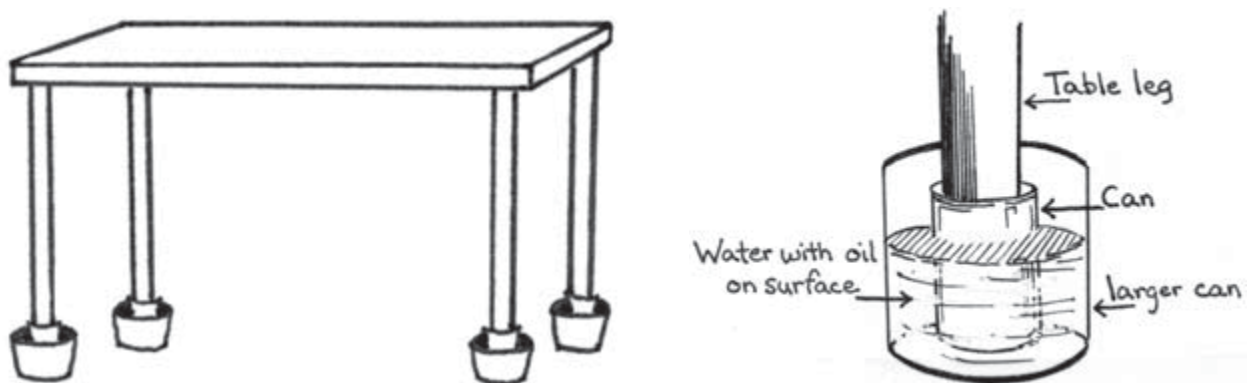



Collection Example

TRACK CASTINGS

If you find a good clear set of tracks you may want to make castings of them. Good tracks can usually be found in moist areas like muddy banks of ponds and streams, or damp forest trails.

How to do it:

Materials:

- ▶ Plaster of Paris
- ▶ Strip of stiff cardboard
- ▶ Plastic container and stick for mixing plaster
- ▶ Water
- ▶ Paper clip

Procedure:

Brush away any loose material from the imprint with a length of stiff grass. Make a ring with the cardboard and paper clip that is slightly larger than the track imprint, and press it slightly into the ground encircling the track. Mix the plaster with water to make a creamy consistency, and pour it *slowly* into the track. The plaster will take a minimum of half an hour to harden, and it will get warm. Dig up the track and the surrounding soil and put it in a plastic bag. Let it set until it is really hard and dry. Once it is very dry, you can clean off the soil with an old toothbrush and water. Label it with the location and date as well as the identity of the track maker.





Collections Example

PLANT COLLECTIONS

There are two ways to collect plants. One is to transplant growing plants, and the other is to press them and save them for viewing or reference. If you will be transplanting them, try to duplicate the natural habitat in the container. Do they live in a sunny or shady location? Is it moist or dry? Make sure to dig up some soil along with the plant root system for transplanting.

Plant collections can have several themes such as:

- ▶ Wildflowers
- ▶ Seeds
- ▶ Fruits
- ▶ Epiphytes or parasitic plants
- ▶ Medicinal Plants
- ▶ Flowers
- ▶ Grasses
- ▶ Trees (leaf, bark, flower, fruit, seed, cone)

If you intend to press plants, note that they will lose some color as part of the process. If you want to remember the colors, take photographs. For pressing plants, you will need a plant press (see directions later in this chapter). To get the best specimens, dry the plants as quickly as possible. They will lose less color and retain their features better. The basic idea of a press is to sandwich the plants between pieces of absorbent paper, apply pressure and allow ventilation while they dry. If you will be using the pressed plants for study, take samples of the entire plant, leaves, stems, flowers, roots, and seeds.

When the plants are completely dry, they can be mounted with tape or glue onto paper. Label the specimen with the name of the plant, its habitat and the date and location gathered.

TREE COOKIES

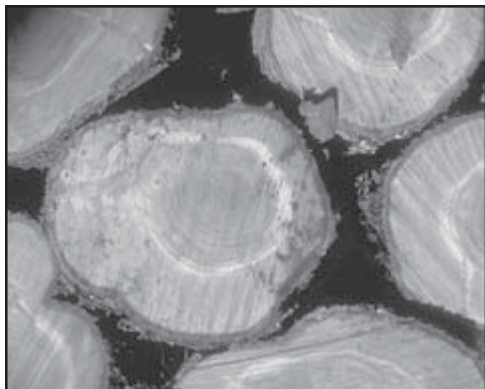

A tree cookie is a slice across the trunk of a tree that shows the tree growth rings. Each ring represents a growing season followed by a dormant season. The ring on the outside is the bark and cambium or growth layer. The next ring is the year the tree was cut down. Each ring represents one year, so counting them gives you the age of the tree. Tree cookies of different species can be compared. Cookies from the same tree in different habitats can be compared to show the difference habitat makes. Tree rings can also be labeled to show historical events.

If you have an increment borer available, you can get a sample of growth rings by boring into a tree. The borer will give a long thin sample of the rings without killing the tree.



Collections Example

WATER ORGANISMS

Around the verges of ponds, or in quiet parts of rivers, there are many small animals. On rocky ocean beaches at low tide, denizens of marine animals live. These animals are relatively easy to collect in a bucket. They can be displayed in a glass jar or aquarium. When collecting these animals and plants, make sure to collect plenty of the water they live in. Their food supply is the plankton in that water. If they live in a fast running stream or the ocean, you may need to include an “airstone” to maintain high levels of oxygen in the water.

How to do it:

Collecting Equipment:

- ▶ Large bucket (2-5 gallons)
- ▶ White basin for viewing animals (1-2 gallons)
- ▶ Sieves or small nets for capturing animals
- ▶ Plankton net for capturing animals (see water sampling equipment)
- ▶ Magnifying glasses for viewing animals
- ▶ Ice cube tray for sorting animals



When collecting animals and plants, look under rocks and in grassy areas. Animals tend to live in sheltered places in streams and oceans. Areas that have quiet water or lots of plant matter are good places to look. Make sure to check with local people about any potential hazards before wading in.

Once you have collected the organisms, place them in a large glass or transparent plastic container. You can probably observe them for a few days to two weeks without damage. If you keep them longer than a couple of days, get more water from the same place so they will have food. You can try feeding them very small amounts of fish food, or other foods you know they eat. Be careful not to over feed them because decaying uneaten food can foul the water and kill the animals. If they come from fast flowing water, place an airstone from an aquarium in the water. If you can't get an airstone, just keep them for a short time then return them to their home. If you are not sure you can care for them, just look at them at the site and return them to the water.

See also the sections following on: Aquaria, Terraria, and Water Sampling Equipment.



Collections Example

SOIL TYPES



Soil can be collected by type or by making profiles. If soil is collected by type, gather samples representing a variety of types of soil and display them. If you want to take a profile, take samples from each stratum (layer) of soil in a given place. You can dig a hole or use a road cut or other area that shows all the layers in a particular place.

To take a sample of soil, use a can (like a tuna can) with a single nail hole in the bottom. Push the can into the soil and remove. It may take a trowel or spoon to help remove the sample. Dry the sample in an oven at low temperature overnight. If an oven is not available, a warm dry place that is well ventilated can be used. Display soil sample in glass jars or other transparent containers. If you are displaying a profile, use a large jar and place the layers of soil in the jar just as they were in nature.

BONES

Sometimes you will be lucky to find the bones of an entire animal. Other times, you will just find one or two bones. In either case, make sure to clean the bones well. You can make displays comparing the bones of different animals. Big, heavy animals have large dense bones. Birds have hollow bones to make them light for flying.

If you are lucky enough to find an entire animal, you can develop an interesting display by asking visitors to try and put the unidentified animal back together again. Once it is back together, examine its characteristics to learn about its lifestyle. Does it have the long legs of a runner? Does it have the large rib cage of a swimmer? Does it have the teeth of an herbivore or a carnivore? Does it have the hollow bones of a bird?

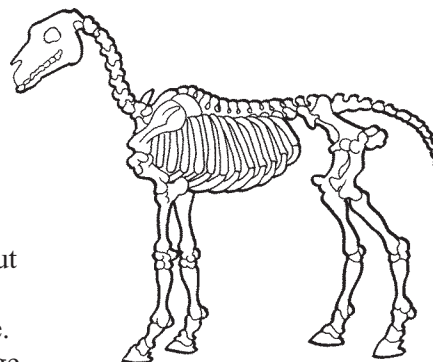

If you have a single bone, try to find out what kind of bone it is. Then it can be displayed showing its characteristics. Is it a heavy bone of a heavy animal or a hollow bone of a bird? What part of the body does it come from? How does it connect to the other bones near it? Are there signs of another animal or human chewing on it or using it to make a tool?



RESOURCES

Durrell, Gerald, *The Amateur Naturalist*. New York: Alfred A. Knopf, 1983.

GLOBE (Global Learning and Observations to Benefit the Environment) Teacher's Guide. The GLOBE Program, 1997. www.globe.gov

New UNESCO Source Book on Science Teaching. UNESCO, 1973. Also available on the Internet at http://upo.unesco.org/details.aspx?Code_Livre=377

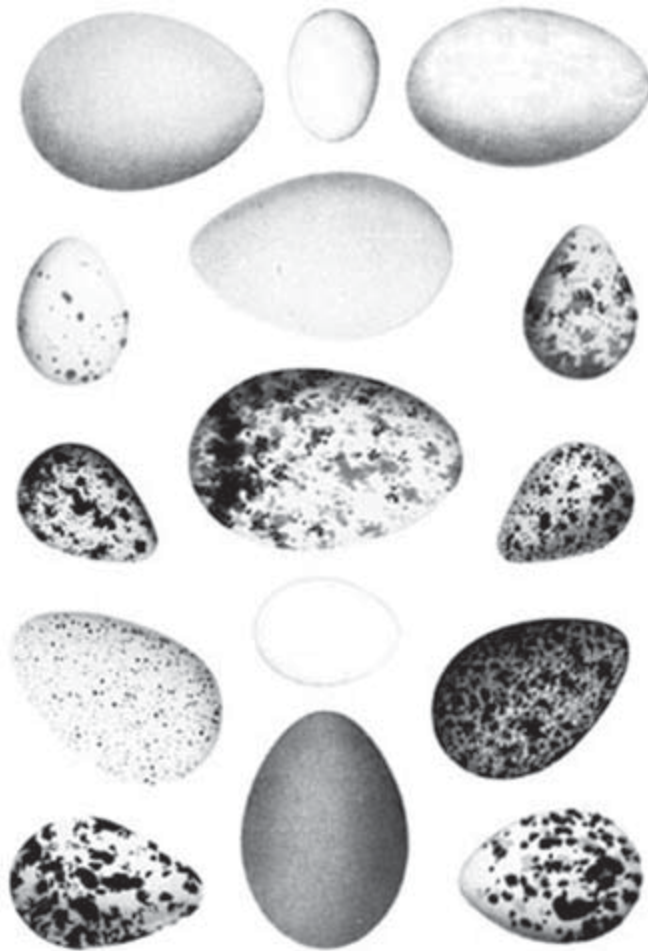



20 LIVING MUSEUMS

DESCRIPTION

A living museum is an exhibit that involves real people acting the part of historical figures or non-human characters. As visitors pass through the museum, they can talk with the actors to find out about the character. The character may be a person, such as a traditional fisherman, an ancient chieftain, or an herbal healer. The character could be an animal or a tree or a rock.



The characters may be stationed at a particular place, or roving. They could be an interpreter or appear at an appropriate moment in a tour. For example, a character could be a fisherman who explains how fish traps were built and used, or a honeybee that describes its life.

HOW TO DO IT

► Do the research.

Find out all that you need to know about the character you are playing. This includes not only what the character knew or did, but also the context in which he or she lived. If, for example, the character is an Indian farm woman, she should be dressed in a sari with bangles and sandals. She would probably not have a watch. She would be able to speak knowledgeably about farming, monsoons, farm animals, raising children, water availability, seasons, etc. If the character is a pine in the forest, it would be able to speak about the life of a pine, and also about the animals and plants nearby, as well as the seasons. It might be dressed in brown with green needles attached to its arms.

► Strive for authenticity and accuracy.

For characters to be convincing, they need to be completely accurate. That means they look and act like the character they are portraying. Audiences are more likely to play along with characters that are completely in character at all times. It is important to have the details correct for credibility.

► Avoid famous personalities.

People have expectations of famous people, and it may be difficult to live up to those expectations.

► Stay in the first person.

The character should always speak from the perspective of the character being portrayed. That means using the present tense and “I.” For example, if you were portraying traditional fisherman from the 1800s, you would talk about how *we* make nets *nowadays*, not how *they* made nets in



those days. If you are a frog, you would have to work most of the day to catch your meals and still be on the lookout for large shadows flying overhead.

► **Create an appropriate setting.**

Choose a location that fits the character, and use props that evoke the time and place where the character is supposed to be. It may be helpful to stay away from cars or phones or buildings that interfere with the setting you wish.

► **Rehearse.**

Plan when and how you will enter and exit, and how you will interact with other people. If you will be working with an interpreter, plan the timing and choose a cue for your entrance and exit. Will you be in character when the audience arrives or will you assume your character after you have spoken with them? Will you appear at a particular place or time in character, or wait for a cue from a tour guide? Practice what you will say and in what order you will say it. You do not necessarily need to memorize a script, but you do need to practice the topics you will cover and how you will respond to audience questions or comments.

► **Converse with the audience.**

Involving the audience in a dialogue makes for a more effective performance. But be ready for the audience to trip you up. They may ask questions that you know the answer to, but your character does not.

► **Enjoy assuming your role.**

You will be convincing and effective if you enjoy what you're doing. If you are portraying a non-human character, do it with humor. Audiences know that rocks don't talk, so acting the part of a rock is done with tongue-in-cheek.

► **Costumes for humans should be accurate for the character.**

But costumes for animals or other non-human characters can exaggerate notable characteristics. For example, a duck might wear swimming flippers to highlight webbed feet.

RESOURCES

Ham, Sam H., *Environmental Interpretation: A Practical Guide for People with Big Ideas and Small Budgets*. Golden, CO: Fulcrum Publishing, 1992. [ICE No. FC190]

For examples of living museum projects see:

Virginia Living Museum
www.valivingmuseum.org

Melbourne West Living Museum
www.livingmuseum.org

Tulsa Zoo and Living Museum
www.tulsazoo.org





21 LIVE ANIMALS

DESCRIPTION

Having live animals in your center or schoolroom is a wonderful opportunity for people to see how animals live; that they need food, water, shelter and space; and that they lead busy lives. Often the most instructive animals are the ones from the local environment, especially some of the often unnoticed smaller animals like insects. But, be very careful in choosing which animals you want to work with, and in recreating their habitat. Wild birds and mammals are difficult to keep in captivity. They require more care and food. They often require complex cages and enough space to move about freely. Take care when working with animals that bite, scratch or sting.



Choose a container that will display the animals well and give them enough space, food, water, air, and shelter. Make an effort to recreate the living circumstances of their natural habitat.

One easy and interesting display is a collection of water animals—insects, fish, frogs or salamanders. You can gather up a large bucket full of the natural water adding fish, snails, insects, or whatever is there. Be sure to include lots of the tiniest water plankton, and water plants which are food sources for the others. Include rocks and sticks and other natural debris that provide shelter. These animals can be fed by replenishing the water with their natural foods every few days.



Be careful in experimenting with foods for animals you are unfamiliar with. Fish food (usually dried algae, shrimp or worms), hard-boiled egg yolks and small insects may work. Beware of overfeeding. If you are able to find the eggs or nymphs of water creatures, you may be able to watch them hatch or metamorphose into adults.

One way to enjoy the animals, but not have to try to figure out how to keep them, is to just keep them for a short time, then release them back in their natural habitat.

Caring for injured animals can be very interesting, and hopefully, you can return them to health and release them. Seek information about the care and feeding of these animals. It can be difficult to care properly for an injured animal. Some young animals cannot be returned to the wild because they need to be taught how to survive by their parents. Others can be successfully rehabilitated.



AQUARIUM

An aquarium is a container for freshwater or marine plants and animals. A successful aquarium recreates the natural environment of the animals and plants as closely as possible.

How to do it:

Preparing the aquarium:

You will need a glass container for the aquarium. The glass container needs to be thoroughly cleaned before adding water and plants and animals. Use lots of clean water, and avoid soaps or detergents. If you have to use soaps, rinse many times to remove all soap from the aquarium. Fill the aquarium with water and let it sit for a few days so the water will absorb any impurities. Then throw this water away.

Place the aquarium in a place where the temperature will remain constant. Do not place it in direct sunlight. The temperature will vary quite a bit between noon and night, and algae growth will be a problem.

Reproduce the habitat:

Gather soil, gravel and/or sand from the place you will gather the animals and plants. Wash the substrate (soil, gravel or sand) before putting it in the aquarium. Put the soil in first, and then add gravel, then sand. Place a heavy sheet of paper or cloth on top of the substrate, and siphon or drip water from the habitat onto the paper so as not to disturb the substrate. Wait twenty-four hours before adding plants.

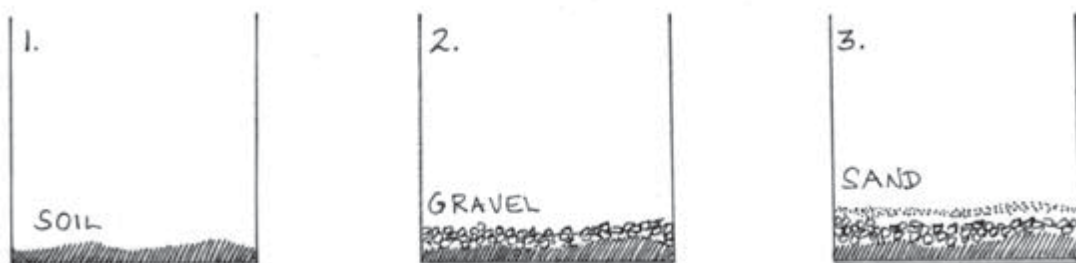

Inspect plants for pests before putting them in the aquarium. Look for snail or insect eggs and remove them. Rinse the plants before putting them in the aquarium. Then plant them carefully so as not to disturb the substrate. Push the roots down into the soil gently. Place taller plants at the back. To oxygenate the water for the animals, plant one or two plants for every liter of water. Let the aquarium sit for a week or so before adding animals so that the plants can take root and the substrate bacteria can grow. Substrate bacteria process wastes. If they are not there, animal wastes will accumulate and poison the water.



When selecting the animals, be aware of who eats who or what. If the aquarium is for children, be prepared to discuss predation with the children. As a general rule, one inch of fish can live in one gallon of water, so a five-gallon tank can support five one-inch fish, or a two-inch fish and a three-inch fish. It is tempting to add many animals, but consider that the aquarium is an ecosystem that needs enough food, oxygen, and bacteria to decompose wastes.

When adding the animals, float them in the collecting container for half an hour or so, until the aquarium and the container have the same temperature. Then add the aquarium water to the container a little at a time to balance the water chemistry and allow the animals to become accustomed to the changes.

Don't feed the animals for a day. Watch the animals, and remove any sick or dead ones. Feed animals carefully. Make sure they have enough, but not too much. Too much food shows up as decomposing waste on the bottom.

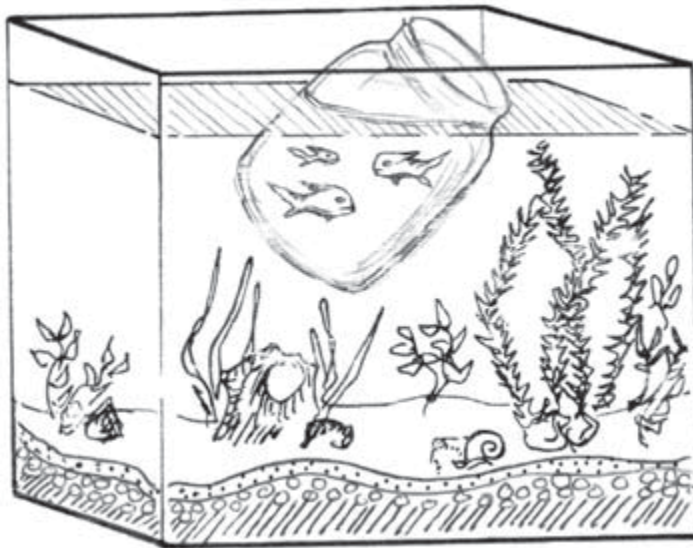

PUSH THE
ROOTS DOWN
INTO SOIL

A Note on Marine Aquariums:

In addition to the above tips, marine aquaria need to keep the proper balance of salt to water. The water will evaporate, which will concentrate the salt. Mark the waterline of the aquarium, and when it gets below that, add fresh water. If you have a hydrometer available, you can monitor the salinity of the water and keep it stable. Try to keep the marine aquarium at the same temperature as the sea the organisms came from. If the animals get too warm, they will die. Likewise, animals that come from great depth need pressure to stay alive. They are very difficult to keep in an aquarium.

RESOURCES

James, Daniel E., *Carolina's Freshwater Aquarium Book*. Gladstone, OR: Carolina Biological Supply Company, 1981.



Live Animals Example

TERRARIUM AND OTHER LAND ANIMAL CONTAINERS

A terrarium is a container for terrestrial or land plants and animals. So, in the broadest sense, bird-houses and cages are kinds of terrarium. There are as many types of terrariums as there are land habitats. You can create a terrarium that holds a desert habitat, a forest habitat, or a wetland habitat. A successful terrarium recreates the natural environment of the animals and plants as closely as possible by considering the temperature, light, moisture, food sources, plants and shelter of the animals in the terrarium. Small mammals, reptiles, amphibians and insects commonly live in terrariums.

A terrarium can be made from any transparent container. Clean recycled plastic containers make good field terraria because they are light, portable, and often abundant. Samples of plants or animals can be carried back to study, or studied in the field. To make a terrarium from a clean water or soda bottle, cut a hole in the side about half way up, or cut the top off so you can place soil and plants inside. The hole allows air into the terrarium, and you can water the plants.

When making an aquarium or terrarium, consider the natural environment of the species. Make sure there is enough food, water, shelter and space for the species to survive. Place a screen lid on terrariums and aquariums to prevent unwanted debris or curious fingers from disturbing the terrarium, and to prevent escapes. Often, it is a good idea to have temporary terrariums. You can bring the plants and animals back to the center or classroom for a few days of observation and then return them to their habitat.

BUILDING A TERRARIUM

How to do it:

Materials:

- ▶ 1 metal tray, a sheet of metal or a board approx. 35 cm x 50 cm
- ▶ 1/2 kilo plaster of Paris
- ▶ 2 pieces of glass 30 cm x 45 cm
- ▶ 2 pieces of glass 30 cm x 30 cm
- ▶ 1 piece fine wire screen 35 cm x 50 cm for the top
- ▶ 1 large can or other disposable container (for mixing plaster of Paris)
- ▶ 1 roll adhesive or plastic tape 4 cm wide
- ▶ Water





Procedure:

1. Lay the four pieces of glass out flat with the 30 cm sides together, leaving about 3 cm between them.
2. Cut four pieces of tape 30 cm long and press the pieces of tape along the sides A, B & C of the glass.
3. Pull the glass inward carefully and tape the last corner D together.
4. Mix plaster of Paris with water in a large can until it is a smooth thick mixture.
5. Pour the mixture quickly (it dries very fast) onto the metal sheet and smooth it evenly.
6. Gently and quickly press the taped glass into the mixture.
7. Let the mixture harden.

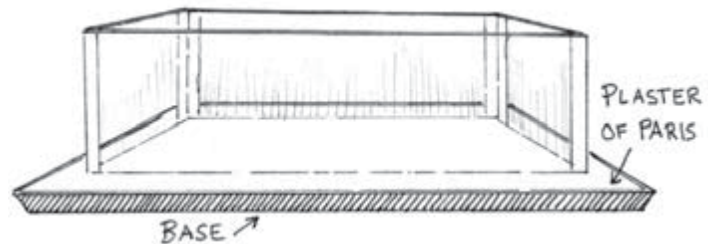
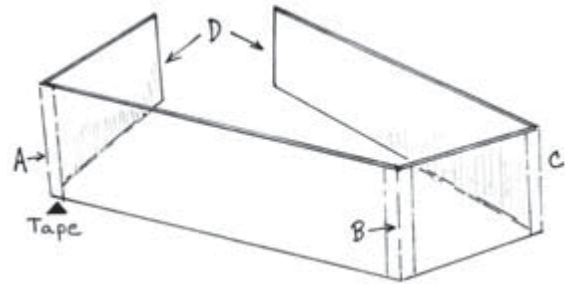

If plaster of Paris is not available, you might be able to sink the glass into sand or gravel in a flat box, making sure that the glass touches the base continuously, so that animals cannot crawl under it. Another alternative might be to use waterproof tape to fix the glass sides onto a base. This would not be as sturdy, and tape would probably need frequent replacement. A wooden frame could be constructed to hold the terrarium with a glass base.

Jar Terrarium

How to do it:

Materials:

- ▶ 1 clean 4-liter glass jar with a large opening and lid (or wire mesh)
- ▶ 1 box about 3 cm x 30 cm x 18 cm (a shoe box)
- ▶ 1/4 kilo plaster of Paris
- ▶ 1 large can or other disposable container (for mixing plaster of Paris)

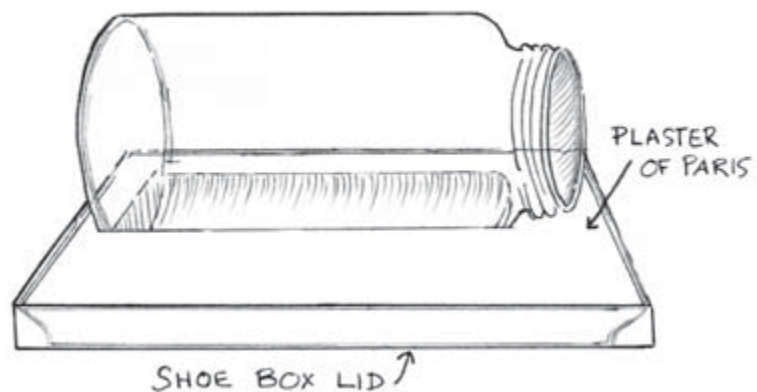



Procedure:

1. Mix plaster of Paris with water in a large can until it is smooth and thick.
2. Pour mixture quickly into the box and place the jar on its side in the plaster mixture.
3. Dry till hard.

If plaster of Paris is not available, you can make a small terrarium habitat with the jar standing upright, or construct a wood or bamboo cradle to hold the jar.

Desert Terrarium

How to do it:

Procedure:

1. Put a layer of soil on the bottom.
2. Cover the soil with a deep layer of clean (washed and dried) sand.
3. Plant one or two desert plants in the soil.
4. Place a small dish (or other container) for water in the sand, which can be removed for cleaning.
5. Place clean rocks carefully so as to give shelter for an animal.
6. Cover the terrarium with wire screening.
7. Hold the screening down with stones if necessary.

Desert snakes, lizards, tortoises or insects are the kinds of animals you can keep in this terrarium. Snakes like live food, and depending on the type, will eat insects, earthworms, frogs or mice. They may also eat eggs or small bits of meat. A snake will not eat every day. However, if it does not eat at all, you should let it go. Lizards are meat and insect eaters; a few are plant eaters. Identify an animal's food needs *before* you decide to collect and keep it.

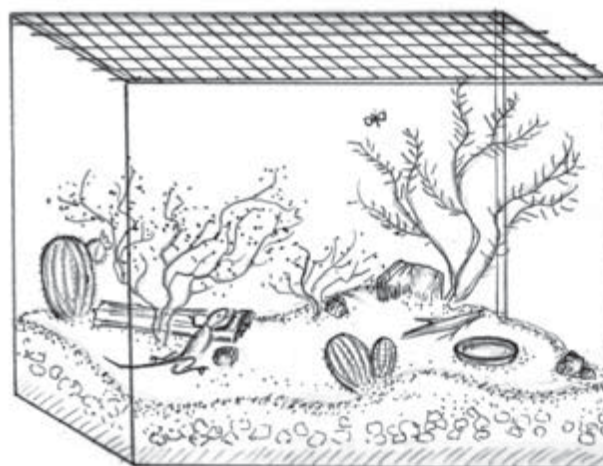

DESERT
TERRARIUM



Forest Terrarium

How to do it:

Procedure:

1. Cover the bottom of your container with a mixture of gravel, charcoal (optional) and soil. This will give air and drainage, and nutrients for the plants.
2. Plant forest-type plants, ferns, mosses, in the soil to the same depth that they were growing in their original habitat.
3. Place a removable water dish in one corner. If the animal needs to swim, the water container should be large enough for this.
4. Place stones, sticks or small branches to provide climbing and shelter for animals.
5. Water the soil by sprinkling it, so that it will retain moisture. It should not be soggy with water, however.
6. If the terrarium becomes too moist and mold starts to grow, raise the top or open the lid for a day or two until the excess moisture has evaporated. Tie a piece of cloth over the opening to prevent the animals' escape while the top is open.

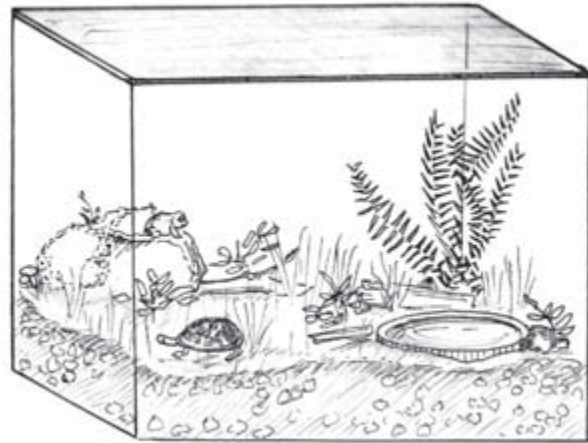

FOREST TERRARIUM

This can be the habitat for insects, spiders, frogs, salamanders and turtles, for example. Spiders eat insects that they have caught, and the insects will often be plant-eaters. Frogs and toads eat flies and earthworms. Some turtles will eat both plants and worms. Be sure you can find food for your animals before you collect them.



Live Animals Example

ANT FARM

A large glass jar will make a fine home for an ant colony. You should choose only ants that are not dangerous, and that live in the soil. To make an ant colony, you will need a queen, workers, and some eggs. To find them, dig into a small ant nest. The queen is larger and shinier than the others.

How to do it:

Procedure:

1. Fill a jar with soil from the area of the ant nest.
2. Put in the queen, workers and eggs.
3. Place a wet sponge on the top of the soil to provide moisture, Wet it whenever it dries out.
4. Cover the top of the jar tightly with fine mesh wire so no ants can escape.
5. Wrap the jar with black paper. This way the ants will make their tunnels against the sides of the jar. Remove the paper only to observe the ants.
6. Feed the ants bits of earthworm, flies, live aphids, scraps of rice, leaves, a drop of honey, until you know what food they prefer.

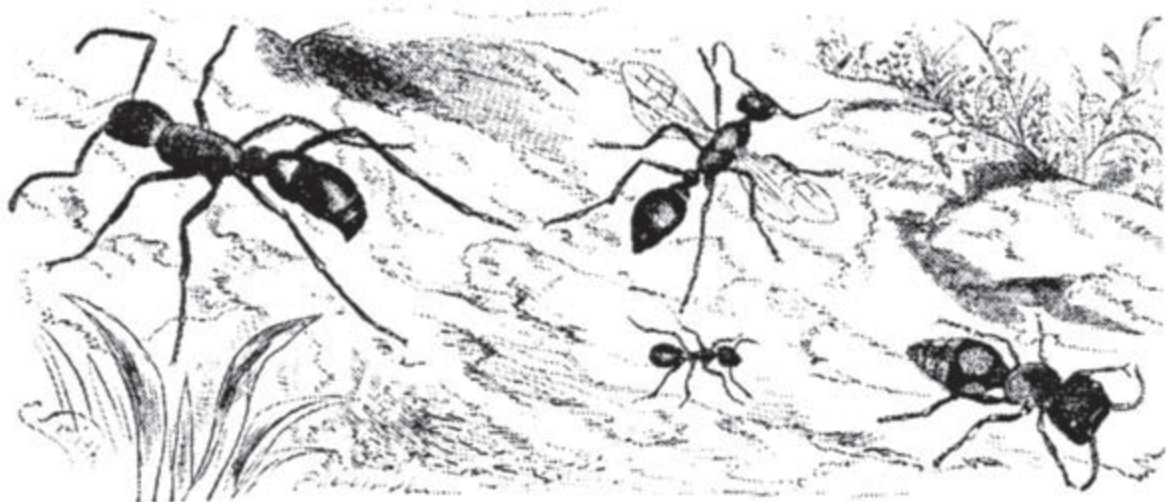



Live Animals Example

EARTHWORM COLONY

You can make an earthworm colony in a large jar, just as you do for ants. Earthworms live in and eat decaying plant matter. That is the habitat you will find them in.

How to do it:**Procedure:**

1. Fill a jar with a mixture of sand, leaf mold and rich topsoil.
2. Put in several small earthworms.
3. Keep the soil moist so that the worms can burrow.
4. Wrap the jar with black paper. This way the earthworms will tunnel against the sides of the jar, and can then be seen.
5. Cover the jar with fine mesh wire.
6. Feed the worms by putting fresh leaves, dead leaves, bits of discarded vegetables, or grass cuttings into the jar.
7. Add worms as you find them, but do not let the jar get too crowded.
8. These worms can be a food supply for other animals.



WRAP JAR IN
BLACK PAPER

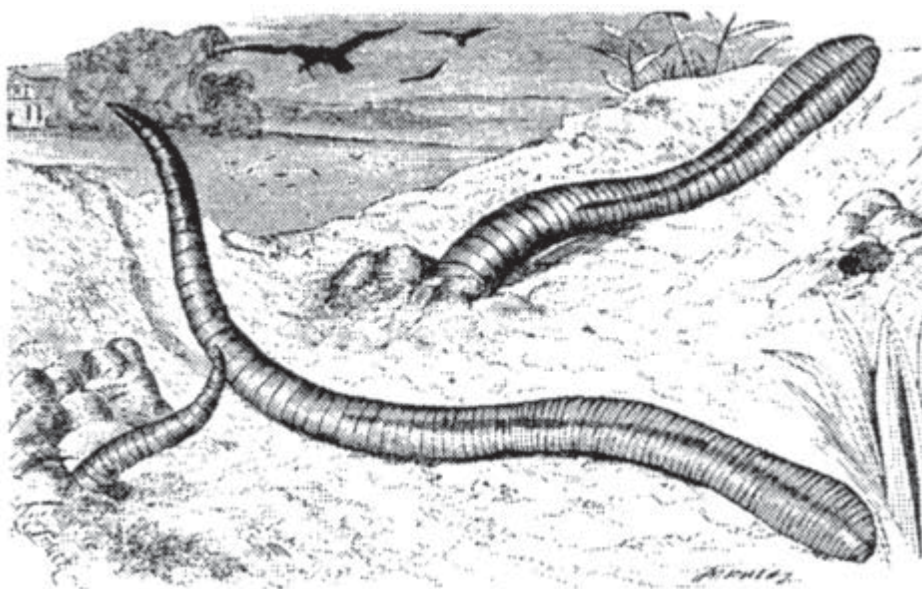



Live Animals Example

INSECT BOX

For short-term insect study, you may want to build a simple cardboard container. It will not be waterproof, so use a container (any kind of low-sided can, pot, dish, calabash) filled with moist soil into which you can stick cut branches, flowers, moss, or other plant material, rather than putting soil directly on the box bottom. For this type of box, be careful to choose insects that do not eat cardboard.

How to do it:

Materials:

- ▶ 1 cardboard box (any size) with at least five sturdy sides
- ▶ Transparent paper, plastic, glass, cloth netting, or wire screening
- ▶ Glue or adhesive tape
- ▶ Scissors and knife

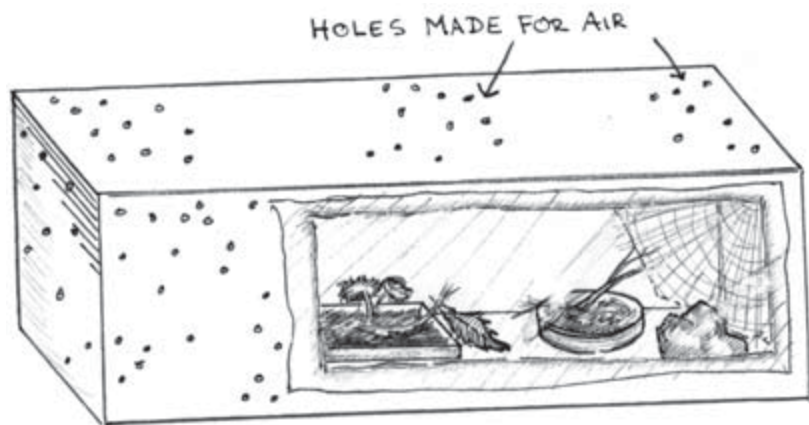

Procedure:

1. If the box has all six sides, cut a large rectangle in one side, for a window.
2. Glue or tape transparent paper, plastic, glass, cloth or screen over the window.
3. If the box has only five sides, glue or tape transparent paper, plastic, glass, cloth or screen over the sixth side.
4. Make a large door by cutting three sides of a rectangle through one side of the box, and bending along the fourth side. Glue or tape a piece of cardboard on the door for a handle.
5. If you have used cloth for your window, the box will have enough air. If you used other material, you may need to punch air holes in the box with a nail.
6. Place a piece of paper on the bottom to make cleaning the box easier.
7. Place containers of moist soil with branches, flowers, etc. on the bottom.
8. Place a small rock or log on the bottom and add insects.
9. Keep the soil moist, replace the plant material when necessary, and keep the box clean.



Live Animals Example

MAMMAL CAGE

You can keep a small mammal in a glass box with a wire top, like the one made for a terrarium or you can make a wood and screen box type. Another cage type can be made of small bamboo slats tied together to make sides, floor and top. Whichever you use, there must be a dish for water, a climbing branch, a small nest box or hollow log to hide in. Old newspapers, wood chips or straw can be used for nesting material. Make sure your cage has sufficient space for the animals that will live in it.

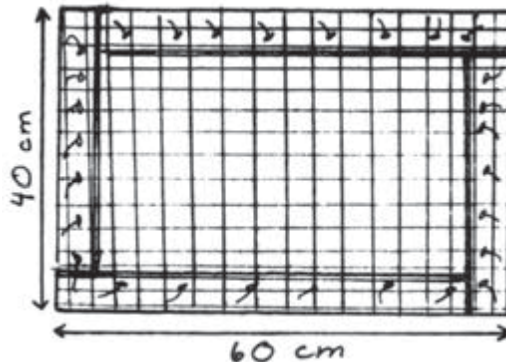

This wood and screen cage has a removable top, and should be large enough for two mouse-sized animals. It can be increased or reduced in size depending on your animal. Sizes of wood strips are approximate.

How to do it:

Materials:

- ▶ 8 pieces of wood 2 cm x 5 cm x 55 cm
- ▶ 8 pieces of wood 2 cm x 5 cm x 35 cm
- ▶ 8 pieces of wood 2 cm x 5 cm x 25 cm
- ▶ 4 pieces of wood 2 cm x 3 cm x 28 cm
- ▶ 2 pieces of wire screen 40 cm x 60 cm
- ▶ 2 pieces of wire screen 30 cm x 60 cm
- ▶ 2 pieces of wire screen 30 cm x 40 cm
- ▶ Nails and hammer

Procedure:

1. For the top and bottom:
 - 2 pieces of wood 2 cm x 5 cm x 55 cm
 - 2 pieces of wood 2 cm x 5 cm x 35 cm
 - 1 piece of wire screen 60 cm x 40 cm

Nail the four pieces of wood together as shown, and attach the wire screen with small nails pounded in, then hammered sideways to secure the screen.

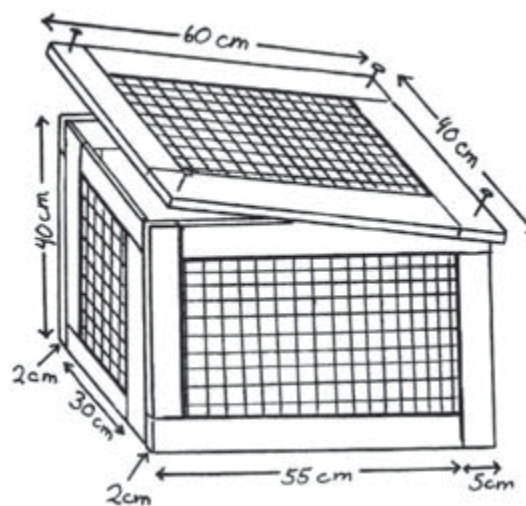



- 2. For the front and back:
2 pieces of wood 2 cm x 5 cm x 55 cm
2 pieces of wood 2 cm x 5 cm x 35 cm
1 piece of wire screen 60 cm x 30 cm

Nail the four pieces of wood together as shown, and attach the wire screen with small nails pounded in, then hammered sideways to secure the screen.

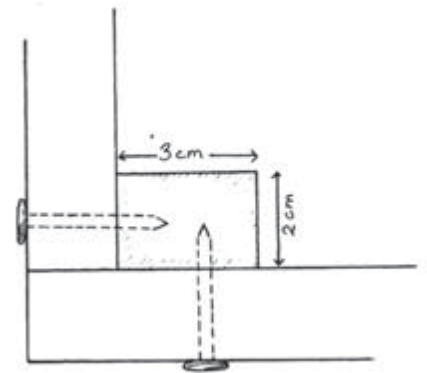

- 3. For each side:
2 pieces of wood 2 cm x 5 cm x 35 cm
2 pieces of wood 2 cm x 5 cm x 25 cm
1 piece of wire screen 30 cm x 40 cm

Nail the four pieces of wood together as before, and attach the wire screen with small nails pounded in, then hammered sideways to secure the screen.

- 4. Nail the two completed sides to the completed front and back.
- 5. Nail the bottom to the sides, front and back as shown.
- 6. Nail a piece of wood 2 cm x 3 cm 3 28 cm in *each* corner for bracing and support.
- 7. Lay top on completed cage or attach with a hinge.

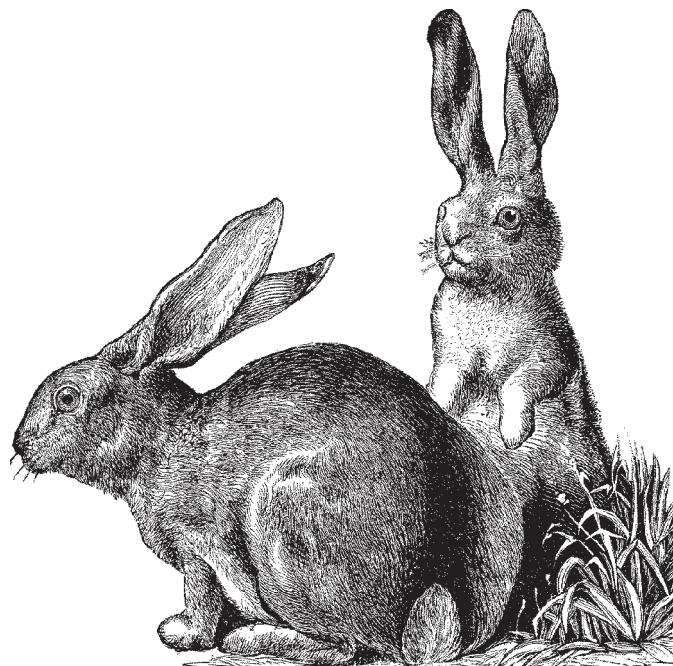
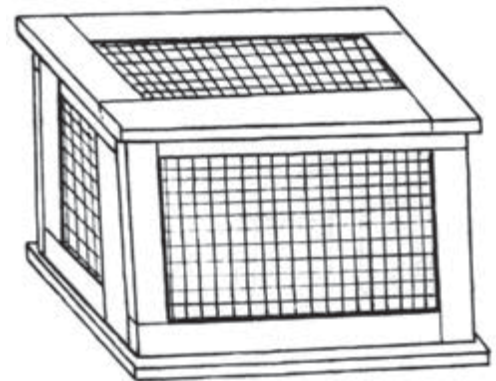



Live Animals Example

ATTRACTING BIRDS

Birds can be attracted to your center by providing feeders, birdbaths, plants, and nest boxes for them.

How to do it:

Feeders

Birds eat seeds, fruits, nectar, insects, meat, suet, greens, and nuts. Depending on the types of birds and animals you have in your local environment, you can place food out for the birds you want to attract. Seeds are the easiest to use in feeders because they keep well and are less likely to attract unwanted animals. Feeders can be made easily from plastic bottles with a hole cut in the side big enough for the birds to reach through to get the food. Or you can build covered wooden or plastic feeders. Feeders can be mounted on poles or attached to the side of buildings. Fruit or suet can be nailed to poles. Suet is particularly attractive in winter; it tends to become rancid in hot weather.

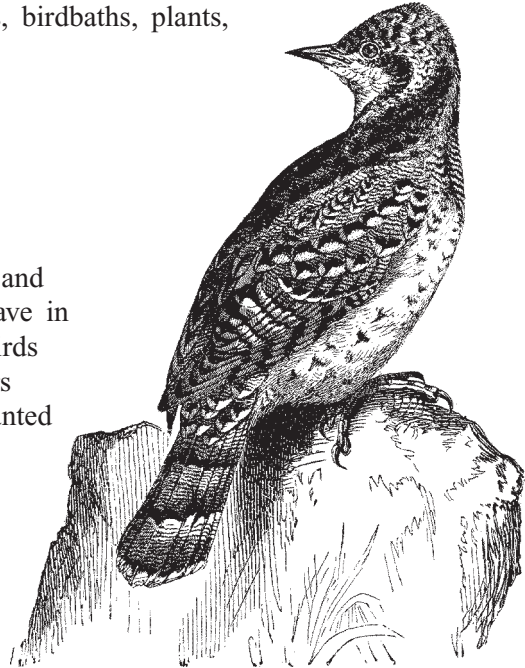

Birdbaths

An added attraction can be a birdbath. Since most birds love to bathe, you could provide a bath near a favorite tree or shrub. A calabash washstand would make a very good birdbath. Since dripping water makes a birdbath even more attractive, hang a large can of water with a hole punched in the bottom, from a branch over the bath. Keep the bath clean and the can filled.



Plants

You can attract birds that live nearby if you provide the kinds of vines, shrubs and trees that give them shelter and food. Plants that attract birds include shrubs that have berries. Hummingbirds like red or pink tubular flowers. Watch what the birds and butterflies are attracted to in your community, and transplant them into your garden.



Nesting Boxes

Nesting boxes, or bird houses, will attract birds that nest in cavities in trees. The boxes should be in low traffic areas and should be in colors that blend with the surroundings. An overhanging roof will keep rain out of the nest. The size of the nest boxes will vary with the species. A chickadee, for instance, will use a box about 4 x 4 x 5 inches with a 2-inch hole in the front. You can also leave nesting materials out in a conspicuous place. Nesting materials include short lengths (no more than two inches) of string or yarn, fleece, dried grass, small feathers, lichens, hair, moss or spider webs.



RESOURCES

Bottle Biology. Dubuque, Iowa: Kendall/Hunt Publishing, 1993.

Durrell, Gerald, *The Amateur Naturalist.* New York: Alfred A. Knopf, 1983.

New UNESCO Source Book on Science Teaching. UNESCO, 1973. Also available on the Internet at http://upo.unesco.org/details.aspx?Code_Livre=377





MATERIALS

22 FLANNEL BOARDS AND PAGIVOLT

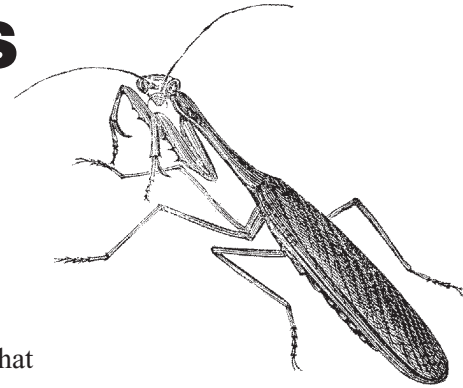

DESCRIPTION

A flannel board is a visual aid that utilizes a flannel or felt covered board as a background, and cut paper or felt figures that stick to the background. A pagivolt is a series of figures drawn on cloth. The figures are used to tell a story, teach a lesson, or describe a problem with suggested solutions. Both techniques are useful ways to teach. They are visual representations that enhance lessons, and are especially useful in areas where literacy is low. Flannel boards and pagivolts are portable and reusable.

USES

Flannel boards and pagivolts can be used to tell a story, describe a process, show relationships, or teach a concept. For example, a flannel board used to teach about the importance of clean water might have figures representing unclean water and how it got unclean, cleaning methods, and clean water. It could include figures and/or words representing bacteria, viruses, protozoans, heavy metals, or toxic chemicals, and a figure representing a sick person and the diseases or conditions caused by unclean water. For water cleaning solutions, the presenter could demonstrate how boiling, filtration, and distillation remove certain bacteria and toxins.

HOW TO DO IT

Materials for Flannel Board:

- ▶ 1 stiff board (wood, cardboard, etc.) any size desired.
- ▶ 1 piece of flannel, felt, or other rough-surfaced material large enough to cover the board plus 5 extra centimeters on each side to fold over edges.
- ▶ Staples, tacks or paste.

Procedure:

1. Cover the board with the material and turn it over.
2. Fold the extra material onto the back and staple, tack or paste it tightly to the back of the board.



Materials for figures:

- ▶ Figures cut from paper or felt, or photographs or drawings pasted onto paper or felt
- ▶ Paste or glue
- ▶ Sand or small pieces of sandpaper or Velcro (two per figure)

Procedure:

1. Spread paste on back of figures.
2. While paste is wet, sprinkle sand over the paste, or paste a piece of sandpaper at the top and at the bottom of each figure.

Materials for pagivolt:

- ▶ Plain fabric, like muslin, in desired size
- ▶ Sketch paper and pencil
- ▶ Paint, markers, fabric paint, wax crayons

Procedure:

1. Plan your presentation beforehand. Decide what you want to depict and draw a sketch. Decide how large you want your fabric to be so your audience will be able to see it clearly.
2. Sketch the presentation on the fabric in pencil.
3. Paint the presentation, or use markers or fabric paint.
4. Crayons can be used to draw the presentation. Then cover the fabric with newspapers or other absorbent paper, and iron the fabric to set the images.

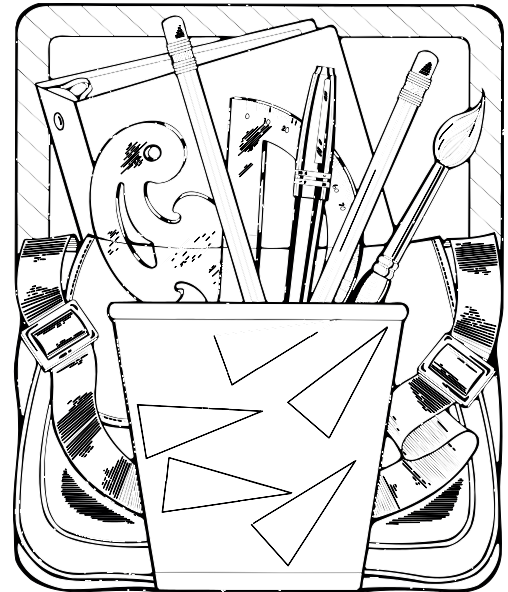



23 POCKET CHARTS

DESCRIPTION

A pocket chart is a chart with pockets for putting cards, word strips, photos or any other visual material.

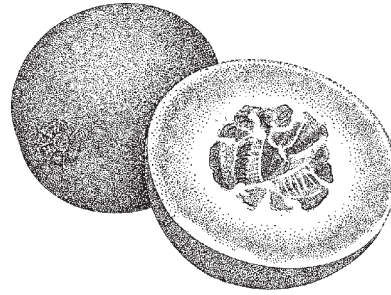

USES

Pocket charts are useful because you can move the cards around as your discussion requires. You can add or subtract cards, and ask participants to add their own ideas on cards.

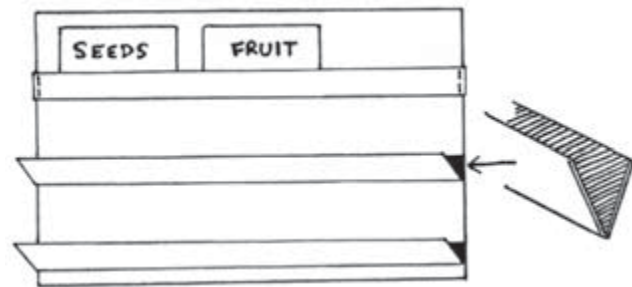

HOW TO DO IT

Materials for cloth pocket chart:

- ▶ Plain colored fabric 1m x 1m
- ▶ 0.5 m clear plastic sheeting
- ▶ 6 strips, 8 cm x 1 m

Procedure:

1. Cut clear plastic into strips.
2. Lay strips on fabric evenly spaced.
3. Stitch sides and bottom of strips to create a transparent pocket. Hem fabric.

Note: This method may be used for constructing a heavy paper pocket chart as well. The cloth model is sturdier than the paper model.

Materials for paper pocket chart:

- ▶ Large piece of heavy paper or light cardboard
- ▶ Glue or staples



Procedure:

1. On a large sheet of heavy paper, draw a solid line 15 cm from the top. Three cm below that, draw a dotted line.
2. Fold solid lines toward the top of the paper, and dotted lines toward the bottom (see diagram) to make pockets.
3. Tape, staple or glue pockets at the side of the chart to hold.

Note: When using cards in this pocket chart, remember that the bottom 3 cm will be covered, so don't write anything there.

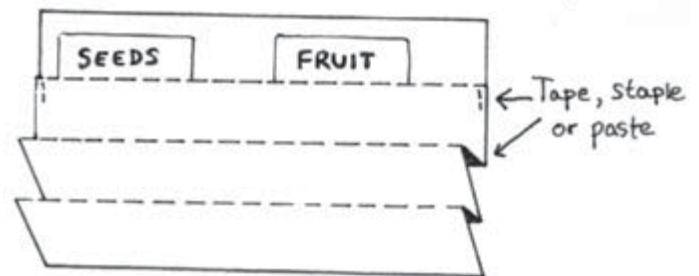
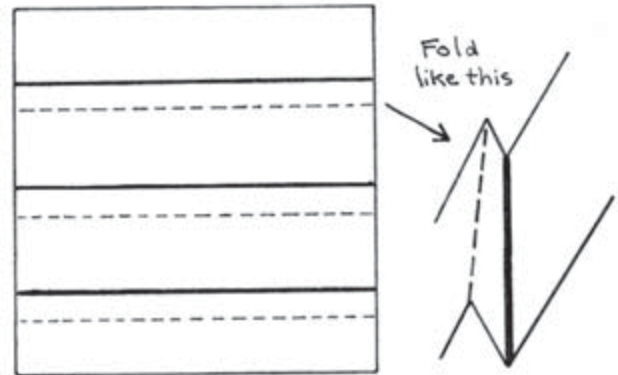



24 ECOTRUNKS

DESCRIPTION



Ecotrunk kits are self-contained kits of educational materials on a particular topic or theme. The kit is meant to have everything a teacher or trainer would need to implement a set of lessons on a particular topic. Schools develop a few kits per year and slowly build a wide selection of topics that any teacher can pick up and use. Museums also develop these traveling educational kits.

HOW TO DO IT



When preparing an ecotrunk, you will need to plan for all possible materials that might be needed. You may even need to plan for blackboards or chart stands. Plan for a normal class size, and then suggest adaptations for classes that are of very different sizes if necessary. A teacher's manual should be included that has lesson plans, materials lists, background information, resources for further information, and contact information for the owner of the kit. You may want to add evaluation information as well. Enclose a complete list of contents so the teacher can make sure to gather up all the materials at the end. If you use consumable materials, make sure to supply sufficient amounts, or let the teacher know if they are responsible for replacing any materials they have used up.



— ECO TRUNK —

“EXPLORING FORESTS” POSSIBLE CONTENTS

Audience: Middle school students, class of 25

Checklist of contents of kit, to be used upon receipt and at the end:

- Teacher's guide including background information on temperate rainforests, lesson plans, list of resources and glossary
- Forest cards with illustrations of organisms that live in the forest as well as cards for sun, water, soil and air
- Succession illustrations and season illustrations
- Increment core borer, 50-meter tape, clinometer, soil thermometer, and plant press
- Field guides to trees and plants, birds, and insects
- Set of 20 forest task cards
- Set of five forest mystery cards (one per 5 students)
- Consumable worksheets: Three sets of 25 per class
- Field white board with three markers and erasing rag
- Five sets of binoculars
- Evaluation forms



EQUIPMENT

25 FIELD EQUIPMENT

DESCRIPTION

Creating “low-tech” equipment is both fun and challenging. Using local materials and local technologies allows community members to make their own equipment in the future. If you are used to expensive manufactured scientific equipment, it may take some thought to devise a low-tech alternative. You need to think about what the equipment is supposed to do, or what it is supposed to measure. A balance and weights, or a spring balance may be able to do just as good a job as the electronic scale in a laboratory. A meter stick can be made from any straight stick or heavy paper. Volunteers have made projecting microscopes from local materials.



For ideas, look in Peace Corps ICE publications or check VITA (Volunteers in Technical Assistance) publications or VITA’s website, www.vita.org.

New UNESCO Source Book on Science Teaching. UNESCO, 1973. Also available on the Internet at http://upo.unesco.org/details.aspx?Code_Livre=377.





26 WEATHER STATIONS

DESCRIPTION

Weather stations usually measure temperature, rainfall, wind direction and intensity, cloud cover and type, barometric pressure and humidity.





Weather Stations Example

WEATHER INSTRUMENTS

Thermometer

Ideally, a maximum/minimum thermometer can be used for temperature. If that is not available, any working thermometer in the proper temperature range will do. It should be kept in a location that is out of the sun and safe from breakage. Often, thermometers are kept in ventilated boxes.

Rain Gauge

A simple rain gauge can be made by placing a funnel in the opening of a bottle. The height of the rain collected is then measured with a ruler in centimeters.

Another slightly higher-tech rain gauge can be made with a can, a straight-sided bottle and a funnel.

How to do it:

Materials:

- ▶ Large can 10 cm in diameter and 14 cm in height
- ▶ Straight-sided glass bottle
- ▶ Funnel
- ▶ Ruler
- ▶ Marker for glass bottle



Procedure:

1. Place the can on a level table and fill it with water to exactly one-centimeter depth as measured by a ruler.
2. To calibrate the glass bottle for measuring, pour the water from the can into the glass bottle and mark the level of water. Label it 1 cm.
3. Repeat at 2 centimeters, etc.
4. To assemble the rain gauge, place the funnel in the top of the calibrated glass bottle and then place the bottle in the can. Set it in an open place where it will not be upset. If the rain is more than the bottle can hold, it will spill into the can and can be measured separately.

Rain gauges are mounted in open, unobstructed areas and must be level. The number of millimeters or inches that is collected is the measure of rainfall.





Barometric Pressure and Humidity

Barometric pressure is measured in millimeters of mercury. The air presses on a column of mercury and pushes it up a thin glass tube. Higher pressure causes the mercury to rise more and indicates the presence of a high-pressure system (usually clear weather, which is hot in summer and cold in winter). Barometers are used to measure pressure, and psychrometers are used to measure humidity. Humidity is the amount of water vapor in the air. When humidity is low, the air is dry. If these instruments are available to you, you can use them in your weather station.

Wind Direction

Wind direction can be measured with a weather vane. Weather vanes can be made of any sturdy weatherproof material and must be mounted so they can swivel easily to indicate wind direction.

How to do it:

Materials:

- ▶ 1 x 1 x 25 cm piece of wood
- ▶ Thin piece of wood or plastic, 10 cm wide x 36 cm long, that will fit into slots (see below)
- ▶ Glass part of a medicine dropper
- ▶ Supporting rod to mount weather vane
- ▶ Nails

Procedure:

1. With a saw, cut a 6 cm slot in both ends of the piece of wood.
2. Cut the thin piece of wood into two pieces shaped like the head and tail of an arrow. Slide one into each end of the slotted wood and fasten with glue or small nails.
3. Balance this wind vane on the blade of a knife to find the exact center, and mark the center.
4. Close the small end of the glass part of a medicine dropper by rotating it in a gas or alcohol flame. Drill a small hole in the center of the wind vane just slightly larger than the small end of the medicine dropper. Drill the hole about three-quarters of the way through the vane.
5. Drive a small nail into the top of the supporting rod. Cut the head off the nail and file it to a point.
6. Balance the medicine dropper on the nail in the top of the supporting rod, and the wind vane on top of the medicine dropper.



Wind Speed

Wind speed is measured with an anemometer. A simple anemometer can be made from local materials and will measure relative wind speed.

How to do it:

Materials:

- ▶ Two pieces of light wood, 1 x 1 x 50 cm
- ▶ Four small plastic dishes or tins (e.g., tuna cans)
- ▶ Medicine dropper
- ▶ Supporting rod
- ▶ Nails



Procedure:

1. Cut a notch 1 cm wide by 0.5 cm deep in the exact center of both pieces of wood.
2. Fit the sticks together to form a cross arm and glue or nail together.
3. Attach plastic dishes or tins to the ends of the four cross arms such that they all face the same direction.
4. Close the small end of the glass part of a medicine dropper by rotating it in a gas or alcohol flame. Drill a small hole in the center of the cross arms just slightly larger than the small end of the medicine dropper. Drill the hole about three-quarters of the way through.
5. Drive a small nail into the top of the supporting rod. Cut the head off the nail and file it to a point.
6. Balance the medicine dropper on the nail in the top of the supporting rod, and the cross arms on top of the medicine dropper.

Calibrating the wind speed indicator (anemometer):

- ▶ You can get a rough idea of the speed of the wind in miles per hour by counting the number of revolutions in 30 seconds and dividing by 5. If it is difficult to count, paint a red dot on one of the dishes, and use that dish to count. If you want the wind speed in kilometers per hour, divide your above result by 0.62.
- ▶ Another way to calibrate your anemometer is to have someone drive on a calm day while you hold the anemometer out the window. Count the number of revolutions per minute at 10, 15, 20, 25, 30 and 40 miles per hour.



Cloud Cover and Type

Cloud type can be determined from cloud type charts. If you are in a country that is a member of the GLOBE program, GLOBE has cloud charts. If not, cloud charts may be available at bookstores or libraries.

Cloud cover is measured in percentages of sky covered: no clouds (0%), clear (0-10%), isolated (10-25%), scattered (25-50%), broken (50-90%) and overcast (90-100%). It takes practice to estimate the percent cover. Standing in an open area and facing one direction shows half the sky. You can use your arms to block off half of that to estimate the cover in one quarter of the sky. Then estimate the other quarter, and then the other half. Decide if half the sky is covered by clouds. If it is slightly more covered, then it is broken. If it is slightly less, it is scattered. If it is less than one quarter covered, it is isolated. If there are only a few clouds, it is clear. If it is entirely covered, it is overcast.

RESOURCES

GLOBE (Global Learning and Observations to Benefit the Environment) Teacher's Guide, The GLOBE Program, 1997. Gives instrument specifications for atmosphere, hydrology, land cover, soils and seasonal change. Includes directions for making some of the equipment.

New UNESCO Source Book on Science Teaching. UNESCO, 1973. Also available on the Internet at http://upo.unesco.org/details.aspx?Code_Livre=377.





27 PLANT PRESSES

DESCRIPTION

Plant presses are used to preserve plant specimens for reference or future examination. The basic idea is to place plant specimens between absorbent materials, usually paper, and then apply pressure to press them flat and allow them to dry with minimal loss of color and detail. The absorbent paper is usually placed between layers of cardboard, and finally all the layers are placed between two pieces of wood (or under a stack of books), and pressure applied. The press can be compressed by using Velcro, weights, or bolts.



HOW TO DO IT

To get good results from pressing plants, it is best to use fresh specimens. If you can't press them immediately, put them in a vase with water until you can get to them.

Plant presses allow you to preserve flowers, leaves, stems and roots. The basic idea is to place the specimens between absorbent pieces of paper and apply pressure. There are several ways to do this.



The Old-Fashioned Book Method:

Place your specimens between paper towels or other absorbent paper. Place the specimen and paper inside a big book, or between several books.

Tennis Racket Press:

A tennis racket frame is a four-sided frame that can be tightened with four wing nuts and bolts at the corners. To turn it into a plant press, cut two boards to the size of the racket frame. Place your specimen and paper between the two boards, and place the boards inside the racket frame. Tighten the wing nuts.



PLANT PRESS

The basic materials that you need for constructing a plant press are:

- Newspaper
- Several pieces of corrugated cardboard (30 centimeters by 45 centimeters is a standard size)
- Straps or cords
- Plywood or lattice made of wooden laths (cut to 30 centimeters by 45 centimeters)

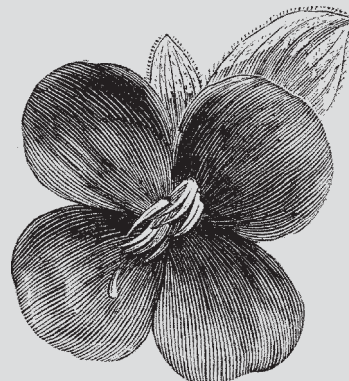

Leaf samples should be put in the press within a few hours of their collection. Place the sample between several sheets of newspaper. Sandwich the sample between two cardboard separators. Place another sample on the flip side of one of the separators and repeat the process until you have prepared all the samples you have gathered for the day. Samples with thicker stems or small fruits can be accommodated by inserting pieces of foam rubber between the newspaper and cardboard separator. Bind the press together with the straps. Check samples daily and change any damp newspaper. Remove them when they are dry. In particularly humid conditions, dry the samples where dry heat is available, e.g., well above or beside (not too close!) a cooking fire. Stiff white paper works best for mounting. Plants can be mounted using sticky tape or rubber cement. Affix a label that includes information on the name(s) of the plant, date of collection, traits used by local people to identify the plant, and notes on habitat. Include other interesting characteristics/uses.

From *Learning Local Environmental Knowledge: A Volunteer's Guide to Community Entry*. Peace Corps [ICE No. M0071], page 61.

RESOURCES

Durrell, Gerald, *The Amateur Naturalist*. New York: Alfred A. Knopf, 1983.



OR

1. Split the bamboo in half lengthwise.
2. Clean out any center nodes.
3. Attach wire screening to the open ends.

Make a sprinkling can by punching holes in the bottom of a large can with a hammer and small nail.



4. Fill one box with loose soil, the other with tightly packed soil. Tilt the boxes so the screened ends are lower, and place containers under the lower ends to catch run-off water.

Sprinkle with water from the sprinkling can and watch to see which soil washes away most, and what the water that is collected looks like.

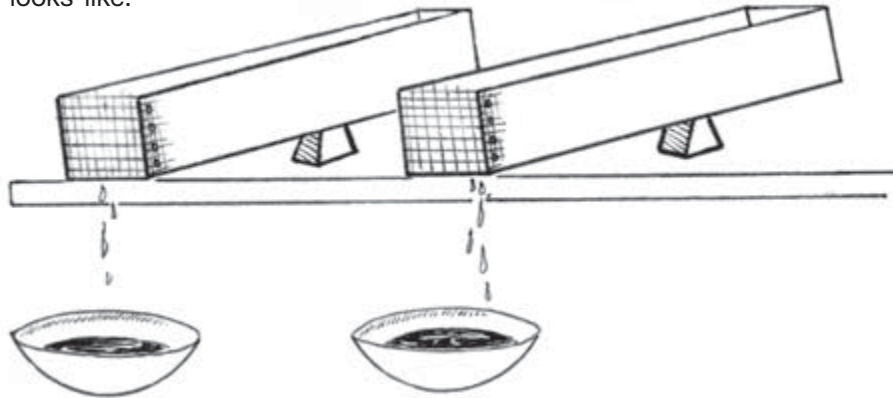

5. Smooth loosely packed soil in each box, and in one box make three or four grooves in the surface with a stick, running the length of the box; in the other, make grooves across the box every 6-8 cm. Tilt the boxes as before.

Sprinkle each box heavily with water from the sprinkling can. Note how water flowing downhill follows the grooves and makes them deeper. Note how grooves cut against the flow of water helps keep the soil from washing away. Note how much soil was washed from each box into the catch containers.

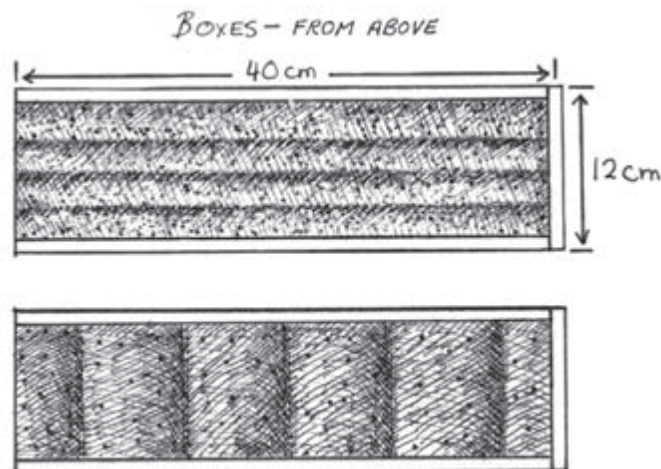

(continued)



6. Sprinkle loosely packed soil in each tilted box with water until the water washes its own grooves into the soil. With little sticks and stones, block the grooves at intervals and sprinkle again. How do obstacles help prevent erosion?
7. In one box, seed the surface generously with some grass or other ground-cover seed. Give the box water and light for the seeds to grow. When the grass is thick and about 2.6 cm high, tilt the box it is in, and the second box which has only soil, as before.

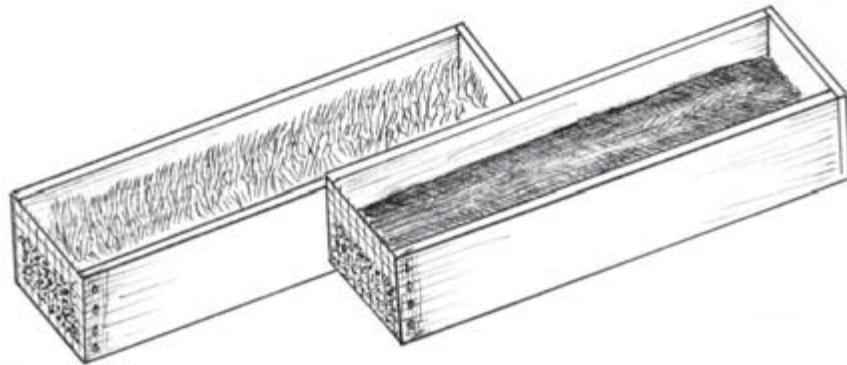

Sprinkle heavily with water from the sprinkling can. Note how the grass prevents the water from moving the soil down and into the catch container. (A piece of sod placed on the soil in one box could demonstrate this also.)

A class project could be to locate a place in the community where water erosion has taken place. Plan and carry out ways that could prevent further erosion; plan ways to upgrade or restore the soil (such as filling with gravel or stones, channeling the water in another direction, planting ground cover).





29 WATER SAMPLING EQUIPMENT

DESCRIPTION

Water quality measurements include flow rate, transparency, chemistry and temperature, as well as biological indicators. Temperature is measured with a thermometer, and water chemistry measurements require chemicals for measuring dissolved oxygen, nitrates, etc. Transparency is measured with a Secchi disk or turbidity tube.

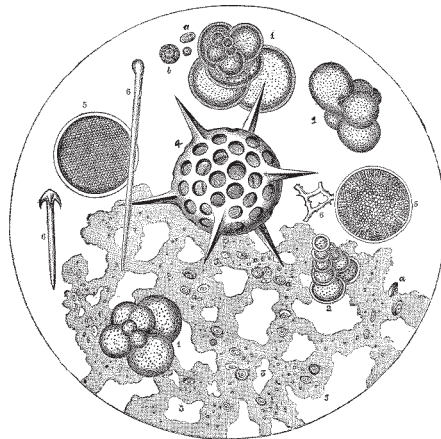

HOW TO DO IT

To examine the plants and animals in the water body, you will need several simple pieces of equipment. The best places for gathering water creatures are grassy areas and under rocks. They tend to be abundant in shallow, warm areas with lots of hiding places. A simple measure of water health is diversity: generally, the more types of life you have in a water body, the healthier the water. That doesn't mean the numbers of organisms, but rather the number of different species.

Examining animals:

White-bottomed basin or tray to temporarily put animals into for examination.

Sorting tray:

If you want to sort them, an ice cube tray works well, or small jars.

Collecting water creatures:

To gather water creatures from the water, use an ordinary kitchen sieve or a net. Simple nets can be made with wire (coat hangers work well), panty hose or fine mesh netting and small jars. The size of the mesh will determine the minimum size of organisms you can capture.



Magnifying water creatures:

Hand lenses are useful for looking at small animals and plants.



Flow rate:

To determine the flow rate of a stream, mark two places along the bank for a start and finish. Measure the distance between these two markers. To make this easy, try to place the markers 10 meters apart. Find a small floating stick to use for timing. You will need a timer with a stopwatch, or a watch with a second hand. When the timer says, “go,” another person drops the stick at the upstream starting stick and watches it as it floats to the downstream finish stick. When it is even with the finish stick, the person tells the timer. To determine the flow rate, divide the number of meters by the number of seconds. For example, if the stick took 20 seconds to float between two markers 10 meters apart, $10 \text{ meters}/20 \text{ seconds} = 1/2 \text{ meter per second}$.

Water chemistry kits:

The most common water chemistry kits are for dissolved oxygen and nitrates. If these are available to you, they will have directions for their use. Dissolved oxygen is an indication of the capacity of the water to allow growth. Generally, the more oxygen there is, the more growth. Colder waters hold more oxygen than warmer waters. When algae blooms in water bodies, it uses up the oxygen, so dissolved oxygen is also a measure of eutrophication, or excessive algal growth. Nitrate chemistry is a general measure of decomposition or pollution. High nitrates are deleterious to organisms because bacteria are not able to process nitrogenous wastes fast enough.

Secchi disk:

Make a Secchi disk from a disk with a black and white pattern on it that is lowered into the water until the pattern cannot be seen. The depth at which the pattern is no longer visible is a measure of the water transparency.

A Secchi disk is a circle of wood or plastic that you can paint black and white. Divide the circle in fourths and paint alternating quarters black and white. This design is highly visible. Attach a sturdy eye screw to the center of the disk, and attach a long rope to the eye screw so the disk may be lowered into the water. Mark the rope at 10-centimeter intervals with survey tape or permanent marker or knots. Lower the disk slowly into the water until you can no longer see the design. Read the depth of the disk by counting the number of marked intervals on the rope.

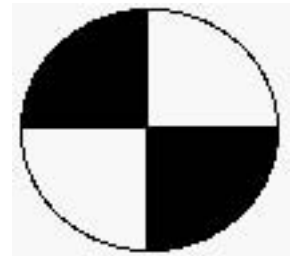

Turbidity tube:

A turbidity tube is a long transparent tube that is marked along its side by centimeters. Water is poured into the tube until the black and white pattern at the bottom can no longer be seen. An easy way to make a turbidity tube is from the clear plastic covers that florescent lights are shipped in. Remove the end caps. Inside one of the caps paint the black and white pattern described above. Replace the cap and seal it with waterproof tape. Along the side of the tube, mark off centimeters with a waterproof marker or paint.

To use the tube, pour the water you are testing into the tube until you can no longer see the pattern at the bottom. Read the height in centimeters off the side of the tube to determine transparency. If you fill the tube and can still see the pattern, the water is highly transparent.



RESOURCES

Angel, Heather and Pat Wolseley, *The Water Naturalist*. New York: Facts of File, 1982.

Durrell, Gerald, *The Amateur Naturalist*. New York: Alfred A. Knopf, 1983.

GLOBE (*Global Learning and Observations to Benefit the Environment*) *Teacher's Guide*, The GLOBE Program, 1997.

Stapp, William, and Mark K. Mitchell, *Field Manual for Global Low Cost Water Quality Monitoring*. Dexter, MI: Thomson Shore Inc, 1995. [ICE No. FC234]

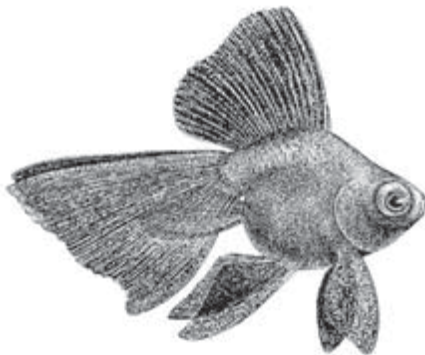
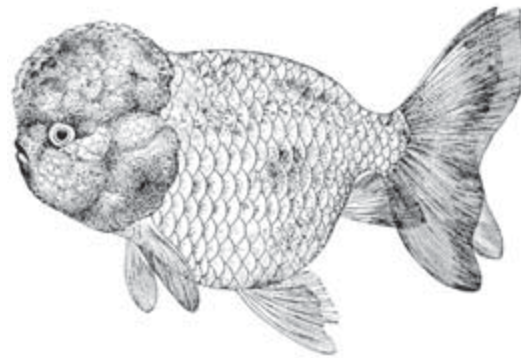
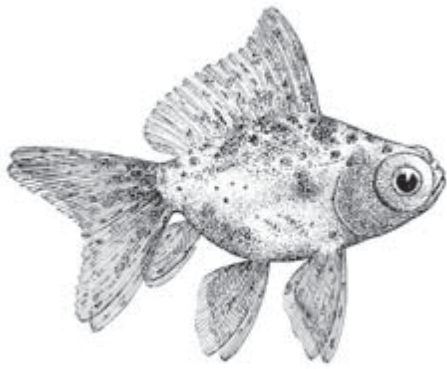



30 MEASURING ACIDITY

DESCRIPTION

Acidity (pH) is measured on a scale of 1.0 (extremely acidic) to 14.0 (extremely basic or alkaline). Pure water has a pH of 7.0. (Lemon juice has a pH of about 2.0; stomach acid is about pH 0.9; blood is about 7.5; seawater is 8.6 and Drano is about 13.5)

For living organisms, the pH of their environment should be neither too acidic nor too basic. Both acids and bases damage cell walls. There are several geological processes that can make water slightly acidic due to dissolved minerals in the water. Many water plants and animals are adapted to slight acidity (a slightly low pH of 5.6-7.0). Excess acidity from either natural sources or human sources such as acid rain or agricultural or industrial chemicals can be harmful to living organisms. Likewise, excess alkalinity (high pH above 8.0) can be harmful. Measuring acidity and alkalinity can, therefore, be an indication of water quality.

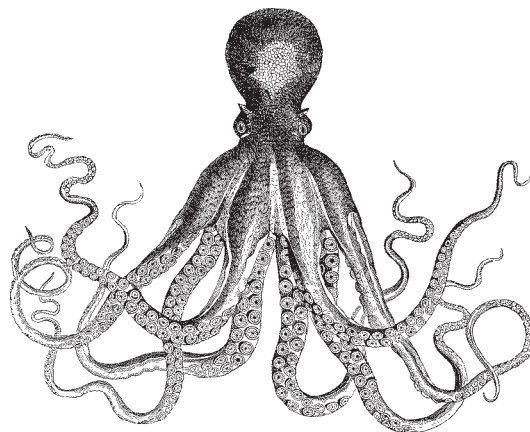

HOW TO DO IT

There are several ways to measure acidity. If you have a pH pen, pH meter or pH paper, measuring acidity is a simple matter of putting the pen, meter probe or paper into the water for two minutes and reading the results on a scale that comes with the instrument.

There are also indicator solutions, such as phenolphthalein, bromthymol blue, phenol red and a range of others. To use a solution, collect a small sample of water or test solution in a cup and add several drops of the indicator. The indicator will be a specific color, depending on the indicator and the acidity of the water. At a specific pH, indicators change color. The indicator's container will give the pH range for that indicator. If you have indicator solutions available to you, the most useful ones for testing water quality will be indicators that test pH 4.0 to 8.0.

Red cabbage juice is also an indicator of acidity. The juice turns from bluish purple to yellow at a pH of 2.4 - 4.5. If this indicator turns yellow, the water is too acidic for most organisms. To make this indicator, cut up a red cabbage and place it in a pot with enough water to completely cover it. Boil it to extract the juice. You will see the water turn purplish. Let the juice cool, and store in a dropper bottle. Add 10 drops to one tablespoon of the indicator to your water sample to test for acidity.

RESOURCES

Bottle Biology. Dubuque, Iowa: Kendall/Hunt Publishing, 1993.





RESEARCH

31 FIELD RESEARCH

DESCRIPTION

You and your community members do not have to have Ph.Ds in science to conduct research. All research is an effort to answer a question by finding evidence. The evidence is in the form of data. Anyone can conduct research, from 7-year-olds to 70-year-olds. There was a first grader in Nenana, Alaska, who wanted to know if the bread really always did fall jelly side down. So he designed an experiment where he dropped bread slices with jelly on them from a standard height (30") with a standard method (pushed off a table jelly side up) 100 times. Bread only drops jelly side down half the time. This experiment was a real, original piece of research.

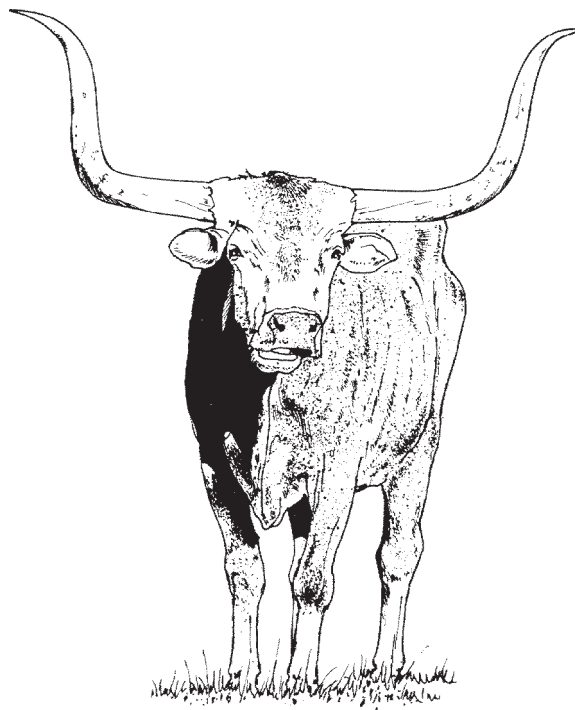

USES

Environmental research is usually more difficult because environmental systems are more complex and less controllable. It may take some thought to figure out what to measure, and how to measure it in order to find an answer to your question. Often community environmental research focuses on taking longitudinal data on a system of interest, like a water system, or fertilizer use. People want to know things like: if the water is clean enough to drink, or if the fertilizer or pesticide really works to increase growth or decrease pests, or if a certain grazing pattern makes for healthier cows. So the research then becomes measuring water quality, testing crops with and without the fertilizer or pesticide, or comparing cow health with different grazing patterns.

HOW TO DO IT

Usually the first step is to create definitions that can be tested. What, for example, defines a healthy cow? Is it weight, or growth over a given time period or hide quality or being disease-free? The next step is to gather baseline data. What do the cows weigh, how fast do they grow and how much, what does their hide look like and how often do they get sick under normal conditions? For the fertilizer example, you would want to know how tall your crop grows before treatment with the fertilizer, or how much you can harvest per hectare before treatment with the fertilizer. Then you apply the question you are studying: in these cases, grazing pattern and fertilizer, and measure again after the treatment to see if there is any difference.



In countries that are just beginning to be aware of environmental issues, much environmental research is gathering baseline data about what their current situation is: how many species, which species, how much area is affected, how many acres of forest, extent of water pollution in a given stream. Volunteers can be very helpful by facilitating the gathering of **inventory and baseline data**.

Another type of research is **demonstration projects**. Communities can set up research to determine the effects of a variety of treatments on their gardens, forests, fishponds, etc. Generally people don't want to experiment on their own cash crop. However, small studies can be conducted by organizations that will not make or break a family. For example, to test types of pesticides, separate plots of the same species can be planted, and all but one treated with a pesticides. One would not be treated at all to act as a control. (What if we did nothing?)

RESEARCH — ECUADOR —

A Volunteer worked with a natural resources foundation in Ecuador. Primarily working in the field of agroforestry with his counterpart agency and its various surrounding communities, he spent much time in the field, observing and using mist nets for the study of the migration of birds to the Podocarpus National Park and its buffer zone. This information was incorporated in his environmental education work in the various communities to help promote and preserve the biodiversity of Ecuador.

During his second year of service, he participated in a study researching the conservation of bird habitats in Podocarpus National Park which is a nationally protected area. This study was in conjunction with the Nature Conservancy and Alas de las Americas (Wings of the Americas). Alas de las Americas collaborated with both the Poconos State Park in Pennsylvania and the National Park of Podocarpus. Through observation and data collection, relations were formed and information regarding migrating birds was shared and exchanged between the two parks. Afterward, the Volunteer was interviewed on a national TV program, which was then aired internationally. This brought worldwide attention in the area of conservation of bird habitats and biodiversity. On a personal level, he used this experience as an opportunity to expand his research techniques.



After completing an initial training period, he taught university students and park guards in the area of biodiversity and bird research. Topics covered included optimal methods to observe, investigate, capture, mark and release bird species.

In addition, the Volunteer developed a bee project with two complementary goals in mind; the first, to conserve the protected forest of El Tundo, and the second to provide an income-generating activity. This was a highly successful project as it fulfilled both goals, using natural resources to better the lives of Ecuadorians without disrupting, but instead fostering, the delicate ecosystem.



EXAMPLES

Some sample research projects:

Ecosystem Studies:

- ▶ Biodiversity: catalogue species living in a certain area,
- ▶ Phenology: Record timing of seasonal changes including budburst, senescence (leaves falling), flowering, harvest, arrival of migratory species, temperature and daylight changes,
- ▶ Species of Interest: in depth observations of a particular species of interest, such as elephants, bees, or medicinal plants. These studies might include population size, seasonal changes, food, breeding season, hibernation, migration, soil and water conditions, or predation,
- ▶ Effects of flooding, fire or drought.
- ▶ Erosion patterns and amounts,
- ▶ Impact of human use on plants, animals, water, air, or soil.

Soil Studies:

- ▶ Types of soil in the area
- ▶ Layers of soil
- ▶ Soil moisture
- ▶ Drainage in different types of soil
- ▶ Soil texture and composition
- ▶ Soil chemistry
- ▶ Methods of preventing erosion
- ▶ Effects of fertilizers or pesticides
- ▶ Which seeds grow in which soils
- ▶ Soil contamination



Water Studies:

- ▶ Indicator species: Insect biodiversity as an indicator of water health
- ▶ Acidity/alkalinity
- ▶ Transparency/turbidity
- ▶ Flow rate
- ▶ Dissolved oxygen
- ▶ Water chemistry
- ▶ Possible sources of water
- ▶ Water filtration methods



- ▶ Water treatment methods
- ▶ Water pollution

Plant Studies:

- ▶ Which plants grow in an area
- ▶ Which plants indicate what soil and water conditions
- ▶ Which plants need sun or shade
- ▶ Which plants are eaten by animals (domestic and wild)
- ▶ Which plants are used by people for what purposes

Animal Studies:

- ▶ Identify resident animals
- ▶ Identify migratory animals
- ▶ Identify animals impacted by humans
- ▶ Identify animal pests
- ▶ Study animals of interest to determine their food, feeding habits, migratory patterns, reproductive behavior, shelter, defensive behaviors or reaction to humans
- ▶ Study dangerous animal behaviors so as to prevent injuries
- ▶ Study animal-human interactions to learn about the impact of humans on animals and vice versa





32 MAKING MAPS

DESCRIPTION

Maps are useful instruments for indicating topography, distance, and characteristics of land areas. Maps can be useful to Volunteers to show where geographic features are located, and the extent of land area covered by certain types of terrain, plant communities, crops or other items of interest. Maps also show the relationship of different types of land use, such as irrigation and farmland, or waste disposal and water supplies.

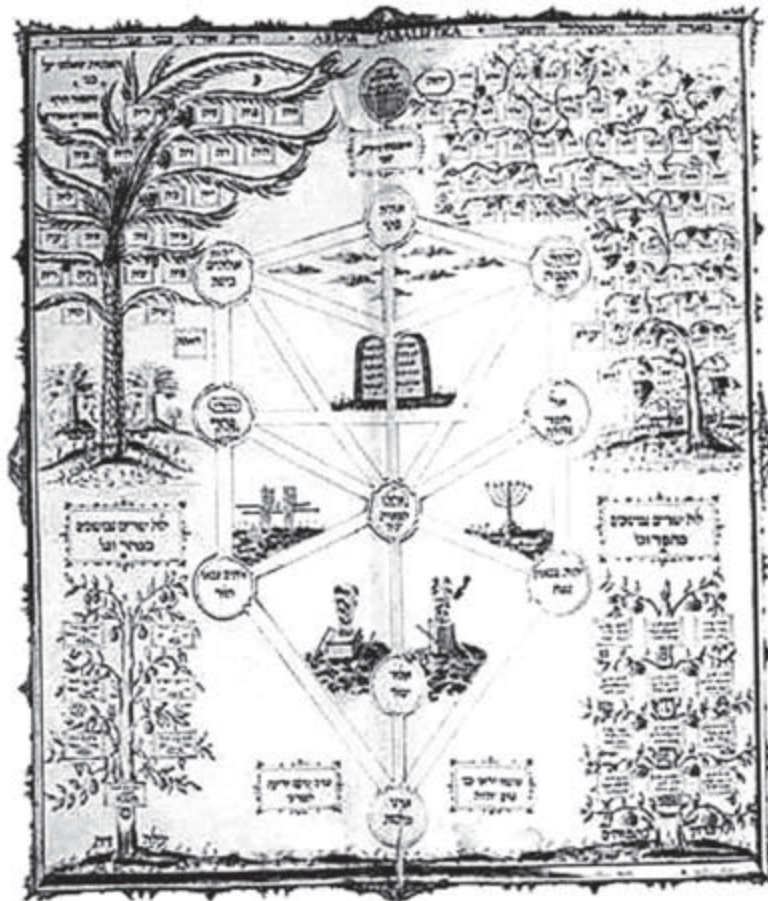

**Making Maps Example**

MAKING MAPS USING A COMPASS, AND PACING OR MEASURING TAPE

Before you start mapping, determine your pace. A pace is two steps, that is, the distance you travel as you step from your right foot to your left and back on to your right. Lay out a 10-meter line, or measuring tape on flat ground. Place your right heel at the beginning of the line and walk naturally to the other end counting every time you put down your right foot. Divide the number of paces you counted by 10 to determine the length of your pace. Repeat three times to get an average. This will be very useful in determining distances.

How to do it:

Make a plan for how you want to map the area of interest. How much area do you want to map? What features do you want to map? Have at least one other person help you with the mapping.

Materials:

- ▶ Compass
- ▶ Measuring tape, 50 meters long if available
- ▶ Grid paper to record landmarks
- ▶ Flagging to record landmarks on the ground

Procedure:

1. Walk the area to be mapped before taking any measurements to get a general idea of what you will be working with. Pace the length and width to get an idea of how large the area will be.
2. Develop a grid sheet with an appropriate grid scale (e.g., 1 cm = 1 m, or 1 cm = 100 m) and take a blank grid sheet into the field to record measurements.
3. Determine a starting point. It should be something easy for anyone to find, like the front door of the Park headquarters, or the corner where a road and a river intersect.
4. From your starting point, choose a direction to walk (e.g., along a perimeter, along a river bank, etc.) and find the compass direction you will be walking. Using the compass to keep you pointed in the same direction while you walk, measure the distance (by pacing or tape) from the starting point in a straight line to a landmark.
5. Using the grid scale, draw a line on the grid that represents that length and direction. For example, if you walked north 100 meters from your starting point, and your grid had a scale of 1 cm = 100 m, you would draw a line in a northerly (towards the top of the paper) direction, one centimeter long. Lay the compass on the grid with North pointing to the top of the grid to determine direction.





6. From that point, choose another compass direction and measure off another segment, marking it on the grid to scale.
7. Continuing in this way, you can map your area of interest. If you are noting buildings, growth patterns or other features, measure their perimeters and compass directions and mark them on the grid.

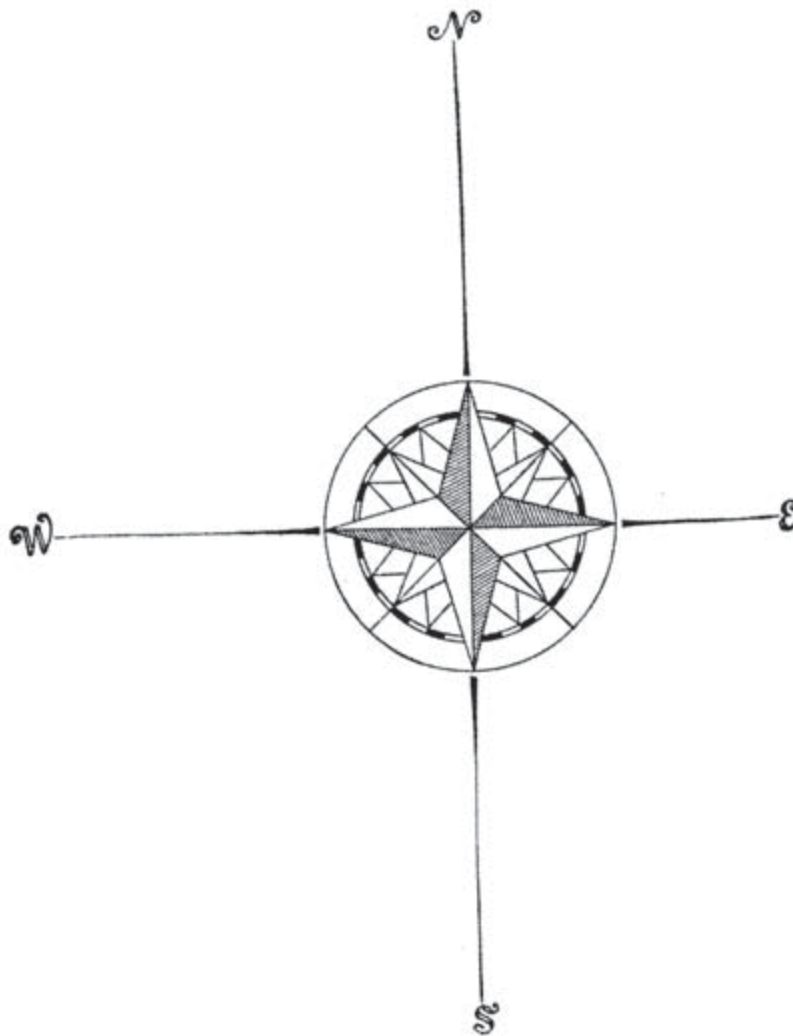



Making Maps Example

MAKING MAPS USING A GLOBAL POSITIONING SYSTEM (GPS) INSTRUMENT

How to do it:

To read a GPS, stand in an open area with a clear view of the sky. Hold the GPS in your hand with the antenna pointing towards the sky. Turn the GPS on by pressing the Power button (it may be labeled PWR or ON or some other designation.) Press Enter to get the Status screen. The Status screen will be showing while the GPS is receiving satellite data. It will show circles with numbers indicating the nearby satellites. It will also show a graph indicating the reading of satellite information. The bars on the graph will turn black when the satellite signal is strong. It will take three or four strong signals before the GPS can determine your location. When the GPS has determined your location, the screen will shift to a position screen that will show your longitude, latitude, elevation date, time and perhaps other data.

There are several ways you can use a GPS to map.

- ▶ If you are mapping a large area, you can take latitude and longitude readings at key points and “connect the dots.” For example, if you want to determine the boundaries of a site, you can take a GPS reading at each corner and transfer that information to a grid. You can set your longitude and latitude readings as waypoints and the GPS will compute the distances between them.
- ▶ A GPS will also allow you to establish waypoints and routes between the waypoints. It will also tell you what direction you are going, like a compass. GPS technology is constantly being updated, so refer to the manual for your particular GPS for operational procedures. GPS readings are taken off satellites and can be constantly updated as you move. The GPS will have a plotting function, or Plot Screen that will allow you to identify waypoints and track your movements. You can set the scale of the plot screen so as to view larger or smaller areas. It will also allow you to compute distances between points.

RESOURCES

GPS 315/320 User Manual, Magellan Corporation, 1999.

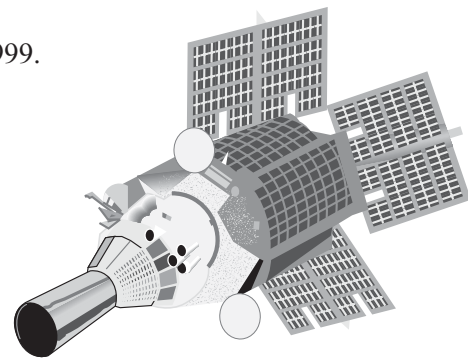



33 TRANSECTS

DESCRIPTION

A transect is literally a set of measurements along a line across an area. For example, if you wanted to know which plants grow at what elevations, you could run a transect from high elevation to low, listing all the plants in a square meter, every 100 meters along a straight line. You would end up with an idea of how plant communities change with elevation. Transects are useful for learning about changes over an area, for studying succession, or for sampling an area.



HOW TO DO IT

1. Determine the area to be studied and the observations to be taken.
 - a. Do you want to know how many trees per hectare?
 - b. Do you want to know which species of trees grow in an area?
 - c. Do you want to know, on average, how many eagle's nests are in a square mile?
 - e. What kind of ground cover plants live in your garden?
2. Determine the most appropriate sampling method. For the above examples:
 - a. Count the trees in 10 samples of 100 meters square, find the average and multiply by 100.
 - b. Choose three transect lines through the study area and walk them identifying every species of tree.
 - c. Determine a transect across eagle nesting areas, count the nests, measure the length of the transect, and divide the number of nests by the length of the transect to determine a per mile average.
 - d. Tie a four-meter long string into a loop. The loop will measure one square meter (one meter per side). Start at one corner of your garden and throw the string. Wherever it lands, spread it out to its full size and identify every plant inside the loop. Walk the diagonal of your garden, throwing the loop every 10 meters. Count up how many of each type of plant you identified to determine percentages for ground cover plants.



APPENDIX - TRAINING MODULES

1

SESSION 1: DO AN ENVIRONMENTAL ASSESSMENT

OVERVIEW



In this session, participants will practice the first step of developing an environmental education program — plan and conduct an environmental assessment of a local community using the templates in Chapter 2.

Note to Trainer: Please read Chapter 2: “Assessing and Discovering the Environmental Situation” to prepare for this lesson.

PURPOSE



- To introduce the concept of environmental assessment and the specific tools and structure contained in *Environmental Education in the Community*.
- To practice the techniques and methodologies of environmental assessment.

TIME



Two hours to all day, depending on how much time is available.

STEPS



1. Break the group up into pairs.
2. Give each pair two copies of the same environmental element (e.g., “biodiversity” or “soils and land”).
3. Explain that each pair will go outside, walk through the community and answer the questions on their sheets as best as they can.
4. Agree upon a time for all pairs to return.





5. Depending on how much time is available, the participants can answer just a few questions, only the questions for the “town” areas, or they can complete the entire form. The length of time that it takes to complete this task will also depend on the language level attained by the participants.

QUESTIONS FOR DISCUSSION



- What did you observe?
- What did listening and observing tell you?
- How did people respond to your questions?
- What can you do next time to be more effective? (List answers on a flip chart.)

FOLLOW-UP ACTIVITY



Have each team choose one environmental issue (or more) that came out of the assessment and make a list of possible solutions and constraints that the issue presents.

Discuss: Is it feasible to work past the constraints to address the issue? If not, choose a different issue.

REVIEW THE SESSION



Remind participants that they have just done a practicum on the first activity in developing an environmental education program. Suggest that participants read Chapter 2: “Assessing and Discovering the Environmental Situation” for more information.





2 SESSION 2: DEVELOPING AN ENVIRONMENTAL EDUCATION ACTIVITY

OVERVIEW

In this session, participants will identify a target group, choose a message and pick an appropriate educational strategy (methodology) based on the issue that they chose in Session 1.

Note to trainer: Please read Chapters 3-5 in *Environmental Education in the Community* to prepare for this lesson.

PURPOSE

- To introduce and practice the concepts of targeting a group, choosing a message and picking an appropriate educational strategy.
- To plan the activity that participants will facilitate in Session 3.

TIME

Three to three-and-a-half hours.

MATERIALS

- Participants' environmental assessment materials from Session 1.
- Flipcharts: Target Group Guidelines (See page 48 in Chapter 3.)
Awareness Continuum (See page 55 in Chapter 4.)
Preparing the Program (See box, next page.)
- Pens
- Paper

STEPS

1. Tape up the Target Group Guidelines flipchart and review it with the group.
2. In the same pairs as Session 1, have participants develop a list of potential target groups for the environmental issue they identified in the previous session.





3. Explain: The goal of an environmental education program is to move the target group along this continuum, so the specific message should be tailored to the needs of a target group depending on their position on the continuum.
4. Discuss the four stages of the continuum with the group.
5. Then, tape up the Awareness Continuum flipchart and have participants determine where their target groups are on the continuum.
6. Tape up the Preparing the Program flipchart and have the pairs develop a statement that describes their environmental issue, a rationale, a goal, and learning outcomes for the environmental education program.
7. Have each pair select a strategy to use to present their environmental message. (Chapter 10: “Environmental Education Community Projects” has many ideas and suggestions.)

REVIEW THE SESSION

Suggest that participants read Chapters 3 through 5, and browse Chapter 10 to review what was presented in this session.

PREPARING THE PROGRAM

Statement

Describe the issue in a short, concise manner.

Rationale

Explain why this situation merits an EE program. Discuss ways to improve the situation and how getting information to the target group will help.

Goal

State what the program intends to accomplish.

Learning Outcomes

List what the target group has to understand and believe in order to change their behavior.





3 SESSION 3: PRACTICE TEACHING (IMPLEMENT, EVALUATE, ADAPT)

OVERVIEW

During this session the participants will practice the activities that they have planned.

Note to trainer: Depending on the needs of the group, an optional session to this is asking the entire group to plan a one-day (or one week) camp using the guidelines in Chapter 8: “Environmental Education Camps.” This optional activity could also be used as a Session 4, after Session 3, if time permits.

PURPOSE

- To give the participants hands-on experience delivering environmental education messages in the culture in which they will be working.
- To provide the participants with constructive feedback on their teaching.

TIME

Will vary.

MATERIALS

Participants will organize their own materials.

STEPS

Each team should prepare and present a short activity. These activities could last anywhere from 15 minutes to half a day, depending on the time available for this session. Working with groups of visitors to a protected area or school groups in the local language would be ideal, but using other participants as “students” is also fine. The goal is to organize and lead an environmental education activity that is similar to their actual situation.

REVIEW THE SESSION

At the end of the session, the participants should evaluate their sessions.

- Did the session meet the goals they had set?
- What went well?



- What would they change for the next time?

Suggest that participants read Chapters 6 and 7, (or Chapter 8, depending on your chosen activity) to review what was presented in this session.

