

---

# Chapter 10

# Agricultural Waste Management System Component Design

---

---

<b>Contents:</b>	<b>651.1000</b>	<b>Introduction</b>	<b>10-1</b>
	<b>651.1001</b>	<b>Production</b>	<b>10-1</b>
		(a) Roof runoff management .....	10-1
		(b) Runoff control .....	10-3
	<b>651.1002</b>	<b>Collection</b>	<b>10-4</b>
		(a) Alleys .....	10-4
		(b) Gutters .....	10-6
		(c) Slatted floors .....	10-8
	<b>651.1003</b>	<b>Storage</b>	<b>10-11</b>
		(a) Waste storage facilities for solids .....	10-11
		(b) Liquid and slurry waste storage .....	10-16
	<b>651.1004</b>	<b>Treatment</b>	<b>10-27</b>
		(a) Anaerobic lagoons .....	10-27
		(b) Aerobic lagoons .....	10-35
		(c) Mechanically aerated lagoons .....	10-39
		(d) Oxidation ditches .....	10-41
		(e) Drying/dewatering .....	10-41
		(f) Composting .....	10-42
		(g) Mechanical separation .....	10-62
		(h) Settling basins .....	10-64
		(i) Dilution .....	10-66
		(j) Vegetative filters .....	10-66
	<b>651.1005</b>	<b>Transfer</b>	<b>10-67</b>
		(a) Reception pits .....	10-67
		(b) Gravity flow pipes .....	10-68
		(c) Push-off ramps .....	10-68
		(d) Picket dams .....	10-68
		(e) Pumps .....	10-70
		(f) Equipment .....	10-70

<b>651.1006</b>	<b>Utilization</b>	<b>10-71</b>
	(a) Nutrient management .....	10-71
	(b) Land application equipment .....	10-72
	(c) Land application of municipal sludge .....	10-72
	(d) Biogas production.....	10-72
<b>651.1007</b>	<b>Ancillary components</b>	<b>10-78</b>
	(a) Fences .....	10-78
	(b) Dead animal disposition.....	10-78
	(c) Human waste management .....	10-79
<b>651.1008</b>	<b>Safety</b>	<b>10-80</b>
	(a) Confined areas .....	10-80
	(b) Aboveground tanks .....	10-81
	(c) Lagoons, ponds, and liquid storage structures.....	10-81
	(d) Equipment .....	10-81
<b>651.1009</b>	<b>References</b>	<b>10-82</b>
<b>651.1050</b>	<b>Appendix 10A—Blank worksheets</b>	<b>10A-1</b>
<b>651.1060</b>	<b>Appendix 10B—Rainfall intensity maps</b>	<b>10B-1</b>
<b>651.1070</b>	<b>Appendix 10C—Runoff from feedlots and evaporation</b>	<b>10C-1</b>
	(a) Runoff .....	10C-1
	(b) Evaporation .....	10C-1
<b>651.1080</b>	<b>Appendix 10D—Geotechnical design and construction guidelines for waste impoundment liners</b>	<b>10D-1</b>

<b>Tables</b>	<b>Table 10-1</b>	Recommended total daily flush volumes	10-5
	<b>Table 10-2</b>	Flush tank volumes and discharge rates	10-5
	<b>Table 10-3</b>	Minimum slope for flush alleys	10-5
	<b>Table 10-4</b>	Sludge accumulation ratios	10-30
	<b>Table 10-5</b>	Minimum top width for lagoon embankments	10-30

<b>Table 10-6</b>	Typical carbon to nitrogen ratios of common composting amendments	10-47
<b>Table 10-7</b>	Poultry mortality rates	10-60
<b>Table 10-8</b>	Broiler compost mix	10-60
<b>Table 10-9</b>	Operational data for solid/liquid separators	10-65
<b>Table 10-10</b>	Characteristics of solid/liquid separators	10-65

**Figures**

<b>Figure 10-1</b>	Roof gutter and downspout	10-1
<b>Figure 10-2</b>	Diversion of "clean" water around feedlot	10-4
<b>Figure 10-3</b>	Scrape alley used in dairy barns	10-4
<b>Figure 10-4</b>	Dairy flush alley	10-6
<b>Figure 10-5</b>	Swine flush alley	10-6
<b>Figure 10-6</b>	Flush tanks	10-7
<b>Figure 10-7</b>	Flush and gravity flow gutters for swine manure	10-8
<b>Figure 10-8</b>	Gravity gutter for dairy manure	10-9
<b>Figure 10-9</b>	Shuttle-stroke gutter cleaner	10-9
<b>Figure 10-10</b>	Chain and flight gutter cleaner	10-10
<b>Figure 10-11</b>	Concrete gang slats	10-10
<b>Figure 10-12</b>	Solid manure stacking facilities	10-12
<b>Figure 10-13</b>	Roofed solid manure storage	10-13
<b>Figure 10-14</b>	Cross section of waste storage pond without a watershed	10-16
<b>Figure 10-15</b>	Cross section of waste storage pond with watershed	10-17
<b>Figure 10-16</b>	Waste storage ponds	10-17
<b>Figure 10-17</b>	Layout of waste storage pond	10-18

---

<b>Figure 10-18</b>	Aboveground waste storage tank	10-19
<b>Figure 10-19</b>	Below ground waste storage structure	10-19
<b>Figure 10-20</b>	BASIC computer program for determining pond volume	10-26
<b>Figure 10-21</b>	Anaerobic lagoon cross section	10-28
<b>Figure 10-22</b>	Anaerobic lagoon loading rate	10-29
<b>Figure 10-23</b>	Anaerobic lagoon recycle systems	10-31
<b>Figure 10-24</b>	Aerobic lagoon cross section	10-35
<b>Figure 10-25</b>	Aerobic lagoon loading rate	10-36
<b>Figure 10-26</b>	Relation of dissolved oxygen saturation to water temperature	10-40
<b>Figure 10-27</b>	Relation of dissolved oxygen saturation to elevation above mean sea level	10-40
<b>Figure 10-28</b>	Numerical values for $O_t - 20$ at different temperatures where $O = 1.024$	10-40
<b>Figure 10-29</b>	Schematic of an oxidation ditch	10-41
<b>Figure 10-30</b>	Windrow schematic	10-42
<b>Figure 10-31</b>	Static pile composting schematic	10-43
<b>Figure 10-32</b>	In-vessel composting schematic	10-44
<b>Figure 10-33</b>	Compost mixture design flow chart	10-48
<b>Figure 10-34</b>	Composting temperature	10-55
<b>Figure 10-35</b>	Typical temperature rhythm of windrow method	10-56
<b>Figure 10-36</b>	Agricultural composting process flow	10-57
<b>Figure 10-37</b>	Dead animal composting bin	10-59
<b>Figure 10-38</b>	Recommended layering for dead bird composting	10-61
<b>Figure 10-39</b>	Schematic of mechanical solid-liquid separators	10-63
<b>Figure 10-40</b>	Design aid to determine quantity of water to add to achieve a desired TS concentration	10-66

---

<b>Figure 10-41</b>	Reception pit for dairy freestall barn	10-67
<b>Figure 10-42</b>	Examples of gravity flow transfer	10-69
<b>Figure 10-43</b>	Push-off ramp	10-70
<b>Figure 10-44</b>	Solid manure storage with picket dam	10-71
<b>Figure 10-45</b>	Two stage, mixed tank anaerobic digester	10-73
<b>Figure 10-46</b>	Typical anaerobic digester types	10-74
<b>Figure 10-47</b>	Gas agitation in an anaerobic digester	10-75
<b>Figure 10-48</b>	Poultry and suckling pig disposal pit constructed with 8" x 8" x 16" concrete blocks	10-78
<b>Figure 10-49</b>	Capacity requirements for poultry disposal pits for laying hens and turkeys	10-79

## 651.1000 Introduction

Alternatives for managing agricultural waste are available for any given agricultural operation. As described in chapters 2 and 9, an agricultural waste management system can consist of any one or all of the following functions: production, collection, storage, treatment, transfer, and utilization. These functions are carried out by planning, applying, and operating individual components.

A component can be a piece of equipment, such as a pump; a structure, such as a waste storage tank; or an operation, such as composting. The combination of the components should allow the flexibility needed to efficiently handle all forms of waste generated for a given enterprise. In addition, the components must be compatible and integrated with each other. All components should be designed to be simple, manageable, and durable, and they should require low maintenance. In this chapter, components are discussed under section headings that describe the function that they are to accomplish.

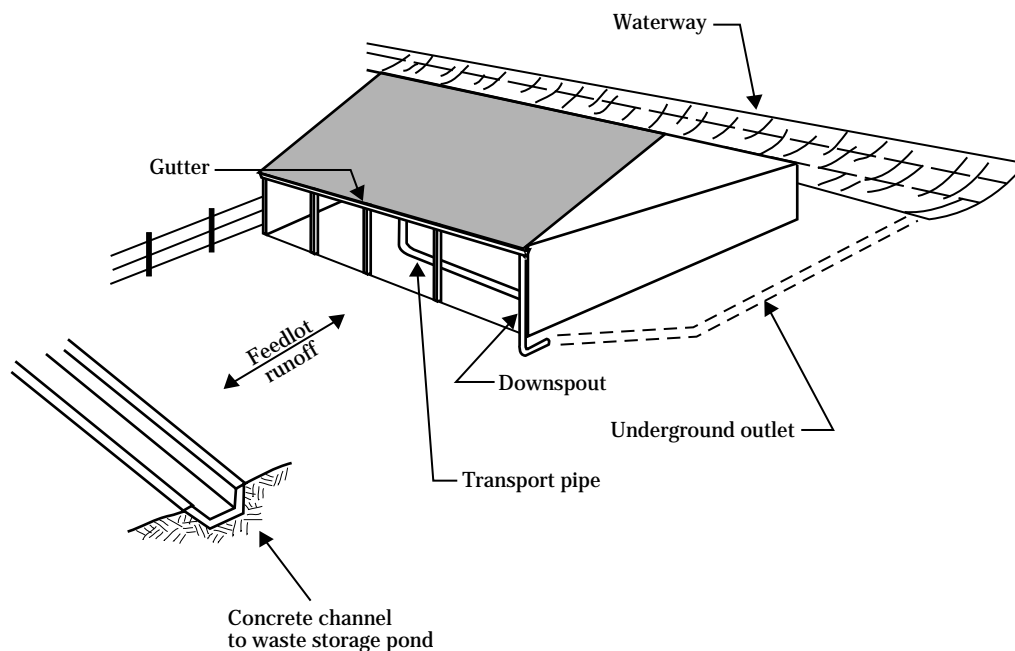
## 651.1001 Production

Components that affect the volume and consistency of agricultural waste produced are included in the production function. Roof gutters and downspouts and diversion to exclude clean water from areas of waste are examples of components that reduce the volume of waste material that needs management. Fences and walls that facilitate collection of waste confine the cattle, thus increase the volume.

### (a) Roof runoff management

Roof runoff should be diverted from feedlots and manure storage areas unless it is needed for some use, such as dilution water for waste storage ponds or treatment lagoons. This can be accomplished by roof gutters and downspouts with underground or open channel outlets (fig. 10-1). Gutters and downspouts may not be needed if the roof drainage will not come into contact with areas accessible to livestock.

**Figure 10-1** Roof gutter and downspout



The area of a roof that can be served by a gutter and downspout system is controlled by either the flow capacity of the gutter (channel flow) or by the capacity of the downspout (orifice flow). The gutter's capacity may be computed using Manning's equation. Design of a gutter and downspout system is based on the runoff from a 10-year frequency, 5-minute rainfall except that a 25-year frequency, 5-minute rainfall is used for exclusion of roof runoff from waste treatment lagoons, waste storage ponds, or similar practices.

Rainfall intensity maps are in appendix 10B. Caution should be used in interpolating these maps. Rainfall probabilities are based on measured data at principal weather stations that are mostly in populated regions. The 10-year, 5-minute rainfall in the 11 Western States was based on NOAA Atlas 1, and that in the 37 Eastern States was based on the National Weather Service HYDRO 35. Both of these publications state their limitations in areas of orographic effect. In the Western States, the 10-year, 5-minute rainfall generally is larger in mountain ranges than in valleys. Rainfall in all mountain ranges could not be shown on these maps because of the map scale and readability considerations. Many of these differences were in the range of 0.05 inch and fall within the contour interval of 0.10 inch.

A procedure for the design of roof gutters and downspouts follows:

**Step 1—Compute the capacity of the selected gutter size.** This may be computed using the Manning's equation. Using the recommended gutter gradient of 1/16 inch per foot and a Manning's roughness coefficient of 0.012, this equation can be expressed as follows:

$$q_g = 0.01184 \times A_g \times r^{0.67}$$

where:

- $q_g$  = capacity of gutter, ft<sup>3</sup>/sec
- $A_g$  = cross sectional area of gutter, in<sup>2</sup>
- $r$  =  $A_g / wp$ , inches
- $wp$  = wetted perimeter of gutter, inches

**Step 2—Compute capacity of downspout.** Using an orifice discharge coefficient of 0.65, the orifice equation may be expressed as follows:

$$q_d = 0.010457 \times A_d \times h^{0.5}$$

where:

- $q_d$  = capacity of downspout, ft<sup>3</sup>/sec
- $A_d$  = cross sectional area of downspout, in<sup>2</sup>
- $h$  = head, inches (generally the depth of the gutter minus 0.5 inch)

**Step 3—Determine whether the system is controlled by the gutter capacity or downspout capacity and adjust number of downspouts if desired.**

$$N_d = \frac{q_g}{q_d}$$

where:

- $N_d$  = number of downspouts

If  $N_d$  is less than 1, the system is gutter capacity controlled. If it is equal to or greater than 1, the system is downspout capacity controlled unless the number of downspouts is equal to or exceeds  $N_d$ .

**Step 4—Determine the roof area that can be served based on the following equation:**

$$A_r = \frac{q \times 3,600}{P}$$

where:

- $A_r$  = Area of roof served, ft<sup>2</sup>
- $q$  = capacity of system, either  $q_g$  or  $q_d$  whichever is smallest, ft<sup>3</sup>/sec
- $P$  = 5-minute precipitation for appropriate storm event, inches

The above procedure is a trial and error process. Different sizes of gutters and downspouts should be evaluated along with multiple downspouts to determine the best gutter and downspout system to serve the roof area involved.

### (1) Design example 10-1—Gutters and downspouts

Mrs. Linda Worth of Pueblo, Colorado, has requested assistance in developing an agricultural waste management system for her livestock operation. The selected alternatives include gutters and downspouts for a barn having a roof with a horizontally projected area of 3,000 square feet. The 10-year, 5-minute precipitation is 0.5 inches. The procedure above is used to size the gutter and downspouts.

**Step 1—Compute the capacity of the selected gutter size.** Try a gutter with a 6-inch depth and 3-inch bottom width. One side wall is vertical, and the other is sloping, so the top width of the gutter is 7 inches. Note that a depth of 5.5 inches is used in the computations to allow for 0.5 inch of freeboard.

$$A_g = (3 \times 5.5) + (0.5 \times 3.67 \times 5.5)$$

$$= 26.6 \text{ in}^2$$

$$wp = 3 + 5.5 + (3.67^2 + 5.5^2)^{0.5}$$

$$= 15.1 \text{ in}$$

$$r = \frac{A_g}{wp}$$

$$= \frac{26.6}{15.1}$$

$$= 1.76 \text{ in}$$

$$q_g = 0.01184 \times A_g \times r^{0.67}$$

$$= 0.01184 \times 26.6 \times 1.76^{0.67}$$

$$= 0.46 \text{ ft}^3 / \text{sec}$$

**Step 2—Compute capacity of downspout.** Try a 3-inch diameter downspout

$$H = \text{depth of gutter} - 0.5 \text{ in}^2$$

$$= 5.5 \text{ in}$$

$$A_d = 3.1416 \times \left(\frac{3}{2}\right)^2$$

$$= 7.06 \text{ in}^2$$

$$q_d = 0.010457 \times 7.06 \times 5.5^{0.5}$$

$$= 0.17 \text{ ft}^3 / \text{sec}$$

**Step 3—Determine whether the system is controlled by the gutter capacity or downspout capacity and make adjustments to number of downspouts if desired.** By inspection it can be determined that the gutter capacity (0.46 ft<sup>3</sup>/sec) exceeds the capacity of one downspout (0.17 ft<sup>3</sup>/sec) Unless a larger downspout or additional downspouts are used, the system capacity would be limited to the capacity of the downspout. Try using multiple down-

spouts. Determine number required to take advantage of gutter capacity.

$$N_d = \frac{q_g}{q_d}$$

$$= \frac{0.46}{0.17}$$

$$= 2.7$$

$N_d$  is greater than 1; therefore, with one downspout the system would be downspout controlled. With three, it would be controlled by the gutter capacity, or 0.46 ft<sup>3</sup>/sec. Use three downspouts to take full advantage of gutter capacity.

**Step 4—Determine the roof area that can be served based on the following equation:**

$$A_r = \frac{q \times 3,600}{P}$$

$$= \frac{0.46 \times 3,600}{0.5}$$

$$= 3,312 \text{ ft}^2$$

This exceeds the roof area to be served; therefore, the gutter dimension selected and the three downspouts with dimensions selected are okay.

## (b) Runoff control

Essentially all livestock facilities in which the animals are housed in open lots or the manure is stored in the open must deal with runoff. "Clean" runoff from land surrounding livestock facilities should be diverted from barns, open animal concentration areas, and waste storage or treatment facilities (fig. 10-2). Runoff from feedlots should be channeled into waste storage facilities.

Appendix 10C presents a series of maps indicating the amount of runoff that can be expected throughout the year for paved and unpaved feedlot conditions. "Clean" runoff should be estimated using information in chapter 2 of the NRCS Engineering Field Manual or by some other hydrologic method.



Diversions are to be designed according to NRCS Conservation Practice Standard, Diversion, Code 362 (USDA 1985). Diversion channels must be maintained to remain effective. If vegetation is allowed to grow tall, the roughness increases and the channel velocity decreases causing possible channel overflow. Therefore, vegetation should be periodically mowed. Earth removed by erosion from earthen channels should be replaced. Unvegetated, earthen channels should not be used in regions of high precipitation because of potential erosion.

## 651.1002 Collection

Livestock and poultry manure collection often depends on the degree of freedom that is allowed the animal. If animals are allowed freedom of movement within a given space the manure produced will be deposited randomly. Components that provide efficient collection of animal waste include paved alleys, gutters, and slatted floors with associated mechanical and hydraulic equipment as described below.

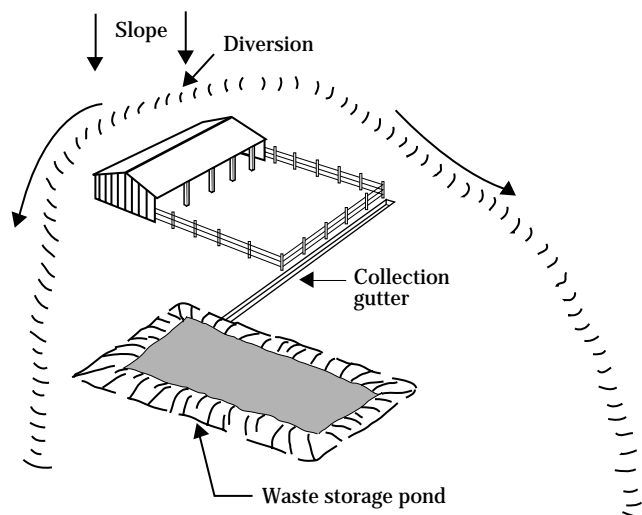
### (a) Alleys

Alleys are paved areas where the animals walk. They generally are arranged in straight lines between animal feeding and bedding areas. On slatted floors, animal hoofs work the manure through the slats into the alleys below, and the manure is collected by flushing or scraping the alleys.

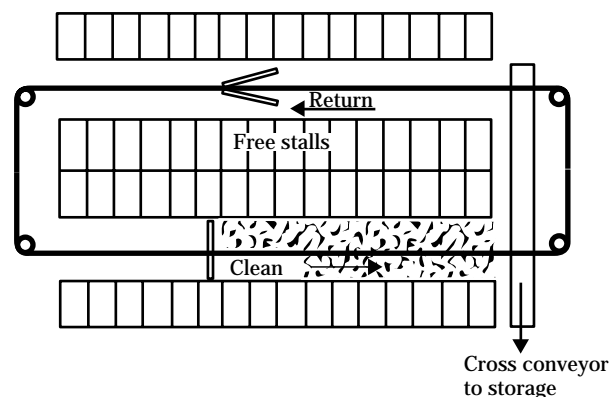
#### (1) Scrape alleys and open areas

Two kinds of manure scrapers are used to clean alleys (fig. 10-3). A mechanical scraper is dedicated to a given alley. It is propelled using electrical drives attached by cables or chains. The drive units are often

**Figure 10-2** Diversion of "clean" water around feedlot



**Figure 10-3** Scrape alley used in dairy barns



used to power two mechanical scrapers that are traveling in opposite directions in parallel alleys in an oscillating manner. Some mechanical scrapers are in alleys under slatted floors.

A tractor scraper can be used in irregularly shaped alleys and open areas where mechanical scrapers cannot function properly. It can be a blade attached to either the front or rear of a tractor or a skid-steer tractor that has a front-mounted bucket.

The width of alleys depends on the desires of the producer and the width of available equipment. Scrape alley widths typically vary from 8 to 14 feet for dairy and beef cattle and from 3 to 8 feet for swine and poultry.

## (2) Flush alleys

Alleys can also be cleaned by flushing. Grade is critical and can vary between 1.25 and 5 percent. It may change for long flush alleys. The alley should be level perpendicular to the centerline. The amount of water used for flushing is also critical. An initial flow depth of 3 inches for underslat gutters and 4 to 6 inches for open alleys is necessary.

The length and width of the flush alley are also factors. Most flush alleys should be less than 200 feet long. The width generally varies from 3 to 10 feet depending on animal type. For underslat gutters and alleys, channel width should not exceed 4 feet. The width of open flush alleys for cattle is frequently 8 to 10 feet.

**Table 10-1** Recommended total daily flush volumes (MWPS 1985)

Animal type	gal/head
Swine	
Sow and litter	35
Prenursery pig	2
Nursery pig	4
Growing pig	10
Finishing pig	15
Gestating sow	25
Dairy cow	100
Beef feeder	100

Flush alleys and gutters should be cleaned at least twice per day. For pump flushing, each flushing event should have a minimum duration of 3 to 5 minutes.

Tables 10-1 and 10-2 indicate general recommendations for the amount of flush volume. Table 10-3 gives the minimum slope required for flush alleys and gutters. Figures 10-4 and 10-5 illustrate flush alleys.

Several mechanisms are used for flushing alleys. The most common rapidly empties large tanks of water or use high-volume pumps. Several kinds of flush tanks are used (fig. 10-6). One known as a tipping tank pivots on a shaft as the water level increases. At a certain design volume, the tank tips, emptying the entire amount in a few seconds, which causes a wave that runs the length of the alley.

**Table 10-2** Flush tank volumes and discharge rates (MWPS 1985)

Initial flow depth, in.	Tank volume, gal/ft of gutter width	Tank discharge rate, gpm/ft of gutter width	Pump discharge, gpm/ft of gutter width
1.5	30	112	55
2.0	40	150	75
2.5	45	195	95
3.0	55	255	110
4.0	75	615	150
5.0	100	985	175
6.0	120	1,440	200

**Table 10-3** Minimum slope for flush alleys (MWPS1985)

Initial flow depth, in.	Underslat alley		Open Alley narrow width (<4')		Open Alley wide width (>4')		
	3.0	1.5	2.0	2.5	4.0	5.0	6.0
Slope, %	1.25	2.0	1.5	1.25	5.0	4.0	3.0

Some flush tanks have manually opened gates. These tanks are emptied by opening either a valve, a stand-pipe, a pipe plug, or a flush gate. Float switches can be used to control flushing devices.

Another kind of flush tank uses the principle of a siphon. In this tank the water level increases to a given point where the head pressure of the liquid overcomes the pressure of the air trapped in the siphon mechanism. At this point the tank rapidly empties, causing the desired flushing effect.

Most flush systems use pumps to recharge the flush tanks or to supply the necessary flow if the pump flush technique is used. Centrifugal pumps typically are used. The pumps should be designed for the work that they will be doing. Low volume pumps (10 to 150 gpm) may be used for flush tanks, but high volume pumps (200 to 1,000 gpm) are needed for alley flushing. Pumps should be the proper size to produce the desired flow rate. Flush systems may rely on recycled lagoon water for the flushing liquid.

In some parts of the country where wastewater is recycled from lagoons for flush water, salt crystals (struvite) may form inside pipes and pumps and cause decreased flow. Use of plastic pipe and fittings and pumps that have plastic impellers can reduce the frequency between cleaning or replacing pipes and

pumps. If struvite formation is anticipated, recycle systems should be designed for periodic clean out of pumps and pipe. A mild acid, such as dilute hydrochloric acid (1 part 20 mole hydrochloric acid to 12 parts water), can be used. A separate pipe may be needed to accomplish acid recycling. The acid solution should be circulated throughout the pumping system until normal flow rates are restored. The acid solution should then be removed. Caution should be exercised when disposing of the spent acid solution to prevent ground or surface water pollution.

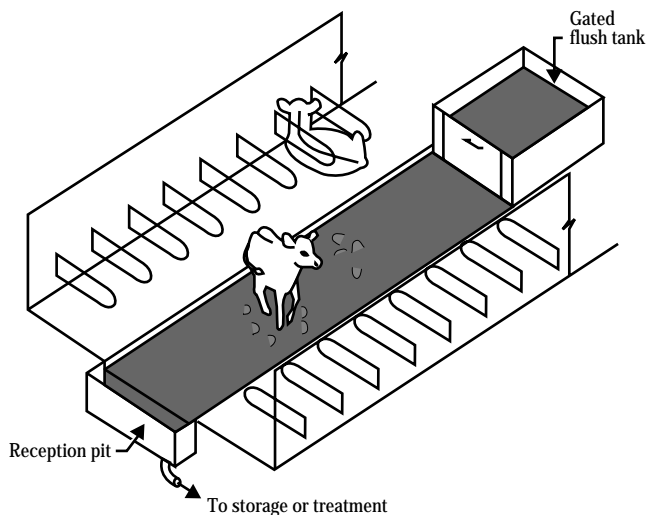
## (b) Gutters

Gutters are narrow trenches used to collect animal waste. They are often employed in confined stall or stanchion dairy barns and in some swine facilities.

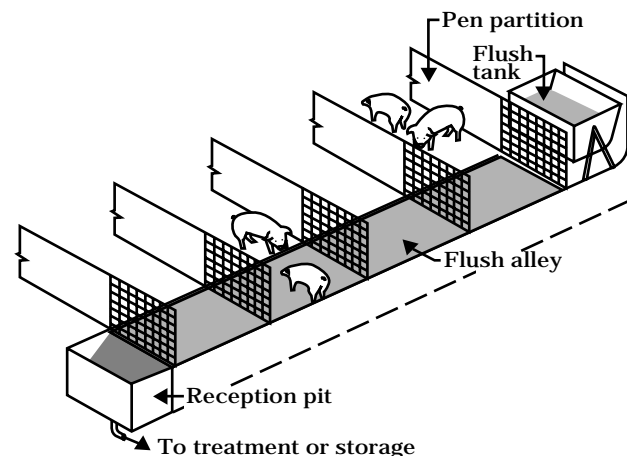
### (1) Gravity drain gutters

Deep, narrow gutters can be used in swine finishing buildings (fig. 10-7). These gutters are at the lowest elevation of the pen. The animal traffic moves the waste to the gutter. The gutter fills and is periodically emptied. Gutters that have Y, U, V, or rectangular cross sectional shapes are used in farrowing and nursery swine facilities. These gutters can be gravity drained periodically.

**Figure 10-4** Dairy flush alley



**Figure 10-5** Swine flush alley



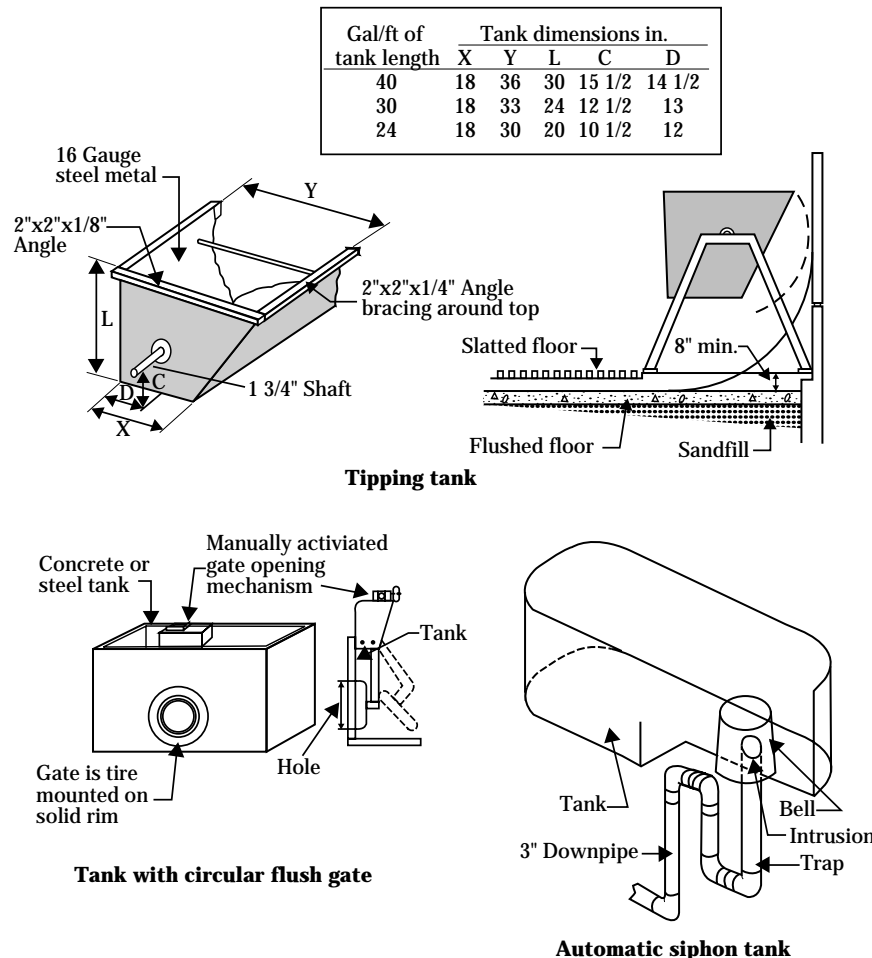
**(2) Step-dam gutters**

Step-dam gutters, which are also known as gravity gutters or gravity flow channels, provide a simple alternative for collecting dairy manure (fig. 10-8). A 6-inch high dam holds back a lubricating layer of manure in a level, flat-bottomed channel. Manure drops through a floor grate or slats and flows down the gutter under its own weight. The gutter is about 30 inches wide and steps down to a deeper cross channel below the dam.

**(3) Scrape gutters**

Scrape gutters are frequently used in confined stall dairy barns. The gutters are 16 to 24 inches wide, 12 to 16 inches deep, and generally do not have any bottom slope. They are cleaned using either shuttle-stroke or chain and flight gutter cleaners (figs. 10-9 & 10-10). Electric motor driven shuttle stroke gutter cleaners have paddles that pivot on a drive rod. The drive rod travels alternately forward for a short distance and then backwards for the same distance. The paddles are designed to move manure forward on the forward stroke and to collapse on the drive rod on the return stroke. This action forces the manure down the gutter. Shuttle stroke gutter cleaners can only be used on straight gutters.

**Figure 10-6** Flush tanks



Chain and flight scrapers are powered by electric motors and are used in continuous loops to service one or more rows of stalls.

**(4) Flush gutters**

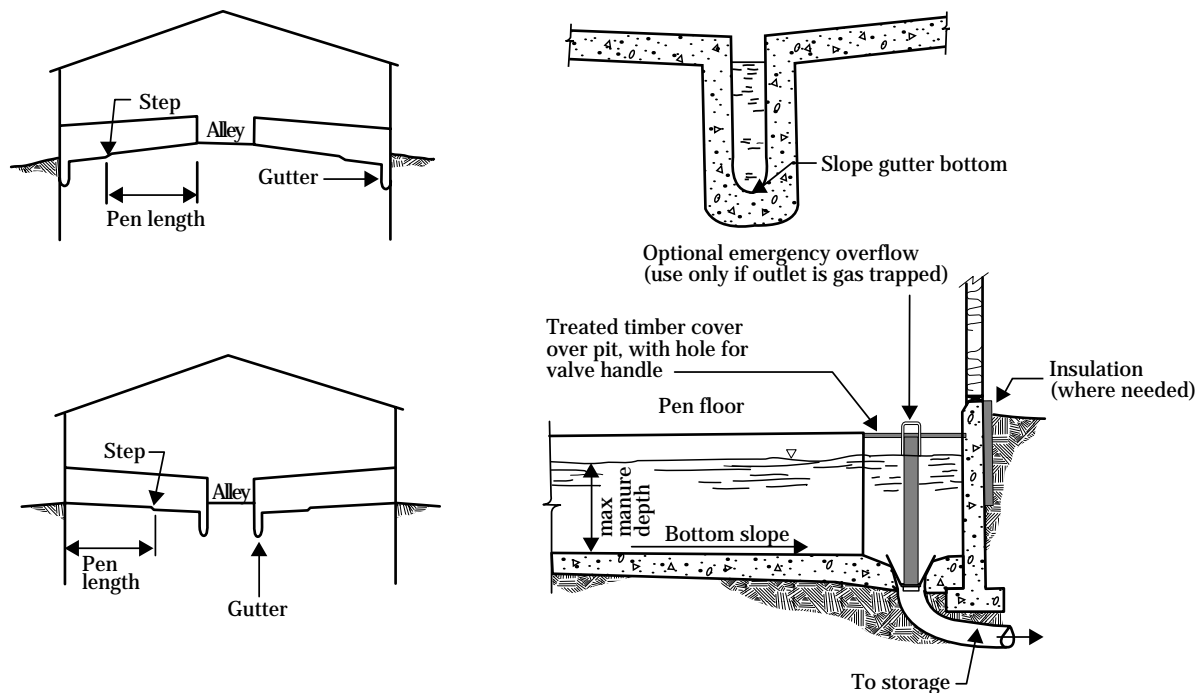
Narrow gutters can also be cleaned by flushing. Flush gutters are usually a minimum of 2 feet deep on the shallow end. The depth may be constant or increase as the length of the gutter increases. The bottom grade can vary from 0 to 5 percent depending on storage requirements and clean out technique. Flushing tanks or high volume pumps may be used to clean flush gutters (refer to the section on flush alternatives for alleys).

**(c) Slatted floors**

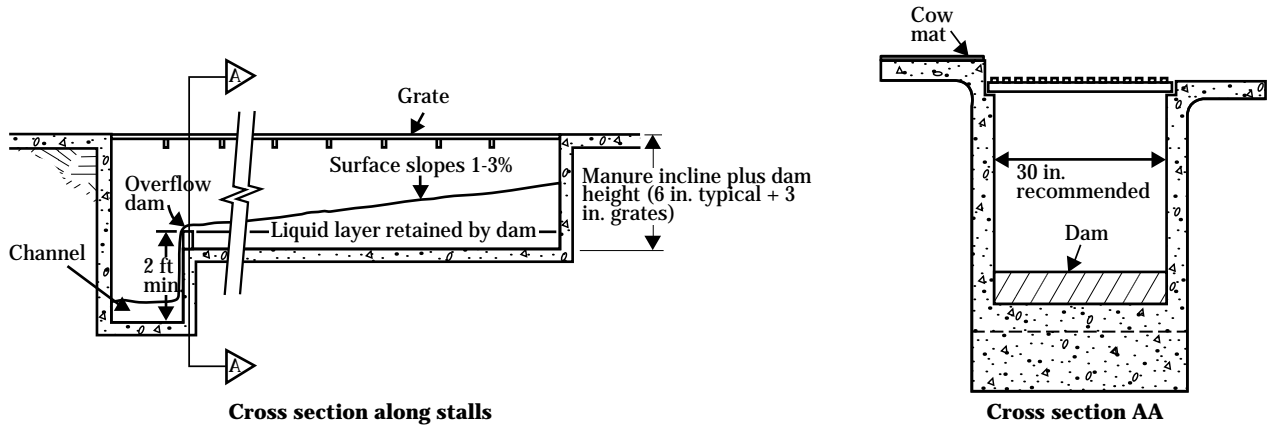
Waste materials are worked through the slats by the animal traffic into a storage tank or alley below. Most slats are constructed of reinforced concrete (fig. 10-11); however, some are made of wood, plastic, or aluminum. They are manufactured either as individual units or as gangs of several slats. Common slat openings range from 3/8 inch to 1 3/4 inches, depending on animal type. For swine, openings between 3/8 and 3/4 inch are not recommended.

Slats are designed to support the weight of the slats plus the live loads (animals, humans, and mobile equipment) expected for the particular facility. Reinforcing steel is required in concrete slats to provide needed strength.

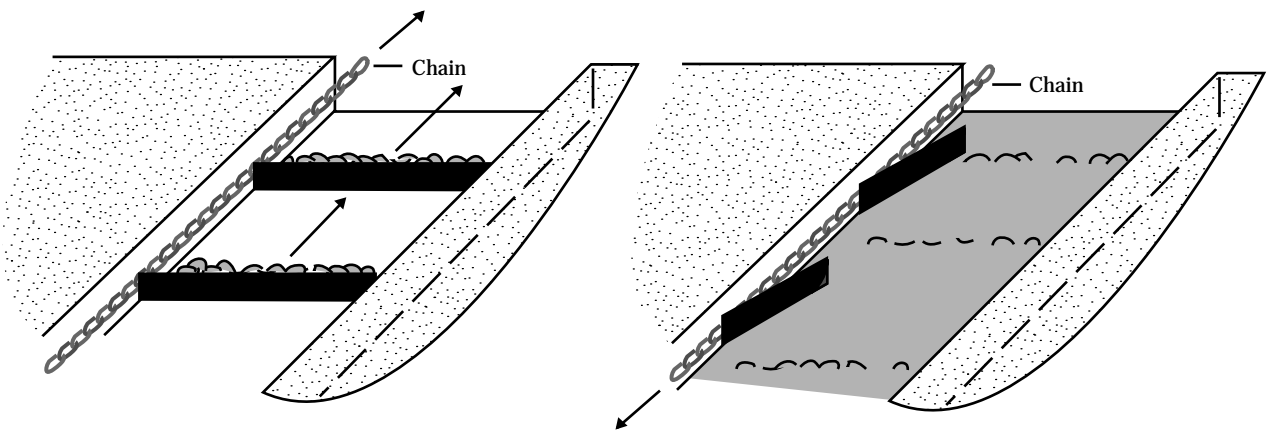
**Figure 10-7** Flush and gravity flow gutters for swine manure



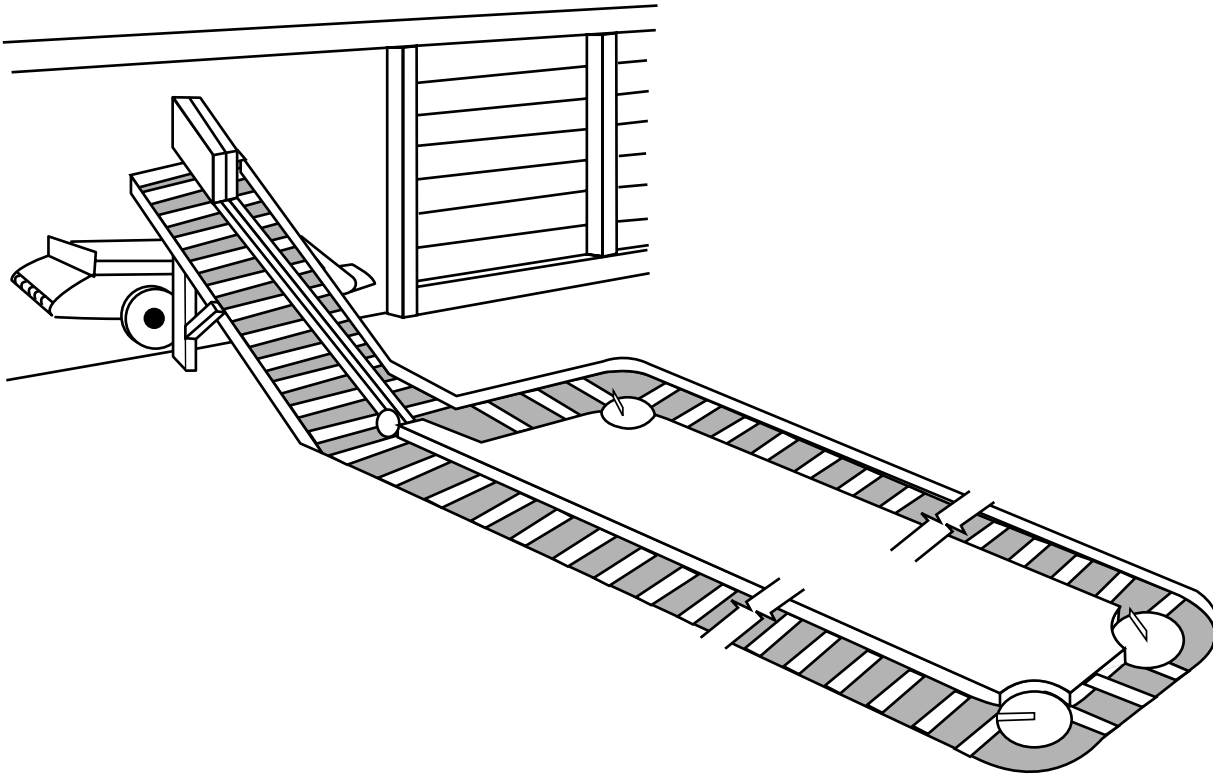
**Figure 10-8** Gravity gutter for dairy manure



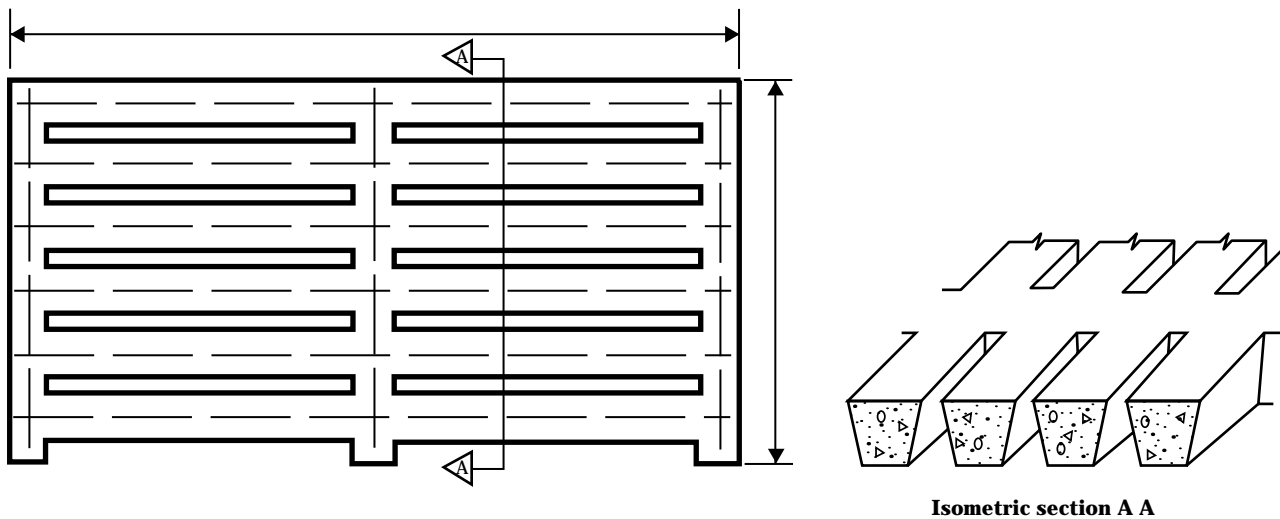
**Figure 10-9** Shuttle-stroke gutter cleaner



**Figure 10-10** Chain and flight gutter cleaner



**Figure 10-11** Concrete gang slats



## 651.1003 Storage

Waste generally must be stored so that it can be used when conditions are appropriate. Storage facilities for wastes of all consistencies must be designed to meet the requirements of a given enterprise.

Determining the storage period for a storage facility is crucial to the proper management of an agricultural waste management system. If too short a period is selected, the facility may fill before the waste can be used in an environmentally sound manner. Too long a period may result in an unjustified expenditure for the facility.

Many factors are involved in determining the storage period. They include the weather, crop, growing season, equipment availability, soil, soil condition, labor requirements, and management flexibility. Generally, when waste utilization is by land application, a storage facility must be sized so that it can store the waste during the nongrowing season. A storage facility that has a longer storage period generally will allow more flexibility in managing the wastes to accommodate weather variability, equipment availability, equipment breakdown, and overall operation management.

### (a) Waste storage facilities for solids

Storage facilities for solid manure include waste storage ponds and waste storage structures. Waste storage ponds are earthen impoundments used to retain manure, bedding, and runoff liquid. Solid and semi-solid manure placed into a storage pond will most likely have to be removed as a liquid unless precipitation is low or a means of draining the liquid is available. The pond bottom and entrance ramps should be paved if emptying equipment will enter the pond.

Waste storage structures can be used for manure that will stack and can be handled by solid manure handling equipment. These structures must be accessible for loading and hauling equipment. They can be open or covered. Roofed structures are used to prevent or reduce excess moisture content. Open stacks can be

used in either arid or humid climate. Seepage and runoff must be managed. Structures for open and covered stacks often have wooden, reinforced concrete, or concrete block sidewalls. The amount of bedding material often dictates whether or not the manure can be handled as a solid.

In some instances manure must be stored in open stacks in fields. Runoff and seepage from these stacks must be managed to prevent movement into streams or other surface or ground water. Figures 10–12 and 10–13 show various solid manure storage facilities.

#### (1) Design considerations

Solid waste storage ponds and structures must be designed correctly to ensure desired performance and safety. Considerations include materials selection, control of runoff and seepage, necessary storage capacity, and proper design of structural components, such as sidewalls, floors, and roofs.

The primary materials used in constructing timber structures for solids storage are pressure-treated or rot-resistant wood and reinforced concrete. These materials are suitable for long-term exposure to animal waste without rapid deterioration. Structural grade steel is also used, but it corrodes and must be protected against corrosion or be periodically replaced. Similarly, high quality and protected metal fasteners must be used with timber structures to reduce corrosion problems.

Seepage and runoff, which frequently occur from manure stacks must be controlled to prevent access into surface and ground water. One method of control is to channel any seepage into a storage pond. At the same time uncontaminated runoff, such as that from the roof and outside the animal housing and lot area, should be diverted around the site.

Concrete ramps are used to gain access to solid manure storage areas. Ramps and floors of solid manure storage structures need to be designed so that handling equipment can be safely operated. Ramp slopes of 8 to 1 (horizontal to vertical) or flatter are considered safe. Slopes steeper than this are difficult to negotiate. Concrete pavement for ramps and storage units should be rough finished to aid in traction. Ramps need to be wide enough that equipment can be safely backed and maneuvered.



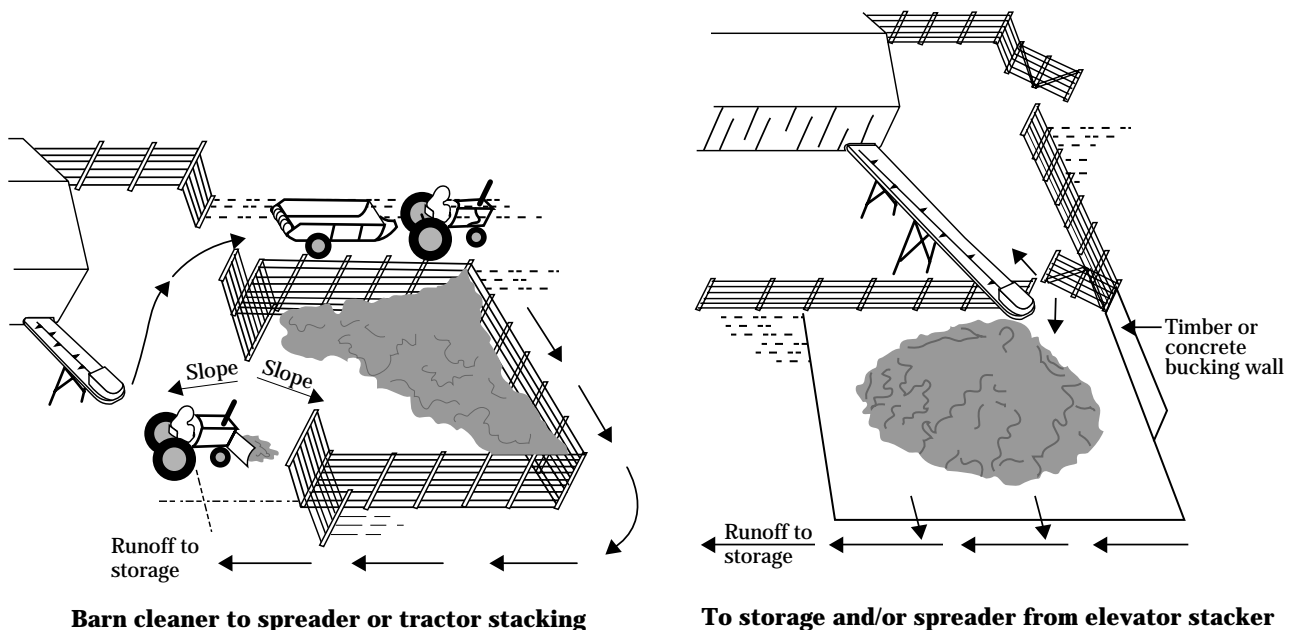
Factors to consider in the design of storage facilities for solids include type, number and size of animals, number of days storage desired, and the amount of bedding that will be added to the manure. Equation 10-1 can be used to calculate the manure storage volume:

$$VMD = AU \times DVM \times D \quad [10-1]$$

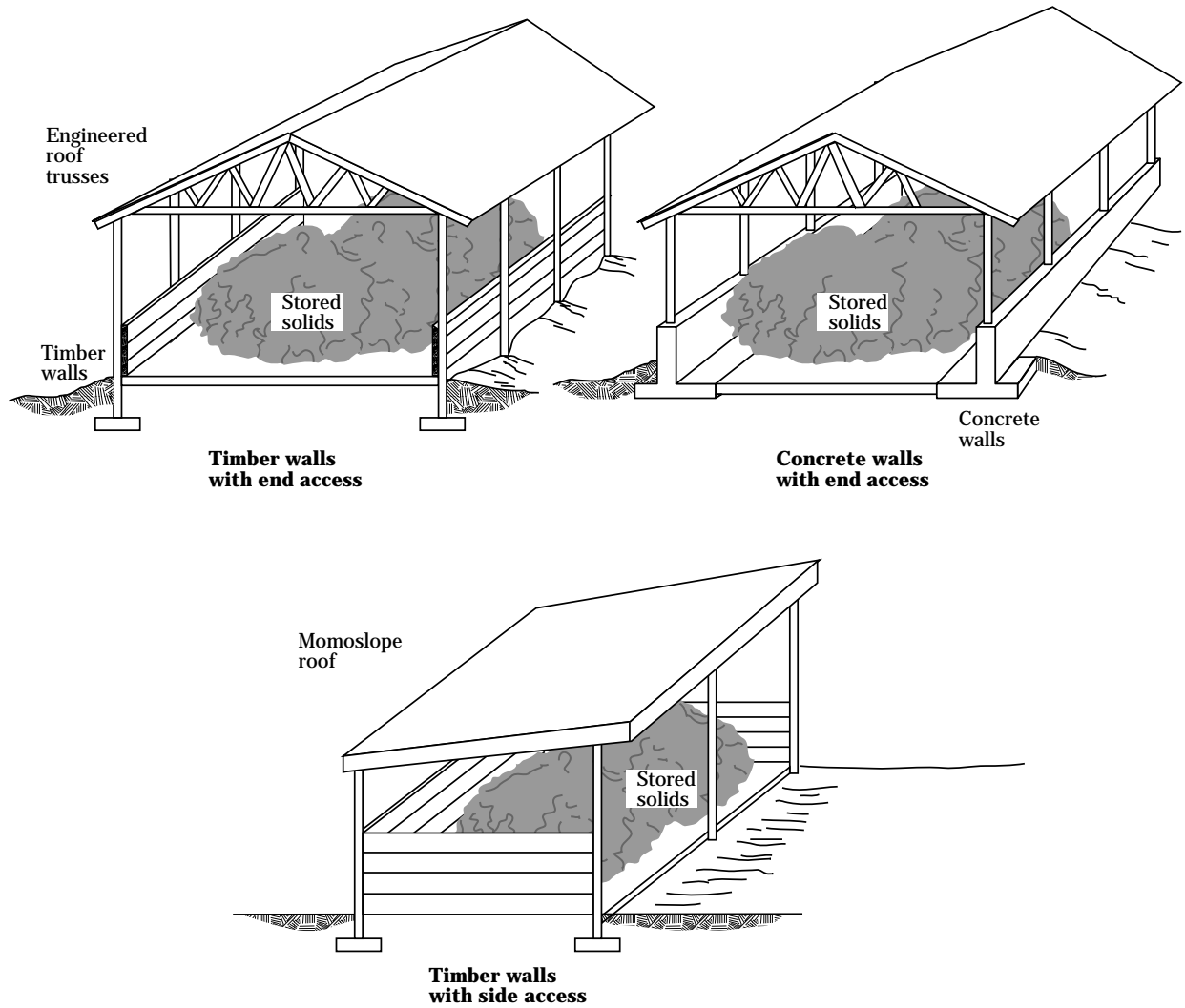
where:

- $VMD$  = volume of manure production for animal type for storage period,  $\text{ft}^3$
- $AU$  = number of 1,000 pound animal units by animal type
- $DVM$  = daily volume of manure production for animal type,  $\text{ft}^3/\text{AU}/\text{day}$
- $D$  = Number of days in storage period

**Figure 10-12** Solid manure stacking facilities



**Figure 10-13** Roofed solid manure storage



The bedding volume to be stored can be computed using:

$$BV = \frac{FR \times WB \times AU \times D}{BUW} \quad [10-2]$$

where:

*FR* = volumetric void ratio (ASAE 1982) (values range from 0.3 to 0.5)

*WB* = weight of bedding used for animal type, lb/AU/day

*BUW* = bedding unit weight, lb/ft<sup>3</sup>

Using the recommended volumetric void ratio of 0.5, the equation becomes:

$$BV = \frac{0.5 \times WB \times AU \times D}{BUW}$$

Characteristics of manure and bedding are described in chapter 4. Other values may be available locally or from the farmer or rancher.

Allowance must be made for the accumulation of precipitation that may fall directly into the storage. Contaminated runoff should be handled separately from a solid manure storage facility. Uncontaminated runoff should be diverted from the storage unit.

## (2) Design example 10-2—Waste stacking facility

Mr. Ralph Kilpatrick of Hoot Ridge, Kentucky, has requested assistance in developing a waste management system. He selected an alternative that includes solid manure storage for his 100 Holstein milking cows and 52 heifers. His nutrient management plan indicates the need for 90 days storage. He uses sawdust bedding for both the milking cows and the heifers. Because of space limitations the storage can be no wider than 50 feet. He would prefer that the facility be no more than 7 feet deep. The structure will not be roofed, so stacking above sidewalls will not be considered in design. Determine the necessary volume and facility dimensions using worksheet 10A-1.

**Manure production**—The animal descriptions, average weight, and numbers are entered on **lines 1 and 2**. The number of equivalent animal units for each animal type is calculated and entered on **line 4**. Daily manure production (**line 4**) is in table 4-5 in chapter

4. The number of days in storage is entered on **line 5**. The manure volume (**line 7**) is calculated using equation 10-1. Add the calculated manure volume for each animal type (VMD) and enter the sum (TVM) on **line 8**.

**Wastewater volume**—Because this design example involves a waste stacking facility, it would not be appropriate to include wastewater in the storage facility. Therefore, **lines 9, 10, and 11** are not involved in estimating the waste volume for this example.

**Bedding volume**—The weight of bedding used daily per animal unit for each animal type is entered on **line 12**. The bedding unit weight, which may be taken from table 4-4, is entered on **line 13**. The bedding volume for each animal type for the storage period is calculated using equation 10-2 and entered on **line 14**. The total bedding volume (TBV) is the sum of the bedding volume for all animal types. Sum the calculated bedding volume (BV) for each animal type and enter it on **line 15**.

**Waste volume**—The total waste volume (WV) (**line 16**) is the sum of the total manure production (TVM) and the total bedding volume (TBV). The storage width and depth are known, so the length (**line 17**) is calculated using the equation:

$$L = \frac{WV}{WI \times H}$$

A waste storage structure for solids should be designed to withstand all anticipated loads. Loadings include internal and external loads, hydrostatic uplift pressure, concentrated surface and impact loads, water pressure because of the seasonal high water table, and frost or ice pressure.

The lateral earth pressure should be calculated from soil strength values determined from results of appropriate soil tests. If soil strength tests are not available, the minimum lateral earth pressure values indicated in the NRCS Conservation Practice Standard, Waste Storage Facility, Code 313, are to be used (NRCS 1995).

Timber sidewalls for storage structures should be designed with the load on the post based on full wall height and spacing of posts.

Completed worksheet for Design example 10-2

<b>Worksheet 10A-1—Waste storage structure capacity design</b>	
Decisionmaker: <u>Ralph Kilpatrick</u>	Date: <u>6/13/91</u>
Site: <u>Hoot Ridge, KY</u>	
<b>Animal units</b>	
1. Animal type <u>Milkers</u> <u>Heifer</u>	3. Number of animals (N) <u>100</u> <u>52</u>
2. Animal weight, lbs (W) <u>1,400</u> <u>1,000</u>	4. Animal units, $AU = \frac{W \times N}{1000} =$ <u>140</u> <u>52</u>
<b>Manure volume</b>	
5. Daily volume of daily manure production per AU, ft <sup>3</sup> /AU/day (DVM) = <u>1.30</u> <u>1.30</u>	7. Total volume of manure production for animal type for storage period, ft <sup>3</sup> VMD = AU x DVM x D = <u>16,380</u> <u>6,084</u>
6. Storage period, days (D) = <u>90</u>	8. Total manure production for storage period, ft <sup>3</sup> (TVM) = <u>22,464</u>
<b>Wastewater volume</b>	
9. Daily wastewater volume per AU, ft <sup>3</sup> /AU/day (DWW) = _____	11. Total wastewater volume for storage period, ft <sup>3</sup> (TWW) = <u>0</u>
10. Total wastewater volume for animal description for storage period, ft <sup>3</sup> WWD = DWW x AU x D = _____	
<b>Bedding volume</b>	
12. Amount of bedding used daily for animal type, lbs/AU/day (WB) = <u>3.1</u> <u>3.1</u>	14. Bedding volume for animal type for storage period, ft <sup>3</sup> (BV) = <u>1,628</u> <u>604</u>
13. Bedding unit weight, lbs/ft <sup>3</sup> (BUW) = <u>12</u>	BV = $\frac{0.5 \times WB \times AU \times D}{BUW}$
	15. Total bedding volume for storage period, ft <sup>3</sup> (TBV) = <u>2,232</u>
<b>Waste volume requirement</b>	
16. Waste volume, ft <sup>3</sup> (WV) = TVM + TWW + TBV = <u>22,464</u> + <u>0</u> + <u>2,232</u> = <u>24,696</u>	
<b>Waste stacking structure sizing</b>	
17. Structure length, ft $L = \frac{WV}{WI \times H} =$ <u>88.2 (USE 90)</u>	19. Structure height, ft $H = \frac{WV}{L \times WI} =$ <u>7</u>
18. Structure width, ft $WI = \frac{WV}{L \times H} =$ <u>40</u>	
Notes for waste stacking structure:	
1. The volume determined (WV) does not include any volume for freeboard. It is recommended that a minimum of 1 foot of freeboard be provided for a waste stacking structure.	
2. The equations for L, WI, and H assume manure is stacked to average height equal to the sidewall height. Available storage volume must be adjusted to account for these types of variations.	
<b>Tank sizing</b>	
20. Effective depth, ft. (EH) Total height (or depth) of tank desired, ft (H) - _____ Less precipitation for storage period, ft. - _____ (uncovered tanks only) Less depth allowance for accumulated solids, ft - _____ (0.5 ft. minimum) Less depth for freeboard (0.5 ft. recommended), ft - _____ Effective depth, ft (EH) = _____	22. Rectangular tank dimensions Total height, ft (H) = _____ Selected width, ft (WI) = _____ Length, ft $L = \frac{SA}{WI} =$ _____
21. Surface area required, ft <sup>2</sup> $SA = \frac{WV}{EH} =$ _____	23. Circular tank dimensions Total height, ft H = _____ Diameter, ft $DIA = (1.273 \times SA)^{0.5} =$ _____
Notes for waste storage tank structure: 1. Final dimensions may be rounded up to whole numbers or to use increments on standard drawings. 2. Trial and error may be required to establish appropriate dimensions.	

**(b) Liquid and slurry waste storage**

Liquid and slurry manure can be stored in waste storage ponds or in aboveground or below-ground tanks. Solids separation of manure and bedding is a problem that must be considered in planning and design. Solids generally can be resuspended with agitation before unloading, but this involves a cost in time, labor, and energy. Another option allows solids to accumulate if the bottom is occasionally cleaned. This requires a paved working surface for equipment.

Earthen storage is frequently the least expensive type of storage; however, certain restrictions, such as limited space availability, high precipitation, water table, permeable soils, or shallow bedrock, can limit the types of storage considered.

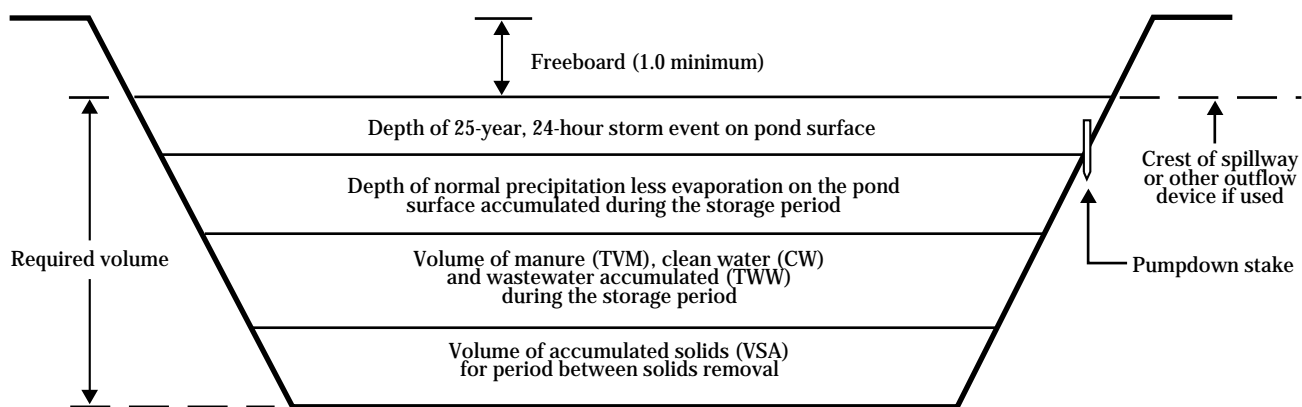
Storage ponds are earthen basins designed to store wastewater and manure (figs. 10-14, 10-15, 10-16). They generally are rectangular, but may be circular or any other shape that is practical for operation and

maintenance. The inside slopes range from 1.5 to 1 (horizontal to vertical) to 3 to 1. The combined slopes (inside plus outside) should not be less than 5 to 1 for embankments. The soil, safety, and operation and maintenance need to be considered in designing the slopes. The minimum top width of embankments should be 8 feet; however, greater widths should be provided for operation of tractors, spreaders, and portable pumps.

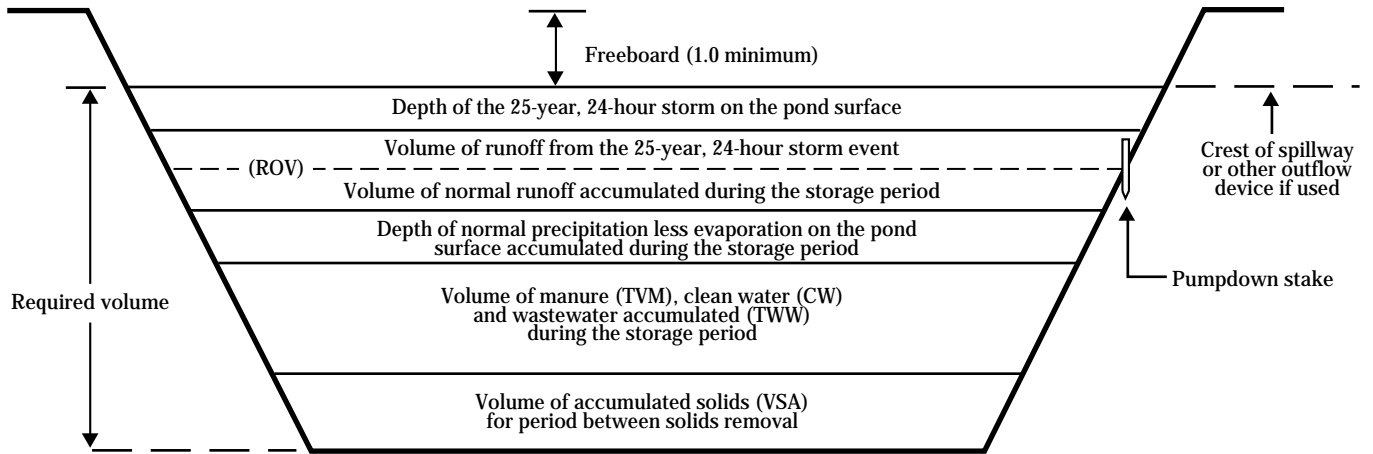
Storage ponds should provide capacity for normal precipitation and runoff (less evaporation) during the storage period. Appendix 10C provides a method for determining runoff and evaporation volumes. A minimum of 1 foot of freeboard is provided.

Inlets to storage ponds can be of any permanent material designed to resist erosion, plugging, or, if freezing is a problem, damage by ice. Typical loading methods are pipes and ramps, which are described in section 651.1005. Flow of wastes away from the inlet should be considered in selecting the location of the inlet.

**Figure 10-14** Cross section of waste storage pond without a watershed

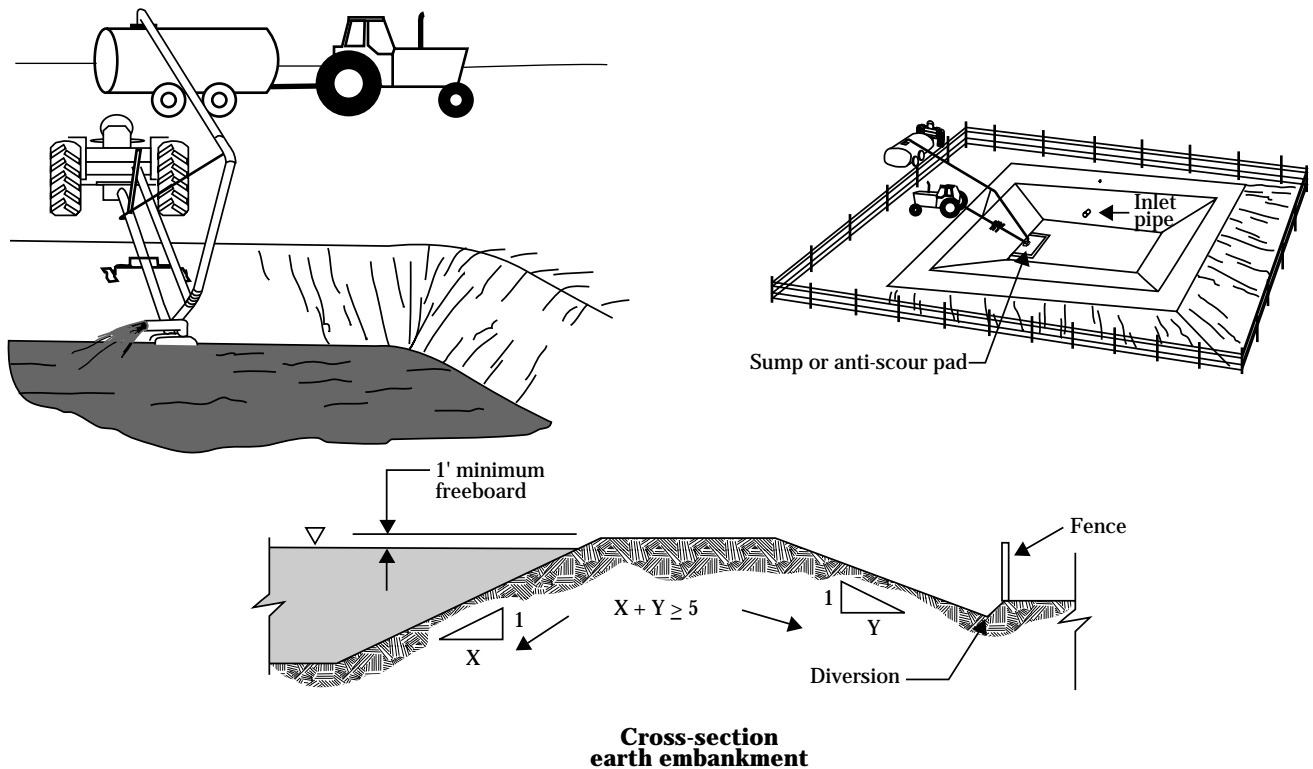


**Figure 10-15** Cross section of waste storage pond with watershed



\*or other outflow device

**Figure 10-16** Waste storage ponds



Gravity pipes, pumping platforms, and ramps are used to unload storage ponds. A method for removing solids should be designed for the storage pond. If the wastes will be pumped, adequate access must be provided to thoroughly agitate the contents of the pond. A ramp should have a slope of 8 to 1 or flatter and be wide enough to provide maneuvering room for unloading equipment.

Pond liners are used in many cases to compensate for site conditions or improve operation of the pond. Concrete, geomembrane, and clay linings reduce permeability and can make an otherwise unsuitable site acceptable. See Appendix 10D, Geotechnical design and construction guidelines for waste impoundment Liners, for detail on clay liners. Concrete also provides a wear surface if unloading equipment will enter the pond.

Figures 10-17, 10-18, and 10-19 represent various kinds of storage ponds and tanks.

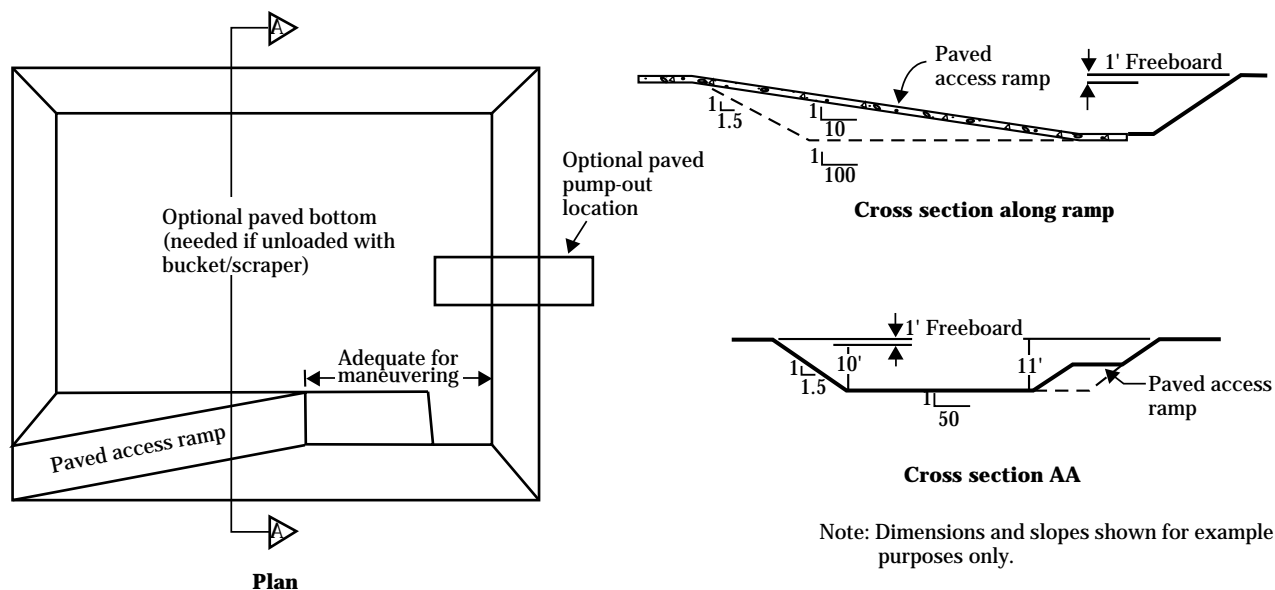
Liquid manure can be stored in aboveground (fig. 10-18) or below-ground (fig. 10-19) tanks. Liquid manure storage tanks can be constructed of metal,

concrete, or wood. Below-ground tanks can be loaded using slatted floors, push-off ramps, gravity pipes or gutters, or pumps. Aboveground tanks are typically loaded by a pump moving the manure from a reception pit. Tank loading can be from the top or bottom of the tank depending on such factors as desired agitation, minimized pumping head, weather conditions, and system management.

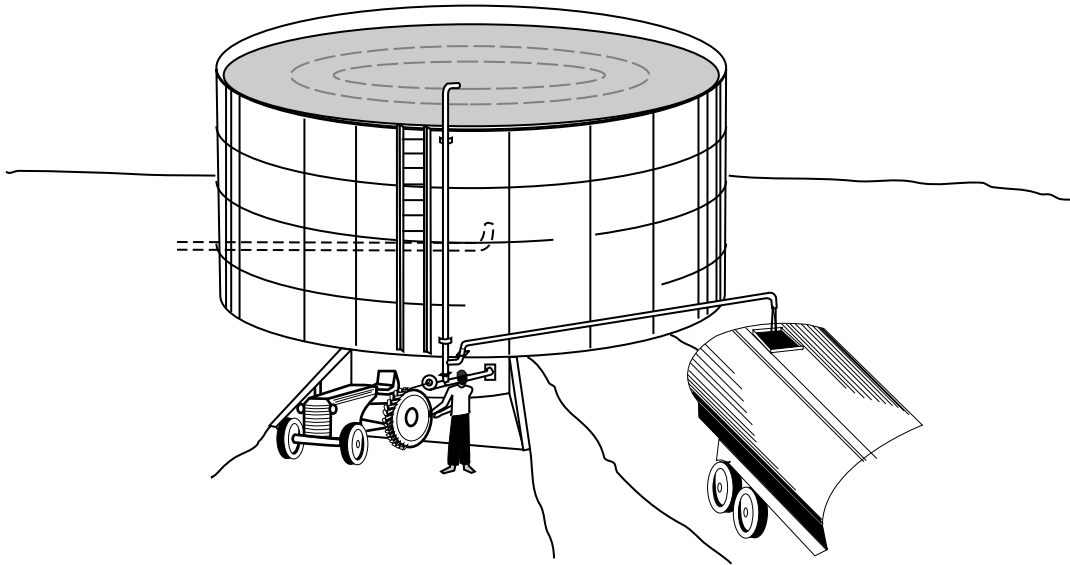
Storage volume requirements for tanks are the same as those for ponds except that provisions are normally made to exclude outside runoff from waste storage tanks because of the relative high cost of storage. Of course, if plans include storage of outside runoff, accommodation for its storage must be included in the tank's volume.

Tanks located beneath slatted floors can sometimes be used for temporary storage with subsequent discharge into lagoons or other storage facilities. Recycled lagoon effluent is added to a depth of 6 to 12 inches in underslat pits to reduce tendency for manure solids to stick to the pit floor. Wastes are allowed to collect for several days, typically 1 to 2 weeks, before the pits are gravity drained.

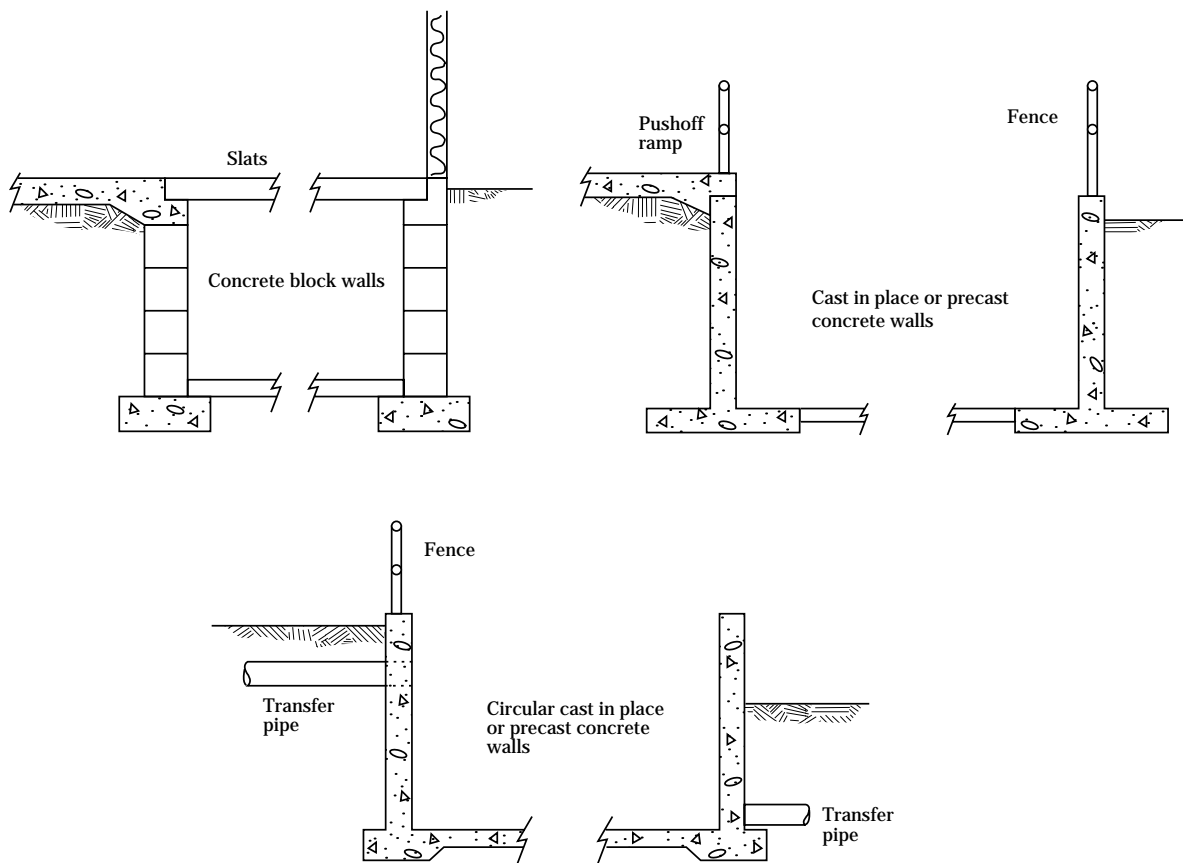
**Figure 10-17** Layout of waste storage pond



**Figure 10-18** Aboveground waste storage tank



**Figure 10-19** Below-ground waste storage structure





**(1) Design considerations**

**Tank material types**—The primary materials used to construct manure tanks are reinforced concrete, metal, and wood. Such tanks must be designed by a professional engineer and constructed by experienced contractors. A variety of manufactured, modular, and cast-in-place tanks are available from commercial suppliers. NRCS concurs in the standard detail drawings for these structures based on a review and approval of the drawings and supporting design calculations. A determination must be made that the site conditions are compatible with the design assumptions on which the design is based. Structures can also be designed on an individual site-specific basis.

Cast-in-place, reinforced concrete, the principal material used in below-ground tanks, can be used in above-ground tanks as well. Tanks can also be constructed of precast concrete panels that are bolted together. Circular tank panels are held in place with metal hoops. The panels are positioned on a concrete foundation or have footings cast as an integral part of the panel. Tank floors are cast-in-place slabs.

Other above-ground tanks are constructed of metal. Glass-fused steel panels are widely used. Such tanks are manufactured commercially and must be constructed by trained crews. Other kinds of metal panels are also used.

At least one company offers a wooden above-ground tank for liquid storage. The preservative treated boards have tongue-and-groove edges and are held in place using metal hoops similar to those used for concrete panel tanks. All manure tanks should meet the standards identified in the section on solid manure storage.

**Sizing**—Liquid waste storage ponds and structures should be sized to hold all of the manure, bedding, wastewater from milkhouse, flushing, and contaminated runoff that can be expected during the storage period. Equation 10-3 can be used to compute the waste volume:

$$WV = TVM = TWM = TBV \quad [10-3]$$

where:

*WV* = Waste volume for storage period, ft<sup>3</sup>

*TVM* = Total volume of manure for storage period, ft<sup>3</sup>  
(see equation 10-1)

*TWM* = Total wastewater volume for storage period, ft<sup>3</sup>

*TBV* = Total bedding volume for storage period, ft<sup>3</sup>  
(see equation 10-2)

Data on wastewater production are available in chapter 4 or from the farmer or rancher. Appendix 10C provides a method of estimating contaminated runoff volume.

In addition to the waste volume, waste storage tanks must, if uncovered, provide a depth to accommodate precipitation less evaporation on the storage surface during the most critical storage period. The most critical storage period is generally the consecutive months that represent the storage period that gives the greatest depth of precipitation less evaporation. Appendix 10C gives a method for estimating precipitation less evaporation. Waste storage tanks must also provide a depth of 0.5 feet for material not removed during emptying. A depth for freeboard of 0.5 feet is also recommended.

Waste storage ponds must also provide a depth to accommodate precipitation less evaporation during the most critical storage period. If the pond does not have a watershed, the depth of the 25-year, 24-hour precipitation on the pond surface must be included. Appendix 10B includes a map giving the precipitation amount for the 25-year, 24-hour precipitation. Frequently, waste storage ponds are designed to include outside runoff from watersheds. For these, the runoff volume of the 25-year, 24-hour storm must be included in the storage volume.

Appendix 10C gives a procedure for estimating the runoff volume from feedlots. The NRCS Engineering Handbook for Conservation Practice, chapter 2, may be used to estimate runoff volumes for other watershed areas.

**(2) Design of sidewalls and floors**

The information on the design of sidewalls and floors in section 651.1003(a) on solid manure storage material is applicable to these items used for liquid manure storage. All possible influences, such as internal and external hydrostatic pressure, flotation and drainage, live loads from equipment and animals, and dead loads from covers and supports, must be considered in the design.

**Pond sealing**—Waste storage ponds must not allow excess seepage. The soil in which the pond is to be located must be evaluated and, if needed, tested during planning and design to determine need for an appropriate liner. Refer to Appendix 10D, Geotechnical design and construction guidelines for waste impoundment liners, for detail on determining need for and design of clay liners. Also refer to Chapter 7, Geology and Ground Water Considerations, for more information on site evaluation, investigations, and testing.

**(3) Design example 10-3—Waste storage tank**

Mr. Bill Walton of Middlesburg, Tennessee, has requested assistance on a waste management system. The selected alternative includes a below-ground, covered, slurry storage tank for his Holstein dairy herd. He has 150 milkers that average 1,400 pounds and 75 heifers that are about 1,000 pounds each. Bedding material is not used with these animals. Based on crop utilization of the nutrients, storage is needed for 75 days. The critical storage periods are January 1 to March 15 and July 1 to September 15. The wash water from the milkhouse and parlor is also stored. No runoff will be directed to the storage. Worksheet 10A-1 shows how to determine the necessary volume for the storage tank and several possible sets of tank dimensions. It also shows how to estimate the total solids content of the stored waste.

**Manure production**—The animal type, average weight, and number are entered on **lines 1, 2, and 3**. The equivalent 1,000 pound animal units (AU) for the animal type is calculated and entered on **line 4**. The daily volume of manure (DVM) production for each animal type is selected from table 4-5 and entered on **line 5**. The storage period (D) is entered on **line 6**. The total manure volume (VMD) is calculated for each animal type and entered on **line 7**. Add the VMD for each animal type and enter the sum (TVM) on **line 8**.

**Wastewater volume**—The daily wastewater volume per animal unit description (DWW) is selected from table 4-6 and entered on **line 9**. The wastewater volume for the animal type for the storage period (WWD) is calculated and entered on **line 10**. Add the wastewater volumes for each animal type and enter the sum (TWW) on **line 11**.

**Bedding volume**—Bedding is not used in this example. If bedding were used, however, its volume for the storage period would be determined using **lines 12 through 15**.

**Waste volume**—WV is the total volume of waste material that will be stored including total manure (TVM), total wastewater (TWW), and total bedding volume (TBV). Provisions are to be made to assure that outside runoff does not enter the tank. In addition, if the tank is not covered, the depth of precipitation less evaporation on the tank surface expected during the most critical storage period must be added to the depth requirements.

**Total depth available**—The desired depth is the total planned depth based on such considerations as foundation condition, tank wall design, and standard drawing depth available.

**Surface area**—The surface area (**line 21**) dimensions are calculated using the equation for SA.

**Tank dimensions**—Because tanks are rectangular or circular, various combinations of length and width can be used to provide the SA required. If the depth is held constant, only one solution for the diameter of a circular tank is possible. The dimensions of either shape can be rounded upward to match a standard detail drawing or for convenience.

**Total solids content**—The initial TS content of the manure is given in table 4–5 in chapter 4. Because there are two sources of manure, the solids content of the total manure must be weighted by the contribution from each animal type. The adjusted total solids content of the stored manure is determined from figure 10–40 using the added water from the milkhouse and parlor, the runoff (none in this example), and the net rainfall during the storage period. Because the total solids content of milking center wastewater is so low, it can be ignored.

$$\begin{aligned}\text{Initial TS} &= \frac{(12.5\% \times 210\text{AU}) + (10.7\% \times 75\text{AU})}{210\text{AU} + 75\text{AU}} \\ &= 12\%\end{aligned}$$

Added water:

$$\begin{aligned}\left[9,450 \text{ ft}^3 + (0.3 \text{ ft} \times 33,580 \text{ ft}^3)\right] \times 7.48 \text{ gal} / \text{ft}^3 \\ = 78,720 \text{ gal}\end{aligned}$$

Added water/ft<sup>3</sup> manure:

$$\frac{78,20}{20,472 + 7,313} = 2.8 \text{ gal} / \text{ft}^3$$

From figure 10–40, adjusted TS = 8.8%.

Completed worksheet for Design example 10-3

<b>Worksheet 10A-1—Waste storage structure capacity design</b>	
Decisionmaker: <u>Bill Walton</u>	Date: <u>6/13/87</u>
Site: <u>Middlesburg, TN</u>	
<b>Animal units</b>	
1. Animal type <u>Milkers</u> <u>Heifers</u>	3. Number of animals (N) <u>150</u> <u>75</u>
2. Animal weight, lbs (W) <u>1,400</u> <u>1,000</u>	4. Animal units, $AU = \frac{W \times N}{1000}$ = <u>210</u> <u>75</u>
<b>Manure volume</b>	
5. Daily volume of daily manure production per AU, ft <sup>3</sup> /AU/day (DVM) = <u>1.3</u> <u>1.3</u>	7. Total volume of manure production for animal type for storage period, ft <sup>3</sup> VMD = AU x DVM x D = <u>20,475</u> <u>7,312</u>
6. Storage period, days (D) = <u>75</u>	8. Total manure production for storage period, ft <sup>3</sup> (TVM) <u>27,787</u>
<b>Wastewater volume</b>	
9. Daily wastewater volume per AU, ft <sup>3</sup> /AU/day (DWW) = <u>0.6</u> <u>0</u>	11. Total wastewater volume for storage period, ft <sup>3</sup> (TWW) <u>9,450</u>
10. Total wastewater volume for animal description for storage period, ft <sup>3</sup> WWD = DWW x AU x D = <u>9,450</u> <u>0</u>	
<b>Bedding volume</b>	
12. Amount of bedding used daily for animal type, lbs/AU/day (WB) = _____	14. Bedding volume for animal type for storage period, ft <sup>3</sup> = _____
13. Bedding unit weight, lbs/lb <sup>3</sup> (BUW) = _____	$VBD = \frac{0.5 \times WB \times AU \times D}{BUW}$
	15. Total bedding volume for storage period, ft <sup>3</sup> (TBV) = <u>0</u>
<b>Minimum waste storage volume requirement</b>	
16. Waste storage volume, ft <sup>3</sup> (WV) = TVM + TWW + TBV = <u>27,787</u> + <u>9,450</u> + <u>0</u> = <u>37,237</u>	
<b>Waste stacking structure sizing</b>	
17. Structure length, ft $L = \frac{WV}{WI \times H}$ = _____	19. Structure height, ft $H = \frac{WV}{L \times WI}$ = _____
18. Structure width, ft $WI = \frac{WV}{L \times H}$ = _____	
Notes for waste stacking structure:	
1. The volume determined (WV) does not include any volume for freeboard. It is recommended that a minimum of 1 foot of freeboard be provided for a waste stacking structure.	
2. The equations for L, WI, and H assume manure is stacked to average height equal to the sidewall height. Available storage volume must be adjusted to account for these types of variations.	
<b>Tank sizing</b>	
20. Effective depth, ft. (EH) _____	22. Rectangular tank dimensions
Total height (or depth) of tank desired, ft (H) <u>12</u>	Total height, ft (H) = <u>12</u> Selected width, ft (WI) = <u>30</u>
Less precipitation for storage period, ft. (uncovered tanks only) <u>0</u>	Length, ft $L = \frac{SA}{WI}$ = <u>112.8</u> (USE 115)
Less depth allowance for accumulated solids, ft (0.5 ft. minimum) <u>0.5</u>	23. Circular tank dimensions
Less depth for freeboard (0.5 ft. recommended), ft <u>0.5</u>	Total height, ft H = <u>12</u>
Effective depth, ft (EH) = <u>11</u>	Diameter, ft DIA = $(1.273 \times SA)^{0.5}$ = <u>65.6</u> (USE 66)
21. Surface area required, ft <sup>2</sup> $SA = \frac{WV}{EH}$ = <u>3,385</u>	Notes for waste storage tank structure:
	1. Final dimensions may be rounded up to whole numbers or to use increments on standard drawings.
	2. Trial and error may be required to establish appropriate dimensions.

**(4) Design example 10-4—Waste storage pond**

Mr. Joe Green of Silverton, Oregon, has requested assistance in developing an agricultural waste management system for his dairy. He has selected an alternative that includes a waste storage pond component. He has a Holstein herd composed of 500 milkers averaging 1,400 pounds; 150 dry cows averaging 1,400 pounds; and 150 heifers averaging 1,000 pounds. He has a freestall barn that has flush alleys. He uses foam pads for bedding. The alternative selected includes land application. A storage period of 180 days is required for storage through the winter months of high precipitation. A solid separator will be used to minimize solid accumulation in the waste storage pond and to allow recycling of the flush water. Water from the milkhouse and parlor will be stored in the pond. Use worksheet 10A-2 to determine the required capacity and size of the pond.

**Manure production**—The animal type, average weight, and numbers are entered on **lines 1, 2, and 3**. The number of 1,000 pound animal units for each animal type (AU) is calculated and entered on **line 4**. The volume of daily manure production (DVM) from table 4-5 is entered on **line 5**. The storage period (D) is entered on **line 6**. The manure volume for the storage period for each animal type (VMD) is then calculated and entered on **line 7**. The total volume (TVM) is added and then entered on **line 8**.

**Wastewater volume**—In this example, only the wastewater from the milkhouse and parlor is accounted for in the waste storage volume requirements because the alley flush water is recycled. The daily wastewater volume per animal unit (DWW) from table 4-6 is entered on **line 9**. The wastewater volume for each animal type for the storage period (WWD) is calculated using the equation and entered on **line 10**. The wastewater volume from each animal type (WWD) is added, and the sum (TWW) is entered on **line 11**.

**Clean water volume**—In this example, no clean water is added. However, if clean water (CW) is added for dilution, for example, the amount added during the storage period would be entered on **line 12**.

**Runoff volume**—For this example, the waste storage pond does not have a watershed and storage for runoff is not needed. However, waste storage ponds are frequently planned to include the runoff from a watershed, such as a feedlot. The ponds that have a watershed must include the normal runoff for the storage period and the runoff volume for the 25-year, 24-hour storm. The runoff volume from feedlots may be calculated using the procedures in appendix 10C. For watersheds or parts of watersheds that have cover other than feedlots, the runoff volume may be determined using the procedure in chapter 2 of the Engineering Field Manual for Conservation Practices. The value for watershed runoff volume (ROV) is entered on **line 13**. Documentation showing the procedure and values used in determining the volume of runoff should be attached to the worksheet.

**Volume of accumulated solids**—This volume is to accommodate the storage of accumulated solids for the period between solids removal. The solids referred to are those that remain after the liquid has been removed. An allowance for accumulated solids is required mainly for ponds used to store wastewater and polluted runoff. Solids separation, agitation before emptying, and length of time between solids removal all affect the amount of storage that must be provided. Enter the value for accumulated solids (VSA) on **line 14**. In this example, the solids from the manure are separated and solids accumulation will be minimal. No storage is provided for accumulated solids.

**Waste volume**—The total waste storage volume (WV) is determined by adding the total volume of manure (TVM), total wastewater volume (TWW), clean water added (CW), and volume allowance for solids accumulation (VSA). Waste storage ponds that have a watershed must also include the normal runoff volume for the storage period and the volume of the 25-year, 24-hour storm runoff (ROV). WSV is calculated on **line 15**. The waste storage pond must be sized to store this volume plus additional depth as explained in "depth adjustment."

Completed worksheet for Design example 10-4

Worksheet 10A-2—Waste storage pond design												
Decisionmaker: <u>Joe Green</u>				Date: <u>10/4/90</u>								
Site: <u>Silverton, OR</u>												
<b>Animal units</b>												
1. Animal type		<u>Milkers</u>	<u>Dry</u>	<u>Heifers</u>	3. Number of animals (N)			<u>500</u>	<u>150</u>	<u>150</u>		
2. Animal weight, lbs (W)		<u>1,400</u>	<u>1,400</u>	<u>1,000</u>	4. Animal units, $AU = \frac{W \times N}{1000}$			<u>700</u>	<u>210</u>	<u>150</u>		
<b>Manure volume</b>												
5. Daily volume of manure production per AU, ft <sup>3</sup> /AU/day (DVM)				<u>1.30</u>	<u>1.30</u>	<u>1.30</u>	7. Total volume of manure production for animal type for storage period, ft <sup>3</sup>			<u>163,800</u>	<u>49,140</u>	<u>35,100</u>
6. Storage period, days (D)								8. Total manure production for storage period, ft <sup>3</sup> (TVM)			<u>248,040</u>	
<b>Wastewater volume</b>												
9. Daily wastewater volume per AU, ft <sup>3</sup> /AU/day (DWW)				<u>0.6</u>	<u>0</u>	<u>0</u>	11. Total wastewater volume for storage period, ft <sup>3</sup> (TWW)			<u>75,600</u>		
10. Total wastewater volume for animal description for storage period, ft <sup>3</sup>				<u>75,600</u>				WWD = DWW x AU x D =				
<b>Clean water volume</b>				12. Clean water added during storage period, ft <sup>3</sup> (CW)				<u>0</u>				
<b>Solids accumulation</b>				14. Volume of solids accumulation, ft <sup>3</sup> (VSA)				<u>0</u>				
<b>Waste volume requirement</b>												
15. Waste volume, ft <sup>3</sup> (WV) = TVM + TWW + CW + ROV + VSA								<u>248,040 + 75,600 + 0 + 0 + 0 = 323,640</u>				
<b>Pond sizing</b>												
16. Sizing by trial and error								Side slope ratio, (Z) = <u>3</u> V must be equal to or greater than WV = <u>323,640</u> ft <sup>3</sup>				
Rectangular pond,				Circular pond,								
$V = \left( \frac{4 \times Z^2 \times d^3}{3} \right) + (Z \times BL \times d^2) + (Z \times BW \times d^2) + (BW \times BL \times d)$				$V = (1.05 \times Z^2 \times d^3) + (1.57 \times W \times Z \times d^2) + (0.79 \times W^2 \times d)$								
Trial no.	Bottom width ft (BW)	Bottom length ft (BL)	Depth* ft (d)	Volume ft <sup>3</sup> (V)	Trial no.	Bottom diameter (DIA)	Depth* ft (d)	Volume ft <sup>3</sup> (V)				
<u>1</u>	<u>100</u>	<u>500</u>	<u>6</u>	<u>367,392</u>								
<u>2</u>	<u>100</u>	<u>400</u>	<u>6</u>	<u>296,592</u>								
<u>3</u>	<u>100</u>	<u>425</u>	<u>6</u>	<u>314,292</u>								
<u>4</u>	<u>100</u>	<u>425</u>	<u>6.2</u>	<u>326,903</u>	<u>WSV OK</u>							
* Depth must be adjusted in Step 17.												
<b>Depth adjustment</b>												
17. Depth adjustment												
Depth, ft (d)				<u>6.2</u>								
Add depth of precipitation less evaporation (For the storage period)				<u>2.3</u>				Add for freeboard (1.0 foot minimum)				
Add depth of 25-year, 24-hour storm				<u>0.3</u>				Final depth				
								<u>9.8</u>				



## 651.1004 Treatment

In many situations it is necessary to treat agricultural waste before final utilization. The purpose of treatment is to reduce pollution potential of the waste through biological, physical, and chemical processes using such components as lagoons, oxidation ditches, and composting. These types of components reduce nutrients, destroy pathogens, and reduce total solids. Composting also reduces the volume of the waste. Treatment also includes any step that might be considered pretreatment, such as solids separation, drying, and dilution that prepares the waste for facilitating another function. By their nature, treatment facilities require a higher level of management than that of storage facilities.

### (a) Anaerobic lagoons

Anaerobic lagoons are widely accepted in the United States for the treatment of animal waste. Anaerobic treatment of animal waste helps to protect water quality by reducing much of the organic concentration (BOD, COD) of the waste. Anaerobic lagoons also reduce the nitrogen content of the waste through ammonia volatilization and effectively reduce animal waste odors if the lagoon is managed properly.

#### (1) Design

The maximum operating level of an anaerobic lagoon is a volume requirement plus a depth requirement. The volume requirement is the sum of the following volumes:

- Minimum treatment volume, ft<sup>3</sup> (MTV)
- Manure volume, wastewater volume, and clean water, ft<sup>3</sup> (WV)
- Sludge volume, ft<sup>3</sup> (SV)

The depth requirement is the normal precipitation less evaporation on the lagoon surface.

Polluted runoff from a watershed must not be included in a lagoon unless a defensible estimate of the volatile solid loading can be made. Runoff from a watershed, such as a feedlot, is not included in a lagoon because loading would only result during storm events and because the magnitude of the loading would be difficult, if not impossible, to estimate. As a result, the lagoon would be shocked with an overload of volatile solids.

If an automatic outflow device, pipe, or spillway is used, it must be placed at a height above the maximum operating level to accommodate the 25-year, 24-hour storm precipitation on the lagoon surface. This depth added to the maximum operating level of the lagoon establishes the level of the required volume or the outflow device, pipe, or spillway. A minimum of 1 foot of freeboard is provided above the outflow and establishes the top of the embankment. Should state regulation preclude the use of an outflow device, pipe, or spillway or if for some other reason the lagoon will not have these, the minimum freeboard is 1 foot above the top of the required volume.

The combination of these volumes and depths is illustrated in figure 10-21. The terms and derivation are explained in the following paragraphs.

Anaerobic waste treatment lagoons are designed on the basis of volatile solids loading rate (VSLR) per 1,000 cubic feet. Volatile solids represent the amount of solid material in wastes that will decompose as opposed to the mineral (inert) fraction. The rate of solids decomposition in anaerobic lagoons is a function of temperature; therefore, the acceptable VSLR varies from one location to another. Figure 10-22 indicates the maximum VSLR's for the United States. If odors need to be minimized, VSLR should be reduced by 25 to 50 percent.

The minimum treatment volume (MTV) represents the volume needed to maintain sustainable biological activity. The minimum treatment volume for VS can be determined using equation 10-4.

$$MTV = \frac{TVS}{VSLR} \quad [10-4]$$

where:

*MTV* = Minimum treatment volume, ft<sup>3</sup>

*TVS* = Total daily volatile solids loading (from all sources), lb/day

*VSLR* = Volatile solids loading rate, lb/1,000 ft<sup>3</sup>/day (from fig. 10-22)



Daily volatile solids production for various wastes can be determined using tables in chapter 4. If feed spillage exceeds 5 percent, *VSP* should be increased by 4 percent for each additional 1 percent spillage.

Waste volume (*WV*) should reflect the actual volume of manure, wastewater, flush water that will not be recycled, and clean dilution water added to the lagoon during the treatment period. The treatment period is either the detention time required to obtain the desired reduction of pollution potential of the waste or the time between land application events, whichever is longer. State regulations may govern the minimum detention time. Generally, the maximum time between land application events determines the treatment period because this time generally exceeds the detention time required.

$$WV = TVM + TWW + CW \quad [10-5]$$

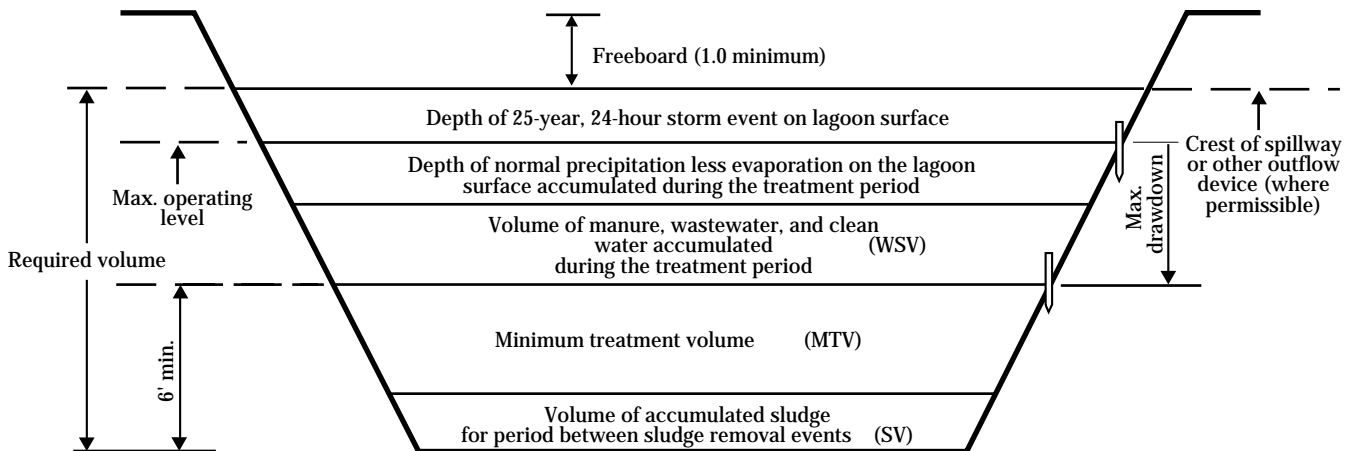
where:

- WV* = Waste volume for treatment period, ft<sup>3</sup>
- TVM* = Total volume of manure for treatment period, ft<sup>3</sup>
- TWW* = Total volume of wastewater for treatment period, ft<sup>3</sup>
- CW* = Clean water added during treatment period, ft<sup>3</sup>

In the absence of site-specific data, values in chapter 4 may be used to make estimates of the volumes.

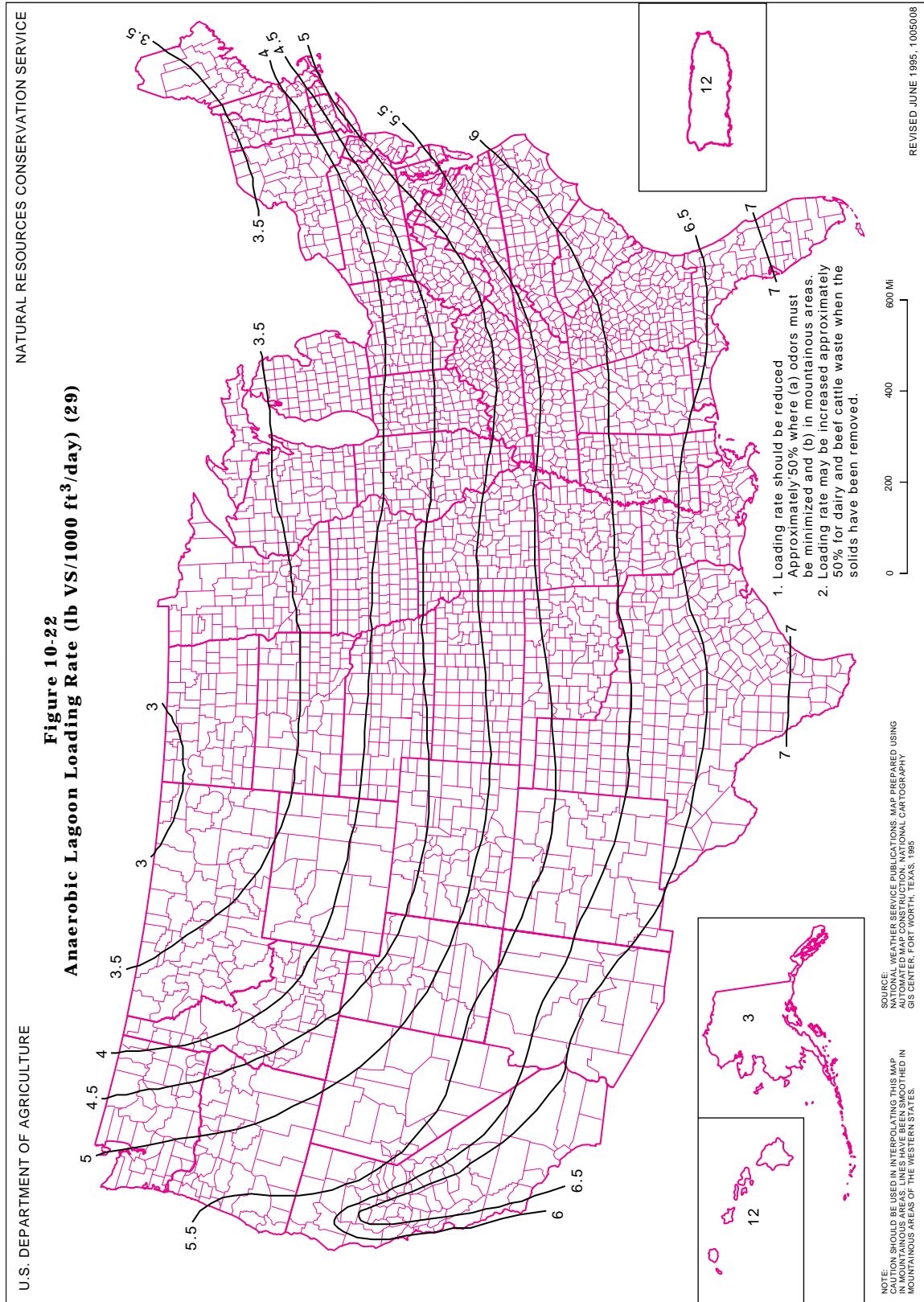
As the manure is decomposed in the anaerobic lagoon only part of the total solids (TS) is reduced. Some of the TS is mineral material that will not decompose, and some of the VS require a long time to decompose. These materials, referred to as sludge, gradually accumulate in the lagoon. To maintain the minimum treatment volume (MTV), the volume of sludge accumulation over the period of time between sludge removal

**Figure 10-21** Anaerobic lagoon cross section



Note: The minimum treatment volume for an anaerobic waste treatment lagoon is based on volatile solids.

**Figure 10-22** Anaerobic lagoon loading rate



must be considered. Lagoons are commonly designed for a 15- to 20-year sludge accumulation period. The sludge volume (SV) can be determined using equation 10-6.

$$SV = 365 \times AU \times TS \times SAR \times T \quad [10-6]$$

where:

- SV* = Sludge volume (ft<sup>3</sup>)
- AU* = Number of 1,000-pound animal units
- T* = Sludge accumulation time (years)
- TS* = Total solids production per animal unit per day (lb/AU/day)
- SAR* = Sludge accumulation ratio (ft<sup>3</sup>/lb TS)

Total solids values can be obtained from the tables in chapter 4. Sludge accumulation ratios should be taken from table 10-4. An SAR is not available for beef, but it can be assumed to be similar to that for dairy cattle.

The lagoon volume requirements are for accommodation of the minimum treatment volume, the sludge volume, and the waste volume for the treatment period. This is expressed in equation 10-7.

$$LV = MTV + SV + WV \quad [10-7]$$

where:

- LV* = Lagoon volume requirement, ft<sup>3</sup>
- MTV* = Minimum treatment volume, ft<sup>3</sup> (see equation 10-4)
- SV* = Sludge volume accumulation for period between sludge removal events, ft<sup>3</sup> (see equation 10-6)
- WV* = Waste volume for treatment period, ft<sup>3</sup> (see equation 10-5)

In addition to the lagoon volume requirement (LV), a provision must be made for depth to accommodate the normal precipitation less evaporation on the lagoon surface; the 25-year, 24-hour storm precipitation; the depth required to operate the emergency outflow; and freeboard. Normal precipitation on the lagoon surface is based on the critical treatment period that produces the maximum depth. This depth can be offset to some degree by evaporation losses on the lagoon surface. This offset varies, according to the climate of the region, from a partial amount of the precipitation to an amount in excess of the precipitation. Precipitation and evaporation can be determined from local climate data.

The minimum acceptable depth for anaerobic lagoons is 6 feet, but in colder climates at least 10 feet is recommended to assure proper operation and odor control.

The design height of an embankment for a lagoon should be increased by the amount needed to ensure that the design elevation is maintained after settlement. This increase should not be less than 5 percent of the design fill height. The minimum top width of the lagoon should be as shown in table 10-5, although a width of 8 feet and less is difficult to construct.

The combined side slopes of the settled embankment should not be less than 5 to 1 (horizontal to vertical). The inside slopes can vary from 1 to 1 for excavated slopes to 3 to 1 or flatter where embankments are used. Construction technique and soil type must also be considered. In some situations a steep slope may be used below the design liquid level, while a flatter slope is used above the liquid level to facilitate maintenance

**Table 10-4** Sludge accumulation ratios (Barth 1985)

Animal type	SAR
Poultry	
Layers	0.0295
Pullets	0.0455
Swine	0.0485
Dairy cattle	0.0729

**Table 10-5** Minimum top width for lagoon embankments (USDA 1984, Waste...)

Maximum height of embankment, ft	Top width, ft
10 or less	6
11-14	8
15-19	10
20-24	12
25-34	14
35 or more	15

and bank stabilization. The minimum elevation of the top of the settled embankment should be 1 foot above the maximum design water surface in the lagoon.

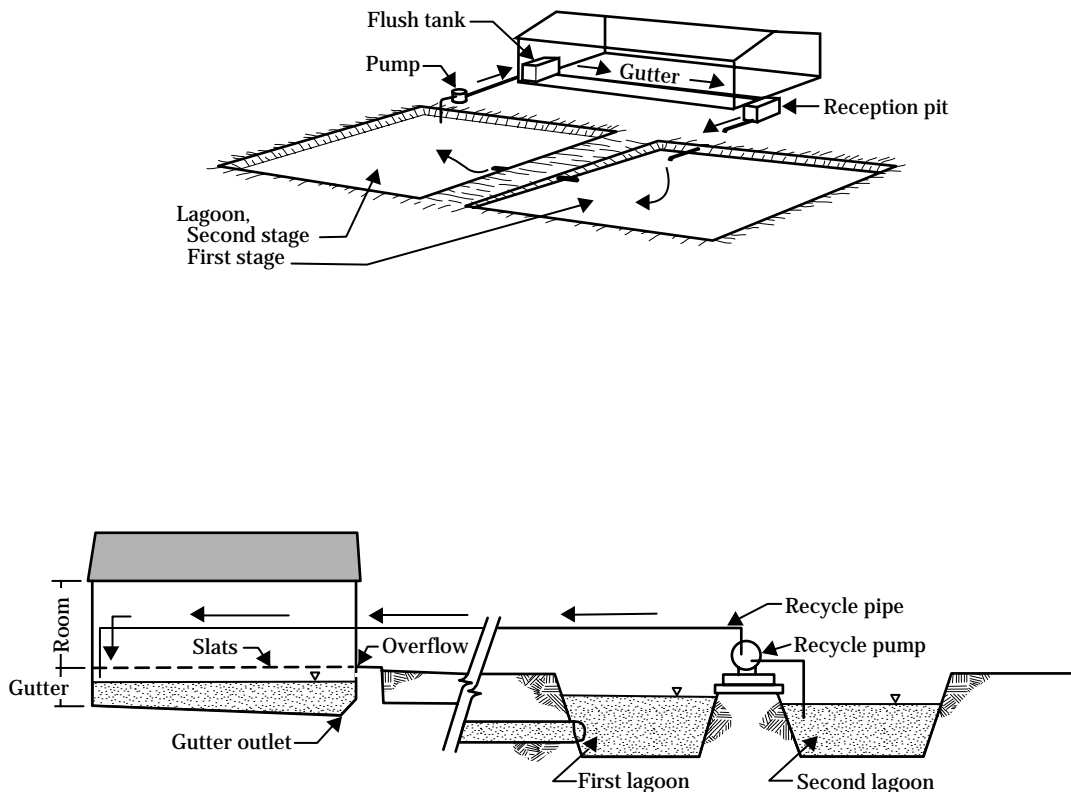
A lagoon should be constructed to avoid seepage and potential ground water pollution. Care in site selection, soils investigation, and design can minimize the potential for these problems. In cases where the lagoon needs to be sealed, the techniques discussed in Appendix 10D, Geotechnical design and construction guidelines for waste impoundment liners, can be used. Also refer to Chapter 7, Geology and Ground Water Considerations, for more information on site evaluation, investigations, and testing. Figure 10-23 shows a two lagoon systems.

If overtopping can cause embankment failure, an emergency spillway or overflow pipe should be provided. A lagoon can have an overflow to maintain a constant liquid level if the overflow liquid is stored in a

waste storage pond or otherwise properly managed. The inlet to a lagoon should be protected from freezing. This can be accomplished by using an open channel that can be cleaned out or by locating the inlet pipe below the freezing level in the lagoon. Because of possible blockages, access to the inlet pipe is needed. Venting inlet pipes prevents backflow of lagoon gases into the animal production facilities.

Sludge removal is an important consideration in the design. This can be accomplished by agitating the lagoon and pumping out the mixed sludge or by using a drag-line for removing floating or settled sludge. Some pumps can remove sludge, but not deposited rocks, sand, or grit. The sludge removal technique should be considered when determining lagoon surface dimensions. Many agitation pumps have an effective radius of 75 to 100 feet. Draglines may only reach 30 to 50 feet into the lagoon.

**Figure 10-23** Anaerobic lagoon recycle systems



## (2) Management

Anaerobic lagoons must be managed properly if they are to function as designed. Specific instructions about lagoon operation and maintenance must be included in the overall waste management plan that is supplied to the decisionmaker. Normally an anaerobic lagoon is managed so that the liquid level is maintained at or below the maximum operating level as shown in figure 10-21. The liquid level is lowered to the minimum treatment level at the end of the treatment period. It is good practice to install markers at the minimum treatment and maximum operating levels.

The minimum liquid level in an anaerobic lagoon before wastes are added should coincide with the MTV. If possible a lagoon should be put into service during the summer to allow adequate development of bacterial populations. A lagoon operates more effectively and has fewer problems if loading is by small, frequent (daily) inflow, rather than large, infrequent slug loads.

The pH should be measured frequently. Many problems associated with lagoons are related to pH in some manner. The optimum pH is about 6.5. When pH falls below this level, methane bacteria are inhibited by the free hydrogen ion concentration. The most frequent cause of low pH in anaerobic digestion is the shock loading of organic material that stimulates the facultative acid-producing bacteria. Add hydrated lime or lye if pH is below 6.5. Add 1 pound per 1,000 square feet daily until pH reaches 7.

Lagoons are designed based on a given loading rate. If an increase in the number of animals is anticipated, sufficient capacity to handle all of the expected waste load should be available. The most common problem in using lagoons is overloading, which can lead to odors, malfunctioning, and complaints. When liquid removal is needed, the liquid level should not be dropped below the MTV plus SV levels. If evaporation exceeds rainfall in a series of dry years, the lagoon should be partly drawn down and refilled to dilute excess concentrations of nutrients, minerals, and toxics. Lagoons are typically designed for 15 to 20 years of sludge accumulation. After this time the sludge must be cleaned out before adding additional waste.

Sometimes operators want to use lagoon effluent as flush water. To polish and store water for this purpose, waste storage ponds can be constructed in series with the anaerobic lagoon. The capacity of the waste storage pond should be sized for the desired storage volume. A minimum capacity of the waste storage pond is the volume for rainfall (RFV), runoff (ROV), and emergency storm storage (ESV). By limiting the depth to less than 6 feet, the pond will function more nearly like an aerobic lagoon. Odors and the level of ammonia, ammonium, and nitrate will be more effectively reduced.

## (3) Design example 10-5—Anaerobic lagoon

Mr. Oscar Smith of Rocky Mount, North Carolina, has requested assistance in developing an agricultural waste management system for his 6,000 pig finishing facility. The alternative selected includes an anaerobic lagoon. The animals average 150 pounds. The 25-year, 24-hour storm for the area is 6 inches (appendix 10B). Mr. Smith needs 180-day intervals between lagoon pumping. During this time the net precipitation should be 2 inches, based on data from appendices 10B and 10C. He wants to use the lagoon for at least 5 years before removing the sludge. Worksheet 10A-3 is used to determine the necessary volume for this lagoon.

## Completed worksheet for Design example 10-5

<b>Worksheet 10A-3—Anaerobic lagoon design</b>	
Decisionmaker: <i>Oscar Smith</i>	Date: <i>6/13/90</i>
Site: <i>Rocky Mount, NC</i>	
<b>Animal units</b>	
1. Animal type <i>Growers</i>	3. Number of animals (N) <i>6000</i>
2. Animal weight, lbs (W) <i>150</i>	4. Animal units, AU = $\frac{W \times N}{1000}$ = <i>900</i>
<b>Manure volume</b>	
5. Daily volume of daily manure production per AU, ft <sup>3</sup> /AU/day (DVM) = <i>1.0</i>	7. Total volume of manure production for animal type for treatment period, ft <sup>3</sup> VMD = AU x DVM x D = <i>162,000</i>
6. Treatment period, days (D) = <i>180</i>	8. Total manure production for treatment period, ft <sup>3</sup> (TVM) = <i>162,000</i>
<b>Wastewater volume</b>	
9. Daily wastewater volume per AU, ft <sup>3</sup> /AU/day (DWW) = _____	11. Total wastewater volume for treatment period, ft <sup>3</sup> (TWW) = <i>0</i>
10. Total wastewater volume for animal description for treatment period, ft <sup>3</sup> WWD = DWW x AU x D = _____	
<b>Clean water volume</b>	
12. Clean water added during treatment period, ft <sup>3</sup> (CW) = _____	<i>0</i>
<b>Waste volume</b>	
13. Waste volume for treatment period, ft <sup>3</sup> $WV = TVM + TWW + CW$ = <i>162,000</i> + <i>0</i> + <i>0</i> = <i>162,000</i>	
<b>Manure total solids</b>	
14. Daily manure total solids production, lbs/AU/day (MTS) = <i>6.34</i>	16. Total manure total solids production, lbs/day (TMTS) = <i>5706</i>
15. Daily manure total solids production for animal type, lbs/day MTSD = MTS x AU = <i>5706</i>	
<b>Manure volatile solids</b>	
17. Daily manure volatile solids production per AU, lbs/AU/day (MVS) = <i>5.4</i>	
18. Daily manure volatile solids production for animal type per day, lbs/day $MVSD = AU \times MVS$ = <i>4860</i>	
19. Total manure volatile solids production, lbs/day (TMVS) = <i>4860</i>	
<b>Wastewater volatile solids</b>	
20. Daily wastewater volatile solids production, lbs/1000 gal (DWVS) = _____	
21. Total wastewater volatile solids production for animal type, lbs/day $WVSD = \frac{DWVS \times DWW \times 7.48}{D \times 1,000}$ = _____	
22. Total wastewater volatile solids production, lbs/day (TWVS) = <i>0</i>	
<b>Total volatile solids (manure and wastewater)</b>	
23. Total daily volatile solids production, lbs/day $TVS = TMVS + TWVS$ = <i>4860</i> + <i>0</i> = <i>4860</i>	
<b>Minimum treatment volume</b>	
24. Selected lagoon VS loading rate, lbs VS/1,000 ft <sup>3</sup> (VSLR) = <i>6</i>	25. Minimum treatment volume, ft <sup>3</sup> $MTV = \frac{TVS \times 1000}{VSLR} = \frac{(4860) \times 1000}{(6)} = 810,000$
<b>Sludge volume requirement</b>	
26. Sludge accumulation ratio, ft <sup>3</sup> /lb TS (SAR) = <i>0.0485</i>	28. Sludge volume requirement, ft <sup>3</sup> $SV = 365 \times TMTS \times T \times SAR$
27. Sludge accumulation period, years (T) = <i>5</i>	= $365 \times (5706) \times (5) \times (0.0485) = 505,052$
<b>Minimum lagoon volume requirement</b>	
29. Minimum lagoon volume requirements, ft <sup>3</sup> (MLVR) = MTV + SV + WV = <i>810,000</i> + <i>505,052</i> + <i>162,000</i> = <i>1,477,052</i>	

Completed worksheet for Design example 10-5—Continued

Worksheet 10A-3—Anaerobic lagoon design—Continued

Lagoon sizing

30. Sizing by trial and error  $V = \frac{(4 \times Z^2 \times d^3)}{3} + (Z \times BL \times d^2) + (Z \times BW \times d^2) + (BW \times BL \times d)$

Side slope ratio, (Z) = 2

V must be equal to or greater than MLVR = 1,477,052 ft<sup>3</sup>

Trial no.	Bottom width ft (BW)	Bottom length ft (BL)	Depth* ft (d)	Volume ft <sup>3</sup> (V)
<u>1</u>	<u>150</u>	<u>1000</u>	<u>8</u>	<u>1,349,931</u>
<u>2</u>	<u>150</u>	<u>1200</u>	<u>8</u>	<u>1,615,531</u>
<u>3</u>	<u>150</u>	<u>1100</u>	<u>8</u>	<u>1,482,731 ≈ MLVR</u>

\* Depth must be adjusted in Step 31.

Depth adjustment

31. Depth adjustment

Depth, ft (d) ..... 8

Add depth of precipitation less evaporation on lagoon surface ..... + 0.6  
(for the treatment period)

Add depth of 25-year, 24-hour storm ..... + 0.5

Add for freeboard (1.0 foot minimum) ..... + 1.0

Final depth ..... 10.1

32. Compute total volume using final depth, ft<sup>3</sup> (use equation in step 30) ..... 2,014,299

## (b) Aerobic lagoons

Aerobic lagoons can be used if minimizing odors is critical (fig. 10-24). These lagoons operate within a depth range of 2 to 5 feet to allow for the oxygen entrainment that is necessary for the aerobic bacteria.

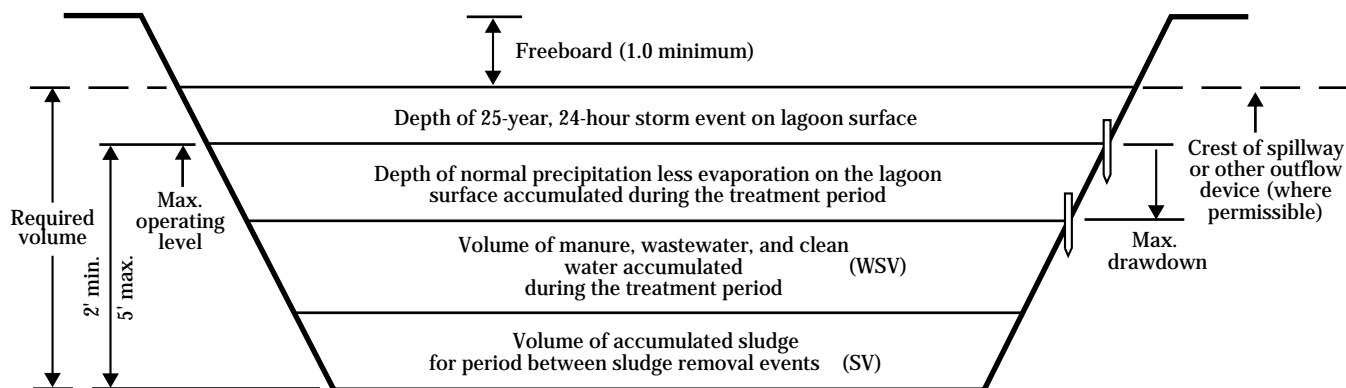
The design of aerobic lagoons is based on the amount of BOD<sub>5</sub> added per day. If local data are not available, use the BOD<sub>5</sub> values from the tables in chapter 4. Figure 10-25 shows the acceptable aerobic loading rates for the United States in lb-BOD<sub>5</sub>/acre/day. The lagoon surface area at the average operating depth is sized so that the acceptable loading rate is not exceeded.

Even though an aerobic lagoon is designed on the basis of surface area, it must have enough capacity to accommodate the waste volume (WV) and sludge volume (SV). In addition, depth must be provided to accommodate the normal precipitation less evapora-

tion on the lagoon surface, the 25-year, 24-hour storm precipitation on the lagoon surface, and freeboard. Should State regulations not permit an emergency outflow or for some other reason one is not used, the minimum freeboard is 1 foot above the top of the required volume. Figure 10-24 demonstrates these volume depth requirements.

Aerobic lagoons need to be managed similarly to anaerobic lagoons in that they should never be overloaded with oxygen demanding material. The lagoon should be filled to the minimum operating level, generally 2 feet, before being loaded with waste. The maximum liquid level should not exceed 5 feet. The water level must be maintained within the designed operating range. Sludge should be removed when it exceeds the designed sludge storage capacity. Aerobic lagoons should also be enclosed in fences and marked with warning signs.

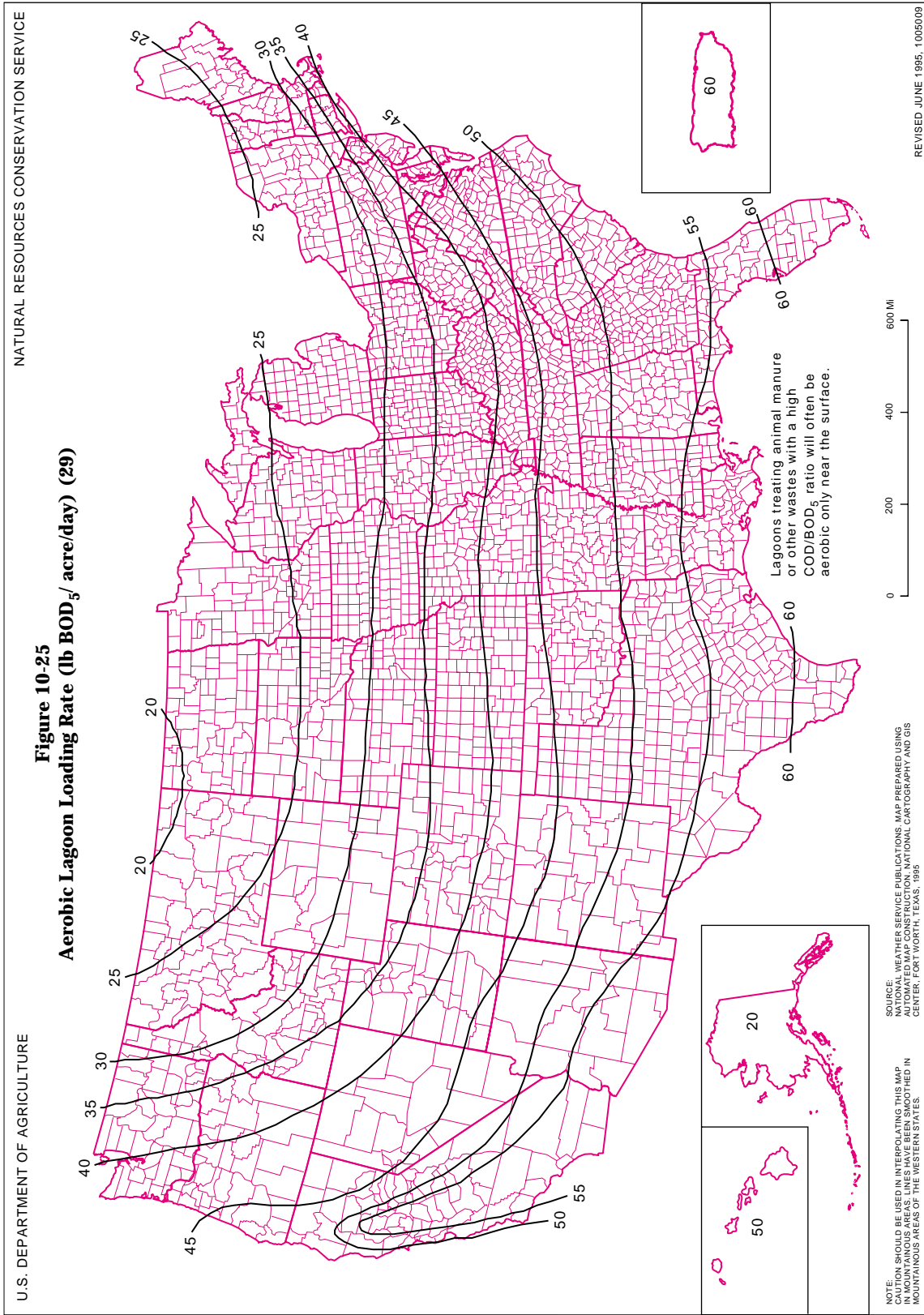
**Figure 10-24** Aerobic lagoon cross section



Note: An aerobic waste treatment lagoon has a required minimum surface area based on BOD<sub>5</sub>



**Figure 10-25** Aerobic lagoon loading rate



**(1) Design example 10-6—Aerobic lagoon**  
Mr. John Sims of Greenville, Mississippi, has requested assistance on the development of an agricultural waste management system. He has requested that an alternative be developed that includes an aerobic lagoon to

treat the waste from his 50,000 caged layers, which have an average weight of 4 pounds. Completed worksheet 10A-4 shows the calculations to size the lagoon for this design example.

### Worksheet 10A-4—Aerobic lagoon design

Decisionmaker: <i>John Sims</i>		Date: <i>11/16/90</i>
Site: <i>Greenville, MS</i>		
<b>Animal units</b>		
1. Animal type	<i>Caged Layers</i>	3. Number of animals (N) <i>50,000</i>
2. Animal weight, lbs (W)	<i>4</i>	4. Animal units, $AU = \frac{W \times N}{1000} =$ <i>200</i>
<b>Manure volume</b>		
5. Daily volume of daily manure production per AU, $ft^3/AU/day$ (DVM) =	<i>0.93</i>	7. Total volume of manure production for animal type for treatment period, $ft^3$ $VMD = AU \times DVM \times D =$ <i>33,480</i>
6. Treatment period, days (D) =	<i>180</i>	8. Total manure production for treatment period, $ft^3$ (TVM) <i>33,480</i>
<b>Wastewater volume</b>		
9. Daily wastewater volume per AU, $ft^3/AU/day$ (DWW) =		11. Total wastewater volume for treatment period, $ft^3$ (TWW) <i>0</i>
10. Total wastewater volume for animal description for treatment period, $ft^3$ $WWD = DWW \times AU \times D =$		
<b>Clean water volume</b>		
12. Clean water added during treatment period, $ft^3$ (CW)		<i>0</i>
<b>Waste volume</b>		
13. Waste volume for treatment period, $ft^3$ $WV = TVM + TWW + CW =$	<i>33,480 + 0 + 0 =</i>	<i>33,480</i>
<b>Manure total solids</b>		
14. Daily manure total solids production, $lbs/AU/day$ (MTS) =	<i>15.1</i>	16. Total manure total solids production, $lbs/day$ (TMTS) = <i>3020</i>
15. Daily manure total solids production for animal type, $lb/day$ $MTSD = MTS \times AU =$	<i>3020</i>	
<b>Manure 5-day biochemical oxygen demand</b>		
17. Daily manure $BOD_5$ production per AU, $lbs/AU/day$ (MBOD) =	<i>3.7</i>	
18. Daily manure $BOD_5$ production for animal type per day, $lbs/day$ $MBOD = AU \times BOD =$	<i>740</i>	
19. Total manure production, $lbs/day$ (TMBOD)		<i>740</i>
<b>Wastewater 5-day biochemical oxygen demand</b>		
20. Daily wastewater $BOD_5$ production, $lbs/1000$ gal (DWBOD) =		
21. Total wastewater $BOD_5$ production for animal type, $lbs/day$ $WBOD = \frac{(DWBOD \times TWW \times 7.48)}{D \times 1,000} =$		<i>0</i>
22. Total wastewater $BOD_5$ production, $lbs/day$ (TWBOD)		
<b>TOTAL <math>BOD_5</math> (manure and wastewater)</b>		
23. Total daily production, $lbs/day$ TBOD = TMBOD + TWBOD =	<i>740 + 0 =</i>	<i>740</i>
<b>Minimum treatment surface area</b>		
24. Selected lagoon $BOD_5$ loading rate, $lbs BOD_5/acre$ (BODLR) =	<i>50</i>	25. Minimum treatment surface area, acres $MTA = \frac{TBOD}{BODLR} = \frac{(740)}{(50)} =$ <i>14.8</i>
<b>Sludge volume requirement</b>		
26. Sludge accumulation ratio, $ft^3/lb$ TS (SAR) =	<i>0.0295</i>	28. Sludge volume requirement, $ft^3$ $SV = 365 \times TMTS \times T \times SAR$
27. Sludge accumulation period, years (T) =	<i>5</i>	$= 365(3020)(5)(0.0295) =$ <i>162,589</i>
<b>Minimum lagoon volume requirement</b>		
29. Minimum lagoon volume requirements, $ft^3$ $MLVR = SV + WV =$		<i>162,589 + 33,480 = 196,069</i>

Worksheet 10A-4—Aerobic Lagoon Design—Continued

**Lagoon sizing**

30. Sizing by trial and error:

Side slope ratio, (Z) = 2

V must be equal to or greater than MLVR = 196,069 ft<sup>3</sup>

SA must be equal to or greater than MTA = 14.8 acres

Rectangular lagoon:

d must be less than 5 feet

$$SA = \frac{(BL + 2Zd)(BW + 2Zd)}{43,560}$$

Trial no.	Bottom width ft (BW)	Bottom length ft (BL)	Depth* ft (d)	Volume ft <sup>3</sup> (V)	Surface area acres (SA)
<u>1</u>	<u>600</u>	<u>1100</u>	<u>1</u>	<u>663,405</u>	<u>15.3 OK</u>
_____	_____	_____	_____	_____	_____
_____	_____	_____	_____	_____	_____
_____	_____	_____	_____	_____	_____
_____	_____	_____	_____	_____	_____
_____	_____	_____	_____	_____	_____
_____	_____	_____	_____	_____	_____

\* Depth must be adjusted in Step 31

**Depth adjustment**

31. Depth adjustment

Depth, ft (d) ..... 1.0

Add depth of precipitation less evaporation on lagoon surface + 0.5  
(for the treatment period)

Add depth of 25-year, 24-hour storm ..... + 0.6

Add for freeboard (1.0 foot minimum) ..... + 1.0

Final depth ..... 3.1

32. Compute total volume using final depth, ft<sup>3</sup>  
(use equation in step 30) ..... 2,146,991=79,518

### (c) Mechanically aerated lagoons

*Much of this material was taken directly from technical notes on the design of mechanically aerated lagoons for odor control (Moffitt 1980).*

Aerated lagoons operate aerobically and are dependent on mechanical aeration to supply the oxygen needed to treat waste and minimize odors. This type of design is used to convert an anaerobic lagoon to an aerobic condition, or as an alternative, to a naturally aerated lagoon that would otherwise need to be much larger. Mechanically aerated lagoons combine the small surface area feature of anaerobic lagoons with relative odor free operation of an aerobic lagoon. The main disadvantages of this type of lagoon are the energy requirements to operate the mechanical aerators and the high level of management required.

The typical design includes 1 pound of oxygen transferred to the lagoon liquid for each pound of BOD<sub>5</sub> added. The TS content in aerated lagoons should be maintained between 1 and 3 percent with dilution water. The depth of aerated lagoons depends on the type of aerator used. Agitation of settled sludge needs to be avoided. As with naturally aerobic lagoons, consideration is required for storage of manure and rainfall.

Two kinds of mechanical aerator are used: the surface pump and the diffused air system. The **surface pump** floats on the surface of the lagoon, lifting water into the air, thus assuring an air-water mixture. The **diffused air system** pumps air through water, but is generally less economical to operate than the surface pump.

#### (1) Lagoon loading

Lagoon loading should be based on 5-day biochemical oxygen (BOD<sub>5</sub>) or carbonaceous oxygen demand (COD). NRCS designs on the basis of BOD<sub>5</sub>. The tables in chapter 4 show recommended BOD<sub>5</sub> production rates, but local data should be used where available.

#### (2) Aerator design

Aerators are designed primarily on their ability to transfer oxygen (O<sub>2</sub>) to the lagoon liquid. Of secondary importance is the ability of the aerator to mix or disperse the O<sub>2</sub> throughout the lagoon. Where the aerator is intended for minimizing odors, complete mixing is not a consideration except as it relates to the surface area.

For the purpose of minimizing odors, aerators should transfer from 1 to 2 pounds of oxygen per pound of BOD<sub>5</sub>. Even a limited amount of oxygen transfer (as little as 1/3 lb O<sub>2</sub> per lb BOD<sub>5</sub>) reduces the release of volatile acids and accompanying gases. For design purposes, use 1 pound of oxygen per pound of BOD<sub>5</sub> unless local research indicates a higher value is needed.

Aerators are tested and rated according to their clean water transfer rate (CWTR) or laboratory transfer rate (LTR), whichever term is preferred. The resulting value is given for transfer at standard atmospheric pressure (14.7 psi), dissolved oxygen equal to 0 percent, and water at 20 °C. The actual transfer rate expected in field operation can be determined by using equation 10-8.

$$FTR = CWTR \times \frac{(B \times C_{dc}) - DO}{C_{sc}} \times O^{t-20} \times a \quad [10-8]$$

where:

$FTR$  = lb O<sub>2</sub> per horsepower-hour transferred under field conditions

$CWTR$  = clean water transfer rate in lb per horsepower-hour transferred under standard laboratory conditions

$B$  = salinity-surface tension factor. It is the ration of the saturated concentration in the wastewater to that of clean water. Values range from 0.95 to 1.0.

$C_{dc}$  = O<sub>2</sub> saturation concentration at design conditions of altitude and temperature (mg/L) from figures 10-26 and 10-27.

$DO$  = Average operating O<sub>2</sub> concentration (mg/L). The recommended value of DO can vary from 1 to 3 depending on the reference material. A value of 1.5 should be considered a minimum. For areas where minimizing odors is particularly critical, a DO of 2 or more should be used.

$t$  = Design temperature (°C)

$O$  = Temperature correction factor; values range from 1.024 to 1.035.

$a$  = The ratio of the rate of O<sub>2</sub> transfer in the wastewater to that of clean water. Generally taken as 0.75 for animal waste.

$C_{sc}$  = Saturation concentration of O<sub>2</sub> in clean water, 20 °C and sea level (9.17 mg/L).

Unless local information supports using other values, the following values for calculating field transfer rates should be used: B=1.0, DO=1.5, O=1.024, a=0.75, and  $C_{sc} = 9.17$ .

Figure 10-28 provides a quick solution to the term  $O^{t-20}$ , where O is equal to 1.024. Designs for both summer and winter temperatures are often necessary to determine the controlling (least) transfer rate.

Having calculated FTR, the next step is to determine horsepower requirements of aeration based on loading rates and FTR as calculated above. Horsepower requirements can be estimated using equation 10-9.

$$HP = \frac{BOD_5}{FTR \times HO} \quad [10-9]$$

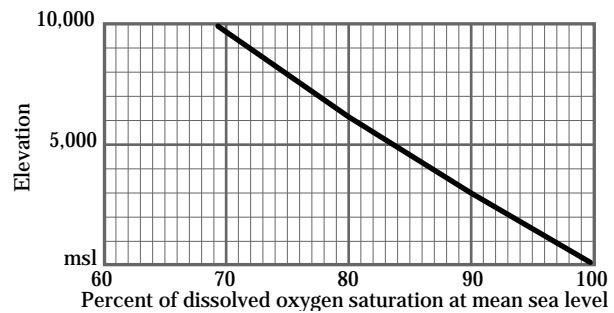
where:

- HP = Horsepower
- BOD<sub>5</sub> = 5-day biochemical oxygen demand loading of waste, lb/day
- HO = Hours of operation per day

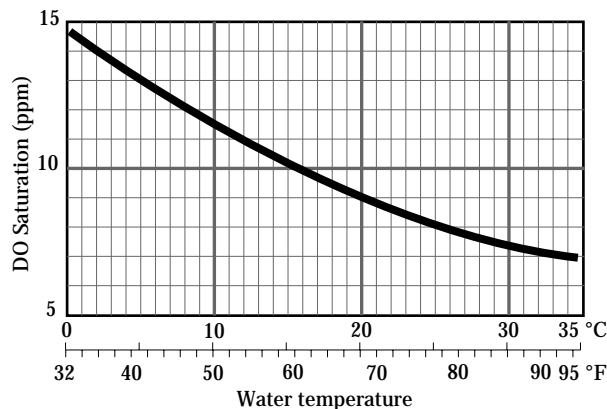
Most lagoon systems should be designed on the basis of continual aerator operations.

The actual selection of aerator(s) is a subjective process and often depends on the availability of models in the particular area. In general, multiple small units are preferred to one large unit. The multiple units provide better coverage of the surface area as well as permit flexibility for the real possibility of equipment failure and reduced aeration.

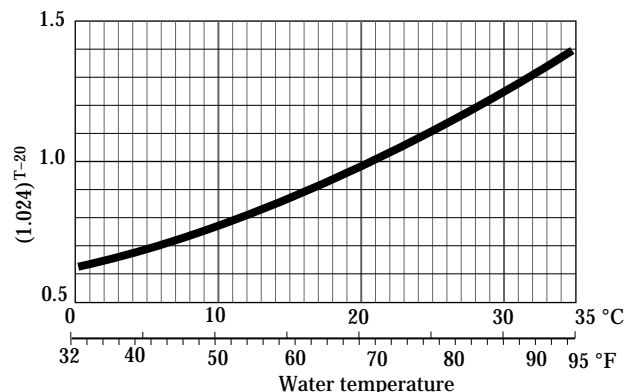
**Figure 10-27** Relation of dissolved oxygen saturation to elevation above mean sea level



**Figure 10-26** Relation of dissolved oxygen saturation to water temperature (clean water at 20 °C and sea level)



**Figure 10-28** Numerical values for  $O^{t-20}$  at different temperatures where O=1.024



### (d) Oxidation ditches

In some situations sufficient space is not available for a lagoon for treating animal waste, and odor control is critical. One option for treating animal waste under these circumstances is an oxidation ditch (fig. 10-29). The shallow, continuous ditch generally is in an oval layout. It has a special aerator spanning the channel. The action of the aerator moves the liquid waste around the channel and keeps the solids in suspension. Because of the need for continuous aeration, this process can be expensive to operate. Oxidation ditches should only be designed by a professional engineer familiar with the process.

The range of loading for an oxidation ditch is 1 pound of BOD<sub>5</sub> per 30 to 100 cubic feet of volume. This provides for a retention time of 30 to 70 days. Solids accumulate over time and must be removed by settling. The TS concentration is maintained in the 2 to 6 percent range, and dilution water must be added periodically.

If oxidation ditches are not overloaded, they work well for minimizing odors. The degree of management required, however, may be more than desired by some operators. Daily attention is often necessary, and equipment failure can lead to toxic gas generation soon after the aerators are stopped. If the ditches are properly managed, they can be effective in reducing nitrogen to N<sub>2</sub> through cyclic aerobic/anaerobic periods, which allows nitrification and then denitrification.

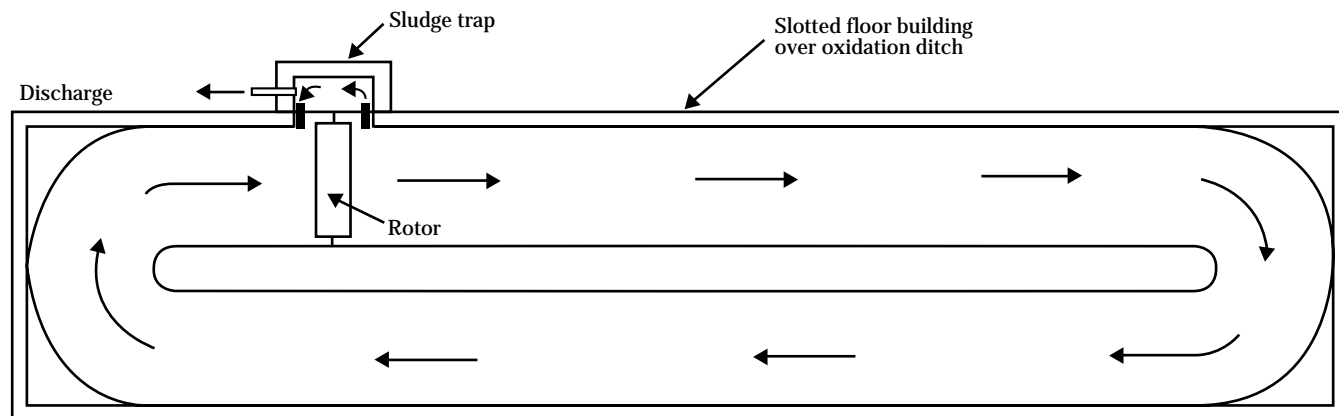
### (e) Drying/dewatering

If the water is removed from freshly excreted manure, the volume to handle can be reduced. The process of removing water is referred to as dewatering. In the arid regions of the United States, most manure is dewatered (dried) by evaporation from sun and wind. Some nutrients may be lost in the drying process.

Dried or dewatered manure solids are often sold as a soil conditioner or garden fertilizer. These solids may also be used as fertilizer on agricultural land. They are high in organic matter and can be expected to produce odors if moisture is added and the material is not redried or composted. Because the water is removed, the concentrations of some nutrients and salts will change. Dried manure should be analyzed to determine the nutrient concentrations before land application.

In humid climates dewatering is accomplished by adding energy to drive off the desired amount of moisture. Processes have been developed for drying manure in greenhouse-type facilities; however, the drying rate is dependent on the temperature and relative humidity. The cost of energy often makes the drying process unattractive.

**Figure 10-29** Schematic of an oxidation ditch



## (f) Composting

Composting is the aerobic biological decomposition of organic matter. It is a natural process that is enhanced and accelerated by the mixing of organic waste with other ingredients in a prescribed manner for optimum microbial growth.

Composting converts an organic waste material into a stable organic product by converting nitrogen from the unstable ammonia form to a more stable organic form. The end result is a product that is safer to use than raw organic material and one that improves soil fertility, tilth, and water holding capacity. In addition, composting reduces the bulk of organic material to be spread; improves its handling properties; reduces odor, fly, and other vector problems; and can destroy weed seeds and pathogens.

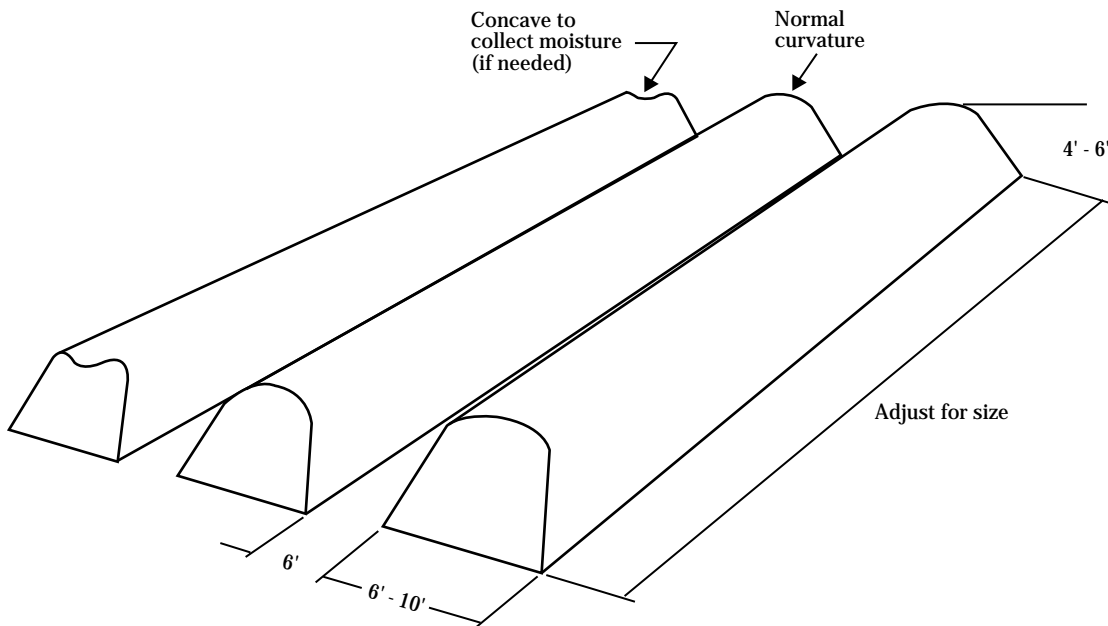
### (1) Composting methods

Three basic methods of composting—windrow, static pile, and in-vessel—are described below.

**(i) Windrow method**—The windrow method involves the arrangement of compost mix in long, narrow piles or windrows (fig. 10-30). To maintain an aerobic condition, the compost mixture must be periodically turned. This exposes the decomposing material to the air and keeps temperatures from getting too high ( $>170^{\circ}\text{F}$ ). The minimum turning frequency varies from 2 to 10 days, depending on the type of mix, volume, and the ambient air temperature. As the compost ages, the frequency of turning can be reduced.

The width and depth of the windrows are limited only by the type of turning equipment used. Turning equipment can range from a front-end loader to an automatic mechanical turner. Windrows generally are 4 to 6 feet deep and 6 to 10 feet wide.

**Figure 10-30** Windrow schematic



Some advantages and disadvantages of the windrow method include:

**Advantages:**

- Rapid drying with elevated temperatures
- Drier product, resulting in easier product handling
- Ability to handle high volumes of material
- Good product stabilization
- Low capital investment

**Disadvantages:**

- Not space efficient
- High operational costs
- Piles should be turned to maintain aerobic conditions
- Turning equipment may be required
- Vulnerable to climate changes
- Odors released on turning of compost
- Large volume of bulking agent might be required

**(ii) Static pile method**—The static pile method consists of mixing the compost material and then stacking the mix on perforated plastic pipe or tubing through which air is drawn or forced. Forcing air through the compost pile may not be necessary with small compost piles that are highly porous or with a mix that is stacked in layers with highly porous material. The exterior of the pile generally is insulated with finished compost or other material. In nonlayered

operations, the materials to be composted must be thoroughly blended before pile placement.

The dimensions of the static pile are limited by the amount of aeration that can be supplied by the blowers and the stacking characteristics of the waste. The compost mixture height generally ranges from 8 to 15 feet, and the width is usually twice the depth. Individual piles generally are spaced about a half the distance of the height.

With forced air systems, air movement through the pile occurs by suction (vacuum) or by positive pressure (forced) through perforated pipes or tubing. A filter pile or material is normally used to absorb odor if air is sucked through the pile (fig. 10-31).

Some advantages and disadvantages of the static pile method include:

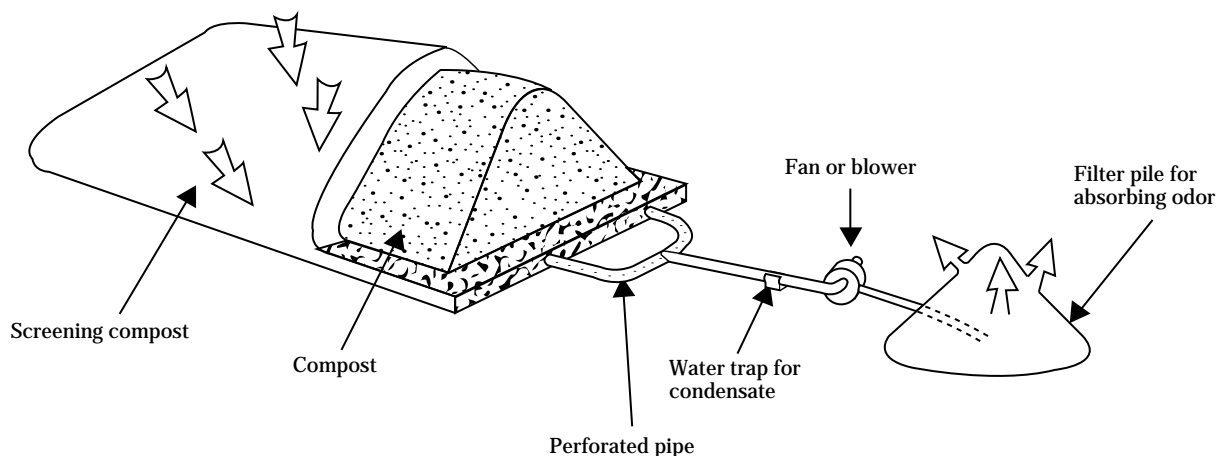
**Advantages:**

- Low capital cost
- High degree of pathogen destruction
- Good odor control
- Good product stabilization

**Disadvantages:**

- Not space efficient
- Vulnerable to climate impacts
- Difficult to work around perforated pipe unless recessed
- Operating cost and maintenance on blowers

**Figure 10-31** Static pile composting schematic





**(iii) In-vessel method**—The in-vessel method involves the mixing of manure or other organic waste with a bulking agent in a reactor, building, container, or vessel (fig. 10–32) and may involve the addition of a controlled amount of air over a specific detention time. This method has the potential to provide a high level of process control because moisture, aeration, and temperature can be maintained with some of the more sophisticated units. Dead animal composting in a composting bin as discussed in section 651.1007(b), Dead animal disposal, is an example of unsophisticated in-vessel composting.

Some of the advantages and disadvantages of the in-vessel method include:

**Advantages:**

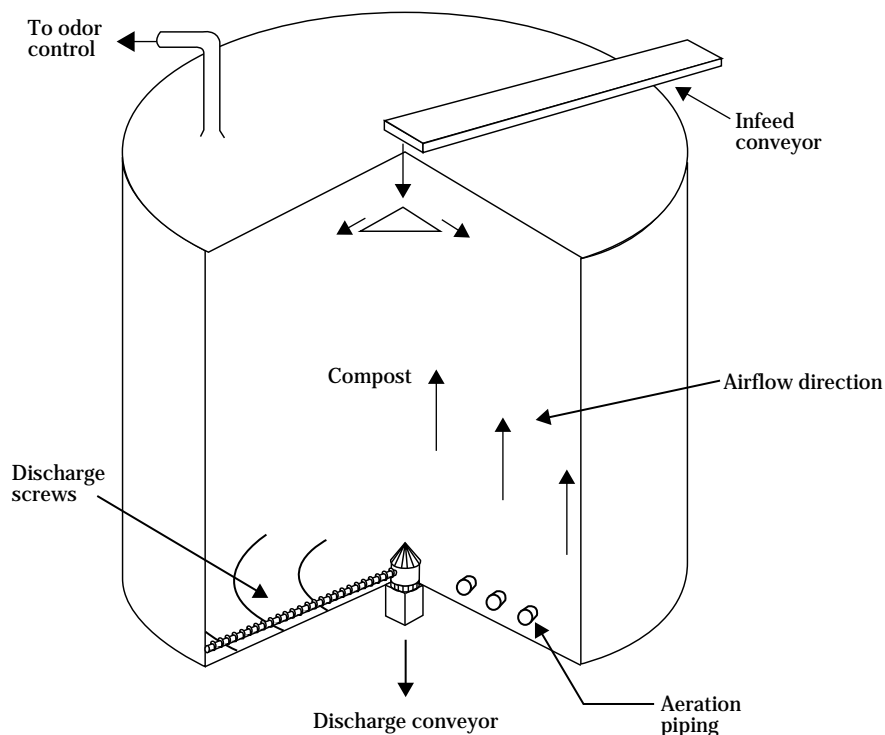
- Space efficient
- Good process control because of self-containment
- Protection from adverse climate conditions

- Good odor control because of self-containment and process control
- Potential for heat recovery dependent on system design
- Can be designed as a continuous process rather than a batch process

**Disadvantages:**

- High capital cost for sophisticated units
- Lack of operating data, particularly for large systems
- Careful management required
- Dependent on specialized mechanical and electrical equipment
- Potential for incomplete stabilization
- Mechanical mixing needs to be provided
- Less flexibility in operation mode than with other methods

**Figure 10–32** In-vessel composting schematic



## **(2) Method selection**

The composting method must fit the individual farm operation. Highly sophisticated and expensive composting operations are not likely to be a viable option for small farming operations. Some factors to consider when selecting the particular method of composting include:

**(i) Operator management capability**—The management capability of the operator is an important consideration when selecting the right composting method. Even simple composting methods require that the operator spend additional time in monitoring and material handling. The operator should fully understand the level of management that is required. The windrow method generally is the simplest method to manage, but requires additional labor for periodically turning the compost mix. The static pile is generally next in complexity because of having to maintain blowers and work around perforated pipe. In-vessel composting can be the simplest or the most difficult to manage, depending on the sophistication of the system.

**(ii) Equipment and labor availability**—Consider what equipment is available for loading, unloading, turning, mixing, and hauling. The windrow method requires extra equipment and labor to periodically turn the rows. All methods require some type of loading and unloading equipment.

**(iii) Site features**—If a limited amount of space is available, then the static pile or in-vessel method may be the only viable composting alternatives. Proximity to neighbors and the appearance of the compost operation may make the windrow and static pile methods unattractive alternatives. If the only composting site has limited accessibility, then the static pile or in-vessel method should be considered because of less mixing requirements. Siting considerations are discussed more fully in the Siting and area considerations section that follows.

**(iv) Compost utilization**—If the compost is to be marketed commercially, then a composting method that produces a predictable, uniform product should be considered. Because of varying climatic conditions, the windrow method may not produce a predictable end product. Sophisticated in-vessel methods provide the most process control; therefore, they produce the most uniform and predictable product.

**(v) Climate**—In extremely wet climates the static pile and aerated composting methods may become too wet to compost properly unless measures are taken to protect the compost from the weather. In very cold climates, the composting process may slow in the winter. Sheltering the compost pile from the wind helps to prevent a slowdown in the composting process. The windrow and static pile methods are the most vulnerable to freezing temperatures because they are exposed to the elements. All methods may perform unsatisfactorily if the organic waste and amendments are initially mixed in a frozen state.

**(vi) Cost**—Composting capital and operating costs vary considerably depending on the degree of sophistication. The windrow method generally has the least capital cost, but also has the most operational costs. The in-vessel method usually has the highest initial capital cost, but the lowest operational cost.

## **(3) Siting and area considerations**

The location of the composting facility is a very important factor in a successful compost operation. To minimize material handling, the composting facility should be located as close as possible to the source of organic waste. If land application is the preferred method of utilization, the facility should also be located with convenient access to the land application sites. Several other important considerations when locating a compost facility are discussed below.

**(i) Wind direction**—Improperly managed compost facilities may generate offensive odors until corrective actions are taken. Wind direction and proximity to neighbors should be considered when locating a composting facility.

**(ii) Topography**—Avoid locating composting facilities on steep slopes where runoff may be a problem and in areas where the composting facility will be subject to inundation.

**(iii) Ground water protection**—The composting facility should be located downgradient and at a safe distance from any wellhead. A roofed compost facility, that is properly managed, should not generate leachate that could contaminate ground water. If a compost facility is not protected from the weather, it should be sited to minimize the risk to ground water.

**(iv) Area requirements**—The area requirements for each composting method vary. The windrow method requires the most land area. The static pile method requires less land area than the windrow method, but more than the in-vessel method. The pile dimensions also affect the amount of land area necessary for composting. A large pile that has a low surface area to total volume ratio requires less composting area for a given volume of manure, but it is also harder to manage. The size and type equipment used to mix, load, and turn the compost should also be considered when sizing a compost area. Enough room must be provided in and around the composting facility to operate equipment. In addition, a buffer area around the compost site should be considered if a visual barrier is needed or desired. In general, given the pile dimensions, a compost bulk density of 35 to 45 pounds per cubic feet can be used to estimate the surface area necessary for stacking the initial compost mix. To this area, add the amount of area necessary for equipment operation, pile turning, and buffer.

**(v) Existing areas**—To reduce the initial capital cost, existing roofed, concrete, paved, or gravel areas should be used if possible as a composting site.

#### **(4) Compost utilization**

Finished compost is used in a variety of ways, but is primarily used as a fertilizer supplement and soil conditioner. Compost improves soil structure and soil fertility, but it generally contains too low a quantity of nitrogen to be considered the only source of crop nitrogen. Nutrients in finished compost will be slowly released over a period of years, thus minimizing the risk of nitrate leaching and high nutrient concentrations in surface runoff. For more information on land application of organic material, see chapter 11.

A good quality compost can result in a product that can be marketed to home gardeners, landscapers, vegetable farmers, garden centers, nursery/greenhouses, turf growers, golf courses, and ornamental crop producers. Generally, the marketing of compost from agricultural operations has not provided enough income to completely cover the cost of composting. If agricultural operations do not have sufficient land to spread the waste, marketing may still be an attractive alternative compared to hauling the waste to another location for land spreading. Often, compost operators generate additional income by charging municipalities and other local governments for composting urban

yard waste with the waste products of the agricultural operations.

Finished compost has also been successfully used as a bedding material for livestock. Because composting generates high temperatures that dry out and sterilize the compost, the finished product is generally acceptable as a clean, dry, bedding material. Refeeding of the poultry compost as a food supplement is currently being tested and may prove to be an acceptable use of poultry compost.

#### **(5) Compost mix design**

Composting of organic waste requires the mixing of an organic waste with amendment(s) or bulking agent(s) in the proper proportions to promote aerobic microbial activity and growth and to achieve optimum temperatures. The following must be provided in the initial compost mix and maintained during the composting process:

- A source of energy (carbon) and nutrients (primarily nitrogen).
- Sufficient moisture.
- Sufficient oxygen for an aerobic environment.
- A pH in the range of 6 to 8.

The proper proportion of waste, amendments, and bulking agents is commonly called the "recipe."

A composting amendment is any item added to the compost mixture that alters the moisture content, C:N ratio, or pH. Many materials are suitable for use as a composting amendment. Crop residue, leaves, grass, straw, hay, and peanut hulls are just some of the examples that may be available on the farm. Others, such as sawdust, wood chips, or shredded paper and cardboard, may be available inexpensively from outside sources. Table 10-6 shows typical C:N ratios of common composting amendments. The C:N ratio is highly variable, and local information or laboratory values should be used whenever possible.

A bulking agent is used primarily to improve the ability of the compost to be self supporting (structure) and to increase porosity to allow internal air movement. Wood chips and shredded tires are examples of a bulking agent. Some bulking agents, such as large wood chips, may also alter the moisture content and C:N ratio, in which case they would be both a bulking agent and a compost amendment.

**(i) Compost design parameters**—To determine the recipe, the characteristics of the waste and the amendments and bulking agents must be known. The characteristics that are the most important in determining the recipe are moisture content (wet basis), carbon content, nitrogen content, and the C:N ratio. If any two of the last three components are known, the remaining one can be calculated.

**Carbon to nitrogen (C:N) ratio**—The balance between carbon and nitrogen in the compost mixture is a critical factor for optimum microbial activity. After the organic waste and the compost ingredients are mixed together, micro-organisms multiply rapidly and consume carbon as a food source and nutrients to metabolize and build proteins. The C:N ratio of the compost mix should be maintained for most compost operations between 25 and 40 to 1. If the C:N ratio is low, a loss of nitrogen generally occurs through rapid

**Table 10-6** Typical carbon to nitrogen ratios of common composting amendments\*

Material	C:N ratios	Material	C:N ratios
Alfalfa (broom stage)	20	Pig manure	5-8
Alfalfa hay	12-18	Pine needles	225-1000
Asparagus	70	Potato tops	25
Austrian pea straw	59	Poultry manure (fresh)	6-10
Austrian peas (green manure)	18	Poultry manure (henhouse litter)	12-18
Bark	100-130	Reeds	20-50
Bell pepper	30	Residue of mushroom culture	40
Breading crumbs	28	Rice straw	48-115
Cantaloupe	20	Rotted manure	20
Cardboard	200-500	Rye straw	60-350
Cattle manure (with straw)	25-30	Saw dust	300-723
Cattle manure (liquid)	8-13	Sawdust (beech)	100
Clover	12-23	Sawdust (fir)	230
Clover (sweet and young)	12	Sawdust (old)	500
Corn & sorghum stover	60-100	Seaweed	19
Cucumber	20	Shredded tires	95
Dairy manure	10-18	Soil organic matter	10-24
Garden wastes	20-60	Soybean residues	20-40
Grain rice	36	Straw	40-80
Grass clippings	12-25	Sugar cane (trash)	50
Green leaves	30-60	Timothy	80
Green rye	36	Tomato leaves	13
Horse manure (peat litter)	30-60	Tomatoes	25-30
Leaves (freshly fallen)	40-80	Watermelon	20
Newspaper	400-500	Water hyacinth	20-30
Oat straw	48-83	Weeds	19
Paper	173	Wheat straw	60-373
Pea vines (native)	29	Wood (pine)	723
Peat (brown or light)	30-50	Wood chips	100-441

\* For further information on C:N ratios, see chapter 4 of this handbook.

decomposition and volatilization of ammonia. If it is high, the composting time increases because the nitrogen becomes the limiting nutrient for growth.

**Moisture**—Micro-organisms need moisture to convert the carbon source to energy. Bacteria generally can tolerate a moisture content as low as 12 to 15 percent; however, with less than 40 percent moisture, the rate of decomposition is slow. At greater than 60 percent moisture, the process turns from one that is aerobic to one that is anaerobic. Anaerobic composting is less desirable because it decomposes more slowly and produces putrid odors. The finished product should result in a material that has a low moisture content.

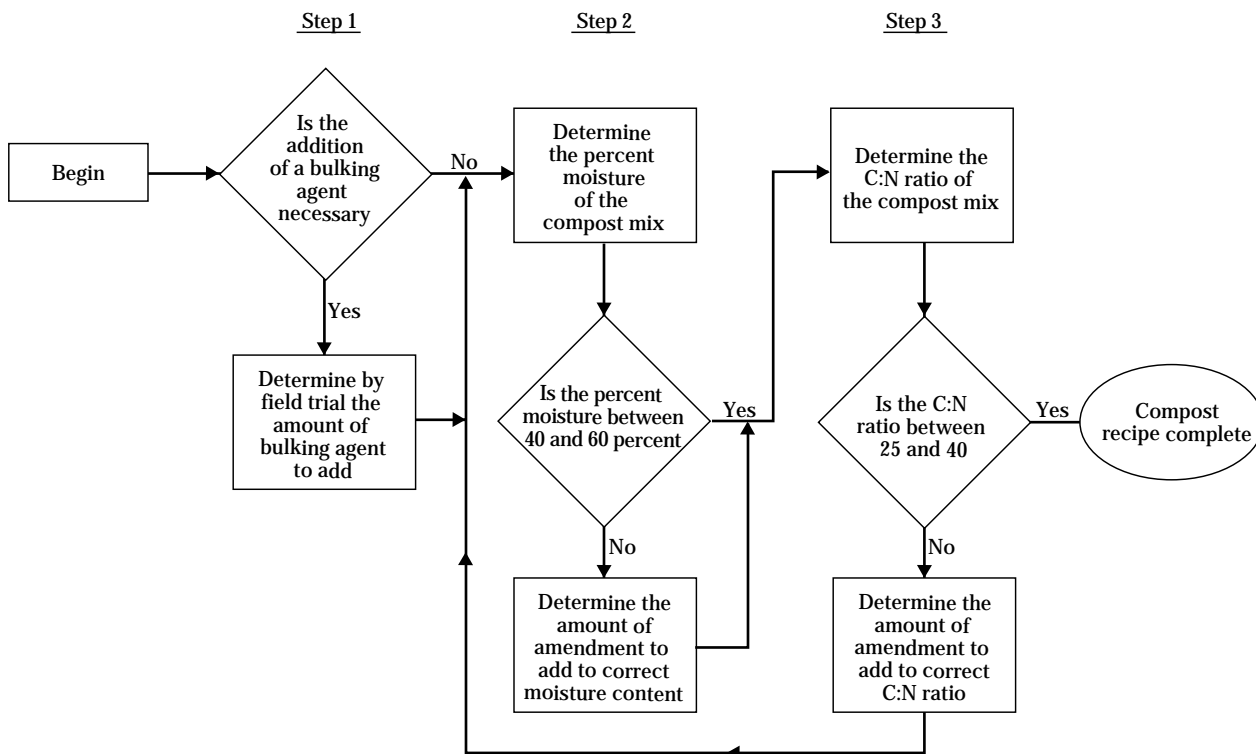
**pH**—Generally, pH is self-regulating and is not a concern when composting agricultural waste. Bacterial growth generally occurs within the range of pH 6.0 to 7.5, and fungi growth usually occurs within the range of 5.5 to 8.5. The pH varies throughout the compost mixture and during the various phases of the

composting process. The pH in the compost mixture is difficult to regulate once decomposition is started. Optimum pH control can be accomplished by adding alkaline or acidic materials to the initial mixture.

**(ii) Compost mix design process**—The determination of the compost mix design (recipe) is normally an iterative process of adjusting the C:N ratio and moisture content by the addition of amendments. If the C:N ratio is out of the acceptable range, then amendments are added to adjust it. If this results in a high or low moisture content, amendments are added to adjust the moisture content. The C:N ratio is again checked, and the process may be repeated. After a couple of iterations, the mixture is normally acceptable. Figure 10-33 is a mixture design process flow chart that outlines the iterative procedure necessary in determining the compost recipe.

The iterative process of the compost mix design can be summarized to a series of steps to determine the

**Figure 10-33** Compost mixture design flow chart



compost mix design. These steps follow the mixture design process flow chart shown in figure 10-33.

**Step 1: Determine the amount of bulking agent to add.** The process normally begins with determining whether or not a bulking agent is needed. The addition of a bulking agent is necessary if the raw waste cannot support itself or if it does not have sufficient porosity to allow internal air movement. A small field trial is the best method to determine the amount of bulking agent required. To do this, a small amount of raw waste would be weighed and incremental quantities of bulking would be added and mixed until the mix has the structure and porosity desired. The wood chips, bark, and shredded tires are examples of bulking agents commonly used.

**Step 2: Calculate the moisture content of the compost mix.** After the need for and quantity of bulking agent have been determined, the moisture content of the mixture or raw waste should be calculated. Chapter 4 of this handbook gives typical values for moisture content (wet basis) of excreted manure for various animals. Because water is often added as a result of spillage from waterers and in the cleaning processes, raw waste that is to be composted may have significantly higher moisture content than that of "as excreted" manure. If the amount of water added to the manure can be determined, the moisture content of the mix can be calculated using equation 10-11, ignoring the inappropriate terms.

In addition to extra water, feed spillage and bedding material can constitute a major part of the raw waste to be composted. The moisture content for each additive can be determined individually and used to determine the moisture content of the entire mix (equation 10-11). A sample of the raw waste (including the bedding, wasted feed, and water) can also be taken, weighed, dried, and weighed again to determine the moisture content of the mix. Using this procedure the moisture content can be calculated as follows:

$$M_i = \frac{\text{Wet weight} - \text{Dry weight}}{\text{Wet weight}} \times 100 \quad [10-10]$$

where:

$M_i$  = Percent moisture content (wet basis)

**Note:** To avoid confusion and repetition, the combination of "as excreted" manure, bedding, water, and bulking agent will be referred to as the "compost mix."

The general equation for the moisture content of the compost mix is as follows. (The equation may contain variables that are not needed in every calculation.)

$$M_M = \frac{(W_w \times M_w) + (W_b \times M_b) + (W_a \times M_a)}{W_m} + H_2O \quad [10-11]$$

where:

$M_m$  = Percent moisture of the compost mixture (wet basis), eq. 10-10

$W_w$  = Wet weight of waste (lb)

$M_w$  = Percent moisture content of waste (wet basis), eq. 10-10

$W_b$  = Wet weight of bulking agent (lb)

$M_b$  = Percent moisture content of bulking agent (wet basis), eq. 10-10

$W_a$  = Wet weight of amendment (lb)

$M_a$  = Moisture content of amendment (wet basis)

$H_2O$  = Weight of water added (lb) =  $G \times 8.36$ , where  $G$  = Gallons of water

$W_m$  = Weight of the compost mix (lb) including wet weight of waste, bulking agent, amendments, and added water.

**Step 2 (continued): Determine the amount of amendment to add, if any, to the compost mix that will result in a final moisture content that is between 40 and 60 percent.** If the moisture content of the compost mix is less than 40 percent, adding an amendment is necessary to raise the moisture content to an acceptable level. Water is the amendment that is generally added to raise the moisture content, but an amendment that has a higher moisture content than the desired moisture content of the compost mix is acceptable. It is generally best to begin the composting process when the moisture content is closer to 60 percent because the process of composting elevates the temperature and reduces moisture.

If the moisture content of the compost mix is above 60 percent, the addition of an amendment is necessary to lower the moisture content at or below 60 percent. Straw, sawdust, wood chips, and leaves are commonly used.

Equation 10-12 can be used to determine the amount of amendment to add to lower or raise the moisture content of the compost mix.

$$W_{aa} = \frac{W_{mb} \times (M_{mb} - M_d)}{M_d - M_{aa}} \quad [10-12]$$

where:

- $W_{aa}$  = Wet weight of amendment to be added
- $W_{mb}$  = Wet weight of mix before adding in amendment.
- $M_{mb}$  = Percent moisture of mix before adding amendment
- $M_d$  = Desired percent moisture content of mix (wet bases)
- $M_{aa}$  = Moisture content of amendment added

**Note:** Equation 10-12 can be used for the addition of water by using:

$$M_{aa} = 100\% \text{ for water.}$$

**Step 3: Calculate the C:N ratio.** The C:N ratio for the compost mix is calculated from the C:N ratios of the waste, bulking agents, and amendments. Typical values for various selected agricultural wastes are shown in chapter 4 of this handbook. The C:N ratios for various waste products and amendments are also shown in table 10-6. The C:N ratios not reported in the literature can be estimated from the amount of fixed solids (amount of ash left after organic matter is burned off) or the volatile solids and the nitrogen content. Equations 10-13 and 10-14 are used to estimate the C:N ratio from the fixed or volatile solids.

$$\%C = \frac{100 - \%FS}{1.8} \quad [10-13a]$$

$$W_c = \frac{VS}{1.8} \quad [10-13b]$$

$$C:N = \frac{\%C}{\%N} = \frac{W_c}{W_n} \quad [10-14]$$

where:

- $\%C$  = Percent carbon (dry basis)
- $\%FS$  = Percent fixed solids (dry basis)
- $W_c$  = Dry weight of carbon
- $VS$  = Weight of volatile solids

$C:N$  = Carbon to nitrogen ratio

$\%N$  = Percent total nitrogen (dry basis)

$W_n$  = Dry weight of nitrogen

Typical values for nitrogen content of manure are reported in chapter 4 of this handbook, and typical values for percent nitrogen (dry basis) for many agricultural crops are reported in chapter 6. The C:N ratio and nitrogen content of manure and of other amendments are highly variable. Using local values for C:N ratios and nitrogen or testing of the compost constituents is highly recommended. The general equation for estimating the C:N ratio of the compost mix is given by equation 10-15.

$$R_m = \frac{W_{cw} + W_{cb} + W_{ca}}{W_{nw} + W_{nb} + W_{na}} \quad [10-15]$$

where:

- $R_m$  = C:N ratio of compost mix
- $W_{cw}$  = Weight of carbon in waste (lb)
- $W_{cb}$  = Weight of carbon in bulking agent (lb)
- $W_{ca}$  = Weight of carbon in amendment (lb)
- $W_{nw}$  = Weight of nitrogen in waste (lb)
- $W_{nb}$  = Weight of nitrogen in bulking agent (lb)
- $W_{na}$  = Weight of nitrogen in amendment (lb)

The weight of carbon and nitrogen in each ingredient can be estimated using the following equations:

$$W_w = \%N \times W_{dry} \quad [10-16a]$$

$$W_n = \frac{W_c}{C:N} \quad [10-16b]$$

$$W_c = \%C \times W_{dry} \quad [10-17a]$$

$$W_c = C:N \times W_n \quad [10-17b]$$

where:

$W_{dry}$  = Dry weight of material in question

The dry weight of material can be calculated using equation 10-18.

$$W_{dry} = W_{wet} \times \frac{100 - M_{wet}}{100} \quad [10-18]$$

where:

- $W_{wet}$  = Wet weight of material in question
- $M_{wet}$  = Percent moisture content of material (wet basis)

**Step 3 (continued): Determine the amount of amendment, if any, to add to the compost mix that will result in an initial C:N ratio that is between 25 and 40.** If the C:N ratio calculated in step 3a is less than 25 or more than 40, the type and amount of amendment to add to the compost mix must be determined. For a compost mix that has a C:N ratio below 25, an amendment should be added that has a C:N ratio higher than the desired C:N ratio. For a compost mix that has a C:N ratio of more than 40, an amendment must be added that has a C:N ratio that is less than the desired C:N ratio.

Equation 10-19 or 10-20 can be used to calculate the weight of amendment to add to achieve a desired C:N ratio.

$$W_{aa} = \frac{W_{nm} \times (R_d - R_{mb}) + 10,000}{N_{aa} \times (100 - M_{aa}) \times (R_{aa} - R_d)} \quad [10-19]$$

$$W_{aa} = \frac{N_m W_{mb} \times (100 - M_{mb}) \times (R_d - R_{mb})}{N_{aa} \times (100 - M_{aa}) \times (R_{aa} - R_d)} \quad [10-20]$$

where:

- $W_{nm}$  = Weight of nitrogen in compost mix (lb)
- $R_d$  = Desired C:N ratio
- $R_{mb}$  = C:N ratio of the compost mix before adding amendment
- $N_{aa}$  = Percent nitrogen in amendment to be added (dry basis)
- $R_{aa}$  = C:N ratio of compost amendment to be added
- $N_m$  = Percent nitrogen in compost mix (dry basis)
- $M_{mb}$  = Percent moisture of compost mix before adding amendment (wet basis), equation 10-10

For a compost mix that has a C:N ratio of more than 40, a carbonless amendment, such as fertilizer, can be added to lower the C:N ratio to within the acceptable range. In this special case, the following equation can be used to estimate the dry weight of nitrogen to add to the mix:

$$W_{nd} = \frac{W_{cw} + W_{cb} + W_{ca}}{R_d} - (W_{nw} + W_{nb} + W_{na}) \quad [10-21]$$

where:

- $W_{nd}$  = Dry weight of nitrogen to add to mix

After the amount of an amendment to add has been determined to correct the C:N ratio, the design process then returns to step 2. If no change is necessary in steps 2 and 3, the compost mix design process is complete.

### (6) Design example 10-7—Compost mix

A dairy farmer wishes to compost the waste generated from the herd in the barn. The waste is scraped daily from the barn and contains straw as a bedding material, but no extra water is added. Straw is the cheapest and most abundant source of a high C:N ratio amendment on the farm. The 100 cow herd is in the barn for an average of 6 hours. The average weight of a cow is 1,200 pounds. Ten 60-pound bales of straw (chopped) are added daily for bedding. It has been determined that in this case no bulking agent is necessary to improve the compost porosity or structure. Determine the design mix for the compost operation on a daily basis.

#### Given:

##### Wheat straw:

- Moisture content = 15% (estimated)
- C:N ratio = 80 (from table 10-6)
- Percent N = 0.67% (from chapter 6 of this handbook)

##### Manure:

- Number of cows = 100
- Size of cows = 1,200 lb
- Number of animal units (AU) = 100 x 1,200/1,000 = 120
- Moisture content = 87.5% (from chapter 4 of this handbook)
- Manure production = 80 lb/day/1000 lb (from chapter 4 of this handbook)
- Fraction in barn = 6 hrs/24 hrs = 0.25
- Nitrogen production = 0.45 lb/1000 lb/day (from chapter 4 of this handbook)
- Volatile solids = 8.5 lb/1000 lb/day (from chapter 4 of this handbook)

**Step 1: Bulking agent.** A sample of the manure was stacked, and the manure appeared to have sufficient porosity to allow air movement and had the ability to support itself. Therefore, the addition of a bulking agent is not necessary.



**Step 2a: Determine the moisture content of the waste.** To determine the quantity of waste:

Manure in barn:

$$120\text{AU} \times 80 \text{ lb / day} \times 0.25 = 2,400 \text{ lb}$$

Weight of straw added daily:

$$10 \text{ bales} \times 60 \text{ lb} = 600 \text{ lb}$$

Weight of manure and straw ( $W_m$ ):

$$10 \text{ bales} \times 60 \text{ lb} = 600 \text{ lb}$$

Using equation 10-11, determine the moisture content of manure plus straw.

$$M_n = \frac{(2,400 \times 87.5) + (600 \times 15)}{3,000 \text{ lb}} \times 100 = 73\%$$

**Step 2 (continued): Using equation 10-12, determine the amount of straw to add to bring the moisture content of the compost mix to 60 percent.**

$$W_{aa} = \frac{3,000 \text{ lb} \times (73\% - 60\%)}{60\% - 15\%} = 867 \text{ lb}$$

$$W_m = 3,000 \text{ lb} + 867 = 3,867 \text{ lb}$$

New weight of compost mix:

**Step 3: Determine the C:N ratio of the compost mix.** Determine the carbon and nitrogen content of the straw:

Total weight of straw:

$$600 \text{ lb} + 867 \text{ lb} = 1,467 \text{ lb}$$

Straw dry weight (equation 10-18):

$$1,467 \text{ lb} + \frac{(10 - 15)}{100} = 1,247.9 \text{ lb}$$

Weight of nitrogen in straw:

$$W_{na} = \frac{(0.67 \times 1,247.9 \text{ lb})}{100} = 8.4 \text{ lb}$$

Weight of carbon in straw (equation 10-17b) :

$$W_{ca} = 8.4 \times 80 = 672.0 \text{ lb}$$

Determine the carbon and nitrogen content in manure:

Volume of volatile solids in barn:

$$120\text{AU} \times 8.5 \text{ lb / day} / \text{AU} \times 0.25 = 2.55 \text{ lb}$$

Weight of carbon in manure (using equation 10-13b):

$$\frac{255 \text{ lb}}{1.8} = 141.7 \text{ lb}$$

Weight of nitrogen in manure:

$$120\text{AU} \times 0.45 \times 0.25 = 13.5 \text{ lb}$$

C:N ratio of manure:

$$\frac{141.7}{13.5} = 10.5$$

Determine C:N ratio of mixture (equation 10-15):

$$\text{C:N} = \frac{141.7 \text{ lb} + 672.0 \text{ lb}}{13.5 \text{ lb} + 8.4 \text{ lb}} = 37.2$$

A compost mix that has a C:N ratio of 37.2 is in the acceptable range, but for purposes of this example, continue step 3.

**Step 3 (continued): Determine the type and amount of amendment to add to bring the C:N ratio of the mix to 30:1.** To lower the C:N ratio, an amendment with a C:N ratio that is less than the desired final C:N ratio is necessary. Fresh manure that has a C:N ratio of 10.5 could be collected outside the barn, or fertilizer could be added to the mix. The farmer would like to see both alternatives.

Weight of nitrogen in current compost mix:

$$(13.5 \text{ lb} + 8.4 \text{ lb}) = 21.9 \text{ lb}$$

Dry weight of manure (equation 10-18):

$$2,400 \times \frac{(100 - 87.5)}{100} = 300 \text{ lb}$$

Percent nitrogen in manure:

$$\frac{13.5}{300} \times 100 = 4.5\%$$

Pounds of manure to add to bring mix to 30:1 (using equation 10-19):

$$W_{aa} \frac{21.9 \times (30.0 - 37.2) \times 10,000}{4.5 \times (100 - 87.5) \times (10.5 - 30)} = 1,437 \text{ lb}$$

Pounds of nitrogen to add to bring compost mix to 30:1 (using equation 10-21)

$$W_{nd} \frac{141.7 + 672}{31} - (13.5 + 8.4) = 5.2 \text{ lb}$$

Adding 5.2 pounds of nitrogen is easier than adding 1,437 pounds of manure, so the obvious choice is to add nitrogen. If the farmer chooses to add nitrogen, no further calculations are necessary, because the moisture content of the mix is not changed with the addition of nitrogen. The design process would continue with step 2 if another type of amendment was added that resulted in a change in the moisture content of the manure.

The final compost mix consists of the following:

Waste scraped from the barn — 3,000 lb  
Additional straw to correct moisture — 867 lb  
Nitrogen added to lower C:N ratio — 5.2 lb

### (7) Design example 10-8

A grass seed farmer wishes to compost straw from rye grass seed harvest. A nearby dairy operation has agreed to furnish fresh manure for 2 weeks. Determine the compost mixture design.

**Given:**

**Rye grass straw:**

Amount = 600 tons  
Moisture content = 7%  
N per ton = 6 lb  
C:N ratio = 100:1

**Manure:**

Number of cows = 400  
Size of cows = 1,400 lb  
Number of animal units (AU) = 400 x 1400/1000 = 560  
Manure production = 80 lb/day/1000 lb  
Nitrogen production = 0.43 lb/day/1000 lb  
Fixed solids = 1.5 lb/day/1000 lb  
Percent moisture = 87.5%

**Step 1:** No bulking agent is needed to improve structure or porosity.

**Step 2: Determine moisture content of rye grass straw and manure mixture:**

Straw weight:

$$600 \text{ tons} \times 2000 \text{ lb} / \text{ton} = 1,200,000 \text{ lb}$$

Manure weight:

$$560 \text{ AU} \times 80 \text{ lb} / \text{day} / \text{AU} \times 14 \text{ days} = 67,200 \text{ lb}$$

Moisture content ( $M_m$ ) of straw and manure (equation 10-11):

$$\frac{(1,200,000 \times 7) + (67,200 \times 87.5)}{1,200,000 + 67,200} \times 100 = 34.6$$

The 34.6 percent moisture content of the mix is less than 40 percent; therefore, water needs to be added to bring the moisture content to 50 percent.

**Step 2 (continued): Using equation 10-12, determine the amount of water to add to bring the moisture content to 50 percent ( $W_{aa}$ ).**

$$\frac{(1,200,000 \times 627,200) \times (34.6 - 50)}{50 - 100} = 562,778 \text{ lb}$$

$$\frac{562,778}{8.33 \text{ lb / gal}} = 67,560 \text{ gal}$$

**Step 3: Determine C:N ratio of the straw and manure mix.** Determine the amount of carbon and nitrogen in the rye straw:

Nitrogen in straw:

$$W_{na} = 600 \text{ ton} \times 6 \text{ lb / ton} = 3,600 \text{ lb}$$

Carbon in straw (equation 10-17b):

$$W_{ca} = 3,600 \text{ lb} - (\text{N}) \times 100 = 360,000 \text{ lb}$$

Determine the amount of carbon and nitrogen in the manure:

Nitrogen in manure (use chapter 4 values for N):

$$560\text{AU} \times 0.45 \times 14 \text{ days} = 3,528 \text{ lb}$$

Assume a 20 percent loss of nitrogen in handling manure. Nitrogen left in manure:

$$W_{nw} = 3,528 \times \frac{100 - 20}{100} = 2,822 \text{ lb}$$

Volume of solids in manure (use chapter 4 values):

$$560\text{AU} \times 8.5 \times 14 \text{ days} = 66,640 \text{ lb}$$

Carbon in manure (using equation 10-13b):

$$W_{cw} = \frac{66,640 \text{ lb}}{1.8} = 37,022 \text{ lb}$$

C:N ratio of straw and manure mix (equation 10-15):

$$\frac{360,000 + 37,022}{3,600 + 2,822} = 62:1$$

A C:N ratio of 62:1 is more than the maximum recommended of 40:1. The compost mix needs more nitrogen.

**Step 3 (continued): Determine the amount of commercial nitrogen to add to the mix to bring the C:N ratio to 40:1.**

Amount of nitrogen to add (equation 10-21):

$$N_a = \frac{36,000 + 37,022}{40} - (3,600 + 2,822)$$

$$= 3,504 \text{ lb}$$

The final design mix is:

Rye grass straw	= 600 tons
Manure (14 days)	= 313.6 tons
Commercial nitrogen	= 3,504 lb

### (8) Composting operational considerations

The landowner/operator should be provided a written set of instructions as a part of the waste management plan. These instructions should detail the operation and maintenance requirements necessary for successful composting operation. They should include the compost mix design (recipe), method or schedule of turning or aerating, and instructions on monitoring the compost process and on long-term storage compost. The final use of the compost should be detailed in the Waste Utilization Plan.

**(i) Composting time**—One of the primary composting considerations is the amount of time it takes to perform the composting operation. Composting time varies with C:N ratio, moisture content, climate, type of operation, management, and the types of wastes and amendments being composted. For a well managed windrow or static pile composting operation, the composting time during the summer months ranges from 14 days to a month. Sophisticated in-vessel methods may take as little as 7 days to complete the composting operation. In addition to the actual composting time, the amount of time necessary for compost curing and storage should be considered.

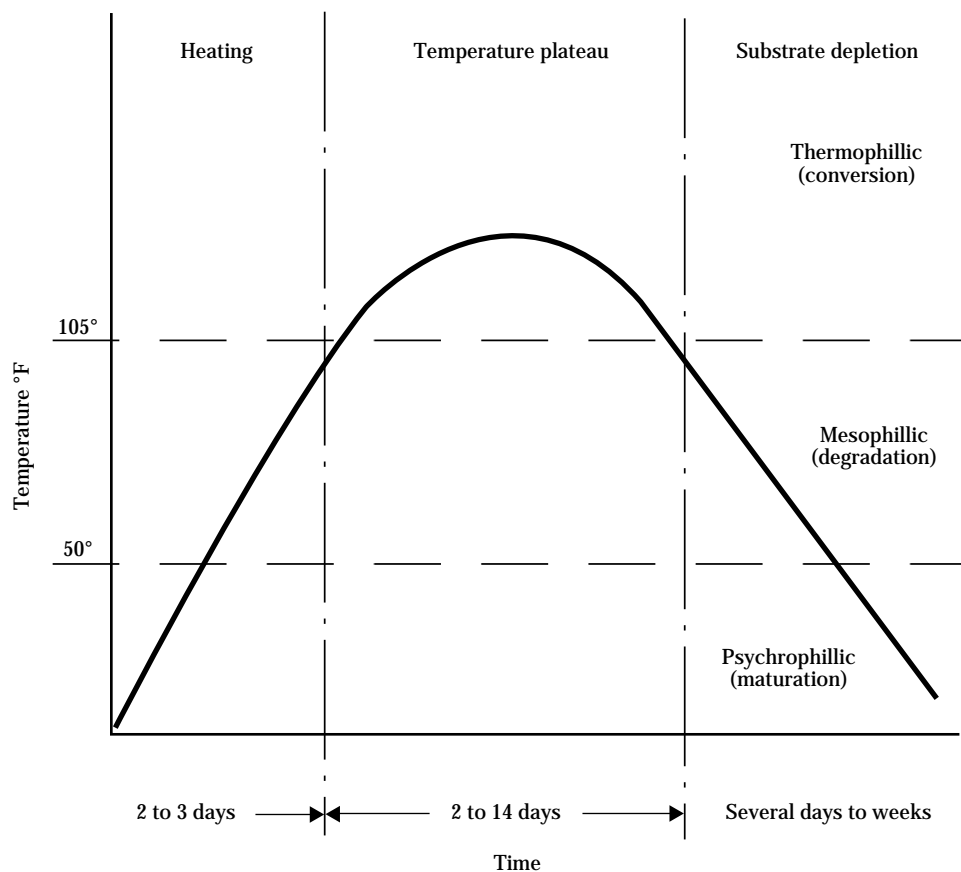
**(ii) Temperature**—Consideration should be given to how the compost temperature is going to be monitored. The temperature probe should be long enough to penetrate a third of the distance from the outside of the pile to the center of mass. The compost temperature should be monitored on a daily basis if possible. The temperature is an indicator of the level of microbial activity within the compost. Failure to achieve the desired temperatures may result in the incomplete destruction of pathogens and weed seeds and can cause fly and odor problems.

Initially, the compost mass is at ambient temperature; however, as the micro-organisms multiply, the temperature rises rapidly.

The composting process is commonly grouped into three phases based on the prominent type of bacteria present in the compost mix. Figure 10-34 illustrates the relationship between time, temperature, and compost phase. If the temperature is less than 50 °F, the compost is said to be in the psychrophilic stage. If it is in the range of 50 °F to 105 °F, the compost is in the mesophilic stage. If the compost temperature exceeds 105 °F, the compost is in the thermophilic stage. For complete pathogen destruction, the compost temperature must exceed 135 °F.

The compost temperature will decline if moisture or oxygen is insufficient or if the food source is exhausted. In compost methods where turning is the

**Figure 10-34** Composting temperature



method of aerating, a temperature rhythm often develops with the turning of the compost pile (fig. 10-35).

**(iii) Moisture**—The moisture content of the compost mixture should be monitored periodically during the process. A low or high moisture content can slow or stop the compost process. A high moisture content generally results in the process turning anaerobic and foul odors developing. A high temperature drives off significant amounts of moisture, and the compost mix may become too dry, resulting in a need to add water.

**(iv) Odor**—The odor given off by the composting operation is a good indicator of how the compost operation is proceeding. Foul odors may mean that the process has turned from aerobic to anaerobic. Anaerobic conditions are the result of insufficient oxygen in the compost. This may be caused by excessive moisture in the compost or the need for turning or aerating of the compost.

### (9) Compost process steps

The composting operation generally follows these steps (fig. 10-36):

**(i) Preconditioning of materials (as needed)**—Grinding or shredding of the raw material may be necessary to increase the exposed surface area of the compost mixture to enhance decomposition by microorganisms.

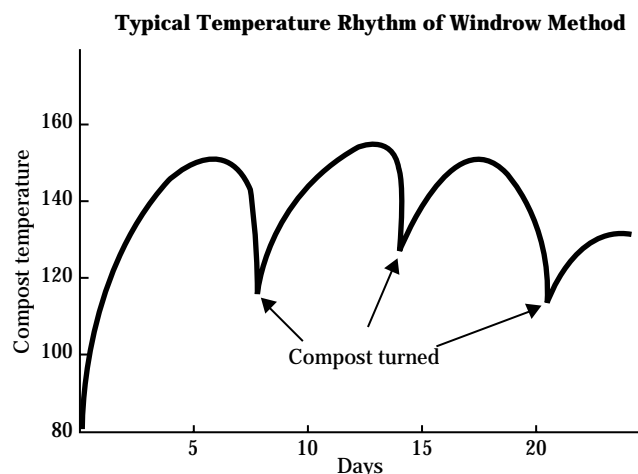
**(ii) Mixing of the waste with a bulking agent or amendment**—A typical agricultural composting operation involves mixing the raw waste with a bulking agent or amendment, or both, according to a prescribed mix or design. The prescribed mix should detail the quantities of raw waste, amendments, and bulking agents to be mixed. The mixing operation is generally done with a front-end loader on a tractor, but other more sophisticated methods can be used.

**(iii) Aeration by forced air or mechanical turning**—Once the materials are mixed, the composting process begins. Bacteria begin to multiply and consume carbon and free oxygen. To sustain microbial activity, air must be added to the mix to re-supply the oxygen to the compost pile. Air can be added by simply remixing or turning the compost pile. With more sophisticated methods, such as an aerated static pile, air is forced or sucked through the compost mix using a blower. The pounds of air per pound of volatile matter per day generally range from 5 to 9. Given in percentage, the optimum oxygen concentration of the compost mixture ranges from 5 to 15 percent, by volume. An increase of oxygen beyond 15 percent generally results in a decrease in temperature because of greater air flow. Low oxygen concentrations generally result in anaerobic conditions and slow processing times. Inadequate aeration results in anaerobic conditions and increased odors. Odor is an excellent indicator of when to turn and aerate a compost pile.

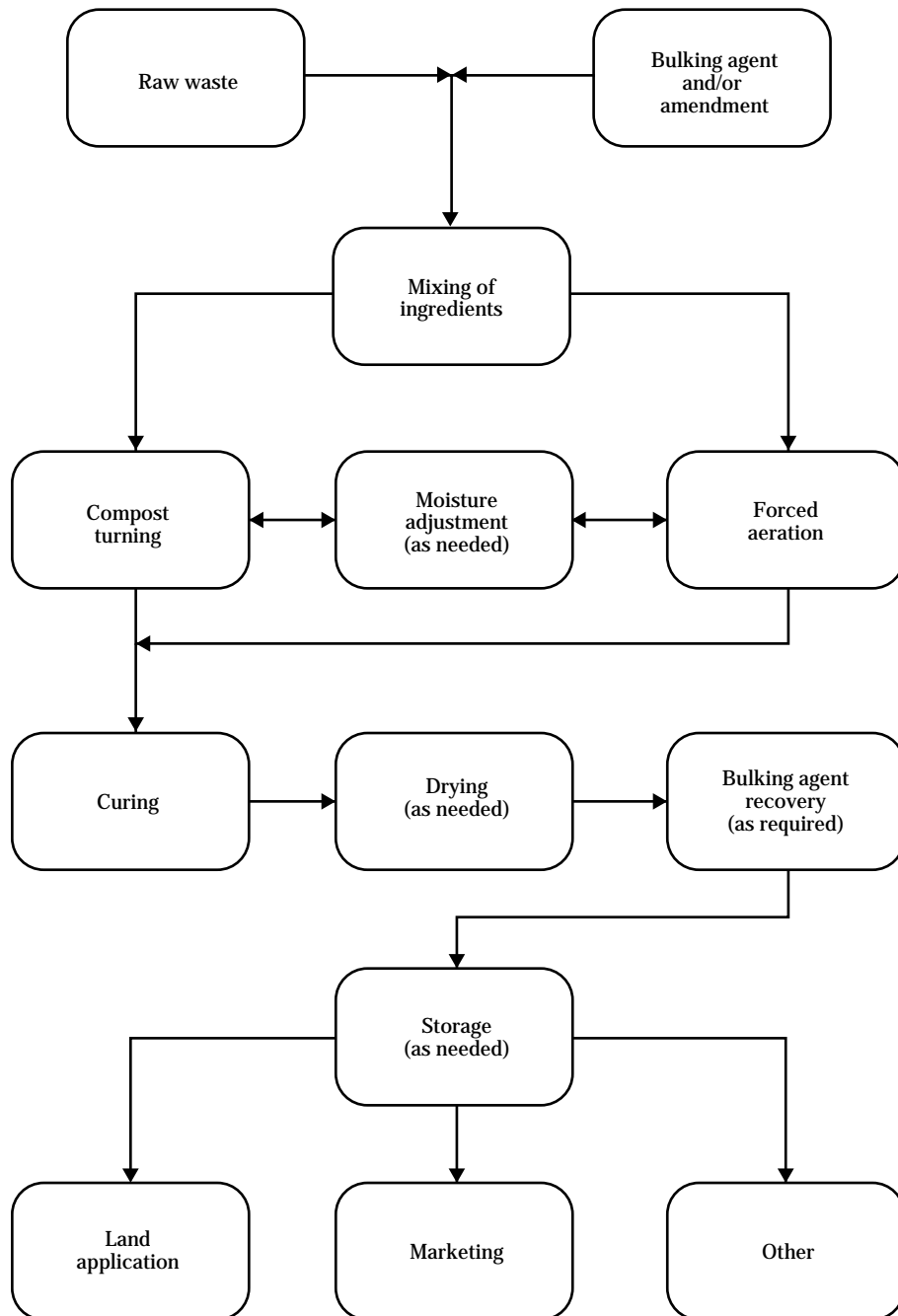
**(iv) Moisture adjustment (as needed)**—Water should be added with caution because too much moisture can easily be added. A compost mix that has excessive moisture problems does not compost properly, appears soggy and compacted, and is not loose and friable. Leachate from the compost mixture is another sign of excessive moisture conditions.

**(v) Curing (optional)**—Once the compost operation is completed, it can be applied directly to the field or stored and allowed to cure for a period of months. During the curing process, the compost temperature returns to ambient conditions and the biological activity slows down. During the curing phase, the compost nutrients are further stabilized. The typical curing time ranges from 30 to 90 days, depending on the type of raw material and end use.

**Figure 10-35** Typical temperature rhythm of windrow method



**Figure 10-36** Agricultural composting process flow



**(vi) Drying (optional)**—Further drying of the compost to reduce weight may be necessary if the finished compost is to be marketed, hauled long distances, or used as bedding. Drying can be accomplished by spreading the compost out in warm, dry weather or under a roofed structure until a sufficient quantity of moisture evaporates.

**(vii) Bulking agent recovery (as needed or required)**—If such bulking agents as shredded tires or large wood chips are used in the compost mixture, they can be recovered from the finished compost by screening. The recovered bulking agents are then reused in the next compost mix.

**(viii) Storage (as needed)**—Finished compost may need to be stored for a period of time during frozen or snow-covered conditions or until the compost product can be marketed. If possible, finished compost should be covered to prevent leaching or runoff.

### **(10) Dead animal composting**

The disposal of dead animals is a major environmental concern. Composting can be an economical and environmentally acceptable method of handling dead animals. This process produces little odor and destroys harmful pathogens. Composting of dead poultry is the most common process. The process does apply equally well to other animals. Some operators have composted dead animals weighing as much as 100 pounds by grinding or cutting them into smaller pieces.

Composting of dead animals should be considered when—

- A preferred use, such as rendering, is not available.
- The mortality rate as a result normal animal production is predictable.
- Sufficient land is available for nutrient utilization.
- State or local regulations permit dead animal composting.
- Other disposal methods are not permitted or desired.
- Marketing of finished compost is feasible.

**(i) Special planning considerations**—Because composting of dead animals is similar in many ways to other methods of composting, the same siting and planning considerations apply. These considerations will not be repeated here. Composting of dead animals does, however, have unique problems that require special attention.

**Many States and localities regulate the disposal of dead animals.** A construction permit may be required before installation of the facility begins, and an operating permit may be necessary to operate the facility. The animal producer is responsible for procuring all necessary permits to install and operate the facility.

**The size of the animals to be composted should be considered when planning a compost facility.** Larger animals require additional equipment, labor, and handling to cut the animals into smaller pieces to facilitate rapid composting.

**Dead animal composting facilities should be roofed to prevent rainfall from interfering with the compost operation.** Dead animal composting must reach a temperature in excess of 130 °F to destroy pathogens. The addition of rainfall can elevate the moisture content and result in a compost mix that is anaerobic. Anaerobic composting takes much longer and creates odor problems.

**(ii) Sizing dead animal composting facilities**—A typical dead animal composting facility consists of two stages. The first stage, also called the primary composter, is made up of equally sized bins in which the dead animals and amendments are initially added and allowed to compost. The mixture is moved from the first stage to the second stage, or secondary digester, when the compost temperature begins to decline. The second stage can also consist of a number of bins, but it is most often one bin or concrete area or alley that allows compost to be stacked with a volume equal to or greater than the sum of the first stage bins.

The design volume for each stage should be based on peak disposal requirements for the animal operation. The peak disposal period normally occurs when the animals are close to their market weight. The volume for each stage is calculated by multiplying the weight of dead animals at maturity times a volume factor. The volume factor (VF) can vary from 1.0 to 2.5 cubic feet

per pound, depending on the type of composter, local conditions, and experiences. Equation 10-22 can be used to calculate the volume for each stage in the compost facility.

$$Vol = B \times \frac{M}{T} \times W \times \frac{VF}{100} \quad [10-22]$$

where:

- $Vol$  = Volume required for each stage (ft<sup>3</sup>)
- $B$  = Number of animals
- $M$  = Percent normal mortality of animals for the entire life cycle expressed as percent
- $T$  = Number of days for animal to reach market weight (days)
- $W$  = Market weight of animals (lb)
- $VF$  = Volume factor

**Note:**  $M/T$  is used to estimate the percentage of dead animals to be composted at maturity. Other estimators or field experience may be more accurate.

The number of bins required for the first and second stages can be estimated to the nearest whole number by dividing the total volume required by the volume of each bin (equation 10-23).

$$\# \text{ Bins} = \frac{\text{Total 1st stage volume (ft}^3\text{)}}{\text{volume of single bin (ft}^3\text{)}} \quad [10-23]$$

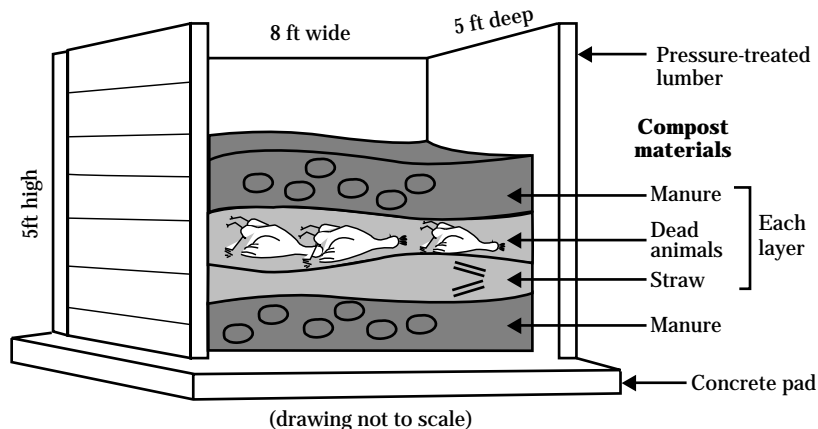
Bins are typically 5 feet high, 5 feet deep, and 8 feet across the front. The width across the front should be sized to accommodate the equipment used to load and unload the facility. To prevent spontaneous combustion and to allow for ease of monitoring, a bin height of no more than 6 feet is recommended. The depth should also be sized to accommodate the equipment used.

A high volume to surface area ratio is important to insulate the compost and allow the internal temperature to rise. The bin height and depth should be no less than one-half the width. Shallow bins are easier to unload and load; therefore the bin depth should be no more than the width. Figure 10-37 is an example of a dead animal composting bin.

Mortality rates vary considerably because of climate and among varieties, species, and types of operation. Information provided by the animal producer/operator should be used whenever possible. Table 10-7 gives typical mortality rates, flock life, and market weights for poultry.

**(iii) Mix requirements**—Rapid composting of dead animals occurs when the C:N ratio of the compost mix is maintained between 10 and 20. This is considerably lower than what is normally recommended for other types of composting. Much of the nitrogen in the dead

**Figure 10-37** Dead animal composting bin





animal mass is not exposed on the surface; therefore, a lower C:N ratio is necessary to ensure rapid composting with elevated temperatures. If the dead animals are shredded or ground up, a higher C:N ratio of 25:1 would be more appropriate. The initial compost mix should have a C:N ratio that is between 13 and 15. As composting proceeds, nitrogen, carbon, and moisture are lost. Once composting is complete, the C:N ratio should be between 20 and 25. A C:N ratio of more than 30 in the initial compost mixture is not recommended because excessive composting time and failure to achieve the temperature necessary to destroy pathogens may result.

The moisture content of the initial compost mixture should be between 45 and 55 percent, by weight, to facilitate rapid decomposition. An initial moisture content of more than 60 percent would be excessively moist and would retard the compost process. The most common problem in dead animal composting is the addition of too much water. Depending on the mass of dead animals and the moisture content of the amendments, water may not need to be added to the

initial mix. Because water is relatively dense compared to the compost mix, the addition of a little water can raise the moisture content of the mix considerably. Even though water may not need to be added to the initial mix, it is advisable to have a source of water available at the compost site for temperature control.

Composting of dead animals should remain aerobic at all times throughout the process. Anaerobic conditions result in putrid odors and may not achieve temperatures necessary to destroy pathogens. Foul odor during the compost process indicates that the compost process has turned anaerobic and that corrective action is needed. These actions will be discussed later. To prevent the compost process from going anaerobic, the initial mix should have enough porosity to allow air movement into and out of the compost mix. This can be accomplished by layering dead animals and amendments in the mix. For example, a dead poultry compost mix would be layered with straw, dead birds, and manure or waste cake from the poultry houses. Layers of such high porosity material as straw, wood chips, peanut hulls, and bark allow lateral movement of air in the compost mix. Figure 10-38 is an example of commonly recommended layering of manure, straw, and dead poultry.

**Table 10-7** Poultry mortality rates

Poultry type	Loss rate %	Flock life (days)	Cycles per year	Market weight (lb)
Broiler	4.5-5.5	42-49	5.5- 6.0	4.2
Roaster				
females	3	42	4	4.0
males	8	70	4	7.5
Laying hens	14	440	0.9	4.5
Breeding hens	10-12	440	0.9	7-8
Breeder males	20-25	300	1.1	10-12
Turkey females	5-6	95	3	14
Turkey male	9	112	3	24
Turkey feather prod.	12	126	2.5	30

Table 10-8 is a typical recipe for composting dead birds. The ingredients are presented by volume as well as weight.

Research and evaluation on composting dead animals other than poultry is limited. The differences between livestock and poultry as related to composting are insignificant except for the size of the animal to be

**Table 10-8** Broiler compost mix

Ingredient	Volumes (parts)	Weights (parts)
Straw	1.0	0.1
Broiler	2.0	1.0
Manure	2.0	1.5
Water*	0.5	0.75

\* More or less water may be necessary depending on the moisture content of the straw and manure.

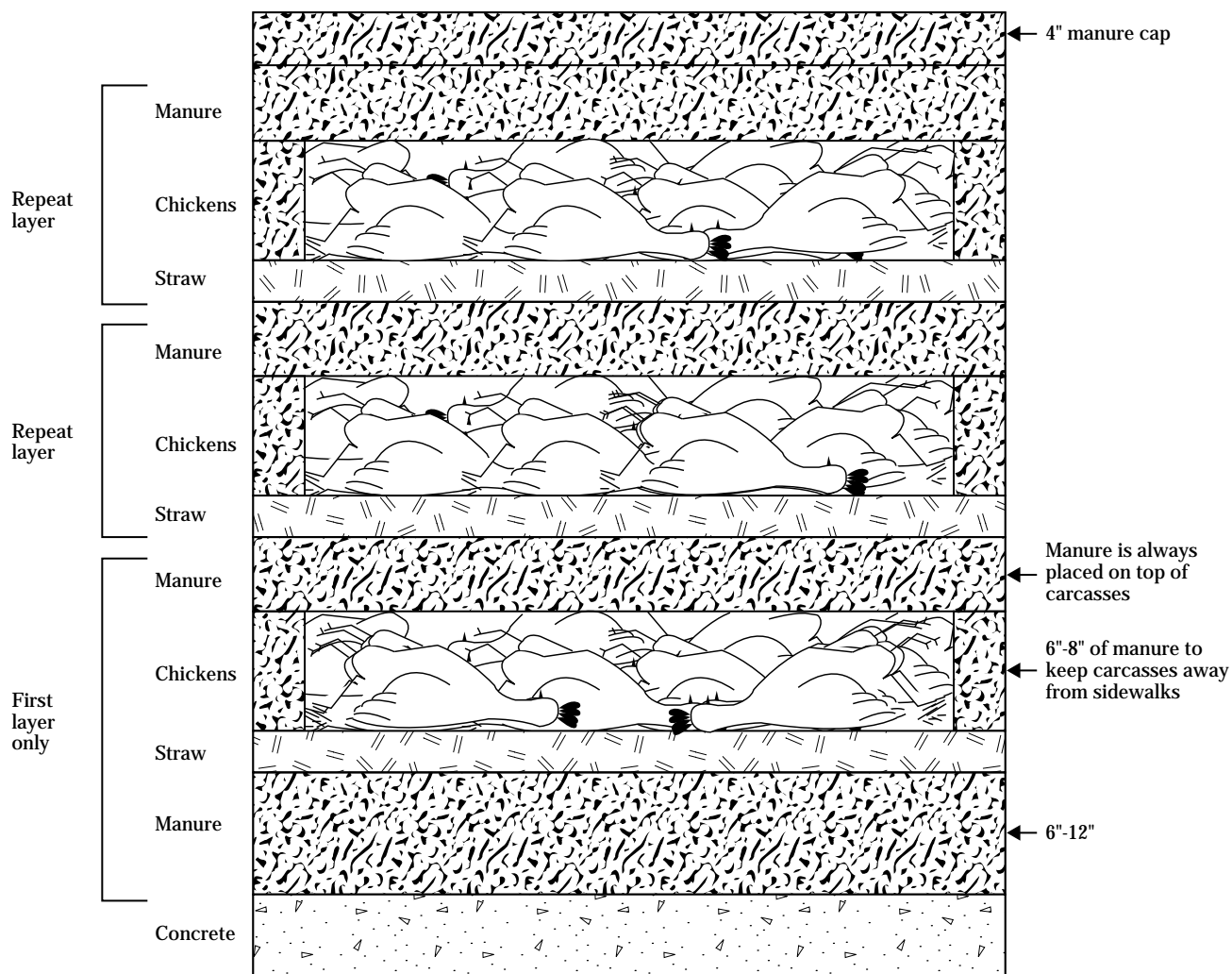
composted and the density of skeletal material. Large birds, such as turkeys, have been successfully composted. If large animals are to be composted, they should be cut into no larger than 15-pound pieces and be cut in a manner to maximize surface exposure. Large animal composting is a promising technology, but it is not well documented. Caution is advised.

**(iv) Operational considerations**—Efficient and rapid composting requires careful control of the C:N ratio, percent moisture and aerobic conditions, and the internal temperature of the compost mix. A deficiency in any of these three areas retards and possibly

inhibits the composting process achieving temperatures too low for pathogen destruction. Careful planning and monitoring is required to ensure that the process is proceeding as expected.

The landowner/operator should be provided a written set of instructions as a part of the waste management plan that detail the operation and maintenance requirements necessary for successful dead animal composting. The instructions should include compost mix design (recipe), method or schedule of when to unload the primary digester (first stage) and load the secondary digester (second stage), methods to moni-

**Figure 10-38** Recommended layering for dead bird composting



for the compost process, and information on long-term compost storage. The final utilization of the compost should be detailed in the Waste Utilization Plan.

Temperature is an important gauge of the progress of the composting operation. After initial loading into the first stage, the compost temperature should peak between 130 and 140 degrees in 5 to 7 days. The same is true for when the compost is moved and stacked in the second stage. Elevated temperatures are necessary to destroy the fly larvae, pathogenic bacteria, and viruses. The two-stage process maximizes the destruction of these elements.

When the compost is initially loaded into the compost bin, the internal temperature begins to rise as a result of bacterial activity. Maximum internal temperatures within the first stage should exceed 130 °F within a few days. Although internal compost temperatures rise to a level necessary for the destruction of pathogenic organisms and fly larvae, the temperatures near the edge of the compost pile will not be sufficient to destroy these elements. The edge of the compost stack in the first stage may remain an incubation area for fly larvae and allow the survival of the more heat-resistant pathogens.

Removing the compost from the first stage and restacking in the second stage mixes and aerates the compost. The compost that was on the edge of the compost pile is mixed with the internal compost material, and subsequently is exposed to temperatures in excess of 130 °F in the second stage stack.

The internal temperature of the compost in the first and second stages should be monitored on a daily basis. The compost should be moved from the first stage to the second stage when the internal temperature of the first stage compost begins to decline. This generally occurs after 5 to 7 days.

If internal temperatures fail to exceed 130 °F in the first or second stages of the composter, the compost material should immediately be incorporated if land applied or remixed and composted a second time.

Excessively high temperatures are also a danger in dead animal composting because spontaneous combustion of the compost material can occur when the compost temperature exceeds 170 °F. If the temperature exceeds 170 °F, the compost should be removed

from the bin and spread out in a uniform layer no more than 6 inches deep. Water should be used, if necessary, to further cool the compost. Once the temperature has fallen to a safe level, the compost can be restacked. Adding moisture to the compost should retard the biological growth and reduce the temperature. Excessive applications of water stops the process and can cause anaerobic conditions to develop. The compost mix should be rehydrated to a moisture content of 55 to 65 percent, by weight, to reduce excessive temperatures.

Anaerobic conditions may develop if the initial porosity of the compost mix is too low, excessive amounts of water are added to the mix, or the C:N ratio is excessively low. Odor generally is a good indicator of anaerobic conditions. If foul odors develop, the reason for the odor problem must be identified before corrective action can be taken. Anaerobic conditions may be the result of any one or a combination of excessive moisture, low porosity, or low C:N ratio.

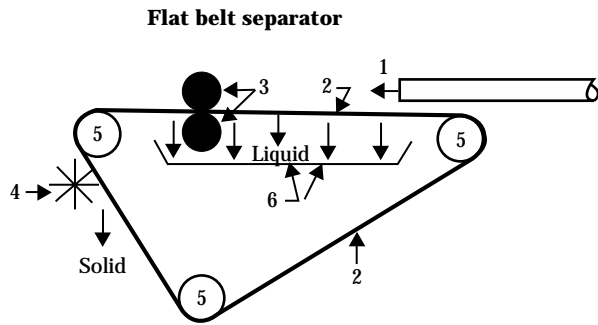
### (g) Mechanical separation

Animal manure contains material that can often be reclaimed. Much of the partly digested feed grain can be recovered from manure of poultry and livestock fed high grain rations. This material can be used as a feed ingredient for other animals. Solids in dairy manure from animals fed a high roughage diet can be removed and processed for use as good quality bedding. Some form of separation must be used to recover these solids. Typically, a mechanical separator is employed. Separators are also used to reduce solids content and required storage volumes.

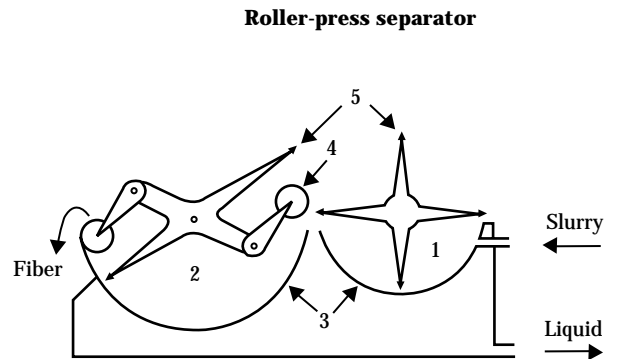
Separators also facilitate handling of manure. For example, solid separation can allow the use of conventional irrigation equipment for land application of the liquids. Separation eliminates many of the problems associated with the introduction of solids into waste storage ponds and treatment lagoons. For example, it eliminates the accelerated filling of storage volumes with solids and also minimizes agitation requirements.

Several kinds of mechanical separators can be used to remove by-products from manure (fig. 10-39). One kind commonly used is a screen. Screens are statically inclined or in continuous motion to aid in separation. The most common type of continuous motion screen is a vibrating screen. The TS concentration of manure

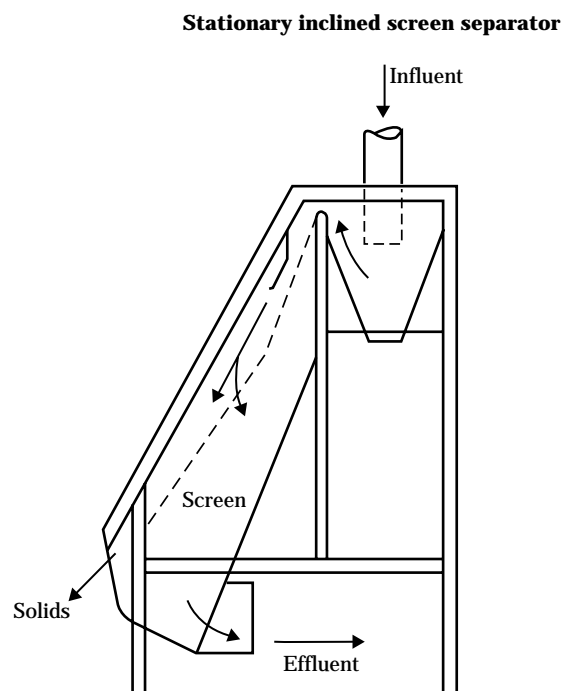
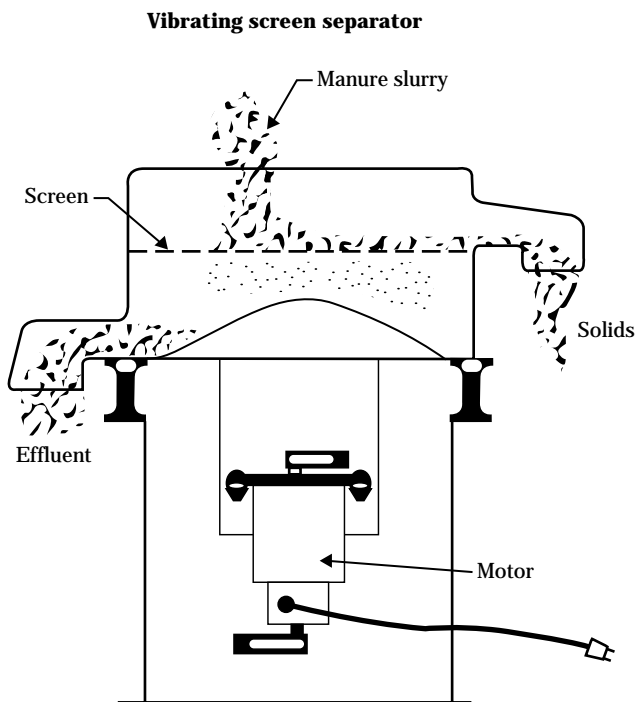
**Figure 10-39** Schematic of mechanical solid-liquid separators



- 1 Slurry input
- 2 Polyester mesh belt
- 3 Press rollers
- 4 Rotary brush
- 5 Belt guide rollers
- 6 Liquid collection trough



- 1 Screening stage
- 2 Roller pressing stage
- 3 Screens
- 4 Spring loaded press roller
- 5 Brushes



to be processed by a screen should be reduced to less than 5 percent. Higher TS concentrations reduce the effectiveness of the separator.

A centrifuge separator uses centrifugal force to remove the solids, which are eliminated from the machine at a different point than the liquids. In addition, various types of presses can be used to force the liquid part of the waste from the solid part.

Several design factors should be considered when selecting a mechanical separator. One factor is the amount of liquid waste that the machine can process in a given amount of time. This is referred to as the "throughput" of the unit. Some units have a relatively low throughput and must be operated for a long time. Another very important factor is the TS content required by the given machine. Centrifuges and presses can operate at a higher TS level than can static screens.

Consideration should be given to handling the separated materials. Liquid can be collected in a reception pit and later pumped to storage or treatment. The separated solids will have a TS concentration of 15 to 40 percent. While a substantial amount of nutrients are removed with the solids, the majority of the nutrients and salt remain in the liquid fraction. In many cases water drains freely from piles of separated solids. This liquid needs to be transferred to storage to reduce odors and fly breeding.

Typically, solids must still be processed before they can be used. If they are intended for bedding, the material should be composted or dried. If the solids are intended for animal feed, they may need to be mixed with other feed ingredients and ensiled before feeding to prevent bacteriological disease transmission. A feed ration using manure must be proportioned by an animal nutritionist so that it is both nutritious and palatable.

A planner/designer needs to know the performance characteristics of the separator being considered for the type of waste to be separated. The best data, if available, would be that provided by the separator manufacturer. If that data is not available, the manufacturer or supplier may agree to demonstrate the separator with waste material to be separated. This can also provide insight as to the effectiveness of the equipment.

If specific data on the separator is not available, tables 10-9 and 10-10 can be used to estimate performance characteristics. Table 10-9 gives data for separating different wastes using different separators, and table 10-10 presents general operational characteristics of mechanical separators.

### (h) Settling basins

In many situations, removing manure solids, soil, and other material from runoff from livestock operations is beneficial. The most common device to accomplish this is the settling or solids separation basin. A settling basin used in association with livestock operations is a shallow basin or pond that is designed for low velocities and the accumulation of settled materials. It is positioned between the waste source and the waste storage or treatment facilities. Most readily settleable solids will settle from the flow if the velocity of the liquid is below 1.5 feet per second.

The basins should be planned and designed in accordance with SCS Conservation Practice Standard, Sediment Basin, Code 350 (USDA 1978). Settling basins should have access ramps that facilitate removal of settled material. Outlets from settling basins should be located so that sediment removal is not restricted.

**Table 10-9** Operational data for solid/liquid separators

Waste type	Separator	----- TS concentration (%) -----			----- % Retained in separated solids -----				
		Raw waste	Separated liquids	Separated solids	TS	VS	COD	N	P
Dairy	Vibrating screen								
	16 mesh	5.8	5.2	12.1	56	—	—	—	—
	24 mesh	1.9	1.5	7.5	70	—	—	—	—
	Decanter centrifuge								
	16-30 gpm	6-8	4.9-6.5	13-33	35-40	—	—	—	—
	Static inclined screen								
	12 mesh	4.6	1.6	12.2	49	—	—	—	—
	32 mesh	2.8	1.1	6.0	68	—	—	—	—
Beef	Static inclined screen	4.4	3.8	13.3	15	—	—	—	—
	Vibrating screen	1-2	—	—	40-50	—	—	—	—
Swine	Decanter centrifuge								
	3 gpm	7.6	2.6	37	14	—	—	—	—
	Vibrating screen								
	22 gpm/ft <sup>2</sup>								
	18 mesh	4.6	3.6	10.6	35	39	39	22	26
	30 mesh	5.4	3.5	9.5	52	56	49	33	34

**Table 10-10** Characteristics of solid/liquid separators (Barker 1986)

Characteristic	Decanter centrifuge	Vibrating screen	Stationary inclined screen
Typical screen opening	—	20 mesh	10-20 mesh
Maximum waste TS concentration	8%	5%	5%
Separated solids TS concentration	to 35%	to 15%	to 10%
TS reduction*	to 45%	to 30%	to 30%
COD reduction*	to 70%	to 25%	to 45%
N reduction*	to 20%	to 15%	to 30%
P reduction*	to 25%	—	—
Throughput (gpm)	to 30	to 300	to 1,000

\* Removed in separated solids

(i) Dilution

Dilution is often used to prepare the waste to facilitate another function. This involves adding clean water or another waste that has less total solids to the waste, resulting in a waste that has a desired percentage of total solids. A common use of dilution is to prepare the waste to facilitate utilization by land application using a sprinkler system. Figure 10-40 is a design aid for determining the amount of clean dilution water required to lower the TS concentration.

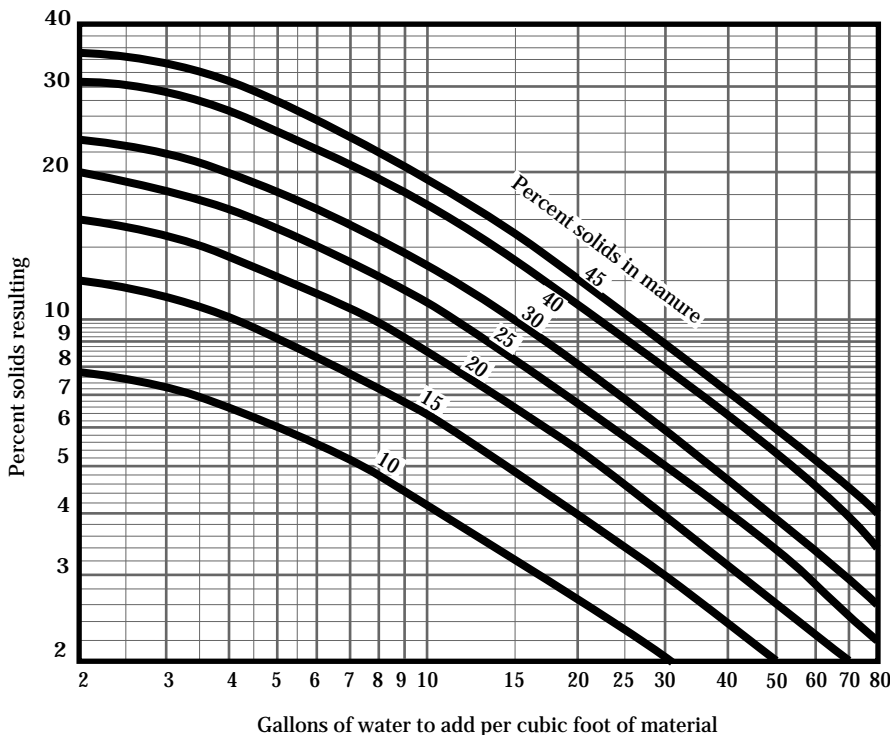
(j) Vegetative filters

A vegetative filter can be a shallow channel or a wide, flat area of vegetation used for removing suspended solids and nutrients from concentrated livestock area runoff and other liquid wastes. The filters are designed with adequate length and limited flow velocities to promote filtration, deposition, infiltration, absorption, adsorption, decomposition, and volatilization of contaminants. Consideration must be given to hydraulic as well as contaminant loading.

Vegetative filters rely on infiltration to remove nitrates and micro-organisms that are in solution because these waste constituents are very mobile in water. Provision for rest periods between loadings is recommended. In cases where a large volume of solids is expected, settling basins are needed above the filter area or channel. "Clean" water must be diverted from the filter. Installation and maintenance are critical.

Vegetative filters are planned and designed according to Conservation Practice Standard, Filter Strip, Code 393 (USDA 1982), which gives more detailed planning considerations and design criteria. See section 651.0605(c) for additional information. If State or local government has restrictions on the use of vegetative filters, the requirements must be met before design and construction. This is especially true if the outflow from the vegetative filter will flow into a stream or waterway. Unless permitted by State regulations, wastewater treatment by vegetative filters is not sufficient to allow discharge to surface water.

**Figure 10-40** Design aid to determine quantity of water to add to achieve a desired TS concentration (USDA 1975)



## 651.1005 Transfer

Manure collected from within a barn or confinement area must be transferred to the storage or treatment facility. In the simplest system, the transfer component is an extension of the collection method. More typically, transfer methods must be designed to overcome distance and elevation changes between the collection and storage facilities. In some cases gravity can be used to move the manure. In many cases, however, mechanical equipment is needed to move the manure. Transfer also involves movement of the waste from storage or treatment to the point of utilization. This may involve pumps, pipelines, and tank wagons.

### (a) Reception pits

Slurry and liquid manure collected by scraping, gravity flow, or flushing are often accumulated in a reception pit (fig. 10-41). Feedlot runoff can also be accumulated. These pits can be sized to hold all the waste produced for several days to improve pump efficiency or to add flexibility in management. Additional capacity might be needed for extra liquids, such as milk

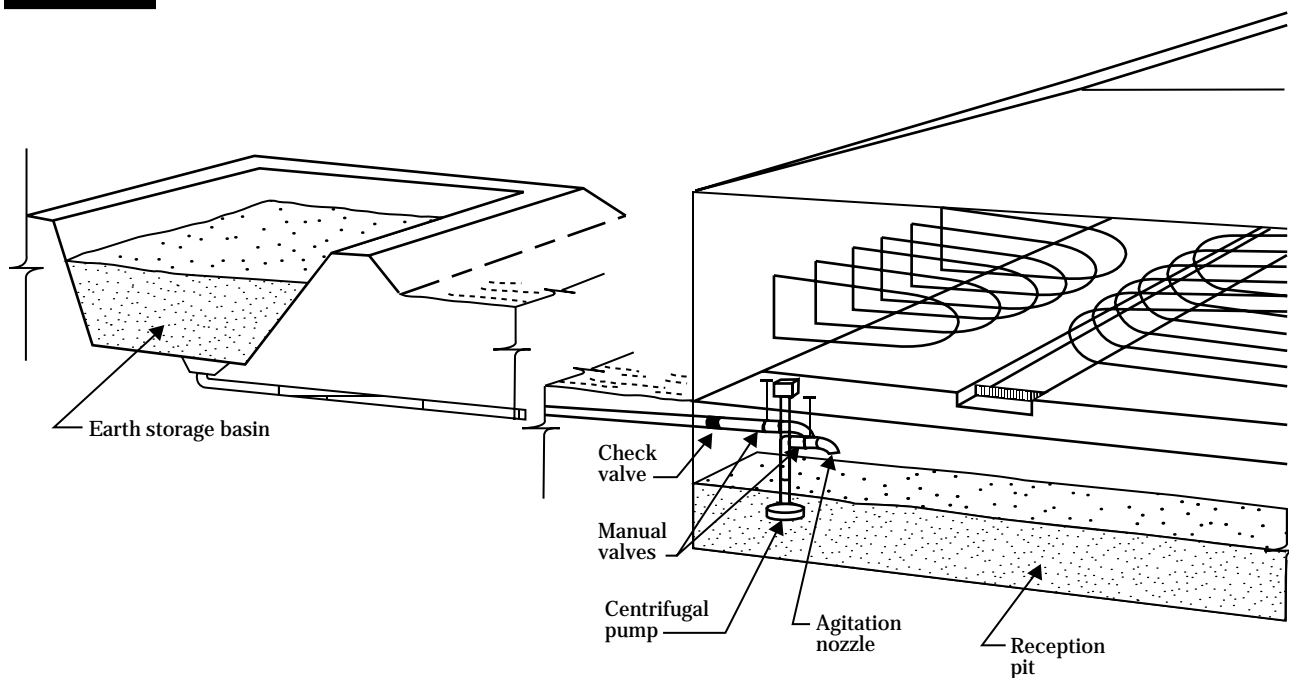
parlor water or runoff from precipitation. For example, if the daily production of manure and parlor cleanup water for a dairy is estimated at 2,500 gallons and 7 days of storage is desired, then a reception pit that has a capacity of 17,500 gallons (2,500 gallons/day x 7 days) is the minimum required. Additional volume should be allowed for freeboard emergency storage.

Reception pits are rectangular or circular and are often constructed of cast-in-place reinforced concrete or reinforced concrete block. Reinforcing steel must be added so that the walls withstand internal and external loads.

Waste can be removed with pumps or by gravity. Centrifugal pumps can be used for agitating and mixing the manure before transferring the material. Both submersible pumps and vertical shaft pumps that have the motor located above the manure can be used. Diluted manure can be pumped using submersible pumps, often operated with float switches. The entrance to reception pits should be restricted by guard rails or covers.

Debris, such as pieces of metal and wood and rocks, must sometimes be removed from the bottom of a reception pit. Most debris must be removed manually,

**Figure 10-41** Reception pit for dairy freestall barn





but if possible, this should be done remotely from outside the pit. The pit should be well ventilated before entering. If waste is in the pit, a self-contained breathing apparatus must be used. Short baffles spaced around the pump intake can effectively guard against debris clogging the pump.

In cold climates, reception pits need to be protected from freezing. This can be accomplished by covering or enclosing it in a building. Adequate ventilation must be provided in all installations. In some installations, hoppers and either piston pumps or compressed air pumps are used instead of reception pits and centrifugal pumps. These systems are used with semi-solid manure that does not flow readily or cannot be handled using centrifugal pumps.

### (b) Gravity flow pipes

Liquid and slurry manure can be moved by gravity if sufficient elevation differences are available or can be established. For slurry manure, a minimum of 4 feet of elevation head should exist between the top of the collection pit or hopper and the surface of the material in storage when storage is at maximum design depth.

Gravity flow slurry manure systems typically use 18- to 36-inch diameter pipe. In some parts of the country 4- to 8-inch diameter pipe is used for the gravity transport of low (<3%) TS concentration waste. The planner/designer should exercise caution when specifying the 4- to 8-inch pipe. Smooth steel, plastic, concrete, and corrugated metal pipe are used. Metal pipes should be coated with asphalt or plastic to retard corrosion, depending upon the type of metal. All joints must be sealed so that the pipe is water tight.

Gravity flow pipes should be designed to minimize changes in grade or direction over the entire length. Pipe slopes that range from 4 to 15 percent will work satisfactorily, but 7 to 8 percent slope is preferable. Excessive slopes allow separation of liquids and solids and increase the chance of plugging. The type and quantity of bedding and the amount of milkhouse waste and wash water added have an effect on the flow characteristics and the slope needed in a particular situation. Straw bedding should be discouraged, especially if it is not chopped. Smooth, rounded transition from reception pit to pipe and the inclusion of an air vent in the pipeline aid the flow and prevent plugging.

Figure 10-42 illustrates the use of gravity flow for manure transfer. At least two valves should be located in an unloading pipe. Proper construction and operation of gravity unloading waste storage structures are extremely important. Containment berms should be considered if the contamination risk is high downslope of the unloading facility.

### (c) Push-off ramps

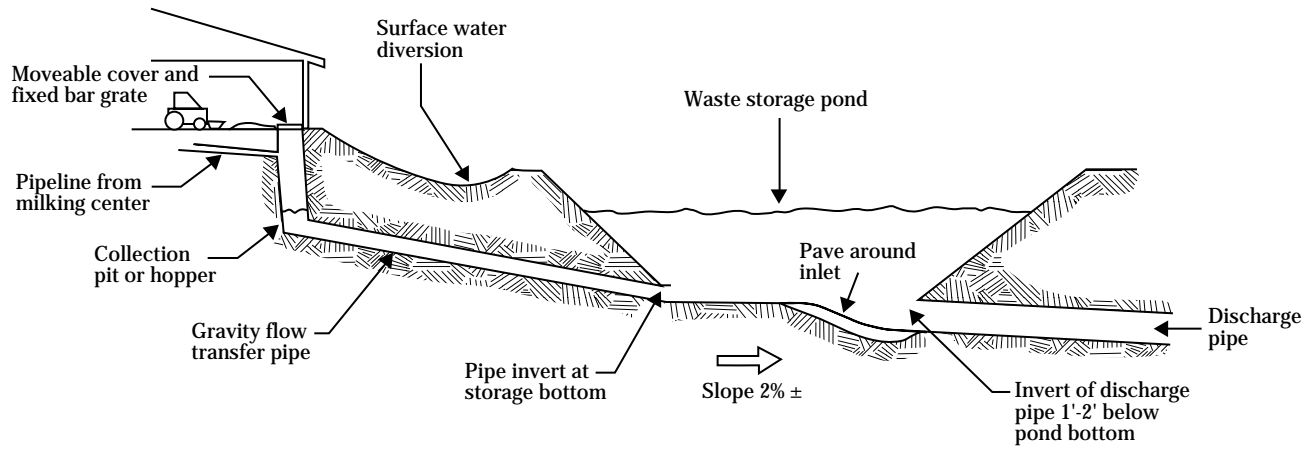
Manure that is scraped from open lots can be loaded into manure spreaders or storage and treatment facilities using push-off ramps (fig. 10-43) or docks. A ramp is a paved structure leading to a manure storage facility. It can be level or inclined and usually includes a retaining wall. A dock is a level ramp that projects into the storage or treatment facility. Runoff should be directed away from ramps and docks unless it is needed for waste dilution. Ramp slopes should not exceed 5 percent. Push-off ramps and docks should have restraints at each end to prevent the scraping tractors from accidentally going off the end.

### (d) Picket dams

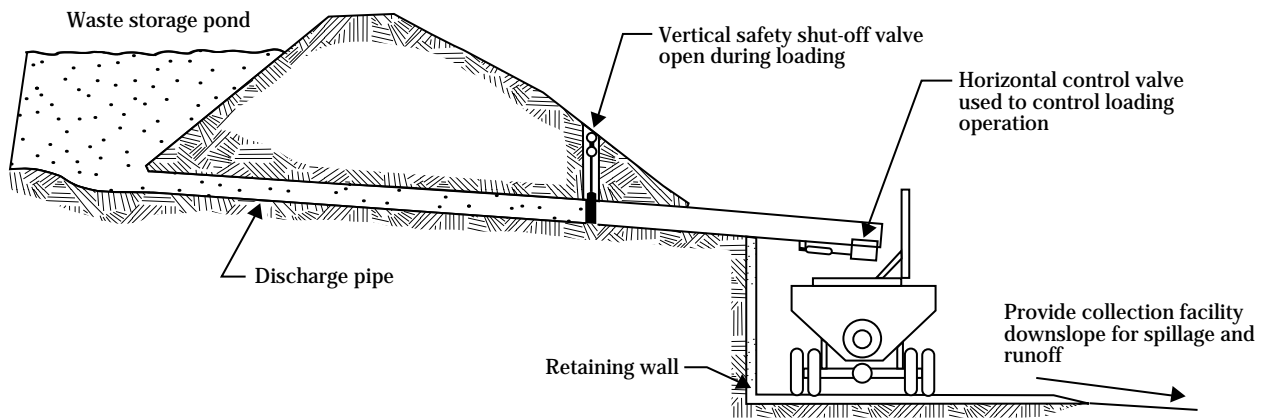
Manure that has considerable bedding added can be stored as a solid or semi-solid. If the manure is stored uncovered, precipitation can accumulate in the storage area. Picket dams can be used to drain runoff from the storage area while retaining the solid manure and bedding within the storage area. Any water drained should be channeled to a waste storage pond. The amount of water that drains from the manure depends on the amount of precipitation and the amount of bedding in the manure. Water will not drain from manure once the manure and water are thoroughly mixed. Picket dams will not dewater liquid manure.

The picket dam should be near the unloading ramp to collect runoff and keep the access as dry as possible. It should also be on the side of the storage area opposite the loading ramp. Water should always have a clear drainage path from the face (leading edge) of the manure pile to the picket dam.

**Figure 10-42** Examples of gravity flow transfer



**Gravity flow transfer**



**Gravity flow from storage**

The floor of the storage area using a picket dam should have slope of no more than 2 percent toward the dam. Picket dams should be made of pressure-treated timbers that have corrosion resistant fasteners. The openings in the dam should be about 0.75 inch wide vertical slots. Figure 10-44 shows different aspects of picket dam design.

### (e) Pumps

Most liquid manure handling systems require one or more pumps to either transport or agitate manure. Pumps are in two broad classifications—displacement and centrifugal. The displacement group are piston, air pressure transfer, diaphragm, and progressive cavity pumps. The first two are used only for transferring manure; however, diaphragm and progressive cavity pumps can be used for transferring, agitating, and irrigating manure.

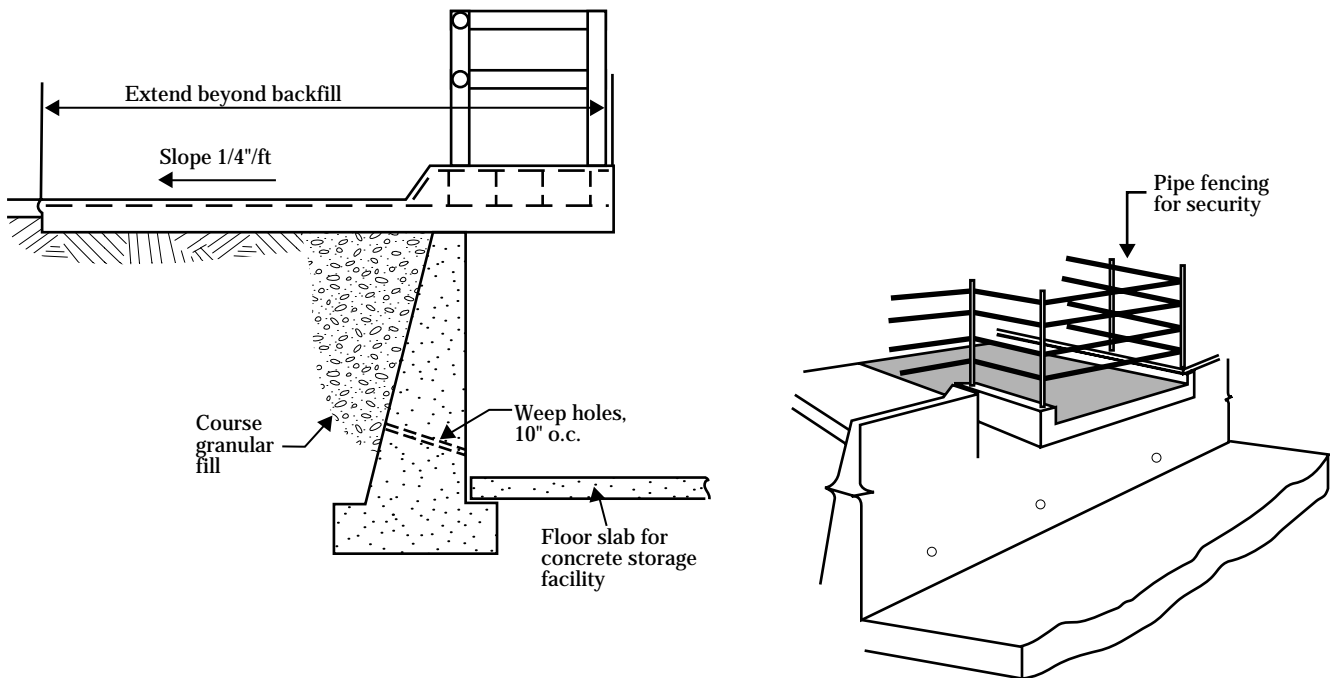
The centrifugal group is vertical shaft, horizontal shaft, and submersible pumps. They can be used for agitation and transfer of liquid manure; however, only vertical and horizontal shaft pumps are used for irrigation because of the head that they can develop.

Pump selection is based on the consistency of the material to be handled, the total head to be overcome, and the desired capacity (pumping rate). Pump manufacturers and suppliers can provide rating curves for a variety of pumps.

### (f) Equipment

Other equipment used in the transfer of agricultural wastes include a variety of pumps including chopper/agitator, centrifugal, ram, and screw types. Elevators, pipelines, and hauling equipment are also used. See chapter 12 for information about specific equipment.

**Figure 10-43** Push-off ramp



## 651.1006 Utilization

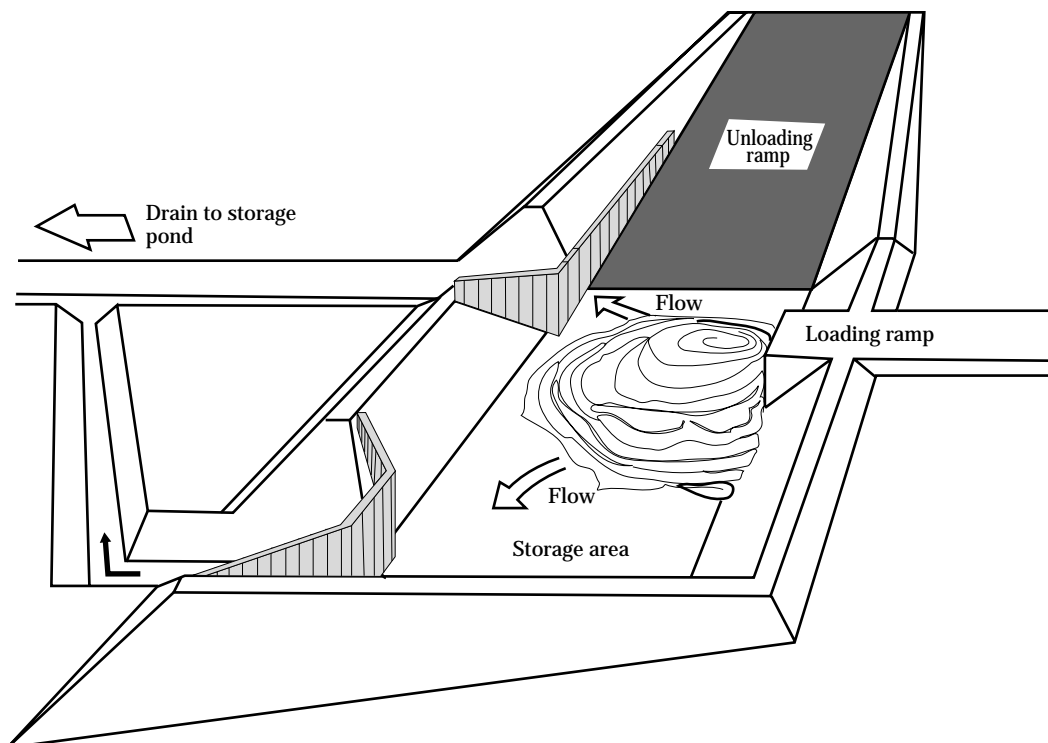
Utilization is a function in a waste management system employed for a beneficial purpose. The typical method is to apply the waste to the land as a source of nutrients for plant growth and of organic matter to improve soil tilth and water holding capacity and to help control erosion. The vast majority of animal waste produced in the United States is applied to cropland, pasture, and hayland. Manure properly managed and applied at the appropriate rates and times can significantly reduce the amount of commercial fertilizer needed for crop production. An anaerobic digester used for biogas production is considered a utilization function component because the waste is being managed for use even though further management of the digester effluent is required.

### (a) Nutrient management

Manure should be applied at rates where the nutrient requirements of the crop to be grown are met. Concentration of nutrients in the manure should be known, and records on manure application rates should be maintained.

Between the time of manure production and the time of application, nutrient concentrations can vary widely because of storage, dilution, volatilization, settling, drying, or treatment. To accurately use manure, representative samples of the material to be land applied should be analyzed for nutrient content. Before application rates can be computed, the soil in the fields where manure will be applied should be analyzed and nutrient recommendations obtained. This information should indicate the amount of nutrients to be applied for a given crop yield.

**Figure 10-44** Solid manure storage with picket dam



Scheduling land application of wastes is critical. Several factors must be considered:

- Amount of available manure storage
- Major agronomic activities, such as planting and harvesting
- Weather and soil conditions
- Availability of land and equipment
- Stage of crop growth

A schedule of manure application should be prepared in advance. It should consider the most likely periods when application is not possible. This can help in determining the amount of storage, equipment, and labor needed to make application at desired times.

### (b) Land application equipment

Animal waste is land applied using a variety of equipment. The kind of equipment used depends on the TS concentration of the waste. If the manure handles as a solid, a box spreader or flail spreader is used. Solids spreaders are used for manure from solid manure structures and for the settled solids in sediment basins.

Slurry wastes are applied using tank wagons or flail spreaders. Some tank wagons can be used to inject the waste directly into the soil. Slurry spreaders are typically used for waste that is stored in above or below ground storage structures, earthen storage structures, and sometimes lagoons.

Waste that has a TS concentration of less than 5 percent can be applied using tank wagons, or it can be irrigated using large diameter nozzles. Irrigation is used primarily for land application of liquids from lagoons, storage ponds, and tanks. Irrigation systems must be designed on a hydraulic loading rate as well as on nutrient utilization.

Custom hauling and application of manure are becoming popular in some locations. This method of utilization reduces the amount of specialized equipment needed by the owner/operator.

### (c) Land application of municipal sludge

Municipalities in the United States treat wastewater biologically using either anaerobic or aerobic processes. These processes generate sludge that has agronomic value as a nutrient source and soil amendment. Land application of sludge is currently recognized as acceptable technology; however, strict regulations and practices must be followed.

### (d) Biogas production

*Some of this material was taken directly from "Tentative guidelines for methane production by anaerobic digestion of manure" (Fogg 1981).*

Liquid manure confined in an air-tight vessel decomposes and produces methane, carbon dioxide, hydrogen sulfide, and water vapor as gaseous by-products. This process is known as anaerobic digestion. Many municipalities use this technique to treat sludge generated in wastewater treatment. Many livestock and poultry producers have become interested in the process because of the potential for onsite energy production.

Biogas, the product of anaerobic digestion, is typically made up of 55 to 65 percent methane ( $\text{CH}_4$ ), 35 to 45 percent carbon dioxide ( $\text{CO}_2$ ), and traces of ammonia ( $\text{NH}_3$ ) and hydrogen sulfide ( $\text{H}_2\text{S}$ ). Pure methane is a highly combustible gas that has an approximate heating value of 994 BTU/ft<sup>3</sup>. Biogas can be burned in boilers to produce hot water, in engines to power electrical generators, and in absorption coolers to produce refrigeration.

The most frequent problem with anaerobic digestion systems is related to the economical use of the biogas. The biogas production rate from a biologically stable anaerobic digester is reasonably constant; however, most onfarm energy use rates vary substantially. Because compression and storage of biogas is expensive, economical use of biogas as an onfarm energy source requires that farm use must closely match the energy production from the anaerobic digester.

Because of the presence of hydrogen sulfide, biogas may have an odor similar to that of rotten eggs. Hydrogen sulfide mixed with water vapor can form sulfuric

acid, which is highly corrosive. It can be removed from biogas by passing the gas through a column of iron-impregnated wood chips. Water vapor can be removed by condensers or condensate traps. Carbon dioxide can be removed by passing biogas through lime water under high pressure.

Biogas can be used to heat the slurry manure in the digester. From 25 to 50 percent of the biogas is required to maintain a working digester temperature of 95 °F, depending on the climate and the amount of insulation used. Below ground digesters require less insulation than those above ground. Engines can burn biogas directly from digesters; however, removal of hydrogen sulfide and water vapor is recommended.

If digested solids are separated from digester effluent and dried, they make an excellent bedding material. A brief period of composting may be necessary before it is used.

Anaerobic digestion in itself is not a pollution control practice. Digester effluent must be managed similarly to undigested manure by storing in waste storage ponds or treating in lagoons. Initial start-up of a digester is critical. The digester should be partly filled with water (50 to 75 percent full) and brought to temperature using an auxiliary heater. Feeding of the digester with manure should increase over a period of

3 to 6 weeks starting with a feeding rate of about 25 percent of full feed (normal operation).

Biogas production rates can be measured using specially designed corrosion resistant gas meters. These rates and carbon dioxide levels are good indicators of digester health during start-up. Several simple tests can be used in the field to determine carbon dioxide.

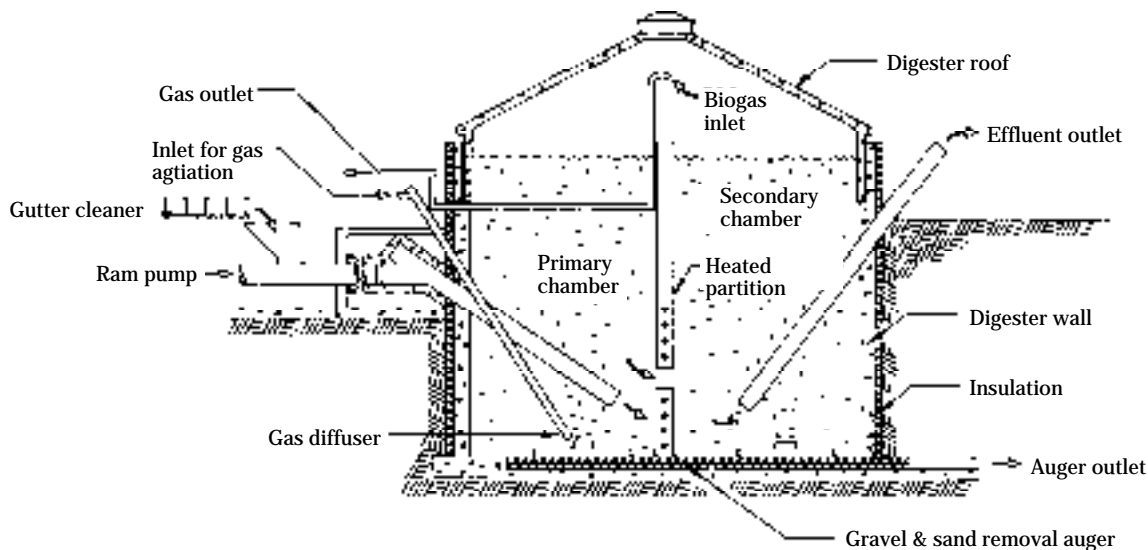
### (1) Design procedure

Because of the safety issues and economic and operational complexities involved, SCS assistance on biogas production is generally limited to planning and feasibility. The information presented here is intended for that type of assistance. Interested farmers and ranchers should be advised to obtain other assistance in the detailed design of the facility.

The guidelines presented here are based on digestion of manure in the mesophilic temperature range (about 95 °F) and may be subject to change as a result of additional research and experience. They provide a basis for considering biogas production facilities based on current knowledge as part of a waste management system.

Several digester types are used (figs. 10-45, 10-46, 10-47). The mixed tank is a concrete or metal cylindrical vessel constructed aboveground. If the manure is

**Figure 10-45** Two stage, mixed tank anaerobic digester



highly liquid (low TS), the digester must be periodically mixed to get good digestion. This can be done mechanically using a mechanical mixer, recirculating digestion liquid, or pumping biogas into the bottom sludge to remix the contents of the digester.

Another digester, known as the plug flow, is used for relatively thick manure (12 to 14 percent TS), such as dairy manure. The manure is introduced at one end and theoretically moves as a "plug" to the other end. However, if the TS content of the influent manure is too low, the manure will "channel," the actual retention time will be reduced, and the biogas yield will diminish.

For any digester, the influent must be managed for consistency in frequency of feeding as well as in the VS concentration. For this to happen the rations fed and manure management must be consistent. Some manure requires preprocessing before it enters the digester. For example, poultry manure must be diluted to about 6 percent TS to allow grit to settle before the manure is pumped into the digester. Grit material is very difficult to remove from digesters. All digesters must be periodically cleaned. The frequency of cleaning can vary from 1 to 4 years.

**(i) Determine manure production**—Manure production can be based on the tables in chapter 4 or on reliable local data. The following data will be needed:

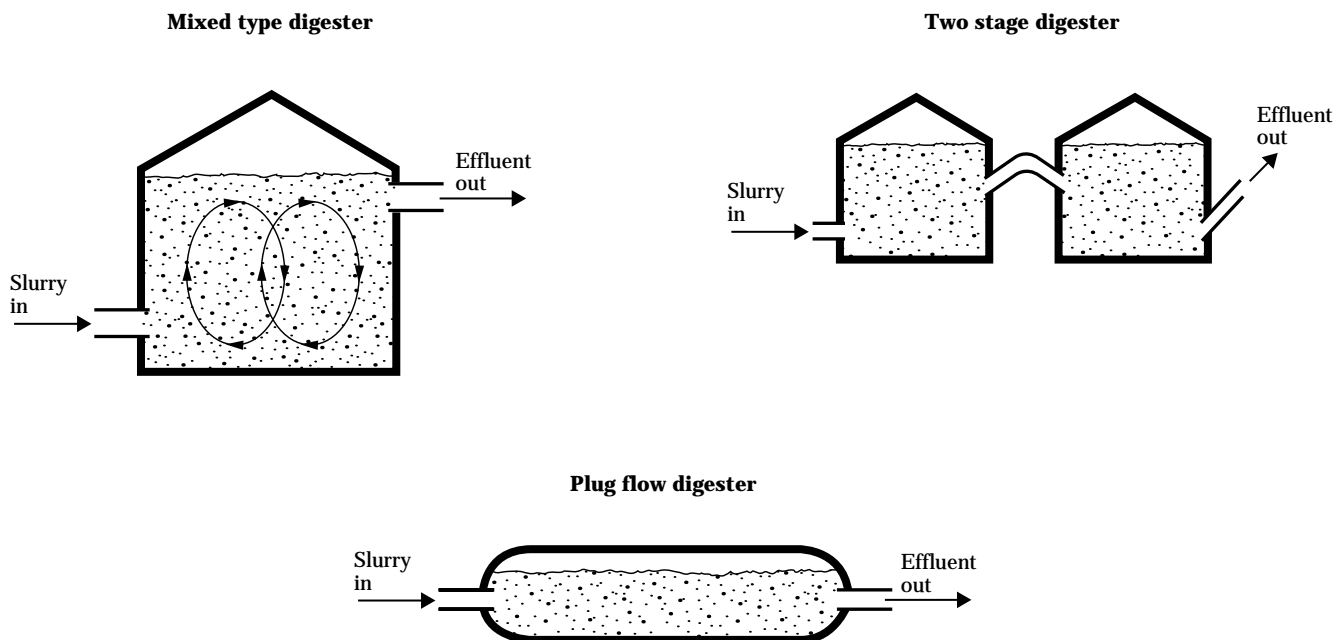
Volume of manure produced	=	_____	ft <sup>3</sup> /day
Wet weight of manure produce	=	_____	lb/day
Total solids (TS)	=	_____	lb/day
Volatile solids (VS)	=	_____	lb/day
Percent solids (TS/wet weight)	=	_____	percent

Fresh manure is desirable for digestion. Characteristics of beef feedlot manure must be determined for each operation.

**(ii) Establish TS concentration for digester feed**—TS concentrations considered desirable as input to the digester can range from about 6 to 12 percent. The following are guidelines:

Dairy manure	10 to 12 %
Confined beef manure	10 to 12 %
Beef feedlot manure (after settling grit)	8 to 10 %
Swine manure	8 to 10 %
Chicken manure	7 to 9 %

**Figure 10-46** Typical anaerobic digester types



These percentages may need to be adjusted to eliminate scum formation and promote natural mixing by the gas produced within the mass. If scum forms, a small increase in percent solids may be desirable. This increase may be limited by pumping characteristics and should seldom go above 12 percent solids.

**(iii) Determine effective digester volume**—A hydraulic detention time of 20 days is suggested. This time appears to be about optimum for efficient biogas production. The daily digester inflow in cubic feet per day can be determined using equation 10-24.

$$DMI = \frac{TMTS \times 100}{DDFSC \times 62.4} \quad [10-24]$$

where:

- DMI* = Daily manure inflow, ft<sup>3</sup>
- TMTS* = Total manure total solids production, lb/day
- DDFSC* = Desired digester input total solids concentration, %

The necessary digester volume in cubic feet can be determined using equation 10-25.

$$DEV = DMI \times 20 \quad [10-25]$$

where:

- DEV* = Digester effective volume, ft<sup>3</sup>
- 20 = Recommended detention time, days

**(iv) Select digester dimensions**—Optimum dimensions of the liquid part of the digester volume have not been established. The digester should be longer than it is wide to allow raw manure to enter one end and digested slurry to be withdrawn at the other. An effectively operating digester has much mixing by heat convection and gas bubbles. True plug flow will not occur.

Sufficient depth should be provided to preclude excessive delay at start-up because of the oxygen interchange at the surface. A combination of width equal to about two times the depth and length equal to about four times the depth is a realistic approach. Other

proportions of width and length should work equally well. For the purpose of discussion assume:

$$H = \left( \frac{DEV}{8} \right)^{0.33}$$

$$WI = 2 \times H$$

$$L = 4 \times H$$

where:

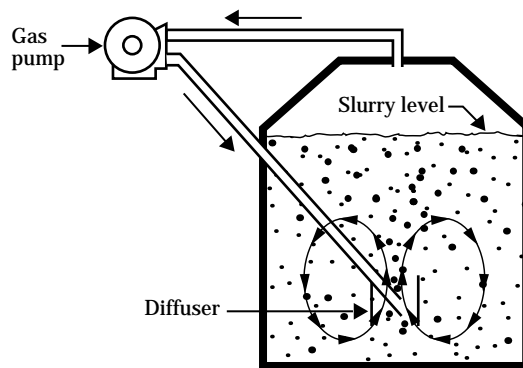
- H* = height, ft
- WI* = width, ft
- L* = length, ft

Dimensions should be adjusted to round numbers to fit the site and provide economical construction.

**(v) Estimate biogas production**—Biogas production is dependent on VS destruction within the digester. An efficient digester that has a 20-day retention should reduce VS by 50 percent. Some research indicates a reduction of 55 percent of VS in swine manure and 60 to 65 percent in poultry manure. Biogas production from poultry manure may vary significantly from the estimates presented below. Animals fed a high roughage ration produce less biogas than those fed a high concentrate ration. Estimated VS reductions are:

Dairy and beef .....	50%
Swine .....	55%
Poultry .....	60%

**Figure 10-47** Gas agitation in an anaerobic digester





Estimated daily biogas production rates are:

Dairy .....	12 ft <sup>3</sup> /lb VS destroyed
Beef .....	10 ft <sup>3</sup> /lb VS destroyed
Swine .....	13 ft <sup>3</sup> /lb VS destroyed
Poultry .....	13 ft <sup>3</sup> /lb VS destroyed

Biogas production per day is estimated by multiplying the percent volatile solids reduction times the estimated daily biogas production rate times the daily volatile solids input. Biogas production in cubic feet per day would be:

Dairy .....	6 x daily VS input
Beef .....	5 x daily VS input
Swine .....	7.2 x daily VS input
Poultry .....	7.8 x daily VS input

Initial start-up of a digester requires a period of time for anaerobic bacteria to become acclimated and multiply to the level required for optimum methane production. If available, sludge from a municipal anaerobic digester or another anaerobic manure digester can be introduced to speedup the start-up process. The digester contents must be maintained at about 95 °F for continuous and uniform biogas production. Hot water tubes within the digester can serve this purpose.

### (2) Other considerations

Biogas is difficult to store because it can't be compressed at normal pressures and temperatures. Storage pressures above 250 psi are rarely used. Because of these reasons, biogas usage is generally planned to match production, and thus eliminate the need for storage.

The most common use of biogas is the production of electricity using an engine-generator set. The thermal conversion efficiency is about 25 percent for this type of equipment. The remainder of the energy is lost as heat. Heat exchangers can be used to capture as much as 50 percent of the initial thermal energy of the biogas from the engine exhaust gases and the engine cooling water. This captured heat can sometimes be used onsite for heating. Some of it must be used to maintain the digester temperature.

Effluent from anaerobic digesters has essentially the same amount of nutrients as the influent. Some of the organic nitrogen will be converted to ammonia, making it more plant available but more susceptible to volatilization unless the liquid is injected. Only a little volume is lost by processing the manure through an anaerobic digester. For manure requiring dilution before digestion, the amount of liquid to be stored and handled actually increases as compared to the original amount of manure.

### (3) Design example 10-9—Biogas digester

Mr. Joe Sims of Hamburg, Pennsylvania, has requested assistance on development of an agricultural waste management system for his 100 Guernsey milk cows that weigh an average of 1,200 pounds. He has requested that an alternative be developed that includes an anaerobic digester to produce methane gas. Determine the approximate size of the digester using worksheet 10A-5.

## Completed worksheet for Design example 10-9

<b>Worksheet 10A-5—Anaerobic digester design</b>	
Decisionmaker: <u>Joe Sims</u>	Date: <u>6/13/89</u>
Site: <u>Hamburg, PA</u>	
<b>Animal units</b>	
1. Animal type <u>Milkers</u>	3. Number of animals (N) <u>100</u>
2. Animal weight, lbs (W) <u>1200</u>	4. Animal units, $AU = \frac{W \times N}{1000} =$ <u>120</u>
<b>Manure volume</b>	
5. Daily volume of daily manure production per AU, ft <sup>3</sup> /AU/day (DVM) = <u>1.30</u>	7. Total daily manure production volume, ft <sup>3</sup> /day (TMP) <u>156</u>
6. Total volume of daily manure production for animal type, ft <sup>3</sup> /day MPD = AU x DVM <u>156</u>	
<b>Manure total solids</b>	
8. Daily manure total solids production, lbs/AU/day (MTS) = <u>10.0</u>	10. Total manure total solids production, lbs/day (TMTS) = <u>1200</u>
9. Daily manure total solids production for animal type, lb/day MTSD = MTS x AU = <u>1200</u>	
<b>Manure volatile solids</b>	
11. Daily manure volatile solids production per AU, lbs/AU/day (MVS) = <u>8.5</u>	
12. Daily manure volatile solids production for animal type per day, lbs/day MVSD = AU x MVS = <u>1020</u>	
13. Total manure volatile solids production, lbs/day (TMVS) <u>1020</u>	
<b>Percent solids</b>	<b>Digester feed solid concentration</b>
14. Percent solids, % (PS) $PS = \frac{TMTS \times 100}{TMP \times 62.4} = \frac{(1200) \times 100}{(156) \times 62.4} =$ <u>12.33</u>	15. Desired digester feed solids concentration, % (DDFSC) = <u>12.0</u>
<b>Daily manure inflow</b>	<b>Digester effective volume</b>
16. Daily manure inflow, ft <sup>3</sup> $DMI = \frac{TMTS \times 100}{DDFSC \times 62.4} = \frac{(1200) \times 100}{(12) \times 62.4} =$ <u>160.2</u>	17. Digester effective volume, ft <sup>3</sup> DEV = DMI x 20 = ( <u>160.2</u> ) x 20 = <u>3205</u>
<b>Digester dimensions</b>	
18. Digester depth, ft $H = \left( \frac{DEV}{8} \right)^{0.33} = \left( \frac{3205}{8} \right)^{0.33} =$ <u>7.37</u>	19. Digest width, ft $WI = 2 \times H = 2 \times (7.37) =$ <u>14.74</u>
	20. Digest length, ft $L = 4 \times H = 4 \times (7.37) =$ <u>29.48</u>
<b>Estimated energy production</b>	
21. Biogas per unit (VS), ft <sup>3</sup> /lb (BUVS) = <u>6</u>	23. Estimated energy production BTU/day EEP = EBP x 600 = (6120) x (600) = <u>3,672,000</u>
22. Estimated biogas production ft <sup>3</sup> /day EBP = BUVS x TMVS = ( <u>6</u> ) x ( <u>1020</u> ) = <u>6120</u>	

## 651.1007 Ancillary components

### (a) Fences

Fences are an important component in some agricultural waste management systems. They are planned and designed in accordance with Conservation Practice Standard, Fencing, Code 382 (USDA-SCS 1980). As they apply to agricultural waste management, fences are used to:

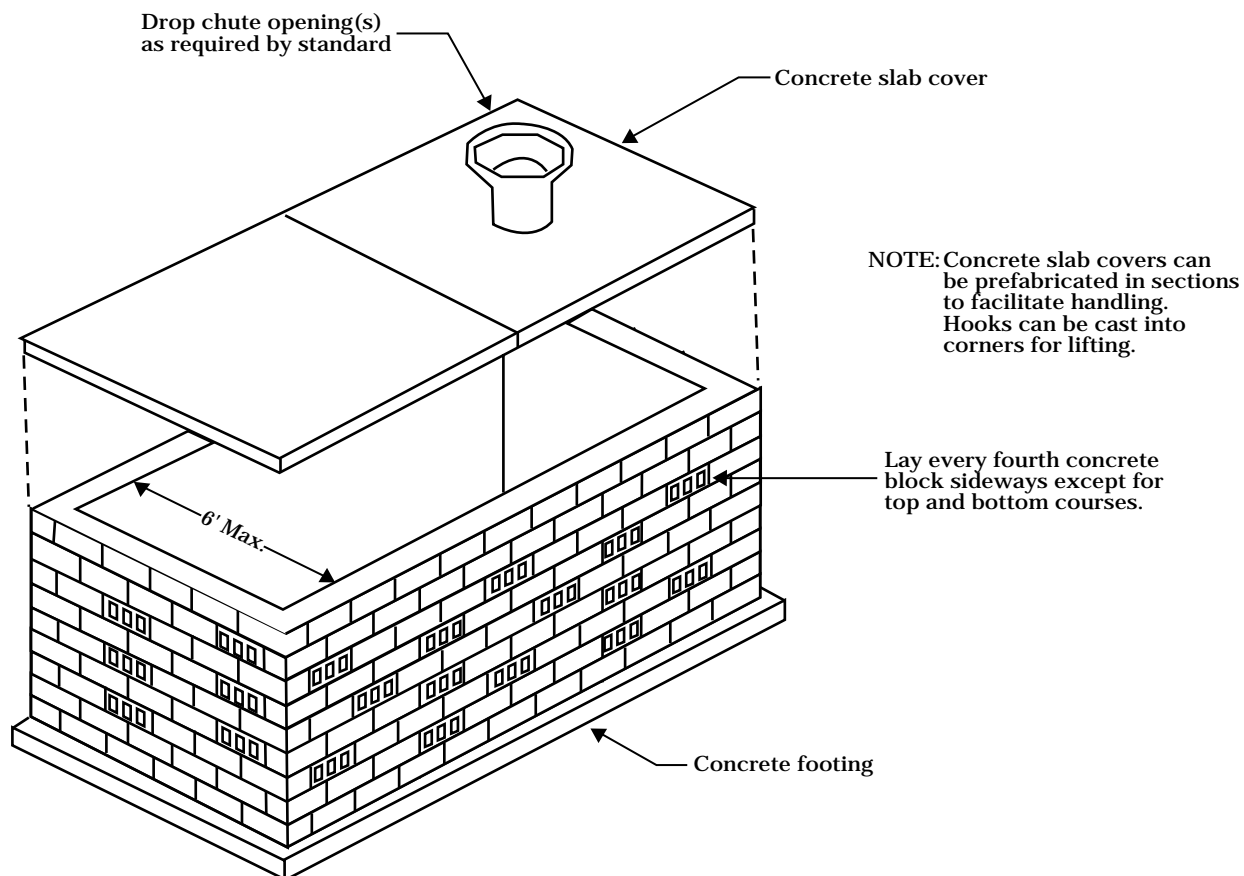
- Confine livestock so that manure can be more efficiently collected.
- Exclude livestock from surface water to prevent direct contamination.

- Provide the necessary distance between the fence and surface water to be protected for the interception of lot runoff in a channel, basin, or other collection or storage facility located above the lot.
- Reduce the lot area and thus reduce the volume of lot runoff to be collected or stored.
- Exclude livestock from hazardous areas, such as waste storage ponds.
- Allow management of livestock for waste utilization purposes.
- Protect vegetative filters from degradation by livestock.

### (b) Dead animal disposition

Every livestock and poultry facility experiences loss of animals by death. Regardless of the method used, the disposition of dead animals should be accomplished in

**Figure 10-48** Poultry and suckling pig disposal pit constructed with 8" x 8" x 16" concrete blocks



a sanitary manner and in accordance with all State and local laws.

Utilization of the energy contained in the dead animals should be given first consideration. Rendering and composting of dead animals both result in by-products that can be used. Refer to 651.1004(g) for discussion on composting animal carcasses. If utilization is not viable, consideration can be given to disposal by incineration or burial. Incineration can cause odor problems unless an afterburner or excess air system is used.

A common method for onsite dead animal disposal is burial. The burial sites need to be at least 150 feet downgradient from any ground water supply source. Sites that have highly permeable soils, fractured or cavernous bedrock, and a seasonal high-water table are not suitable and should be avoided. In no case should the bottom of the burial pit be closer than 5 feet from the ground water table. Surface water should be diverted from the pit.

For large animals (cattle and mature swine), individual pits should be opened for each occasion of burial. The pits should be closed and marked after burial. For small animals (poultry and small pigs), pits can be constructed for use over a period of time.

Typical pit sizes for small animals are 4 to 6 feet wide, 4 to 12 feet long, and 4 to 6 feet deep. The sides of the pit should be constructed of concrete block, treated timber, or pre-cast concrete. The side walls must have some openings to allow for pressure equalization. The bottom of small animal pits is not lined. The top should be airtight with a single capped opening to allow for adding dead animals. Figure 10-48 illustrates one possible disposal pit configuration.

Disposal pits should have adequate capacity. The recommended capacity for broilers is 100 cubic feet per 10,000 broilers. For small pigs, the capacity is 1 cubic foot per sow. The pit size for layers and turkeys can be determined using figure 10-49.

### (c) Human waste management

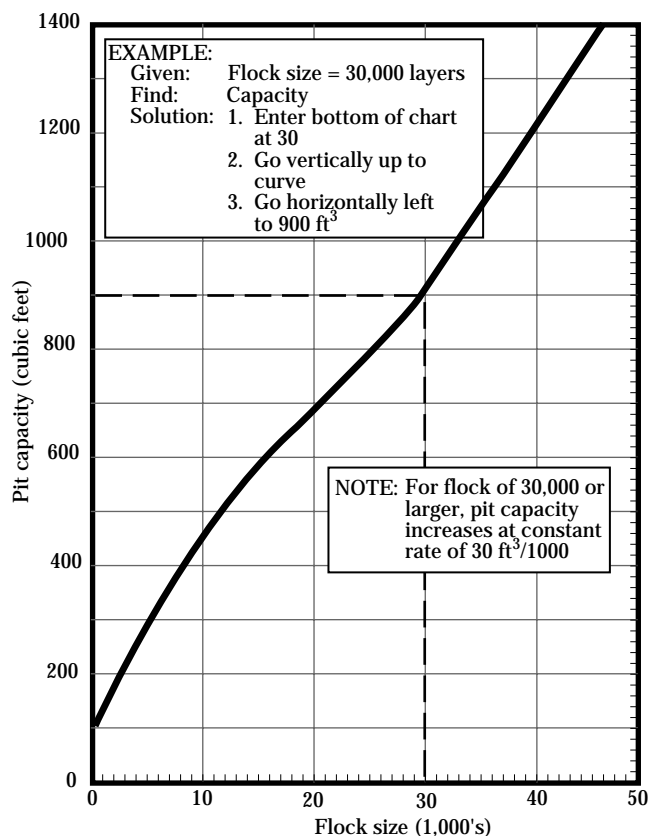
If at all possible, human waste should be treated in municipal facilities designed to provide proper treatment. However, in many rural areas this is not possible.

Septic tank systems designed for specific soil conditions are typically used for treating human waste in areas not served by municipal treatment facilities.

Most home sewage systems rely on anaerobic decomposition in septic tanks with the resulting effluent being discharged into a leaching field. Some conditions, such as a high water table, require that the septic system be constructed above ground in mounds. Human waste is not to be stored or processed in animal waste management facilities because of the potential for disease transmission.

Landowners should contact local health authorities for design requirements and permit information before installing treatment systems for human waste. SCS does not design human waste management systems, but some States have extension specialists or environmental engineers that can assist in designing suitable systems.

**Figure 10-49** Capacity requirements for poultry disposal pits for laying hens and turkeys



## 651.1008 Safety

*Much of this material was taken from the publication, "Safety and Liquid Manure Handling" (White and Young 1980).*

Safety must be a primary consideration in managing animal waste. It must be considered during planning and designing of waste management system components as well as during the actual operation of handling wastes. The operator must be made aware of safety aspects of any waste management system components under consideration. Accidents involving waste management may be the result of:

- Poor design or construction
- Lack of knowledge or training about components and their characteristics
- Poor judgement, carelessness, or lack of maintenance
- Lack of adequate safety devices, such as shields, guard rails, fences, or warning signs

The potential for an accident with waste management components is always present. However, accidents do not have to happen if components are properly designed, constructed, and maintained and if all persons involved with the components are adequately trained and supervised.

First aid equipment should be near storage units and lagoons. A special, easily accessible area should be provided for storing the equipment. The area should be inspected periodically to ensure that all equipment is available and in proper working condition. The telephone numbers of the local fire department and/or rescue squad should be posted near the safety equipment and near all telephones.

### (a) Confined areas

Manure gases can accumulate when manure is stored in environments that do not have adequate ventilation, such as underground covered waste storage tanks. These gases can reach toxic concentrations, and displace oxygen. The four main gases are ammonia ( $\text{NH}_3$ ), carbon dioxide ( $\text{CO}_2$ ), hydrogen sulfide ( $\text{H}_2\text{S}$ ),

and methane ( $\text{CH}_4$ ). The gases produced under anaerobic conditions and the requirements for safety because of these deadly gases are described in chapter 3. Because of the importance of safety considerations, the following repeats and elaborates on these safety requirements.

Ammonia is an irritant at concentrations below 20 ppm. At higher levels it can be an asphyxiant.

Carbon dioxide is released from liquid or slurry manure. The rate of release is increased with agitation of the manure. High concentrations of carbon dioxide can cause headaches and drowsiness and even death by asphyxiation.

Hydrogen sulfide is the most dangerous of the manure gases and can cause discomfort, headaches, nausea, and dizziness. These symptoms become severe at concentrations of 800 ppm for exposures over 30 minutes. Hydrogen sulfide concentrations above 800 ppm can lead to unconsciousness and death through paralysis of the respiratory system.

Methane is also an asphyxiant; however, its most dangerous characteristic is that it is explosive.

Several rules should be followed when dealing with manure stored in poorly ventilated environments:

**Safety equipment can include air packs and face masks, nylon line with snap buckles, safety harness, first-aid kits, flotation devices, safety signs, and hazardous atmosphere testing kits or monitors.** All family members and employees should be trained in first-aid, CPR techniques, and safety procedures and policies. The following material discusses specific safety considerations.

**Do not enter a manure pit unless absolutely necessary** and then only if (1) the pit is first ventilated, (2) you have air supplied to a mask or a self contained breathing apparatus, and (3) you have on a safety harness and attached rope and have two people standing by.

**If at all feasible, construct lids for manure pits or tanks and keep access covers in place.** If an open, ground level pit or tank is necessary, put a fence around it and post "Keep Out" signs.

**Do not attempt without assistance to rescue humans or livestock that have fallen into a manure storage structure or reception pit.**

**Move all the animals out of the building if possible when agitating manure stored beneath that building.** If the animals cannot be removed, the following steps should be taken:

- If the building is mechanically ventilated, turn fans on full capacity when beginning to agitate, even in the winter.
- If the building is naturally ventilated, do not agitate unless there is a brisk breeze blowing. The animals should be watched when agitation begins, and at the first sign of trouble, the pump should be turned off. The critical area of the building is where the pumped manure breaks the liquid surface in the pit. If an animal drops over because of asphyxiation, do not try to rescue it, or you might also become a victim. Turn off the pump and allow time for the gases to escape before entering the building.

**Do not smoke, weld, or use an open flame in confined, poorly ventilated areas where methane can accumulate.**

**Keep electric motors, fixtures, and wiring near manure storage structures in good condition.**

### (b) Aboveground tanks

Aboveground tanks can be dangerous if access is not restricted. Uncontrolled access can lead to injury or death from falls from ladders and to death from drowning if someone falls into the storage tank. The following rules should be enforced:

**Permanent ladders on the outside of aboveground tanks should have entry guards locked in place or the ladder should be terminated above the reach of individuals.**

**A ladder must never be left standing against an aboveground tank.**

### (c) Lagoons, ponds, and liquid storage structures

Lagoons, ponds, and liquid storage structures present the potential for drowning of animals and humans if access is not restricted. Floating crusts can appear capable of supporting a person's weight and provide a false sense of security. Tractors and equipment can fall or slide into storage ponds or lagoons if they are operated too close to them. The following rules should be obeyed:

**Rails should be built along all walkways or ramps of open manure storage structures.**

**Fence around storage ponds and lagoons, and post signs "Caution Manure Storage (or Lagoon)." The fence keeps livestock and children away from the structure. Additional precautions include a minimum of one lifesaving station equipped with a reaching pole and a ring buoy on a line.**

**Place a barrier strong enough to stop a slow-moving tractor on all push-off platforms or ramps.**

**If manure storage is outside the livestock building, use a water trap or other device to prevent gases in the storage structure from entering the building, especially during agitation.**

### (d) Equipment

All equipment associated with waste management, such as spreaders, pumps, conveyors, and tractors, can be dangerous if improperly maintained or operated. Operators should be thoroughly familiar with the operator's manual for each piece of equipment. Equipment should be inspected frequently and serviced as required. All guards and safety shields must be kept in place on pumps, around pump hoppers, and on manure spreaders, tank wagons, and power units.

---

**651.1009** References

- Allen, M.W. 1986. Roof runoff management—gutter selection size. NENTC Tech. Notes, Ag. Engr. No. 1. U.S. Dep. Agric., Soil Conserv. Serv., Chester, PA. 10 pp.
- Alpert, Joel E. 1987. Composting process and operations. Univ. of MA, On-Farm Composting Conference, E & A Environmental Consultants, Sloughton, MA.
- Alpert, Joel E. 1987. Windrow and Static Pile Composting. Univ. of MA, On-Farm Composting Conference, E & A Environmental Consultants, Sloughton, MA.
- American Society Agricultural Engineers. 1982. Solid and liquid manure storages. Engineering Practice 393. *Agricultural Engineering Yearbook*, ASAE, St. Joseph, MI. pp 303-305.
- Barker, J.C. 1986. Course notes from agricultural waste management class, North Carolina State University.
- Barth, C.L. 1985. The rational design standard for anaerobic livestock lagoons. Proceedings of the Fifth International Symposium on Agricultural Wastes. ASAE, St. Joseph, MI. pp. 638-646.
- Barth, C.L. 1985. Livestock waste characterization-a new approach. Proceedings of the Fifth International Symposium on Agricultural Wastes. ASAE, St. Joseph, MI. pp 286-294.
- Bartlett, Andrew. Windrow composting of poultry and horse manure with hay. White Oak Farm, Belchertown, MA.
- Bos, R.E. 1974. Dewatering bovine manure. M.S. Thesis, Agric. Eng. Dep., The PA State Univ., State College, PA.
- Brinton, Will. Agricultural and horticultural applications of compost. Woods End Lab., Mt. Vernon, ME.
- Brinton, William F., Jr. 1990. Agricultural waste management and composting. Woods End Res. Lab., Amer. Soc. Agron., NE An. Meet., Univ. NH.
- Brinton, William F., and Milton D. Seekins. 1988. Composting fish by-products—A feasibility study.
- Calhoun, G.D. 1982. Personal communication. DeLaval, Agric. Div., Kansas City, MO.
- Cassidy, James M. Agricultural regulations for Massachusetts compost products. Bur. Farm Prod., MA. Dep. Food and Agric.
- Cathcart, T.P., D.W. Lipton, F.W. Wheaton, R.B. Brinsfield, D.G. Swartz, and I.E. Strand. Composting of blue crab waste. Univ. MD, College Park, Pub. No. UM-SG-Ts-84-01.
- Cathcart, T.P., F.W. Wheaton, and R.B. Brinsfield. 1986. Optimizing variables affecting composting of blue crab scrap. Univ. MD, College Park.
- Cheresminoff, Paul N., and Richard A. Young. (date). Pollution engineering practice handbook. Ann Arbor Sci. Pub., Inc., pp 788-792.
- Clark, John W., Warren Viessman, Jr., and Mark J. Hammer. 1971. Water supply and pollution control. Int. Textbook Co., pp 579-584.
- Commonwealth Marketing and Development. 1988. Midcoast compost project market study. Portland, MA.
- Costa, Charles A. 1987. Introduction: Why consider composting. MA Dep. Food and Agric., On-Farm Composting Conf., Univ. MA.
- Eberhardt, Daniel L., and Wesley O. Pipes. 1972. Composting applications for Illinois. IIEQ Doc.No. 73-5, IL Inst. Environ.Qual.
- Eccles, C., and E.I. Stentiford. 1987. Microcomputers monitor static pile performance. Biocycle, pp. 42-45.
- Ely, Jennifer F., and Edward L. Spencer. 1978. The composting alternative waste disposal in remote locations. Res. Dep., Appalachian MT.

- Fairbank, C.W. 1974. Energy values. *Agricultural Engineering*, ASAE, St. Joseph, MI. Sept. issue.
- Fogg, C.E. 1981. Tentative guidelines for methane production by anaerobic digestion of manure. National Bulletin No. 210-1-13. U.S. Dep. Agric., Soil Conserv. Serv., Wash., D.C. 7 pp.
- Fulford, Bruce. Composting dairy manure with newspaper and cardboard. The New Alchemy Inst., Falmouth, MA.
- Geiger, James S. Composting with dairy and horse manure and fish wastes. Appleton Farms, Ipswich, MA.
- Glerum, J.C., G. Klamp, and H.R. Poelma. 1971. The separation of solid and liquid parts of pig slurry. *In* Livestock Waste Management and Pollution Abatement, ASAE, St. Joseph, MI. pp. 345-347.
- Graves, R.E., and J.T. Clayton. 1972. Stationary sloping screen to separate solids from dairy cattle manure slurries. ASAE Paper 72-951, St. Joseph, MI. 16 pp.
- Graves, R.E. et al. 1986. Manure management for environmental protection. PA Dep. Env. Resourc., Harrisburg, PA.
- Guest, R.W. 1984. Gravity manure handling. NRAES/NDPC 27.10, Agric. Eng. Dep., Cornell Univ., Ithaca, NY. 4 pp.
- Hansen, Robert C., and Karen M. Mancl. Modern composting, a natural way to recycle wastes. The Ohio State Univ.
- Haug, Roger T., and Liberato D. Tortorici. 1986. Composting process design criteria. *Biocycle*, Nov/Dec 1986 issue.
- Hegg, R.O., R.E. Larson, and J.A. Moore. 1981. Mechanical liquid-solid separation in beef, dairy, and swine waste slurries. *TRANSACTIONS of ASAE* 24(1):159-163.
- Higgins, Andrew J. 1990. Engineering parameters for the selection of compost bulking agents. ASAE, NAR 83-207.
- Holmberg, R.D., D.T. Hill, T.J. Prince, and N.J. Van Dyke. 1982. Solid-liquid separation effect on physical properties of flushed swine waste. ASAE Paper 82-4081, St. Joseph, MI. 26 pp.
- Jones, D.D., D.L. Day, and A.C. Dale. 1971. Aerobic treatment of livestock wastes. Univ. IL, Agric. Exp. Sta. Bull. 737, Urbana-Champaign, IL. 55 pp.
- Kilmer, Victor J. 1982. Handbook of soils and climate in agriculture. CRC Press, Boca Roton, FL.
- Kuter, Geoffrey. Commercial in-vessel composting of agricultural wastes. Int. Process Sys., Lebanon, CT.
- Laliberty, Lucien. Composting for a cash crop. Farm Res. Ctr., Putnam, CT.
- MacLean, A.J., and F.R. Hore. 1974. Manures and compost. Canada Dep. Agric. Pub. 868.
- McKinney, Ross E. 1962. Microbiology for sanitary engineers. McGraw Hill, Inc., pp. 260-265.
- Mezitt, R. Wayne. Composting for the nursery industry. Weston Nurs., Inc.
- Midwest Plan Service. 1985. Biological treatment. Livest. waste fac. handb. MWPS-18., IA State Univ., ch. 7.
- Millar, C.G., L.M. Turk, and H.D. Foth. 1965. Fundamentals of soil science. John Wiley & Sons, Inc., NY.
- Moffitt, D.C. 1980. Design of mechanically aerated lagoons for odor control. U.S. Dep. Agric., Soil Conserv. Serv. Tech. Notes, WTSC, Portland, OR. 9 pp.
- Murphy, Dennis W. Composting of dead birds. Dep. Poult. Sci., Univ. MD, Princess Anne.
- Nessen, Fifi. Present and future composting regulation in Massachusetts. MA Dep. Environ. Qual. & Eng.
- New Hampshire Department of Agriculture. 1989. Good neighbor guide for horse-keeping: Manure management. USDA Ext. Serv. Pub. No. 89-EWQI-1-9186.



- Ngoddy, P.O., J.P. Hayser, R.K. Collins, G.D. Wells, and F.A. Heider. 1971. Closed system waste management for livestock water pollution control. Research Series, USEPA, Project 13040DKP.
- North Carolina State University. 1980. Earthen liquid manure storage basin with access ramp. Agric. Ext. Serv., Raleigh, NC.
- Parsons, R.A. 1984. On-farm biogas production. NRAES-20. NE Reg. Agric. Eng. Serv., Cornell Univ. 38 pp.
- Pennsylvania Department of Environmental Resources. 1990. Assessment of field manure nutrient management with regards to surface and ground water quality.
- Plovanich Charles J. In-vessel composting of cattle and swine manure. Revere Copper and Brass, Inc., Rome, NY.
- Plovanich, Charles J. In-vessel composting overview. Revere Copper and Brass, Inc., Rome, NY.
- Poincelot, Raymond P. 1975. The biochemistry and methodology of composting. CT Agric. Exp.Stat.
- Rynk, Robert. 1987. On farm composting: The opportunities, benefits and drawbacks. Eng. Notes, Univ. MA.
- Rynk, Robert. 1988. On farm composting: The process and methods. Eng. Notes, Univ. MA.
- Rynk, Robert. 1989. Composting as a dairy manure management technique. Dairy Manure Mgt. Symp., Syracuse, NY, NRAES-31.
- Rodale, J.I. 1975. The complete book of composting. Rodale Books, Inc., Emmaus, PA.
- Rodale, J.I. 1968. The encyclopedia of organic gardening. Rodale Books, Inc., Emmaus, PA, pp 151-153.
- Safley, L.M., Jr., and W.C. Fairbank. 1983. Separation and utilization of manure solids. Proceed. Sec. Natl. Dairy Housing Conf., ASAE, St. Joseph, MI. pp. 77-91.
- Salvato, Joseph A., Jr. 1982. Environmental engineering and sanitation. Wiley Interscience, pp 403-406.
- Shutt, J.W., R.K. White, E.P. Taiganides, and C.R. Mote. 1975. Evaluation of solids separation devices. *In* Managing livestock wastes, ASAE, St. Joseph, MI. pp. 463-467.
- Simpson, Michael. Economics of agricultural composting. Bur. Solid Waste Disposal, MA.
- Singley, Mark E. Preparing organic materials for composting. ASAE Paper NAP 83-208.
- Small Farm Energy Project Newsletter. 1979. Composting of farm manure. Issue No. 17.
- Sweeten, John M. Composting manure and sludge. TX Agric. Exp. Sta. Pub. No. 1-2289.
- Sweeten, John M. Manure management for cattle feedlots. TX Agric. Exp. Sta., Coop. Ext. Serv., Great Plains States, Great Plains Beef Cattle Handb. GPE-7600.
- United States Department of Agriculture. 1965. Rule of thumb estimates of the relationships of carbon to nitrogen in crop residues. USDA, Soil Conserv. Serv., Portland, Or., Tech. Notes.
- United States Department of Agriculture. 1978. Sediment basin. SCS Conservation Practice Standard, Code 350. Soil Conserv. Serv., Wash., DC.
- United States Department of Agriculture. 1979. Waste management system. SCS Conservation Practice Standard, Code 312. Soil Conserv. Serv., Wash., DC.
- United States Department of Agriculture. 1979. Waste storage pond. SCS Conservation Practice Standard, Code 425. Soil Conserv. Serv., Wash., DC.
- United States Department of Agriculture. 1980. Fencing. SCS Conservation Practice Standard, Code 382. Soil Conserv. Serv., Wash., DC.
- United States Department of Agriculture. 1980. Waste storage structure. SCS Conservation Practice Standard, Code 313. Soil Conserv. Serv., Wash., DC.

- United States Department of Agriculture. 1982. Filter strip. SCS Conservation Practice Standard, Code 393. Soil Conserv. Serv., Wash., DC.
- United States Department of Agriculture. 1984. Pond sealing or lining. SCS Conservation Practice Standard, Code 521. Soil Conserv. Serv., Wash., DC.
- United States Department of Agriculture. 1984. Waste treatment lagoon. SCS Conservation Practice Standard, Code 359. Soil Conserv. Serv., Wash., DC.
- United States Department of Agriculture. 1985. Diversion. SCS Conservation Practice, Code 362. Soil Conserv. Serv., Wash., DC.
- United States Department of Agriculture. 1987. Guide on design, operation and management of anaerobic lagoons. Tech. Note Ser. 711. SNTC, Soil Conserv. Serv., Wash., DC., 32 pp.
- United States Department of Agriculture. 1987. Interim engineering standard for poultry and swine disposal pit. SNTC, Soil Conserv. Serv., Wash., DC, 26 pp.
- United States Department of Agriculture. 1989. Interim standard for dead poultry composting. Soil Conserv. Serv., Auburn, AL.
- United States Department of Agriculture. 1990. Design and construction guidelines for considering seepage from agricultural waste storage ponds and treatment lagoons. Tech. Note Ser. 716. SNTC, Soil Conserv. Serv., Wash., DC, 10 pp.
- United States Environmental Protection Agency. 1977. Municipal sludge management: Environmental factors. EPA 430/9-77-004, USEPA, Wash., DC, Oct. 1977.
- United States Environmental Protection Agency. 1988. Design manual—Constructed wetlands and aquatic plant systems for municipal wastewater treatment. EPA/625/1-88/022.
- United States Environmental Protection Agency. 1989. In-vessel composting of municipal wastewater sludge. USEPA Summary Rep. No. EPA/625/8-89/016.
- University of Arkansas, Cooperative Extension Service. Composting poultry carcasses. Mp 317.
- University of Delaware, College of Agricultural Sciences, Agricultural Experiment Station. 1989. Dead poultry disposal.
- University of Tennessee. 1977. Covered dry stack manure storage. Agric. Ext. Serv., Plan No. T4029, Univ. TN, Knoxville, TN.
- White, R.K., and D.L. Forster. 1978. Evaluation and economic analysis of livestock waste management systems. EPA/2-78-102. USEPA, Ada, OK., 302 pp.
- White, R.K., and C.W. Young. 1980. Safety and liquid manure handling. OH Coop. Ext. Serv., AEX 703. OH State Univ., Columbus, OH., 3 pp.
- Woods End Research Laboratory. Compost standards for MaDEQE.
- Wright, R.E. Assoc., Inc. 1990. Assessment of field manure nutrient management with regards to surface and ground water quality. PA Dep. Environ. Resourc., Harrisburg, PA.

